

Plot file version 1 created 03-APR-2017 18:27:36

J1642+3948 EM126B.UVDATA.1

Freq = 4.7995 GHz, Bw = 32.000 MH No calibration applied and no bandpass applied

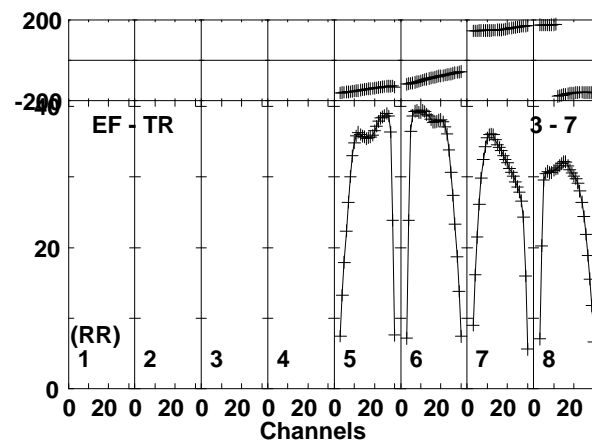
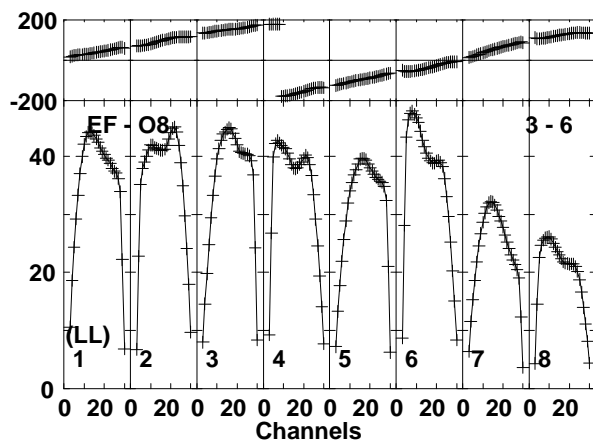
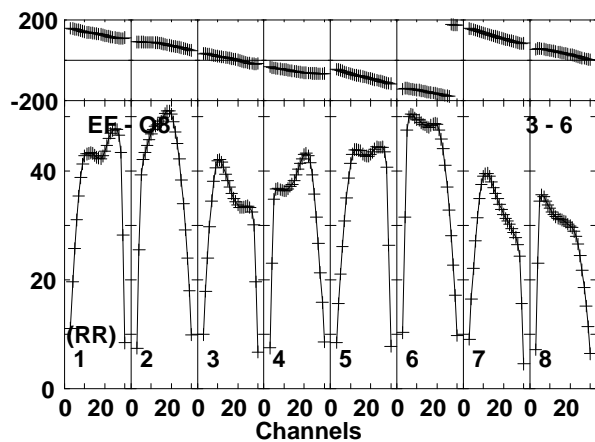
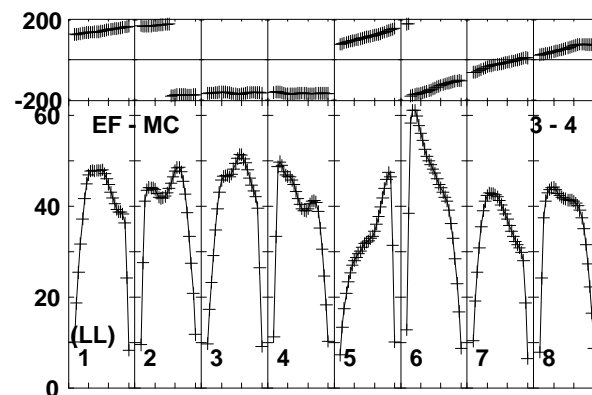
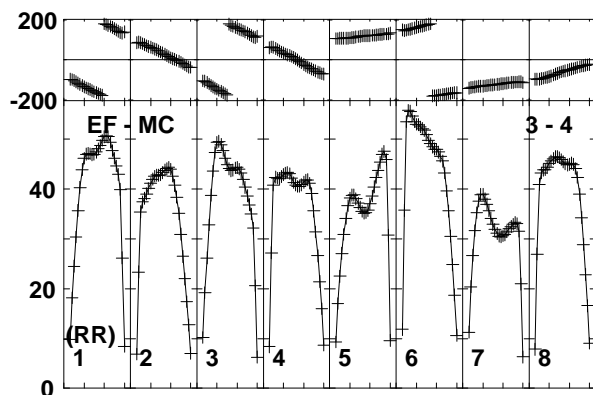
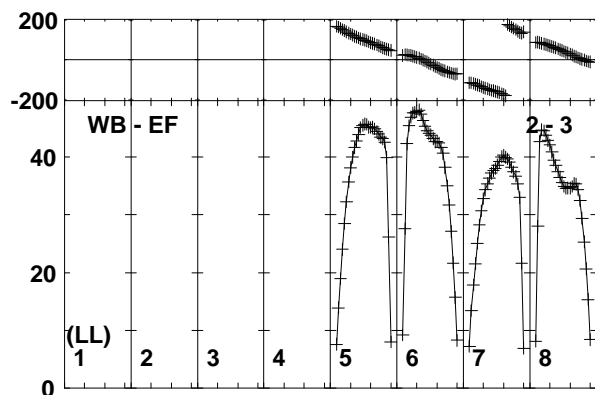
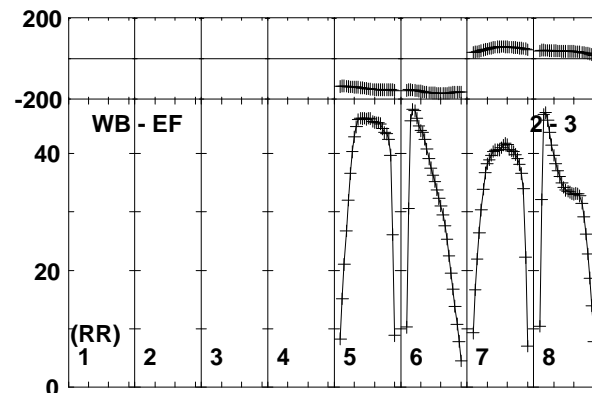
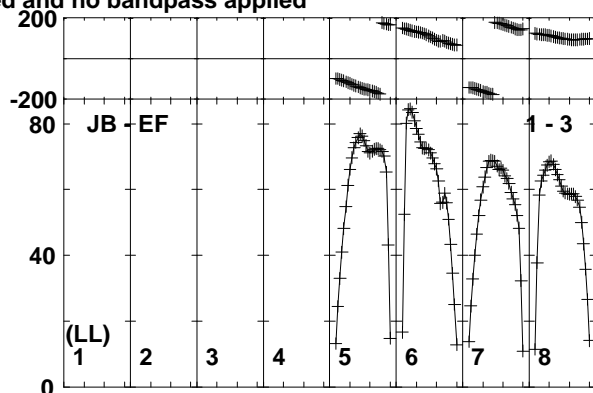
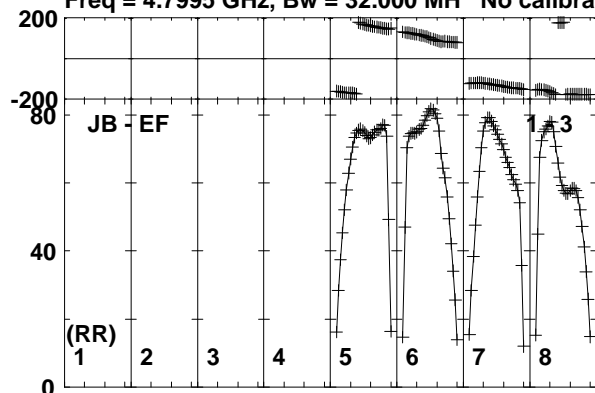

Lower frame: Milli Ampl Jy Top frame: Phas deg
Vector averaged cross-power spectrum Baseline: JB (01) - EF (03)
Timerange: 00:13:15:01 to 00:13:17:59

Plot file version 2 created 03-APR-2017 18:27:36

J1642+3948 EM126B.UVDATA.1

Freq = 4.7995 GHz, Bw = 32.000 MH No calibration applied and no bandpass applied

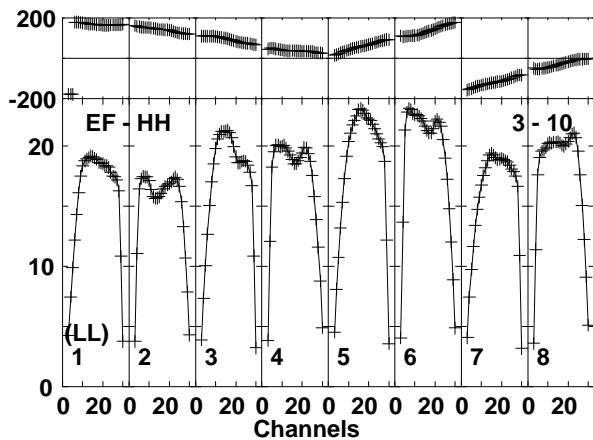
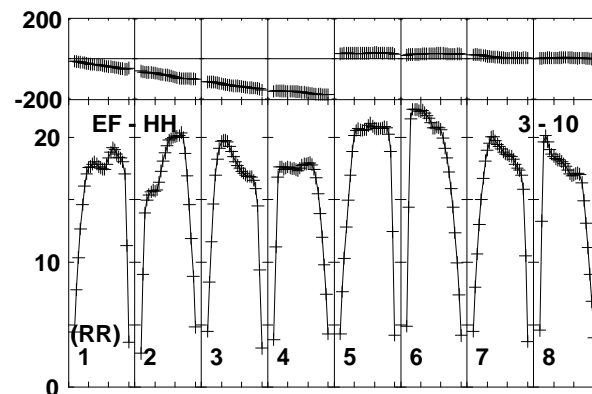
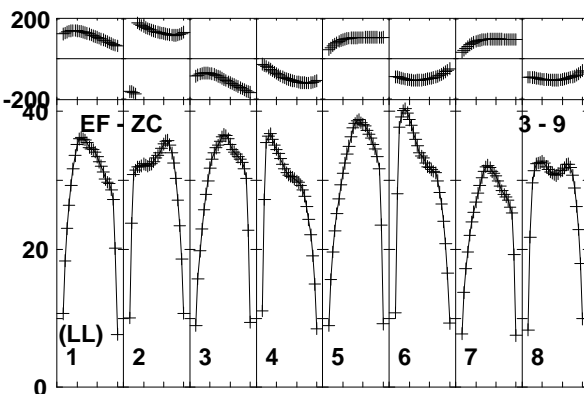
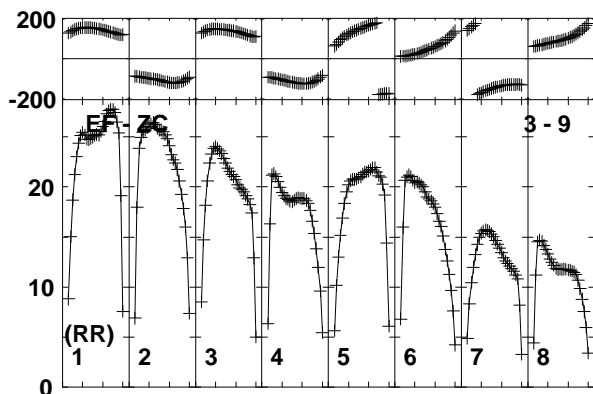
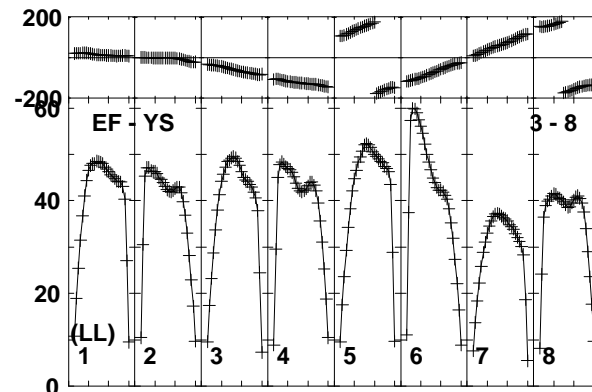
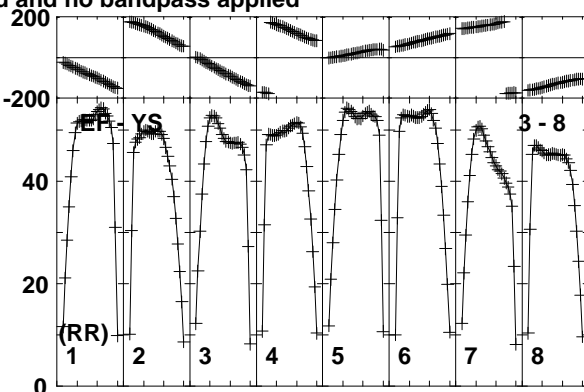
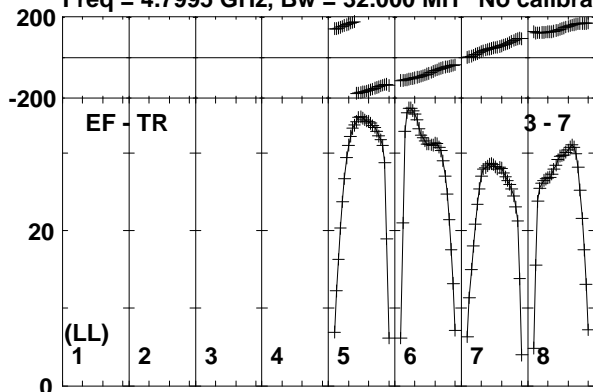

Lower frame: Milli Ampl Jy Top frame: Phas deg
Vector averaged cross-power spectrum Baseline: EF (03) - TR (07)
Timerange: 00/13:15:01 to 00/13:17:59

Plot file version 3 created 03-APR-2017 18:27:37

J1834-2341 EM126B.UVDATA.1

Freq = 4.7995 GHz, Bw = 32.000 MH No calibration applied and no bandpass applied

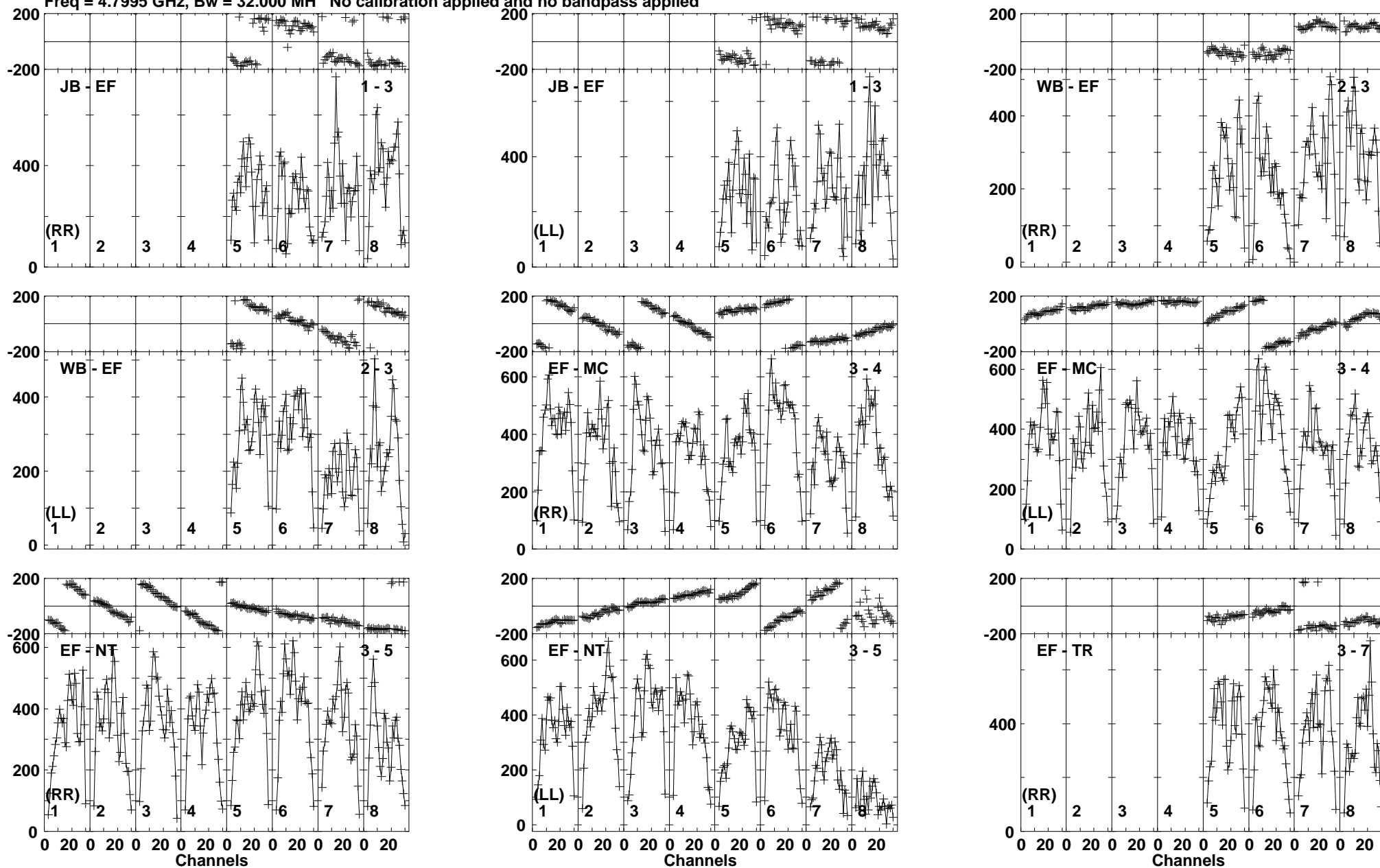

Lower frame: Micro Ampl Jy Top frame: Phas deg
Vector averaged cross-power spectrum Baseline: JB (01) - EF (03)
Timerange: 00/13:25:41 to 00/13:26:59

Plot file version 4 created 03-APR-2017 18:27:37

J1834-2341 EM126B.UVDATA.1

Freq = 4.7995 GHz, Bw = 32.000 MH No calibration applied and no bandpass applied

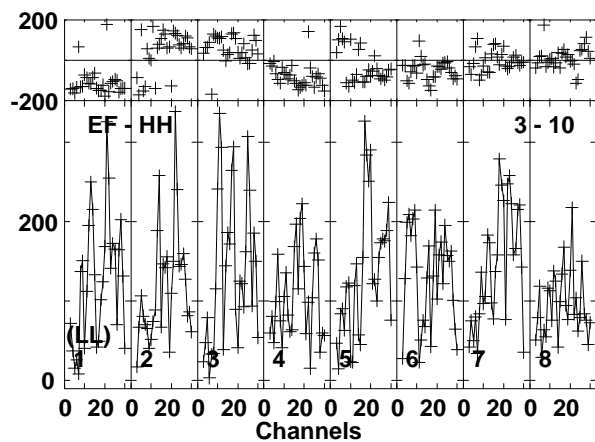
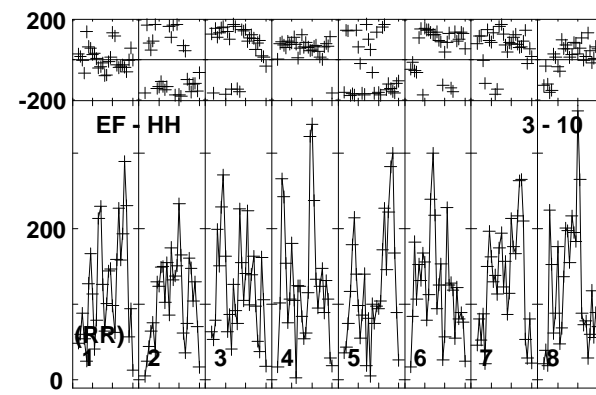
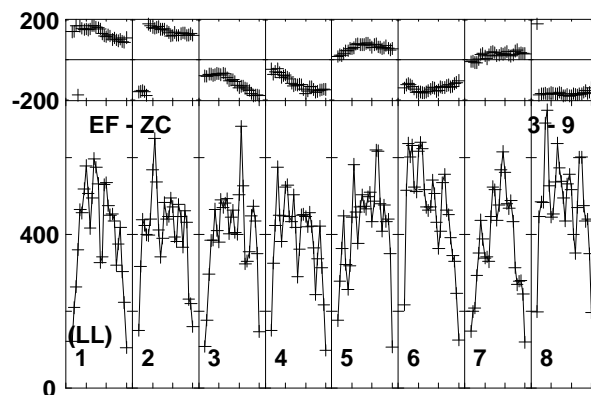
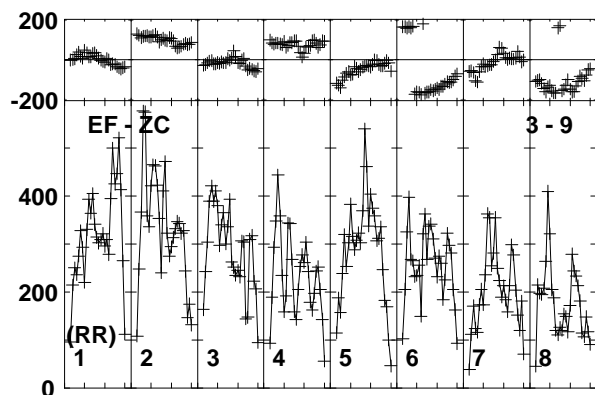
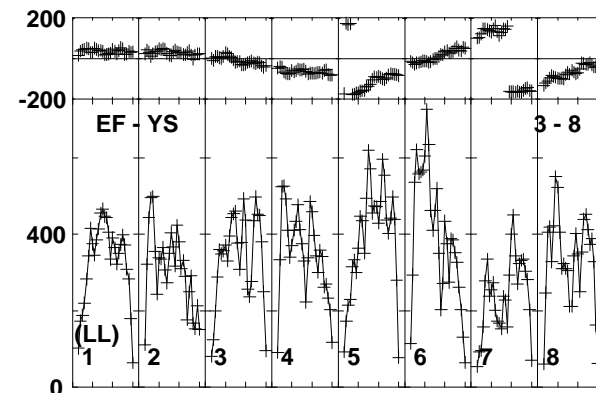
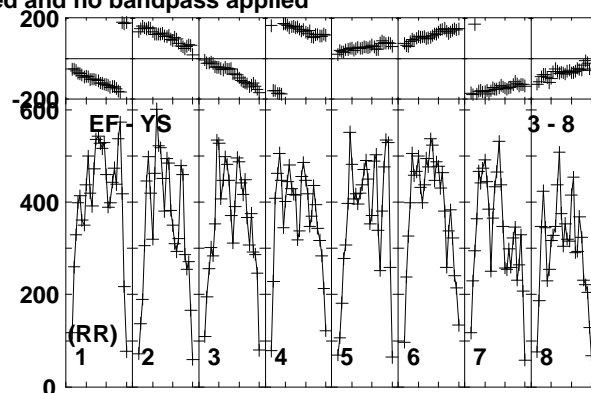
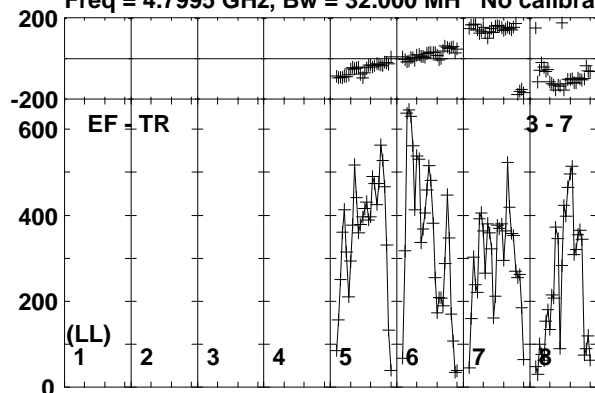

Lower frame: Micro Ampl Jy Top frame: Phas deg
Vector averaged cross-power spectrum Baseline: EF (03) - TR (07)
Timerange: 00/13:25:41 to 00/13:26:59

Plot file version 5 created 03-APR-2017 18:27:37

M22-VLA1 EM126B.UVDATA.1

Freq = 4.7995 GHz, Bw = 32.000 MH No calibration applied and no bandpass applied

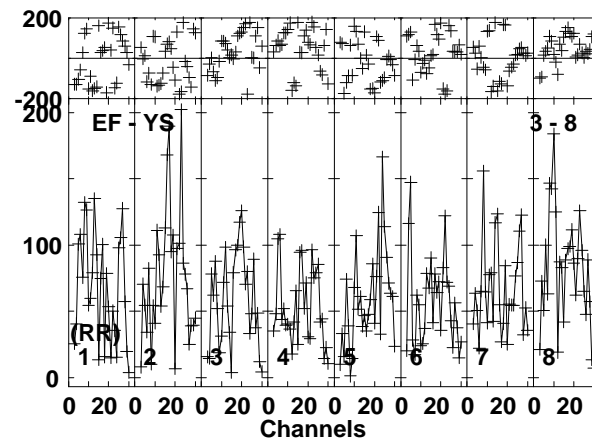
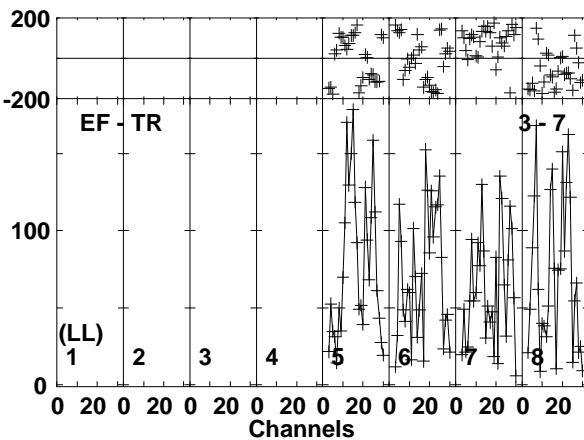
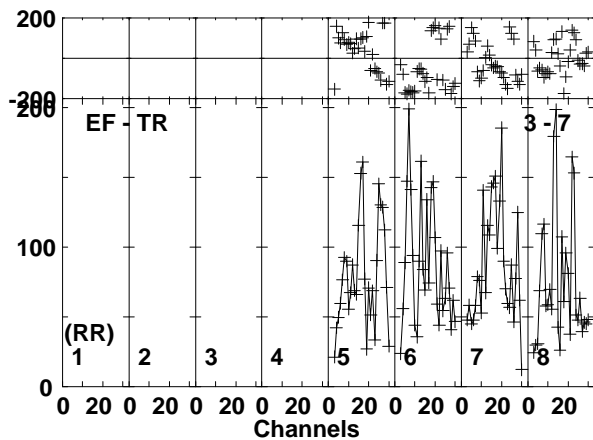
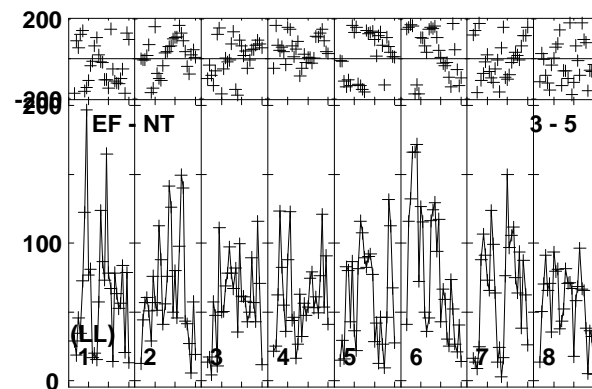
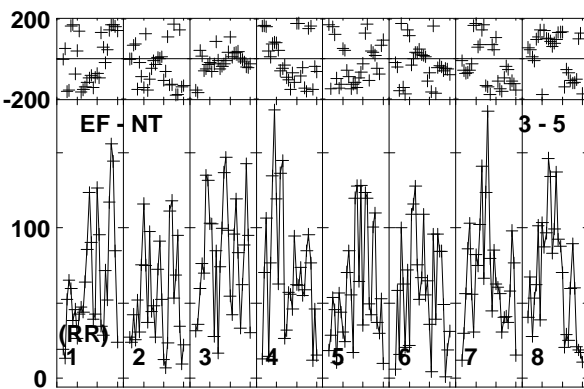
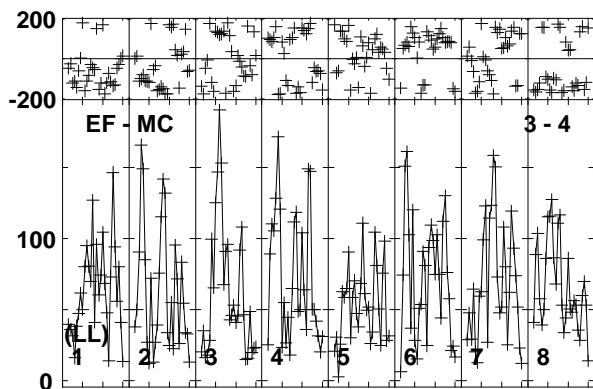
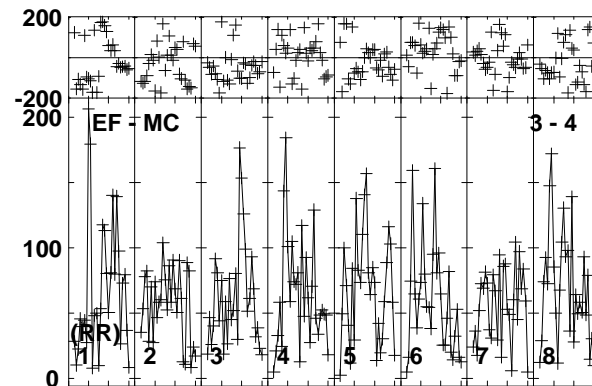
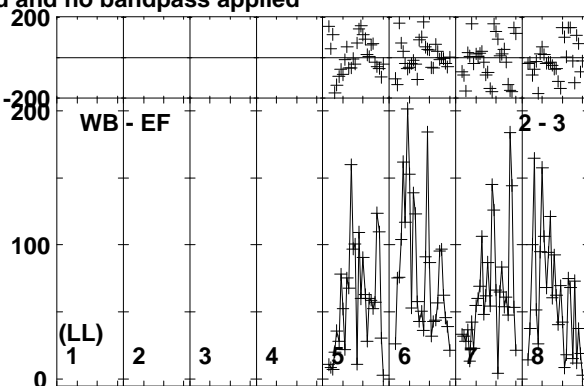
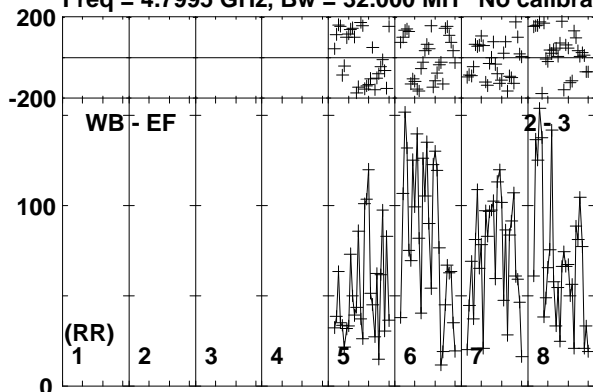

Lower frame: Micro Ampl Jy Top frame: Phas deg
Vector averaged cross-power spectrum Baseline: WB (02) - EF (03)
Timerange: 00/13:27:04 to 00/13:29:08

Plot file version 6 created 03-APR-2017 18:27:37

M22-VLA1 EM126B.UVDATA.1

Freq = 4.7995 GHz, Bw = 32.000 MH No calibration applied and no bandpass applied

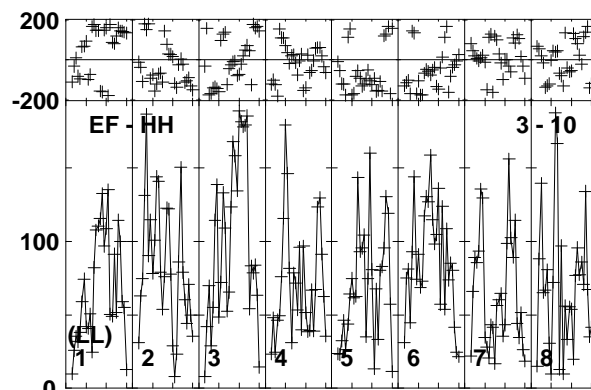
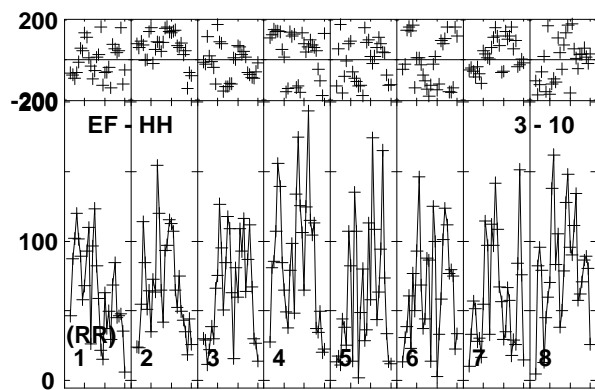
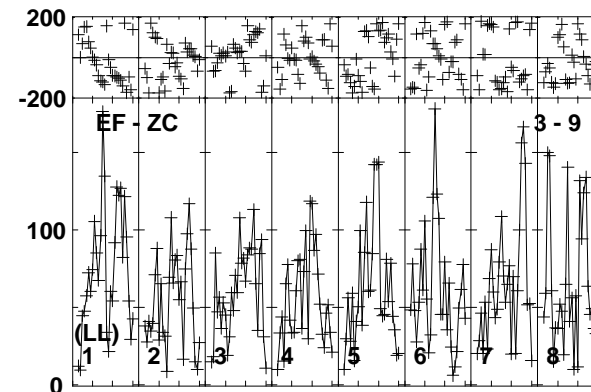
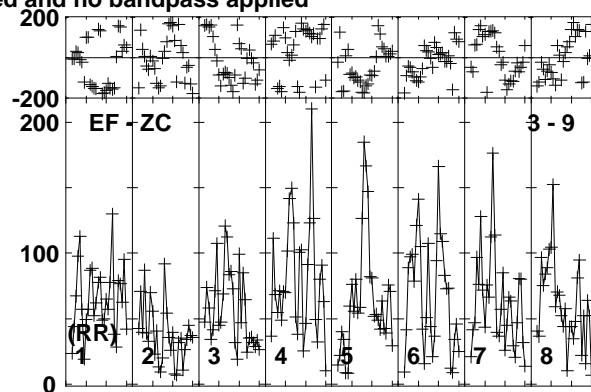
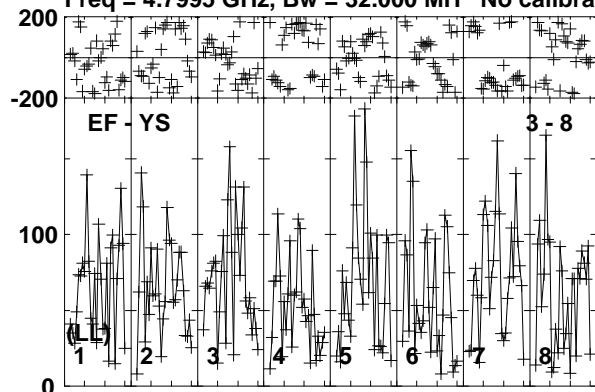

Lower frame: Micro Ampl Jy Top frame: Phas deg
Vector averaged cross-power spectrum Baseline: EF (03) - YS (08)
Timerange: 00/13:27:04 to 00/13:29:08

Plot file version 7 created 03-APR-2017 18:27:37

J1834-2341 EM126B.UVDATA.1

Freq = 4.7995 GHz, Bw = 32.000 MH No calibration applied and no bandpass applied

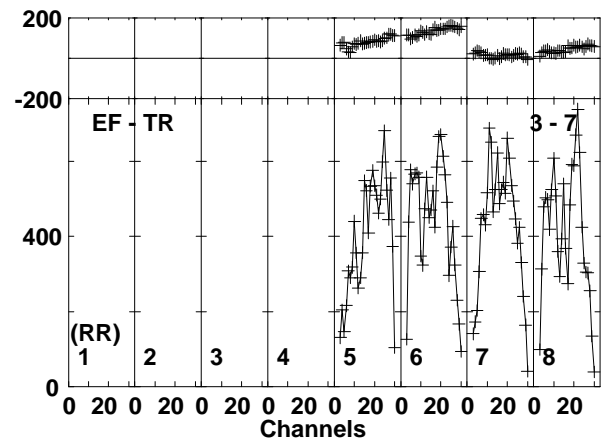
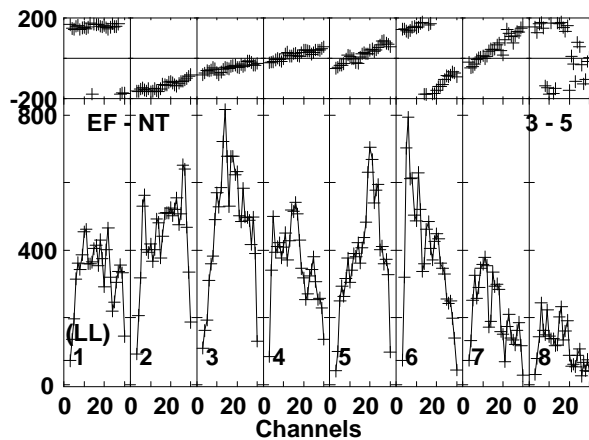
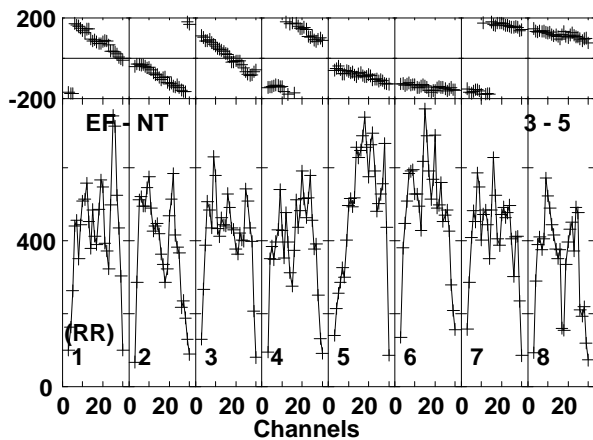
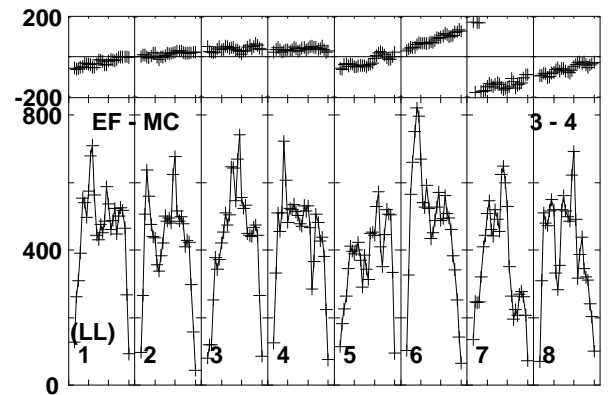
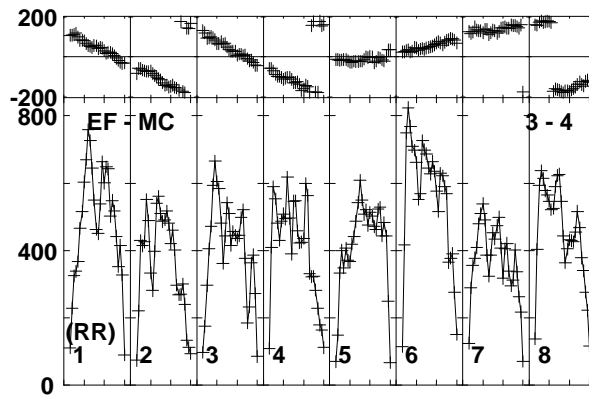
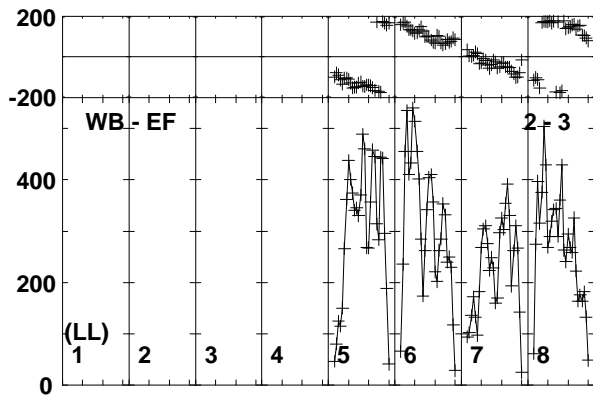
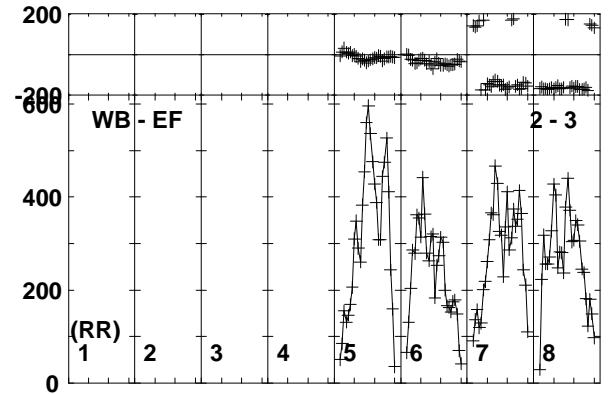
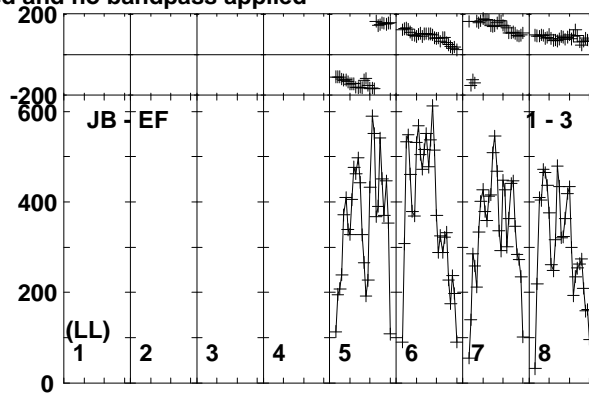
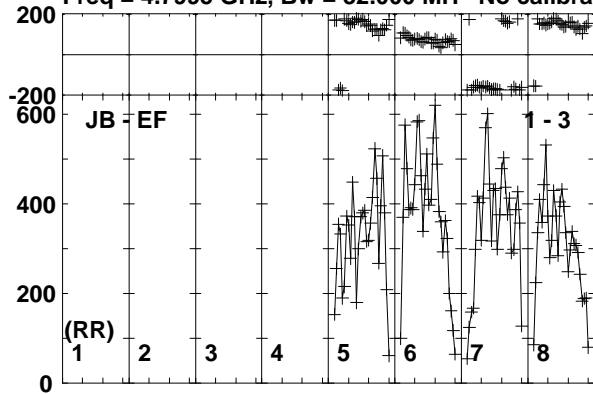

Lower frame: Micro Ampl Jy Top frame: Phas deg
Vector averaged cross-power spectrum Baseline: JB (01) - EF (03)
Timerange: 00/13:29:41 to 00/13:30:29

Plot file version 8 created 03-APR-2017 18:27:37

J1834-2341 EM126B.UVDATA.1

Freq = 4.7995 GHz, Bw = 32.000 MH No calibration applied and no bandpass applied

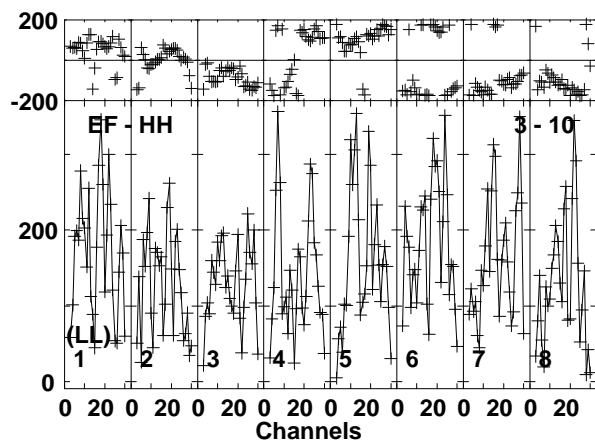
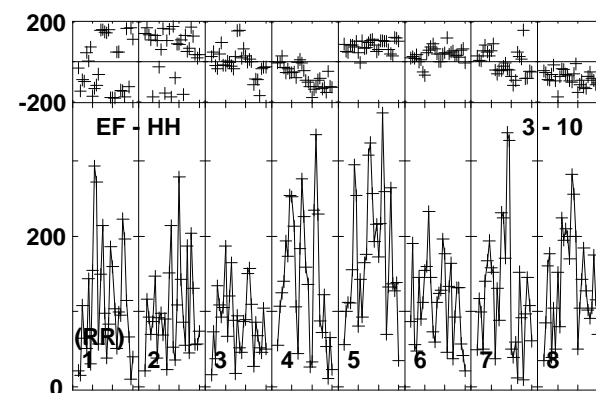
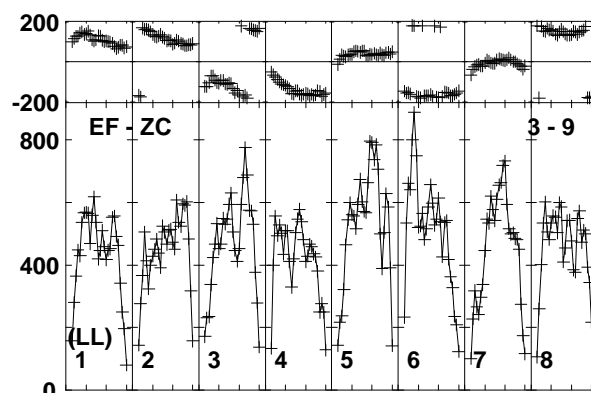
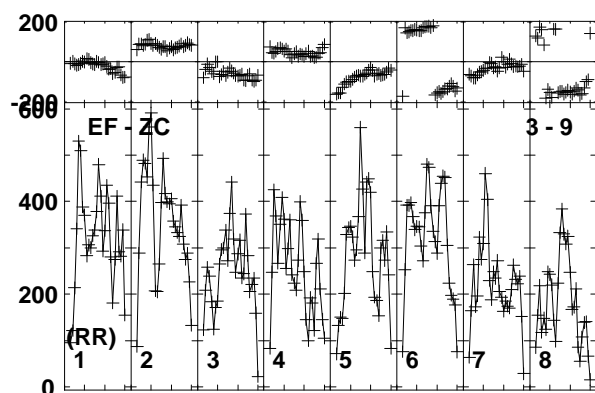
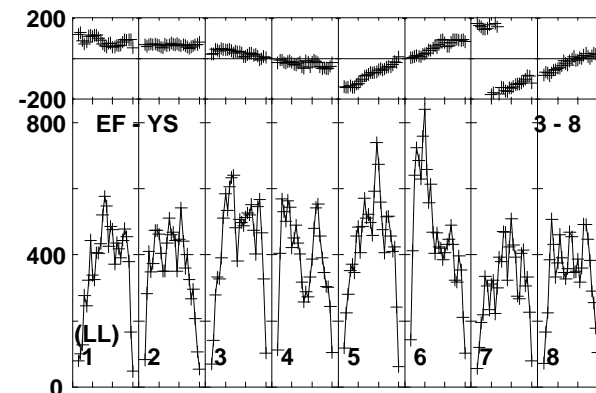
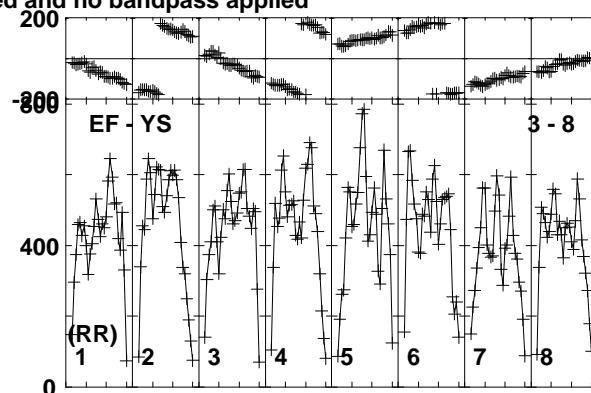
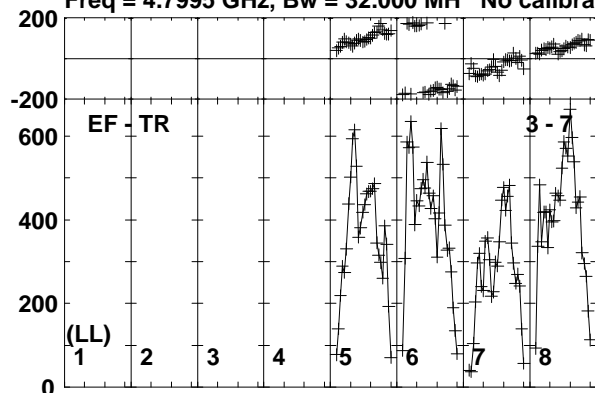

Lower frame: Micro Ampl Jy Top frame: Phas deg
Vector averaged cross-power spectrum Baseline: EF (03) - TR (07)
Timerange: 00/13:29:41 to 00/13:30:29

Plot file version 9 created 03-APR-2017 18:27:37

M22-VLA1 EM126B.UVDATA.1

Freq = 4.7995 GHz, Bw = 32.000 MH No calibration applied and no bandpass applied

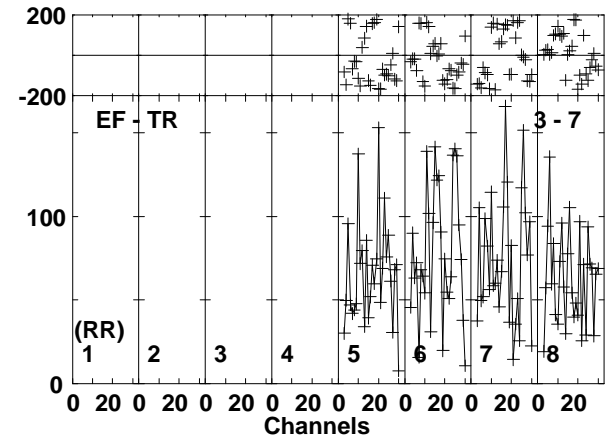
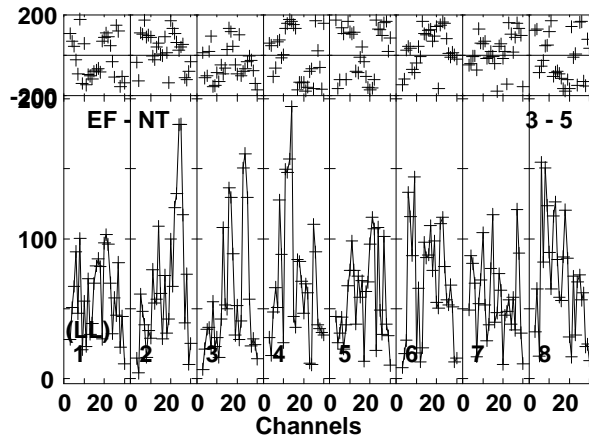
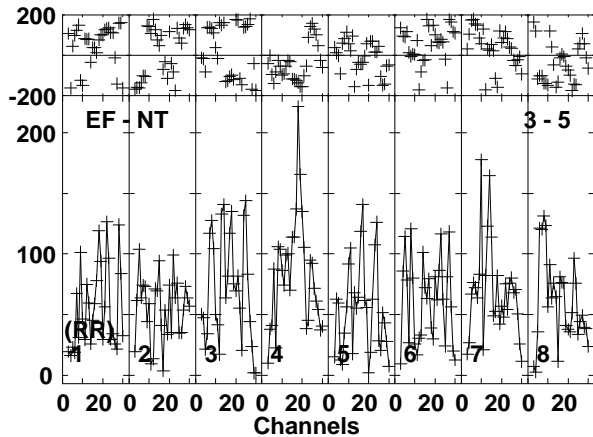
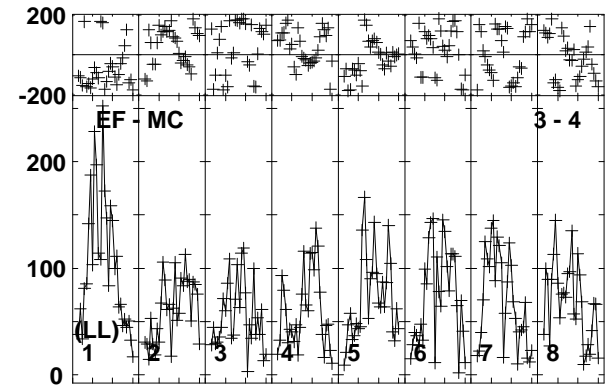
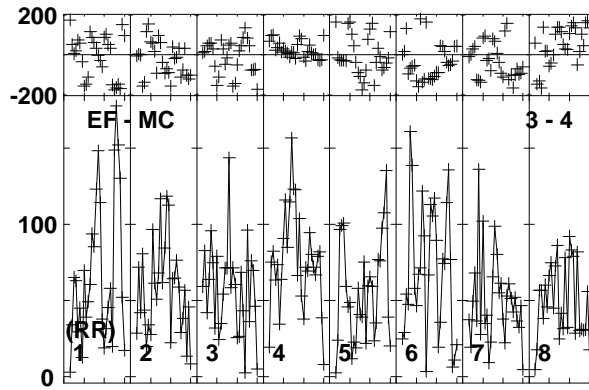
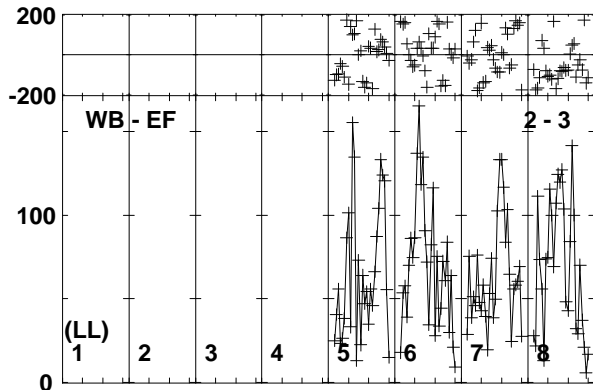
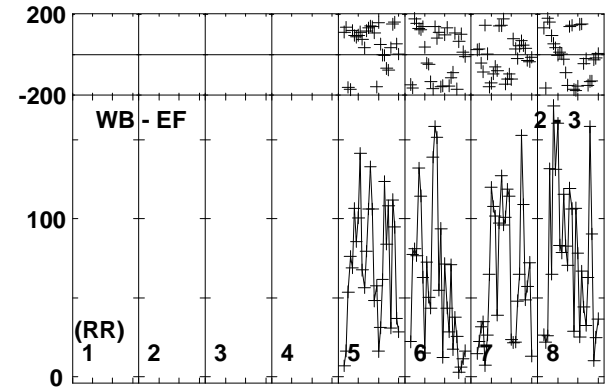
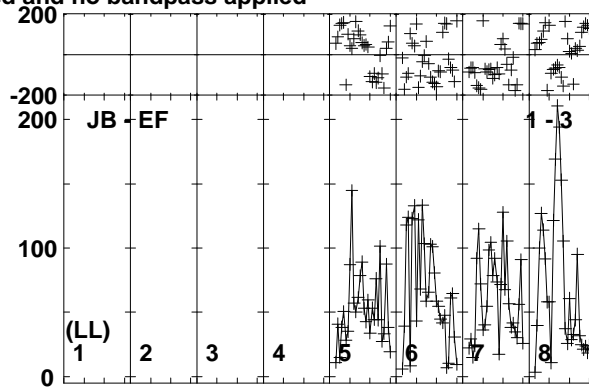
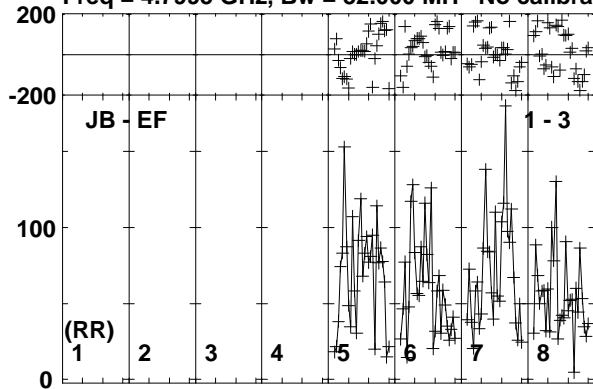

Lower frame: Micro Ampl Jy Top frame: Phas deg
Vector averaged cross-power spectrum Baseline: JB (01) - EF (03)
Timerange: 00/13:30:34 to 00/13:32:38

Plot file version 10 created 03-APR-2017 18:27:37

M22-VLA1 EM126B.UVDATA.1

Freq = 4.7995 GHz, Bw = 32.000 MH No calibration applied and no bandpass applied

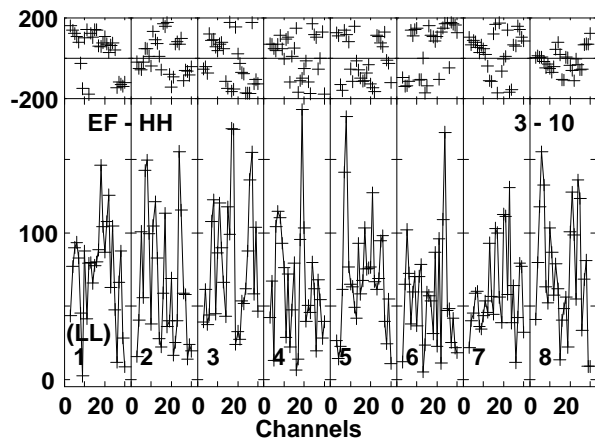
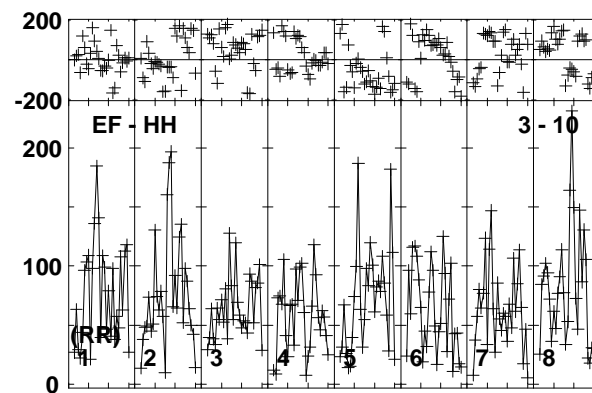
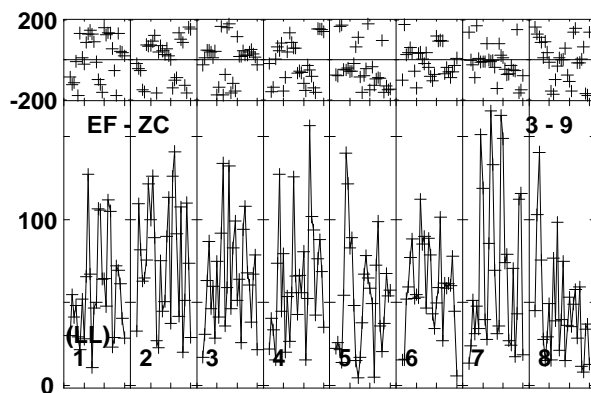
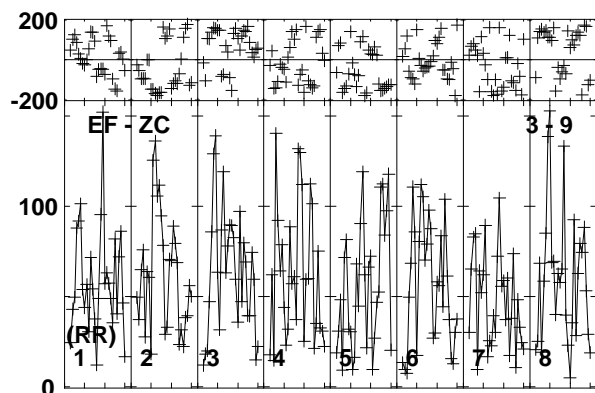
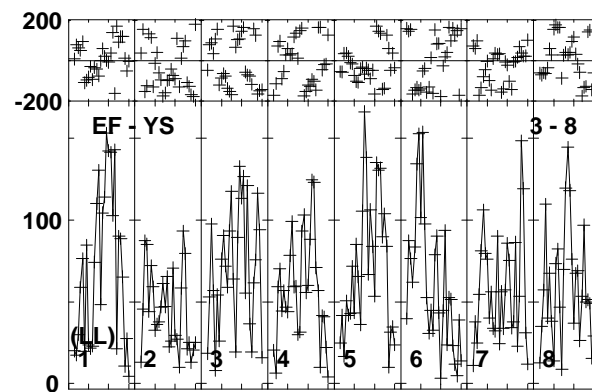
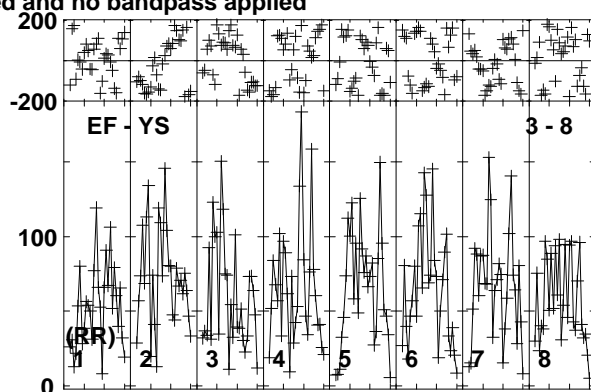
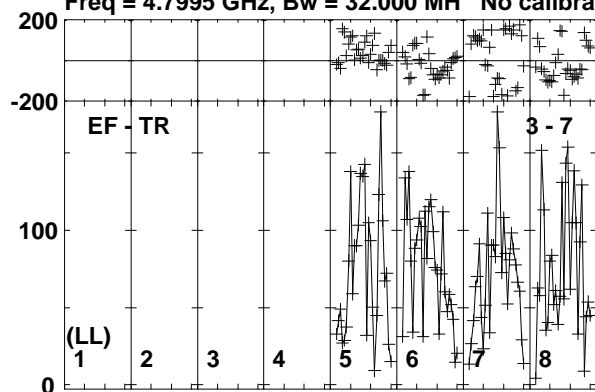

Lower frame: Micro Ampl Jy Top frame: Phas deg
Vector averaged cross-power spectrum Baseline: EF (03) - TR (07)
Timerange: 00/13:30:34 to 00/13:32:38

Plot file version 11 created 03-APR-2017 18:27:37

J1834-2341 EM126B.UVDATA.1

Freq = 4.7995 GHz, Bw = 32.000 MH No calibration applied and no bandpass applied

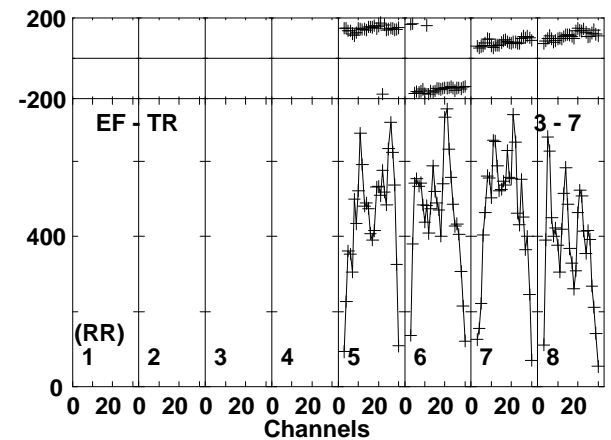
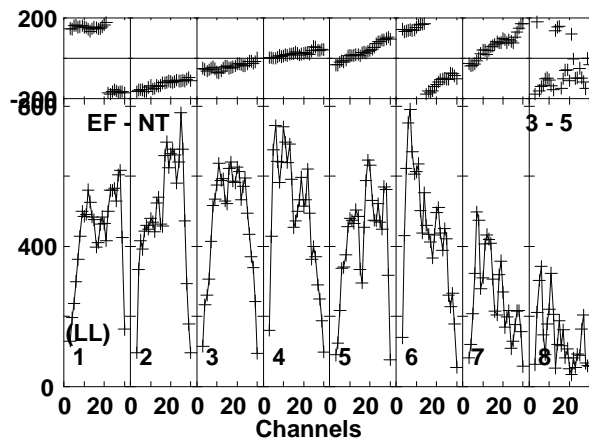
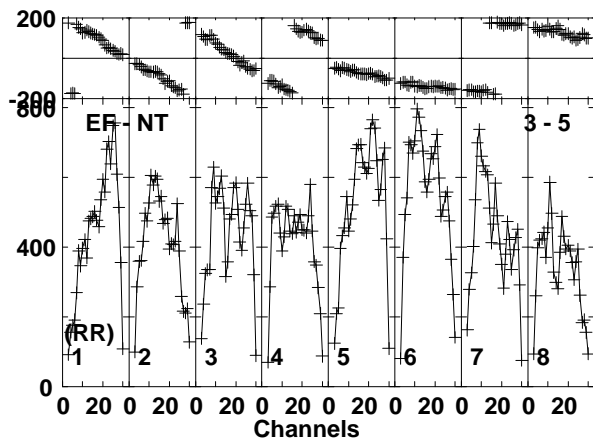
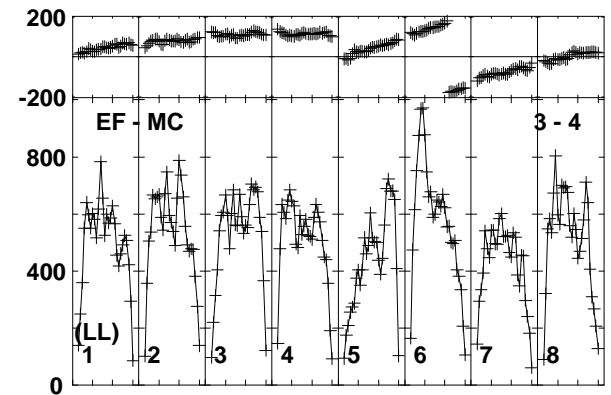
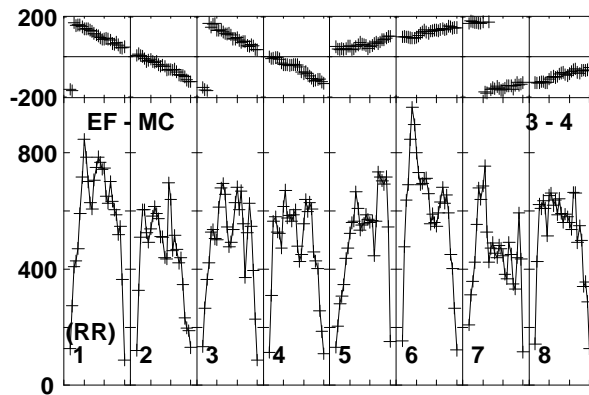
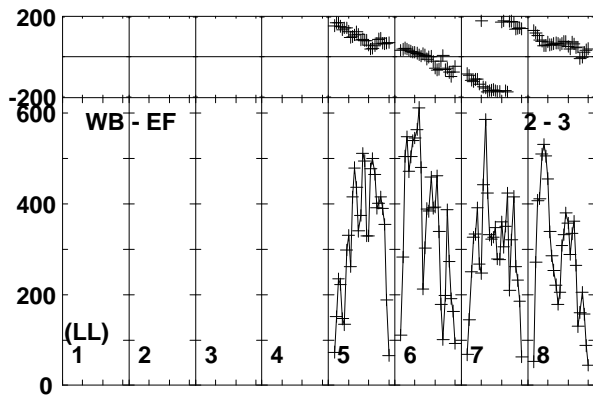
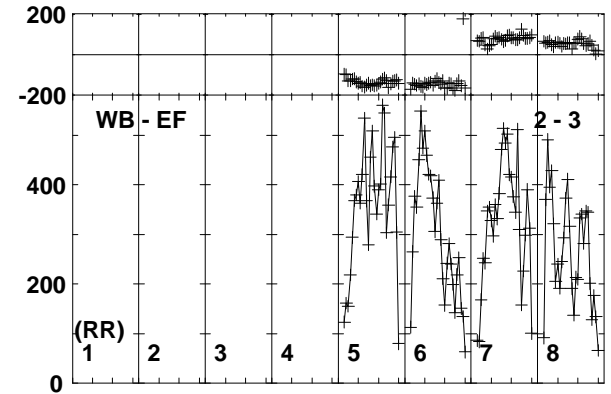
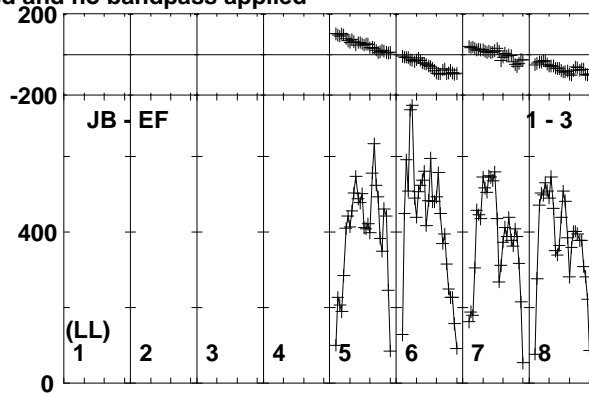
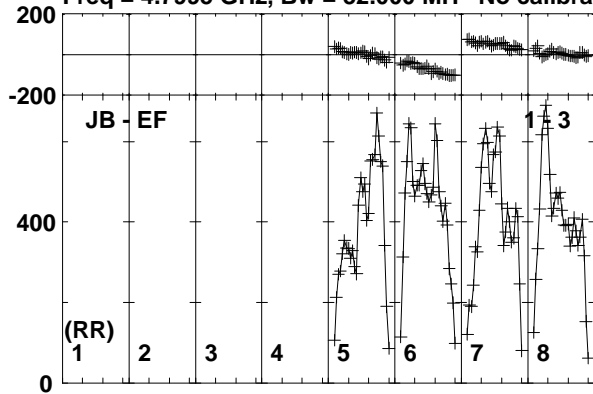

Lower frame: Micro Ampl Jy Top frame: Phas deg
Vector averaged cross-power spectrum Baseline: JB (01) - EF (03)
Timerange: 00/13:32:44 to 00/13:33:58

Plot file version 12 created 03-APR-2017 18:27:37

J1834-2341 EM126B.UVDATA.1

Freq = 4.7995 GHz, Bw = 32.000 MH No calibration applied and no bandpass applied

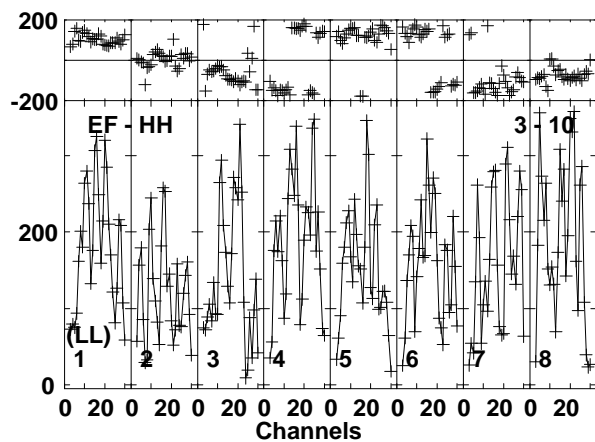
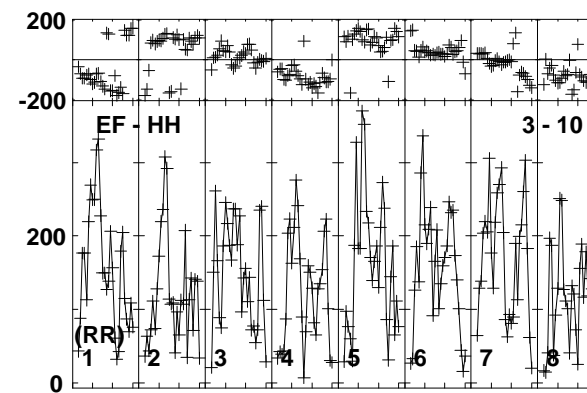
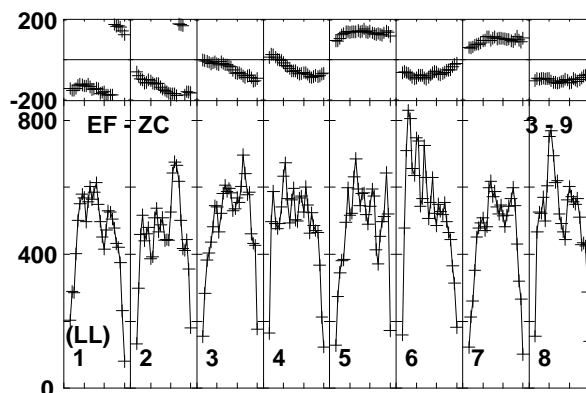
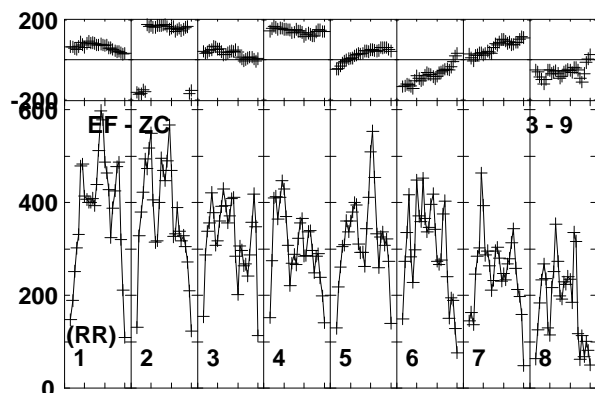
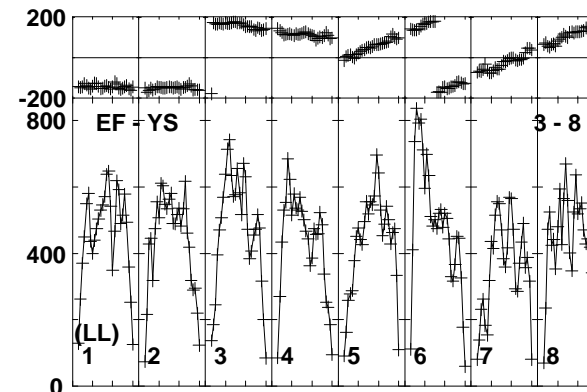
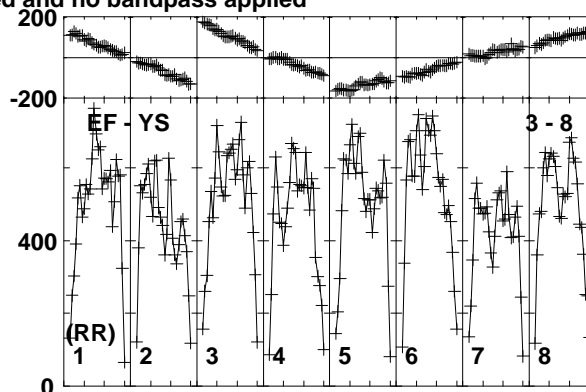
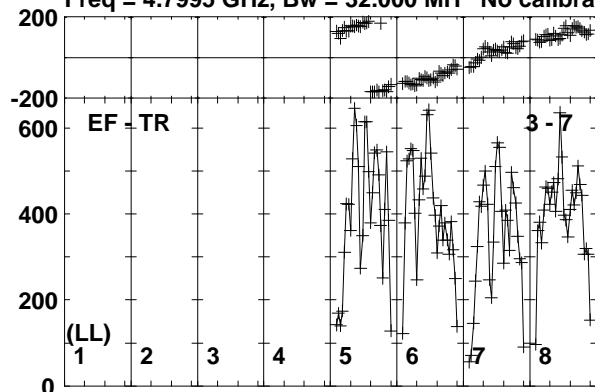

Lower frame: Micro Ampl Jy Top frame: Phas deg
Vector averaged cross-power spectrum Baseline: EF (03) - TR (07)
Timerange: 00/13:32:44 to 00/13:33:58

Plot file version 13 created 03-APR-2017 18:27:37

M22-VLA1 EM126B.UVDATA.1

Freq = 4.7995 GHz, Bw = 32.000 MH No calibration applied and no bandpass applied

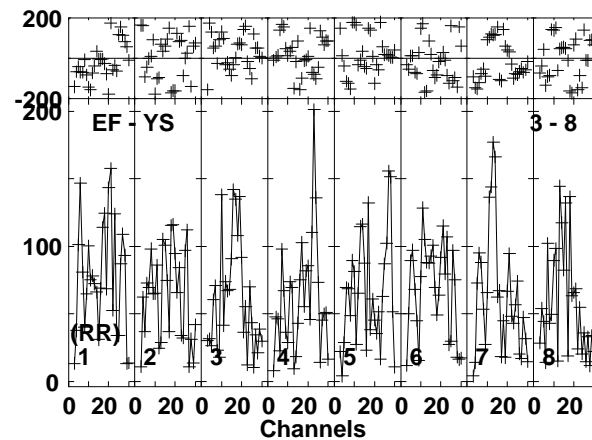
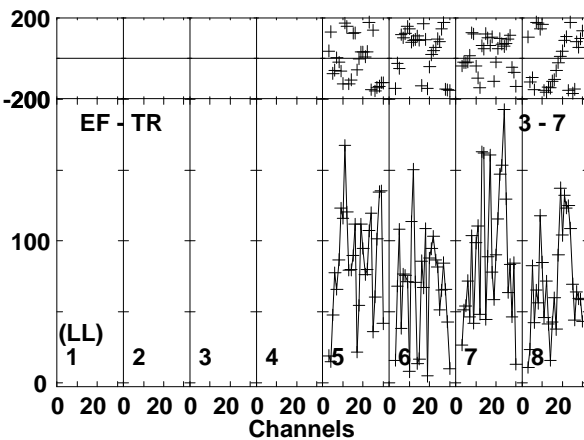
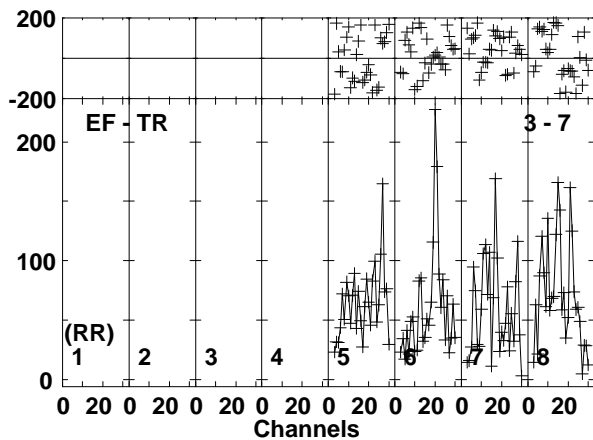
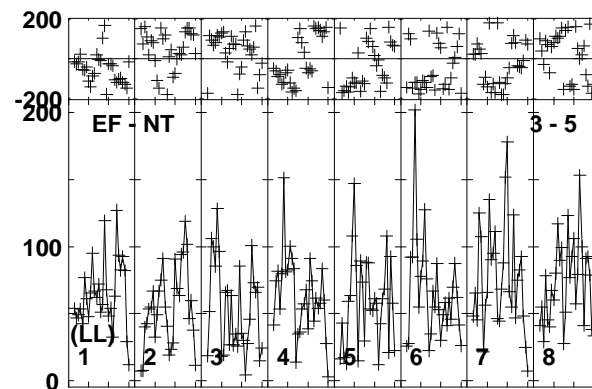
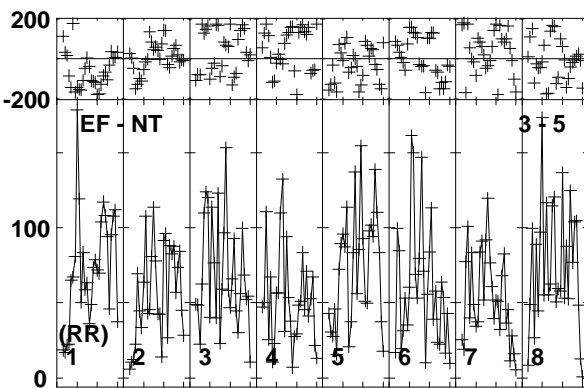
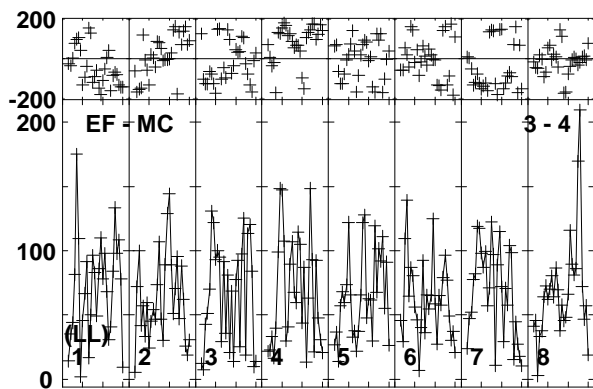
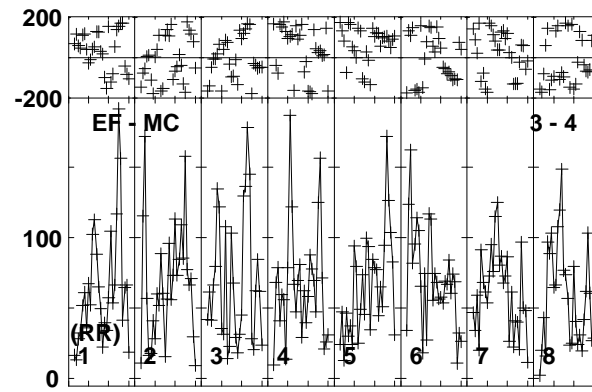
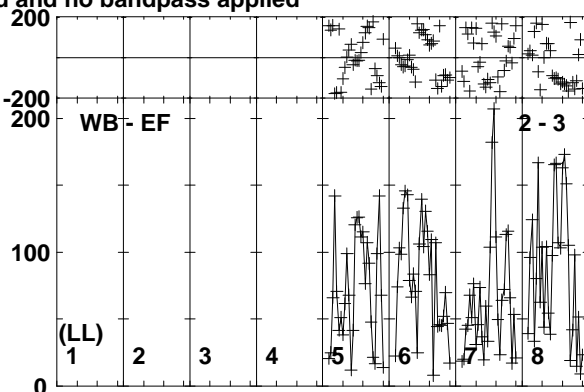
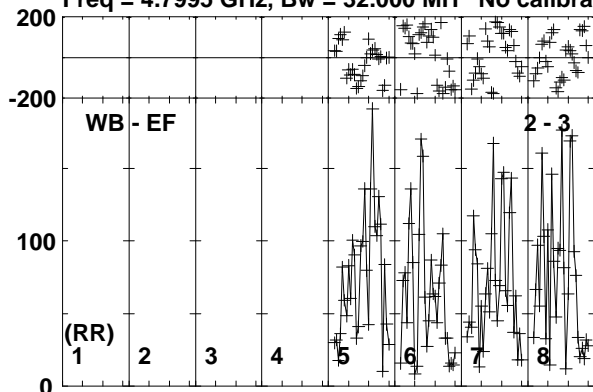

Lower frame: Micro Ampl Jy Top frame: Phas deg
Vector averaged cross-power spectrum Baseline: WB (02) - EF (03)
Timerange: 00/13:34:04 to 00/13:36:08

Plot file version 14 created 03-APR-2017 18:27:37

M22-VLA1 EM126B.UVDATA.1

Freq = 4.7995 GHz, Bw = 32.000 MH No calibration applied and no bandpass applied

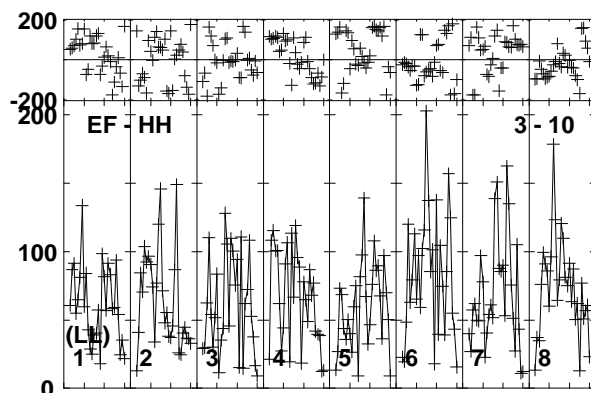
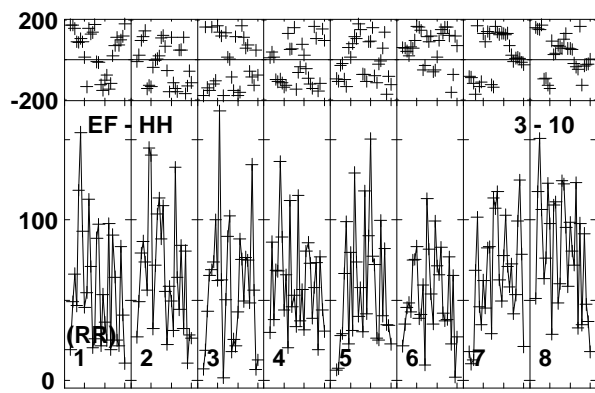
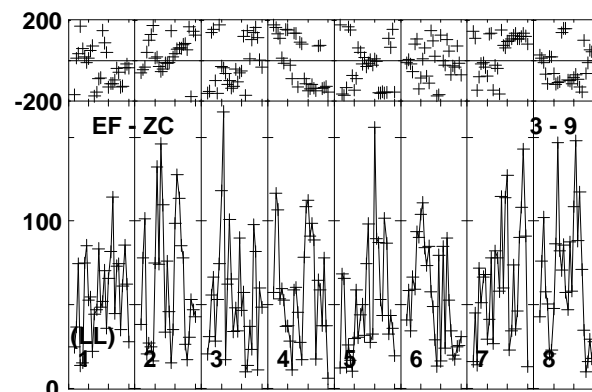
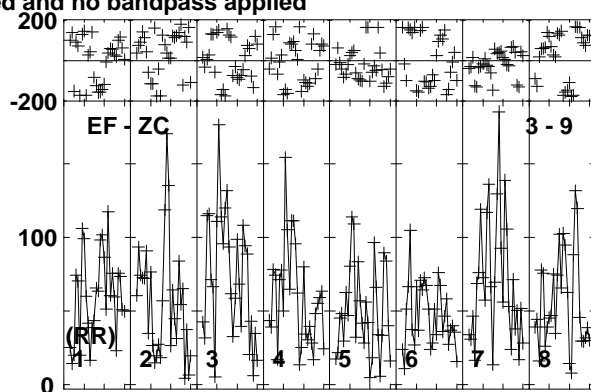
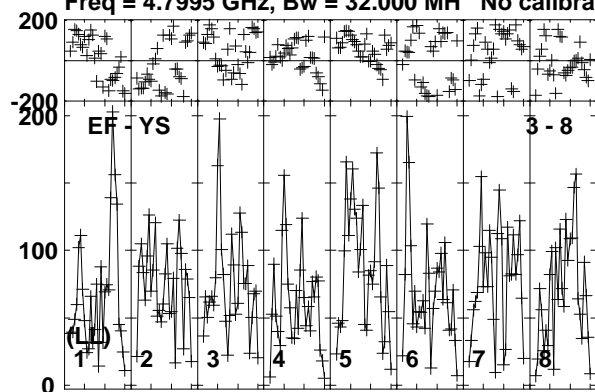

Lower frame: Micro Ampl Jy Top frame: Phas deg
Vector averaged cross-power spectrum Baseline: EF (03) - YS (08)
Timerange: 00/13:34:04 to 00/13:36:08

Plot file version 15 created 03-APR-2017 18:27:37

J1834-2341 EM126B.UVDATA.1

Freq = 4.7995 GHz, Bw = 32.000 MH No calibration applied and no bandpass applied

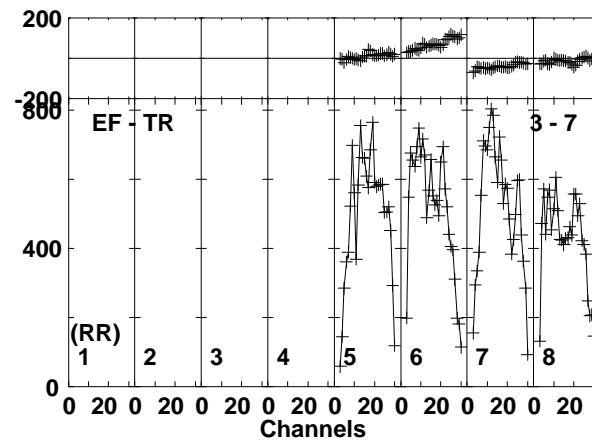
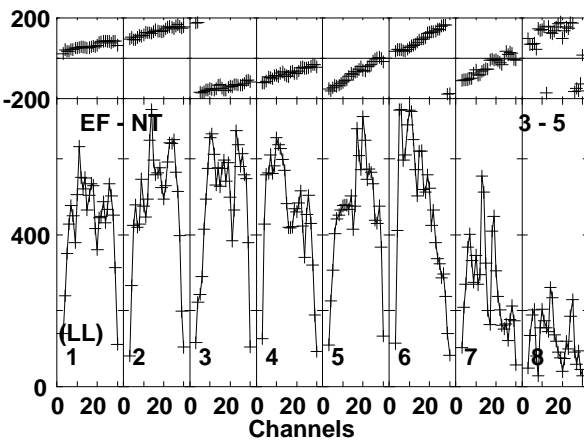
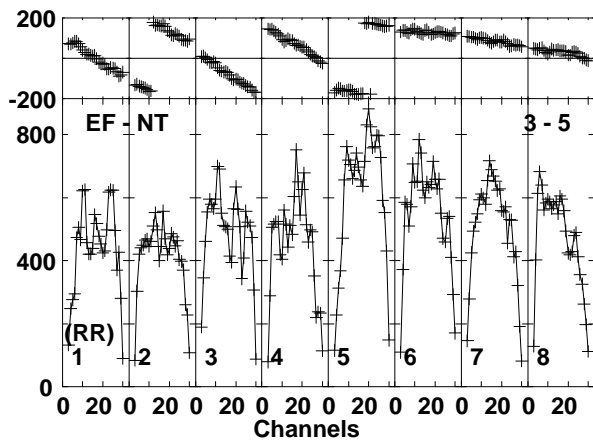
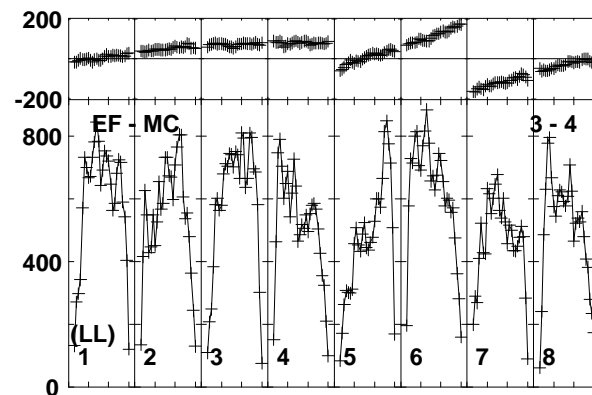
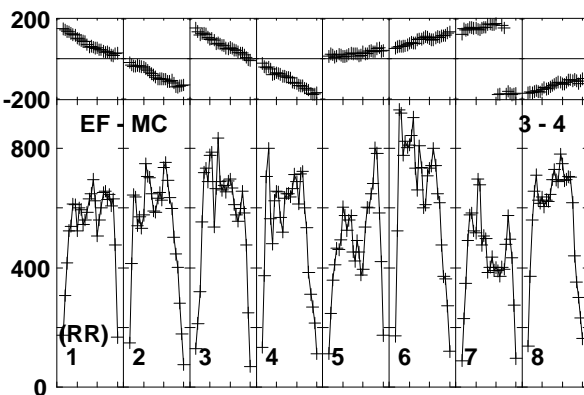
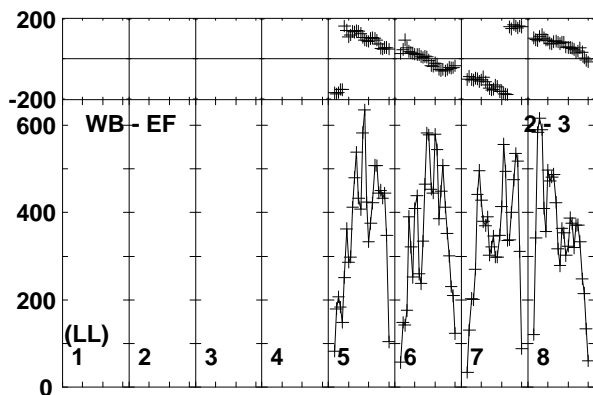
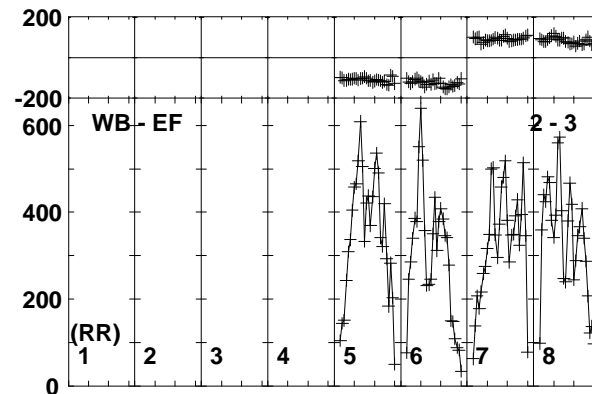
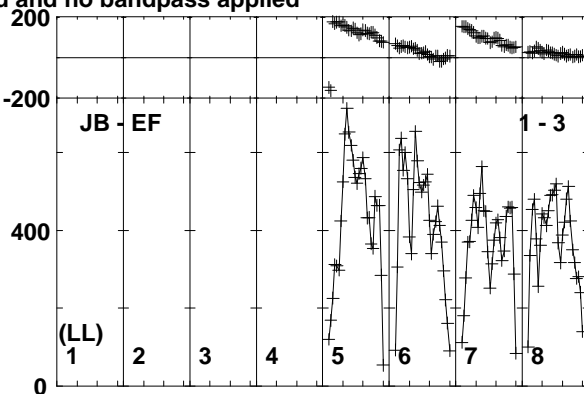
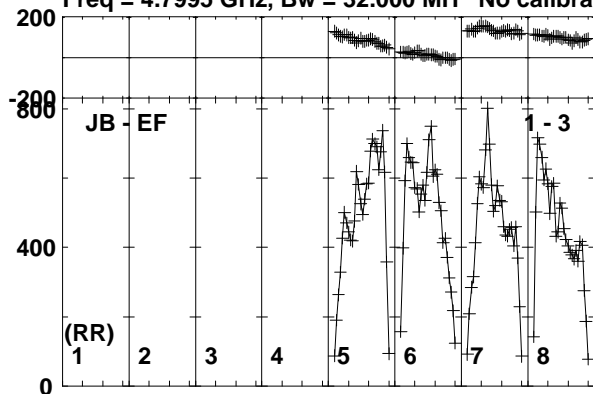

Lower frame: Micro Ampl Jy Top frame: Phas deg
Vector averaged cross-power spectrum Baseline: JB (01) - EF (03)
Timerange: 00/13:36:14 to 00/13:37:28

Plot file version 16 created 03-APR-2017 18:27:37

J1834-2341 EM126B.UVDATA.1

Freq = 4.7995 GHz, Bw = 32.000 MH No calibration applied and no bandpass applied

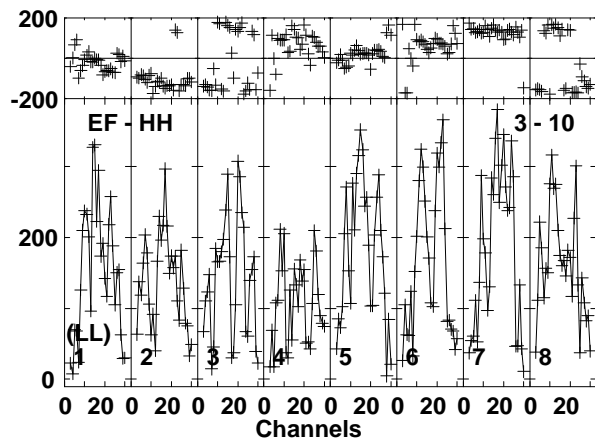
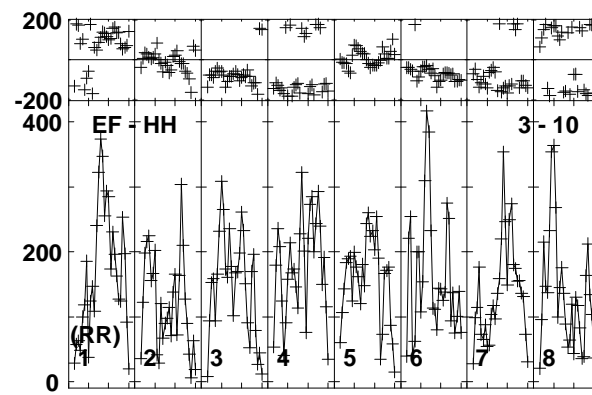
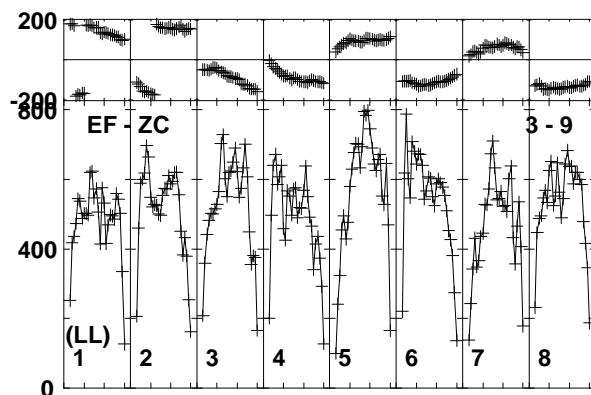
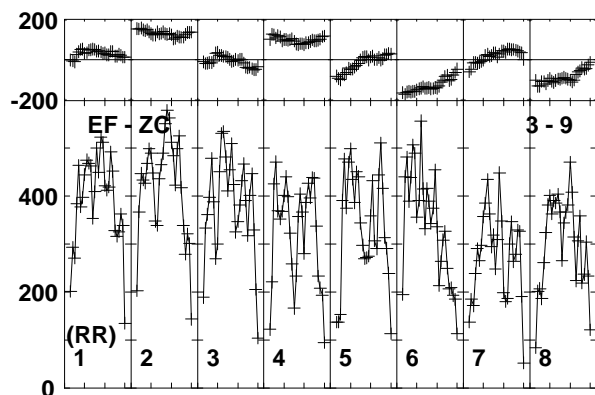
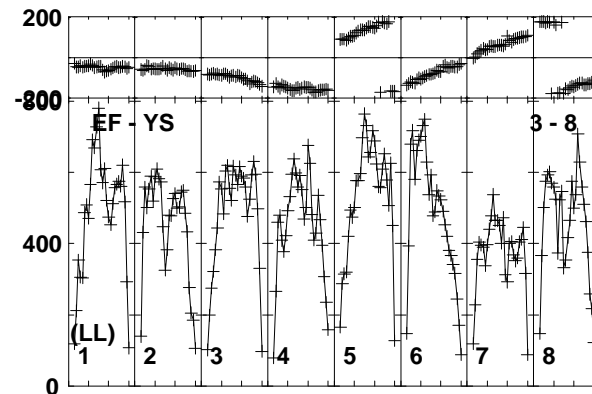
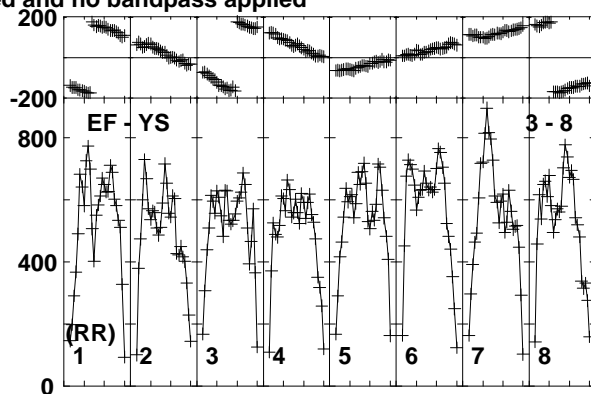
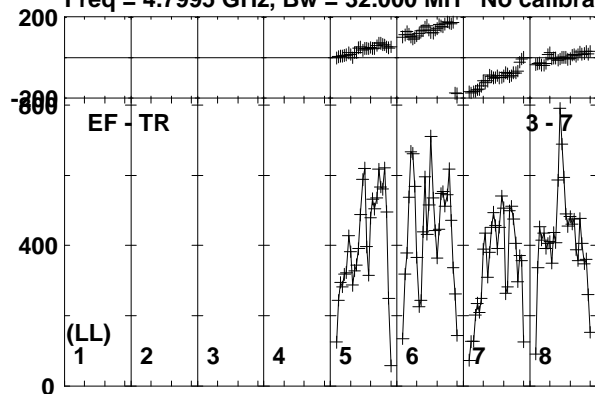

Lower frame: Micro Ampl Jy Top frame: Phas deg
Vector averaged cross-power spectrum Baseline: EF (03) - TR (07)
Timerange: 00/13:36:14 to 00/13:37:28

Plot file version 17 created 03-APR-2017 18:27:37

M22-VLA1 EM126B.UVDATA.1

Freq = 4.7995 GHz, Bw = 32.000 MH No calibration applied and no bandpass applied

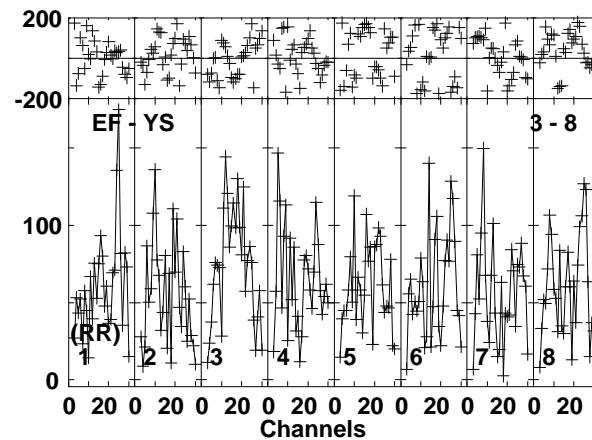
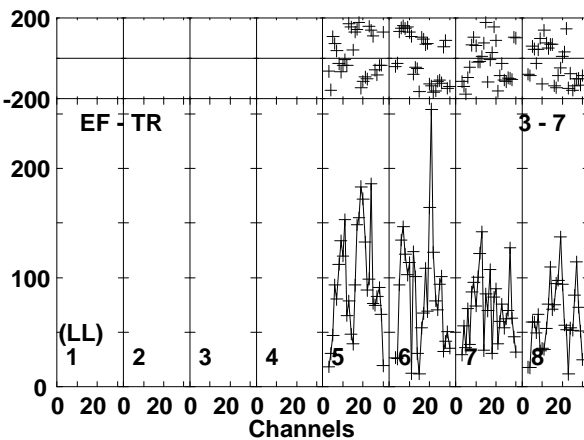
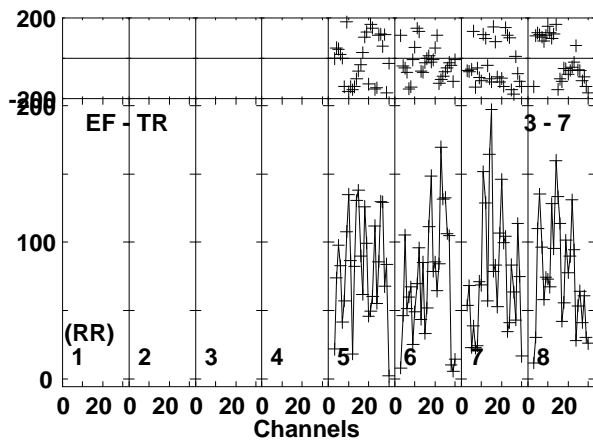
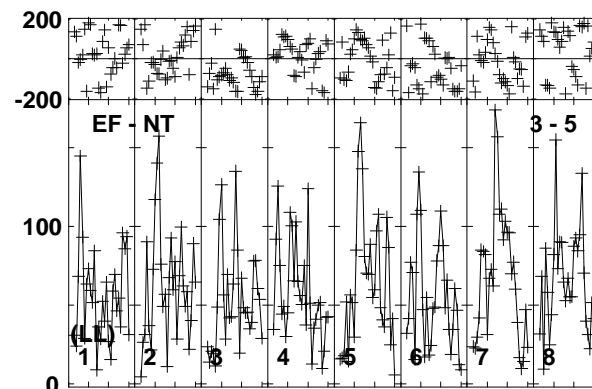
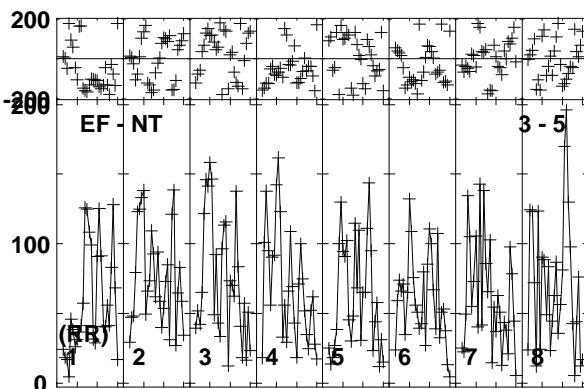
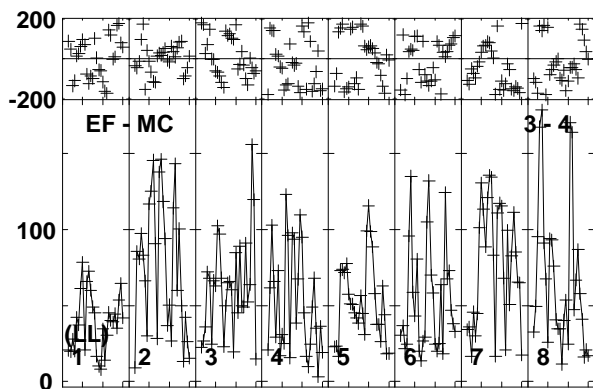
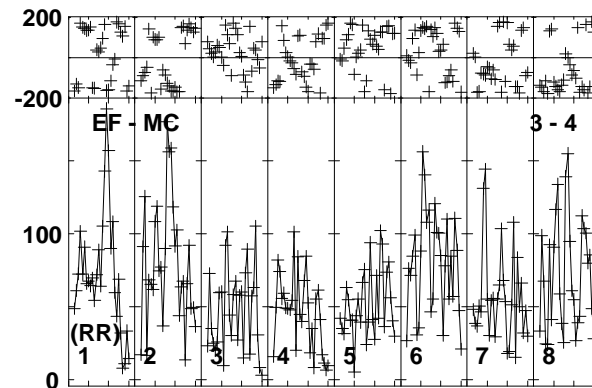
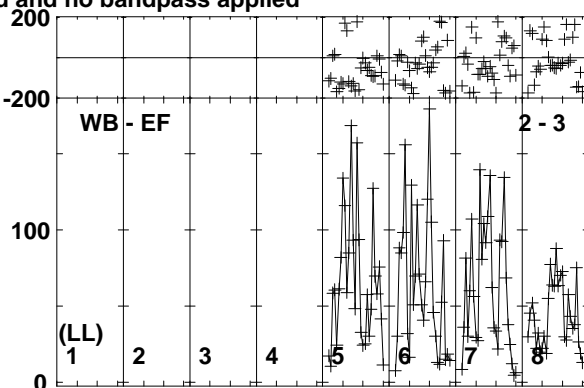
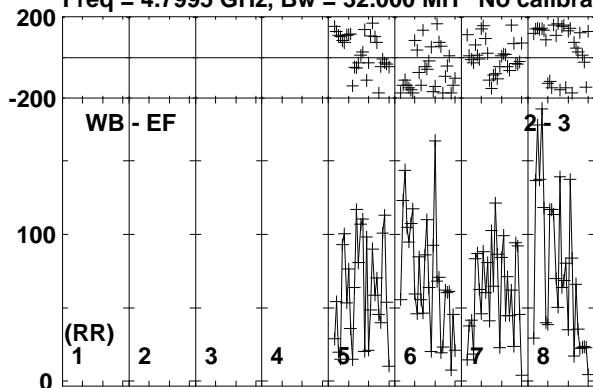

Lower frame: Micro Ampl Jy Top frame: Phas deg
Vector averaged cross-power spectrum Baseline: WB (02) - EF (03)
Timerange: 00/13:37:34 to 00/13:39:38

Plot file version 18 created 03-APR-2017 18:27:37

M22-VLA1 EM126B.UVDATA.1

Freq = 4.7995 GHz, Bw = 32.000 MH No calibration applied and no bandpass applied

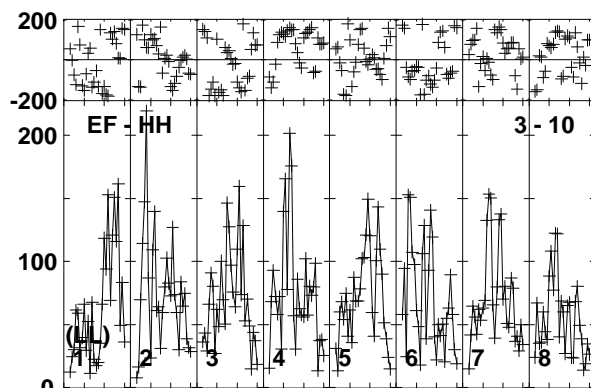
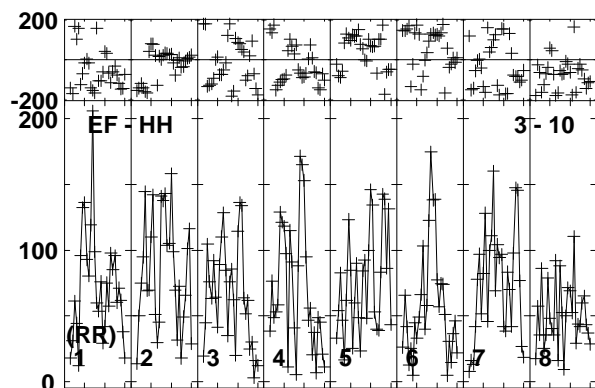
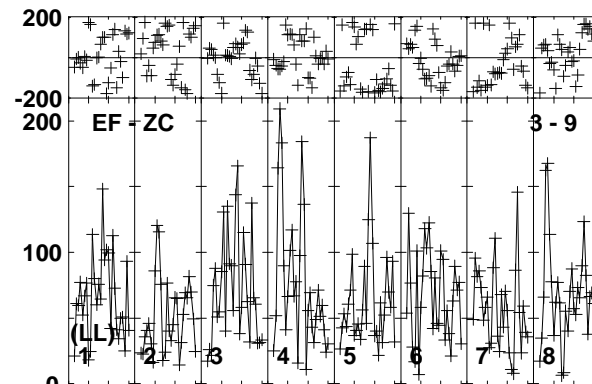
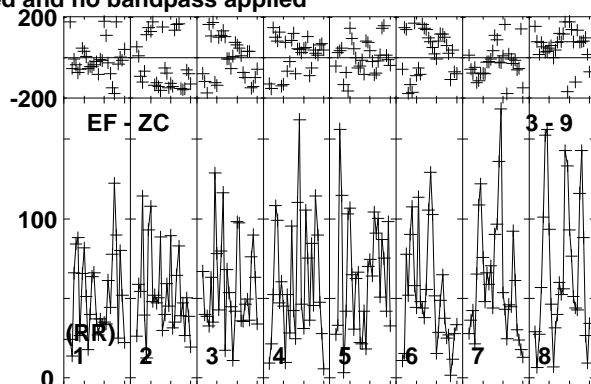
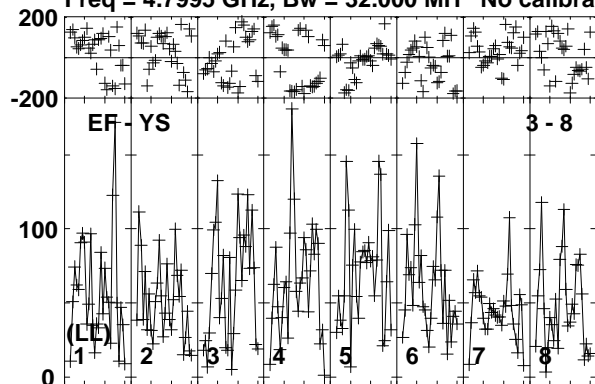

Lower frame: Micro Ampl Jy Top frame: Phas deg
Vector averaged cross-power spectrum Baseline: EF (03) - YS (08)
Timerange: 00/13:37:34 to 00/13:39:38

Plot file version 19 created 03-APR-2017 18:27:37

J1834-2341 EM126B.UVDATA.1

Freq = 4.7995 GHz, Bw = 32.000 MH No calibration applied and no bandpass applied

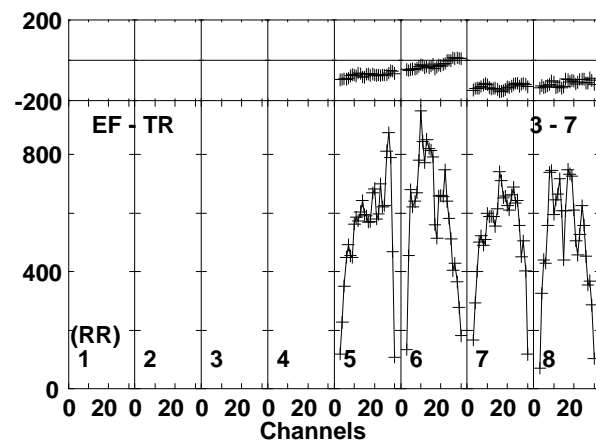
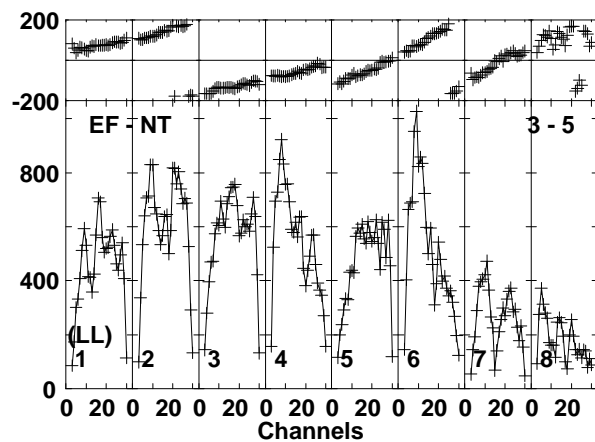
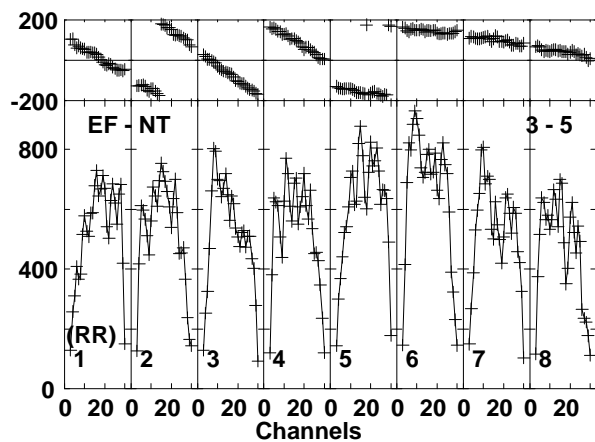
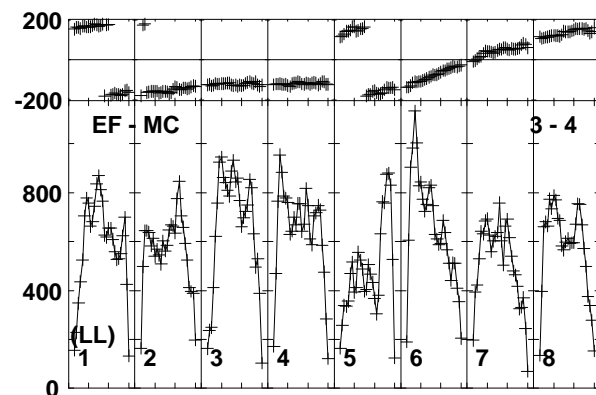
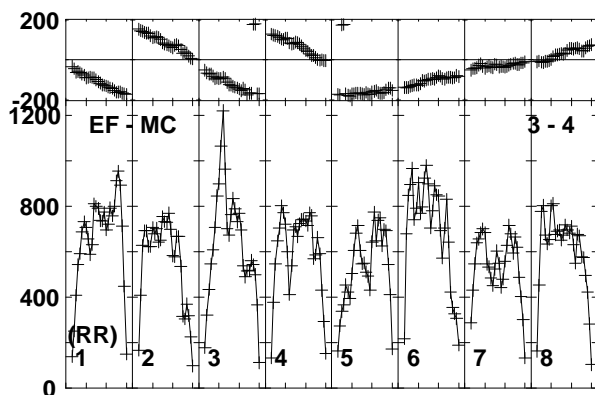
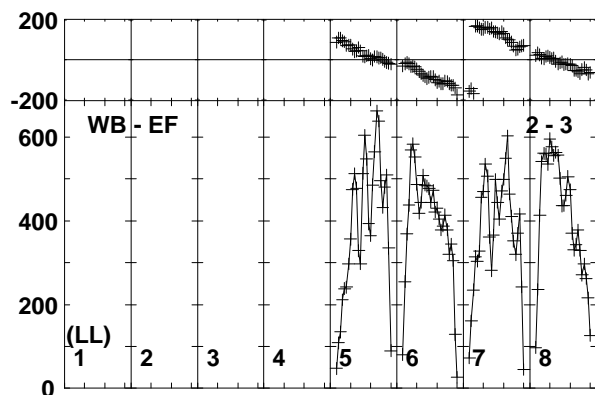
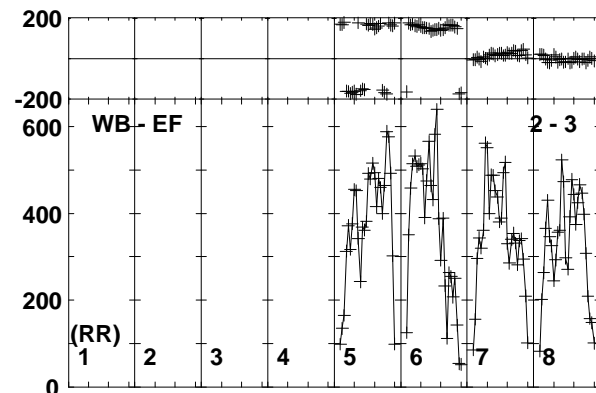
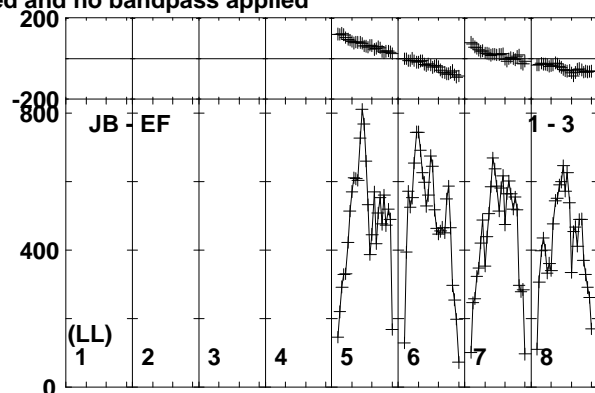
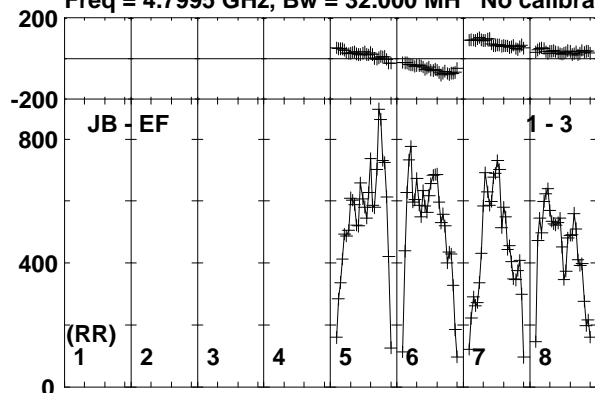

Lower frame: Micro Ampl Jy Top frame: Phas deg
Vector averaged cross-power spectrum Baseline: JB (01) - EF (03)
Timerange: 00:13:40:11 to 00:13:40:59

Plot file version 20 created 03-APR-2017 18:27:37

J1834-2341 EM126B.UVDATA.1

Freq = 4.7995 GHz, Bw = 32.000 MH No calibration applied and no bandpass applied

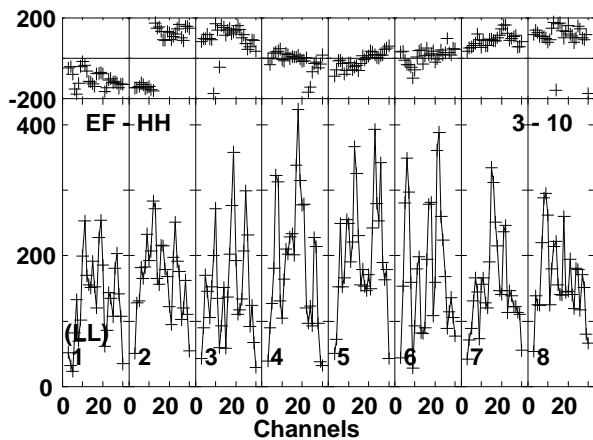
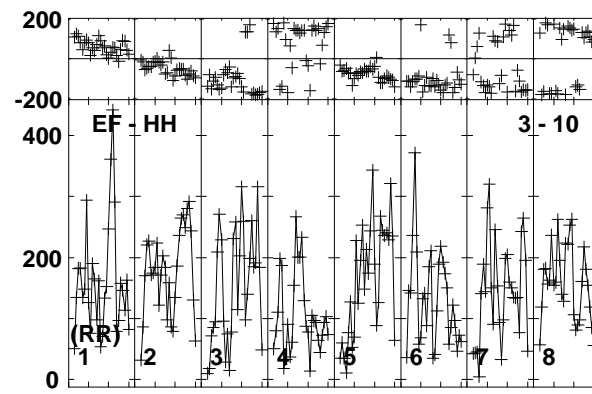
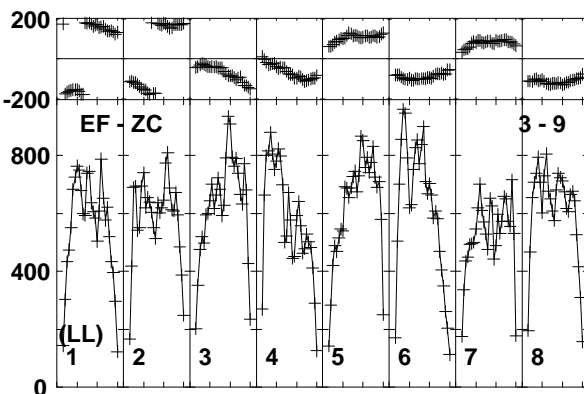
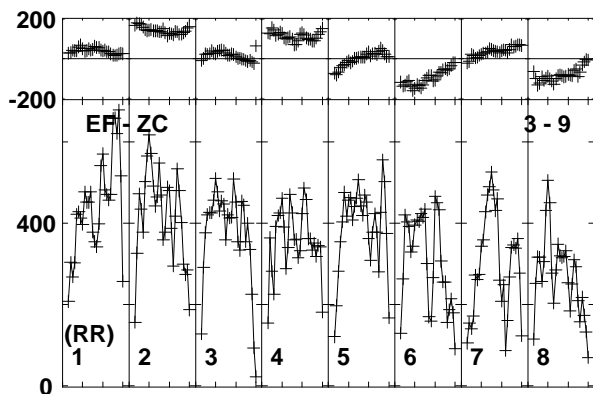
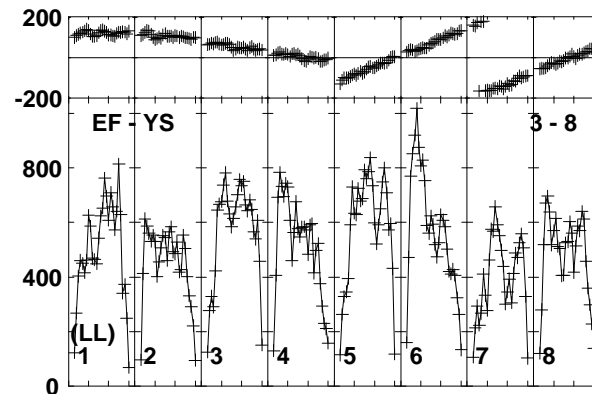
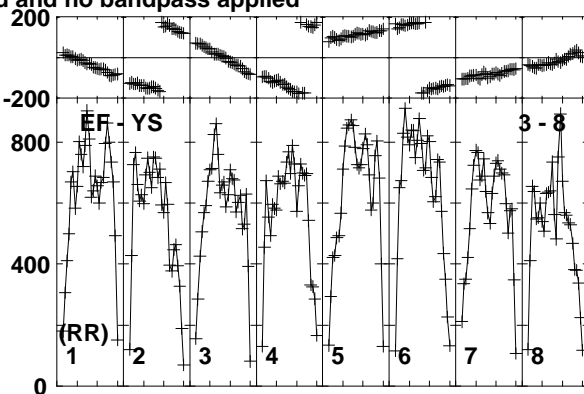
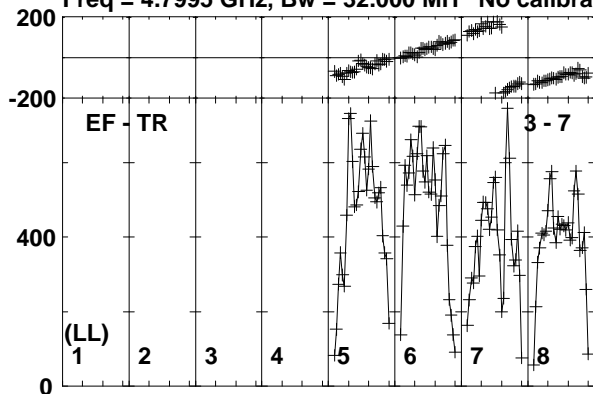

Lower frame: Micro Ampl Jy Top frame: Phas deg
Vector averaged cross-power spectrum Baseline: EF (03) - TR (07)
Timerange: 00/13:40:11 to 00/13:40:59

Plot file version 21 created 03-APR-2017 18:27:37

M22-VLA1 EM126B.UVDATA.1

Freq = 4.7995 GHz, Bw = 32.000 MH No calibration applied and no bandpass applied

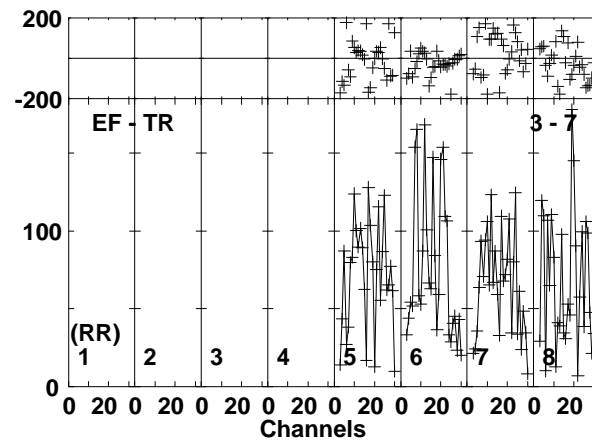
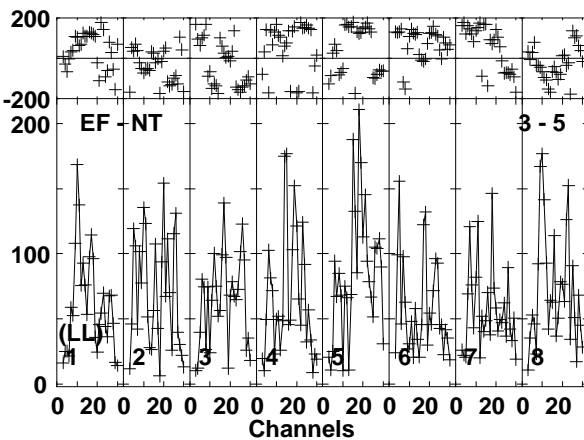
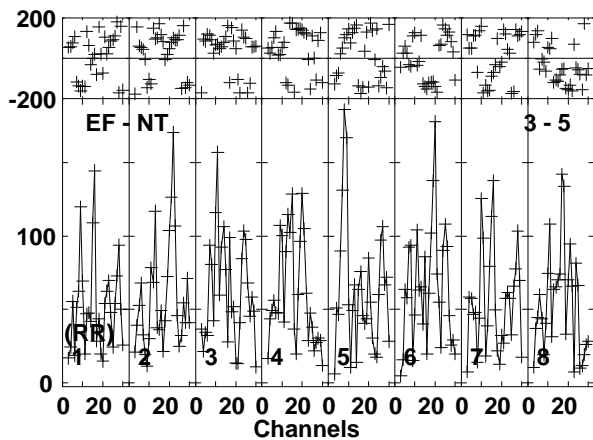
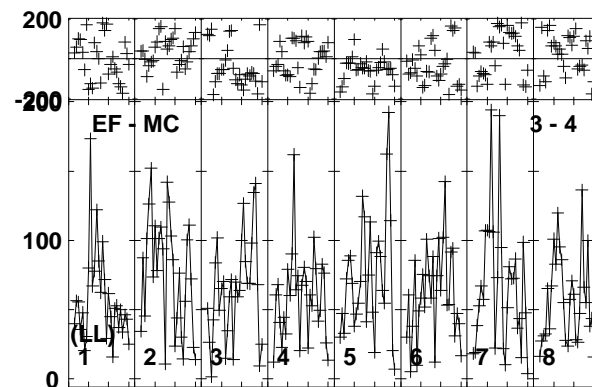
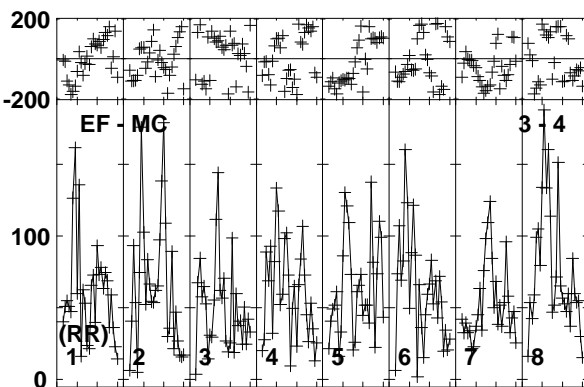
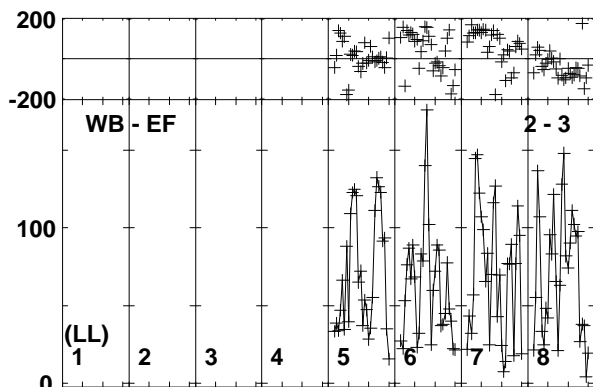
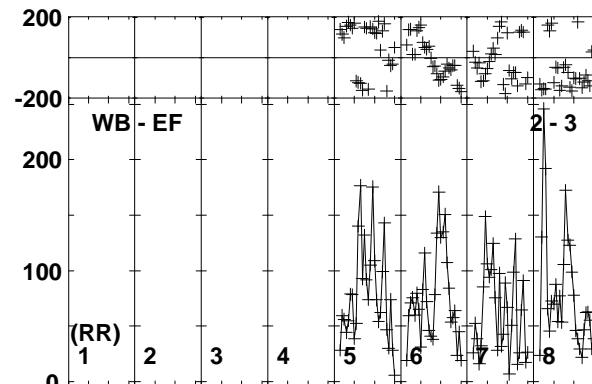
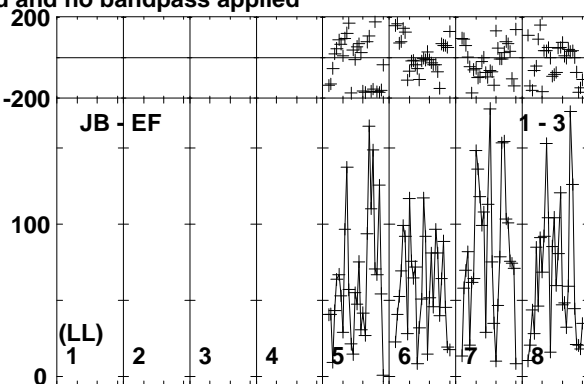
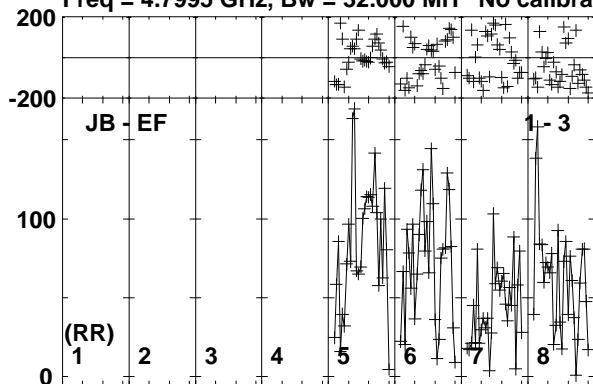

Lower frame: Micro Ampl Jy Top frame: Phas deg
Vector averaged cross-power spectrum Baseline: JB (01) - EF (03)
Timerange: 00/13:41:04 to 00/13:43:08

Plot file version 22 created 03-APR-2017 18:27:37

M22-VLA1 EM126B.UVDATA.1

Freq = 4.7995 GHz, Bw = 32.000 MH No calibration applied and no bandpass applied

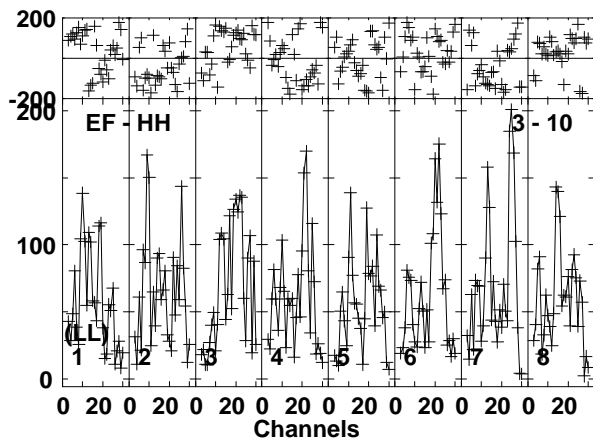
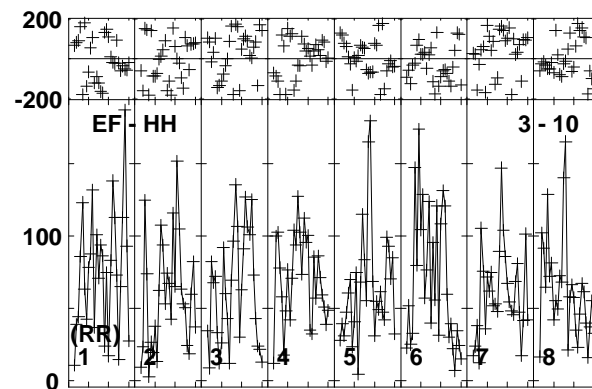
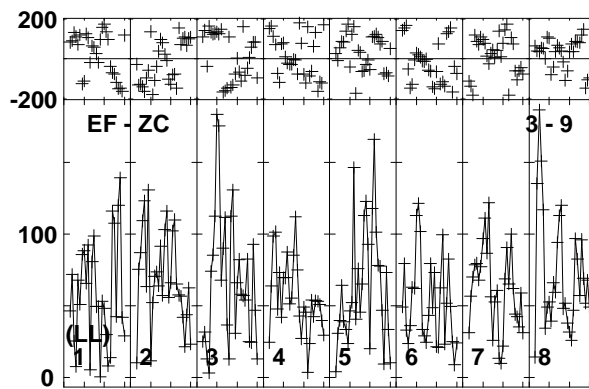
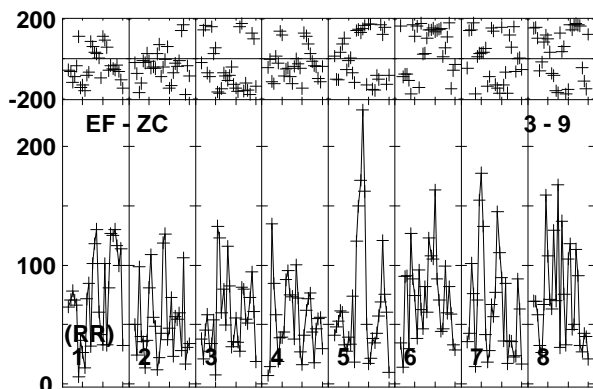
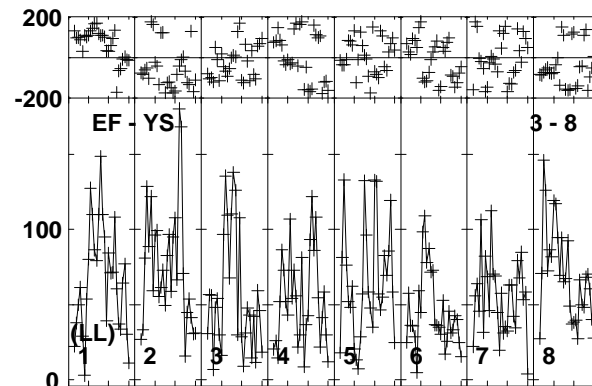
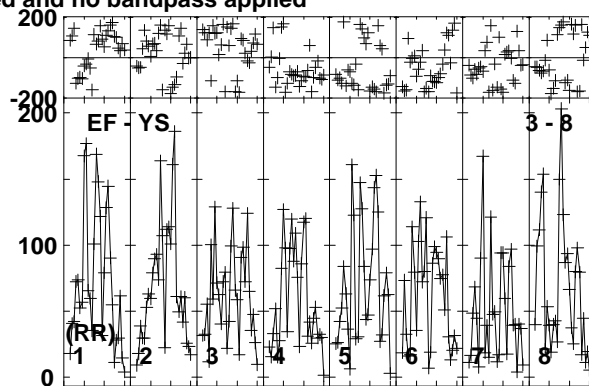
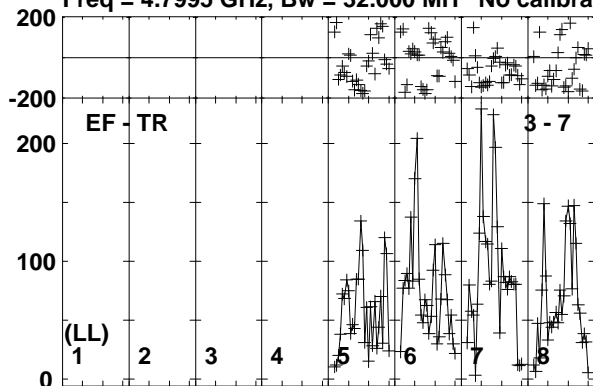

Lower frame: Micro Ampl Jy Top frame: Phas deg
Vector averaged cross-power spectrum Baseline: EF (03) - TR (07)
Timerange: 00/13:41:04 to 00/13:43:08

Plot file version 23 created 03-APR-2017 18:27:37

J1834-2341 EM126B.UVDATA.1

Freq = 4.7995 GHz, Bw = 32.000 MH No calibration applied and no bandpass applied

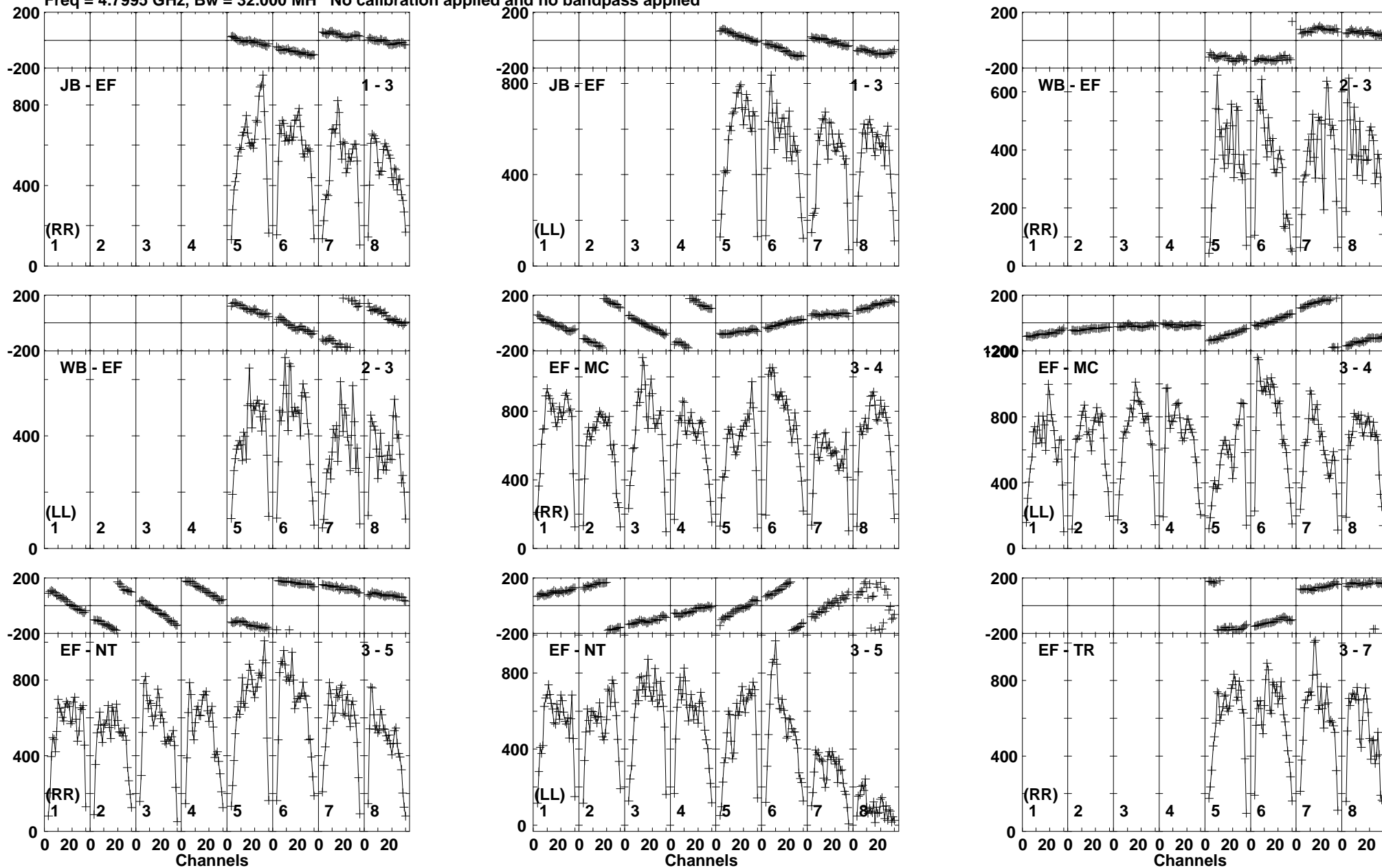

Lower frame: Micro Ampl Jy Top frame: Phas deg
Vector averaged cross-power spectrum Baseline: JB (01) - EF (03)
Timerange: 00/13:43:14 to 00/13:44:28

Plot file version 24 created 03-APR-2017 18:27:37

J1834-2341 EM126B.UVDATA.1

Freq = 4.7995 GHz, Bw = 32.000 MH No calibration applied and no bandpass applied

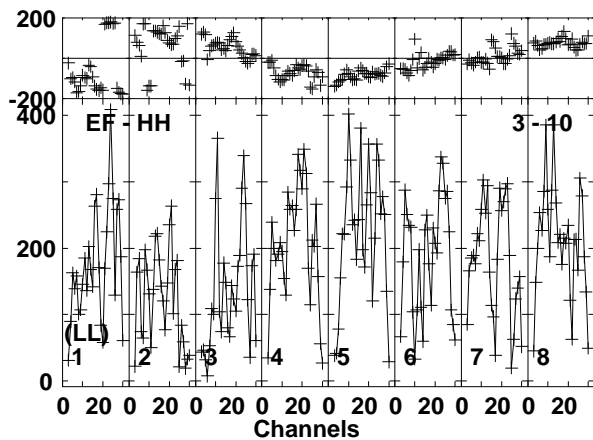
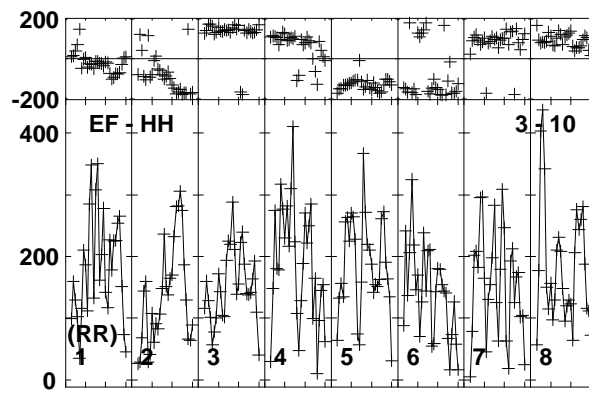
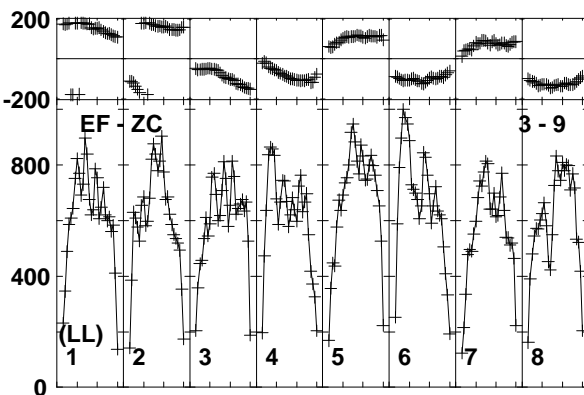
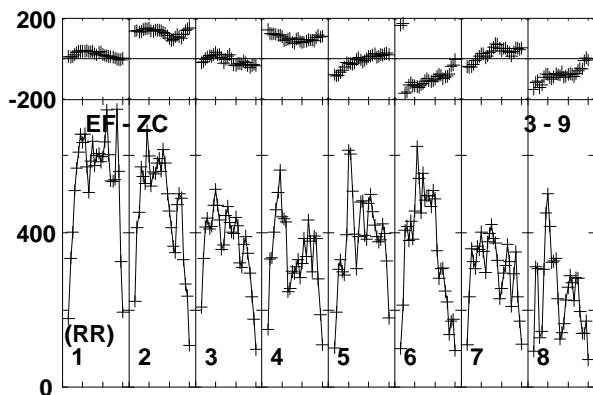
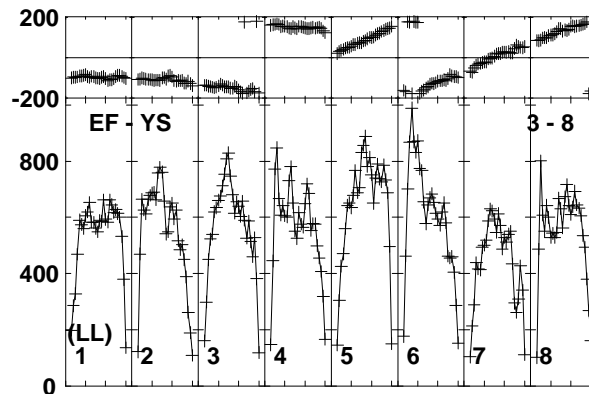
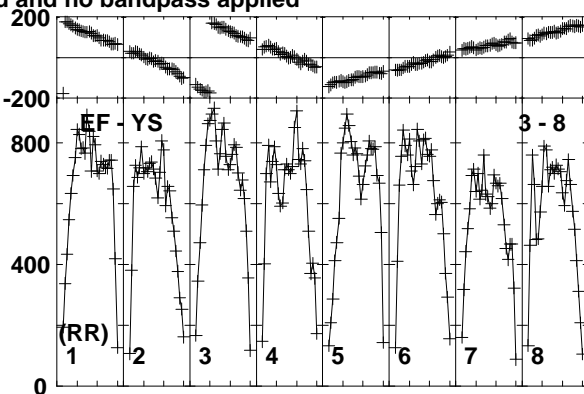
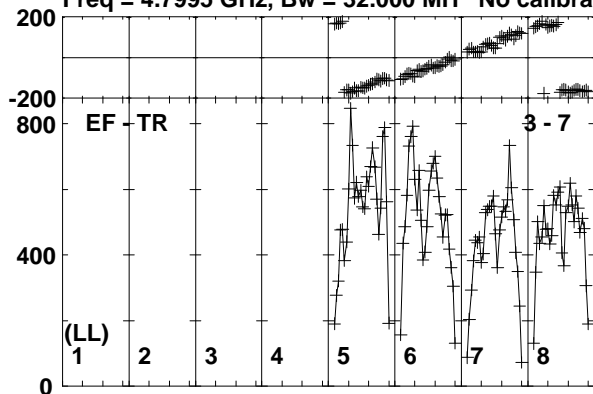

Lower frame: Micro Ampl Jy Top frame: Phas deg
Vector averaged cross-power spectrum Baseline: EF (03) - TR (07)
Timerange: 00/13:43:14 to 00/13:44:28

Plot file version 25 created 03-APR-2017 18:27:37

M22-VLA1 EM126B.UVDATA.1

Freq = 4.7995 GHz, Bw = 32.000 MH No calibration applied and no bandpass applied

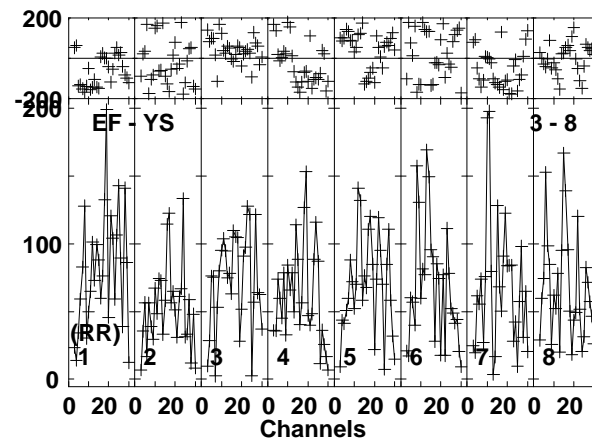
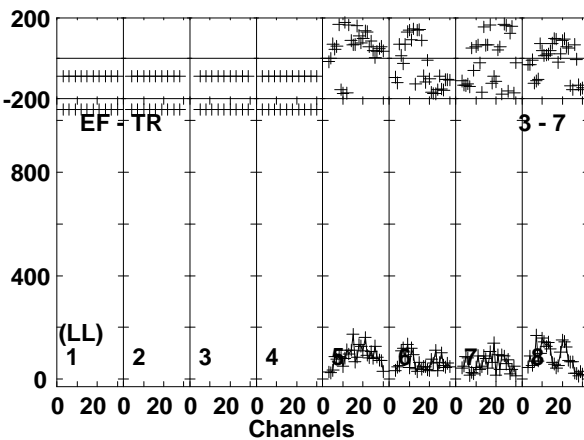
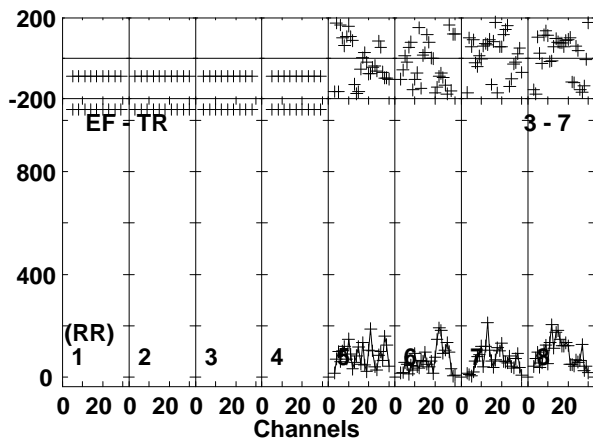
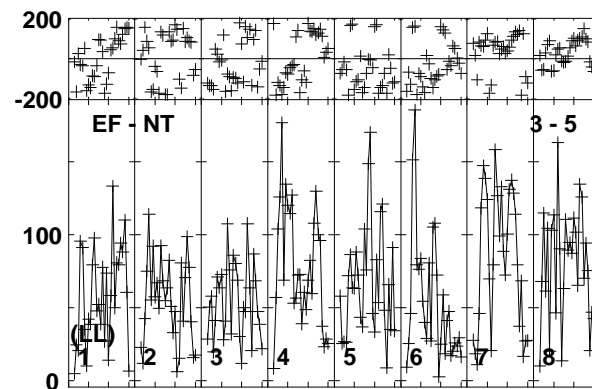
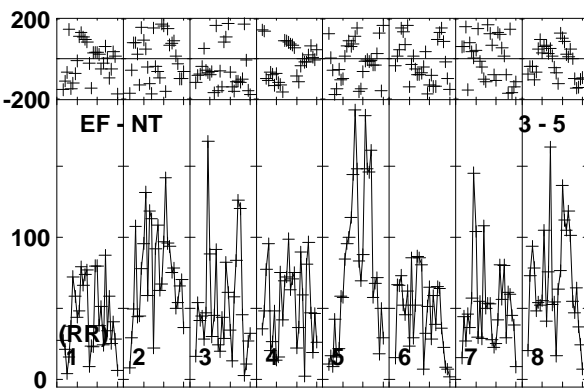
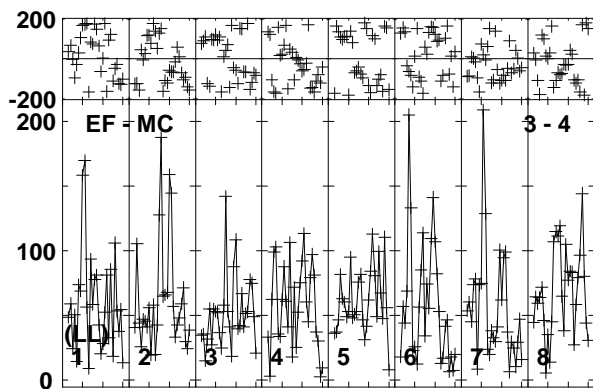
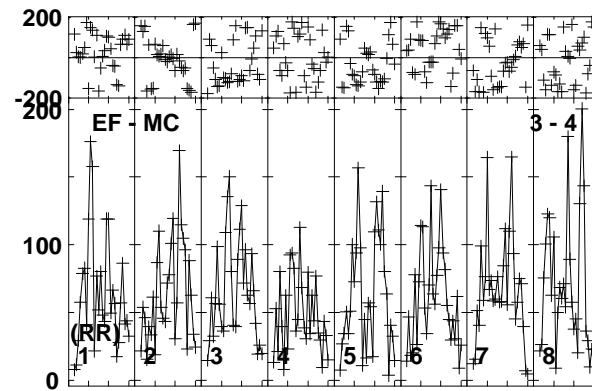
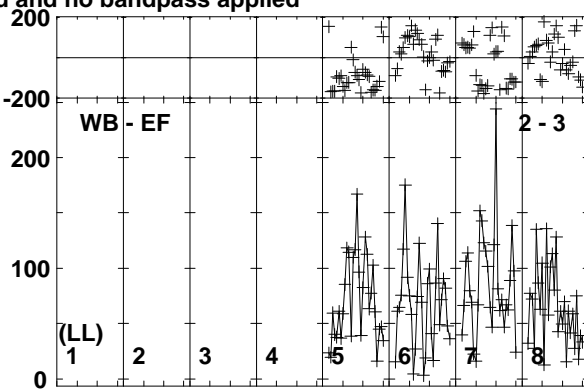
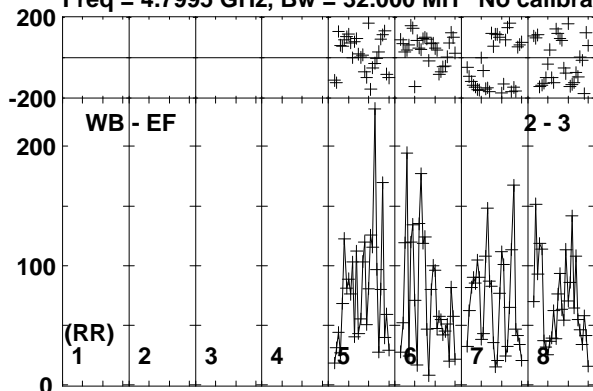

Lower frame: Micro Ampl Jy Top frame: Phas deg
Vector averaged cross-power spectrum Baseline: WB (02) - EF (03)
Timerange: 00/13:44:34 to 00/13:46:38

Plot file version 26 created 03-APR-2017 18:27:37

M22-VLA1 EM126B.UVDATA.1

Freq = 4.7995 GHz, Bw = 32.000 MH No calibration applied and no bandpass applied

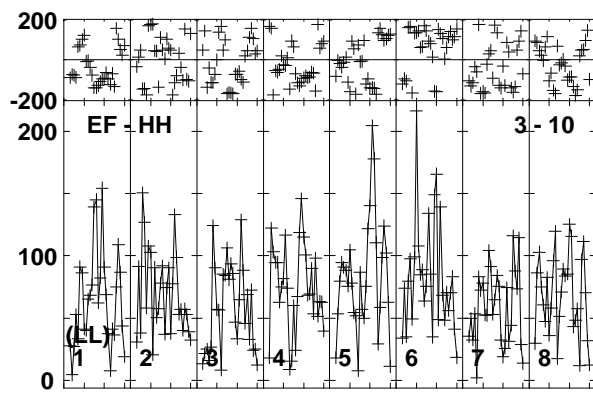
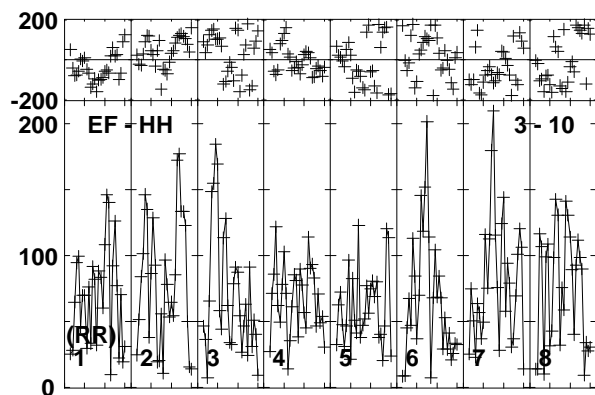
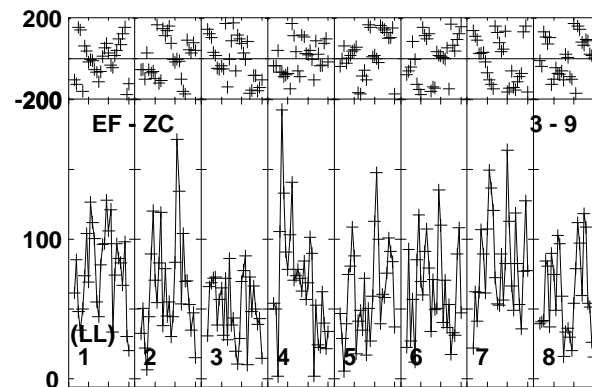
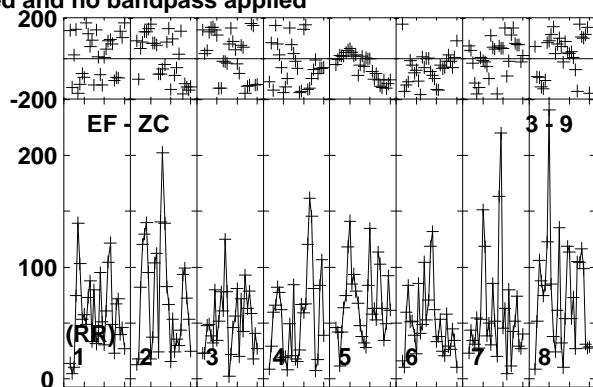
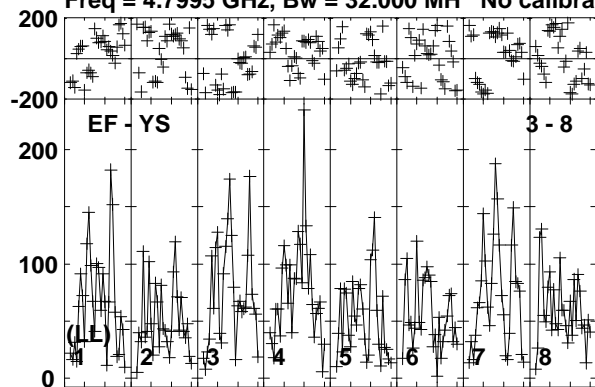

Lower frame: Micro Ampl Jy Top frame: Phas deg
Vector averaged cross-power spectrum Baseline: EF (03) - YS (08)
Timerange: 00/13:44:34 to 00/13:46:38

Plot file version 27 created 03-APR-2017 18:27:37

J1834-2341 EM126B.UVDATA.1

Freq = 4.7995 GHz, Bw = 32.000 MH No calibration applied and no bandpass applied

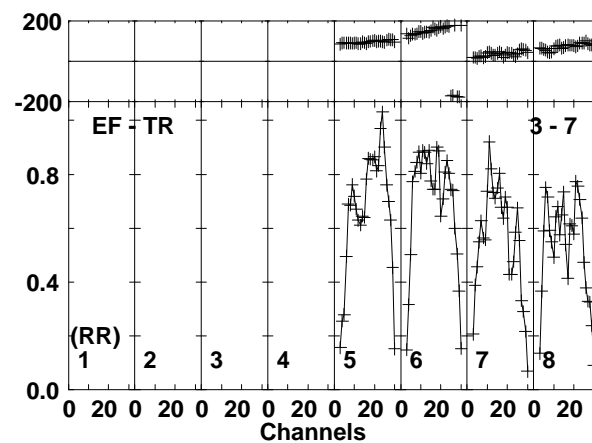
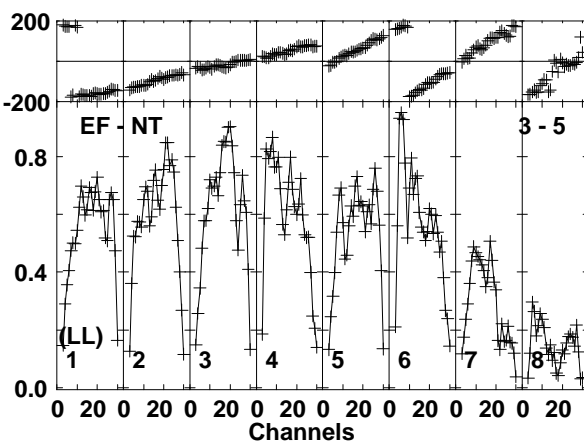
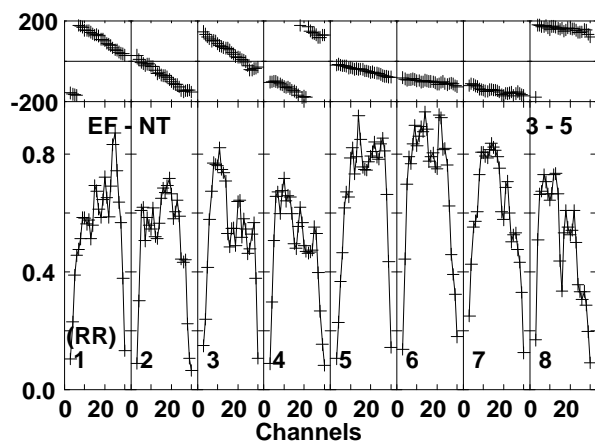
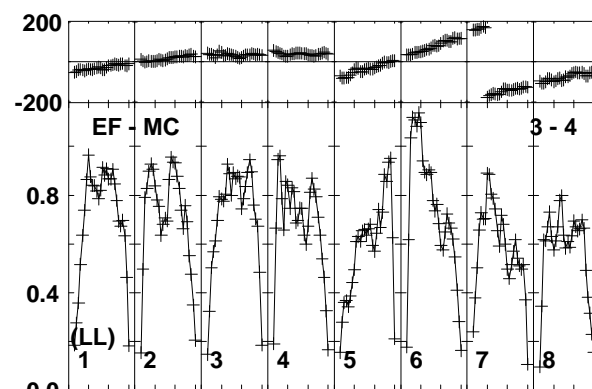
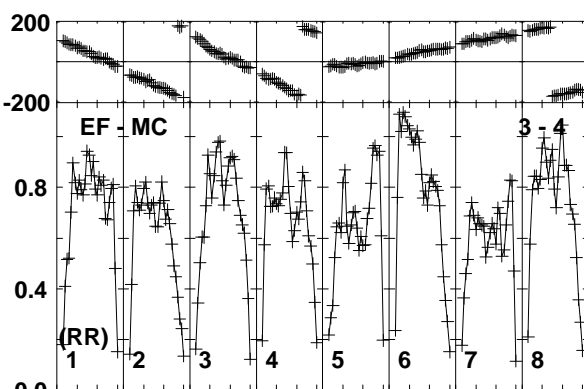
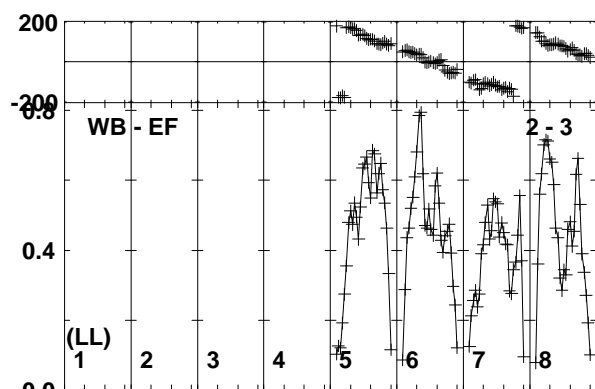
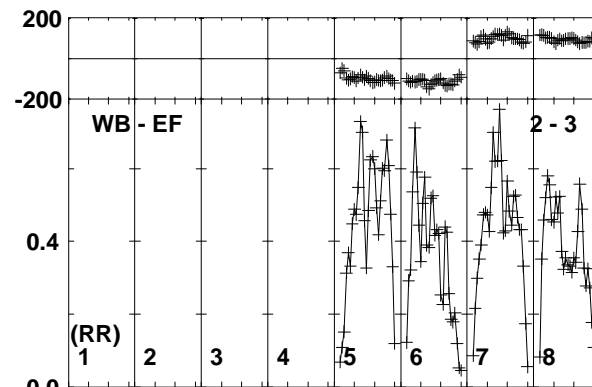
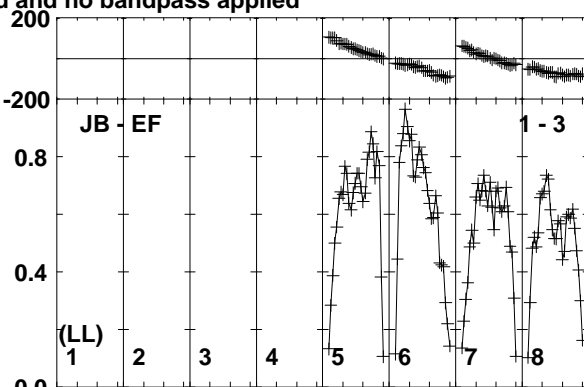
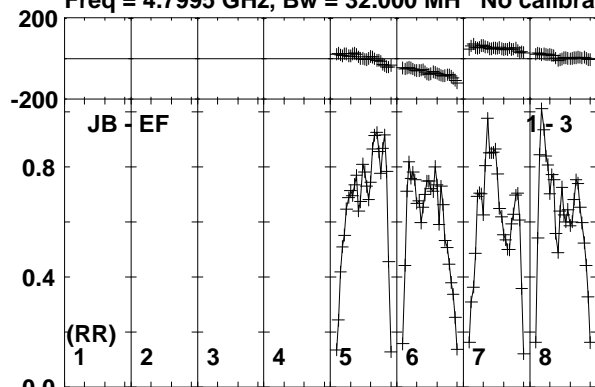

Lower frame: Milli Ampl Jy Top frame: Phas deg
Vector averaged cross-power spectrum Baseline: JB (01) - EF (03)
Timerange: 00/13:46:44 to 00/13:47:58

Plot file version 28 created 03-APR-2017 18:27:37

J1834-2341 EM126B.UVDATA.1

Freq = 4.7995 GHz, Bw = 32.000 MH No calibration applied and no bandpass applied

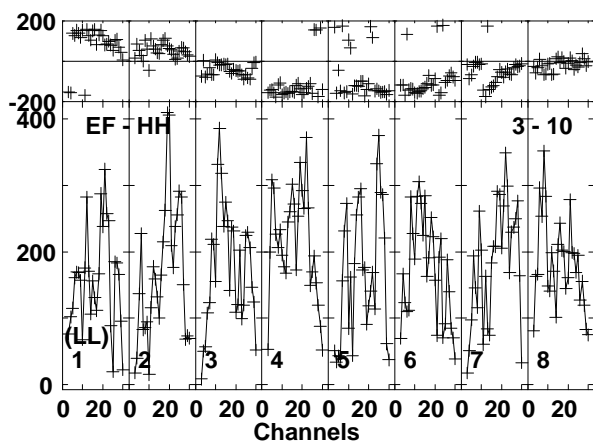
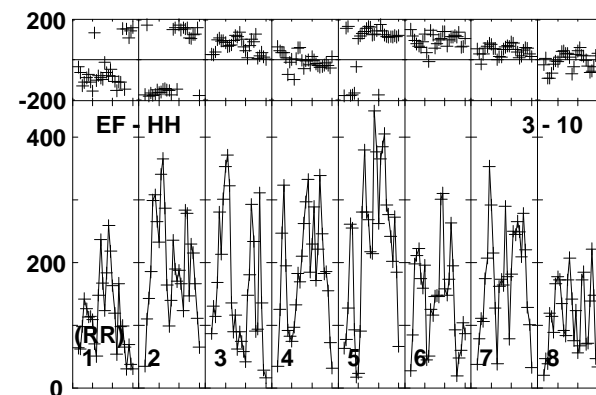
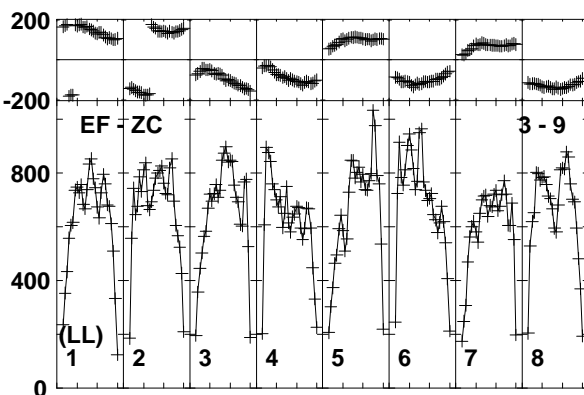
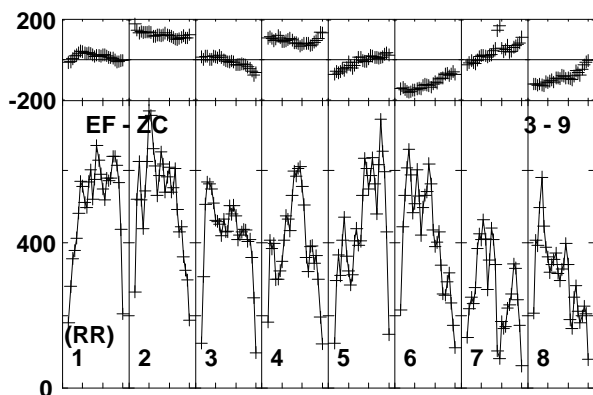
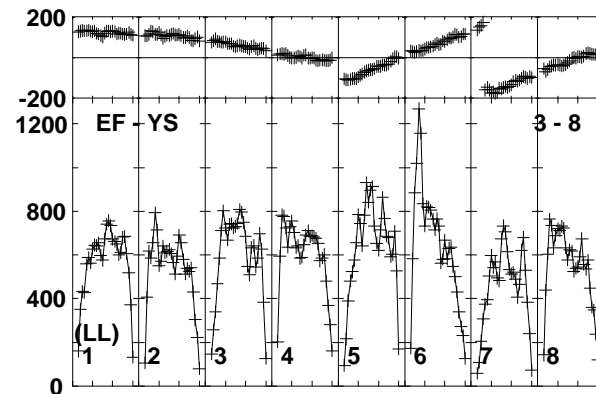
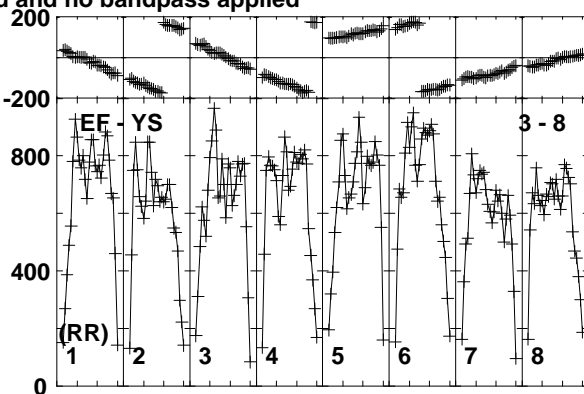
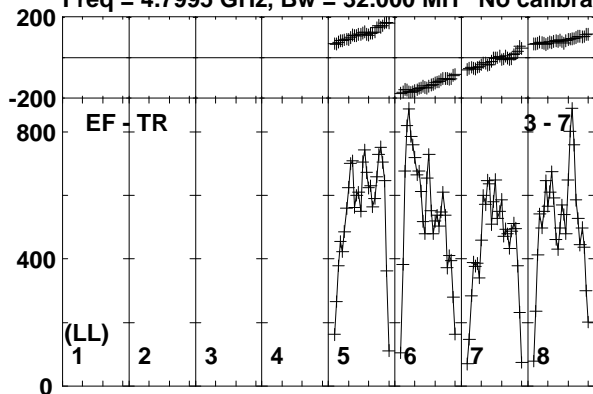

Lower frame: Micro Ampl Jy Top frame: Phas deg
Vector averaged cross-power spectrum Baseline: EF (03) - TR (07)
Timerange: 00/13:46:44 to 00/13:47:58

Plot file version 29 created 03-APR-2017 18:27:37

M22-VLA1 EM126B.UVDATA.1

Freq = 4.7995 GHz, Bw = 32.000 MH No calibration applied and no bandpass applied

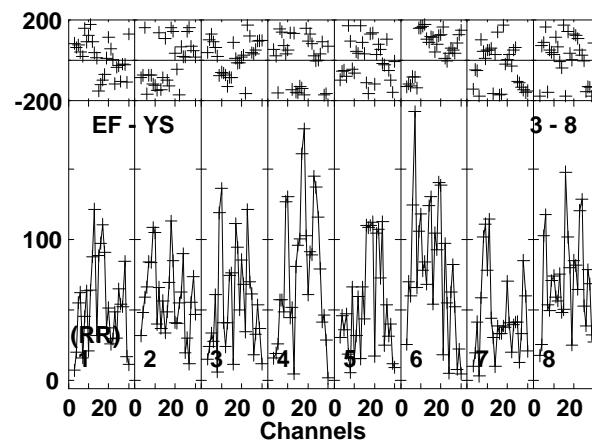
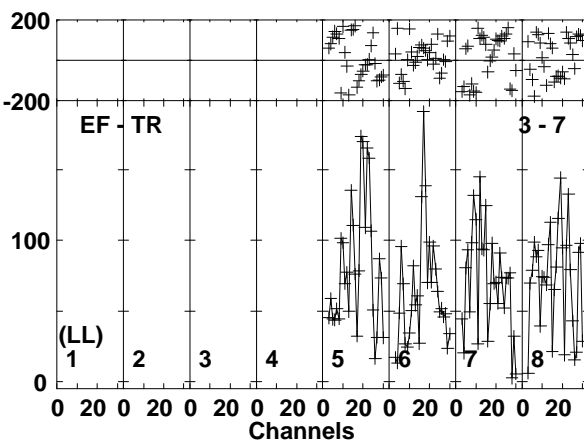
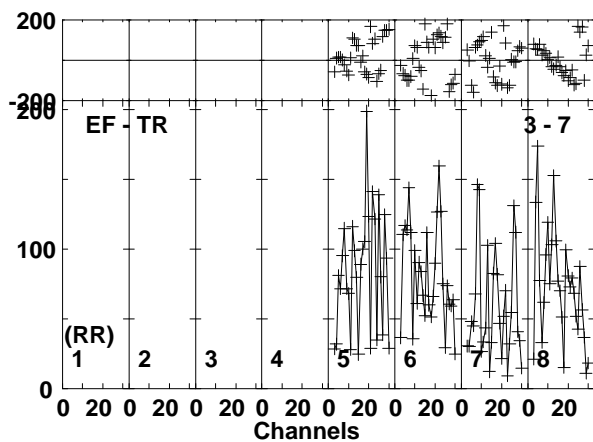
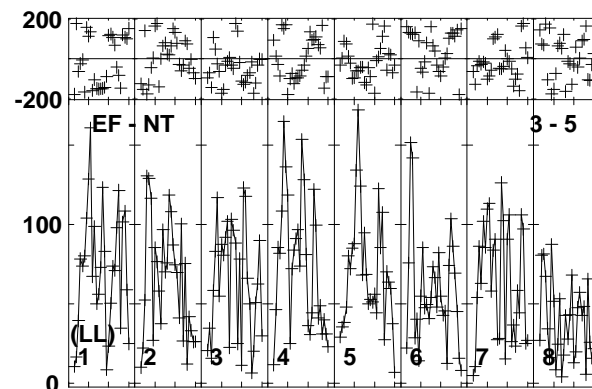
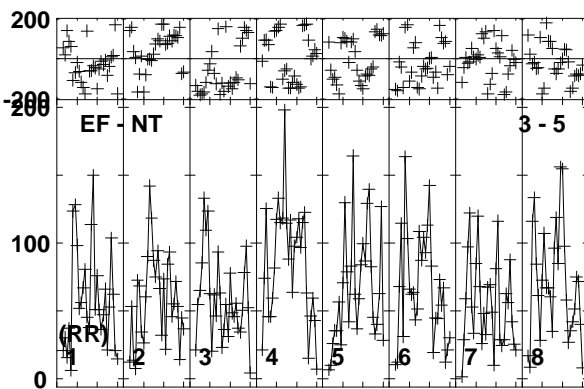
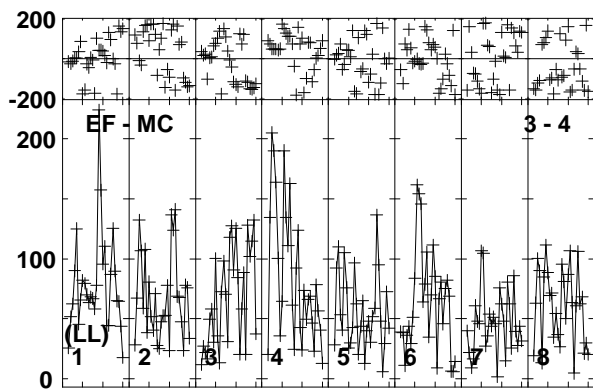
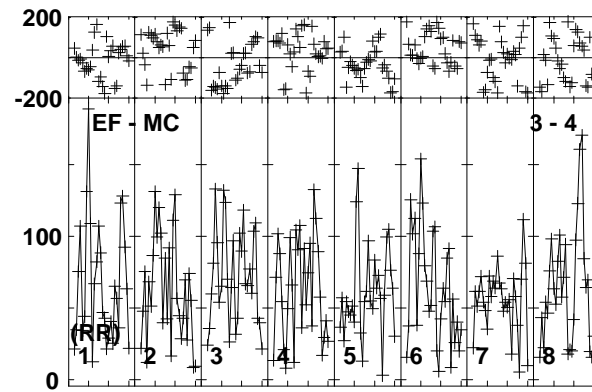
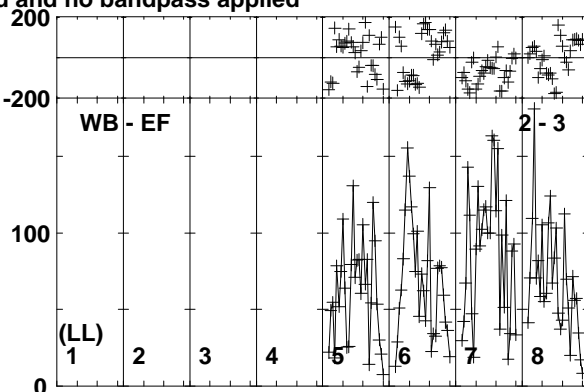
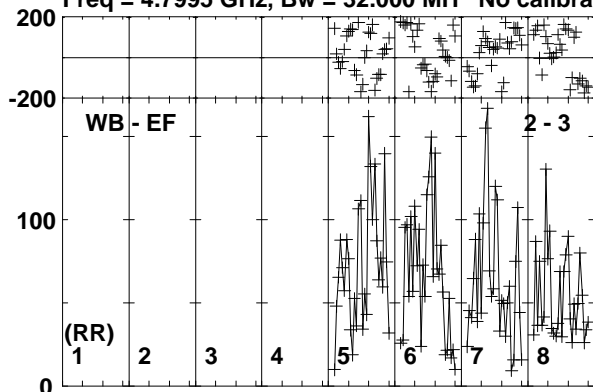

Lower frame: Micro Ampl Jy Top frame: Phas deg
Vector averaged cross-power spectrum Baseline: WB (02) - EF (03)
Timerange: 00/13:48:04 to 00/13:50:08

Plot file version 30 created 03-APR-2017 18:27:37

M22-VLA1 EM126B.UVDATA.1

Freq = 4.7995 GHz, Bw = 32.000 MH No calibration applied and no bandpass applied

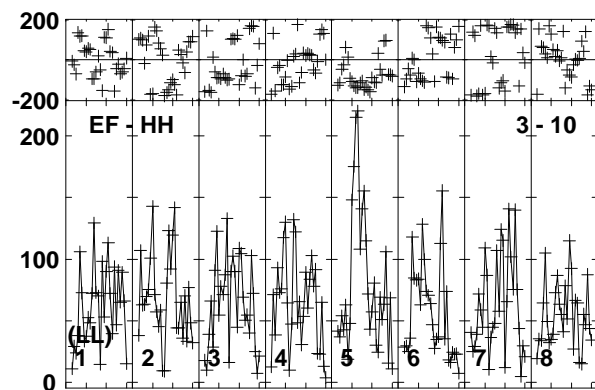
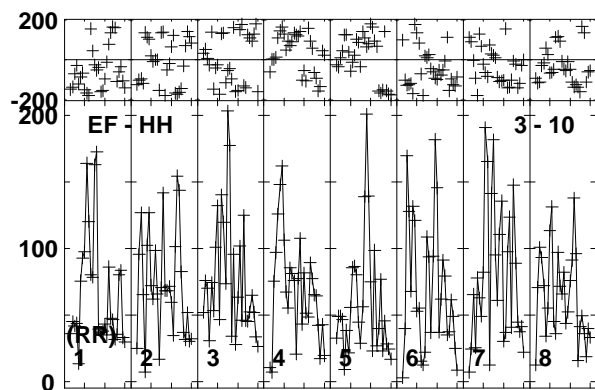
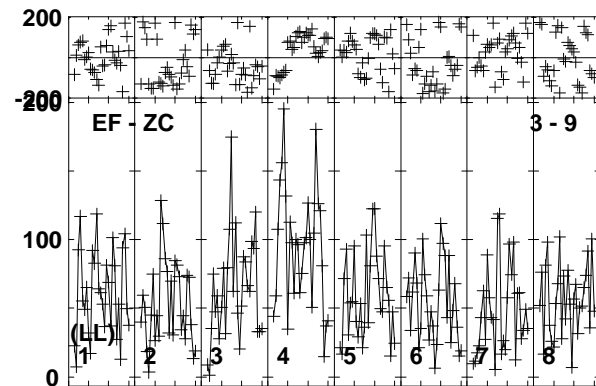
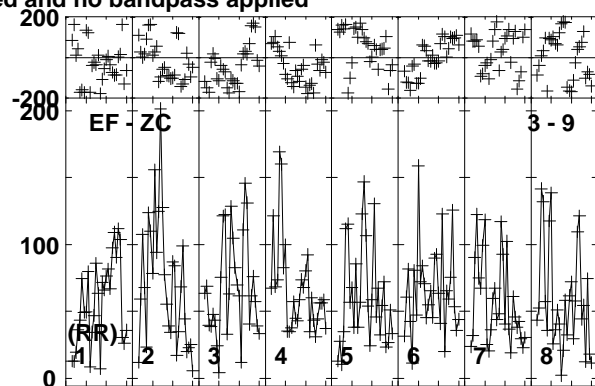
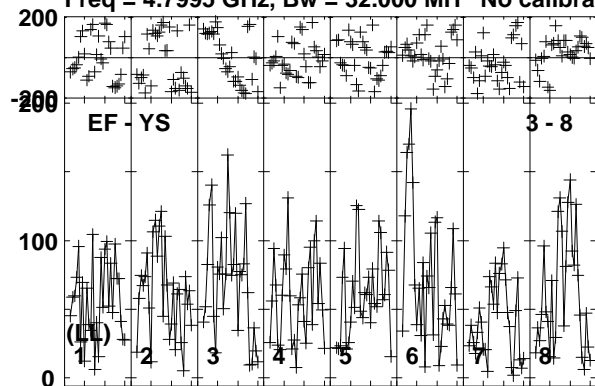

Lower frame: Micro Ampl Jy Top frame: Phas deg
Vector averaged cross-power spectrum Baseline: EF (03) - YS (08)
Timerange: 00/13:48:04 to 00/13:50:08

Plot file version 31 created 03-APR-2017 18:27:37

J1834-2341 EM126B.UVDATA.1

Freq = 4.7995 GHz, Bw = 32.000 MH No calibration applied and no bandpass applied

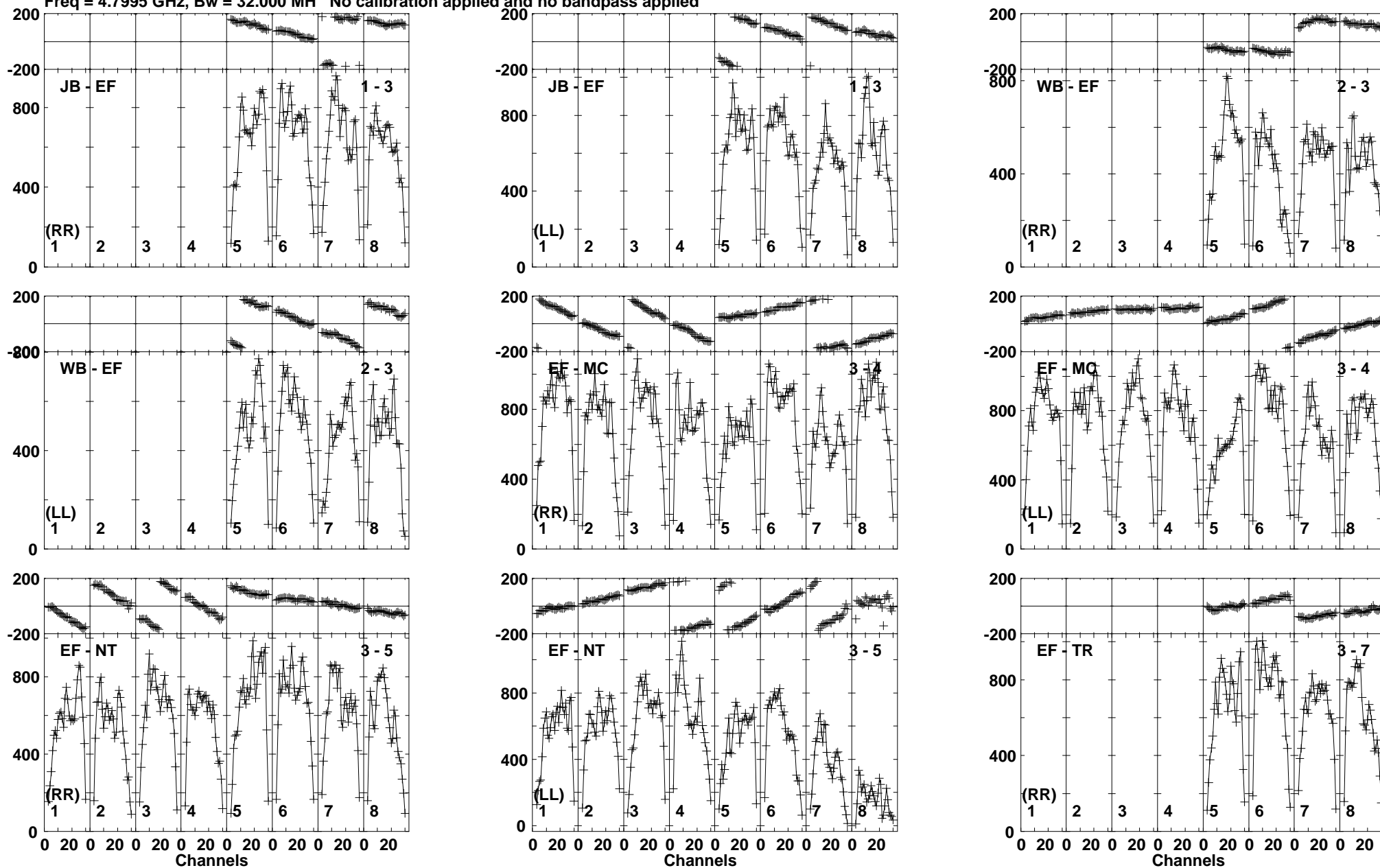

Lower frame: Micro Ampl Jy Top frame: Phas deg
Vector averaged cross-power spectrum Baseline: JB (01) - EF (03)
Timerange: 00/13:50:41 to 00/13:51:29

Plot file version 32 created 03-APR-2017 18:27:37

J1834-2341 EM126B.UVDATA.1

Freq = 4.7995 GHz, Bw = 32.000 MH No calibration applied and no bandpass applied

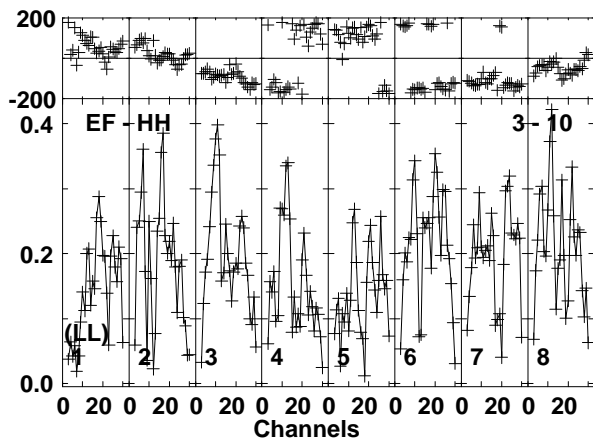
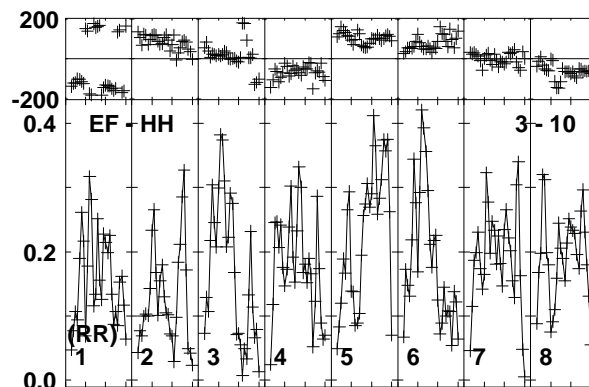
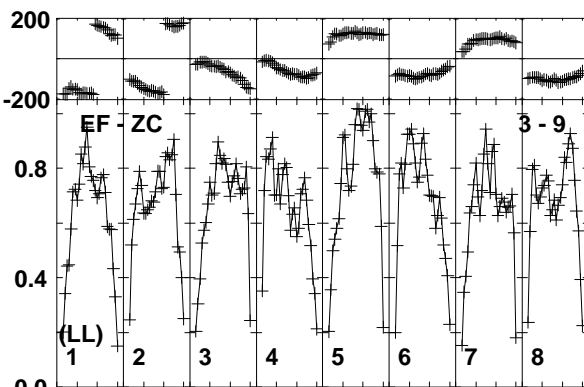
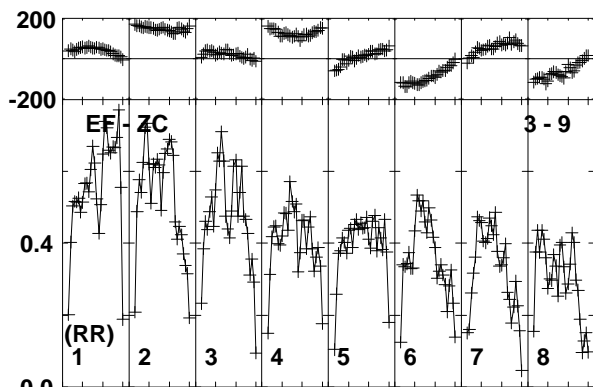
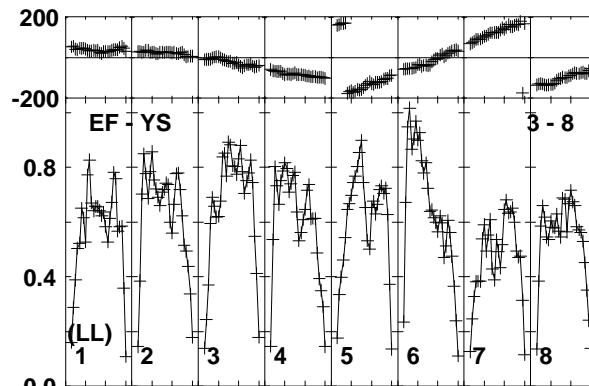
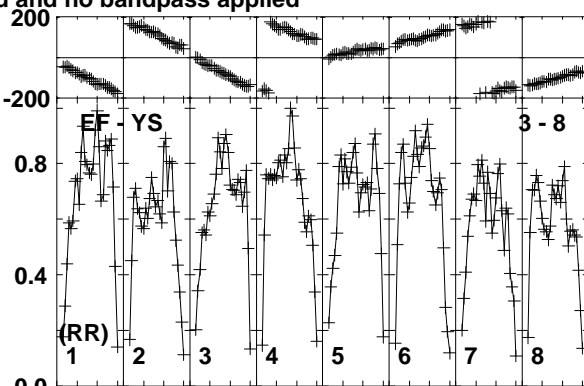
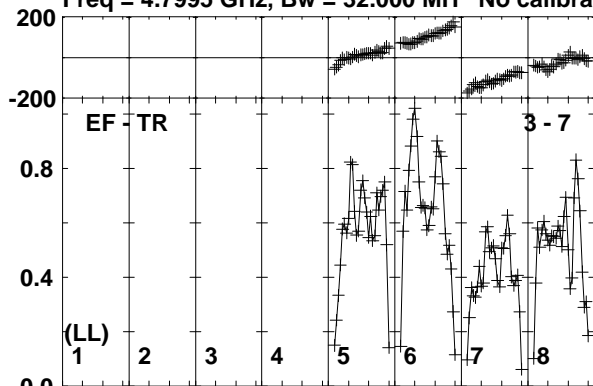

Lower frame: Milli Ampl Jy Top frame: Phas deg
Vector averaged cross-power spectrum Baseline: EF (03) - TR (07)
Timerange: 00/13:50:41 to 00/13:51:29

Plot file version 33 created 03-APR-2017 18:27:37

M22-VLA1 EM126B.UVDATA.1

Freq = 4.7995 GHz, Bw = 32.000 MH No calibration applied and no bandpass applied

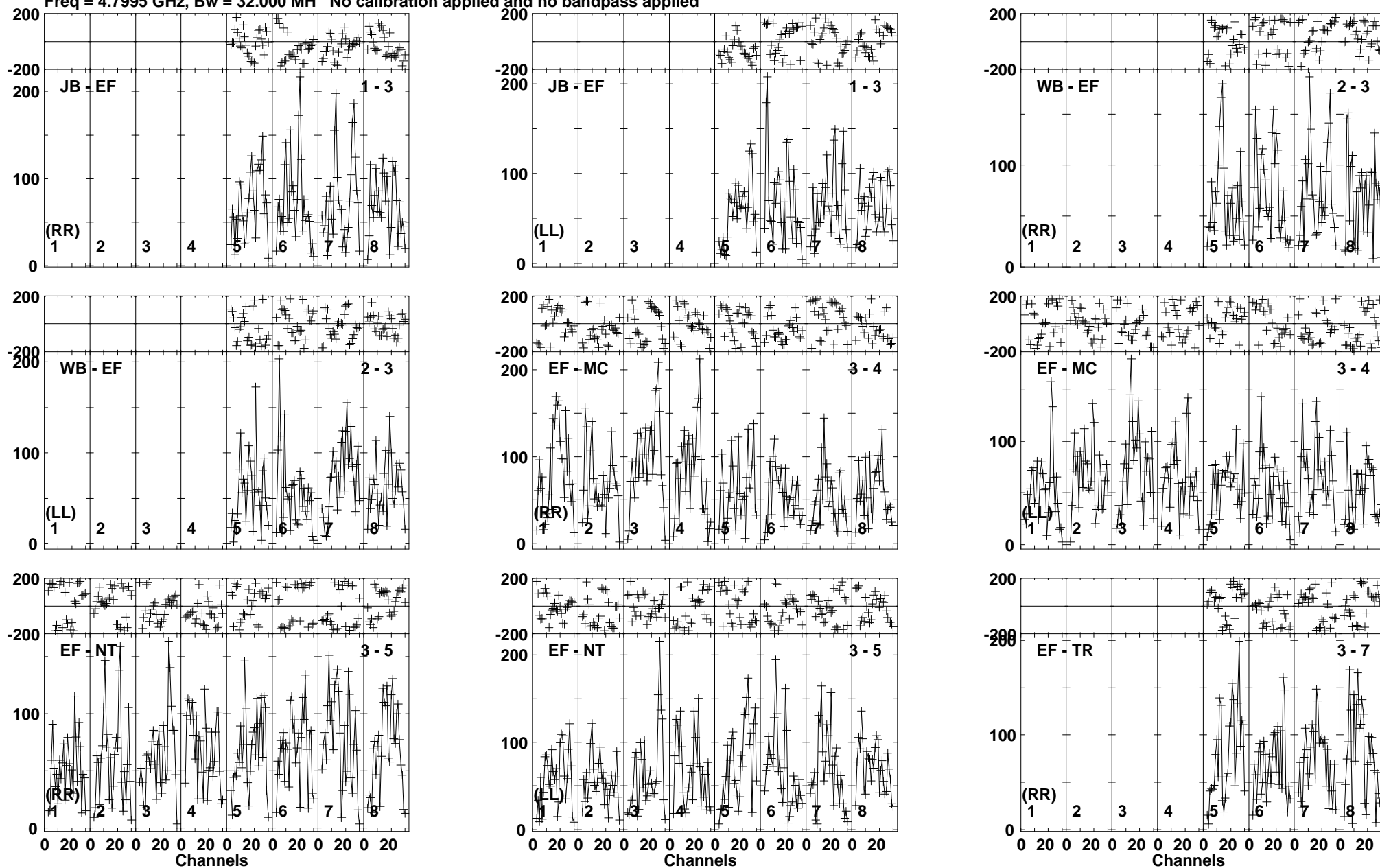

Lower frame: Micro Ampl Jy Top frame: Phas deg
Vector averaged cross-power spectrum Baseline: JB (01) - EF (03)
Timerange: 00/13:51:34 to 00/13:53:38

Plot file version 35 created 03-APR-2017 18:27:37

J1834-2341 EM126B.UVDATA.1

Freq = 4.7995 GHz, Bw = 32.000 MH No calibration applied and no bandpass applied

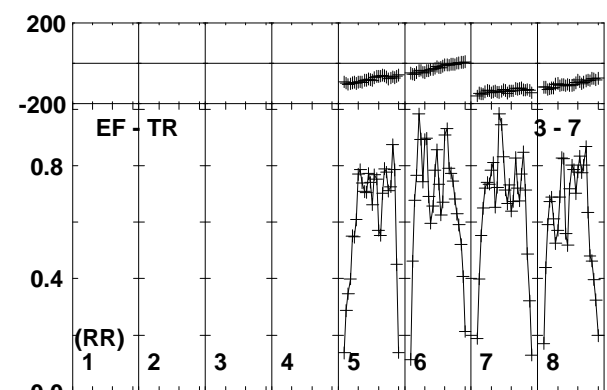
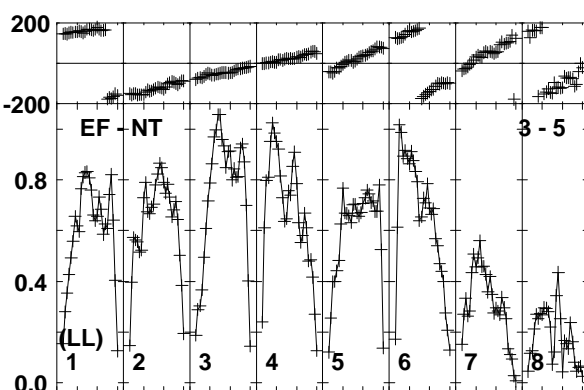
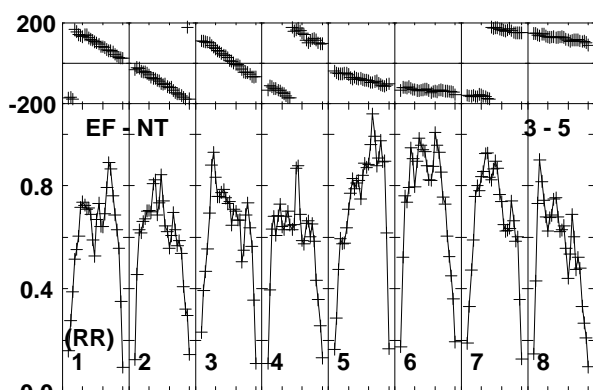
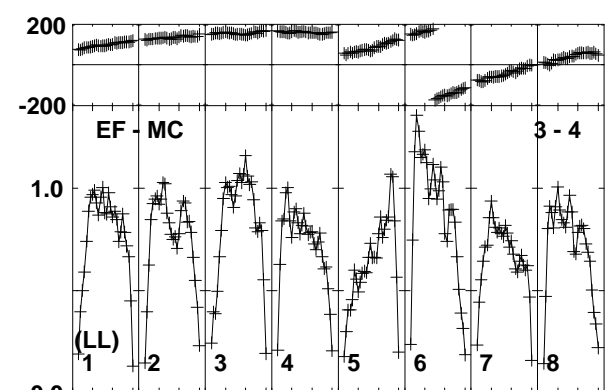
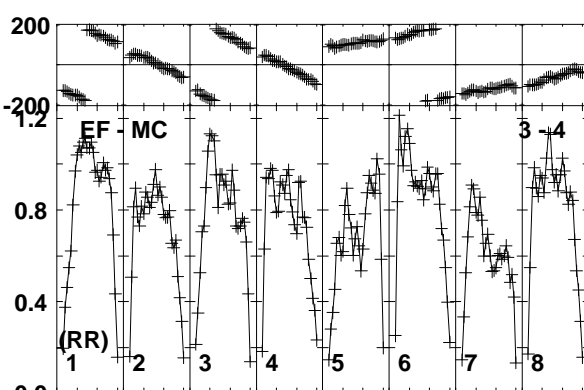
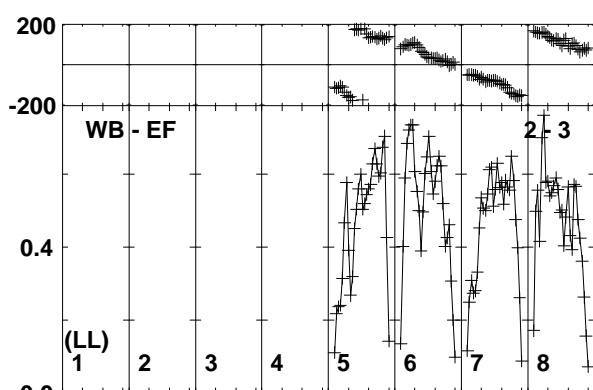
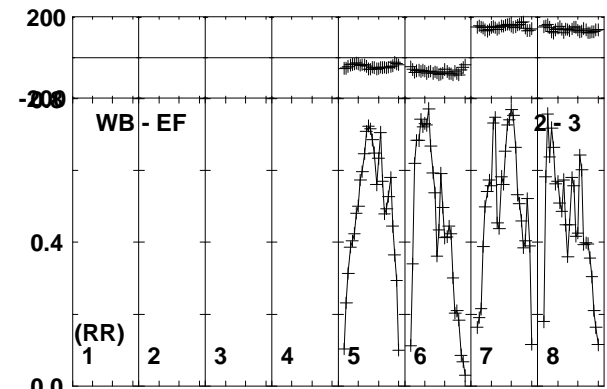
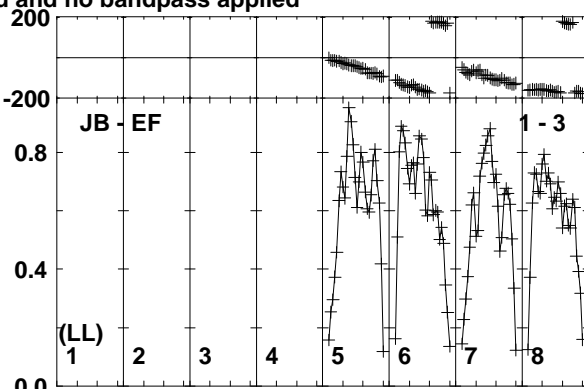
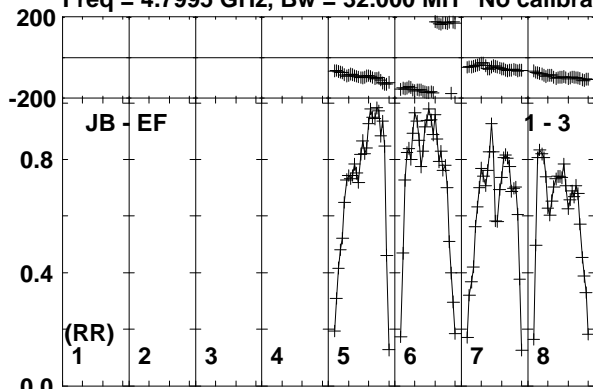

Lower frame: Milli Ampl Jy Top frame: Phas deg
Vector averaged cross-power spectrum Baseline: JB (01) - EF (03)
Timerange: 00/13:53:44 to 00/13:54:58

Plot file version 36 created 03-APR-2017 18:27:37

J1834-2341 EM126B.UVDATA.1

Freq = 4.7995 GHz, Bw = 32.000 MH No calibration applied and no bandpass applied

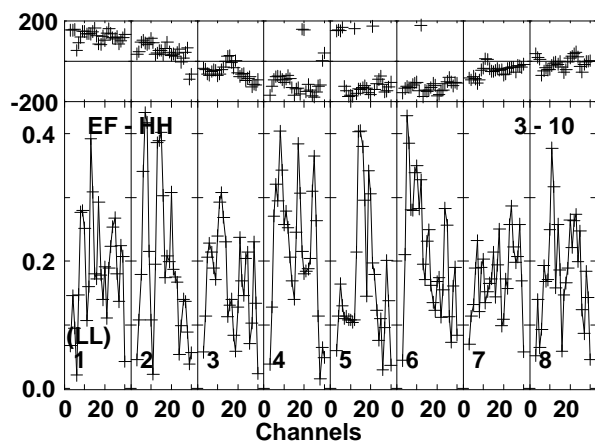
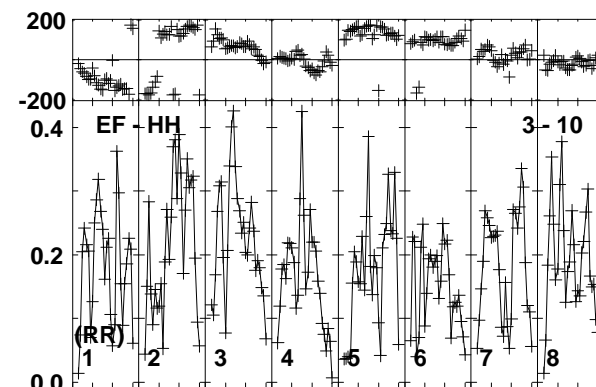
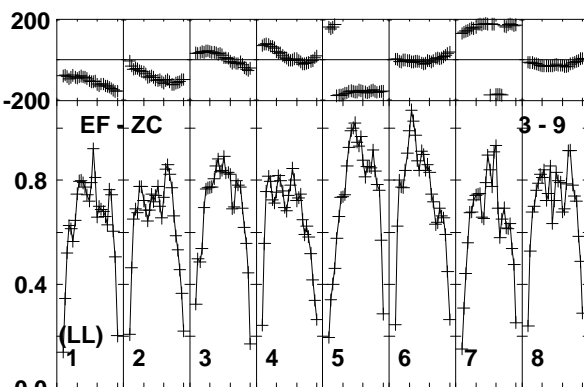
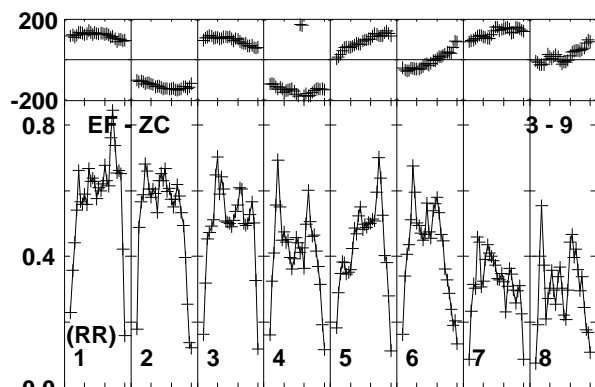
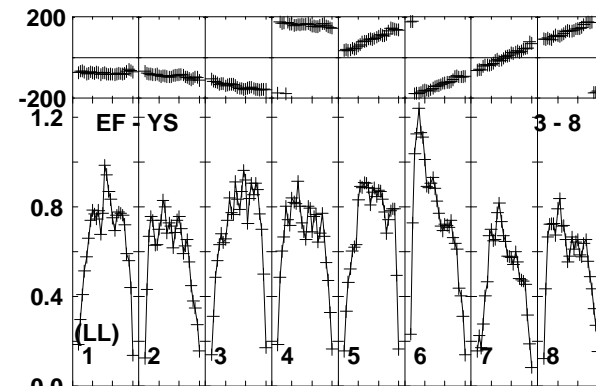
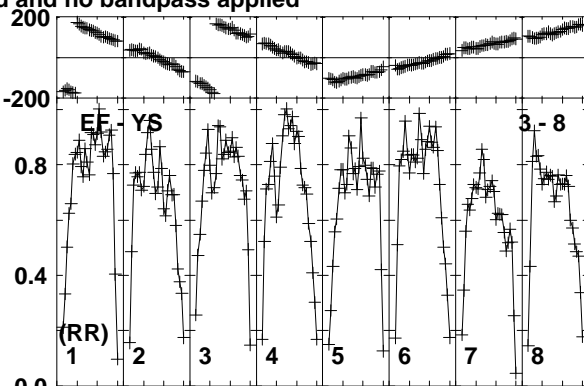
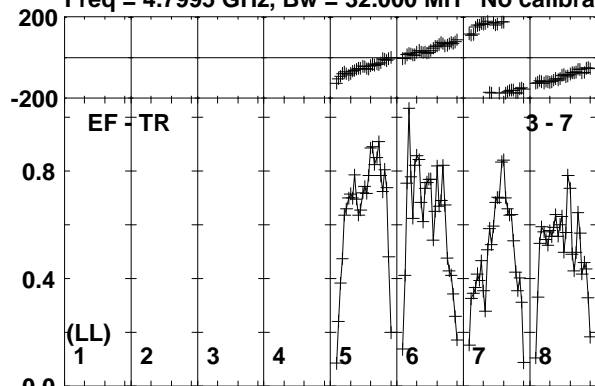

Lower frame: Milli Ampl Jy Top frame: Phas deg
Vector averaged cross-power spectrum Baseline: EF (03) - TR (07)
Timerange: 00/13:53:44 to 00/13:54:58

Plot file version 37 created 03-APR-2017 18:27:37

M22-VLA1 EM126B.UVDATA.1

Freq = 4.7995 GHz, Bw = 32.000 MH No calibration applied and no bandpass applied

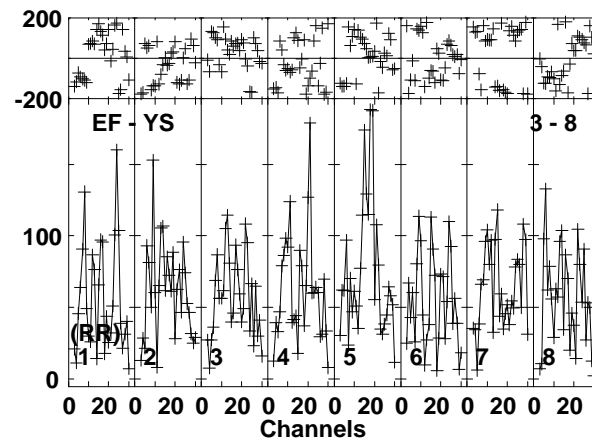
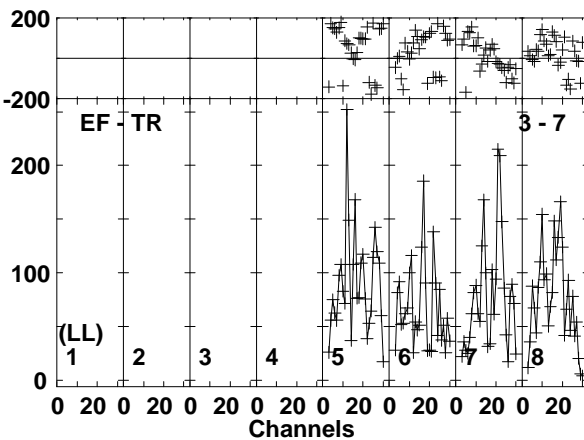
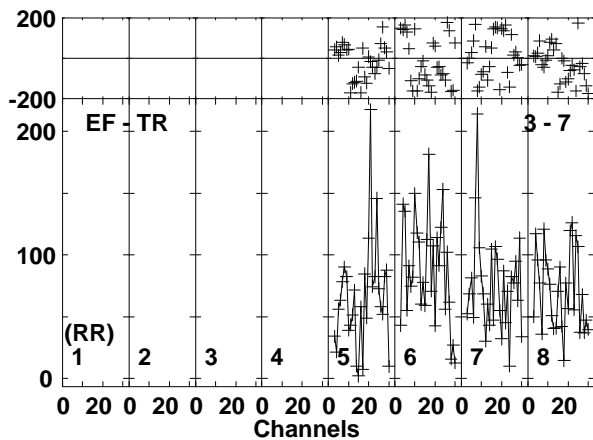
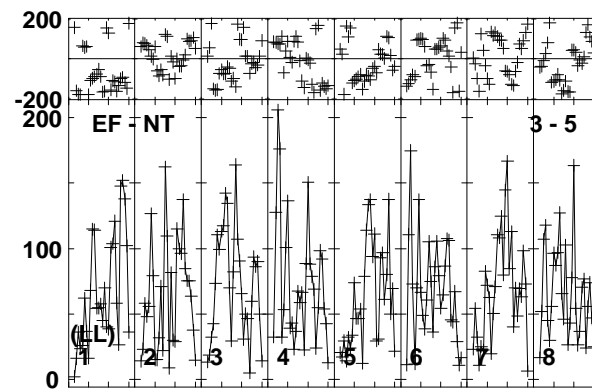
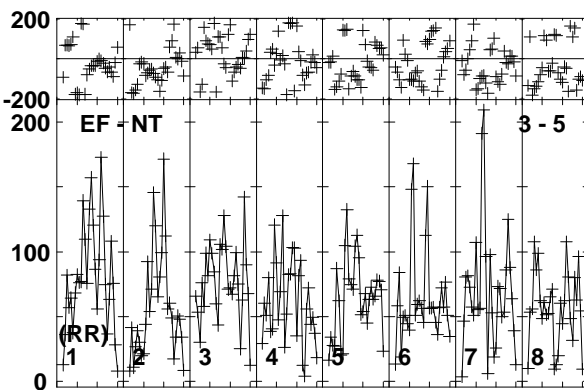
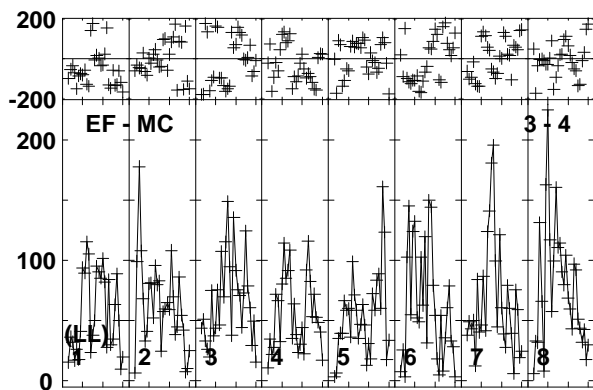
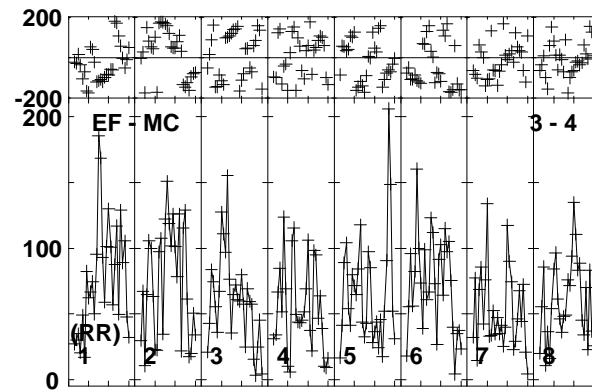
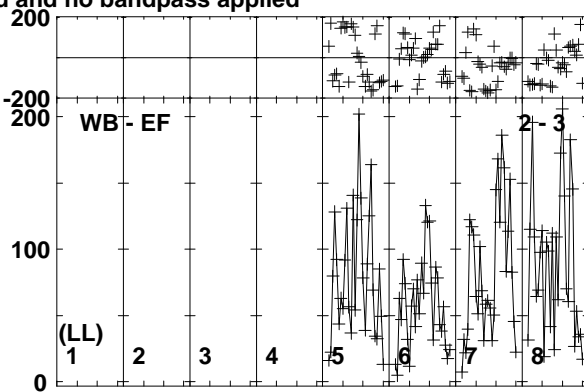
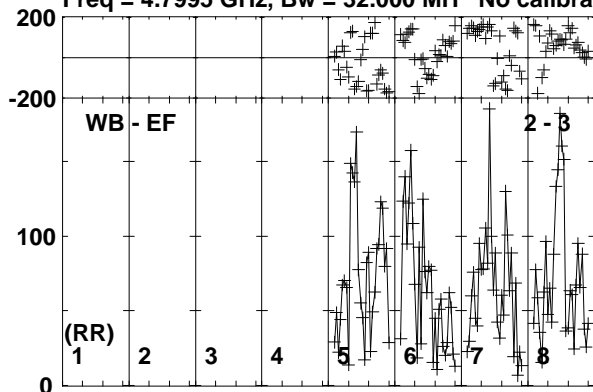

Lower frame: Micro Ampl Jy Top frame: Phas deg
Vector averaged cross-power spectrum Baseline: WB (02) - EF (03)
Timerange: 00/13:55:04 to 00/13:57:08

Plot file version 38 created 03-APR-2017 18:27:37

M22-VLA1 EM126B.UVDATA.1

Freq = 4.7995 GHz, Bw = 32.000 MH No calibration applied and no bandpass applied

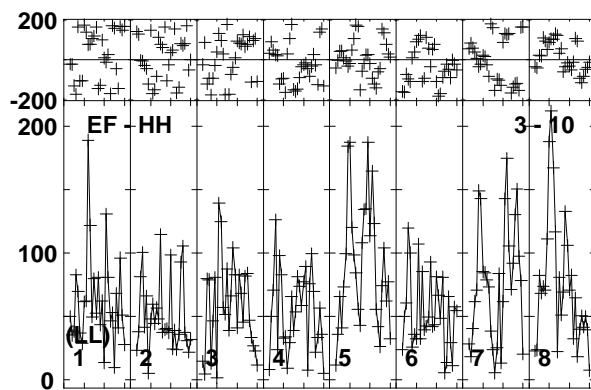
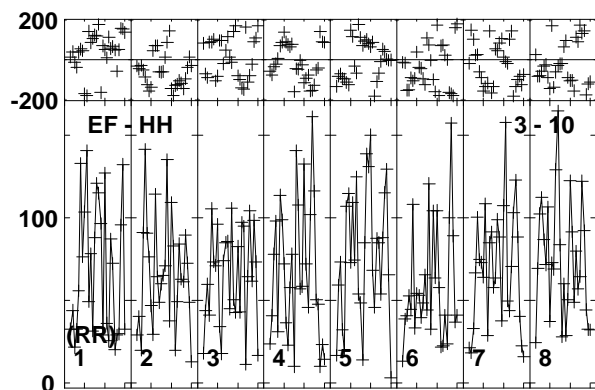
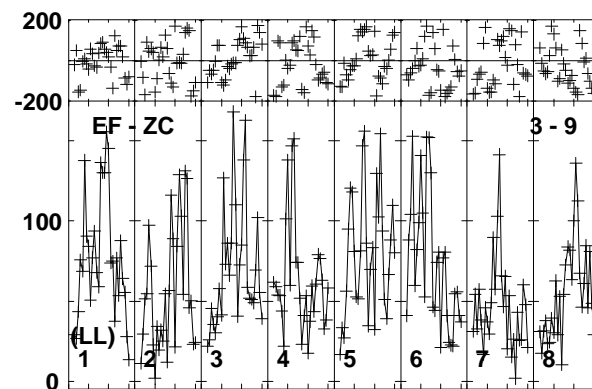
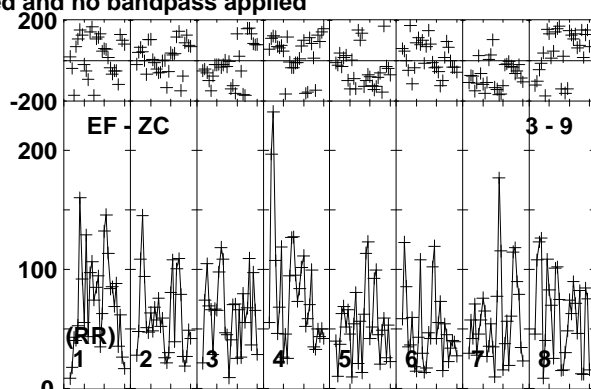
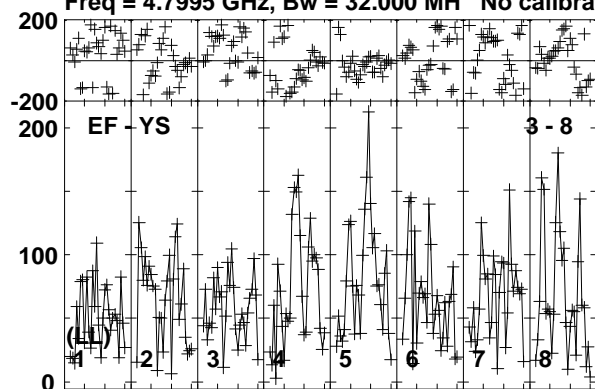

Lower frame: Micro Ampl Jy Top frame: Phas deg
Vector averaged cross-power spectrum Baseline: EF (03) - YS (08)
Timerange: 00/13:55:04 to 00/13:57:08

Plot file version 40 created 03-APR-2017 18:27:38

J1834-2341 EM126B.UVDATA.1

Freq = 4.7995 GHz, Bw = 32.000 MH No calibration applied and no bandpass applied

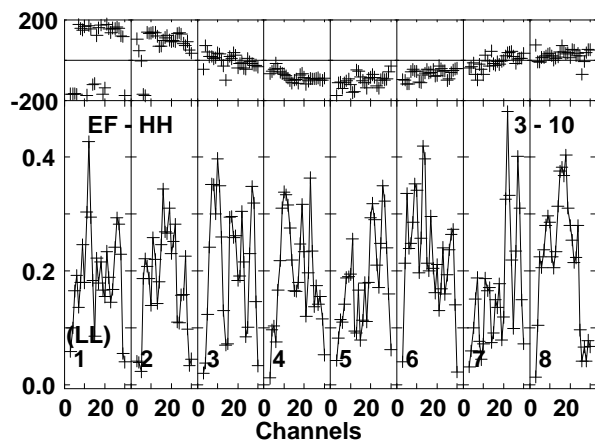
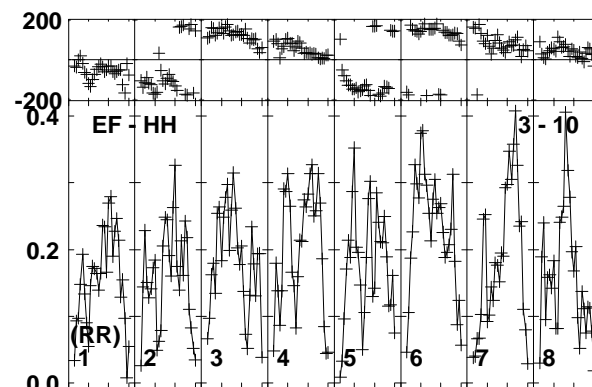
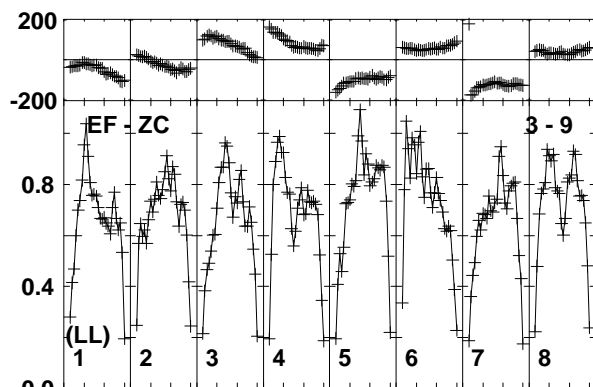
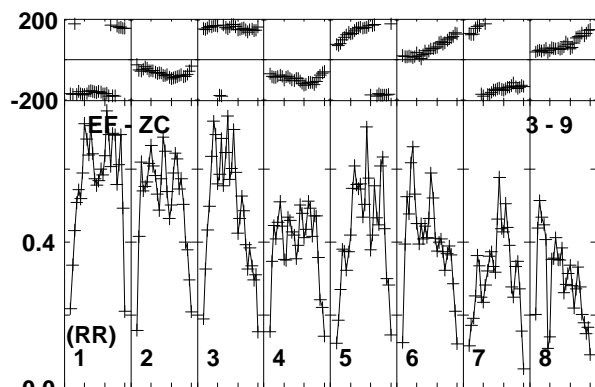
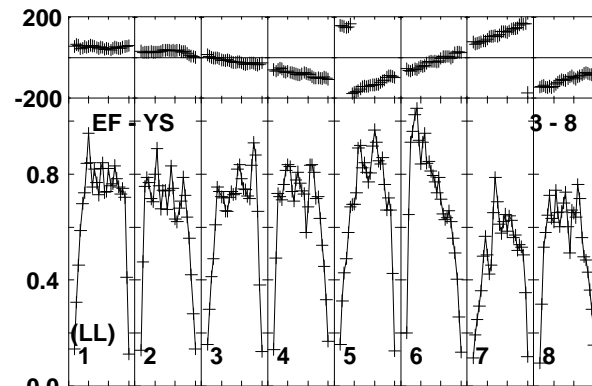
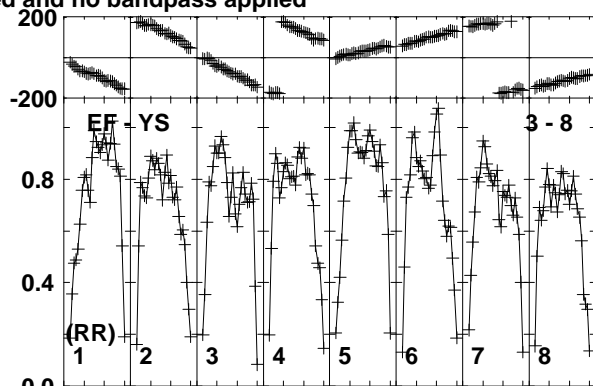
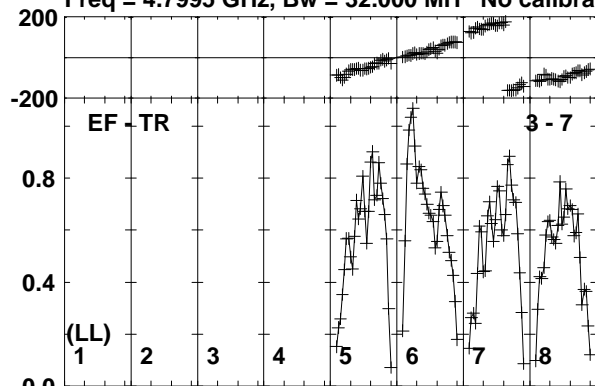

Lower frame: Milli Ampl Jy Top frame: Phas deg
Vector averaged cross-power spectrum Baseline: EF (03) - TR (07)
Timerange: 00/13:57:14 to 00/13:58:28

Plot file version 41 created 03-APR-2017 18:27:38

M22-VLA1 EM126B.UVDATA.1

Freq = 4.7995 GHz, Bw = 32.000 MH No calibration applied and no bandpass applied

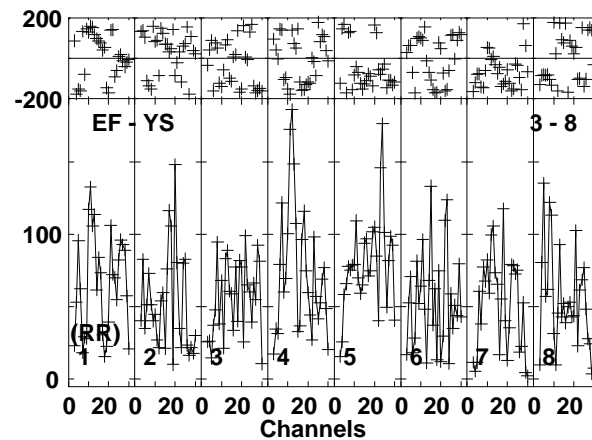
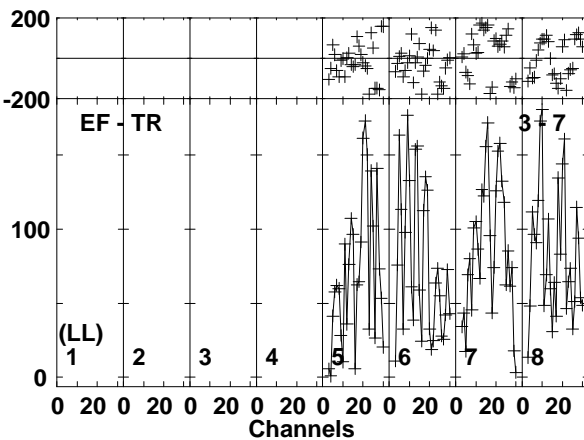
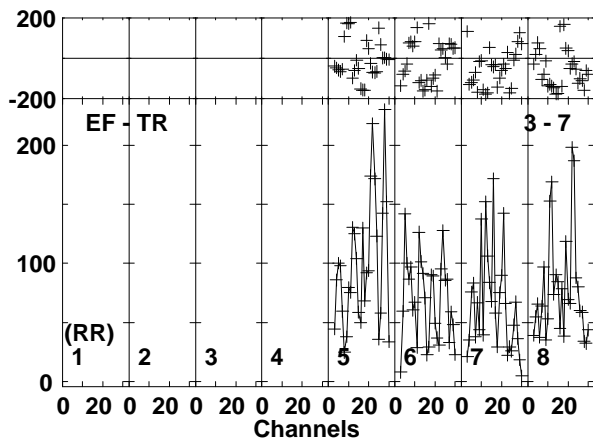
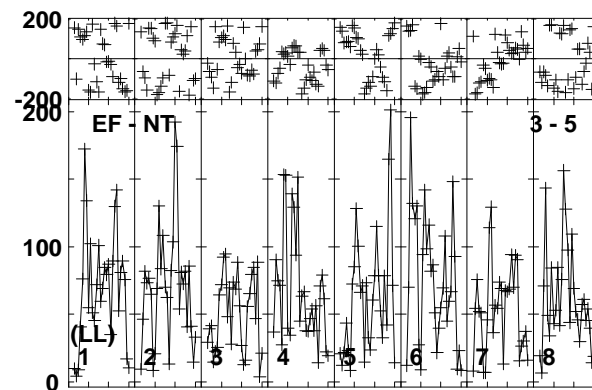
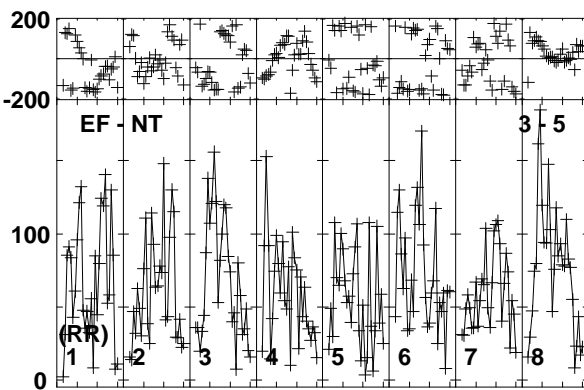
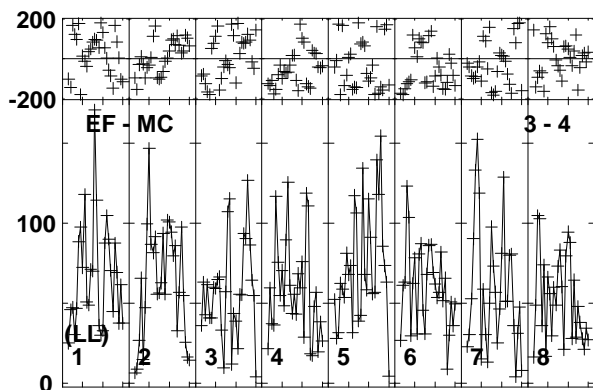
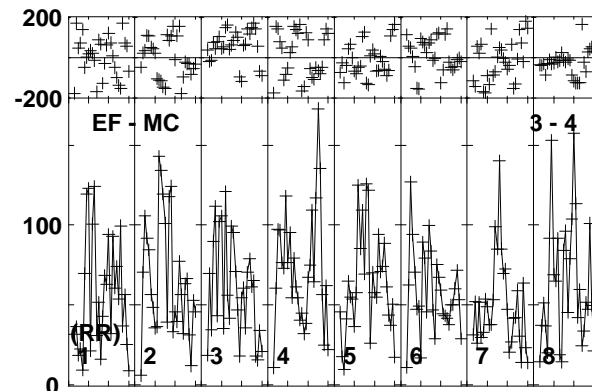
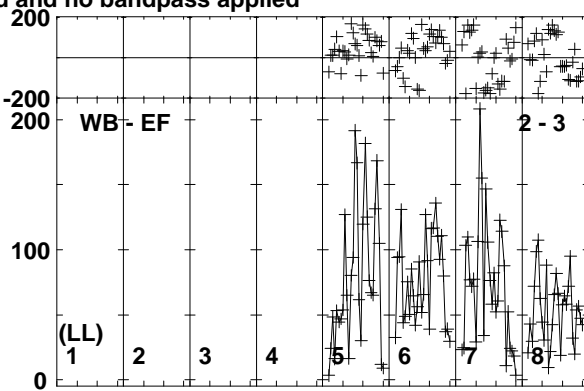
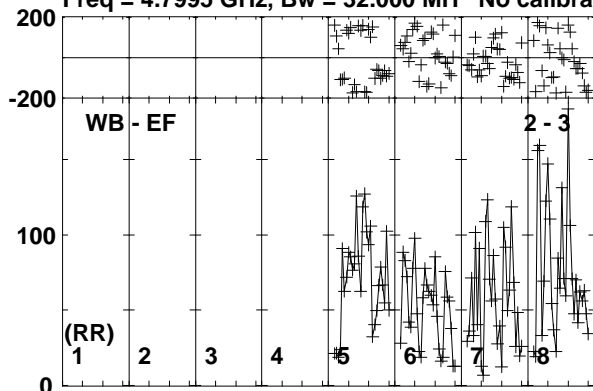

Lower frame: Micro Ampl Jy Top frame: Phas deg
Vector averaged cross-power spectrum Baseline: WB (02) - EF (03)
Timerange: 00/13:58:34 to 00/14:00:38

Plot file version 42 created 03-APR-2017 18:27:38

M22-VLA1 EM126B.UVDATA.1

Freq = 4.7995 GHz, Bw = 32.000 MH No calibration applied and no bandpass applied

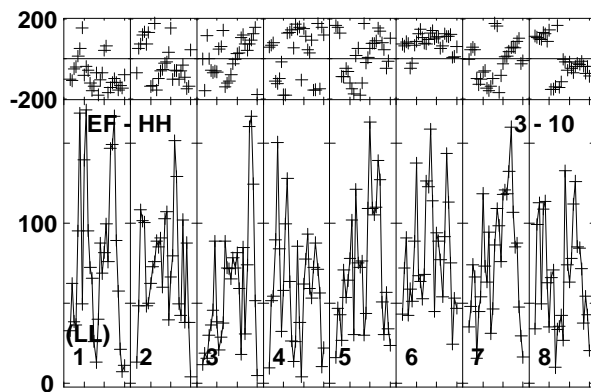
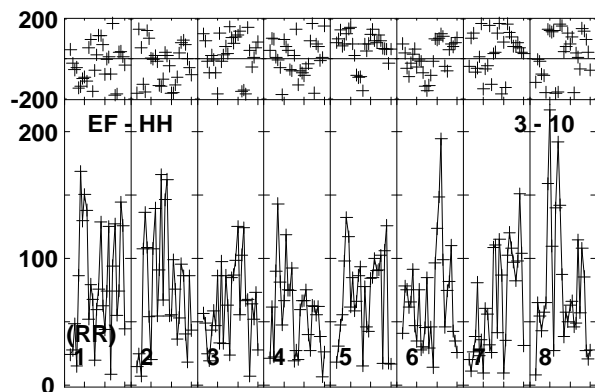
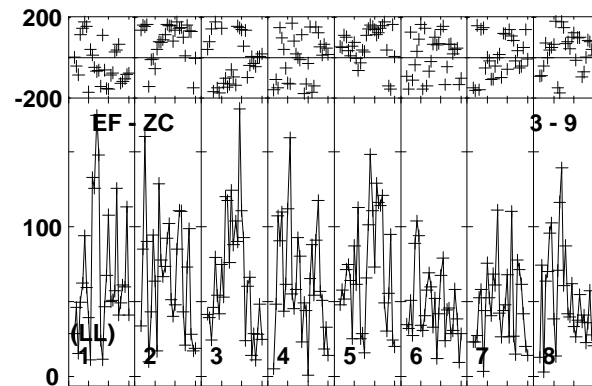
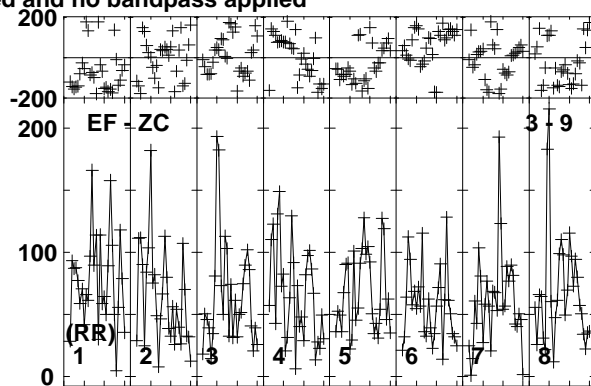
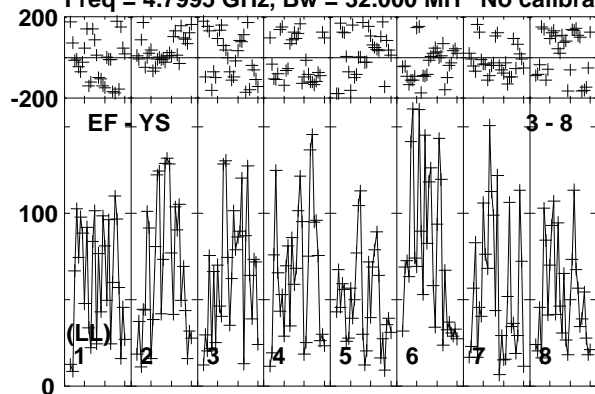

Lower frame: Micro Ampl Jy Top frame: Phas deg
Vector averaged cross-power spectrum Baseline: EF (03) - YS (08)
Timerange: 00/13:58:34 to 00/14:00:38

Plot file version 44 created 03-APR-2017 18:27:38

J1834-2341 EM126B.UVDATA.1

Freq = 4.7995 GHz, Bw = 32.000 MH No calibration applied and no bandpass applied

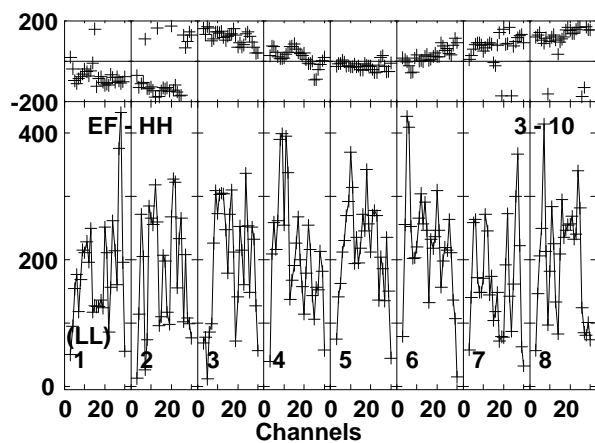
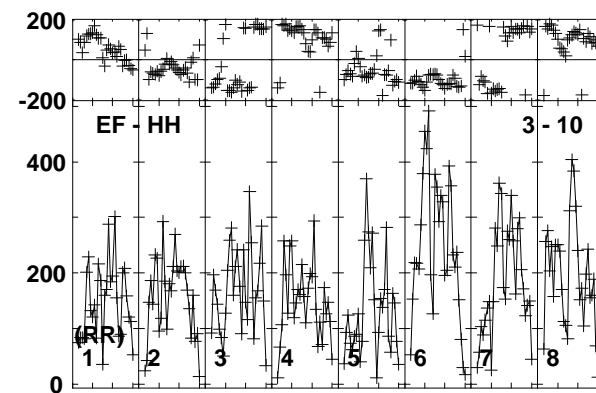
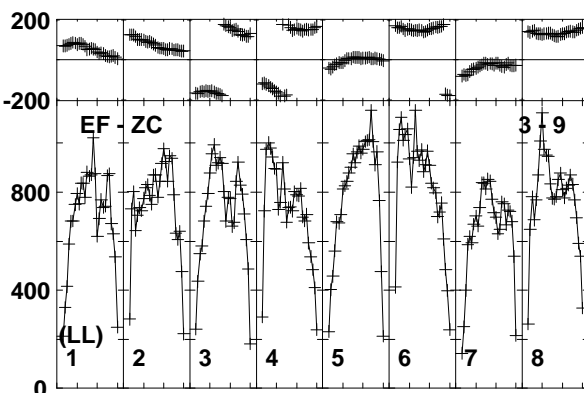
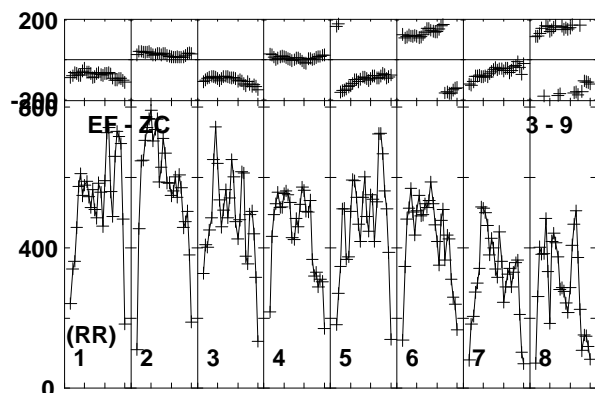
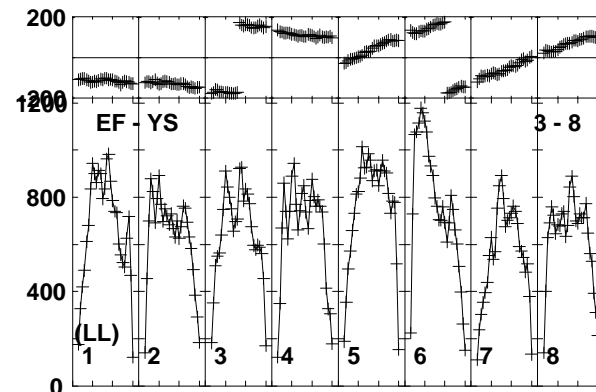
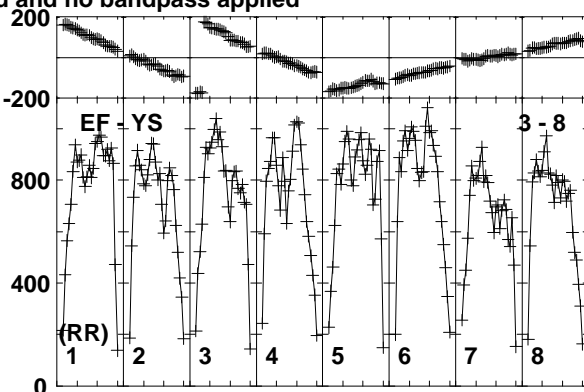
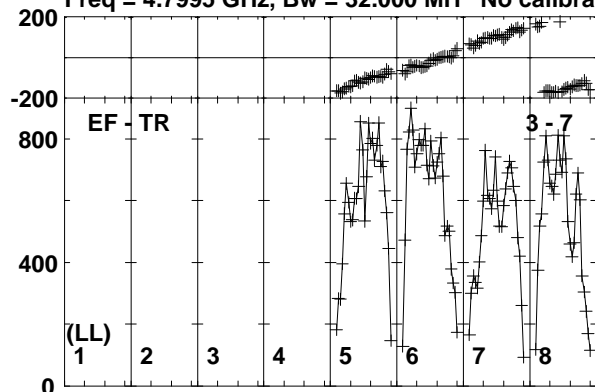

Lower frame: Micro Ampl Jy Top frame: Phas deg
Vector averaged cross-power spectrum Baseline: EF (03) - TR (07)
Timerange: 00/14:01:11 to 00/14:01:59

Plot file version 45 created 03-APR-2017 18:27:38

M22-VLA1 EM126B.UVDATA.1

Freq = 4.7995 GHz, Bw = 32.000 MH No calibration applied and no bandpass applied

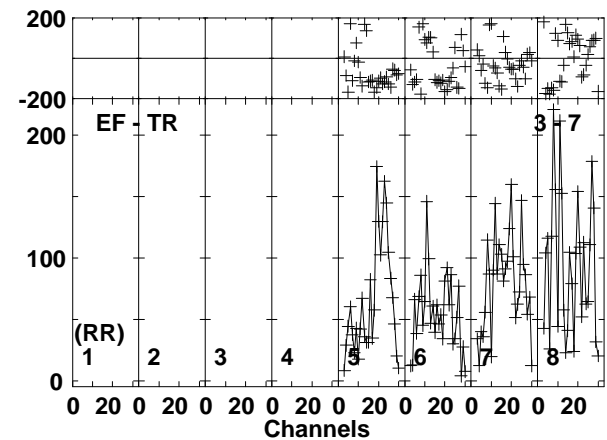
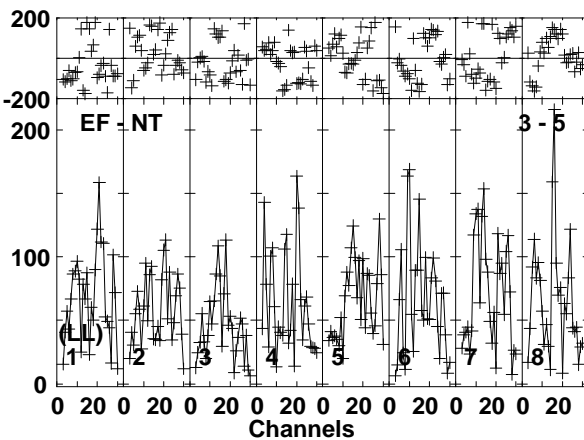
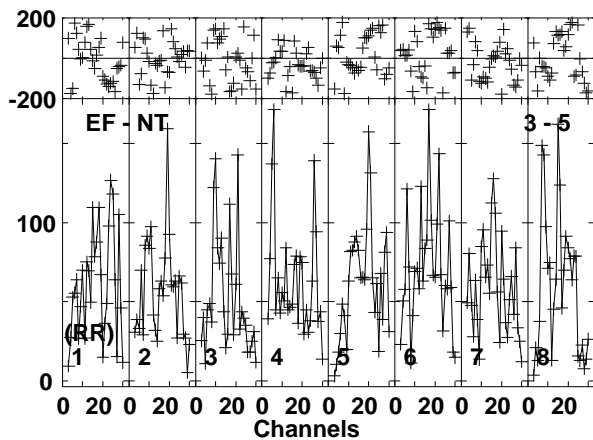
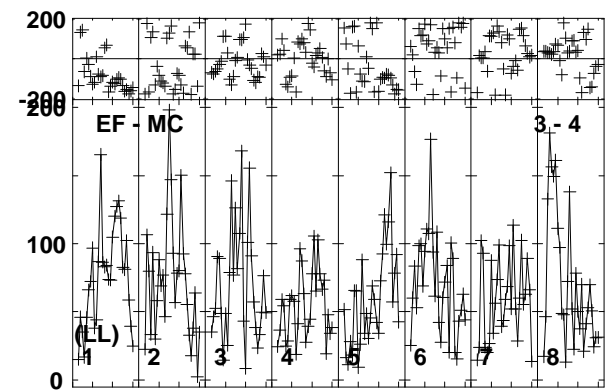
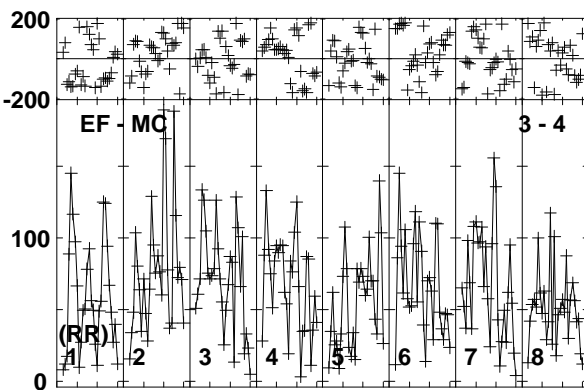
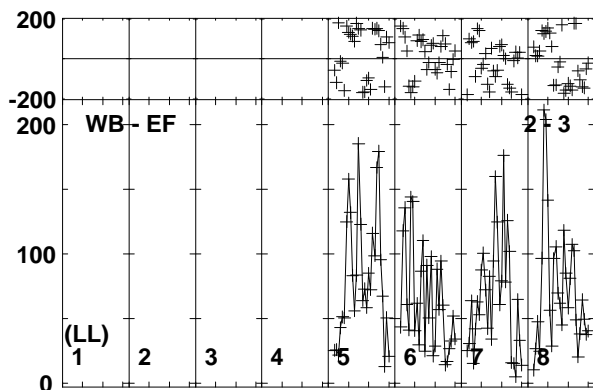
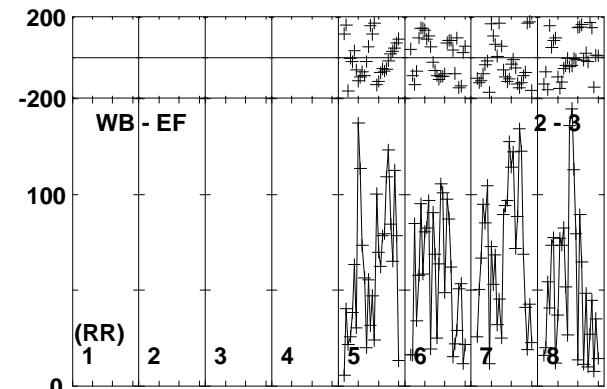
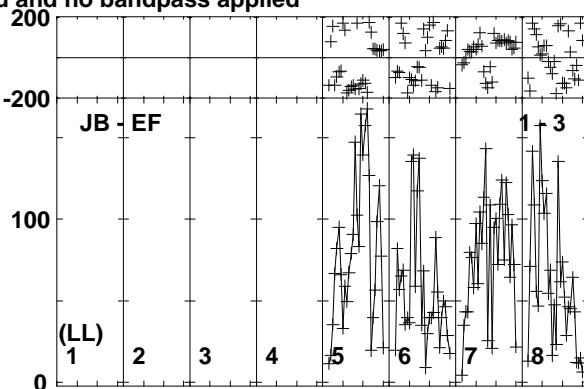
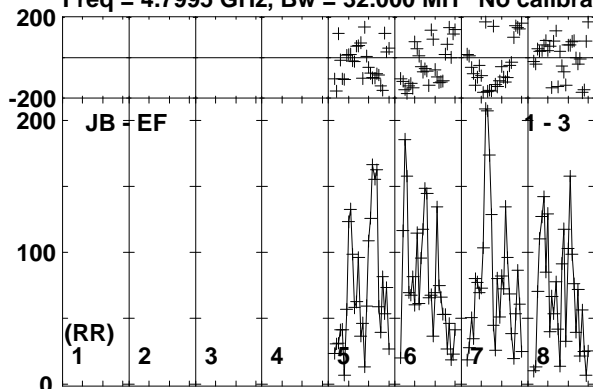

Lower frame: Micro Ampl Jy Top frame: Phas deg
Vector averaged cross-power spectrum Baseline: JB (01) - EF (03)
Timerange: 00/14:02:04 to 00/14:04:08

Plot file version 46 created 03-APR-2017 18:27:38

M22-VLA1 EM126B.UVDATA.1

Freq = 4.7995 GHz, Bw = 32.000 MH No calibration applied and no bandpass applied

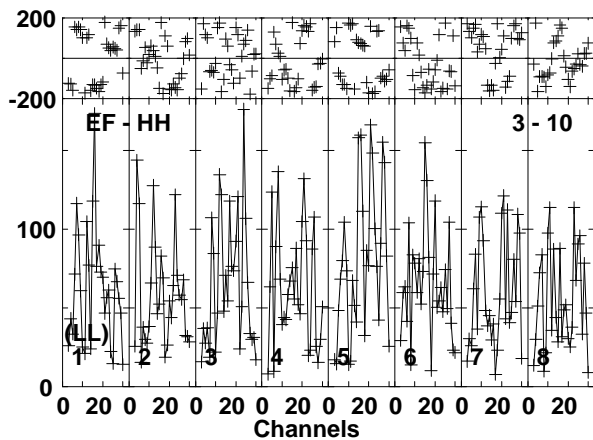
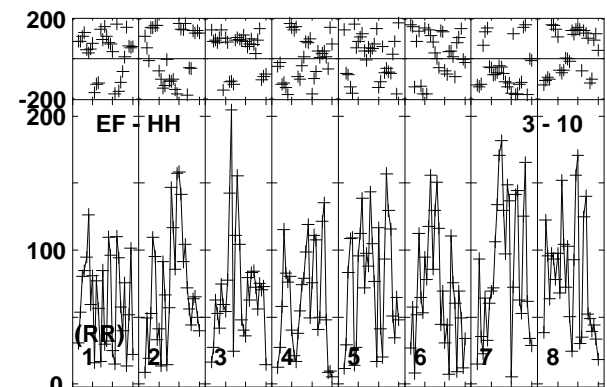
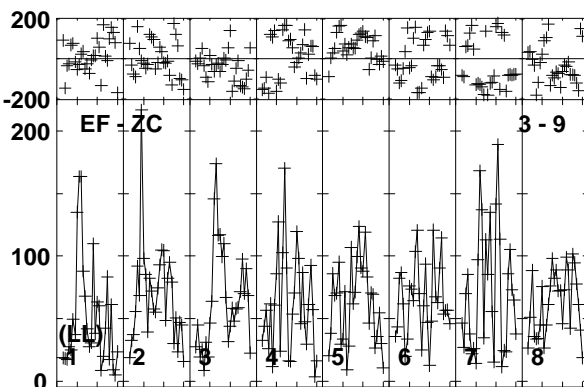
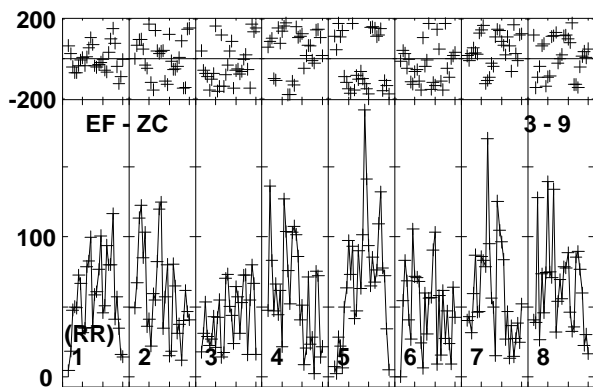
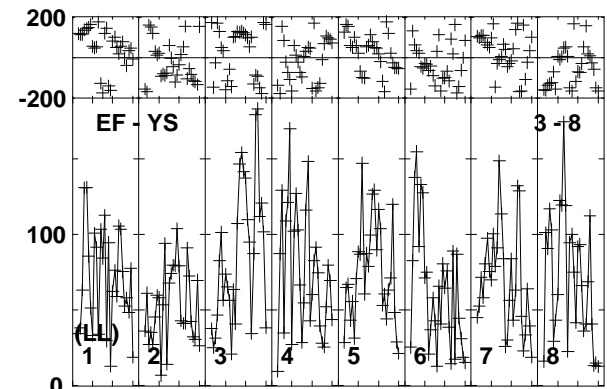
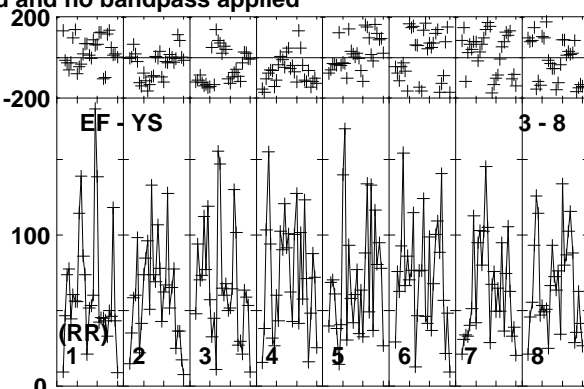
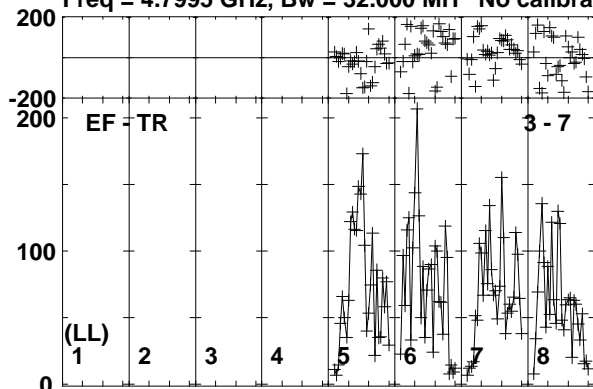

Lower frame: Micro Ampl Jy Top frame: Phas deg
Vector averaged cross-power spectrum Baseline: EF (03) - TR (07)
Timerange: 00/14:02:04 to 00/14:04:08

Plot file version 47 created 03-APR-2017 18:27:38

J1834-2341 EM126B.UVDATA.1

Freq = 4.7995 GHz, Bw = 32.000 MH No calibration applied and no bandpass applied

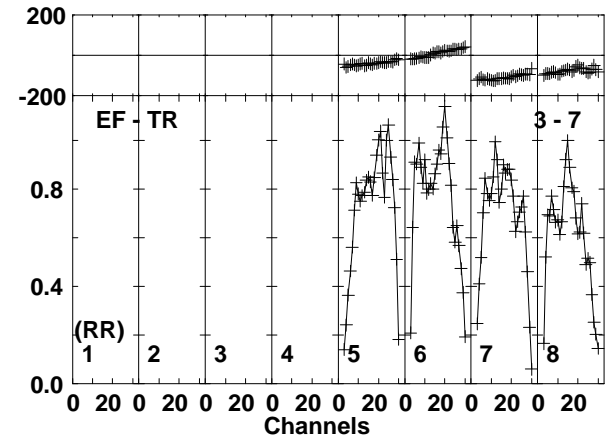
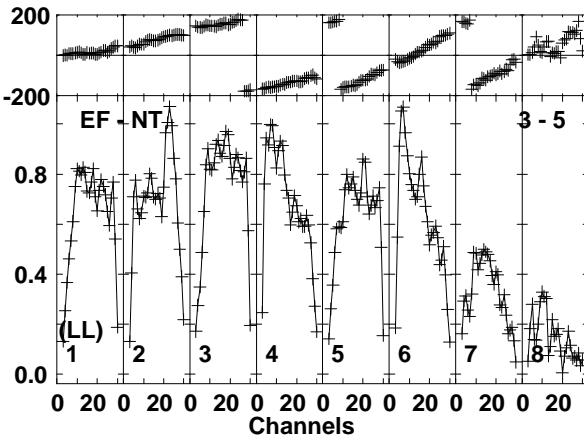
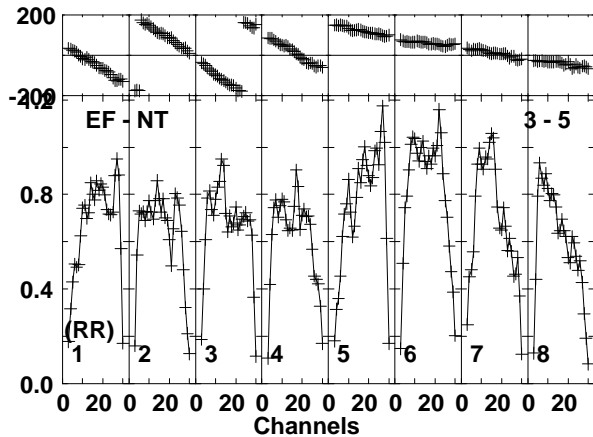
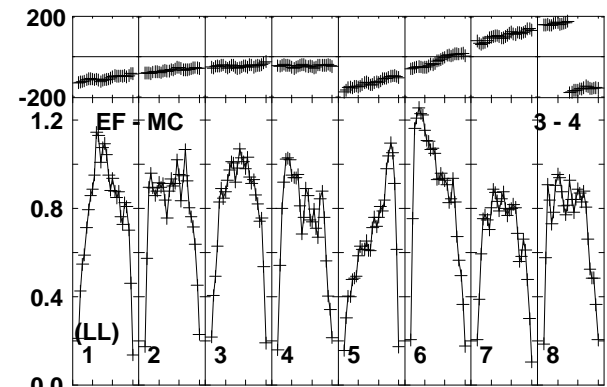
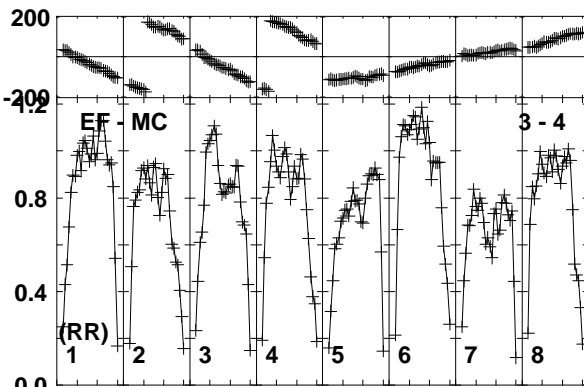
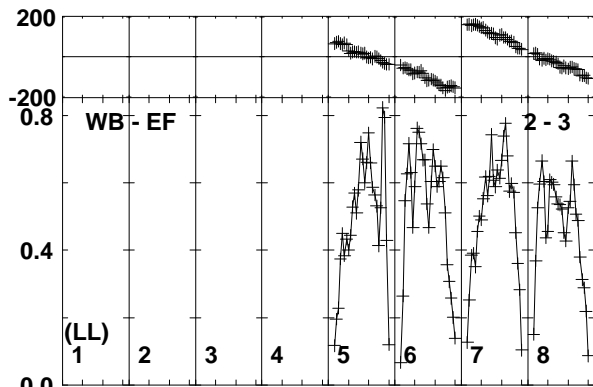
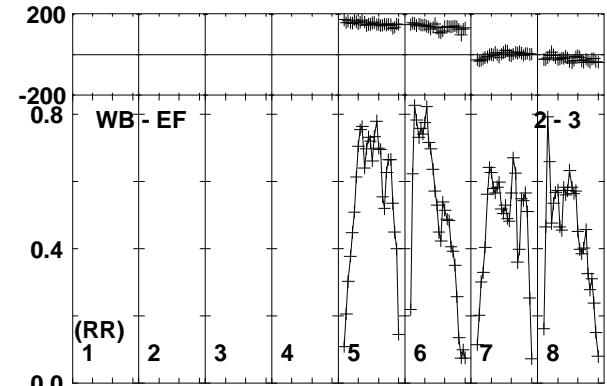
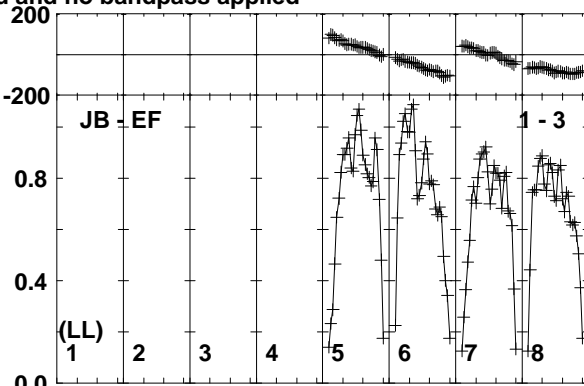
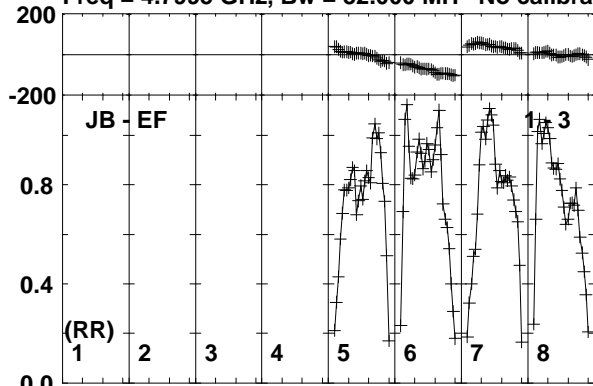

Lower frame: Milli Ampl Jy Top frame: Phas deg
Vector averaged cross-power spectrum Baseline: JB (01) - EF (03)
Timerange: 00/14:04:14 to 00/14:05:28

Plot file version 48 created 03-APR-2017 18:27:38

J1834-2341 EM126B.UVDATA.1

Freq = 4.7995 GHz, Bw = 32.000 MH No calibration applied and no bandpass applied

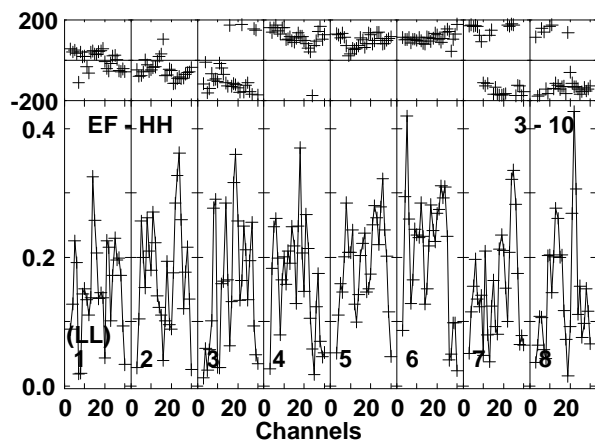
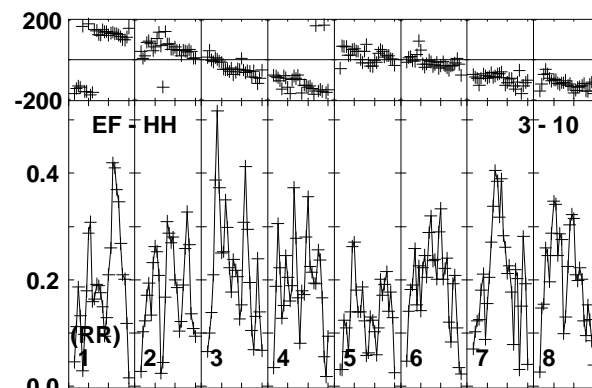
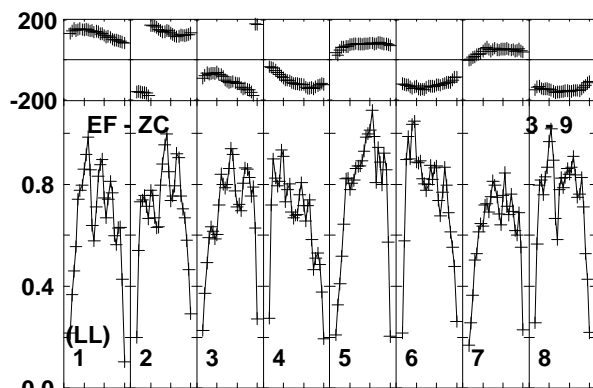
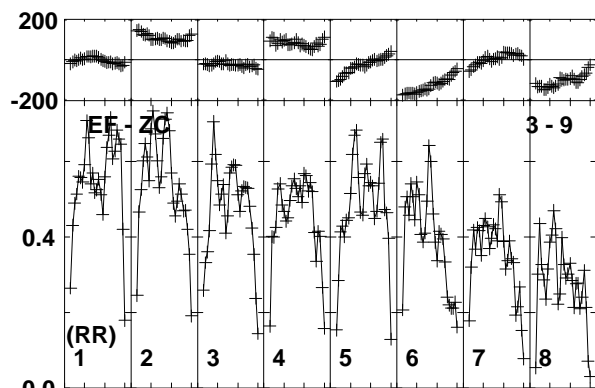
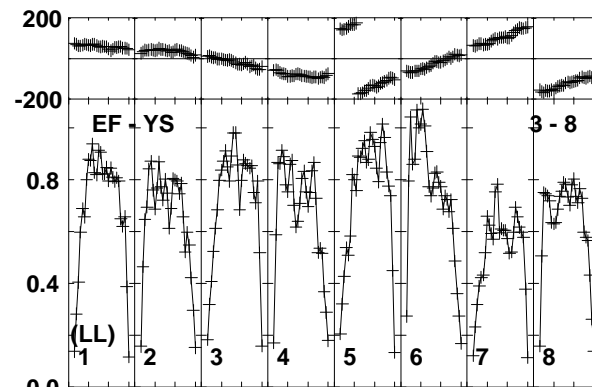
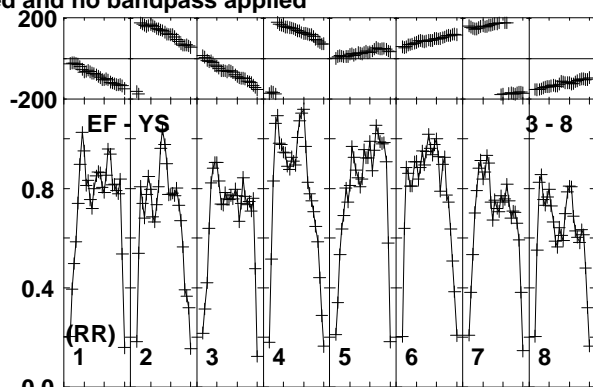
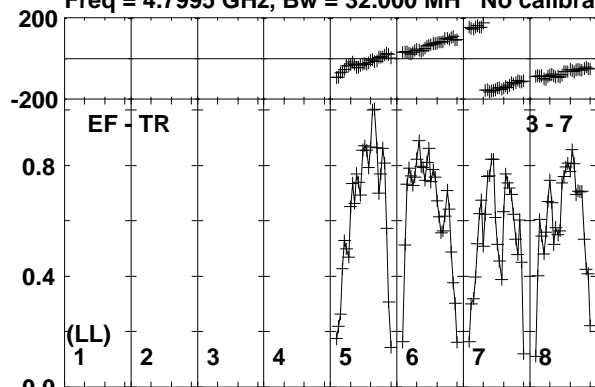

Lower frame: Milli Ampl Jy Top frame: Phas deg
Vector averaged cross-power spectrum Baseline: EF (03) - TR (07)
Timerange: 00/14:04:14 to 00/14:05:28

Plot file version 49 created 03-APR-2017 18:27:38

M22-VLA1 EM126B.UVDATA.1

Freq = 4.7995 GHz, Bw = 32.000 MH No calibration applied and no bandpass applied

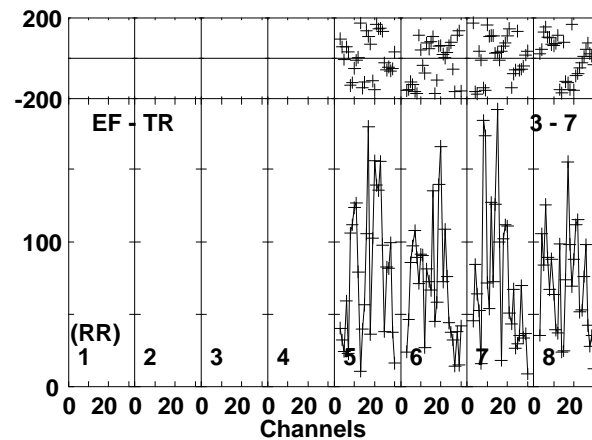
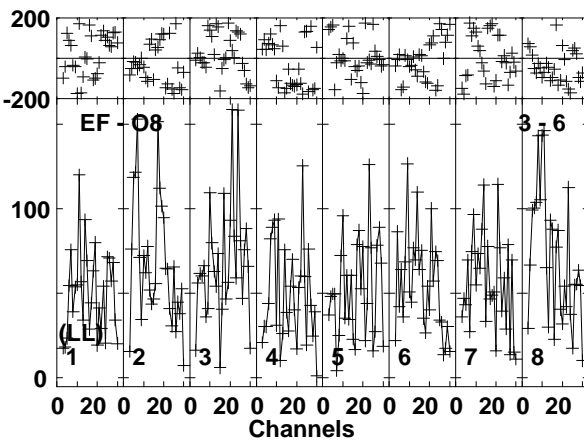
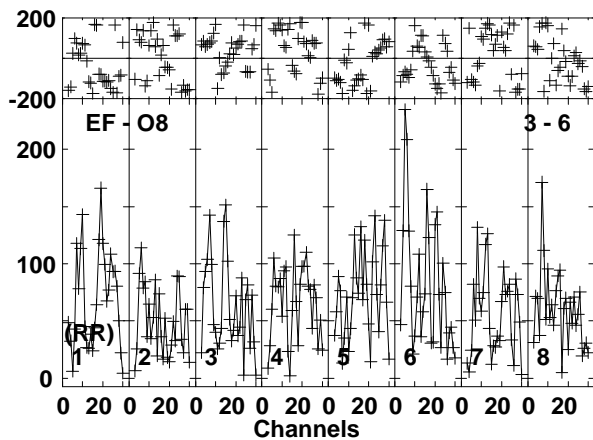
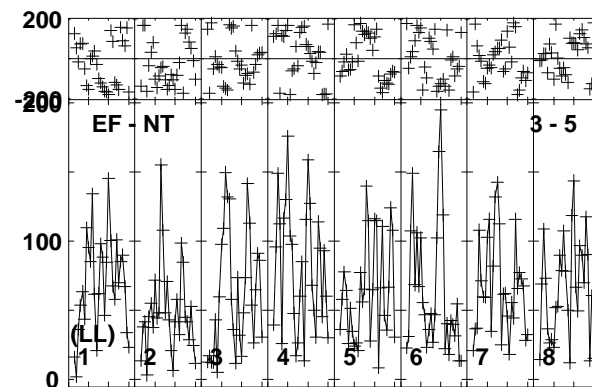
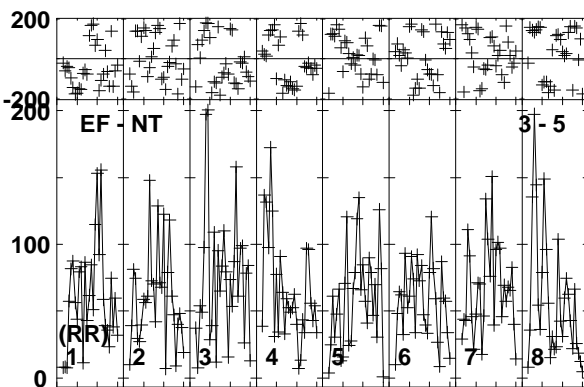
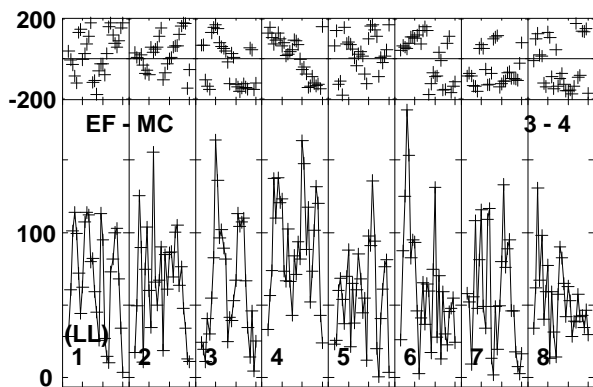
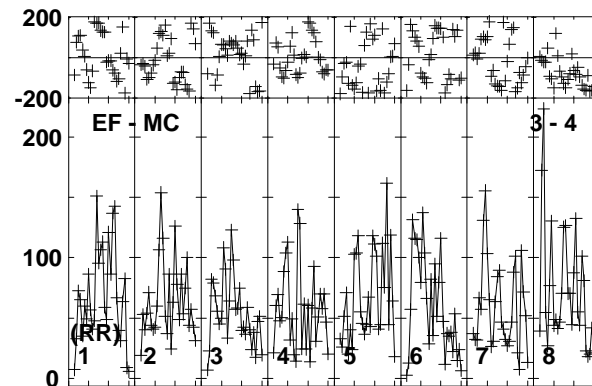
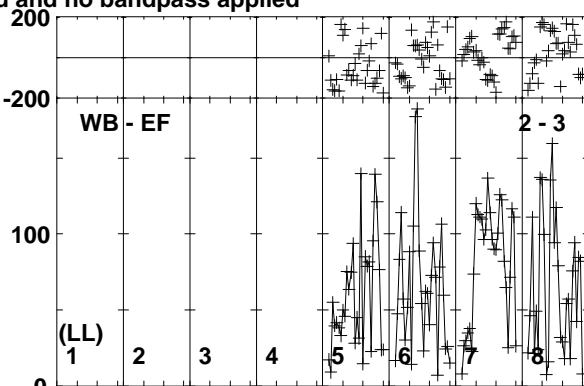
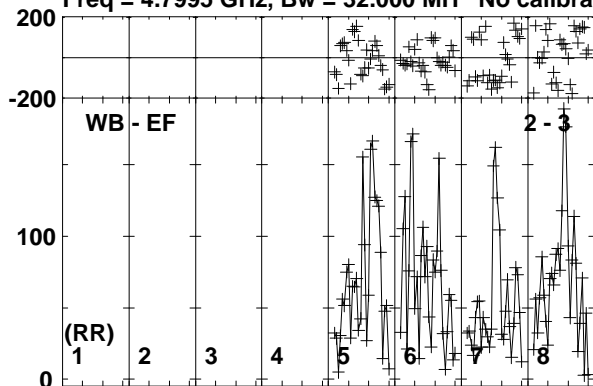

Lower frame: Micro Ampl Jy Top frame: Phas deg
Vector averaged cross-power spectrum Baseline: WB (02) - EF (03)
Timerange: 00/14:05:34 to 00/14:07:38

Plot file version 50 created 03-APR-2017 18:27:38

M22-VLA1 EM126B.UVDATA.1

Freq = 4.7995 GHz, Bw = 32.000 MH No calibration applied and no bandpass applied

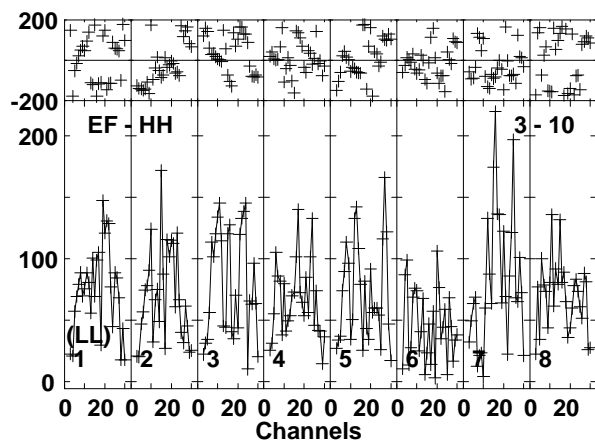
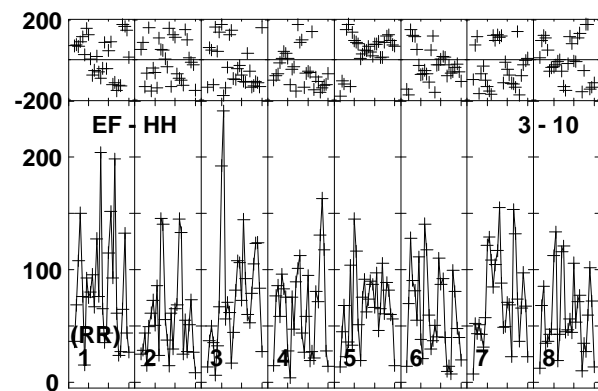
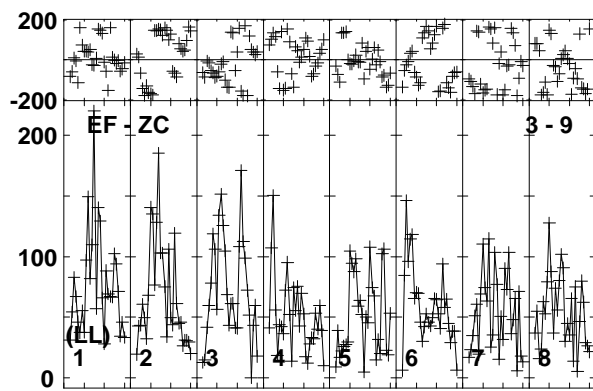
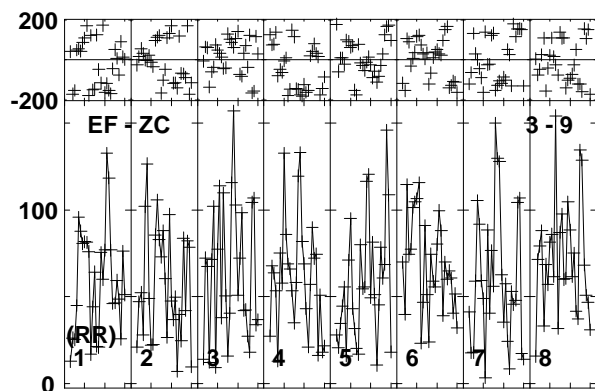
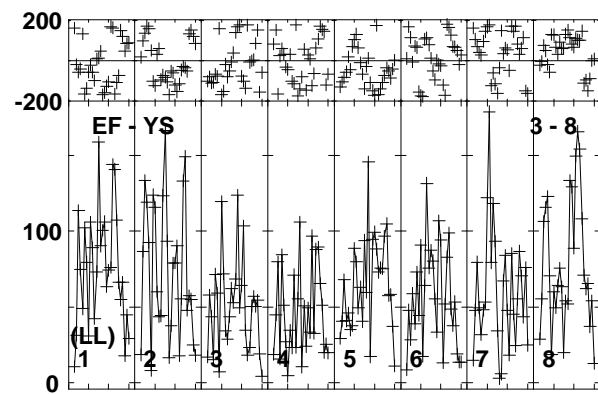
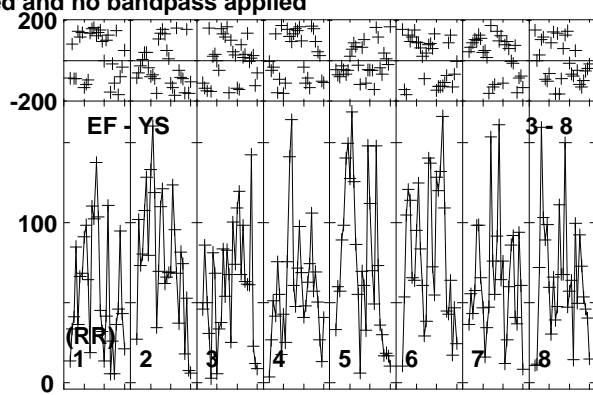
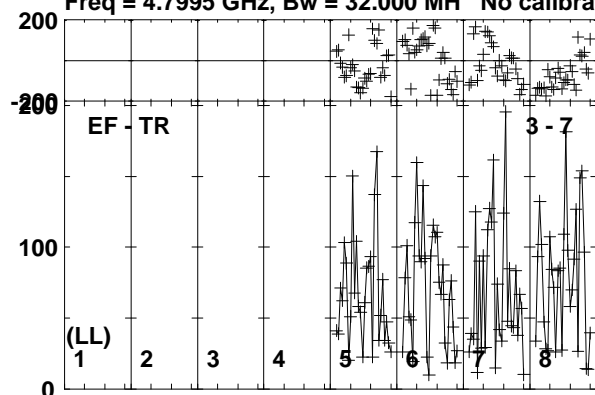

Lower frame: Micro Ampl Jy Top frame: Phas deg
Vector averaged cross-power spectrum Baseline: EF (03) - TR (07)
Timerange: 00/14:05:34 to 00/14:07:38

Plot file version 51 created 03-APR-2017 18:27:38

J1834-2341 EM126B.UVDATA.1

Freq = 4.7995 GHz, Bw = 32.000 MH No calibration applied and no bandpass applied

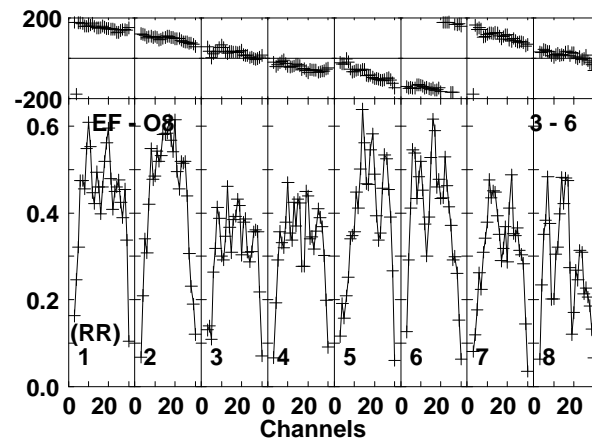
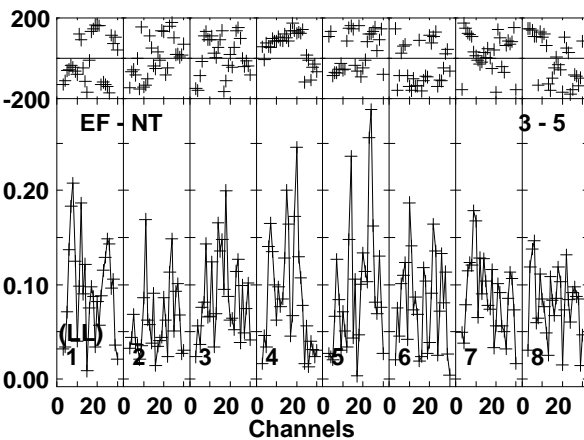
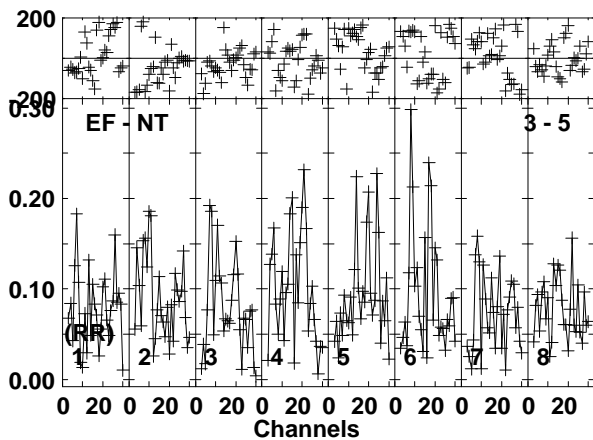
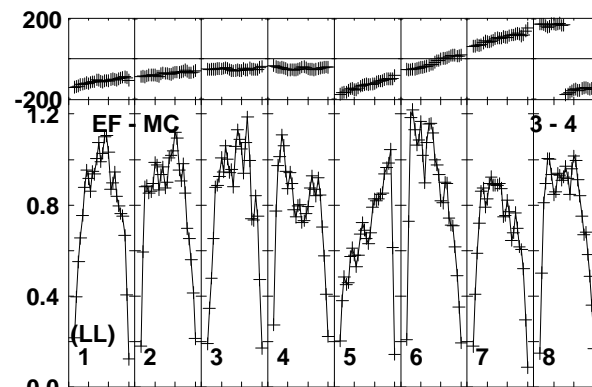
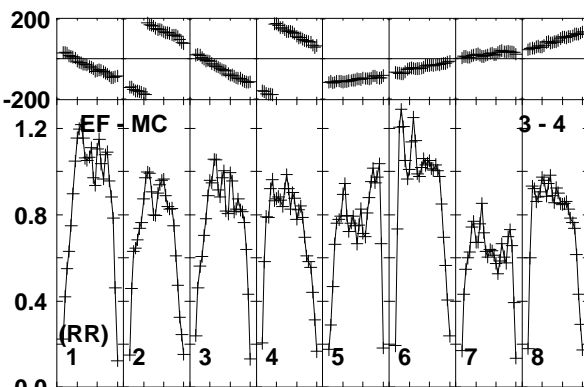
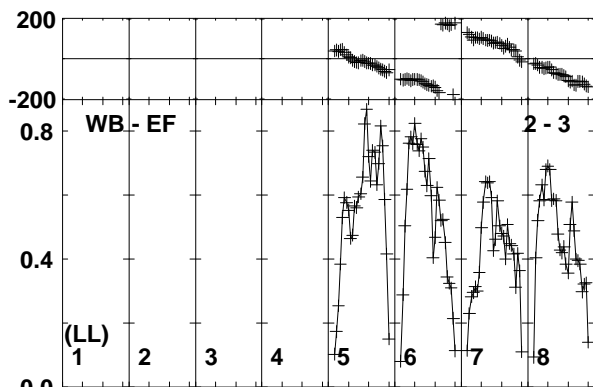
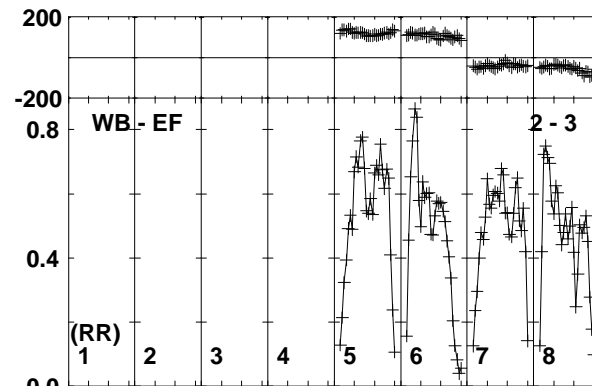
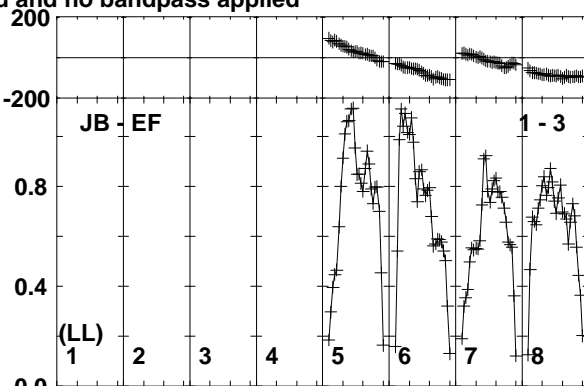
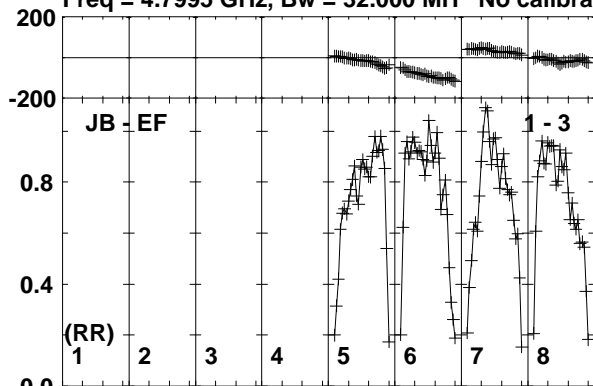

Lower frame: Milli Ampl Jy Top frame: Phas deg
Vector averaged cross-power spectrum Baseline: JB (01) - EF (03)
Timerange: 00/14:07:44 to 00/14:08:58

Plot file version 52 created 03-APR-2017 18:27:38

J1834-2341 EM126B.UVDATA.1

Freq = 4.7995 GHz, Bw = 32.000 MH No calibration applied and no bandpass applied

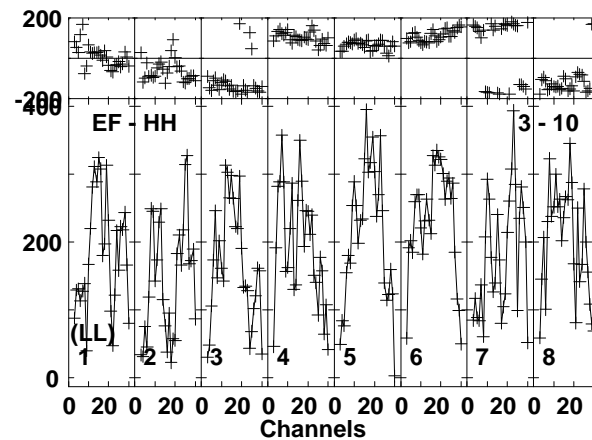
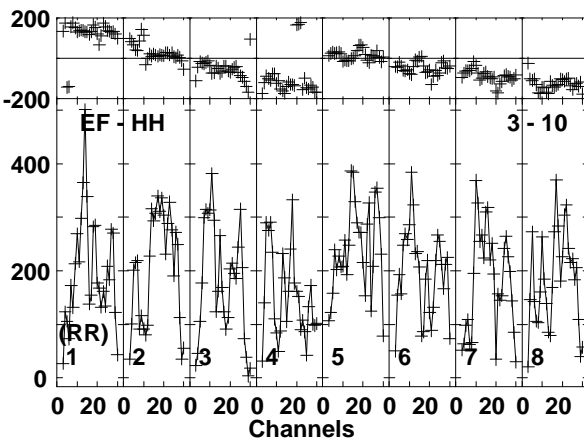
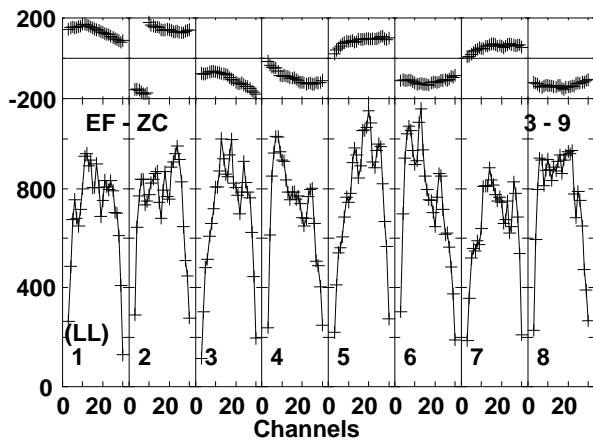
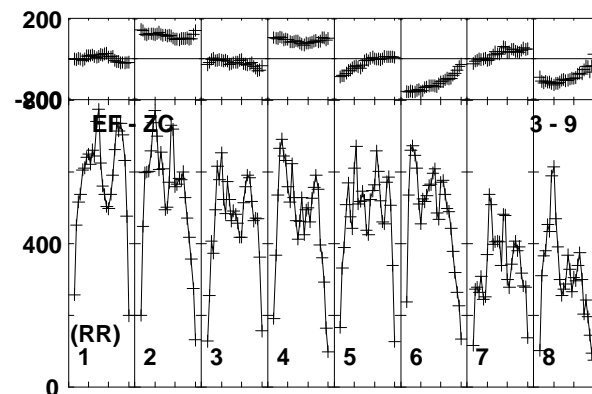
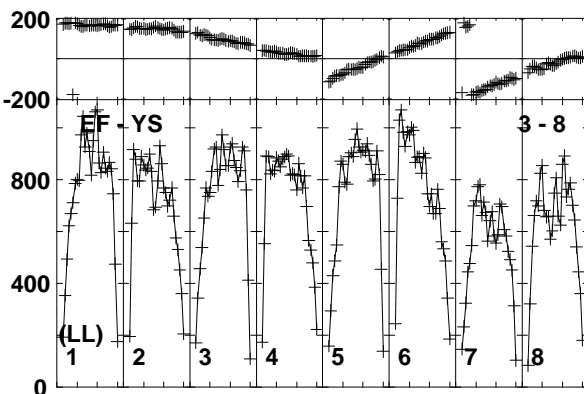
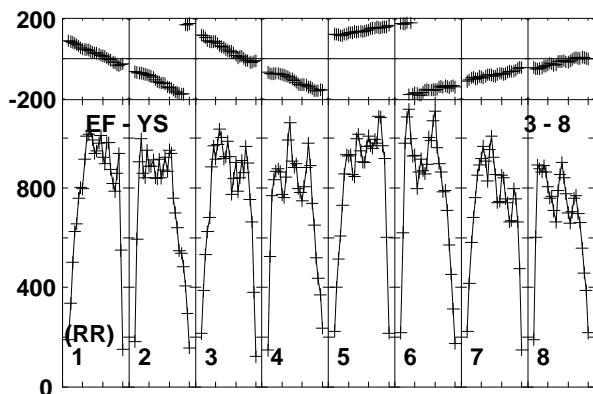
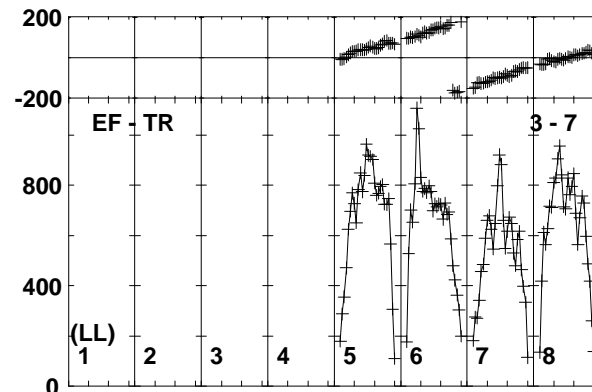
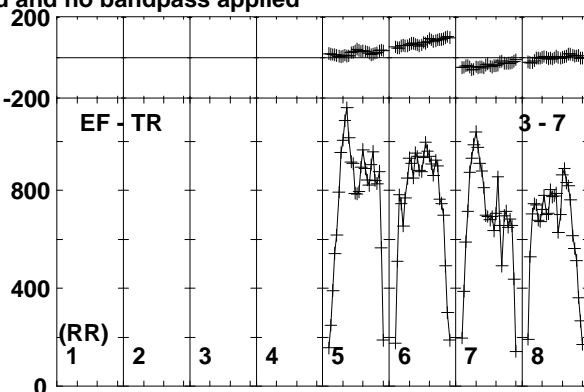
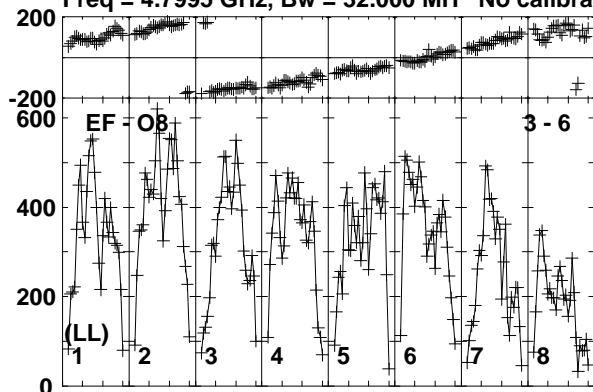

Lower frame: Micro Ampl Jy Top frame: Phas deg
Vector averaged cross-power spectrum Baseline: EF (03) - O8 (06)
Timerange: 00/14:07:44 to 00/14:08:58

Plot file version 53 created 03-APR-2017 18:27:38

M22-VLA1 EM126B.UVDATA.1

Freq = 4.7995 GHz, Bw = 32.000 MH No calibration applied and no bandpass applied

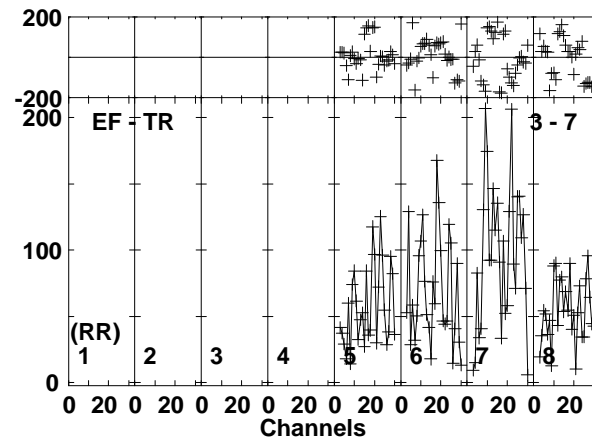
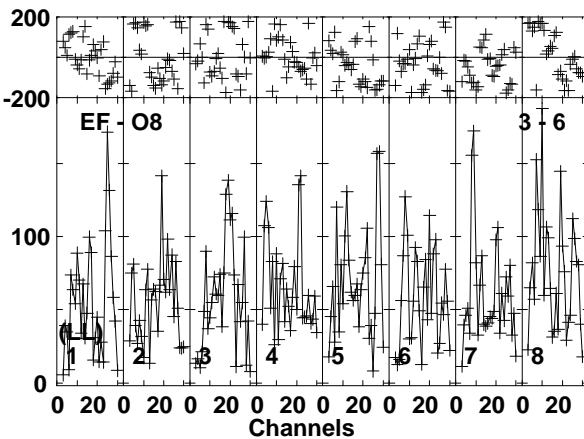
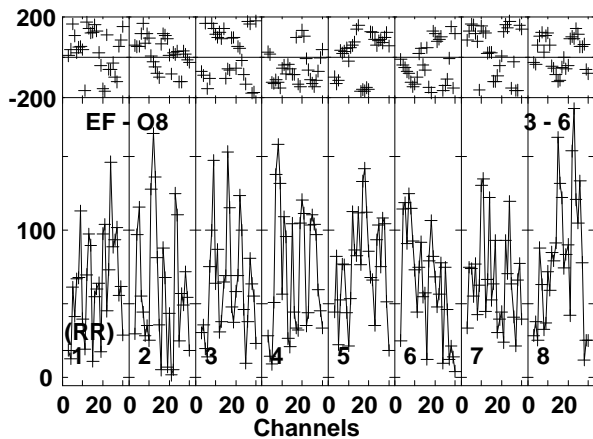
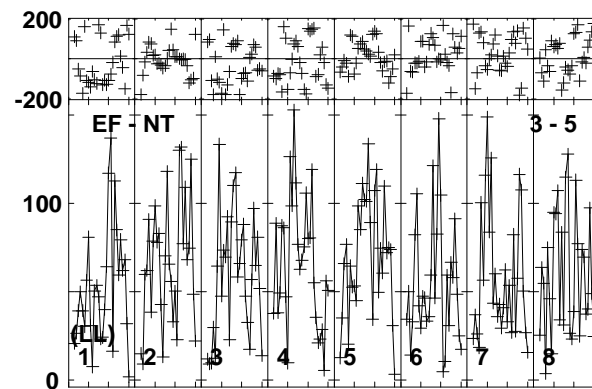
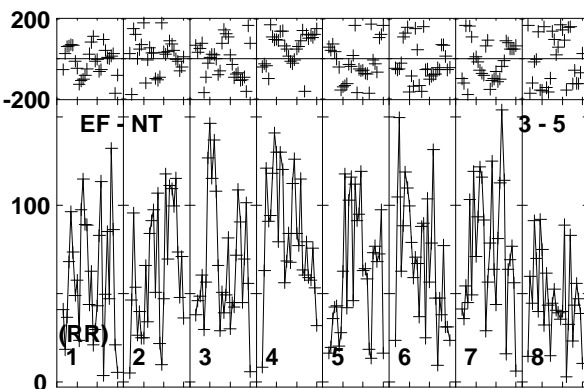
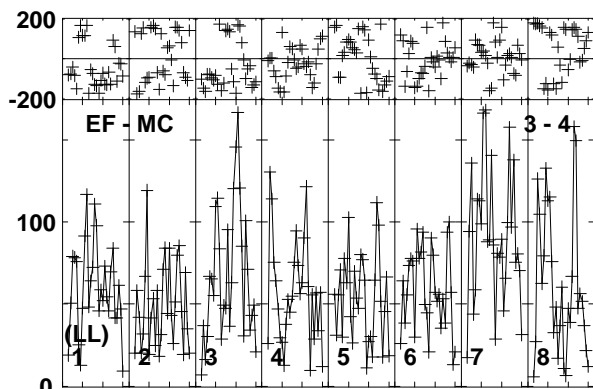
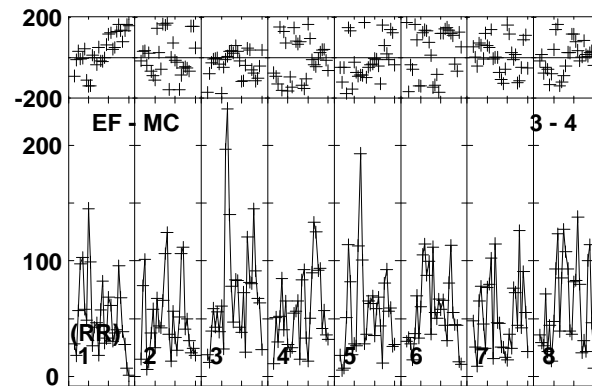
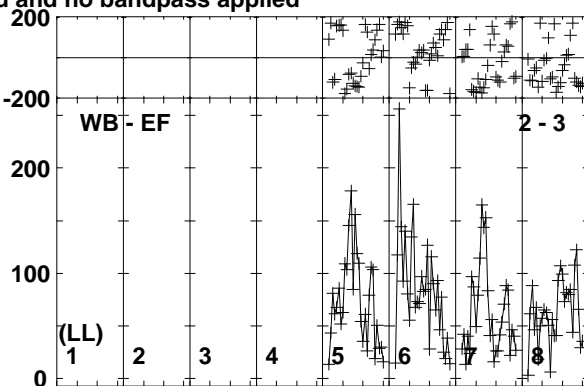
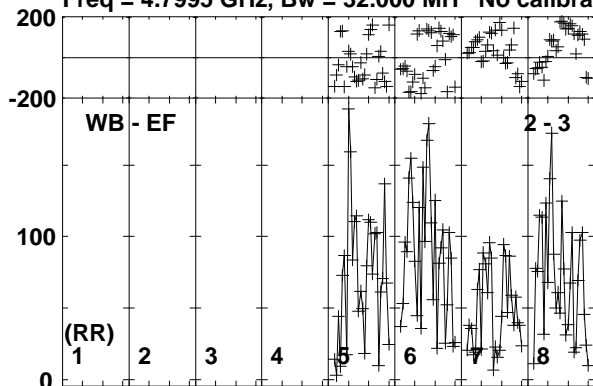

Lower frame: Micro Ampl Jy Top frame: Phas deg
Vector averaged cross-power spectrum Baseline: WB (02) - EF (03)
Timerange: 00/14:09:06 to 00/14:11:08

Plot file version 54 created 03-APR-2017 18:27:38

M22-VLA1 EM126B.UVDATA.1

Freq = 4.7995 GHz, Bw = 32.000 MH No calibration applied and no bandpass applied

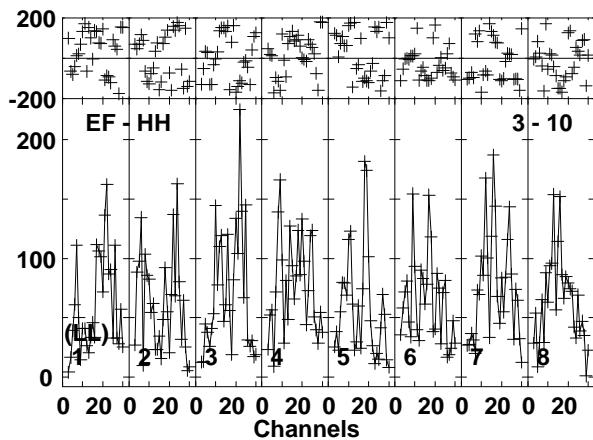
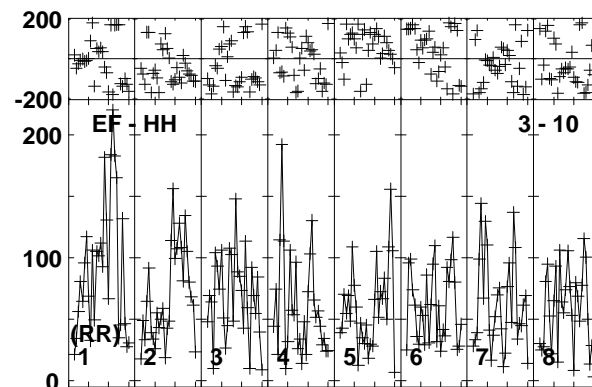
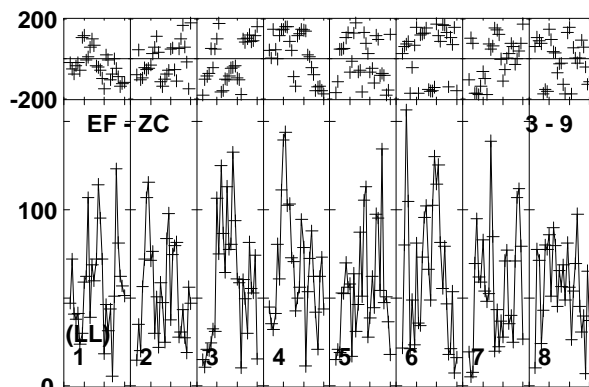
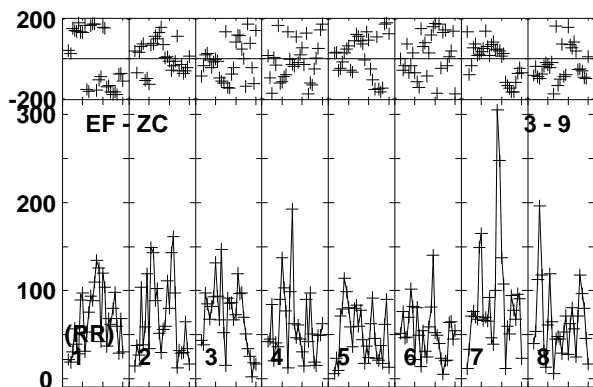
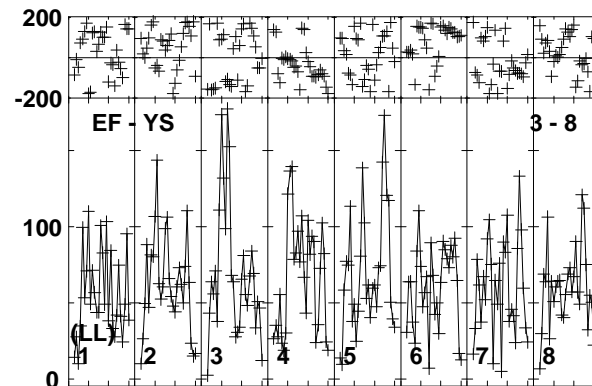
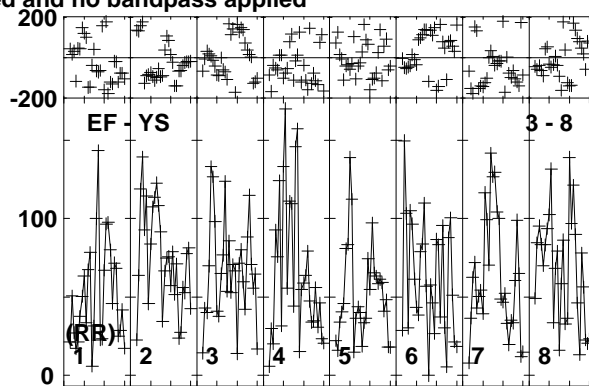
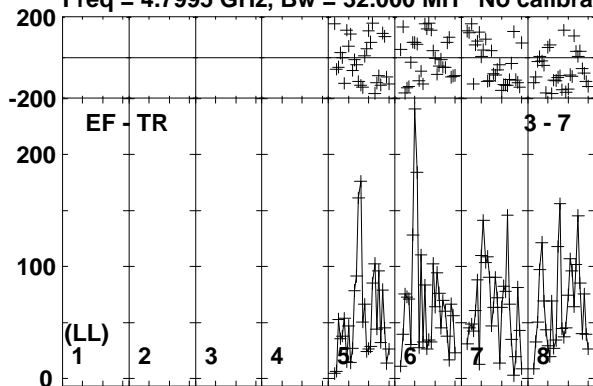

Lower frame: Micro Ampl Jy Top frame: Phas deg
Vector averaged cross-power spectrum Baseline: EF (03) - TR (07)
Timerange: 00/14:09:06 to 00/14:11:08

Plot file version 55 created 03-APR-2017 18:27:38

J1834-2341 EM126B.UVDATA.1

Freq = 4.7995 GHz, Bw = 32.000 MH No calibration applied and no bandpass applied

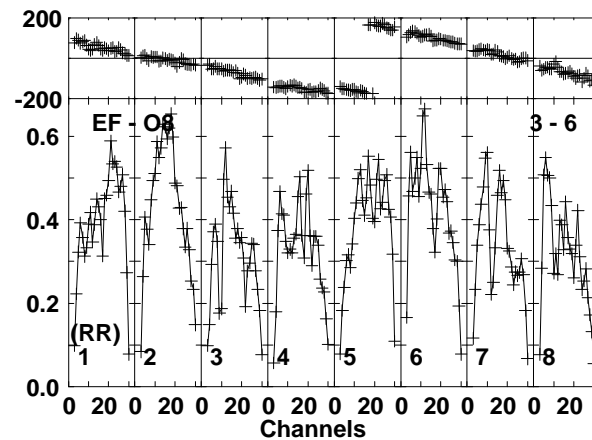
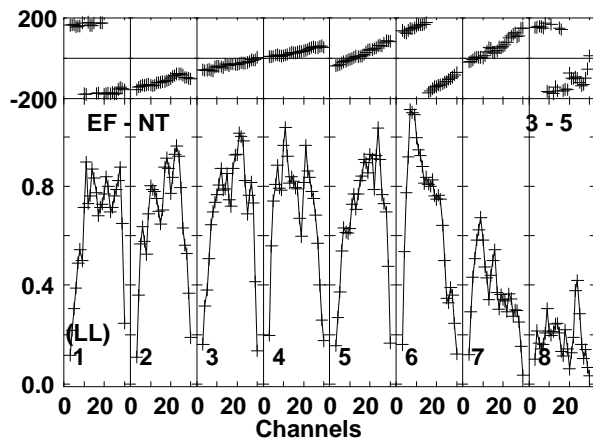
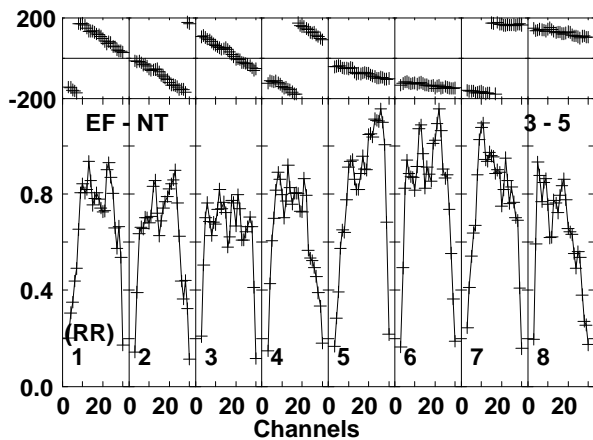
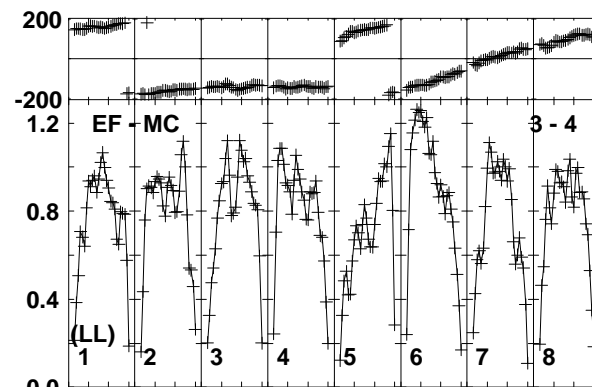
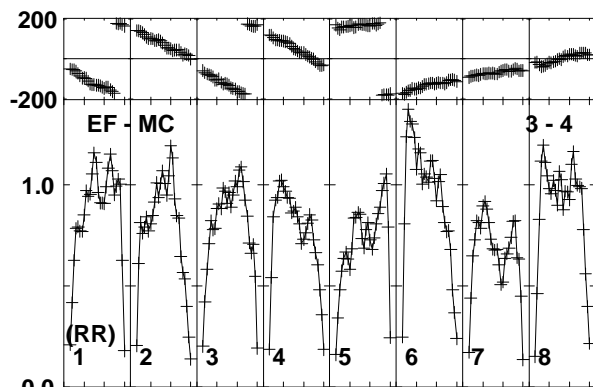
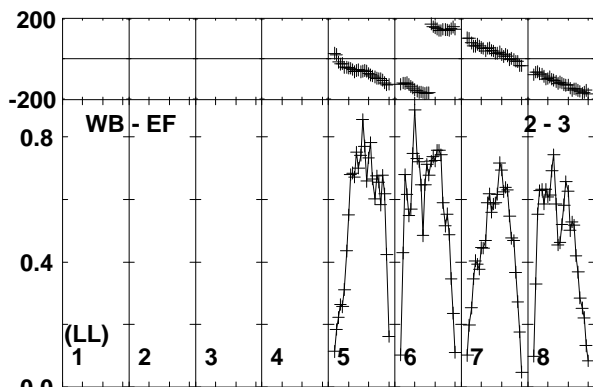
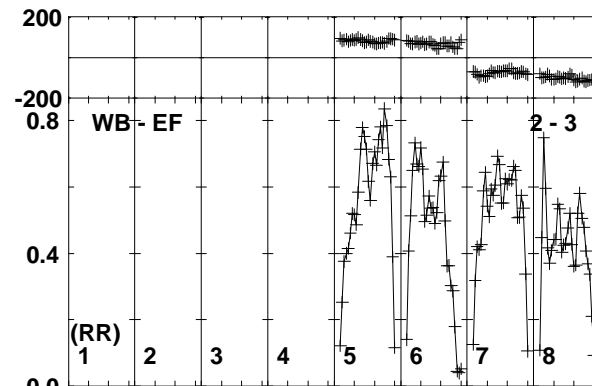
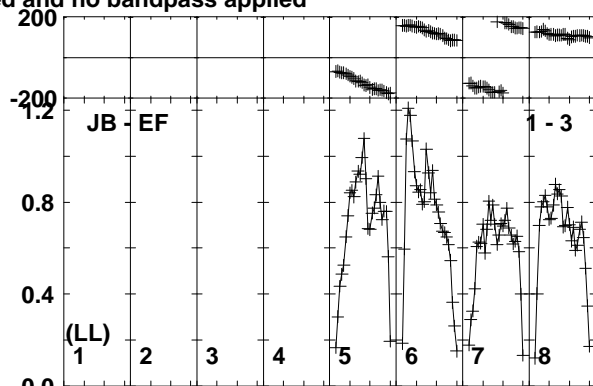
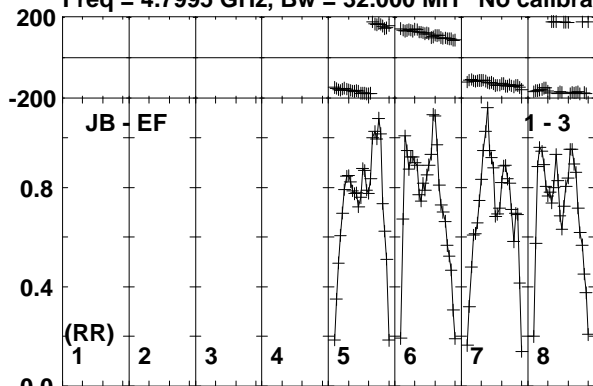

Lower frame: Milli Ampl Jy Top frame: Phas deg
Vector averaged cross-power spectrum Baseline: JB (01) - EF (03)
Timerange: 00/14:11:41 to 00/14:12:29

Plot file version 56 created 03-APR-2017 18:27:38

J1834-2341 EM126B.UVDATA.1

Freq = 4.7995 GHz, Bw = 32.000 MH No calibration applied and no bandpass applied

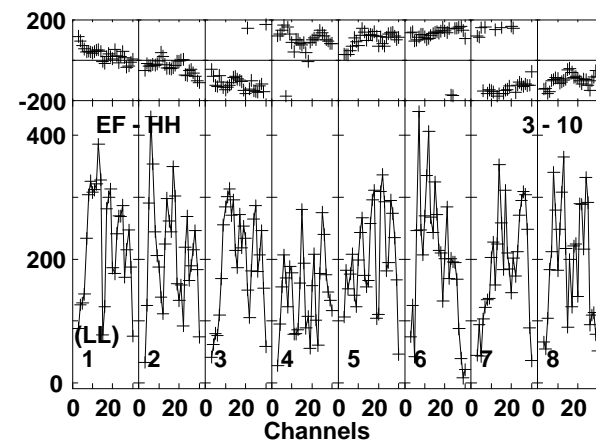
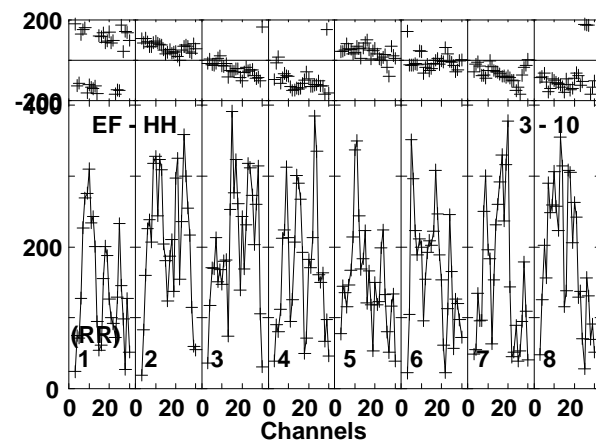
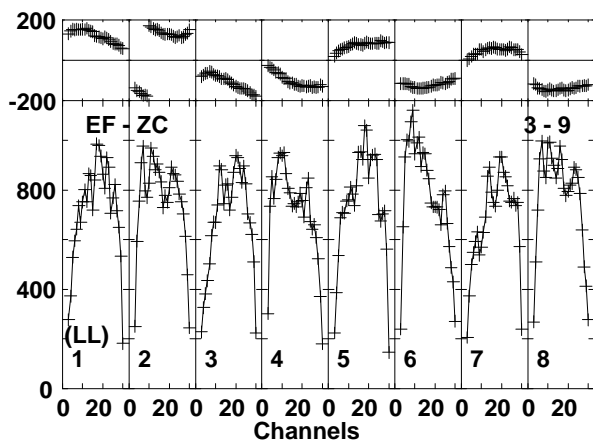
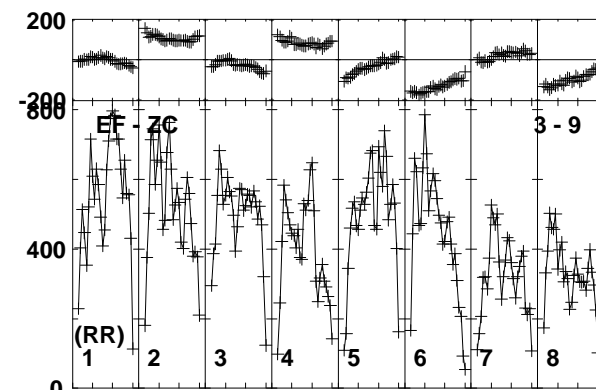
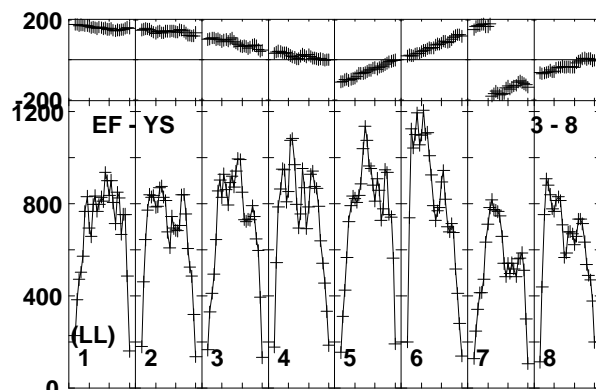
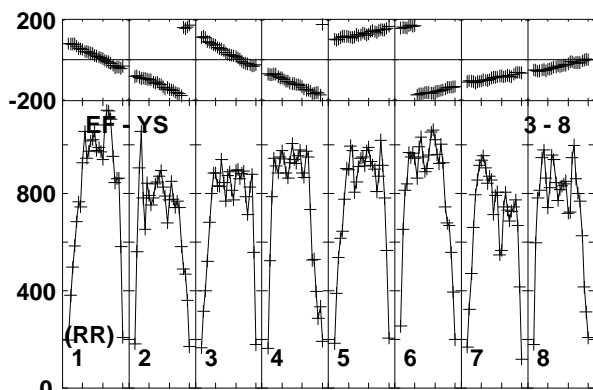
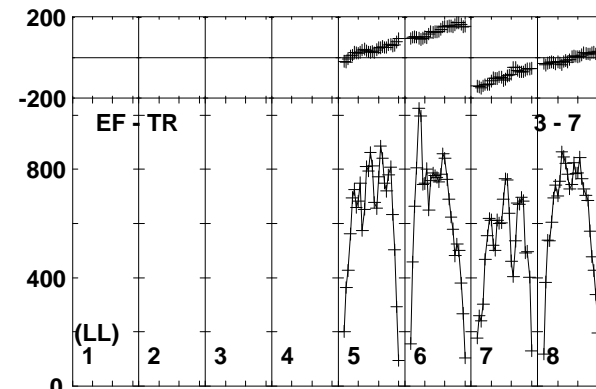
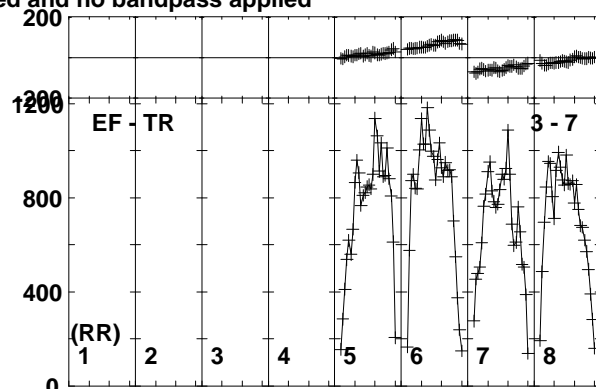
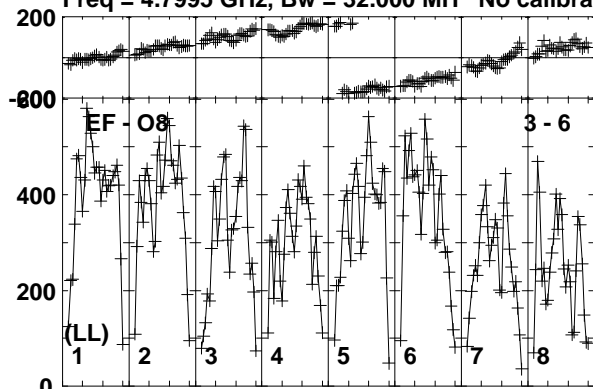

Lower frame: Micro Ampl Jy Top frame: Phas deg
Vector averaged cross-power spectrum Baseline: EF (03) - O8 (06)
Timerange: 00/14:11:41 to 00/14:12:29

Plot file version 57 created 03-APR-2017 18:27:38

M22-VLA1 EM126B.UVDATA.1

Freq = 4.7995 GHz, Bw = 32.000 MH No calibration applied and no bandpass applied

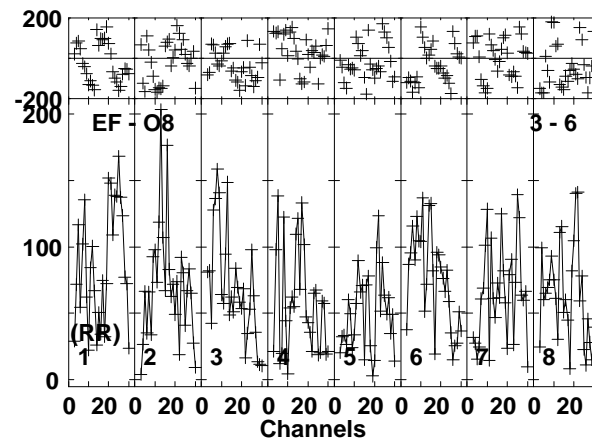
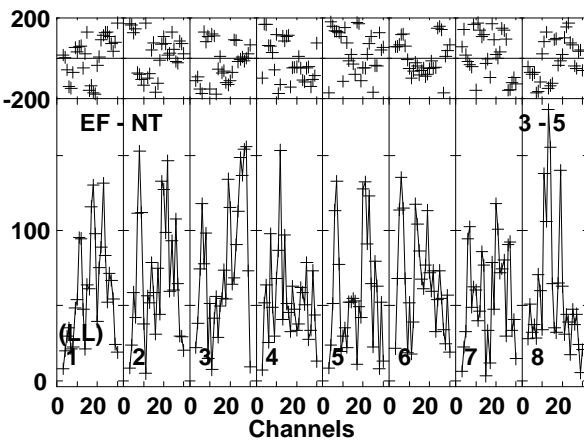
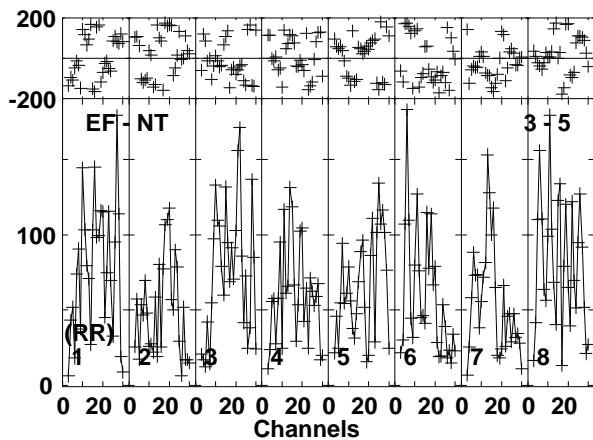
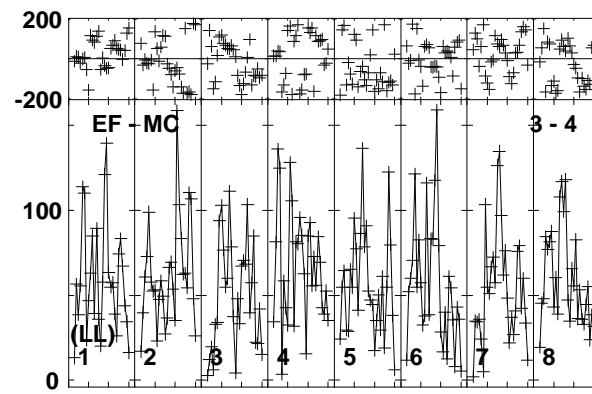
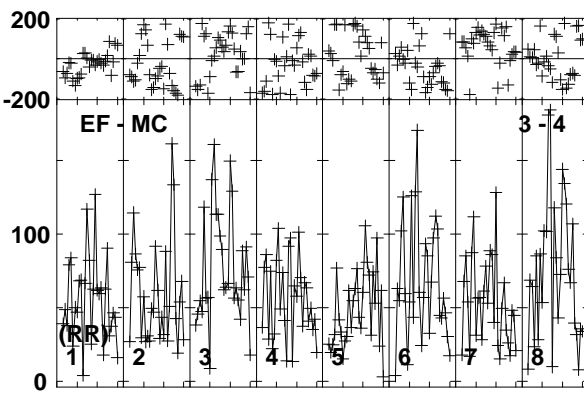
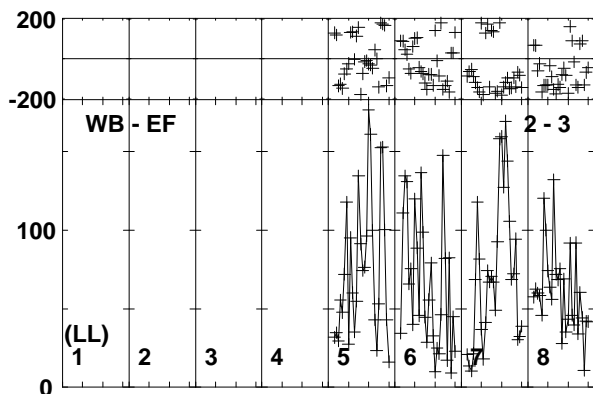
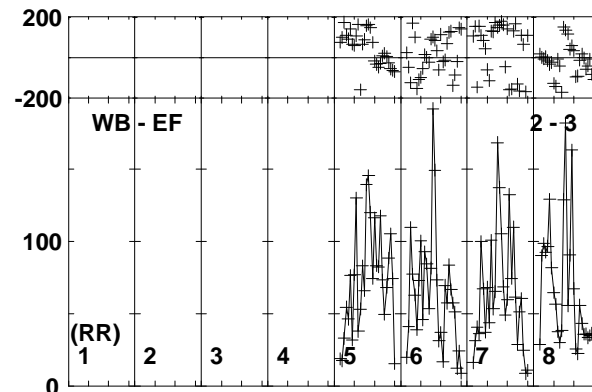
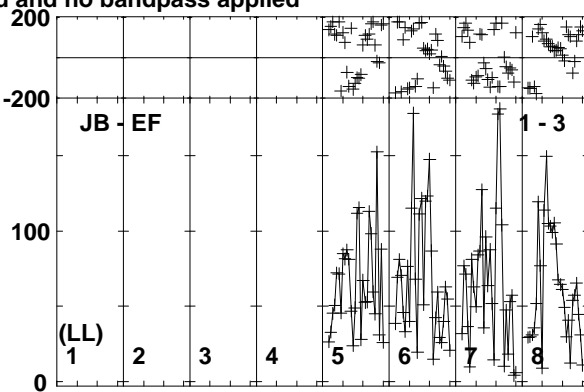
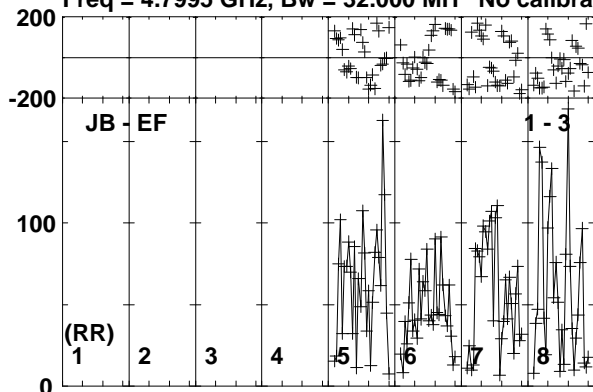

Lower frame: Micro Ampl Jy Top frame: Phas deg
Vector averaged cross-power spectrum Baseline: JB (01) - EF (03)
Timerange: 00/14:12:34 to 00/14:14:38

Plot file version 58 created 03-APR-2017 18:27:38

M22-VLA1 EM126B.UVDATA.1

Freq = 4.7995 GHz, Bw = 32.000 MH No calibration applied and no bandpass applied

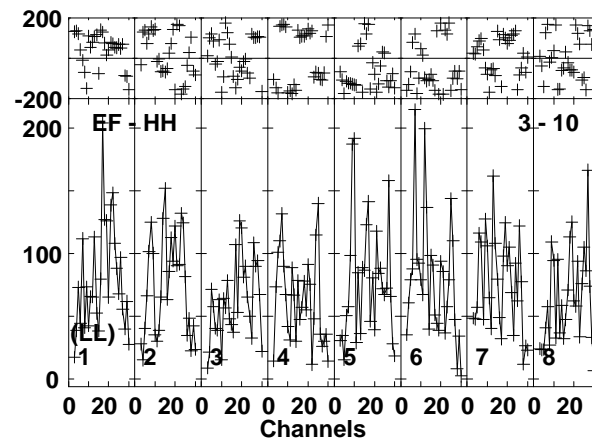
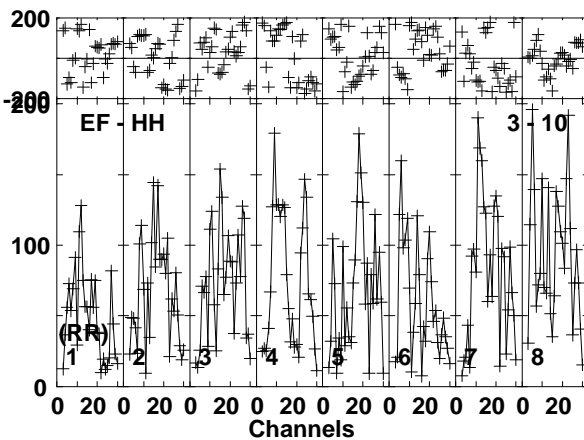
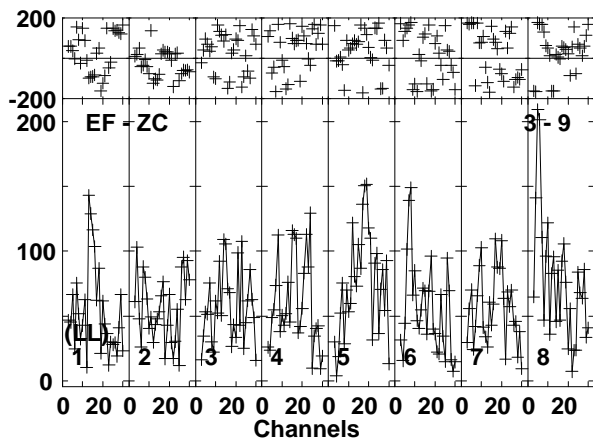
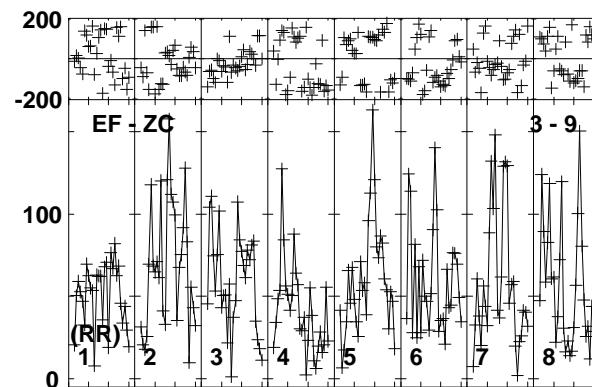
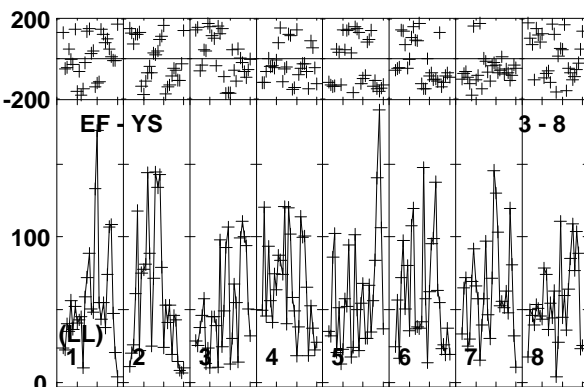
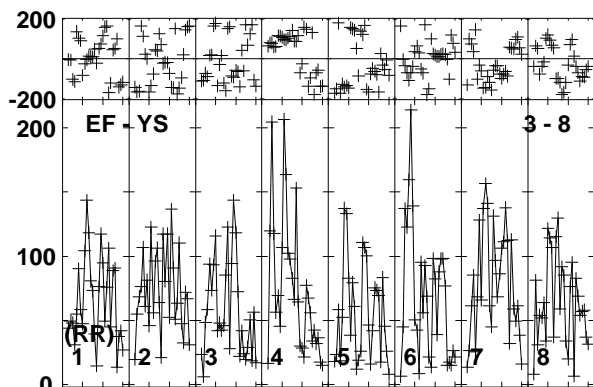
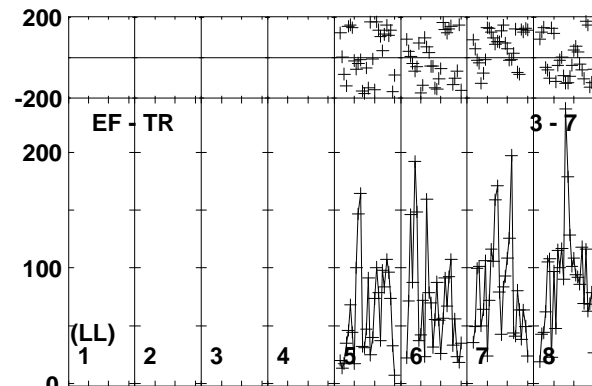
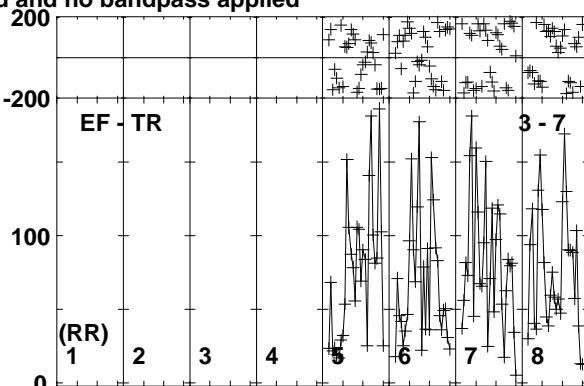
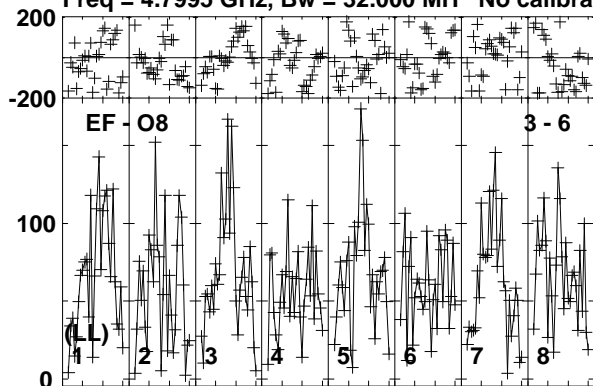

Lower frame: Micro Ampl Jy Top frame: Phas deg
Vector averaged cross-power spectrum Baseline: EF (03) - O8 (06)
Timerange: 00/14:12:34 to 00/14:14:38

Plot file version 59 created 03-APR-2017 18:27:38

J1834-2341 EM126B.UVDATA.1

Freq = 4.7995 GHz, Bw = 32.000 MH No calibration applied and no bandpass applied

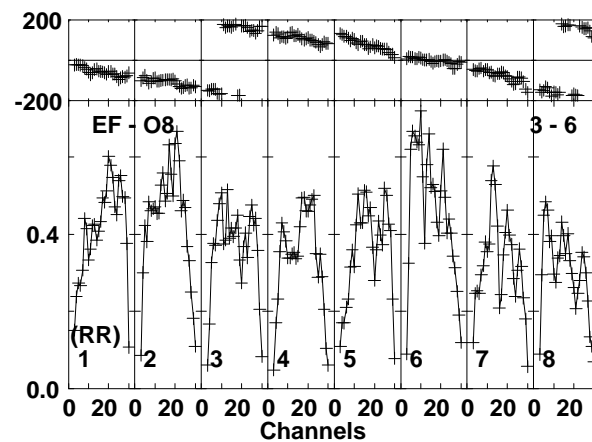
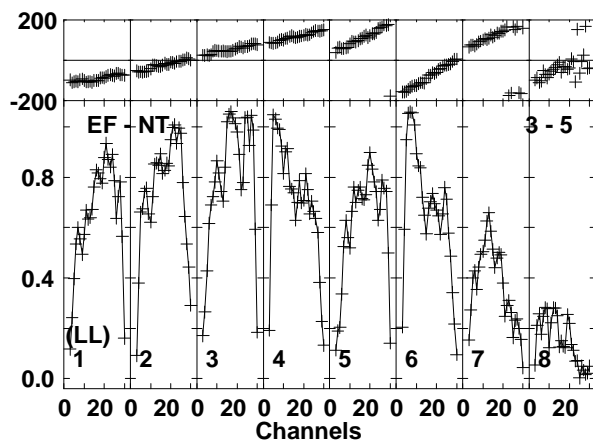
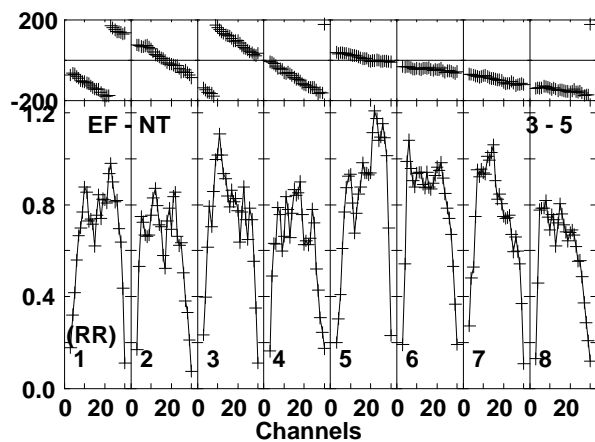
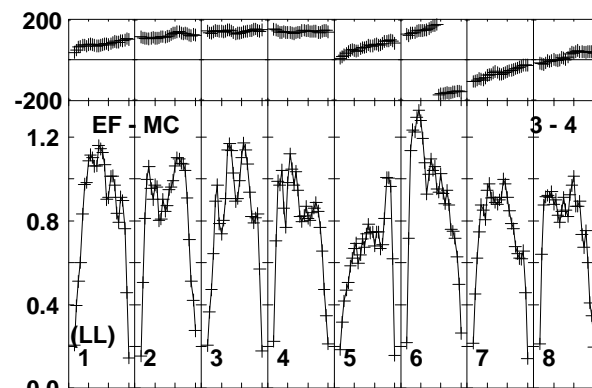
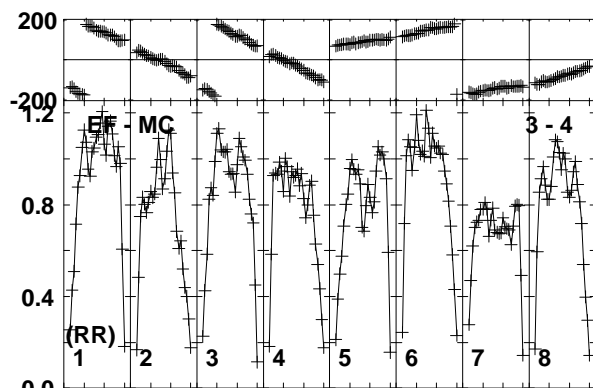
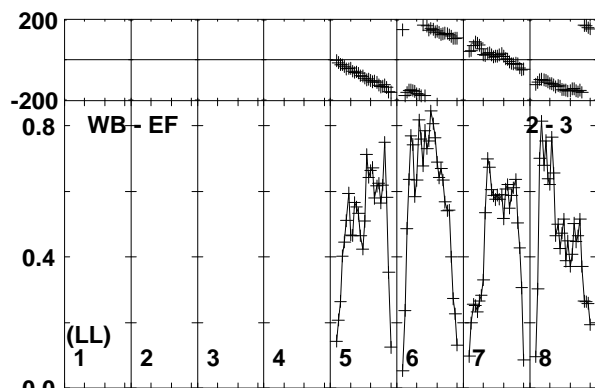
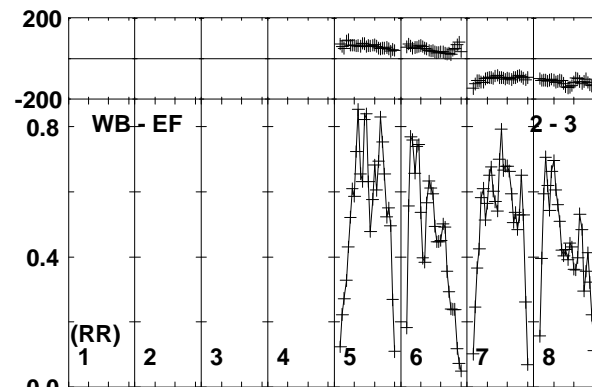
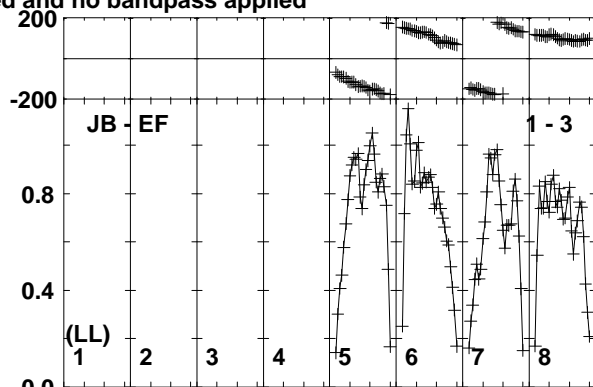
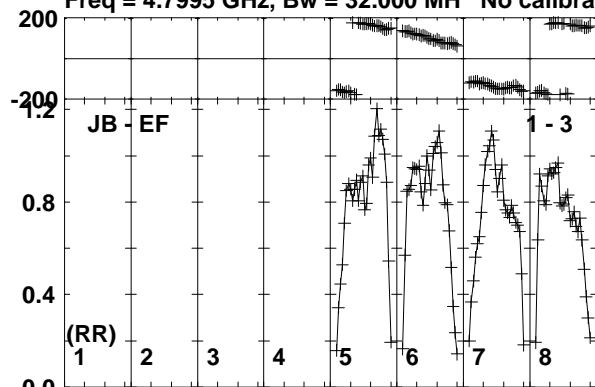

Lower frame: Milli Ampl Jy Top frame: Phas deg
Vector averaged cross-power spectrum Baseline: JB (01) - EF (03)
Timerange: 00/14:14:44 to 00/14:15:58

Plot file version 60 created 03-APR-2017 18:27:38

J1834-2341 EM126B.UVDATA.1

Freq = 4.7995 GHz, Bw = 32.000 MH No calibration applied and no bandpass applied

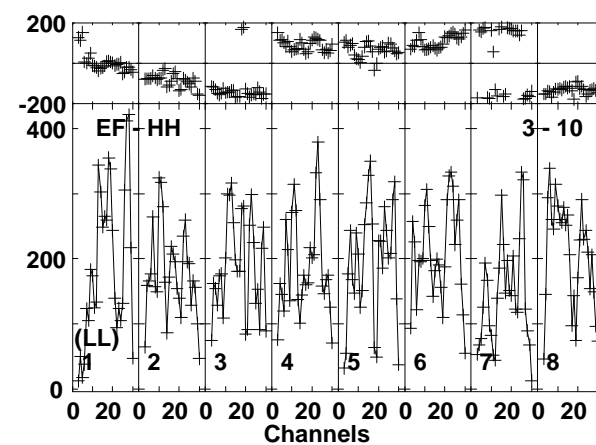
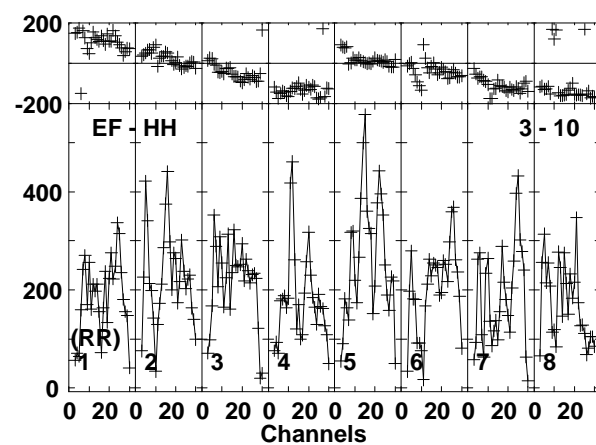
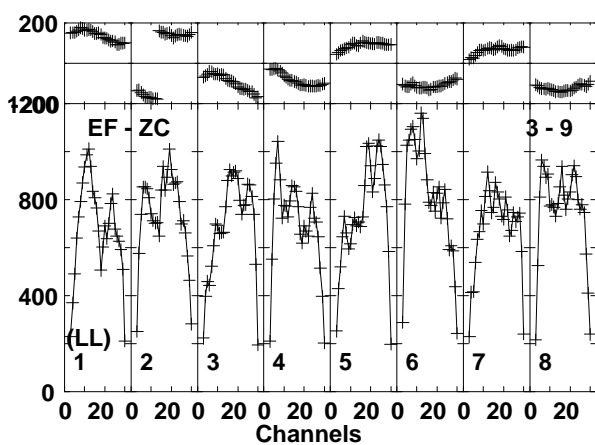
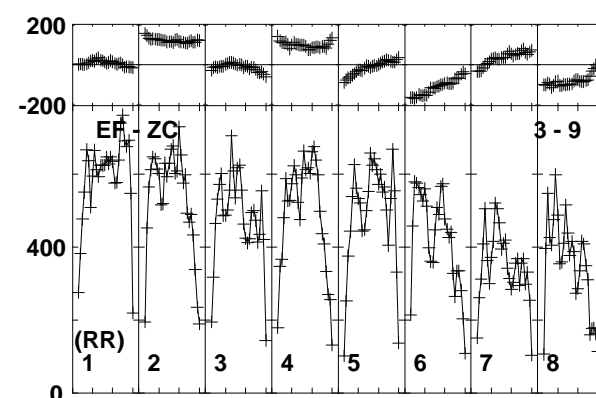
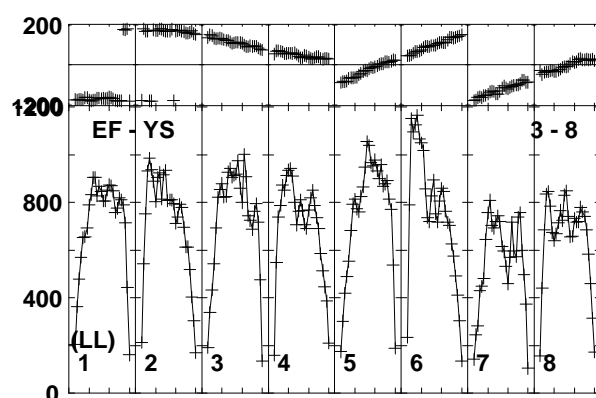
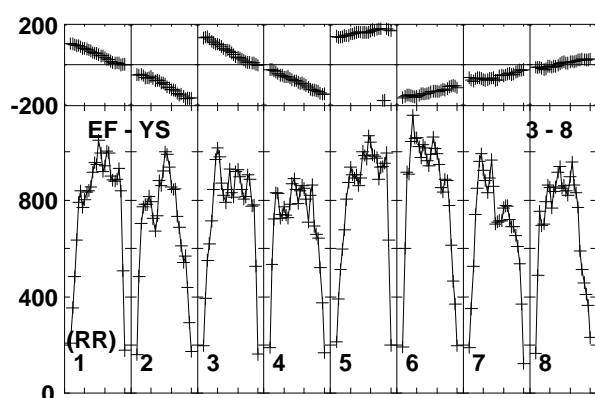
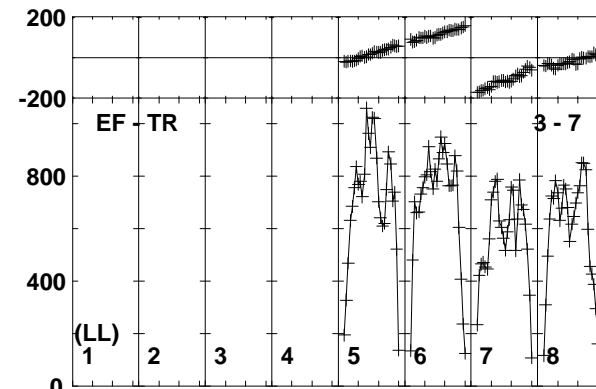
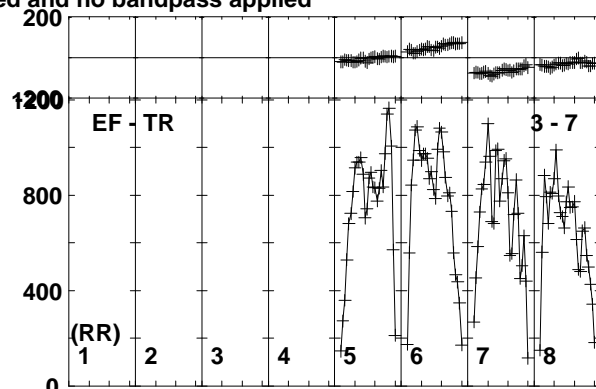
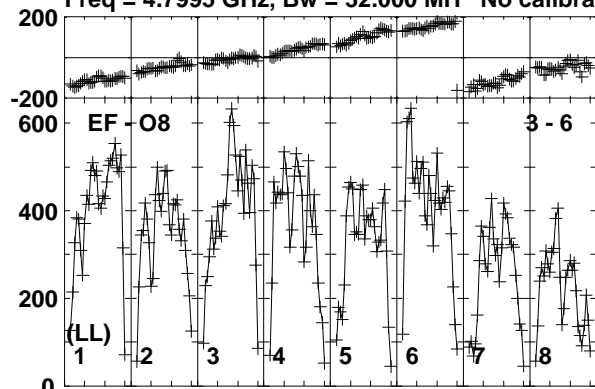

Lower frame: Micro Ampl Jy Top frame: Phas deg
Vector averaged cross-power spectrum Baseline: EF (03) - O8 (06)
Timerange: 00/14:14:44 to 00/14:15:58

Plot file version 61 created 03-APR-2017 18:27:38

M22-VLA1 EM126B.UVDATA.1

Freq = 4.7995 GHz, Bw = 32.000 MH No calibration applied and no bandpass applied

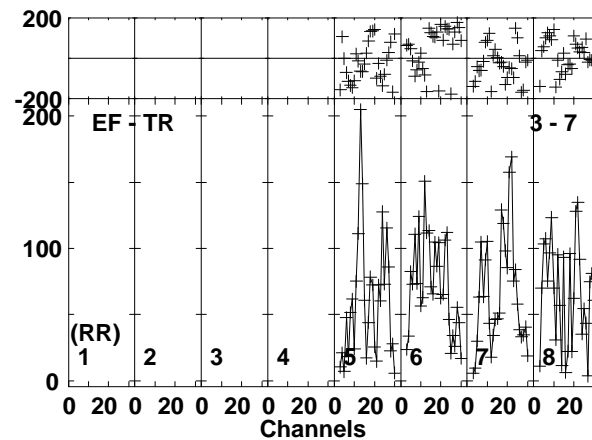
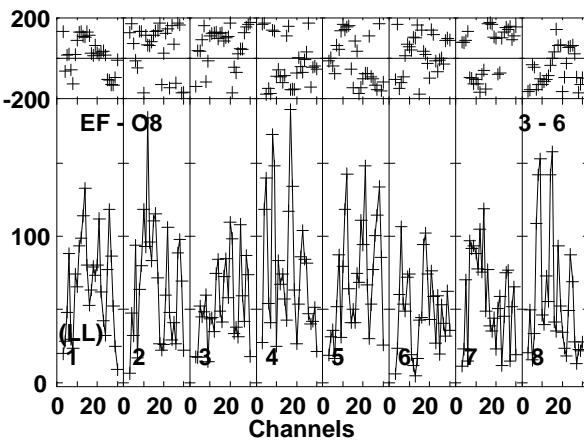
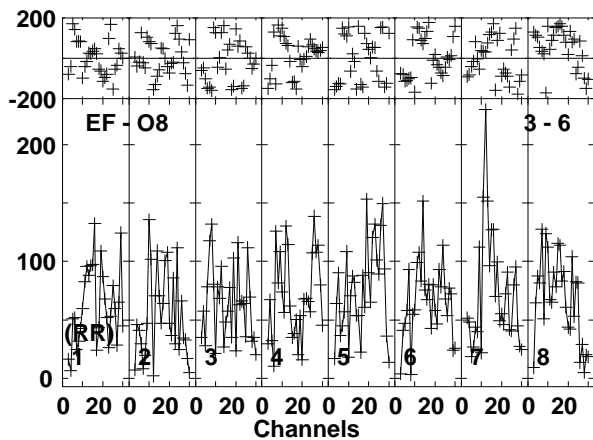
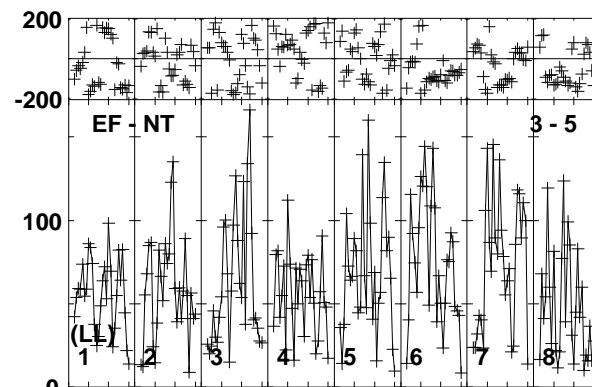
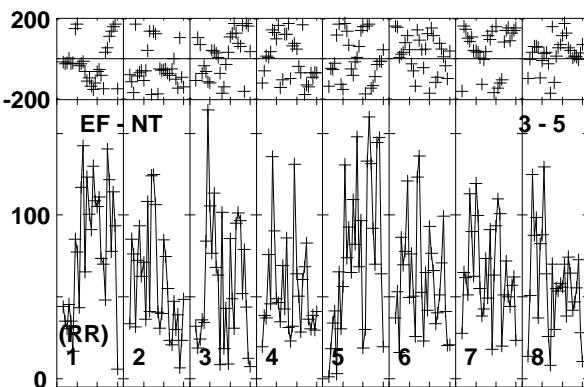
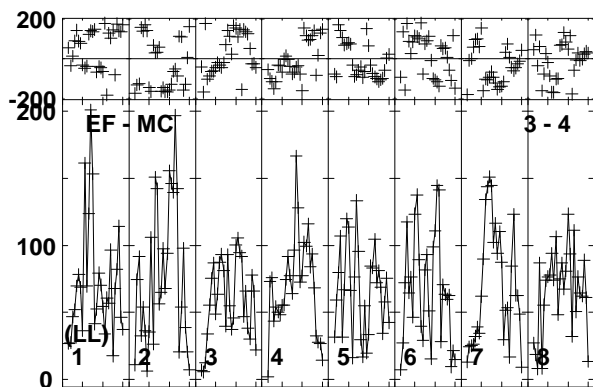
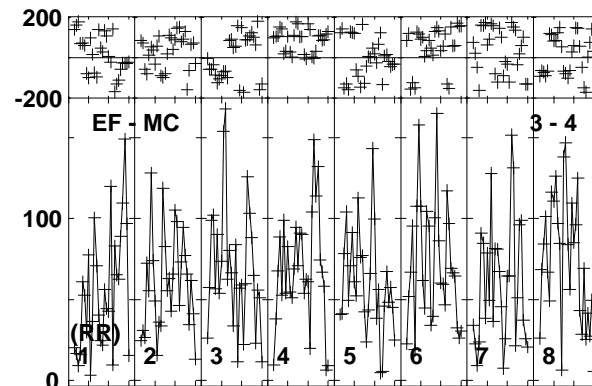
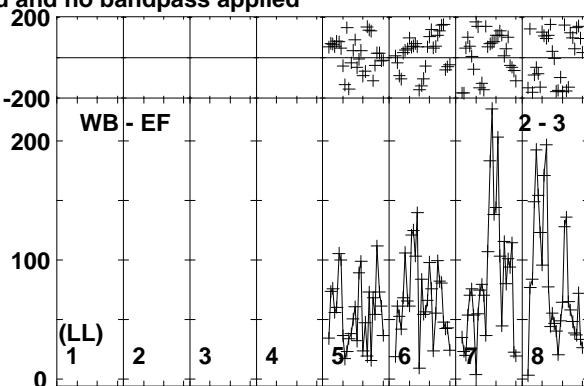
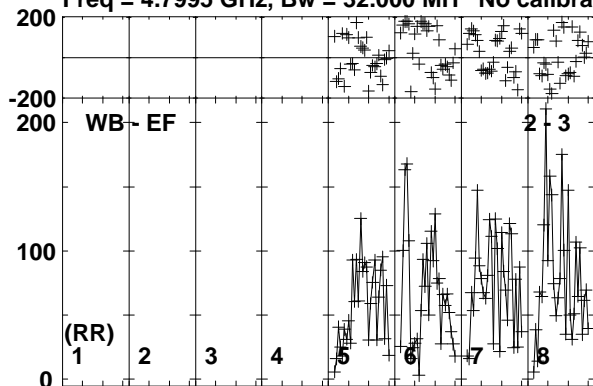

Lower frame: Micro Ampl Jy Top frame: Phas deg
Vector averaged cross-power spectrum Baseline: WB (02) - EF (03)
Timerange: 00/14:16:04 to 00/14:18:08

Plot file version 62 created 03-APR-2017 18:27:38

M22-VLA1 EM126B.UVDATA.1

Freq = 4.7995 GHz, Bw = 32.000 MH No calibration applied and no bandpass applied

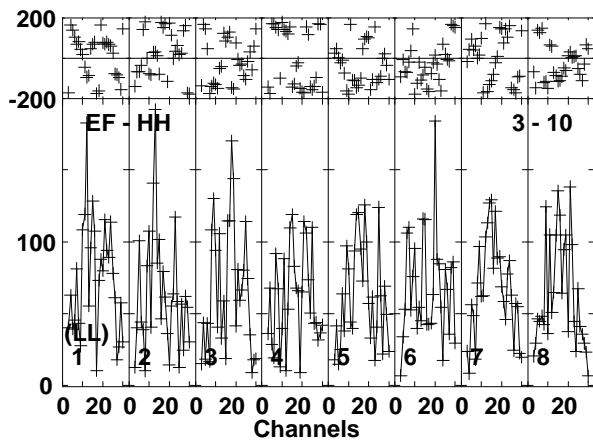
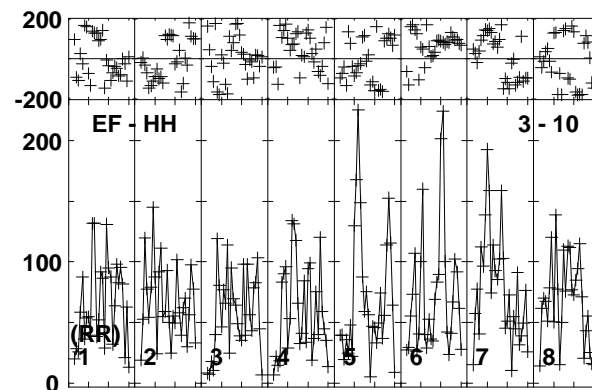
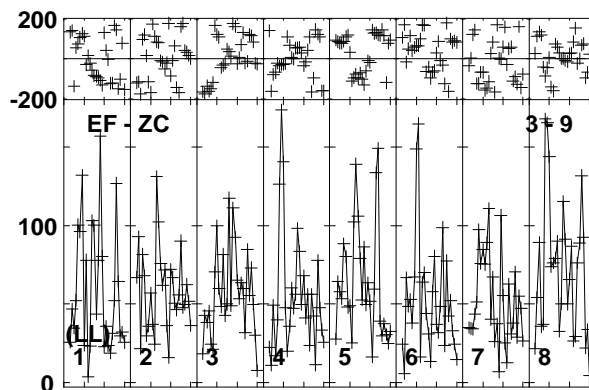
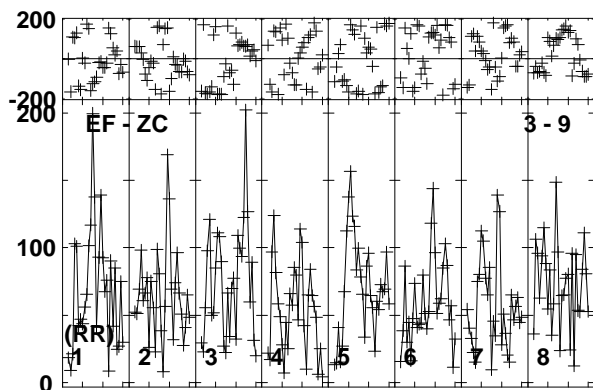
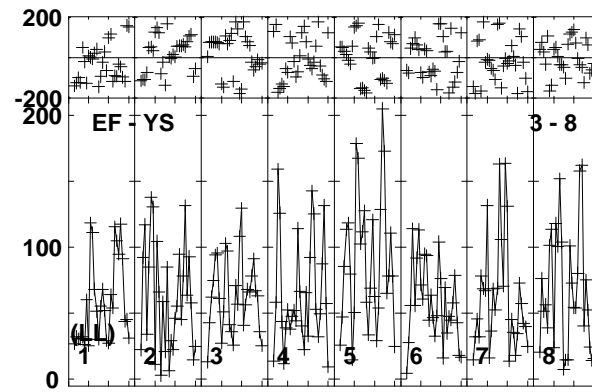
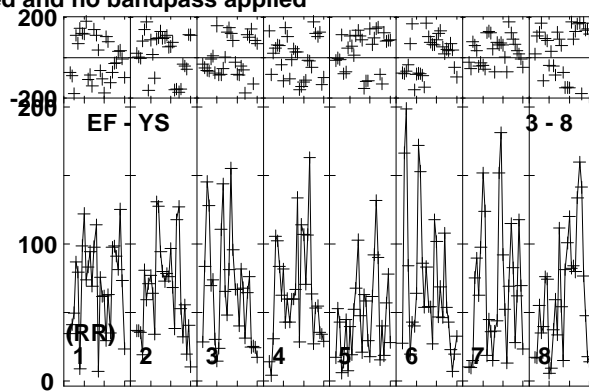
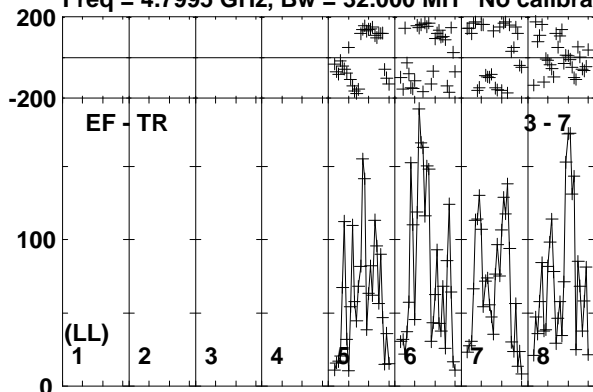

Lower frame: Micro Ampl Jy Top frame: Phas deg
Vector averaged cross-power spectrum Baseline: EF (03) - TR (07)
Timerange: 00/14:16:04 to 00/14:18:08

Plot file version 63 created 03-APR-2017 18:27:38

J1834-2341 EM126B.UVDATA.1

Freq = 4.7995 GHz, Bw = 32.000 MH No calibration applied and no bandpass applied

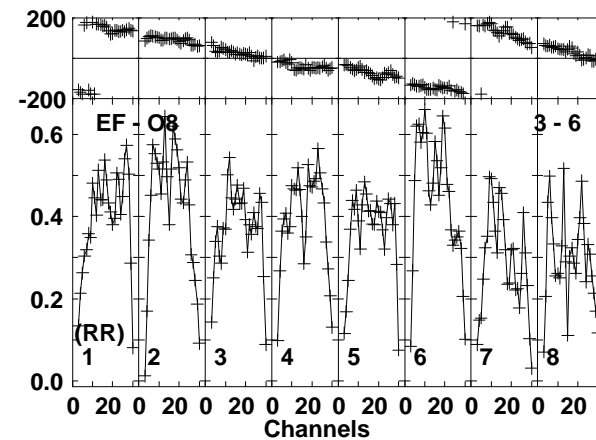
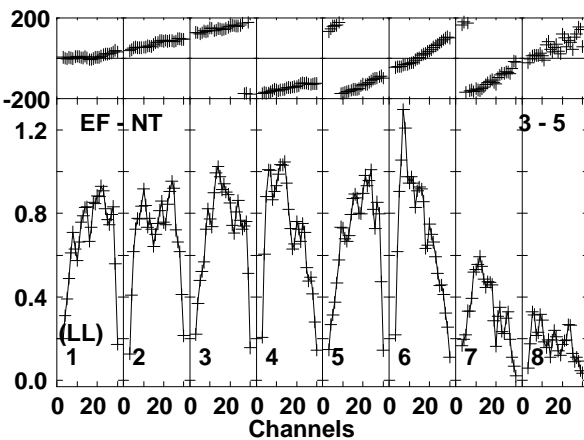
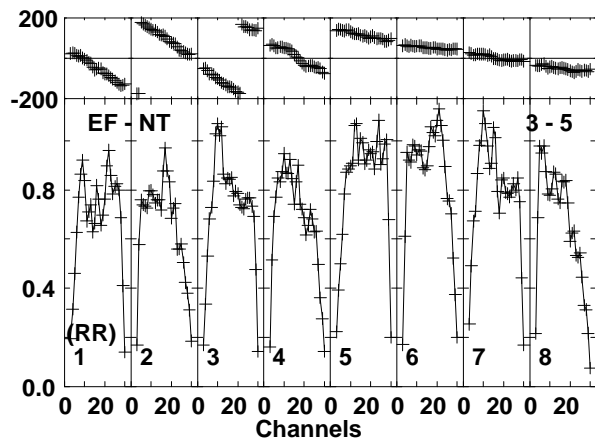
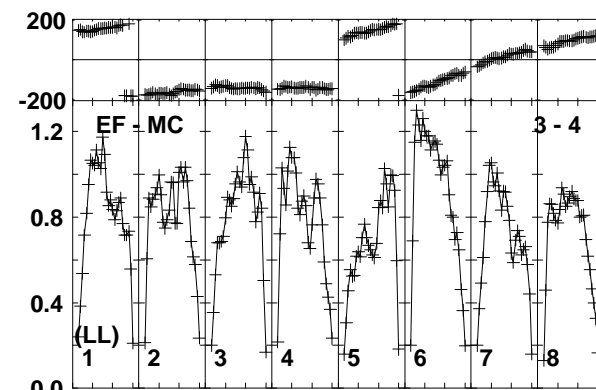
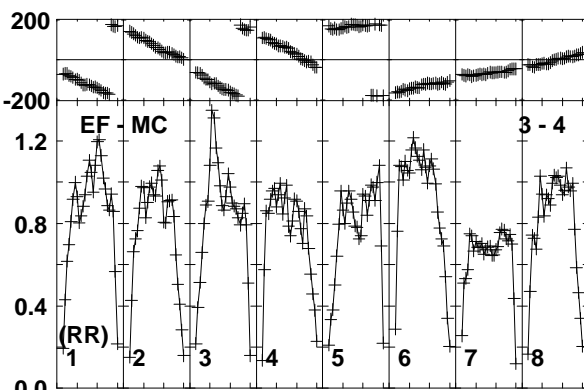
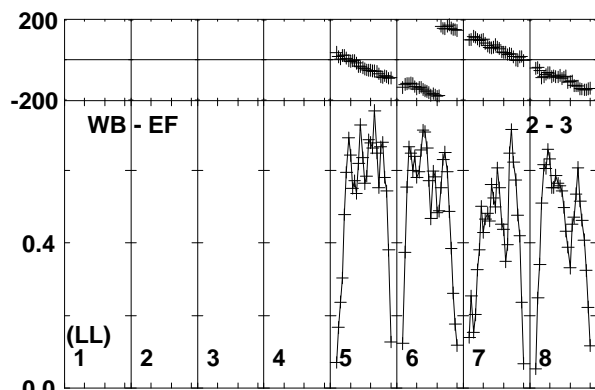
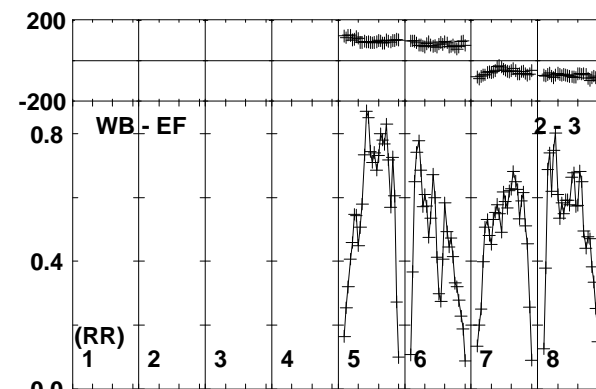
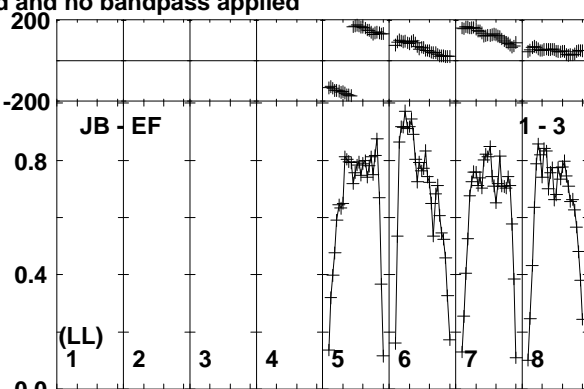
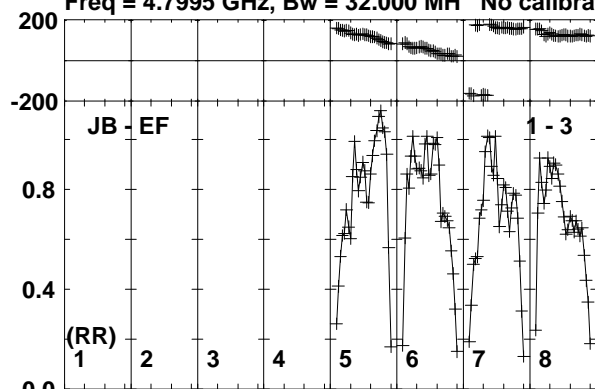

Lower frame: Milli Ampl Jy Top frame: Phas deg
Vector averaged cross-power spectrum Baseline: JB (01) - EF (03)
Timerange: 00/14:18:14 to 00/14:19:28

Plot file version 64 created 03-APR-2017 18:27:38

J1834-2341 EM126B.UVDATA.1

Freq = 4.7995 GHz, Bw = 32.000 MH No calibration applied and no bandpass applied

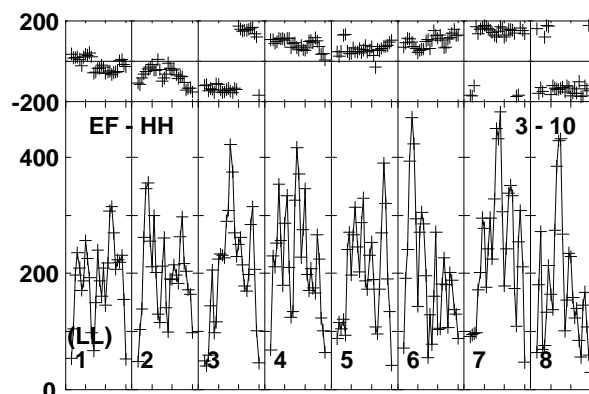
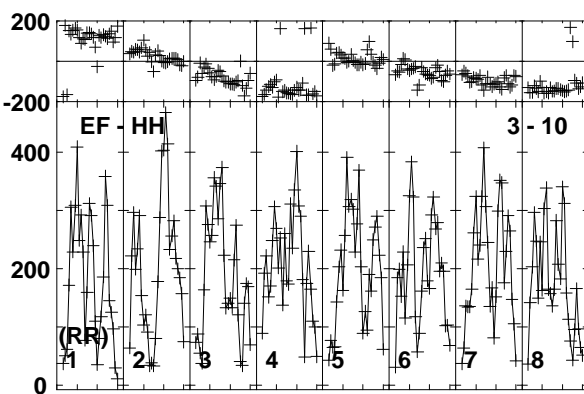
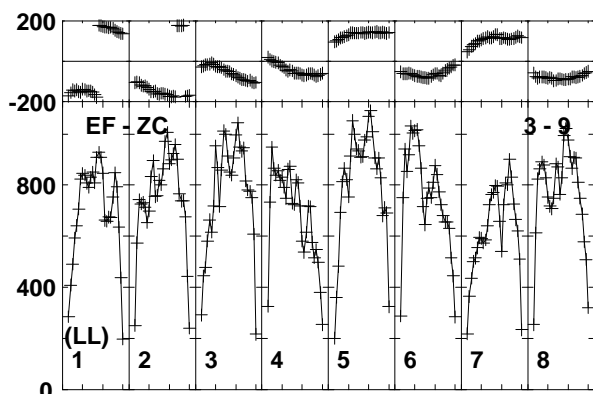
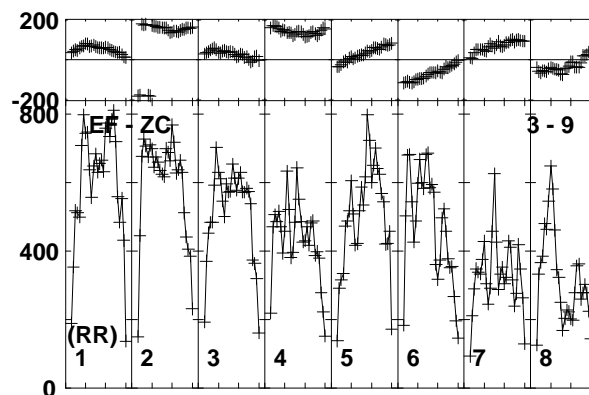
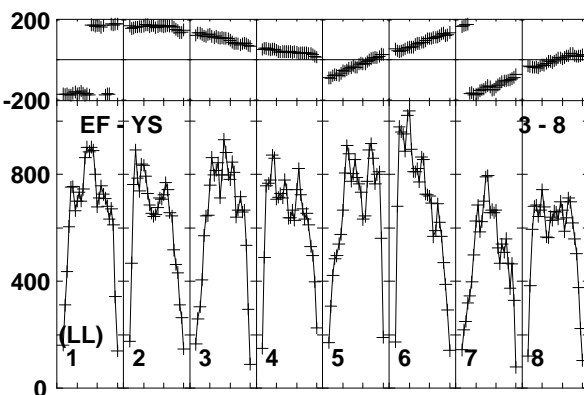
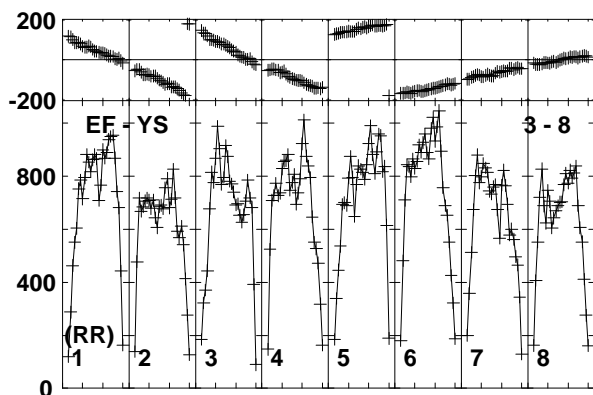
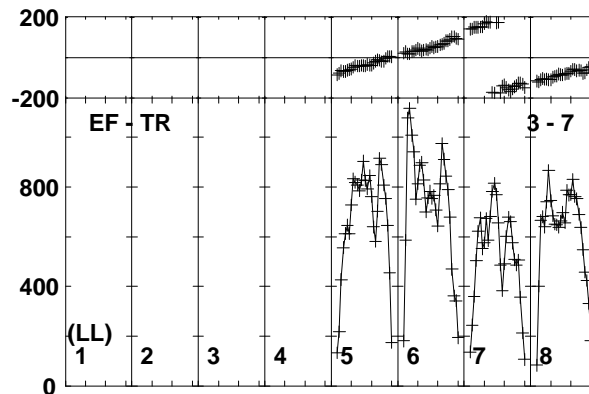
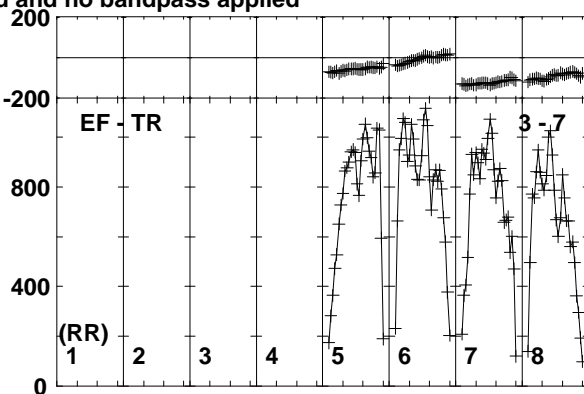
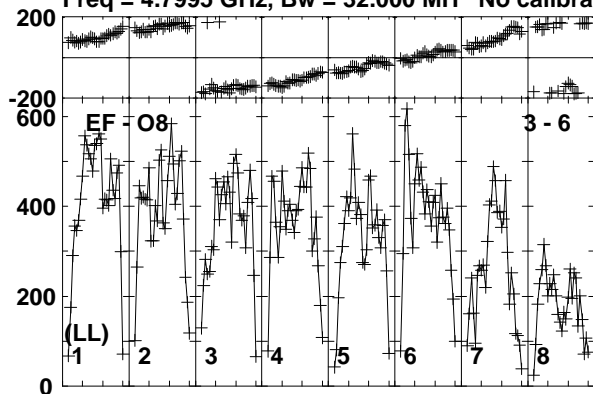

Lower frame: Micro Ampl Jy Top frame: Phas deg
Vector averaged cross-power spectrum Baseline: EF (03) - O8 (06)
Timerange: 00/14:18:14 to 00/14:19:28

Plot file version 65 created 03-APR-2017 18:27:38

M22-VLA1 EM126B.UVDATA.1

Freq = 4.7995 GHz, Bw = 32.000 MH No calibration applied and no bandpass applied

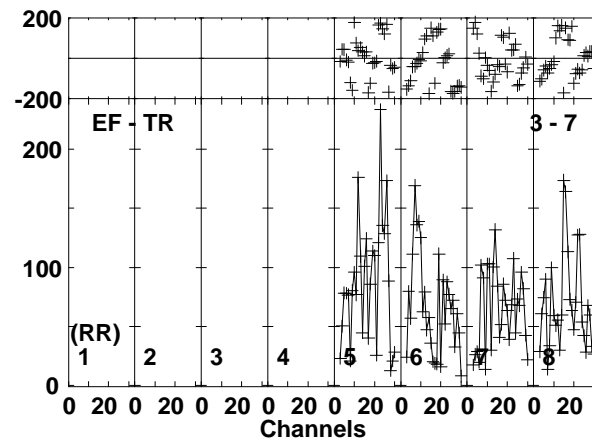
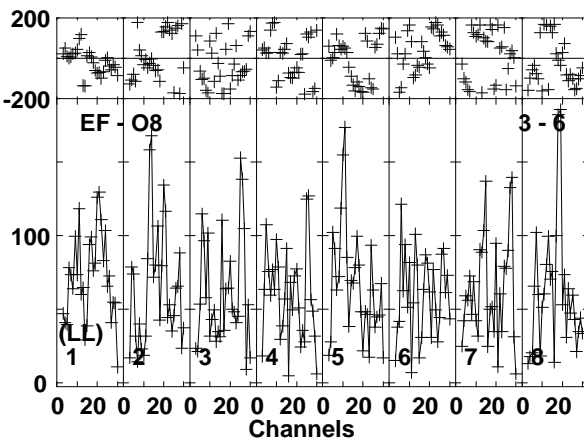
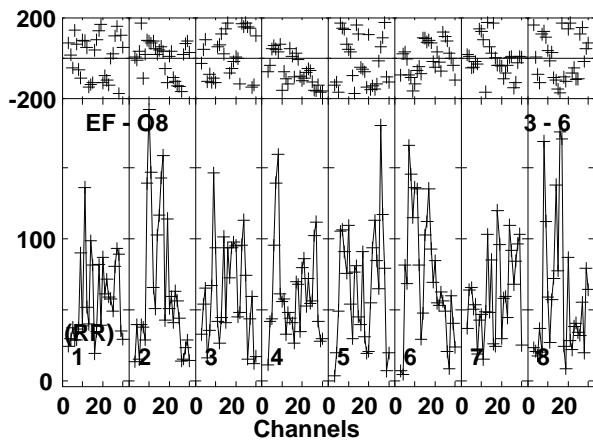
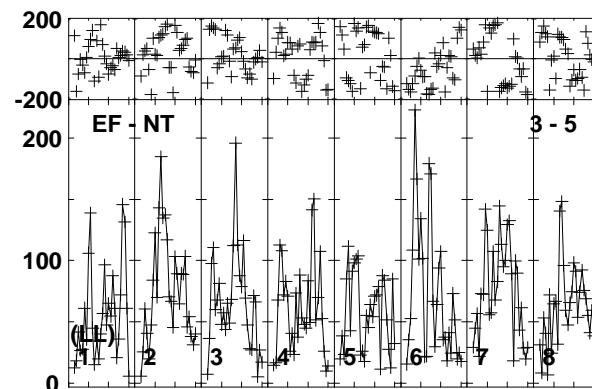
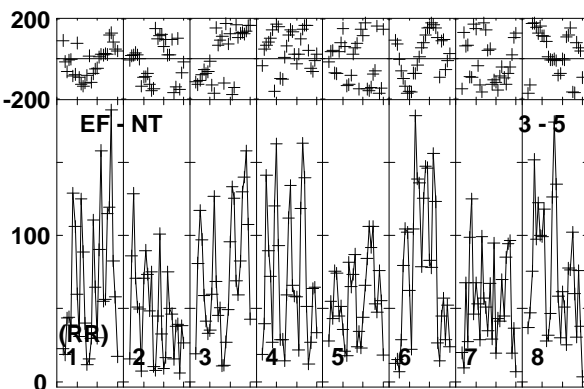
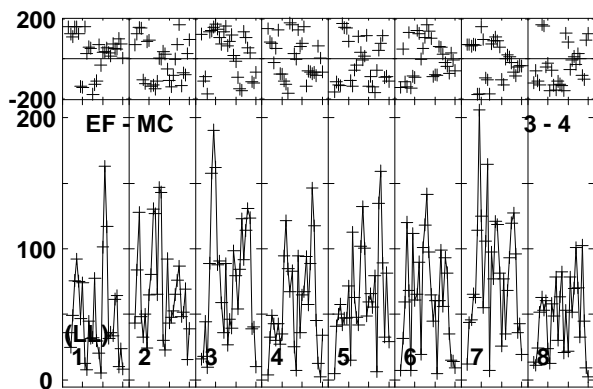
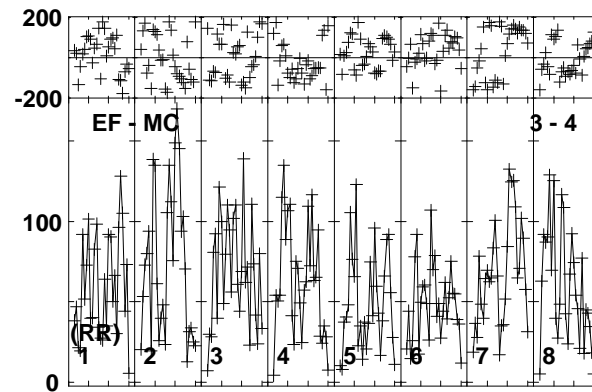
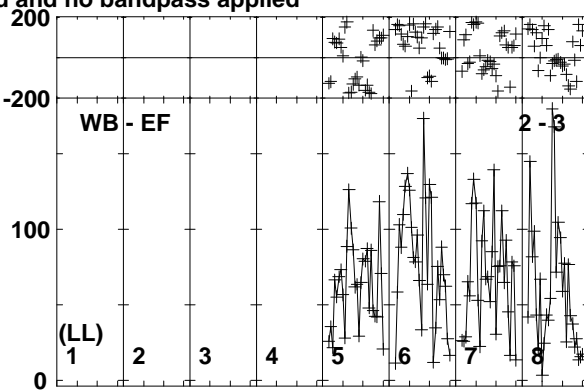
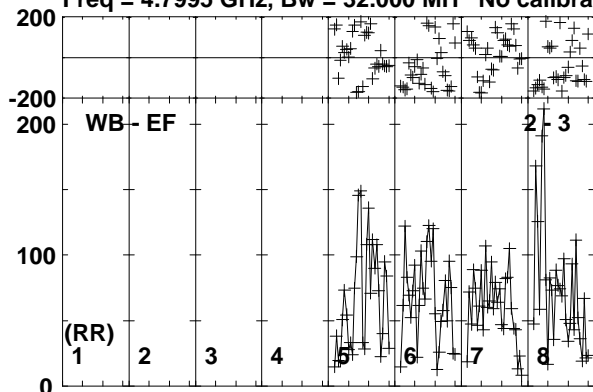

Lower frame: Micro Ampl Jy Top frame: Phas deg
Vector averaged cross-power spectrum Baseline: WB (02) - EF (03)
Timerange: 00/14:19:34 to 00/14:21:38

Plot file version 66 created 03-APR-2017 18:27:38

M22-VLA1 EM126B.UVDATA.1

Freq = 4.7995 GHz, Bw = 32.000 MH No calibration applied and no bandpass applied

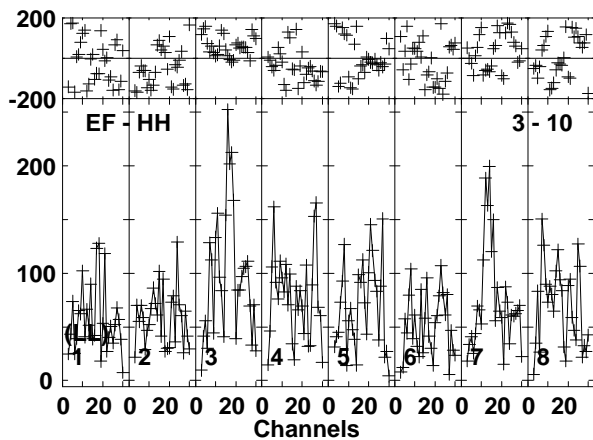
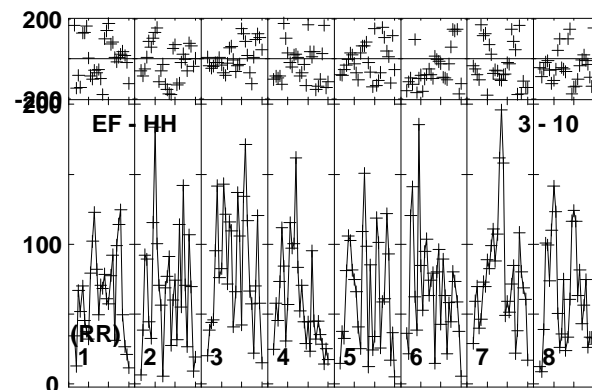
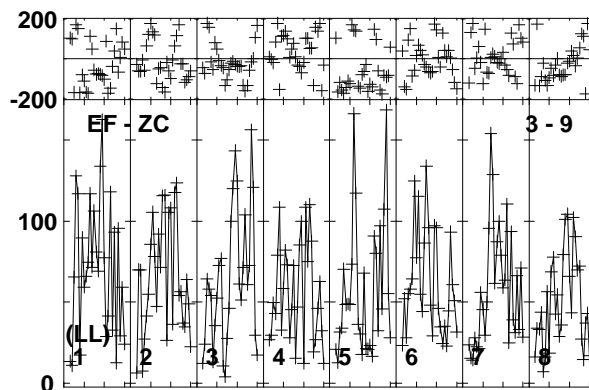
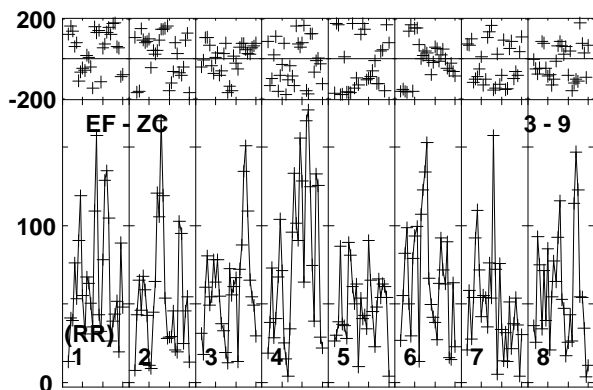
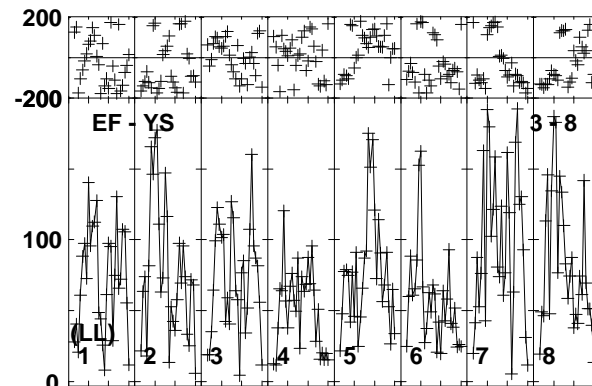
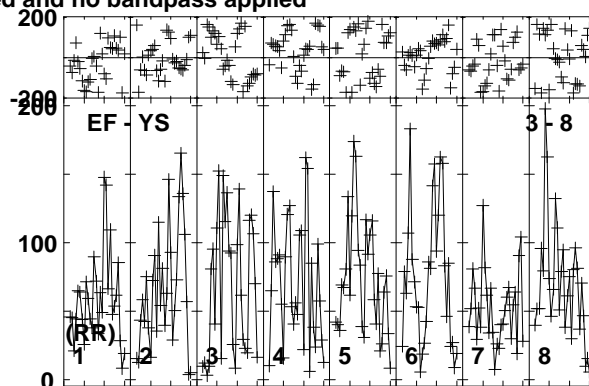
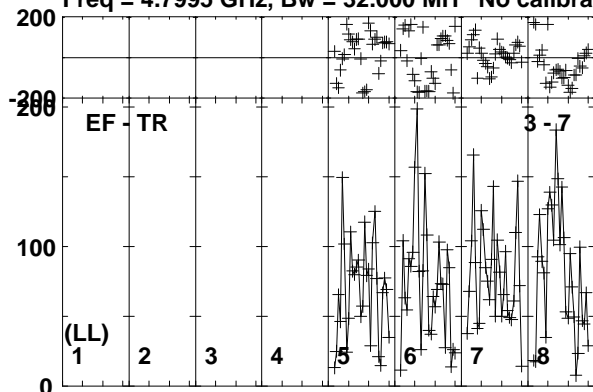

Lower frame: Micro Ampl Jy Top frame: Phas deg
Vector averaged cross-power spectrum Baseline: EF (03) - TR (07)
Timerange: 00/14:19:34 to 00/14:21:38

Plot file version 67 created 03-APR-2017 18:27:38

J1834-2341 EM126B.UVDATA.1

Freq = 4.7995 GHz, Bw = 32.000 MH No calibration applied and no bandpass applied

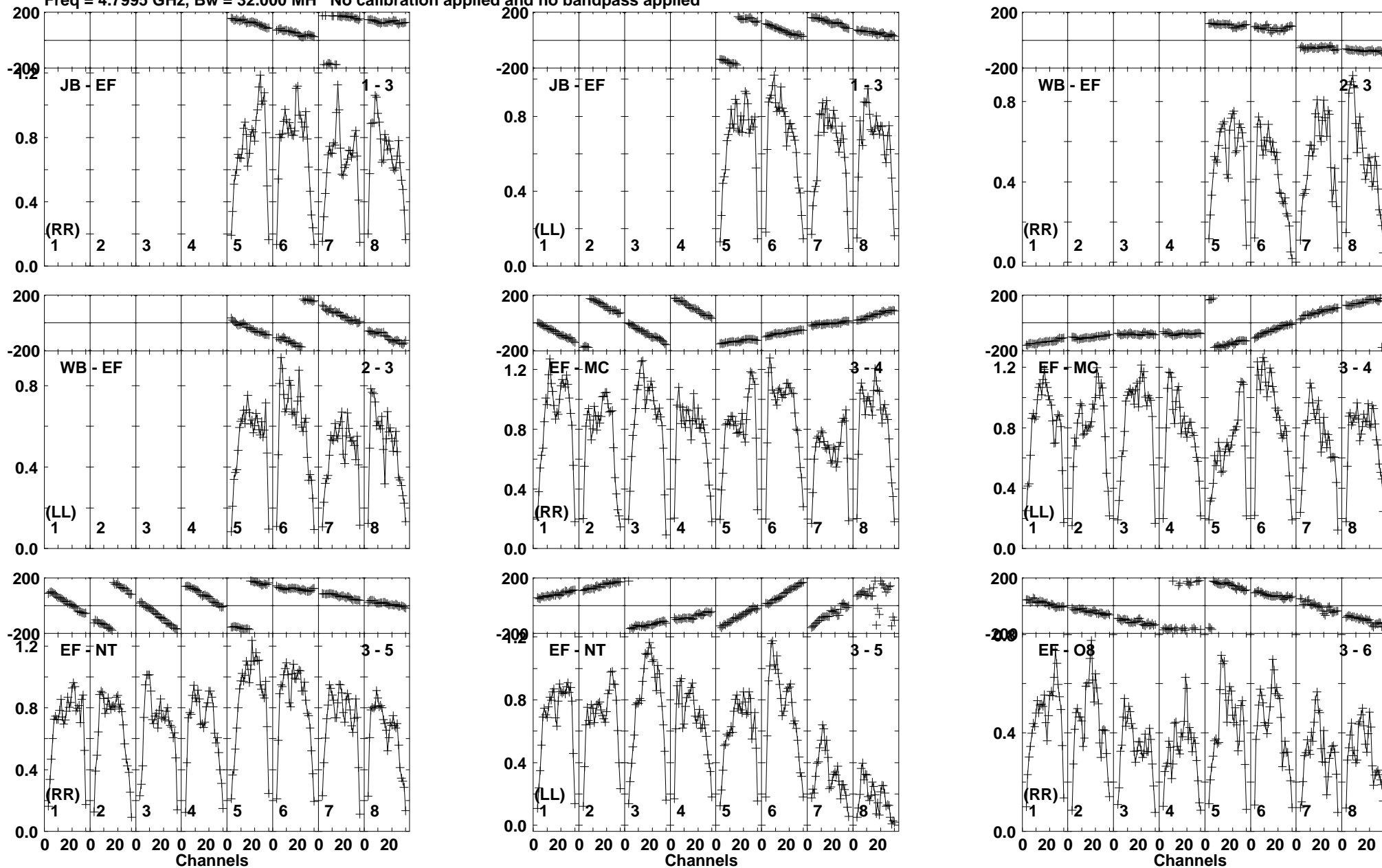

Lower frame: Milli Ampl Jy Top frame: Phas deg
Vector averaged cross-power spectrum Baseline: JB (01) - EF (03)
Timerange: 00/14:22:11 to 00/14:22:59

Plot file version 68 created 03-APR-2017 18:27:38

J1834-2341 EM126B.UVDATA.1

Freq = 4.7995 GHz, Bw = 32.000 MH No calibration applied and no bandpass applied

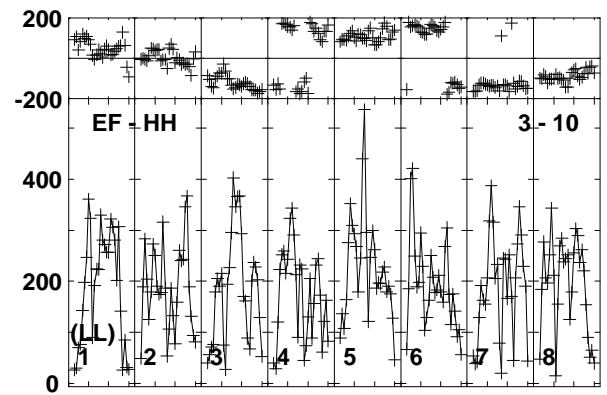
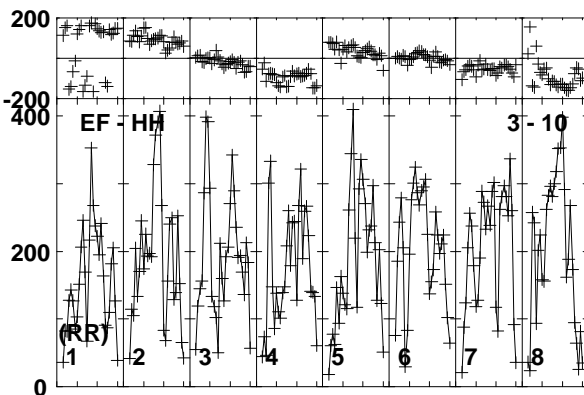
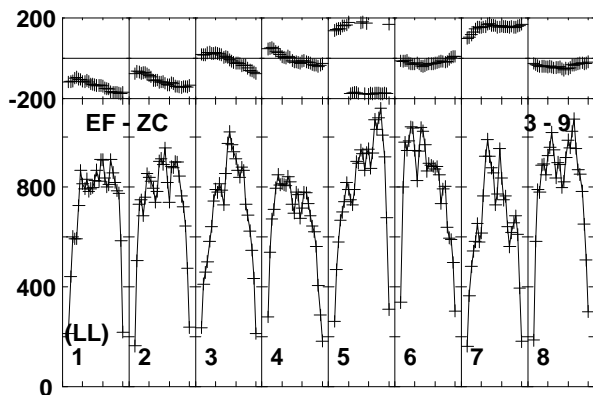
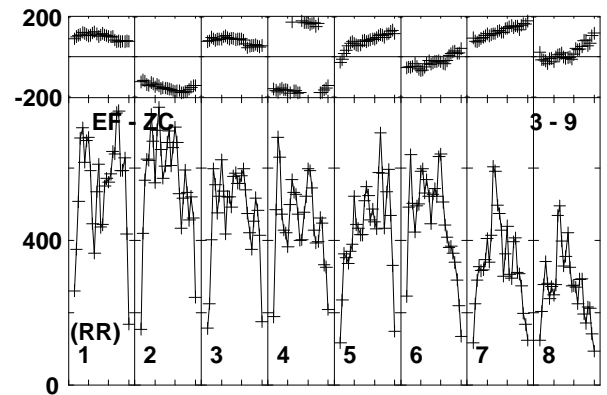
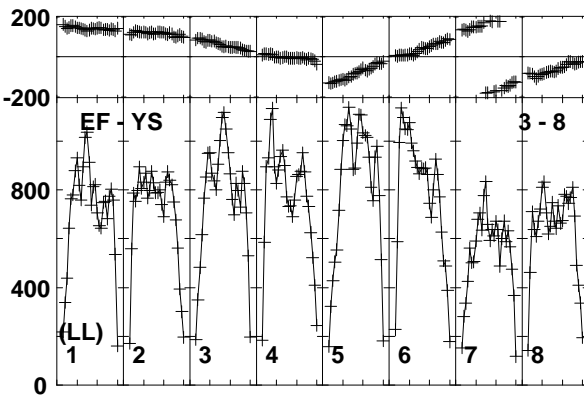
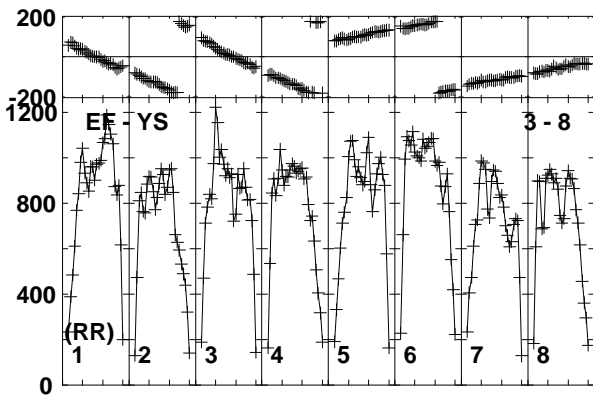
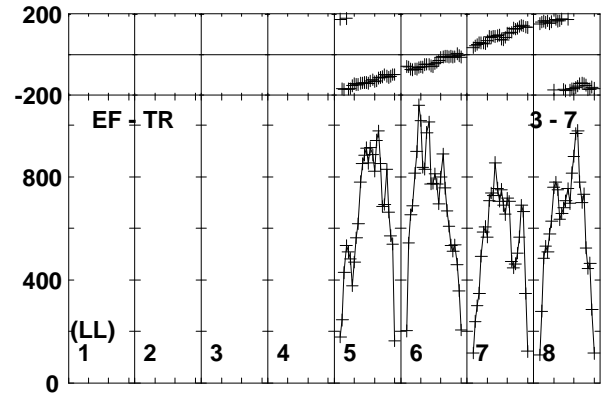
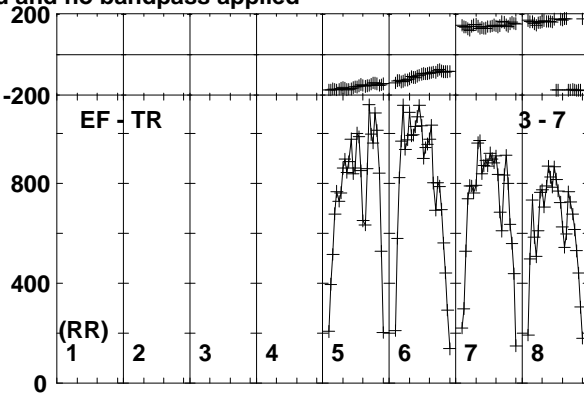
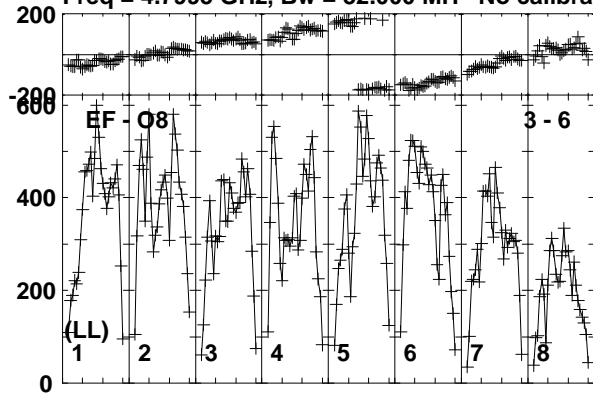

Lower frame: Micro Ampl Jy Top frame: Phas deg
Vector averaged cross-power spectrum Baseline: EF (03) - O8 (06)
Timerange: 00/14:22:11 to 00/14:22:59

Plot file version 69 created 03-APR-2017 18:27:38

M22-VLA1 EM126B.UVDATA.1

Freq = 4.7995 GHz, Bw = 32.000 MH No calibration applied and no bandpass applied

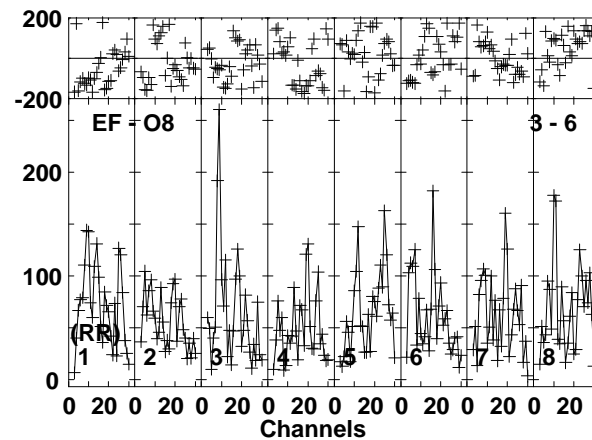
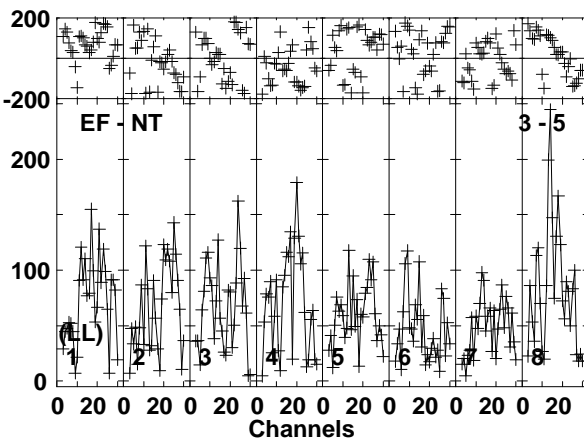
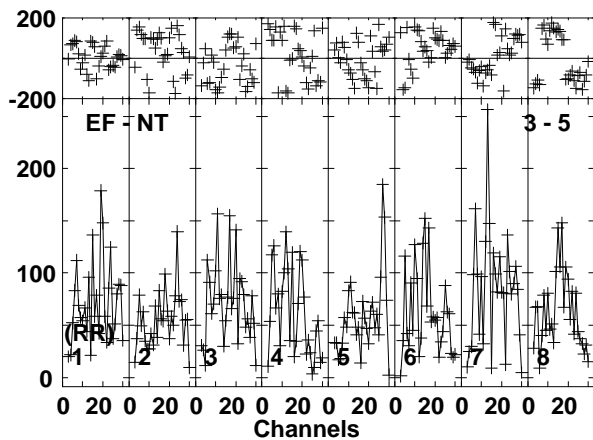
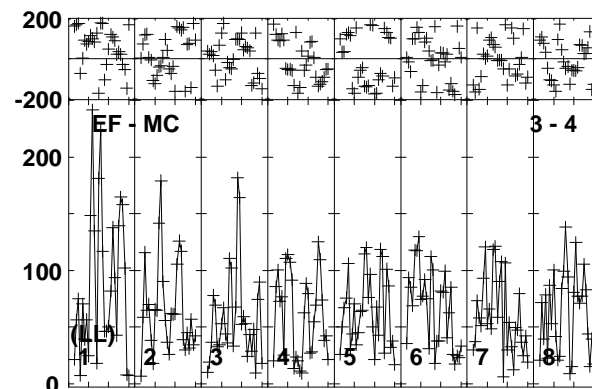
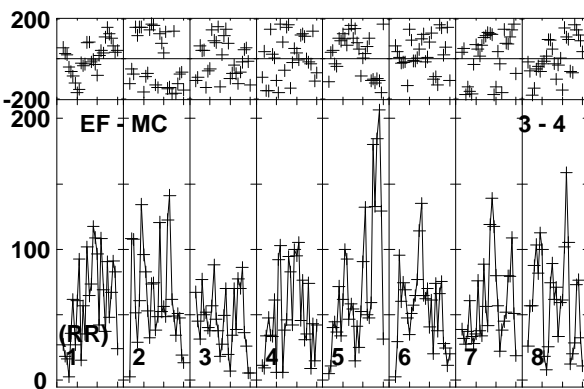
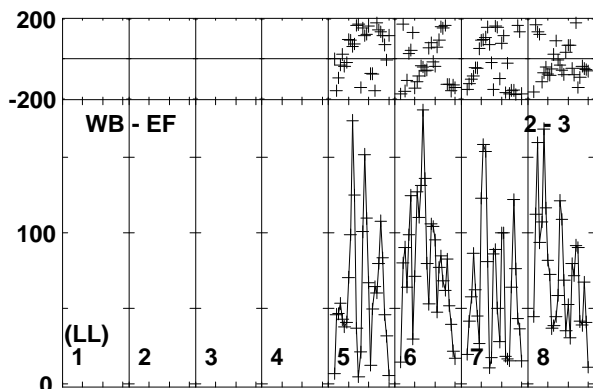
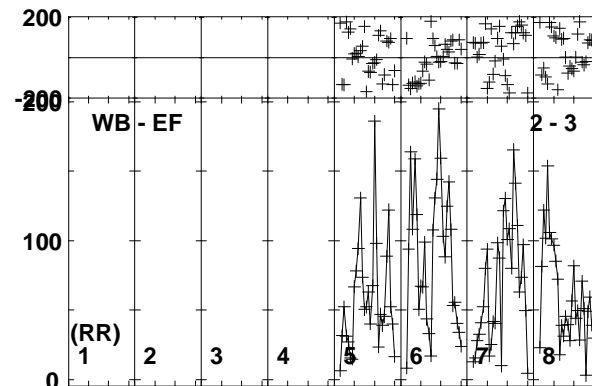
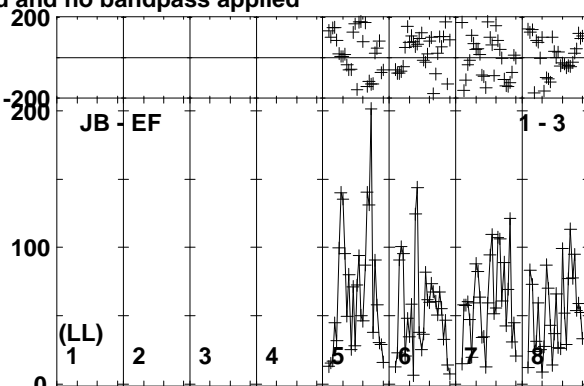
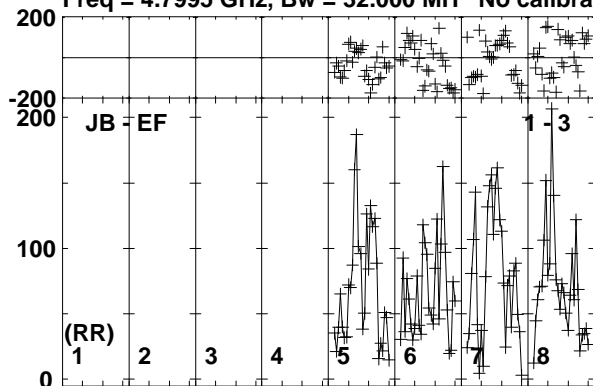

Lower frame: Micro Ampl Jy Top frame: Phas deg
Vector averaged cross-power spectrum Baseline: JB (01) - EF (03)
Timerange: 00/14:23:04 to 00/14:25:08

Plot file version 70 created 03-APR-2017 18:27:38

M22-VLA1 EM126B.UVDATA.1

Freq = 4.7995 GHz, Bw = 32.000 MH No calibration applied and no bandpass applied

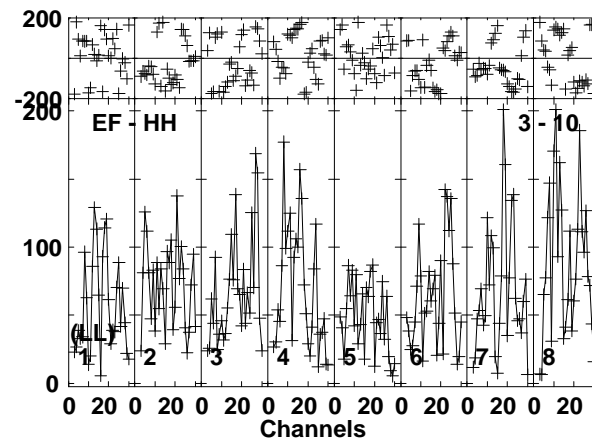
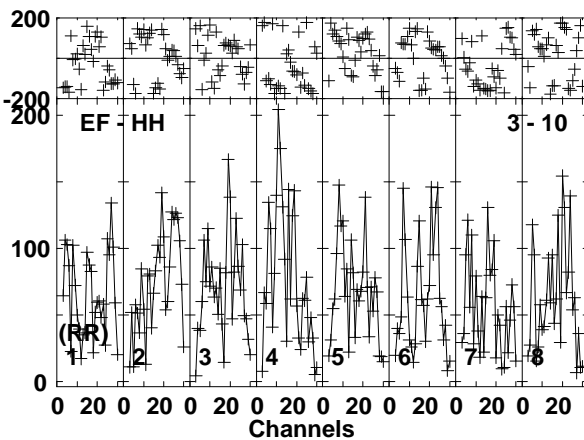
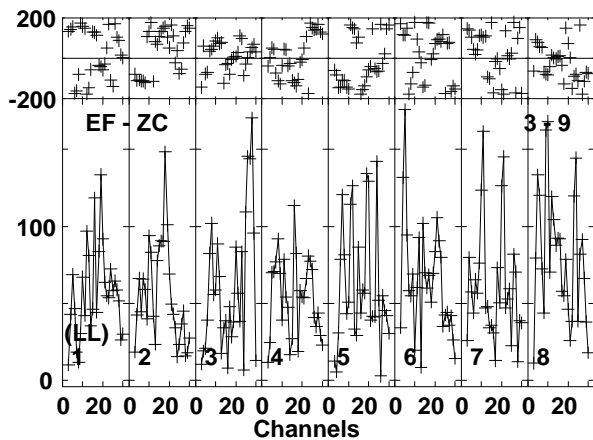
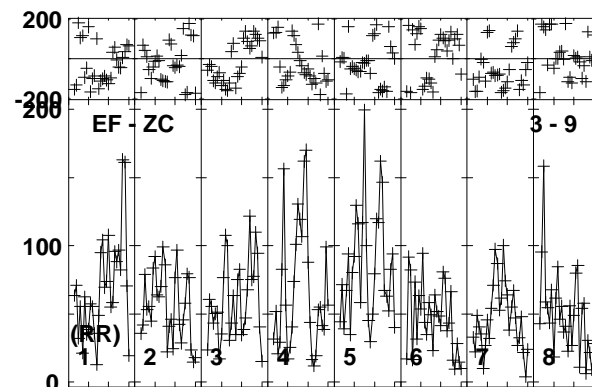
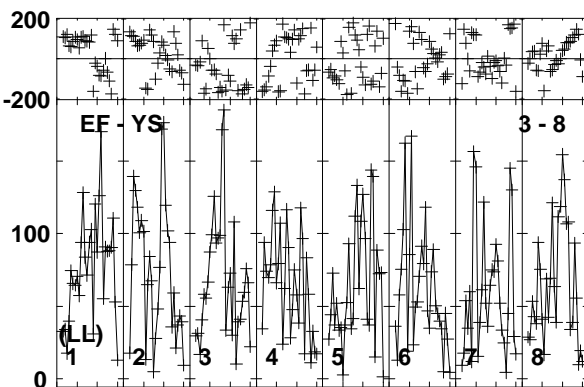
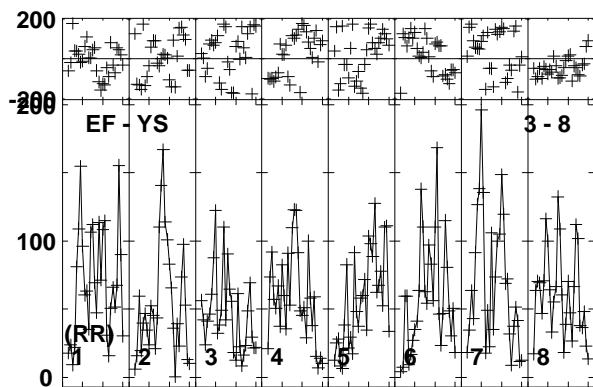
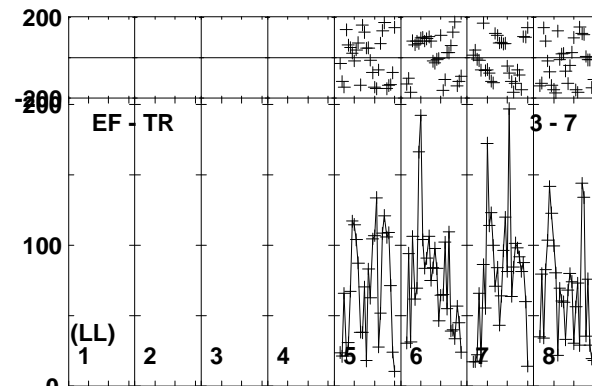
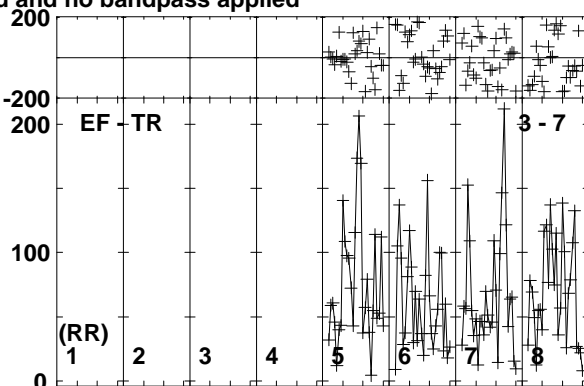
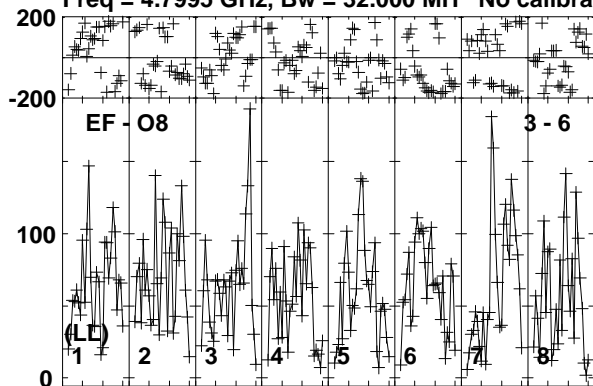

Lower frame: Micro Ampl Jy Top frame: Phas deg
Vector averaged cross-power spectrum Baseline: EF (03) - O8 (06)
Timerange: 00/14:23:04 to 00/14:25:08

Plot file version 71 created 03-APR-2017 18:27:38

J1834-2341 EM126B.UVDATA.1

Freq = 4.7995 GHz, Bw = 32.000 MH No calibration applied and no bandpass applied

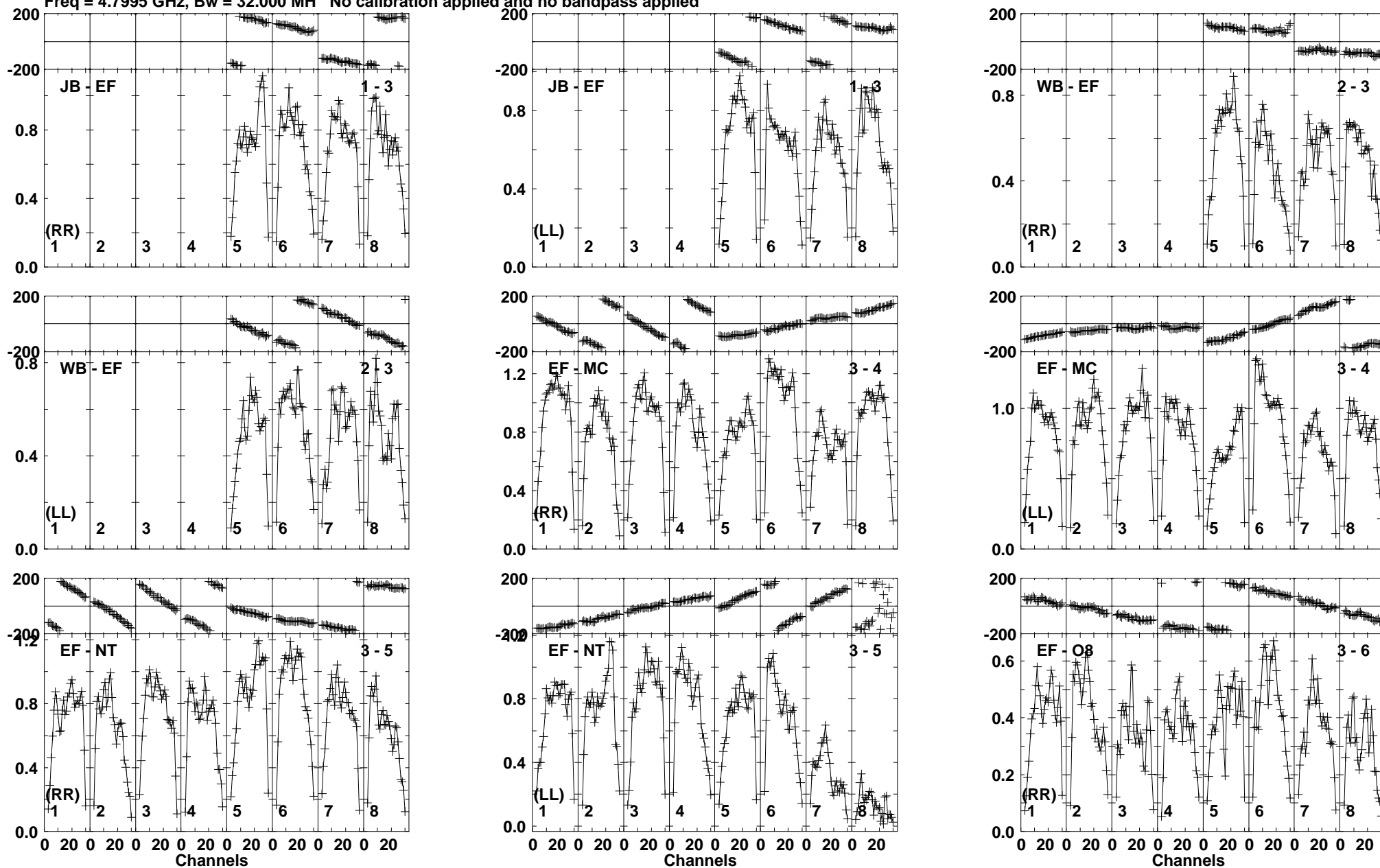

Lower frame: Milli Ampl Jy Top frame: Phas deg
Vector averaged cross-power spectrum Baseline: JB (01) - EF (03)
Timerange: 00/14:25:14 to 00/14:26:28

Plot file version 72 created 03-APR-2017 18:27:38

J1834-2341 EM126B.UVDATA.1

Freq = 4.7995 GHz, Bw = 32.000 MH No calibration applied and no bandpass applied

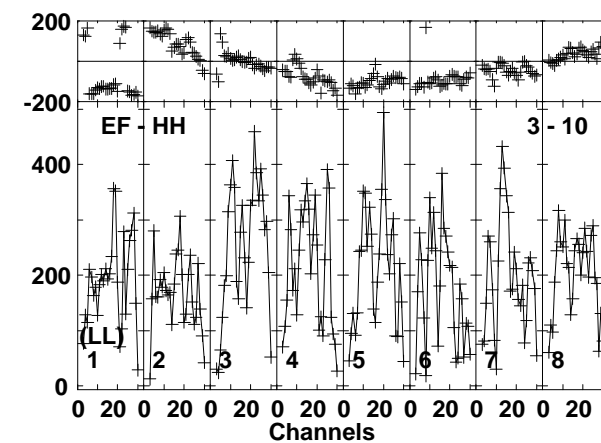
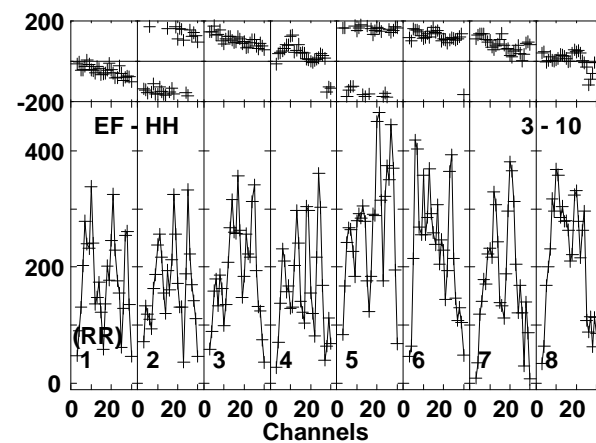
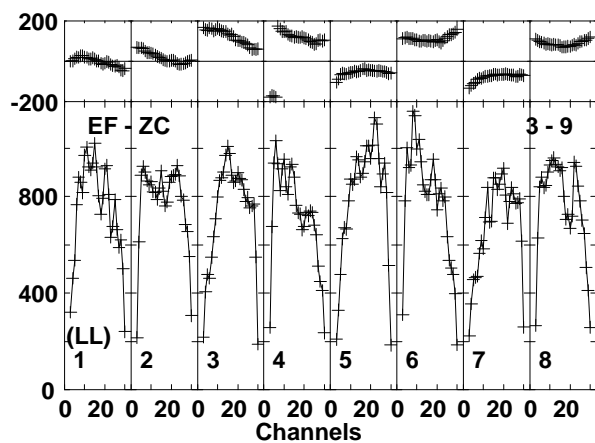
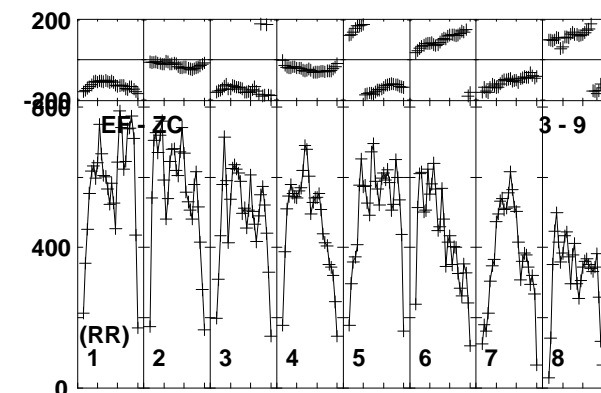
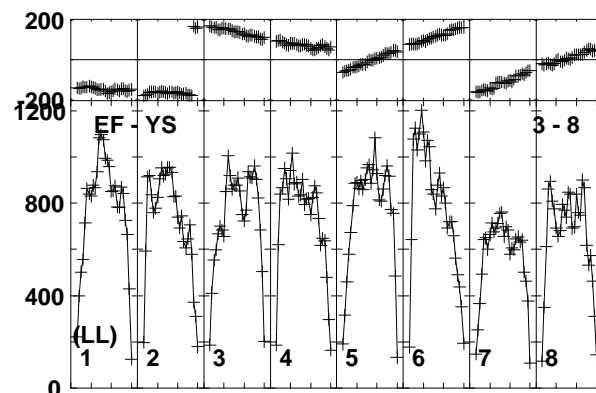
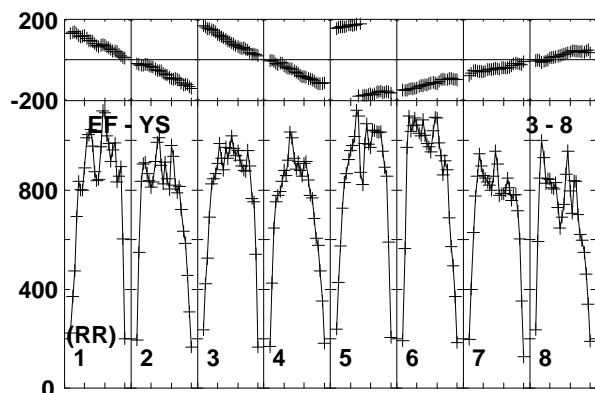
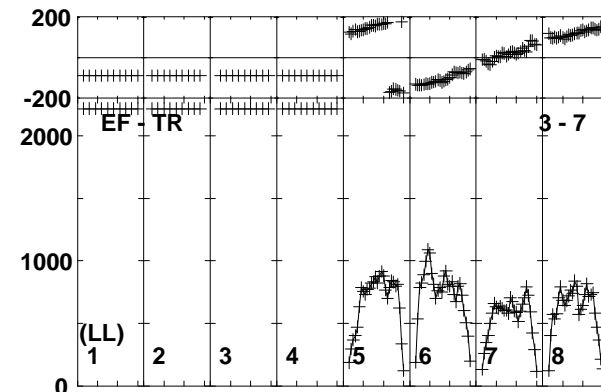
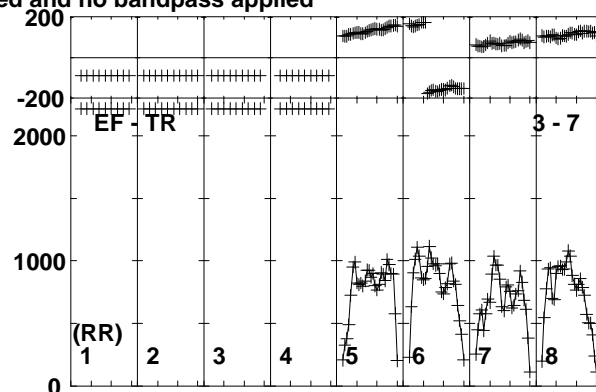
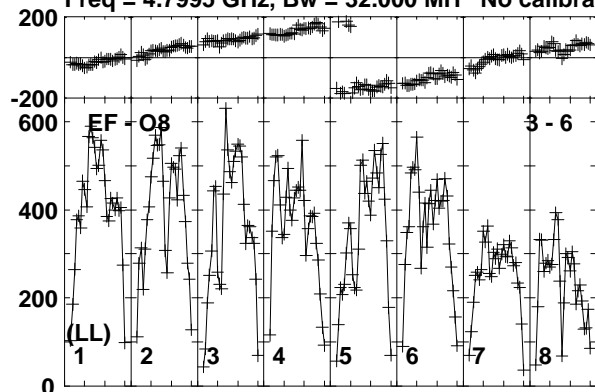

Lower frame: Micro Ampl Jy Top frame: Phas deg
Vector averaged cross-power spectrum Baseline: EF (03) - O8 (06)
Timerange: 00/14:25:14 to 00/14:26:28

Plot file version 73 created 03-APR-2017 18:27:39

M22-VLA1 EM126B.UVDATA.1

Freq = 4.7995 GHz, Bw = 32.000 MH No calibration applied and no bandpass applied

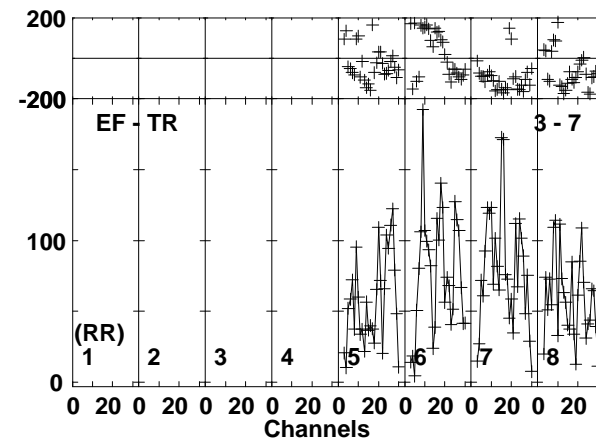
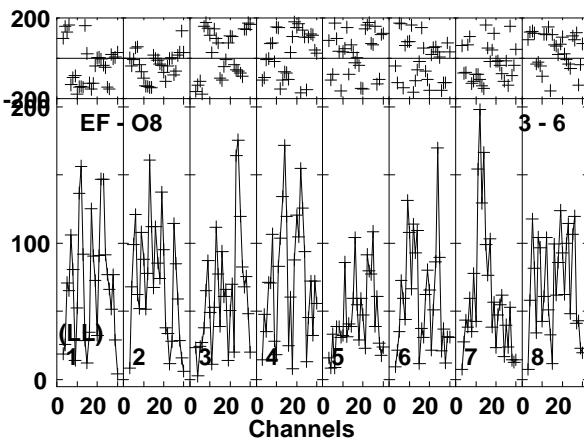
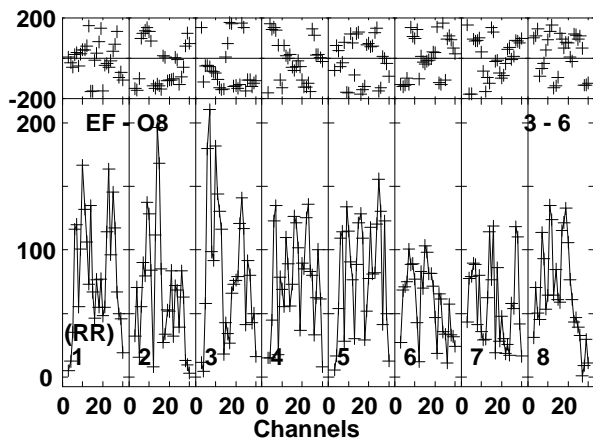
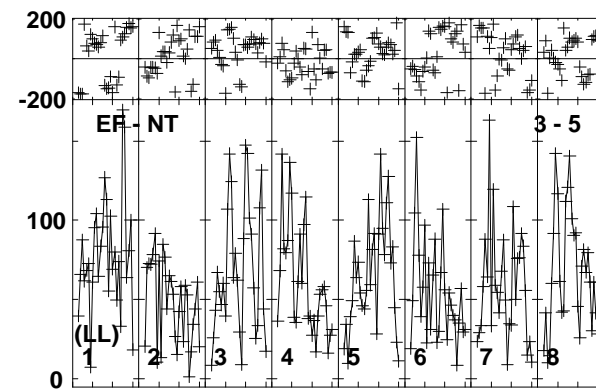
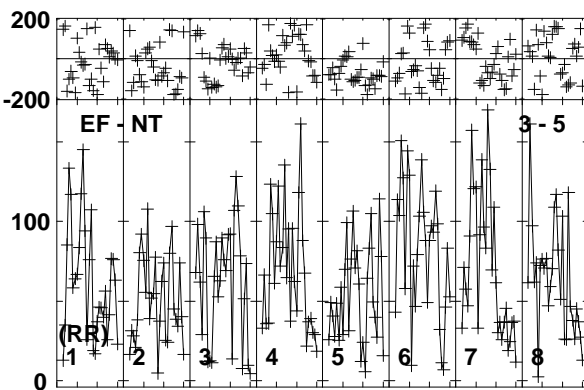
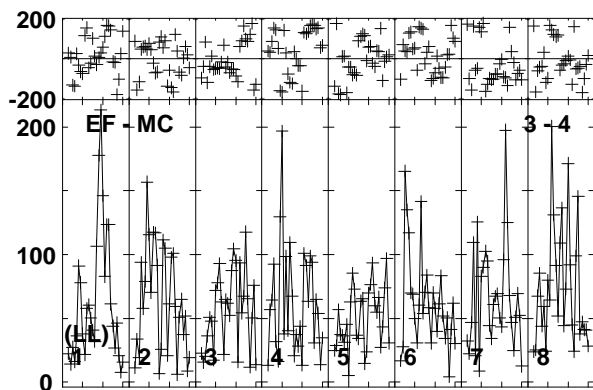
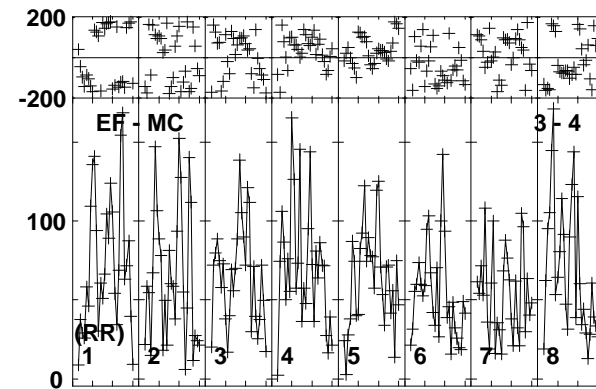
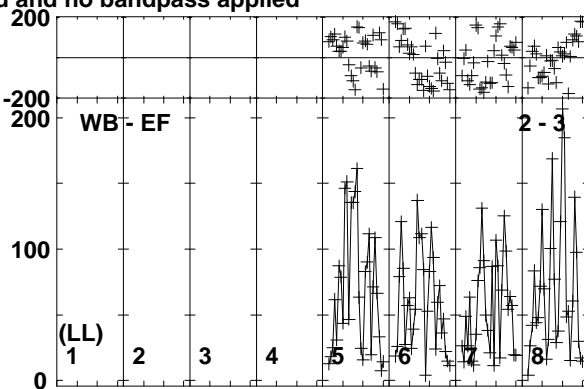
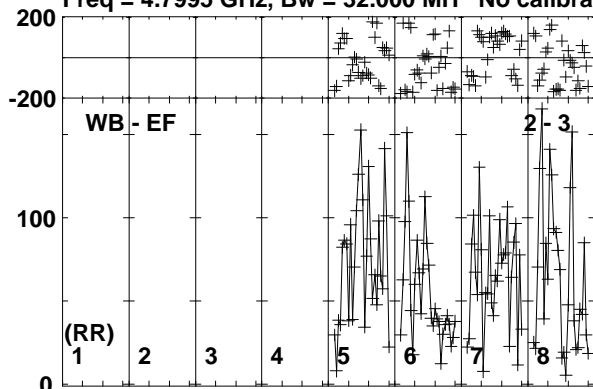

Lower frame: Micro Ampl Jy Top frame: Phas deg
Vector averaged cross-power spectrum Baseline: WB (02) - EF (03)
Timerange: 00/14:26:34 to 00/14:28:38

Plot file version 74 created 03-APR-2017 18:27:39

M22-VLA1 EM126B.UVDATA.1

Freq = 4.7995 GHz, Bw = 32.000 MH No calibration applied and no bandpass applied

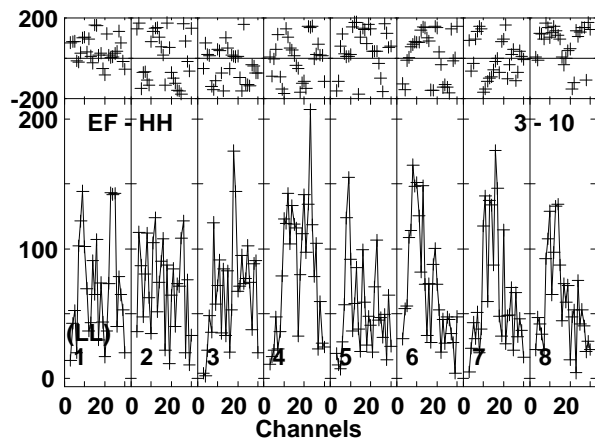
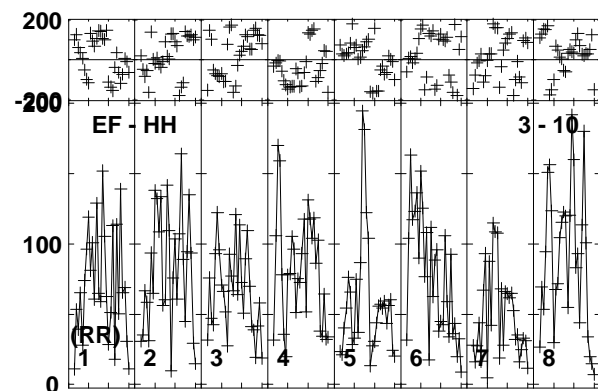
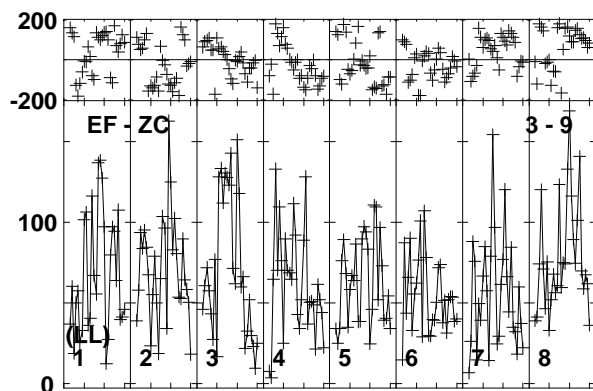
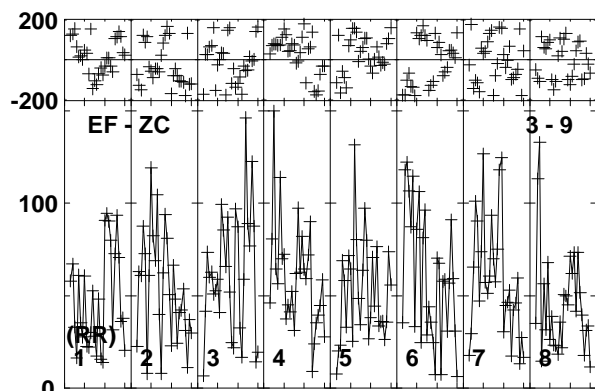
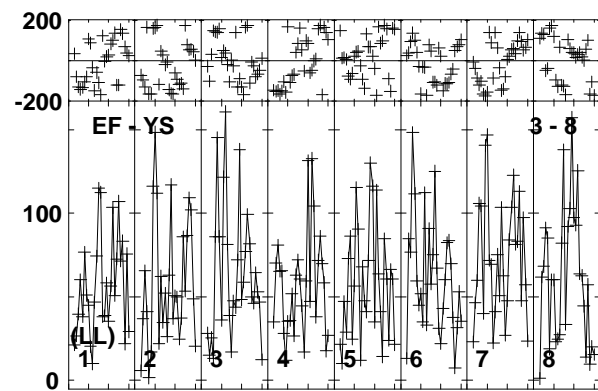
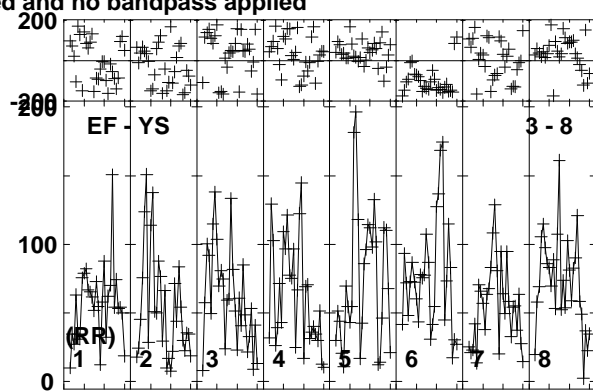
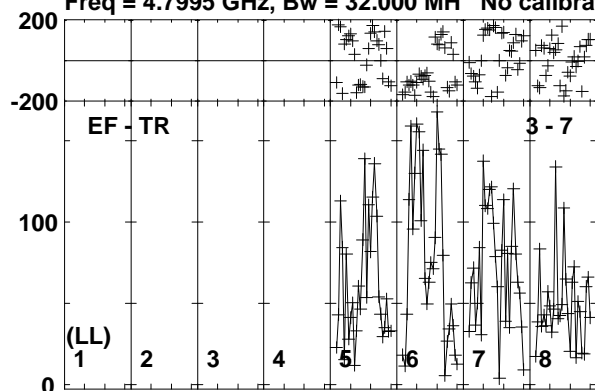

Lower frame: Micro Ampl Jy Top frame: Phas deg
Vector averaged cross-power spectrum Baseline: EF (03) - TR (07)
Timerange: 00/14:26:34 to 00/14:28:38

Plot file version 75 created 03-APR-2017 18:27:39

J1834-2341 EM126B.UVDATA.1

Freq = 4.7995 GHz, Bw = 32.000 MH No calibration applied and no bandpass applied

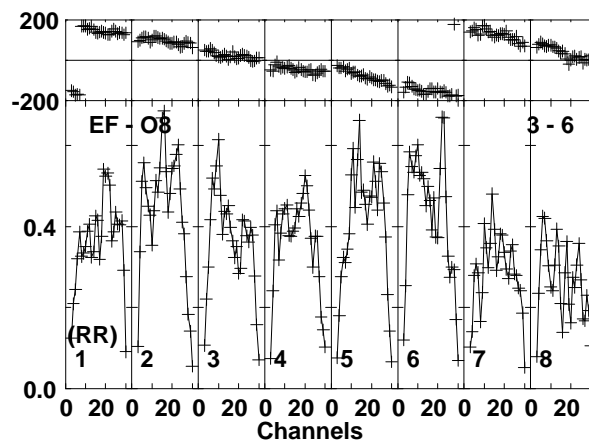
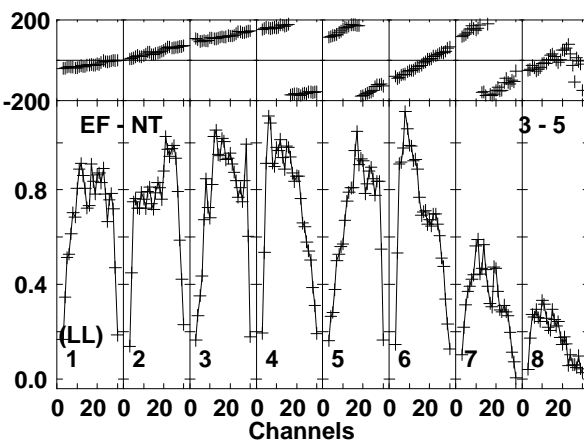
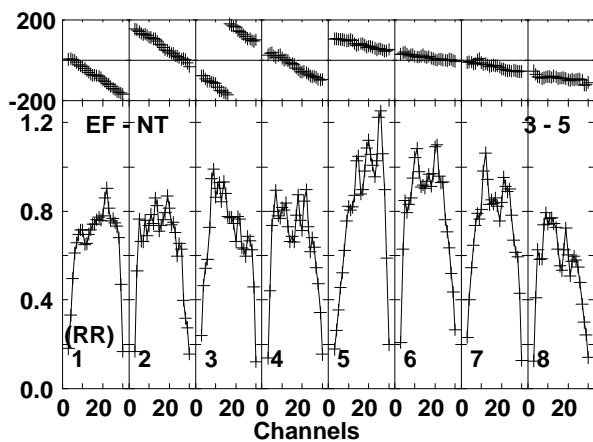
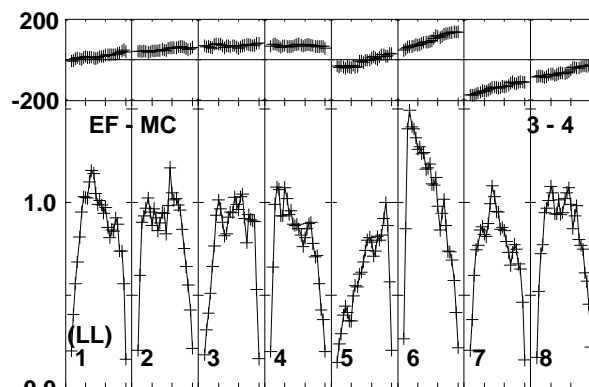
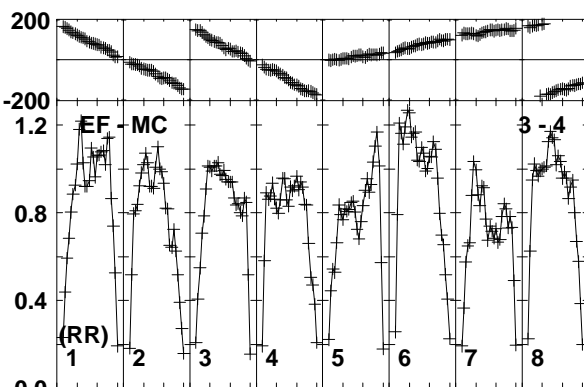
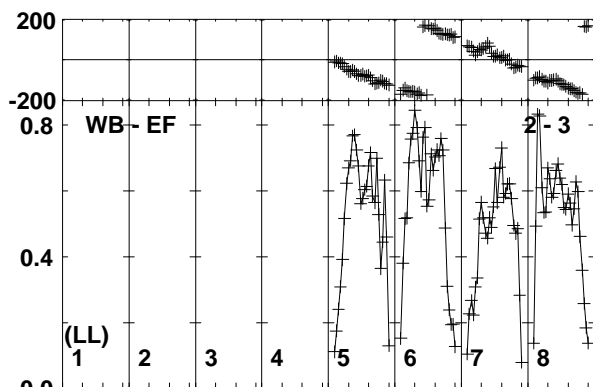
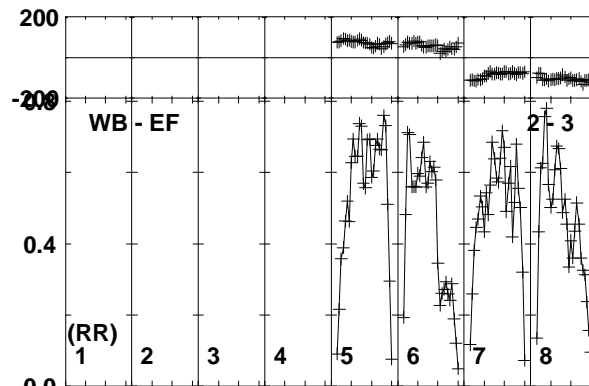
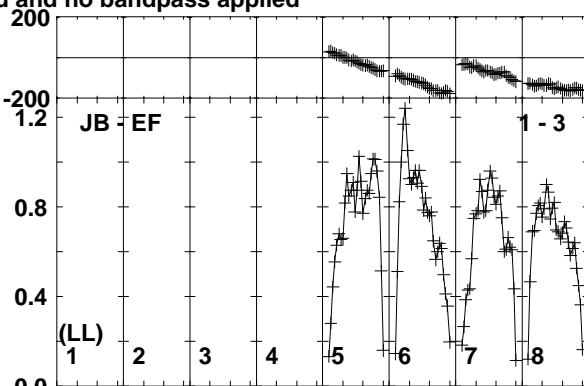
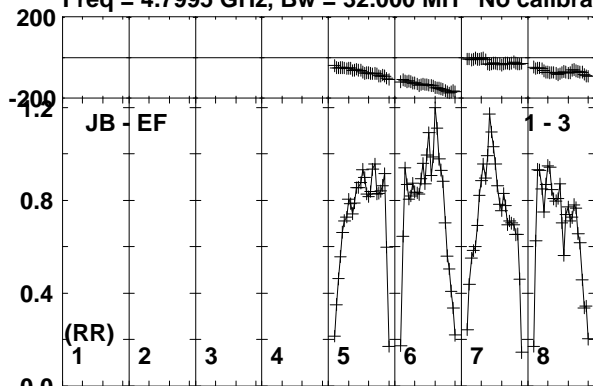

Lower frame: Milli Ampl Jy Top frame: Phas deg
Vector averaged cross-power spectrum Baseline: JB (01) - EF (03)
Timerange: 00/14:28:44 to 00/14:29:58

Plot file version 76 created 03-APR-2017 18:27:39

J1834-2341 EM126B.UVDATA.1

Freq = 4.7995 GHz, Bw = 32.000 MH No calibration applied and no bandpass applied

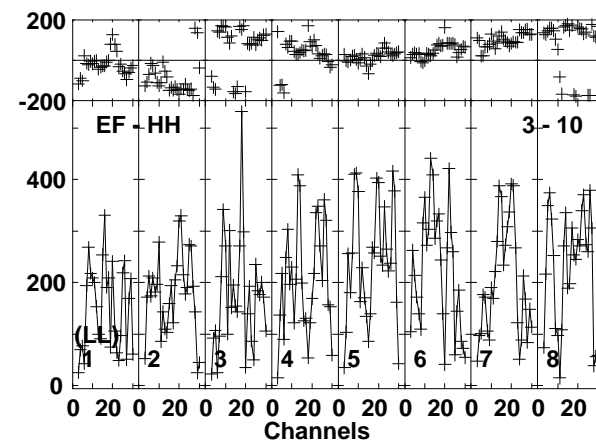
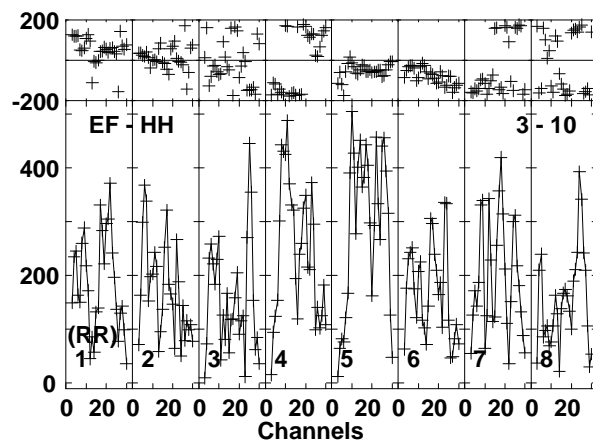
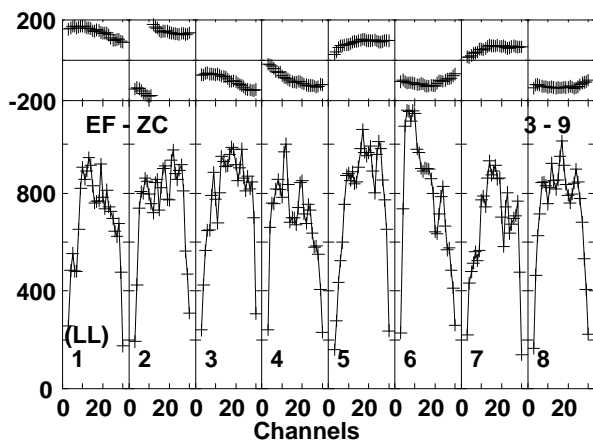
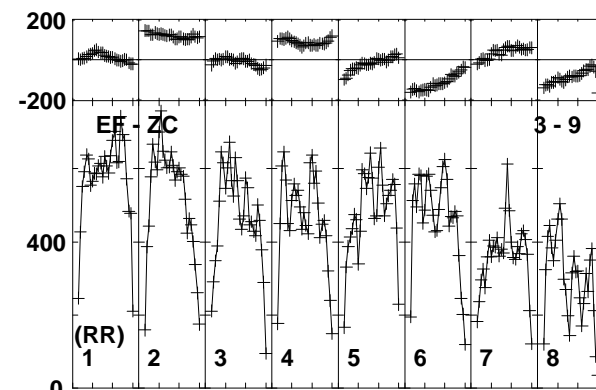
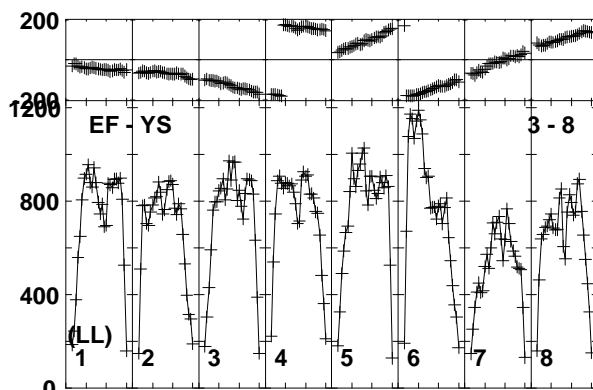
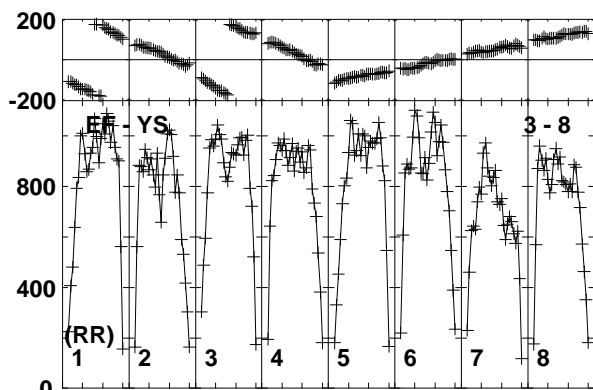
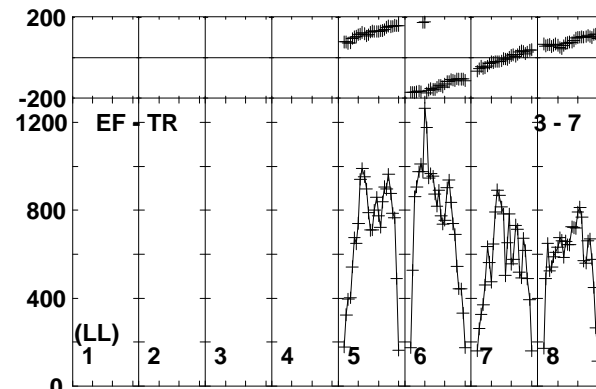
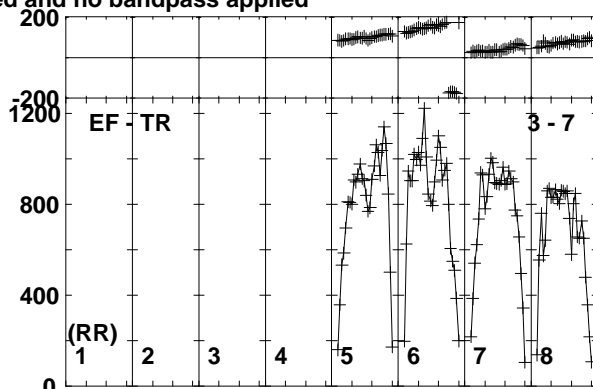
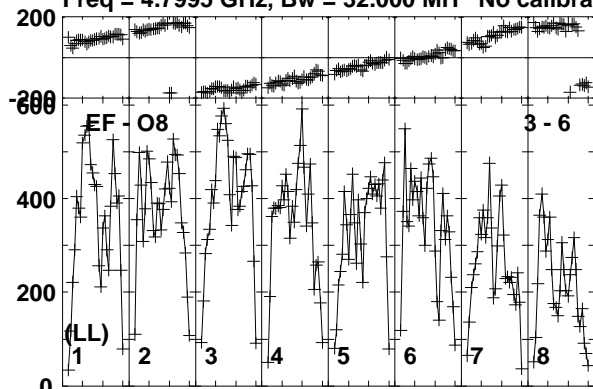

Lower frame: Micro Ampl Jy Top frame: Phas deg
Vector averaged cross-power spectrum Baseline: EF (03) - O8 (06)
Timerange: 00/14:28:44 to 00/14:29:58

Plot file version 77 created 03-APR-2017 18:27:39

M22-VLA1 EM126B.UVDATA.1

Freq = 4.7995 GHz, Bw = 32.000 MH No calibration applied and no bandpass applied

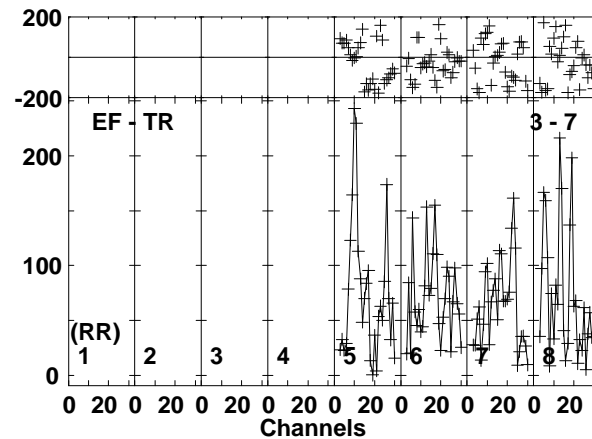
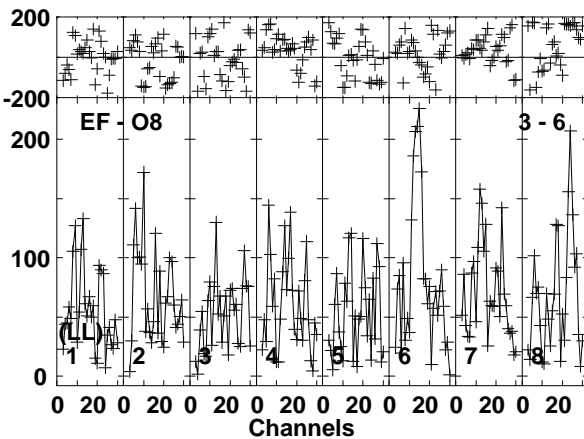
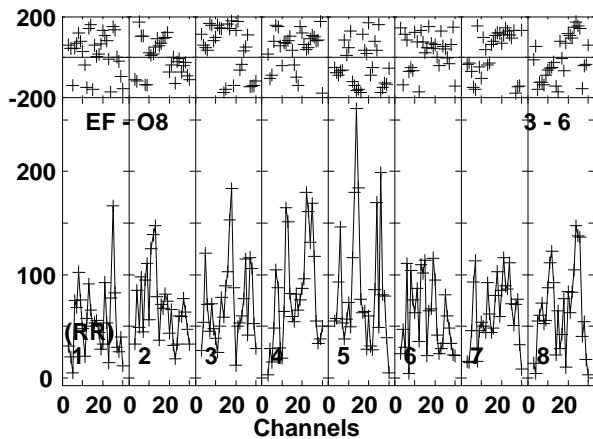
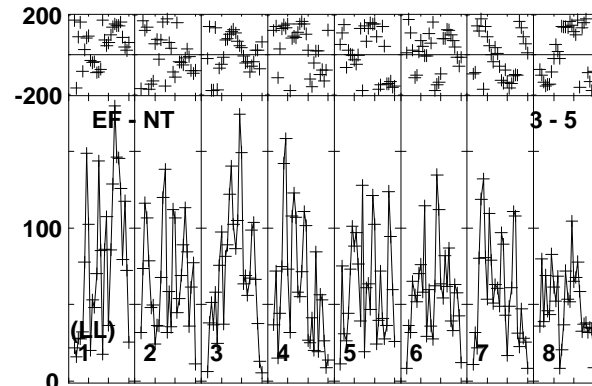
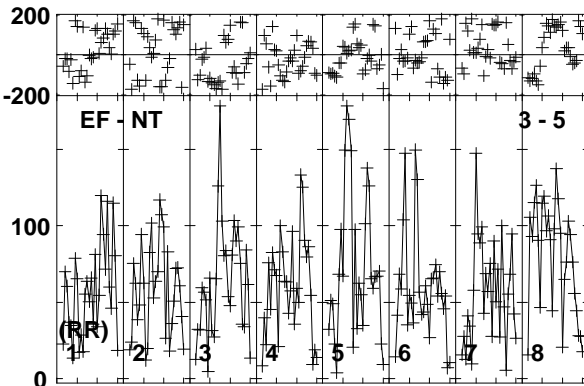
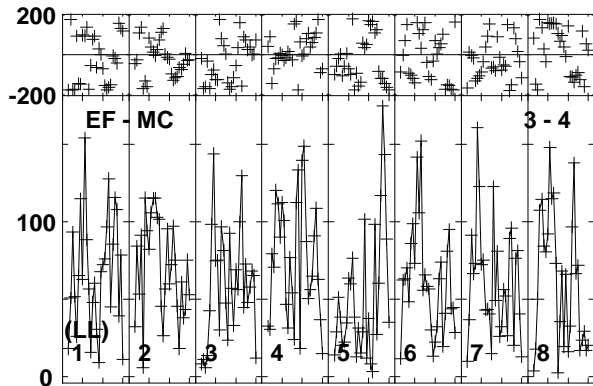
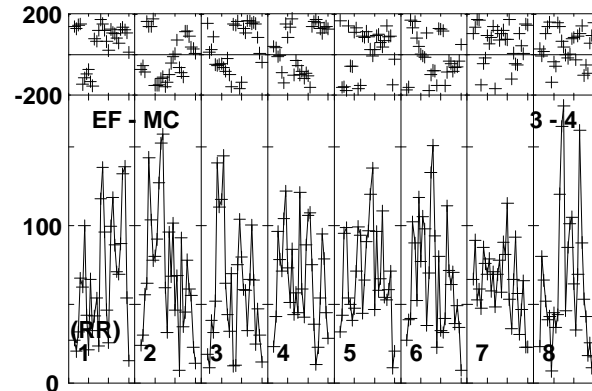
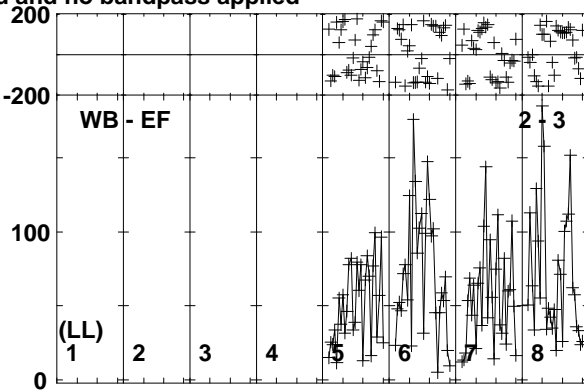
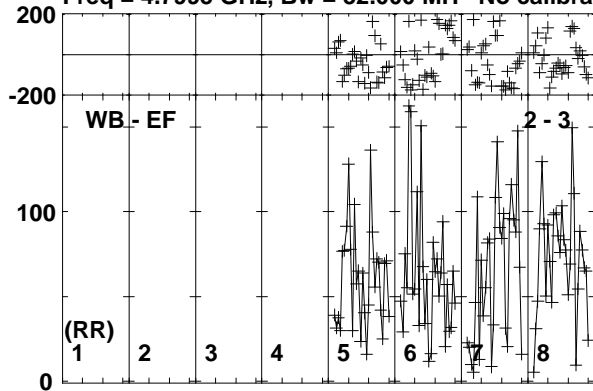

Lower frame: Micro Ampl Jy Top frame: Phas deg
Vector averaged cross-power spectrum Baseline: WB (02) - EF (03)
Timerange: 00/14:30:04 to 00/14:32:08

Plot file version 78 created 03-APR-2017 18:27:39

M22-VLA1 EM126B.UVDATA.1

Freq = 4.7995 GHz, Bw = 32.000 MH No calibration applied and no bandpass applied

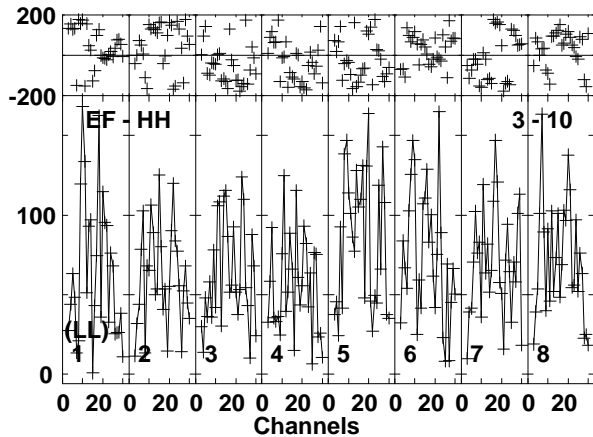
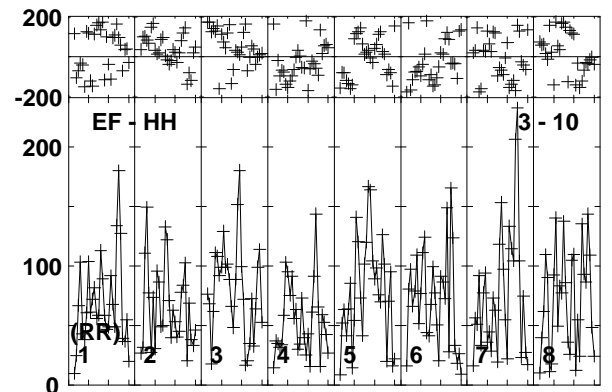
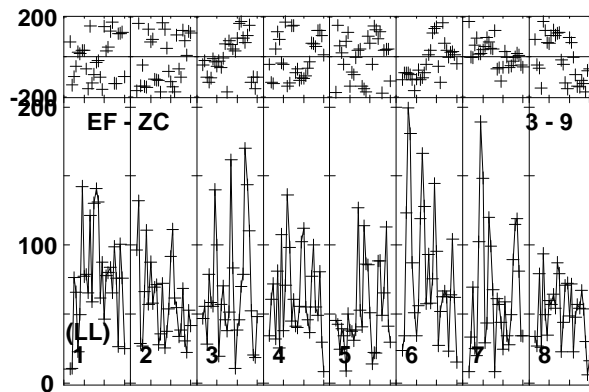
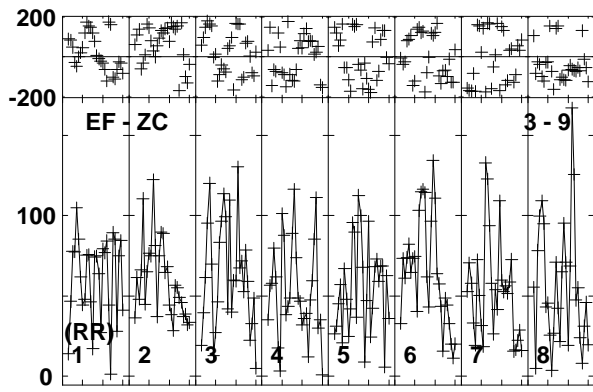
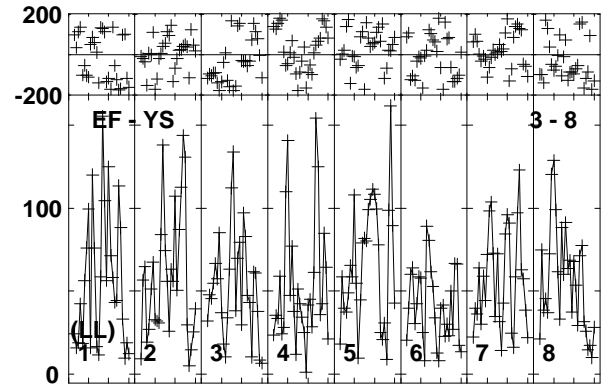
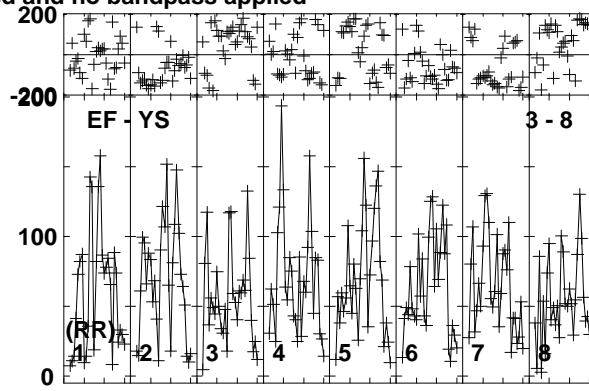
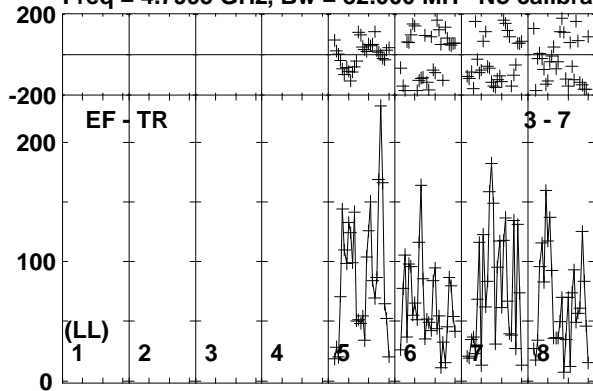

Lower frame: Micro Ampl Jy Top frame: Phas deg
Vector averaged cross-power spectrum Baseline: EF (03) - TR (07)
Timerange: 00/14:30:04 to 00/14:32:08

Plot file version 79 created 03-APR-2017 18:27:39

J1834-2341 EM126B.UVDATA.1

Freq = 4.7995 GHz, Bw = 32.000 MH No calibration applied and no bandpass applied

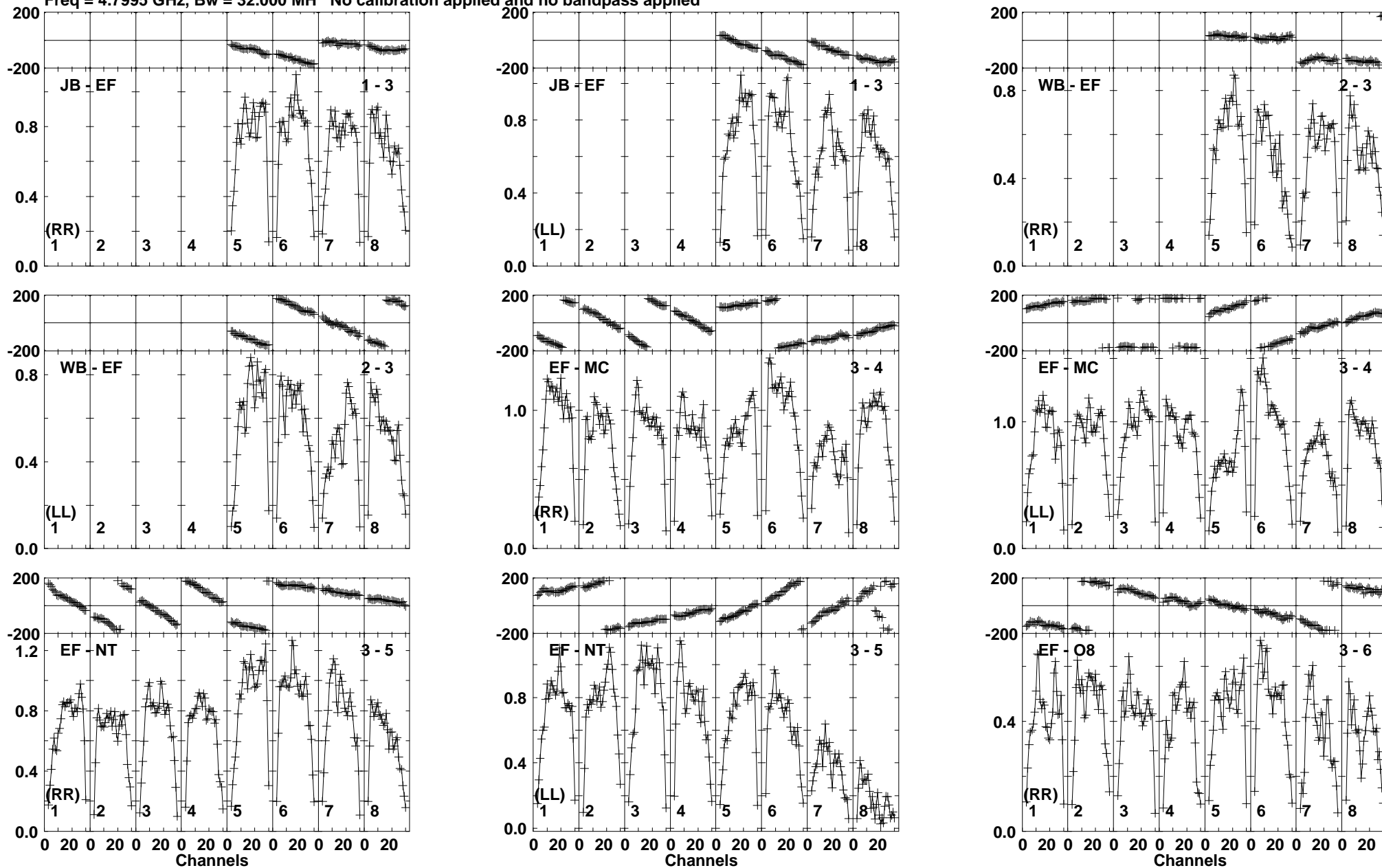

Lower frame: Milli Ampl Jy Top frame: Phas deg
Vector averaged cross-power spectrum Baseline: JB (01) - EF (03)
Timerange: 00/14:32:41 to 00/14:33:29

Plot file version 80 created 03-APR-2017 18:27:39

J1834-2341 EM126B.UVDATA.1

Freq = 4.7995 GHz, Bw = 32.000 MH No calibration applied and no bandpass applied

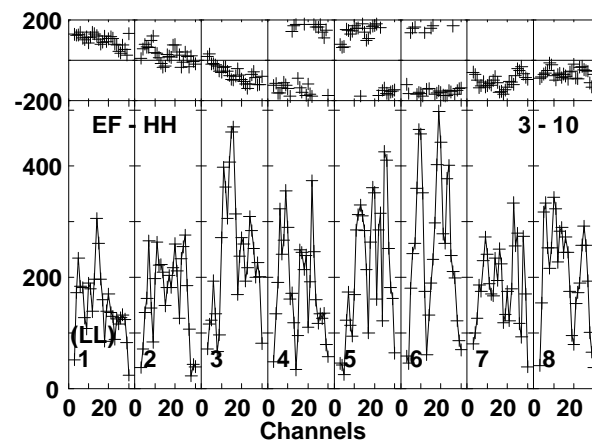
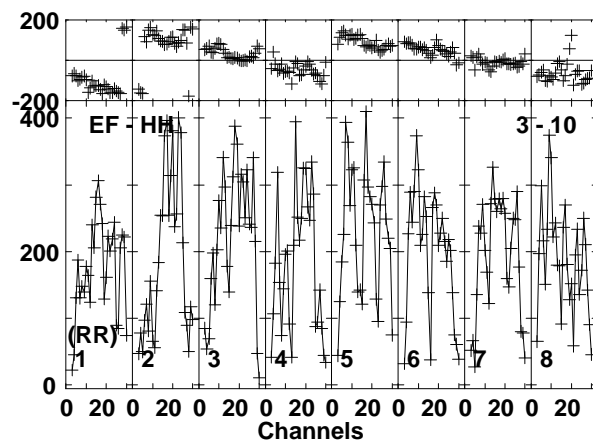
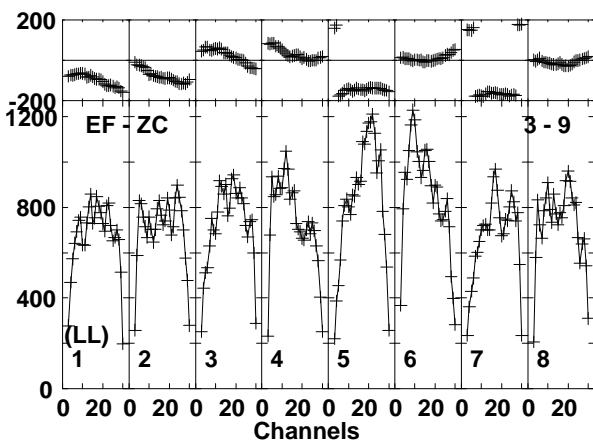
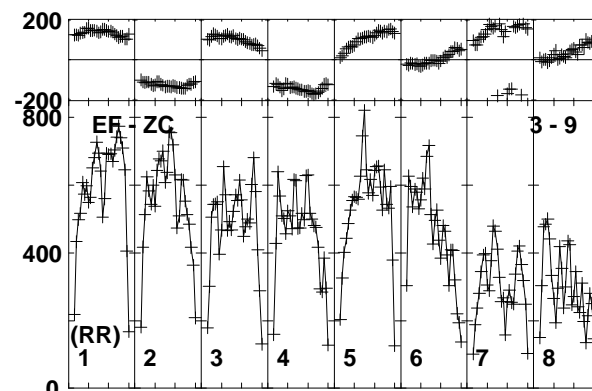
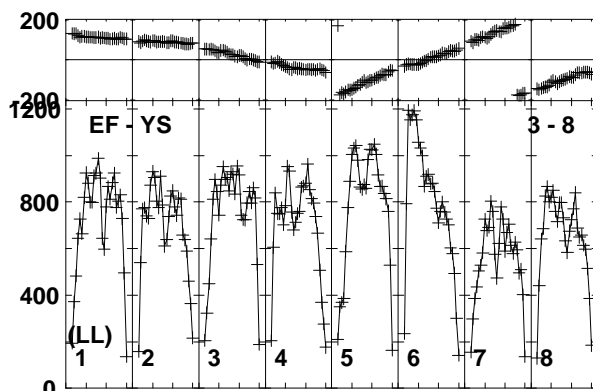
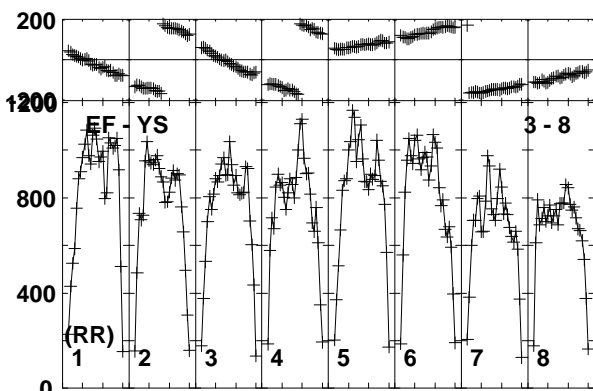
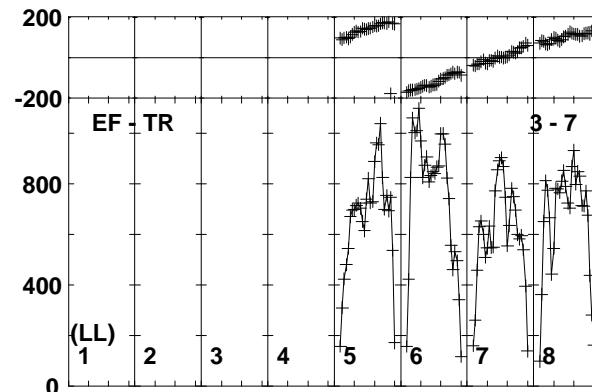
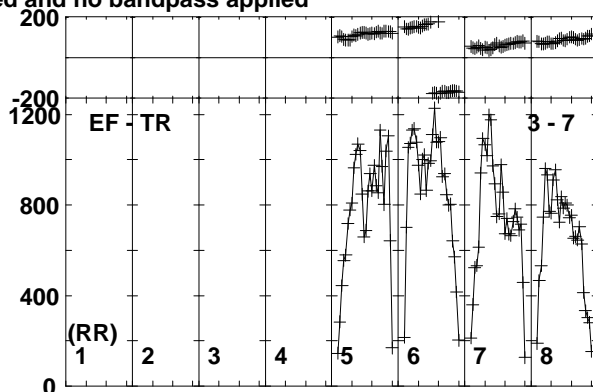
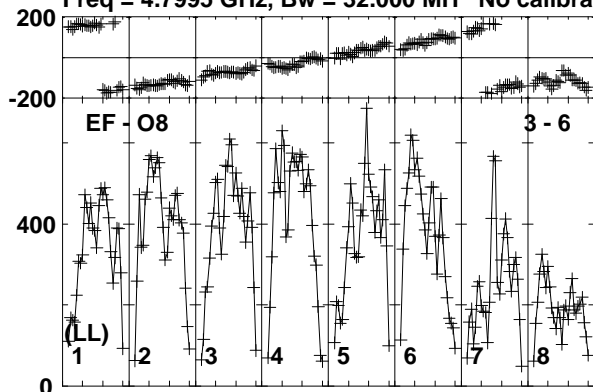

Lower frame: Micro Ampl Jy Top frame: Phas deg
Vector averaged cross-power spectrum Baseline: EF (03) - O8 (06)
Timerange: 00/14:32:41 to 00/14:33:29

Plot file version 81 created 03-APR-2017 18:27:39

M22-VLA1 EM126B.UVDATA.1

Freq = 4.7995 GHz, Bw = 32.000 MH No calibration applied and no bandpass applied

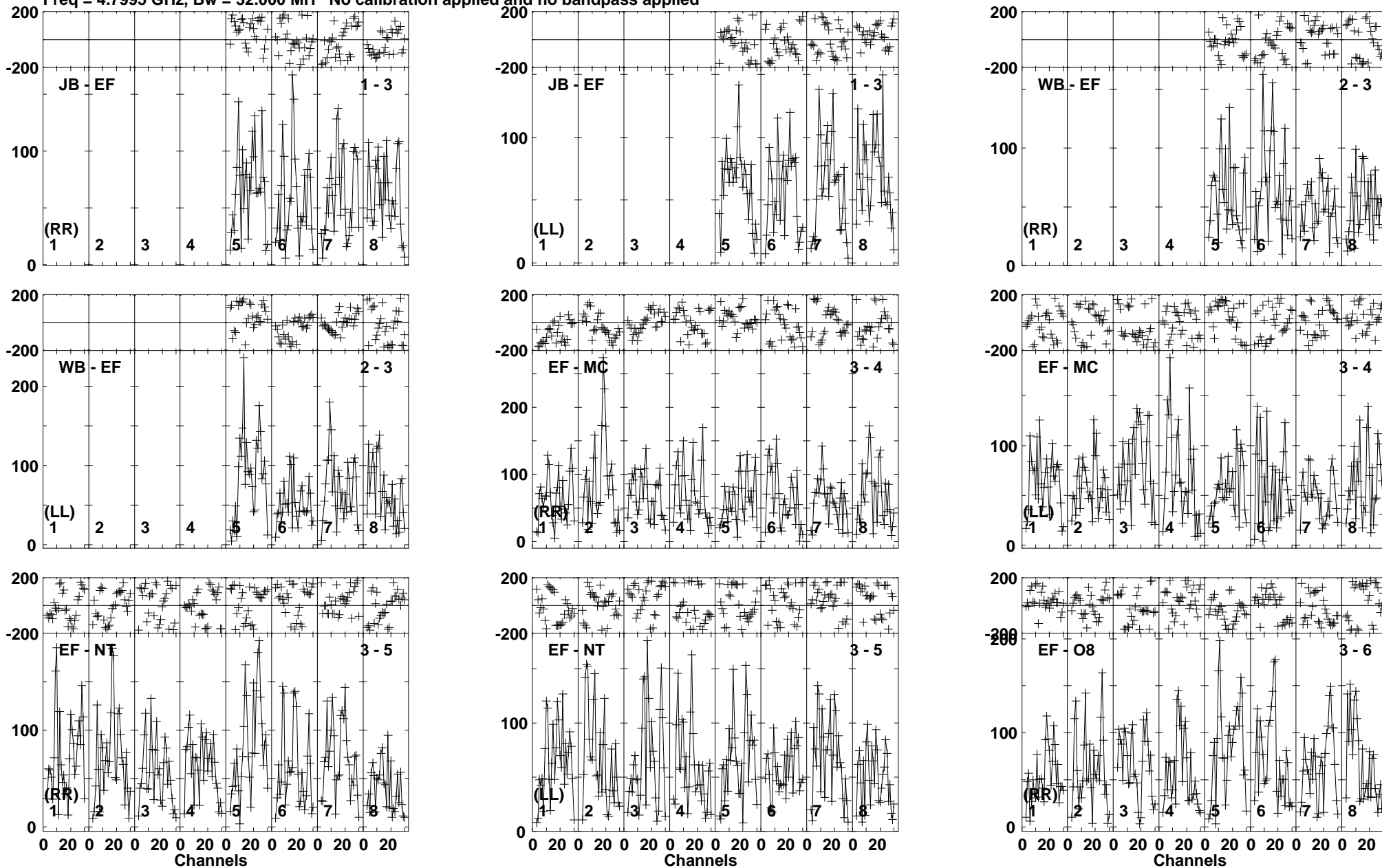

Lower frame: Micro Ampl Jy Top frame: Phas deg
Vector averaged cross-power spectrum Baseline: JB (01) - EF (03)
Timerange: 00/14:33:34 to 00/14:35:38

Plot file version 82 created 03-APR-2017 18:27:39

M22-VLA1 EM126B.UVDATA.1

Freq = 4.7995 GHz, Bw = 32.000 MH No calibration applied and no bandpass applied

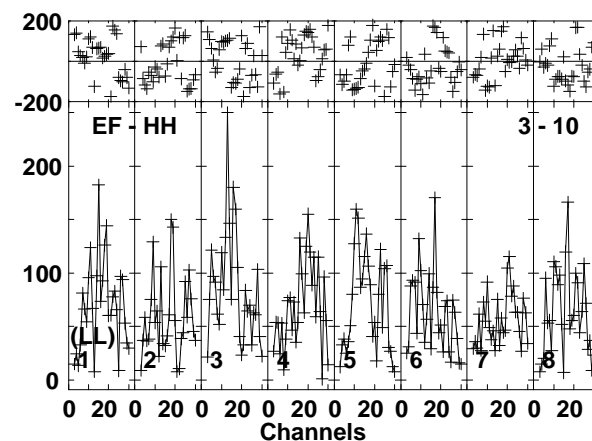
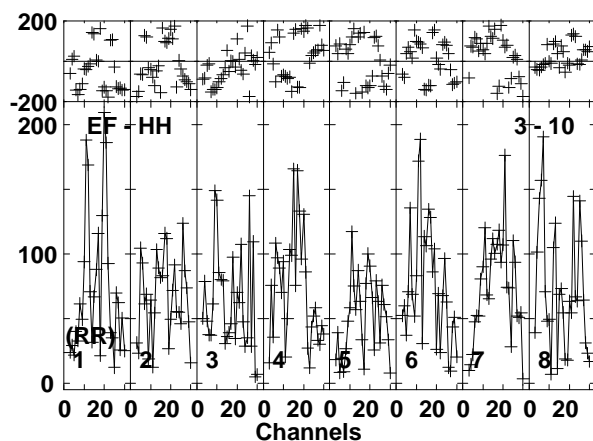
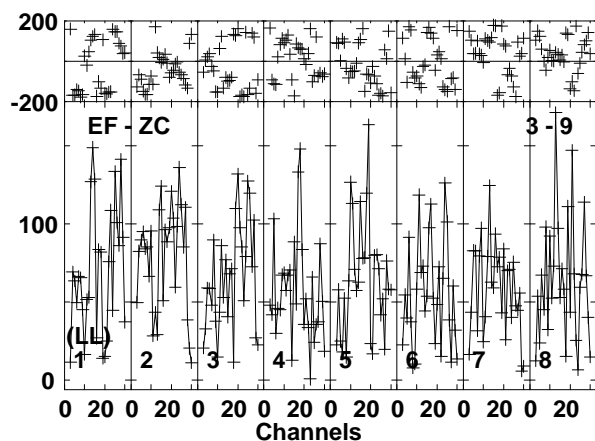
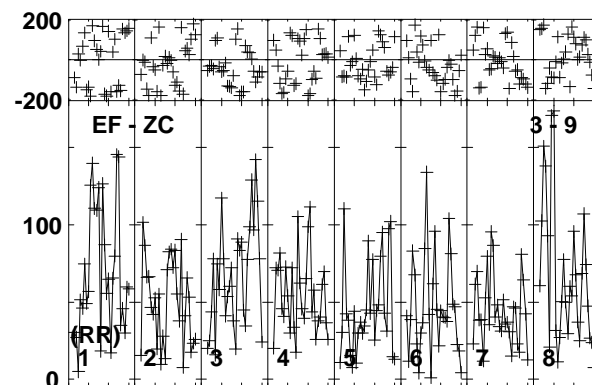
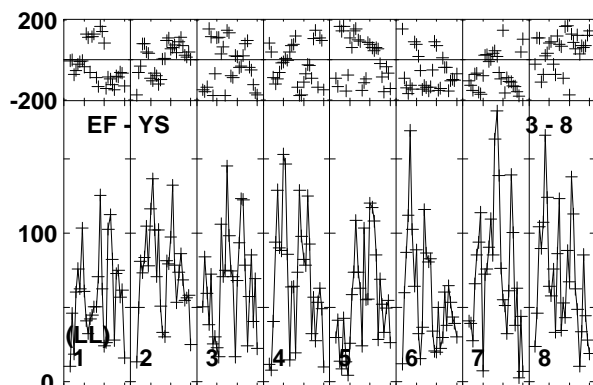
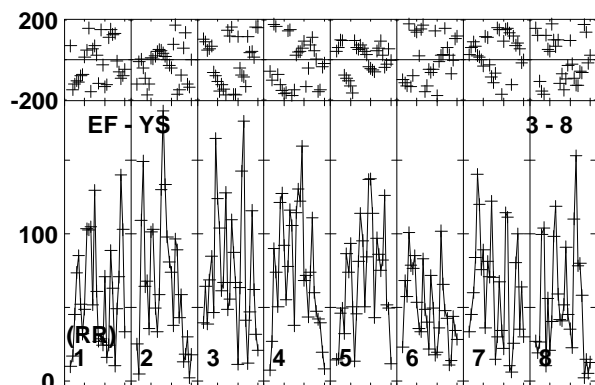
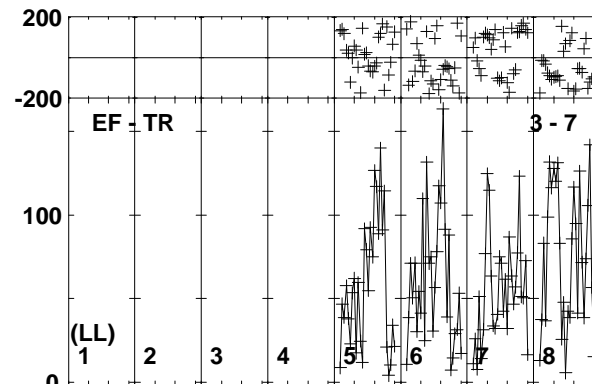
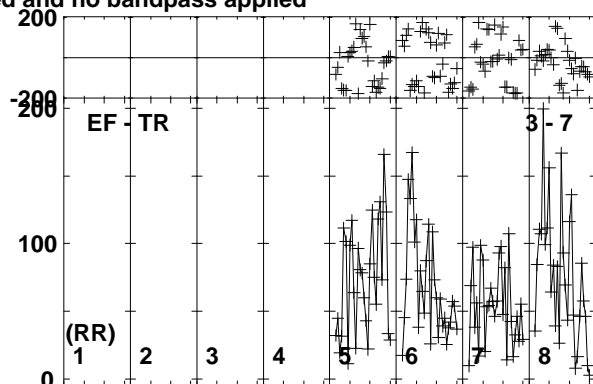
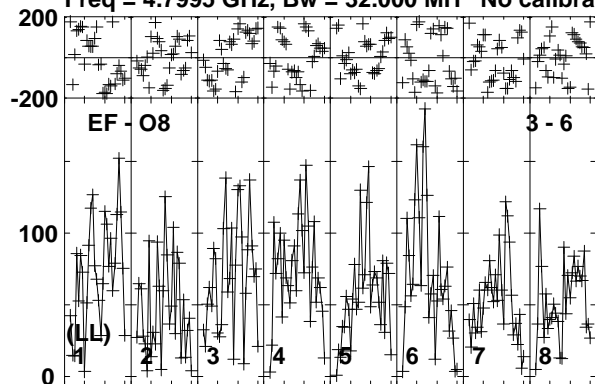

Lower frame: Micro Ampl Jy Top frame: Phas deg
Vector averaged cross-power spectrum Baseline: EF (03) - O8 (06)
Timerange: 00/14:33:34 to 00/14:35:38

Plot file version 83 created 03-APR-2017 18:27:39

J1834-2341 EM126B.UVDATA.1

Freq = 4.7995 GHz, Bw = 32.000 MH No calibration applied and no bandpass applied

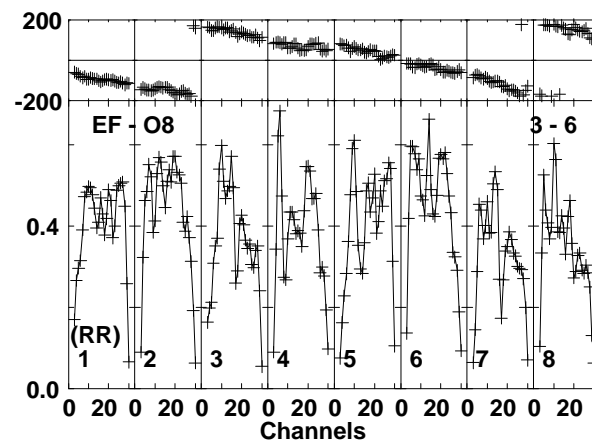
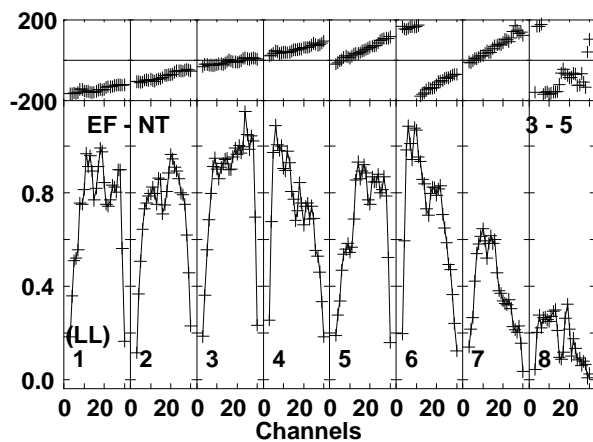
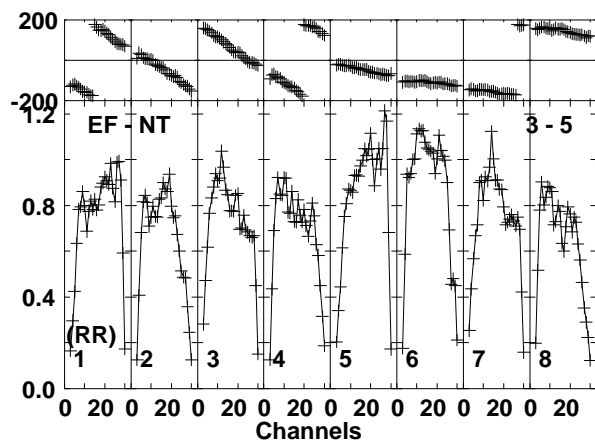
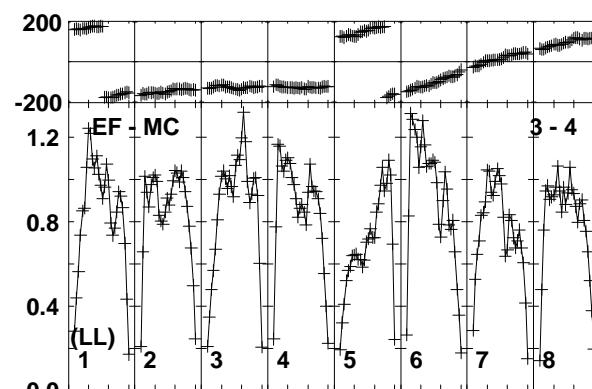
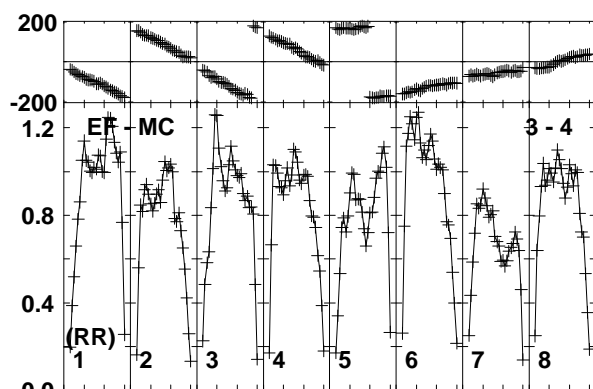
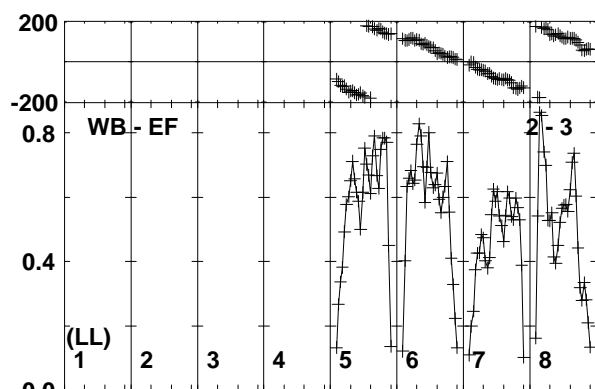
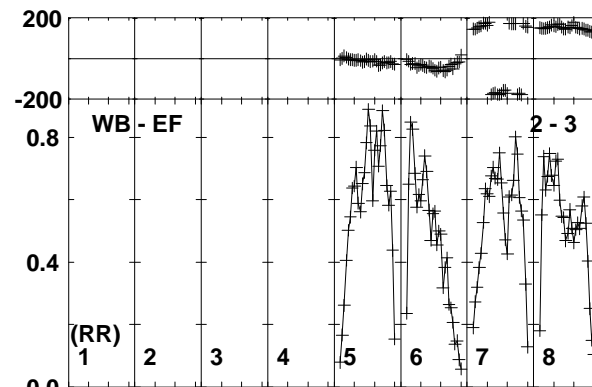
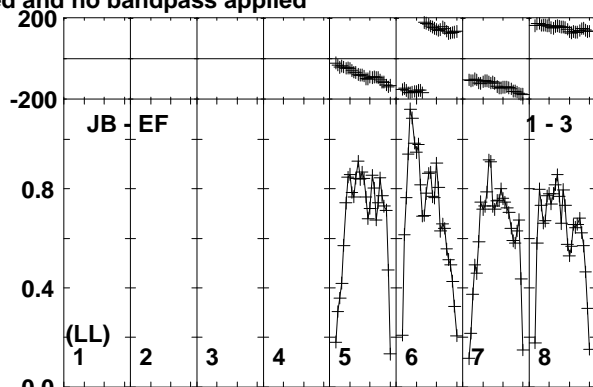
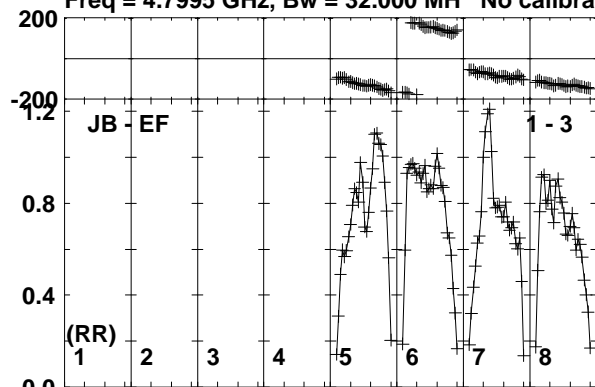

Lower frame: Milli Ampl Jy Top frame: Phas deg
Vector averaged cross-power spectrum Baseline: JB (01) - EF (03)
Timerange: 00/14:35:44 to 00/14:36:58

Plot file version 84 created 03-APR-2017 18:27:39

J1834-2341 EM126B.UVDATA.1

Freq = 4.7995 GHz, Bw = 32.000 MH No calibration applied and no bandpass applied

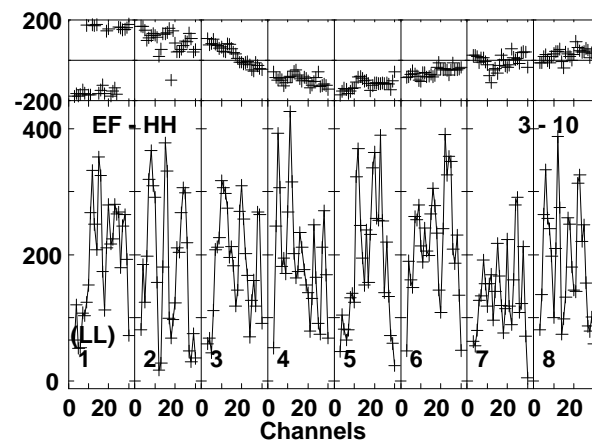
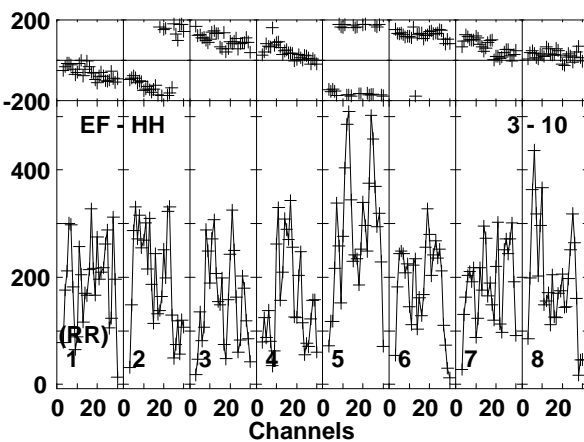
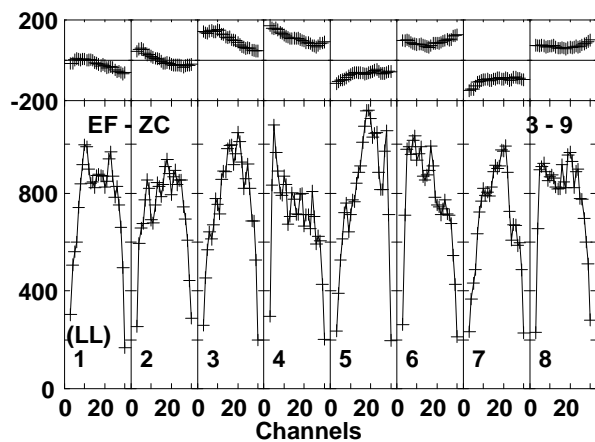
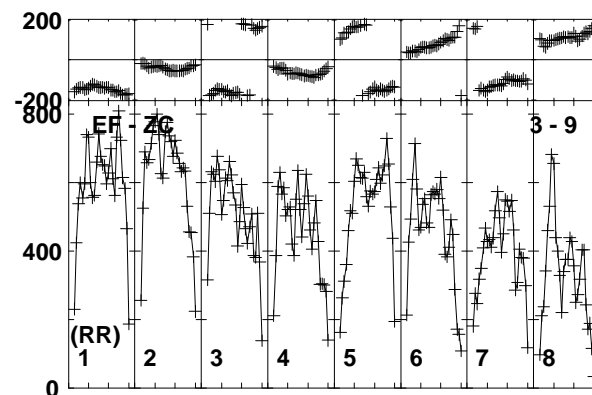
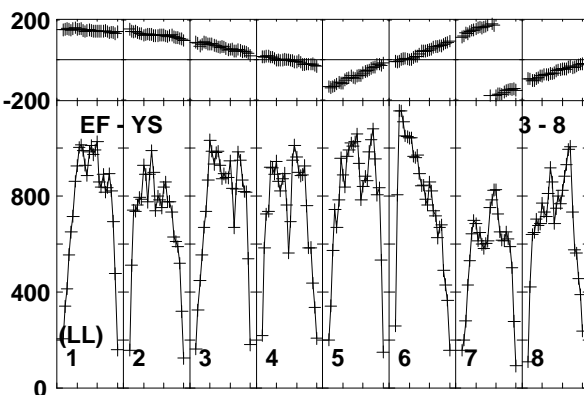
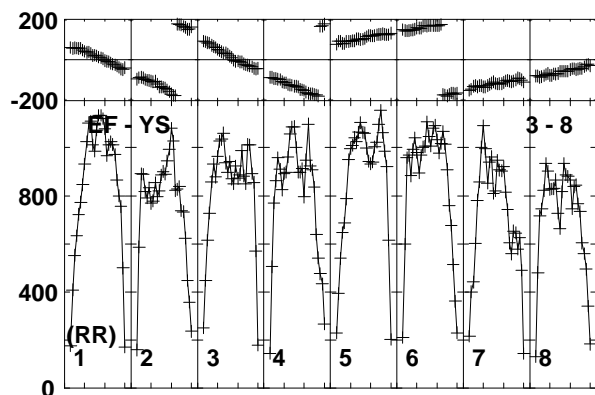
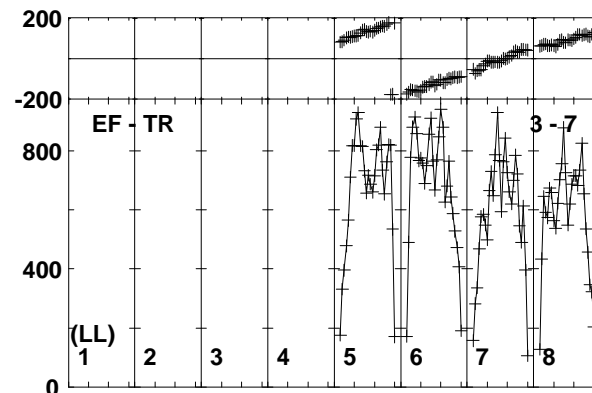
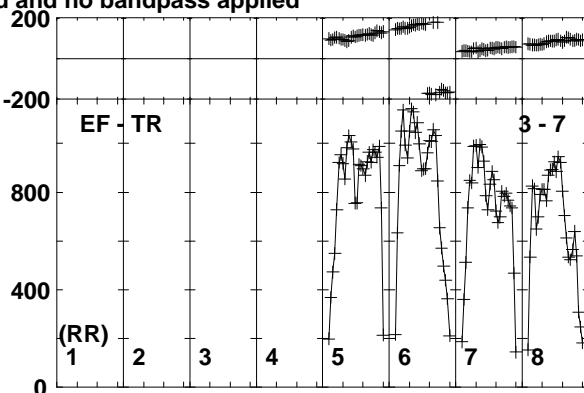
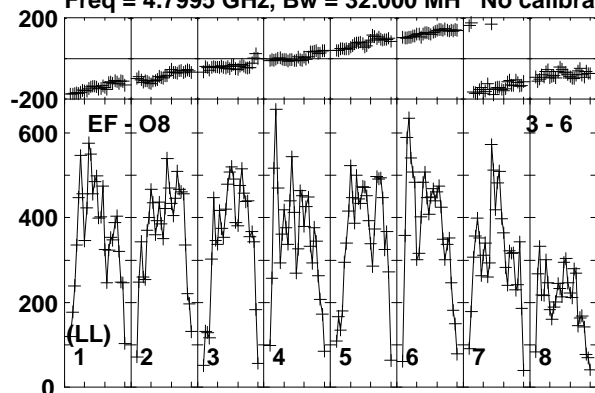

Lower frame: Micro Ampl Jy Top frame: Phas deg
Vector averaged cross-power spectrum Baseline: EF (03) - O8 (06)
Timerange: 00/14:35:44 to 00/14:36:58

Plot file version 85 created 03-APR-2017 18:27:39

M22-VLA1 EM126B.UVDATA.1

Freq = 4.7995 GHz, Bw = 32.000 MH No calibration applied and no bandpass applied

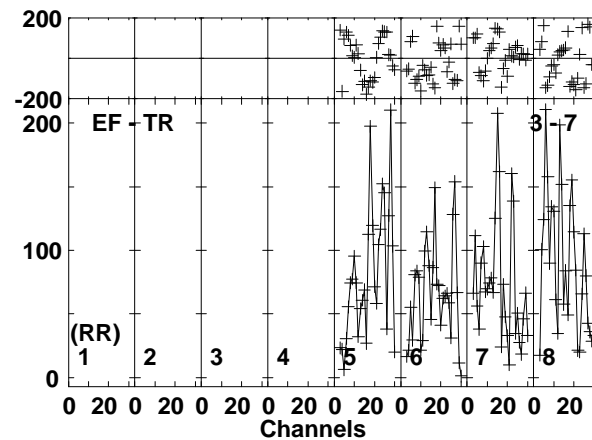
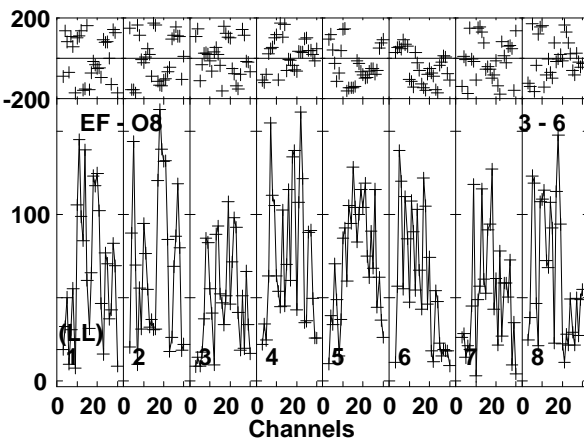
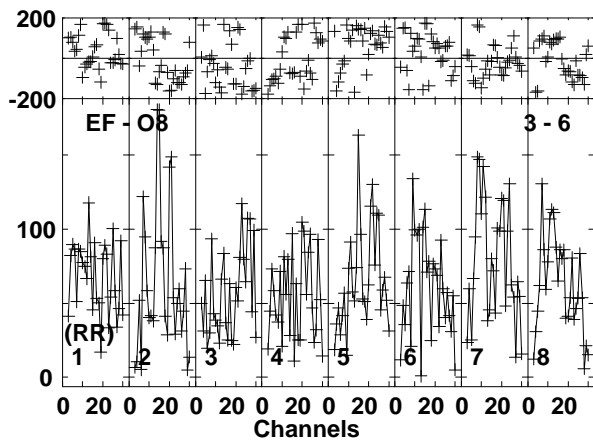
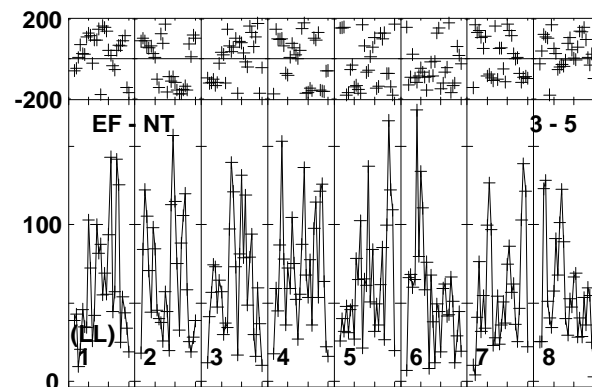
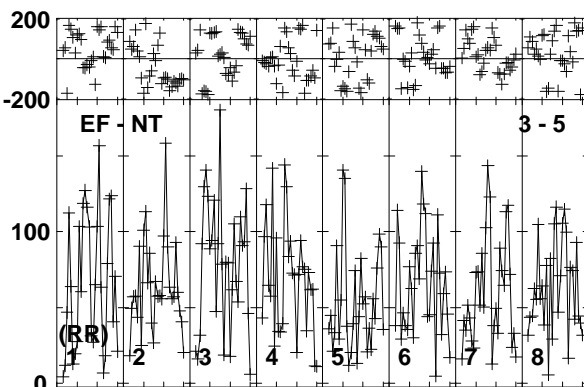
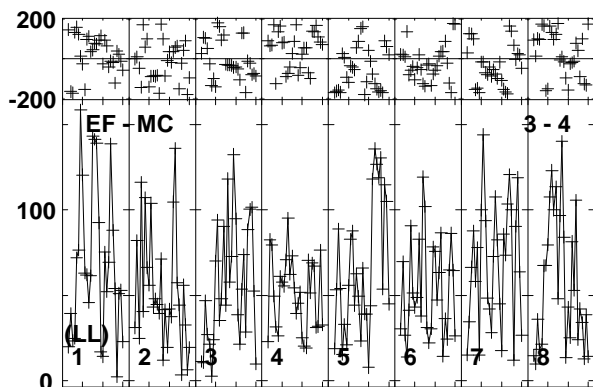
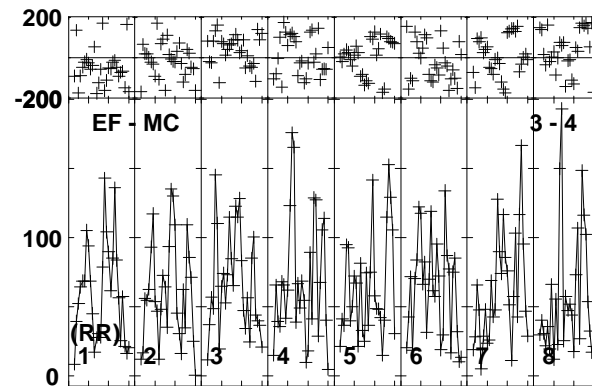
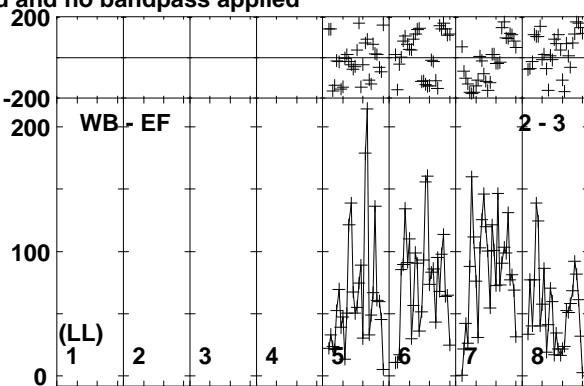
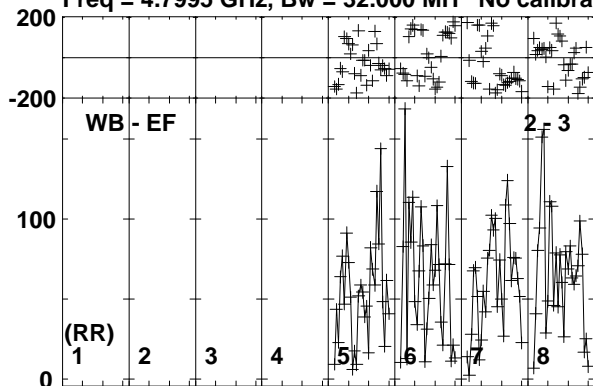

Lower frame: Micro Ampl Jy Top frame: Phas deg
Vector averaged cross-power spectrum Baseline: WB (02) - EF (03)
Timerange: 00/14:37:04 to 00/14:39:08

Plot file version 86 created 03-APR-2017 18:27:39

M22-VLA1 EM126B.UVDATA.1

Freq = 4.7995 GHz, Bw = 32.000 MH No calibration applied and no bandpass applied

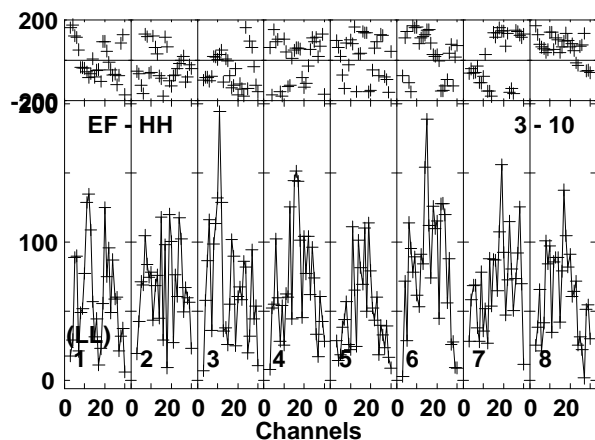
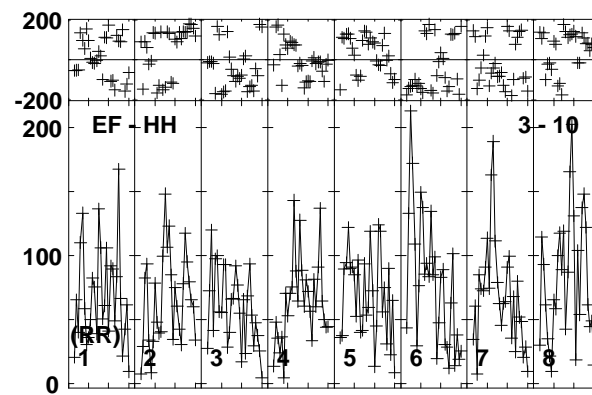
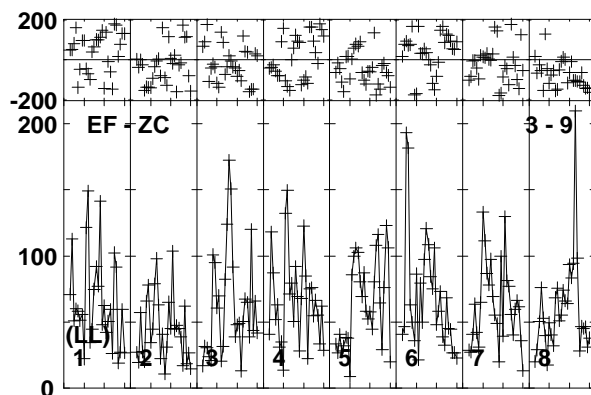
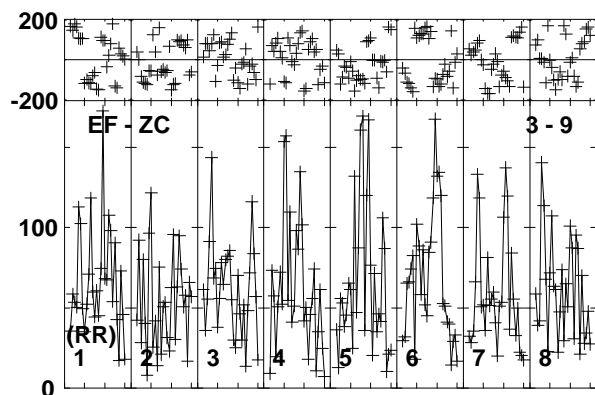
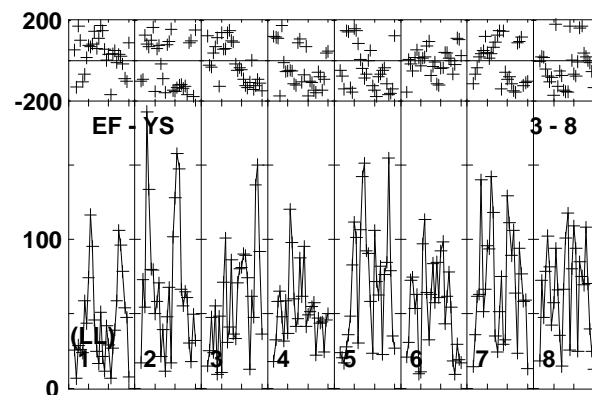
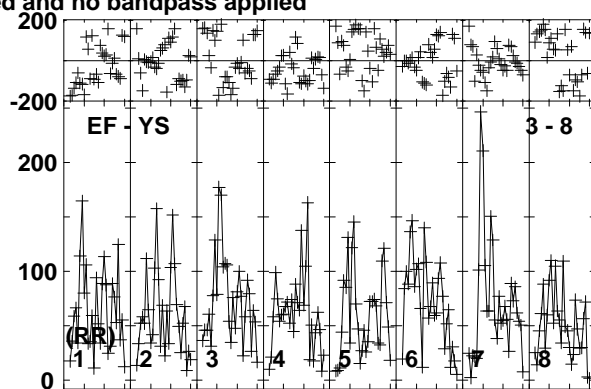
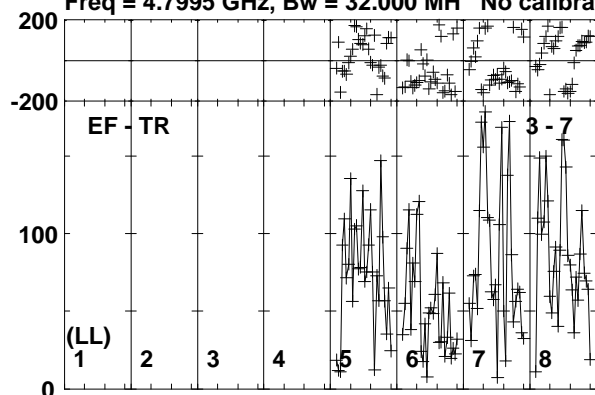

Lower frame: Micro Ampl Jy Top frame: Phas deg
Vector averaged cross-power spectrum Baseline: EF (03) - TR (07)
Timerange: 00/14:37:04 to 00/14:39:08

Plot file version 87 created 03-APR-2017 18:27:39

J1834-2341 EM126B.UVDATA.1

Freq = 4.7995 GHz, Bw = 32.000 MH No calibration applied and no bandpass applied

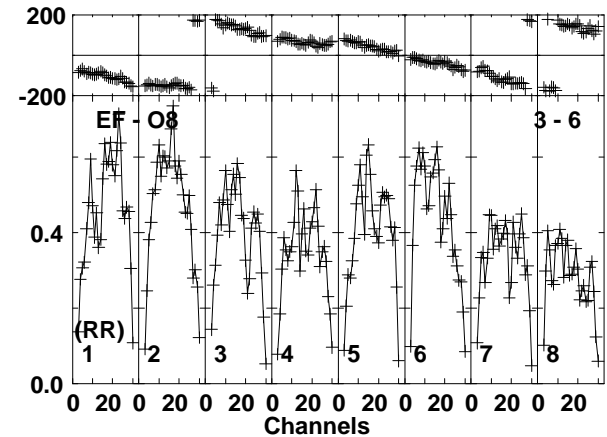
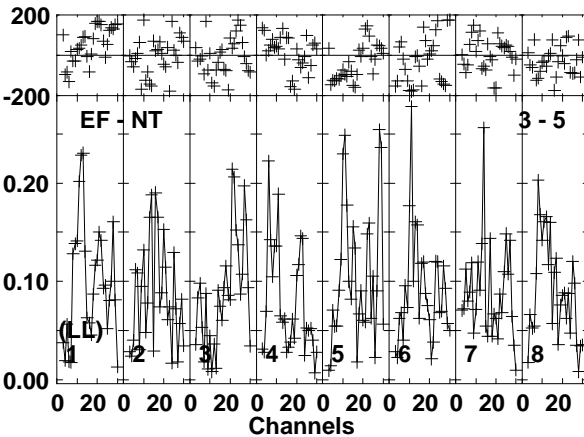
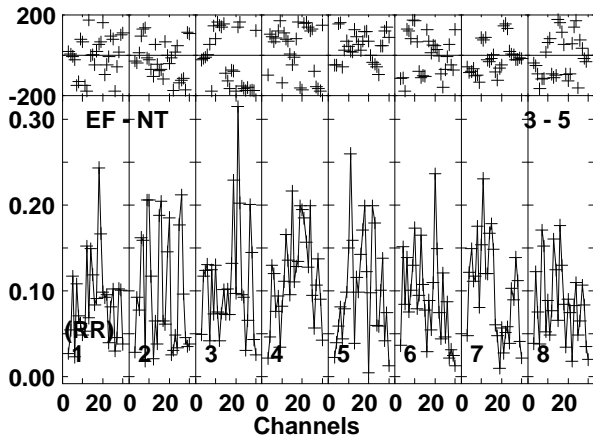
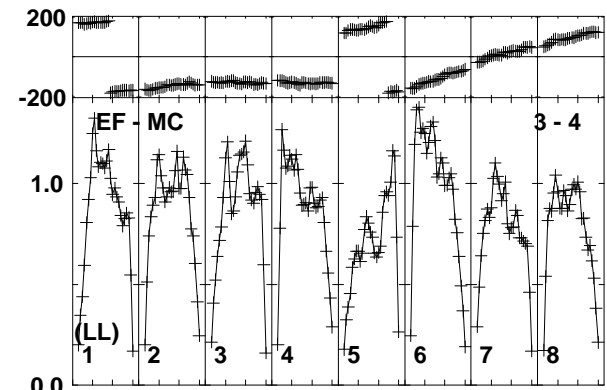
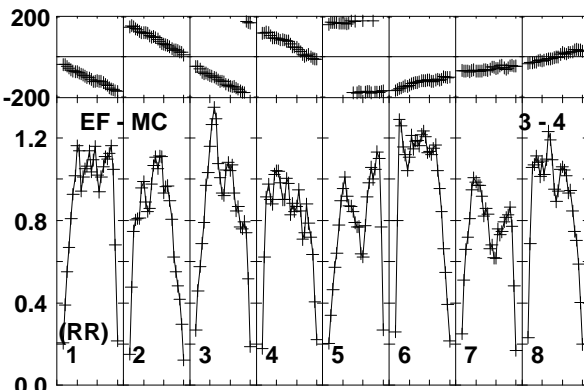
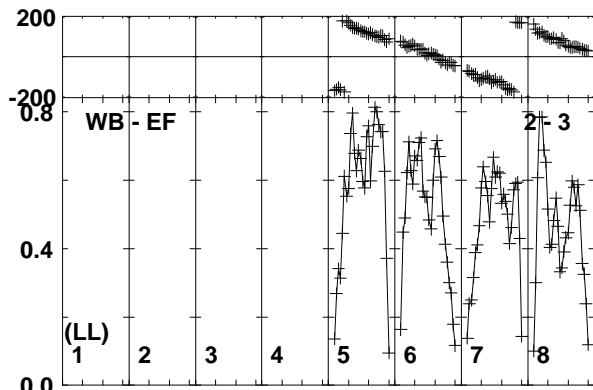
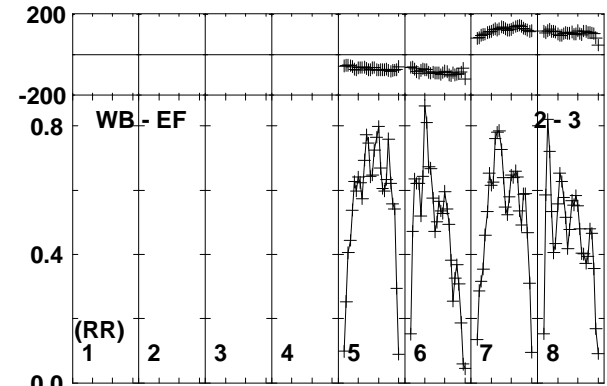
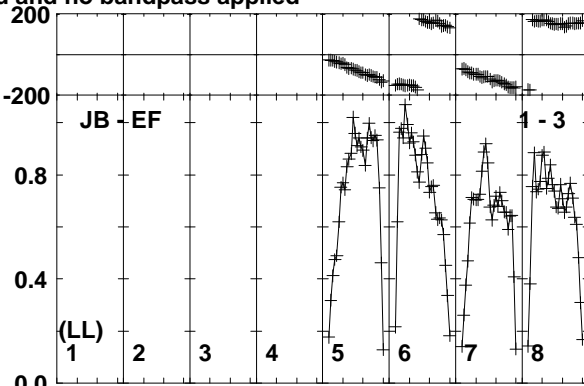
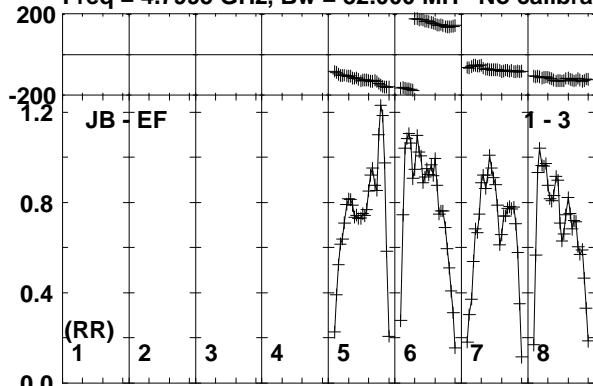

Lower frame: Milli Ampl Jy Top frame: Phas deg
Vector averaged cross-power spectrum Baseline: JB (01) - EF (03)
Timerange: 00/14:39:14 to 00/14:40:28

Plot file version 88 created 03-APR-2017 18:27:39

J1834-2341 EM126B.UVDATA.1

Freq = 4.7995 GHz, Bw = 32.000 MH No calibration applied and no bandpass applied

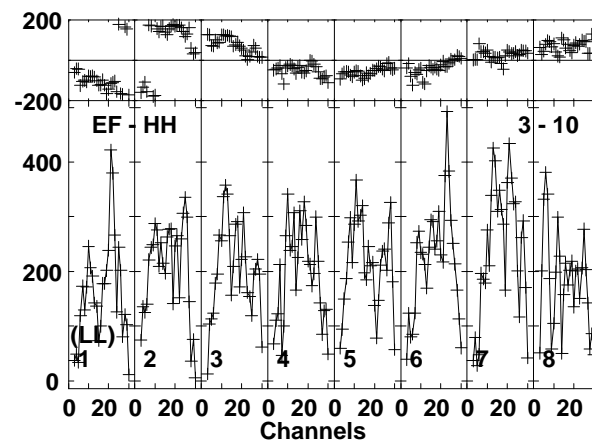
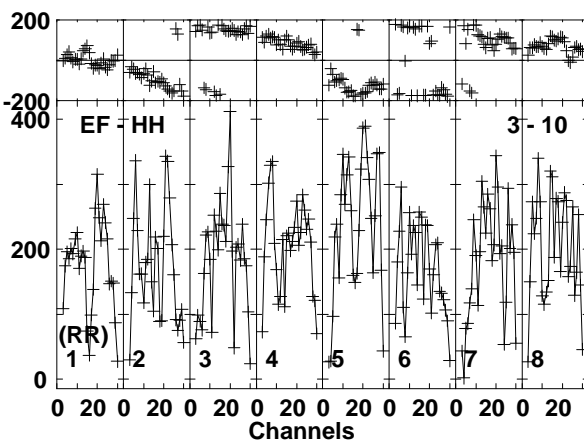
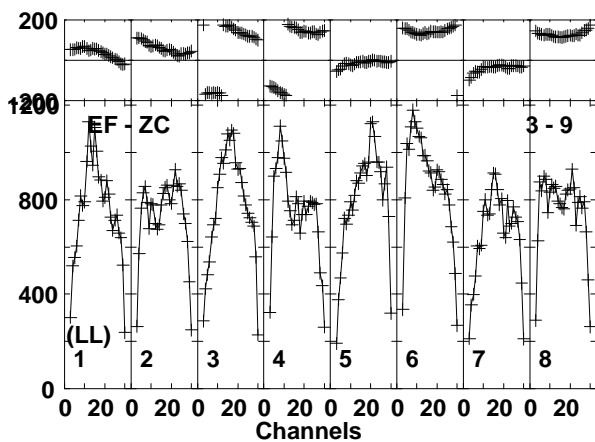
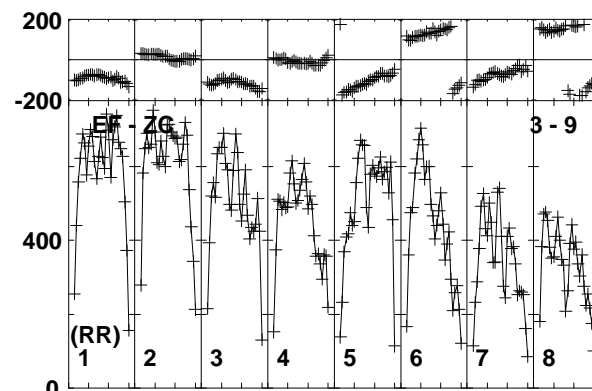
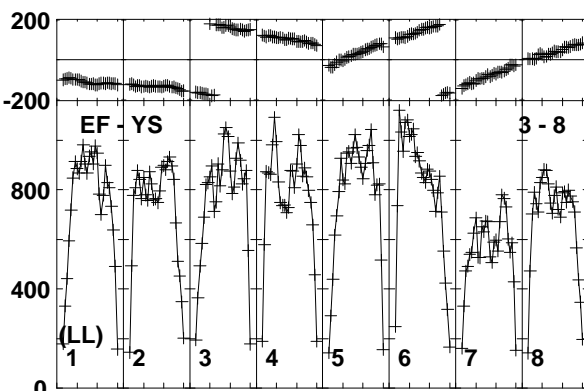
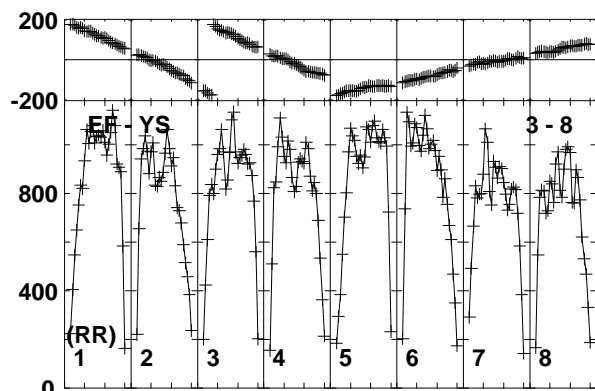
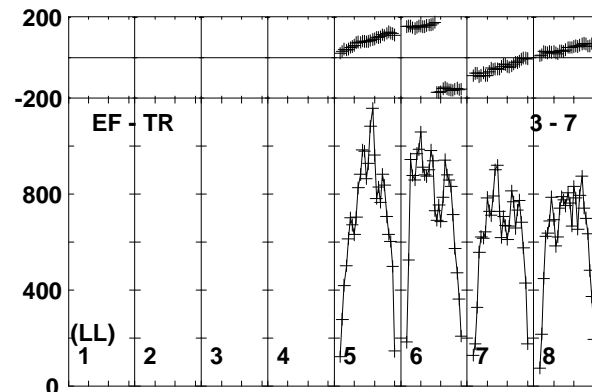
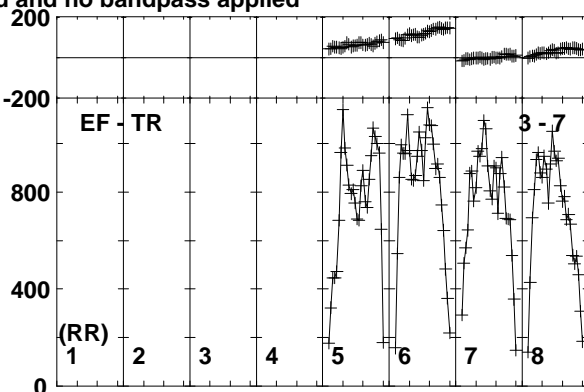
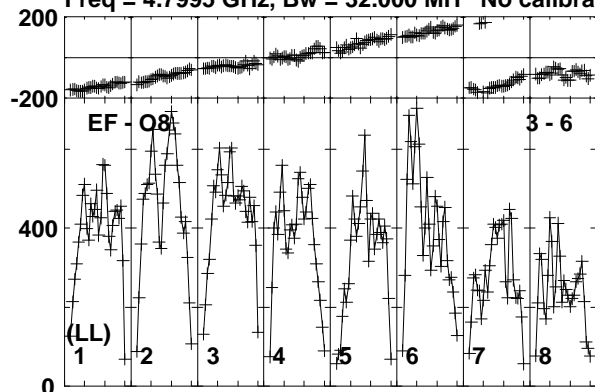

Lower frame: Micro Ampl Jy Top frame: Phas deg
Vector averaged cross-power spectrum Baseline: EF (03) - O8 (06)
Timerange: 00/14:39:14 to 00/14:40:28

Plot file version 89 created 03-APR-2017 18:27:39

M22-VLA1 EM126B.UVDATA.1

Freq = 4.7995 GHz, Bw = 32.000 MH No calibration applied and no bandpass applied

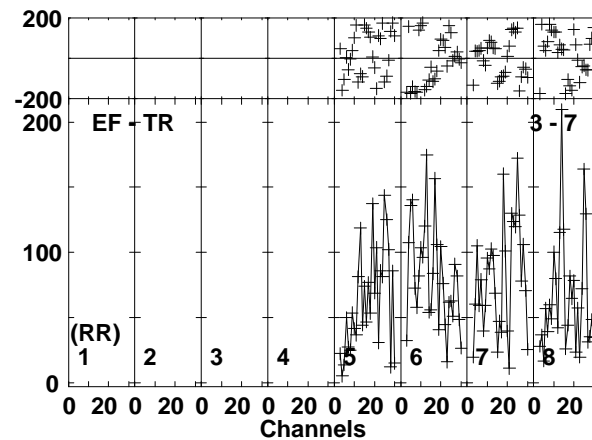
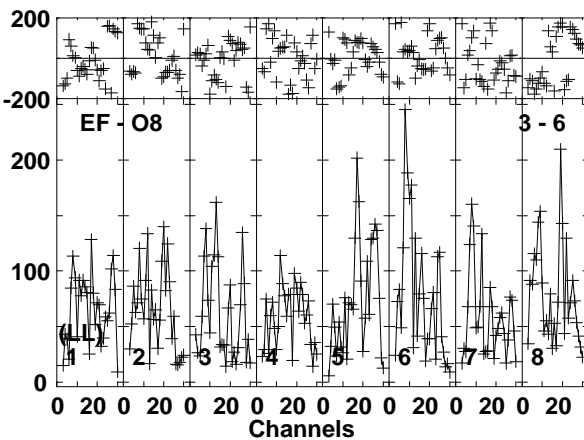
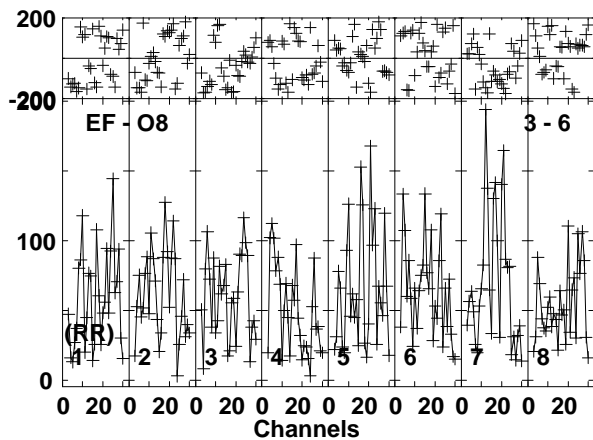
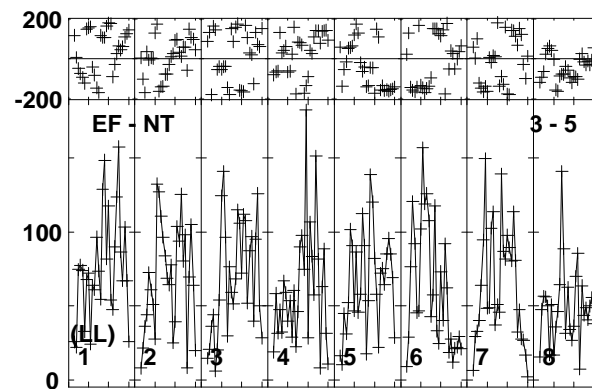
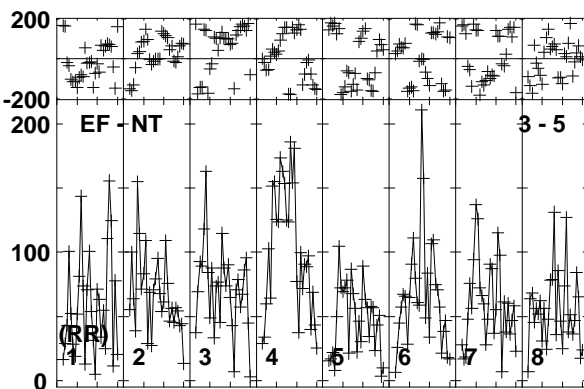
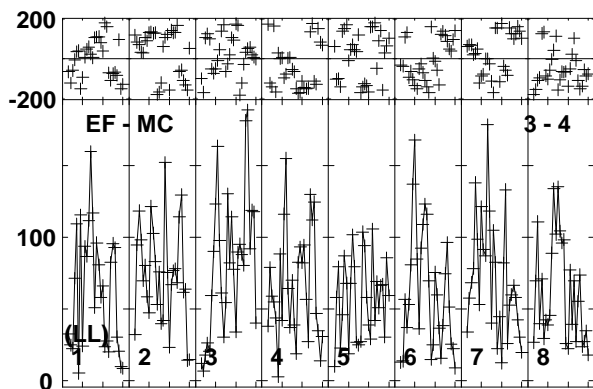
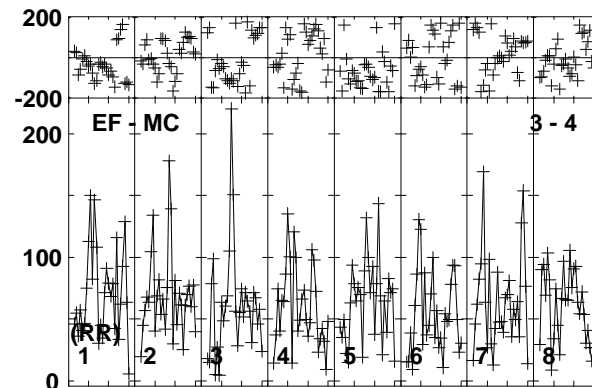
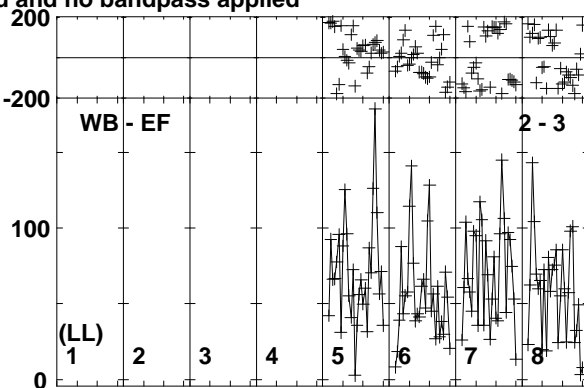
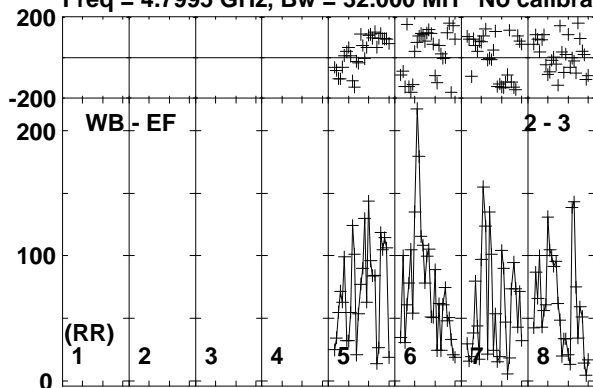

Lower frame: Micro Ampl Jy Top frame: Phas deg
Vector averaged cross-power spectrum Baseline: WB (02) - EF (03)
Timerange: 00/14:40:34 to 00/14:42:38

Plot file version 90 created 03-APR-2017 18:27:39

M22-VLA1 EM126B.UVDATA.1

Freq = 4.7995 GHz, Bw = 32.000 MH No calibration applied and no bandpass applied

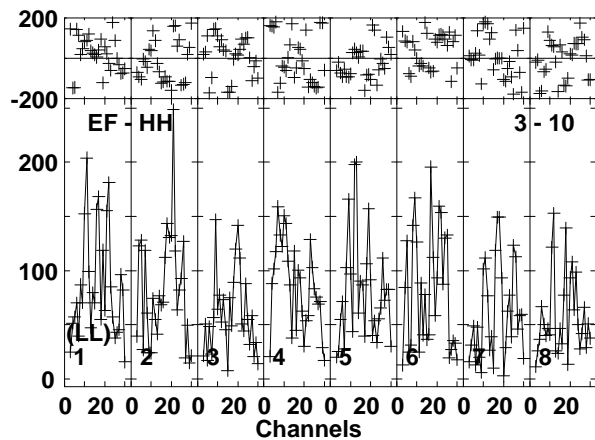
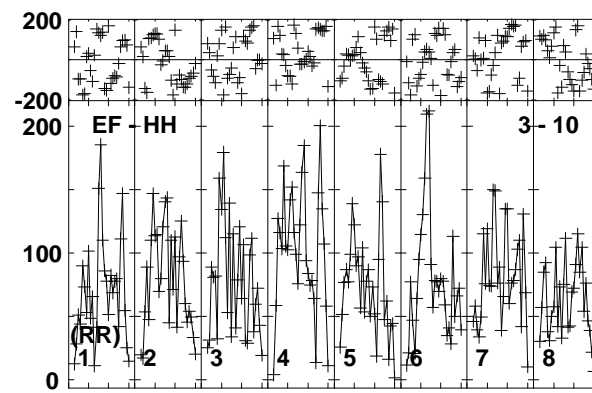
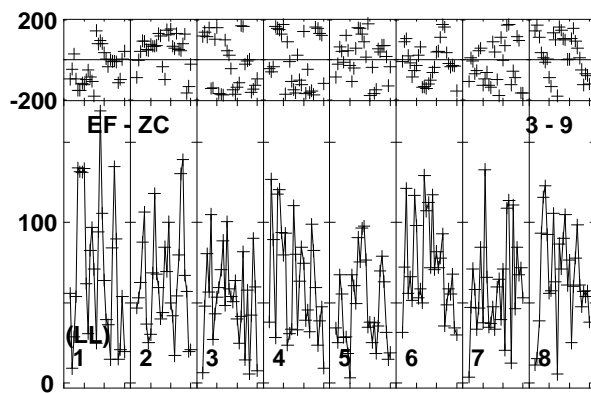
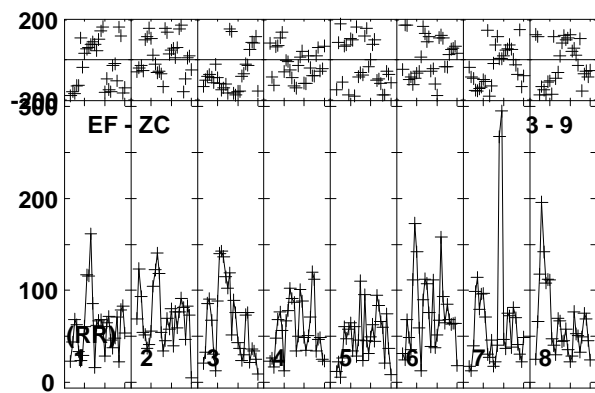
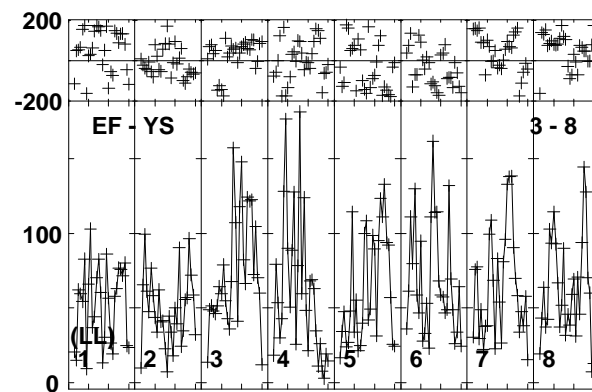
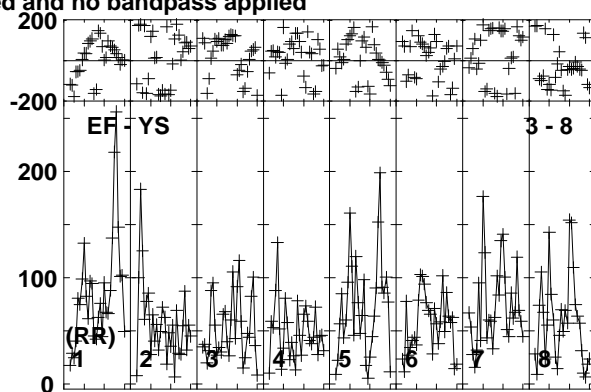
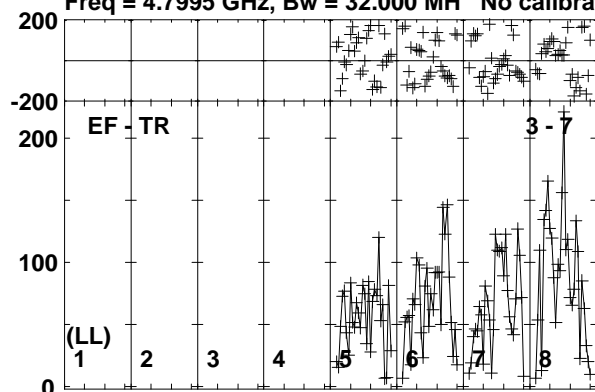

Lower frame: Micro Ampl Jy Top frame: Phas deg
Vector averaged cross-power spectrum Baseline: EF (03) - TR (07)
Timerange: 00/14:40:34 to 00/14:42:38

Plot file version 91 created 03-APR-2017 18:27:39

J1834-2341 EM126B.UVDATA.1

Freq = 4.7995 GHz, Bw = 32.000 MH No calibration applied and no bandpass applied

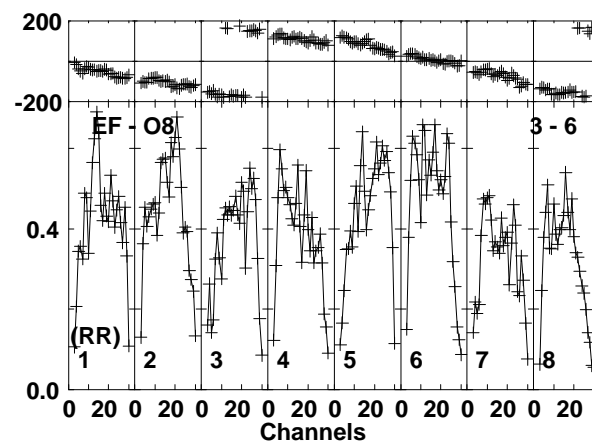
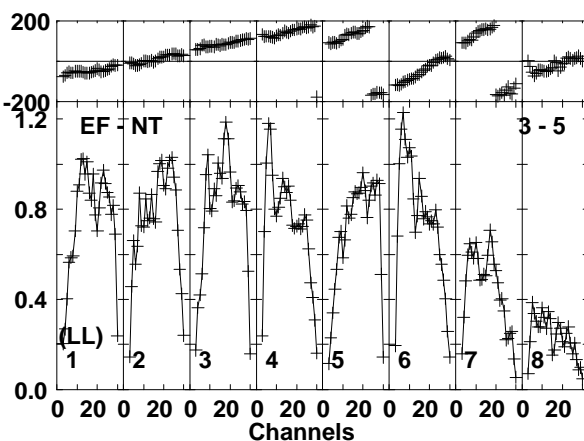
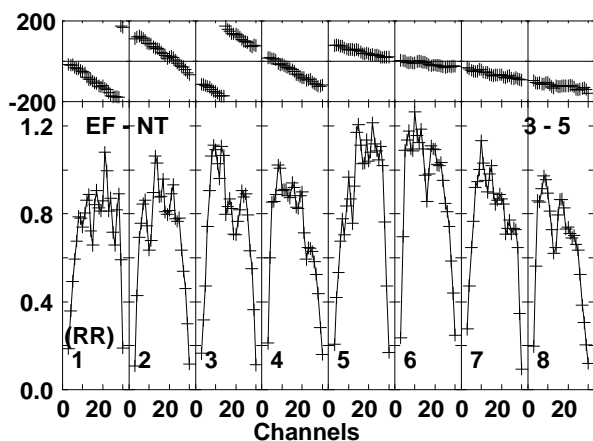
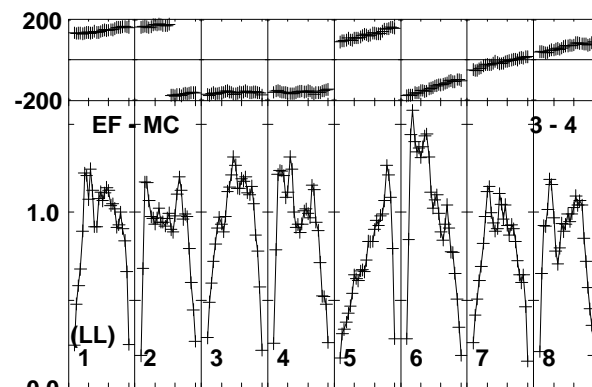
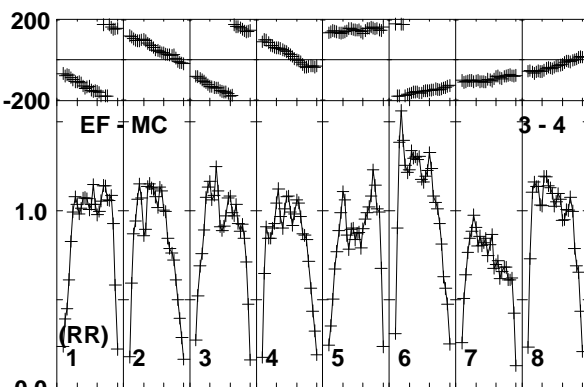
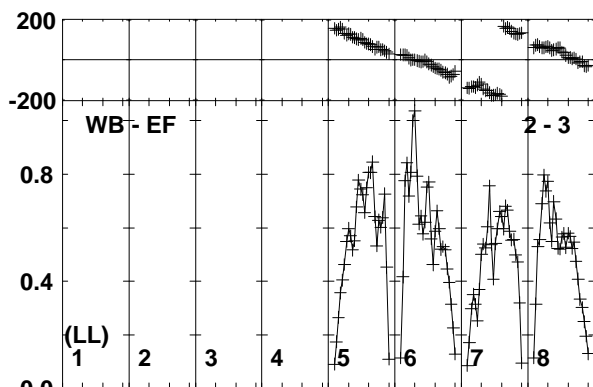
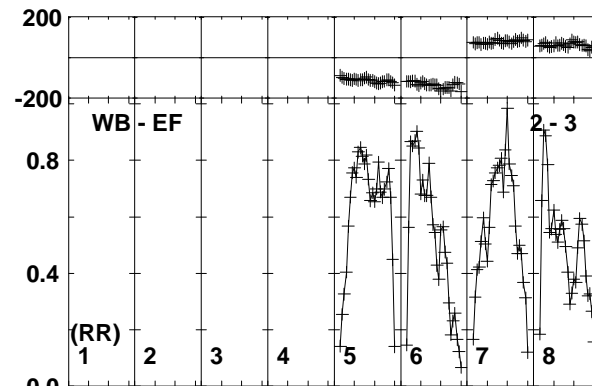
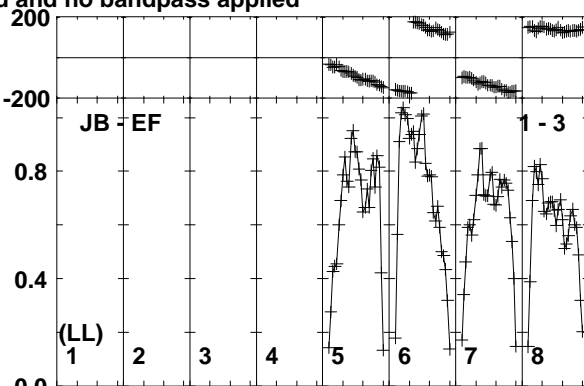
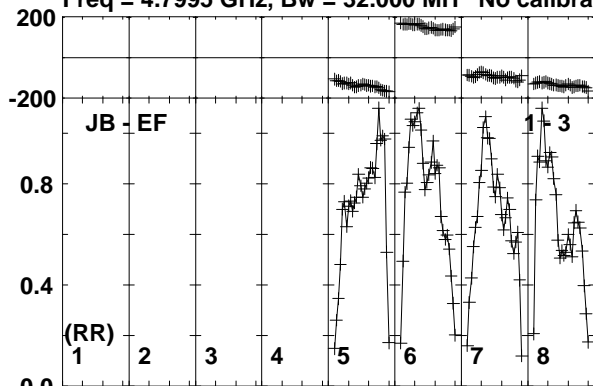

Lower frame: Milli Ampl Jy Top frame: Phas deg
Vector averaged cross-power spectrum Baseline: JB (01) - EF (03)
Timerange: 00/14:43:11 to 00/14:43:59

Plot file version 92 created 03-APR-2017 18:27:39

J1834-2341 EM126B.UVDATA.1

Freq = 4.7995 GHz, Bw = 32.000 MH No calibration applied and no bandpass applied

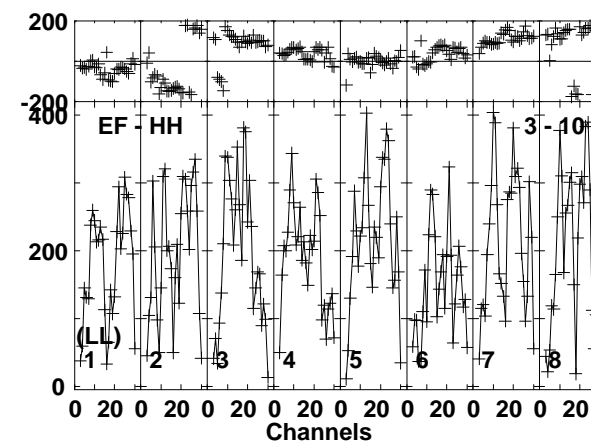
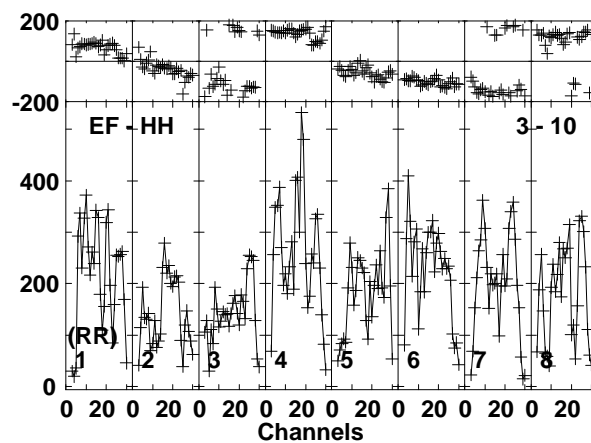
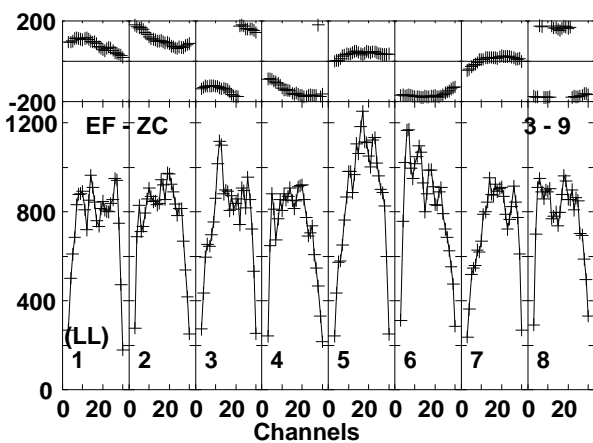
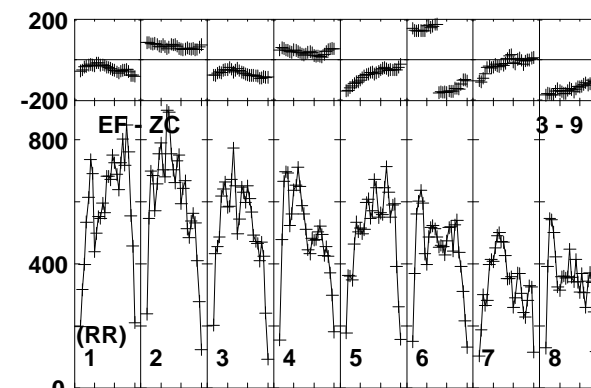
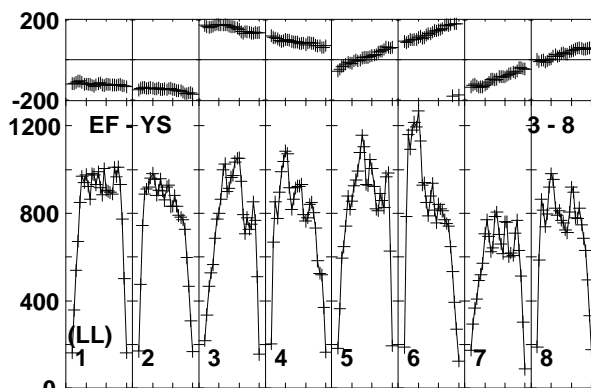
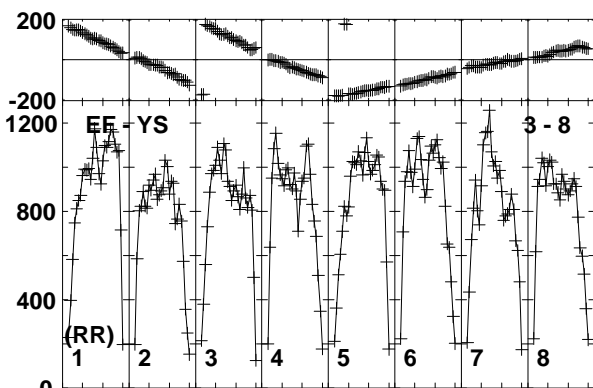
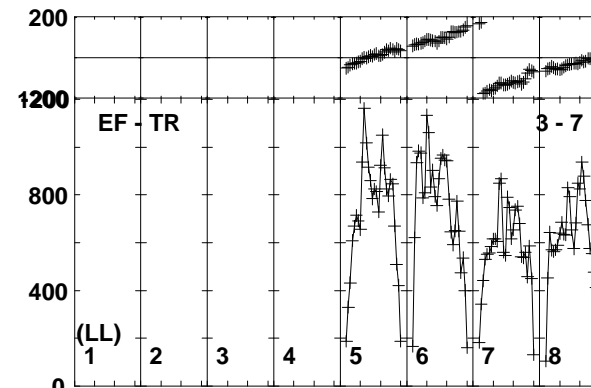
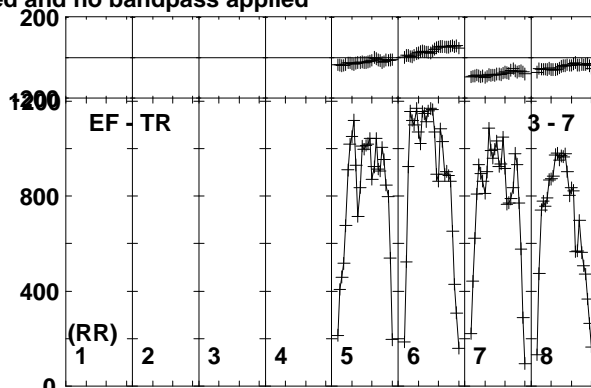
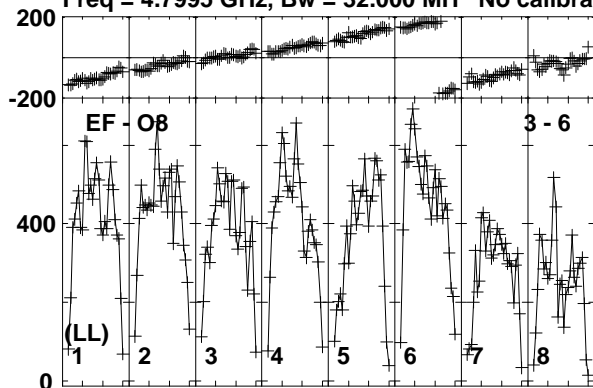

Lower frame: Micro Ampl Jy Top frame: Phas deg
Vector averaged cross-power spectrum Baseline: EF (03) - O8 (06)
Timerange: 00/14:43:11 to 00/14:43:59

Plot file version 93 created 03-APR-2017 18:27:39

M22-VLA1 EM126B.UVDATA.1

Freq = 4.7995 GHz, Bw = 32.000 MH No calibration applied and no bandpass applied

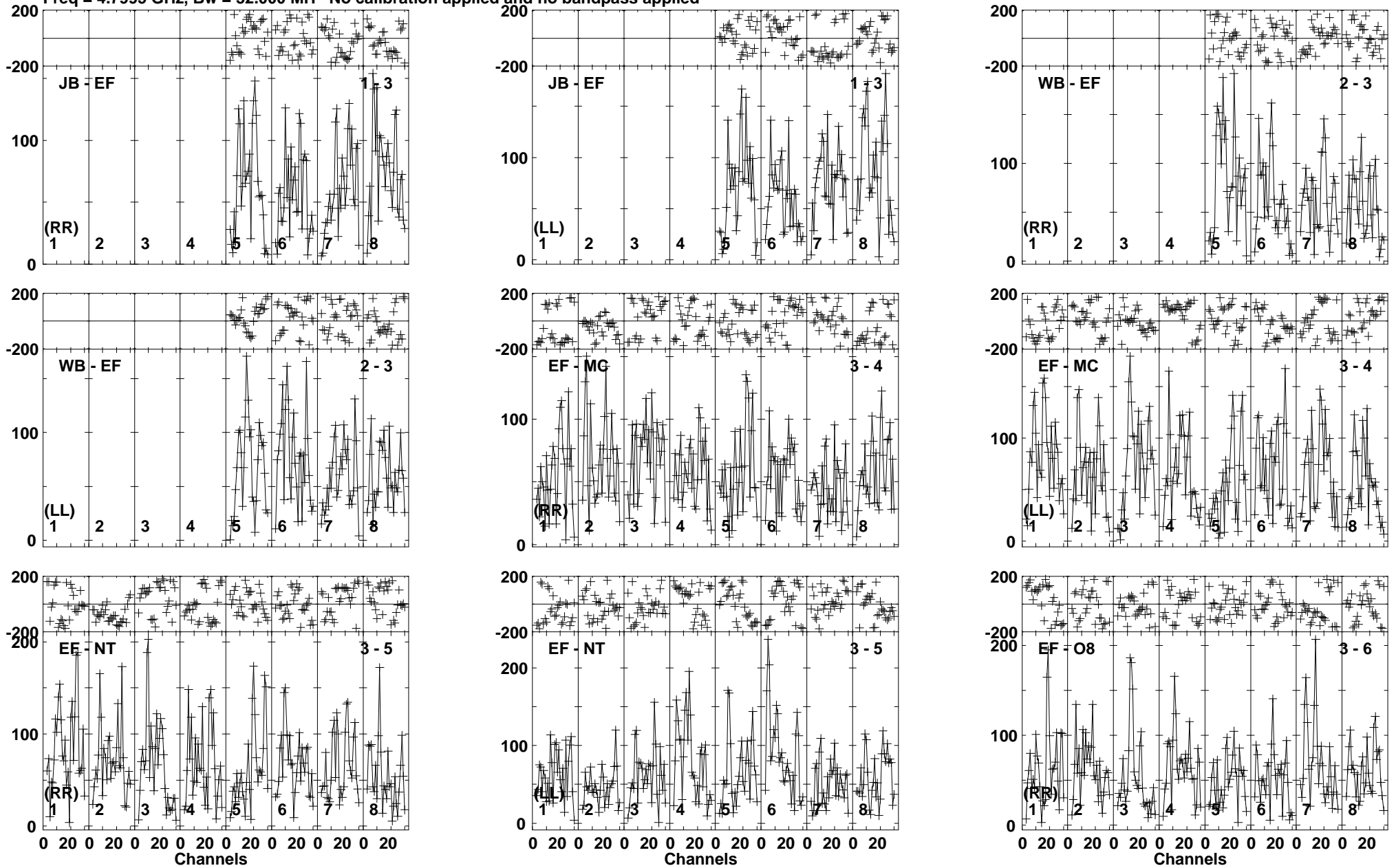

Lower frame: Micro Ampl Jy Top frame: Phas deg
Vector averaged cross-power spectrum Baseline: JB (01) - EF (03)
Timerange: 00/14:44:04 to 00/14:46:08

Plot file version 94 created 03-APR-2017 18:27:39

M22-VLA1 EM126B.UVDATA.1

Freq = 4.7995 GHz, Bw = 32.000 MH No calibration applied and no bandpass applied

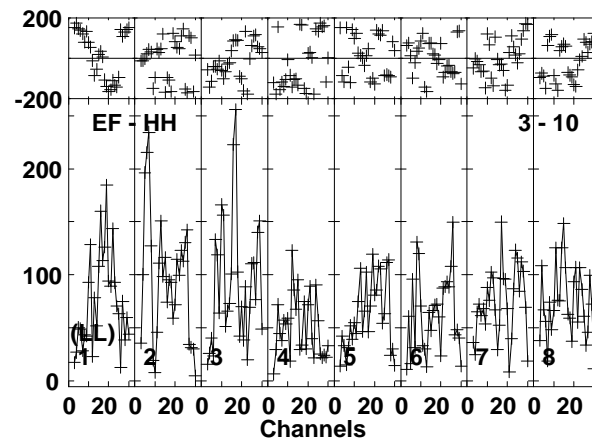
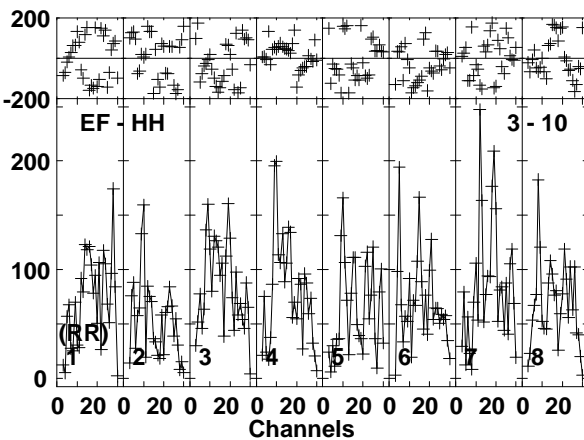
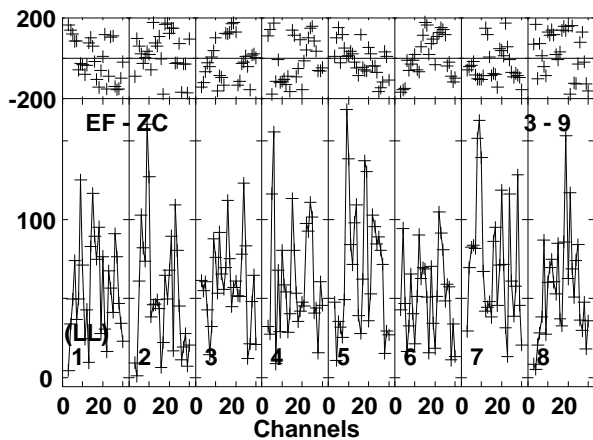
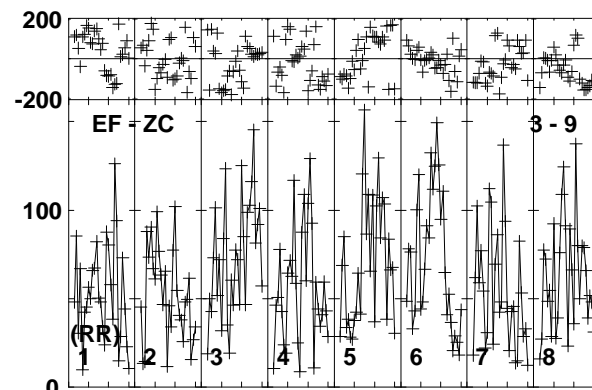
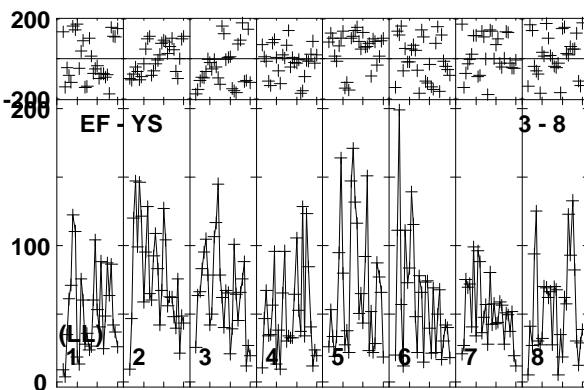
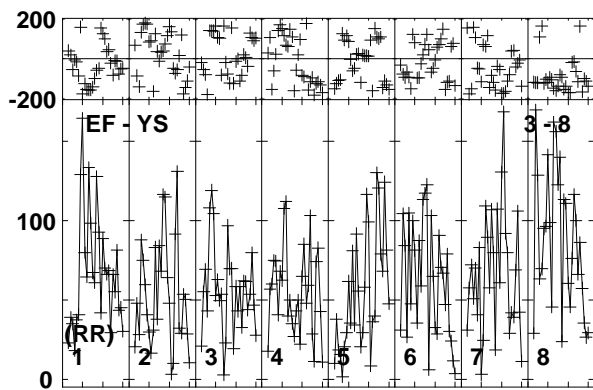
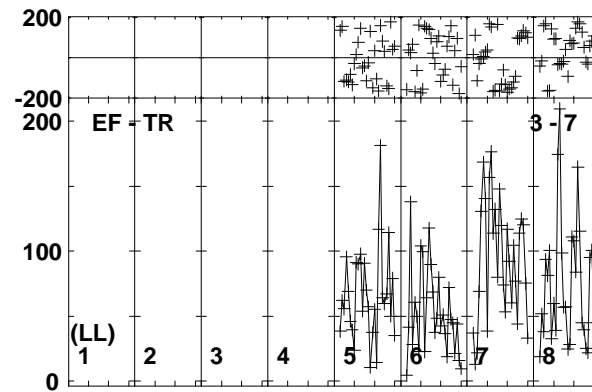
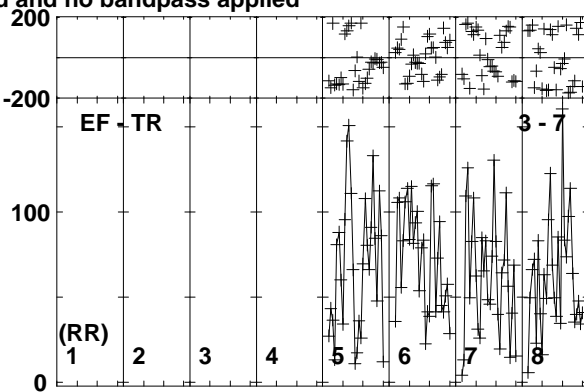
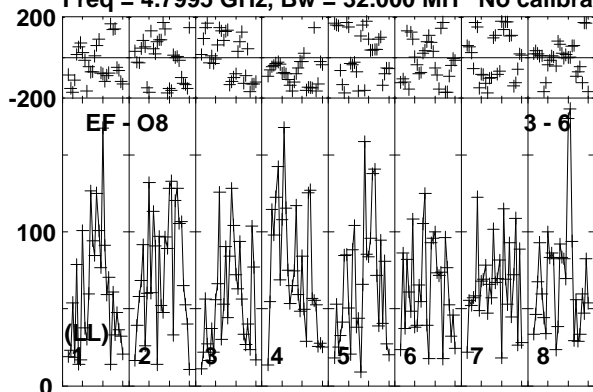

Lower frame: Micro Ampl Jy Top frame: Phas deg
Vector averaged cross-power spectrum Baseline: EF (03) - O8 (06)
Timerange: 00/14:44:04 to 00/14:46:08

Plot file version 95 created 03-APR-2017 18:27:39

J1834-2341 EM126B.UVDATA.1

Freq = 4.7995 GHz, Bw = 32.000 MH No calibration applied and no bandpass applied

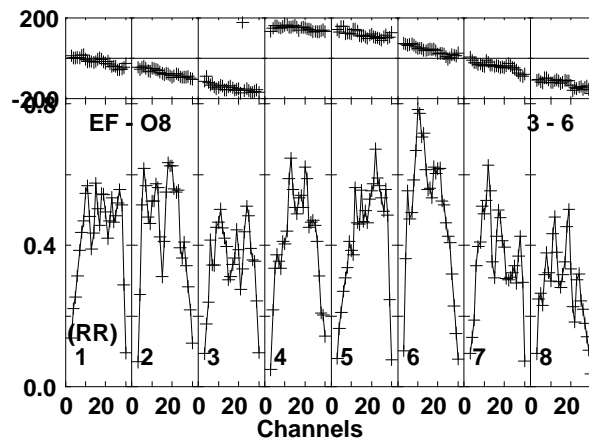
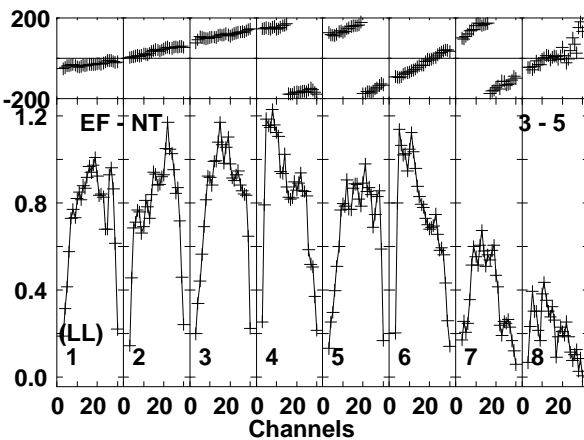
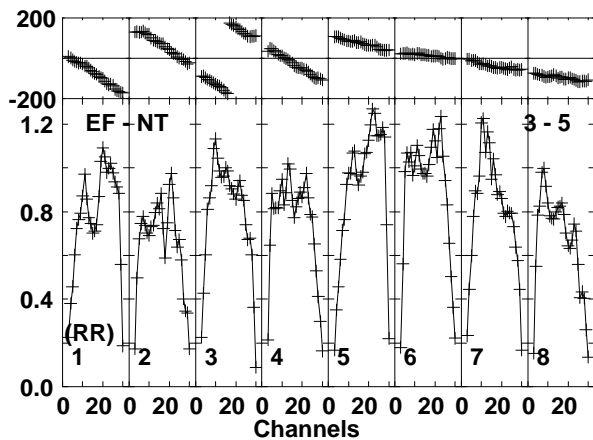
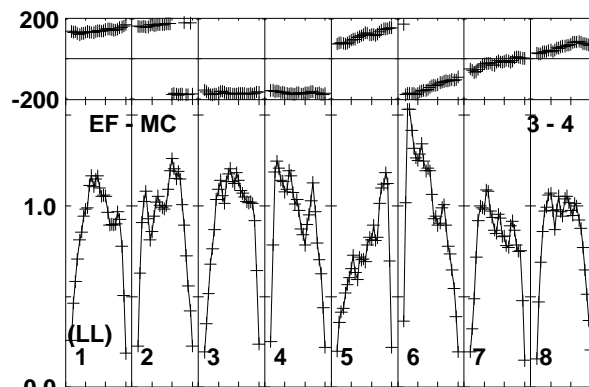
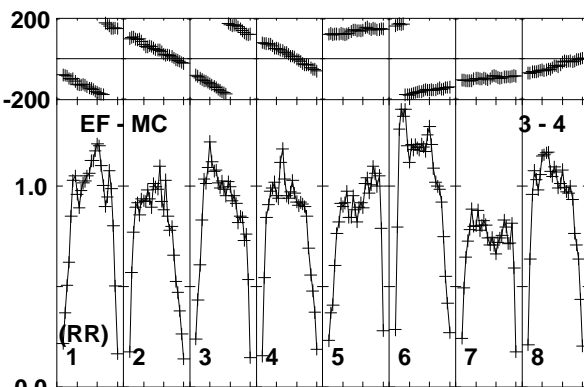
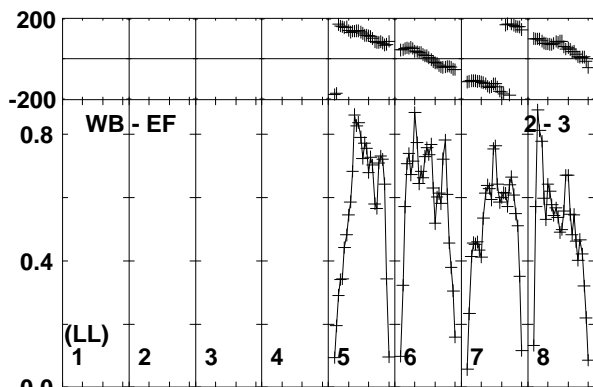
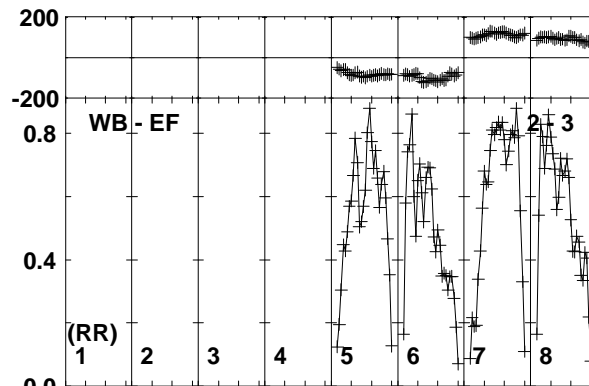
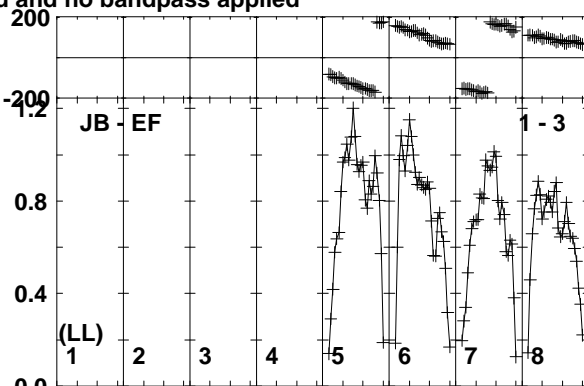
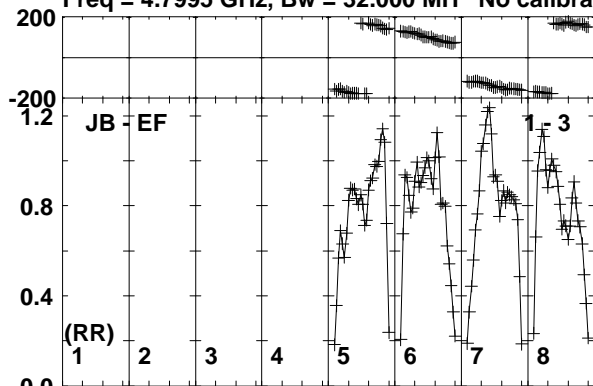

Lower frame: Milli Ampl Jy Top frame: Phas deg
Vector averaged cross-power spectrum Baseline: JB (01) - EF (03)
Timerange: 00/14:46:14 to 00/14:47:28

Plot file version 96 created 03-APR-2017 18:27:39

J1834-2341 EM126B.UVDATA.1

Freq = 4.7995 GHz, Bw = 32.000 MH No calibration applied and no bandpass applied

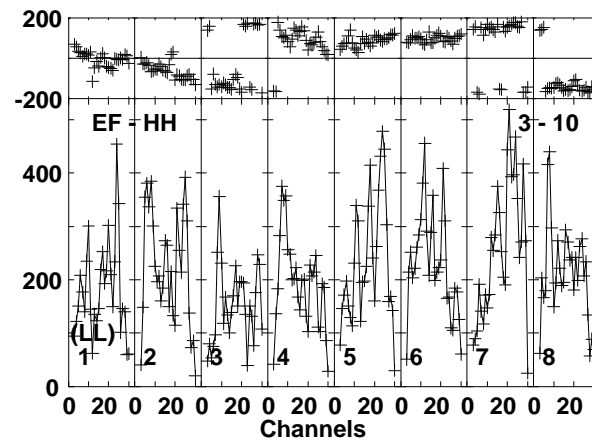
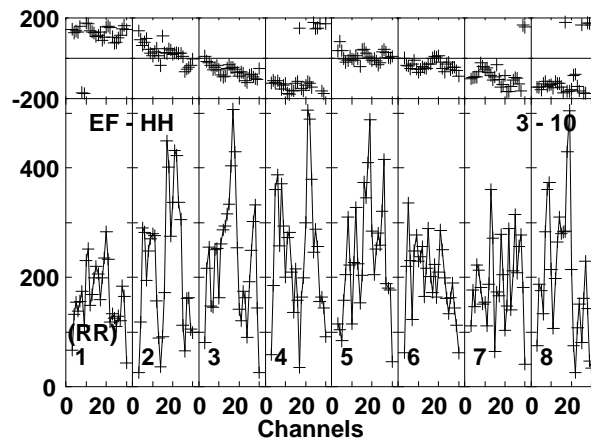
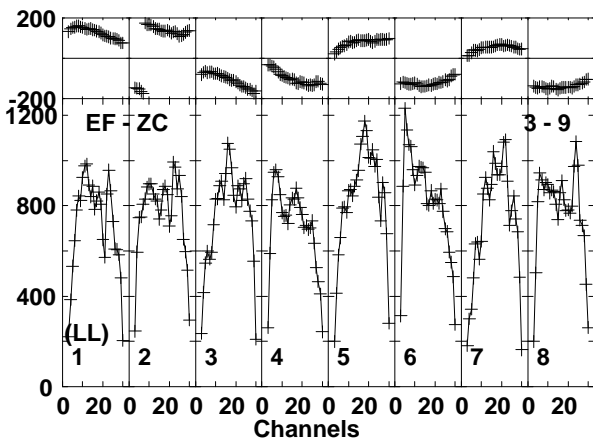
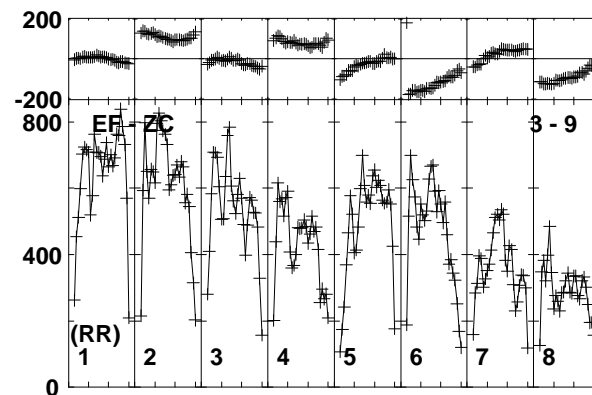
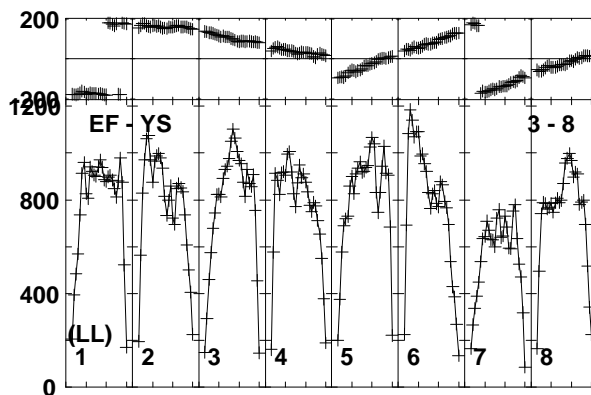
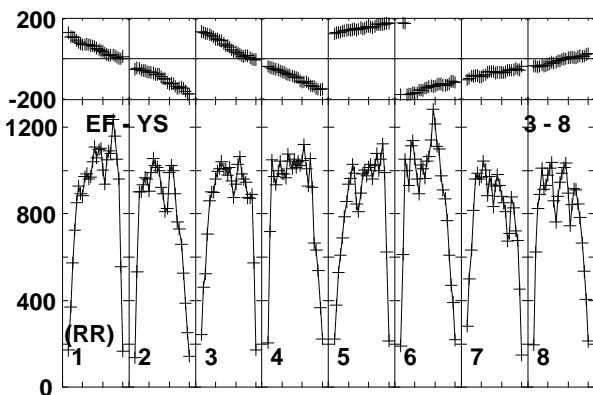
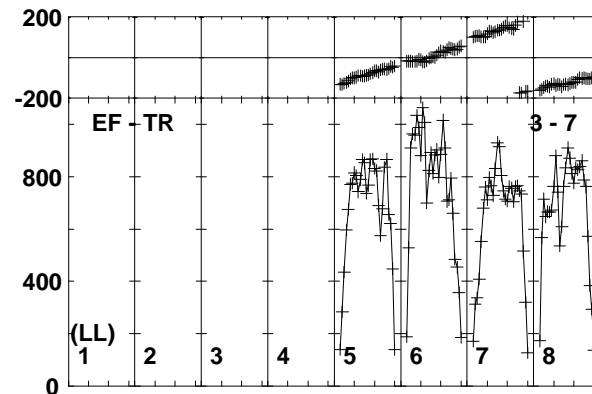
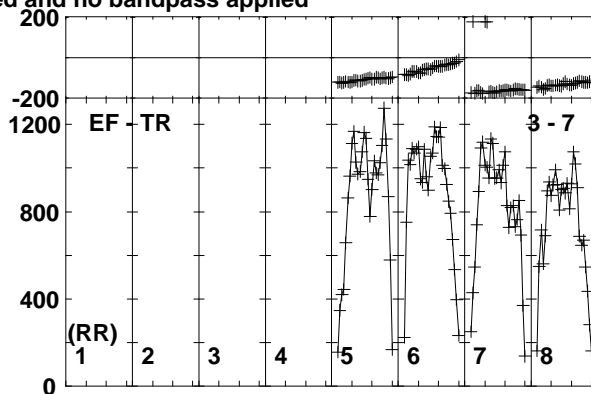
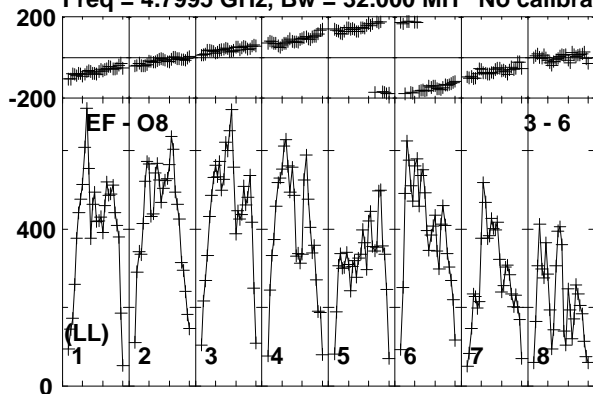

Lower frame: Micro Ampl Jy Top frame: Phas deg
Vector averaged cross-power spectrum Baseline: EF (03) - O8 (06)
Timerange: 00/14:46:14 to 00/14:47:28

Plot file version 97 created 03-APR-2017 18:27:39

M22-VLA1 EM126B.UVDATA.1

Freq = 4.7995 GHz, Bw = 32.000 MH No calibration applied and no bandpass applied

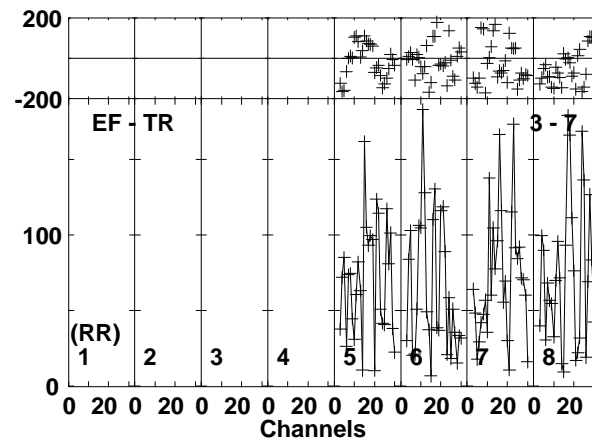
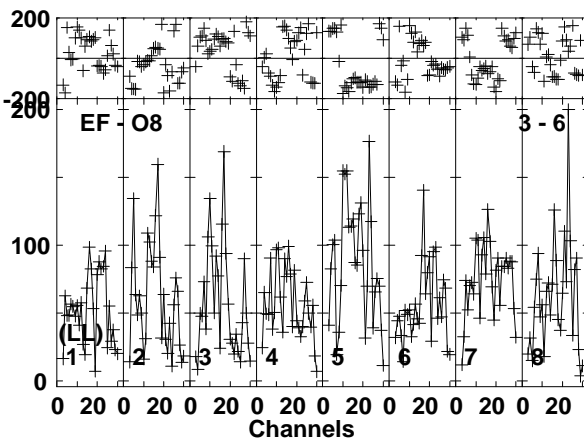
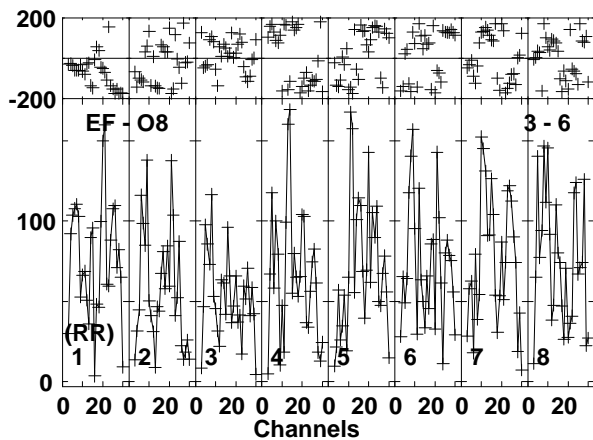
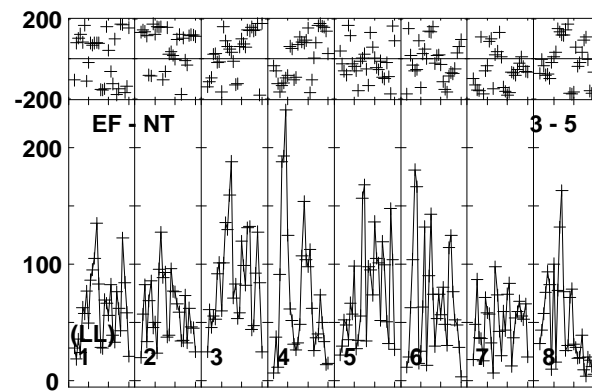
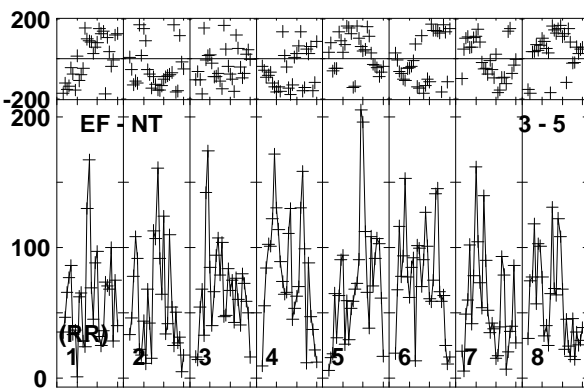
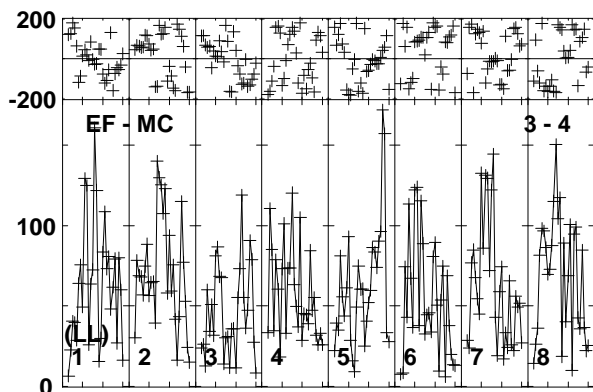
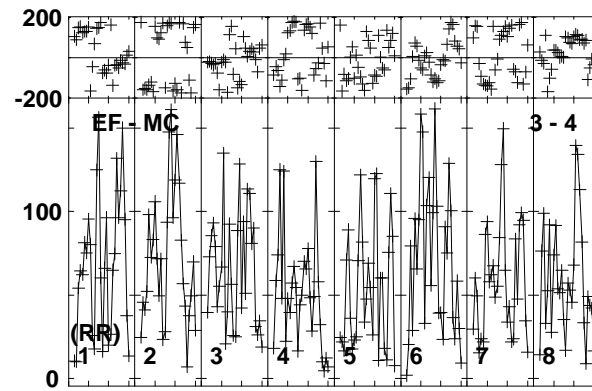
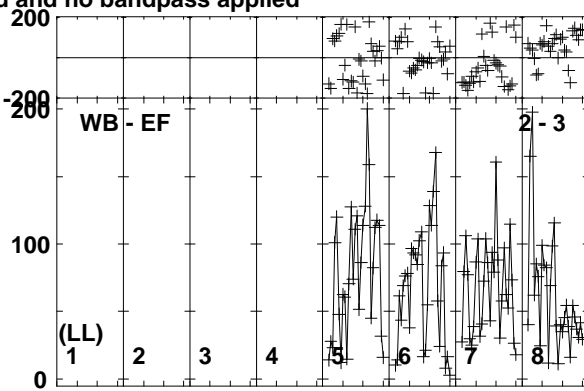
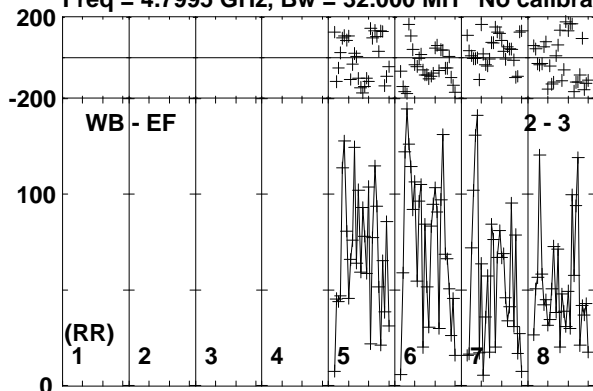

Lower frame: Micro Ampl Jy Top frame: Phas deg
Vector averaged cross-power spectrum Baseline: WB (02) - EF (03)
Timerange: 00/14:47:34 to 00/14:49:38

Plot file version 98 created 03-APR-2017 18:27:39

M22-VLA1 EM126B.UVDATA.1

Freq = 4.7995 GHz, Bw = 32.000 MH No calibration applied and no bandpass applied

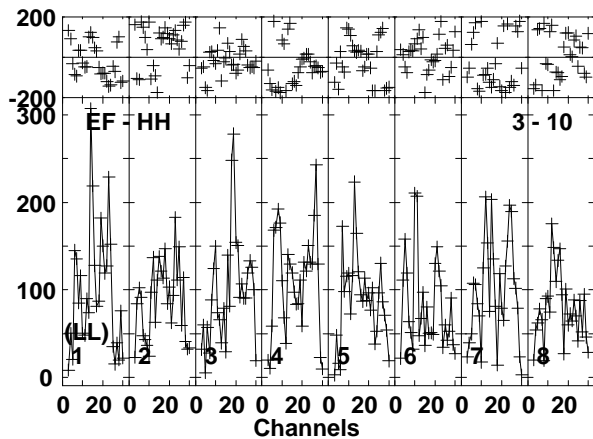
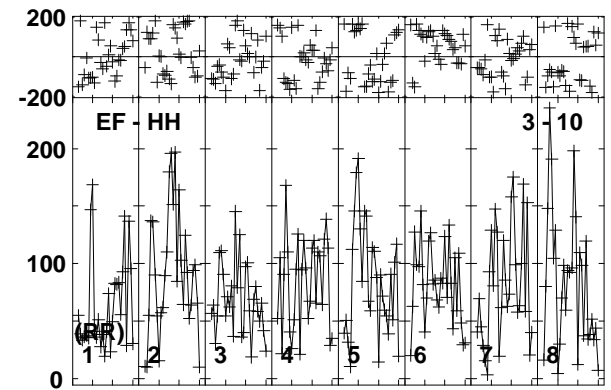
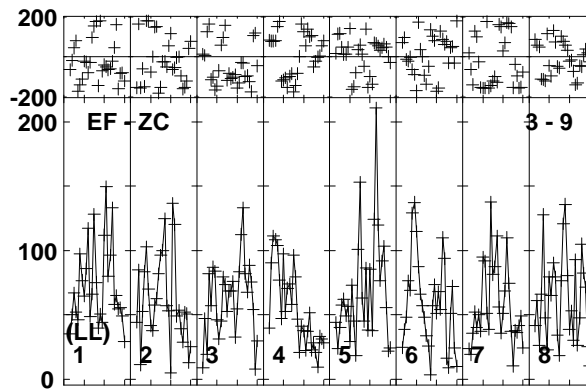
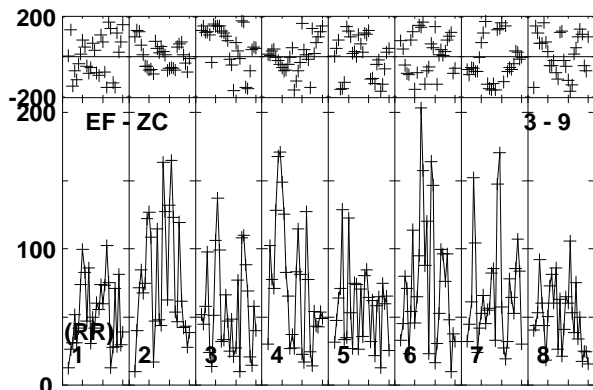
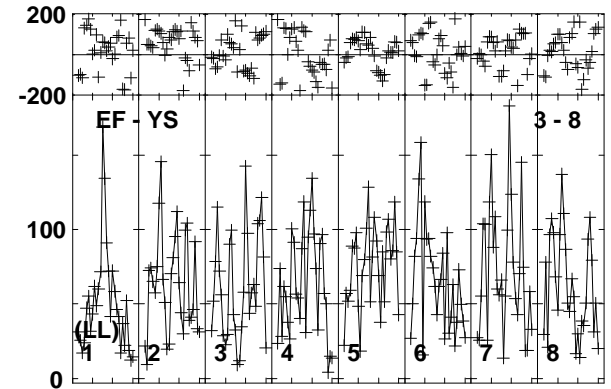
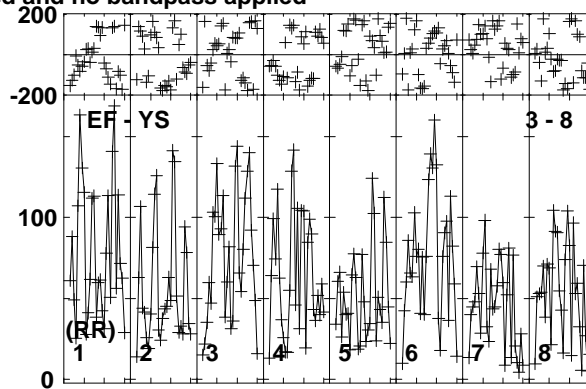
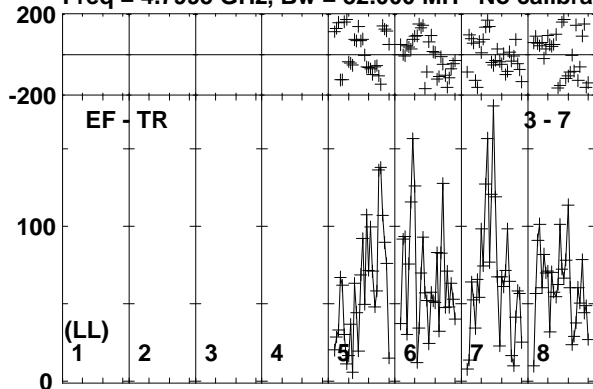

Lower frame: Micro Ampl Jy Top frame: Phas deg
Vector averaged cross-power spectrum Baseline: EF (03) - TR (07)
Timerange: 00/14:47:34 to 00/14:49:38

Plot file version 99 created 03-APR-2017 18:27:39

J1834-2341 EM126B.UVDATA.1

Freq = 4.7995 GHz, Bw = 32.000 MH No calibration applied and no bandpass applied

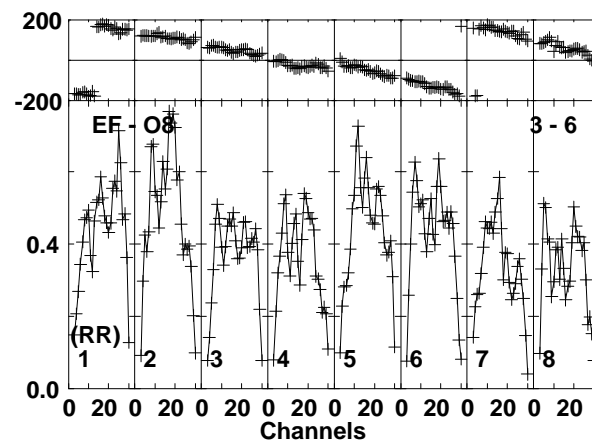
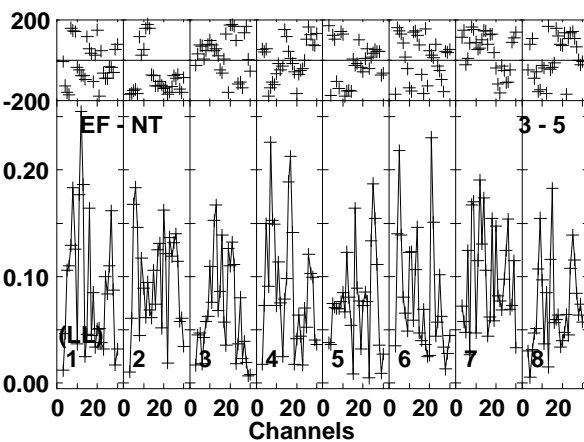
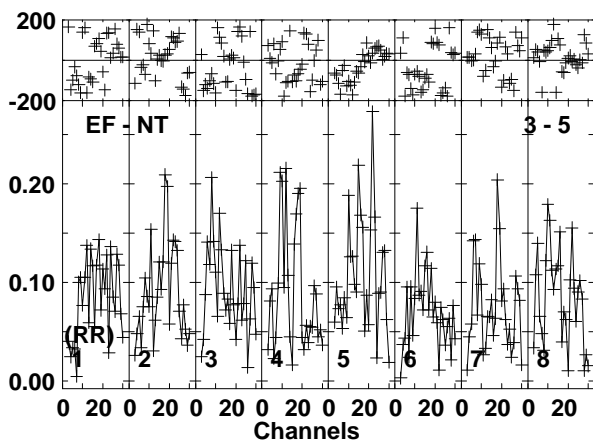
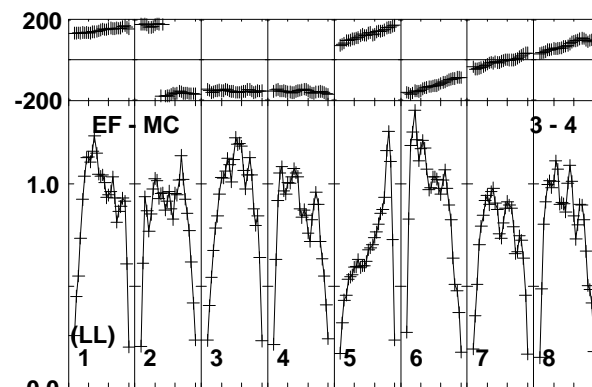
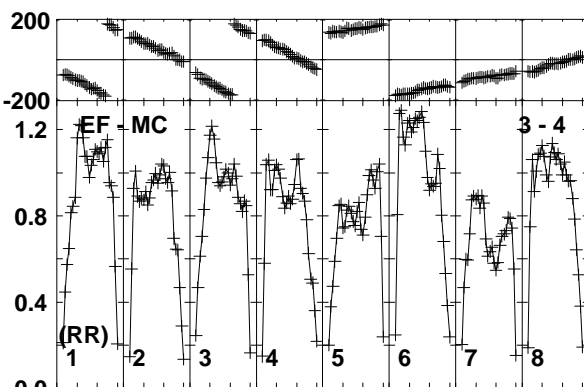
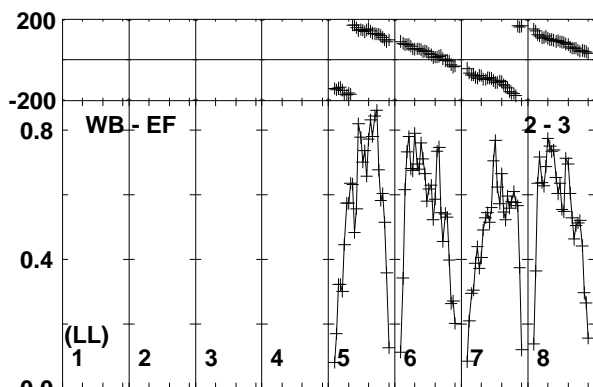
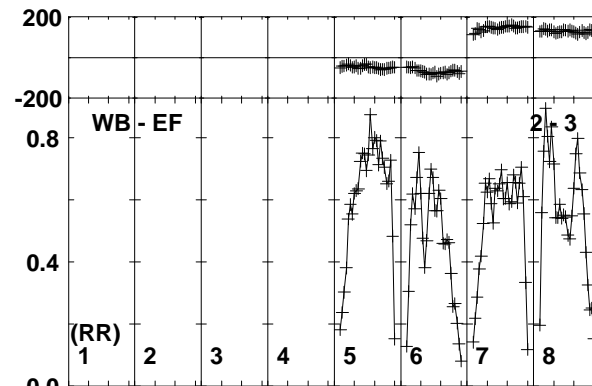
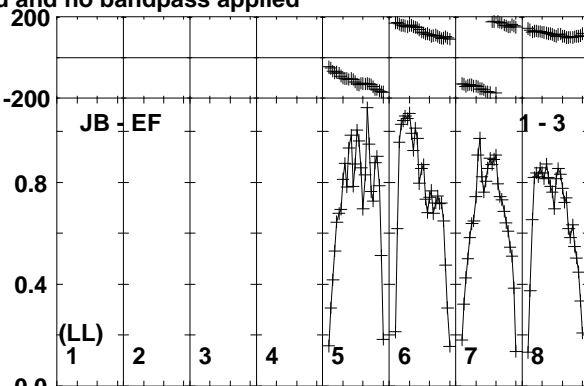
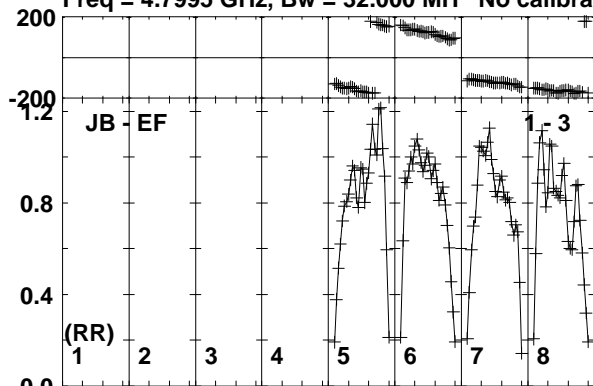

Lower frame: Milli Ampl Jy Top frame: Phas deg
Vector averaged cross-power spectrum Baseline: JB (01) - EF (03)
Timerange: 00/14:49:44 to 00/14:50:58

Plot file version 100 created 03-APR-2017 18:27:39

J1834-2341 EM126B.UVDATA.1

Freq = 4.7995 GHz, Bw = 32.000 MH No calibration applied and no bandpass applied

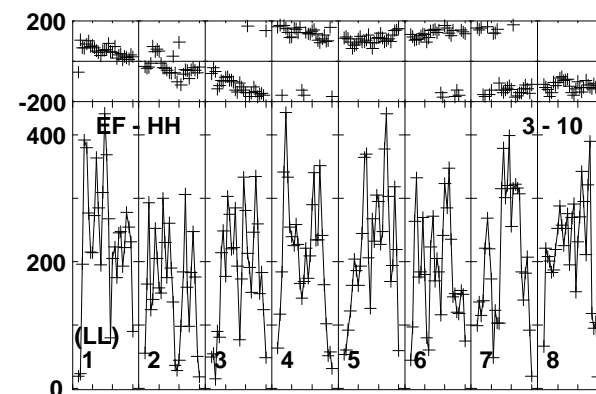
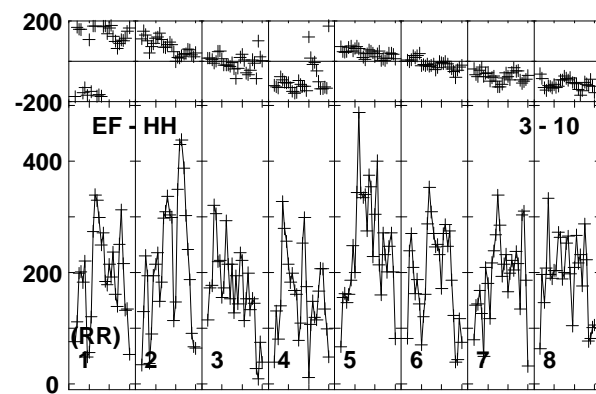
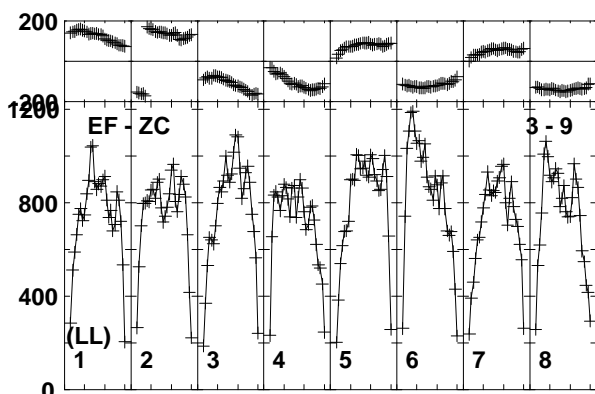
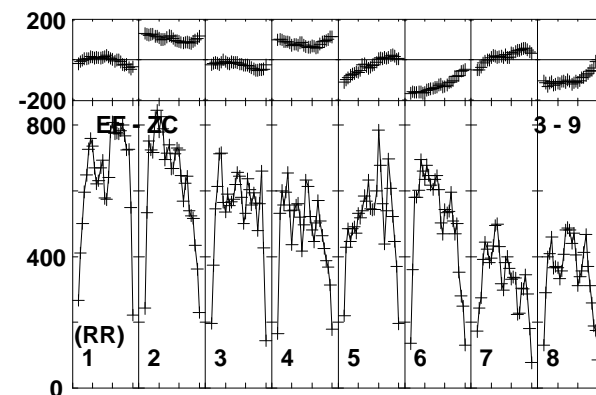
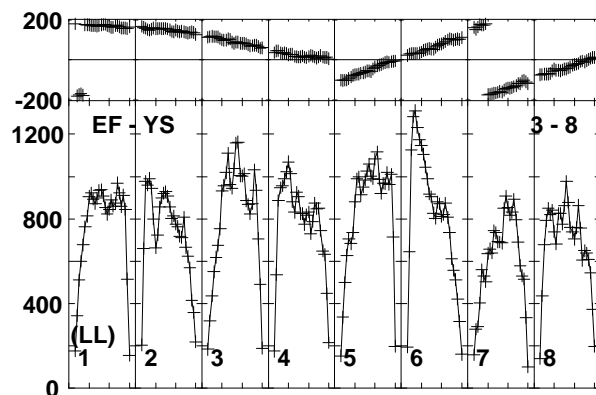
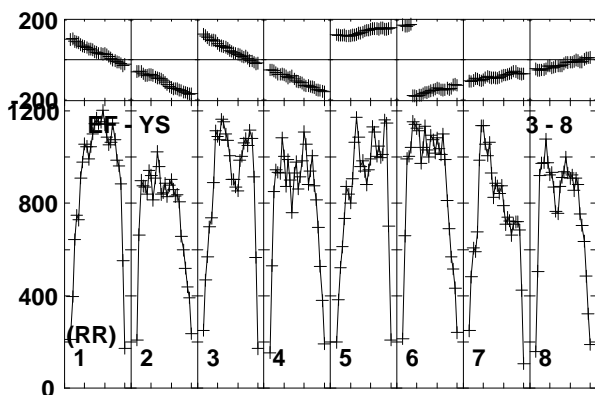
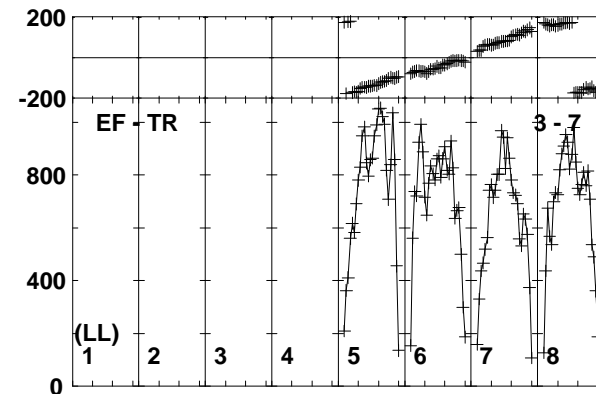
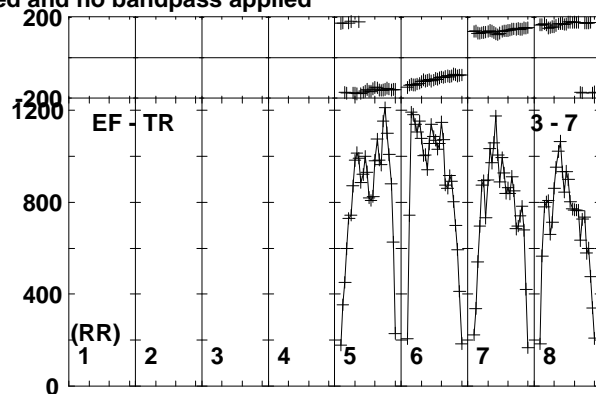
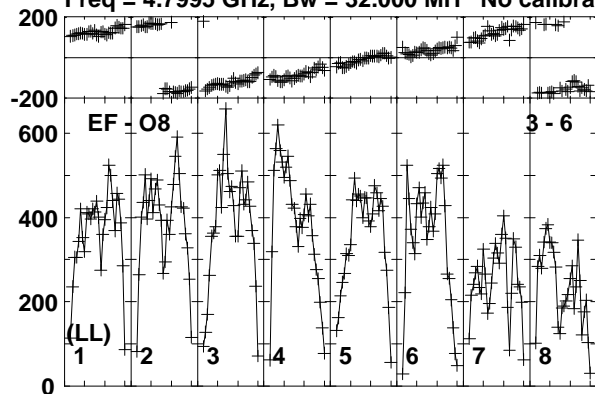

Lower frame: Micro Ampl Jy Top frame: Phas deg
Vector averaged cross-power spectrum Baseline: EF (03) - O8 (06)
Timerange: 00/14:49:44 to 00/14:50:58

Plot file version 101 created 03-APR-2017 18:27:39

M22-VLA1 EM126B.UVDATA.1

Freq = 4.7995 GHz, Bw = 32.000 MH No calibration applied and no bandpass applied

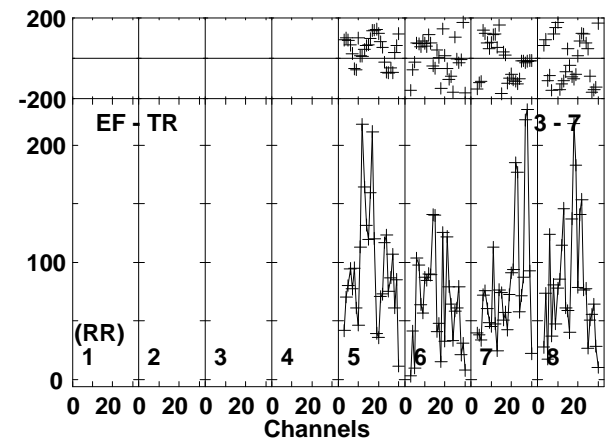
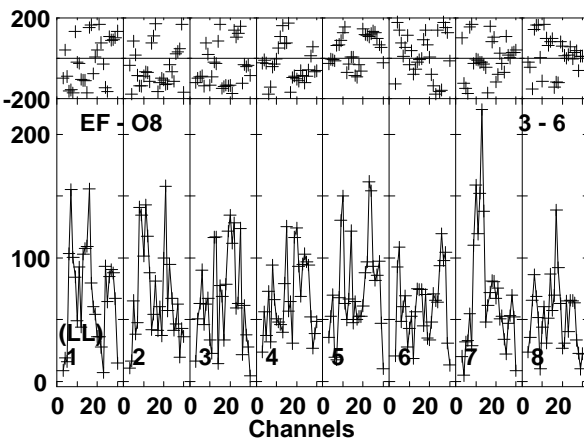
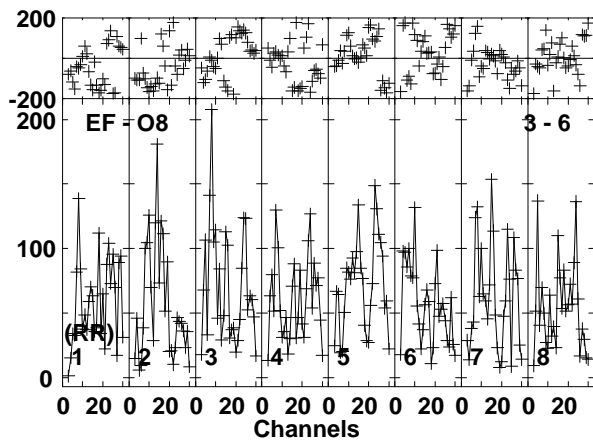
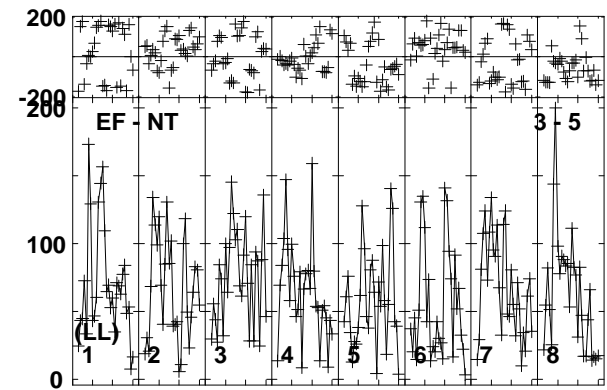
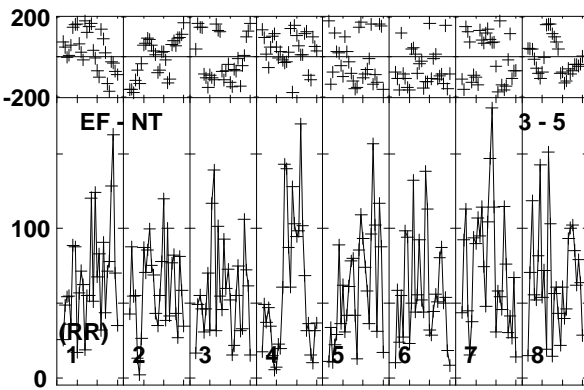
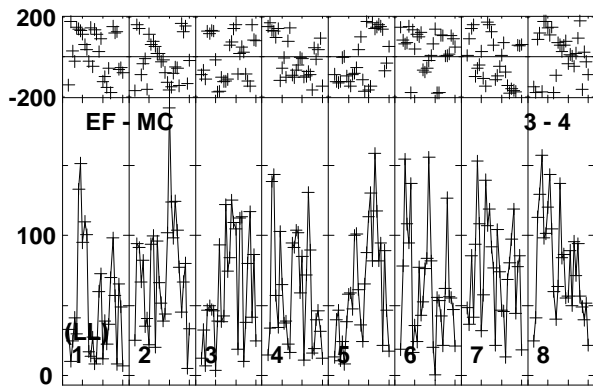
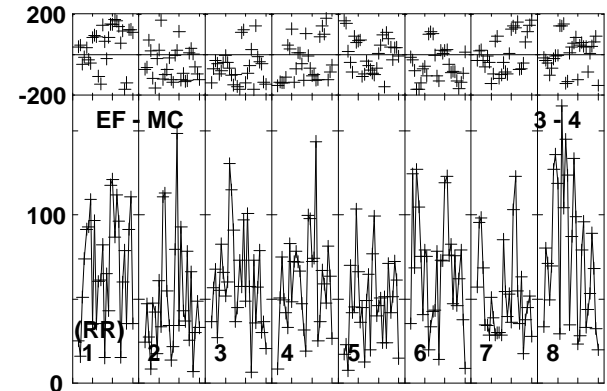
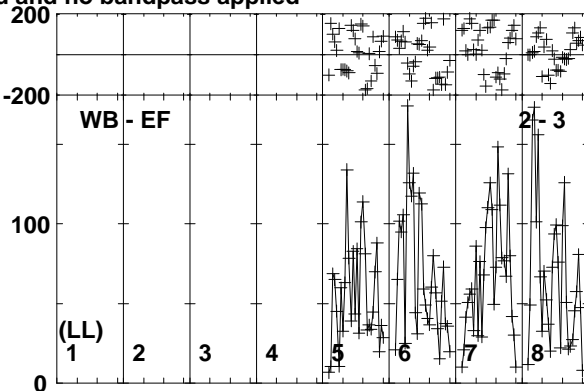
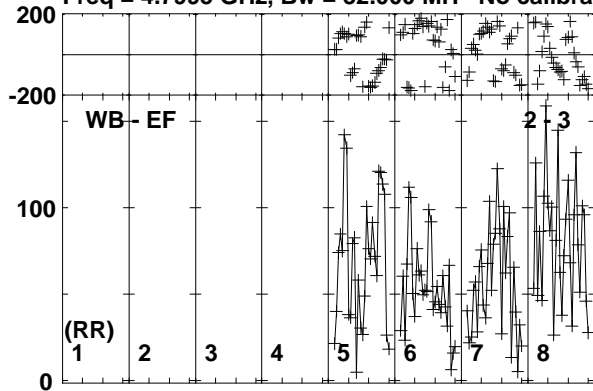

Lower frame: Micro Ampl Jy Top frame: Phas deg
Vector averaged cross-power spectrum Baseline: WB (02) - EF (03)
Timerange: 00/14:51:04 to 00/14:53:08

Plot file version 102 created 03-APR-2017 18:27:39

M22-VLA1 EM126B.UVDATA.1

Freq = 4.7995 GHz, Bw = 32.000 MH No calibration applied and no bandpass applied

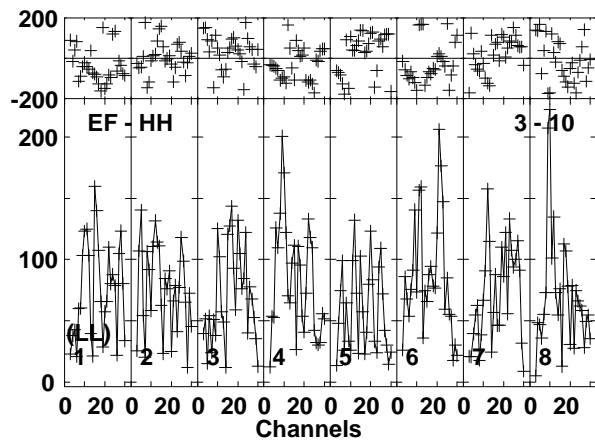
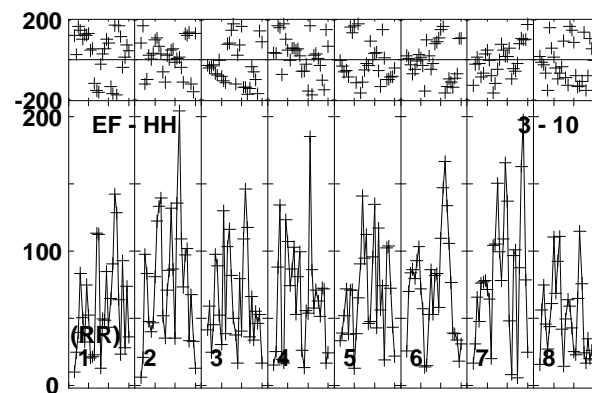
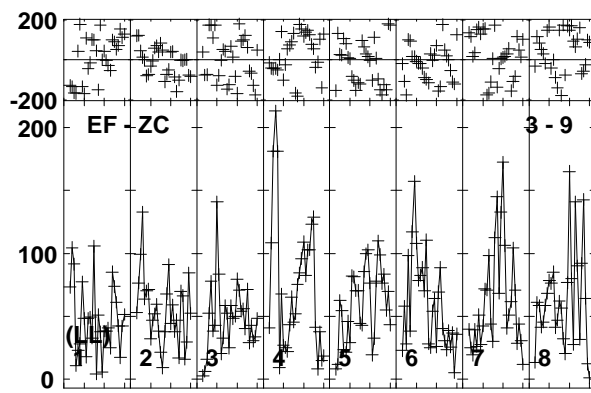
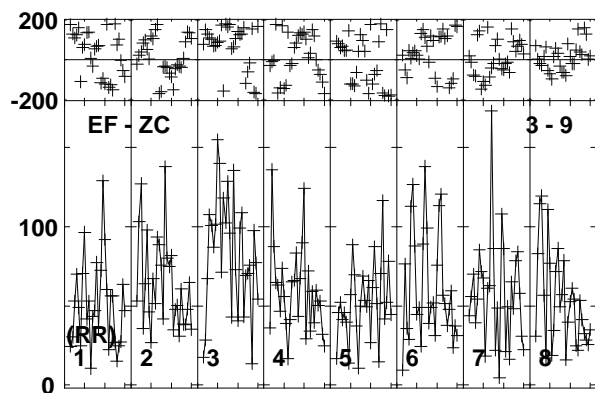
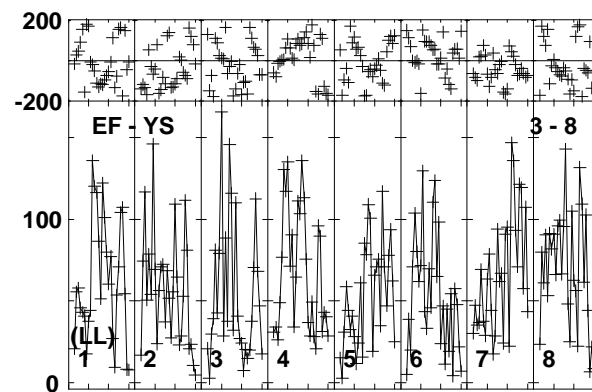
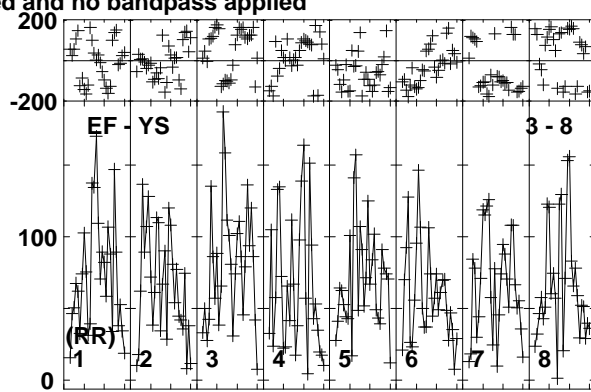
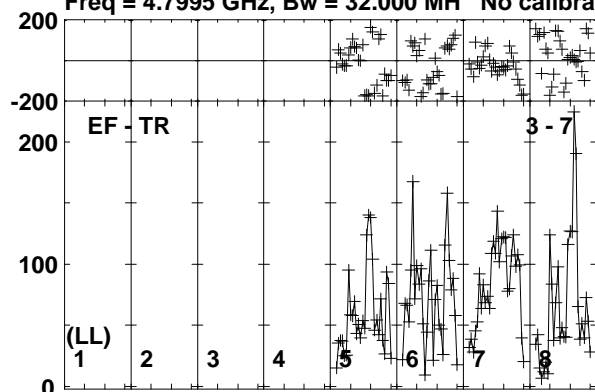

Lower frame: Micro Ampl Jy Top frame: Phas deg
Vector averaged cross-power spectrum Baseline: EF (03) - TR (07)
Timerange: 00/14:51:04 to 00/14:53:08

Plot file version 103 created 03-APR-2017 18:27:39

J1834-2341 EM126B.UVDATA.1

Freq = 4.7995 GHz, Bw = 32.000 MH No calibration applied and no bandpass applied

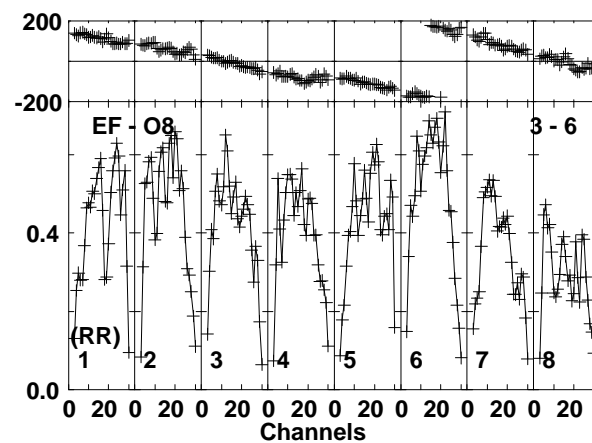
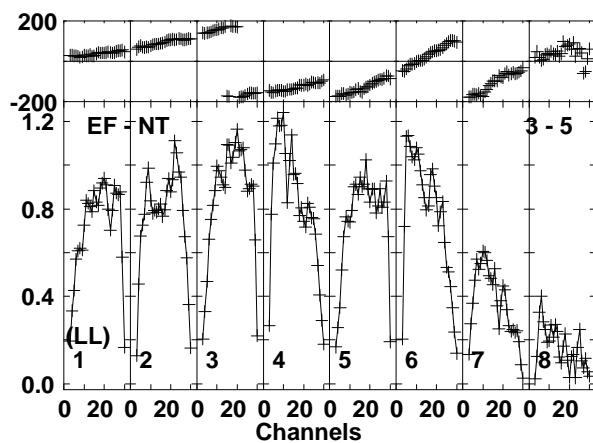
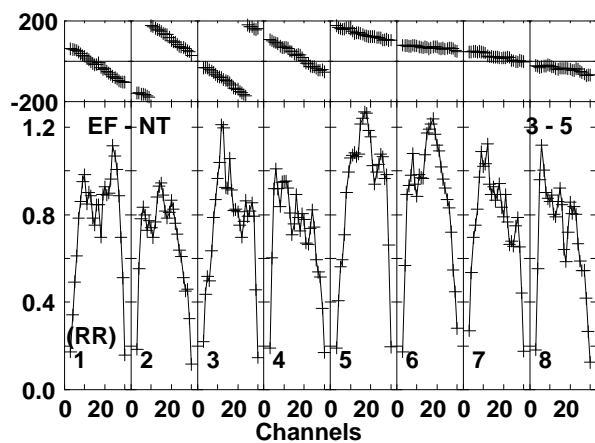
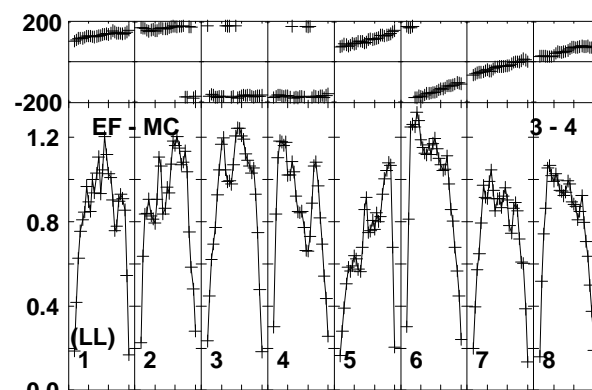
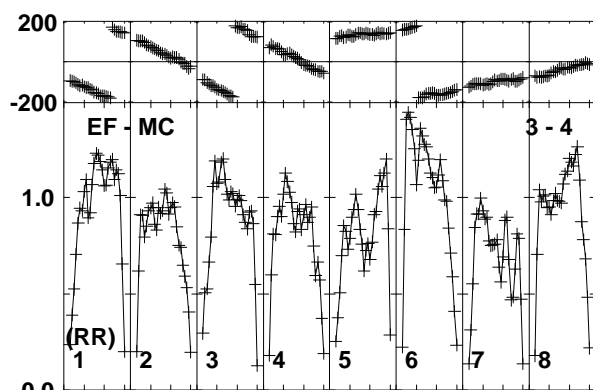
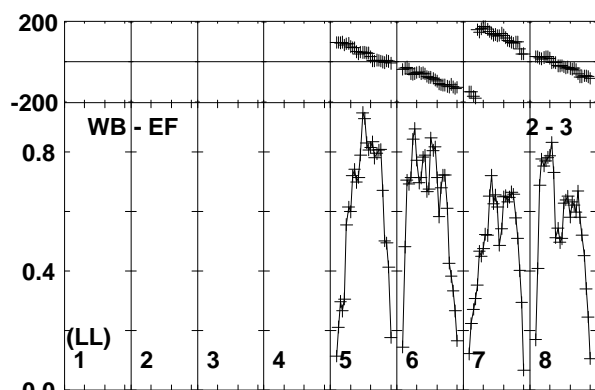
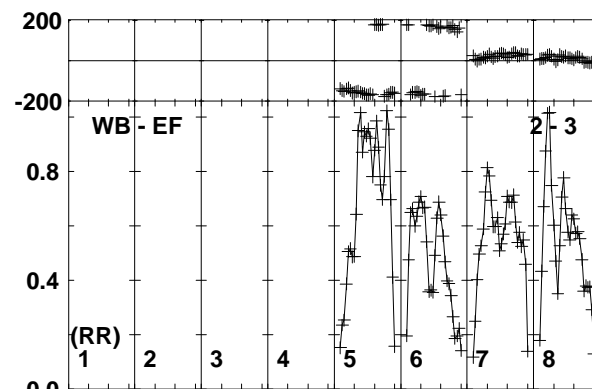
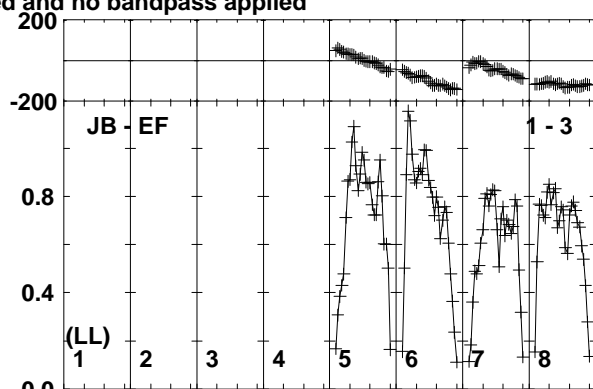
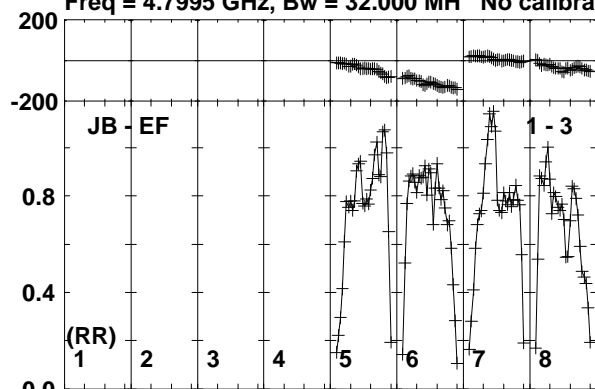

Lower frame: Milli Ampl Jy Top frame: Phas deg
Vector averaged cross-power spectrum Baseline: JB (01) - EF (03)
Timerange: 00/14:53:41 to 00/14:54:29

Plot file version 104 created 03-APR-2017 18:27:39

J1834-2341 EM126B.UVDATA.1

Freq = 4.7995 GHz, Bw = 32.000 MH No calibration applied and no bandpass applied

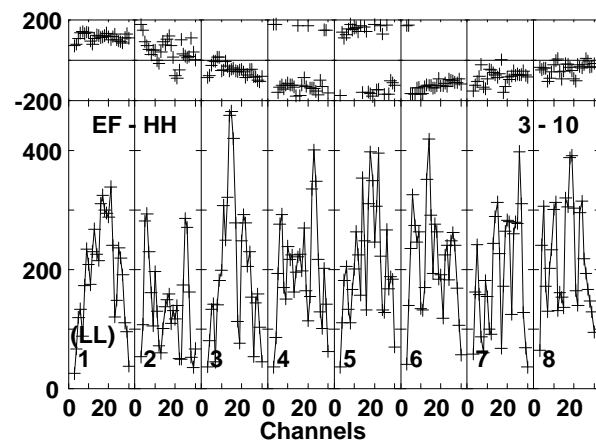
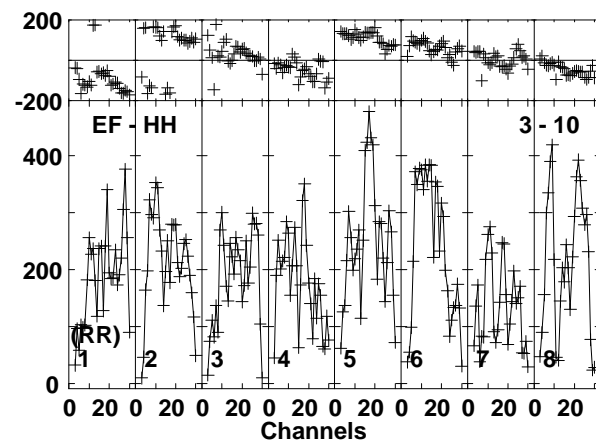
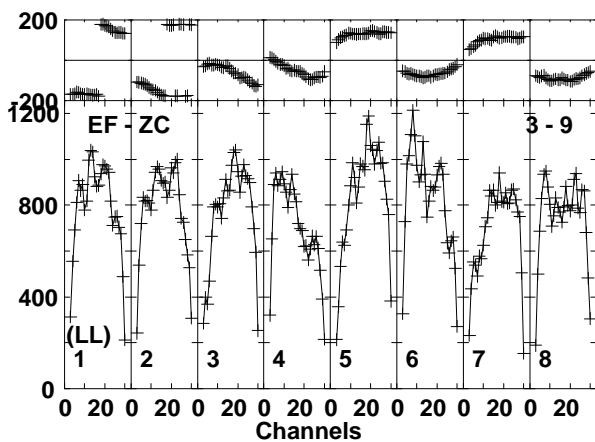
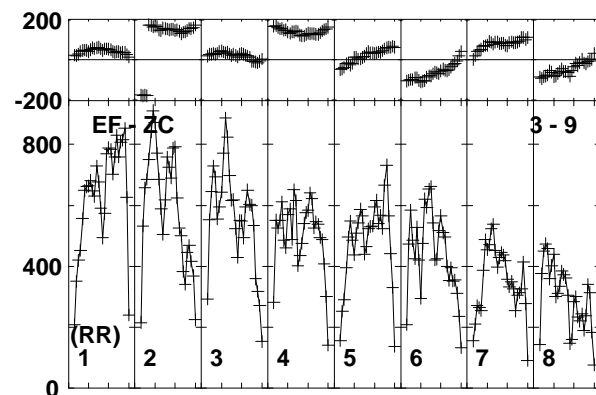
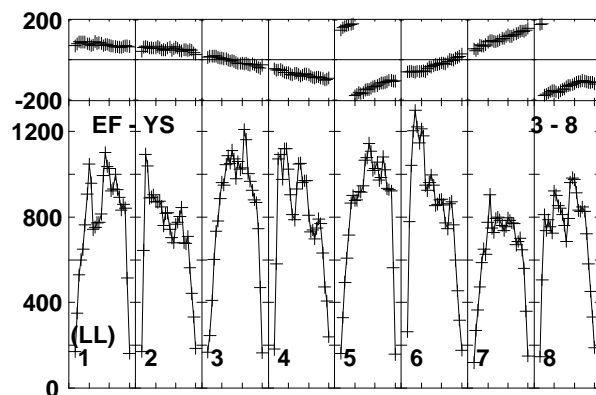
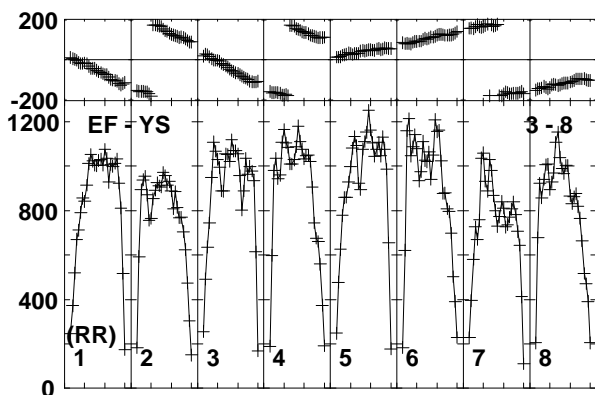
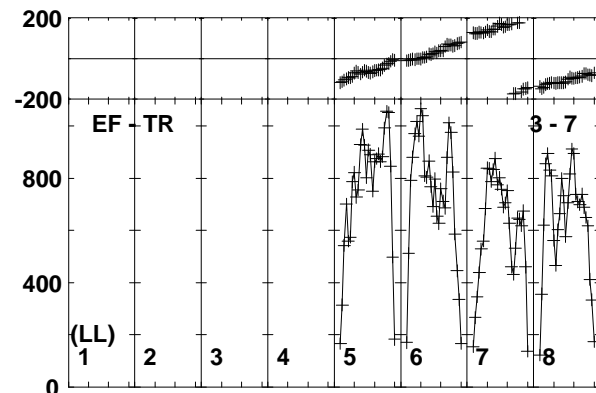
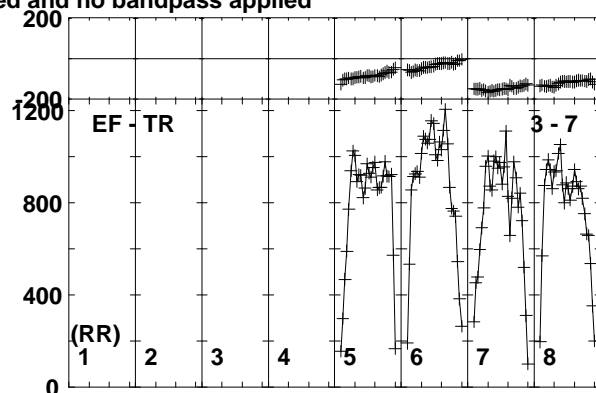
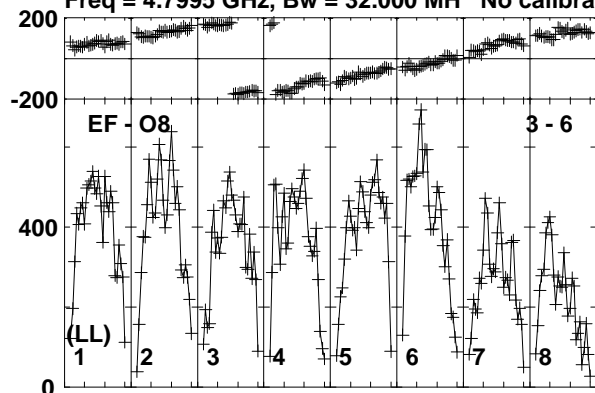

Lower frame: Micro Ampl Jy Top frame: Phas deg
Vector averaged cross-power spectrum Baseline: EF (03) - O8 (06)
Timerange: 00/14:53:41 to 00/14:54:29

Plot file version 105 created 03-APR-2017 18:27:40

M22-VLA1 EM126B.UVDATA.1

Freq = 4.7995 GHz, Bw = 32.000 MH No calibration applied and no bandpass applied

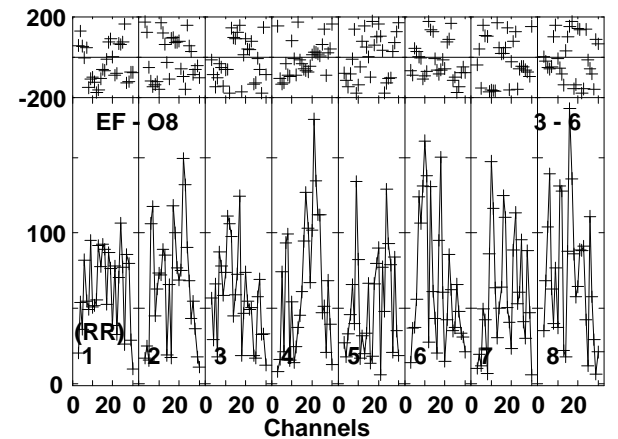
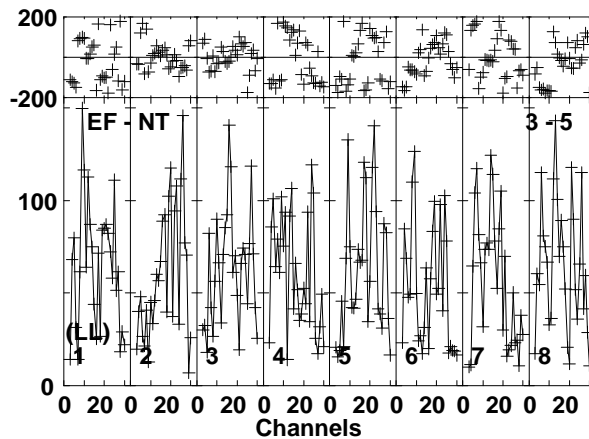
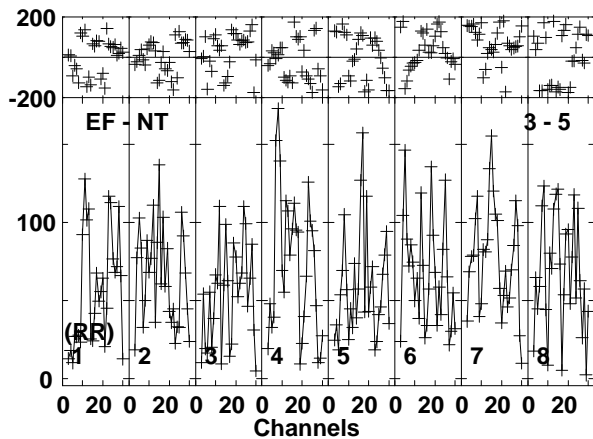
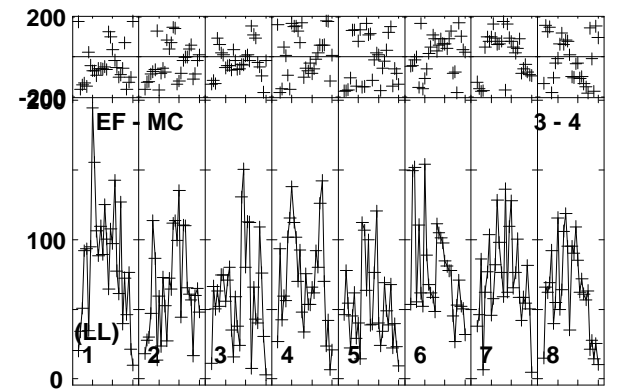
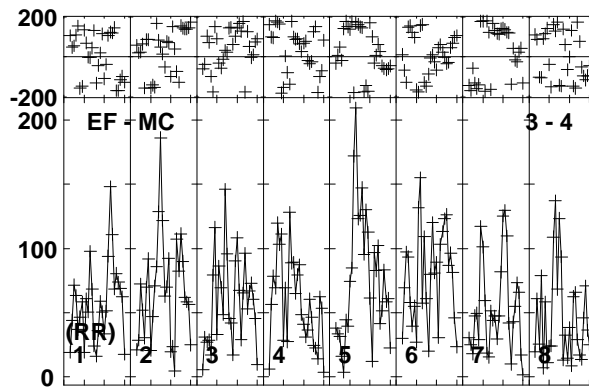
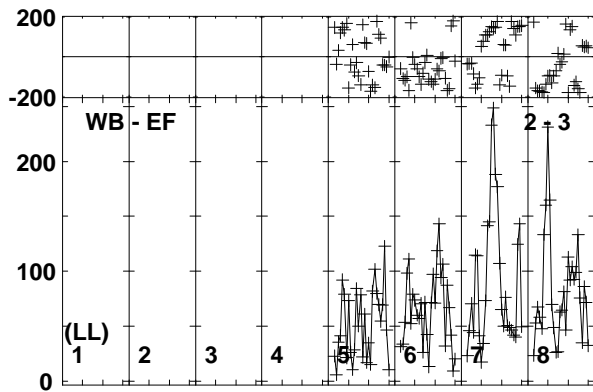
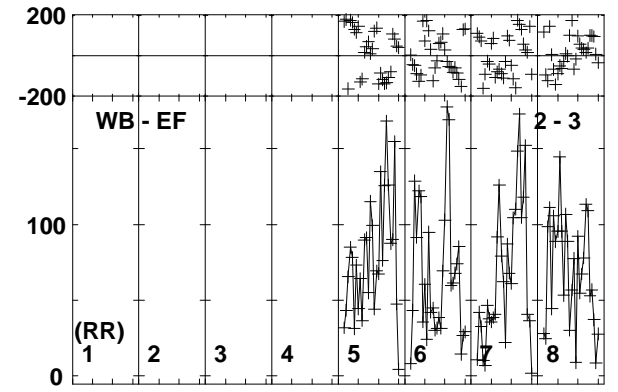
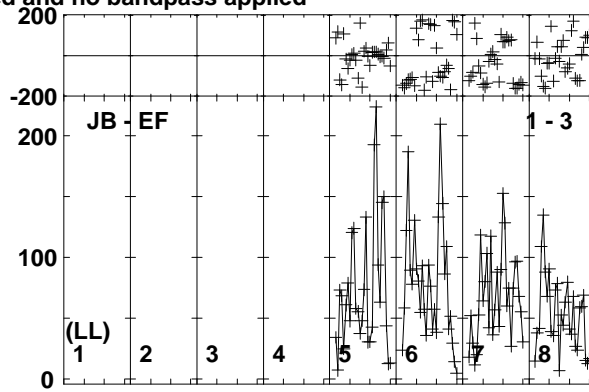
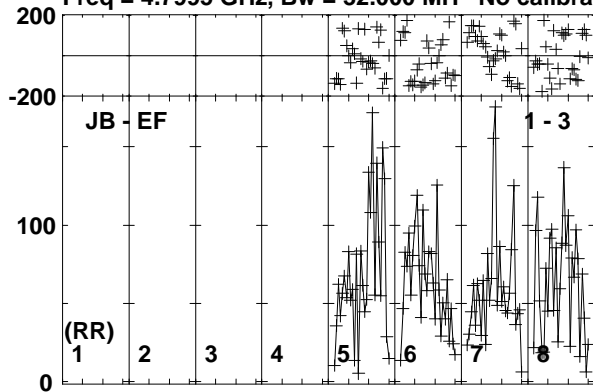

Lower frame: Micro Ampl Jy Top frame: Phas deg
Vector averaged cross-power spectrum Baseline: JB (01) - EF (03)
Timerange: 00/14:54:34 to 00/14:56:38

Plot file version 106 created 03-APR-2017 18:27:40

M22-VLA1 EM126B.UVDATA.1

Freq = 4.7995 GHz, Bw = 32.000 MH No calibration applied and no bandpass applied

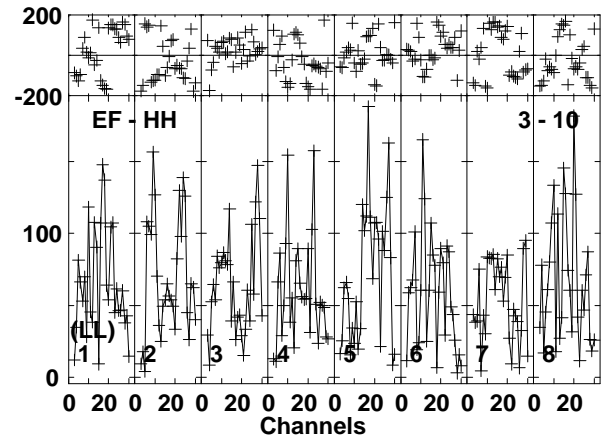
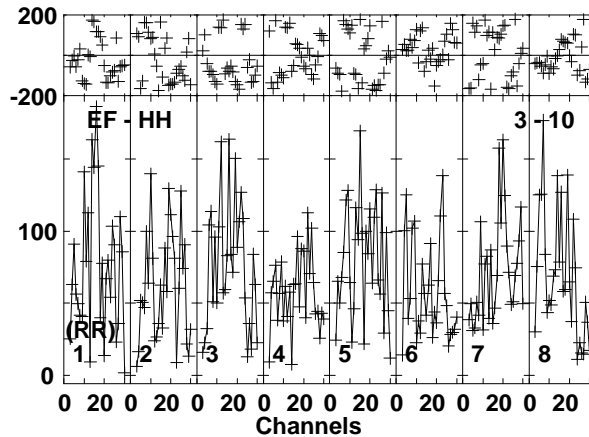
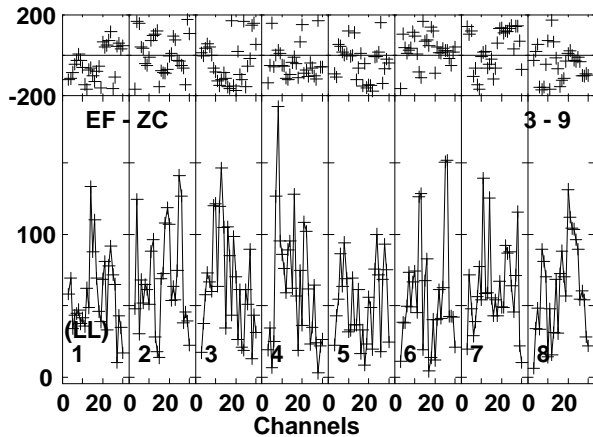
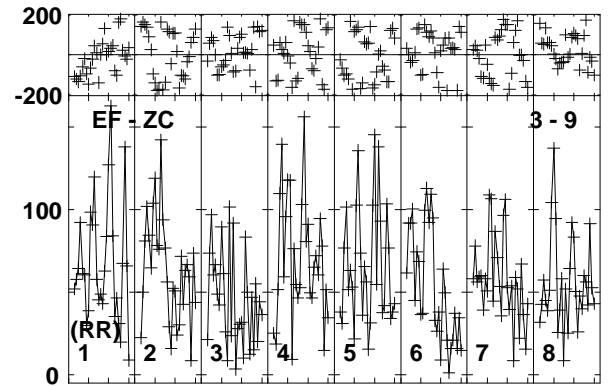
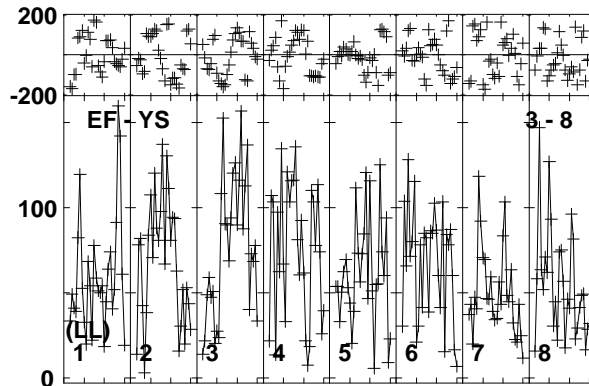
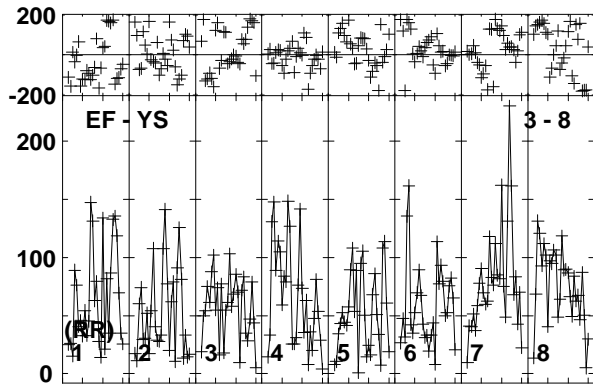
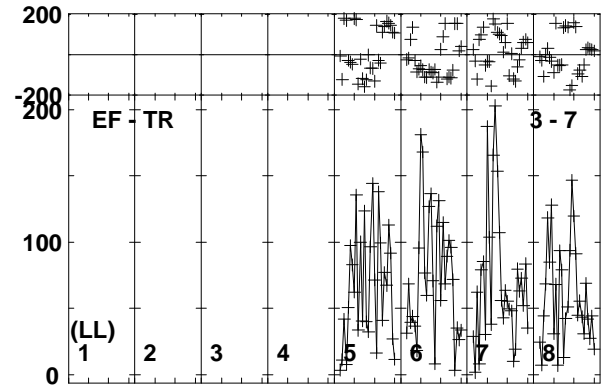
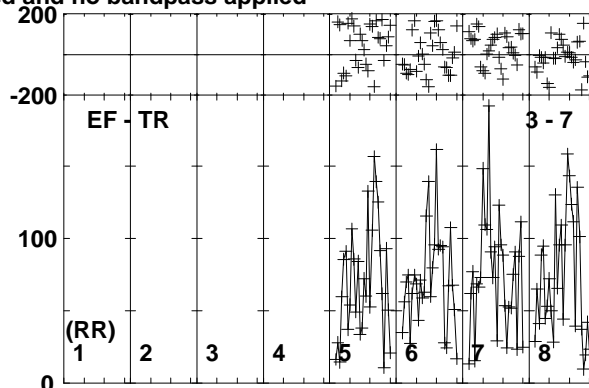
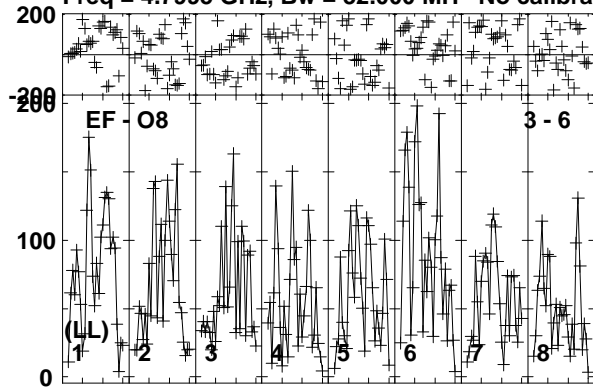

Lower frame: Micro Ampl Jy Top frame: Phas deg
Vector averaged cross-power spectrum Baseline: EF (03) - O8 (06)
Timerange: 00/14:54:34 to 00/14:56:38

Plot file version 107 created 03-APR-2017 18:27:40

J1834-2341 EM126B.UVDATA.1

Freq = 4.7995 GHz, Bw = 32.000 MH No calibration applied and no bandpass applied

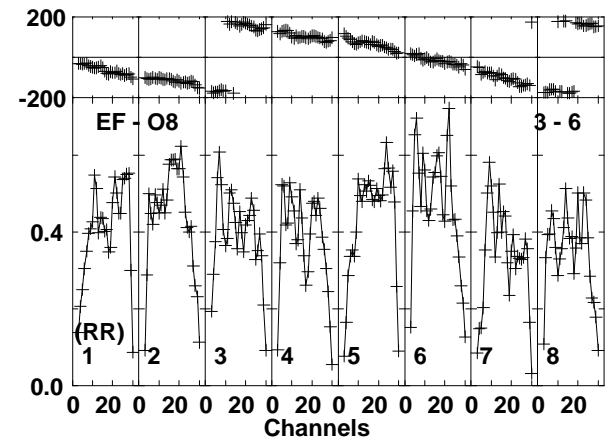
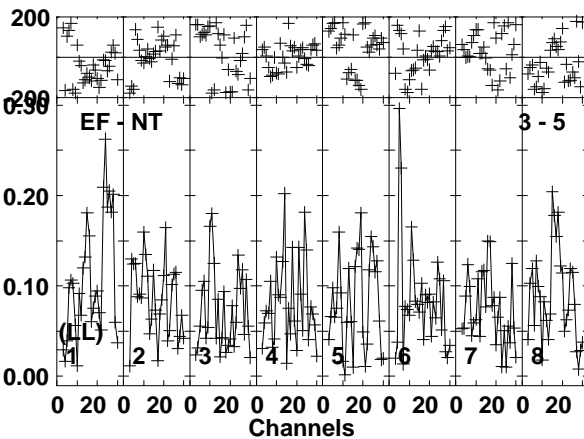
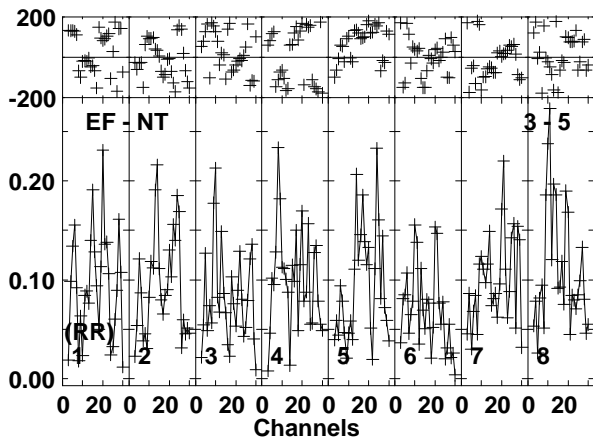
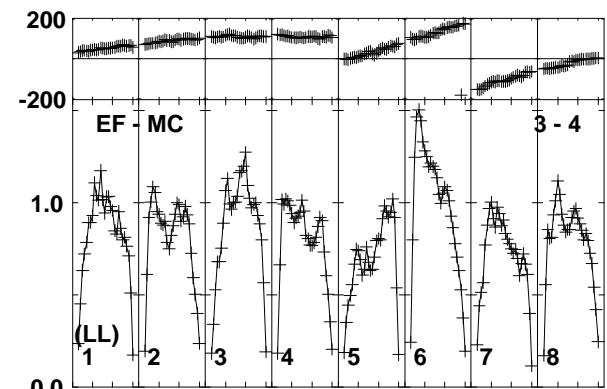
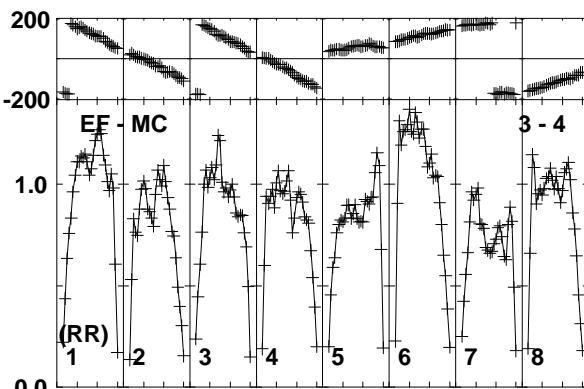
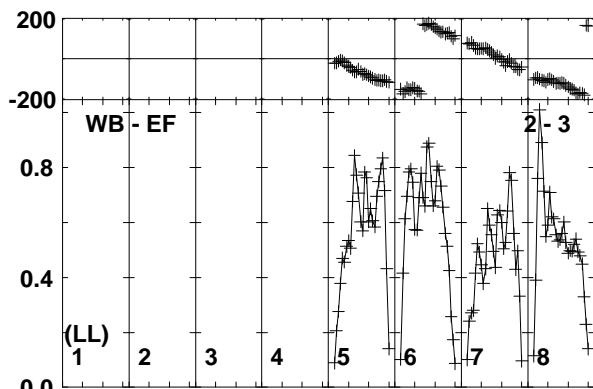
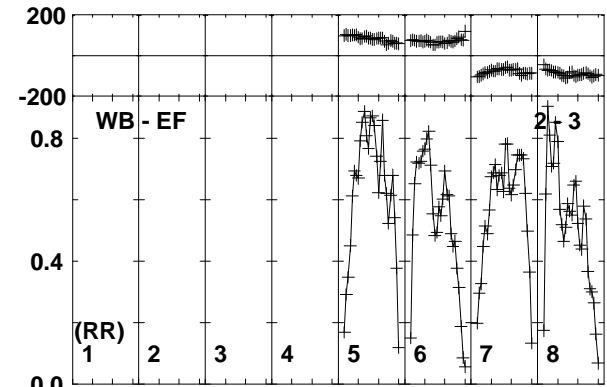
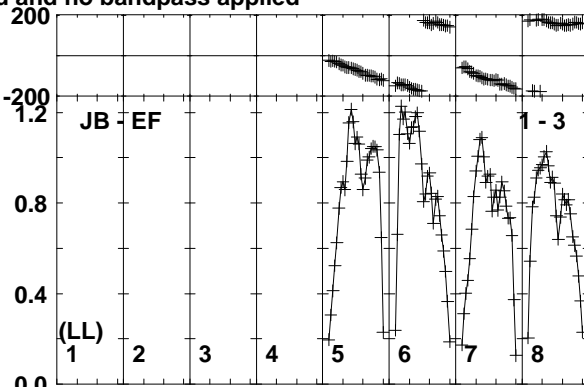
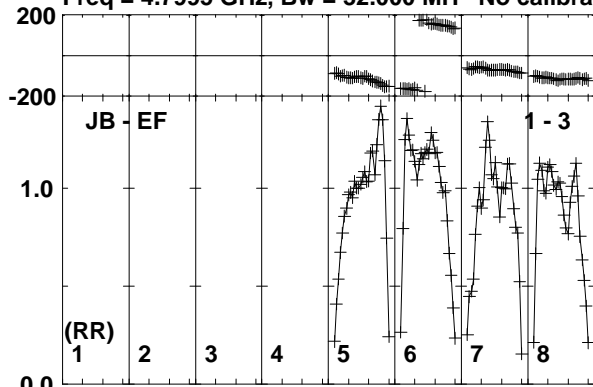

Lower frame: Milli Ampl Jy Top frame: Phas deg
Vector averaged cross-power spectrum Baseline: JB (01) - EF (03)
Timerange: 00/14:56:44 to 00/14:57:58

Plot file version 108 created 03-APR-2017 18:27:40

J1834-2341 EM126B.UVDATA.1

Freq = 4.7995 GHz, Bw = 32.000 MH No calibration applied and no bandpass applied

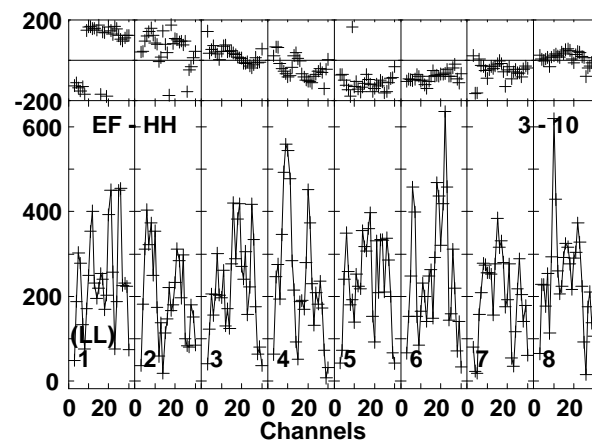
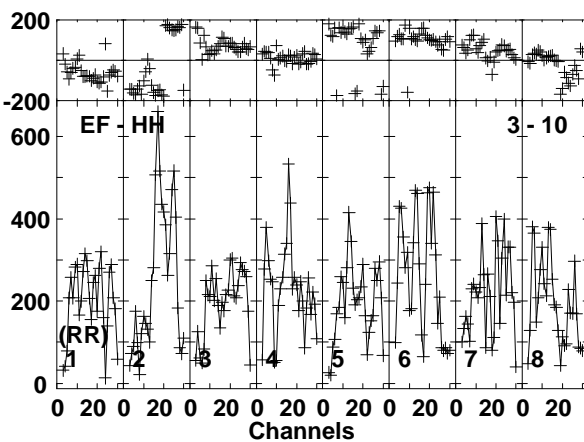
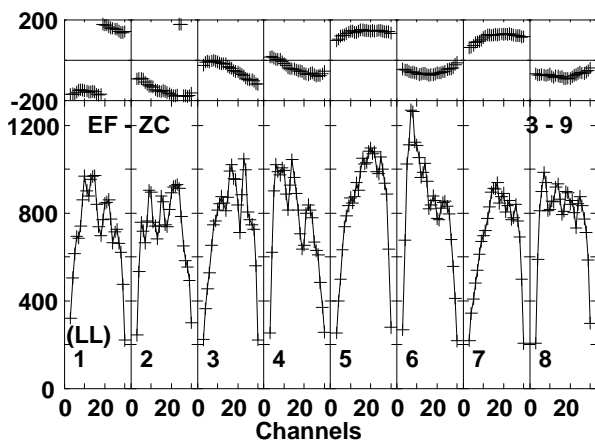
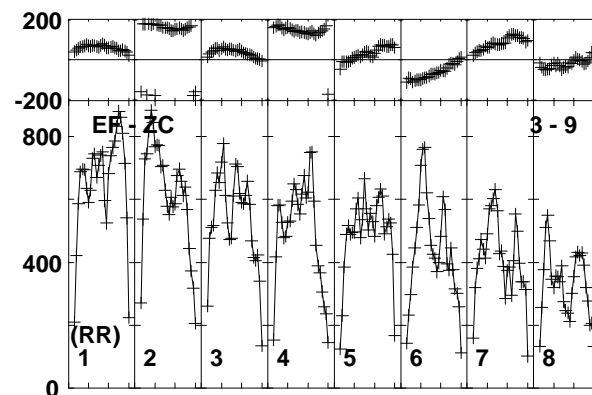
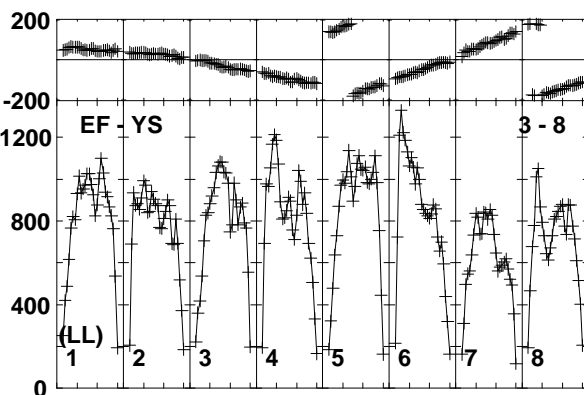
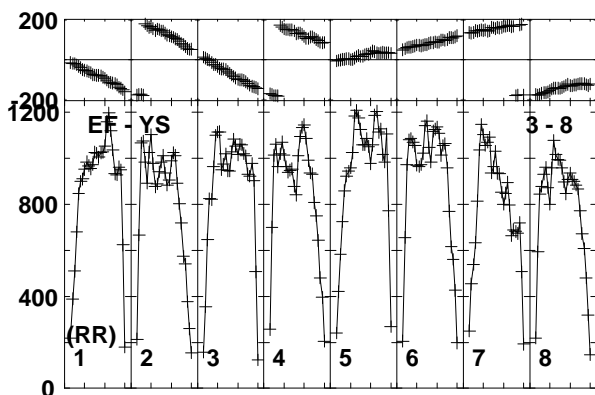
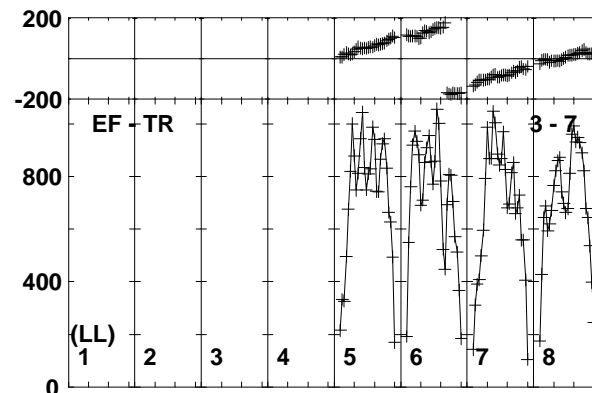
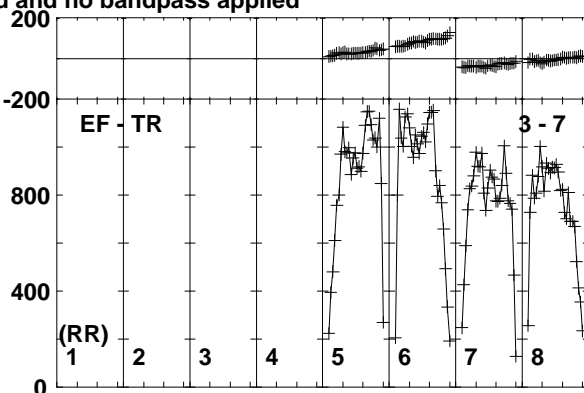
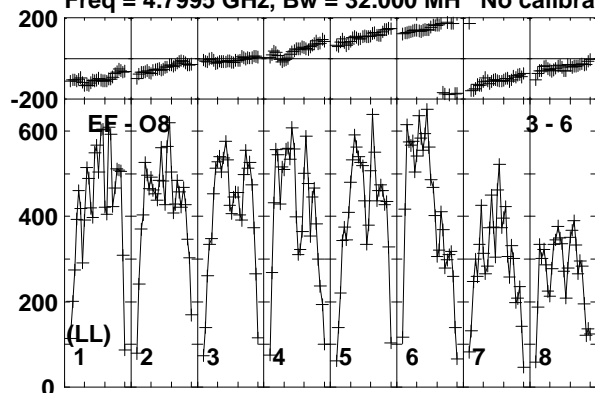

Lower frame: Micro Ampl Jy Top frame: Phas deg
Vector averaged cross-power spectrum Baseline: EF (03) - O8 (06)
Timerange: 00/14:56:44 to 00/14:57:58

Plot file version 109 created 03-APR-2017 18:27:40

M22-VLA1 EM126B.UVDATA.1

Freq = 4.7995 GHz, Bw = 32.000 MH No calibration applied and no bandpass applied

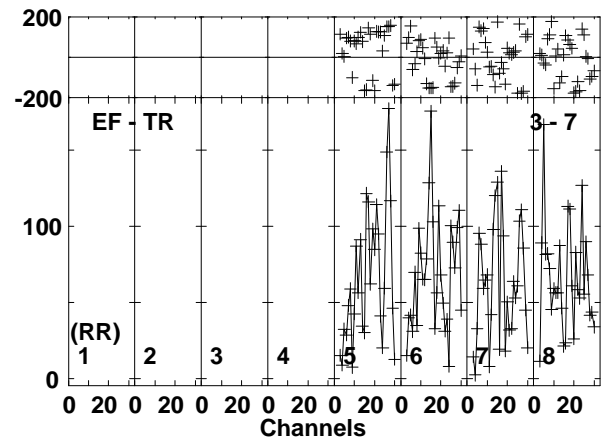
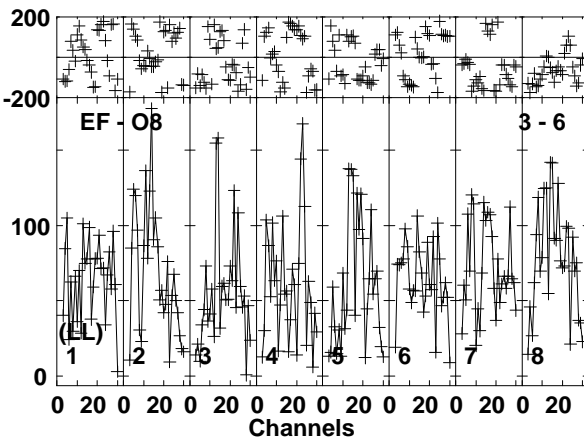
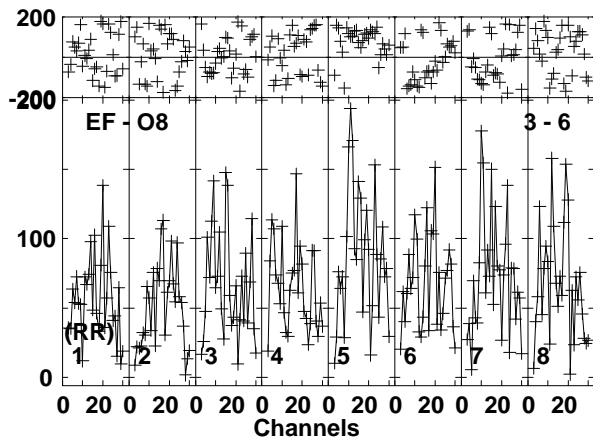
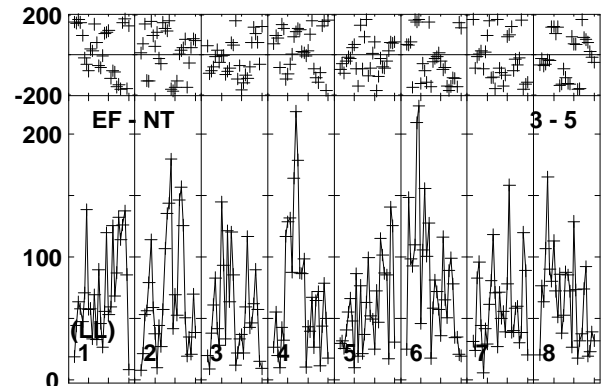
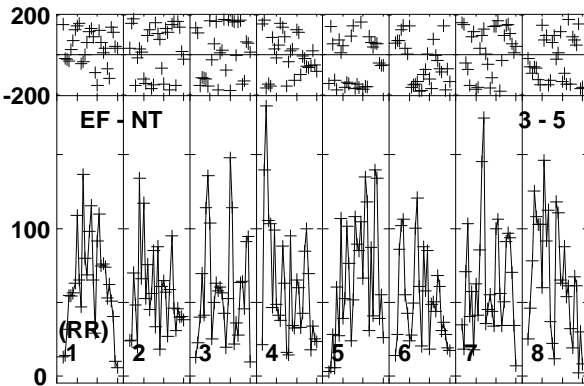
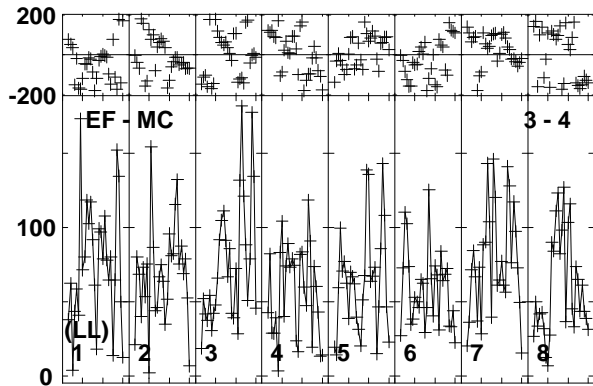
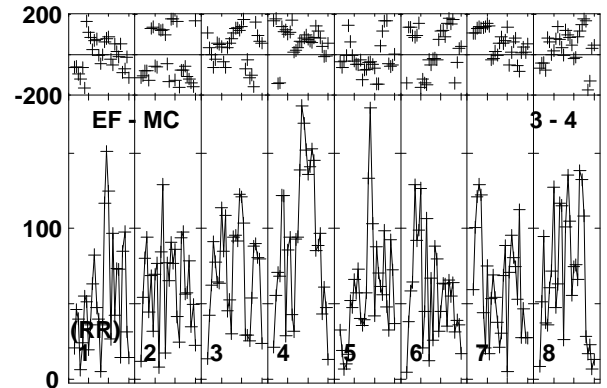
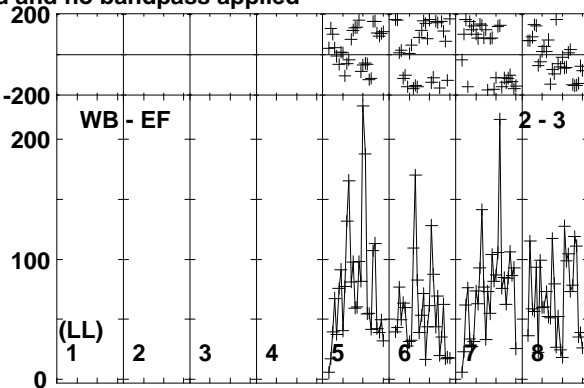
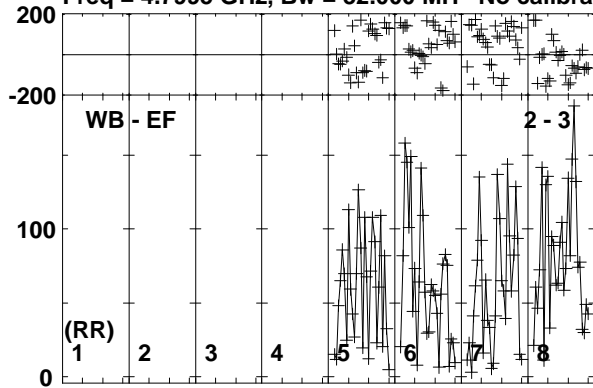

Lower frame: Micro Ampl Jy Top frame: Phas deg
Vector averaged cross-power spectrum Baseline: WB (02) - EF (03)
Timerange: 00/14:58:04 to 00/15:00:08

Plot file version 110 created 03-APR-2017 18:27:40

M22-VLA1 EM126B.UVDATA.1

Freq = 4.7995 GHz, Bw = 32.000 MH No calibration applied and no bandpass applied

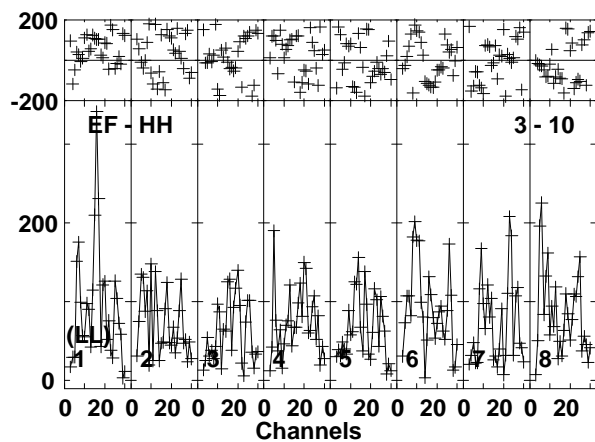
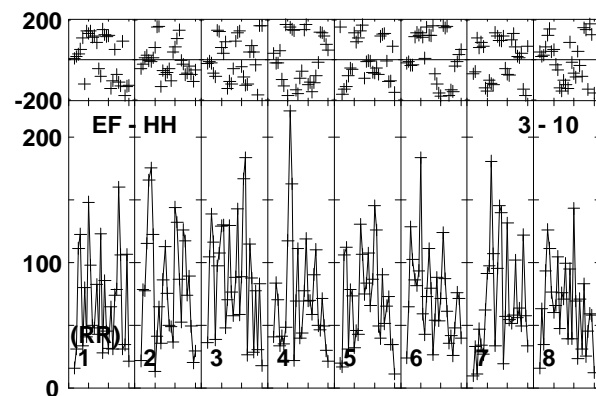
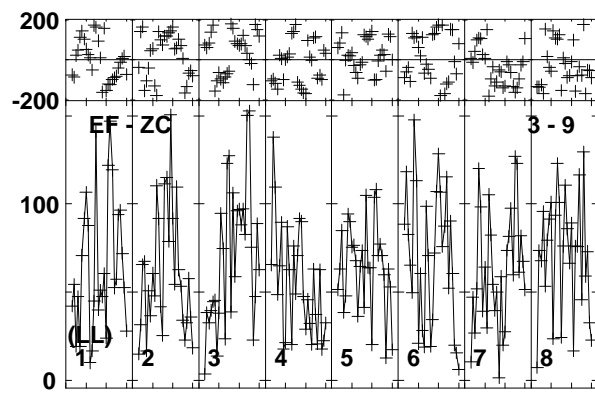
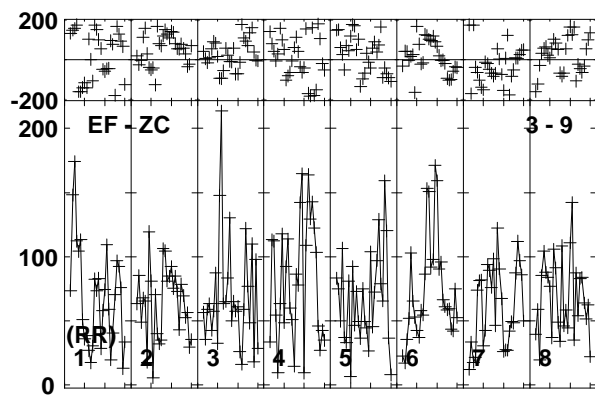
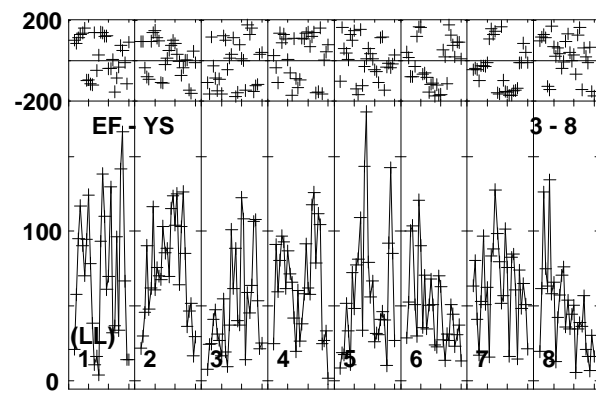
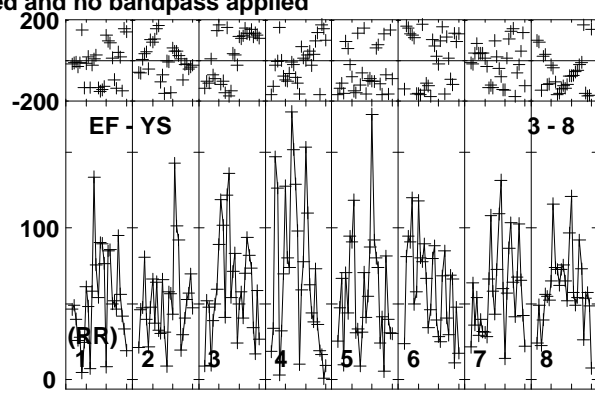
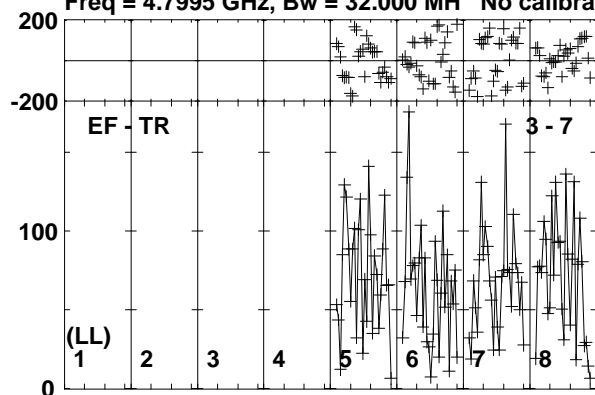

Lower frame: Micro Ampl Jy Top frame: Phas deg
Vector averaged cross-power spectrum Baseline: EF (03) - TR (07)
Timerange: 00/14:58:04 to 00/15:00:08

Plot file version 111 created 03-APR-2017 18:27:40

J1834-2341 EM126B.UVDATA.1

Freq = 4.7995 GHz, Bw = 32.000 MH No calibration applied and no bandpass applied

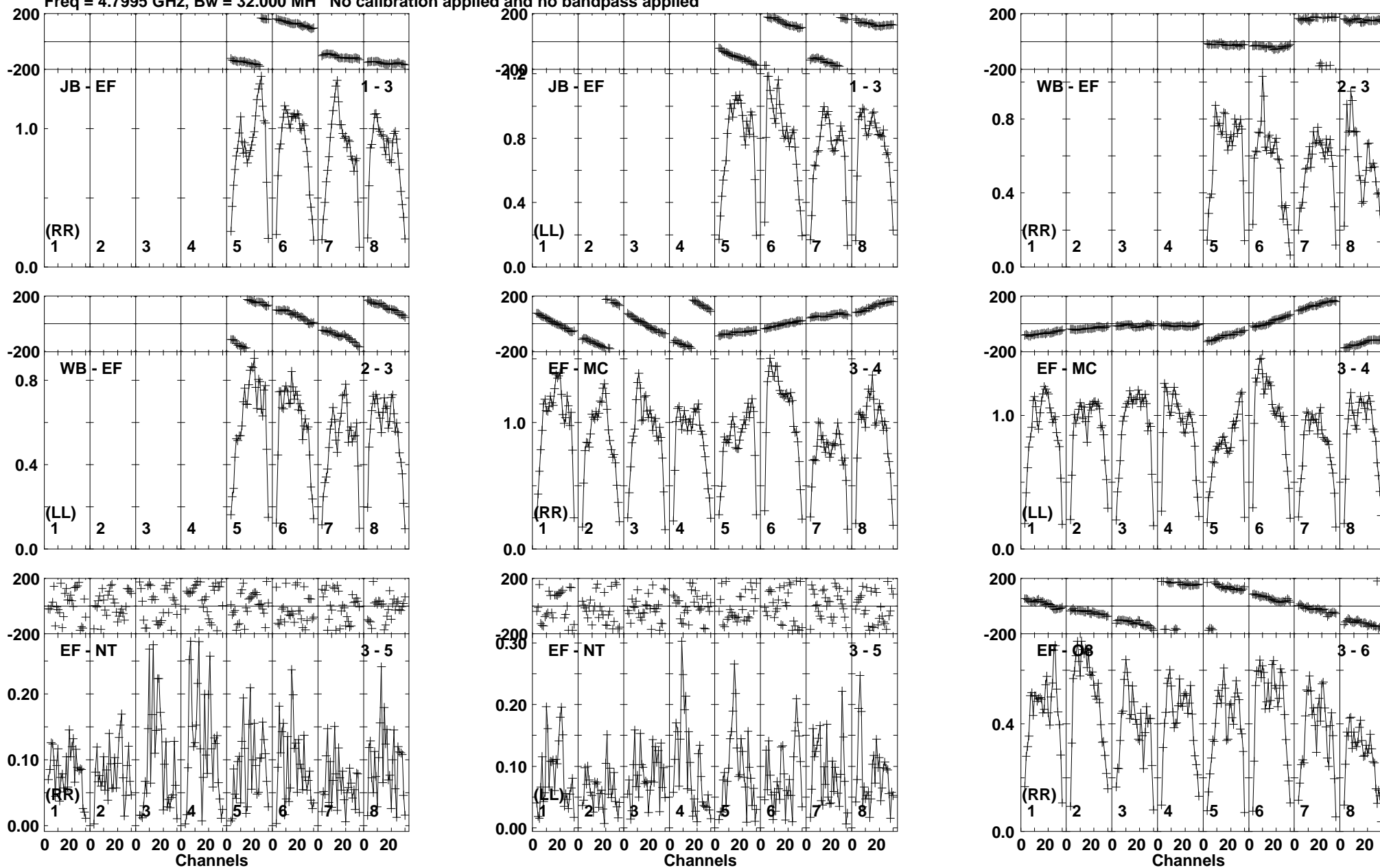

Lower frame: Milli Ampl Jy Top frame: Phas deg
Vector averaged cross-power spectrum Baseline: JB (01) - EF (03)
Timerange: 00/15:00:14 to 00/15:01:28

Plot file version 112 created 03-APR-2017 18:27:40

J1834-2341 EM126B.UVDATA.1

Freq = 4.7995 GHz, Bw = 32.000 MH No calibration applied and no bandpass applied

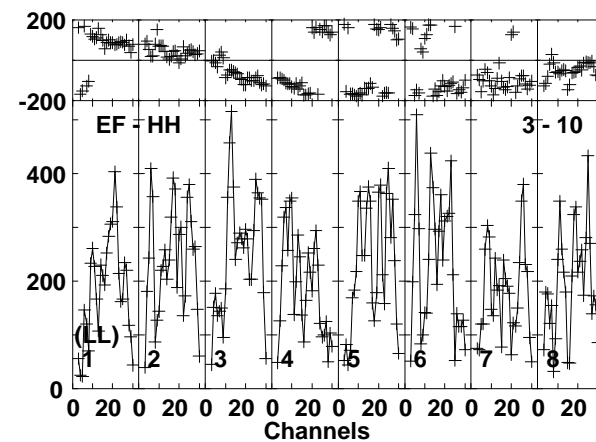
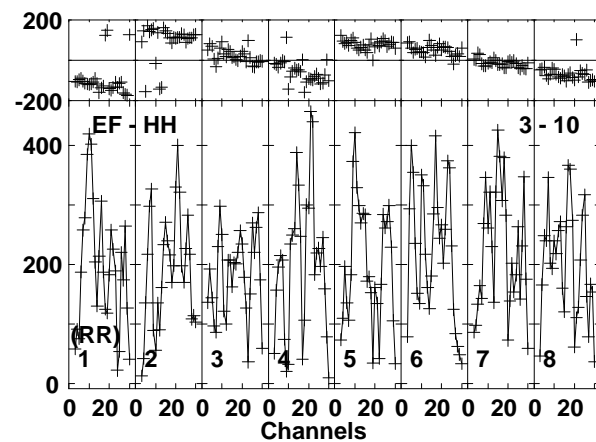
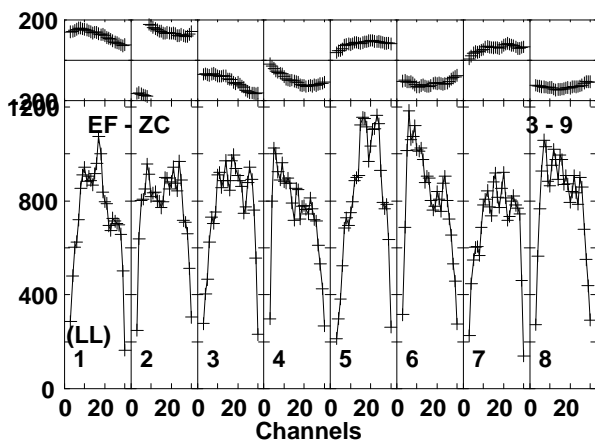
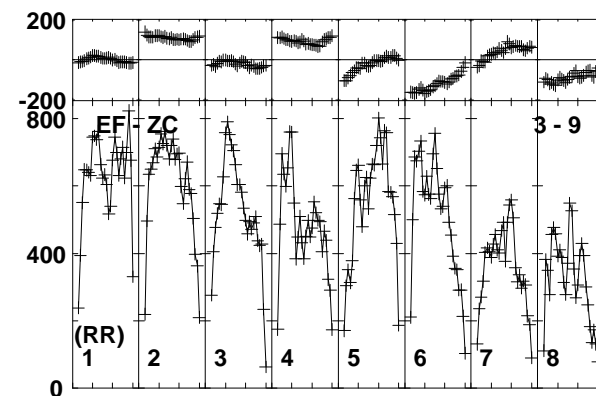
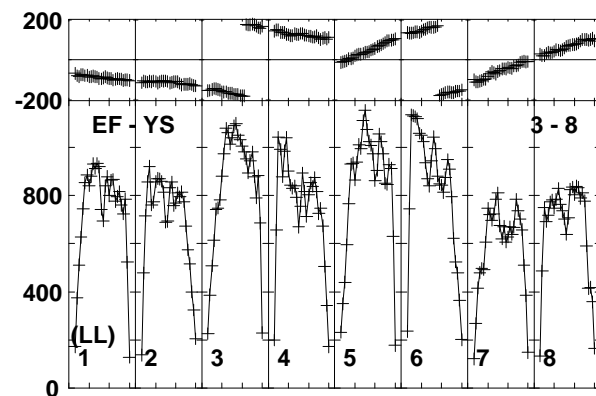
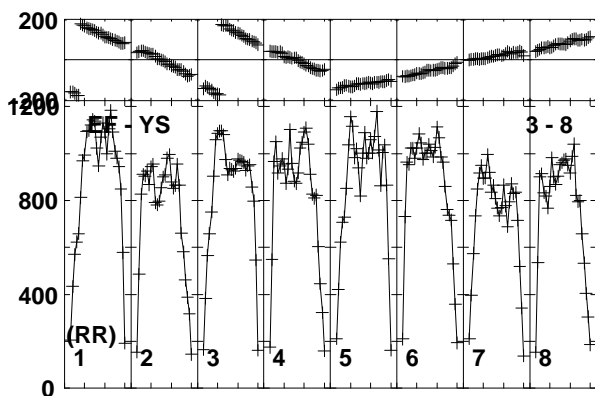
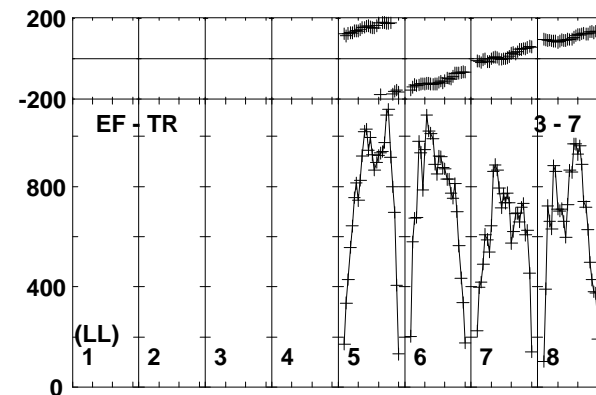
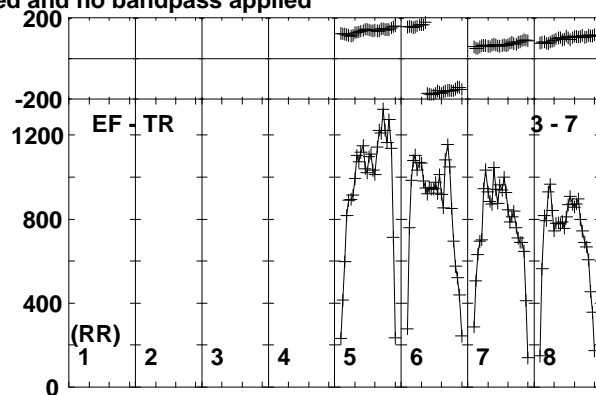
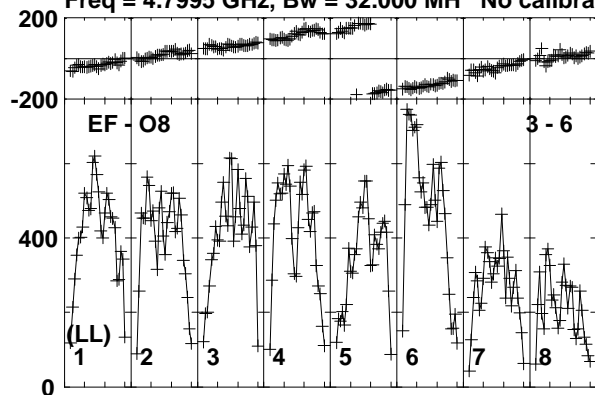

Lower frame: Micro Ampl Jy Top frame: Phas deg
Vector averaged cross-power spectrum Baseline: EF (03) - O8 (06)
Timerange: 00/15:00:14 to 00/15:01:28

Plot file version 113 created 03-APR-2017 18:27:40

M22-VLA1 EM126B.UVDATA.1

Freq = 4.7995 GHz, Bw = 32.000 MH No calibration applied and no bandpass applied

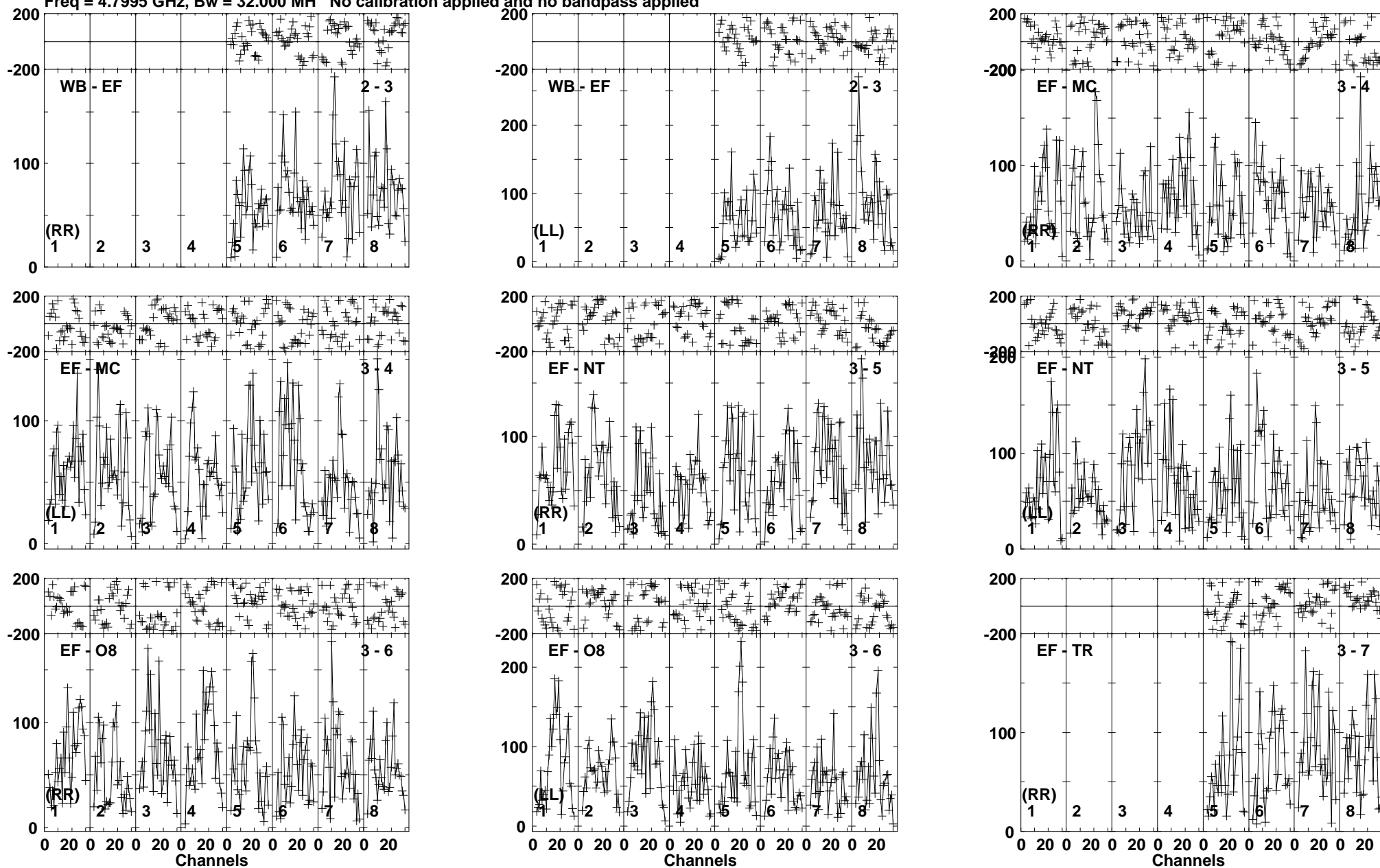

Lower frame: Micro Ampl Jy Top frame: Phas deg
Vector averaged cross-power spectrum Baseline: WB (02) - EF (03)
Timerange: 00/15:01:36 to 00/15:03:38

Plot file version 114 created 03-APR-2017 18:27:40

M22-VLA1 EM126B.UVDATA.1

Freq = 4.7995 GHz, Bw = 32.000 MH No calibration applied and no bandpass applied

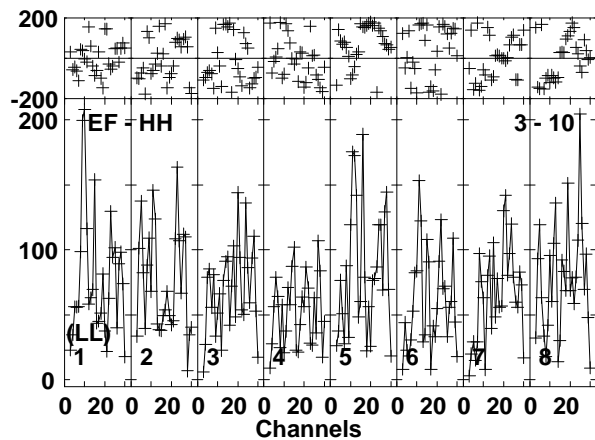
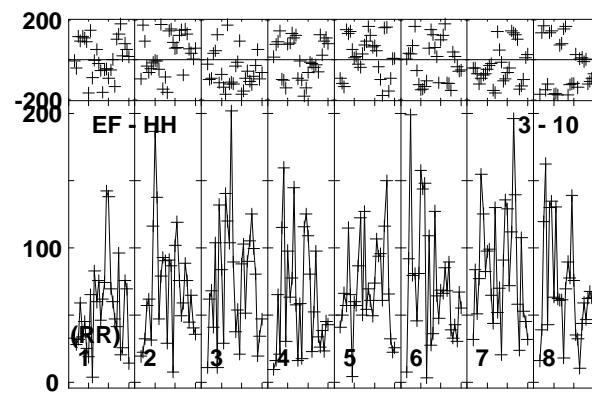
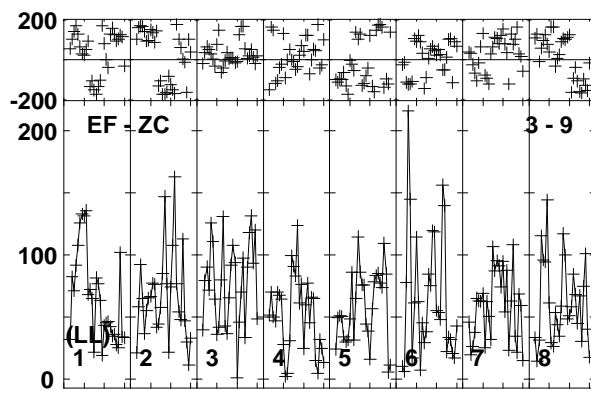
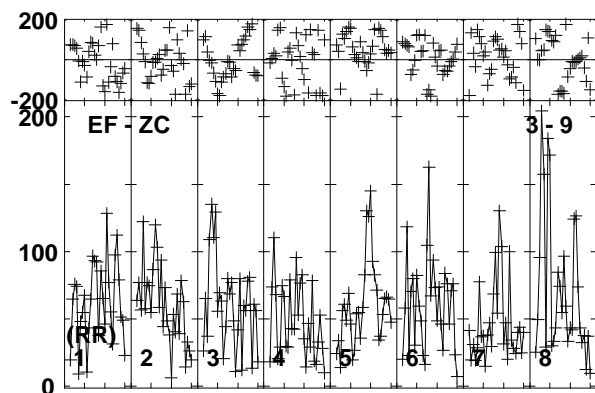
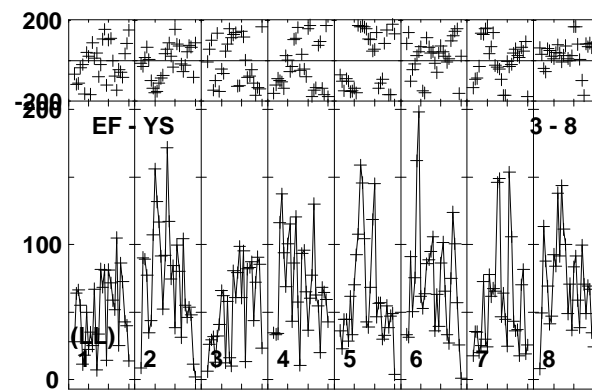
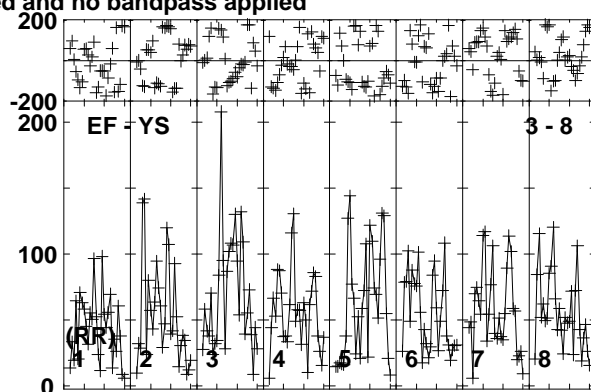
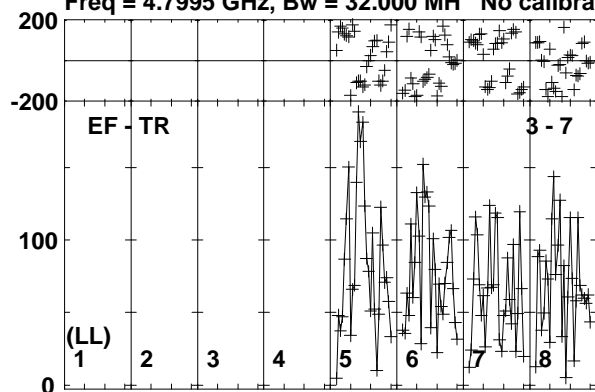

Lower frame: Micro Ampl Jy Top frame: Phas deg
Vector averaged cross-power spectrum Baseline: EF (03) - TR (07)
Timerange: 00/15:01:36 to 00/15:03:38

Plot file version 115 created 03-APR-2017 18:27:40

J1834-2341 EM126B.UVDATA.1

Freq = 4.7995 GHz, Bw = 32.000 MH No calibration applied and no bandpass applied

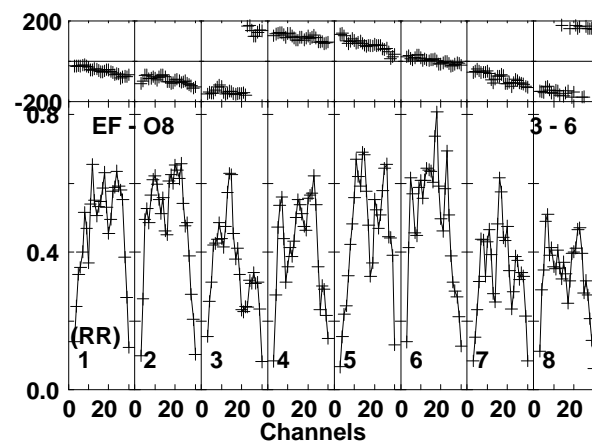
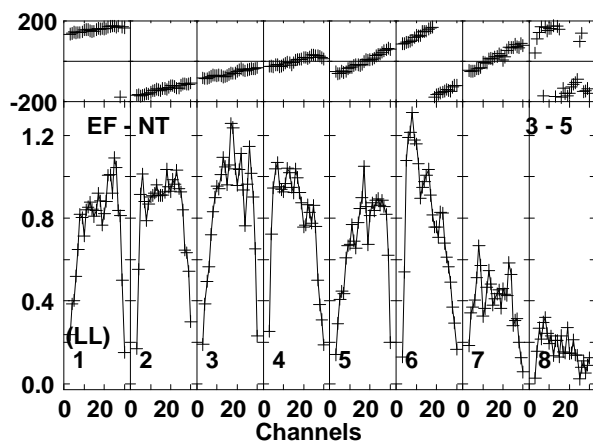
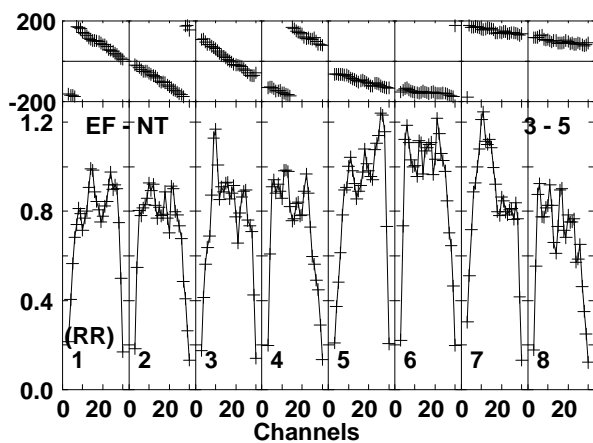
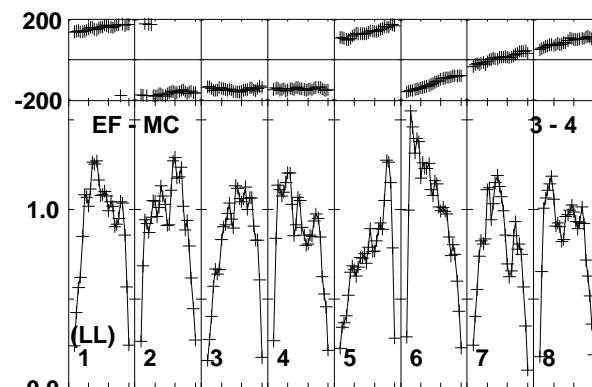
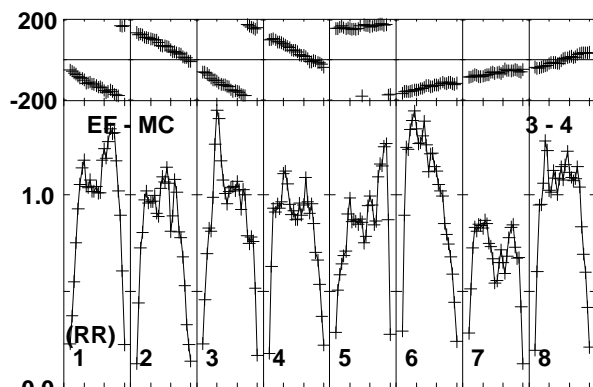
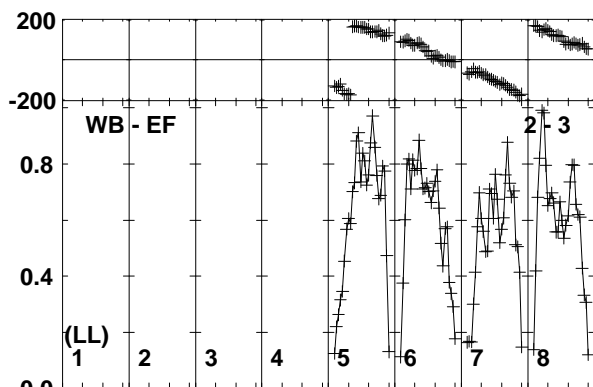
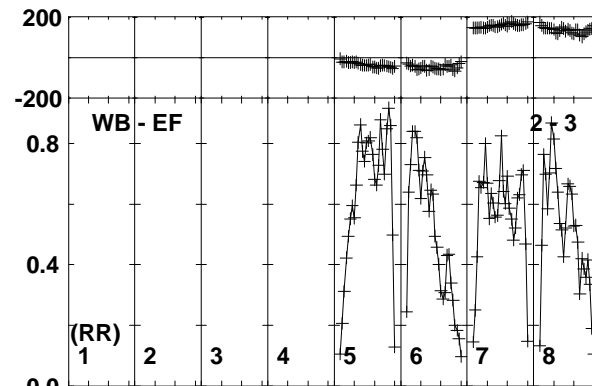
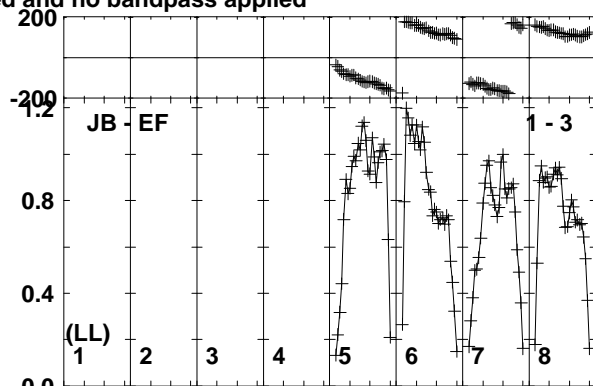
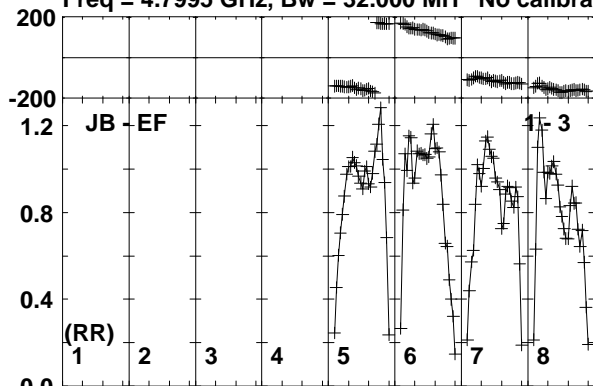

Lower frame: Milli Ampl Jy Top frame: Phas deg
Vector averaged cross-power spectrum Baseline: JB (01) - EF (03)
Timerange: 00/15:04:11 to 00/15:04:59

Plot file version 116 created 03-APR-2017 18:27:40

J1834-2341 EM126B.UVDATA.1

Freq = 4.7995 GHz, Bw = 32.000 MH No calibration applied and no bandpass applied

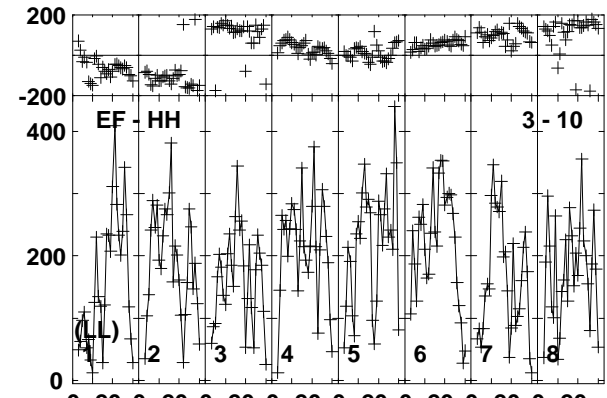
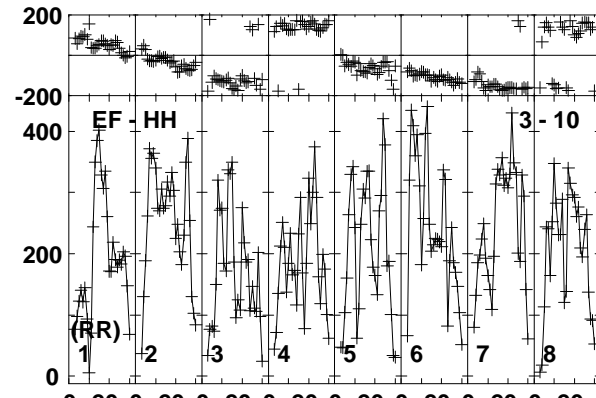
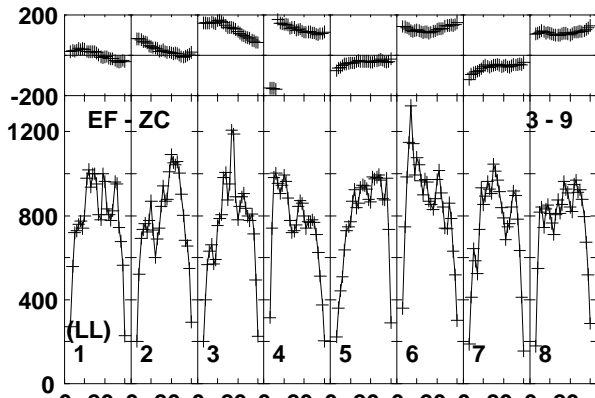
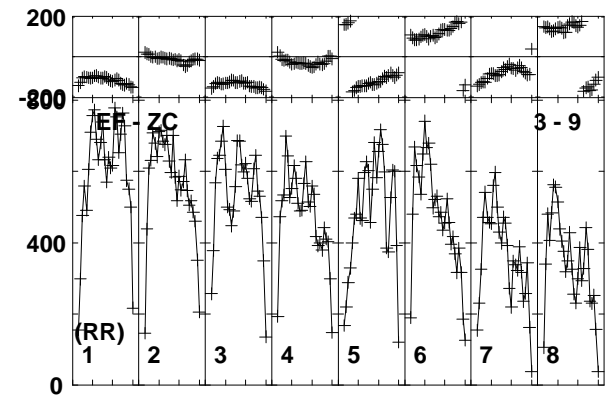
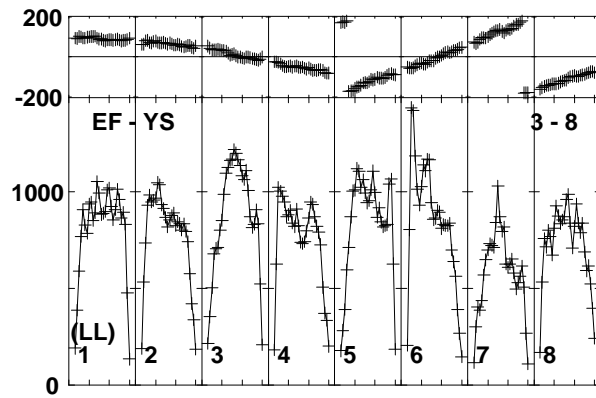
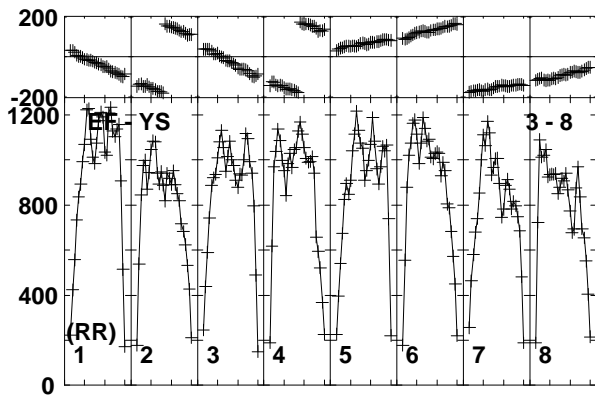
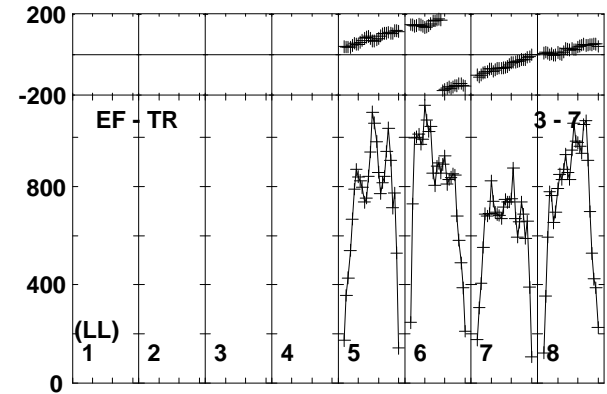
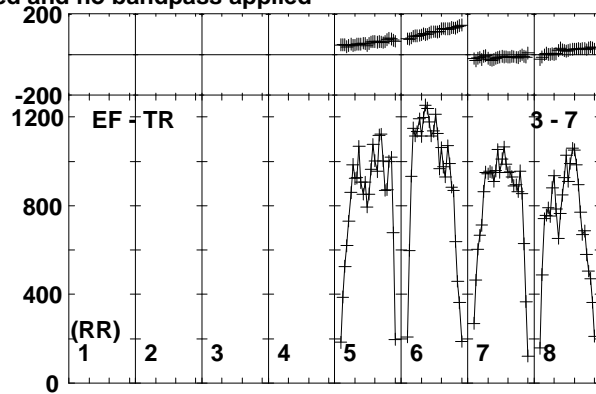
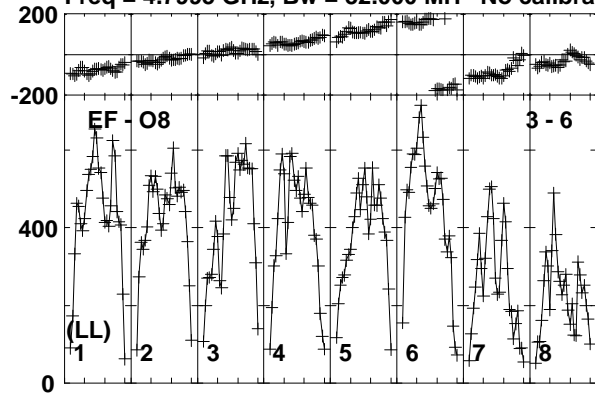

Lower frame: Micro Ampl Jy Top frame: Phas deg
Vector averaged cross-power spectrum Baseline: EF (03) - O8 (06)
Timerange: 00/15:04:11 to 00/15:04:59

Plot file version 117 created 03-APR-2017 18:27:40

M22-VLA1 EM126B.UVDATA.1

Freq = 4.7995 GHz, Bw = 32.000 MH No calibration applied and no bandpass applied

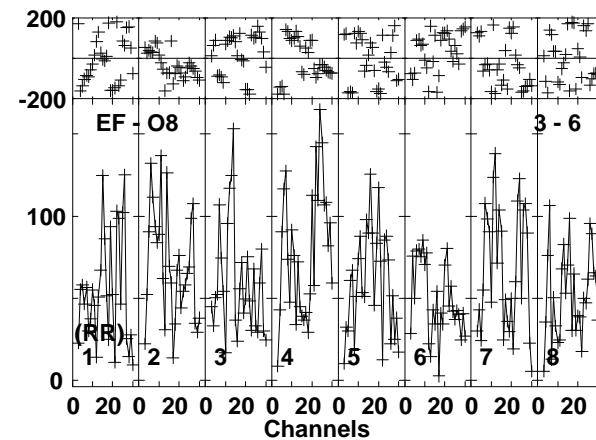
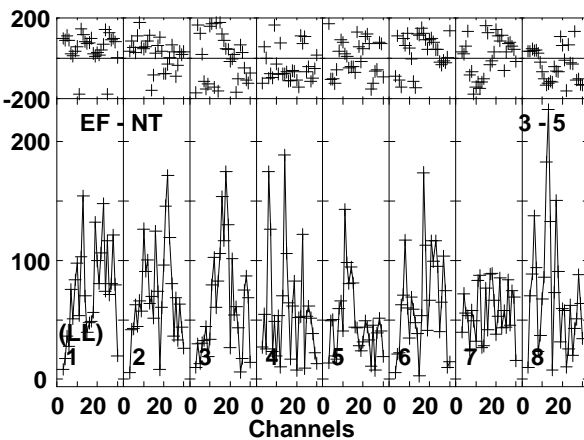
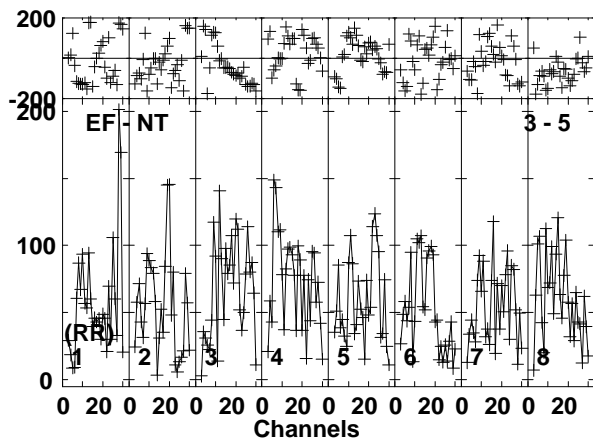
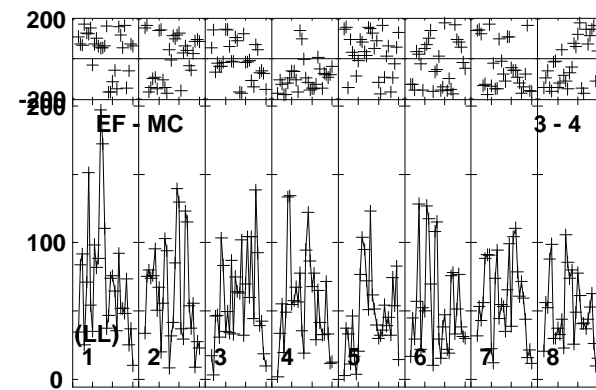
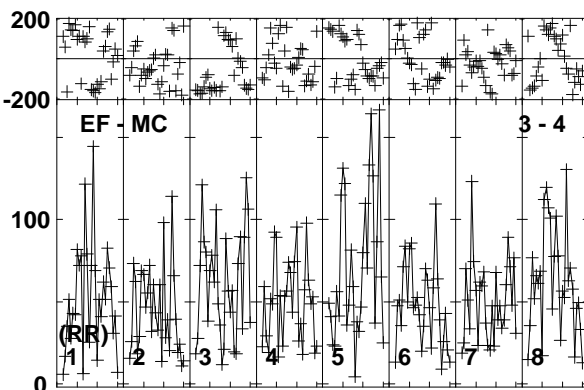
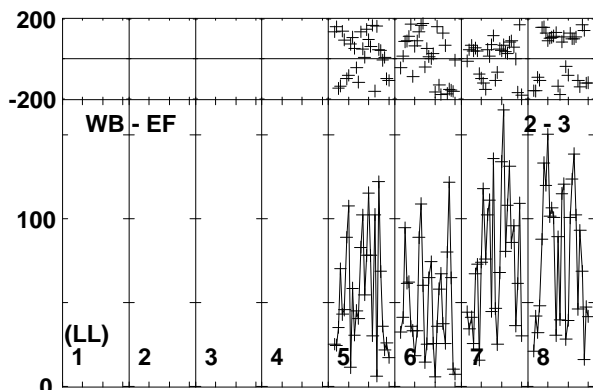
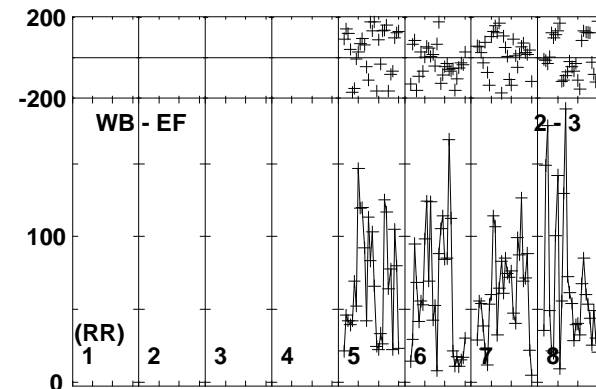
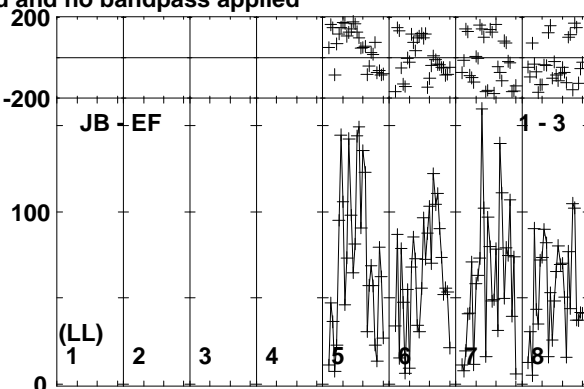
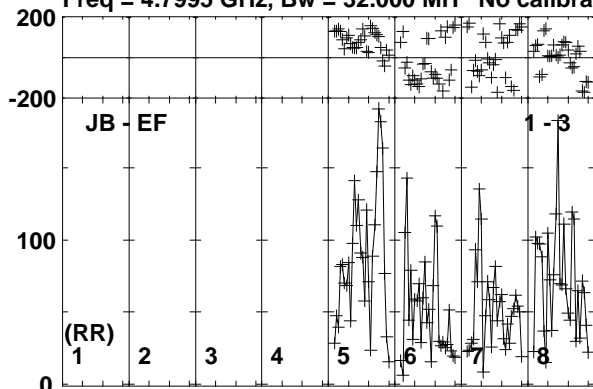

Lower frame: Micro Ampl Jy Top frame: Phas deg
Vector averaged cross-power spectrum Baseline: JB (01) - EF (03)
Timerange: 00/15:05:04 to 00/15:07:08

Plot file version 118 created 03-APR-2017 18:27:40

M22-VLA1 EM126B.UVDATA.1

Freq = 4.7995 GHz, Bw = 32.000 MH No calibration applied and no bandpass applied

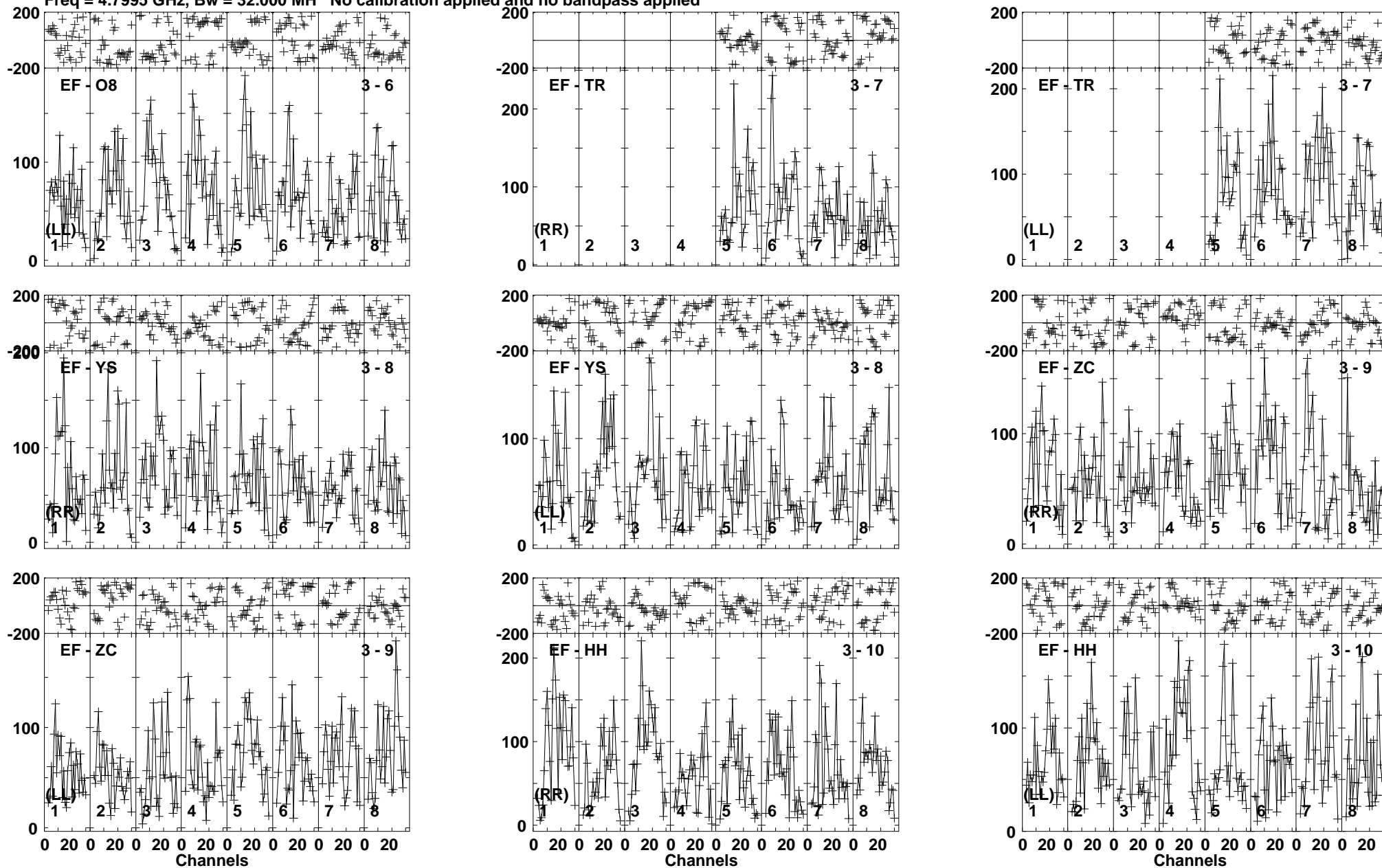

Lower frame: Micro Ampl Jy Top frame: Phas deg
Vector averaged cross-power spectrum Baseline: EF (03) - O8 (06)
Timerange: 00/15:05:04 to 00/15:07:08

Plot file version 119 created 03-APR-2017 18:27:40

J1834-2341 EM126B.UVDATA.1

Freq = 4.7995 GHz, Bw = 32.000 MH No calibration applied and no bandpass applied

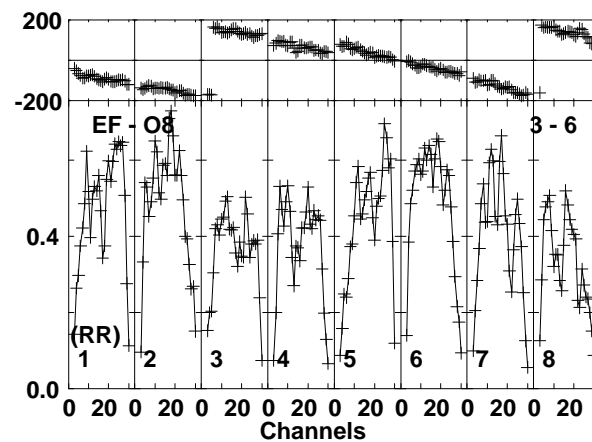
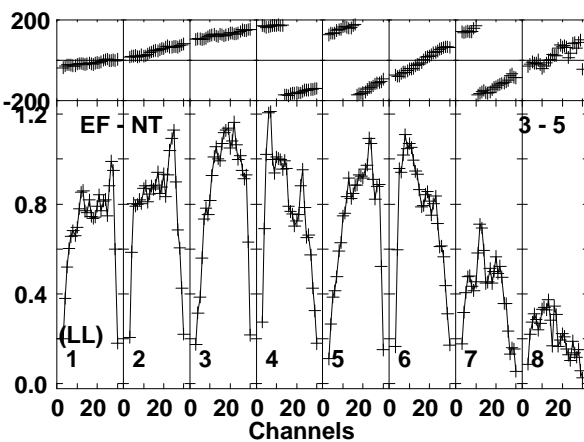
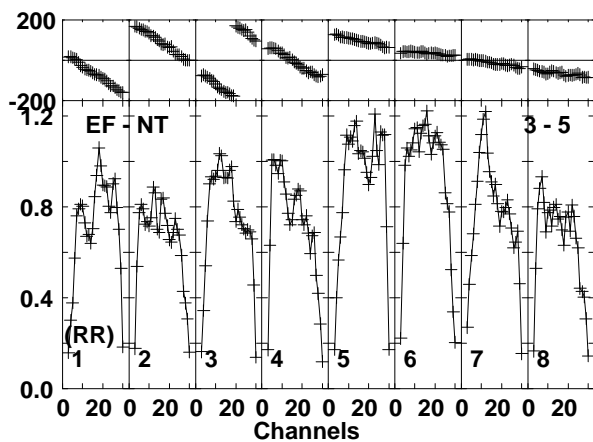
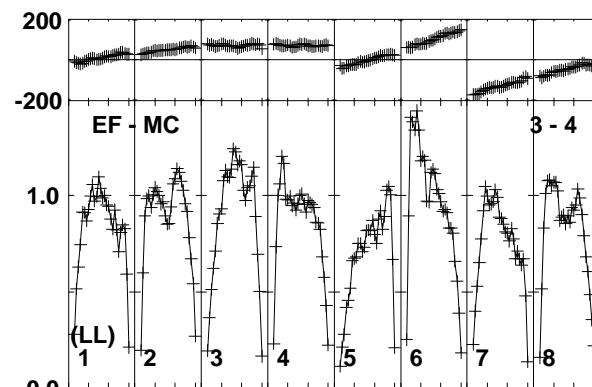
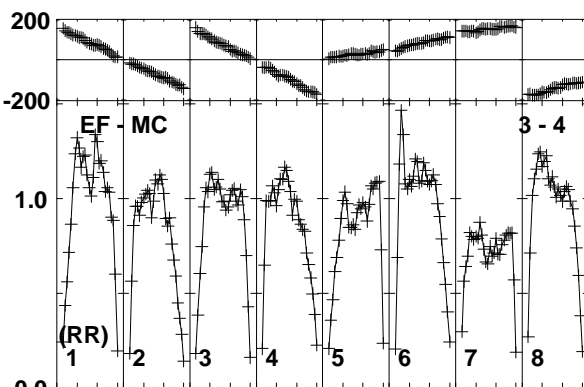
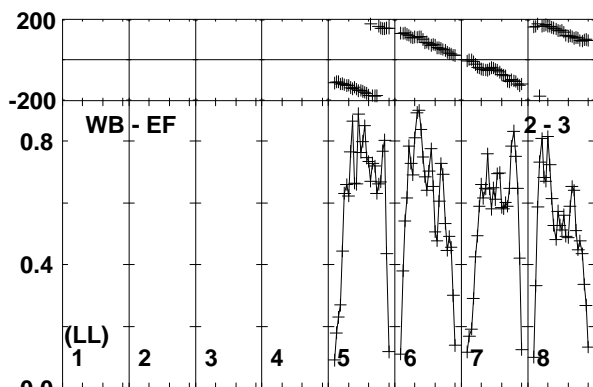
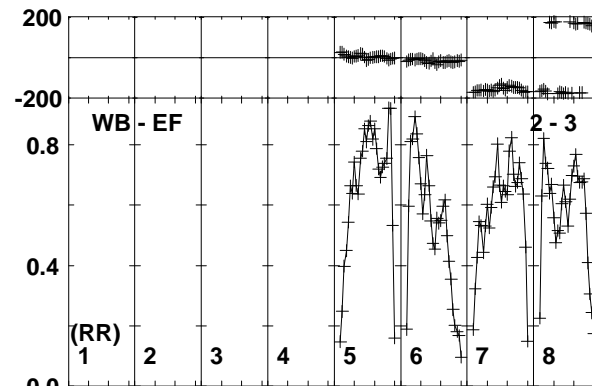
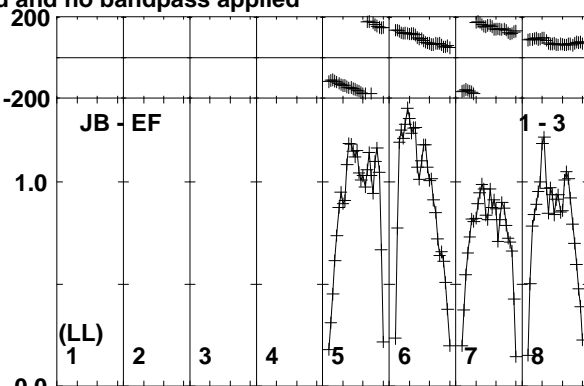
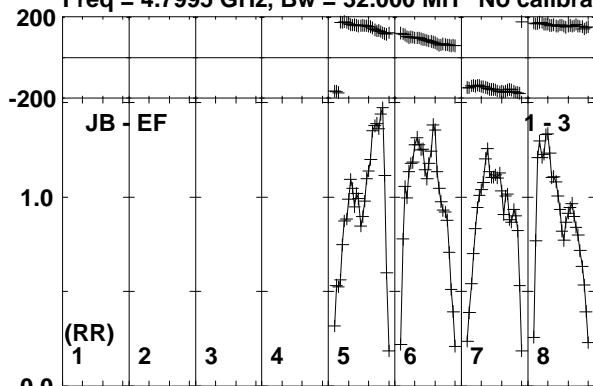

Lower frame: Milli Ampl Jy Top frame: Phas deg
Vector averaged cross-power spectrum Baseline: JB (01) - EF (03)
Timerange: 00/15:07:14 to 00/15:08:28

Plot file version 120 created 03-APR-2017 18:27:40

J1834-2341 EM126B.UVDATA.1

Freq = 4.7995 GHz, Bw = 32.000 MH No calibration applied and no bandpass applied

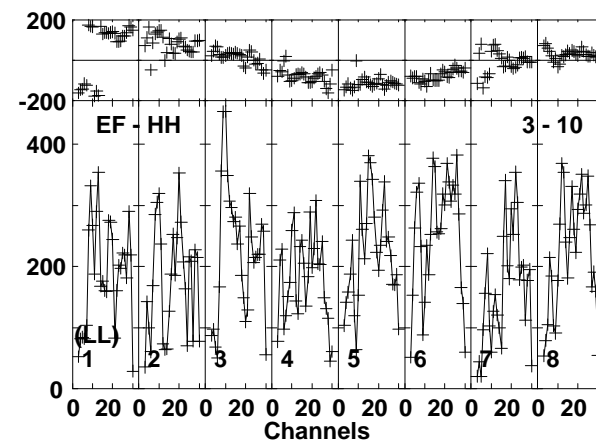
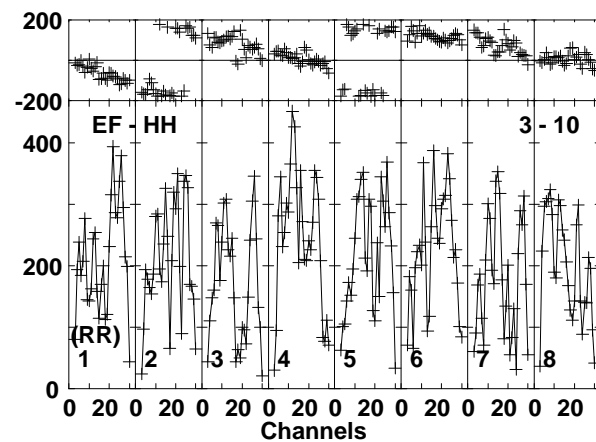
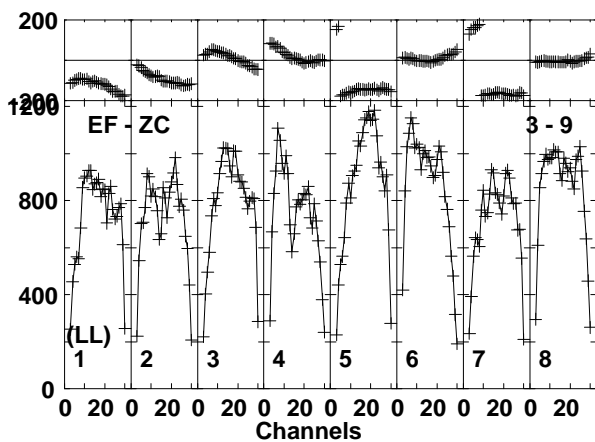
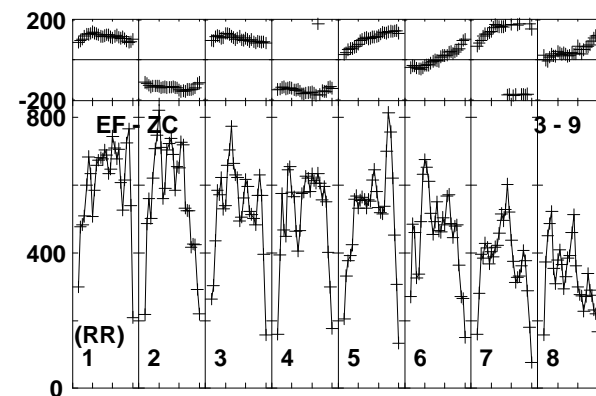
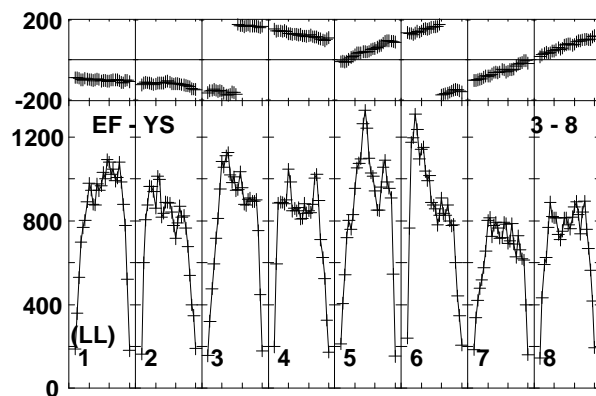
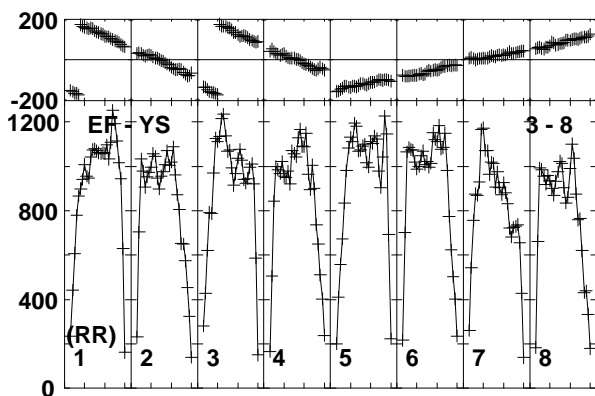
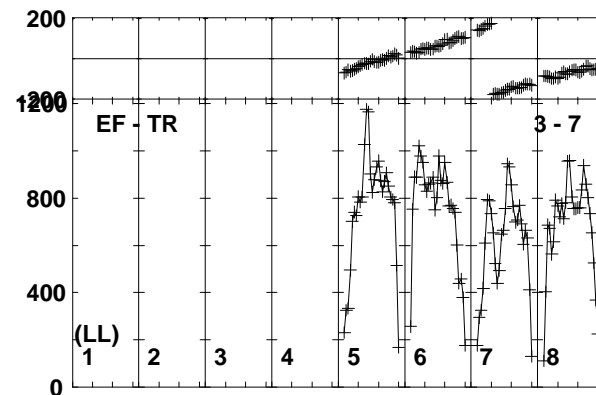
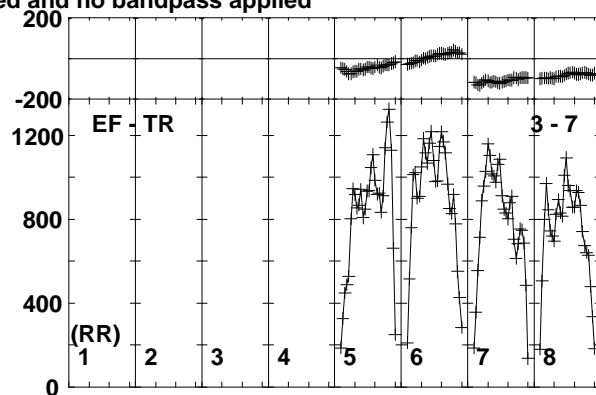
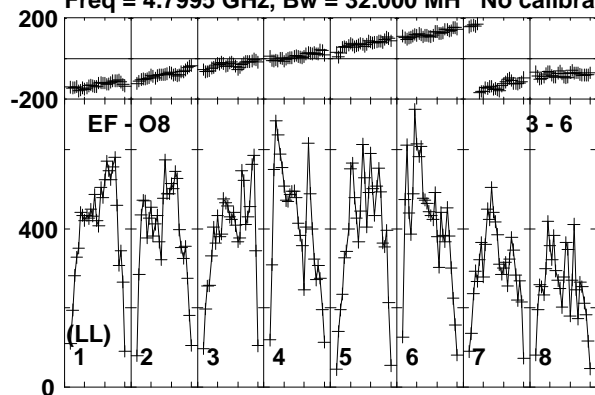

Lower frame: Micro Ampl Jy Top frame: Phas deg
Vector averaged cross-power spectrum Baseline: EF (03) - O8 (06)
Timerange: 00/15:07:14 to 00/15:08:28

Plot file version 121 created 03-APR-2017 18:27:40

M22-VLA1 EM126B.UVDATA.1

Freq = 4.7995 GHz, Bw = 32.000 MH No calibration applied and no bandpass applied

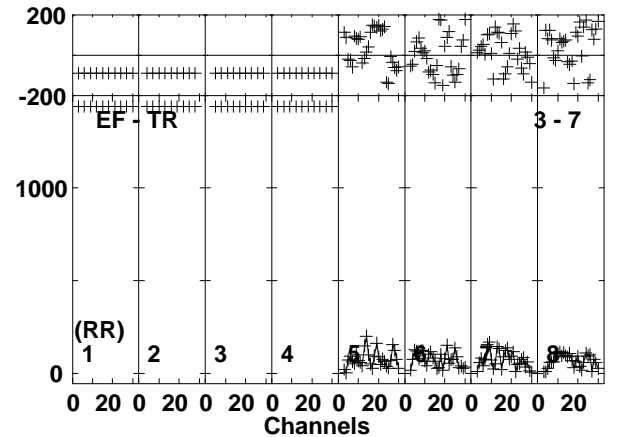
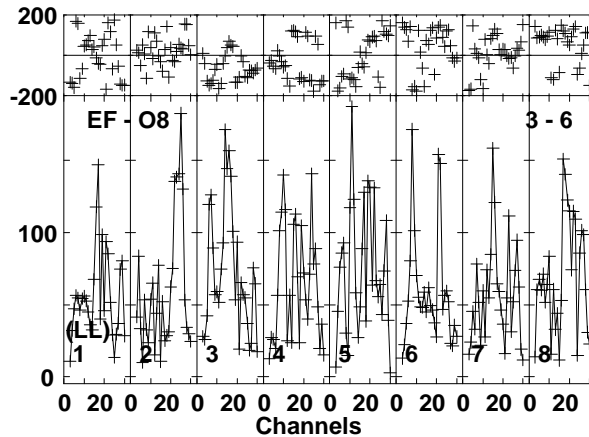
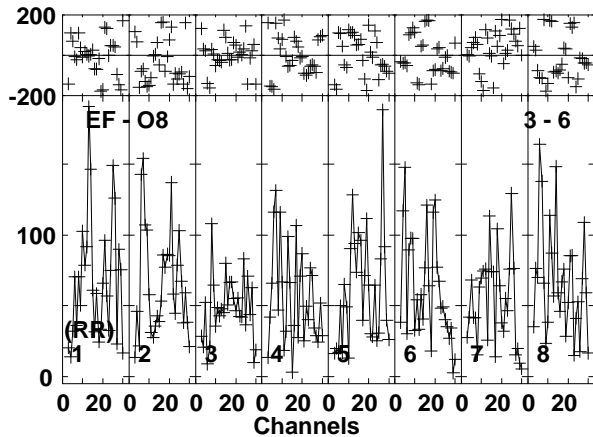
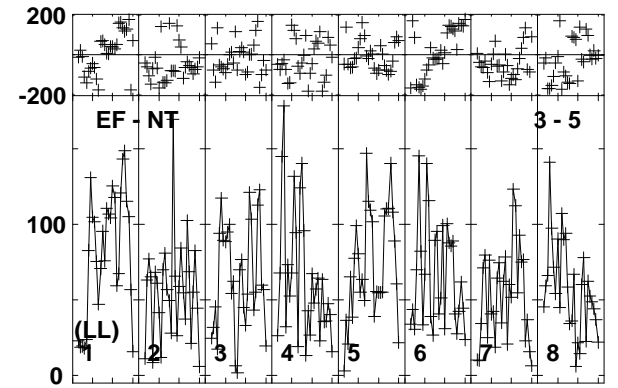
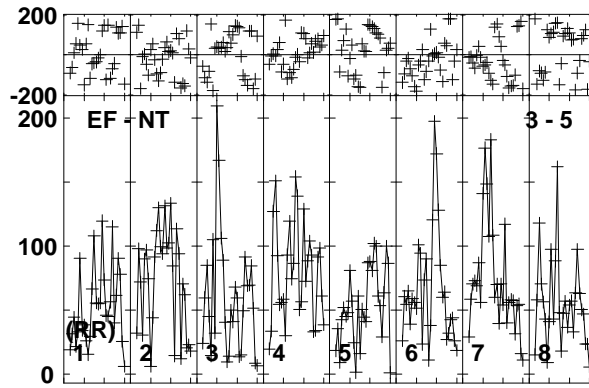
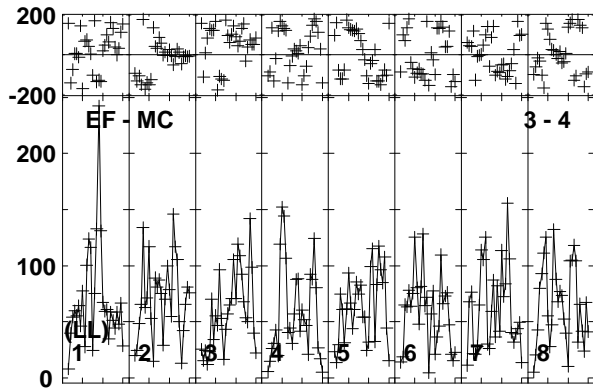
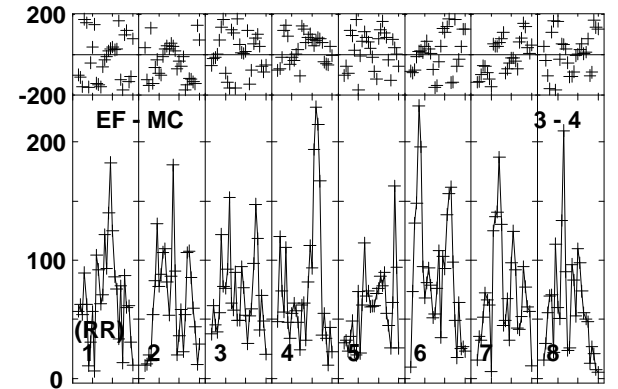
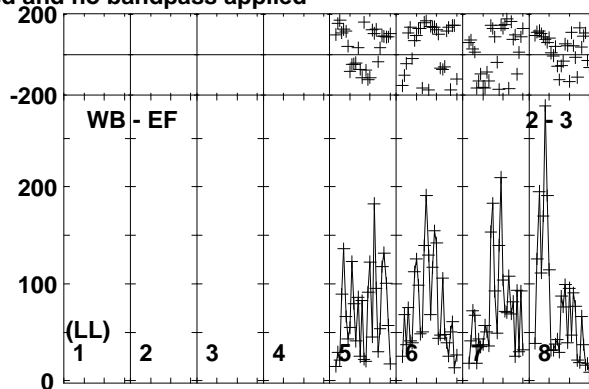
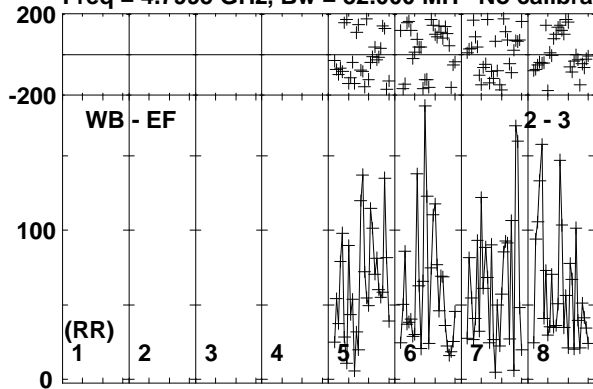

Lower frame: Micro Ampl Jy Top frame: Phas deg
Vector averaged cross-power spectrum Baseline: WB (02) - EF (03)
Timerange: 00/15:08:34 to 00/15:10:38

Plot file version 122 created 03-APR-2017 18:27:40

M22-VLA1 EM126B.UVDATA.1

Freq = 4.7995 GHz, Bw = 32.000 MH No calibration applied and no bandpass applied

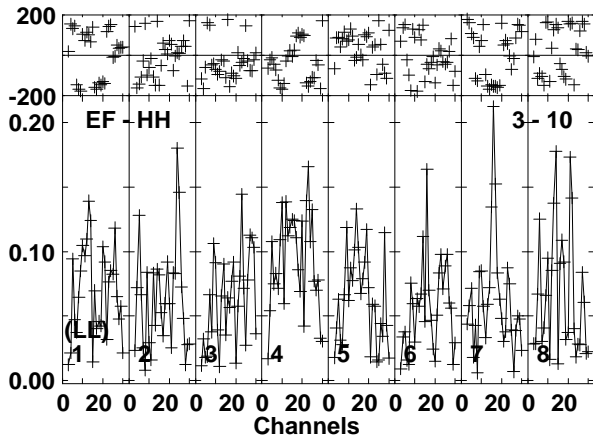
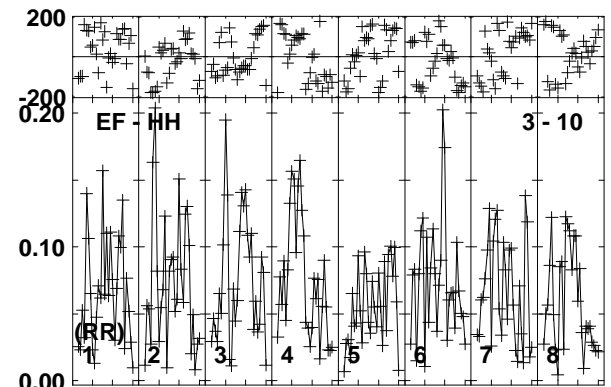
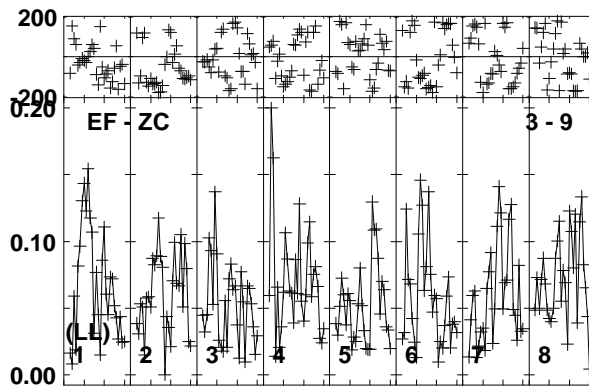
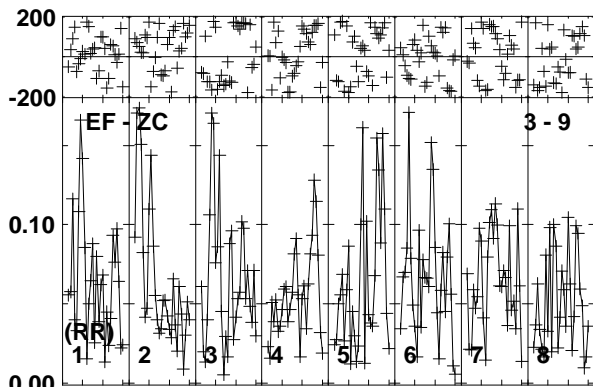
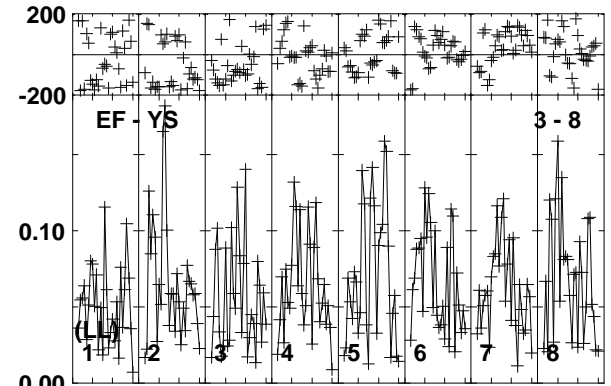
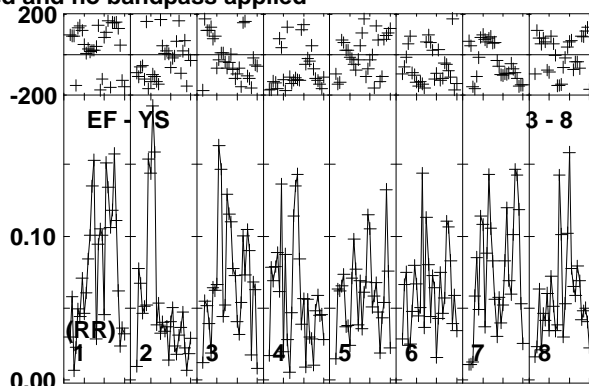
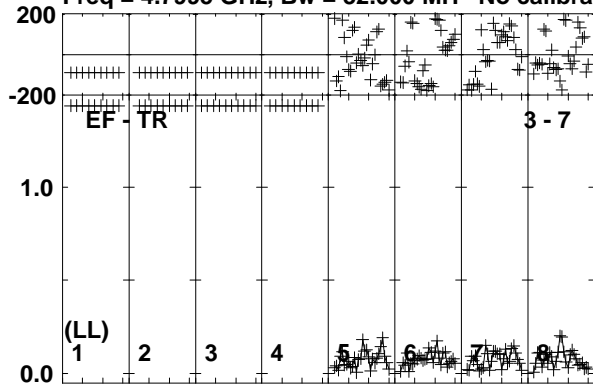

Lower frame: Milli Ampl Jy Top frame: Phas deg
Vector averaged cross-power spectrum Baseline: EF (03) - TR (07)
Timerange: 00/15:08:34 to 00/15:10:38

Plot file version 123 created 03-APR-2017 18:27:40

J1834-2341 EM126B.UVDATA.1

Freq = 4.7995 GHz, Bw = 32.000 MH No calibration applied and no bandpass applied

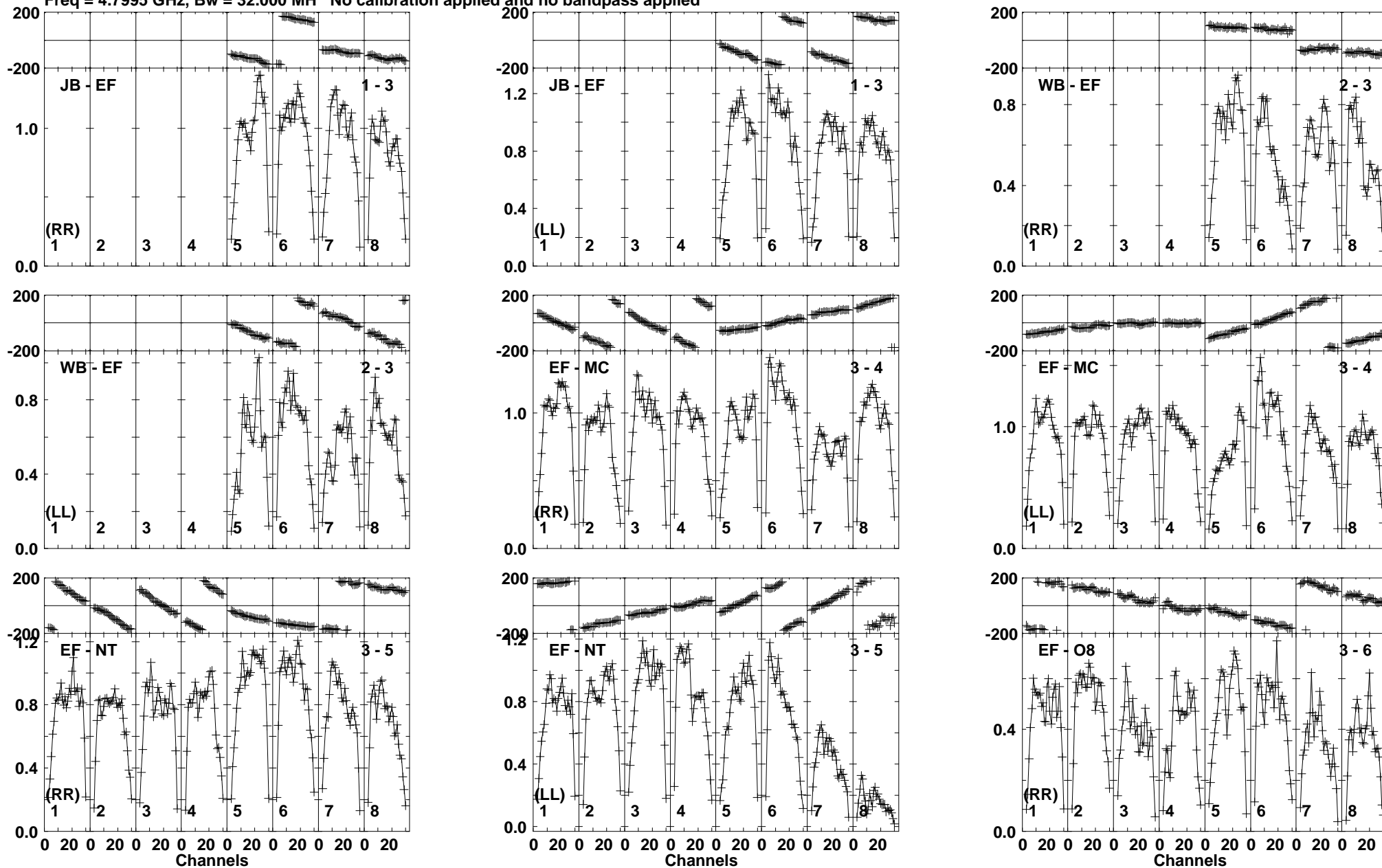

Lower frame: Milli Ampl Jy Top frame: Phas deg
Vector averaged cross-power spectrum Baseline: JB (01) - EF (03)
Timerange: 00/15:10:44 to 00/15:11:58

Plot file version 124 created 03-APR-2017 18:27:40

J1834-2341 EM126B.UVDATA.1

Freq = 4.7995 GHz, Bw = 32.000 MH No calibration applied and no bandpass applied

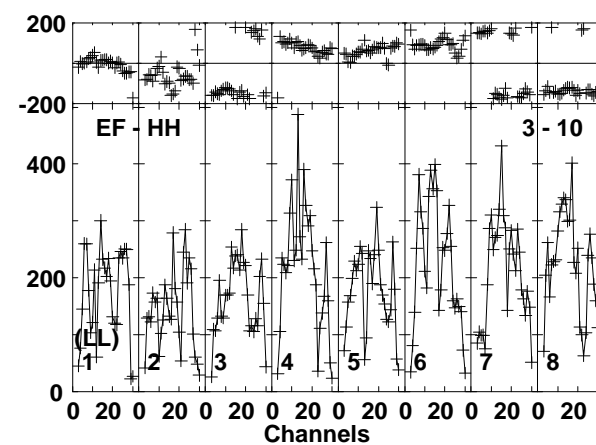
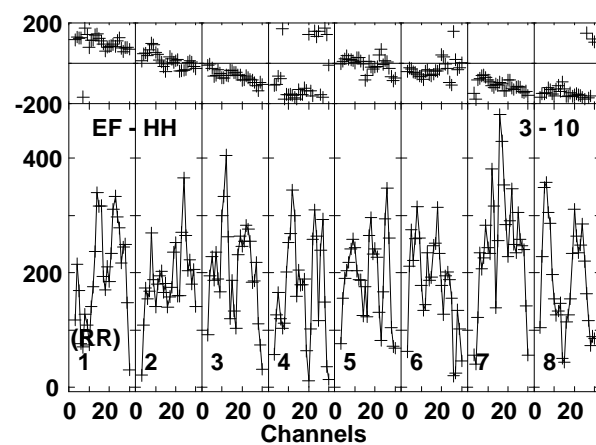
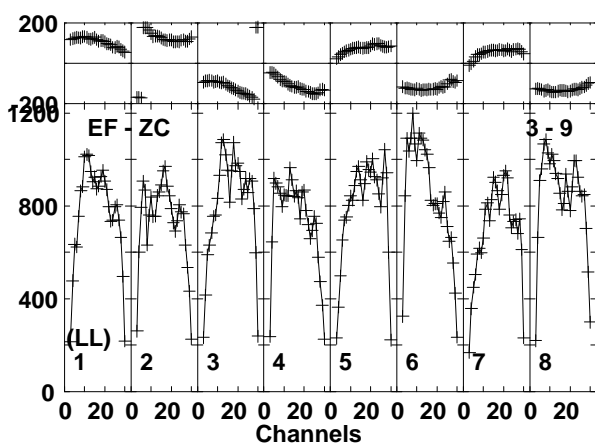
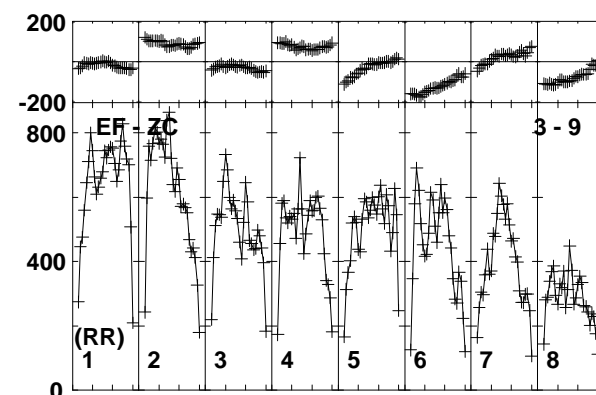
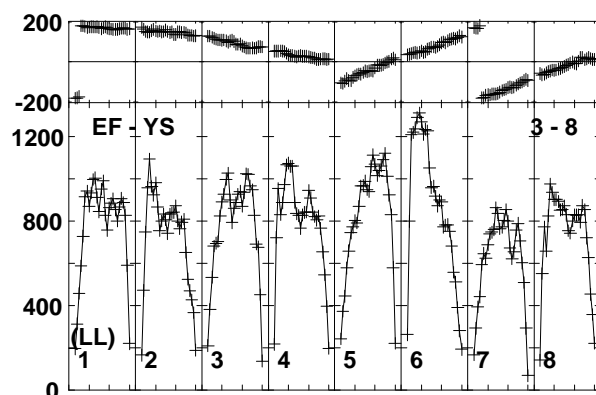
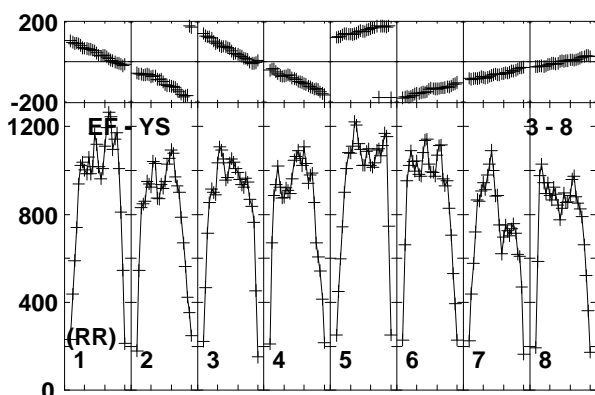
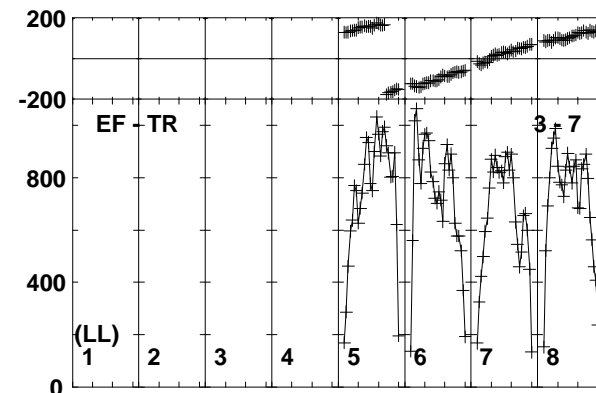
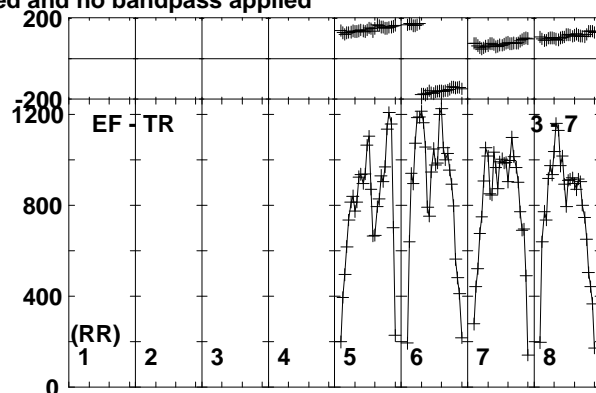
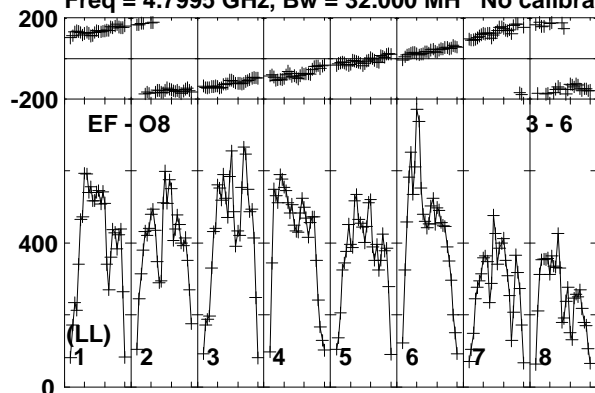

Lower frame: Micro Ampl Jy Top frame: Phas deg
Vector averaged cross-power spectrum Baseline: EF (03) - O8 (06)
Timerange: 00/15:10:44 to 00/15:11:58

Plot file version 125 created 03-APR-2017 18:27:40

M22-VLA1 EM126B.UVDATA.1

Freq = 4.7995 GHz, Bw = 32.000 MH No calibration applied and no bandpass applied

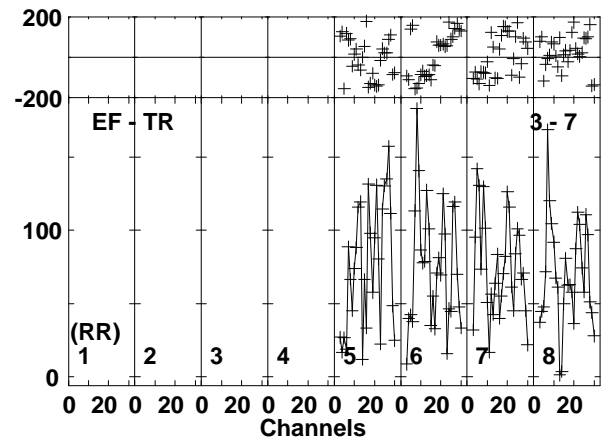
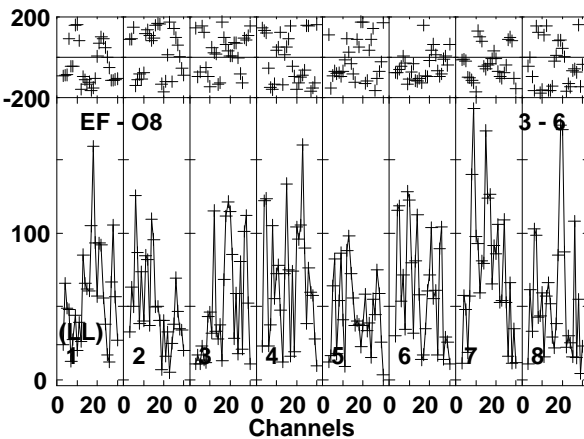
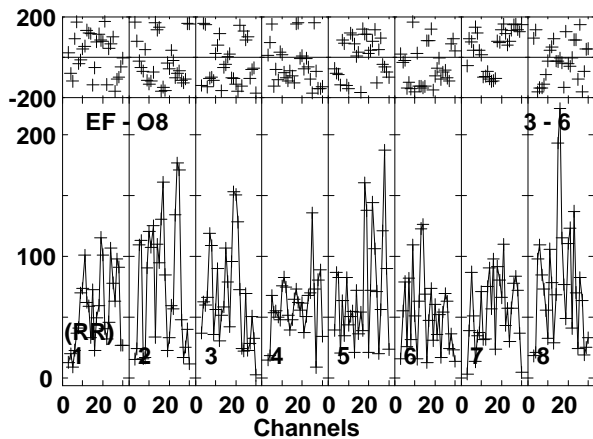
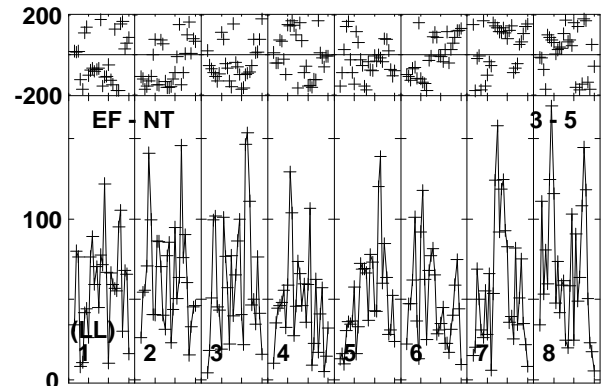
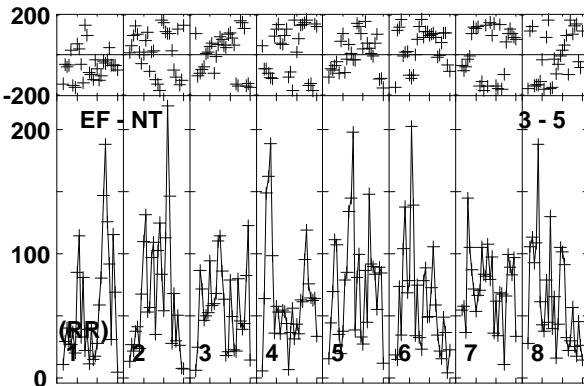
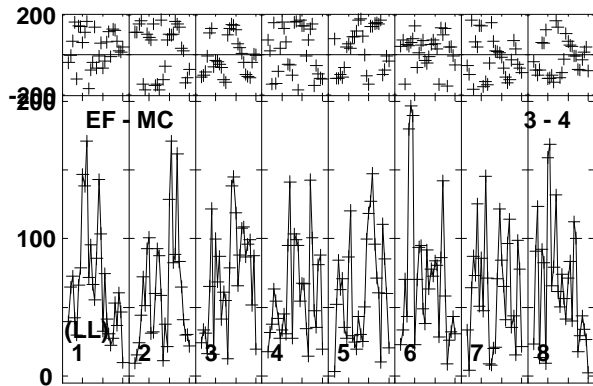
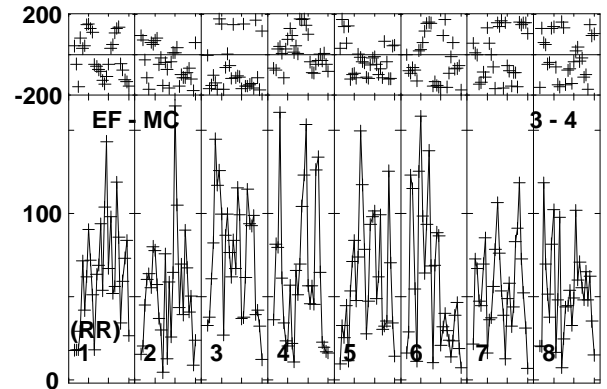
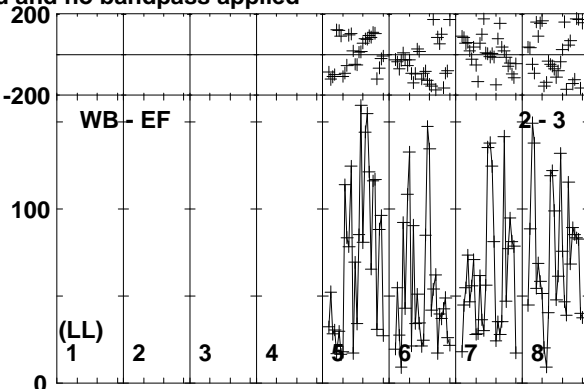
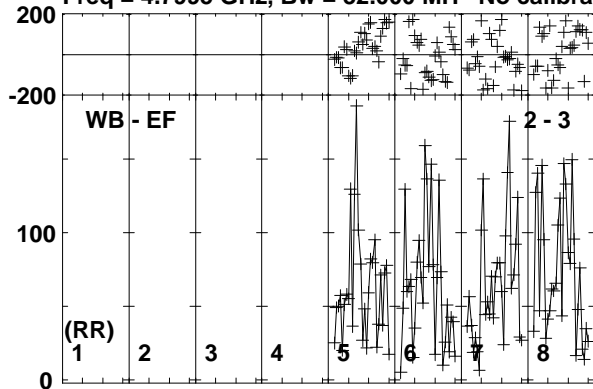

Lower frame: Micro Ampl Jy Top frame: Phas deg
Vector averaged cross-power spectrum Baseline: WB (02) - EF (03)
Timerange: 00/15:12:04 to 00/15:14:08

Plot file version 126 created 03-APR-2017 18:27:40

M22-VLA1 EM126B.UVDATA.1

Freq = 4.7995 GHz, Bw = 32.000 MH No calibration applied and no bandpass applied

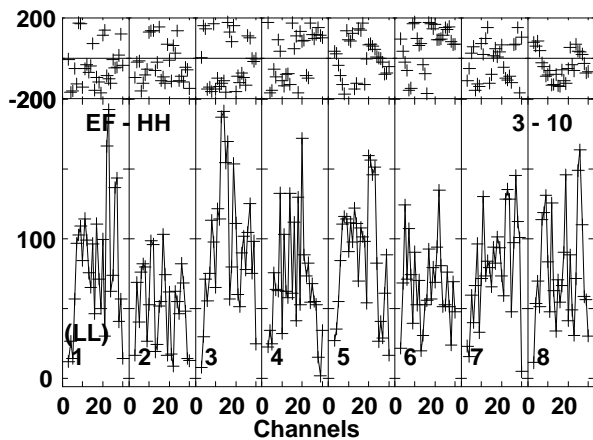
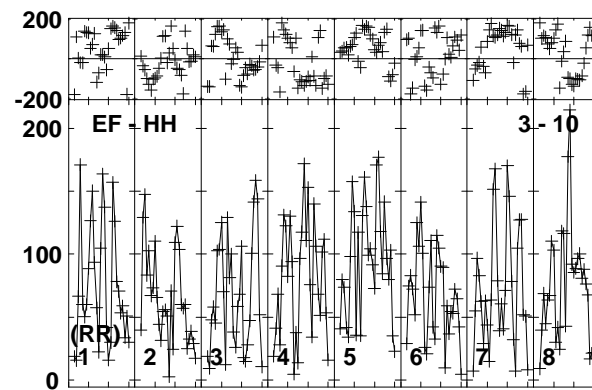
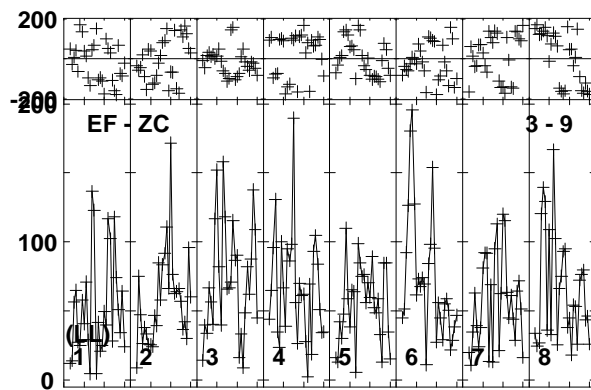
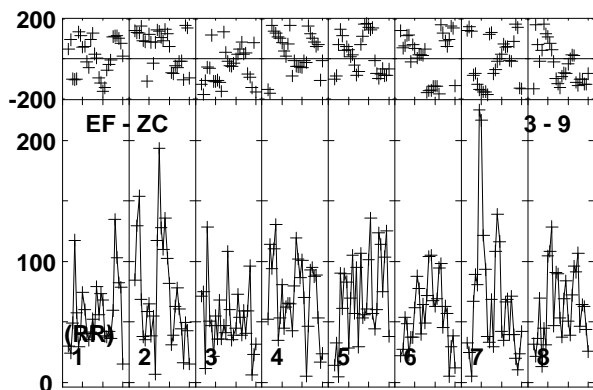
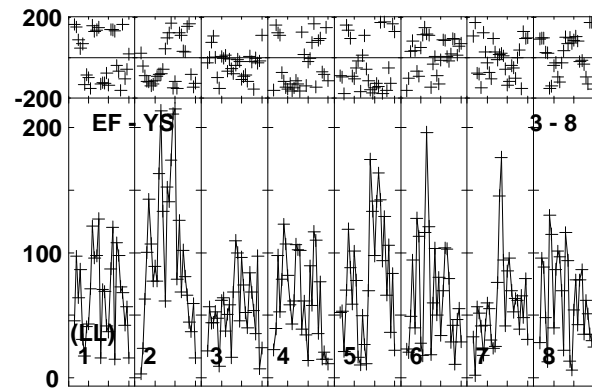
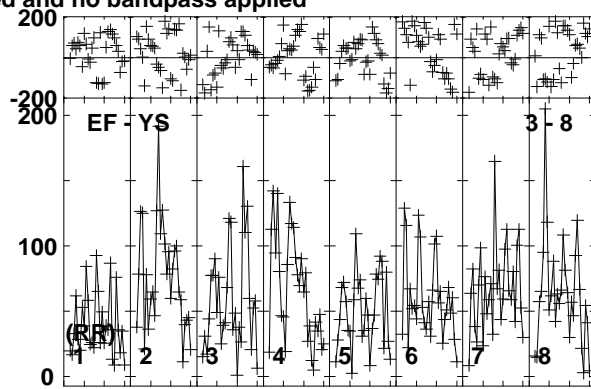
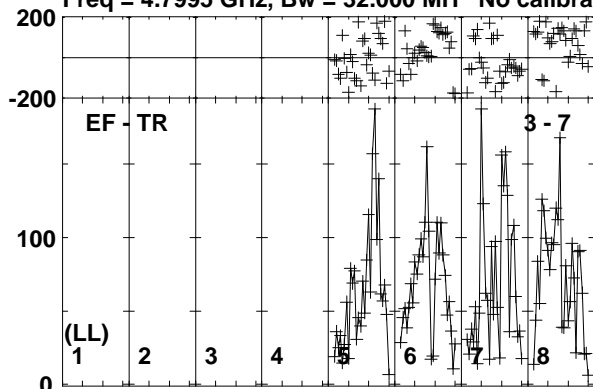

Lower frame: Micro Ampl Jy Top frame: Phas deg
Vector averaged cross-power spectrum Baseline: EF (03) - TR (07)
Timerange: 00/15:12:04 to 00/15:14:08

Plot file version 127 created 03-APR-2017 18:27:40

J1834-2341 EM126B.UVDATA.1

Freq = 4.7995 GHz, Bw = 32.000 MH No calibration applied and no bandpass applied

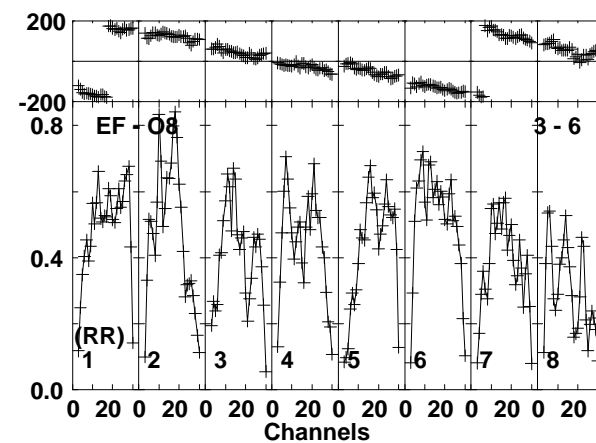
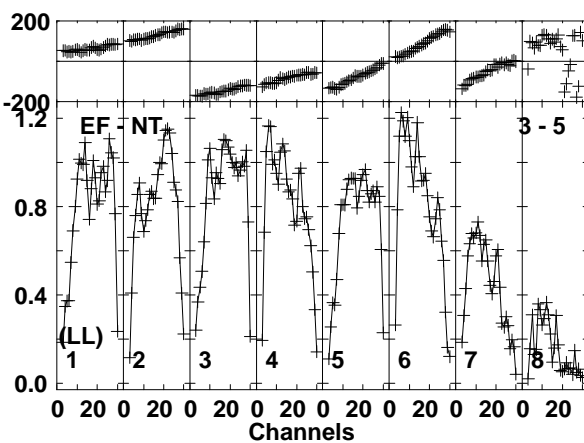
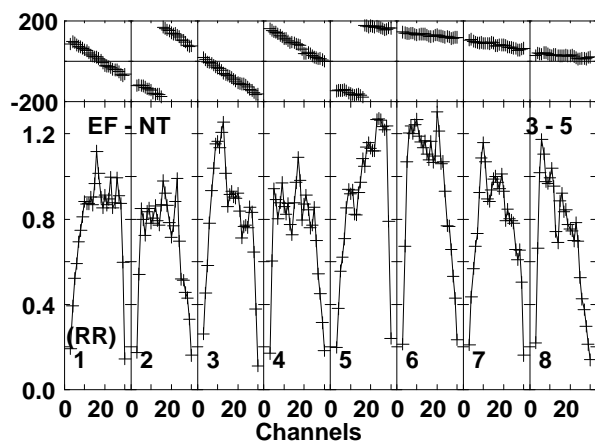
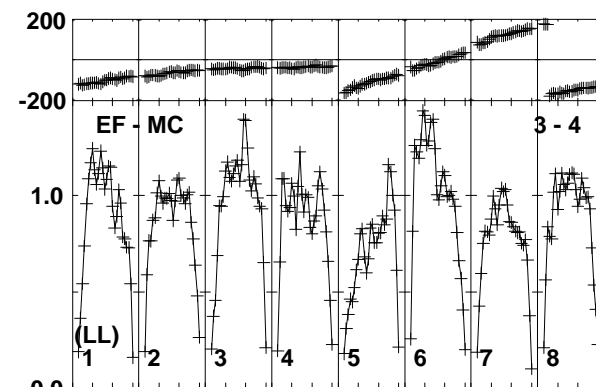
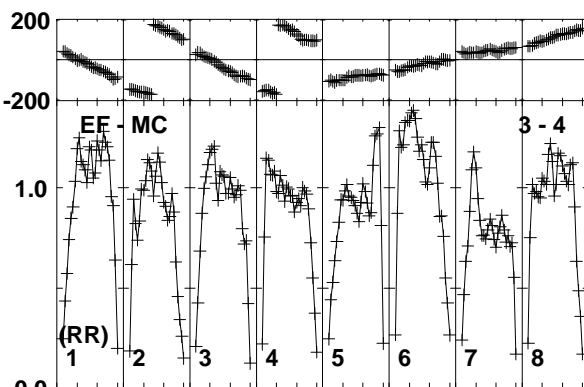
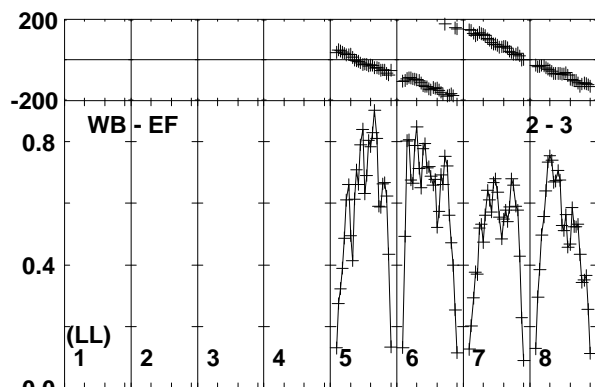
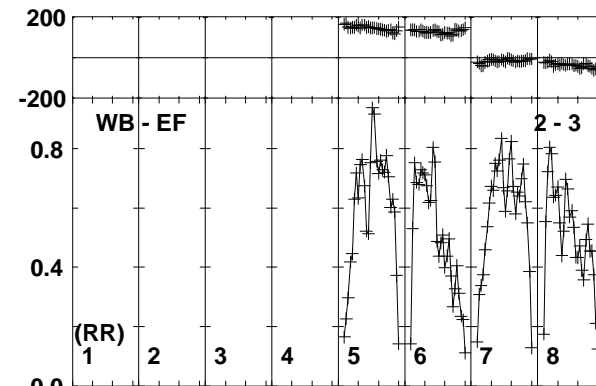
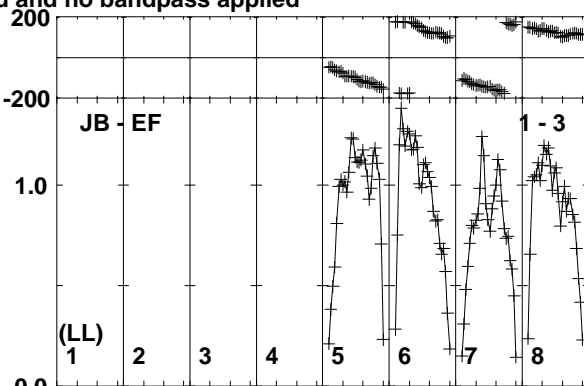
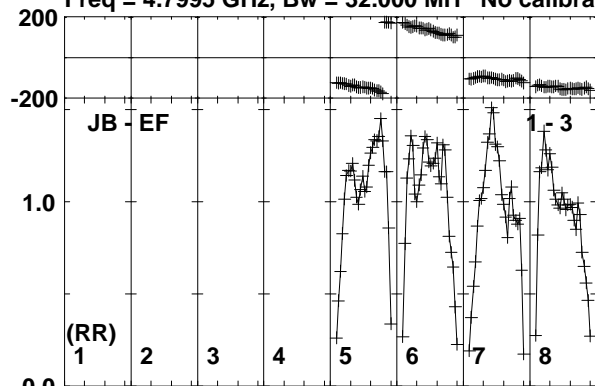

Lower frame: Milli Ampl Jy Top frame: Phas deg
Vector averaged cross-power spectrum Baseline: JB (01) - EF (03)
Timerange: 00/15:14:41 to 00/15:15:29

Plot file version 128 created 03-APR-2017 18:27:40

J1834-2341 EM126B.UVDATA.1

Freq = 4.7995 GHz, Bw = 32.000 MH No calibration applied and no bandpass applied

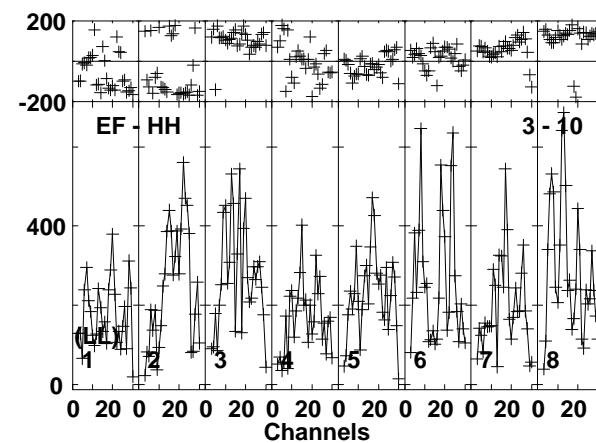
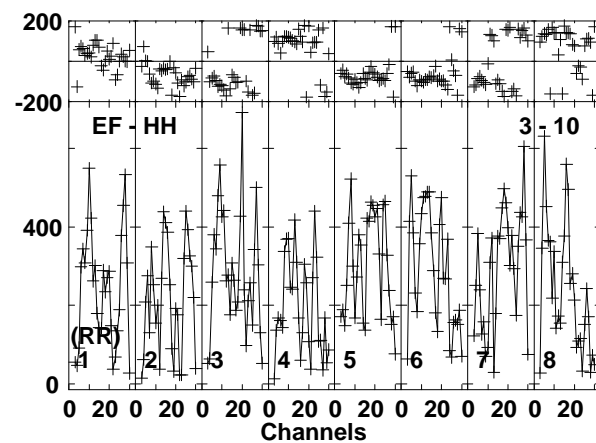
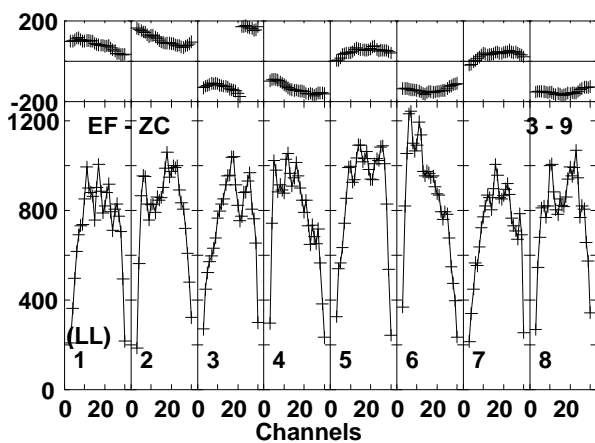
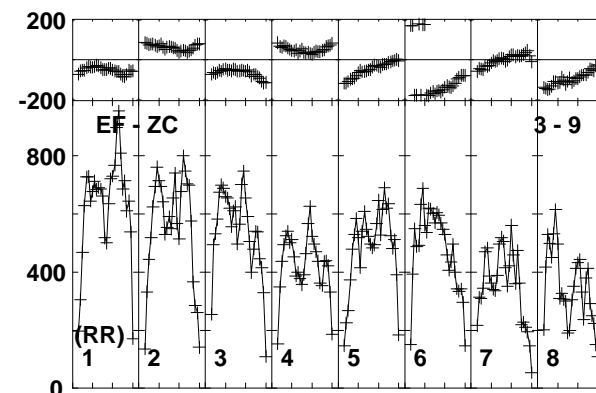
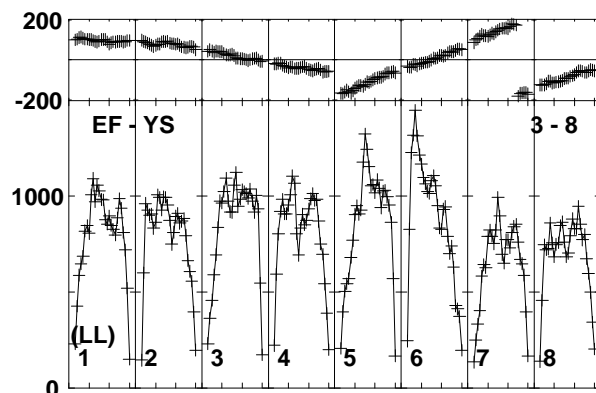
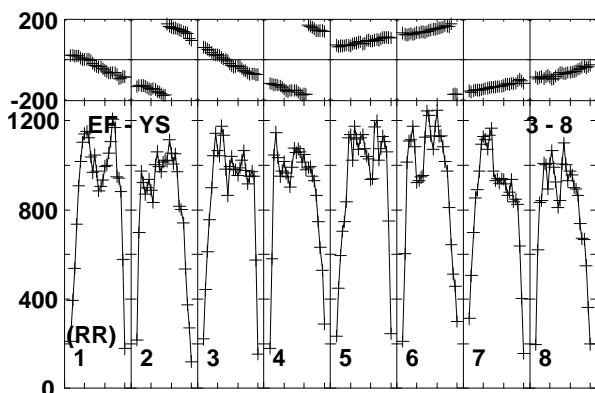
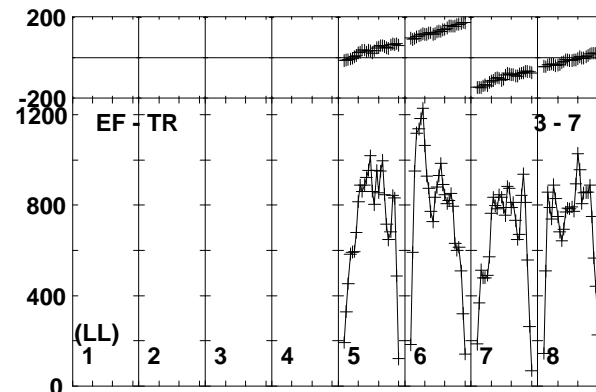
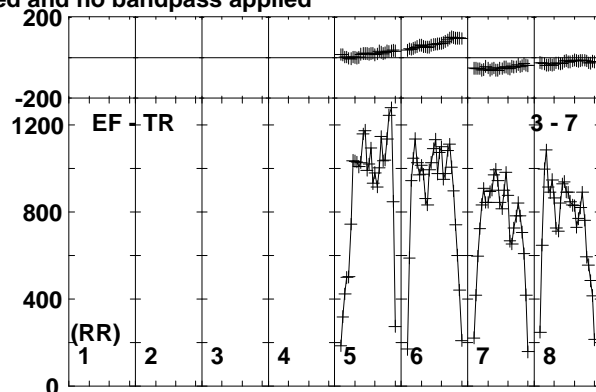
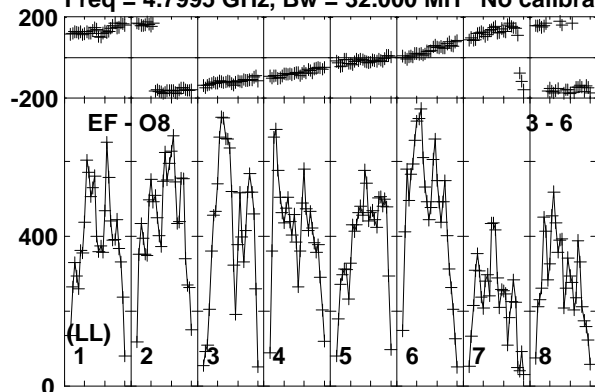

Lower frame: Micro Ampl Jy Top frame: Phas deg
Vector averaged cross-power spectrum Baseline: EF (03) - O8 (06)
Timerange: 00/15:14:41 to 00/15:15:29

Plot file version 129 created 03-APR-2017 18:27:40

M22-VLA1 EM126B.UVDATA.1

Freq = 4.7995 GHz, Bw = 32.000 MH No calibration applied and no bandpass applied

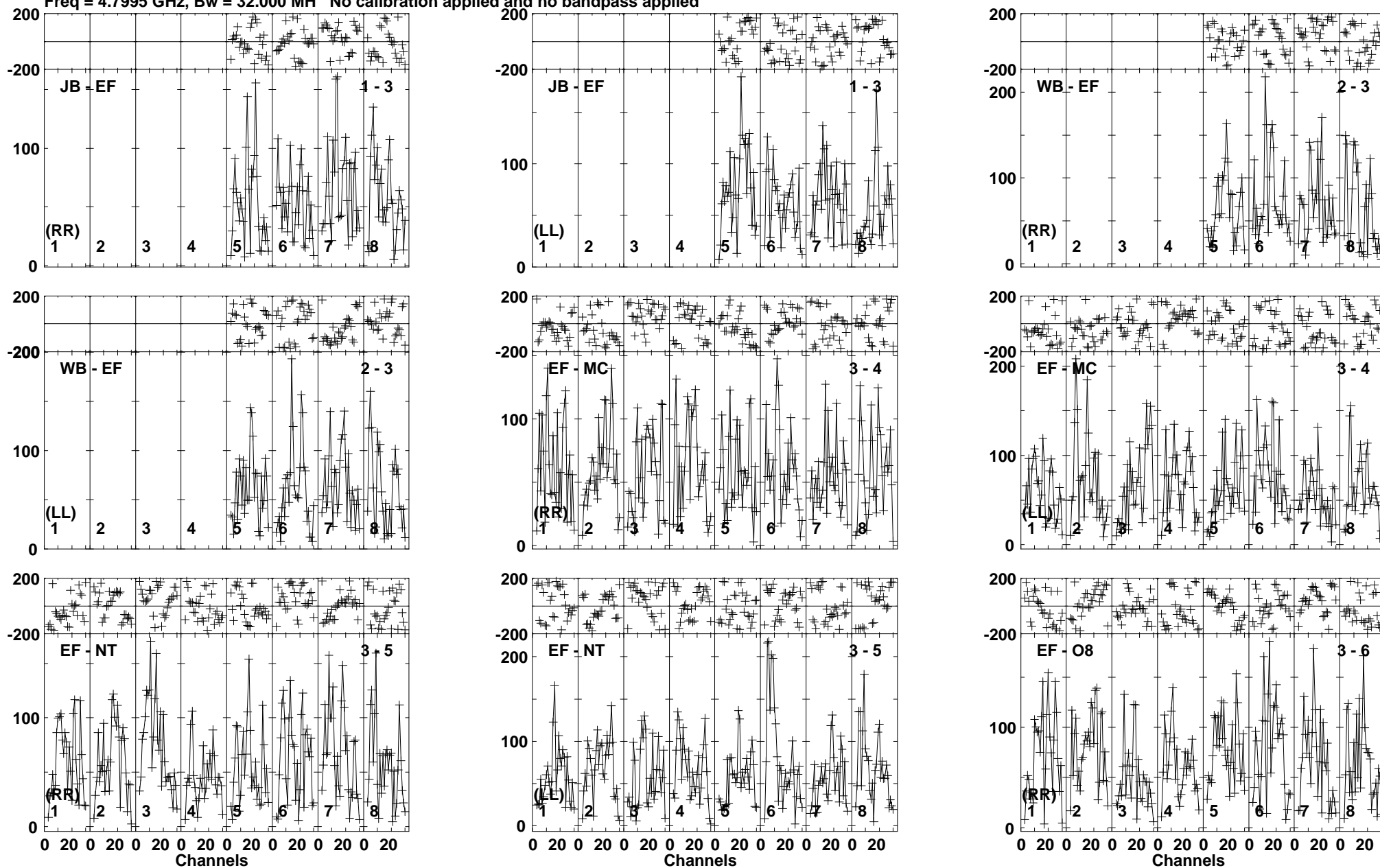

Lower frame: Micro Ampl Jy Top frame: Phas deg
Vector averaged cross-power spectrum Baseline: JB (01) - EF (03)
Timerange: 00/15:15:34 to 00/15:17:38

Plot file version 130 created 03-APR-2017 18:27:40

M22-VLA1 EM126B.UVDATA.1

Freq = 4.7995 GHz, Bw = 32.000 MH No calibration applied and no bandpass applied

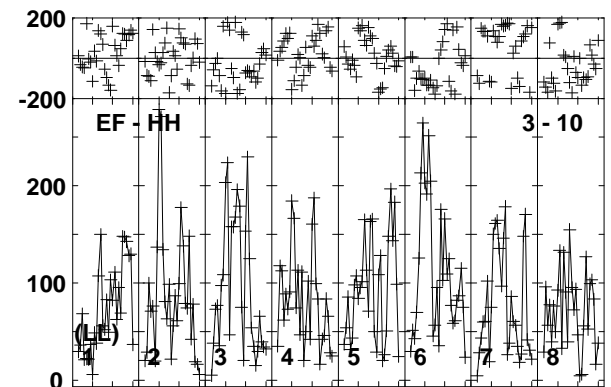
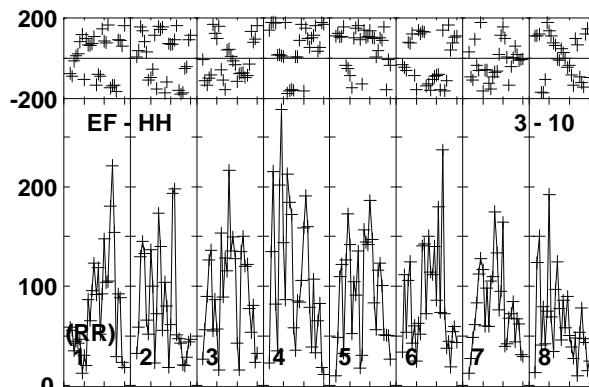
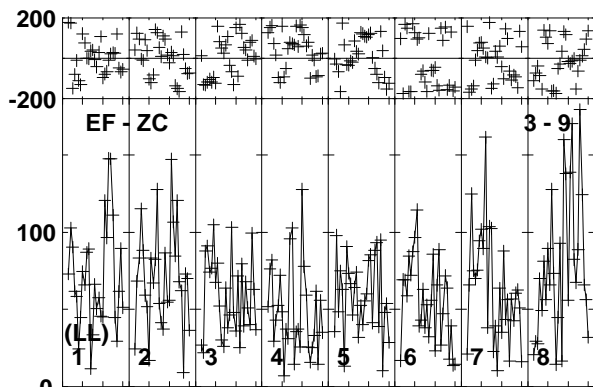
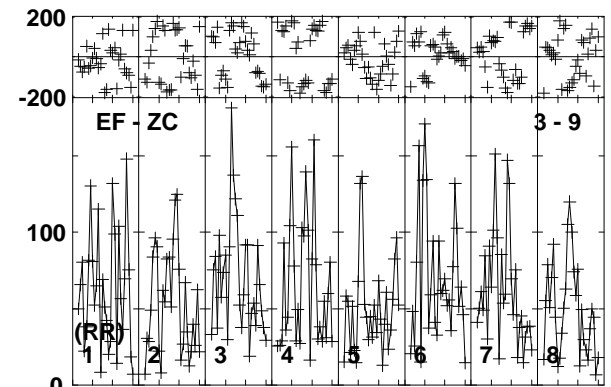
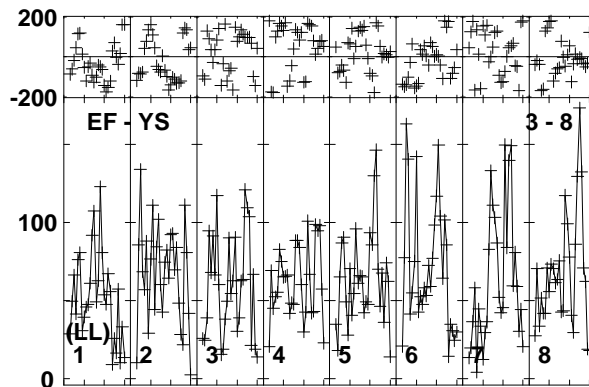
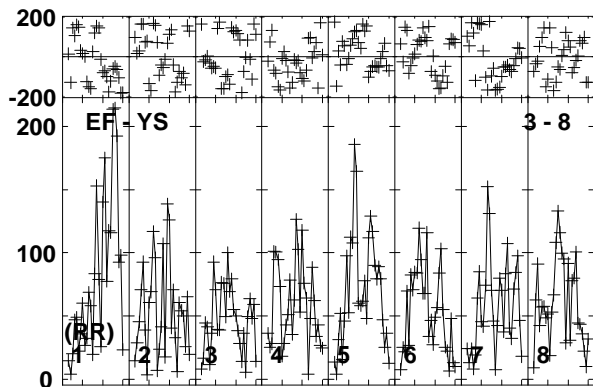
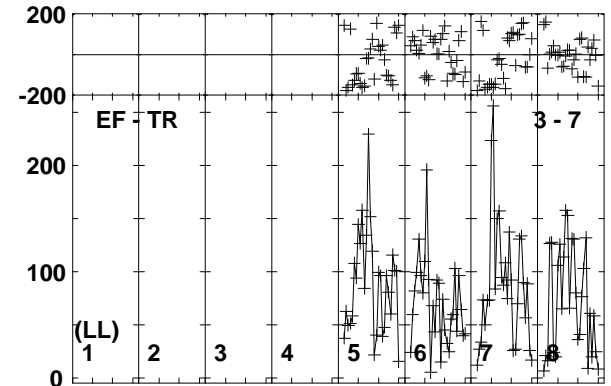
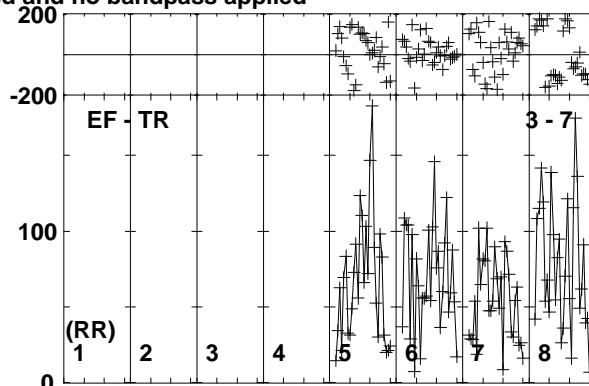
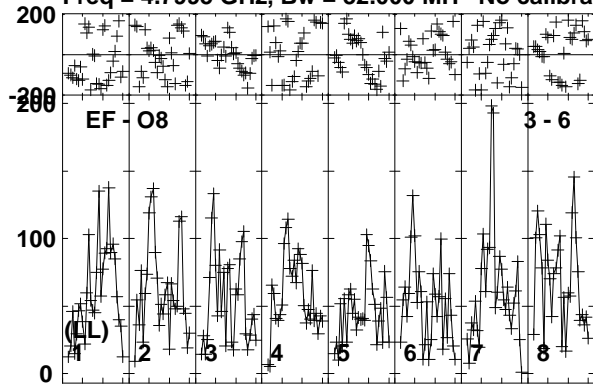

Lower frame: Micro Ampl Jy Top frame: Phas deg
Vector averaged cross-power spectrum Baseline: EF (03) - O8 (06)
Timerange: 00/15:15:34 to 00/15:17:38

Plot file version 131 created 03-APR-2017 18:27:40

J1834-2341 EM126B.UVDATA.1

Freq = 4.7995 GHz, Bw = 32.000 MH No calibration applied and no bandpass applied

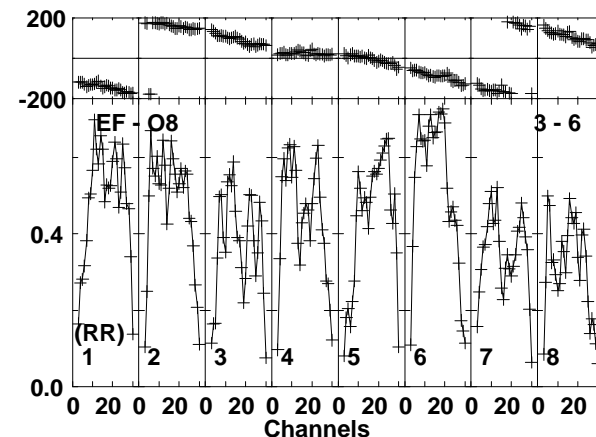
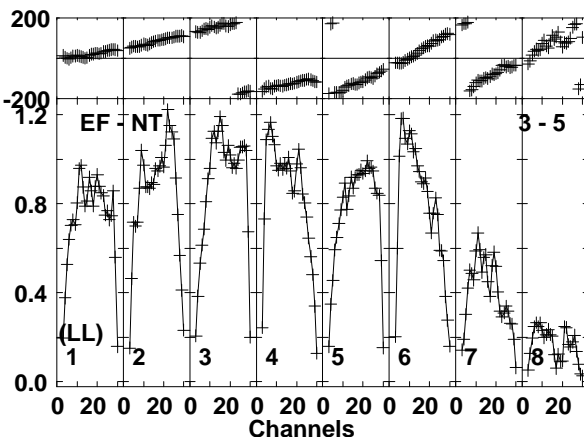
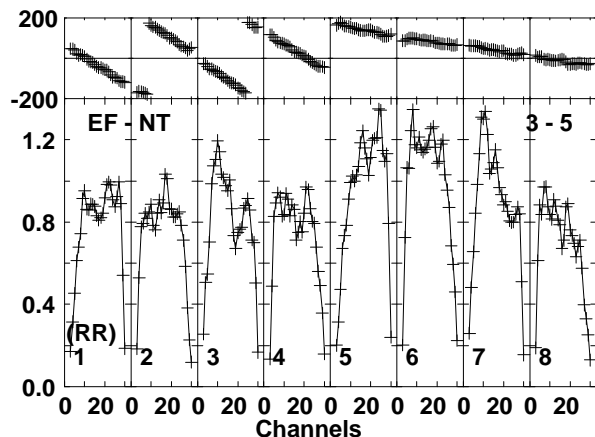
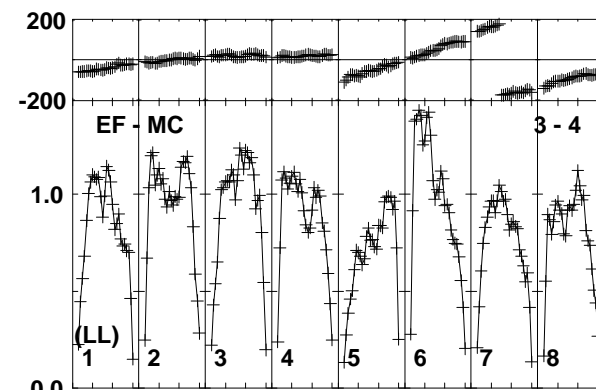
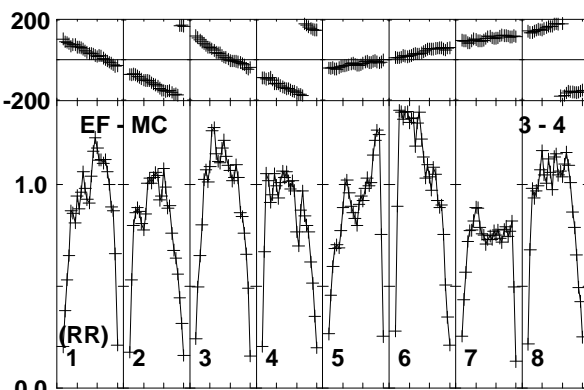
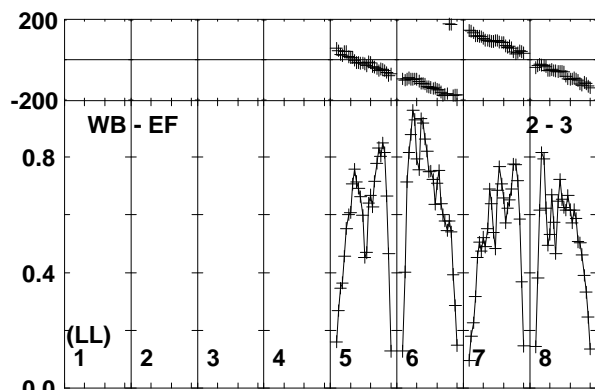
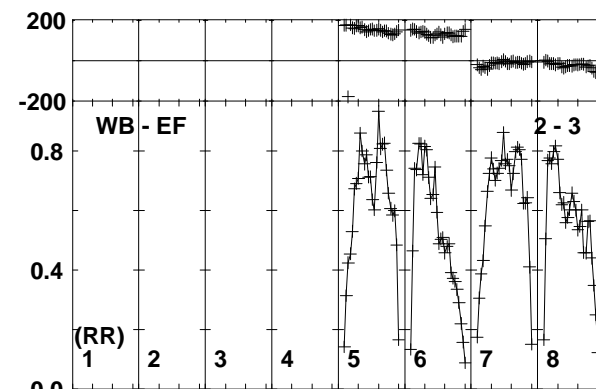
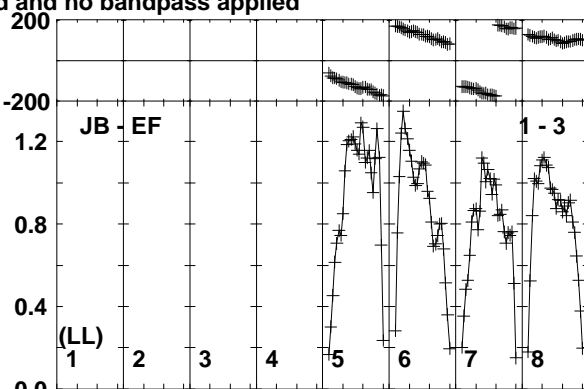
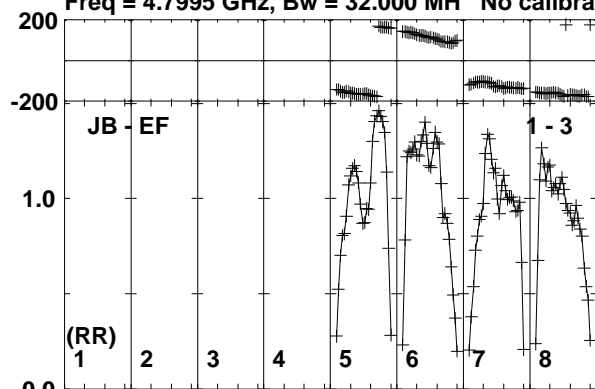

Lower frame: Milli Ampl Jy Top frame: Phas deg
Vector averaged cross-power spectrum Baseline: JB (01) - EF (03)
Timerange: 00:15:17:44 to 00:15:18:58

Plot file version 132 created 03-APR-2017 18:27:40

J1834-2341 EM126B.UVDATA.1

Freq = 4.7995 GHz, Bw = 32.000 MH No calibration applied and no bandpass applied

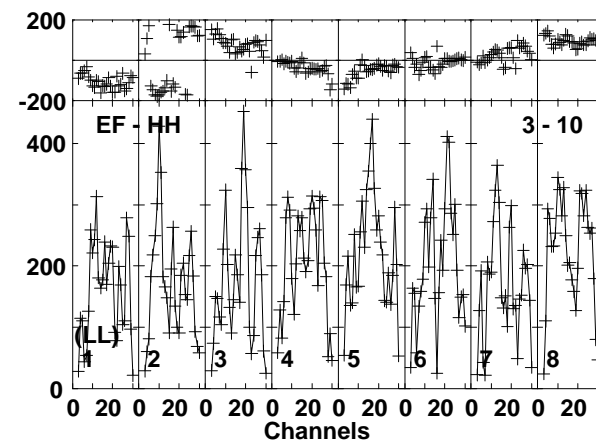
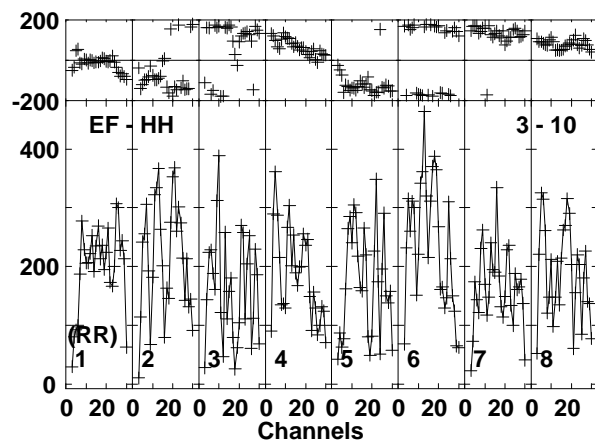
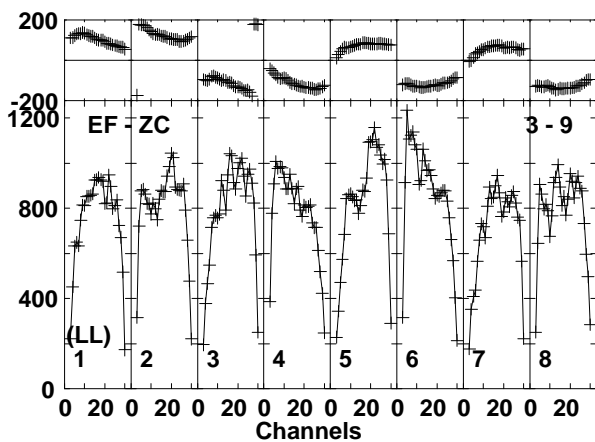
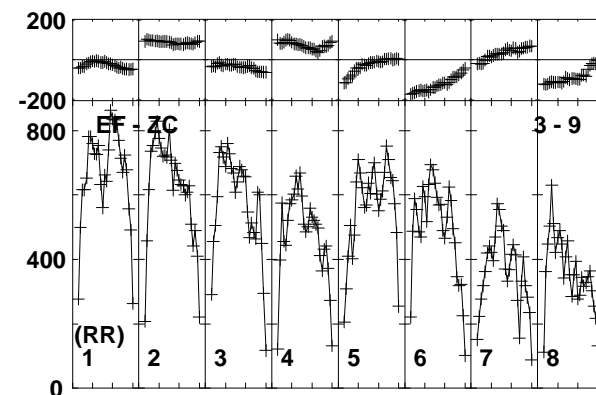
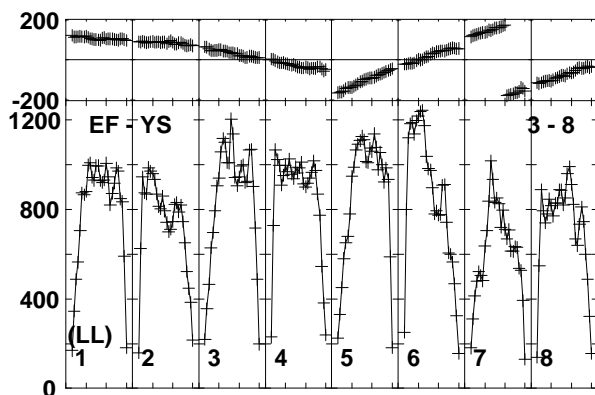
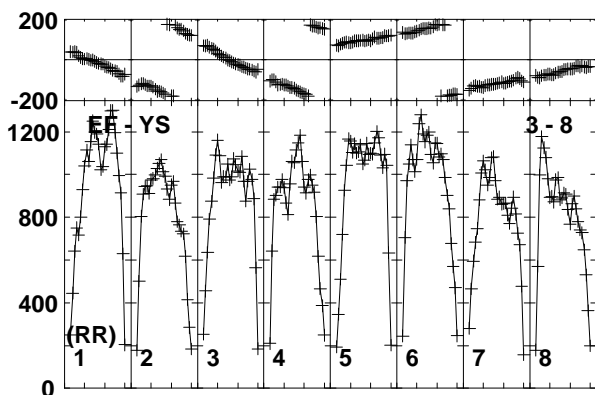
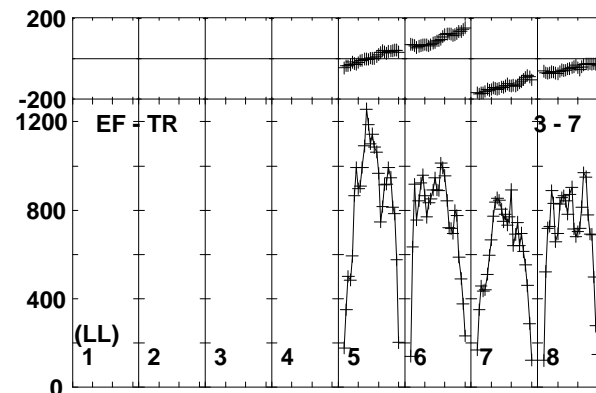
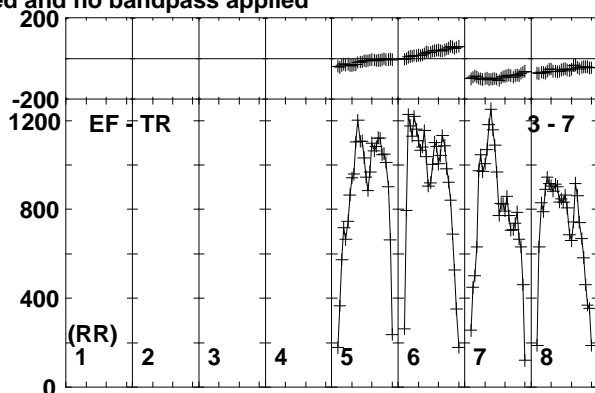
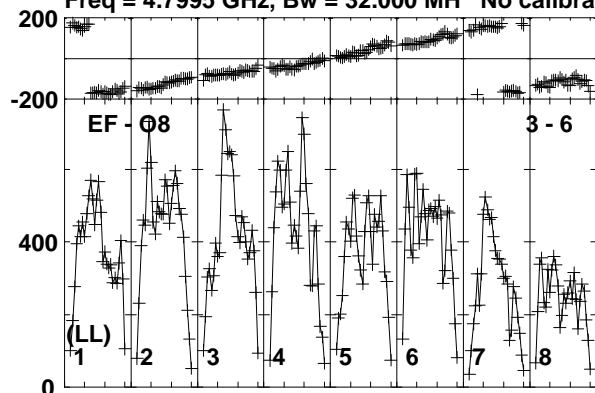

Lower frame: Micro Ampl Jy Top frame: Phas deg
Vector averaged cross-power spectrum Baseline: EF (03) - O8 (06)
Timerange: 00/15:17:44 to 00/15:18:58

Plot file version 133 created 03-APR-2017 18:27:40

M22-VLA1 EM126B.UVDATA.1

Freq = 4.7995 GHz, Bw = 32.000 MH No calibration applied and no bandpass applied

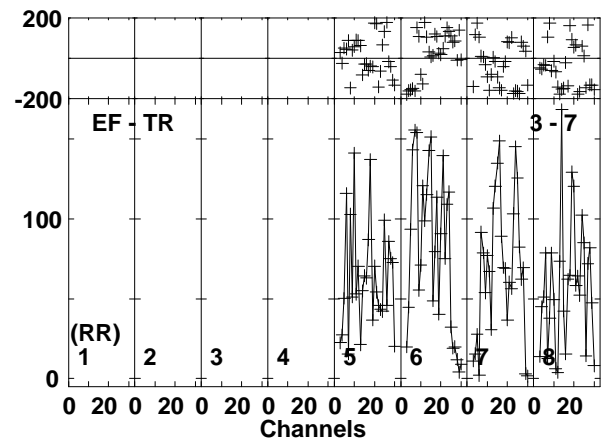
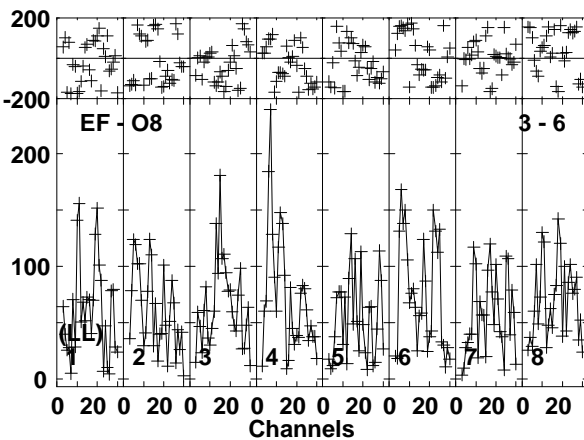
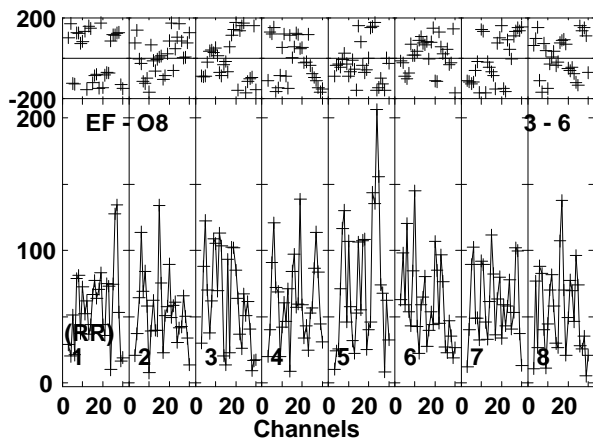
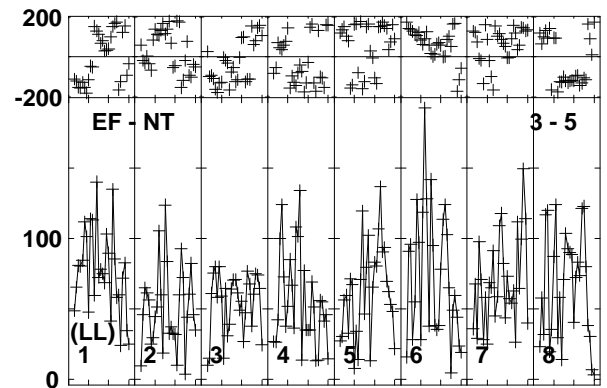
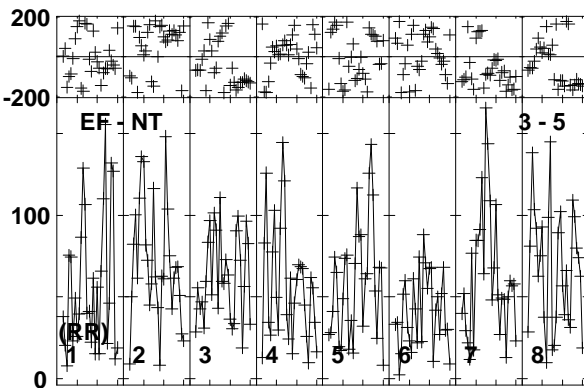
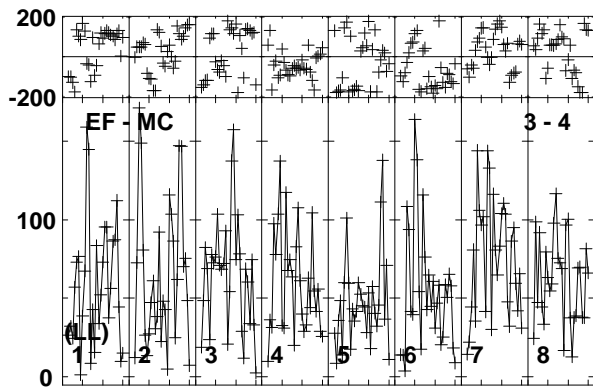
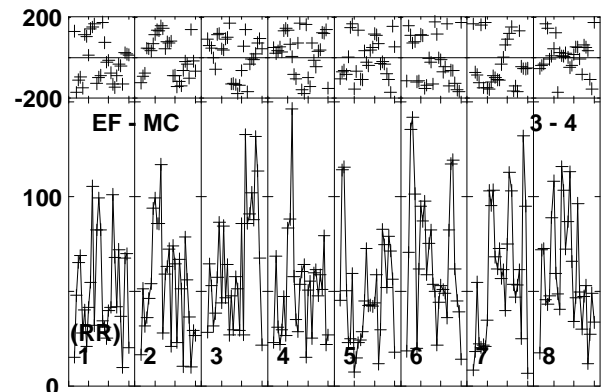
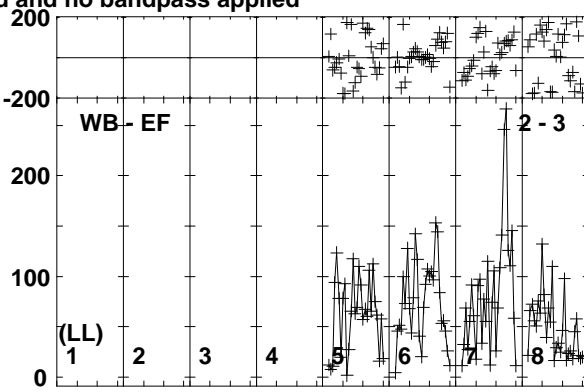
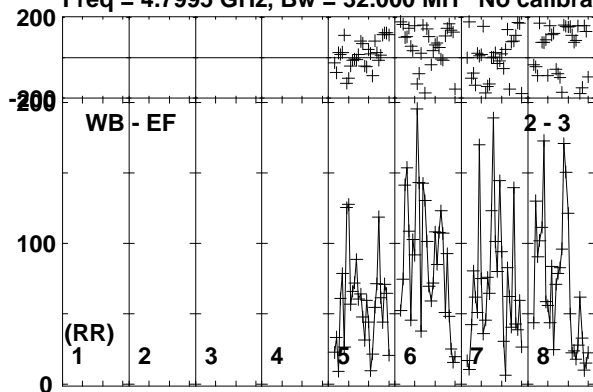

Lower frame: Micro Ampl Jy Top frame: Phas deg
Vector averaged cross-power spectrum Baseline: WB (02) - EF (03)
Timerange: 00/15:19:04 to 00/15:21:08

Plot file version 134 created 03-APR-2017 18:27:40

M22-VLA1 EM126B.UVDATA.1

Freq = 4.7995 GHz, Bw = 32.000 MH No calibration applied and no bandpass applied

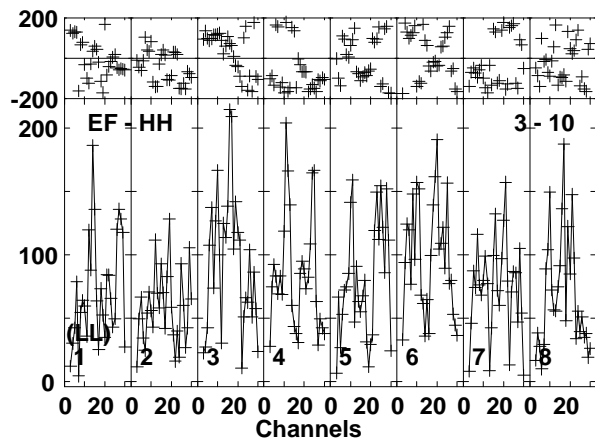
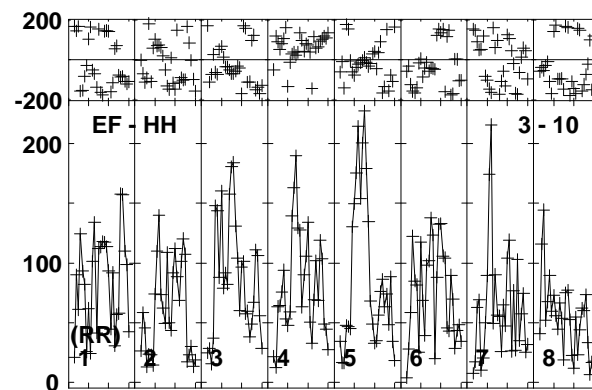
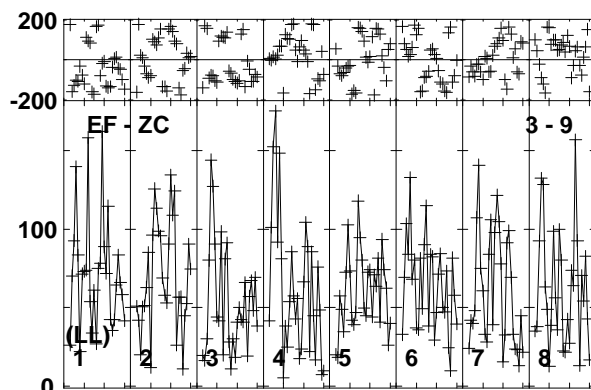
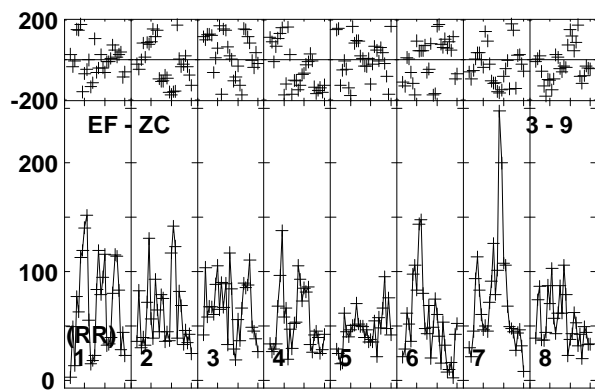
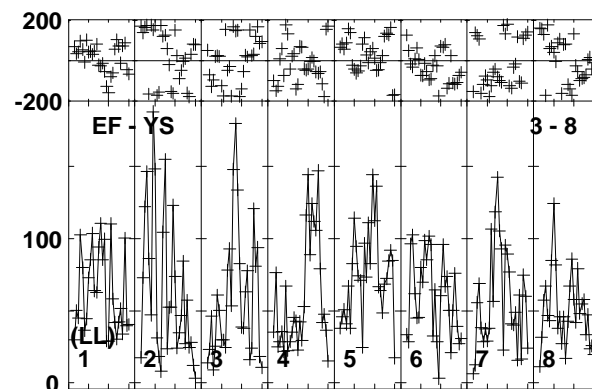
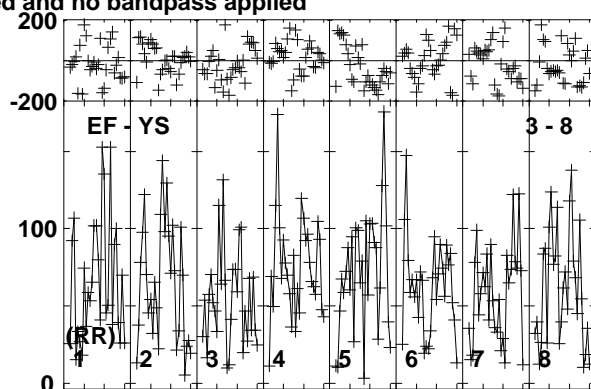
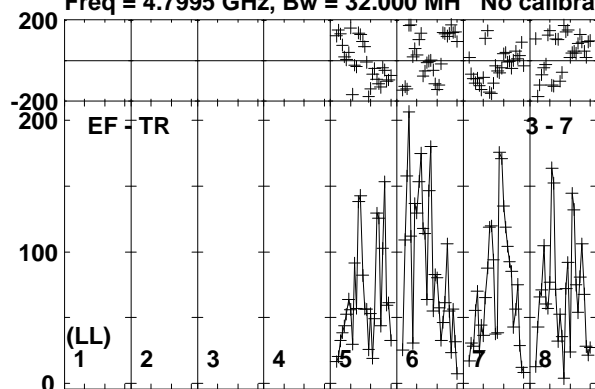

Lower frame: Micro Ampl Jy Top frame: Phas deg
Vector averaged cross-power spectrum Baseline: EF (03) - TR (07)
Timerange: 00/15:19:04 to 00/15:21:08

Plot file version 135 created 03-APR-2017 18:27:41

J1834-2341 EM126B.UVDATA.1

Freq = 4.7995 GHz, Bw = 32.000 MH No calibration applied and no bandpass applied

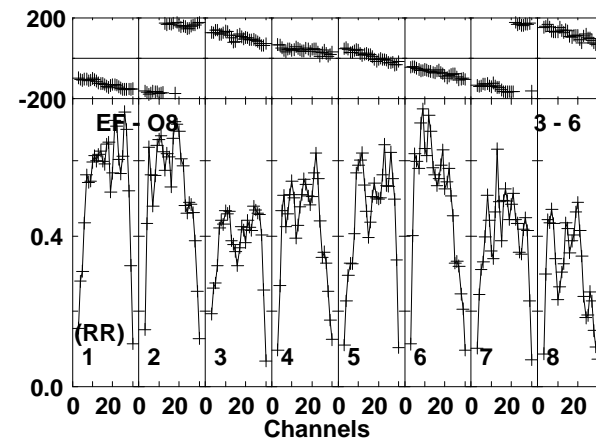
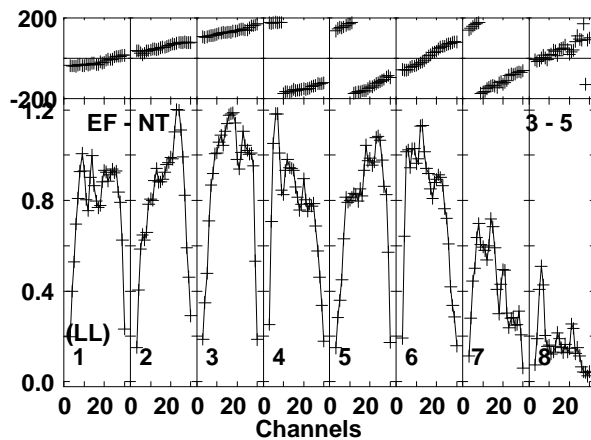
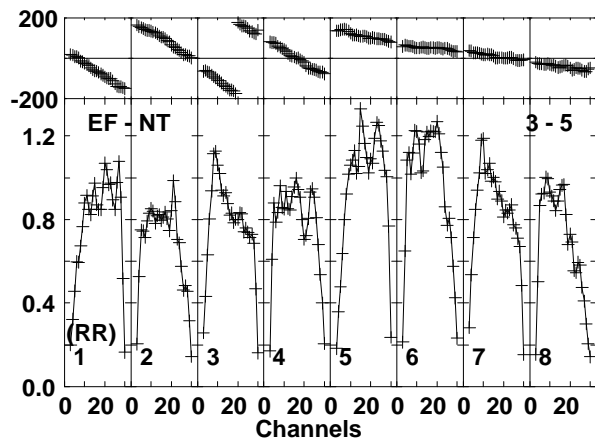
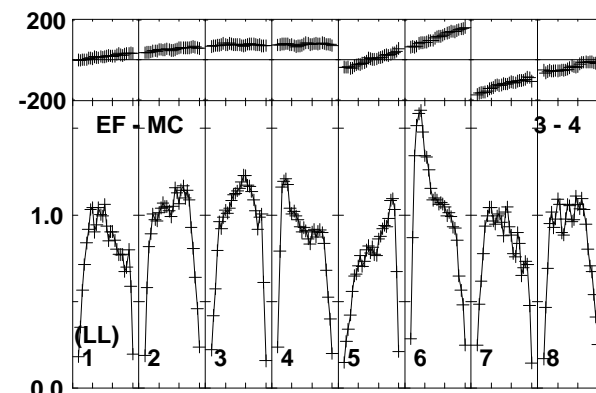
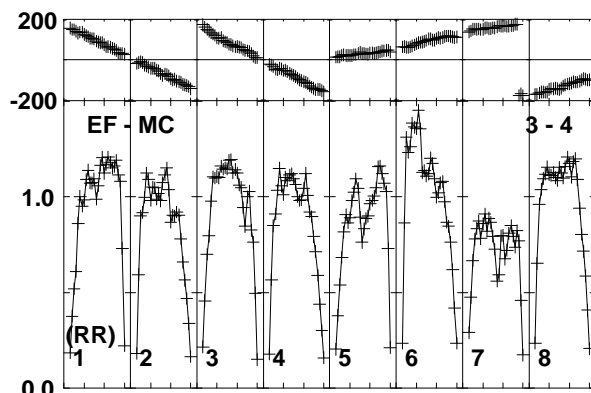
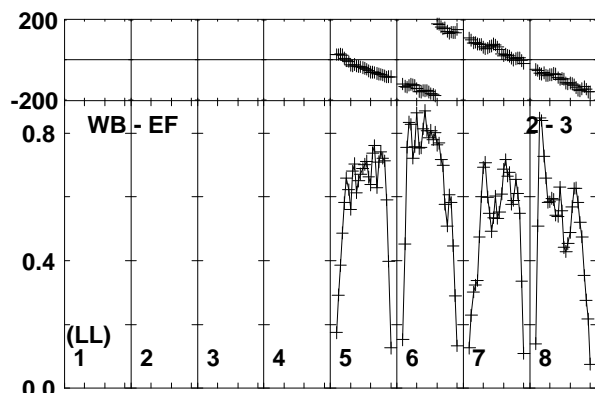
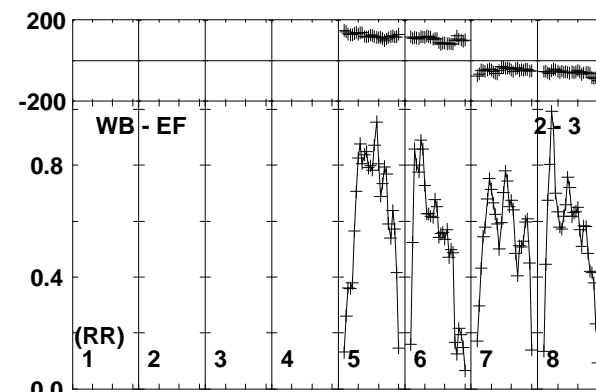
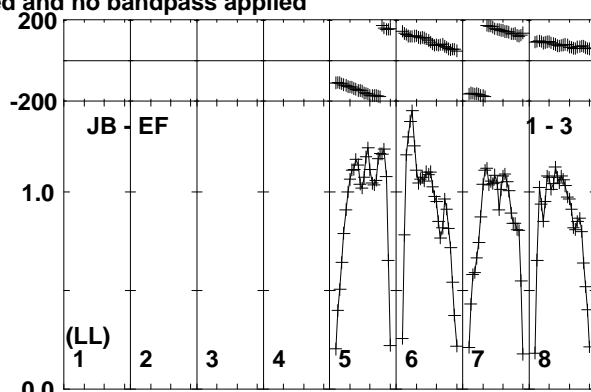
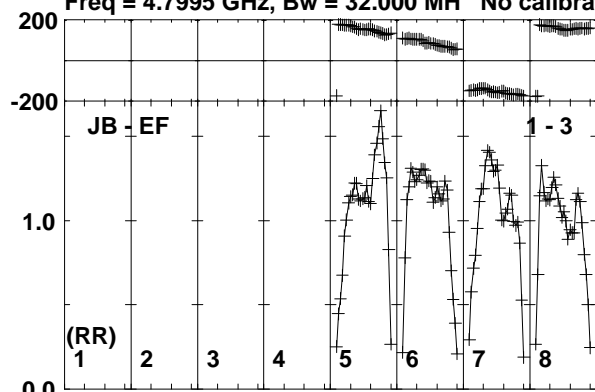

Lower frame: Milli Ampl Jy Top frame: Phas deg
Vector averaged cross-power spectrum Baseline: JB (01) - EF (03)
Timerange: 00/15:21:14 to 00/15:22:28

Plot file version 136 created 03-APR-2017 18:27:41

J1834-2341 EM126B.UVDATA.1

Freq = 4.7995 GHz, Bw = 32.000 MH No calibration applied and no bandpass applied

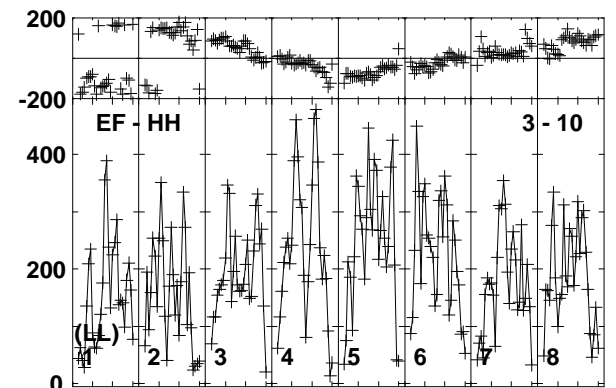
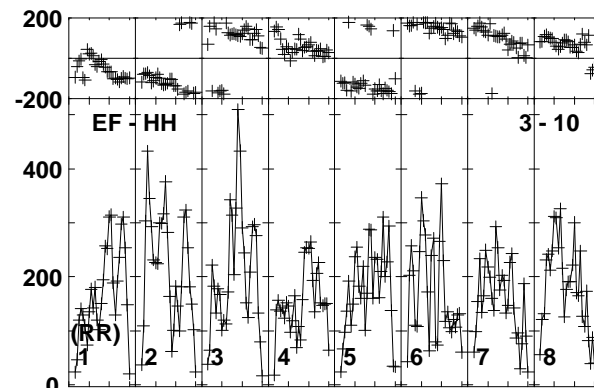
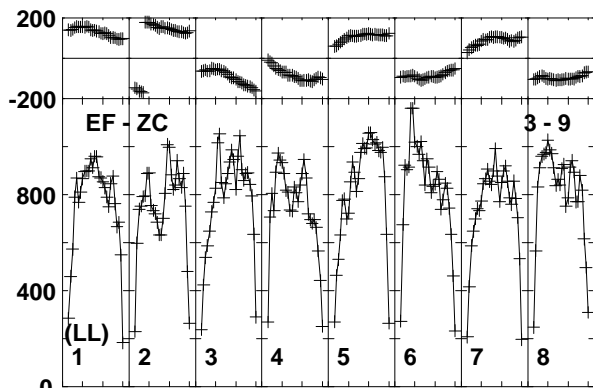
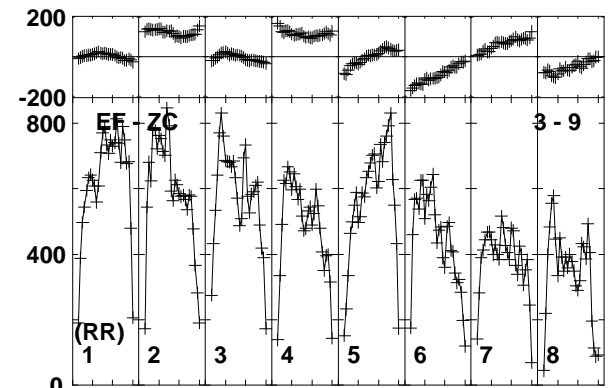
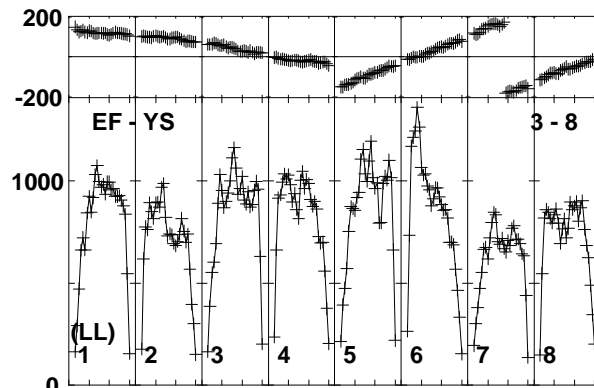
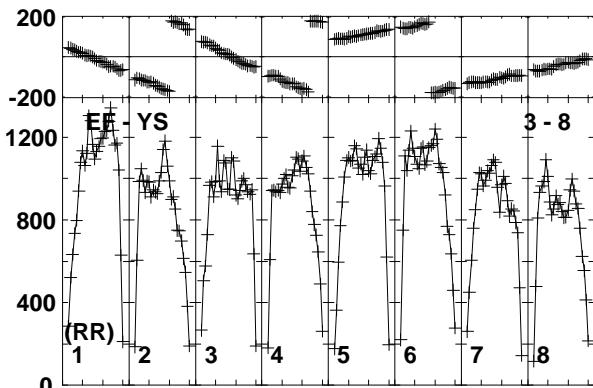
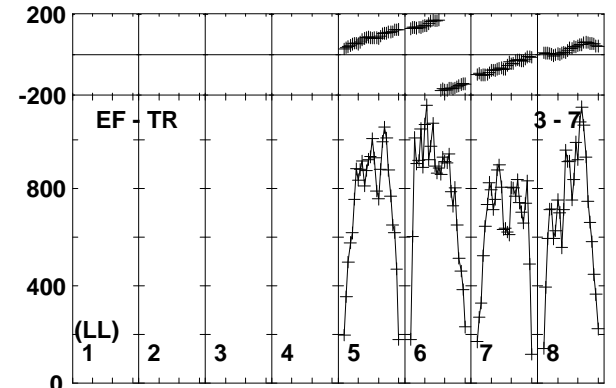
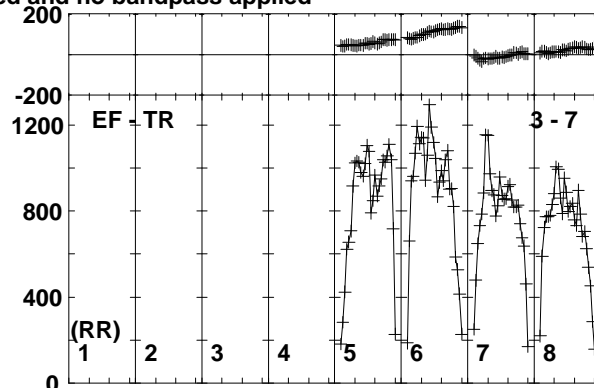
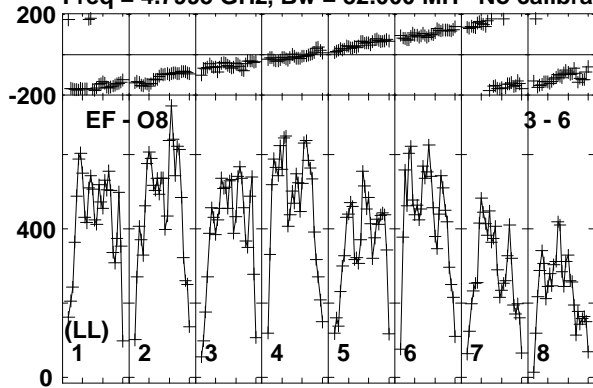

Lower frame: Micro Ampl Jy Top frame: Phas deg
Vector averaged cross-power spectrum Baseline: EF (03) - O8 (06)
Timerange: 00/15:21:14 to 00/15:22:28

Plot file version 137 created 03-APR-2017 18:27:41

M22-VLA1 EM126B.UVDATA.1

Freq = 4.7995 GHz, Bw = 32.000 MH No calibration applied and no bandpass applied

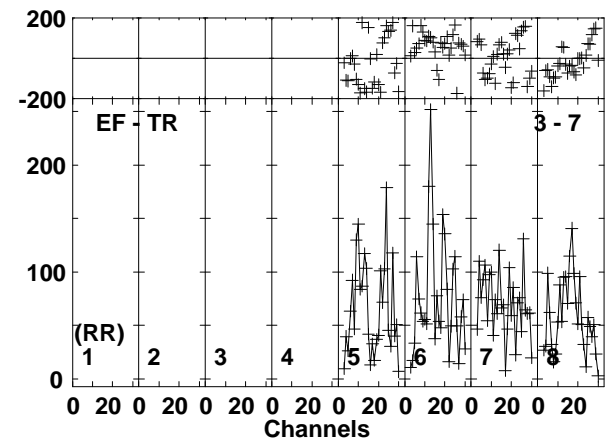
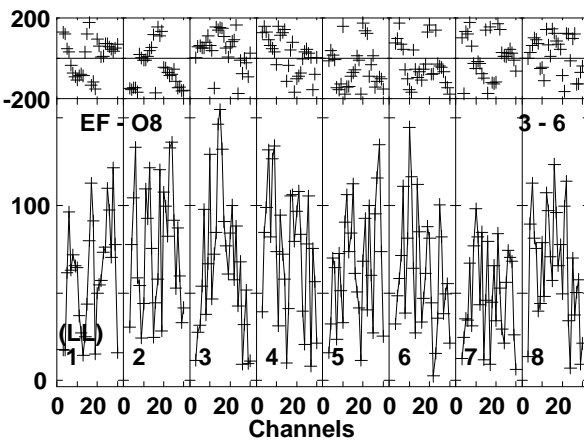
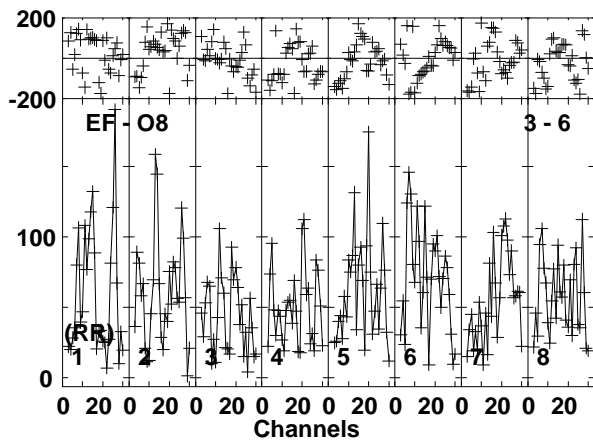
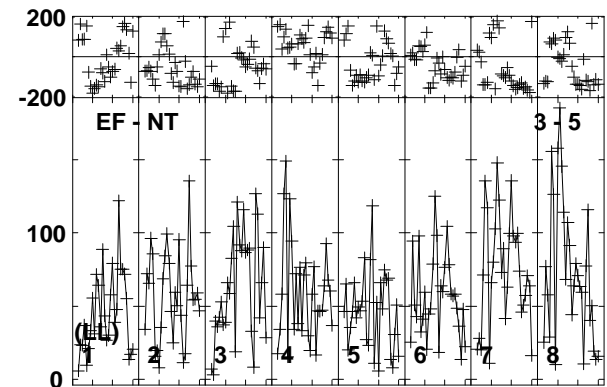
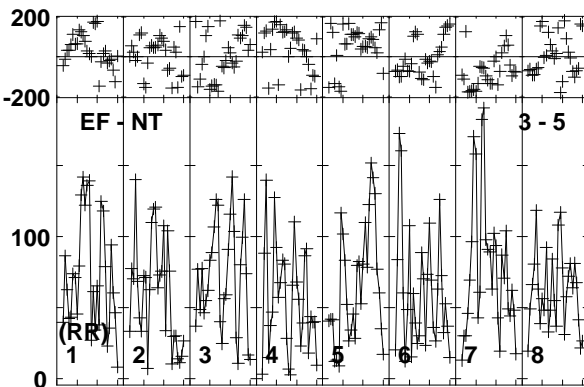
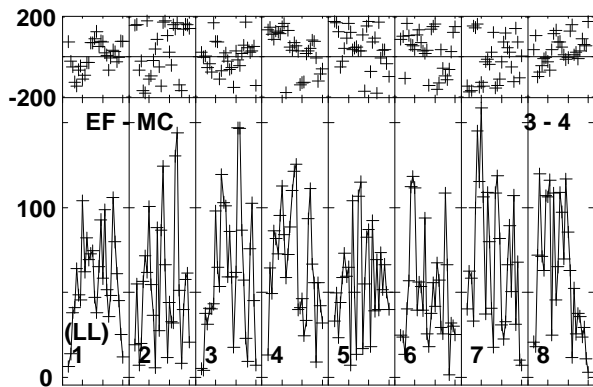
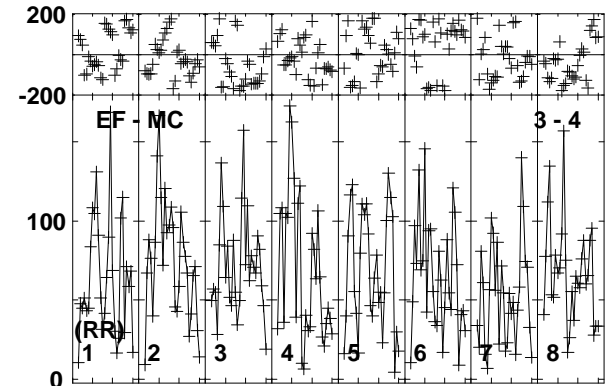
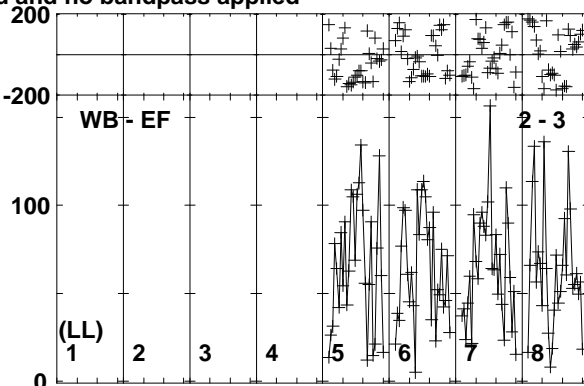
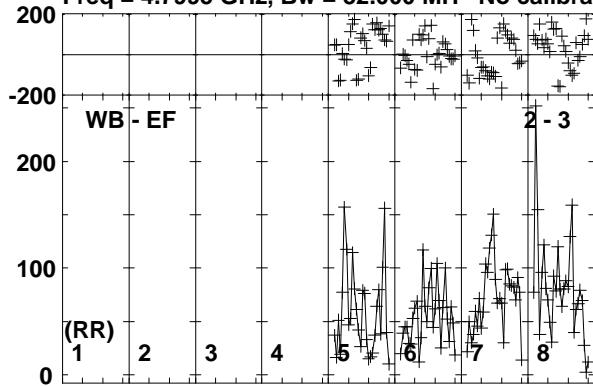

Lower frame: Micro Ampl Jy Top frame: Phas deg
Vector averaged cross-power spectrum Baseline: WB (02) - EF (03)
Timerange: 00/15:22:34 to 00/15:24:38

Plot file version 138 created 03-APR-2017 18:27:41

M22-VLA1 EM126B.UVDATA.1

Freq = 4.7995 GHz, Bw = 32.000 MH No calibration applied and no bandpass applied

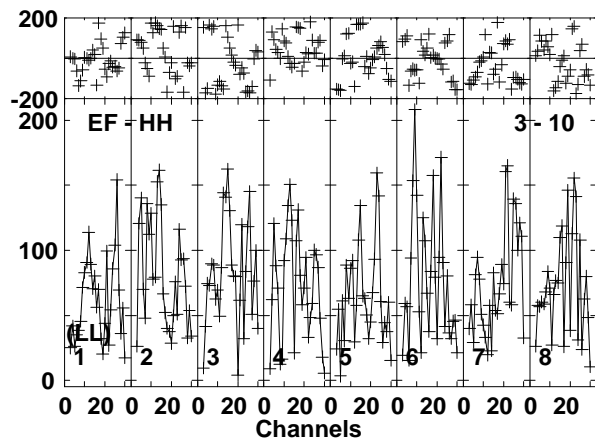
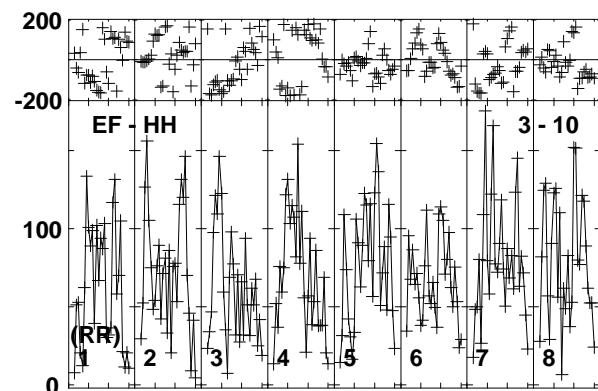
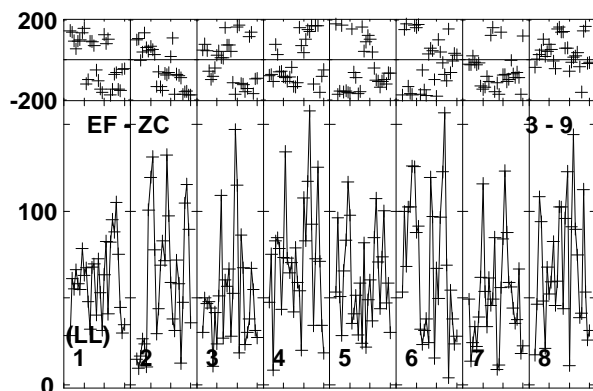
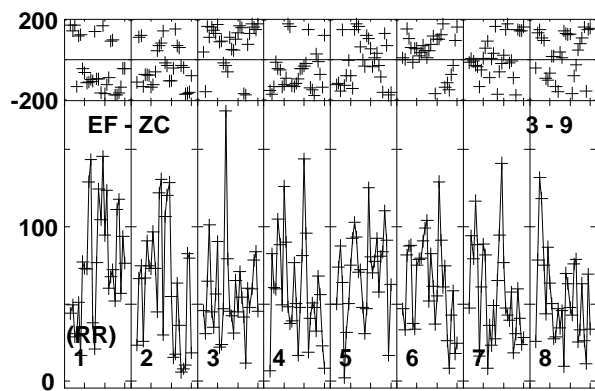
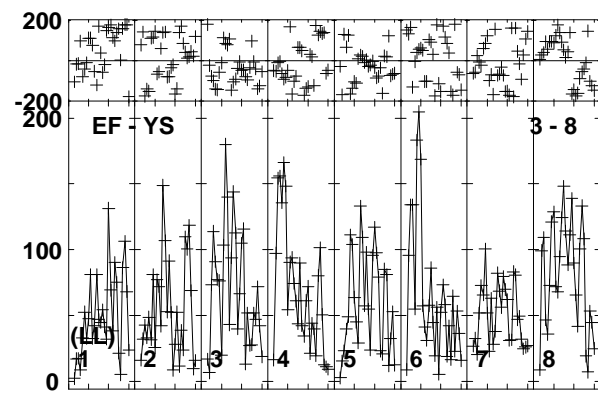
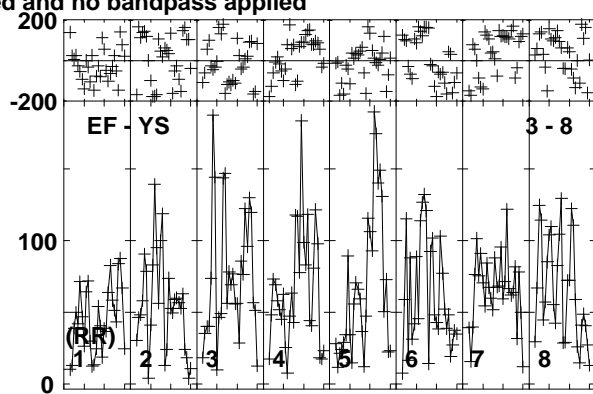
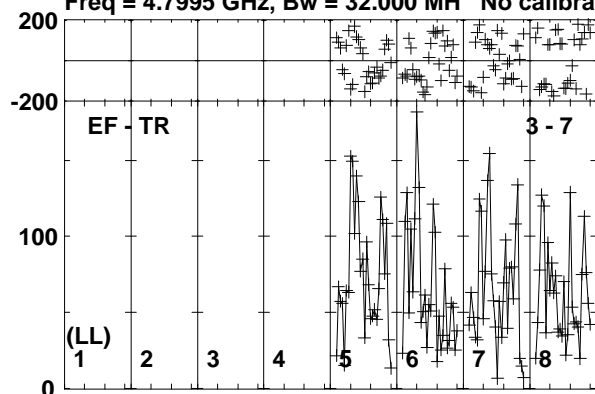

Lower frame: Micro Ampl Jy Top frame: Phas deg
Vector averaged cross-power spectrum Baseline: EF (03) - TR (07)
Timerange: 00/15:22:34 to 00/15:24:38

Plot file version 139 created 03-APR-2017 18:27:41

J1834-2341 EM126B.UVDATA.1

Freq = 4.7995 GHz, Bw = 32.000 MH No calibration applied and no bandpass applied

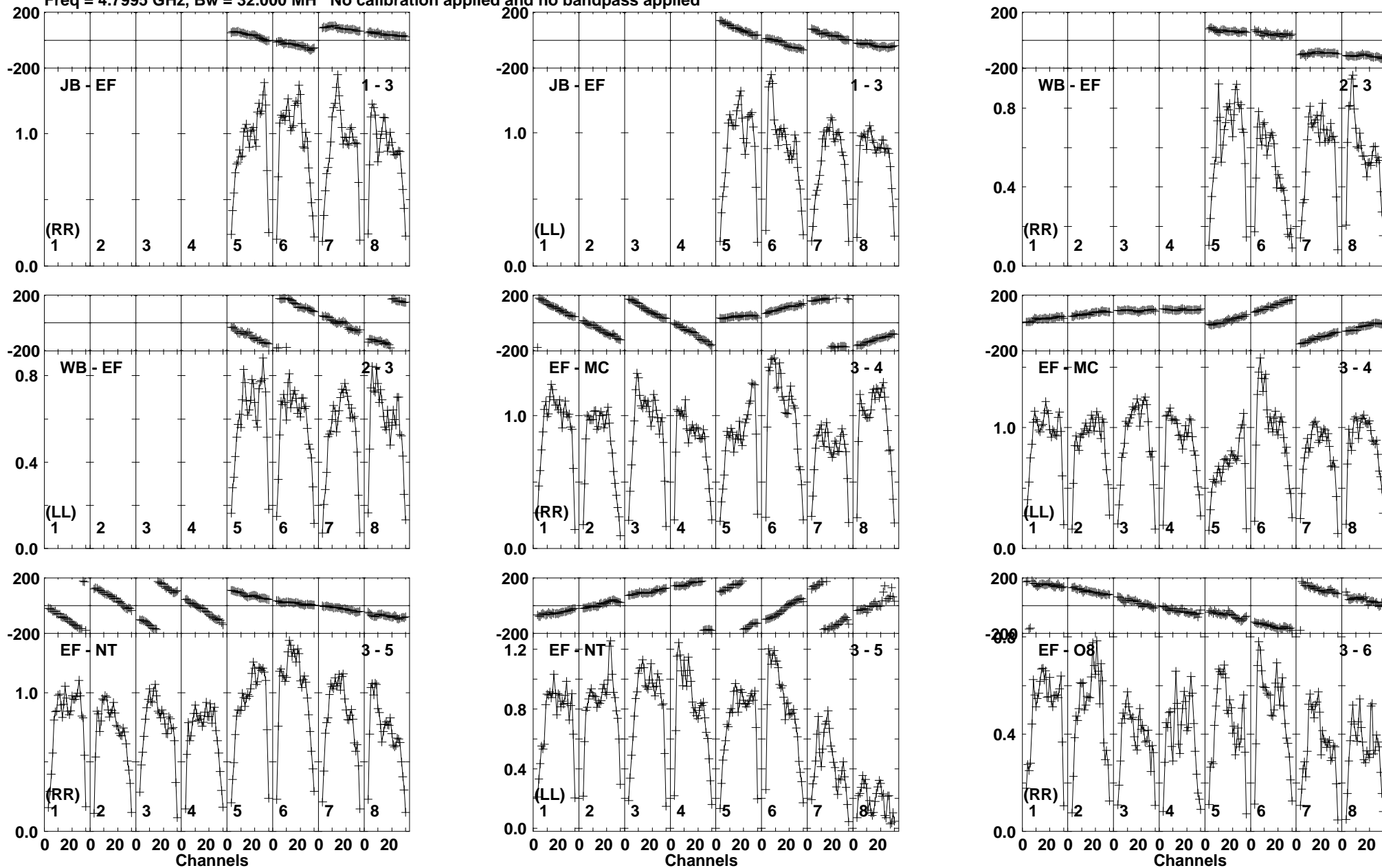

Lower frame: Milli Ampl Jy Top frame: Phas deg
Vector averaged cross-power spectrum Baseline: JB (01) - EF (03)
Timerange: 00/15:25:11 to 00/15:25:59

Plot file version 140 created 03-APR-2017 18:27:41

J1834-2341 EM126B.UVDATA.1

Freq = 4.7995 GHz, Bw = 32.000 MH No calibration applied and no bandpass applied

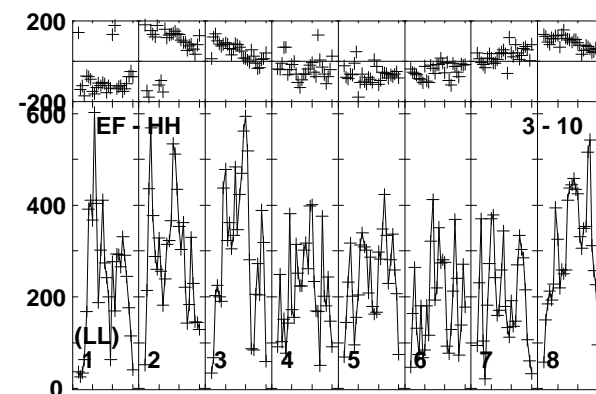
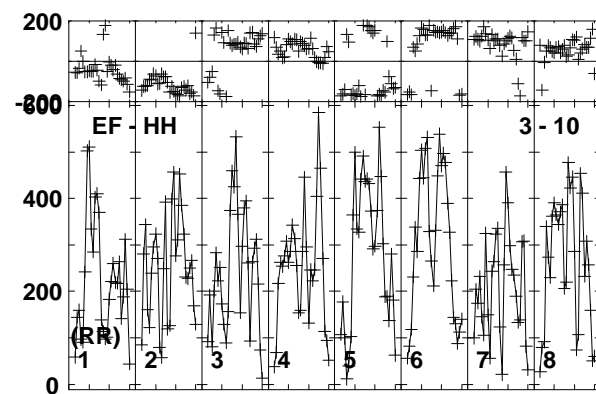
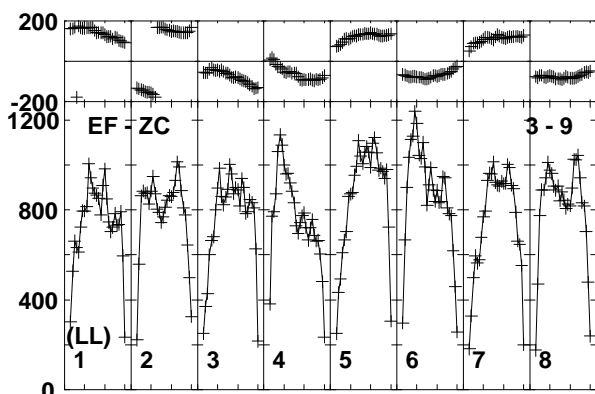
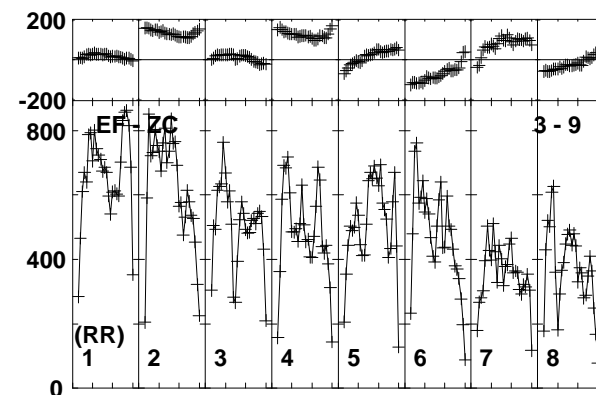
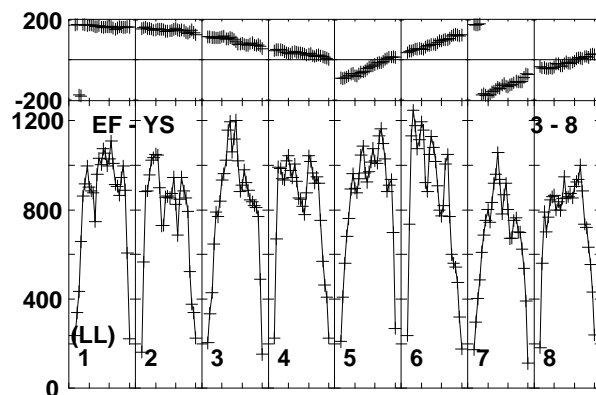
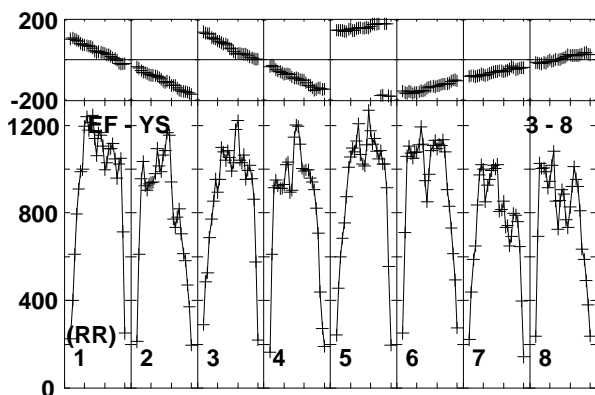
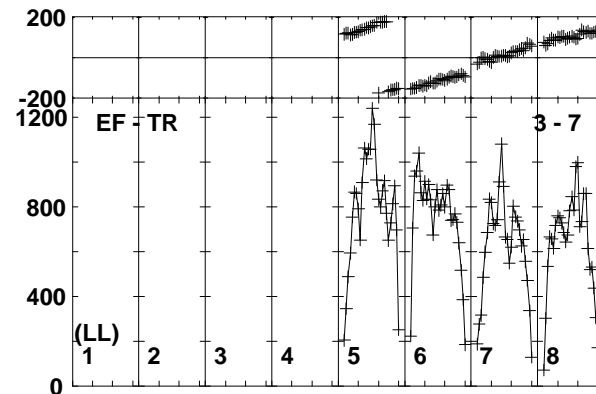
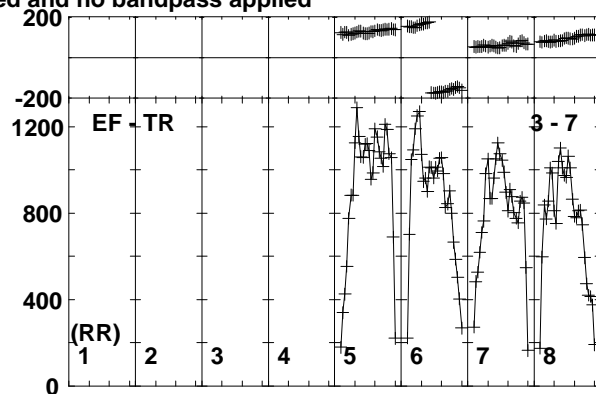
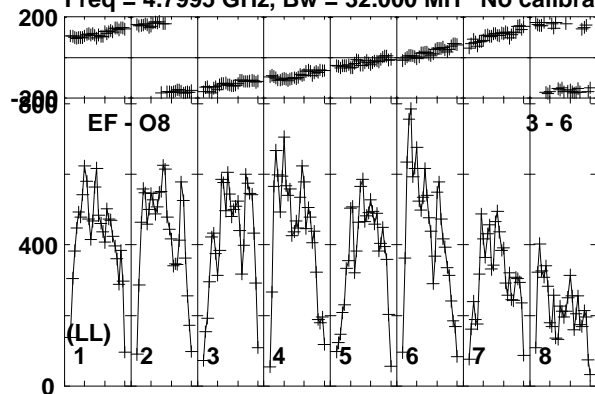

Lower frame: Micro Ampl Jy Top frame: Phas deg
Vector averaged cross-power spectrum Baseline: EF (03) - O8 (06)
Timerange: 00/15:25:11 to 00/15:25:59

Plot file version 141 created 03-APR-2017 18:27:41

M22-VLA1 EM126B.UVDATA.1

Freq = 4.7995 GHz, Bw = 32.000 MH No calibration applied and no bandpass applied

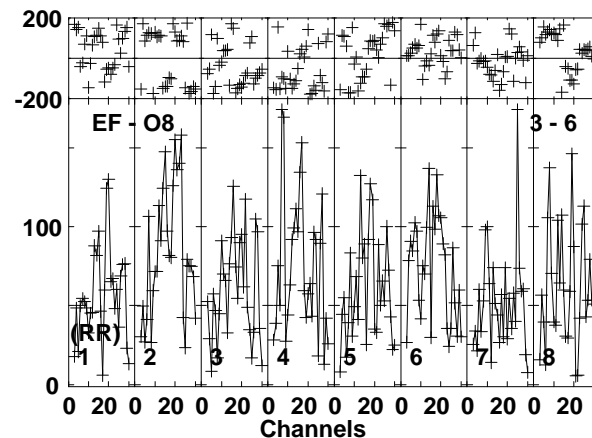
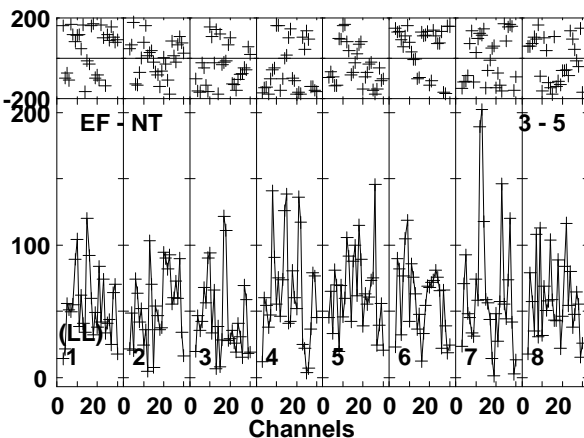
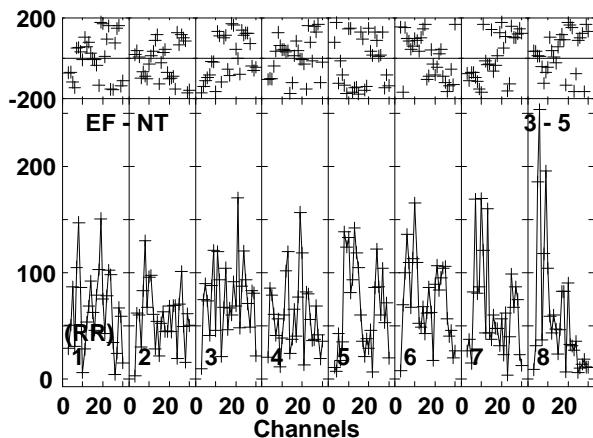
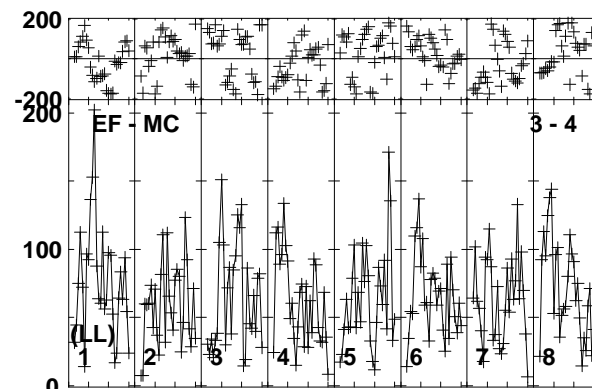
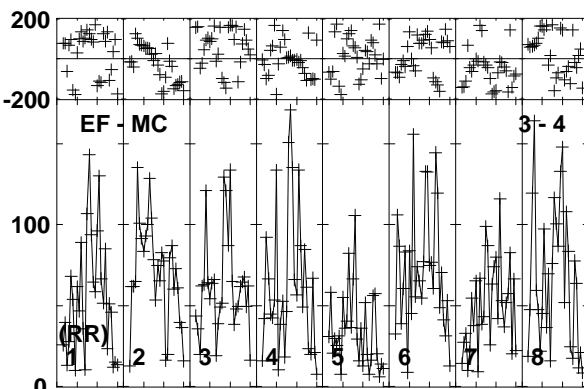
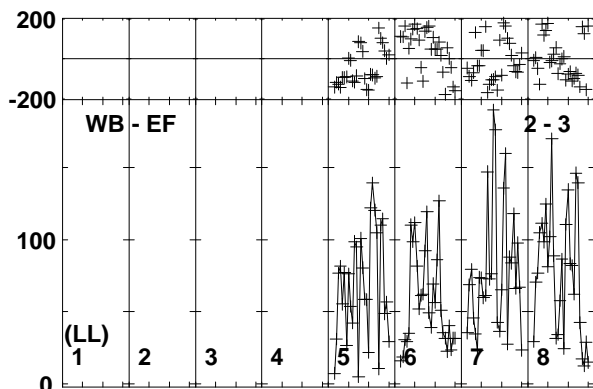
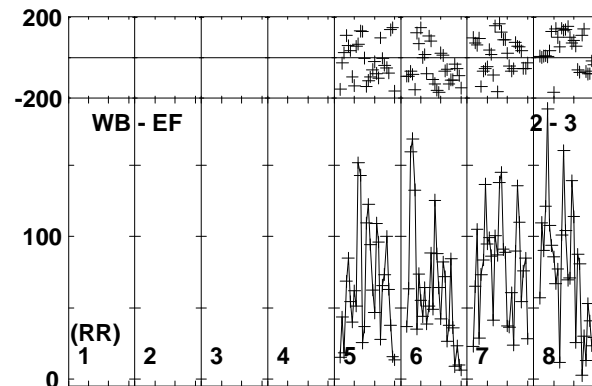
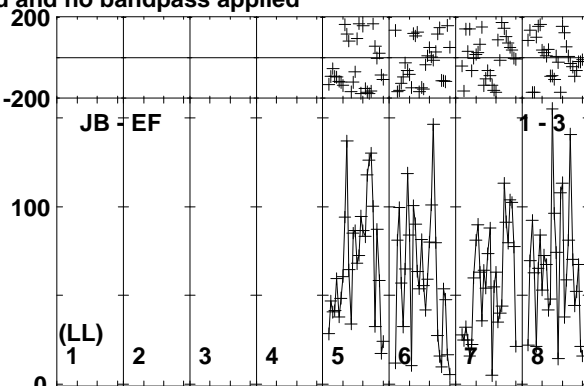
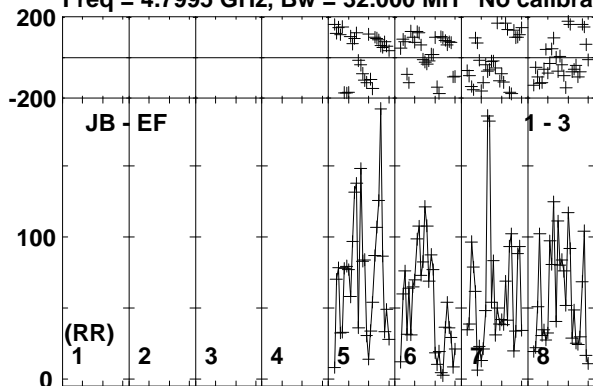

Lower frame: Micro Ampl Jy Top frame: Phas deg
Vector averaged cross-power spectrum Baseline: JB (01) - EF (03)
Timerange: 00/15:26:04 to 00/15:28:08

Plot file version 142 created 03-APR-2017 18:27:41

M22-VLA1 EM126B.UVDATA.1

Freq = 4.7995 GHz, Bw = 32.000 MH No calibration applied and no bandpass applied

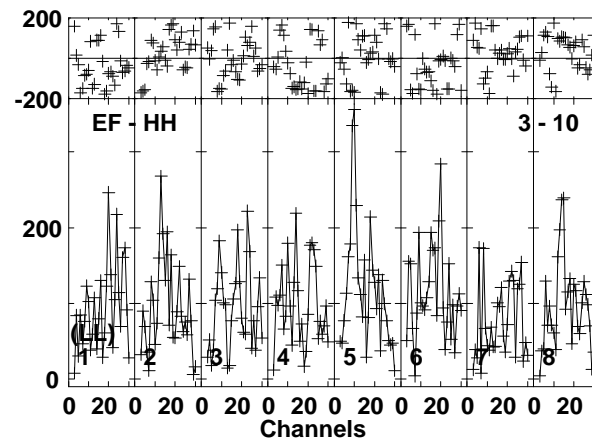
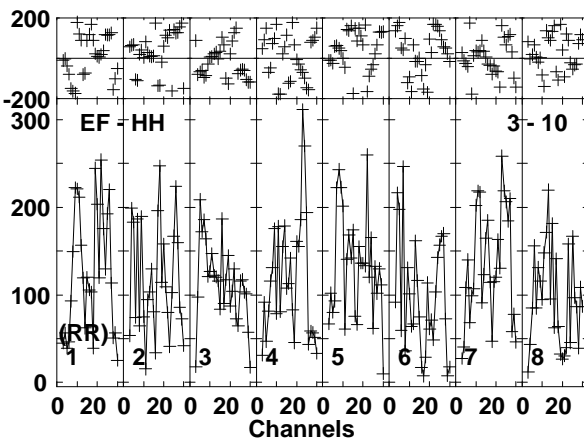
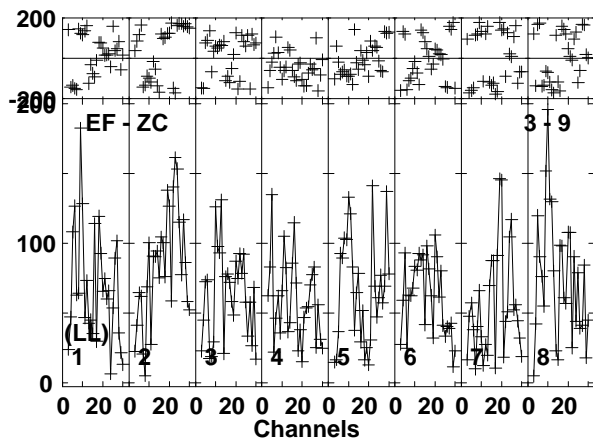
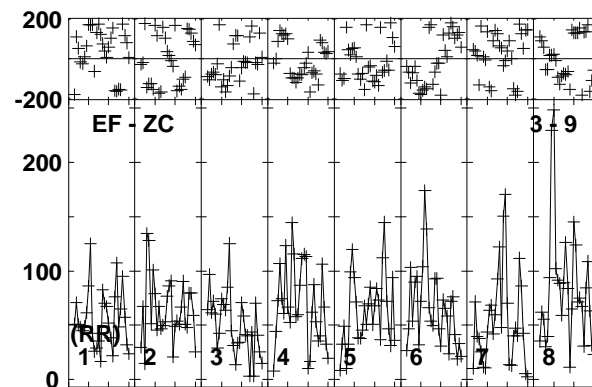
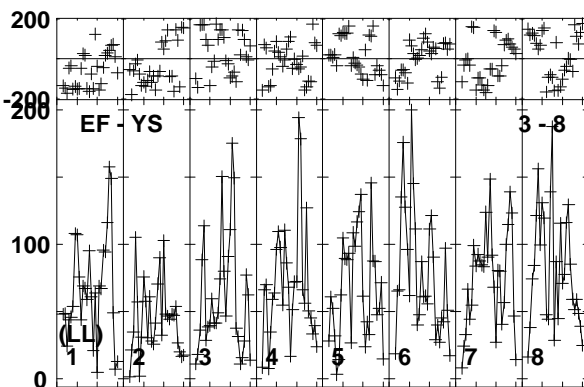
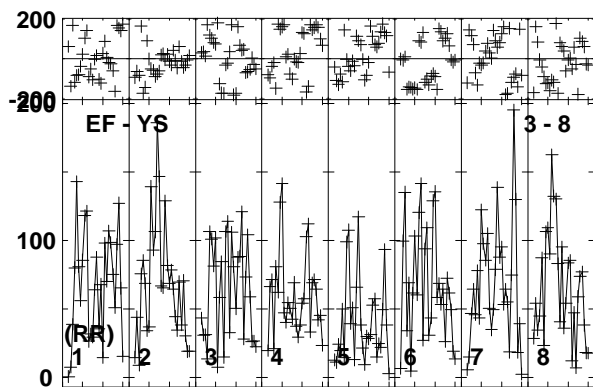
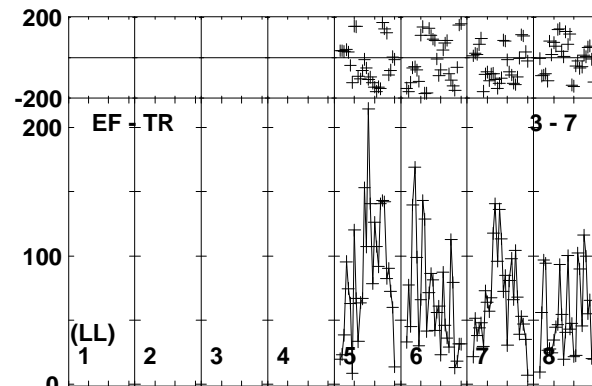
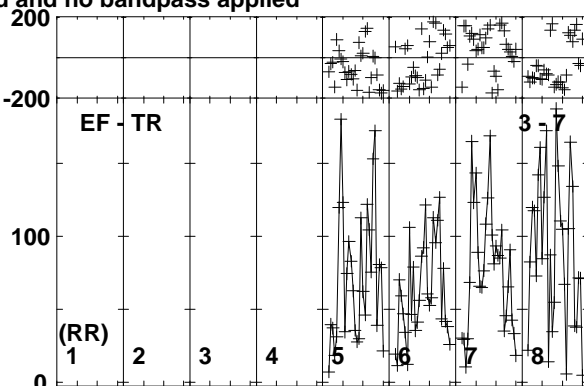
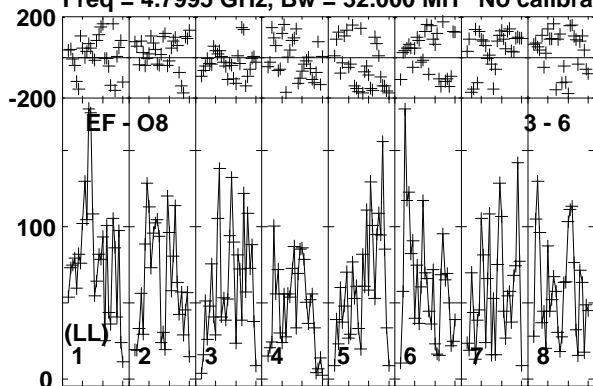

Lower frame: Micro Ampl Jy Top frame: Phas deg
Vector averaged cross-power spectrum Baseline: EF (03) - O8 (06)
Timerange: 00:15:26:04 to 00:15:28:08

Plot file version 143 created 03-APR-2017 18:27:41

J1834-2341 EM126B.UVDATA.1

Freq = 4.7995 GHz, Bw = 32.000 MH No calibration applied and no bandpass applied

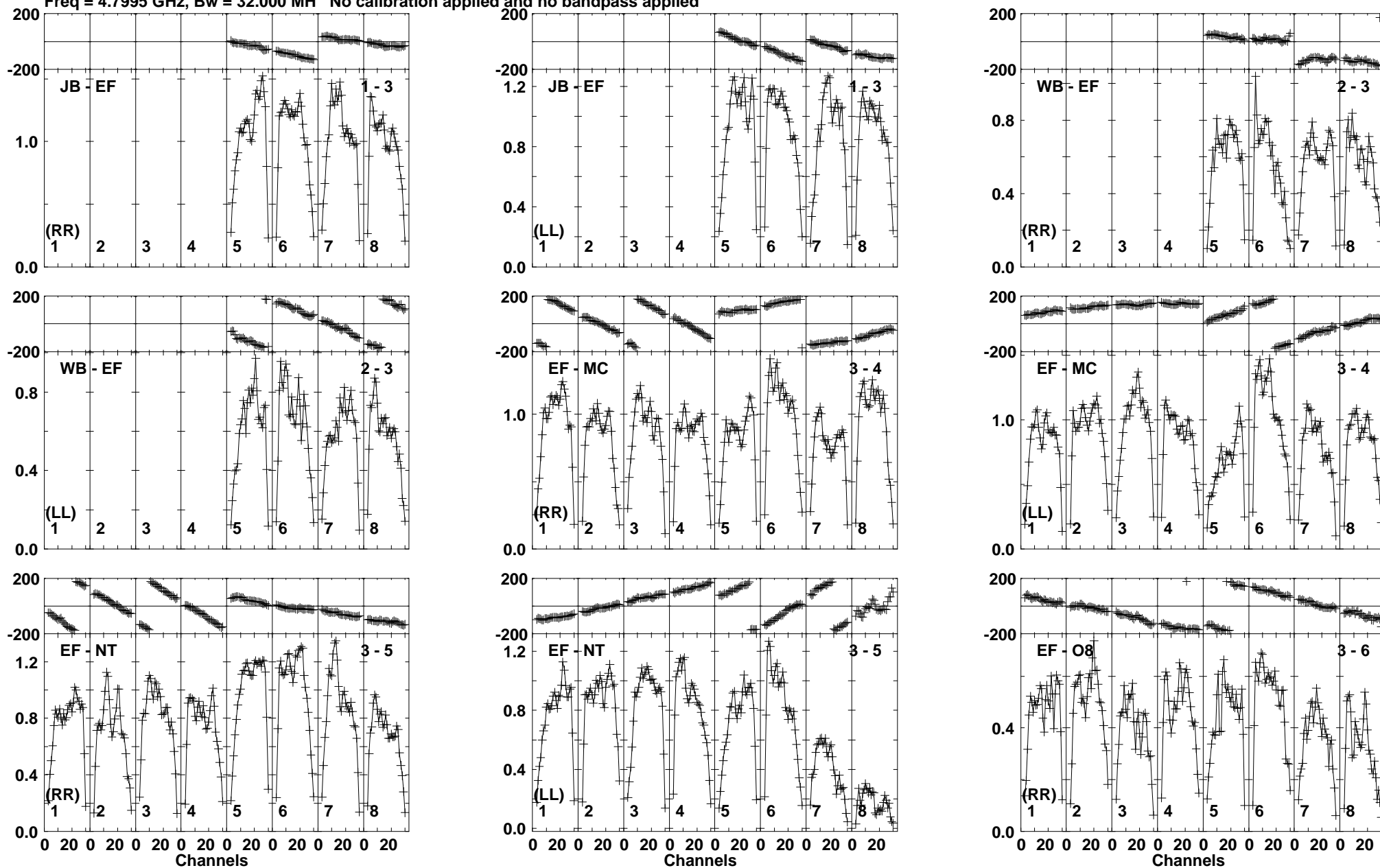

Lower frame: Milli Ampl Jy Top frame: Phas deg
Vector averaged cross-power spectrum Baseline: JB (01) - EF (03)
Timerange: 00/15:28:14 to 00/15:29:28

Plot file version 144 created 03-APR-2017 18:27:41

J1834-2341 EM126B.UVDATA.1

Freq = 4.7995 GHz, Bw = 32.000 MH No calibration applied and no bandpass applied

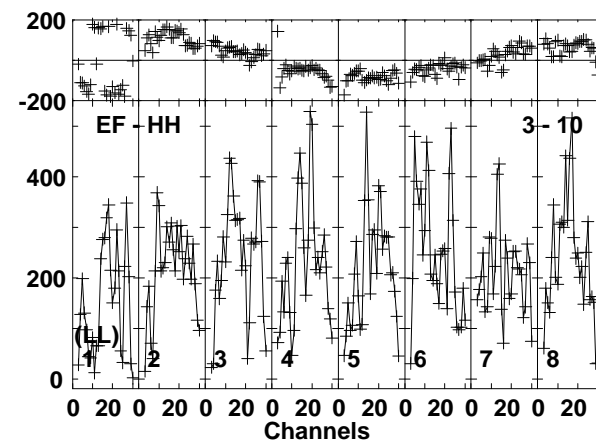
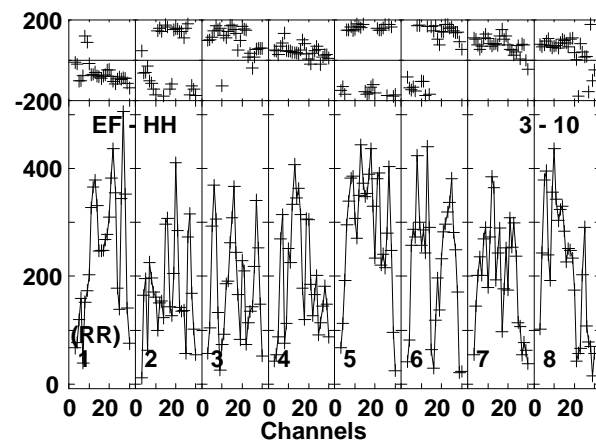
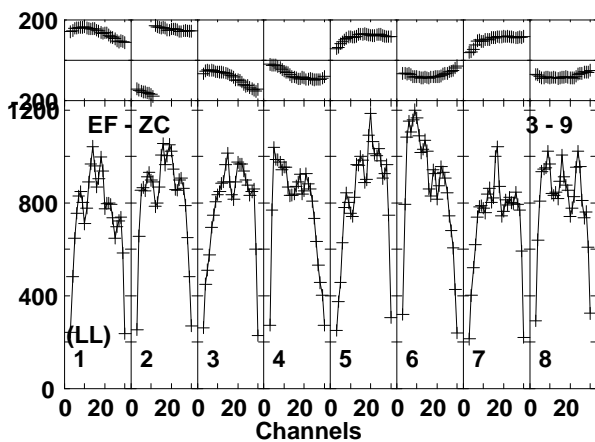
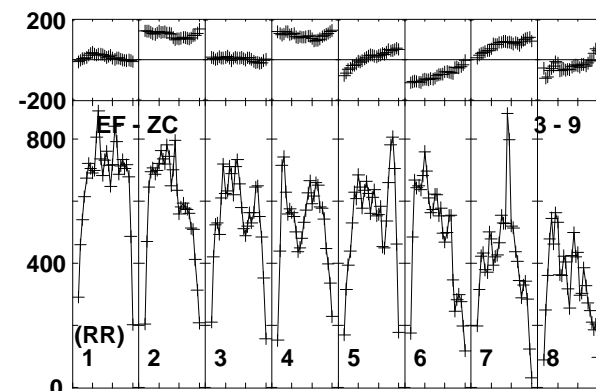
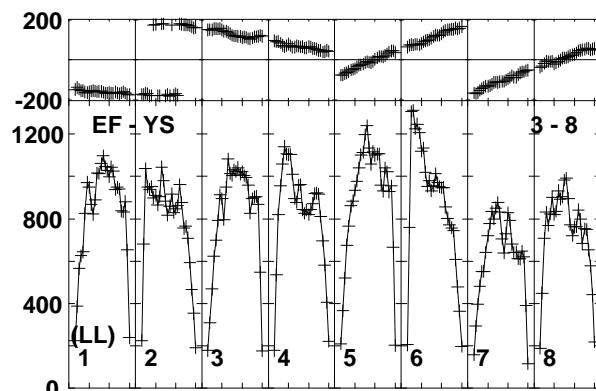
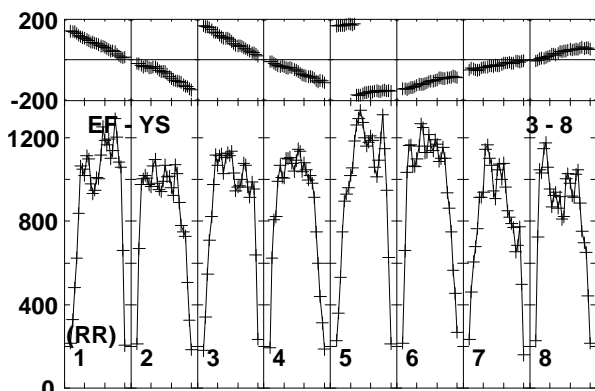
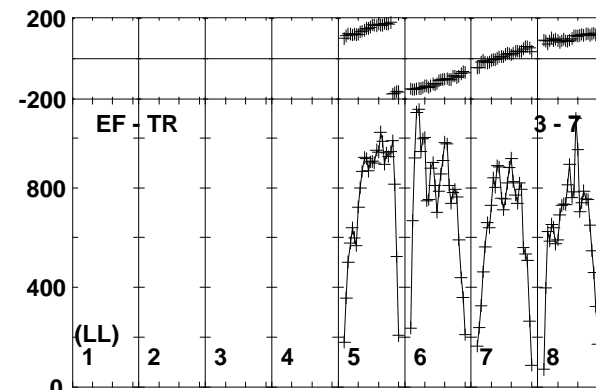
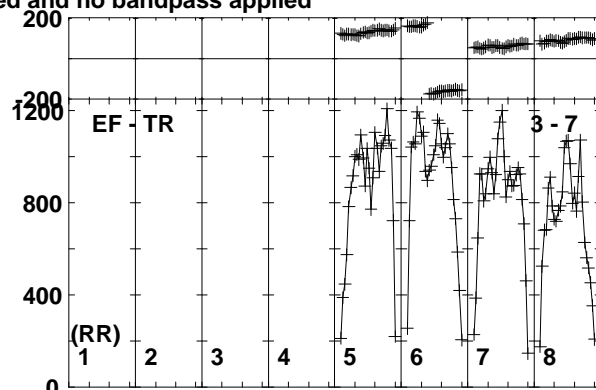
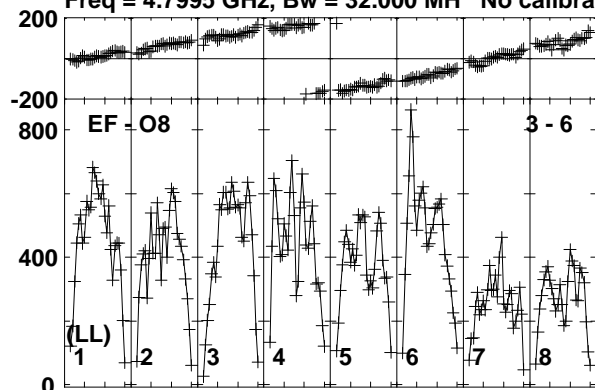

Lower frame: Micro Ampl Jy Top frame: Phas deg
Vector averaged cross-power spectrum Baseline: EF (03) - O8 (06)
Timerange: 00/15:28:14 to 00/15:29:28

Plot file version 145 created 03-APR-2017 18:27:41

M22-VLA1 EM126B.UVDATA.1

Freq = 4.7995 GHz, Bw = 32.000 MH No calibration applied and no bandpass applied

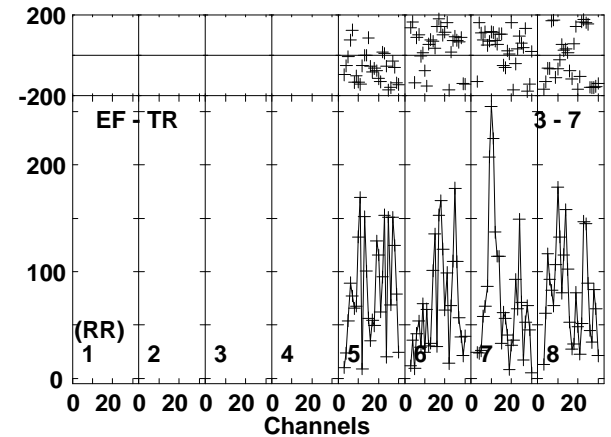
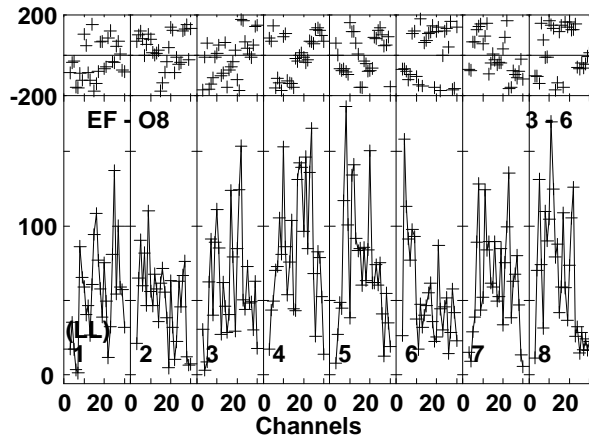
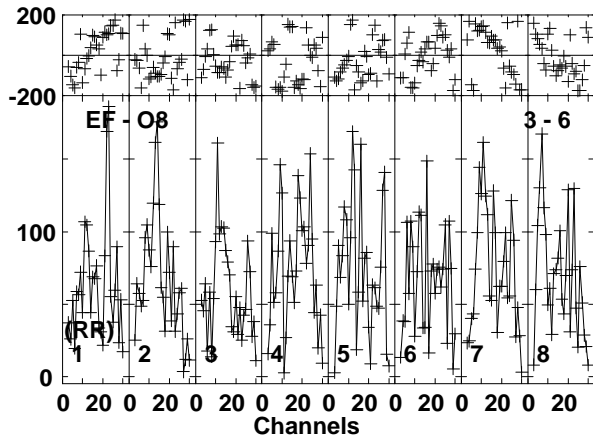
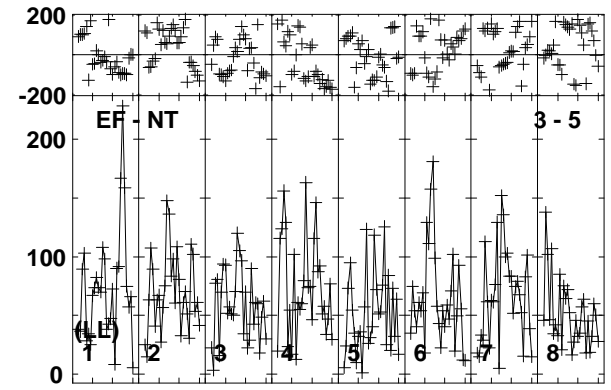
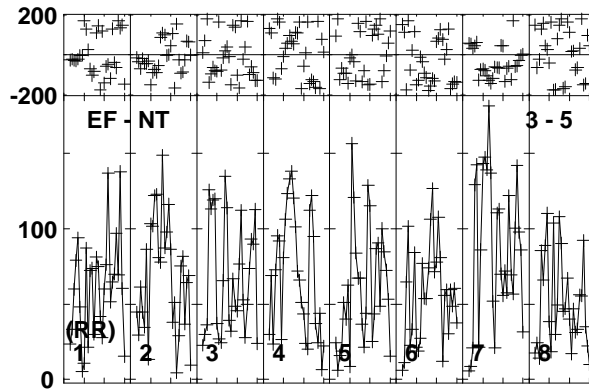
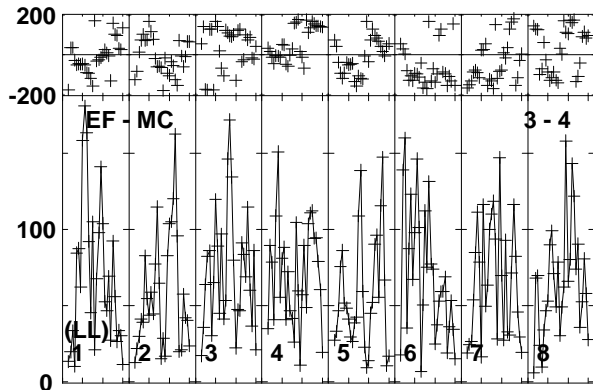
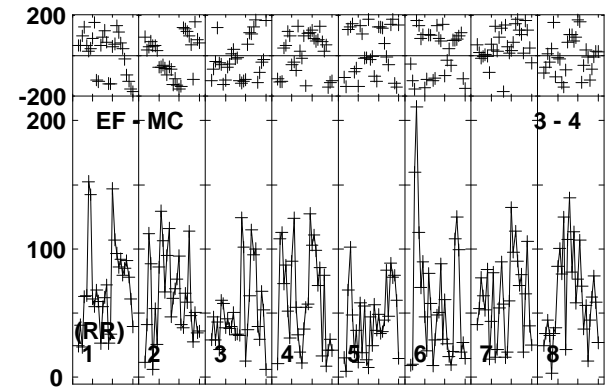
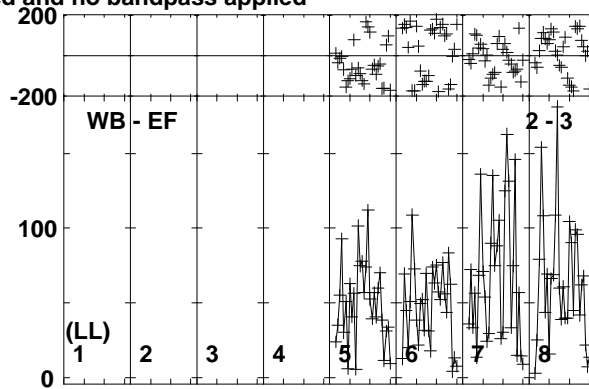
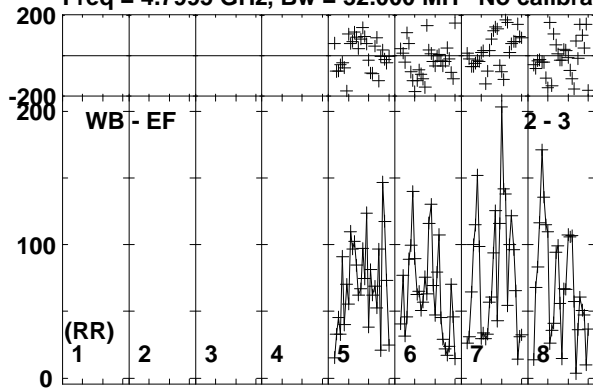

Lower frame: Micro Ampl Jy Top frame: Phas deg
Vector averaged cross-power spectrum Baseline: WB (02) - EF (03)
Timerange: 00/15:29:34 to 00/15:31:38

Plot file version 146 created 03-APR-2017 18:27:41

M22-VLA1 EM126B.UVDATA.1

Freq = 4.7995 GHz, Bw = 32.000 MH No calibration applied and no bandpass applied

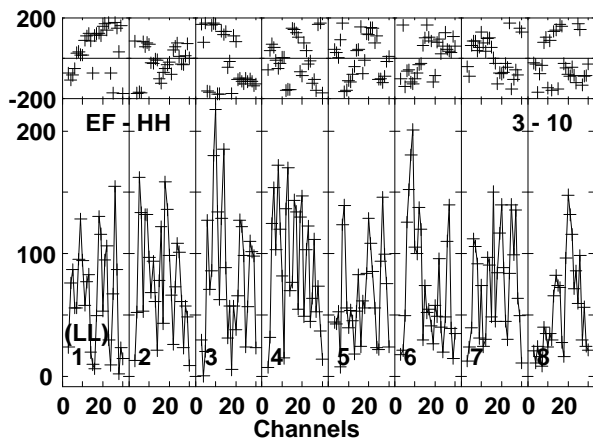
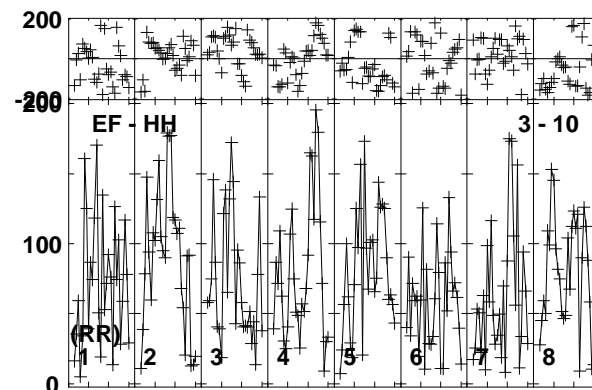
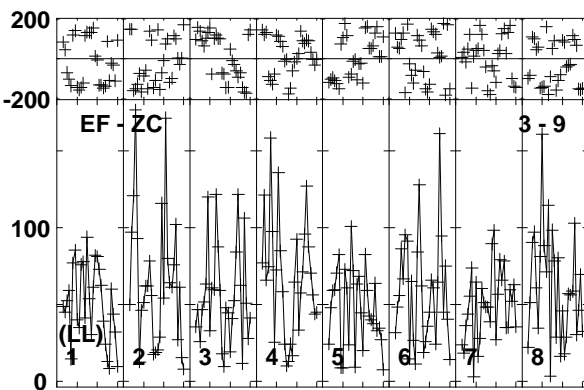
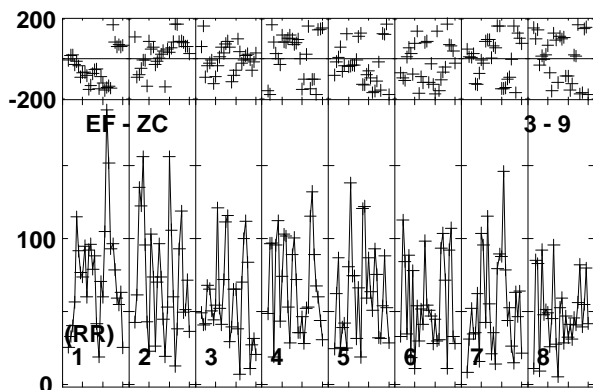
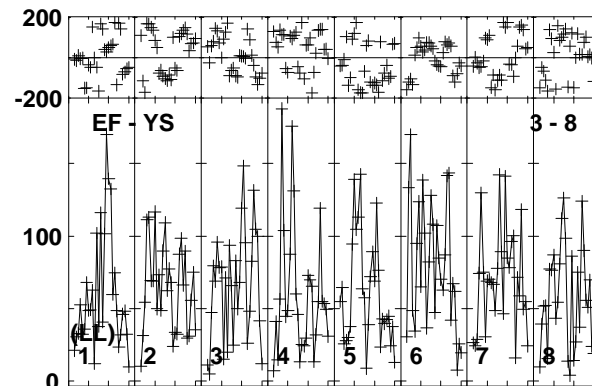
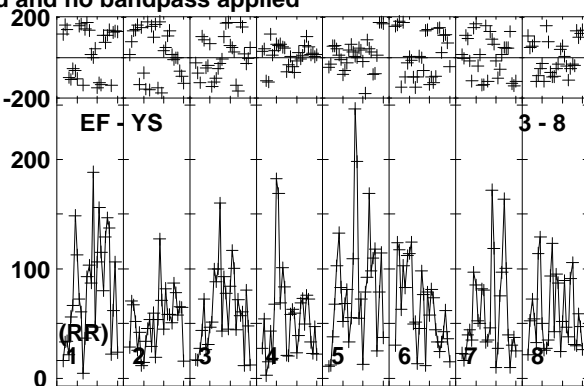
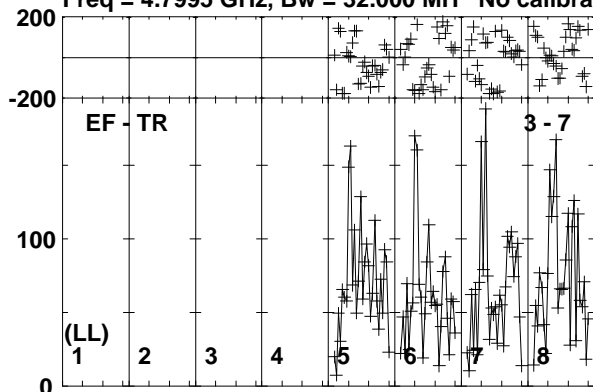

Lower frame: Micro Ampl Jy Top frame: Phas deg
Vector averaged cross-power spectrum Baseline: EF (03) - TR (07)
Timerange: 00/15:29:34 to 00/15:31:38

Plot file version 147 created 03-APR-2017 18:27:41

J1834-2341 EM126B.UVDATA.1

Freq = 4.7995 GHz, Bw = 32.000 MH No calibration applied and no bandpass applied

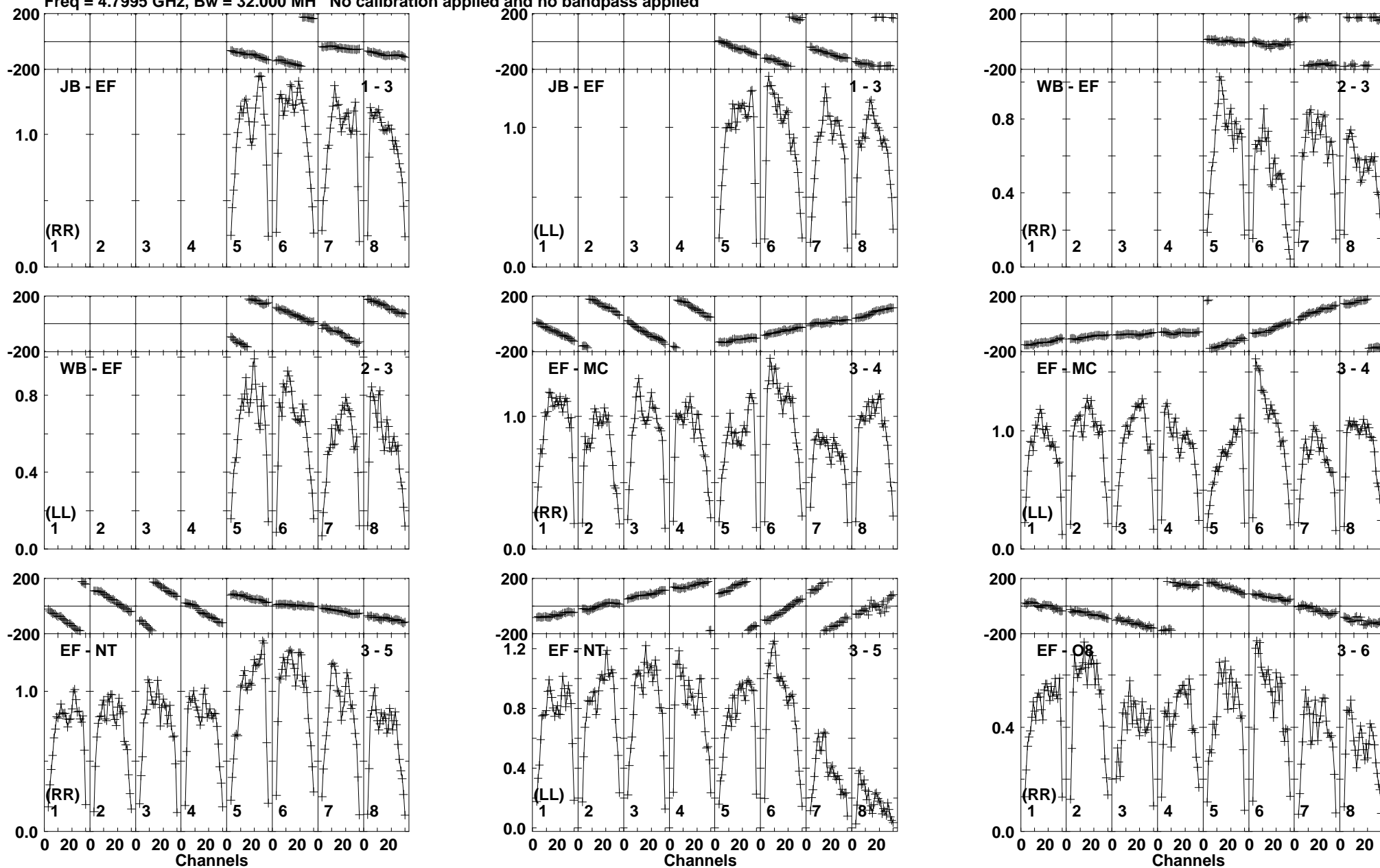

Lower frame: Milli Ampl Jy Top frame: Phas deg
Vector averaged cross-power spectrum Baseline: JB (01) - EF (03)
Timerange: 00/15:31:44 to 00/15:32:58

Plot file version 148 created 03-APR-2017 18:27:41

J1834-2341 EM126B.UVDATA.1

Freq = 4.7995 GHz, Bw = 32.000 MH No calibration applied and no bandpass applied

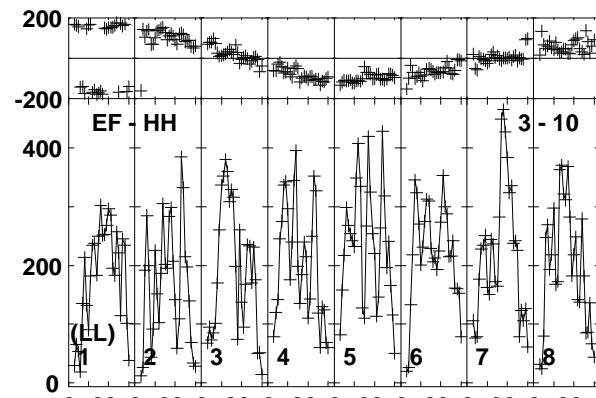
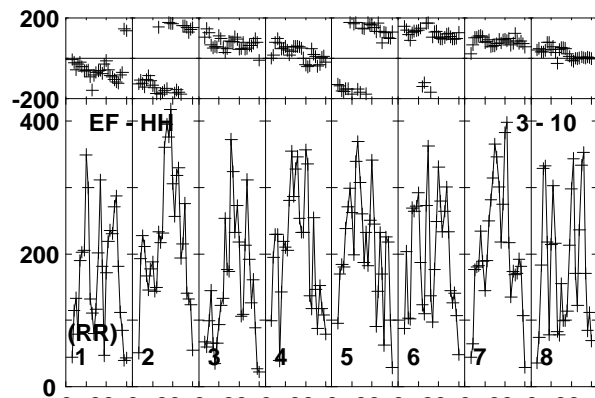
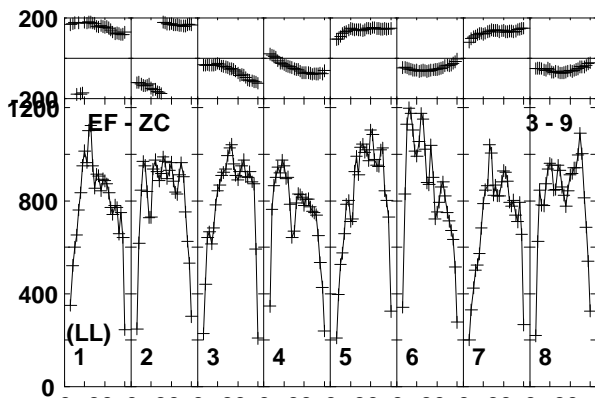
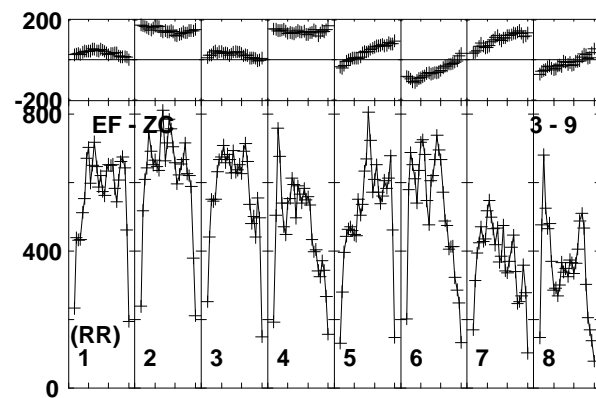
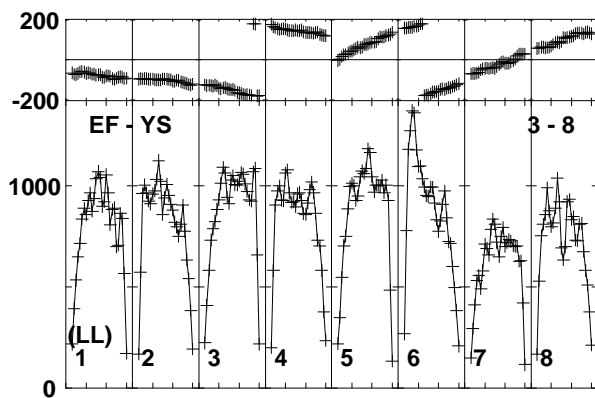
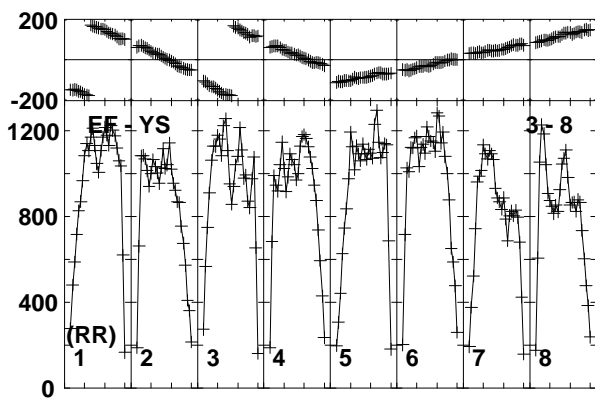
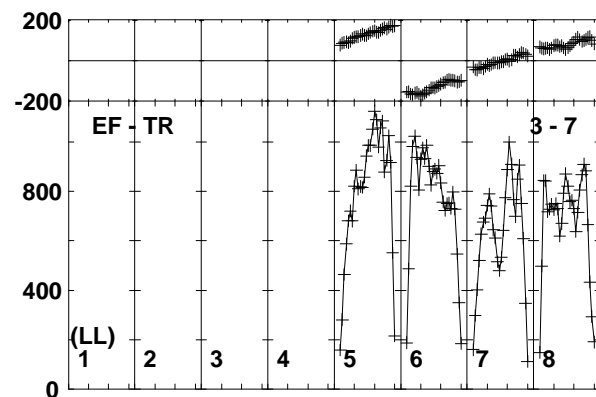
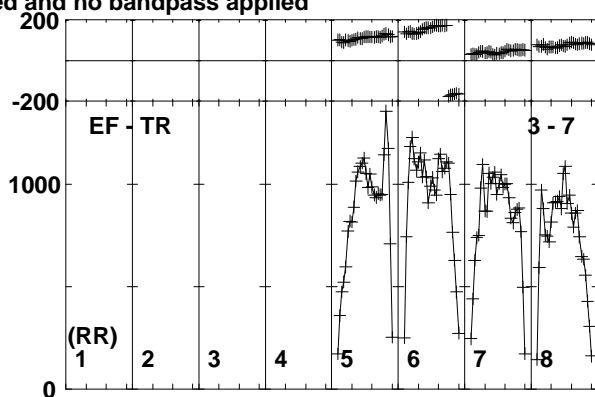
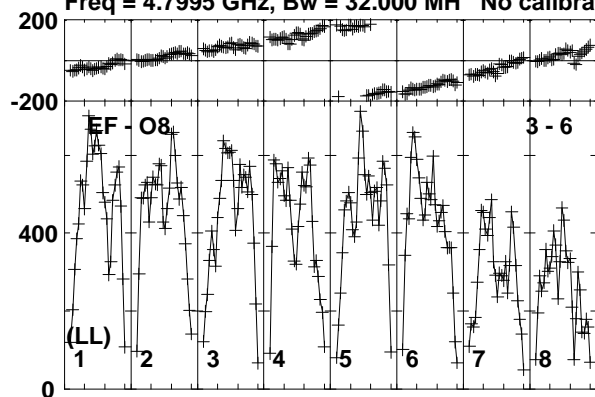

Lower frame: Micro Ampl Jy Top frame: Phas deg
Vector averaged cross-power spectrum Baseline: EF (03) - O8 (06)
Timerange: 00/15:31:44 to 00/15:32:58

Plot file version 149 created 03-APR-2017 18:27:41

M22-VLA1 EM126B.UVDATA.1

Freq = 4.7995 GHz, Bw = 32.000 MH No calibration applied and no bandpass applied

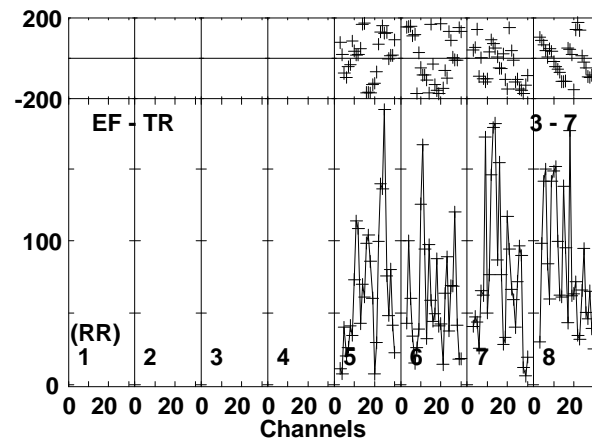
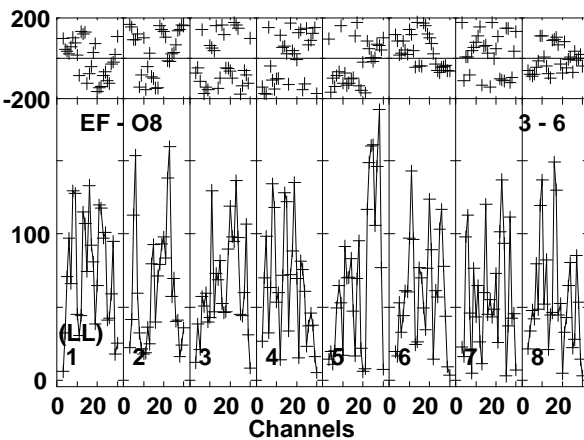
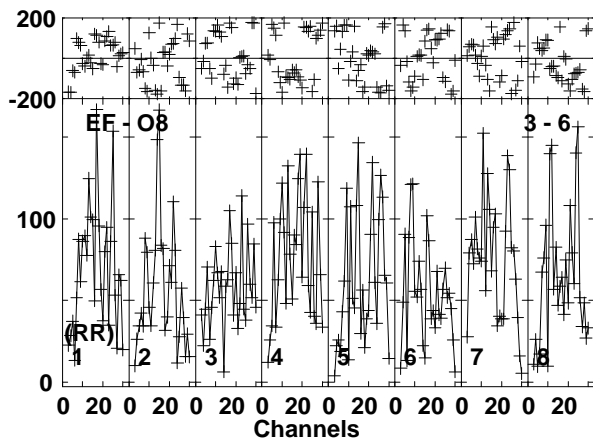
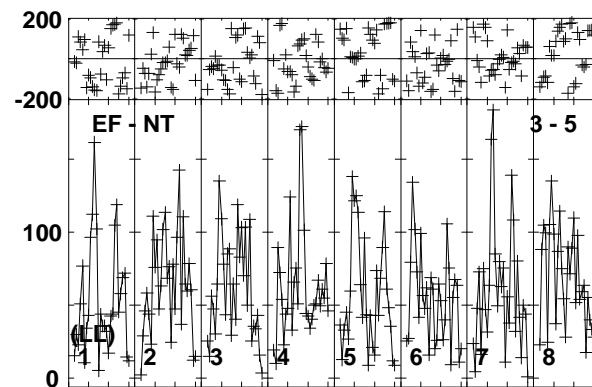
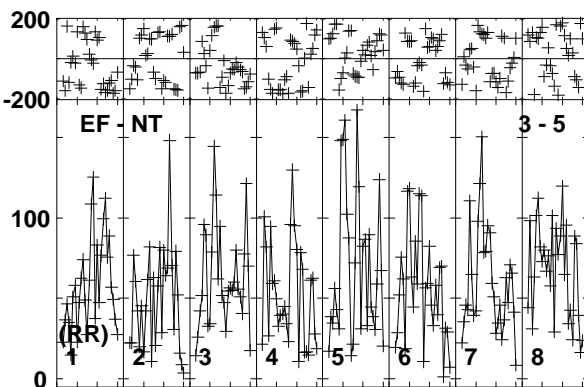
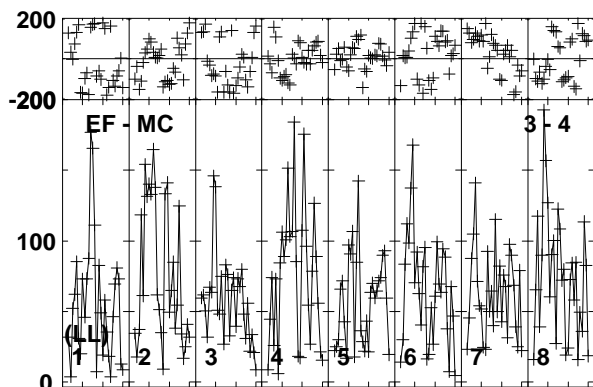
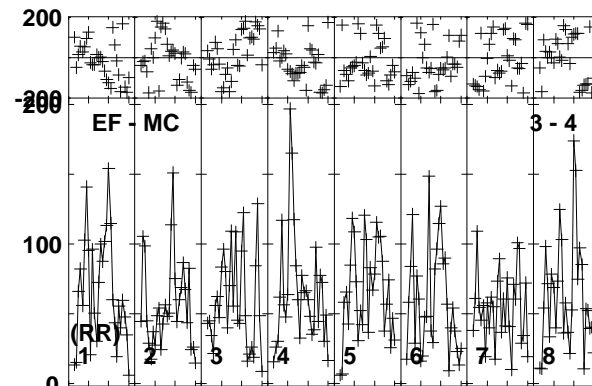
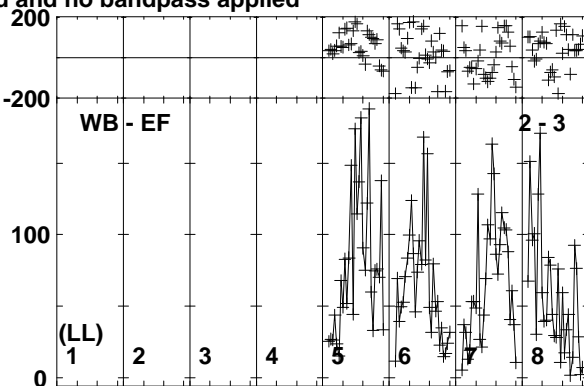
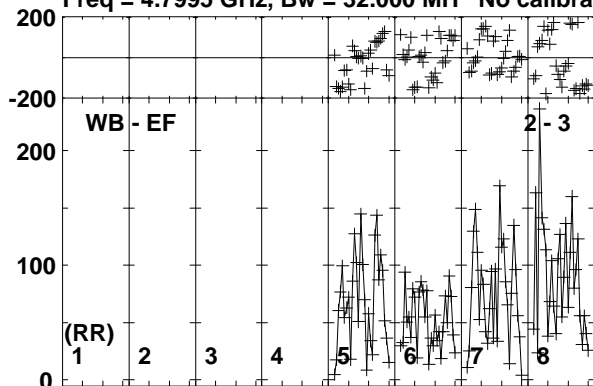

Lower frame: Micro Ampl Jy Top frame: Phas deg
Vector averaged cross-power spectrum Baseline: WB (02) - EF (03)
Timerange: 00/15:33:04 to 00/15:35:08

Plot file version 150 created 03-APR-2017 18:27:41

M22-VLA1 EM126B.UVDATA.1

Freq = 4.7995 GHz, Bw = 32.000 MH No calibration applied and no bandpass applied

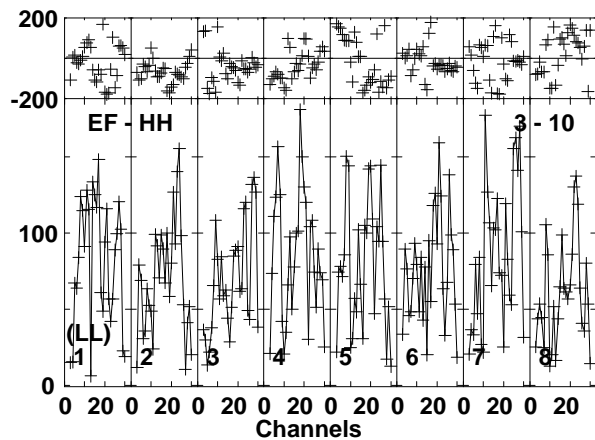
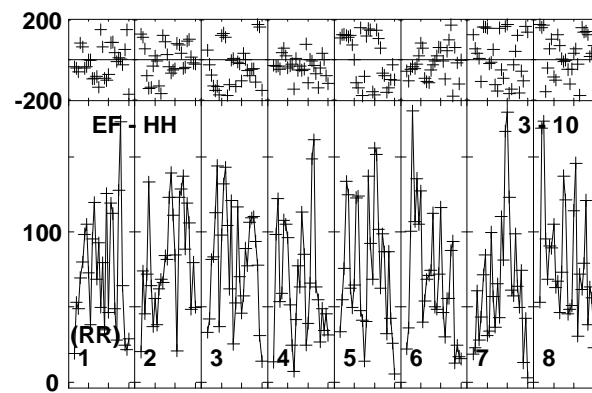
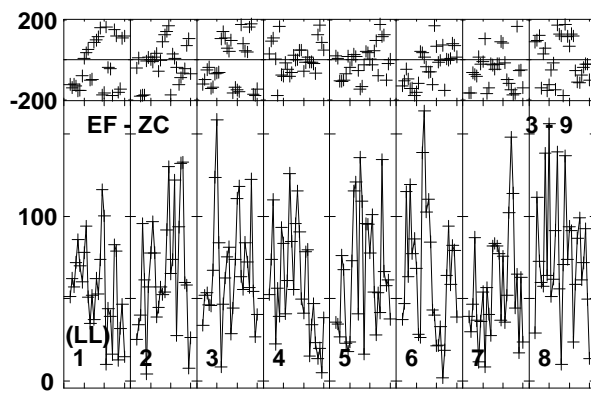
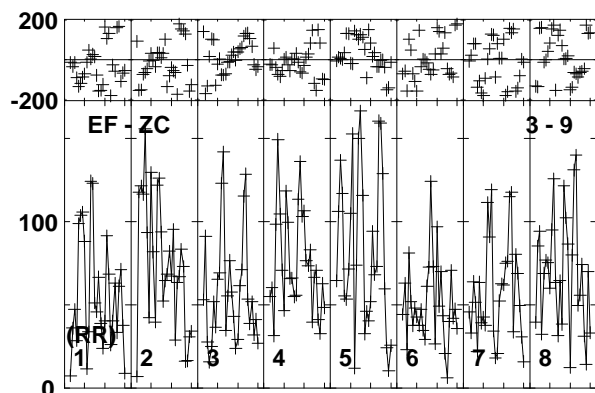
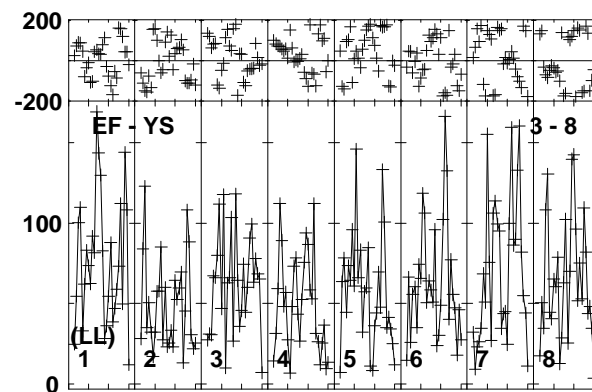
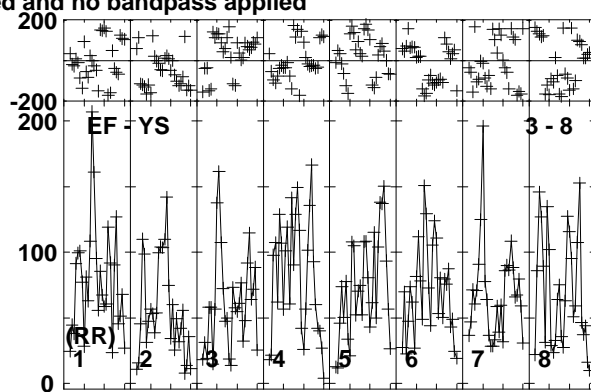
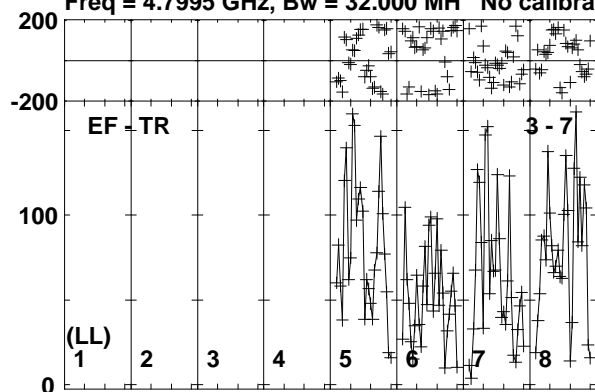

Lower frame: Micro Ampl Jy Top frame: Phas deg
Vector averaged cross-power spectrum Baseline: EF (03) - TR (07)
Timerange: 00/15:33:04 to 00/15:35:08

Plot file version 151 created 03-APR-2017 18:27:41

J1834-2341 EM126B.UVDATA.1

Freq = 4.7995 GHz, Bw = 32.000 MH No calibration applied and no bandpass applied

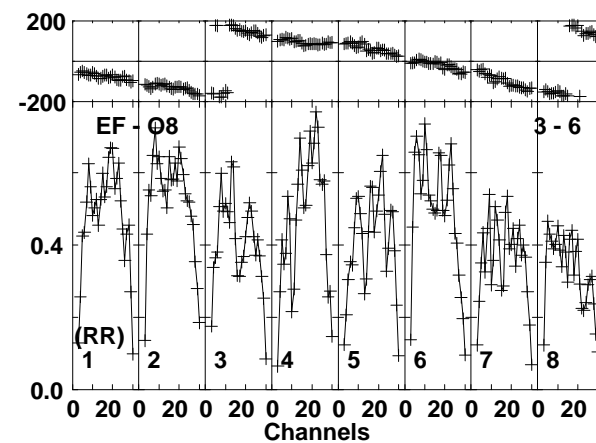
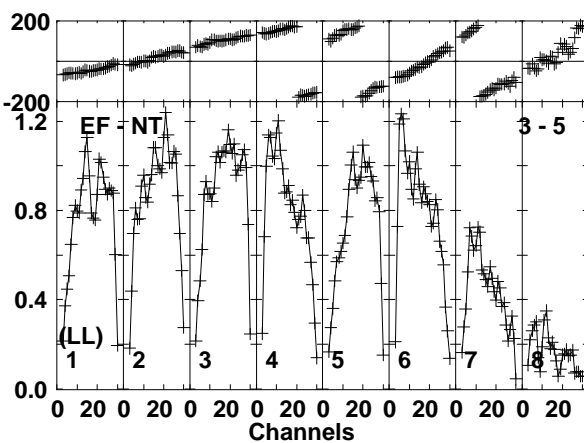
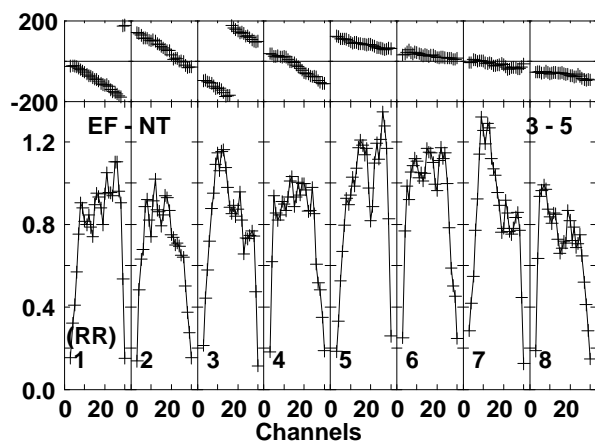
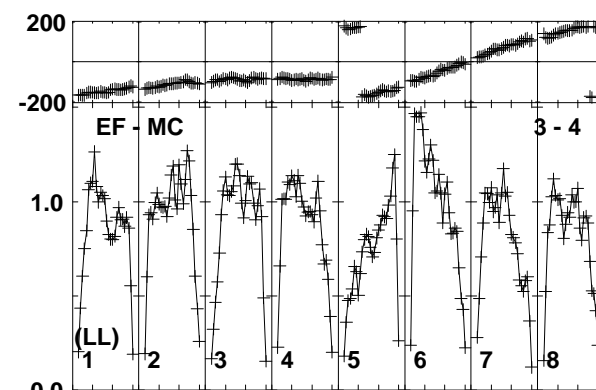
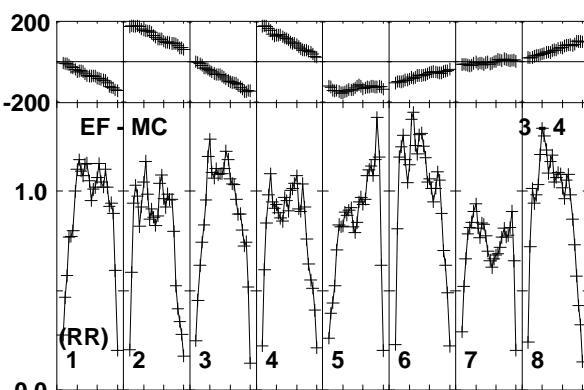
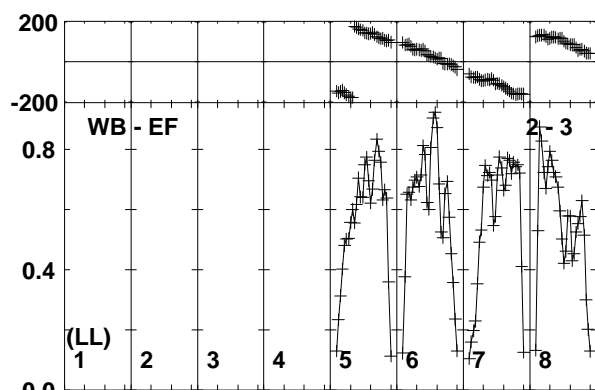
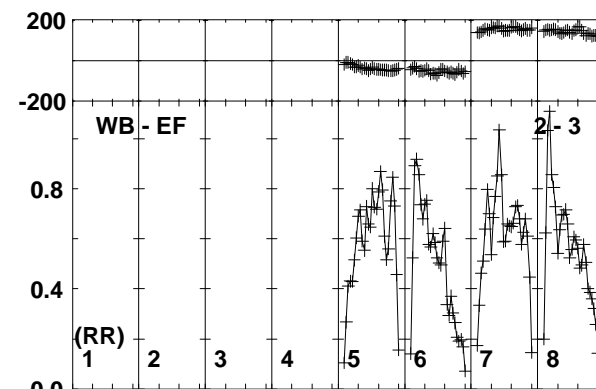
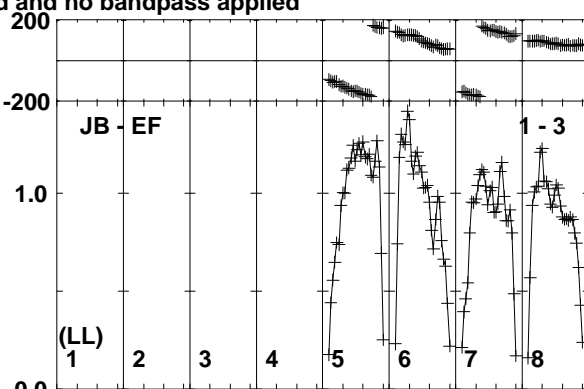
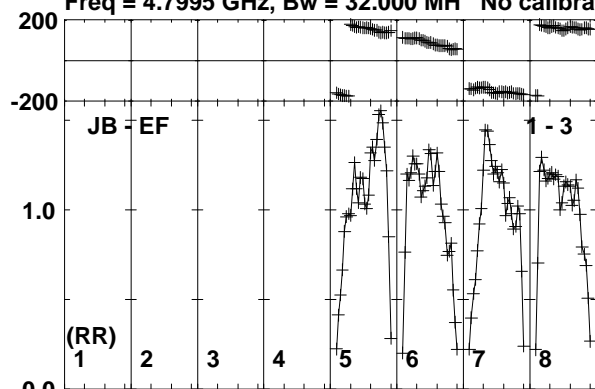

Lower frame: Milli Ampl Jy Top frame: Phas deg
Vector averaged cross-power spectrum Baseline: JB (01) - EF (03)
Timerange: 00/15:35:41 to 00/15:36:29

Plot file version 152 created 03-APR-2017 18:27:41

J1834-2341 EM126B.UVDATA.1

Freq = 4.7995 GHz, Bw = 32.000 MH No calibration applied and no bandpass applied

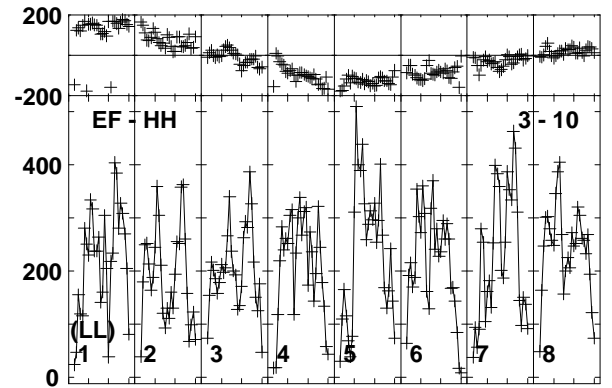
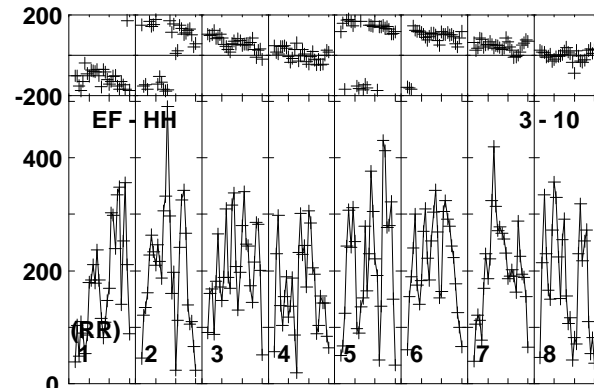
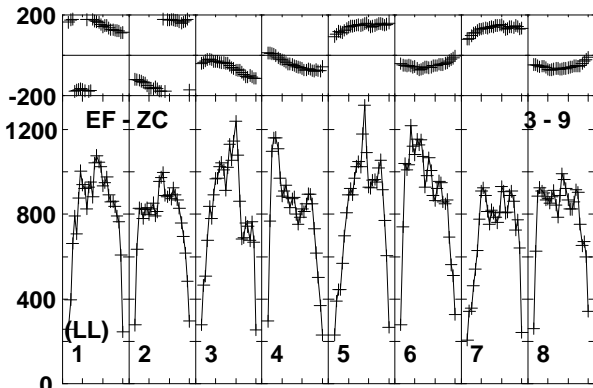
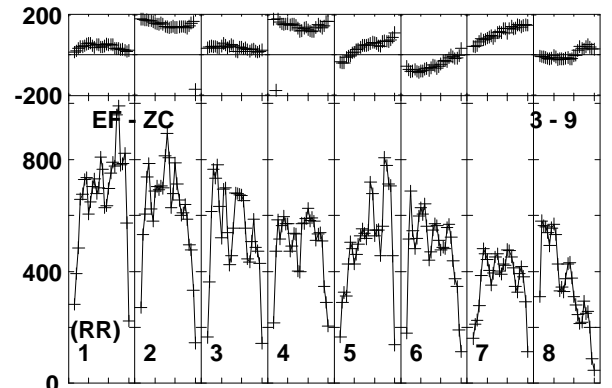
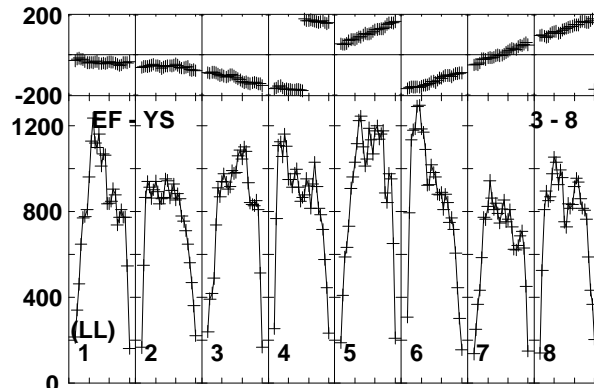
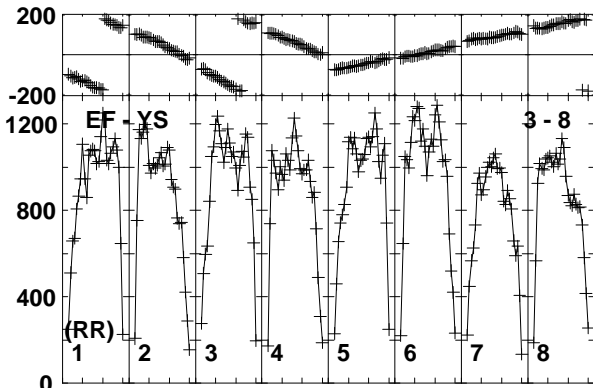
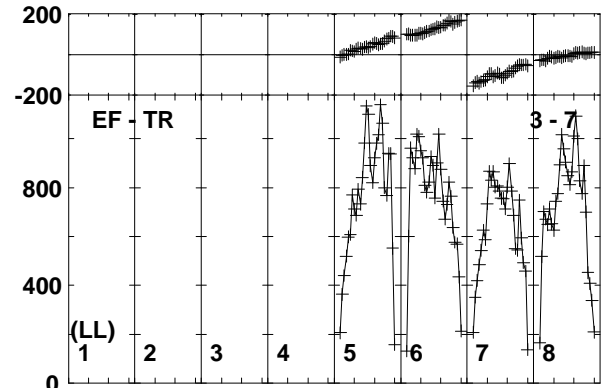
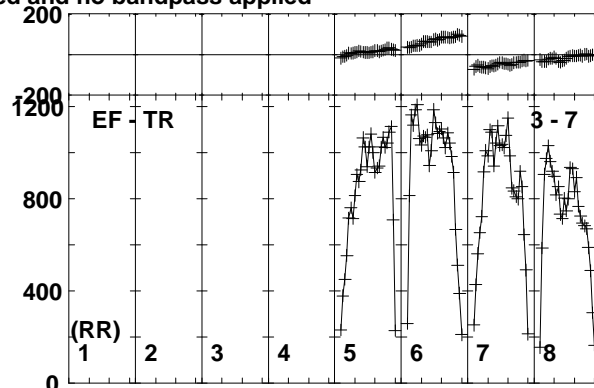
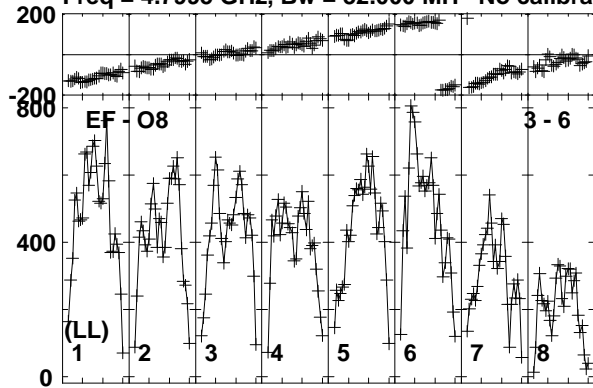

Lower frame: Micro Ampl Jy Top frame: Phas deg
Vector averaged cross-power spectrum Baseline: EF (03) - O8 (06)
Timerange: 00/15:35:41 to 00/15:36:29

Plot file version 153 created 03-APR-2017 18:27:41

M22-VLA1 EM126B.UVDATA.1

Freq = 4.7995 GHz, Bw = 32.000 MH No calibration applied and no bandpass applied

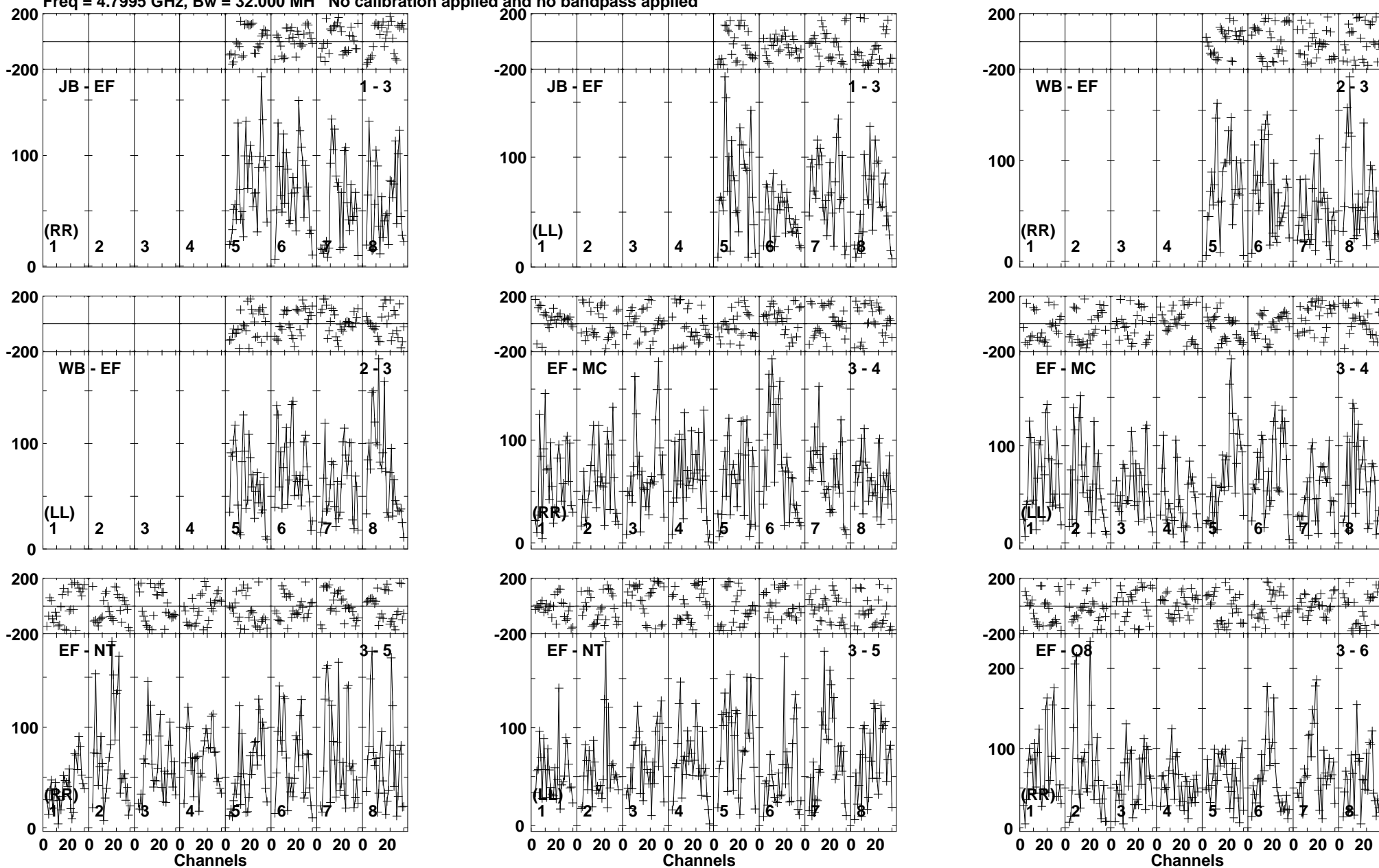

Lower frame: Micro Ampl Jy Top frame: Phas deg
Vector averaged cross-power spectrum Baseline: JB (01) - EF (03)
Timerange: 00/15:36:34 to 00/15:38:38

Plot file version 154 created 03-APR-2017 18:27:41

M22-VLA1 EM126B.UVDATA.1

Freq = 4.7995 GHz, Bw = 32.000 MH No calibration applied and no bandpass applied

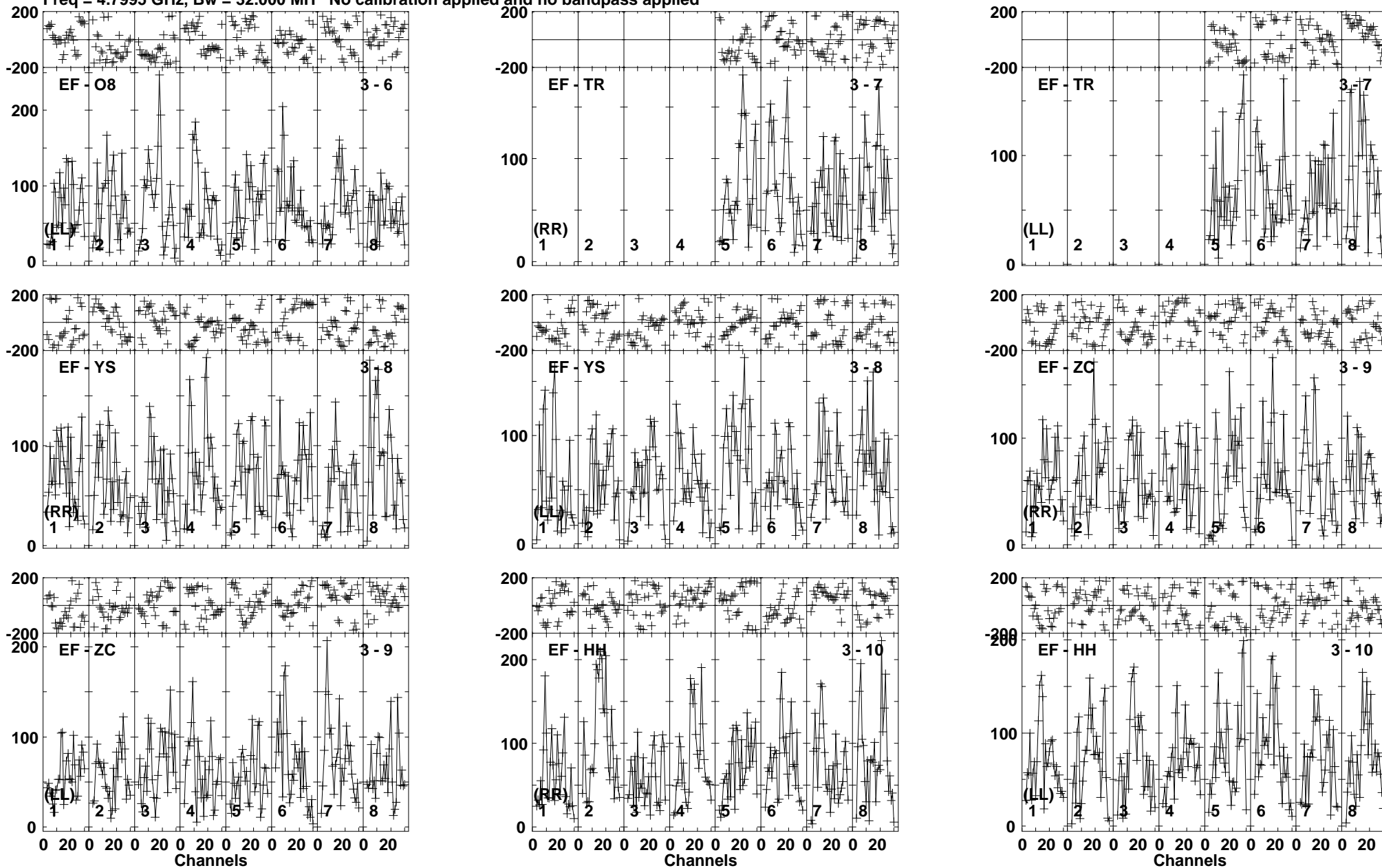

Lower frame: Micro Ampl Jy Top frame: Phas deg
Vector averaged cross-power spectrum Baseline: EF (03) - O8 (06)
Timerange: 00/15:36:34 to 00/15:38:38

Plot file version 155 created 03-APR-2017 18:27:41

J1834-2341 EM126B.UVDATA.1

Freq = 4.7995 GHz, Bw = 32.000 MH No calibration applied and no bandpass applied

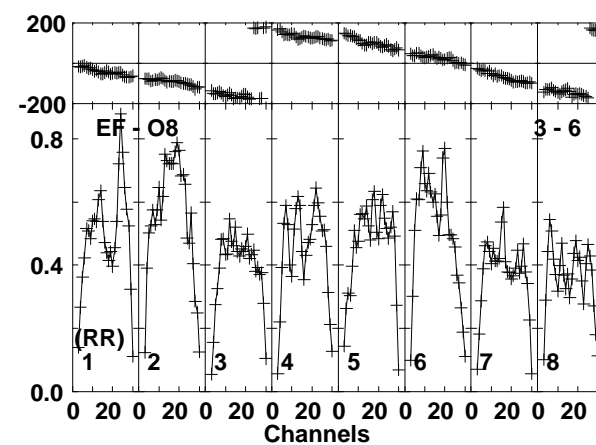
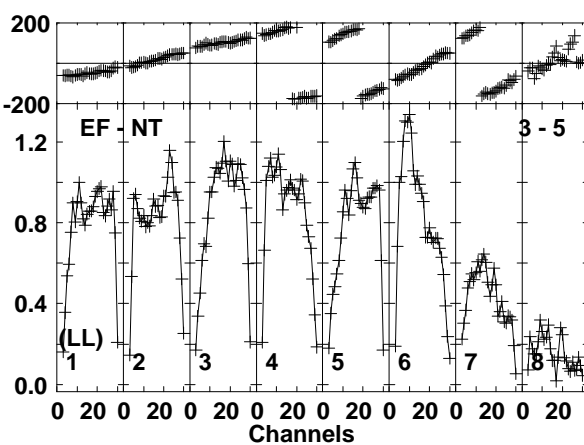
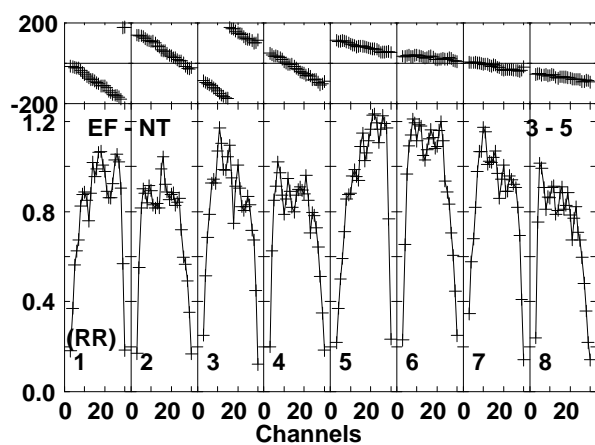
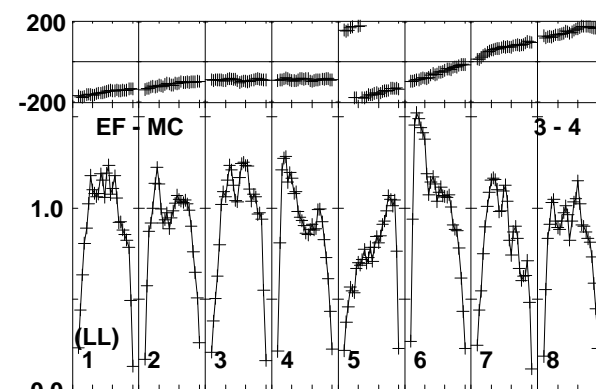
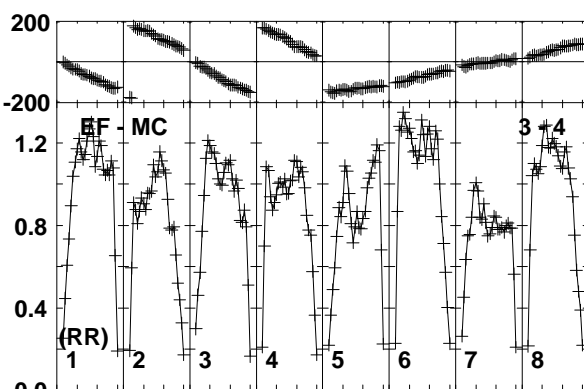
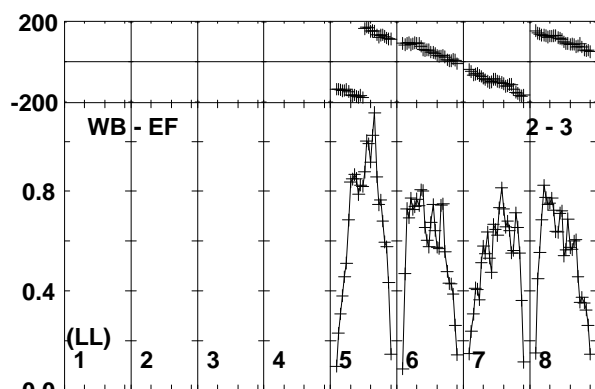
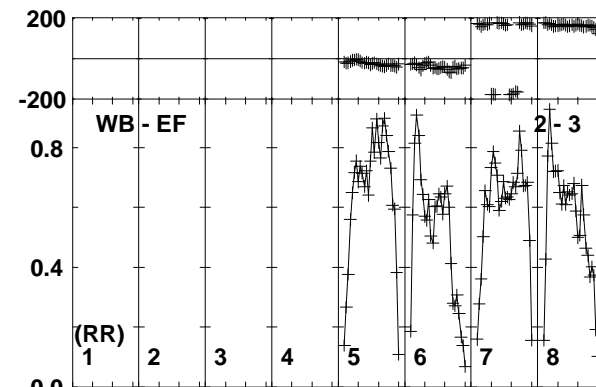
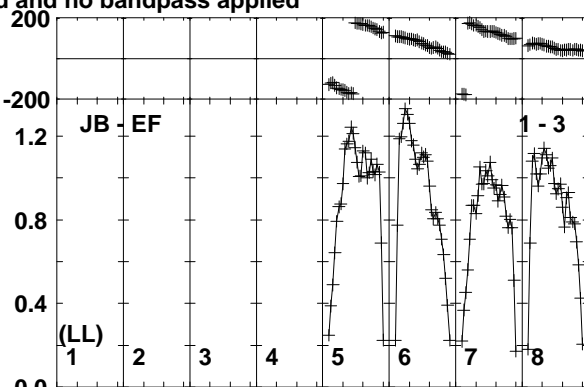
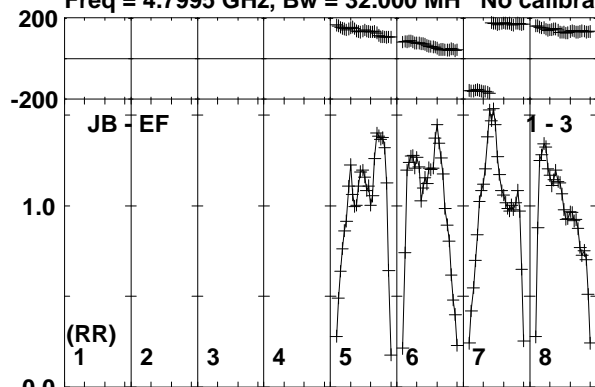

Lower frame: Milli Ampl Jy Top frame: Phas deg
Vector averaged cross-power spectrum Baseline: JB (01) - EF (03)
Timerange: 00/15:38:44 to 00/15:39:58

Plot file version 156 created 03-APR-2017 18:27:41

J1834-2341 EM126B.UVDATA.1

Freq = 4.7995 GHz, Bw = 32.000 MH No calibration applied and no bandpass applied

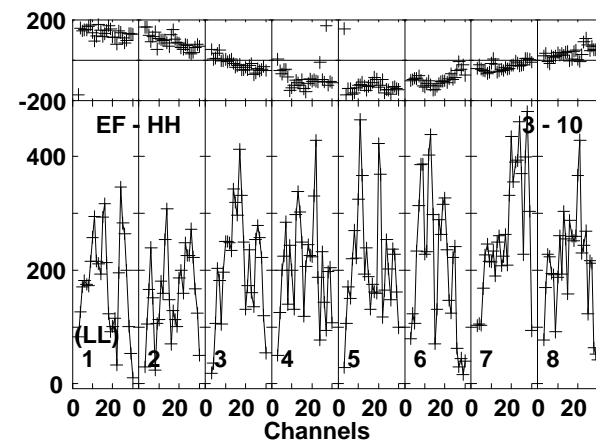
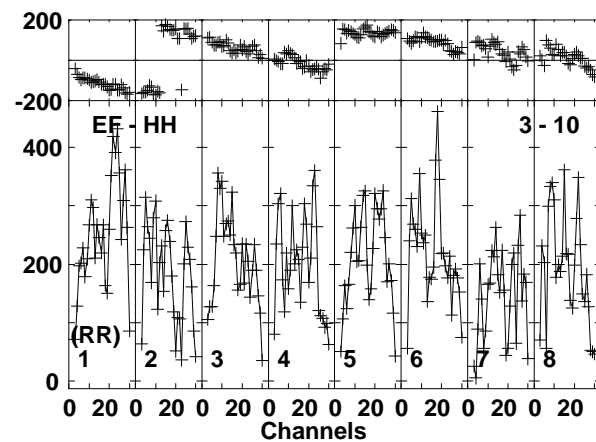
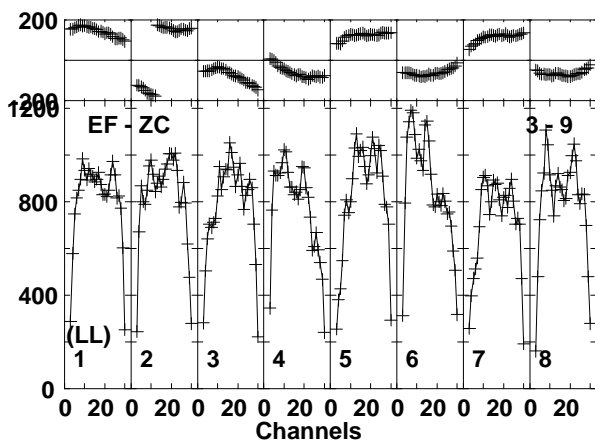
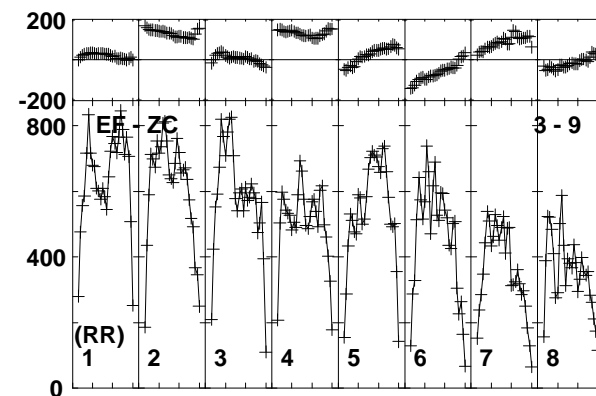
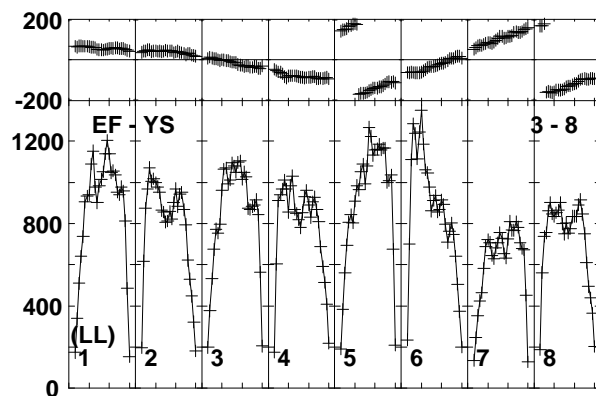
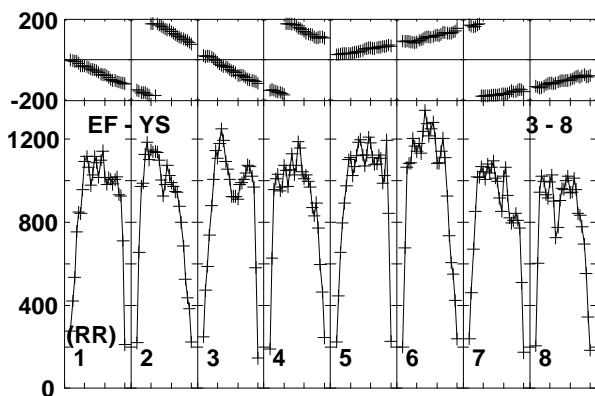
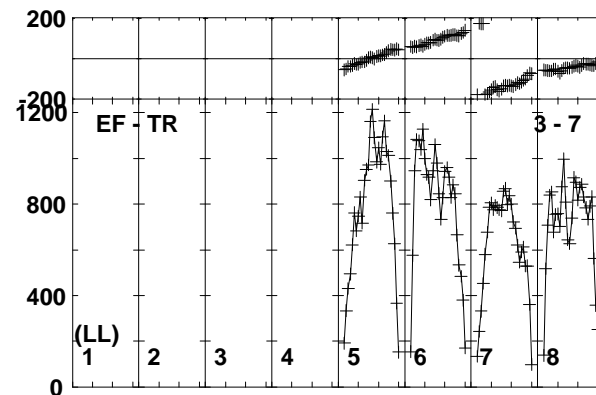
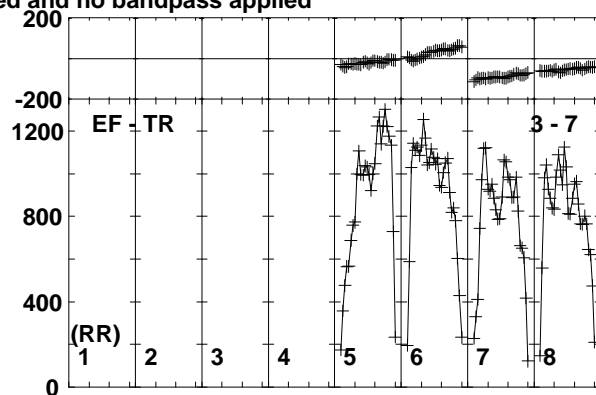
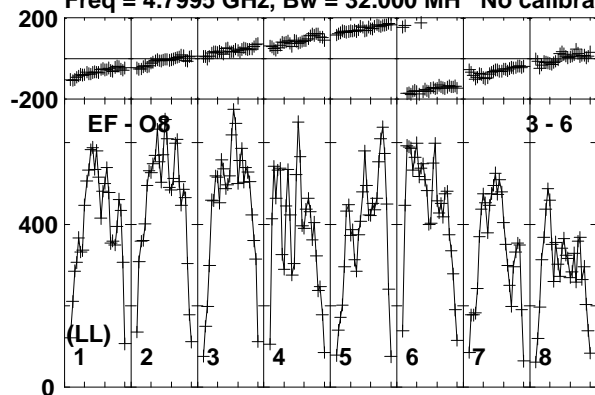

Lower frame: Micro Ampl Jy Top frame: Phas deg
Vector averaged cross-power spectrum Baseline: EF (03) - O8 (06)
Timerange: 00/15:38:44 to 00/15:39:58

Plot file version 157 created 03-APR-2017 18:27:41

M22-VLA1 EM126B.UVDATA.1

Freq = 4.7995 GHz, Bw = 32.000 MH No calibration applied and no bandpass applied

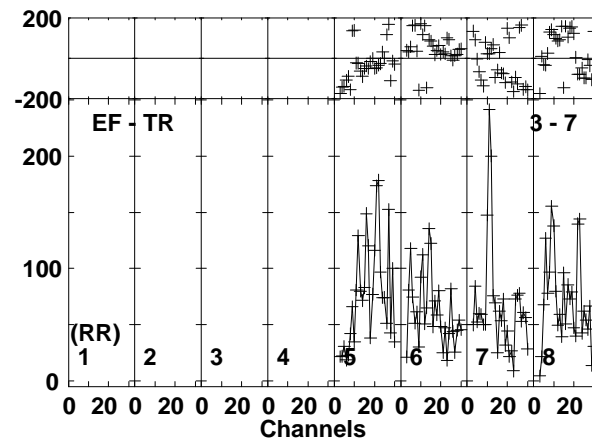
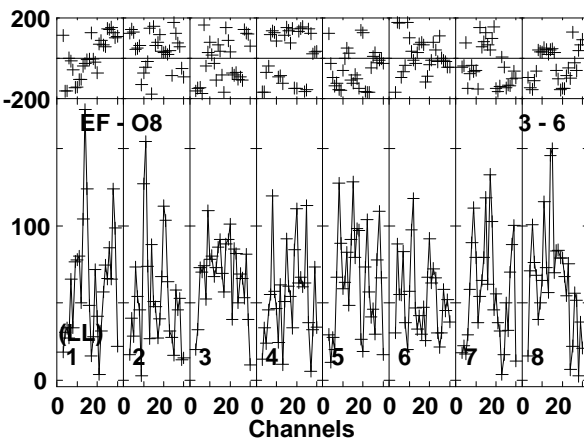
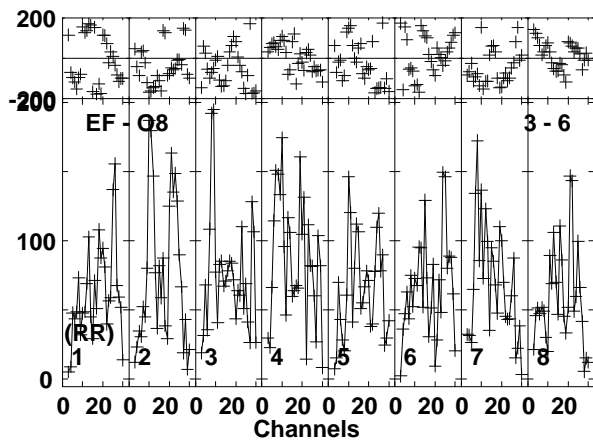
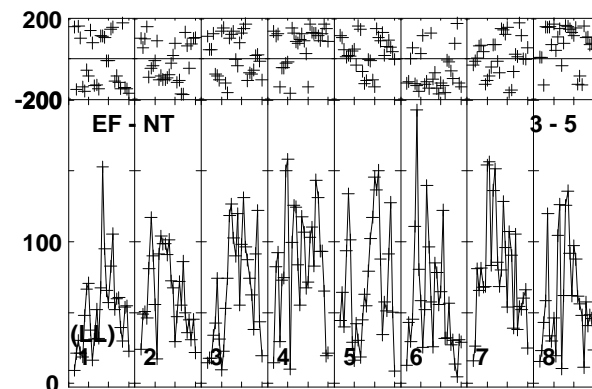
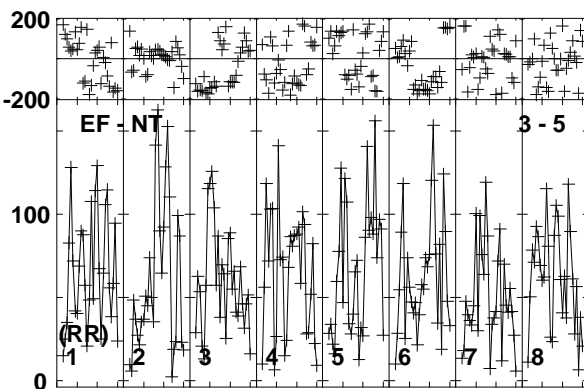
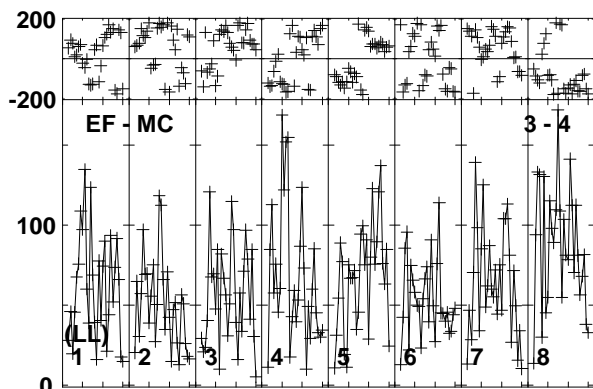
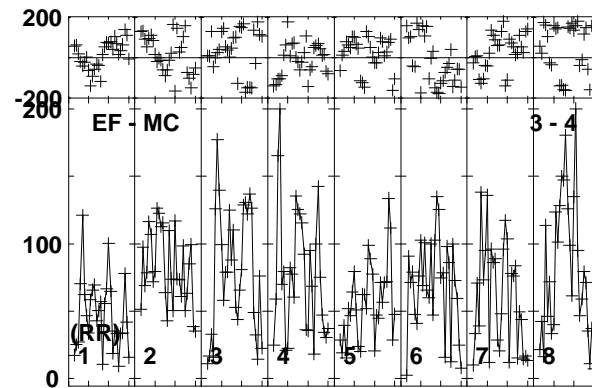
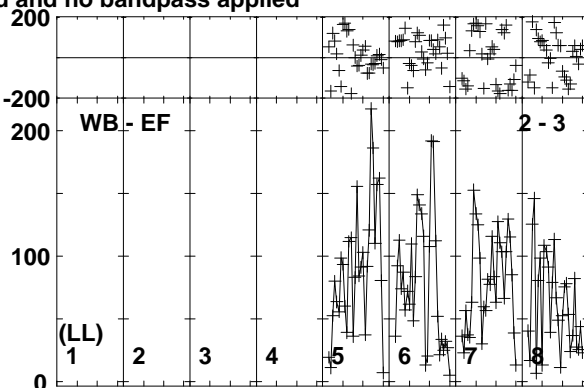
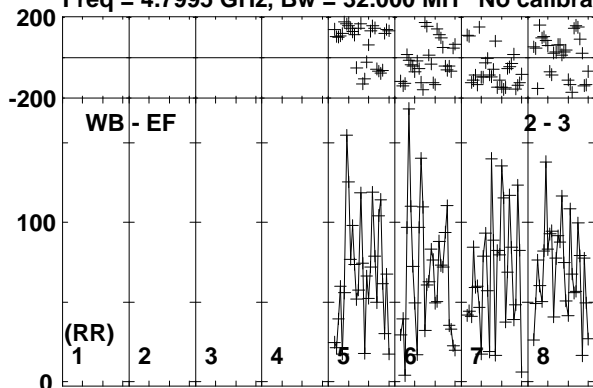

Lower frame: Micro Ampl Jy Top frame: Phas deg
Vector averaged cross-power spectrum Baseline: WB (02) - EF (03)
Timerange: 00/15:40:04 to 00/15:42:08

Plot file version 158 created 03-APR-2017 18:27:41

M22-VLA1 EM126B.UVDATA.1

Freq = 4.7995 GHz, Bw = 32.000 MH No calibration applied and no bandpass applied

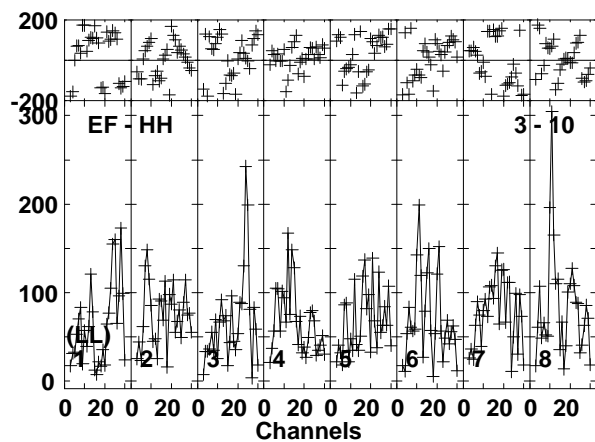
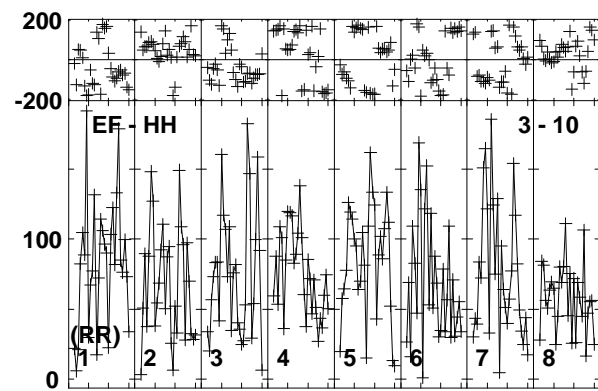
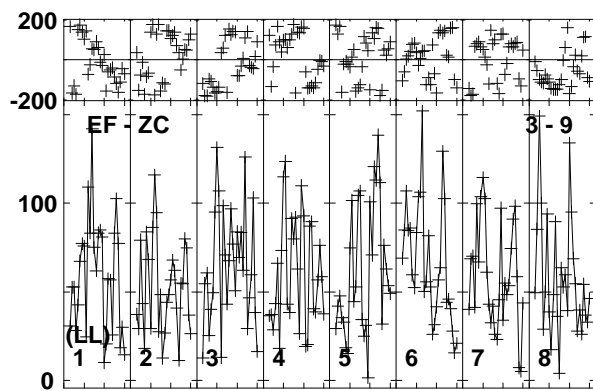
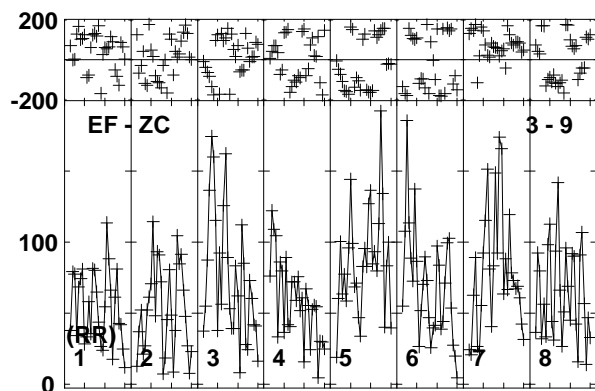
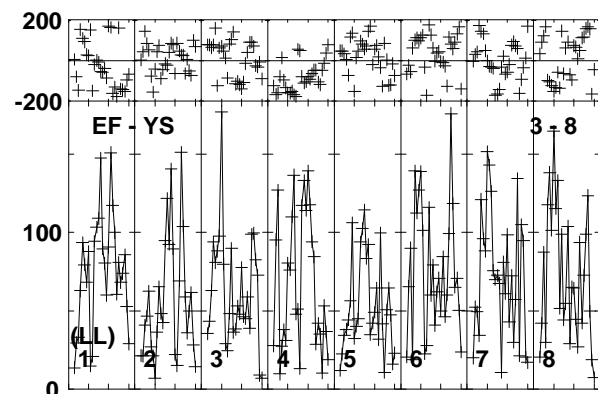
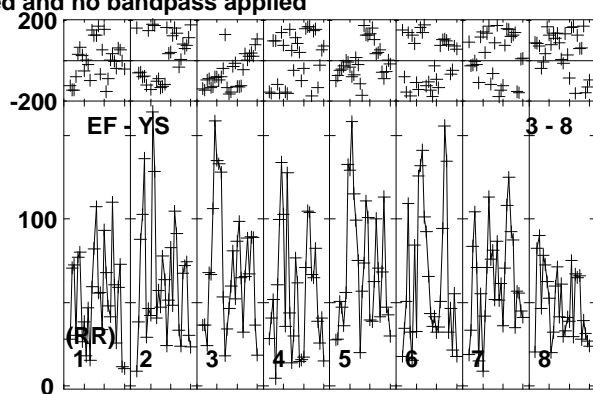
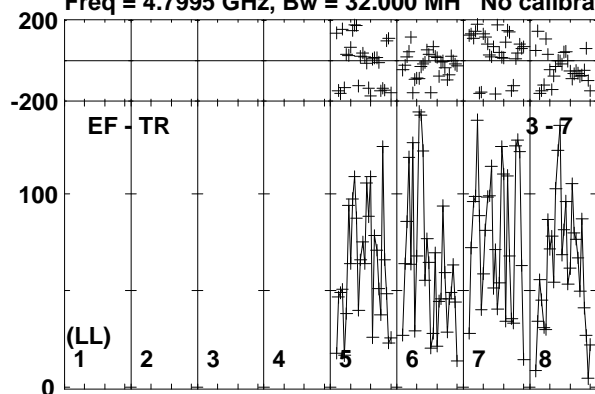

Lower frame: Micro Ampl Jy Top frame: Phas deg
Vector averaged cross-power spectrum Baseline: EF (03) - TR (07)
Timerange: 00/15:40:04 to 00/15:42:08

Plot file version 159 created 03-APR-2017 18:27:41

J1834-2341 EM126B.UVDATA.1

Freq = 4.7995 GHz, Bw = 32.000 MH No calibration applied and no bandpass applied

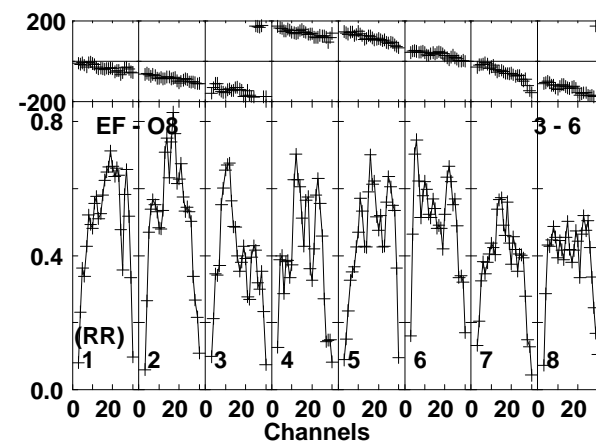
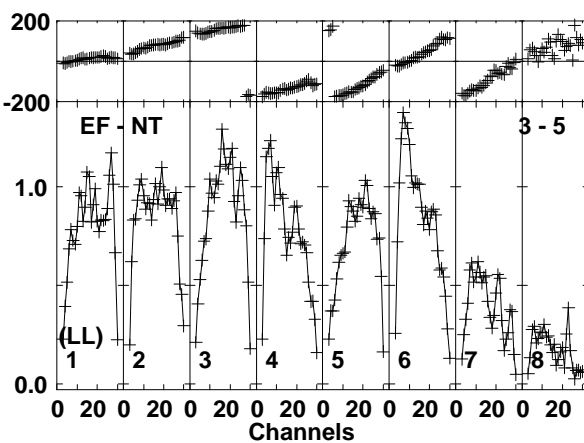
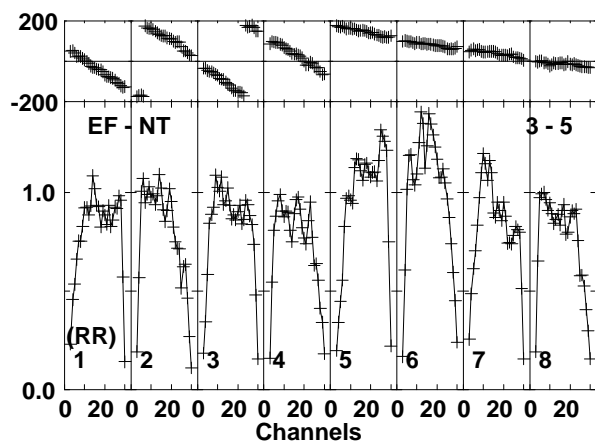
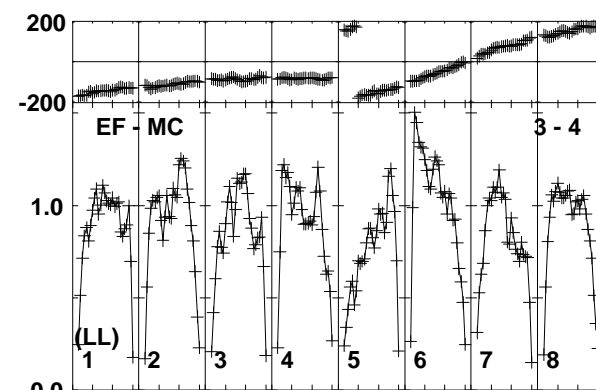
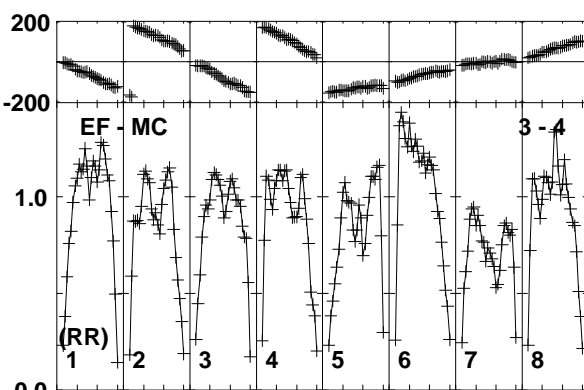
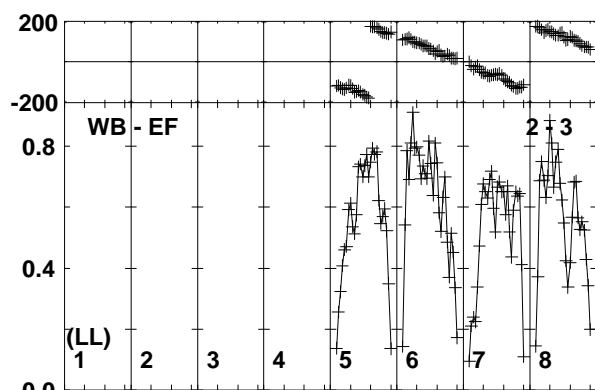
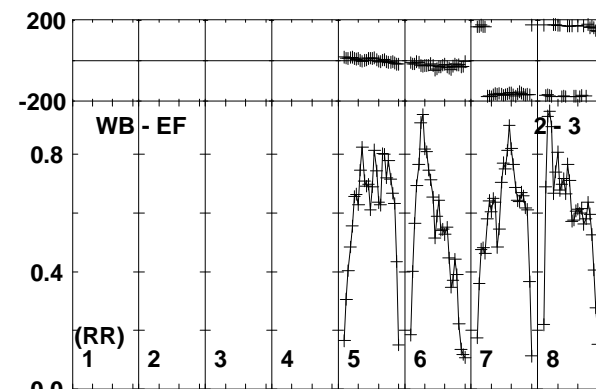
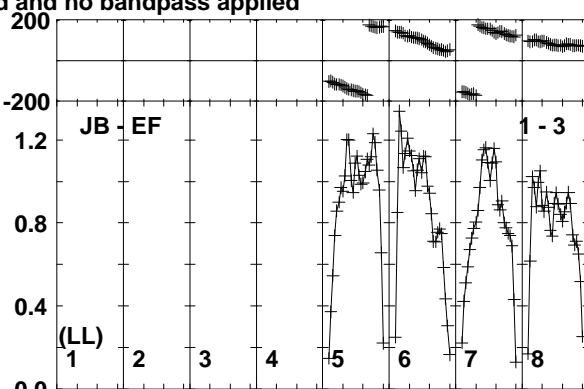
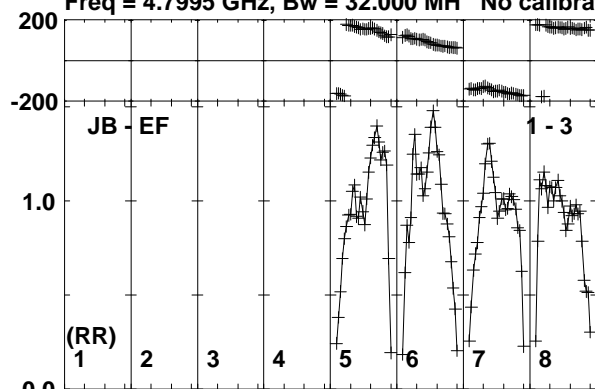

Lower frame: Milli Ampl Jy Top frame: Phas deg
Vector averaged cross-power spectrum Baseline: JB (01) - EF (03)
Timerange: 00/15:42:41 to 00/15:43:29

Plot file version 160 created 03-APR-2017 18:27:41

J1834-2341 EM126B.UVDATA.1

Freq = 4.7995 GHz, Bw = 32.000 MH No calibration applied and no bandpass applied

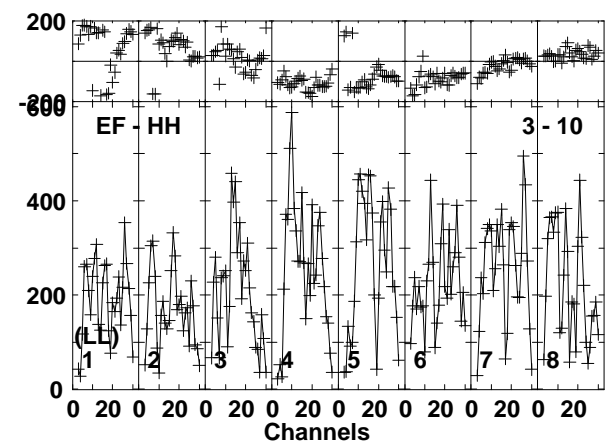
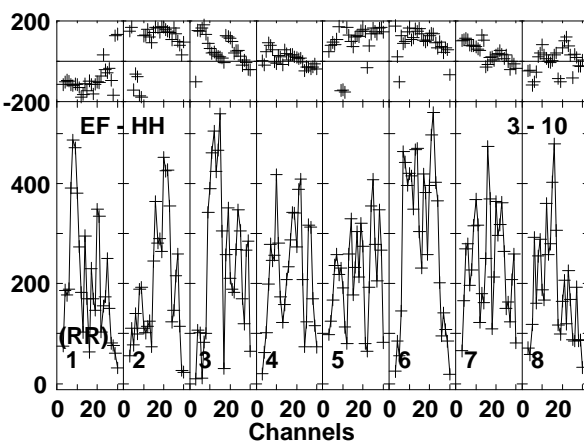
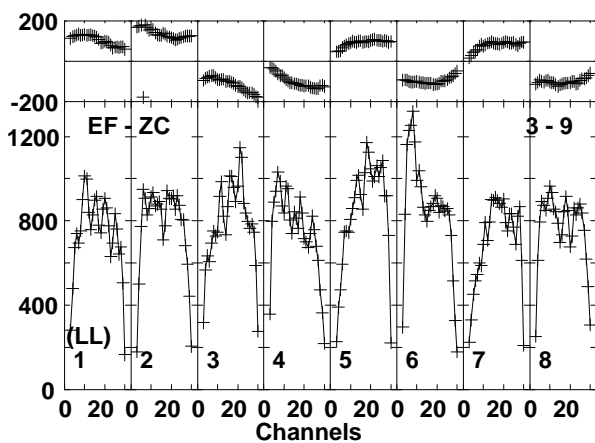
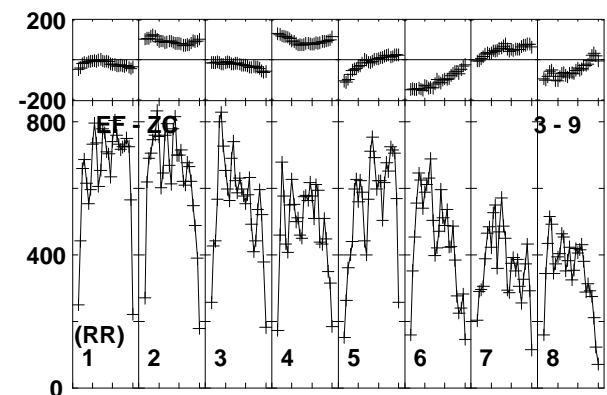
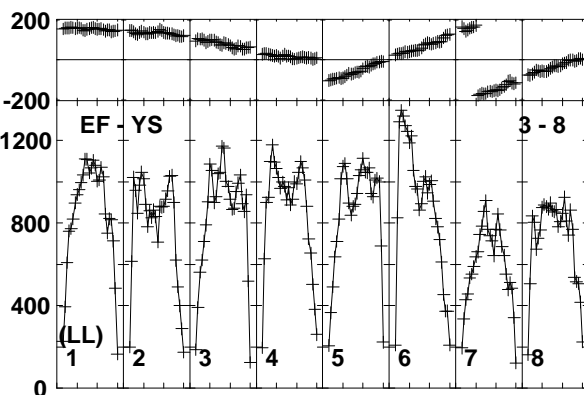
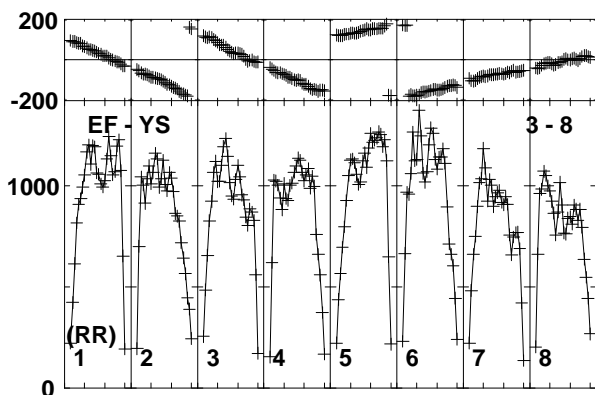
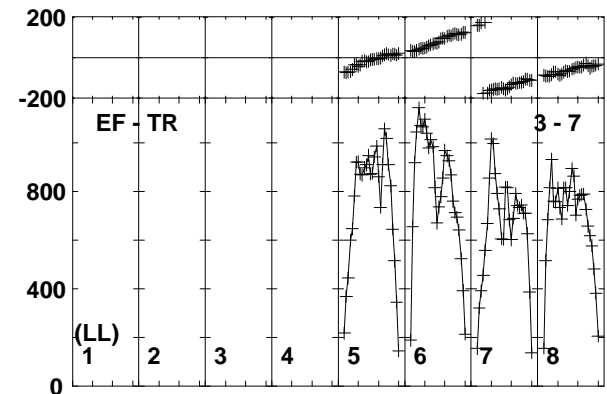
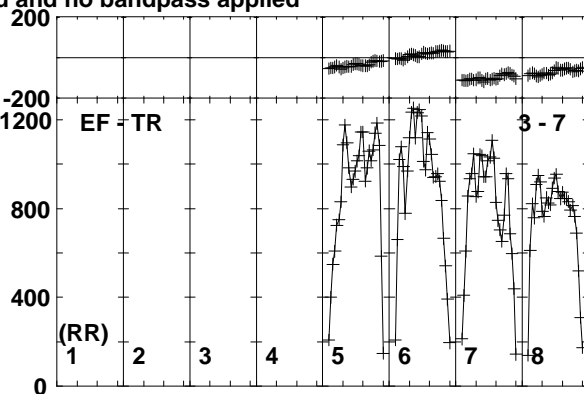
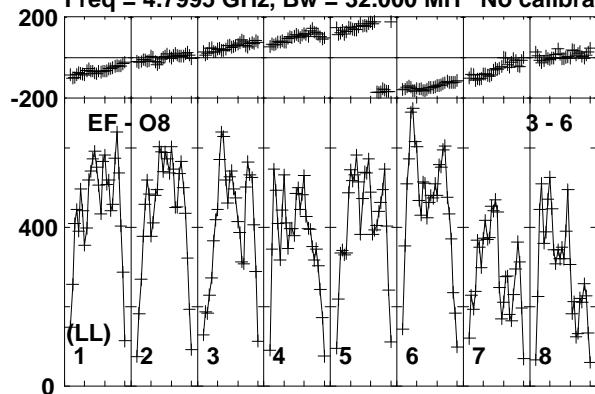

Lower frame: Micro Ampl Jy Top frame: Phas deg
Vector averaged cross-power spectrum Baseline: EF (03) - O8 (06)
Timerange: 00/15:42:41 to 00/15:43:29

Plot file version 161 created 03-APR-2017 18:27:41

J1924-2914 EM126B.UVDATA.1

Freq = 4.7995 GHz, Bw = 32.000 MH No calibration applied and no bandpass applied

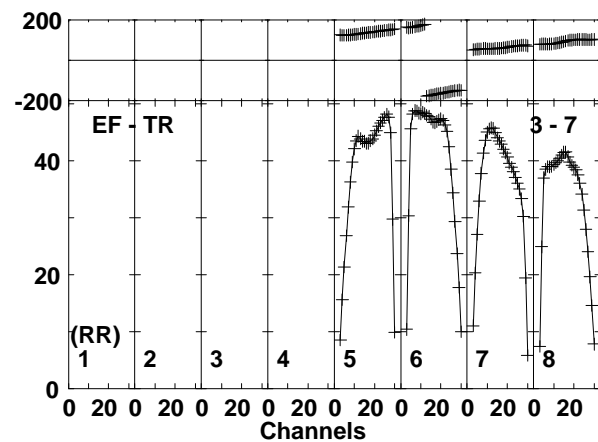
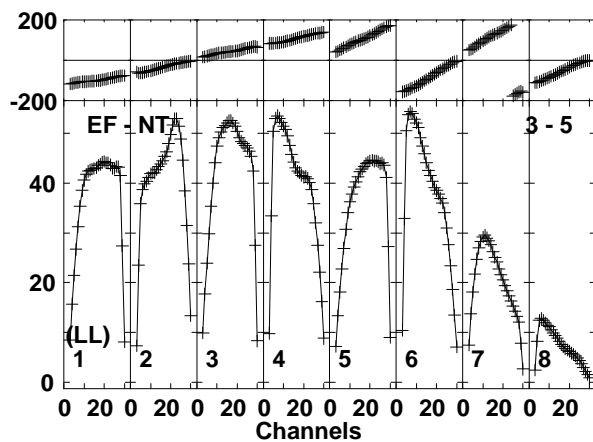
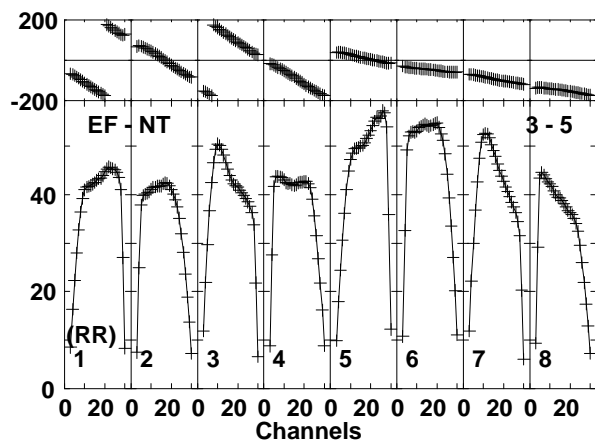
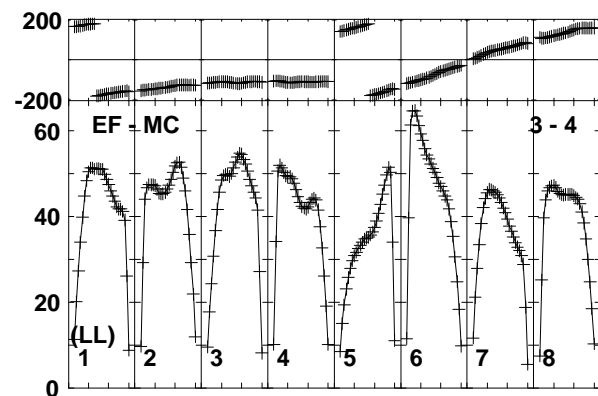
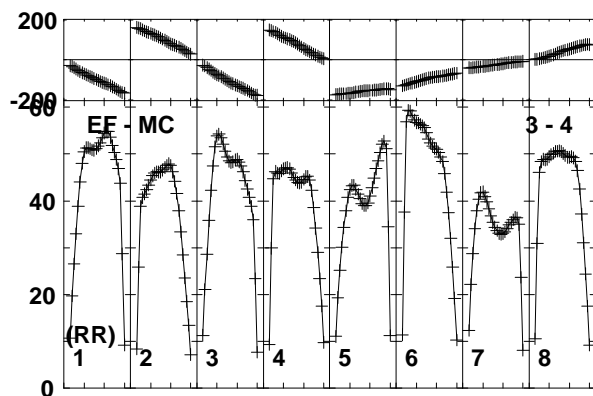
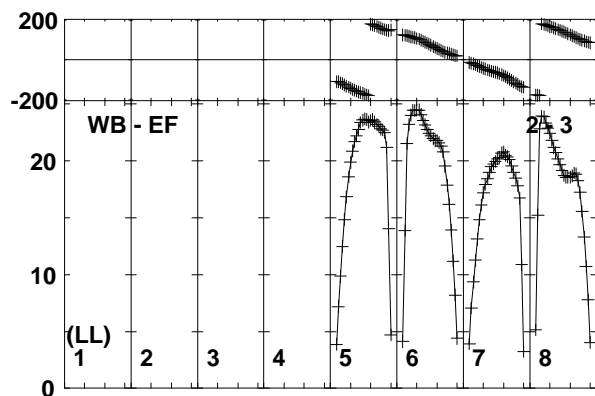
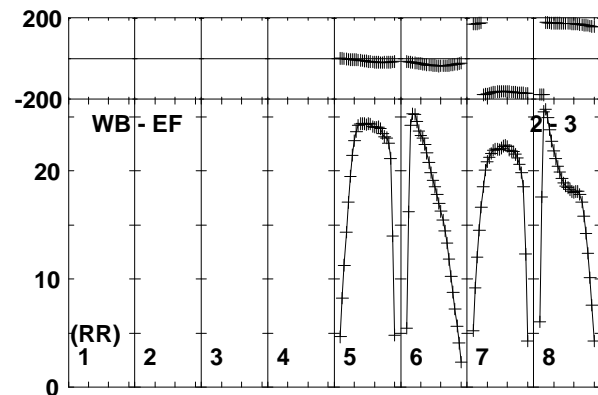
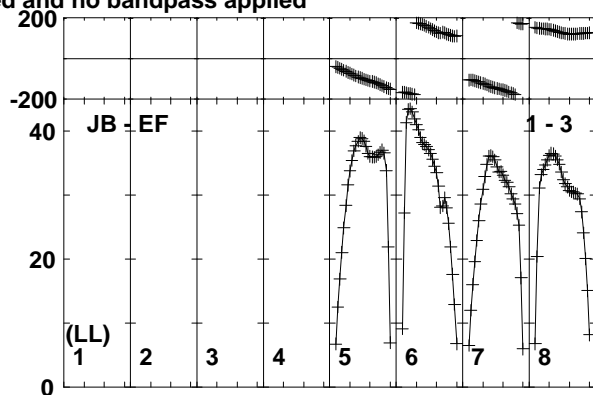
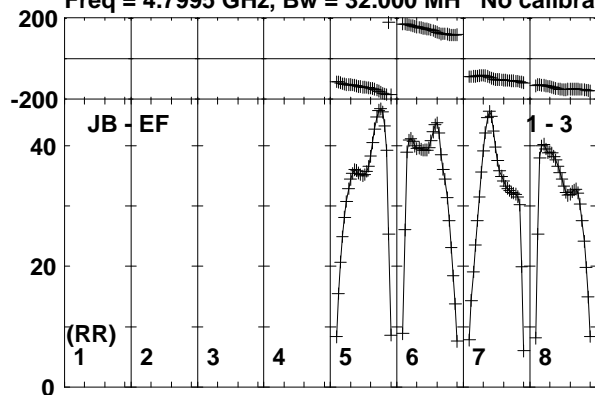

Lower frame: Milli Ampl Jy Top frame: Phas deg
Vector averaged cross-power spectrum Baseline: JB (01) - EF (03)
Timerange: 00/15:44:01 to 00/15:46:59

Plot file version 162 created 03-APR-2017 18:27:41

J1924-2914 EM126B.UVDATA.1

Freq = 4.7995 GHz, Bw = 32.000 MH No calibration applied and no bandpass applied

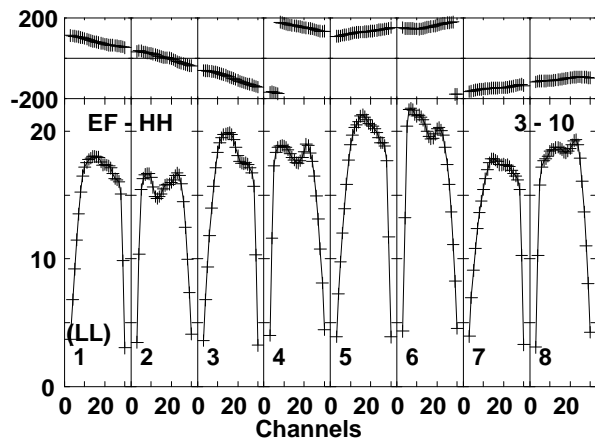
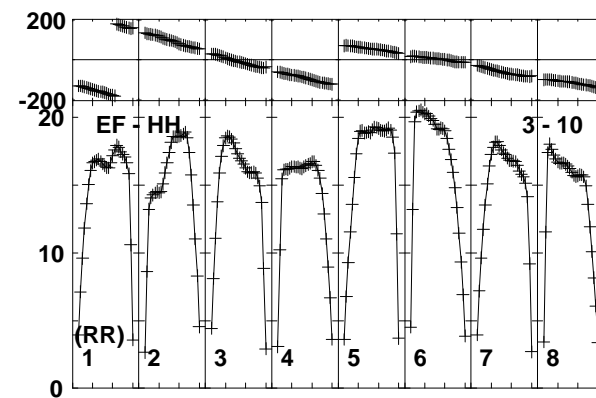
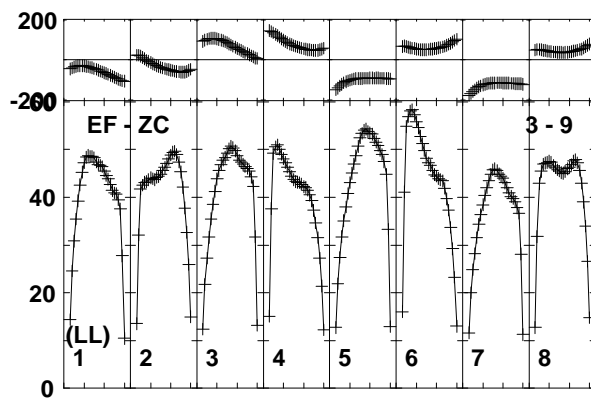
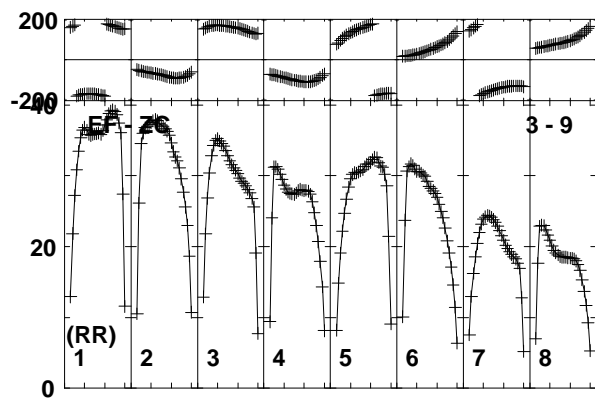
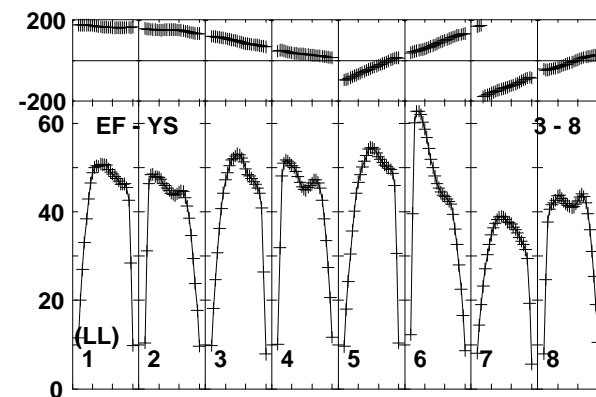
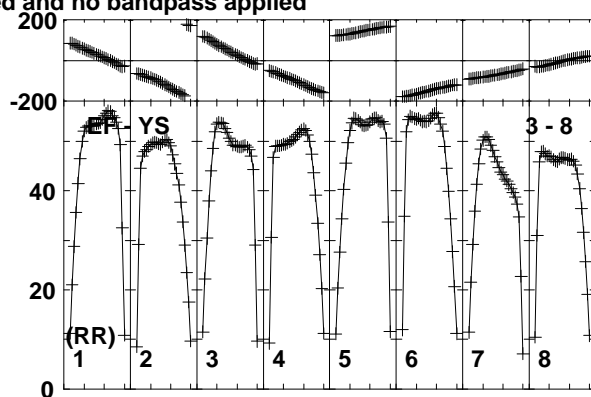
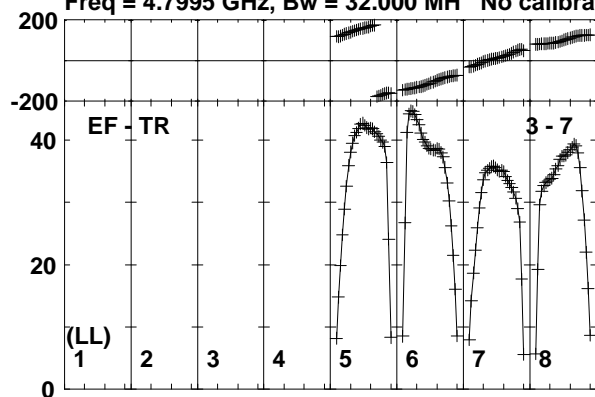

Lower frame: Milli Ampl Jy Top frame: Phas deg
Vector averaged cross-power spectrum Baseline: EF (03) - TR (07)
Timerange: 00/15:44:01 to 00/15:46:59

Plot file version 163 created 03-APR-2017 18:27:41

J1834-2341 EM126B.UVDATA.1

Freq = 4.7995 GHz, Bw = 32.000 MH No calibration applied and no bandpass applied

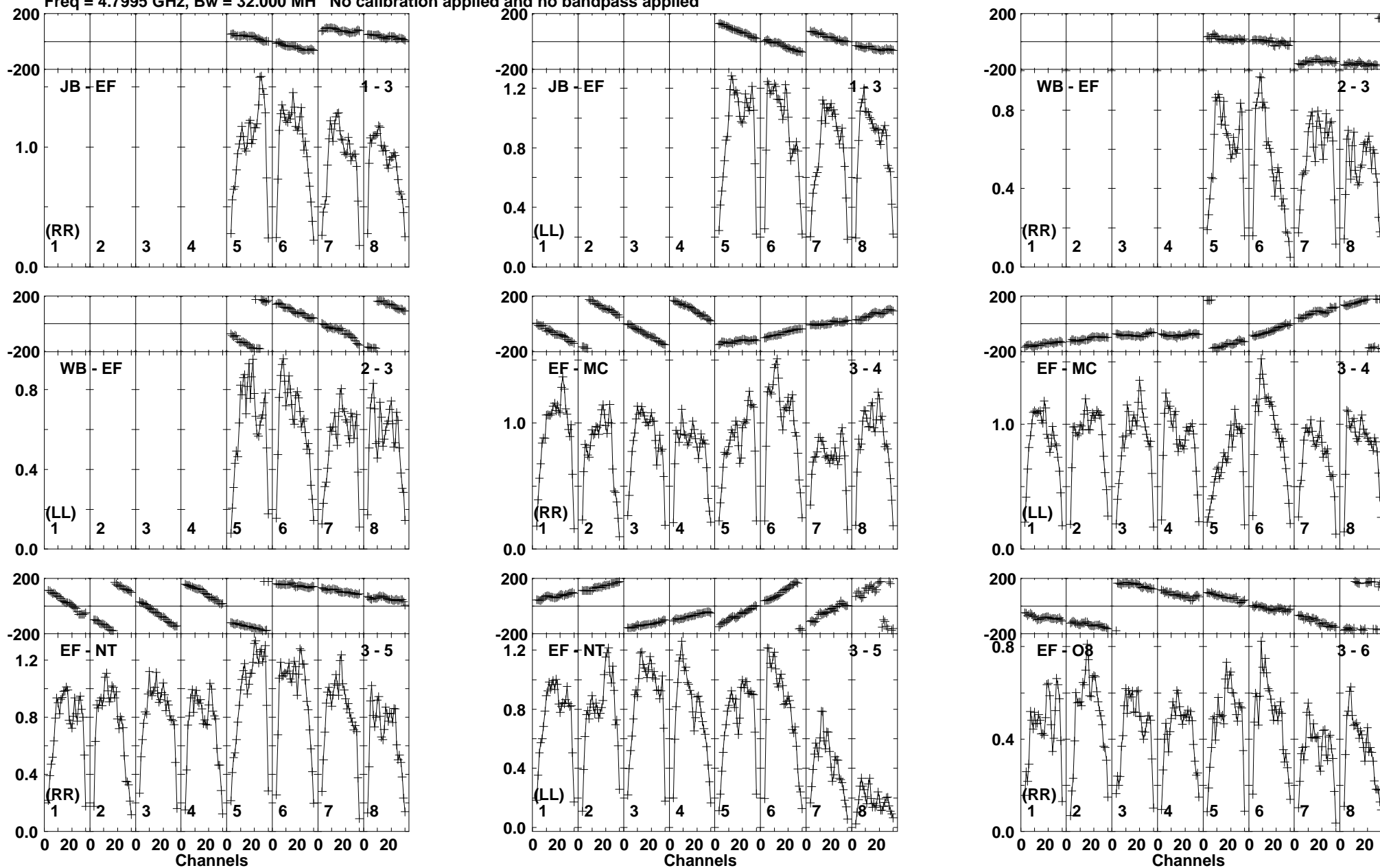

Lower frame: Milli Ampl Jy Top frame: Phas deg
Vector averaged cross-power spectrum Baseline: JB (01) - EF (03)
Timerange: 00/15:47:31 to 00/15:48:59

Plot file version 164 created 03-APR-2017 18:27:42

J1834-2341 EM126B.UVDATA.1

Freq = 4.7995 GHz, Bw = 32.000 MH No calibration applied and no bandpass applied

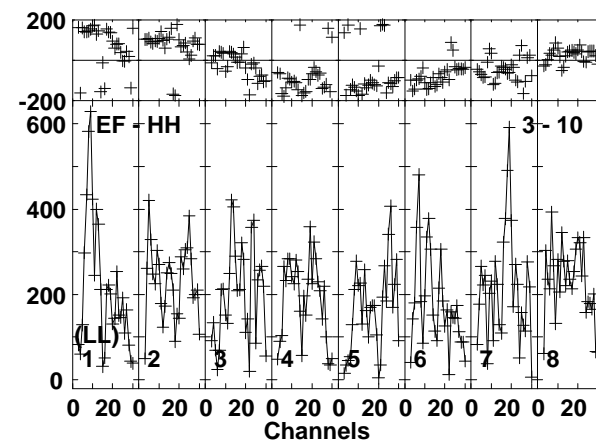
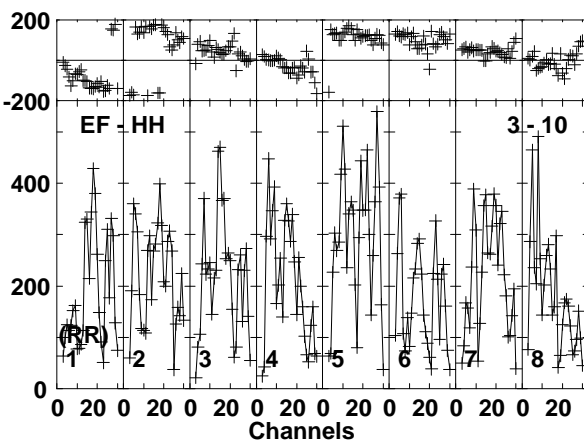
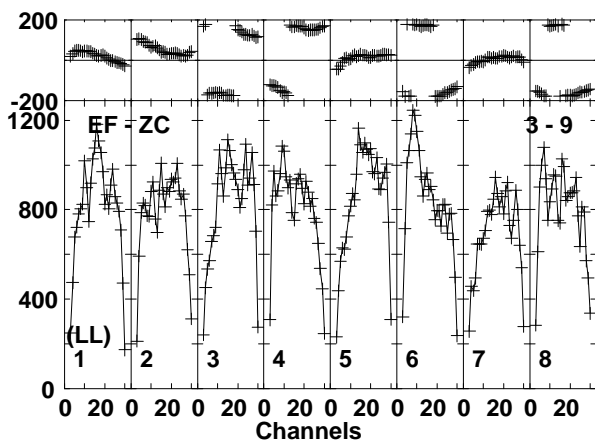
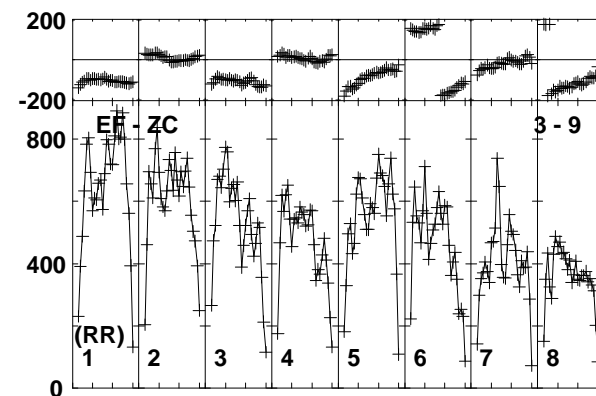
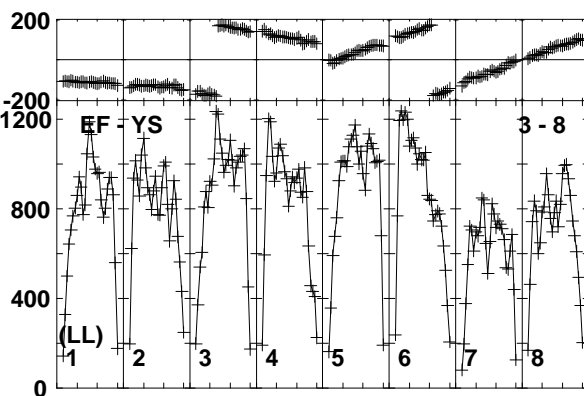
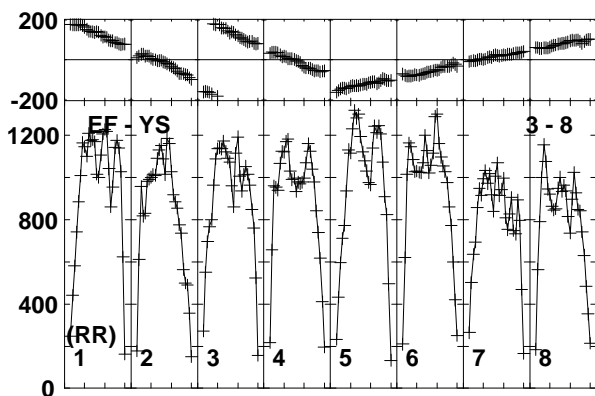
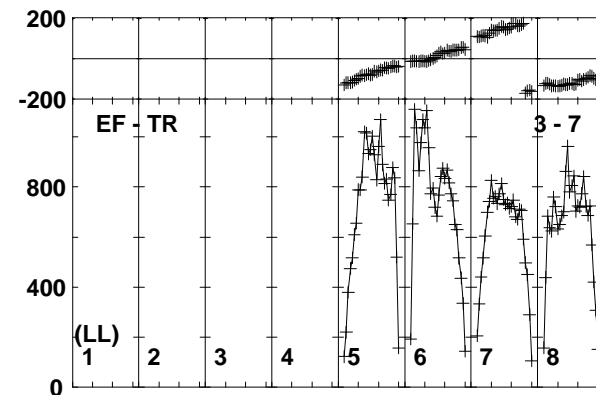
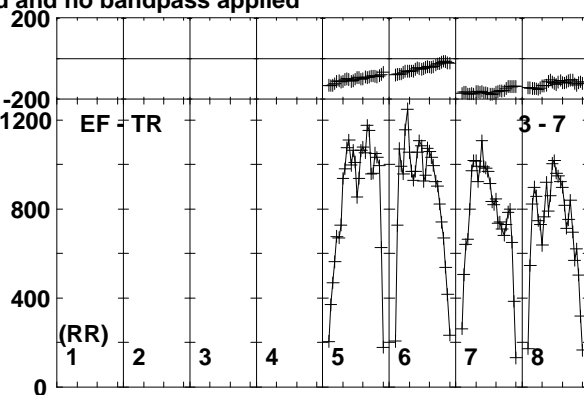
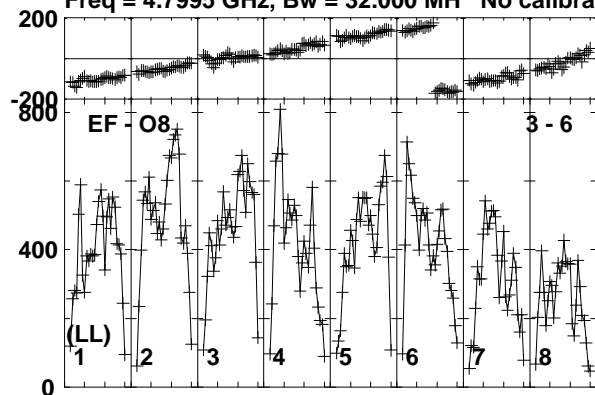

Lower frame: Micro Ampl Jy Top frame: Phas deg
Vector averaged cross-power spectrum Baseline: EF (03) - O8 (06)
Timerange: 00/15:47:31 to 00/15:48:59

Plot file version 165 created 03-APR-2017 18:27:42

M22-VLA1 EM126B.UVDATA.1

Freq = 4.7995 GHz, Bw = 32.000 MH No calibration applied and no bandpass applied

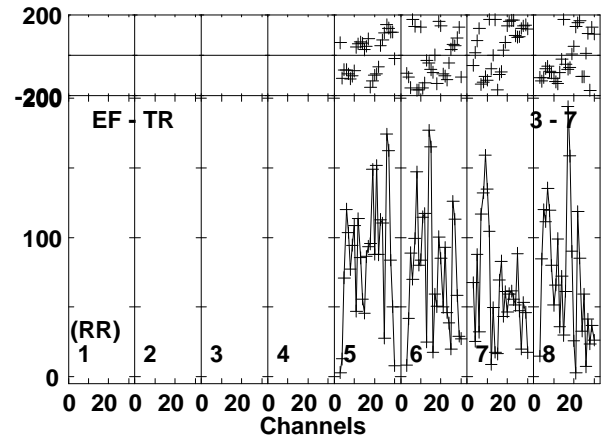
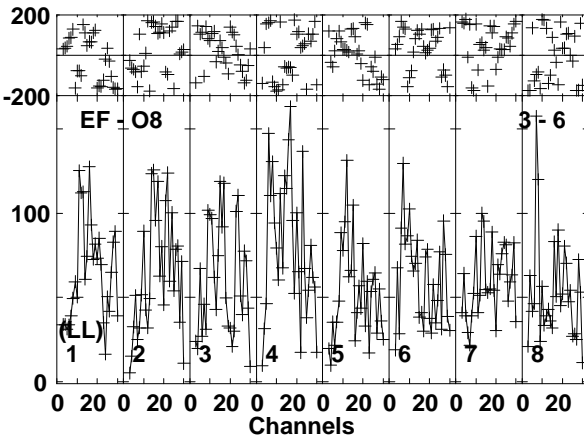
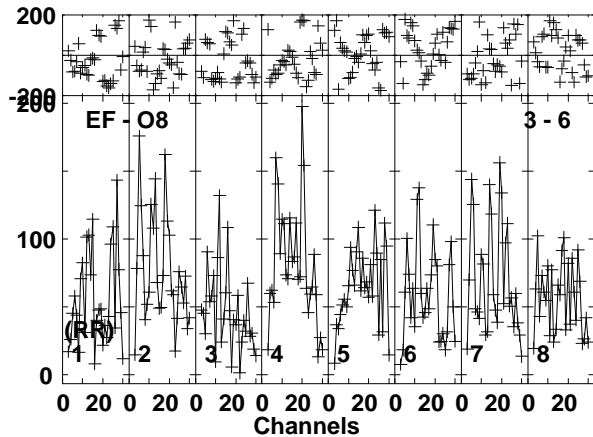
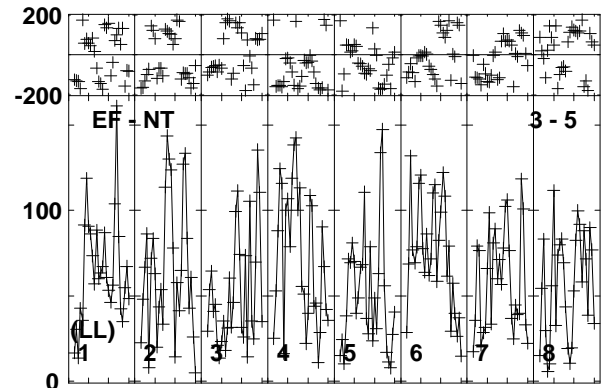
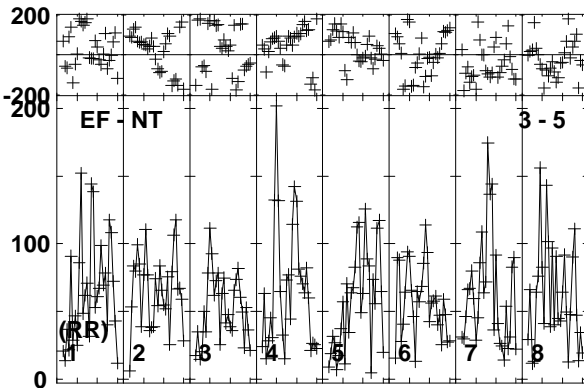
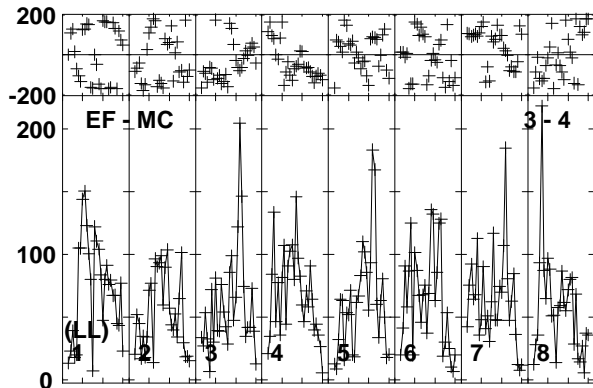
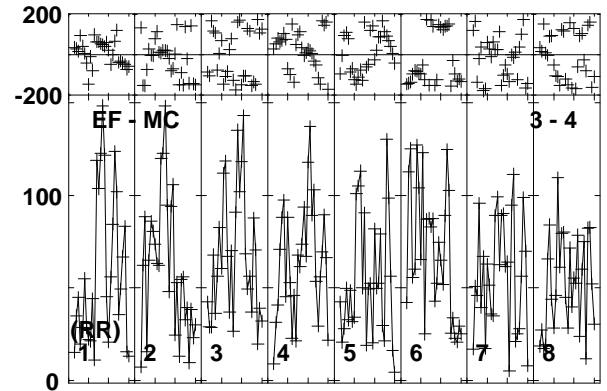
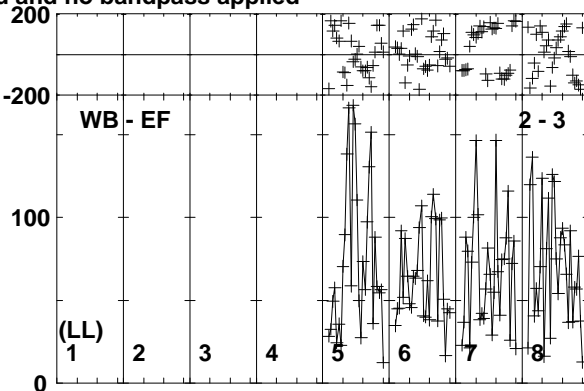
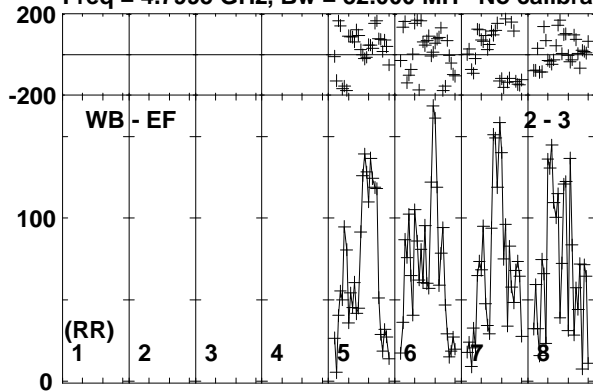

Lower frame: Micro Ampl Jy Top frame: Phas deg
Vector averaged cross-power spectrum Baseline: WB (02) - EF (03)
Timerange: 00/15:49:04 to 00/15:51:08

Plot file version 166 created 03-APR-2017 18:27:42

M22-VLA1 EM126B.UVDATA.1

Freq = 4.7995 GHz, Bw = 32.000 MH No calibration applied and no bandpass applied

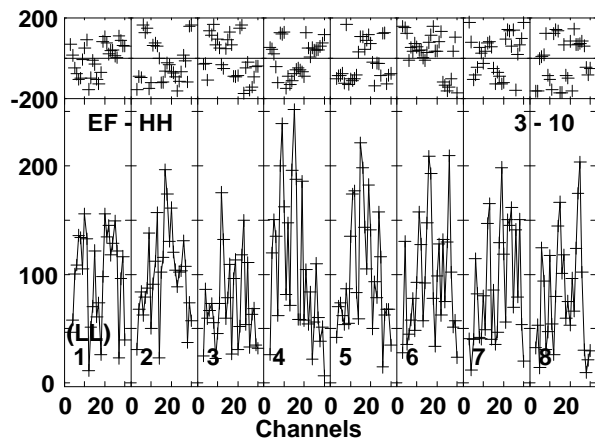
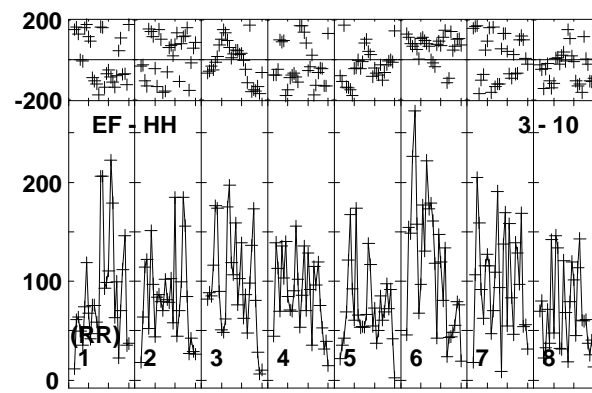
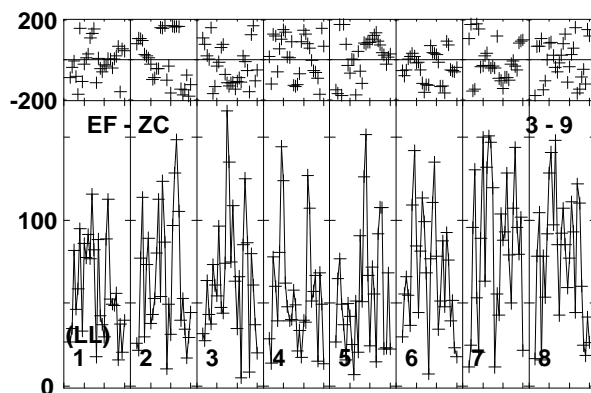
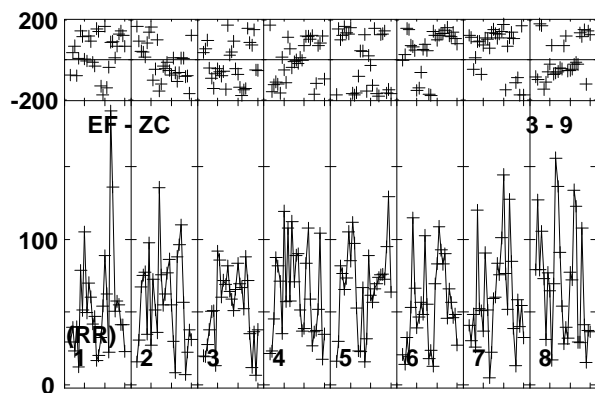
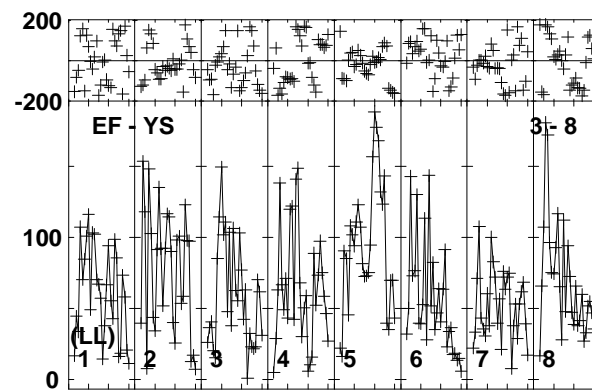
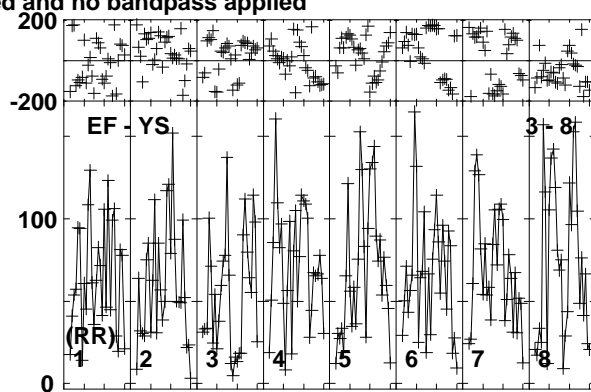
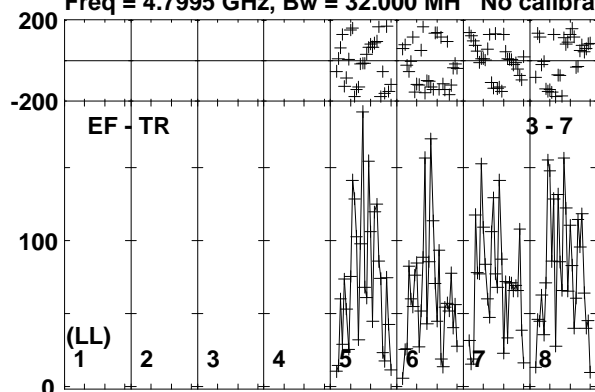

Lower frame: Micro Ampl Jy Top frame: Phas deg
Vector averaged cross-power spectrum Baseline: EF (03) - TR (07)
Timerange: 00/15:49:04 to 00/15:51:08

Plot file version 167 created 03-APR-2017 18:27:42

J1834-2341 EM126B.UVDATA.1

Freq = 4.7995 GHz, Bw = 32.000 MH No calibration applied and no bandpass applied

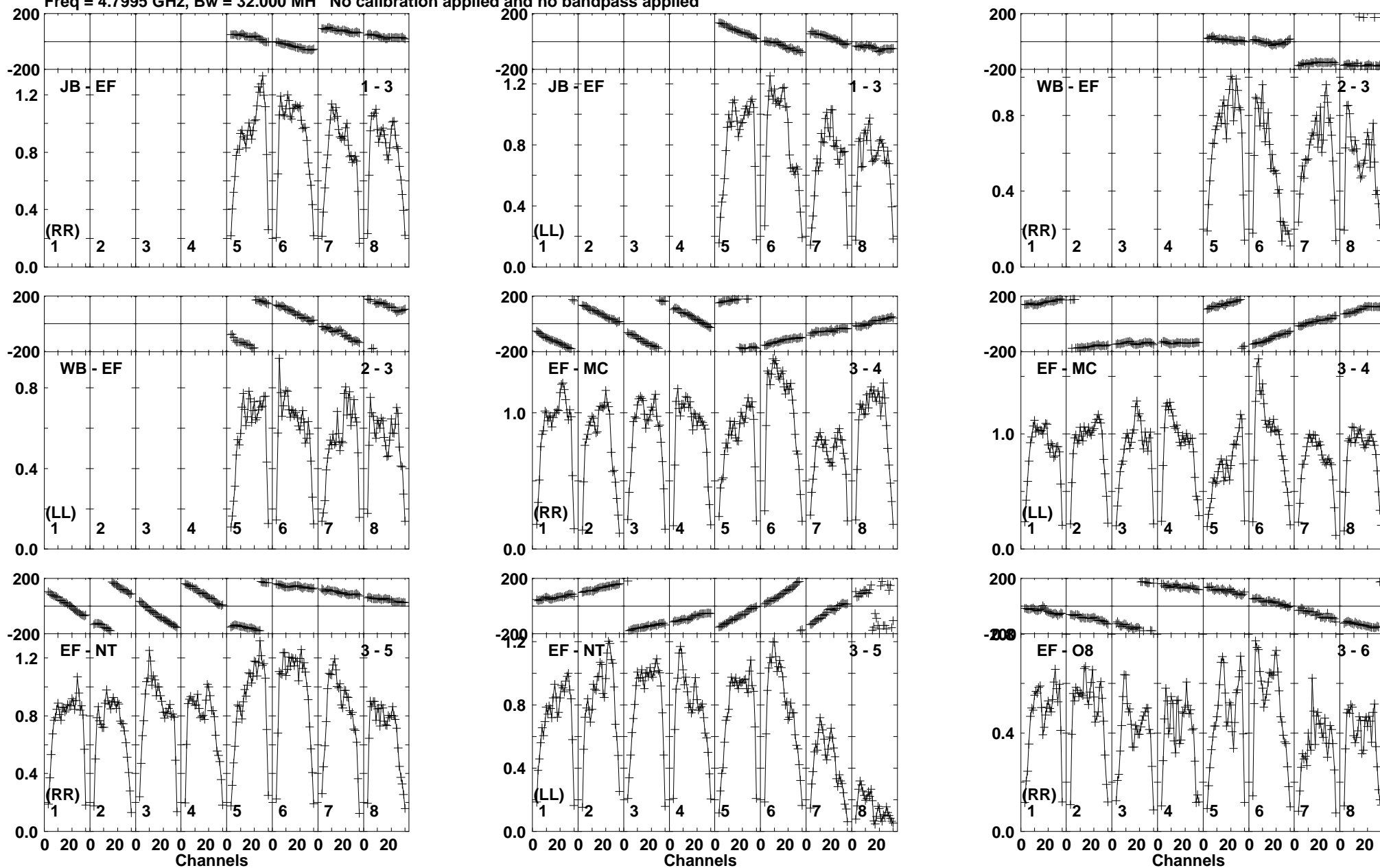

Lower frame: Milli Ampl Jy Top frame: Phas deg
Vector averaged cross-power spectrum Baseline: JB (01) - EF (03)
Timerange: 00/15:51:14 to 00/15:52:28

Plot file version 168 created 03-APR-2017 18:27:42

J1834-2341 EM126B.UVDATA.1

Freq = 4.7995 GHz, Bw = 32.000 MH No calibration applied and no bandpass applied

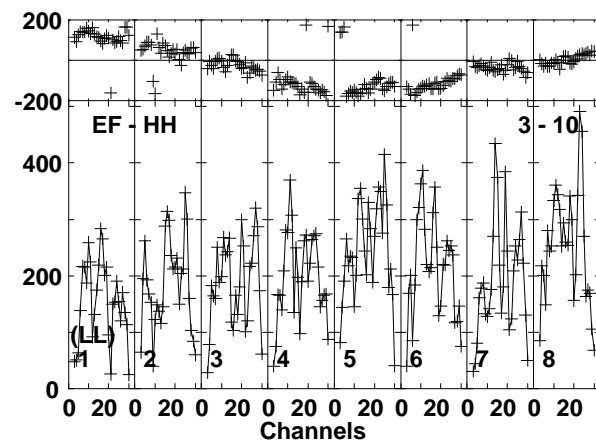
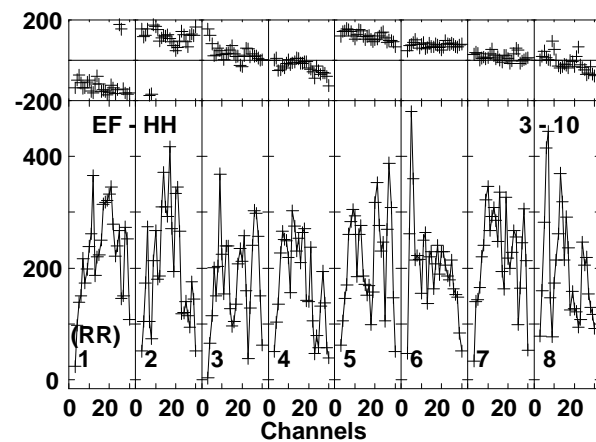
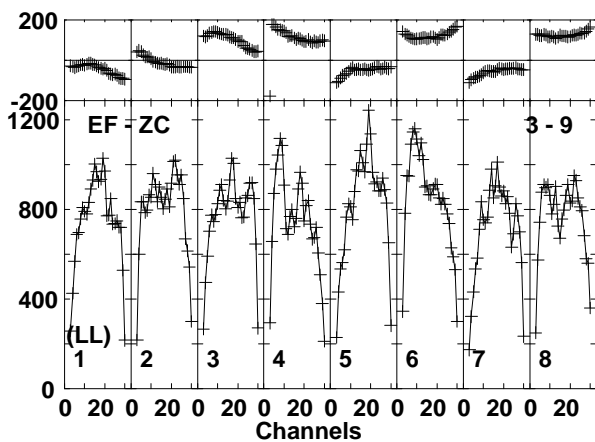
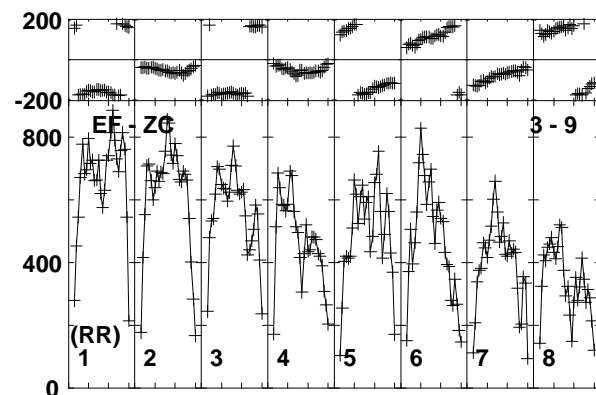
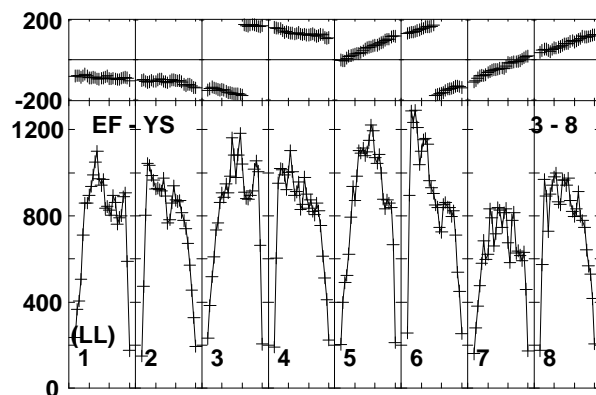
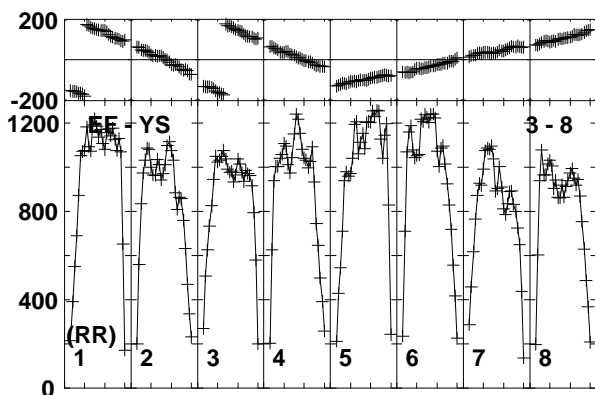
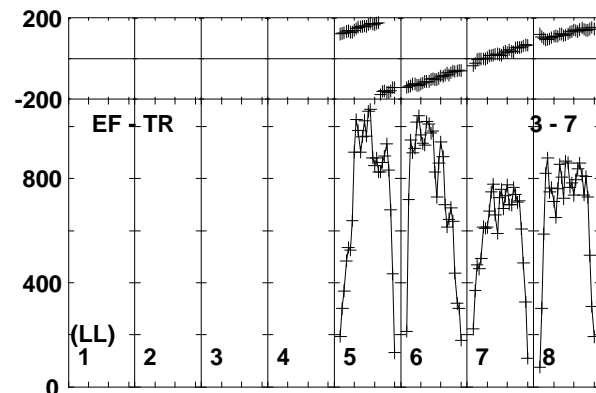
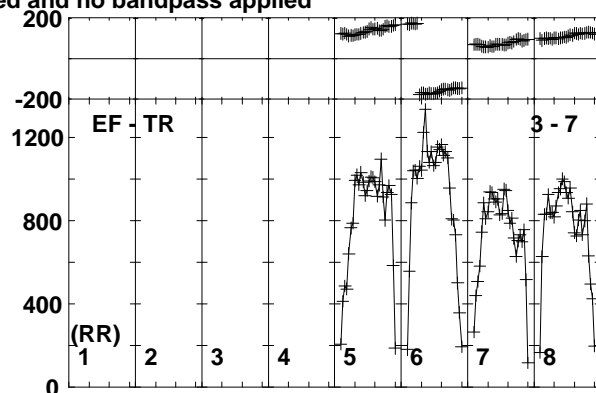
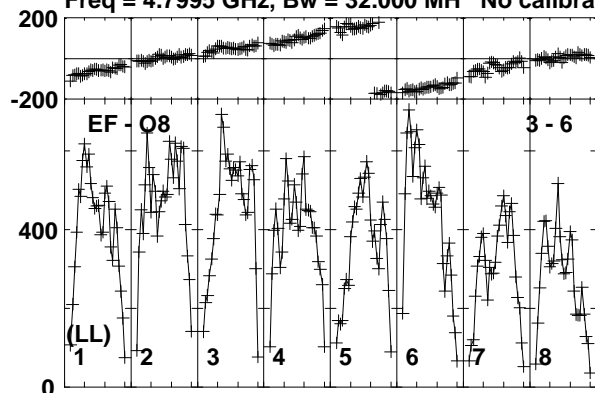

Lower frame: Micro Ampl Jy Top frame: Phas deg
Vector averaged cross-power spectrum Baseline: EF (03) - O8 (06)
Timerange: 00:15:51:14 to 00:15:52:28

Plot file version 169 created 03-APR-2017 18:27:42

M22-VLA1 EM126B.UVDATA.1

Freq = 4.7995 GHz, Bw = 32.000 MH No calibration applied and no bandpass applied

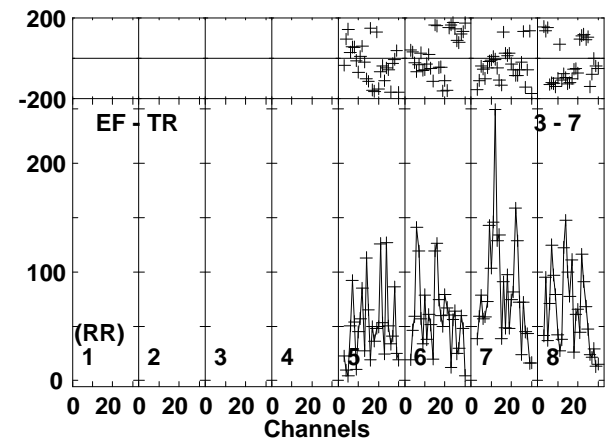
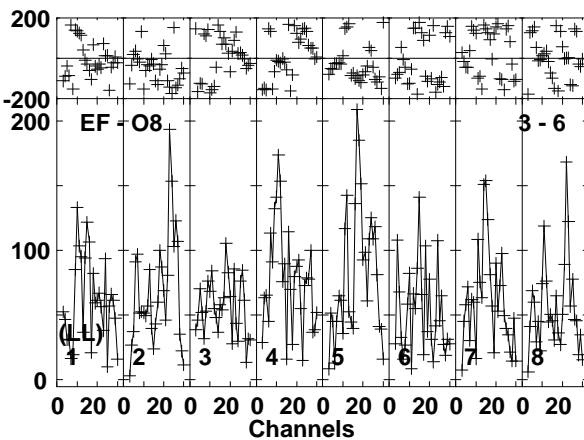
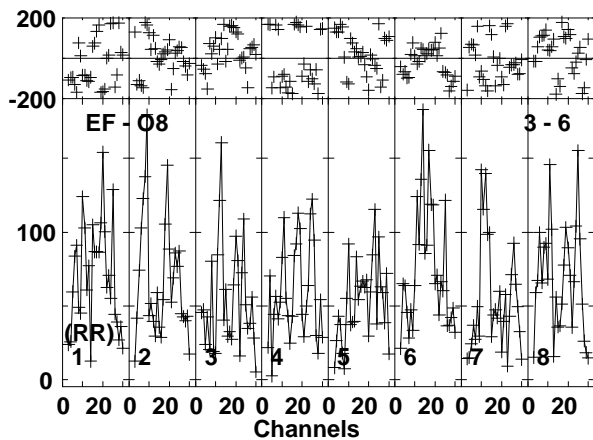
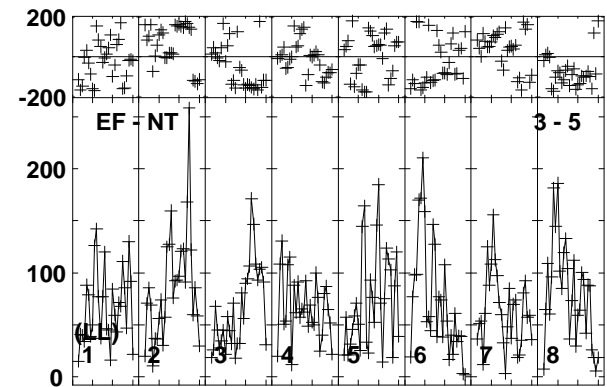
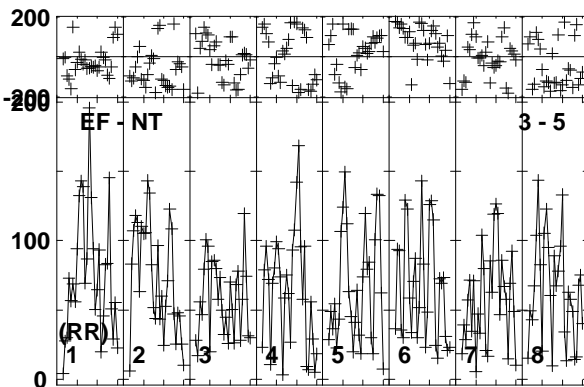
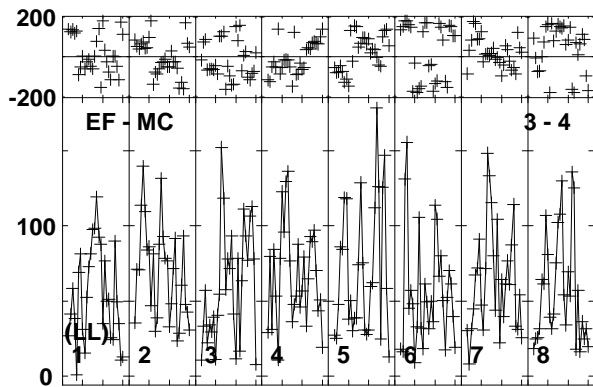
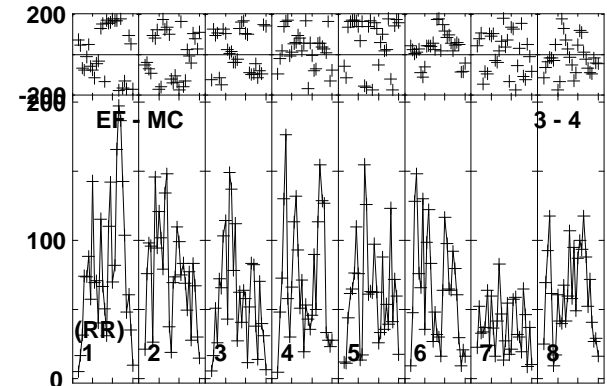
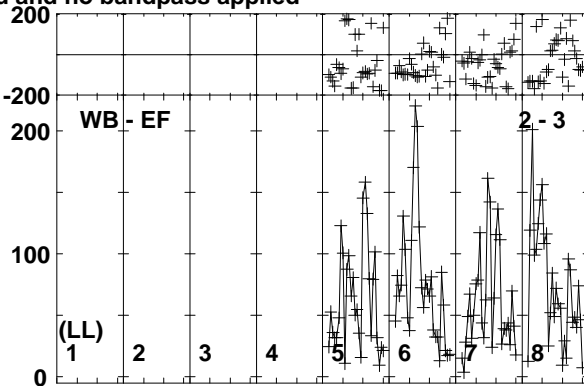
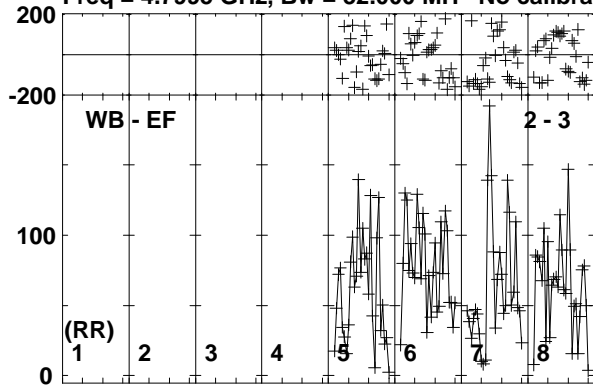

Lower frame: Micro Ampl Jy Top frame: Phas deg
Vector averaged cross-power spectrum Baseline: WB (02) - EF (03)
Timerange: 00/15:52:34 to 00/15:54:38

Plot file version 170 created 03-APR-2017 18:27:42

M22-VLA1 EM126B.UVDATA.1

Freq = 4.7995 GHz, Bw = 32.000 MH No calibration applied and no bandpass applied

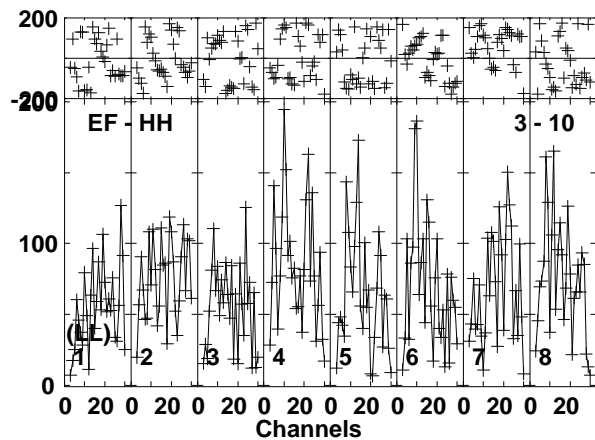
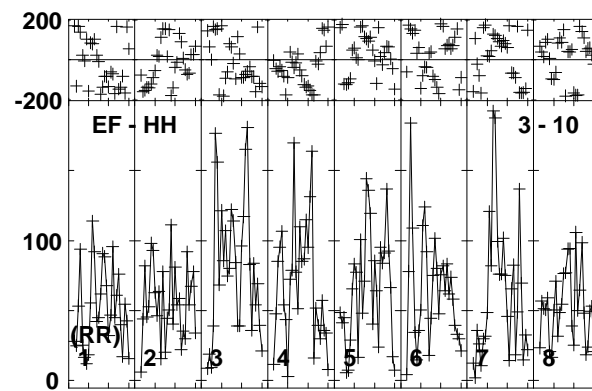
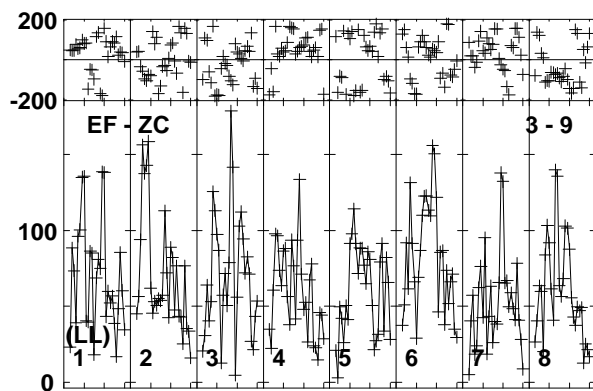
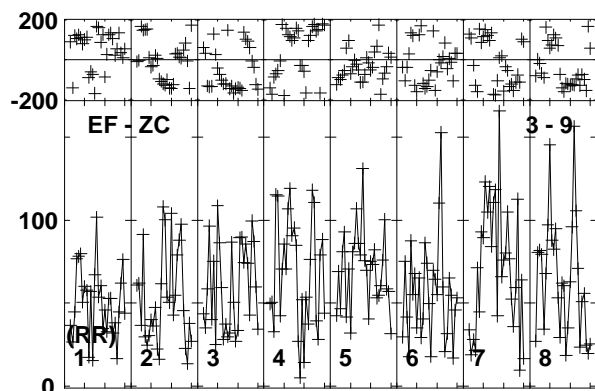
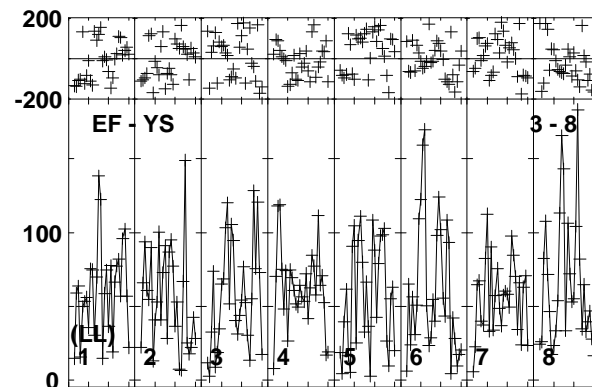
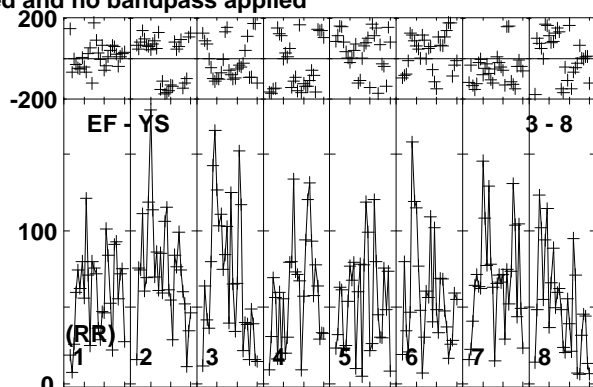
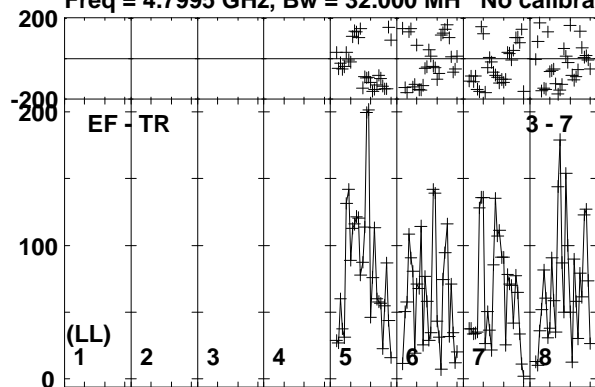

Lower frame: Micro Ampl Jy Top frame: Phas deg
Vector averaged cross-power spectrum Baseline: EF (03) - TR (07)
Timerange: 00/15:52:34 to 00/15:54:38

Plot file version 171 created 03-APR-2017 18:27:42

J1834-2341 EM126B.UVDATA.1

Freq = 4.7995 GHz, Bw = 32.000 MH No calibration applied and no bandpass applied

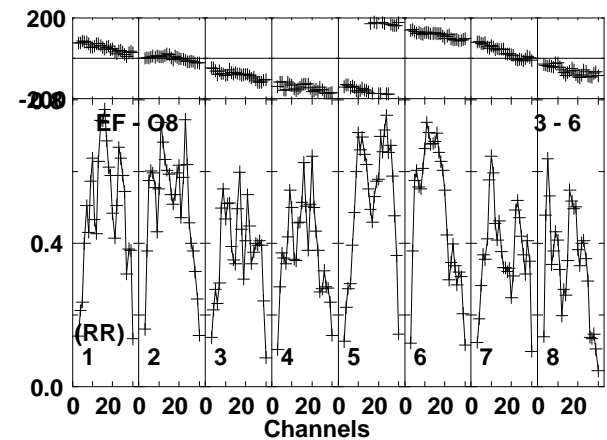
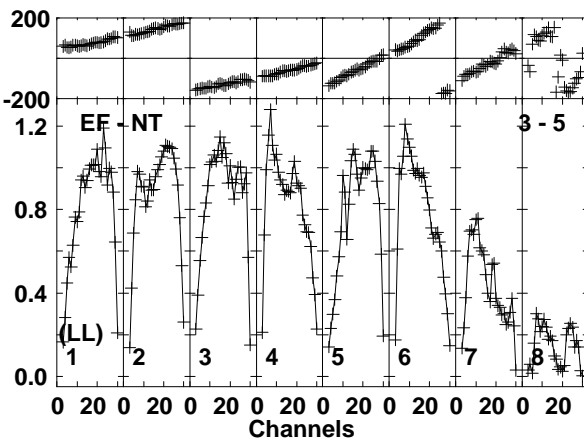
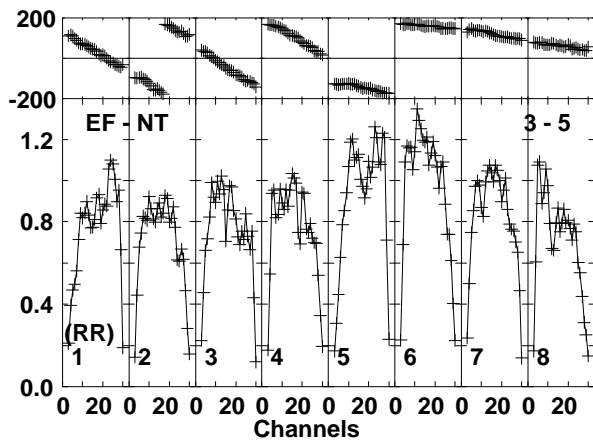
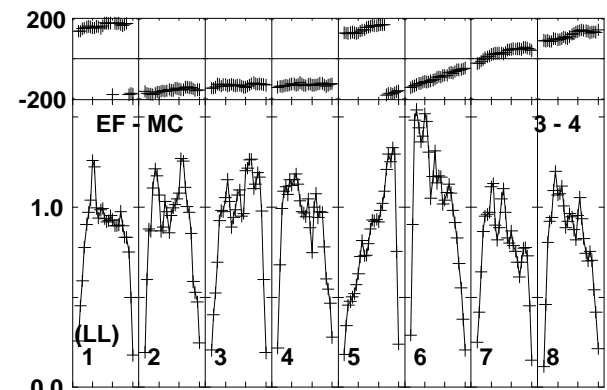
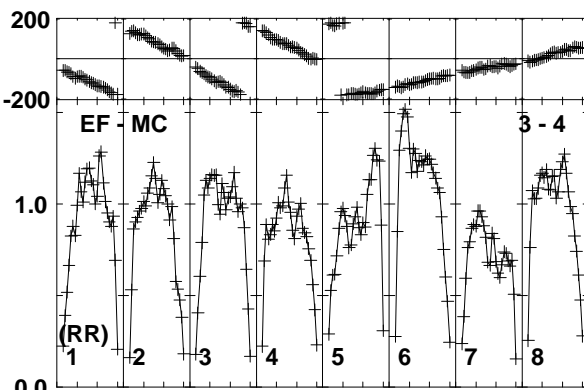
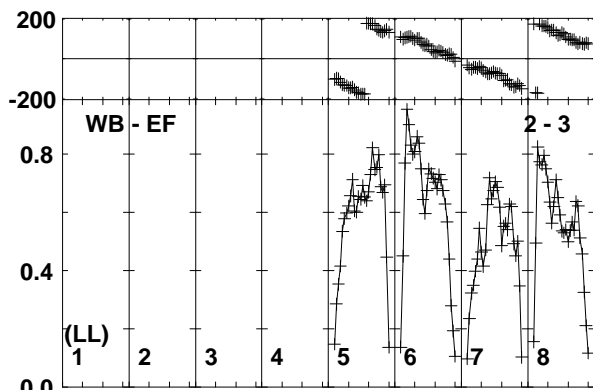
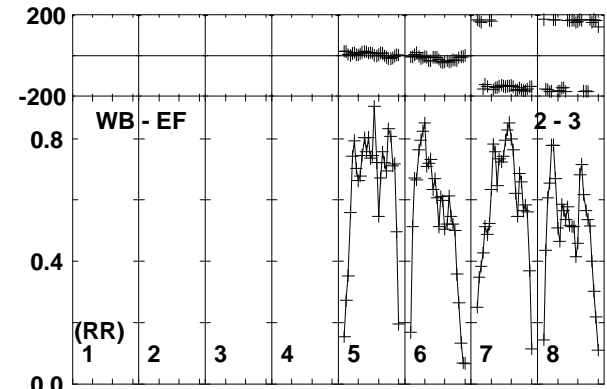
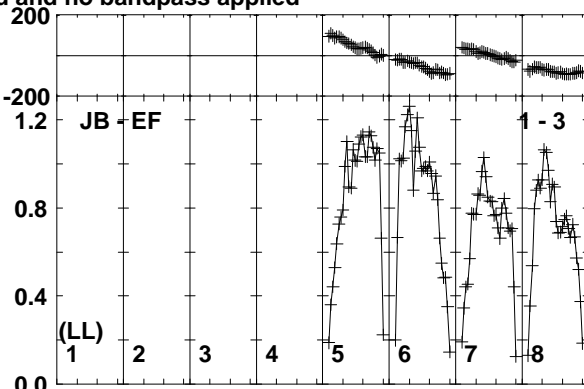
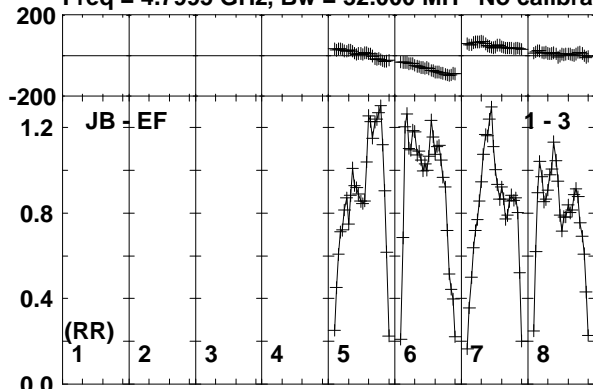

Lower frame: Milli Ampl Jy Top frame: Phas deg
Vector averaged cross-power spectrum Baseline: JB (01) - EF (03)
Timerange: 00/15:55:11 to 00/15:55:59

Plot file version 172 created 03-APR-2017 18:27:42

J1834-2341 EM126B.UVDATA.1

Freq = 4.7995 GHz, Bw = 32.000 MH No calibration applied and no bandpass applied

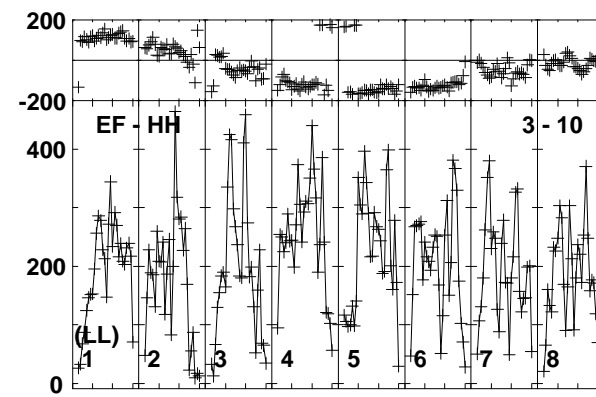
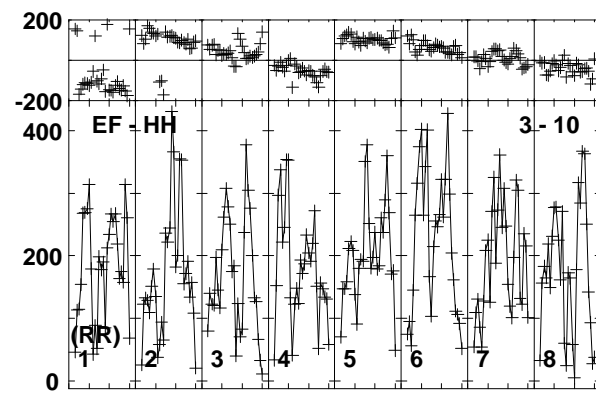
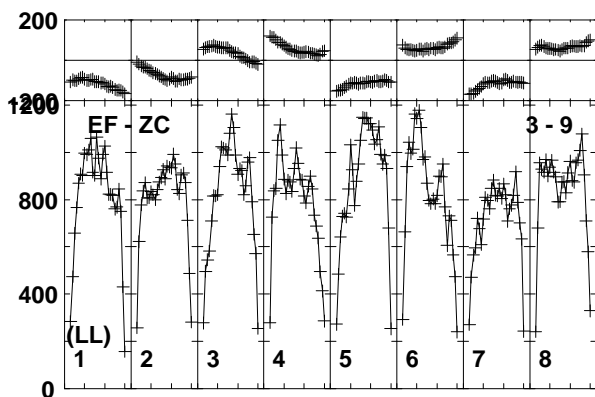
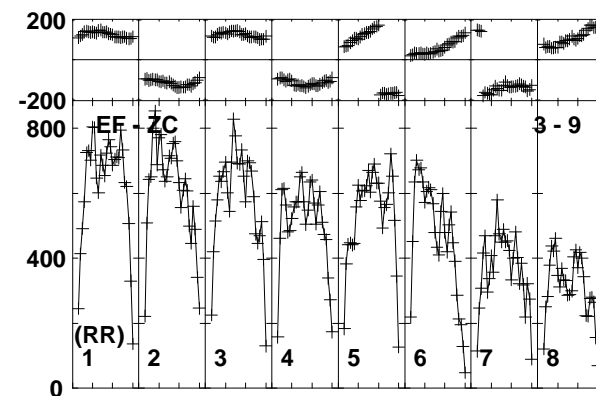
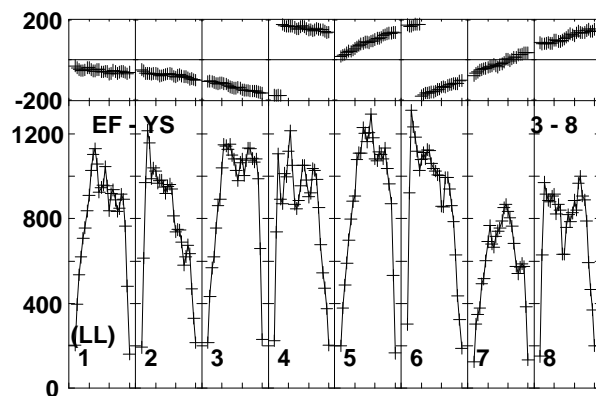
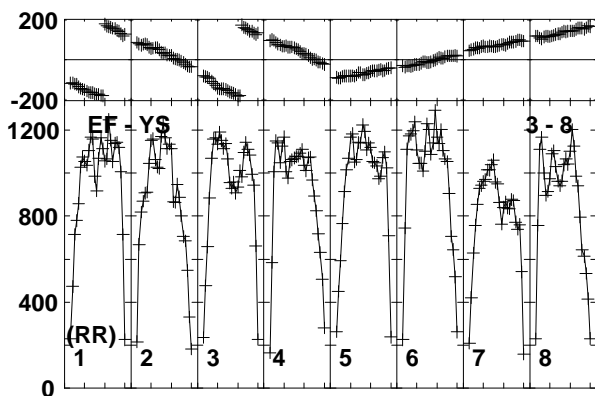
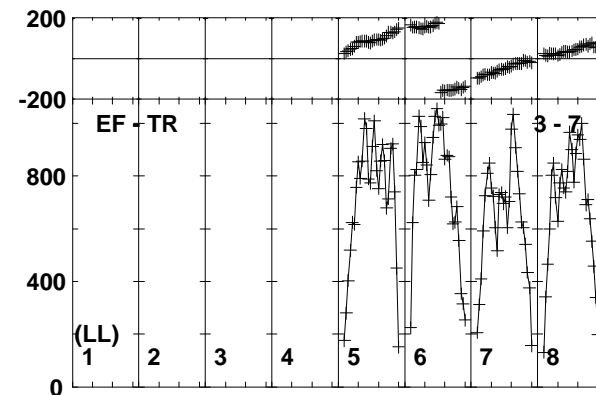
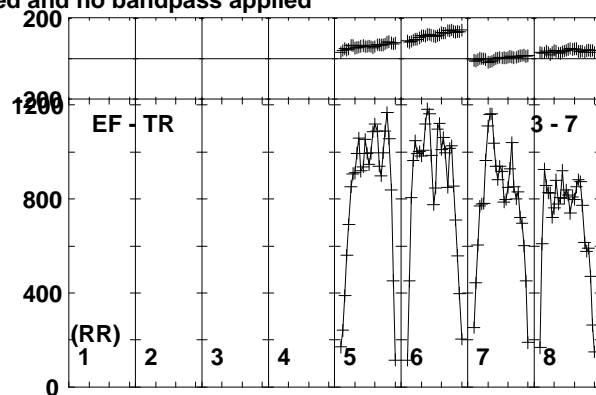
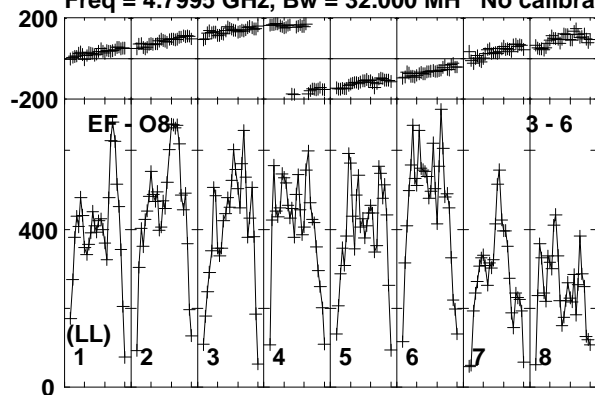

Lower frame: Micro Ampl Jy Top frame: Phas deg
Vector averaged cross-power spectrum Baseline: EF (03) - O8 (06)
Timerange: 00/15:55:11 to 00/15:55:59

Plot file version 173 created 03-APR-2017 18:27:42

M22-VLA1 EM126B.UVDATA.1

Freq = 4.7995 GHz, Bw = 32.000 MH No calibration applied and no bandpass applied

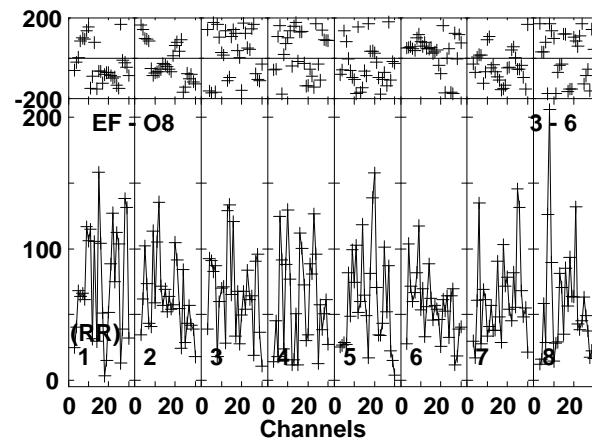
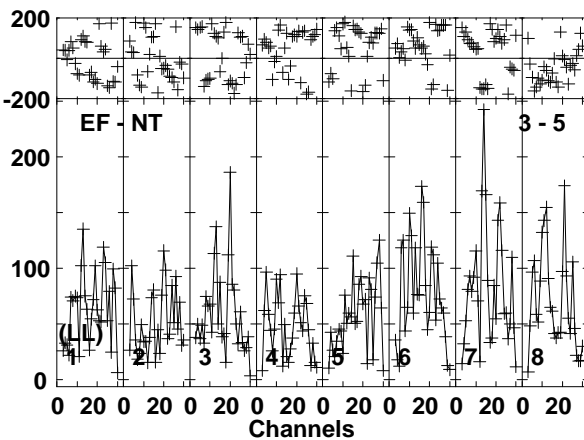
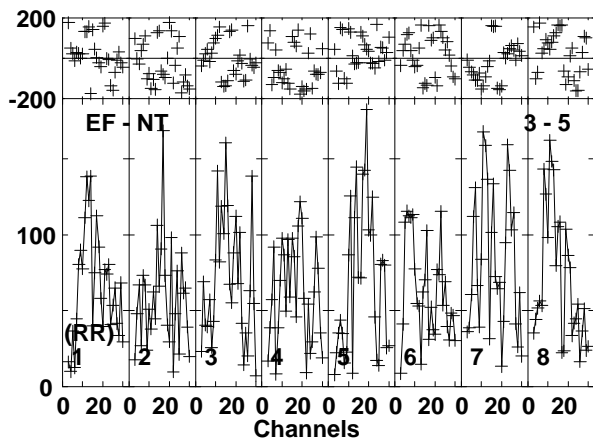
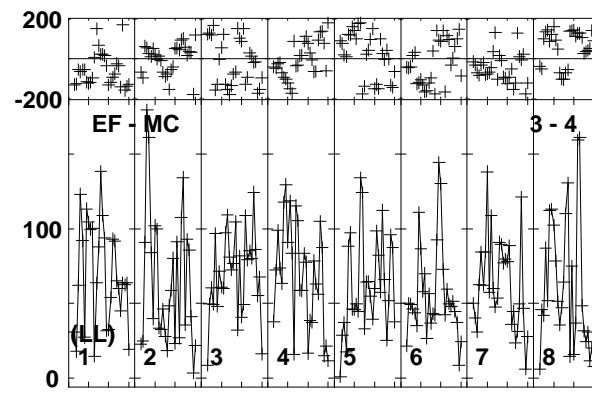
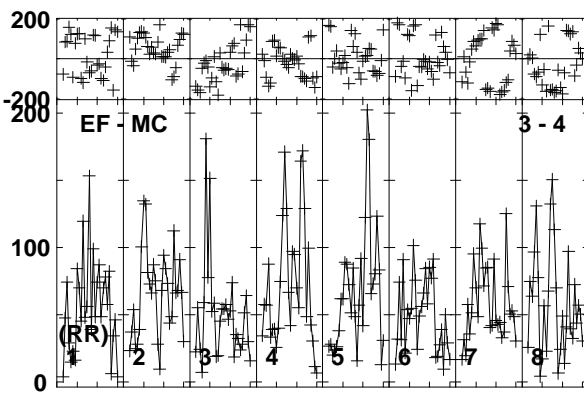
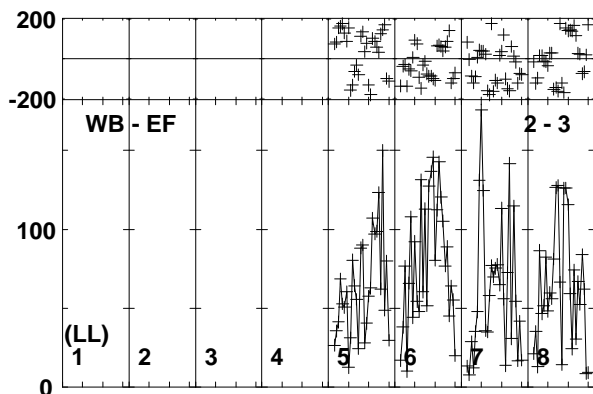
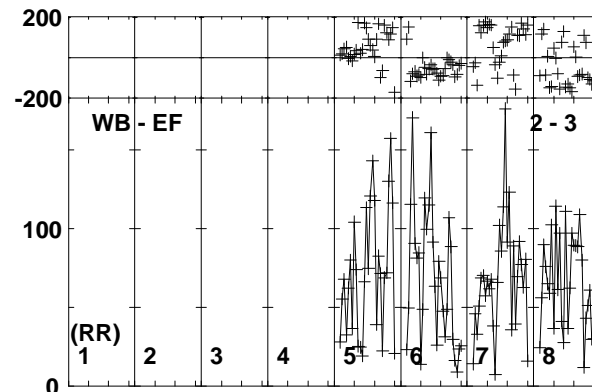
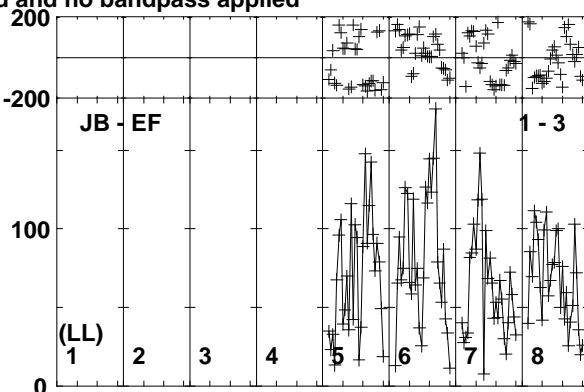
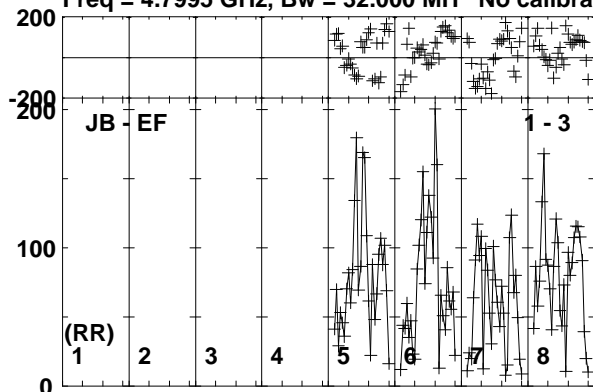

Lower frame: Micro Ampl Jy Top frame: Phas deg
Vector averaged cross-power spectrum Baseline: JB (01) - EF (03)
Timerange: 00/15:56:04 to 00/15:58:08

Plot file version 174 created 03-APR-2017 18:27:42

M22-VLA1 EM126B.UVDATA.1

Freq = 4.7995 GHz, Bw = 32.000 MH No calibration applied and no bandpass applied

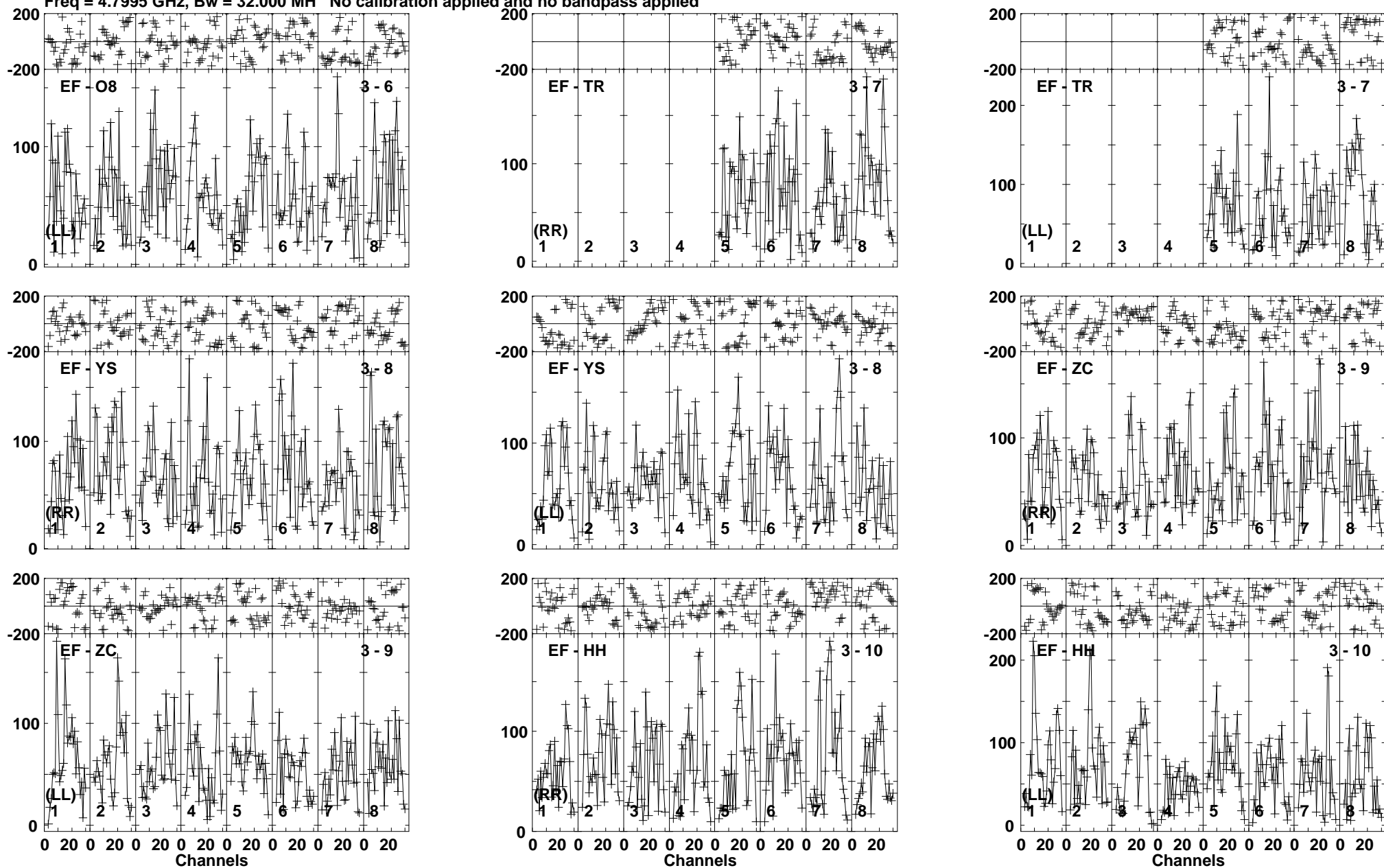

Lower frame: Micro Ampl Jy Top frame: Phas deg
Vector averaged cross-power spectrum Baseline: EF (03) - O8 (06)
Timerange: 00/15:56:04 to 00/15:58:08

Plot file version 175 created 03-APR-2017 18:27:42

J1834-2341 EM126B.UVDATA.1

Freq = 4.7995 GHz, Bw = 32.000 MH No calibration applied and no bandpass applied

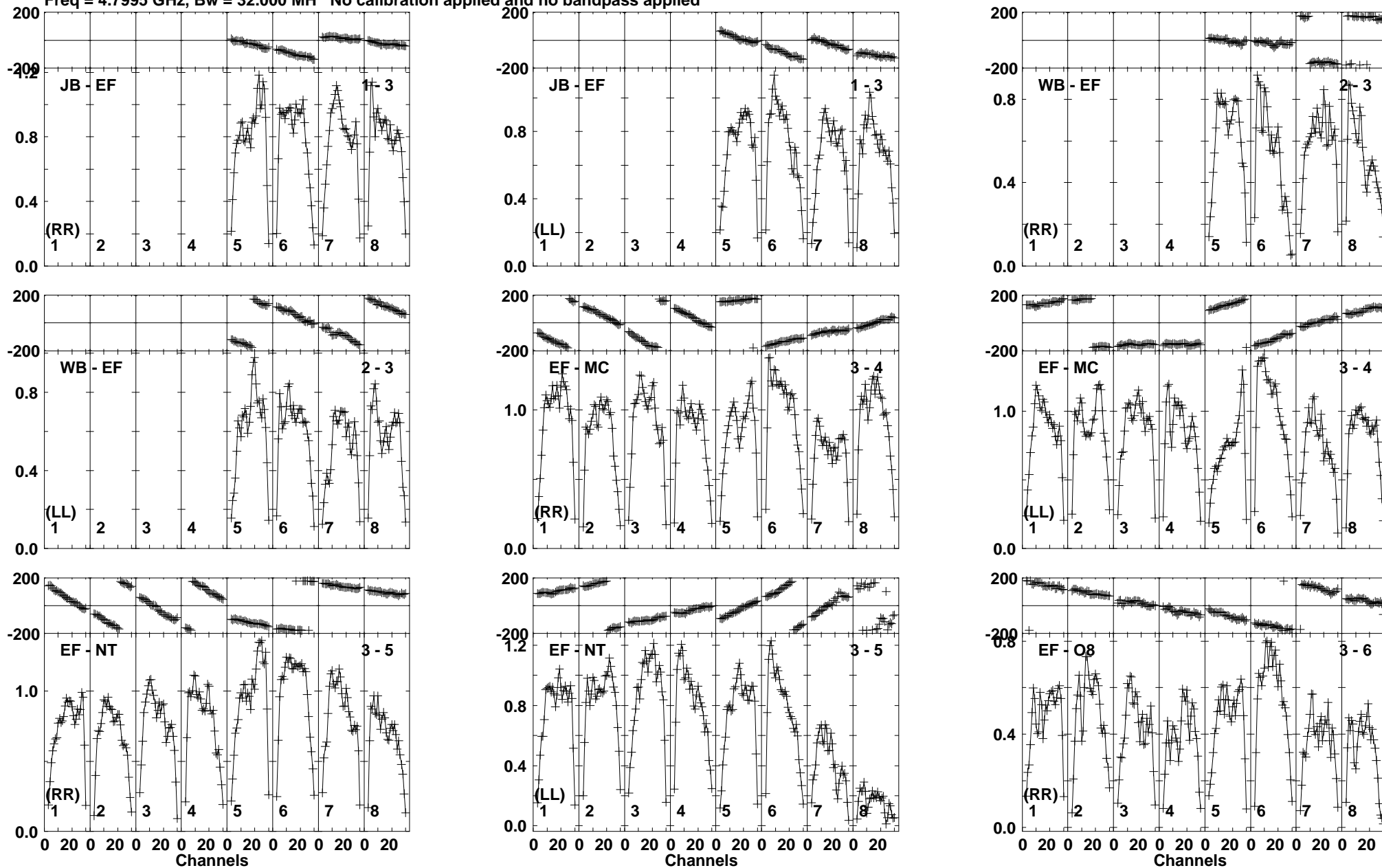

Lower frame: Milli Ampl Jy Top frame: Phas deg
Vector averaged cross-power spectrum Baseline: JB (01) - EF (03)
Timerange: 00/15:58:14 to 00/15:59:28

Plot file version 176 created 03-APR-2017 18:27:42

J1834-2341 EM126B.UVDATA.1

Freq = 4.7995 GHz, Bw = 32.000 MH No calibration applied and no bandpass applied

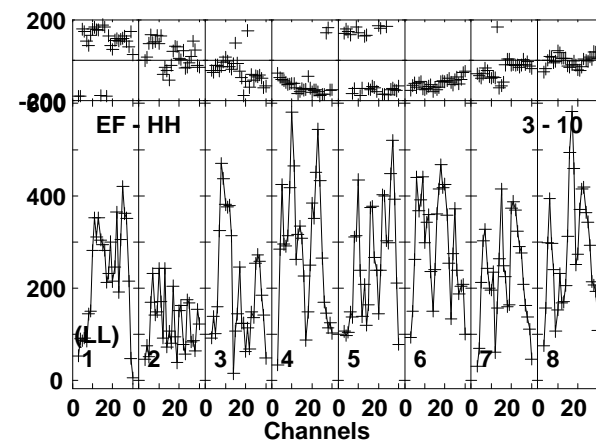
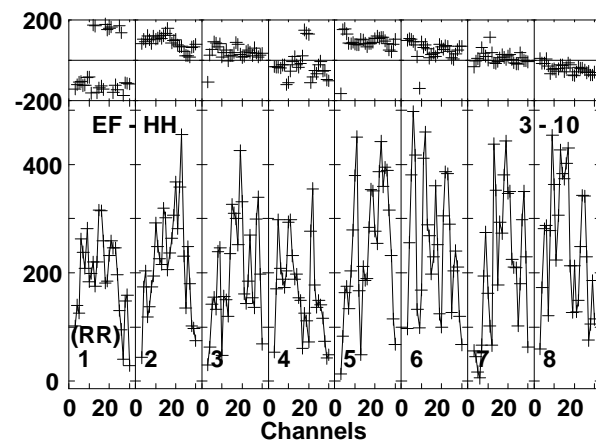
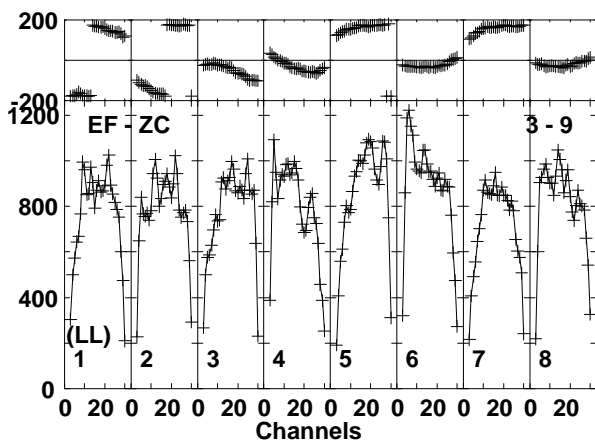
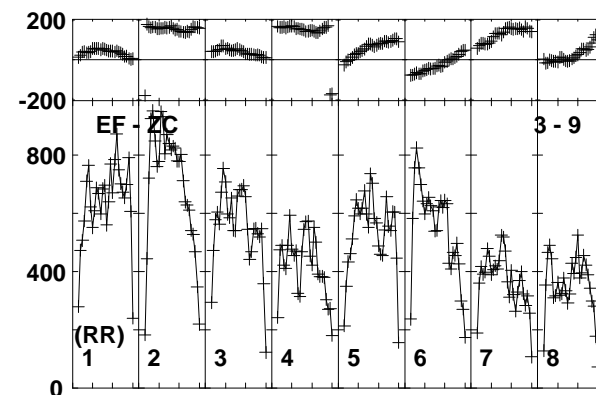
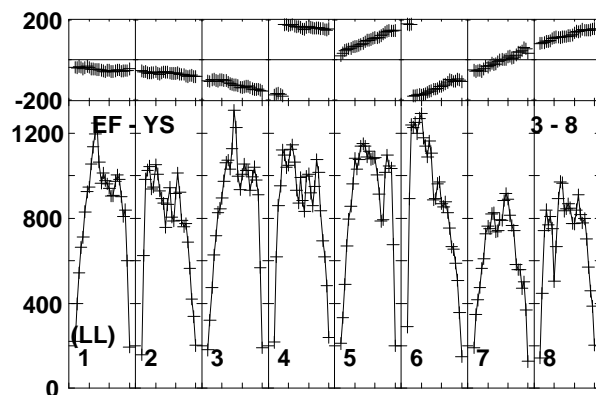
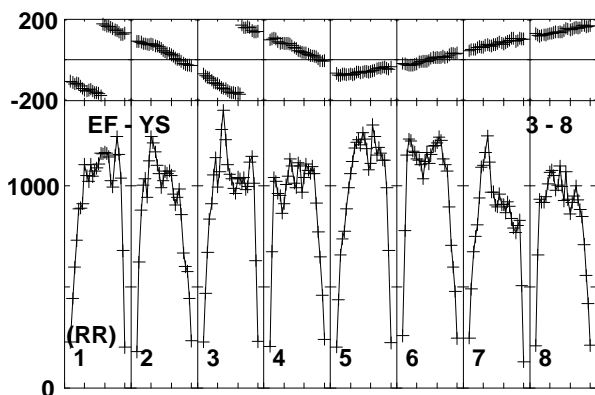
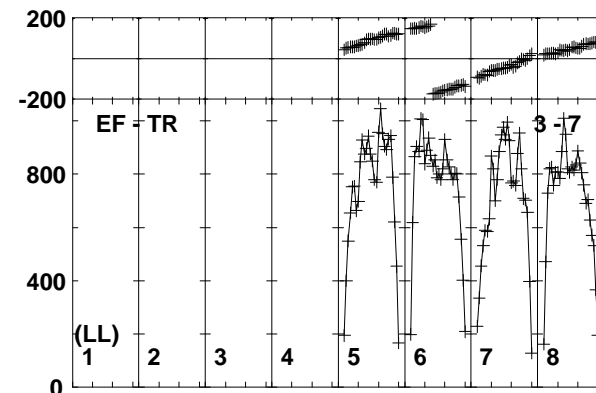
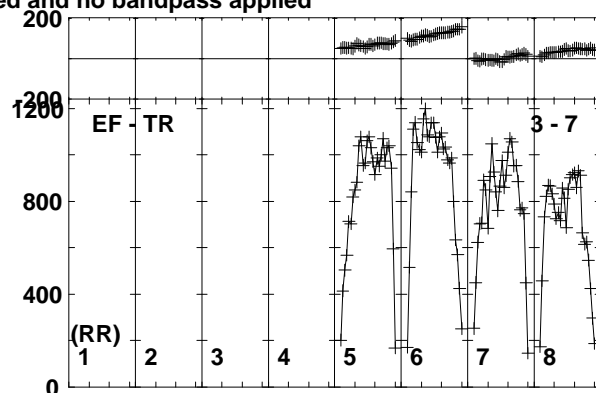
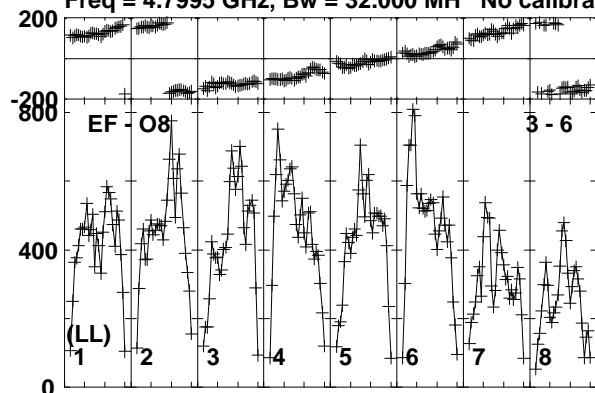

Lower frame: Micro Ampl Jy Top frame: Phas deg
Vector averaged cross-power spectrum Baseline: EF (03) - O8 (06)
Timerange: 00/15:58:14 to 00/15:59:28

Plot file version 177 created 03-APR-2017 18:27:42

M22-VLA1 EM126B.UVDATA.1

Freq = 4.7995 GHz, Bw = 32.000 MH No calibration applied and no bandpass applied

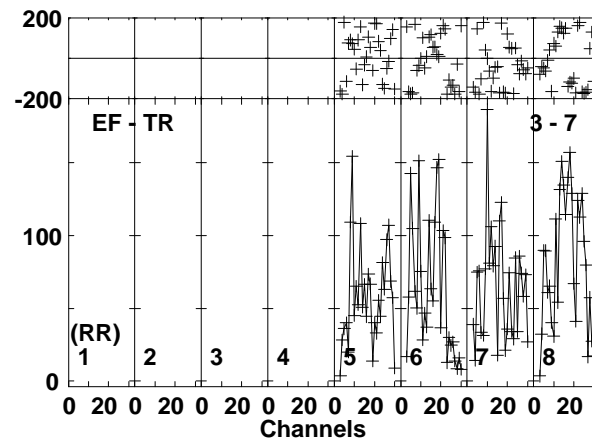
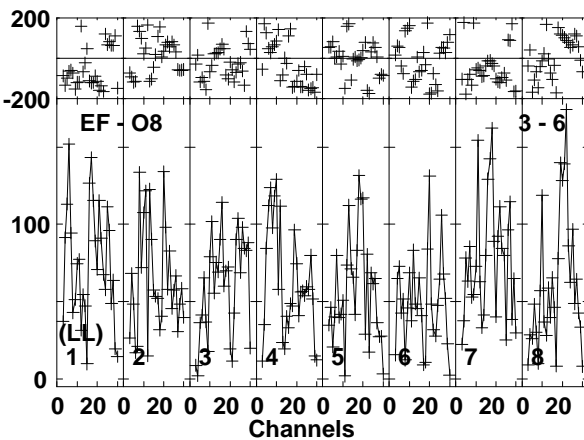
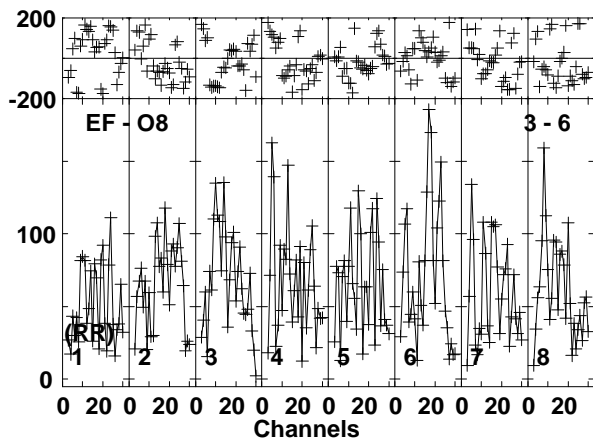
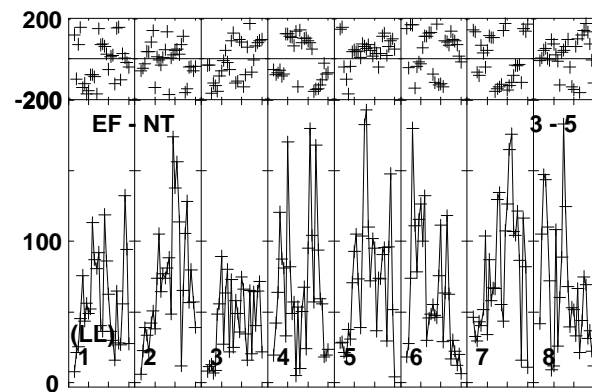
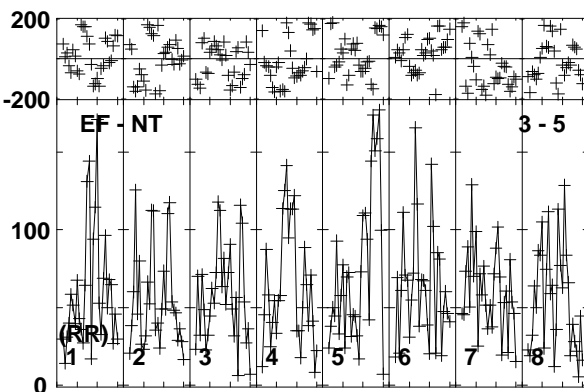
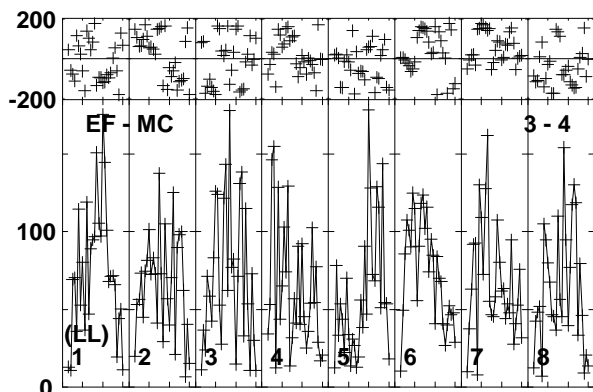
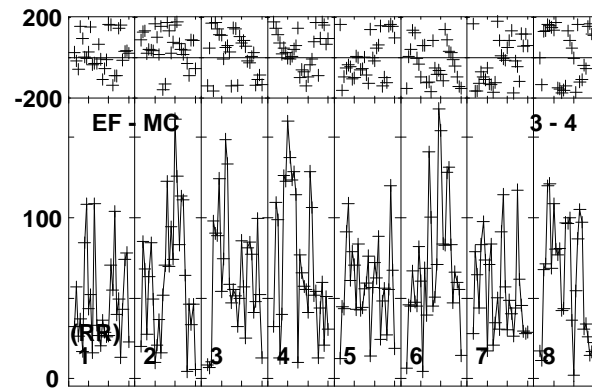
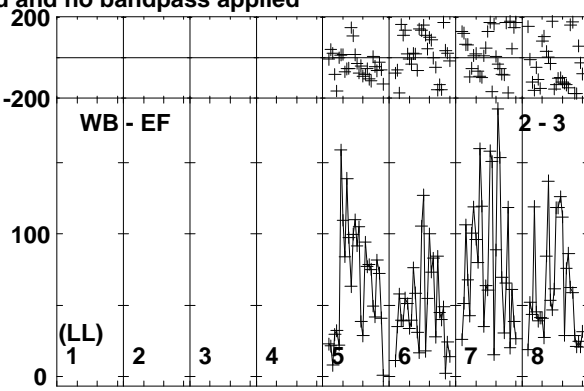
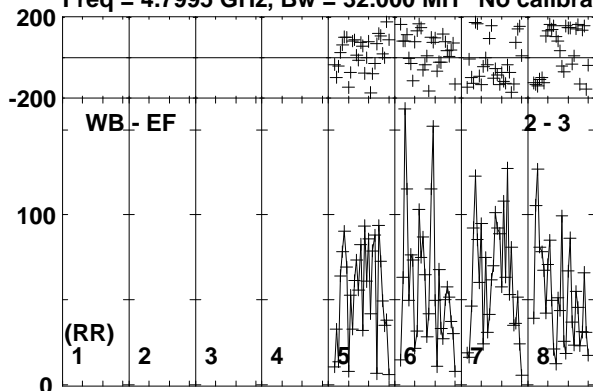

Lower frame: Micro Ampl Jy Top frame: Phas deg
Vector averaged cross-power spectrum Baseline: WB (02) - EF (03)
Timerange: 00/15:59:34 to 00/16:01:38

Plot file version 178 created 03-APR-2017 18:27:42

M22-VLA1 EM126B.UVDATA.1

Freq = 4.7995 GHz, Bw = 32.000 MH No calibration applied and no bandpass applied

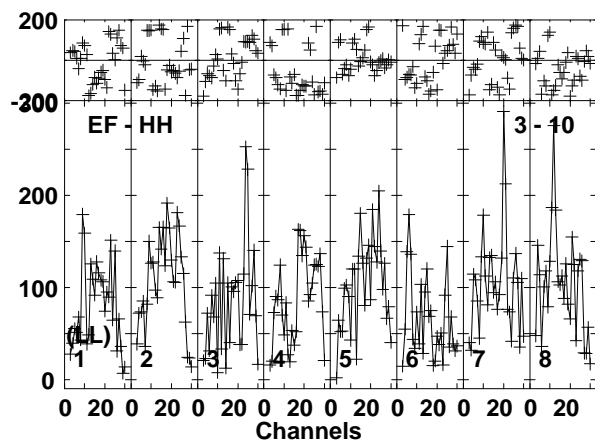
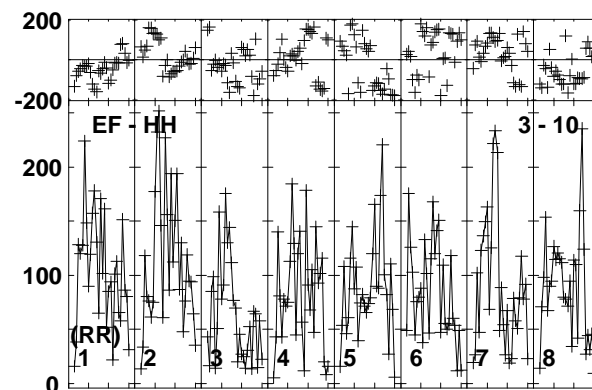
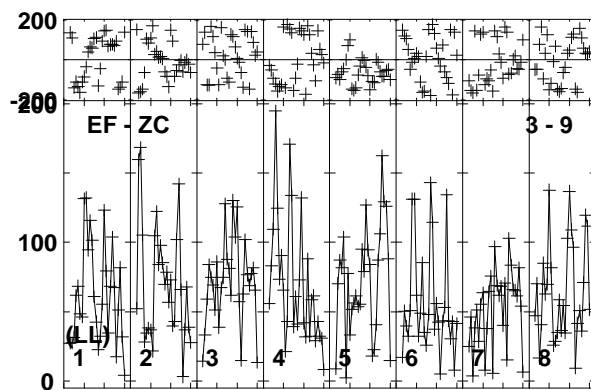
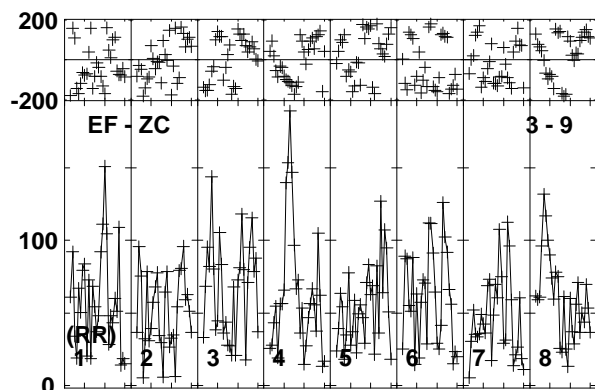
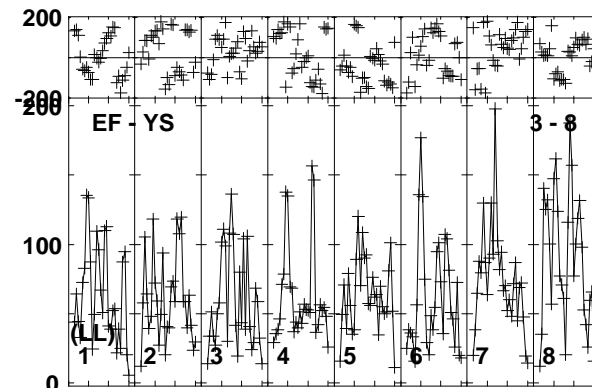
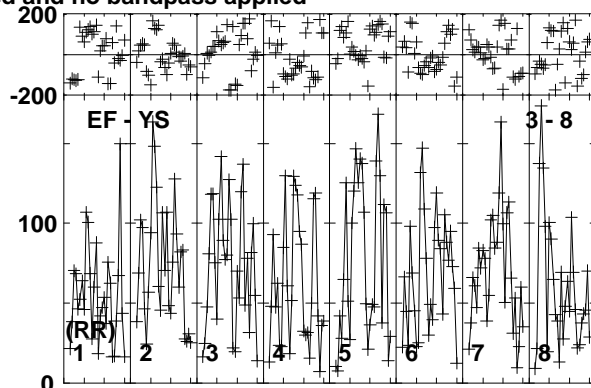
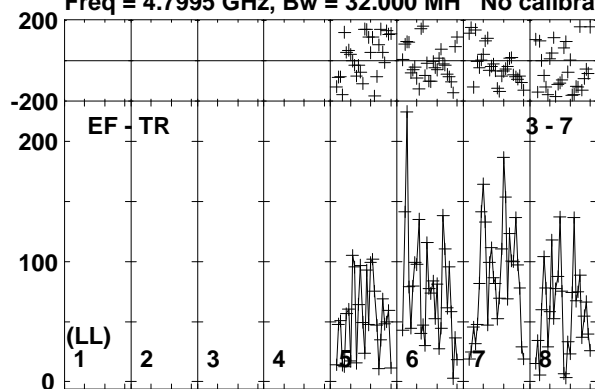

Lower frame: Micro Ampl Jy Top frame: Phas deg
Vector averaged cross-power spectrum Baseline: EF (03) - TR (07)
Timerange: 00/15:59:34 to 00/16:01:38

Plot file version 179 created 03-APR-2017 18:27:42

J1834-2341 EM126B.UVDATA.1

Freq = 4.7995 GHz, Bw = 32.000 MH No calibration applied and no bandpass applied

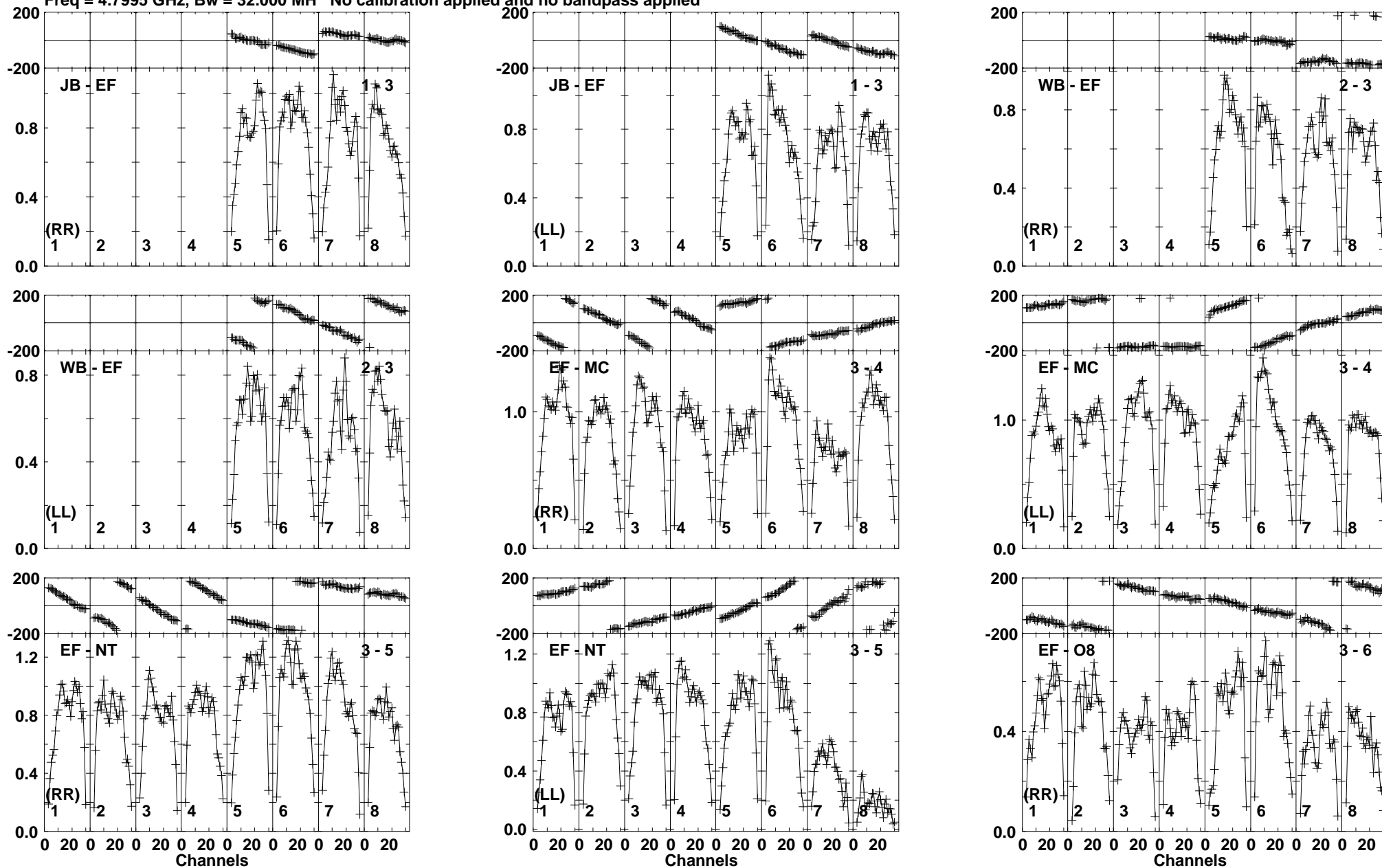

Lower frame: Milli Ampl Jy Top frame: Phas deg
Vector averaged cross-power spectrum Baseline: JB (01) - EF (03)
Timerange: 00/16:01:44 to 00/16:02:58

Plot file version 180 created 03-APR-2017 18:27:42

J1834-2341 EM126B.UVDATA.1

Freq = 4.7995 GHz, Bw = 32.000 MH No calibration applied and no bandpass applied

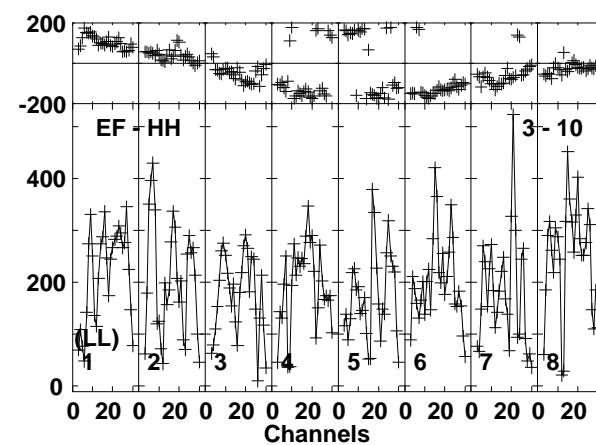
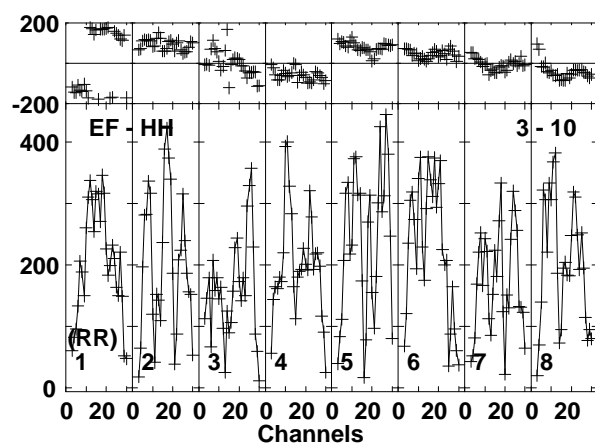
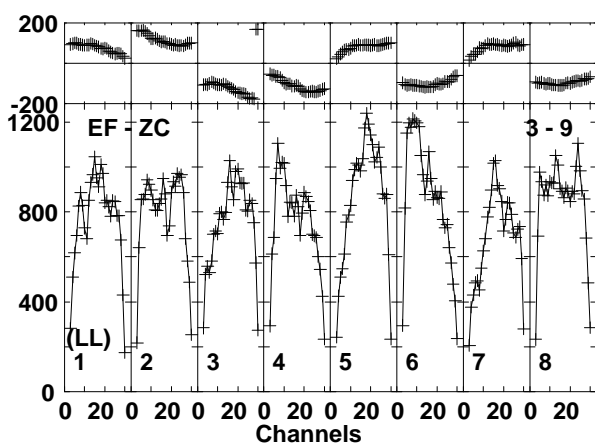
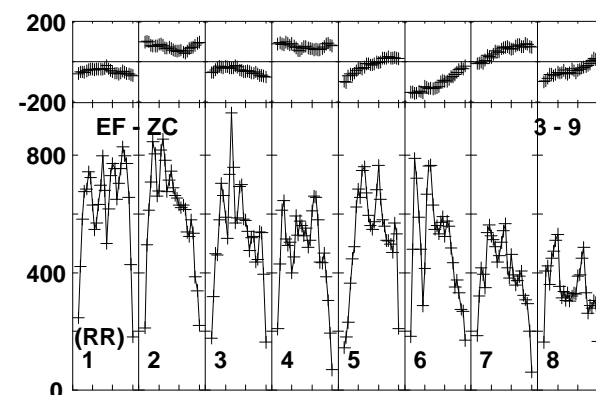
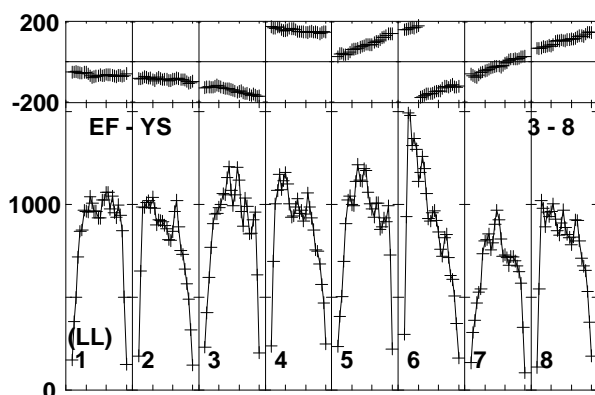
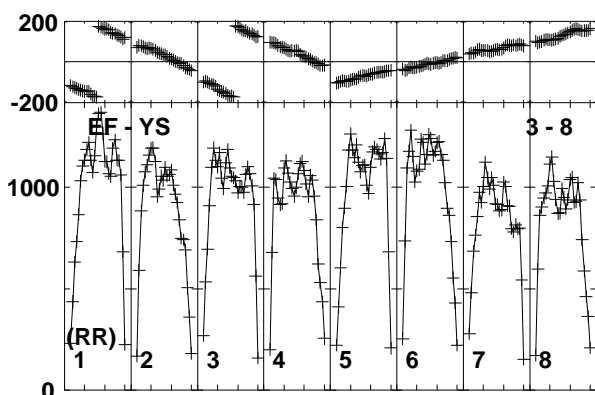
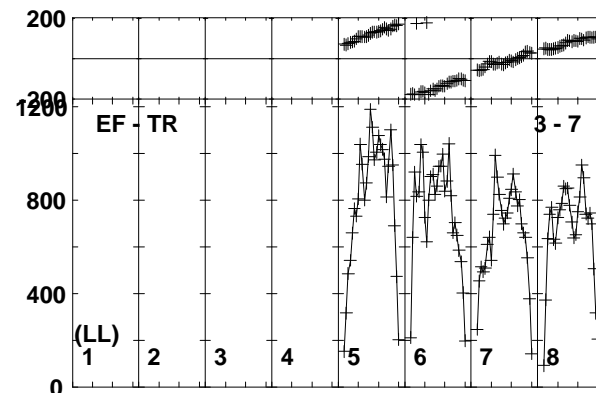
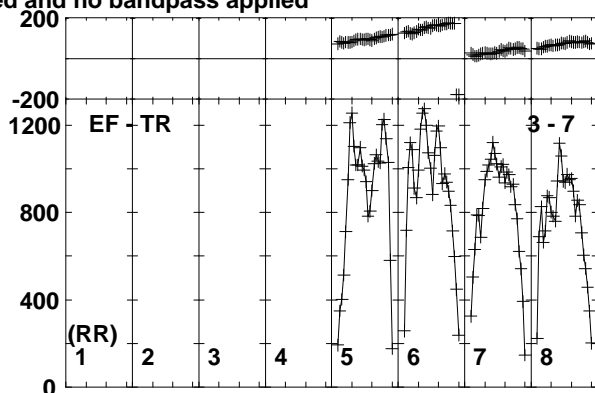
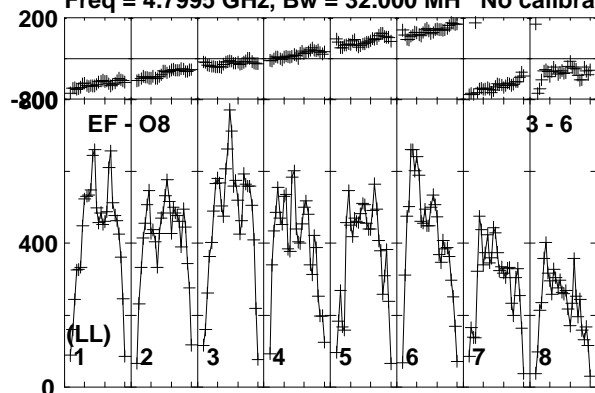

Lower frame: Micro Ampl Jy Top frame: Phas deg
Vector averaged cross-power spectrum Baseline: EF (03) - O8 (06)
Timerange: 00/16:01:44 to 00/16:02:58

Plot file version 181 created 03-APR-2017 18:27:42

M22-VLA1 EM126B.UVDATA.1

Freq = 4.7995 GHz, Bw = 32.000 MH No calibration applied and no bandpass applied

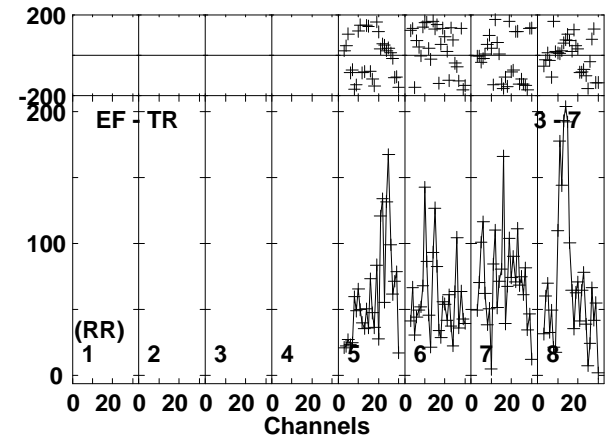
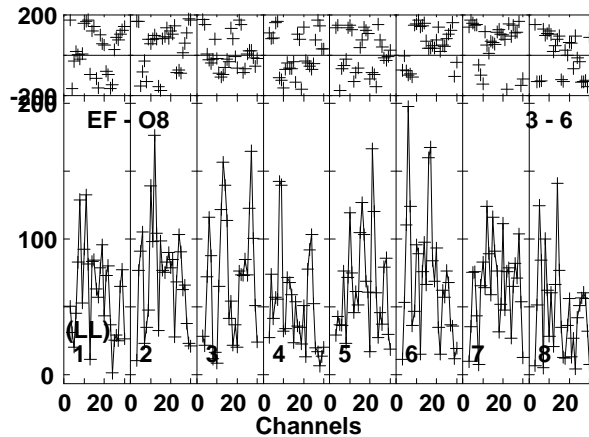
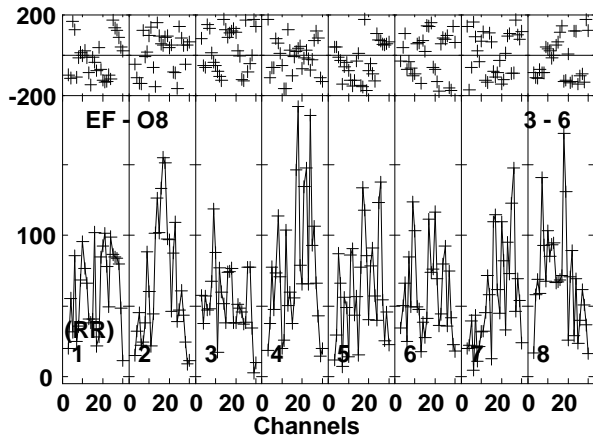
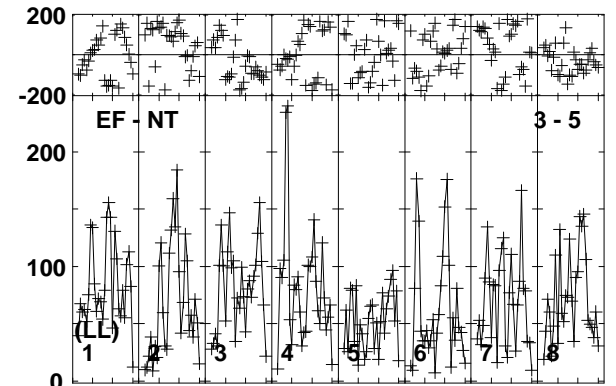
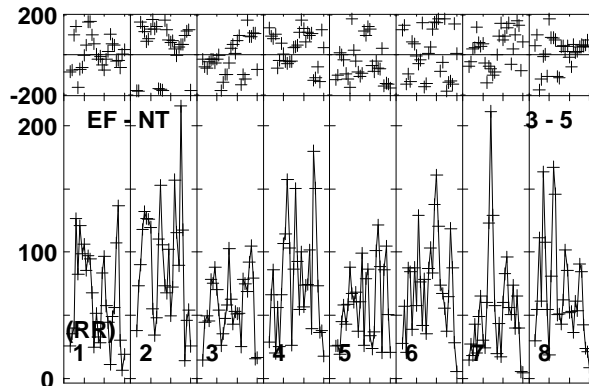
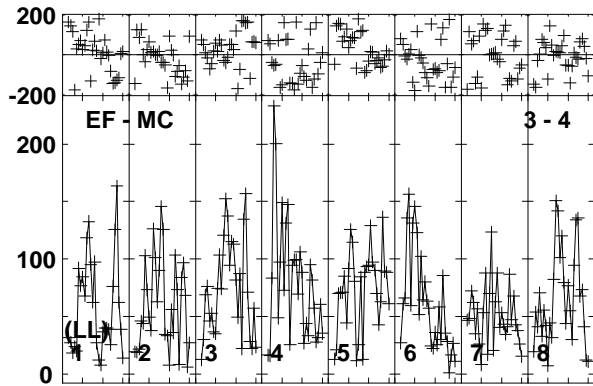
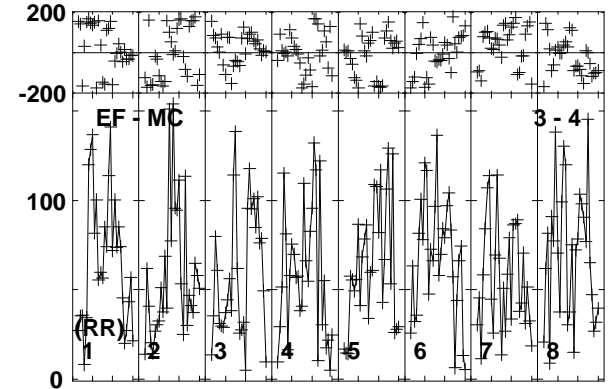
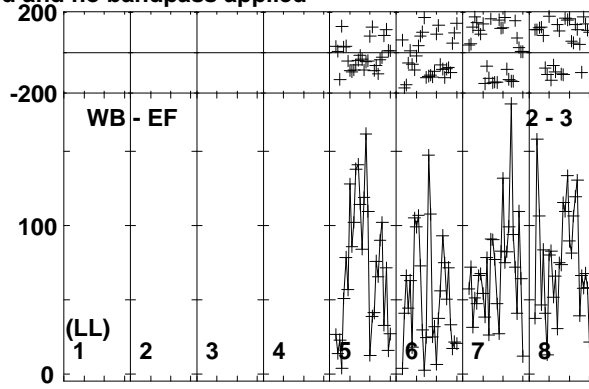
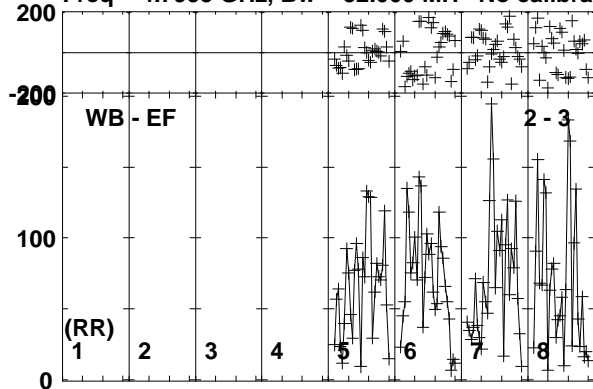

Lower frame: Micro Ampl Jy Top frame: Phas deg
Vector averaged cross-power spectrum Baseline: WB (02) - EF (03)
Timerange: 00/16:03:04 to 00/16:05:08

Plot file version 182 created 03-APR-2017 18:27:42

M22-VLA1 EM126B.UVDATA.1

Freq = 4.7995 GHz, Bw = 32.000 MH No calibration applied and no bandpass applied

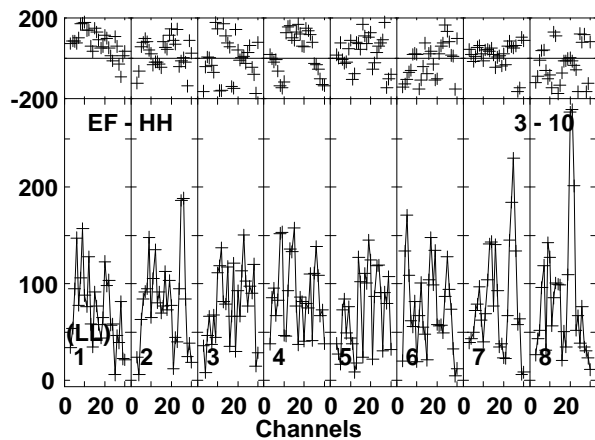
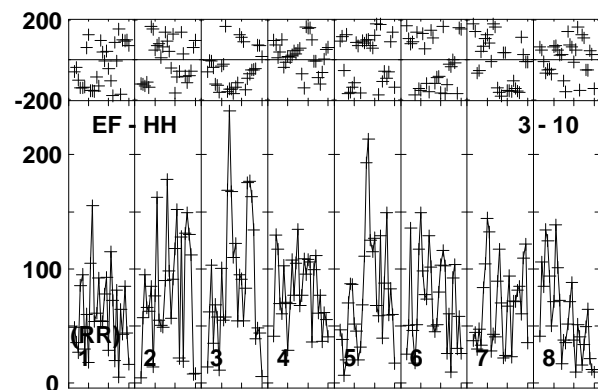
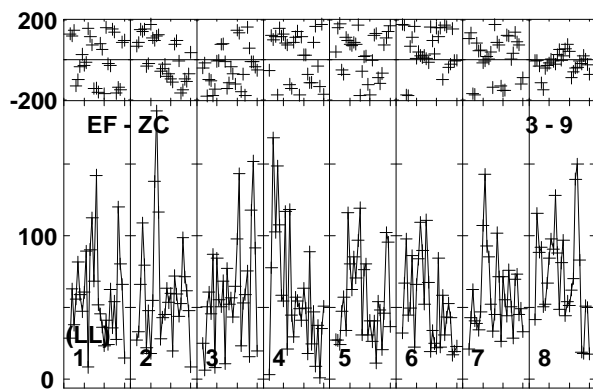
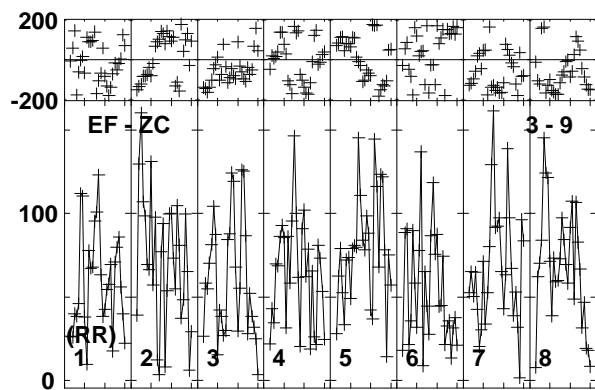
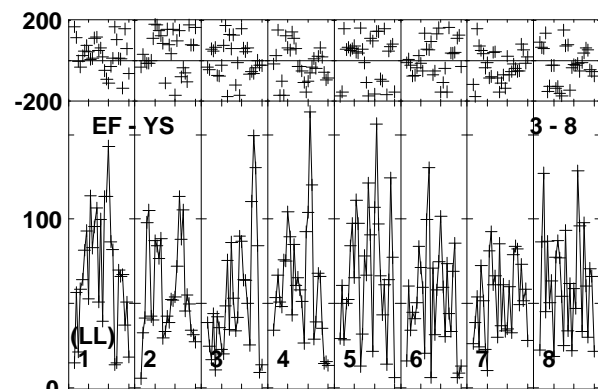
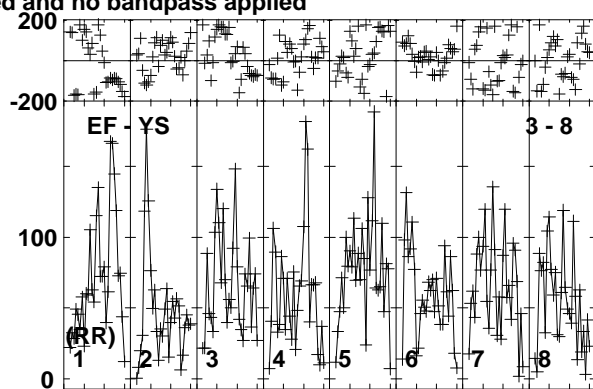
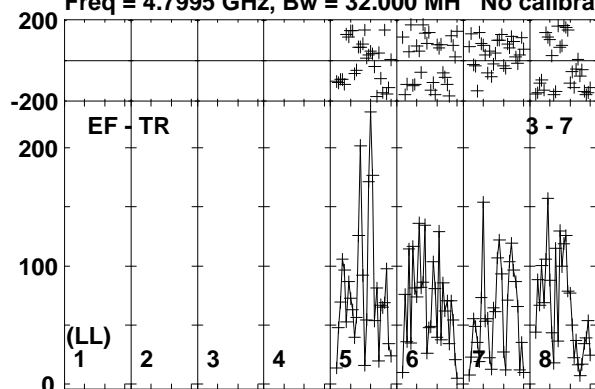

Lower frame: Micro Ampl Jy Top frame: Phas deg
Vector averaged cross-power spectrum Baseline: EF (03) - TR (07)
Timerange: 00/16:03:04 to 00/16:05:08

Plot file version 183 created 03-APR-2017 18:27:42

J1834-2341 EM126B.UVDATA.1

Freq = 4.7995 GHz, Bw = 32.000 MH No calibration applied and no bandpass applied

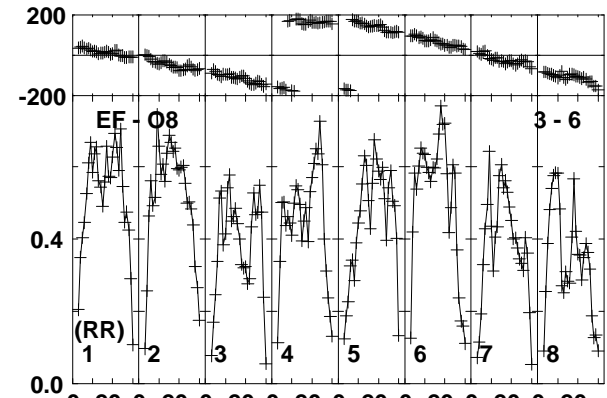
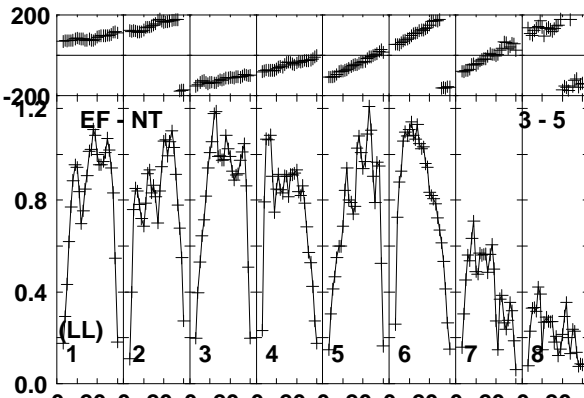
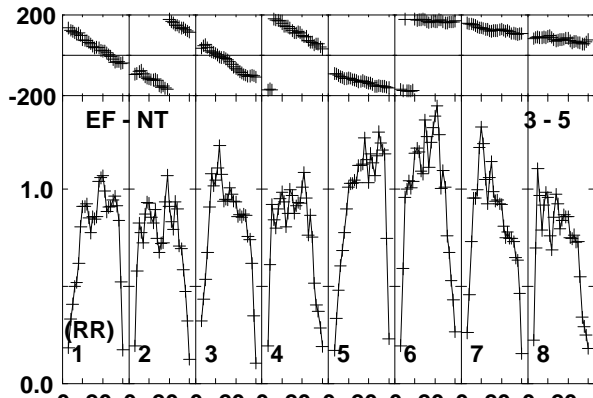
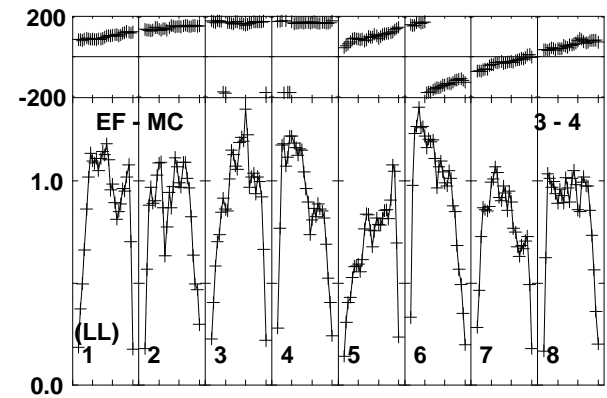
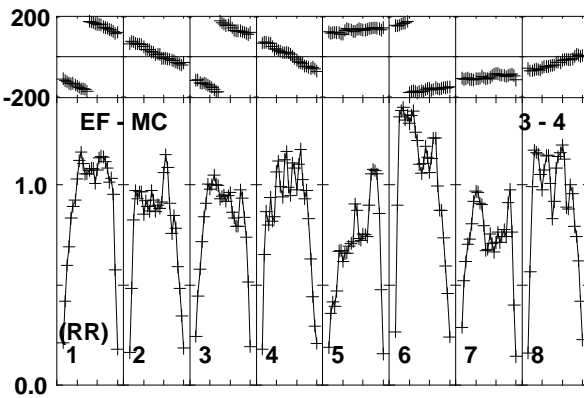
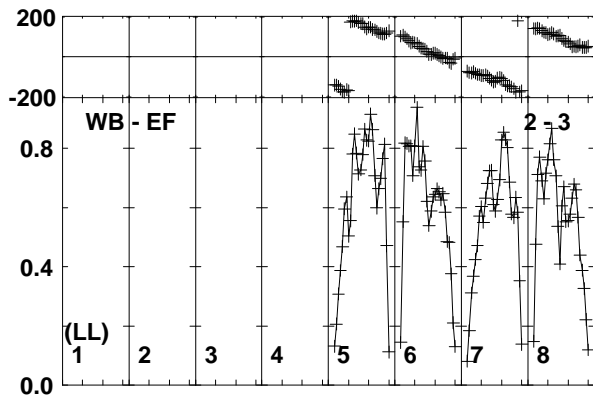
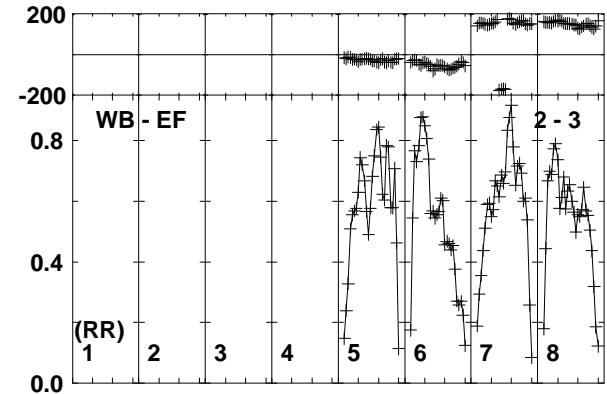
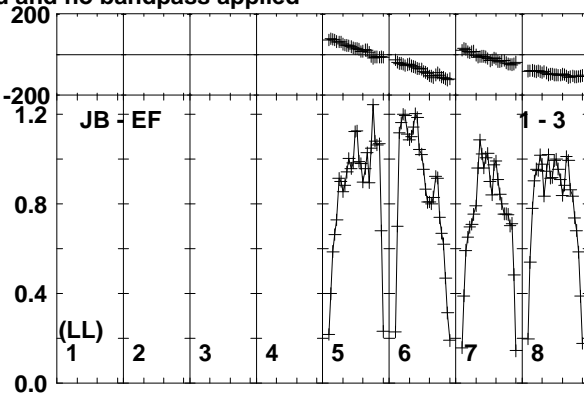
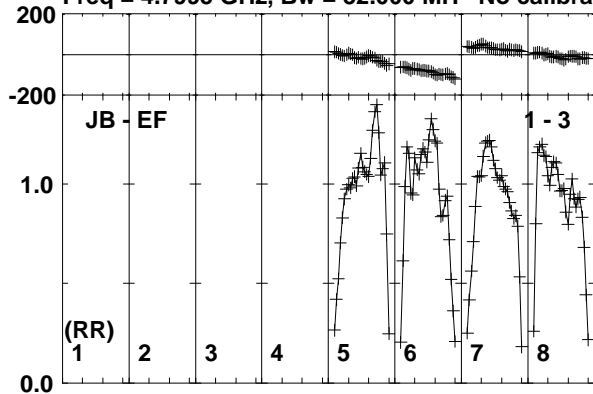

Lower frame: Milli Ampl Jy Top frame: Phas deg
Vector averaged cross-power spectrum Baseline: JB (01) - EF (03)
Timerange: 00/16:05:41 to 00/16:06:29

Plot file version 184 created 03-APR-2017 18:27:42

J1834-2341 EM126B.UVDATA.1

Freq = 4.7995 GHz, Bw = 32.000 MH No calibration applied and no bandpass applied

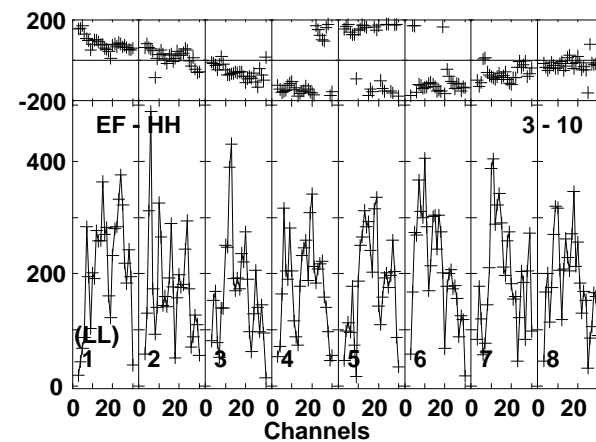
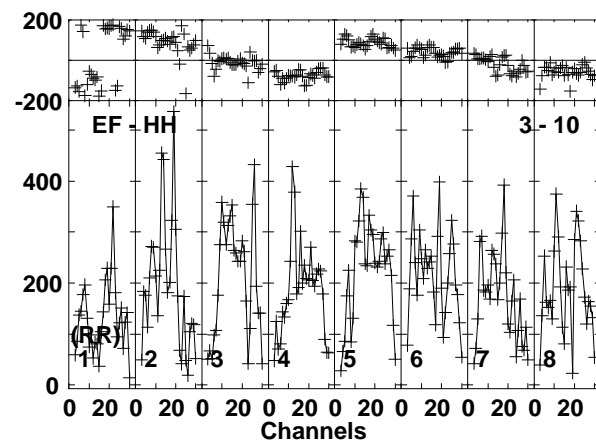
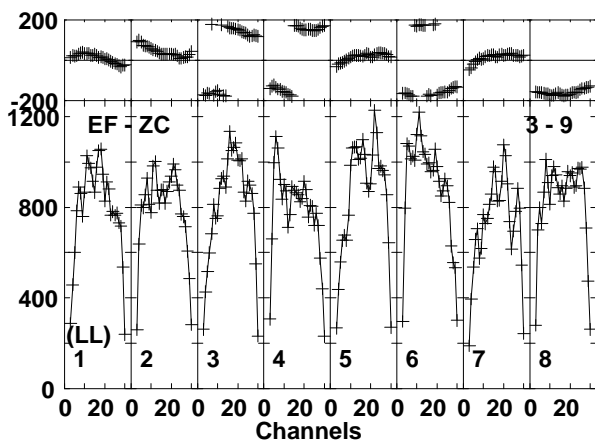
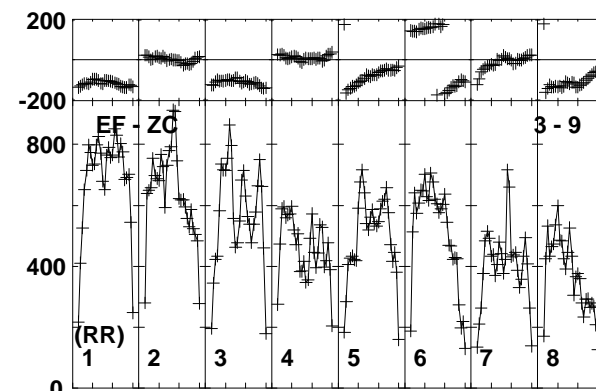
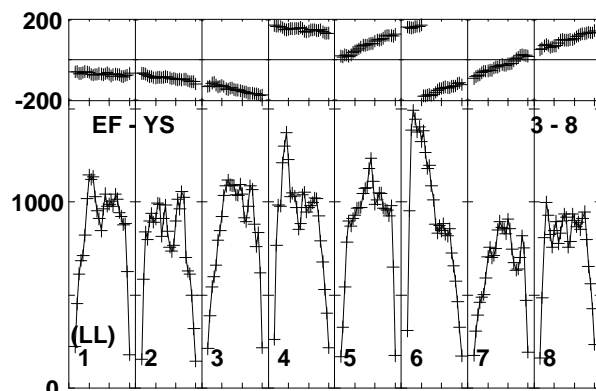
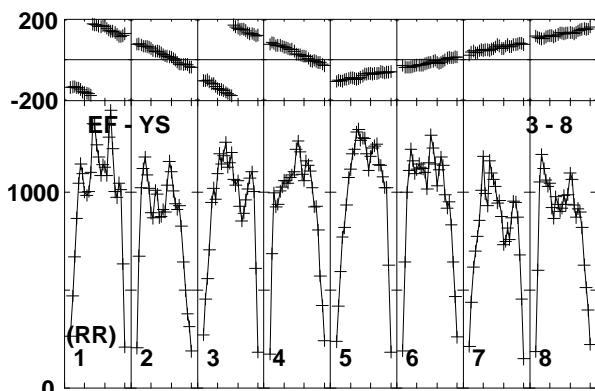
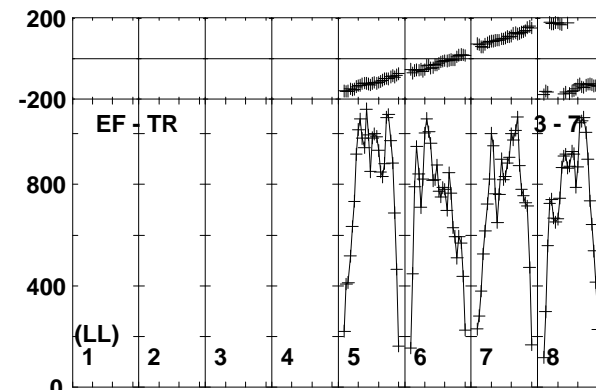
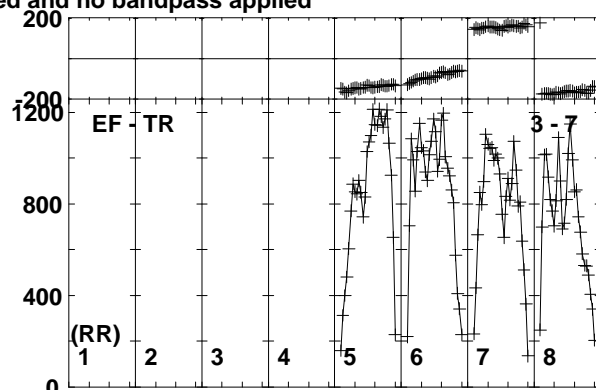
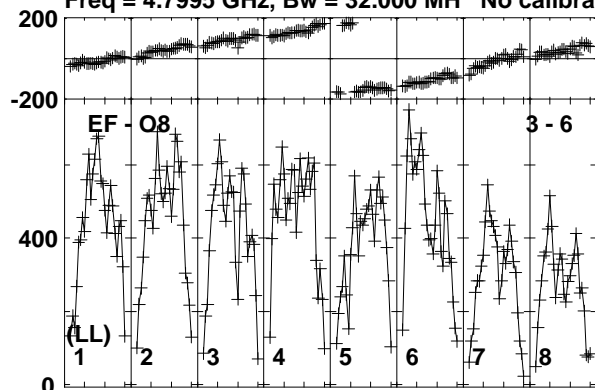

Lower frame: Micro Ampl Jy Top frame: Phas deg
Vector averaged cross-power spectrum Baseline: EF (03) - O8 (06)
Timerange: 00/16:05:41 to 00/16:06:29

Plot file version 185 created 03-APR-2017 18:27:42

M22-VLA1 EM126B.UVDATA.1

Freq = 4.7995 GHz, Bw = 32.000 MH No calibration applied and no bandpass applied

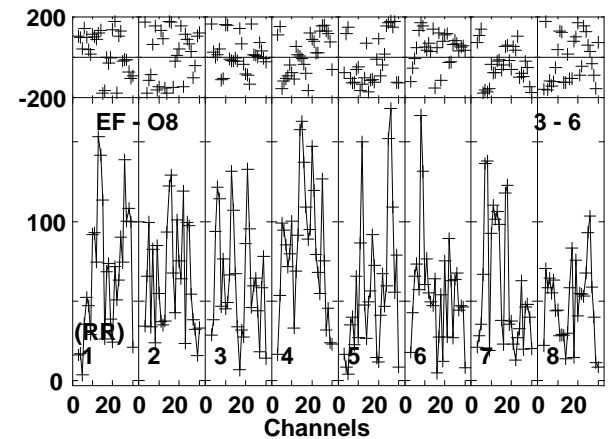
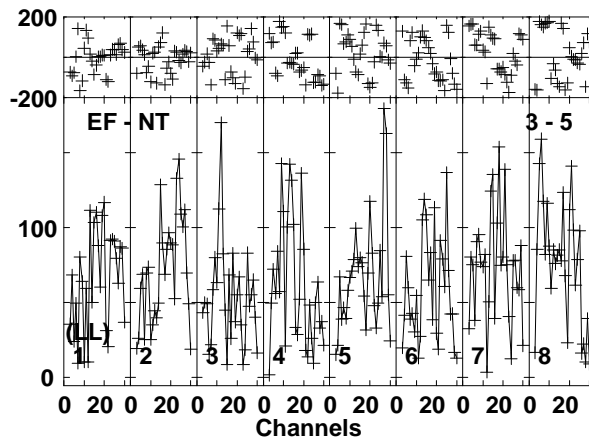
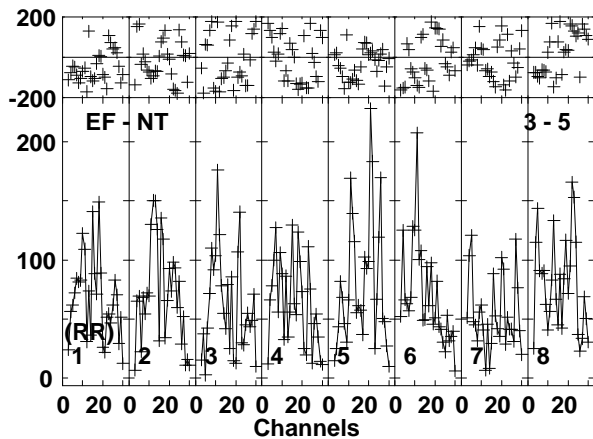
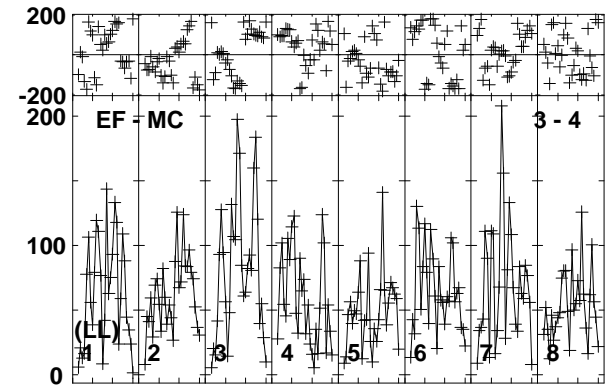
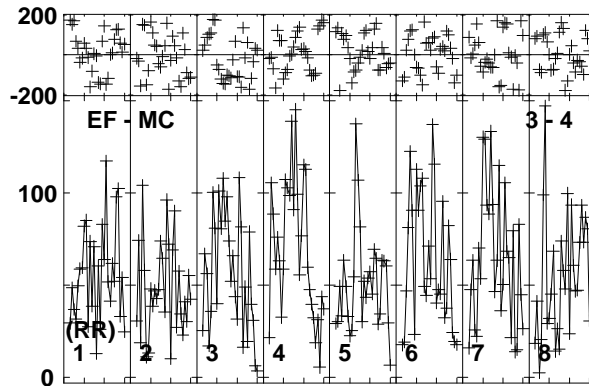
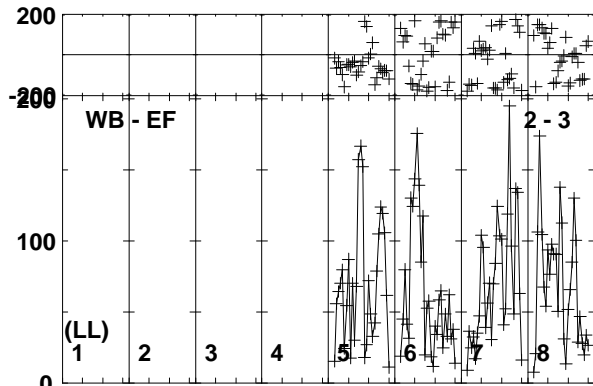
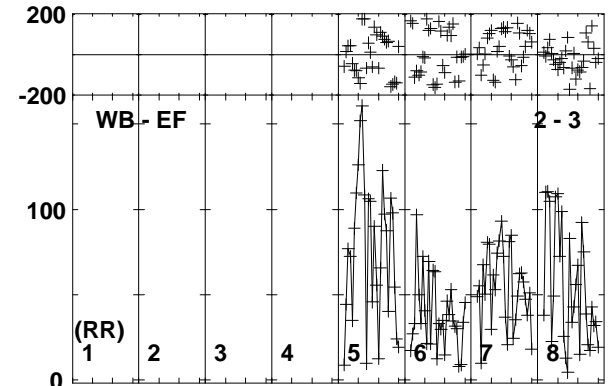
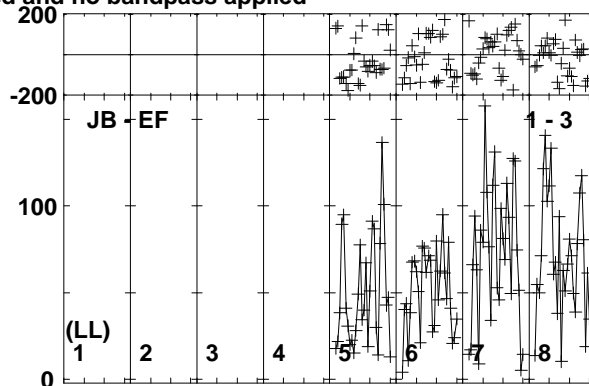
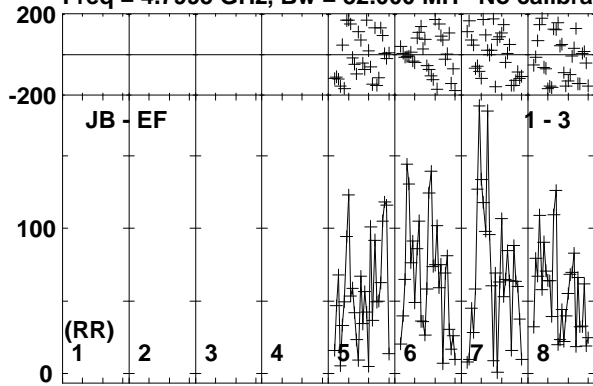

Lower frame: Micro Ampl Jy Top frame: Phas deg
Vector averaged cross-power spectrum Baseline: JB (01) - EF (03)
Timerange: 00/16:06:34 to 00/16:08:38

Plot file version 186 created 03-APR-2017 18:27:42

M22-VLA1 EM126B.UVDATA.1

Freq = 4.7995 GHz, Bw = 32.000 MH No calibration applied and no bandpass applied

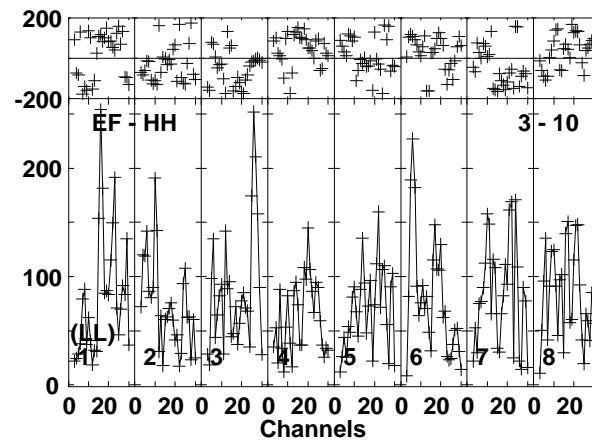
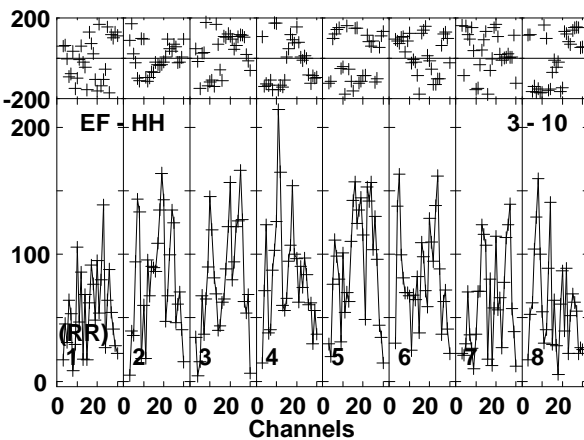
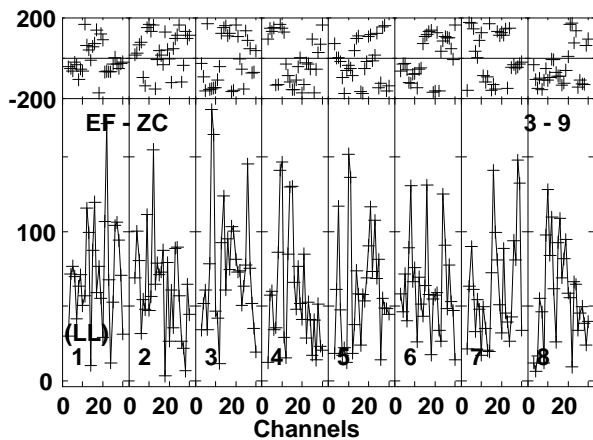
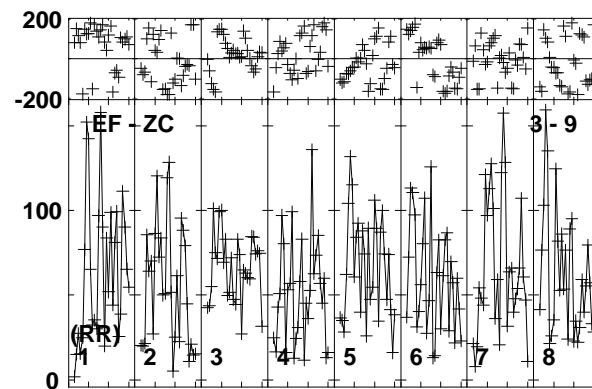
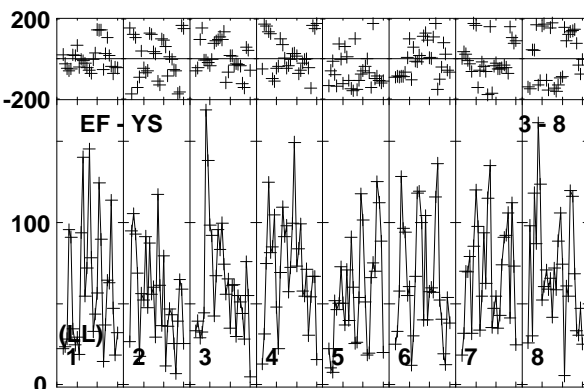
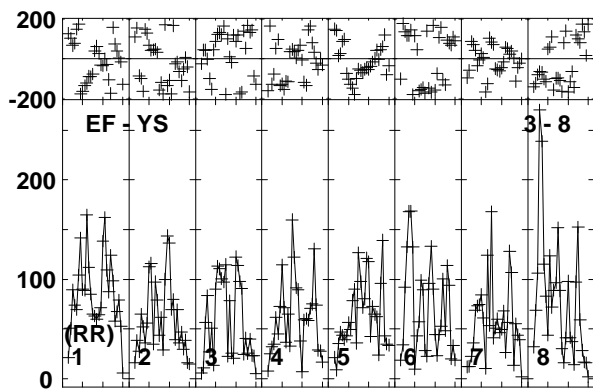
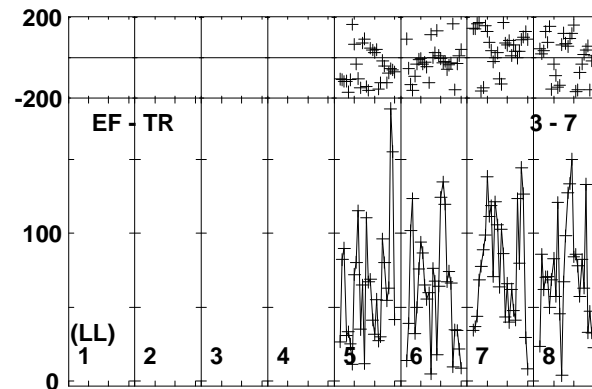
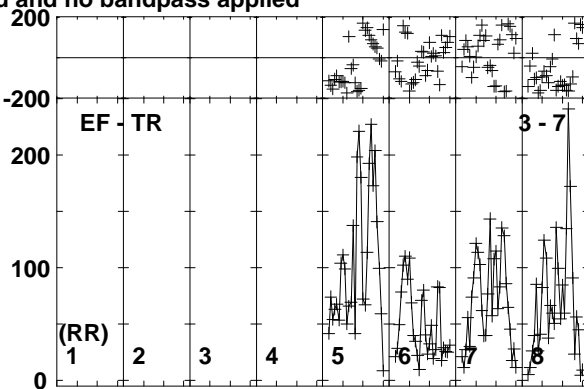
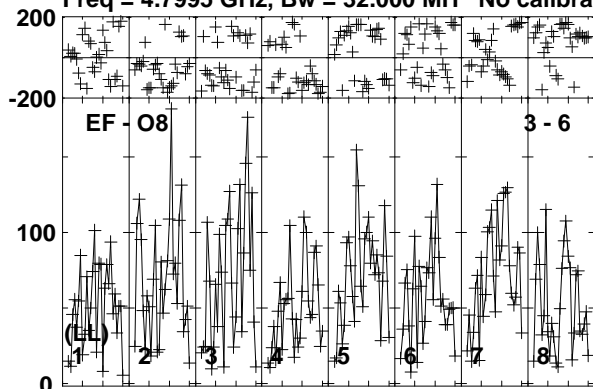

Lower frame: Micro Ampl Jy Top frame: Phas deg
Vector averaged cross-power spectrum Baseline: EF (03) - O8 (06)
Timerange: 00/16:06:34 to 00/16:08:38

Plot file version 187 created 03-APR-2017 18:27:42

J1834-2341 EM126B.UVDATA.1

Freq = 4.7995 GHz, Bw = 32.000 MH No calibration applied and no bandpass applied

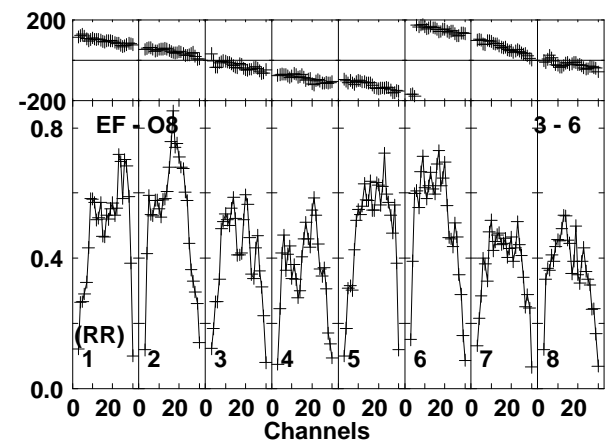
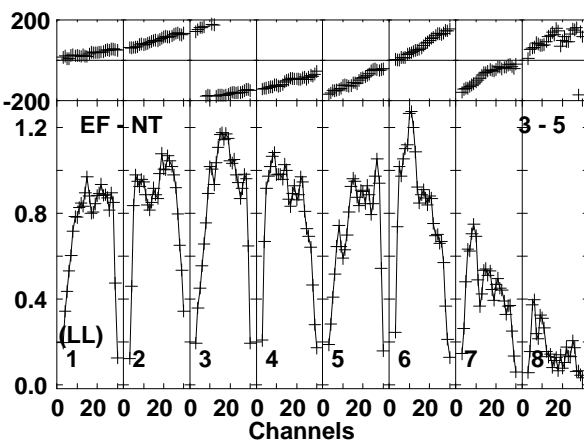
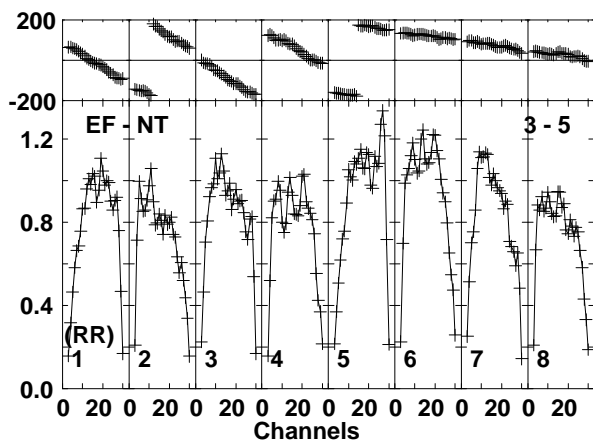
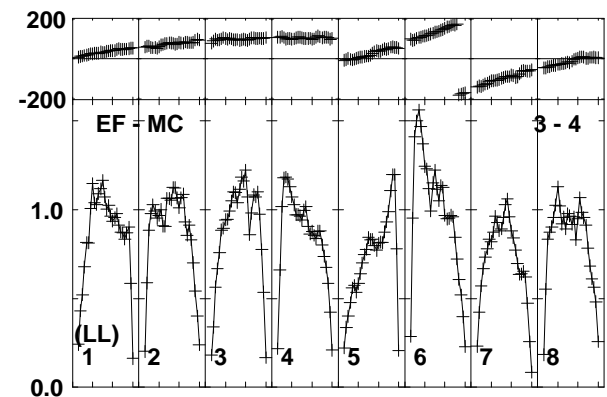
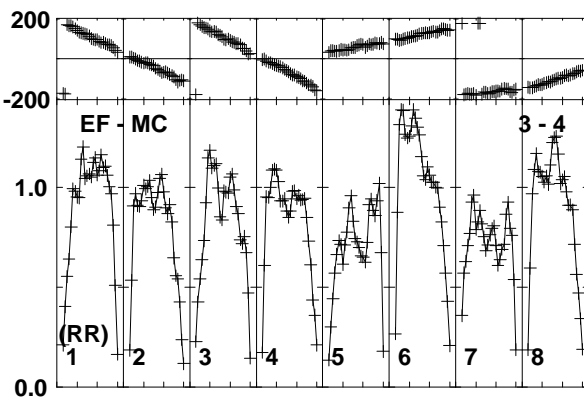
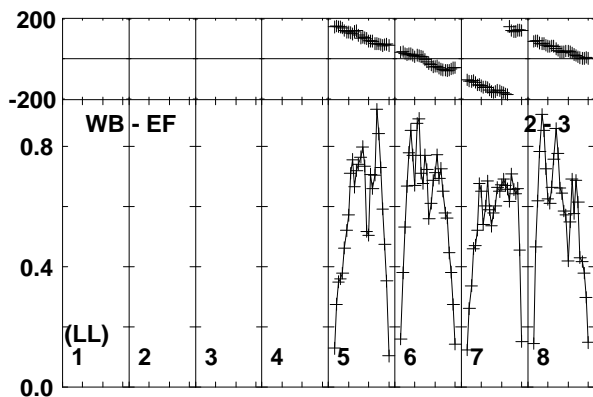
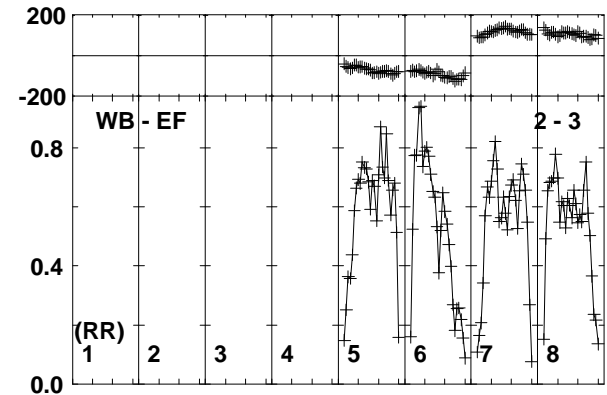
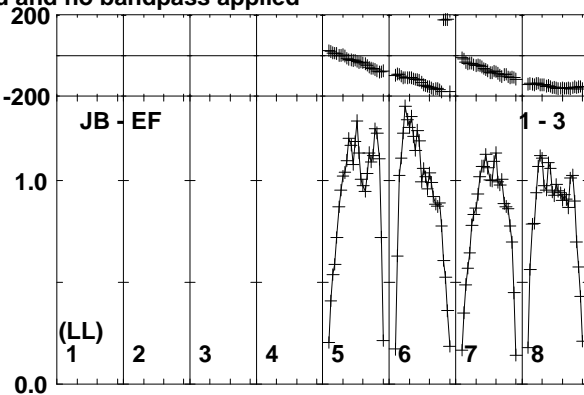
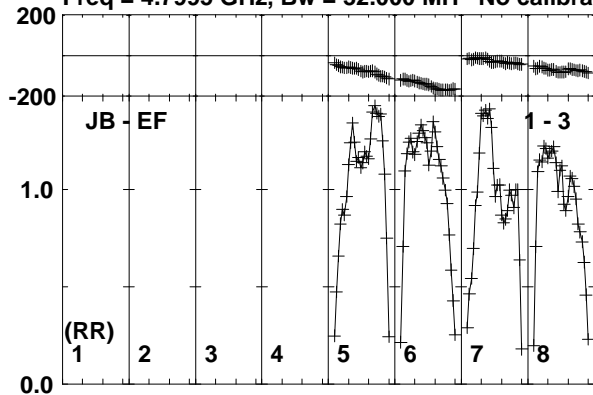

Lower frame: Milli Ampl Jy Top frame: Phas deg
Vector averaged cross-power spectrum Baseline: JB (01) - EF (03)
Timerange: 00/16:08:44 to 00/16:09:58

Plot file version 188 created 03-APR-2017 18:27:42

J1834-2341 EM126B.UVDATA.1

Freq = 4.7995 GHz, Bw = 32.000 MH No calibration applied and no bandpass applied

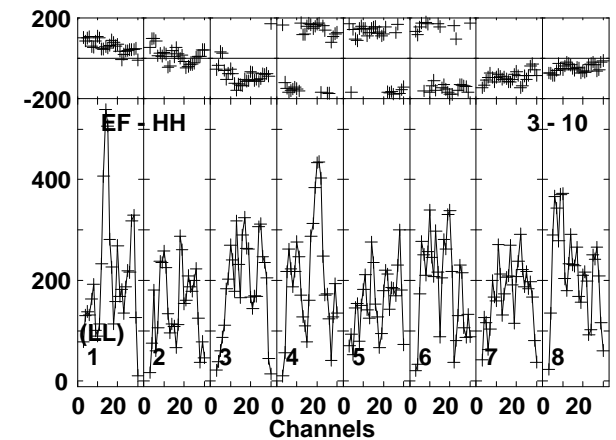
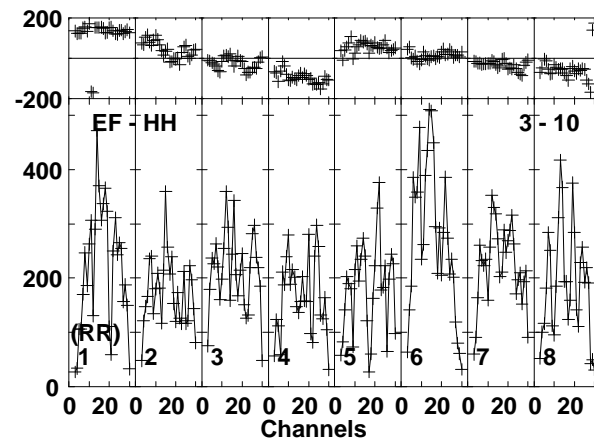
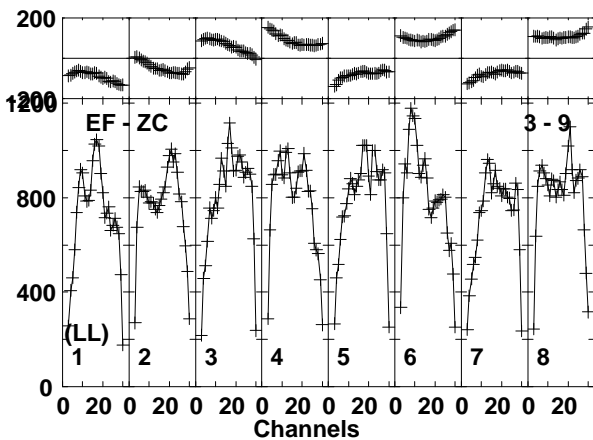
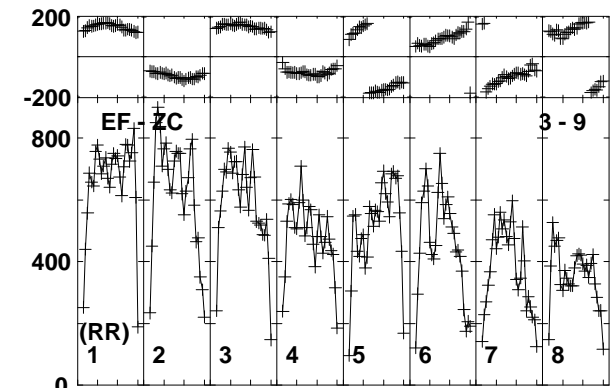
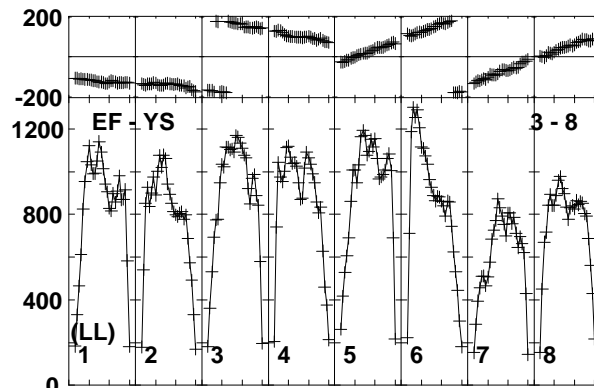
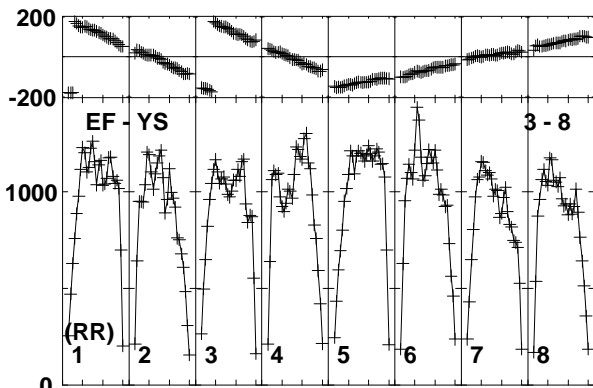
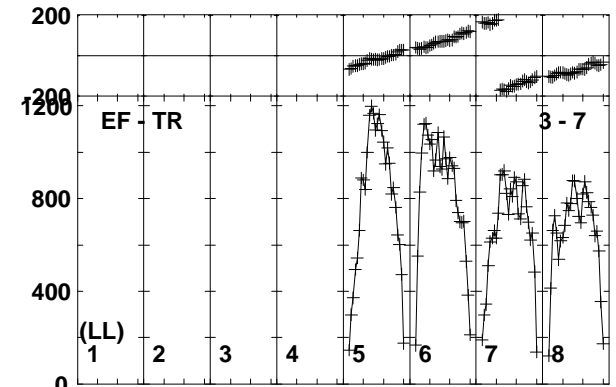
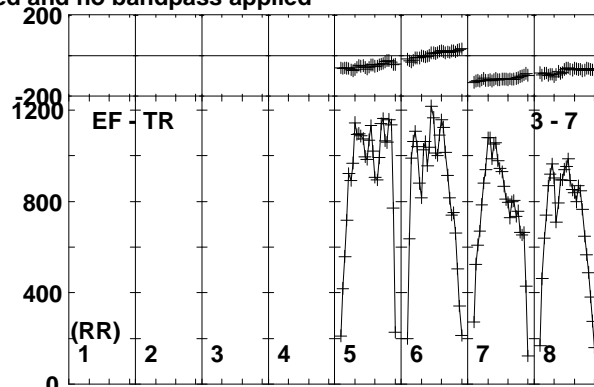
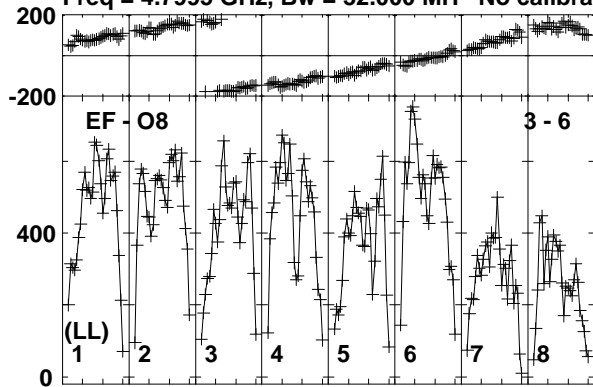

Lower frame: Micro Ampl Jy Top frame: Phas deg
Vector averaged cross-power spectrum Baseline: EF (03) - O8 (06)
Timerange: 00/16:08:44 to 00/16:09:58

Plot file version 189 created 03-APR-2017 18:27:42

M22-VLA1 EM126B.UVDATA.1

Freq = 4.7995 GHz, Bw = 32.000 MH No calibration applied and no bandpass applied

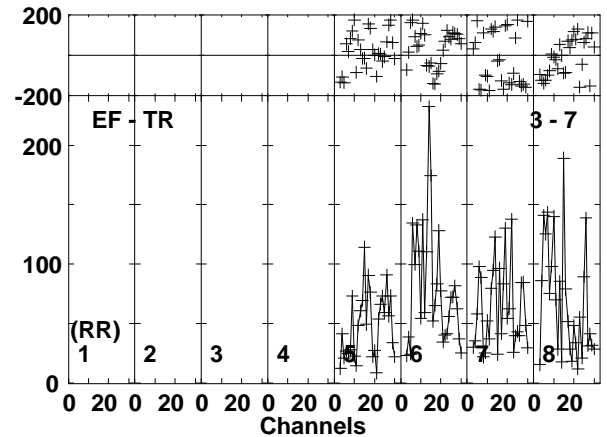
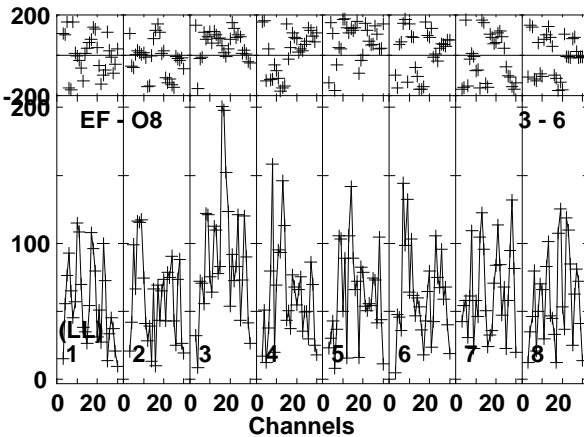
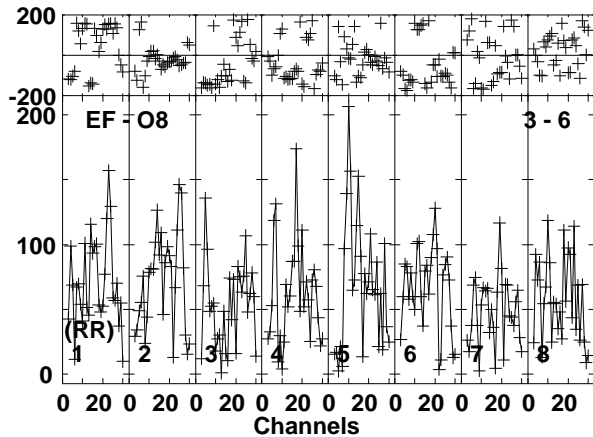
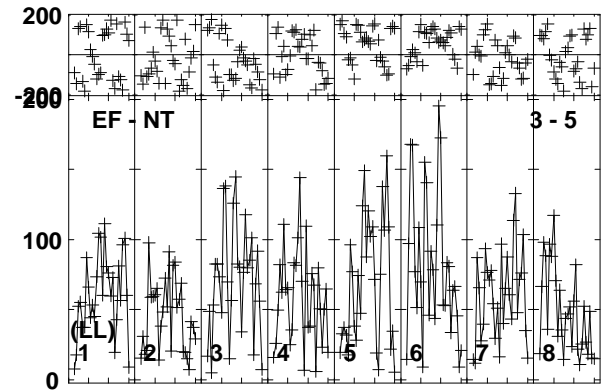
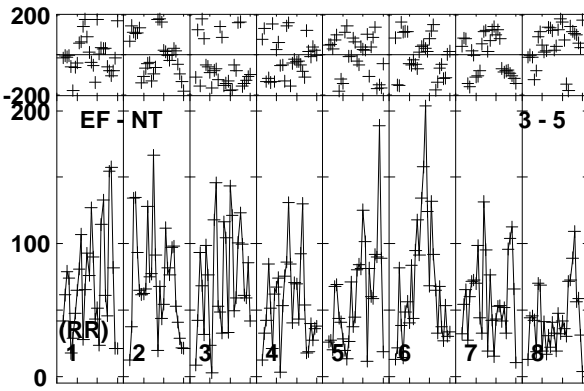
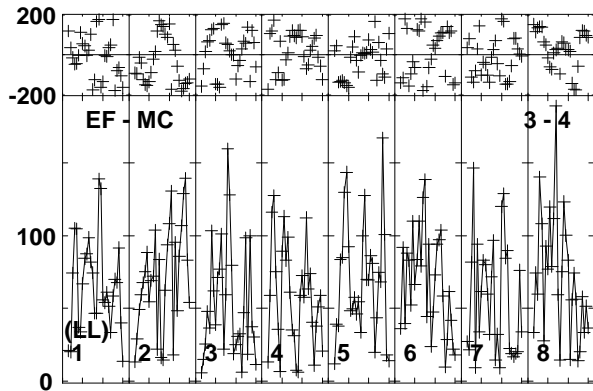
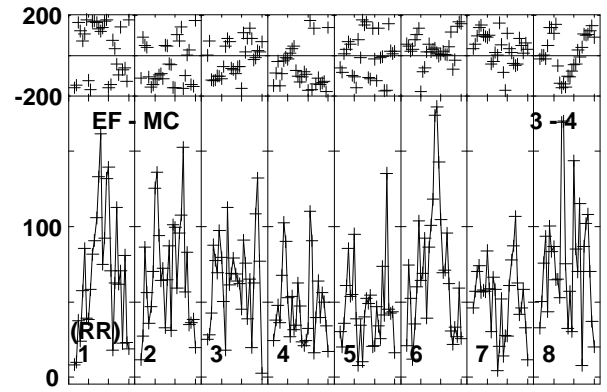
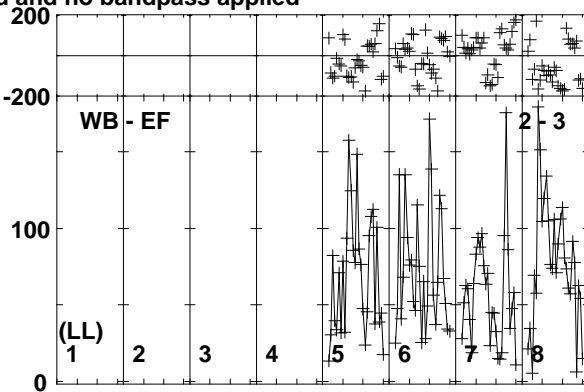
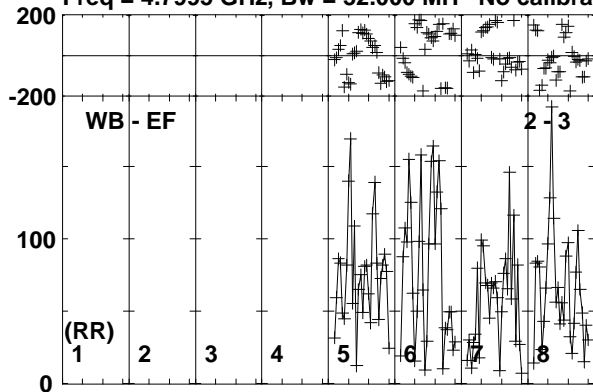

Lower frame: Micro Ampl Jy Top frame: Phas deg
Vector averaged cross-power spectrum Baseline: WB (02) - EF (03)
Timerange: 00/16:10:04 to 00/16:12:08

Plot file version 190 created 03-APR-2017 18:27:42

M22-VLA1 EM126B.UVDATA.1

Freq = 4.7995 GHz, Bw = 32.000 MH No calibration applied and no bandpass applied

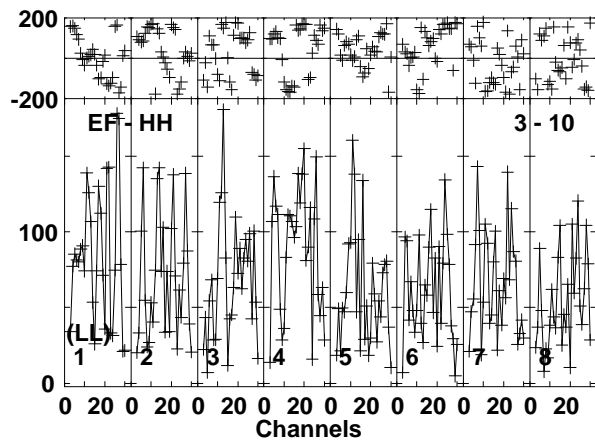
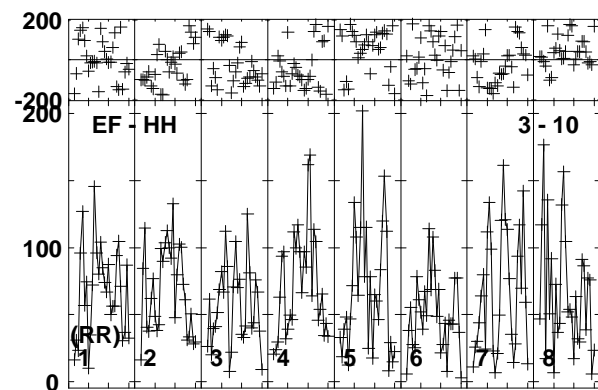
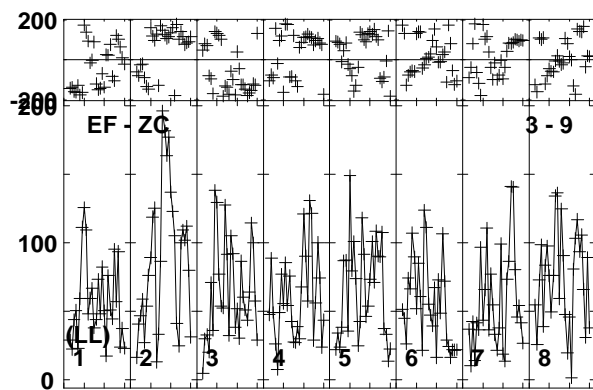
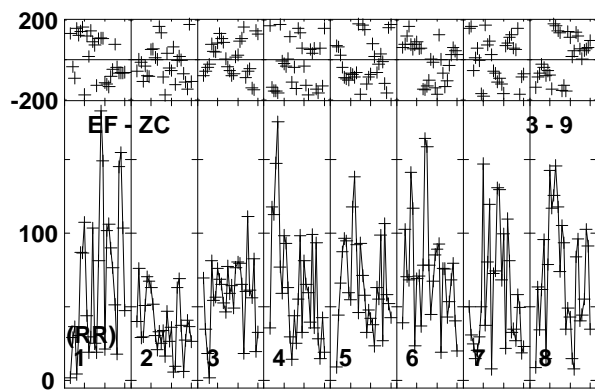
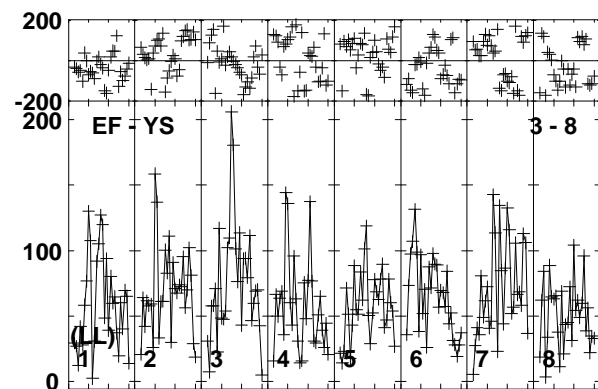
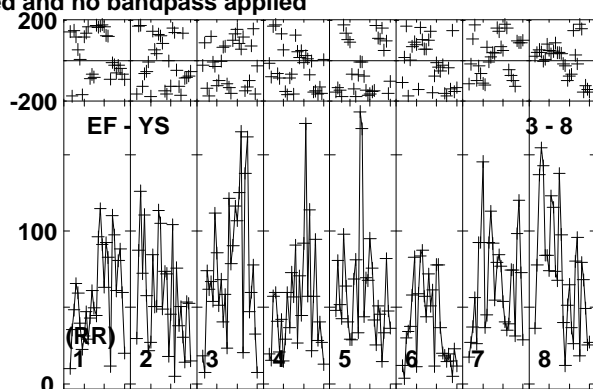
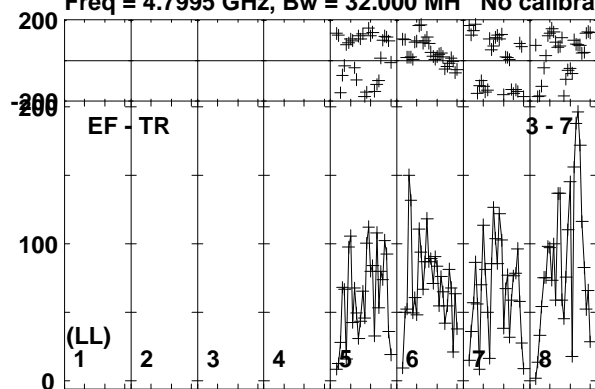

Lower frame: Micro Ampl Jy Top frame: Phas deg
Vector averaged cross-power spectrum Baseline: EF (03) - TR (07)
Timerange: 00/16:10:04 to 00/16:12:08

Plot file version 191 created 03-APR-2017 18:27:42

J1834-2341 EM126B.UVDATA.1

Freq = 4.7995 GHz, Bw = 32.000 MH No calibration applied and no bandpass applied

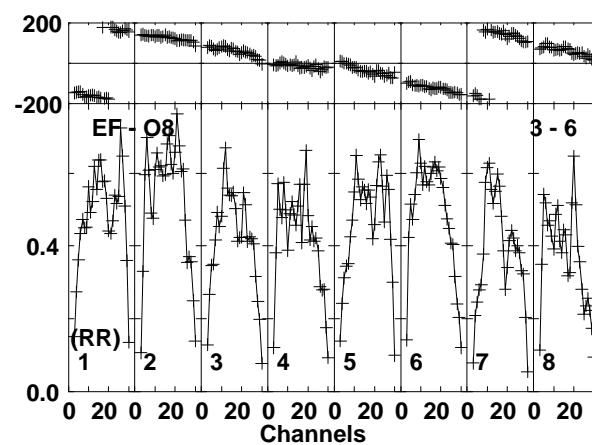
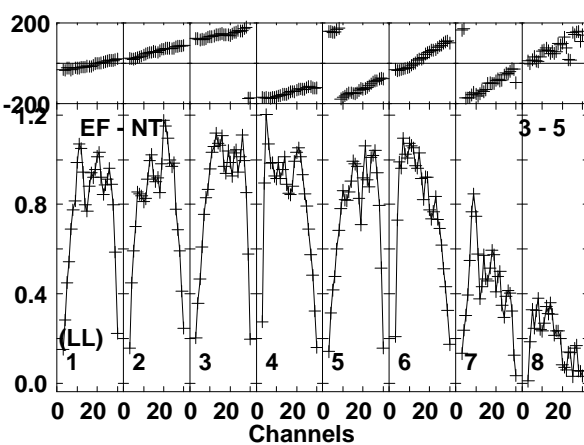
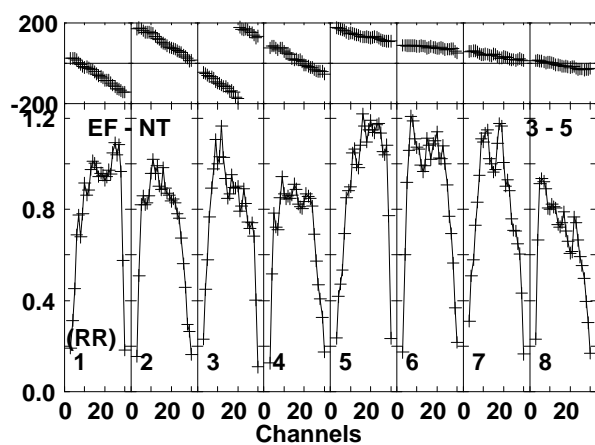
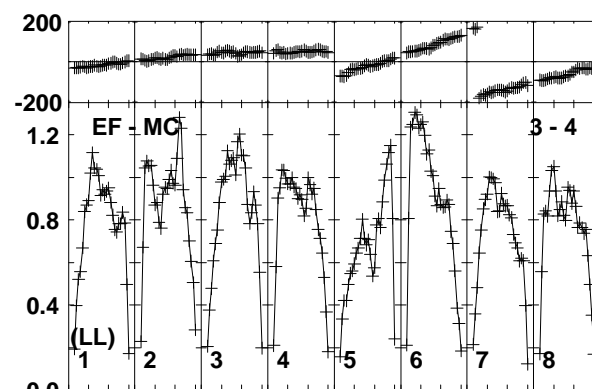
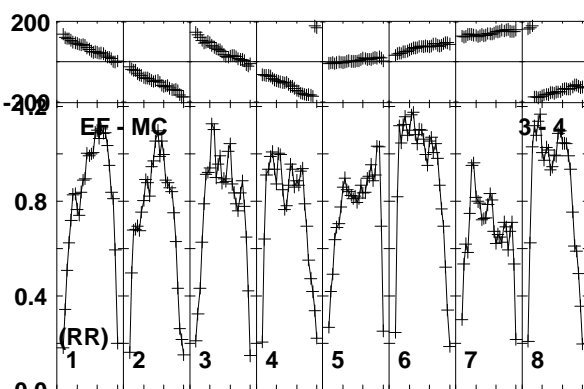
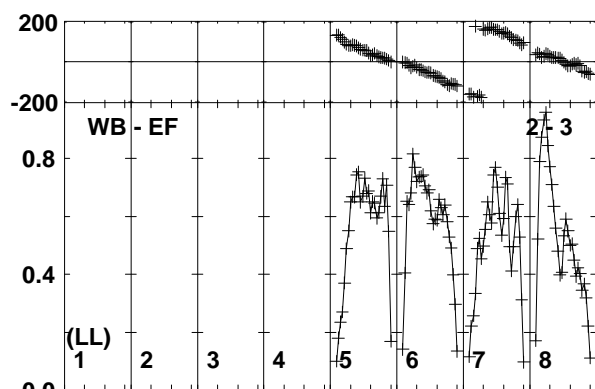
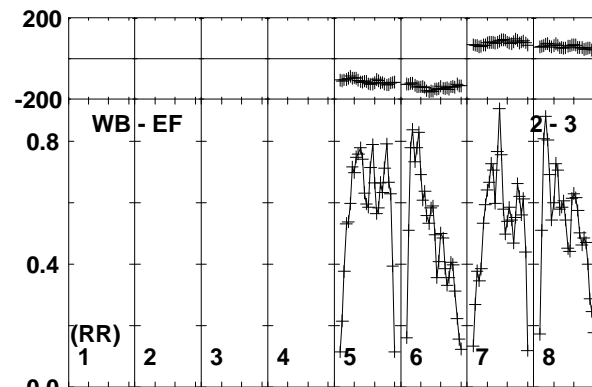
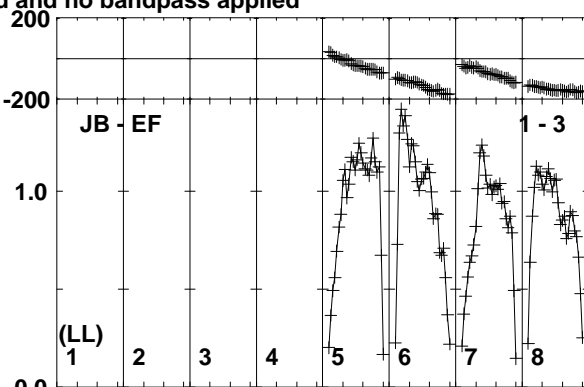
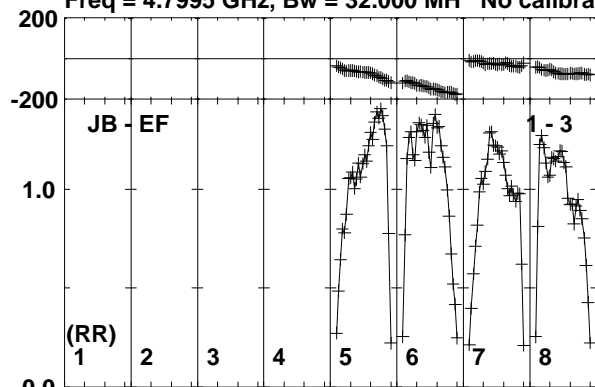

Lower frame: Milli Ampl Jy Top frame: Phas deg
Vector averaged cross-power spectrum Baseline: JB (01) - EF (03)
Timerange: 00:16:12:14 to 00:16:13:28

Plot file version 192 created 03-APR-2017 18:27:42

J1834-2341 EM126B.UVDATA.1

Freq = 4.7995 GHz, Bw = 32.000 MH No calibration applied and no bandpass applied

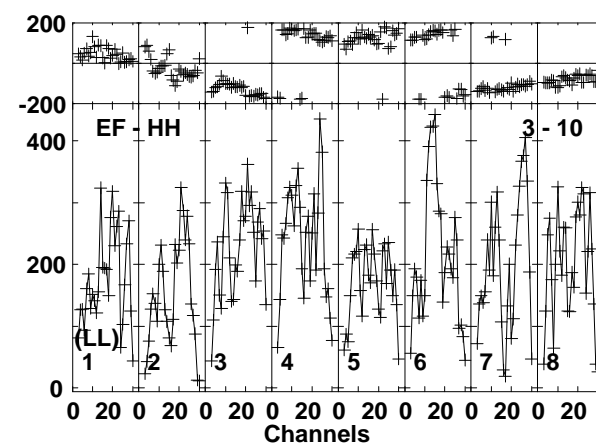
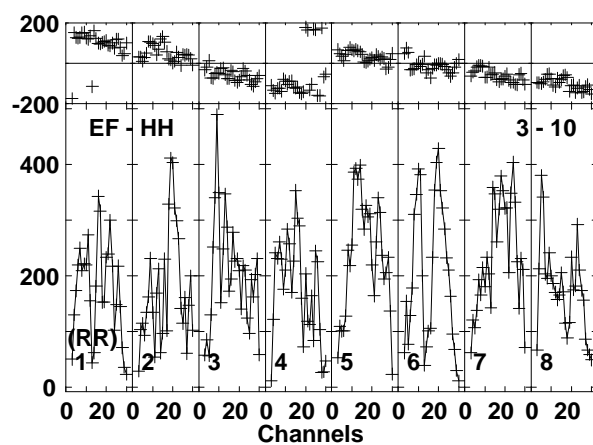
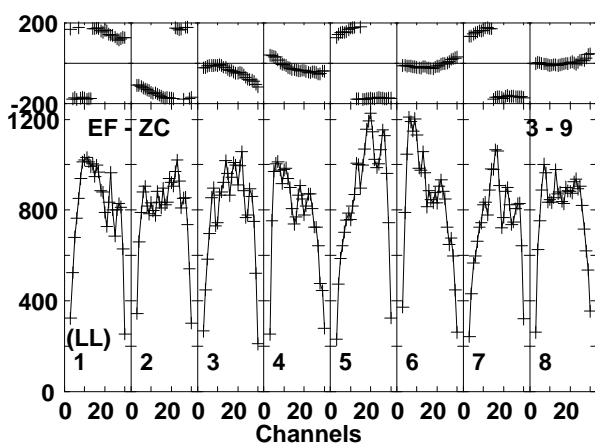
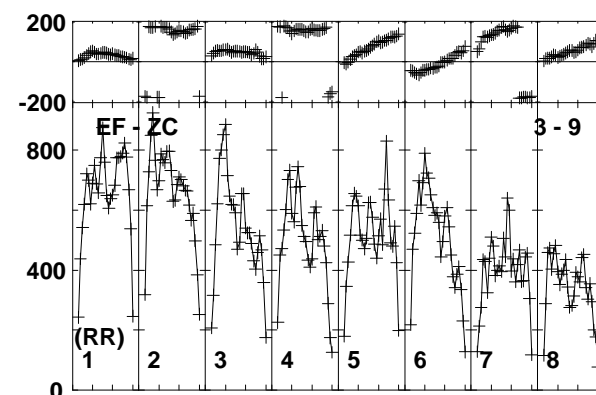
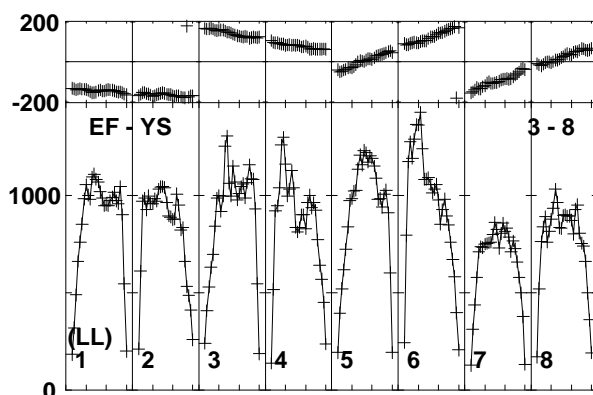
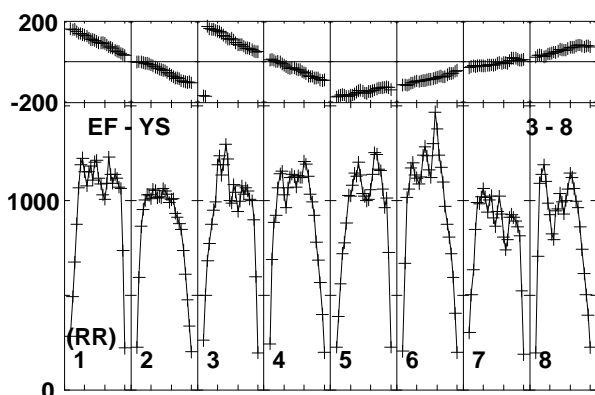
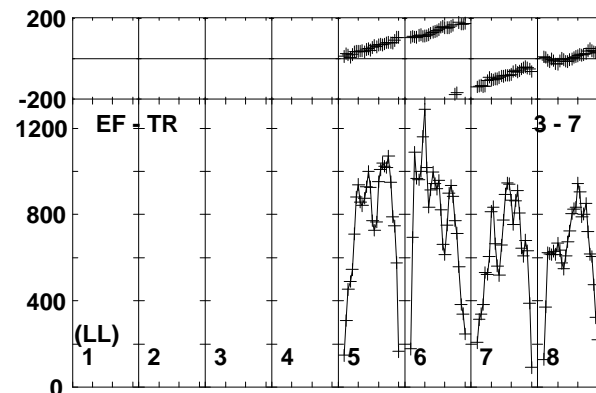
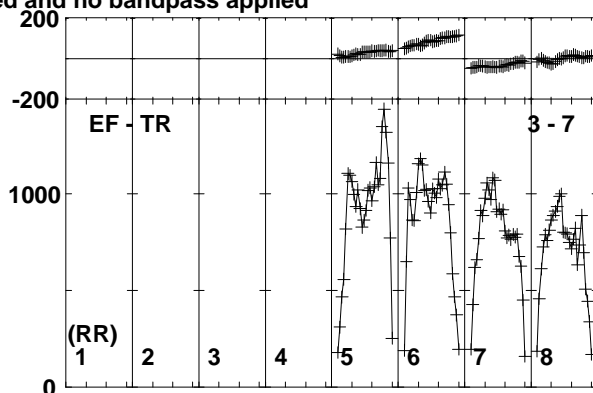
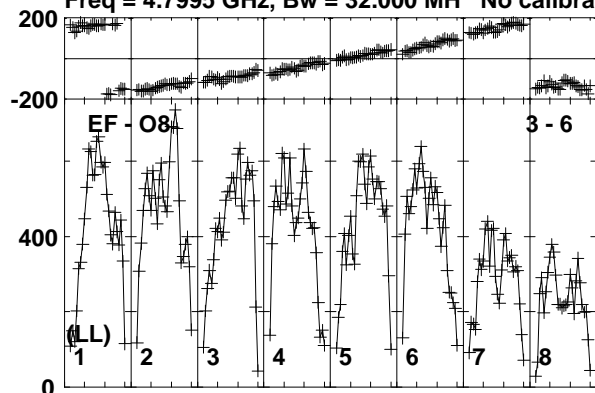

Lower frame: Micro Ampl Jy Top frame: Phas deg
Vector averaged cross-power spectrum Baseline: EF (03) - O8 (06)
Timerange: 00/16:12:14 to 00/16:13:28

Plot file version 193 created 03-APR-2017 18:27:42

M22-VLA1 EM126B.UVDATA.1

Freq = 4.7995 GHz, Bw = 32.000 MH No calibration applied and no bandpass applied

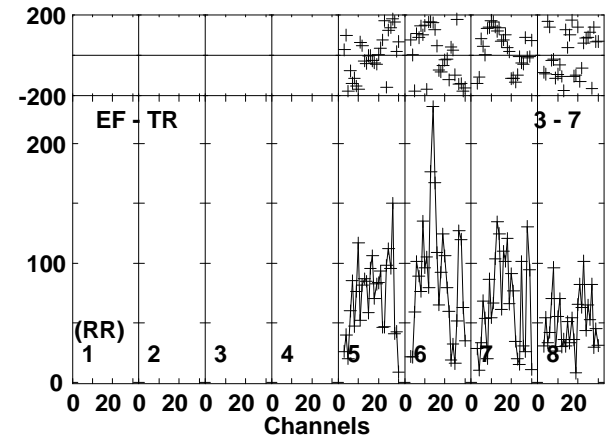
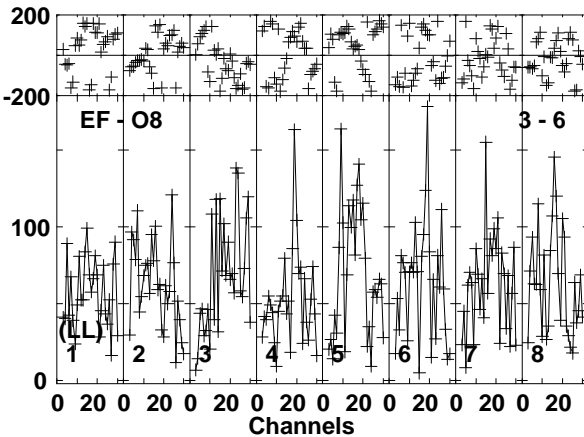
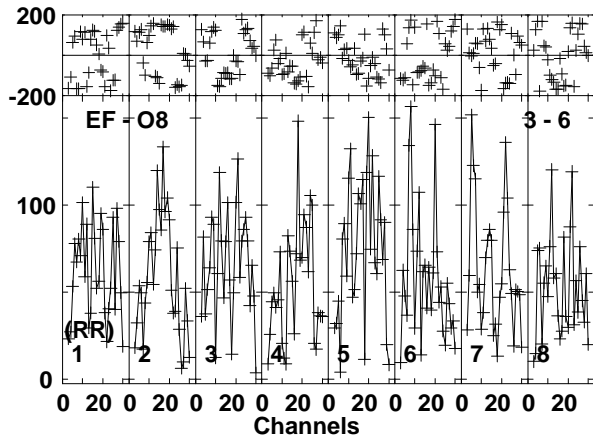
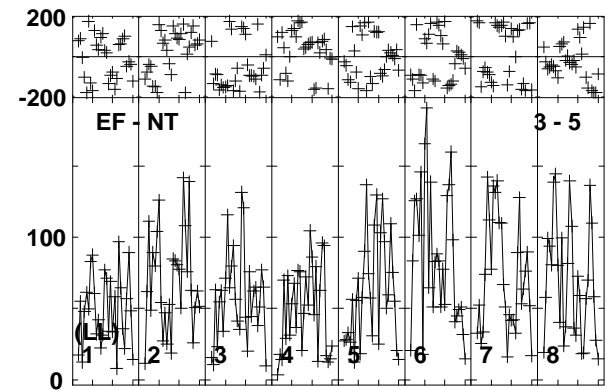
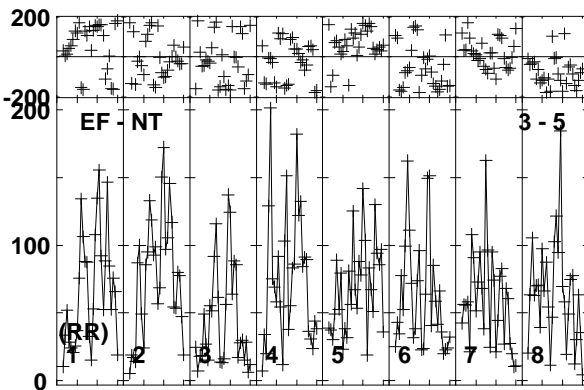
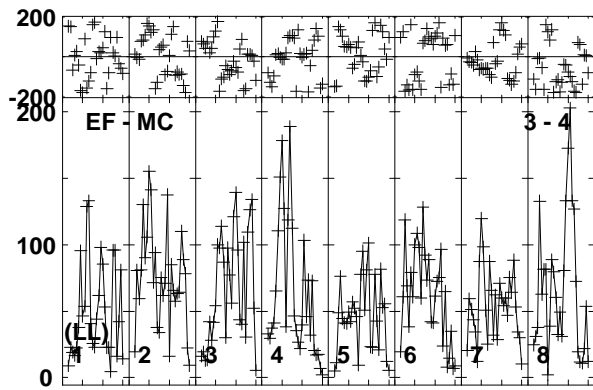
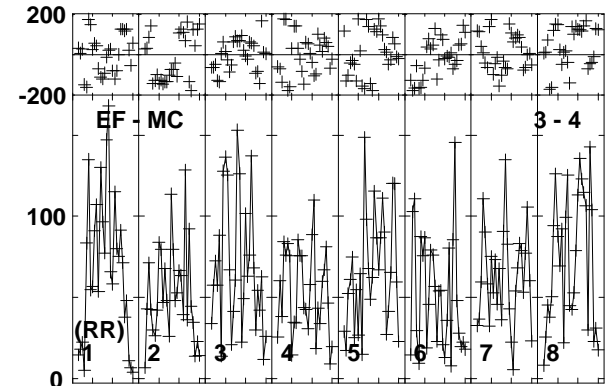
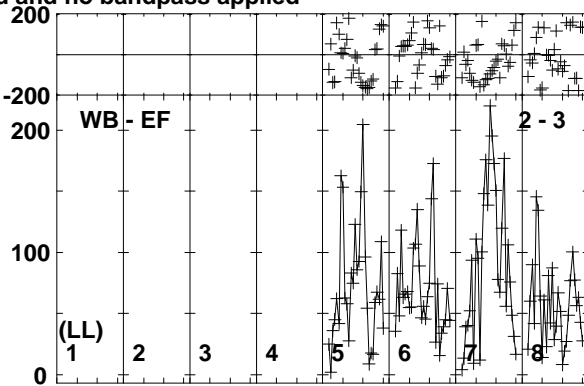
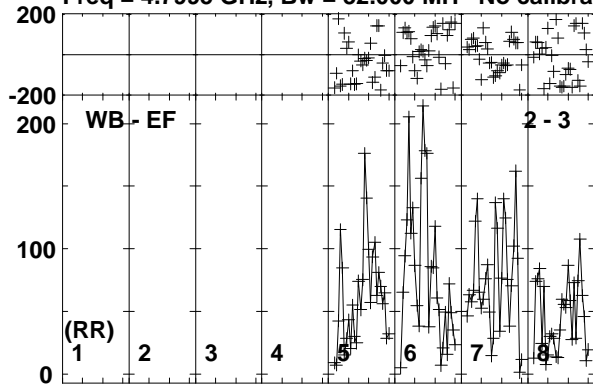

Lower frame: Micro Ampl Jy Top frame: Phas deg
Vector averaged cross-power spectrum Baseline: WB (02) - EF (03)
Timerange: 00/16:13:34 to 00/16:15:38

Plot file version 194 created 03-APR-2017 18:27:43

M22-VLA1 EM126B.UVDATA.1

Freq = 4.7995 GHz, Bw = 32.000 MH No calibration applied and no bandpass applied

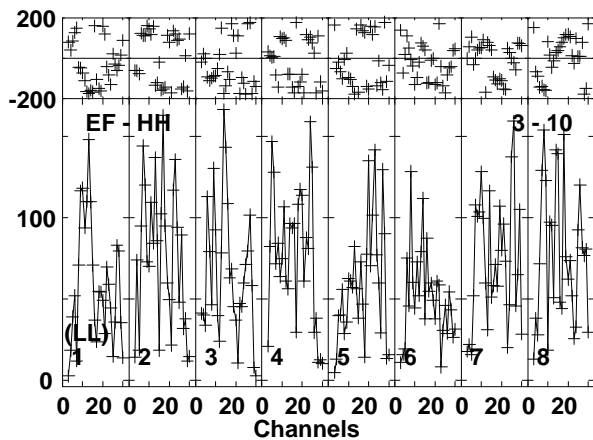
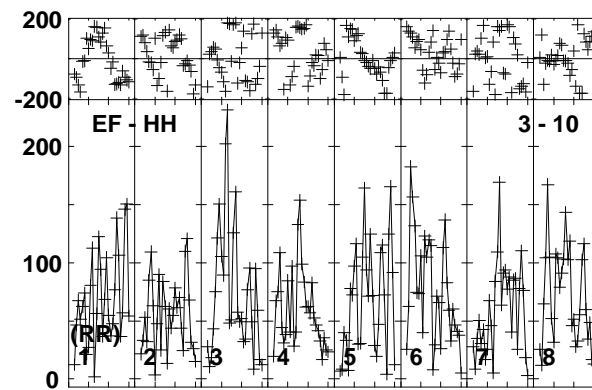
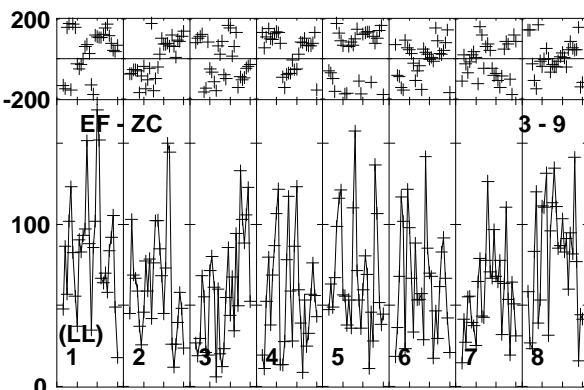
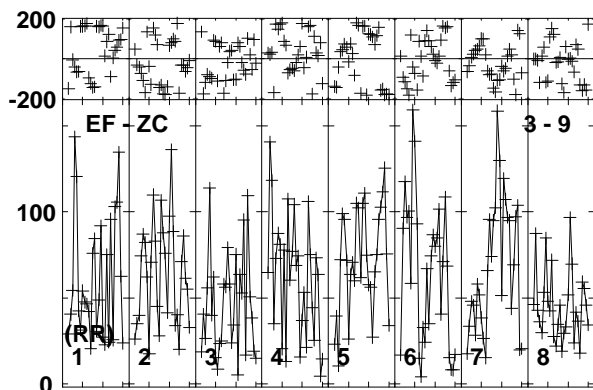
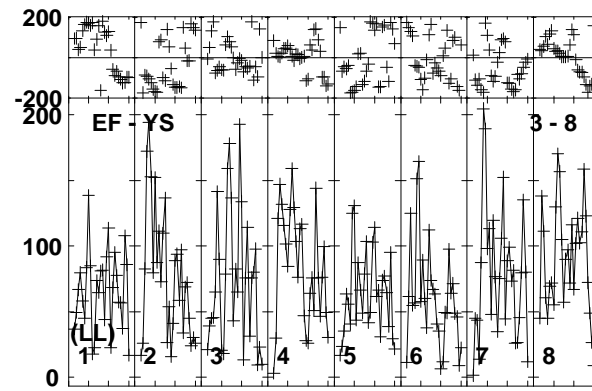
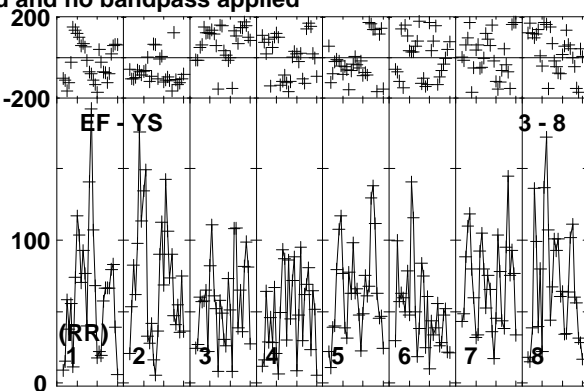
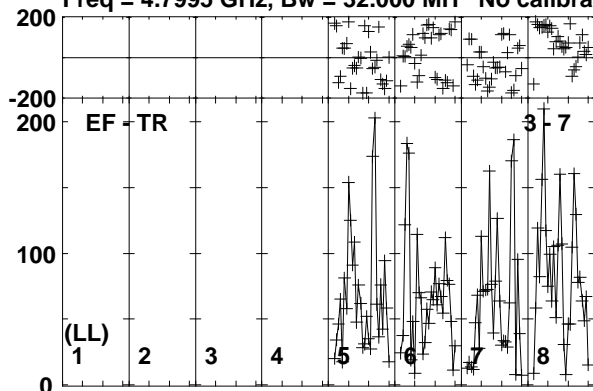

Lower frame: Micro Ampl Jy Top frame: Phas deg
Vector averaged cross-power spectrum Baseline: EF (03) - TR (07)
Timerange: 00/16:13:34 to 00/16:15:38

Plot file version 195 created 03-APR-2017 18:27:43

J1834-2341 EM126B.UVDATA.1

Freq = 4.7995 GHz, Bw = 32.000 MH No calibration applied and no bandpass applied

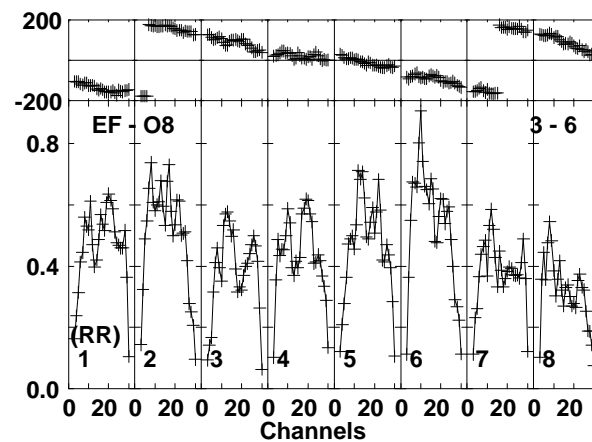
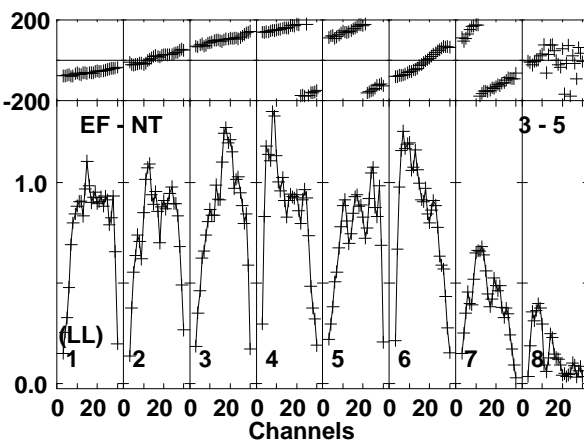
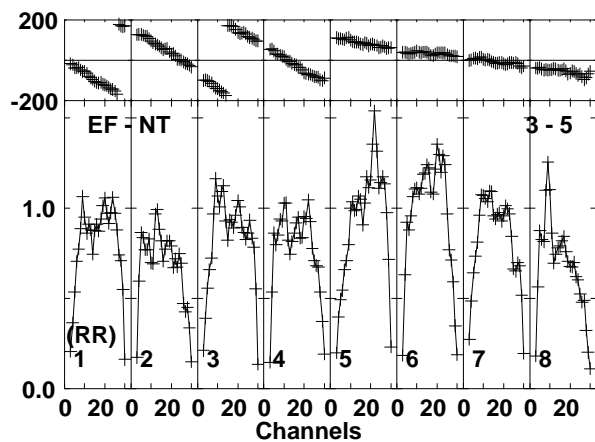
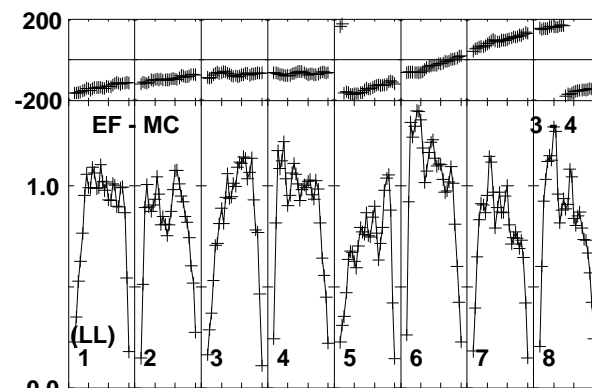
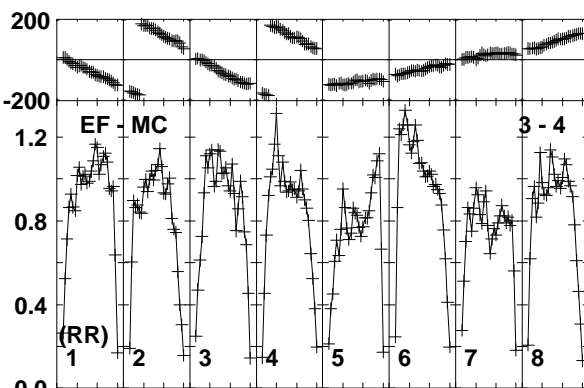
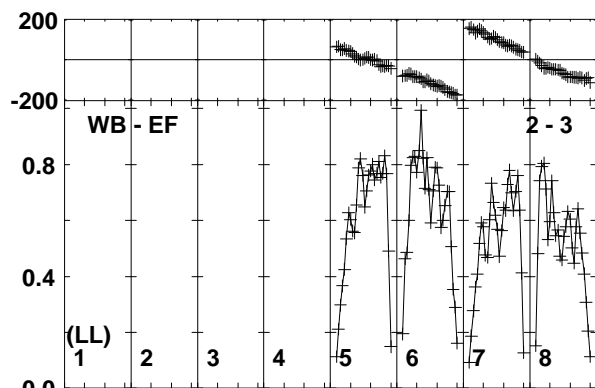
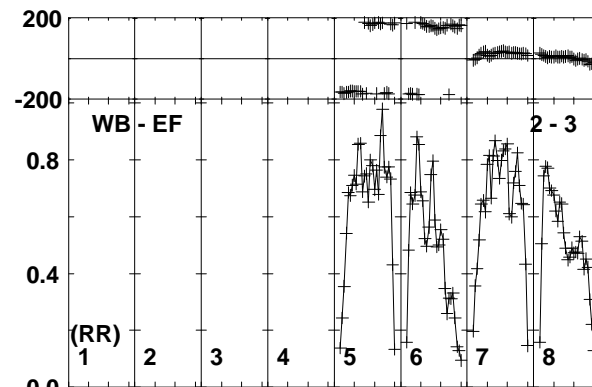
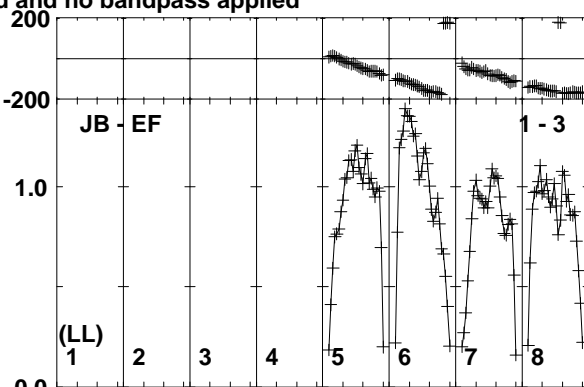
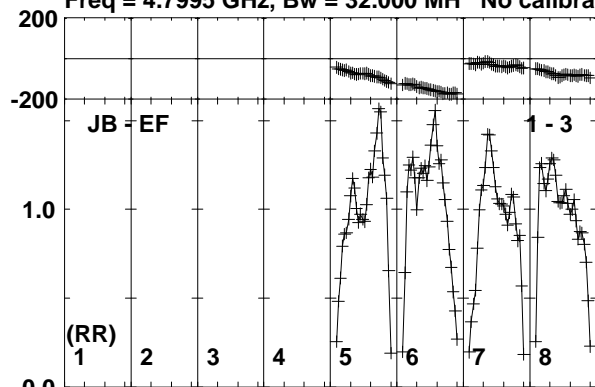

Lower frame: Milli Ampl Jy Top frame: Phas deg
Vector averaged cross-power spectrum Baseline: JB (01) - EF (03)
Timerange: 00/16:16:11 to 00/16:16:59

Plot file version 196 created 03-APR-2017 18:27:43

J1834-2341 EM126B.UVDATA.1

Freq = 4.7995 GHz, Bw = 32.000 MH No calibration applied and no bandpass applied

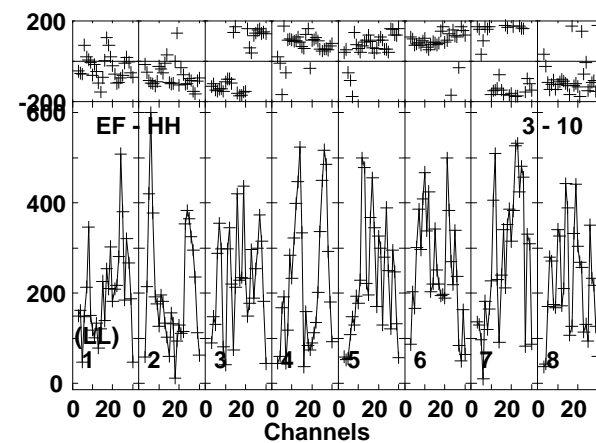
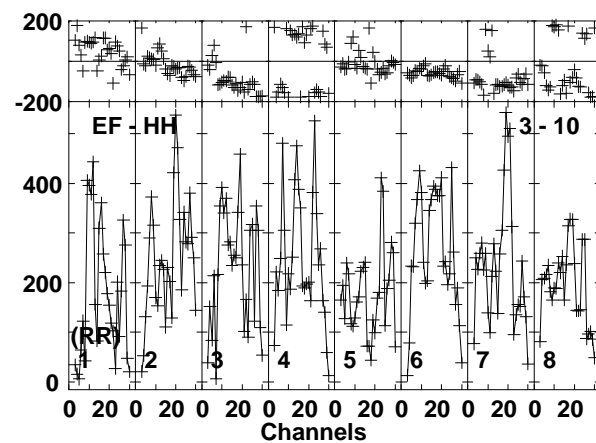
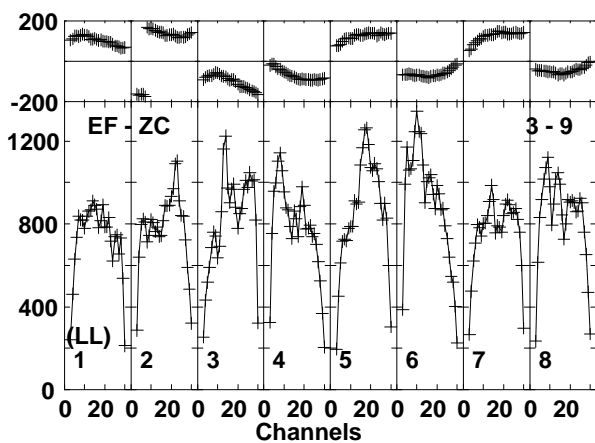
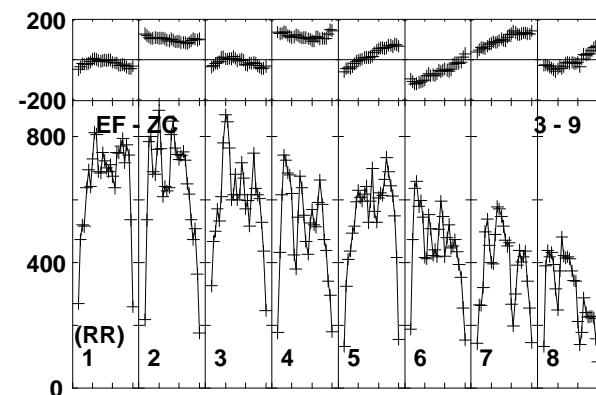
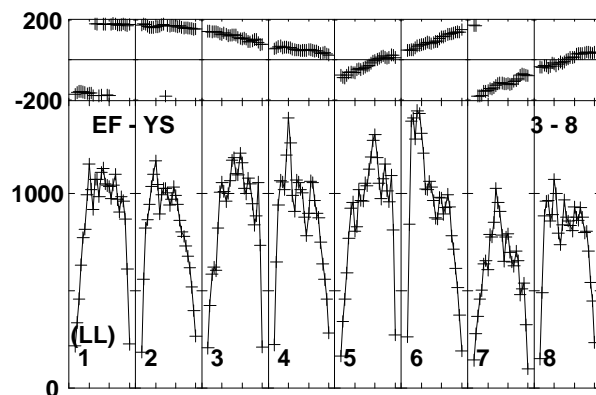
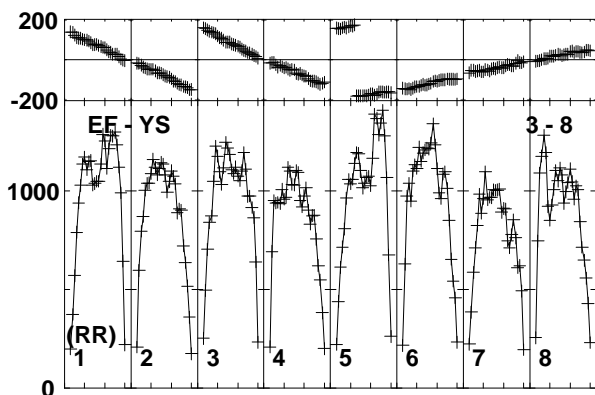
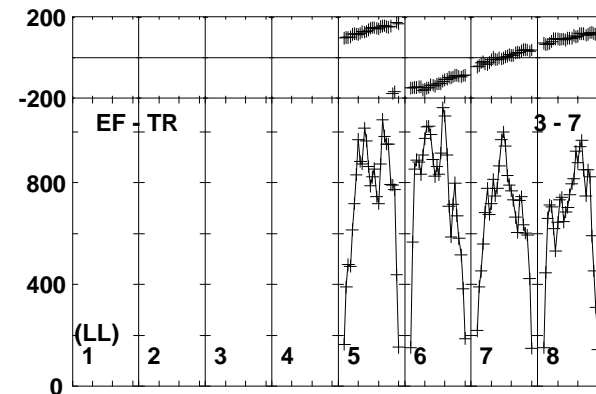
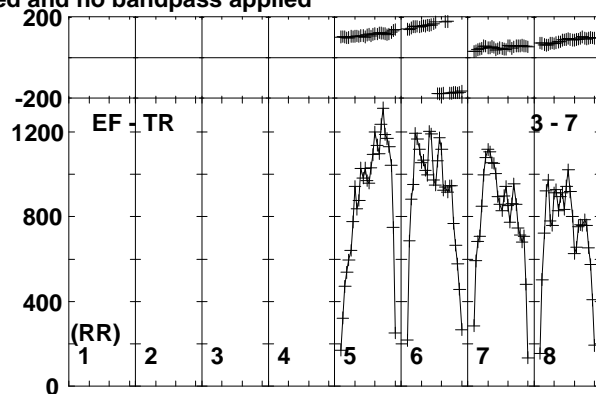
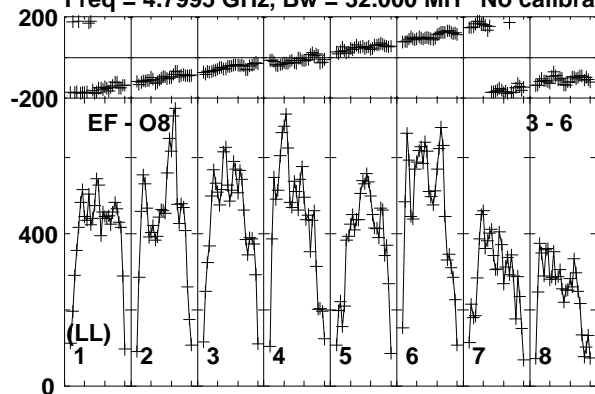

Lower frame: Micro Ampl Jy Top frame: Phas deg
Vector averaged cross-power spectrum Baseline: EF (03) - O8 (06)
Timerange: 00/16:16:11 to 00/16:16:59

Plot file version 197 created 03-APR-2017 18:27:43

M22-VLA1 EM126B.UVDATA.1

Freq = 4.7995 GHz, Bw = 32.000 MH No calibration applied and no bandpass applied

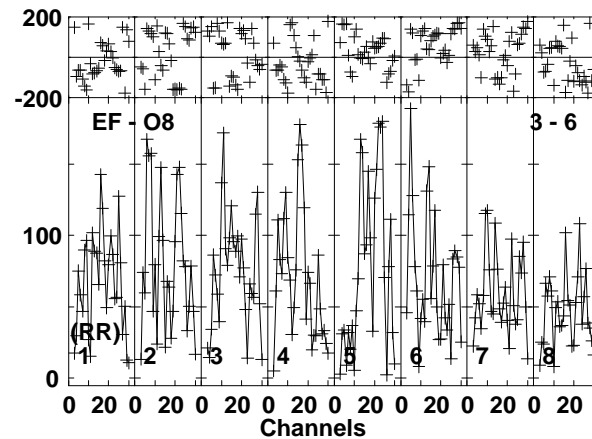
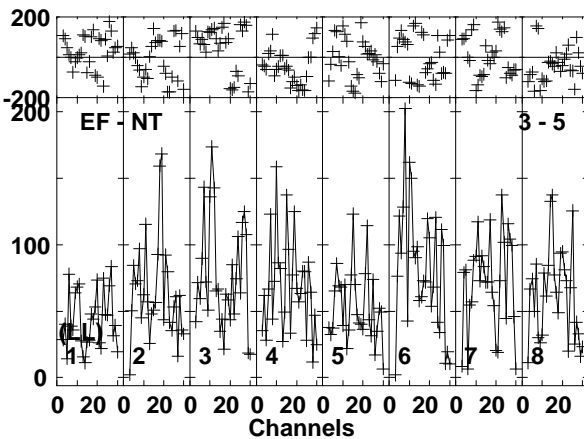
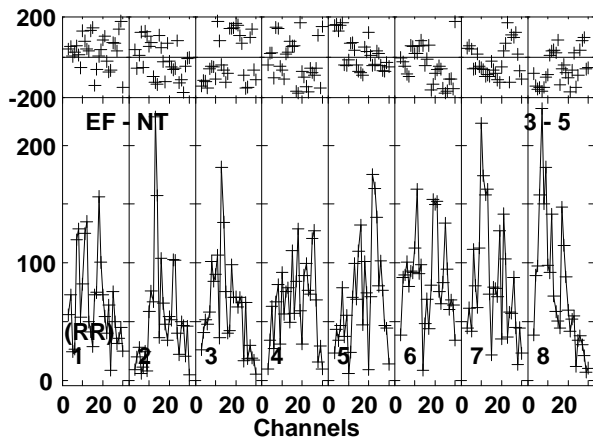
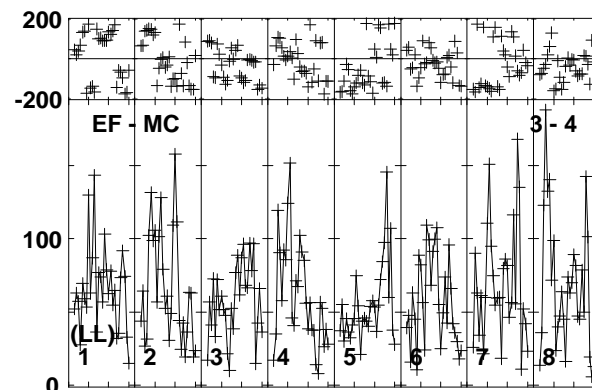
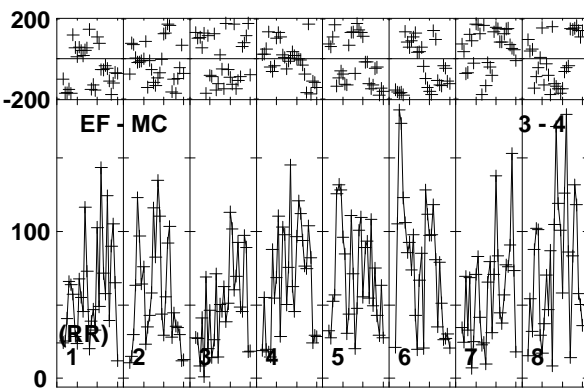
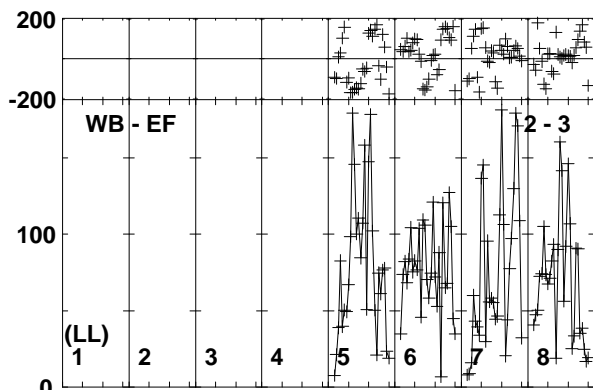
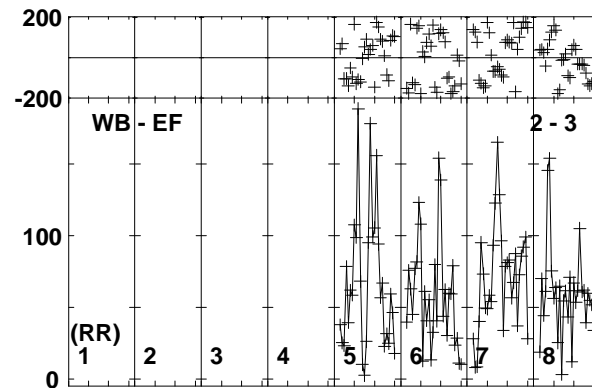
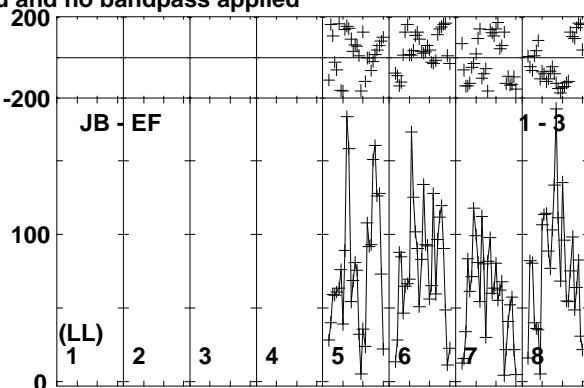
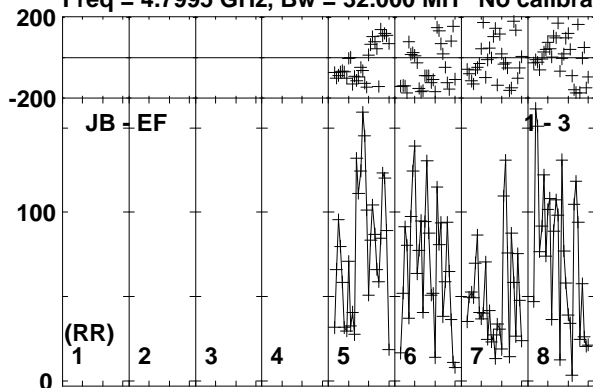

Lower frame: Micro Ampl Jy Top frame: Phas deg
Vector averaged cross-power spectrum Baseline: JB (01) - EF (03)
Timerange: 00/16:17:04 to 00/16:19:08

Plot file version 198 created 03-APR-2017 18:27:43

M22-VLA1 EM126B.UVDATA.1

Freq = 4.7995 GHz, Bw = 32.000 MH No calibration applied and no bandpass applied

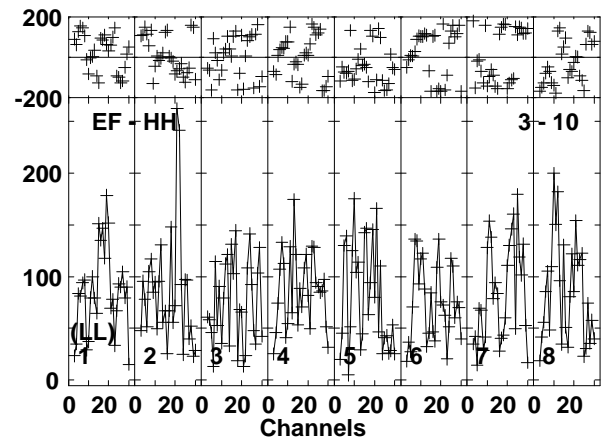
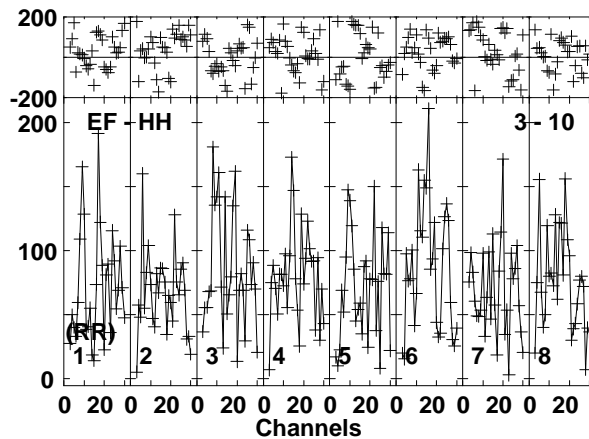
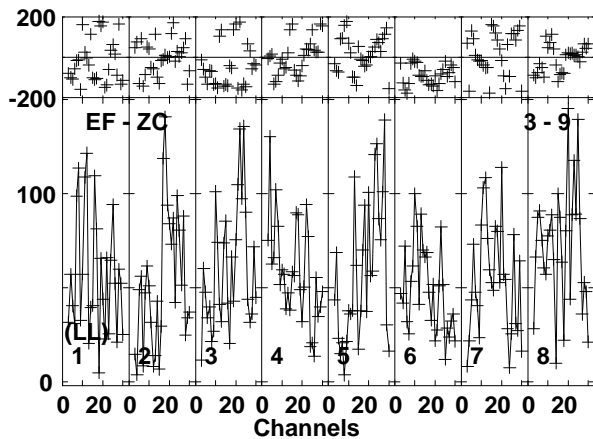
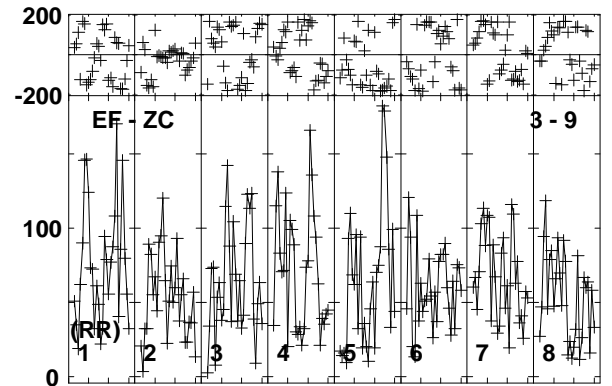
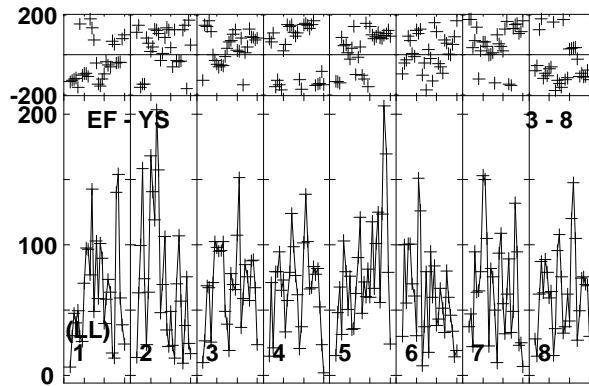
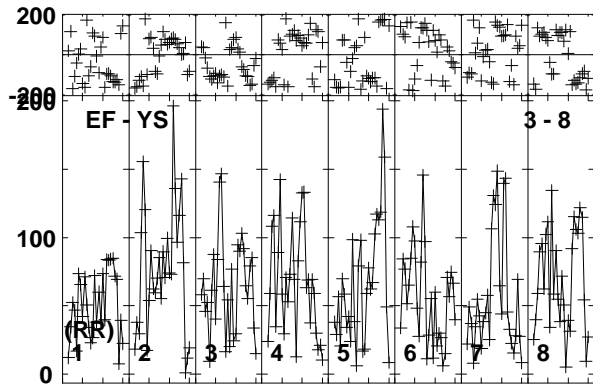
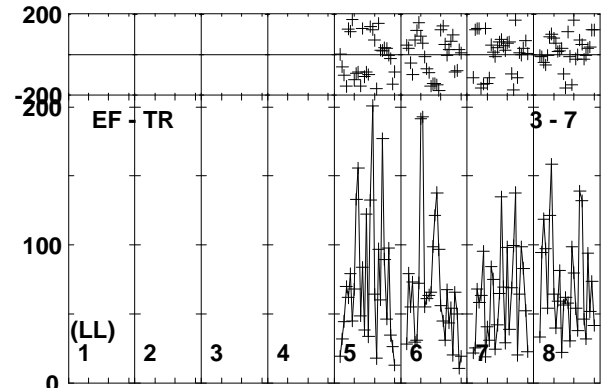
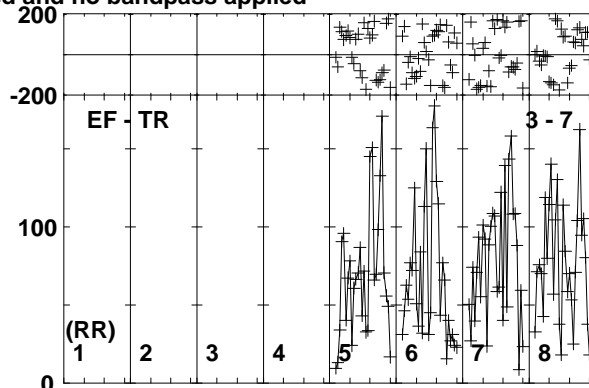
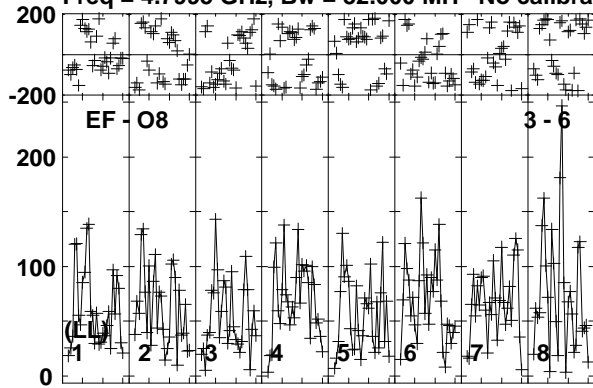

Lower frame: Micro Ampl Jy Top frame: Phas deg
Vector averaged cross-power spectrum Baseline: EF (03) - O8 (06)
Timerange: 00/16:17:04 to 00/16:19:08

Plot file version 199 created 03-APR-2017 18:27:43

J1834-2341 EM126B.UVDATA.1

Freq = 4.7995 GHz, Bw = 32.000 MH No calibration applied and no bandpass applied

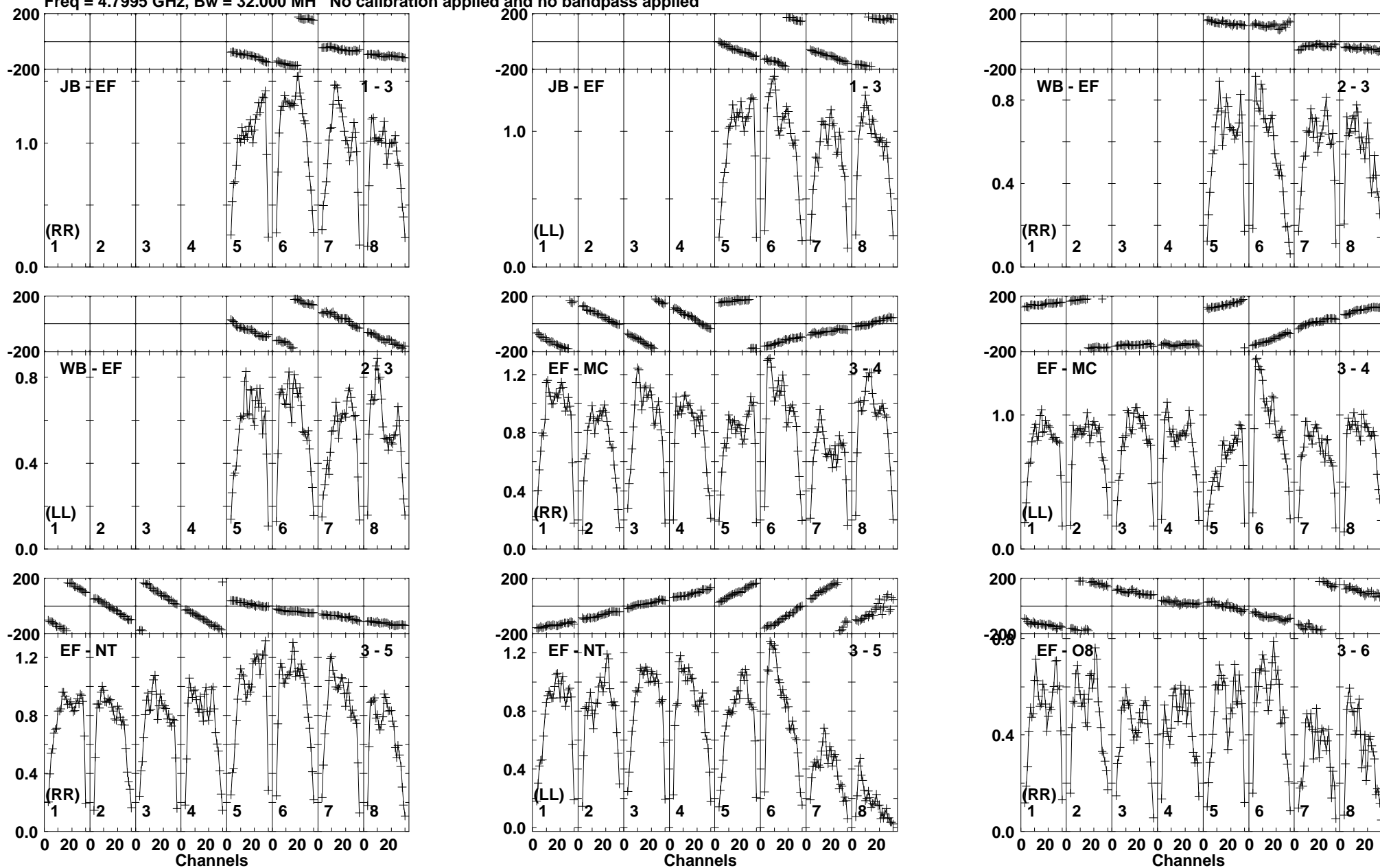

Lower frame: Milli Ampl Jy Top frame: Phas deg
Vector averaged cross-power spectrum Baseline: JB (01) - EF (03)
Timerange: 00/16:19:14 to 00/16:20:28

Plot file version 200 created 03-APR-2017 18:27:43

J1834-2341 EM126B.UVDATA.1

Freq = 4.7995 GHz, Bw = 32.000 MH No calibration applied and no bandpass applied

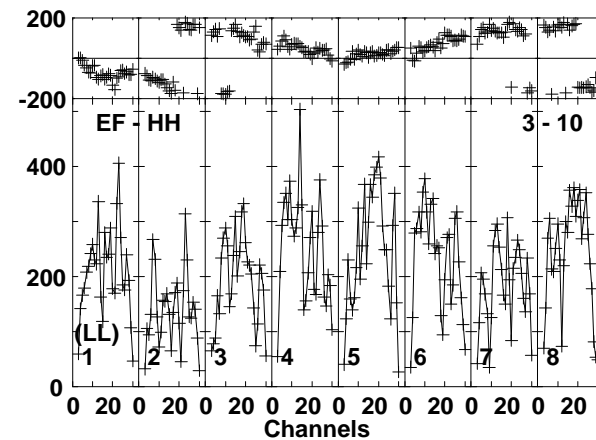
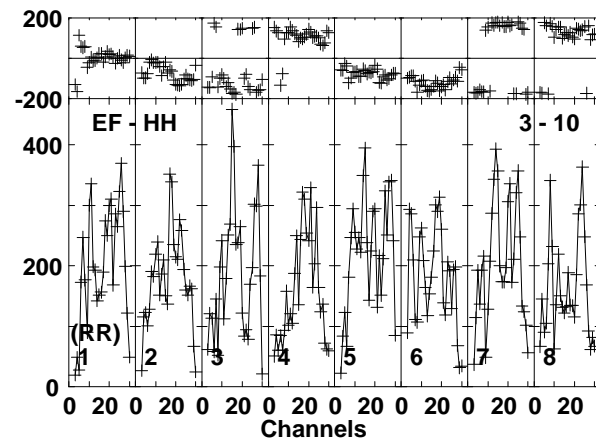
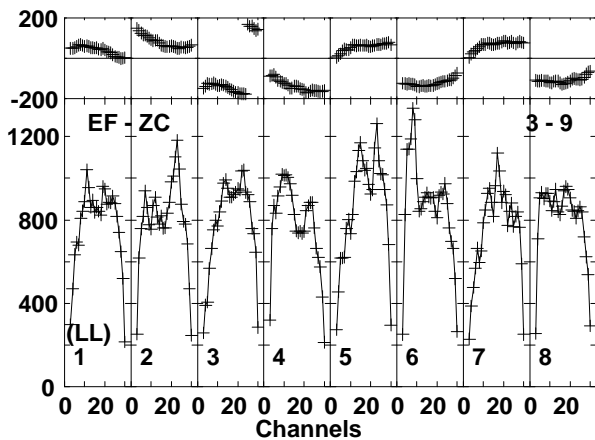
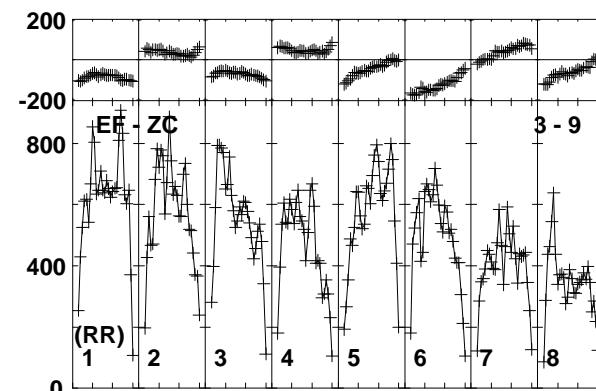
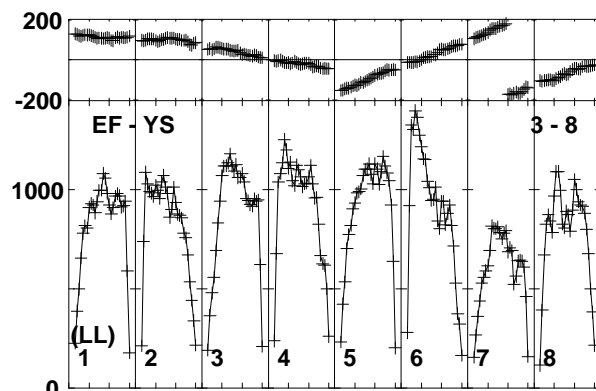
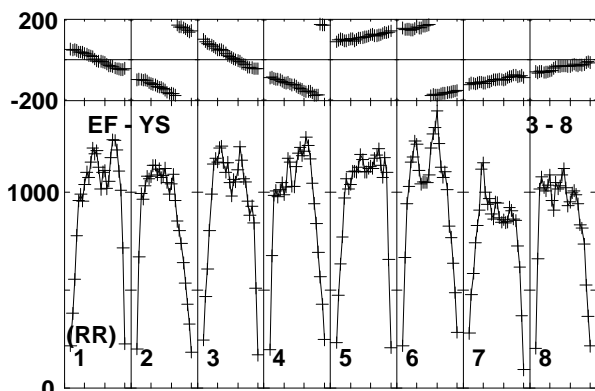
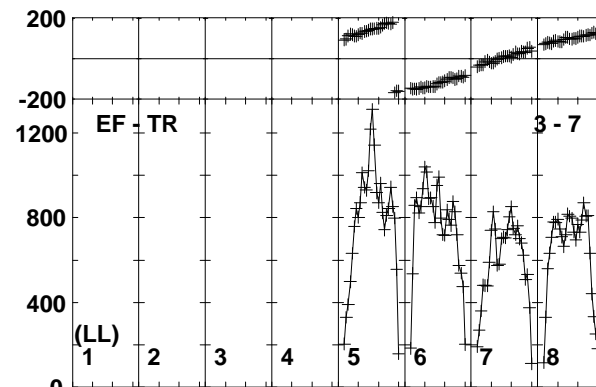
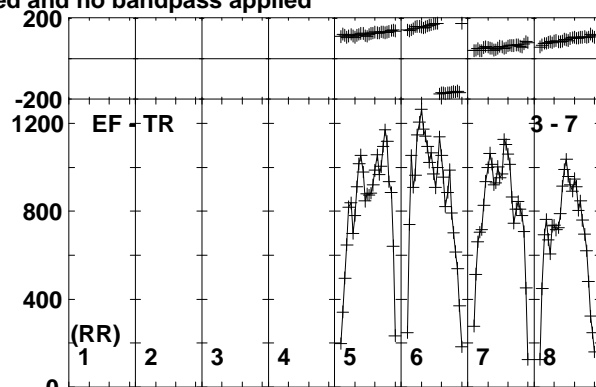
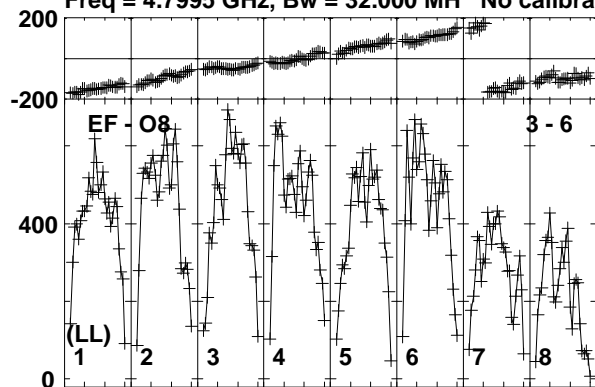

Lower frame: Micro Ampl Jy Top frame: Phas deg
Vector averaged cross-power spectrum Baseline: EF (03) - O8 (06)
Timerange: 00/16:19:14 to 00/16:20:28

Plot file version 201 created 03-APR-2017 18:27:43

M22-VLA1 EM126B.UVDATA.1

Freq = 4.7995 GHz, Bw = 32.000 MH No calibration applied and no bandpass applied

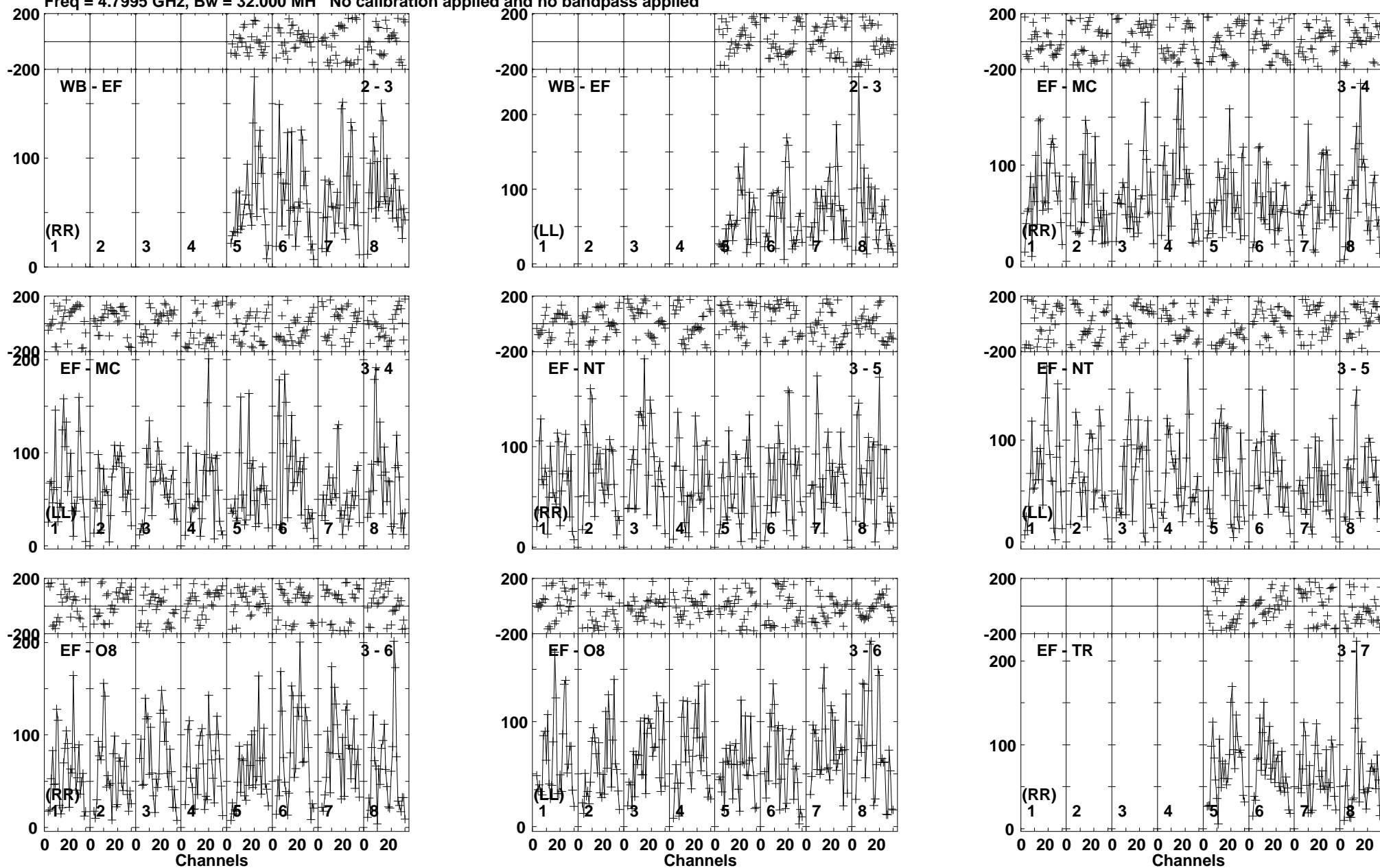

Lower frame: Micro Ampl Jy Top frame: Phas deg
Vector averaged cross-power spectrum Baseline: WB (02) - EF (03)
Timerange: 00/16:20:34 to 00/16:22:38

Plot file version 202 created 03-APR-2017 18:27:43

M22-VLA1 EM126B.UVDATA.1

Freq = 4.7995 GHz, Bw = 32.000 MH No calibration applied and no bandpass applied

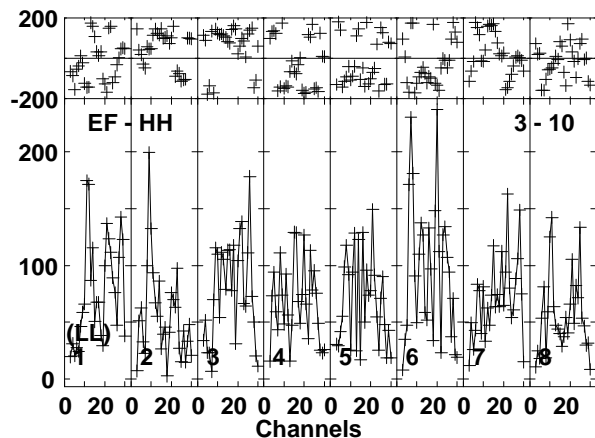
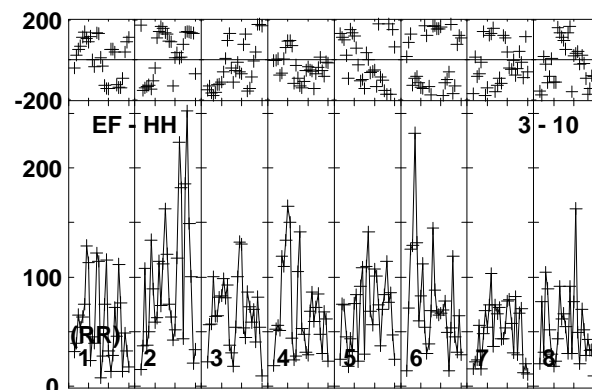
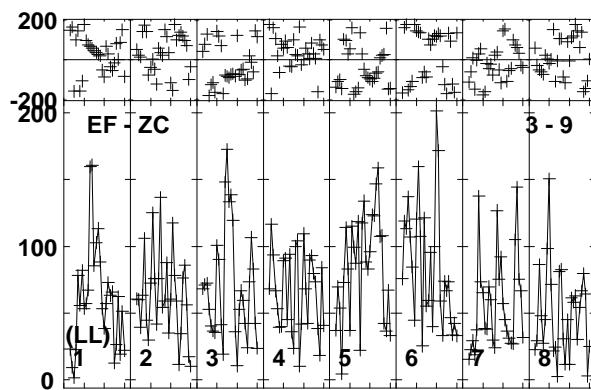
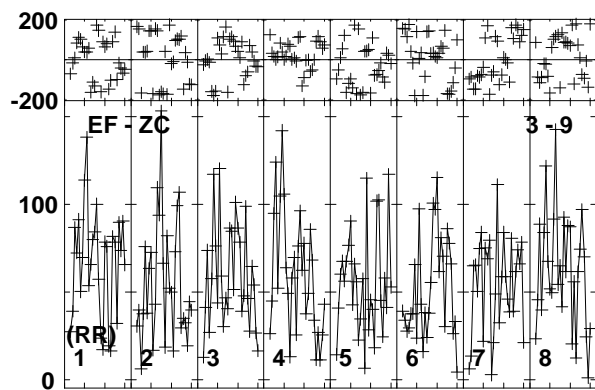
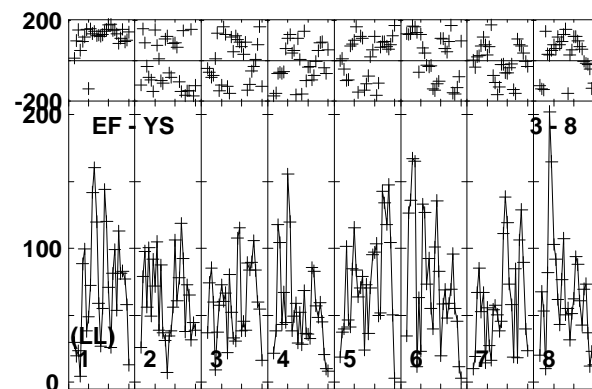
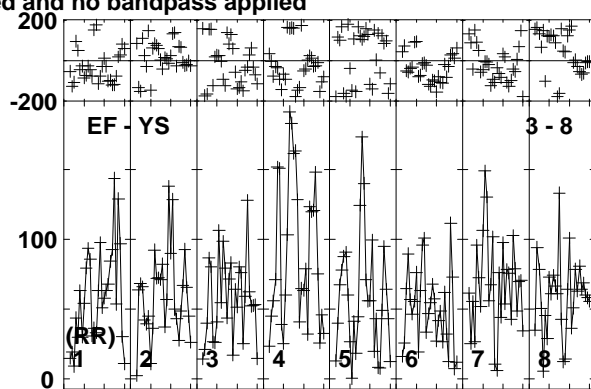
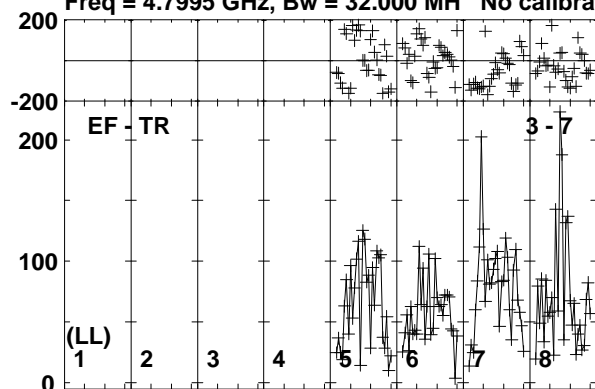

Lower frame: Micro Ampl Jy Top frame: Phas deg
Vector averaged cross-power spectrum Baseline: EF (03) - TR (07)
Timerange: 00/16:20:34 to 00/16:22:38

Plot file version 203 created 03-APR-2017 18:27:43

J1834-2341 EM126B.UVDATA.1

Freq = 4.7995 GHz, Bw = 32.000 MH No calibration applied and no bandpass applied

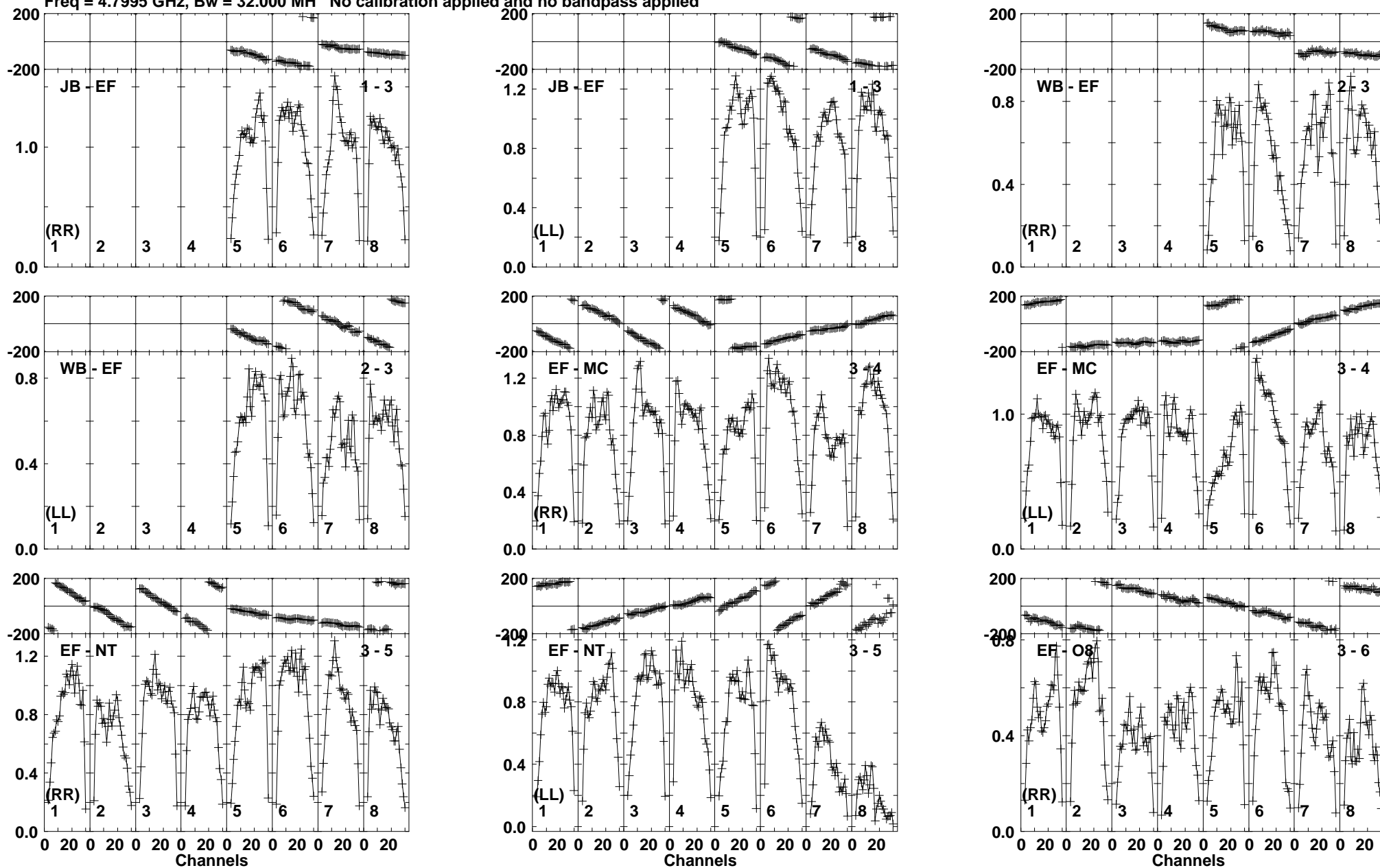

Lower frame: Milli Ampl Jy Top frame: Phas deg
Vector averaged cross-power spectrum Baseline: JB (01) - EF (03)
Timerange: 00/16:22:44 to 00/16:23:58

Plot file version 204 created 03-APR-2017 18:27:43

J1834-2341 EM126B.UVDATA.1

Freq = 4.7995 GHz, Bw = 32.000 MH No calibration applied and no bandpass applied

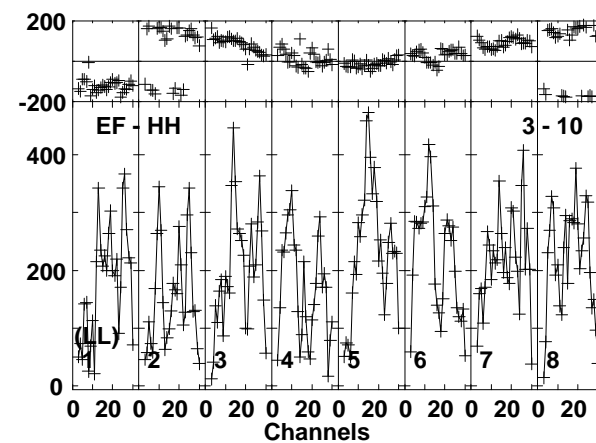
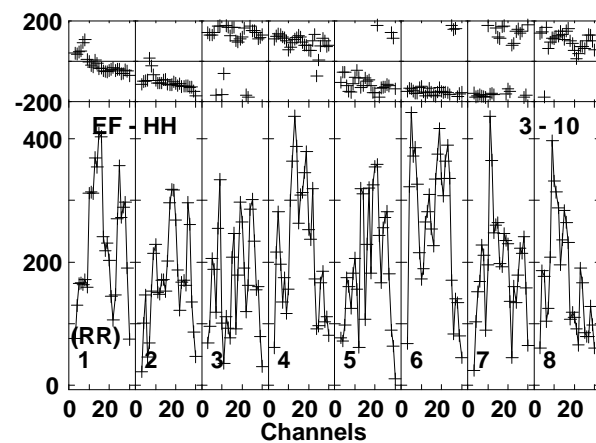
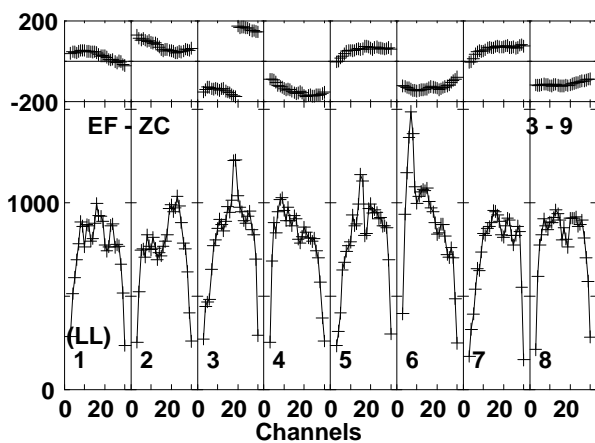
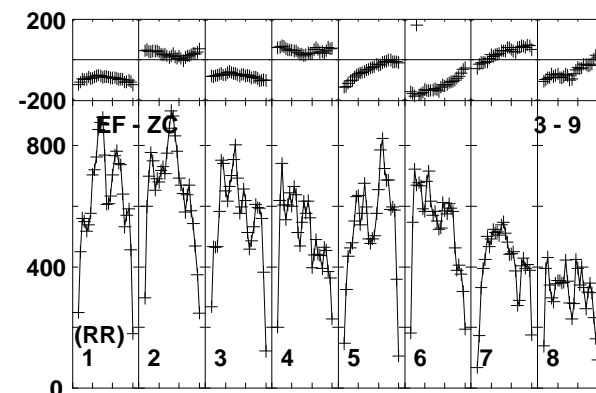
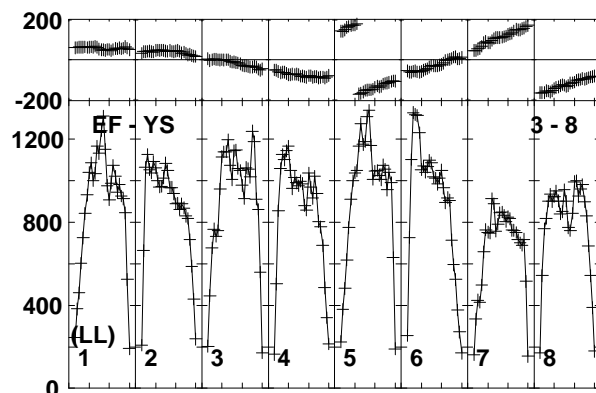
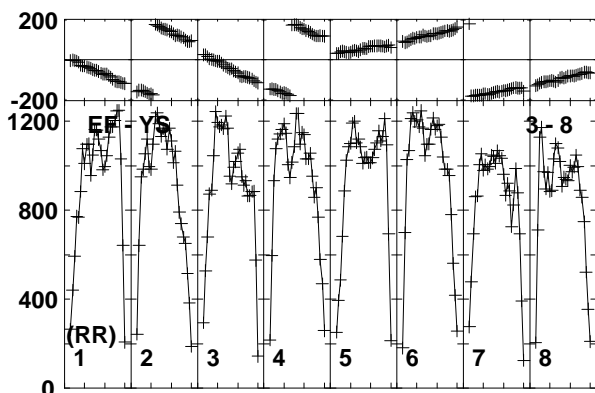
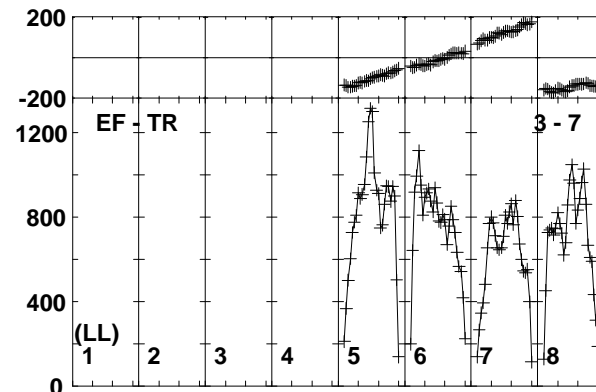
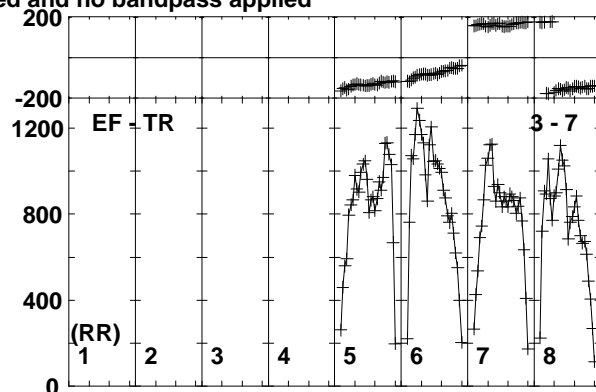
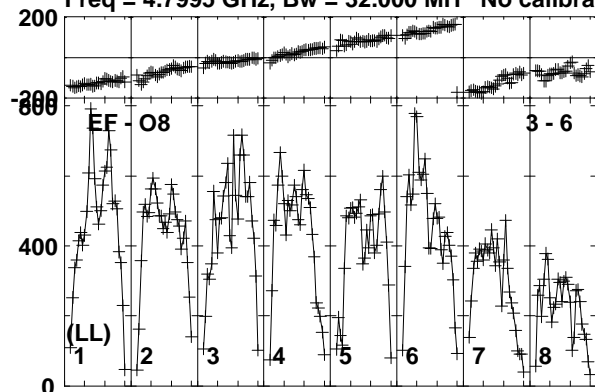

Lower frame: Micro Ampl Jy Top frame: Phas deg
Vector averaged cross-power spectrum Baseline: EF (03) - O8 (06)
Timerange: 00/16:22:44 to 00/16:23:58

Plot file version 205 created 03-APR-2017 18:27:43

M22-VLA1 EM126B.UVDATA.1

Freq = 4.7995 GHz, Bw = 32.000 MH No calibration applied and no bandpass applied

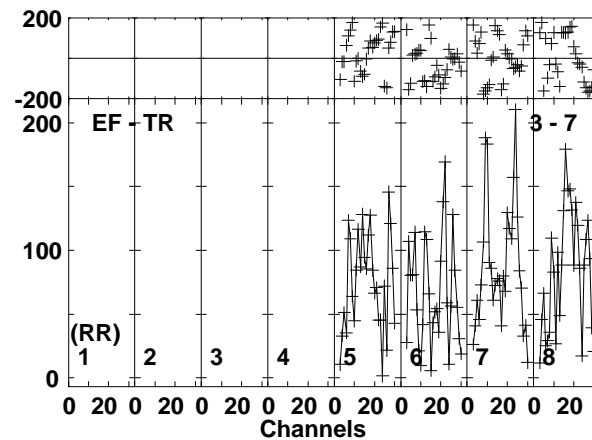
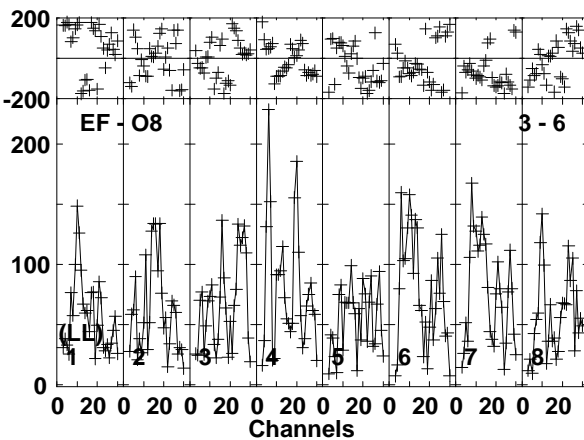
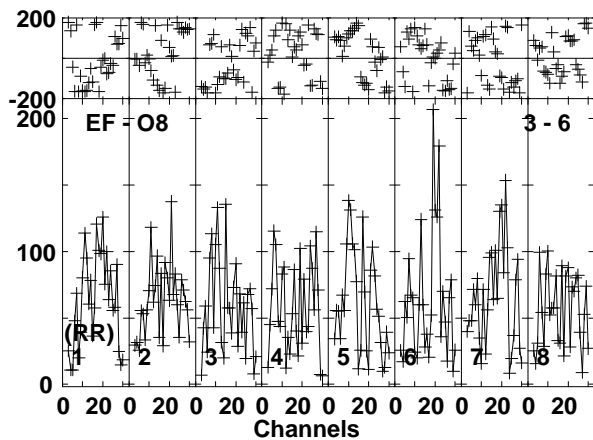
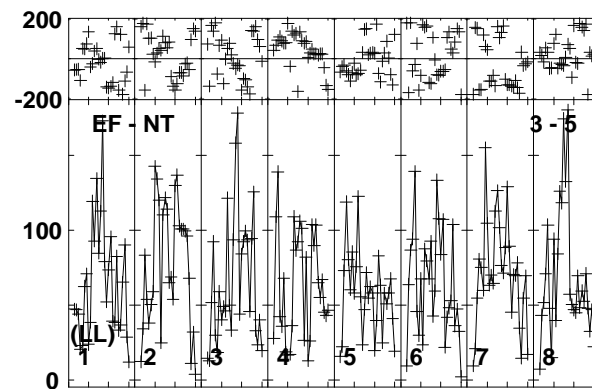
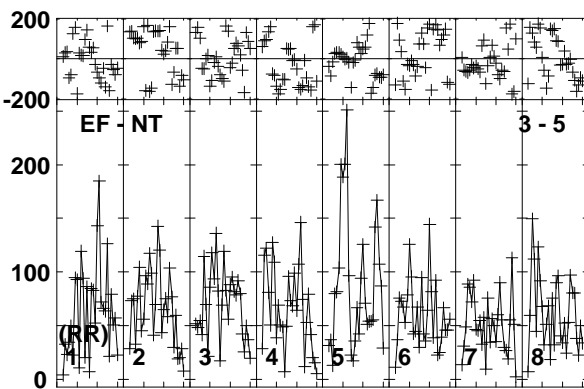
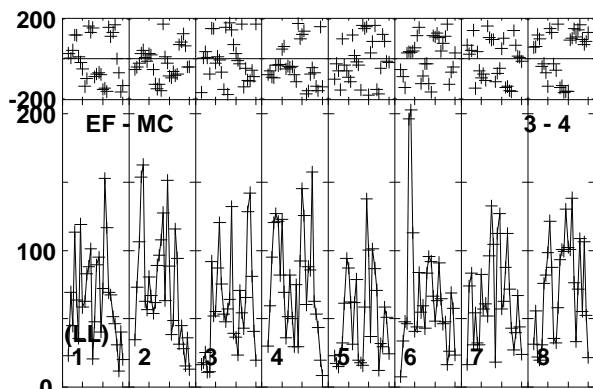
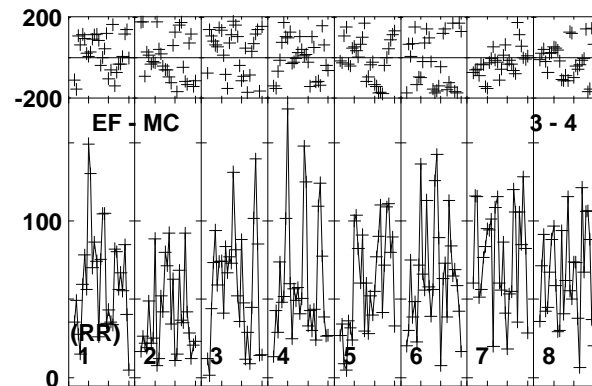
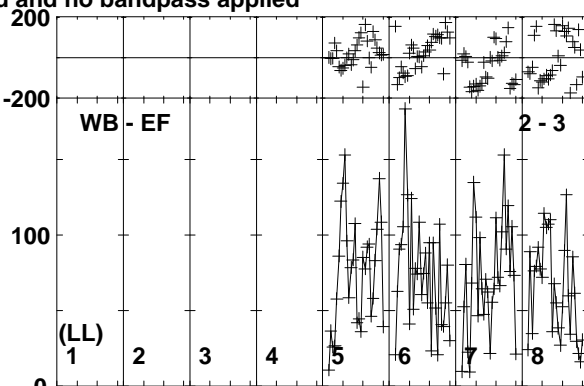
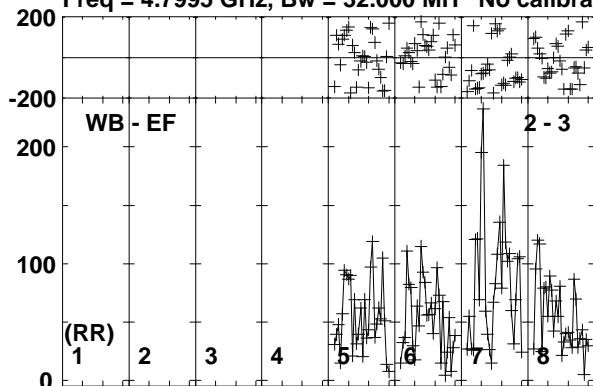

Lower frame: Micro Ampl Jy Top frame: Phas deg
Vector averaged cross-power spectrum Baseline: WB (02) - EF (03)
Timerange: 00/16:24:04 to 00/16:26:08

Plot file version 206 created 03-APR-2017 18:27:43

M22-VLA1 EM126B.UVDATA.1

Freq = 4.7995 GHz, Bw = 32.000 MH No calibration applied and no bandpass applied

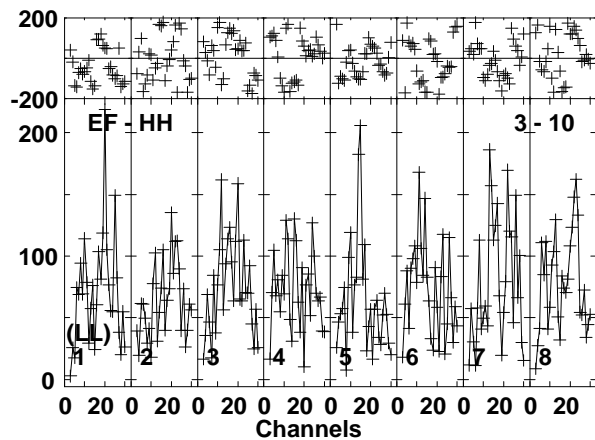
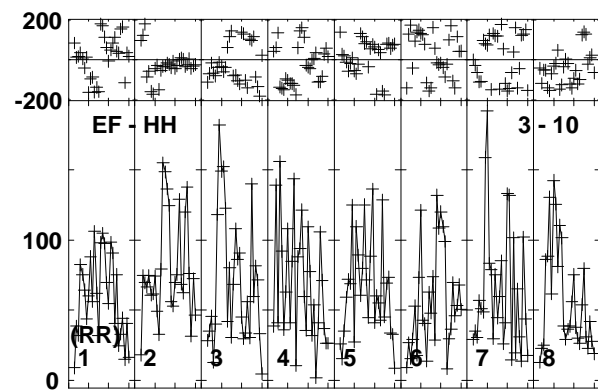
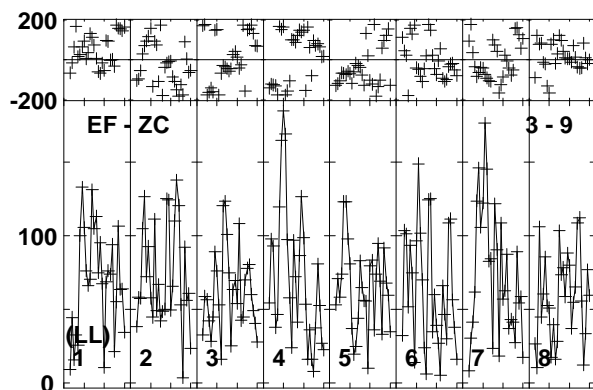
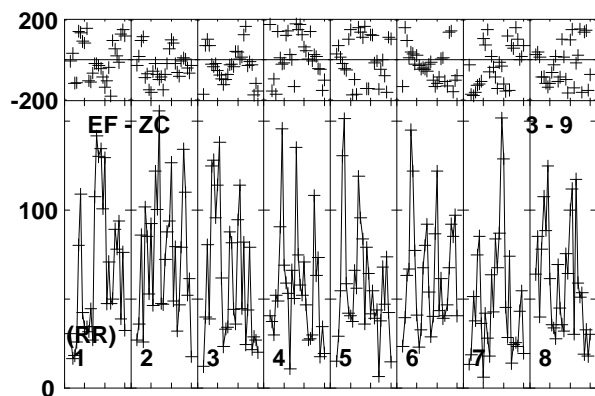
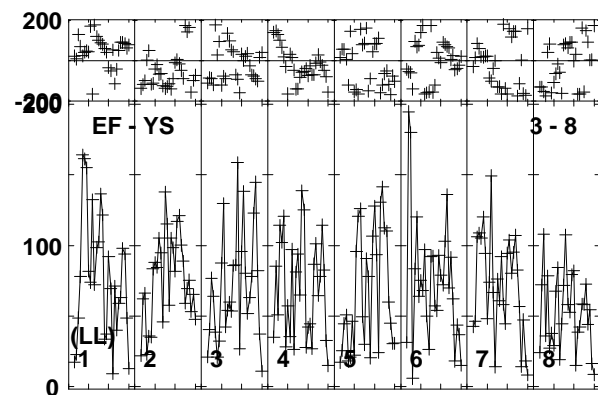
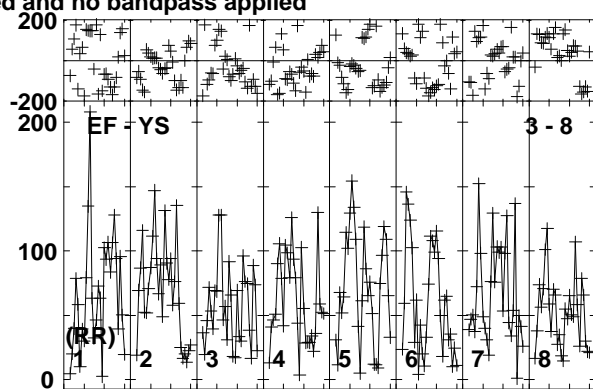
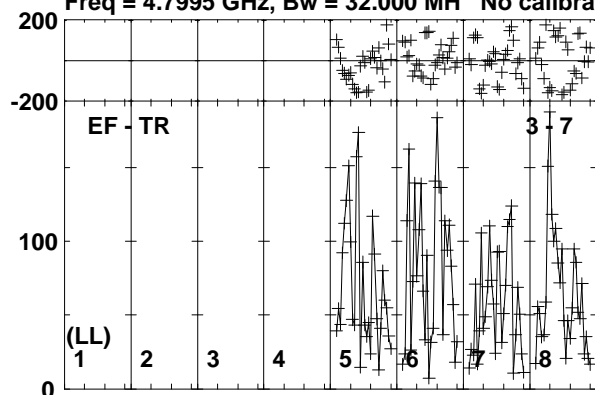

Lower frame: Micro Ampl Jy Top frame: Phas deg
Vector averaged cross-power spectrum Baseline: EF (03) - TR (07)
Timerange: 00/16:24:04 to 00/16:26:08

Plot file version 207 created 03-APR-2017 18:27:43

J1834-2341 EM126B.UVDATA.1

Freq = 4.7995 GHz, Bw = 32.000 MH No calibration applied and no bandpass applied

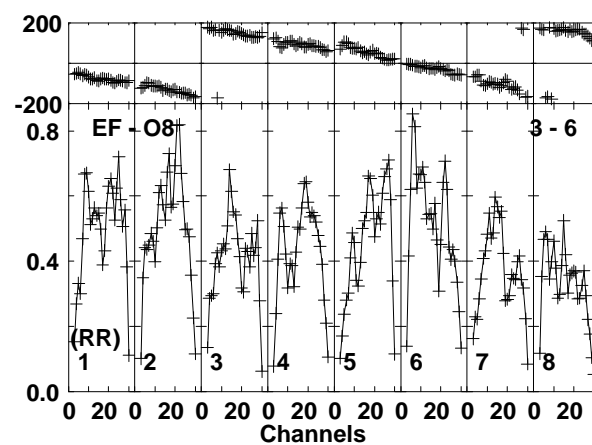
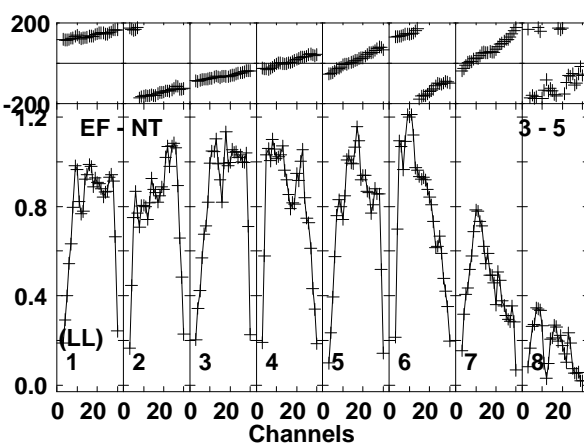
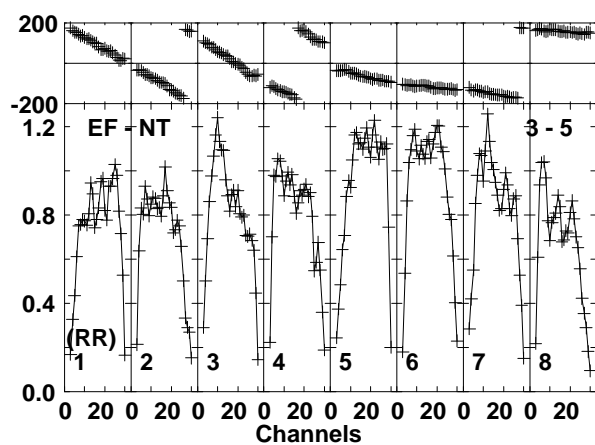
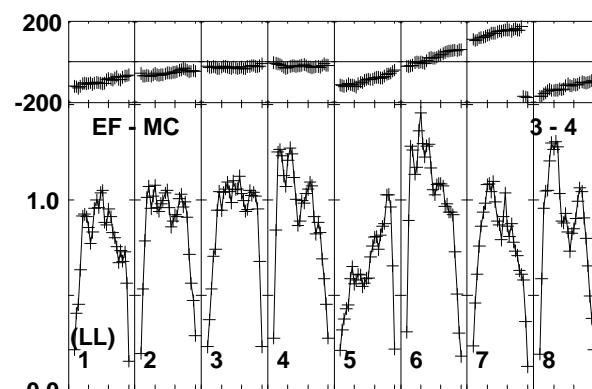
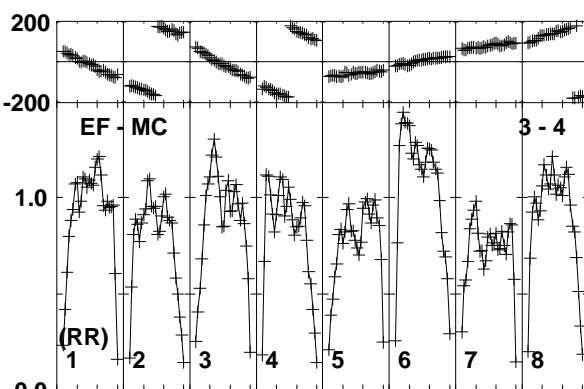
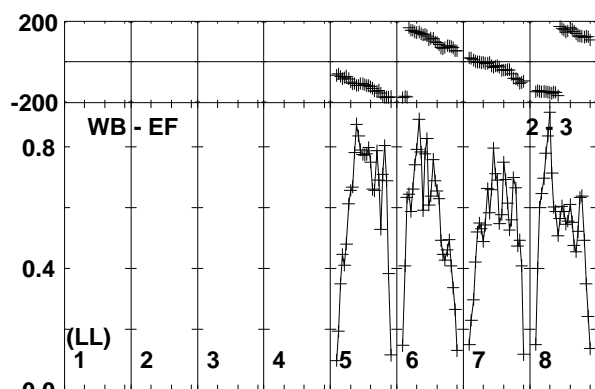
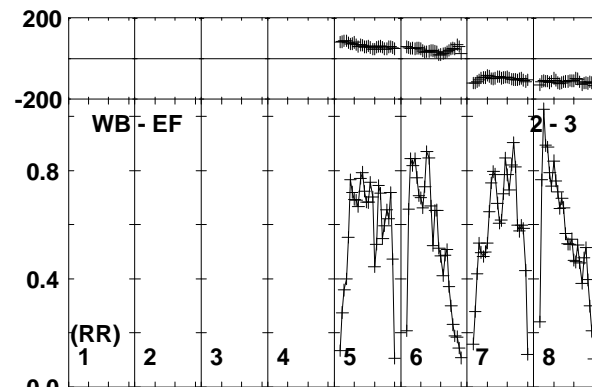
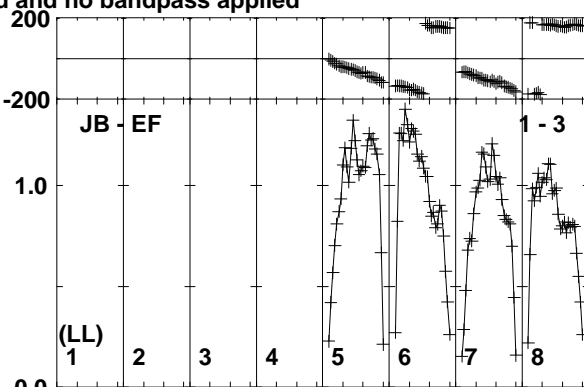
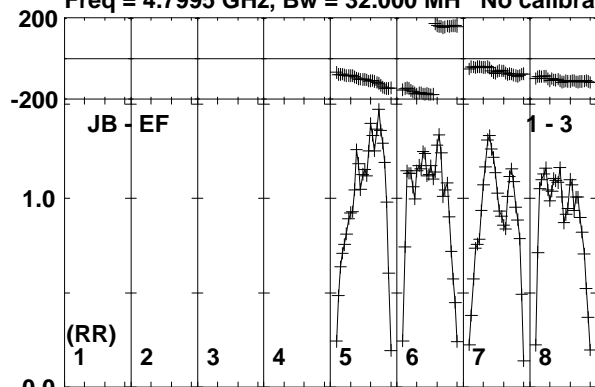

Lower frame: Milli Ampl Jy Top frame: Phas deg
Vector averaged cross-power spectrum Baseline: JB (01) - EF (03)
Timerange: 00/16:26:41 to 00/16:27:29

Plot file version 208 created 03-APR-2017 18:27:43

J1834-2341 EM126B.UVDATA.1

Freq = 4.7995 GHz, Bw = 32.000 MH No calibration applied and no bandpass applied

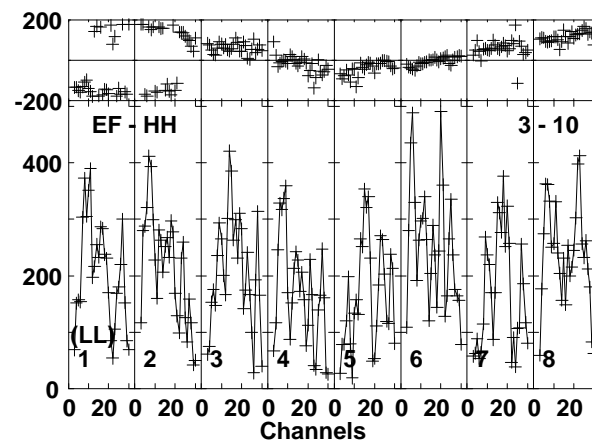
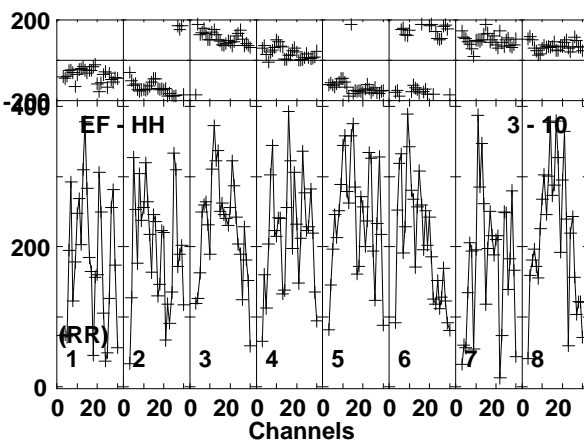
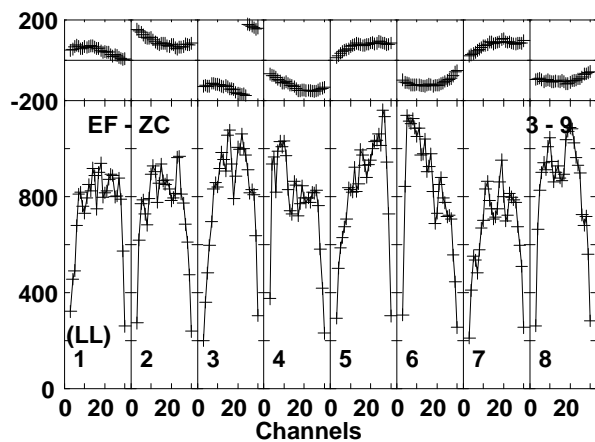
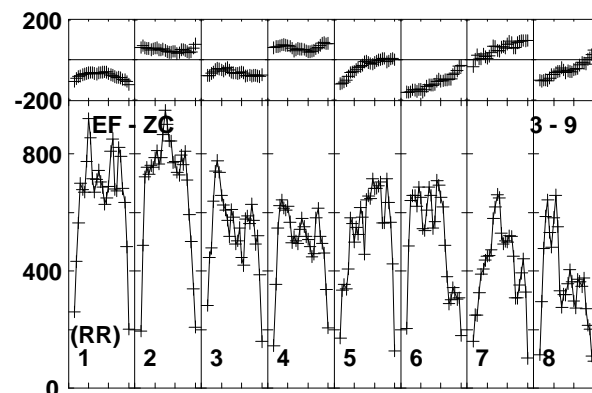
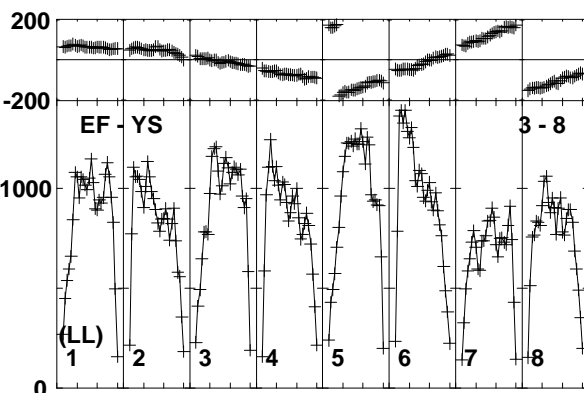
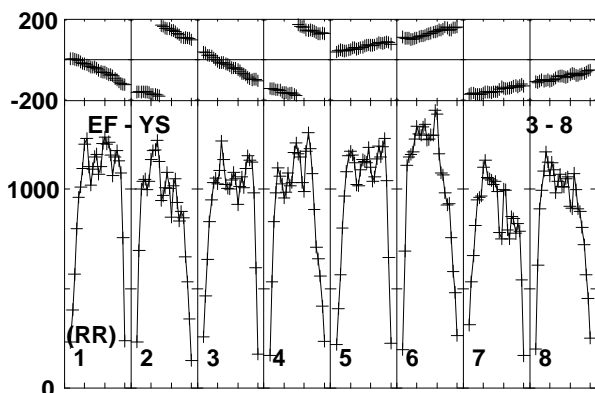
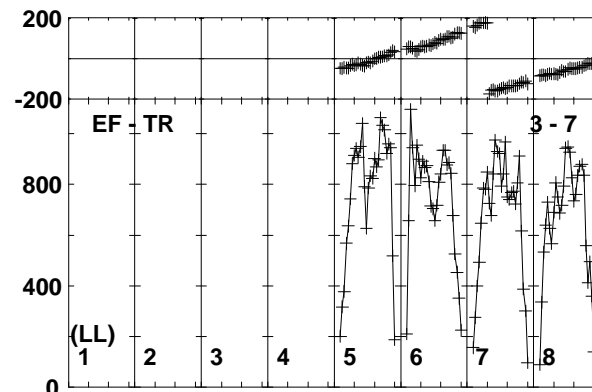
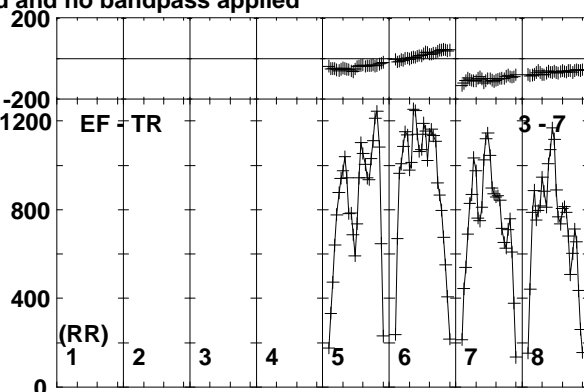
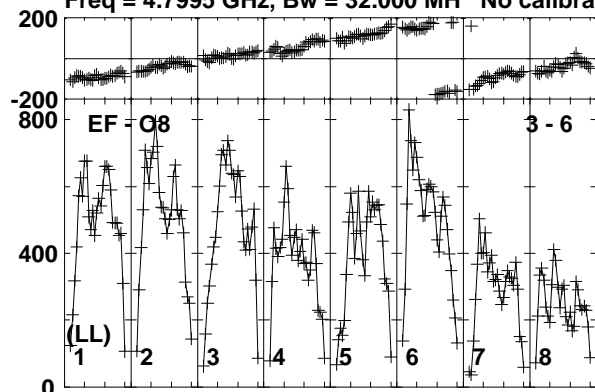

Lower frame: Micro Ampl Jy Top frame: Phas deg
Vector averaged cross-power spectrum Baseline: EF (03) - O8 (06)
Timerange: 00/16:26:41 to 00/16:27:29

Plot file version 211 created 03-APR-2017 18:27:43

J1834-2341 EM126B.UVDATA.1

Freq = 4.7995 GHz, Bw = 32.000 MH No calibration applied and no bandpass applied

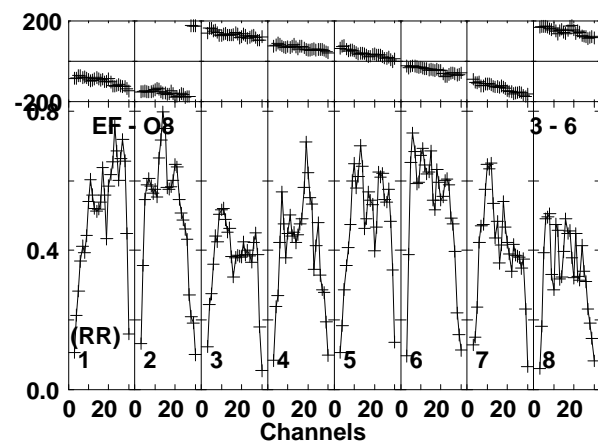
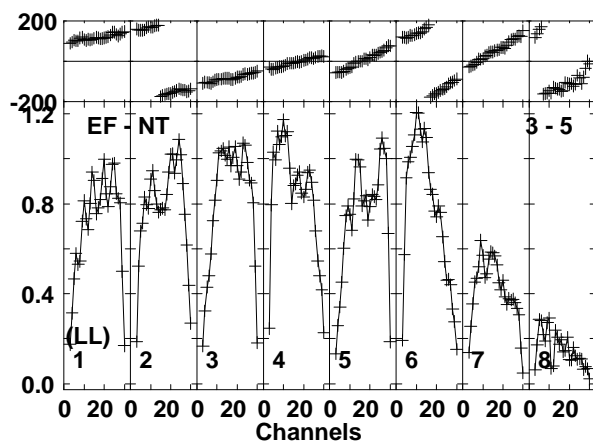
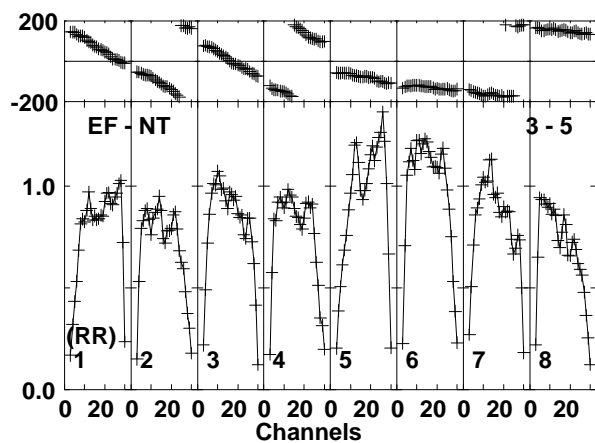
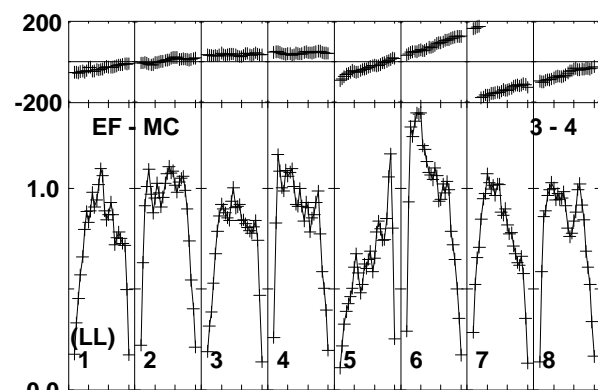
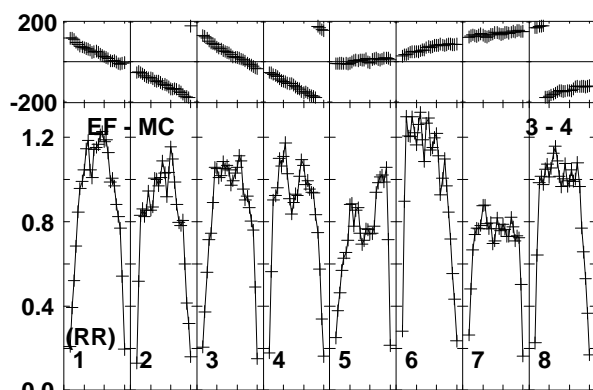
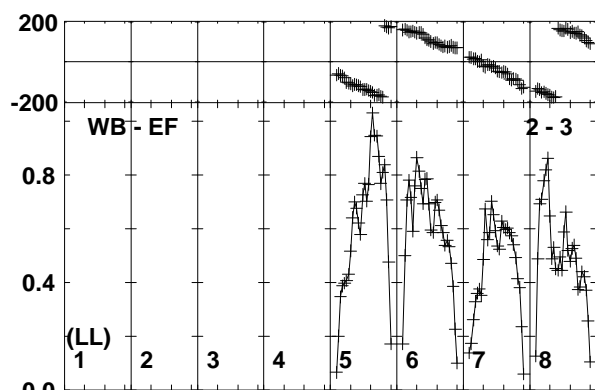
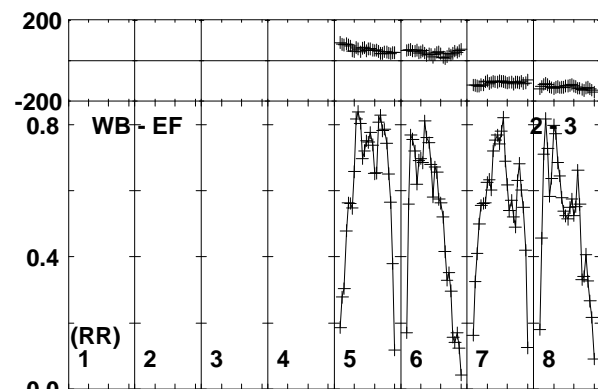
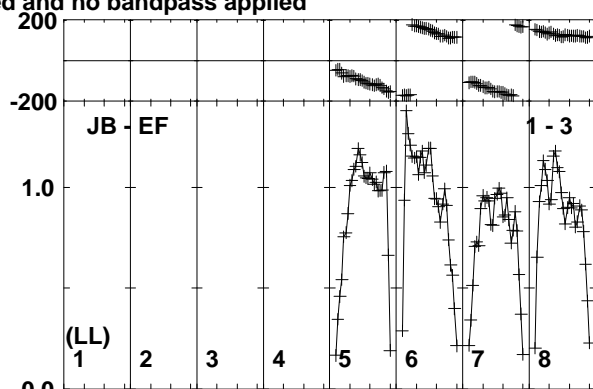
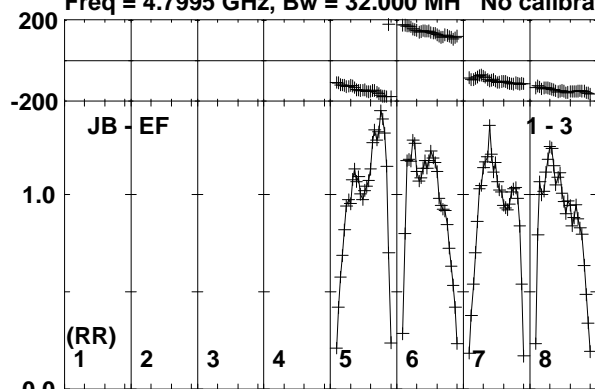

Lower frame: Milli Ampl Jy Top frame: Phas deg
Vector averaged cross-power spectrum Baseline: JB (01) - EF (03)
Timerange: 00:16:29:44 to 00:16:30:58

Plot file version 212 created 03-APR-2017 18:27:43

J1834-2341 EM126B.UVDATA.1

Freq = 4.7995 GHz, Bw = 32.000 MH No calibration applied and no bandpass applied

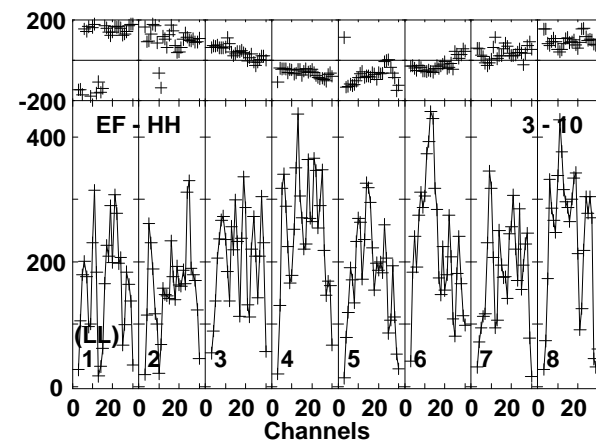
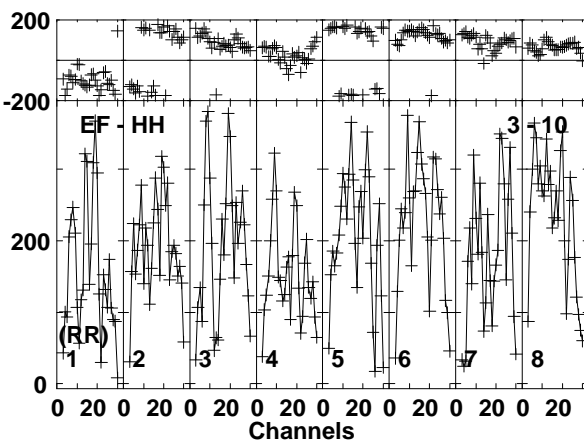
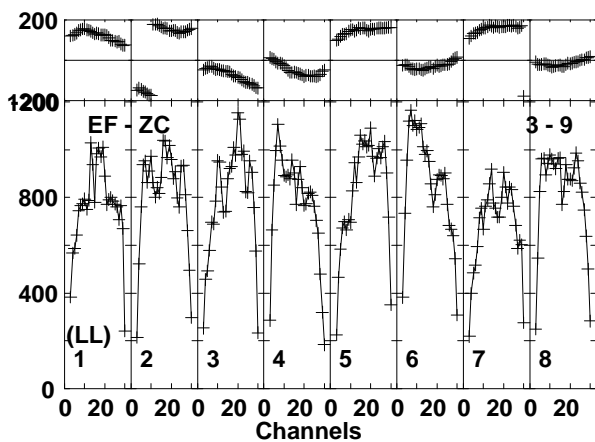
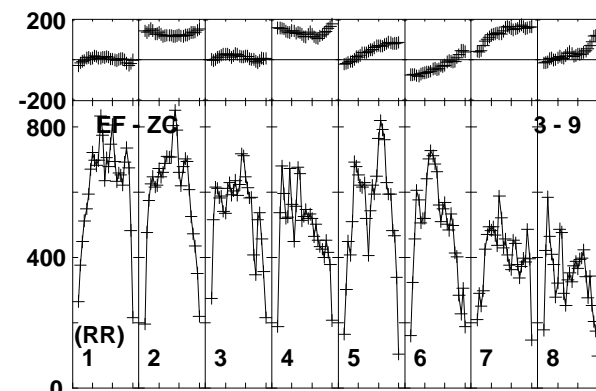
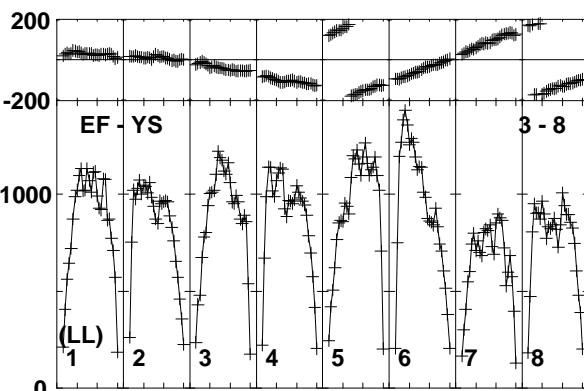
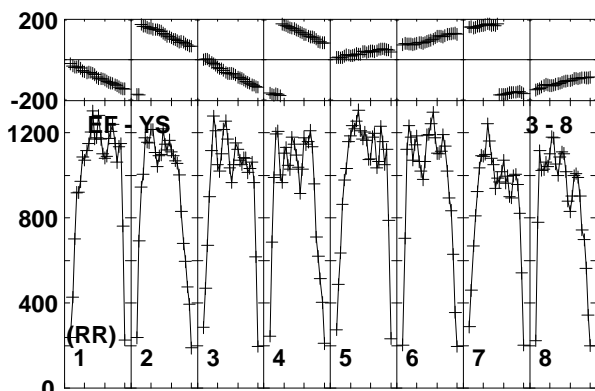
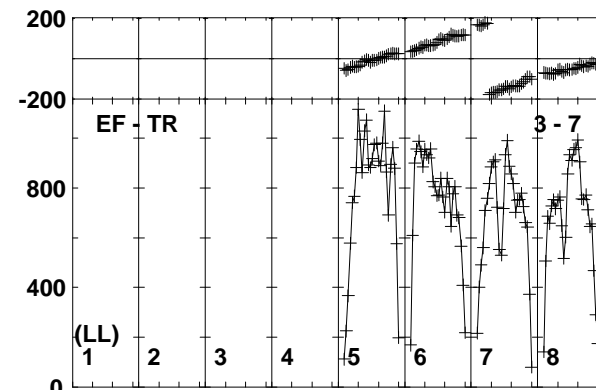
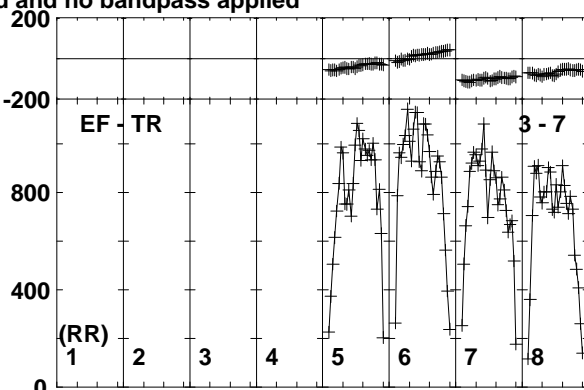
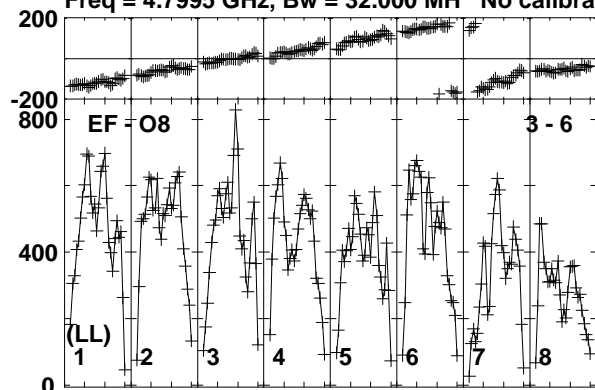

Lower frame: Micro Ampl Jy Top frame: Phas deg
Vector averaged cross-power spectrum Baseline: EF (03) - O8 (06)
Timerange: 00/16:29:44 to 00/16:30:58

Plot file version 213 created 03-APR-2017 18:27:43

M22-VLA1 EM126B.UVDATA.1

Freq = 4.7995 GHz, Bw = 32.000 MH No calibration applied and no bandpass applied

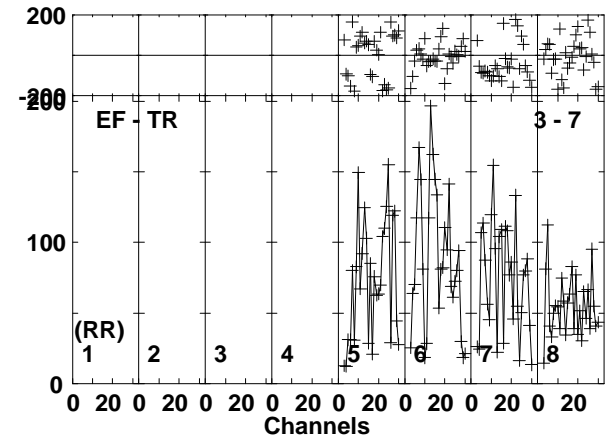
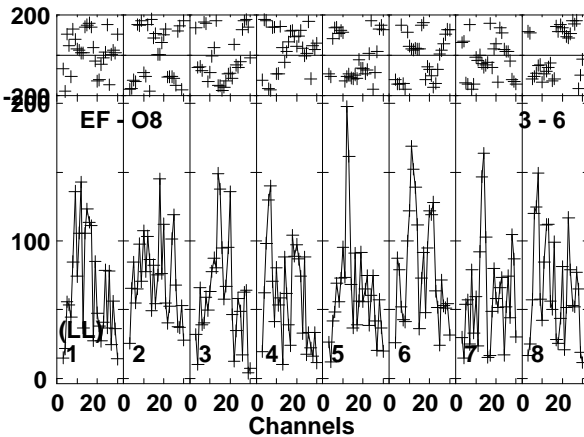
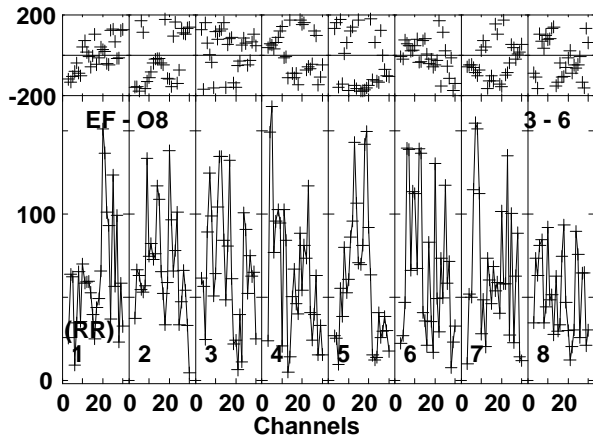
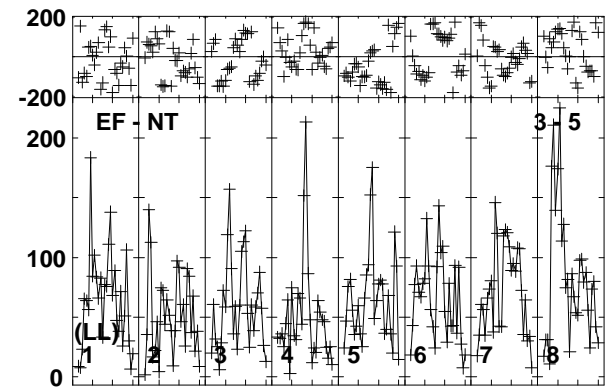
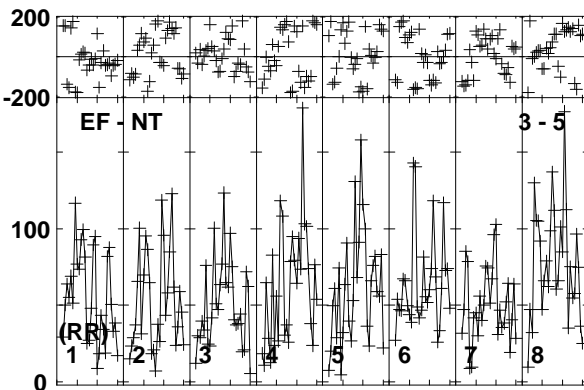
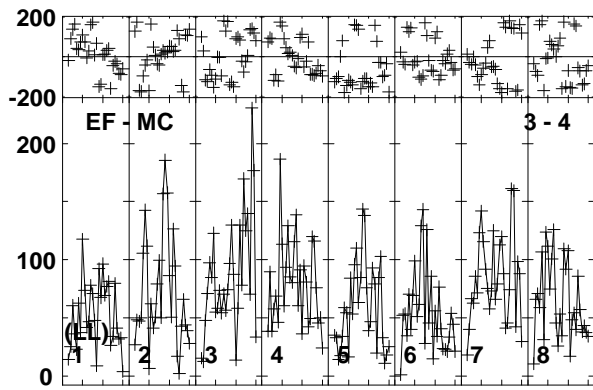
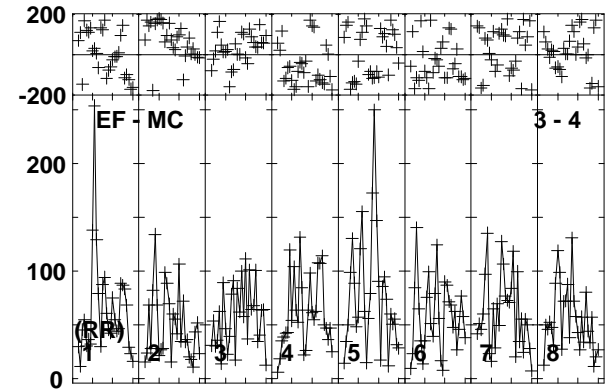
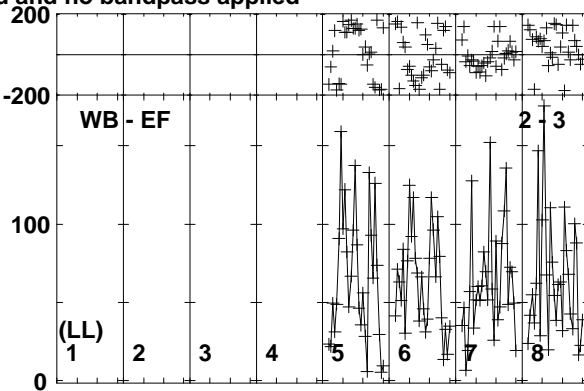
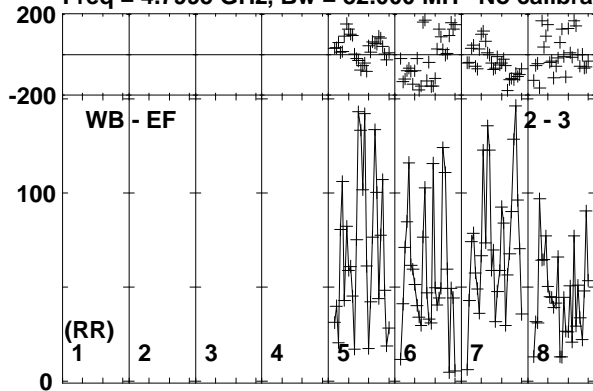

Lower frame: Micro Ampl Jy Top frame: Phas deg
Vector averaged cross-power spectrum Baseline: WB (02) - EF (03)
Timerange: 00/16:31:04 to 00/16:33:08

Plot file version 214 created 03-APR-2017 18:27:43

M22-VLA1 EM126B.UVDATA.1

Freq = 4.7995 GHz, Bw = 32.000 MH No calibration applied and no bandpass applied

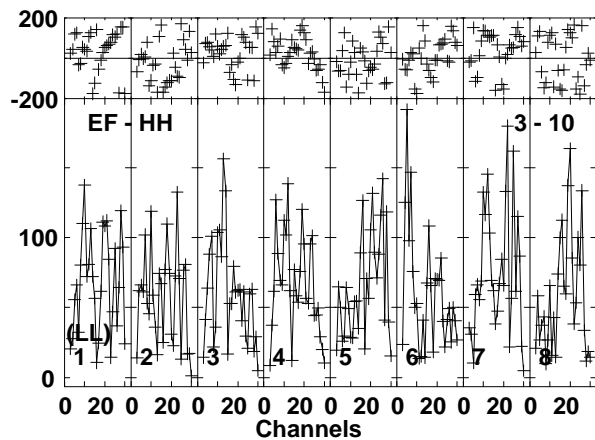
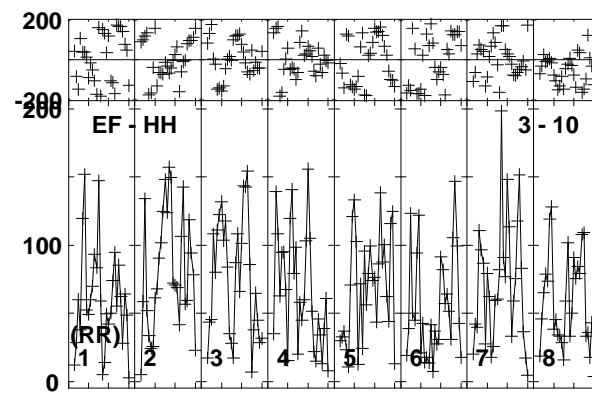
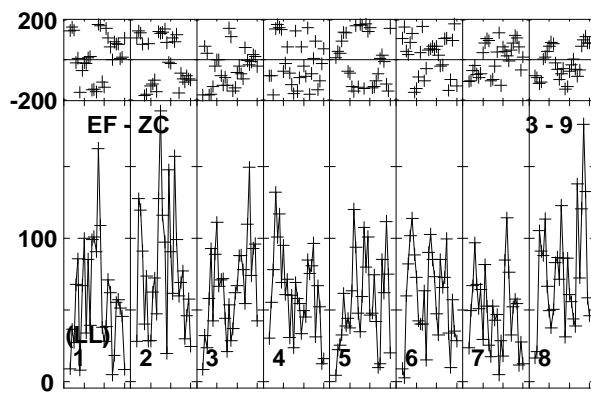
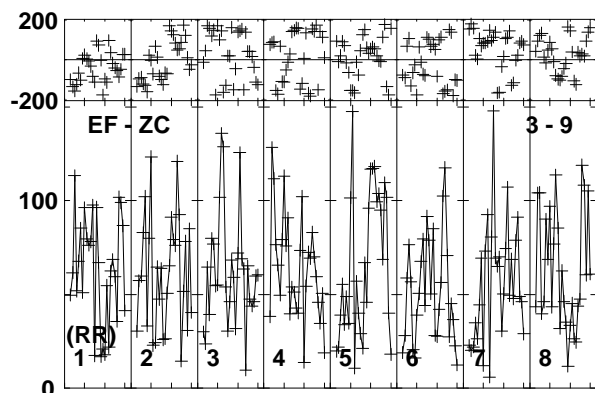
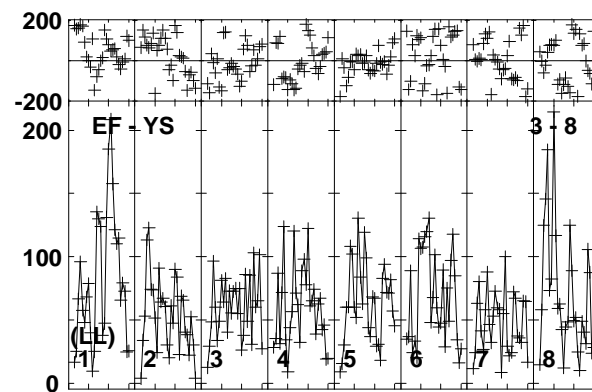
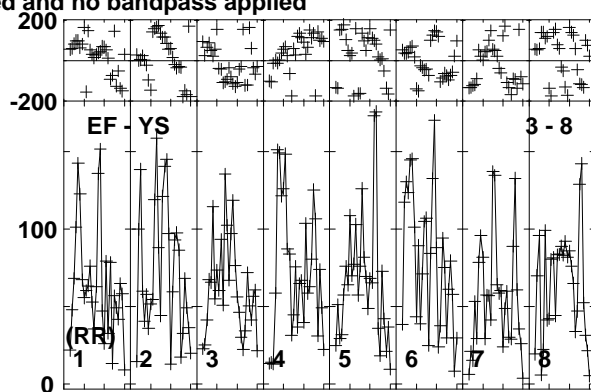
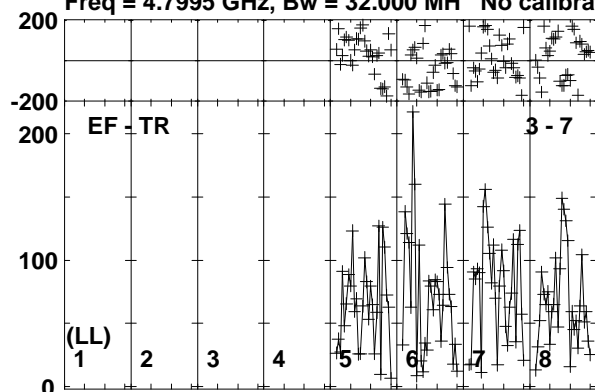

Lower frame: Micro Ampl Jy Top frame: Phas deg
Vector averaged cross-power spectrum Baseline: EF (03) - TR (07)
Timerange: 00/16:31:04 to 00/16:33:08

Plot file version 215 created 03-APR-2017 18:27:43

J1834-2341 EM126B.UVDATA.1

Freq = 4.7995 GHz, Bw = 32.000 MH No calibration applied and no bandpass applied

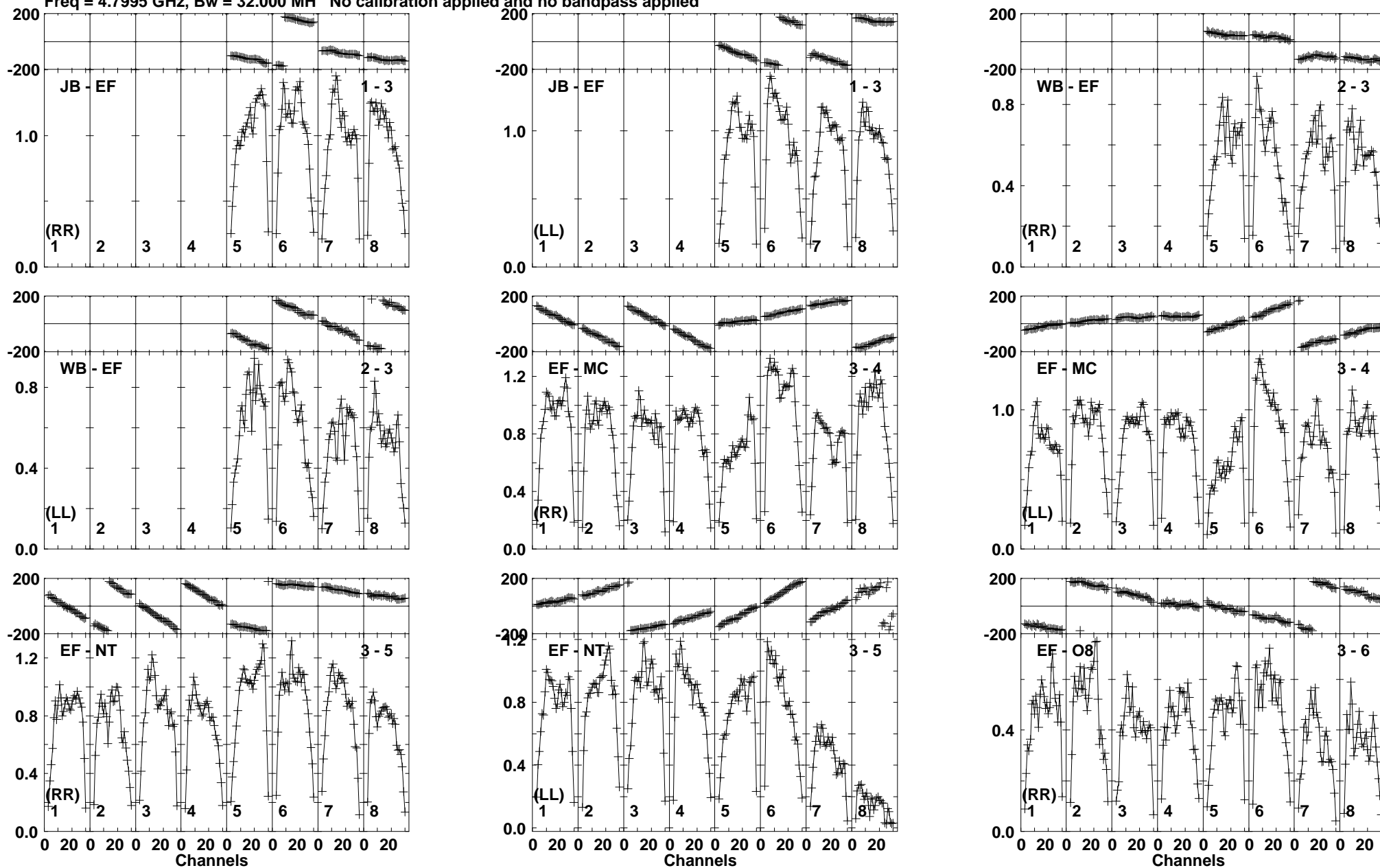

Lower frame: Milli Ampl Jy Top frame: Phas deg
Vector averaged cross-power spectrum Baseline: JB (01) - EF (03)
Timerange: 00/16:33:14 to 00/16:34:28

Plot file version 216 created 03-APR-2017 18:27:43

J1834-2341 EM126B.UVDATA.1

Freq = 4.7995 GHz, Bw = 32.000 MH No calibration applied and no bandpass applied

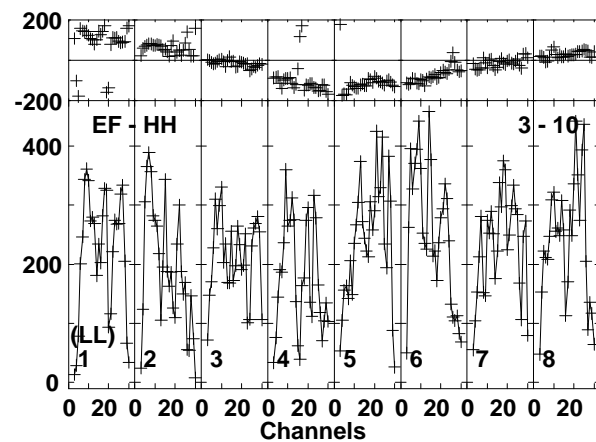
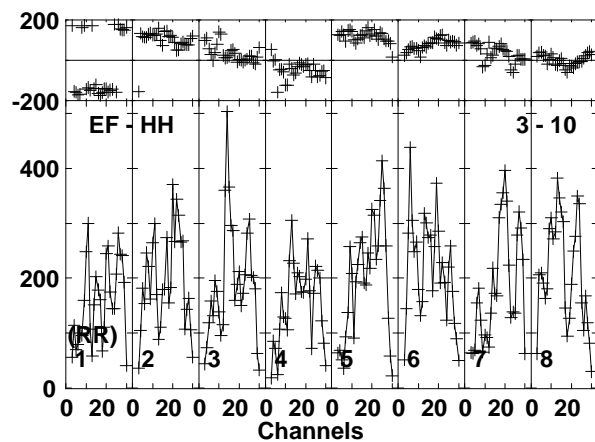
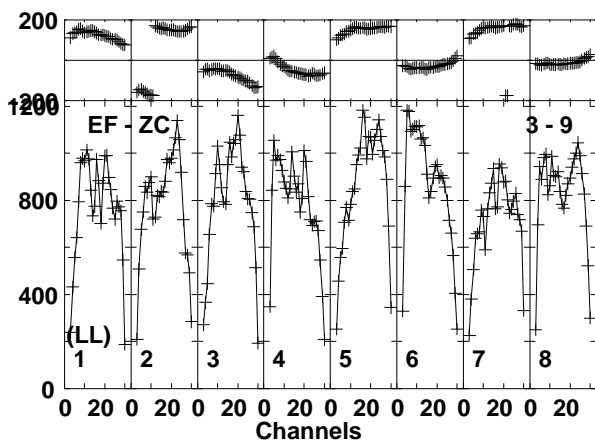
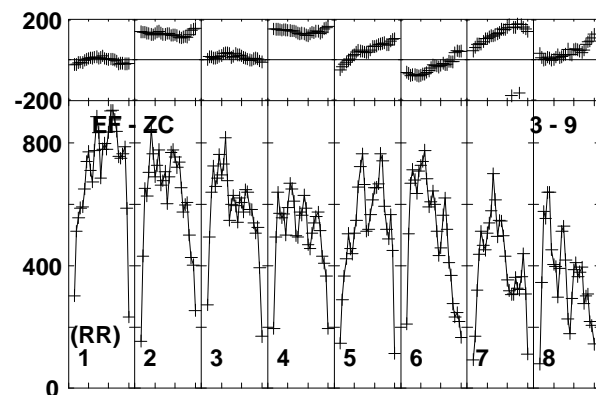
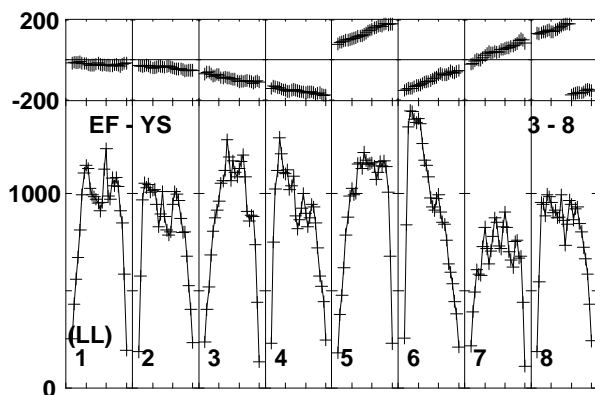
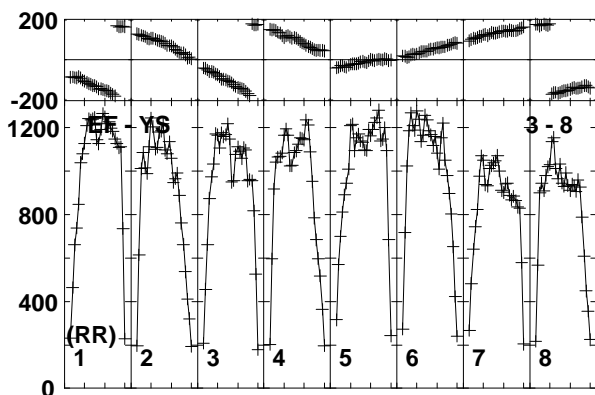
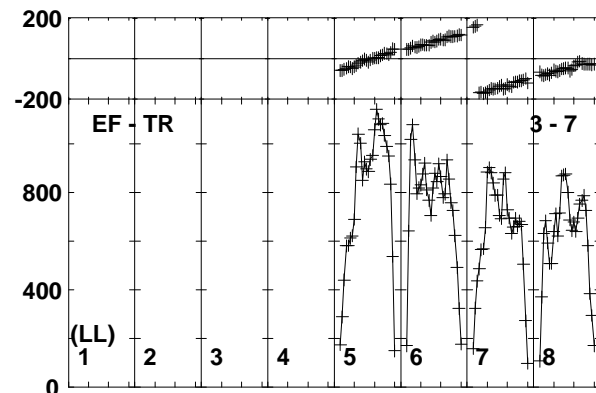
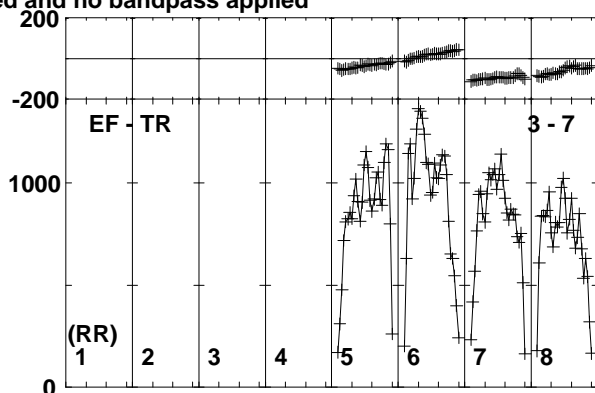
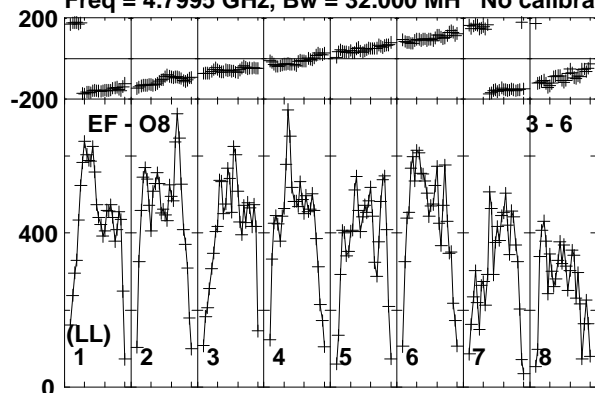

Lower frame: Micro Ampl Jy Top frame: Phas deg
Vector averaged cross-power spectrum Baseline: EF (03) - O8 (06)
Timerange: 00/16:33:14 to 00/16:34:28

Plot file version 217 created 03-APR-2017 18:27:43

M22-VLA1 EM126B.UVDATA.1

Freq = 4.7995 GHz, Bw = 32.000 MH No calibration applied and no bandpass applied

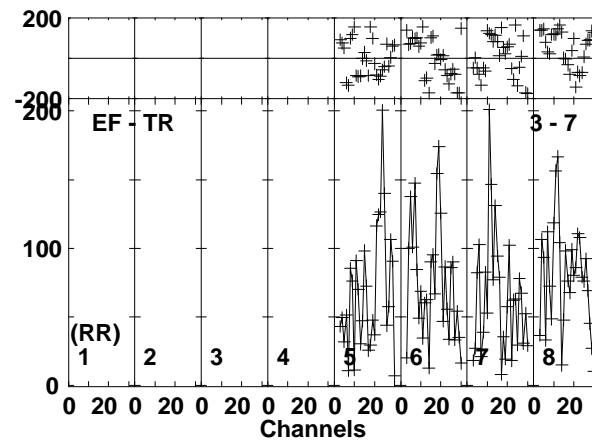
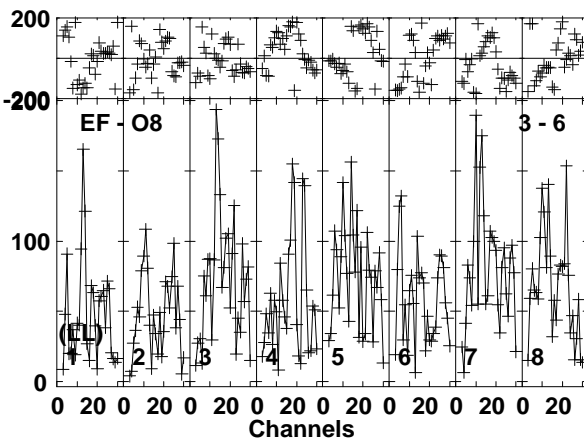
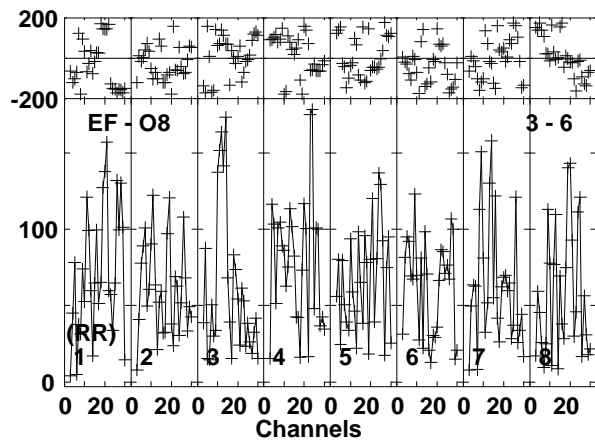
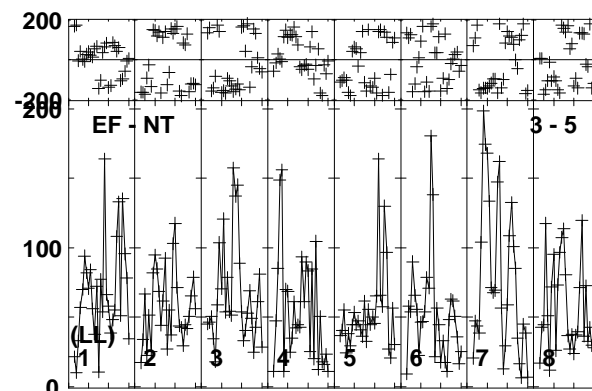
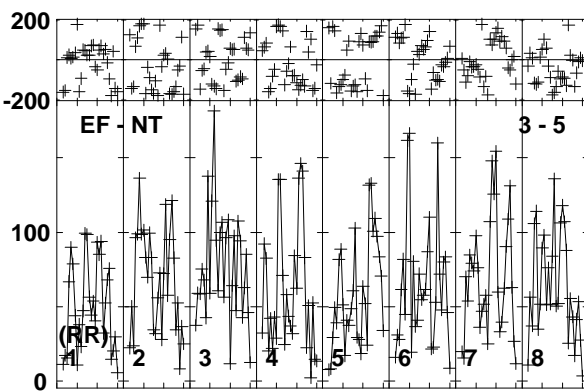
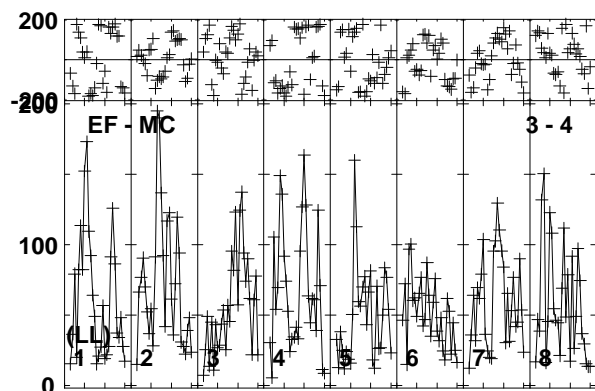
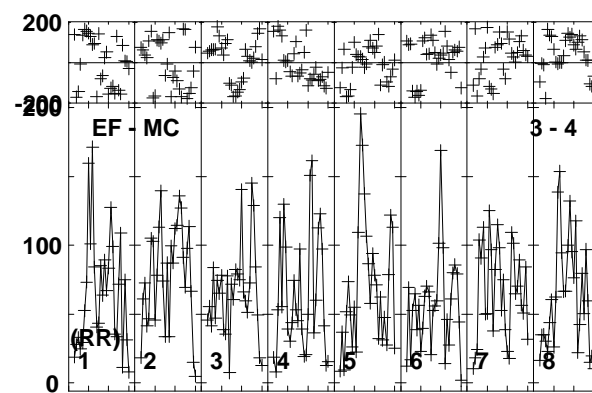
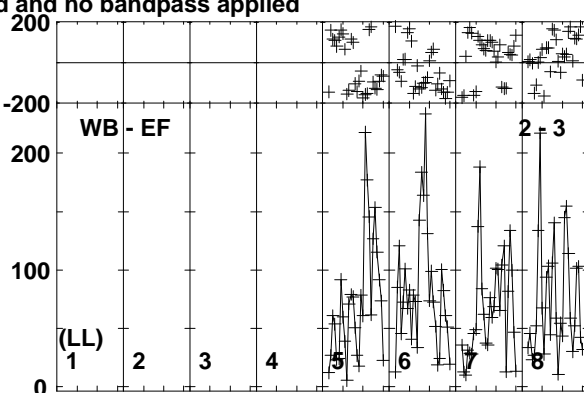
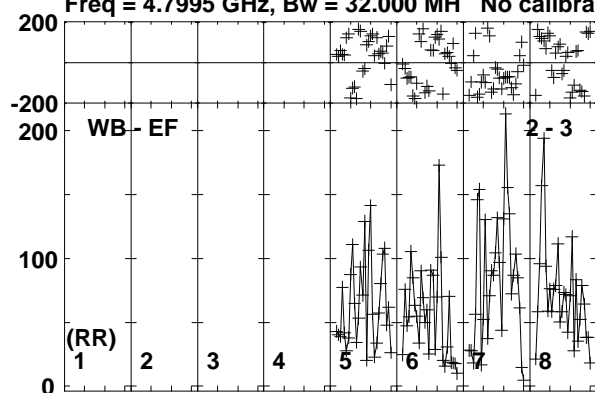

Lower frame: Micro Ampl Jy Top frame: Phas deg
Vector averaged cross-power spectrum Baseline: WB (02) - EF (03)
Timerange: 00/16:34:34 to 00/16:36:38

Plot file version 218 created 03-APR-2017 18:27:43

M22-VLA1 EM126B.UVDATA.1

Freq = 4.7995 GHz, Bw = 32.000 MH No calibration applied and no bandpass applied

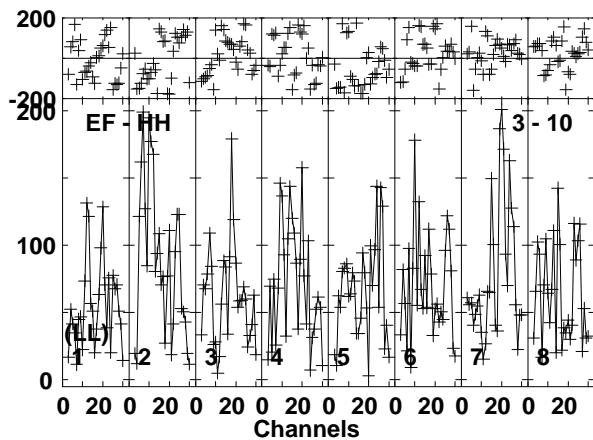
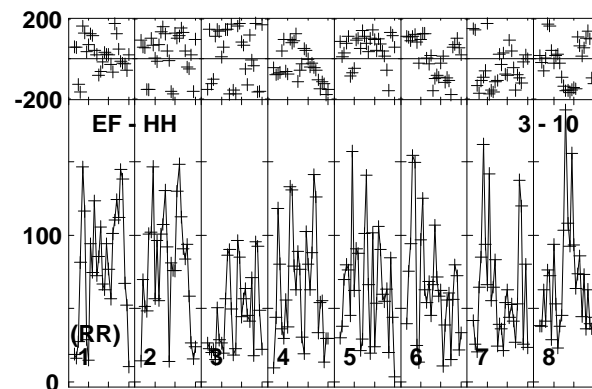
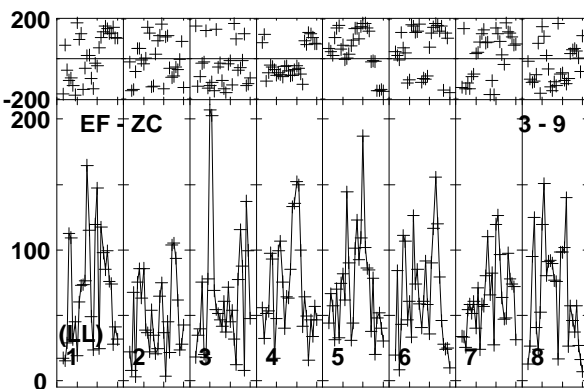
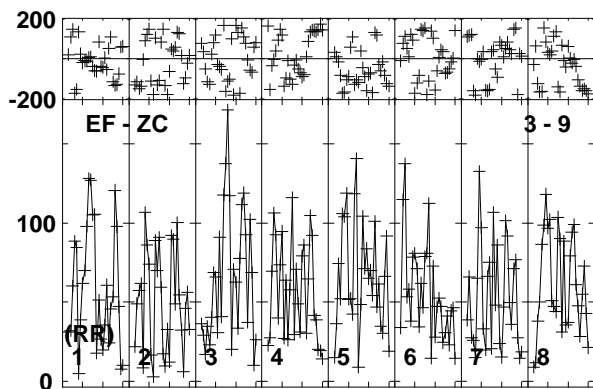
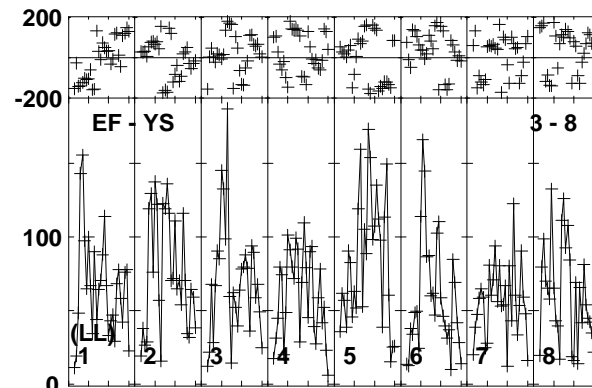
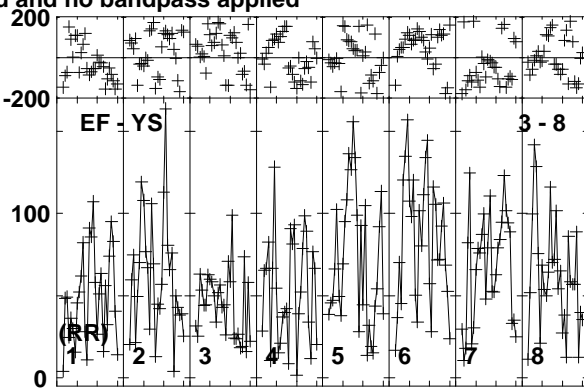
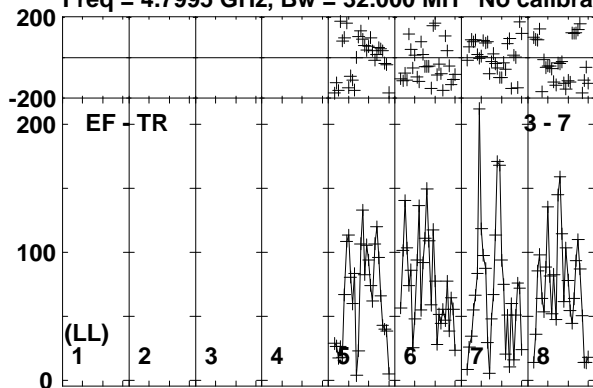

Lower frame: Micro Ampl Jy Top frame: Phas deg
Vector averaged cross-power spectrum Baseline: EF (03) - TR (07)
Timerange: 00/16:34:34 to 00/16:36:38

Plot file version 219 created 03-APR-2017 18:27:43

J1834-2341 EM126B.UVDATA.1

Freq = 4.7995 GHz, Bw = 32.000 MH No calibration applied and no bandpass applied

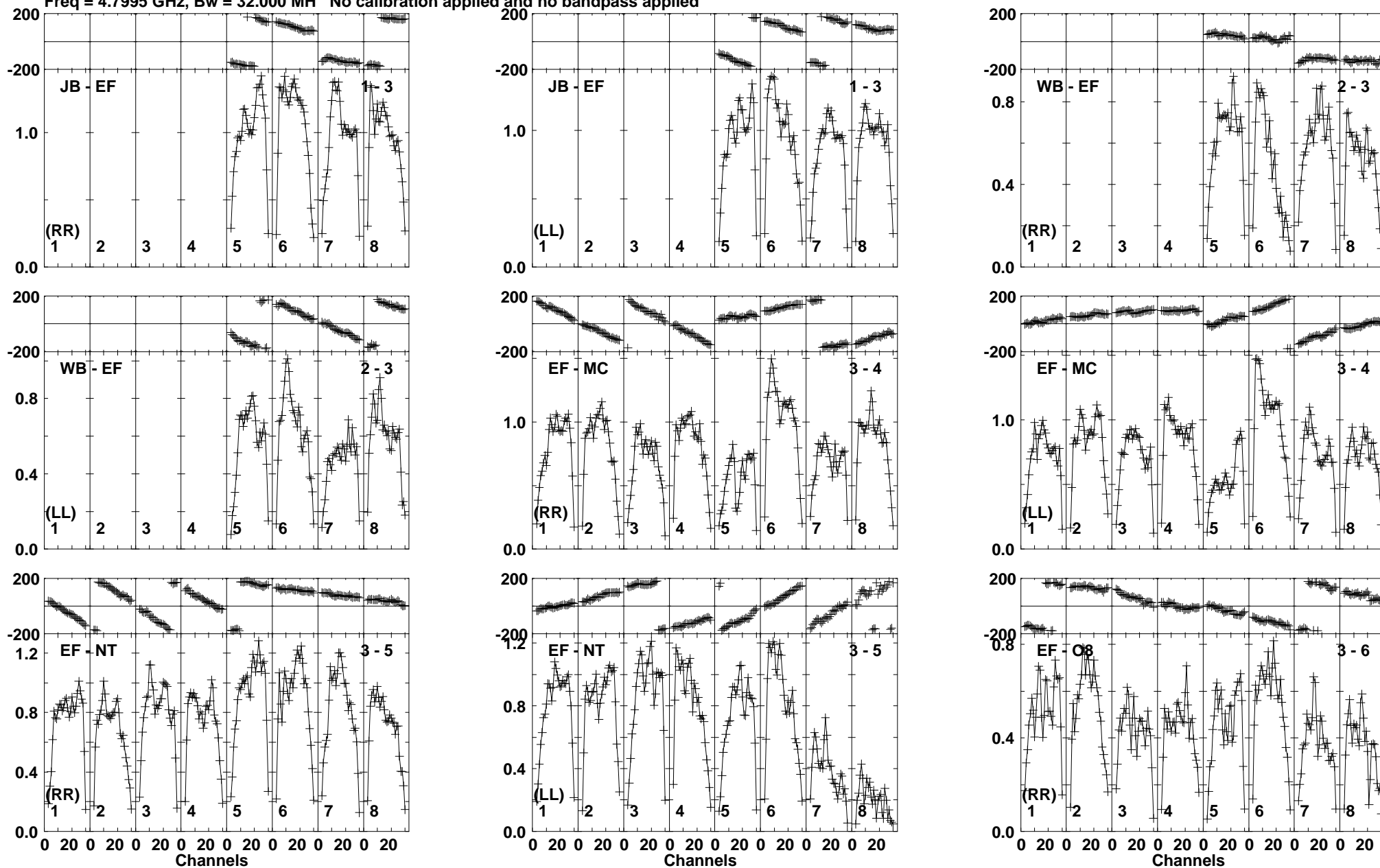

Lower frame: Milli Ampl Jy Top frame: Phas deg
Vector averaged cross-power spectrum Baseline: JB (01) - EF (03)
Timerange: 00/16:37:11 to 00/16:37:59

Plot file version 220 created 03-APR-2017 18:27:43

J1834-2341 EM126B.UVDATA.1

Freq = 4.7995 GHz, Bw = 32.000 MH No calibration applied and no bandpass applied

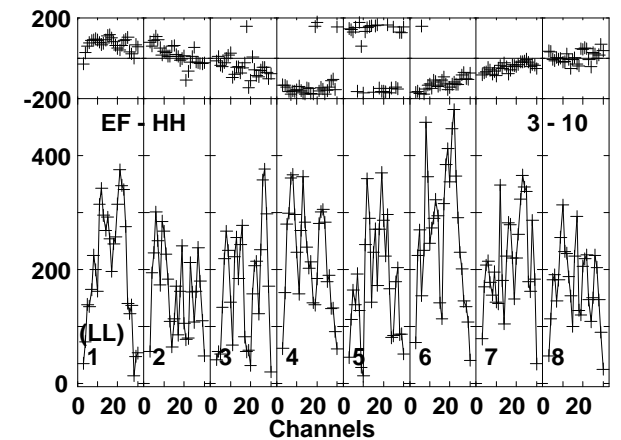
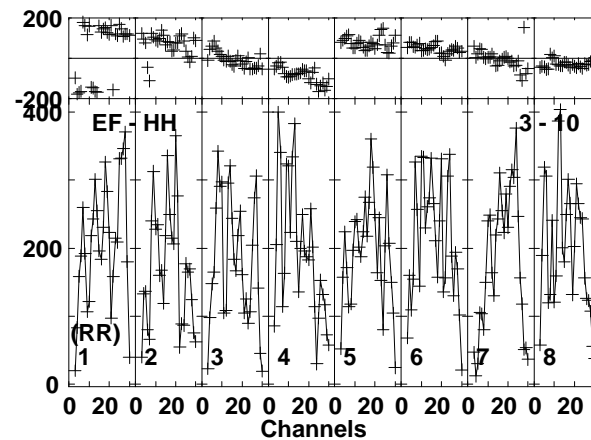
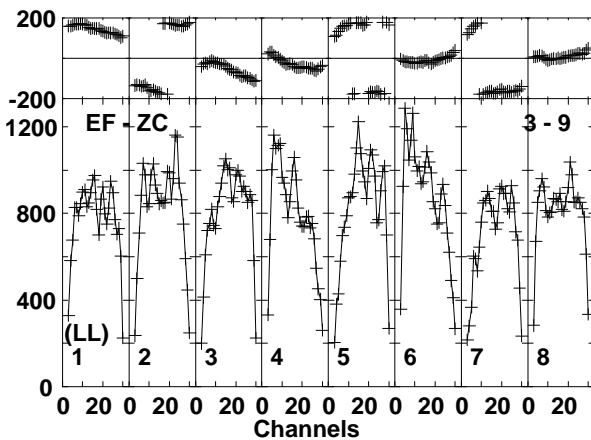
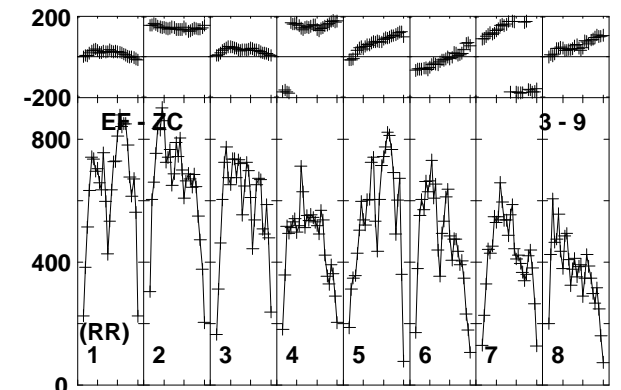
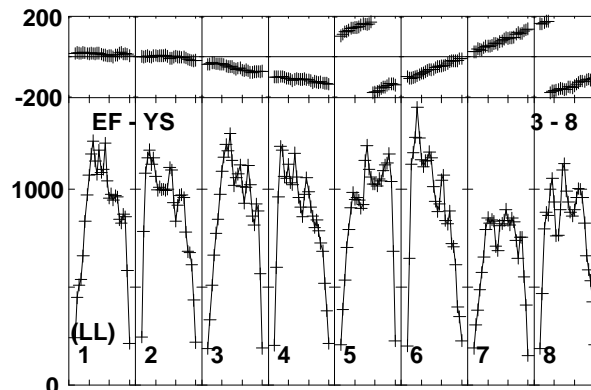
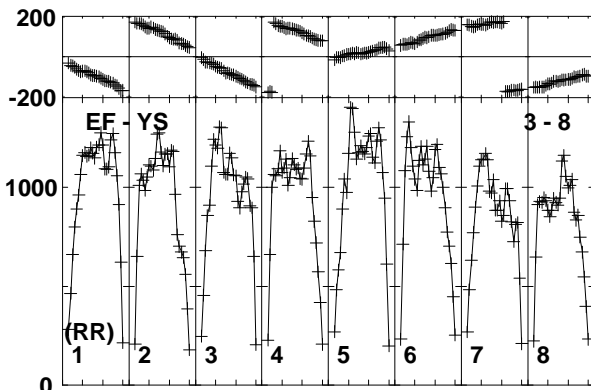
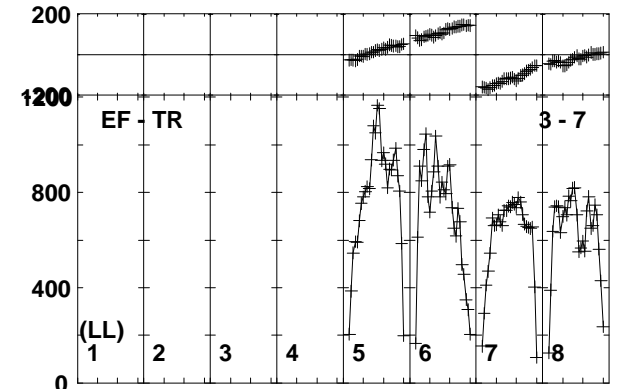
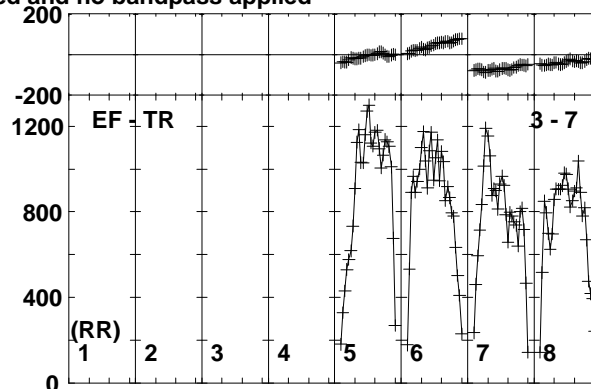
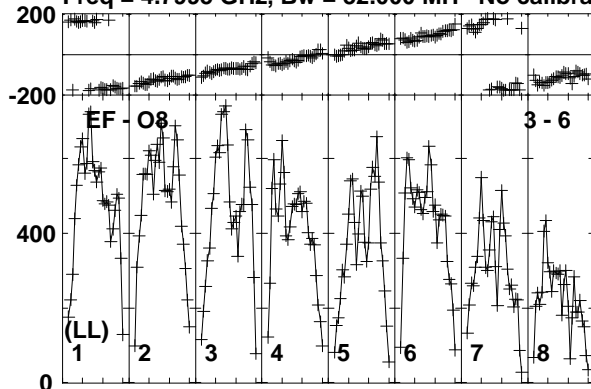

Lower frame: Micro Ampl Jy Top frame: Phas deg
Vector averaged cross-spectrum Baseline: EF (03) - O8 (06)
Timerange: 00/16:37:11 to 00/16:37:59

Plot file version 221 created 03-APR-2017 18:27:43

M22-VLA1 EM126B.UVDATA.1

Freq = 4.7995 GHz, Bw = 32.000 MH No calibration applied and no bandpass applied

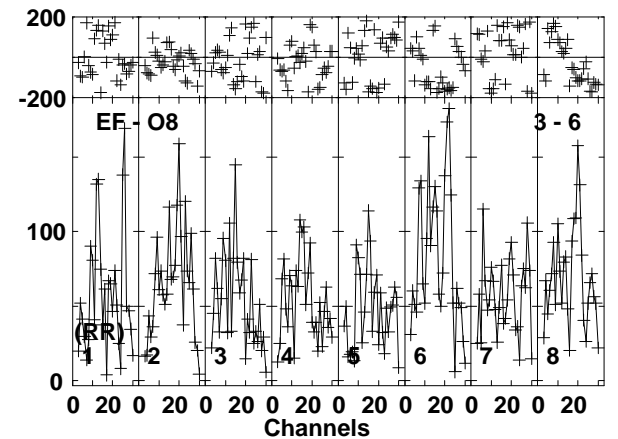
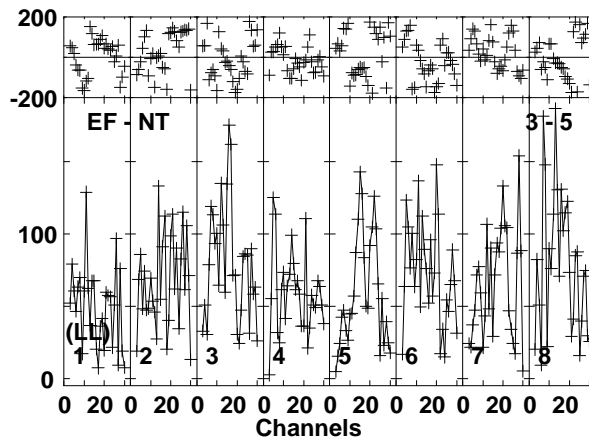
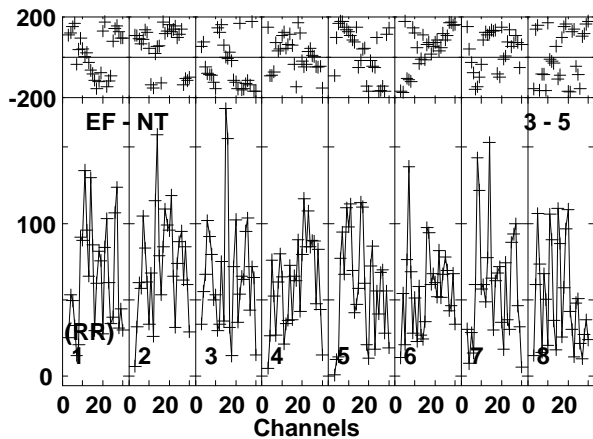
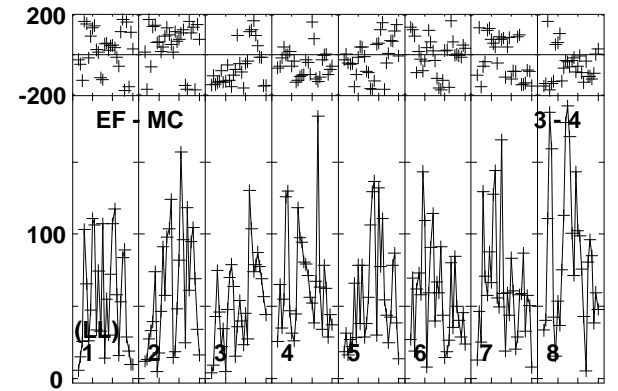
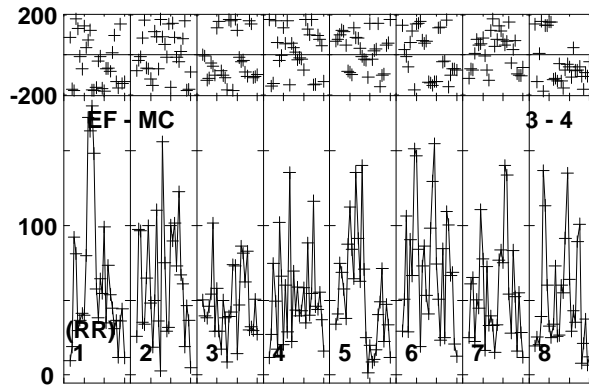
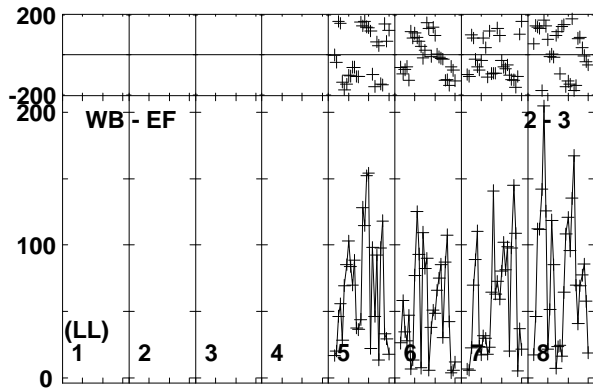
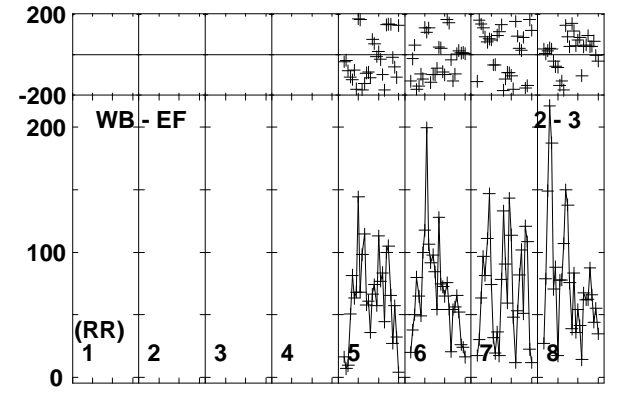
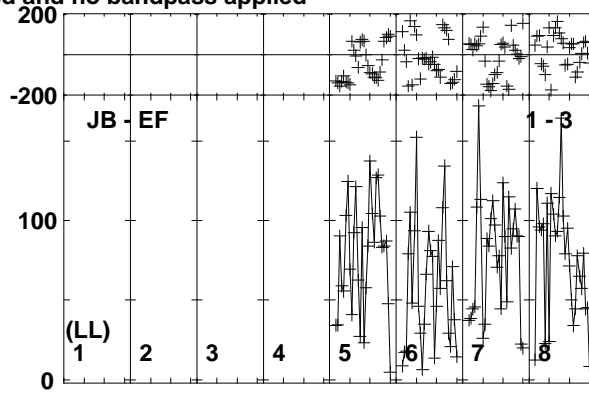
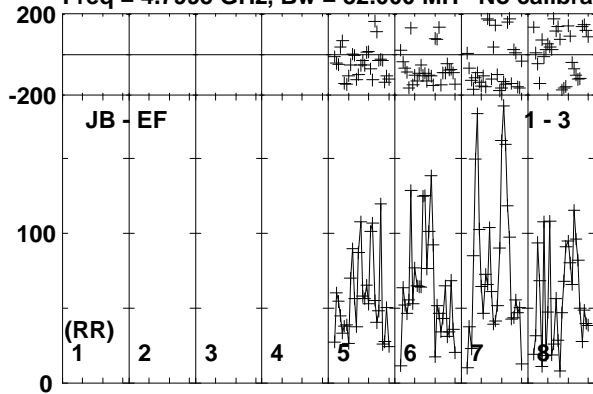

Lower frame: Micro Ampl Jy Top frame: Phas deg
Vector averaged cross-power spectrum Baseline: JB (01) - EF (03)
Timerange: 00/16:38:04 to 00/16:40:08

Plot file version 222 created 03-APR-2017 18:27:43

M22-VLA1 EM126B.UVDATA.1

Freq = 4.7995 GHz, Bw = 32.000 MH No calibration applied and no bandpass applied

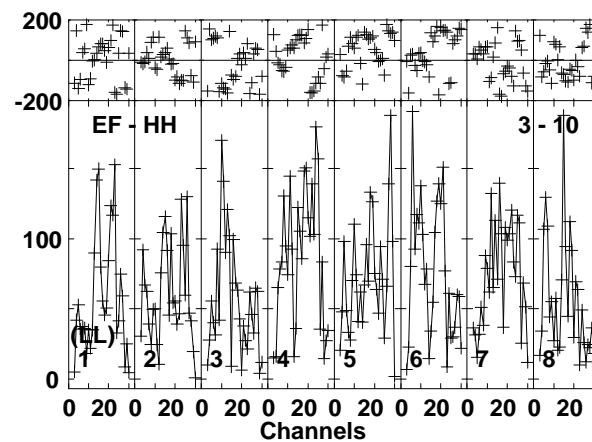
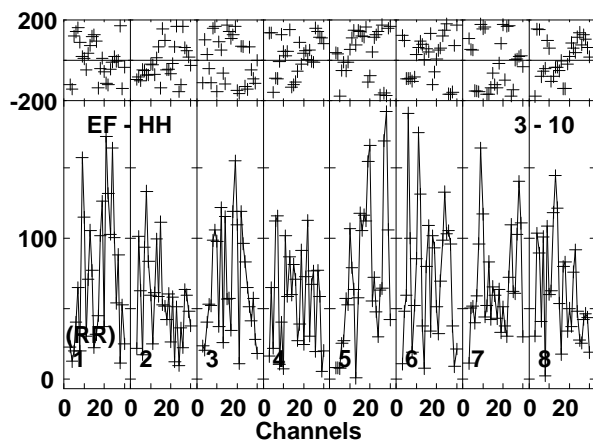
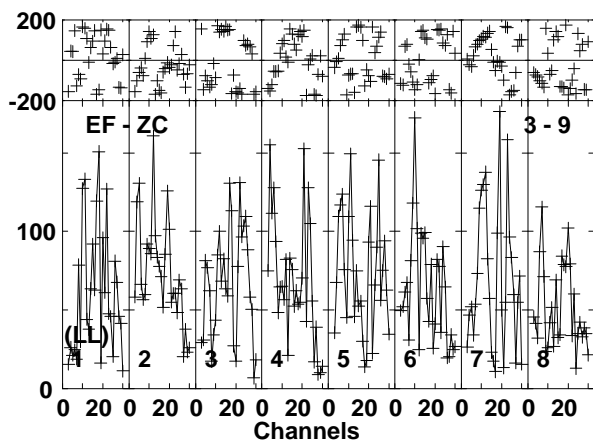
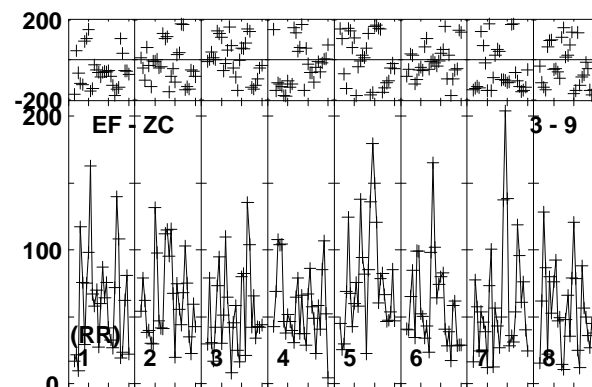
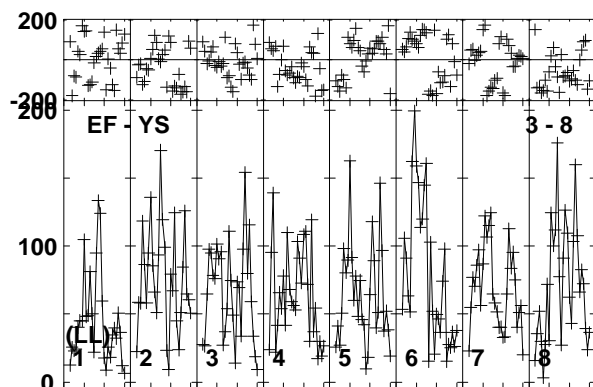
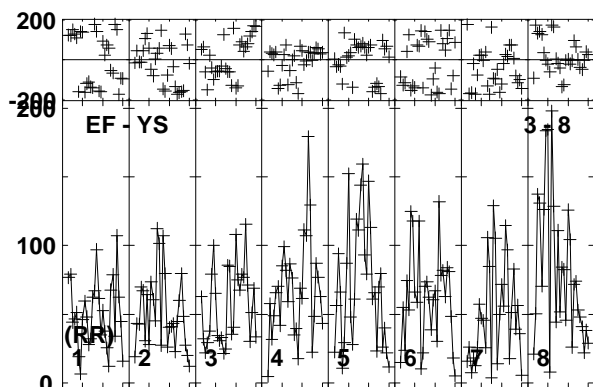
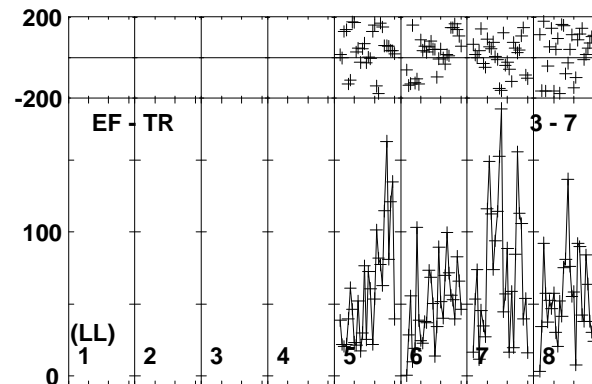
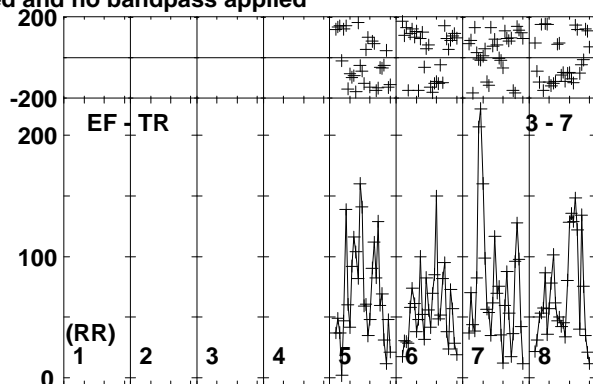
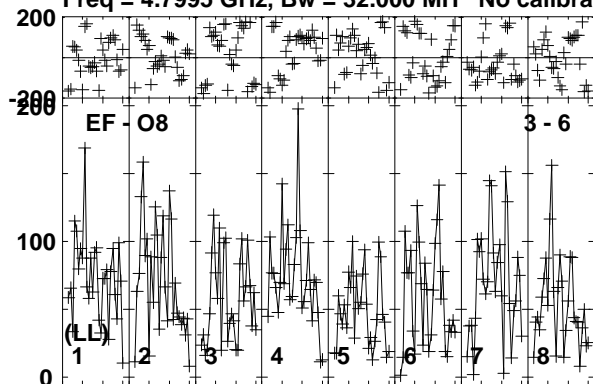

Lower frame: Micro Ampl Jy Top frame: Phas deg
Vector averaged cross-power spectrum Baseline: EF (03) - O8 (06)
Timerange: 00:16:38:04 to 00:16:40:08

Plot file version 223 created 03-APR-2017 18:27:44

J1834-2341 EM126B.UVDATA.1

Freq = 4.7995 GHz, Bw = 32.000 MH No calibration applied and no bandpass applied

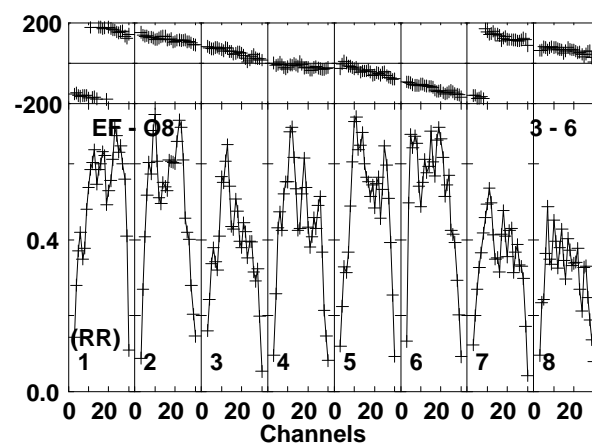
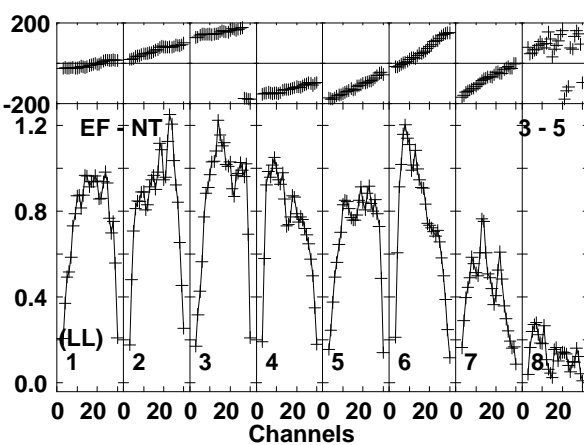
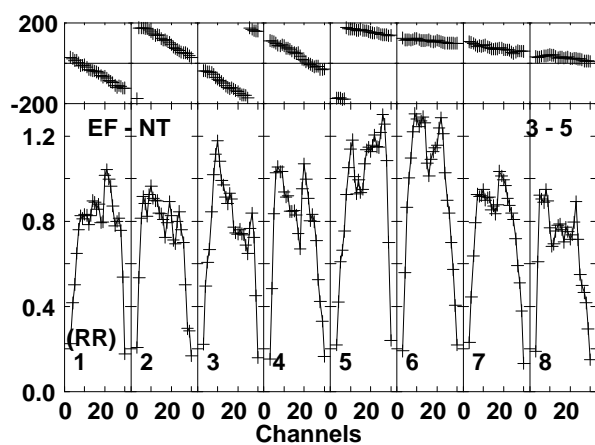
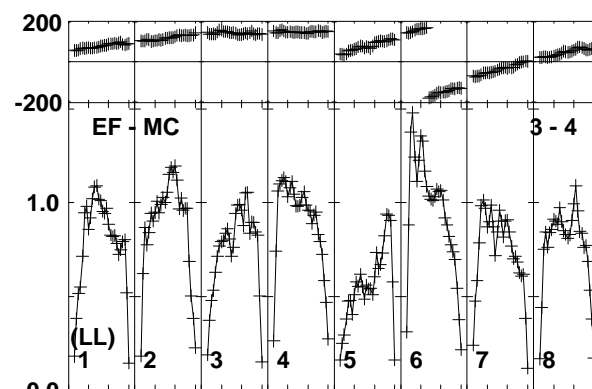
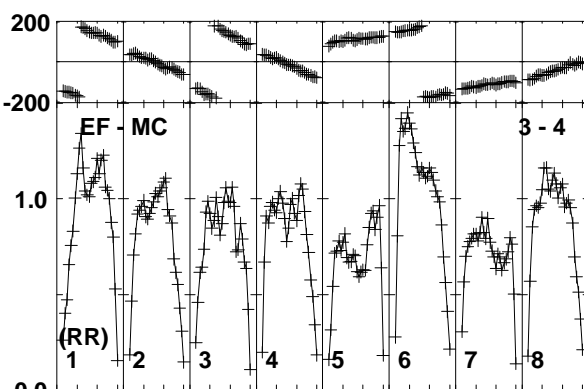
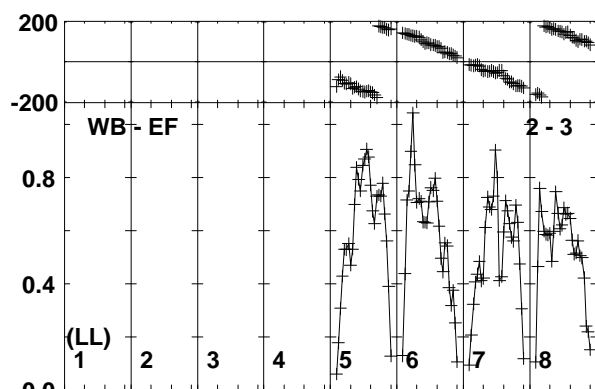
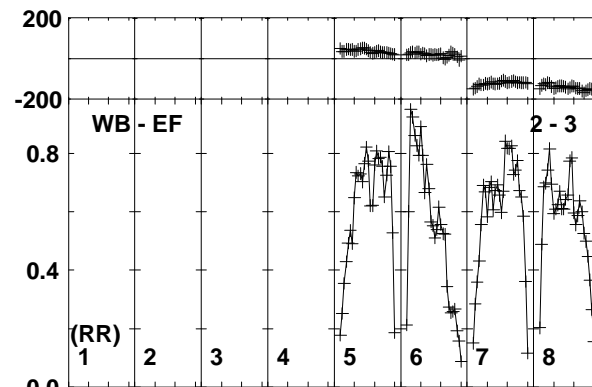
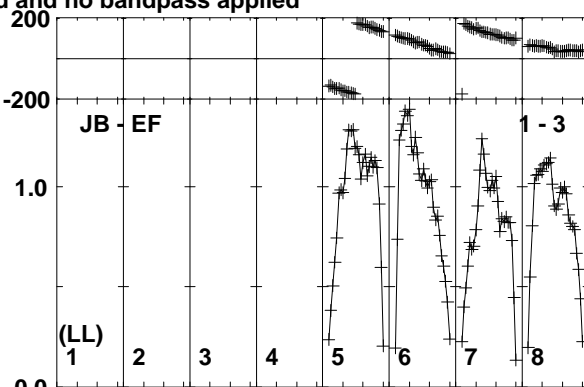
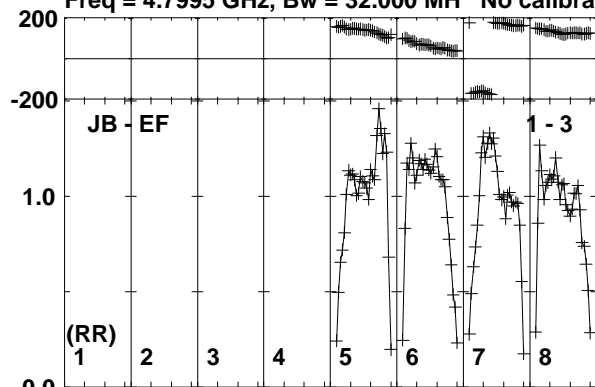

Lower frame: Milli Ampl Jy Top frame: Phas deg
Vector averaged cross-power spectrum Baseline: JB (01) - EF (03)
Timerange: 00:16:40:14 to 00:16:41:28

Plot file version 224 created 03-APR-2017 18:27:44

J1834-2341 EM126B.UVDATA.1

Freq = 4.7995 GHz, Bw = 32.000 MH No calibration applied and no bandpass applied

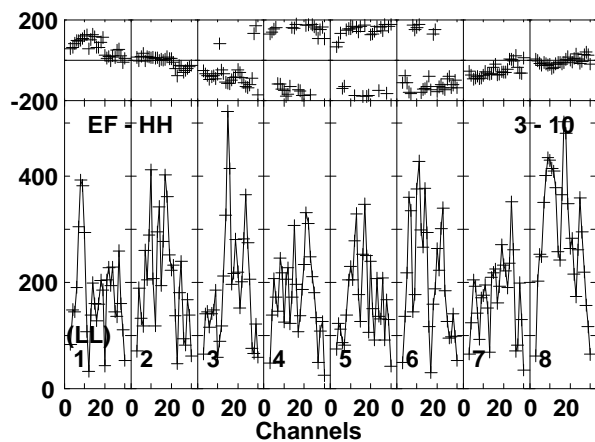
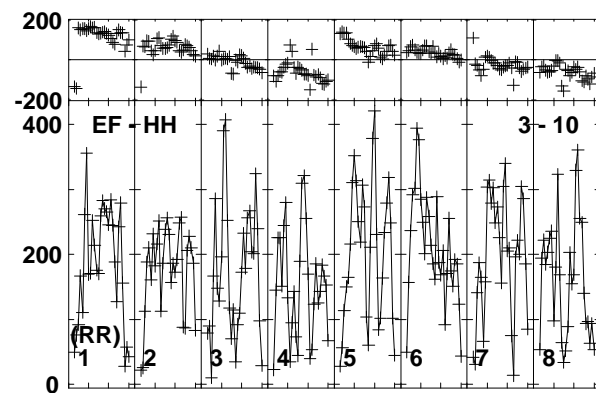
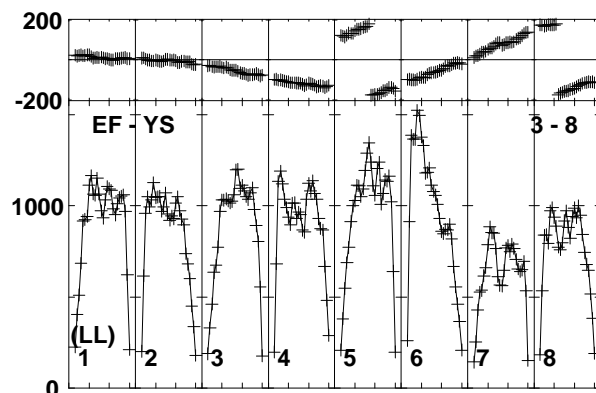
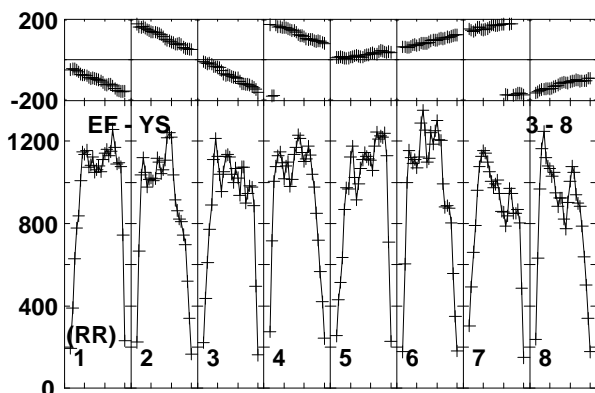
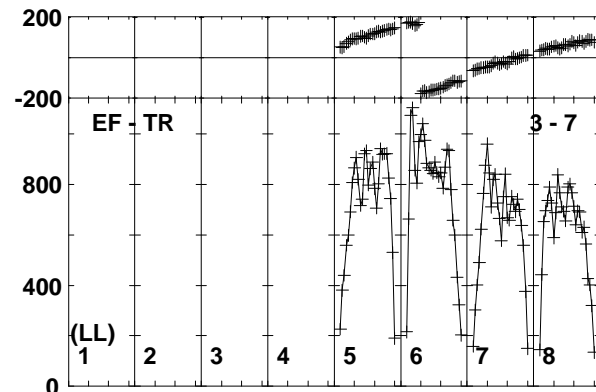
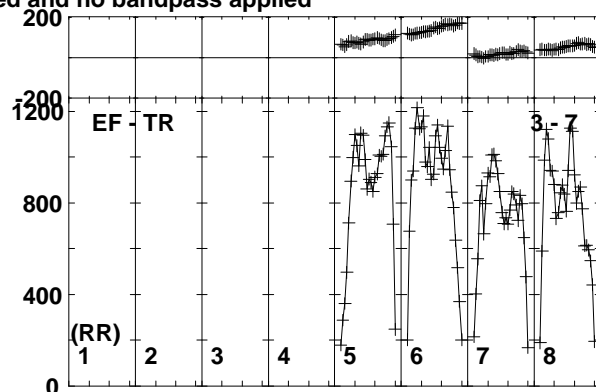
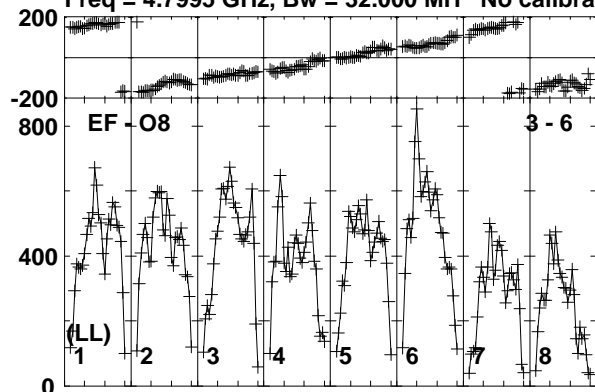

Lower frame: Micro Ampl Jy Top frame: Phas deg
Vector averaged cross-power spectrum Baseline: EF (03) - O8 (06)
Timerange: 00/16:40:14 to 00/16:41:28

Plot file version 225 created 03-APR-2017 18:27:44

M22-VLA1 EM126B.UVDATA.1

Freq = 4.7995 GHz, Bw = 32.000 MH No calibration applied and no bandpass applied

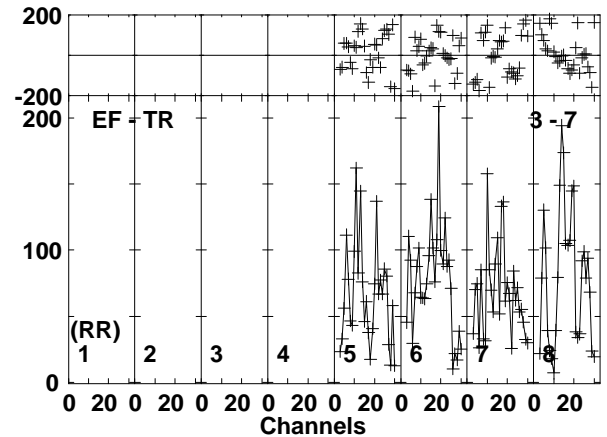
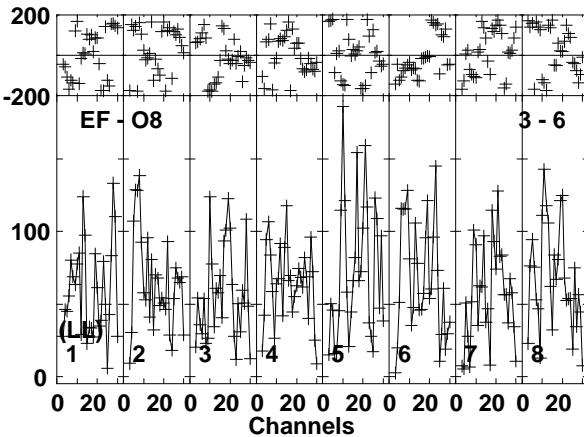
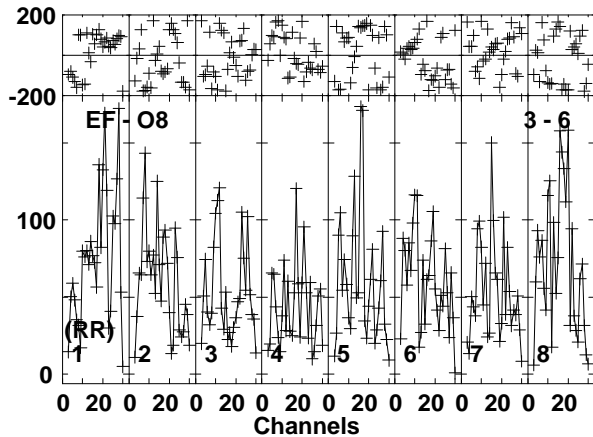
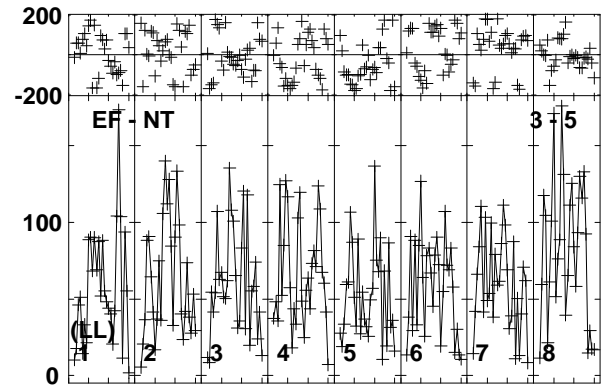
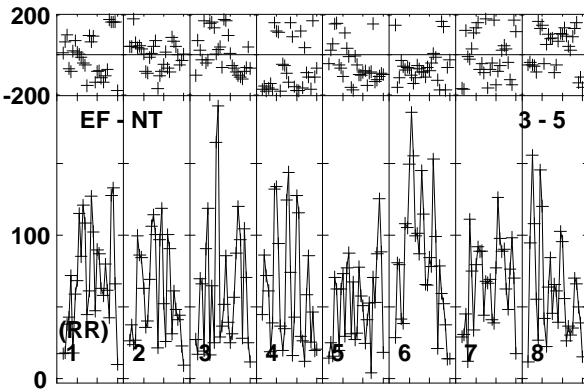
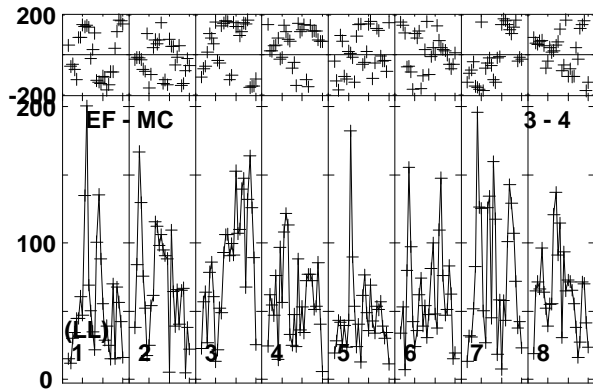
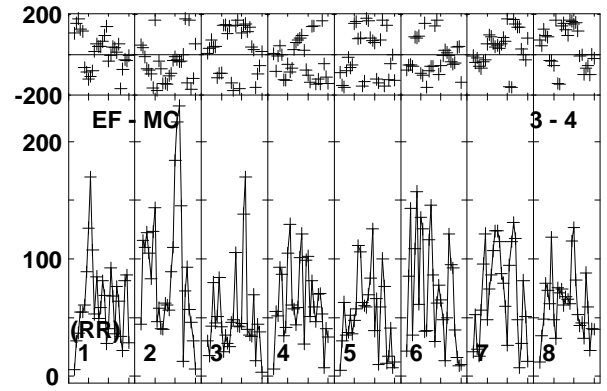
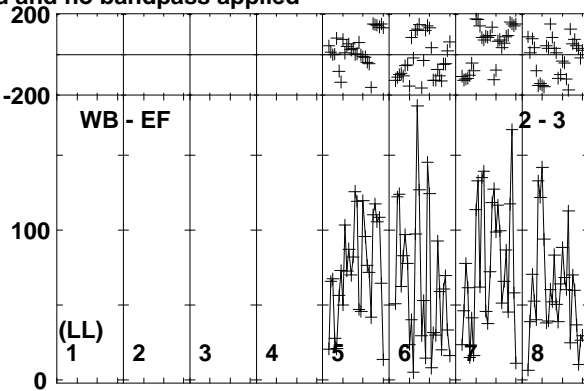
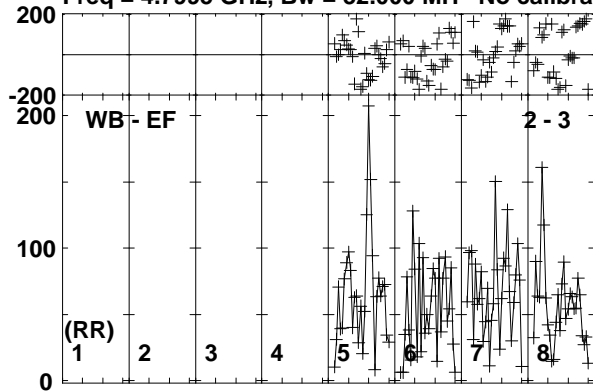

Lower frame: Micro Ampl Jy Top frame: Phas deg
Vector averaged cross-power spectrum Baseline: WB (02) - EF (03)
Timerange: 00/16:41:34 to 00/16:43:38

Plot file version 226 created 03-APR-2017 18:27:44

M22-VLA1 EM126B.UVDATA.1

Freq = 4.7995 GHz, Bw = 32.000 MH No calibration applied and no bandpass applied

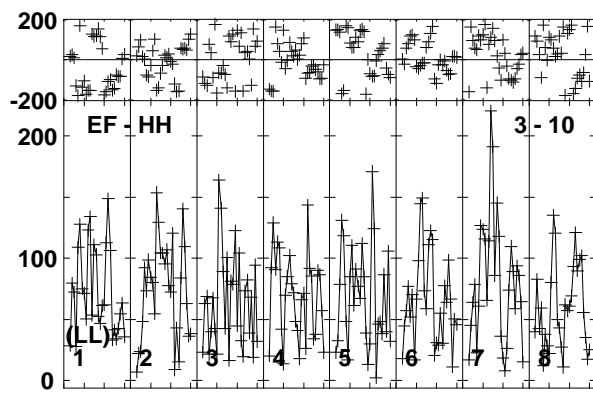
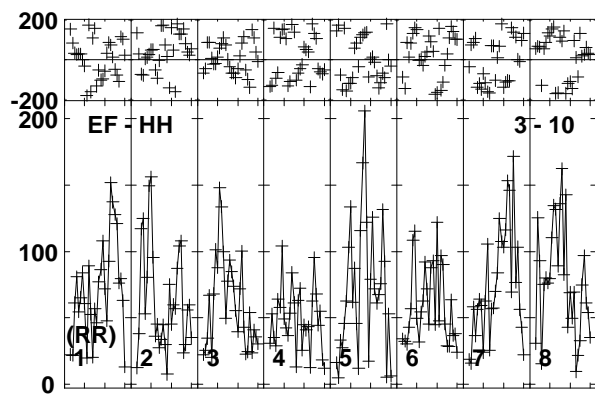
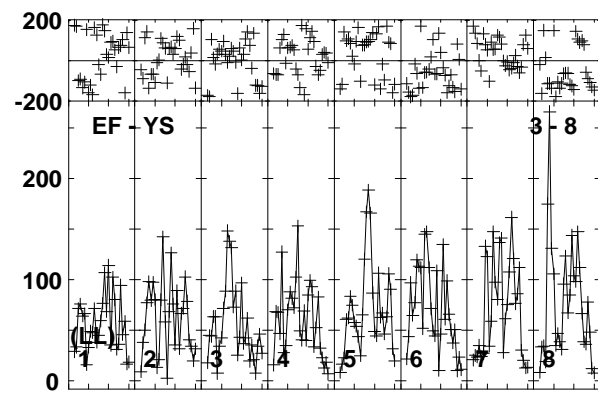
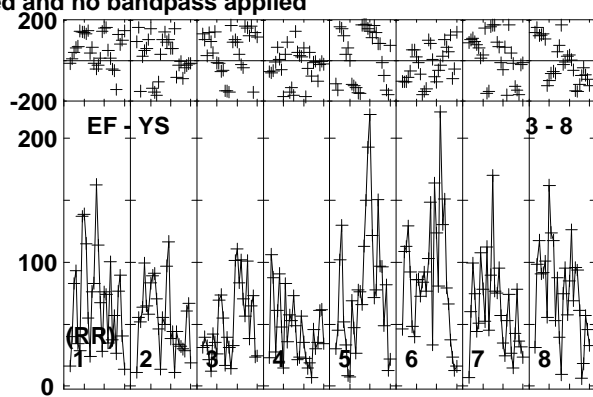
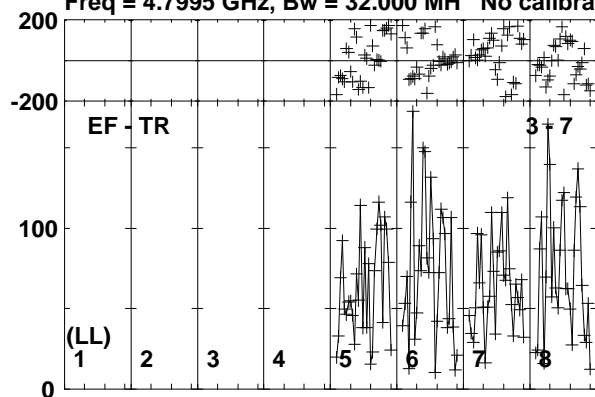

Lower frame: Micro Ampl Jy Top frame: Phas deg
Vector averaged cross-power spectrum Baseline: EF (03) - TR (07)
Timerange: 00:16:41:34 to 00:16:43:38

Plot file version 227 created 03-APR-2017 18:27:44

J1834-2341 EM126B.UVDATA.1

Freq = 4.7995 GHz, Bw = 32.000 MH No calibration applied and no bandpass applied

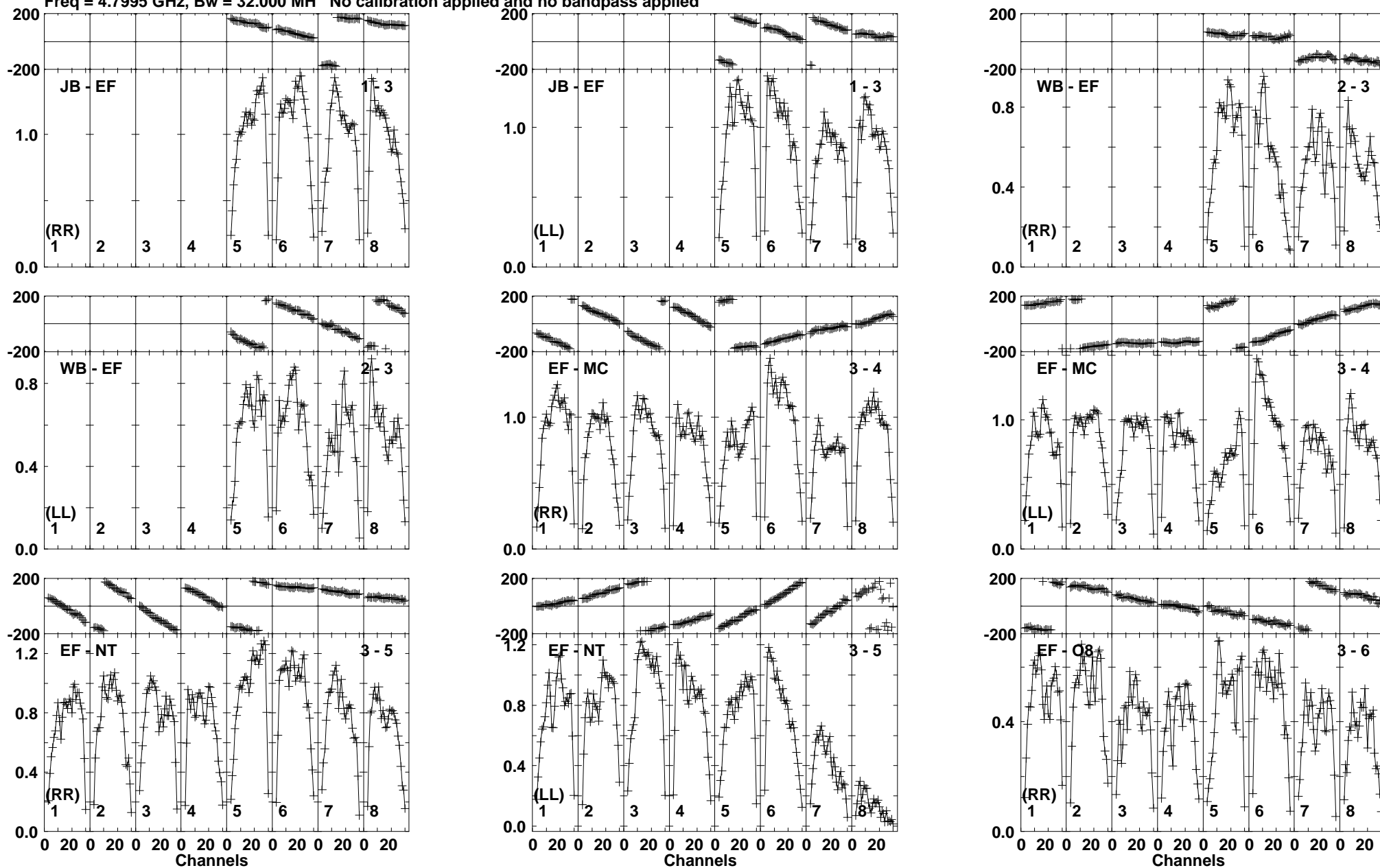

Lower frame: Milli Ampl Jy Top frame: Phas deg
Vector averaged cross-power spectrum Baseline: JB (01) - EF (03)
Timerange: 00/16:43:44 to 00/16:44:58

Plot file version 228 created 03-APR-2017 18:27:44

J1834-2341 EM126B.UVDATA.1

Freq = 4.7995 GHz, Bw = 32.000 MH No calibration applied and no bandpass applied

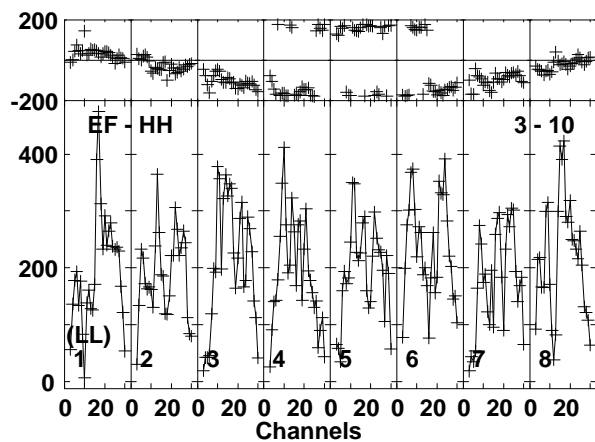
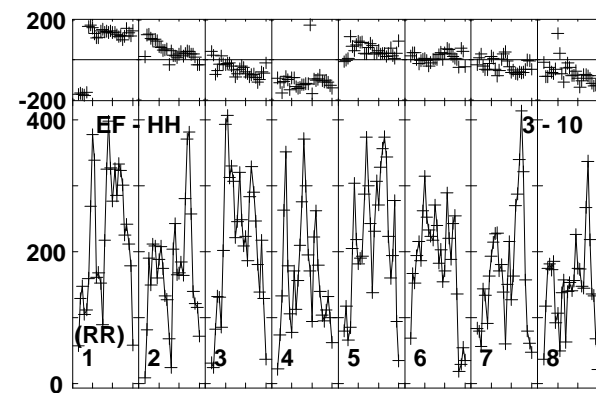
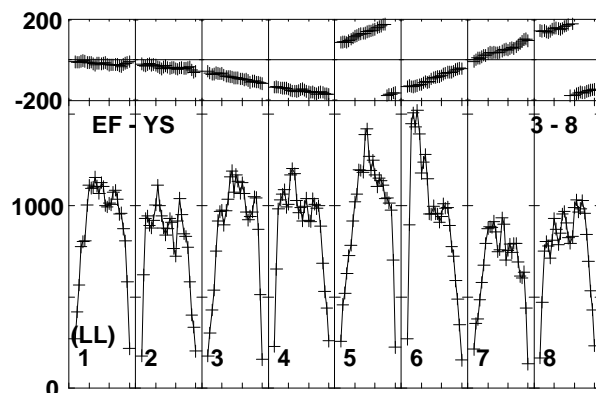
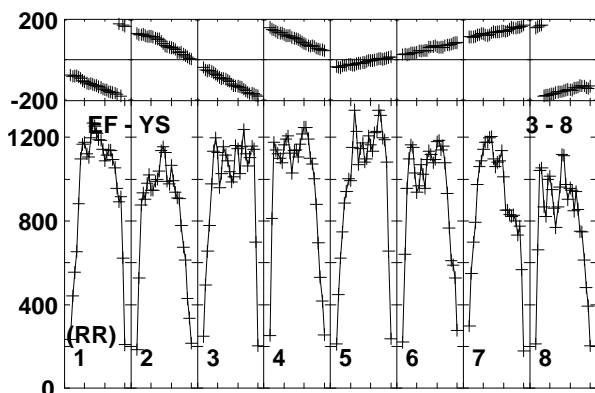
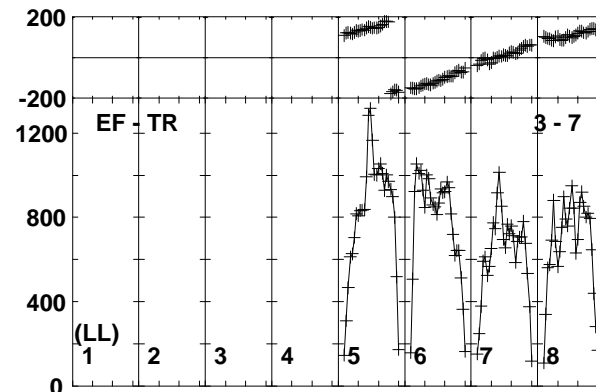
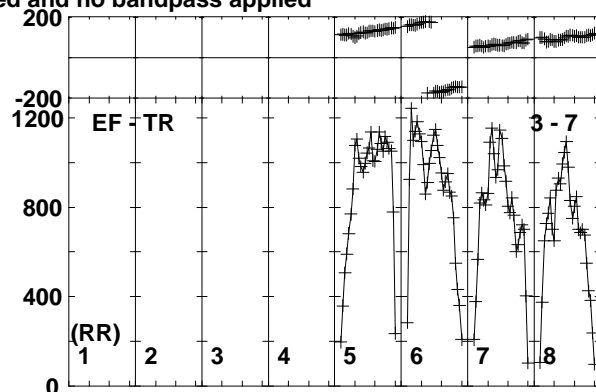
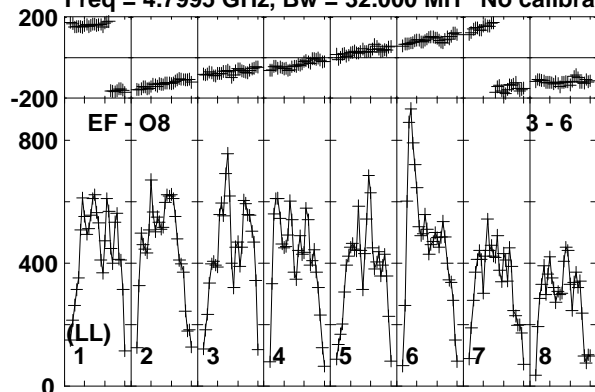

Lower frame: Micro Ampl Jy Top frame: Phas deg
Vector averaged cross-power spectrum Baseline: EF (03) - O8 (06)
Timerange: 00/16:43:44 to 00/16:44:58

Plot file version 229 created 03-APR-2017 18:27:44

M22-VLA1 EM126B.UVDATA.1

Freq = 4.7995 GHz, Bw = 32.000 MH No calibration applied and no bandpass applied

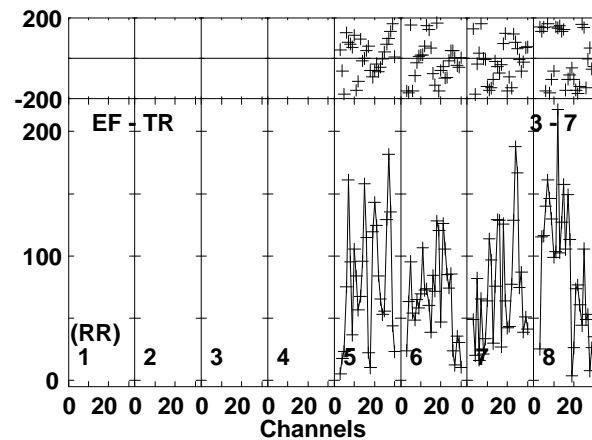
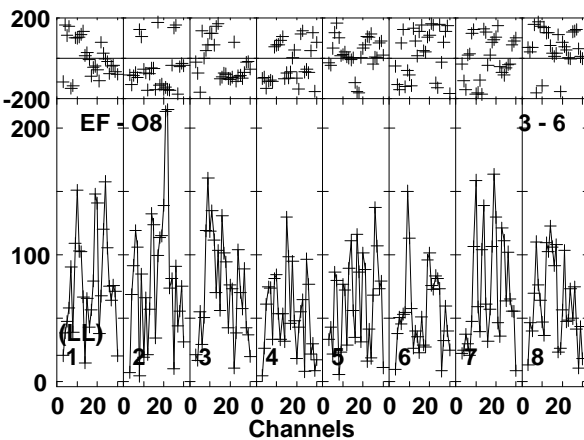
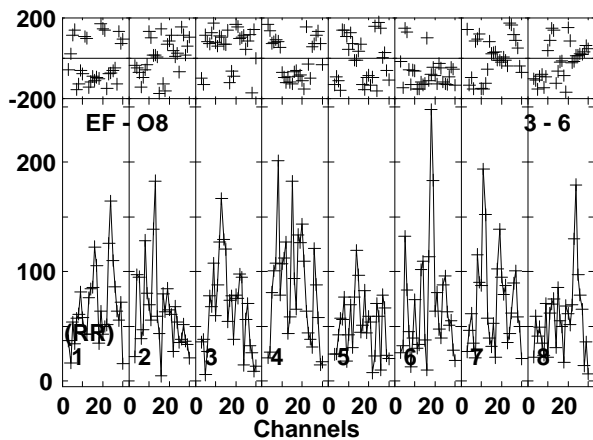
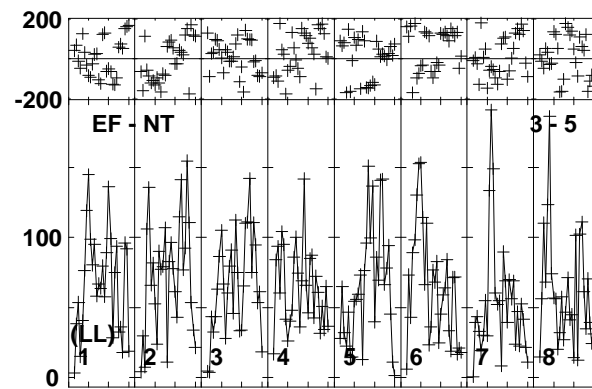
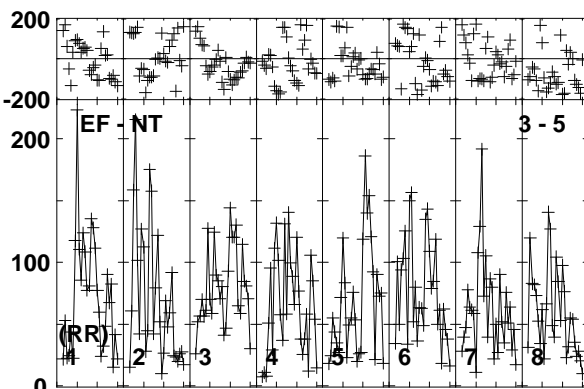
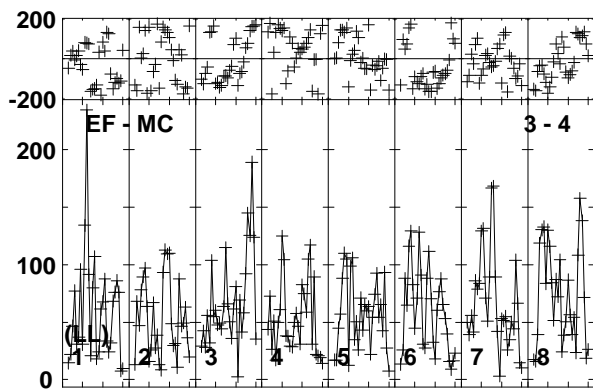
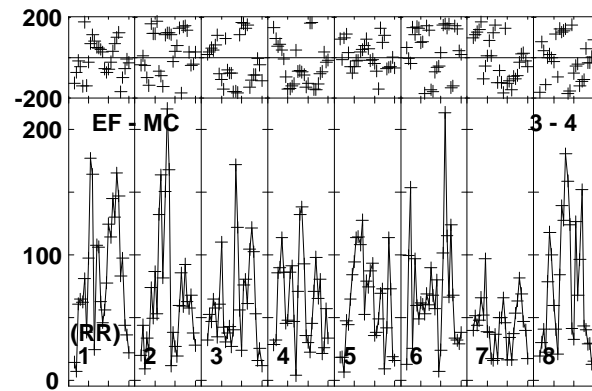
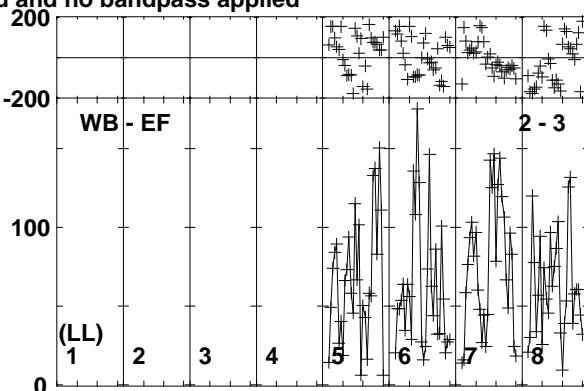
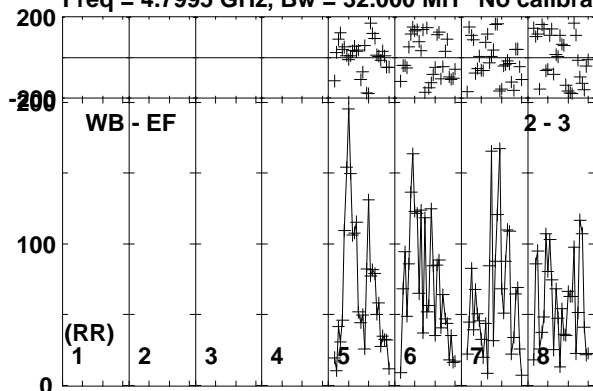

Lower frame: Micro Ampl Jy Top frame: Phas deg
Vector averaged cross-power spectrum Baseline: WB (02) - EF (03)
Timerange: 00/16:45:04 to 00/16:47:08

Plot file version 230 created 03-APR-2017 18:27:44

M22-VLA1 EM126B.UVDATA.1

Freq = 4.7995 GHz, Bw = 32.000 MH No calibration applied and no bandpass applied

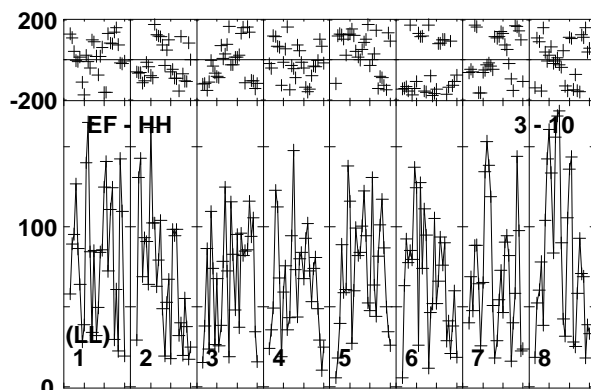
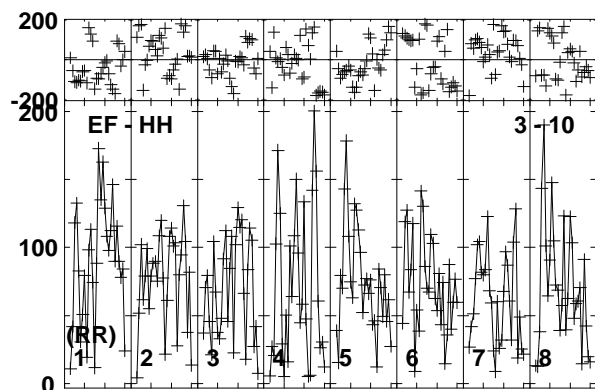
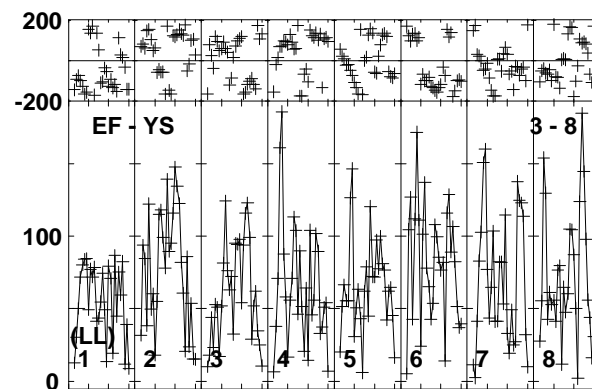
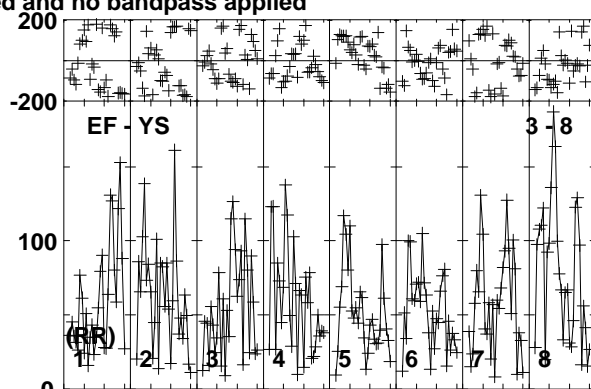
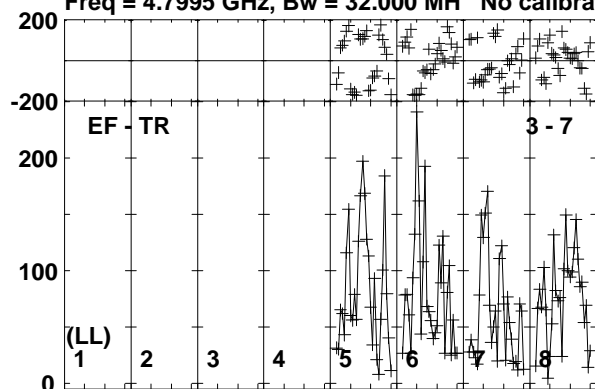

Lower frame: Micro Ampl Jy Top frame: Phas deg
Vector averaged cross-power spectrum Baseline: EF (03) - TR (07)
Timerange: 00/16:45:04 to 00/16:47:08

Plot file version 231 created 03-APR-2017 18:27:44

J1834-2341 EM126B.UVDATA.1

Freq = 4.7995 GHz, Bw = 32.000 MH No calibration applied and no bandpass applied

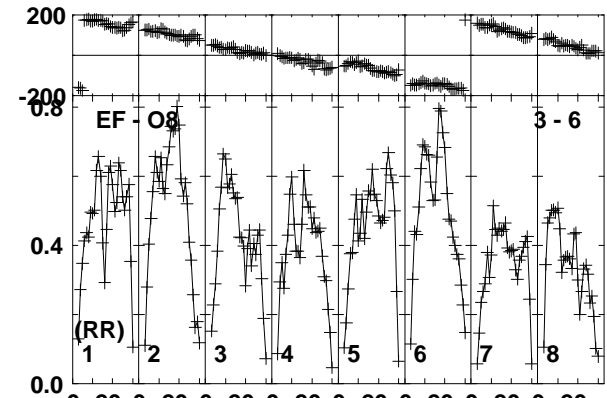
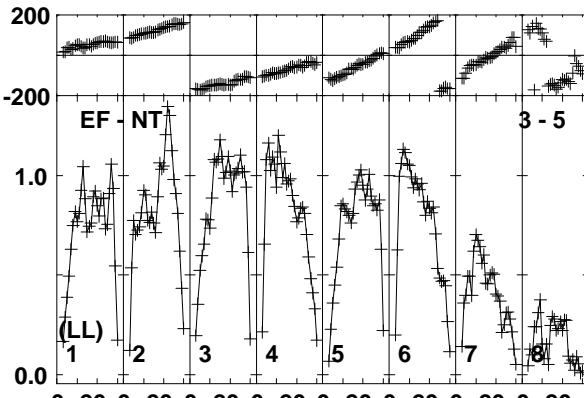
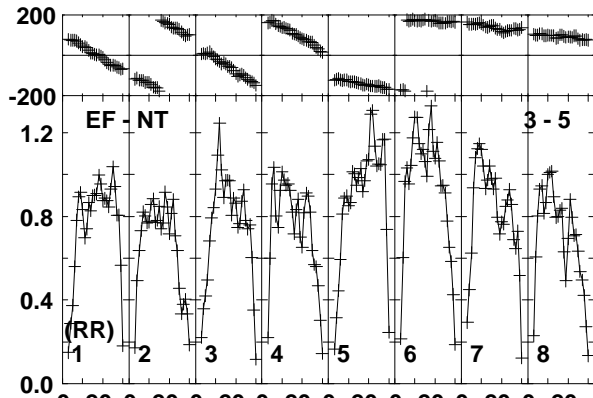
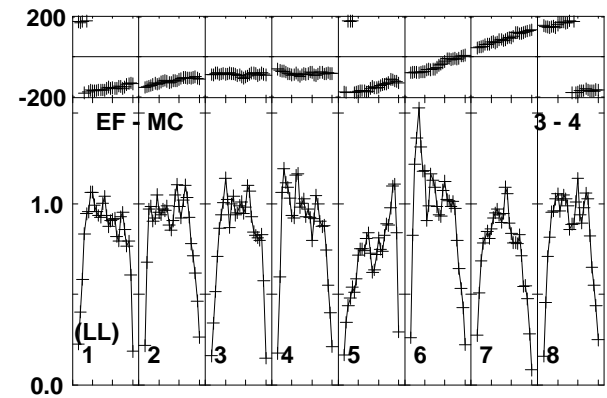
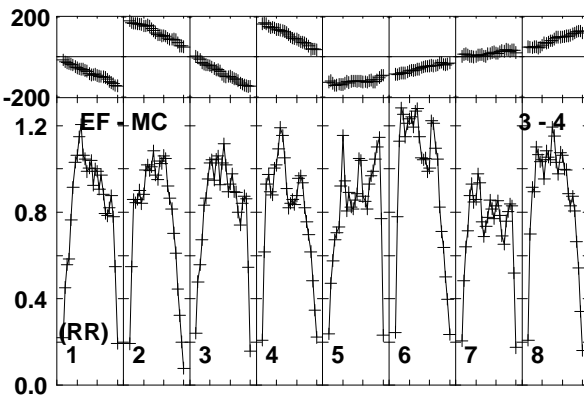
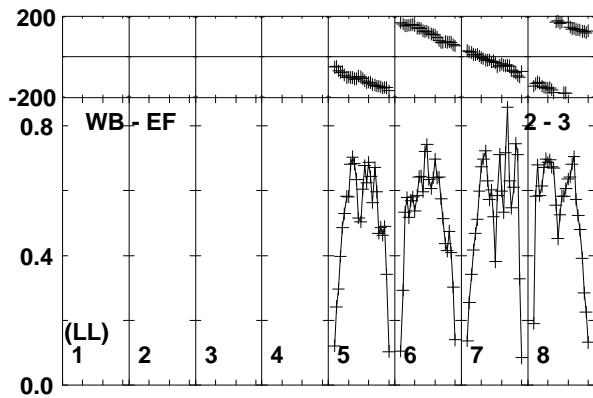
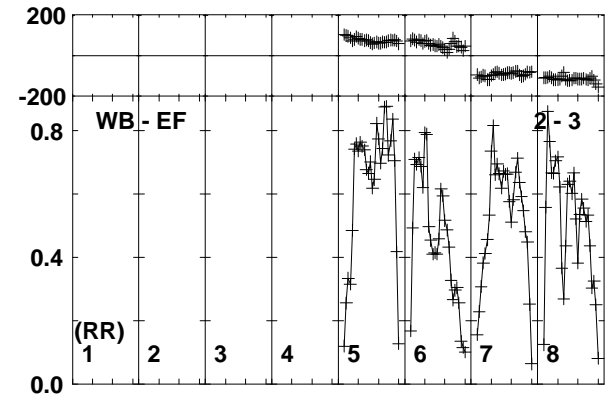
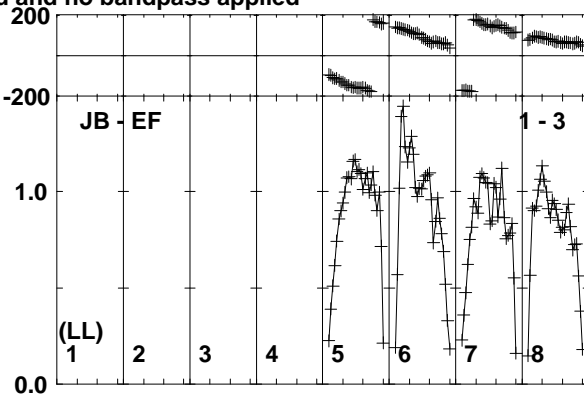
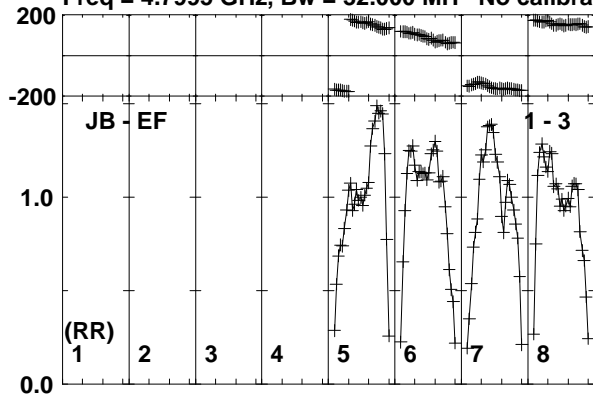

Lower frame: Milli Ampl Jy Top frame: Phas deg
Vector averaged cross-power spectrum Baseline: JB (01) - EF (03)
Timerange: 00/16:47:41 to 00/16:48:29

Plot file version 232 created 03-APR-2017 18:27:44

J1834-2341 EM126B.UVDATA.1

Freq = 4.7995 GHz, Bw = 32.000 MH No calibration applied and no bandpass applied

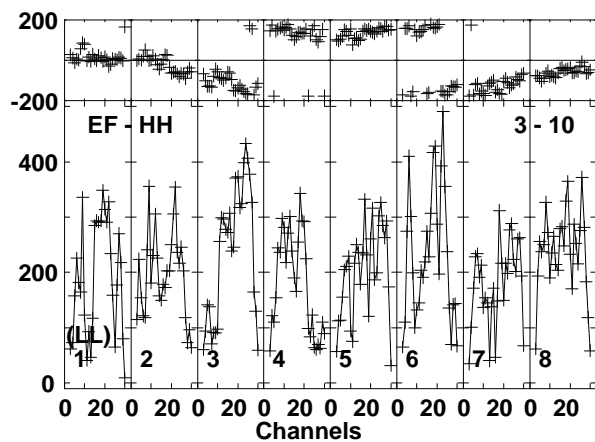
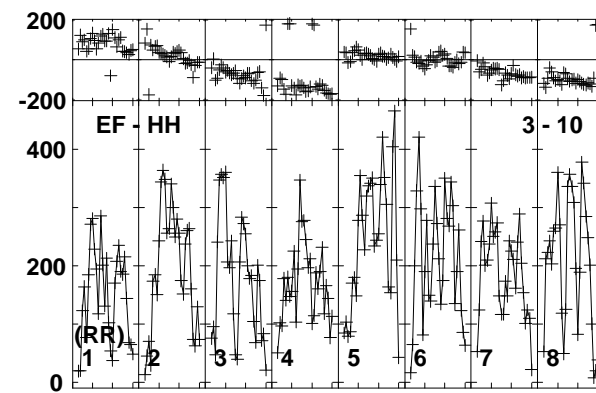
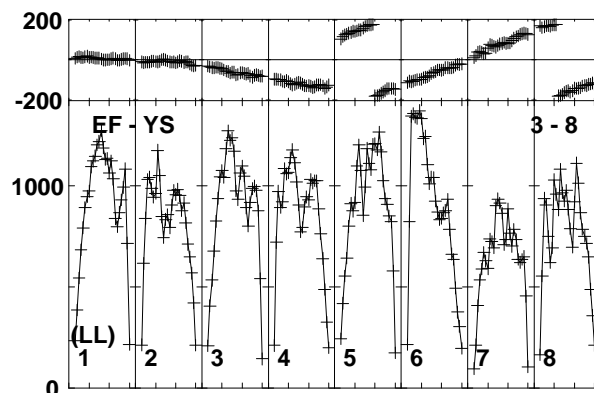
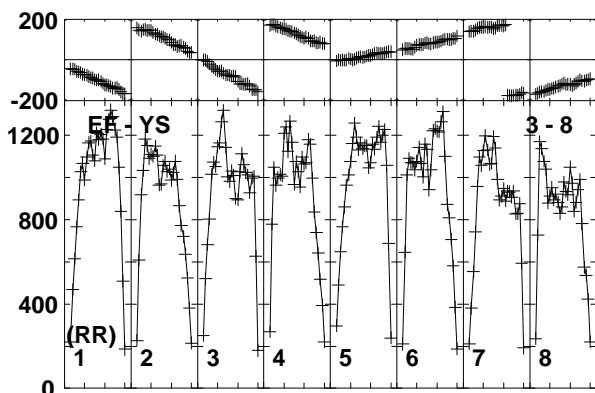
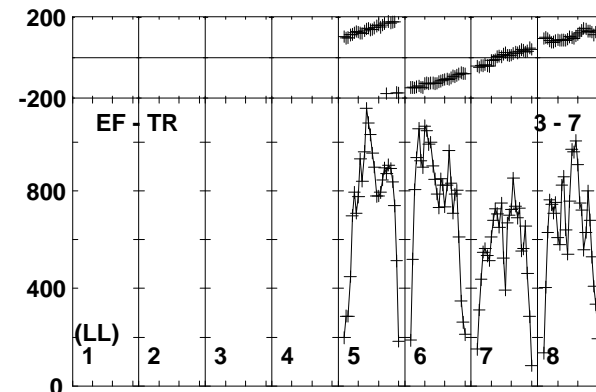
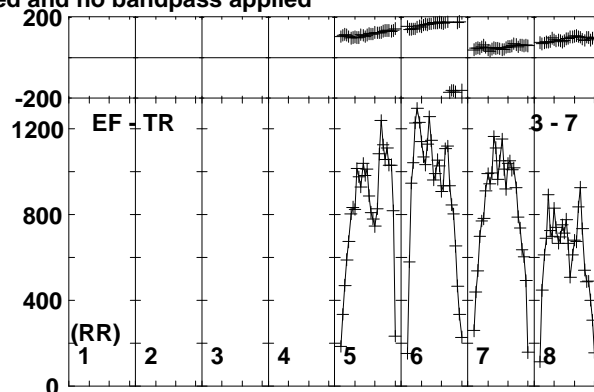
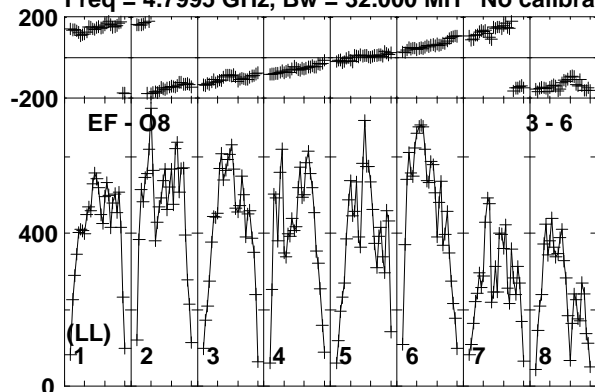

Lower frame: Micro Ampl Jy Top frame: Phas deg
Vector averaged cross-power spectrum Baseline: EF (03) - O8 (06)
Timerange: 00/16:47:41 to 00/16:48:29

Plot file version 233 created 03-APR-2017 18:27:44

M22-VLA1 EM126B.UVDATA.1

Freq = 4.7995 GHz, Bw = 32.000 MH No calibration applied and no bandpass applied

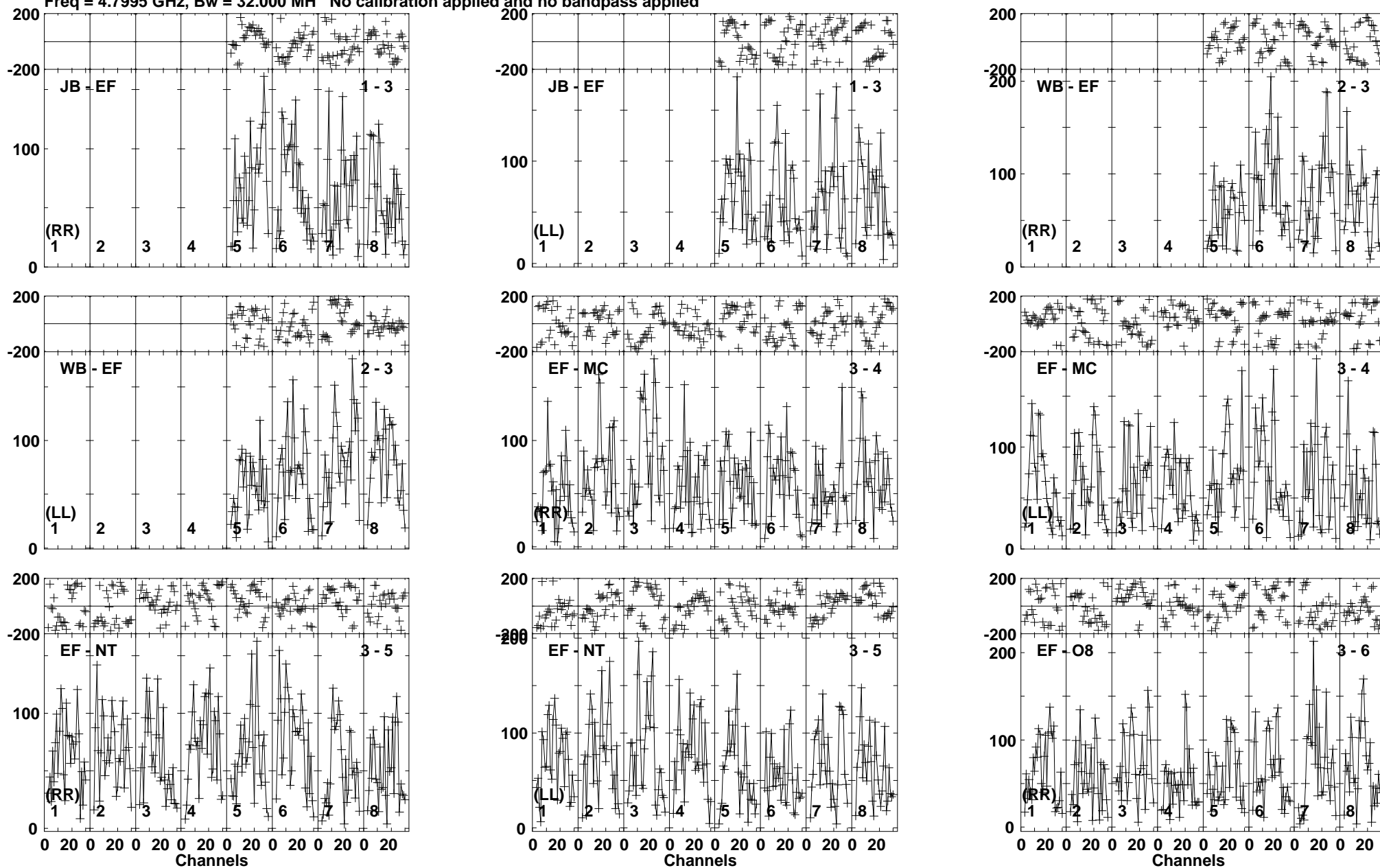

Lower frame: Micro Ampl Jy Top frame: Phas deg
Vector averaged cross-power spectrum Baseline: JB (01) - EF (03)
Timerange: 00/16:48:34 to 00/16:50:38

Plot file version 234 created 03-APR-2017 18:27:44

M22-VLA1 EM126B.UVDATA.1

Freq = 4.7995 GHz, Bw = 32.000 MH No calibration applied and no bandpass applied

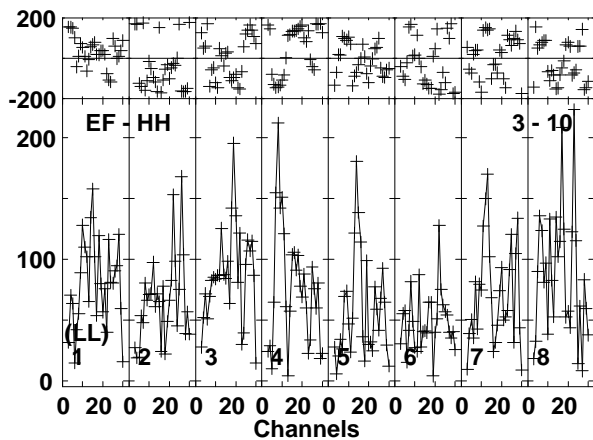
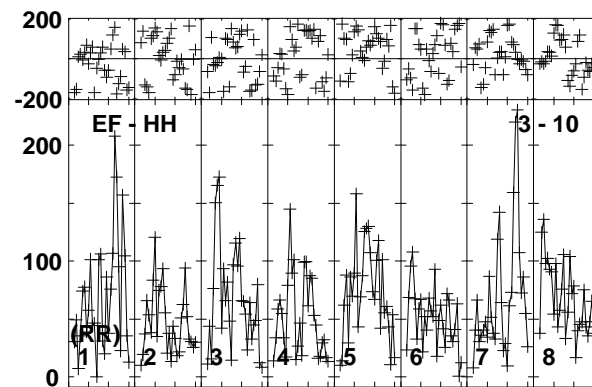
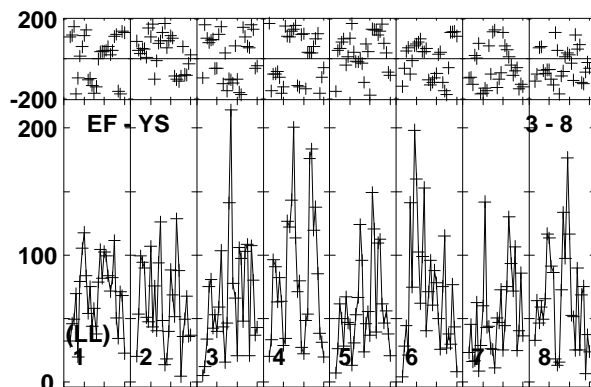
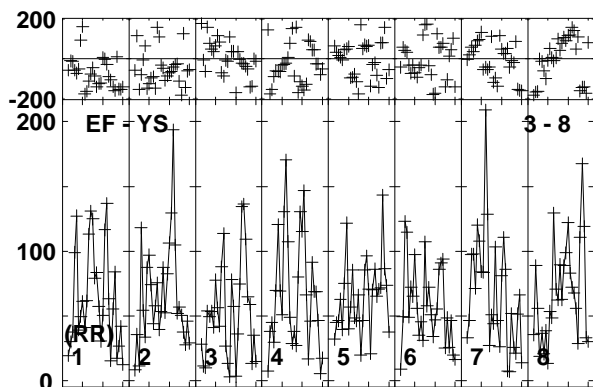
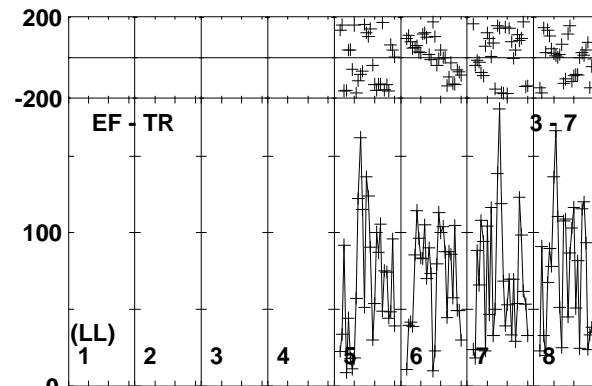
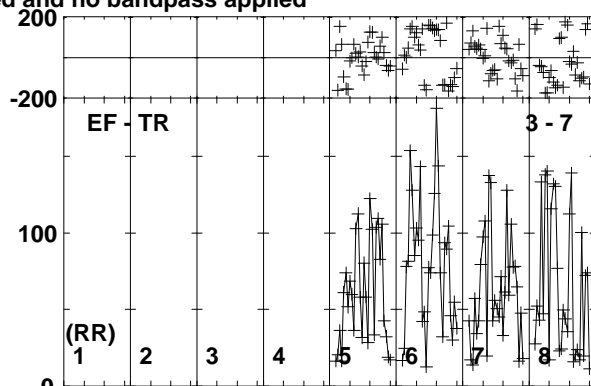
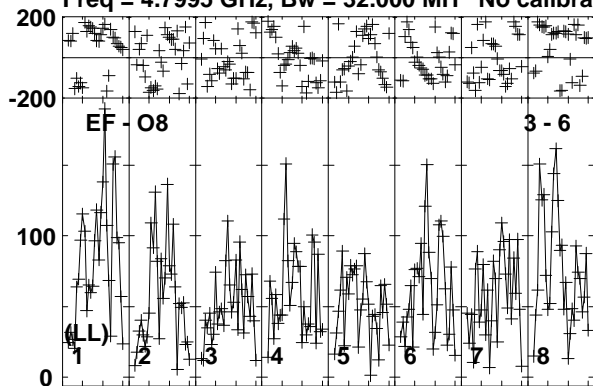

Lower frame: Micro Ampl Jy Top frame: Phas deg
Vector averaged cross-power spectrum Baseline: EF (03) - O8 (06)
Timerange: 00/16:48:34 to 00/16:50:38

Plot file version 235 created 03-APR-2017 18:27:44

J1834-2341 EM126B.UVDATA.1

Freq = 4.7995 GHz, Bw = 32.000 MH No calibration applied and no bandpass applied

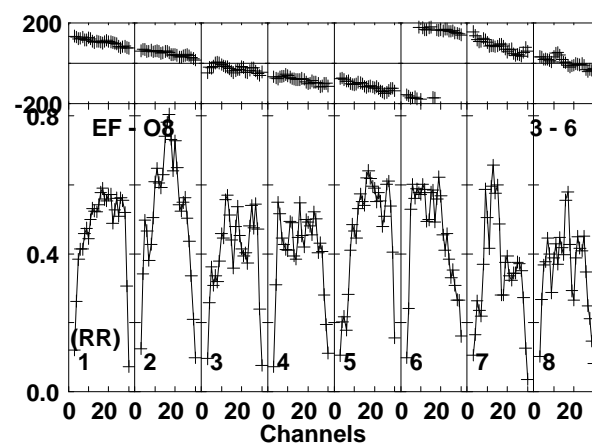
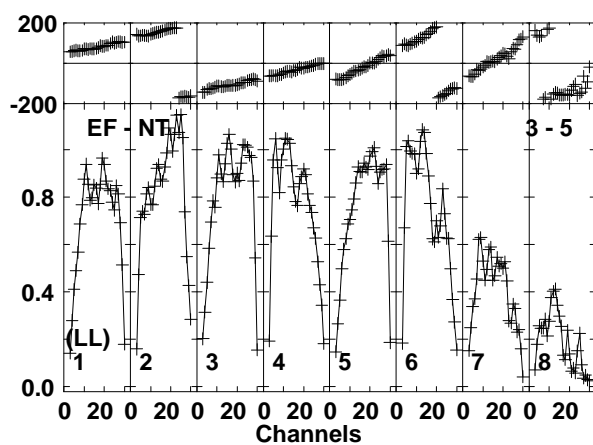
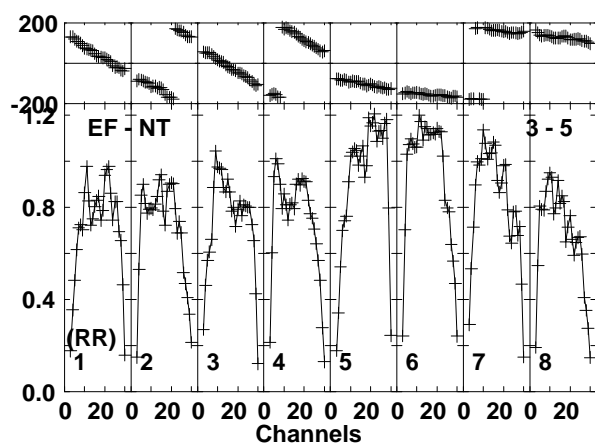
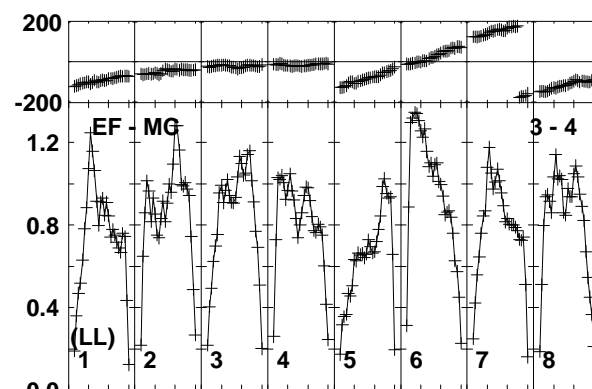
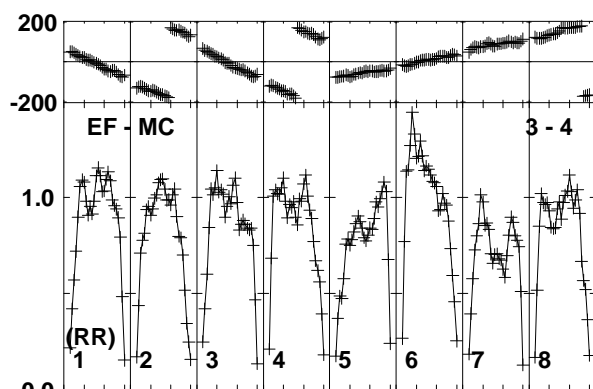
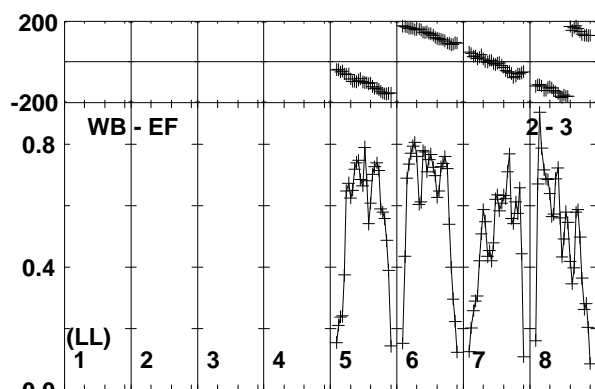
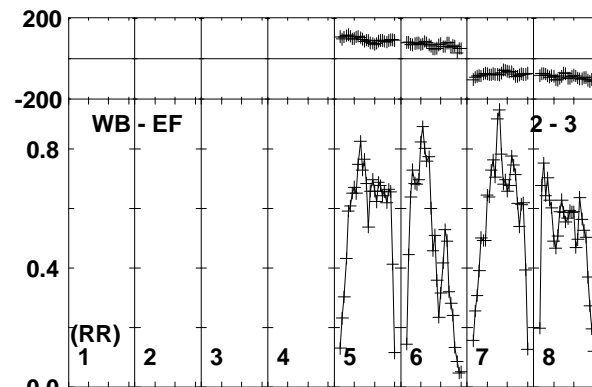
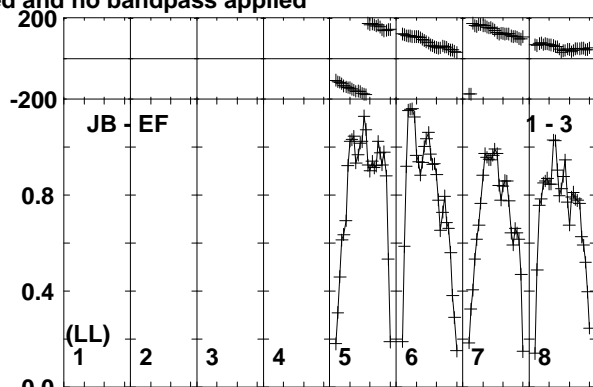
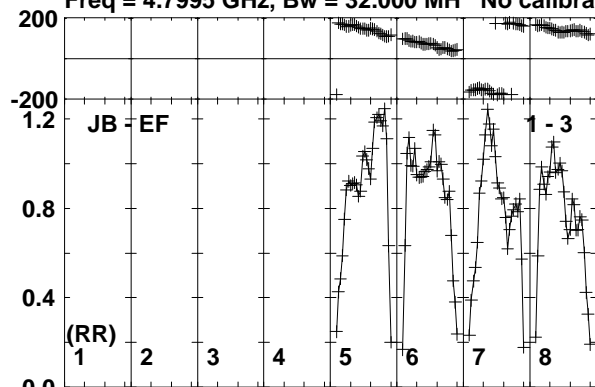

Lower frame: Milli Ampl Jy Top frame: Phas deg
Vector averaged cross-power spectrum Baseline: JB (01) - EF (03)
Timerange: 00/16:50:44 to 00/16:51:58

Plot file version 236 created 03-APR-2017 18:27:44

J1834-2341 EM126B.UVDATA.1

Freq = 4.7995 GHz, Bw = 32.000 MH No calibration applied and no bandpass applied

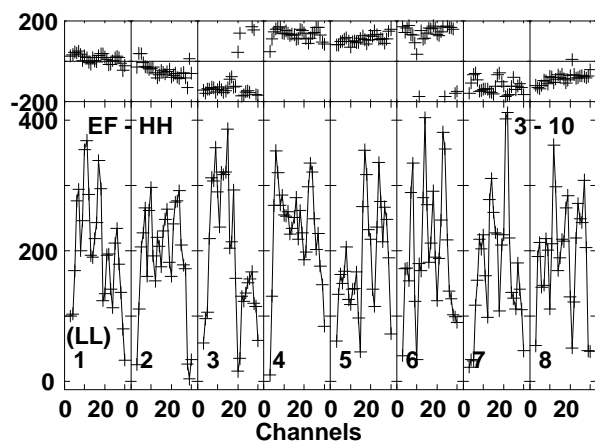
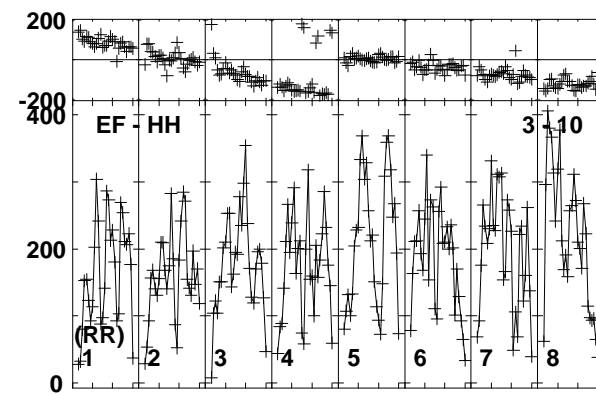
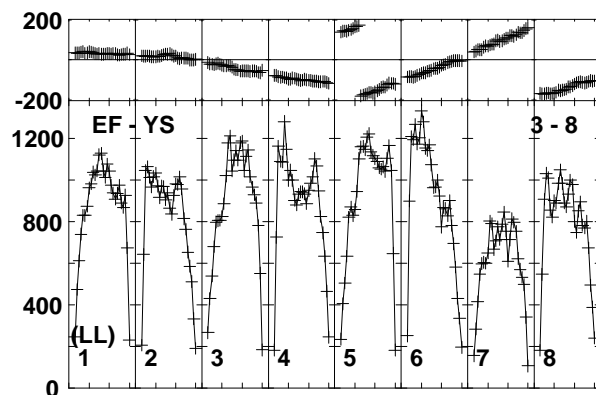
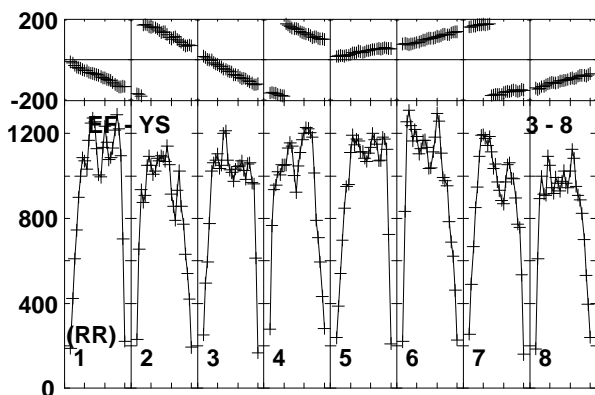
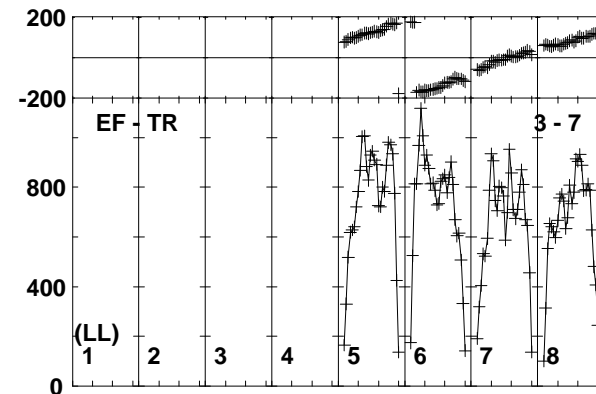
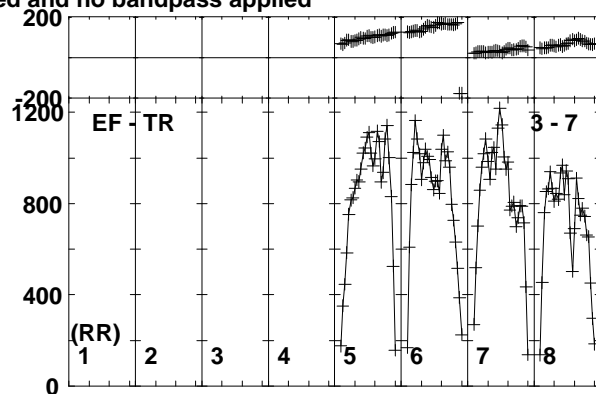
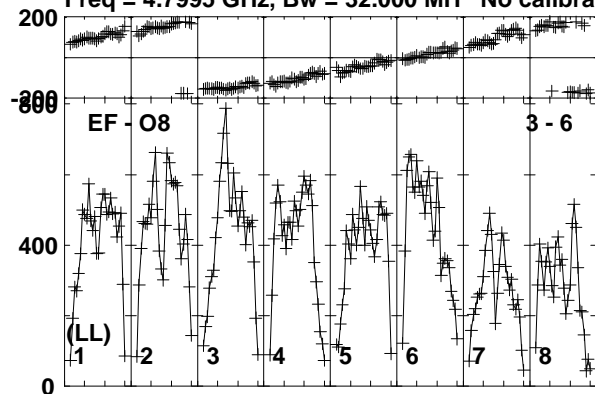

Lower frame: Micro Ampl Jy Top frame: Phas deg
Vector averaged cross-power spectrum Baseline: EF (03) - O8 (06)
Timerange: 00/16:50:44 to 00/16:51:58

Plot file version 237 created 03-APR-2017 18:27:44

M22-VLA1 EM126B.UVDATA.1

Freq = 4.7995 GHz, Bw = 32.000 MH No calibration applied and no bandpass applied

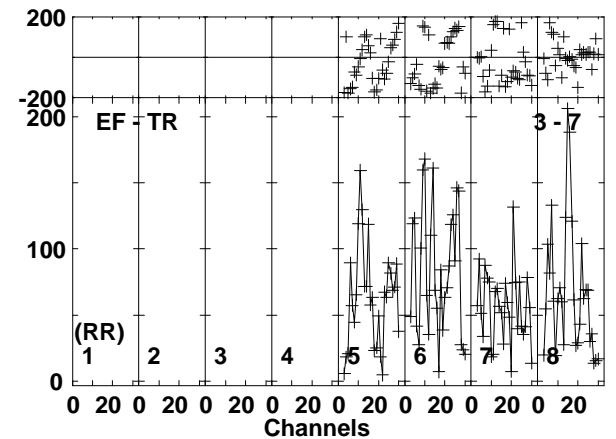
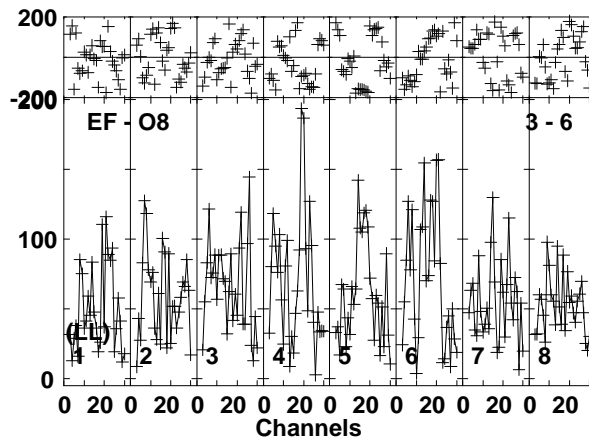
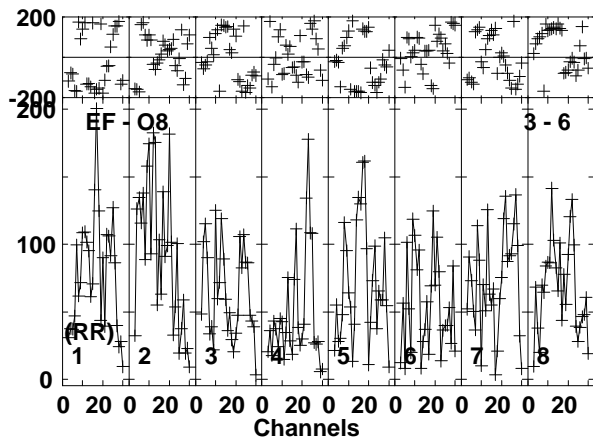
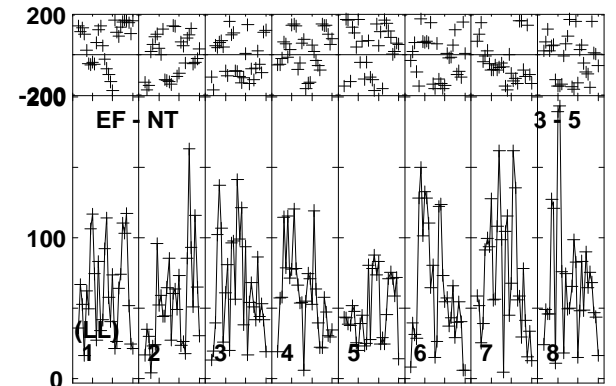
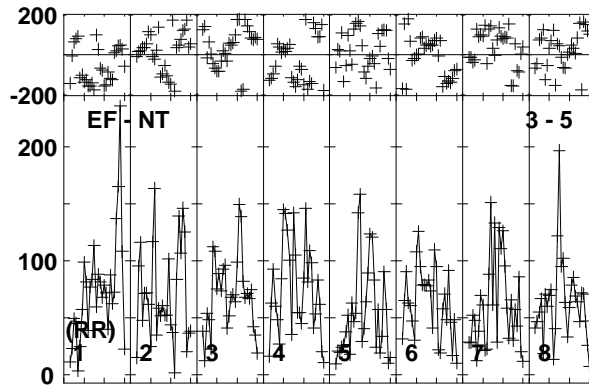
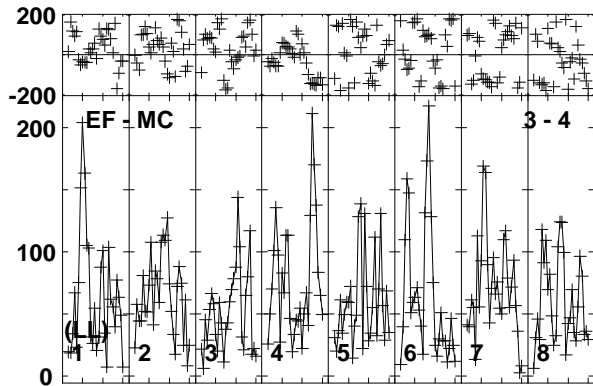
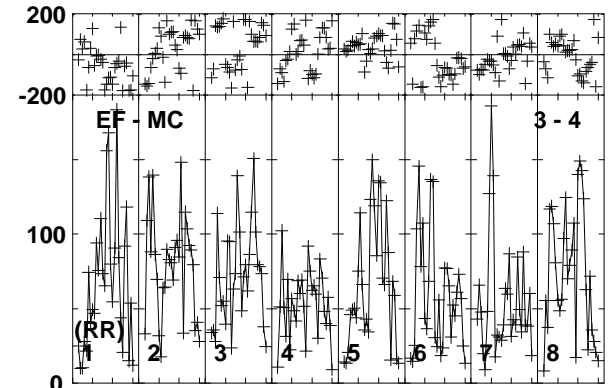
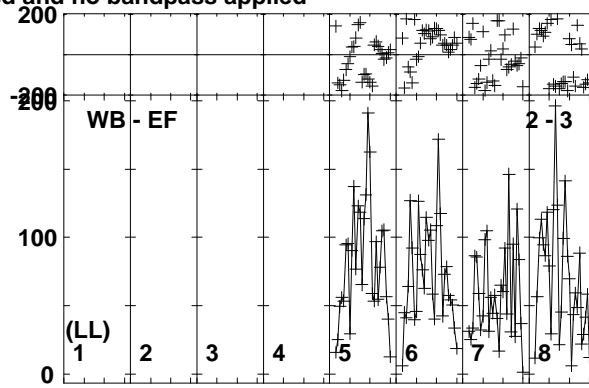
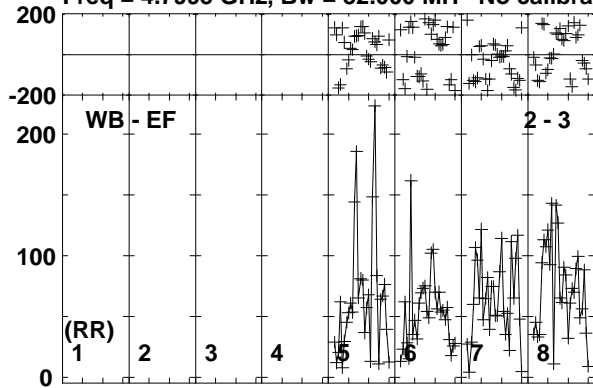

Lower frame: Micro Ampl Jy Top frame: Phas deg
Vector averaged cross-power spectrum Baseline: WB (02) - EF (03)
Timerange: 00/16:52:04 to 00/16:54:08

Plot file version 238 created 03-APR-2017 18:27:44

M22-VLA1 EM126B.UVDATA.1

Freq = 4.7995 GHz, Bw = 32.000 MH No calibration applied and no bandpass applied

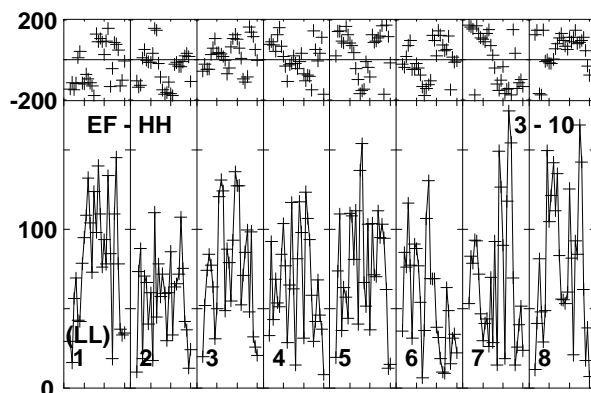
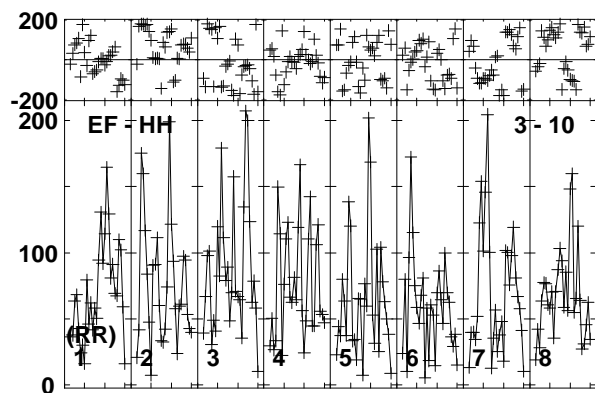
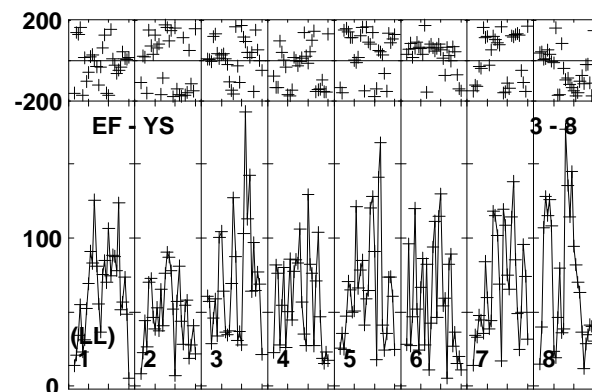
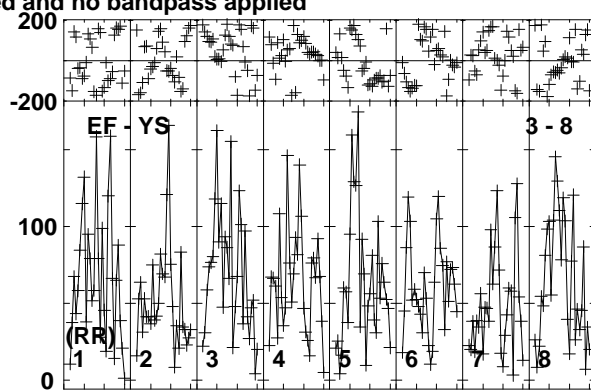
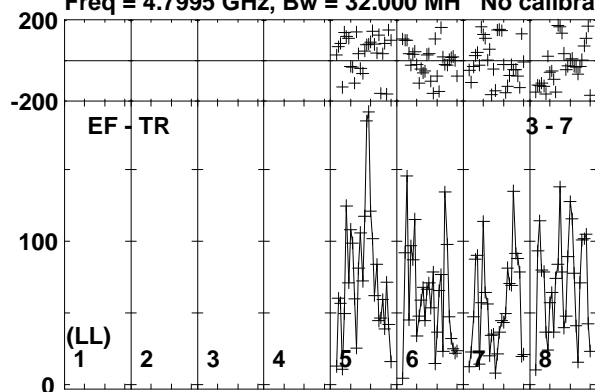

Lower frame: Micro Ampl Jy Top frame: Phas deg
Vector averaged cross-power spectrum Baseline: EF (03) - TR (07)
Timerange: 00/16:52:04 to 00/16:54:08

Plot file version 239 created 03-APR-2017 18:27:44

J1834-2341 EM126B.UVDATA.1

Freq = 4.7995 GHz, Bw = 32.000 MH No calibration applied and no bandpass applied

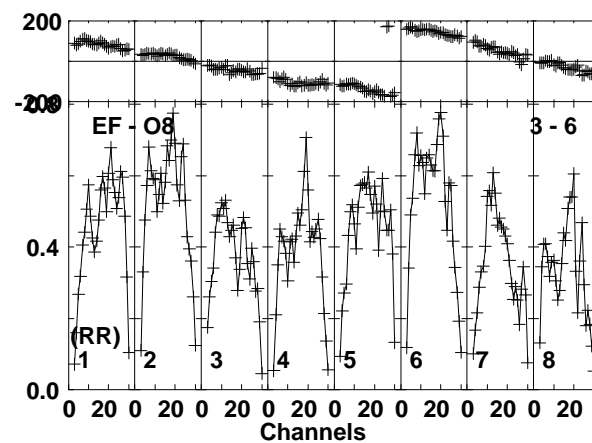
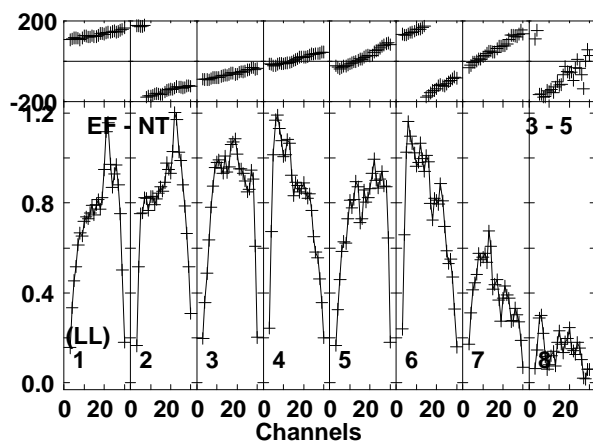
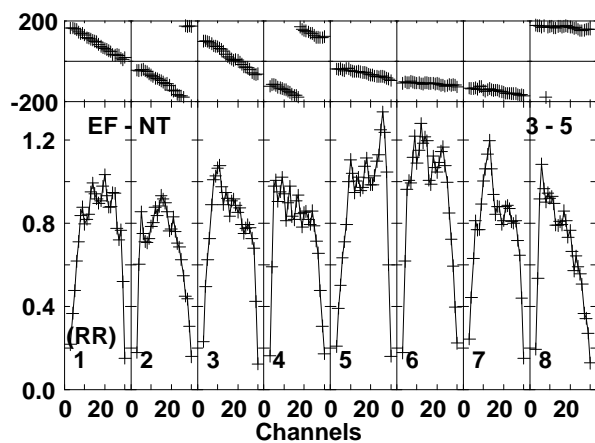
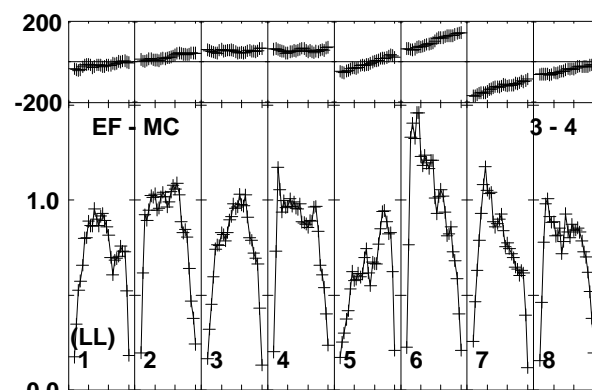
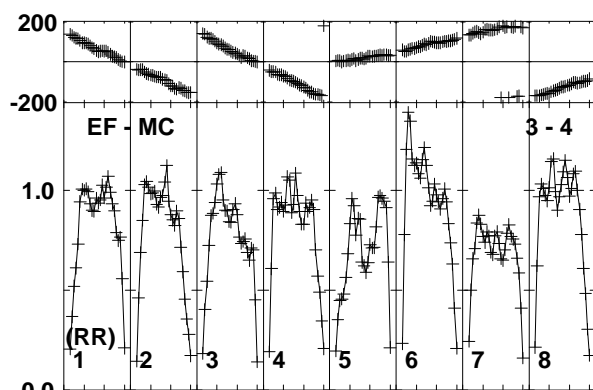
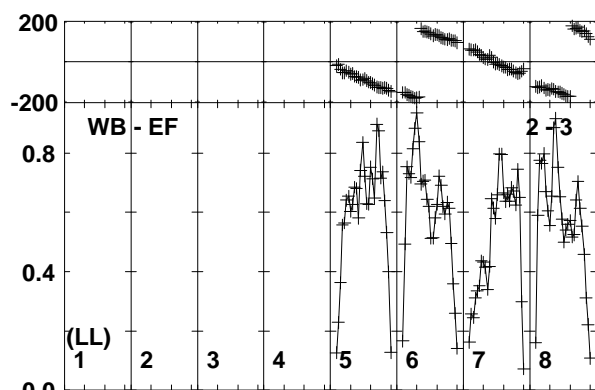
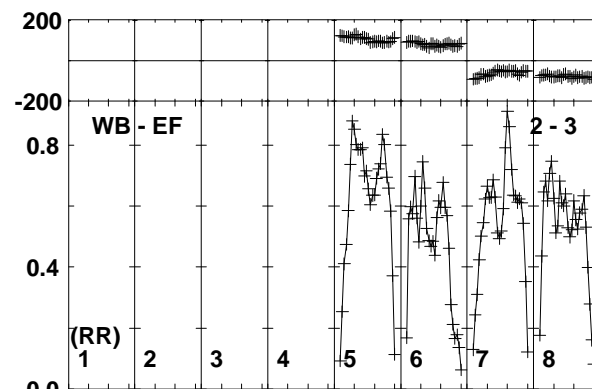
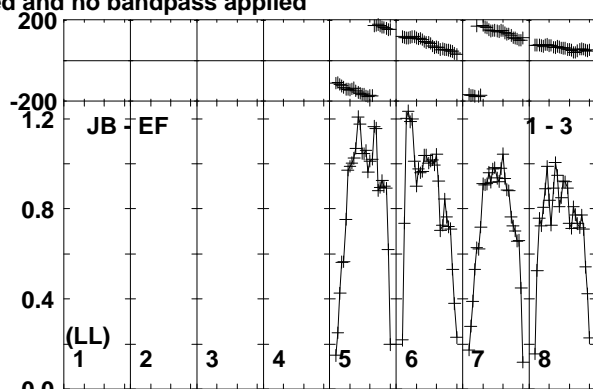
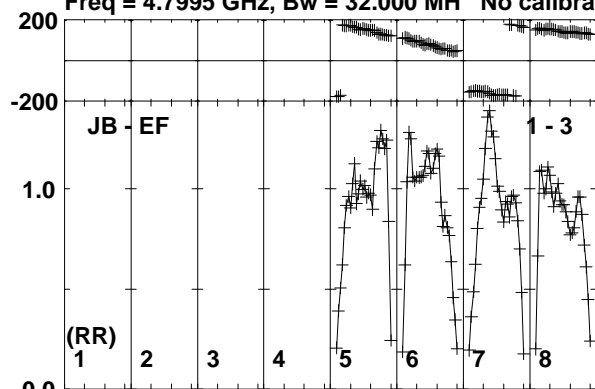

Lower frame: Milli Ampl Jy Top frame: Phas deg
Vector averaged cross-power spectrum Baseline: JB (01) - EF (03)
Timerange: 00/16:54:14 to 00/16:55:28

Plot file version 240 created 03-APR-2017 18:27:44

J1834-2341 EM126B.UVDATA.1

Freq = 4.7995 GHz, Bw = 32.000 MH No calibration applied and no bandpass applied

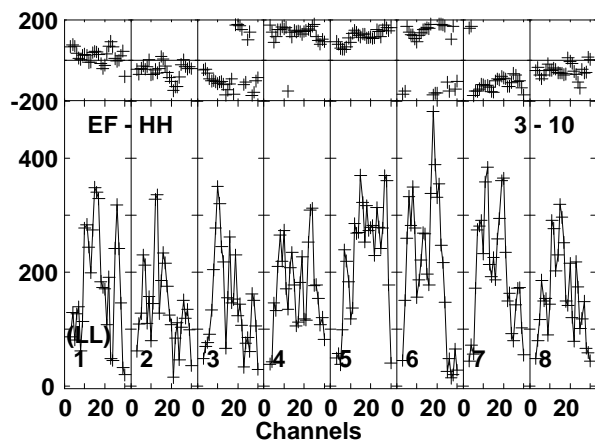
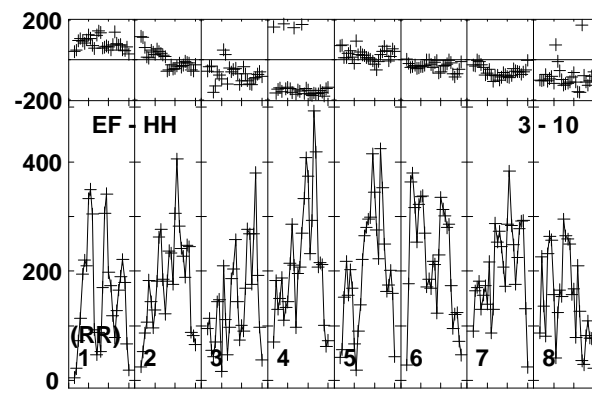
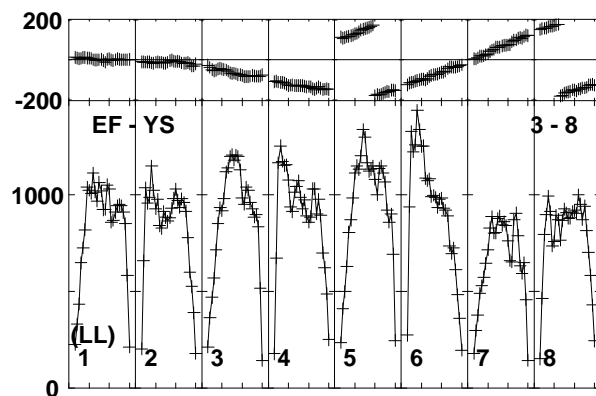
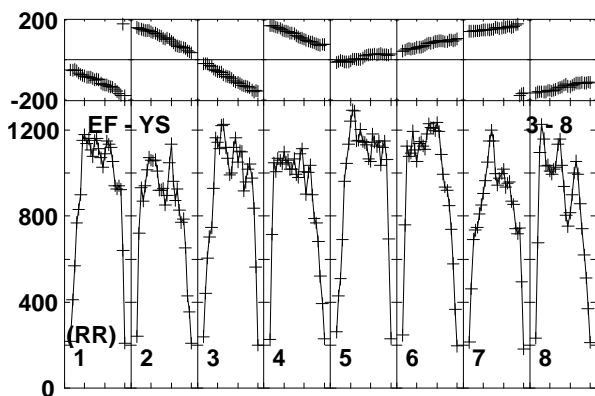
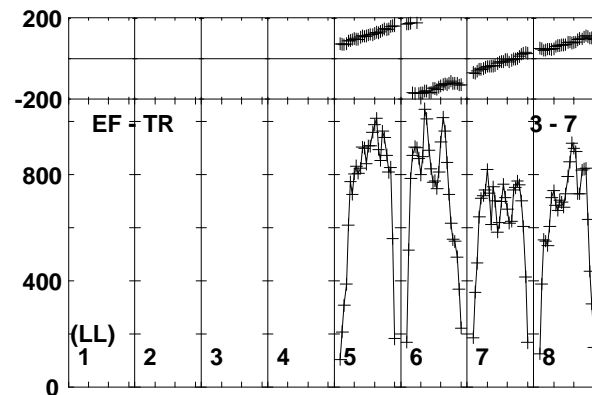
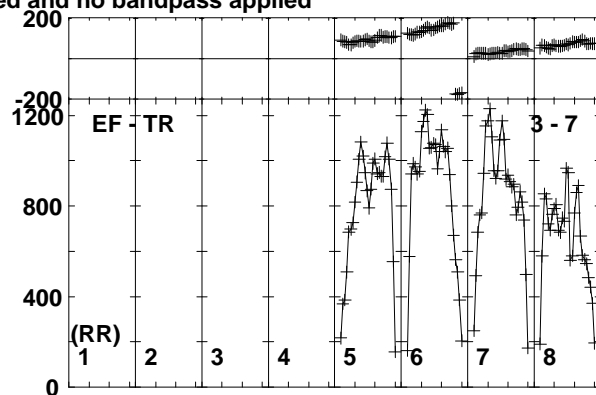
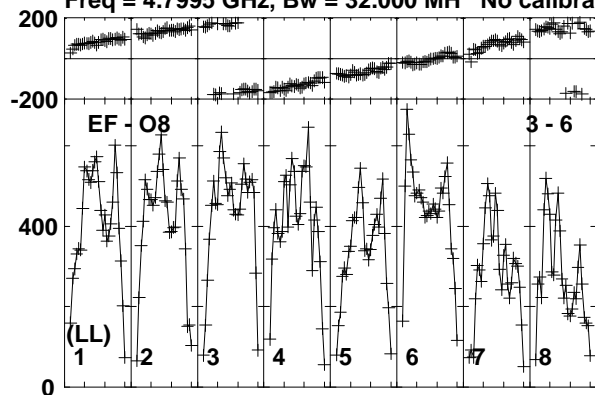

Lower frame: Micro Ampl Jy Top frame: Phas deg
Vector averaged cross-power spectrum Baseline: EF (03) - O8 (06)
Timerange: 00/16:54:14 to 00/16:55:28

Plot file version 241 created 03-APR-2017 18:27:44

M22-VLA1 EM126B.UVDATA.1

Freq = 4.7995 GHz, Bw = 32.000 MH No calibration applied and no bandpass applied

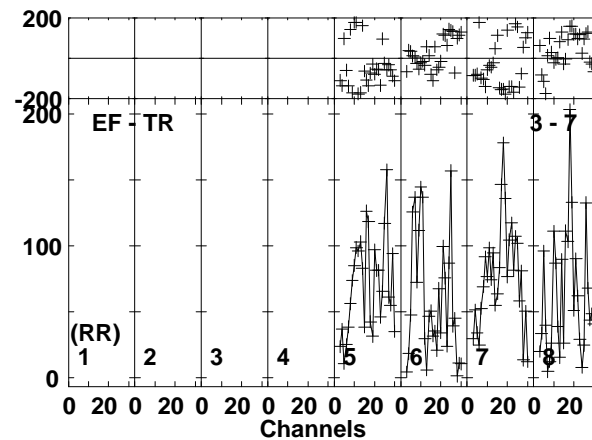
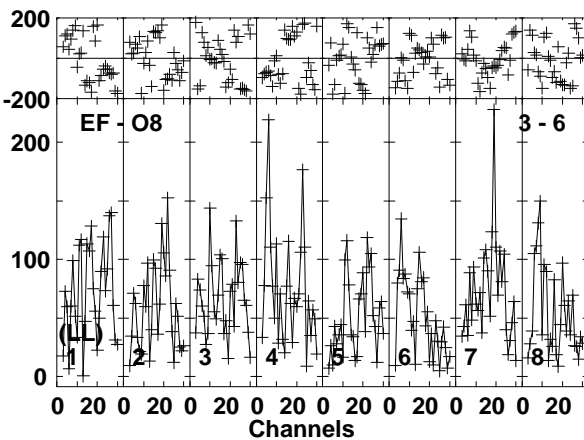
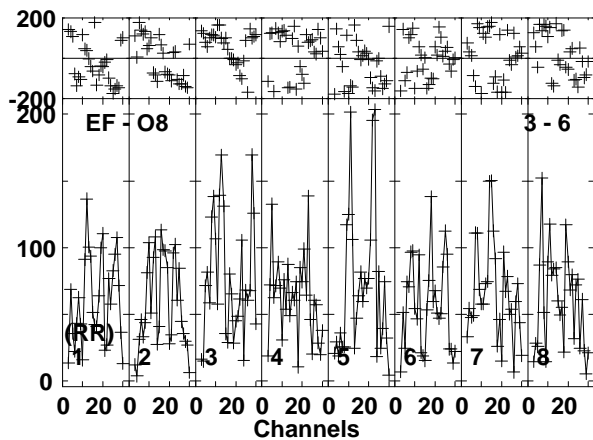
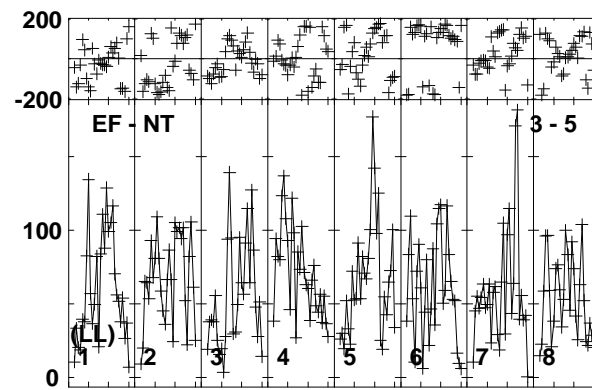
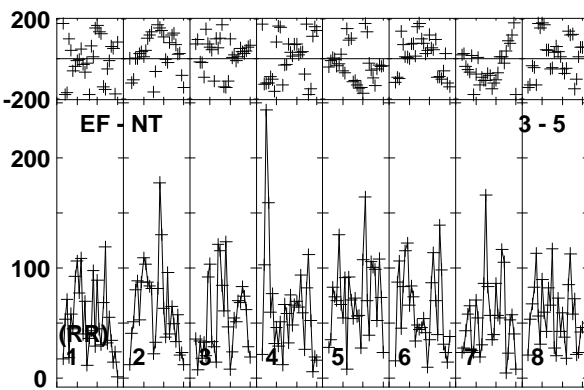
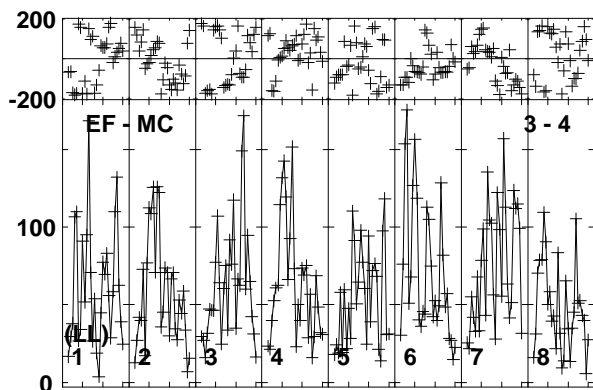
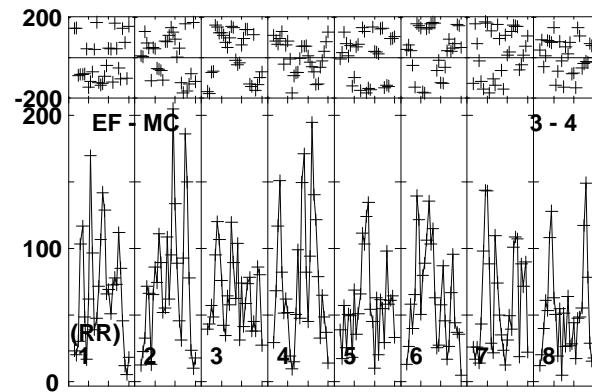
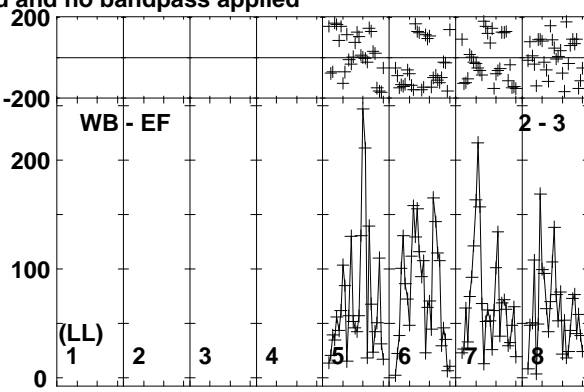
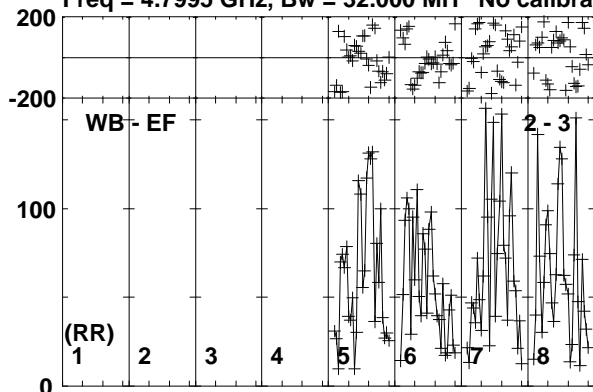

Lower frame: Micro Ampl Jy Top frame: Phas deg
Vector averaged cross-power spectrum Baseline: WB (02) - EF (03)
Timerange: 00/16:55:34 to 00/16:57:38

Plot file version 242 created 03-APR-2017 18:27:44

M22-VLA1 EM126B.UVDATA.1

Freq = 4.7995 GHz, Bw = 32.000 MH No calibration applied and no bandpass applied

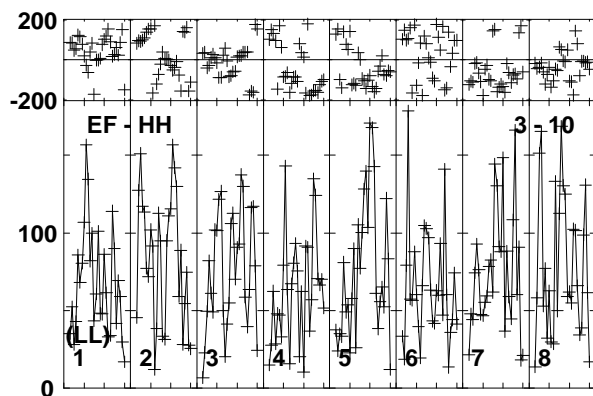
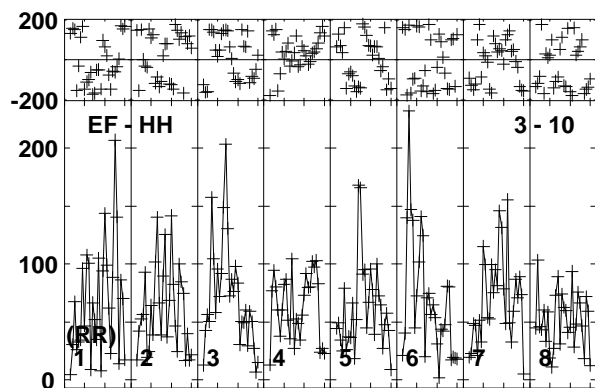
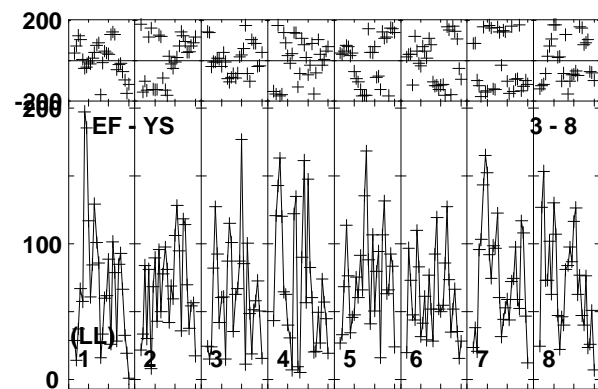
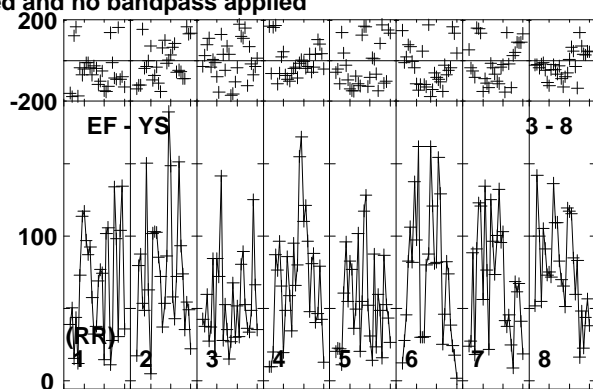
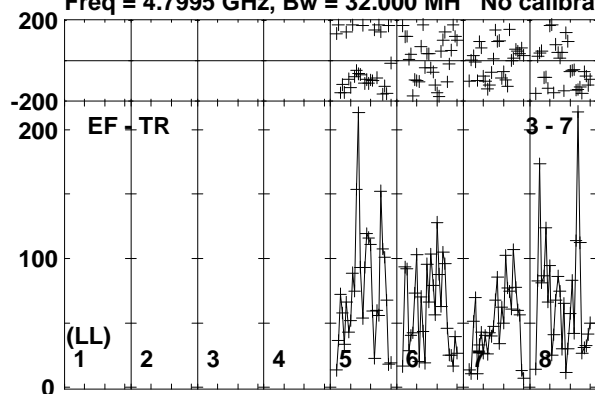

Lower frame: Micro Ampl Jy Top frame: Phas deg
Vector averaged cross-power spectrum Baseline: EF (03) - TR (07)
Timerange: 00/16:55:34 to 00/16:57:38

Plot file version 243 created 03-APR-2017 18:27:44

J1834-2341 EM126B.UVDATA.1

Freq = 4.7995 GHz, Bw = 32.000 MH No calibration applied and no bandpass applied

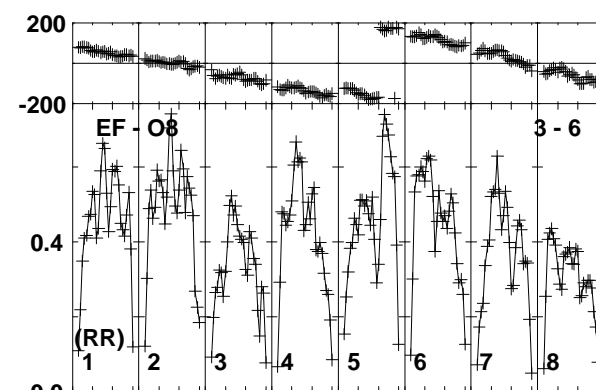
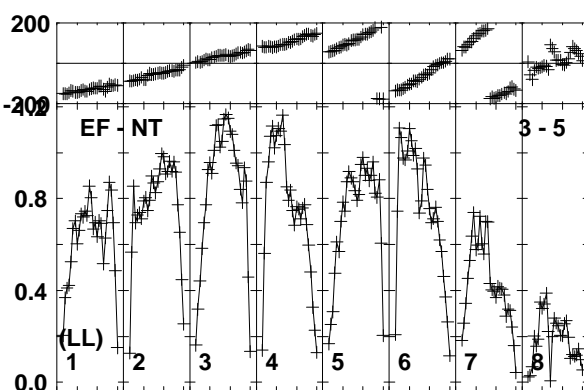
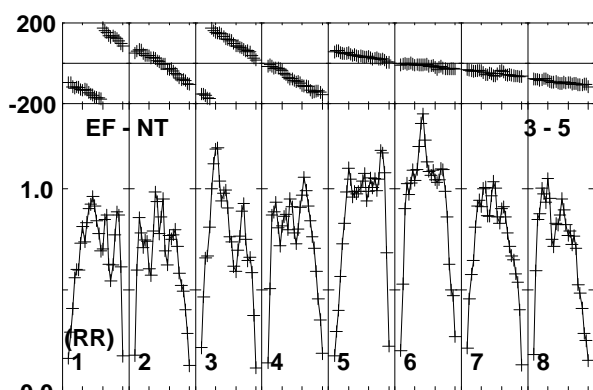
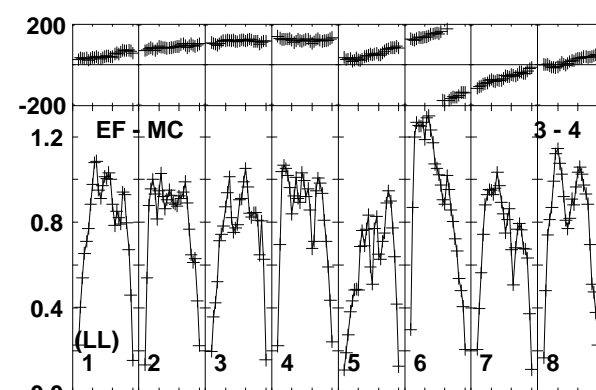
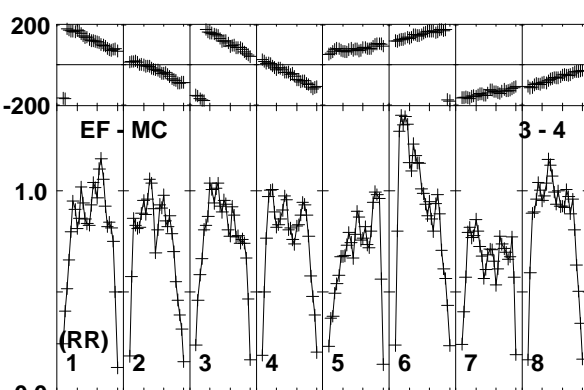
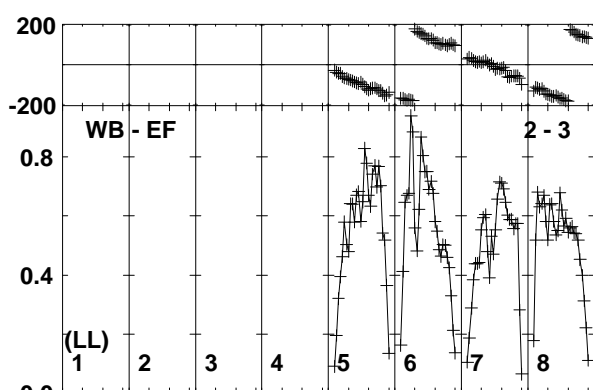
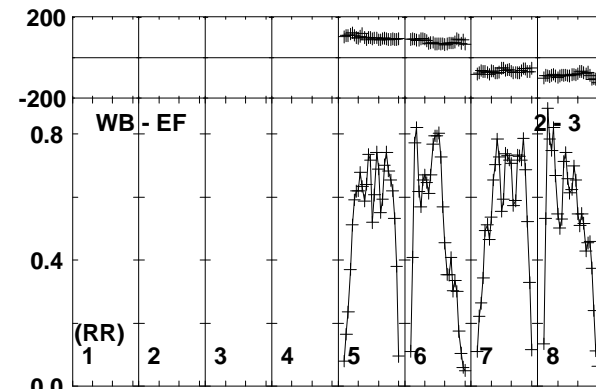
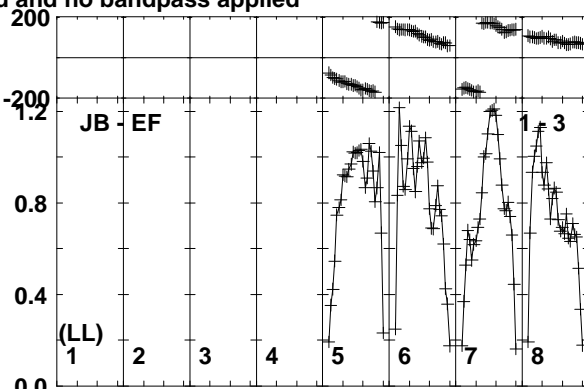
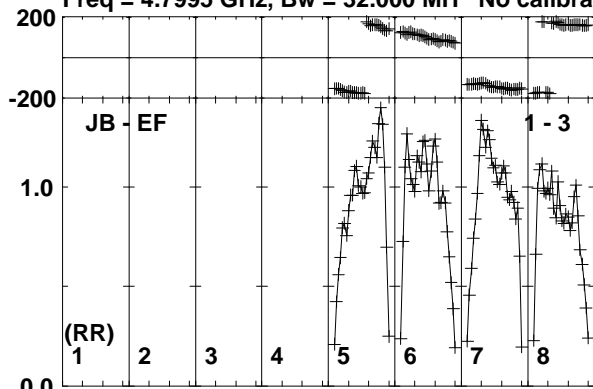

Lower frame: Milli Ampl Jy Top frame: Phas deg
Vector averaged cross-power spectrum Baseline: JB (01) - EF (03)
Timerange: 00/16:58:11 to 00/16:58:59

Plot file version 244 created 03-APR-2017 18:27:44

J1834-2341 EM126B.UVDATA.1

Freq = 4.7995 GHz, Bw = 32.000 MH No calibration applied and no bandpass applied

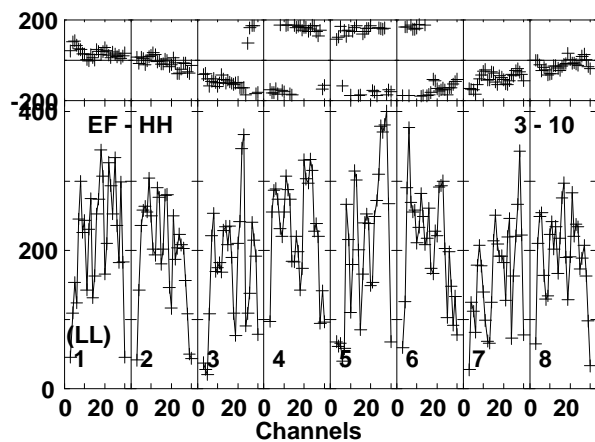
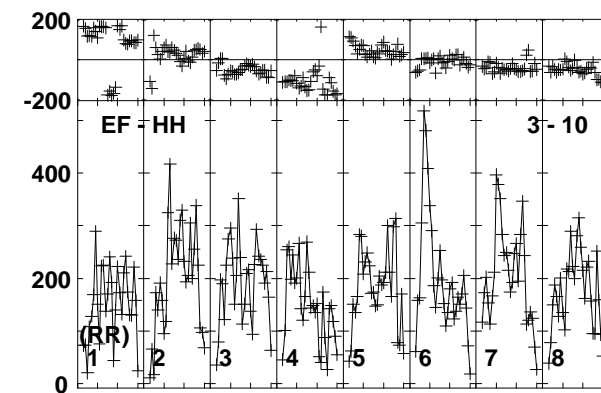
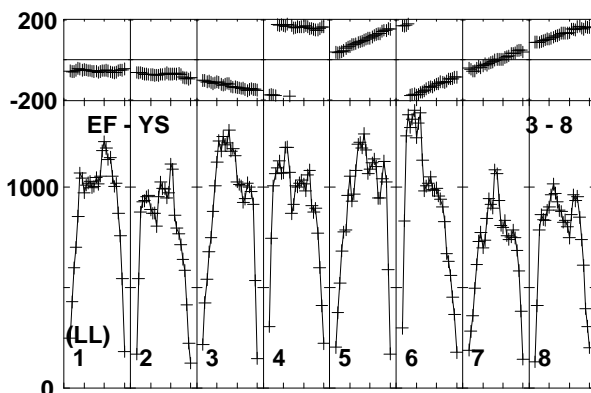
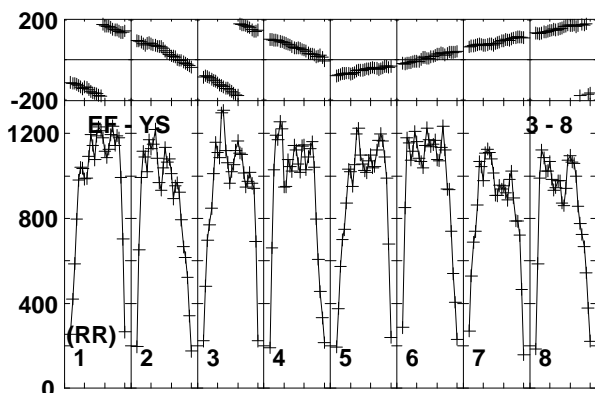
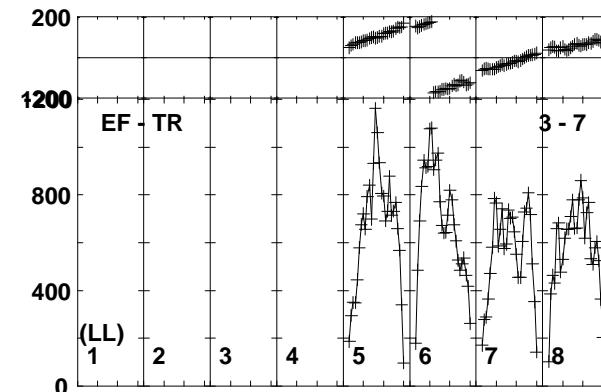
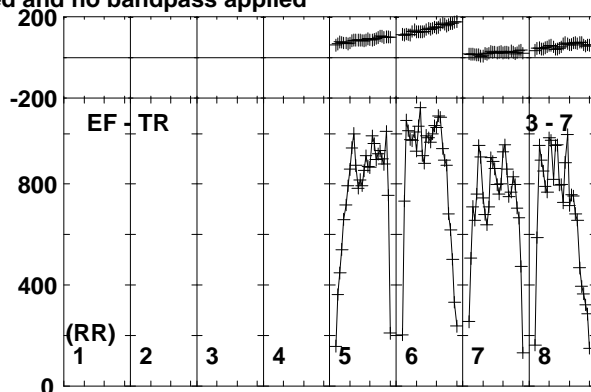
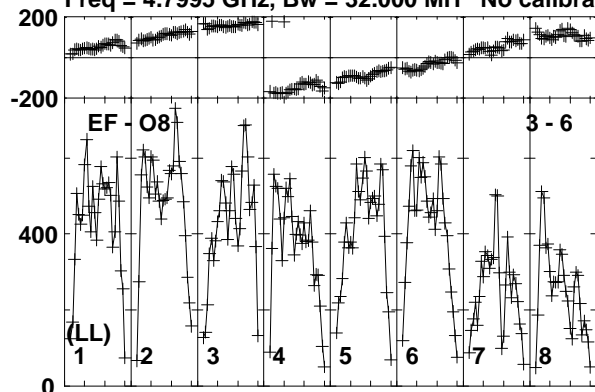

Lower frame: Micro Ampl Jy Top frame: Phas deg
Vector averaged cross-power spectrum Baseline: EF (03) - O8 (06)
Timerange: 00/16:58:11 to 00/16:58:59

Plot file version 245 created 03-APR-2017 18:27:44

M22-VLA1 EM126B.UVDATA.1

Freq = 4.7995 GHz, Bw = 32.000 MH No calibration applied and no bandpass applied

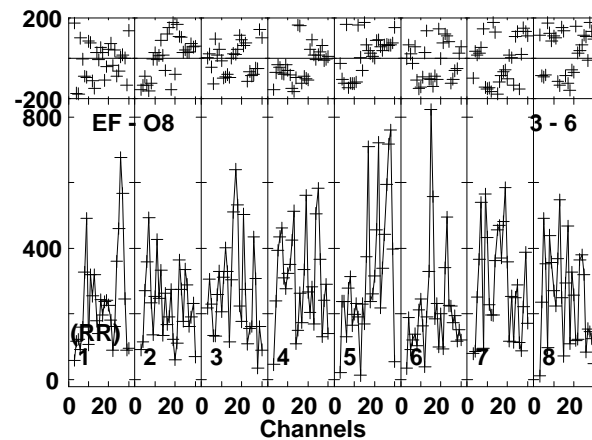
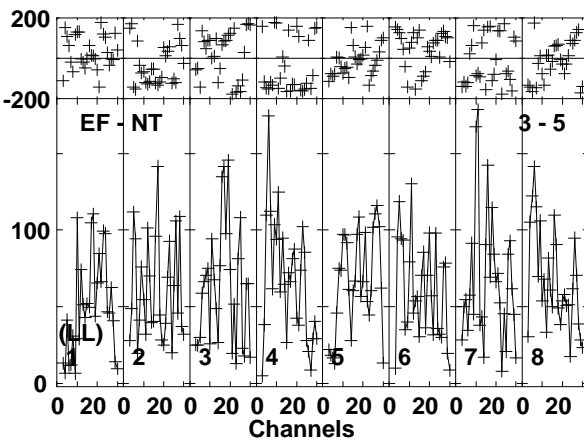
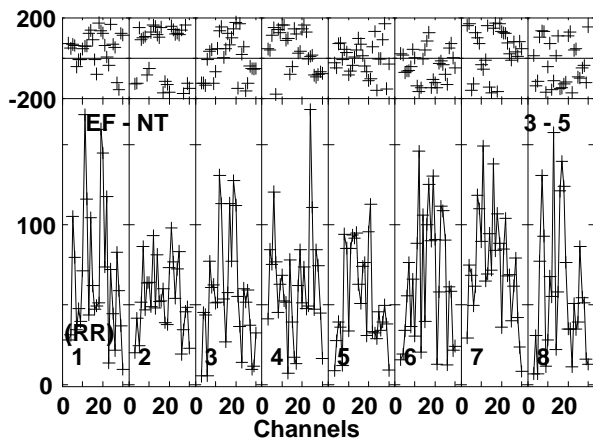
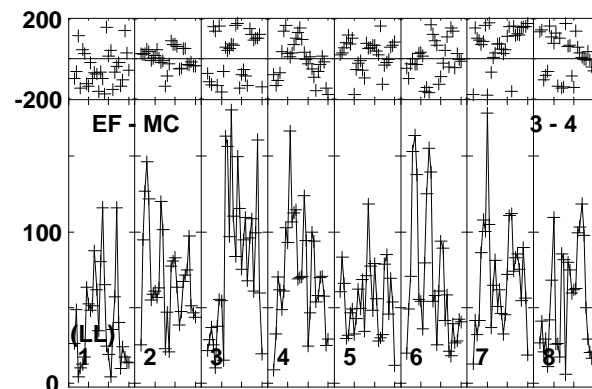
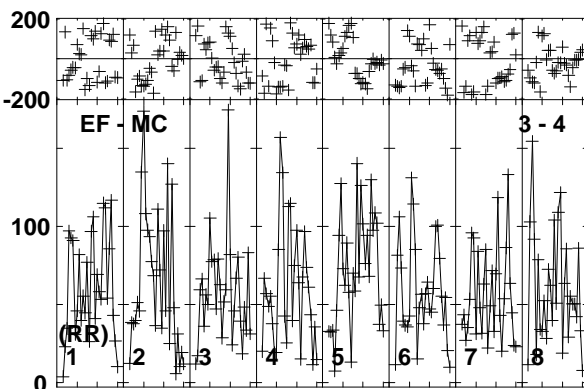
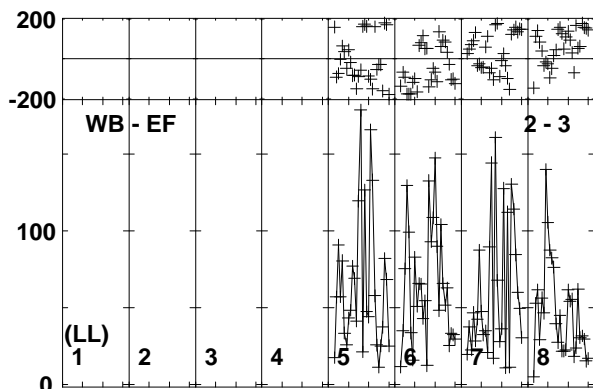
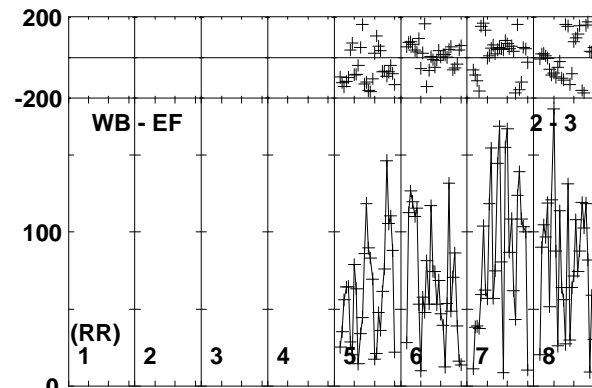
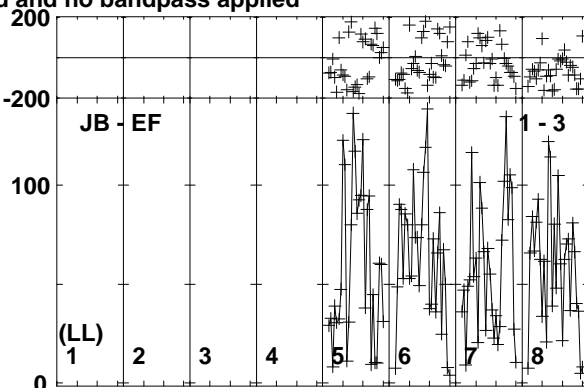
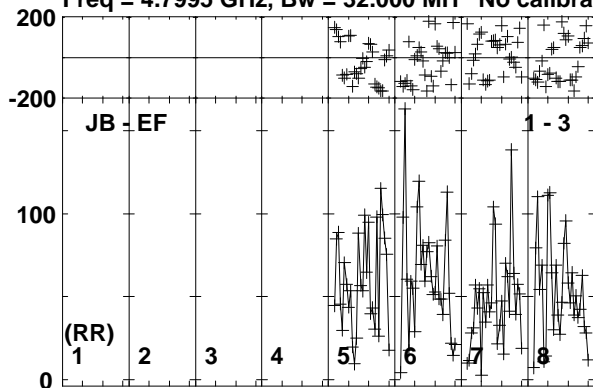

Lower frame: Micro Ampl Jy Top frame: Phas deg
Vector averaged cross-power spectrum Baseline: JB (01) - EF (03)
Timerange: 00/16:59:04 to 00/17:01:08

Plot file version 246 created 03-APR-2017 18:27:44

M22-VLA1 EM126B.UVDATA.1

Freq = 4.7995 GHz, Bw = 32.000 MH No calibration applied and no bandpass applied

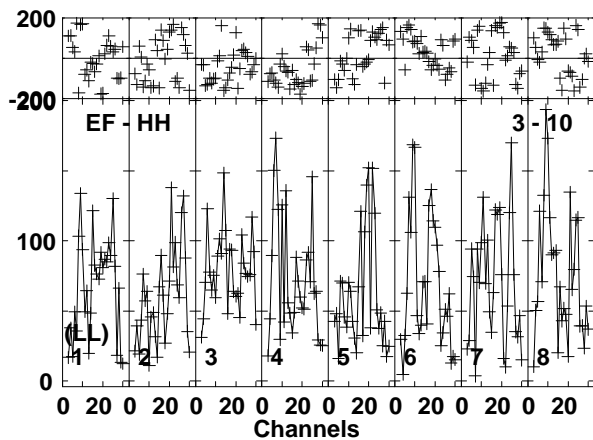
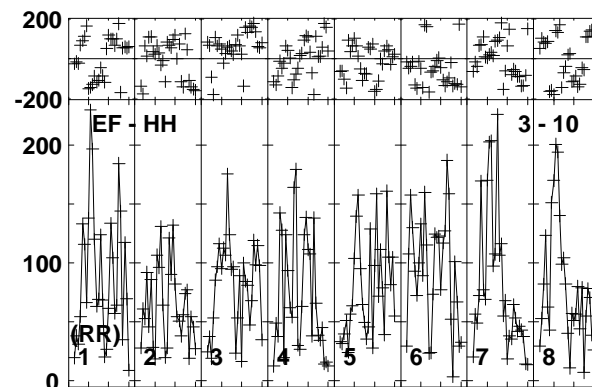
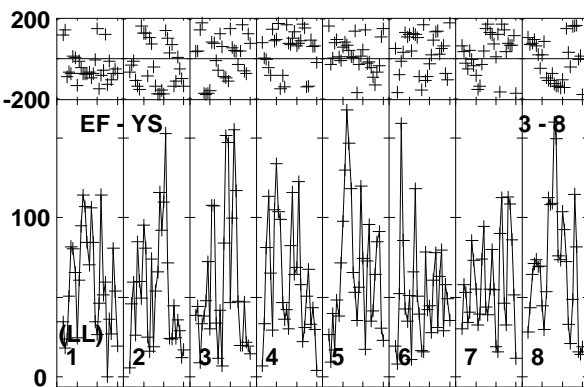
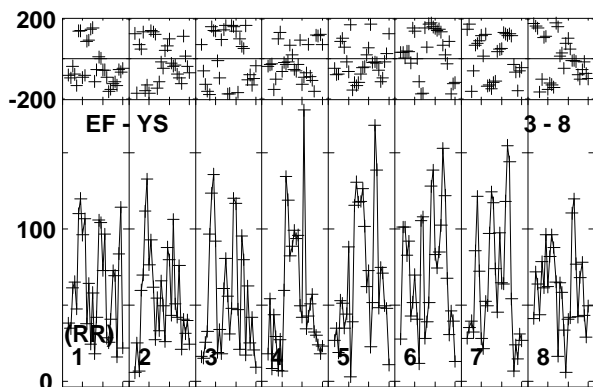
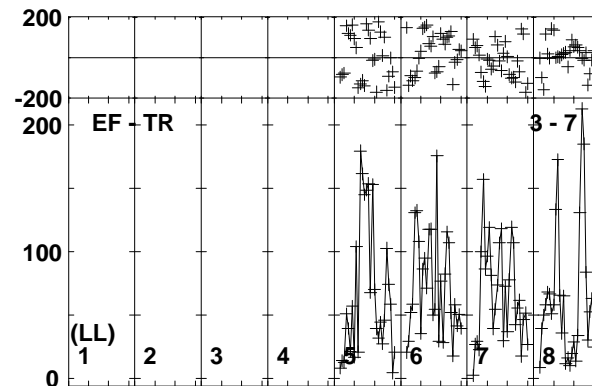
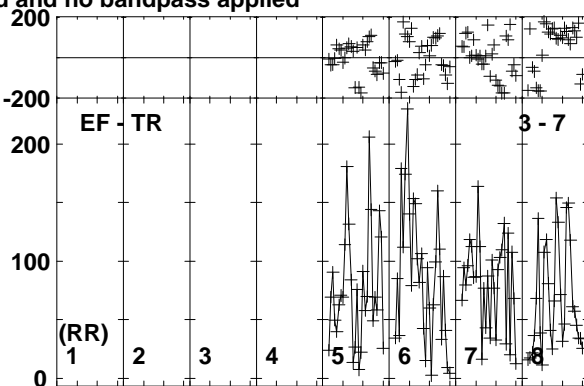
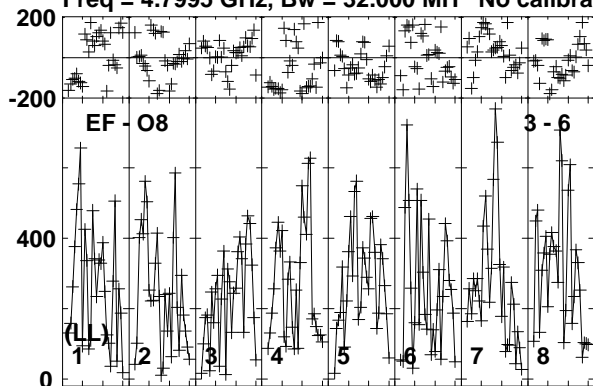

Lower frame: Micro Ampl Jy Top frame: Phas deg
Vector averaged cross-power spectrum Baseline: EF (03) - O8 (06)
Timerange: 00/16:59:04 to 00/17:01:08

Plot file version 247 created 03-APR-2017 18:27:44

J1834-2341 EM126B.UVDATA.1

Freq = 4.7995 GHz, Bw = 32.000 MH No calibration applied and no bandpass applied

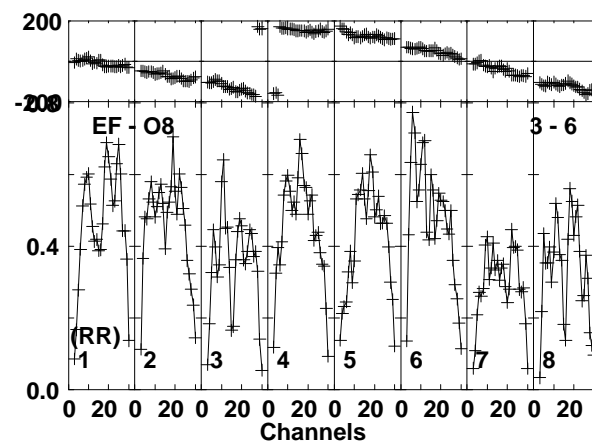
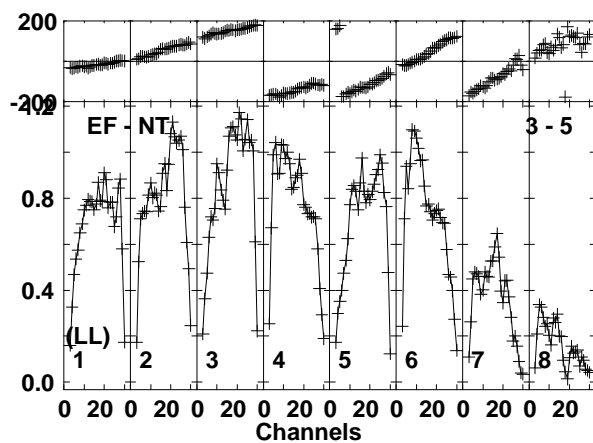
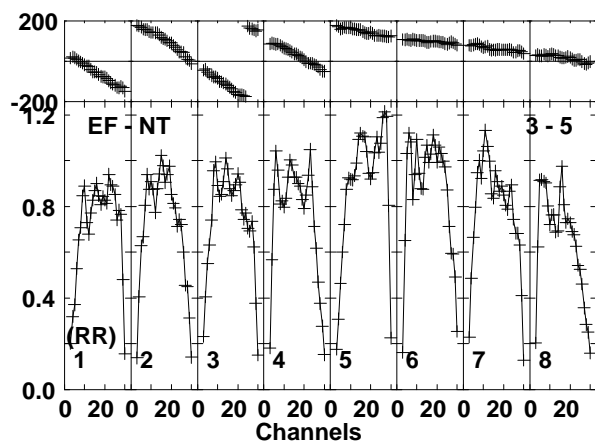
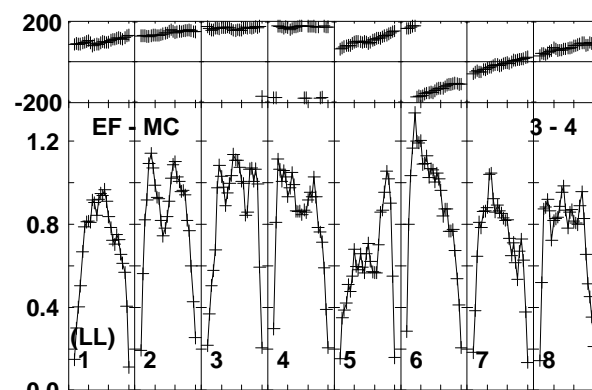
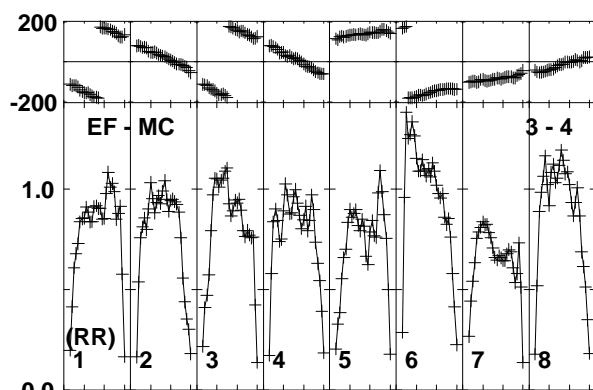
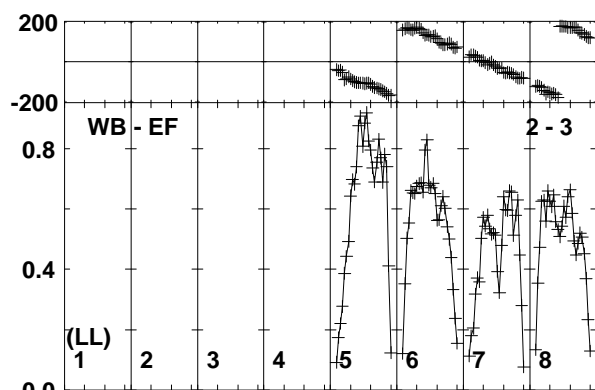
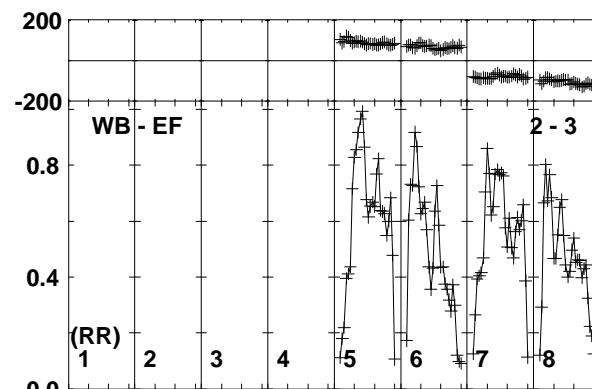
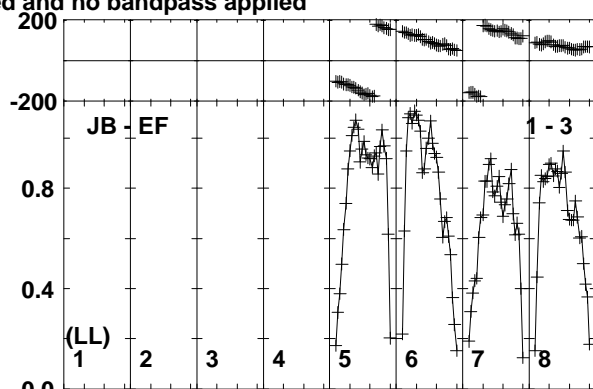
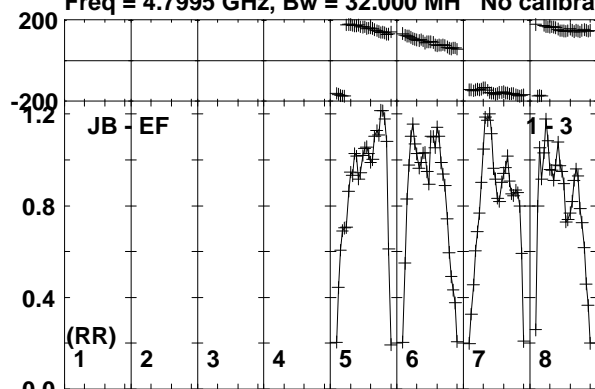

Lower frame: Milli Ampl Jy Top frame: Phas deg
Vector averaged cross-power spectrum Baseline: JB (01) - EF (03)
Timerange: 00/17:01:14 to 00/17:02:28

Plot file version 248 created 03-APR-2017 18:27:44

J1834-2341 EM126B.UVDATA.1

Freq = 4.7995 GHz, Bw = 32.000 MH No calibration applied and no bandpass applied

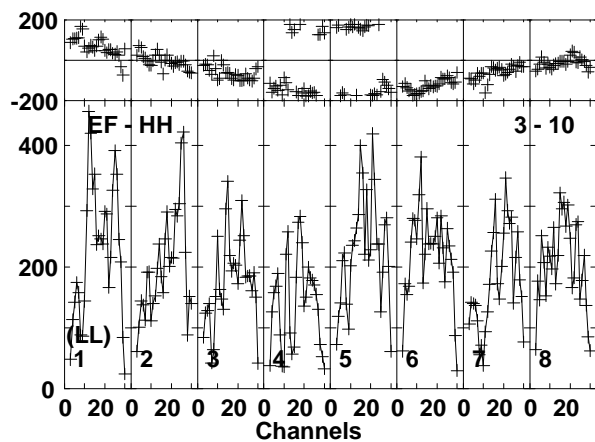
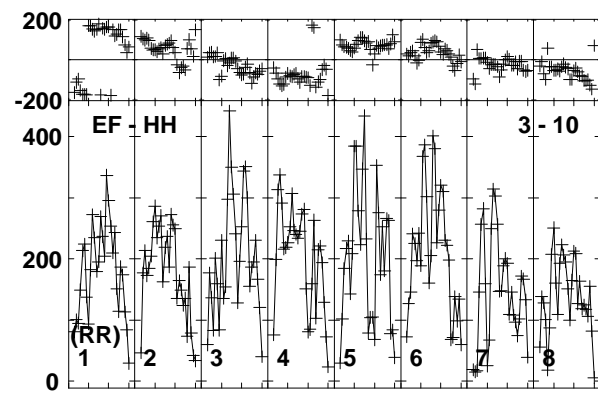
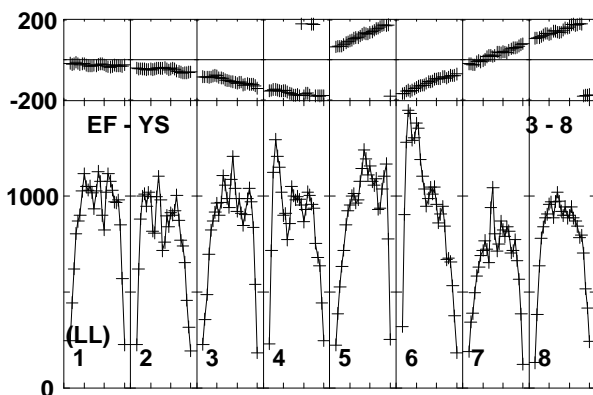
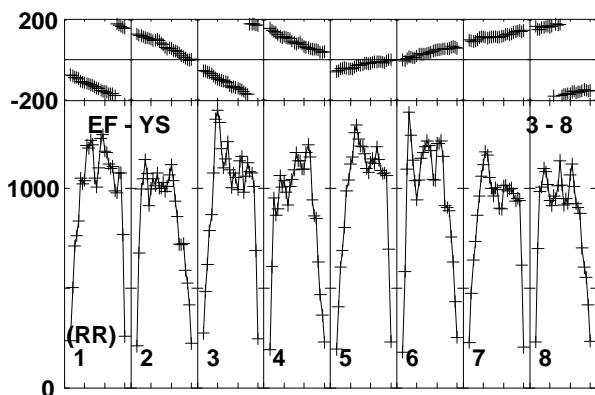
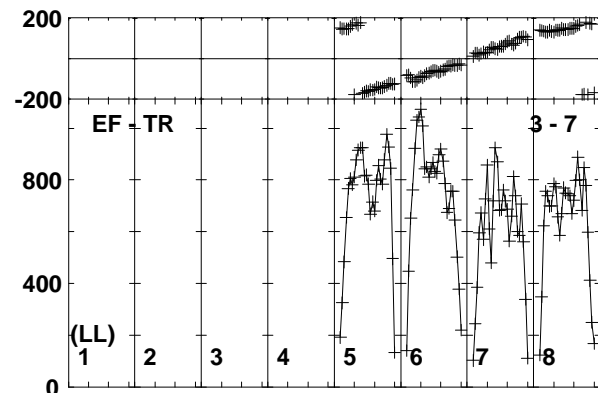
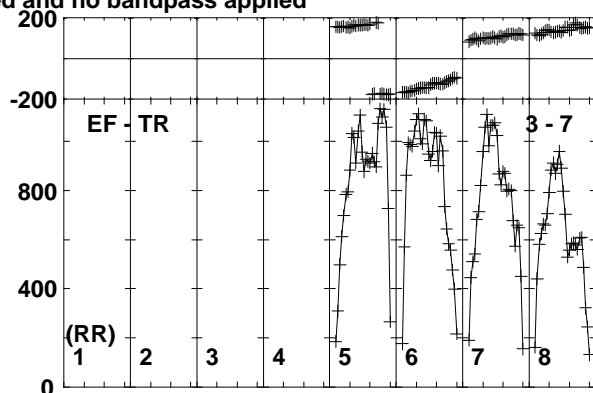
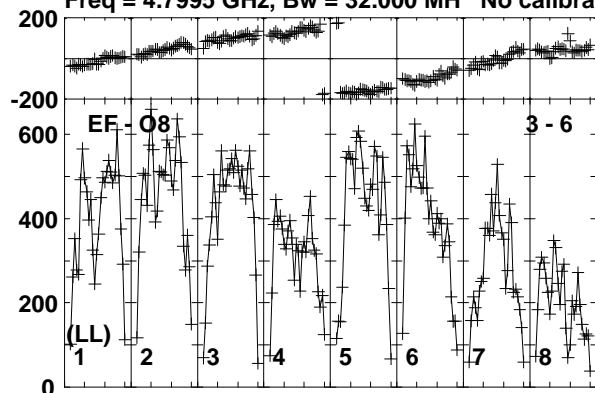

Lower frame: Micro Ampl Jy Top frame: Phas deg
Vector averaged cross-power spectrum Baseline: EF (03) - O8 (06)
Timerange: 00/17:01:14 to 00/17:02:28

Plot file version 249 created 03-APR-2017 18:27:44

M22-VLA1 EM126B.UVDATA.1

Freq = 4.7995 GHz, Bw = 32.000 MH No calibration applied and no bandpass applied

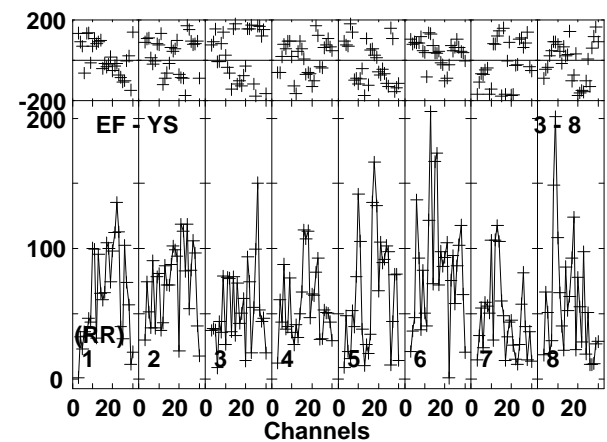
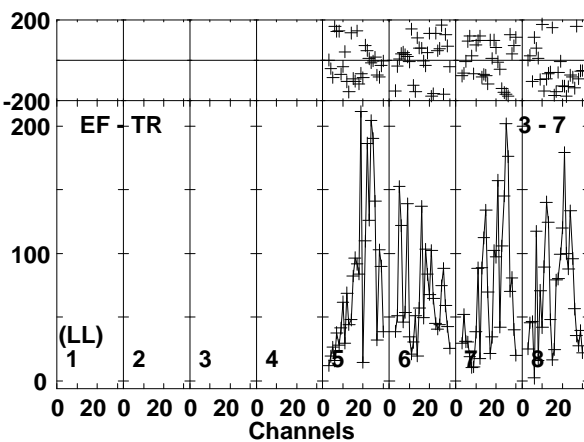
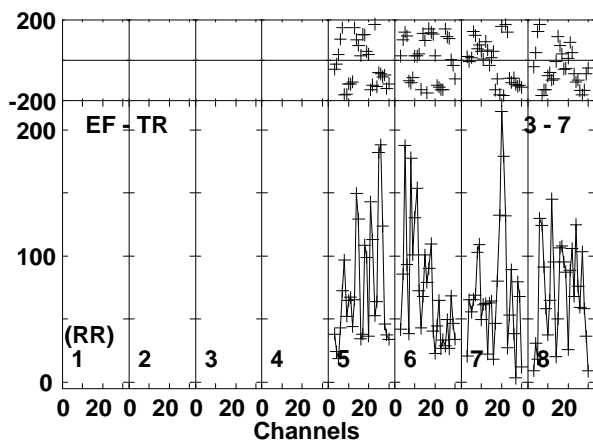
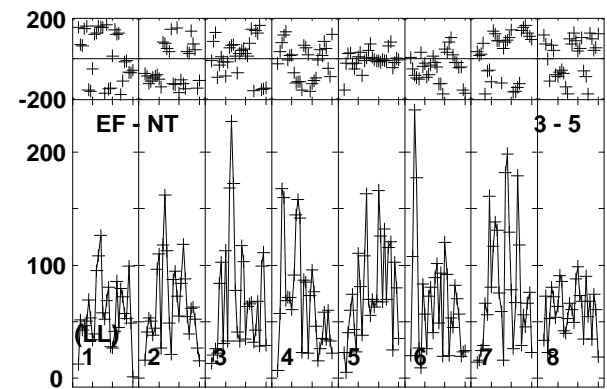
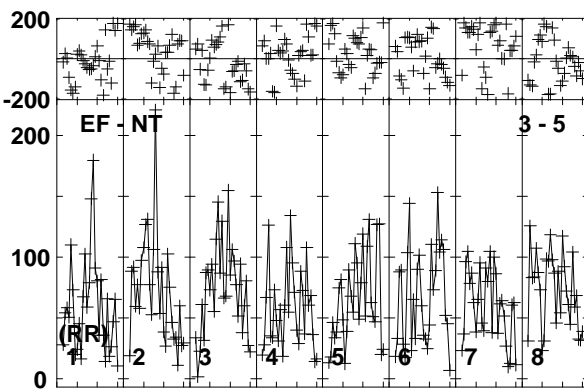
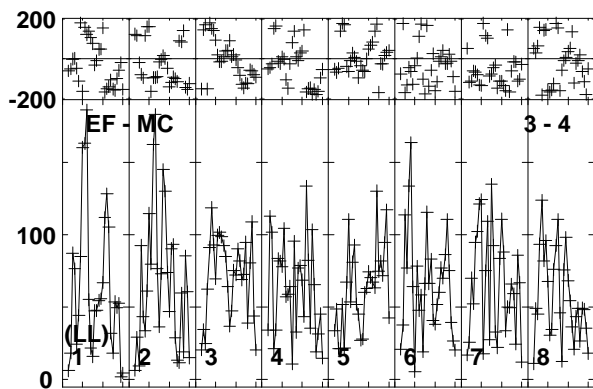
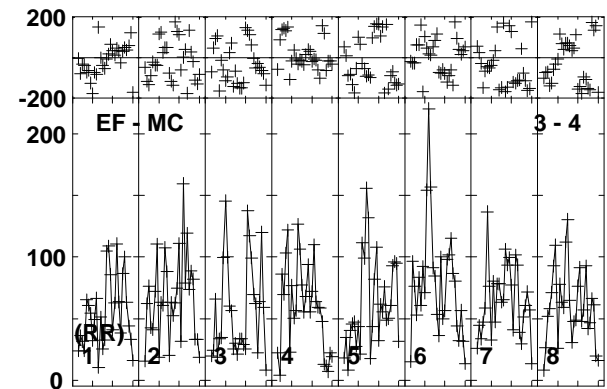
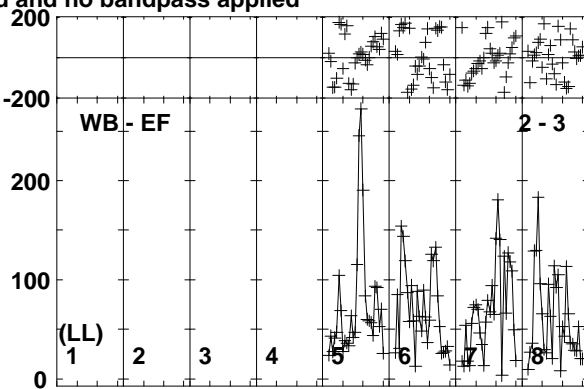
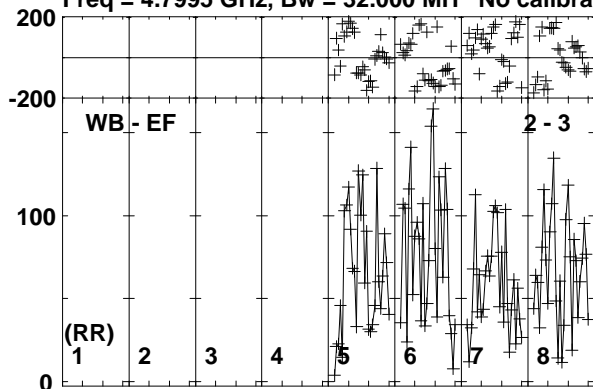

Lower frame: Micro Ampl Jy Top frame: Phas deg
Vector averaged cross-power spectrum Baseline: WB (02) - EF (03)
Timerange: 00/17:02:34 to 00/17:04:38

Plot file version 250 created 03-APR-2017 18:27:44

M22-VLA1 EM126B.UVDATA.1

Freq = 4.7995 GHz, Bw = 32.000 MH No calibration applied and no bandpass applied

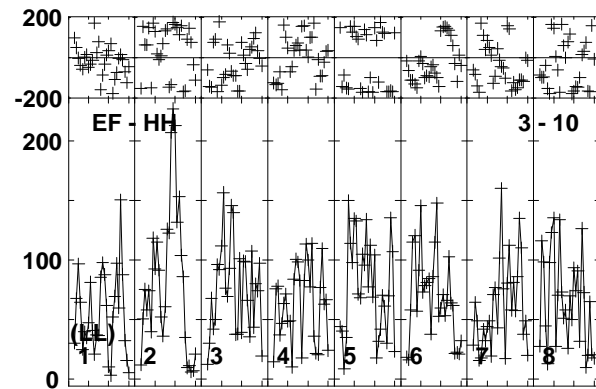
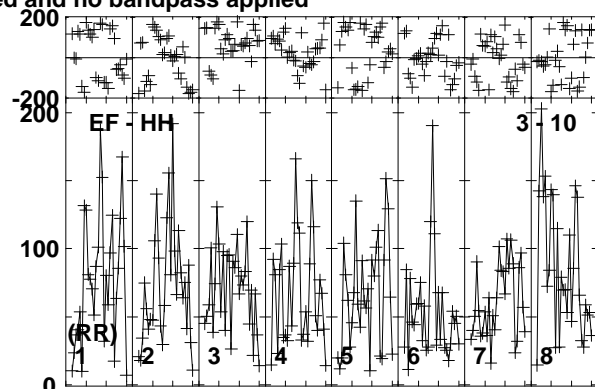
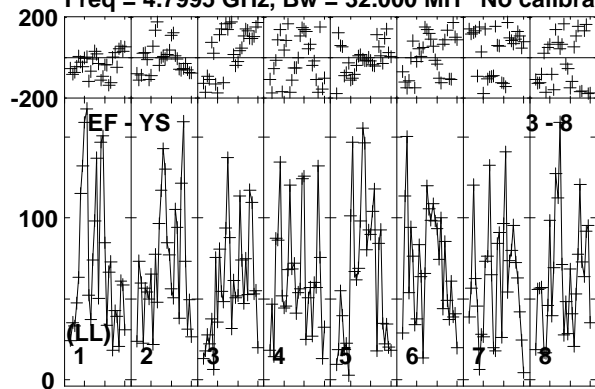

Lower frame: Micro Ampl Jy Top frame: Phas deg
Vector averaged cross-power spectrum Baseline: EF (03) - YS (08)
Timerange: 00/17:02:34 to 00/17:04:38

Plot file version 251 created 03-APR-2017 18:27:44

J1834-2341 EM126B.UVDATA.1

Freq = 4.7995 GHz, Bw = 32.000 MH No calibration applied and no bandpass applied

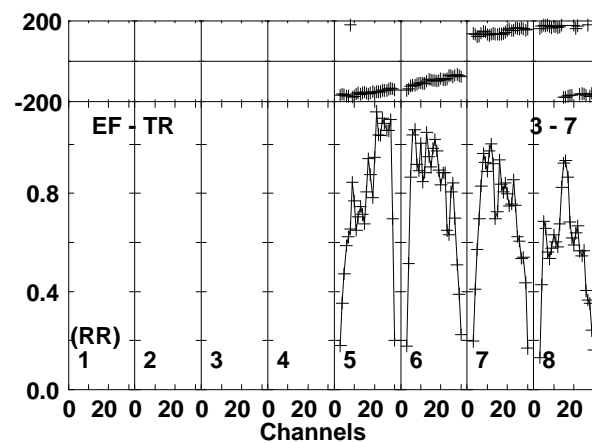
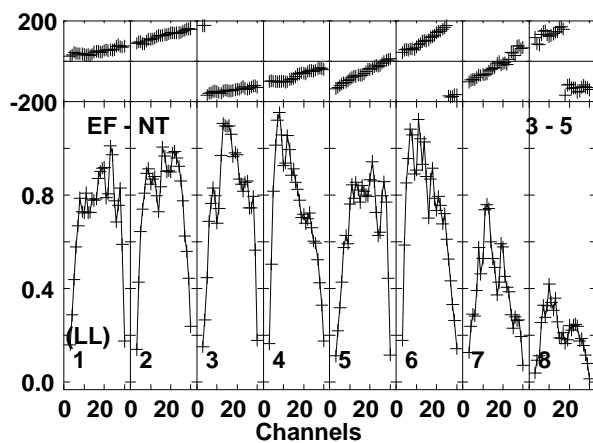
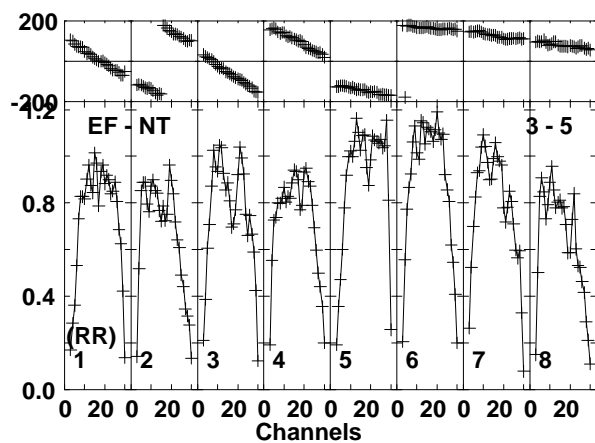
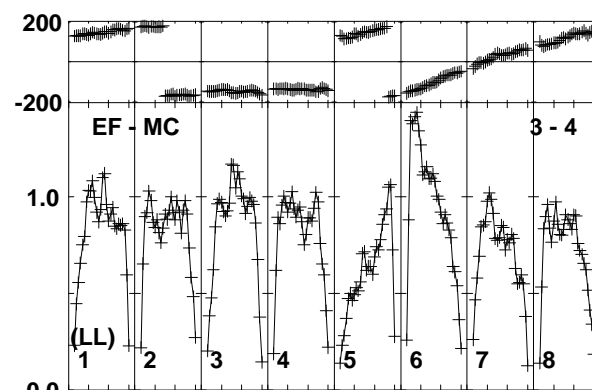
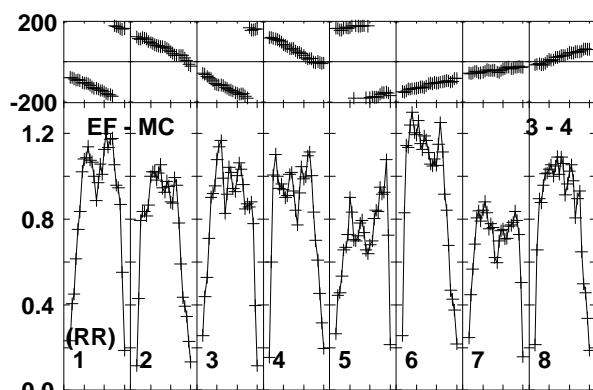
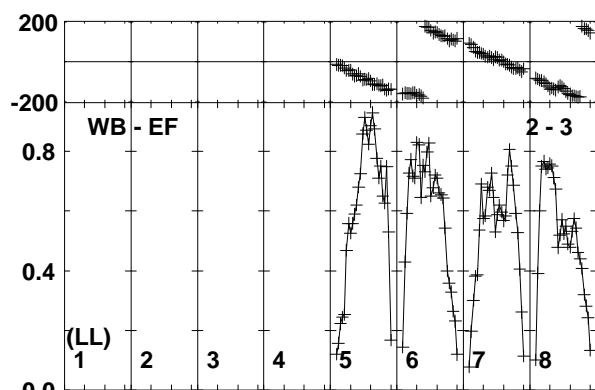
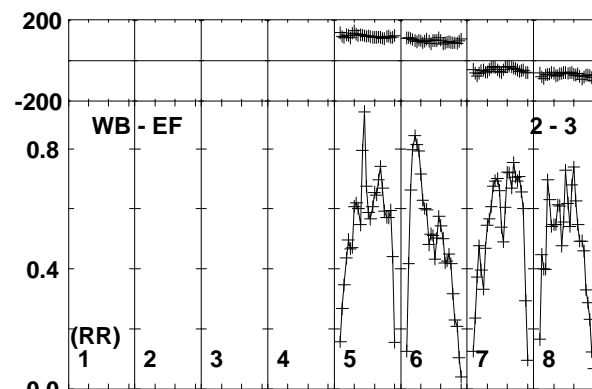
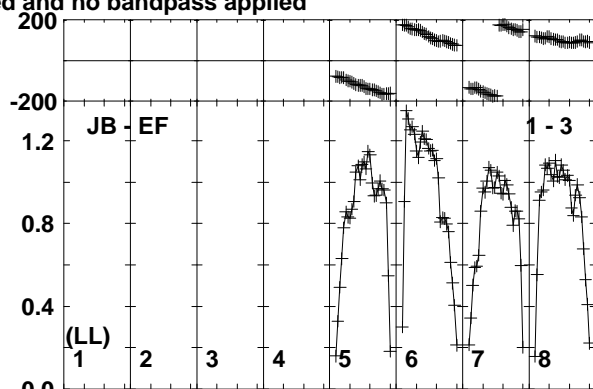
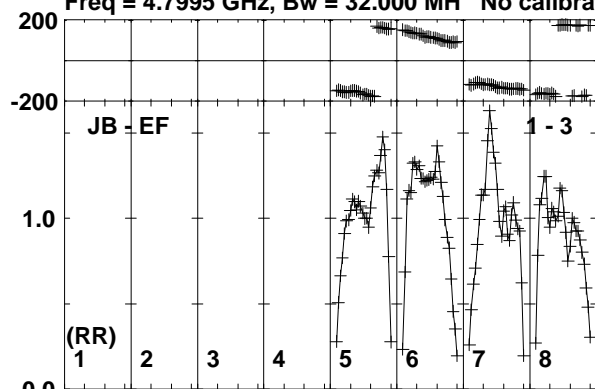

Lower frame: Milli Ampl Jy Top frame: Phas deg
Vector averaged cross-power spectrum Baseline: JB (01) - EF (03)
Timerange: 00/17:04:44 to 00/17:05:58

Plot file version 252 created 03-APR-2017 18:27:44

J1834-2341 EM126B.UVDATA.1

Freq = 4.7995 GHz, Bw = 32.000 MH No calibration applied and no bandpass applied

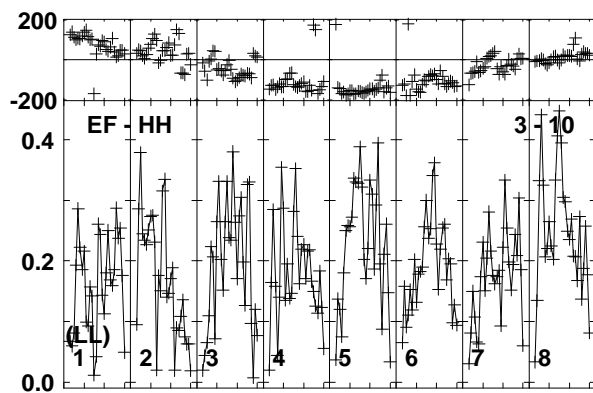
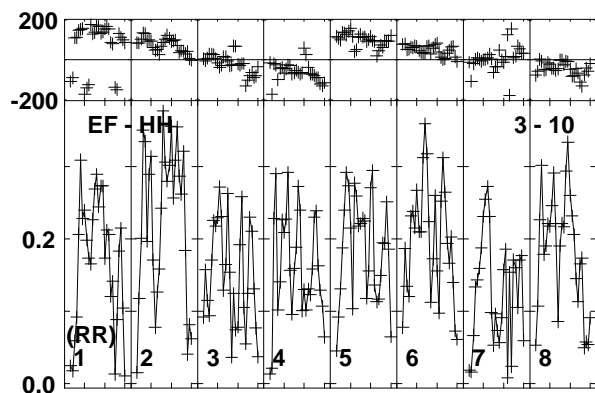
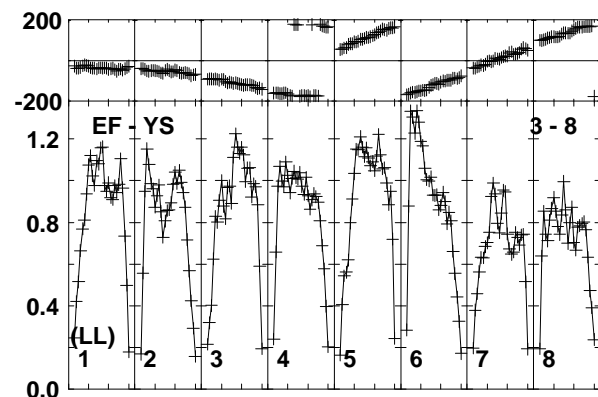
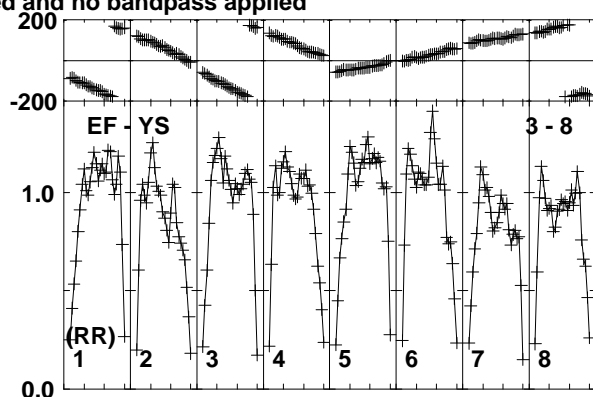
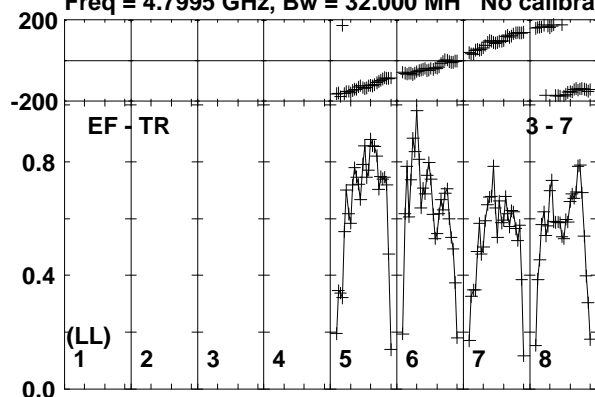

Lower frame: Milli Ampl Jy Top frame: Phas deg
Vector averaged cross-power spectrum Baseline: EF (03) - TR (07)
Timerange: 00/17:04:44 to 00/17:05:58

Plot file version 253 created 03-APR-2017 18:27:44

M22-VLA1 EM126B.UVDATA.1

Freq = 4.7995 GHz, Bw = 32.000 MH No calibration applied and no bandpass applied

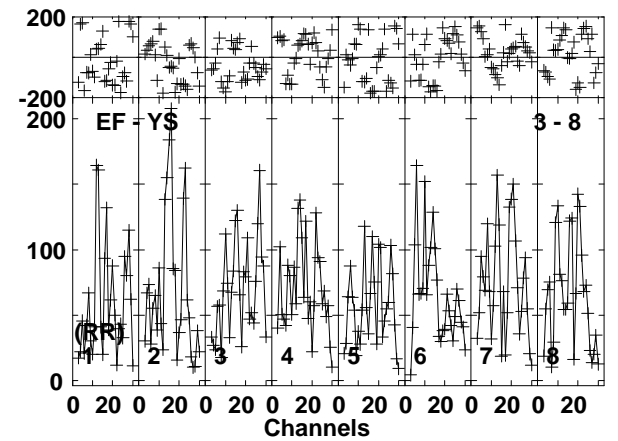
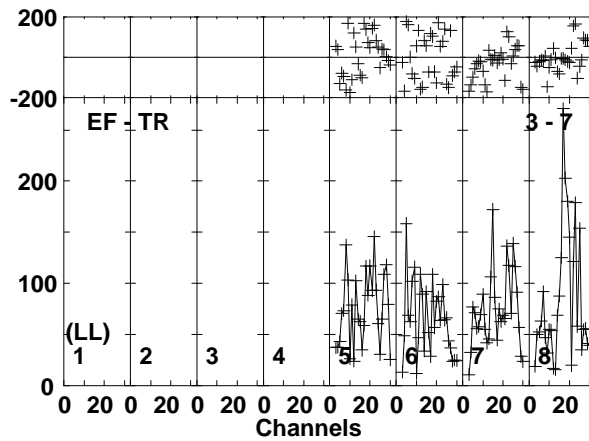
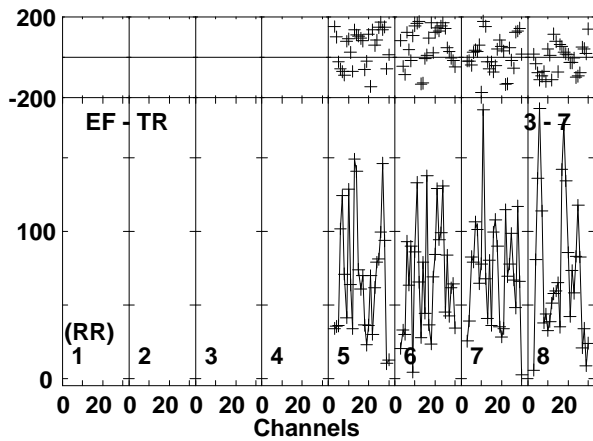
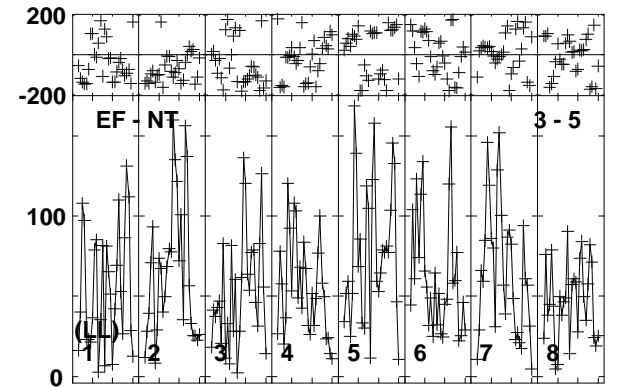
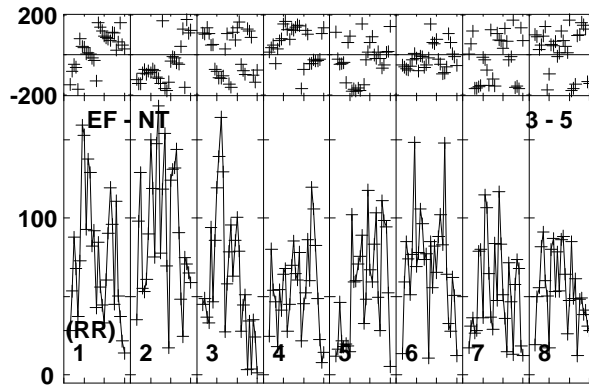
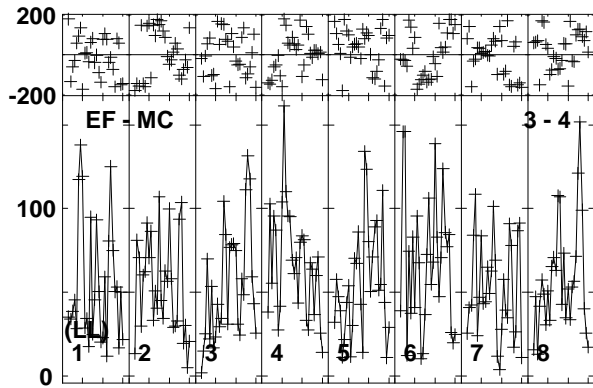
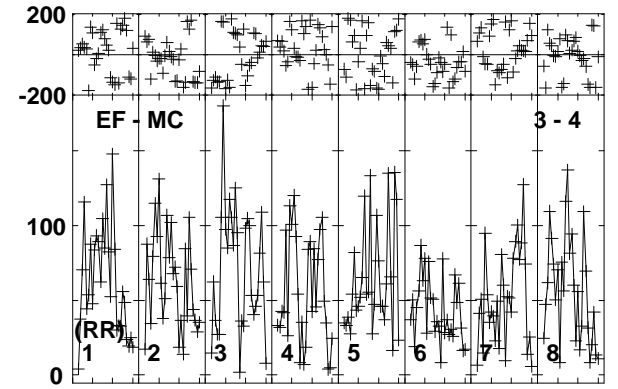
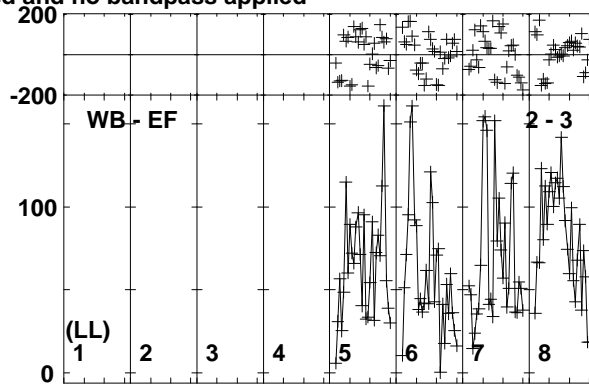
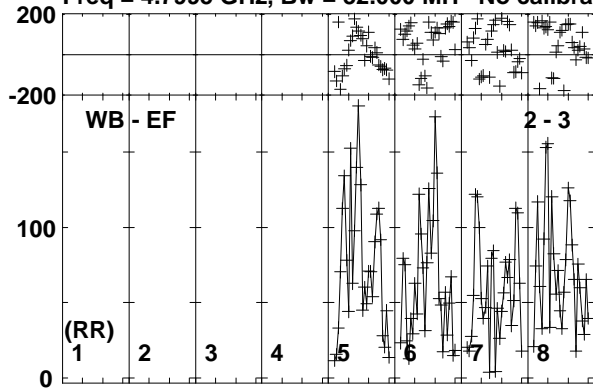

Lower frame: Micro Ampl Jy Top frame: Phas deg
Vector averaged cross-power spectrum Baseline: WB (02) - EF (03)
Timerange: 00/17:06:04 to 00/17:08:08

Plot file version 254 created 03-APR-2017 18:27:44

M22-VLA1 EM126B.UVDATA.1

Freq = 4.7995 GHz, Bw = 32.000 MH No calibration applied and no bandpass applied

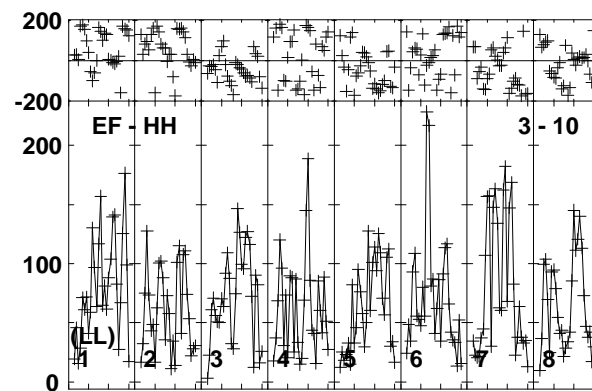
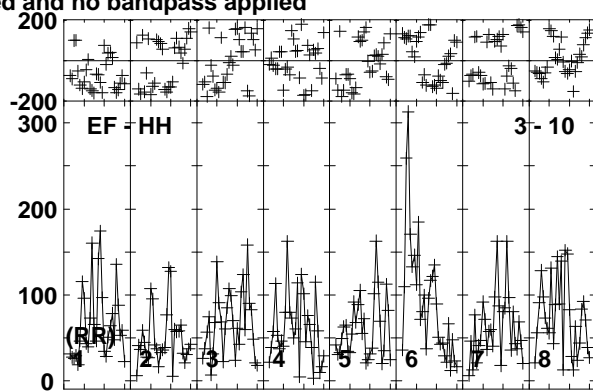
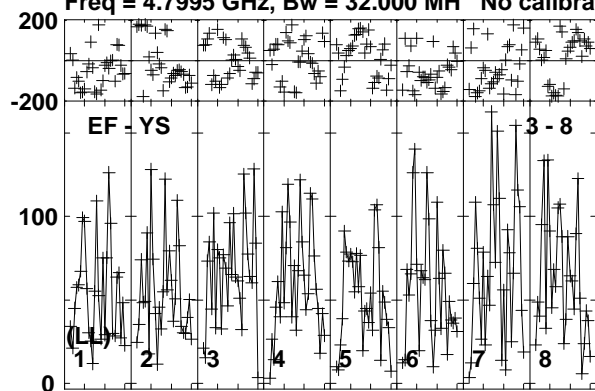

Lower frame: Micro Ampl Jy Top frame: Phas deg
Vector averaged cross-power spectrum Baseline: EF (03) - YS (08)
Timerange: 00/17:06:04 to 00/17:08:08

Plot file version 255 created 03-APR-2017 18:27:44

J1834-2341 EM126B.UVDATA.1

Freq = 4.7995 GHz, Bw = 32.000 MH No calibration applied and no bandpass applied

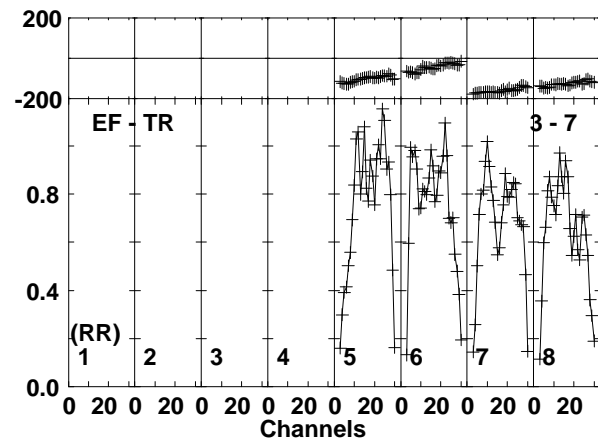
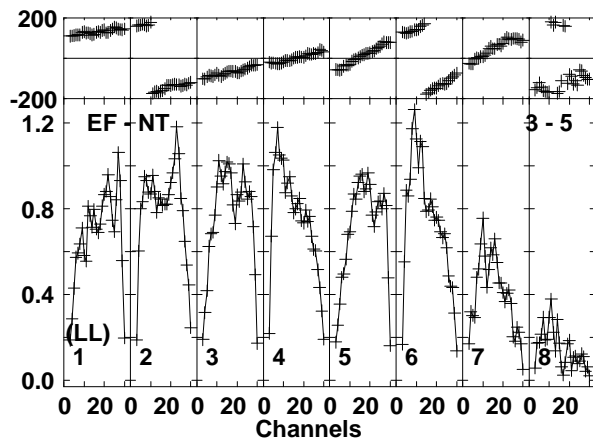
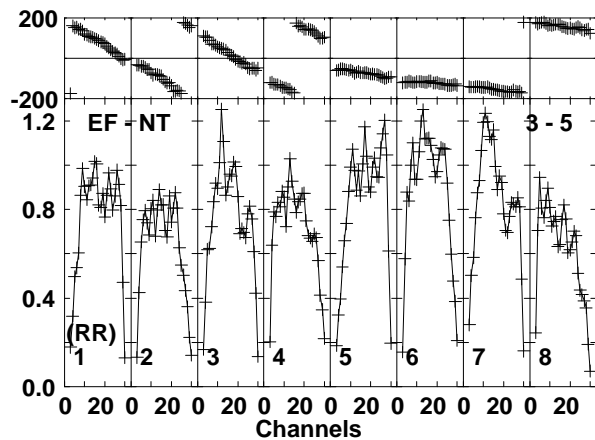
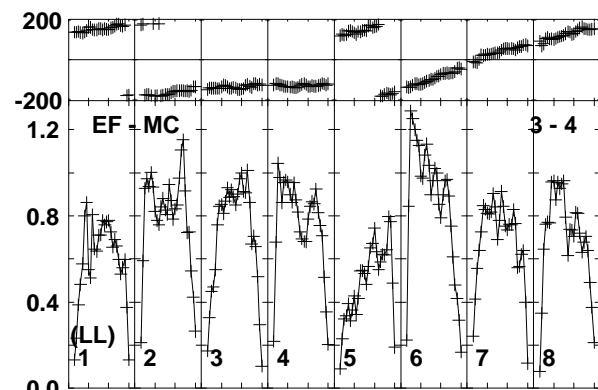
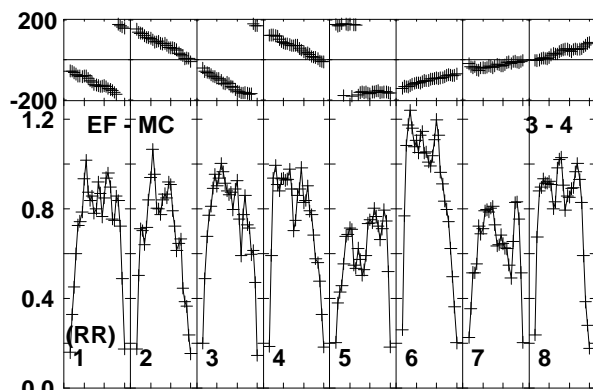
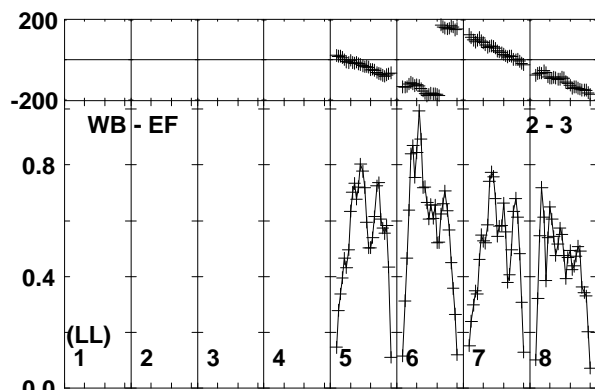
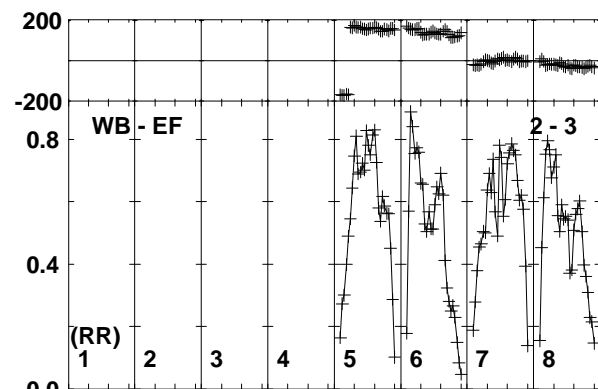
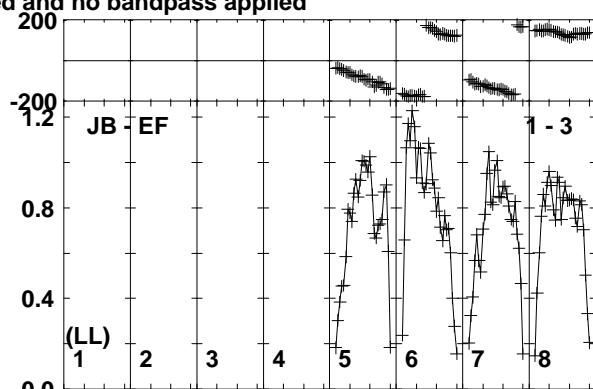
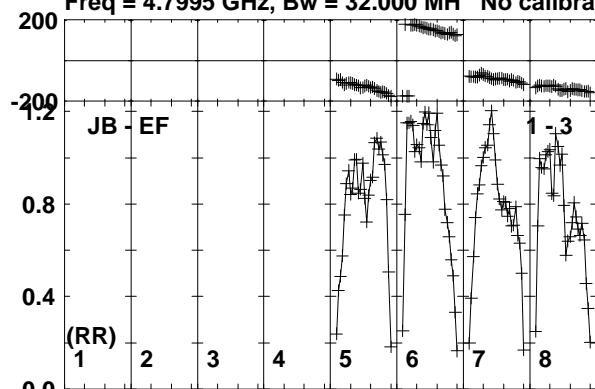

Lower frame: Milli Ampl Jy Top frame: Phas deg
Vector averaged cross-power spectrum Baseline: JB (01) - EF (03)
Timerange: 00/17:08:41 to 00/17:09:29

Plot file version 256 created 03-APR-2017 18:27:44

J1834-2341 EM126B.UVDATA.1

Freq = 4.7995 GHz, Bw = 32.000 MH No calibration applied and no bandpass applied

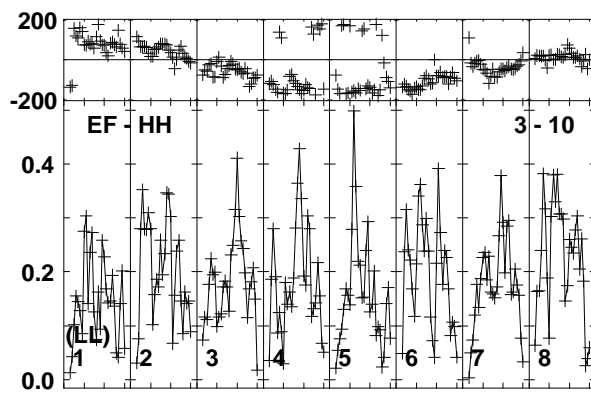
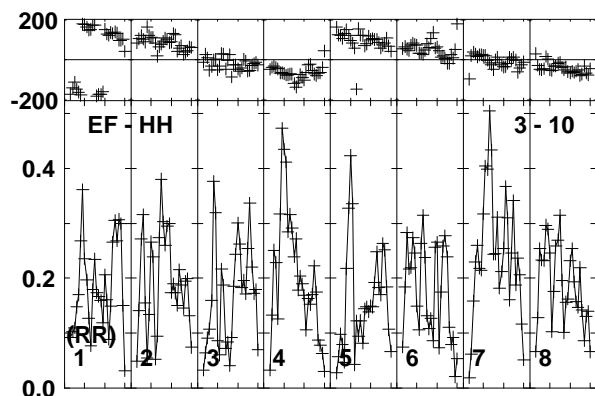
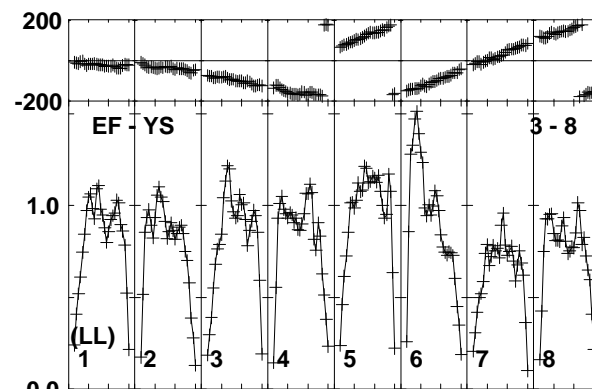
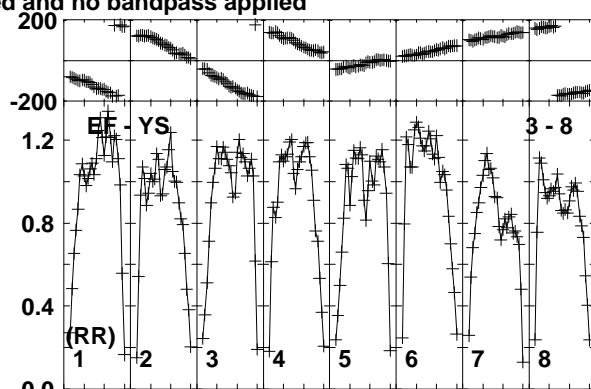
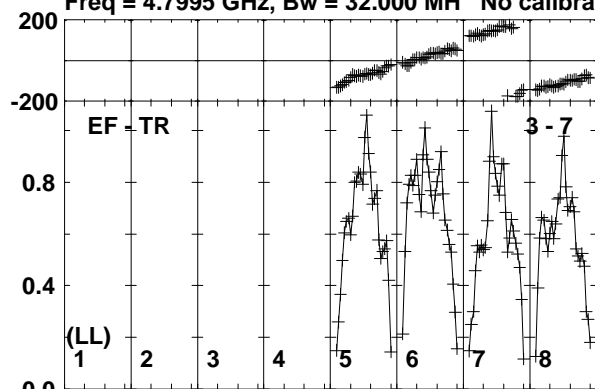

Lower frame: Milli Ampl Jy Top frame: Phas deg
Vector averaged cross-power spectrum Baseline: EF (03) - TR (07)
Timerange: 00/17:08:41 to 00/17:09:29

Plot file version 257 created 03-APR-2017 18:27:44

M22-VLA1 EM126B.UVDATA.1

Freq = 4.7995 GHz, Bw = 32.000 MH No calibration applied and no bandpass applied

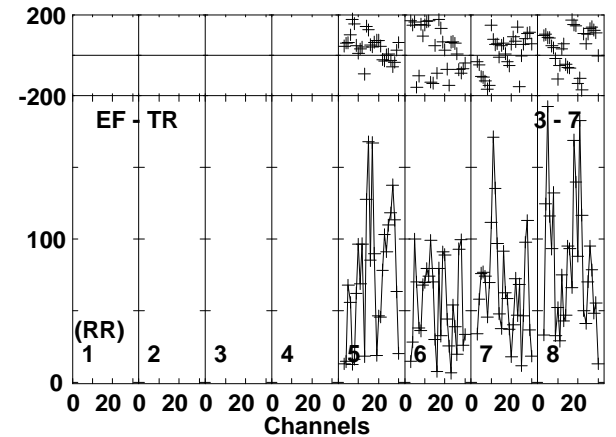
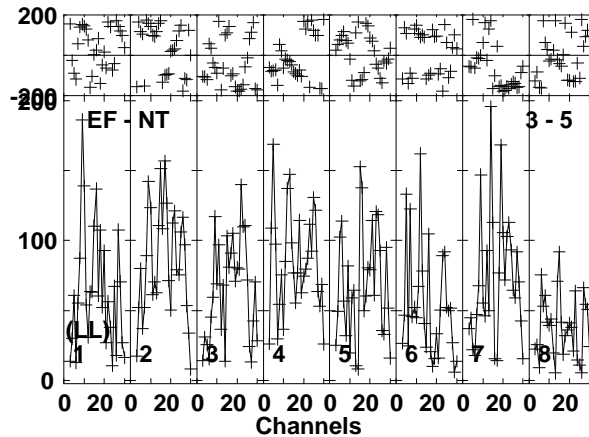
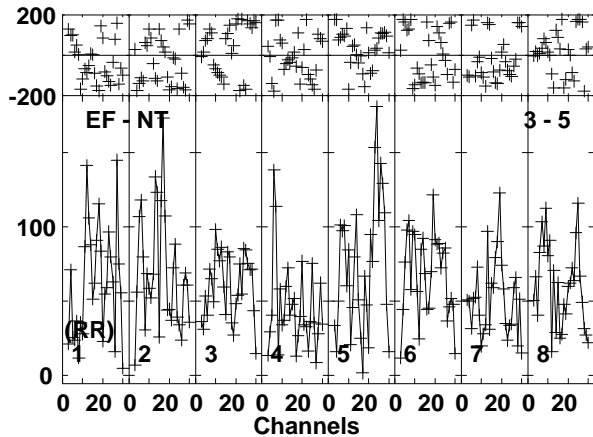
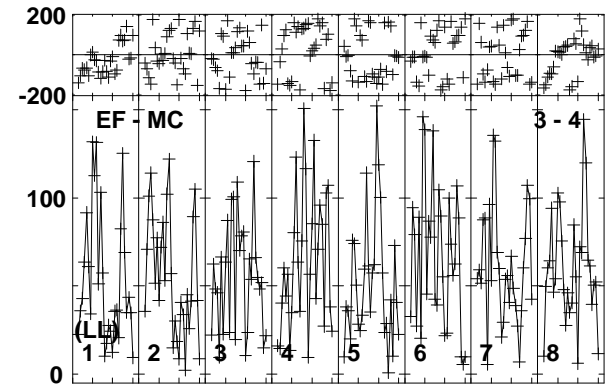
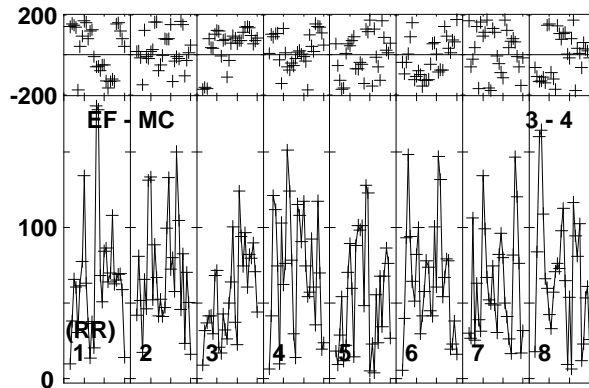
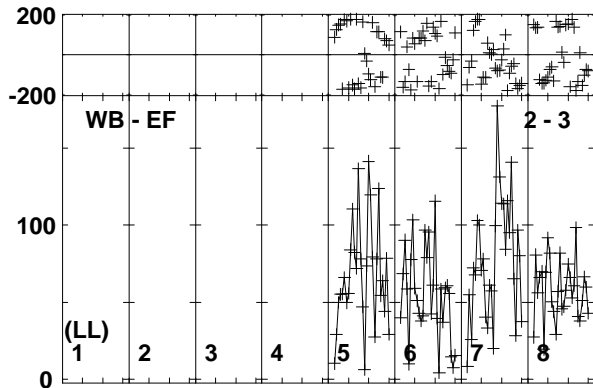
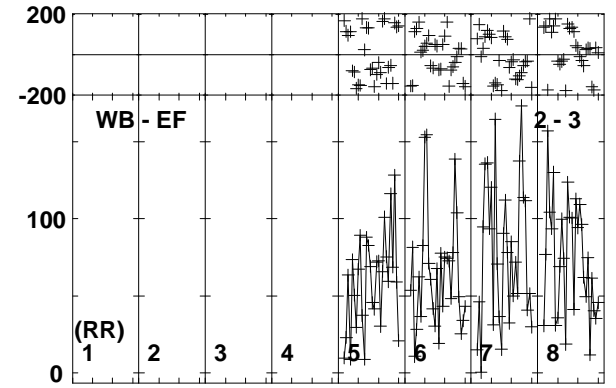
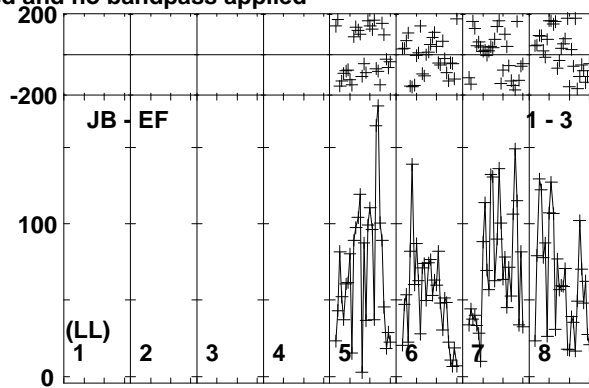
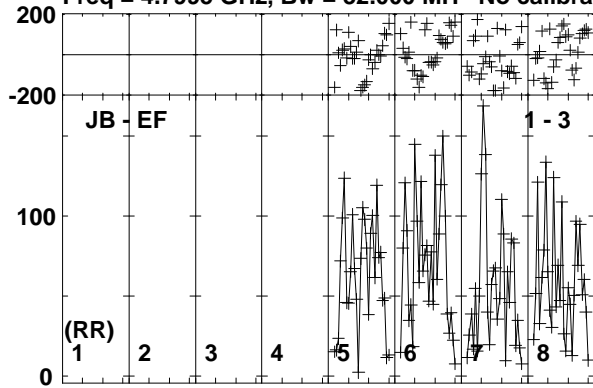

Lower frame: Micro Ampl Jy Top frame: Phas deg
Vector averaged cross-power spectrum Baseline: JB (01) - EF (03)
Timerange: 00/17:09:34 to 00/17:11:38

Plot file version 258 created 03-APR-2017 18:27:45

M22-VLA1 EM126B.UVDATA.1

Freq = 4.7995 GHz, Bw = 32.000 MH No calibration applied and no bandpass applied

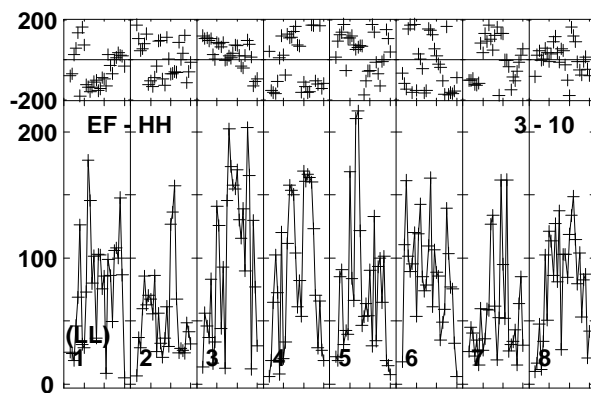
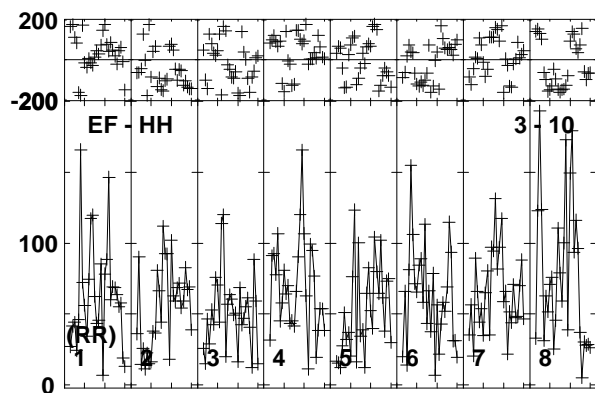
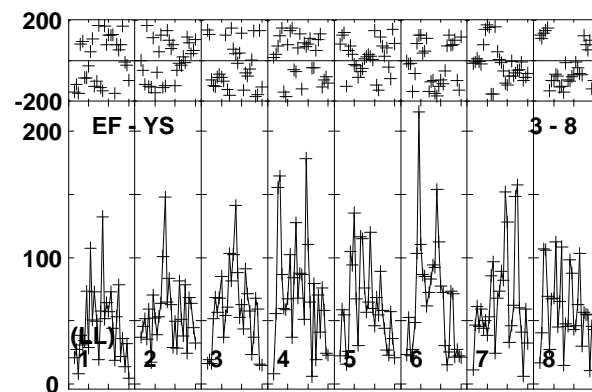
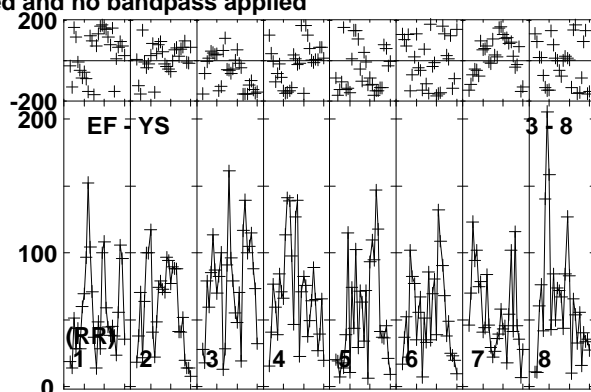
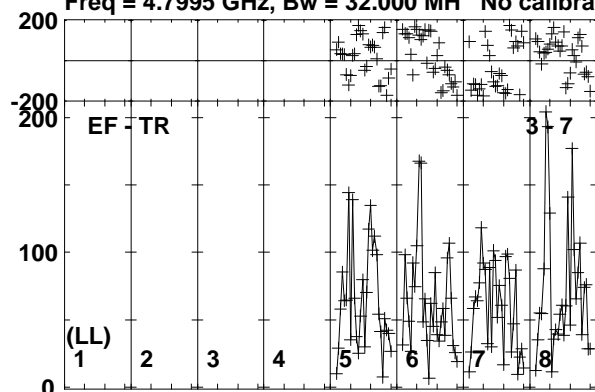

Lower frame: Micro Ampl Jy Top frame: Phas deg
Vector averaged cross-power spectrum Baseline: EF (03) - TR (07)
Timerange: 00/17:09:34 to 00/17:11:38

Plot file version 259 created 03-APR-2017 18:27:45

J1834-2341 EM126B.UVDATA.1

Freq = 4.7995 GHz, Bw = 32.000 MH No calibration applied and no bandpass applied

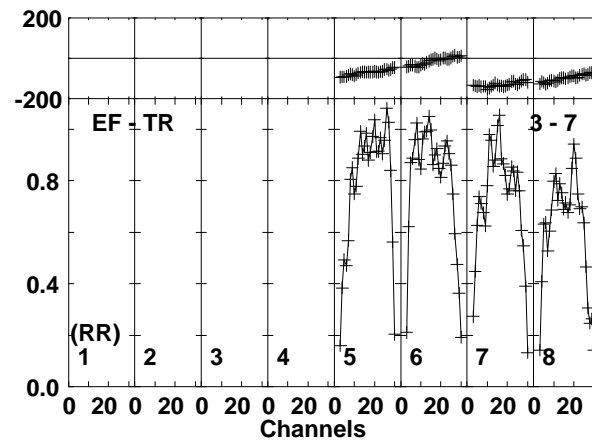
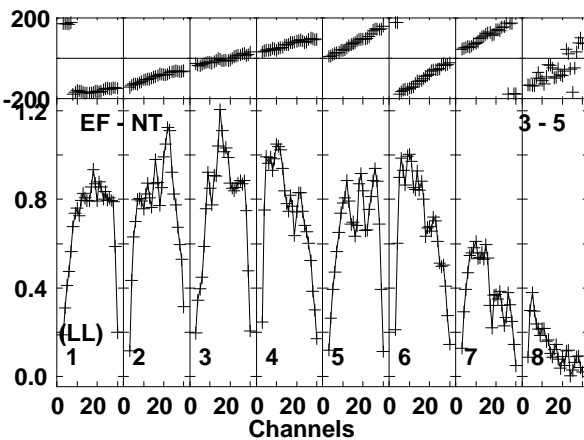
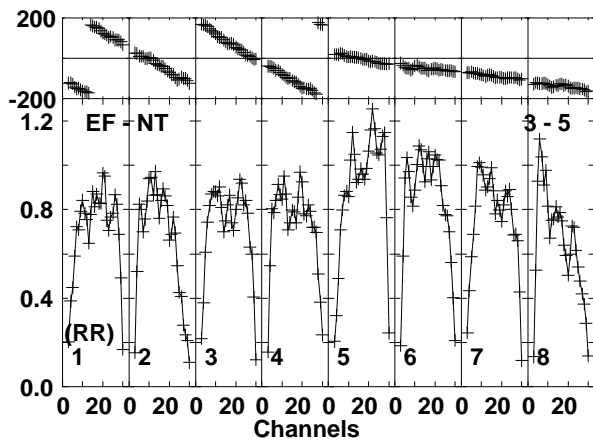
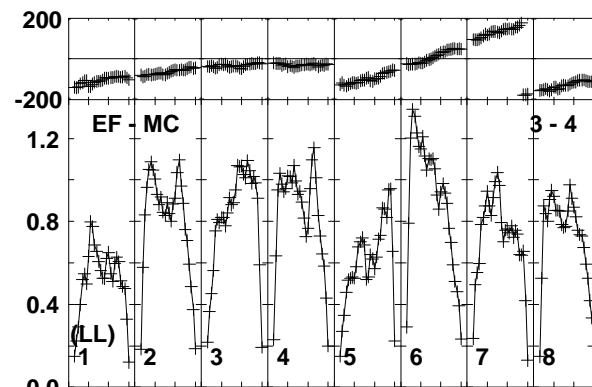
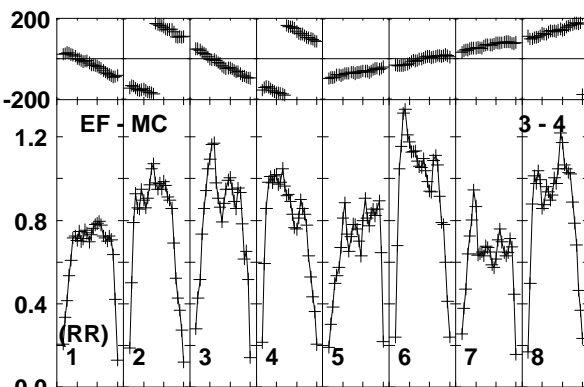
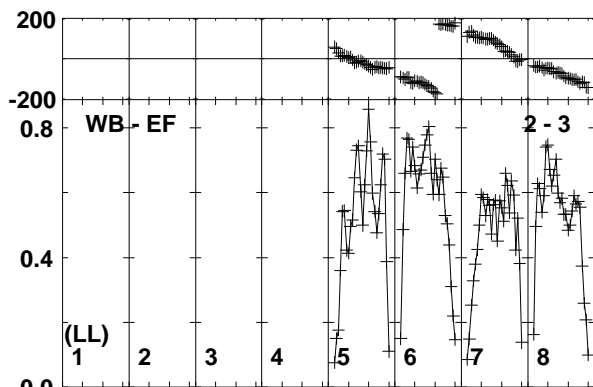
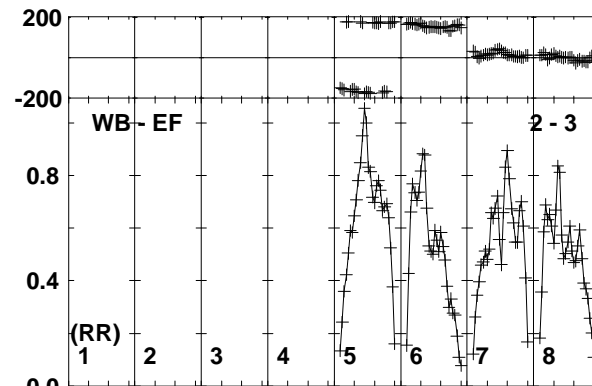
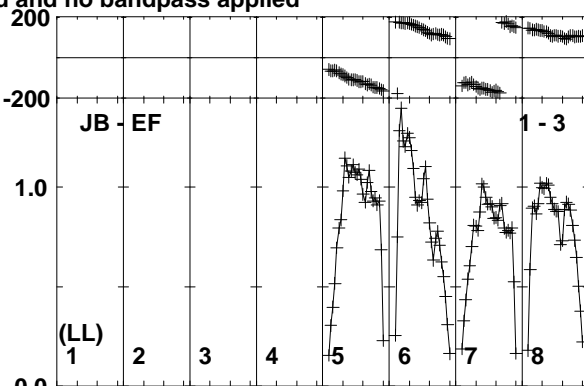
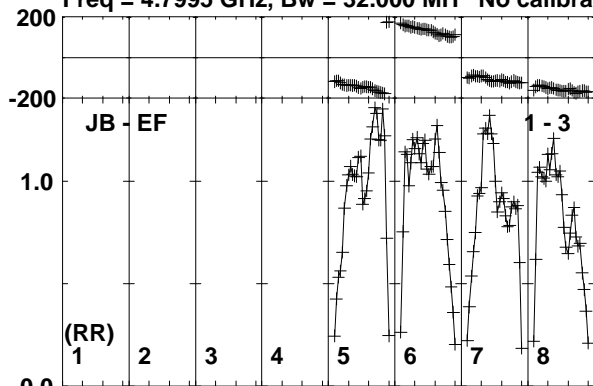

Lower frame: Milli Ampl Jy Top frame: Phas deg
Vector averaged cross-power spectrum Baseline: JB (01) - EF (03)
Timerange: 00/17:11:44 to 00/17:12:58

Plot file version 260 created 03-APR-2017 18:27:45

J1834-2341 EM126B.UVDATA.1

Freq = 4.7995 GHz, Bw = 32.000 MH No calibration applied and no bandpass applied

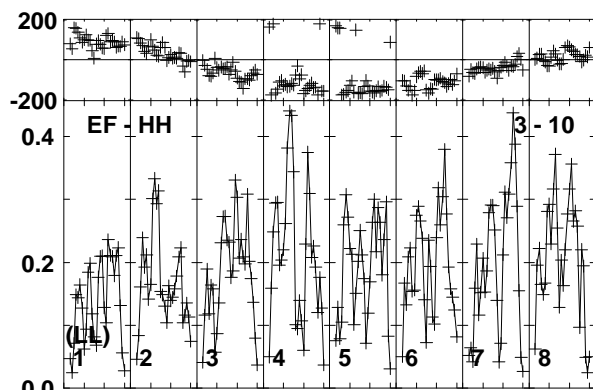
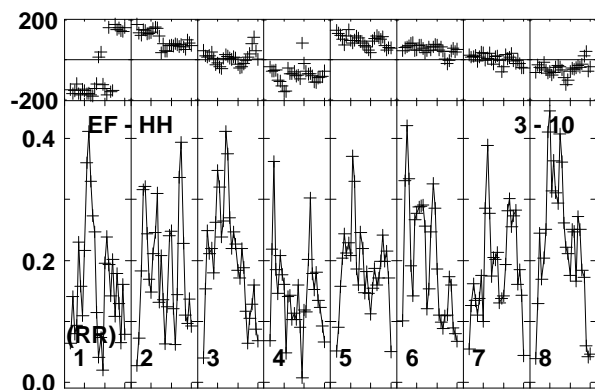
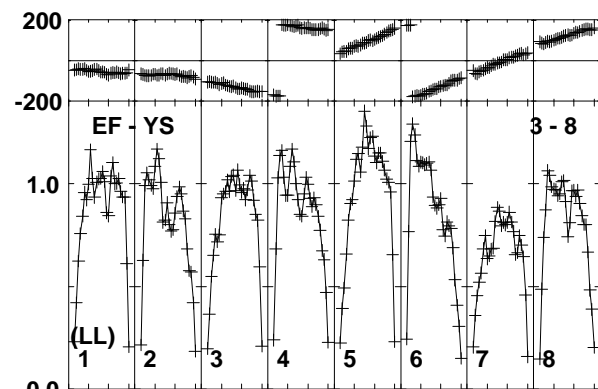
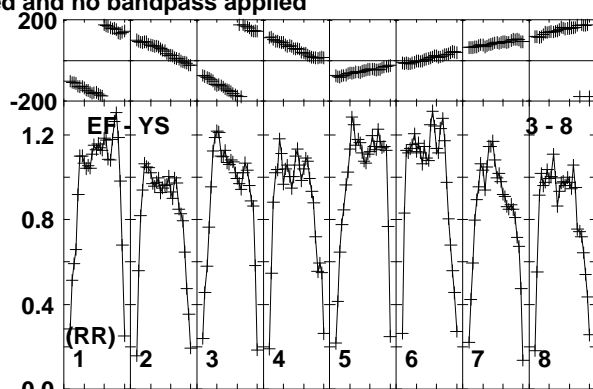
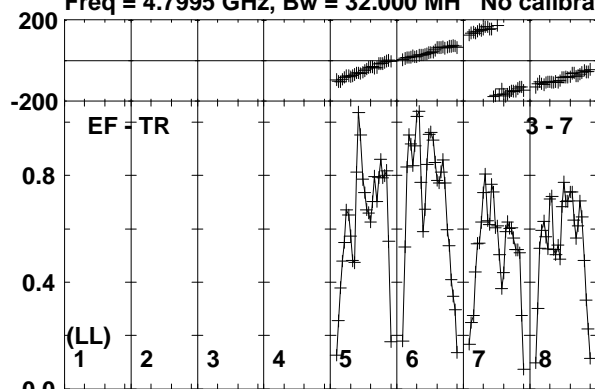

Lower frame: Milli Ampl Jy Top frame: Phas deg
Vector averaged cross-power spectrum Baseline: EF (03) - TR (07)
Timerange: 00/17:11:44 to 00/17:12:58

Plot file version 261 created 03-APR-2017 18:27:45

M22-VLA1 EM126B.UVDATA.1

Freq = 4.7995 GHz, Bw = 32.000 MH No calibration applied and no bandpass applied

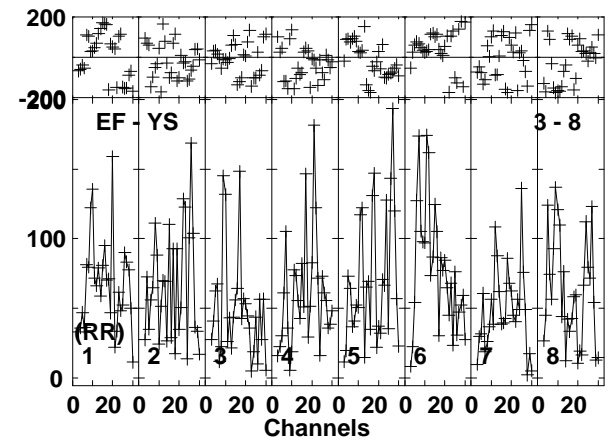
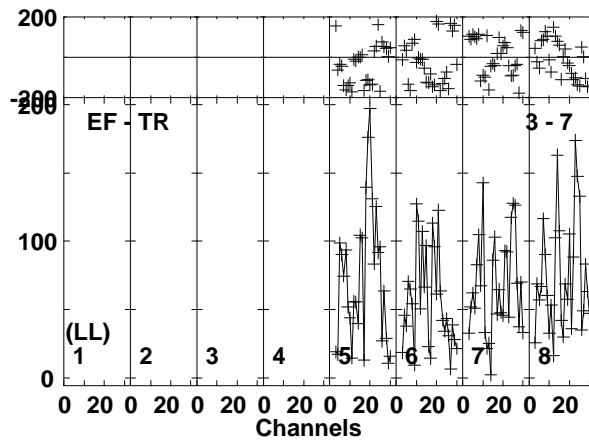
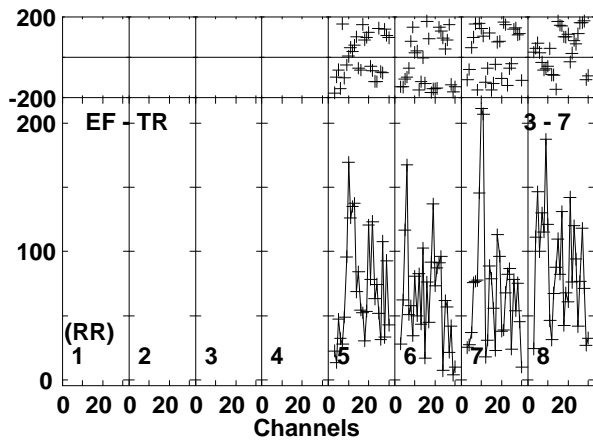
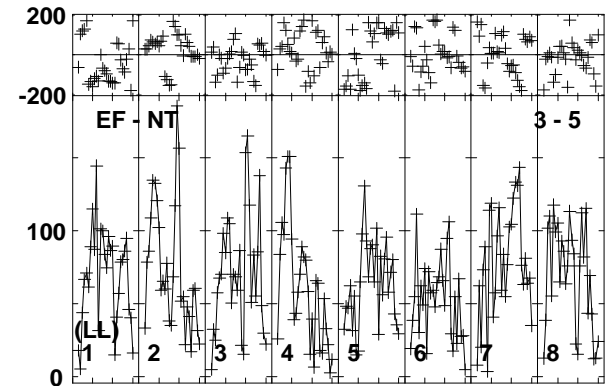
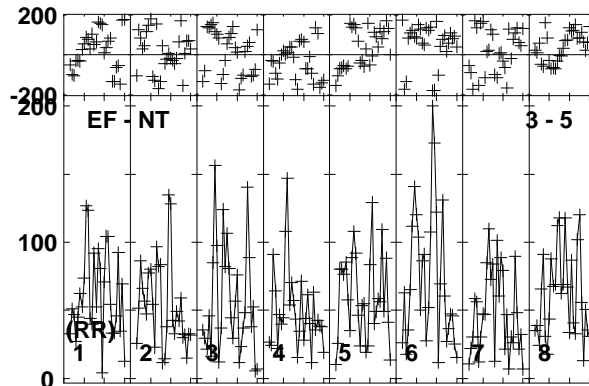
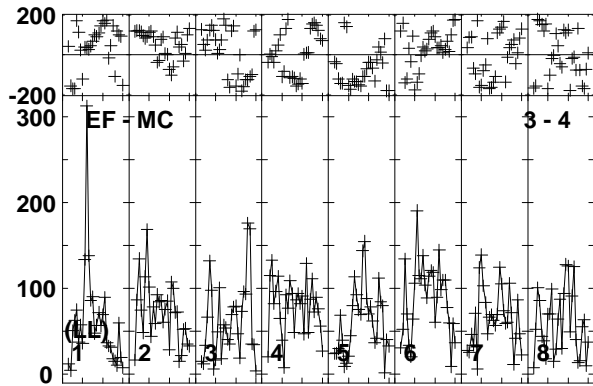
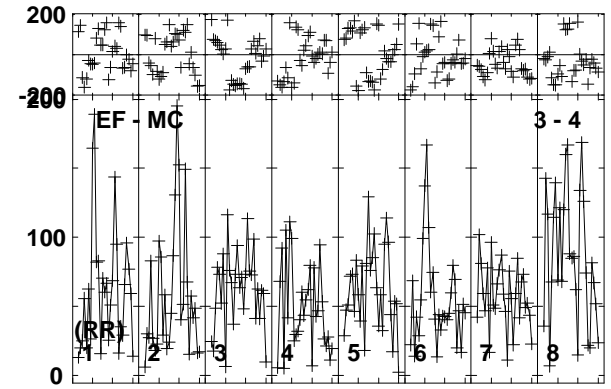
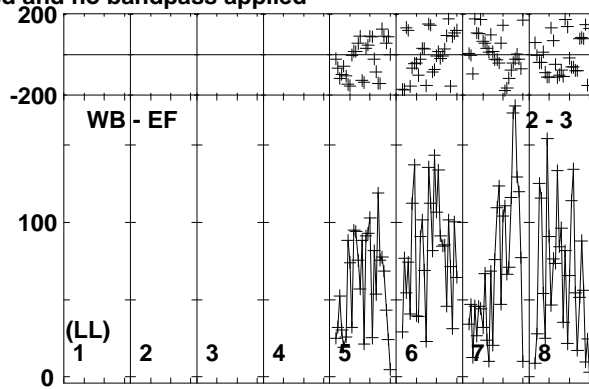
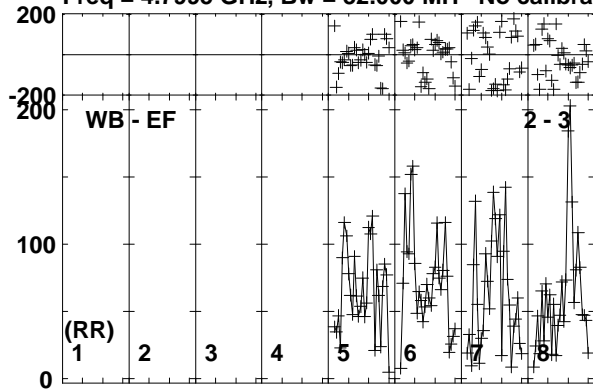

Lower frame: Micro Ampl Jy Top frame: Phas deg
Vector averaged cross-power spectrum Baseline: WB (02) - EF (03)
Timerange: 00:17:13:04 to 00:17:15:08

Plot file version 262 created 03-APR-2017 18:27:45

M22-VLA1 EM126B.UVDATA.1

Freq = 4.7995 GHz, Bw = 32.000 MH No calibration applied and no bandpass applied

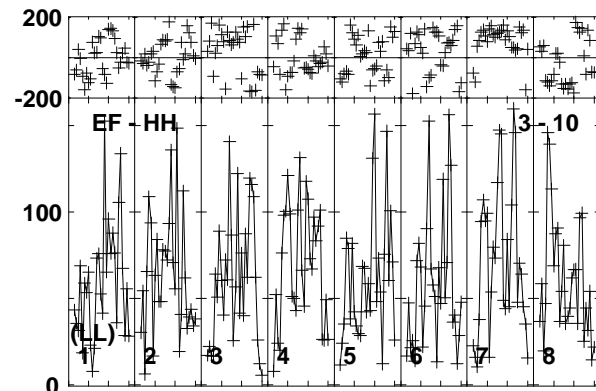
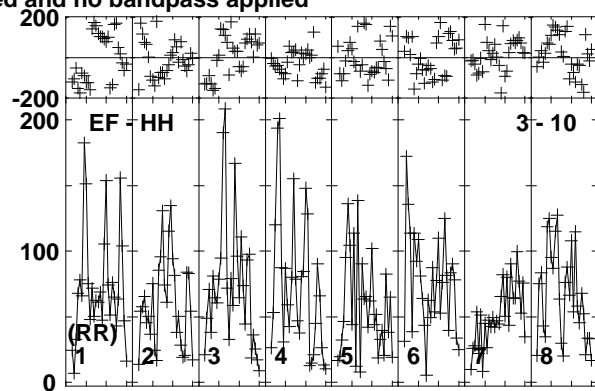
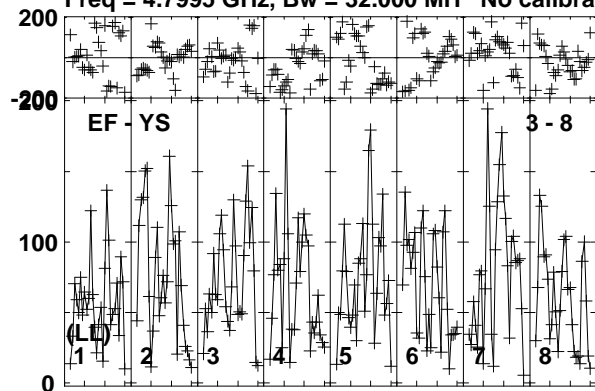

Lower frame: Micro Ampl Jy Top frame: Phas deg
Vector averaged cross-power spectrum Baseline: EF (03) - YS (08)
Timerange: 00/17:13:04 to 00/17:15:08

Plot file version 263 created 03-APR-2017 18:27:45

J1834-2341 EM126B.UVDATA.1

Freq = 4.7995 GHz, Bw = 32.000 MH No calibration applied and no bandpass applied

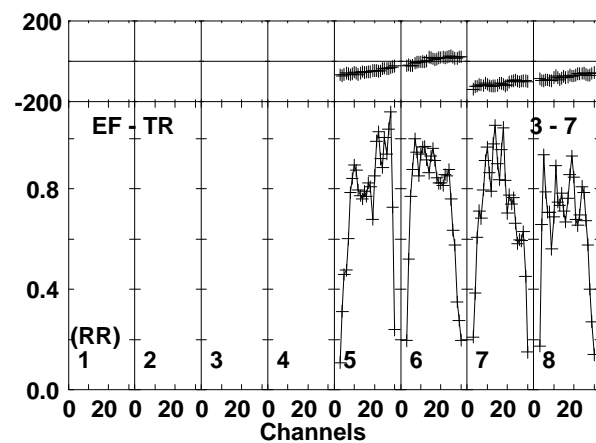
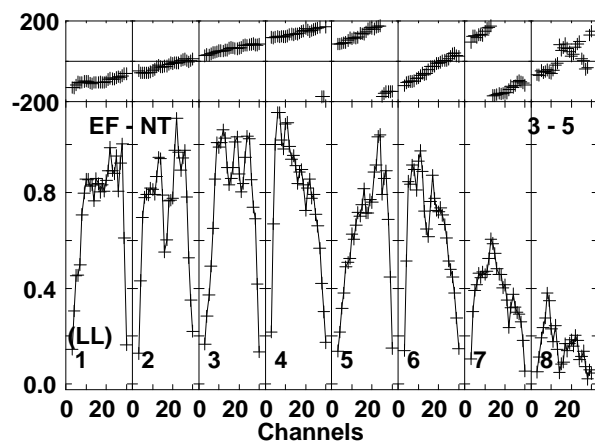
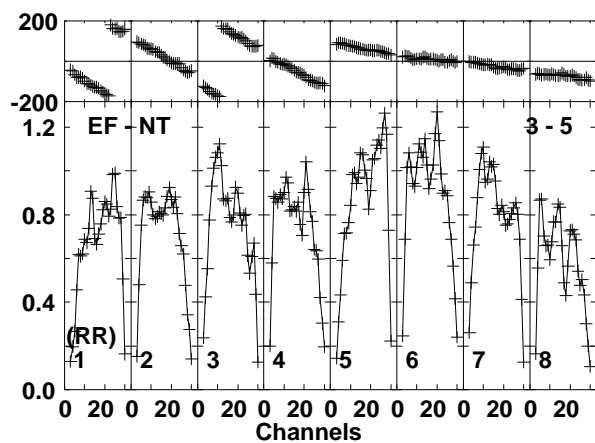
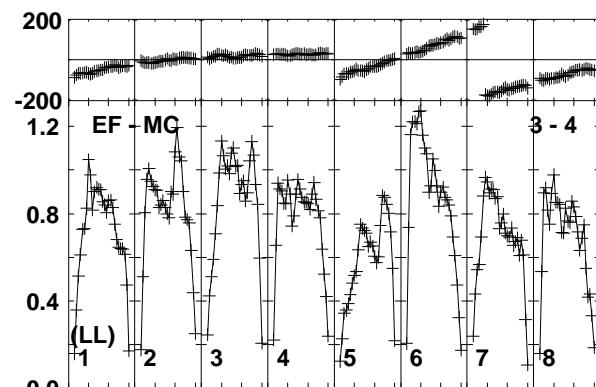
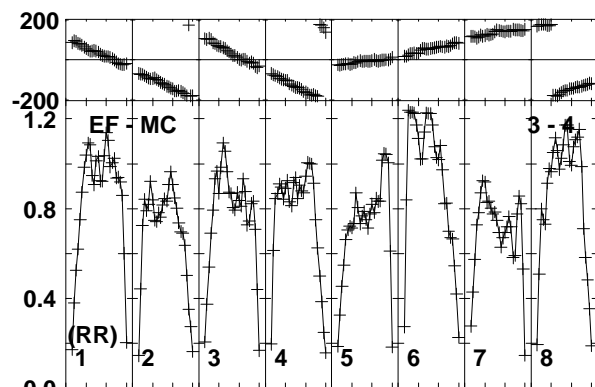
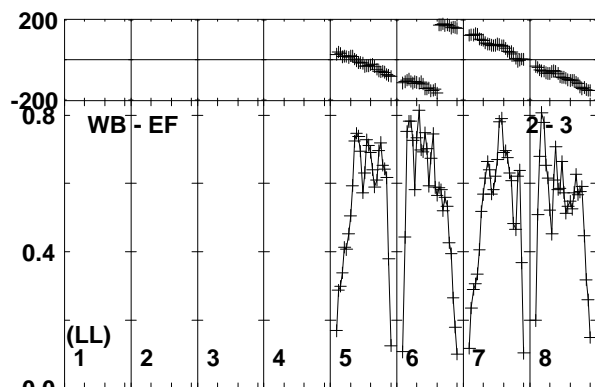
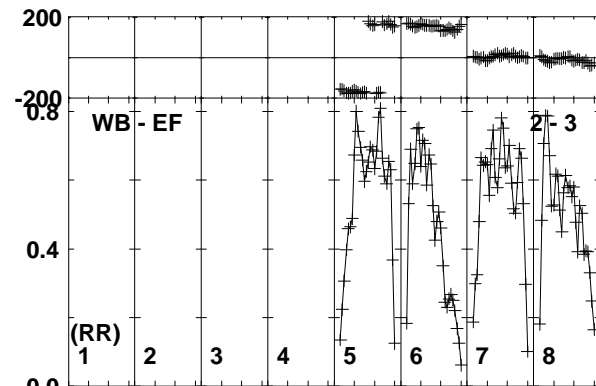
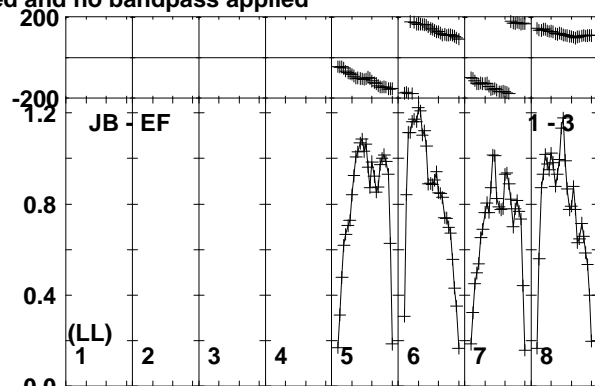
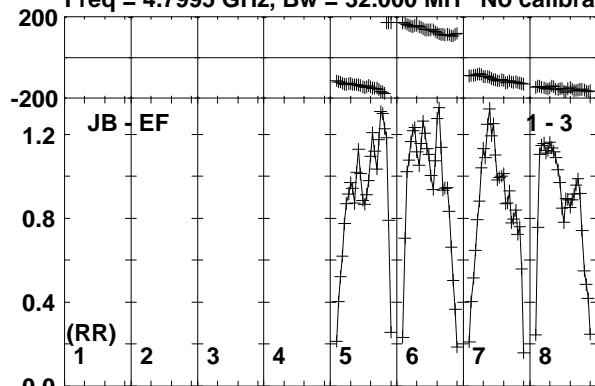

Lower frame: Milli Ampl Jy Top frame: Phas deg
Vector averaged cross-power spectrum Baseline: JB (01) - EF (03)
Timerange: 00/17:15:14 to 00/17:16:28

Plot file version 264 created 03-APR-2017 18:27:45

J1834-2341 EM126B.UVDATA.1

Freq = 4.7995 GHz, Bw = 32.000 MH No calibration applied and no bandpass applied

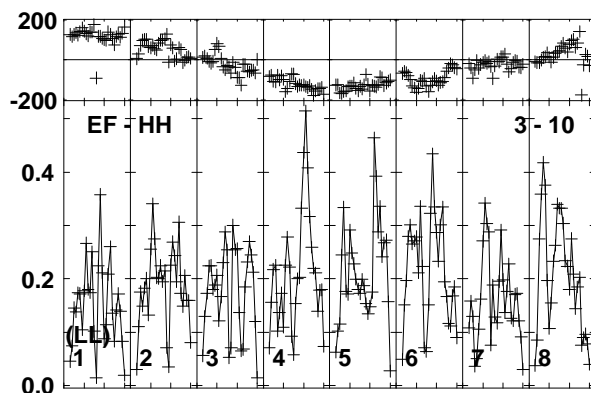
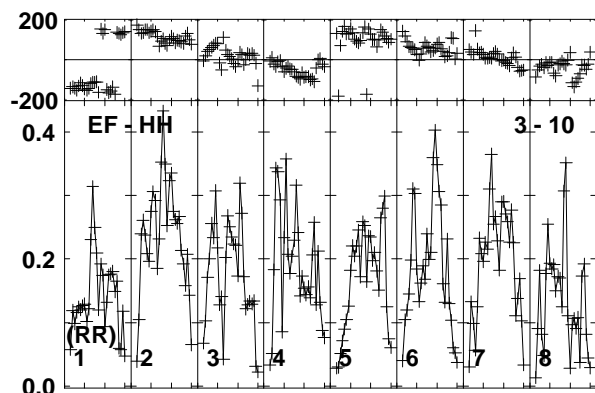
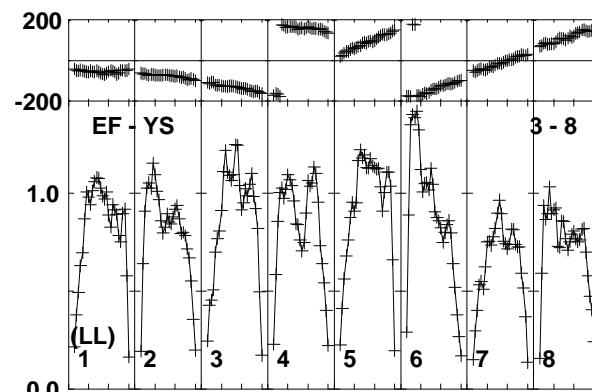
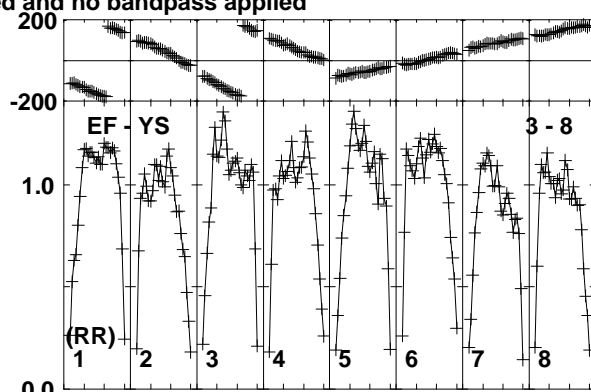
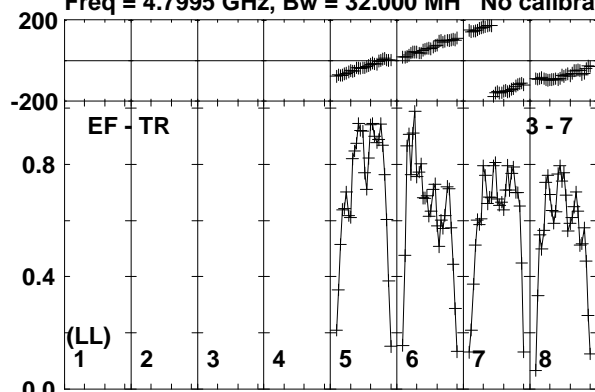

Lower frame: Milli Ampl Jy Top frame: Phas deg
Vector averaged cross-power spectrum Baseline: EF (03) - TR (07)
Timerange: 00/17:15:14 to 00/17:16:28

Plot file version 265 created 03-APR-2017 18:27:45

M22-VLA1 EM126B.UVDATA.1

Freq = 4.7995 GHz, Bw = 32.000 MH No calibration applied and no bandpass applied

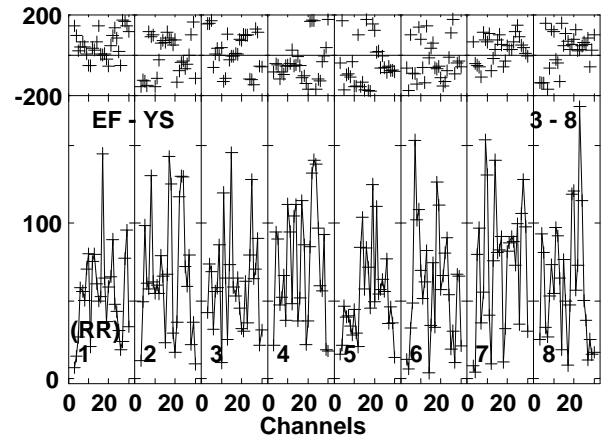
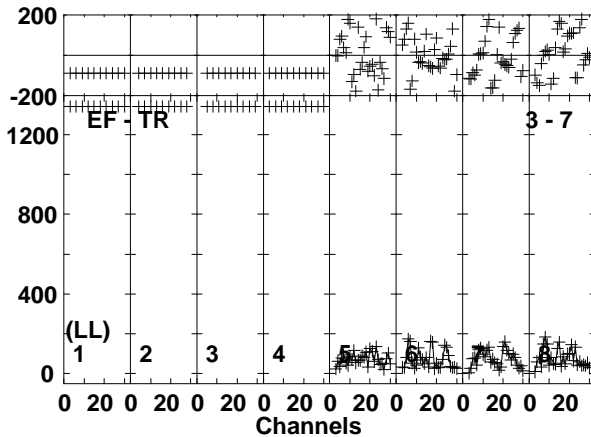
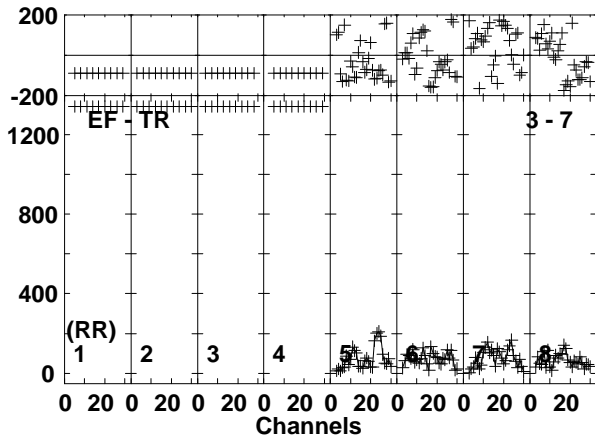
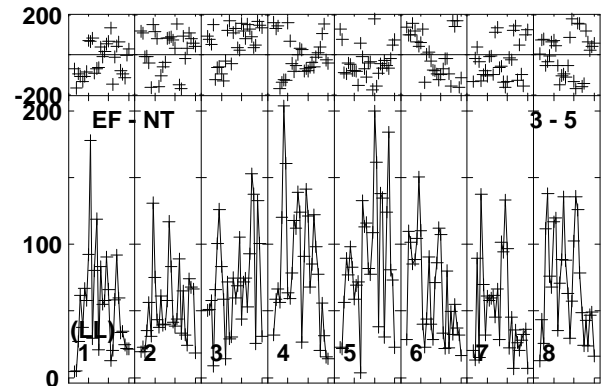
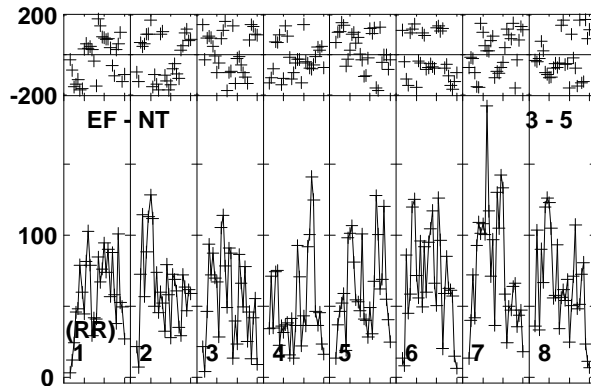
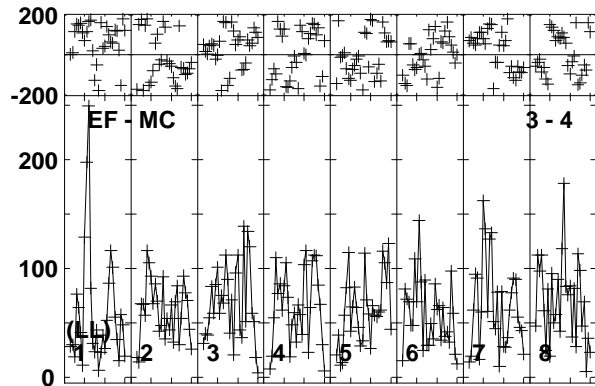
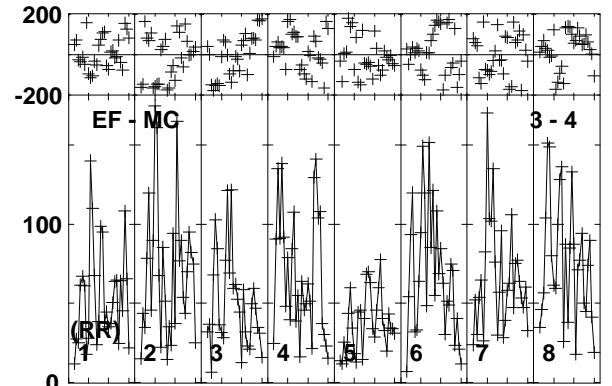
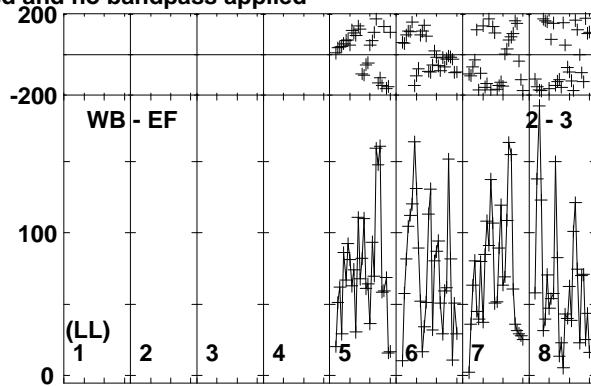
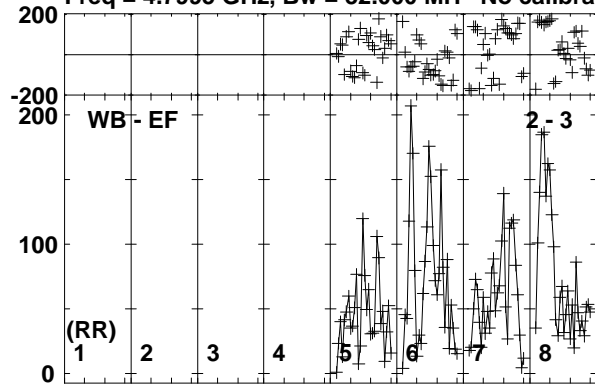

Lower frame: Micro Ampl Jy Top frame: Phas deg
Vector averaged cross-power spectrum Baseline: WB (02) - EF (03)
Timerange: 00/17:16:34 to 00/17:18:38

Plot file version 266 created 03-APR-2017 18:27:45

M22-VLA1 EM126B.UVDATA.1

Freq = 4.7995 GHz, Bw = 32.000 MH No calibration applied and no bandpass applied

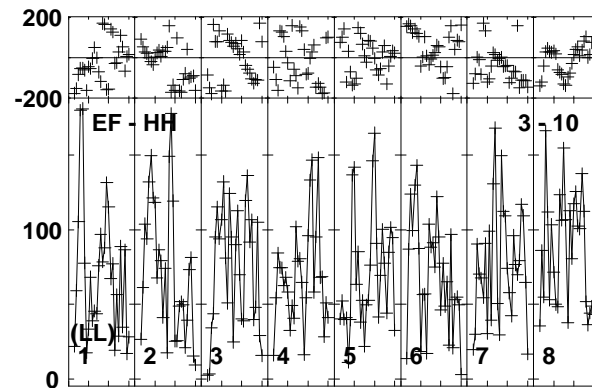
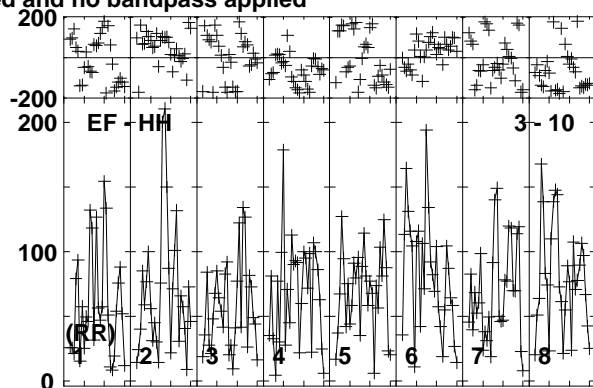
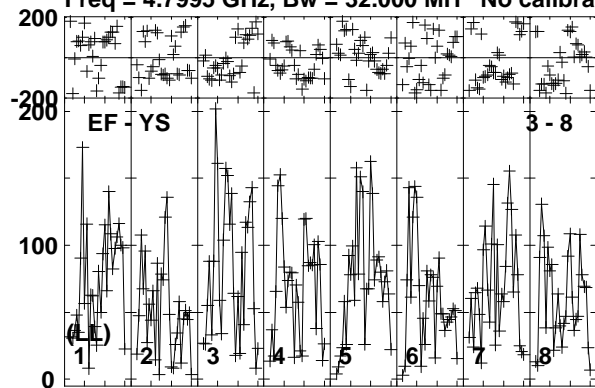

Lower frame: Micro Ampl Jy Top frame: Phas deg
Vector averaged cross-power spectrum Baseline: EF (03) - YS (08)
Timerange: 00/17:16:34 to 00/17:18:38

Plot file version 267 created 03-APR-2017 18:27:45

J1834-2341 EM126B.UVDATA.1

Freq = 4.7995 GHz, Bw = 32.000 MH No calibration applied and no bandpass applied

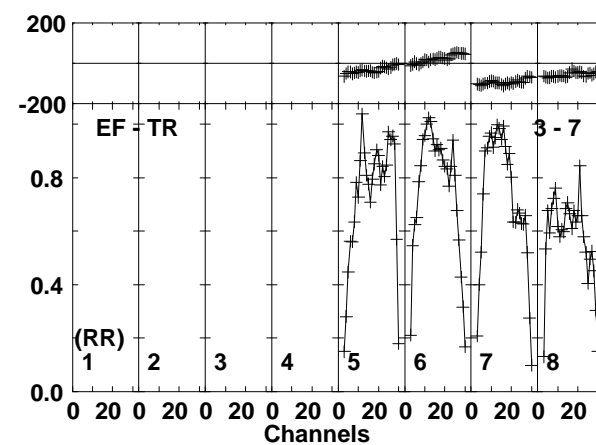
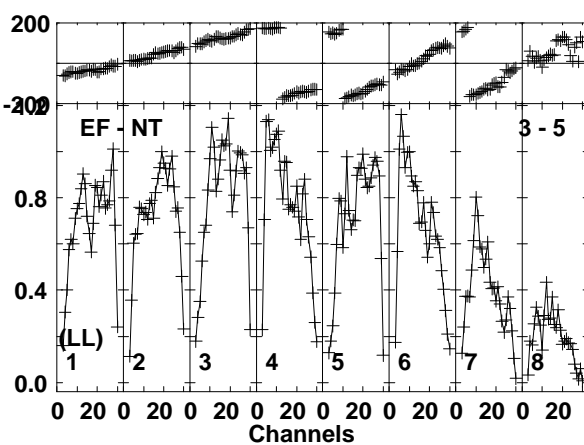
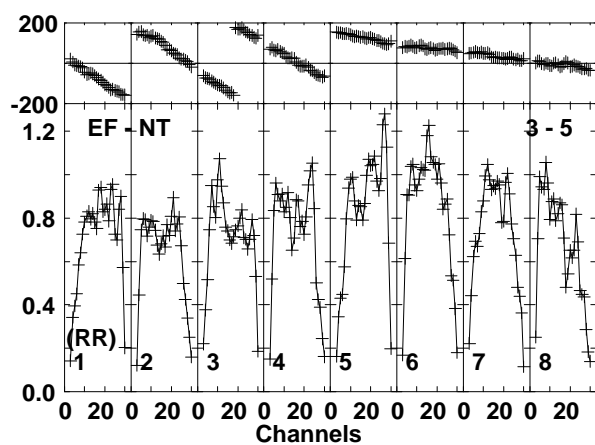
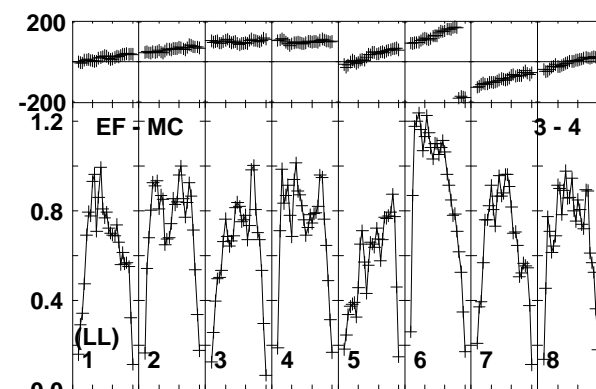
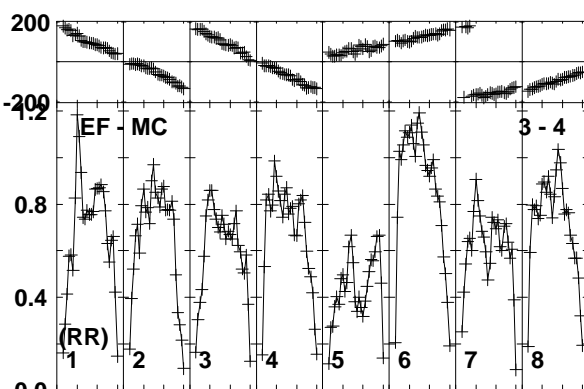
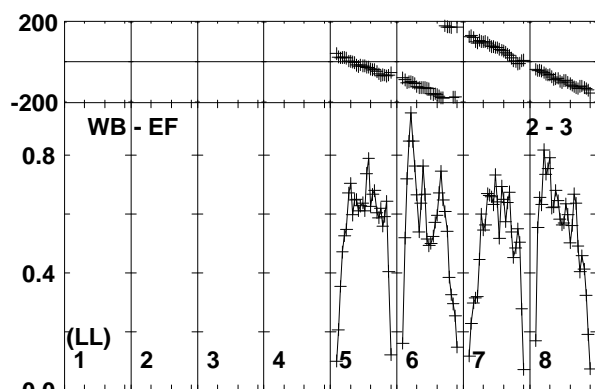
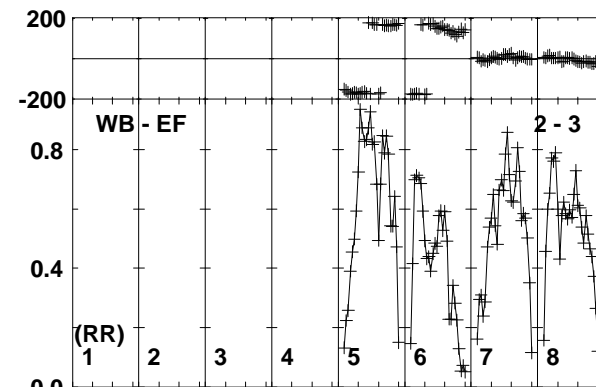
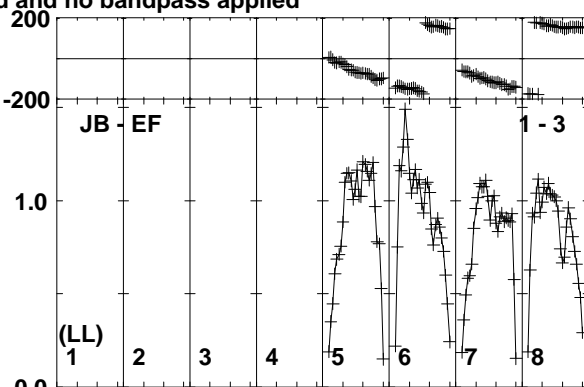
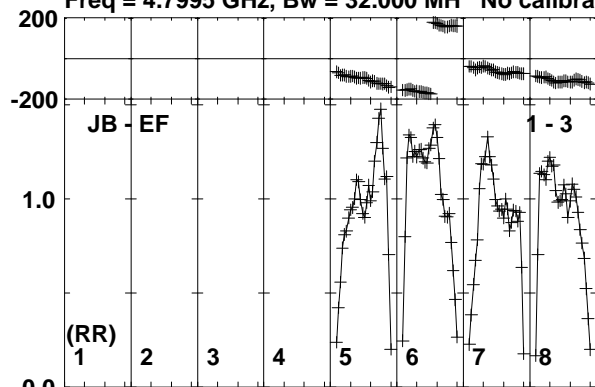

Lower frame: Milli Ampl Jy Top frame: Phas deg
Vector averaged cross-power spectrum Baseline: JB (01) - EF (03)
Timerange: 00/17:19:11 to 00/17:19:59

Plot file version 268 created 03-APR-2017 18:27:45

J1834-2341 EM126B.UVDATA.1

Freq = 4.7995 GHz, Bw = 32.000 MH No calibration applied and no bandpass applied

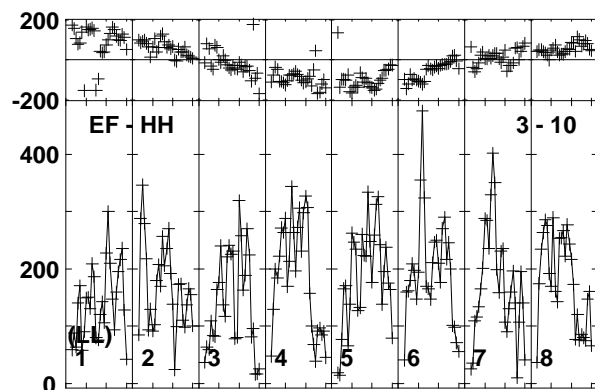
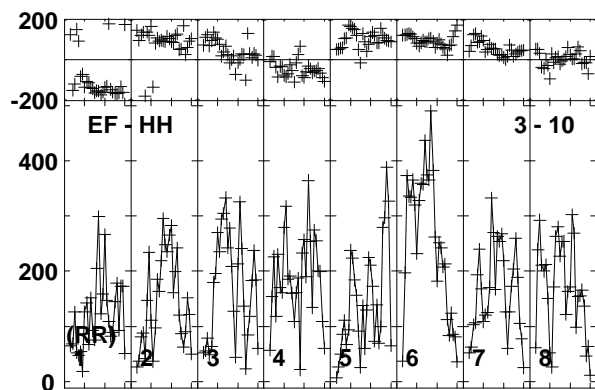
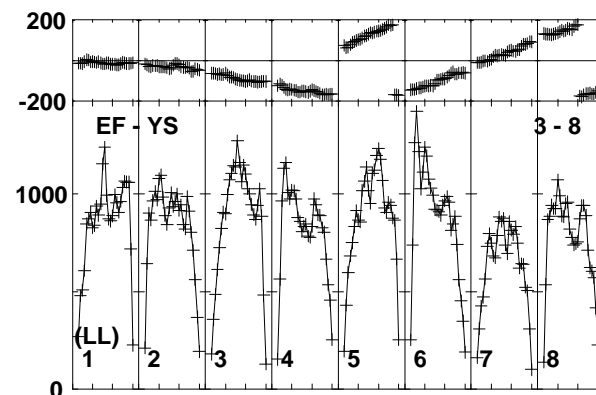
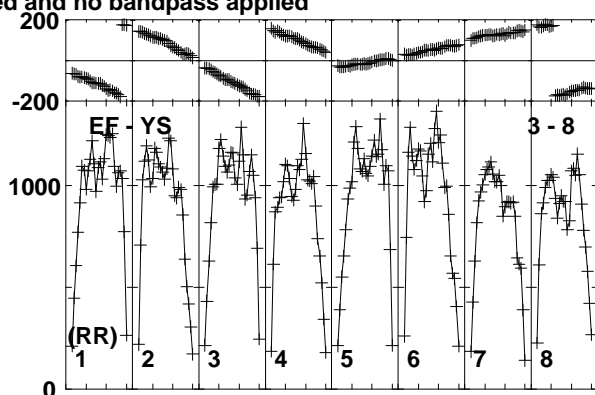
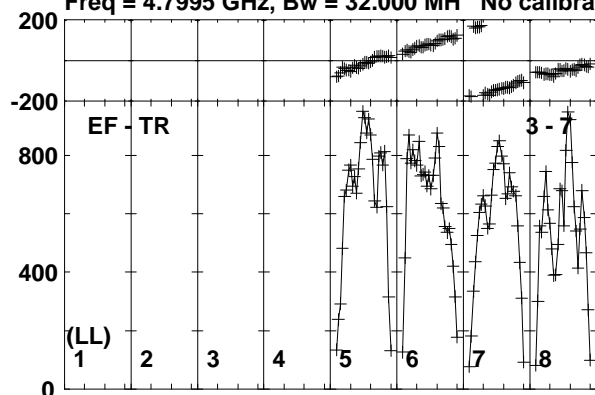

Lower frame: Micro Ampl Jy Top frame: Phas deg
Vector averaged cross-power spectrum Baseline: EF (03) - TR (07)
Timerange: 00/17:19:11 to 00/17:19:59

Plot file version 269 created 03-APR-2017 18:27:45

M22-VLA1 EM126B.UVDATA.1

Freq = 4.7995 GHz, Bw = 32.000 MH No calibration applied and no bandpass applied

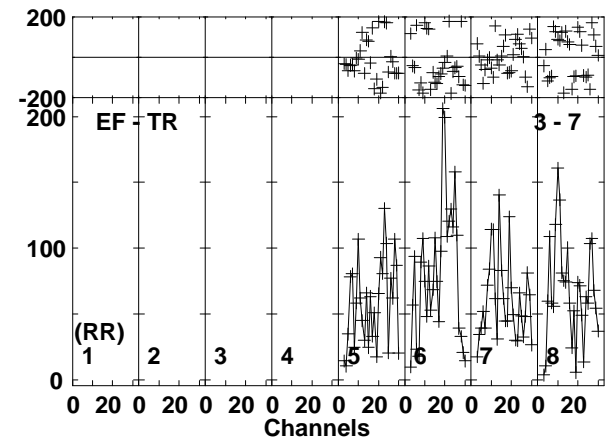
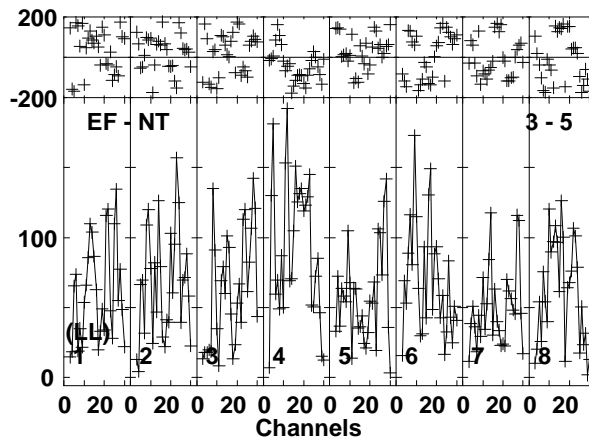
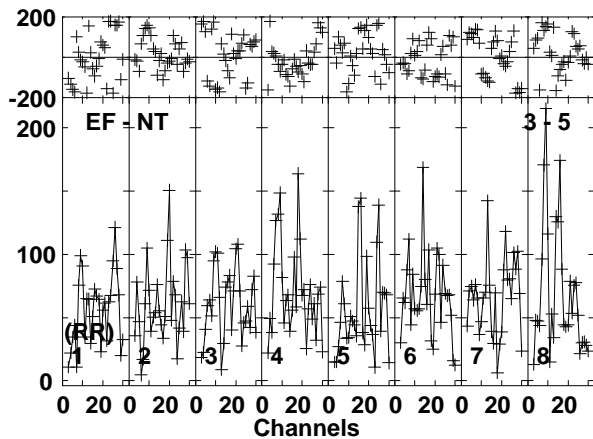
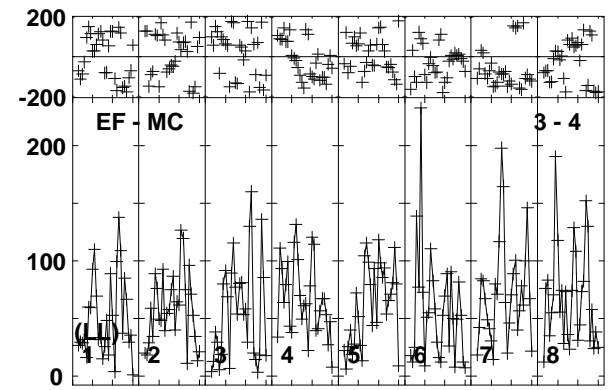
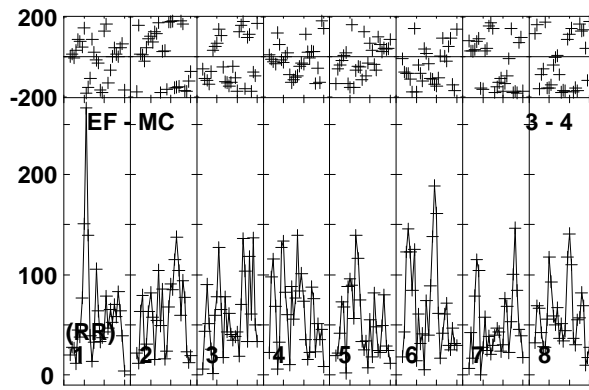
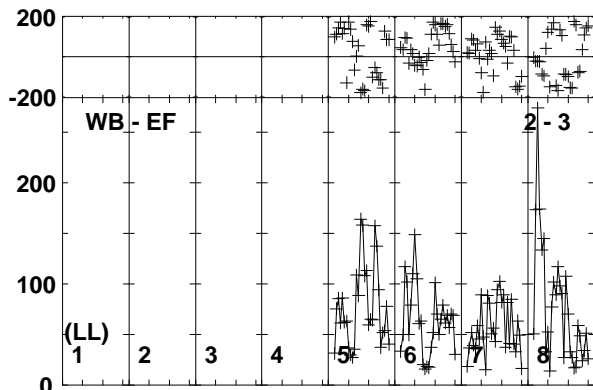
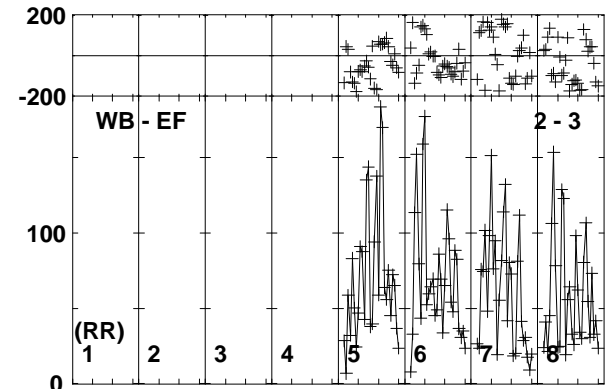
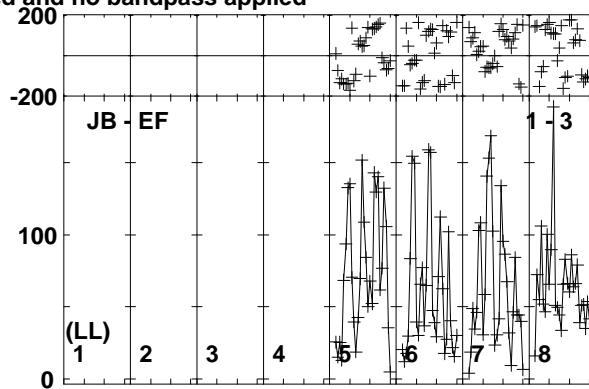
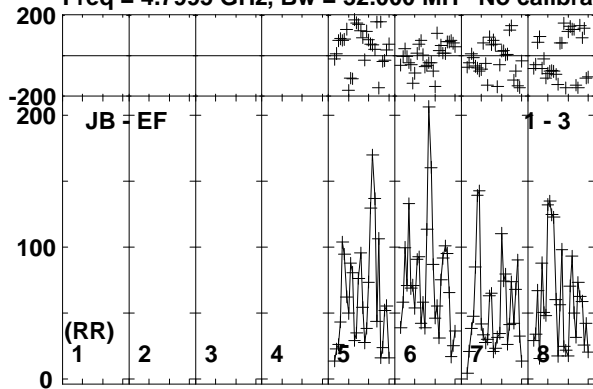

Lower frame: Micro Ampl Jy Top frame: Phas deg
Vector averaged cross-power spectrum Baseline: JB (01) - EF (03)
Timerange: 00/17:20:04 to 00/17:22:08

Plot file version 270 created 03-APR-2017 18:27:45

M22-VLA1 EM126B.UVDATA.1

Freq = 4.7995 GHz, Bw = 32.000 MH No calibration applied and no bandpass applied

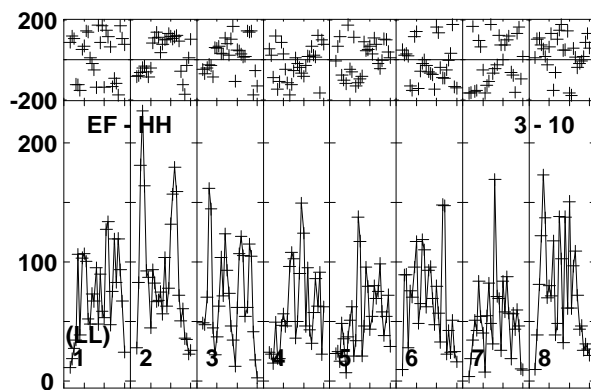
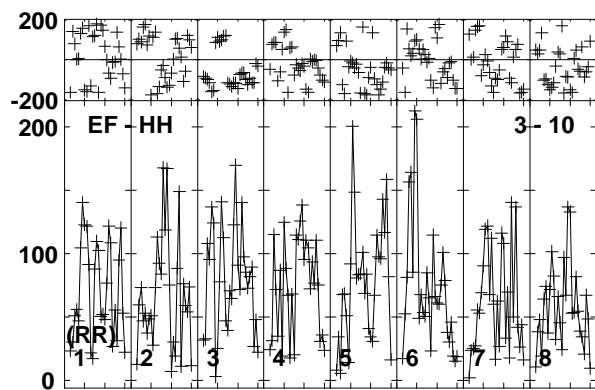
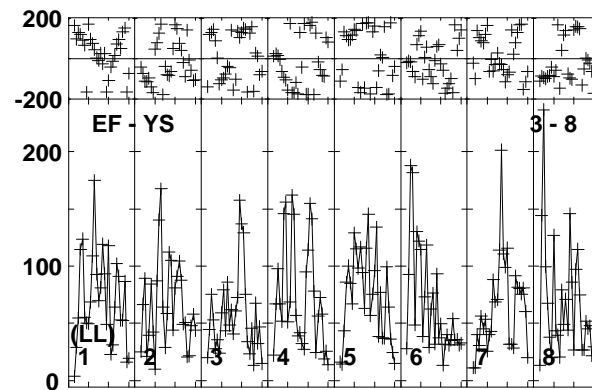
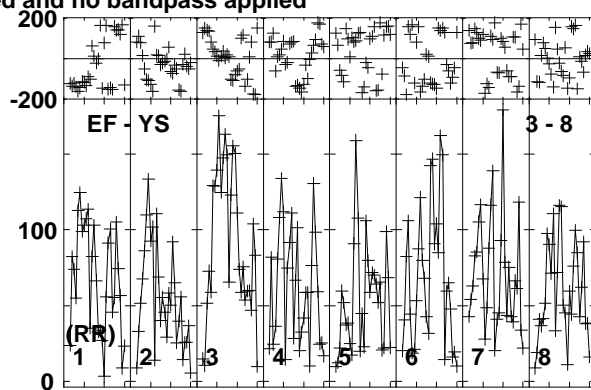
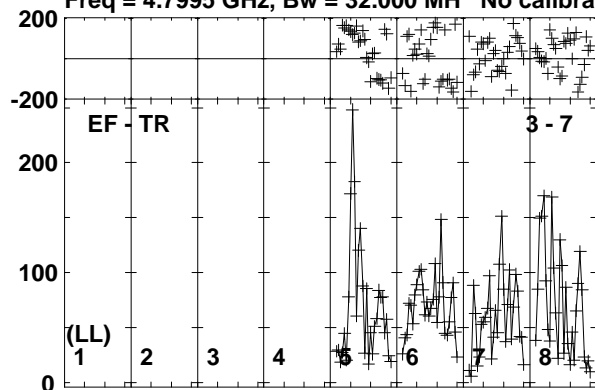

Lower frame: Micro Ampl Jy Top frame: Phas deg
Vector averaged cross-power spectrum Baseline: EF (03) - TR (07)
Timerange: 00/17:20:04 to 00/17:22:08

Plot file version 271 created 03-APR-2017 18:27:45
 J1834-2341 EM126B.UVDATA.1
 Freq = 4.7995 GHz, Bw = 32.000 MH No calibration applied and no bandpass applied

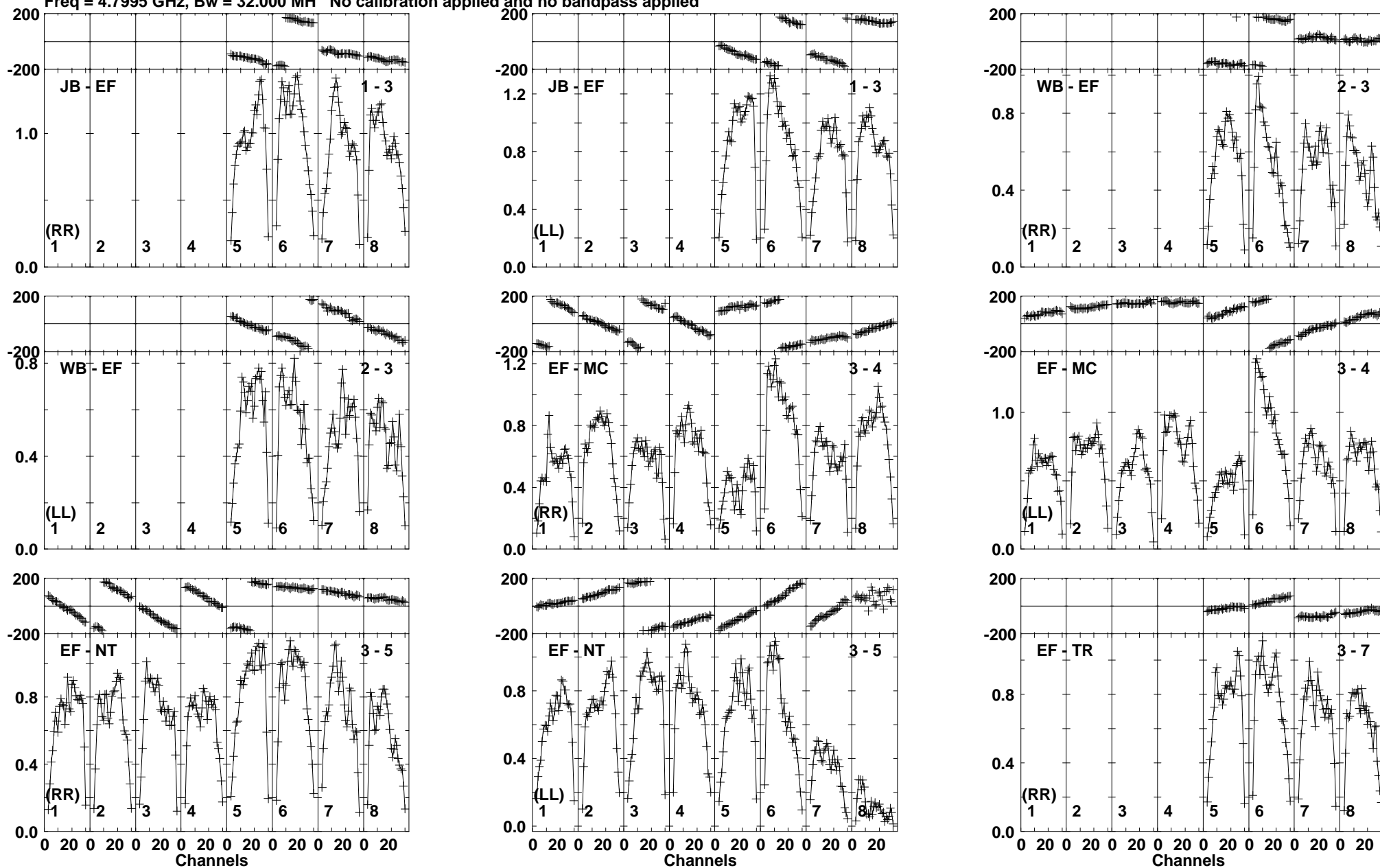

Lower frame: Milli Ampl Jy Top frame: Phas deg
 Vector averaged cross-power spectrum Baseline: JB (01) - EF (03)
 Timerange: 00/17:22:14 to 00/17:23:28

Plot file version 272 created 03-APR-2017 18:27:45

J1834-2341 EM126B.UVDATA.1

Freq = 4.7995 GHz, Bw = 32.000 MH No calibration applied and no bandpass applied

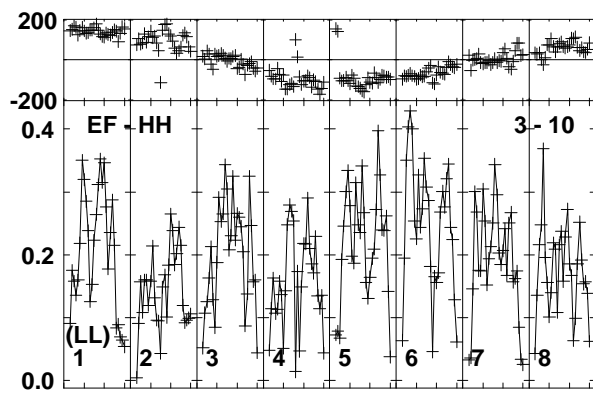
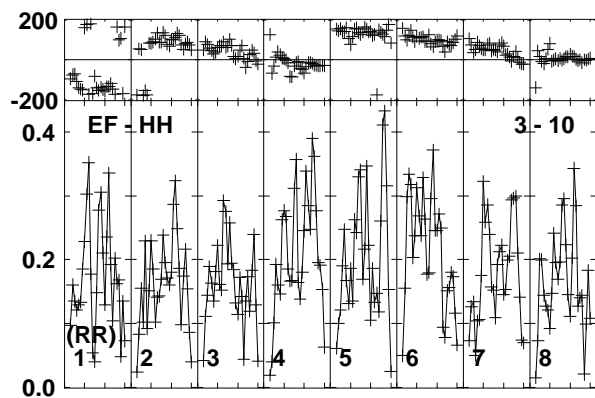
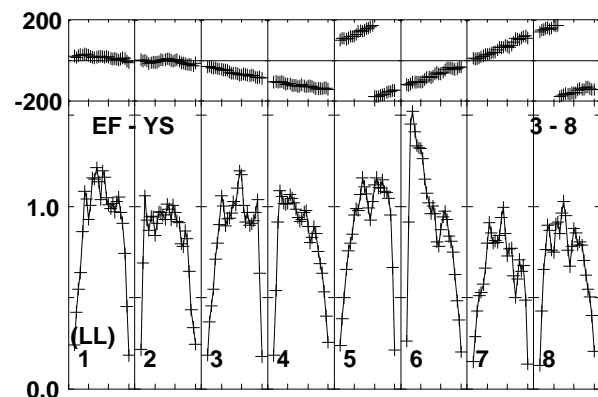
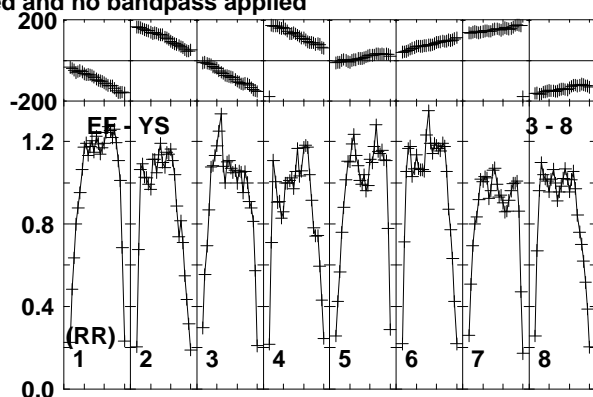
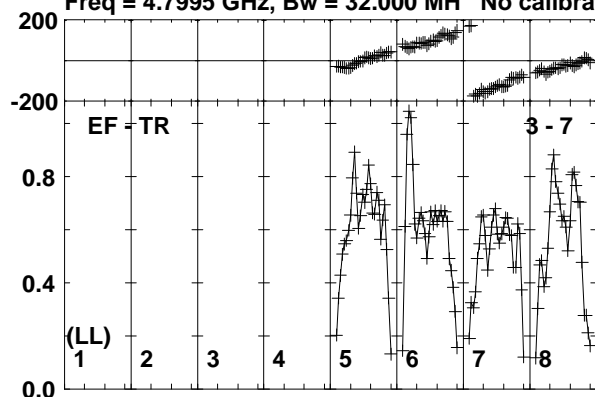

Lower frame: Milli Ampl Jy Top frame: Phas deg
Vector averaged cross-power spectrum Baseline: EF (03) - TR (07)
Timerange: 00/17:22:14 to 00/17:23:28

Plot file version 273 created 03-APR-2017 18:27:45

M22-VLA1 EM126B.UVDATA.1

Freq = 4.7995 GHz, Bw = 32.000 MH No calibration applied and no bandpass applied

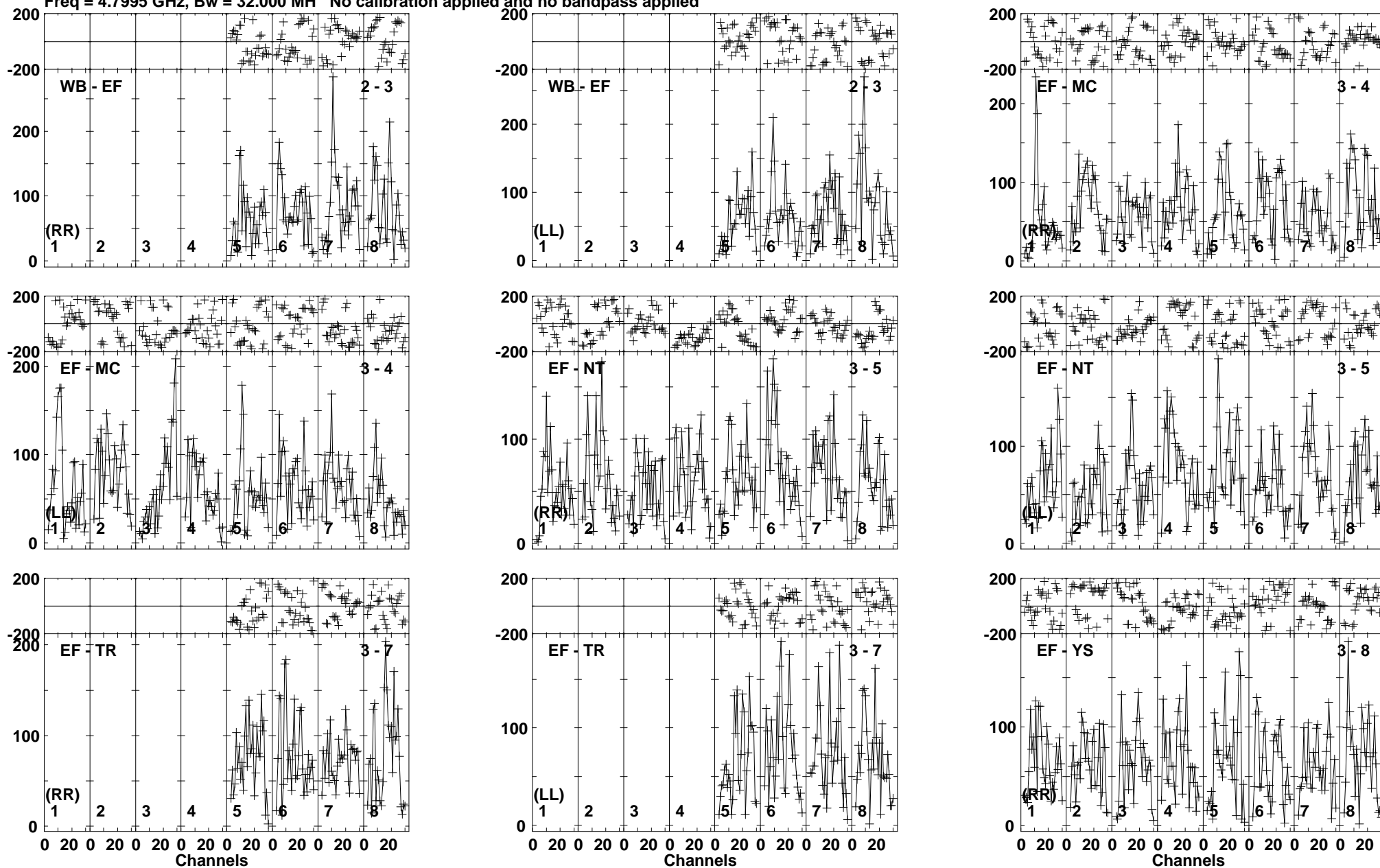

Lower frame: Micro Ampl Jy Top frame: Phas deg
Vector averaged cross-power spectrum Baseline: WB (02) - EF (03)
Timerange: 00/17:23:34 to 00/17:25:38

Plot file version 274 created 03-APR-2017 18:27:45

M22-VLA1 EM126B.UVDATA.1

Freq = 4.7995 GHz, Bw = 32.000 MH No calibration applied and no bandpass applied

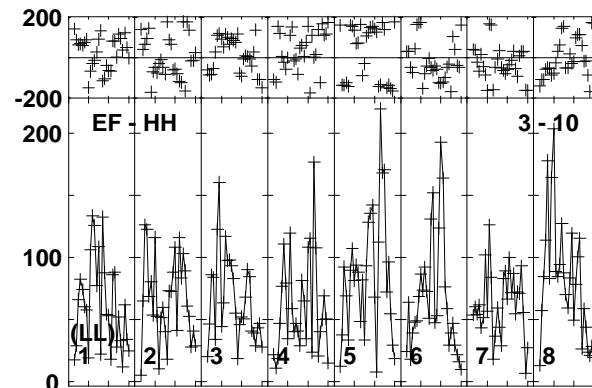
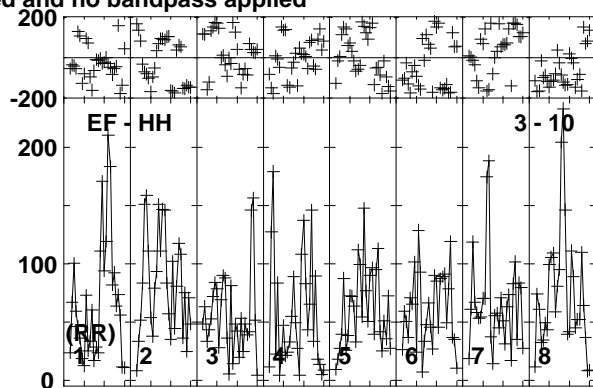
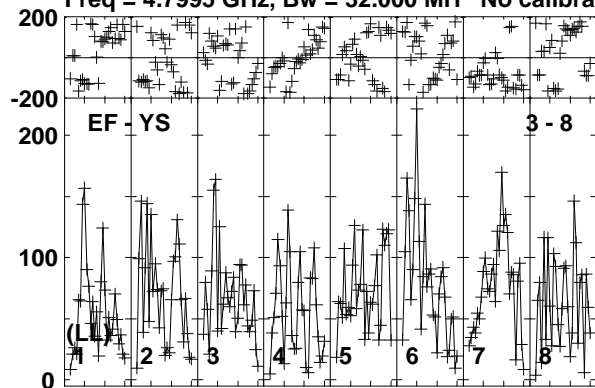

Lower frame: Micro Ampl Jy Top frame: Phas deg
Vector averaged cross-power spectrum Baseline: EF (03) - YS (08)
Timerange: 00/17:23:34 to 00/17:25:38

Plot file version 275 created 03-APR-2017 18:27:45

J1834-2341 EM126B.UVDATA.1

Freq = 4.7995 GHz, Bw = 32.000 MH No calibration applied and no bandpass applied

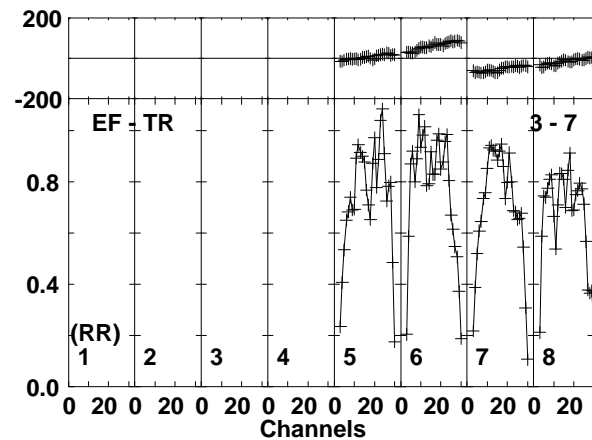
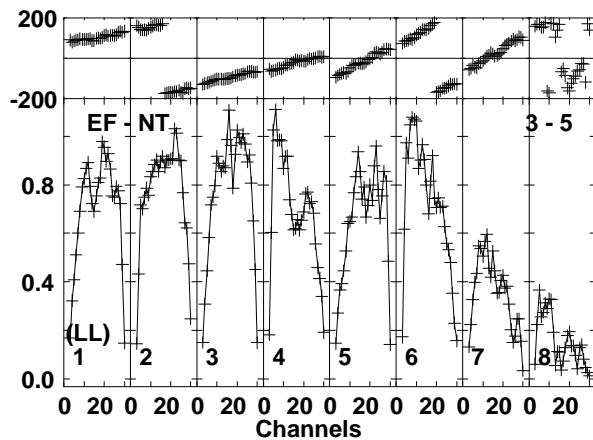
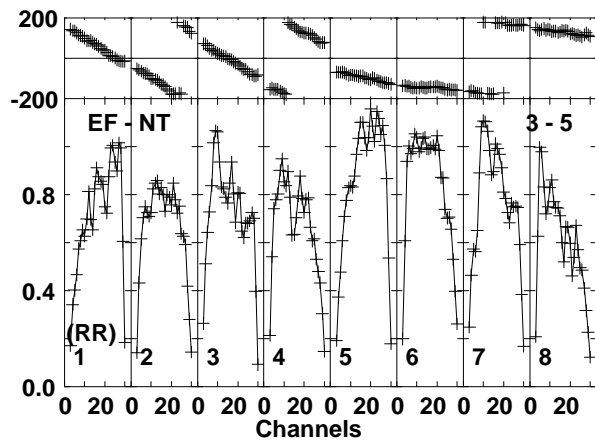
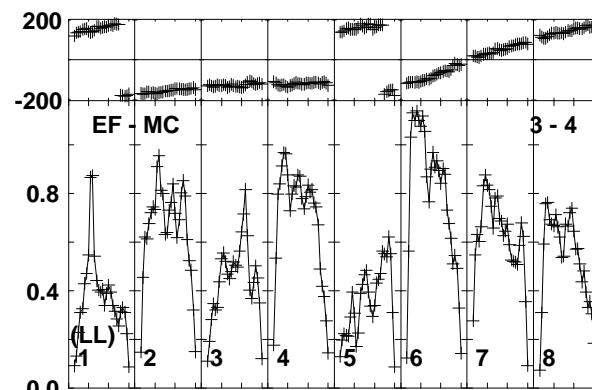
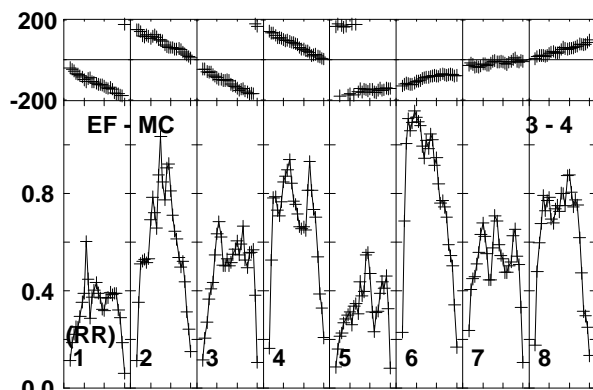
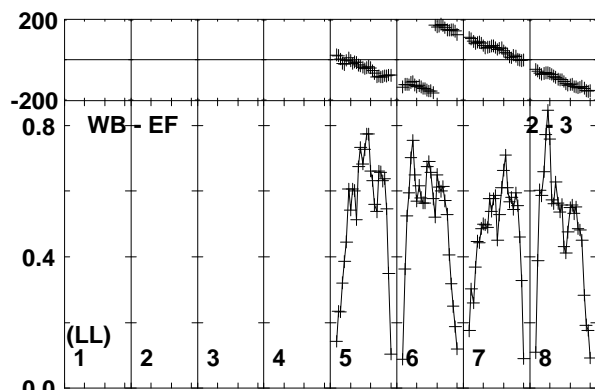
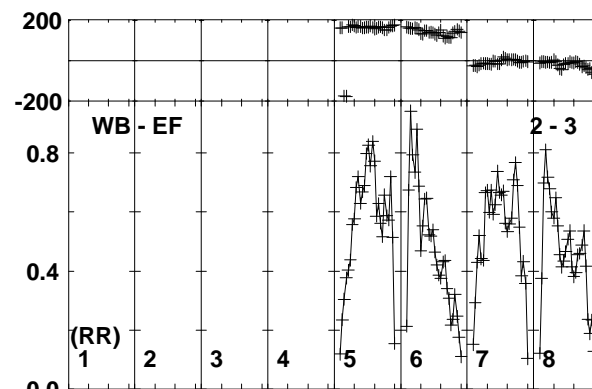
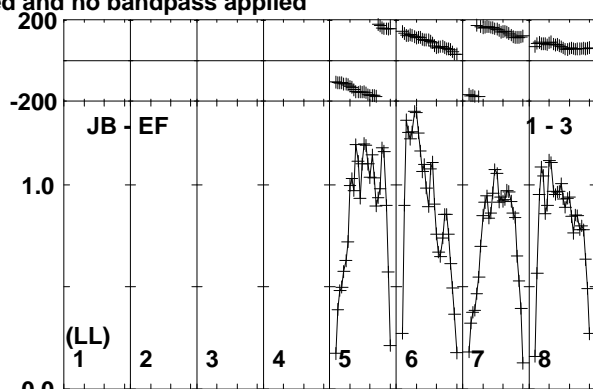
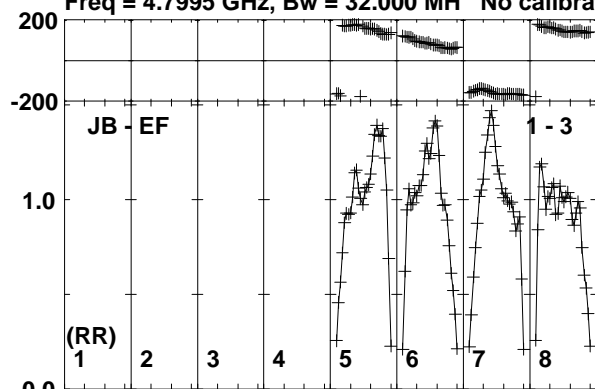

Lower frame: Milli Ampl Jy Top frame: Phas deg
Vector averaged cross-power spectrum Baseline: JB (01) - EF (03)
Timerange: 00/17:25:44 to 00/17:26:58

Plot file version 276 created 03-APR-2017 18:27:45

J1834-2341 EM126B.UVDATA.1

Freq = 4.7995 GHz, Bw = 32.000 MH No calibration applied and no bandpass applied

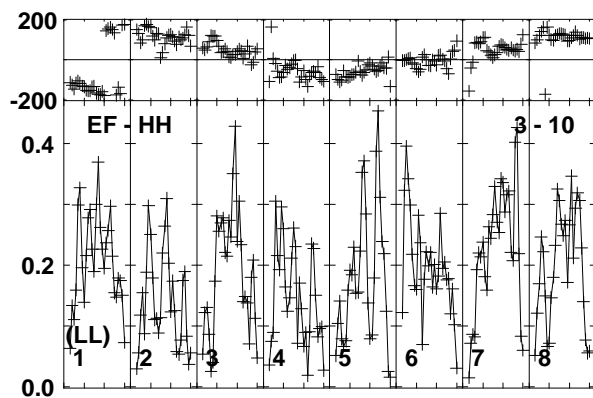
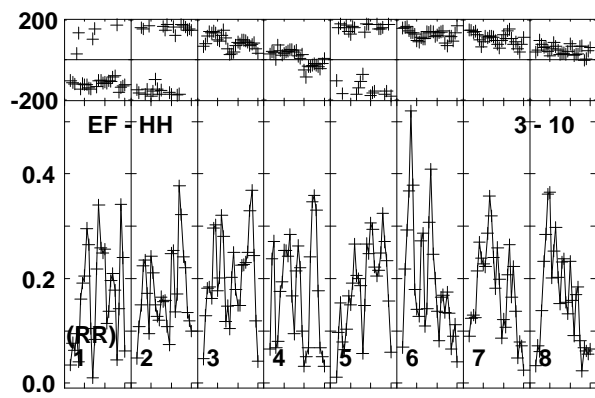
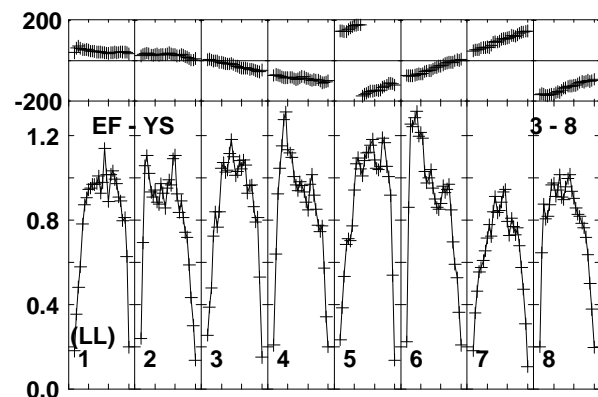
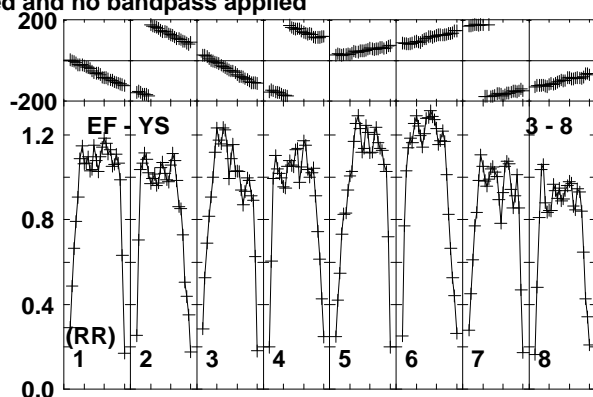
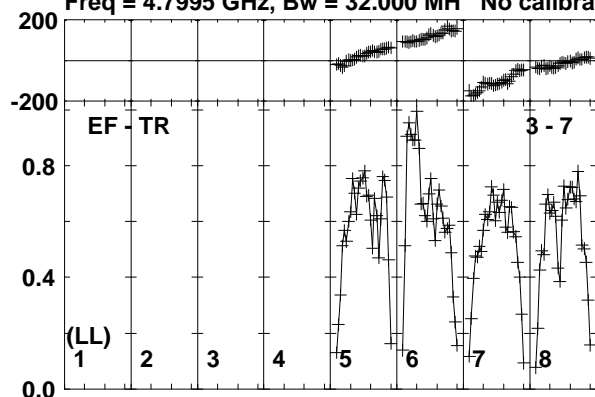

Lower frame: Milli Ampl Jy Top frame: Phas deg
Vector averaged cross-power spectrum Baseline: EF (03) - TR (07)
Timerange: 00/17:25:44 to 00/17:26:58

Plot file version 277 created 03-APR-2017 18:27:45

M22-VLA1 EM126B.UVDATA.1

Freq = 4.7995 GHz, Bw = 32.000 MH No calibration applied and no bandpass applied

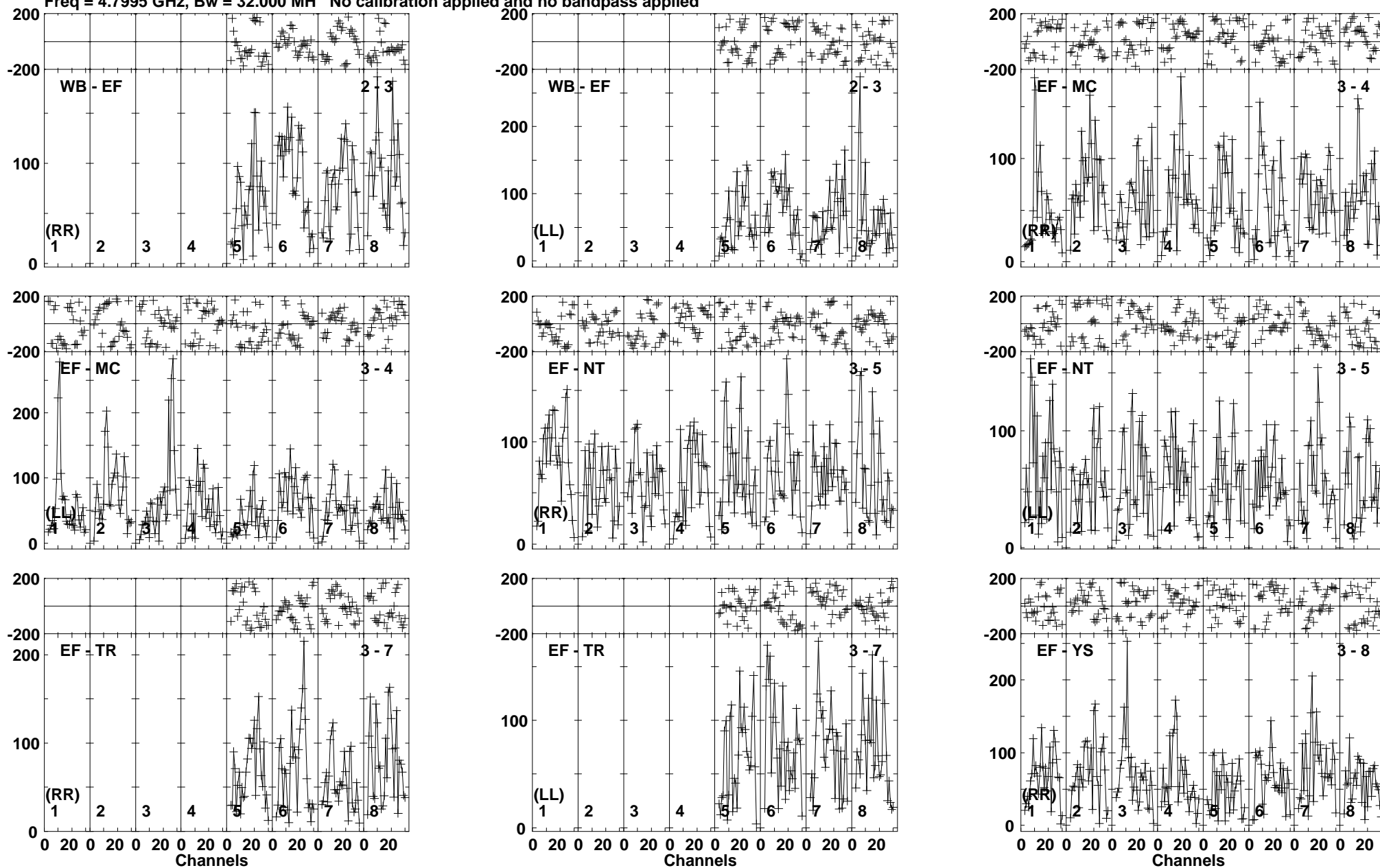

Lower frame: Micro Ampl Jy Top frame: Phas deg
Vector averaged cross-power spectrum Baseline: WB (02) - EF (03)
Timerange: 00/17:27:04 to 00/17:29:08

Plot file version 278 created 03-APR-2017 18:27:45

M22-VLA1 EM126B.UVDATA.1

Freq = 4.7995 GHz, Bw = 32.000 MH No calibration applied and no bandpass applied

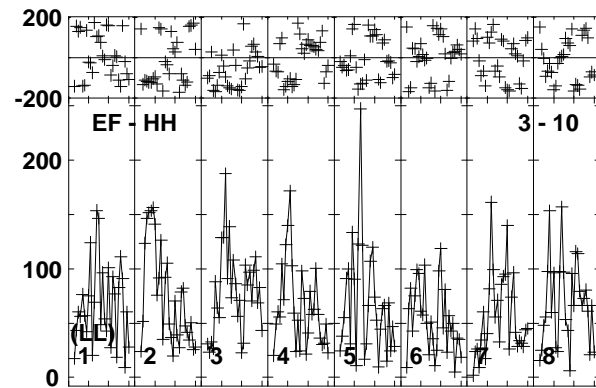
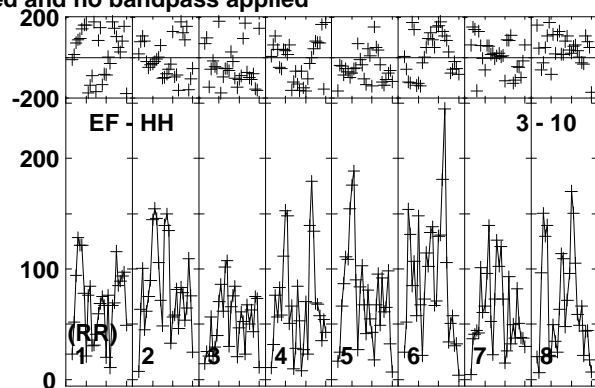
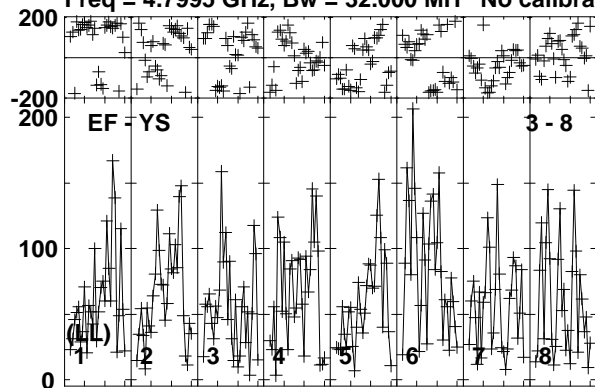

Lower frame: Micro Ampl Jy Top frame: Phas deg
Vector averaged cross-power spectrum Baseline: EF (03) - YS (08)
Timerange: 00/17:27:04 to 00/17:29:08

Plot file version 279 created 03-APR-2017 18:27:45

J1834-2341 EM126B.UVDATA.1

Freq = 4.7995 GHz, Bw = 32.000 MH No calibration applied and no bandpass applied

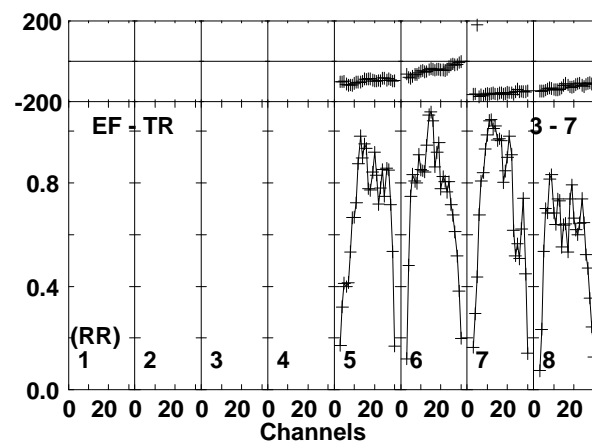
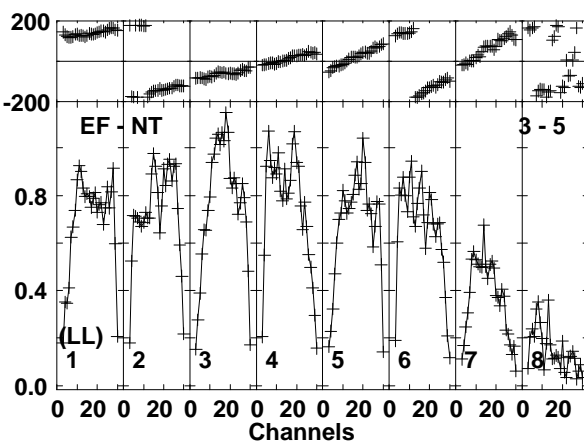
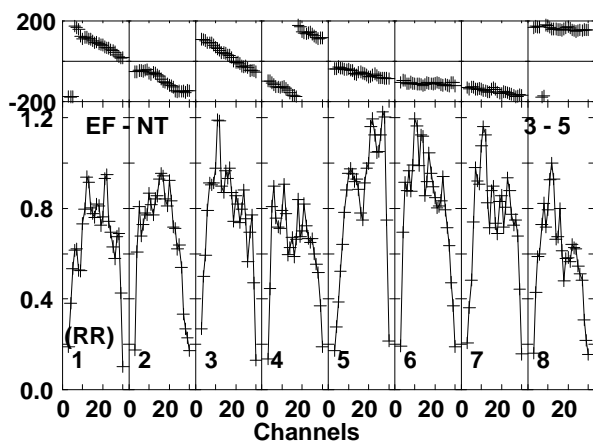
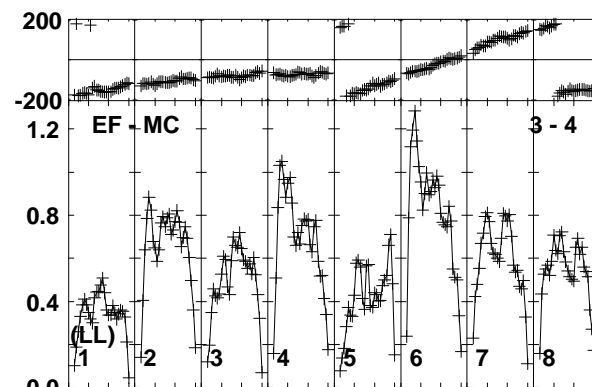
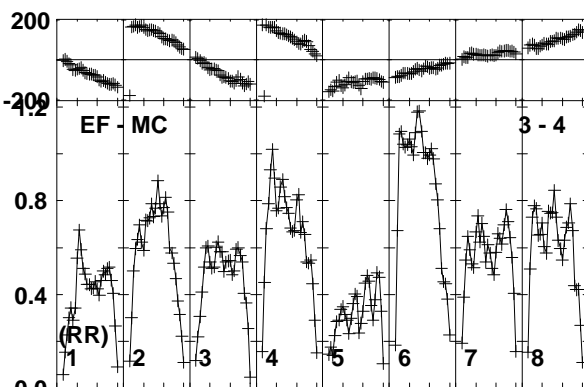
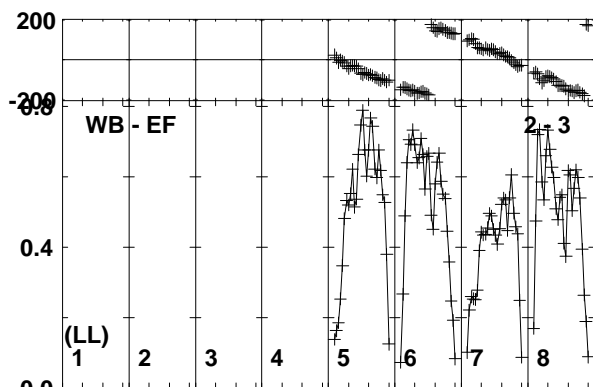
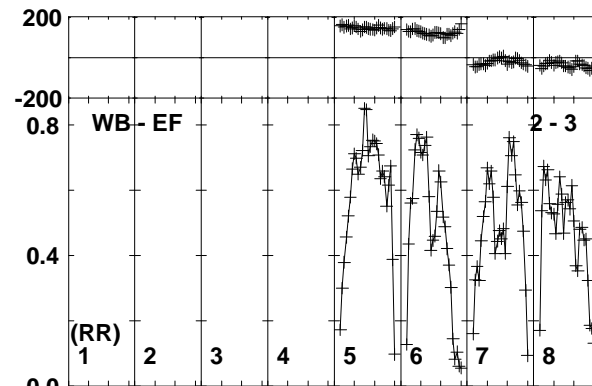
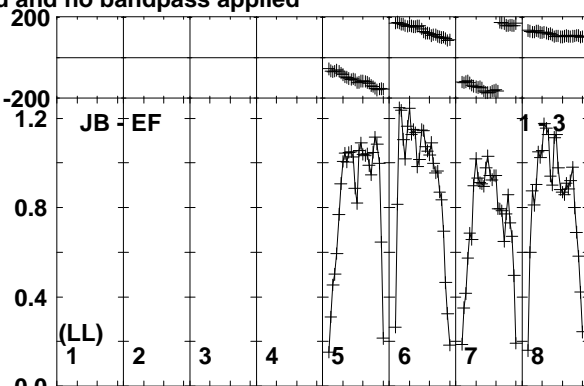
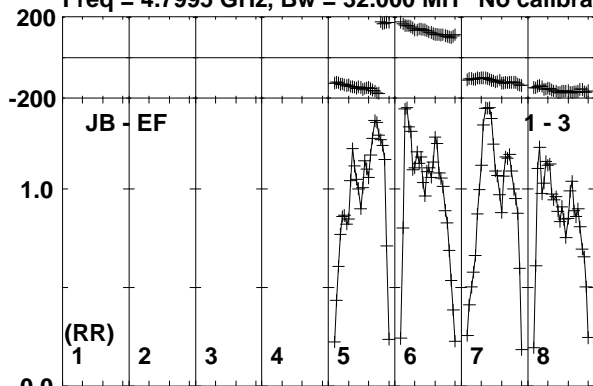

Lower frame: Milli Ampl Jy Top frame: Phas deg
Vector averaged cross-power spectrum Baseline: JB (01) - EF (03)
Timerange: 00/17:29:41 to 00/17:30:29

Plot file version 280 created 03-APR-2017 18:27:45

J1834-2341 EM126B.UVDATA.1

Freq = 4.7995 GHz, Bw = 32.000 MH No calibration applied and no bandpass applied

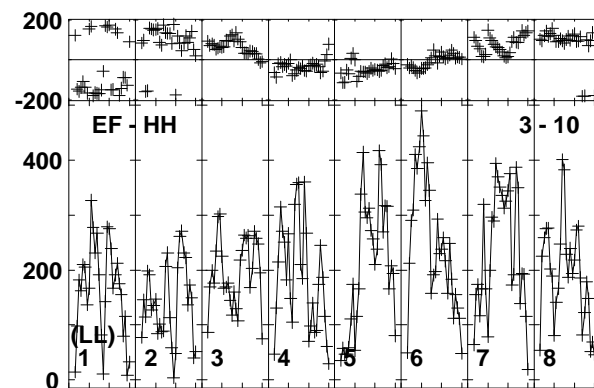
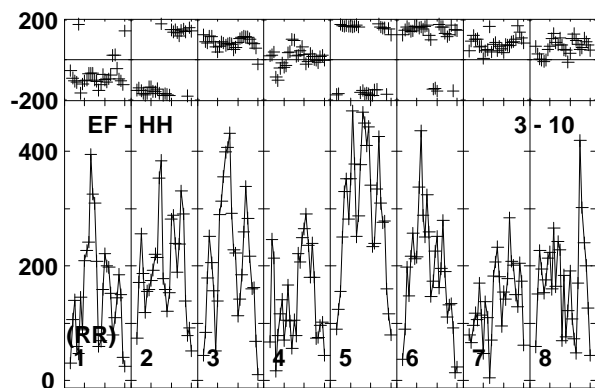
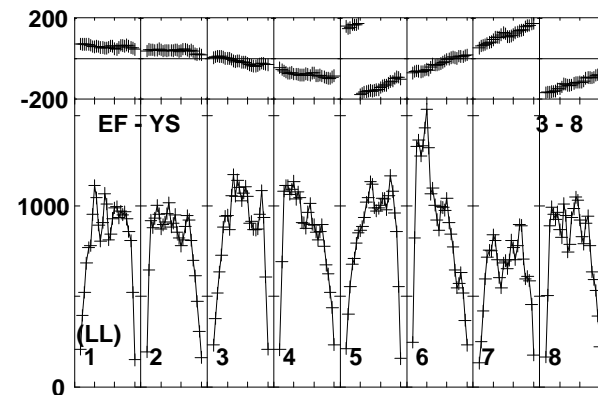
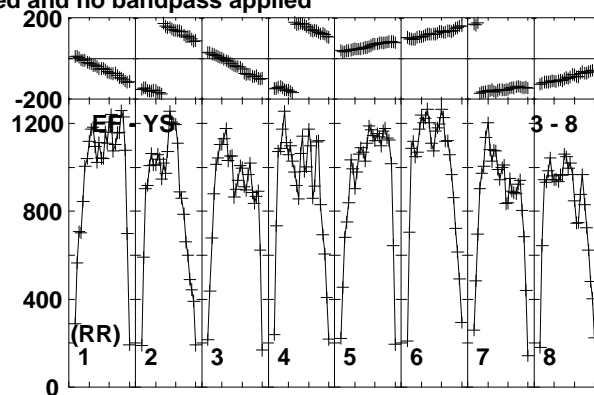
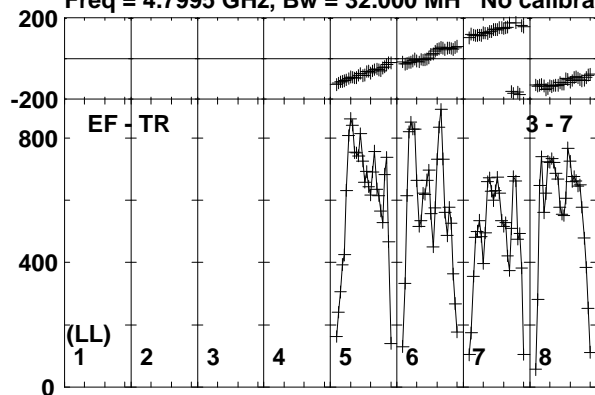

Lower frame: Micro Ampl Jy Top frame: Phas deg
Vector averaged cross-power spectrum Baseline: EF (03) - TR (07)
Timerange: 00/17:29:41 to 00/17:30:29

Plot file version 281 created 03-APR-2017 18:27:45

M22-VLA1 EM126B.UVDATA.1

Freq = 4.7995 GHz, Bw = 32.000 MH No calibration applied and no bandpass applied

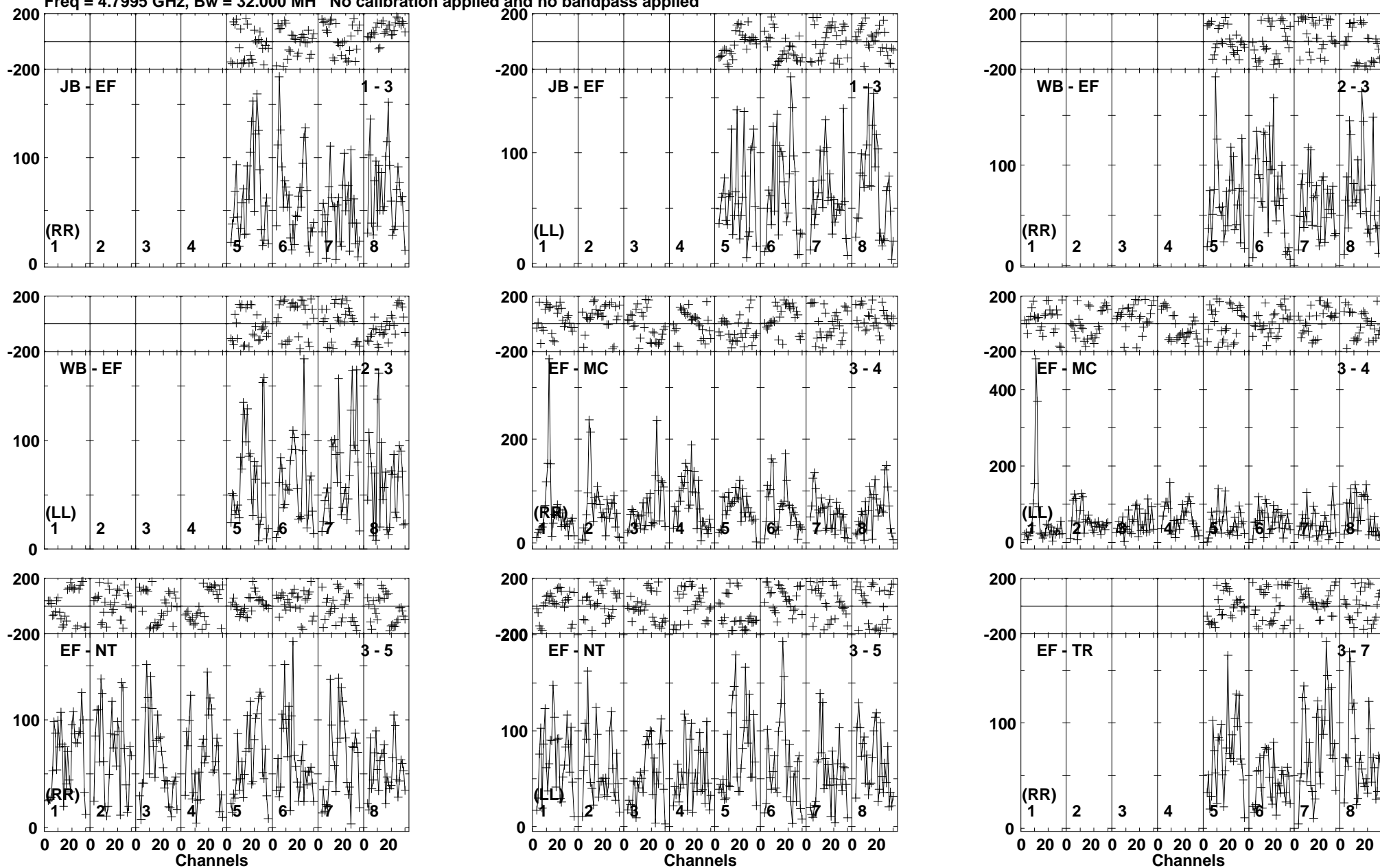

Lower frame: Micro Ampl Jy Top frame: Phas deg
Vector averaged cross-power spectrum Baseline: JB (01) - EF (03)
Timerange: 00/17:30:34 to 00/17:32:38

Plot file version 282 created 03-APR-2017 18:27:45

M22-VLA1 EM126B.UVDATA.1

Freq = 4.7995 GHz, Bw = 32.000 MH No calibration applied and no bandpass applied

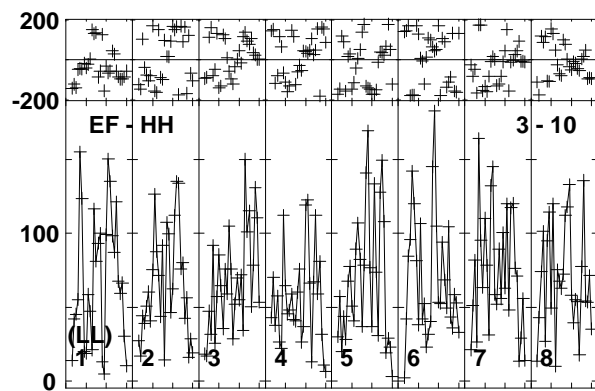
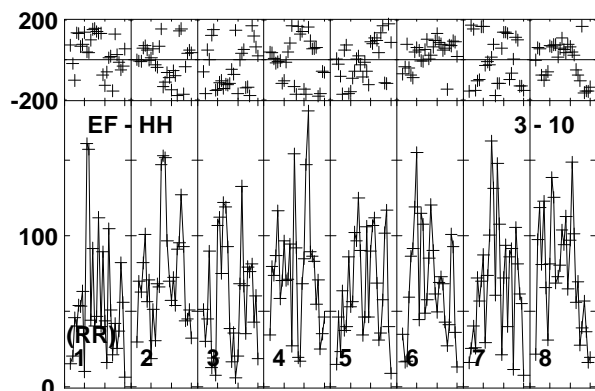
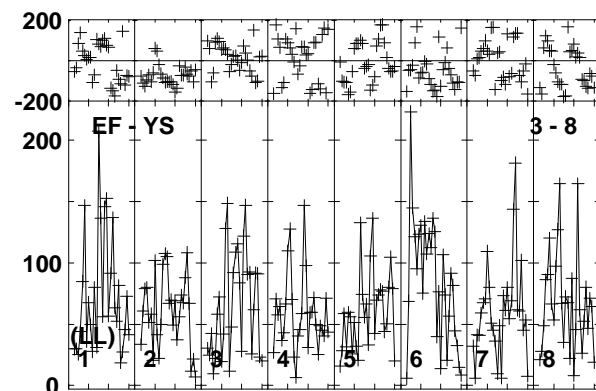
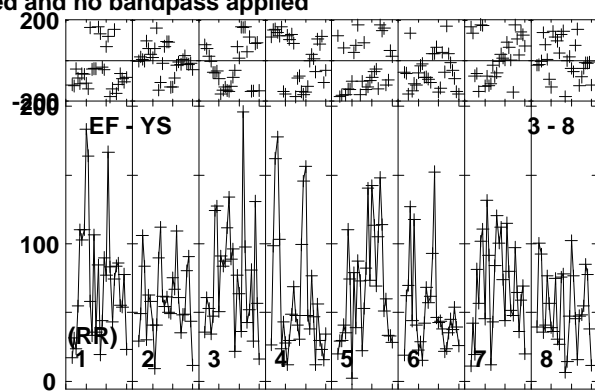
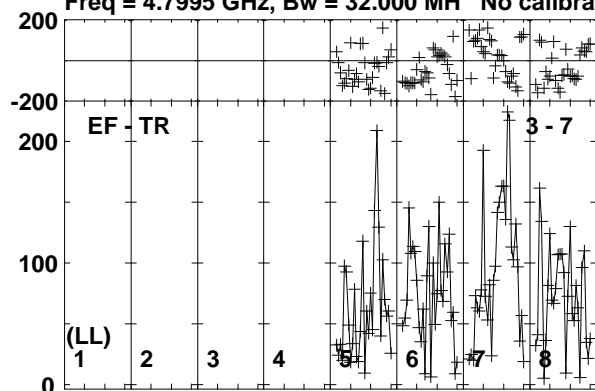

Lower frame: Micro Ampl Jy Top frame: Phas deg
Vector averaged cross-power spectrum Baseline: EF (03) - TR (07)
Timerange: 00/17:30:34 to 00/17:32:38

Plot file version 283 created 03-APR-2017 18:27:45

J1834-2341 EM126B.UVDATA.1

Freq = 4.7995 GHz, Bw = 32.000 MH No calibration applied and no bandpass applied

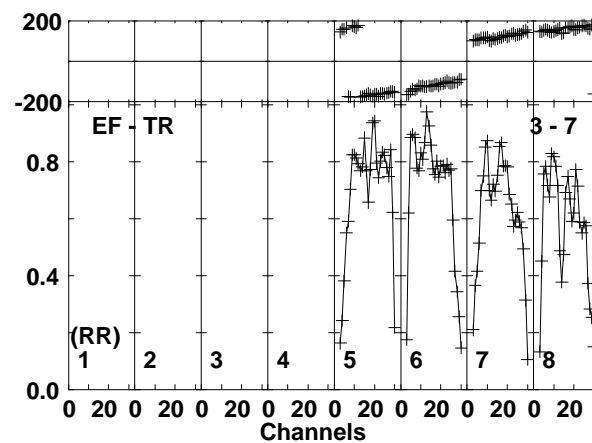
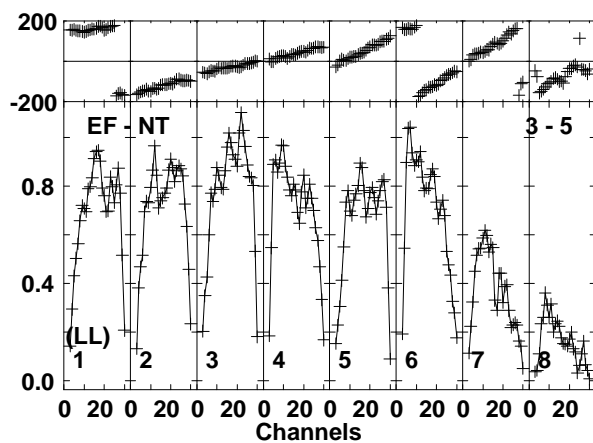
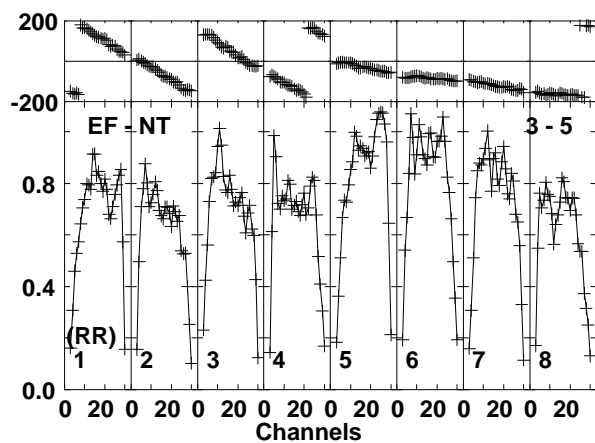
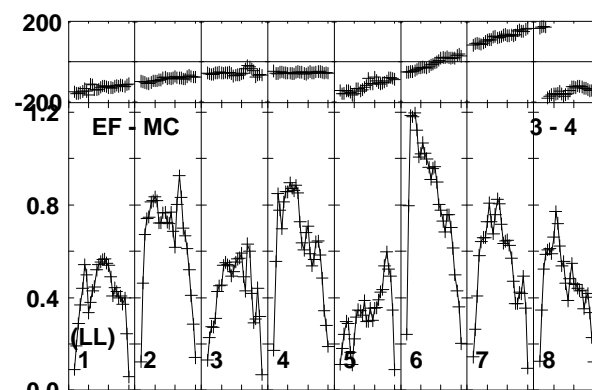
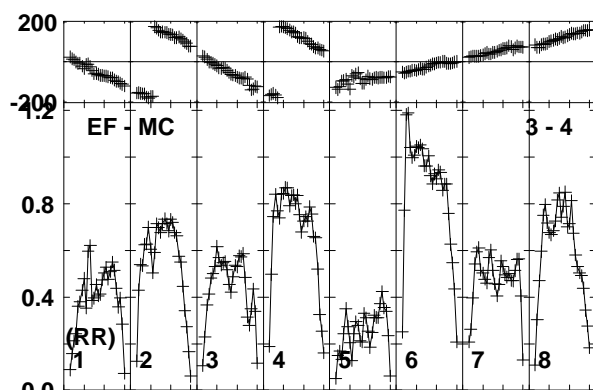
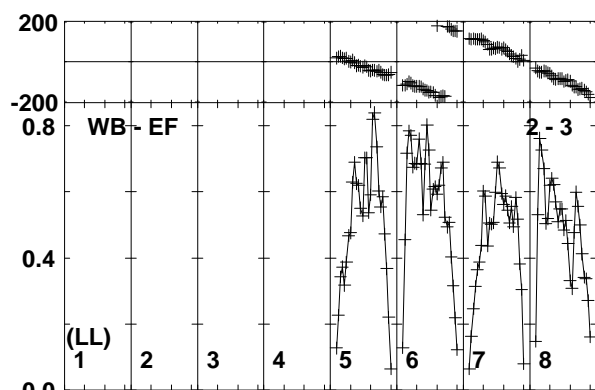
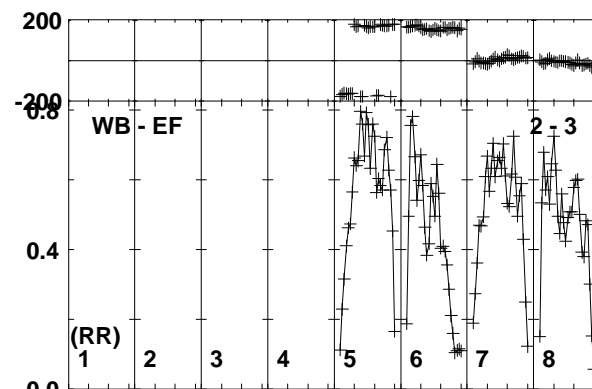
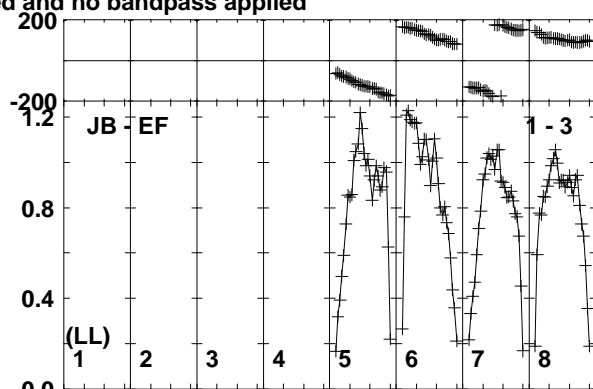
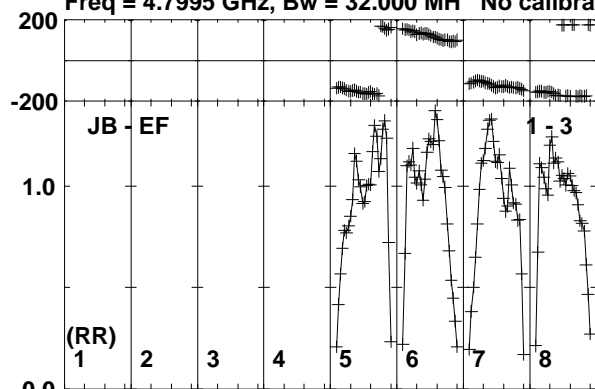

Lower frame: Milli Ampl Jy Top frame: Phas deg
Vector averaged cross-power spectrum Baseline: JB (01) - EF (03)
Timerange: 00/17:32:44 to 00/17:33:58

Plot file version 284 created 03-APR-2017 18:27:45

J1834-2341 EM126B.UVDATA.1

Freq = 4.7995 GHz, Bw = 32.000 MH No calibration applied and no bandpass applied

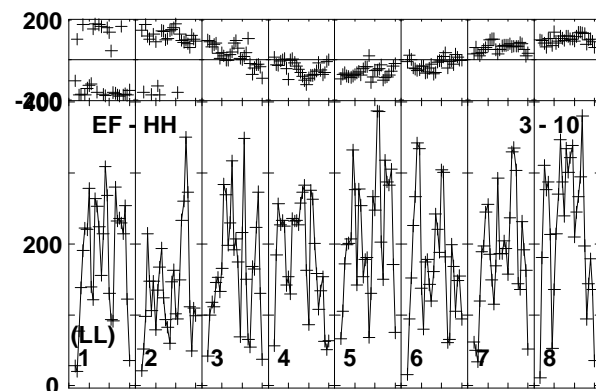
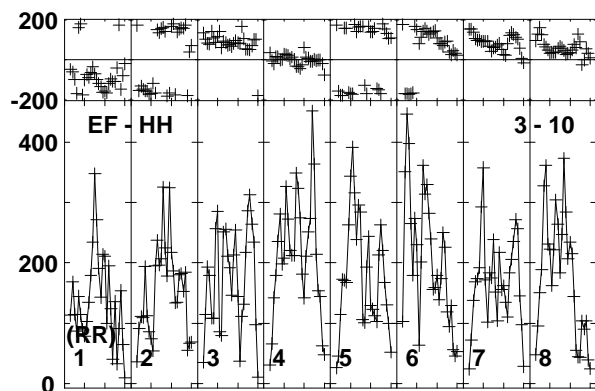
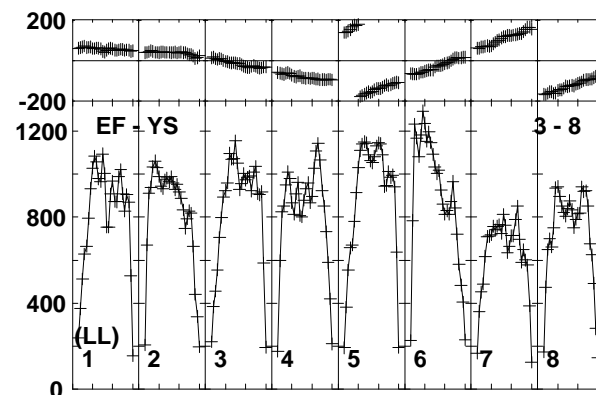
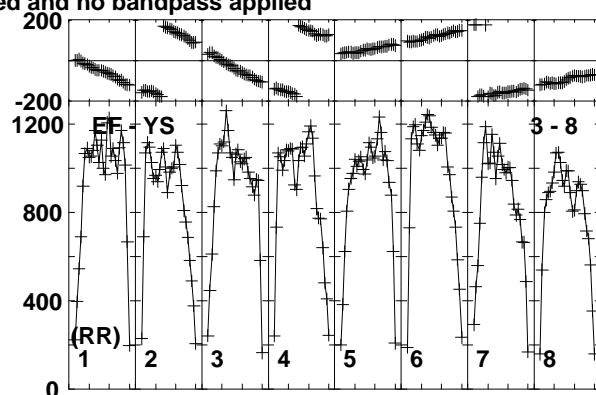
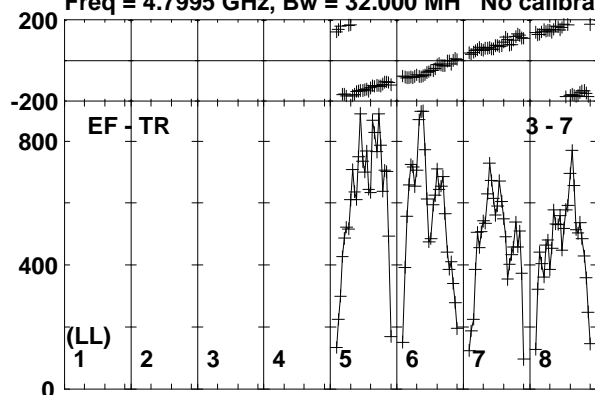

Lower frame: Micro Ampl Jy Top frame: Phas deg
Vector averaged cross-power spectrum Baseline: EF (03) - TR (07)
Timerange: 00/17:32:44 to 00/17:33:58

Plot file version 285 created 03-APR-2017 18:27:45

M22-VLA1 EM126B.UVDATA.1

Freq = 4.7995 GHz, Bw = 32.000 MH No calibration applied and no bandpass applied

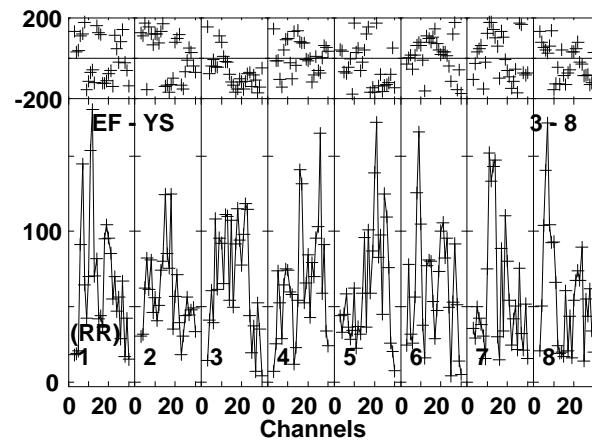
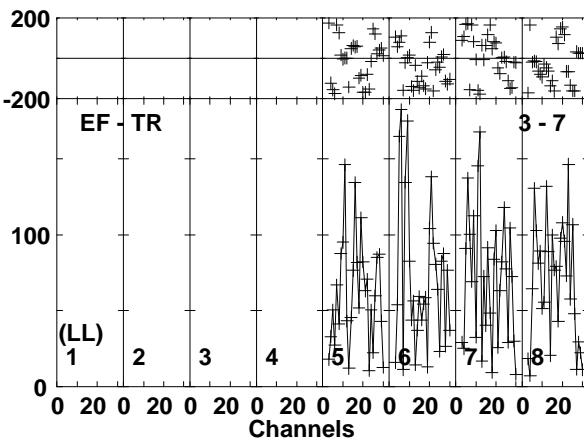
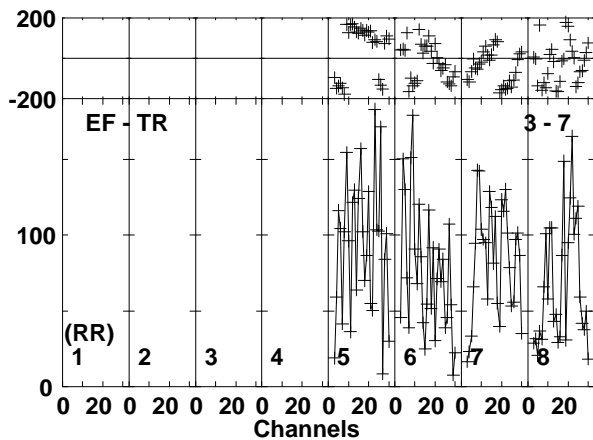
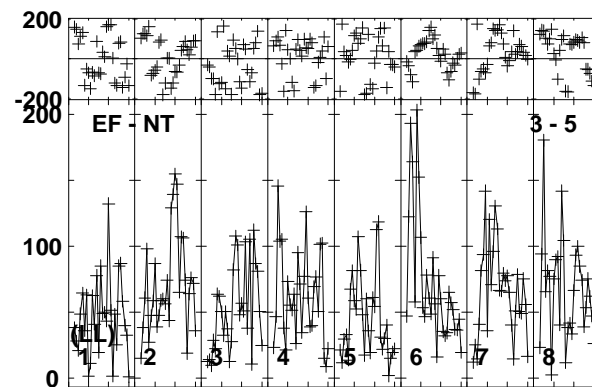
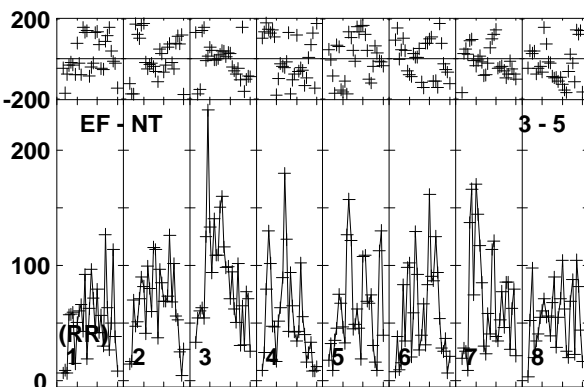
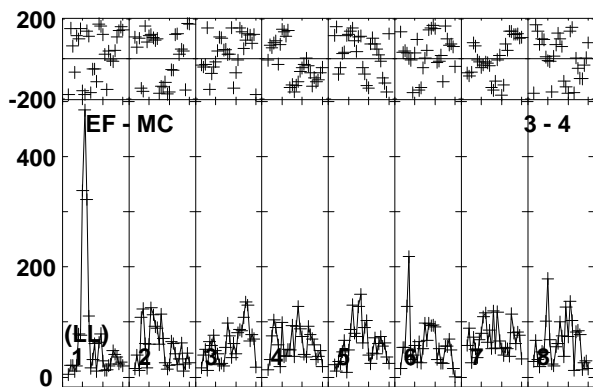
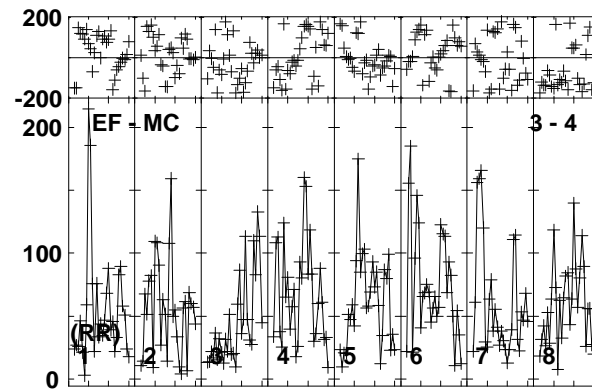
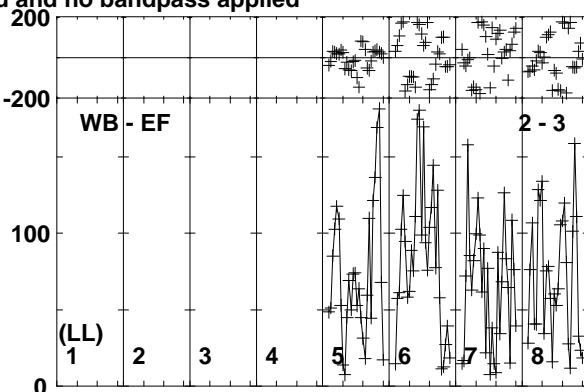
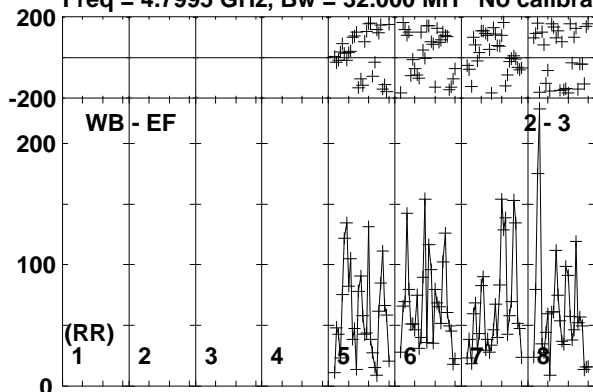

Lower frame: Micro Ampl Jy Top frame: Phas deg
Vector averaged cross-power spectrum Baseline: WB (02) - EF (03)
Timerange: 00:17:34:04 to 00:17:36:08

Plot file version 286 created 03-APR-2017 18:27:45

M22-VLA1 EM126B.UVDATA.1

Freq = 4.7995 GHz, Bw = 32.000 MH No calibration applied and no bandpass applied

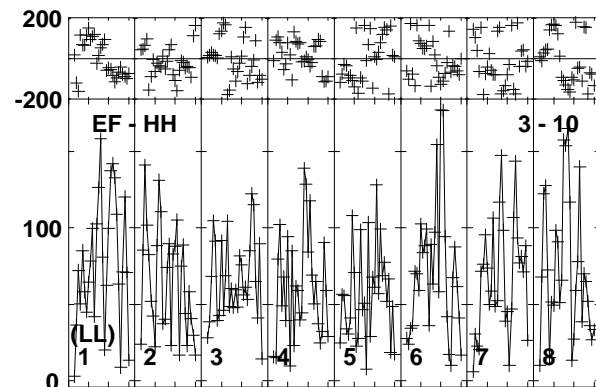
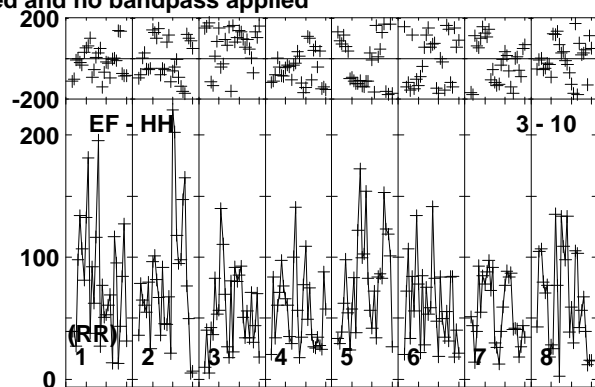
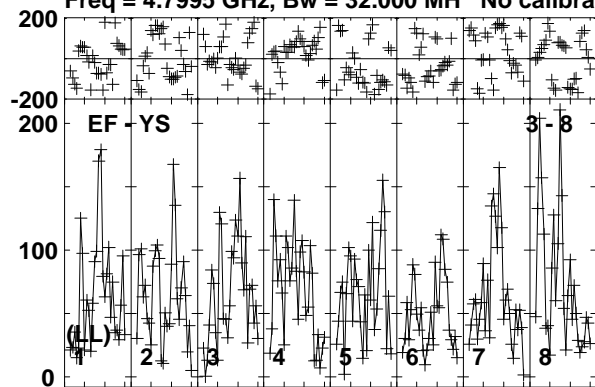

Lower frame: Micro Ampl Jy Top frame: Phas deg
Vector averaged cross-power spectrum Baseline: EF (03) - YS (08)
Timerange: 00/17:34:04 to 00/17:36:08

Plot file version 287 created 03-APR-2017 18:27:45

J1834-2341 EM126B.UVDATA.1

Freq = 4.7995 GHz, Bw = 32.000 MH No calibration applied and no bandpass applied

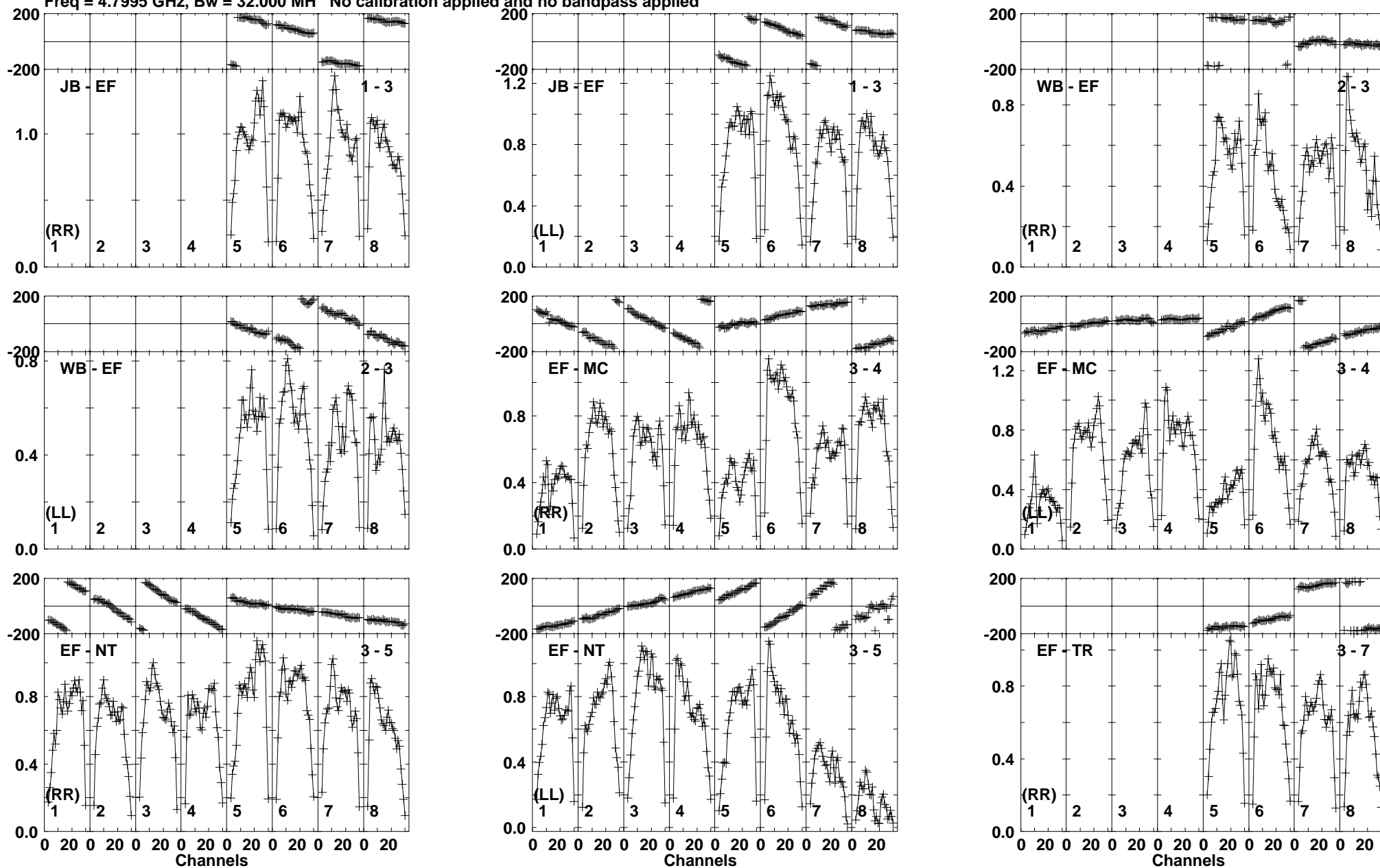

Lower frame: Milli Ampl Jy Top frame: Phas deg
Vector averaged cross-power spectrum Baseline: JB (01) - EF (03)
Timerange: 00/17:36:14 to 00/17:37:28

Plot file version 288 created 03-APR-2017 18:27:45

J1834-2341 EM126B.UVDATA.1

Freq = 4.7995 GHz, Bw = 32.000 MH No calibration applied and no bandpass applied

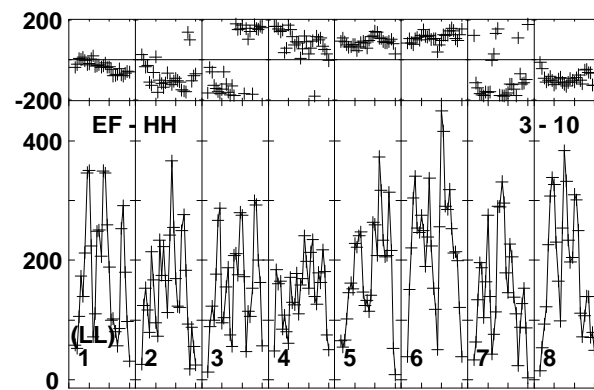
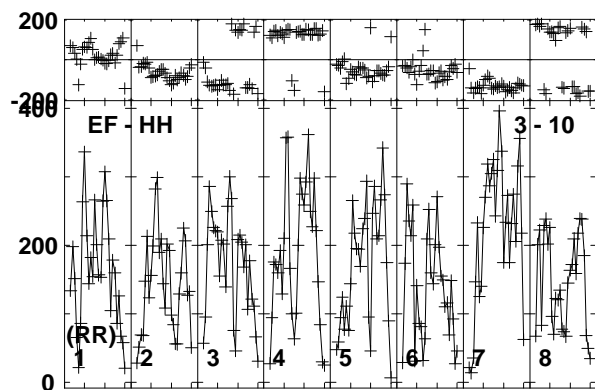
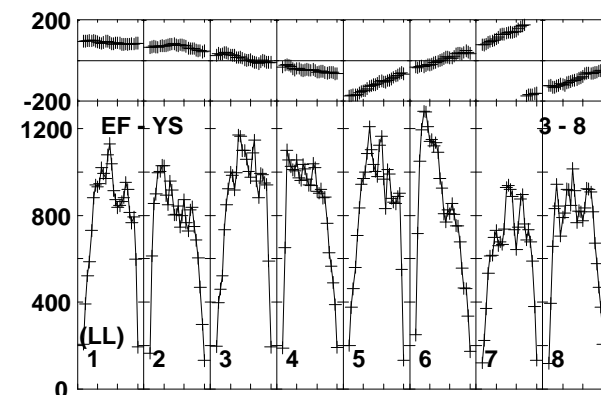
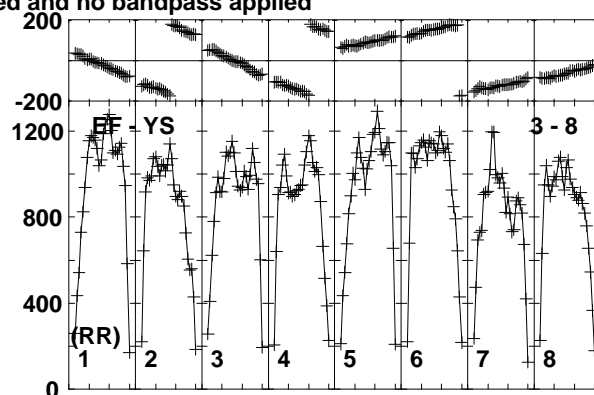
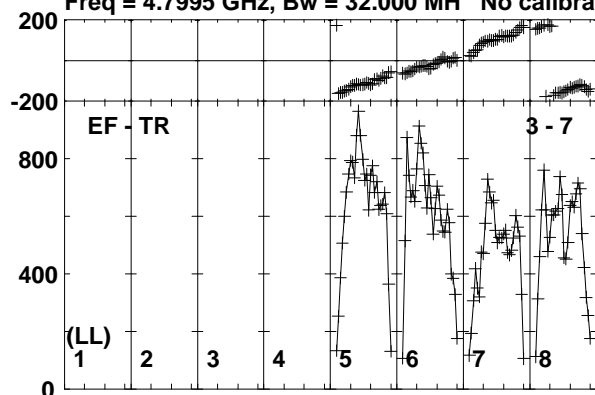

Lower frame: Micro Ampl Jy Top frame: Phas deg
Vector averaged cross-power spectrum Baseline: EF (03) - TR (07)
Timerange: 00/17:36:14 to 00/17:37:28

Plot file version 289 created 03-APR-2017 18:27:45

M22-VLA1 EM126B.UVDATA.1

Freq = 4.7995 GHz, Bw = 32.000 MH No calibration applied and no bandpass applied

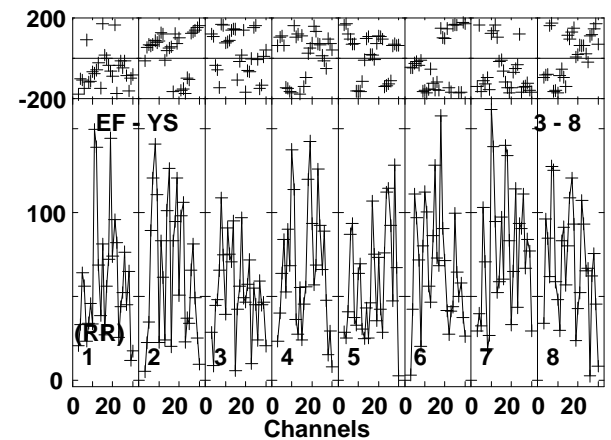
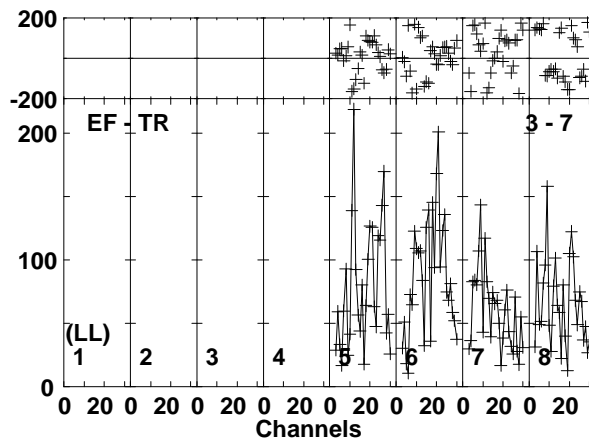
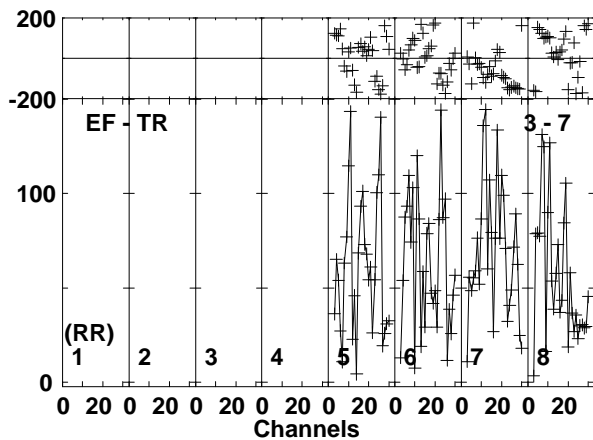
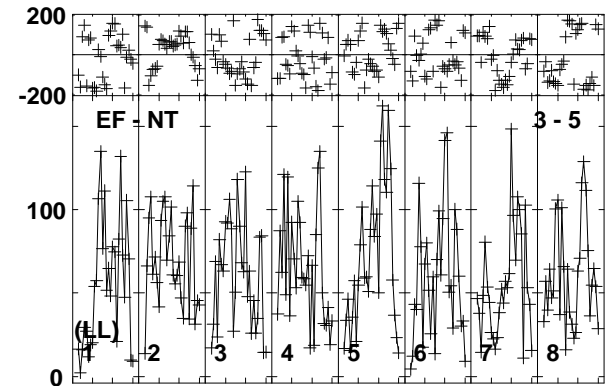
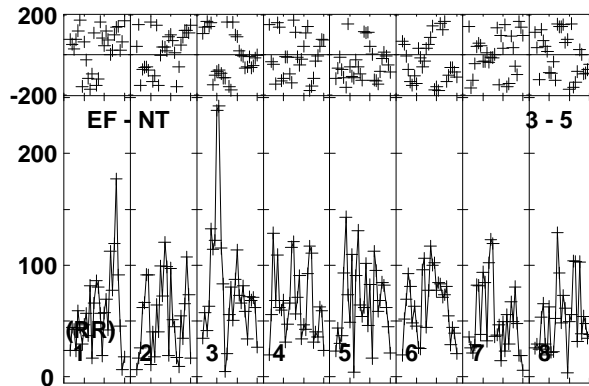
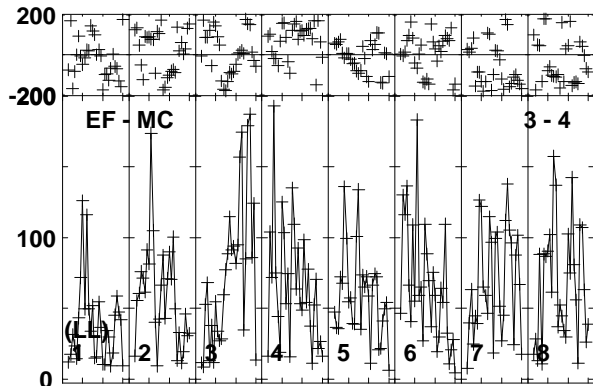
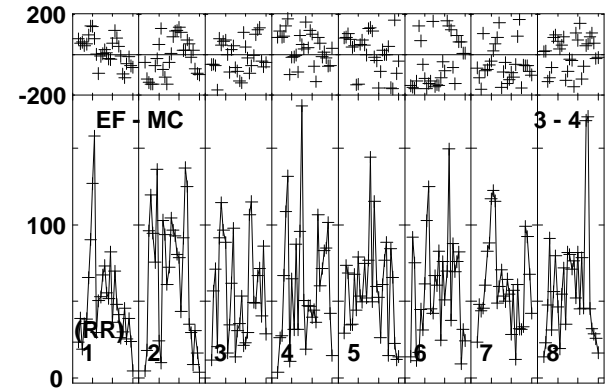
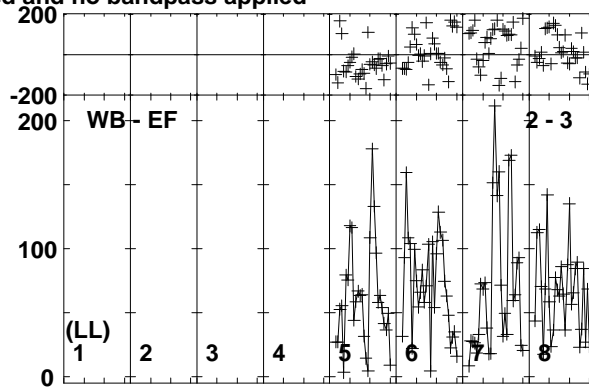
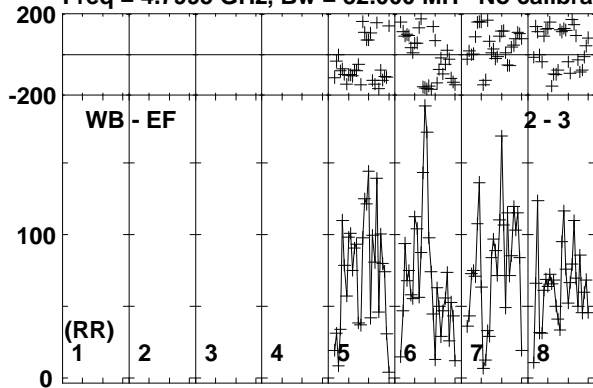

Lower frame: Micro Ampl Jy Top frame: Phas deg
Vector averaged cross-power spectrum Baseline: WB (02) - EF (03)
Timerange: 00/17:37:34 to 00/17:39:38

Plot file version 290 created 03-APR-2017 18:27:45

M22-VLA1 EM126B.UVDATA.1

Freq = 4.7995 GHz, Bw = 32.000 MH No calibration applied and no bandpass applied

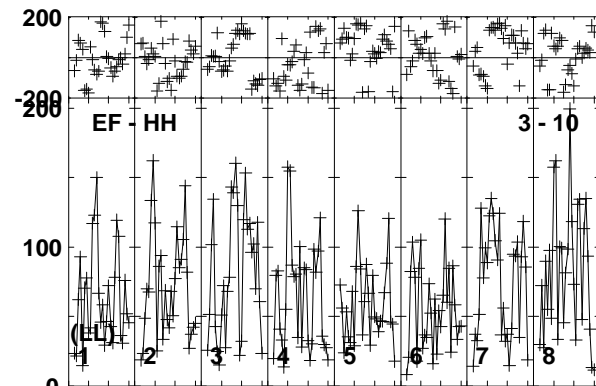
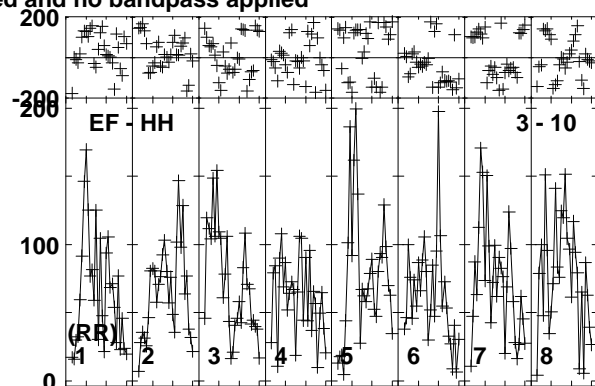
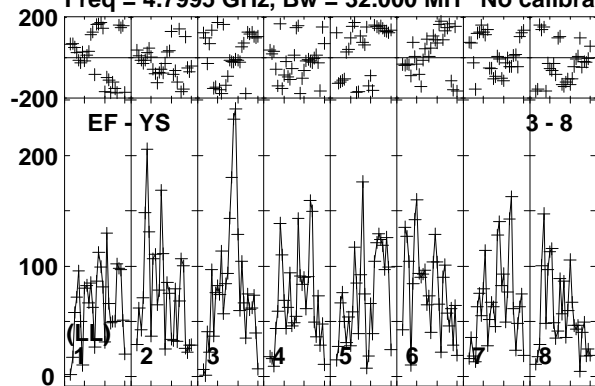

Lower frame: Micro Ampl Jy Top frame: Phas deg
Vector averaged cross-power spectrum Baseline: EF (03) - YS (08)
Timerange: 00/17:37:34 to 00/17:39:38

Plot file version 291 created 03-APR-2017 18:27:45

J1834-2341 EM126B.UVDATA.1

Freq = 4.7995 GHz, Bw = 32.000 MH No calibration applied and no bandpass applied

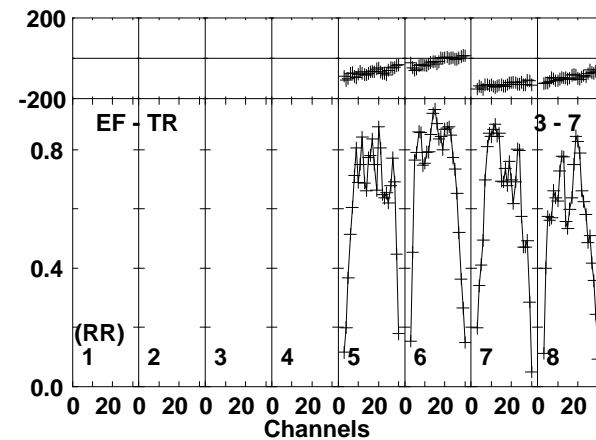
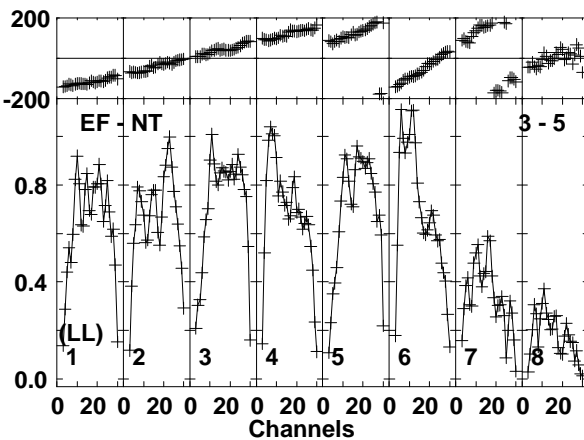
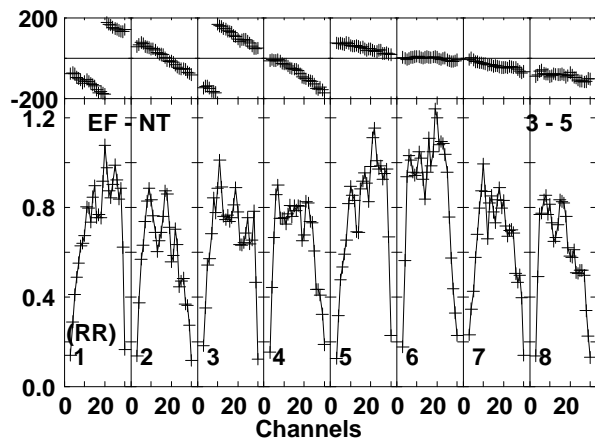
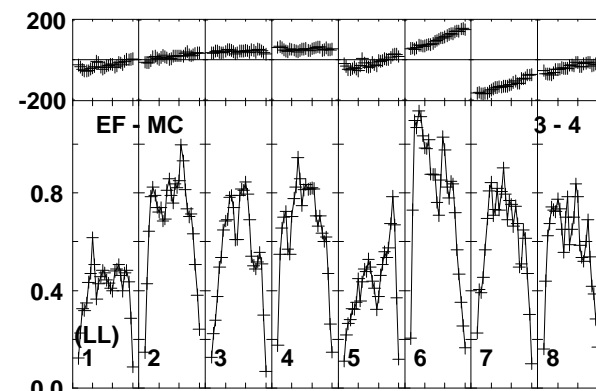
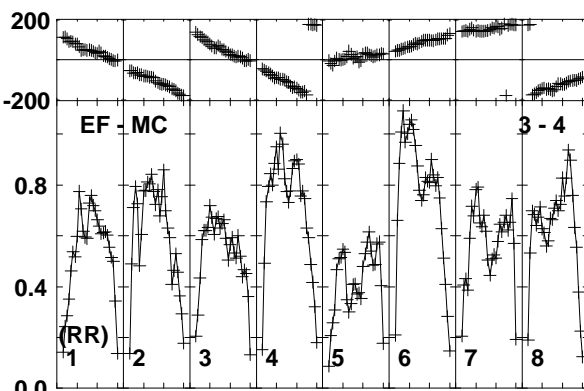
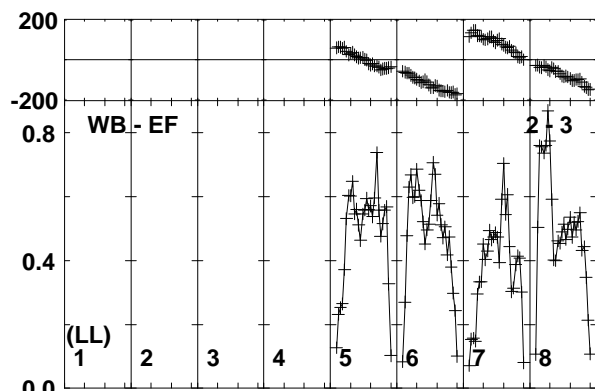
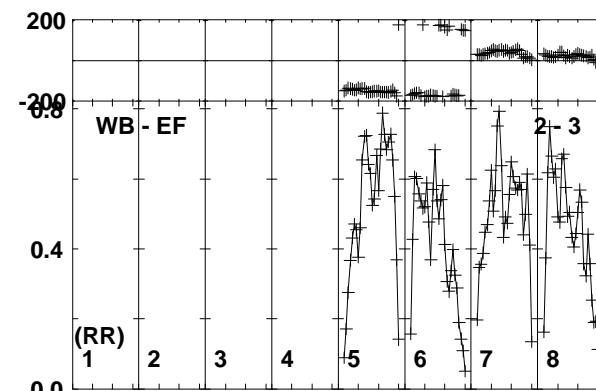
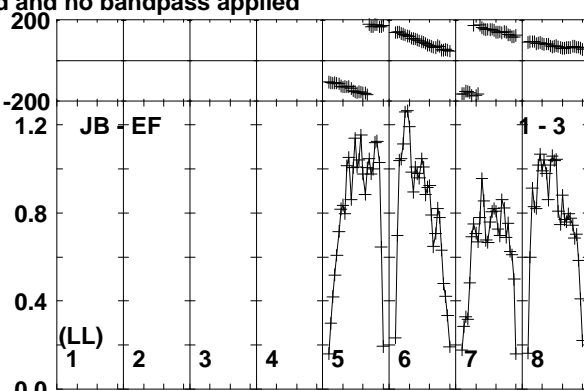
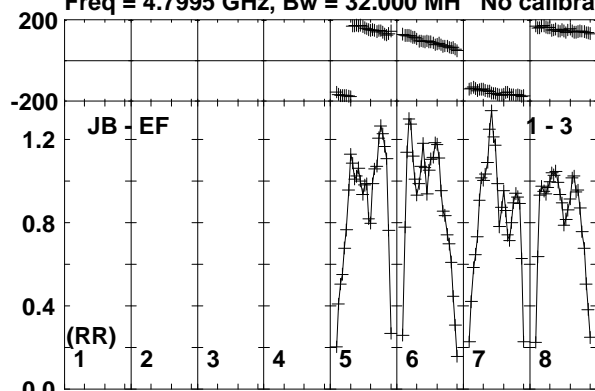

Lower frame: Milli Ampl Jy Top frame: Phas deg
Vector averaged cross-power spectrum Baseline: JB (01) - EF (03)
Timerange: 00/17:40:11 to 00/17:40:59

Plot file version 292 created 03-APR-2017 18:27:45

J1834-2341 EM126B.UVDATA.1

Freq = 4.7995 GHz, Bw = 32.000 MH No calibration applied and no bandpass applied

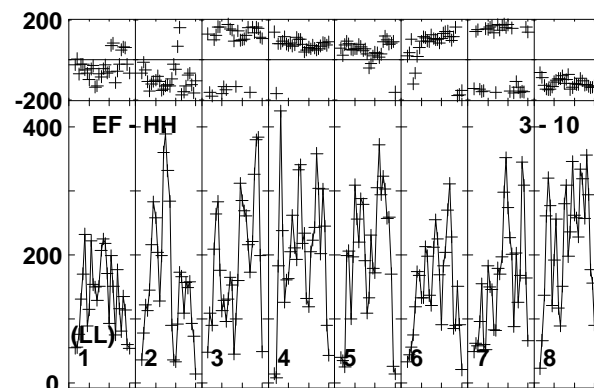
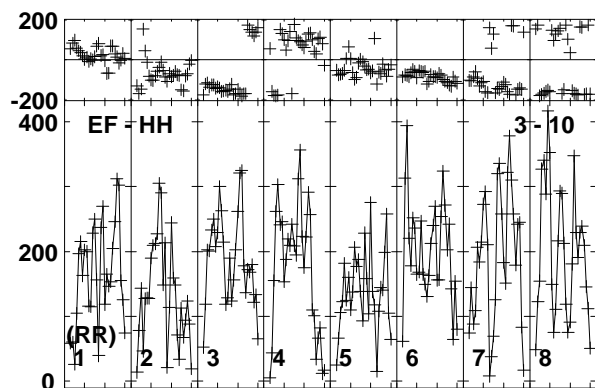
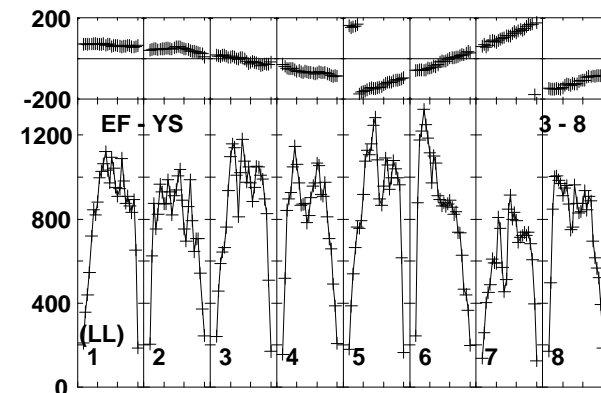
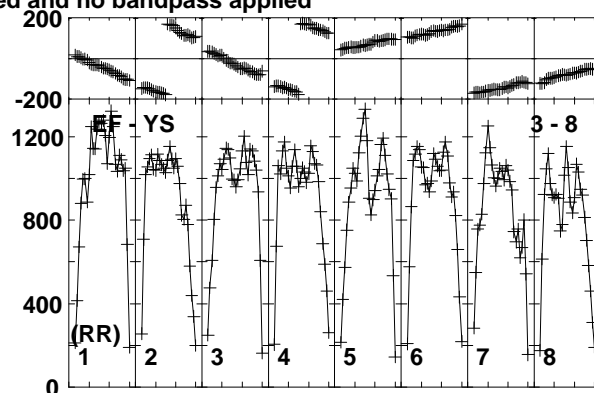
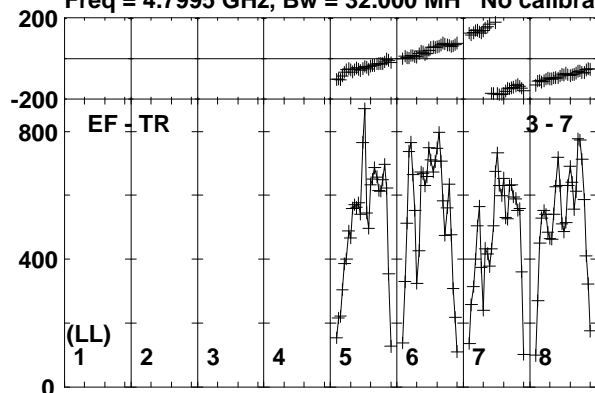

Lower frame: Micro Ampl Jy Top frame: Phas deg
Vector averaged cross-power spectrum Baseline: EF (03) - TR (07)
Timerange: 00/17:40:11 to 00/17:40:59

Plot file version 293 created 03-APR-2017 18:27:45
 M22-VLA1 EM126B.UVDATA.1
 Freq = 4.7995 GHz, Bw = 32.000 MH No calibration applied and no bandpass applied

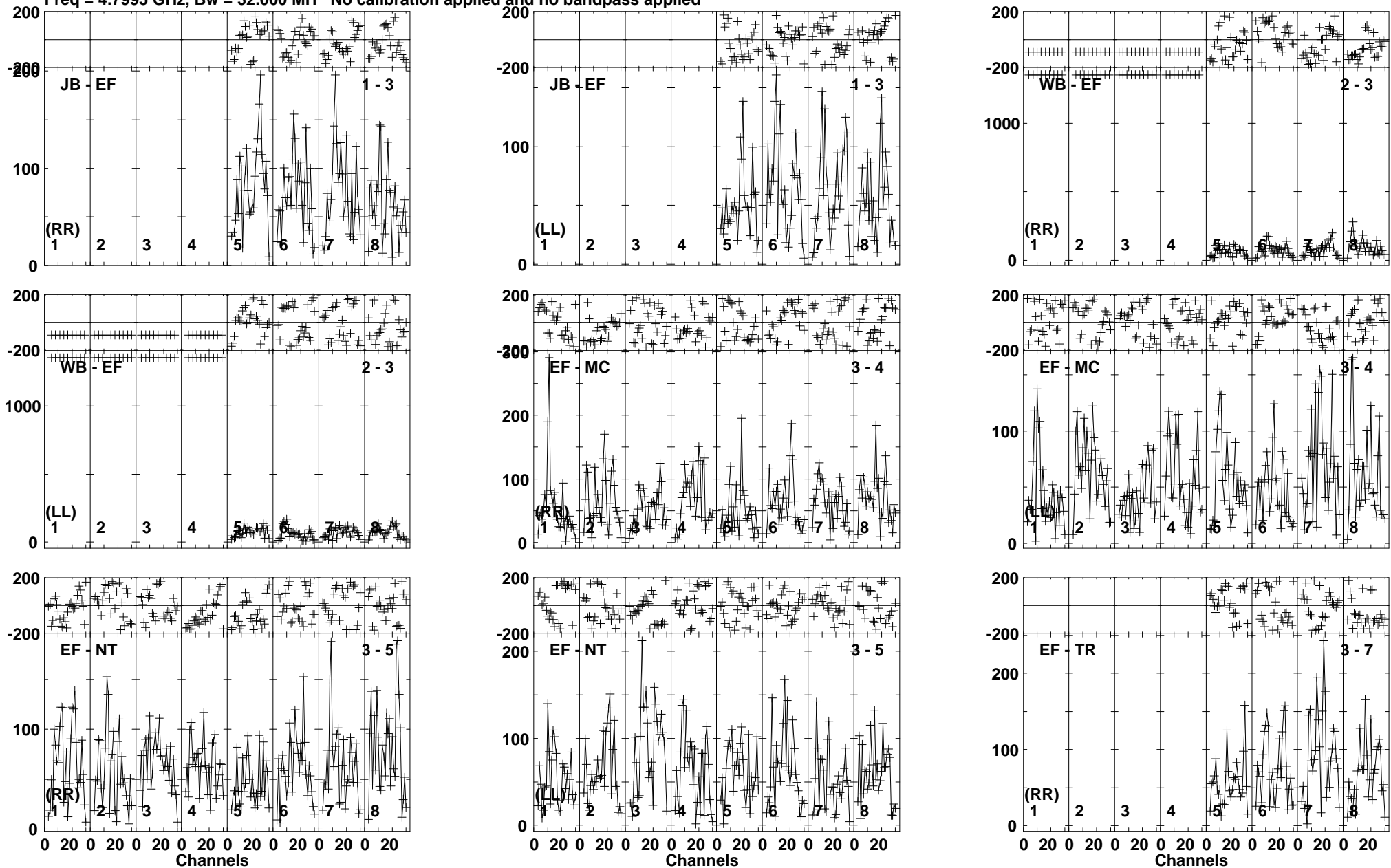

Lower frame: Micro Ampl Jy Top frame: Phas deg
 Vector averaged cross-power spectrum Baseline: JB (01) - EF (03)
 Timerange: 00/17:41:04 to 00/17:43:08

Plot file version 294 created 03-APR-2017 18:27:45

M22-VLA1 EM126B.UVDATA.1

Freq = 4.7995 GHz, Bw = 32.000 MH No calibration applied and no bandpass applied

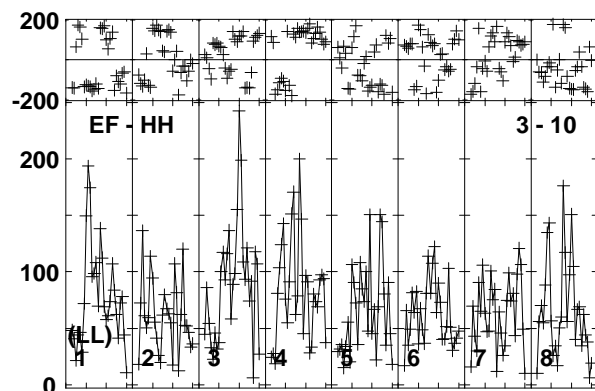
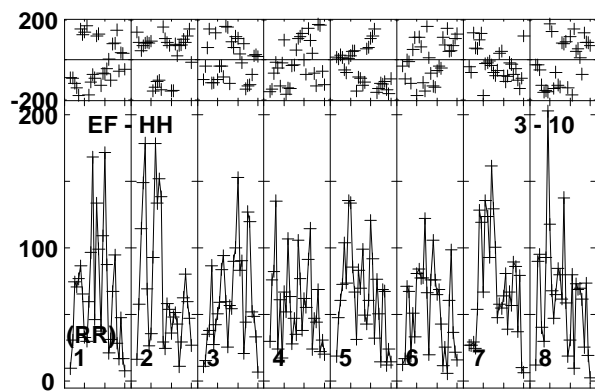
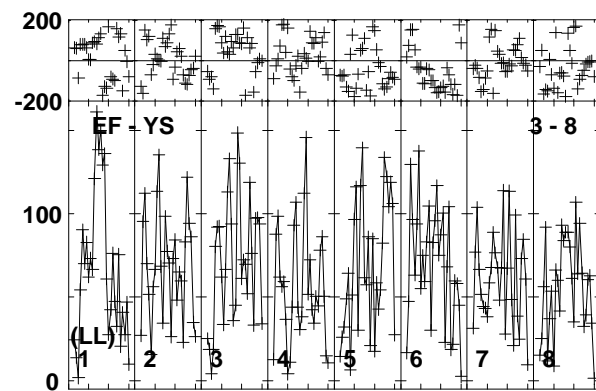
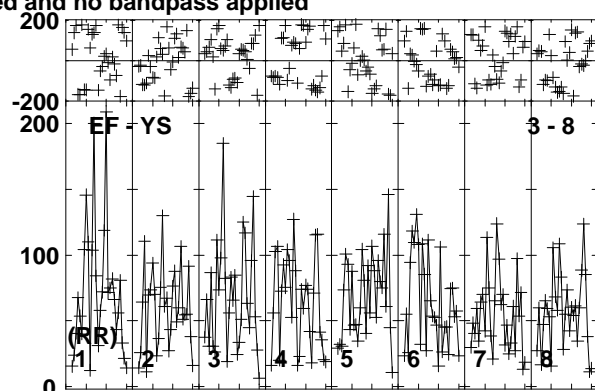
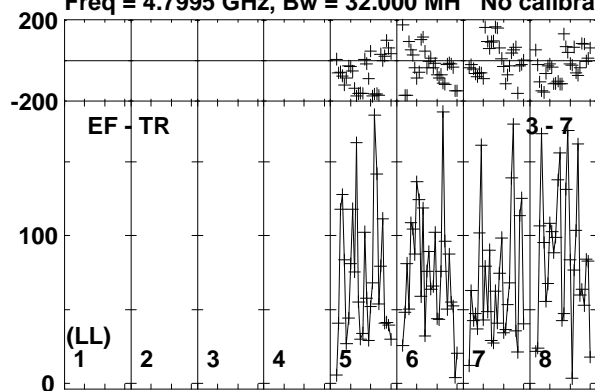

Lower frame: Micro Ampl Jy Top frame: Phas deg
Vector averaged cross-power spectrum Baseline: EF (03) - TR (07)
Timerange: 00/17:41:04 to 00/17:43:08

Plot file version 295 created 03-APR-2017 18:27:45

J1834-2341 EM126B.UVDATA.1

Freq = 4.7995 GHz, Bw = 32.000 MH No calibration applied and no bandpass applied

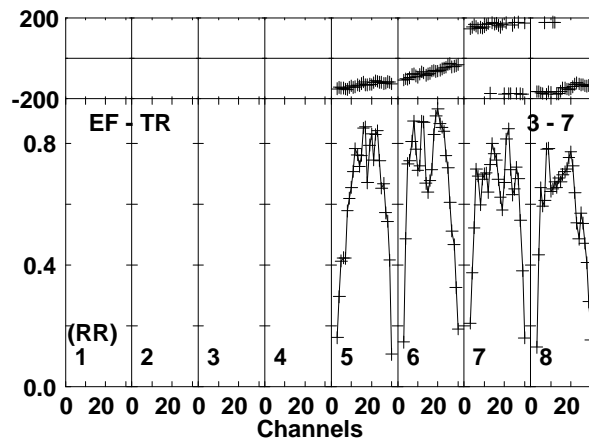
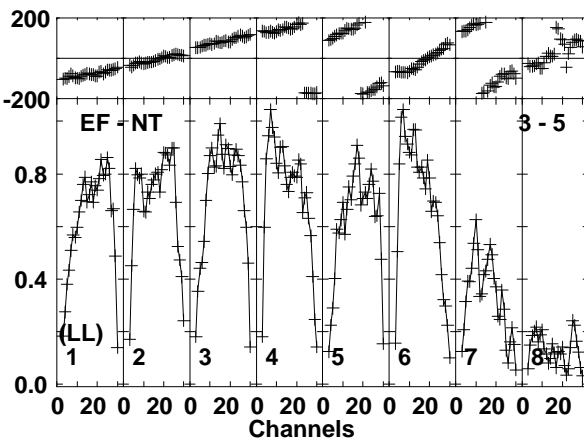
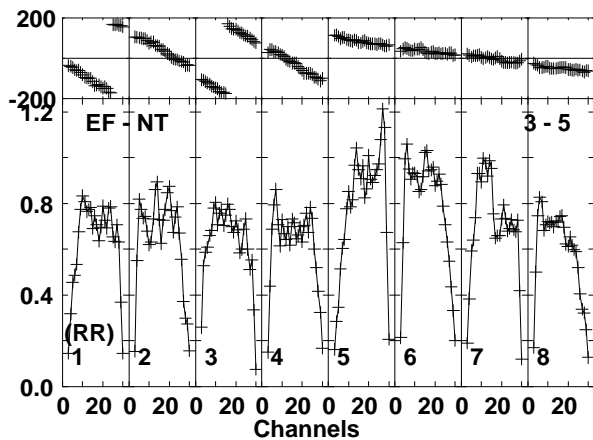
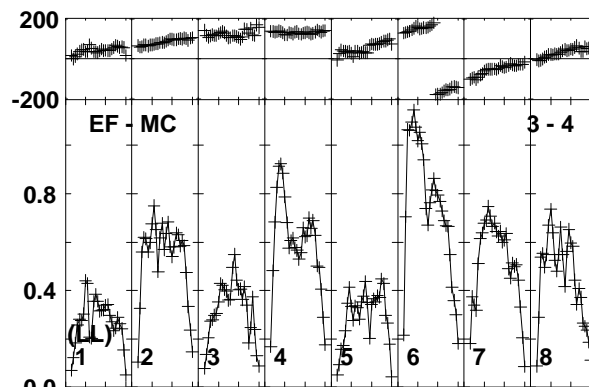
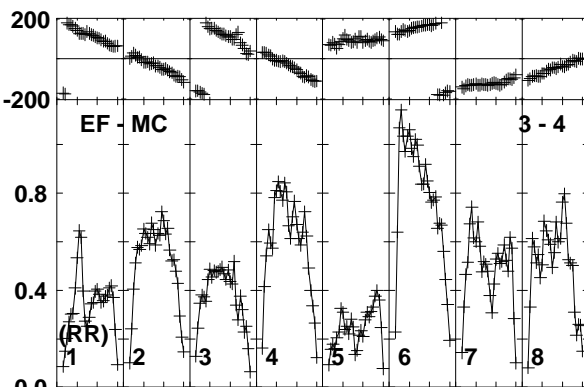
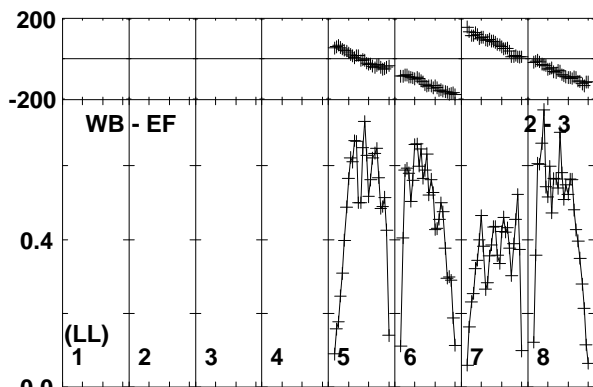
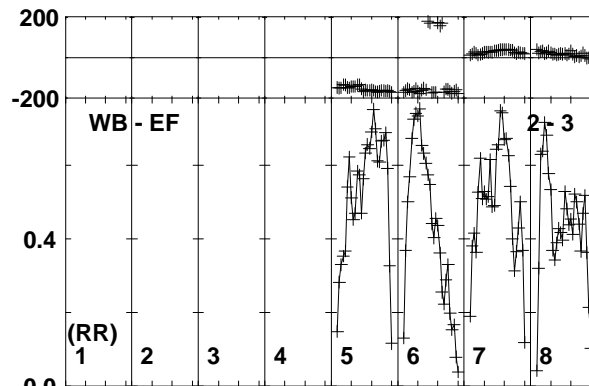
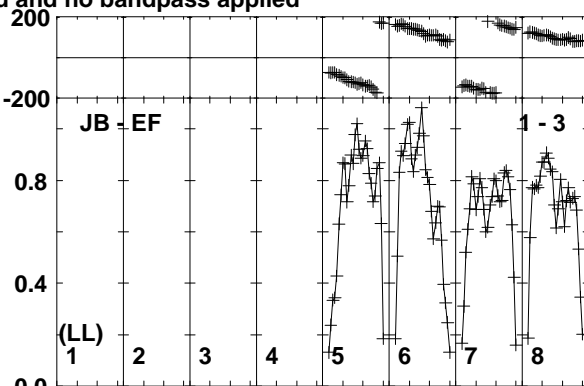
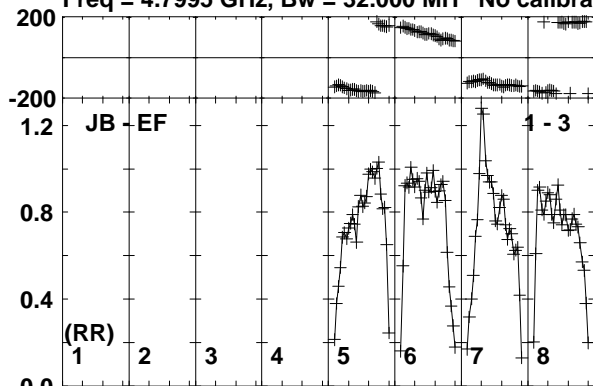

Lower frame: Milli Ampl Jy Top frame: Phas deg
Vector averaged cross-power spectrum Baseline: JB (01) - EF (03)
Timerange: 00:17:43:14 to 00:17:44:28

Plot file version 296 created 03-APR-2017 18:27:45

J1834-2341 EM126B.UVDATA.1

Freq = 4.7995 GHz, Bw = 32.000 MH No calibration applied and no bandpass applied

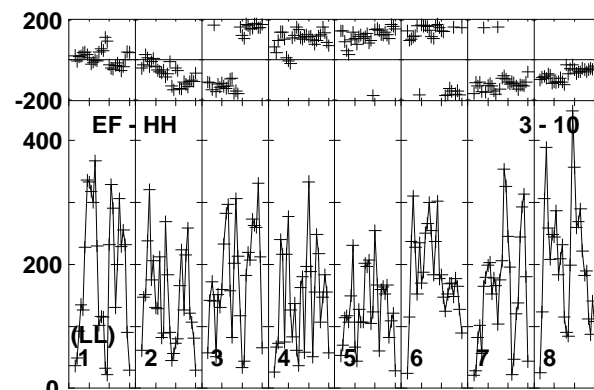
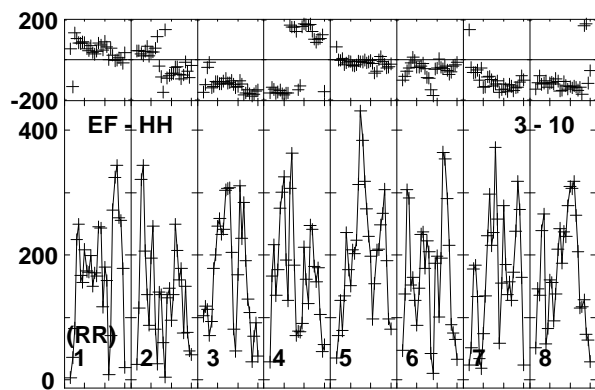
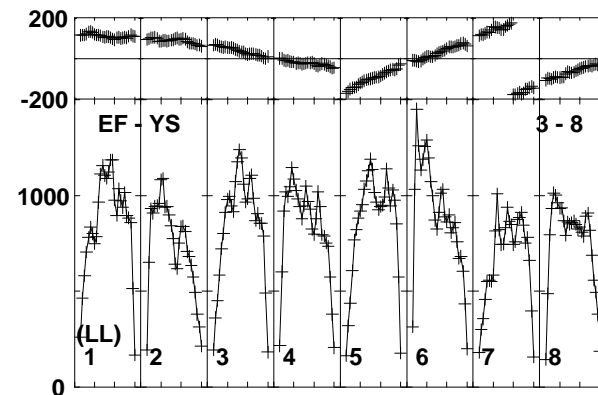
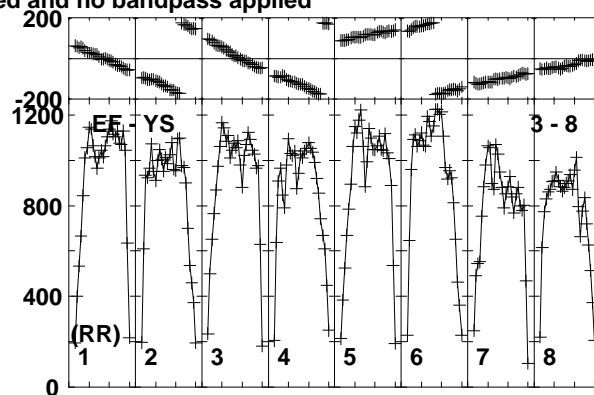
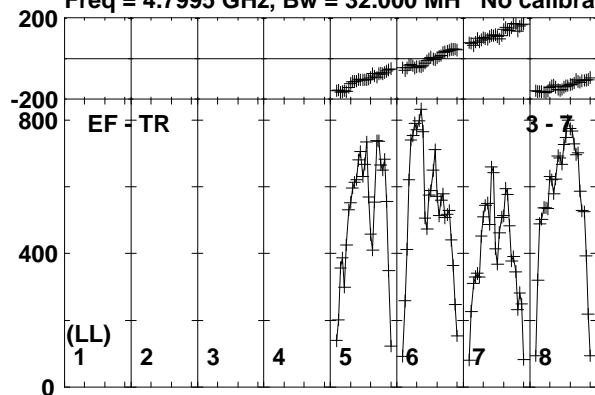

Lower frame: Micro Ampl Jy Top frame: Phas deg
Vector averaged cross-power spectrum Baseline: EF (03) - TR (07)
Timerange: 00/17:43:14 to 00/17:44:28

Plot file version 297 created 03-APR-2017 18:27:45

M22-VLA1 EM126B.UVDATA.1

Freq = 4.7995 GHz, Bw = 32.000 MH No calibration applied and no bandpass applied

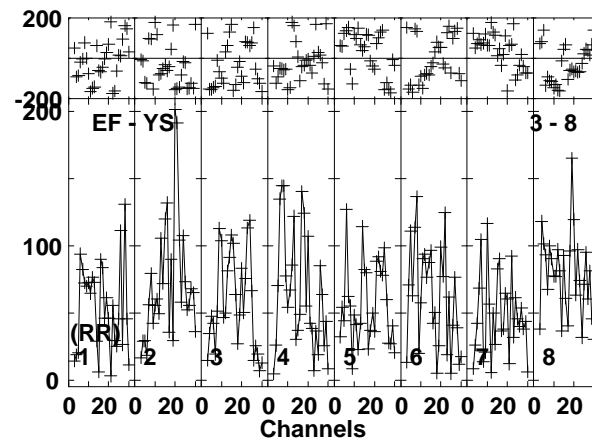
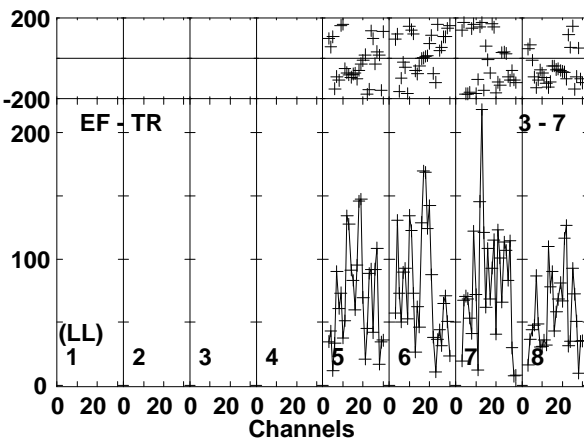
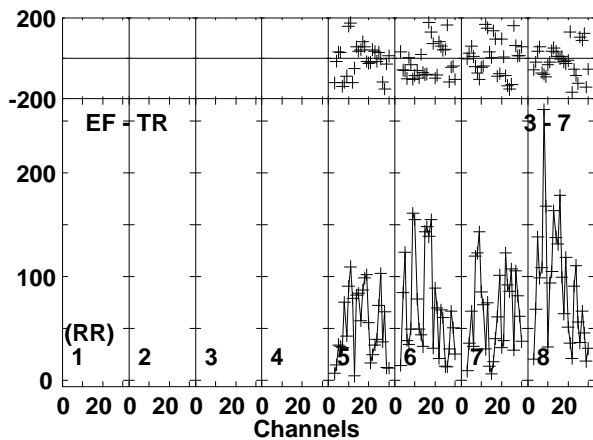
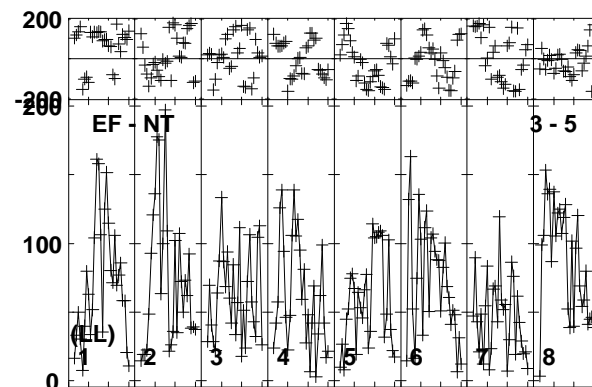
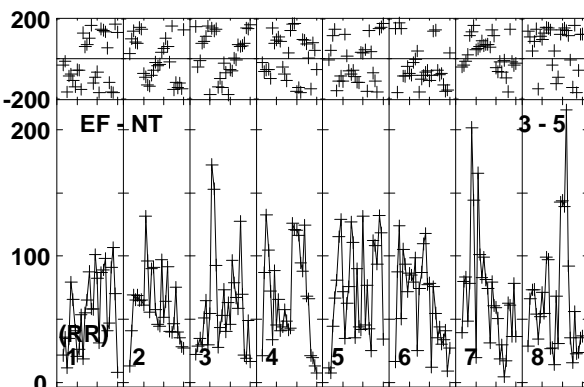
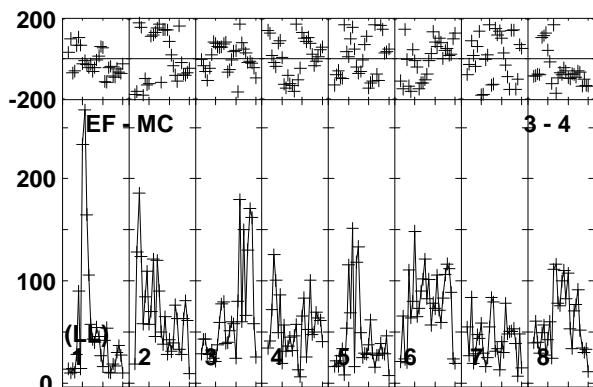
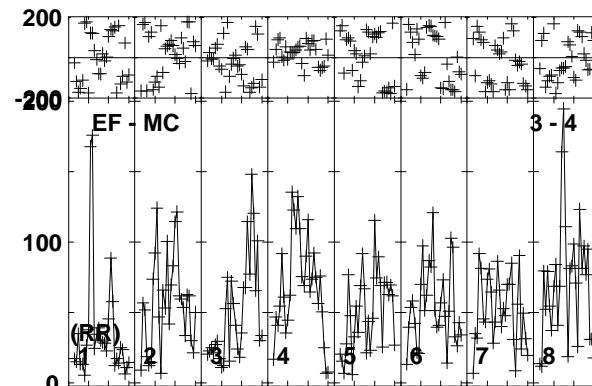
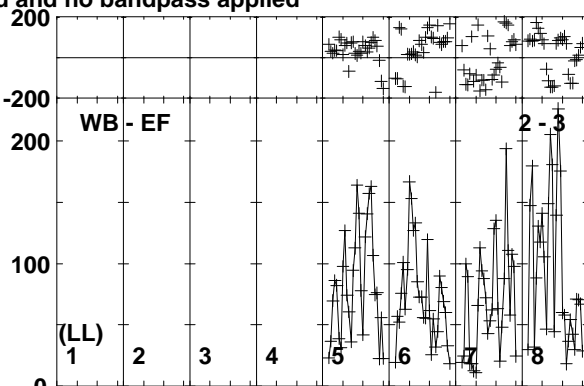
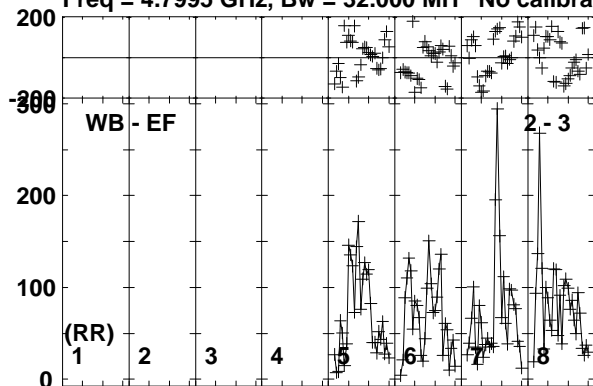

Lower frame: Micro Ampl Jy Top frame: Phas deg
Vector averaged cross-power spectrum Baseline: WB (02) - EF (03)
Timerange: 00/17:44:34 to 00/17:46:38

Plot file version 298 created 03-APR-2017 18:27:45

M22-VLA1 EM126B.UVDATA.1

Freq = 4.7995 GHz, Bw = 32.000 MH No calibration applied and no bandpass applied

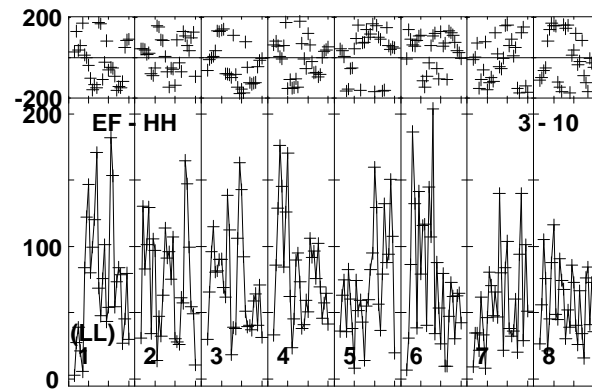
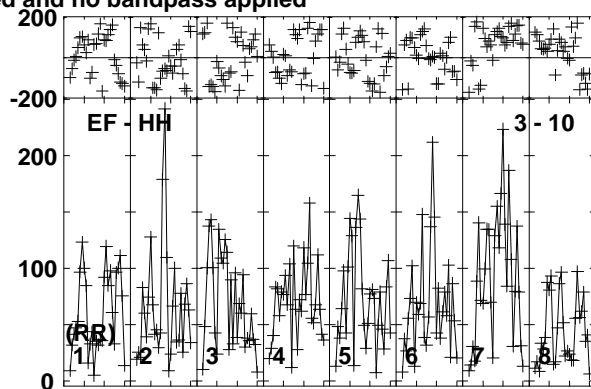
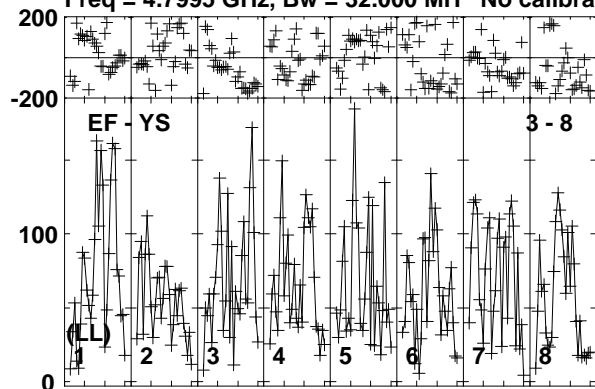

Lower frame: Micro Ampl Jy Top frame: Phas deg
Vector averaged cross-power spectrum Baseline: EF (03) - YS (08)
Timerange: 00/17:44:34 to 00/17:46:38

Plot file version 299 created 03-APR-2017 18:27:46

J1834-2341 EM126B.UVDATA.1

Freq = 4.7995 GHz, Bw = 32.000 MH No calibration applied and no bandpass applied

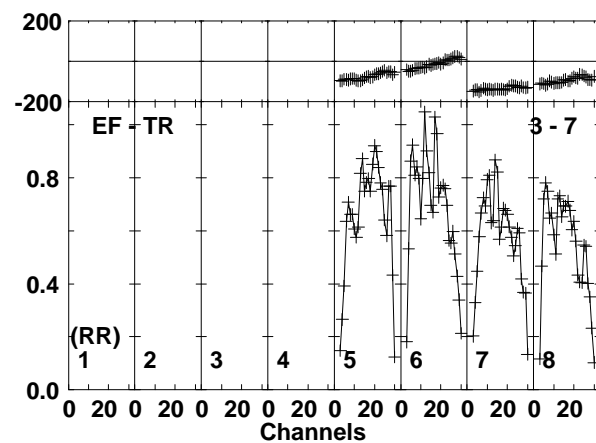
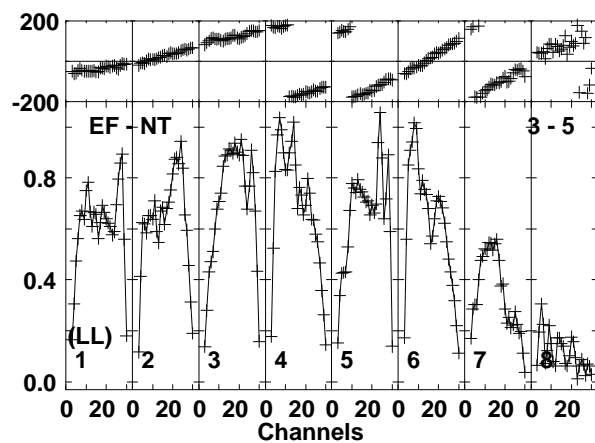
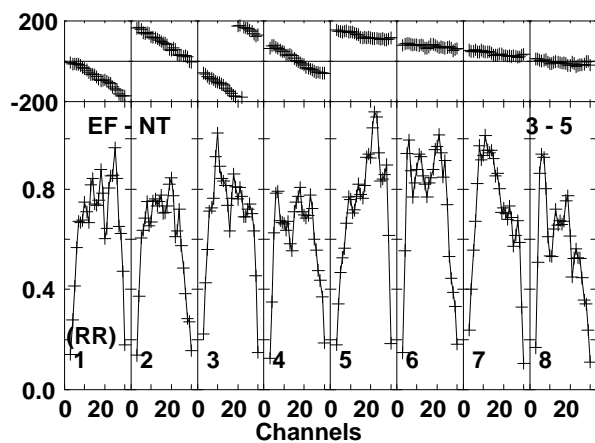
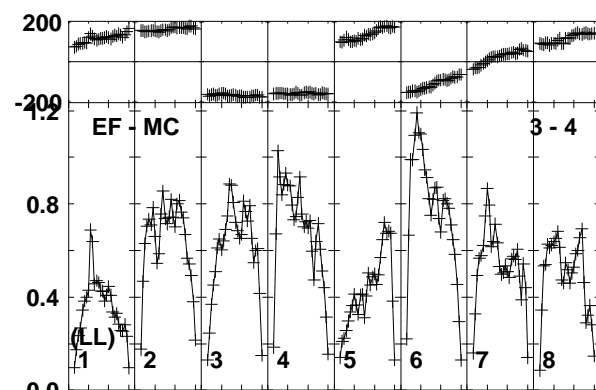
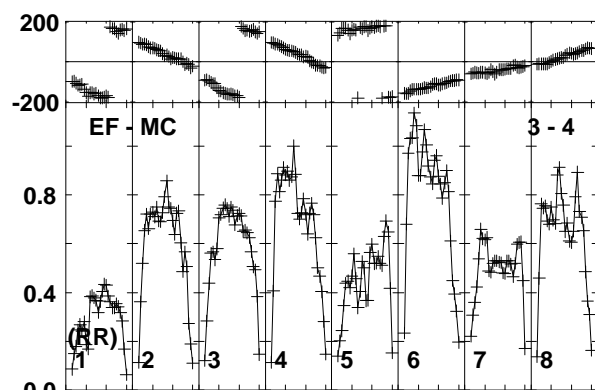
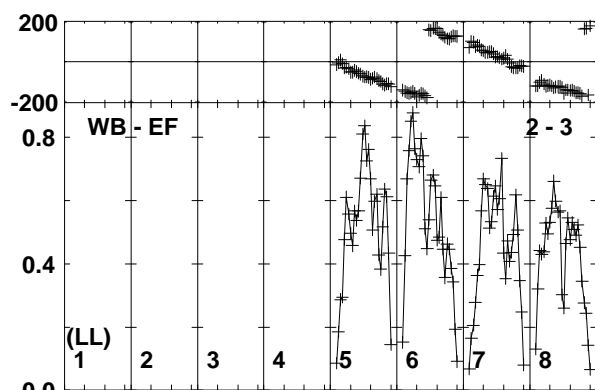
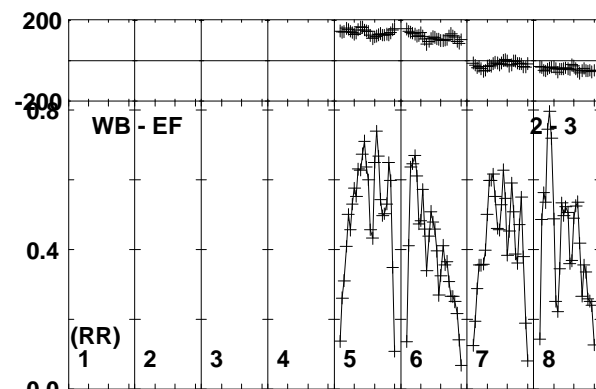
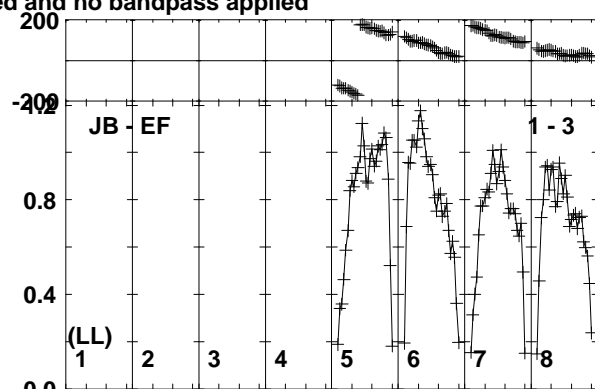
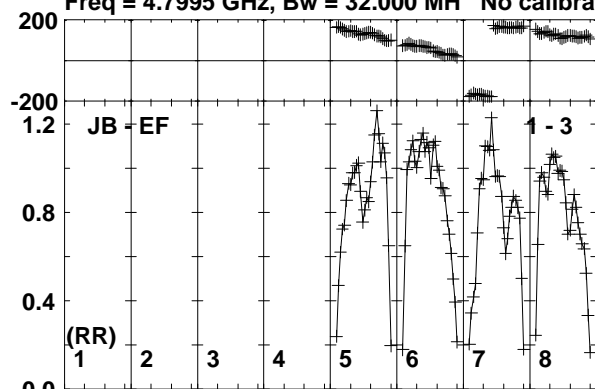

Lower frame: Milli Ampl Jy Top frame: Phas deg
Vector averaged cross-power spectrum Baseline: JB (01) - EF (03)
Timerange: 00:17:46:44 to 00:17:47:58

Plot file version 300 created 03-APR-2017 18:27:46

J1834-2341 EM126B.UVDATA.1

Freq = 4.7995 GHz, Bw = 32.000 MH No calibration applied and no bandpass applied

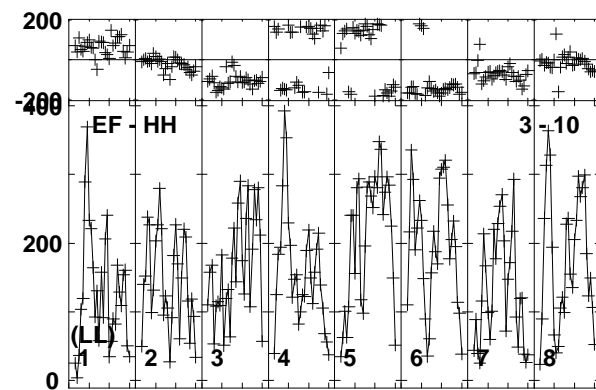
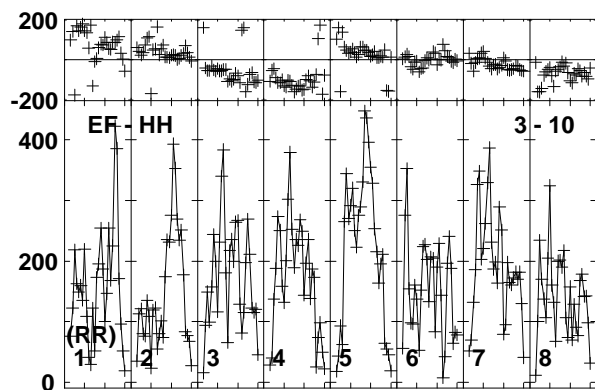
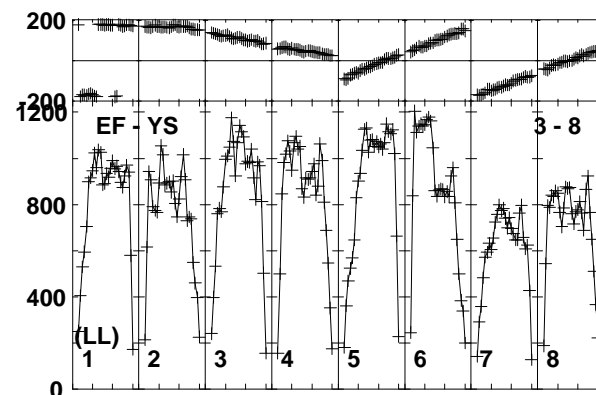
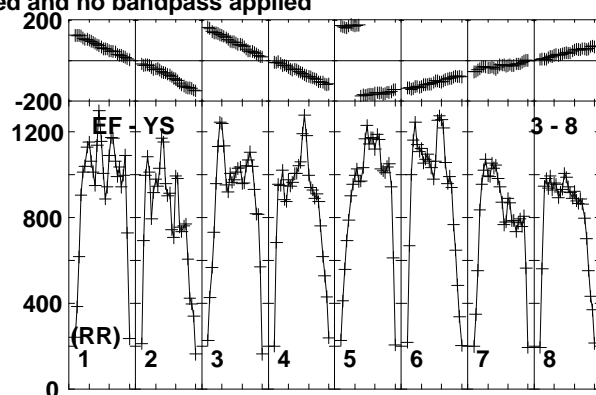
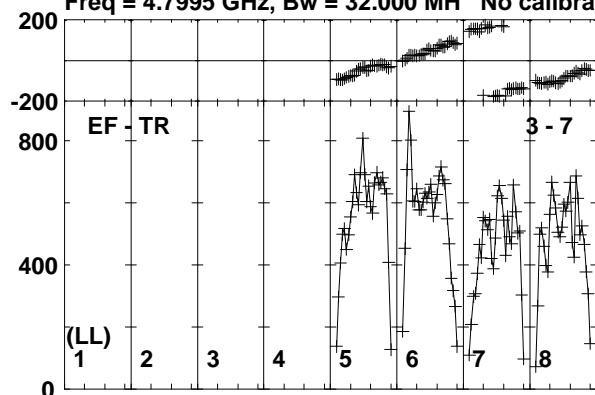

Lower frame: Micro Ampl Jy Top frame: Phas deg
Vector averaged cross-power spectrum Baseline: EF (03) - TR (07)
Timerange: 00/17:46:44 to 00/17:47:58

Plot file version 301 created 03-APR-2017 18:27:46

M22-VLA1 EM126B.UVDATA.1

Freq = 4.7995 GHz, Bw = 32.000 MH No calibration applied and no bandpass applied

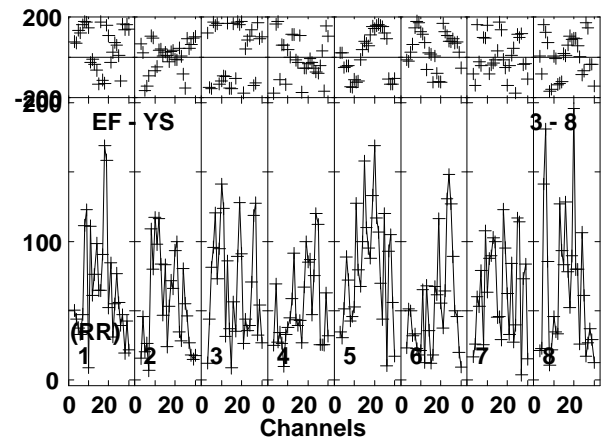
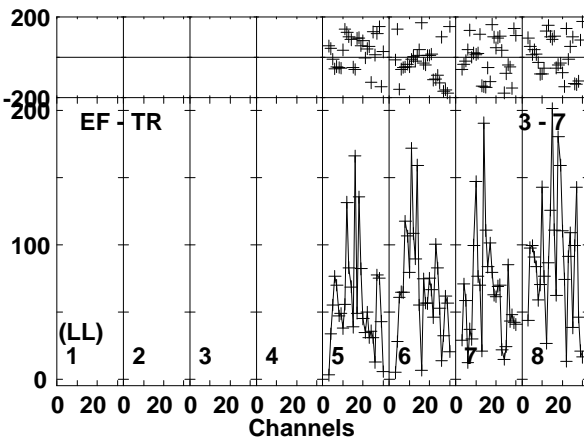
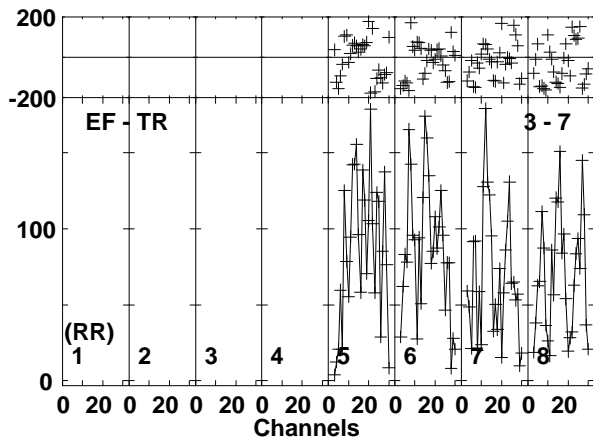
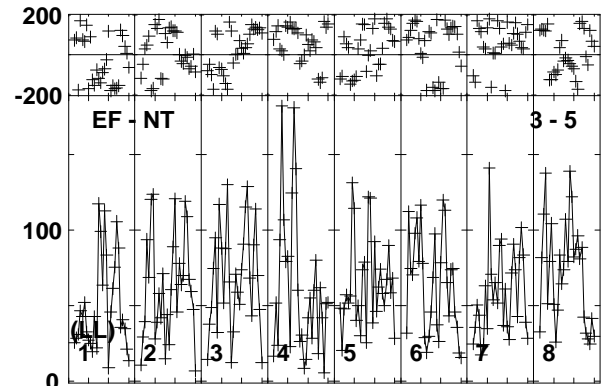
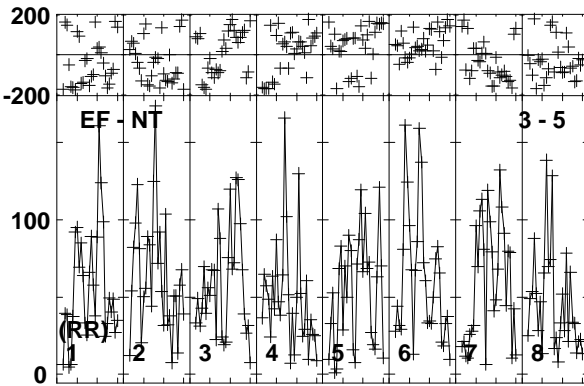
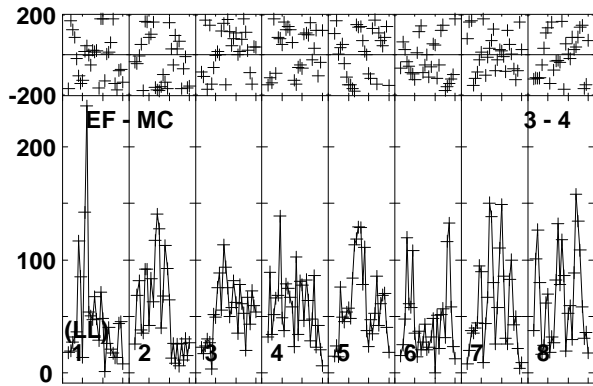
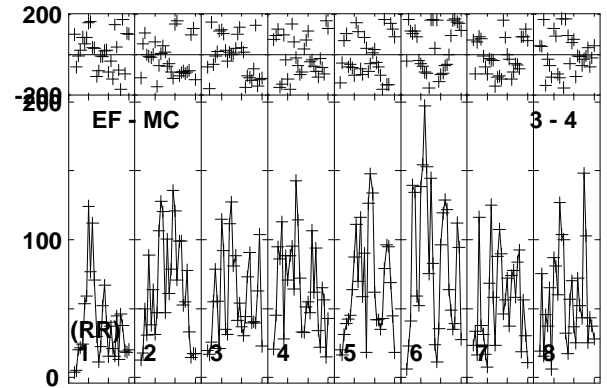
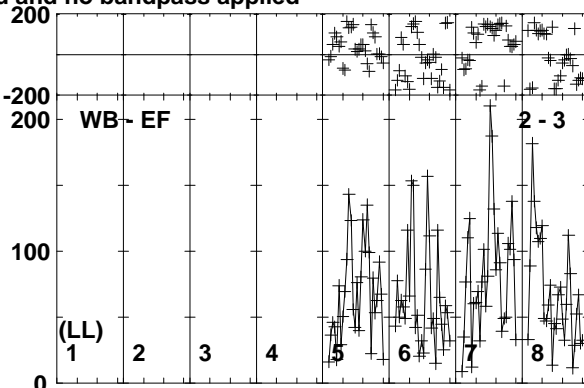
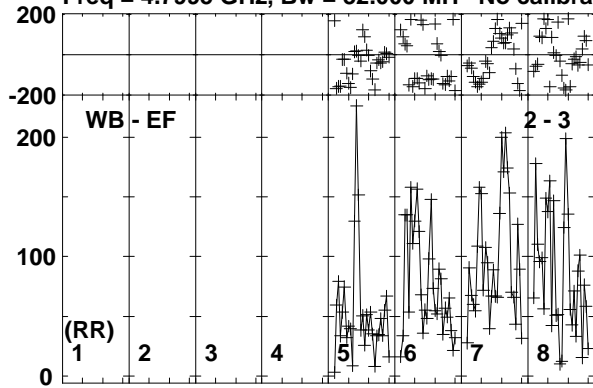

Lower frame: Micro Ampl Jy Top frame: Phas deg
Vector averaged cross-power spectrum Baseline: WB (02) - EF (03)
Timerange: 00/17:48:04 to 00/17:50:08

Plot file version 302 created 03-APR-2017 18:27:46

M22-VLA1 EM126B.UVDATA.1

Freq = 4.7995 GHz, Bw = 32.000 MH No calibration applied and no bandpass applied

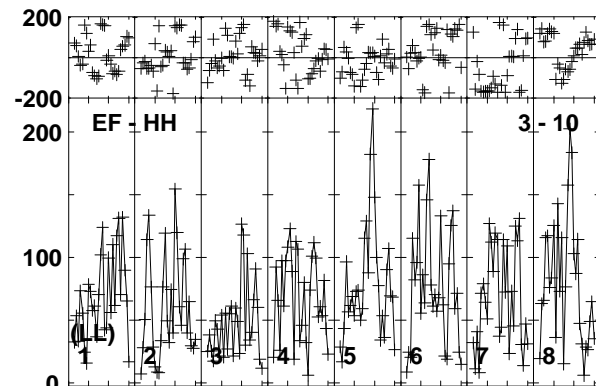
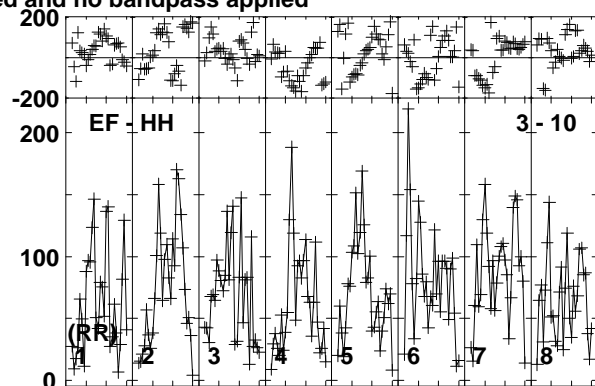
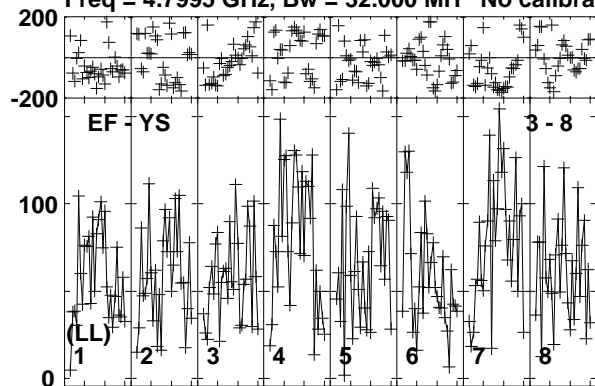

Lower frame: Micro Ampl Jy Top frame: Phas deg
Vector averaged cross-power spectrum Baseline: EF (03) - YS (08)
Timerange: 00/17:48:04 to 00/17:50:08

Plot file version 303 created 03-APR-2017 18:27:46

J1834-2341 EM126B.UVDATA.1

Freq = 4.7995 GHz, Bw = 32.000 MH No calibration applied and no bandpass applied

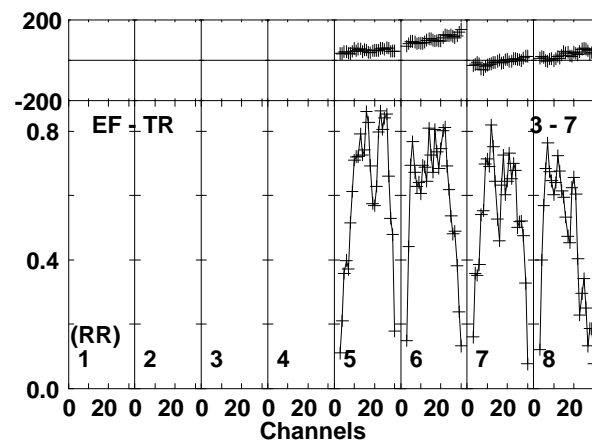
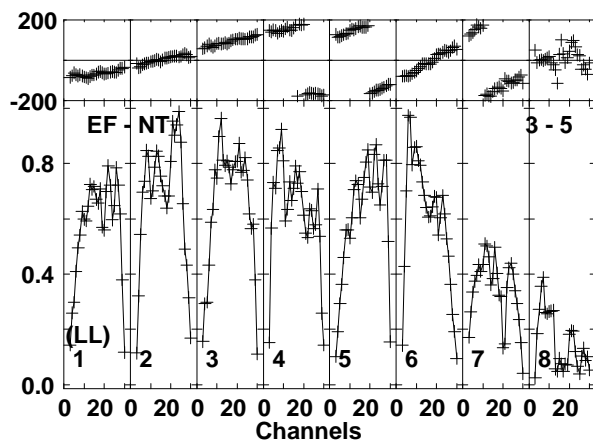
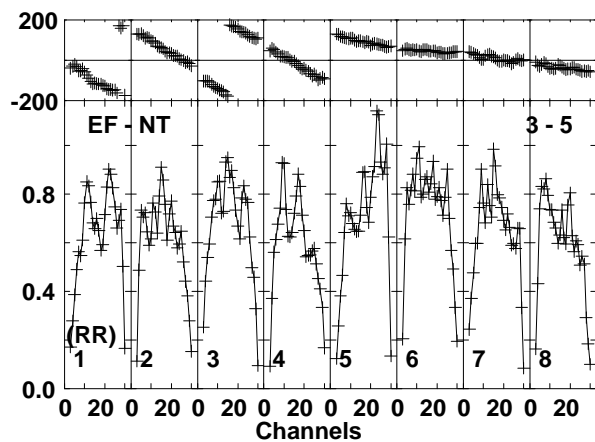
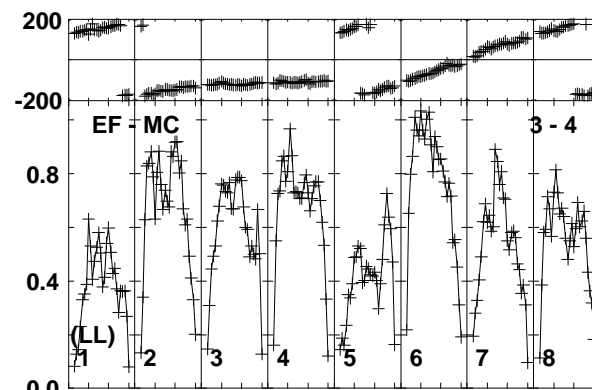
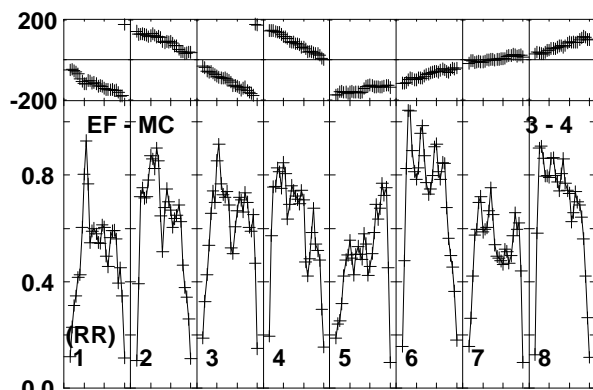
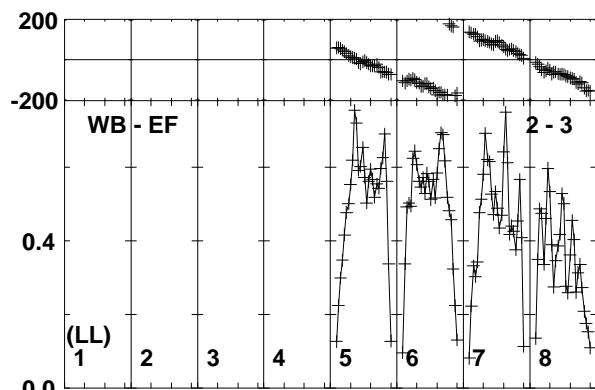
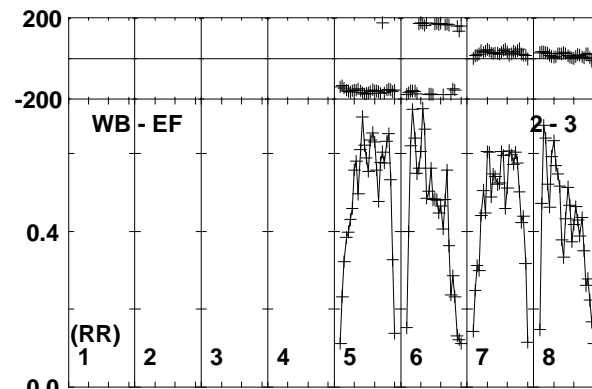
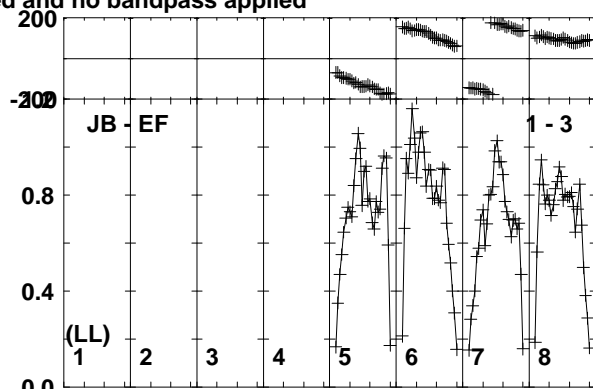
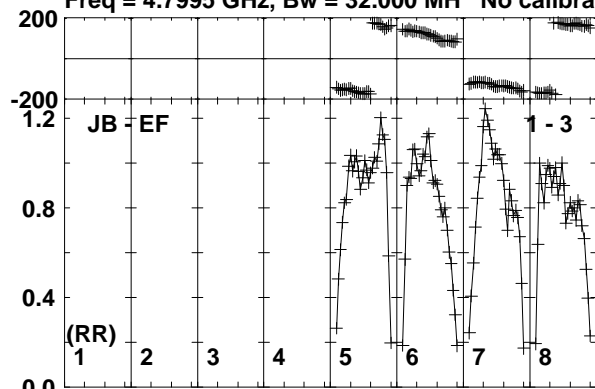

Lower frame: Milli Ampl Jy Top frame: Phas deg
Vector averaged cross-power spectrum Baseline: JB (01) - EF (03)
Timerange: 00/17:50:41 to 00/17:51:29

Plot file version 304 created 03-APR-2017 18:27:46

J1834-2341 EM126B.UVDATA.1

Freq = 4.7995 GHz, Bw = 32.000 MH No calibration applied and no bandpass applied

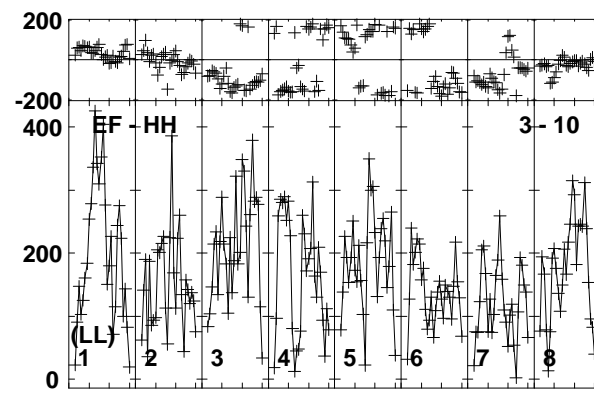
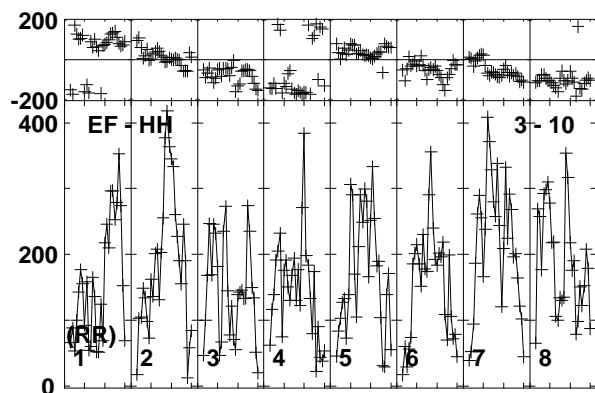
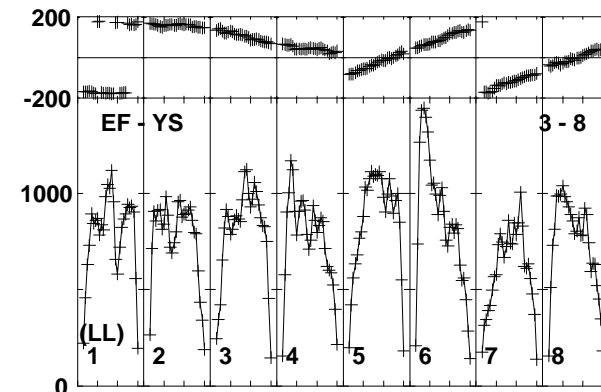
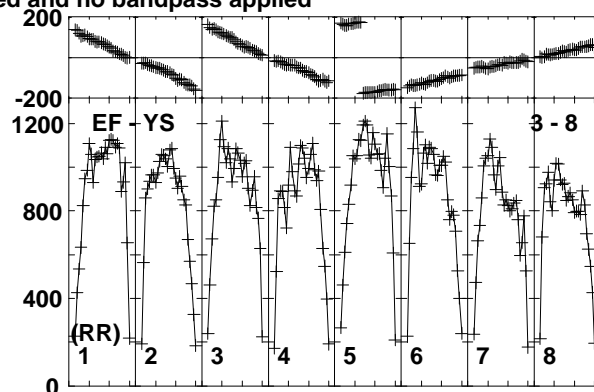
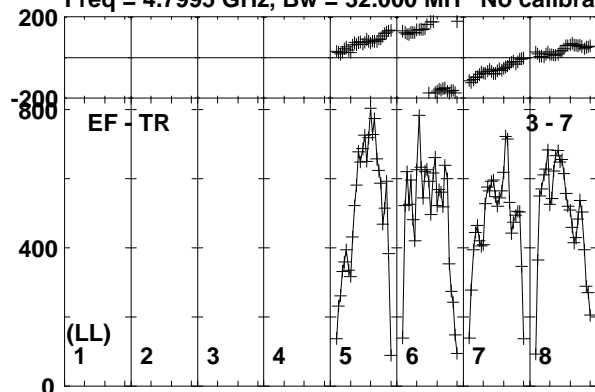

Lower frame: Micro Ampl Jy Top frame: Phas deg
Vector averaged cross-power spectrum Baseline: EF (03) - TR (07)
Timerange: 00:17:50:41 to 00:17:51:29

Plot file version 305 created 03-APR-2017 18:27:46

M22-VLA1 EM126B.UVDATA.1

Freq = 4.7995 GHz, Bw = 32.000 MH No calibration applied and no bandpass applied

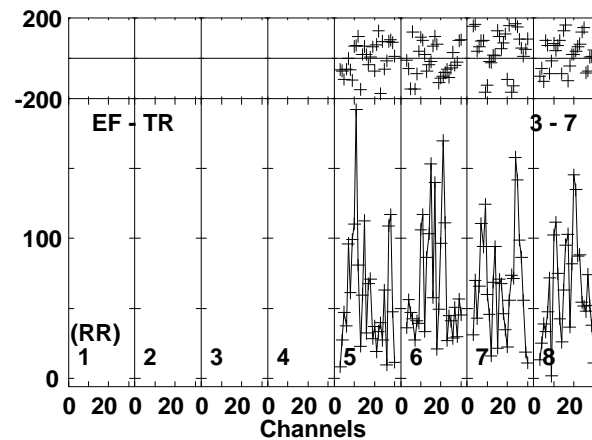
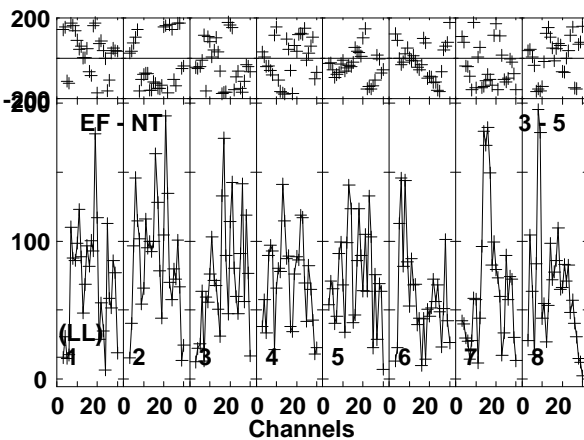
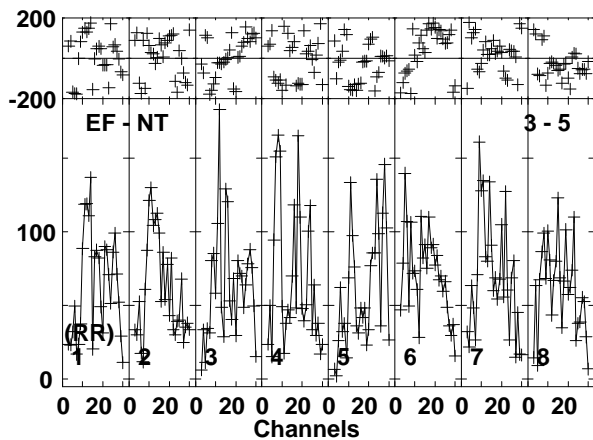
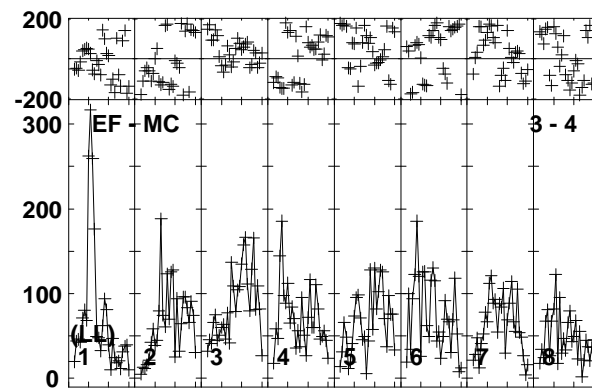
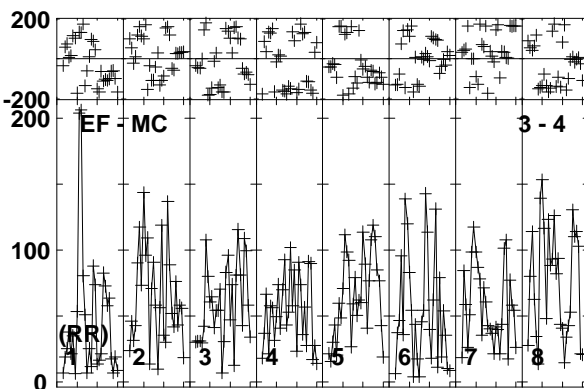
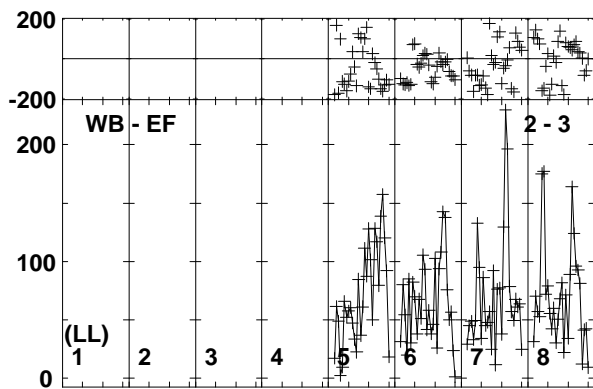
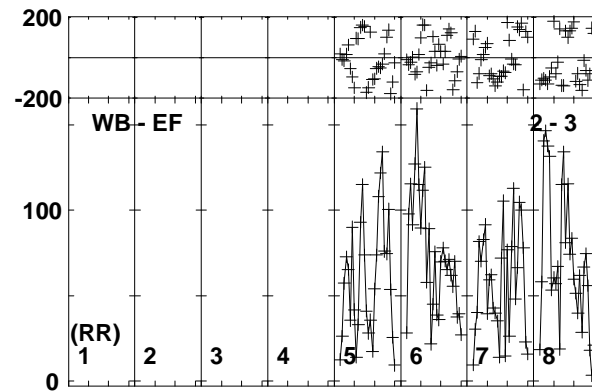
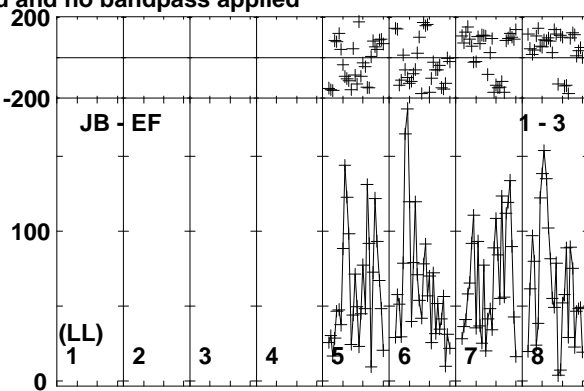
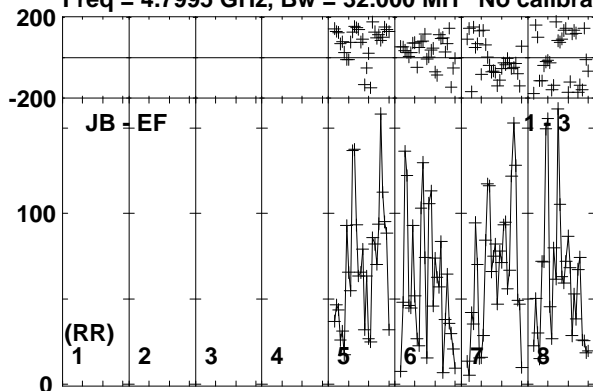

Lower frame: Micro Ampl Jy Top frame: Phas deg
Vector averaged cross-power spectrum Baseline: JB (01) - EF (03)
Timerange: 00/17:51:34 to 00/17:53:38

Plot file version 306 created 03-APR-2017 18:27:46

M22-VLA1 EM126B.UVDATA.1

Freq = 4.7995 GHz, Bw = 32.000 MH No calibration applied and no bandpass applied

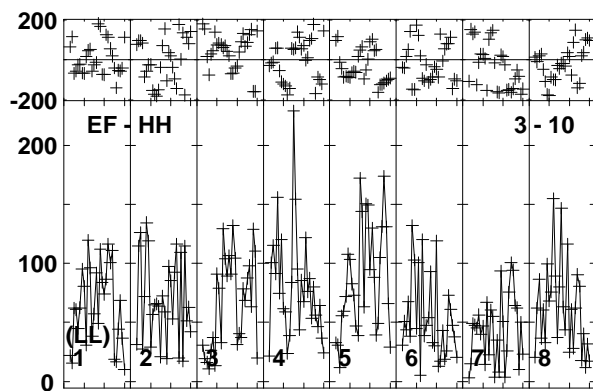
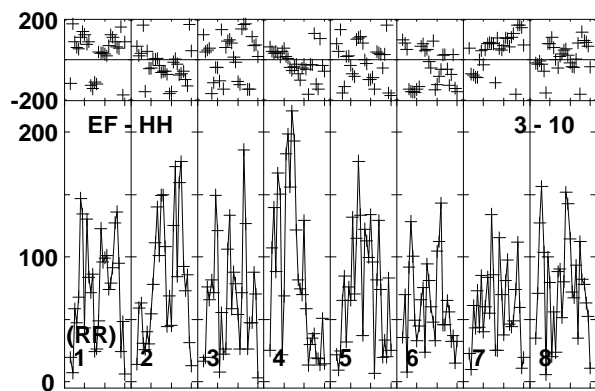
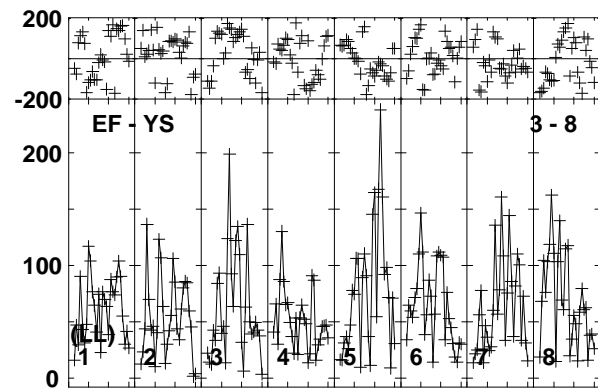
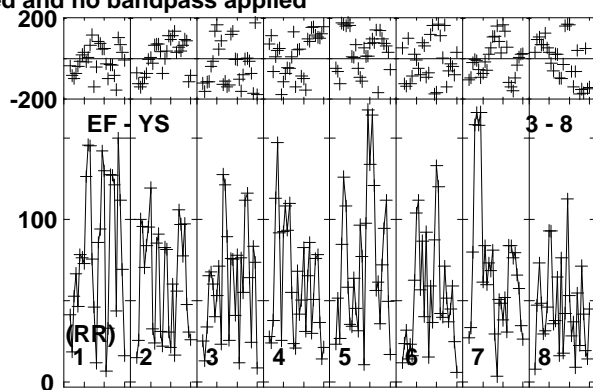
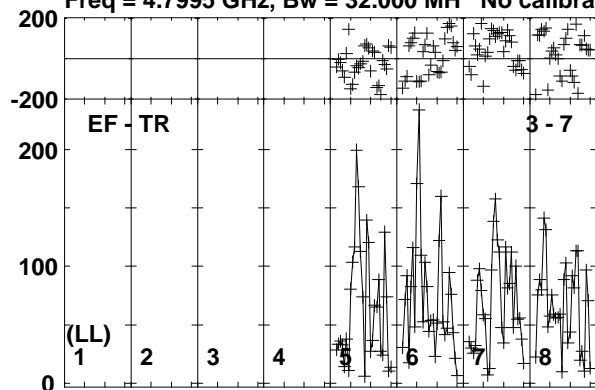

Lower frame: Micro Ampl Jy Top frame: Phas deg
Vector averaged cross-power spectrum Baseline: EF (03) - TR (07)
Timerange: 00:17:51:34 to 00:17:53:38

Plot file version 307 created 03-APR-2017 18:27:46

J1834-2341 EM126B.UVDATA.1

Freq = 4.7995 GHz, Bw = 32.000 MH No calibration applied and no bandpass applied

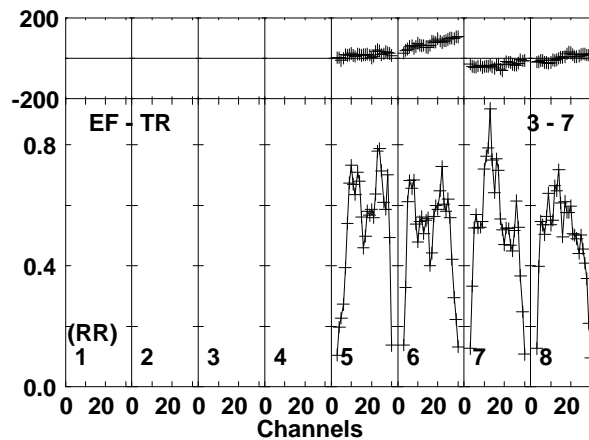
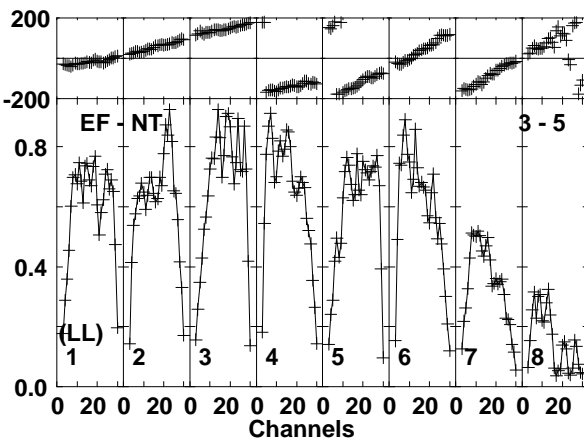
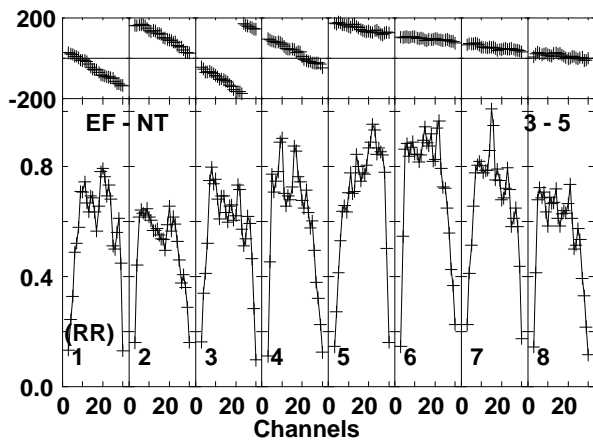
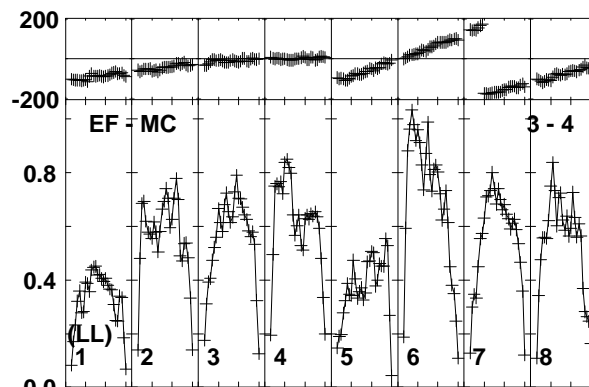
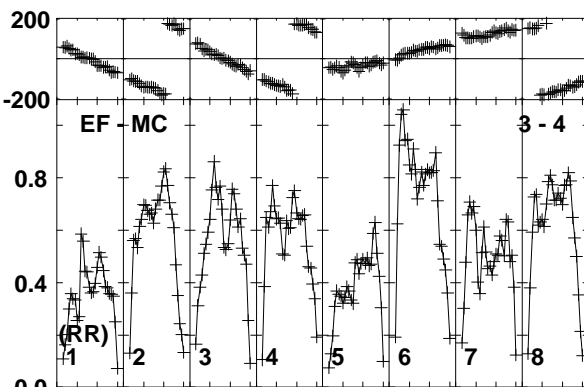
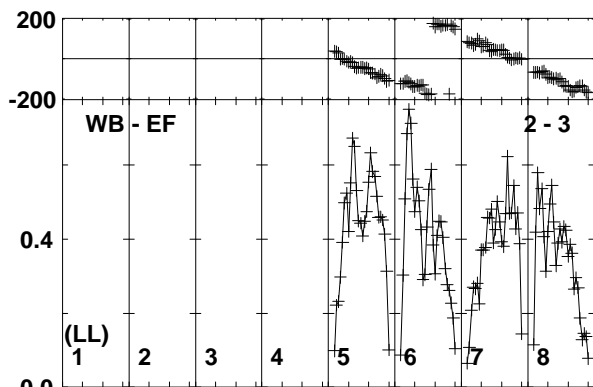
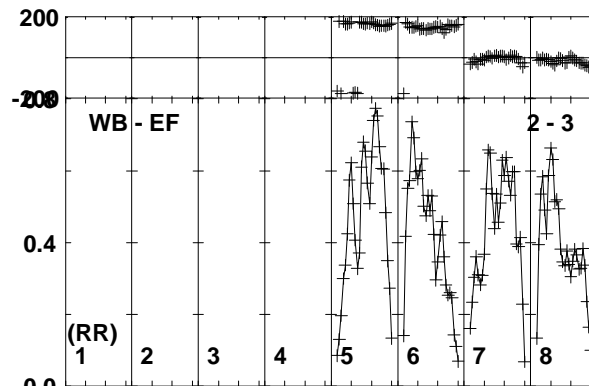
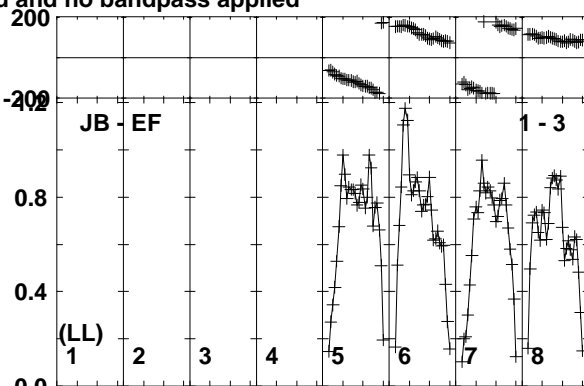
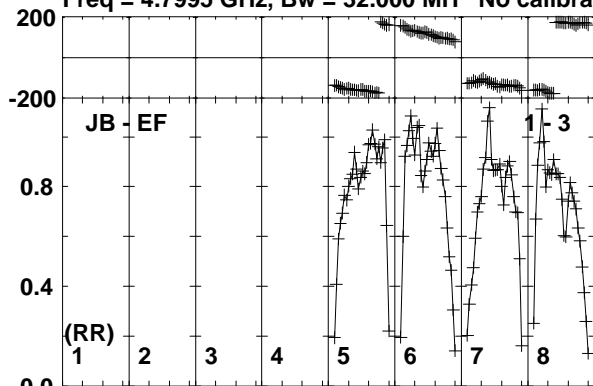

Lower frame: Milli Ampl Jy Top frame: Phas deg
Vector averaged cross-power spectrum Baseline: JB (01) - EF (03)
Timerange: 00:17:53:44 to 00:17:54:58

Plot file version 308 created 03-APR-2017 18:27:46

J1834-2341 EM126B.UVDATA.1

Freq = 4.7995 GHz, Bw = 32.000 MH No calibration applied and no bandpass applied

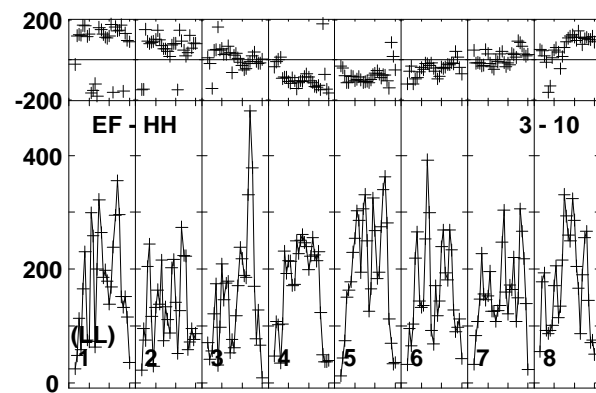
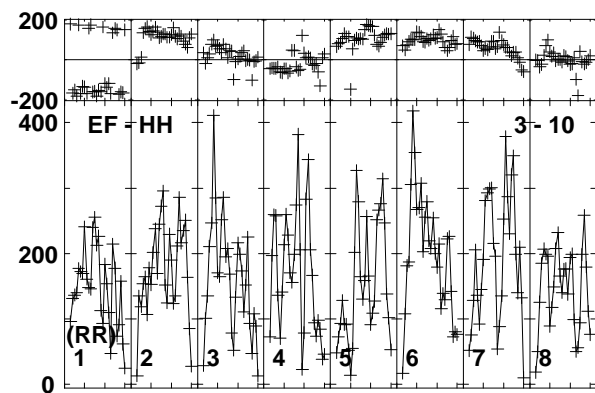
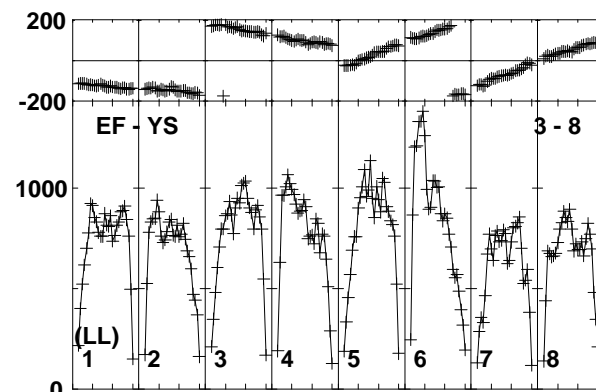
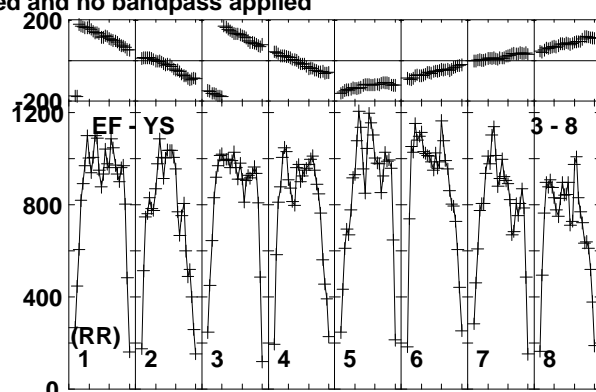
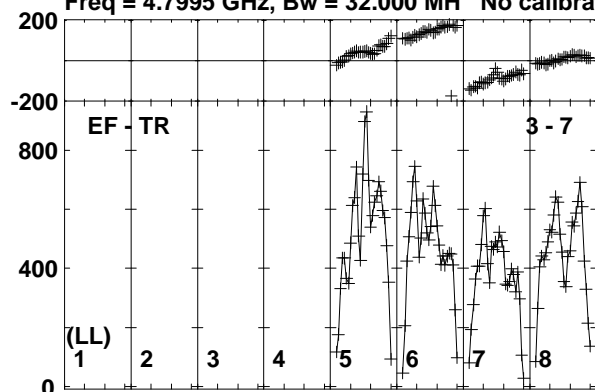

Lower frame: Micro Ampl Jy Top frame: Phas deg
Vector averaged cross-power spectrum Baseline: EF (03) - TR (07)
Timerange: 00/17:53:44 to 00/17:54:58

Plot file version 309 created 03-APR-2017 18:27:46

M22-VLA1 EM126B.UVDATA.1

Freq = 4.7995 GHz, Bw = 32.000 MH No calibration applied and no bandpass applied

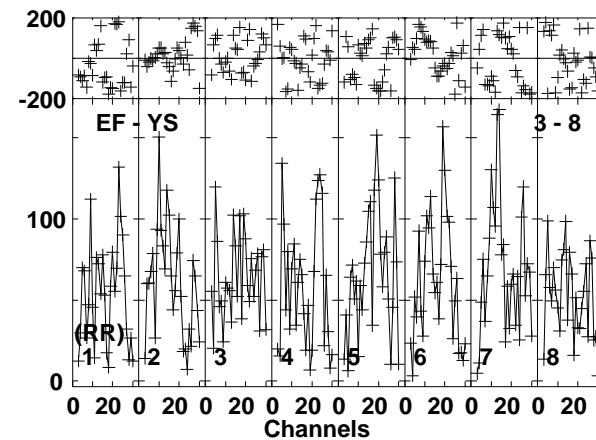
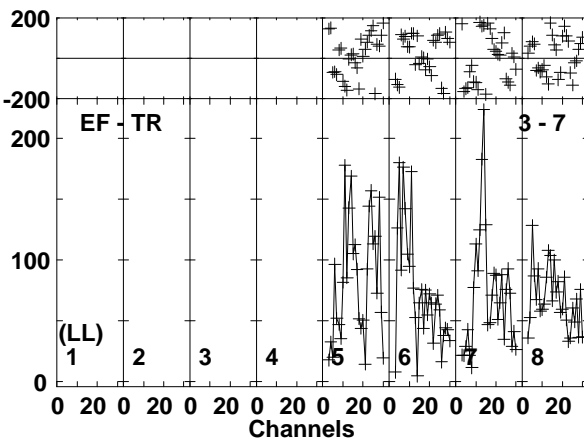
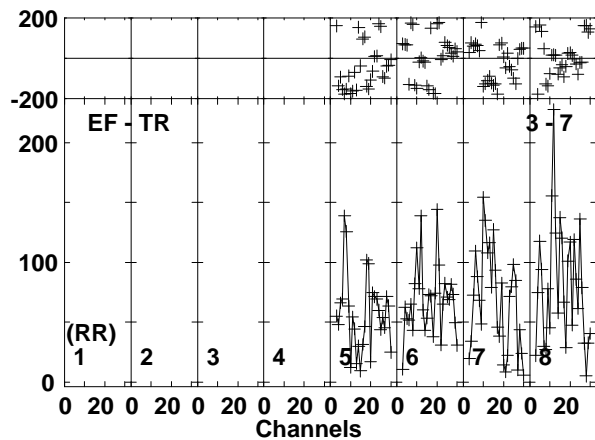
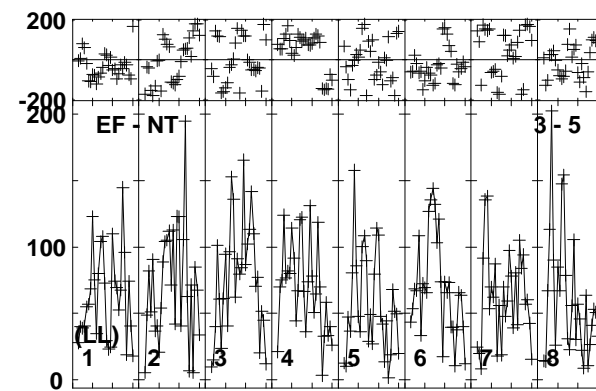
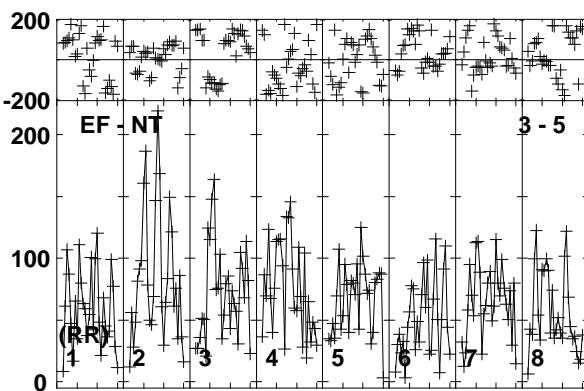
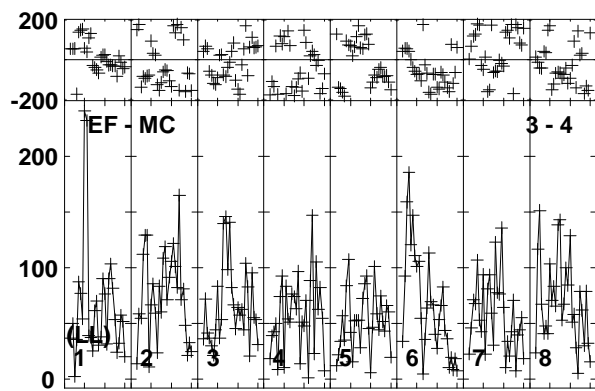
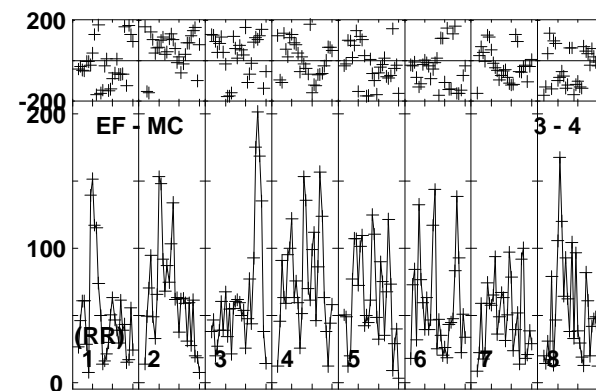
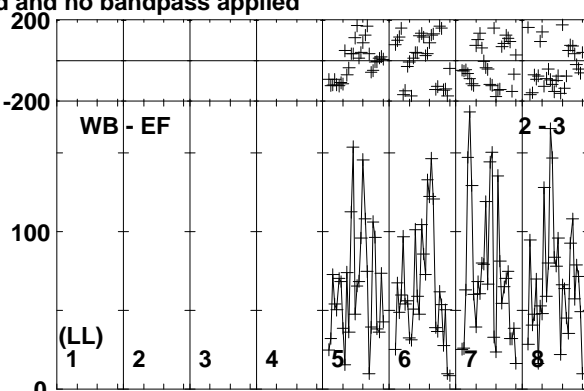
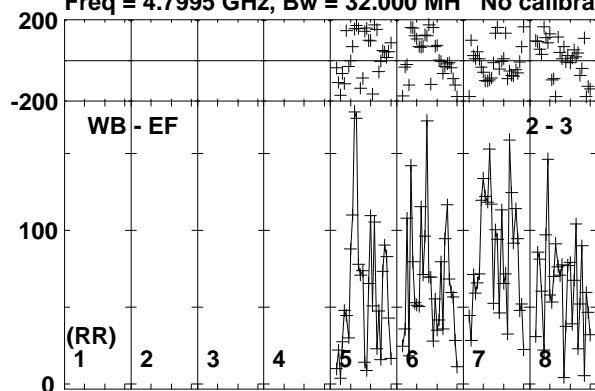

Lower frame: Micro Ampl Jy Top frame: Phas deg
Vector averaged cross-power spectrum Baseline: WB (02) - EF (03)
Timerange: 00/17:55:04 to 00/17:57:08

Plot file version 310 created 03-APR-2017 18:27:46

M22-VLA1 EM126B.UVDATA.1

Freq = 4.7995 GHz, Bw = 32.000 MH No calibration applied and no bandpass applied

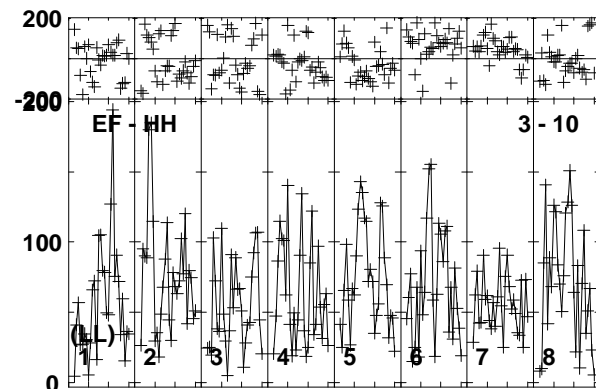
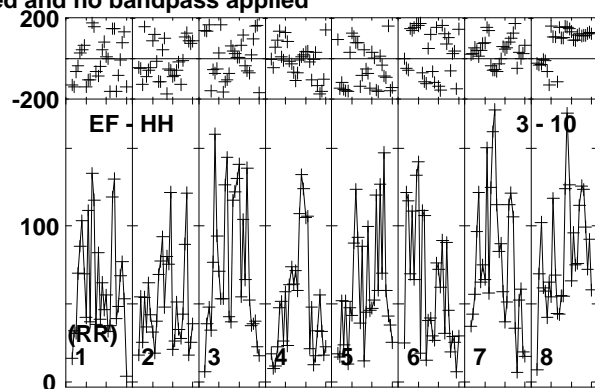
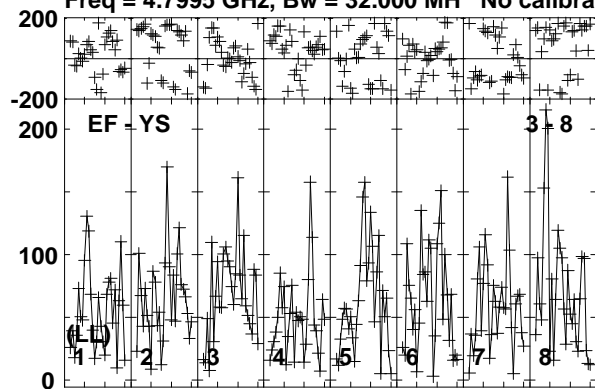

Lower frame: Micro Ampl Jy Top frame: Phas deg
Vector averaged cross-power spectrum Baseline: EF (03) - YS (08)
Timerange: 00/17:55:04 to 00/17:57:08

Plot file version 311 created 03-APR-2017 18:27:46

J1834-2341 EM126B.UVDATA.1

Freq = 4.7995 GHz, Bw = 32.000 MH No calibration applied and no bandpass applied

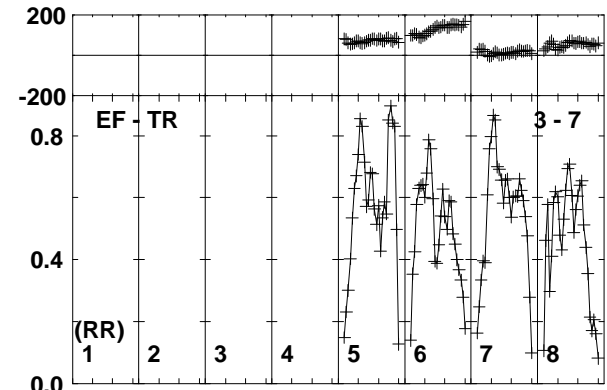
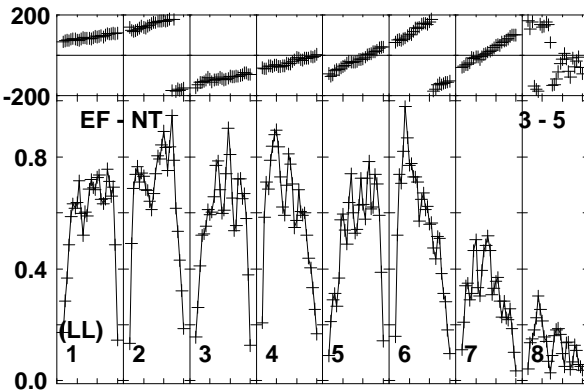
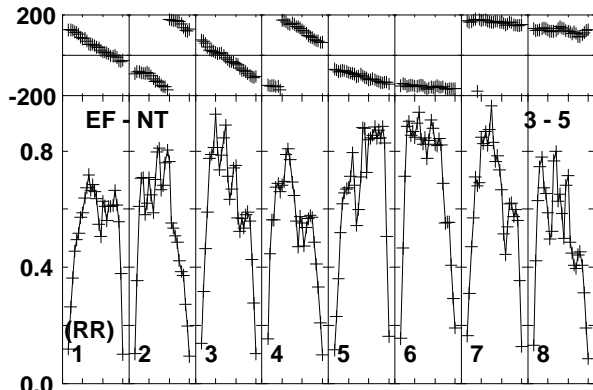
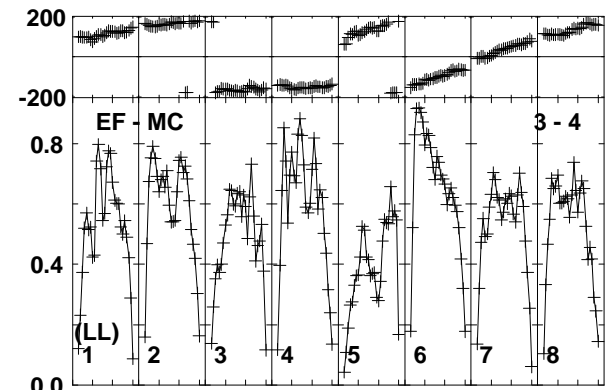
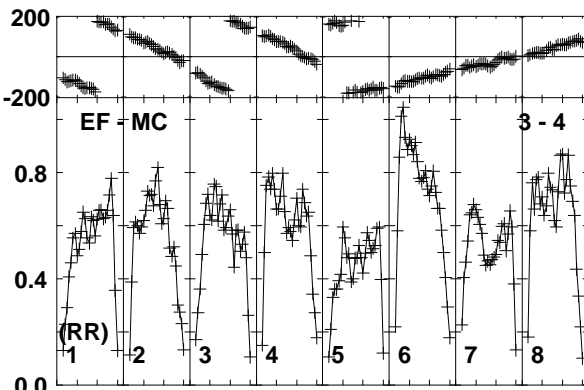
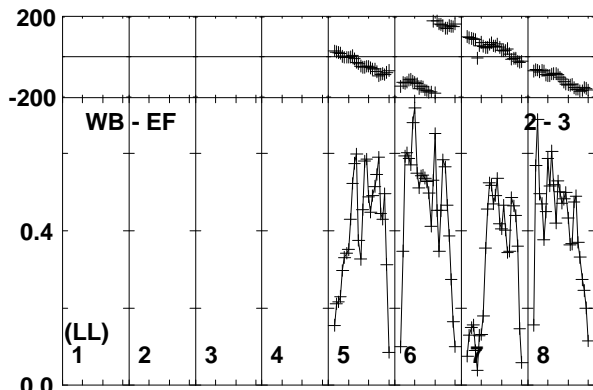
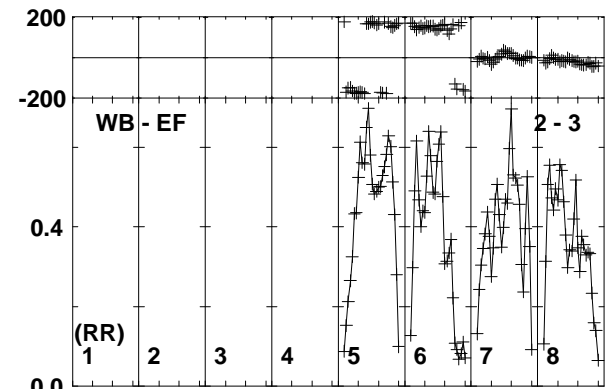
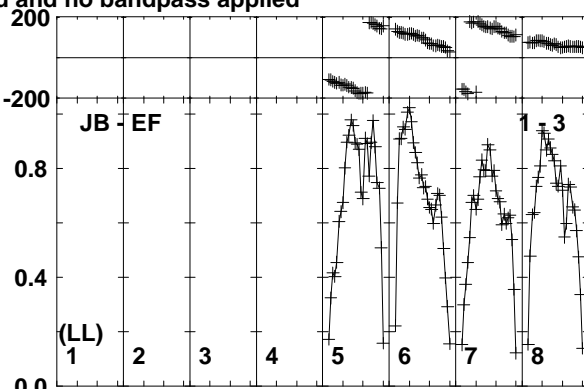
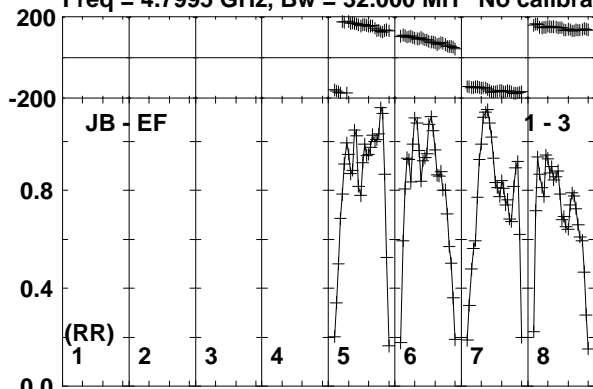

Lower frame: Milli Ampl Jy Top frame: Phas deg
Vector averaged cross-power spectrum Baseline: JB (01) - EF (03)
Timerange: 00/17:57:14 to 00/17:58:28

Plot file version 312 created 03-APR-2017 18:27:46

J1834-2341 EM126B.UVDATA.1

Freq = 4.7995 GHz, Bw = 32.000 MH No calibration applied and no bandpass applied

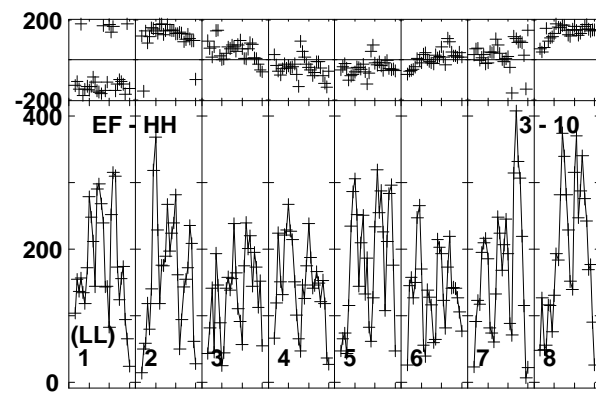
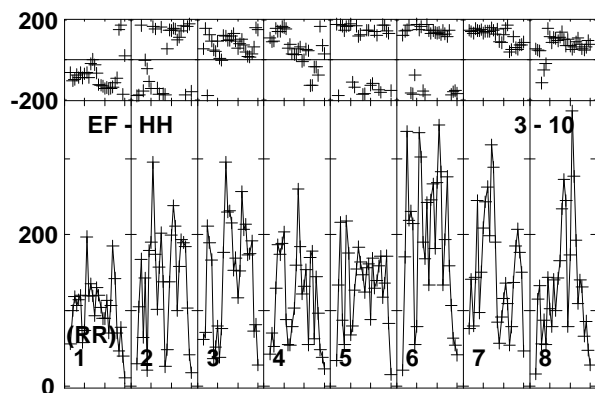
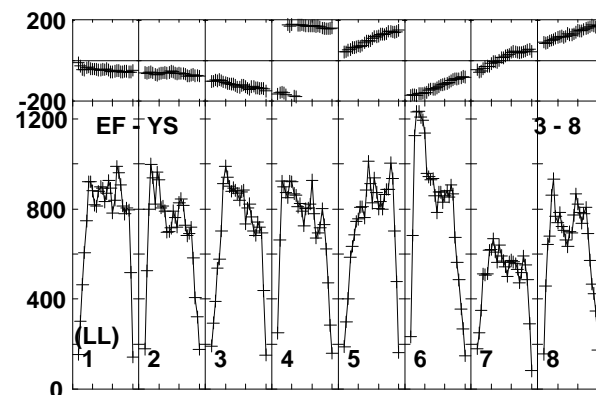
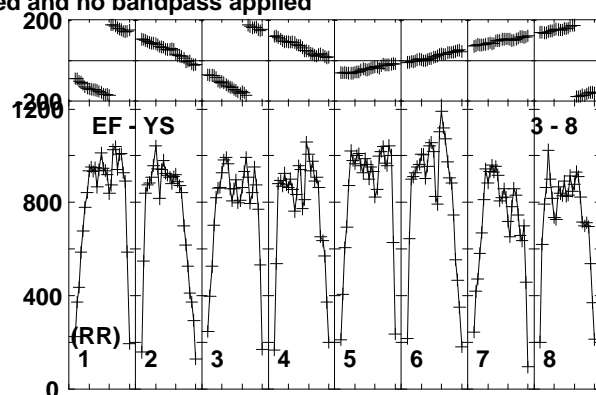
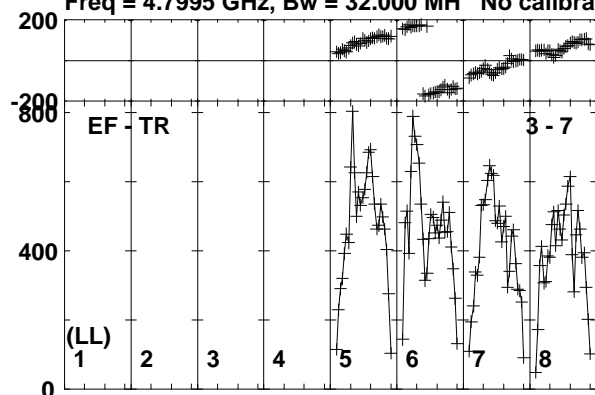

Lower frame: Micro Ampl Jy Top frame: Phas deg
Vector averaged cross-power spectrum Baseline: EF (03) - TR (07)
Timerange: 00/17:57:14 to 00/17:58:28

Plot file version 313 created 03-APR-2017 18:27:46

M22-VLA1 EM126B.UVDATA.1

Freq = 4.7995 GHz, Bw = 32.000 MH No calibration applied and no bandpass applied

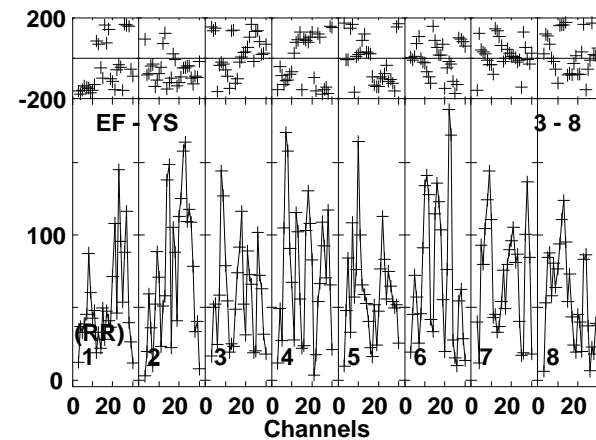
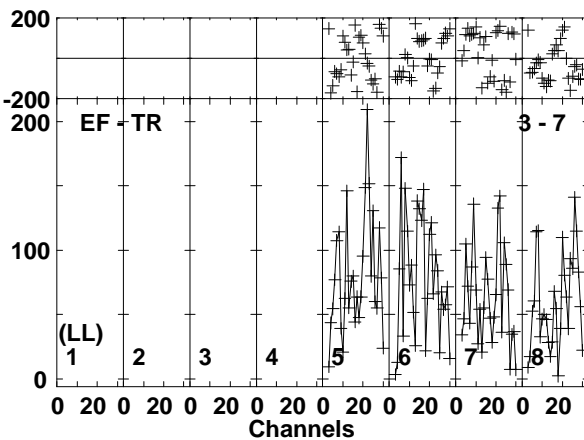
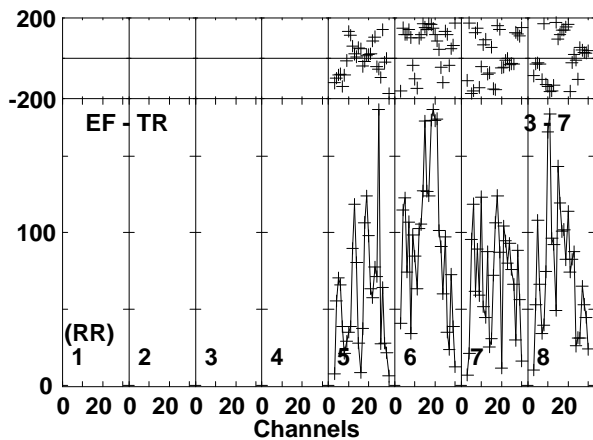
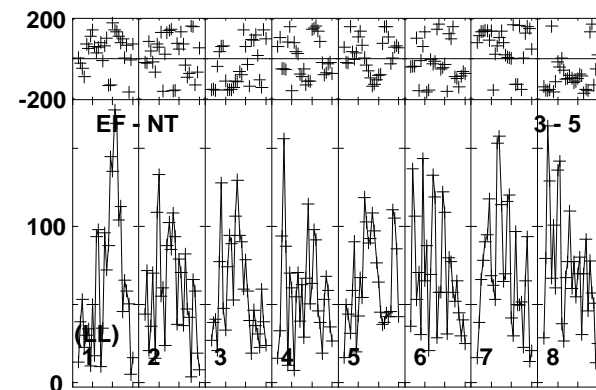
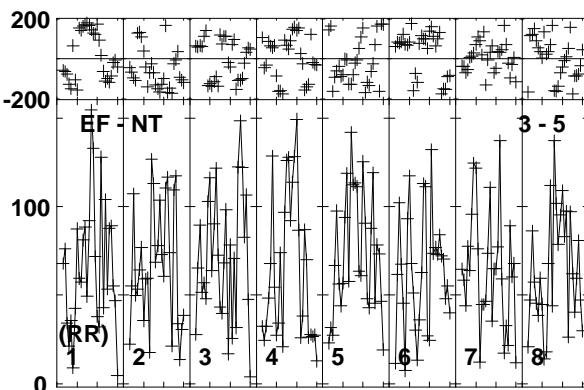
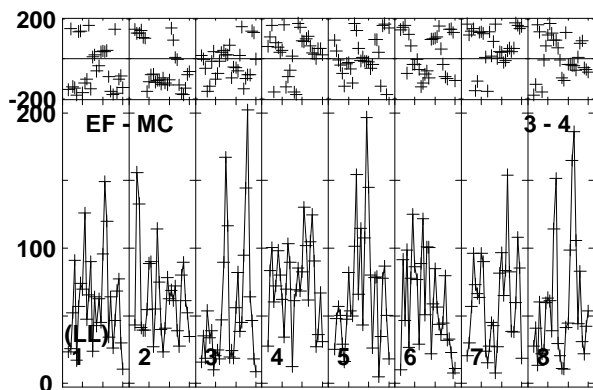
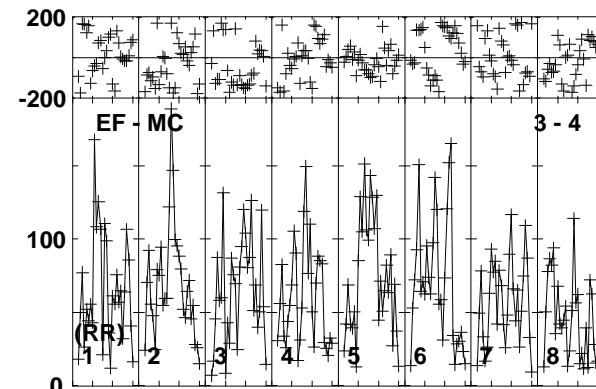
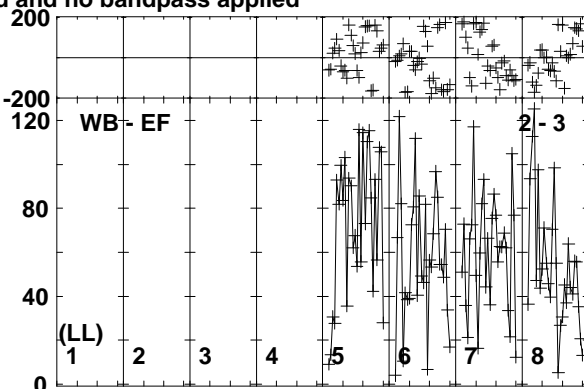
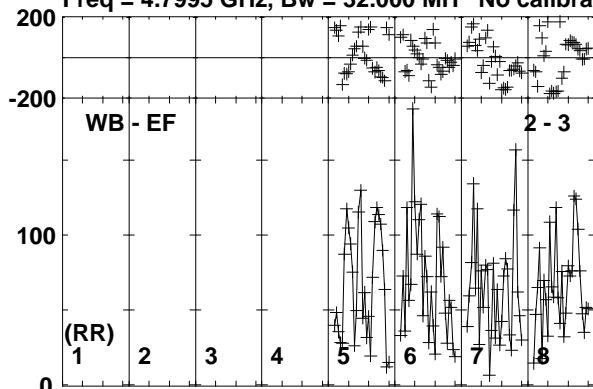

Lower frame: Micro Ampl Jy Top frame: Phas deg
Vector averaged cross-power spectrum Baseline: WB (02) - EF (03)
Timerange: 00/17:58:34 to 00/18:00:38

Plot file version 314 created 03-APR-2017 18:27:46

M22-VLA1 EM126B.UVDATA.1

Freq = 4.7995 GHz, Bw = 32.000 MH No calibration applied and no bandpass applied

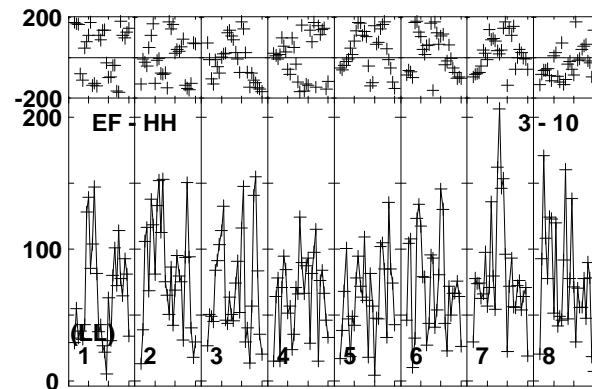
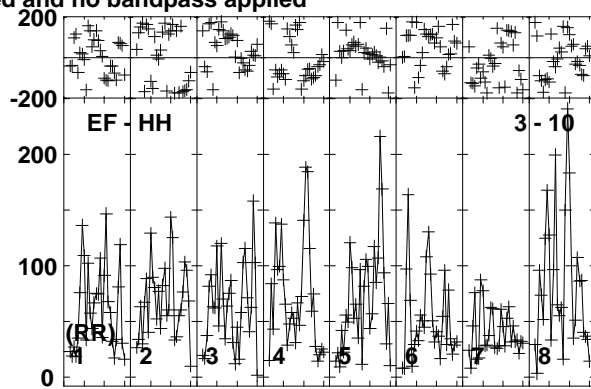
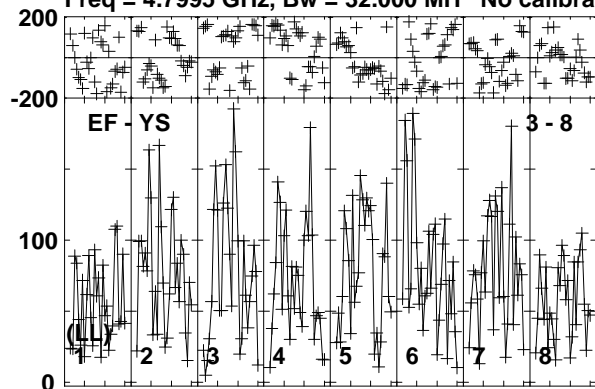

Lower frame: Micro Ampl Jy Top frame: Phas deg
Vector averaged cross-power spectrum Baseline: EF (03) - YS (08)
Timerange: 00/17:58:34 to 00/18:00:38

Plot file version 315 created 03-APR-2017 18:27:46

J1834-2341 EM126B.UVDATA.1

Freq = 4.7995 GHz, Bw = 32.000 MH No calibration applied and no bandpass applied

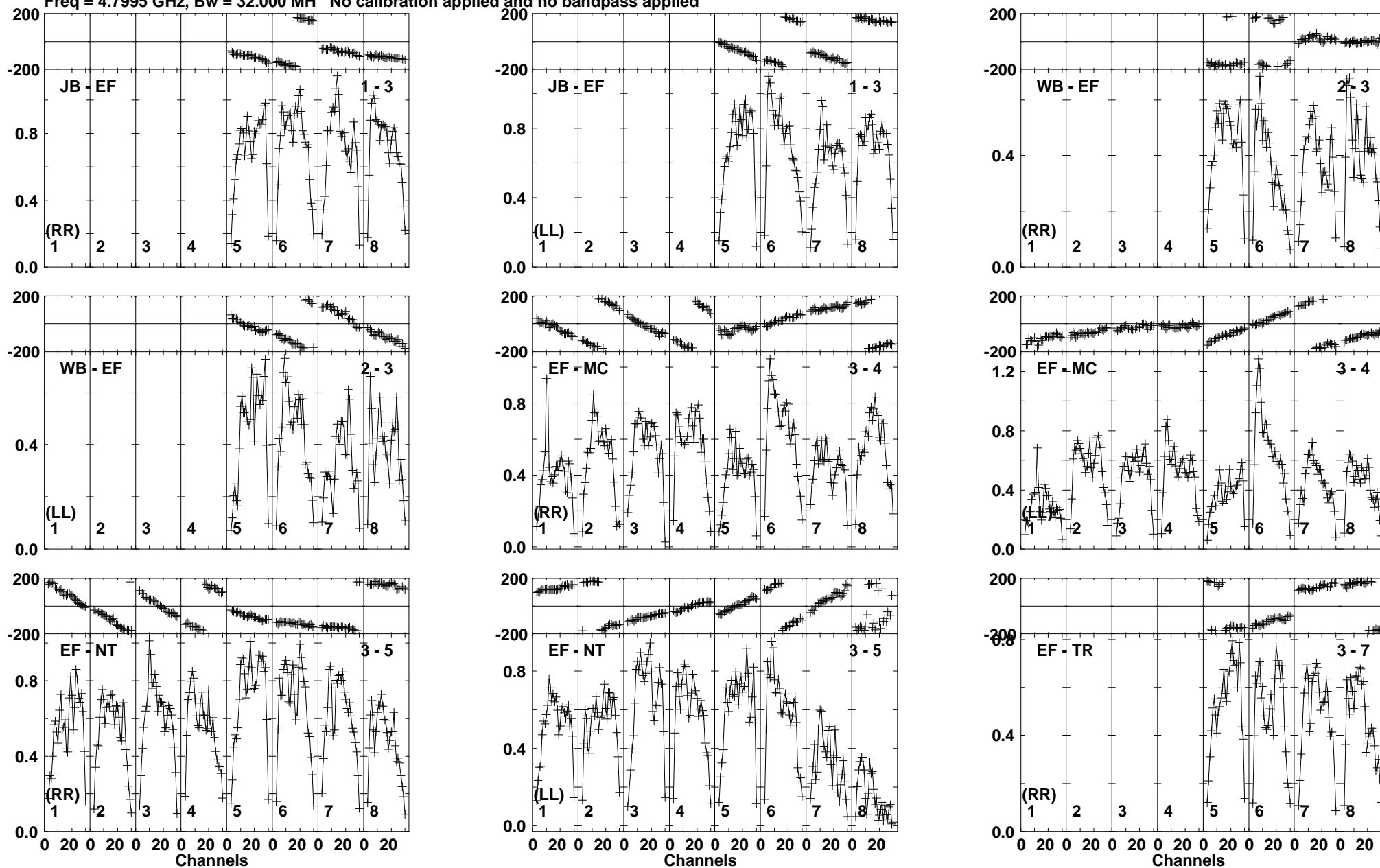

Lower frame: Milli Ampl Jy Top frame: Phas deg
Vector averaged cross-power spectrum Baseline: JB (01) - EF (03)
Timerange: 00/18:01:11 to 00/18:01:59

Plot file version 316 created 03-APR-2017 18:27:46

J1834-2341 EM126B.UVDATA.1

Freq = 4.7995 GHz, Bw = 32.000 MH No calibration applied and no bandpass applied

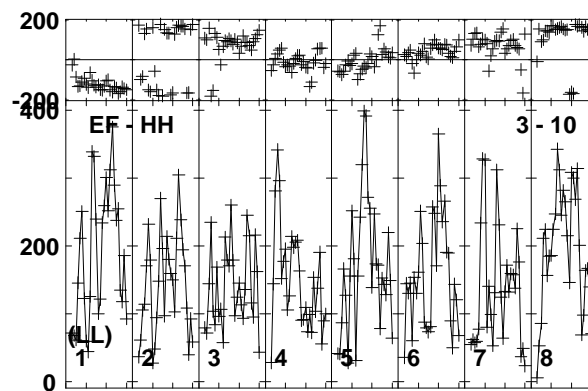
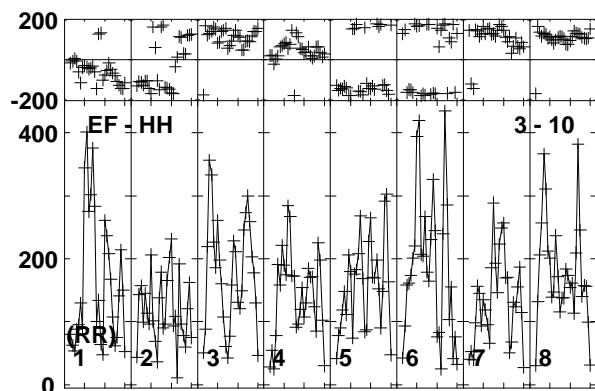
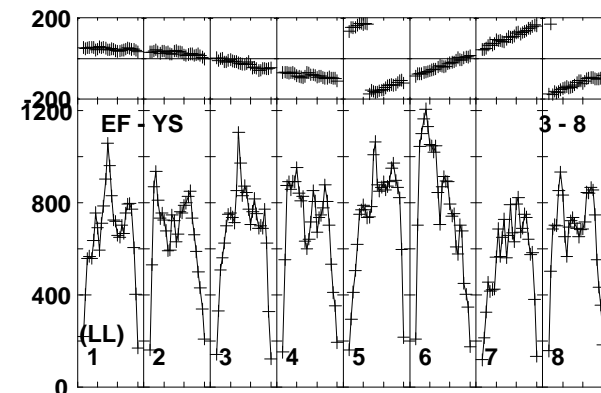
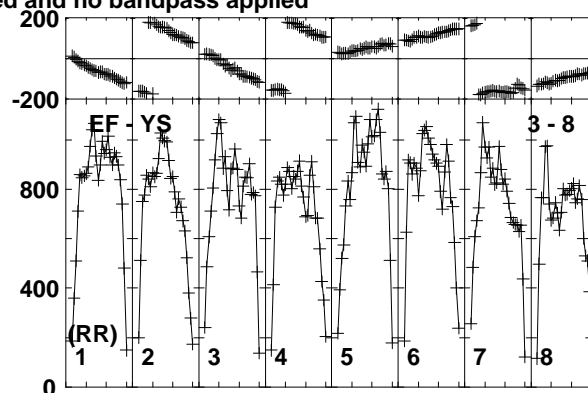
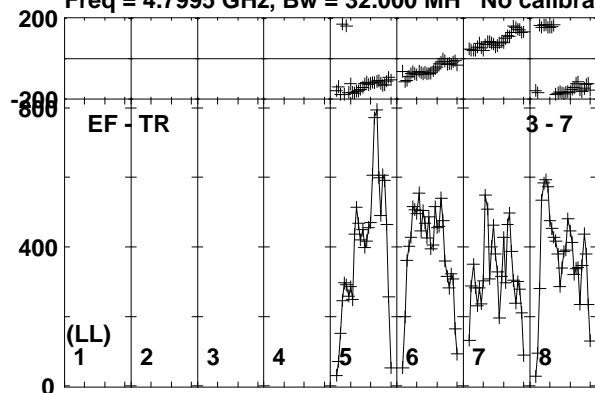

Lower frame: Micro Ampl Jy Top frame: Phas deg
Vector averaged cross-power spectrum Baseline: EF (03) - TR (07)
Timerange: 00/18:01:11 to 00/18:01:59

Plot file version 317 created 03-APR-2017 18:27:46

M22-VLA1 EM126B.UVDATA.1

Freq = 4.7995 GHz, Bw = 32.000 MH No calibration applied and no bandpass applied

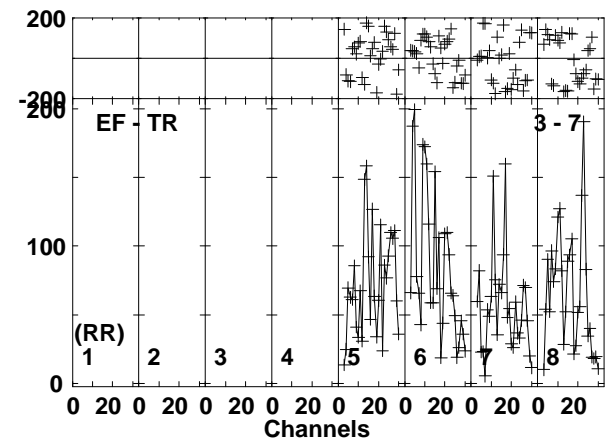
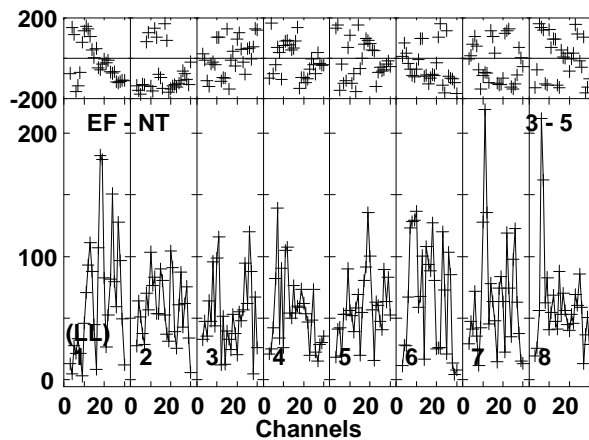
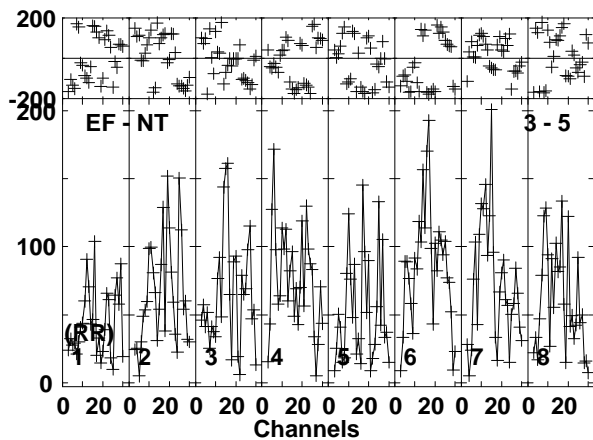
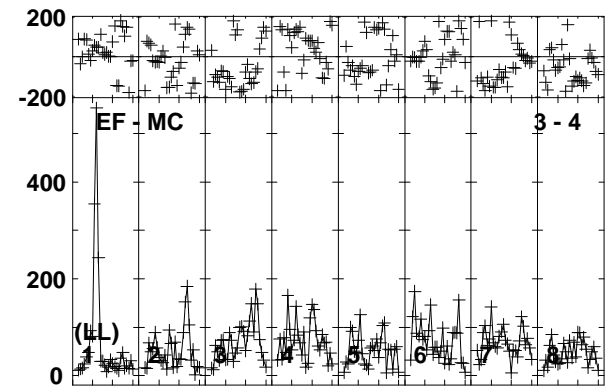
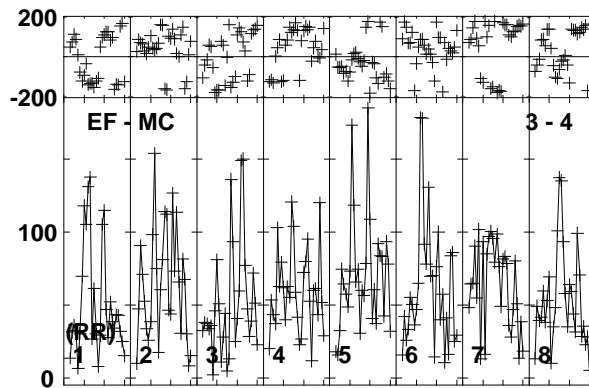
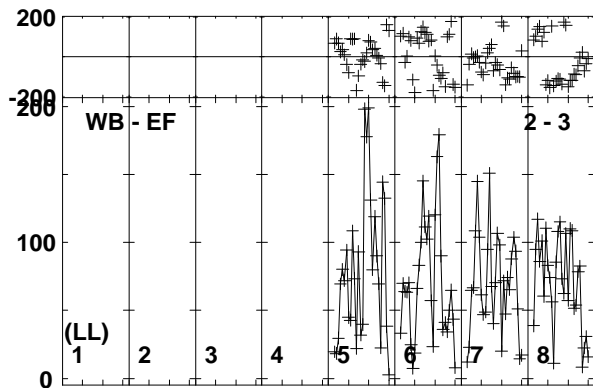
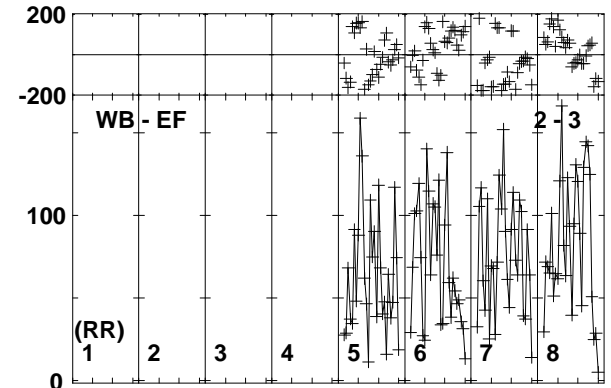
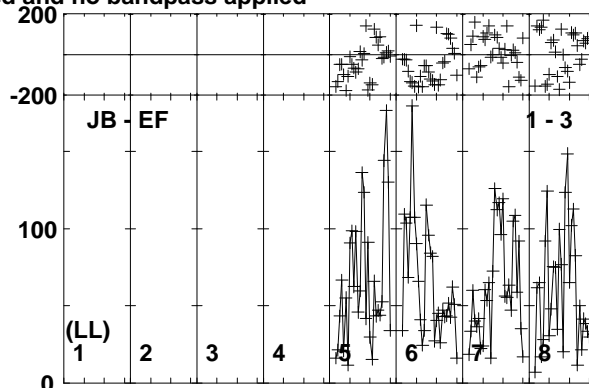
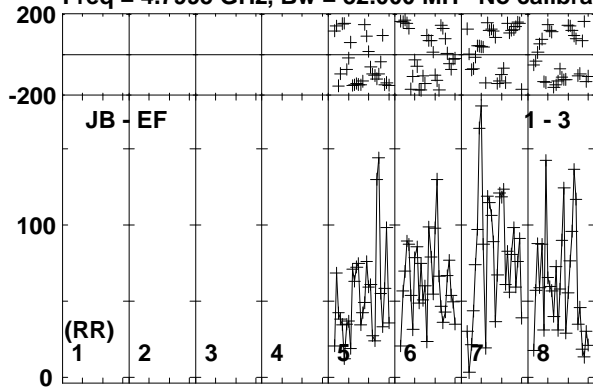

Lower frame: Micro Ampl Jy Top frame: Phas deg
Vector averaged cross-power spectrum Baseline: JB (01) - EF (03)
Timerange: 00/18:02:04 to 00/18:04:08

Plot file version 318 created 03-APR-2017 18:27:46

M22-VLA1 EM126B.UVDATA.1

Freq = 4.7995 GHz, Bw = 32.000 MH No calibration applied and no bandpass applied

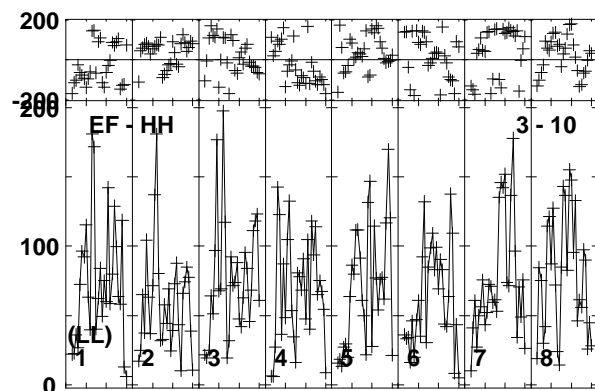
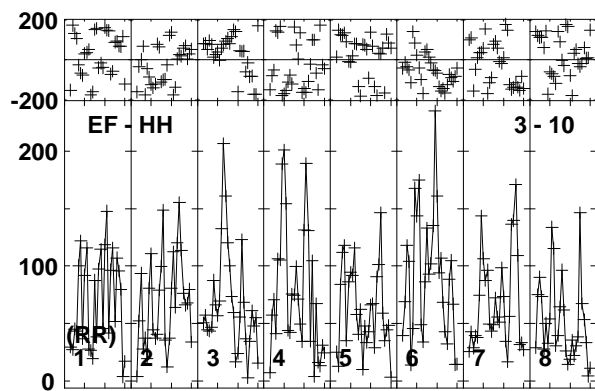
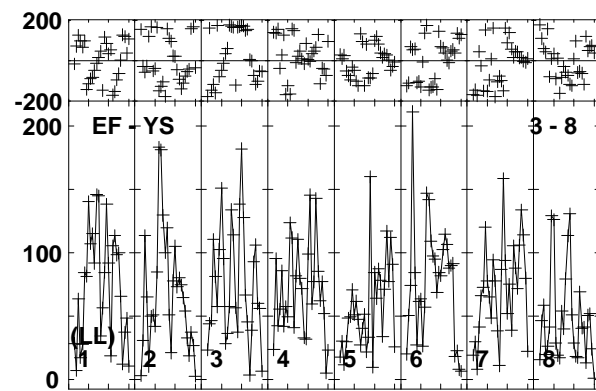
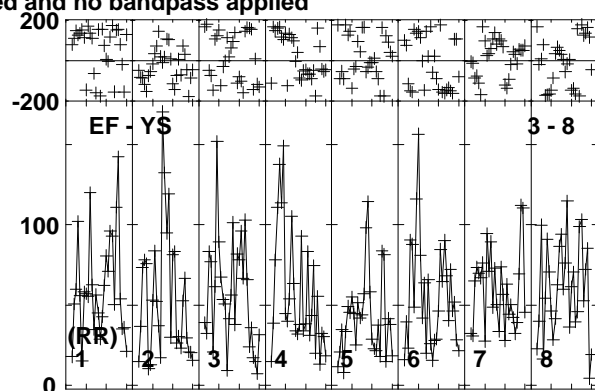
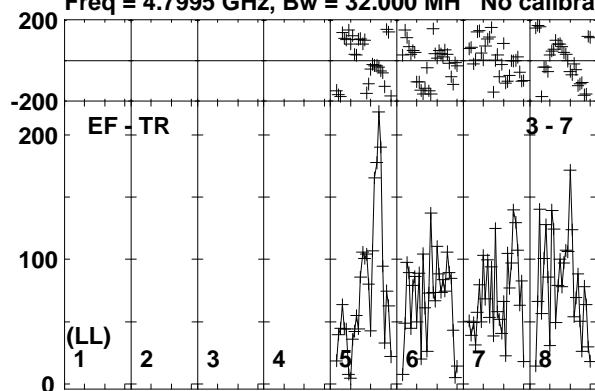

Lower frame: Micro Ampl Jy Top frame: Phas deg
Vector averaged cross-power spectrum Baseline: EF (03) - TR (07)
Timerange: 00/18:02:04 to 00/18:04:08

Plot file version 319 created 03-APR-2017 18:27:46

J1834-2341 EM126B.UVDATA.1

Freq = 4.7995 GHz, Bw = 32.000 MH No calibration applied and no bandpass applied

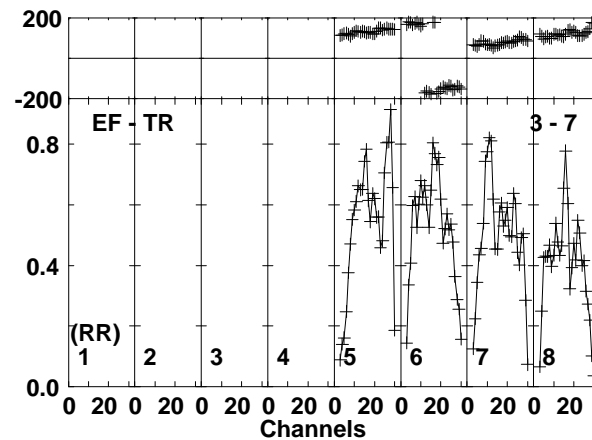
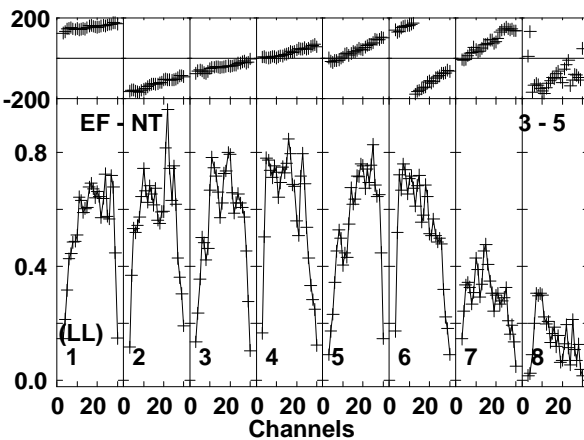
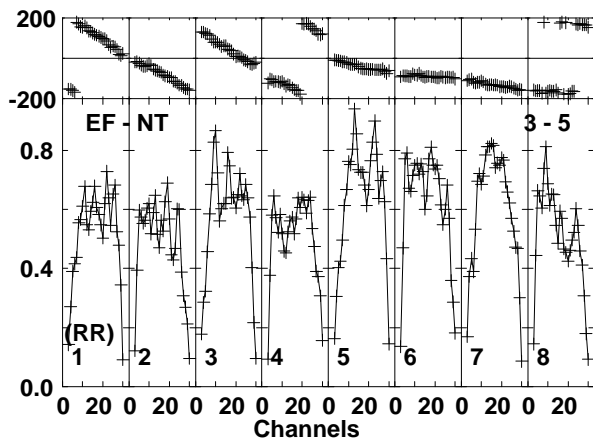
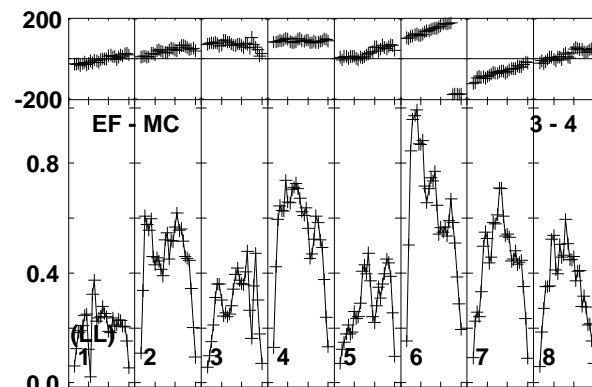
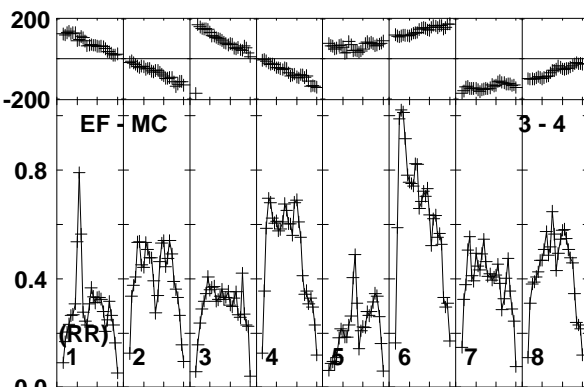
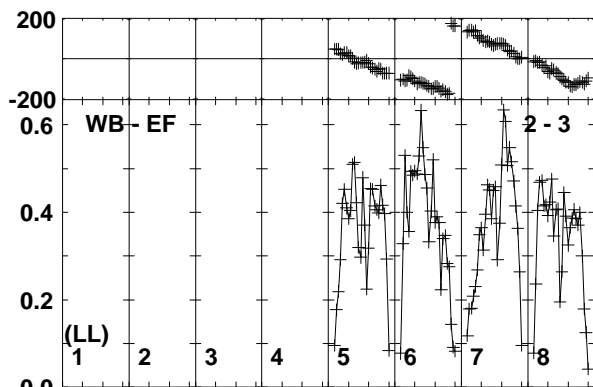
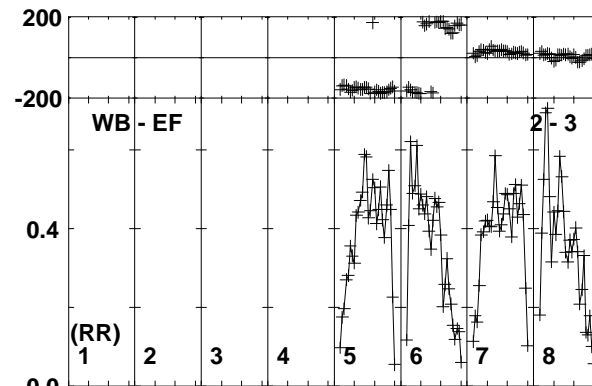
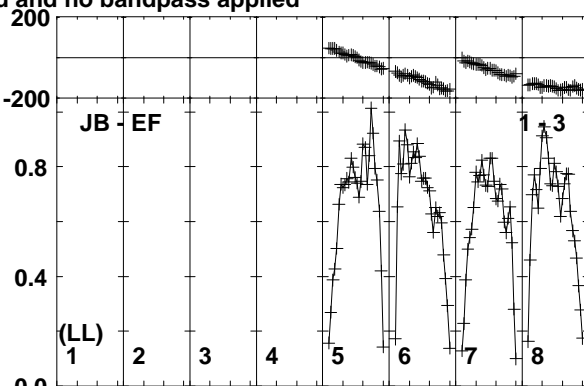
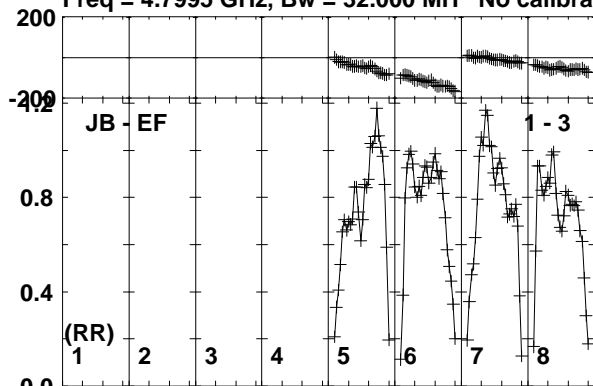

Lower frame: Milli Ampl Jy Top frame: Phas deg
Vector averaged cross-power spectrum Baseline: JB (01) - EF (03)
Timerange: 00:18:04:14 to 00:18:05:28

Plot file version 320 created 03-APR-2017 18:27:46

J1834-2341 EM126B.UVDATA.1

Freq = 4.7995 GHz, Bw = 32.000 MH No calibration applied and no bandpass applied

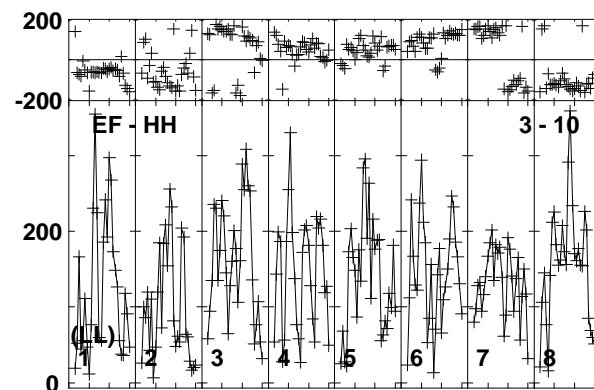
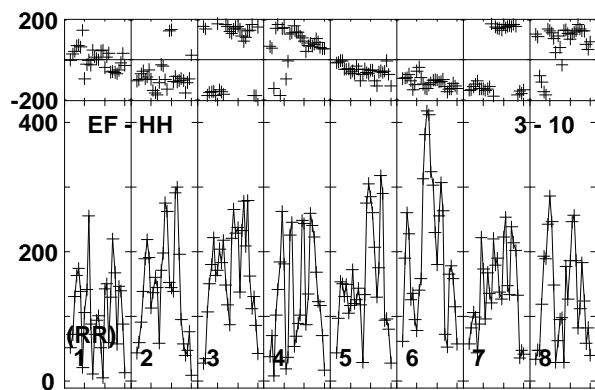
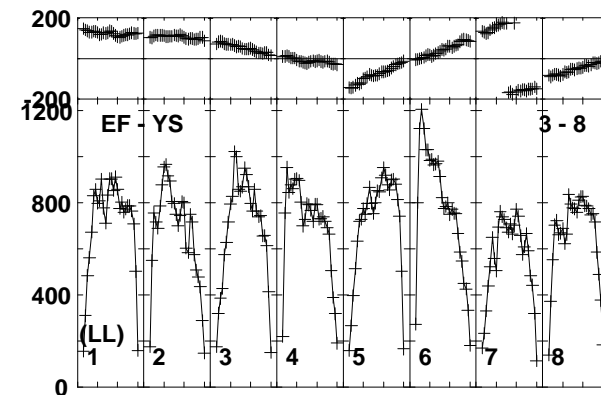
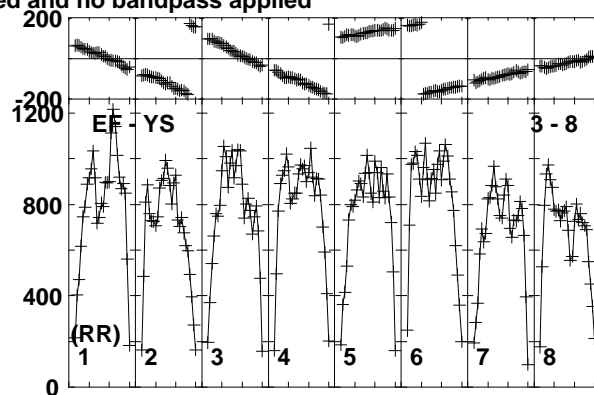
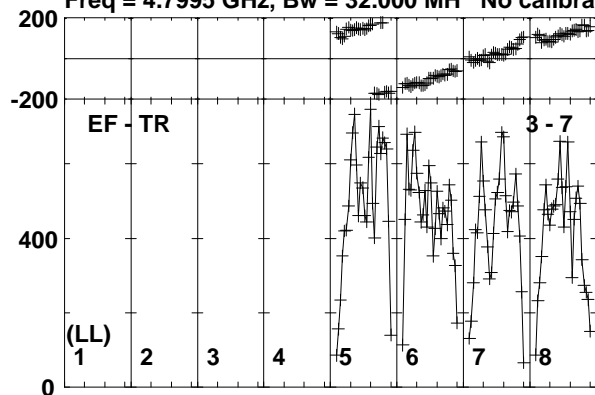

Lower frame: Micro Ampl Jy Top frame: Phas deg
Vector averaged cross-power spectrum Baseline: EF (03) - TR (07)
Timerange: 00/18:04:14 to 00/18:05:28

Plot file version 321 created 03-APR-2017 18:27:46

M22-VLA1 EM126B.UVDATA.1

Freq = 4.7995 GHz, Bw = 32.000 MH No calibration applied and no bandpass applied

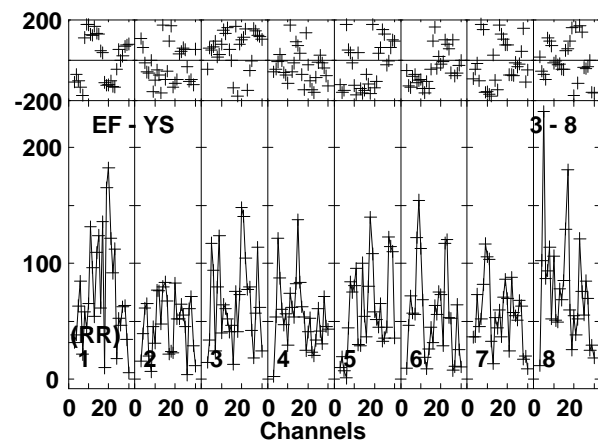
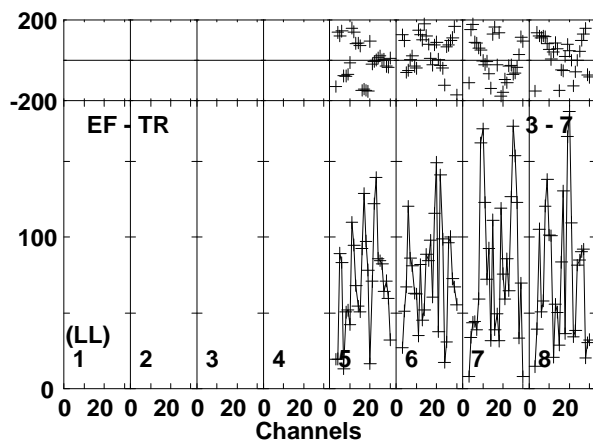
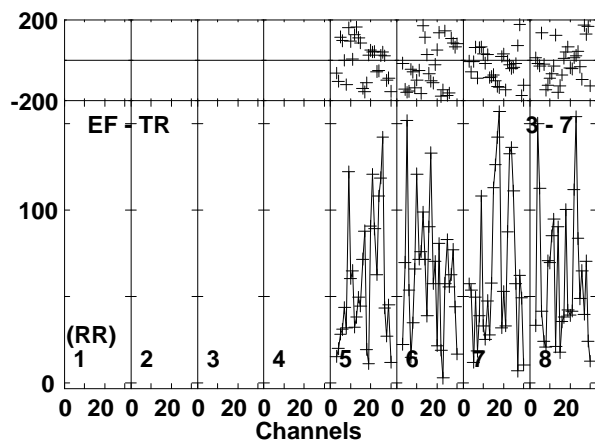
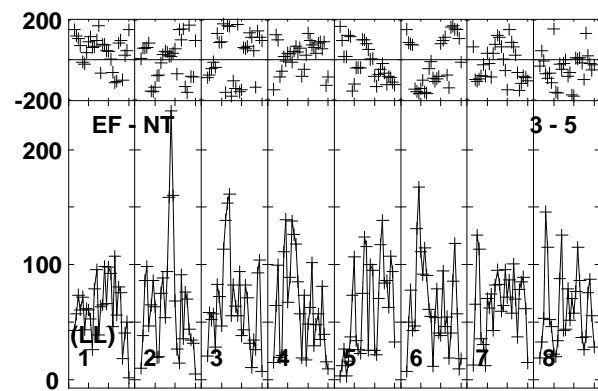
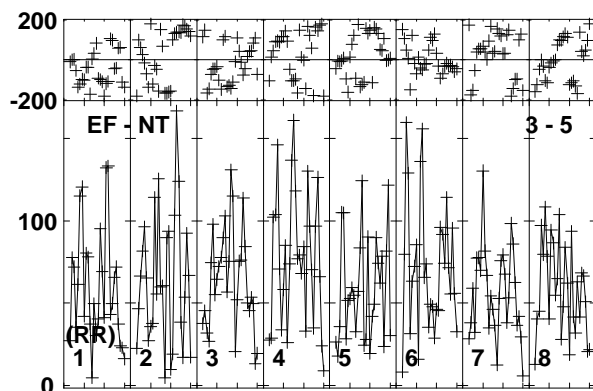
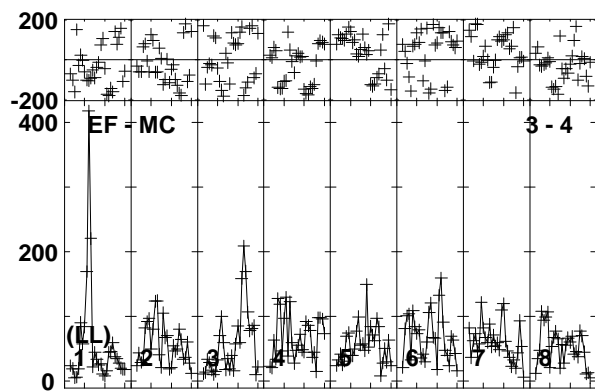
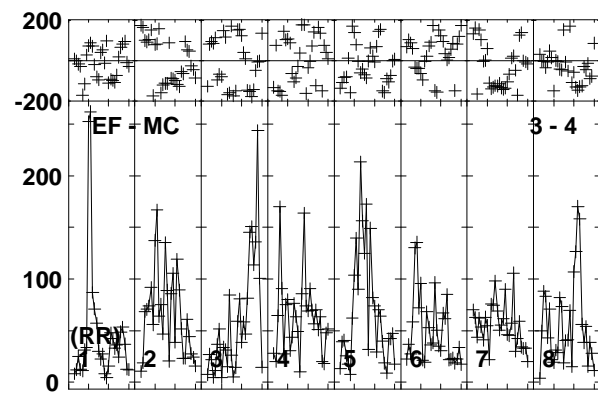
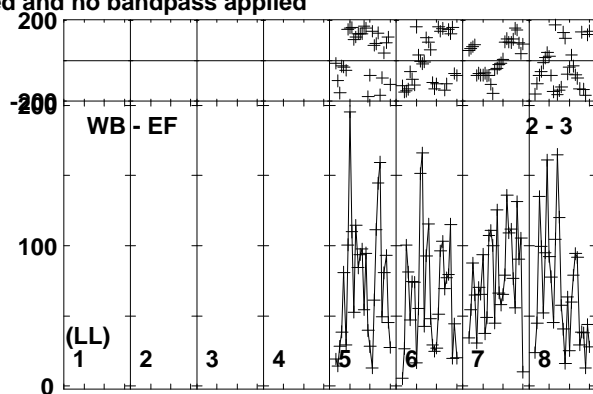
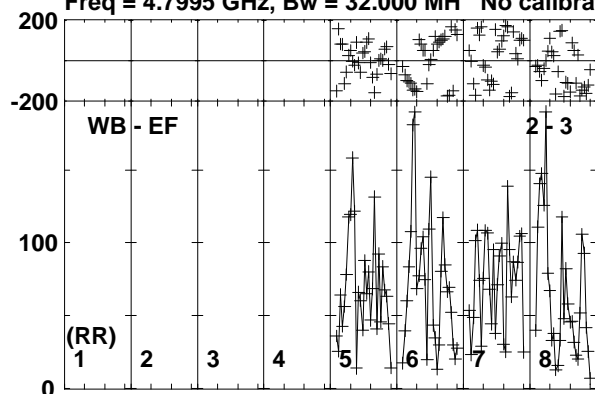

Lower frame: Micro Ampl Jy Top frame: Phas deg
Vector averaged cross-power spectrum Baseline: WB (02) - EF (03)
Timerange: 00/18:05:34 to 00/18:07:38

Plot file version 322 created 03-APR-2017 18:27:46

M22-VLA1 EM126B.UVDATA.1

Freq = 4.7995 GHz, Bw = 32.000 MH No calibration applied and no bandpass applied

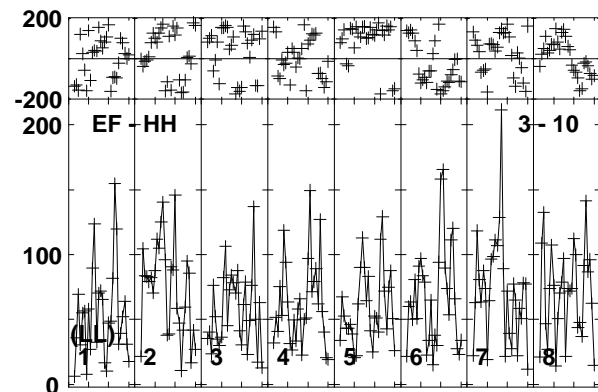
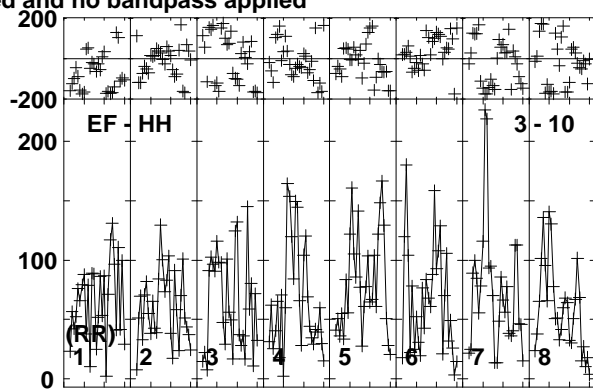
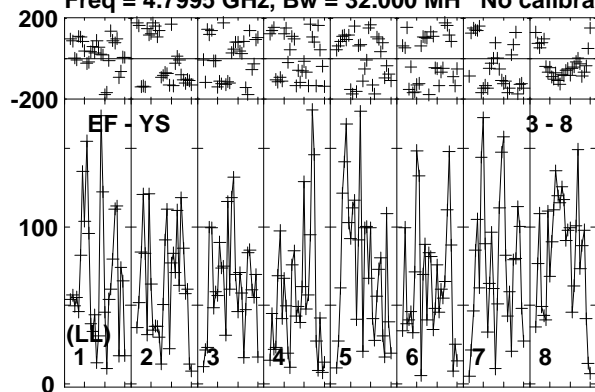

Lower frame: Micro Ampl Jy Top frame: Phas deg
Vector averaged cross-power spectrum Baseline: EF (03) - YS (08)
Timerange: 00/18:05:34 to 00/18:07:38

Plot file version 323 created 03-APR-2017 18:27:46

J1834-2341 EM126B.UVDATA.1

Freq = 4.7995 GHz, Bw = 32.000 MH No calibration applied and no bandpass applied

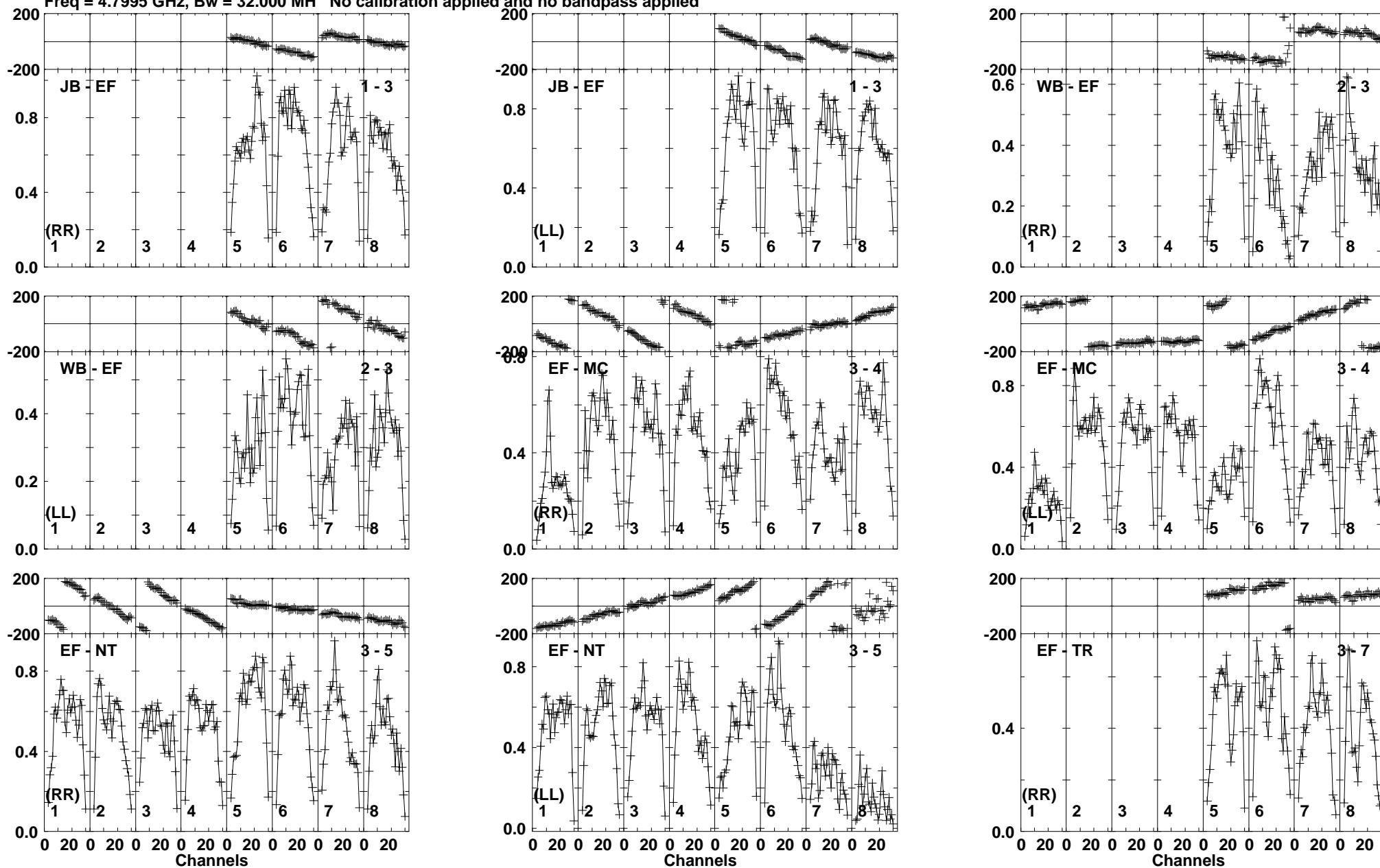

Lower frame: Milli Ampl Jy Top frame: Phas deg
Vector averaged cross-power spectrum Baseline: JB (01) - EF (03)
Timerange: 00:18:08:11 to 00:18:08:59

Plot file version 324 created 03-APR-2017 18:27:46

J1834-2341 EM126B.UVDATA.1

Freq = 4.7995 GHz, Bw = 32.000 MH No calibration applied and no bandpass applied

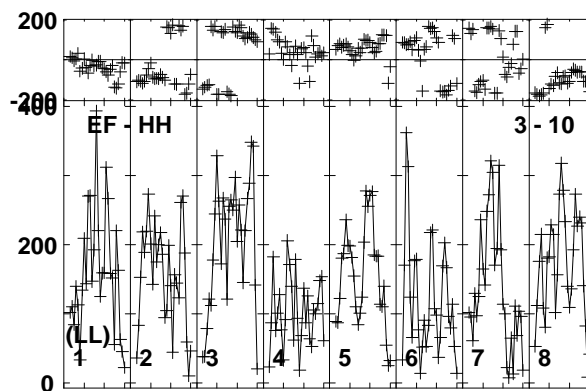
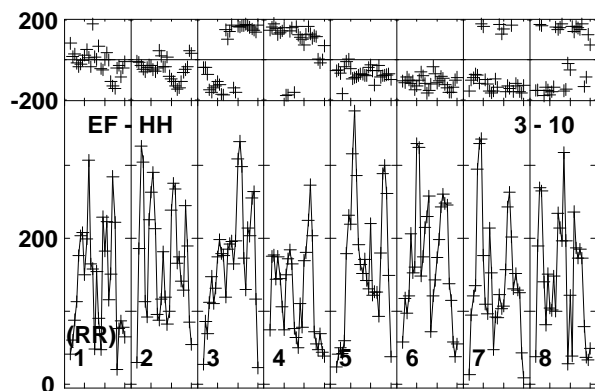
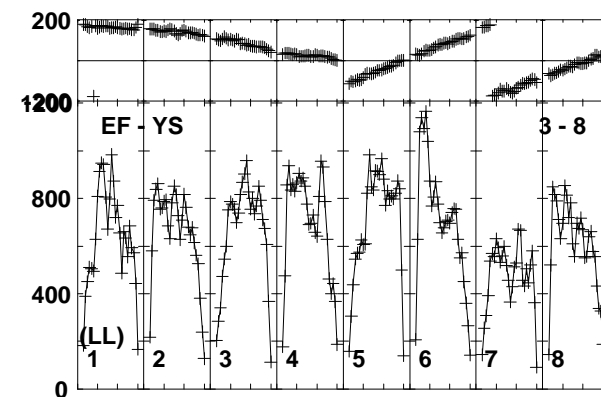
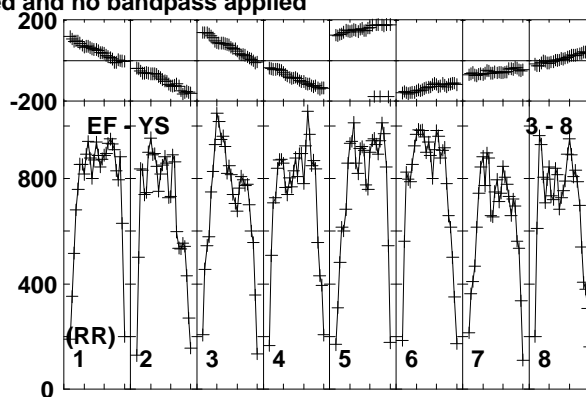
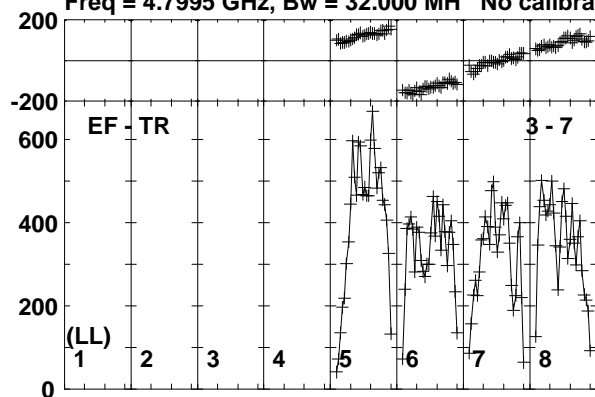

Lower frame: Micro Ampl Jy Top frame: Phas deg
Vector averaged cross-power spectrum Baseline: EF (03) - TR (07)
Timerange: 00:18:08:11 to 00:18:08:59

Plot file version 325 created 03-APR-2017 18:27:46

J2253+1608 EM126B.UVDATA.1

Freq = 4.7995 GHz, Bw = 32.000 MH No calibration applied and no bandpass applied

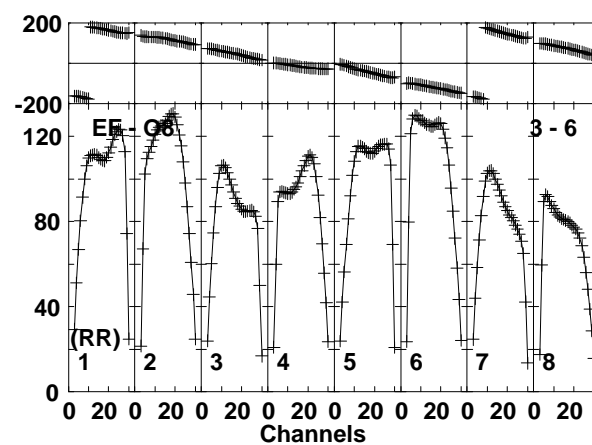
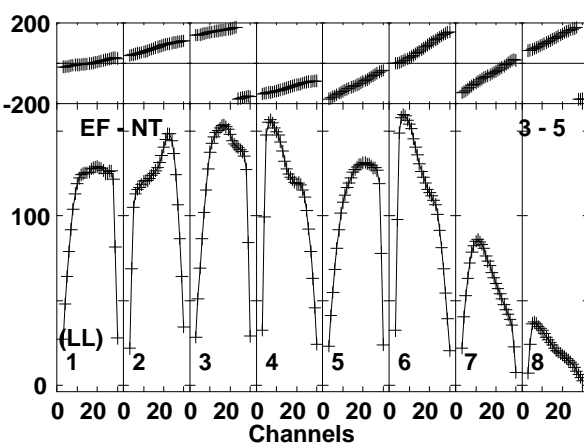
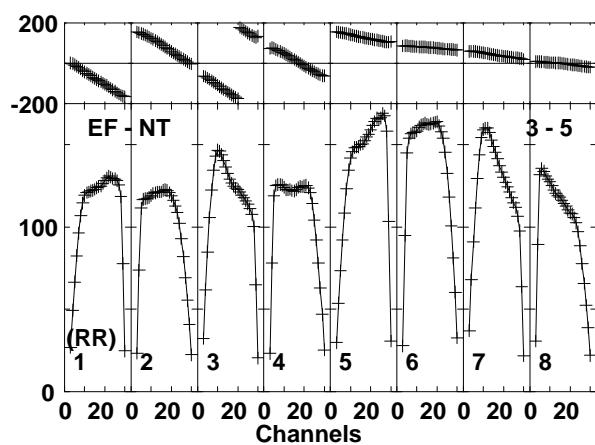
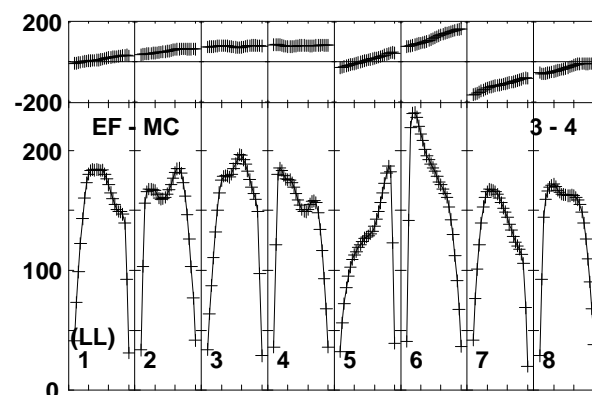
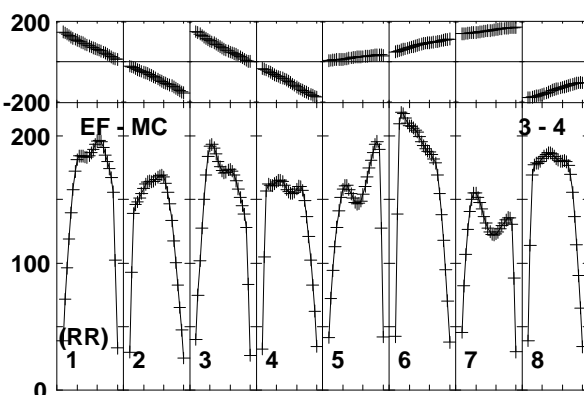
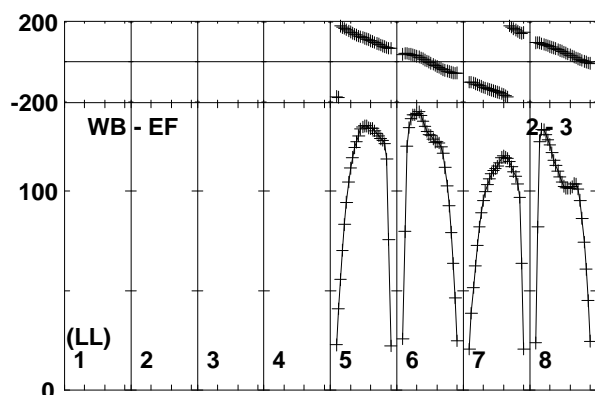
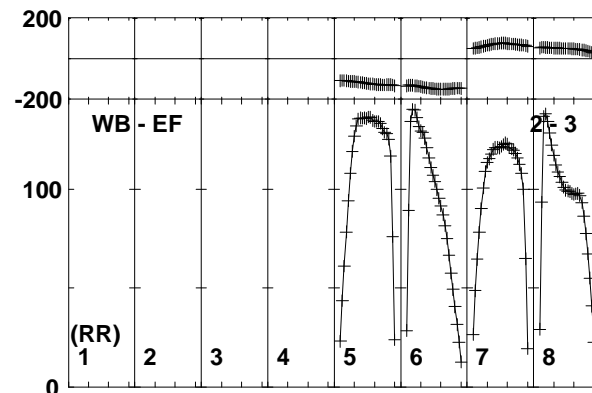
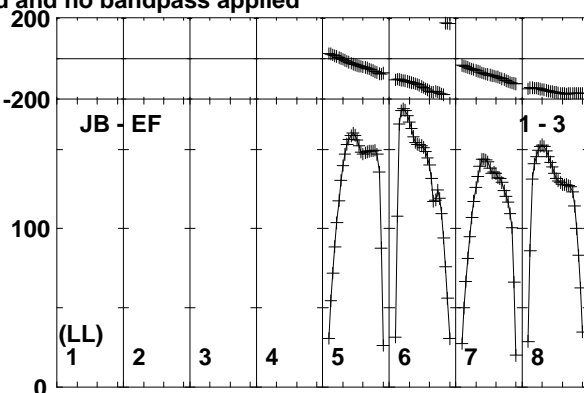
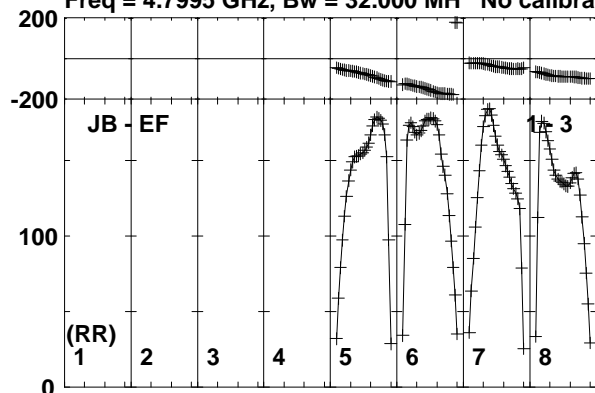

Lower frame: Milli Ampl Jy Top frame: Phas deg
Vector averaged cross-power spectrum Baseline: JB (01) - EF (03)
Timerange: 00:18:09:35 to 00:18:14:59

Plot file version 326 created 03-APR-2017 18:27:46

J2253+1608 EM126B.UVDATA.1

Freq = 4.7995 GHz, Bw = 32.000 MH No calibration applied and no bandpass applied

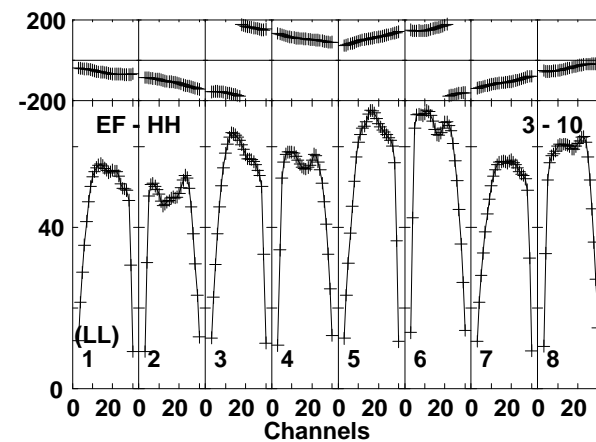
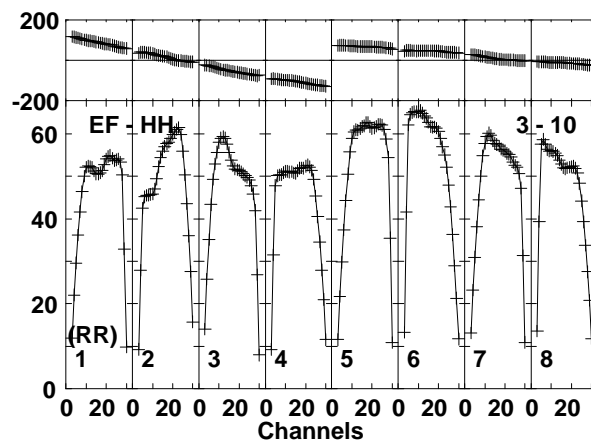
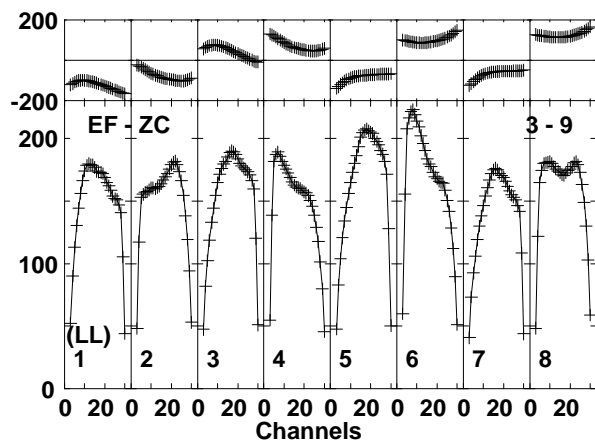
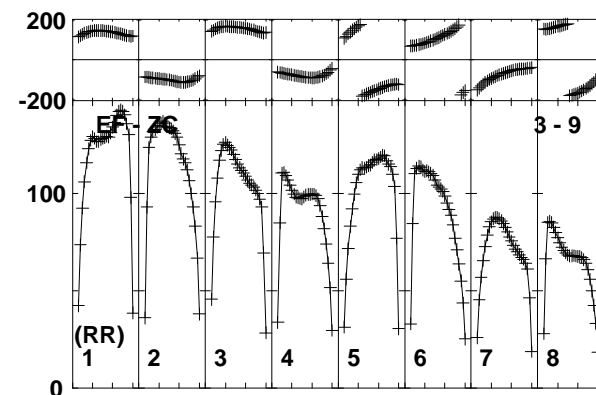
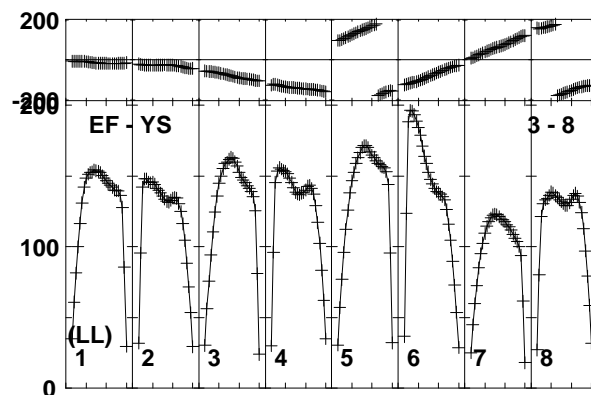
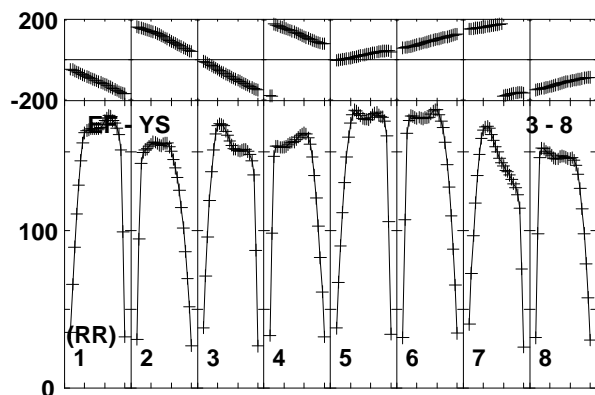
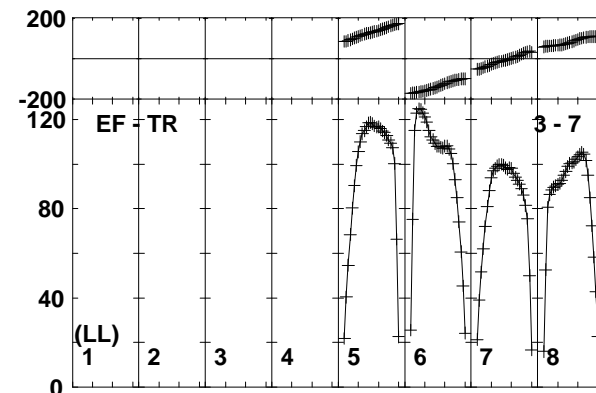
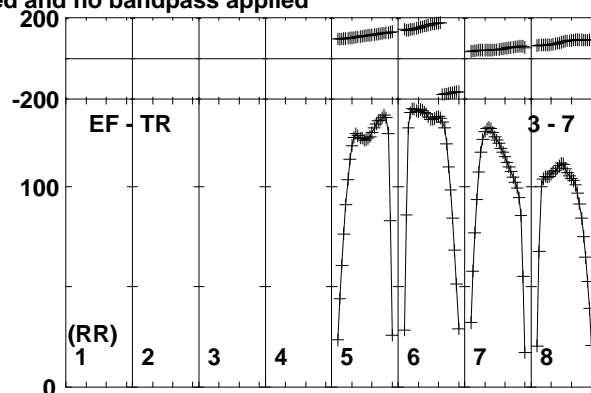
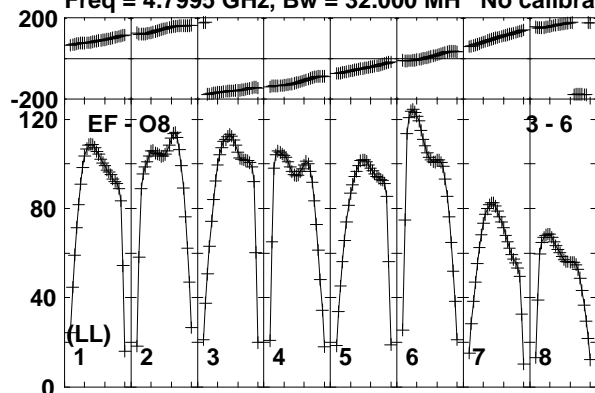

Lower frame: Milli Ampl Jy Top frame: Phas deg
Vector averaged cross-power spectrum Baseline: EF (03) - O8 (06)
Timerange: 00/18:09:35 to 00/18:14:59