

Plot file version 1 created 08-APR-2019 12:09:29

J0927+3902 EM133B.UVDATA.1

Freq = 4.9270 GHz, Bw = 16.000 MH No calibration applied and no bandpass applied

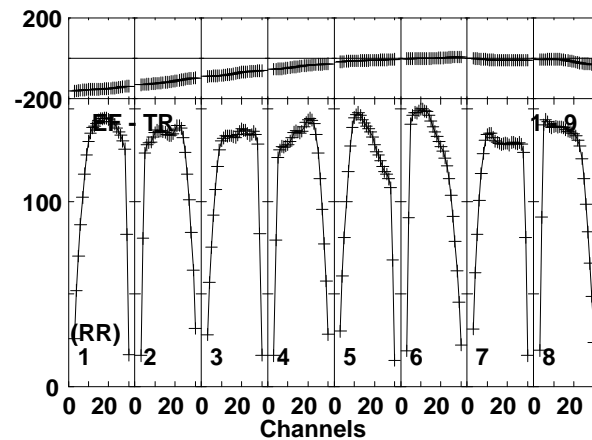
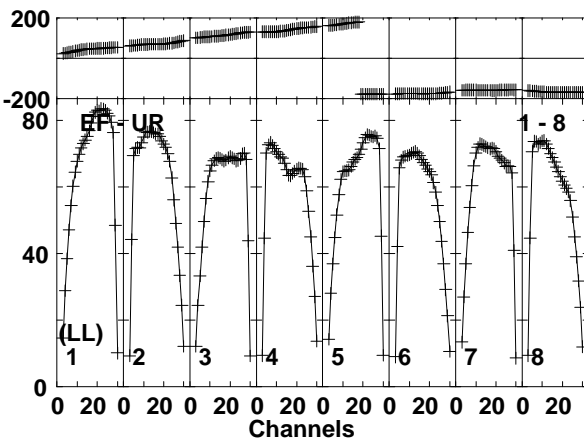
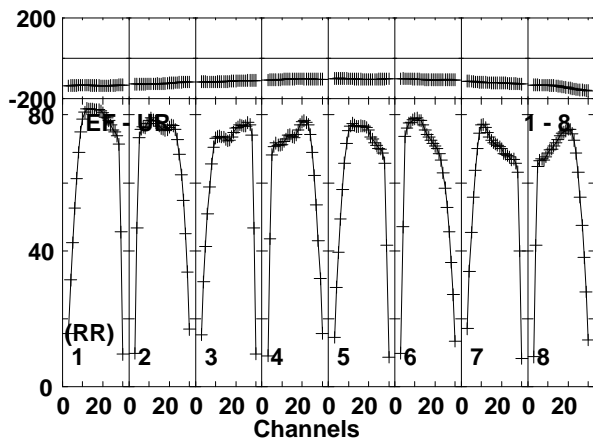
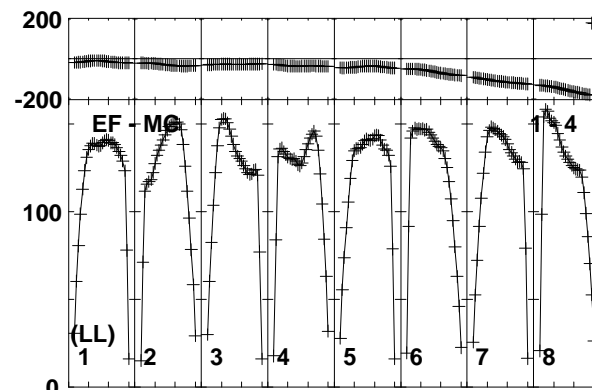
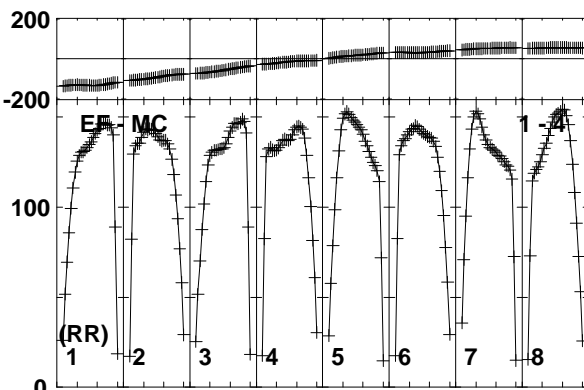
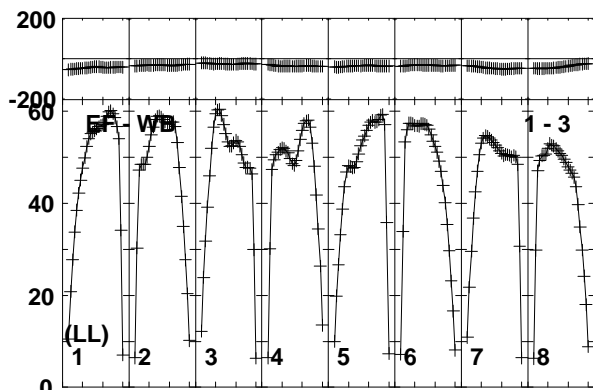
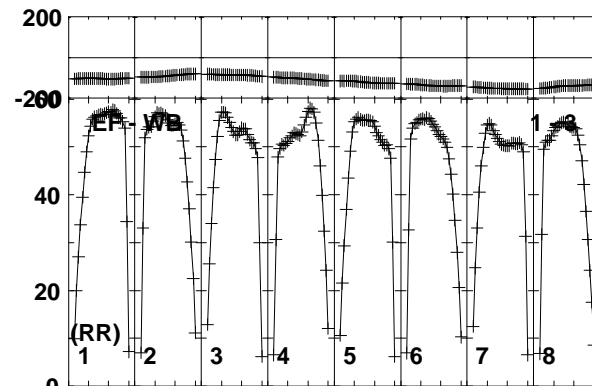
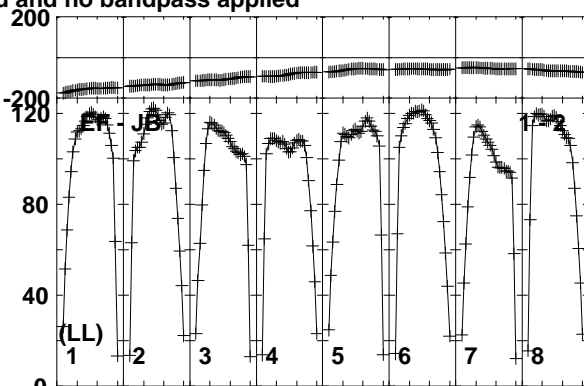
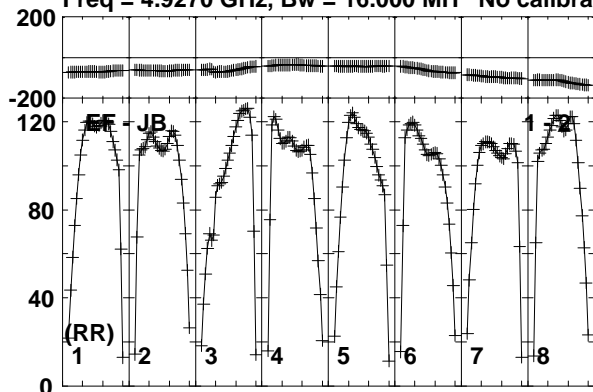

Lower frame: Milli Ampl Jy Top frame: Phas deg  
Vector averaged cross-power spectrum Baseline: EF (01) - JB (02)  
Timerange: 00/03:00:01 to 00/03:03:59

Plot file version 2 created 08-APR-2019 12:09:29

J0927+3902 EM133B.UVDATA.1

Freq = 4.9270 GHz, Bw = 16.000 MH No calibration applied and no bandpass applied

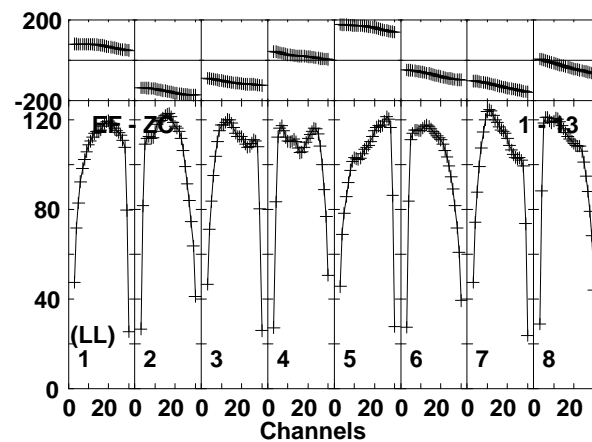
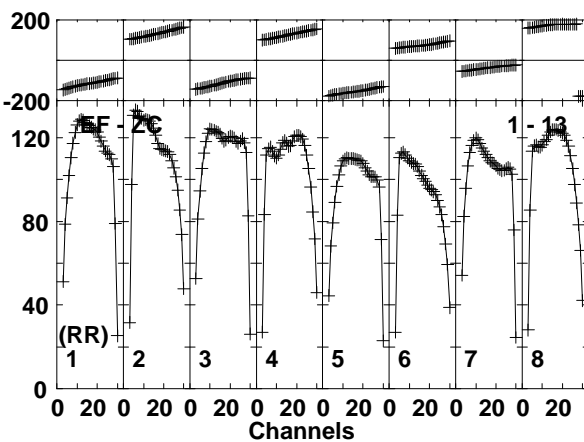
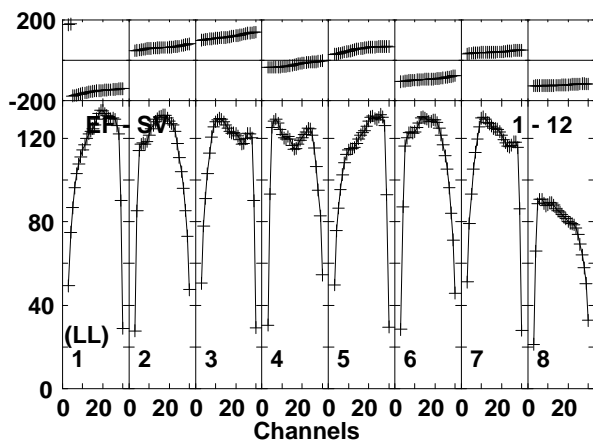
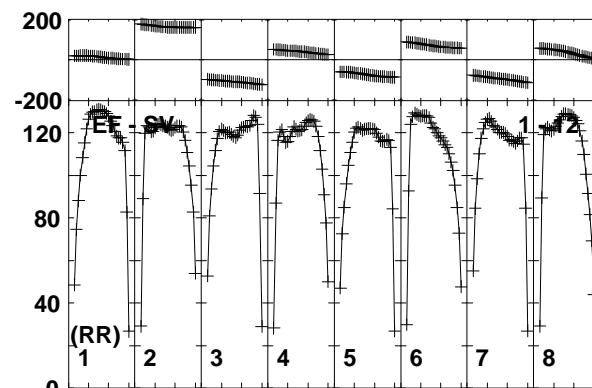
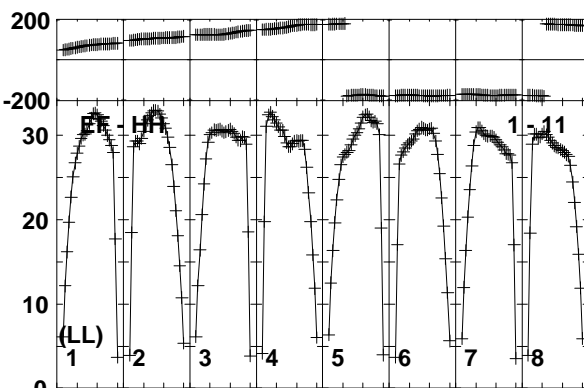
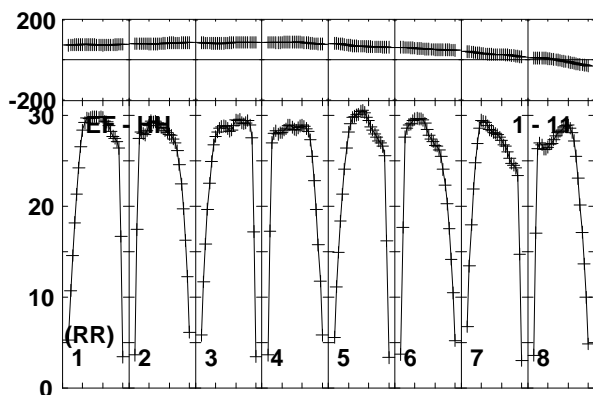
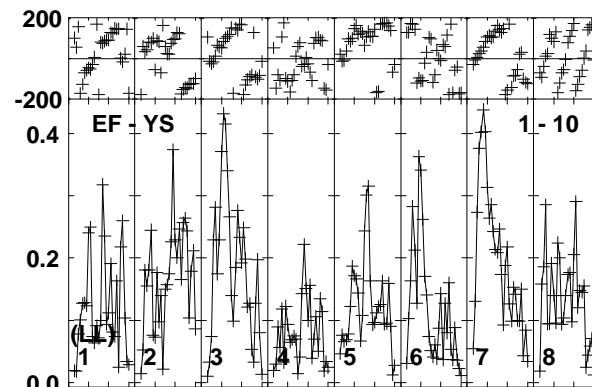
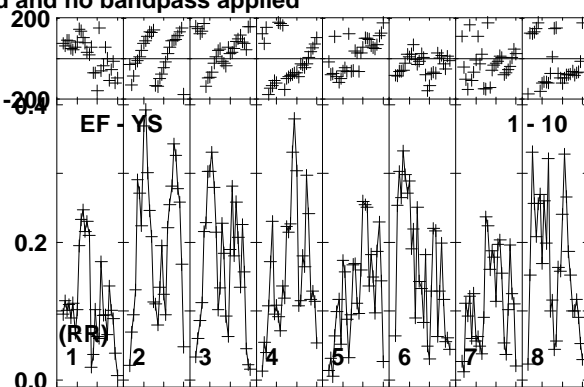
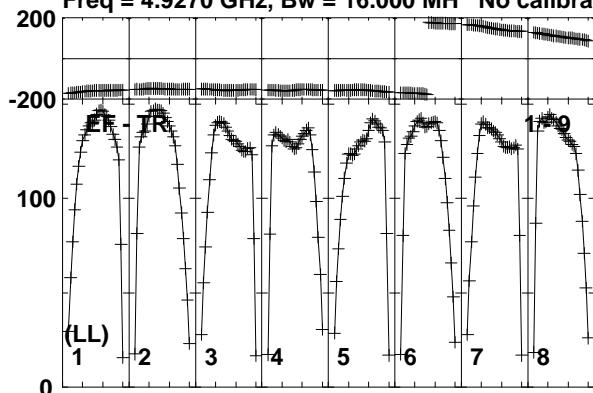

Lower frame: Milli Ampl Jy Top frame: Phas deg  
Vector averaged cross-power spectrum Baseline: EF (01) - TR (09)  
Timerange: 00/03:00:01 to 00/03:03:59

Plot file version 3 created 08-APR-2019 12:09:29

J0927+3902 EM133B.UVDATA.1

Freq = 4.9270 GHz, Bw = 16.000 MH No calibration applied and no bandpass applied

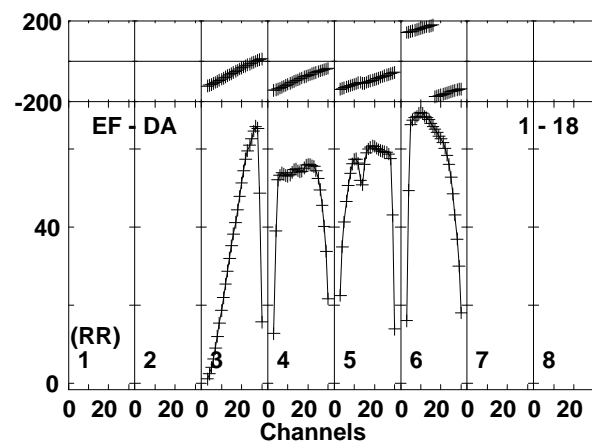
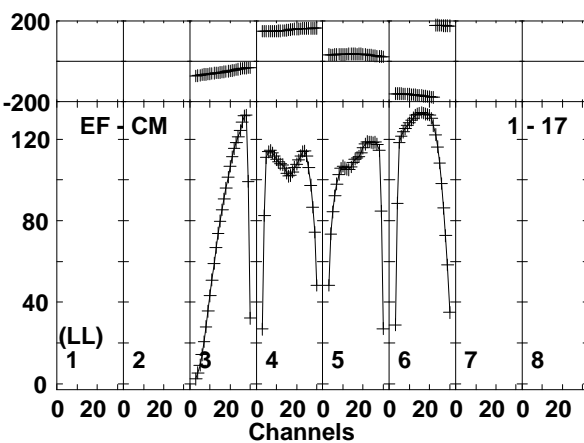
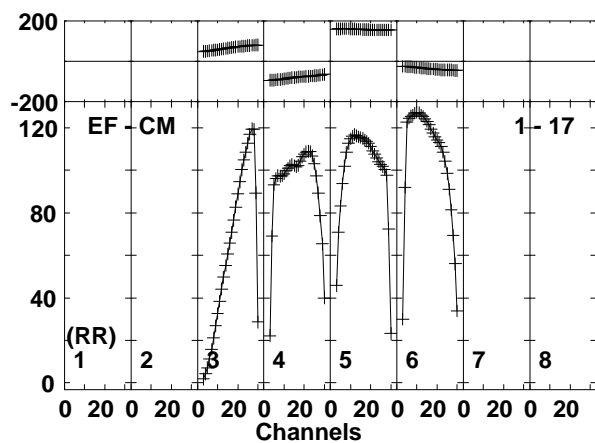
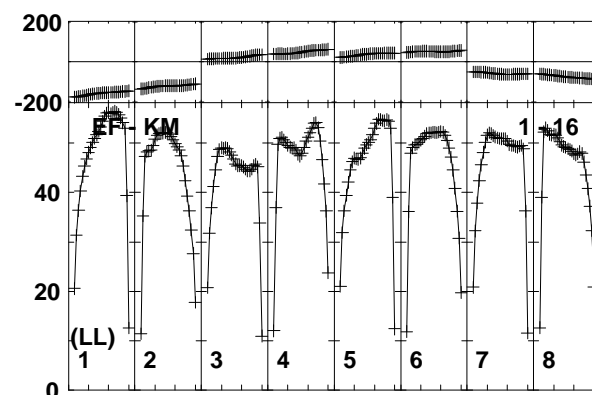
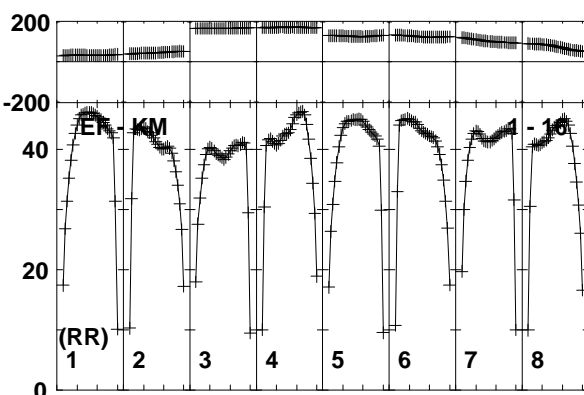
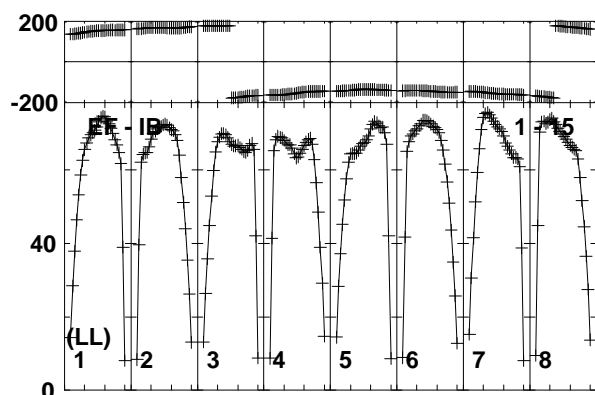
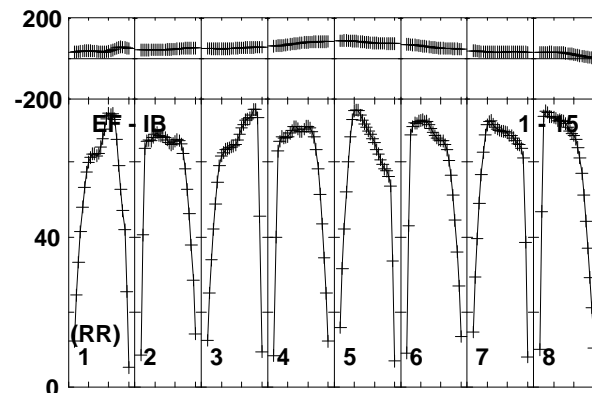
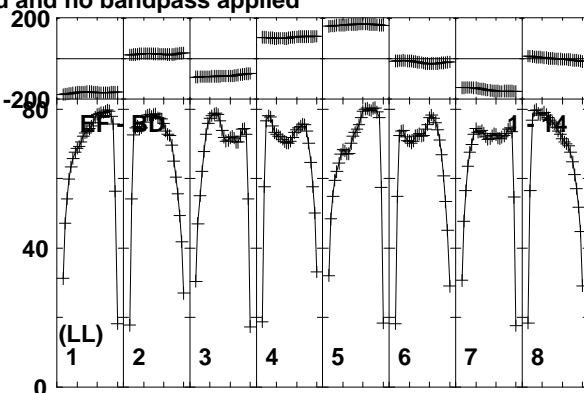
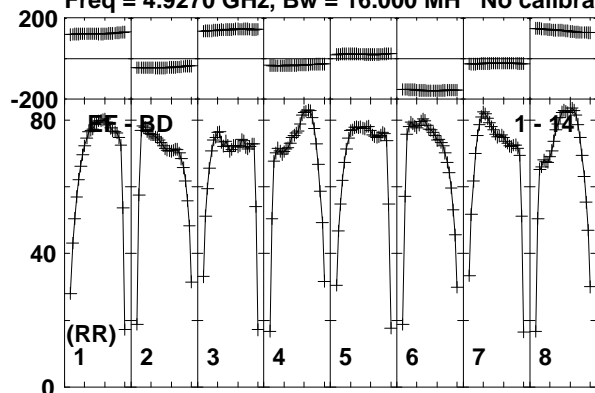

Lower frame: Milli Ampl Jy Top frame: Phas deg  
Vector averaged cross-power spectrum Baseline: EF (01) - BD (14)  
Timerange: 00/03:00:01 to 00/03:03:59

Plot file version 4 created 08-APR-2019 12:09:29

J0927+3902 EM133B.UVDATA.1

Freq = 4.9270 GHz, Bw = 16.000 MH No calibration applied and no bandpass applied

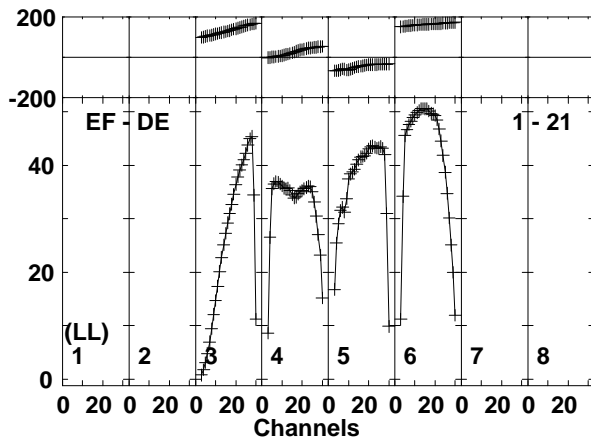
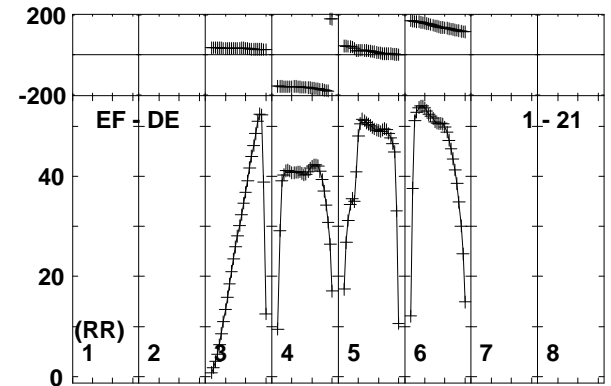
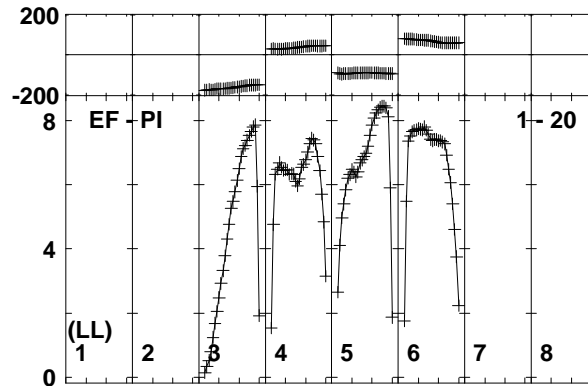
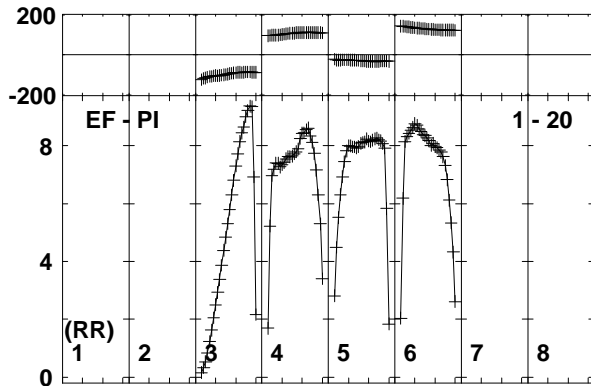
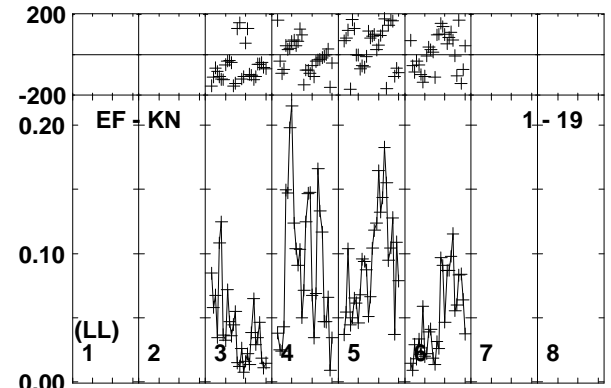
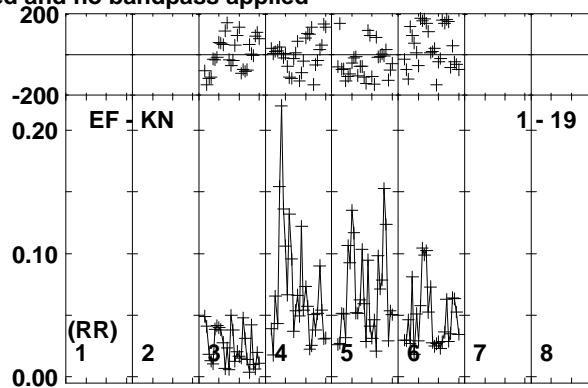
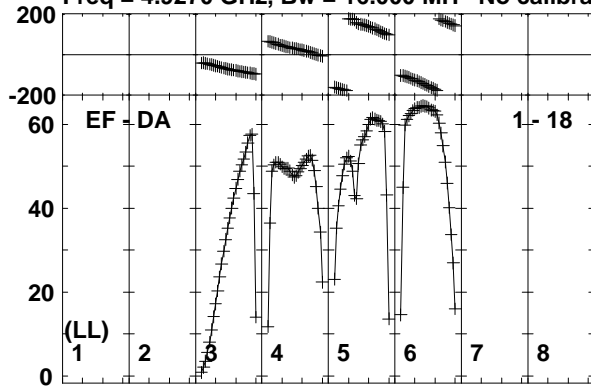

Lower frame: Milli Ampl Jy Top frame: Phas deg  
Vector averaged cross-power spectrum Baseline: EF (01) - DA (18)  
Timerange: 00/03:00:01 to 00/03:03:59

Plot file version 5 created 08-APR-2019 12:09:30

J0815+3635 EM133B.UVDATA.1

Freq = 4.9270 GHz, Bw = 16.000 MH No calibration applied and no bandpass applied

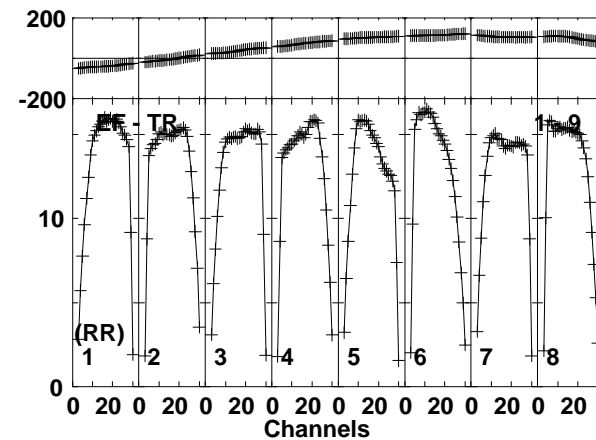
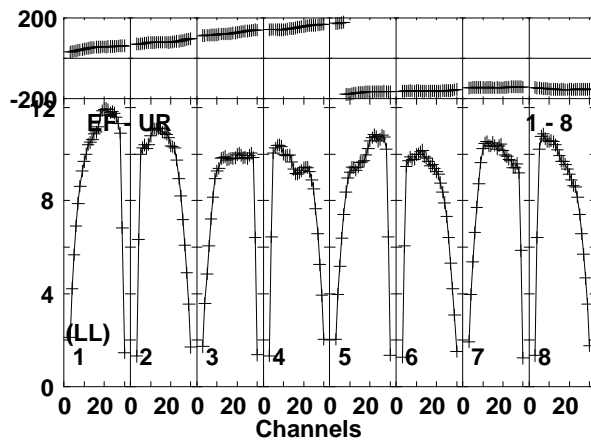
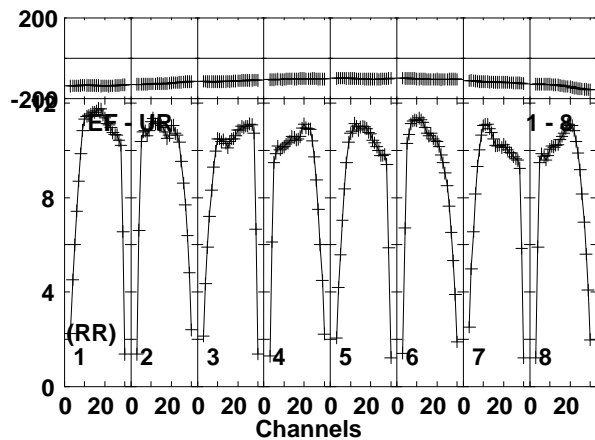
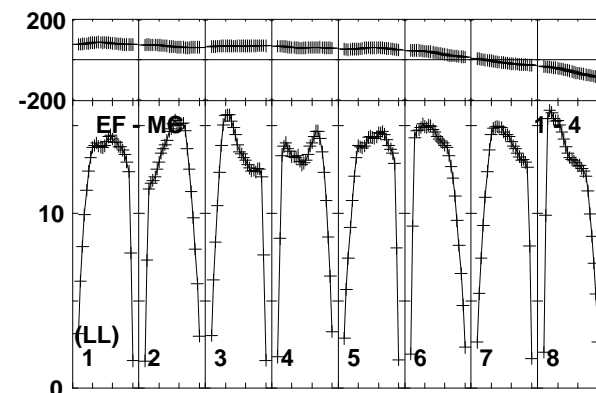
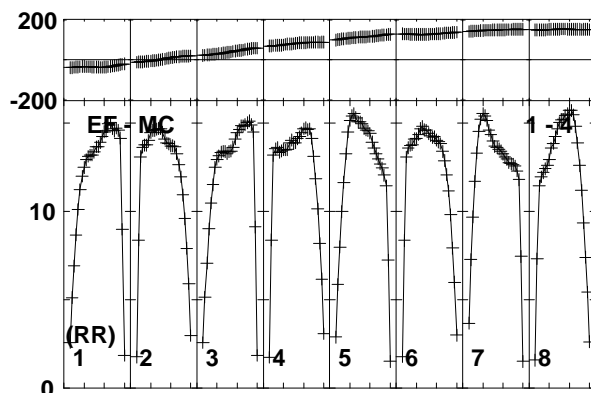
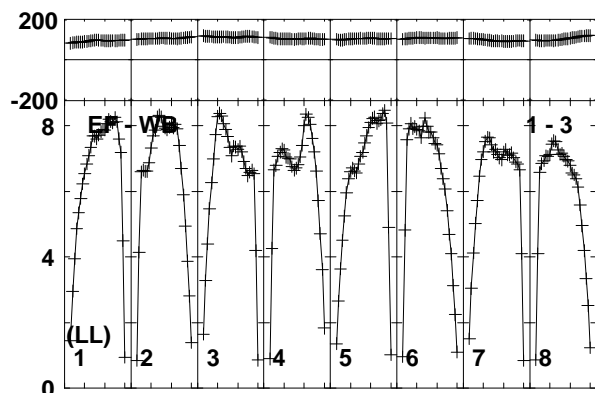
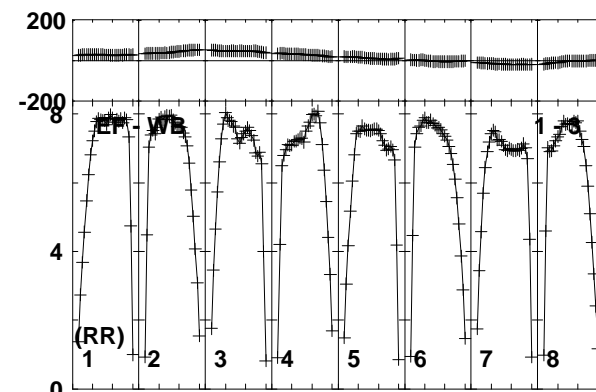
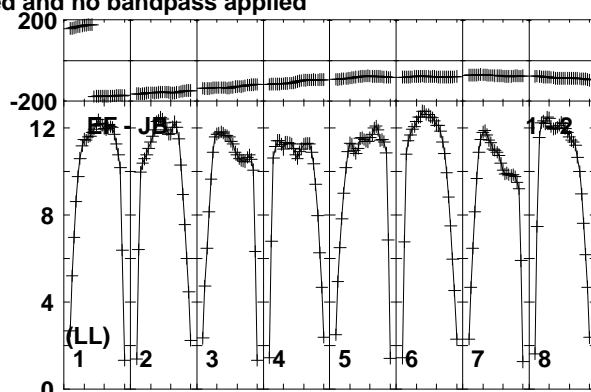
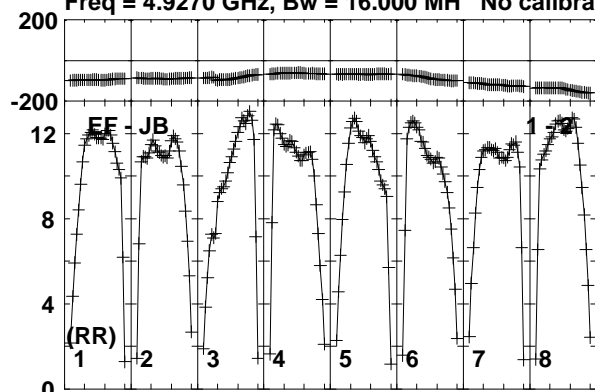

Lower frame: Milli Ampl Jy Top frame: Phas deg  
Vector averaged cross-power spectrum Baseline: EF (01) - JB (02)  
Timerange: 00/03:05:31 to 00/03:07:29

Plot file version 6 created 08-APR-2019 12:09:30

J0815+3635 EM133B.UVDATA.1

Freq = 4.9270 GHz, Bw = 16.000 MH No calibration applied and no bandpass applied

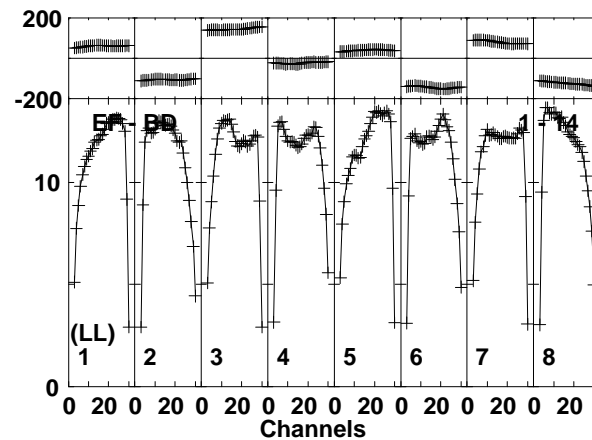
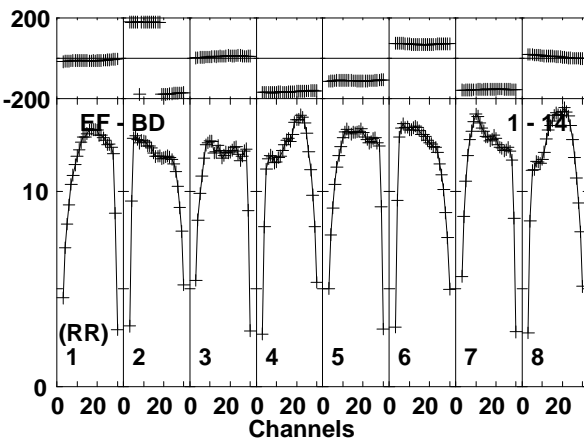
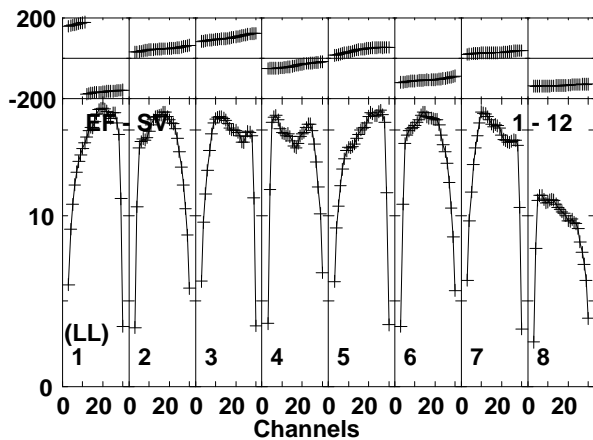
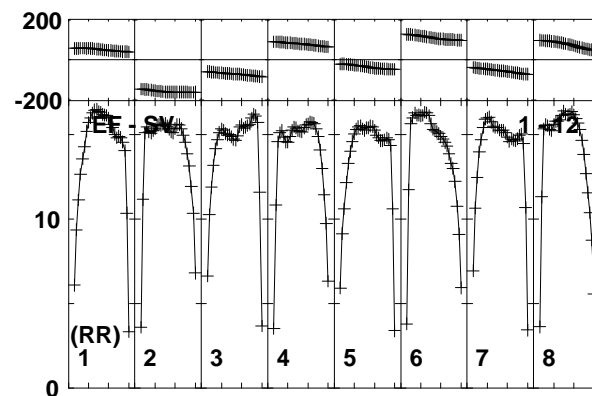
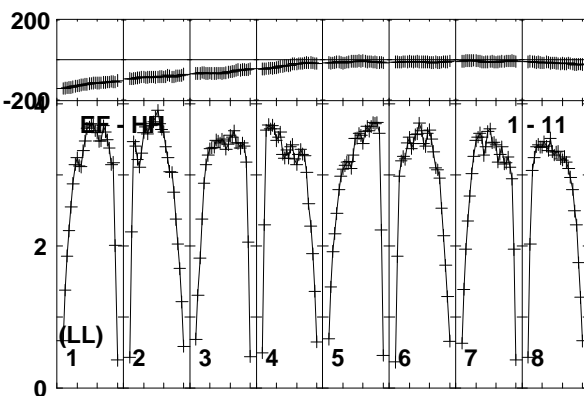
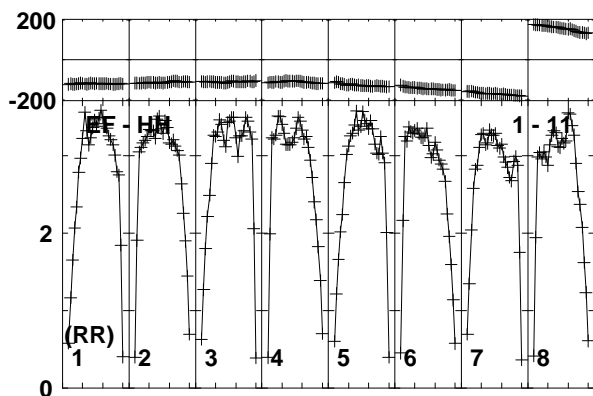
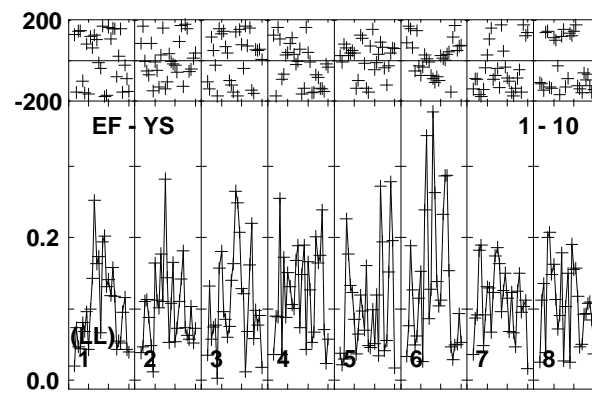
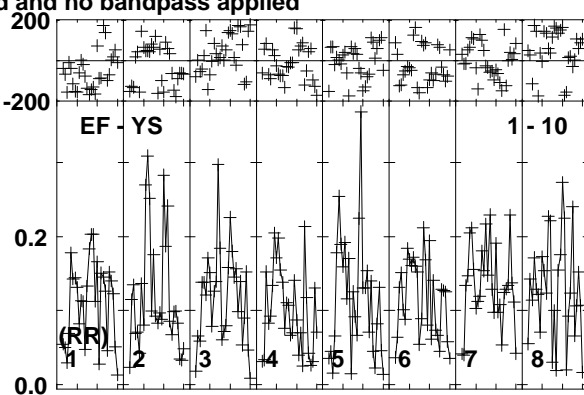
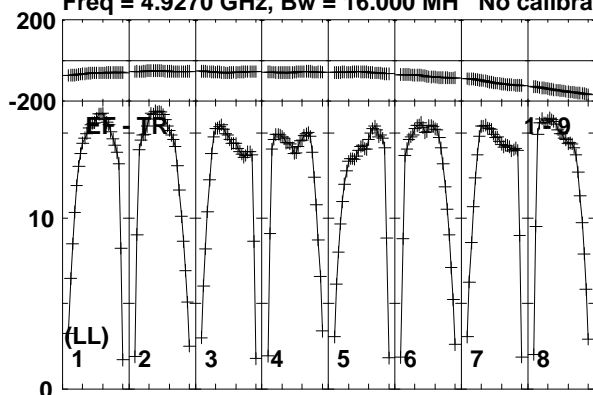

Lower frame: Milli Ampl Jy Top frame: Phas deg  
Vector averaged cross-power spectrum Baseline: EF (01) - TR (09)  
Timerange: 00/03:05:31 to 00/03:07:29

Plot file version 7 created 08-APR-2019 12:09:30

J0815+3635 EM133B.UVDATA.1

Freq = 4.9270 GHz, Bw = 16.000 MH No calibration applied and no bandpass applied

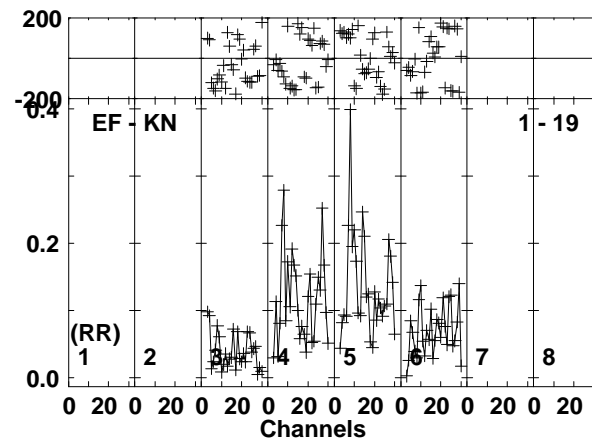
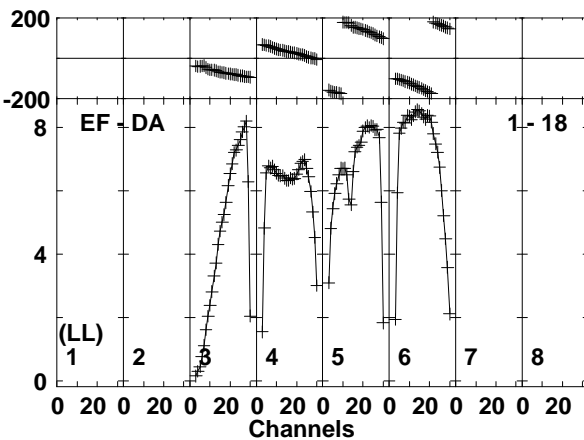
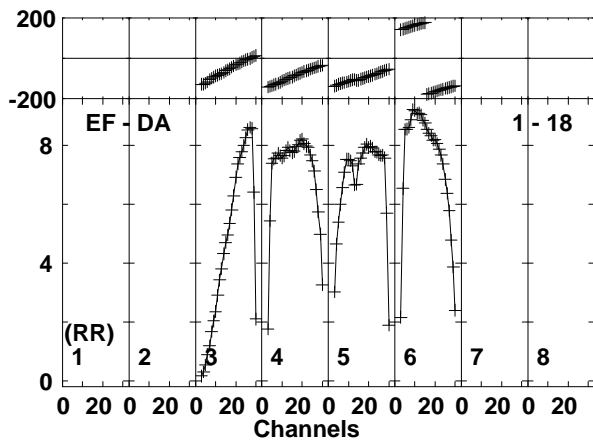
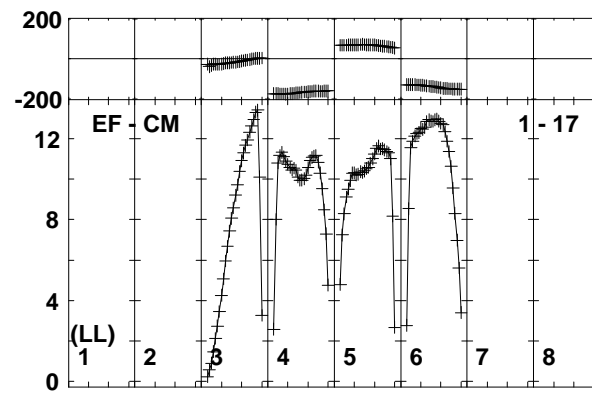
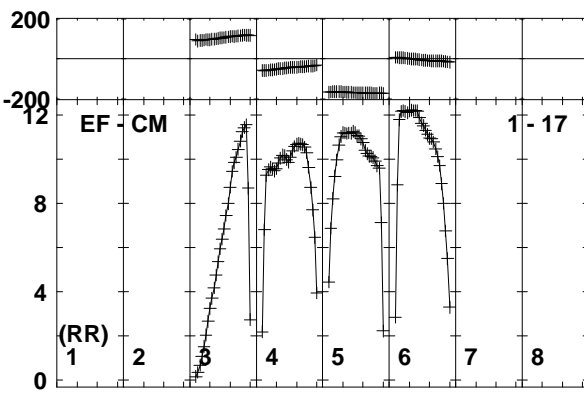
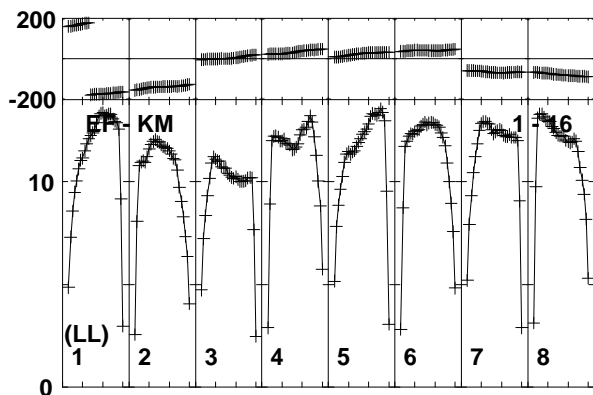
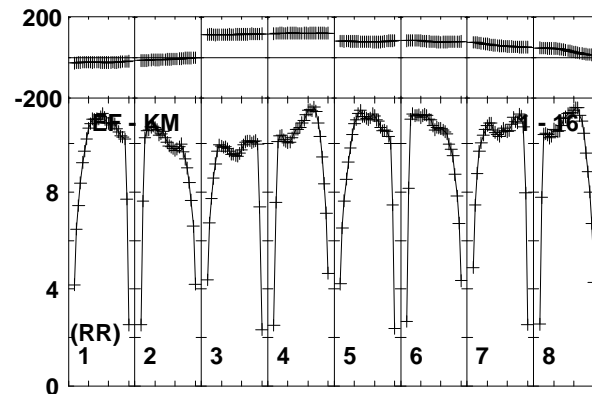
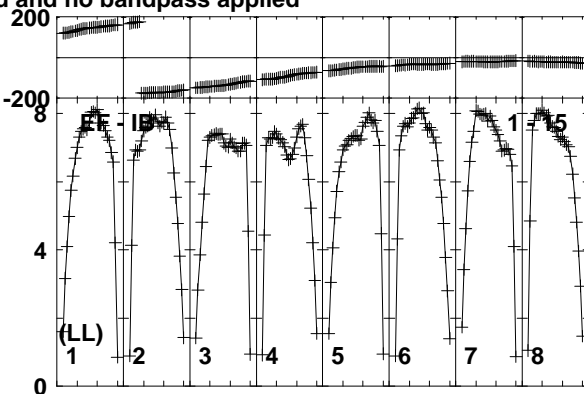
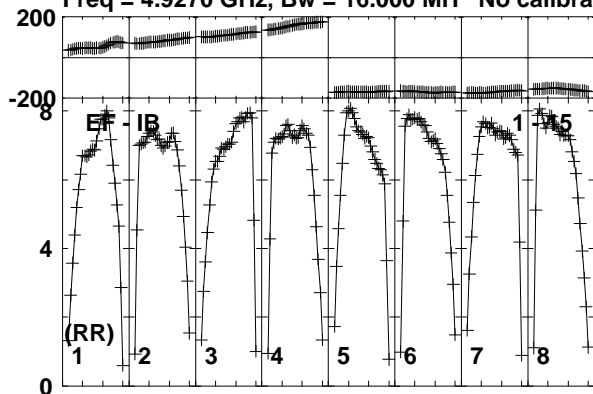

Lower frame: Milli Ampl Jy Top frame: Phas deg  
Vector averaged cross-power spectrum Baseline: EF (01) - IB (15)  
Timerange: 00/03:05:31 to 00/03:07:29

Plot file version 8 created 08-APR-2019 12:09:30

J0815+3635 EM133B.UVDATA.1

Freq = 4.9270 GHz, Bw = 16.000 MH No calibration applied and no bandpass applied

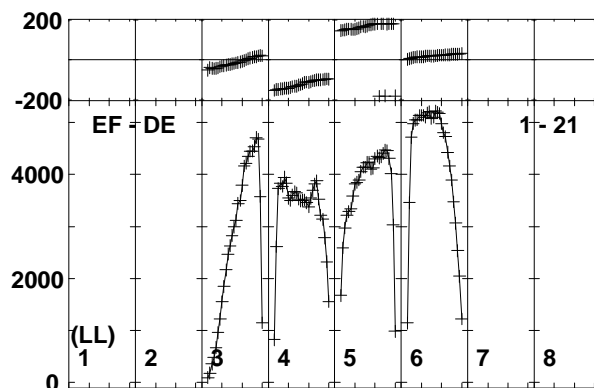
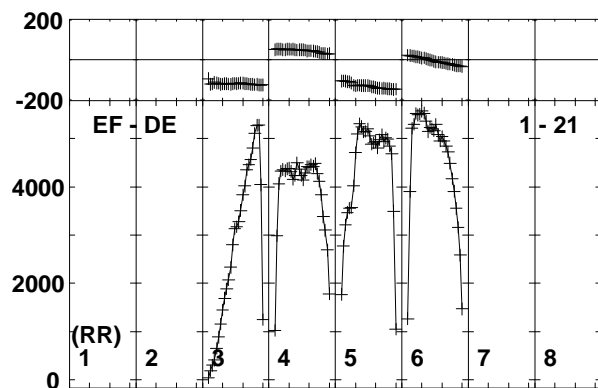
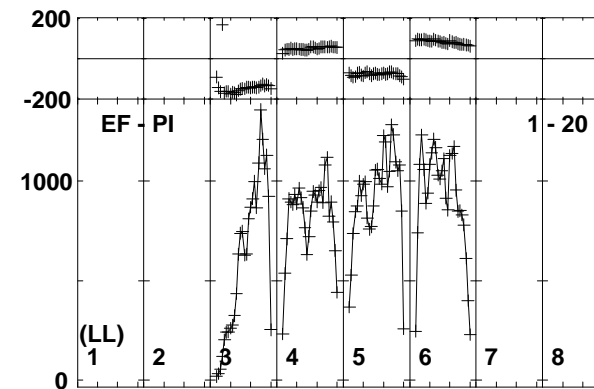
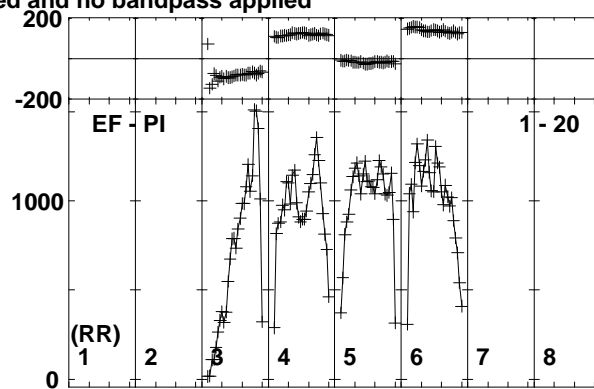
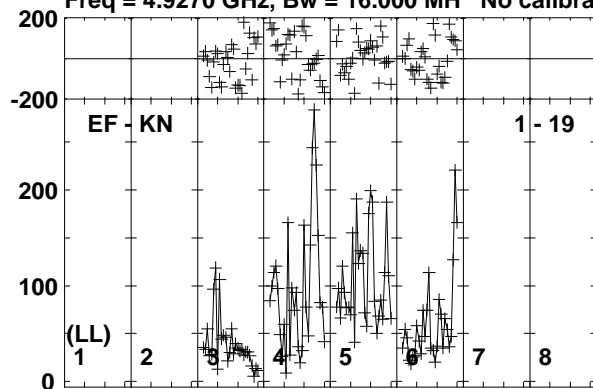

Lower frame: Micro Ampl Jy Top frame: Phas deg  
Vector averaged cross-power spectrum Baseline: EF (01) - KN (19)  
Timerange: 00/03:05:31 to 00/03:07:29



Plot file version 9 created 08-APR-2019 12:09:30

MRK622 EM133B.UVDATA.1

Freq = 4.9270 GHz, Bw = 16.000 MH No calibration applied and no bandpass applied

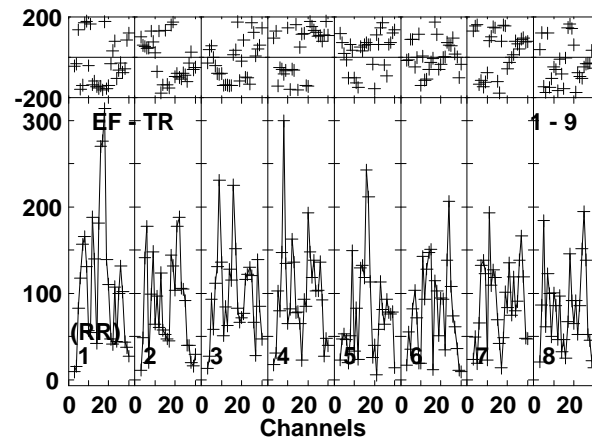
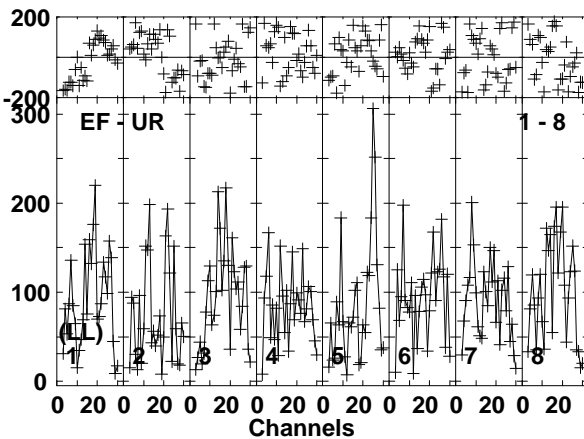
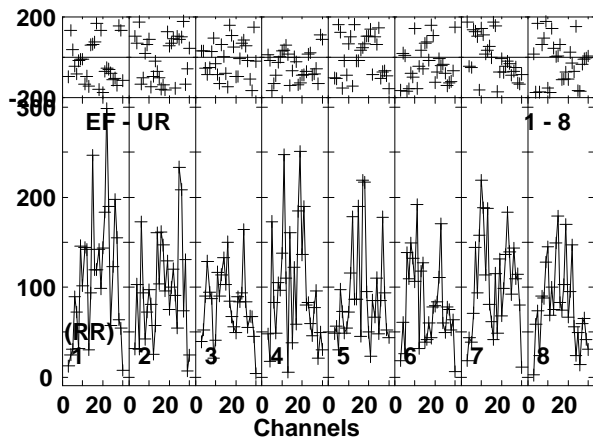
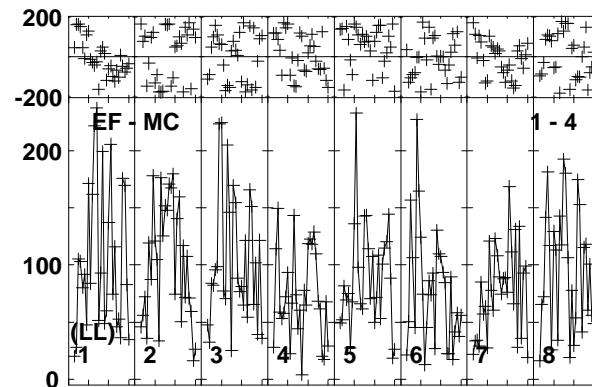
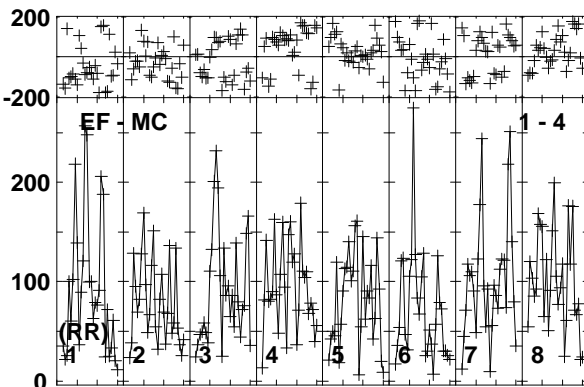
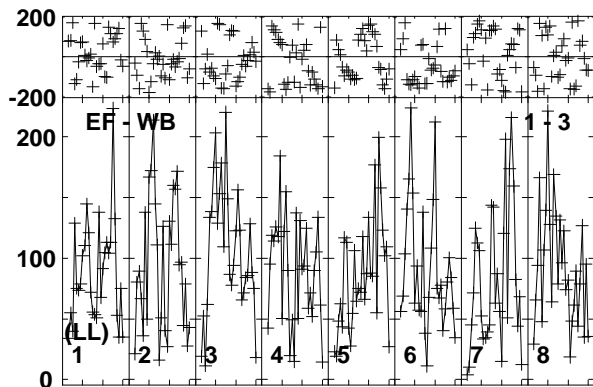
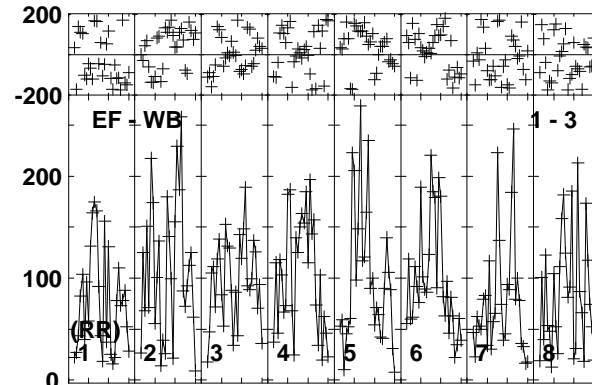
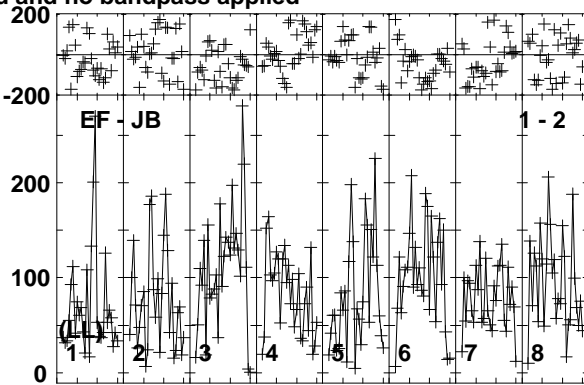
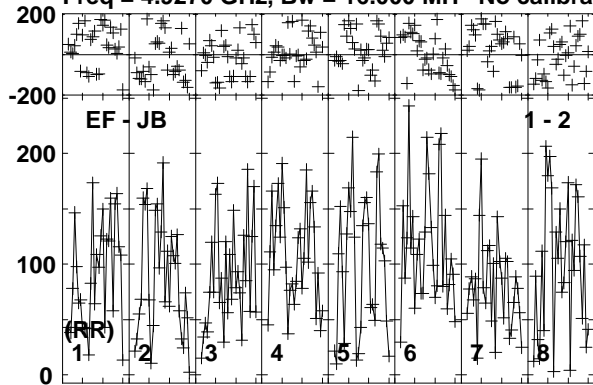

Lower frame: Micro Ampl Jy Top frame: Phas deg  
Vector averaged cross-power spectrum Baseline: EF (01) - JB (02)  
Timerange: 00/03:07:31 to 00/03:10:59



Plot file version 11 created 08-APR-2019 12:09:31

MRK622 EM133B.UVDATA.1

Freq = 4.9270 GHz, Bw = 16.000 MH No calibration applied and no bandpass applied

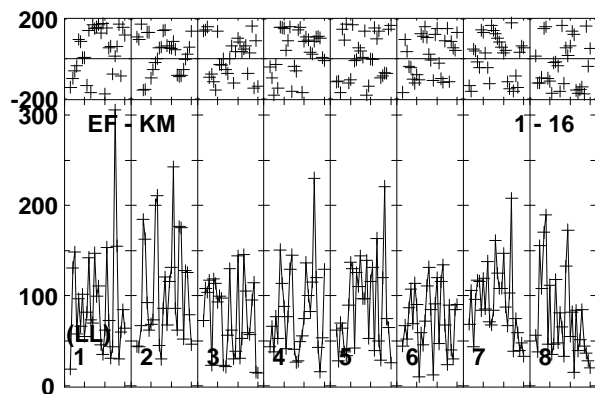
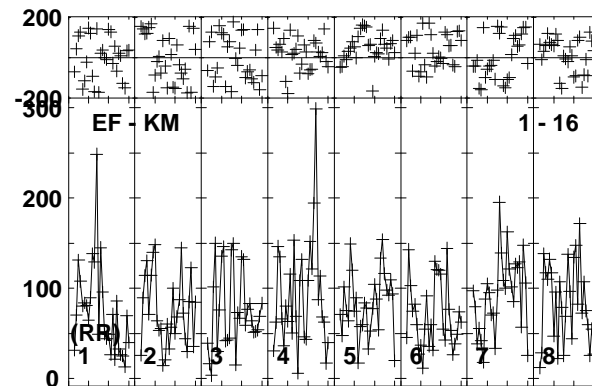
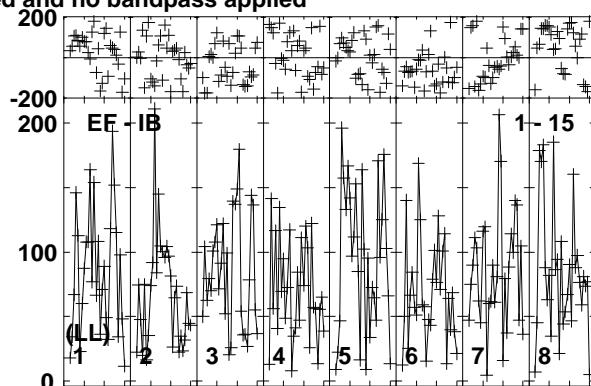
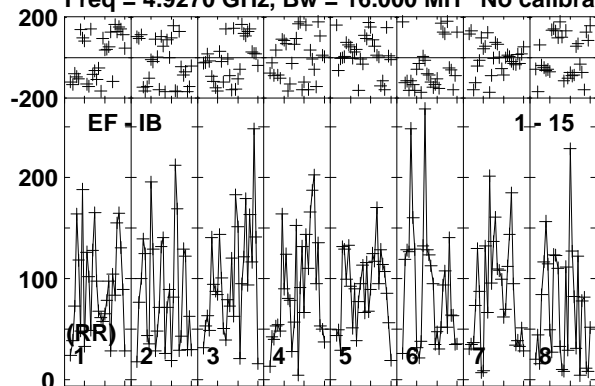

Lower frame: Micro Ampl Jy Top frame: Phas deg  
Vector averaged cross-power spectrum Baseline: EF (01) - IB (15)  
Timerange: 00/03:07:31 to 00/03:10:59

Plot file version 12 created 08-APR-2019 12:09:31

J0815+3635 EM133B.UVDATA.1

Freq = 4.9270 GHz, Bw = 16.000 MH No calibration applied and no bandpass applied

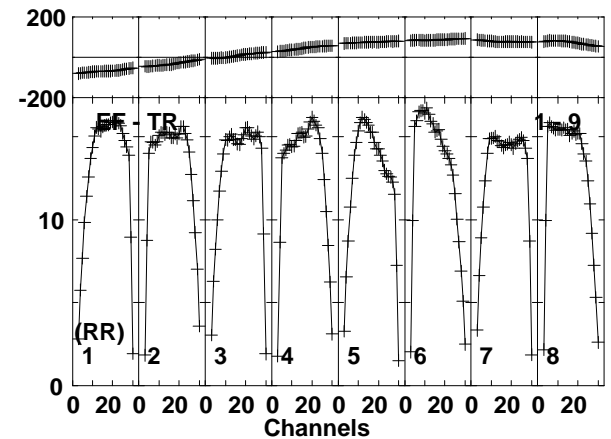
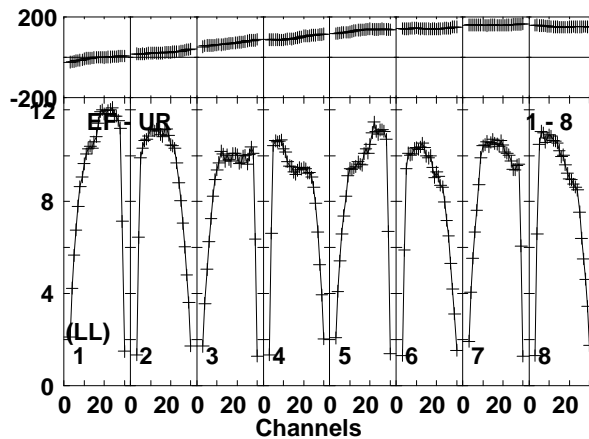
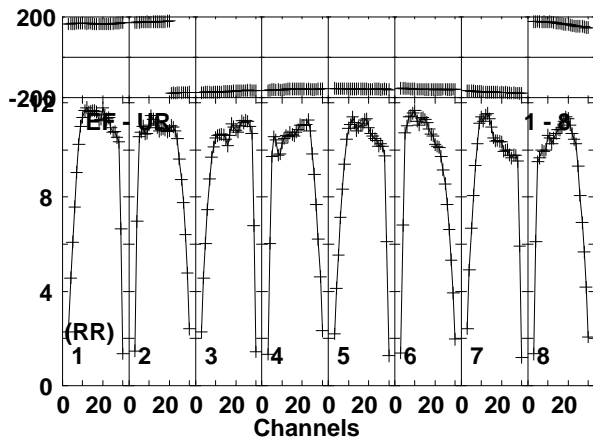
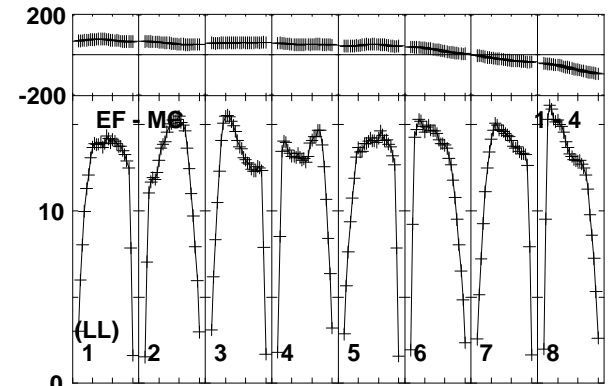
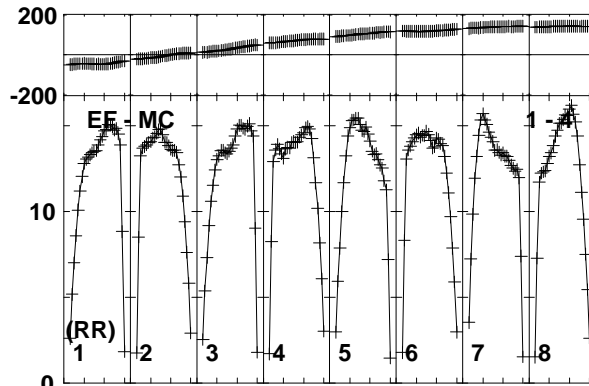
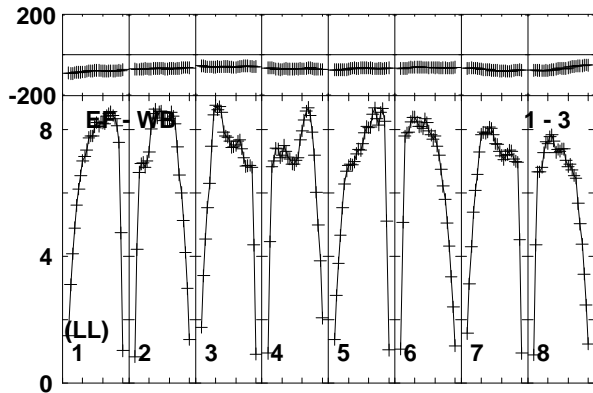
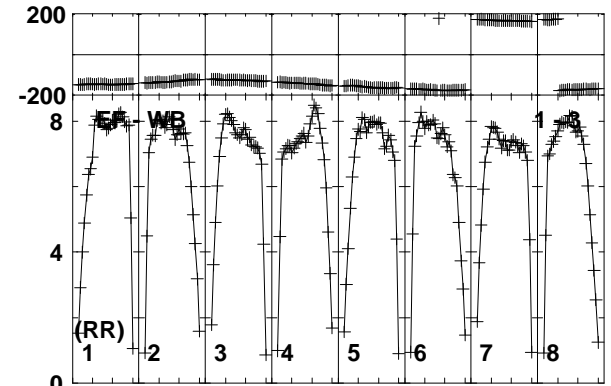
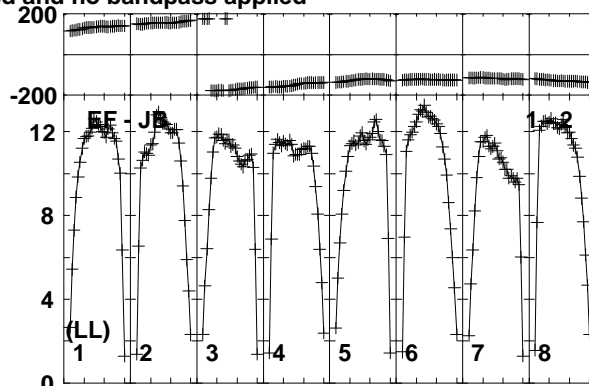
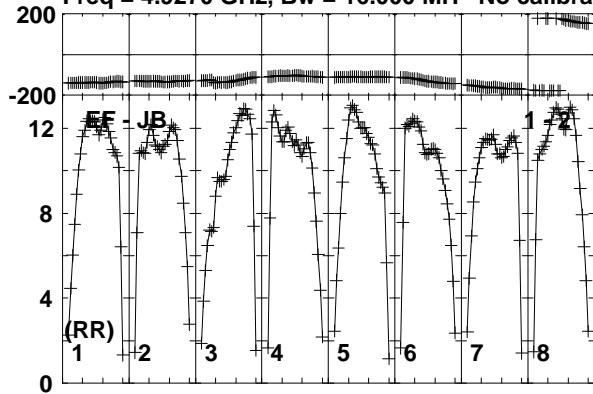

Lower frame: Milli Ampl Jy Top frame: Phas deg  
Vector averaged cross-power spectrum Baseline: EF (01) - JB (02)  
Timerange: 00/03:11:01 to 00/03:12:29

Plot file version 13 created 08-APR-2019 12:09:31

J0815+3635 EM133B.UVDATA.1

Freq = 4.9270 GHz, Bw = 16.000 MH No calibration applied and no bandpass applied

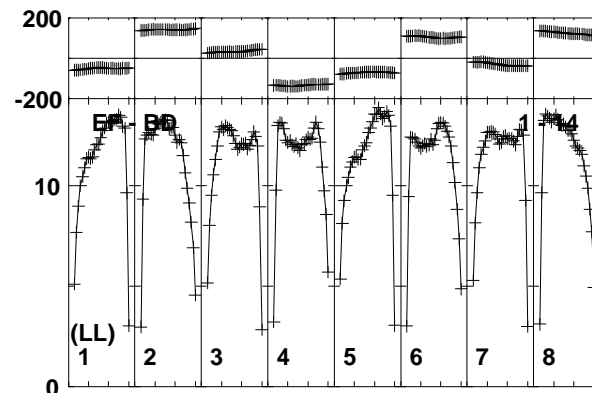
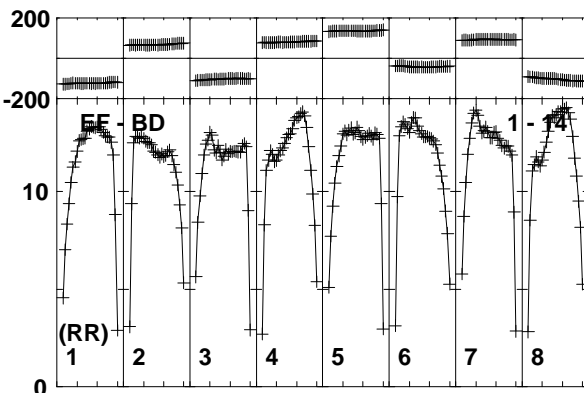
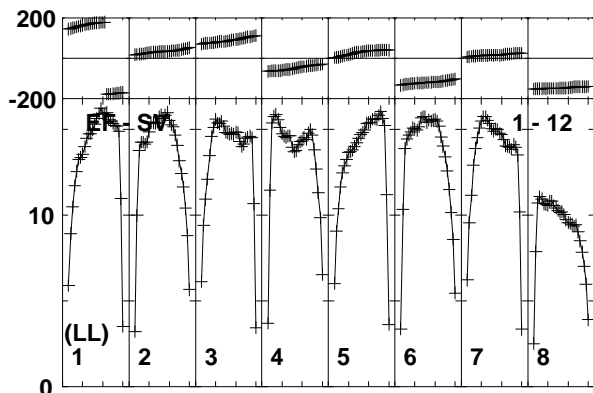
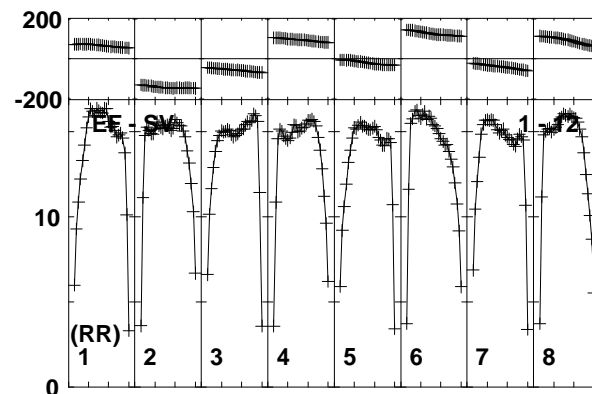
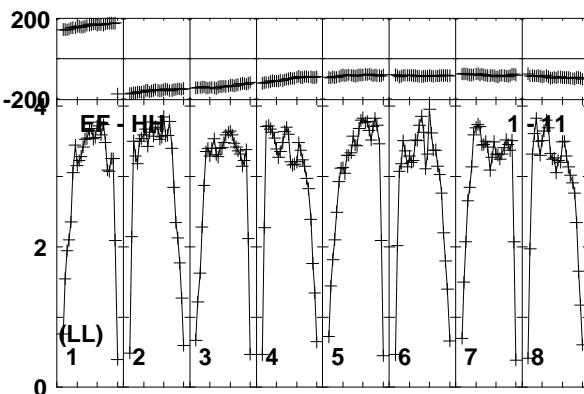
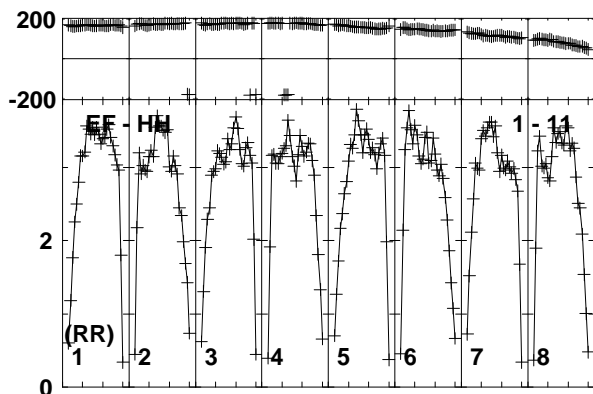
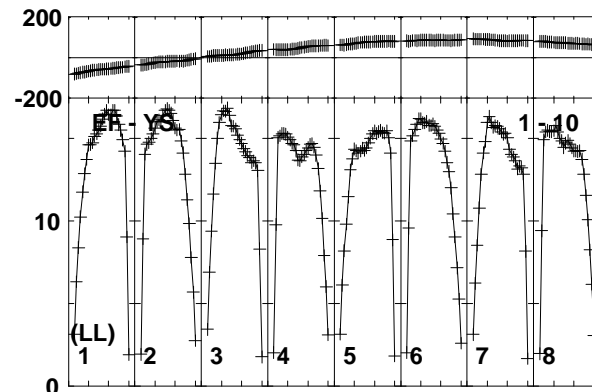
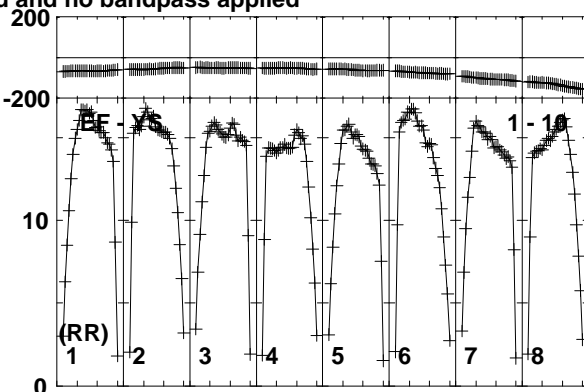
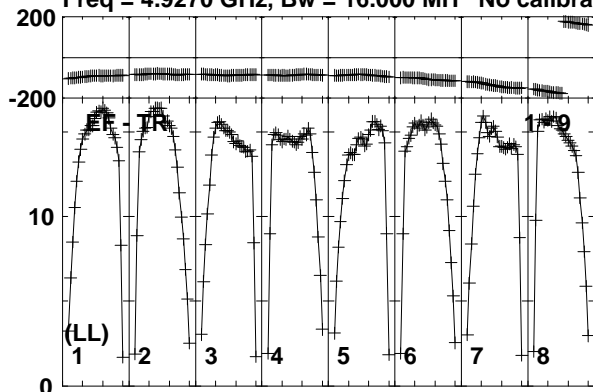

Lower frame: Milli Ampl Jy Top frame: Phas deg  
Vector averaged cross-power spectrum Baseline: EF (01) - TR (09)  
Timerange: 00/03:11:01 to 00/03:12:29

Plot file version 14 created 08-APR-2019 12:09:31

J0815+3635 EM133B.UVDATA.1

Freq = 4.9270 GHz, Bw = 16.000 MH No calibration applied and no bandpass applied

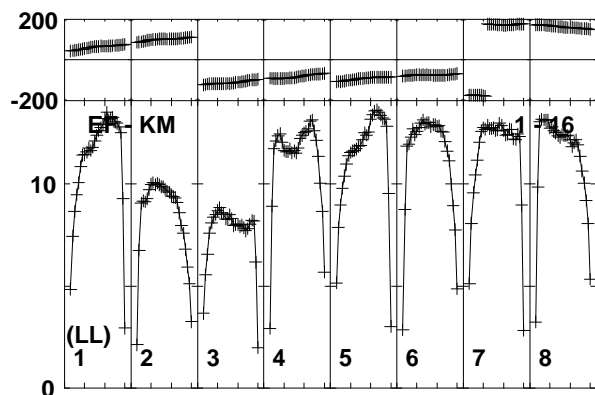
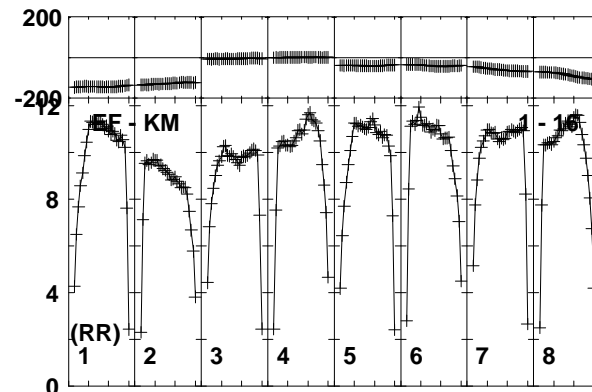
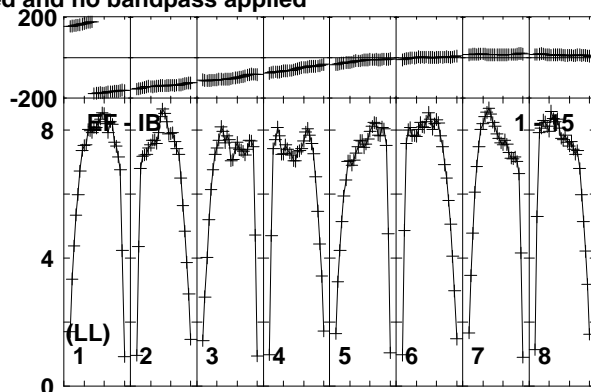
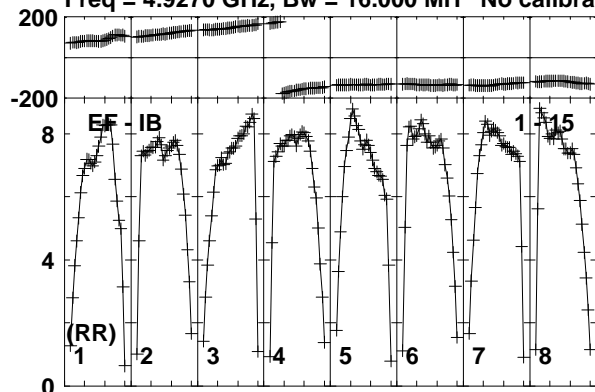

Lower frame: Milli Ampl Jy Top frame: Phas deg  
Vector averaged cross-power spectrum Baseline: EF (01) - IB (15)  
Timerange: 00/03:11:01 to 00/03:12:29

Plot file version 15 created 08-APR-2019 12:09:31

MRK622 EM133B.UVDATA.1

Freq = 4.9270 GHz, Bw = 16.000 MH No calibration applied and no bandpass applied

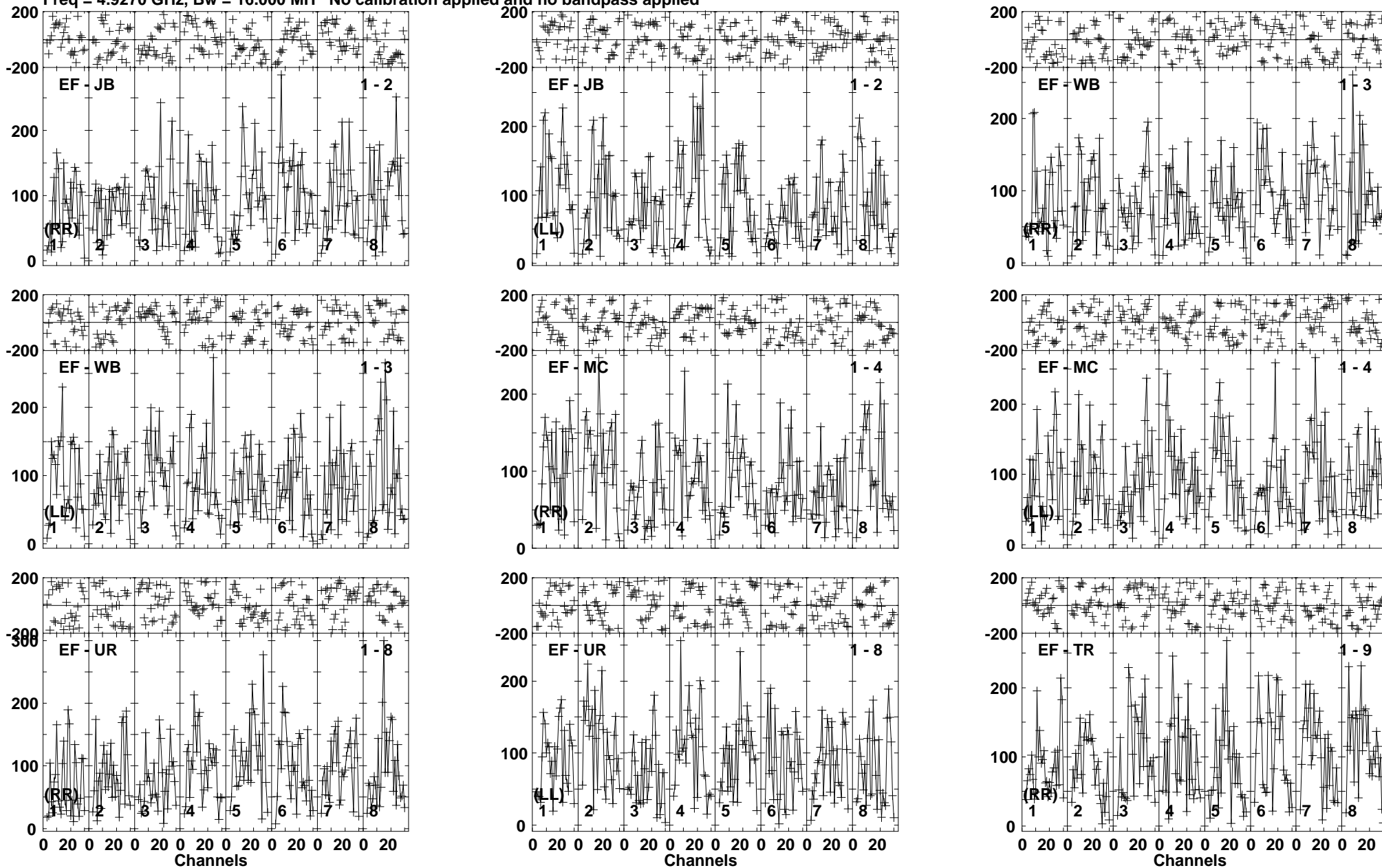

Lower frame: Micro Ampl Jy Top frame: Phas deg  
Vector averaged cross-power spectrum Baseline: EF (01) - JB (02)  
Timerange: 00/03:12:33 to 00/03:15:59

Plot file version 16 created 08-APR-2019 12:09:31

MRK622 EM133B.UVDATA.1

Freq = 4.9270 GHz, Bw = 16.000 MH No calibration applied and no bandpass applied

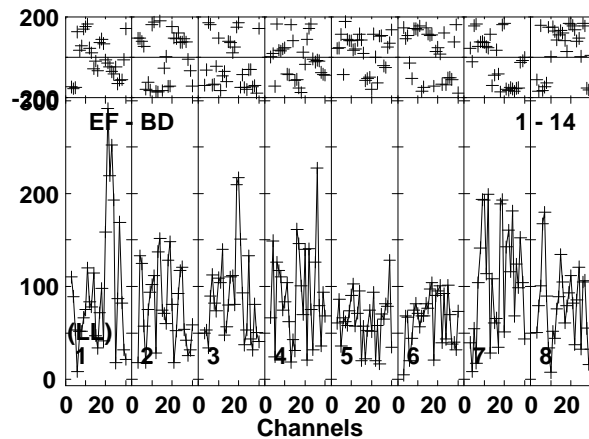
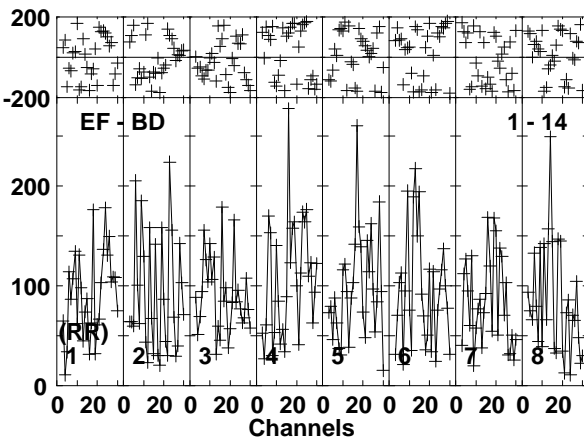
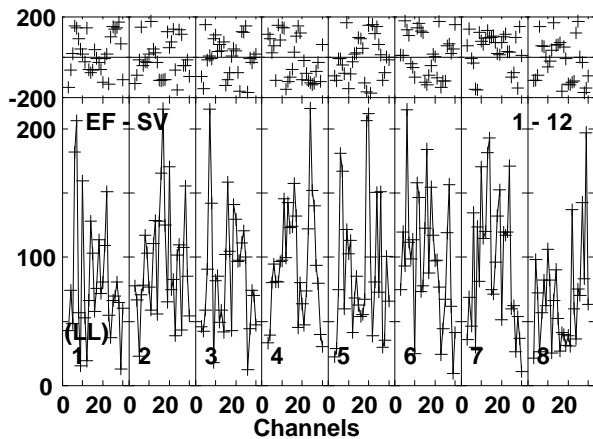
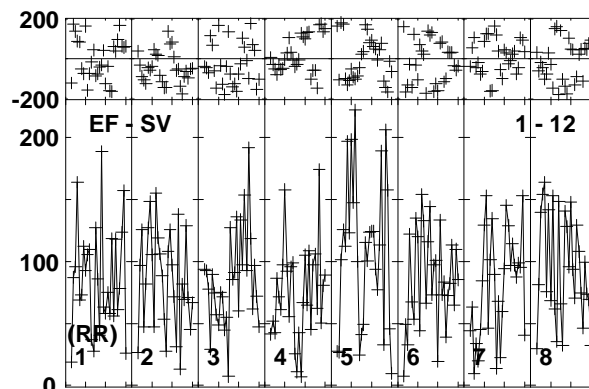
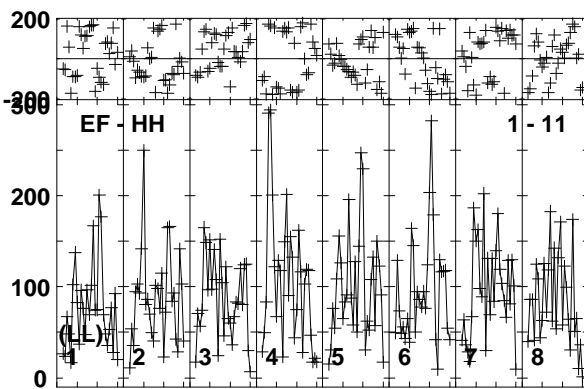
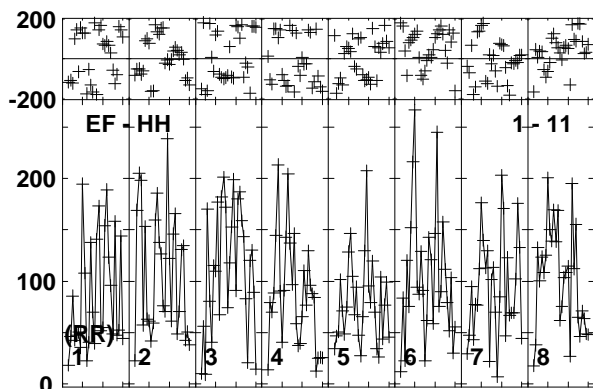
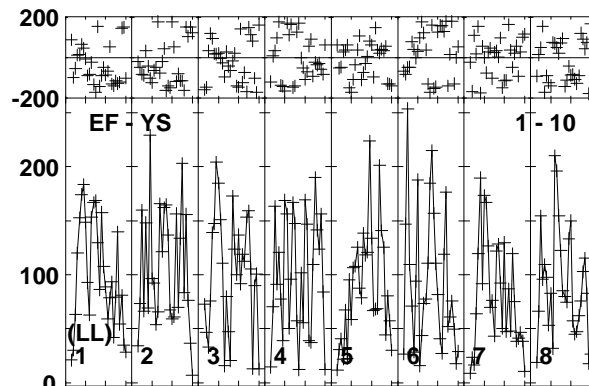
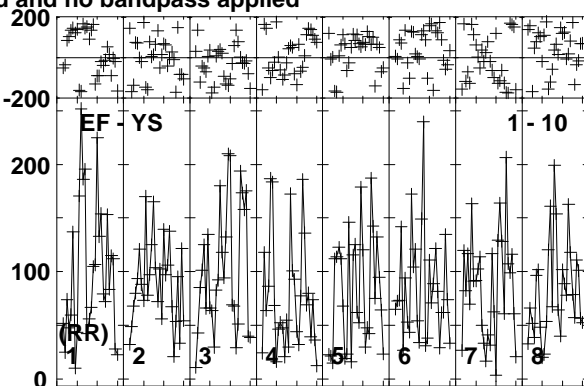
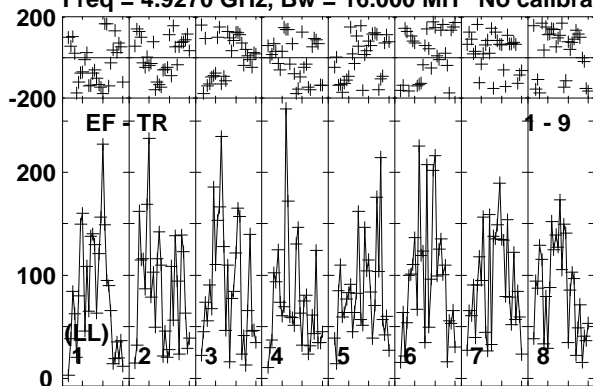

Lower frame: Micro Ampl Jy Top frame: Phas deg  
Vector averaged cross-power spectrum Baseline: EF (01) - TR (09)  
Timerange: 00/03:12:33 to 00/03:15:59



Plot file version 17 created 08-APR-2019 12:09:31

MRK622 EM133B.UVDATA.1

Freq = 4.9270 GHz, Bw = 16.000 MH No calibration applied and no bandpass applied

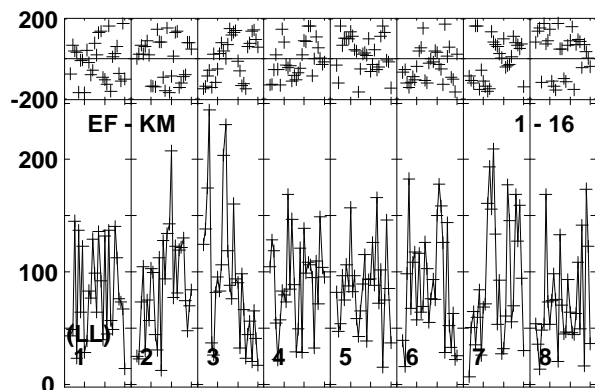
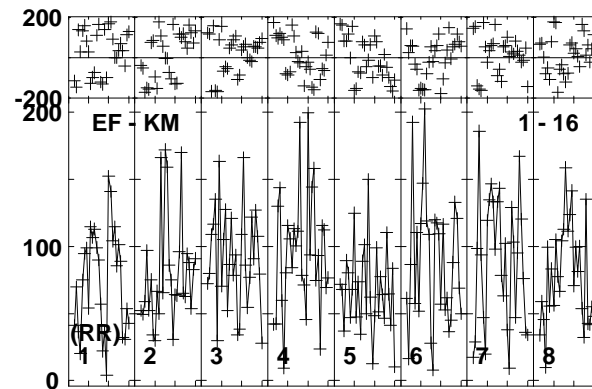
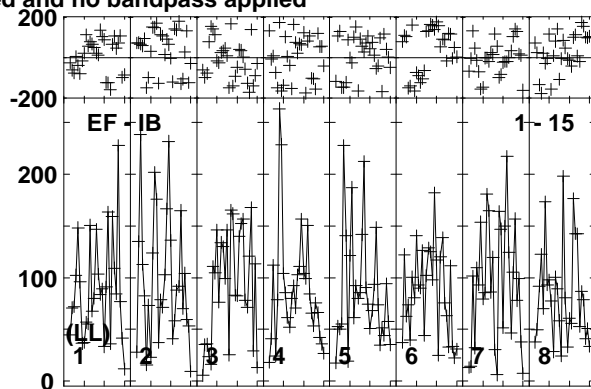
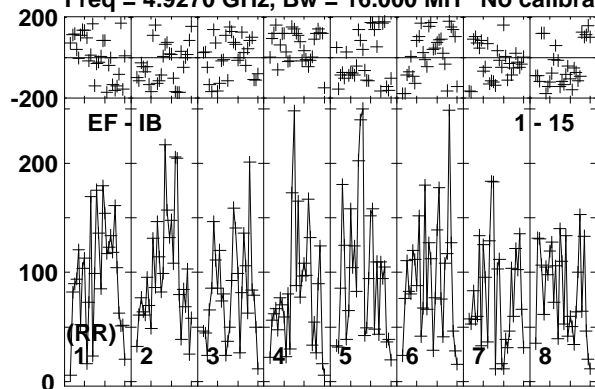

Lower frame: Micro Ampl Jy Top frame: Phas deg  
Vector averaged cross-power spectrum Baseline: EF (01) - IB (15)  
Timerange: 00/03:12:33 to 00/03:15:59

Plot file version 18 created 08-APR-2019 12:09:31

J0815+3635 EM133B.UVDATA.1

Freq = 4.9270 GHz, Bw = 16.000 MH No calibration applied and no bandpass applied

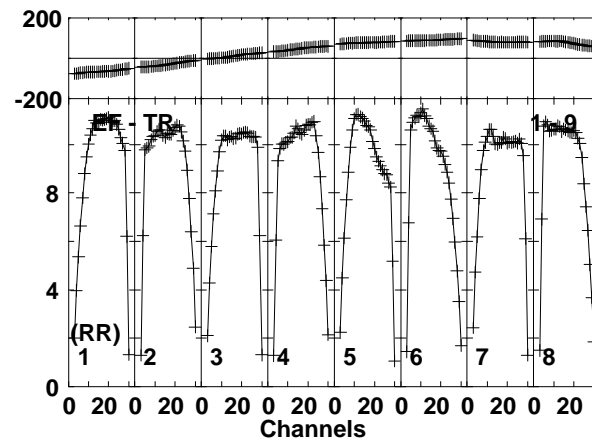
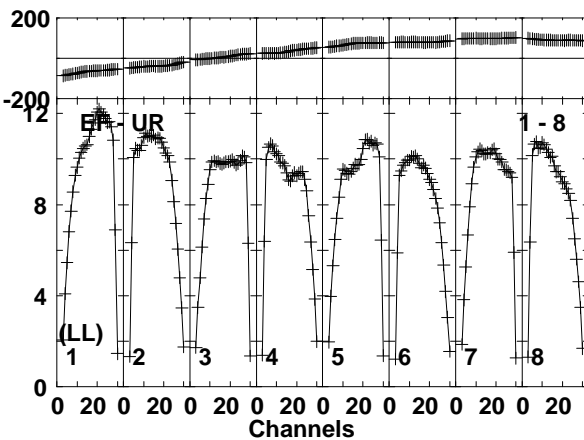
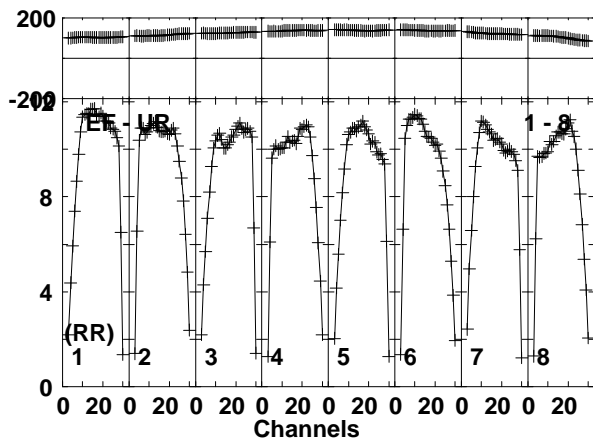
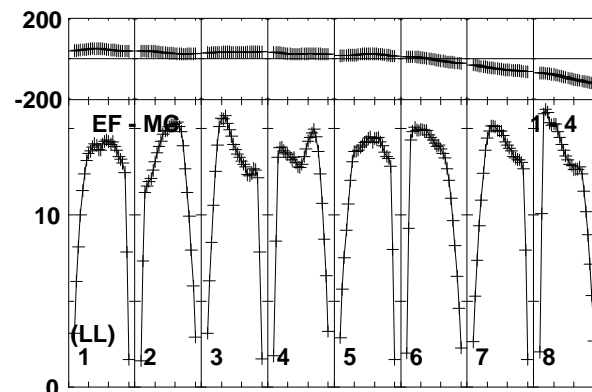
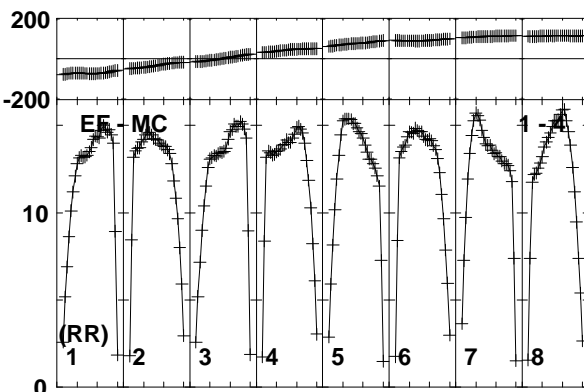
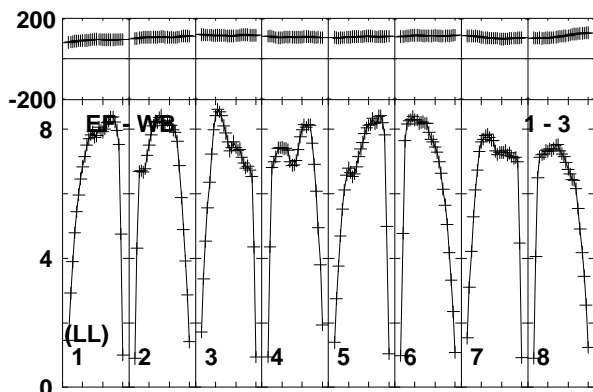
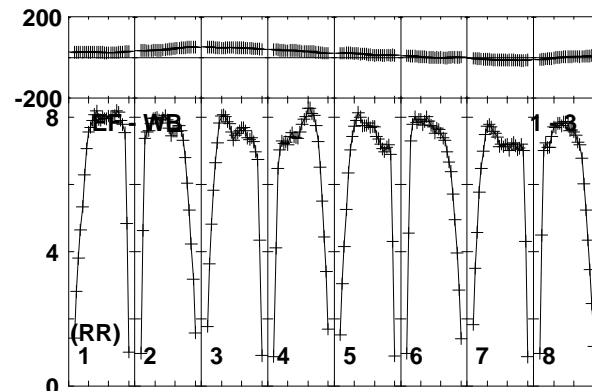
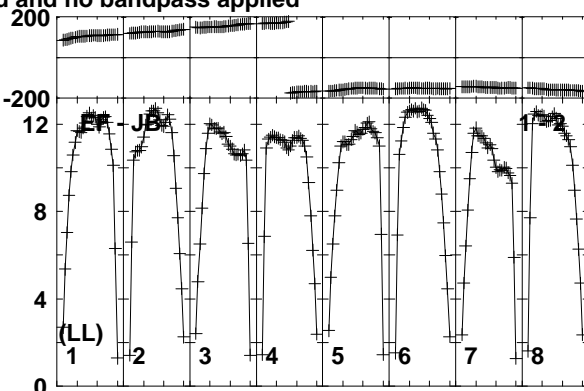
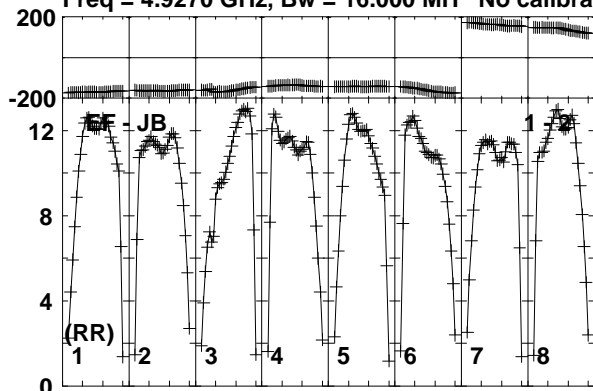

Lower frame: Milli Ampl Jy Top frame: Phas deg  
Vector averaged cross-power spectrum Baseline: EF (01) - JB (02)  
Timerange: 00/03:16:51 to 00/03:18:19

Plot file version 19 created 08-APR-2019 12:09:32

J0815+3635 EM133B.UVDATA.1

Freq = 4.9270 GHz, Bw = 16.000 MH No calibration applied and no bandpass applied

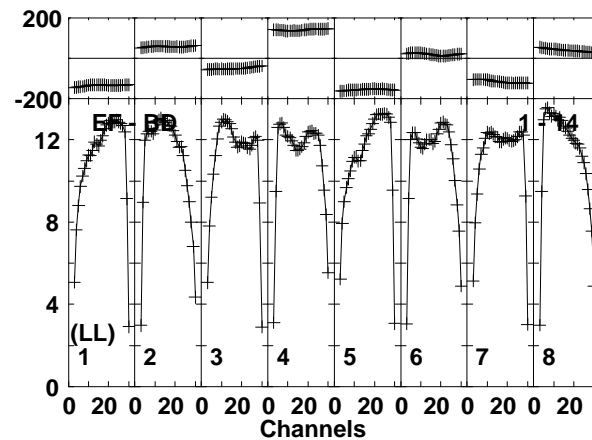
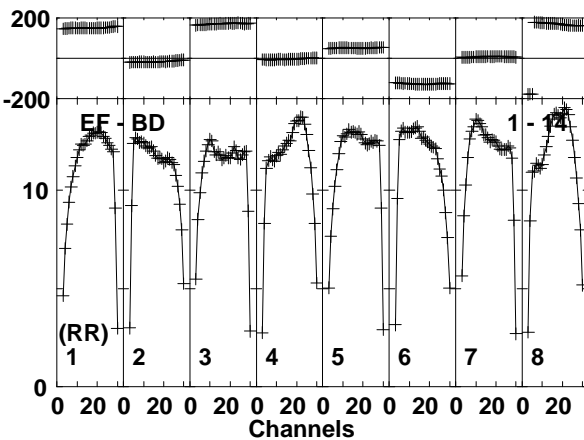
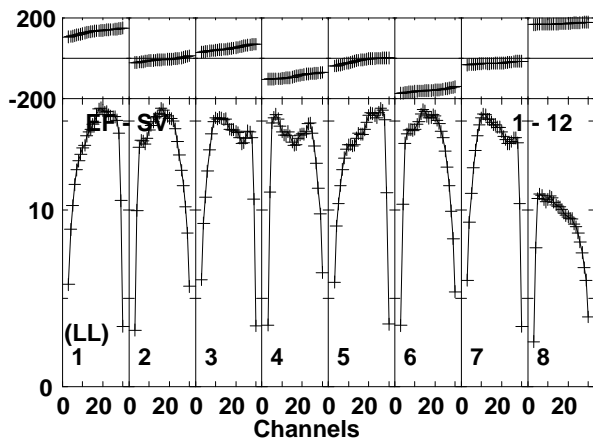
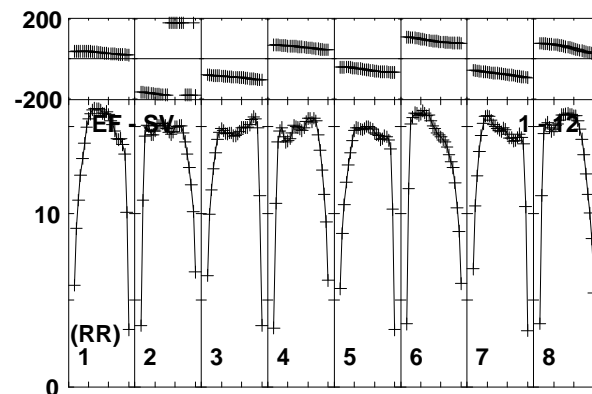
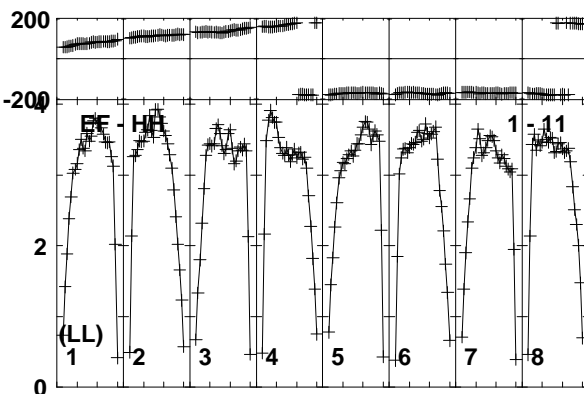
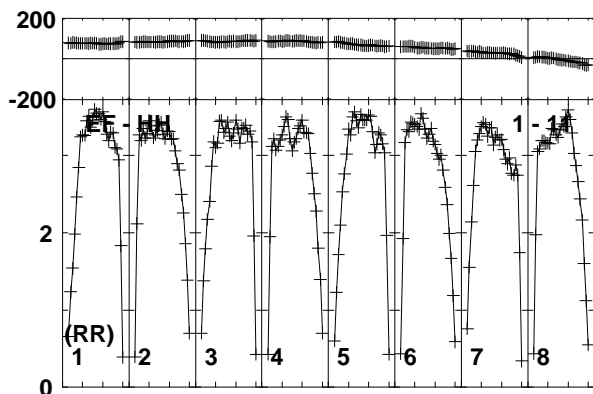
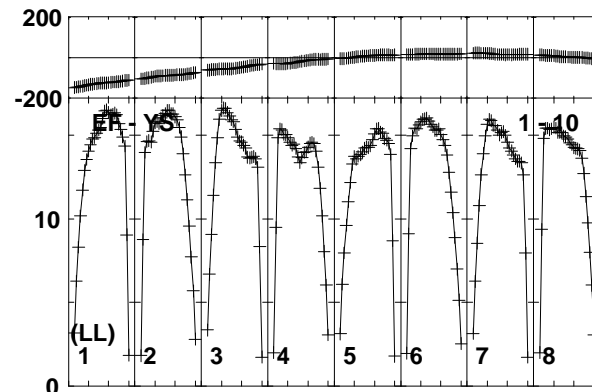
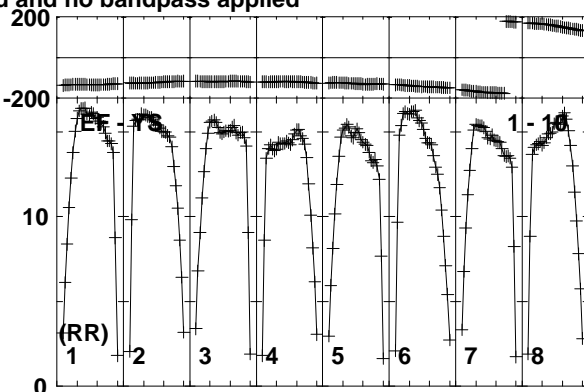
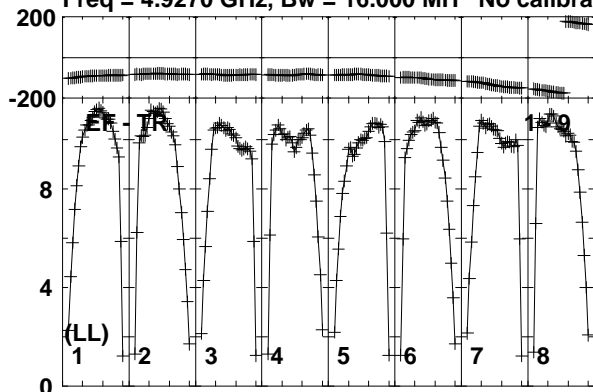

Lower frame: Milli Ampl Jy Top frame: Phas deg  
Vector averaged cross-power spectrum Baseline: EF (01) - TR (09)  
Timerange: 00/03:16:51 to 00/03:18:19

Plot file version 20 created 08-APR-2019 12:09:32

J0815+3635 EM133B.UVDATA.1

Freq = 4.9270 GHz, Bw = 16.000 MH No calibration applied and no bandpass applied

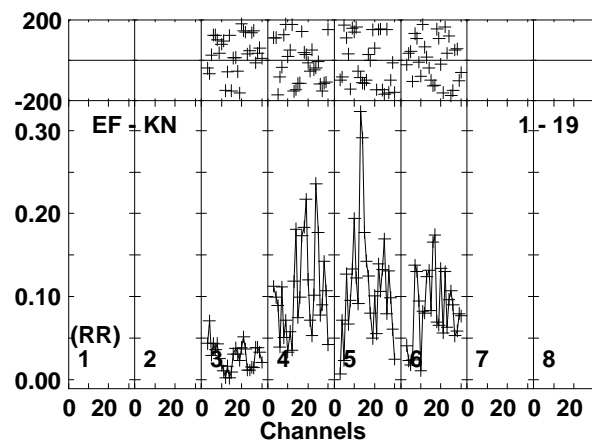
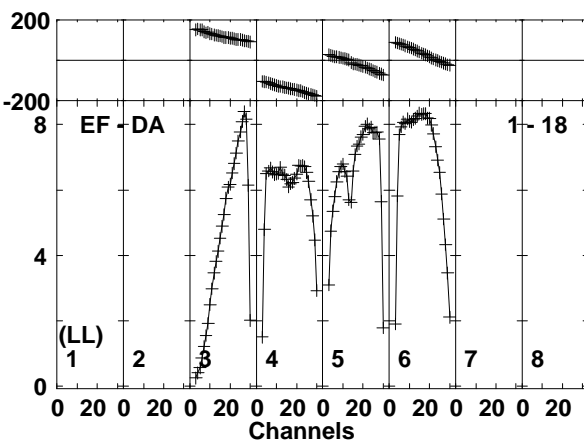
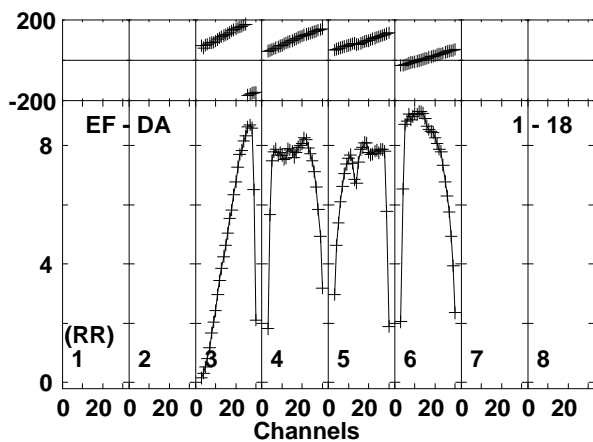
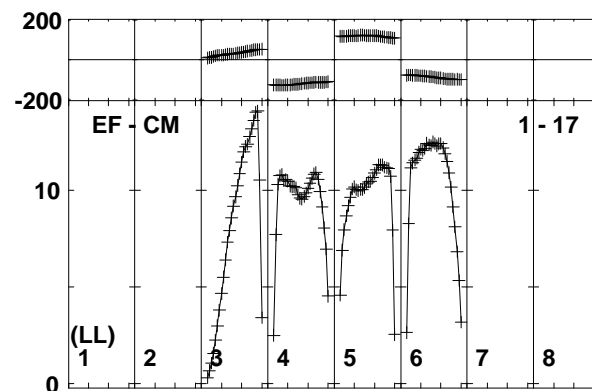
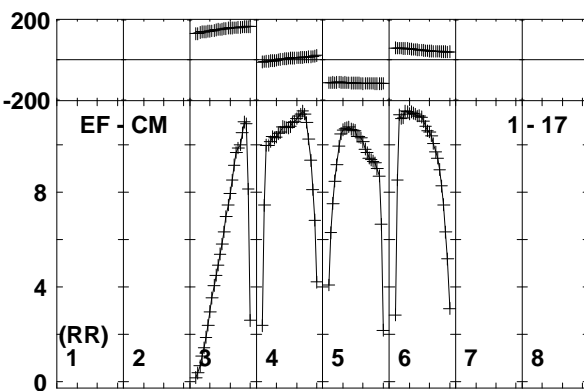
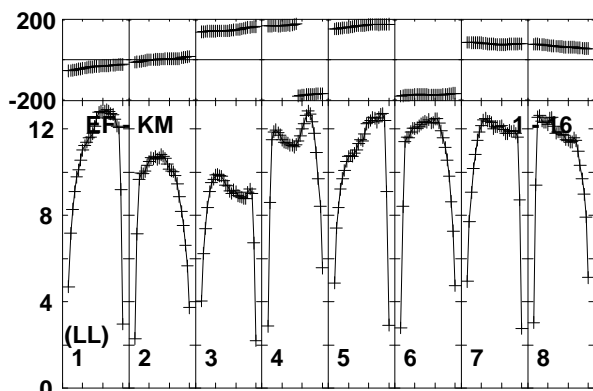
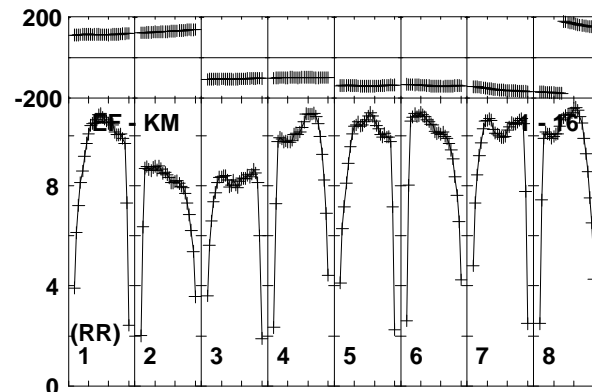
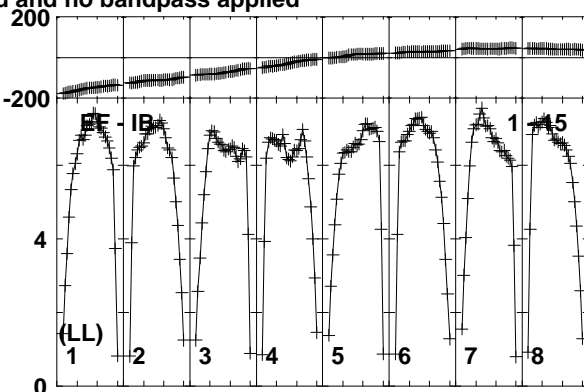
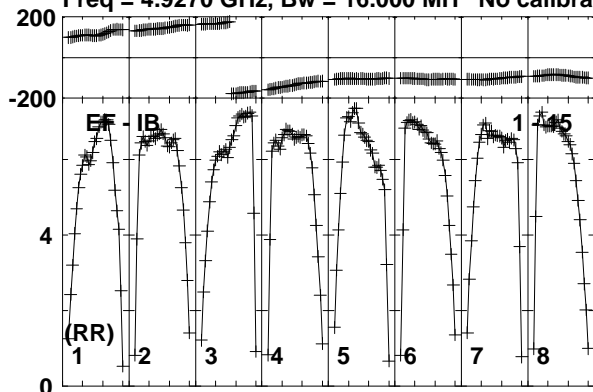

Lower frame: Milli Ampl Jy Top frame: Phas deg  
Vector averaged cross-power spectrum Baseline: EF (01) - IB (15)  
Timerange: 00/03:16:51 to 00/03:18:19

Plot file version 21 created 08-APR-2019 12:09:32

J0815+3635 EM133B.UVDATA.1

Freq = 4.9270 GHz, Bw = 16.000 MH No calibration applied and no bandpass applied

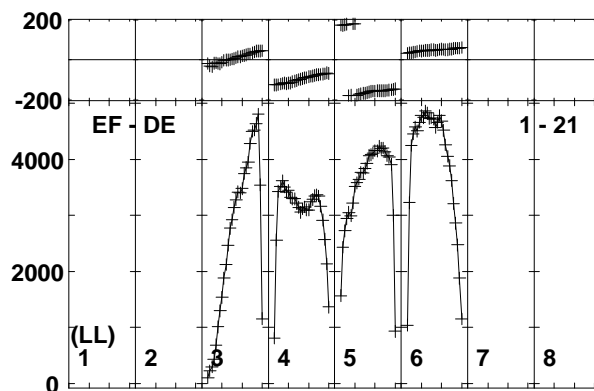
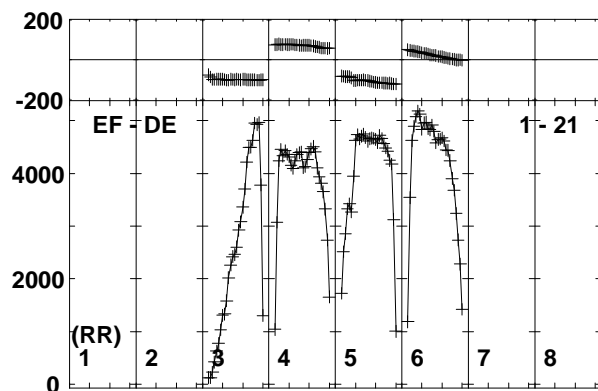
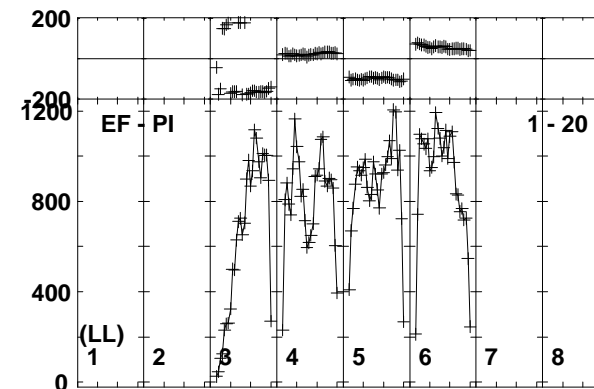
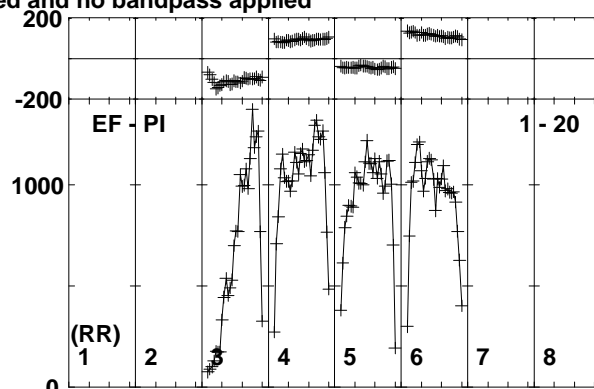
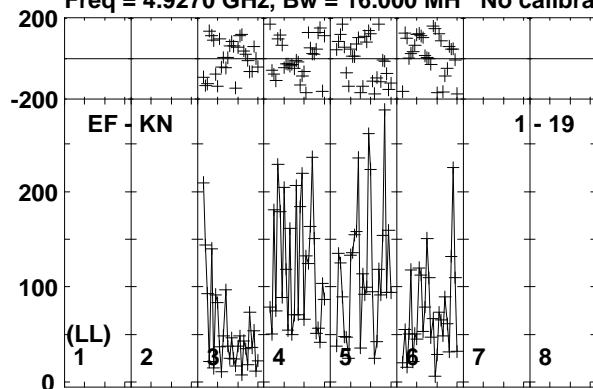

Lower frame: Micro Ampl Jy Top frame: Phas deg  
Vector averaged cross-power spectrum Baseline: EF (01) - KN (19)  
Timerange: 00/03:16:51 to 00/03:18:19

Plot file version 22 created 08-APR-2019 12:09:32

MRK622 EM133B.UVDATA.1

Freq = 4.9270 GHz, Bw = 16.000 MH No calibration applied and no bandpass applied

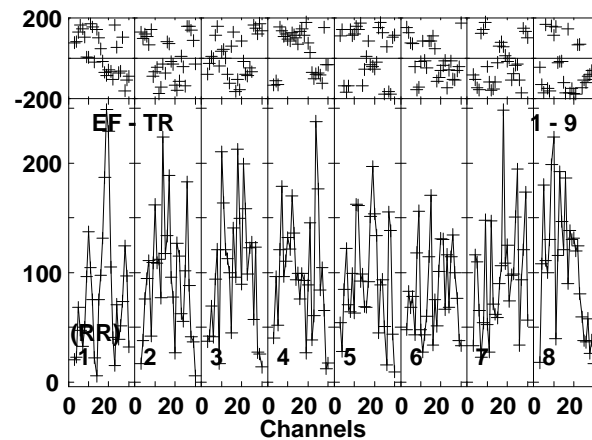
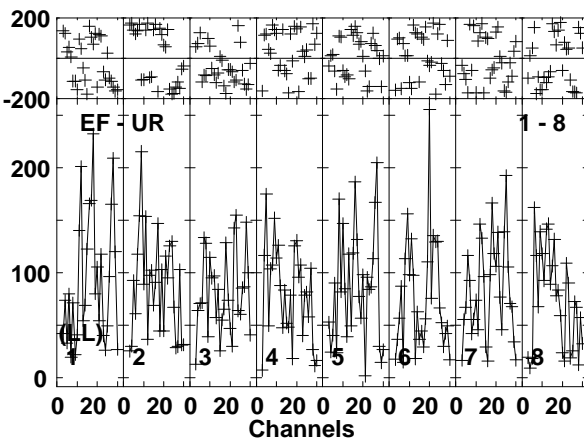
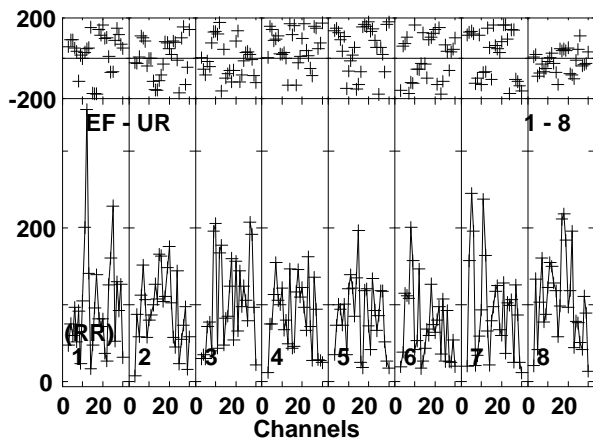
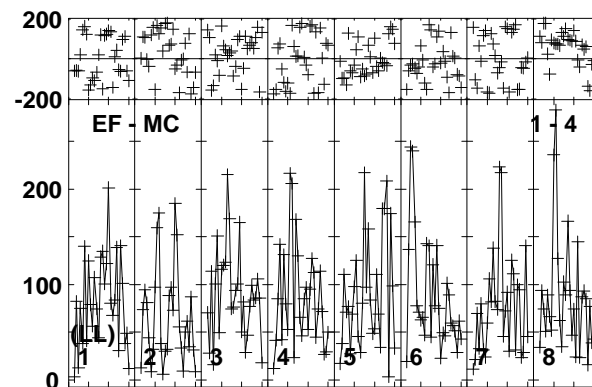
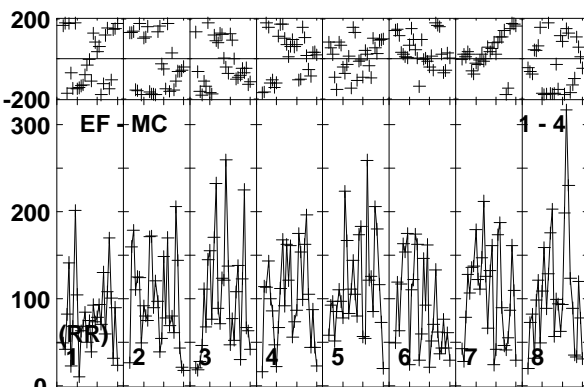
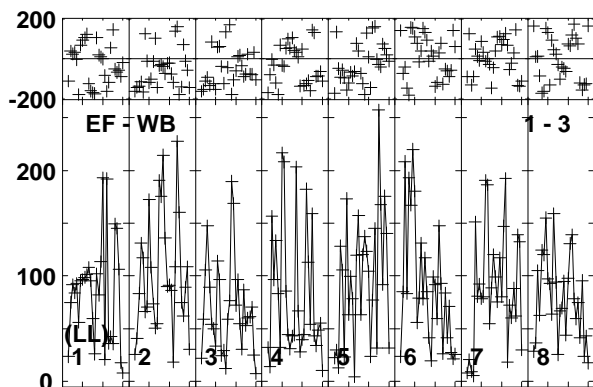
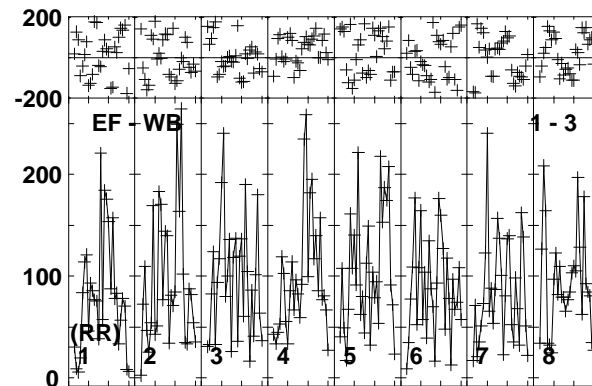
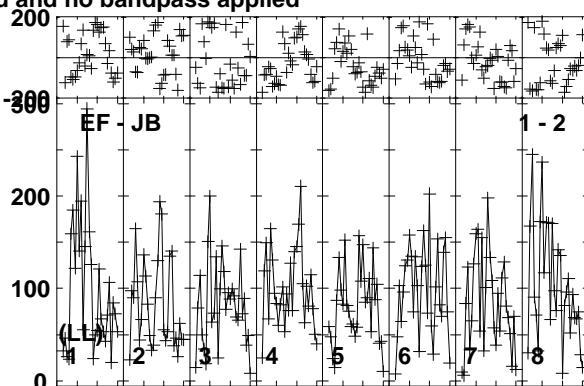
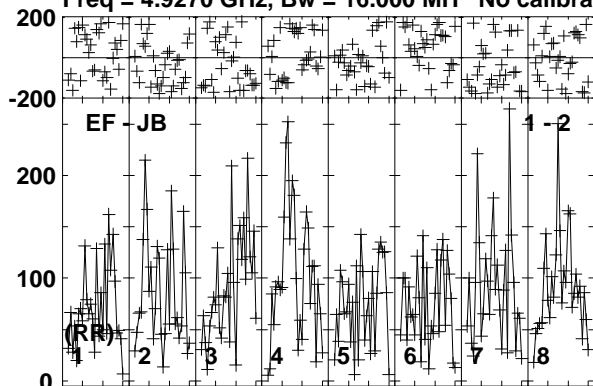

Lower frame: Micro Ampl Jy Top frame: Phas deg  
Vector averaged cross-power spectrum Baseline: EF (01) - JB (02)  
Timerange: 00/03:18:21 to 00/03:21:49

Plot file version 23 created 08-APR-2019 12:09:32

MRK622 EM133B.UVDATA.1

Freq = 4.9270 GHz, Bw = 16.000 MH No calibration applied and no bandpass applied

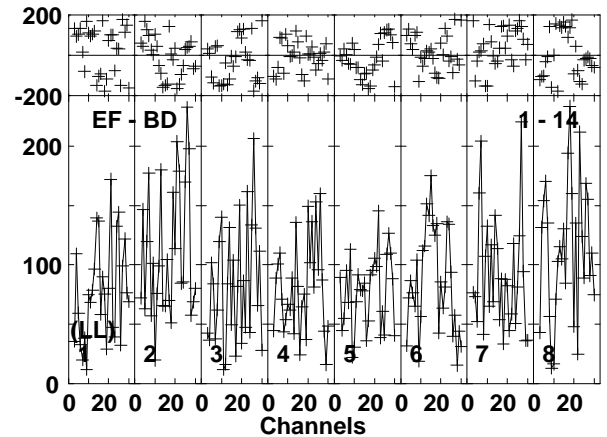
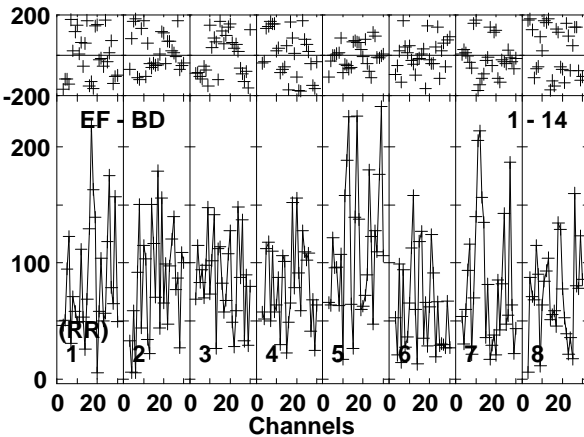
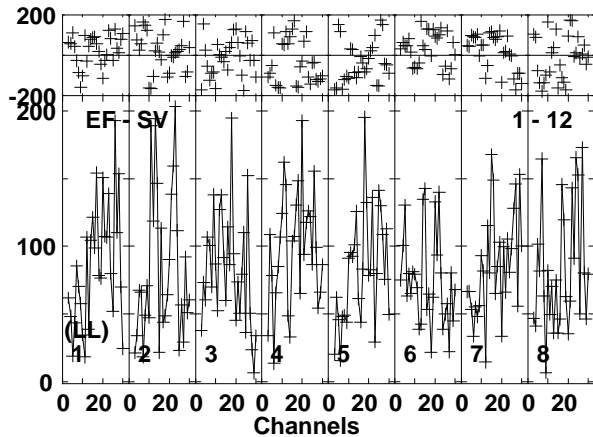
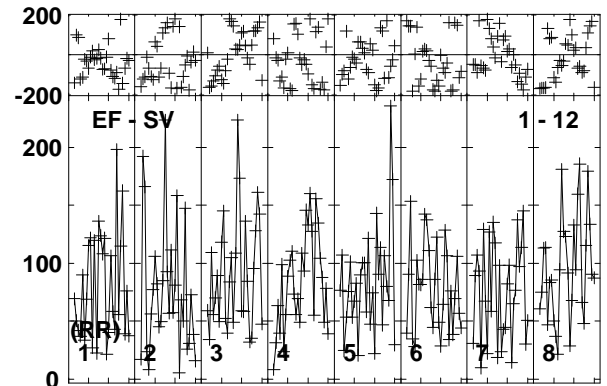
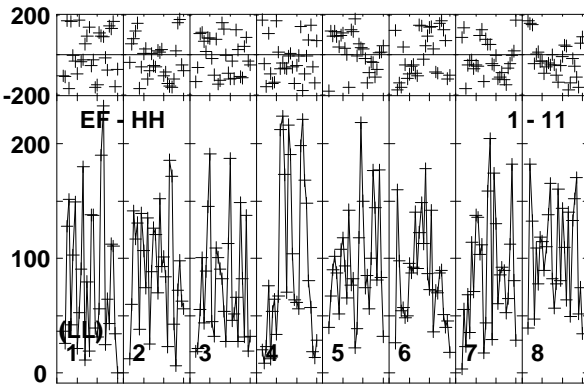
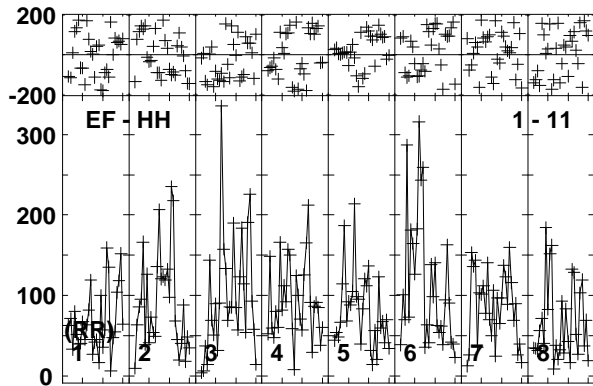
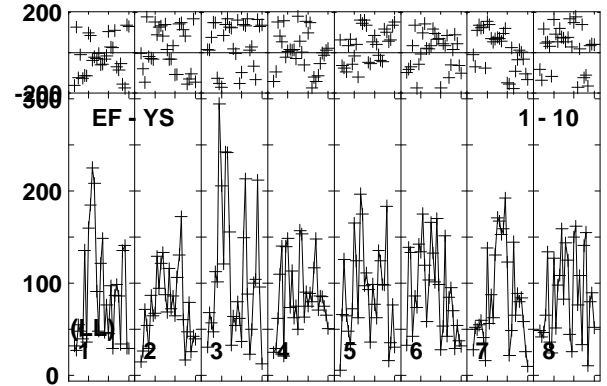
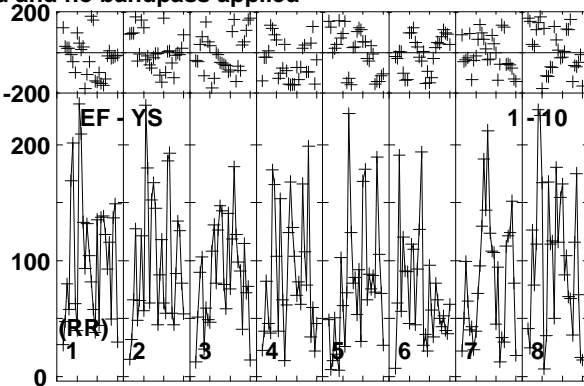
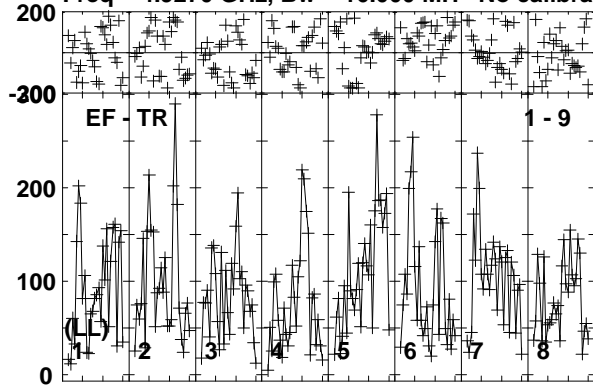

Lower frame: Micro Ampl Jy Top frame: Phas deg  
Vector averaged cross-power spectrum Baseline: EF (01) - TR (09)  
Timerange: 00/03:18:21 to 00/03:21:49

Plot file version 24 created 08-APR-2019 12:09:32

MRK622 EM133B.UVDATA.1

Freq = 4.9270 GHz, Bw = 16.000 MH No calibration applied and no bandpass applied

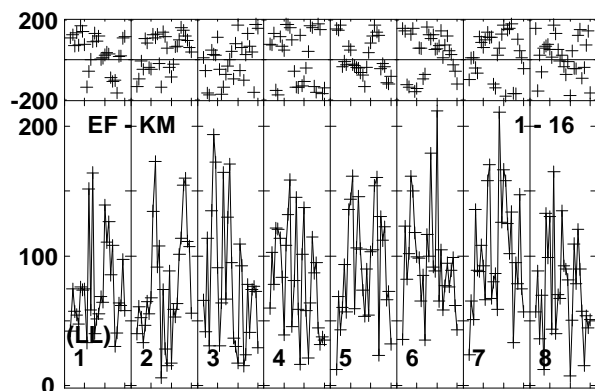
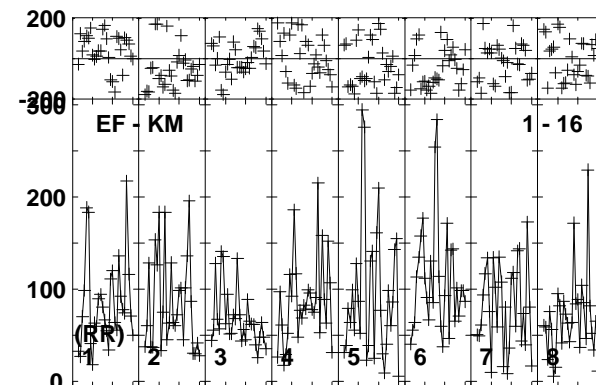
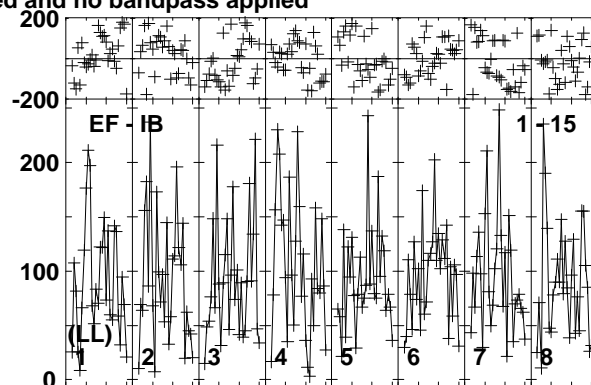
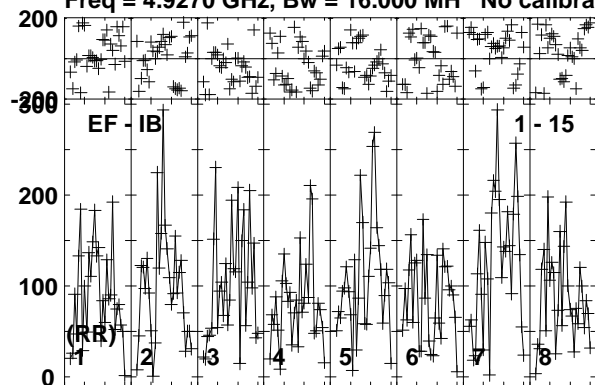

Lower frame: Micro Ampl Jy Top frame: Phas deg  
Vector averaged cross-power spectrum Baseline: EF (01) - IB (15)  
Timerange: 00/03:18:21 to 00/03:21:49



Plot file version 25 created 08-APR-2019 12:09:32

J0815+3635 EM133B.UVDATA.1

Freq = 4.9270 GHz, Bw = 16.000 MH No calibration applied and no bandpass applied

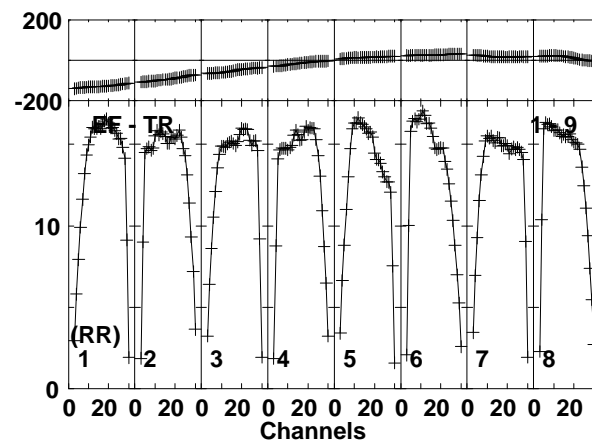
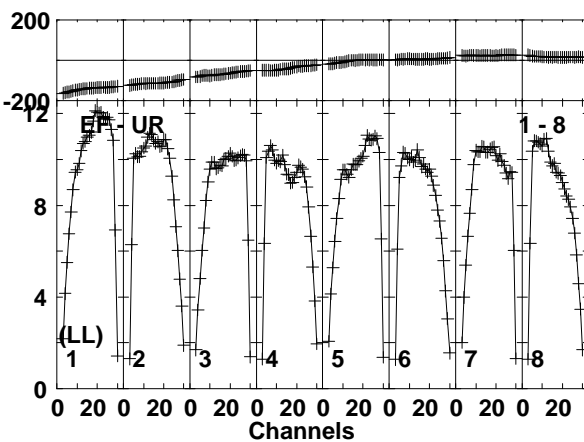
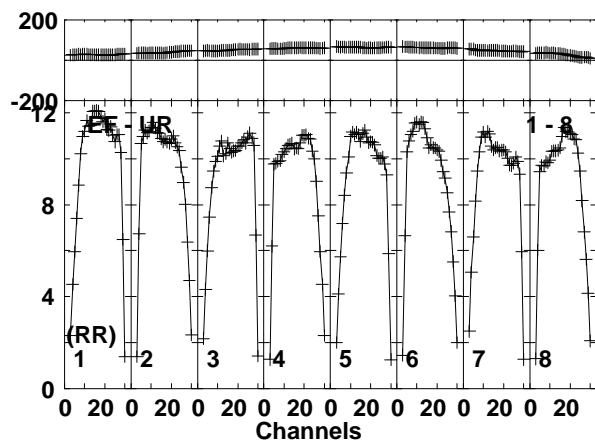
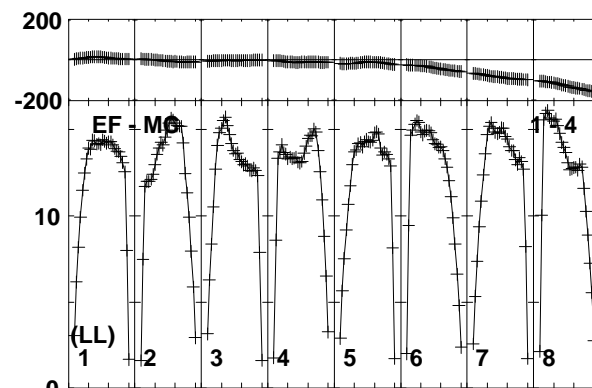
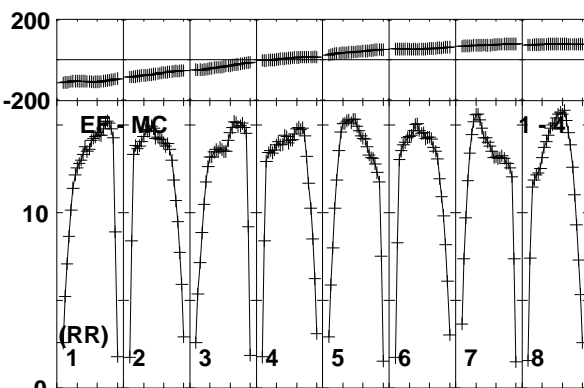
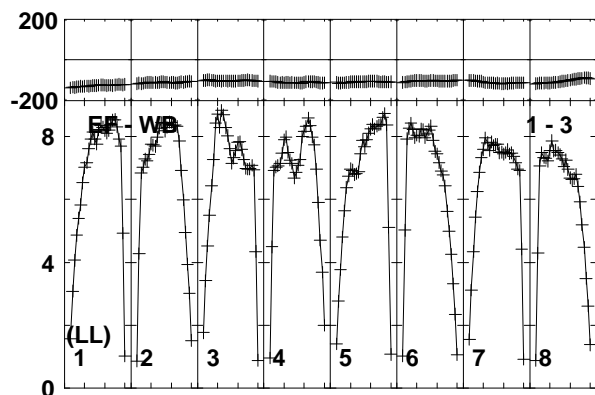
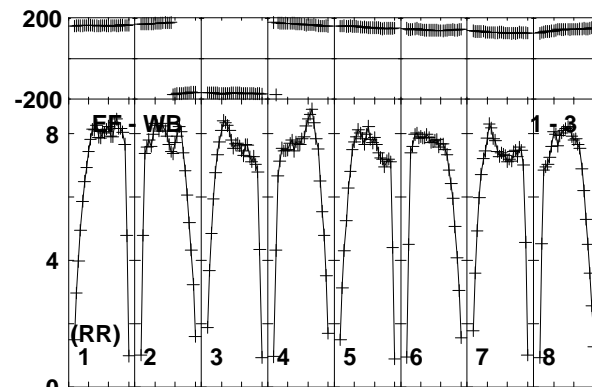
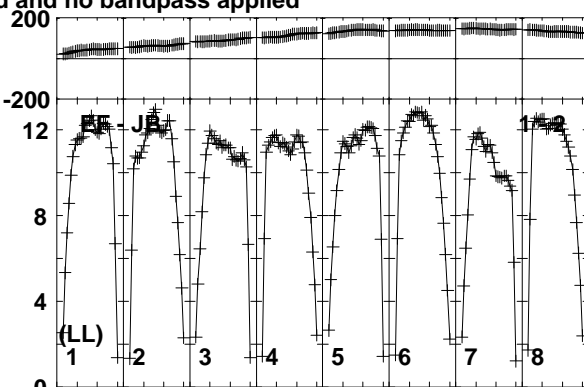
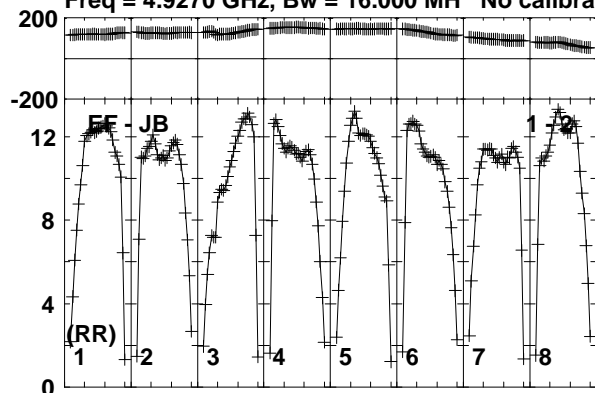

Lower frame: Milli Ampl Jy Top frame: Phas deg  
Vector averaged cross-power spectrum Baseline: EF (01) - JB (02)  
Timerange: 00/03:21:51 to 00/03:23:19

Plot file version 26 created 08-APR-2019 12:09:32

J0815+3635 EM133B.UVDATA.1

Freq = 4.9270 GHz, Bw = 16.000 MH No calibration applied and no bandpass applied

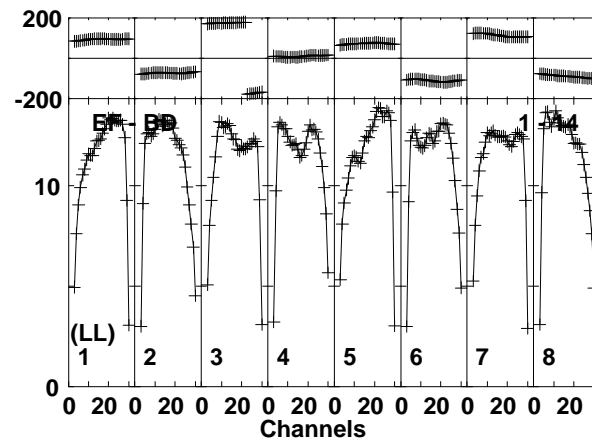
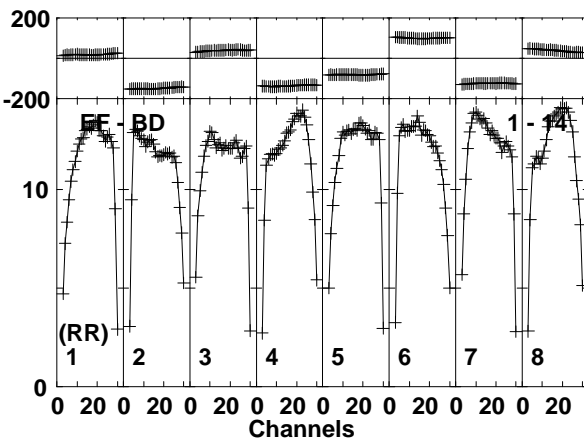
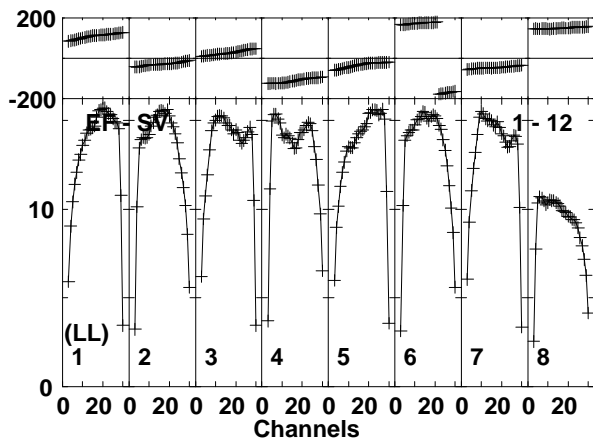
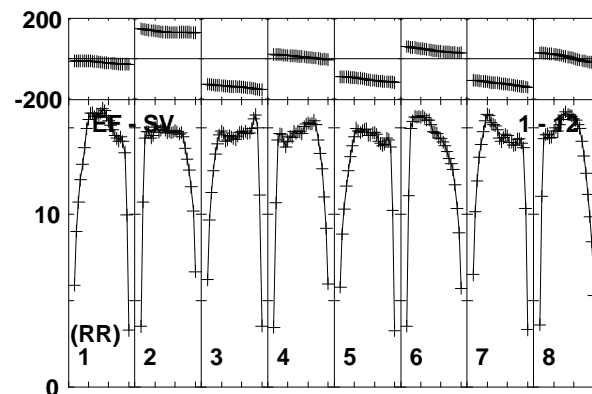
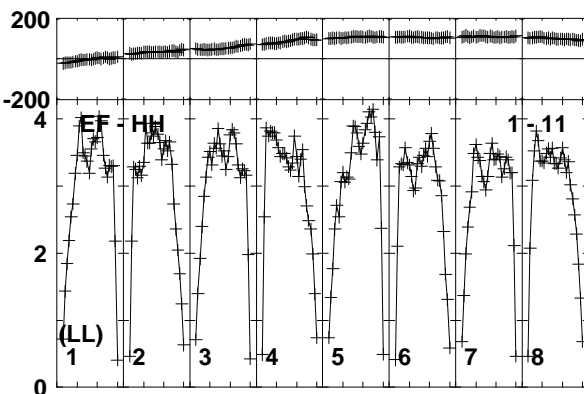
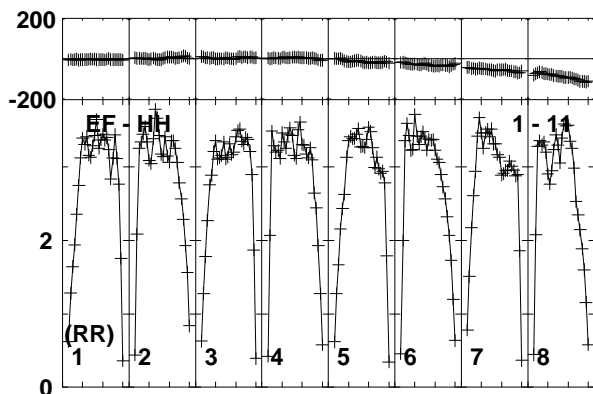
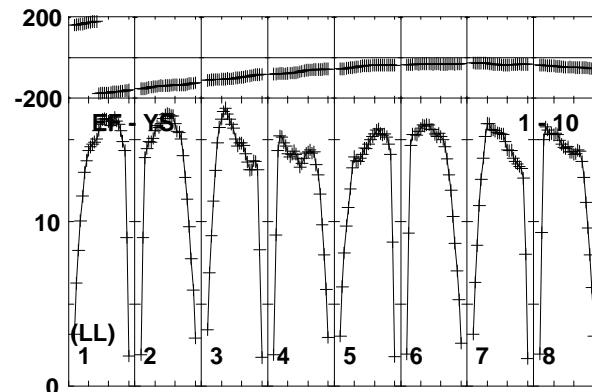
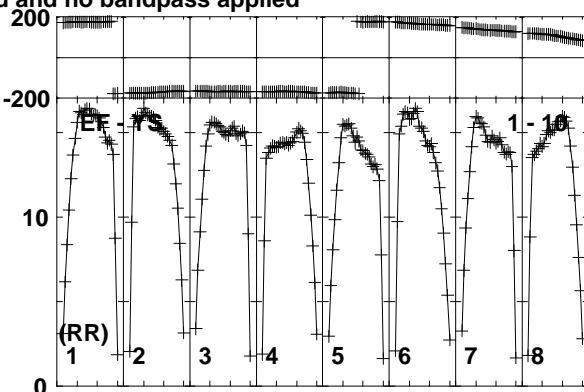
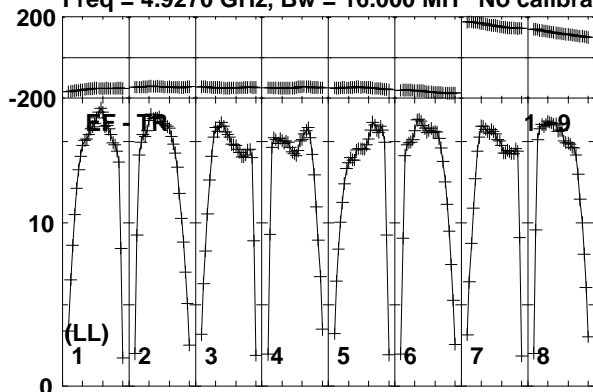

Lower frame: Milli Ampl Jy Top frame: Phas deg  
Vector averaged cross-power spectrum Baseline: EF (01) - TR (09)  
Timerange: 00/03:21:51 to 00/03:23:19

Plot file version 27 created 08-APR-2019 12:09:32

J0815+3635 EM133B.UVDATA.1

Freq = 4.9270 GHz, Bw = 16.000 MH No calibration applied and no bandpass applied

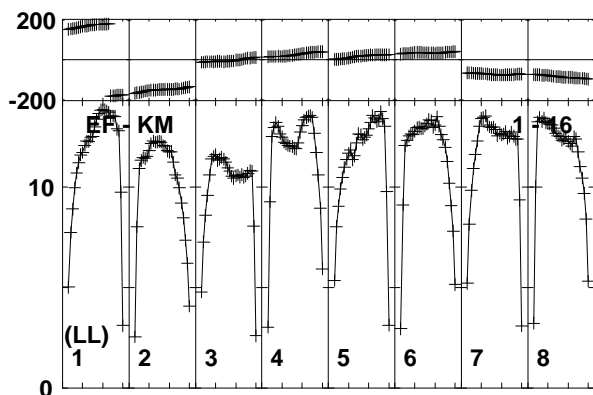
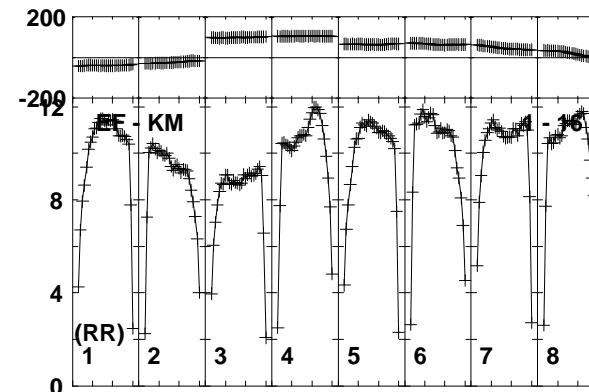
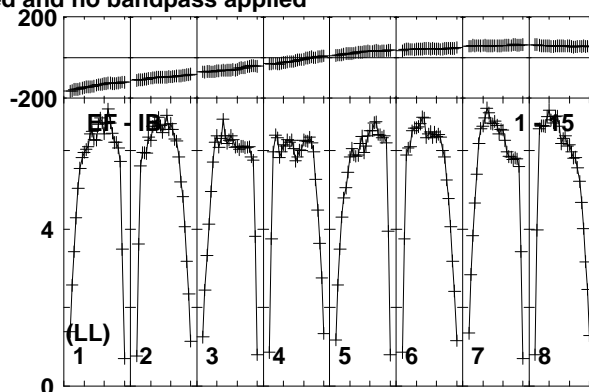
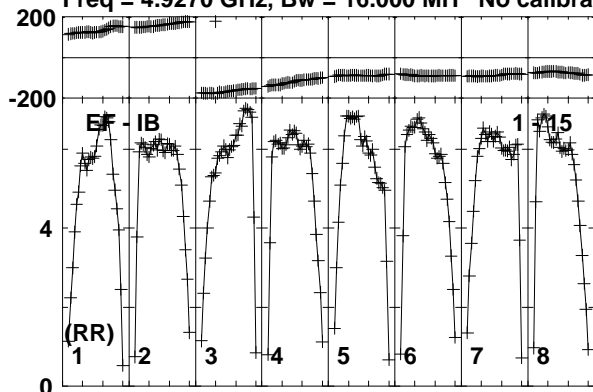

Lower frame: Milli Ampl Jy Top frame: Phas deg  
Vector averaged cross-power spectrum Baseline: EF (01) - IB (15)  
Timerange: 00/03:21:51 to 00/03:23:19

Plot file version 28 created 08-APR-2019 12:09:33

MRK622 EM133B.UVDATA.1

Freq = 4.9270 GHz, Bw = 16.000 MH No calibration applied and no bandpass applied

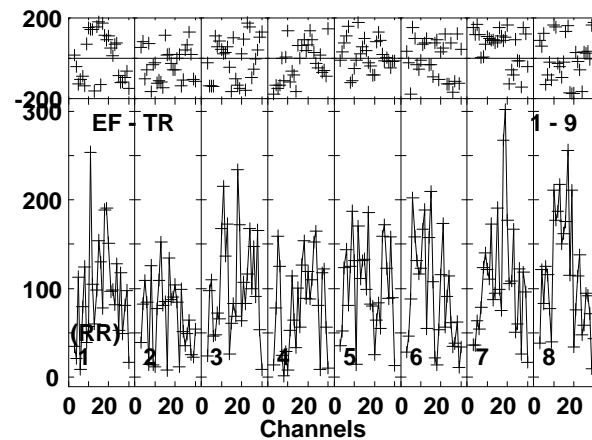
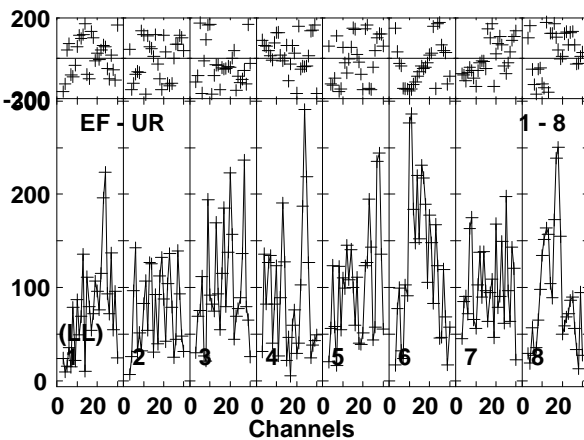
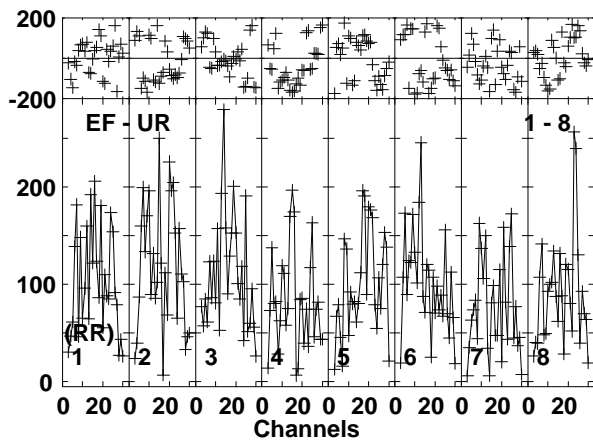
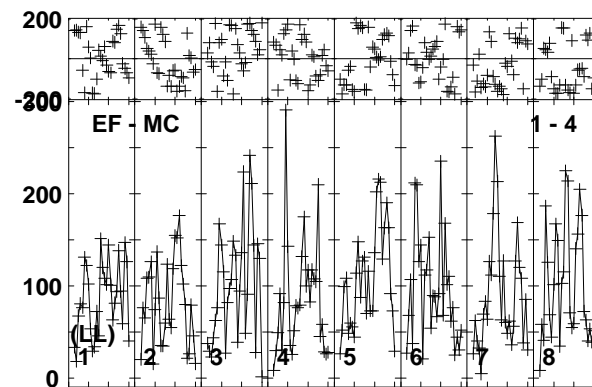
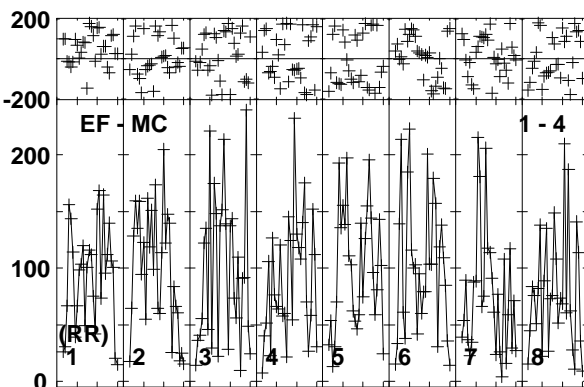
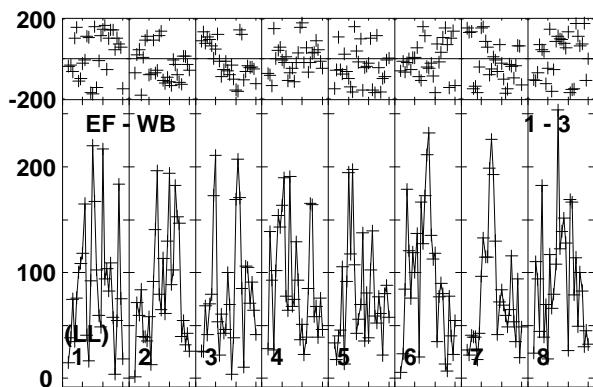
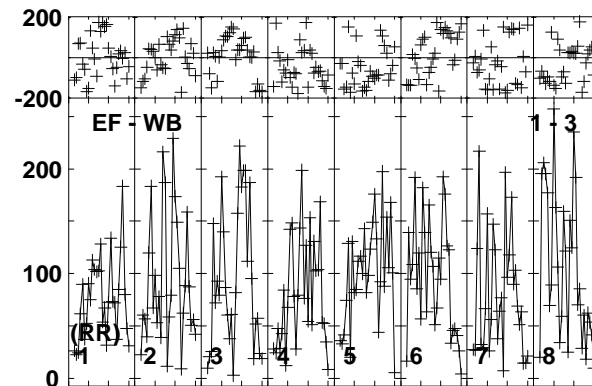
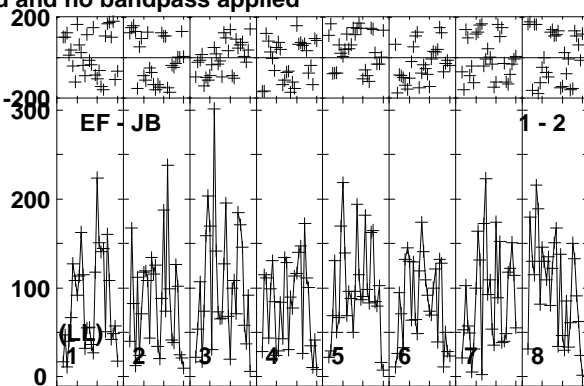
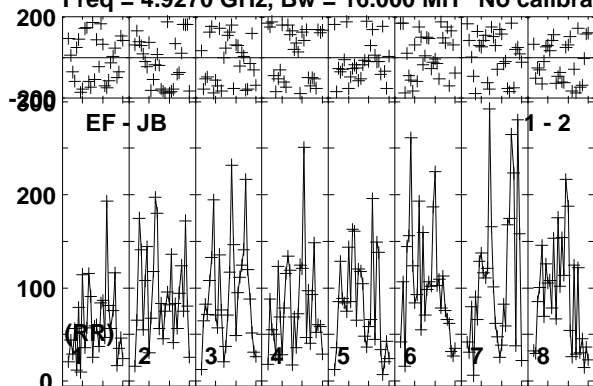

Lower frame: Micro Ampl Jy Top frame: Phas deg  
Vector averaged cross-power spectrum Baseline: EF (01) - JB (02)  
Timerange: 00/03:23:23 to 00/03:26:49

Plot file version 29 created 08-APR-2019 12:09:33

MRK622 EM133B.UVDATA.1

Freq = 4.9270 GHz, Bw = 16.000 MH No calibration applied and no bandpass applied

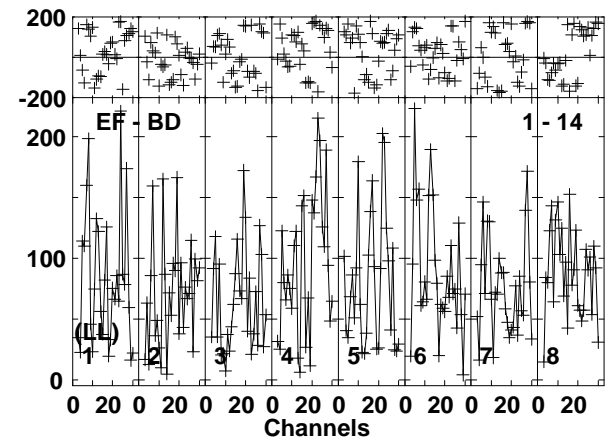
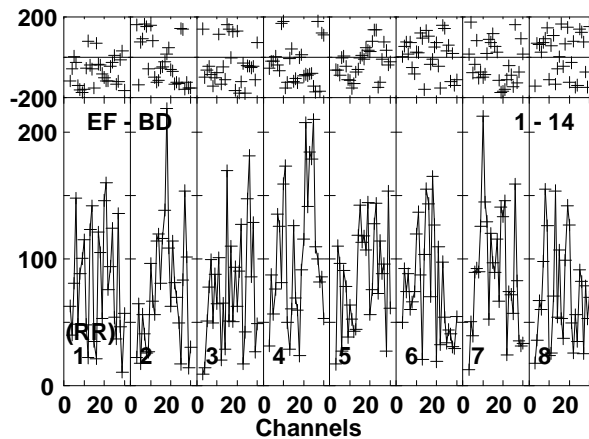
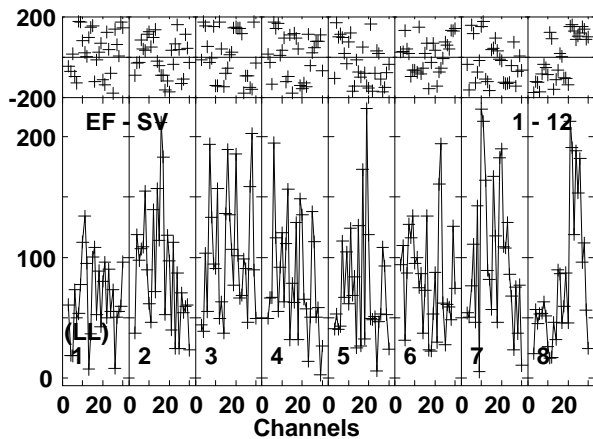
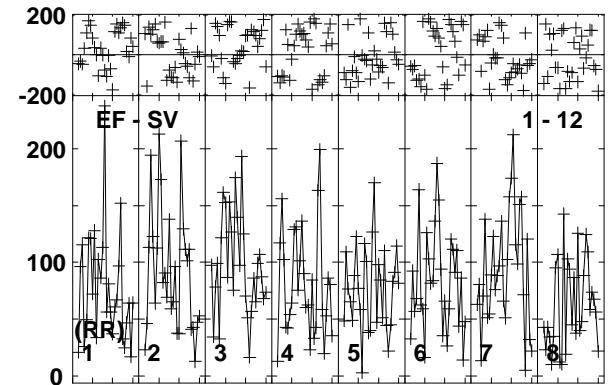
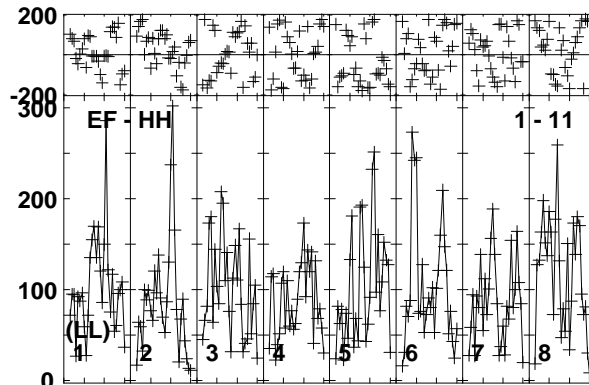
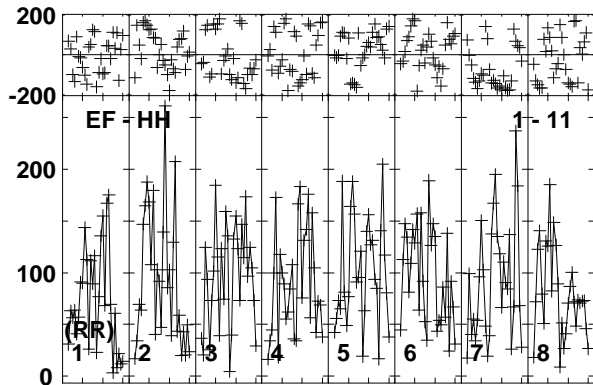
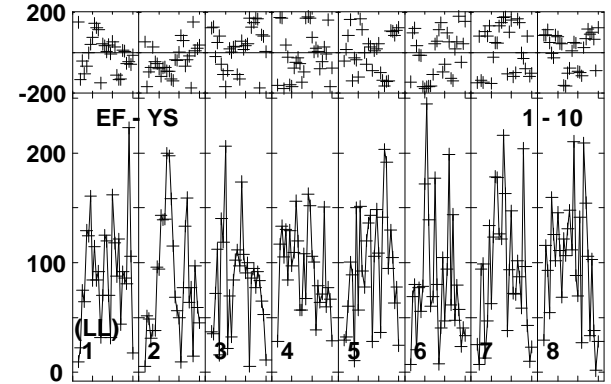
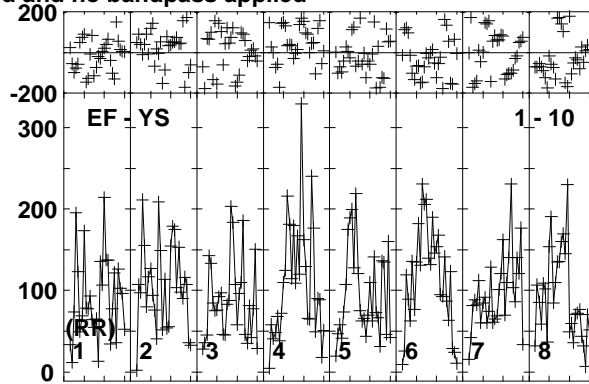
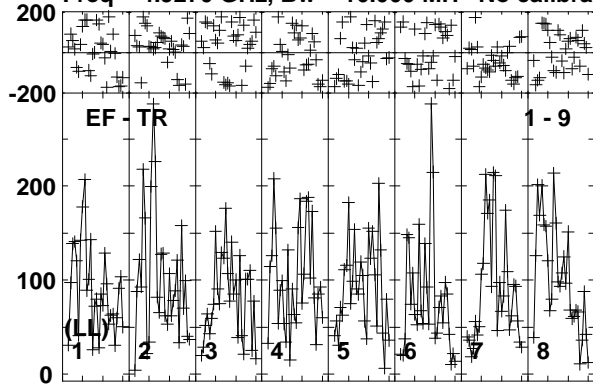

Lower frame: Micro Ampl Jy Top frame: Phas deg  
Vector averaged cross-power spectrum Baseline: EF (01) - TR (09)  
Timerange: 00/03:23:23 to 00/03:26:49

Plot file version 30 created 08-APR-2019 12:09:33

MRK622 EM133B.UVDATA.1

Freq = 4.9270 GHz, Bw = 16.000 MH No calibration applied and no bandpass applied

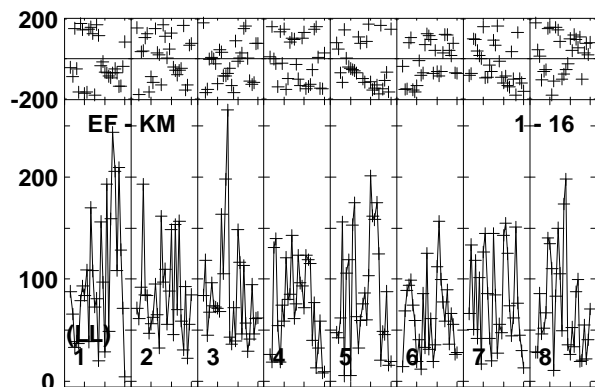
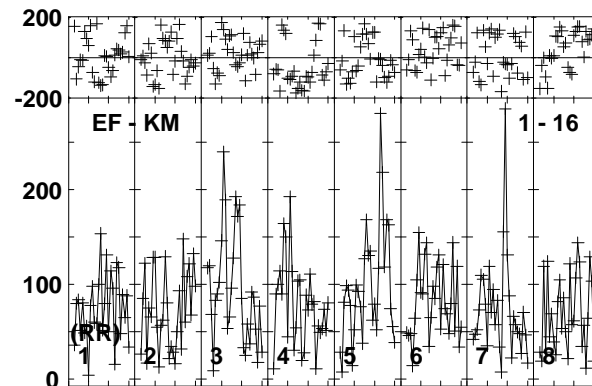
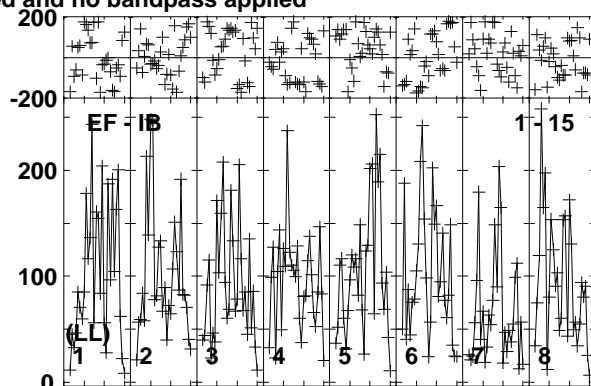
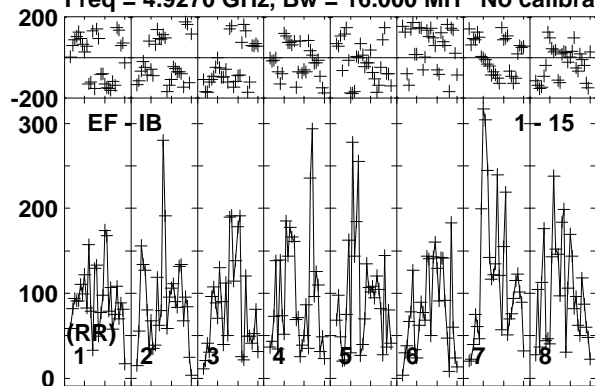

Lower frame: Micro Ampl Jy Top frame: Phas deg  
Vector averaged cross-power spectrum Baseline: EF (01) - IB (15)  
Timerange: 00/03:23:23 to 00/03:26:49

Plot file version 31 created 08-APR-2019 12:09:33

J0815+3635 EM133B.UVDATA.1

Freq = 4.9270 GHz, Bw = 16.000 MH No calibration applied and no bandpass applied

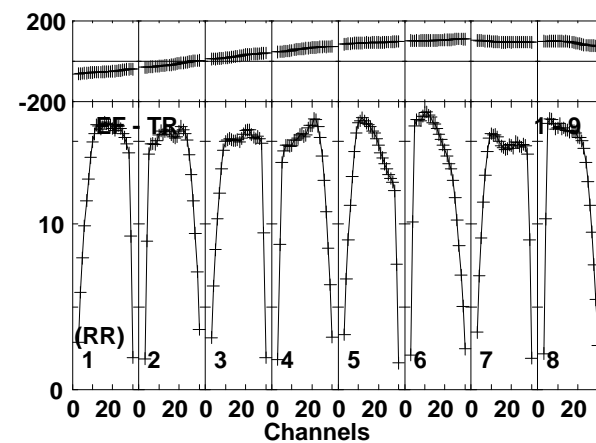
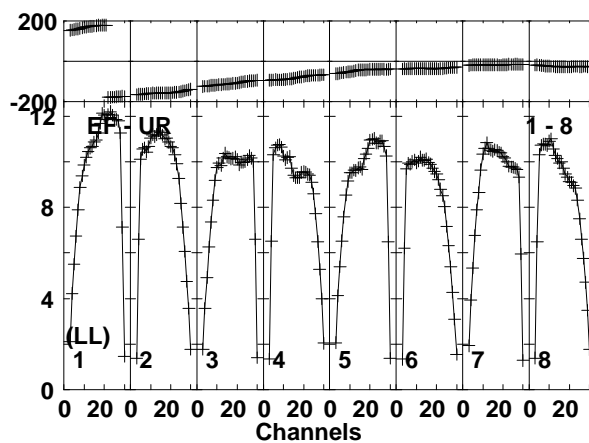
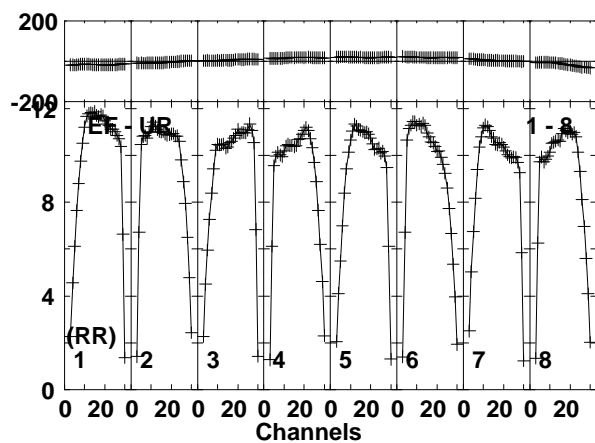
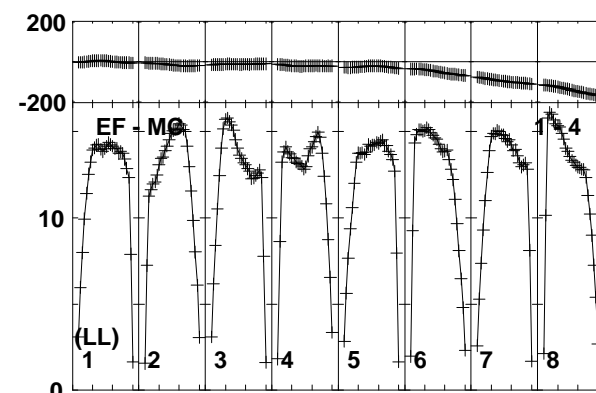
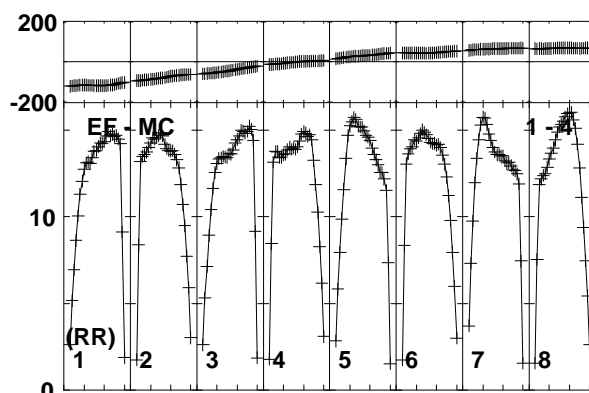
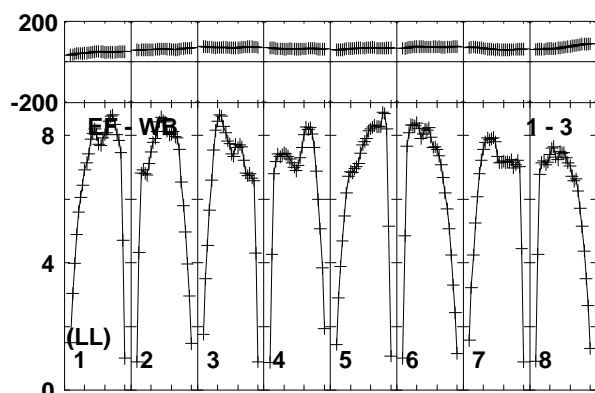
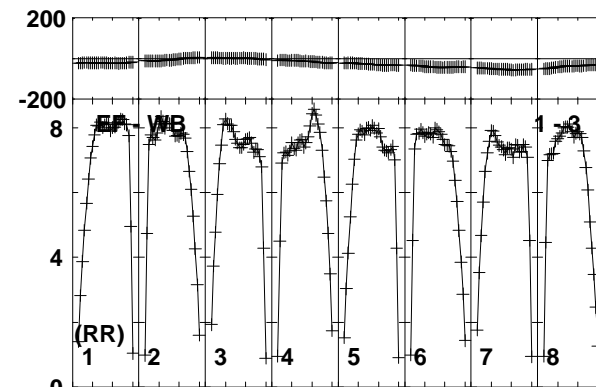
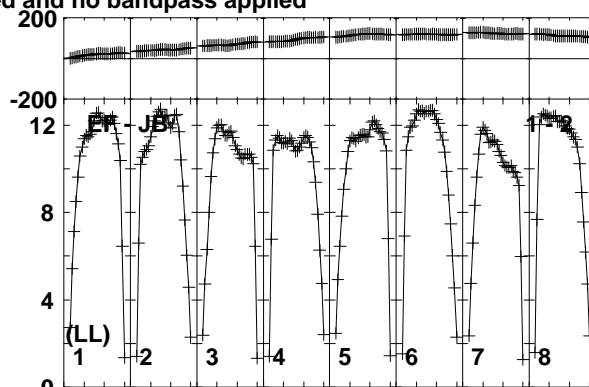
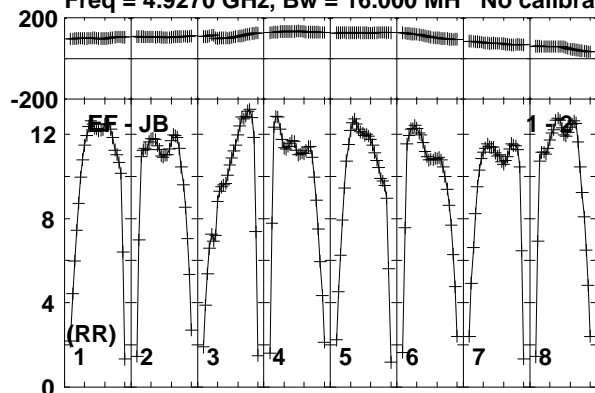

Lower frame: Milli Ampl Jy Top frame: Phas deg  
Vector averaged cross-power spectrum Baseline: EF (01) - JB (02)  
Timerange: 00/03:27:41 to 00/03:29:09

Plot file version 32 created 08-APR-2019 12:09:33

J0815+3635 EM133B.UVDATA.1

Freq = 4.9270 GHz, Bw = 16.000 MH No calibration applied and no bandpass applied

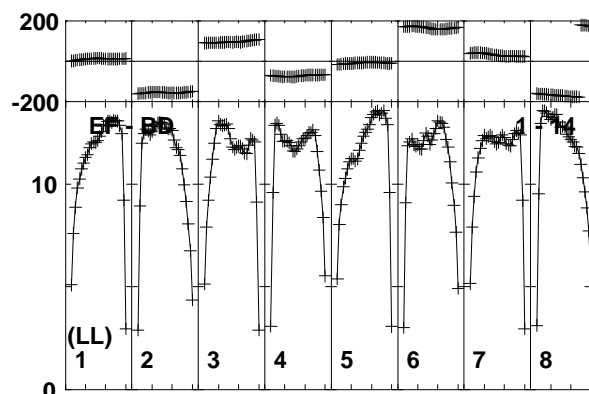
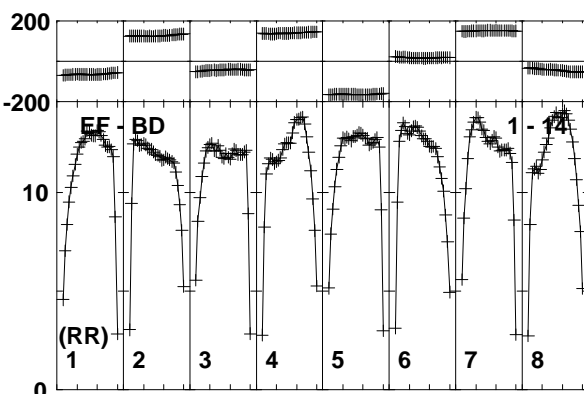
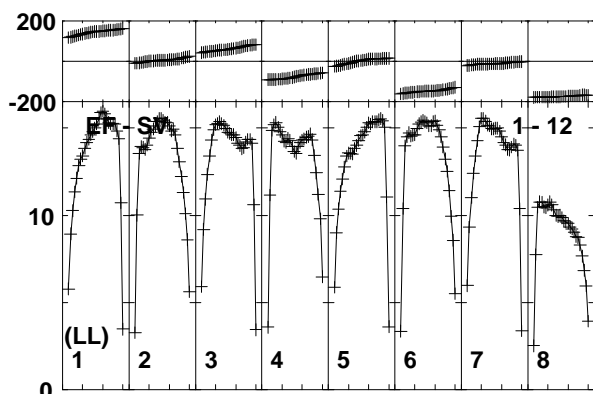
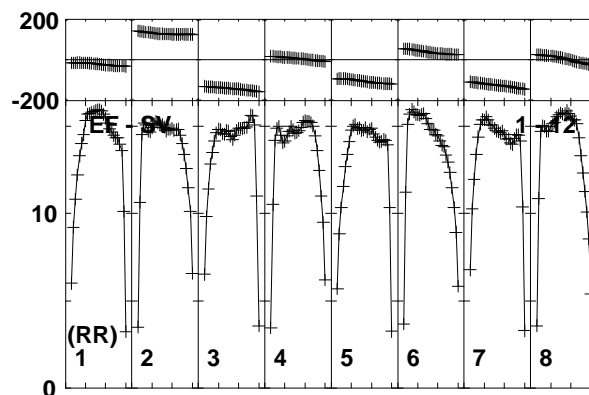
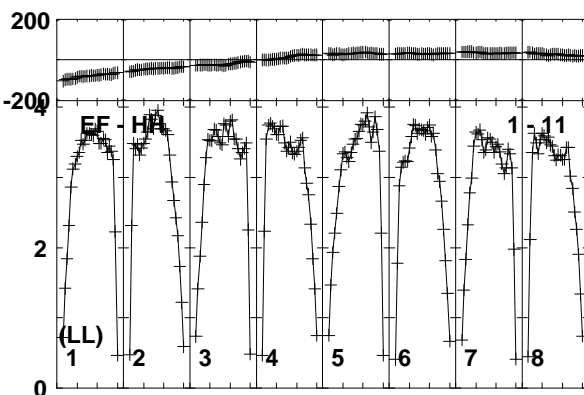
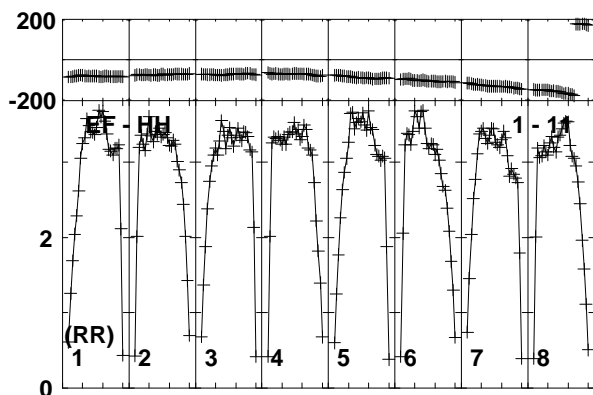
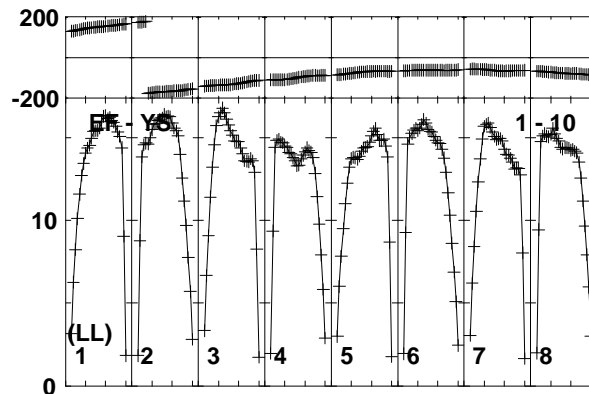
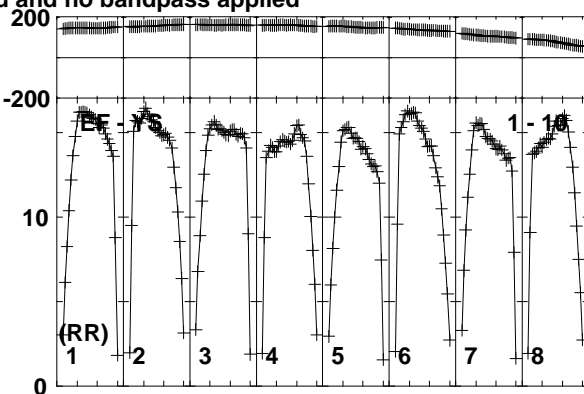
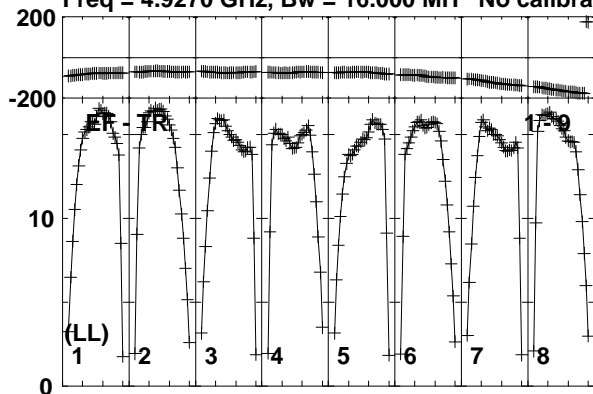

Lower frame: Milli Ampl Jy Top frame: Phas deg  
Vector averaged cross-power spectrum Baseline: EF (01) - TR (09)  
Timerange: 00/03:27:41 to 00/03:29:09



Plot file version 33 created 08-APR-2019 12:09:33

J0815+3635 EM133B.UVDATA.1

Freq = 4.9270 GHz, Bw = 16.000 MH No calibration applied and no bandpass applied

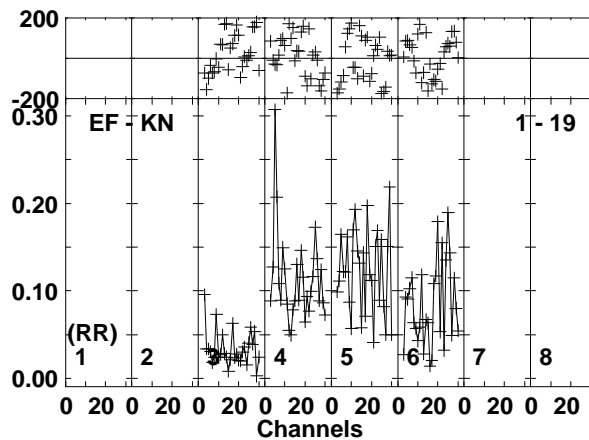
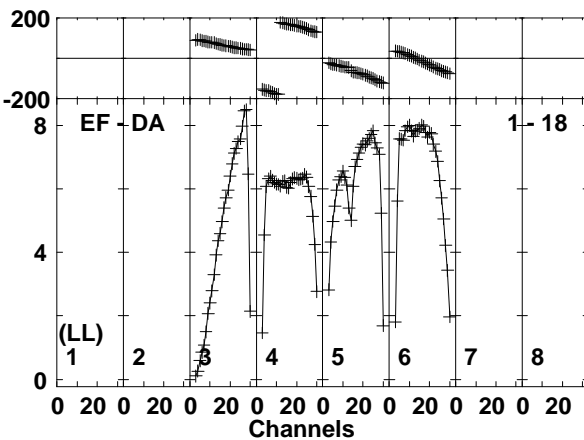
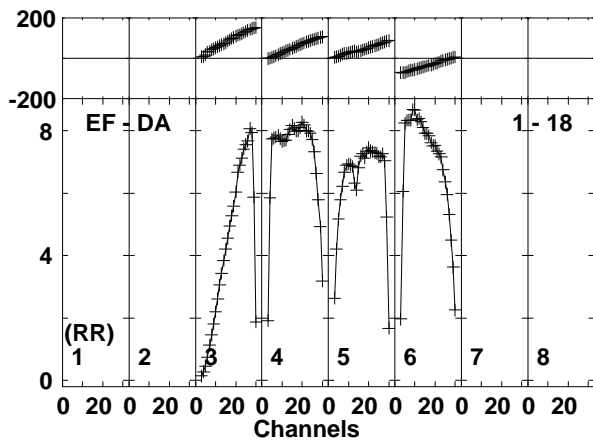
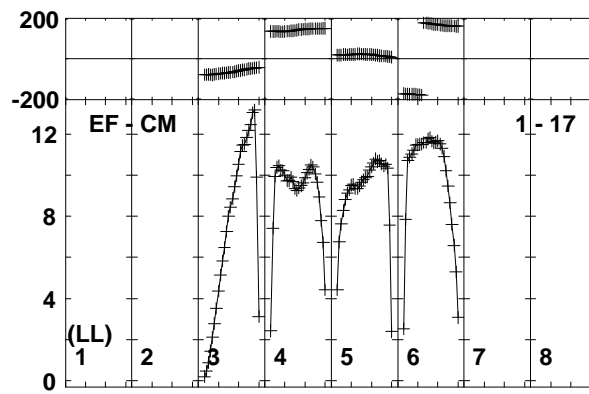
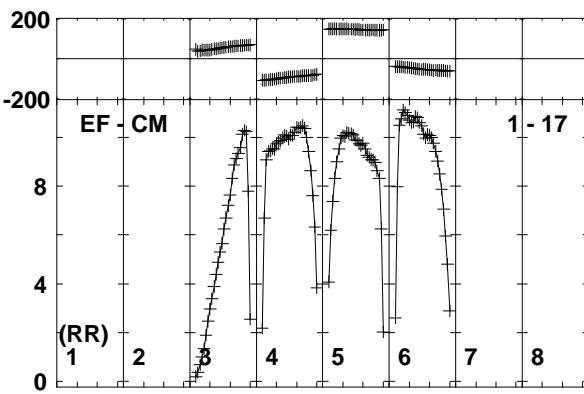
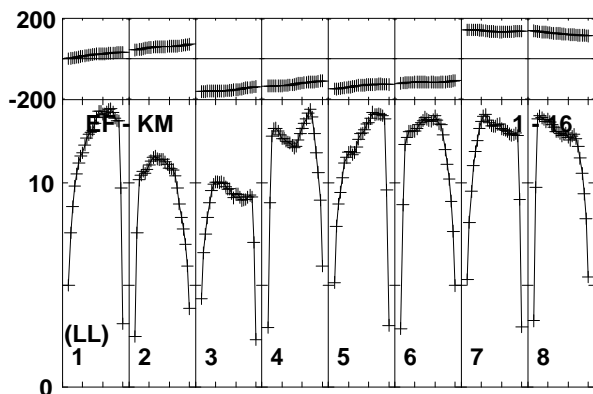
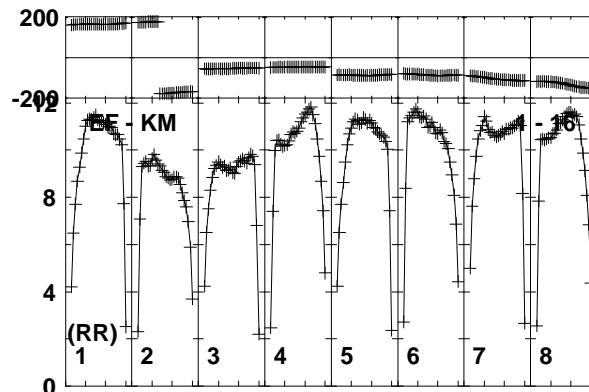
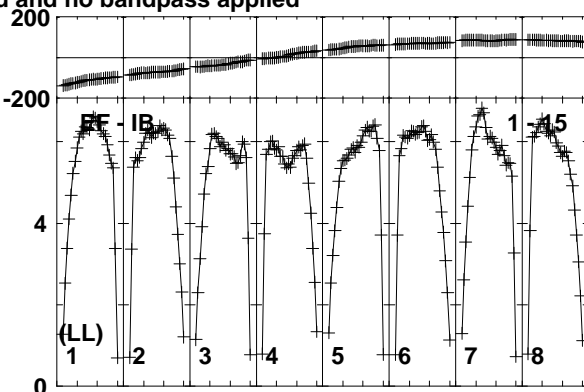
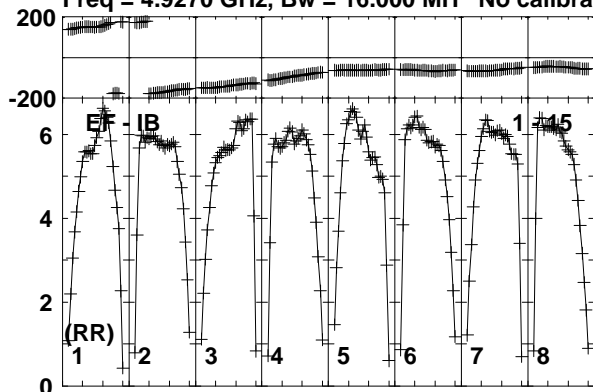

Lower frame: Milli Ampl Jy Top frame: Phas deg  
Vector averaged cross-power spectrum Baseline: EF (01) - IB (15)  
Timerange: 00/03:27:41 to 00/03:29:09

Plot file version 34 created 08-APR-2019 12:09:33

J0815+3635 EM133B.UVDATA.1

Freq = 4.9270 GHz, Bw = 16.000 MH No calibration applied and no bandpass applied

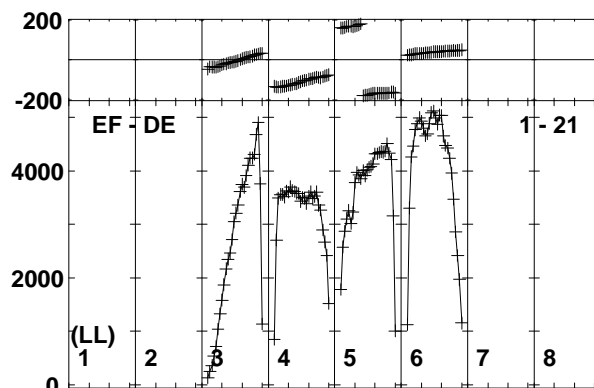
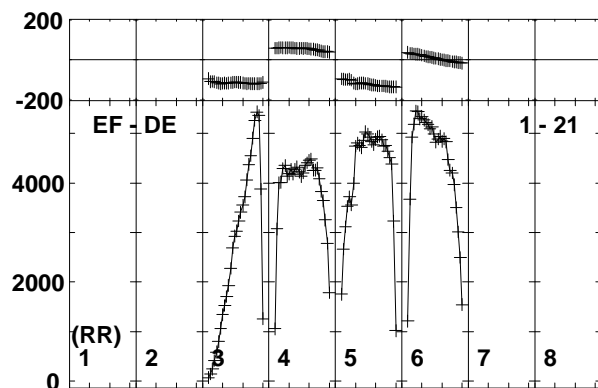
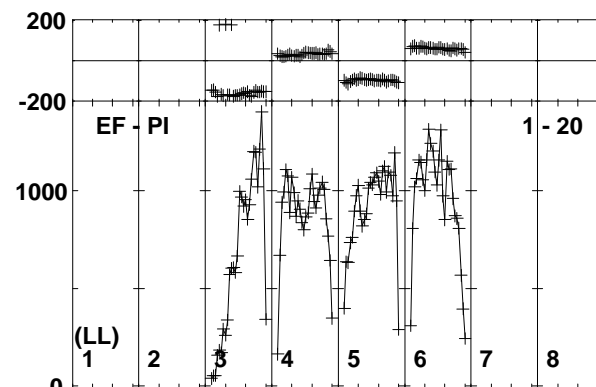
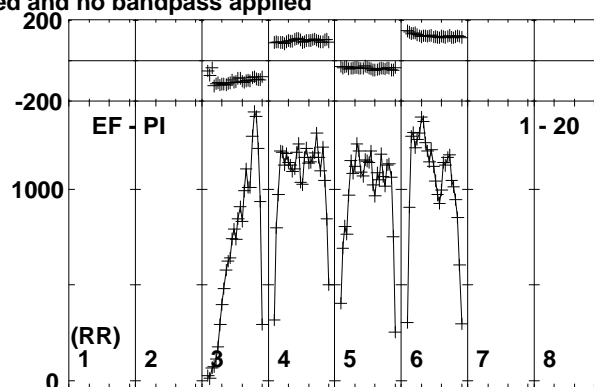
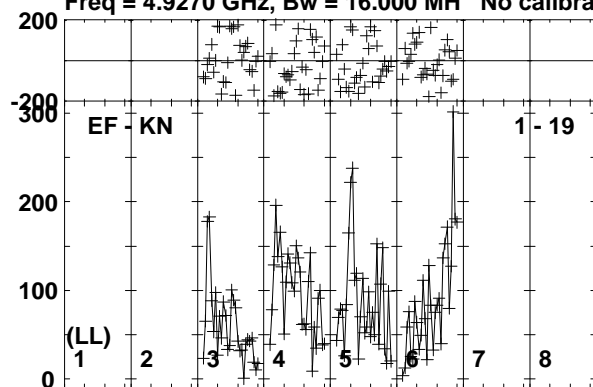

Lower frame: Micro Ampl Jy Top frame: Phas deg  
Vector averaged cross-power spectrum Baseline: EF (01) - KN (19)  
Timerange: 00/03:27:41 to 00/03:29:09

Plot file version 35 created 08-APR-2019 12:09:33

MRK622 EM133B.UVDATA.1

Freq = 4.9270 GHz, Bw = 16.000 MH No calibration applied and no bandpass applied

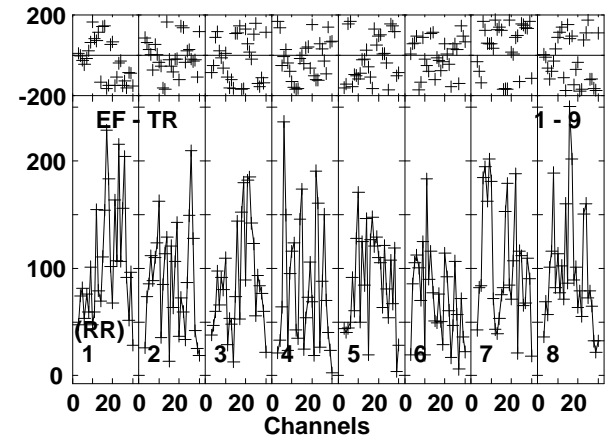
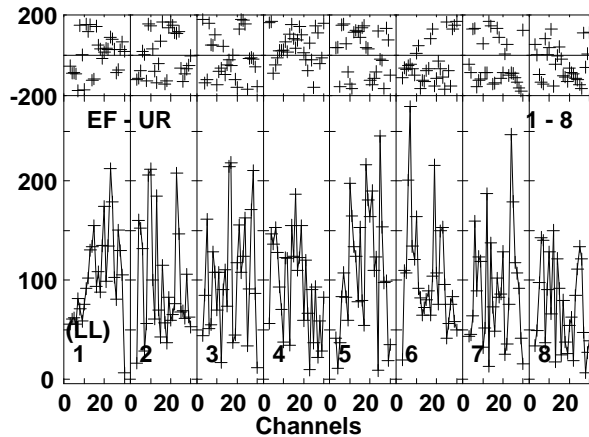
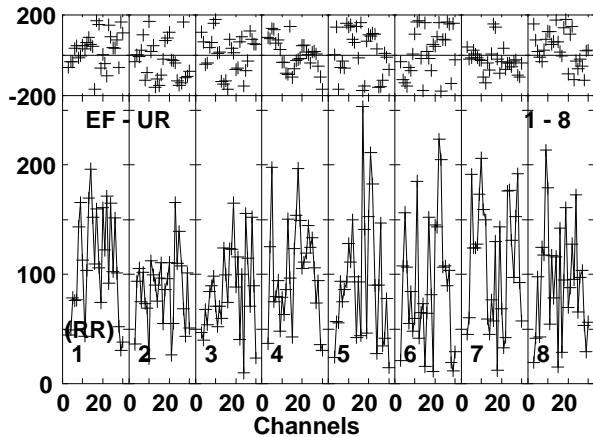
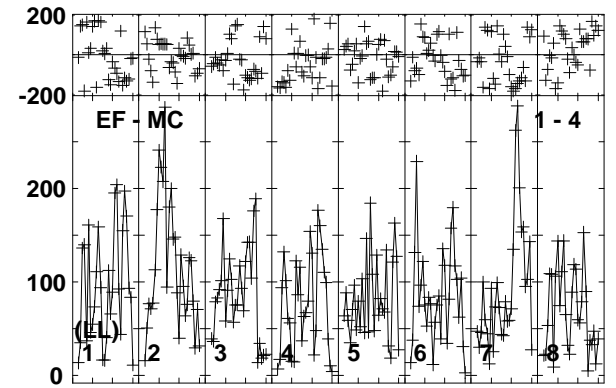
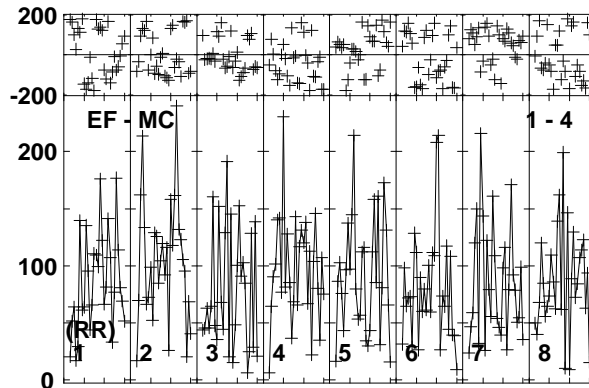
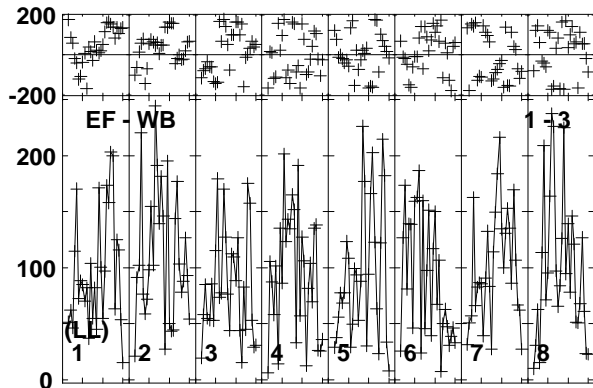
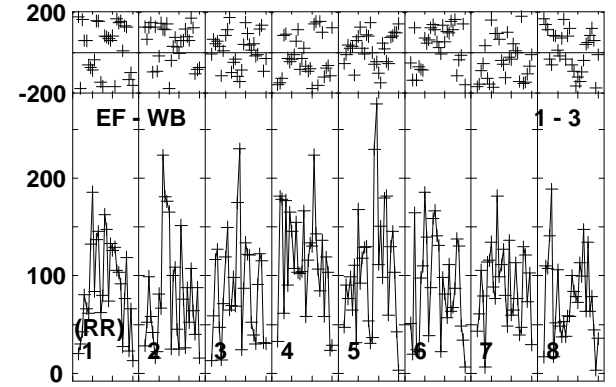
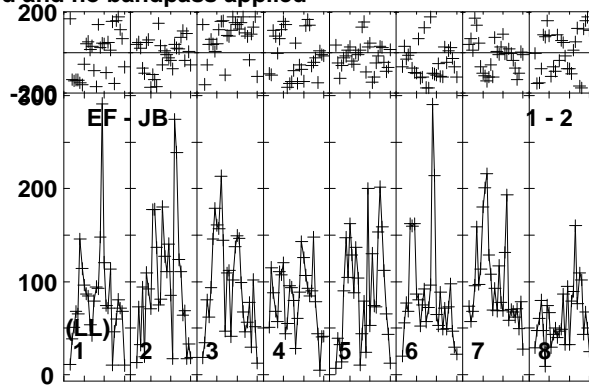
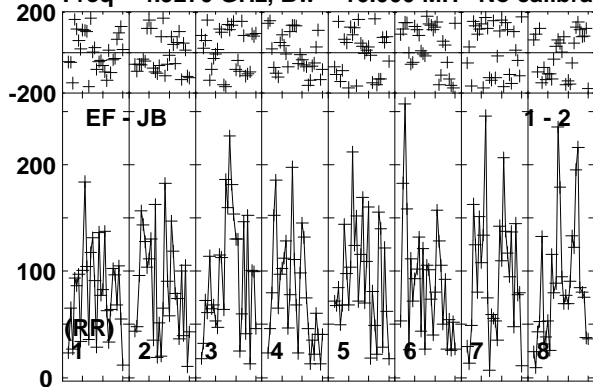

Lower frame: Micro Ampl Jy Top frame: Phas deg  
Vector averaged cross-power spectrum Baseline: EF (01) - JB (02)  
Timerange: 00/03:29:11 to 00/03:32:39



Plot file version 37 created 08-APR-2019 12:09:34

MRK622 EM133B.UVDATA.1

Freq = 4.9270 GHz, Bw = 16.000 MH No calibration applied and no bandpass applied

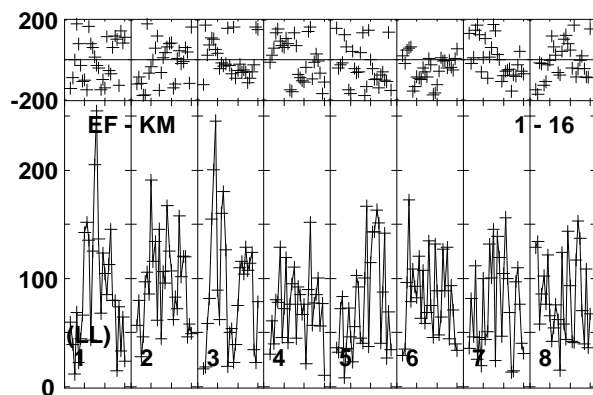
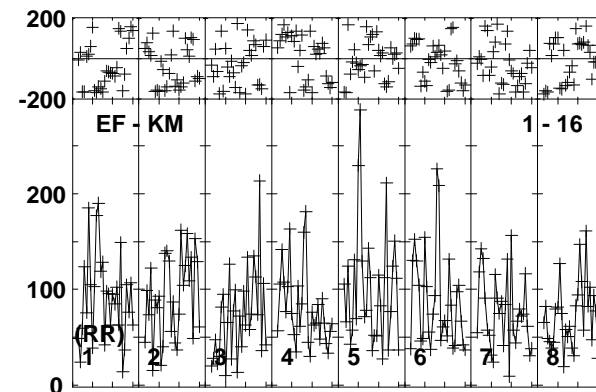
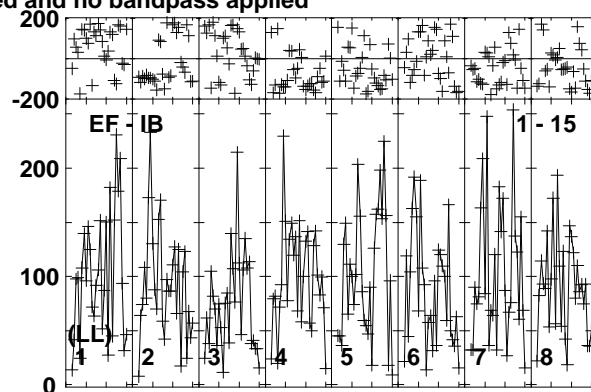
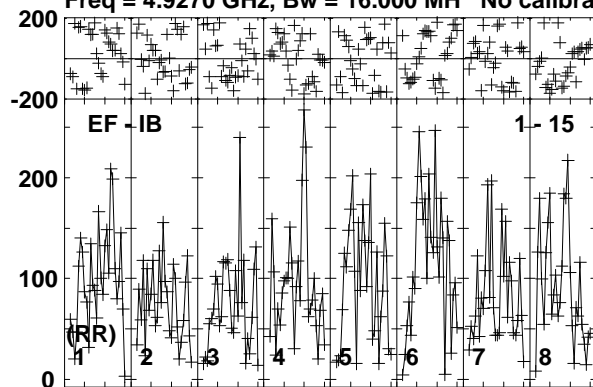

Lower frame: Micro Ampl Jy Top frame: Phas deg  
Vector averaged cross-power spectrum Baseline: EF (01) - IB (15)  
Timerange: 00/03:29:11 to 00/03:32:39

Plot file version 38 created 08-APR-2019 12:09:34

J0815+3635 EM133B.UVDATA.1

Freq = 4.9270 GHz, Bw = 16.000 MH No calibration applied and no bandpass applied

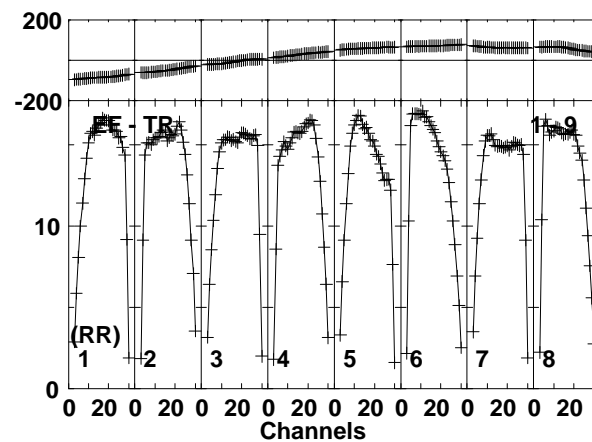
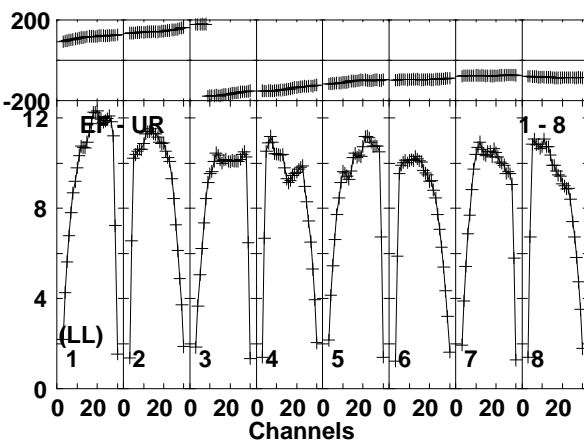
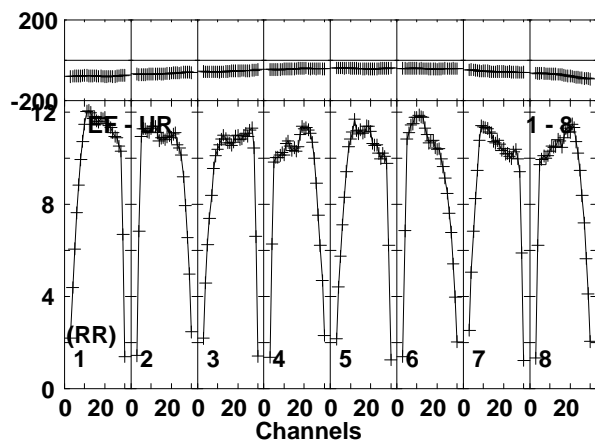
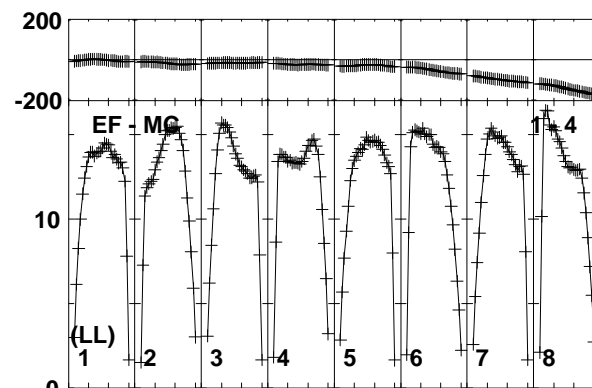
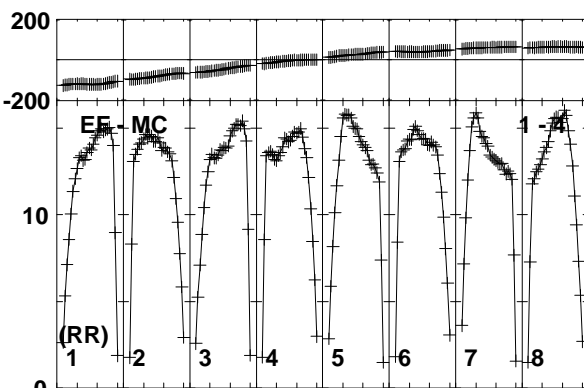
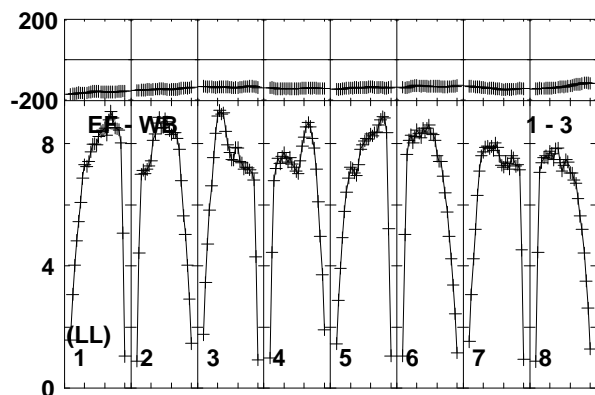
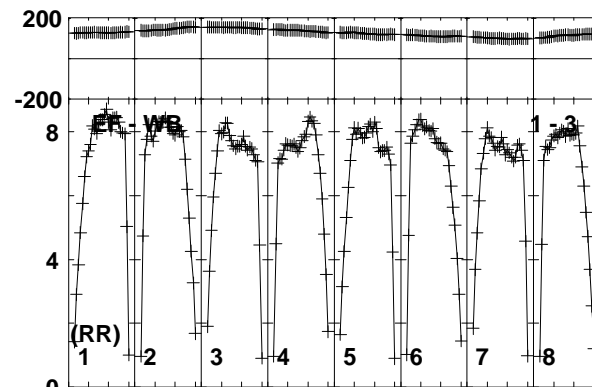
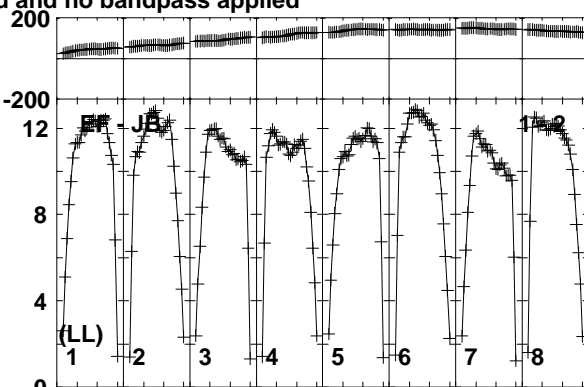
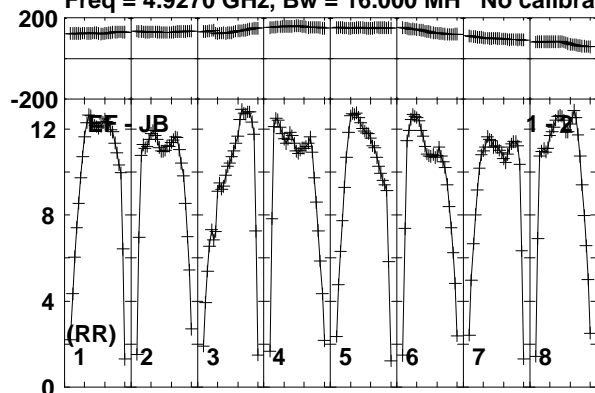

Lower frame: Milli Ampl Jy Top frame: Phas deg  
Vector averaged cross-power spectrum Baseline: EF (01) - JB (02)  
Timerange: 00/03:32:41 to 00/03:34:09

Plot file version 39 created 08-APR-2019 12:09:34

J0815+3635 EM133B.UVDATA.1

Freq = 4.9270 GHz, Bw = 16.000 MH No calibration applied and no bandpass applied

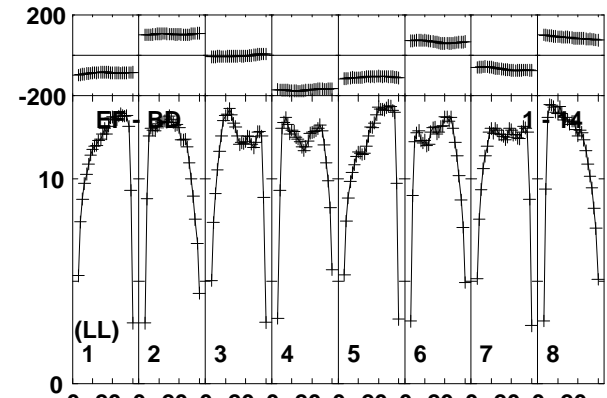
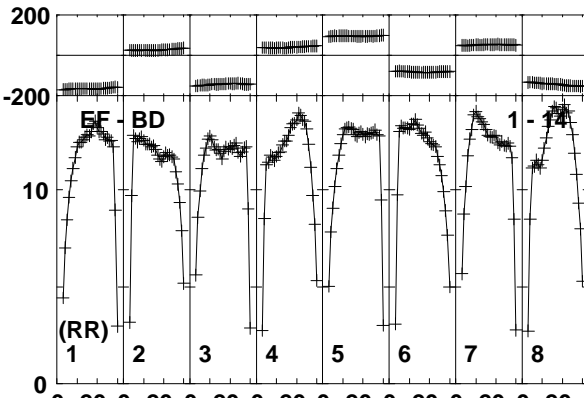
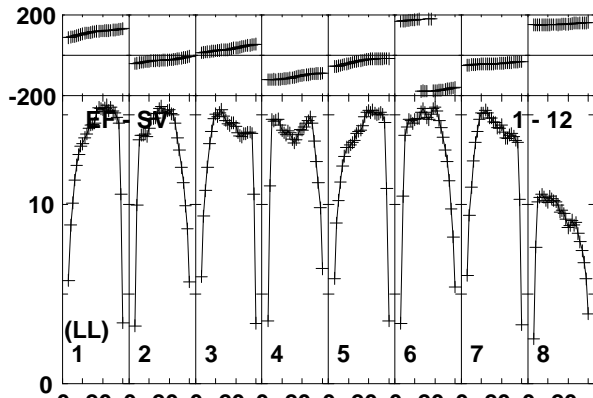
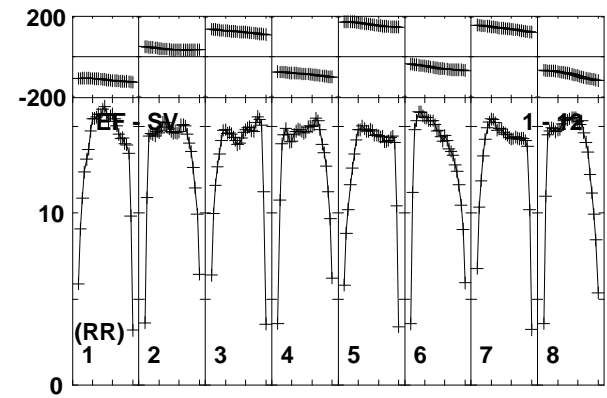
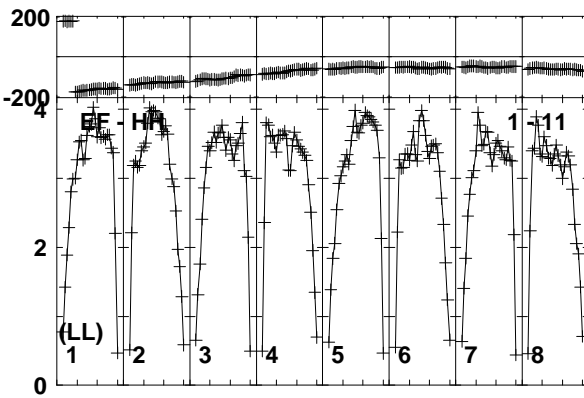
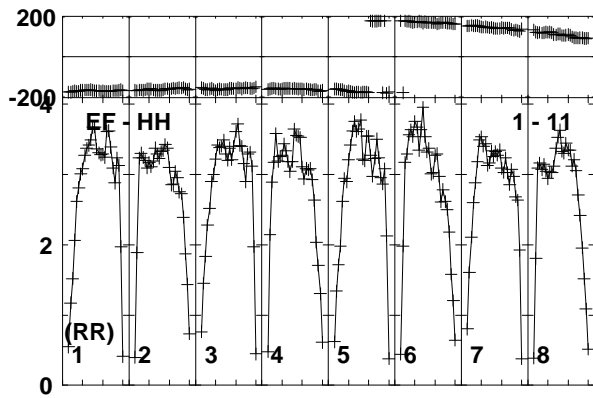
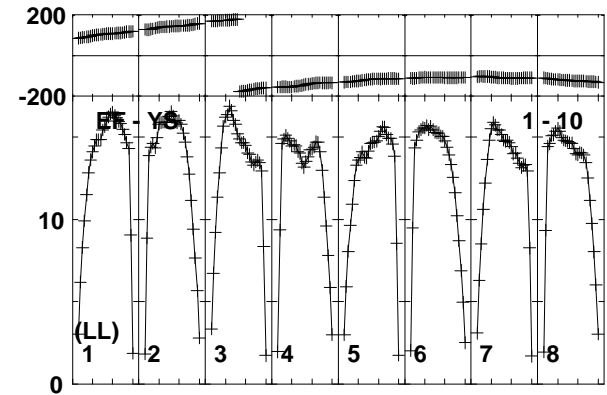
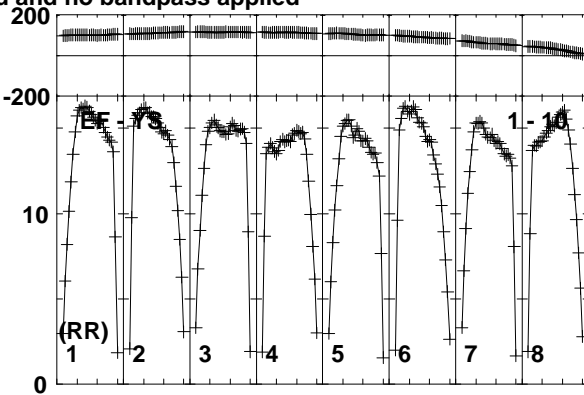
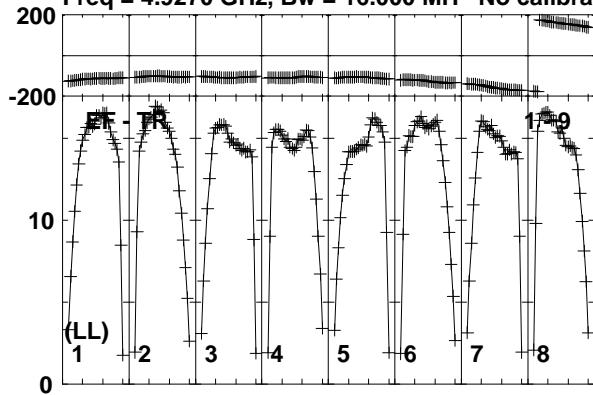

Lower frame: Milli Ampl Jy Top frame: Phas deg  
Vector averaged cross-power spectrum Baseline: EF (01) - TR (09)  
Timerange: 00/03:32:41 to 00/03:34:09

Plot file version 40 created 08-APR-2019 12:09:34

J0815+3635 EM133B.UVDATA.1

Freq = 4.9270 GHz, Bw = 16.000 MH No calibration applied and no bandpass applied

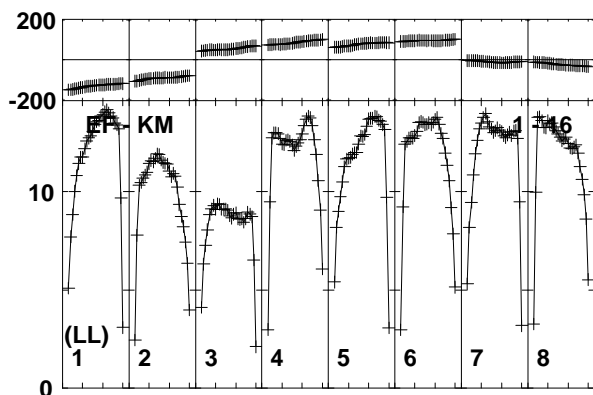
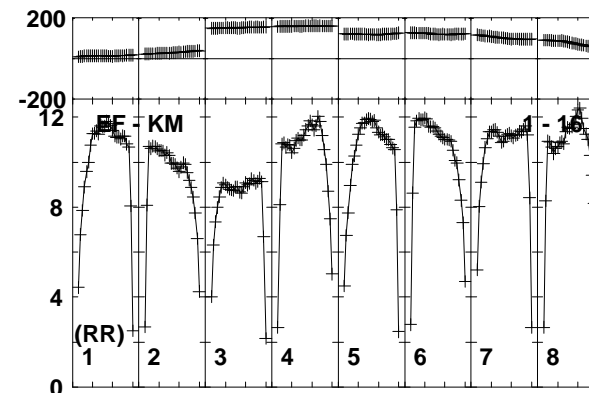
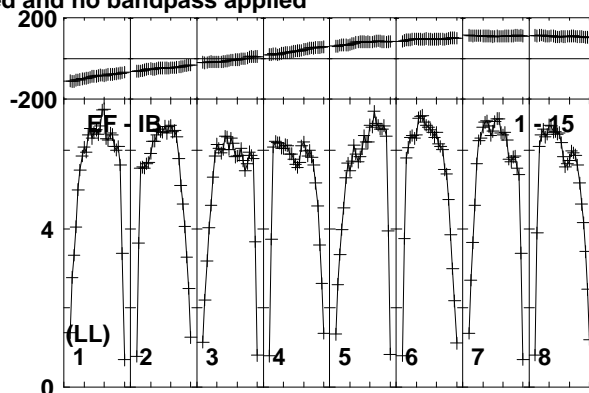
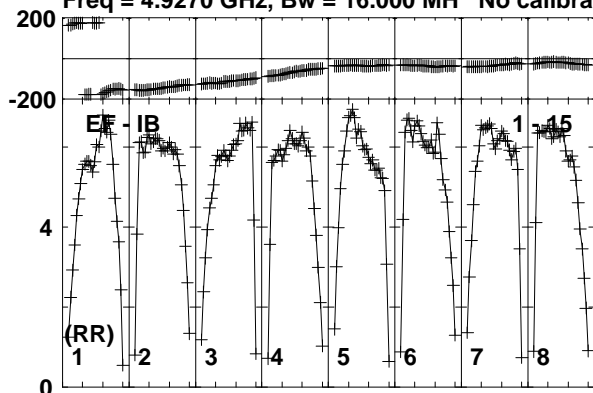

Lower frame: Milli Ampl Jy Top frame: Phas deg  
Vector averaged cross-power spectrum Baseline: EF (01) - IB (15)  
Timerange: 00/03:32:41 to 00/03:34:09



Plot file version 41 created 08-APR-2019 12:09:34

MRK622 EM133B.UVDATA.1

Freq = 4.9270 GHz, Bw = 16.000 MH No calibration applied and no bandpass applied

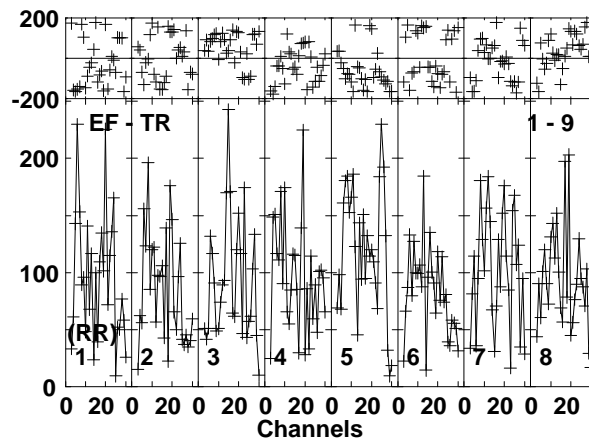
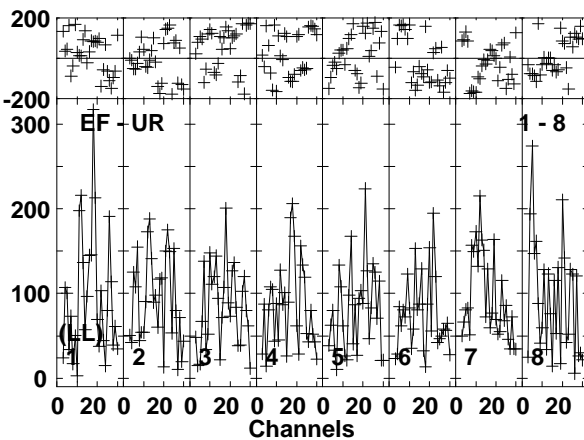
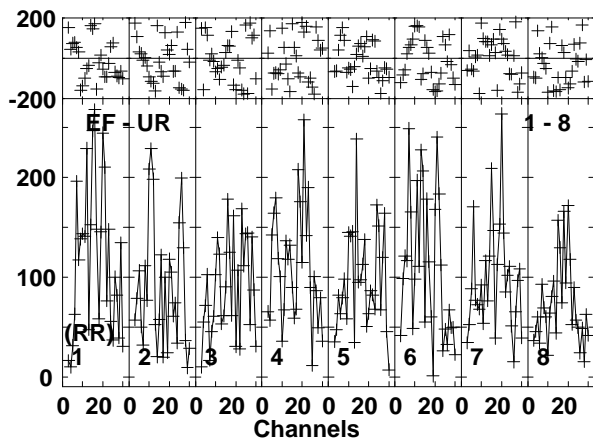
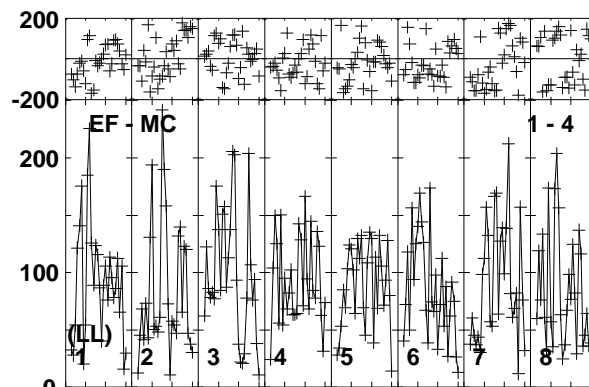
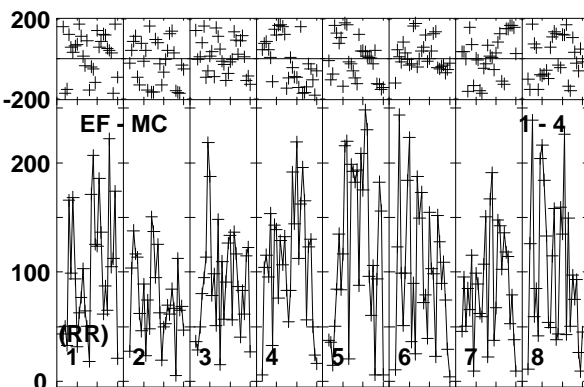
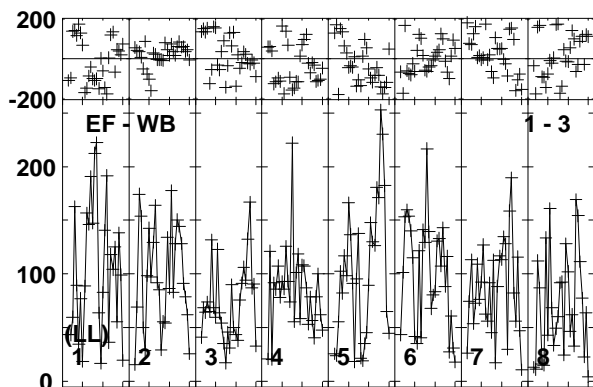
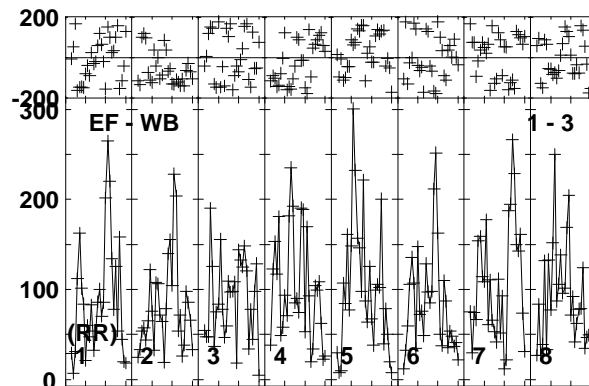
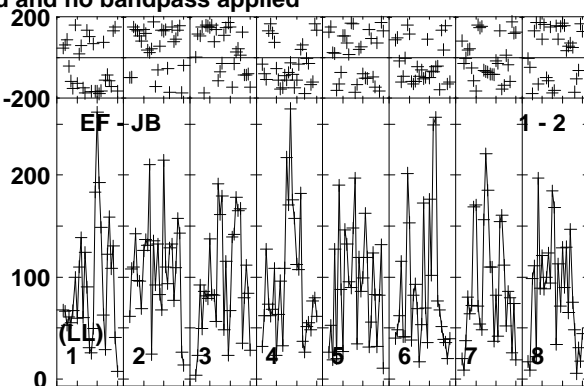
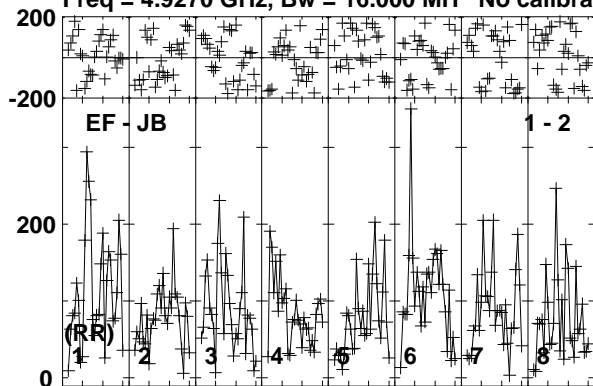

Lower frame: Micro Ampl Jy Top frame: Phas deg  
Vector averaged cross-power spectrum Baseline: EF (01) - JB (02)  
Timerange: 00/03:34:13 to 00/03:37:39



Plot file version 43 created 08-APR-2019 12:09:34

MRK622 EM133B.UVDATA.1

Freq = 4.9270 GHz, Bw = 16.000 MH No calibration applied and no bandpass applied

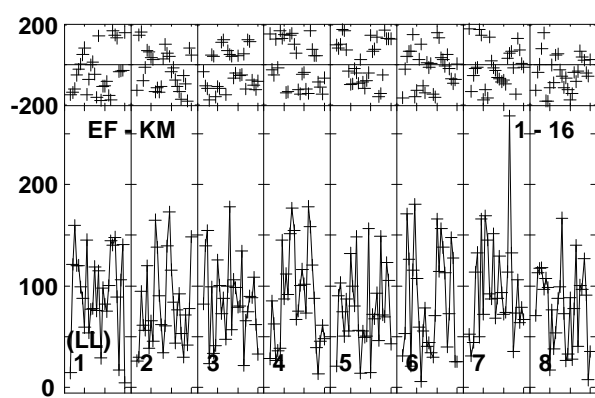
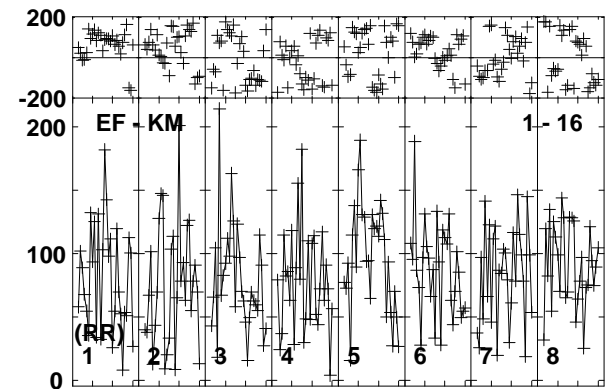
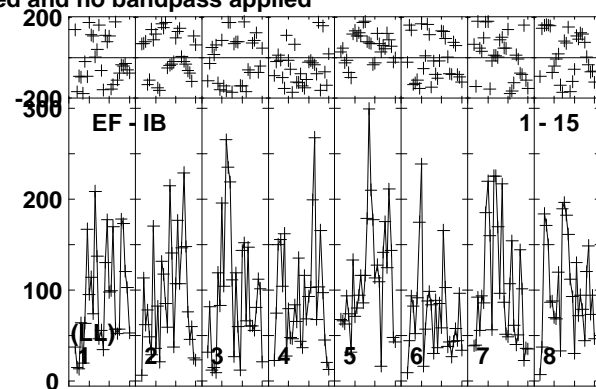
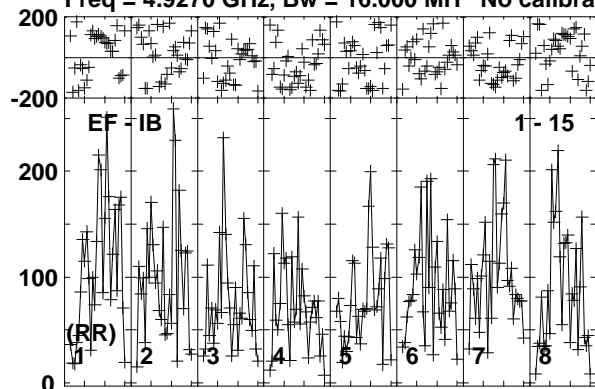

Lower frame: Micro Ampl Jy Top frame: Phas deg  
Vector averaged cross-power spectrum Baseline: EF (01) - IB (15)  
Timerange: 00/03:34:13 to 00/03:37:39

Plot file version 44 created 08-APR-2019 12:09:35

J0815+3635 EM133B.UVDATA.1

Freq = 4.9270 GHz, Bw = 16.000 MH No calibration applied and no bandpass applied

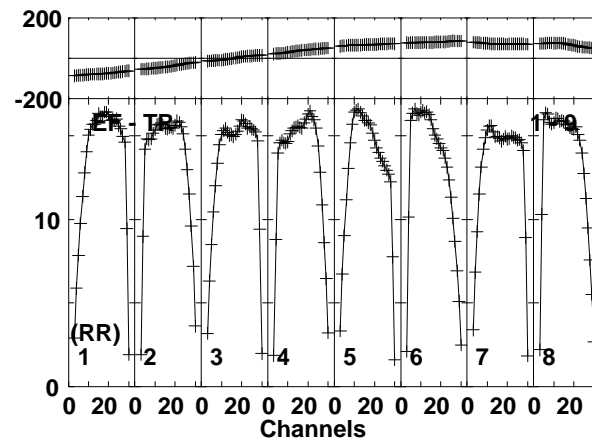
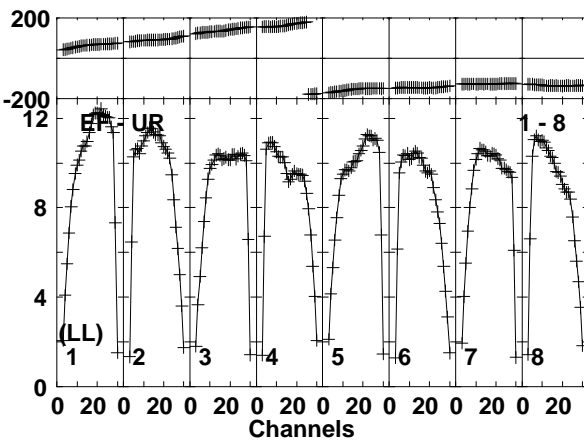
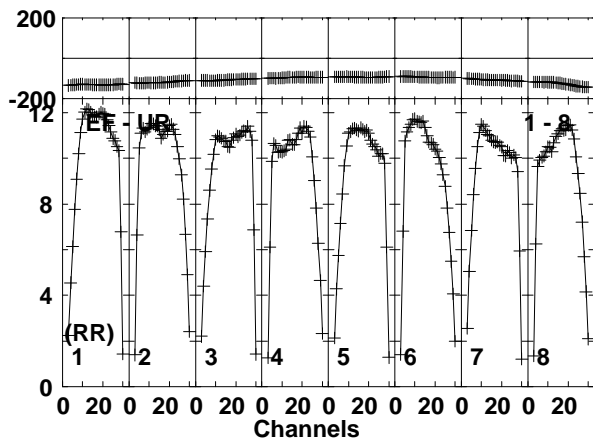
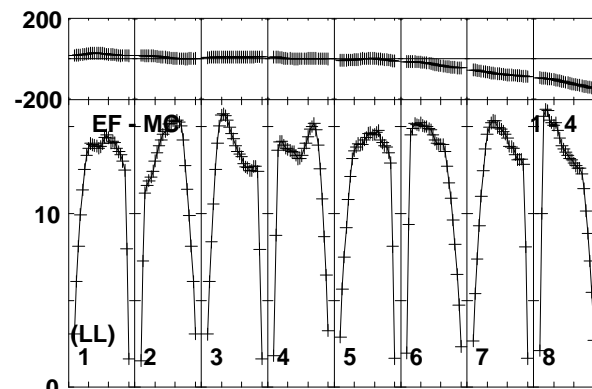
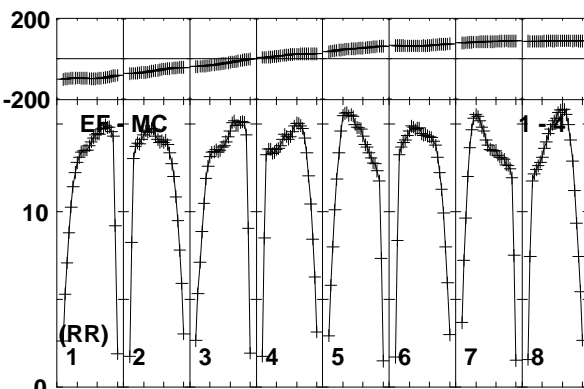
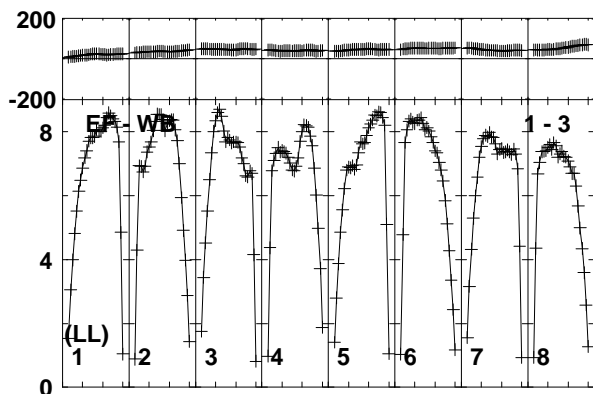
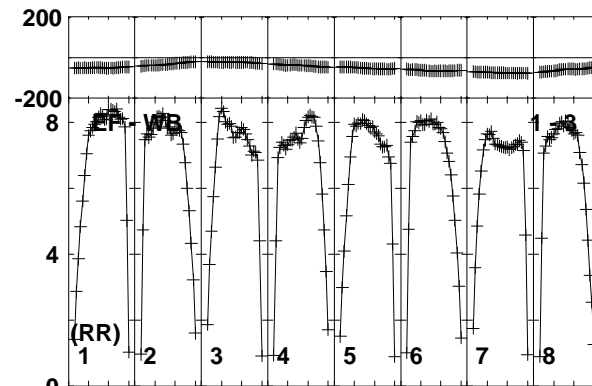
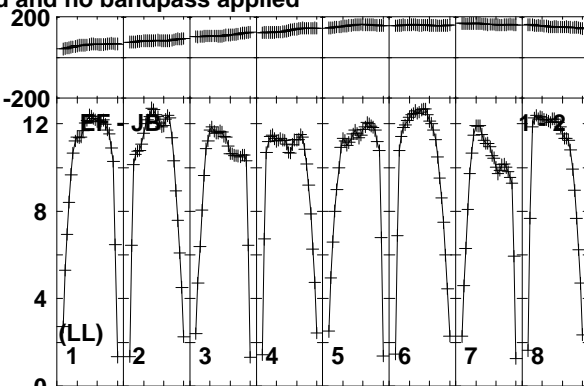
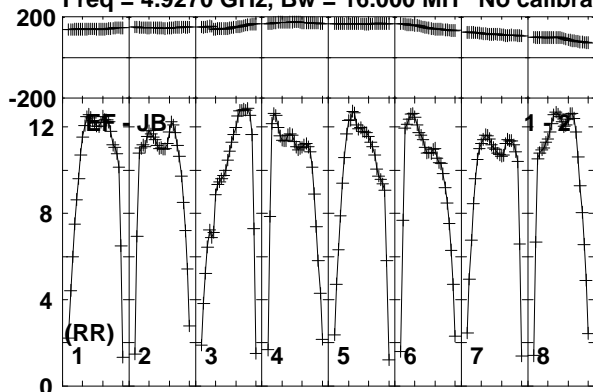

Lower frame: Milli Ampl Jy Top frame: Phas deg  
Vector averaged cross-power spectrum Baseline: EF (01) - JB (02)  
Timerange: 00/03:38:31 to 00/03:39:59

Plot file version 45 created 08-APR-2019 12:09:35

J0815+3635 EM133B.UVDATA.1

Freq = 4.9270 GHz, Bw = 16.000 MH No calibration applied and no bandpass applied

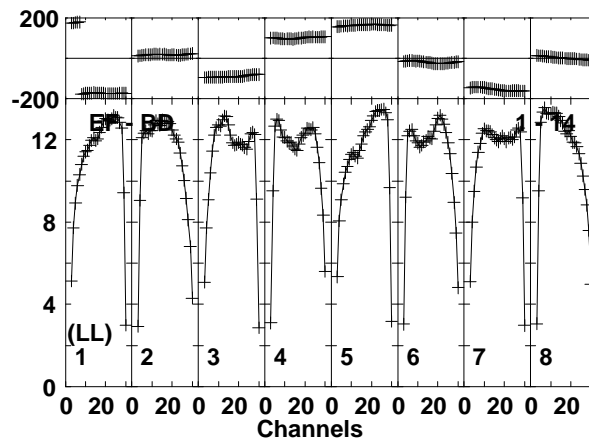
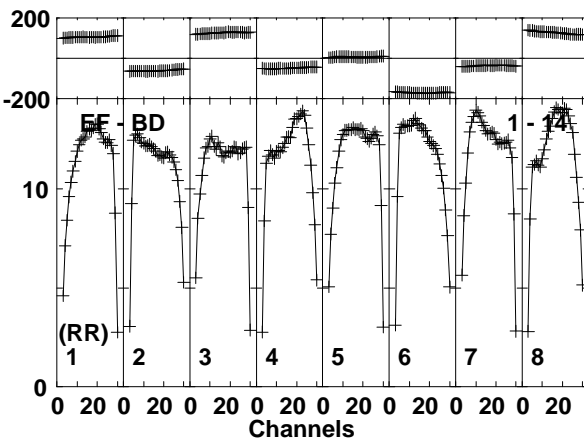
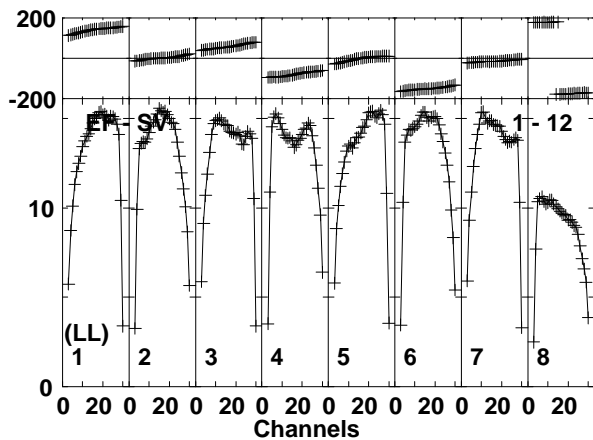
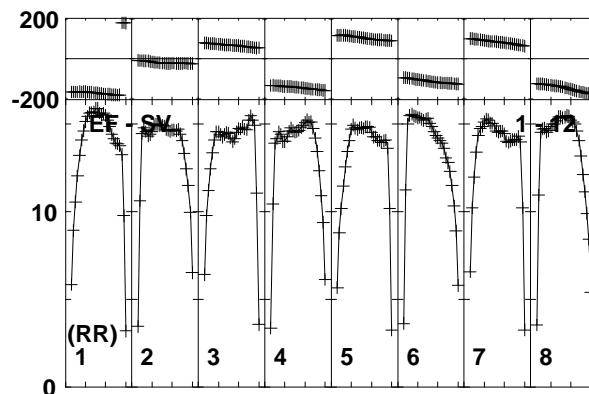
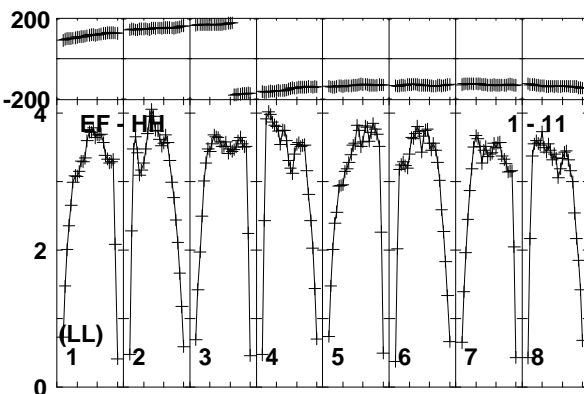
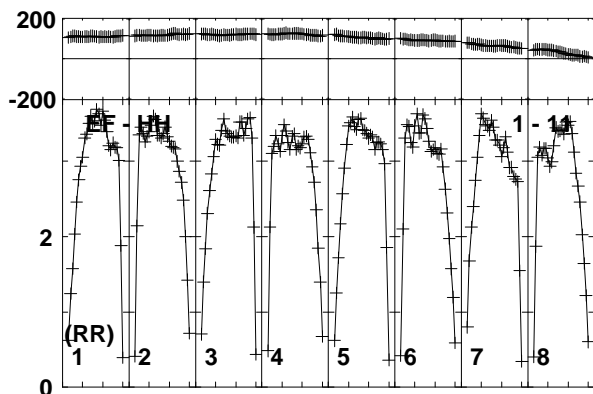
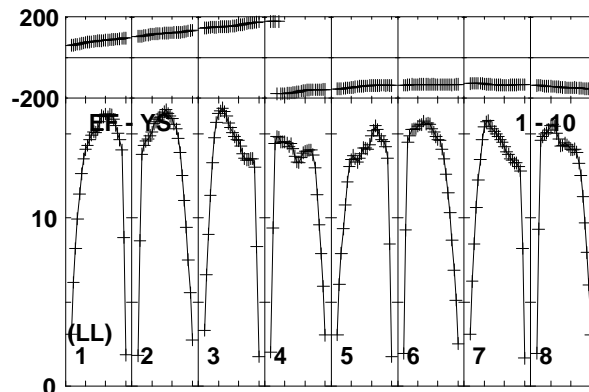
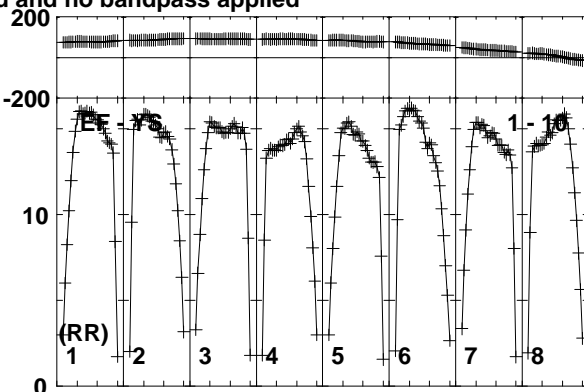
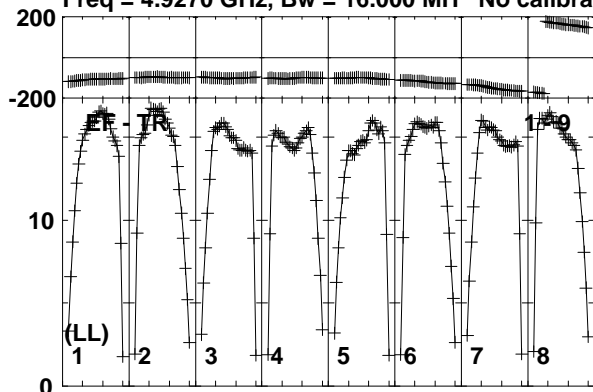

Lower frame: Milli Ampl Jy Top frame: Phas deg  
Vector averaged cross-power spectrum Baseline: EF (01) - TR (09)  
Timerange: 00/03:38:31 to 00/03:39:59

Plot file version 46 created 08-APR-2019 12:09:35

J0815+3635 EM133B.UVDATA.1

Freq = 4.9270 GHz, Bw = 16.000 MH No calibration applied and no bandpass applied

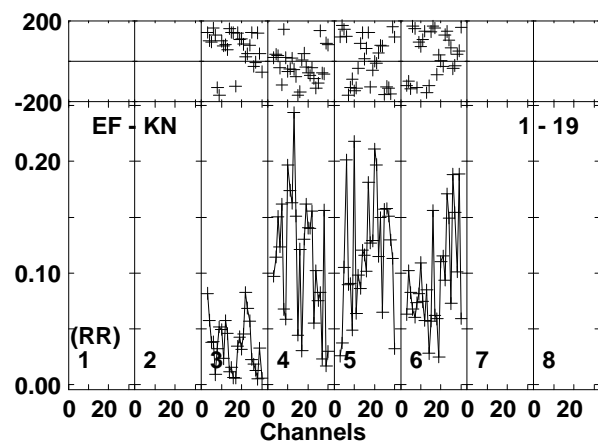
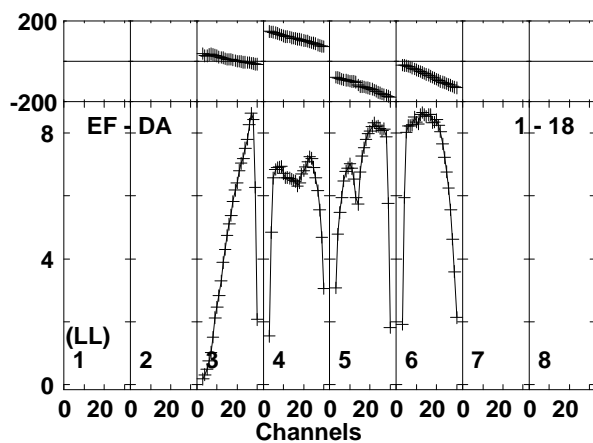
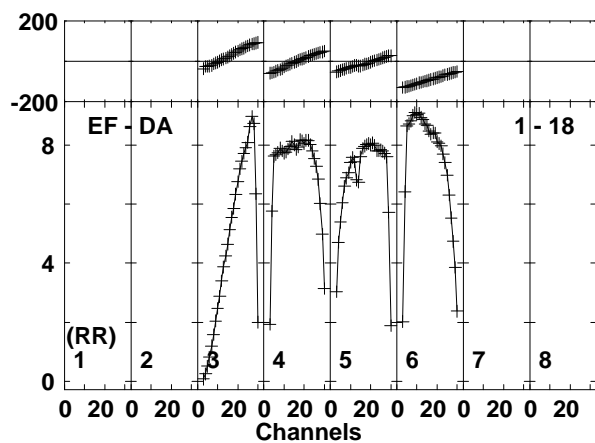
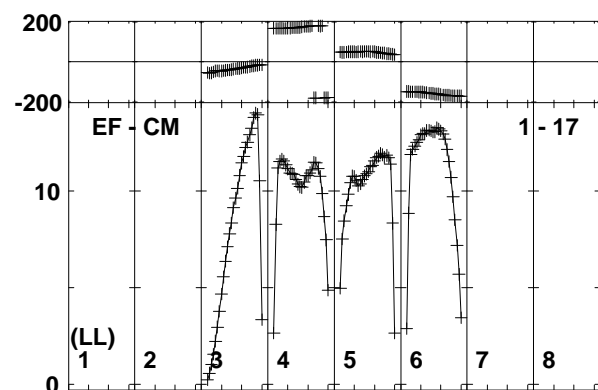
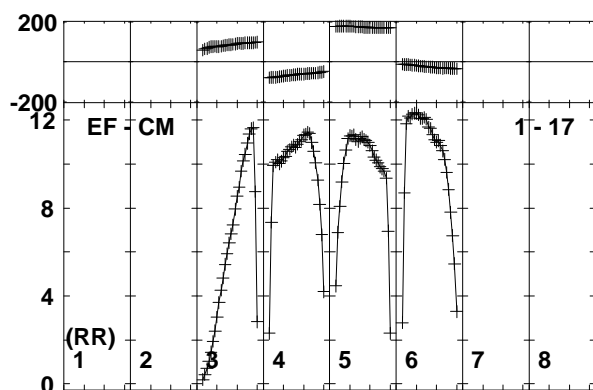
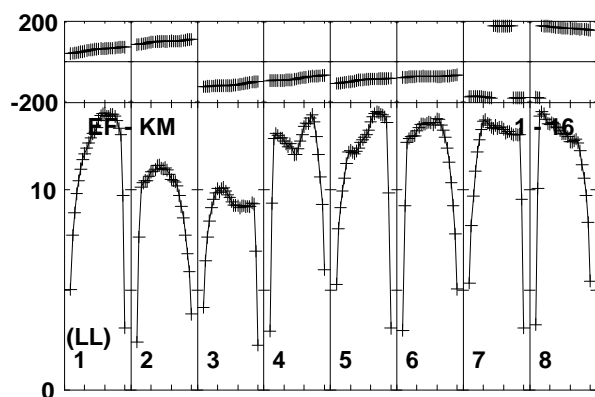
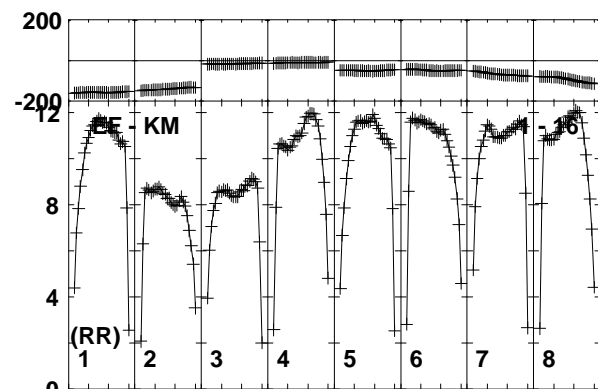
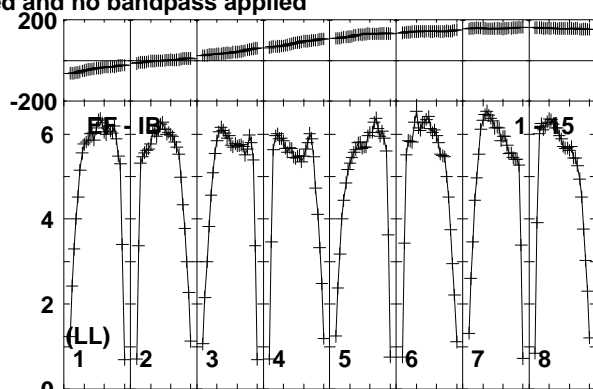
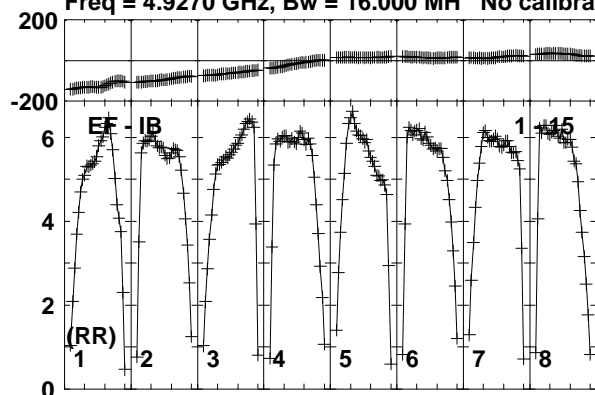

Lower frame: Milli Ampl Jy Top frame: Phas deg  
Vector averaged cross-power spectrum Baseline: EF (01) - IB (15)  
Timerange: 00/03:38:31 to 00/03:39:59

Plot file version 47 created 08-APR-2019 12:09:35

J0815+3635 EM133B.UVDATA.1

Freq = 4.9270 GHz, Bw = 16.000 MH No calibration applied and no bandpass applied

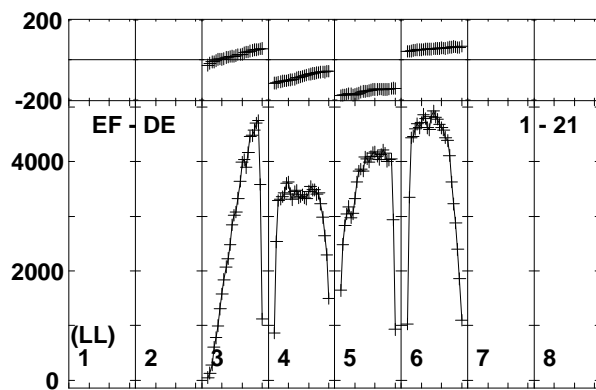
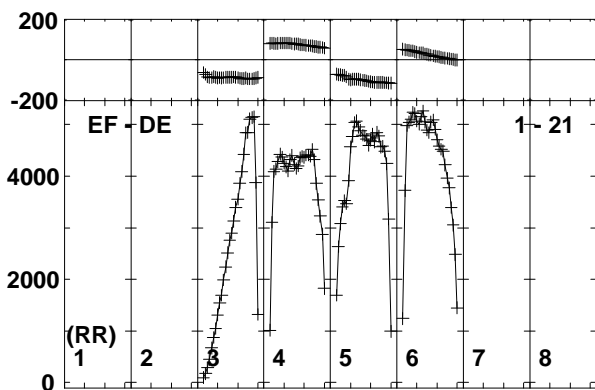
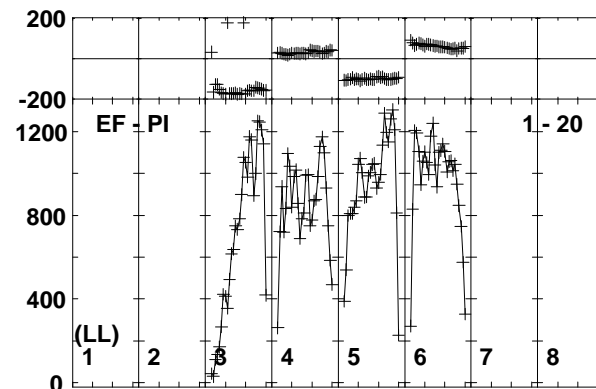
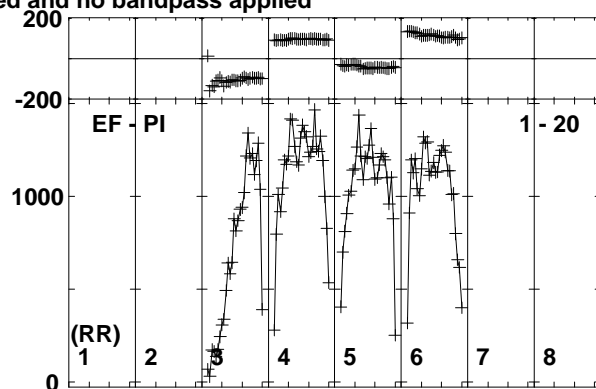
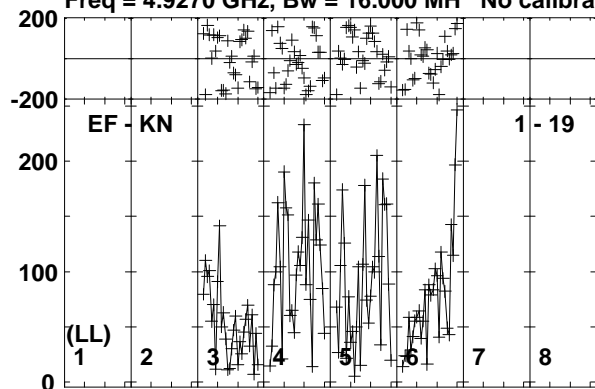

Lower frame: Micro Ampl Jy Top frame: Phas deg  
Vector averaged cross-power spectrum Baseline: EF (01) - KN (19)  
Timerange: 00/03:38:31 to 00/03:39:59

Plot file version 48 created 08-APR-2019 12:09:35

J0927+3902 EM133B.UVDATA.1

Freq = 4.9270 GHz, Bw = 16.000 MH No calibration applied and no bandpass applied

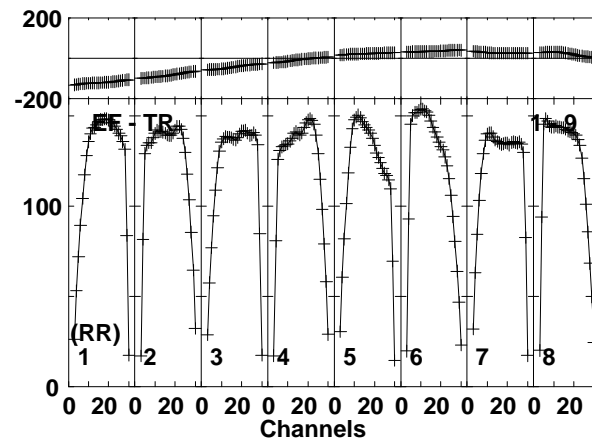
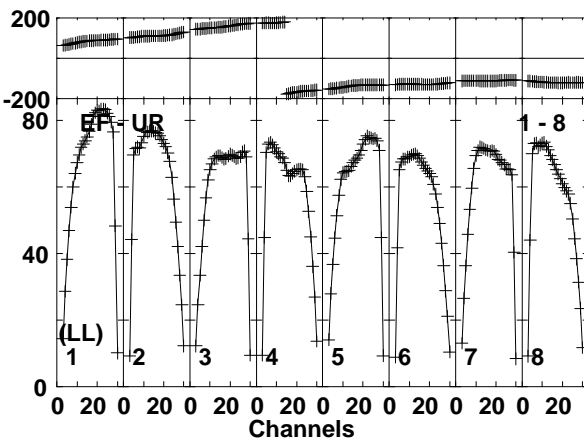
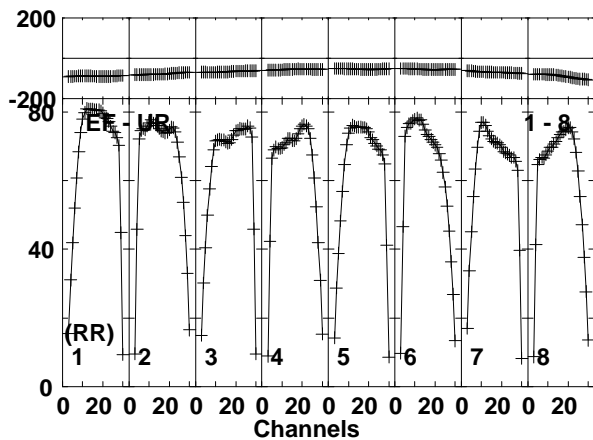
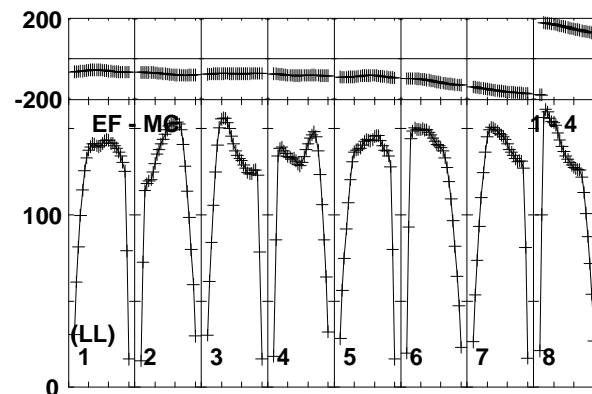
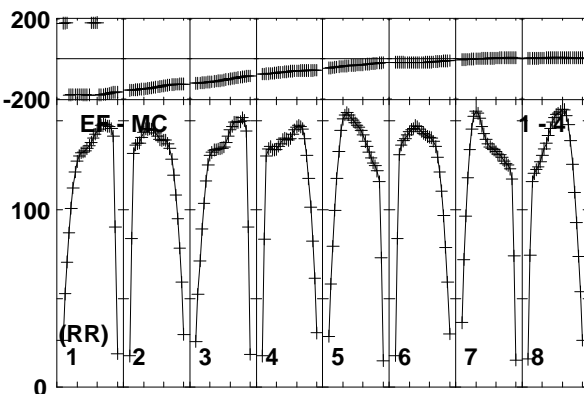
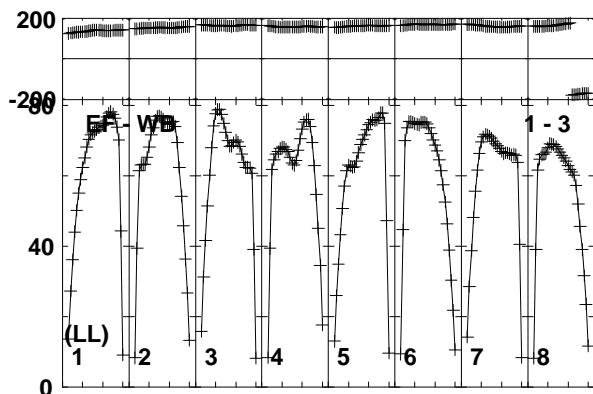
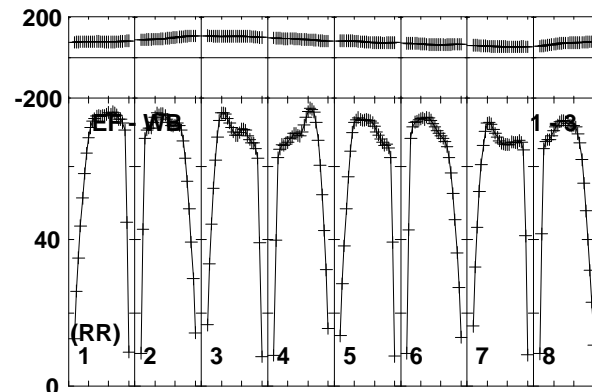
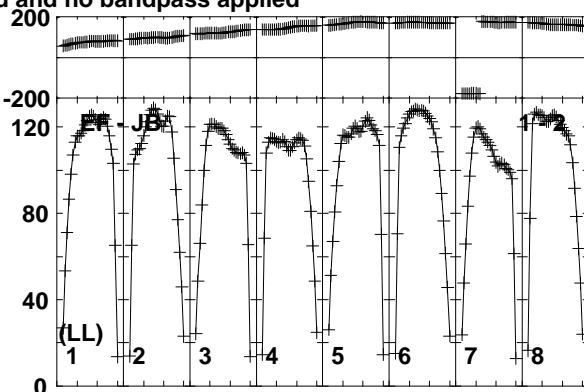
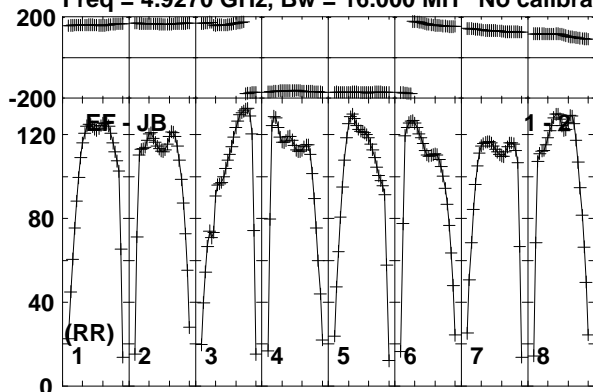

Lower frame: Milli Ampl Jy Top frame: Phas deg  
Vector averaged cross-power spectrum Baseline: EF (01) - JB (02)  
Timerange: 00/03:40:01 to 00/03:43:59



Plot file version 49 created 08-APR-2019 12:09:35

J0927+3902 EM133B.UVDATA.1

Freq = 4.9270 GHz, Bw = 16.000 MH No calibration applied and no bandpass applied

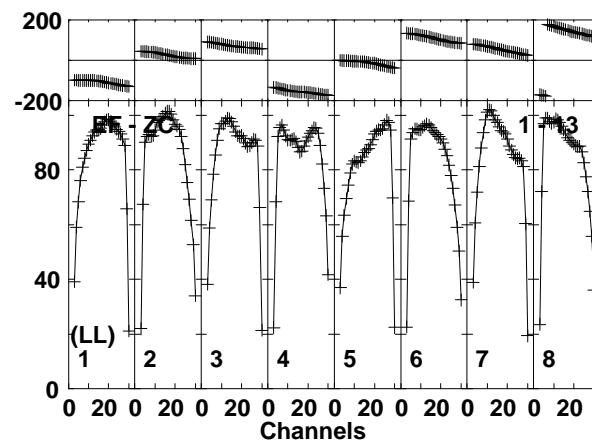
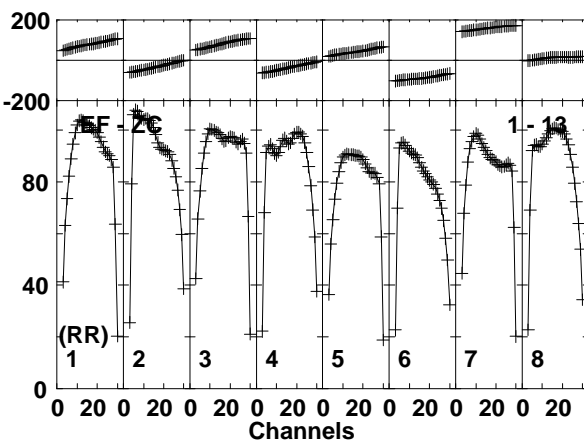
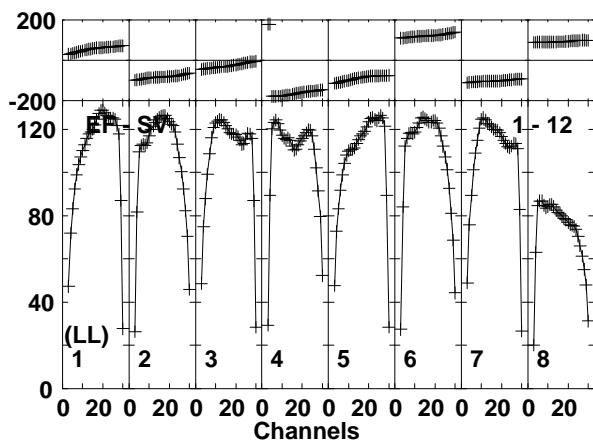
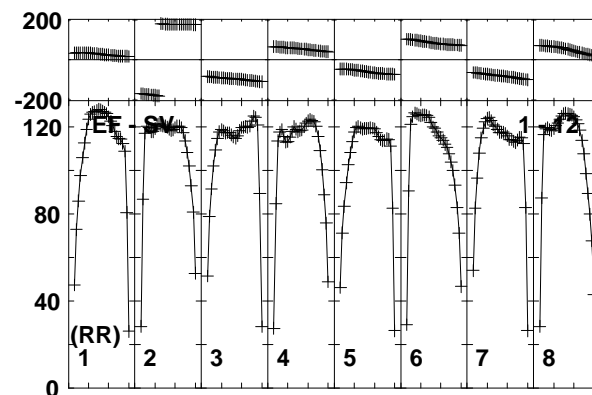
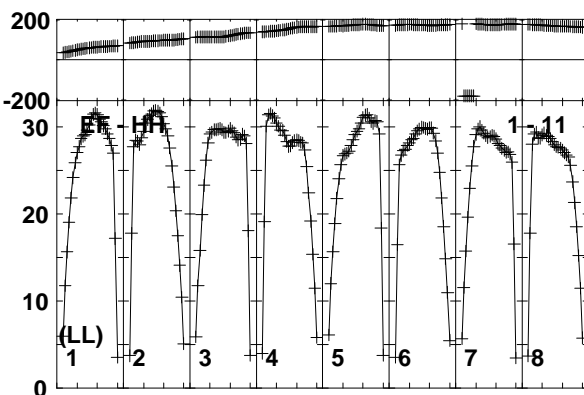
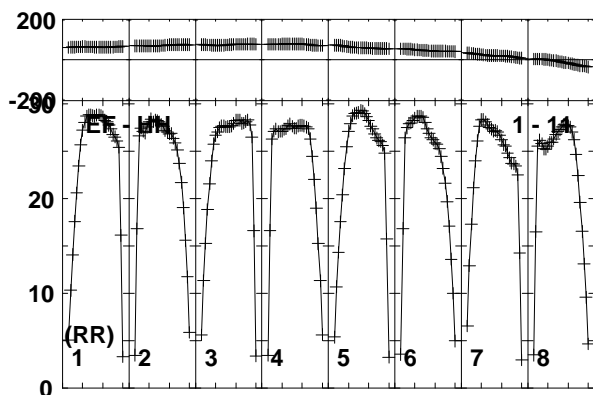
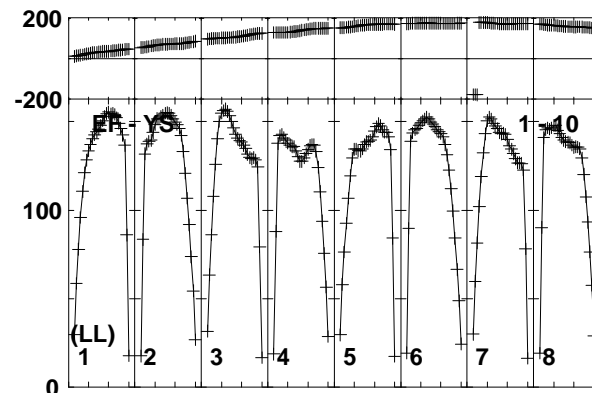
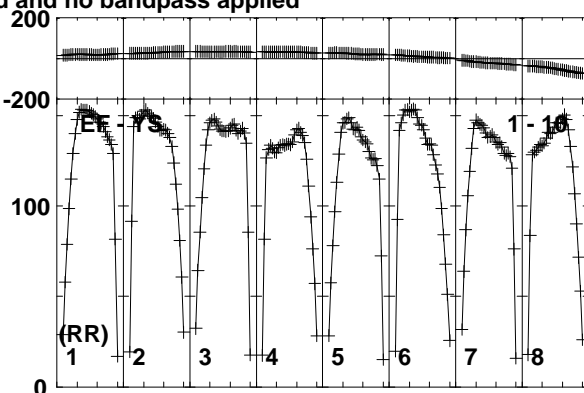
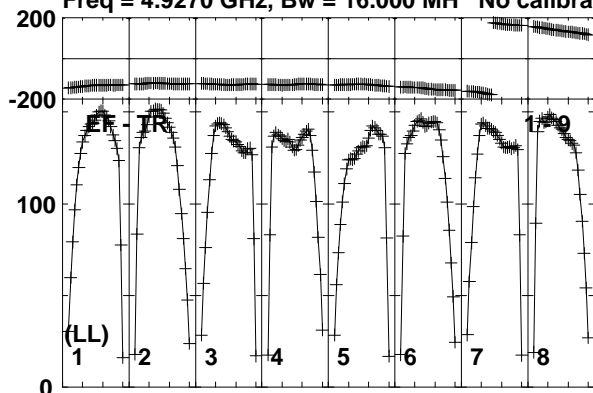

Lower frame: Milli Ampl Jy Top frame: Phas deg  
Vector averaged cross-power spectrum Baseline: EF (01) - TR (09)  
Timerange: 00/03:40:01 to 00/03:43:59

Plot file version 50 created 08-APR-2019 12:09:35

J0927+3902 EM133B.UVDATA.1

Freq = 4.9270 GHz, Bw = 16.000 MH No calibration applied and no bandpass applied

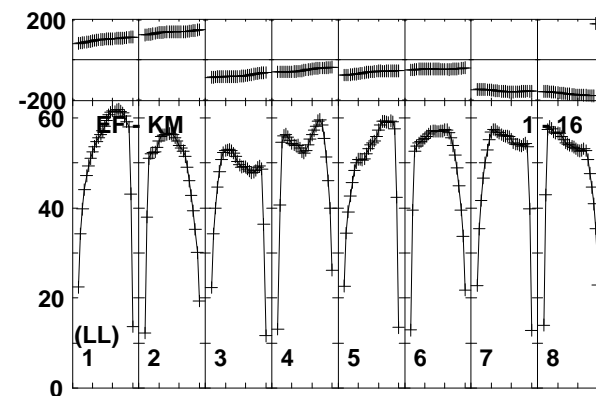
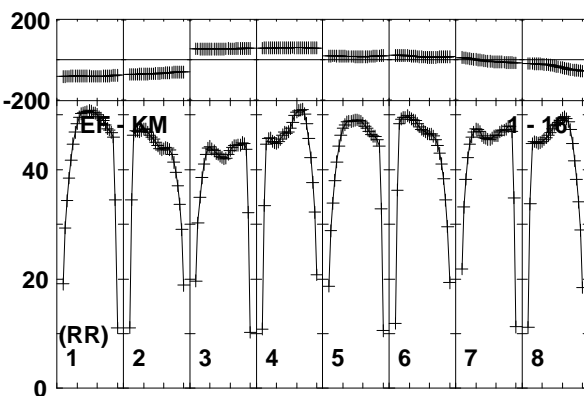
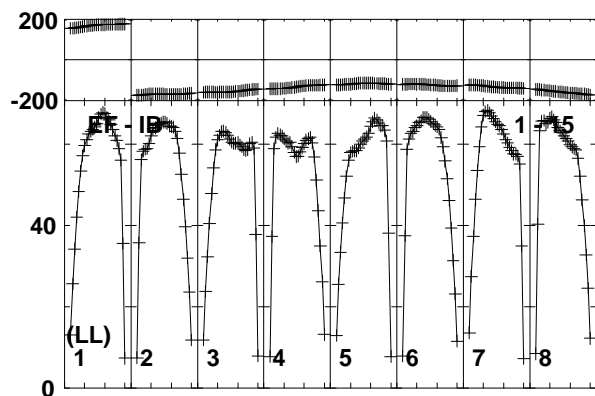
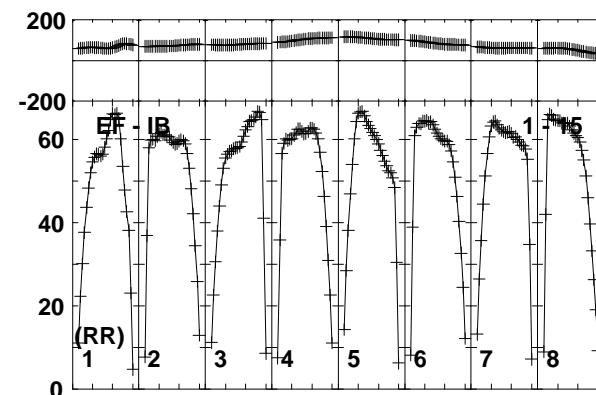
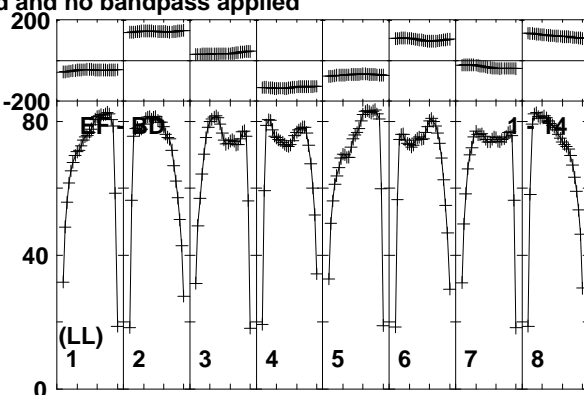
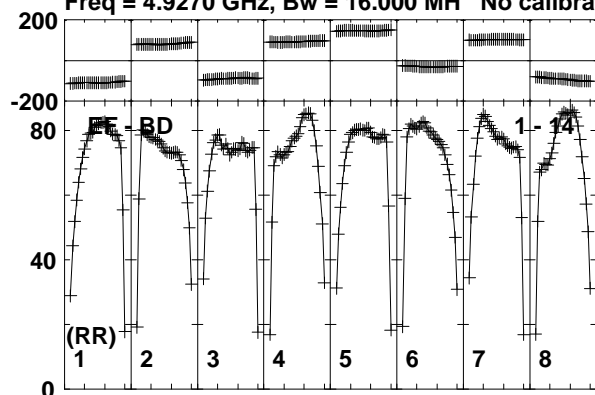

Lower frame: Milli Ampl Jy Top frame: Phas deg  
Vector averaged cross-power spectrum Baseline: EF (01) - BD (14)  
Timerange: 00/03:40:01 to 00/03:43:59

Plot file version 51 created 08-APR-2019 12:09:36

J0815+3635 EM133B.UVDATA.1

Freq = 4.9270 GHz, Bw = 16.000 MH No calibration applied and no bandpass applied

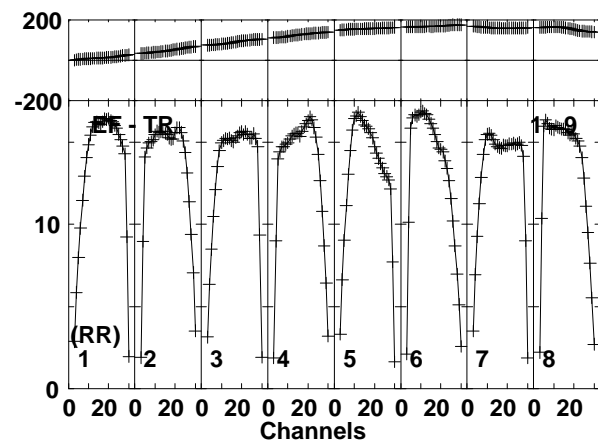
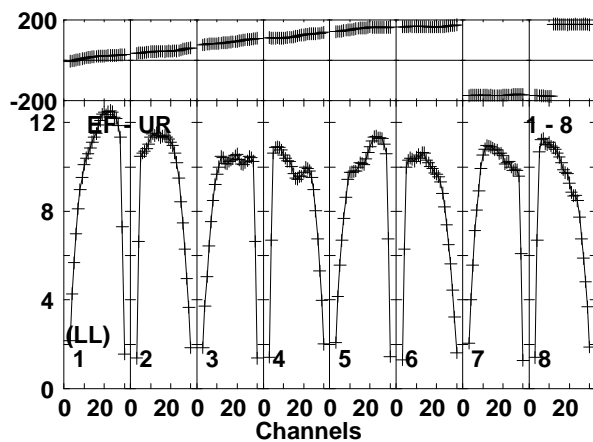
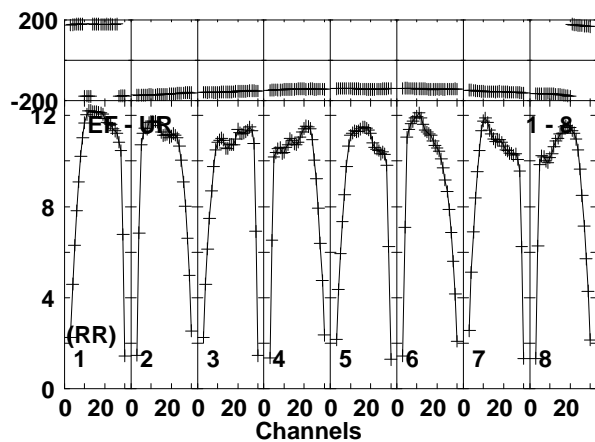
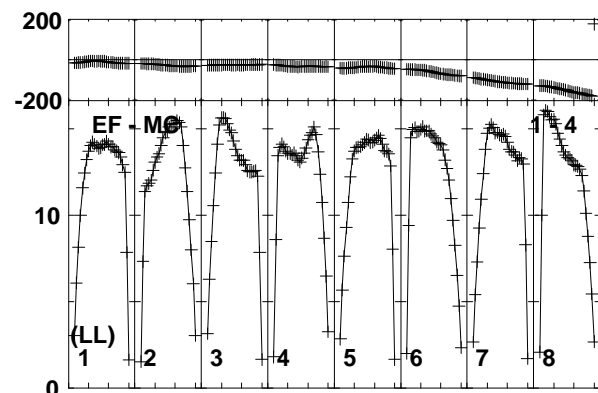
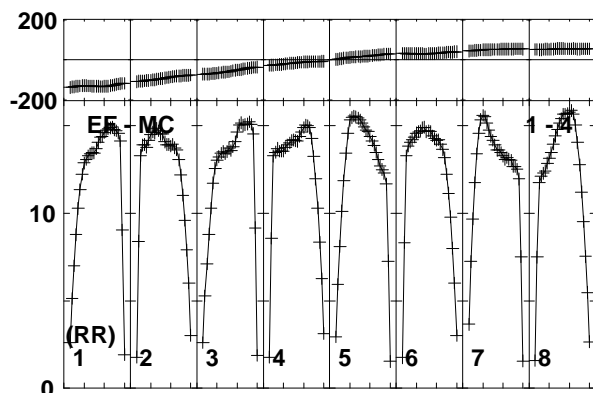
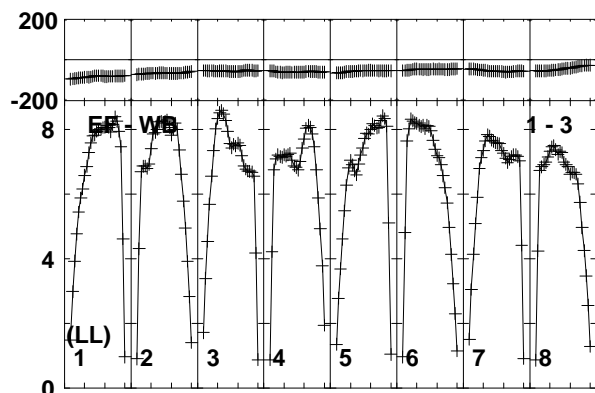
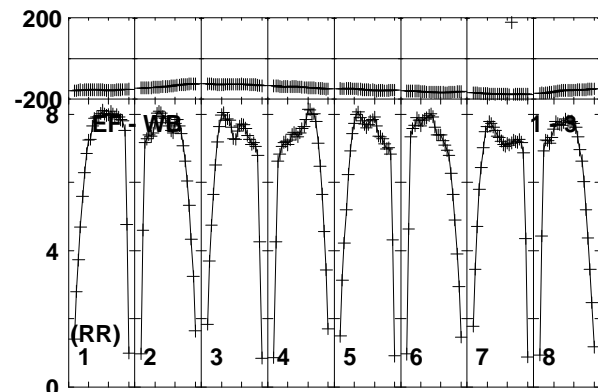
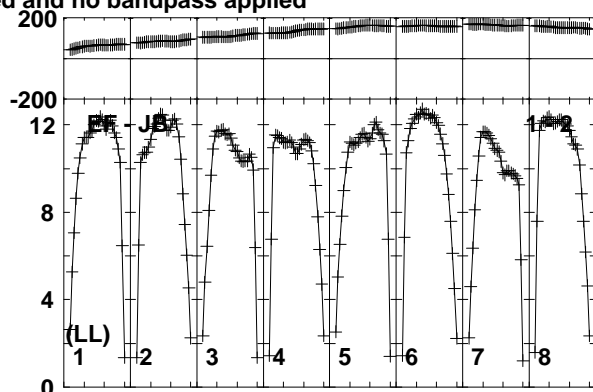
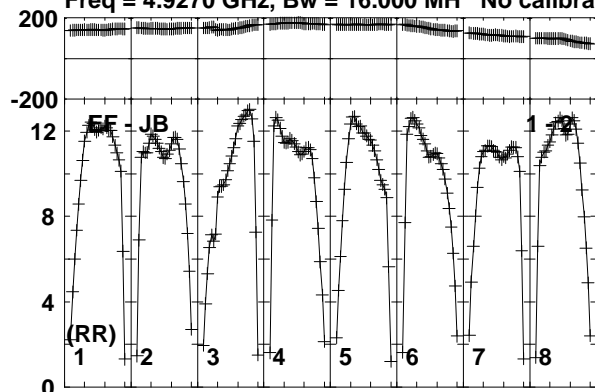

Lower frame: Milli Ampl Jy Top frame: Phas deg  
Vector averaged cross-power spectrum Baseline: EF (01) - JB (02)  
Timerange: 00/03:45:31 to 00/03:47:29

Plot file version 52 created 08-APR-2019 12:09:36

J0815+3635 EM133B.UVDATA.1

Freq = 4.9270 GHz, Bw = 16.000 MH No calibration applied and no bandpass applied

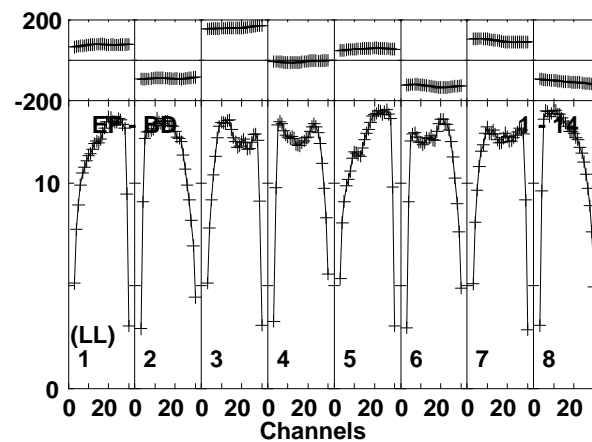
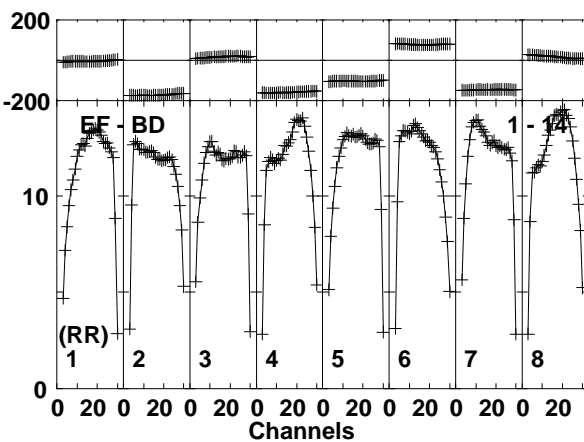
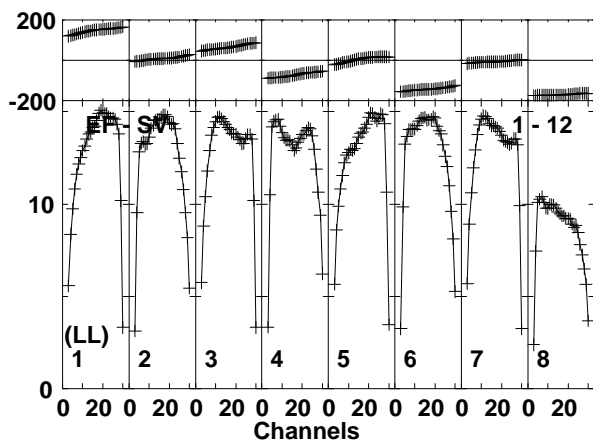
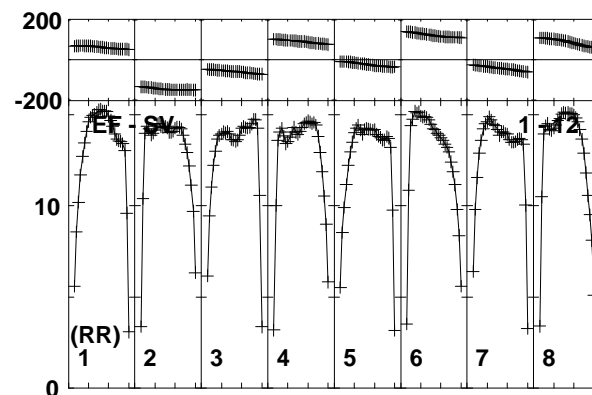
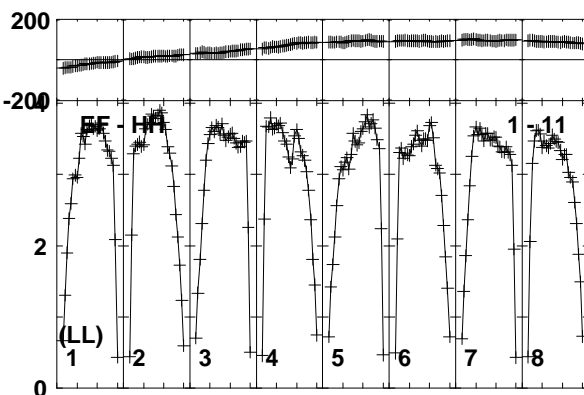
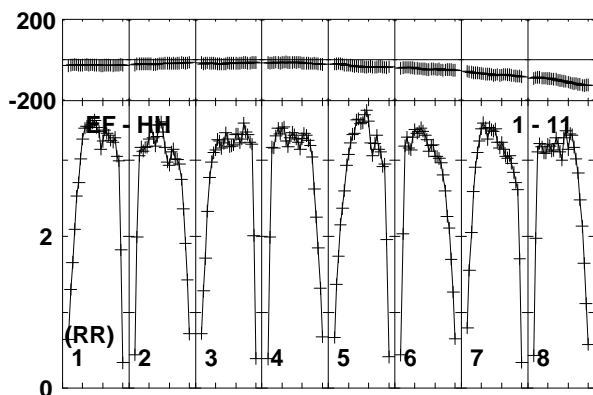
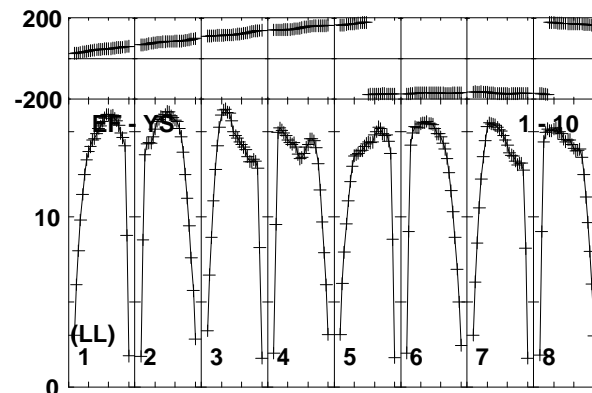
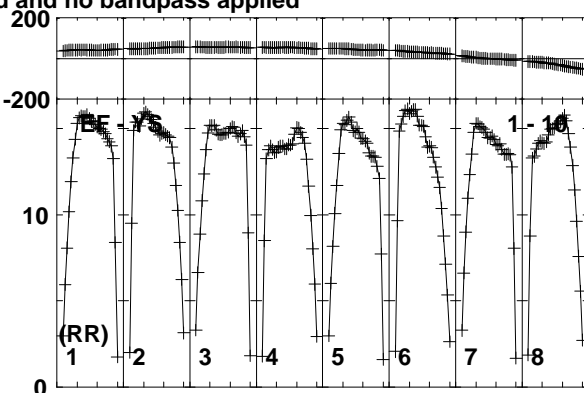
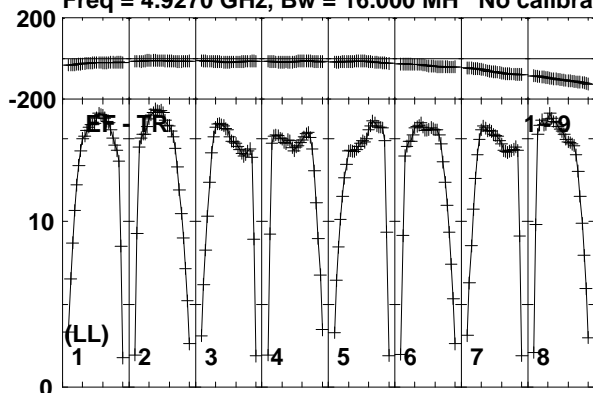

Lower frame: Milli Ampl Jy Top frame: Phas deg  
Vector averaged cross-power spectrum Baseline: EF (01) - TR (09)  
Timerange: 00/03:45:31 to 00/03:47:29

Plot file version 53 created 08-APR-2019 12:09:36

J0815+3635 EM133B.UVDATA.1

Freq = 4.9270 GHz, Bw = 16.000 MH No calibration applied and no bandpass applied

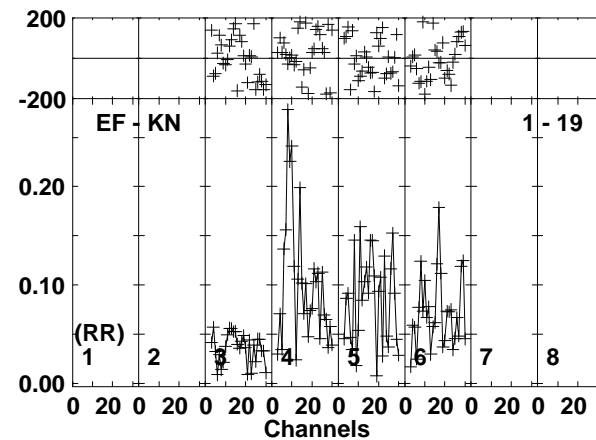
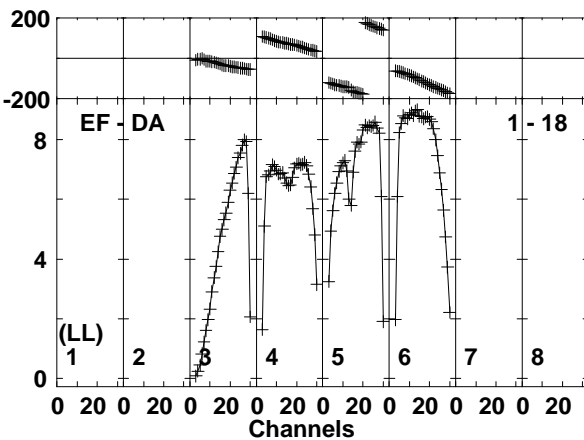
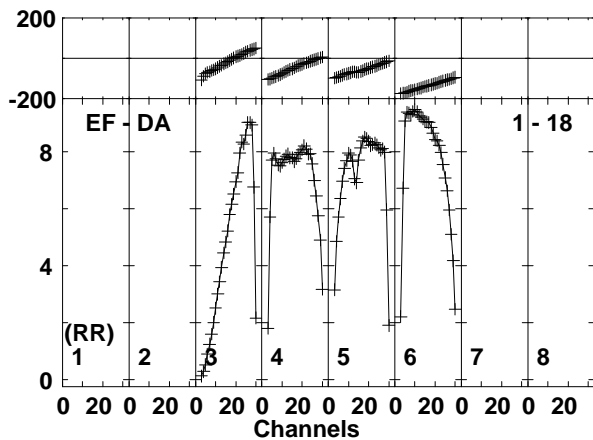
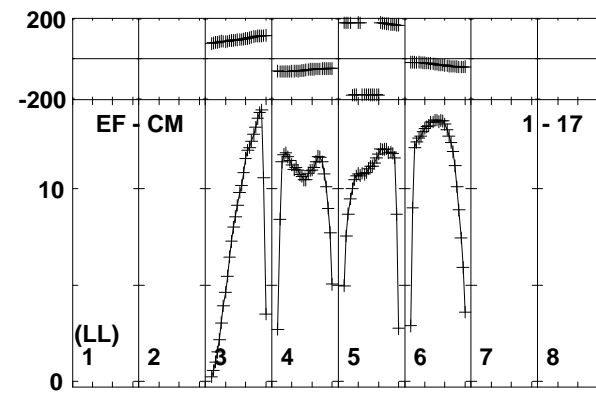
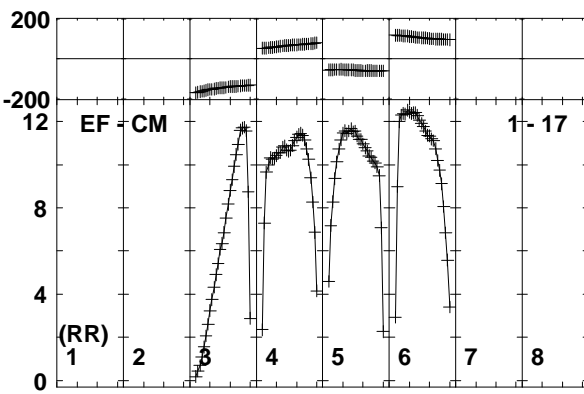
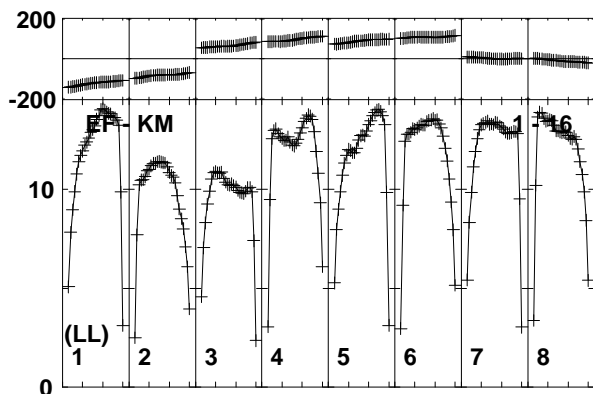
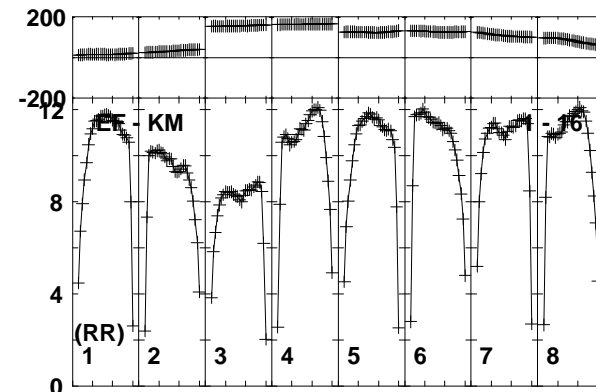
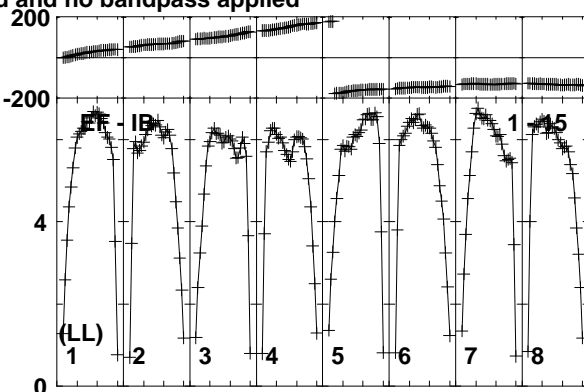
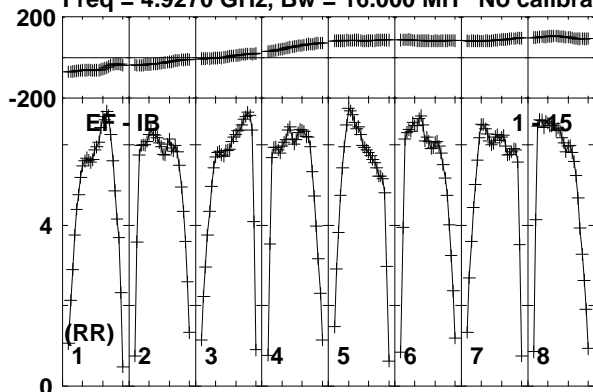

Lower frame: Milli Ampl Jy Top frame: Phas deg  
Vector averaged cross-power spectrum Baseline: EF (01) - IB (15)  
Timerange: 00/03:45:31 to 00/03:47:29

Plot file version 54 created 08-APR-2019 12:09:36

J0815+3635 EM133B.UVDATA.1

Freq = 4.9270 GHz, Bw = 16.000 MH No calibration applied and no bandpass applied

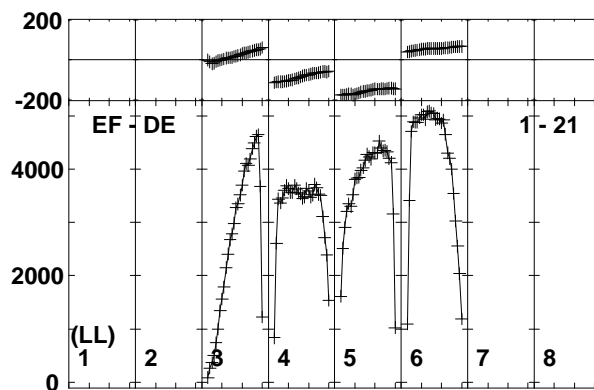
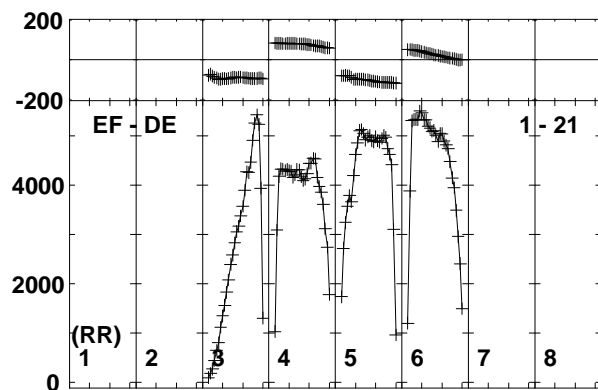
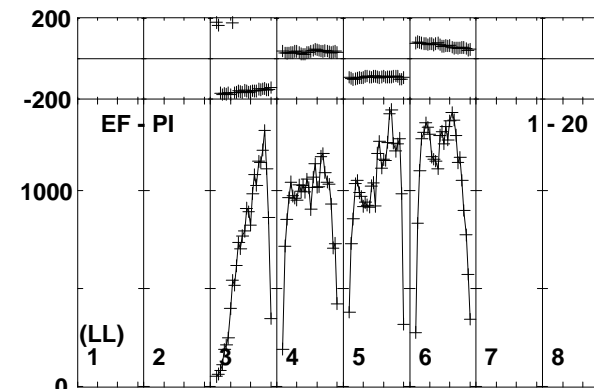
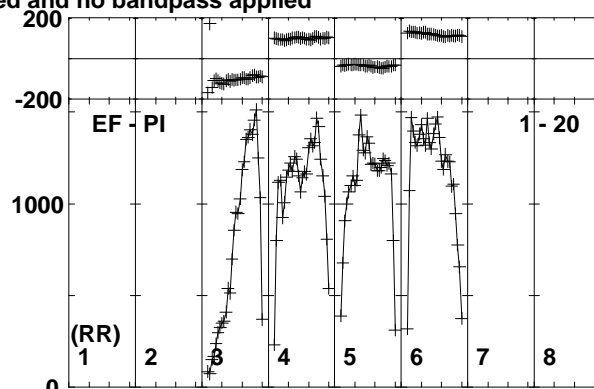
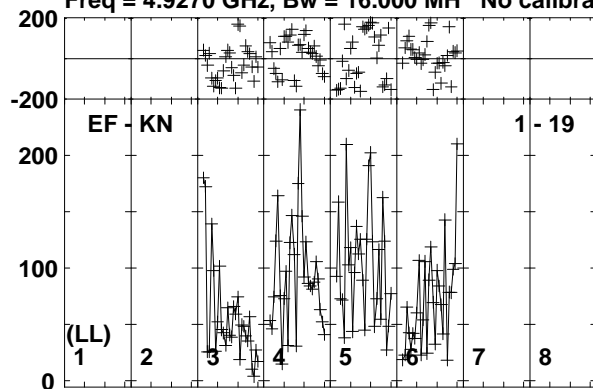

Lower frame: Micro Ampl Jy Top frame: Phas deg  
Vector averaged cross-power spectrum Baseline: EF (01) - KN (19)  
Timerange: 00/03:45:31 to 00/03:47:29

Plot file version 55 created 08-APR-2019 12:09:36

MRK622 EM133B.UVDATA.1

Freq = 4.9270 GHz, Bw = 16.000 MH No calibration applied and no bandpass applied

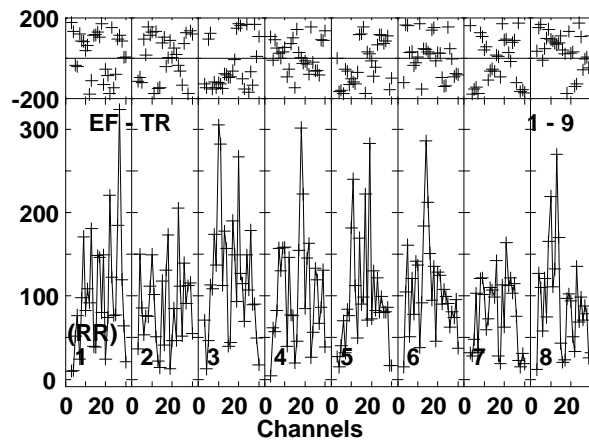
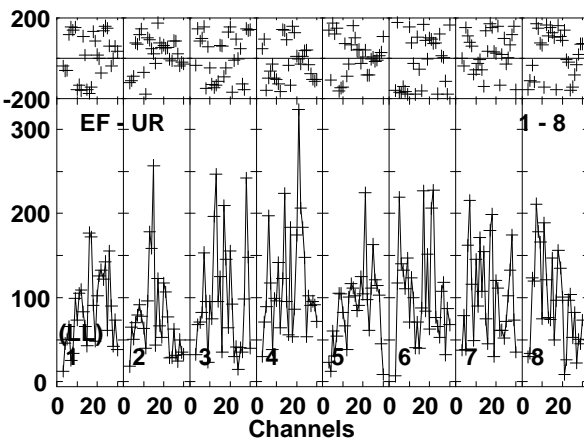
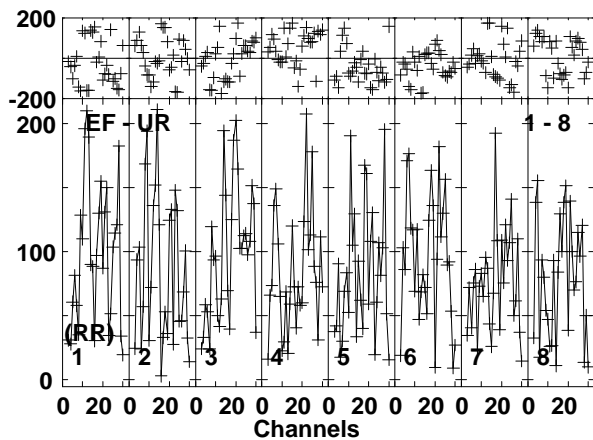
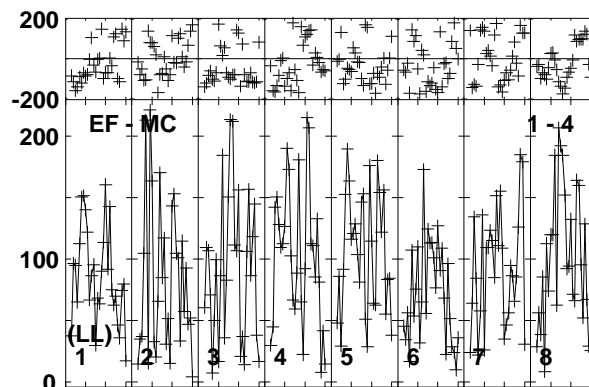
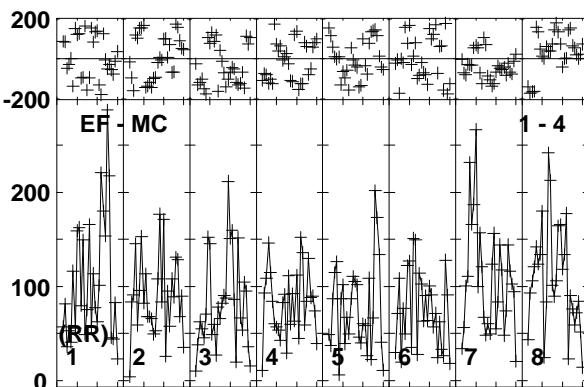
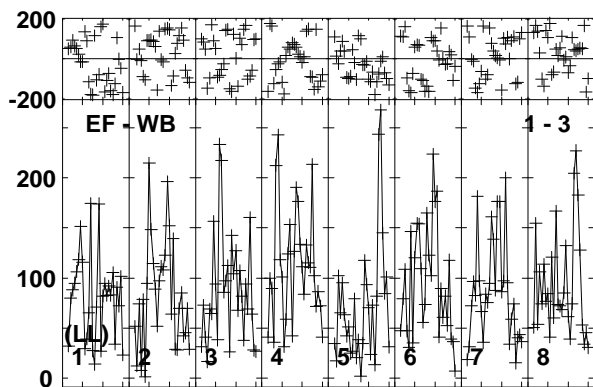
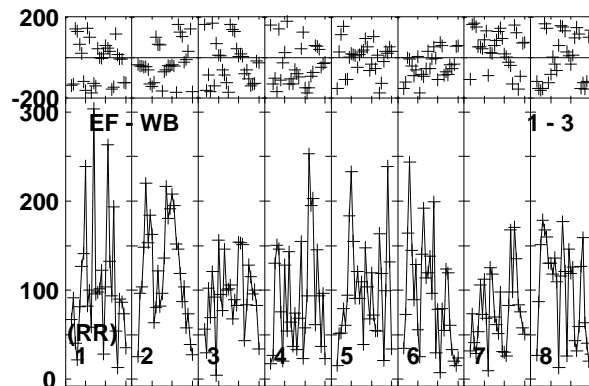
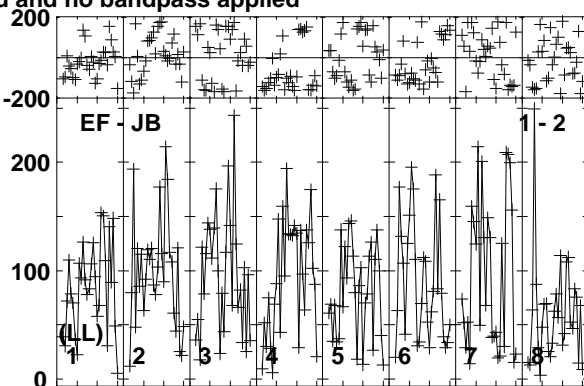
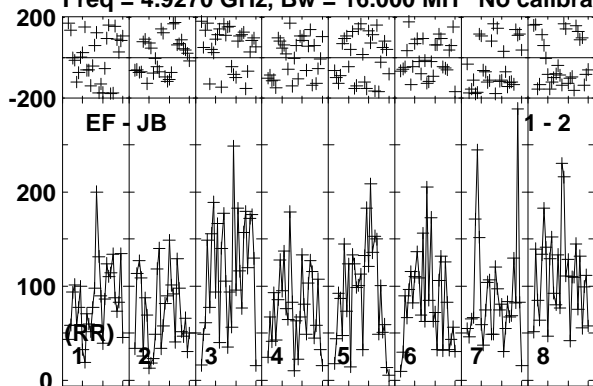

Lower frame: Micro Ampl Jy Top frame: Phas deg  
Vector averaged cross-power spectrum Baseline: EF (01) - JB (02)  
Timerange: 00/03:47:31 to 00/03:50:59

Plot file version 56 created 08-APR-2019 12:09:36

MRK622 EM133B.UVDATA.1

Freq = 4.9270 GHz, Bw = 16.000 MH No calibration applied and no bandpass applied

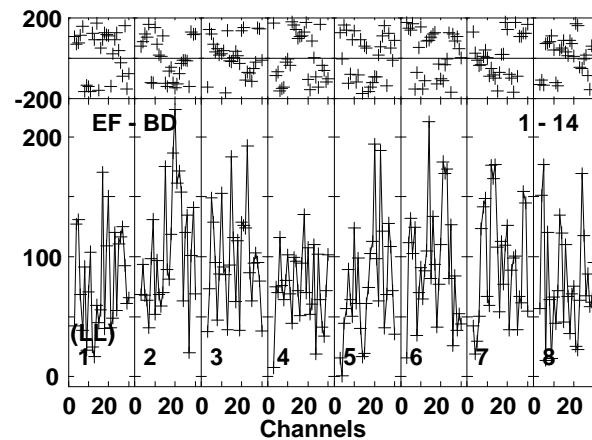
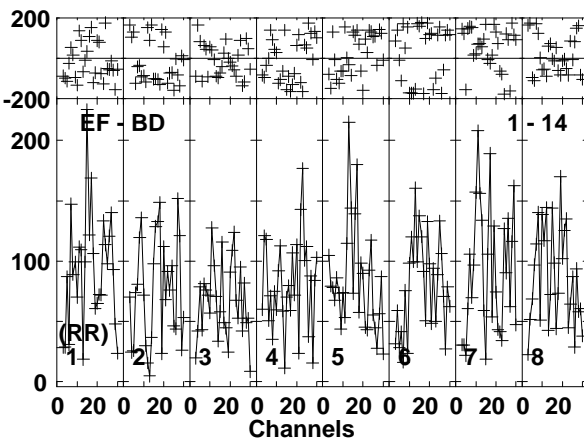
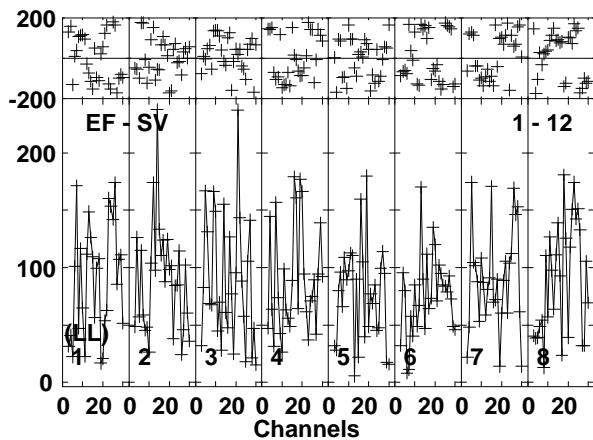
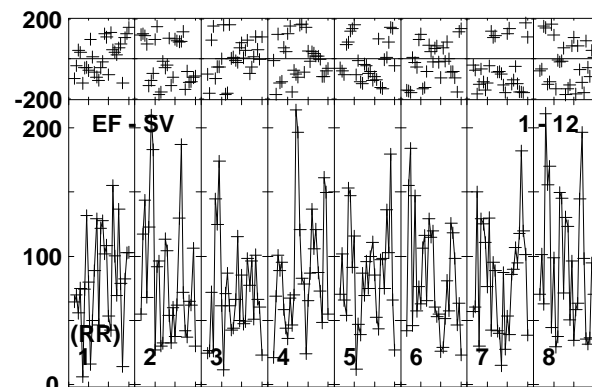
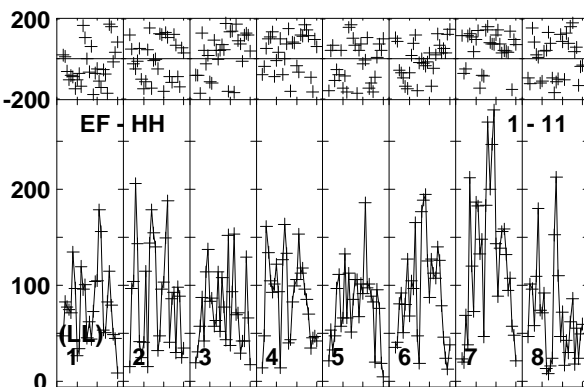
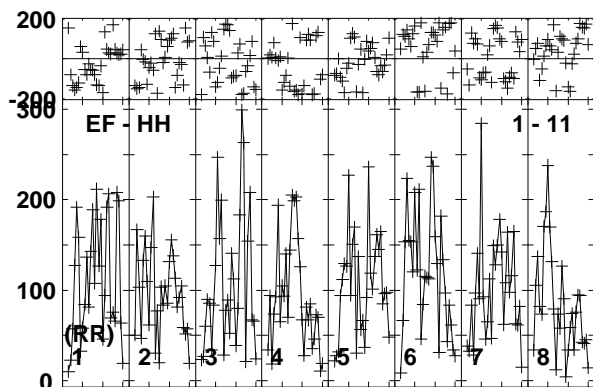
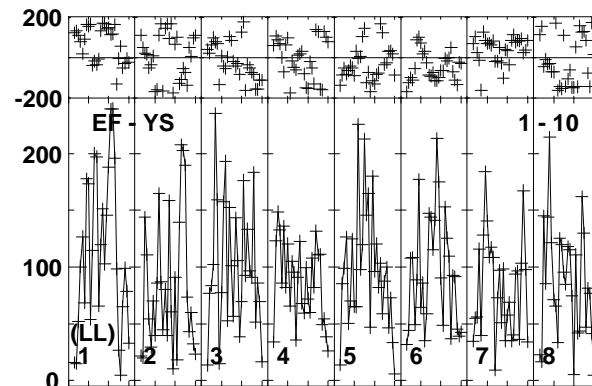
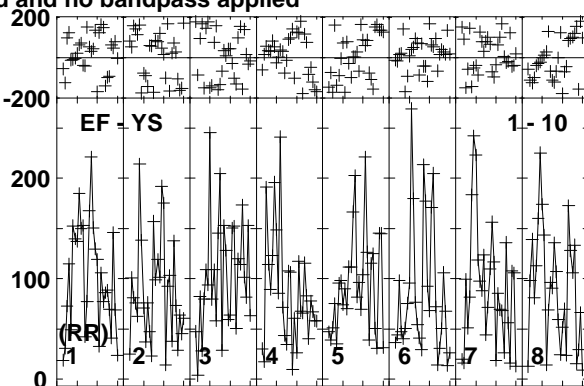
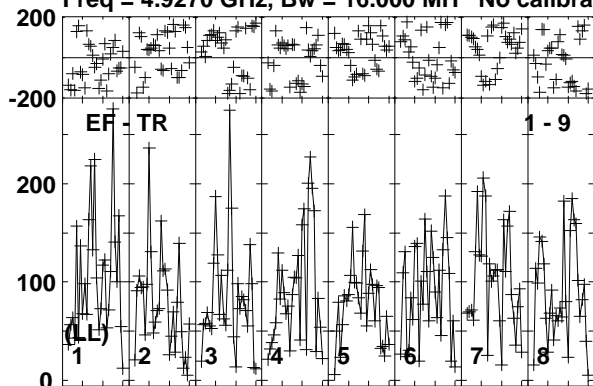

Lower frame: Micro Ampl Jy Top frame: Phas deg  
Vector averaged cross-power spectrum Baseline: EF (01) - TR (09)  
Timerange: 00/03:47:31 to 00/03:50:59



Plot file version 57 created 08-APR-2019 12:09:36

MRK622 EM133B.UVDATA.1

Freq = 4.9270 GHz, Bw = 16.000 MH No calibration applied and no bandpass applied

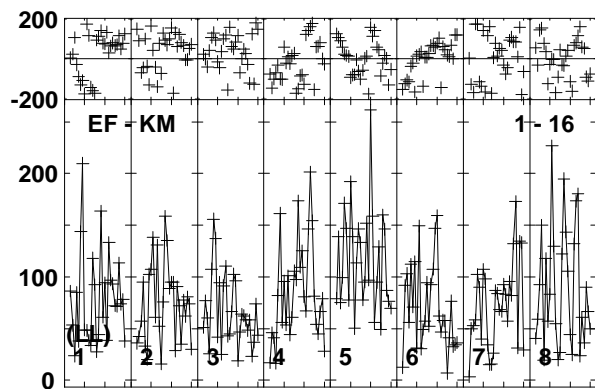
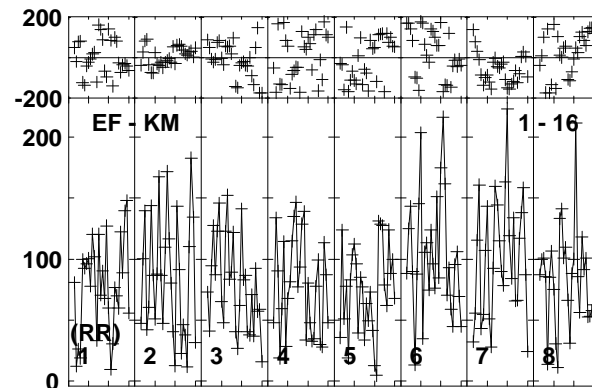
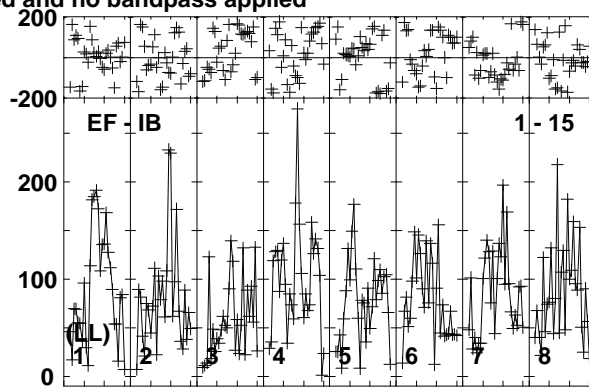
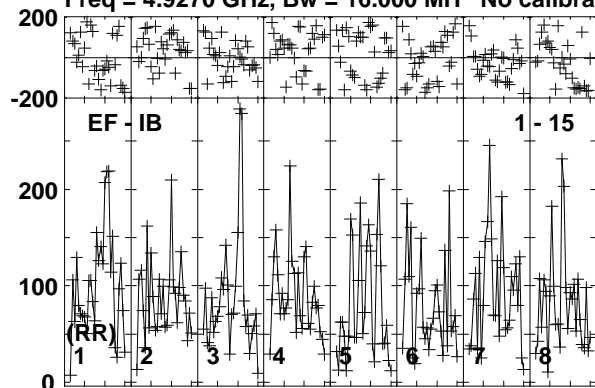

Lower frame: Micro Ampl Jy Top frame: Phas deg  
Vector averaged cross-power spectrum Baseline: EF (01) - IB (15)  
Timerange: 00/03:47:31 to 00/03:50:59

Plot file version 58 created 08-APR-2019 12:09:36

J0815+3635 EM133B.UVDATA.1

Freq = 4.9270 GHz, Bw = 16.000 MH No calibration applied and no bandpass applied

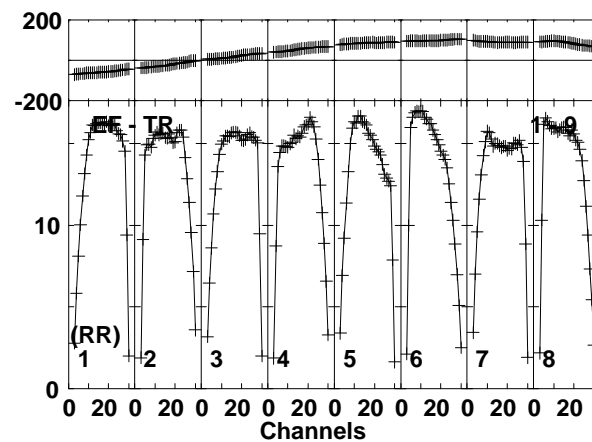
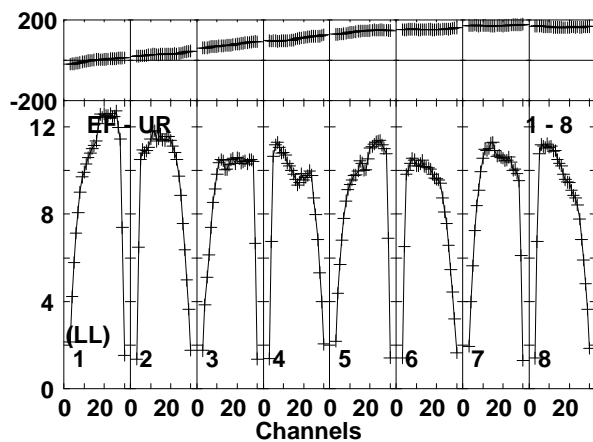
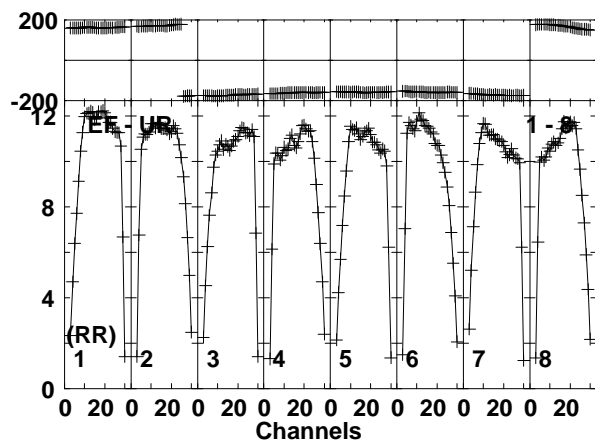
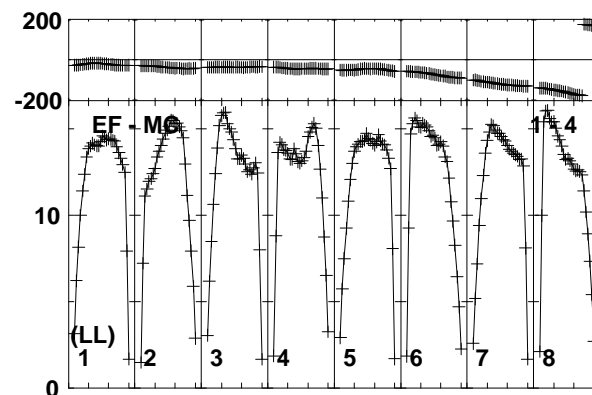
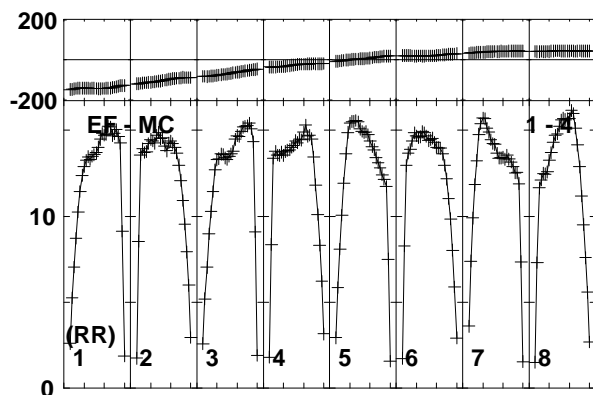
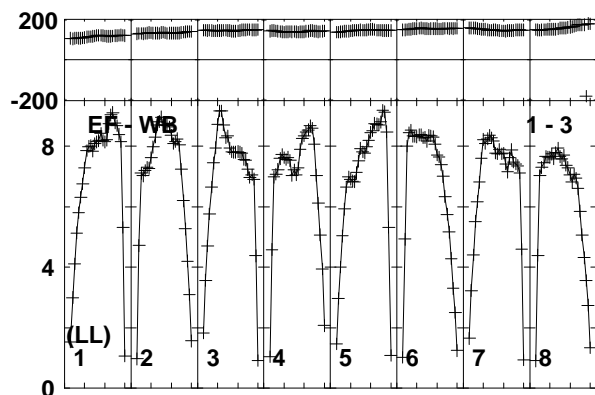
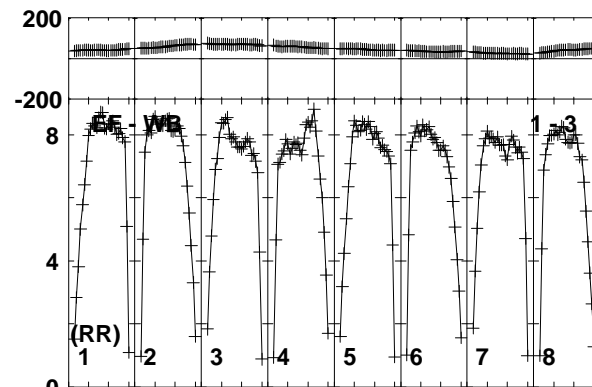
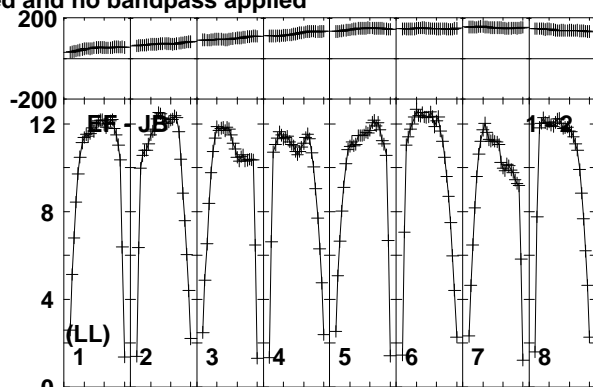
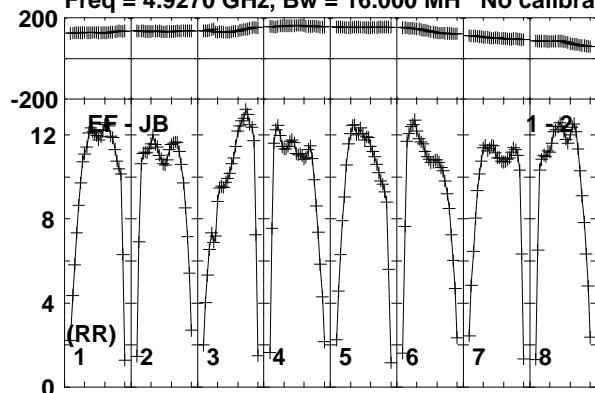

Lower frame: Milli Ampl Jy Top frame: Phas deg  
Vector averaged cross-power spectrum Baseline: EF (01) - JB (02)  
Timerange: 00/03:51:01 to 00/03:52:29

Plot file version 59 created 08-APR-2019 12:09:37

J0815+3635 EM133B.UVDATA.1

Freq = 4.9270 GHz, Bw = 16.000 MH No calibration applied and no bandpass applied

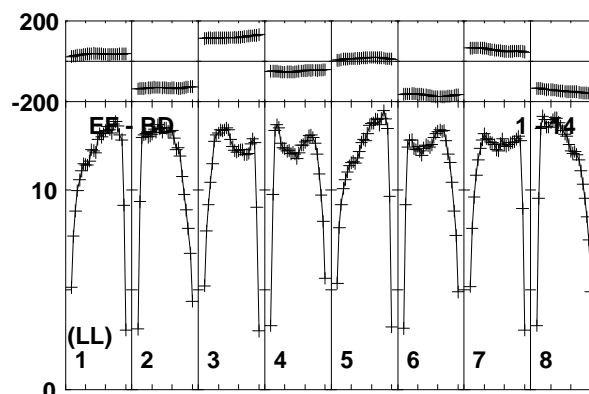
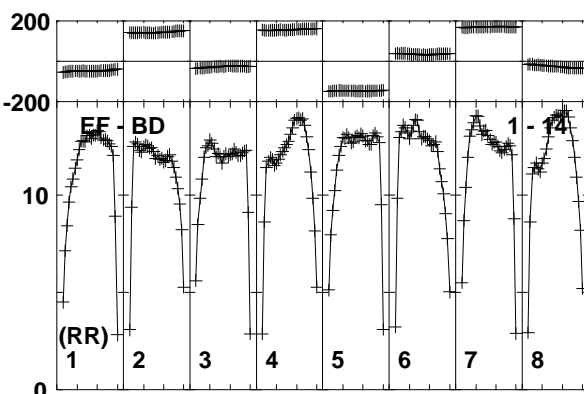
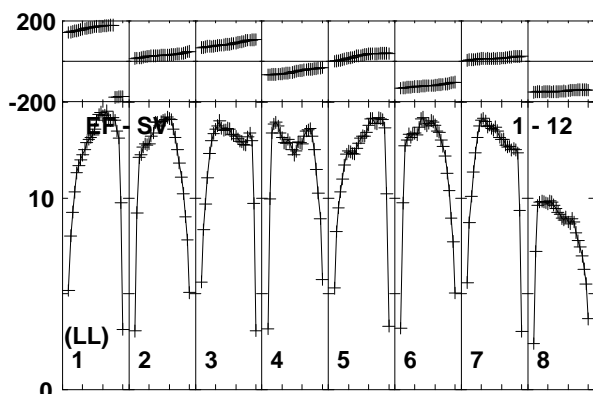
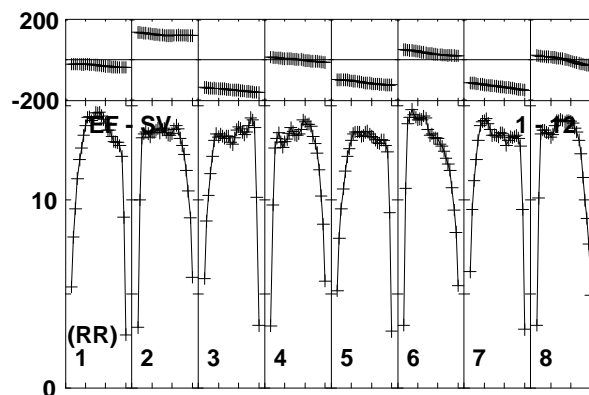
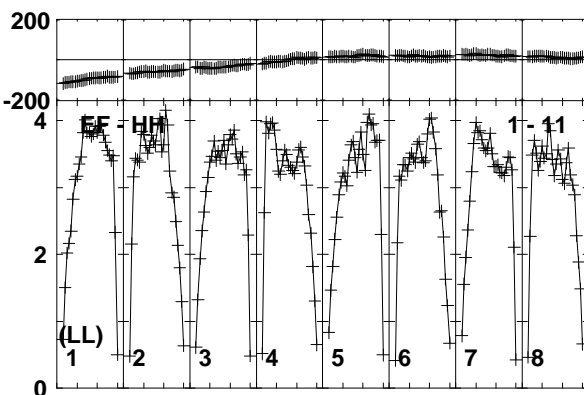
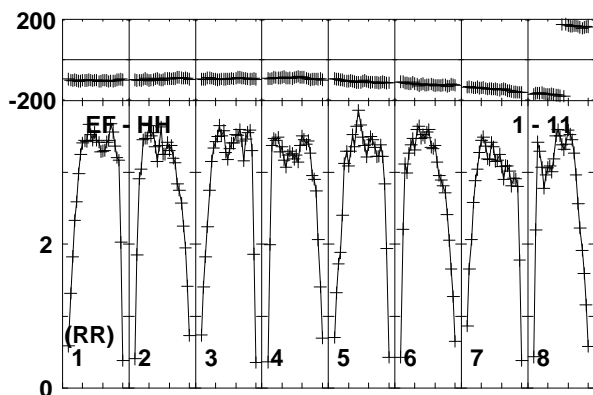
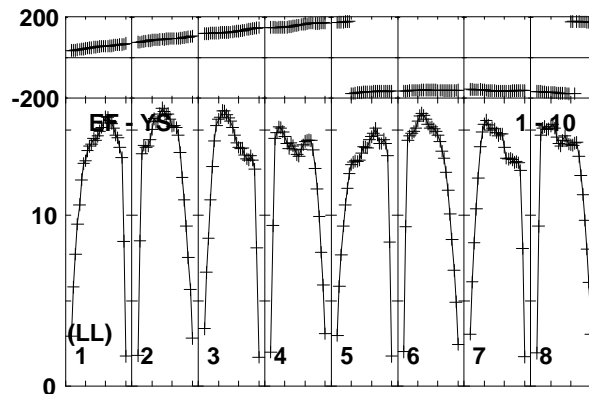
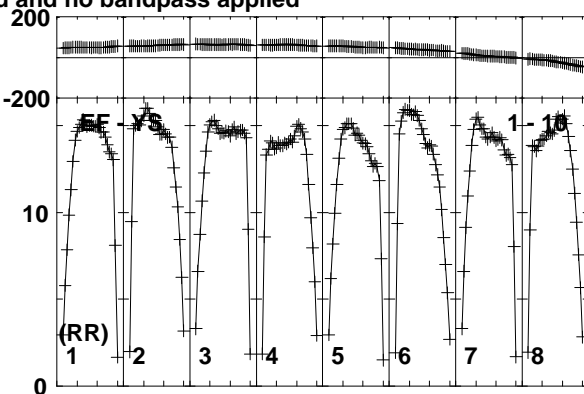
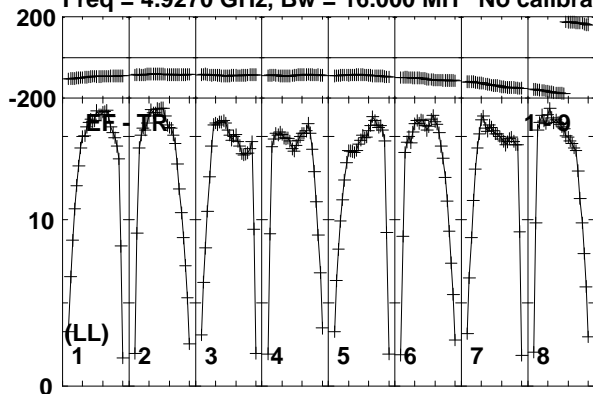

Lower frame: Milli Ampl Jy Top frame: Phas deg  
Vector averaged cross-power spectrum Baseline: EF (01) - TR (09)  
Timerange: 00/03:51:01 to 00/03:52:29

Plot file version 60 created 08-APR-2019 12:09:37

J0815+3635 EM133B.UVDATA.1

Freq = 4.9270 GHz, Bw = 16.000 MH No calibration applied and no bandpass applied

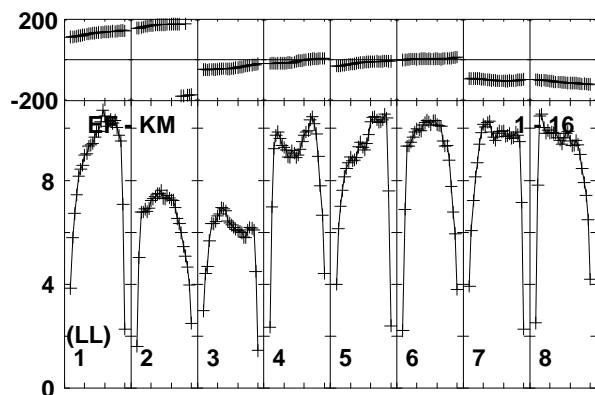
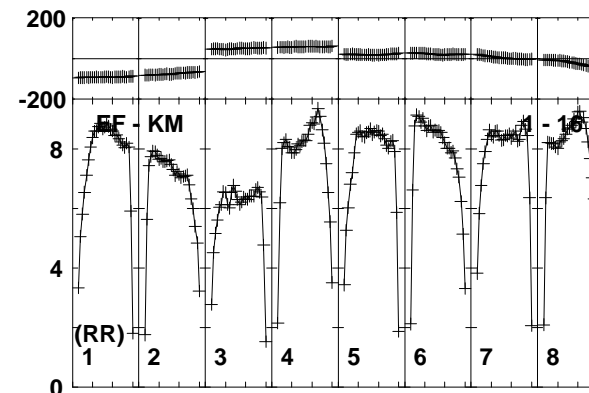
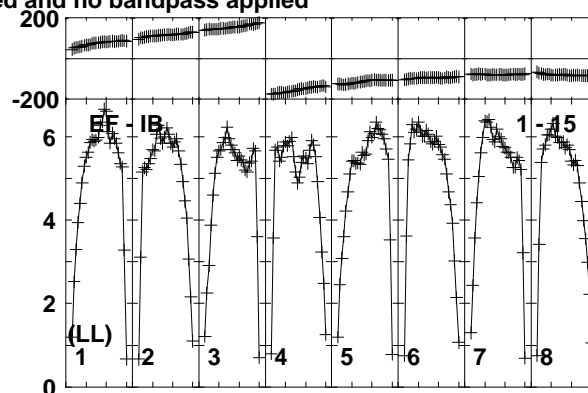
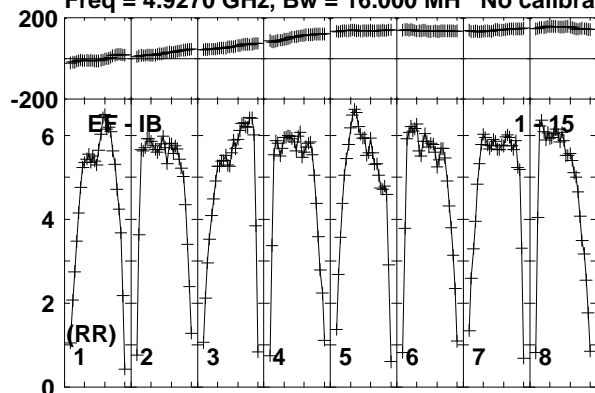

Lower frame: Milli Ampl Jy Top frame: Phas deg  
Vector averaged cross-power spectrum Baseline: EF (01) - IB (15)  
Timerange: 00/03:51:01 to 00/03:52:29

Plot file version 61 created 08-APR-2019 12:09:37

MRK622 EM133B.UVDATA.1

Freq = 4.9270 GHz, Bw = 16.000 MH No calibration applied and no bandpass applied

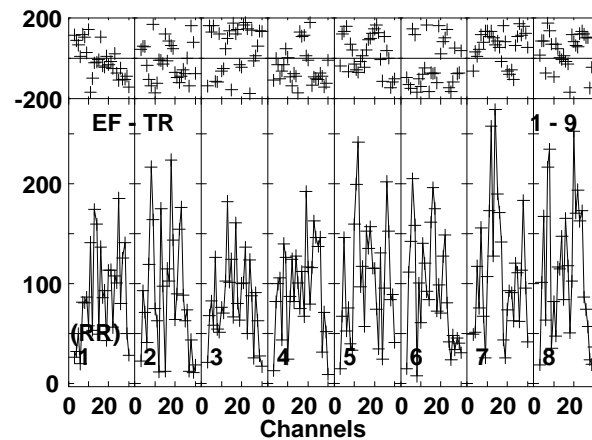
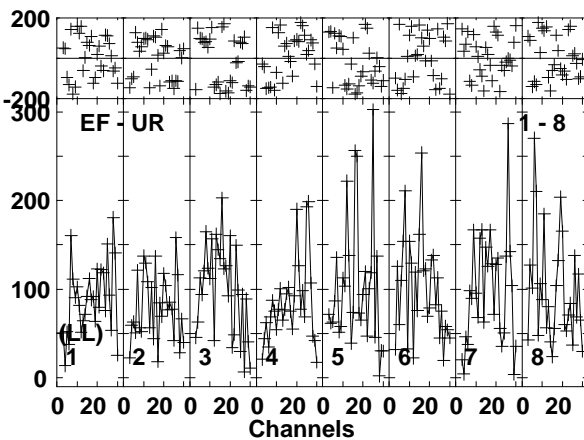
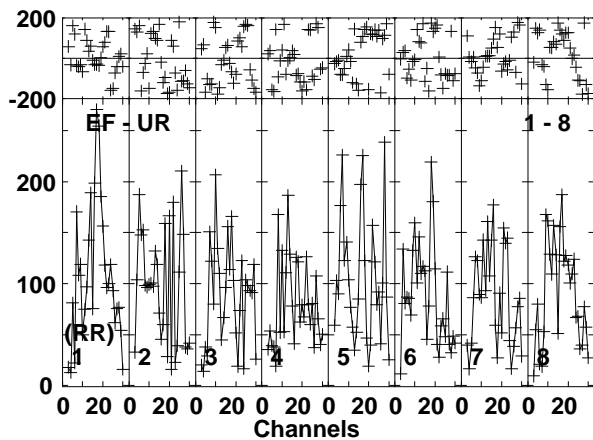
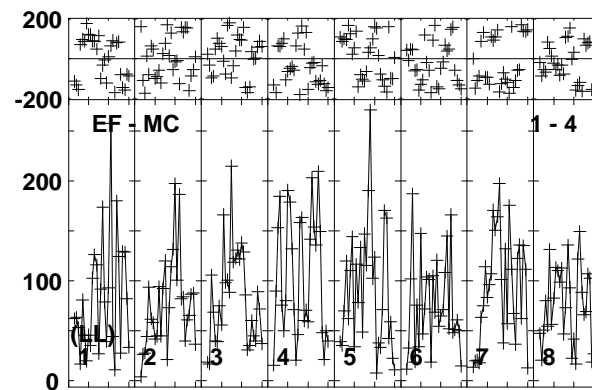
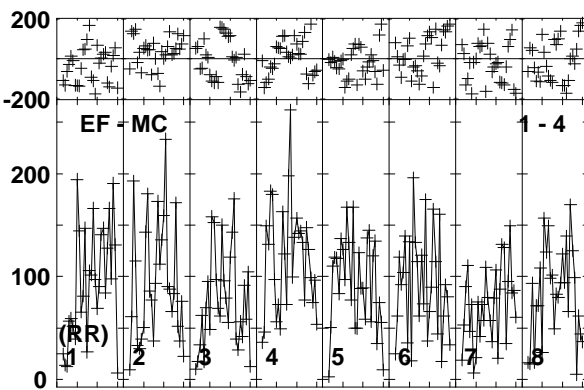
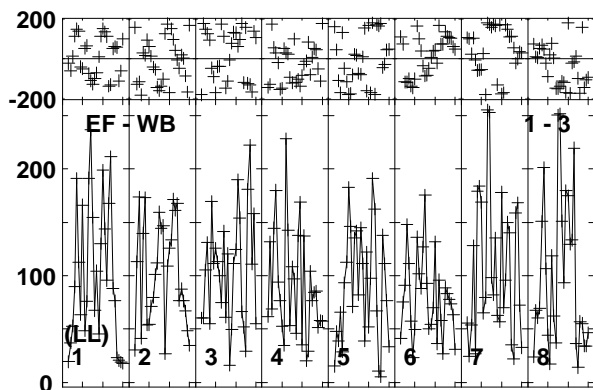
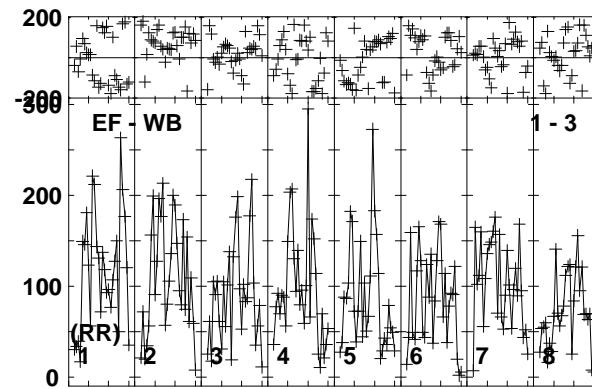
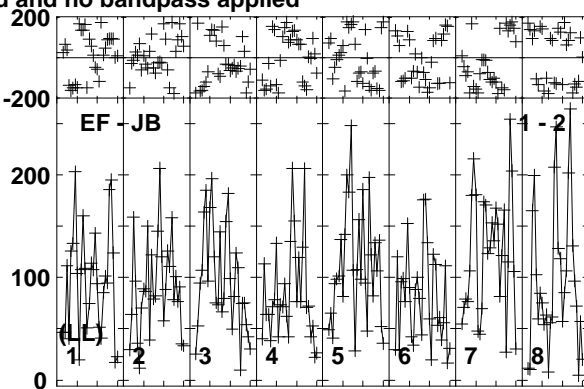
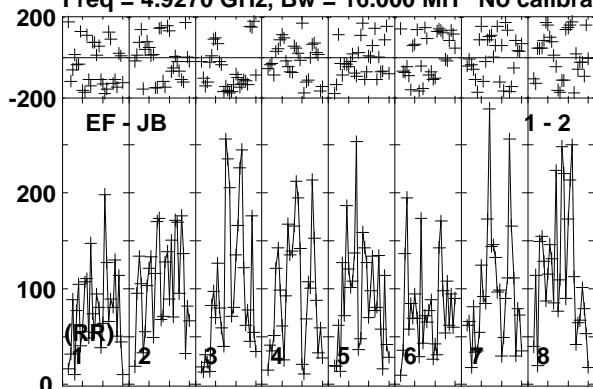

Lower frame: Micro Ampl Jy Top frame: Phas deg  
Vector averaged cross-power spectrum Baseline: EF (01) - JB (02)  
Timerange: 00/03:52:33 to 00/03:55:59

Plot file version 62 created 08-APR-2019 12:09:37

MRK622 EM133B.UVDATA.1

Freq = 4.9270 GHz, Bw = 16.000 MH No calibration applied and no bandpass applied

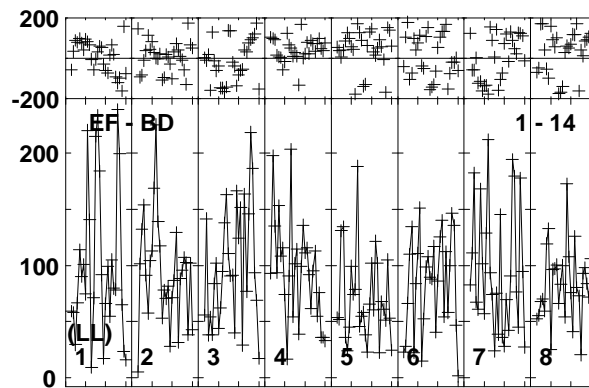
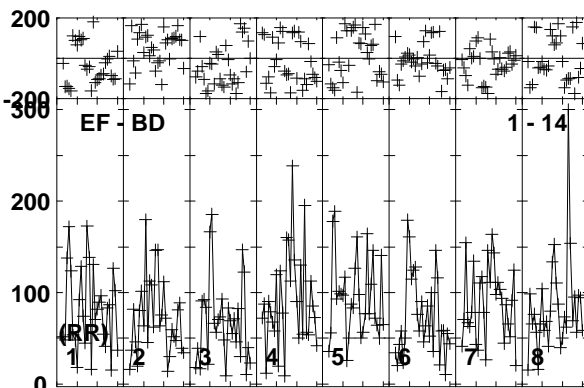
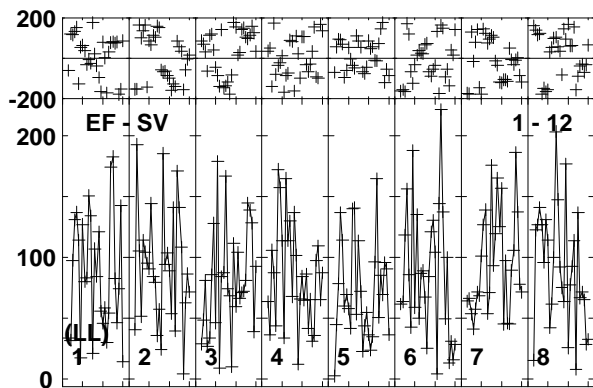
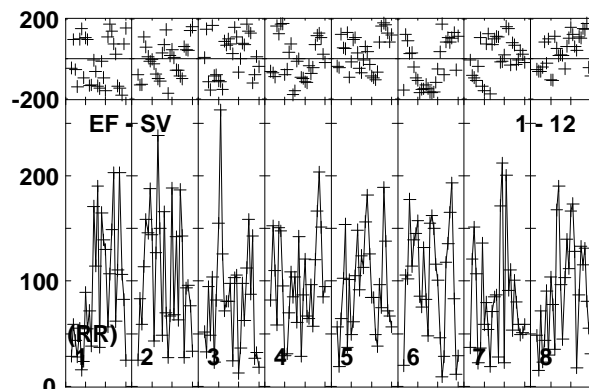
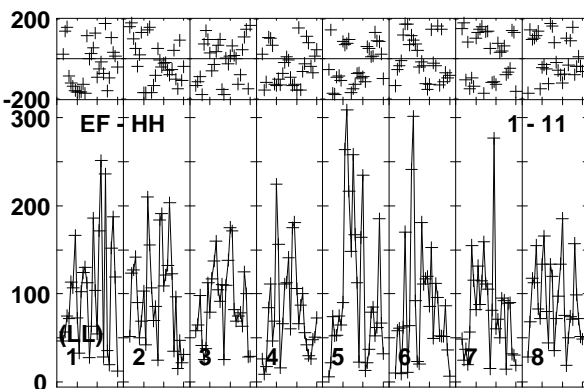
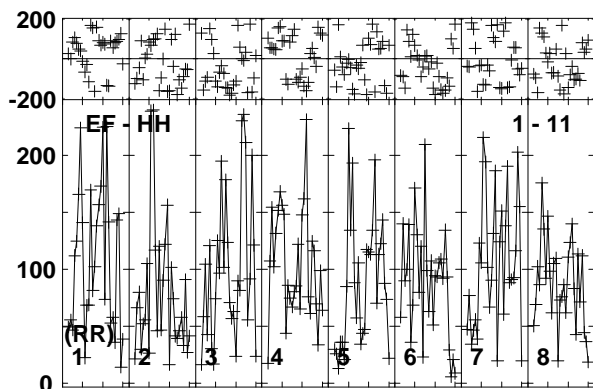
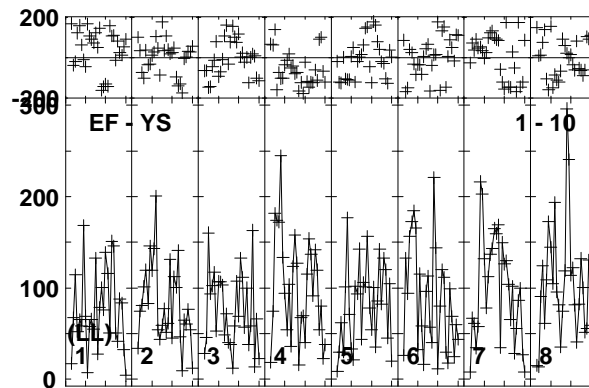
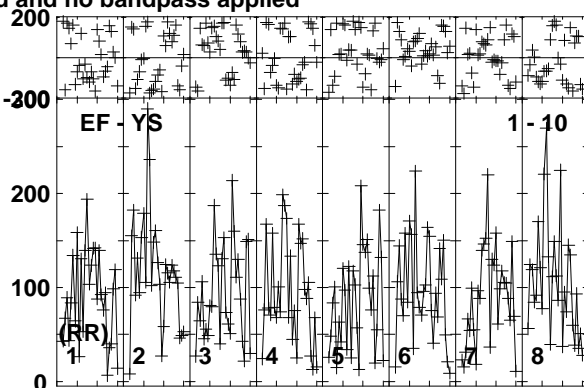
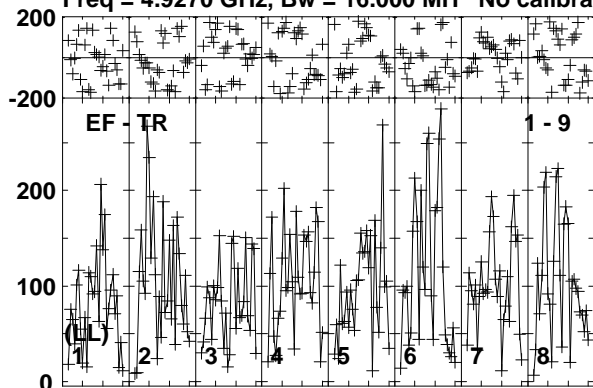

Lower frame: Micro Ampl Jy Top frame: Phas deg  
Vector averaged cross-power spectrum Baseline: EF (01) - TR (09)  
Timerange: 00/03:52:33 to 00/03:55:59

Plot file version 63 created 08-APR-2019 12:09:37

MRK622 EM133B.UVDATA.1

Freq = 4.9270 GHz, Bw = 16.000 MH No calibration applied and no bandpass applied

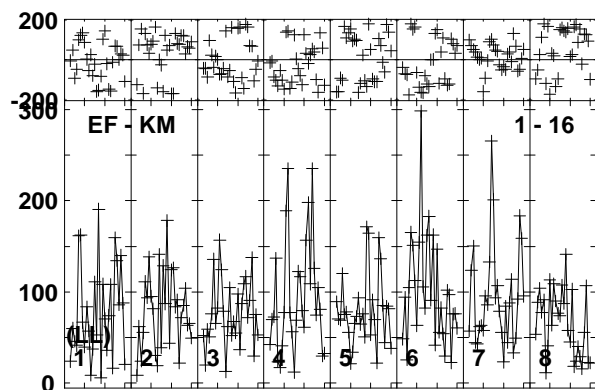
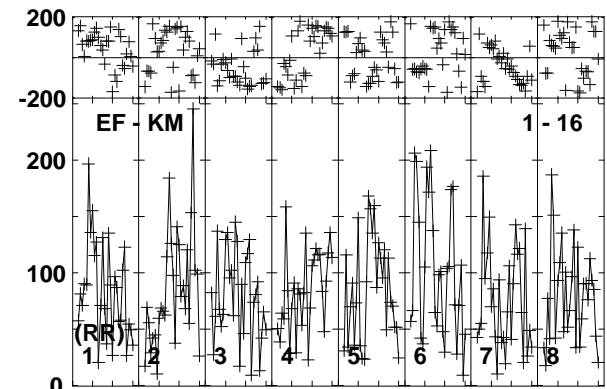
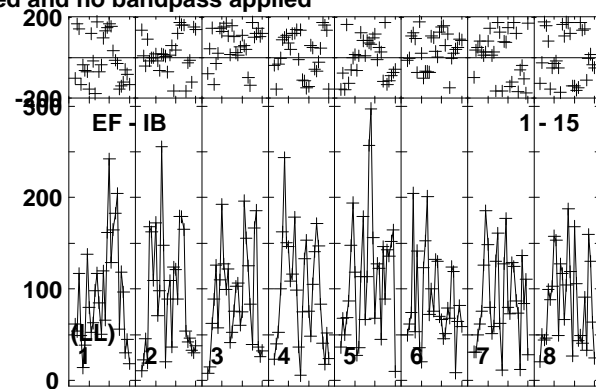
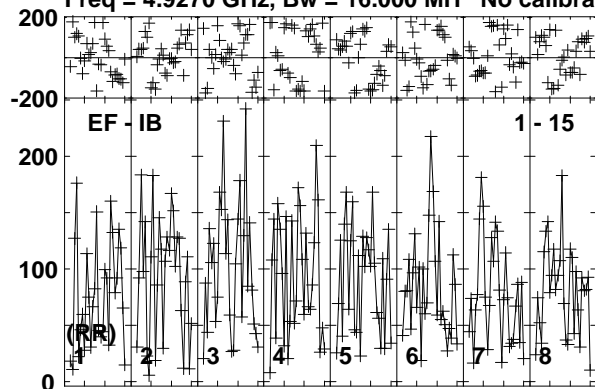

Lower frame: Micro Ampl Jy Top frame: Phas deg  
Vector averaged cross-power spectrum Baseline: EF (01) - IB (15)  
Timerange: 00/03:52:33 to 00/03:55:59

Plot file version 64 created 08-APR-2019 12:09:37

J0815+3635 EM133B.UVDATA.1

Freq = 4.9270 GHz, Bw = 16.000 MH No calibration applied and no bandpass applied

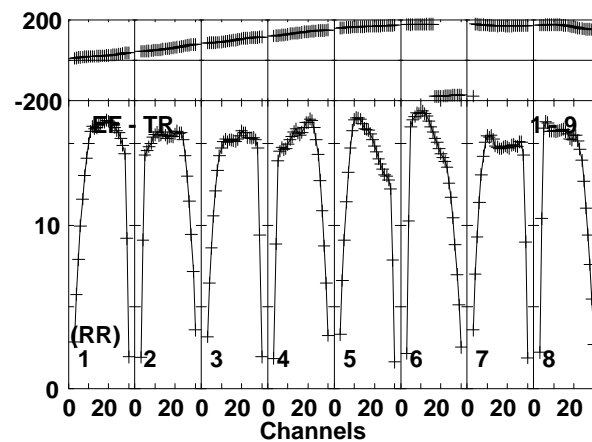
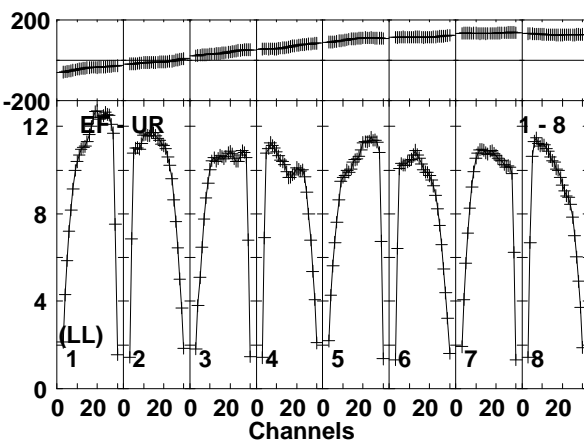
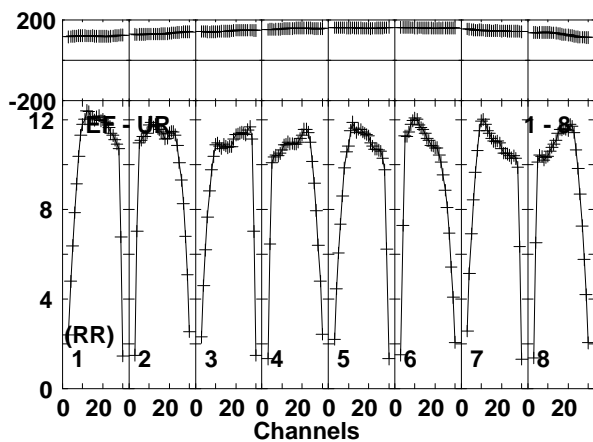
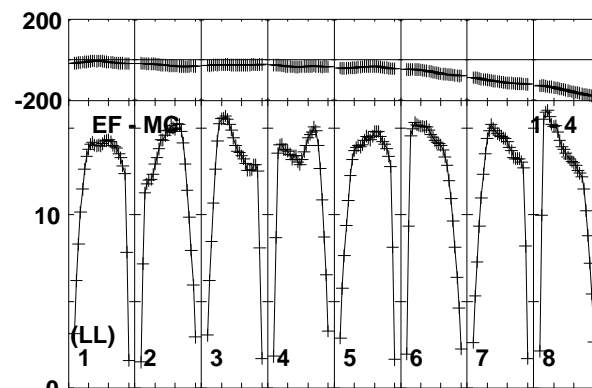
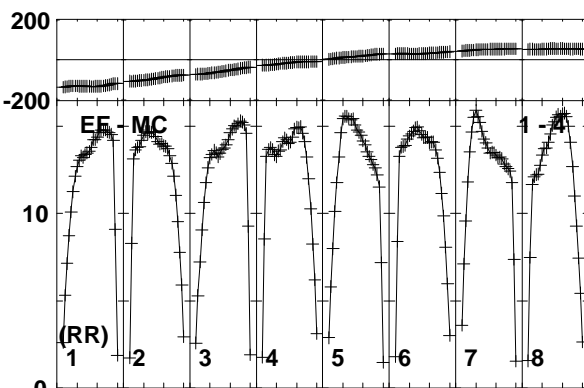
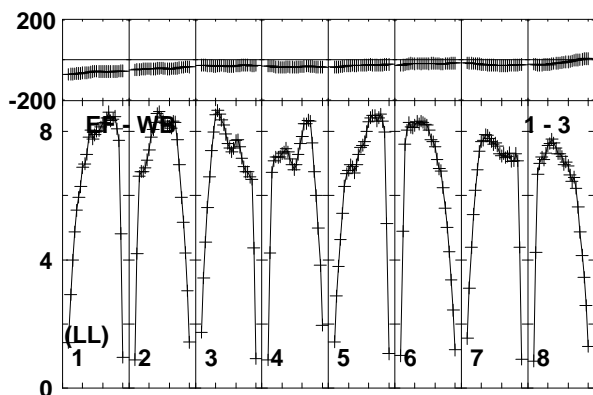
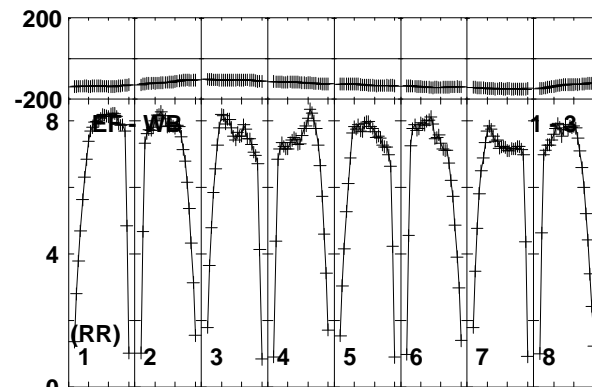
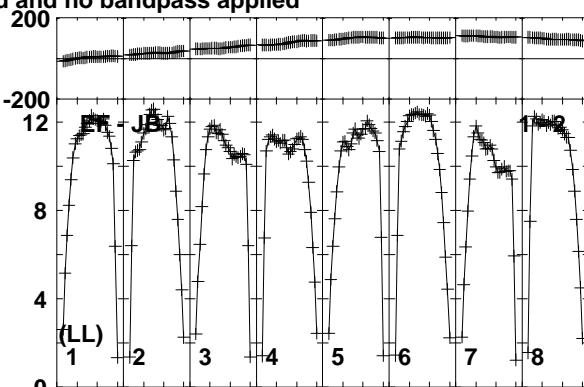
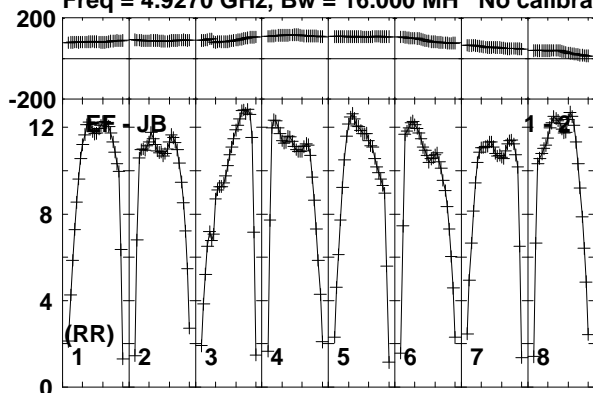

Lower frame: Milli Ampl Jy Top frame: Phas deg  
Vector averaged cross-power spectrum Baseline: EF (01) - JB (02)  
Timerange: 00/03:56:51 to 00/03:58:19



Plot file version 65 created 08-APR-2019 12:09:37

J0815+3635 EM133B.UVDATA.1

Freq = 4.9270 GHz, Bw = 16.000 MH No calibration applied and no bandpass applied

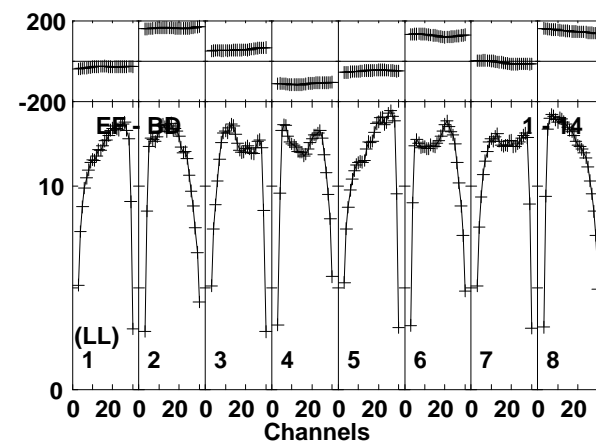
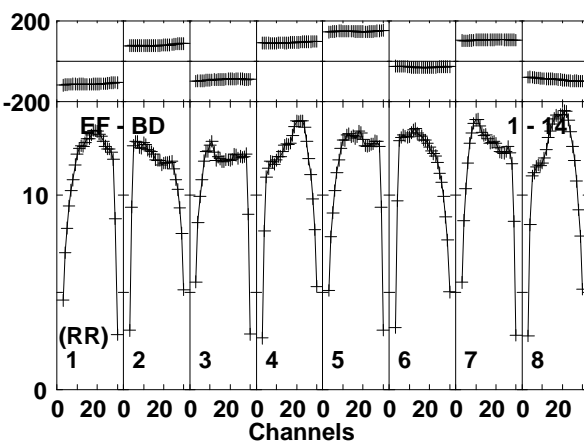
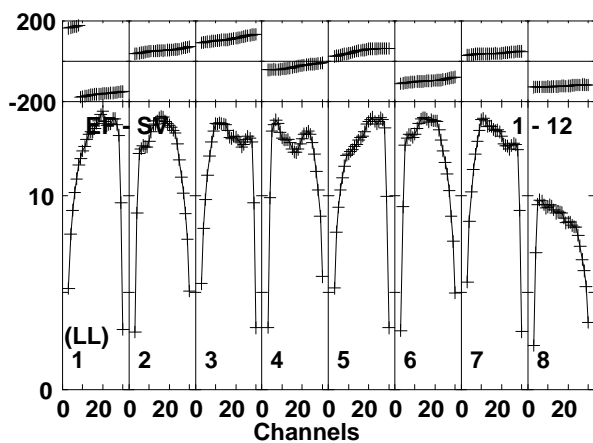
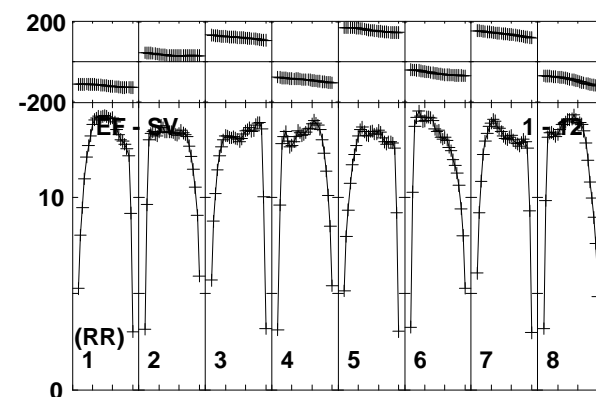
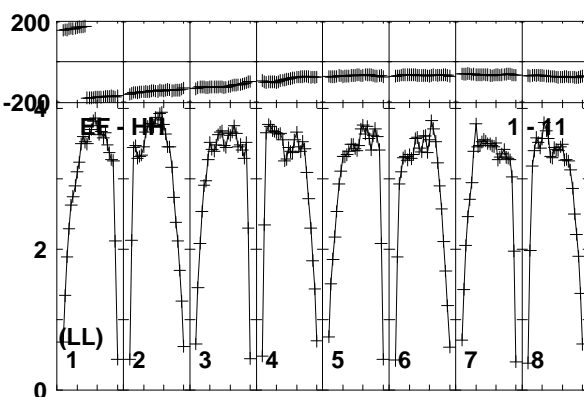
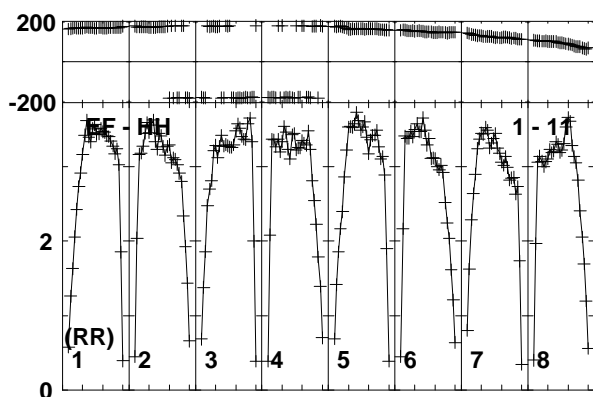
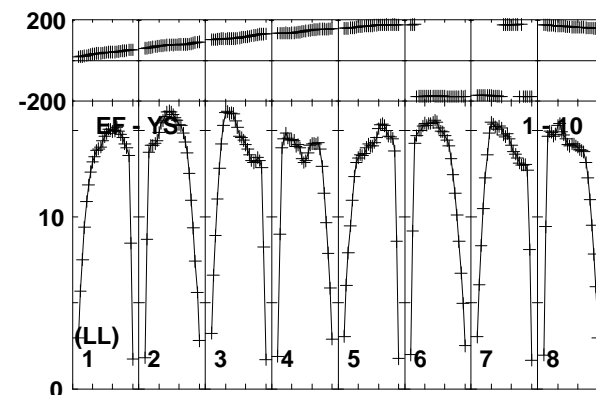
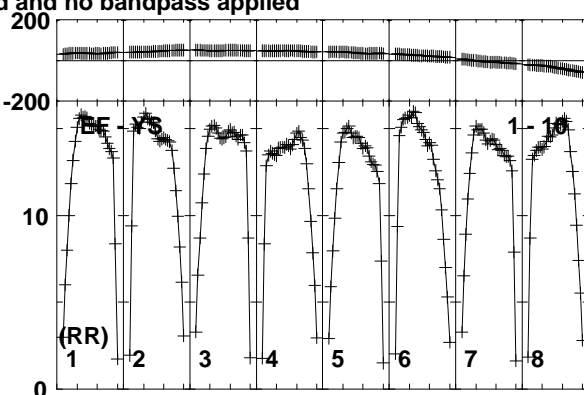
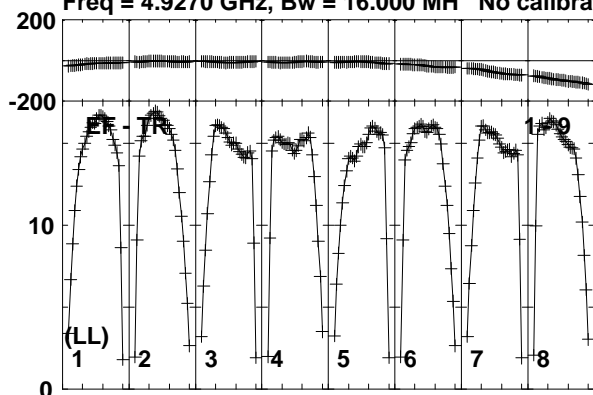

Lower frame: Milli Ampl Jy Top frame: Phas deg  
Vector averaged cross-power spectrum Baseline: EF (01) - TR (09)  
Timerange: 00/03:56:51 to 00/03:58:19

Plot file version 66 created 08-APR-2019 12:09:38

J0815+3635 EM133B.UVDATA.1

Freq = 4.9270 GHz, Bw = 16.000 MH No calibration applied and no bandpass applied

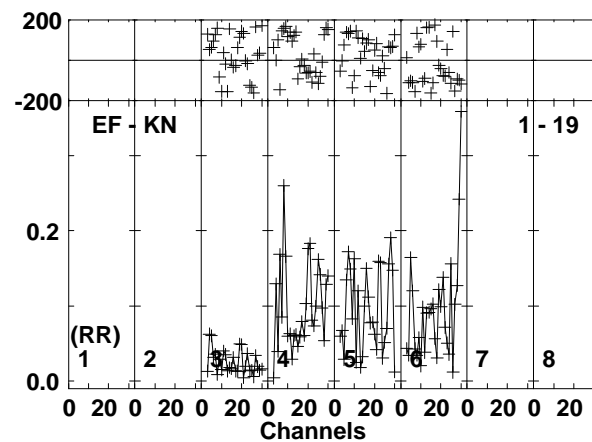
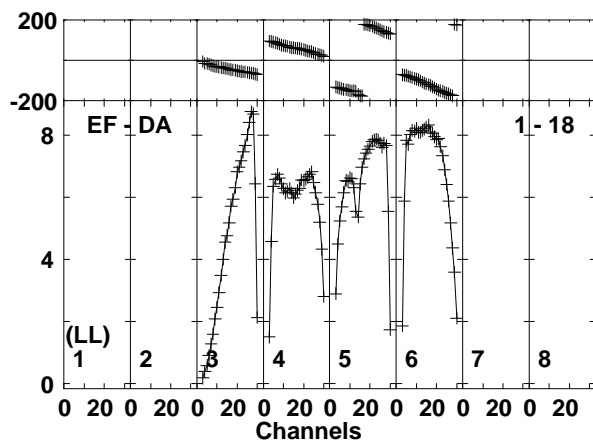
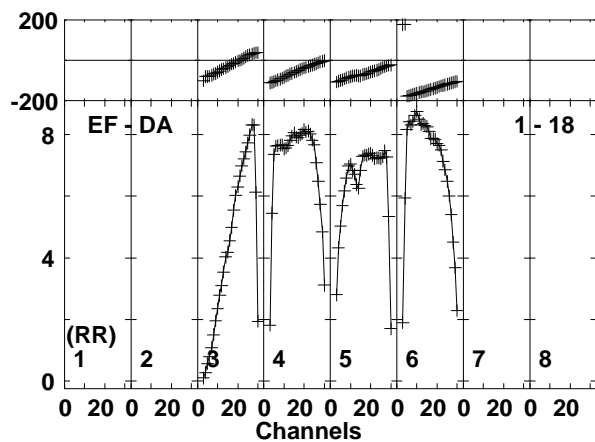
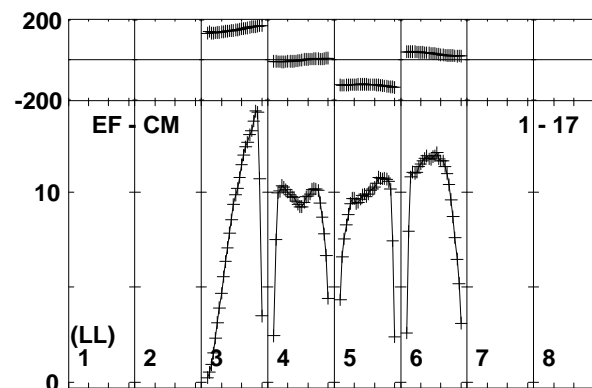
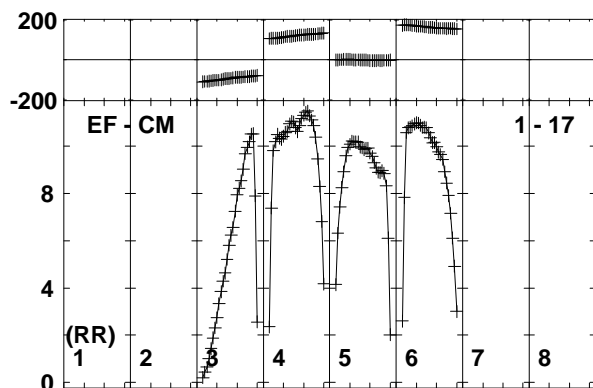
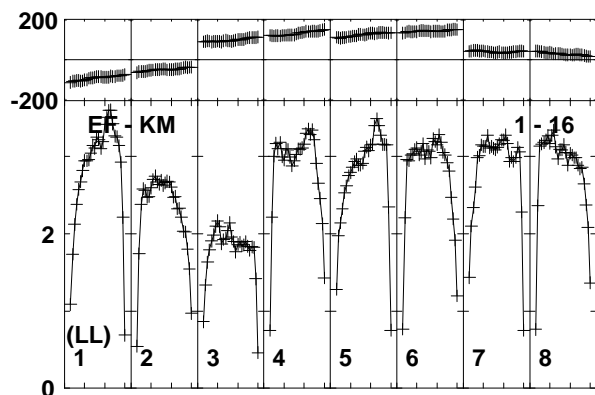
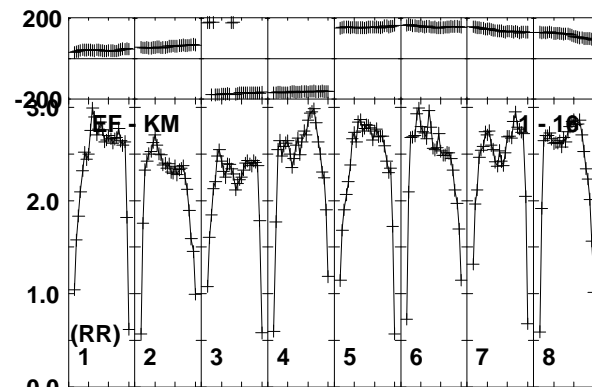
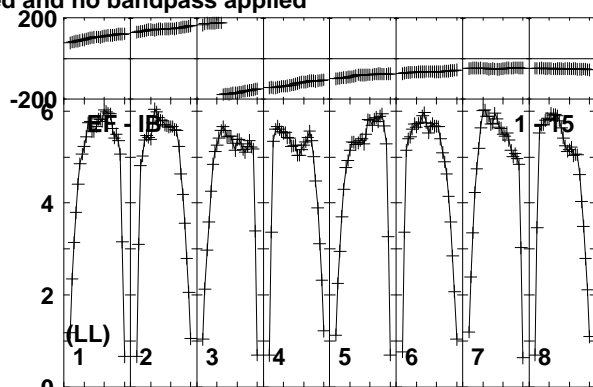
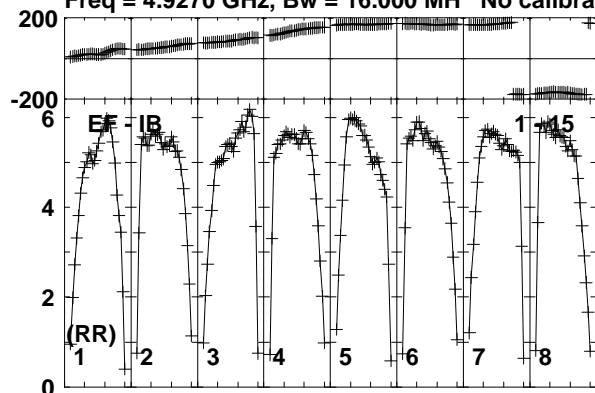

Lower frame: Milli Ampl Jy Top frame: Phas deg  
Vector averaged cross-power spectrum Baseline: EF (01) - IB (15)  
Timerange: 00/03:56:51 to 00/03:58:19

Plot file version 67 created 08-APR-2019 12:09:38

J0815+3635 EM133B.UVDATA.1

Freq = 4.9270 GHz, Bw = 16.000 MH No calibration applied and no bandpass applied

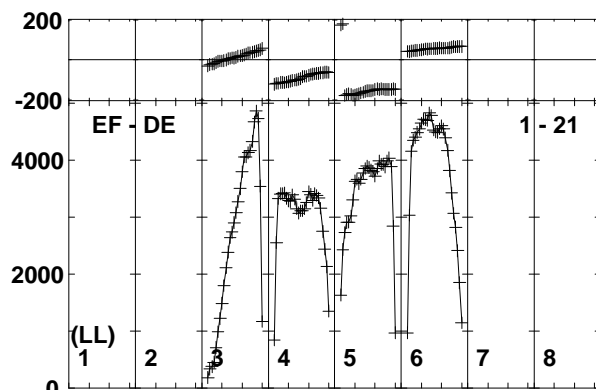
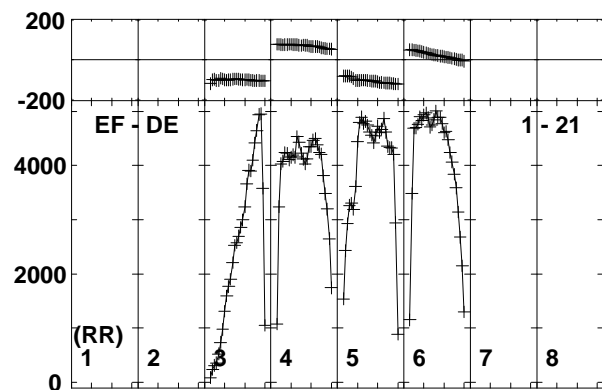
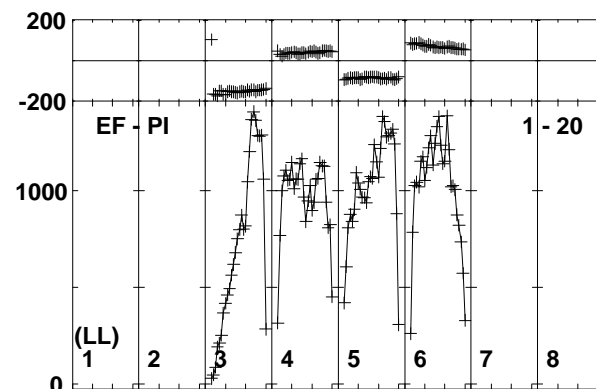
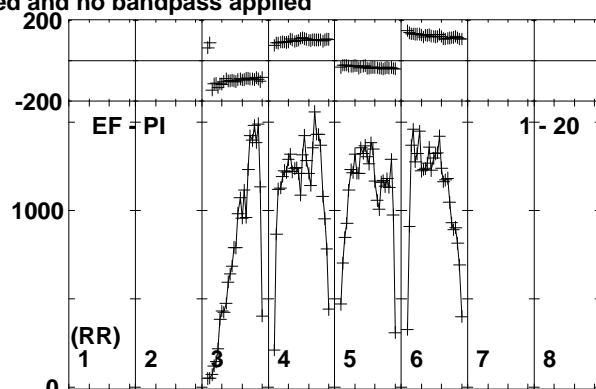
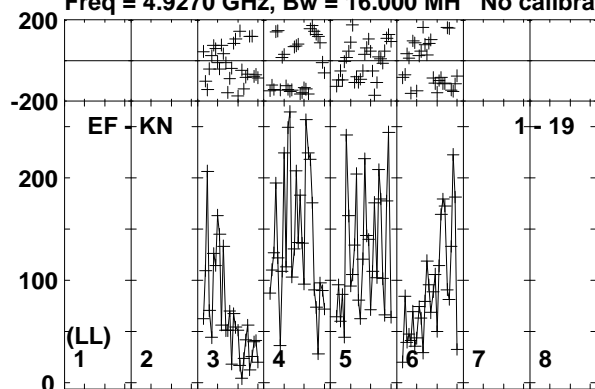

Lower frame: Micro Ampl Jy Top frame: Phas deg  
Vector averaged cross-power spectrum Baseline: EF (01) - KN (19)  
Timerange: 00/03:56:51 to 00/03:58:19

Plot file version 68 created 08-APR-2019 12:09:38

MRK622 EM133B.UVDATA.1

Freq = 4.9270 GHz, Bw = 16.000 MH No calibration applied and no bandpass applied

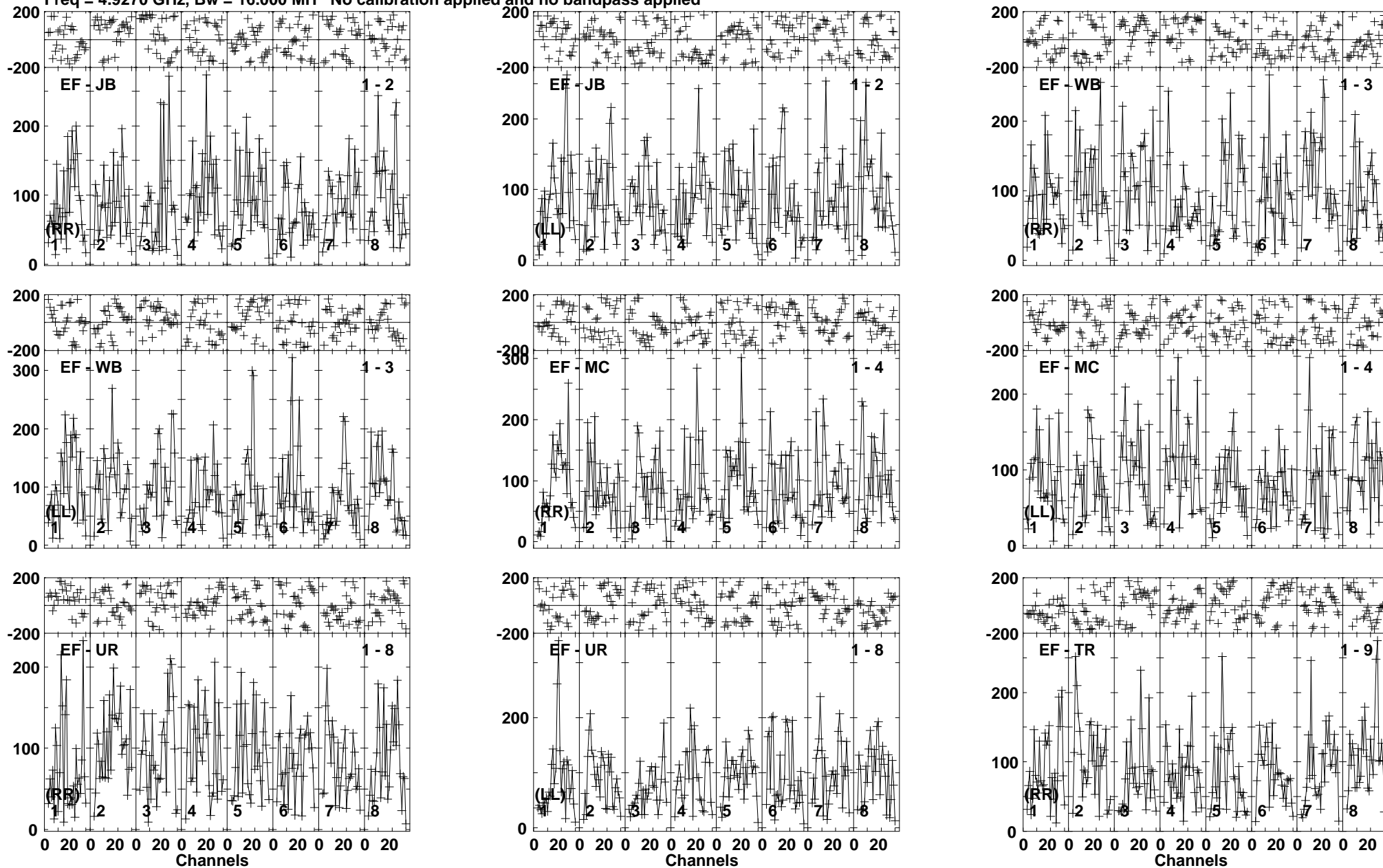

Lower frame: Micro Ampl Jy Top frame: Phas deg  
Vector averaged cross-power spectrum Baseline: EF (01) - JB (02)  
Timerange: 00/03:58:21 to 00/04:01:49

Plot file version 69 created 08-APR-2019 12:09:38

MRK622 EM133B.UVDATA.1

Freq = 4.9270 GHz, Bw = 16.000 MH No calibration applied and no bandpass applied

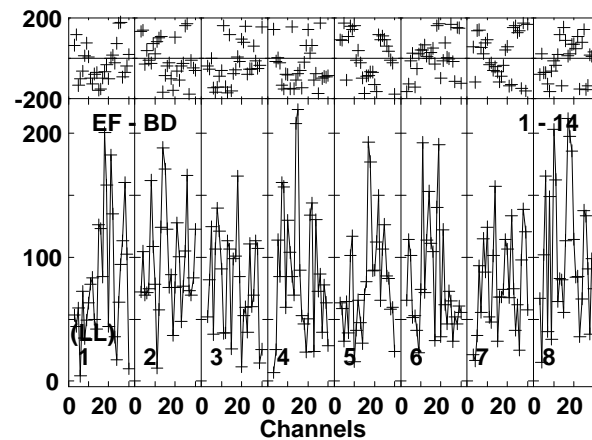
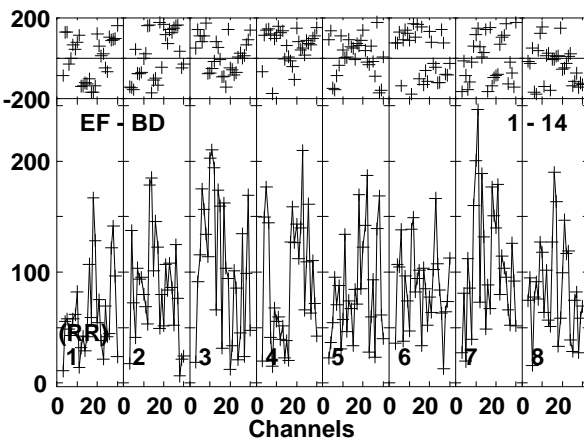
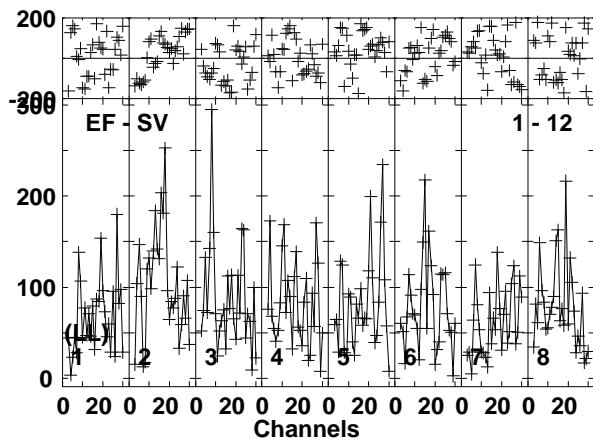
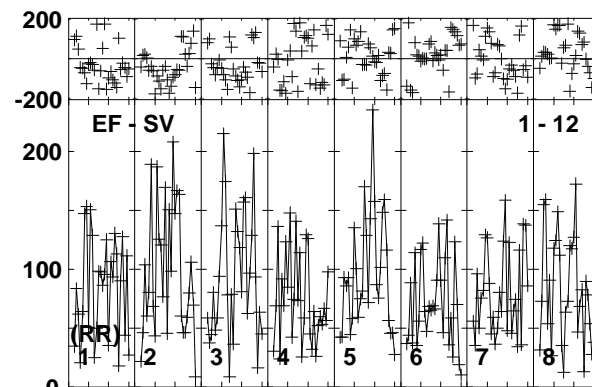
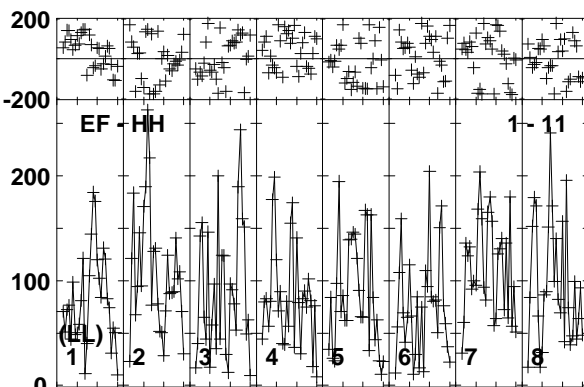
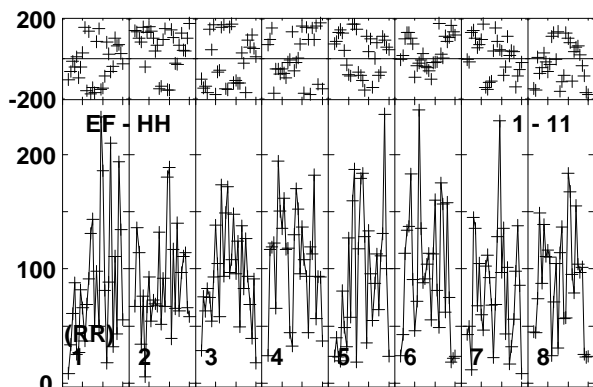
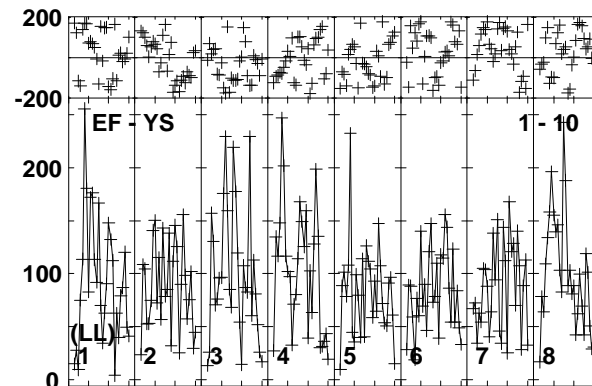
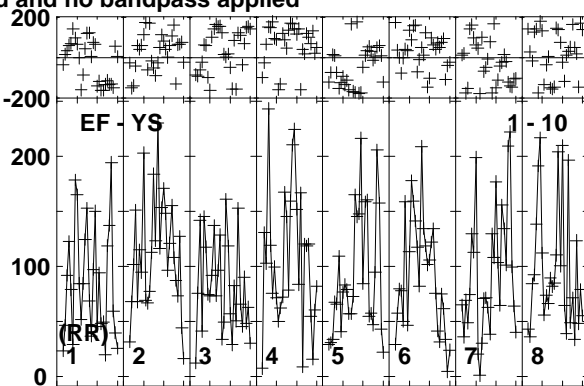
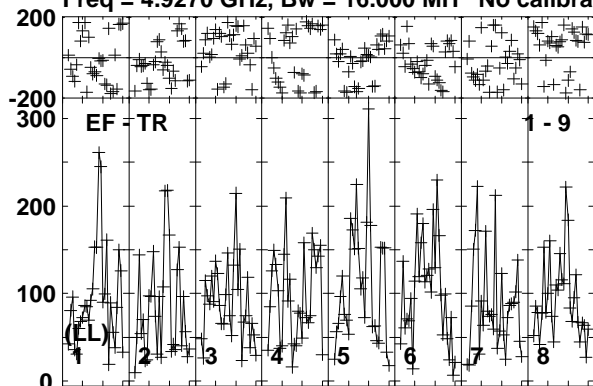

Lower frame: Micro Ampl Jy Top frame: Phas deg  
Vector averaged cross-power spectrum Baseline: EF (01) - TR (09)  
Timerange: 00/03:58:21 to 00/04:01:49

Plot file version 70 created 08-APR-2019 12:09:38

MRK622 EM133B.UVDATA.1

Freq = 4.9270 GHz, Bw = 16.000 MH No calibration applied and no bandpass applied

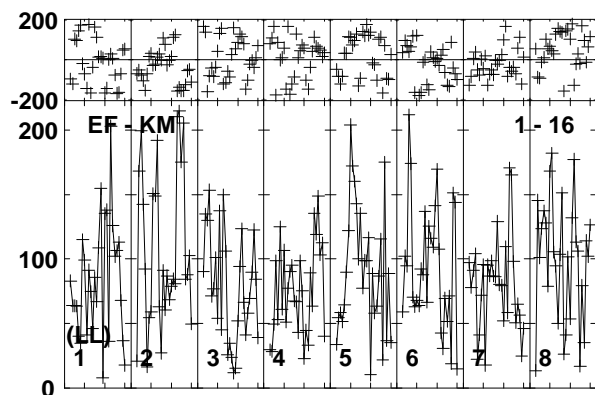
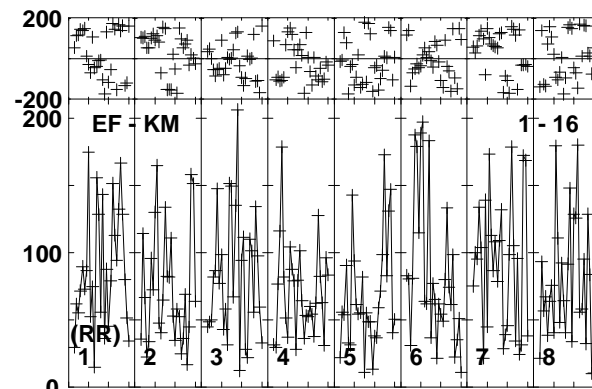
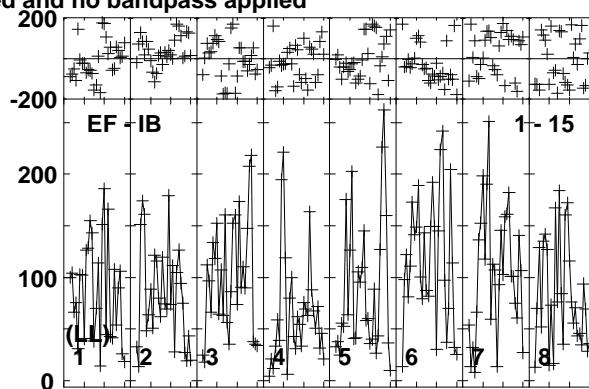
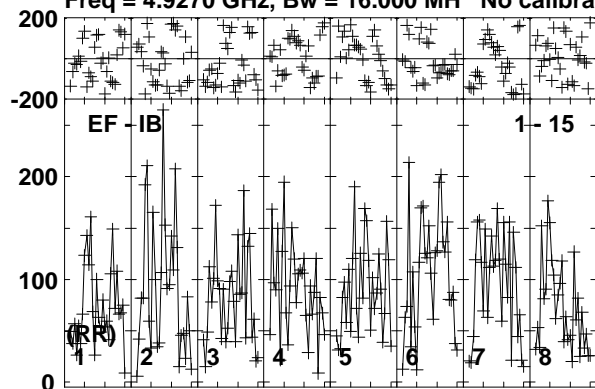

Lower frame: Micro Ampl Jy Top frame: Phas deg  
Vector averaged cross-power spectrum Baseline: EF (01) - IB (15)  
Timerange: 00/03:58:21 to 00/04:01:49

Plot file version 71 created 08-APR-2019 12:09:38

J0815+3635 EM133B.UVDATA.1

Freq = 4.9270 GHz, Bw = 16.000 MH No calibration applied and no bandpass applied

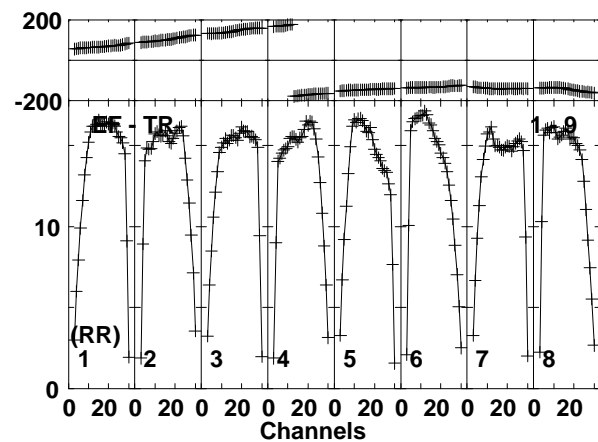
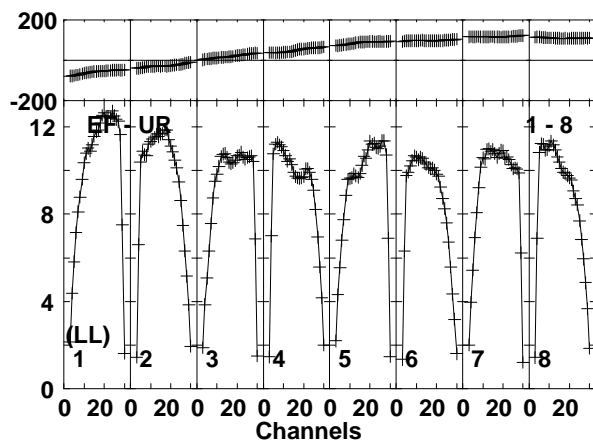
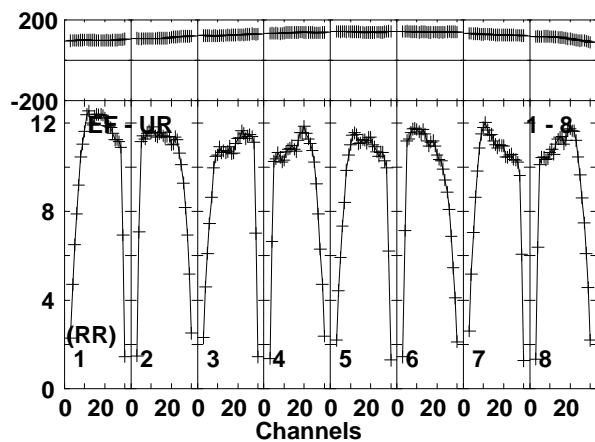
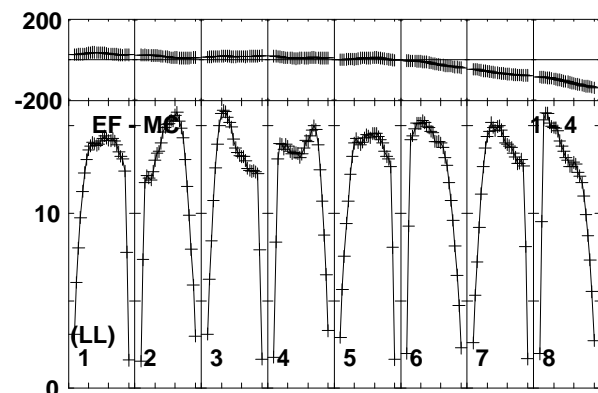
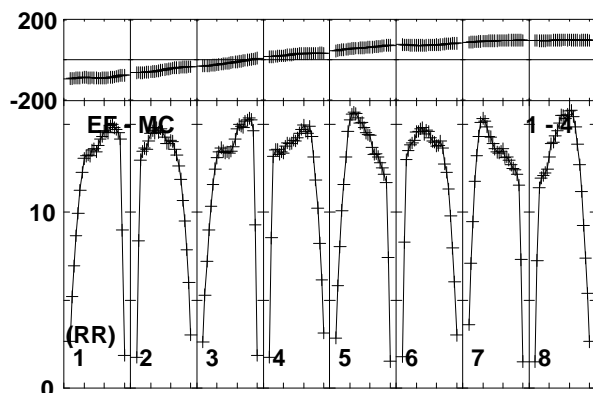
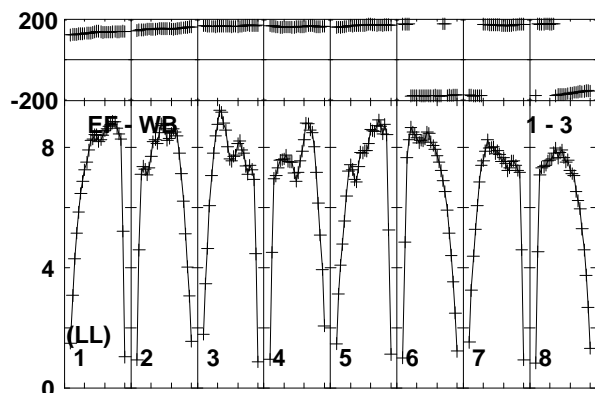
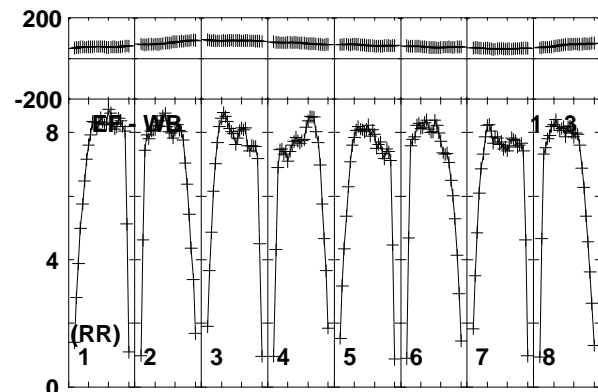
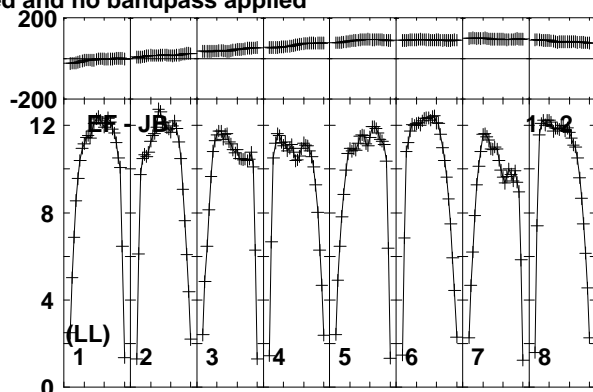
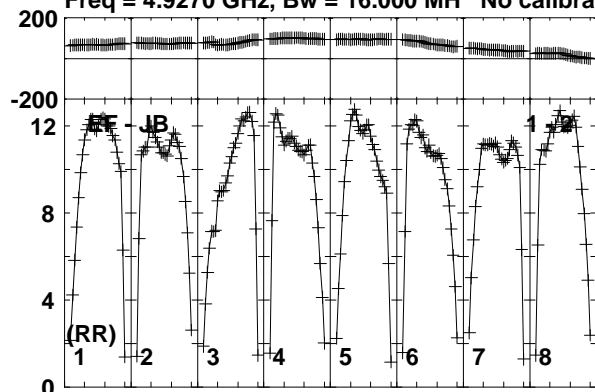

Lower frame: Milli Ampl Jy Top frame: Phas deg  
Vector averaged cross-power spectrum Baseline: EF (01) - JB (02)  
Timerange: 00/04:01:51 to 00/04:03:19

Plot file version 72 created 08-APR-2019 12:09:38

J0815+3635 EM133B.UVDATA.1

Freq = 4.9270 GHz, Bw = 16.000 MH No calibration applied and no bandpass applied

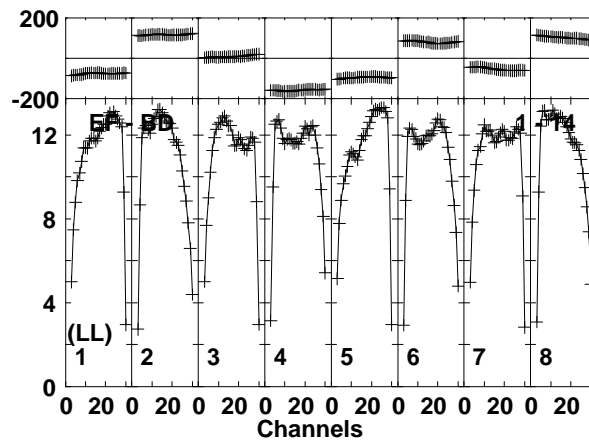
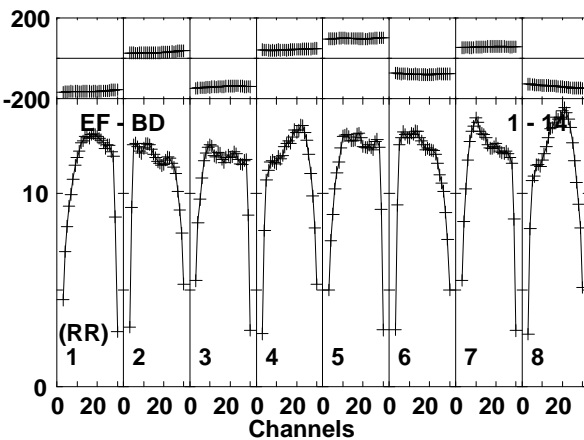
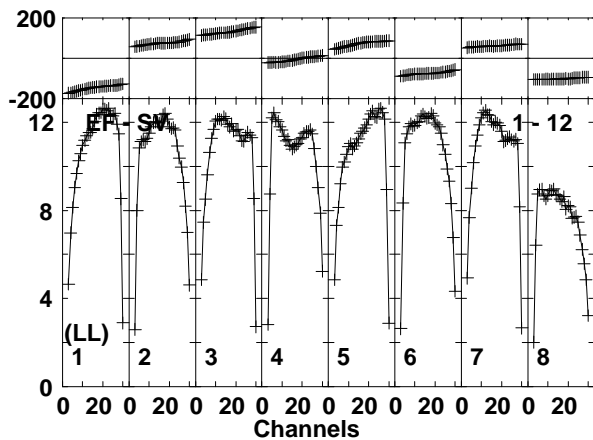
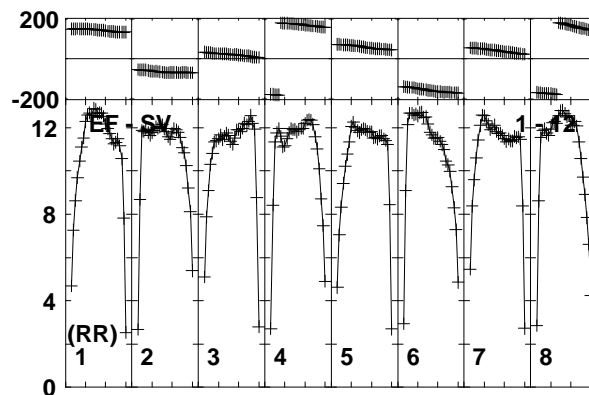
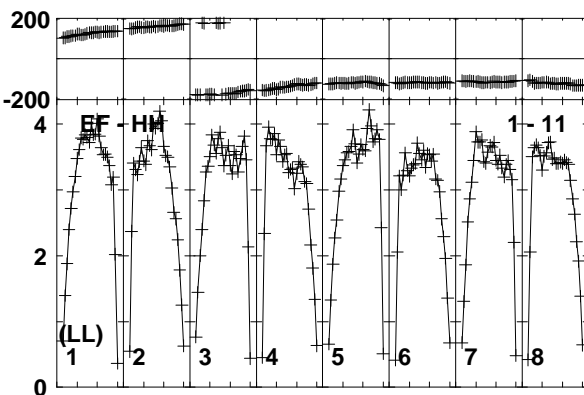
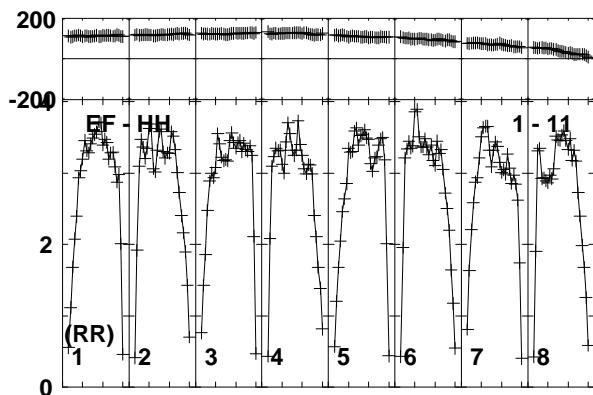
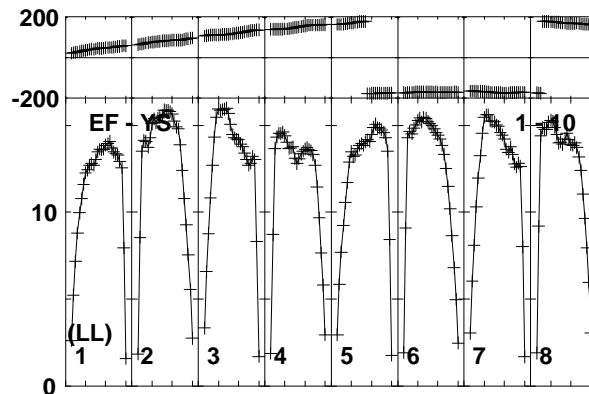
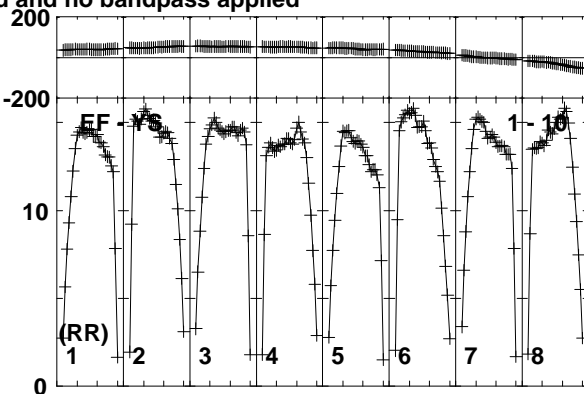
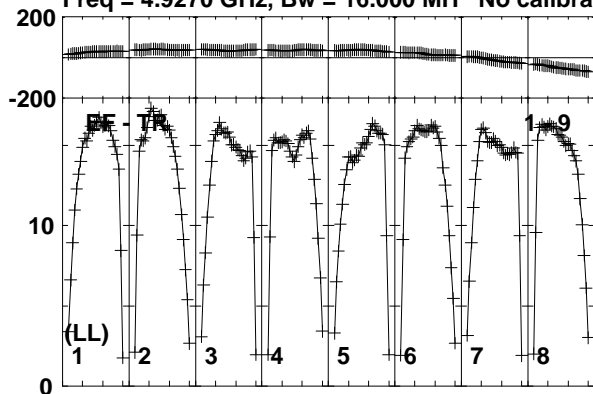

Lower frame: Milli Ampl Jy Top frame: Phas deg  
Vector averaged cross-power spectrum Baseline: EF (01) - TR (09)  
Timerange: 00/04:01:51 to 00/04:03:19



Plot file version 73 created 08-APR-2019 12:09:38

J0815+3635 EM133B.UVDATA.1

Freq = 4.9270 GHz, Bw = 16.000 MH No calibration applied and no bandpass applied

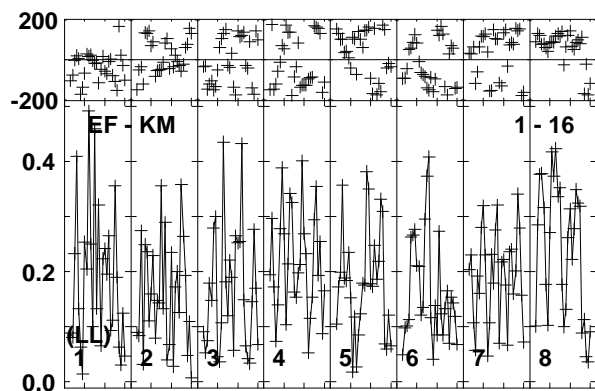
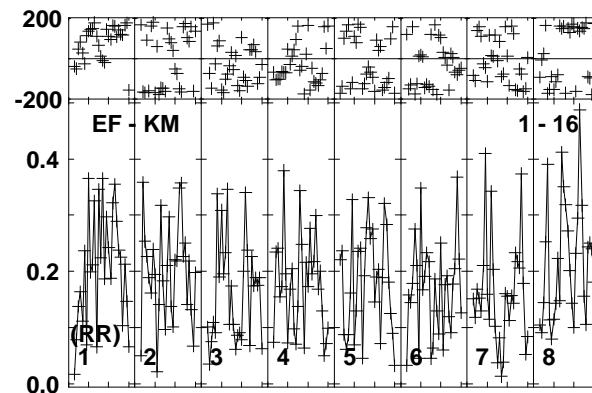
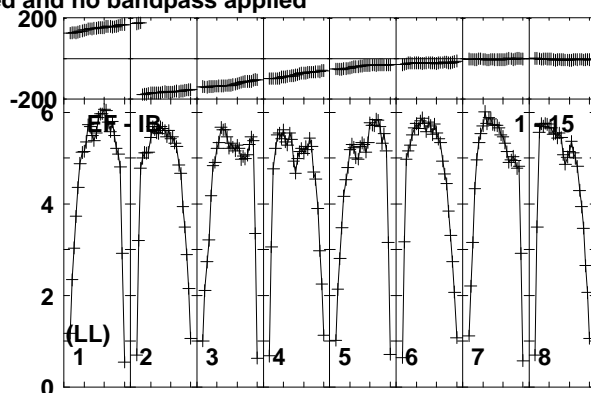
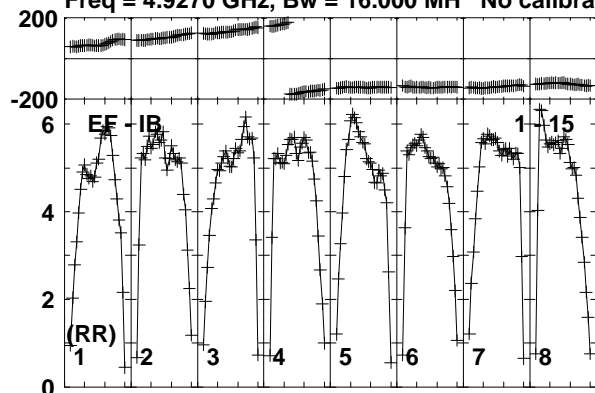

Lower frame: Milli Ampl Jy Top frame: Phas deg  
Vector averaged cross-power spectrum Baseline: EF (01) - IB (15)  
Timerange: 00/04:01:51 to 00/04:03:19

Plot file version 74 created 08-APR-2019 12:09:39

MRK622 EM133B.UVDATA.1

Freq = 4.9270 GHz, Bw = 16.000 MH No calibration applied and no bandpass applied

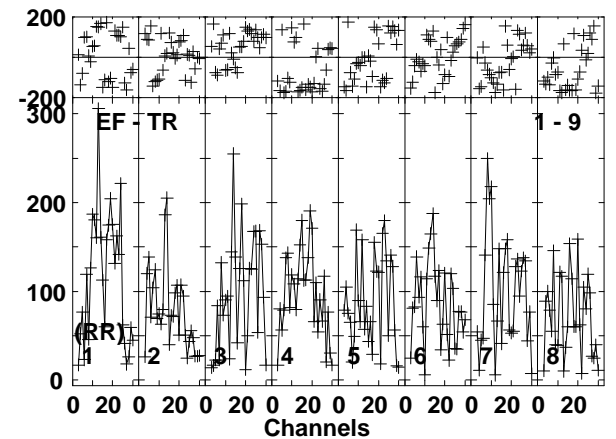
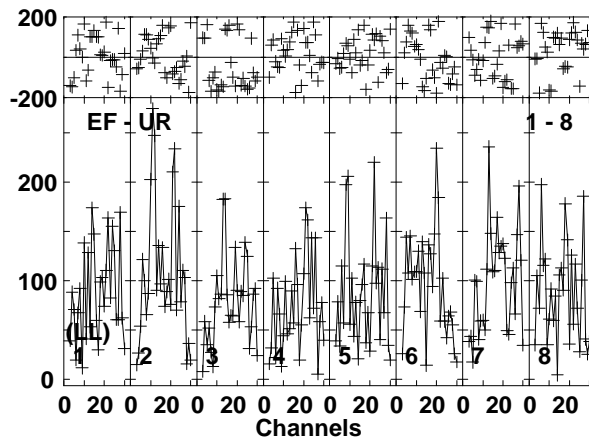
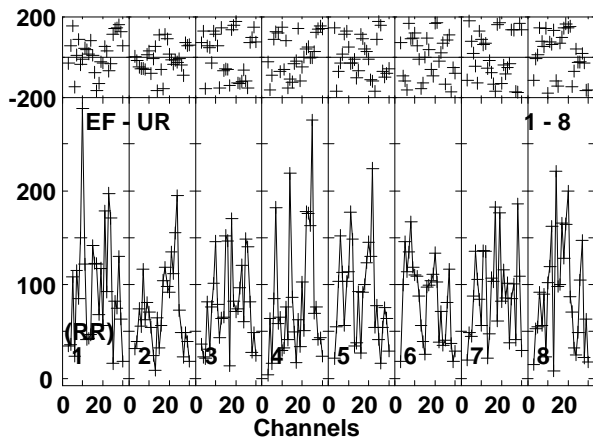
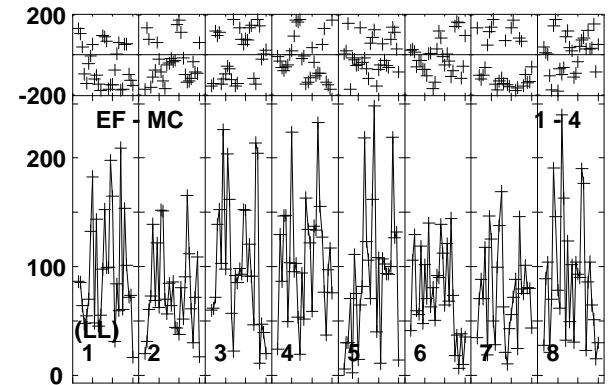
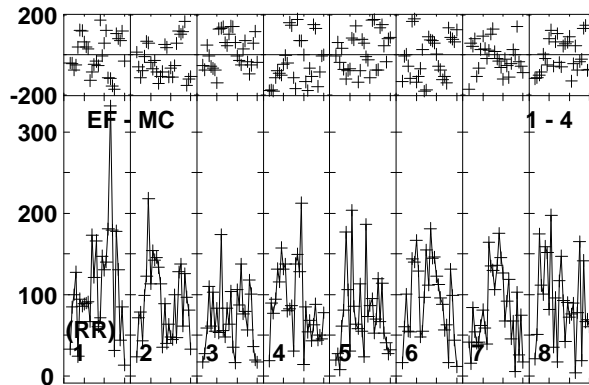
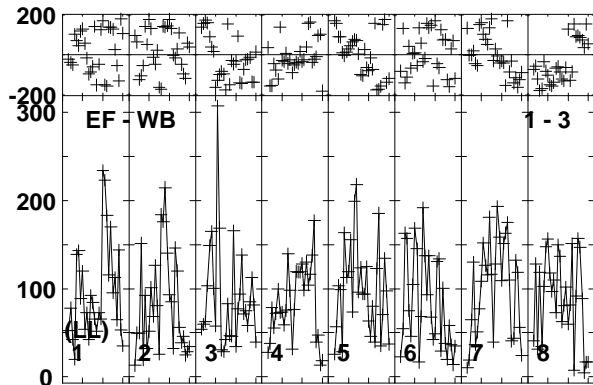
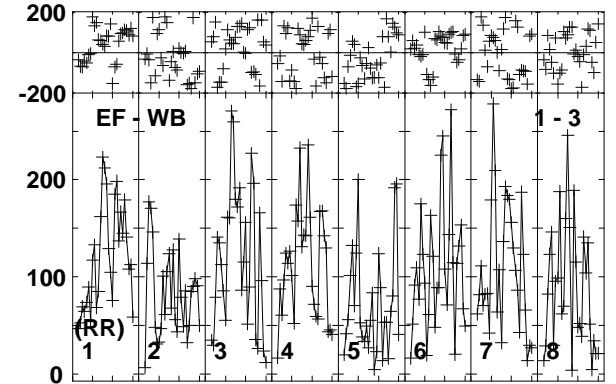
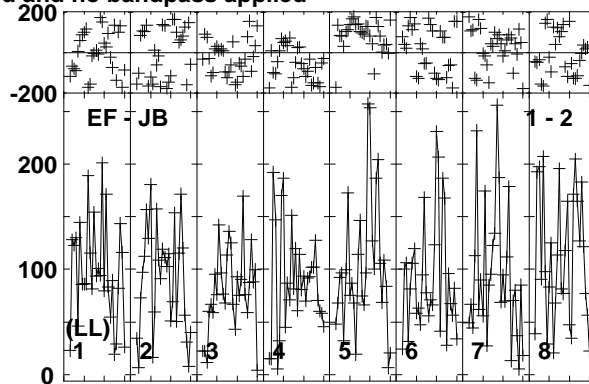
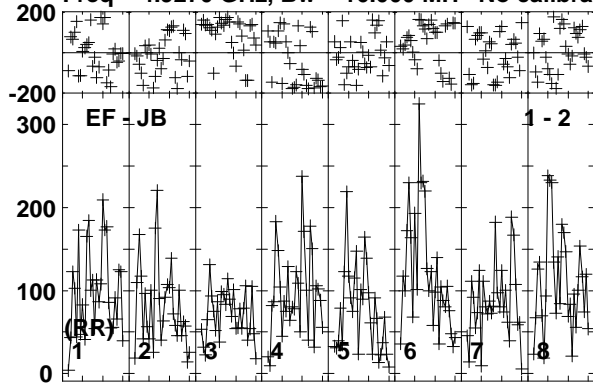

Lower frame: Micro Ampl Jy Top frame: Phas deg  
Vector averaged cross-power spectrum Baseline: EF (01) - JB (02)  
Timerange: 00/04:03:23 to 00/04:06:49

Plot file version 75 created 08-APR-2019 12:09:39

MRK622 EM133B.UVDATA.1

Freq = 4.9270 GHz, Bw = 16.000 MH No calibration applied and no bandpass applied

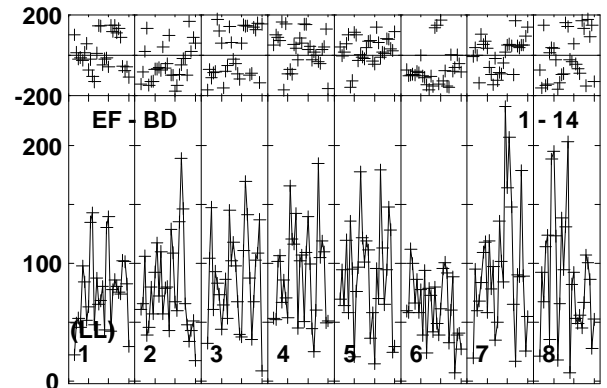
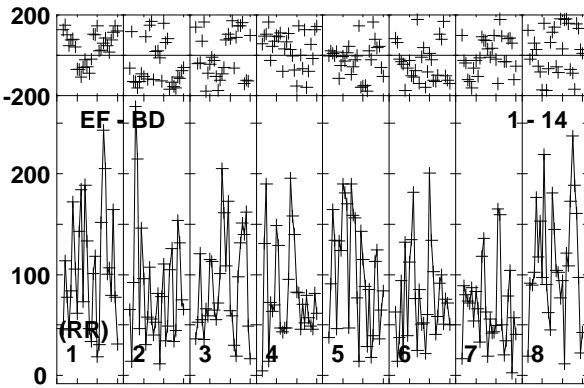
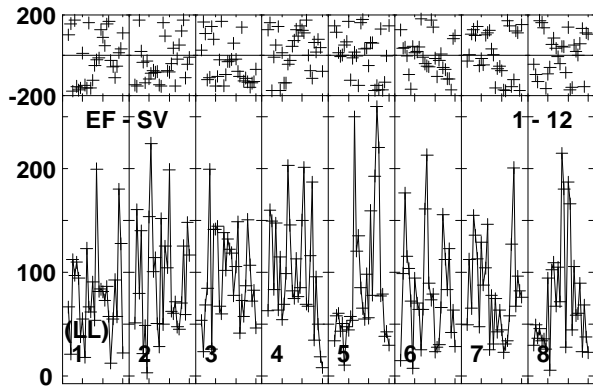
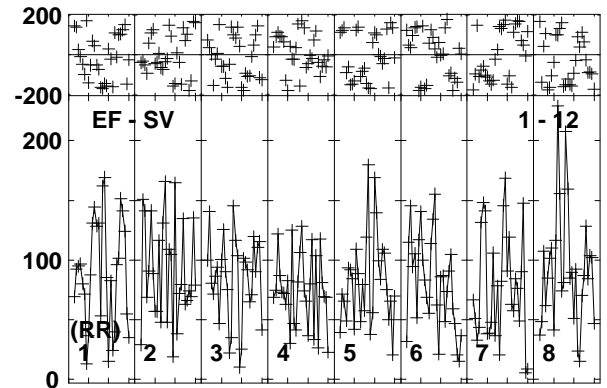
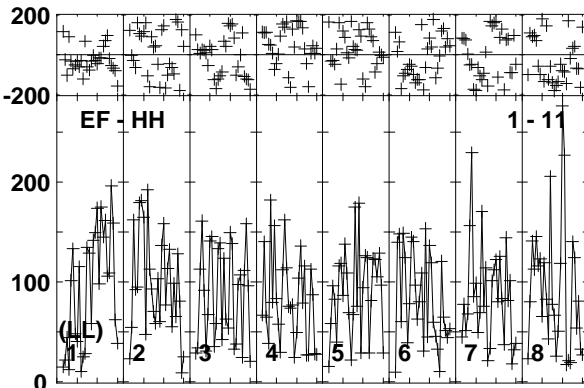
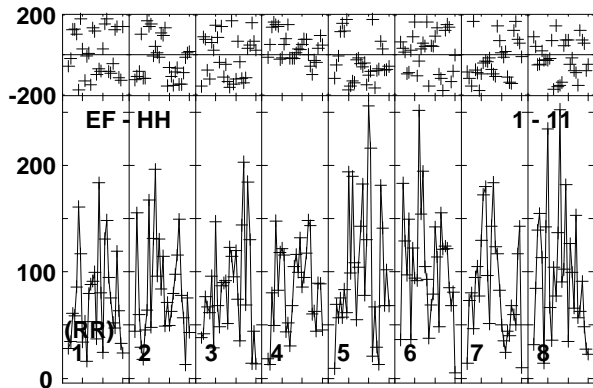
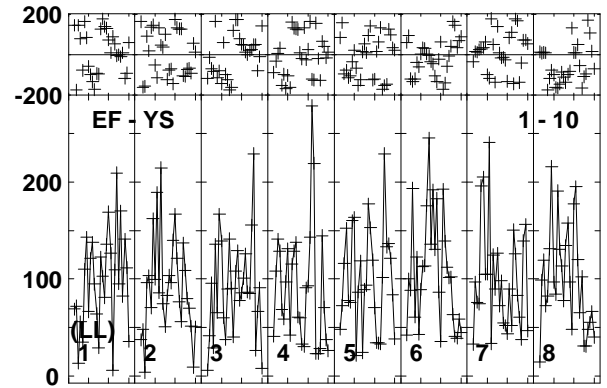
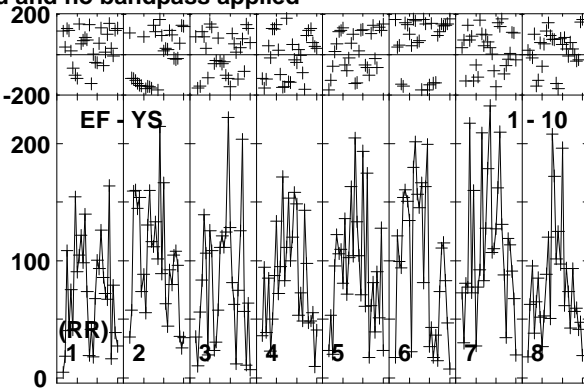
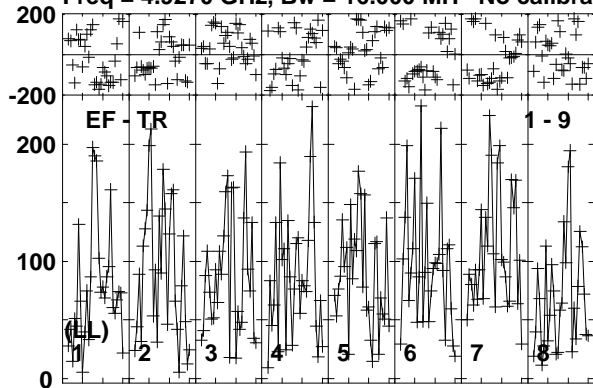

Lower frame: Micro Ampl Jy Top frame: Phas deg  
Vector averaged cross-power spectrum Baseline: EF (01) - TR (09)  
Timerange: 00/04:03:23 to 00/04:06:49

Plot file version 76 created 08-APR-2019 12:09:39

MRK622 EM133B.UVDATA.1

Freq = 4.9270 GHz, Bw = 16.000 MH No calibration applied and no bandpass applied

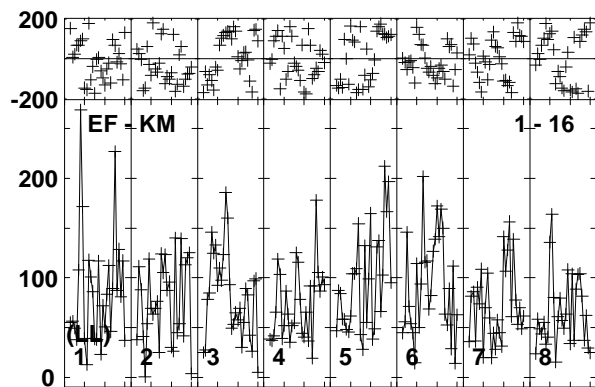
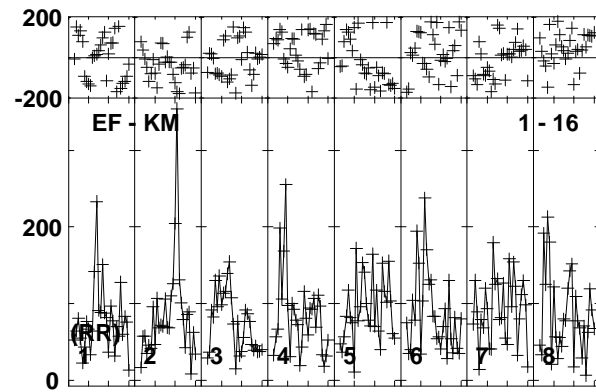
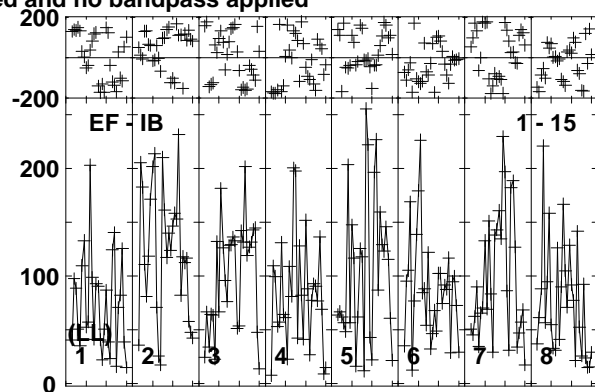
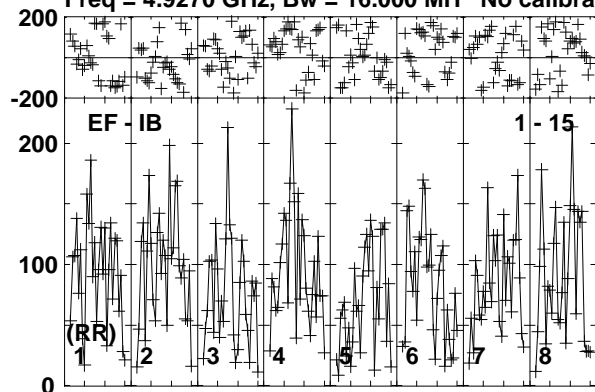

Lower frame: Micro Ampl Jy Top frame: Phas deg  
Vector averaged cross-power spectrum Baseline: EF (01) - IB (15)  
Timerange: 00/04:03:23 to 00/04:06:49

Plot file version 77 created 08-APR-2019 12:09:39

J0815+3635 EM133B.UVDATA.1

Freq = 4.9270 GHz, Bw = 16.000 MH No calibration applied and no bandpass applied

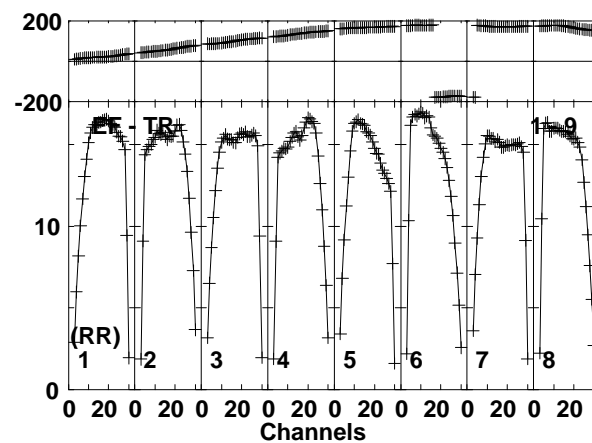
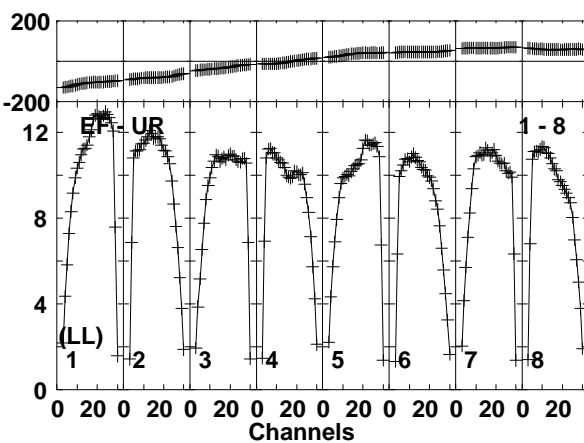
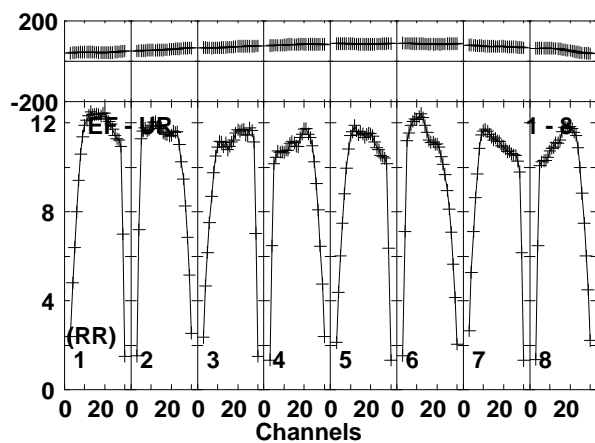
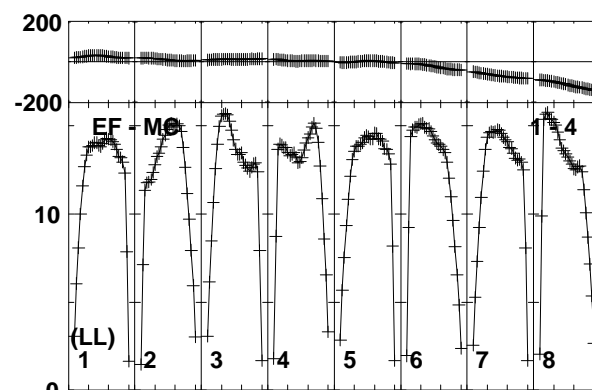
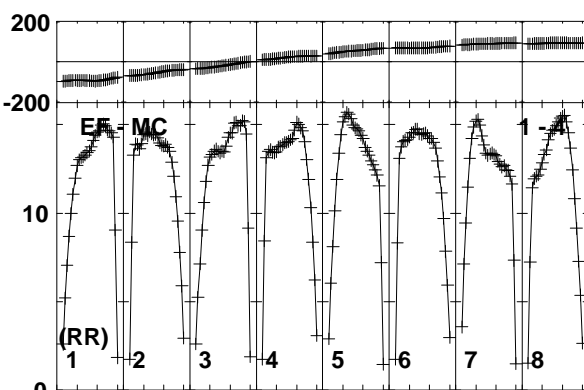
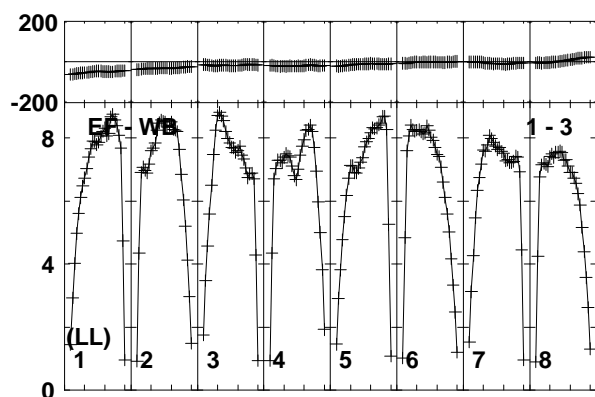
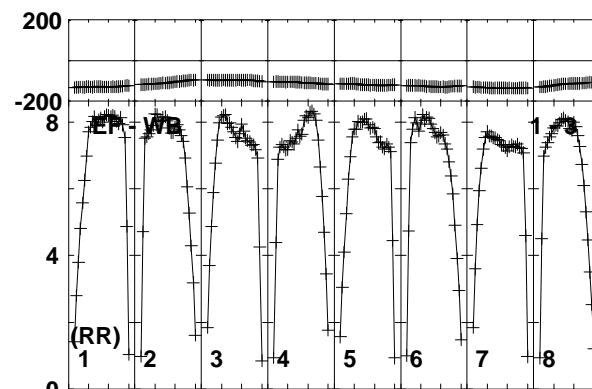
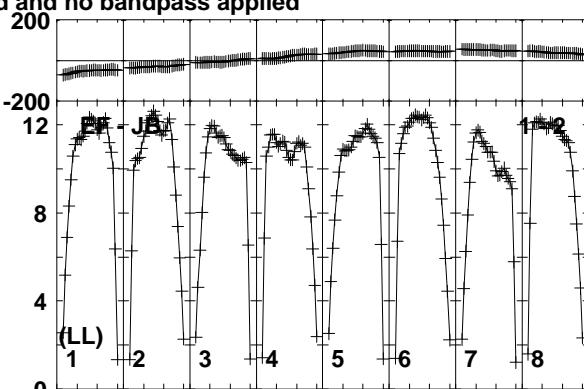
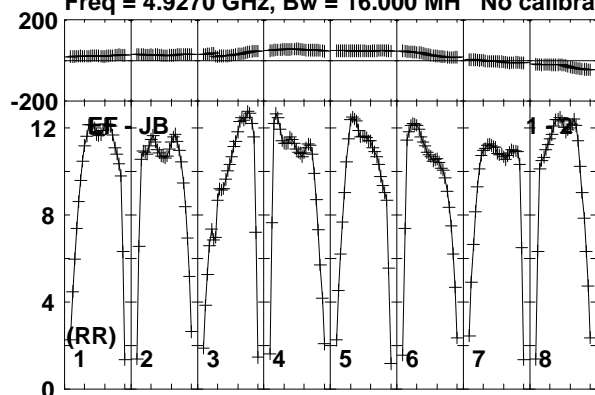

Lower frame: Milli Ampl Jy Top frame: Phas deg  
Vector averaged cross-power spectrum Baseline: EF (01) - JB (02)  
Timerange: 00/04:07:41 to 00/04:09:09

Plot file version 78 created 08-APR-2019 12:09:39

J0815+3635 EM133B.UVDATA.1

Freq = 4.9270 GHz, Bw = 16.000 MH No calibration applied and no bandpass applied

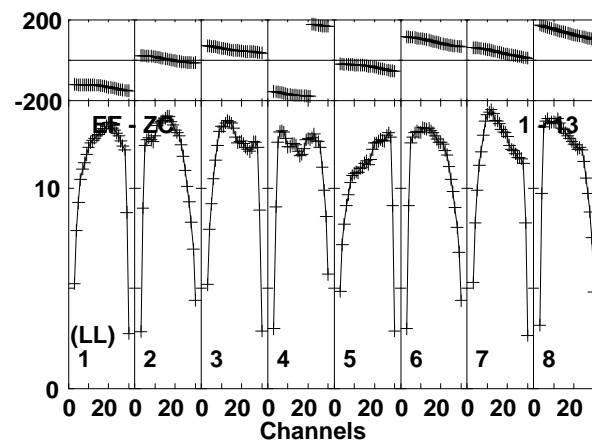
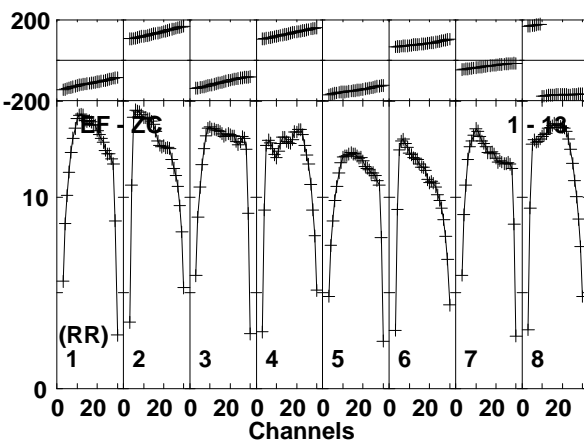
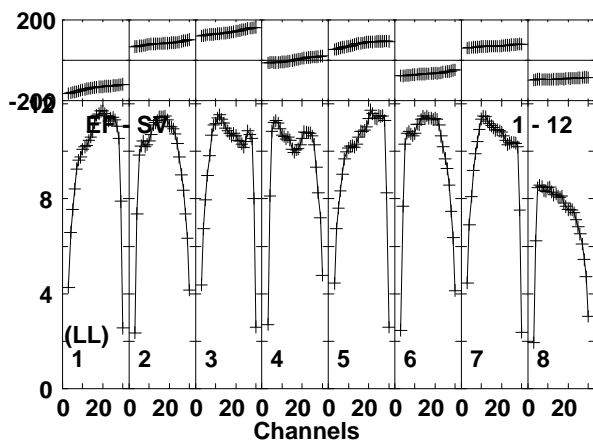
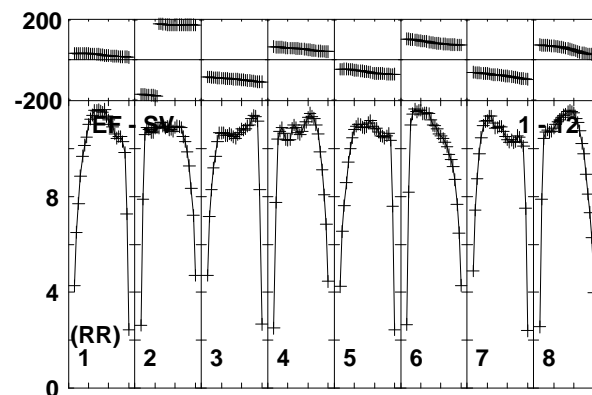
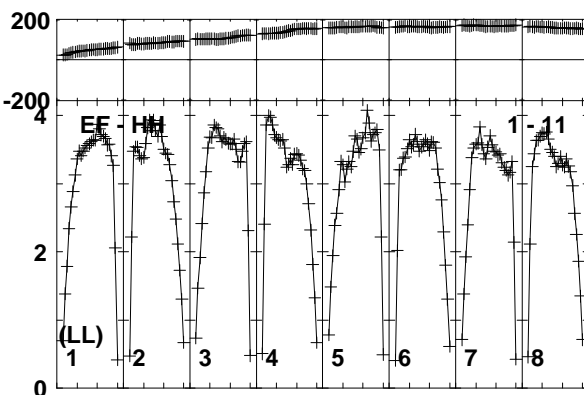
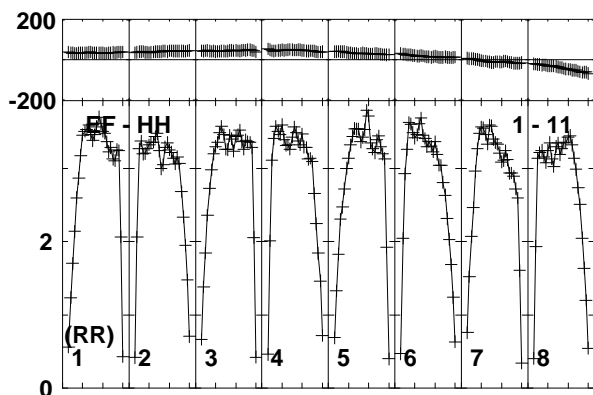
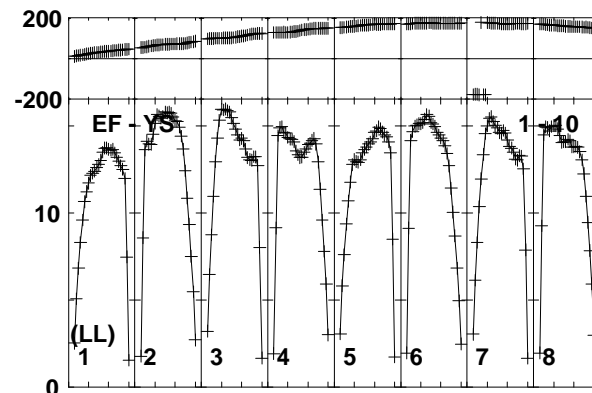
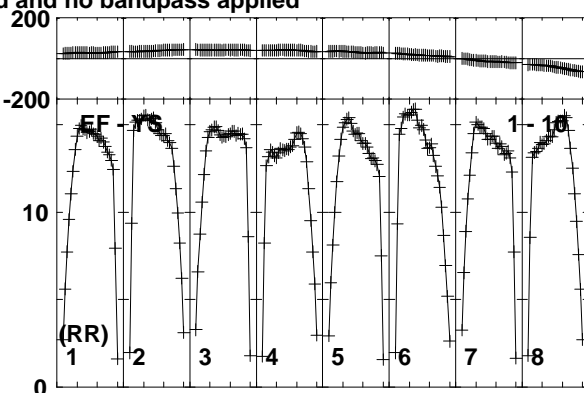
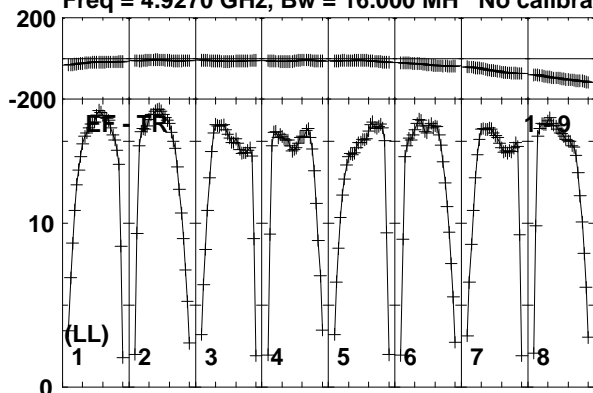

Lower frame: Milli Ampl Jy Top frame: Phas deg  
Vector averaged cross-power spectrum Baseline: EF (01) - TR (09)  
Timerange: 00/04:07:41 to 00/04:09:09

Plot file version 79 created 08-APR-2019 12:09:39

J0815+3635 EM133B.UVDATA.1

Freq = 4.9270 GHz, Bw = 16.000 MH No calibration applied and no bandpass applied

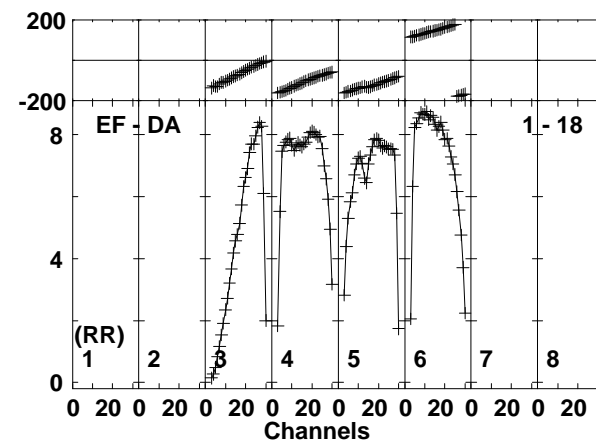
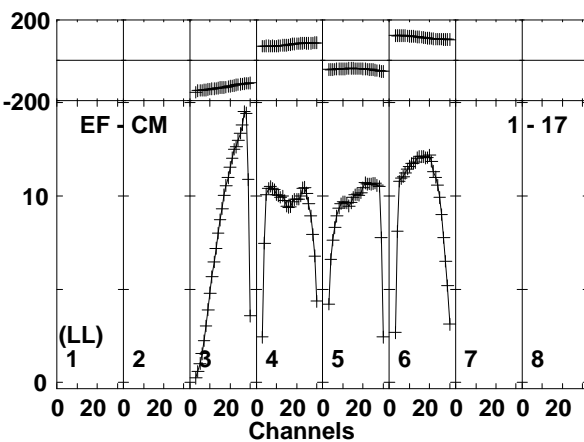
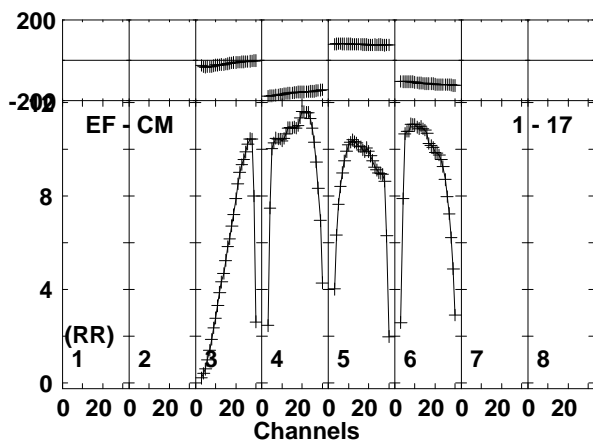
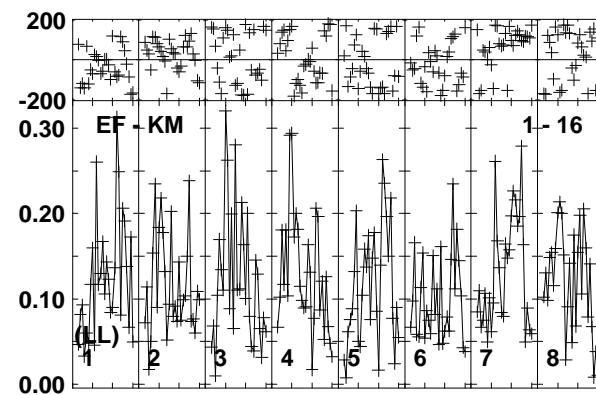
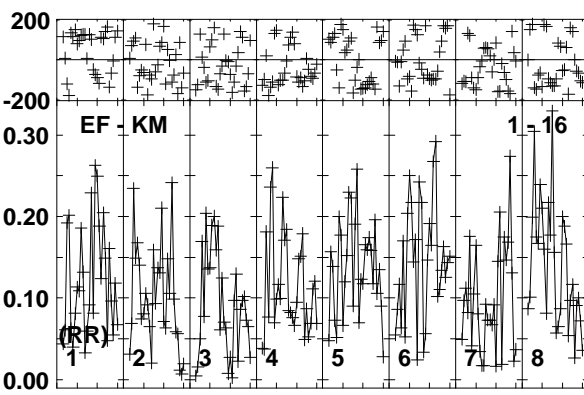
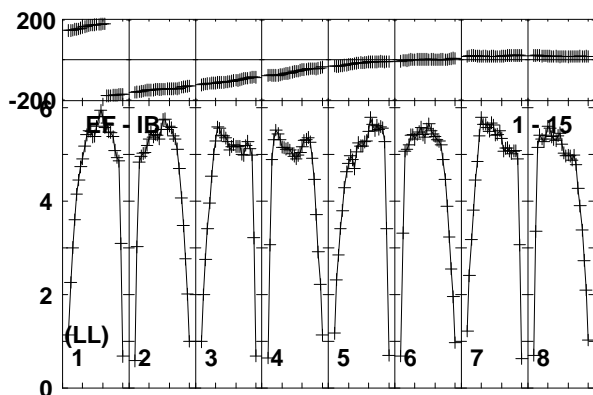
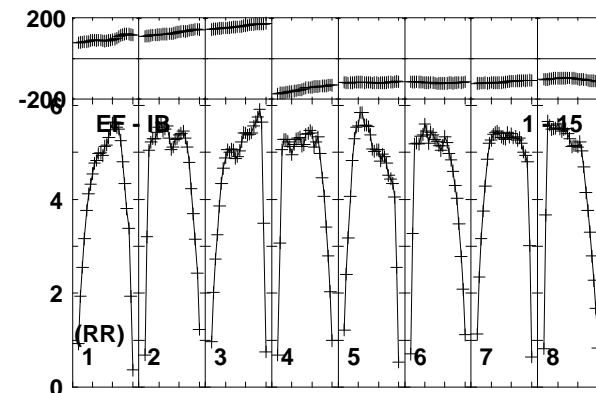
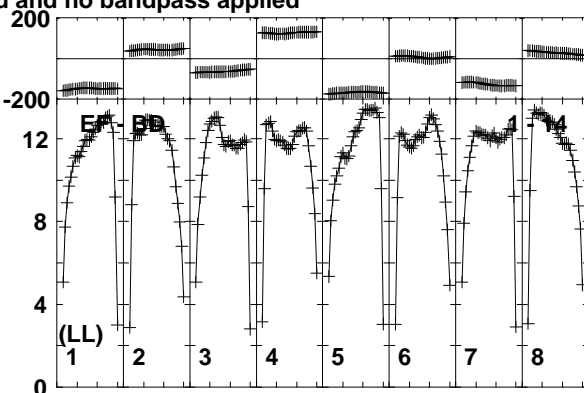
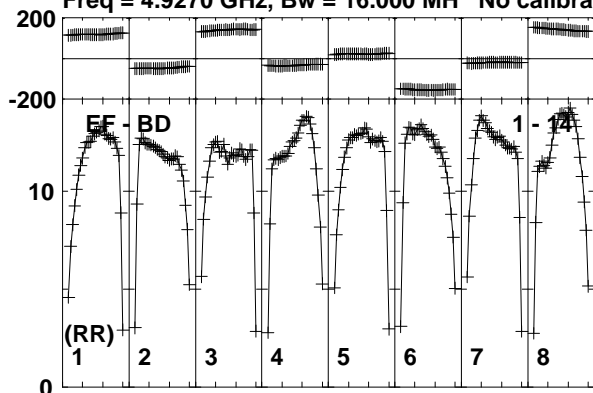

Lower frame: Milli Ampl Jy Top frame: Phas deg  
Vector averaged cross-power spectrum Baseline: EF (01) - BD (14)  
Timerange: 00/04:07:41 to 00/04:09:09

Plot file version 80 created 08-APR-2019 12:09:39

J0815+3635 EM133B.UVDATA.1

Freq = 4.9270 GHz, Bw = 16.000 MH No calibration applied and no bandpass applied

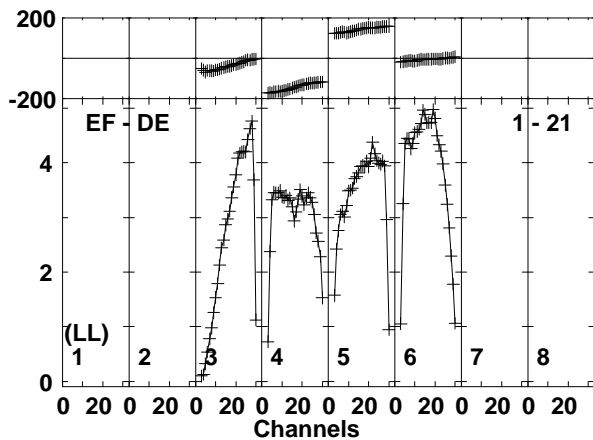
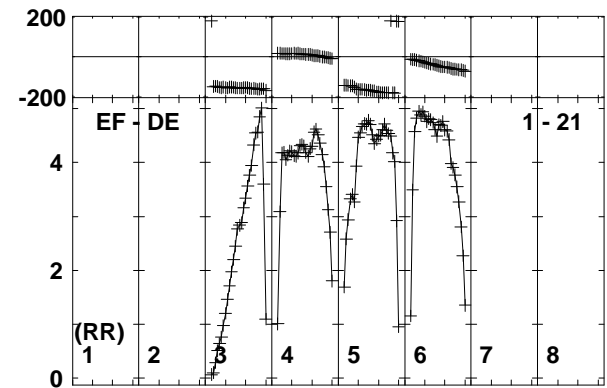
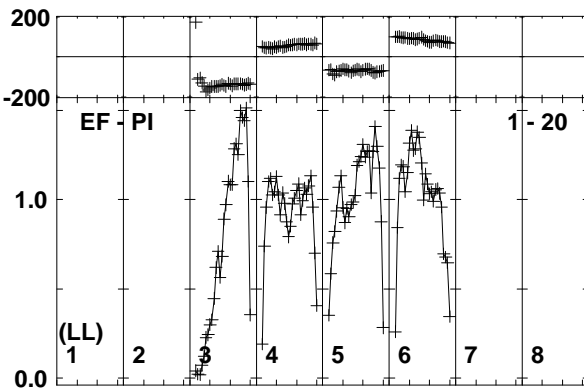
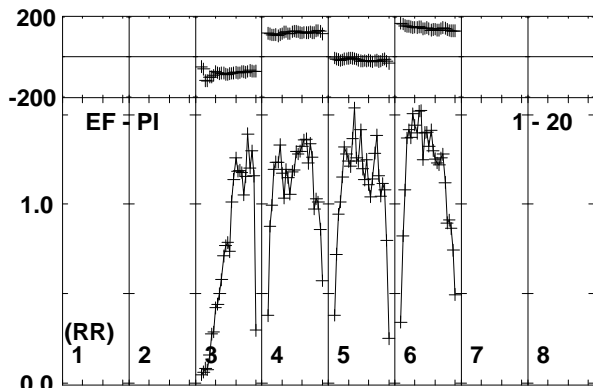
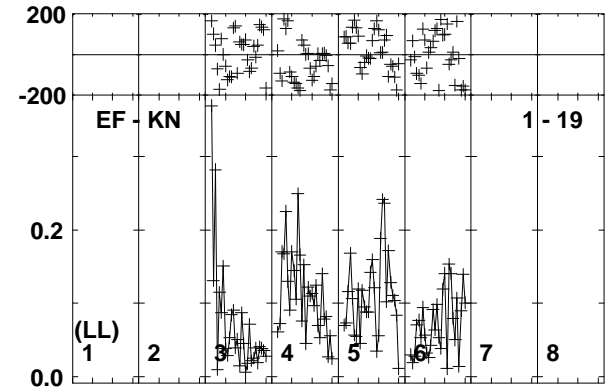
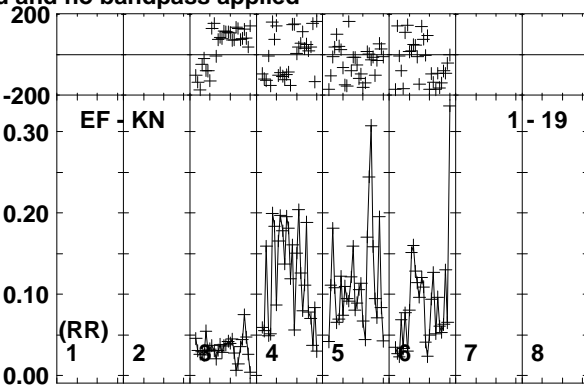
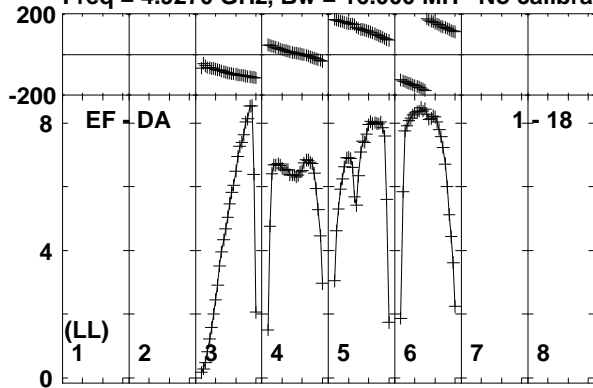

Lower frame: Milli Ampl Jy Top frame: Phas deg  
Vector averaged cross-power spectrum Baseline: EF (01) - DA (18)  
Timerange: 00/04:07:41 to 00/04:09:09



Plot file version 81 created 08-APR-2019 12:09:39

MRK622 EM133B.UVDATA.1

Freq = 4.9270 GHz, Bw = 16.000 MH No calibration applied and no bandpass applied

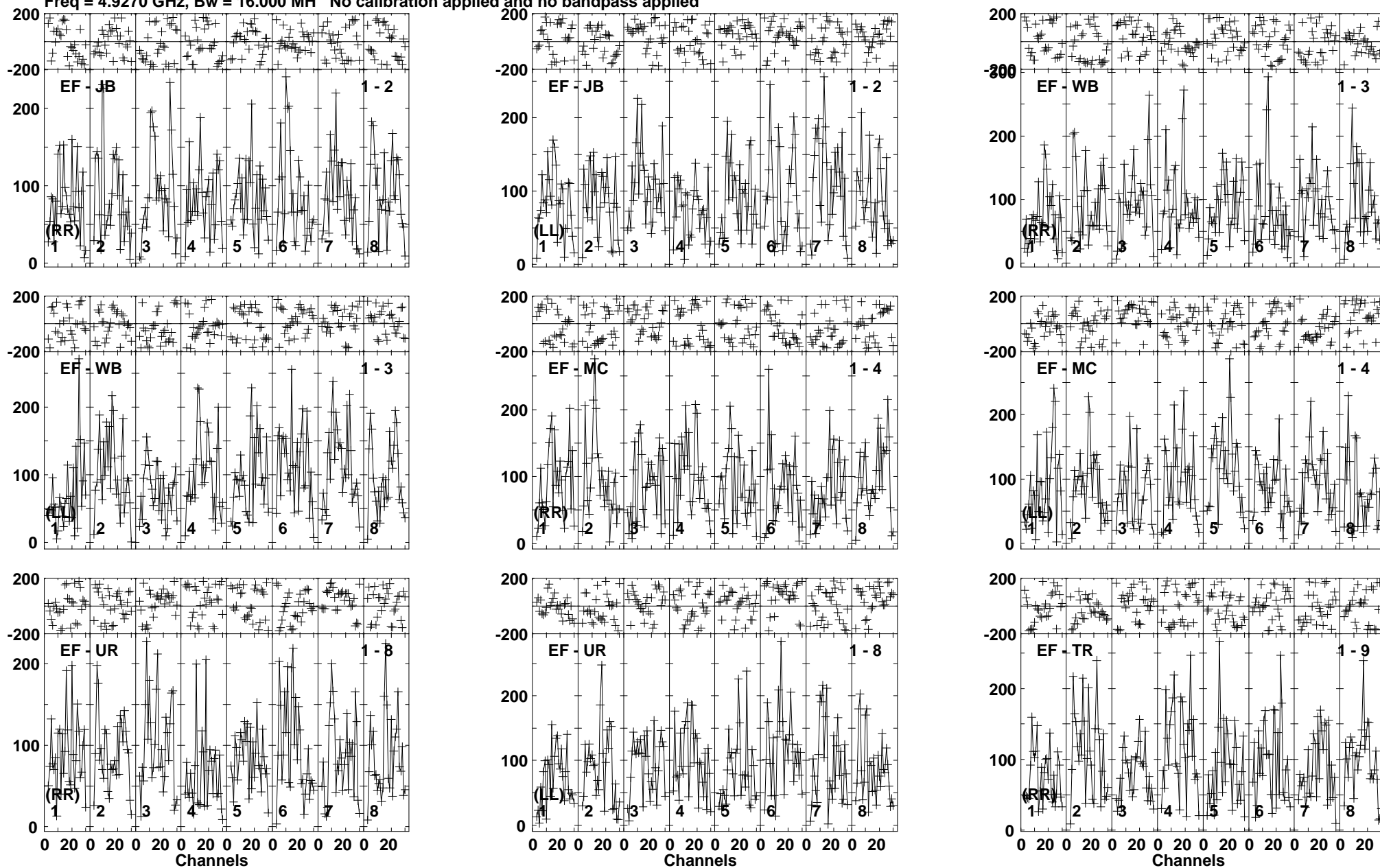

Lower frame: Micro Ampl Jy Top frame: Phas deg  
Vector averaged cross-power spectrum Baseline: EF (01) - JB (02)  
Timerange: 00/04:09:11 to 00/04:12:39

Plot file version 82 created 08-APR-2019 12:09:40

MRK622 EM133B.UVDATA.1

Freq = 4.9270 GHz, Bw = 16.000 MH No calibration applied and no bandpass applied

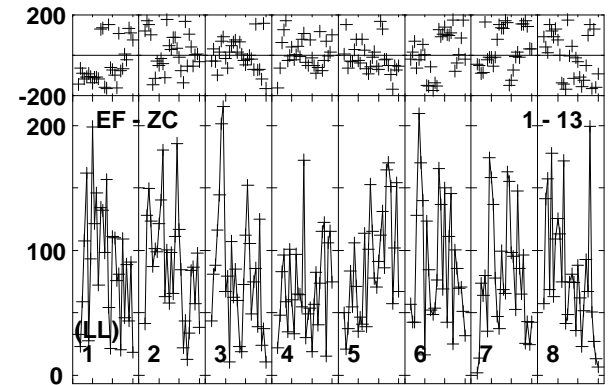
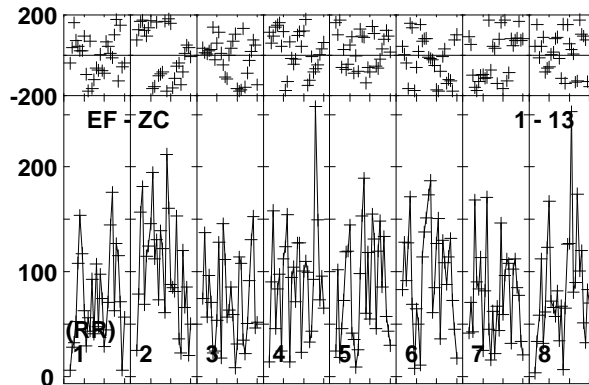
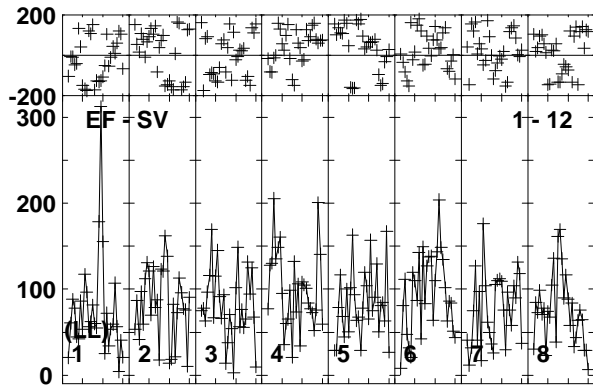
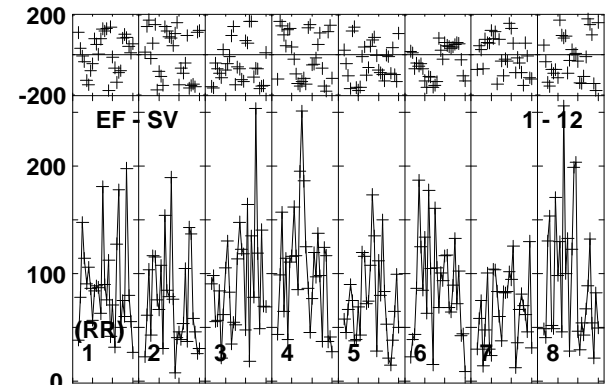
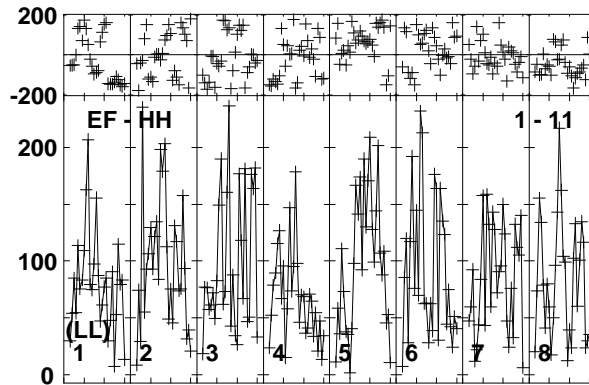
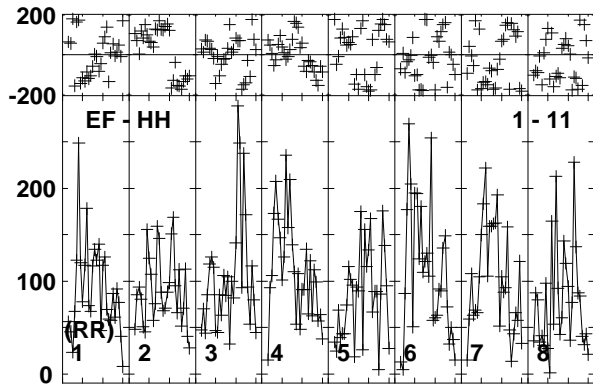
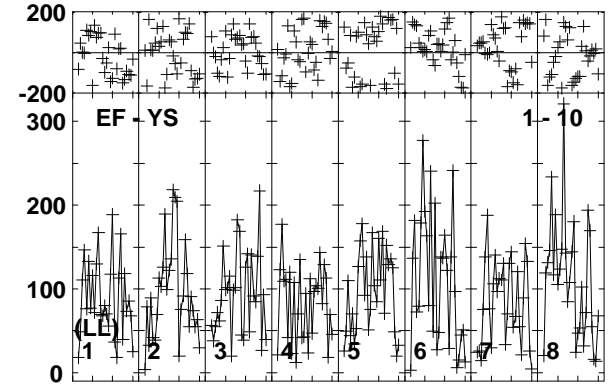
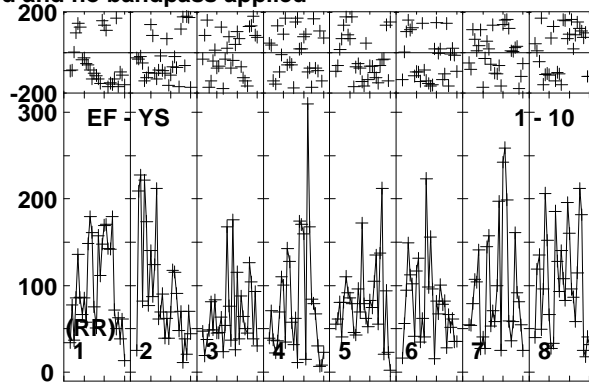
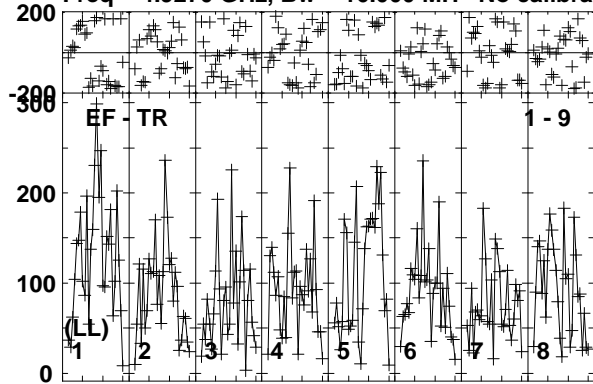

Lower frame: Micro Ampl Jy Top frame: Phas deg  
Vector averaged cross-power spectrum Baseline: EF (01) - TR (09)  
Timerange: 00/04:09:11 to 00/04:12:39

Plot file version 83 created 08-APR-2019 12:09:40

MRK622 EM133B.UVDATA.1

Freq = 4.9270 GHz, Bw = 16.000 MH No calibration applied and no bandpass applied

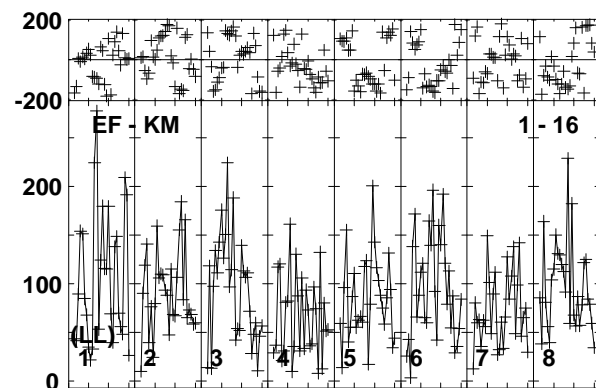
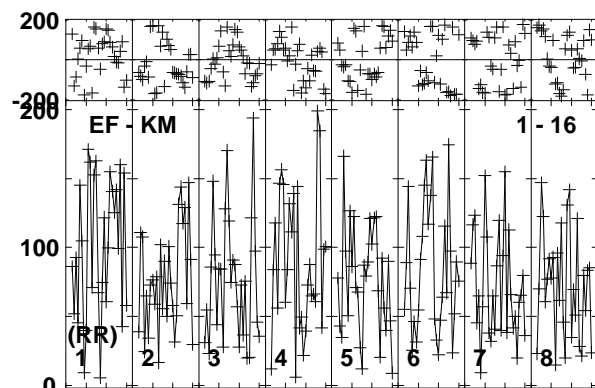
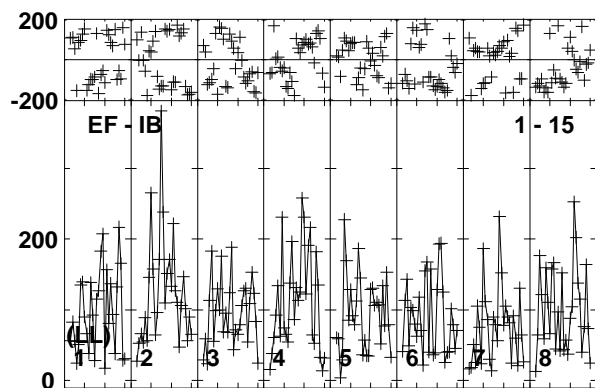
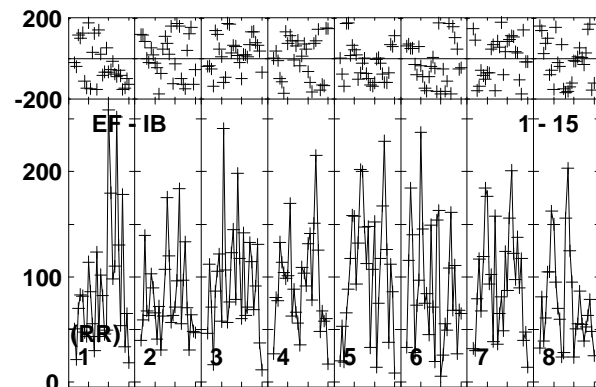
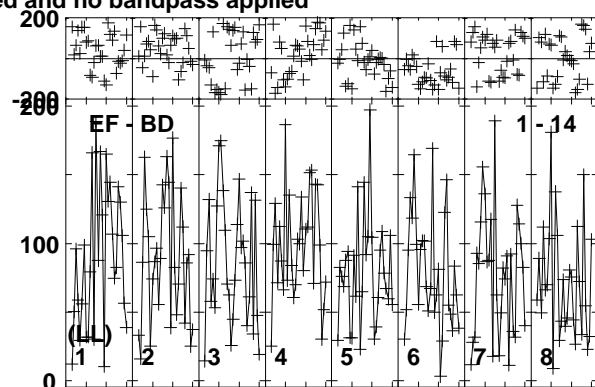
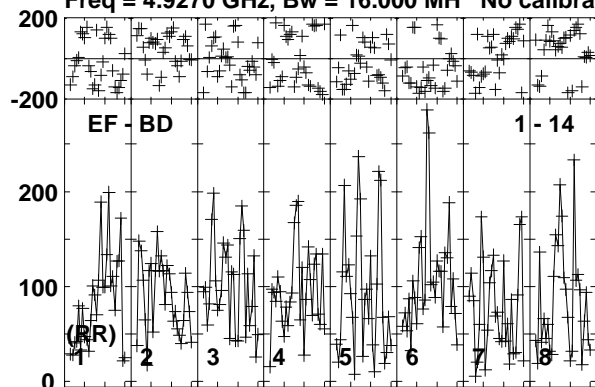

Lower frame: Micro Ampl Jy Top frame: Phas deg  
Vector averaged cross-power spectrum Baseline: EF (01) - BD (14)  
Timerange: 00/04:09:11 to 00/04:12:39

Plot file version 84 created 08-APR-2019 12:09:40

J0815+3635 EM133B.UVDATA.1

Freq = 4.9270 GHz, Bw = 16.000 MH No calibration applied and no bandpass applied

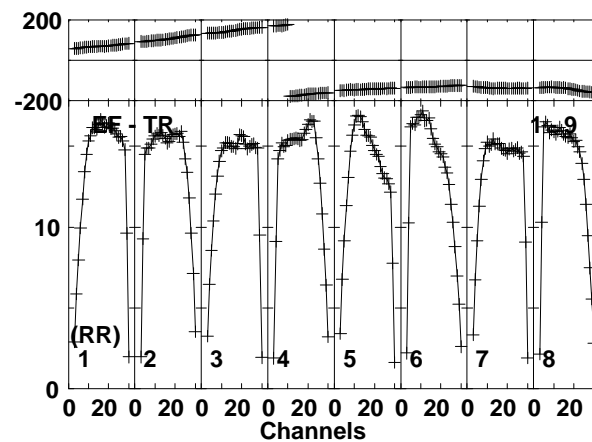
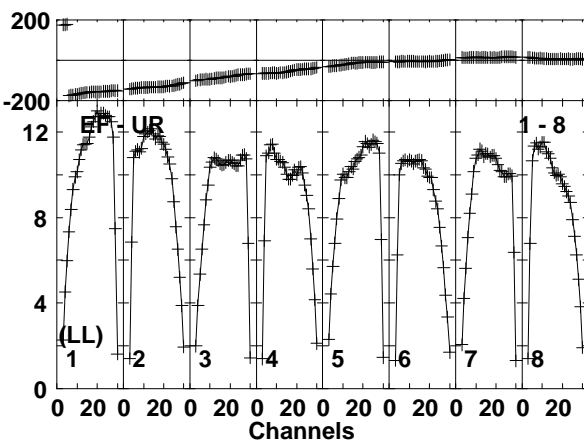
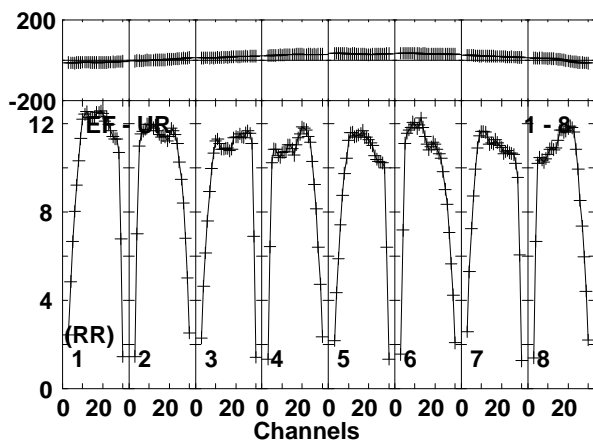
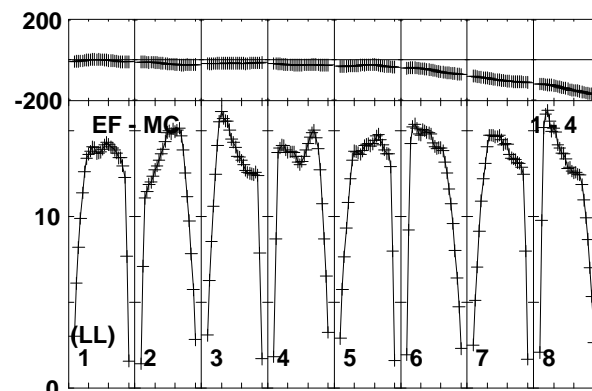
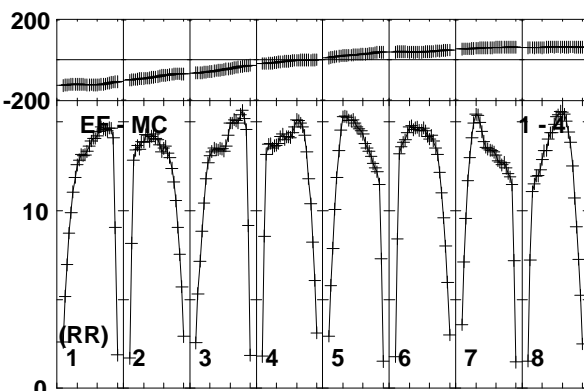
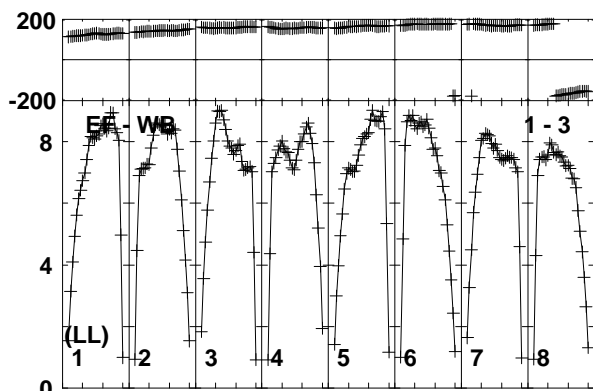
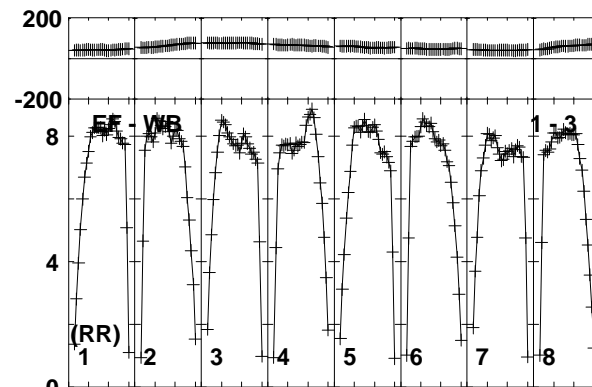
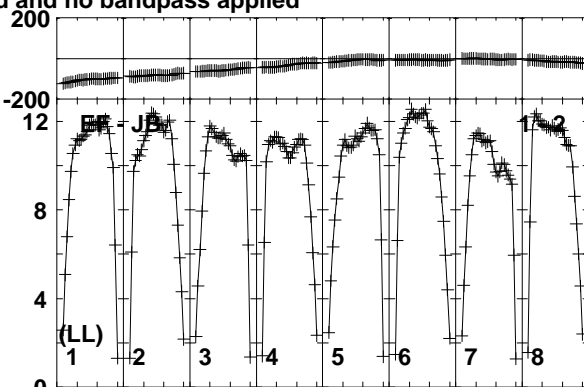
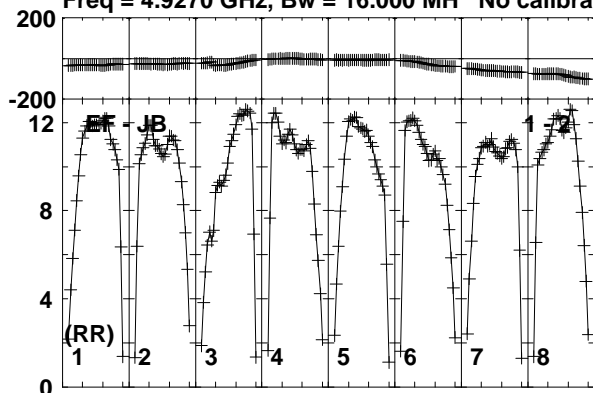

Lower frame: Milli Ampl Jy Top frame: Phas deg  
Vector averaged cross-power spectrum Baseline: EF (01) - JB (02)  
Timerange: 00/04:12:41 to 00/04:14:09

Plot file version 85 created 08-APR-2019 12:09:40

J0815+3635 EM133B.UVDATA.1

Freq = 4.9270 GHz, Bw = 16.000 MH No calibration applied and no bandpass applied

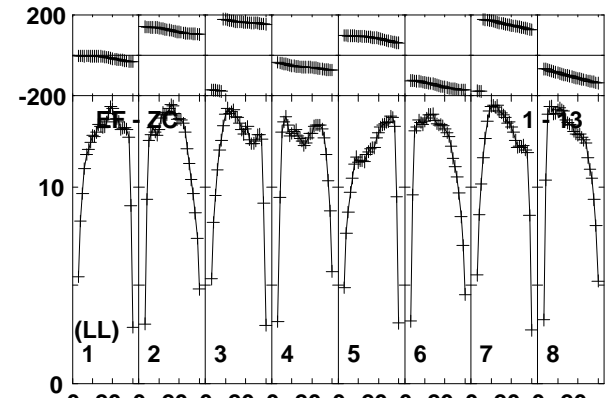
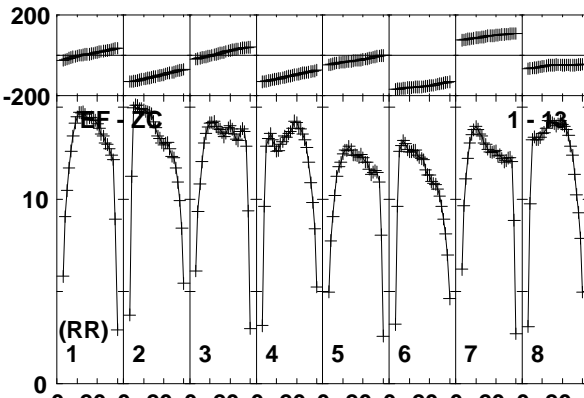
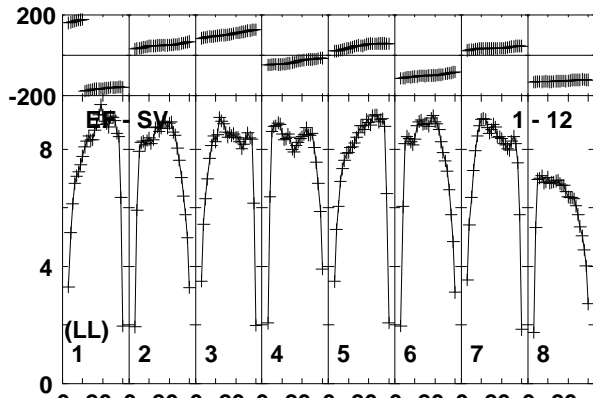
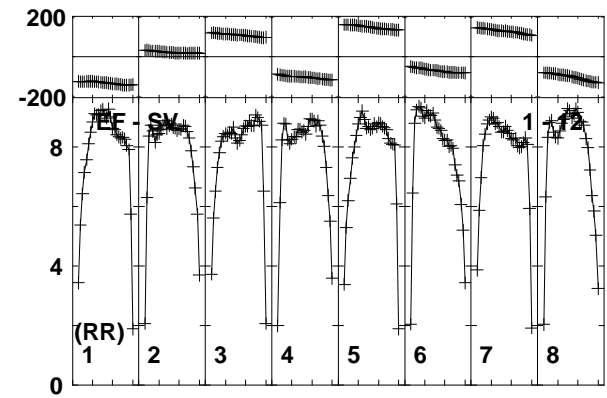
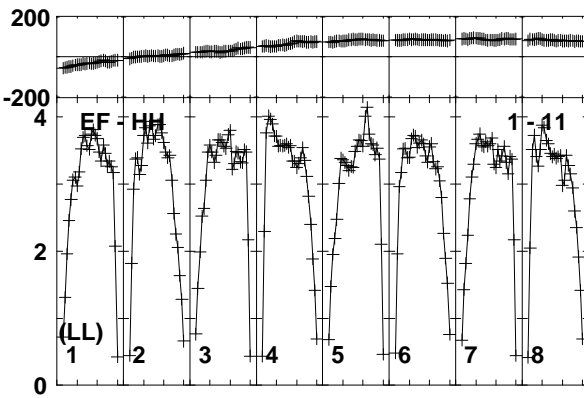
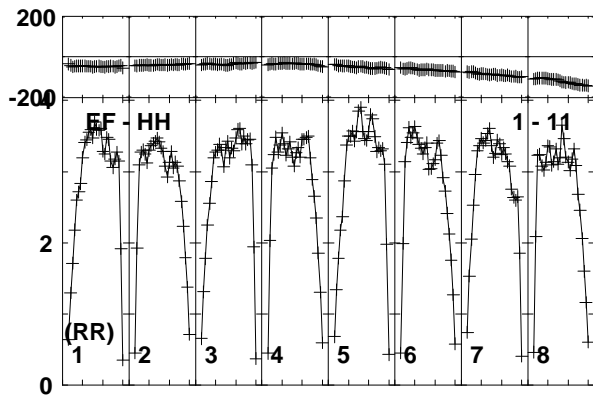
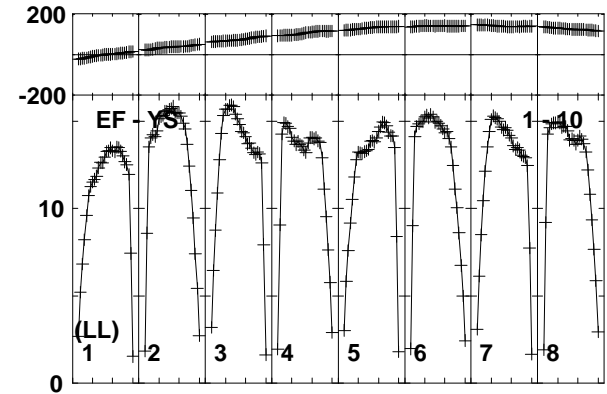
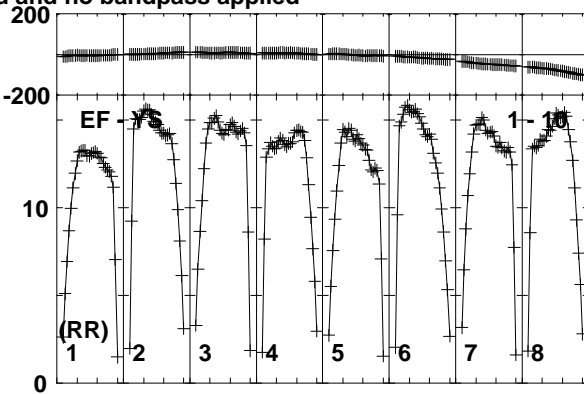
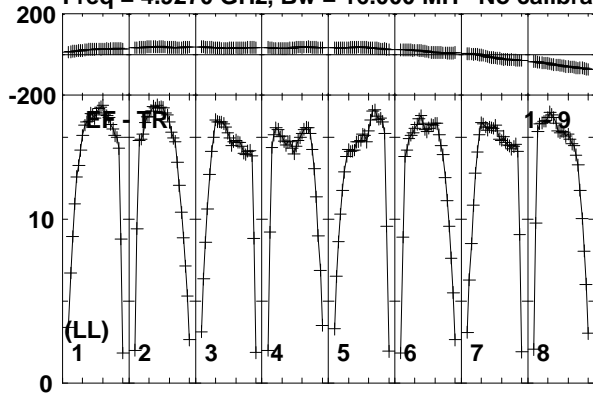

Lower frame: Milli Ampl Jy Top frame: Phas deg  
Vector averaged cross-power spectrum Baseline: EF (01) - TR (09)  
Timerange: 00/04:12:41 to 00/04:14:09

Plot file version 86 created 08-APR-2019 12:09:40

J0815+3635 EM133B.UVDATA.1

Freq = 4.9270 GHz, Bw = 16.000 MH No calibration applied and no bandpass applied

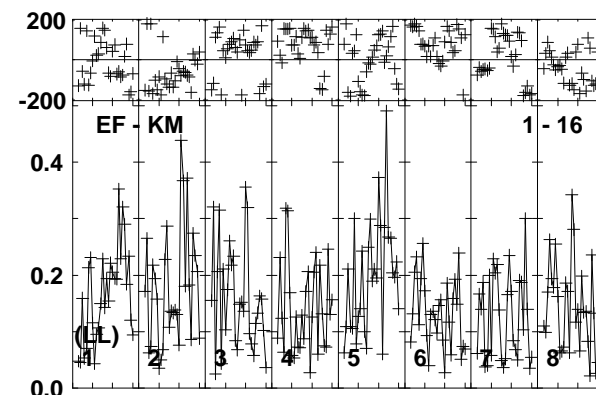
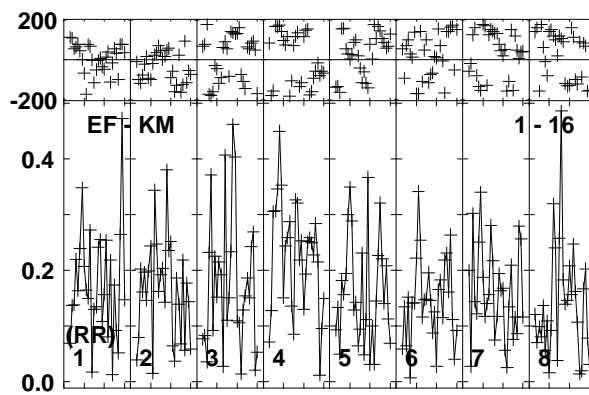
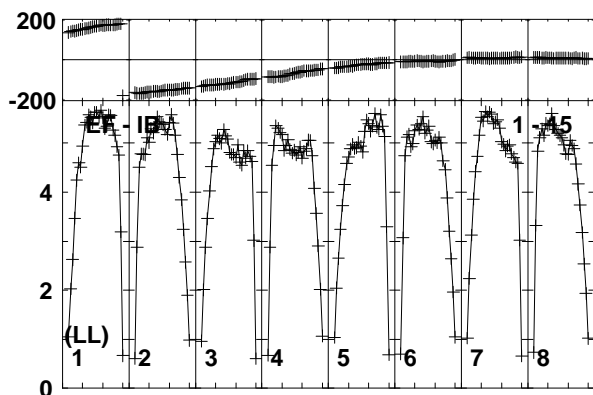
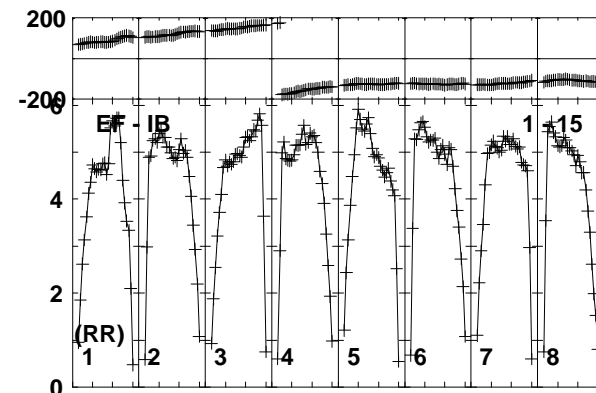
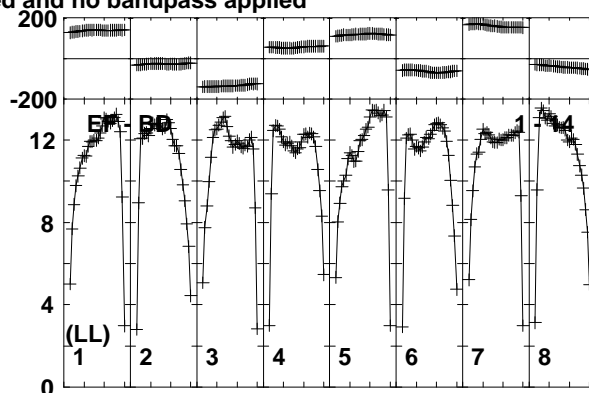
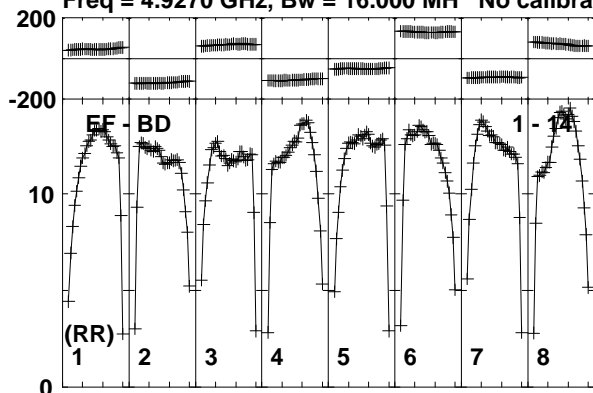

Lower frame: Milli Ampl Jy Top frame: Phas deg  
Vector averaged cross-power spectrum Baseline: EF (01) - BD (14)  
Timerange: 00/04:12:41 to 00/04:14:09

Plot file version 87 created 08-APR-2019 12:09:40

MRK622 EM133B.UVDATA.1

Freq = 4.9270 GHz, Bw = 16.000 MH No calibration applied and no bandpass applied

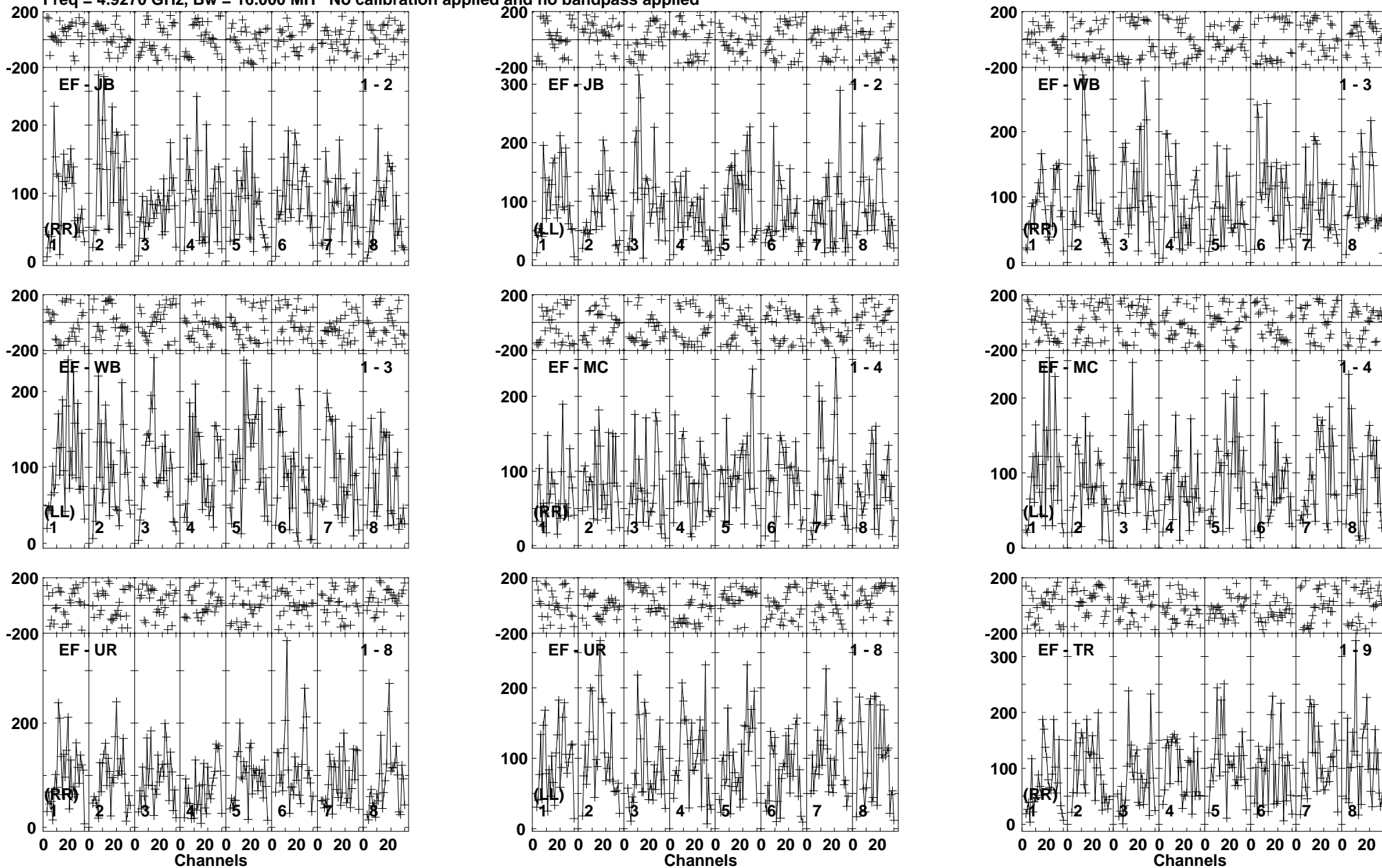

Lower frame: Micro Ampl Jy Top frame: Phas deg  
Vector averaged cross-power spectrum Baseline: EF (01) - JB (02)  
Timerange: 00/04:14:11 to 00/04:17:39

Plot file version 88 created 08-APR-2019 12:09:40

MRK622 EM133B.UVDATA.1

Freq = 4.9270 GHz, Bw = 16.000 MH No calibration applied and no bandpass applied

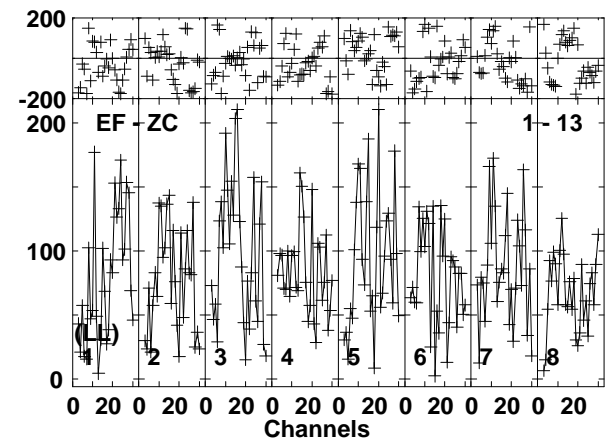
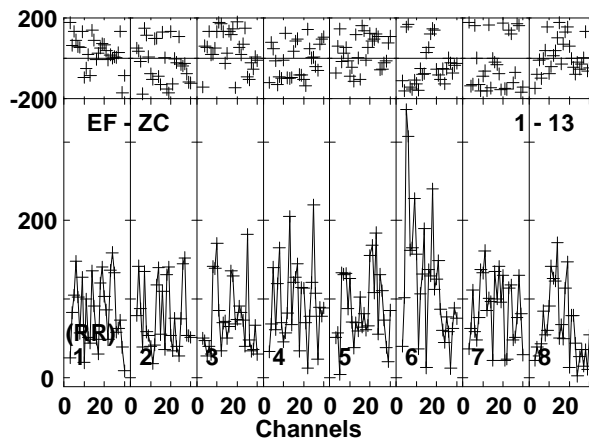
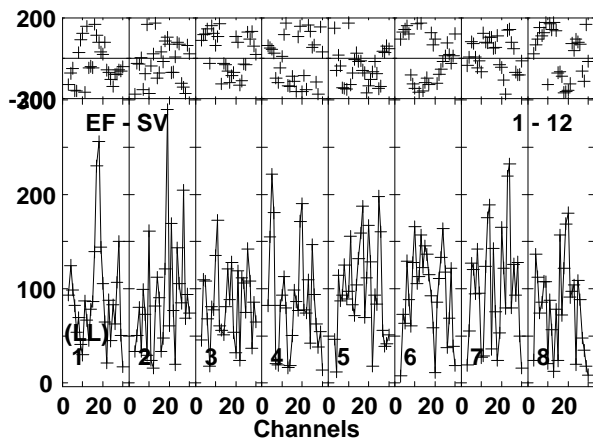
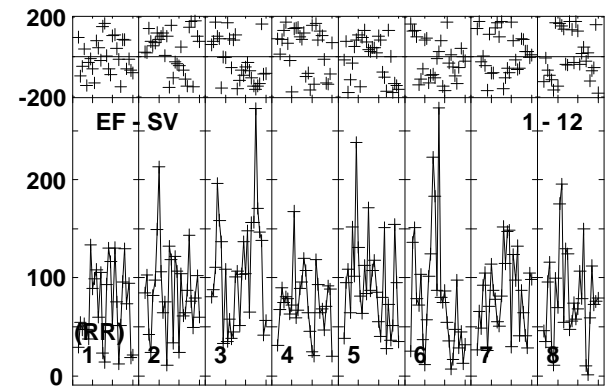
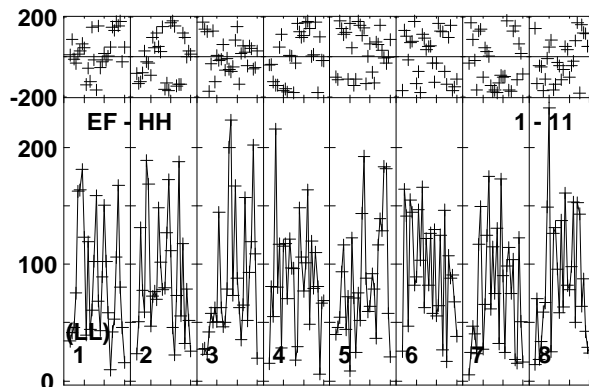
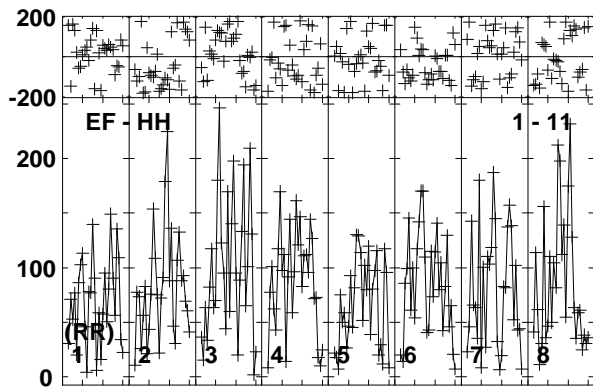
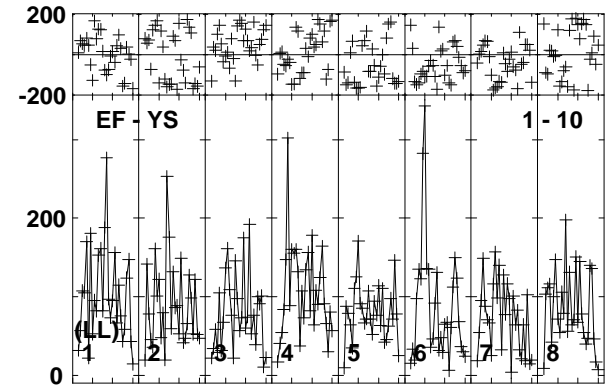
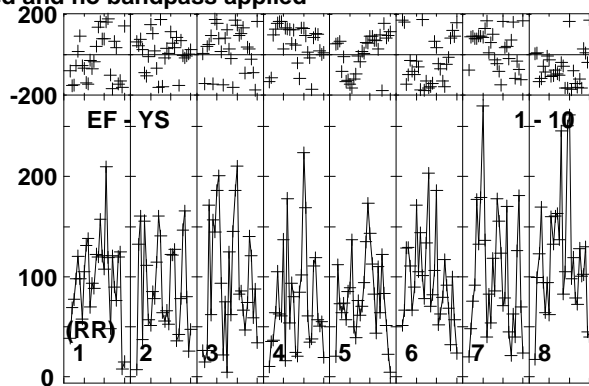
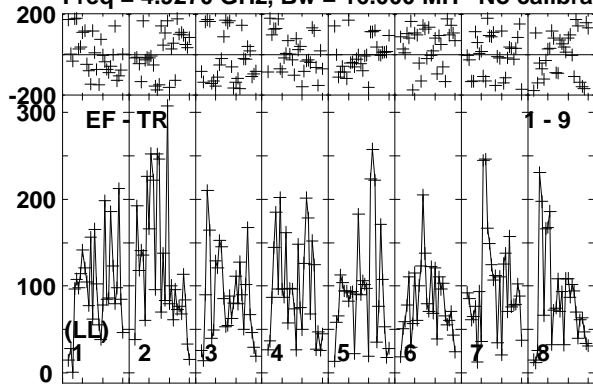

Lower frame: Micro Ampl Jy Top frame: Phas deg  
Vector averaged cross-power spectrum Baseline: EF (01) - TR (09)  
Timerange: 00/04:14:11 to 00/04:17:39



Plot file version 89 created 08-APR-2019 12:09:41

MRK622 EM133B.UVDATA.1

Freq = 4.9270 GHz, Bw = 16.000 MH No calibration applied and no bandpass applied

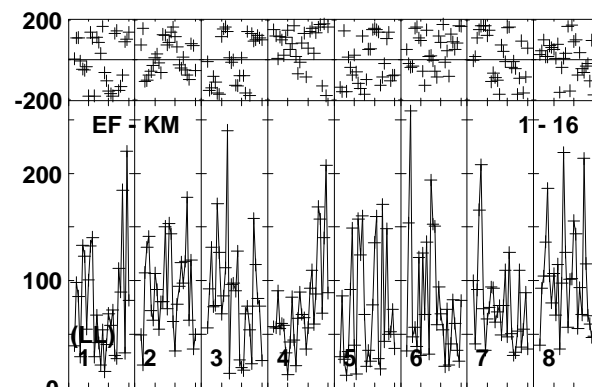
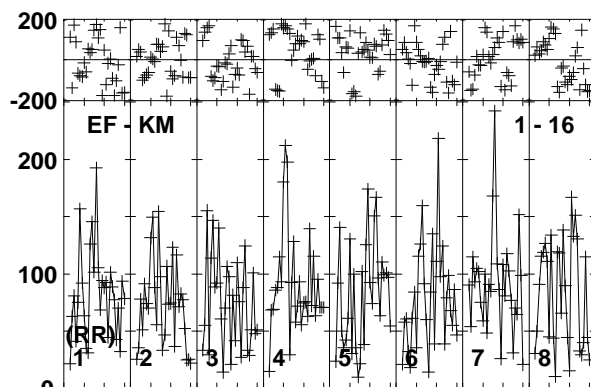
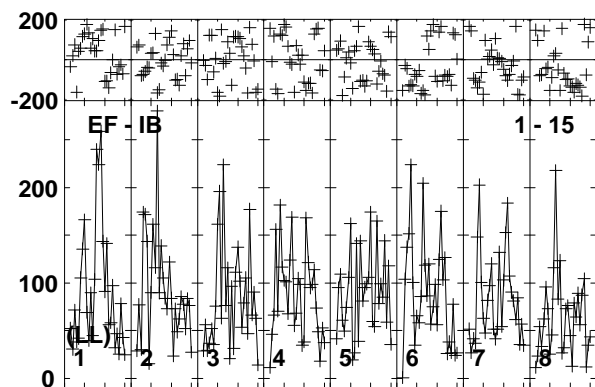
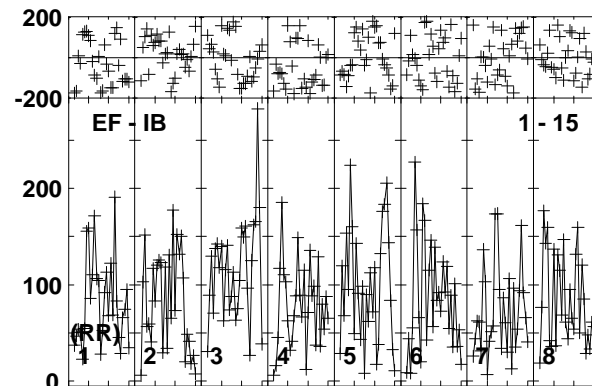
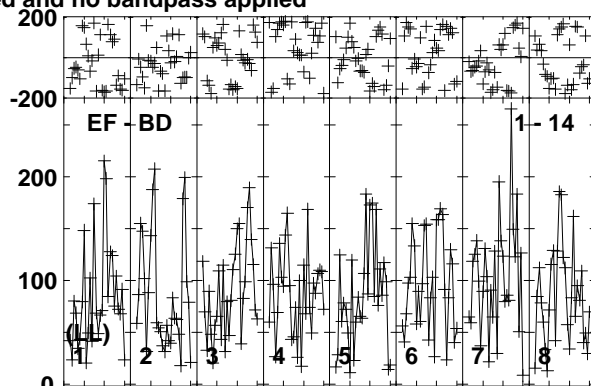
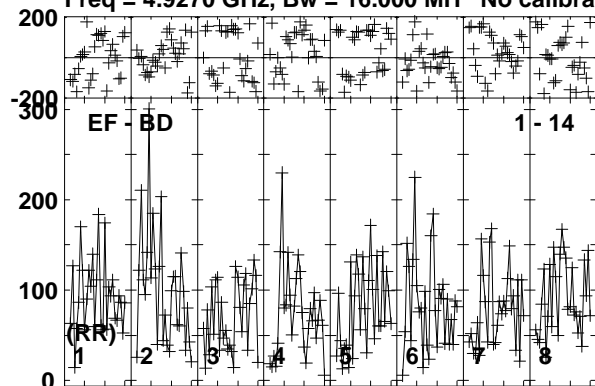

Lower frame: Micro Ampl Jy Top frame: Phas deg  
Vector averaged cross-power spectrum Baseline: EF (01) - BD (14)  
Timerange: 00/04:14:11 to 00/04:17:39

Plot file version 90 created 08-APR-2019 12:09:41

J0815+3635 EM133B.UVDATA.1

Freq = 4.9270 GHz, Bw = 16.000 MH No calibration applied and no bandpass applied

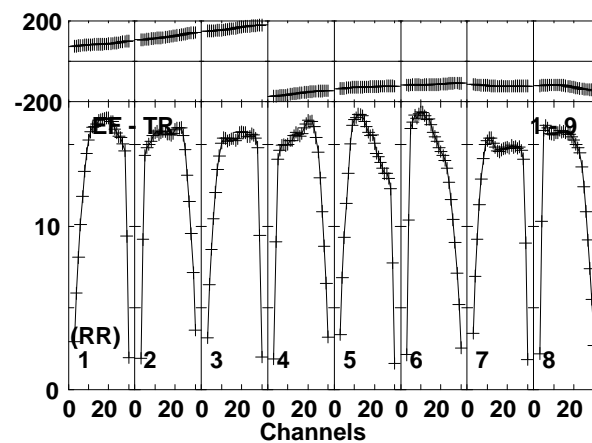
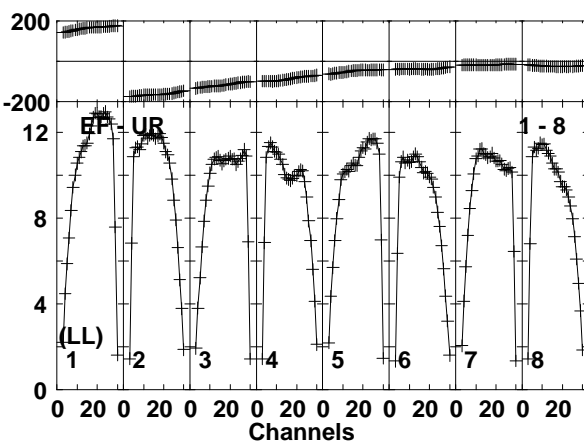
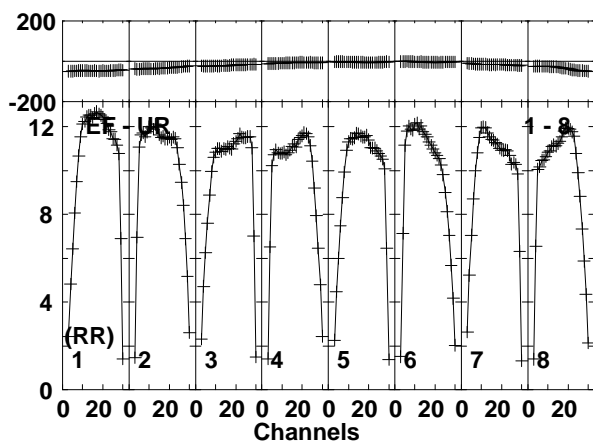
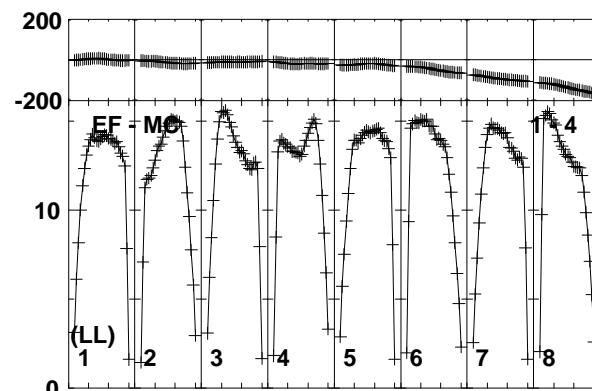
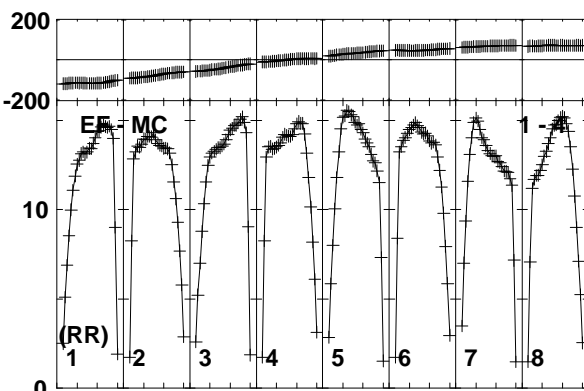
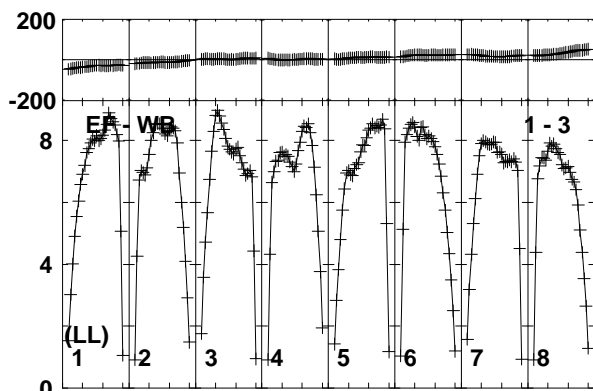
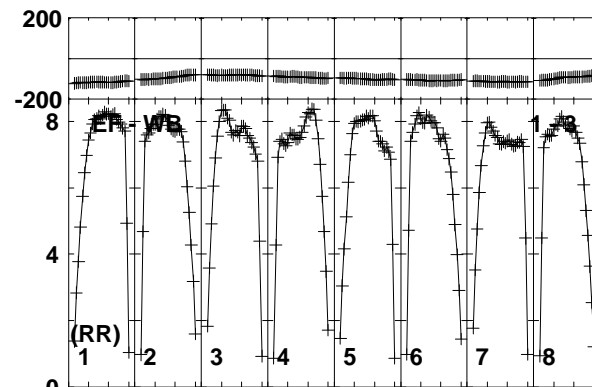
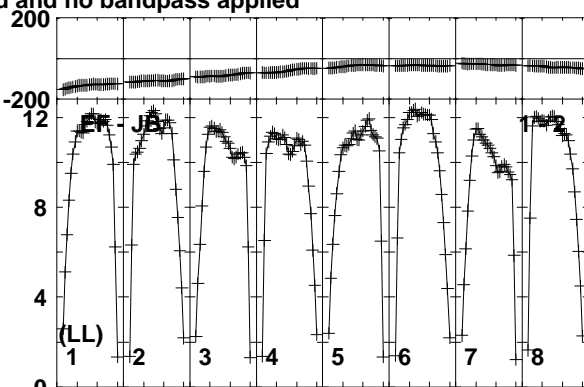
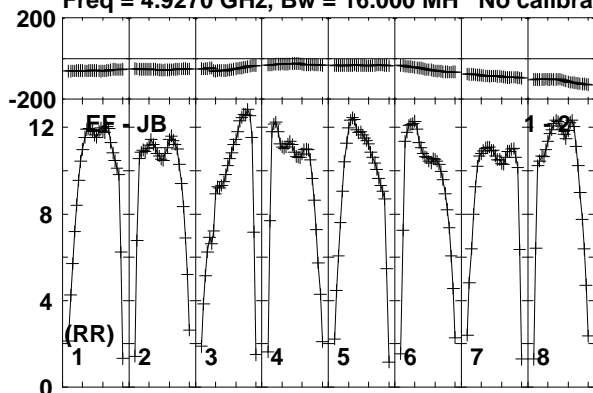

Lower frame: Milli Ampl Jy Top frame: Phas deg  
Vector averaged cross-power spectrum Baseline: EF (01) - JB (02)  
Timerange: 00/04:18:31 to 00/04:19:59

Plot file version 91 created 08-APR-2019 12:09:41

J0815+3635 EM133B.UVDATA.1

Freq = 4.9270 GHz, Bw = 16.000 MH No calibration applied and no bandpass applied

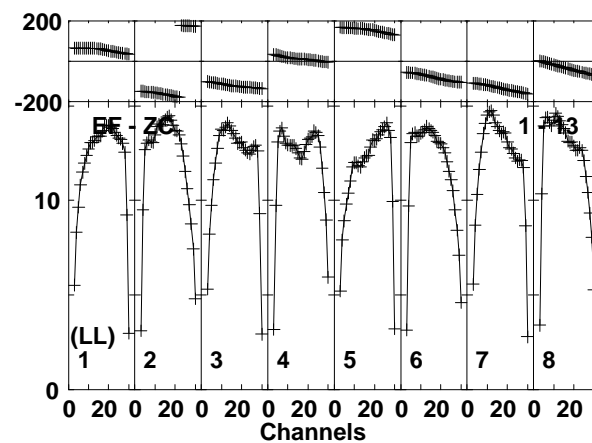
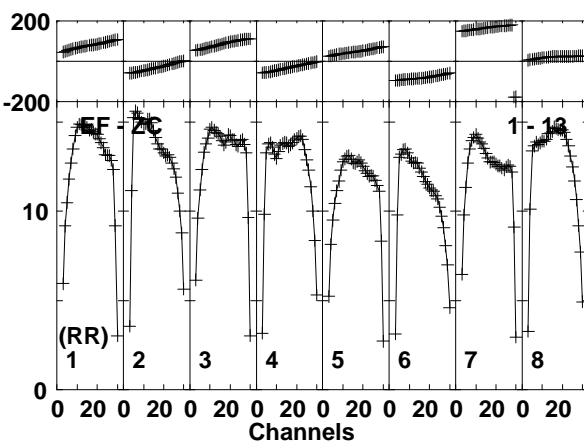
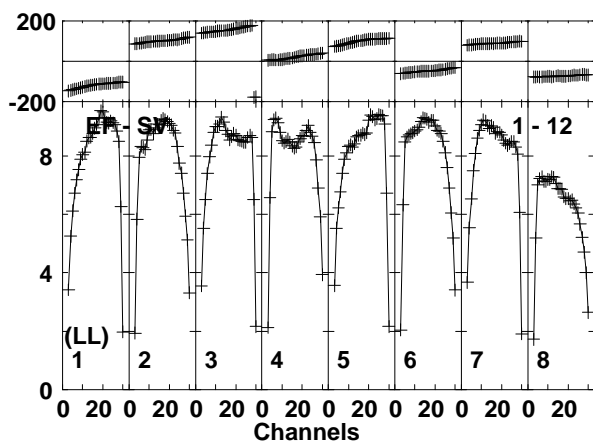
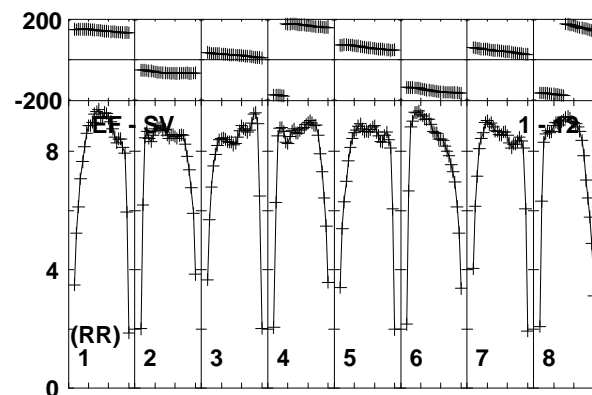
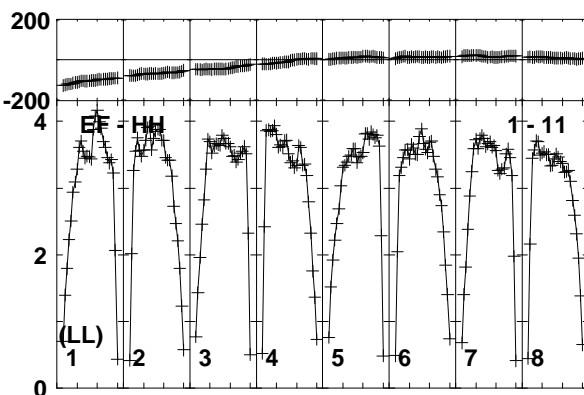
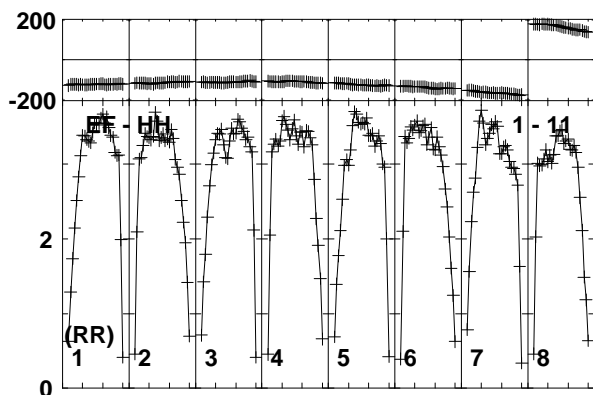
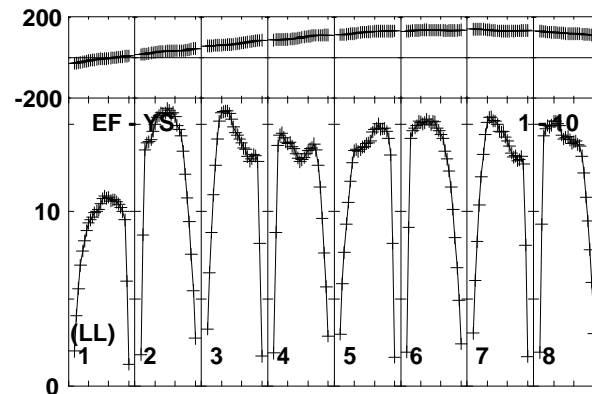
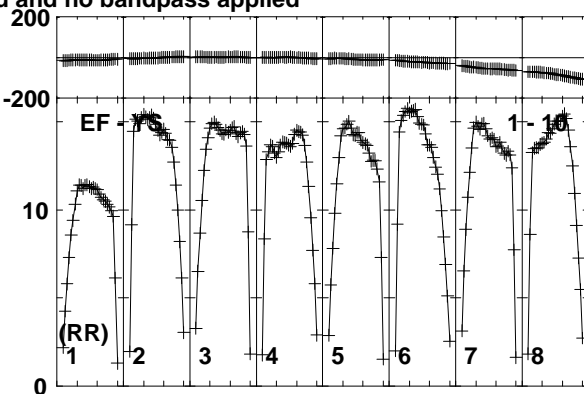
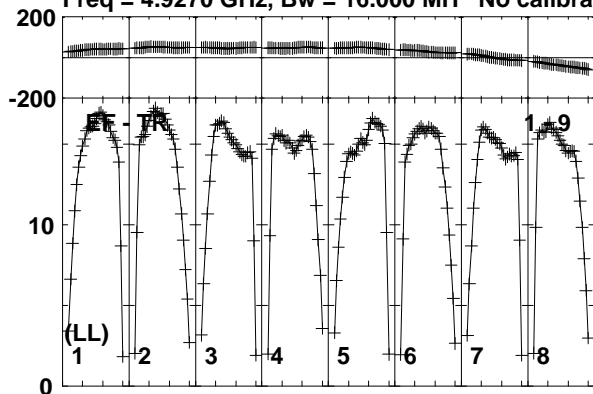

Lower frame: Milli Ampl Jy Top frame: Phas deg  
Vector averaged cross-power spectrum Baseline: EF (01) - TR (09)  
Timerange: 00/04:18:31 to 00/04:19:59

Plot file version 92 created 08-APR-2019 12:09:41

J0815+3635 EM133B.UVDATA.1

Freq = 4.9270 GHz, Bw = 16.000 MH No calibration applied and no bandpass applied

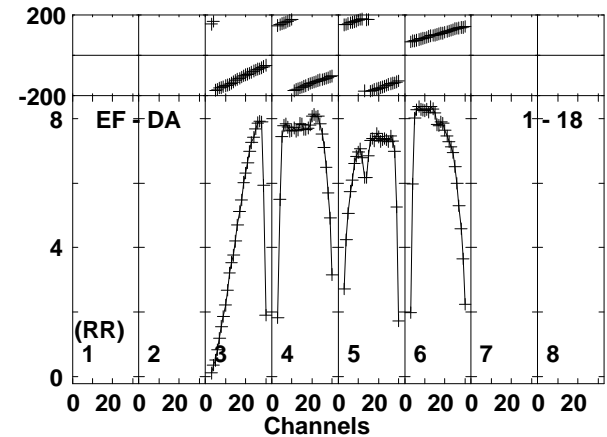
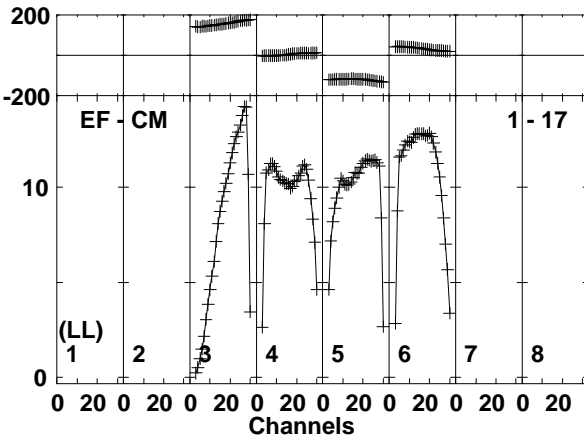
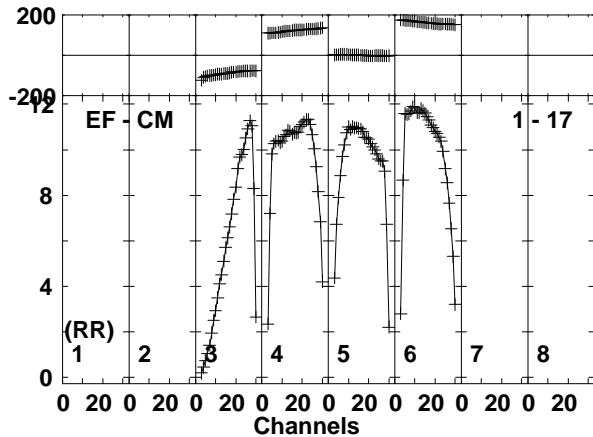
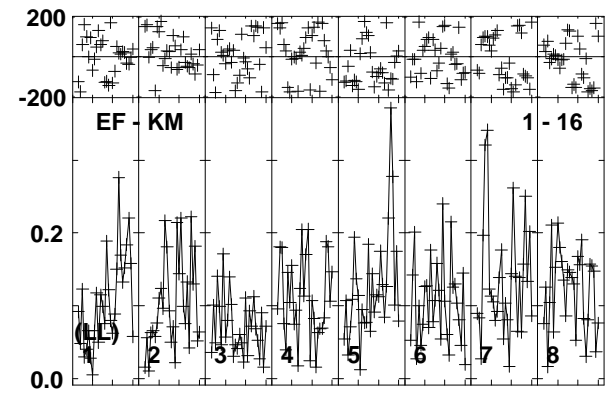
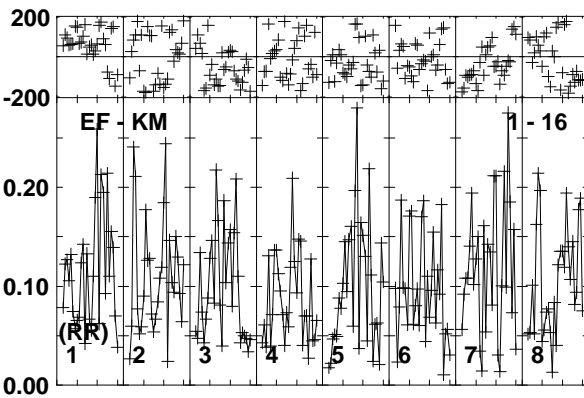
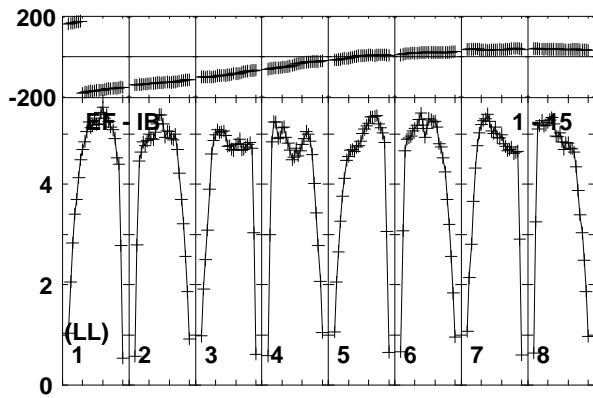
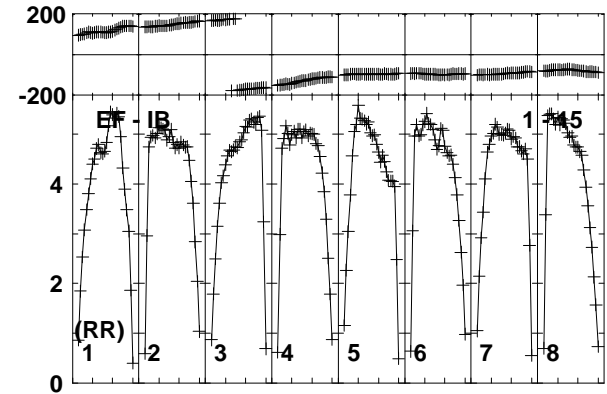
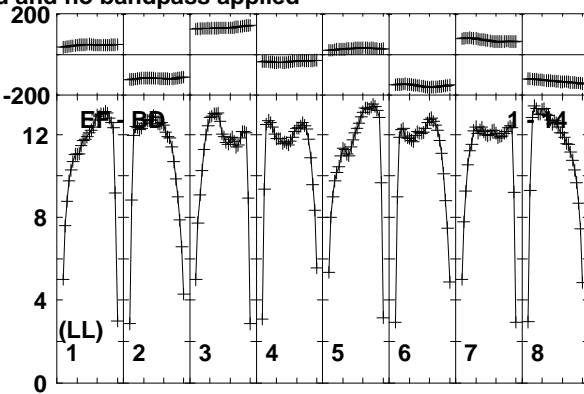
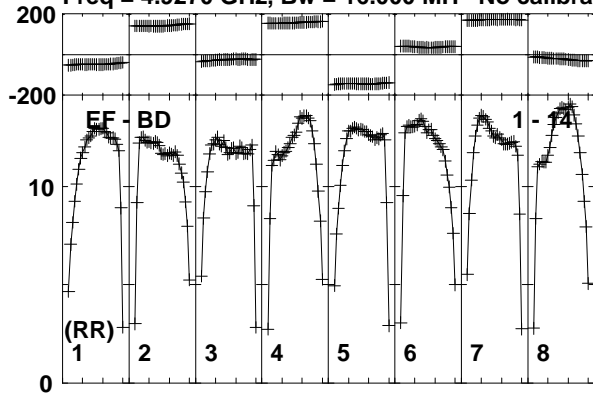

Lower frame: Milli Ampl Jy Top frame: Phas deg  
Vector averaged cross-power spectrum Baseline: EF (01) - BD (14)  
Timerange: 00/04:18:31 to 00/04:19:59

Plot file version 93 created 08-APR-2019 12:09:41

J0815+3635 EM133B.UVDATA.1

Freq = 4.9270 GHz, Bw = 16.000 MH No calibration applied and no bandpass applied

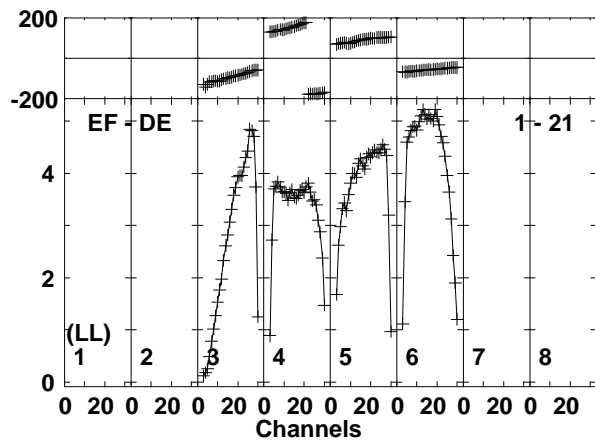
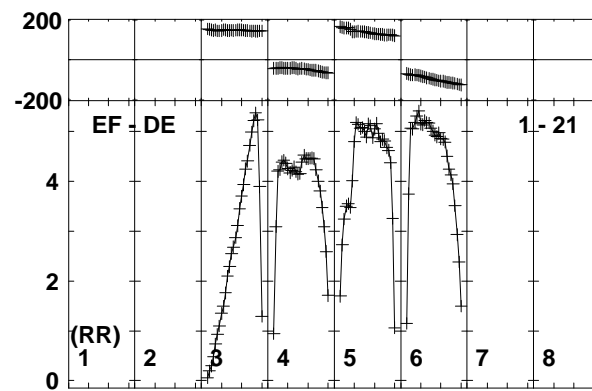
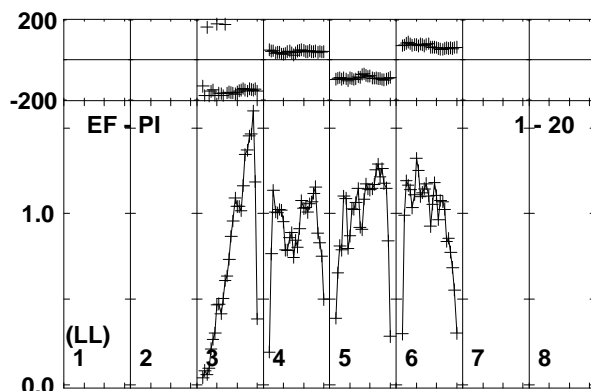
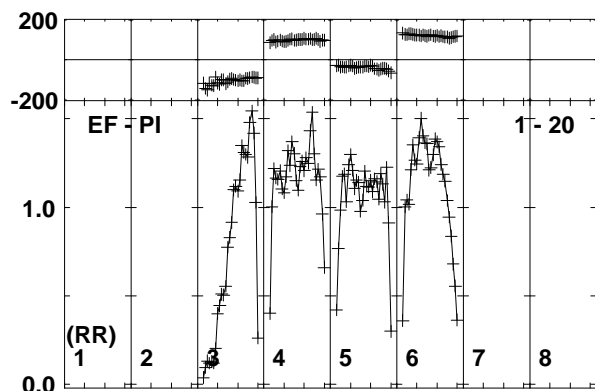
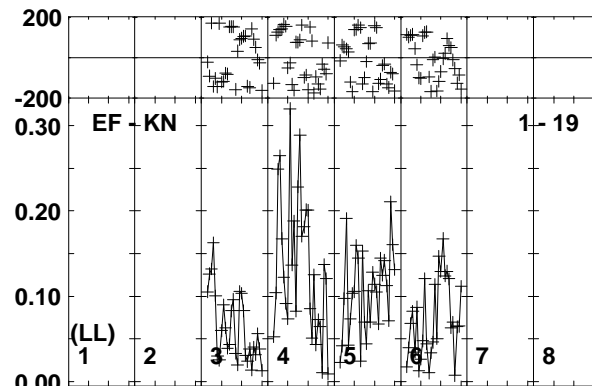
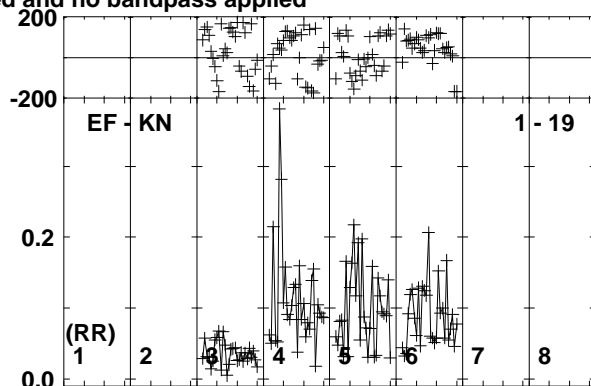
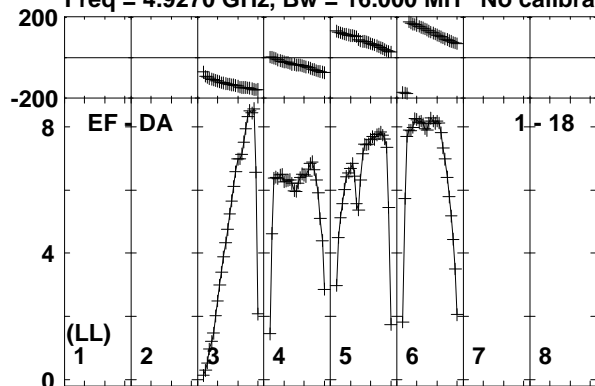

Lower frame: Milli Ampl Jy Top frame: Phas deg  
Vector averaged cross-power spectrum Baseline: EF (01) - DA (18)  
Timerange: 00/04:18:31 to 00/04:19:59

Plot file version 94 created 08-APR-2019 12:09:41

MRK622 EM133B.UVDATA.1

Freq = 4.9270 GHz, Bw = 16.000 MH No calibration applied and no bandpass applied

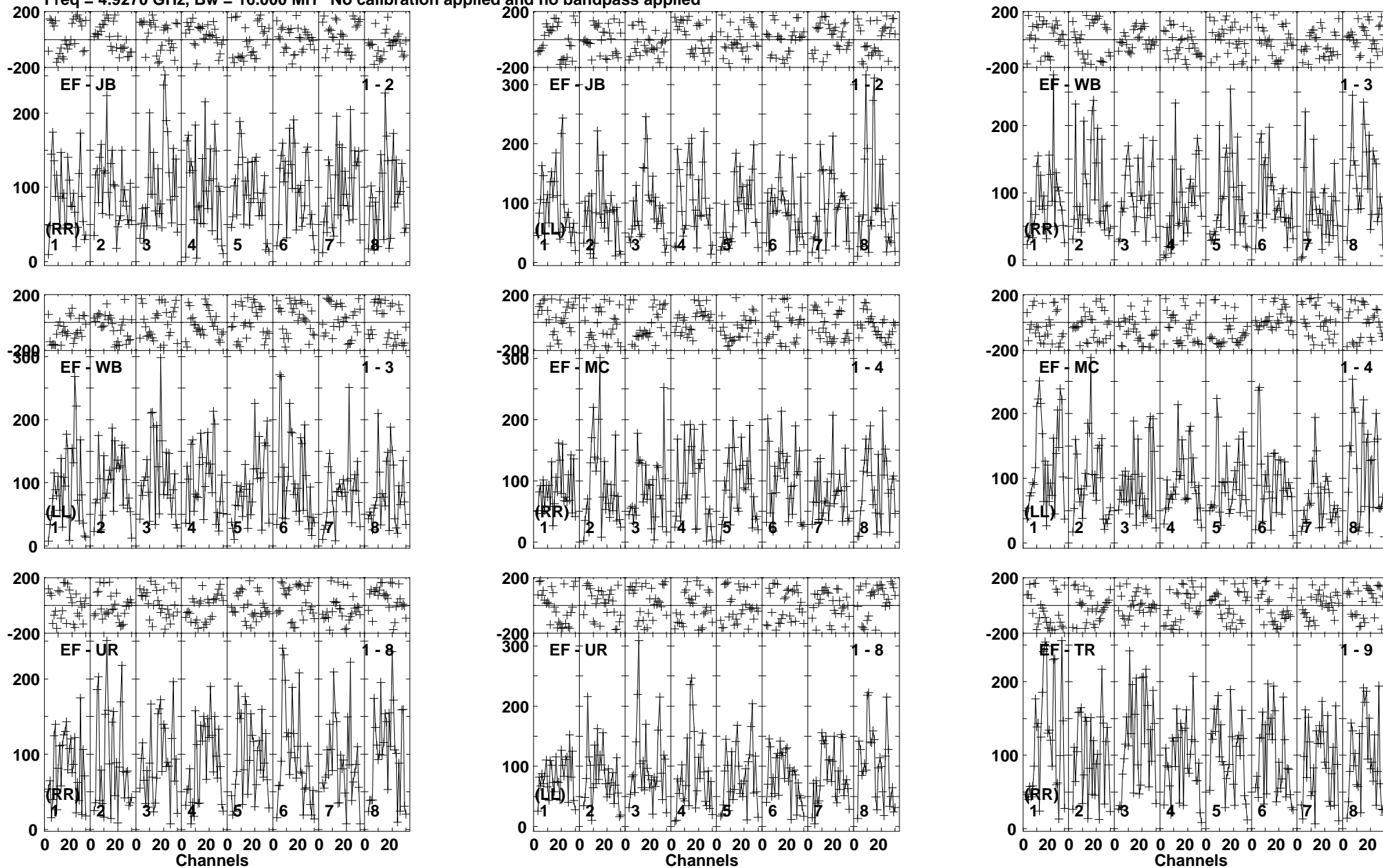

Lower frame: Micro Ampl Jy Top frame: Phas deg  
Vector averaged cross-power spectrum Baseline: EF (01) - JB (02)  
Timerange: 00/04:20:01 to 00/04:23:29

Plot file version 95 created 08-APR-2019 12:09:41

MRK622 EM133B.UVDATA.1

Freq = 4.9270 GHz, Bw = 16.000 MH No calibration applied and no bandpass applied

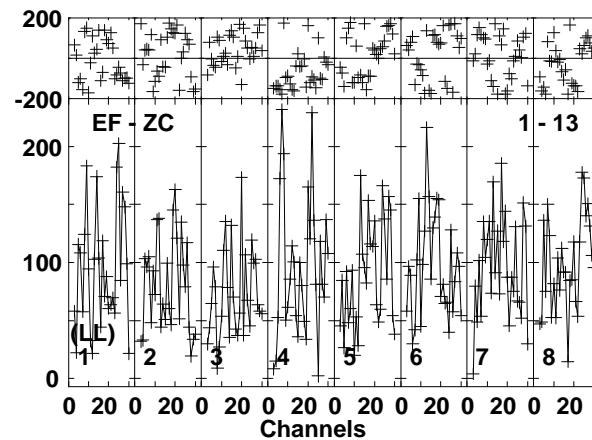
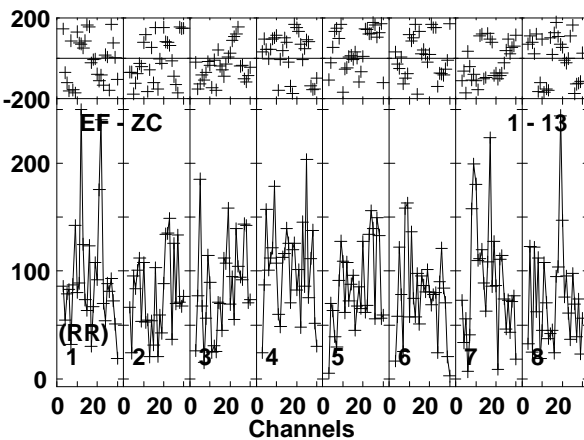
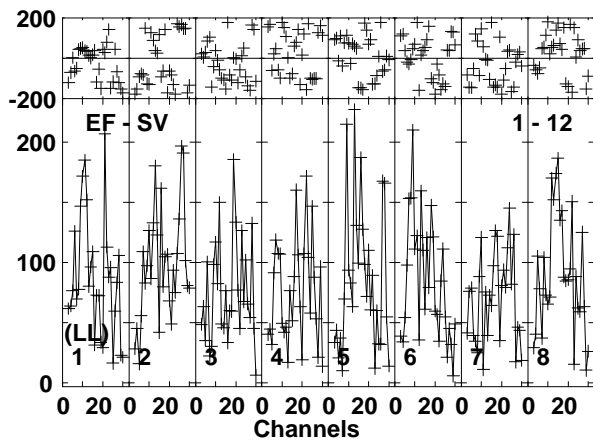
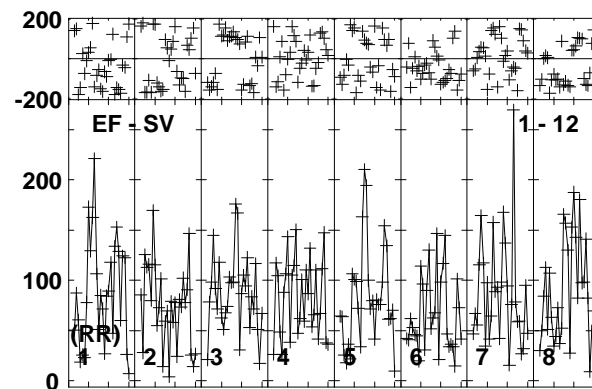
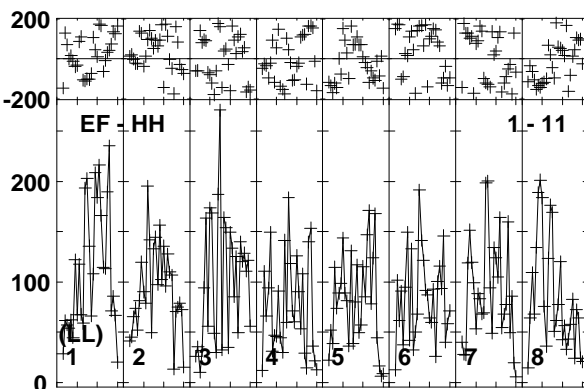
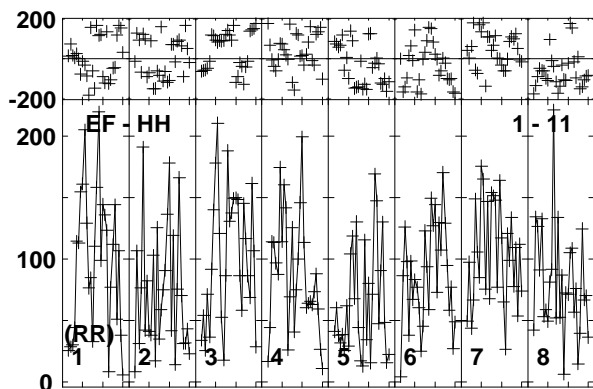
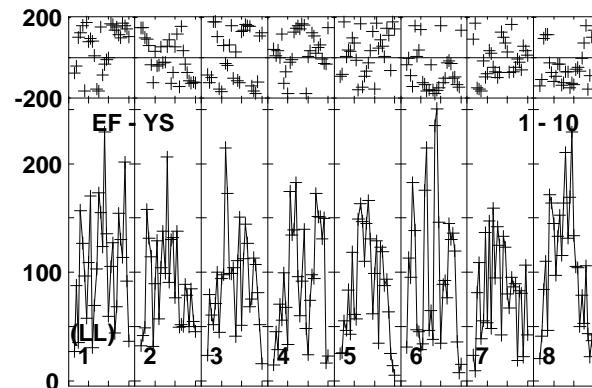
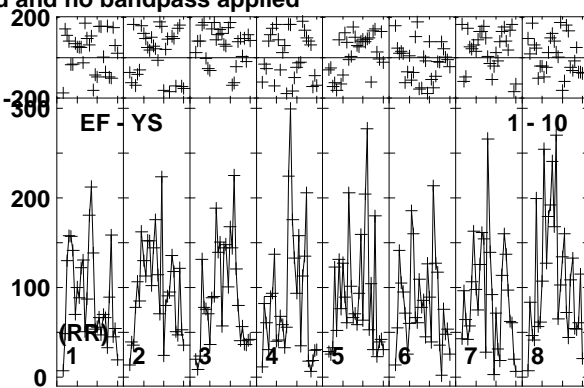
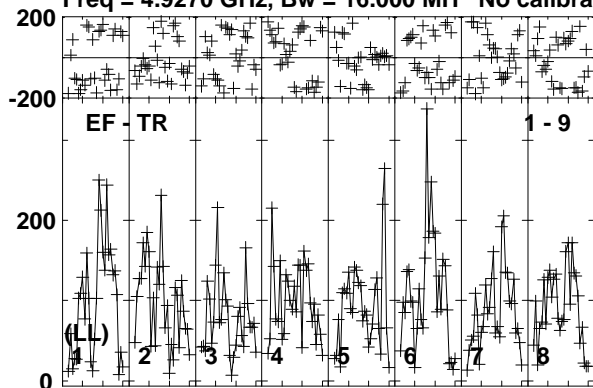

Lower frame: Micro Ampl Jy Top frame: Phas deg  
Vector averaged cross-power spectrum Baseline: EF (01) - TR (09)  
Timerange: 00/04:20:01 to 00/04:23:29

Plot file version 96 created 08-APR-2019 12:09:42

MRK622 EM133B.UVDATA.1

Freq = 4.9270 GHz, Bw = 16.000 MH No calibration applied and no bandpass applied

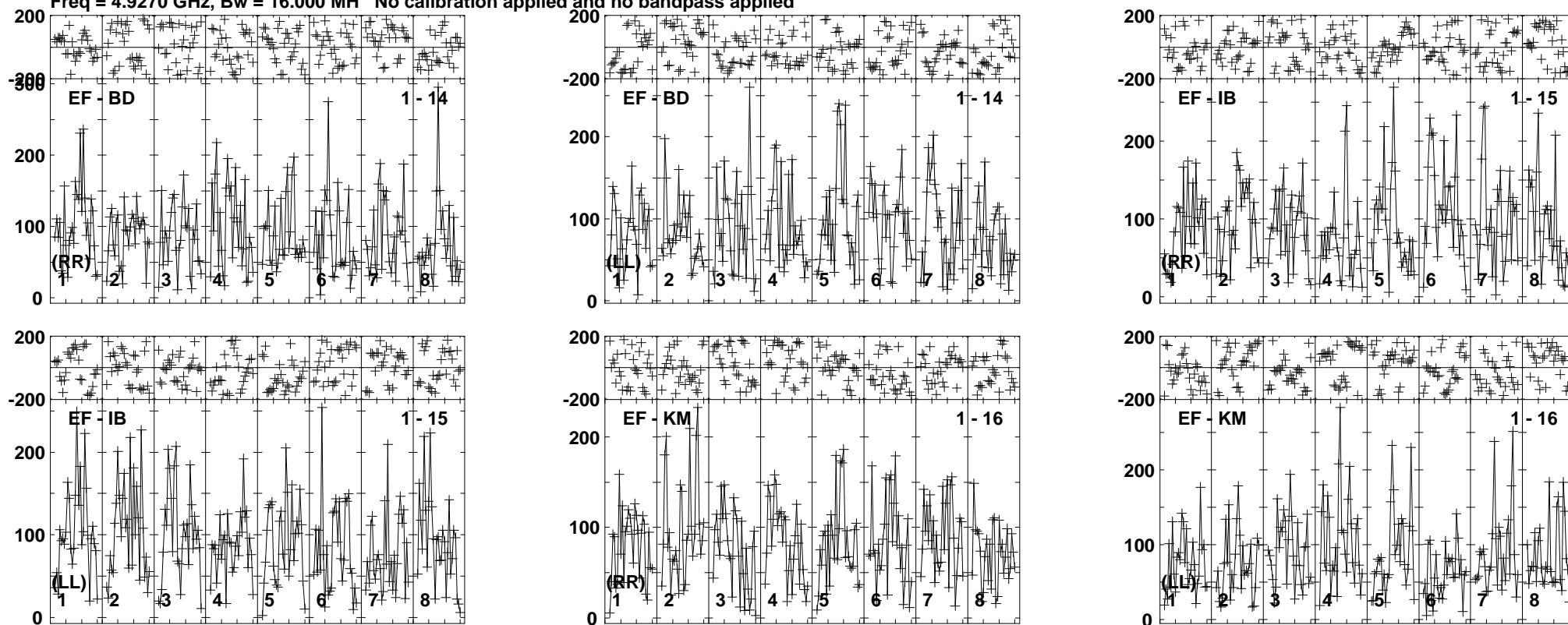

Lower frame: Micro Ampl Jy Top frame: Phas deg  
Vector averaged cross-power spectrum Baseline: EF (01) - BD (14)  
Timerange: 00/04:20:01 to 00/04:23:29



Plot file version 97 created 08-APR-2019 12:09:42

J0815+3635 EM133B.UVDATA.1

Freq = 4.9270 GHz, Bw = 16.000 MH No calibration applied and no bandpass applied

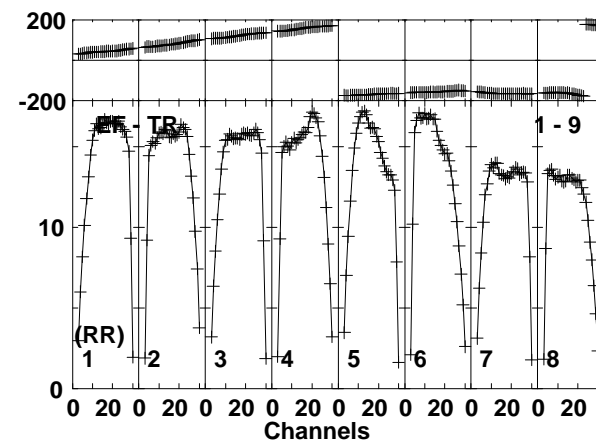
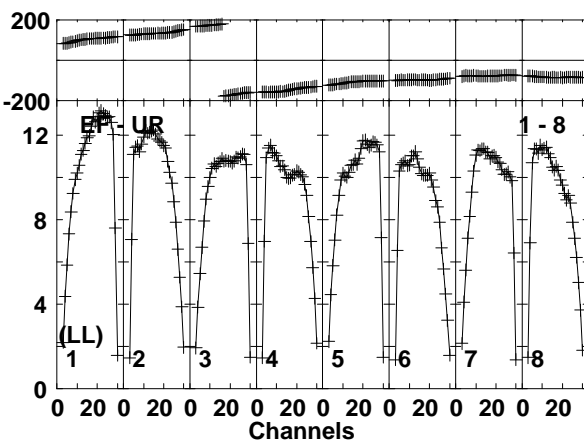
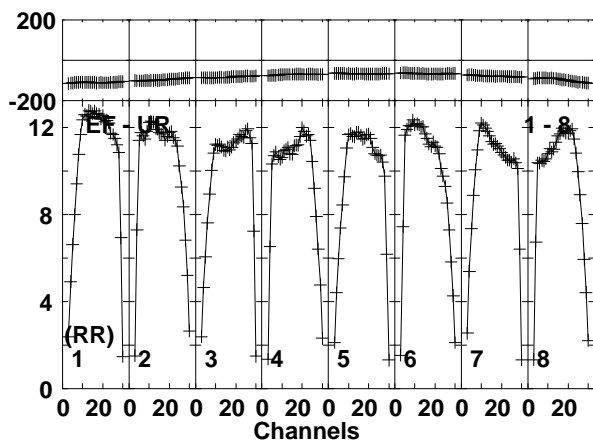
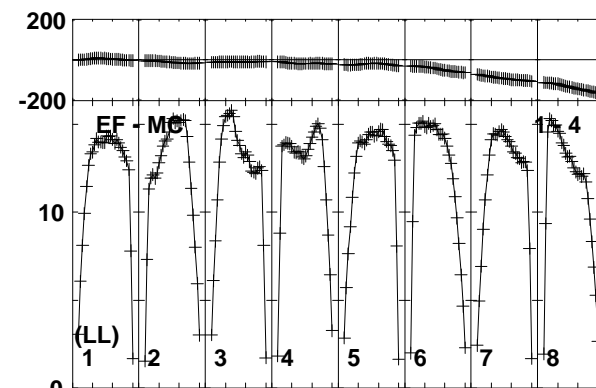
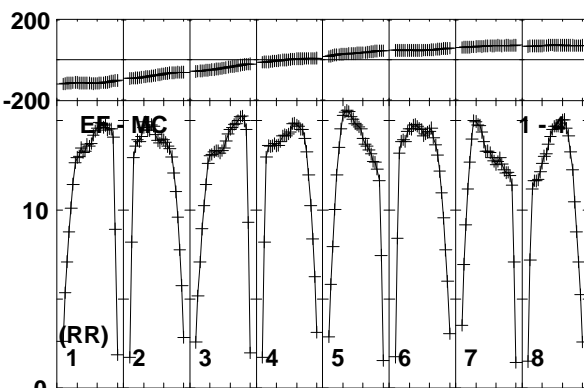
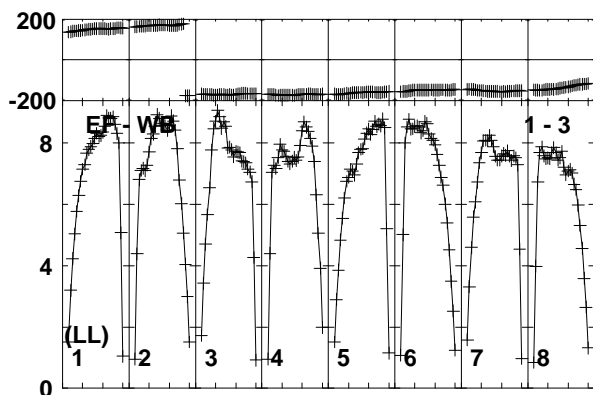
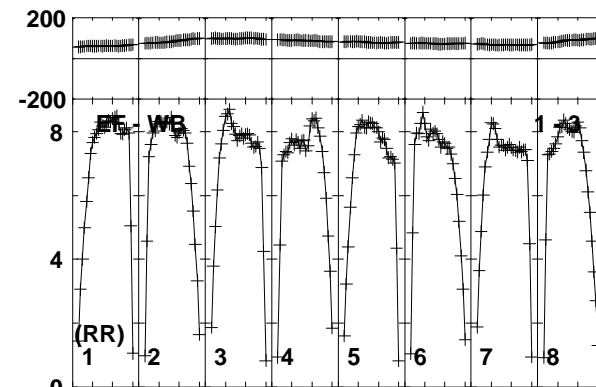
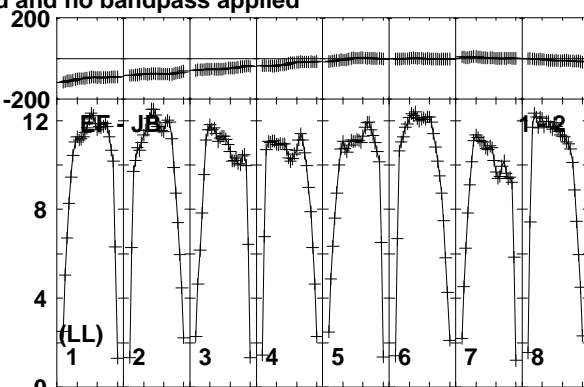
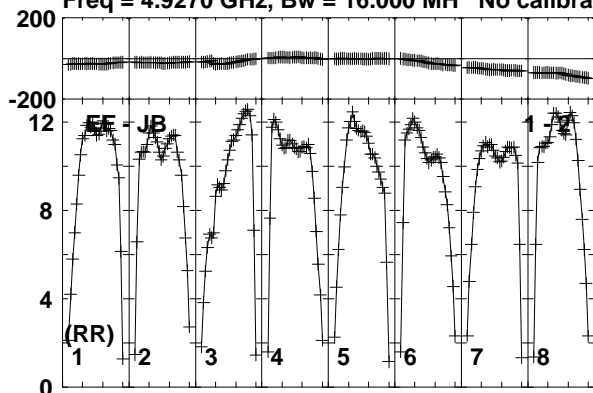

Lower frame: Milli Ampl Jy Top frame: Phas deg  
Vector averaged cross-power spectrum Baseline: EF (01) - JB (02)  
Timerange: 00/04:23:31 to 00/04:24:59

Plot file version 98 created 08-APR-2019 12:09:42

J0815+3635 EM133B.UVDATA.1

Freq = 4.9270 GHz, Bw = 16.000 MH No calibration applied and no bandpass applied

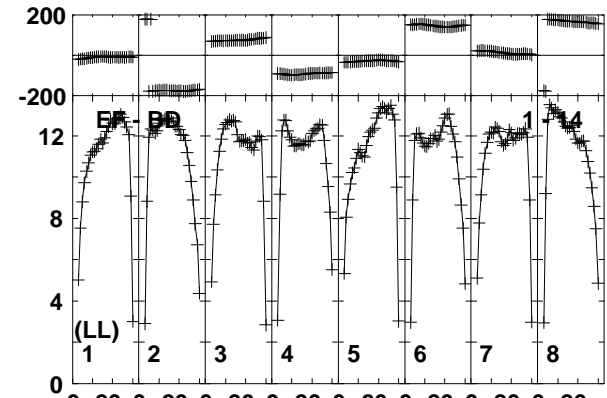
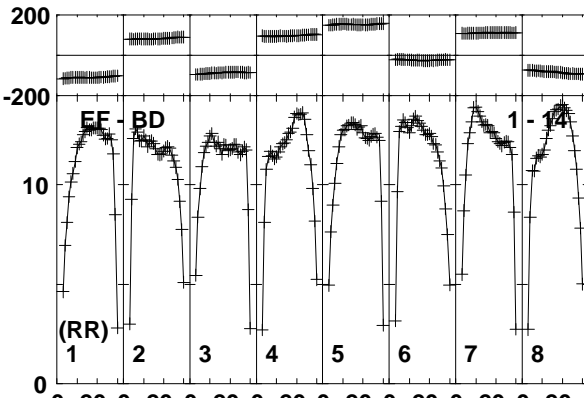
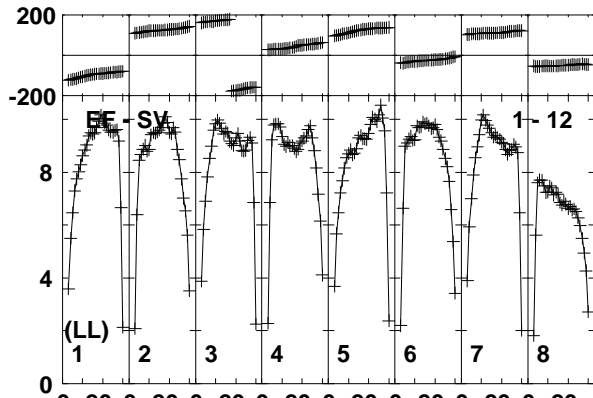
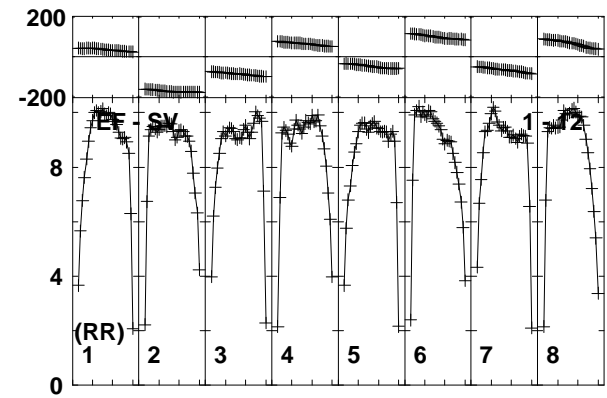
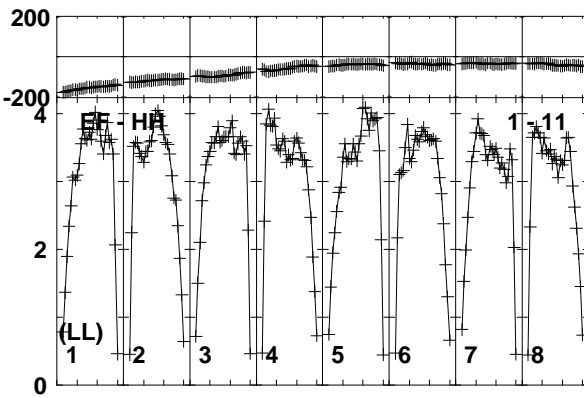
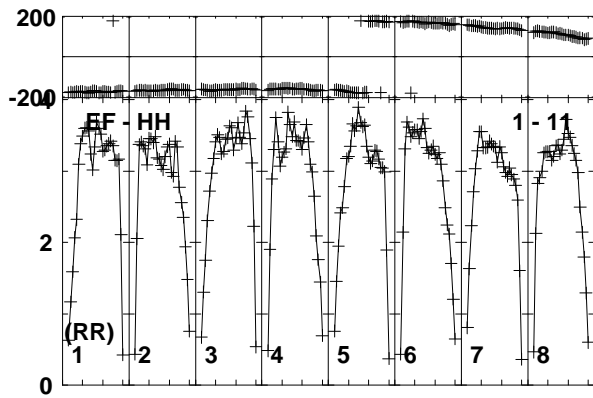
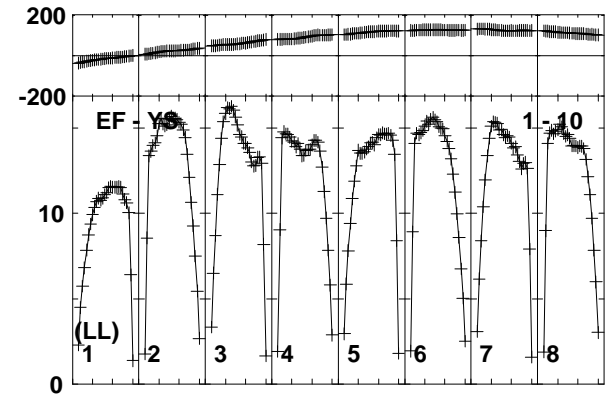
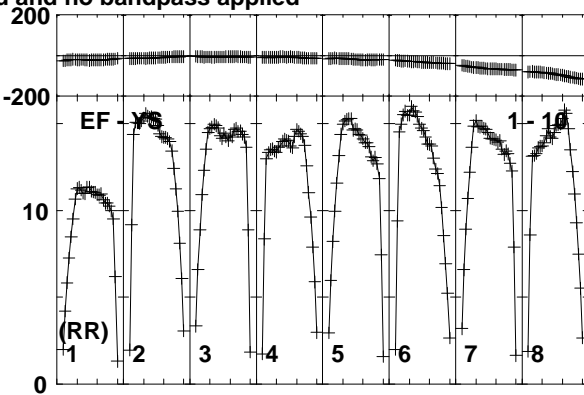
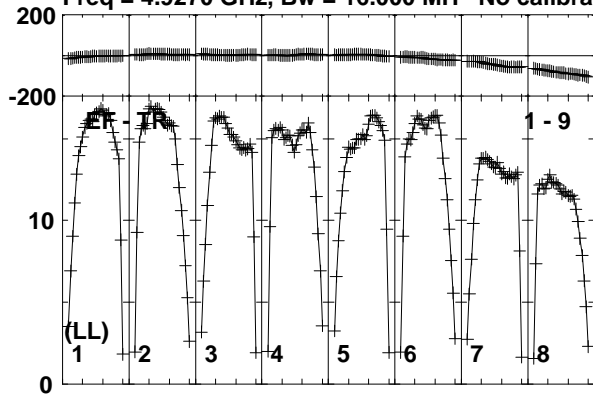

Lower frame: Milli Ampl Jy Top frame: Phas deg  
Vector averaged cross-power spectrum Baseline: EF (01) - TR (09)  
Timerange: 00/04:23:31 to 00/04:24:59

Plot file version 99 created 08-APR-2019 12:09:42

J0815+3635 EM133B.UVDATA.1

Freq = 4.9270 GHz, Bw = 16.000 MH No calibration applied and no bandpass applied

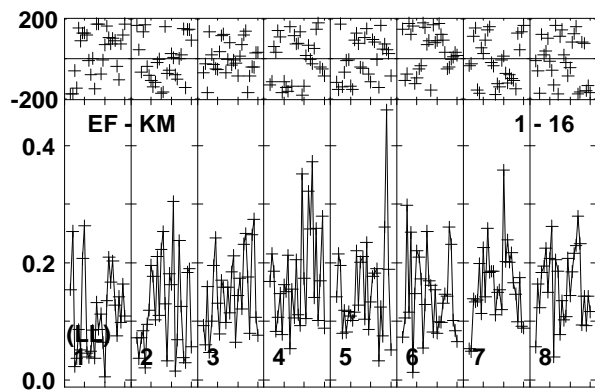
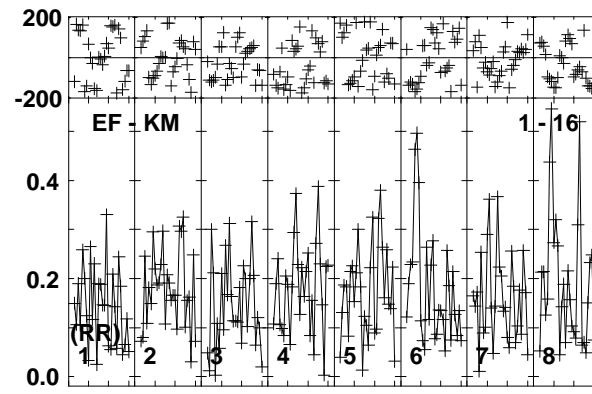
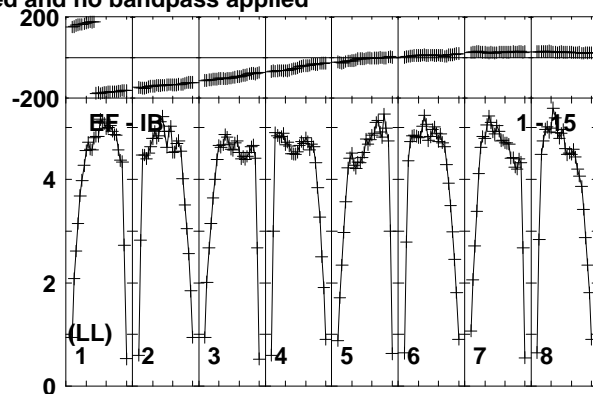
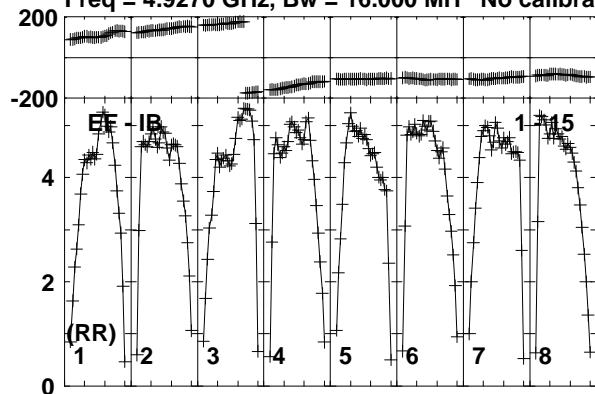

Lower frame: Milli Ampl Jy Top frame: Phas deg  
Vector averaged cross-power spectrum Baseline: EF (01) - IB (15)  
Timerange: 00/04:23:31 to 00/04:24:59

Plot file version 100 created 08-APR-2019 12:09:42

MRK622 EM133B.UVDATA.1

Freq = 4.9270 GHz, Bw = 16.000 MH No calibration applied and no bandpass applied

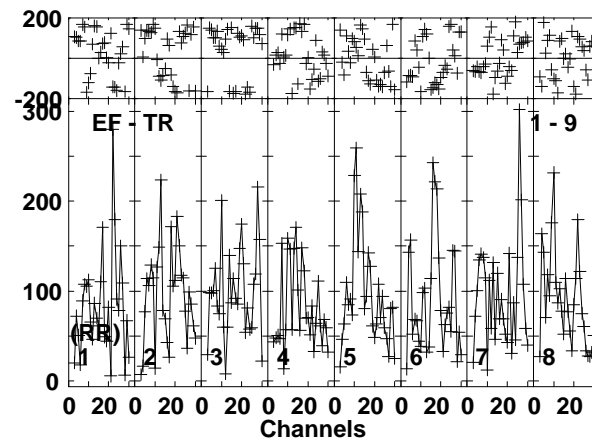
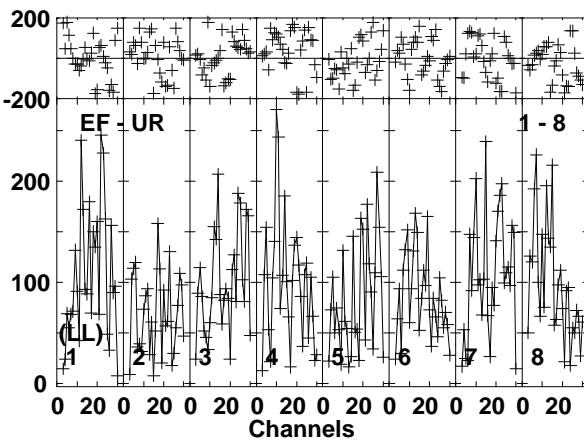
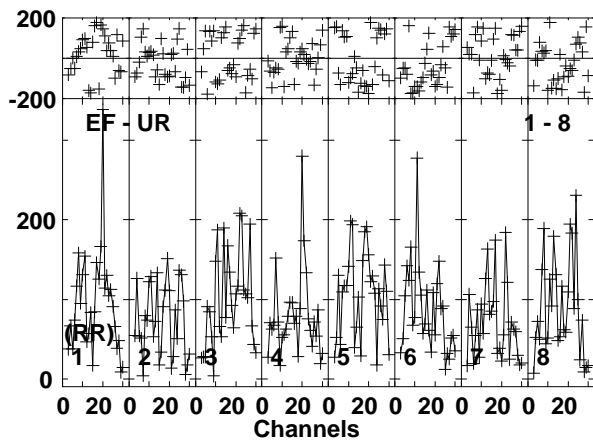
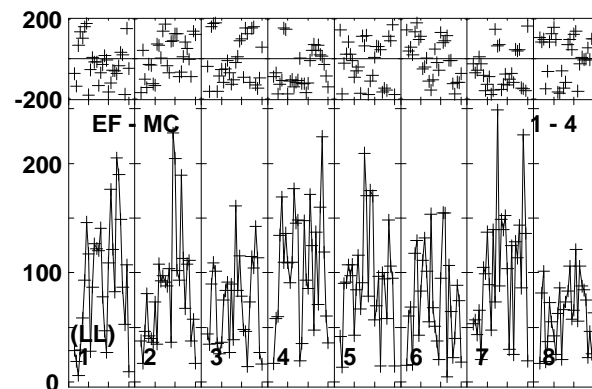
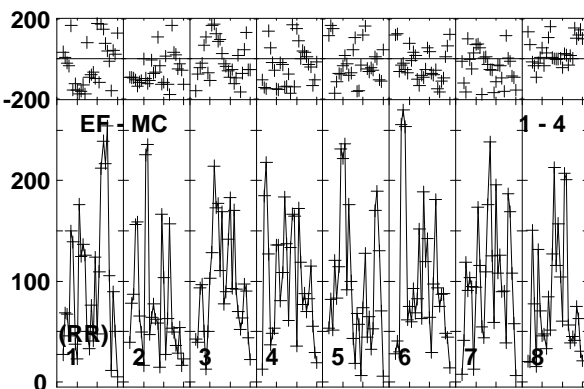
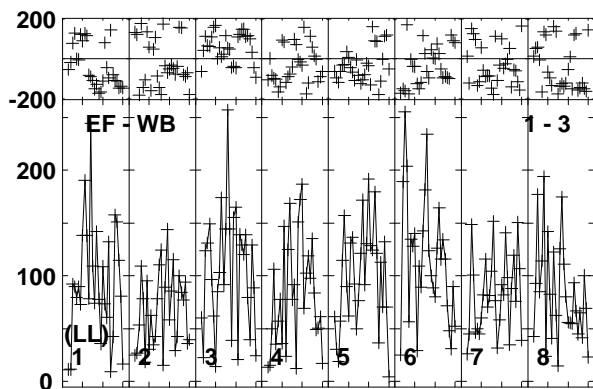
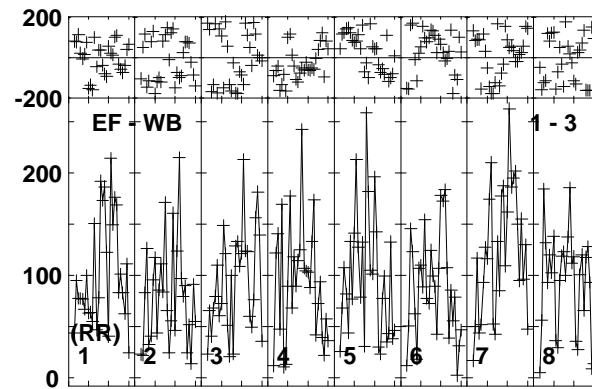
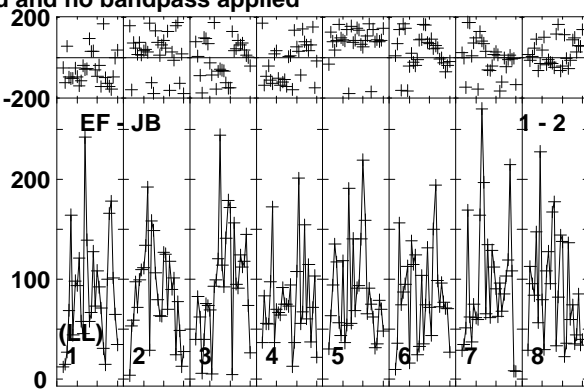
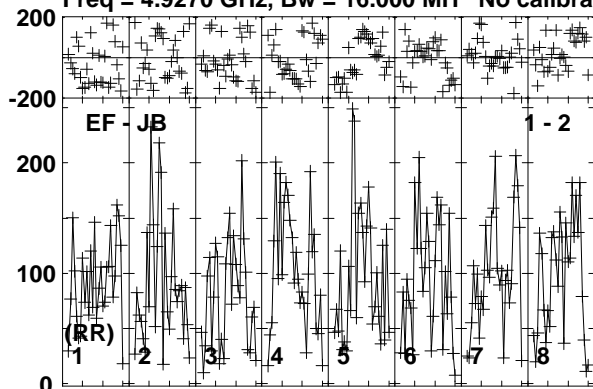

Lower frame: Micro Ampl Jy Top frame: Phas deg  
Vector averaged cross-power spectrum Baseline: EF (01) - JB (02)  
Timerange: 00/04:25:03 to 00/04:28:29

Plot file version 101 created 08-APR-2019 12:09:42

MRK622 EM133B.UVDATA.1

Freq = 4.9270 GHz, Bw = 16.000 MH No calibration applied and no bandpass applied

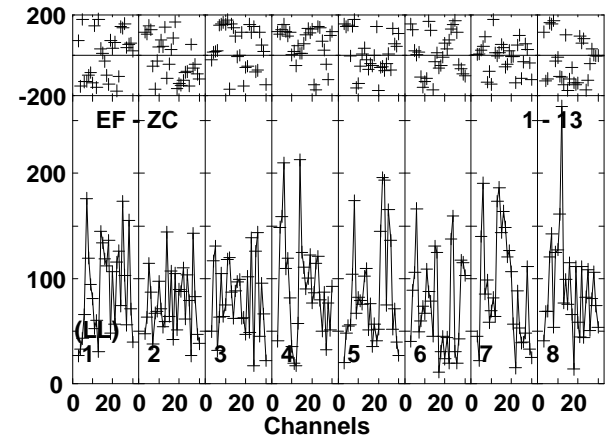
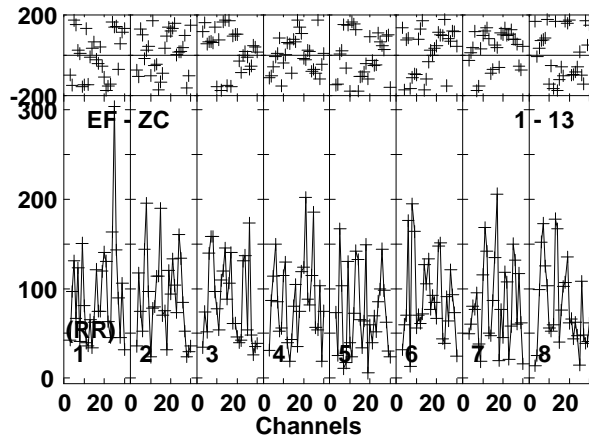
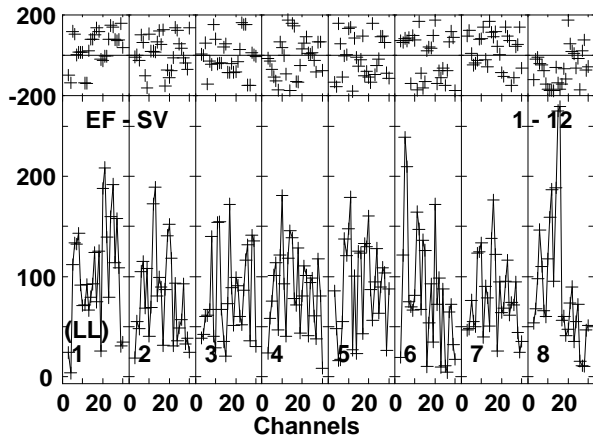
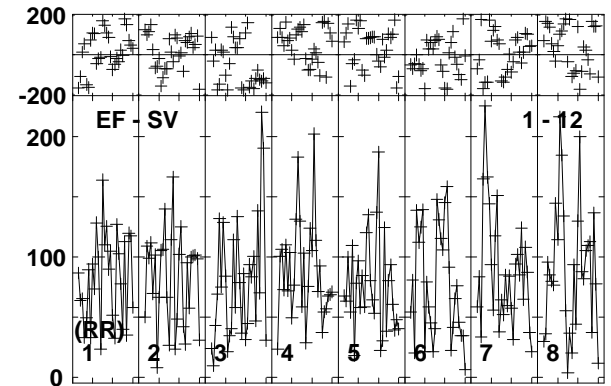
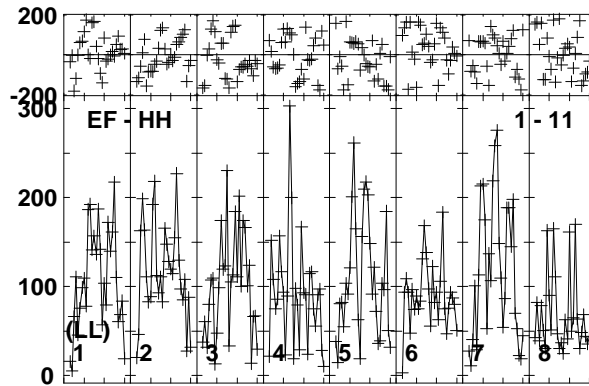
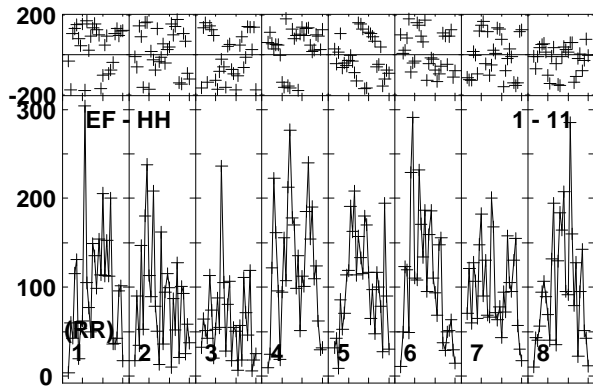
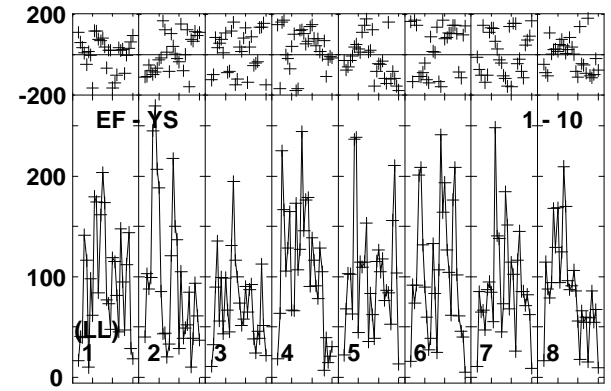
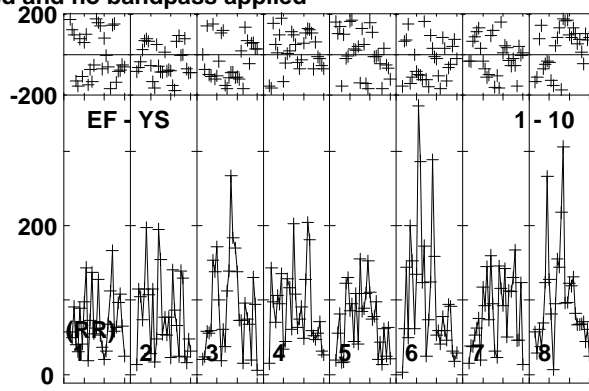
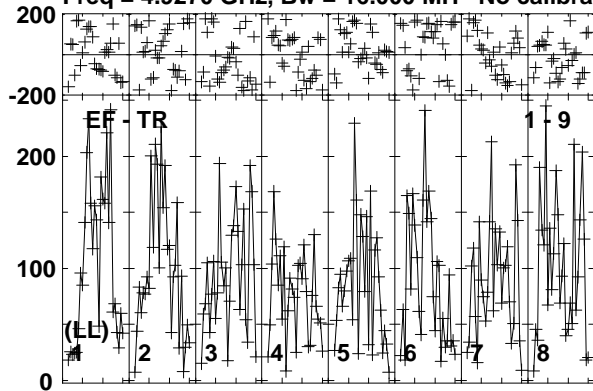

Lower frame: Micro Ampl Jy Top frame: Phas deg  
Vector averaged cross-power spectrum Baseline: EF (01) - TR (09)  
Timerange: 00/04:25:03 to 00/04:28:29

Plot file version 102 created 08-APR-2019 12:09:43

MRK622 EM133B.UVDATA.1

Freq = 4.9270 GHz, Bw = 16.000 MH No calibration applied and no bandpass applied

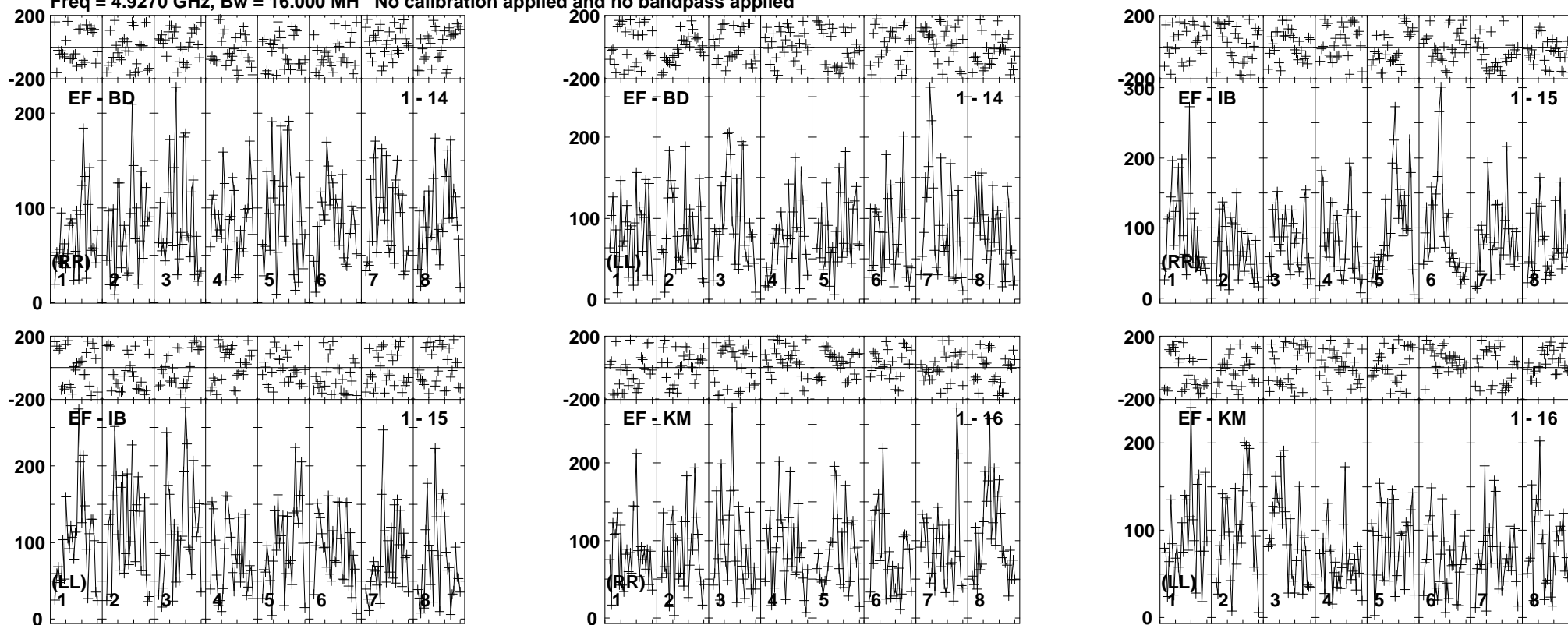

Lower frame: Micro Ampl Jy Top frame: Phas deg  
Vector averaged cross-power spectrum Baseline: EF (01) - BD (14)  
Timerange: 00/04:25:03 to 00/04:28:29

Plot file version 103 created 08-APR-2019 12:09:43

J0815+3635 EM133B.UVDATA.1

Freq = 4.9270 GHz, Bw = 16.000 MH No calibration applied and no bandpass applied

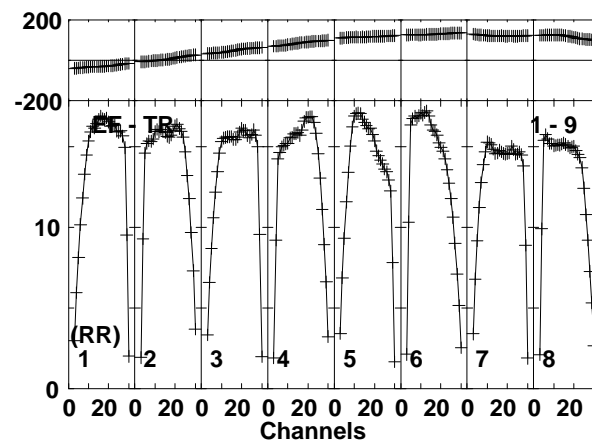
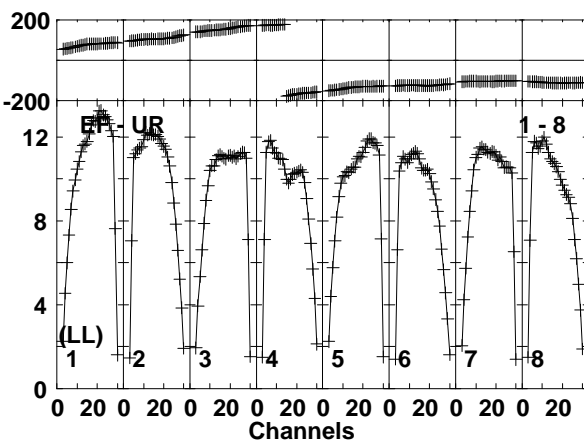
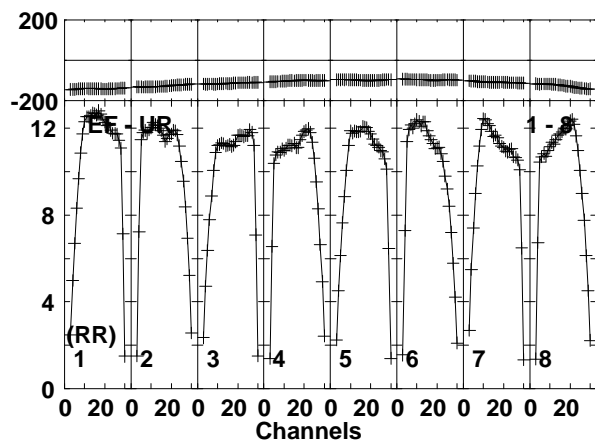
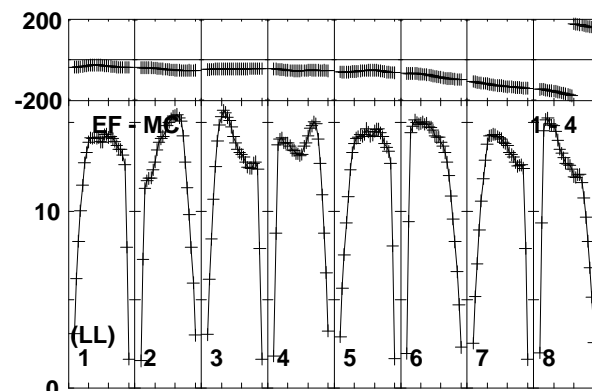
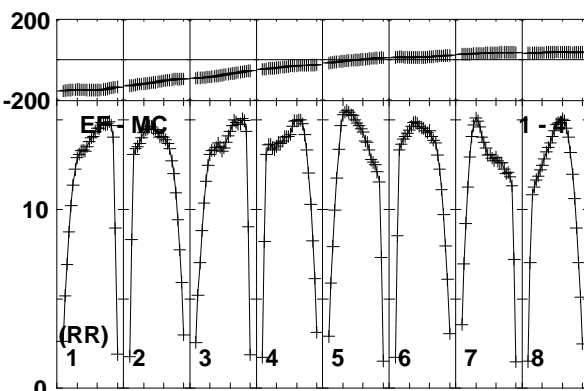
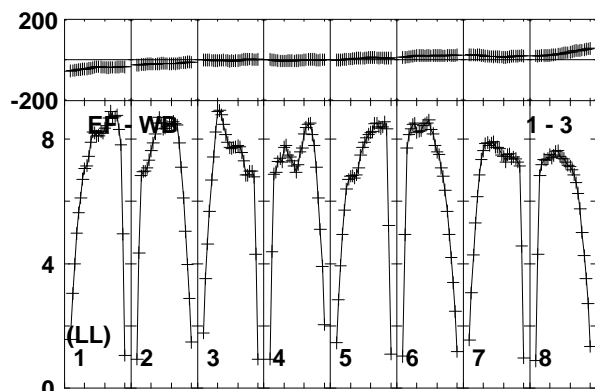
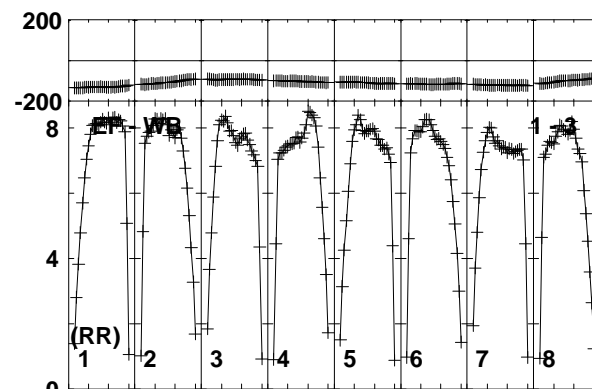
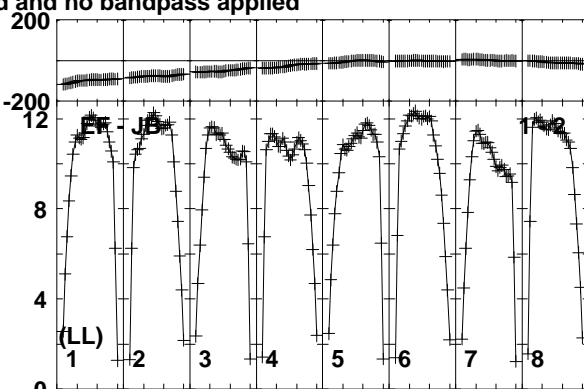
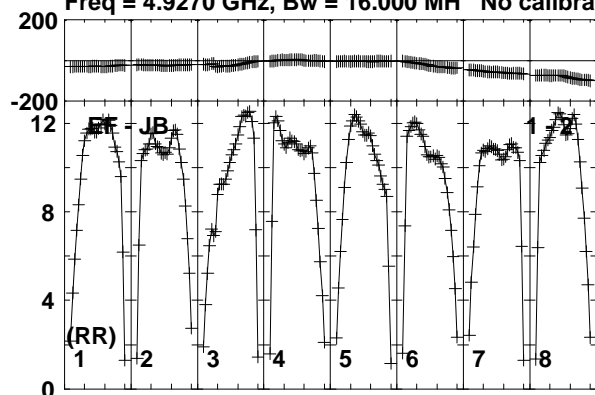

Lower frame: Milli Ampl Jy Top frame: Phas deg  
Vector averaged cross-power spectrum Baseline: EF (01) - JB (02)  
Timerange: 00/04:29:21 to 00/04:30:49

Plot file version 104 created 08-APR-2019 12:09:43

J0815+3635 EM133B.UVDATA.1

Freq = 4.9270 GHz, Bw = 16.000 MH No calibration applied and no bandpass applied

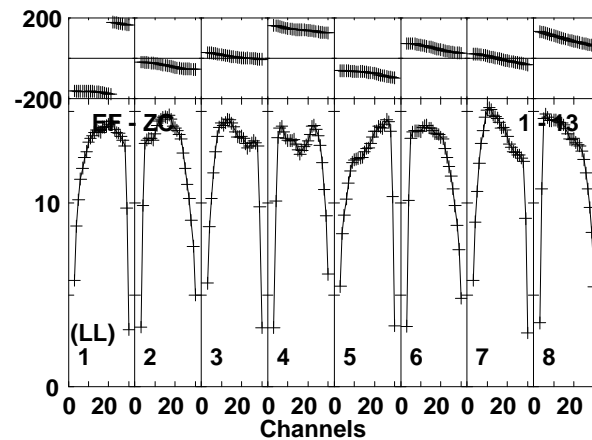
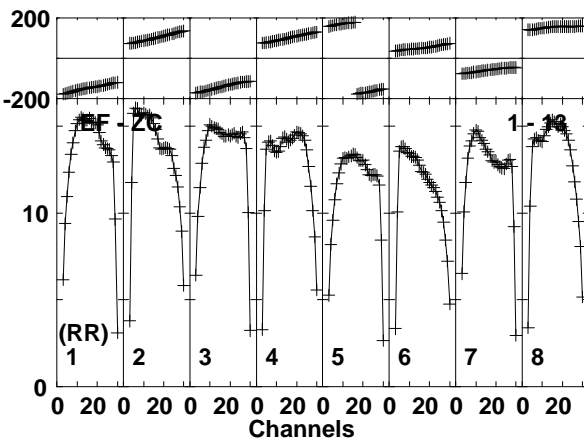
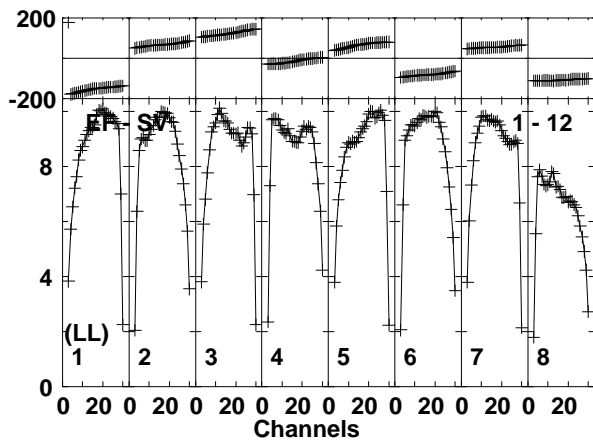
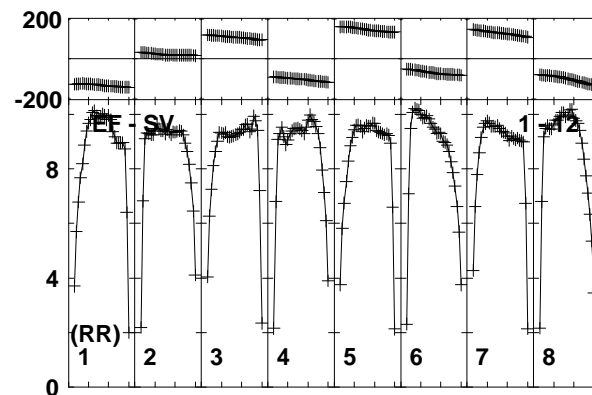
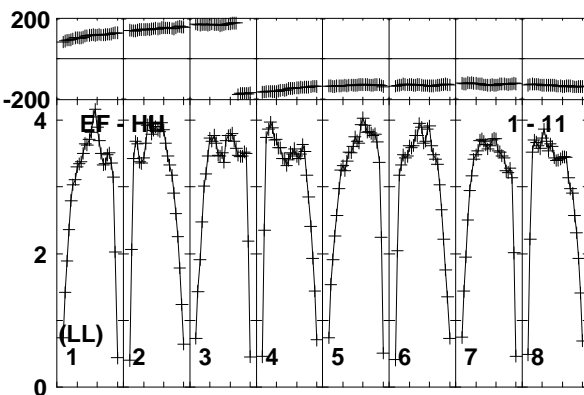
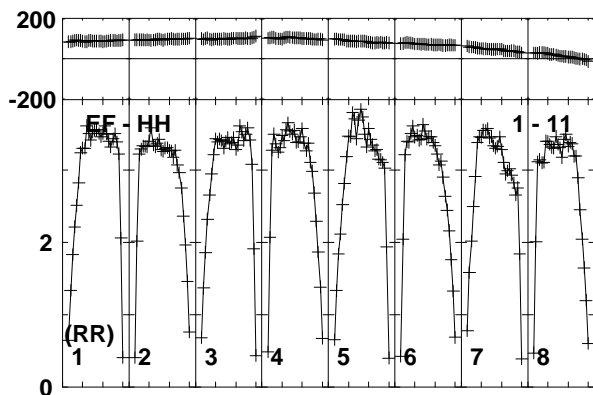
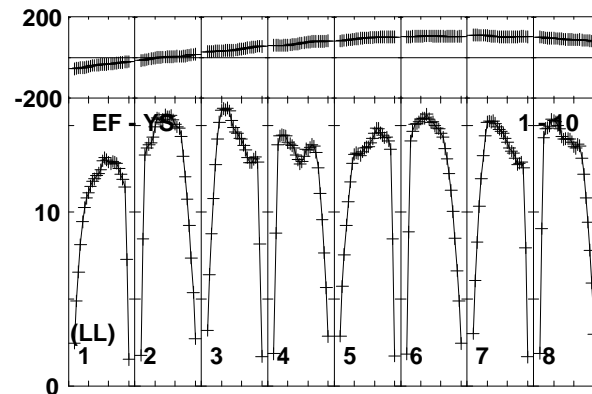
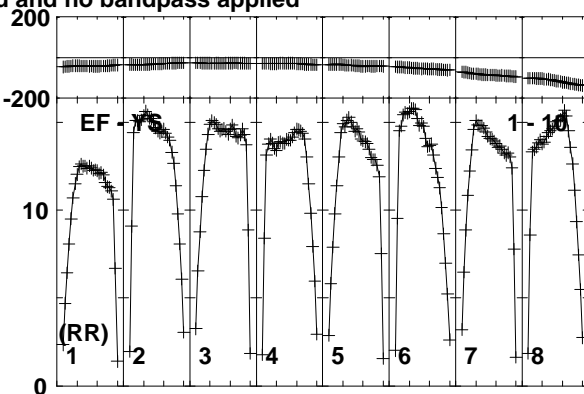
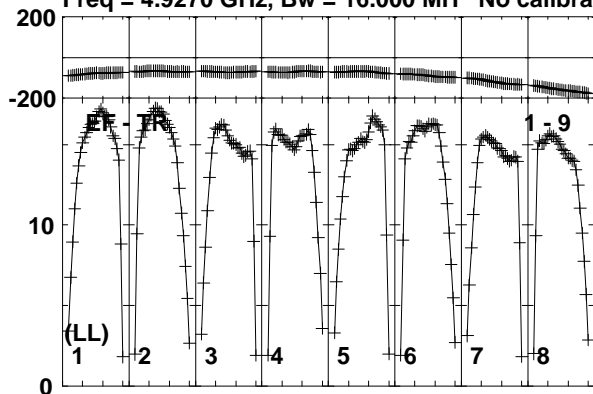

Lower frame: Milli Ampl Jy Top frame: Phas deg  
Vector averaged cross-power spectrum Baseline: EF (01) - TR (09)  
Timerange: 00/04:29:21 to 00/04:30:49



Plot file version 105 created 08-APR-2019 12:09:43

J0815+3635 EM133B.UVDATA.1

Freq = 4.9270 GHz, Bw = 16.000 MH No calibration applied and no bandpass applied

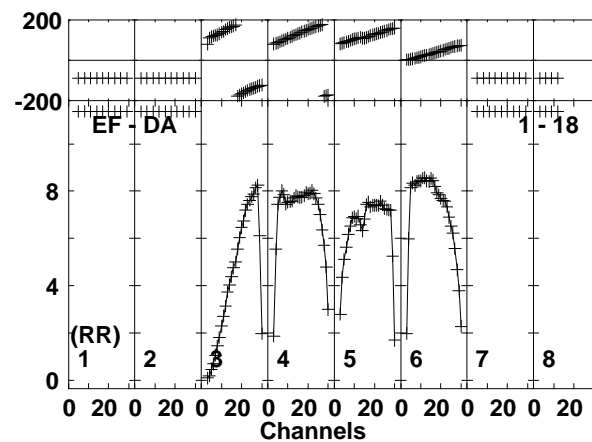
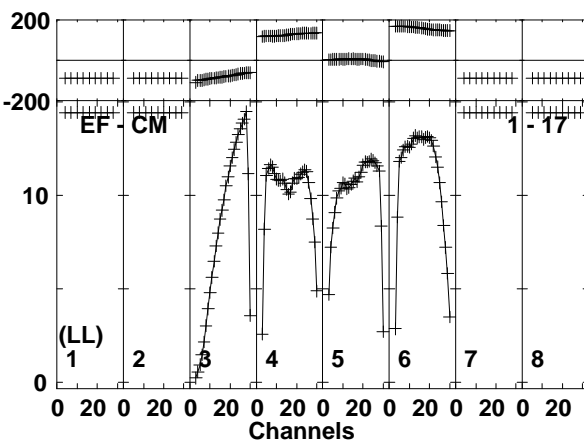
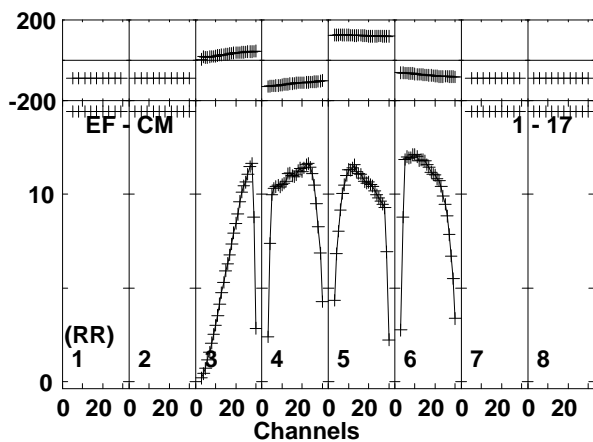
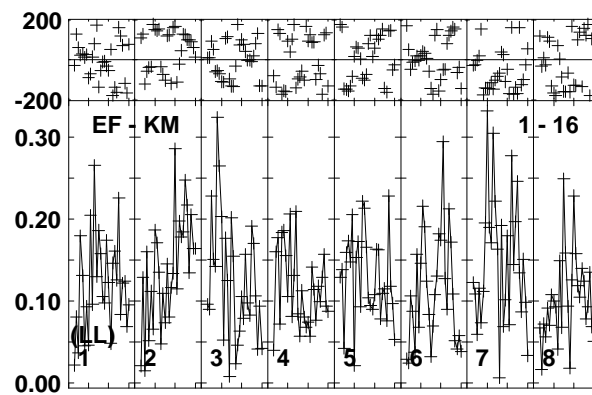
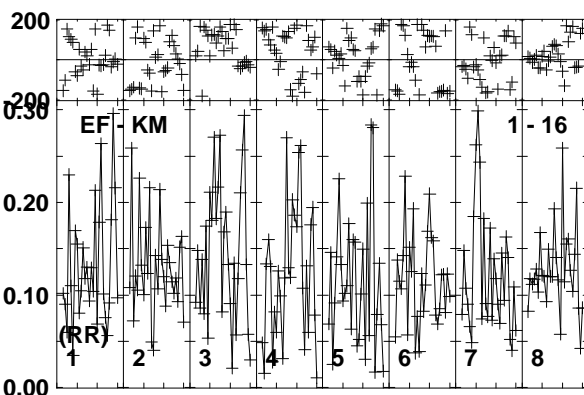
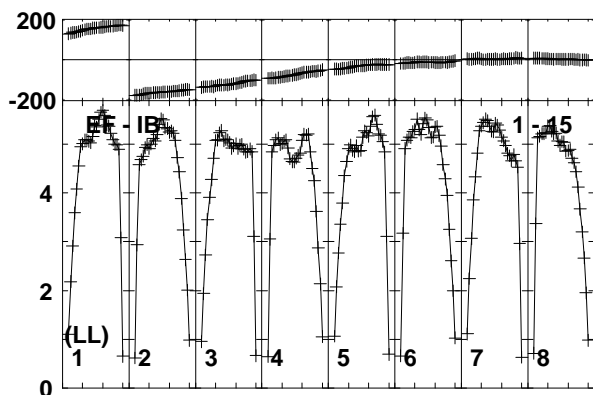
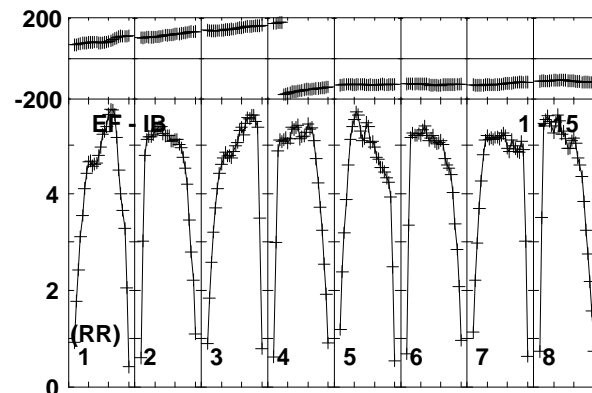
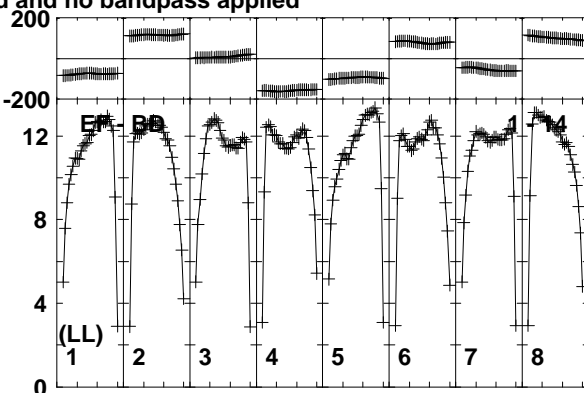
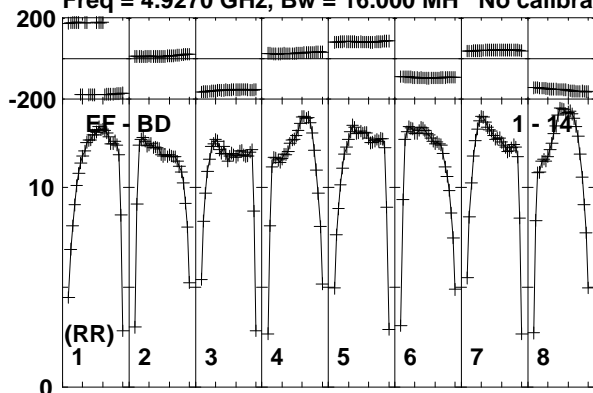

Lower frame: Milli Ampl Jy Top frame: Phas deg  
Vector averaged cross-power spectrum Baseline: EF (01) - BD (14)  
Timerange: 00/04:29:21 to 00/04:30:49

Plot file version 106 created 08-APR-2019 12:09:43

J0815+3635 EM133B.UVDATA.1

Freq = 4.9270 GHz, Bw = 16.000 MH No calibration applied and no bandpass applied

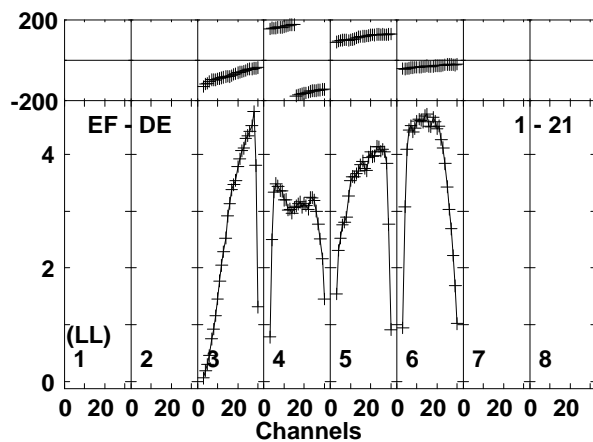
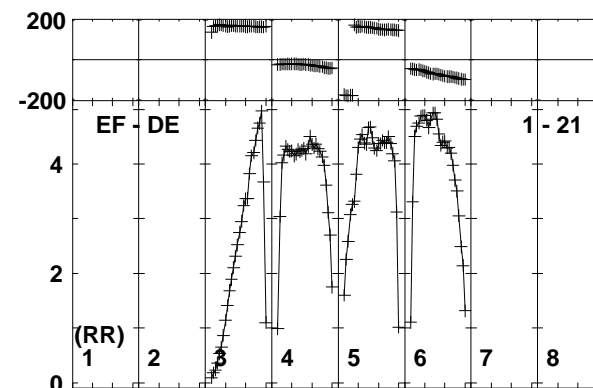
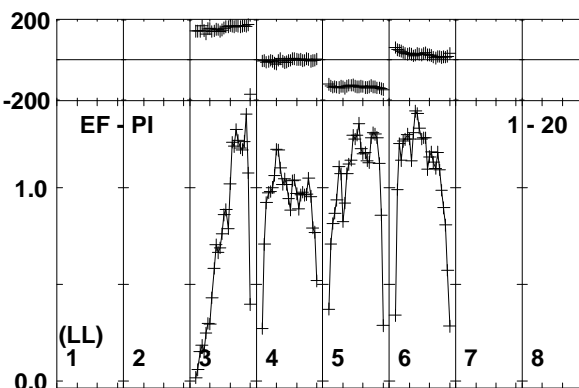
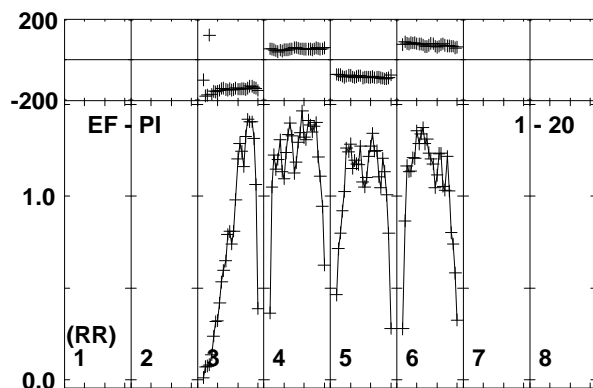
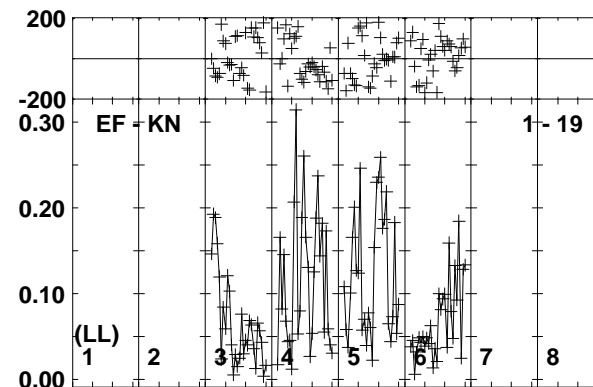
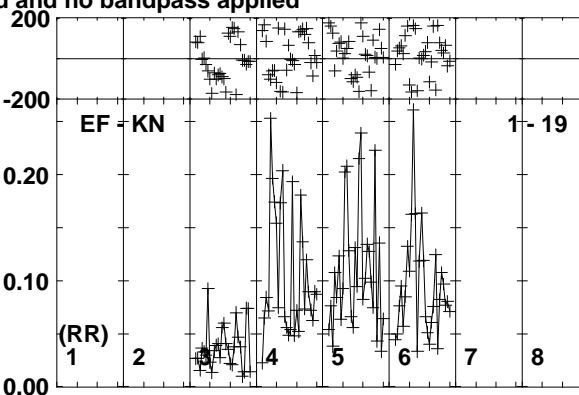
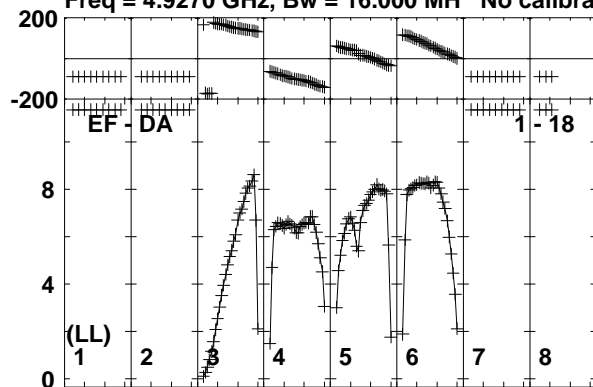

Lower frame: Milli Ampl Jy Top frame: Phas deg  
Vector averaged cross-power spectrum Baseline: EF (01) - DA (18)  
Timerange: 00/04:29:21 to 00/04:30:49

Plot file version 107 created 08-APR-2019 12:09:43

MRK622 EM133B.UVDATA.1

Freq = 4.9270 GHz, Bw = 16.000 MH No calibration applied and no bandpass applied

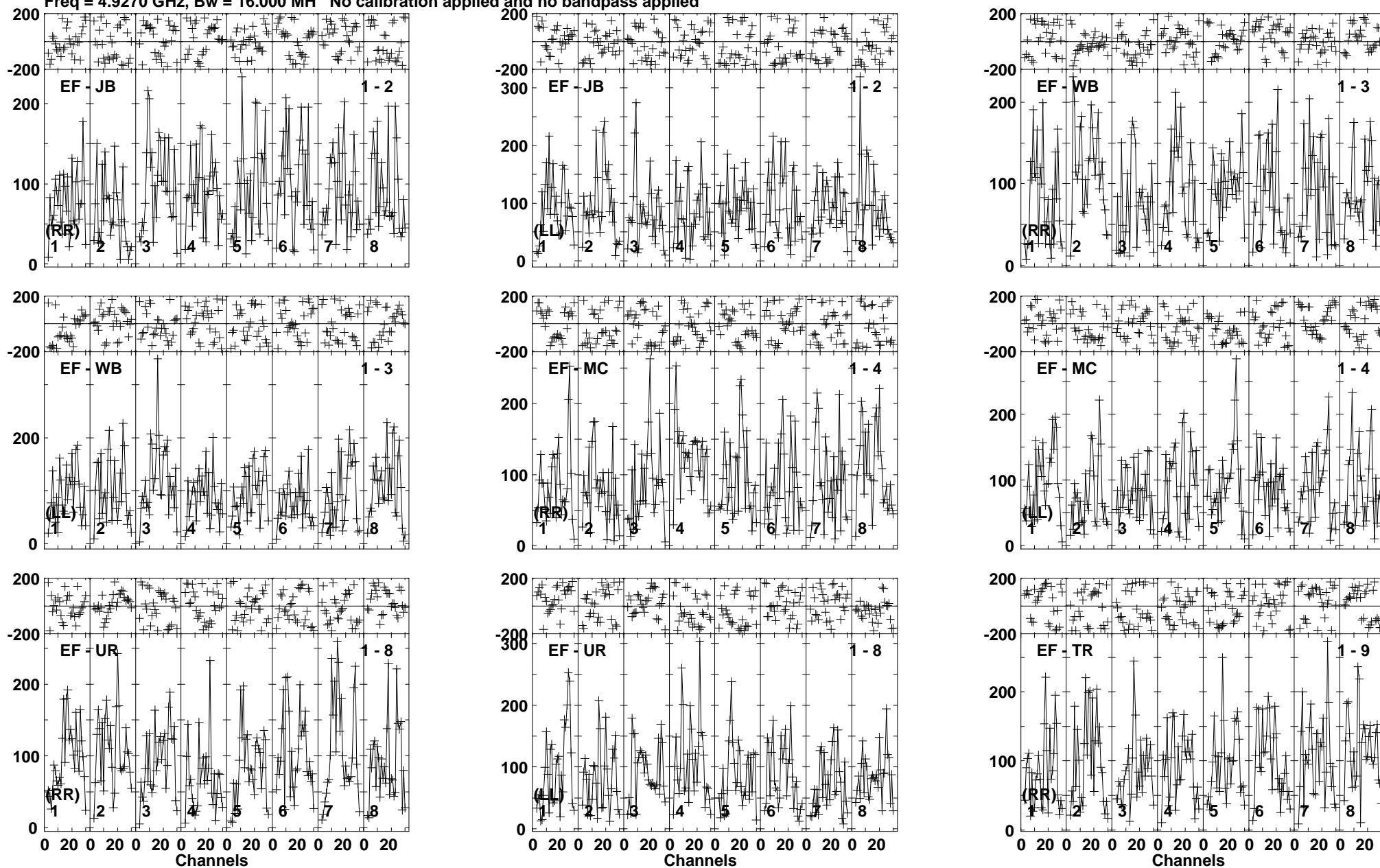

Lower frame: Micro Ampl Jy Top frame: Phas deg  
Vector averaged cross-power spectrum Baseline: EF (01) - JB (02)  
Timerange: 00/04:30:51 to 00/04:34:19

Plot file version 108 created 08-APR-2019 12:09:43

MRK622 EM133B.UVDATA.1

Freq = 4.9270 GHz, Bw = 16.000 MH No calibration applied and no bandpass applied

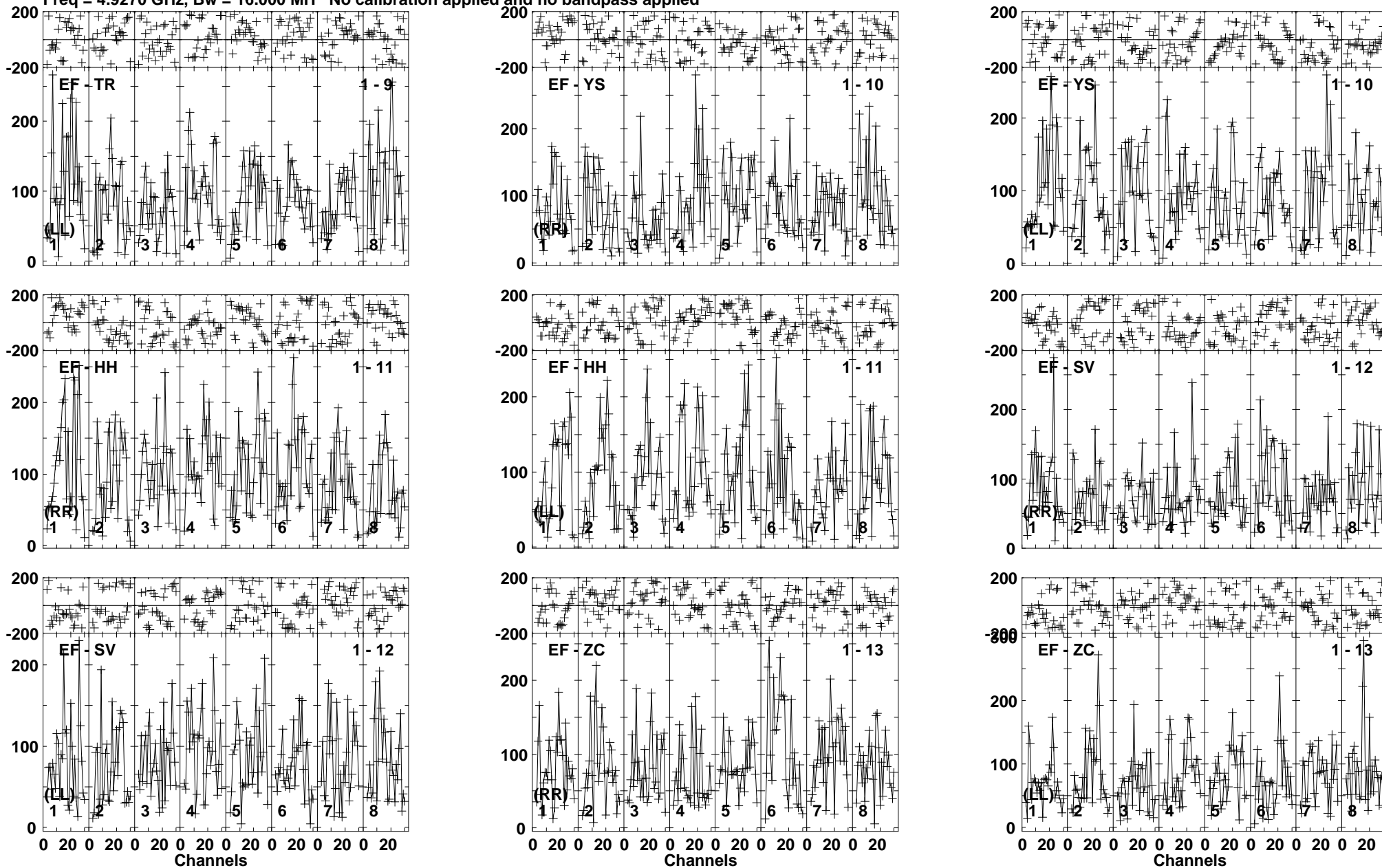

Lower frame: Micro Ampl Jy Top frame: Phas deg  
Vector averaged cross-power spectrum Baseline: EF (01) - TR (09)  
Timerange: 00/04:30:51 to 00/04:34:19

Plot file version 109 created 08-APR-2019 12:09:44

MRK622 EM133B.UVDATA.1

Freq = 4.9270 GHz, Bw = 16.000 MH No calibration applied and no bandpass applied

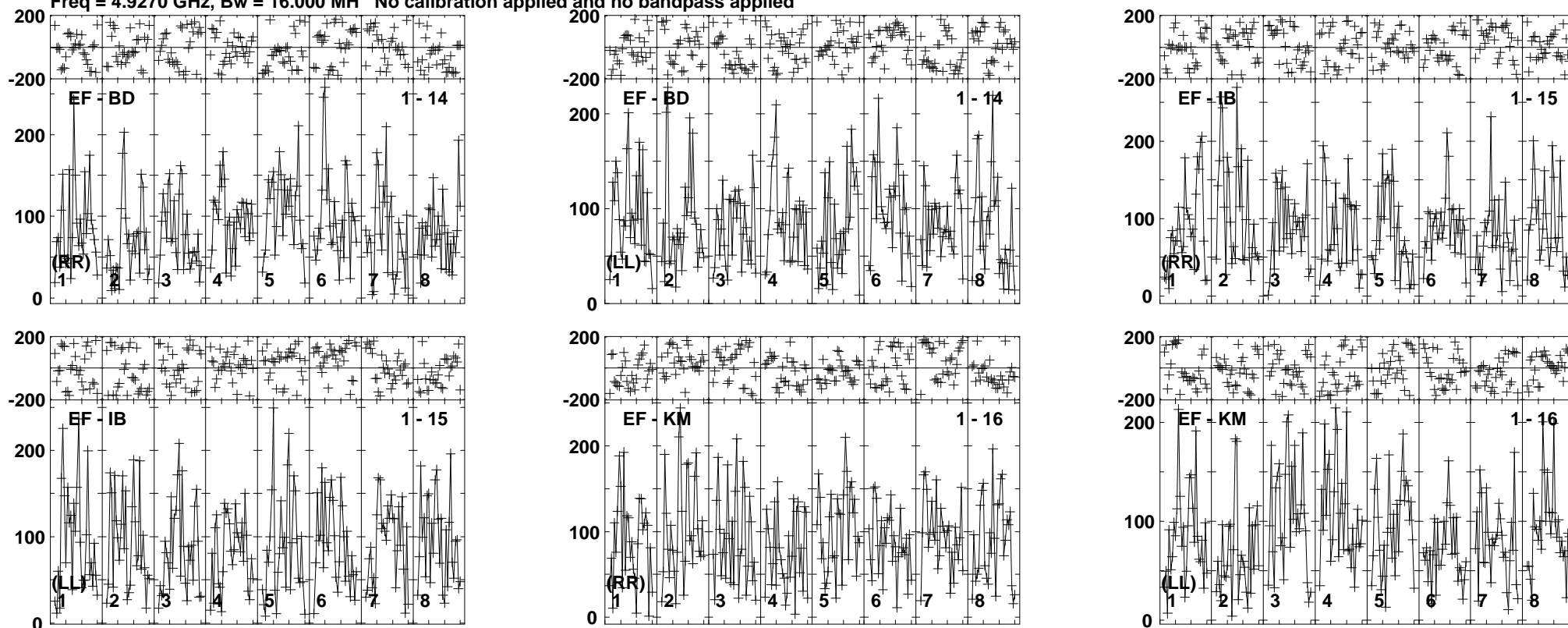

Lower frame: Micro Ampl Jy Top frame: Phas deg  
Vector averaged cross-power spectrum Baseline: EF (01) - BD (14)  
Timerange: 00/04:30:51 to 00/04:34:19

Plot file version 110 created 08-APR-2019 12:09:44

J0815+3635 EM133B.UVDATA.1

Freq = 4.9270 GHz, Bw = 16.000 MH No calibration applied and no bandpass applied

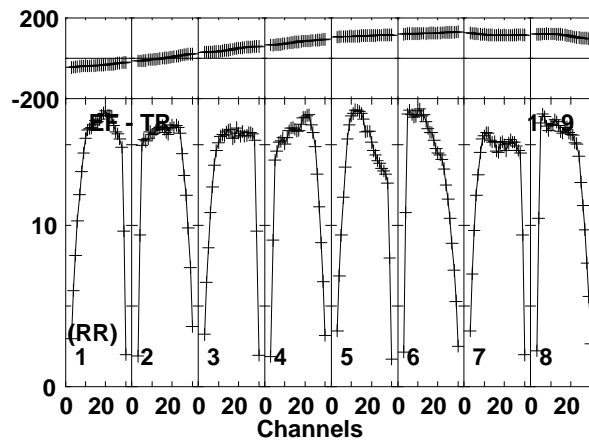
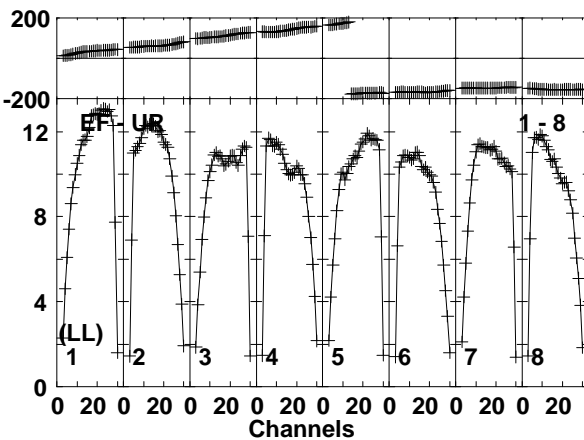
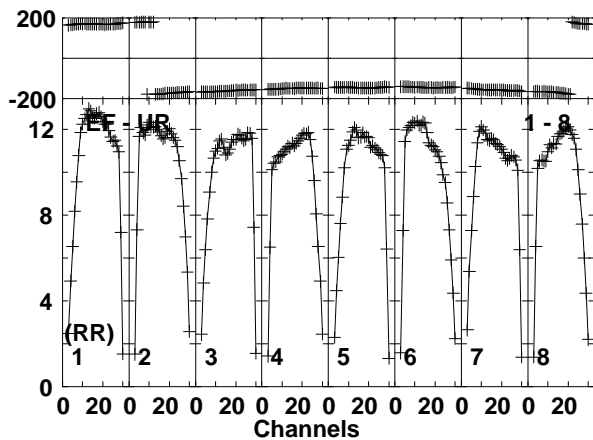
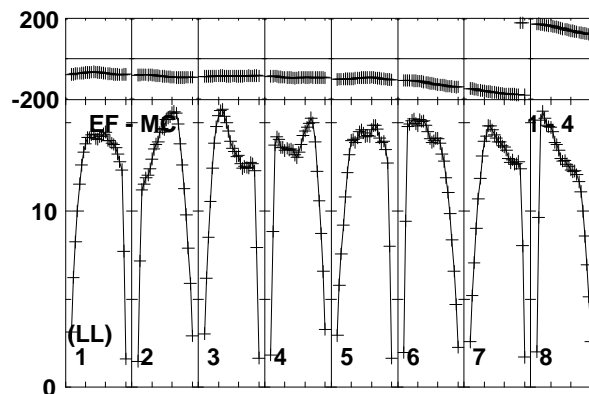
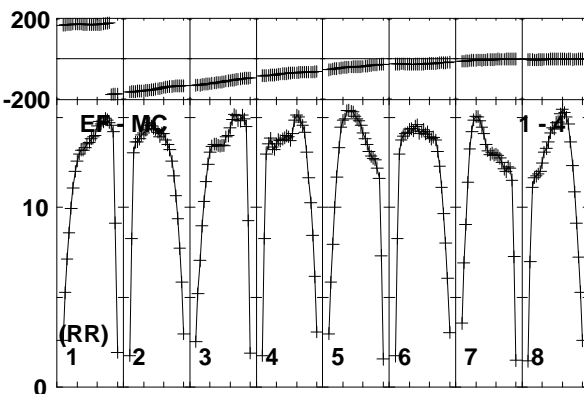
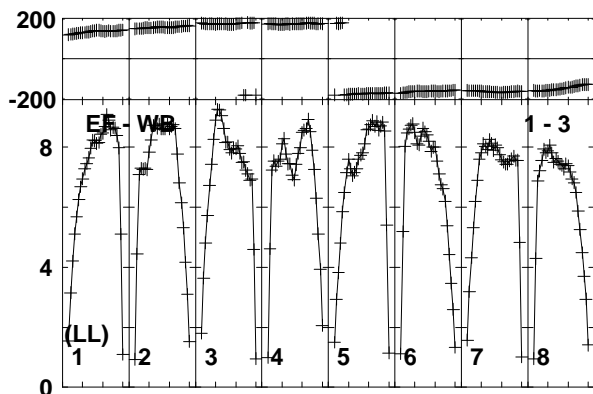
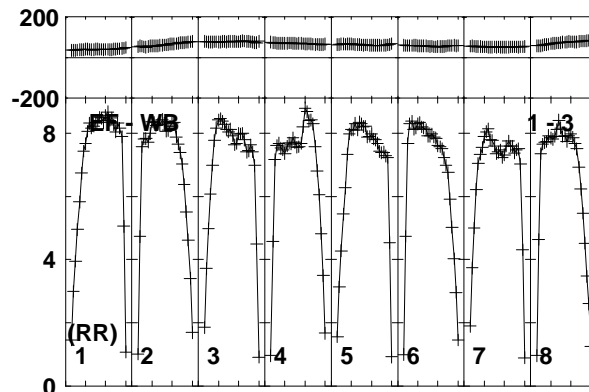
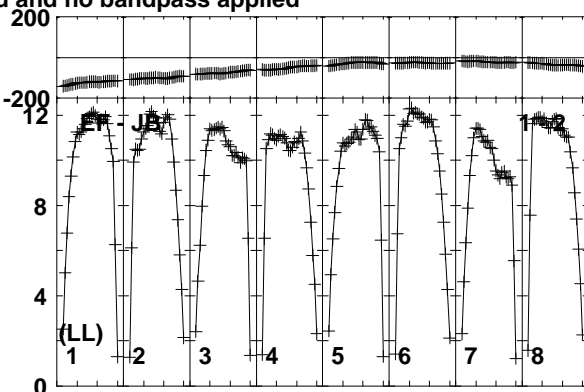
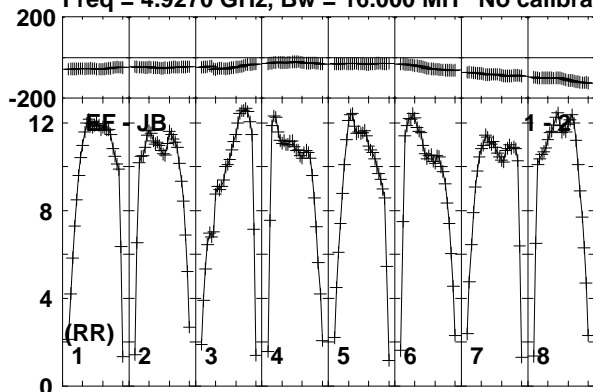

Lower frame: Milli Ampl Jy Top frame: Phas deg  
Vector averaged cross-power spectrum Baseline: EF (01) - JB (02)  
Timerange: 00/04:34:21 to 00/04:35:49

Plot file version 111 created 08-APR-2019 12:09:44

J0815+3635 EM133B.UVDATA.1

Freq = 4.9270 GHz, Bw = 16.000 MH No calibration applied and no bandpass applied

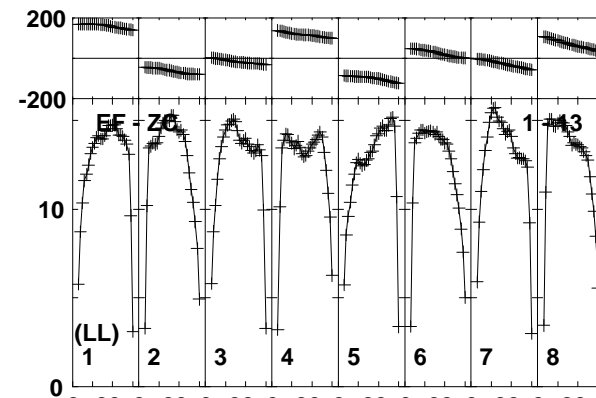
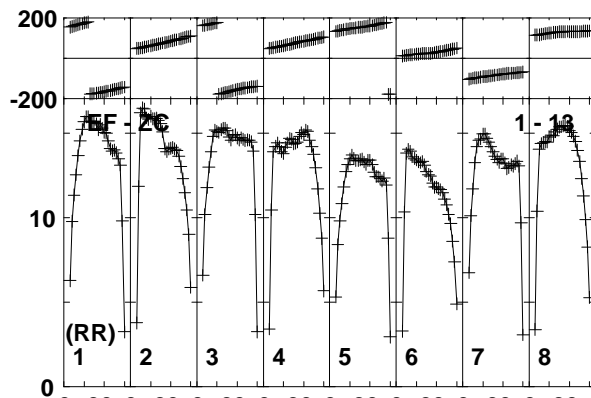
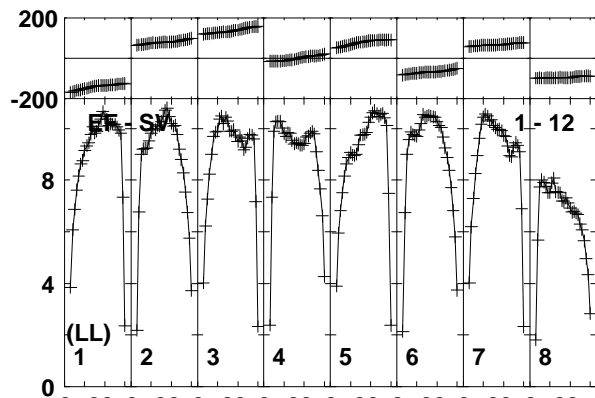
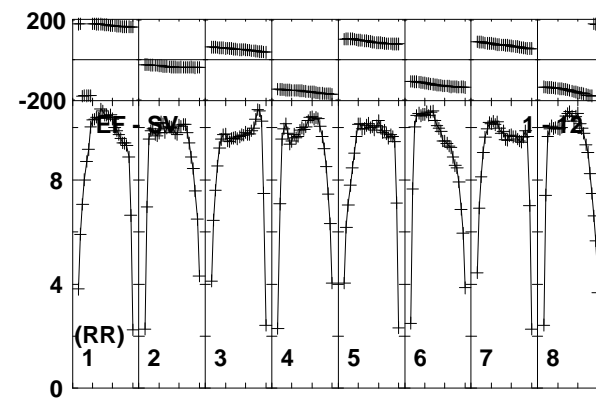
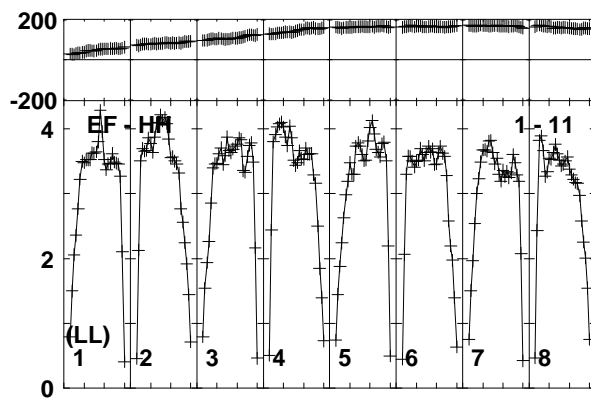
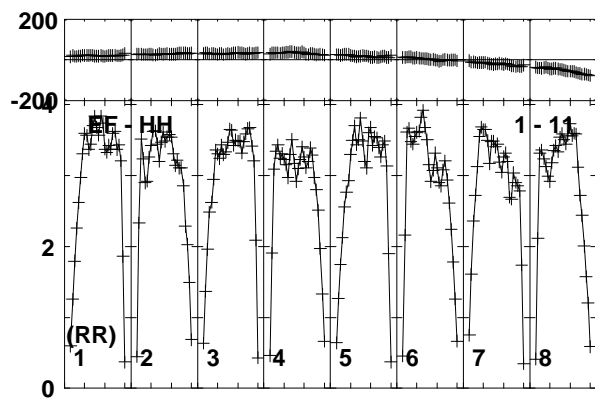
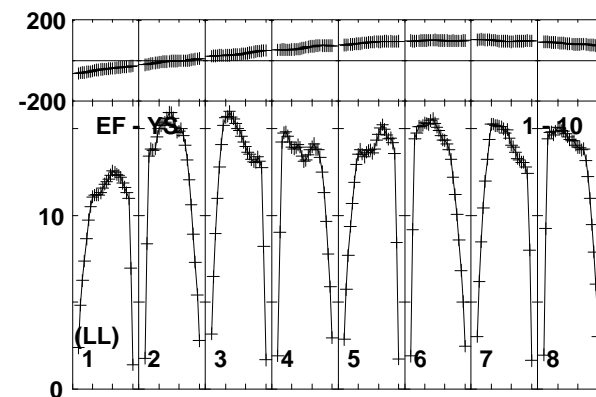
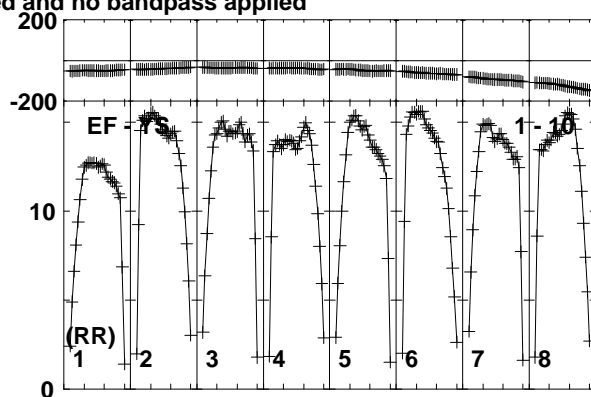
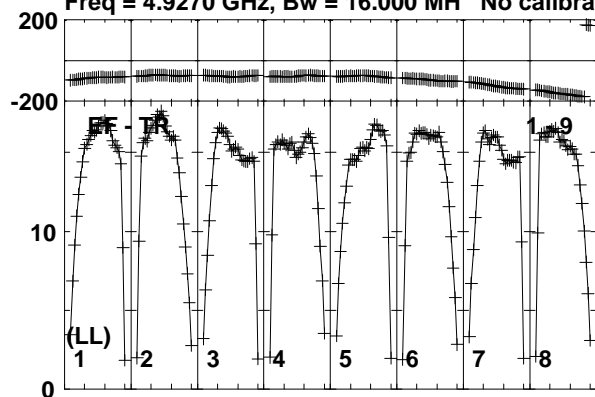

Lower frame: Milli Ampl Jy Top frame: Phas deg  
Vector averaged cross-power spectrum Baseline: EF (01) - TR (09)  
Timerange: 00/04:34:21 to 00/04:35:49

Plot file version 112 created 08-APR-2019 12:09:44

J0815+3635 EM133B.UVDATA.1

Freq = 4.9270 GHz, Bw = 16.000 MH No calibration applied and no bandpass applied

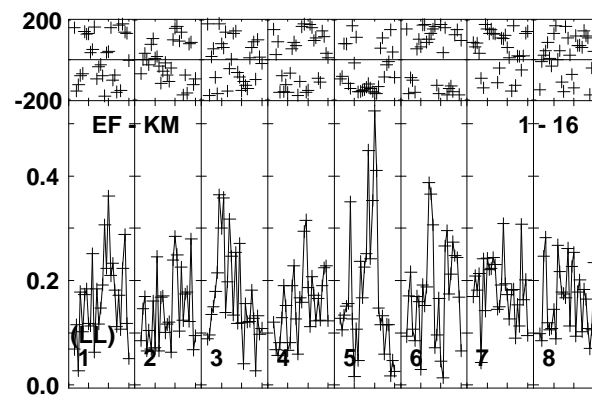
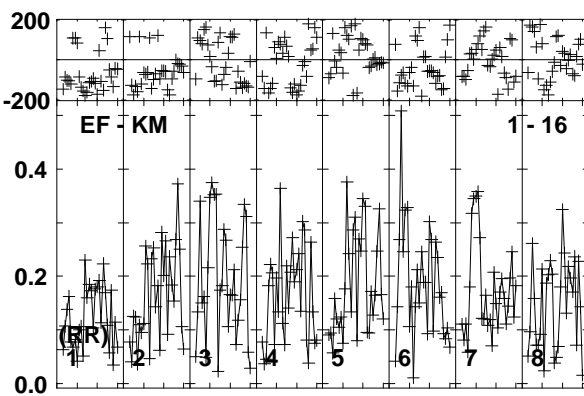
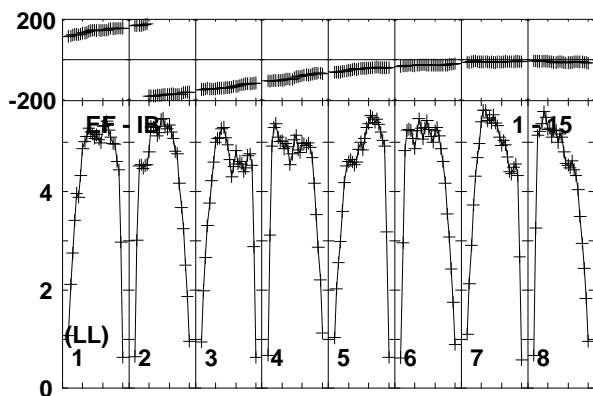
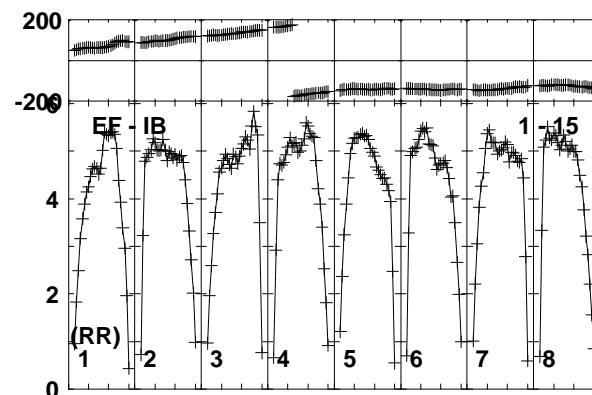
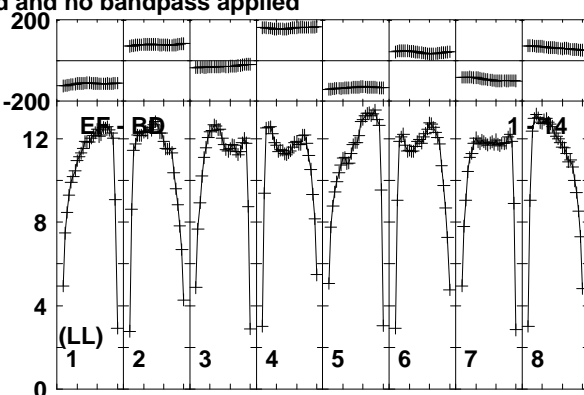
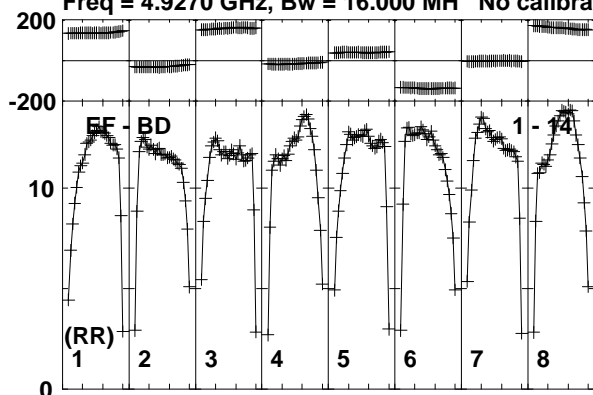

Lower frame: Milli Ampl Jy Top frame: Phas deg  
Vector averaged cross-power spectrum Baseline: EF (01) - BD (14)  
Timerange: 00/04:34:21 to 00/04:35:49



Plot file version 113 created 08-APR-2019 12:09:44

MRK622 EM133B.UVDATA.1

Freq = 4.9270 GHz, Bw = 16.000 MH No calibration applied and no bandpass applied

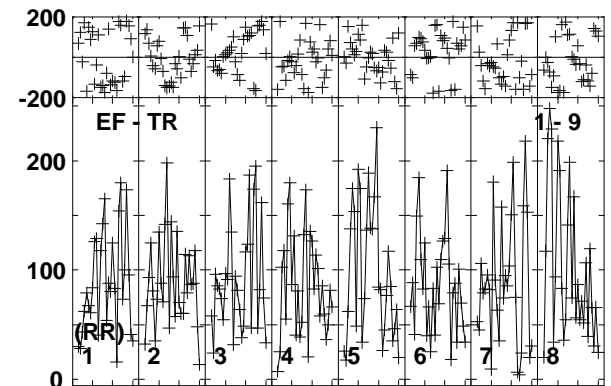
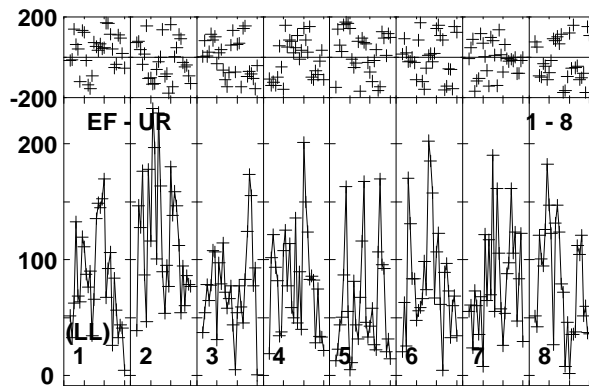
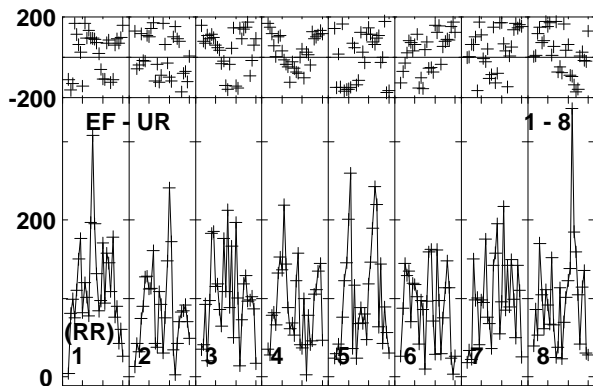
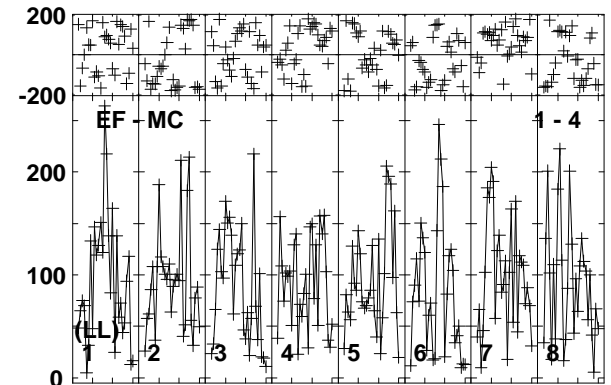
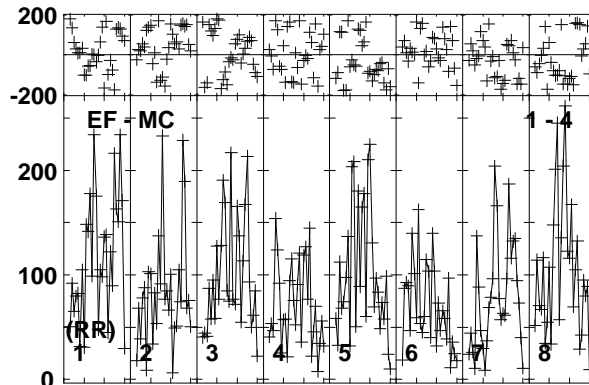
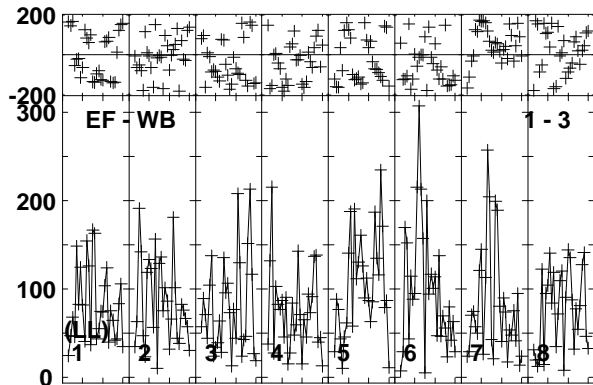
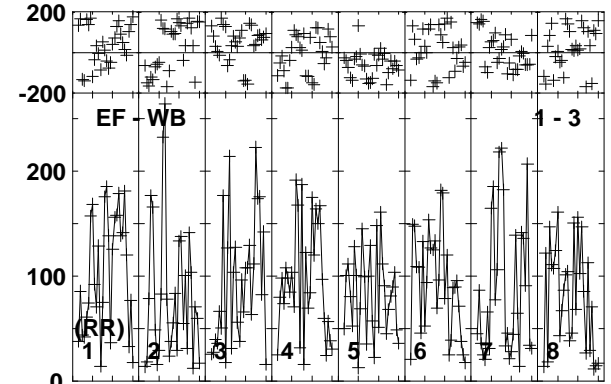
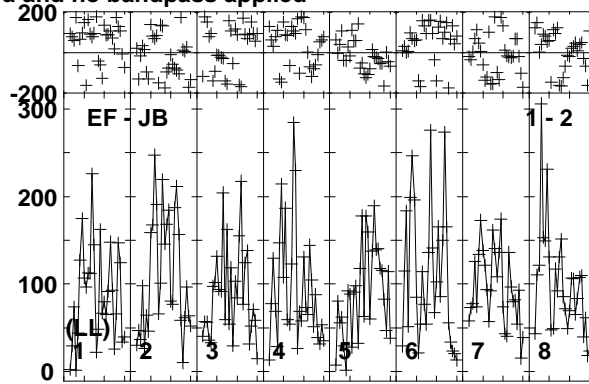
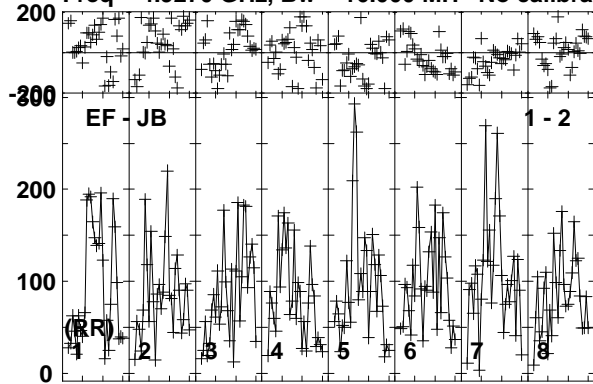

Lower frame: Micro Ampl Jy Top frame: Phas deg  
Vector averaged cross-power spectrum Baseline: EF (01) - JB (02)  
Timerange: 00/04:35:53 to 00/04:39:19

Plot file version 114 created 08-APR-2019 12:09:44

MRK622 EM133B.UVDATA.1

Freq = 4.9270 GHz, Bw = 16.000 MH No calibration applied and no bandpass applied

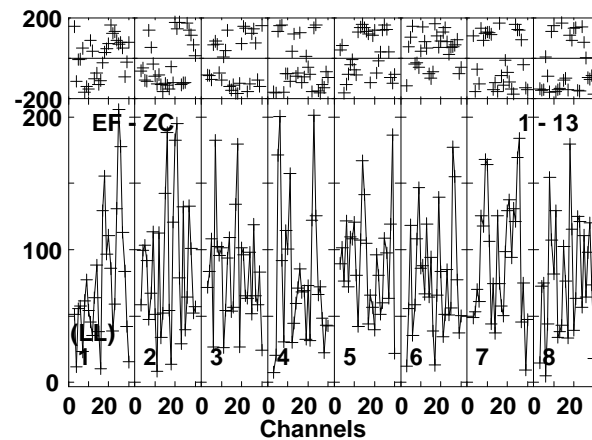
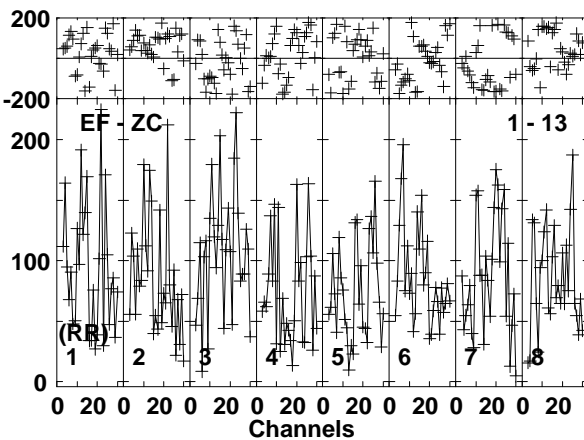
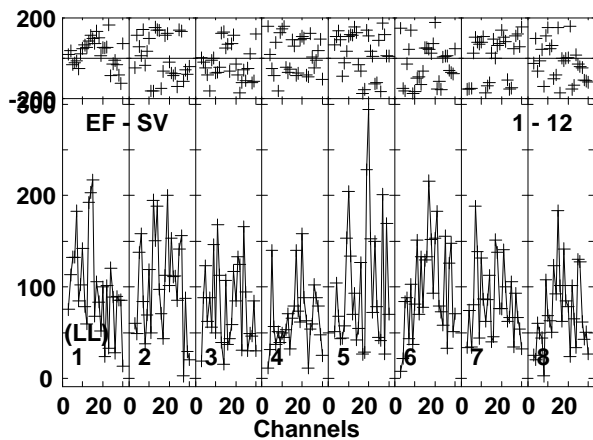
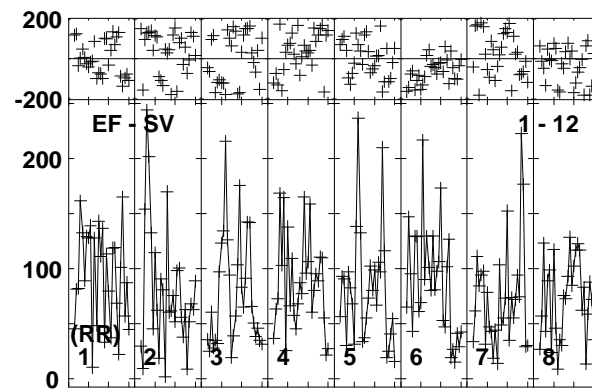
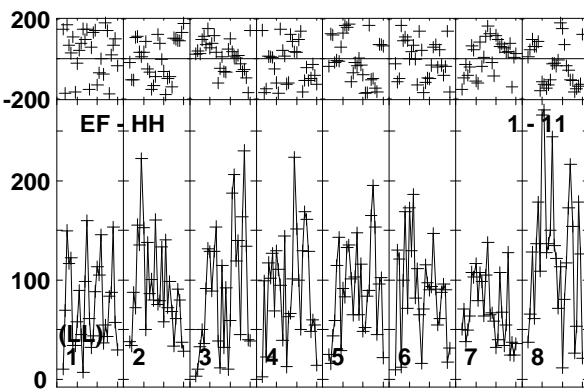
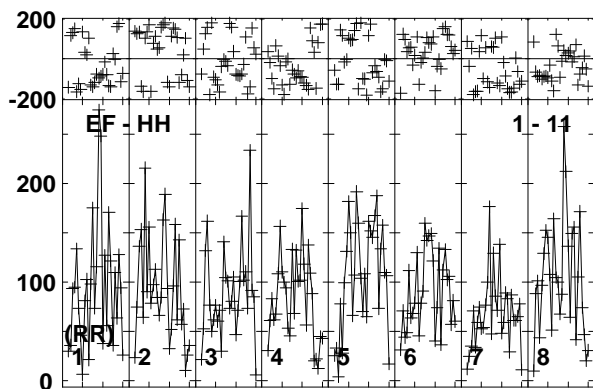
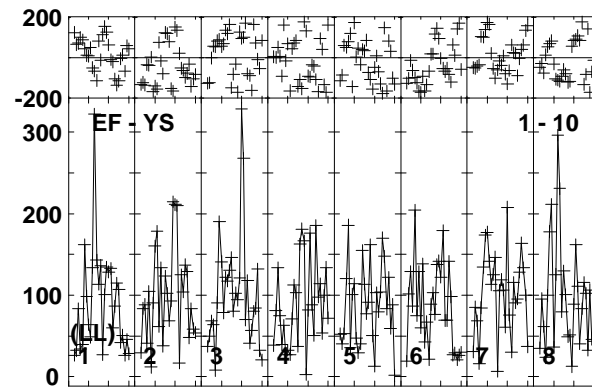
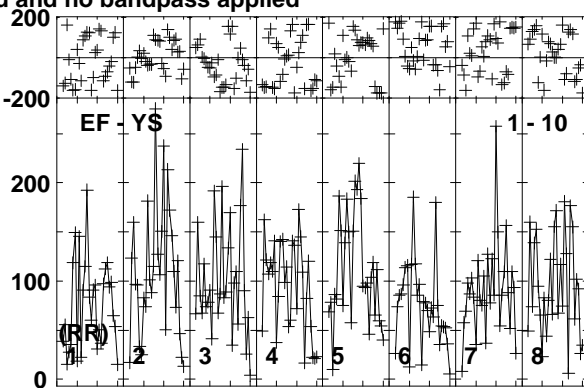
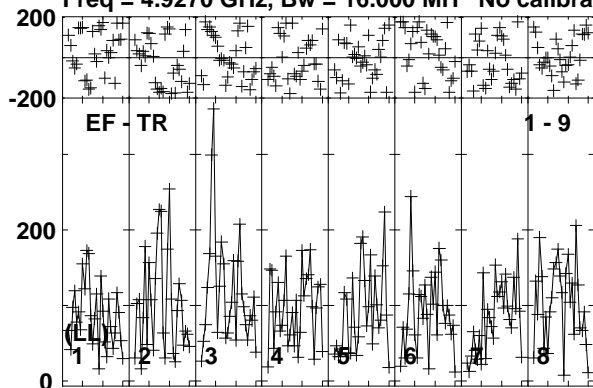

Lower frame: Micro Ampl Jy Top frame: Phas deg  
Vector averaged cross-power spectrum Baseline: EF (01) - TR (09)  
Timerange: 00/04:35:53 to 00/04:39:19

Plot file version 115 created 08-APR-2019 12:09:45

MRK622 EM133B.UVDATA.1

Freq = 4.9270 GHz, Bw = 16.000 MH No calibration applied and no bandpass applied

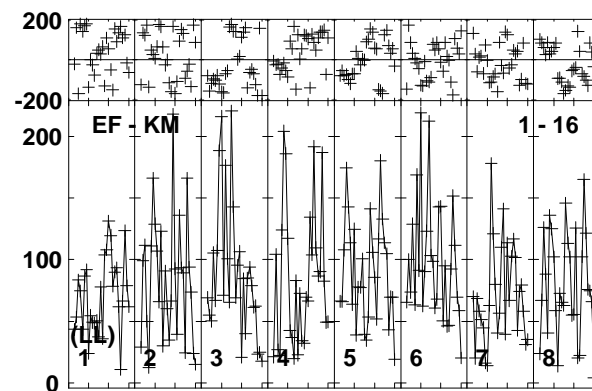
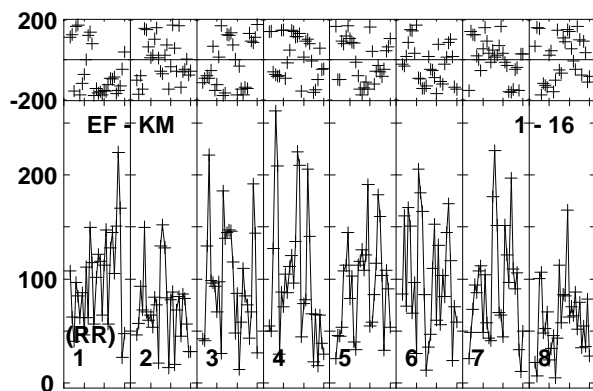
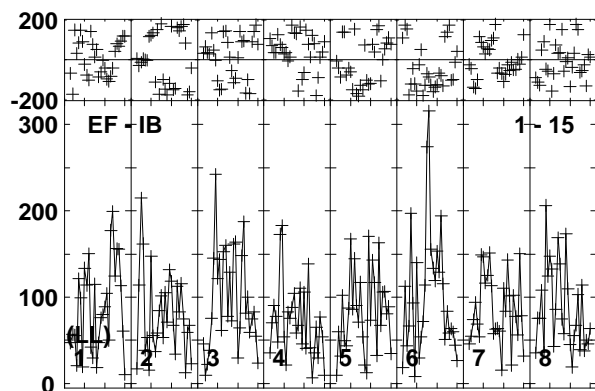
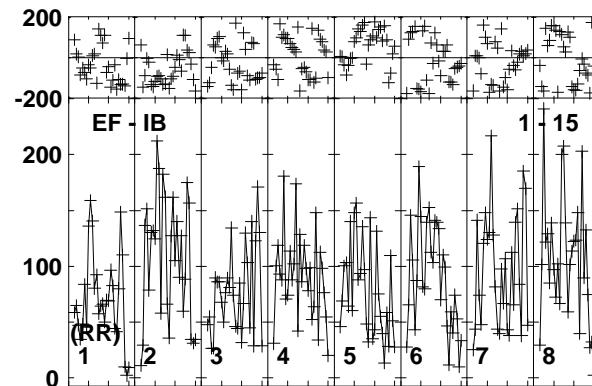
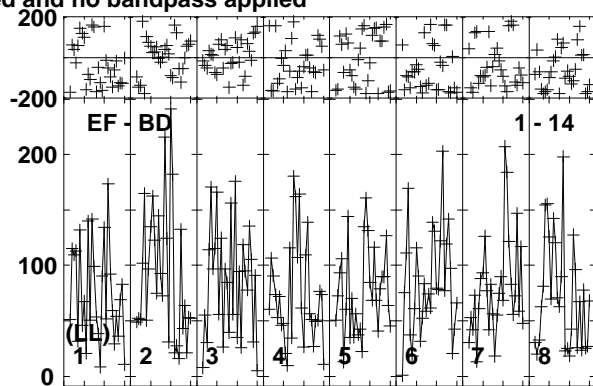
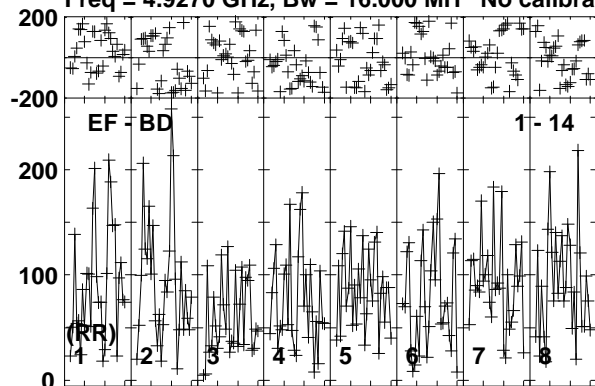

Lower frame: Micro Ampl Jy Top frame: Phas deg  
Vector averaged cross-power spectrum Baseline: EF (01) - BD (14)  
Timerange: 00/04:35:53 to 00/04:39:19

Plot file version 116 created 08-APR-2019 12:09:45

J0815+3635 EM133B.UVDATA.1

Freq = 4.9270 GHz, Bw = 16.000 MH No calibration applied and no bandpass applied

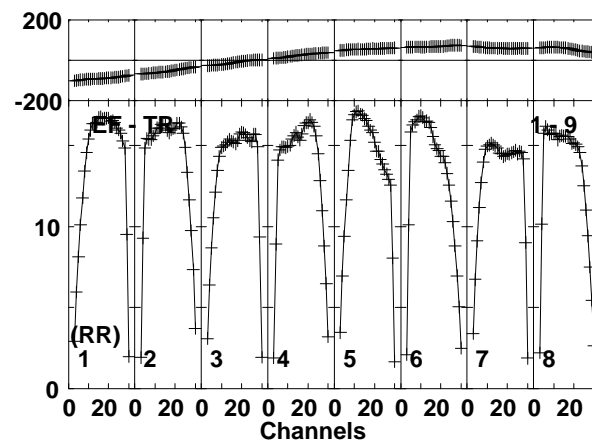
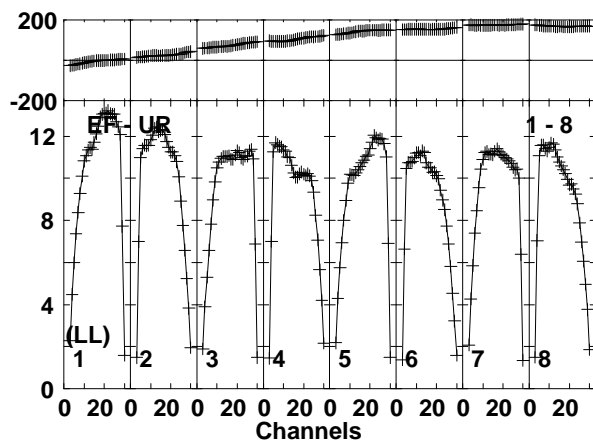
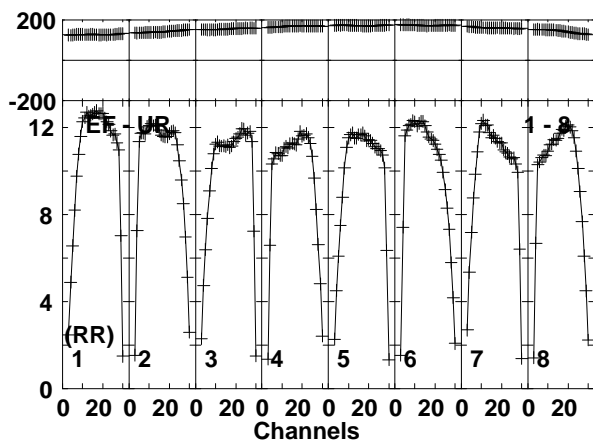
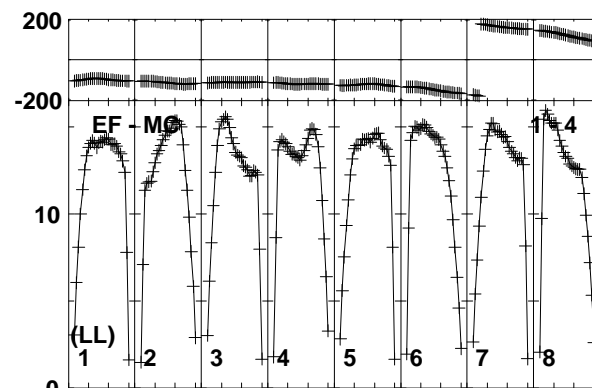
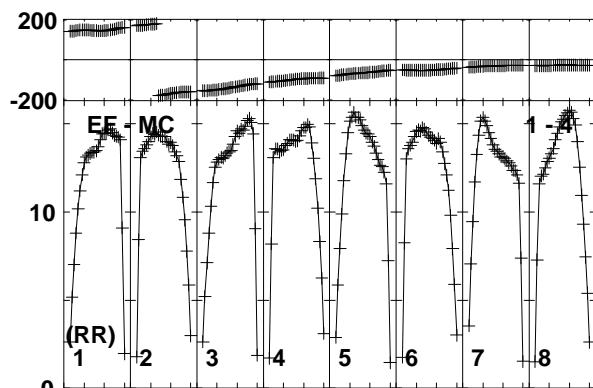
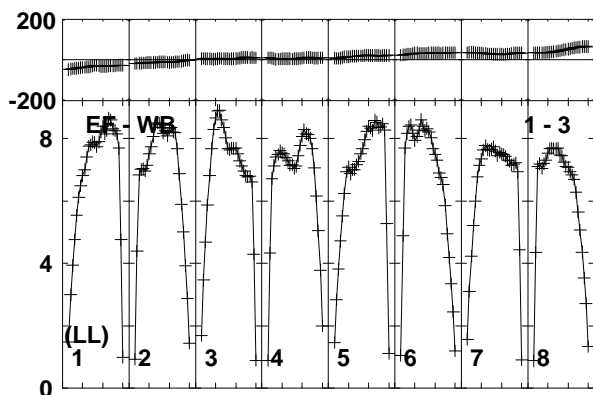
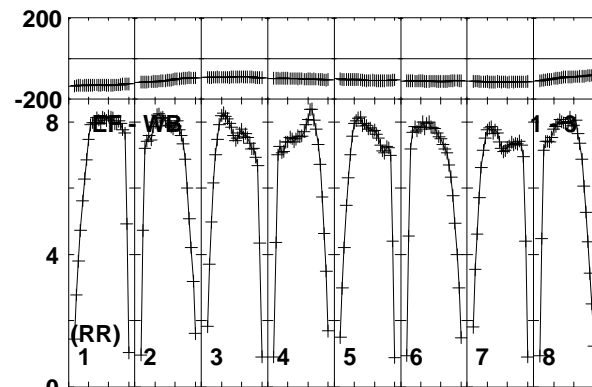
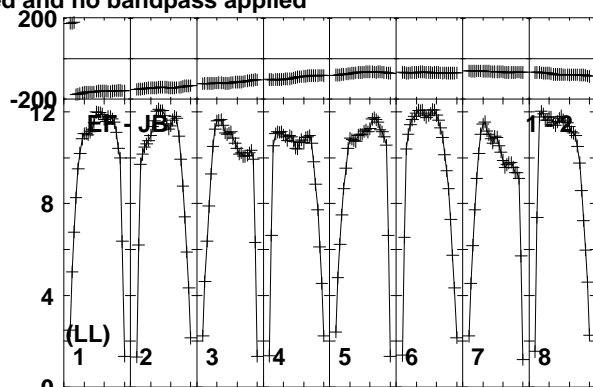
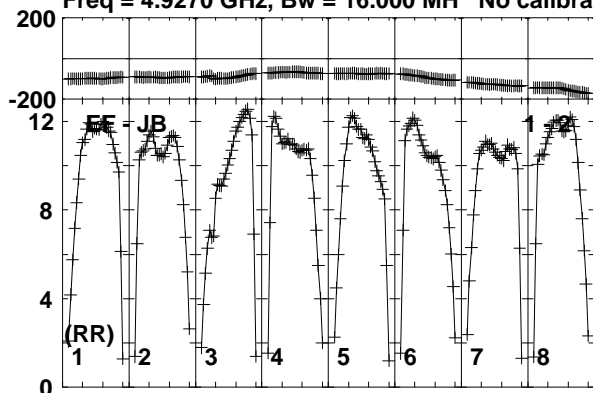

Lower frame: Milli Ampl Jy Top frame: Phas deg  
Vector averaged cross-power spectrum Baseline: EF (01) - JB (02)  
Timerange: 00/04:40:11 to 00/04:41:39

Plot file version 117 created 08-APR-2019 12:09:45

J0815+3635 EM133B.UVDATA.1

Freq = 4.9270 GHz, Bw = 16.000 MH No calibration applied and no bandpass applied

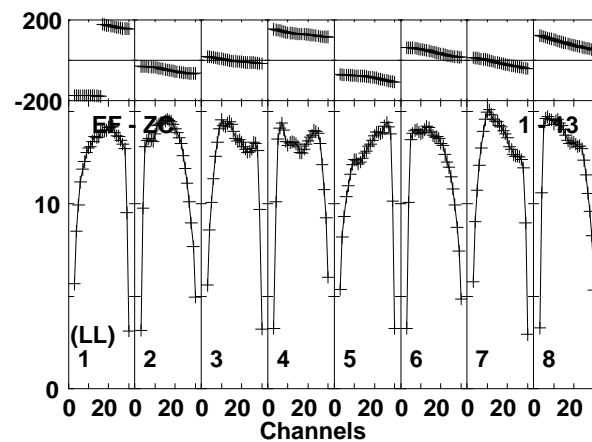
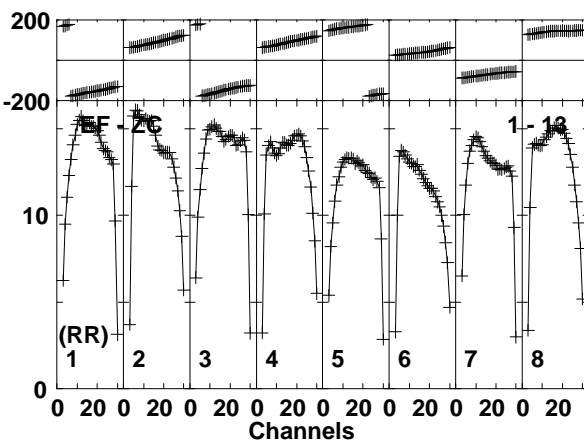
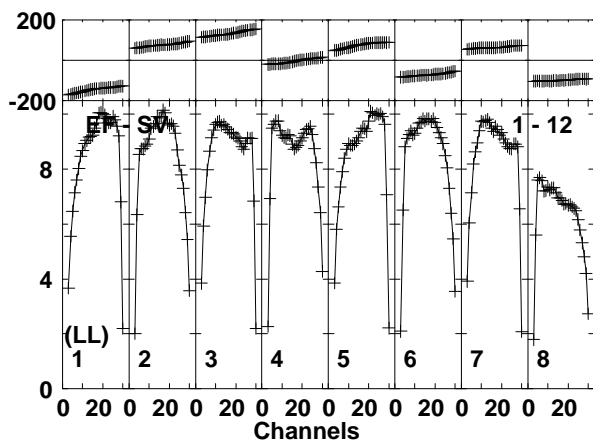
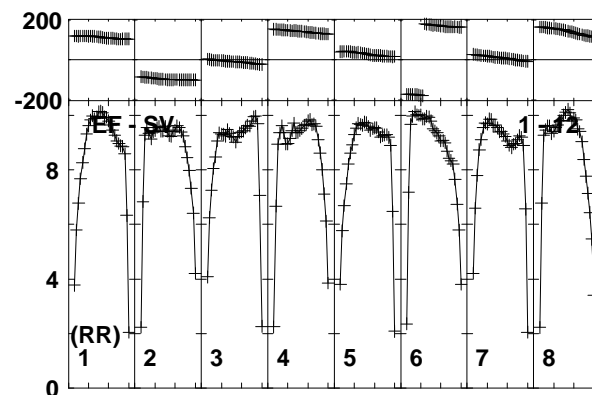
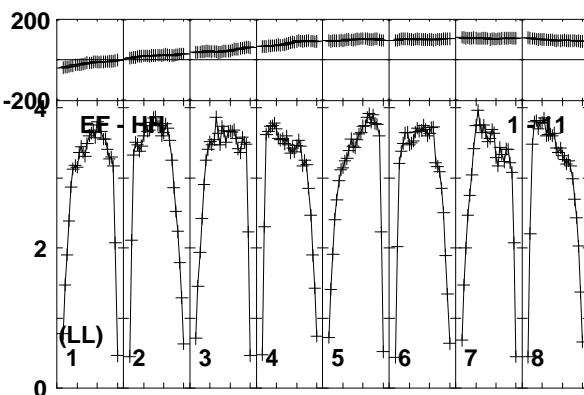
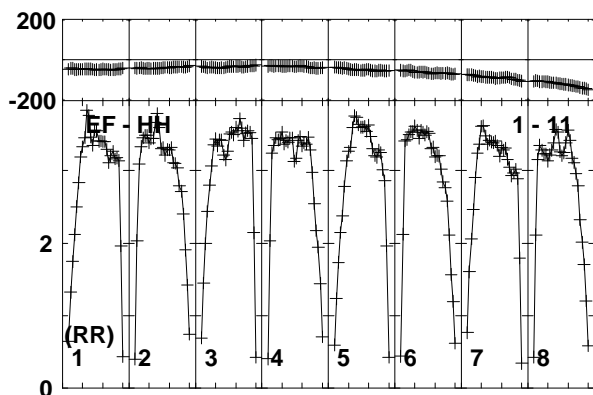
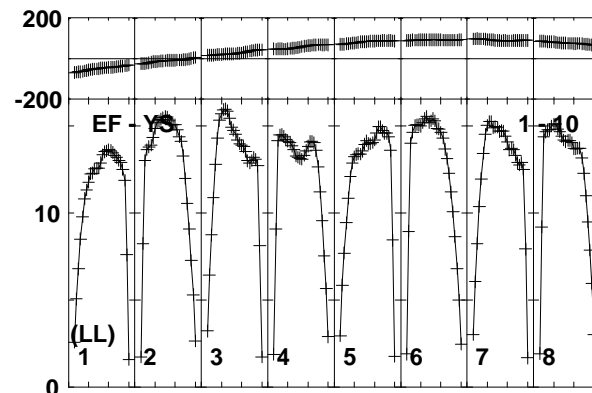
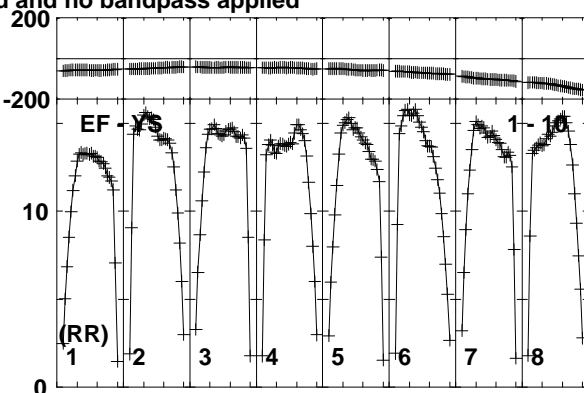
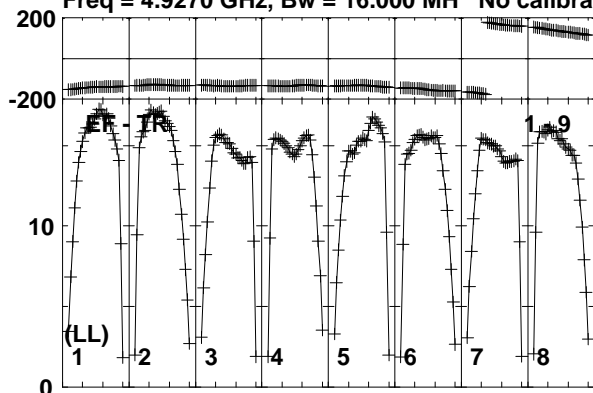

Lower frame: Milli Ampl Jy Top frame: Phas deg  
Vector averaged cross-power spectrum Baseline: EF (01) - TR (09)  
Timerange: 00/04:40:11 to 00/04:41:39

Plot file version 118 created 08-APR-2019 12:09:45

J0815+3635 EM133B.UVDATA.1

Freq = 4.9270 GHz, Bw = 16.000 MH No calibration applied and no bandpass applied

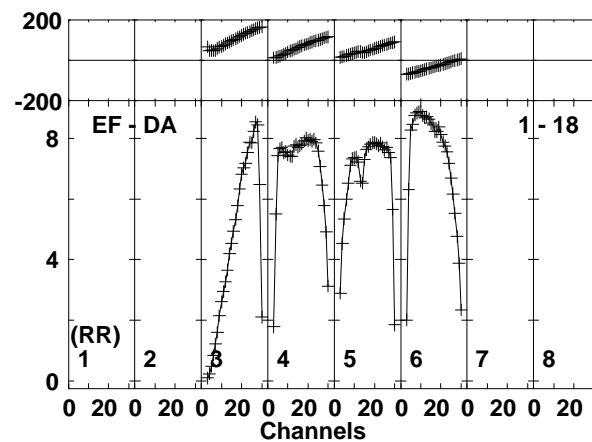
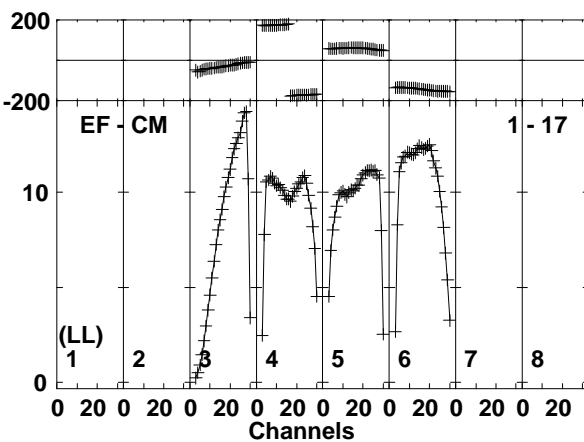
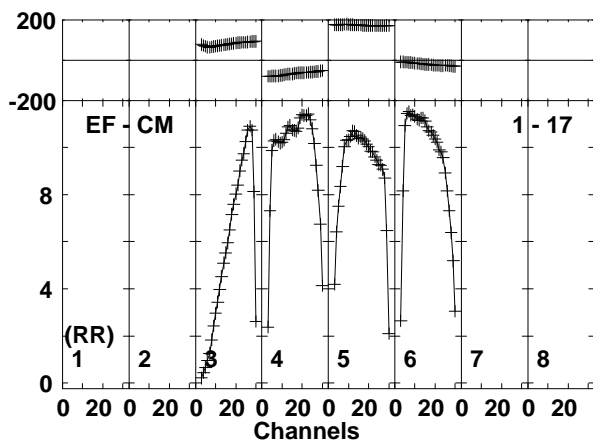
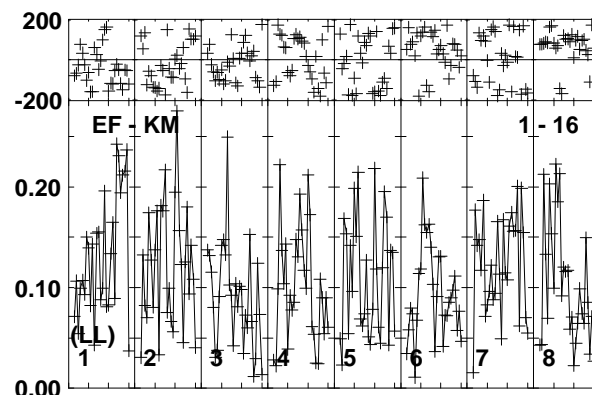
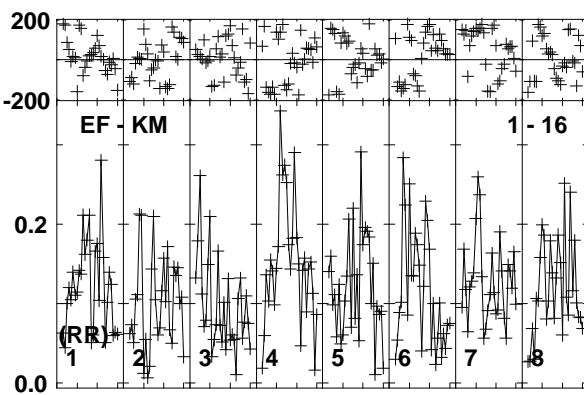
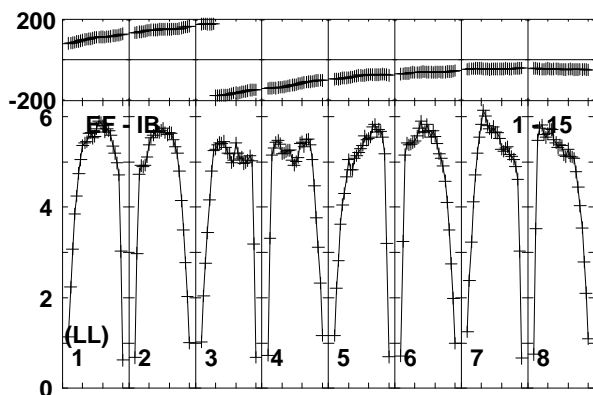
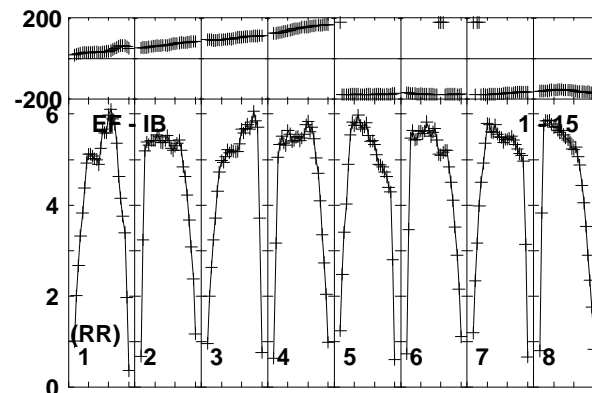
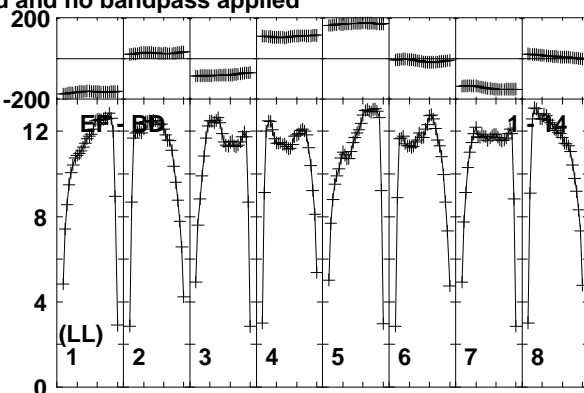
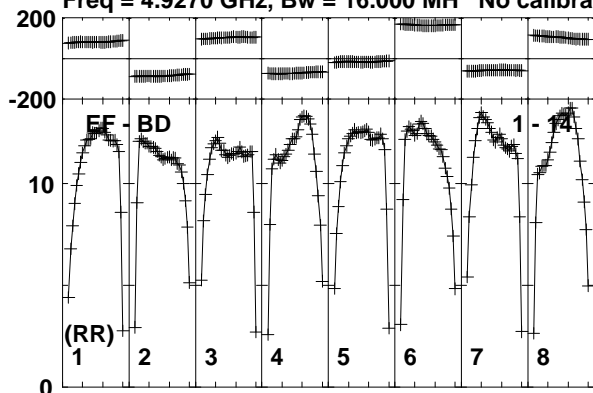

Lower frame: Milli Ampl Jy Top frame: Phas deg  
Vector averaged cross-power spectrum Baseline: EF (01) - BD (14)  
Timerange: 00/04:40:11 to 00/04:41:39

Plot file version 119 created 08-APR-2019 12:09:45

J0815+3635 EM133B.UVDATA.1

Freq = 4.9270 GHz, Bw = 16.000 MH No calibration applied and no bandpass applied

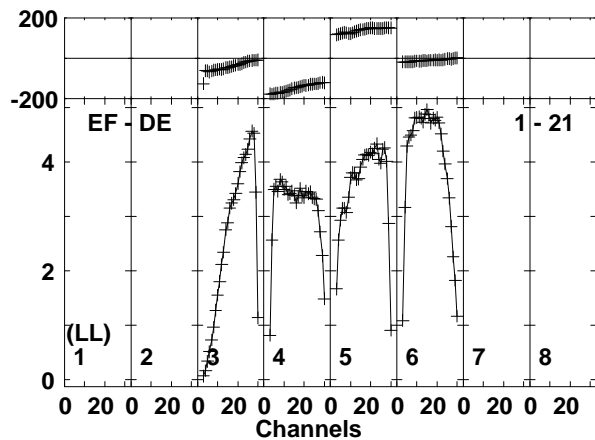
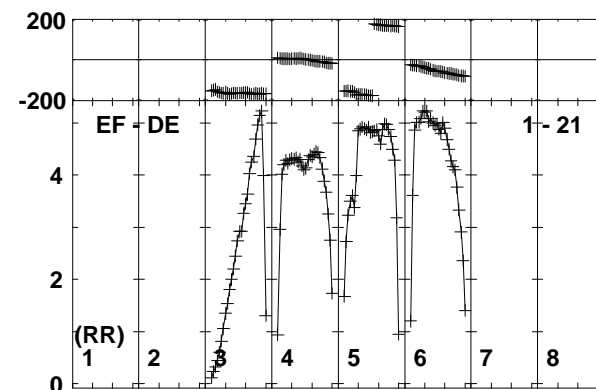
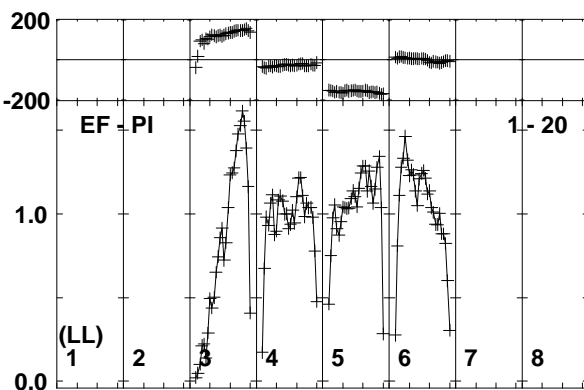
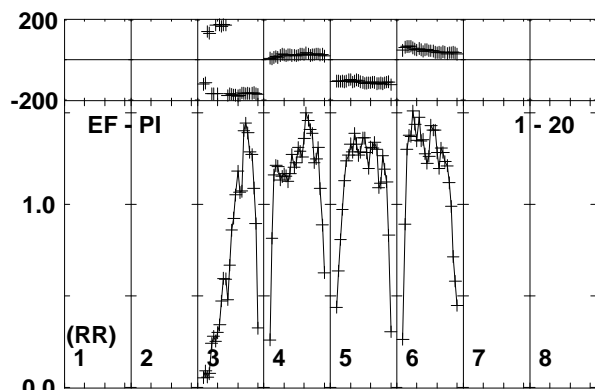
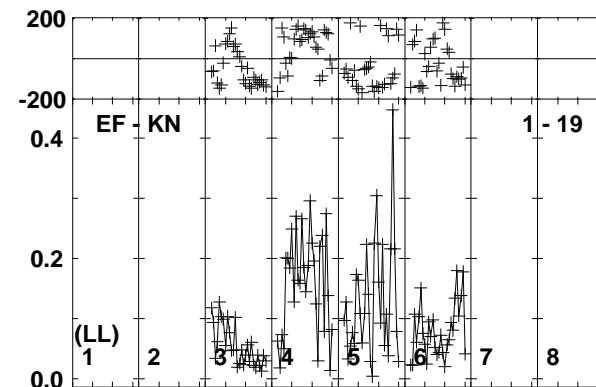
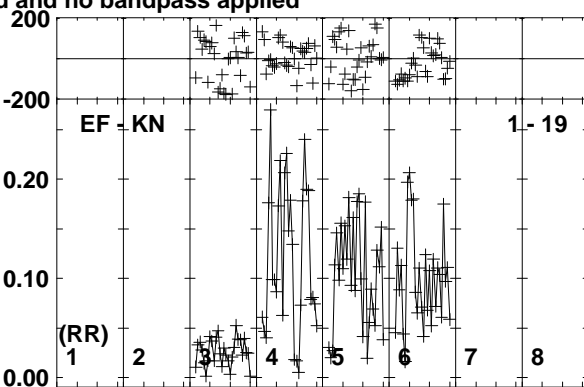
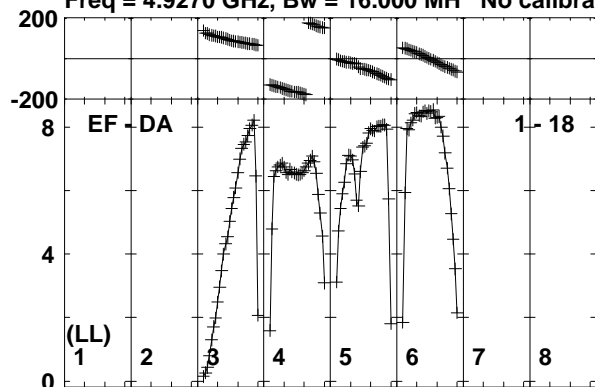

Lower frame: Milli Ampl Jy Top frame: Phas deg  
Vector averaged cross-power spectrum Baseline: EF (01) - DA (18)  
Timerange: 00/04:40:11 to 00/04:41:39

Plot file version 120 created 08-APR-2019 12:09:45

MRK622 EM133B.UVDATA.1

Freq = 4.9270 GHz, Bw = 16.000 MH No calibration applied and no bandpass applied

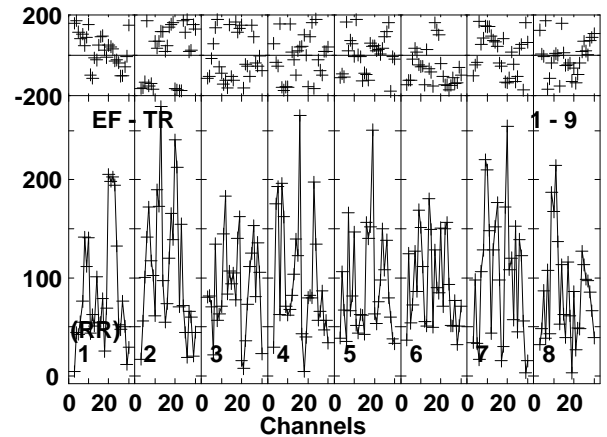
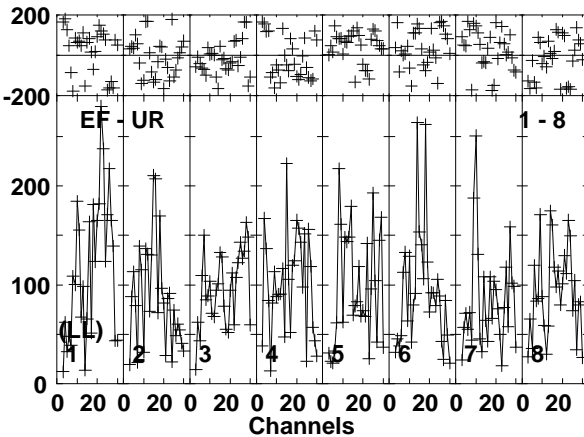
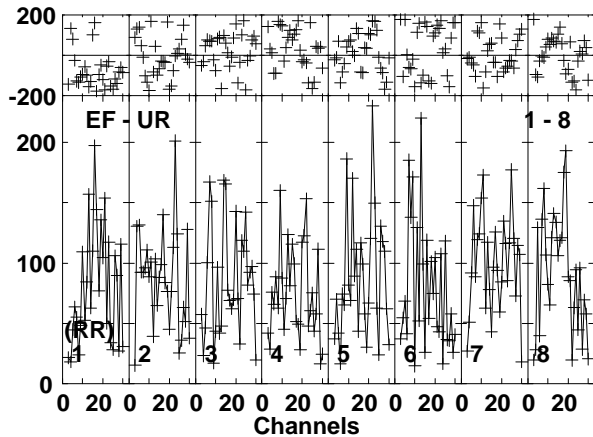
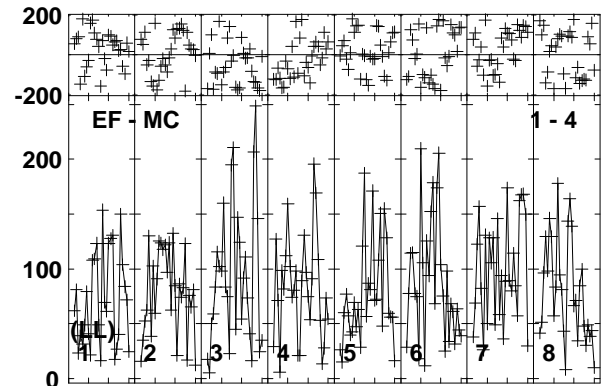
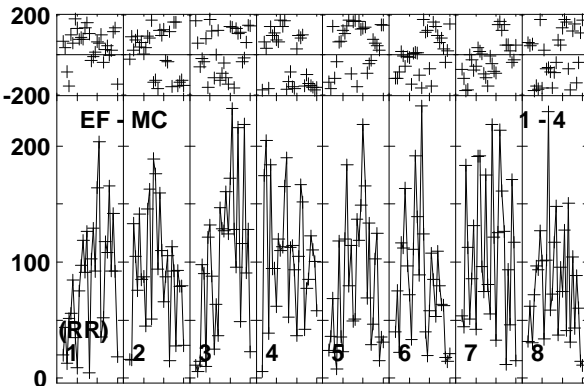
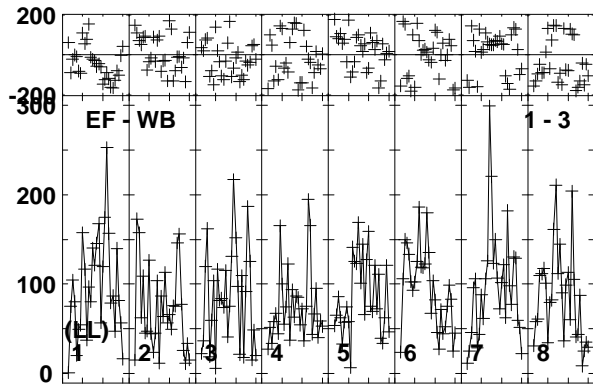
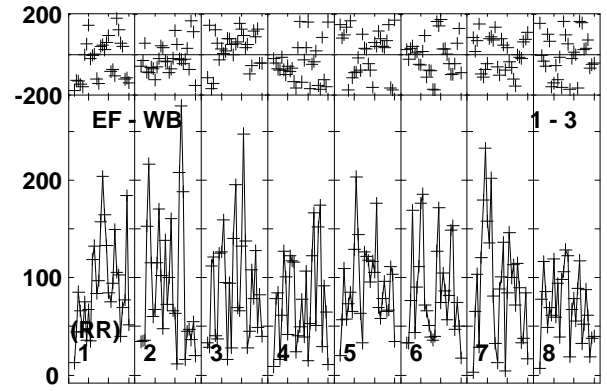
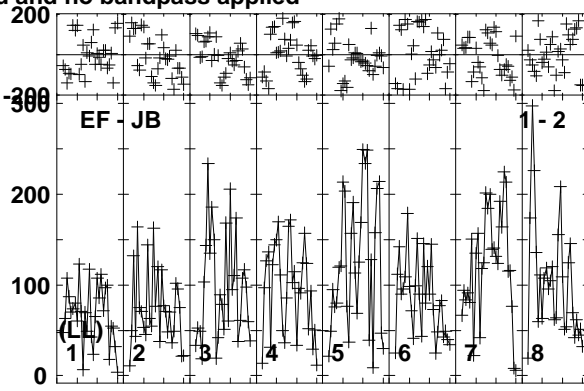
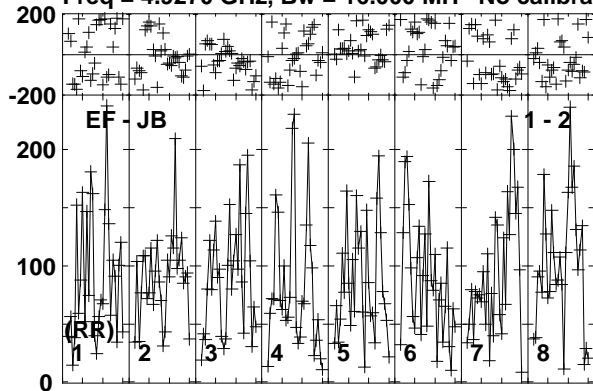

Lower frame: Micro Ampl Jy Top frame: Phas deg  
Vector averaged cross-power spectrum Baseline: EF (01) - JB (02)  
Timerange: 00/04:41:41 to 00/04:45:09



Plot file version 121 created 08-APR-2019 12:09:45

MRK622 EM133B.UVDATA.1

Freq = 4.9270 GHz, Bw = 16.000 MH No calibration applied and no bandpass applied

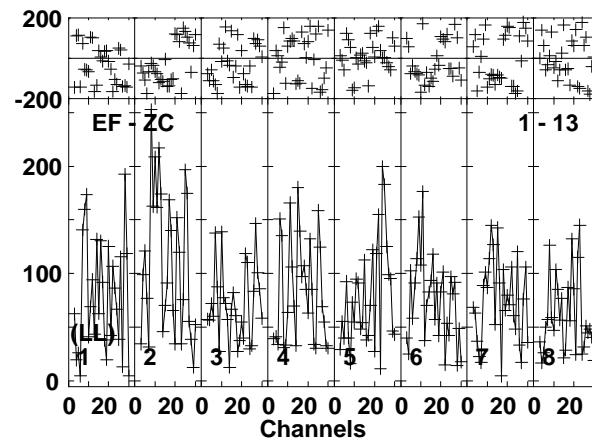
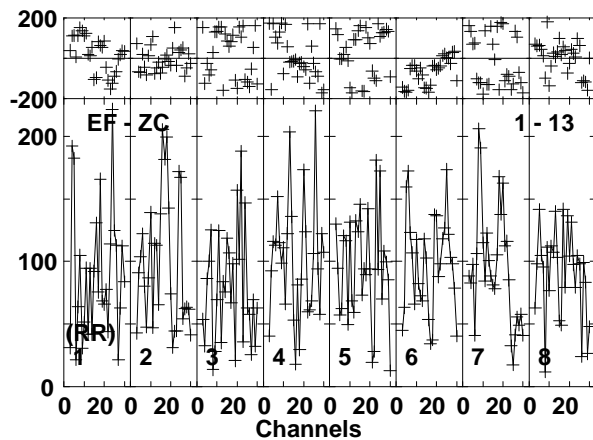
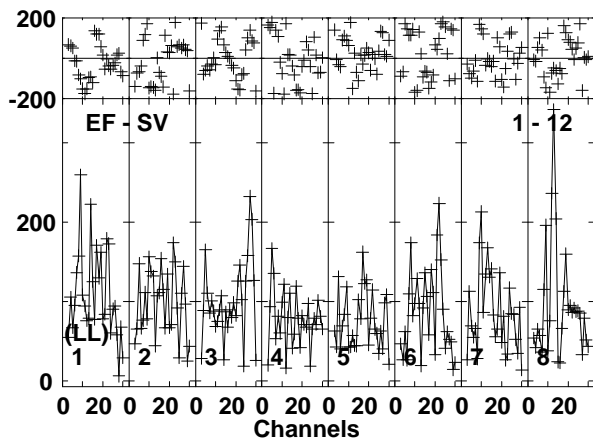
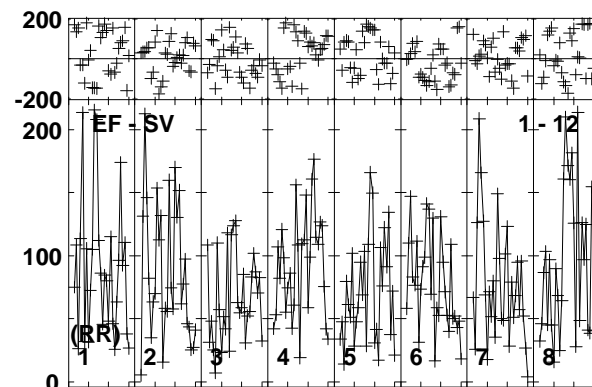
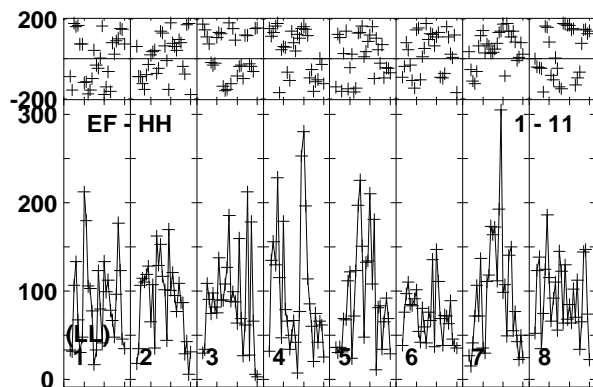
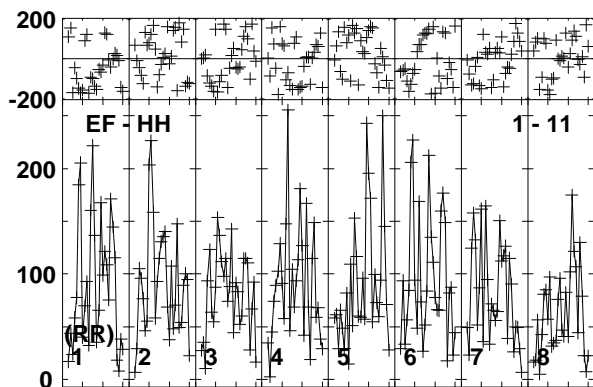
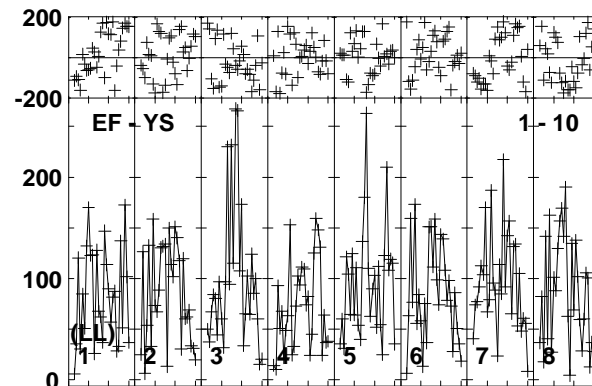
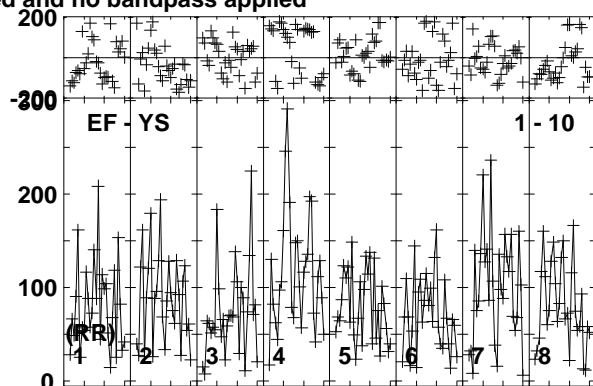
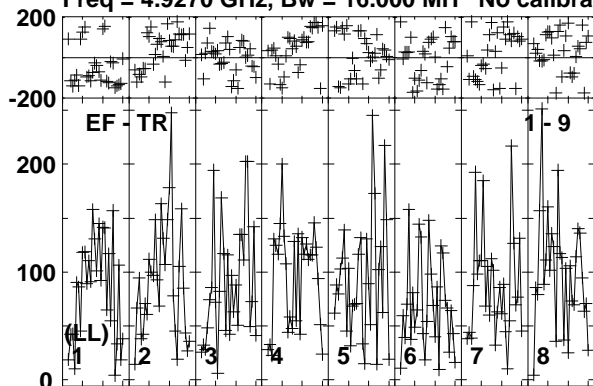

Lower frame: Micro Ampl Jy Top frame: Phas deg  
Vector averaged cross-power spectrum Baseline: EF (01) - TR (09)  
Timerange: 00/04:41:41 to 00/04:45:09

Plot file version 122 created 08-APR-2019 12:09:46

MRK622 EM133B.UVDATA.1

Freq = 4.9270 GHz, Bw = 16.000 MH No calibration applied and no bandpass applied

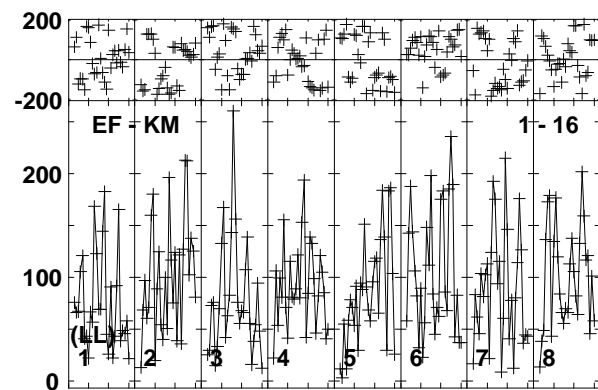
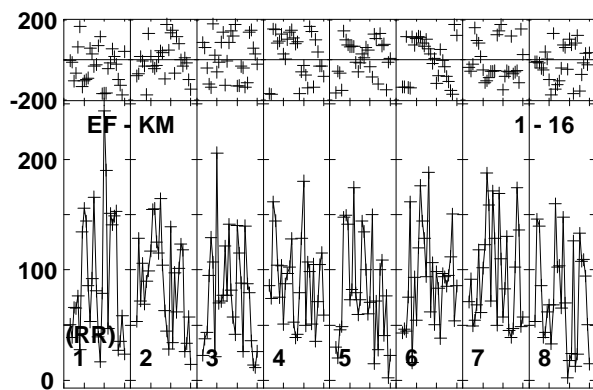
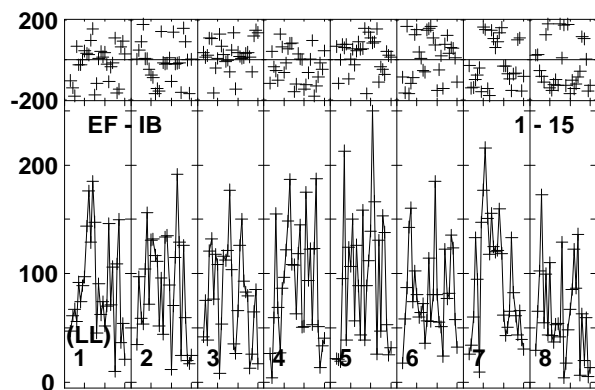
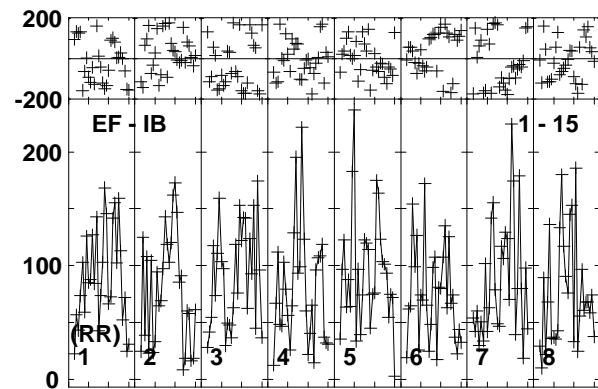
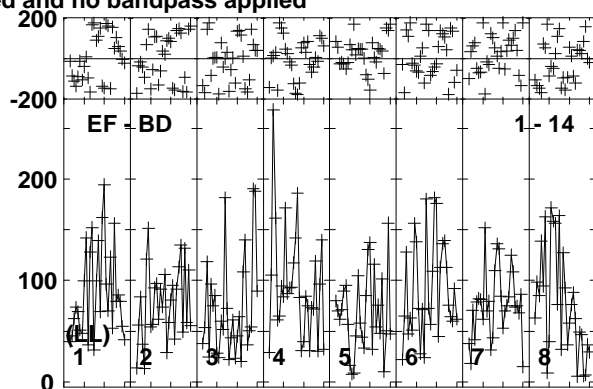
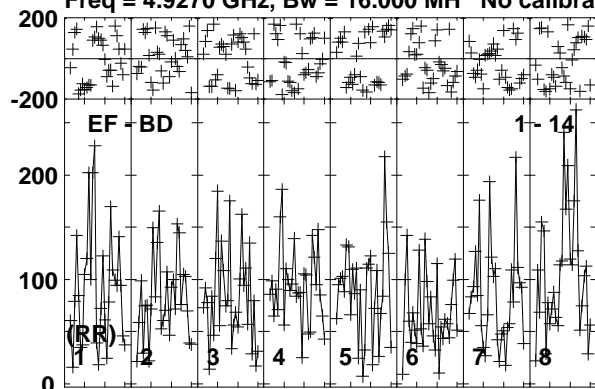

Lower frame: Micro Ampl Jy Top frame: Phas deg  
Vector averaged cross-power spectrum Baseline: EF (01) - BD (14)  
Timerange: 00/04:41:41 to 00/04:45:09

Plot file version 123 created 08-APR-2019 12:09:46

J0815+3635 EM133B.UVDATA.1

Freq = 4.9270 GHz, Bw = 16.000 MH No calibration applied and no bandpass applied

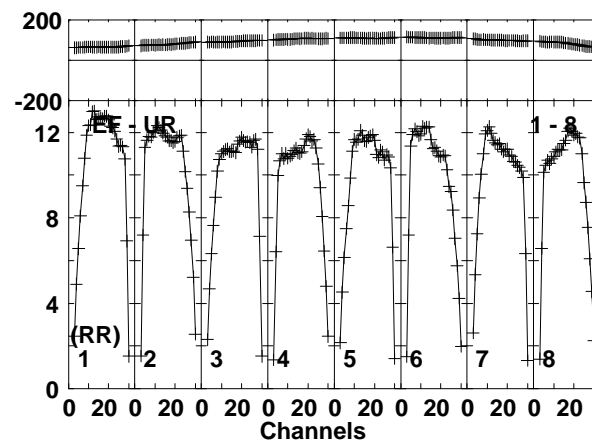
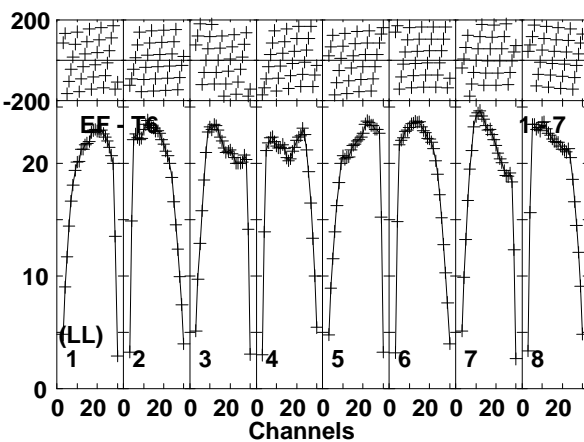
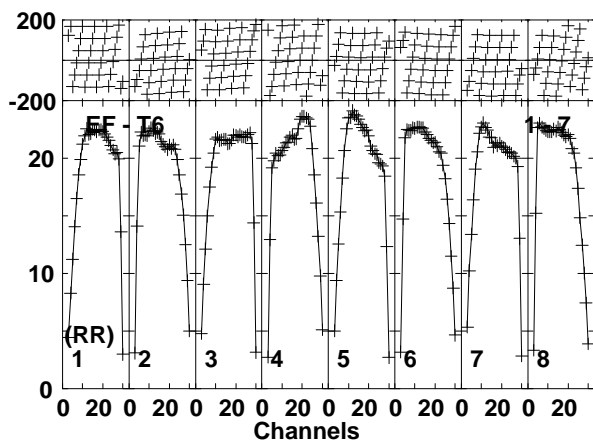
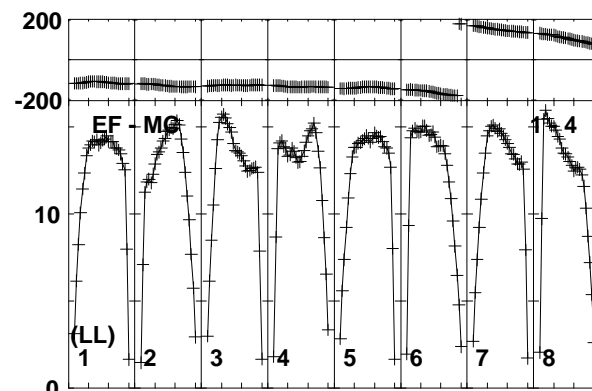
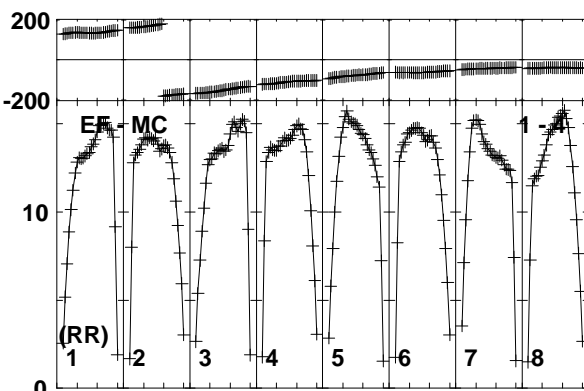
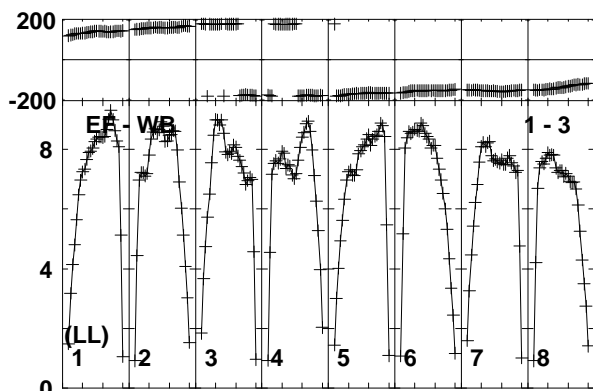
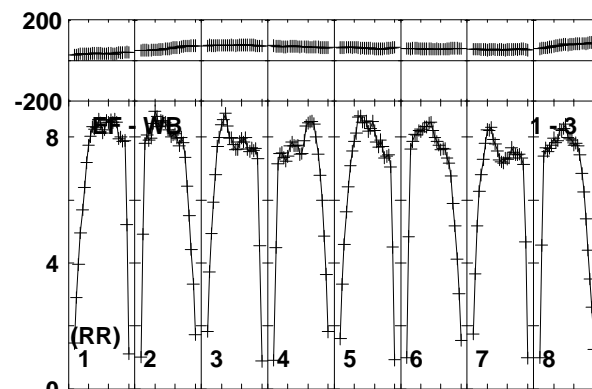
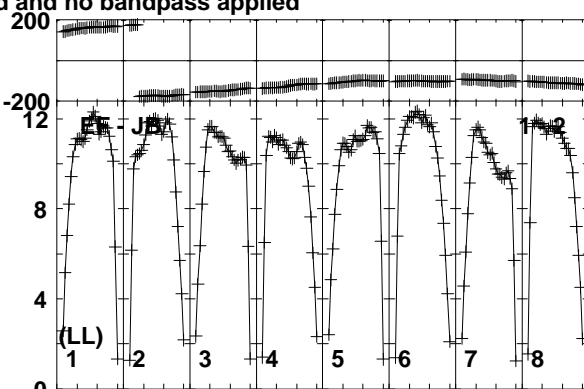
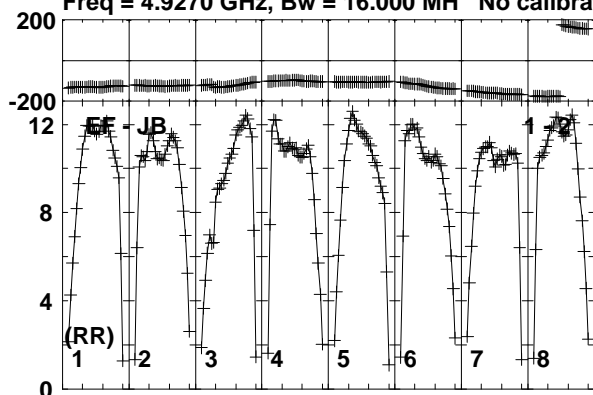

Lower frame: Milli Ampl Jy Top frame: Phas deg  
Vector averaged cross-power spectrum Baseline: EF (01) - JB (02)  
Timerange: 00/04:45:11 to 00/04:46:39

Plot file version 124 created 08-APR-2019 12:09:46

J0815+3635 EM133B.UVDATA.1

Freq = 4.9270 GHz, Bw = 16.000 MH No calibration applied and no bandpass applied

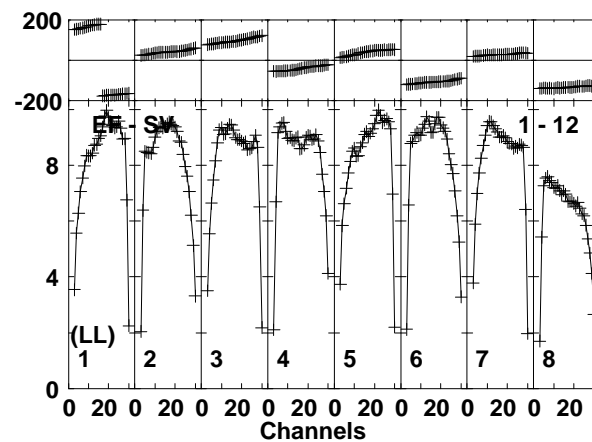
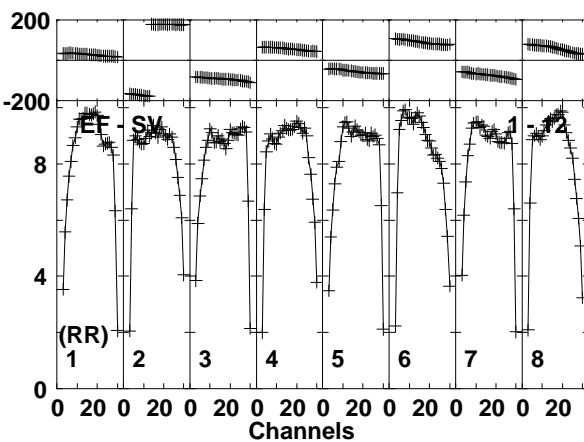
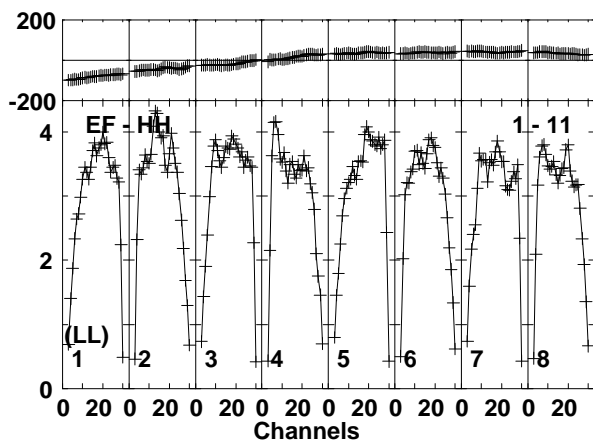
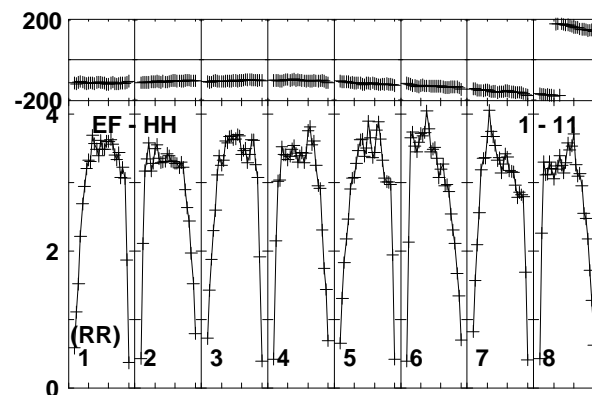
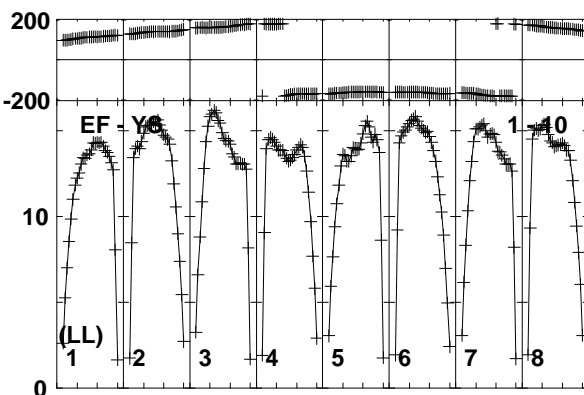
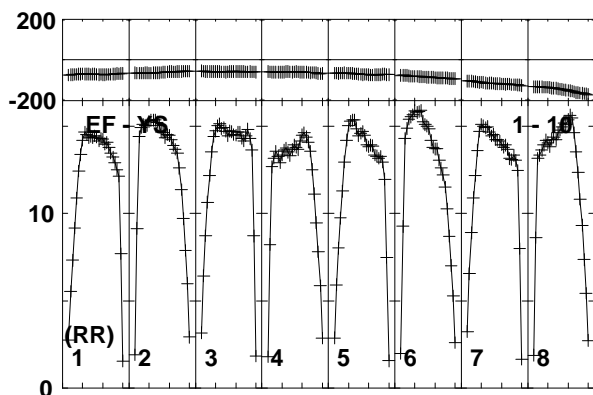
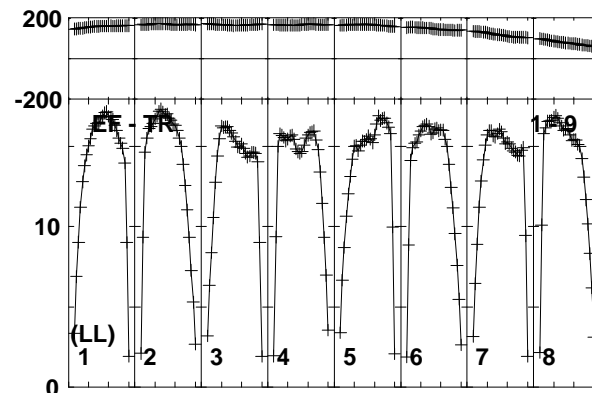
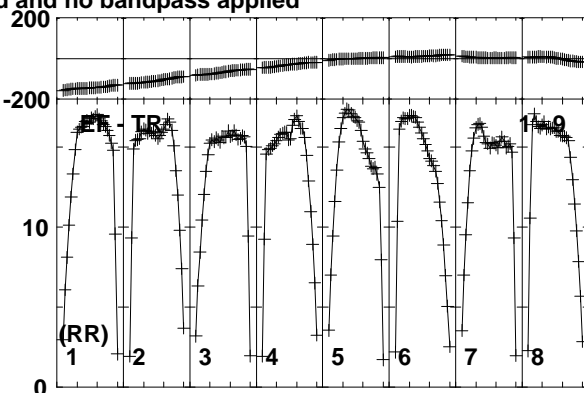
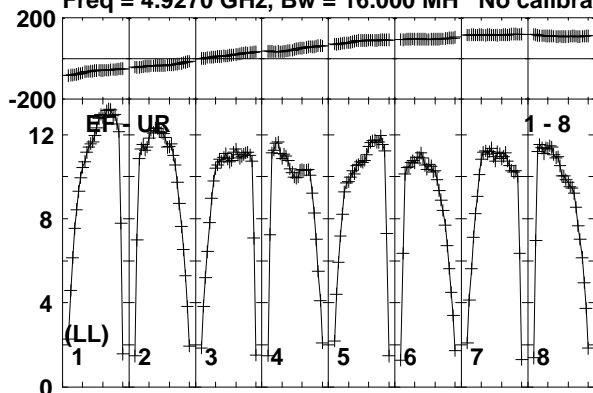

Lower frame: Milli Ampl Jy Top frame: Phas deg  
Vector averaged cross-power spectrum Baseline: EF (01) - UR (08)  
Timerange: 00/04:45:11 to 00/04:46:39

Plot file version 125 created 08-APR-2019 12:09:46

J0815+3635 EM133B.UVDATA.1

Freq = 4.9270 GHz, Bw = 16.000 MH No calibration applied and no bandpass applied

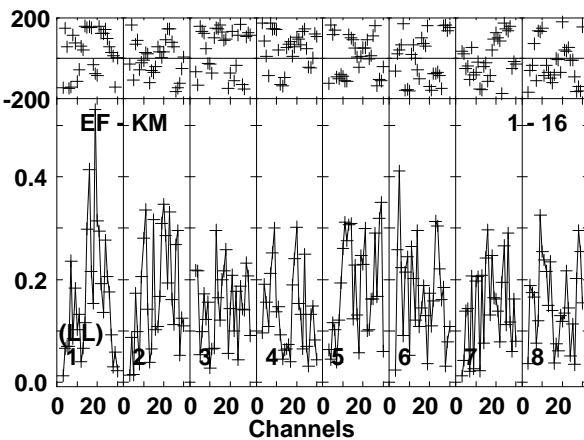
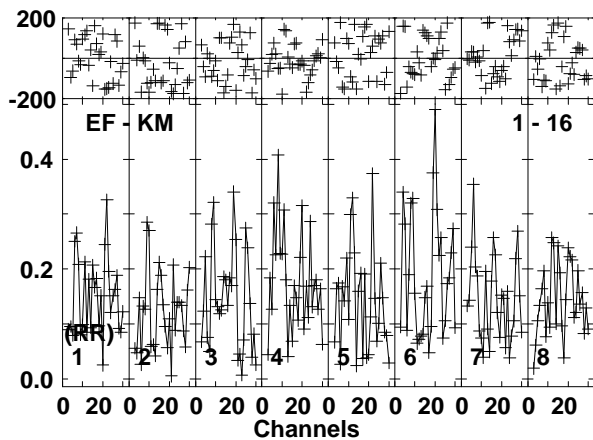
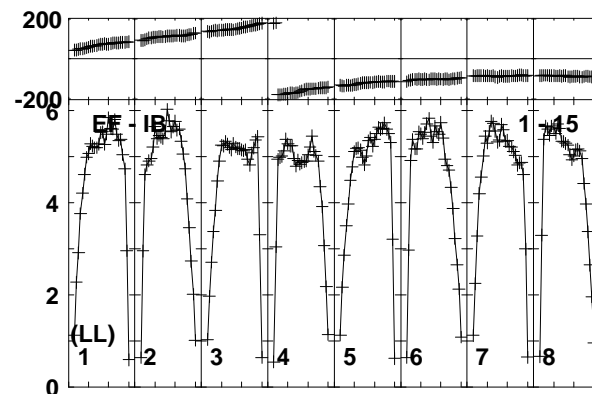
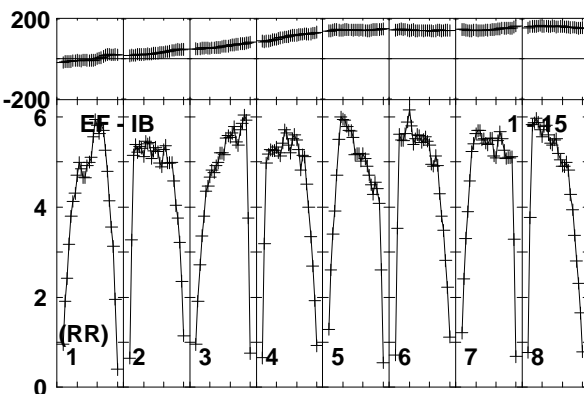
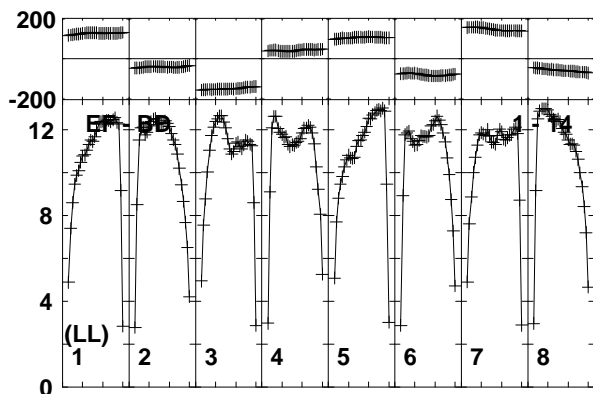
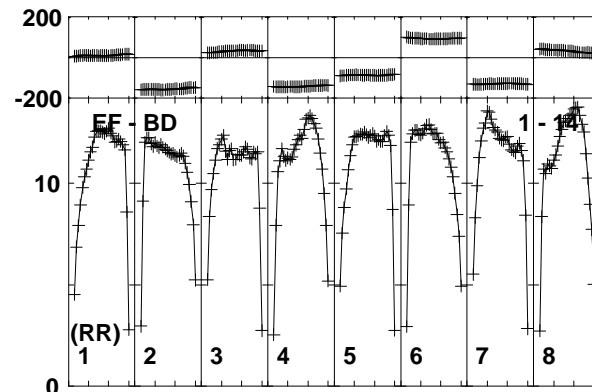
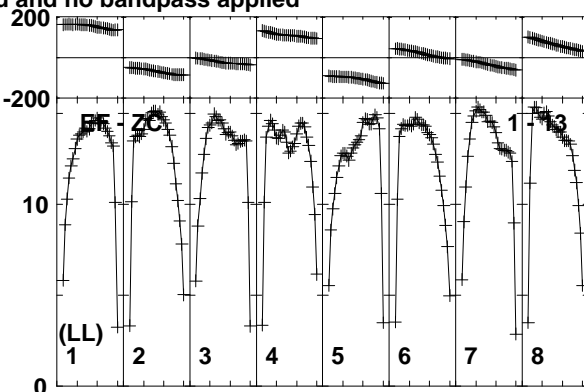
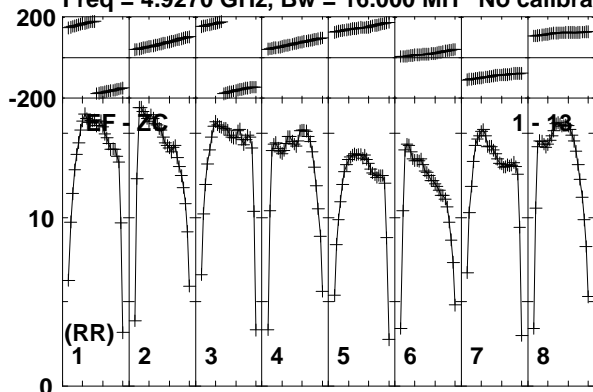

Lower frame: Milli Ampl Jy Top frame: Phas deg  
Vector averaged cross-power spectrum Baseline: EF (01) - ZC (13)  
Timerange: 00/04:45:11 to 00/04:46:39

Plot file version 126 created 08-APR-2019 12:09:46

MRK622 EM133B.UVDATA.1

Freq = 4.9270 GHz, Bw = 16.000 MH No calibration applied and no bandpass applied

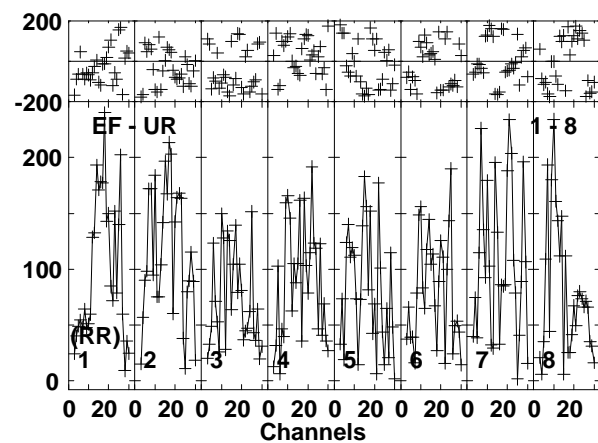
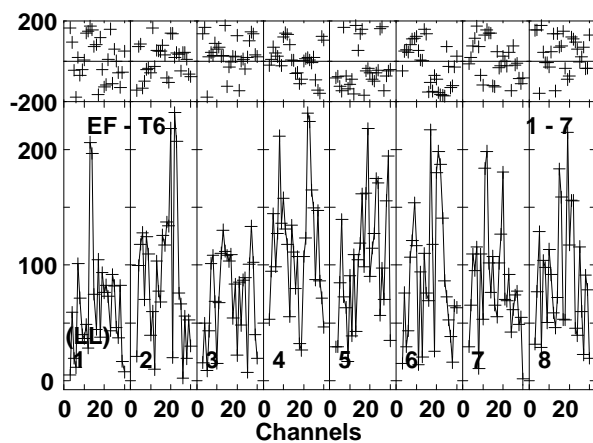
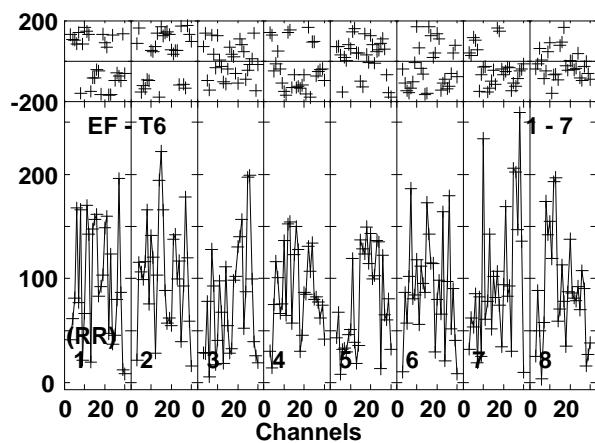
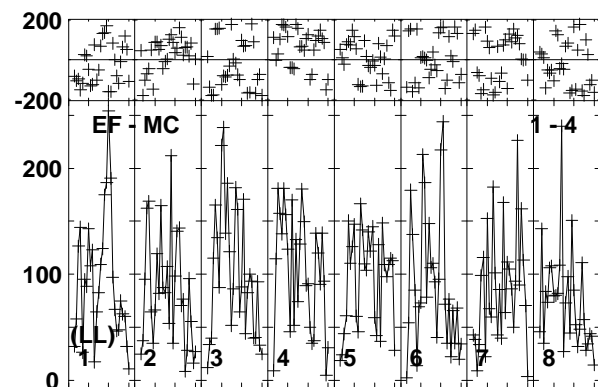
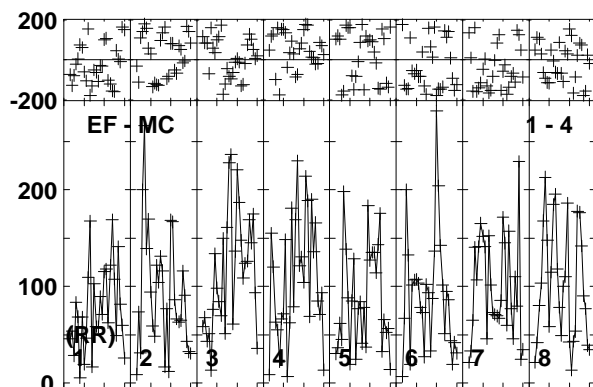
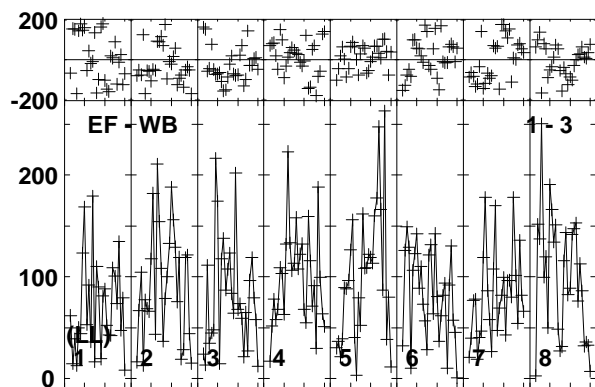
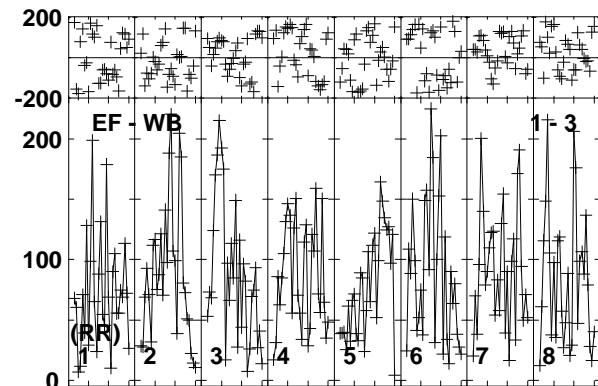
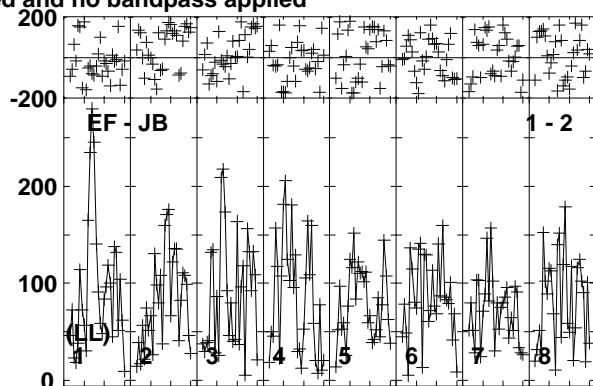
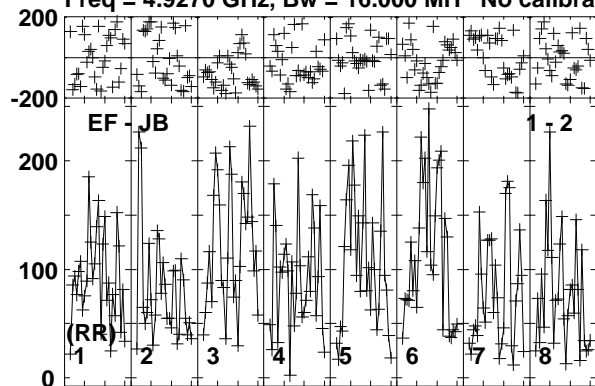

Lower frame: Micro Ampl Jy Top frame: Phas deg  
Vector averaged cross-power spectrum Baseline: EF (01) - JB (02)  
Timerange: 00/04:46:43 to 00/04:50:09

Plot file version 127 created 08-APR-2019 12:09:46

MRK622 EM133B.UVDATA.1

Freq = 4.9270 GHz, Bw = 16.000 MH No calibration applied and no bandpass applied

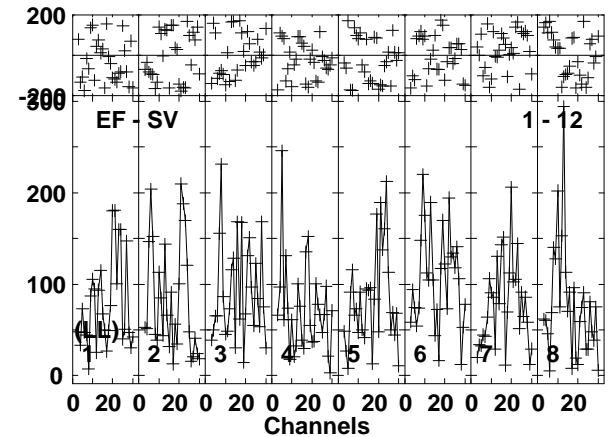
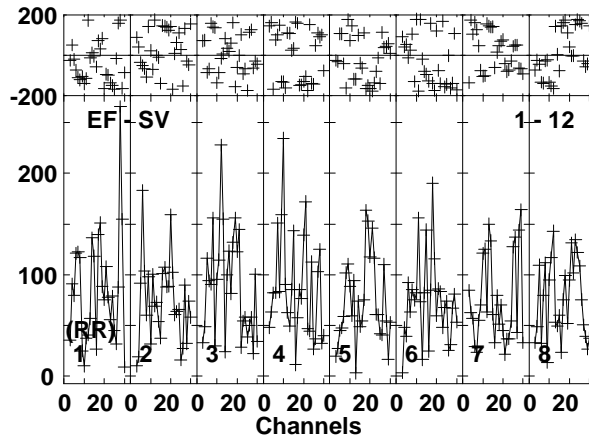
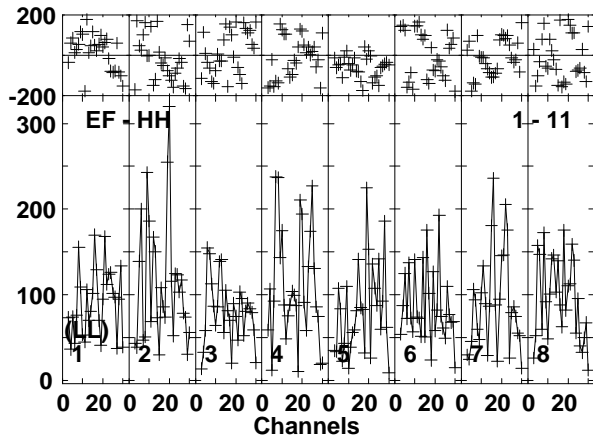
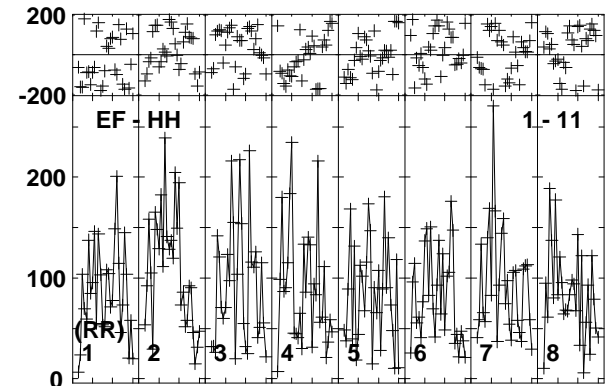
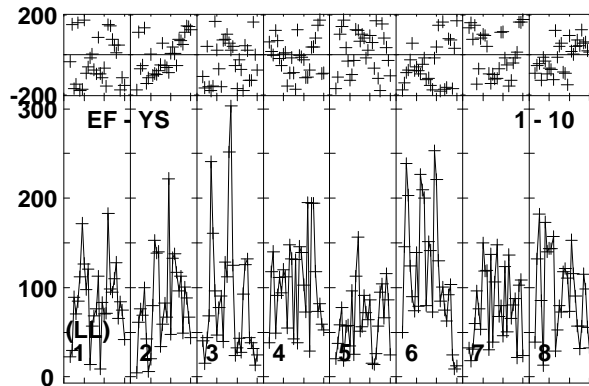
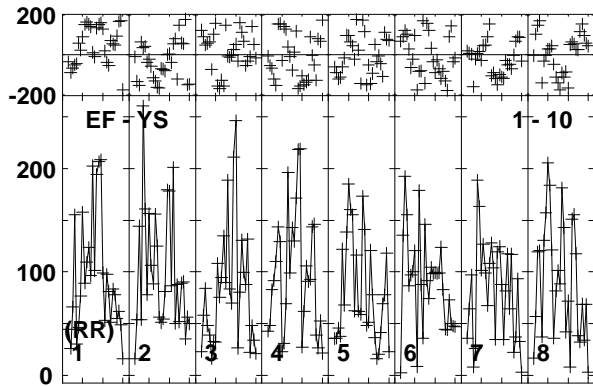
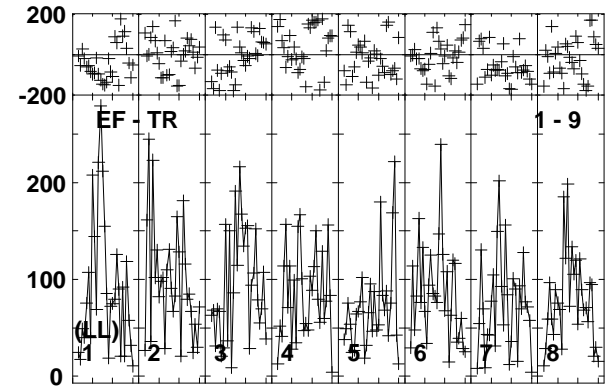
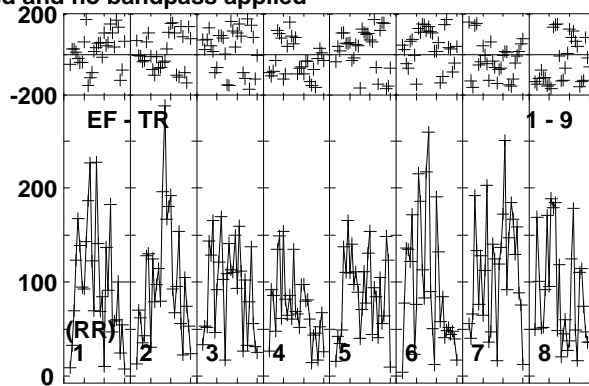
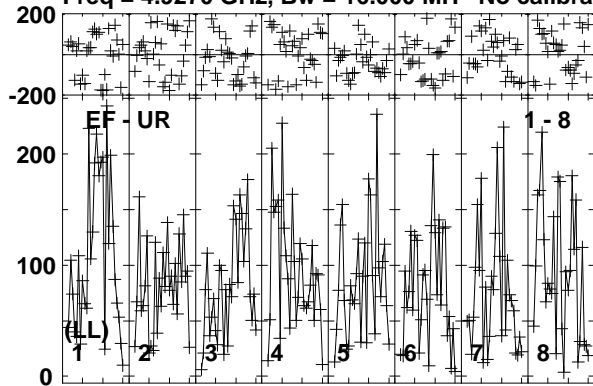

Lower frame: Micro Ampl Jy Top frame: Phas deg  
Vector averaged cross-power spectrum Baseline: EF (01) - UR (08)  
Timerange: 00/04:46:43 to 00/04:50:09

Plot file version 128 created 08-APR-2019 12:09:47

MRK622 EM133B.UVDATA.1

Freq = 4.9270 GHz, Bw = 16.000 MH No calibration applied and no bandpass applied

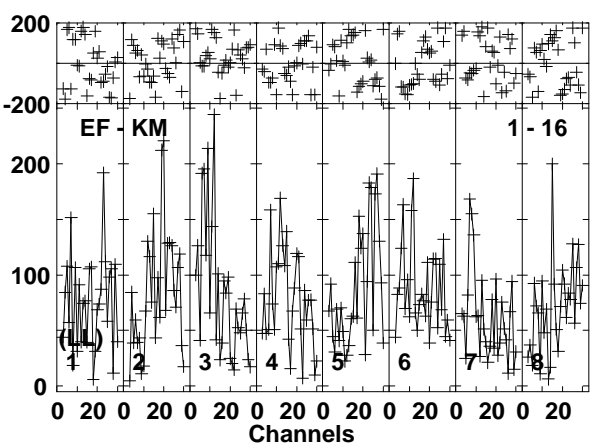
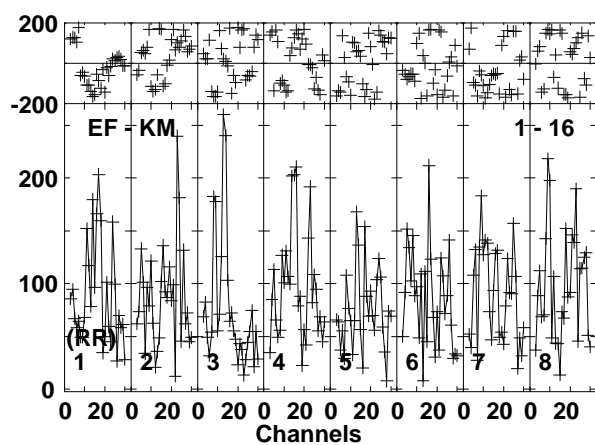
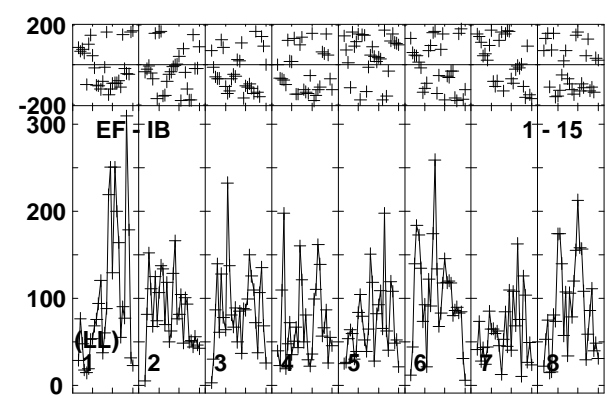
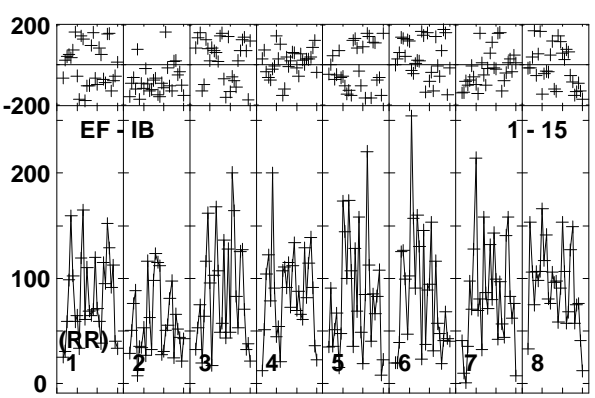
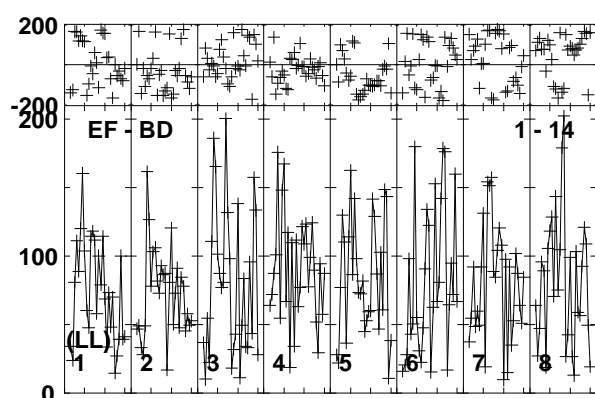
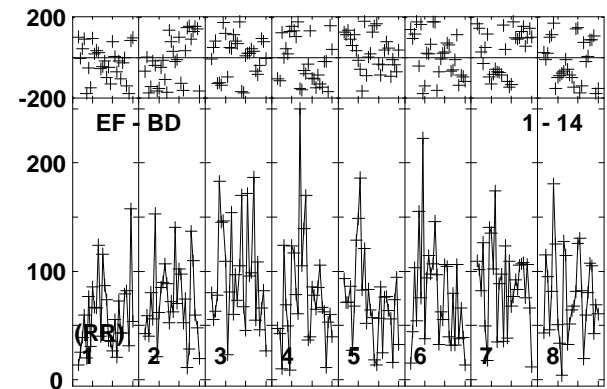
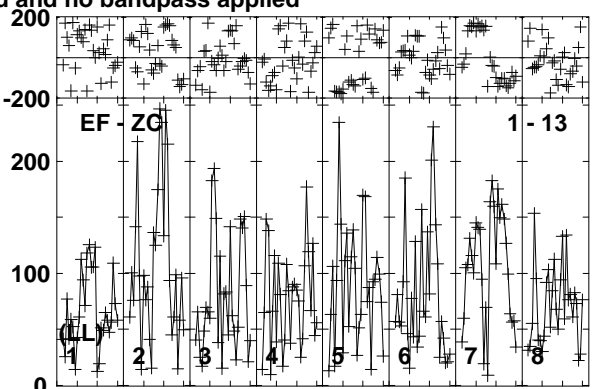
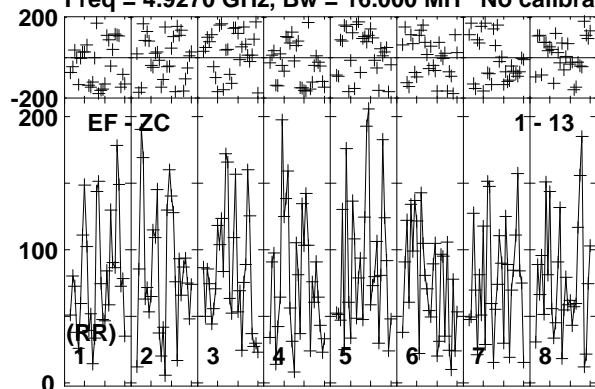

Lower frame: Micro Ampl Jy Top frame: Phas deg  
Vector averaged cross-power spectrum Baseline: EF (01) - ZC (13)  
Timerange: 00/04:46:43 to 00/04:50:09



Plot file version 129 created 08-APR-2019 12:09:47

J0815+3635 EM133B.UVDATA.1

Freq = 4.9270 GHz, Bw = 16.000 MH No calibration applied and no bandpass applied

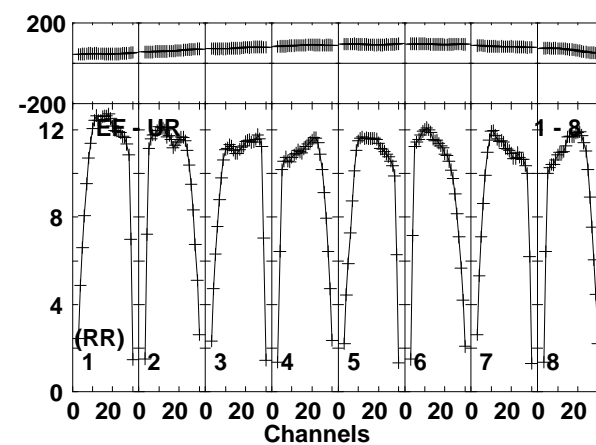
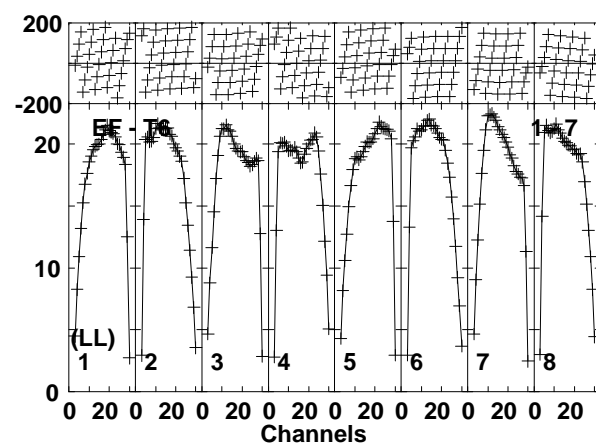
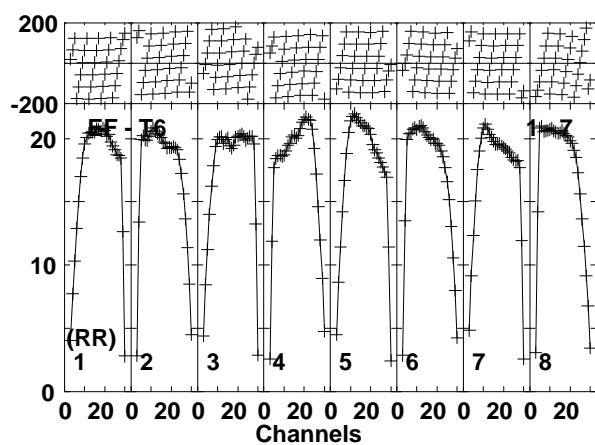
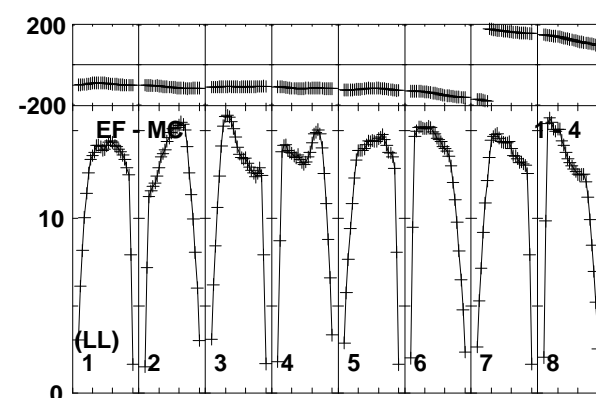
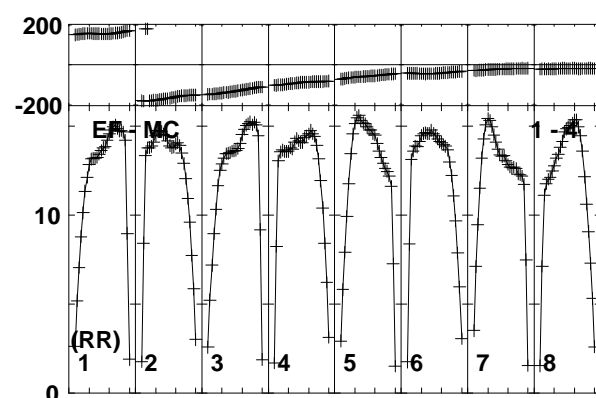
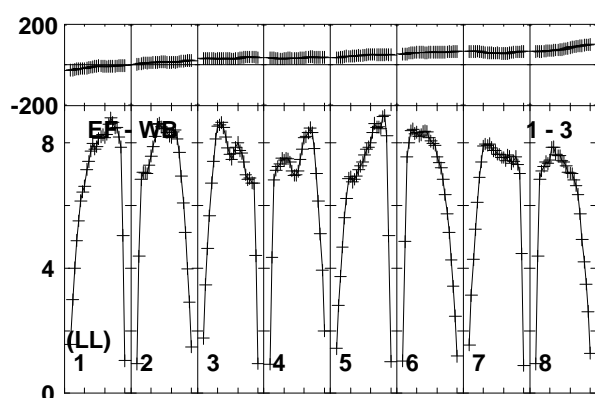
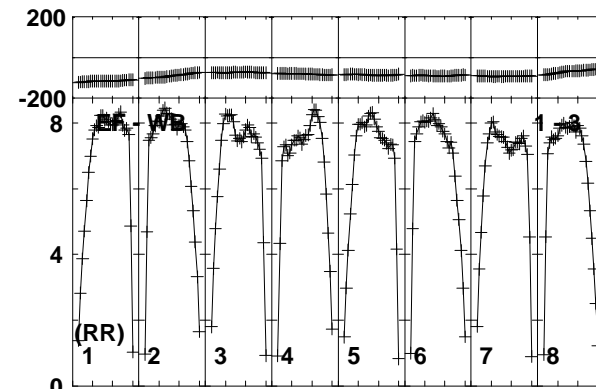
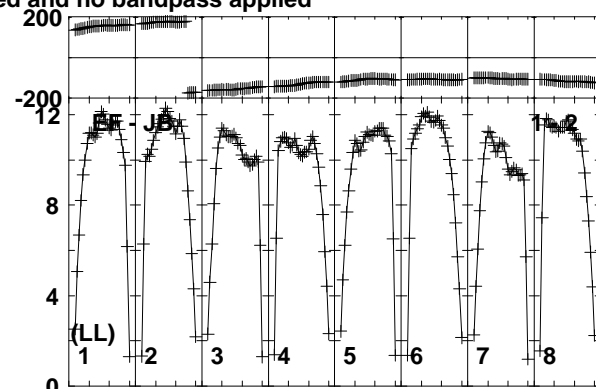
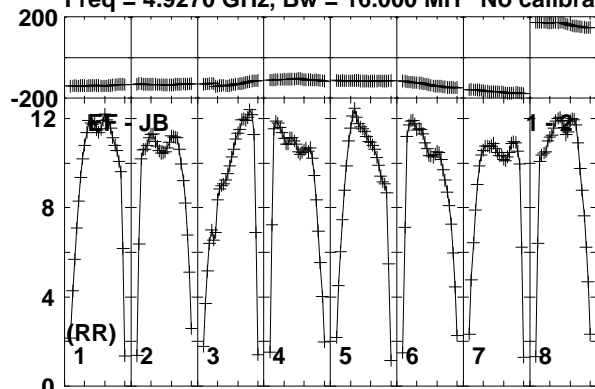

Lower frame: Milli Ampl Jy Top frame: Phas deg  
Vector averaged cross-power spectrum Baseline: EF (01) - JB (02)  
Timerange: 00/04:51:01 to 00/04:52:29

Plot file version 130 created 08-APR-2019 12:09:47

J0815+3635 EM133B.UVDATA.1

Freq = 4.9270 GHz, Bw = 16.000 MH No calibration applied and no bandpass applied

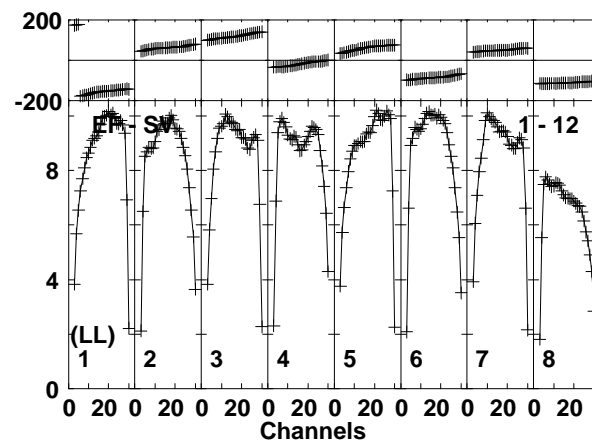
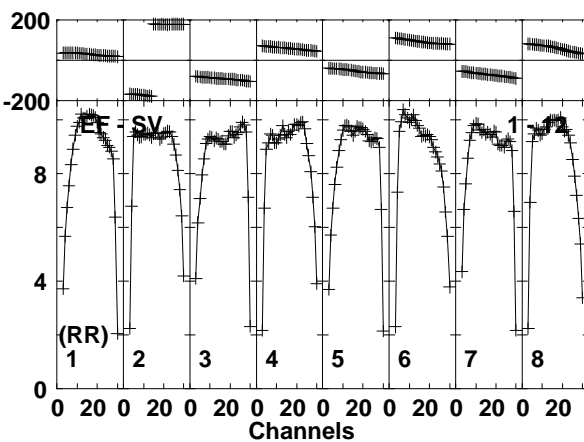
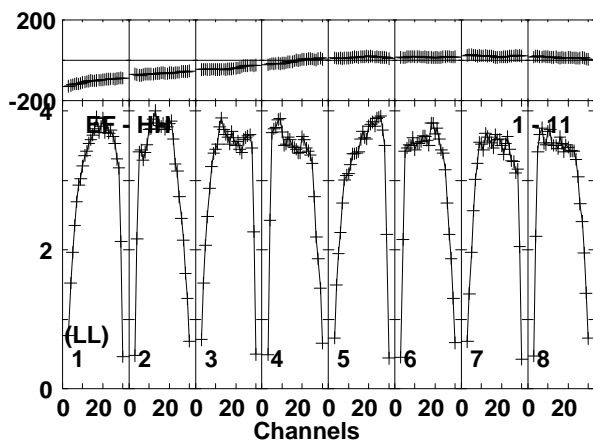
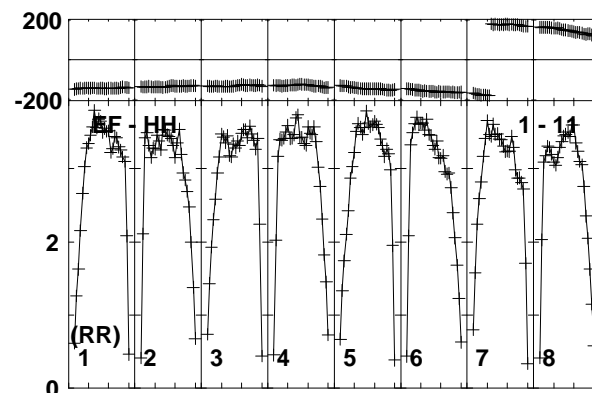
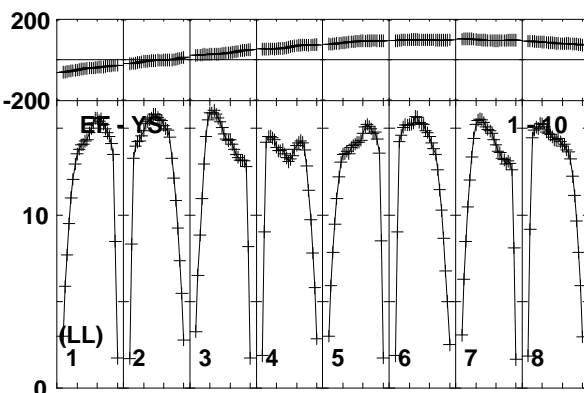
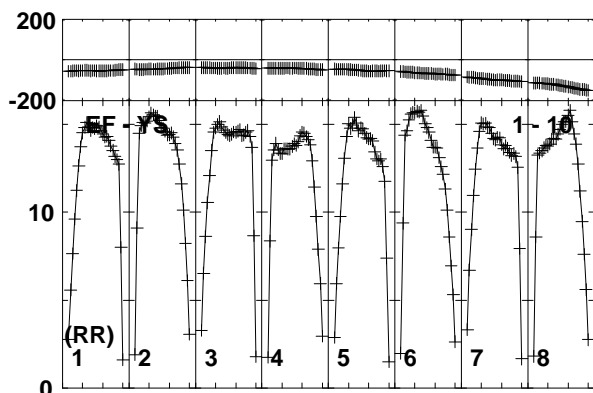
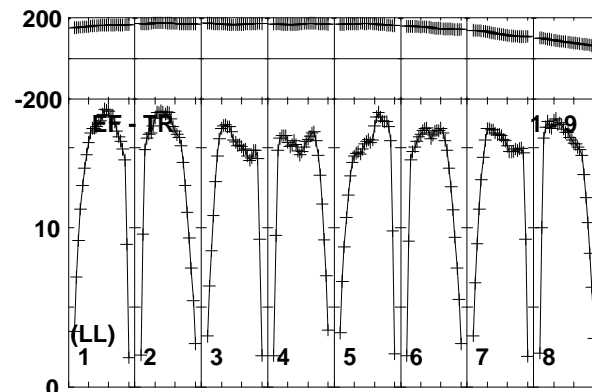
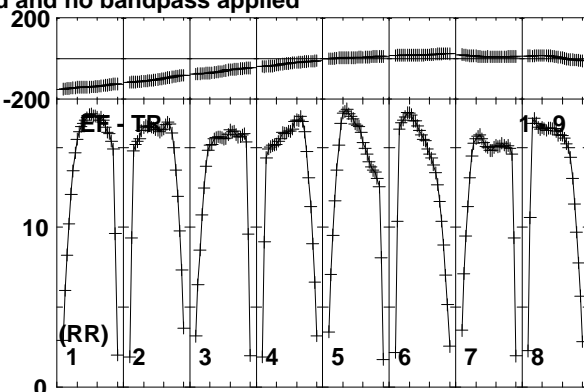
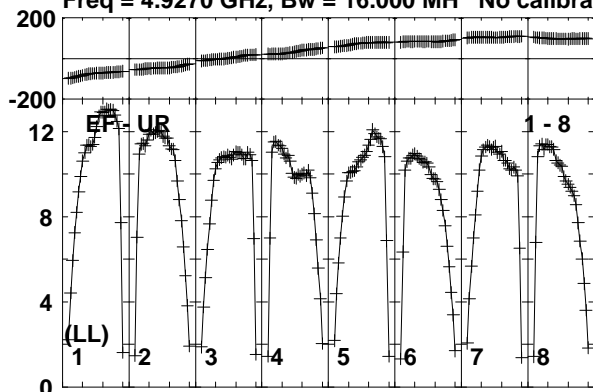

Lower frame: Milli Ampl Jy Top frame: Phas deg  
Vector averaged cross-power spectrum Baseline: EF (01) - UR (08)  
Timerange: 00/04:51:01 to 00/04:52:29

Plot file version 131 created 08-APR-2019 12:09:47

J0815+3635 EM133B.UVDATA.1

Freq = 4.9270 GHz, Bw = 16.000 MH No calibration applied and no bandpass applied

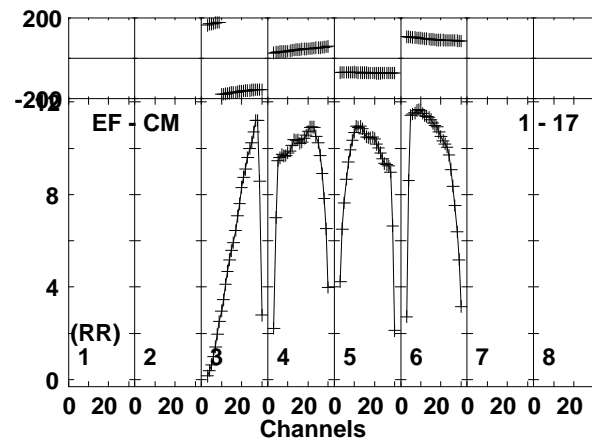
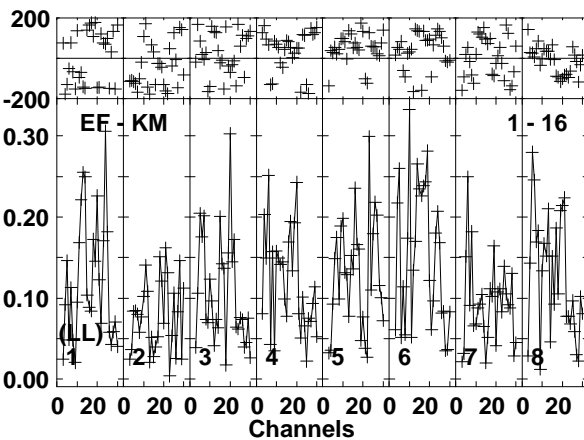
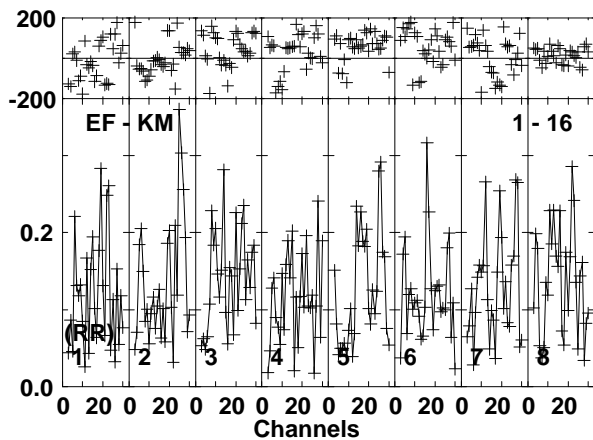
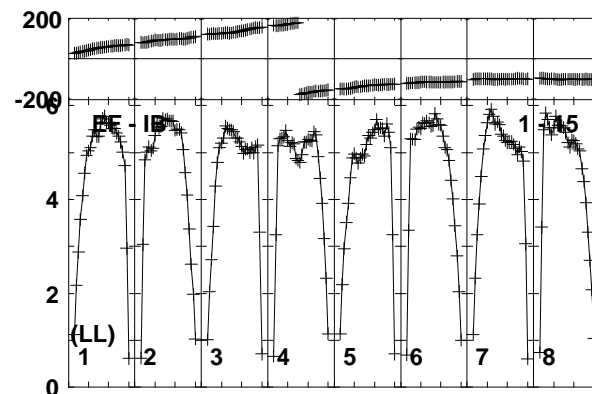
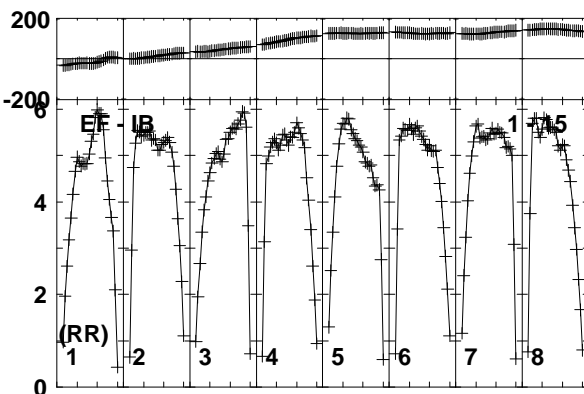
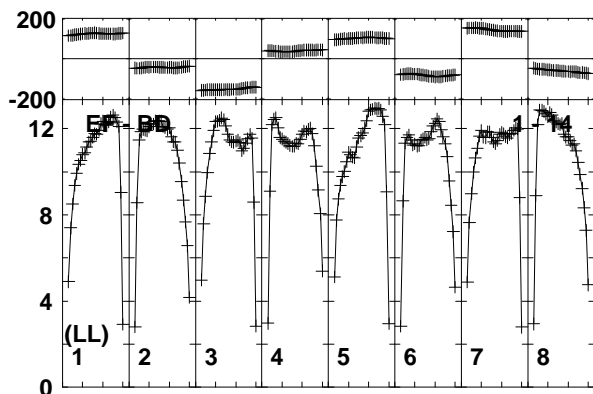
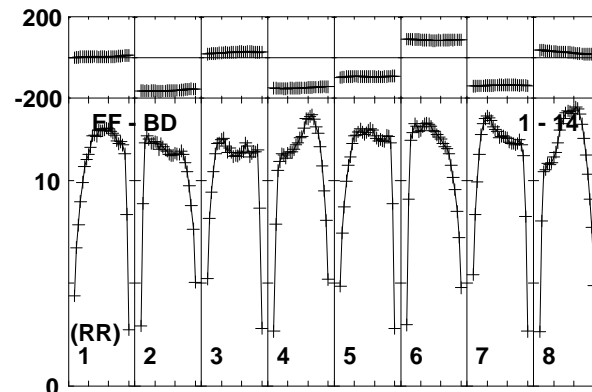
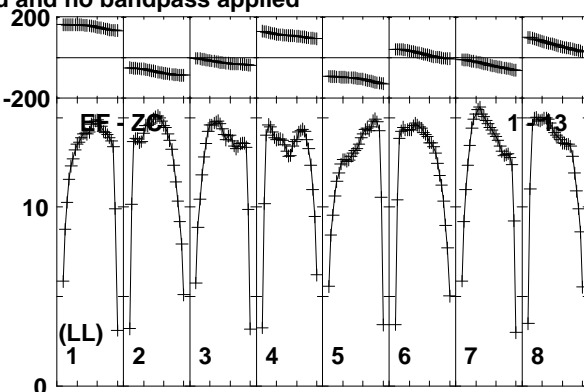
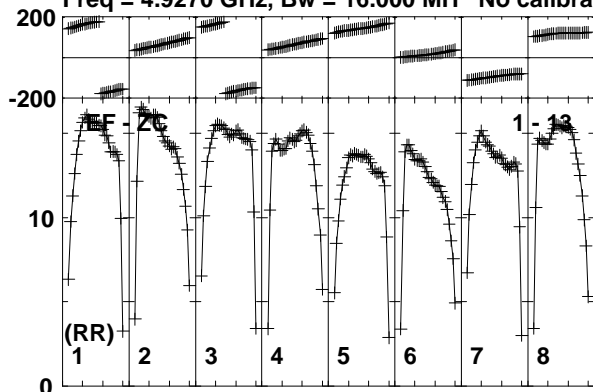

Lower frame: Milli Ampl Jy Top frame: Phas deg  
Vector averaged cross-power spectrum Baseline: EF (01) - ZC (13)  
Timerange: 00/04:51:01 to 00/04:52:29

Plot file version 132 created 08-APR-2019 12:09:47

J0815+3635 EM133B.UVDATA.1

Freq = 4.9270 GHz, Bw = 16.000 MH No calibration applied and no bandpass applied

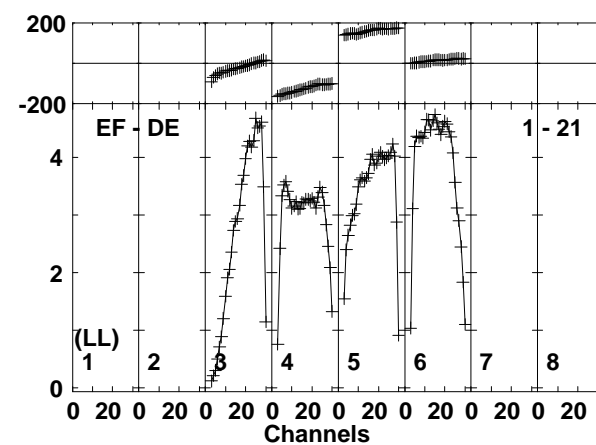
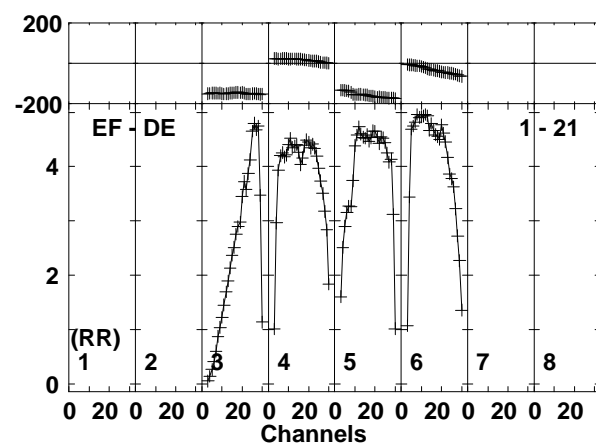
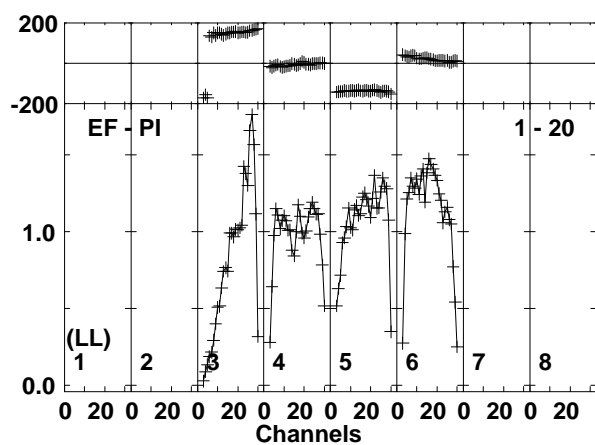
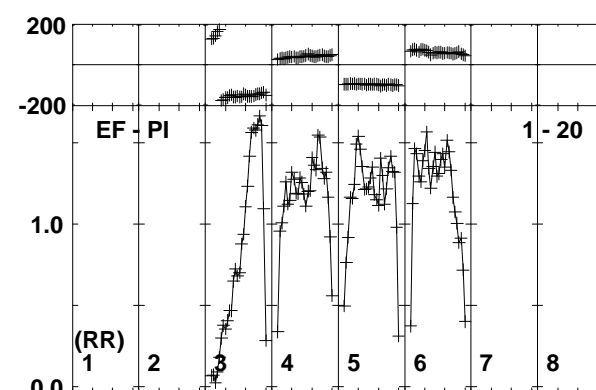
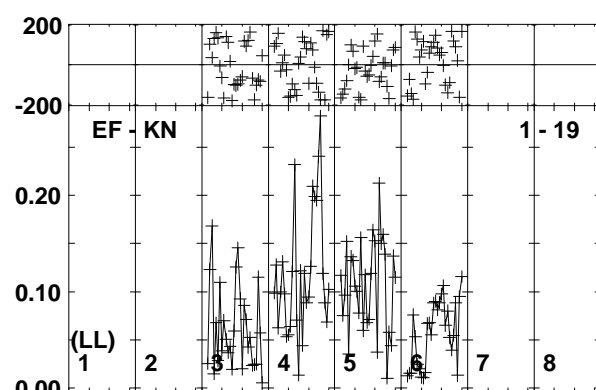
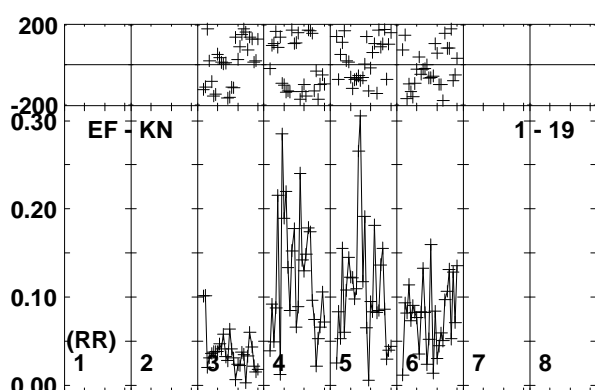
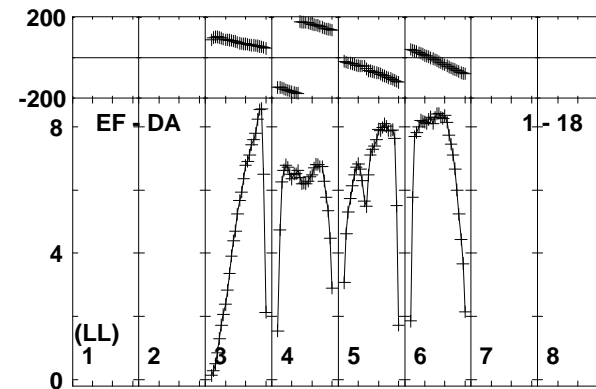
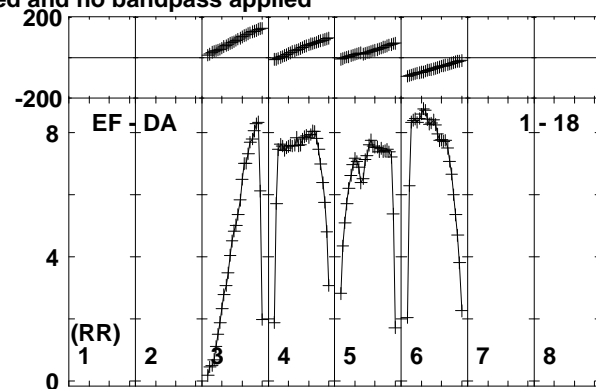
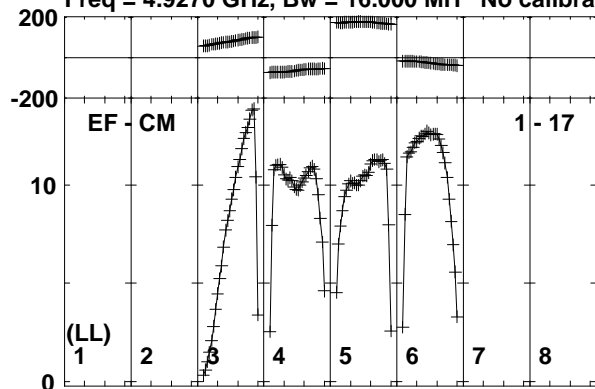

Lower frame: Milli Ampl Jy Top frame: Phas deg  
Vector averaged cross-power spectrum Baseline: EF (01) - CM (17)  
Timerange: 00/04:51:01 to 00/04:52:29

Plot file version 133 created 08-APR-2019 12:09:47

MRK622 EM133B.UVDATA.1

Freq = 4.9270 GHz, Bw = 16.000 MH No calibration applied and no bandpass applied

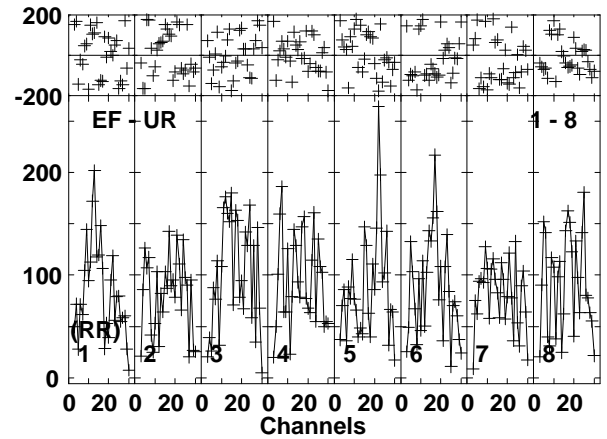
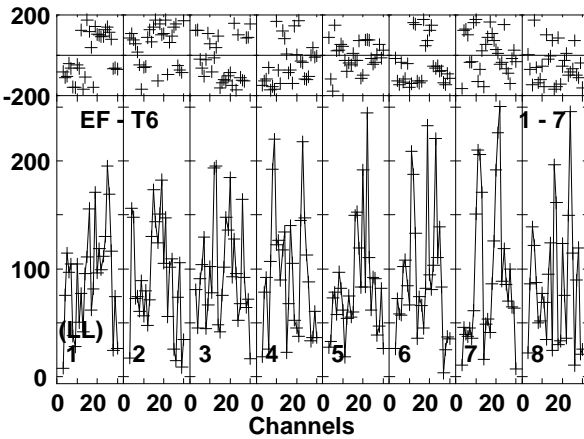
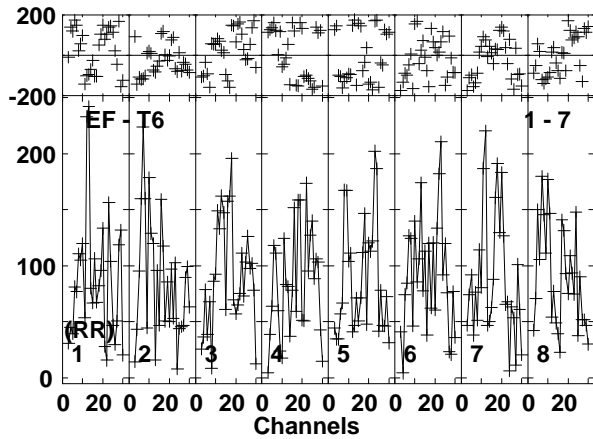
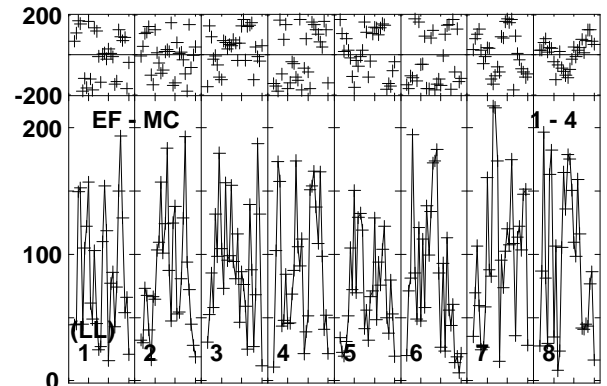
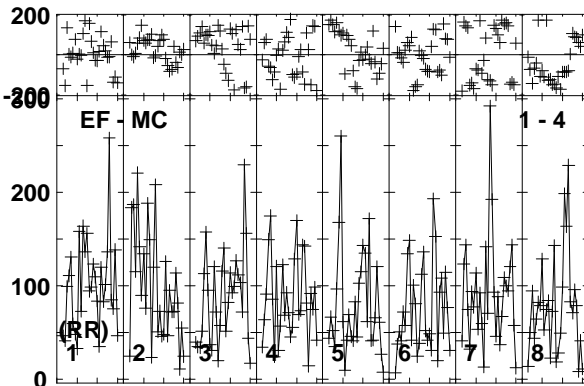
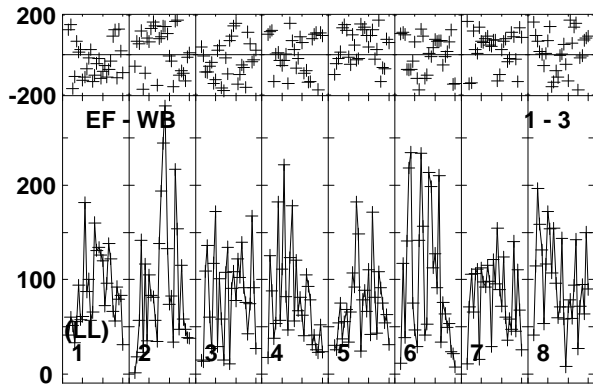
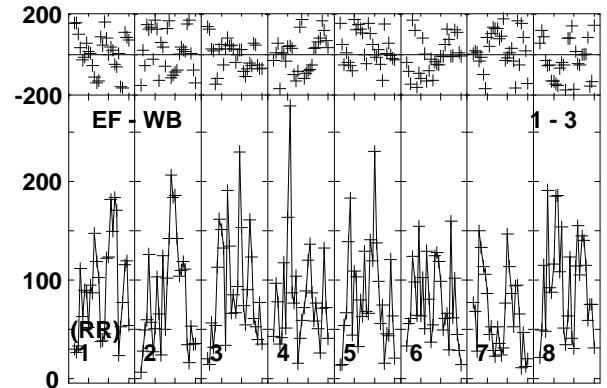
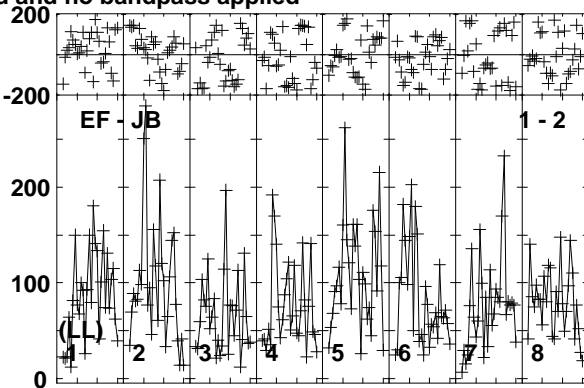
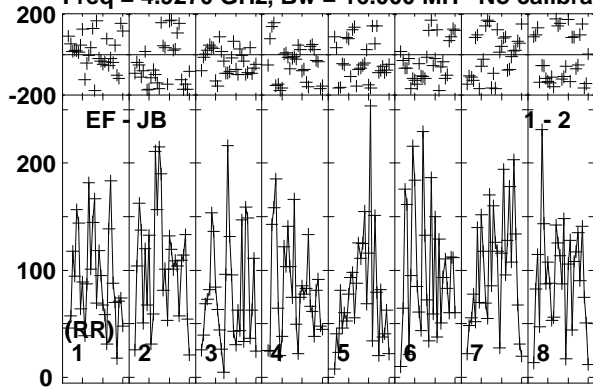

Lower frame: Micro Ampl Jy Top frame: Phas deg  
Vector averaged cross-power spectrum Baseline: EF (01) - JB (02)  
Timerange: 00/04:52:31 to 00/04:55:59

Plot file version 134 created 08-APR-2019 12:09:48

MRK622 EM133B.UVDATA.1

Freq = 4.9270 GHz, Bw = 16.000 MH No calibration applied and no bandpass applied

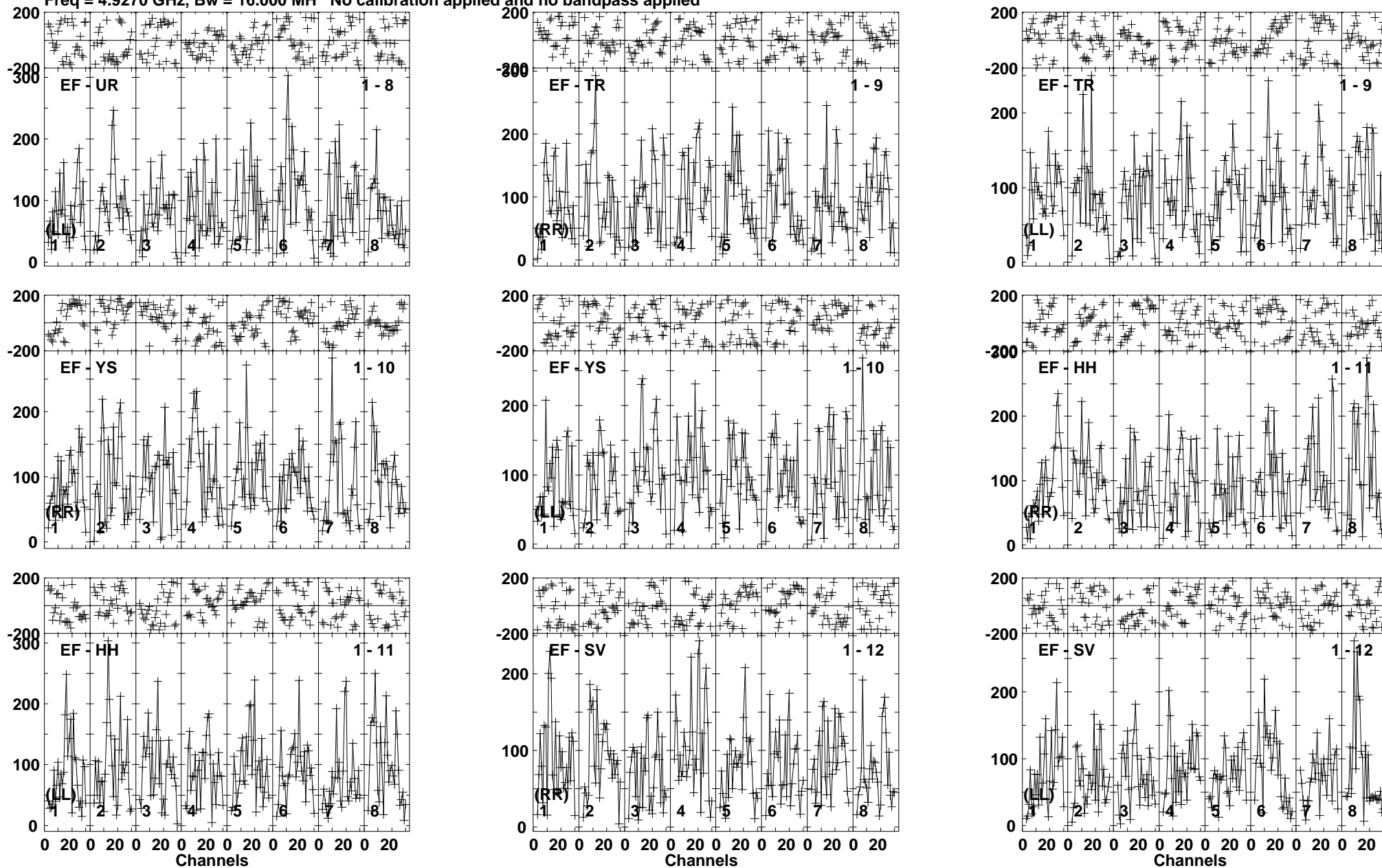

Lower frame: Micro Ampl Jy Top frame: Phas deg  
Vector averaged cross-power spectrum Baseline: EF (01) - UR (08)  
Timerange: 00/04:52:31 to 00/04:55:59

Plot file version 135 created 08-APR-2019 12:09:48  
MRK622 EM133B.UVDATA.1

Freq = 4.9270 GHz, Bw = 16.000 MH No calibration applied and no bandpass applied

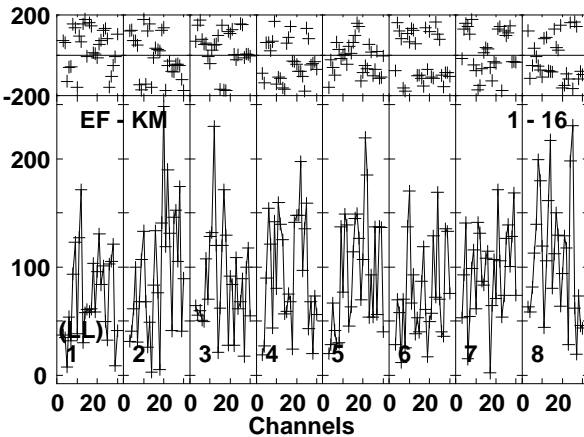
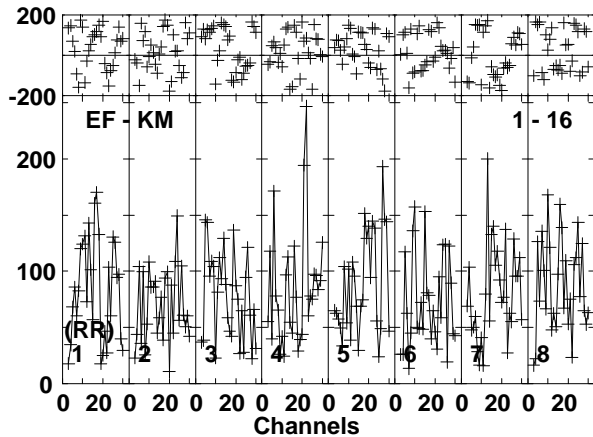
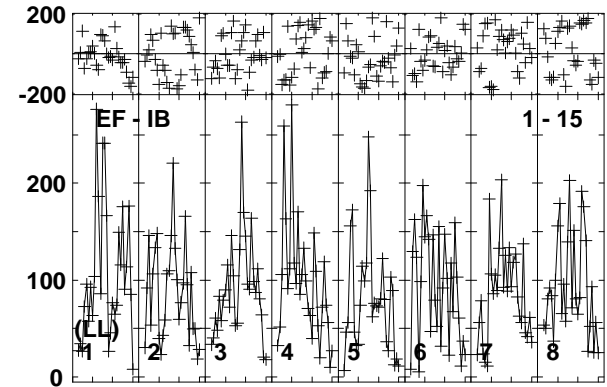
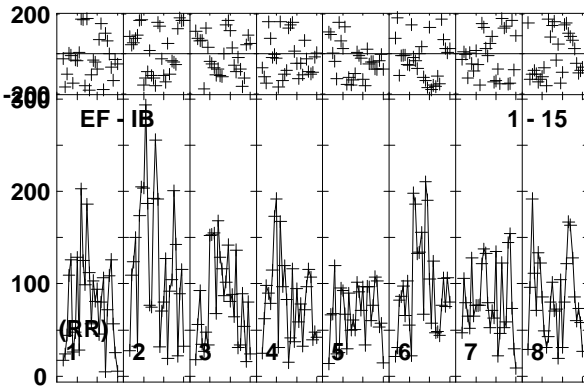
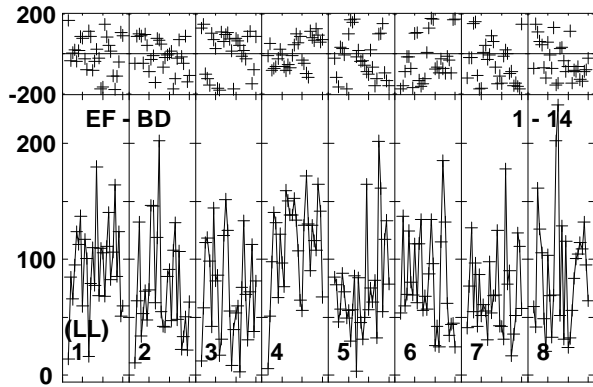
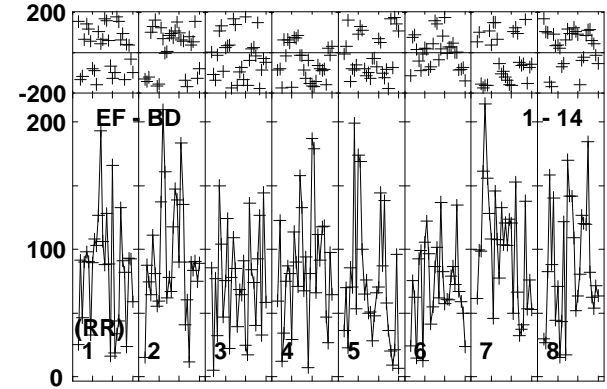
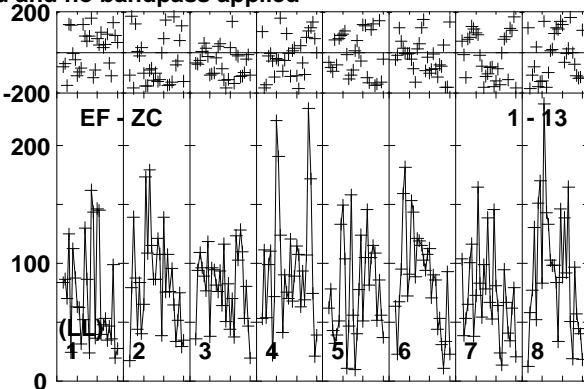
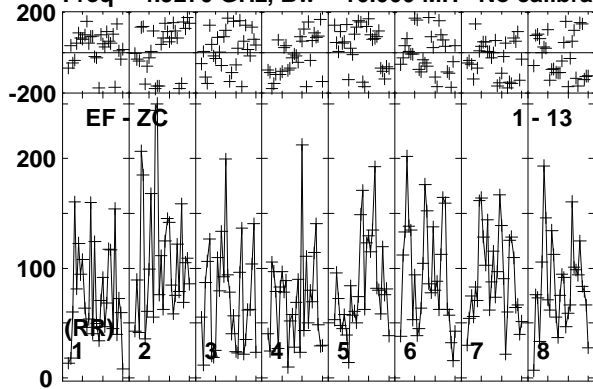

Lower frame: Micro Ampl Jy Top frame: Phas deg  
Vector averaged cross-power spectrum Baseline: EF (01) - ZC (13)  
Timerange: 00/04:52:31 to 00/04:55:59

Plot file version 136 created 08-APR-2019 12:09:48

J0815+3635 EM133B.UVDATA.1

Freq = 4.9270 GHz, Bw = 16.000 MH No calibration applied and no bandpass applied

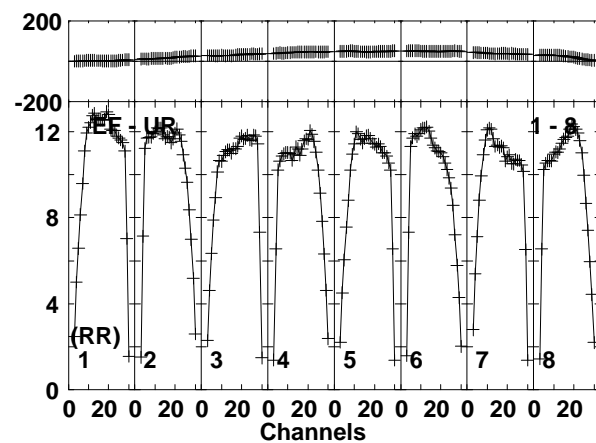
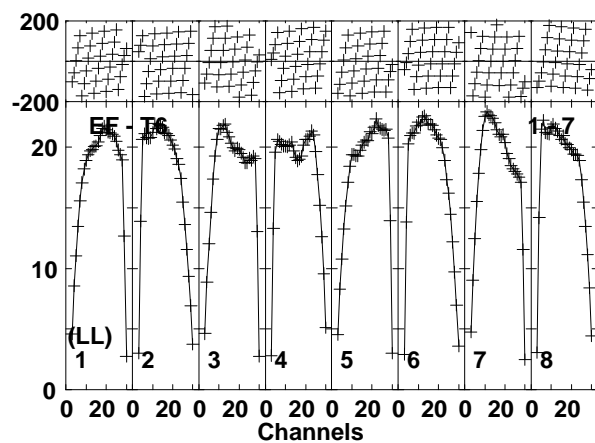
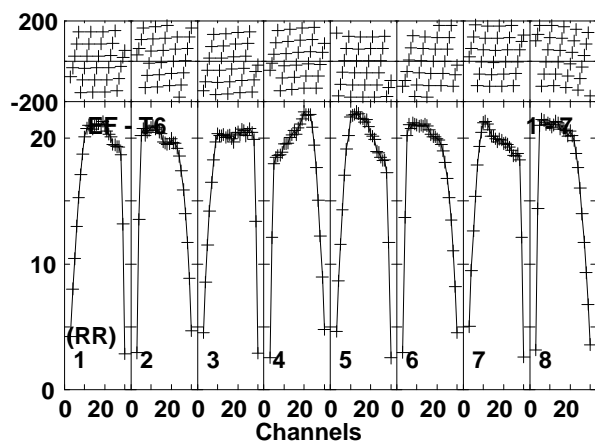
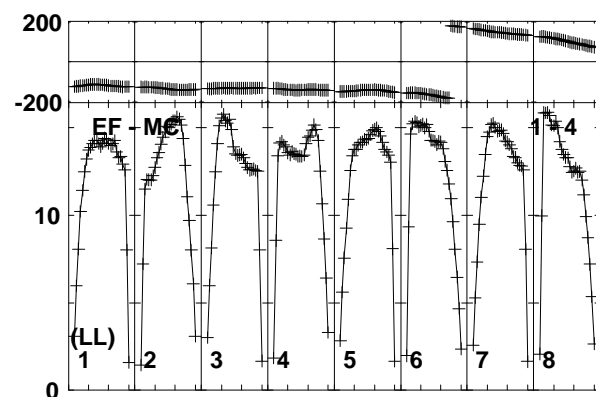
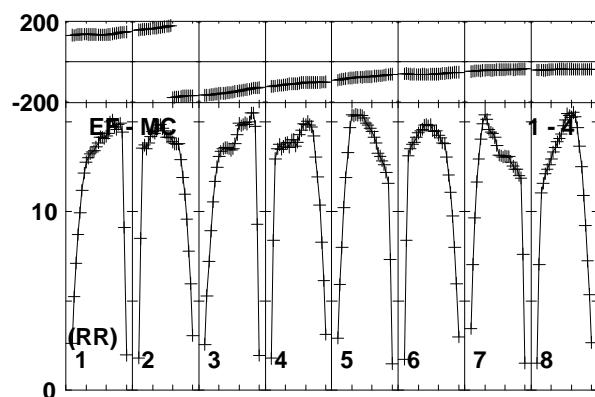
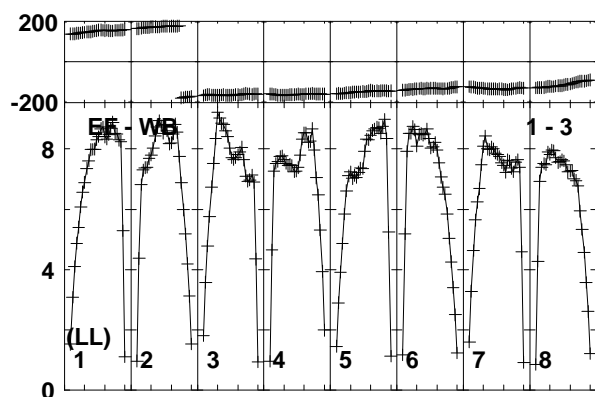
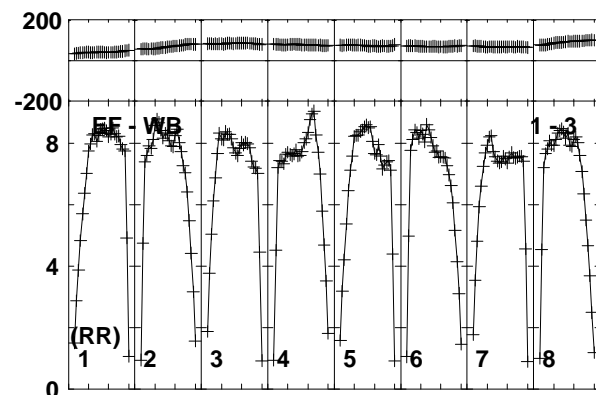
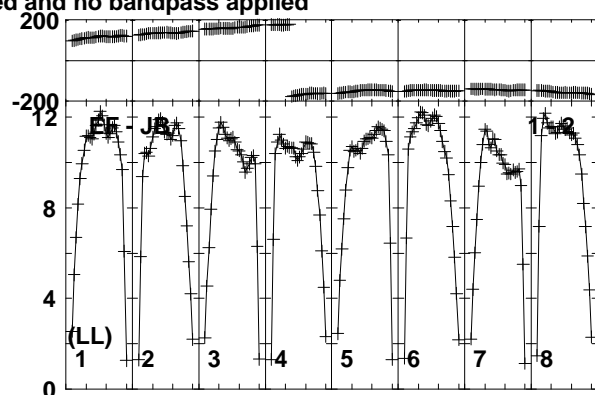
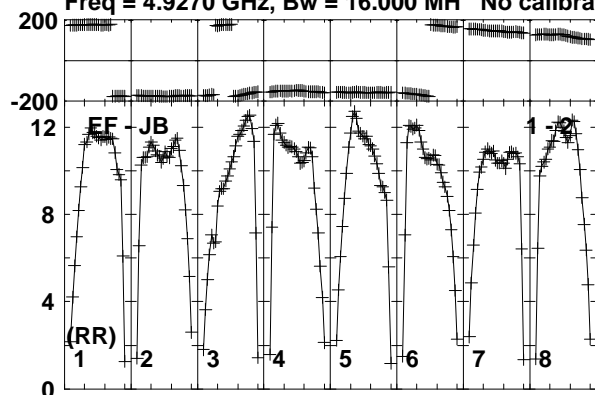

Lower frame: Milli Ampl Jy Top frame: Phas deg  
Vector averaged cross-power spectrum Baseline: EF (01) - JB (02)  
Timerange: 00/04:56:01 to 00/04:57:29



Plot file version 137 created 08-APR-2019 12:09:48

J0815+3635 EM133B.UVDATA.1

Freq = 4.9270 GHz, Bw = 16.000 MH No calibration applied and no bandpass applied

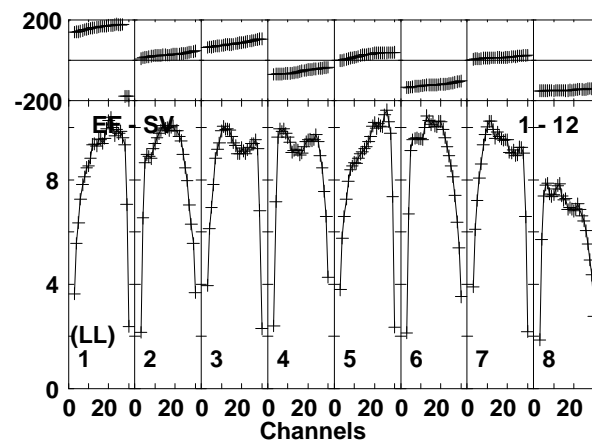
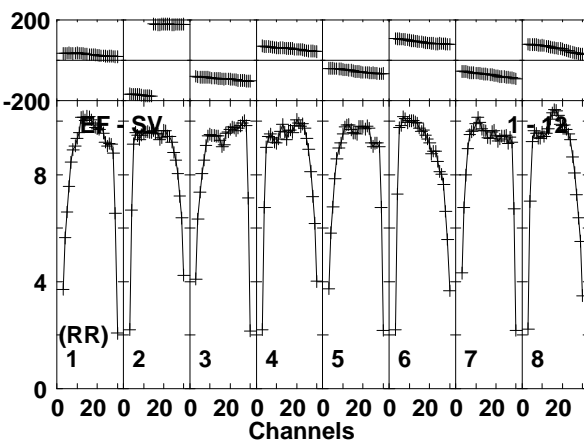
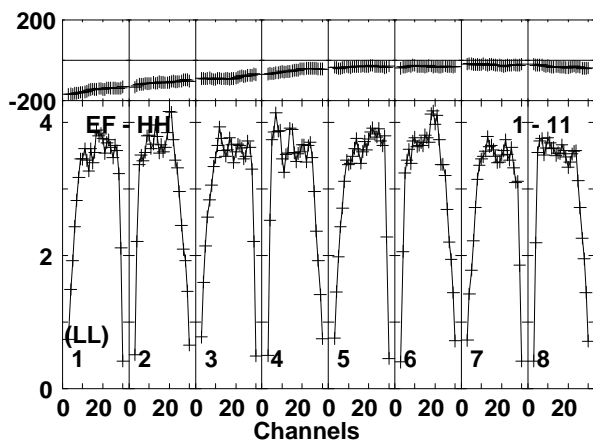
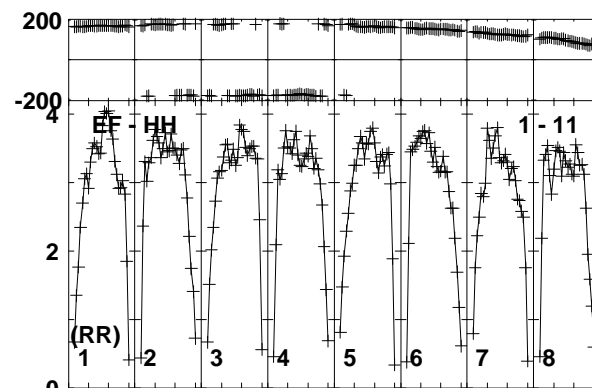
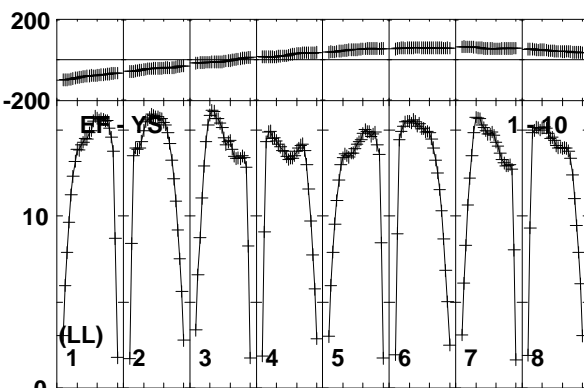
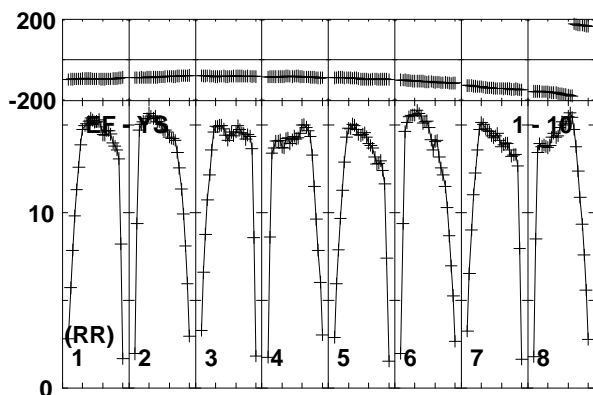
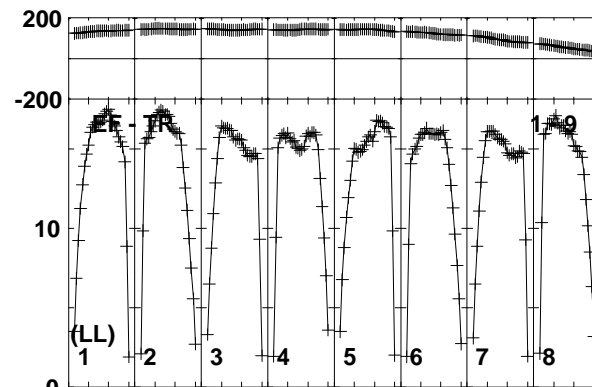
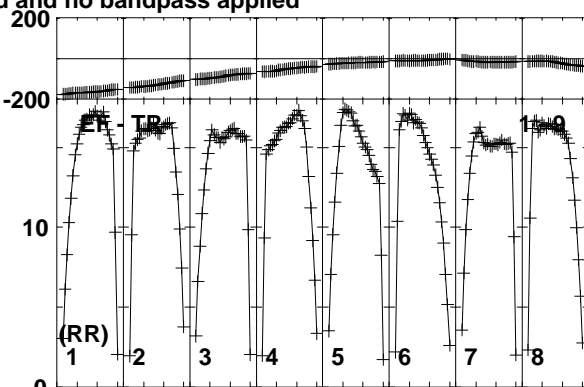
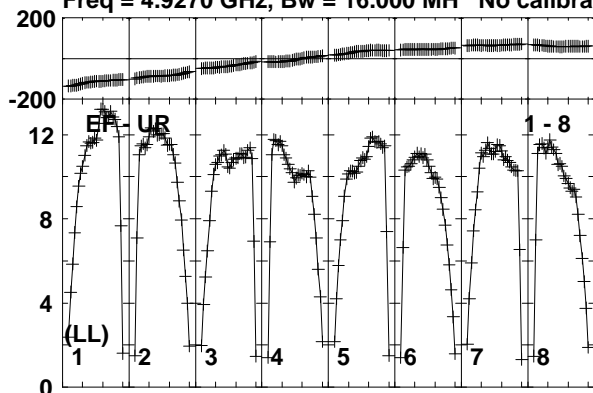

Lower frame: Milli Ampl Jy Top frame: Phas deg  
Vector averaged cross-power spectrum Baseline: EF (01) - UR (08)  
Timerange: 00/04:56:01 to 00/04:57:29

Plot file version 138 created 08-APR-2019 12:09:48

J0815+3635 EM133B.UVDATA.1

Freq = 4.9270 GHz, Bw = 16.000 MH No calibration applied and no bandpass applied

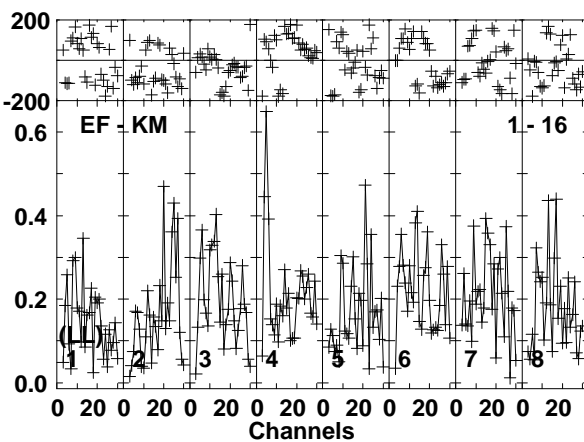
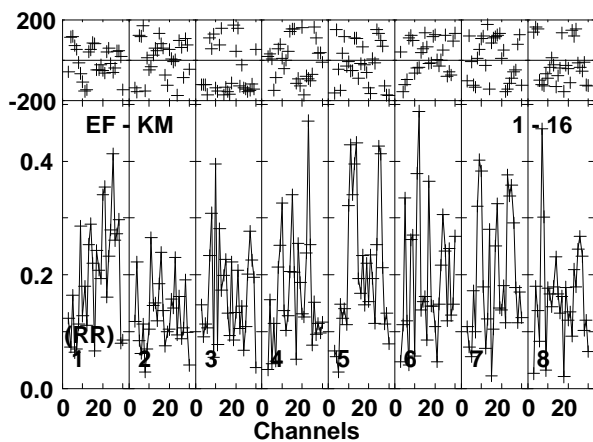
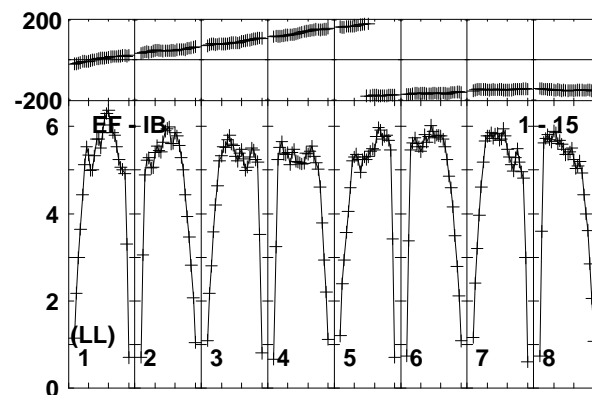
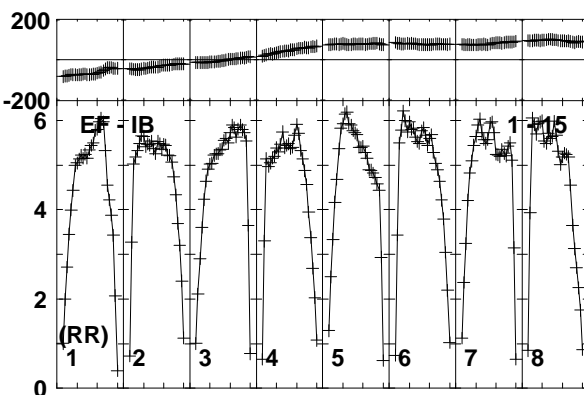
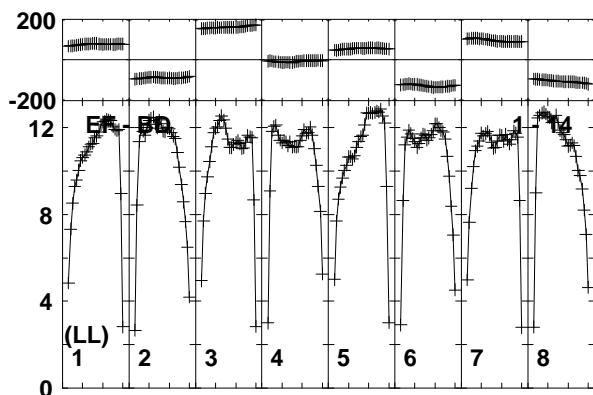
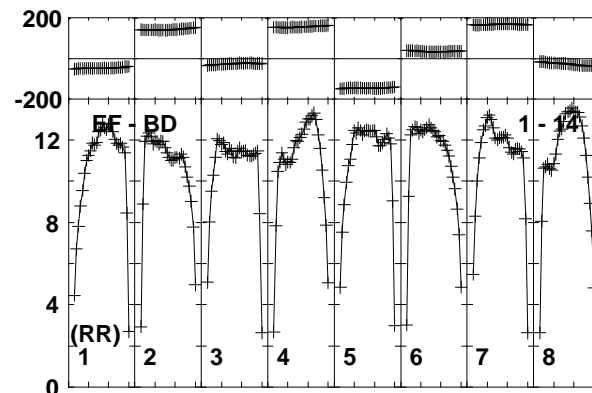
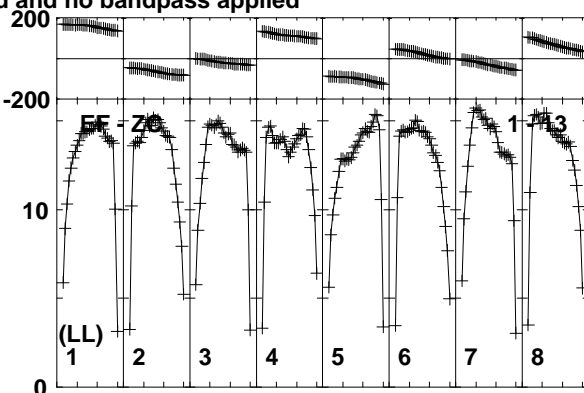
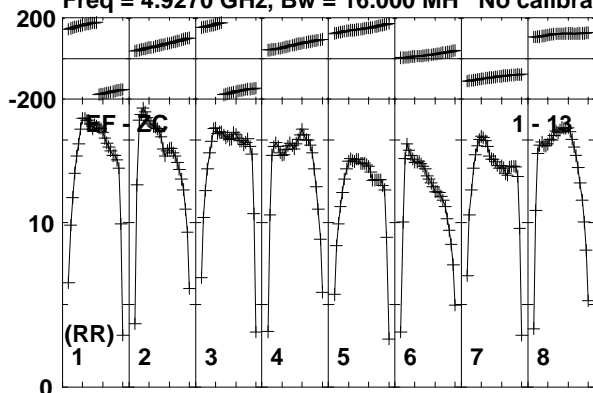

Lower frame: Milli Ampl Jy Top frame: Phas deg  
Vector averaged cross-power spectrum Baseline: EF (01) - ZC (13)  
Timerange: 00/04:56:01 to 00/04:57:29

Plot file version 139 created 08-APR-2019 12:09:48

MRK622 EM133B.UVDATA.1

Freq = 4.9270 GHz, Bw = 16.000 MH No calibration applied and no bandpass applied

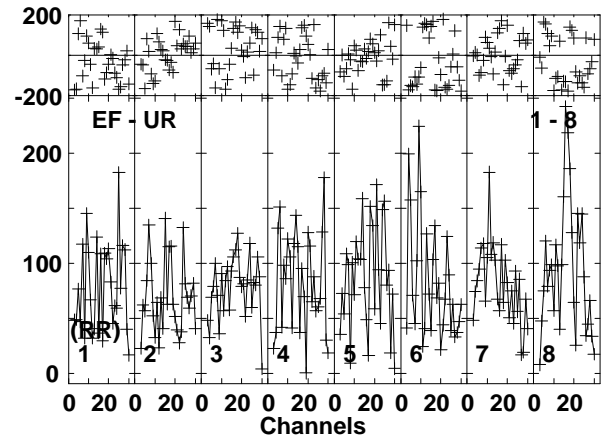
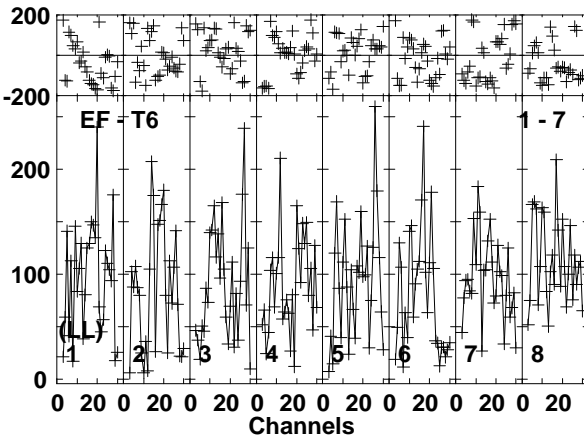
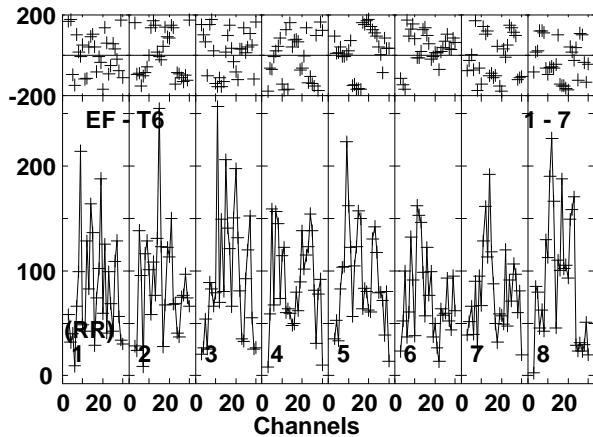
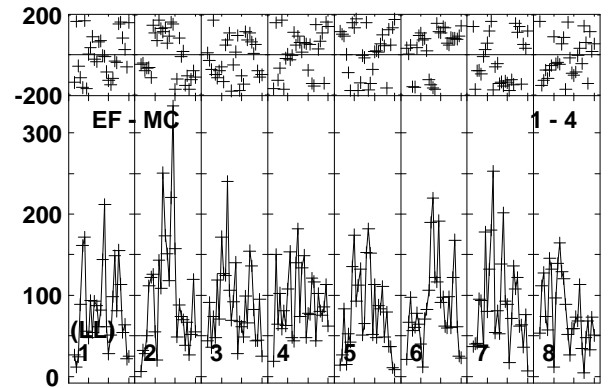
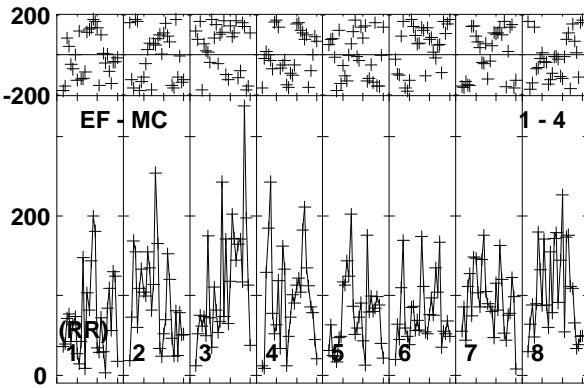
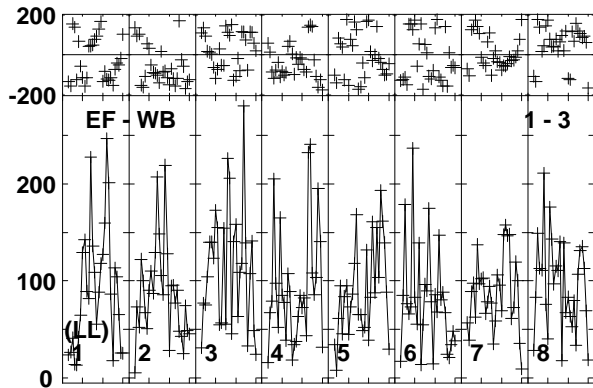
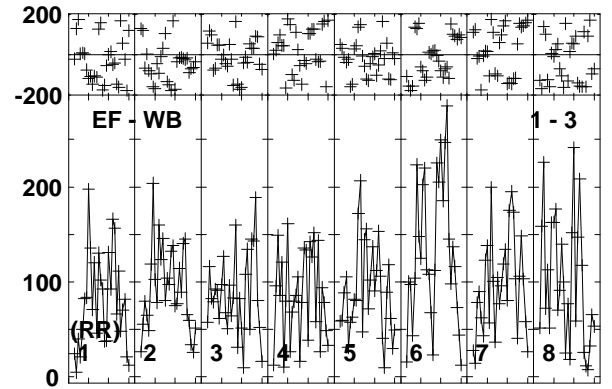
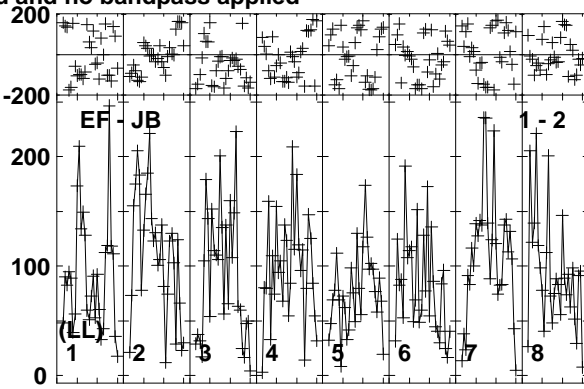
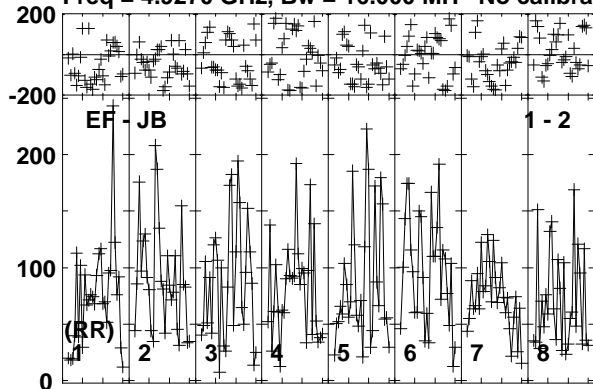

Lower frame: Micro Ampl Jy Top frame: Phas deg  
Vector averaged cross-power spectrum Baseline: EF (01) - JB (02)  
Timerange: 00/04:57:33 to 00/05:00:59

Plot file version 140 created 08-APR-2019 12:09:49

MRK622 EM133B.UVDATA.1

Freq = 4.9270 GHz, Bw = 16.000 MH No calibration applied and no bandpass applied

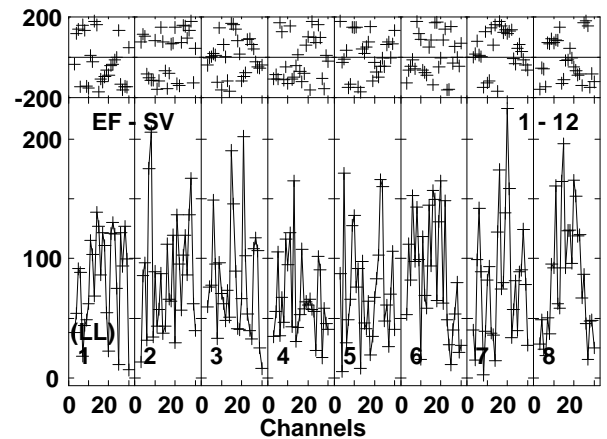
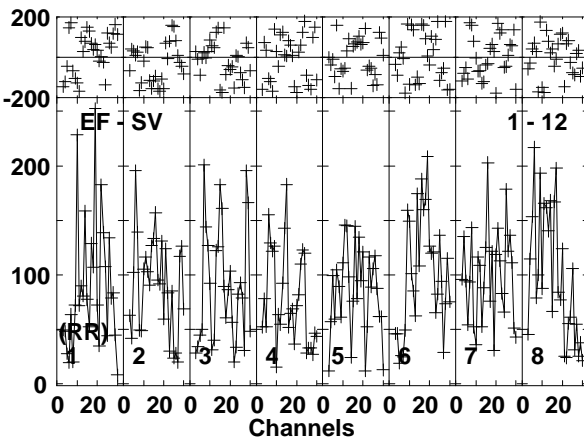
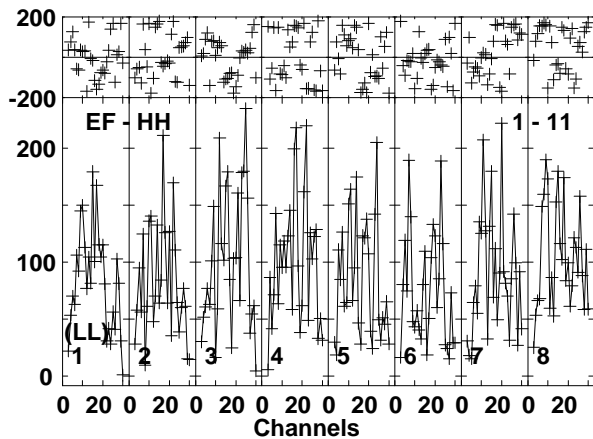
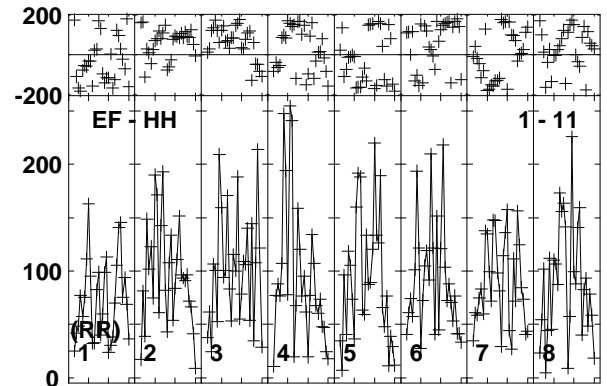
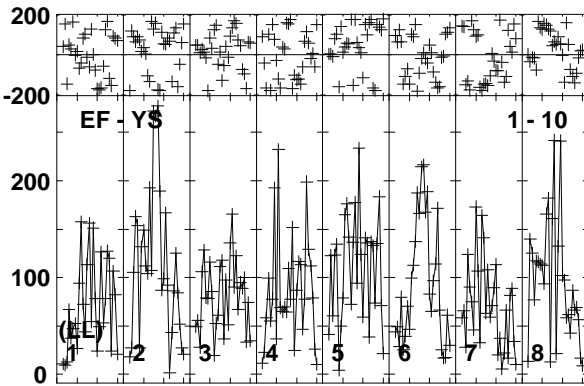
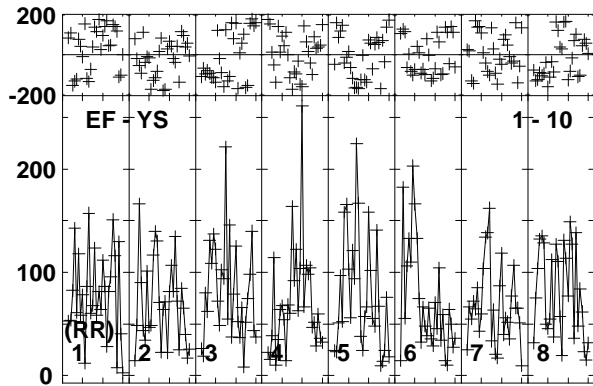
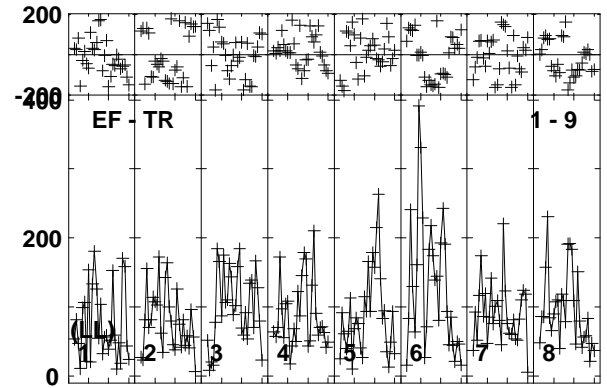
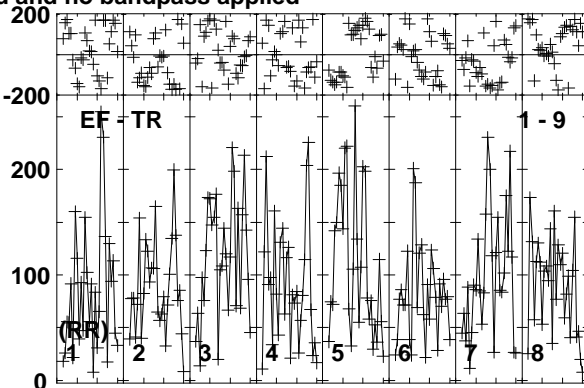
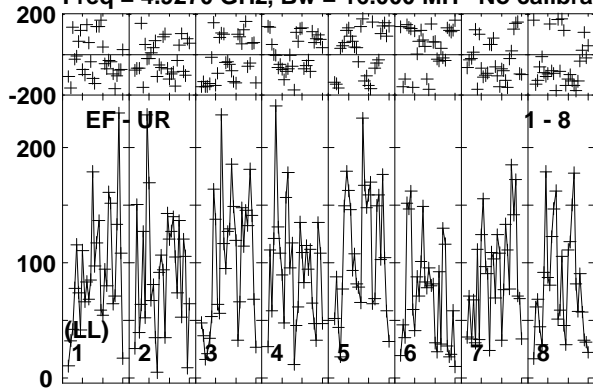

Lower frame: Micro Ampl Jy Top frame: Phas deg  
Vector averaged cross-power spectrum Baseline: EF (01) - UR (08)  
Timerange: 00/04:57:33 to 00/05:00:59

Plot file version 141 created 08-APR-2019 12:09:49

MRK622 EM133B.UVDATA.1

Freq = 4.9270 GHz, Bw = 16.000 MH No calibration applied and no bandpass applied

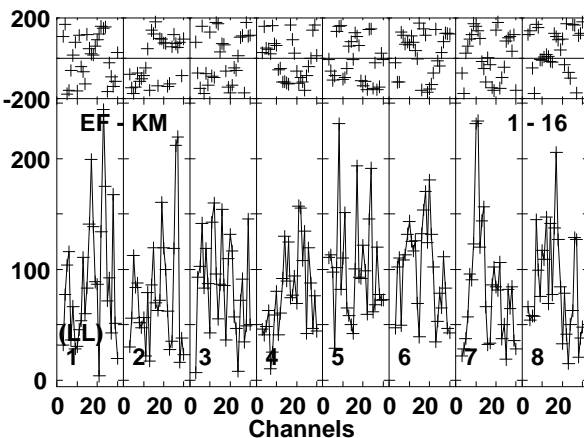
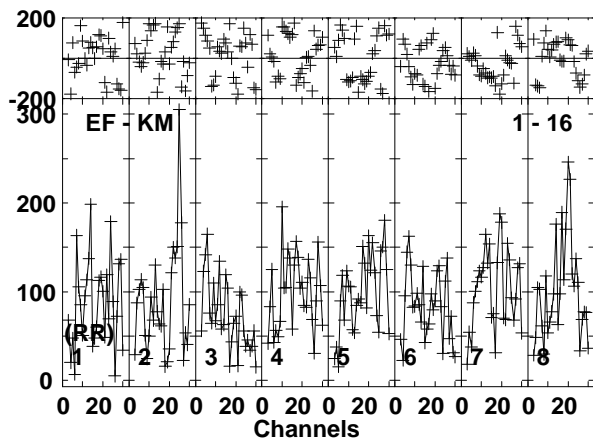
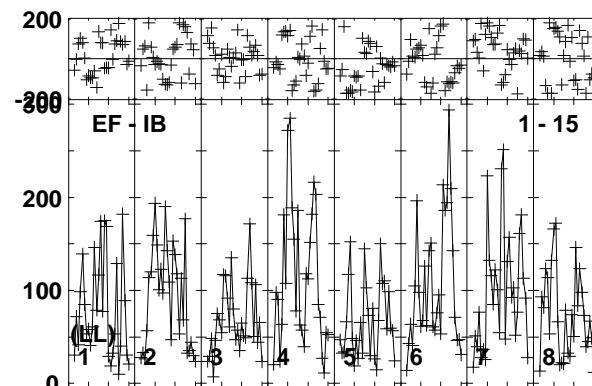
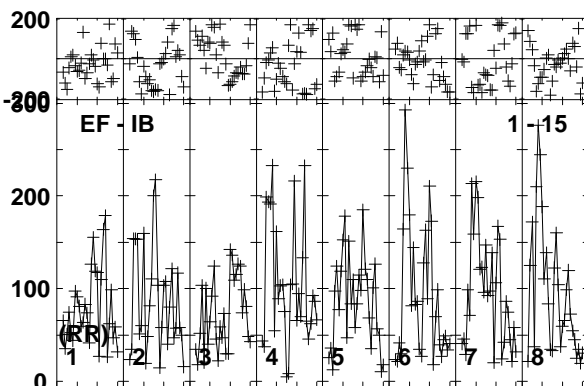
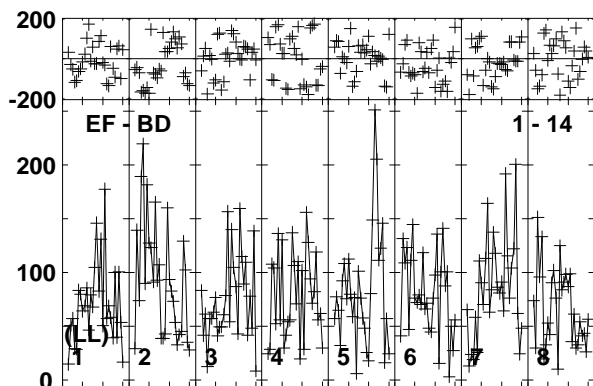
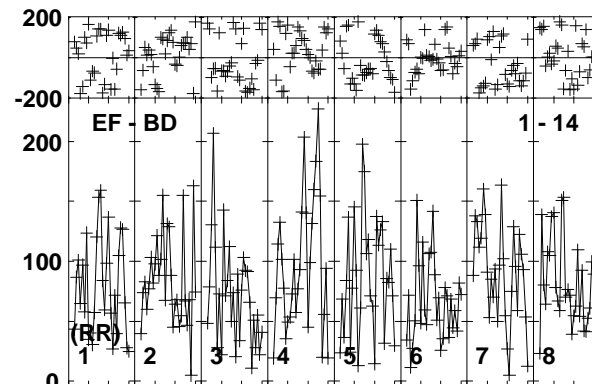
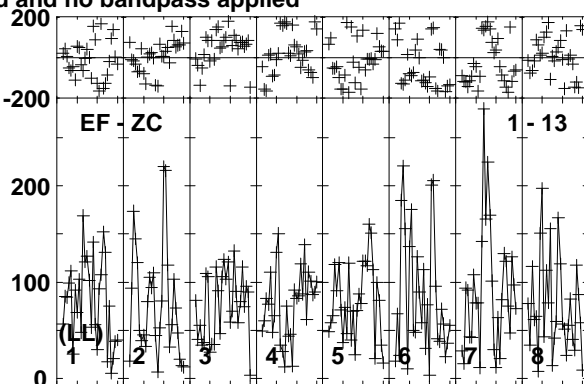
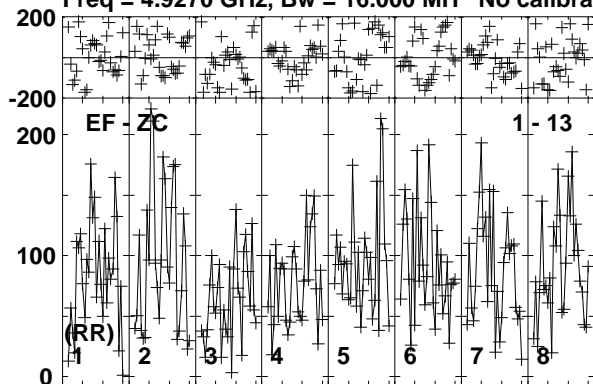

Lower frame: Micro Ampl Jy Top frame: Phas deg  
Vector averaged cross-power spectrum Baseline: EF (01) - ZC (13)  
Timerange: 00/04:57:33 to 00/05:00:59

Plot file version 142 created 08-APR-2019 12:09:49

J0815+3635 EM133B.UVDATA.1

Freq = 4.9270 GHz, Bw = 16.000 MH No calibration applied and no bandpass applied

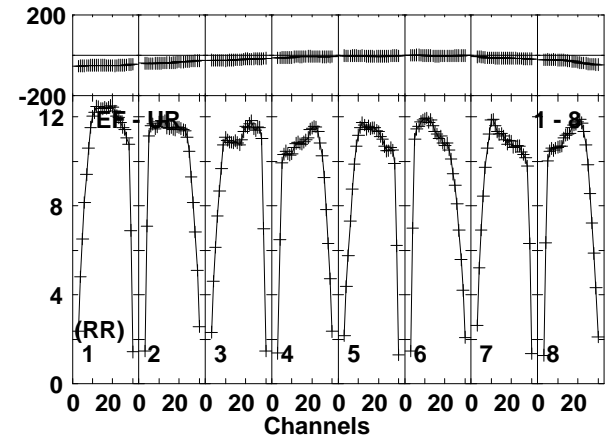
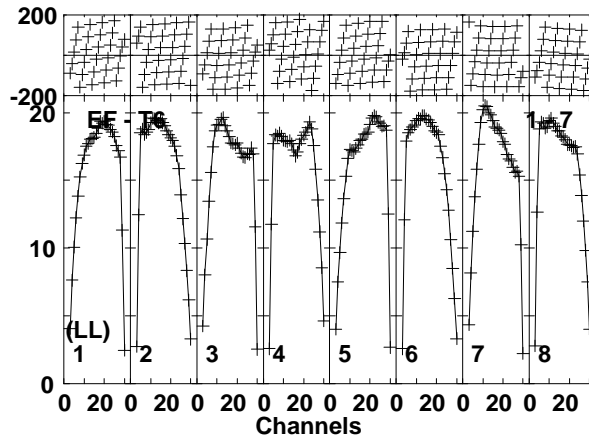
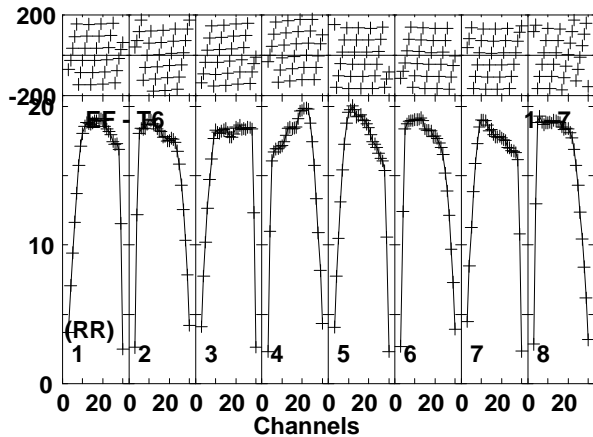
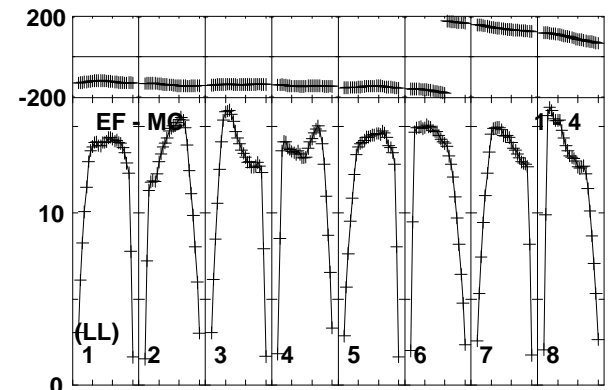
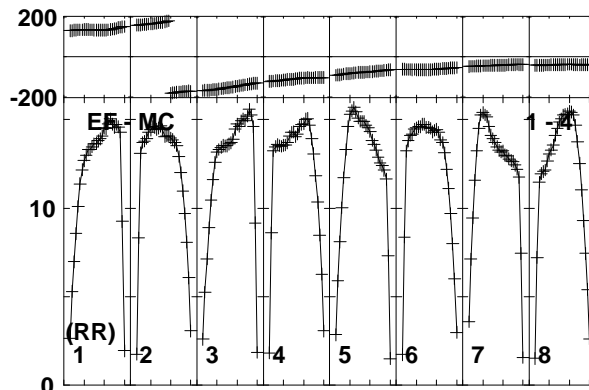
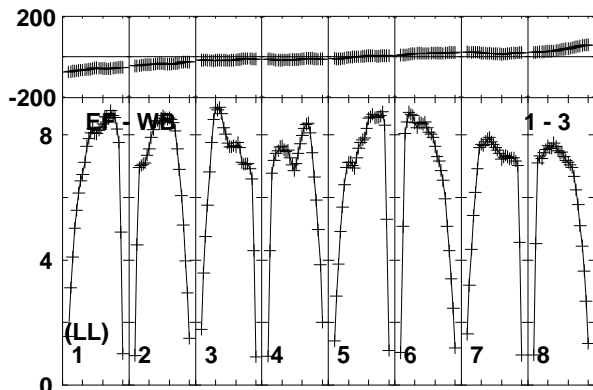
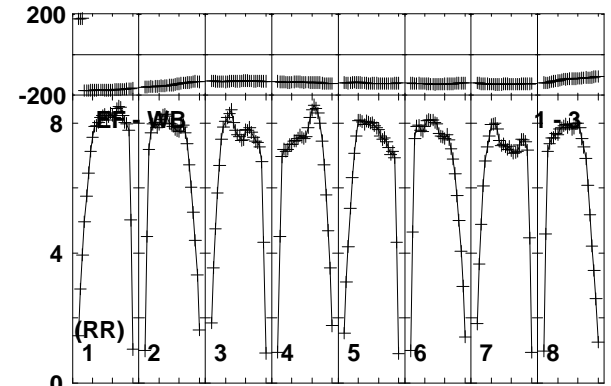
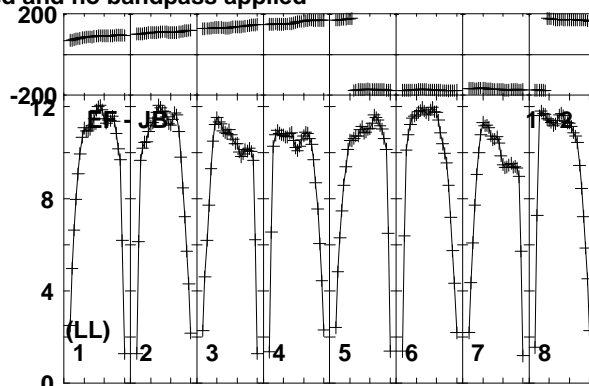
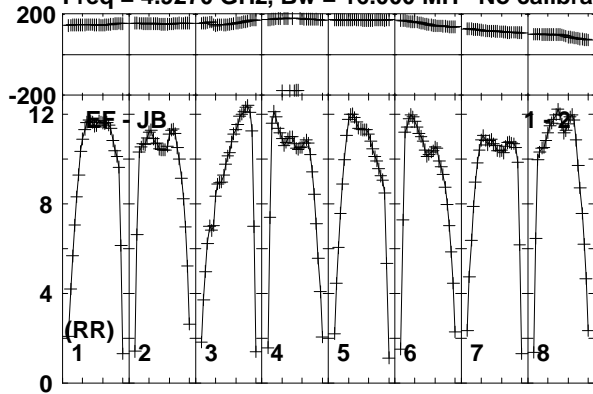

Lower frame: Milli Ampl Jy Top frame: Phas deg  
Vector averaged cross-power spectrum Baseline: EF (01) - JB (02)  
Timerange: 00/05:01:51 to 00/05:03:19

Plot file version 143 created 08-APR-2019 12:09:49

J0815+3635 EM133B.UVDATA.1

Freq = 4.9270 GHz, Bw = 16.000 MH No calibration applied and no bandpass applied

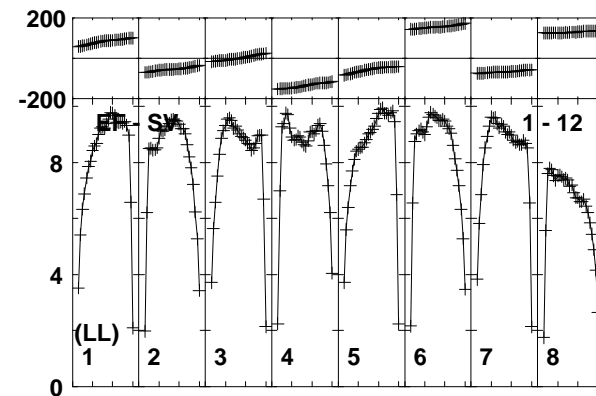
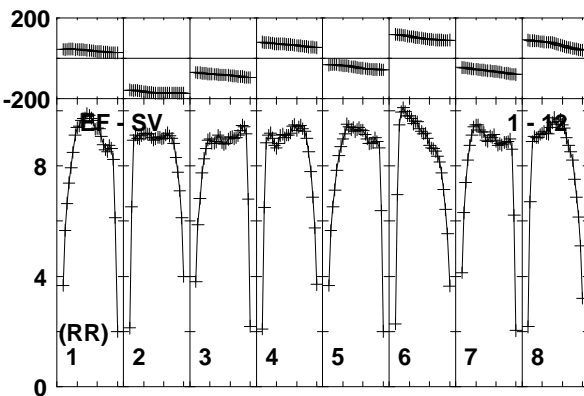
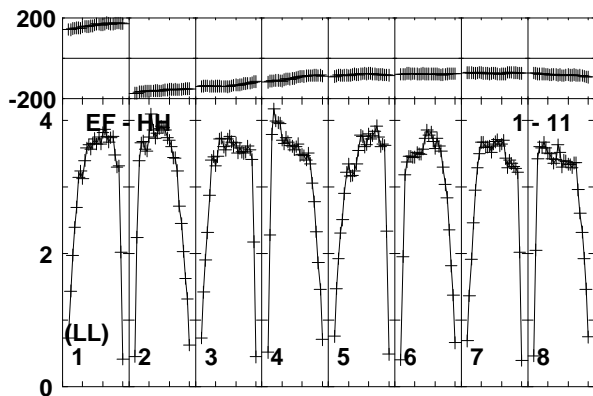
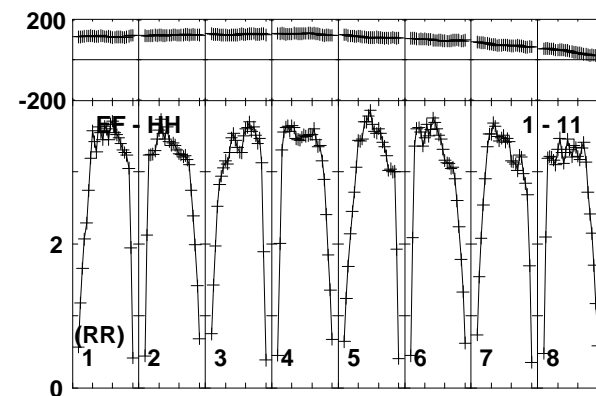
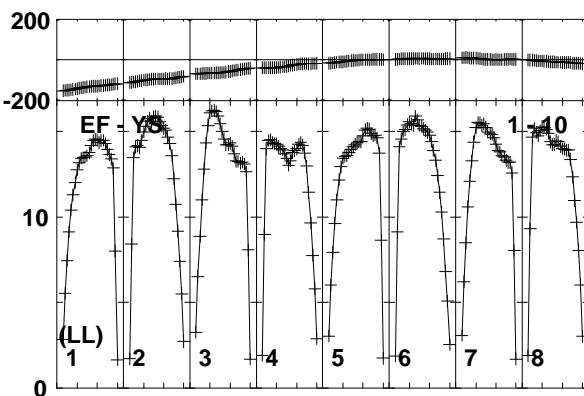
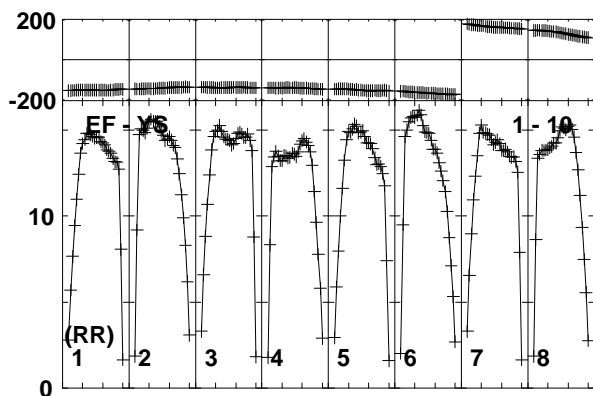
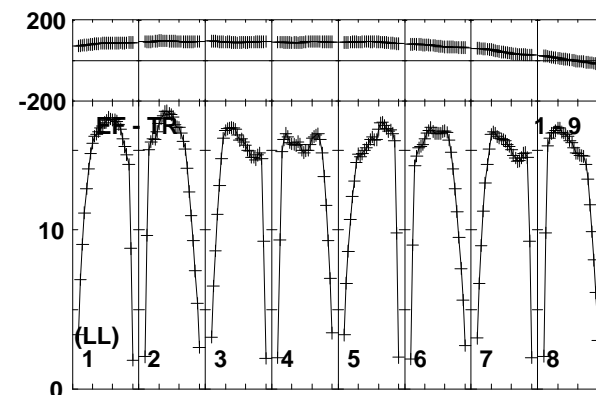
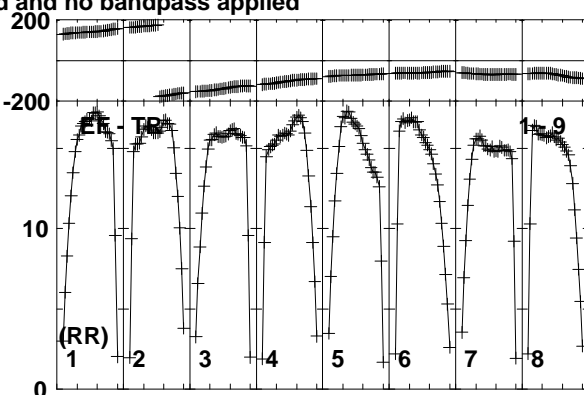
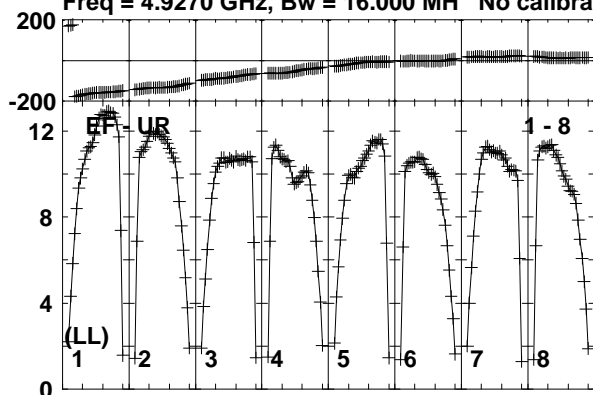

Lower frame: Milli Ampl Jy Top frame: Phas deg  
Vector averaged cross-power spectrum Baseline: EF (01) - UR (08)  
Timerange: 00/05:01:51 to 00/05:03:19

Plot file version 144 created 08-APR-2019 12:09:49

J0815+3635 EM133B.UVDATA.1

Freq = 4.9270 GHz, Bw = 16.000 MH No calibration applied and no bandpass applied

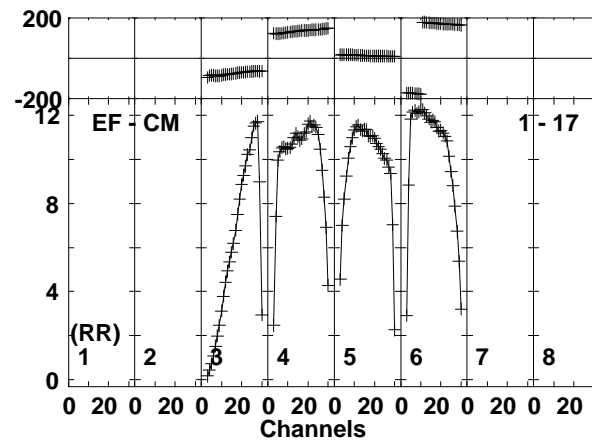
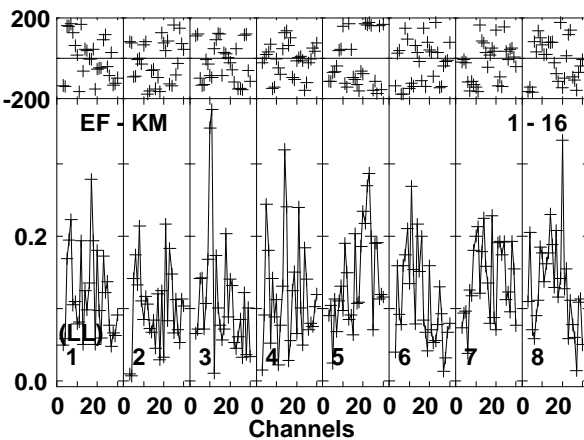
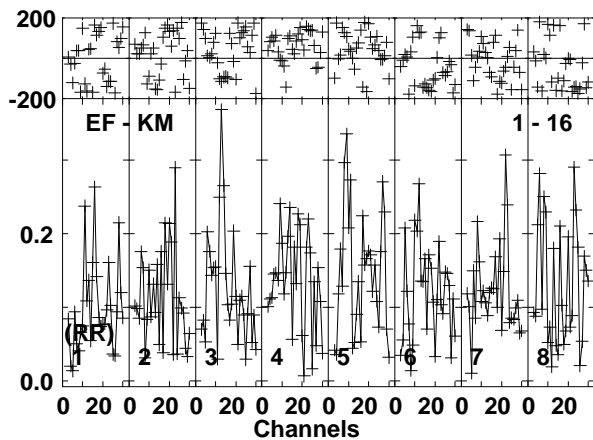
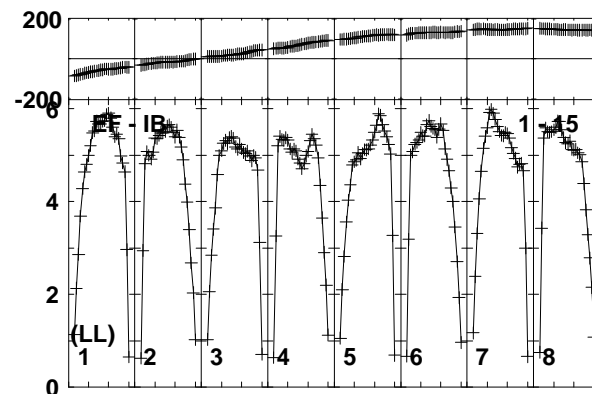
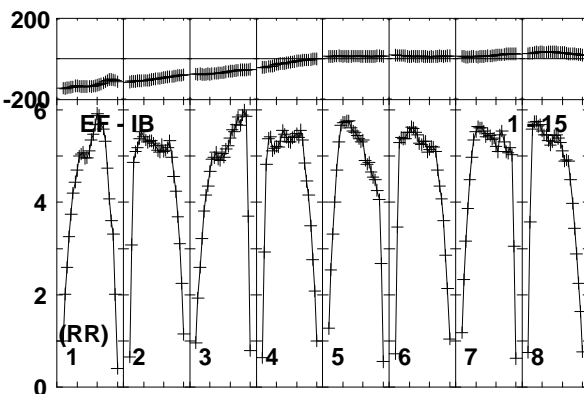
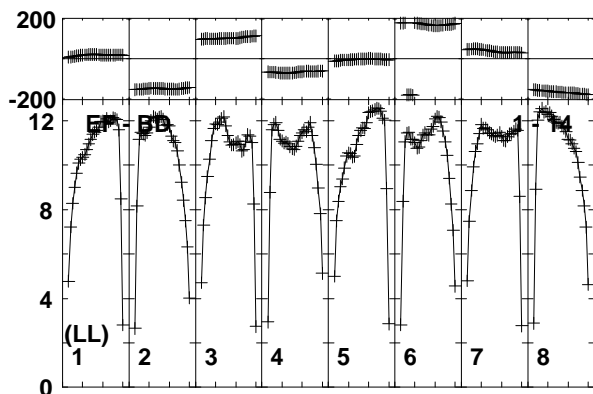
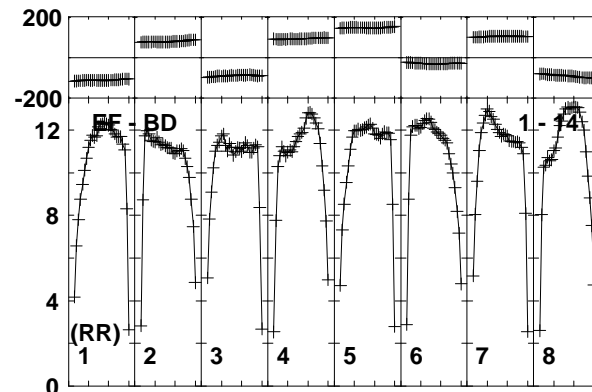
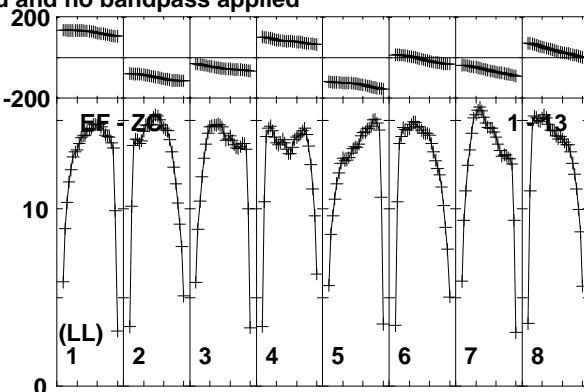
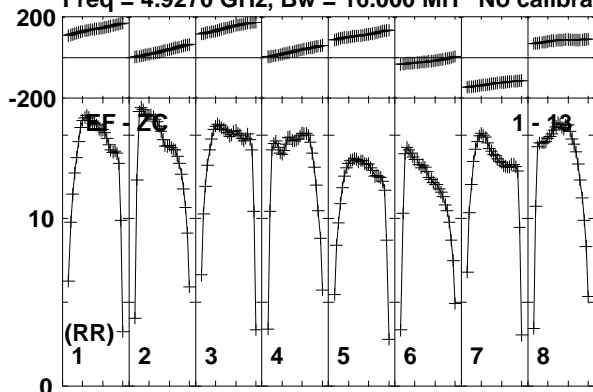

Lower frame: Milli Ampl Jy Top frame: Phas deg  
Vector averaged cross-power spectrum Baseline: EF (01) - ZC (13)  
Timerange: 00/05:01:51 to 00/05:03:19



Plot file version 145 created 08-APR-2019 12:09:49

J0815+3635 EM133B.UVDATA.1

Freq = 4.9270 GHz, Bw = 16.000 MH No calibration applied and no bandpass applied

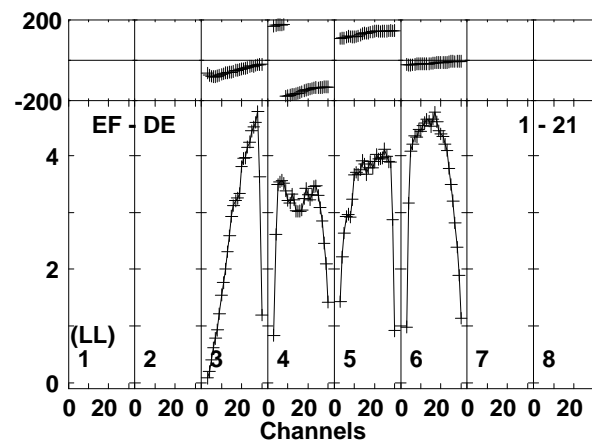
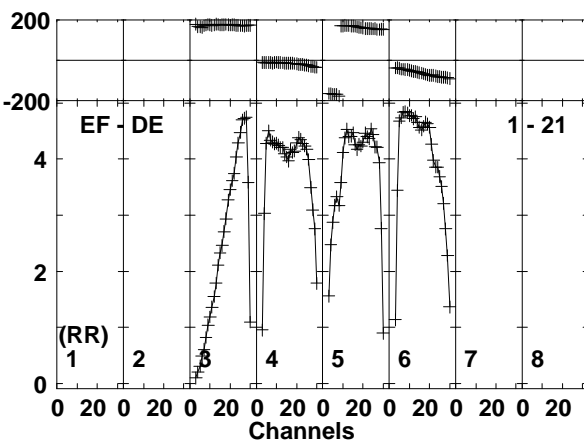
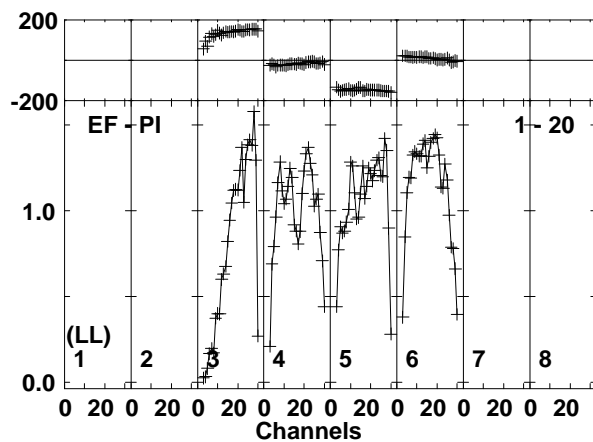
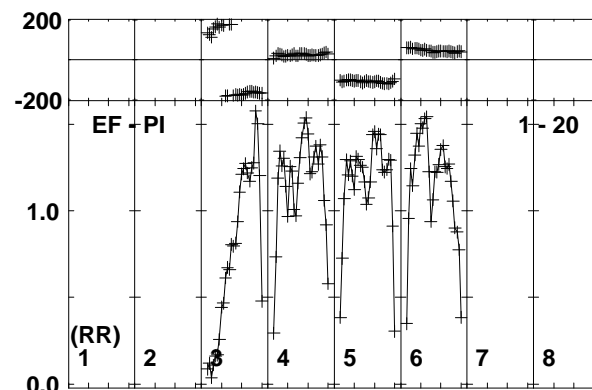
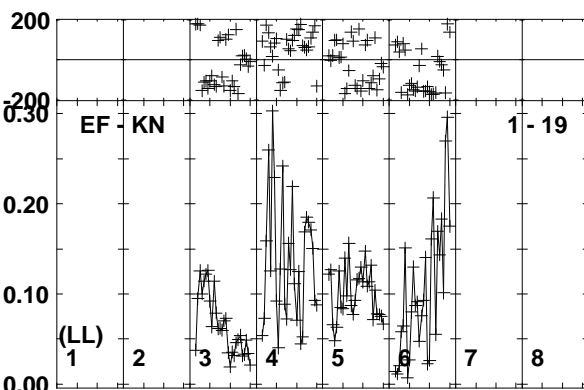
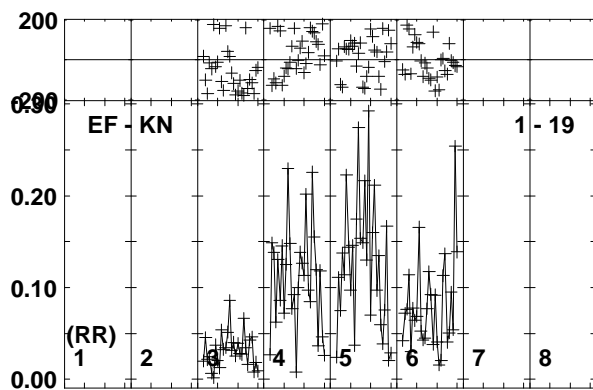
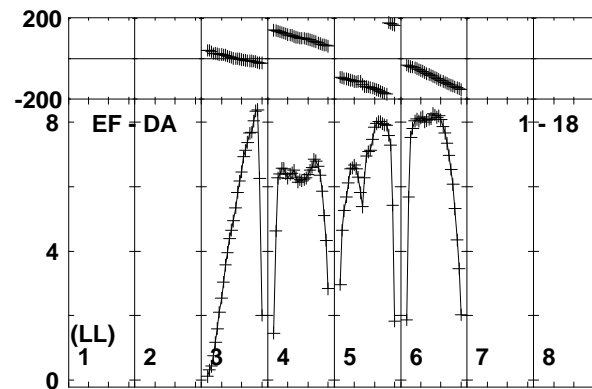
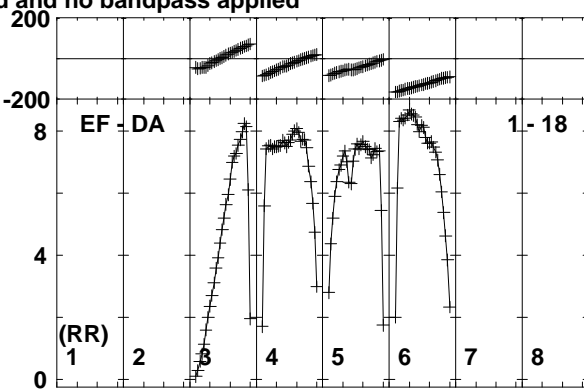
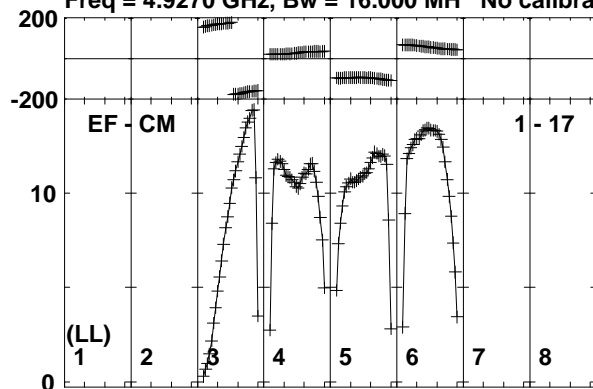

Lower frame: Milli Ampl Jy Top frame: Phas deg  
Vector averaged cross-power spectrum Baseline: EF (01) - CM (17)  
Timerange: 00/05:01:51 to 00/05:03:19

Plot file version 146 created 08-APR-2019 12:09:49

MRK622 EM133B.UVDATA.1

Freq = 4.9270 GHz, Bw = 16.000 MH No calibration applied and no bandpass applied

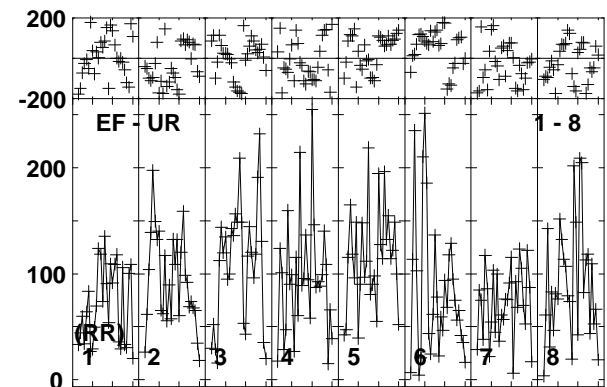
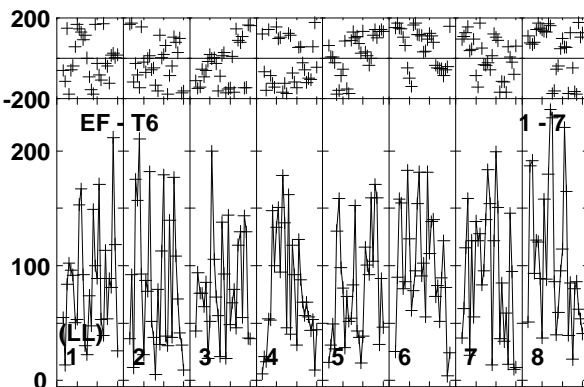
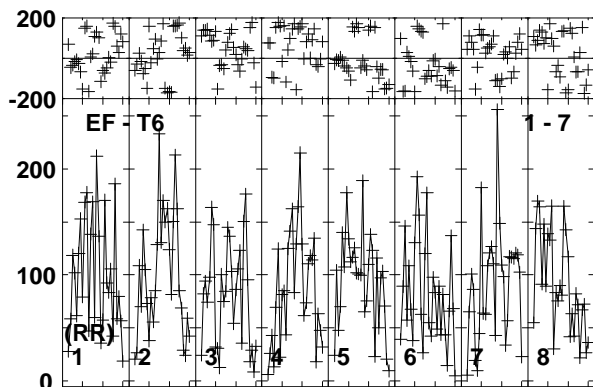
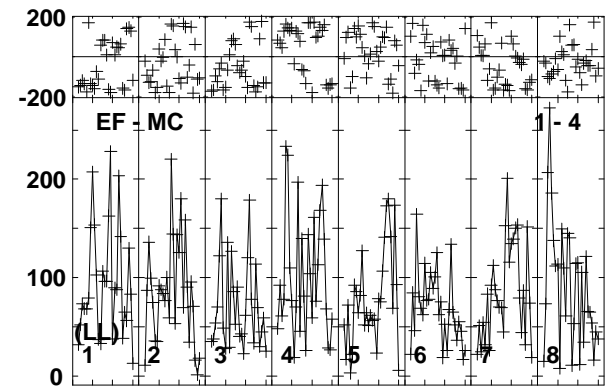
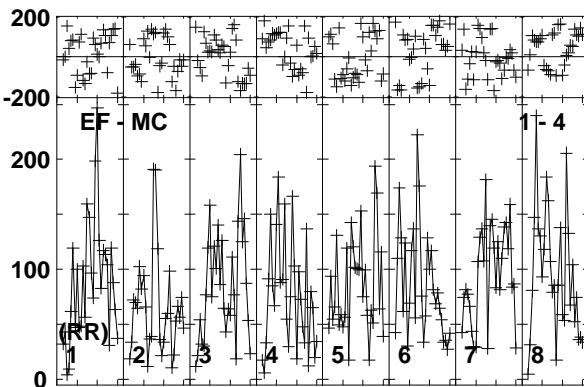
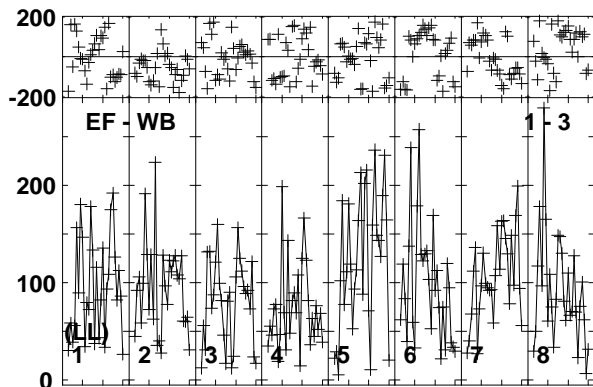
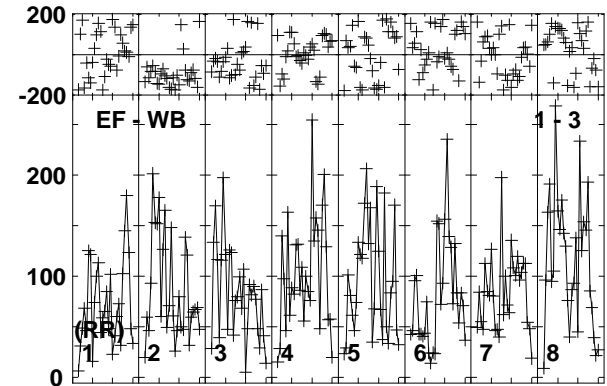
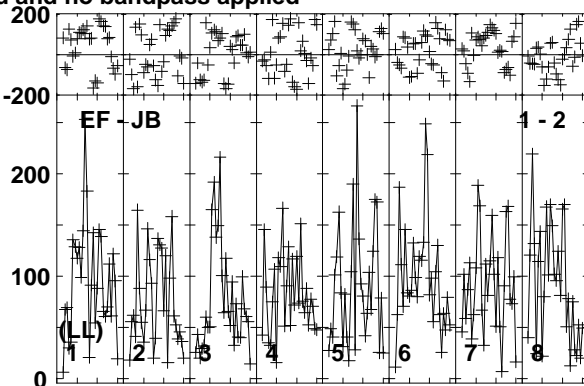
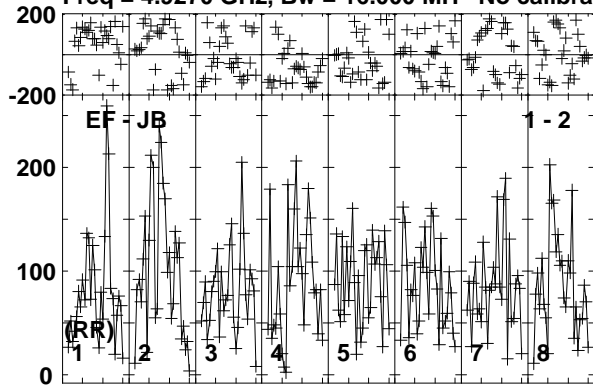

Lower frame: Micro Ampl Jy Top frame: Phas deg  
Vector averaged cross-power spectrum Baseline: EF (01) - JB (02)  
Timerange: 00/05:03:21 to 00/05:06:49

Plot file version 147 created 08-APR-2019 12:09:50

MRK622 EM133B.UVDATA.1

Freq = 4.9270 GHz, Bw = 16.000 MH No calibration applied and no bandpass applied

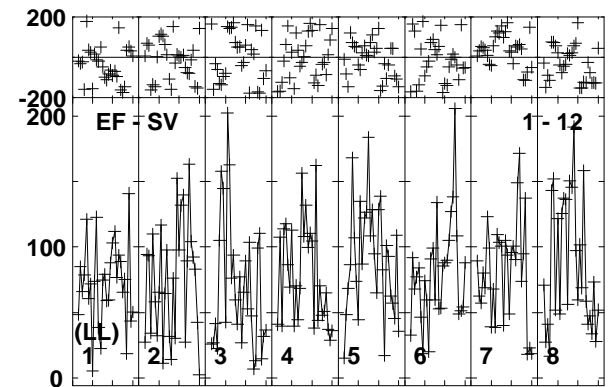
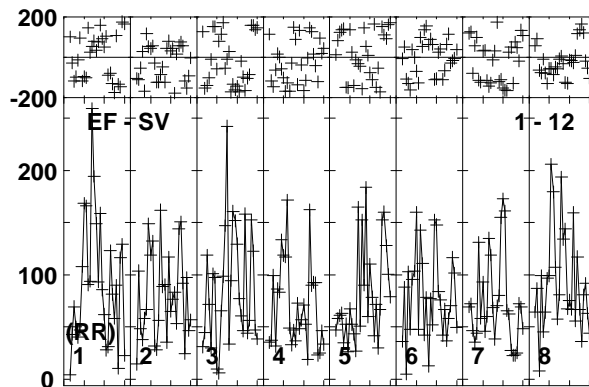
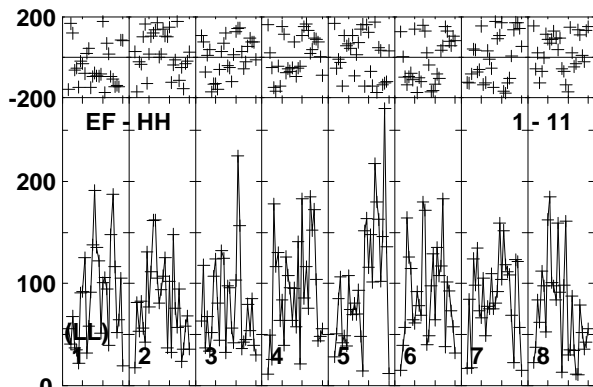
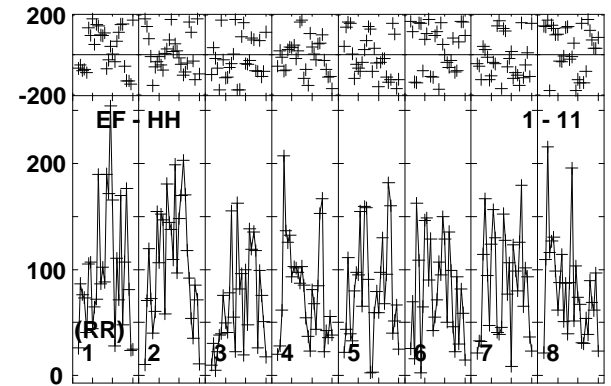
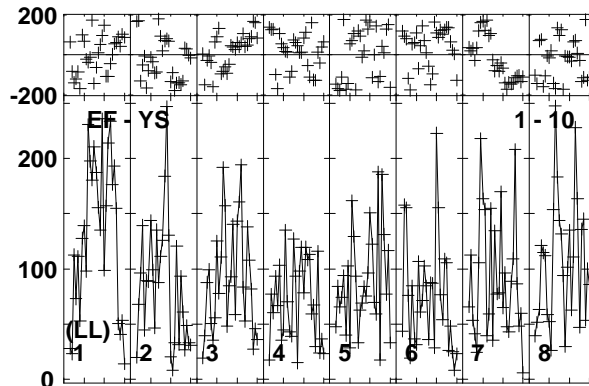
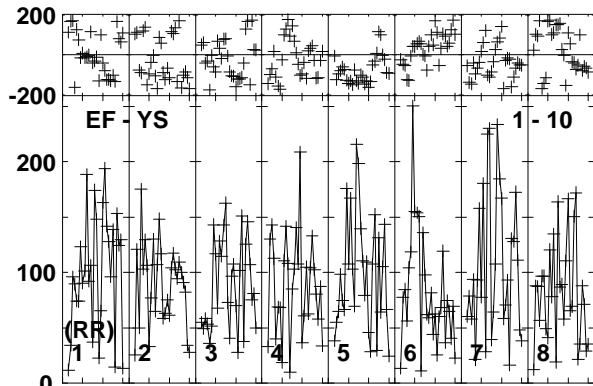
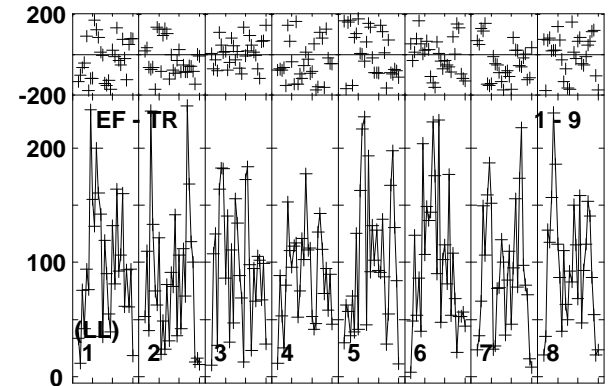
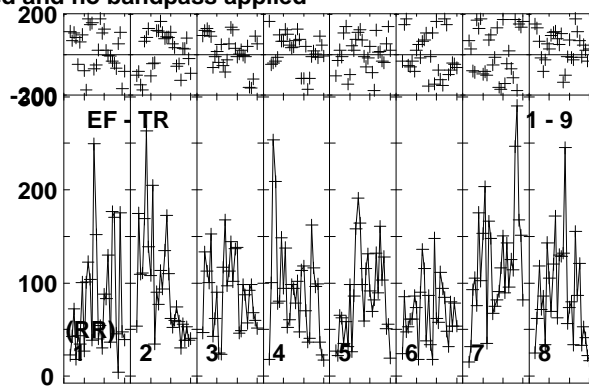
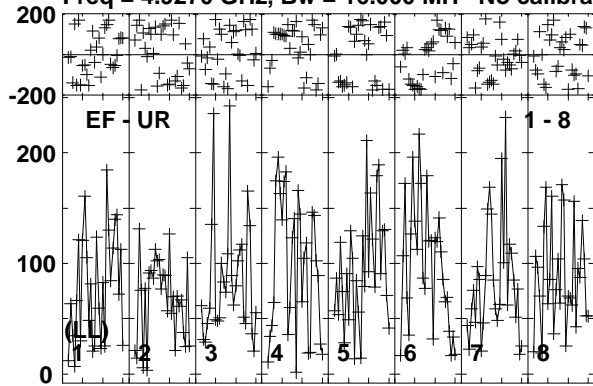

Lower frame: Micro Ampl Jy Top frame: Phas deg  
Vector averaged cross-power spectrum Baseline: EF (01) - UR (08)  
Timerange: 00/05:03:21 to 00/05:06:49

Plot file version 148 created 08-APR-2019 12:09:50

MRK622 EM133B.UVDATA.1

Freq = 4.9270 GHz, Bw = 16.000 MH No calibration applied and no bandpass applied

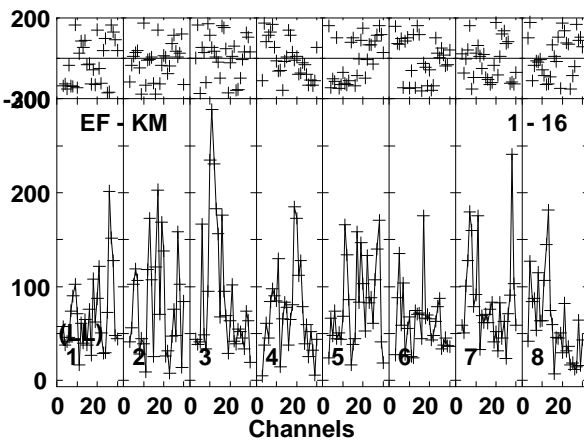
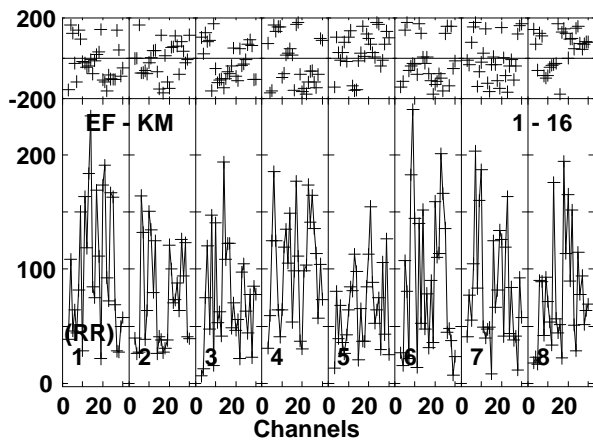
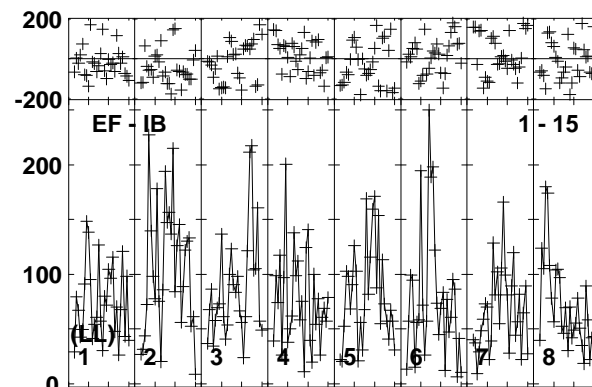
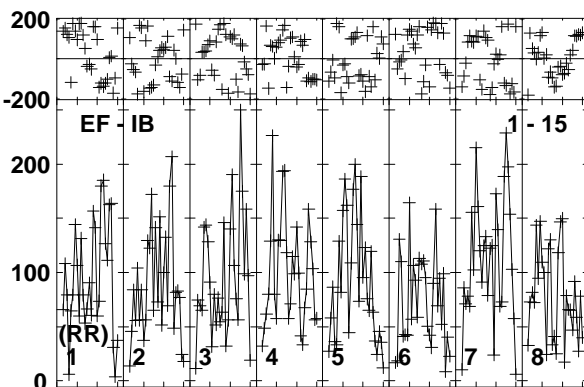
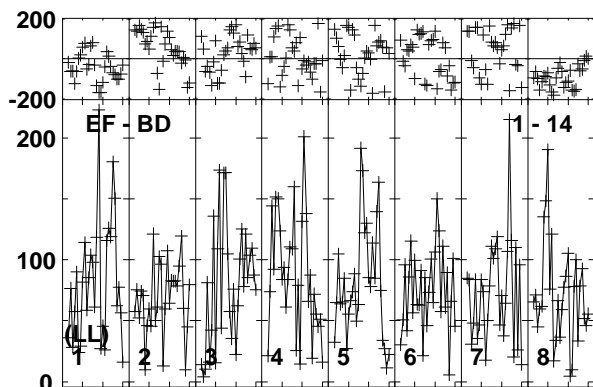
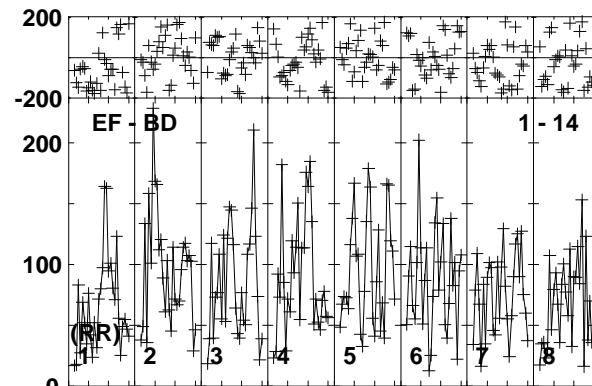
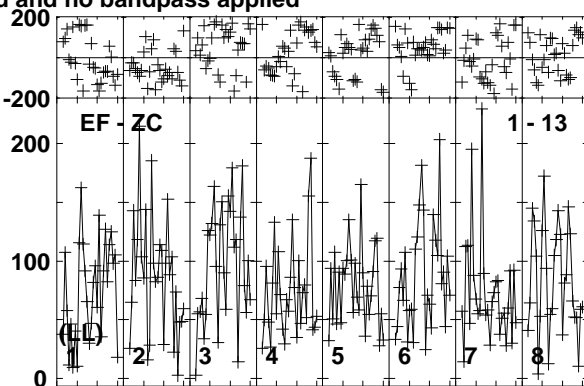
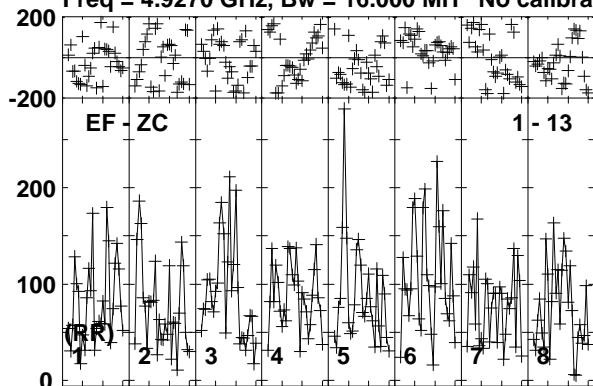

Lower frame: Micro Ampl Jy Top frame: Phas deg  
Vector averaged cross-power spectrum Baseline: EF (01) - ZC (13)  
Timerange: 00/05:03:21 to 00/05:06:49

Plot file version 149 created 08-APR-2019 12:09:50

J0815+3635 EM133B.UVDATA.1

Freq = 4.9270 GHz, Bw = 16.000 MH No calibration applied and no bandpass applied

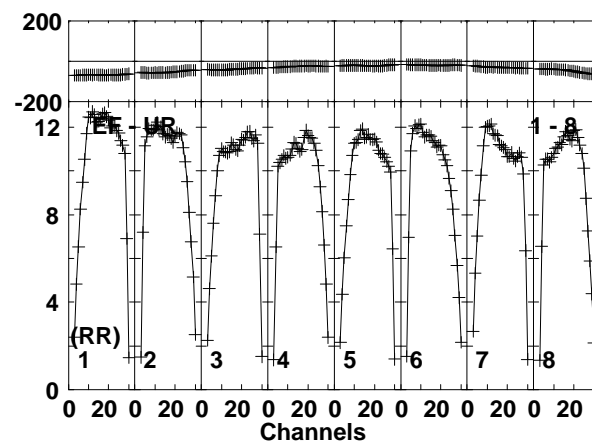
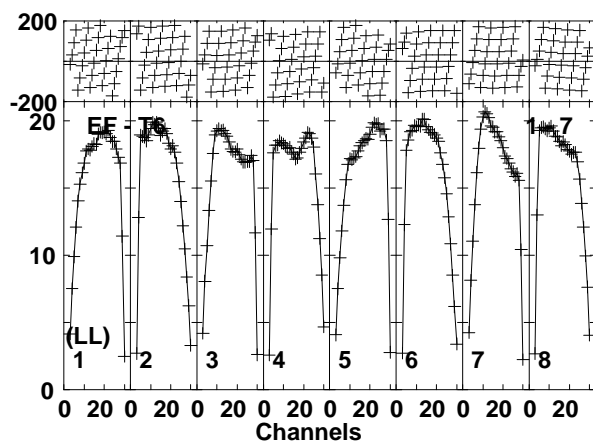
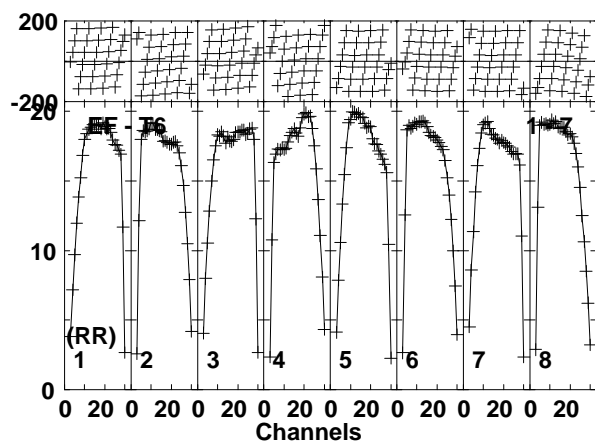
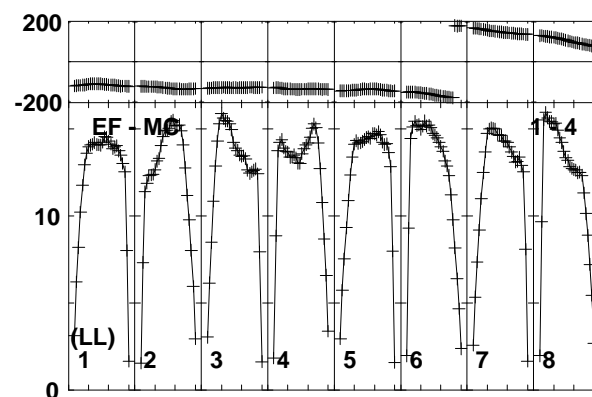
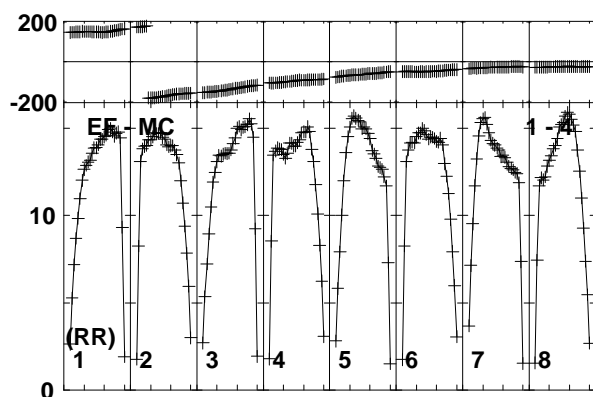
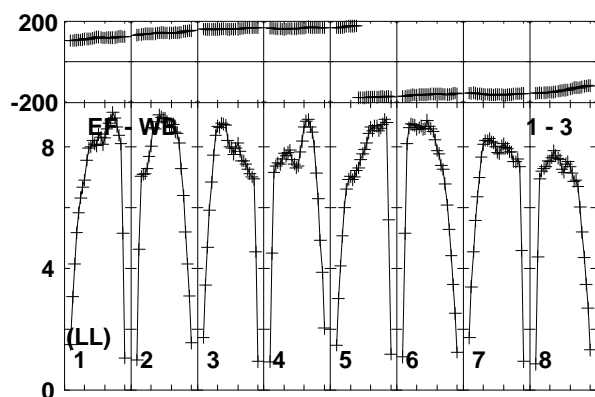
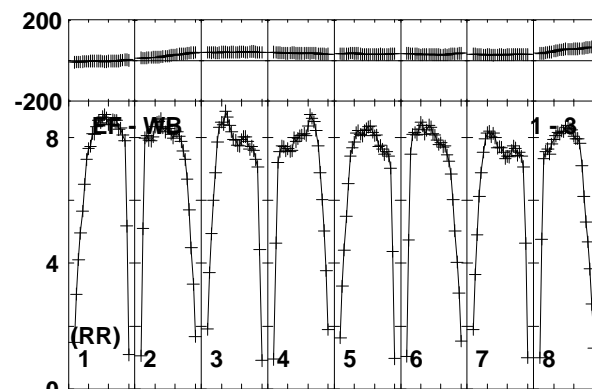
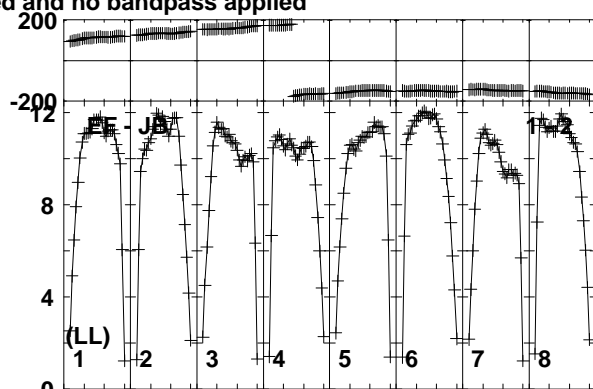
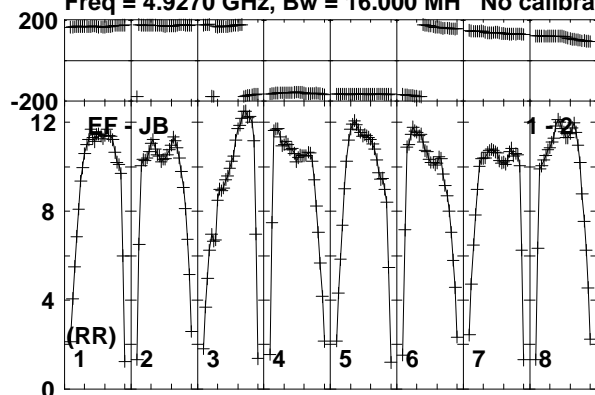

Lower frame: Milli Ampl Jy Top frame: Phas deg

Vector averaged cross-power spectrum Baseline: EF (01) - JB (02)

Timerange: 00/05:06:51 to 00/05:08:19

Plot file version 150 created 08-APR-2019 12:09:50

J0815+3635 EM133B.UVDATA.1

Freq = 4.9270 GHz, Bw = 16.000 MH No calibration applied and no bandpass applied

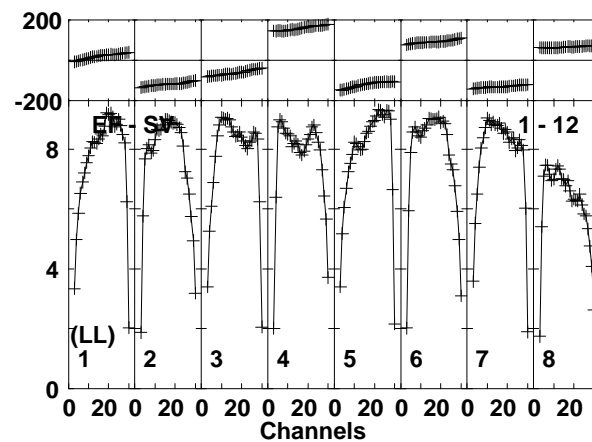
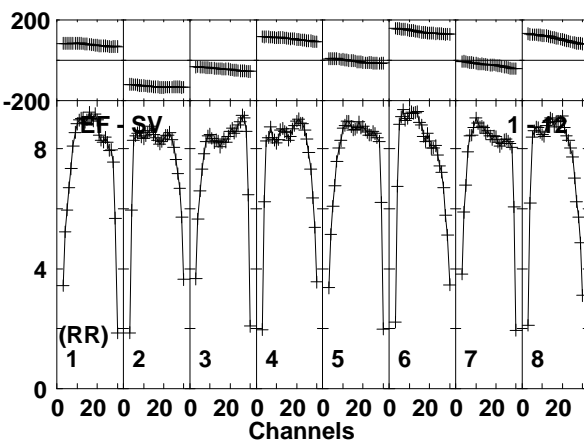
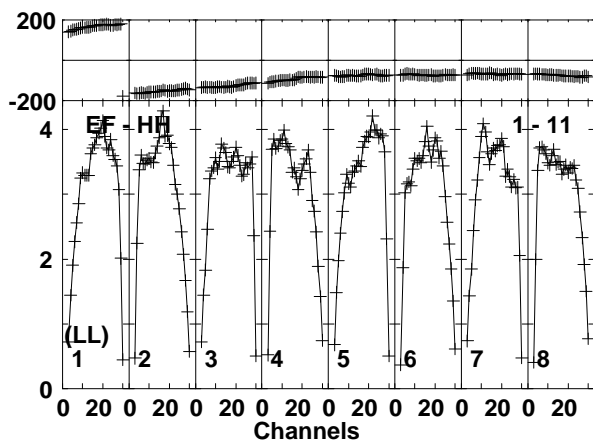
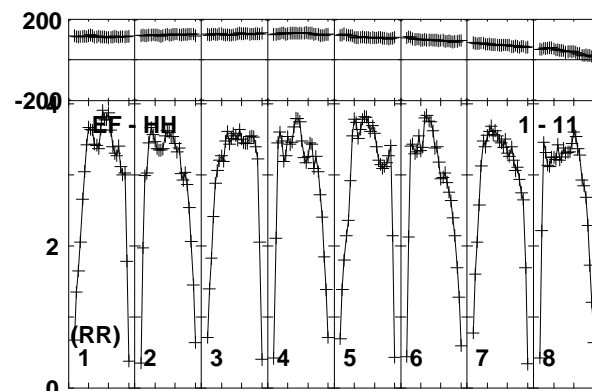
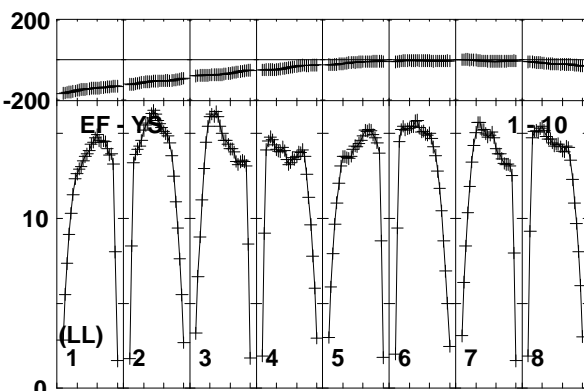
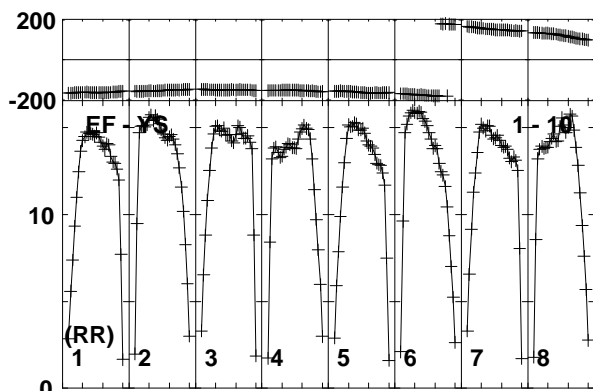
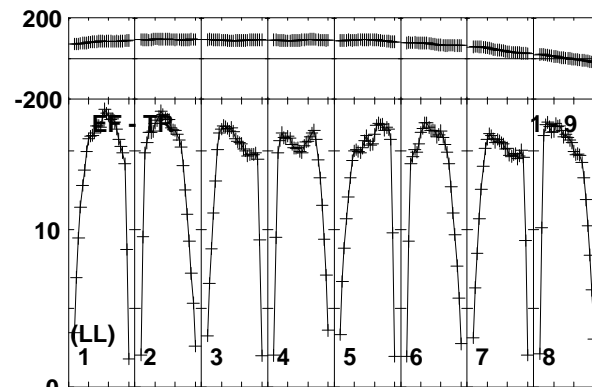
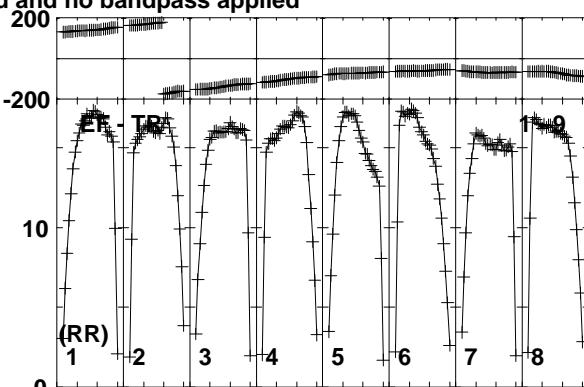
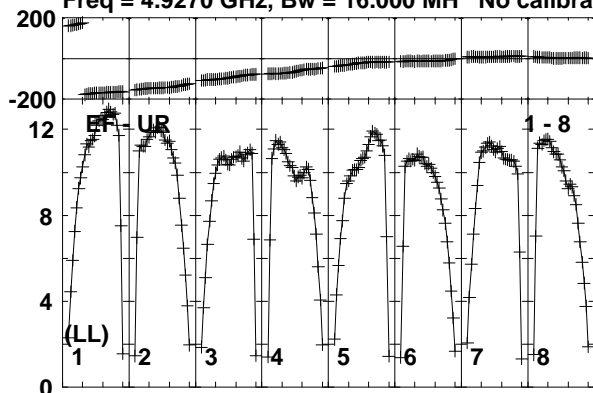

Lower frame: Milli Ampl Jy Top frame: Phas deg  
Vector averaged cross-power spectrum Baseline: EF (01) - UR (08)  
Timerange: 00/05:06:51 to 00/05:08:19

Plot file version 151 created 08-APR-2019 12:09:50

J0815+3635 EM133B.UVDATA.1

Freq = 4.9270 GHz, Bw = 16.000 MH No calibration applied and no bandpass applied

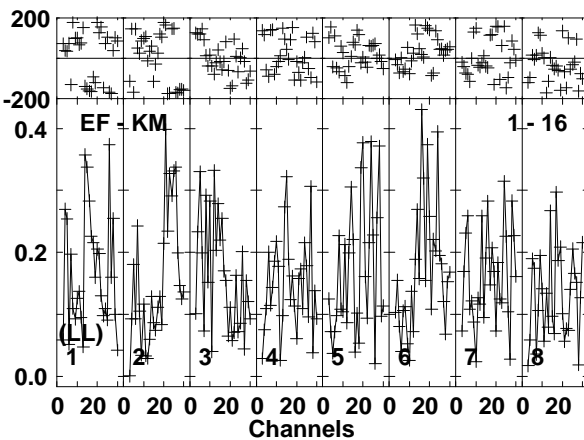
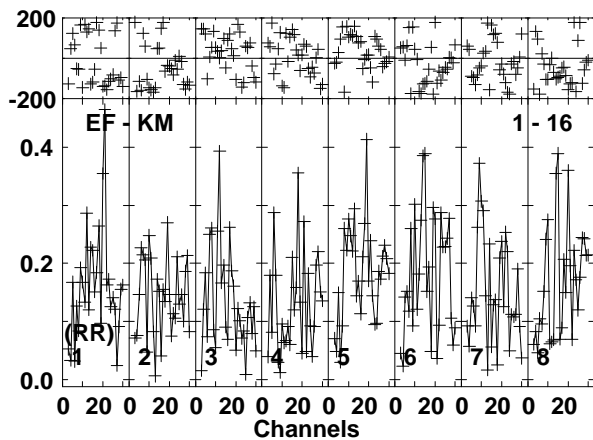
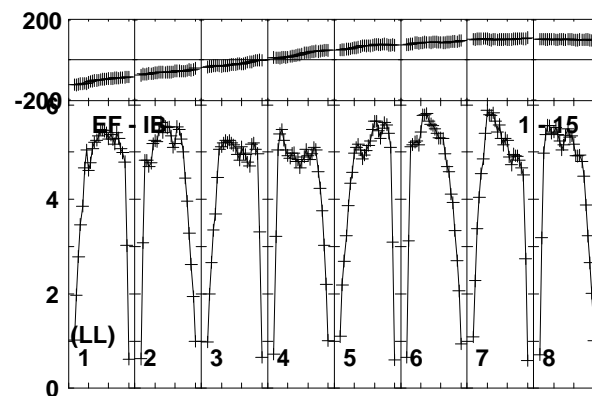
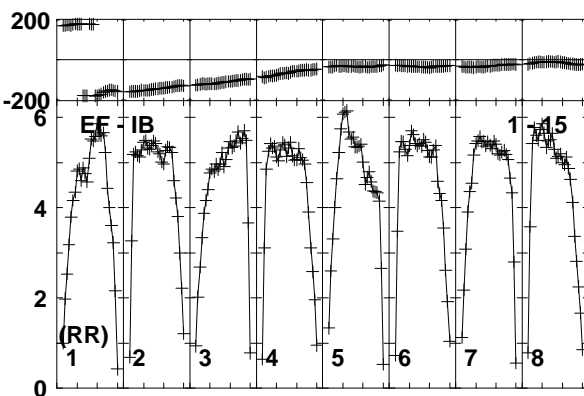
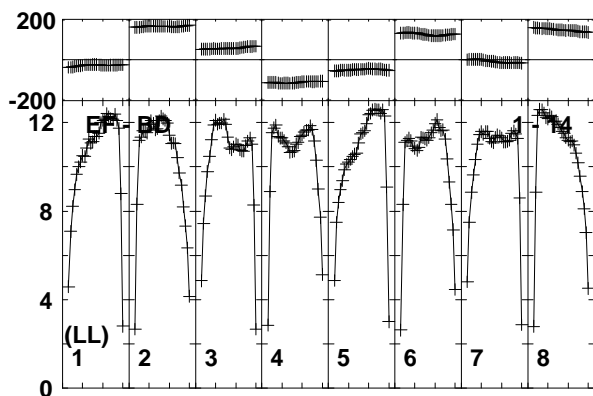
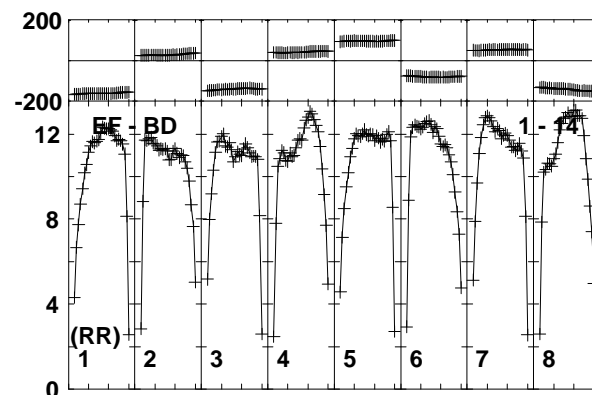
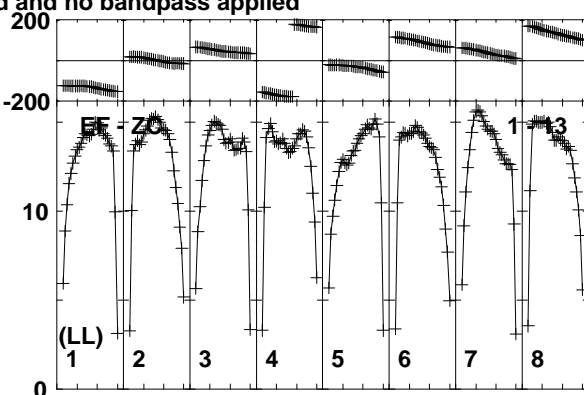
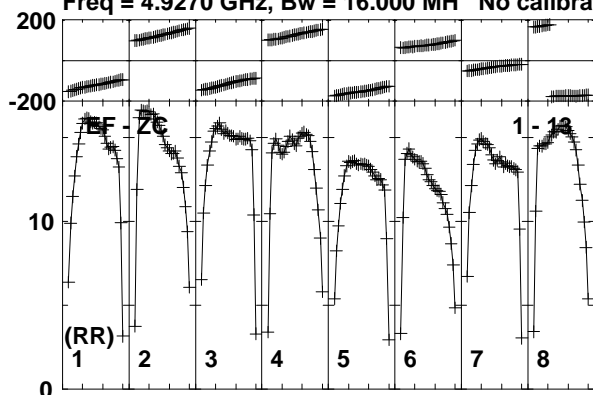

Lower frame: Milli Ampl Jy Top frame: Phas deg  
Vector averaged cross-power spectrum Baseline: EF (01) - ZC (13)  
Timerange: 00/05:06:51 to 00/05:08:19

Plot file version 152 created 08-APR-2019 12:09:50

MRK622 EM133B.UVDATA.1

Freq = 4.9270 GHz, Bw = 16.000 MH No calibration applied and no bandpass applied

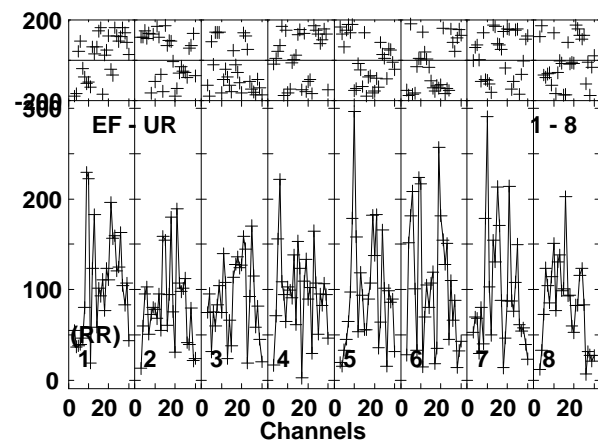
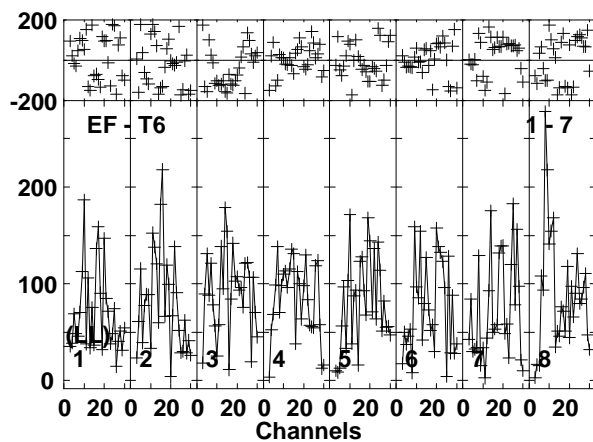
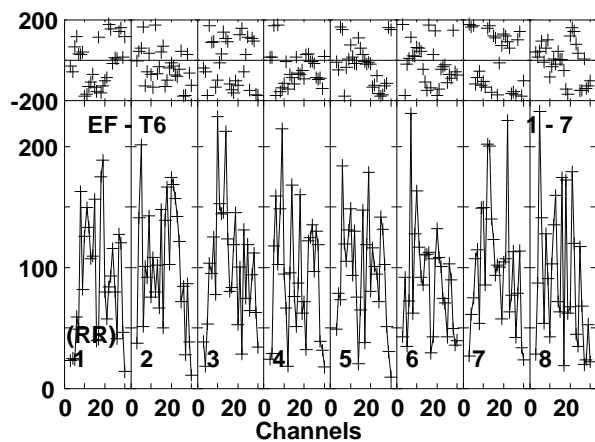
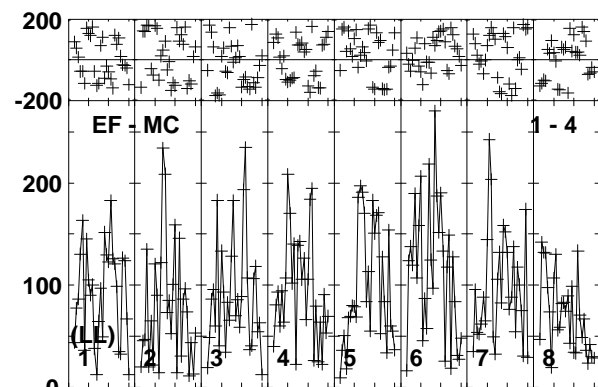
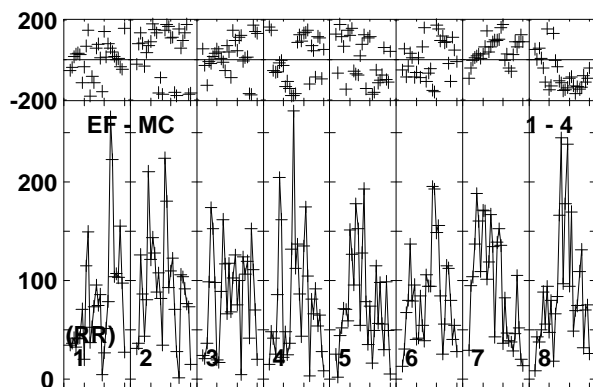
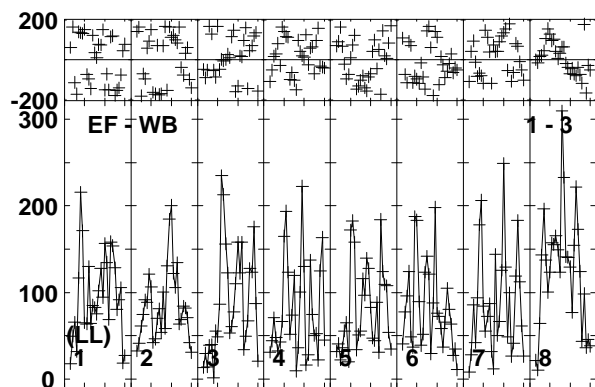
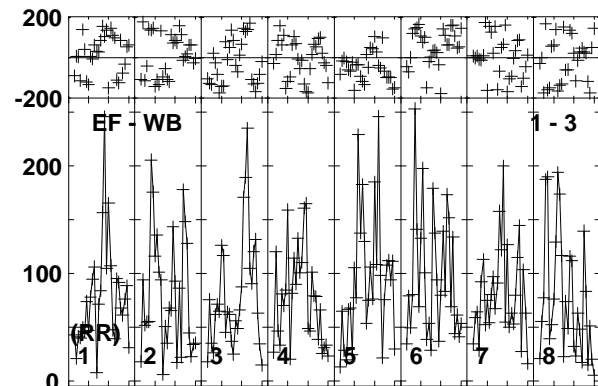
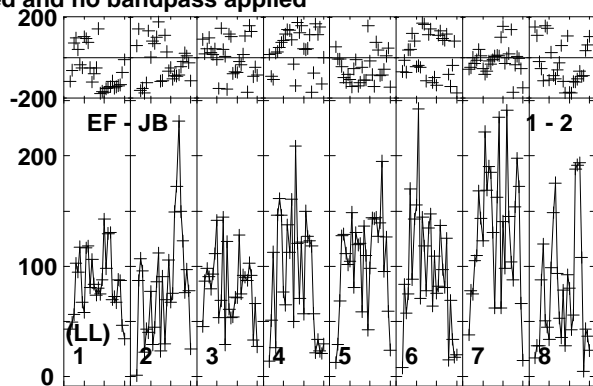
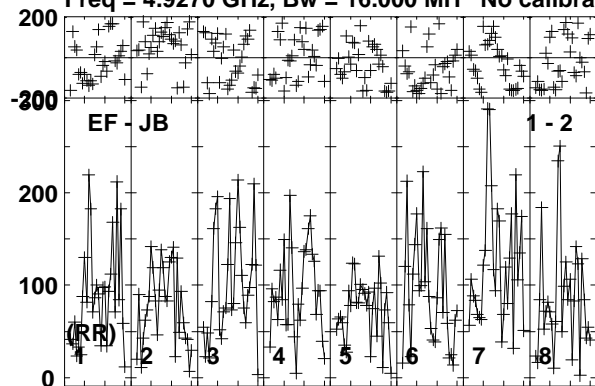

Lower frame: Micro Ampl Jy Top frame: Phas deg  
Vector averaged cross-power spectrum Baseline: EF (01) - JB (02)  
Timerange: 00/05:08:23 to 00/05:11:49



Plot file version 153 created 08-APR-2019 12:09:50

MRK622 EM133B.UVDATA.1

Freq = 4.9270 GHz, Bw = 16.000 MH No calibration applied and no bandpass applied

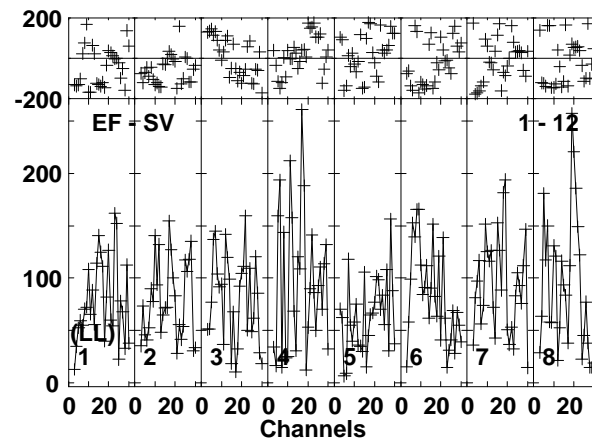
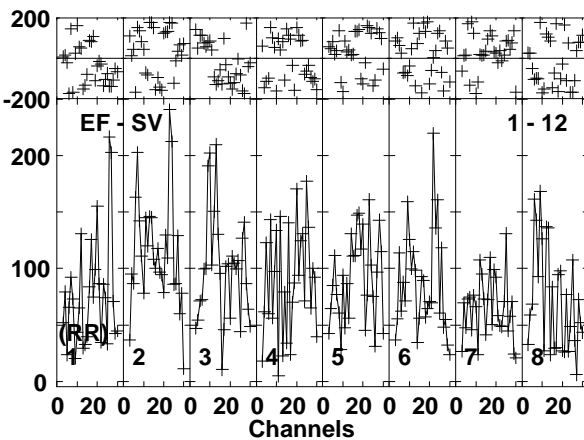
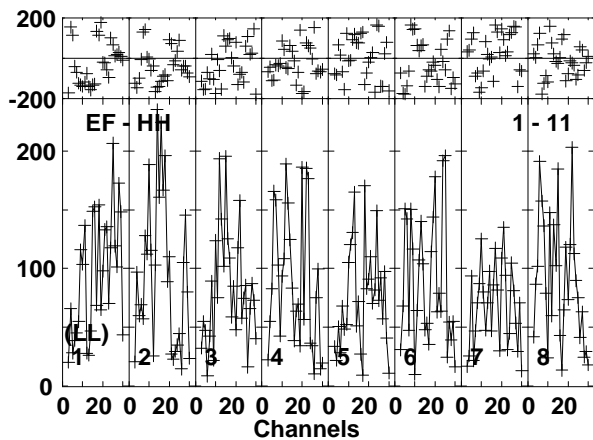
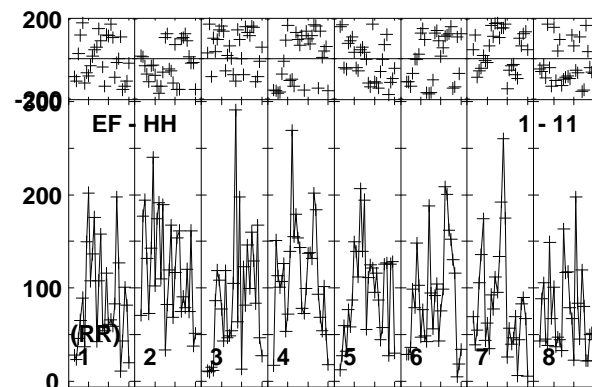
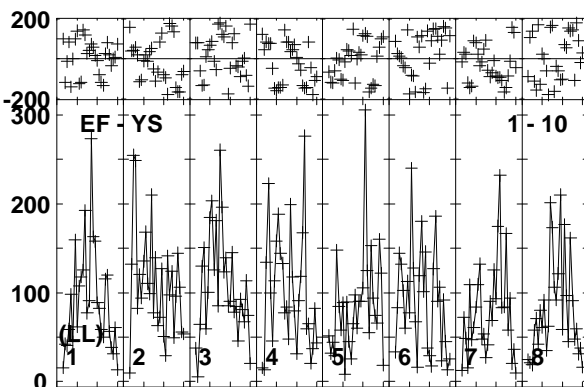
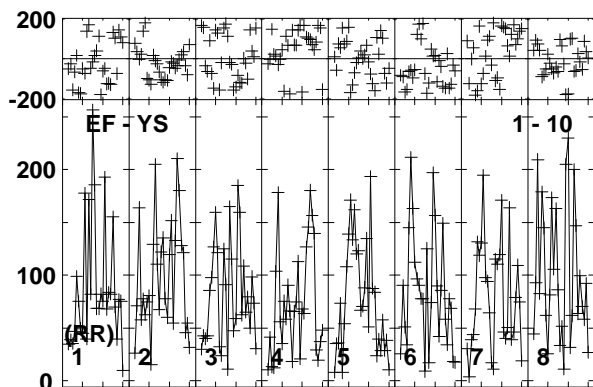
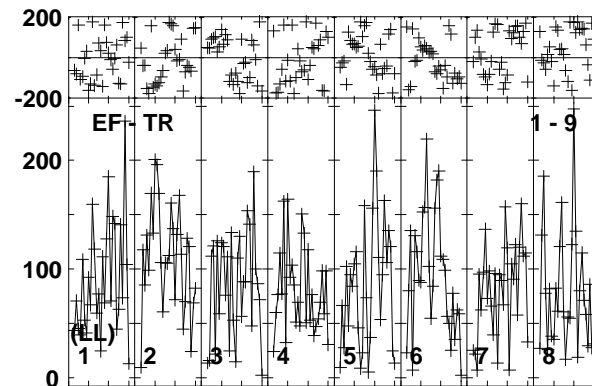
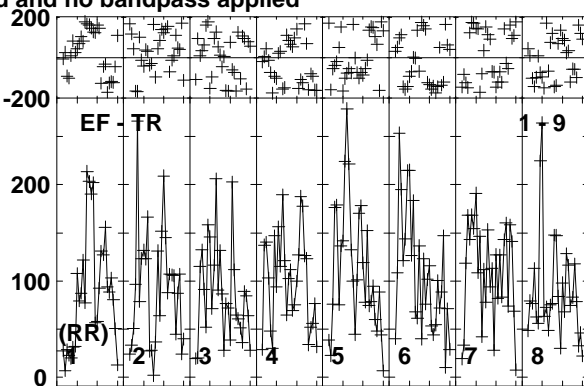
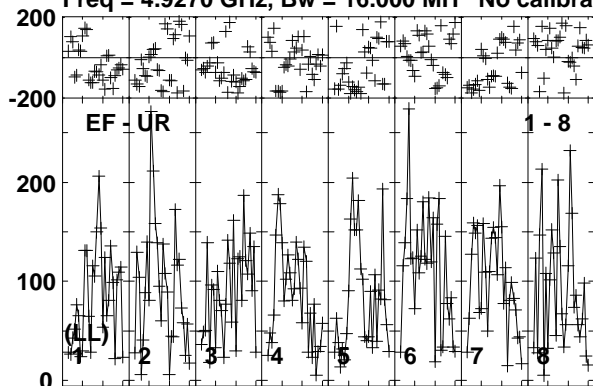

Lower frame: Micro Ampl Jy Top frame: Phas deg  
Vector averaged cross-power spectrum Baseline: EF (01) - UR (08)  
Timerange: 00/05:08:23 to 00/05:11:49

Plot file version 154 created 08-APR-2019 12:09:51

MRK622 EM133B.UVDATA.1

Freq = 4.9270 GHz, Bw = 16.000 MH No calibration applied and no bandpass applied

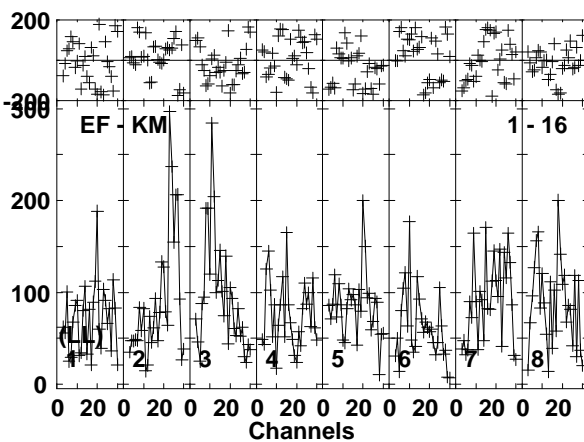
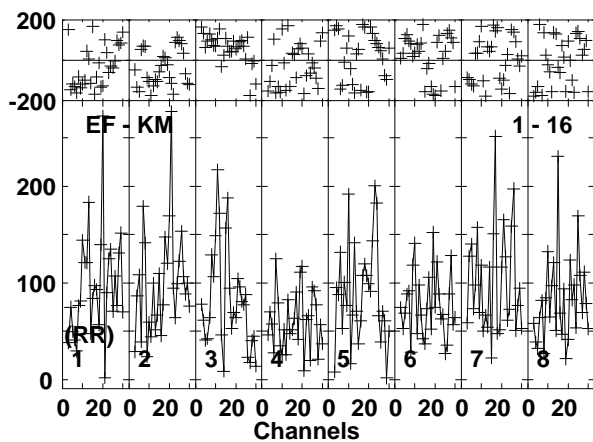
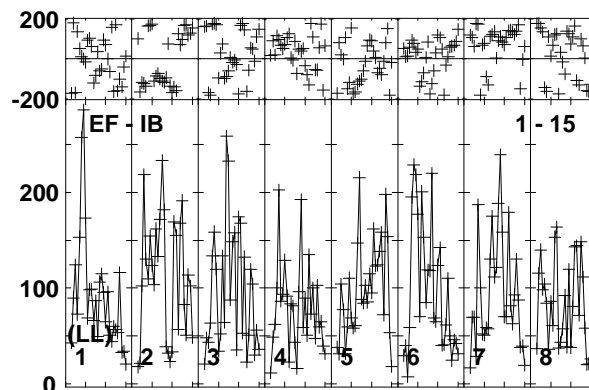
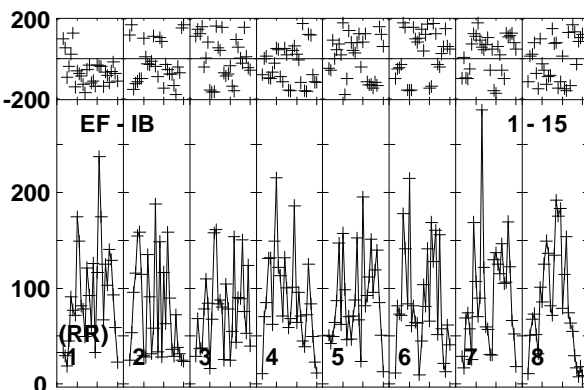
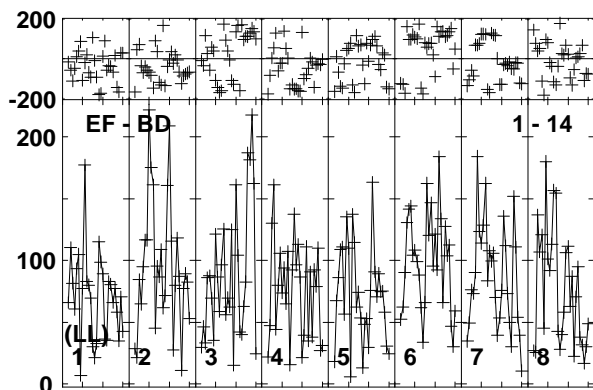
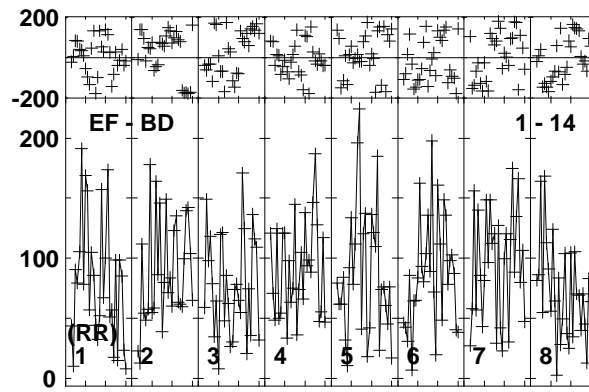
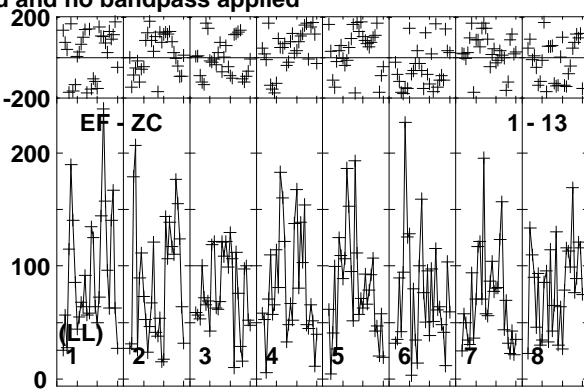
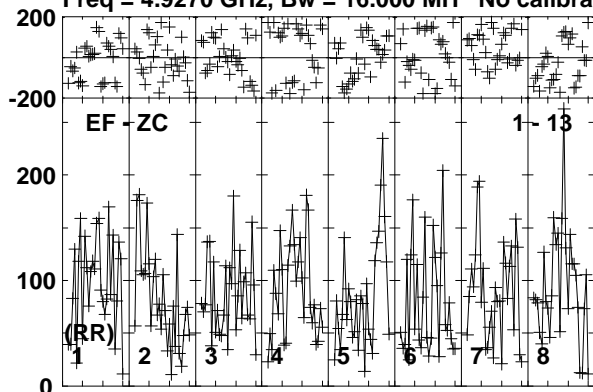

Lower frame: Micro Ampl Jy Top frame: Phas deg  
Vector averaged cross-power spectrum Baseline: EF (01) - ZC (13)  
Timerange: 00/05:08:23 to 00/05:11:49

Plot file version 155 created 08-APR-2019 12:09:51

J0815+3635 EM133B.UVDATA.1

Freq = 4.9270 GHz, Bw = 16.000 MH No calibration applied and no bandpass applied

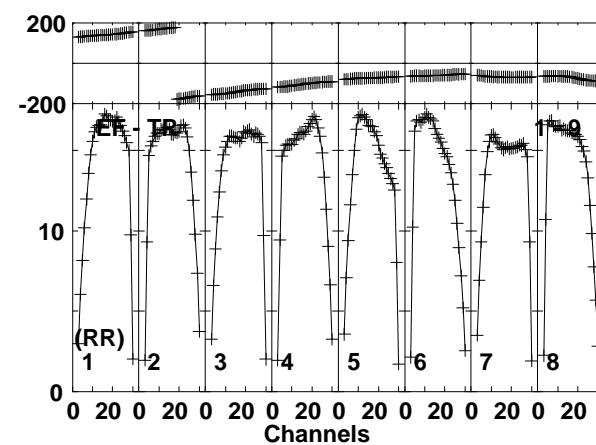
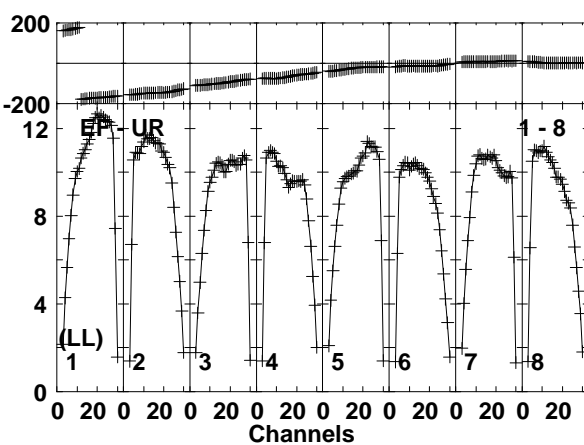
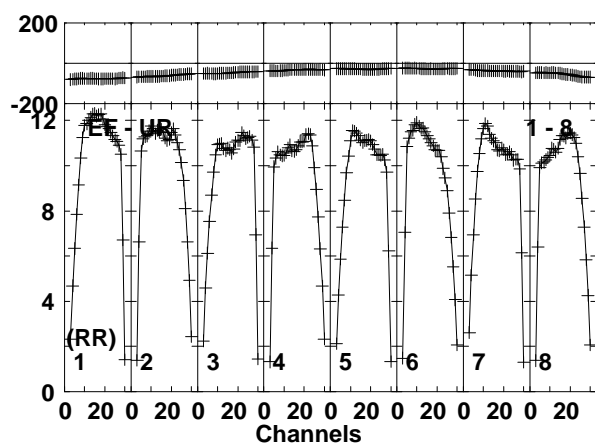
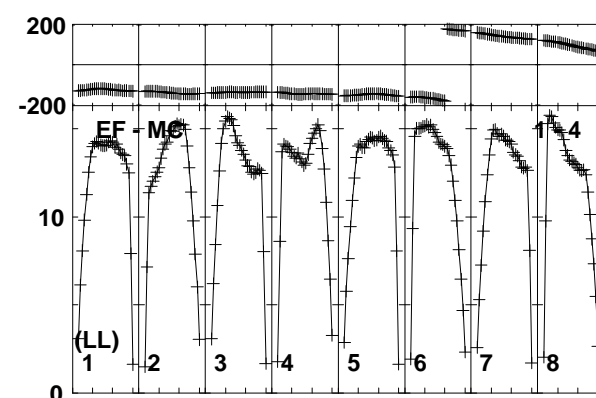
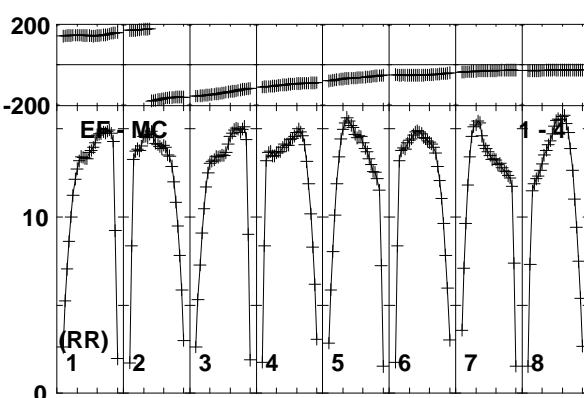
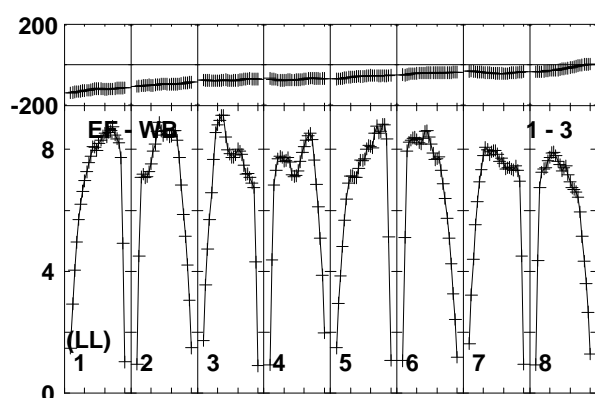
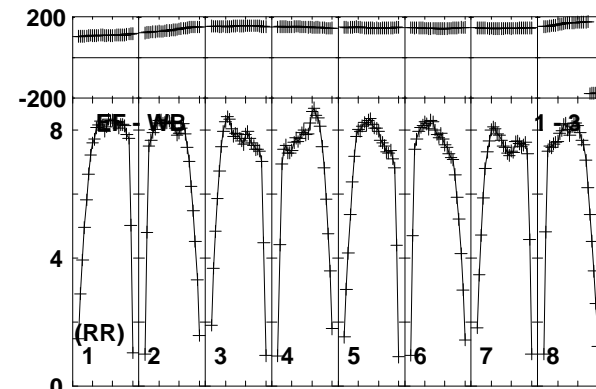
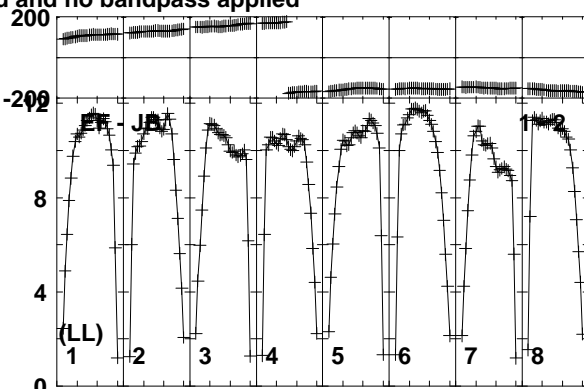
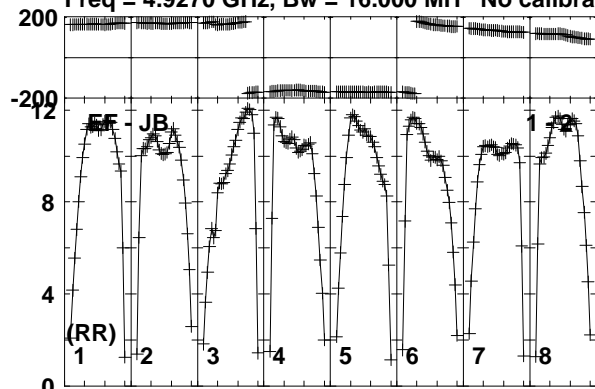

Lower frame: Milli Ampl Jy Top frame: Phas deg  
Vector averaged cross-power spectrum Baseline: EF (01) - JB (02)  
Timerange: 00/05:12:41 to 00/05:14:09

Plot file version 156 created 08-APR-2019 12:09:51

J0815+3635 EM133B.UVDATA.1

Freq = 4.9270 GHz, Bw = 16.000 MH No calibration applied and no bandpass applied

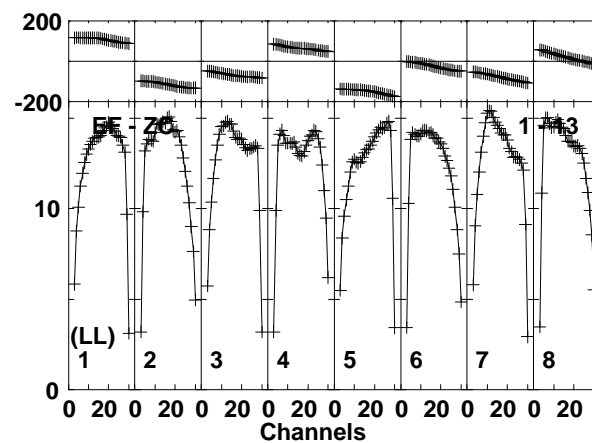
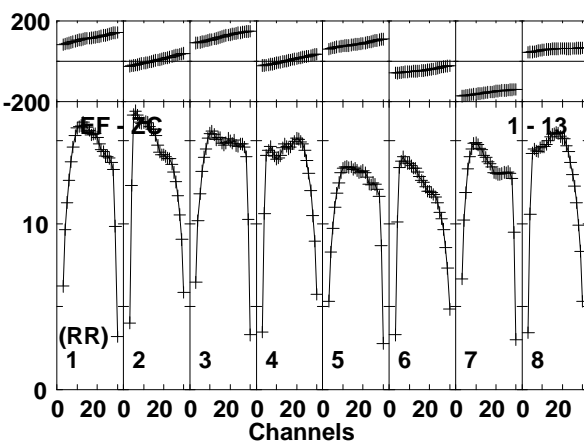
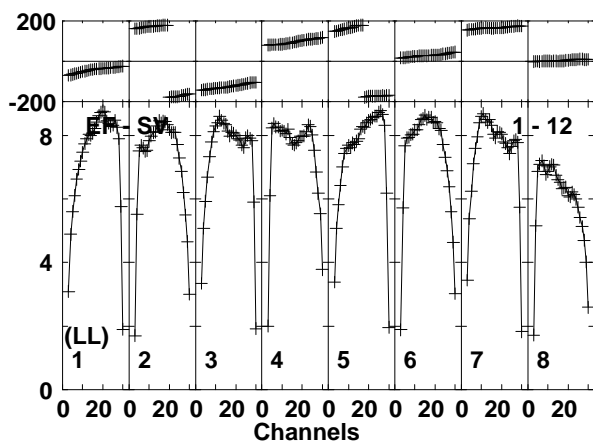
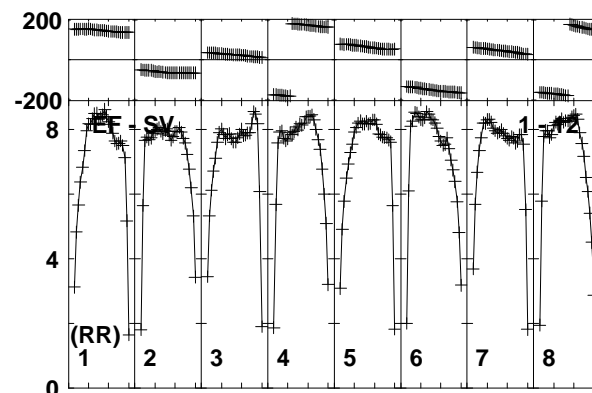
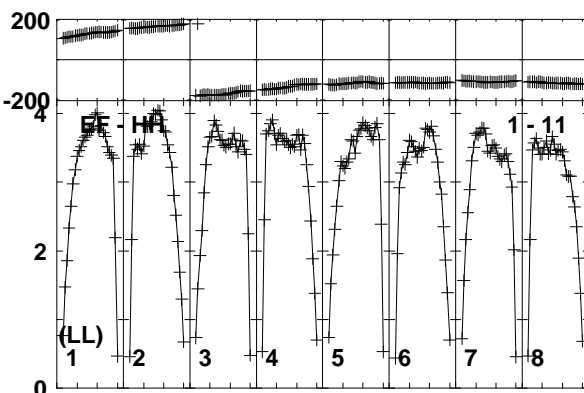
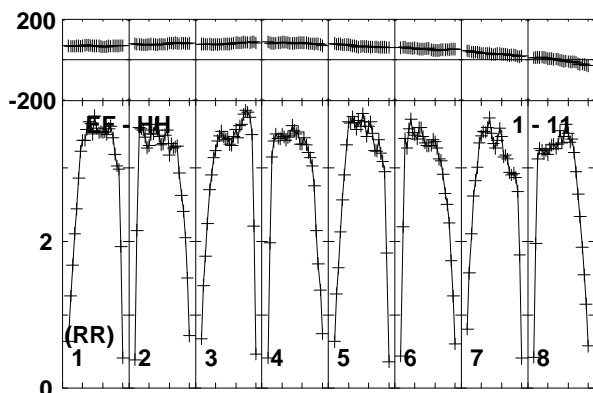
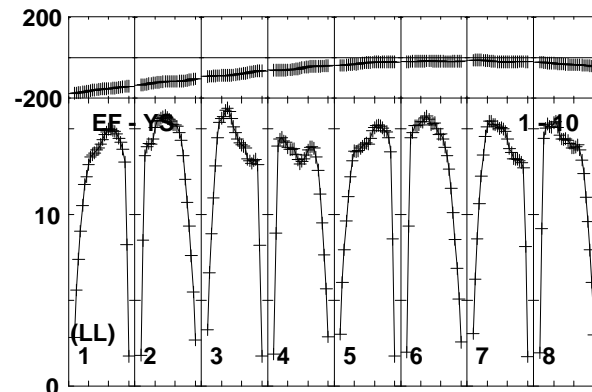
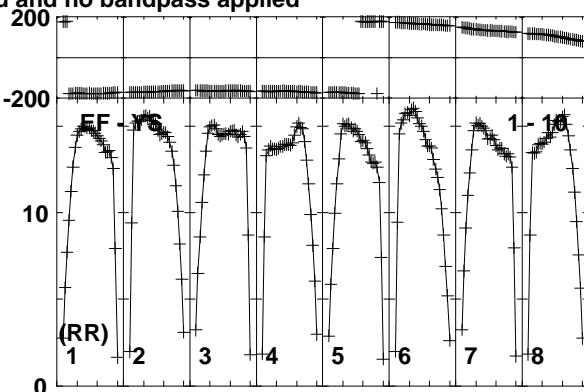
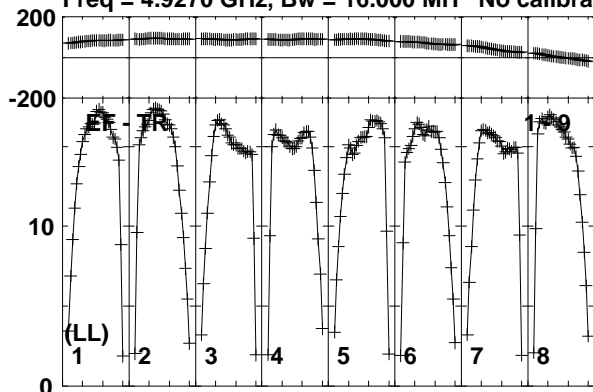

Lower frame: Milli Ampl Jy Top frame: Phas deg  
Vector averaged cross-power spectrum Baseline: EF (01) - TR (09)  
Timerange: 00/05:12:41 to 00/05:14:09

Plot file version 157 created 08-APR-2019 12:09:51

J0815+3635 EM133B.UVDATA.1

Freq = 4.9270 GHz, Bw = 16.000 MH No calibration applied and no bandpass applied

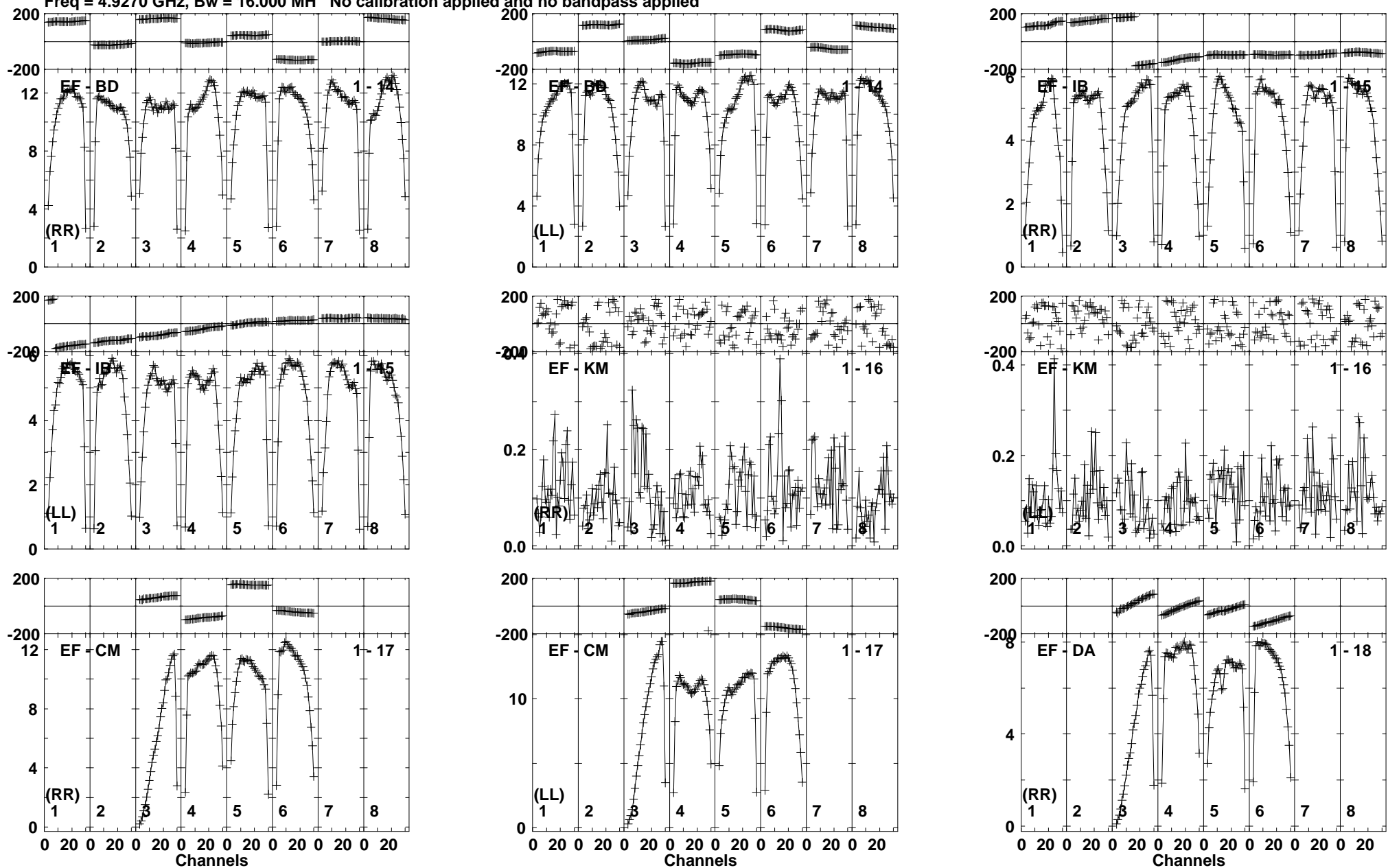

Lower frame: Milli Ampl Jy Top frame: Phas deg  
Vector averaged cross-power spectrum Baseline: EF (01) - BD (14)  
Timerange: 00/05:12:41 to 00/05:14:09

Plot file version 158 created 08-APR-2019 12:09:51

J0815+3635 EM133B.UVDATA.1

Freq = 4.9270 GHz, Bw = 16.000 MH No calibration applied and no bandpass applied

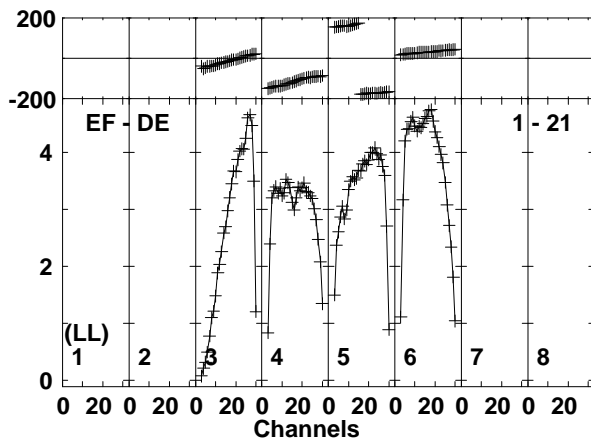
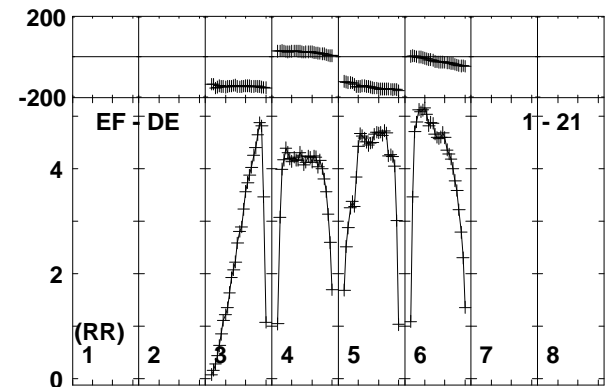
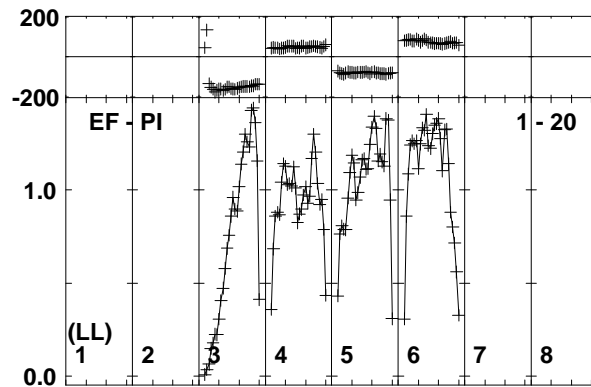
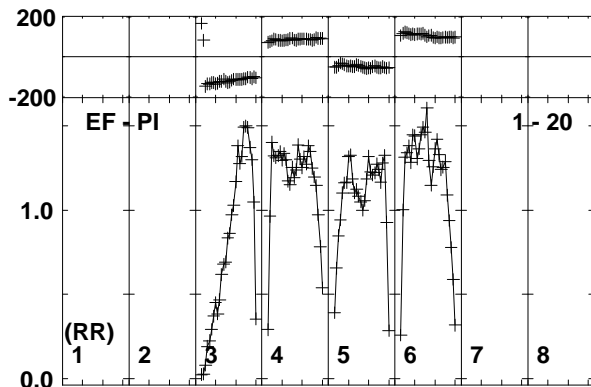
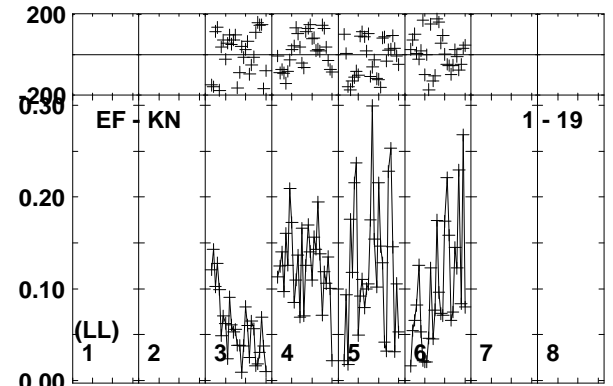
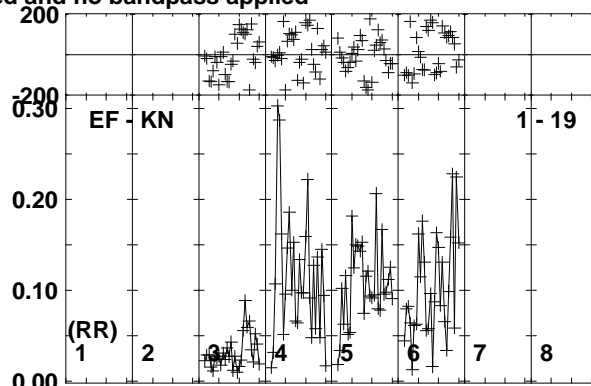
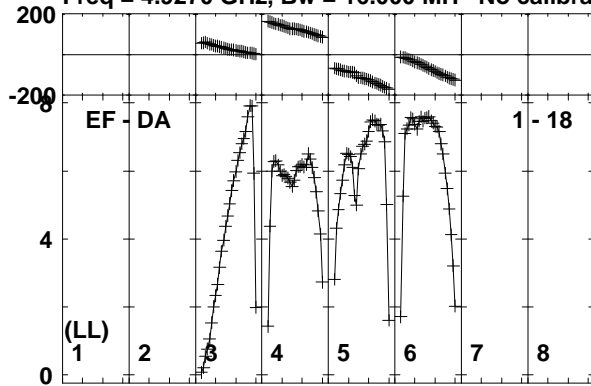

Lower frame: Milli Ampl Jy Top frame: Phas deg  
Vector averaged cross-power spectrum Baseline: EF (01) - DA (18)  
Timerange: 00/05:12:41 to 00/05:14:09

Plot file version 159 created 08-APR-2019 12:09:51

MRK622 EM133B.UVDATA.1

Freq = 4.9270 GHz, Bw = 16.000 MH No calibration applied and no bandpass applied

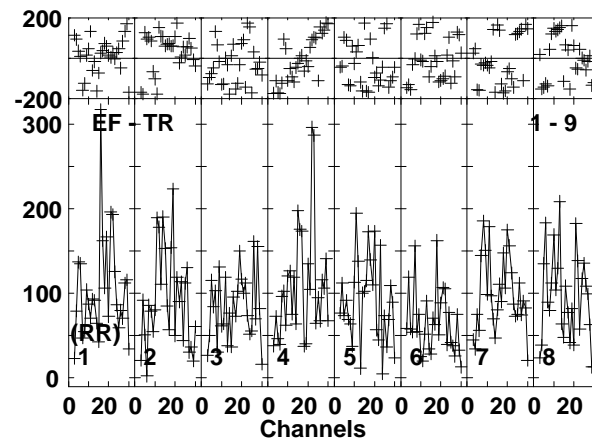
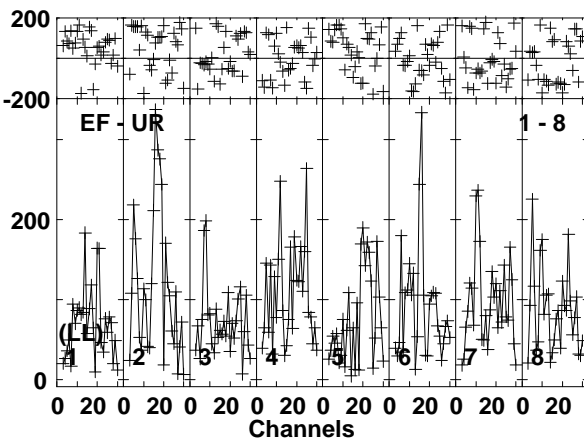
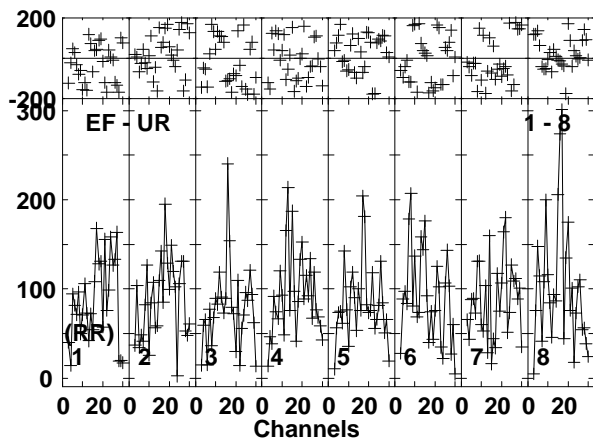
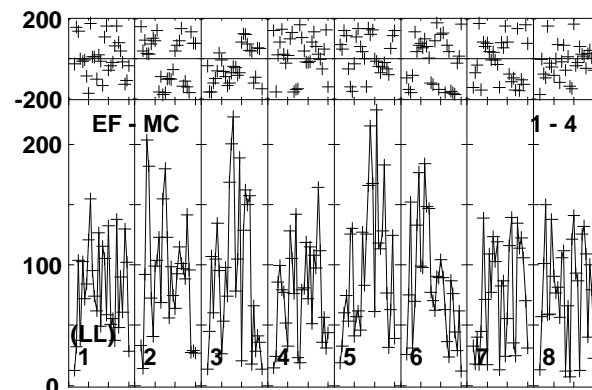
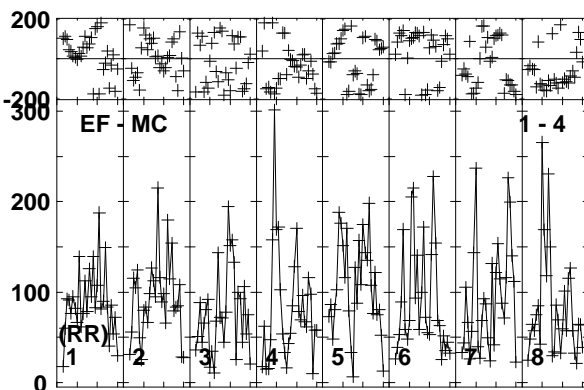
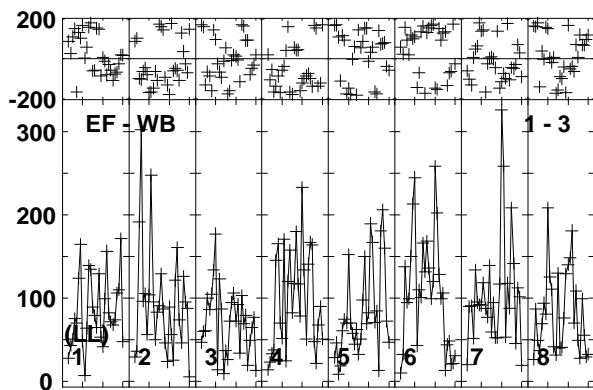
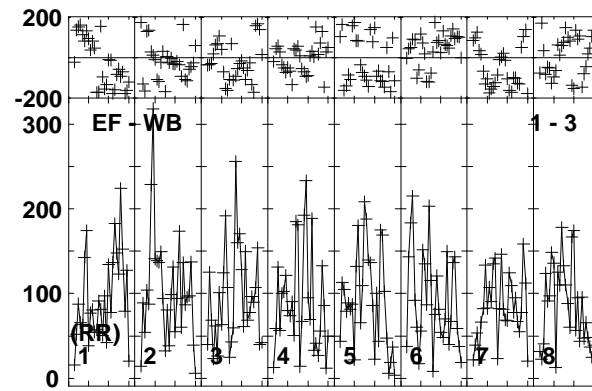
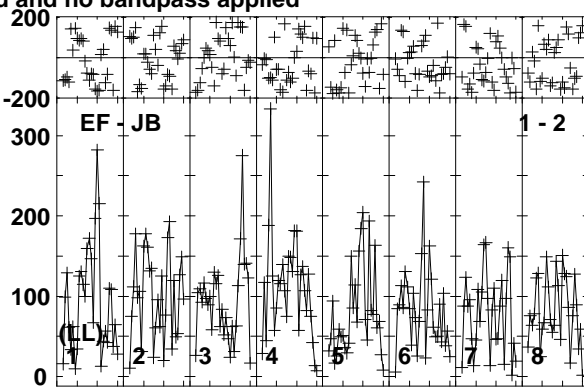
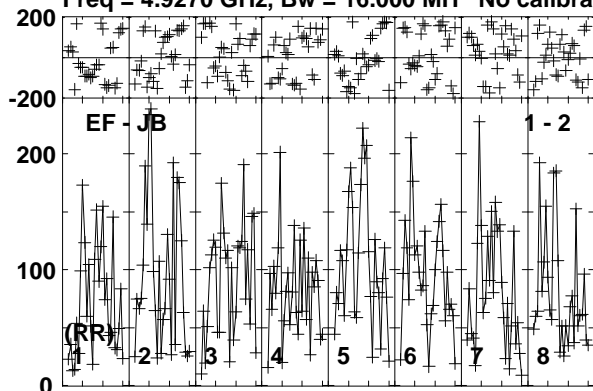

Lower frame: Micro Ampl Jy Top frame: Phas deg  
Vector averaged cross-power spectrum Baseline: EF (01) - JB (02)  
Timerange: 00/05:14:11 to 00/05:17:39

Plot file version 160 created 08-APR-2019 12:09:51

MRK622 EM133B.UVDATA.1

Freq = 4.9270 GHz, Bw = 16.000 MH No calibration applied and no bandpass applied

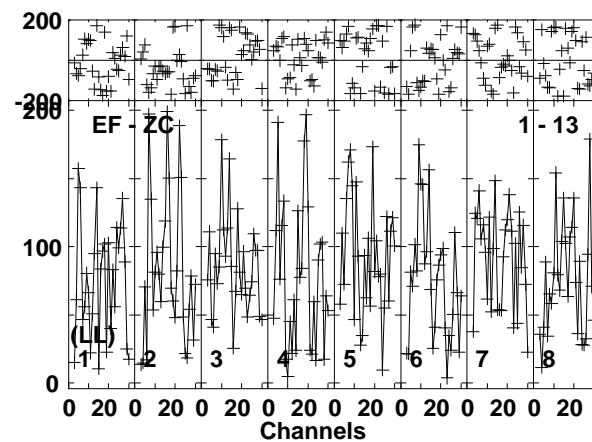
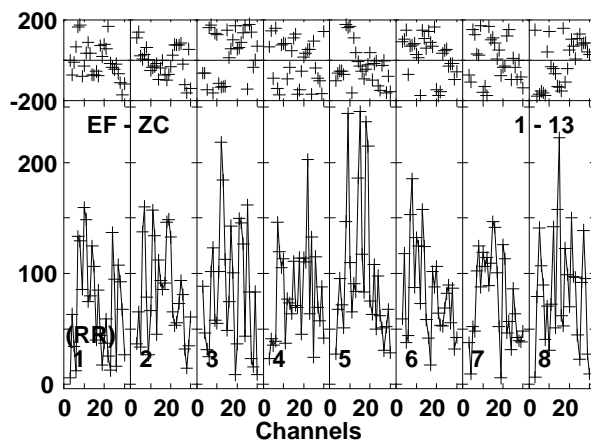
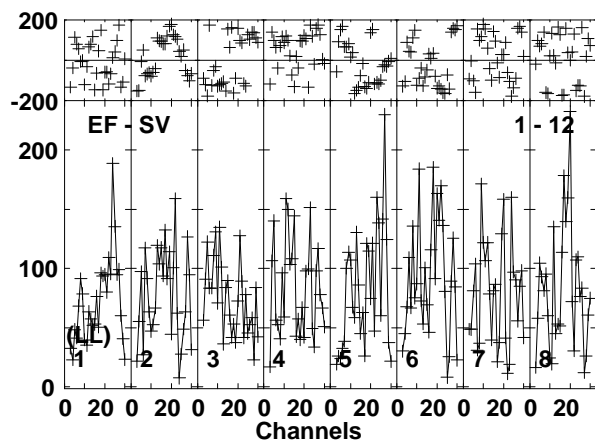
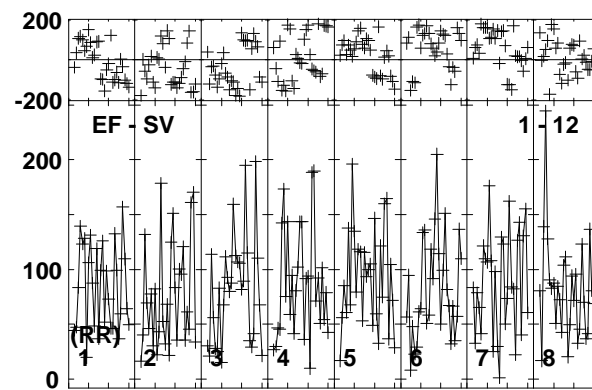
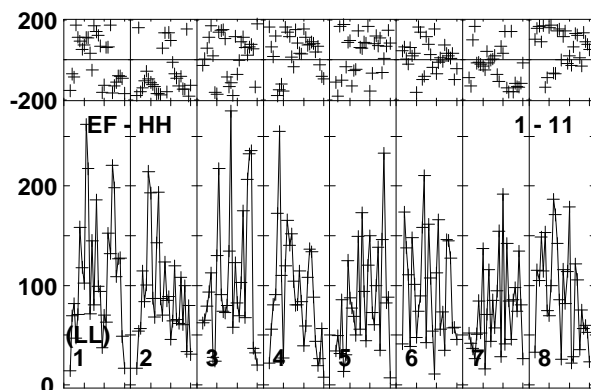
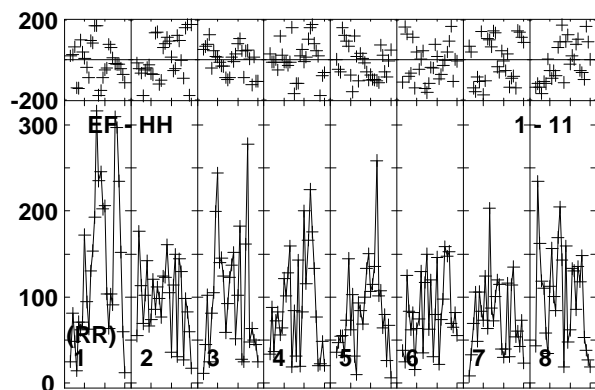
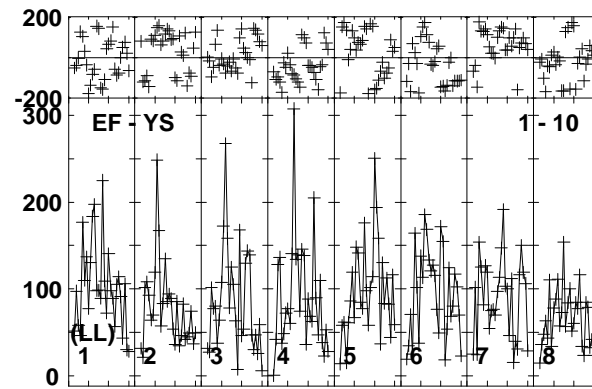
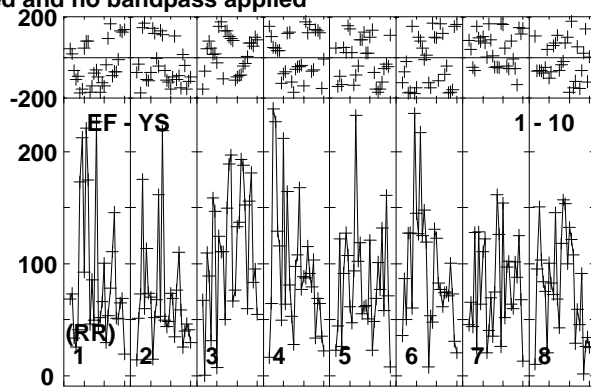
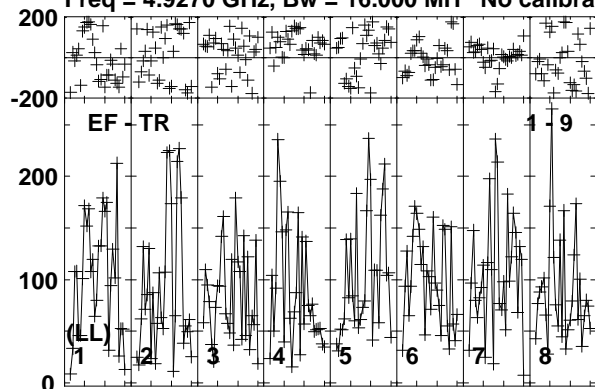

Lower frame: Micro Ampl Jy Top frame: Phas deg  
Vector averaged cross-power spectrum Baseline: EF (01) - TR (09)  
Timerange: 00/05:14:11 to 00/05:17:39



Plot file version 161 created 08-APR-2019 12:09:52

MRK622 EM133B.UVDATA.1

Freq = 4.9270 GHz, Bw = 16.000 MH No calibration applied and no bandpass applied

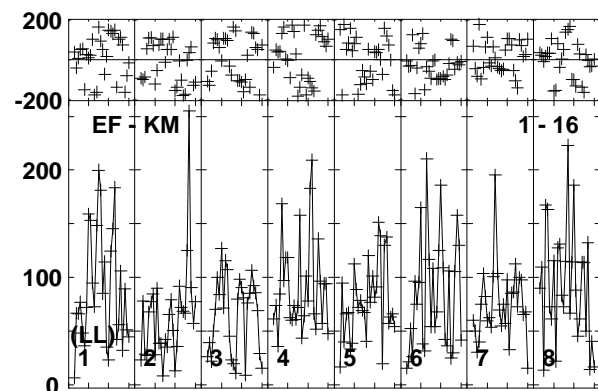
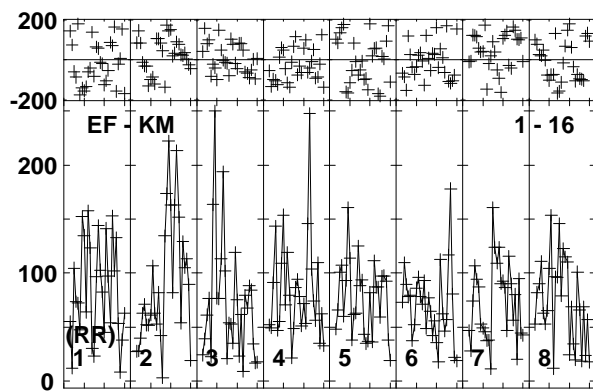
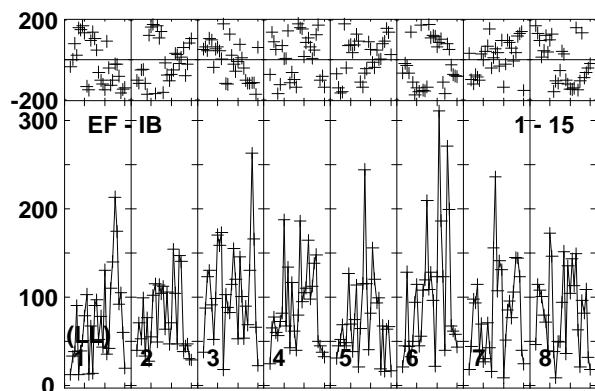
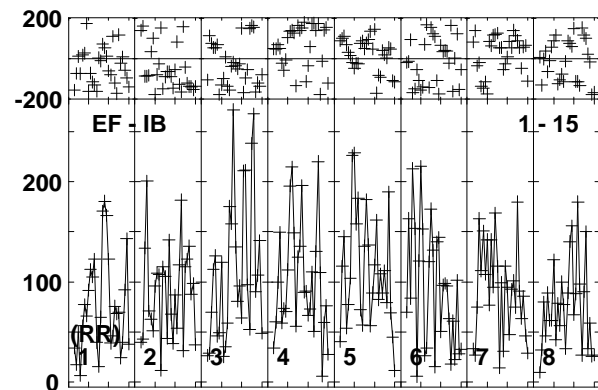
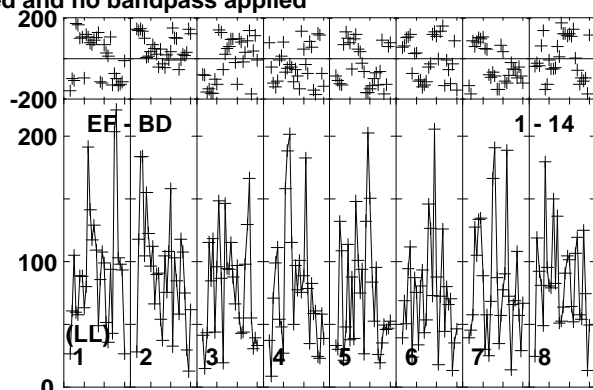
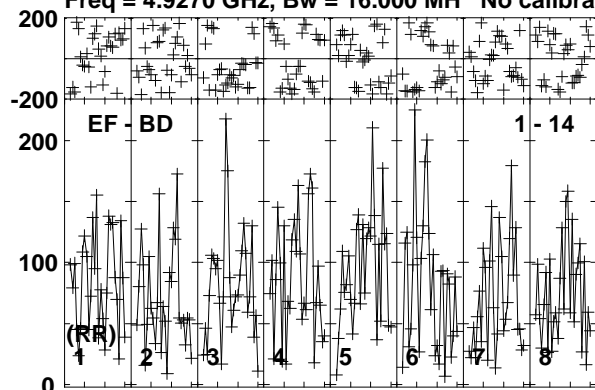

Lower frame: Micro Ampl Jy Top frame: Phas deg  
Vector averaged cross-power spectrum Baseline: EF (01) - BD (14)  
Timerange: 00/05:14:11 to 00/05:17:39

Plot file version 162 created 08-APR-2019 12:09:52

J0815+3635 EM133B.UVDATA.1

Freq = 4.9270 GHz, Bw = 16.000 MH No calibration applied and no bandpass applied

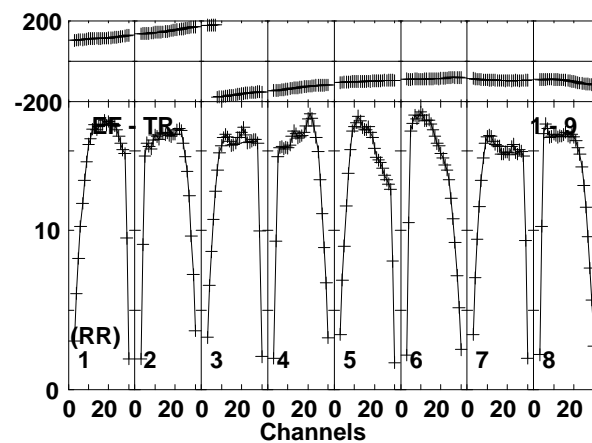
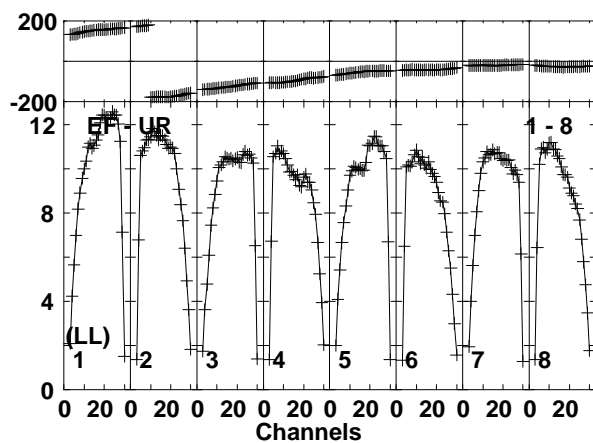
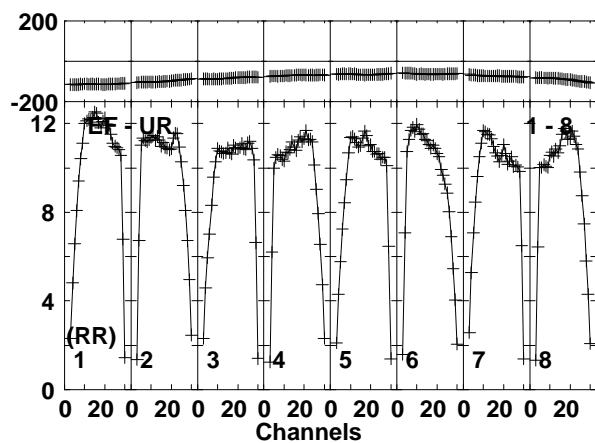
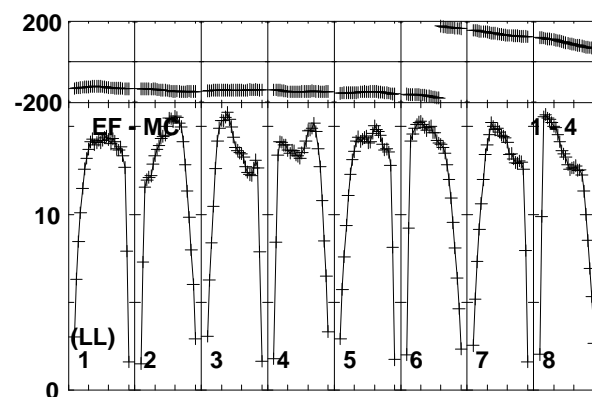
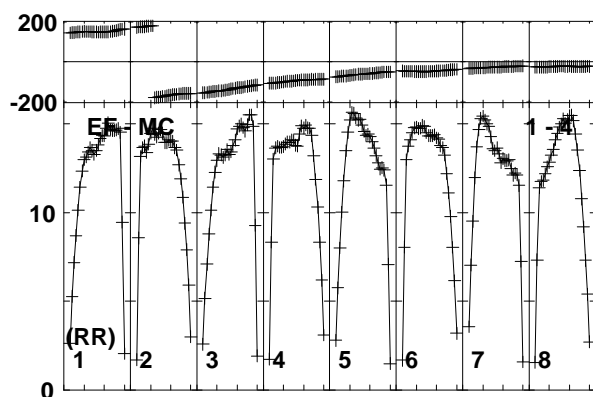
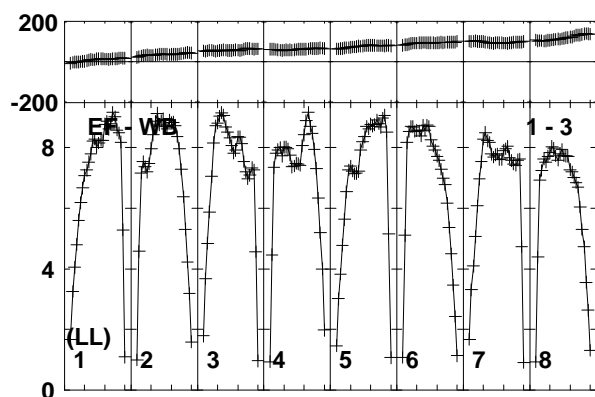
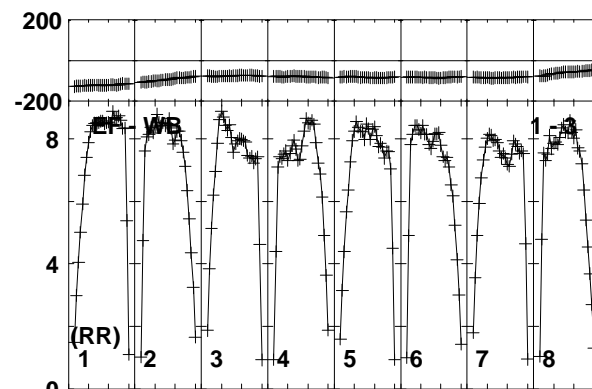
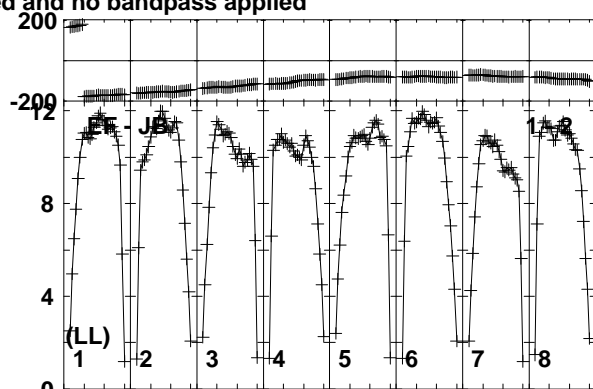
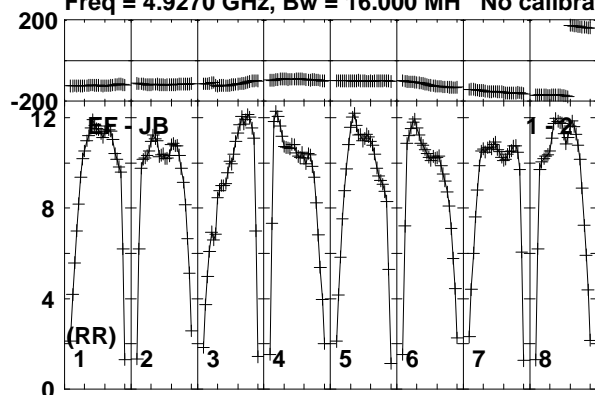

Lower frame: Milli Ampl Jy Top frame: Phas deg  
Vector averaged cross-power spectrum Baseline: EF (01) - JB (02)  
Timerange: 00/05:17:41 to 00/05:19:09

Plot file version 163 created 08-APR-2019 12:09:52

J0815+3635 EM133B.UVDATA.1

Freq = 4.9270 GHz, Bw = 16.000 MH No calibration applied and no bandpass applied

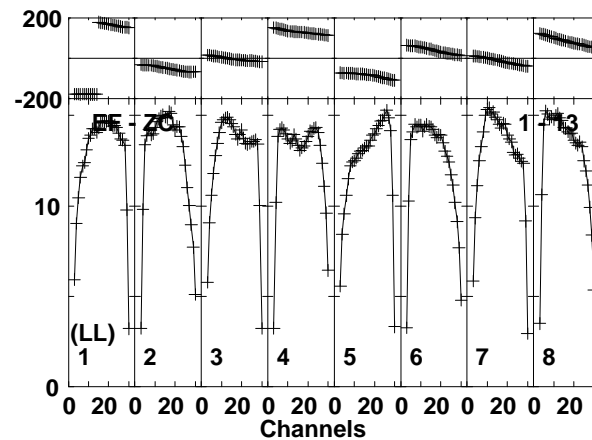
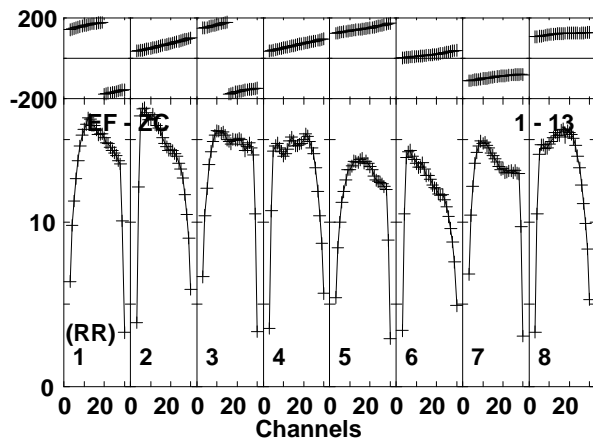
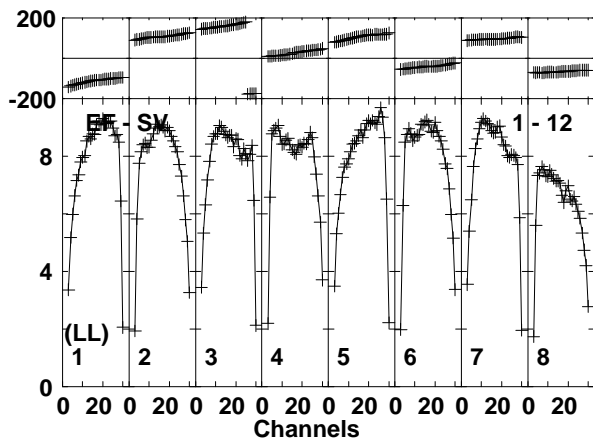
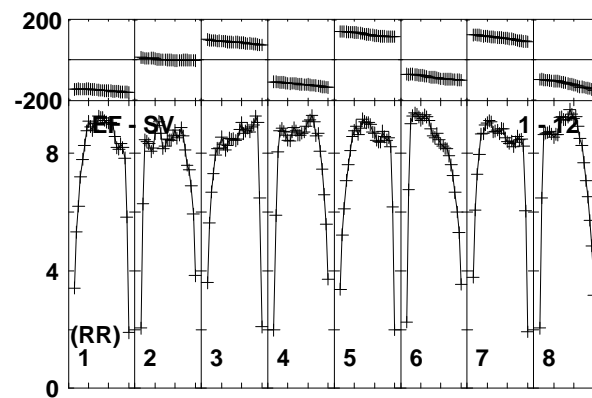
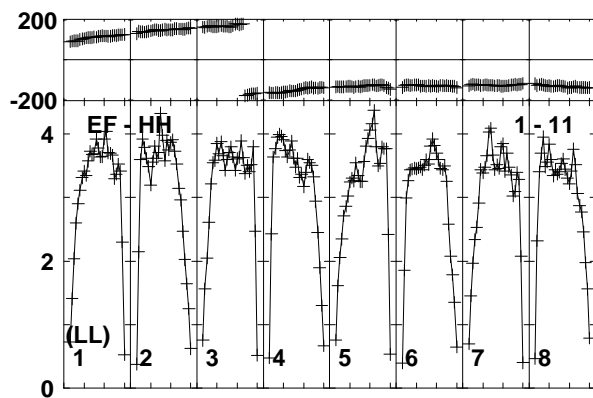
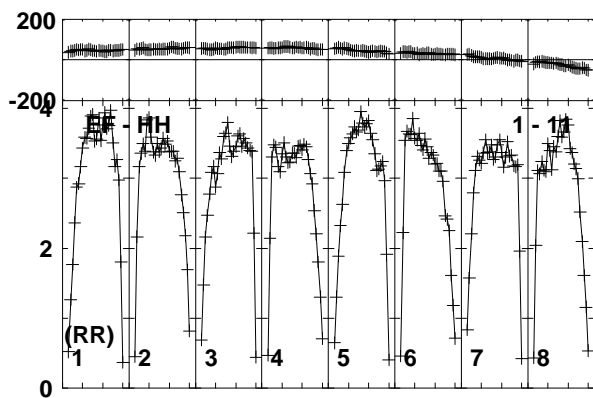
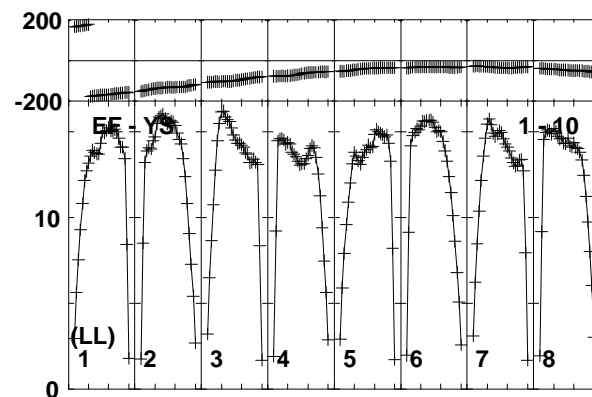
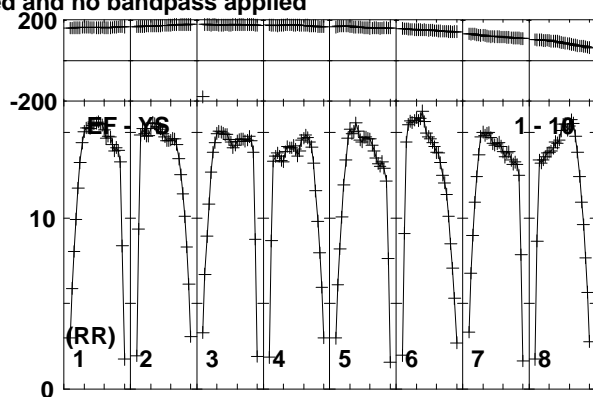
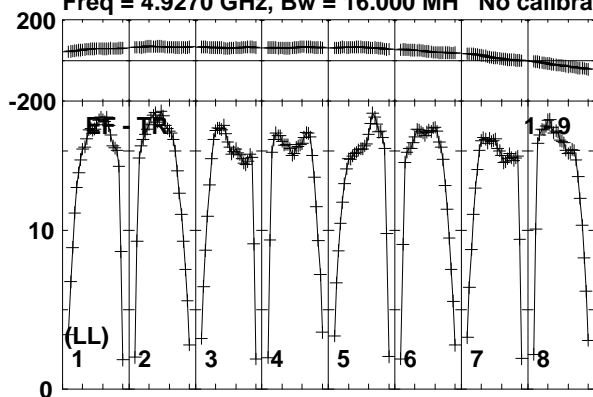

Lower frame: Milli Ampl Jy Top frame: Phas deg  
Vector averaged cross-power spectrum Baseline: EF (01) - TR (09)  
Timerange: 00/05:17:41 to 00/05:19:09

Plot file version 164 created 08-APR-2019 12:09:52

J0815+3635 EM133B.UVDATA.1

Freq = 4.9270 GHz, Bw = 16.000 MH No calibration applied and no bandpass applied

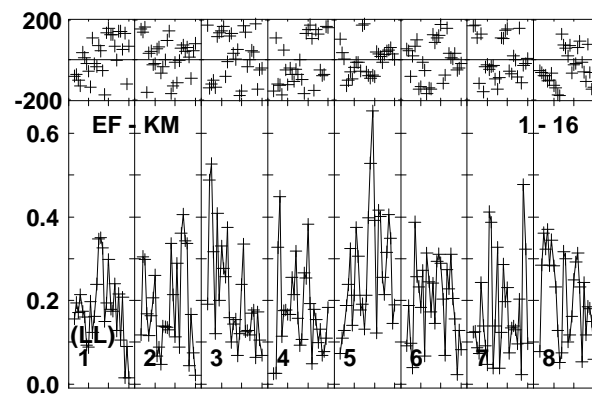
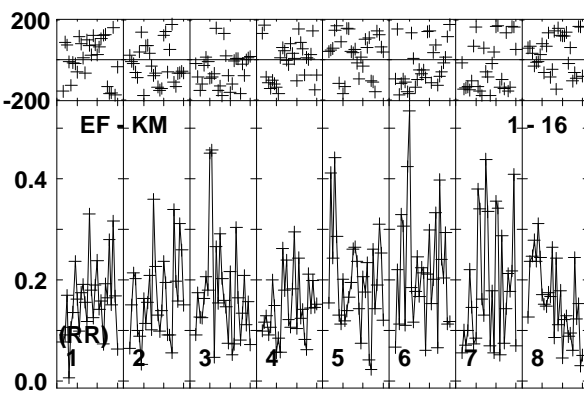
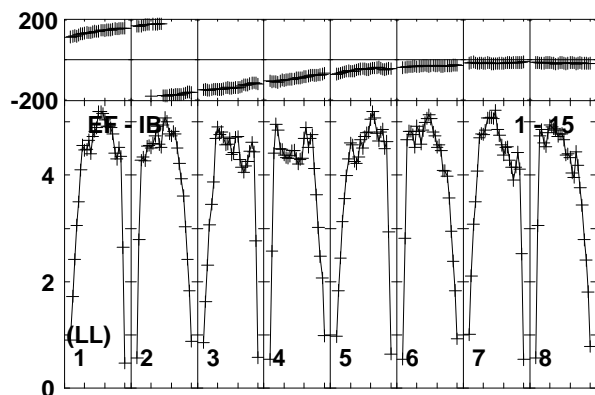
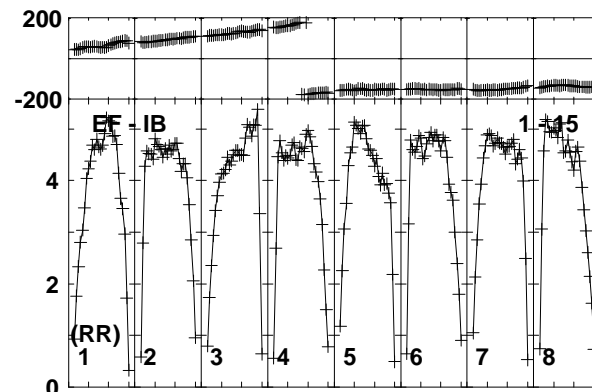
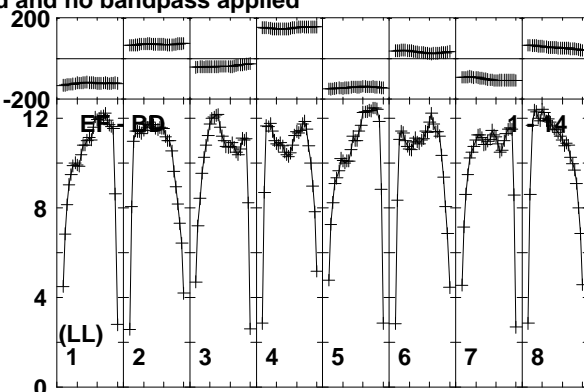
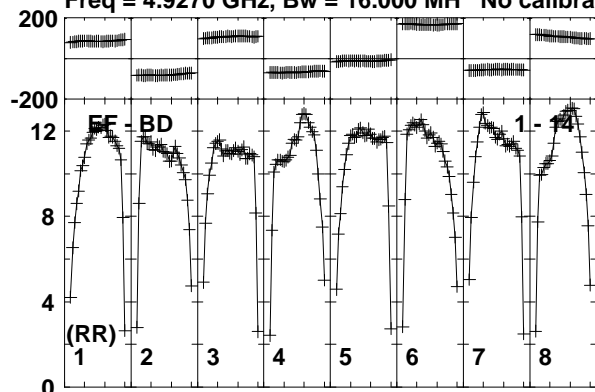

Lower frame: Milli Ampl Jy Top frame: Phas deg  
Vector averaged cross-power spectrum Baseline: EF (01) - BD (14)  
Timerange: 00/05:17:41 to 00/05:19:09

Plot file version 165 created 08-APR-2019 12:09:52

MRK622 EM133B.UVDATA.1

Freq = 4.9270 GHz, Bw = 16.000 MH No calibration applied and no bandpass applied

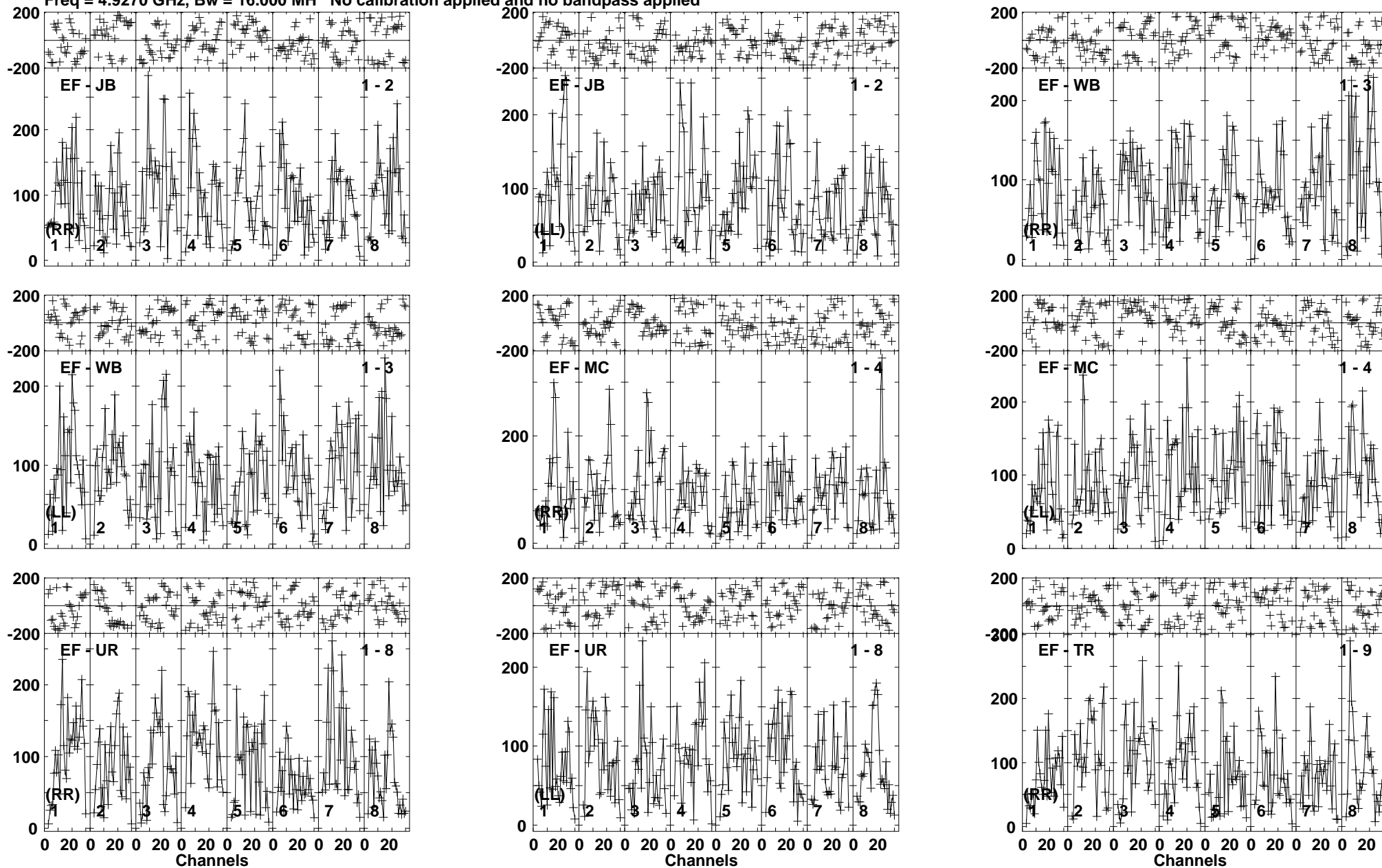

Lower frame: Micro Ampl Jy Top frame: Phas deg  
Vector averaged cross-power spectrum Baseline: EF (01) - JB (02)  
Timerange: 00/05:19:13 to 00/05:22:39

Plot file version 166 created 08-APR-2019 12:09:52

MRK622 EM133B.UVDATA.1

Freq = 4.9270 GHz, Bw = 16.000 MH No calibration applied and no bandpass applied

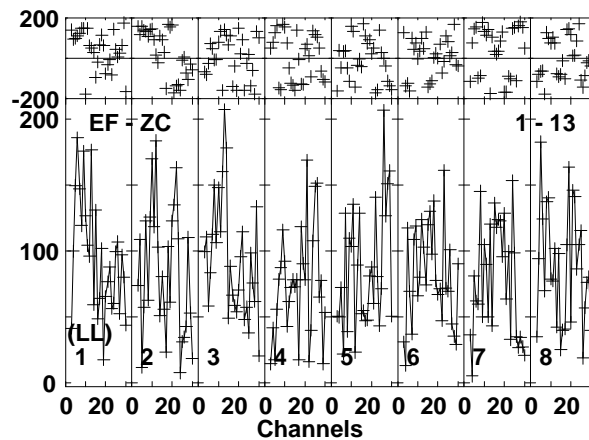
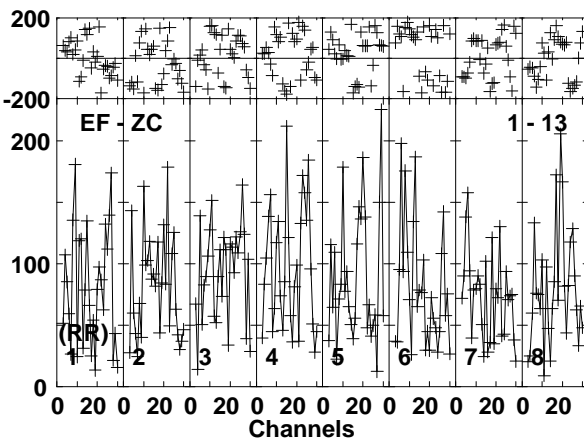
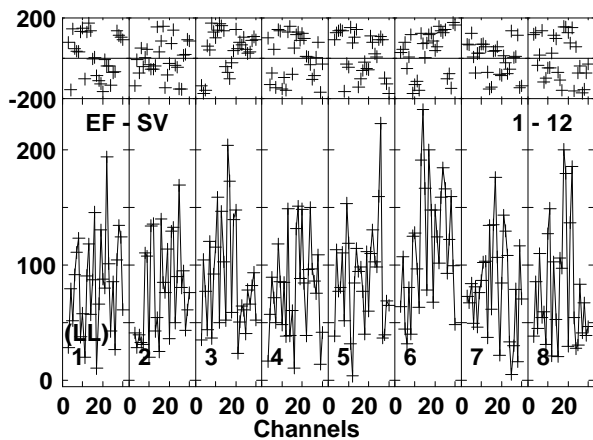
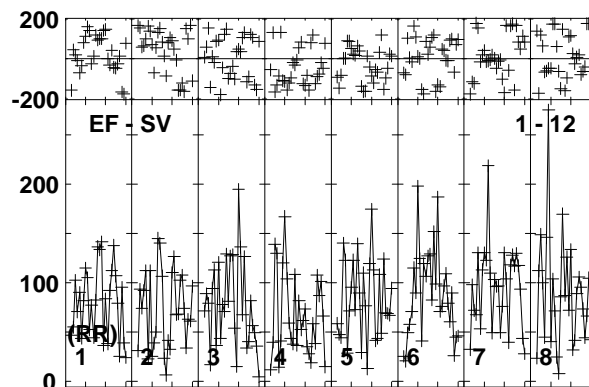
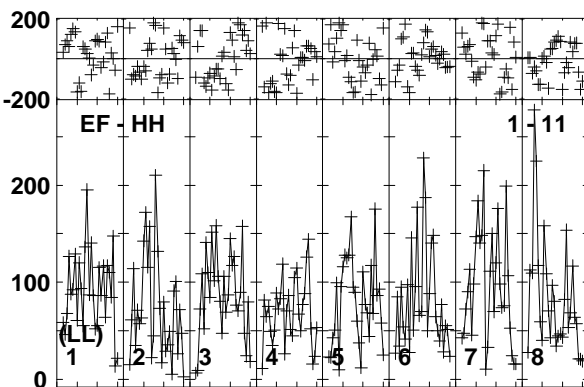
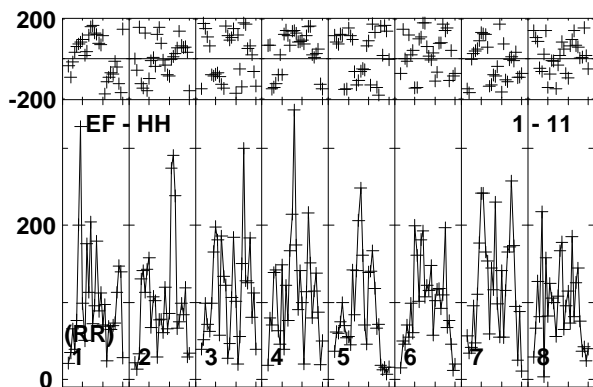
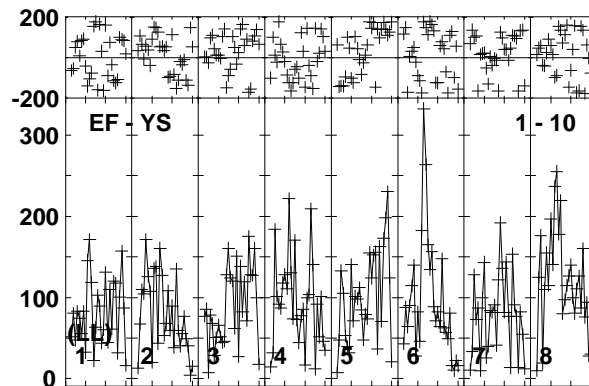
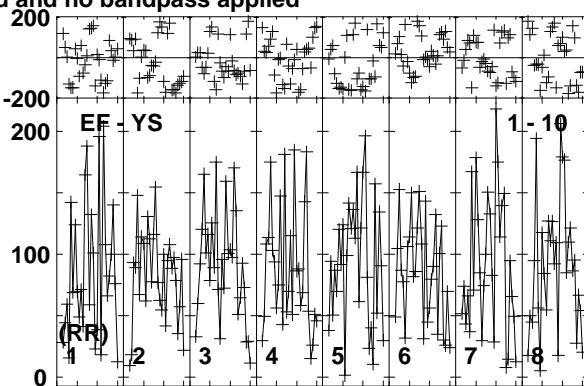
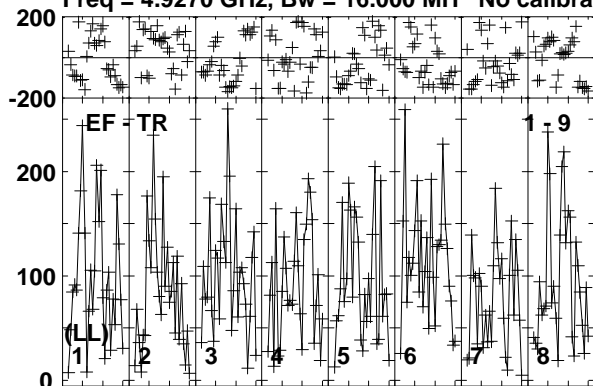

Lower frame: Micro Ampl Jy Top frame: Phas deg  
Vector averaged cross-power spectrum Baseline: EF (01) - TR (09)  
Timerange: 00/05:19:13 to 00/05:22:39

Plot file version 167 created 08-APR-2019 12:09:52

MRK622 EM133B.UVDATA.1

Freq = 4.9270 GHz, Bw = 16.000 MH No calibration applied and no bandpass applied

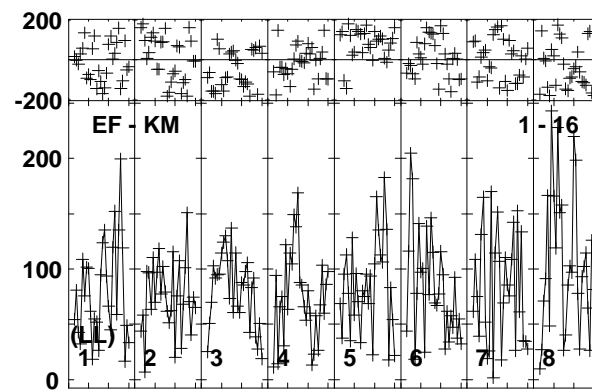
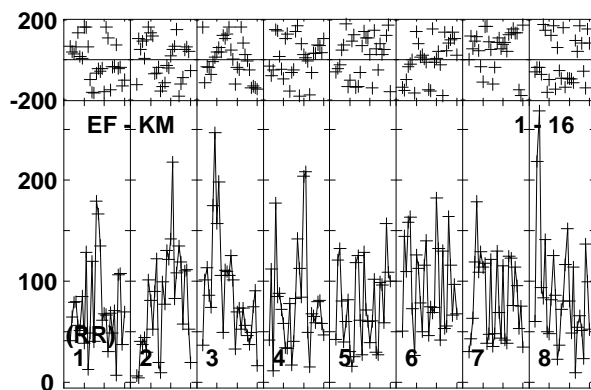
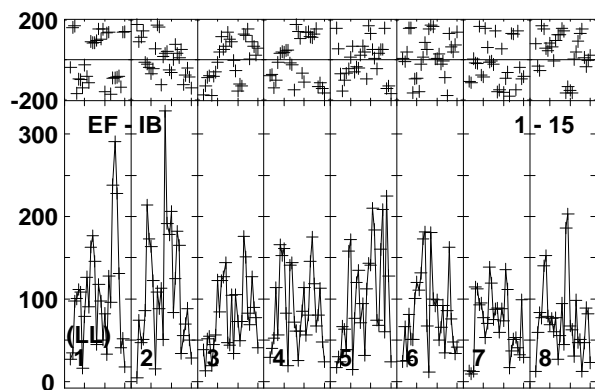
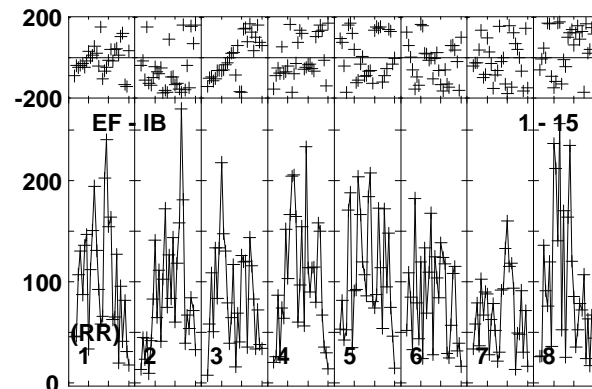
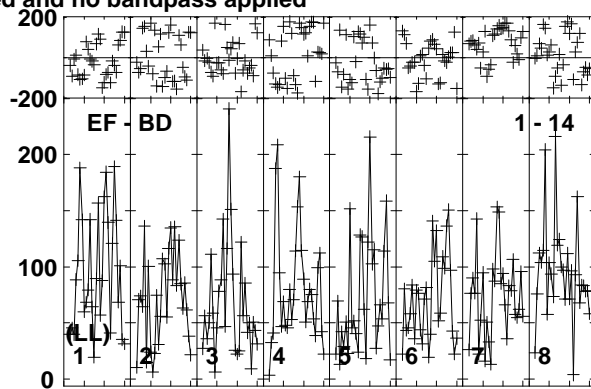
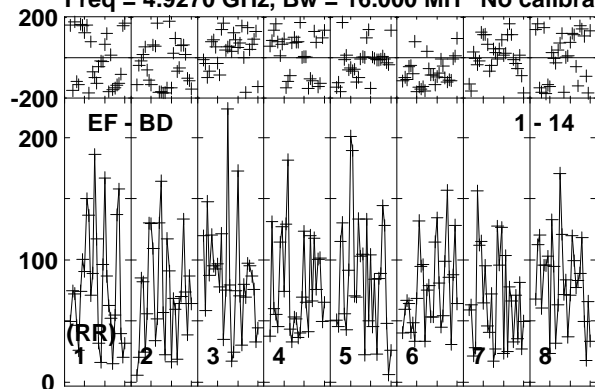

Lower frame: Micro Ampl Jy Top frame: Phas deg  
Vector averaged cross-power spectrum Baseline: EF (01) - BD (14)  
Timerange: 00/05:19:13 to 00/05:22:39

Plot file version 168 created 08-APR-2019 12:09:53

J0815+3635 EM133B.UVDATA.1

Freq = 4.9270 GHz, Bw = 16.000 MH No calibration applied and no bandpass applied

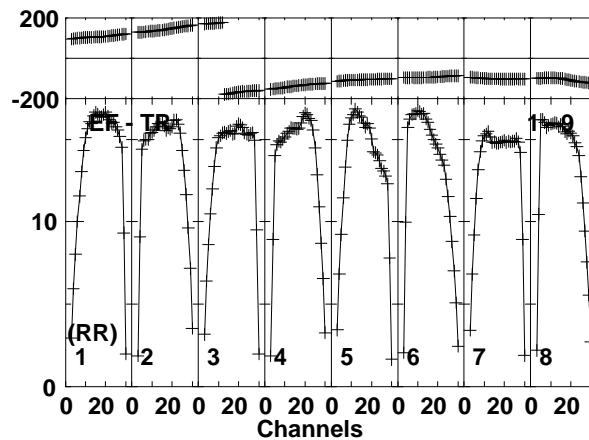
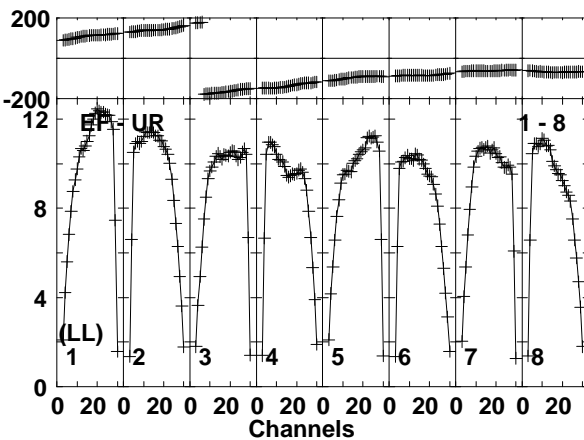
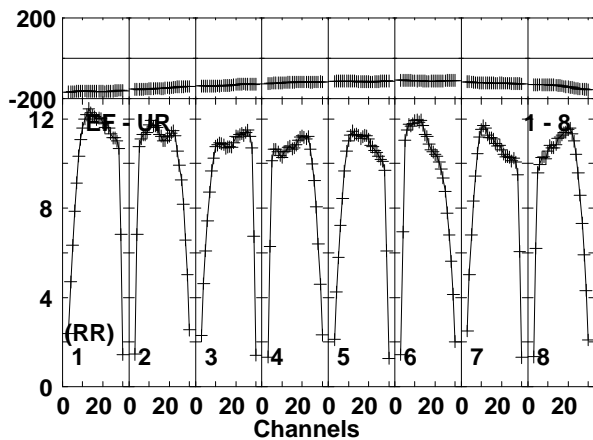
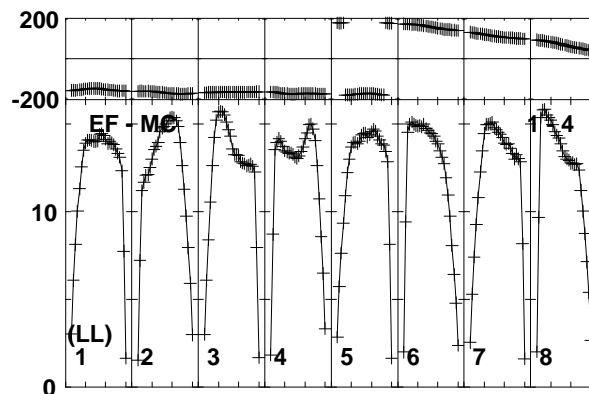
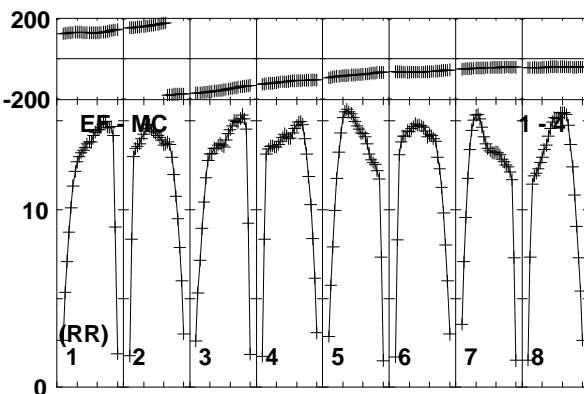
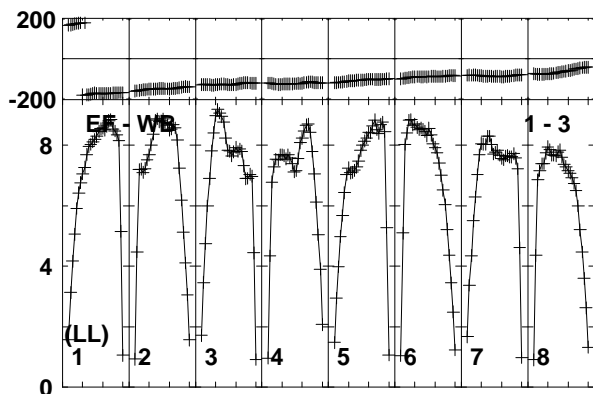
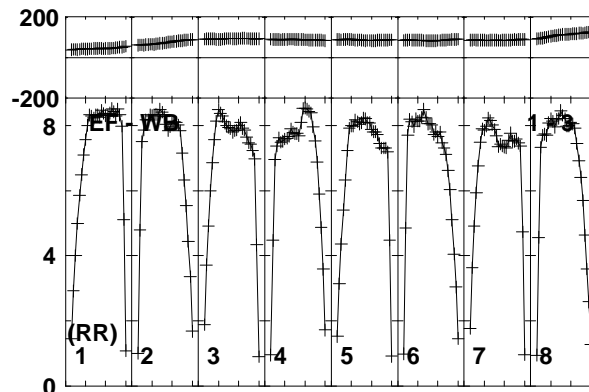
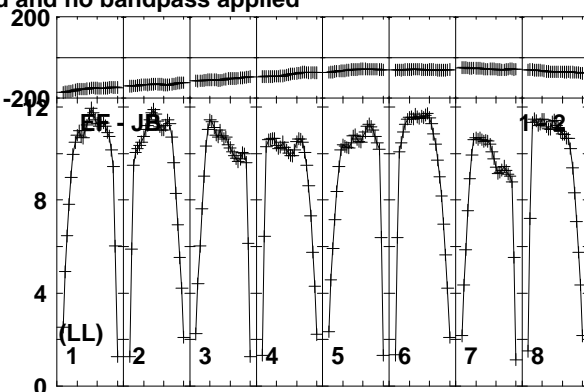
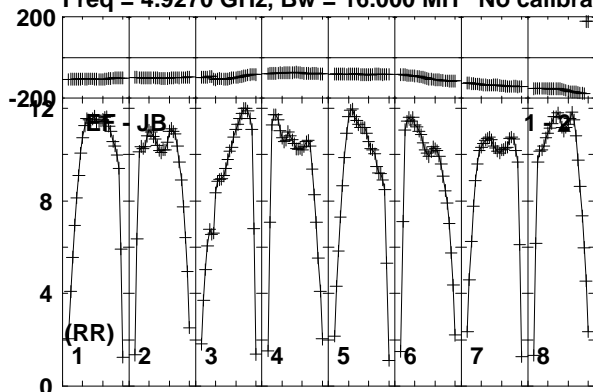

Lower frame: Milli Ampl Jy Top frame: Phas deg  
Vector averaged cross-power spectrum Baseline: EF (01) - JB (02)  
Timerange: 00/05:23:31 to 00/05:24:59



Plot file version 169 created 08-APR-2019 12:09:53

J0815+3635 EM133B.UVDATA.1

Freq = 4.9270 GHz, Bw = 16.000 MH No calibration applied and no bandpass applied

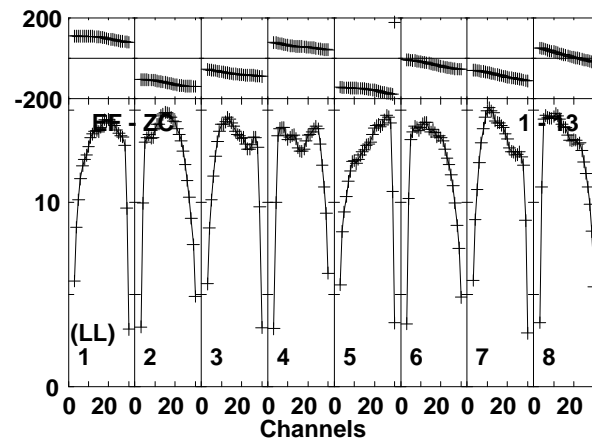
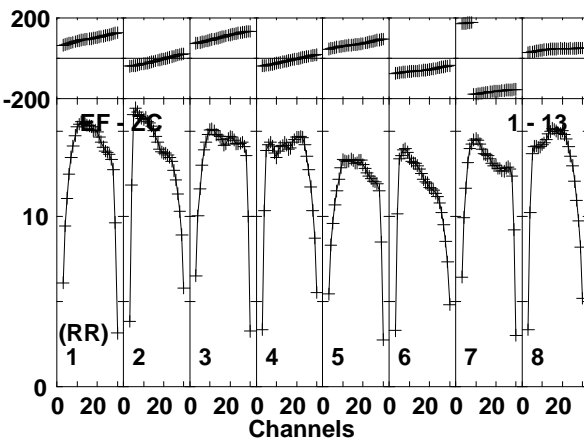
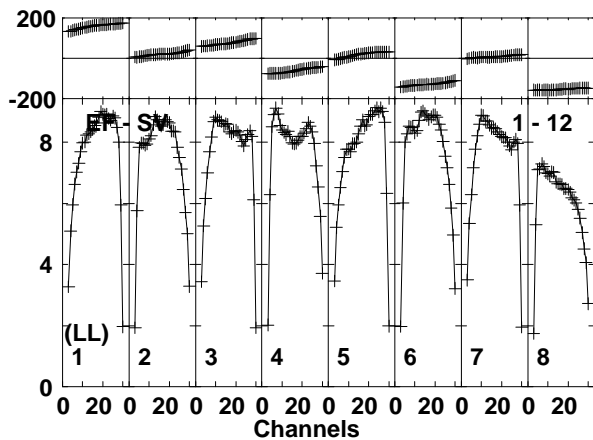
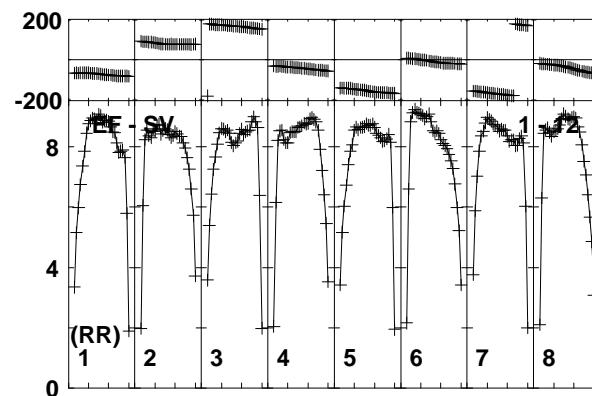
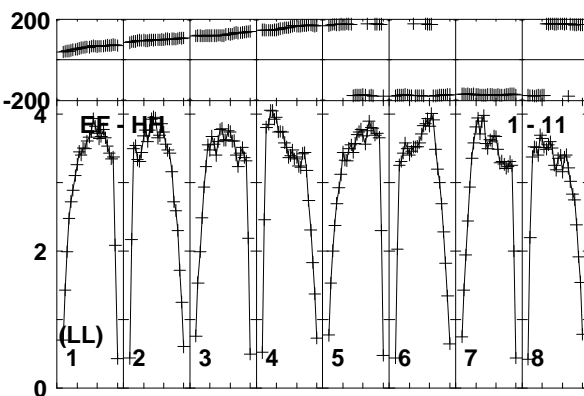
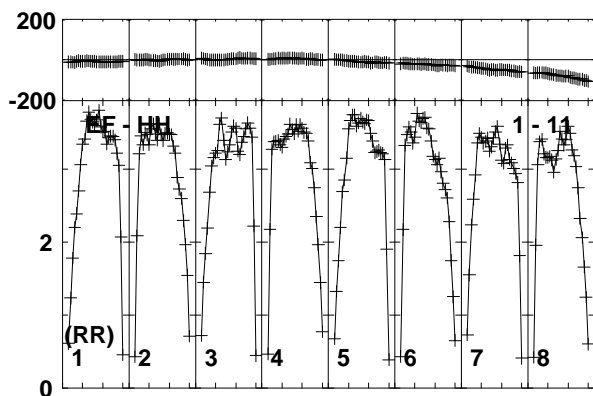
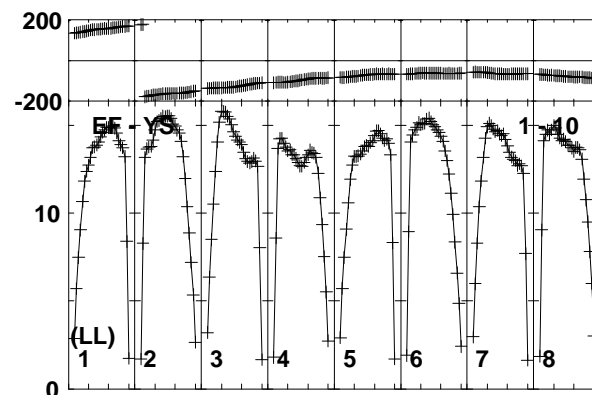
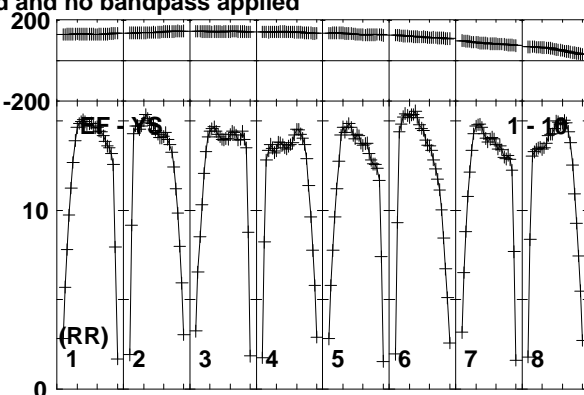
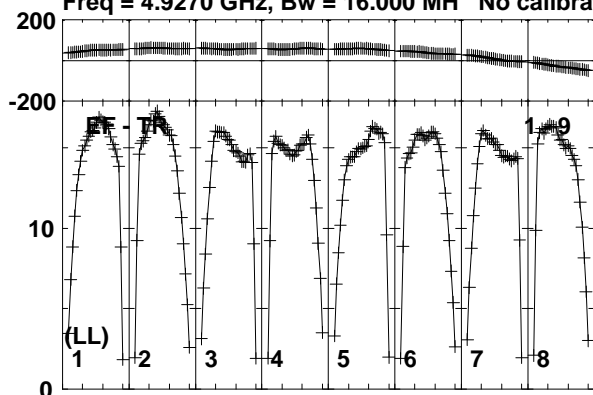

Lower frame: Milli Ampl Jy Top frame: Phas deg  
Vector averaged cross-power spectrum Baseline: EF (01) - TR (09)  
Timerange: 00/05:23:31 to 00/05:24:59

Plot file version 170 created 08-APR-2019 12:09:53

J0815+3635 EM133B.UVDATA.1

Freq = 4.9270 GHz, Bw = 16.000 MH No calibration applied and no bandpass applied

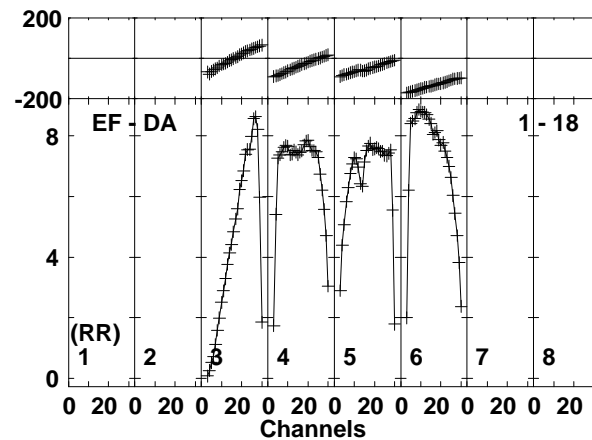
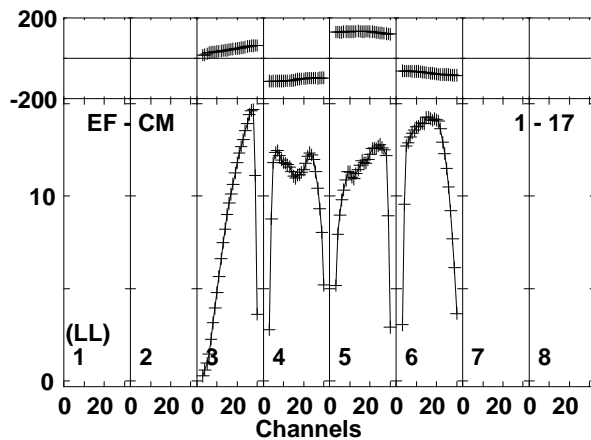
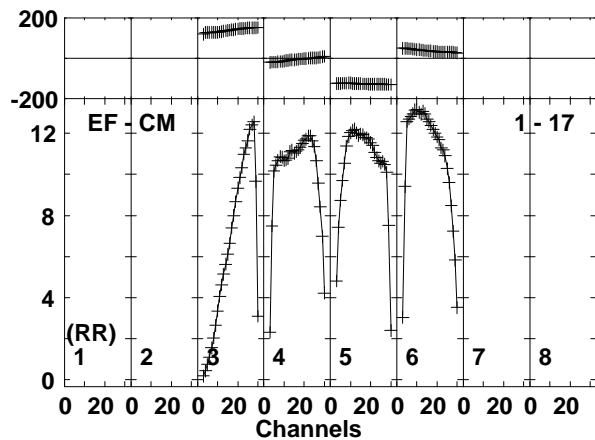
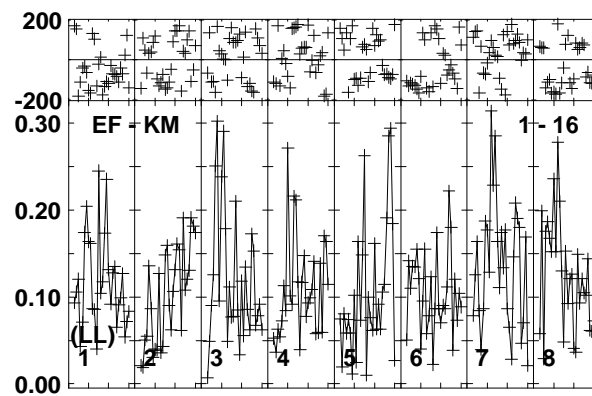
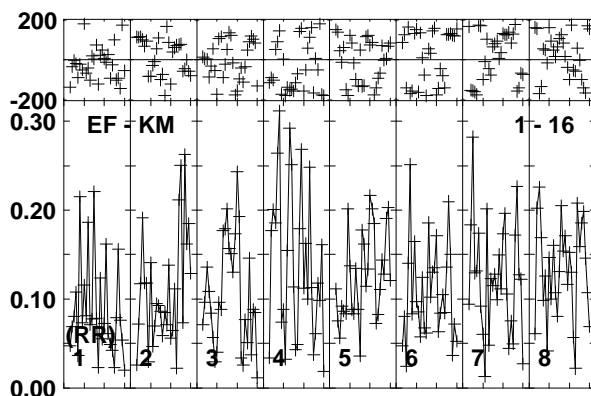
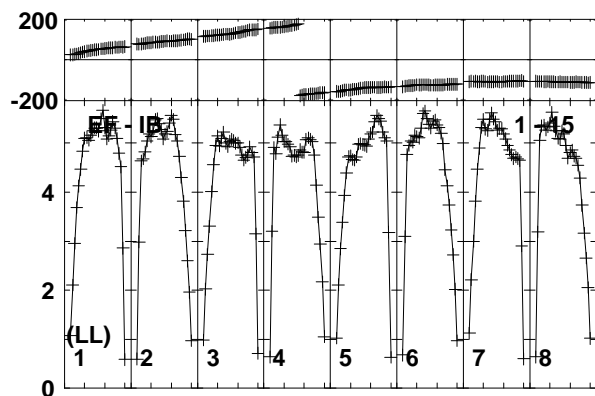
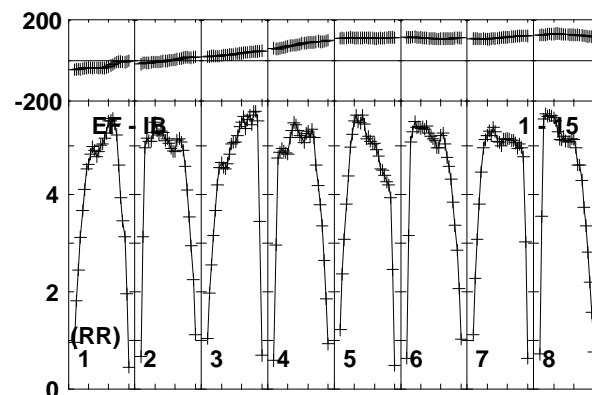
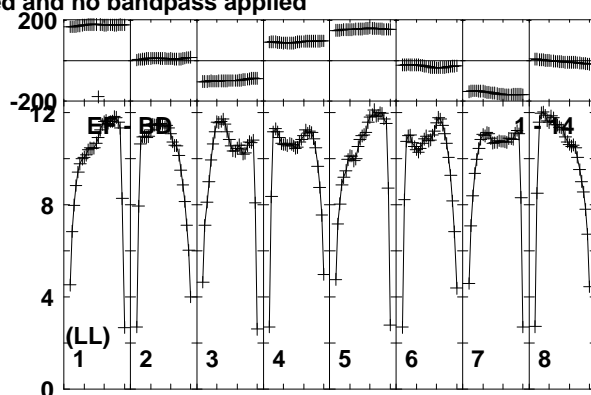
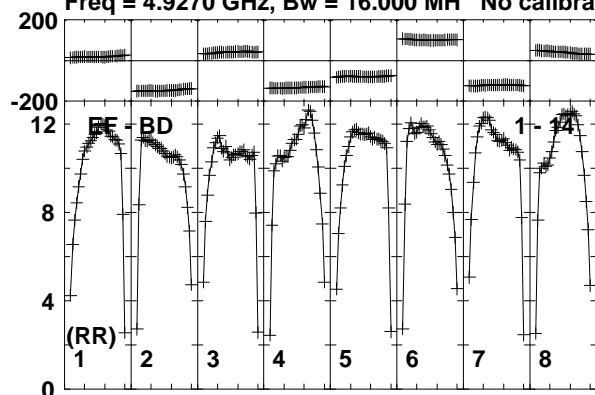

Lower frame: Milli Ampl Jy Top frame: Phas deg  
Vector averaged cross-power spectrum Baseline: EF (01) - BD (14)  
Timerange: 00/05:23:31 to 00/05:24:59

Plot file version 171 created 08-APR-2019 12:09:53

J0815+3635 EM133B.UVDATA.1

Freq = 4.9270 GHz, Bw = 16.000 MH No calibration applied and no bandpass applied

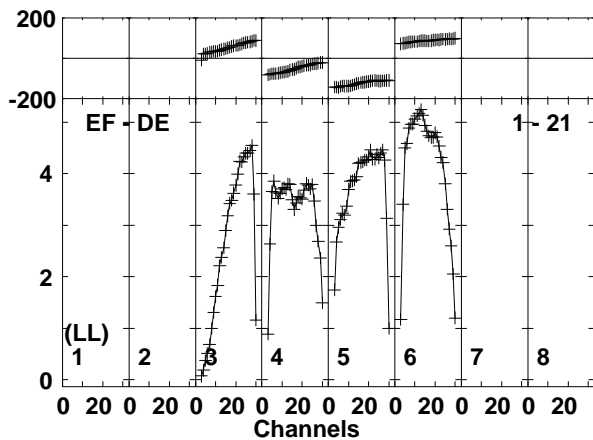
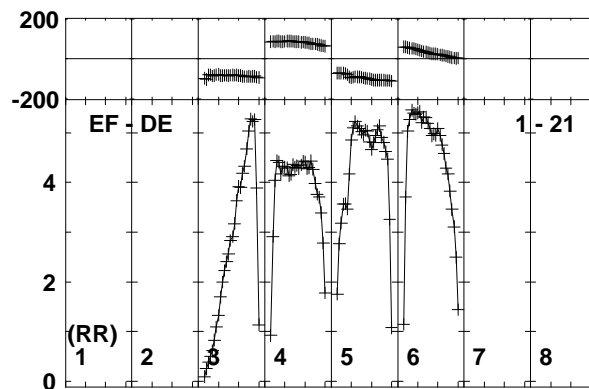
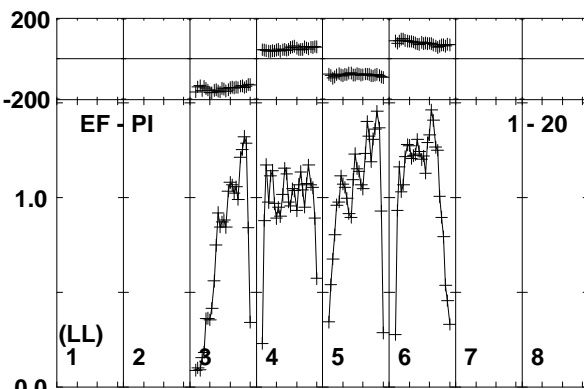
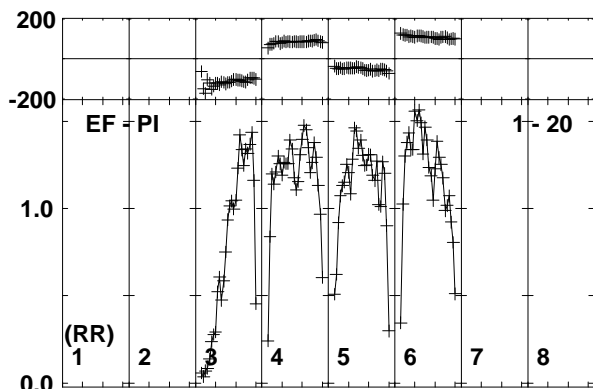
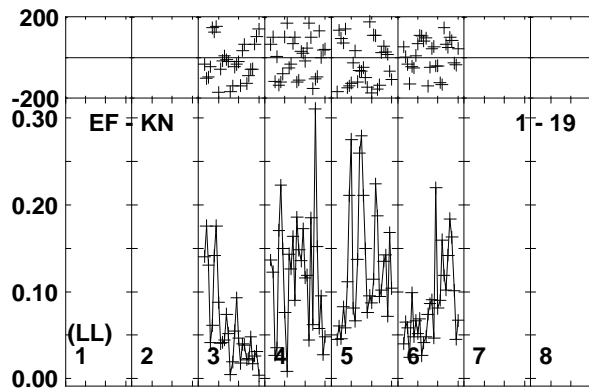
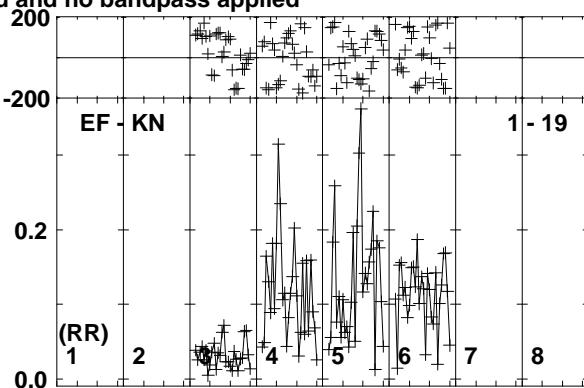
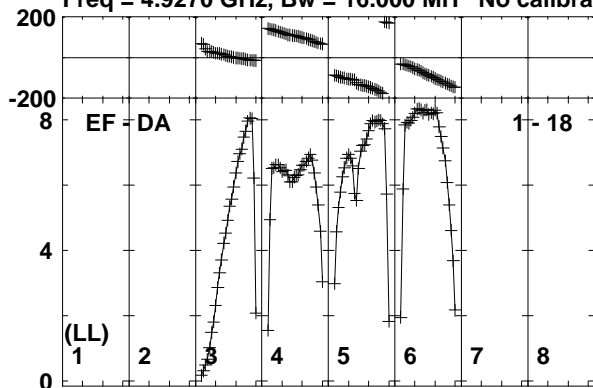

Lower frame: Milli Ampl Jy Top frame: Phas deg  
Vector averaged cross-power spectrum Baseline: EF (01) - DA (18)  
Timerange: 00/05:23:31 to 00/05:24:59

Plot file version 172 created 08-APR-2019 12:09:53

MRK622 EM133B.UVDATA.1

Freq = 4.9270 GHz, Bw = 16.000 MH No calibration applied and no bandpass applied

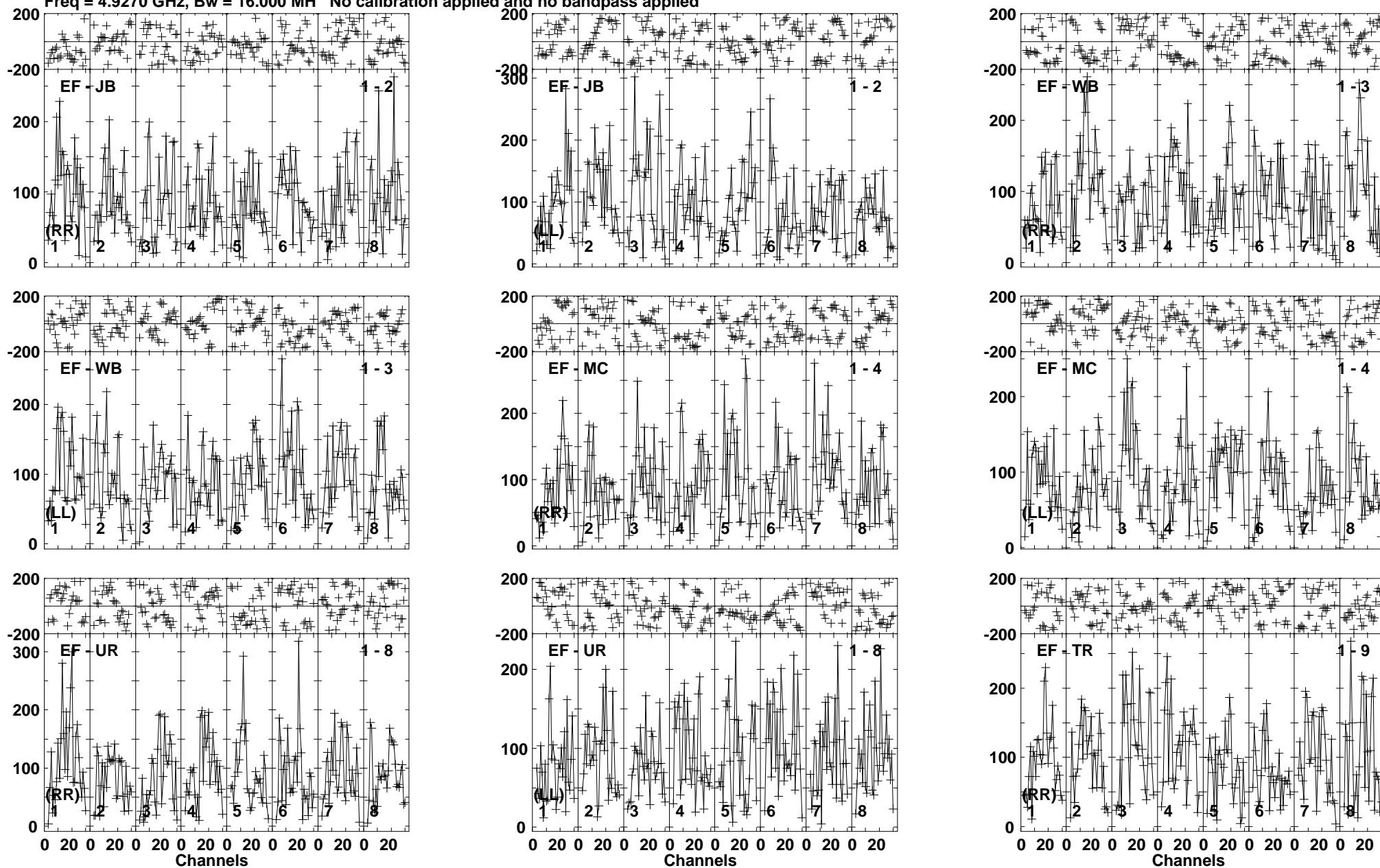

Lower frame: Micro Ampl Jy Top frame: Phas deg  
Vector averaged cross-power spectrum Baseline: EF (01) - JB (02)  
Timerange: 00/05:25:01 to 00/05:28:29

Plot file version 173 created 08-APR-2019 12:09:53

MRK622 EM133B.UVDATA.1

Freq = 4.9270 GHz, Bw = 16.000 MH No calibration applied and no bandpass applied

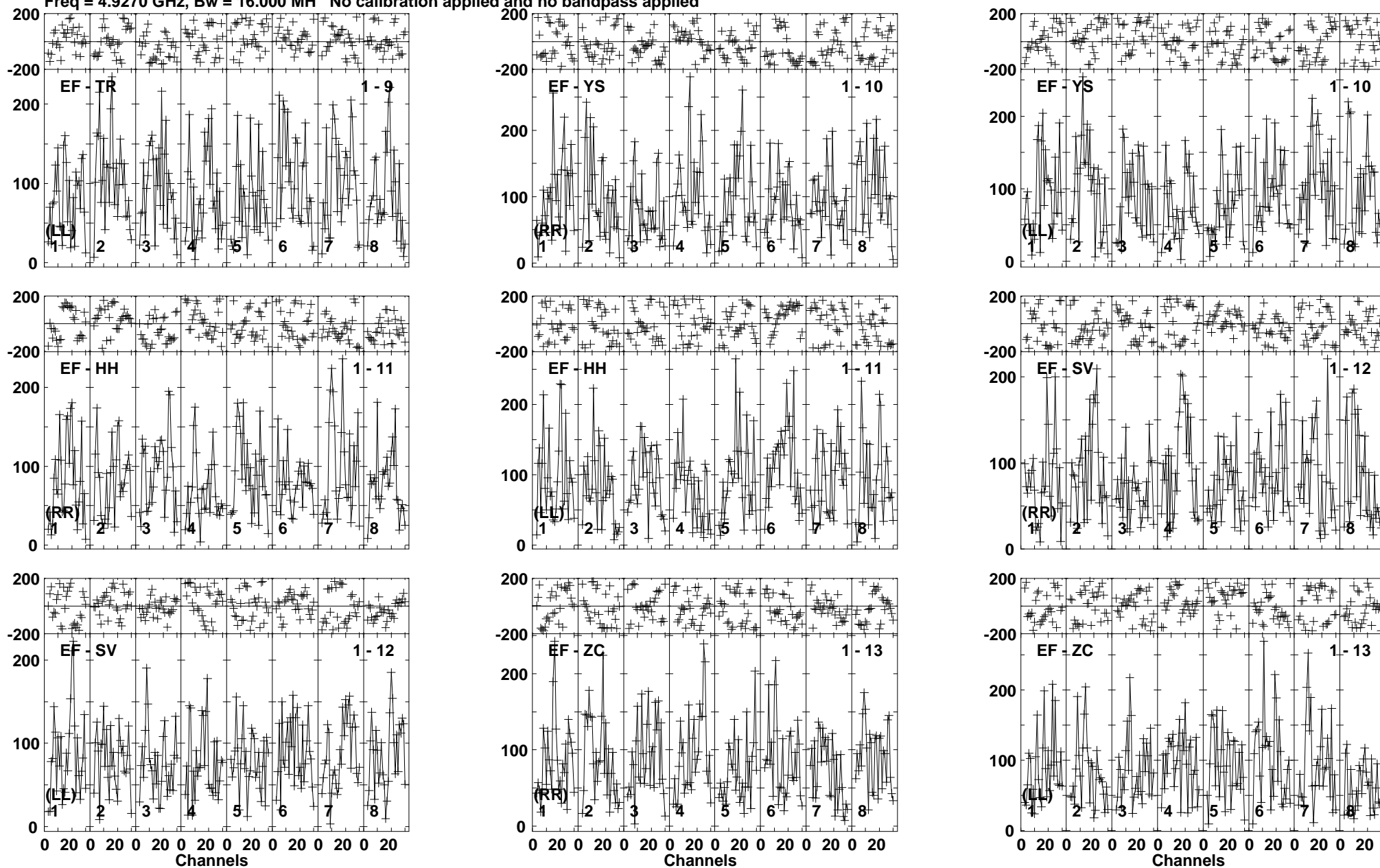

Lower frame: Micro Ampl Jy Top frame: Phas deg  
Vector averaged cross-power spectrum Baseline: EF (01) - TR (09)  
Timerange: 00/05:25:01 to 00/05:28:29

Plot file version 174 created 08-APR-2019 12:09:53

MRK622 EM133B.UVDATA.1

Freq = 4.9270 GHz, Bw = 16.000 MH No calibration applied and no bandpass applied

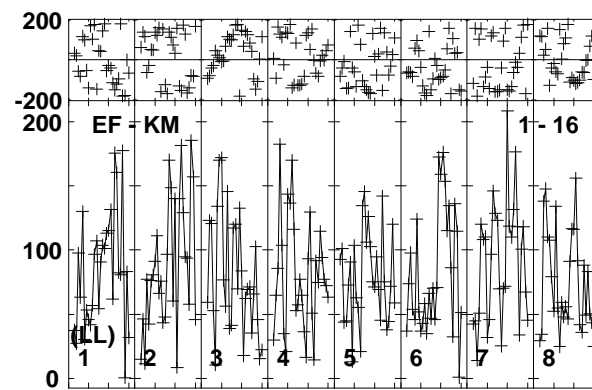
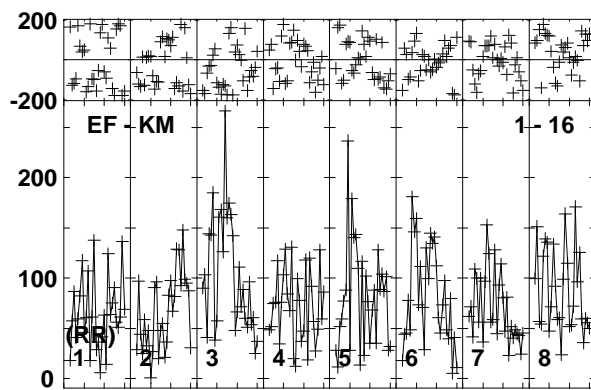
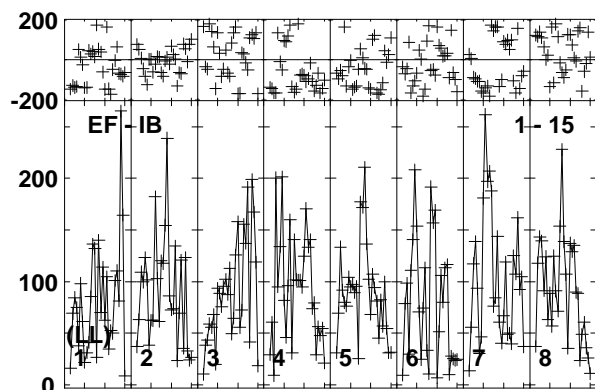
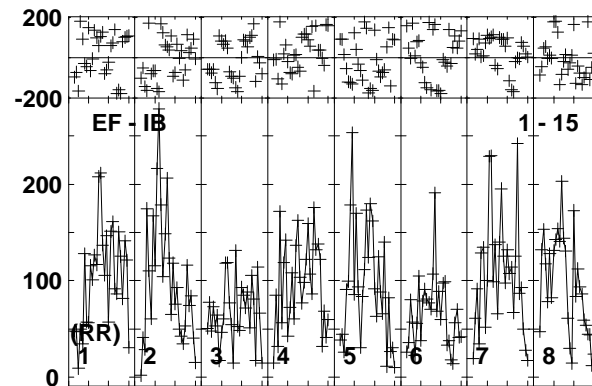
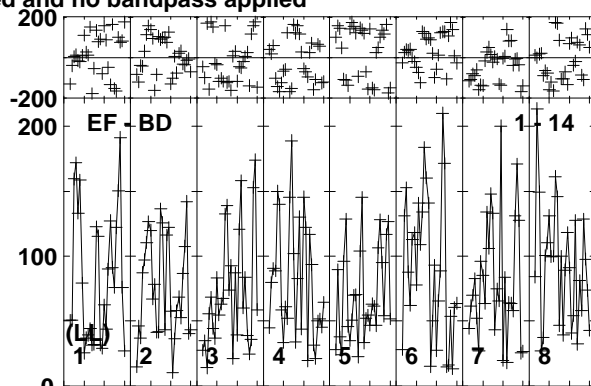
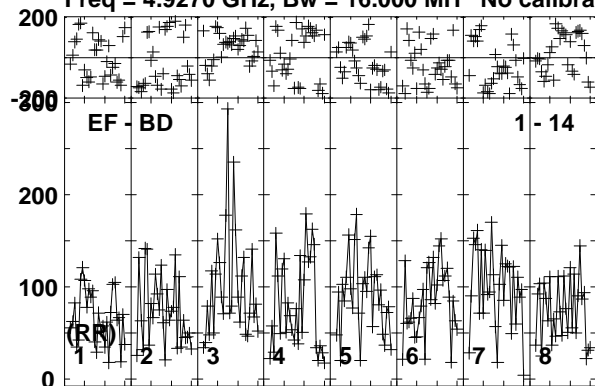

Lower frame: Micro Ampl Jy Top frame: Phas deg  
Vector averaged cross-power spectrum Baseline: EF (01) - BD (14)  
Timerange: 00/05:25:01 to 00/05:28:29

Plot file version 175 created 08-APR-2019 12:09:54

J0815+3635 EM133B.UVDATA.1

Freq = 4.9270 GHz, Bw = 16.000 MH No calibration applied and no bandpass applied

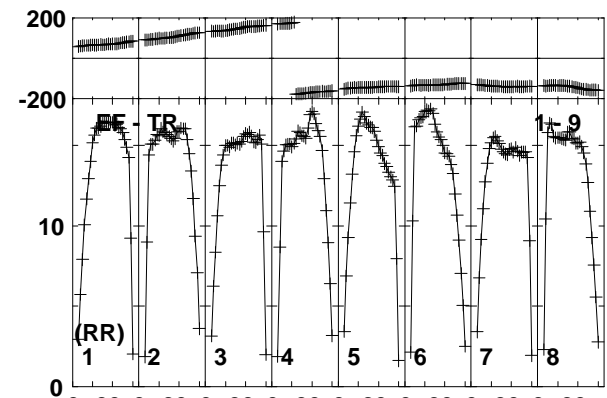
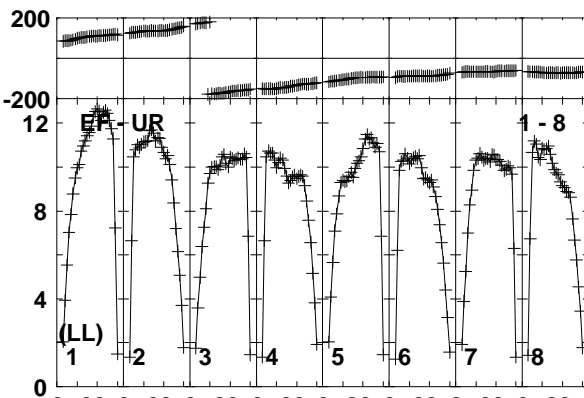
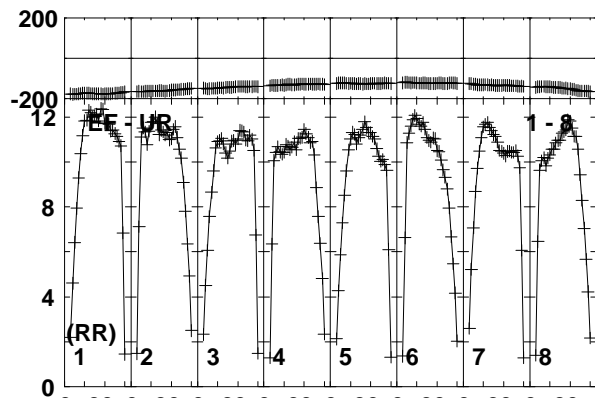
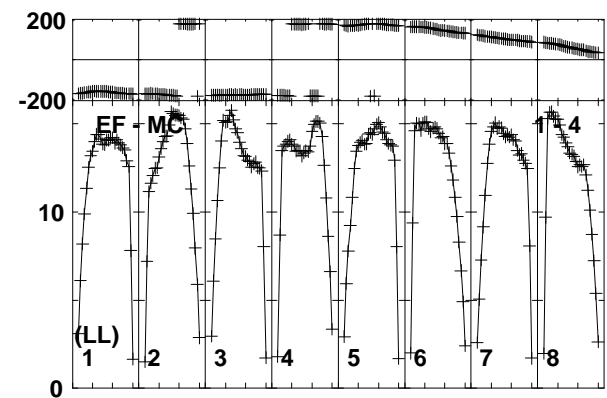
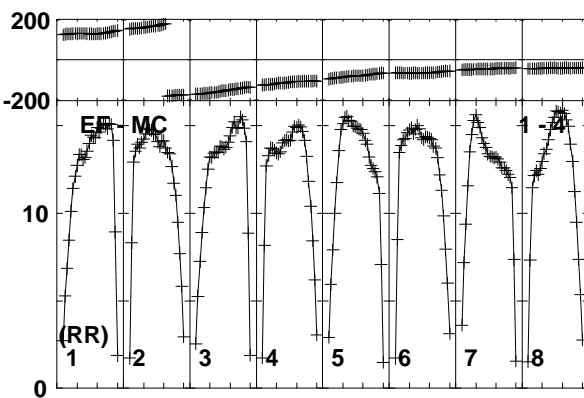
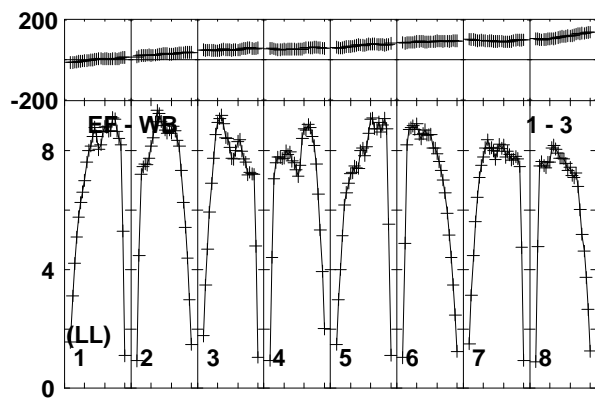
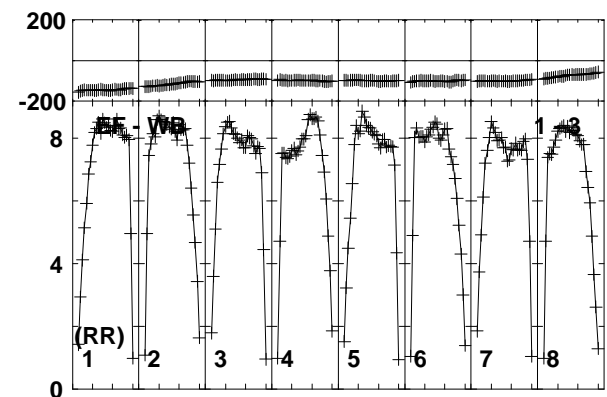
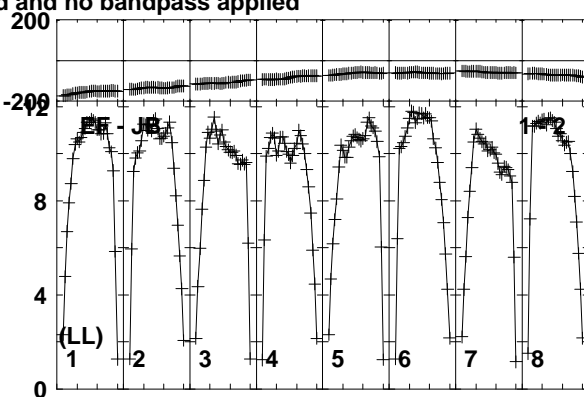
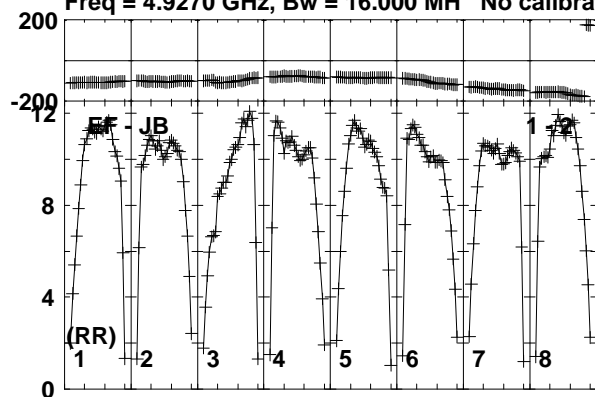

Lower frame: Milli Ampl Jy Top frame: Phas deg  
Vector averaged cross-power spectrum Baseline: EF (01) - JB (02)  
Timerange: 00/05:28:31 to 00/05:29:59

Plot file version 176 created 08-APR-2019 12:09:54

J0815+3635 EM133B.UVDATA.1

Freq = 4.9270 GHz, Bw = 16.000 MH No calibration applied and no bandpass applied

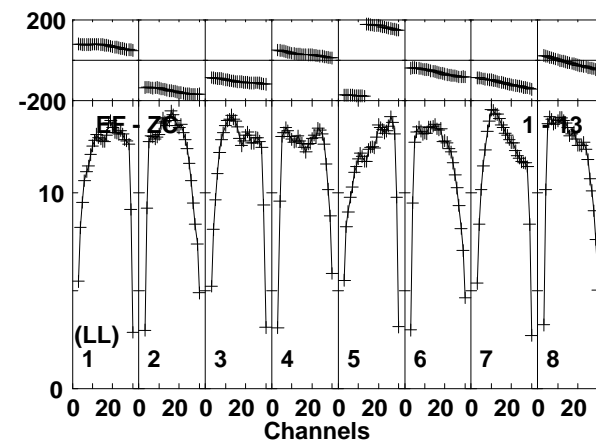
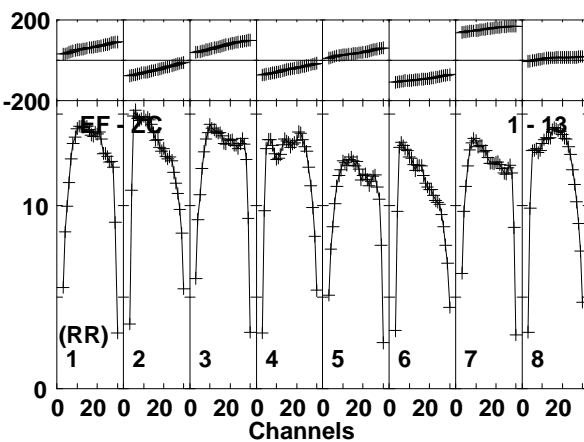
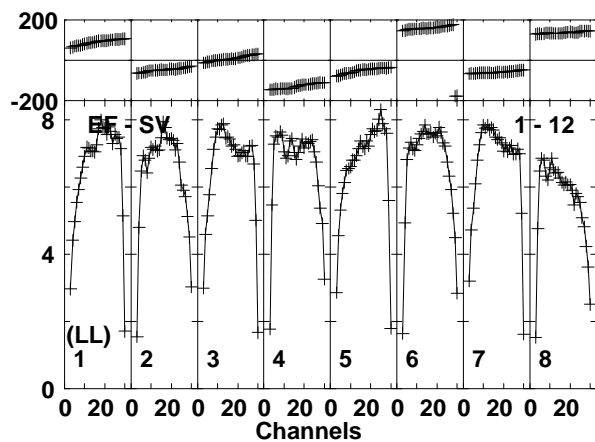
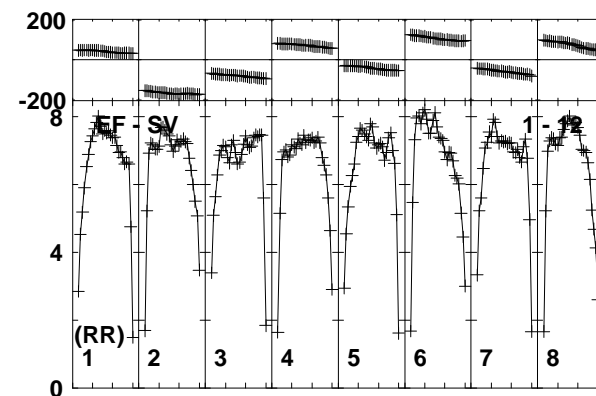
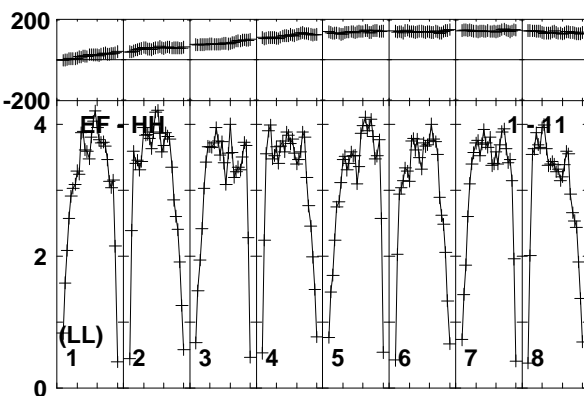
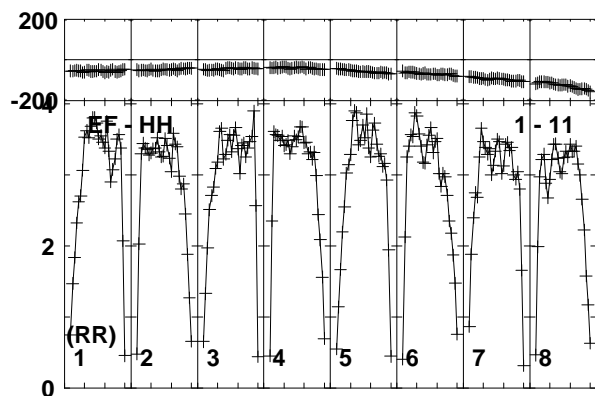
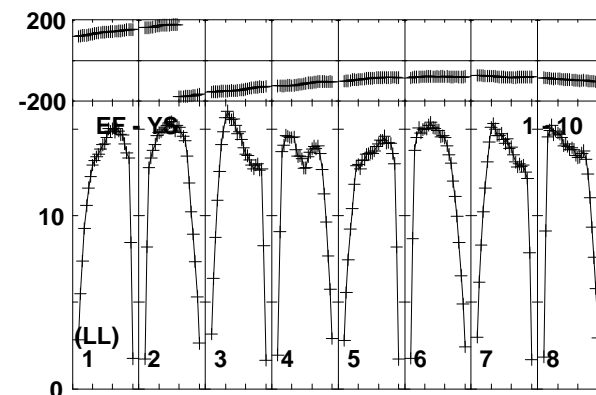
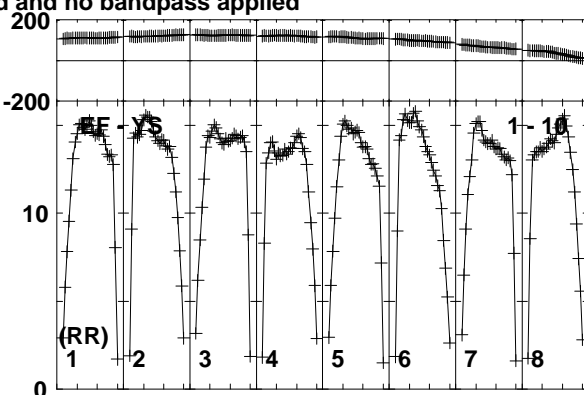
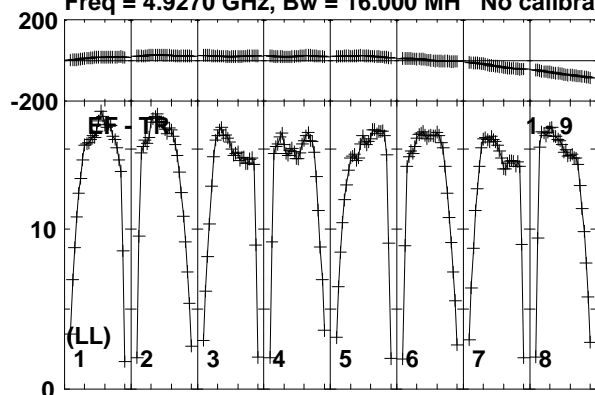

Lower frame: Milli Ampl Jy Top frame: Phas deg  
Vector averaged cross-power spectrum Baseline: EF (01) - TR (09)  
Timerange: 00/05:28:31 to 00/05:29:59



Plot file version 177 created 08-APR-2019 12:09:54

J0815+3635 EM133B.UVDATA.1

Freq = 4.9270 GHz, Bw = 16.000 MH No calibration applied and no bandpass applied

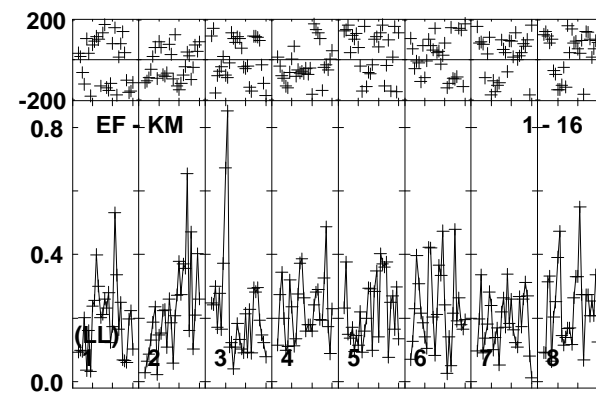
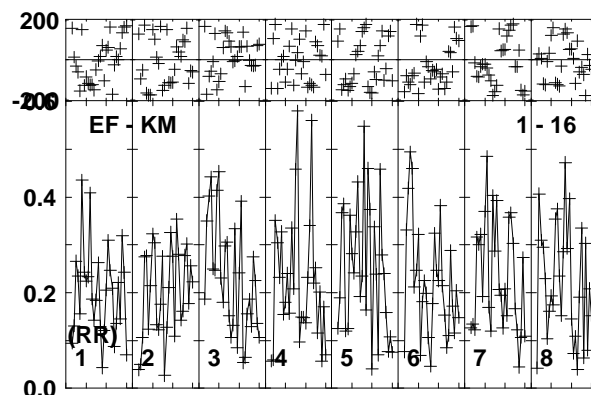
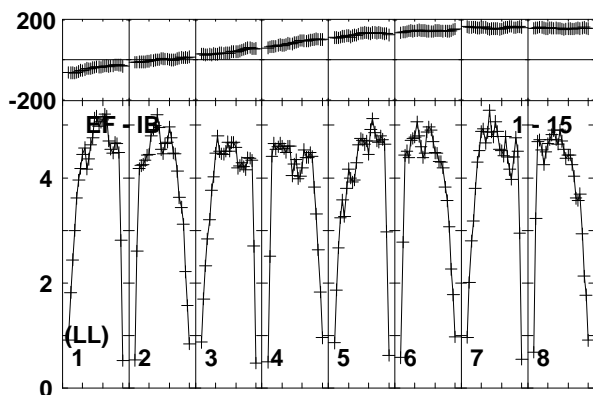
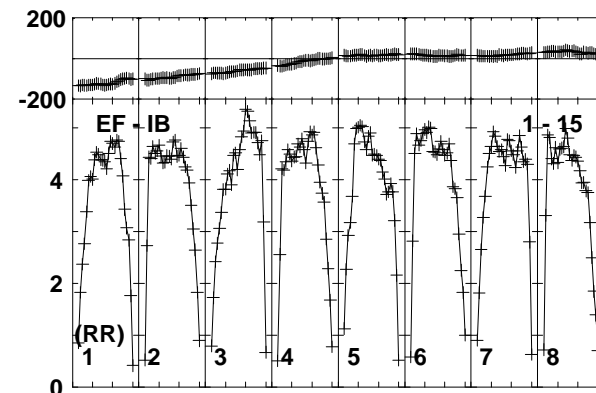
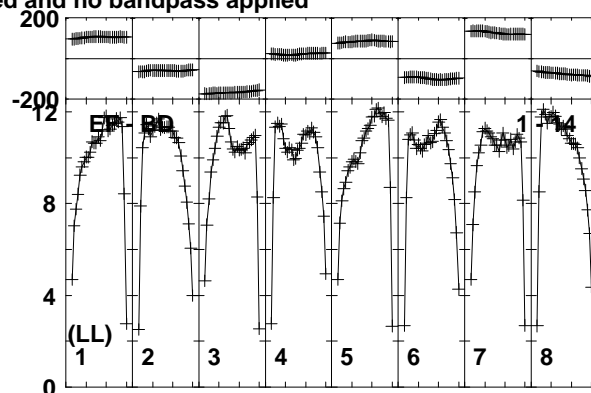
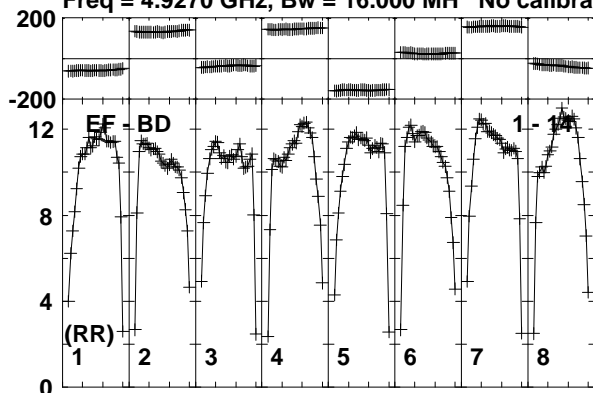

Lower frame: Milli Ampl Jy Top frame: Phas deg  
Vector averaged cross-power spectrum Baseline: EF (01) - BD (14)  
Timerange: 00/05:28:31 to 00/05:29:59

Plot file version 178 created 08-APR-2019 12:09:54

MRK622 EM133B.UVDATA.1

Freq = 4.9270 GHz, Bw = 16.000 MH No calibration applied and no bandpass applied

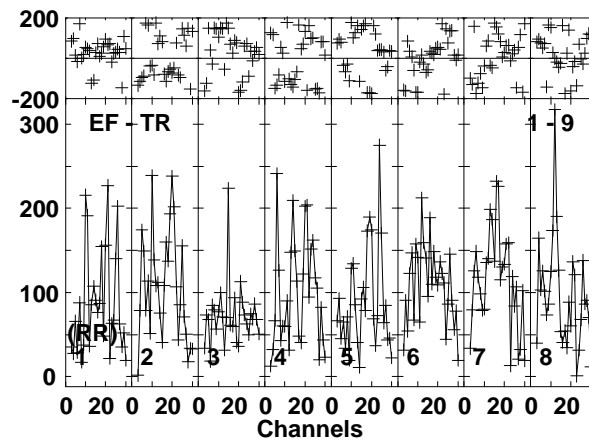
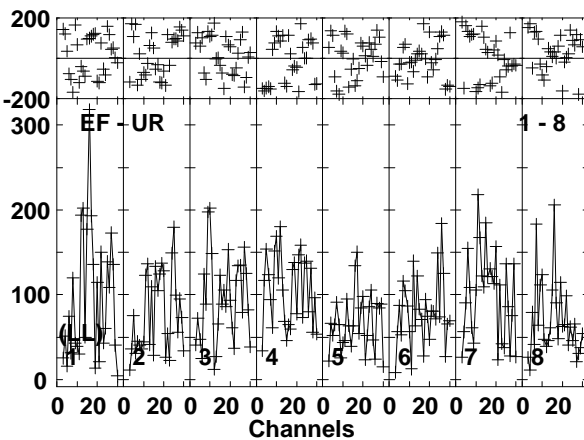
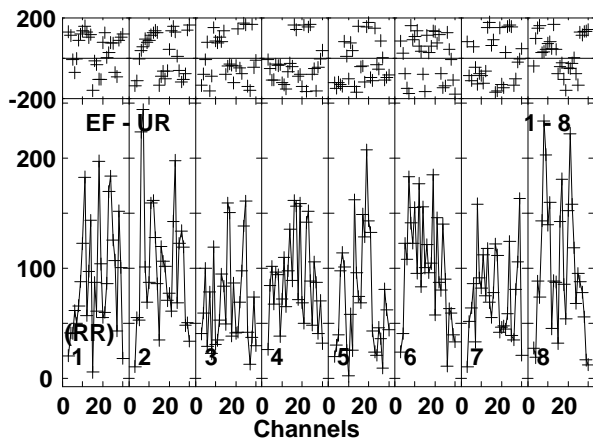
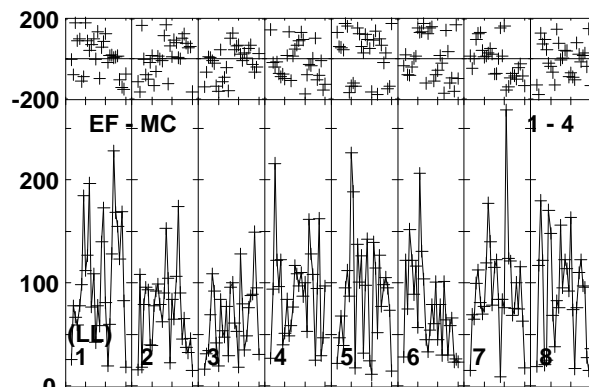
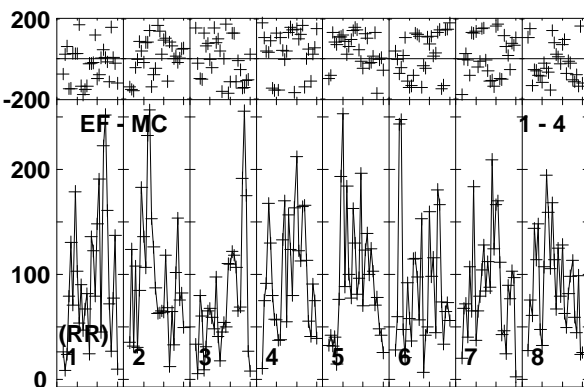
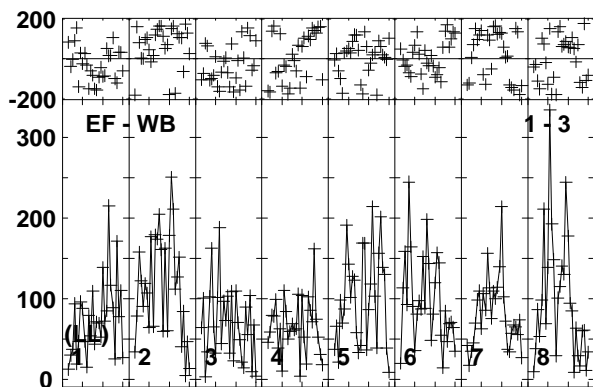
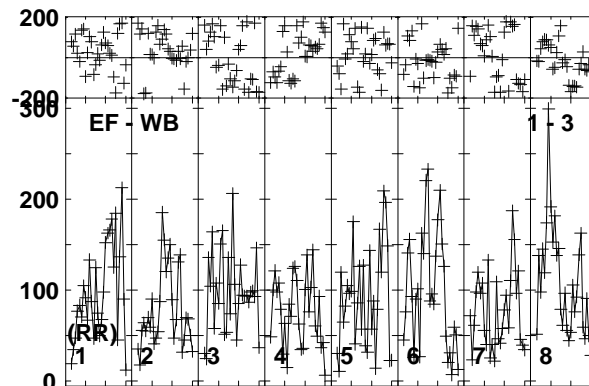
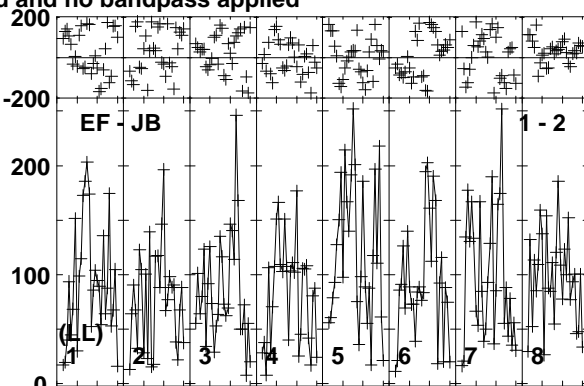
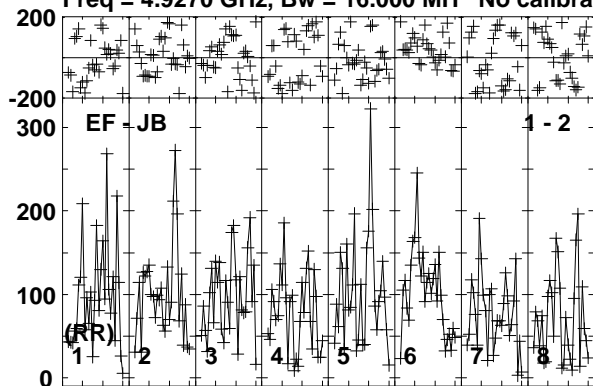

Lower frame: Micro Ampl Jy Top frame: Phas deg  
Vector averaged cross-power spectrum Baseline: EF (01) - JB (02)  
Timerange: 00/05:30:03 to 00/05:33:29

Plot file version 179 created 08-APR-2019 12:09:54

MRK622 EM133B.UVDATA.1

Freq = 4.9270 GHz, Bw = 16.000 MH No calibration applied and no bandpass applied

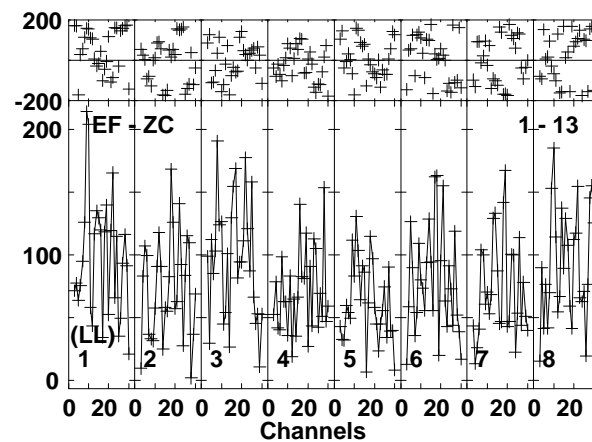
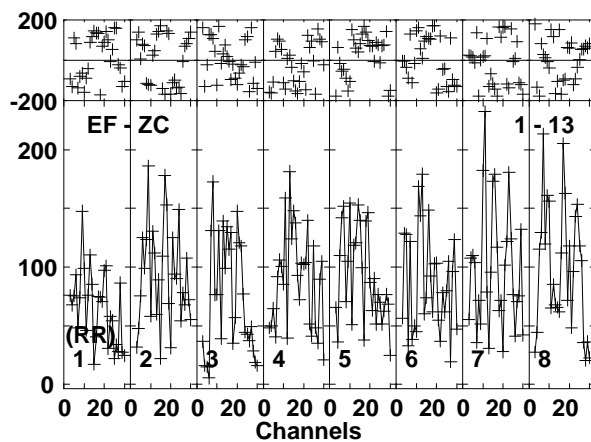
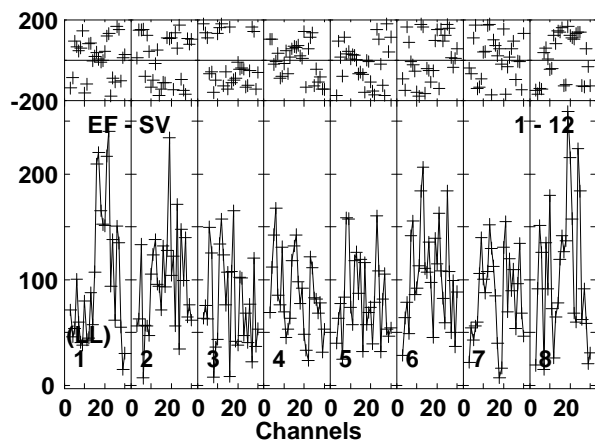
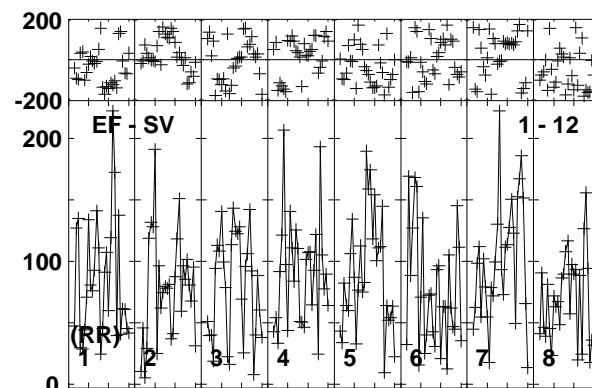
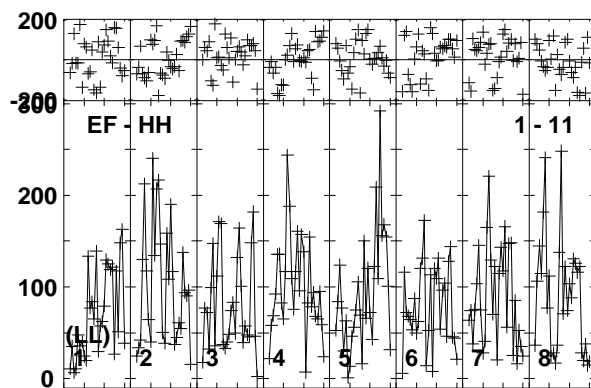
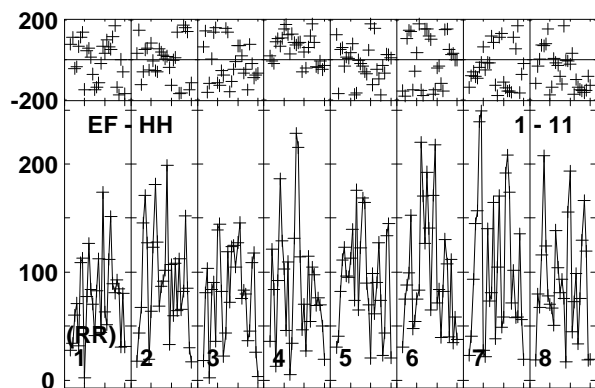
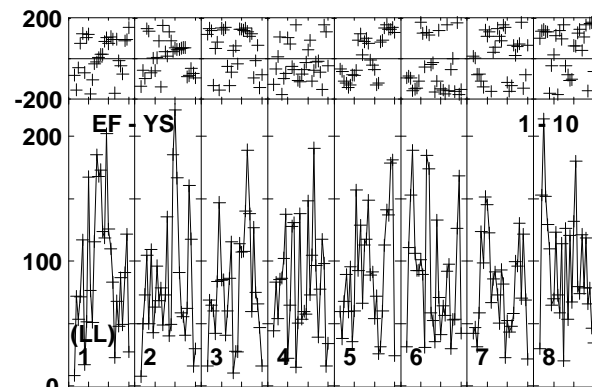
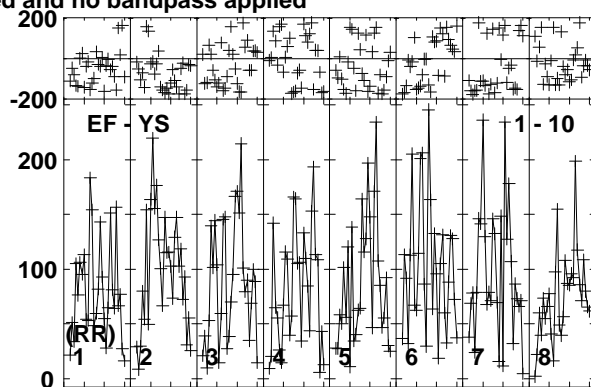
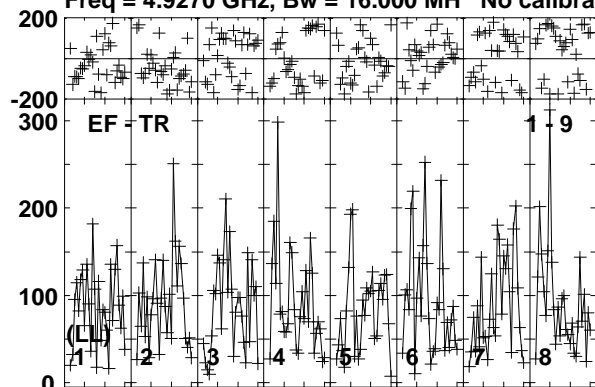

Lower frame: Micro Ampl Jy Top frame: Phas deg  
Vector averaged cross-power spectrum Baseline: EF (01) - TR (09)  
Timerange: 00/05:30:03 to 00/05:33:29

Plot file version 180 created 08-APR-2019 12:09:54

MRK622 EM133B.UVDATA.1

Freq = 4.9270 GHz, Bw = 16.000 MH No calibration applied and no bandpass applied

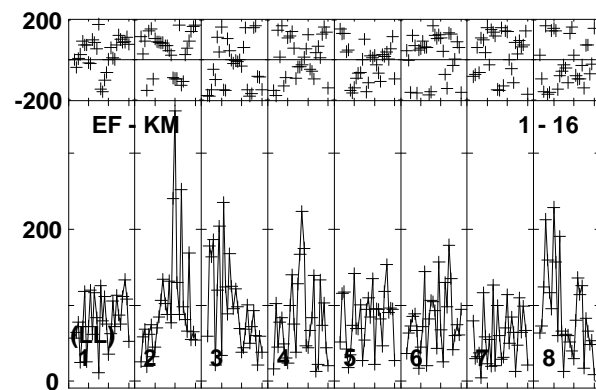
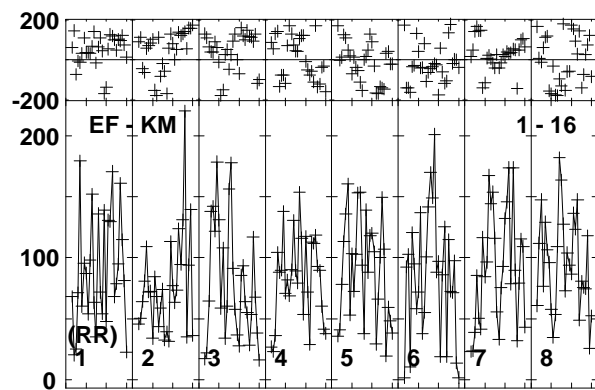
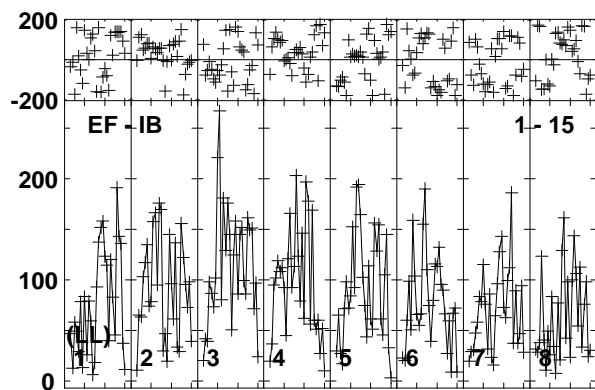
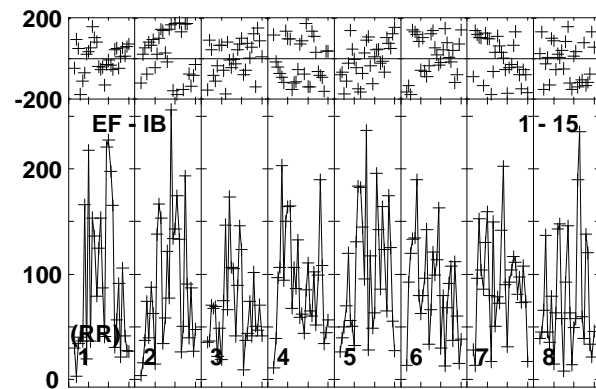
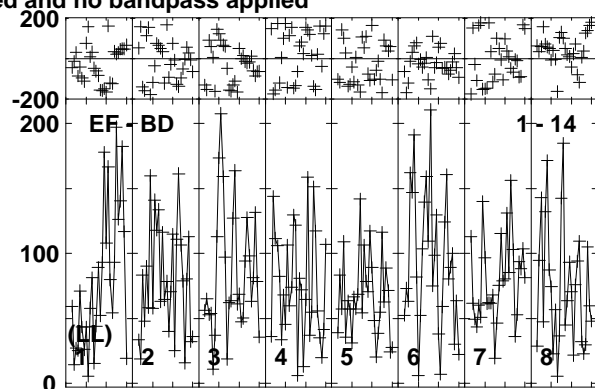
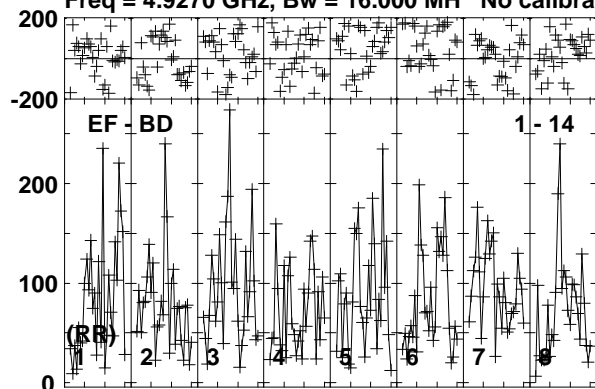

Lower frame: Micro Ampl Jy Top frame: Phas deg  
Vector averaged cross-power spectrum Baseline: EF (01) - BD (14)  
Timerange: 00/05:30:03 to 00/05:33:29

Plot file version 181 created 08-APR-2019 12:09:54

J0815+3635 EM133B.UVDATA.1

Freq = 4.9270 GHz, Bw = 16.000 MH No calibration applied and no bandpass applied

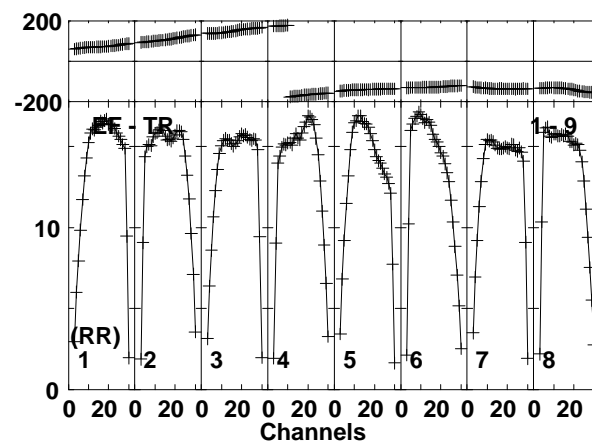
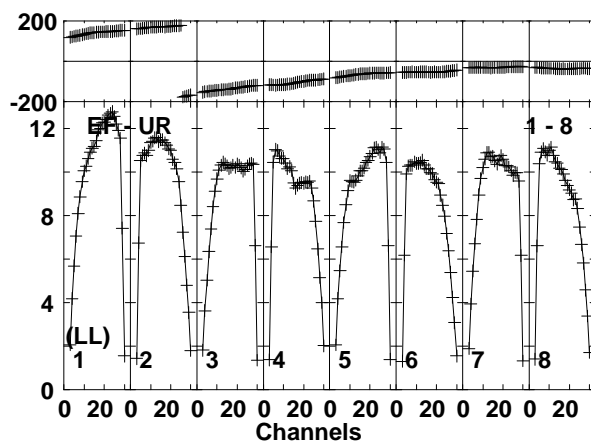
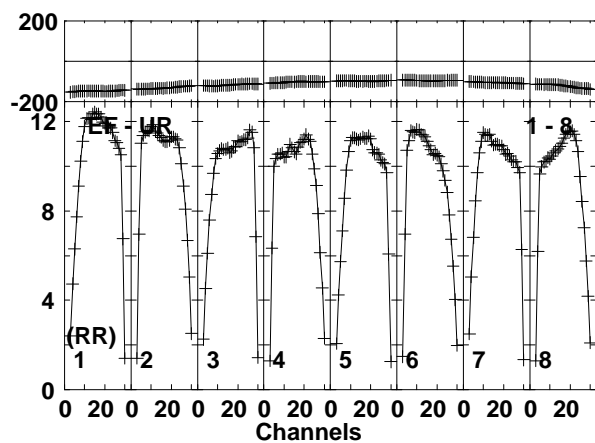
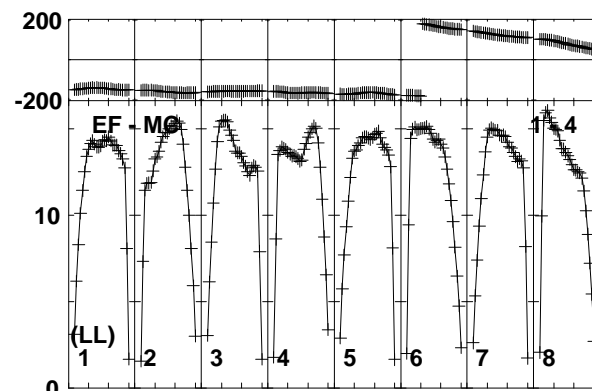
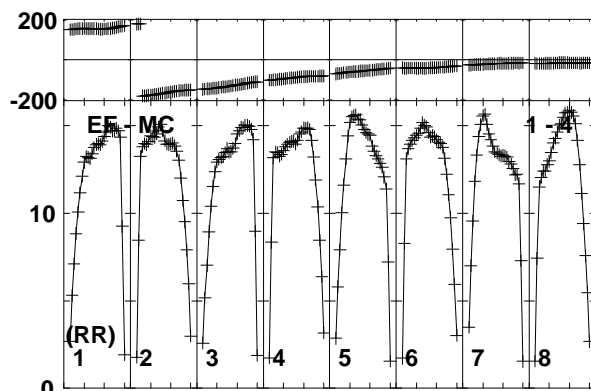
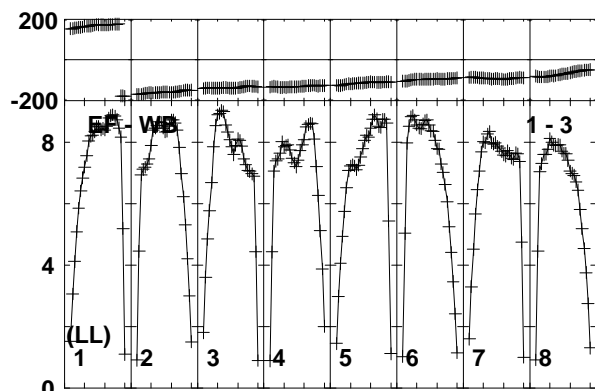
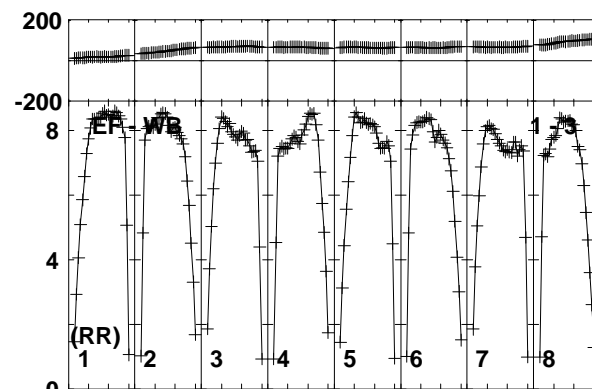
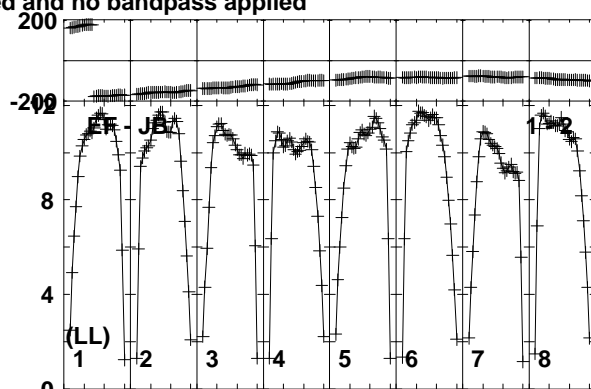
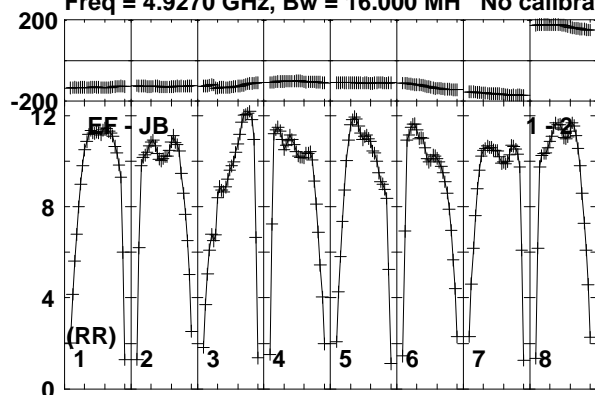

Lower frame: Milli Ampl Jy Top frame: Phas deg  
Vector averaged cross-power spectrum Baseline: EF (01) - JB (02)  
Timerange: 00/05:34:21 to 00/05:35:49

Plot file version 182 created 08-APR-2019 12:09:55

J0815+3635 EM133B.UVDATA.1

Freq = 4.9270 GHz, Bw = 16.000 MH No calibration applied and no bandpass applied

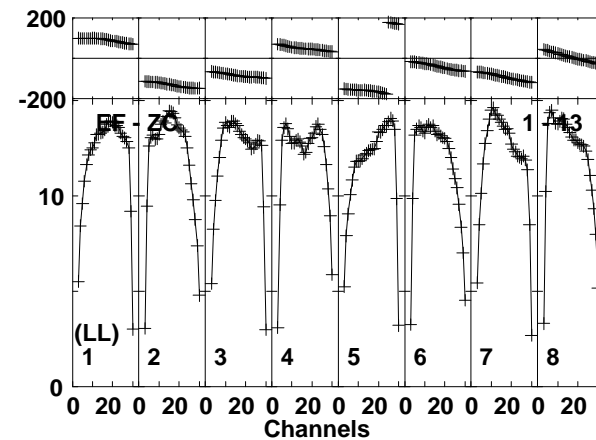
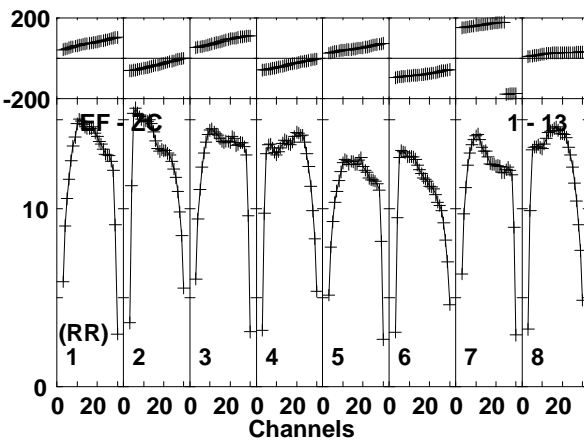
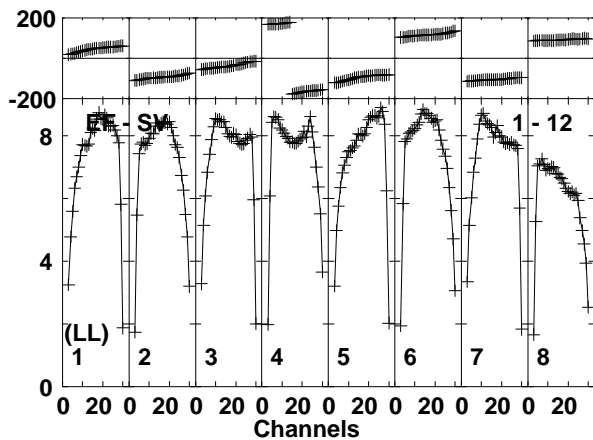
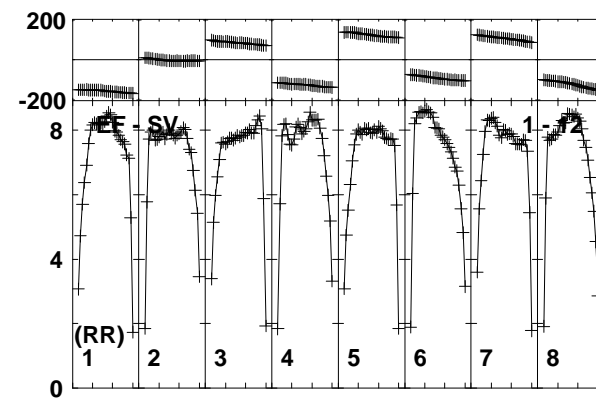
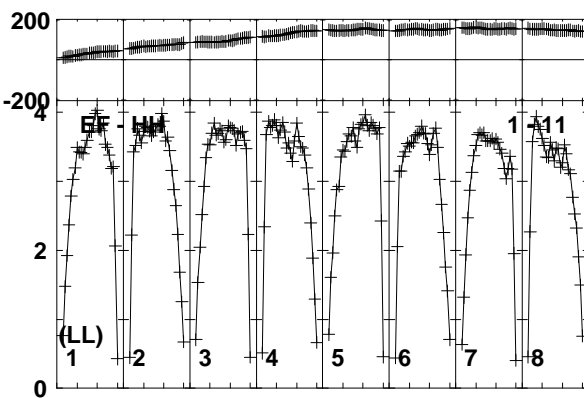
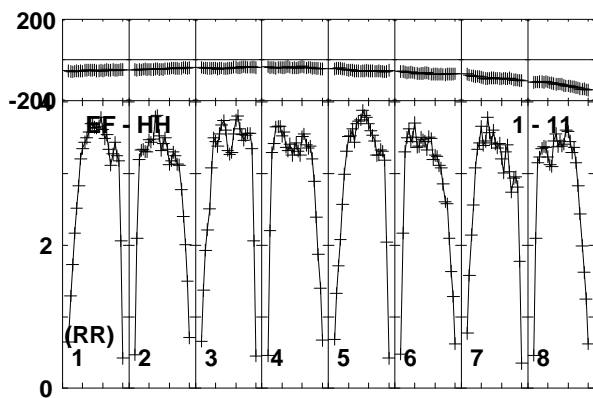
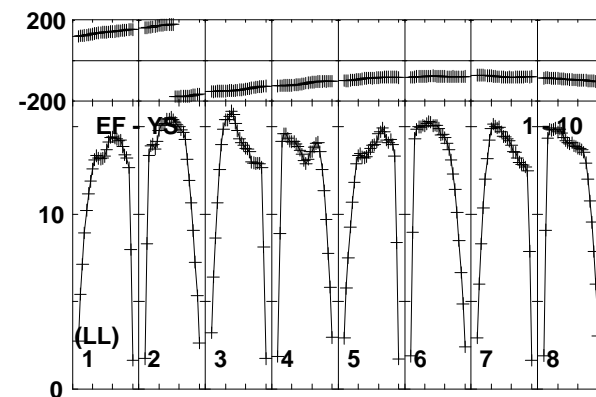
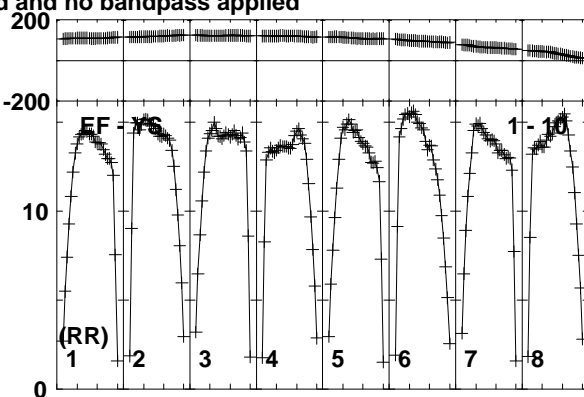
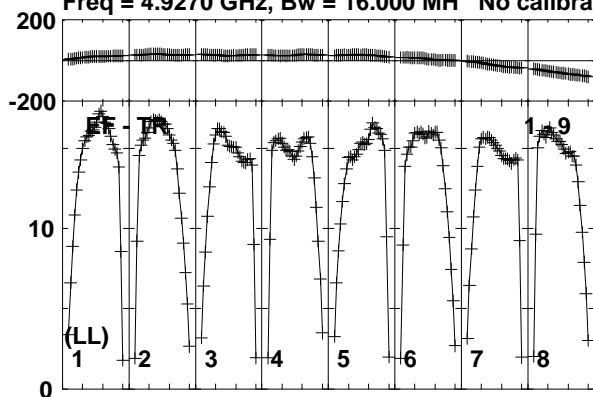

Lower frame: Milli Ampl Jy Top frame: Phas deg  
Vector averaged cross-power spectrum Baseline: EF (01) - TR (09)  
Timerange: 00/05:34:21 to 00/05:35:49

Plot file version 183 created 08-APR-2019 12:09:55

J0815+3635 EM133B.UVDATA.1

Freq = 4.9270 GHz, Bw = 16.000 MH No calibration applied and no bandpass applied

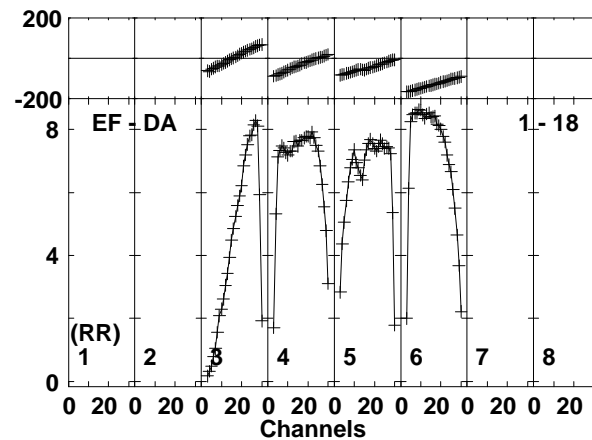
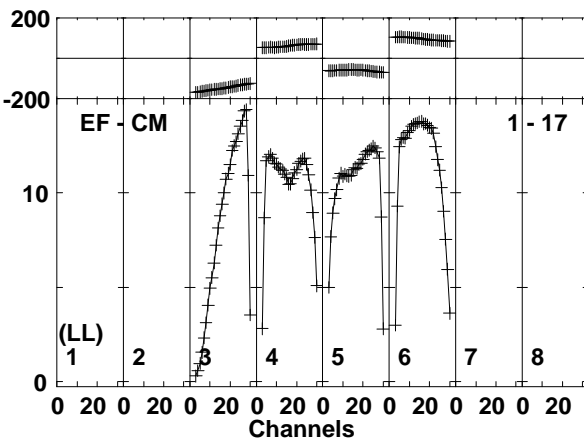
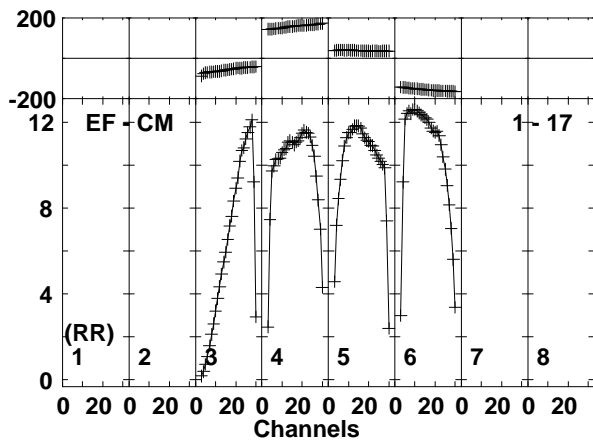
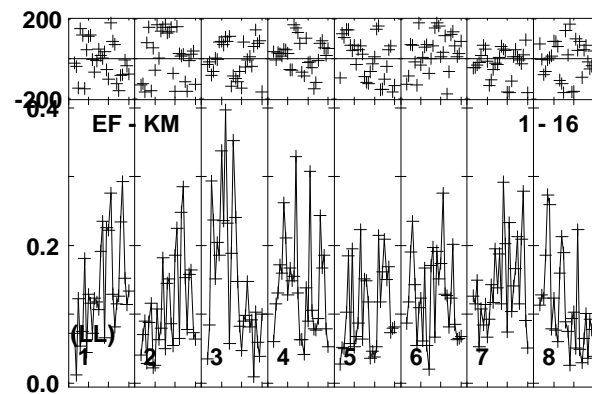
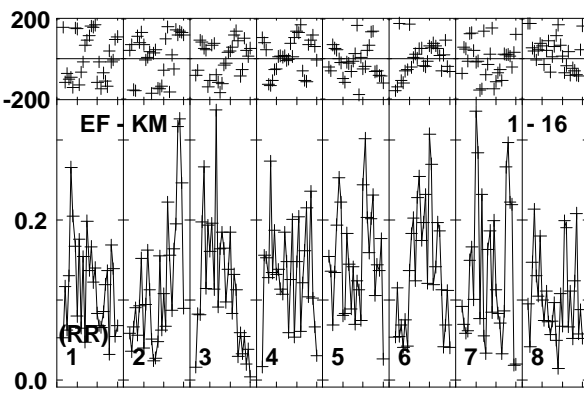
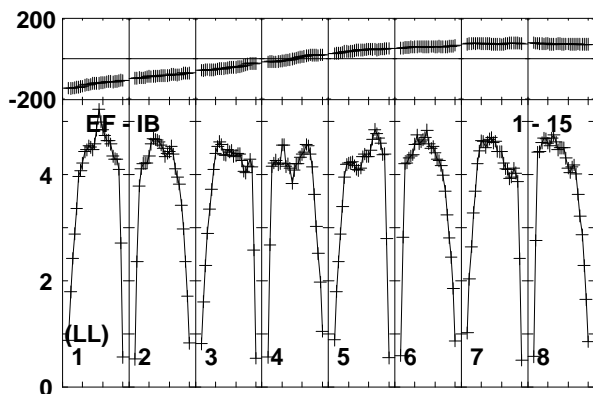
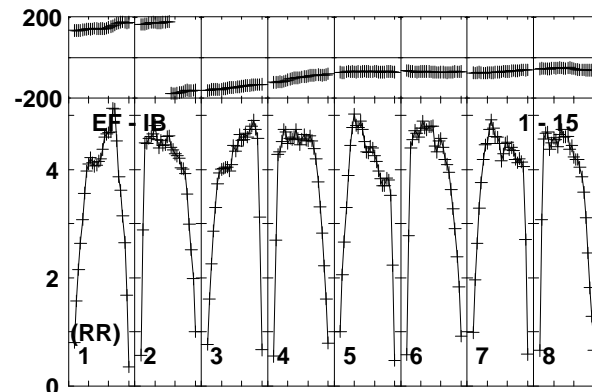
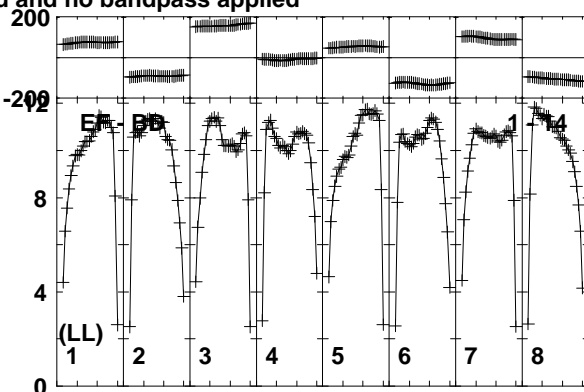
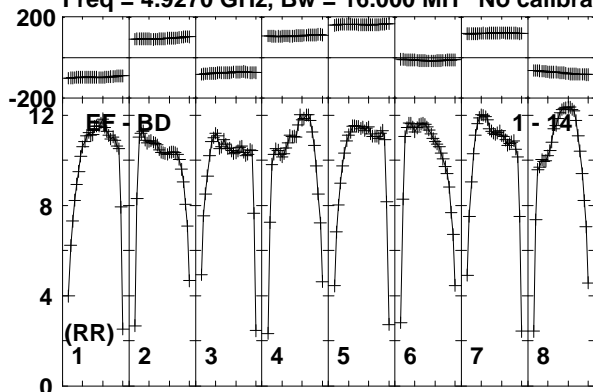

Lower frame: Milli Ampl Jy Top frame: Phas deg  
Vector averaged cross-power spectrum Baseline: EF (01) - BD (14)  
Timerange: 00/05:34:21 to 00/05:35:49

Plot file version 184 created 08-APR-2019 12:09:55

J0815+3635 EM133B.UVDATA.1

Freq = 4.9270 GHz, Bw = 16.000 MH No calibration applied and no bandpass applied

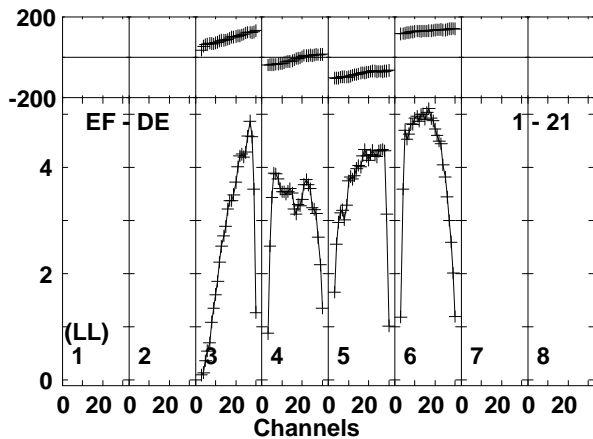
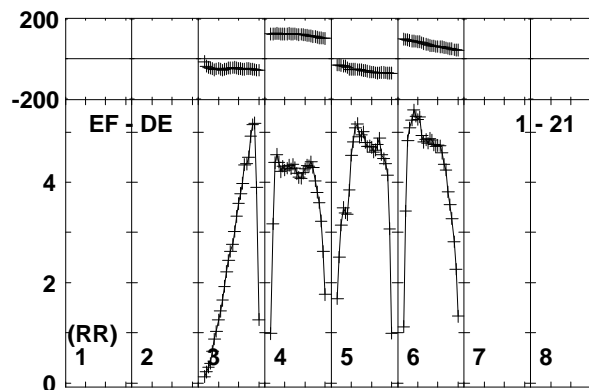
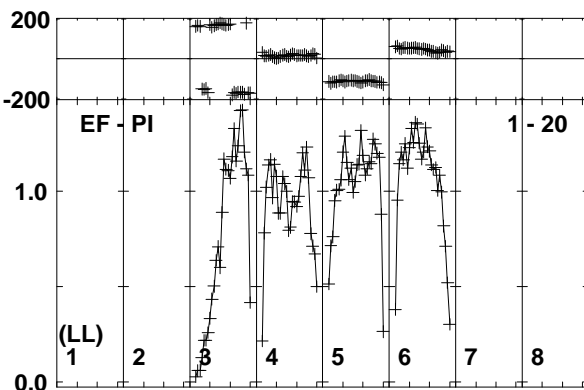
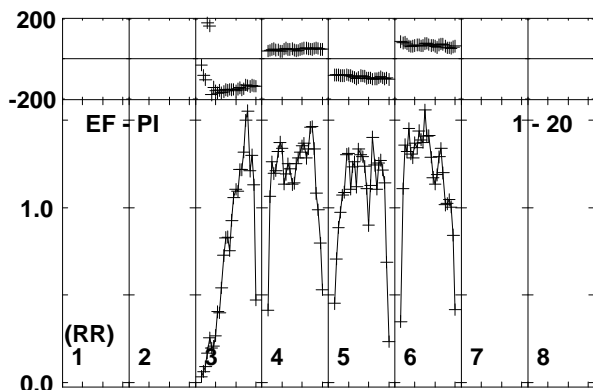
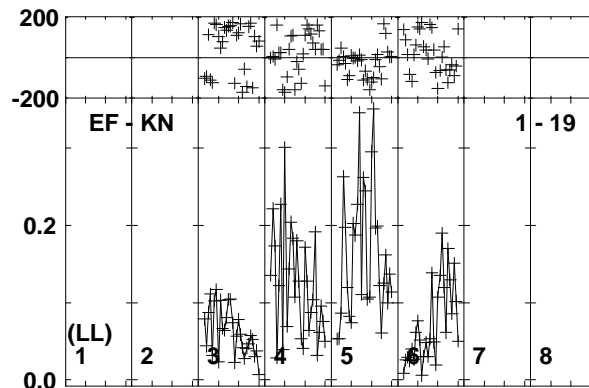
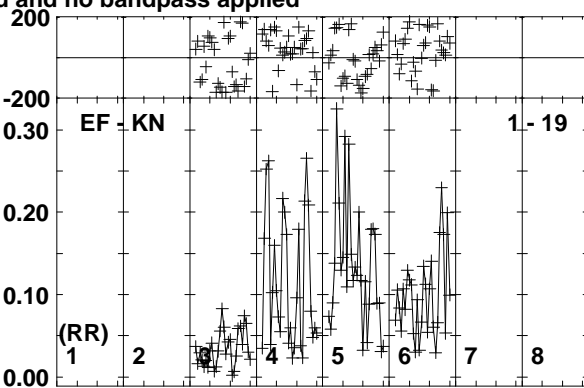
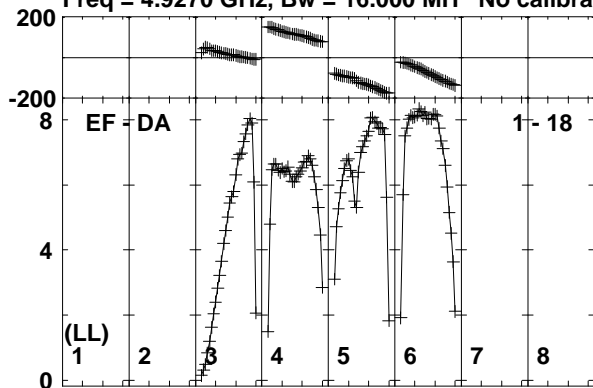

Lower frame: Milli Ampl Jy Top frame: Phas deg  
Vector averaged cross-power spectrum Baseline: EF (01) - DA (18)  
Timerange: 00/05:34:21 to 00/05:35:49



Plot file version 185 created 08-APR-2019 12:09:55

MRK622 EM133B.UVDATA.1

Freq = 4.9270 GHz, Bw = 16.000 MH No calibration applied and no bandpass applied

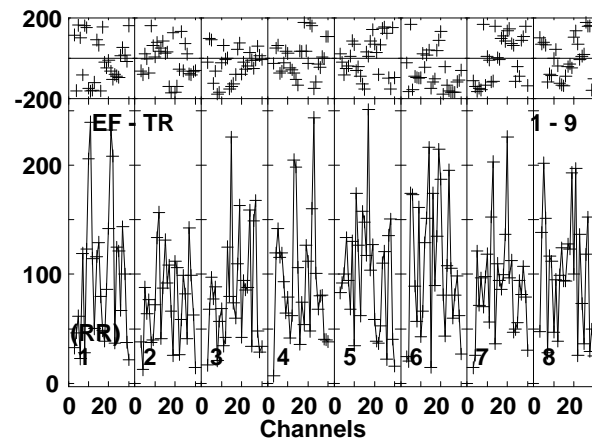
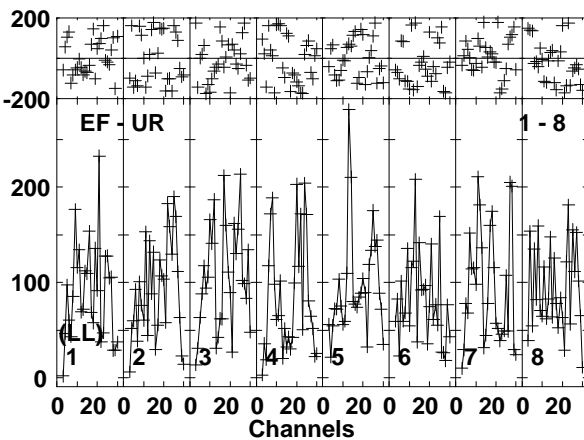
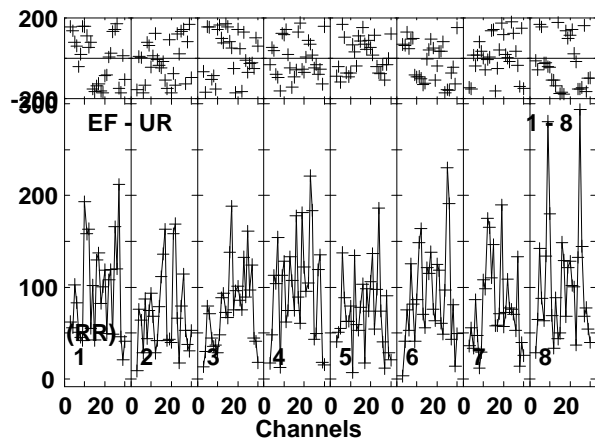
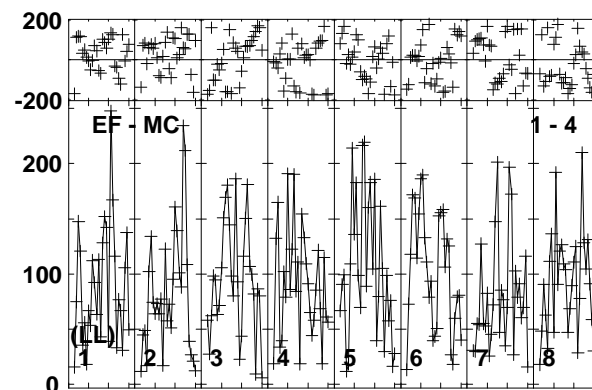
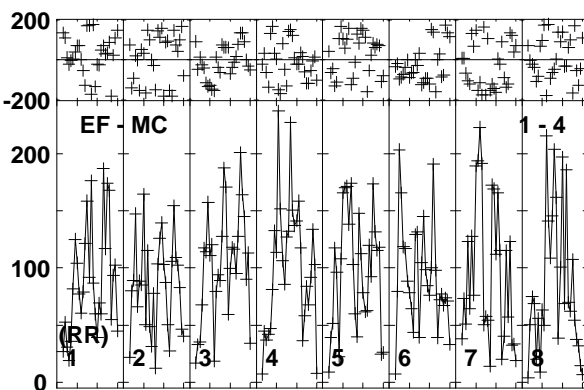
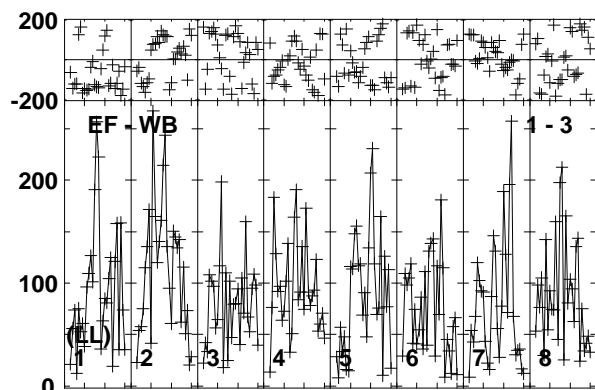
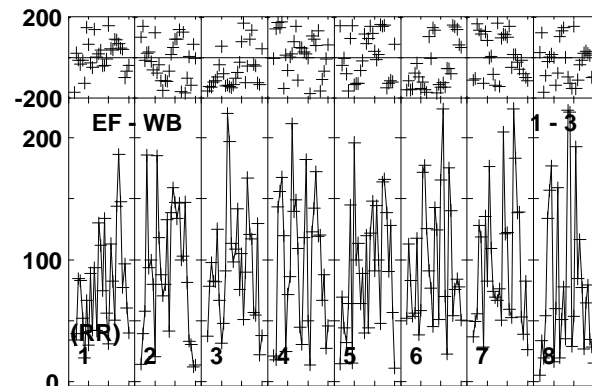
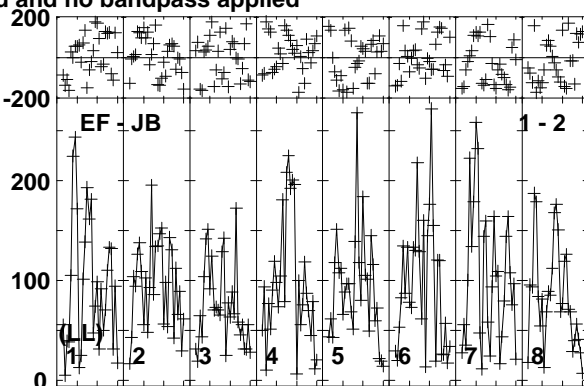
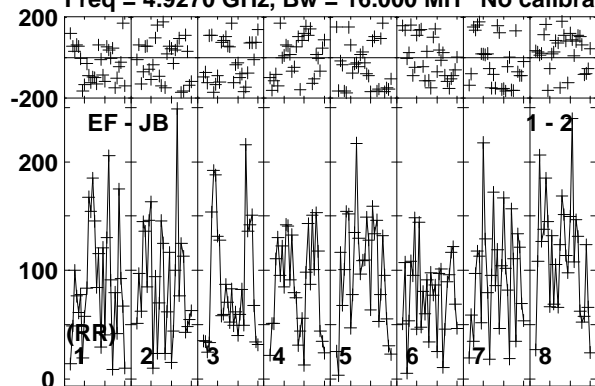

Lower frame: Micro Ampl Jy Top frame: Phas deg  
Vector averaged cross-power spectrum Baseline: EF (01) - JB (02)  
Timerange: 00/05:35:51 to 00/05:39:19

Plot file version 186 created 08-APR-2019 12:09:55

MRK622 EM133B.UVDATA.1

Freq = 4.9270 GHz, Bw = 16.000 MH No calibration applied and no bandpass applied

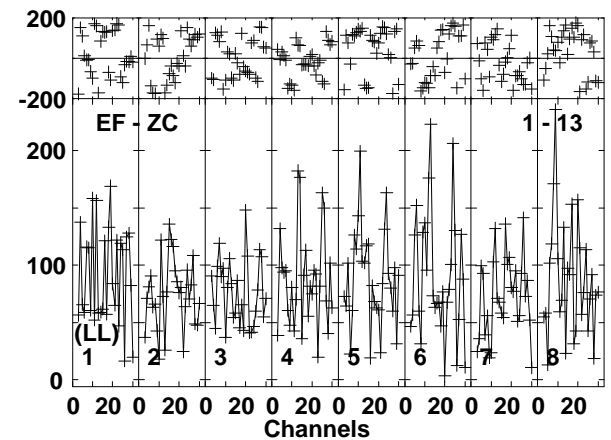
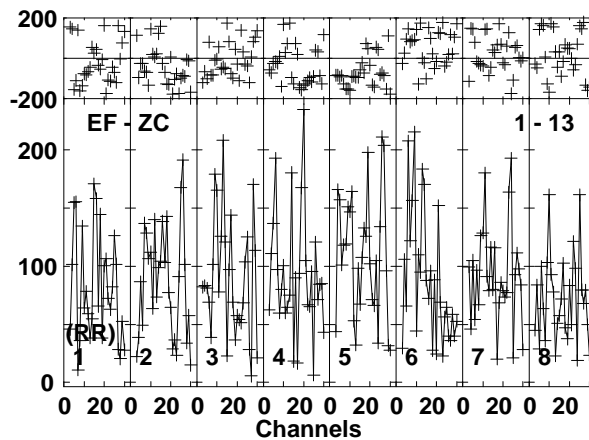
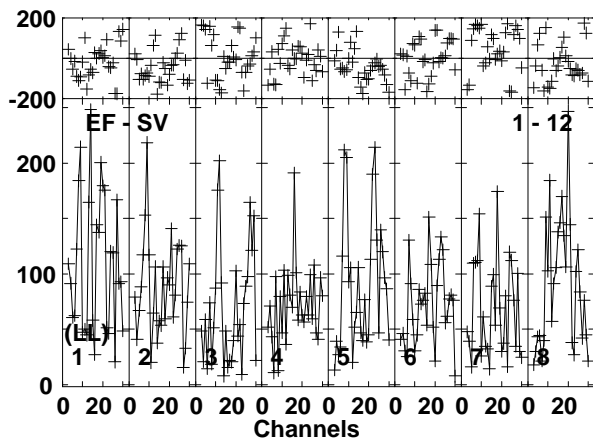
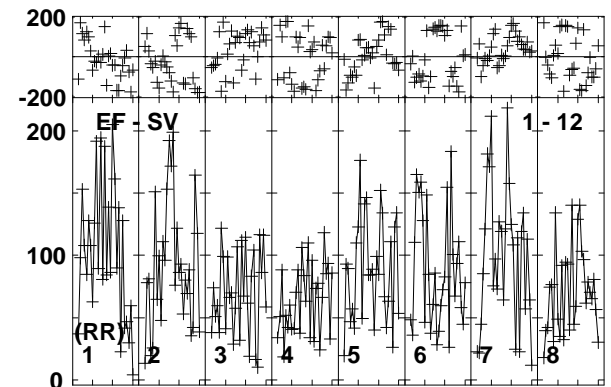
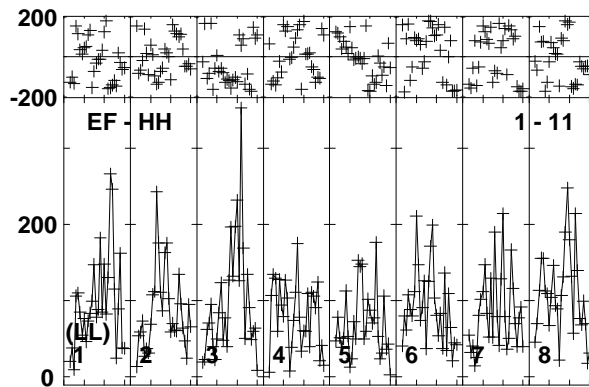
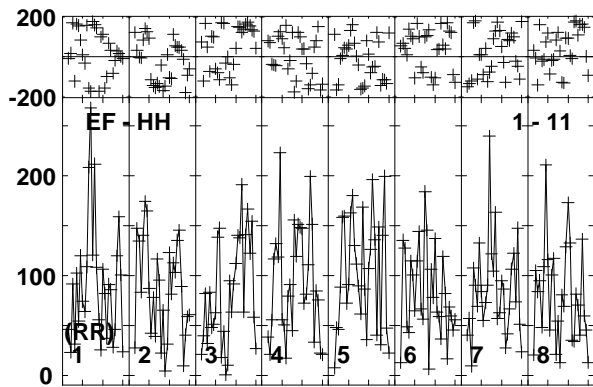
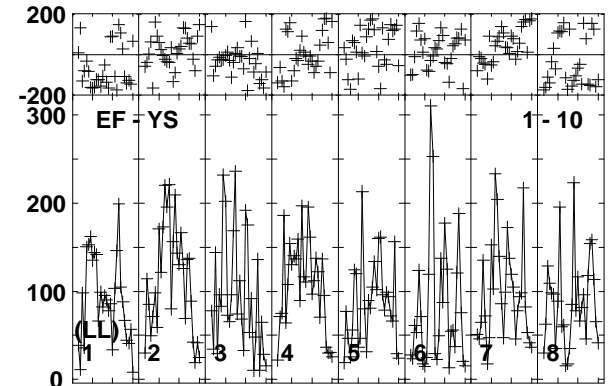
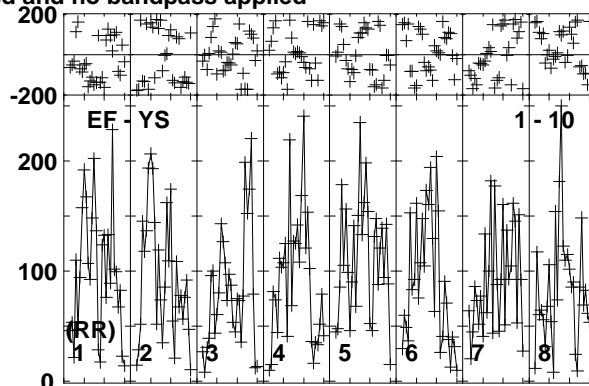
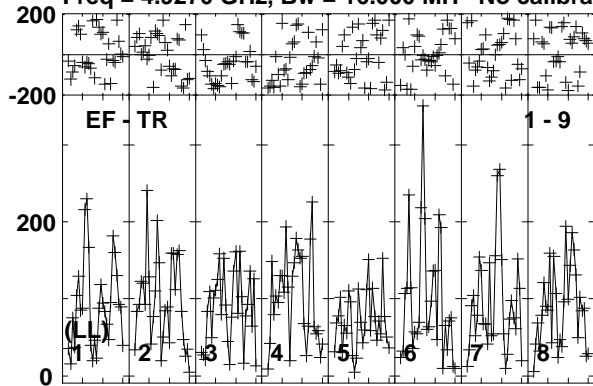

Lower frame: Micro Ampl Jy Top frame: Phas deg  
Vector averaged cross-power spectrum Baseline: EF (01) - TR (09)  
Timerange: 00/05:35:51 to 00/05:39:19

Plot file version 187 created 08-APR-2019 12:09:55

MRK622 EM133B.UVDATA.1

Freq = 4.9270 GHz, Bw = 16.000 MH No calibration applied and no bandpass applied

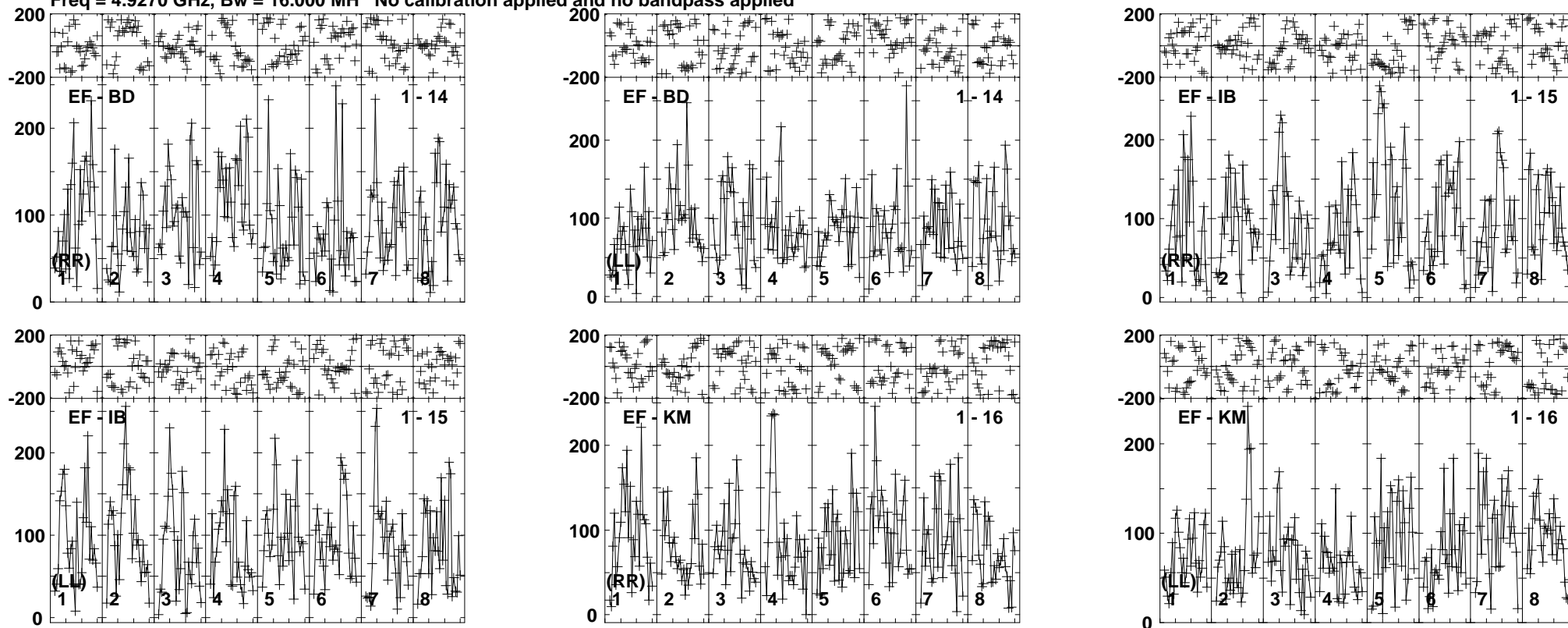

Lower frame: Micro Ampl Jy Top frame: Phas deg  
Vector averaged cross-power spectrum Baseline: EF (01) - BD (14)  
Timerange: 00/05:35:51 to 00/05:39:19

Plot file version 188 created 08-APR-2019 12:09:55

J0815+3635 EM133B.UVDATA.1

Freq = 4.9270 GHz, Bw = 16.000 MH No calibration applied and no bandpass applied

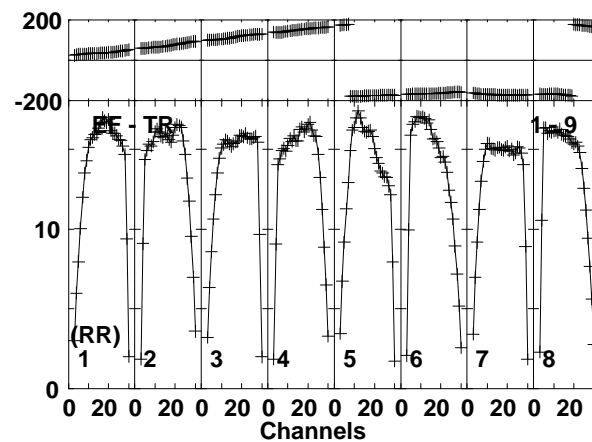
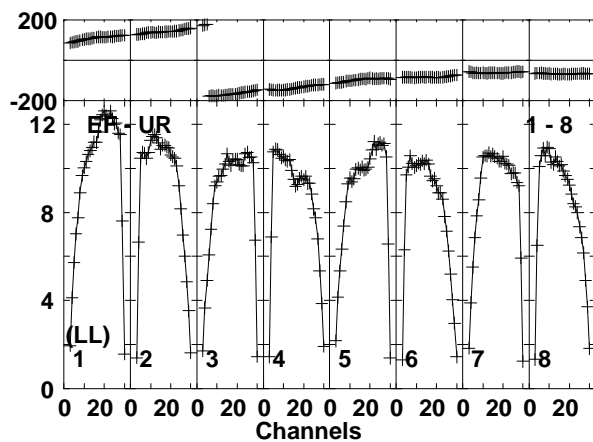
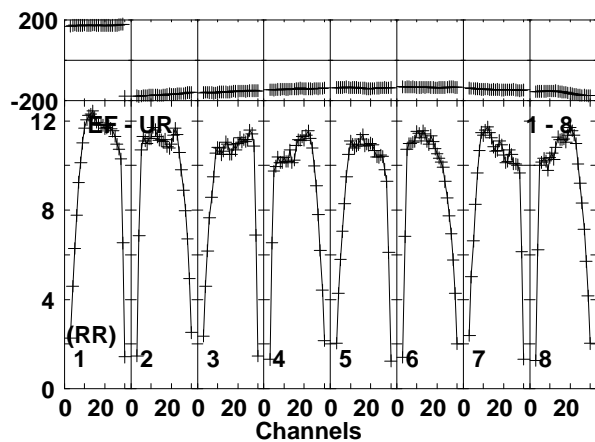
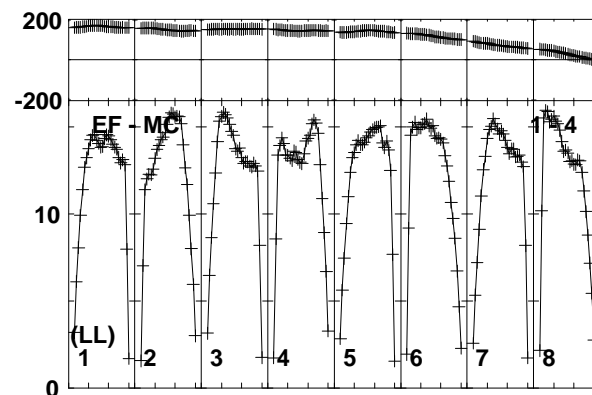
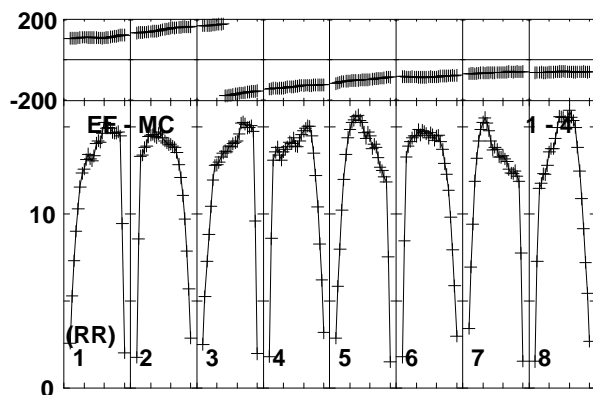
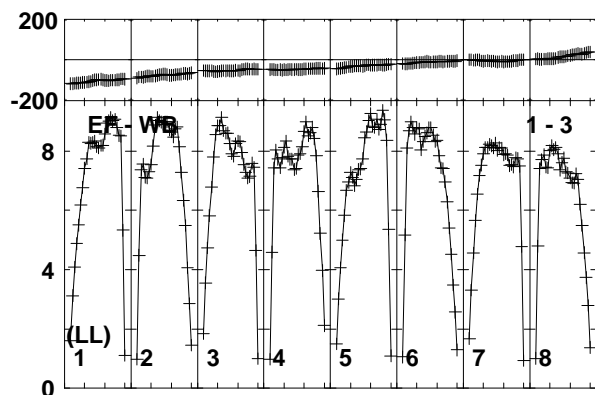
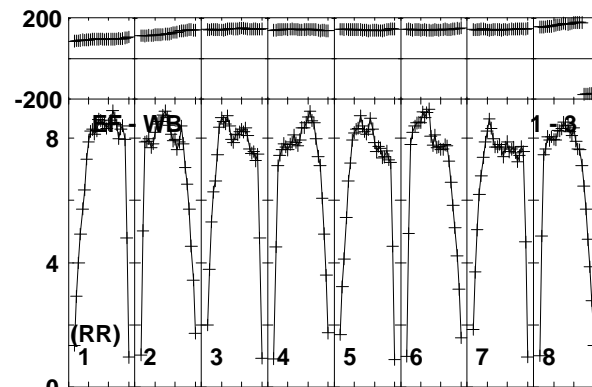
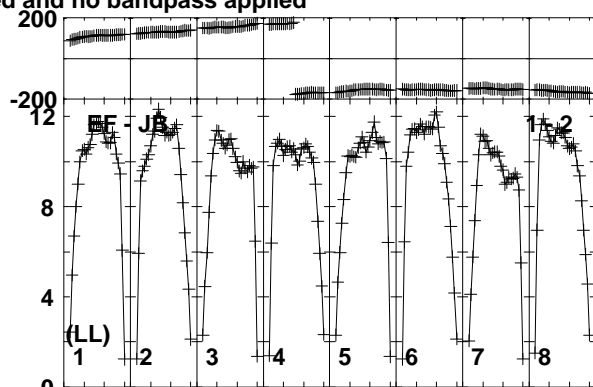
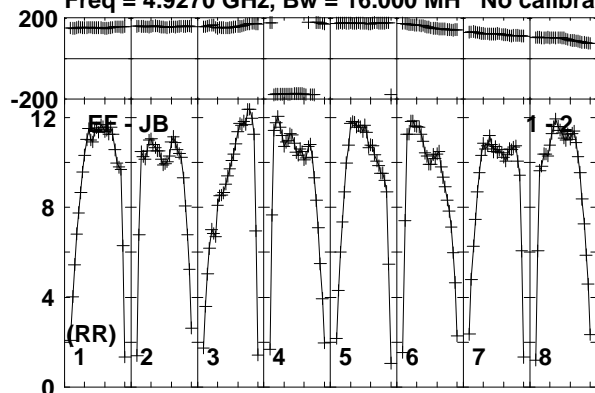

Lower frame: Milli Ampl Jy Top frame: Phas deg  
Vector averaged cross-power spectrum Baseline: EF (01) - JB (02)  
Timerange: 00/05:39:21 to 00/05:40:49

Plot file version 189 created 08-APR-2019 12:09:56

J0815+3635 EM133B.UVDATA.1

Freq = 4.9270 GHz, Bw = 16.000 MH No calibration applied and no bandpass applied

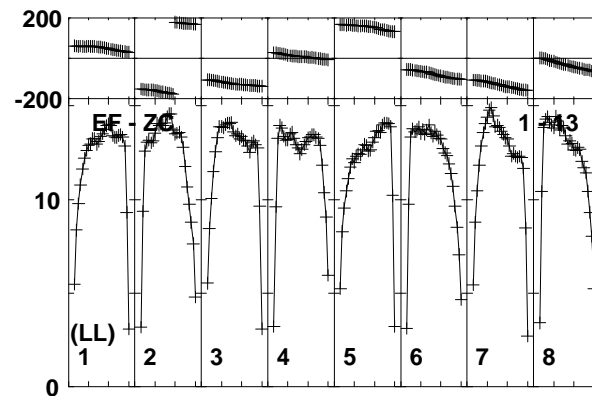
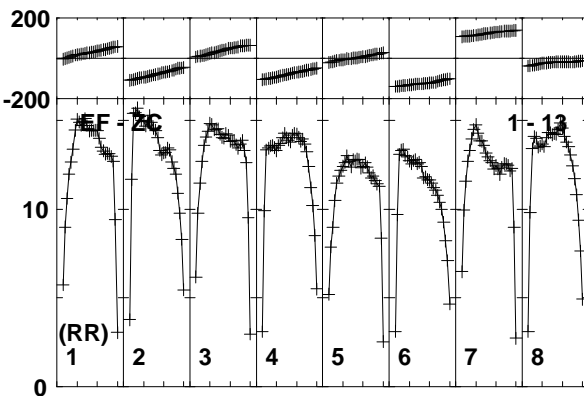
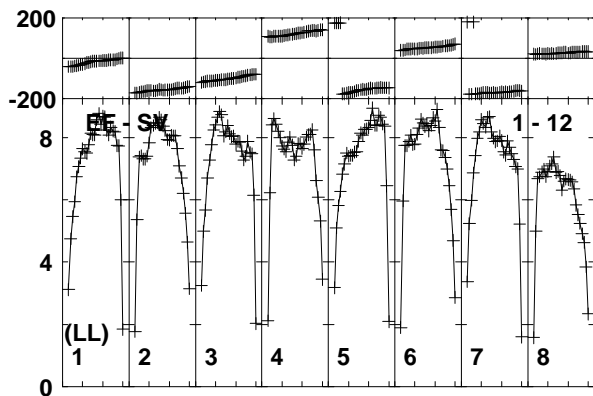
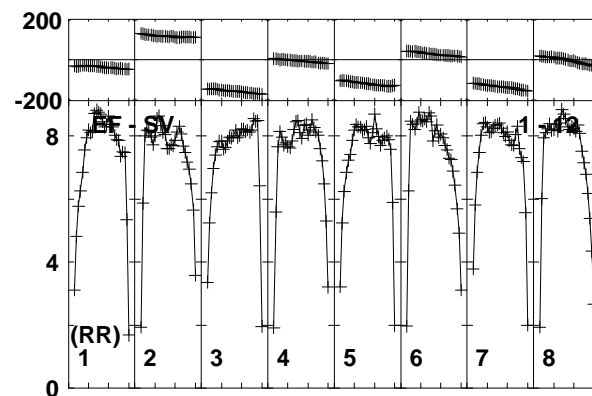
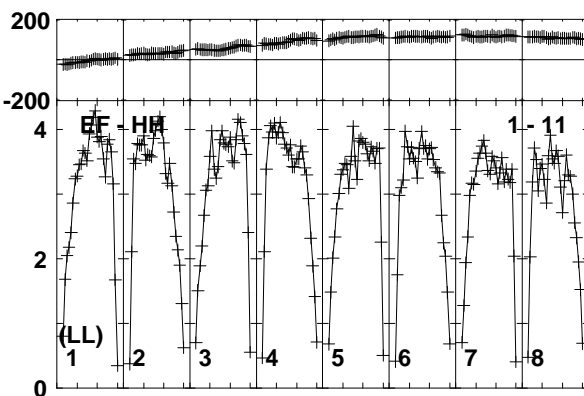
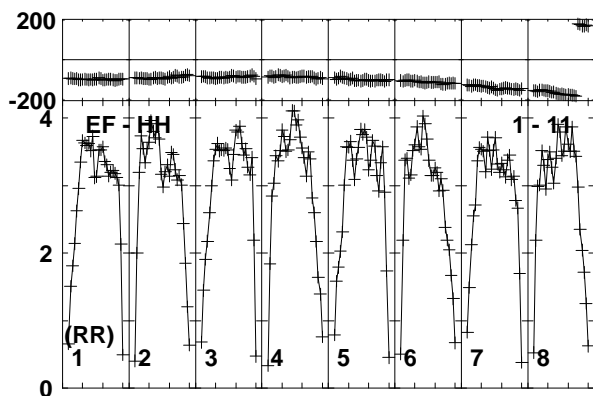
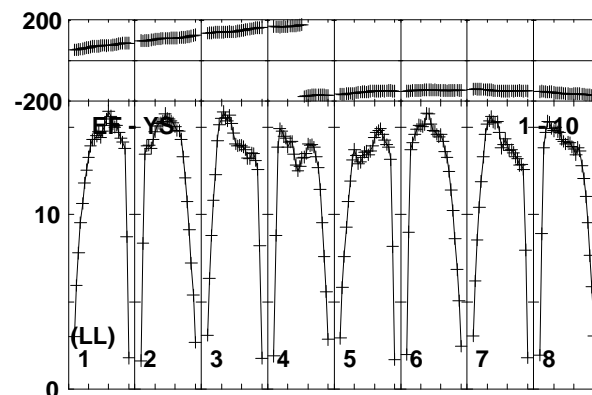
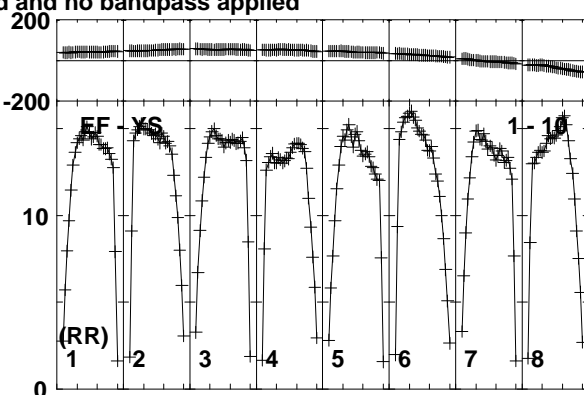
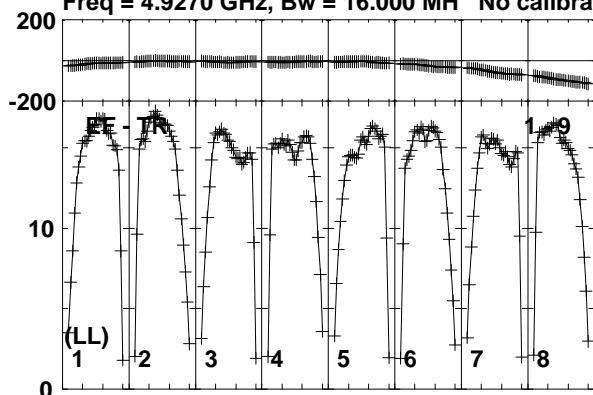

Lower frame: Milli Ampl Jy Top frame: Phas deg  
Vector averaged cross-power spectrum Baseline: EF (01) - TR (09)  
Timerange: 00/05:39:21 to 00/05:40:49

Plot file version 190 created 08-APR-2019 12:09:56

J0815+3635 EM133B.UVDATA.1

Freq = 4.9270 GHz, Bw = 16.000 MH No calibration applied and no bandpass applied

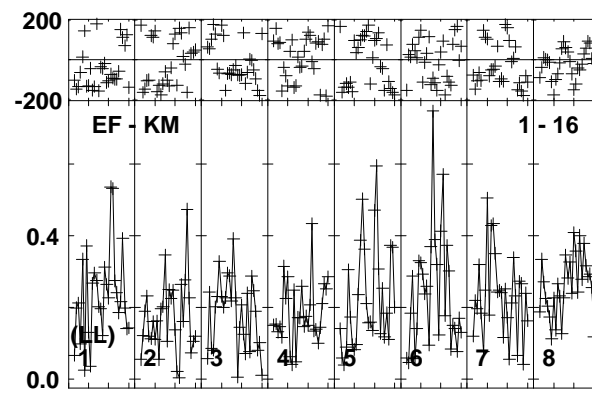
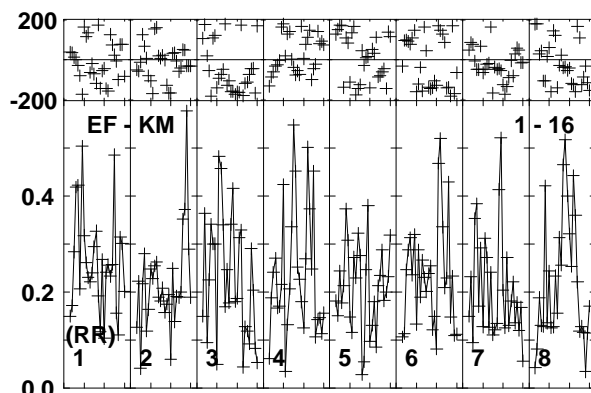
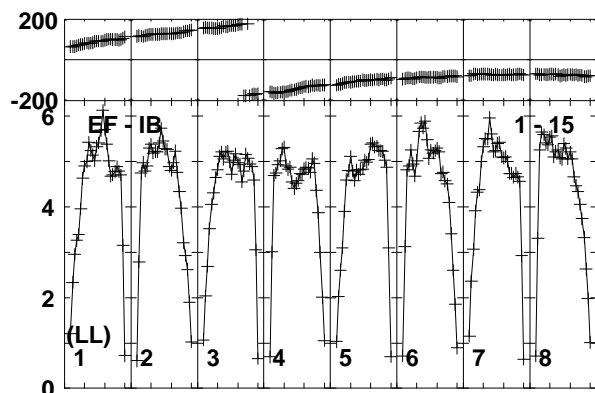
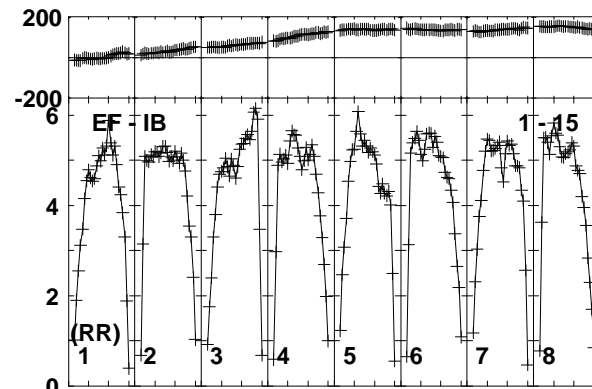
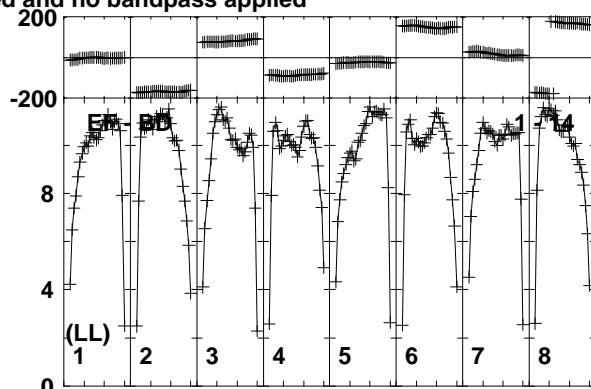
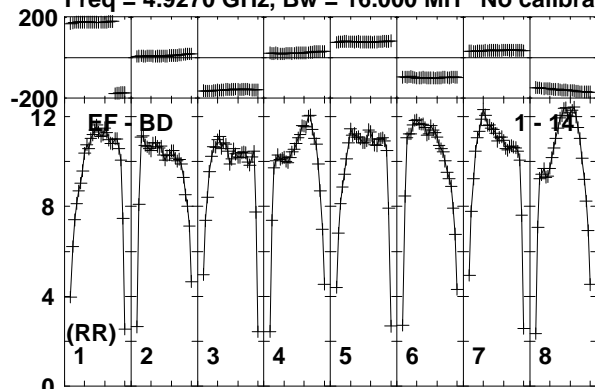

Lower frame: Milli Ampl Jy Top frame: Phas deg  
Vector averaged cross-power spectrum Baseline: EF (01) - BD (14)  
Timerange: 00/05:39:21 to 00/05:40:49

Plot file version 191 created 08-APR-2019 12:09:56

MRK622 EM133B.UVDATA.1

Freq = 4.9270 GHz, Bw = 16.000 MH No calibration applied and no bandpass applied

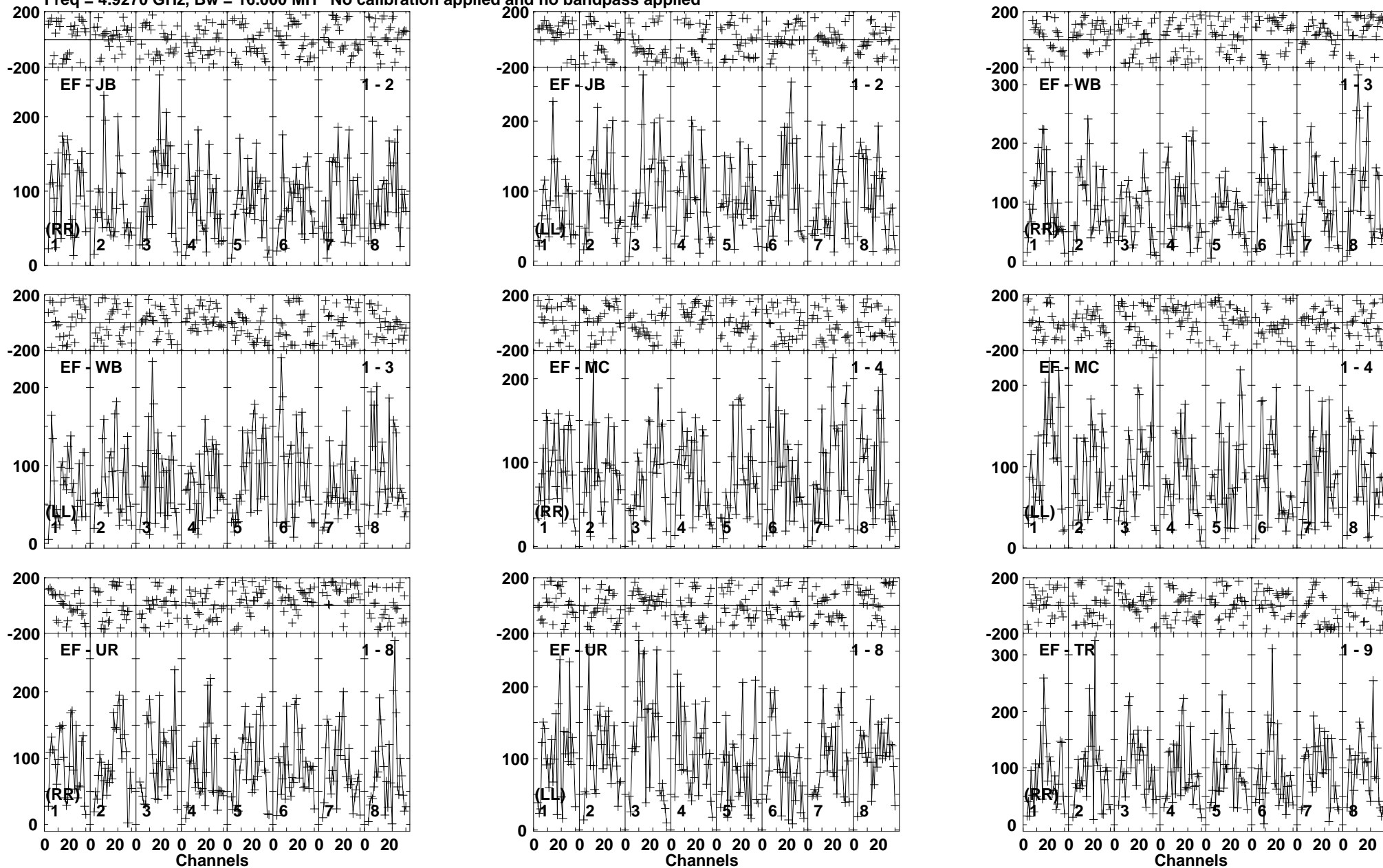

Lower frame: Micro Ampl Jy Top frame: Phas deg  
Vector averaged cross-power spectrum Baseline: EF (01) - JB (02)  
Timerange: 00/05:40:53 to 00/05:44:19

Plot file version 192 created 08-APR-2019 12:09:56

MRK622 EM133B.UVDATA.1

Freq = 4.9270 GHz, Bw = 16.000 MH No calibration applied and no bandpass applied

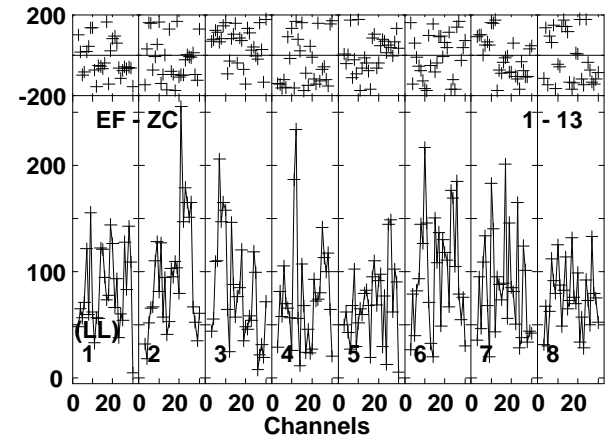
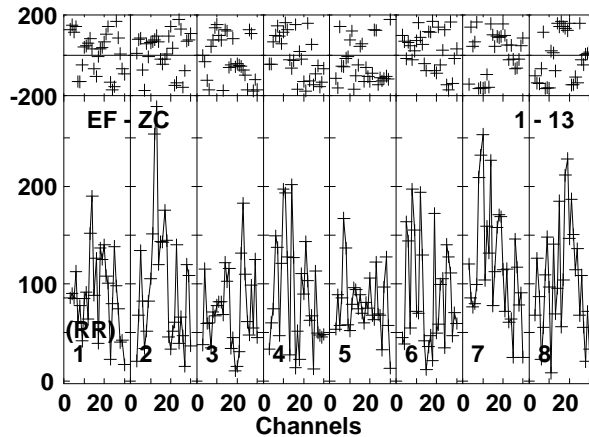
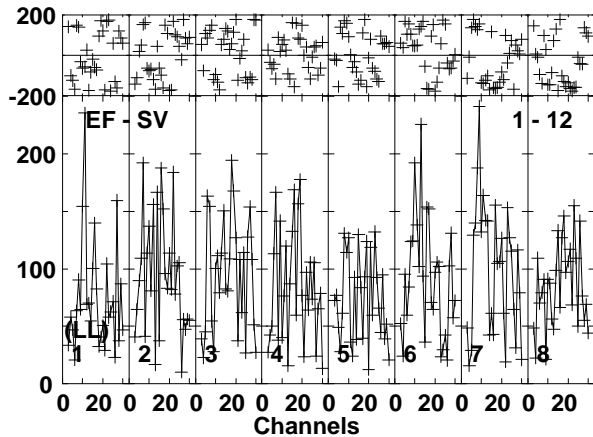
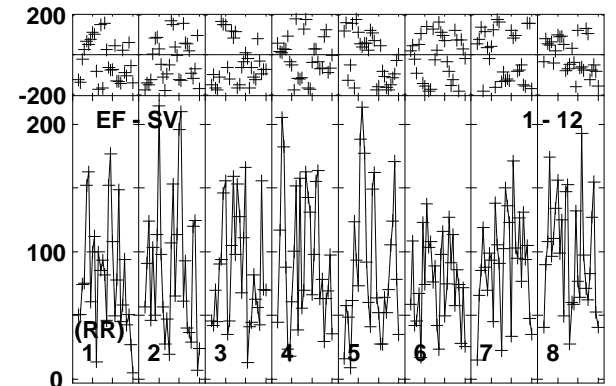
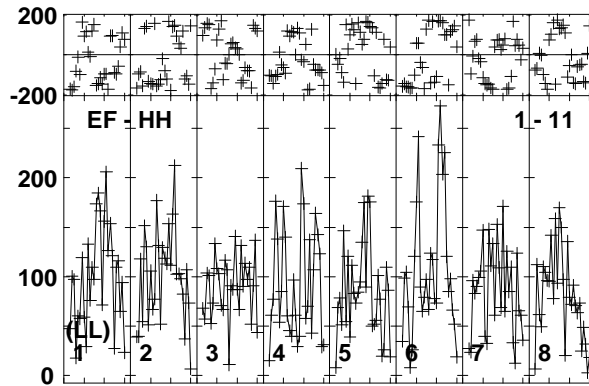
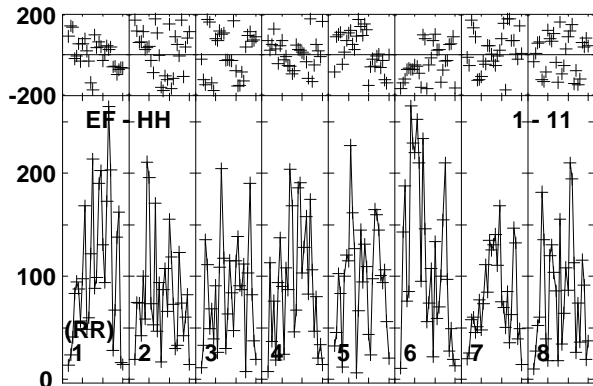
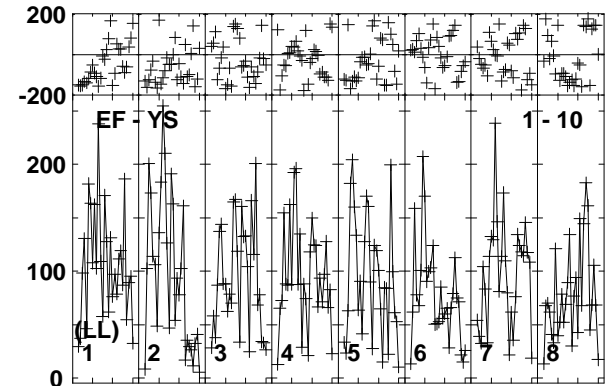
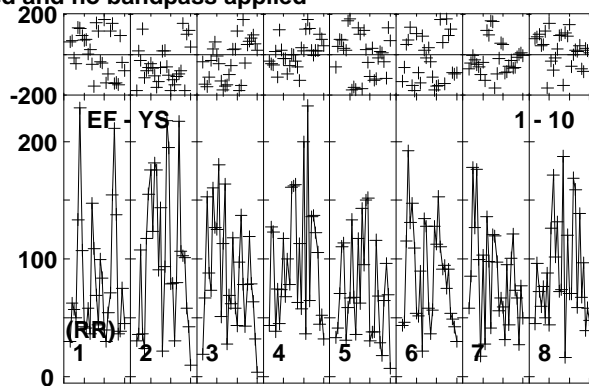
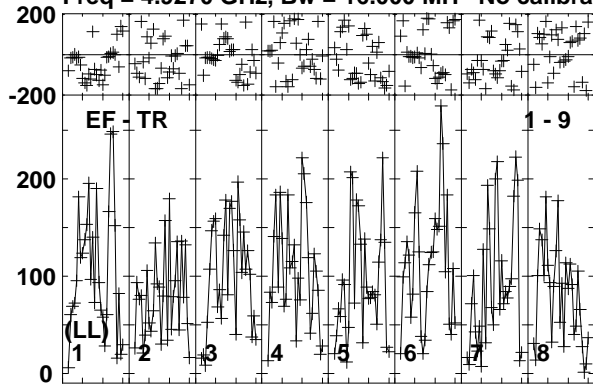

Lower frame: Micro Ampl Jy Top frame: Phas deg  
Vector averaged cross-power spectrum Baseline: EF (01) - TR (09)  
Timerange: 00/05:40:53 to 00/05:44:19



Plot file version 193 created 08-APR-2019 12:09:56

MRK622 EM133B.UVDATA.1

Freq = 4.9270 GHz, Bw = 16.000 MH No calibration applied and no bandpass applied

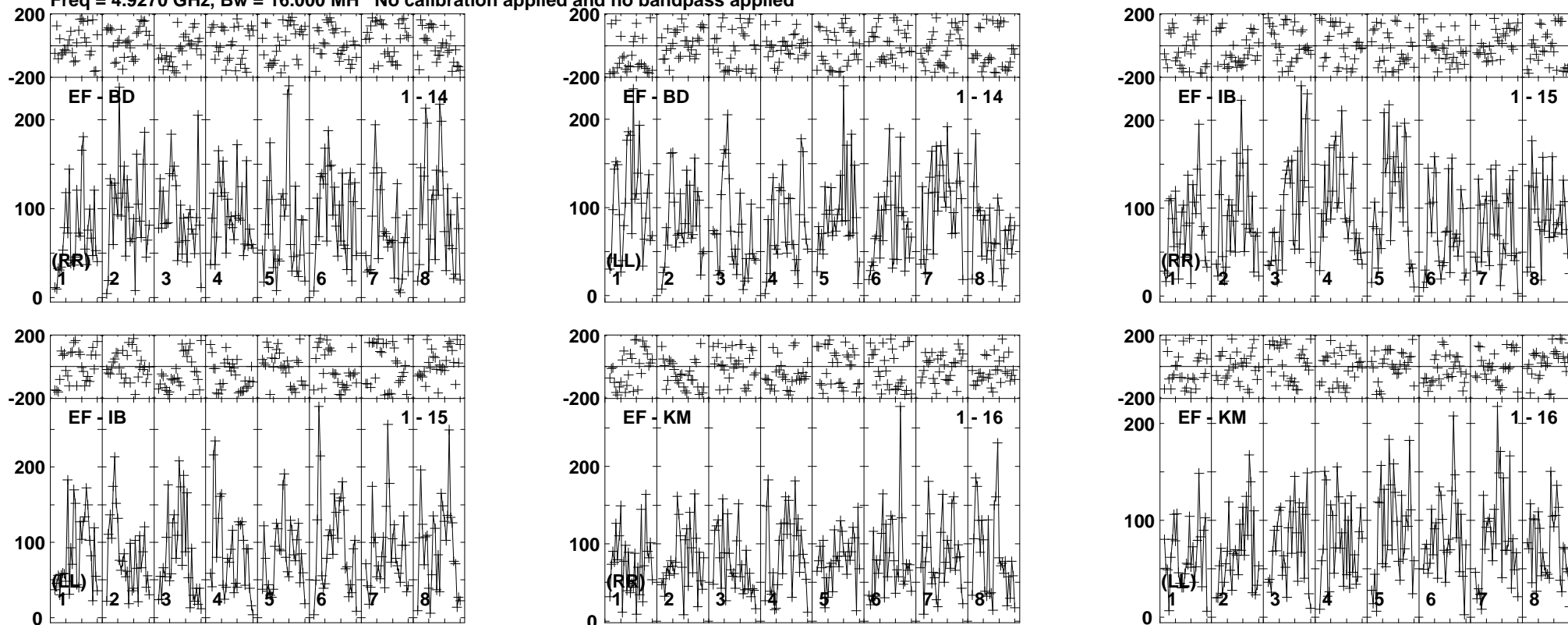

Lower frame: Micro Ampl Jy Top frame: Phas deg  
Vector averaged cross-power spectrum Baseline: EF (01) - BD (14)  
Timerange: 00/05:40:53 to 00/05:44:19

Plot file version 194 created 08-APR-2019 12:09:56

J0815+3635 EM133B.UVDATA.1

Freq = 4.9270 GHz, Bw = 16.000 MH No calibration applied and no bandpass applied

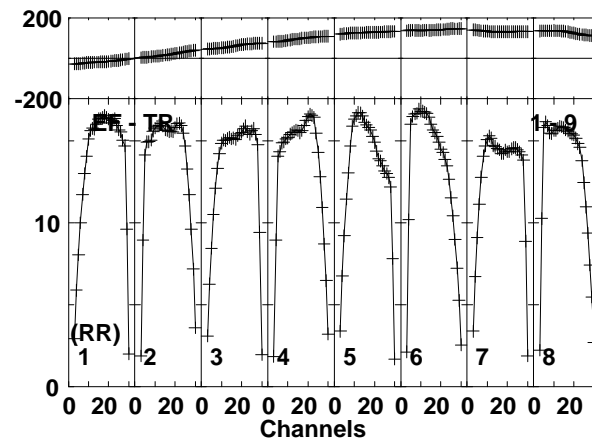
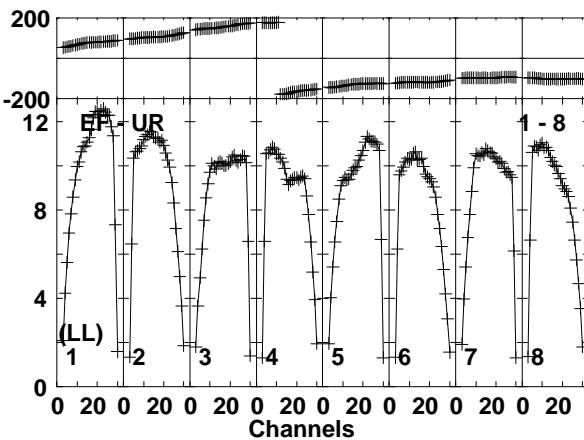
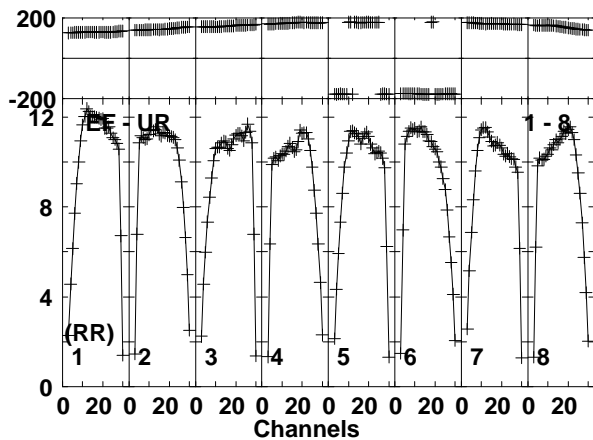
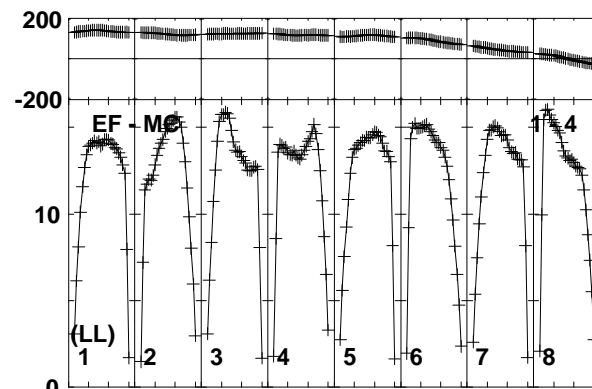
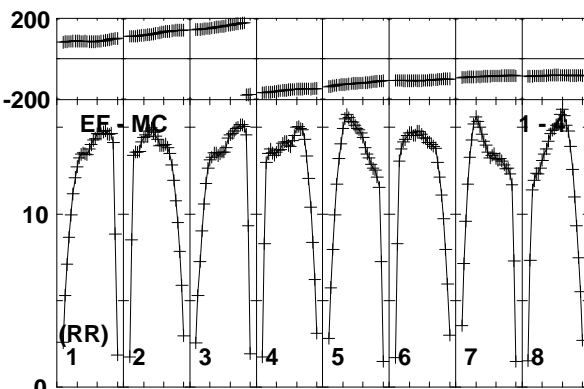
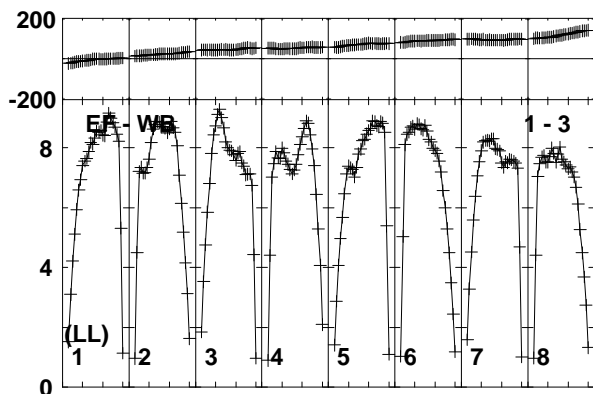
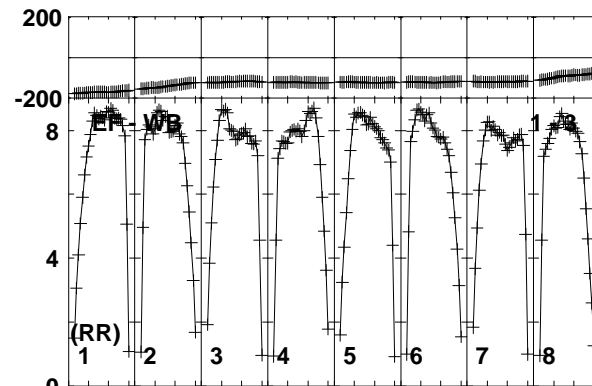
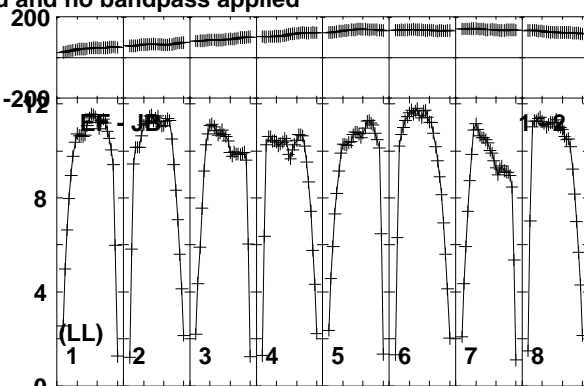
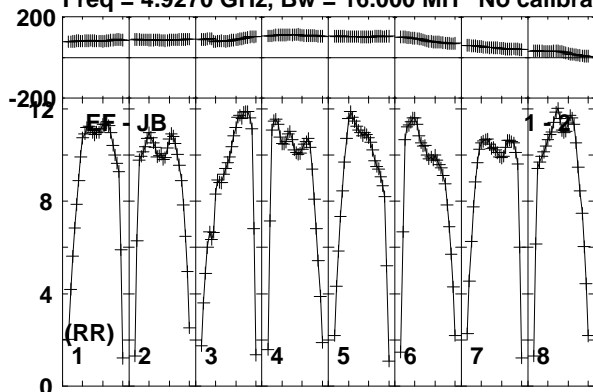

Lower frame: Milli Ampl Jy Top frame: Phas deg  
Vector averaged cross-power spectrum Baseline: EF (01) - JB (02)  
Timerange: 00/05:45:11 to 00/05:46:39

Plot file version 195 created 08-APR-2019 12:09:57

J0815+3635 EM133B.UVDATA.1

Freq = 4.9270 GHz, Bw = 16.000 MH No calibration applied and no bandpass applied

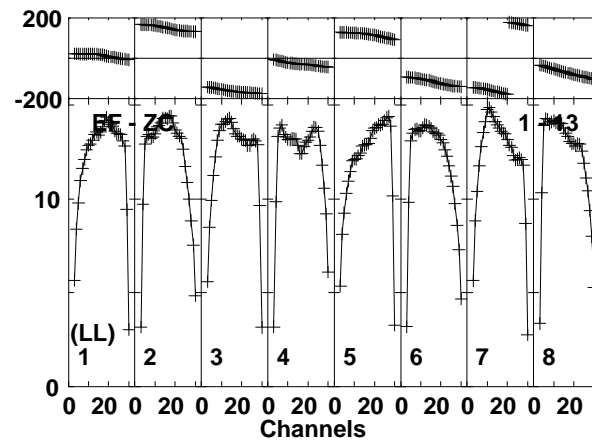
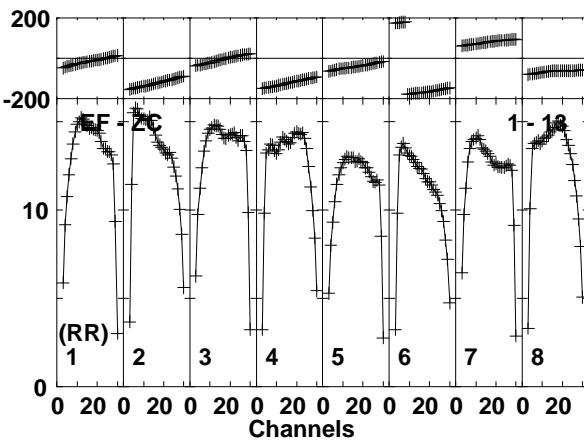
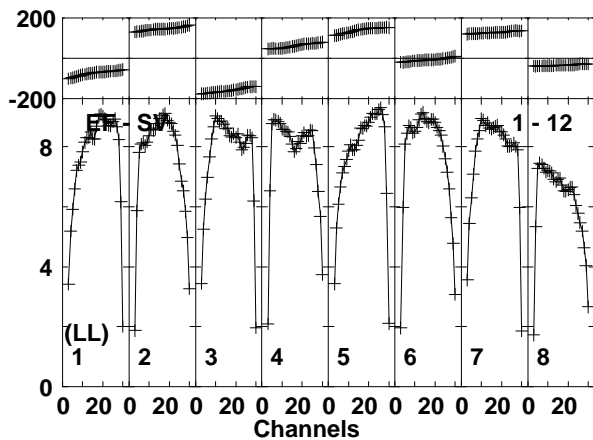
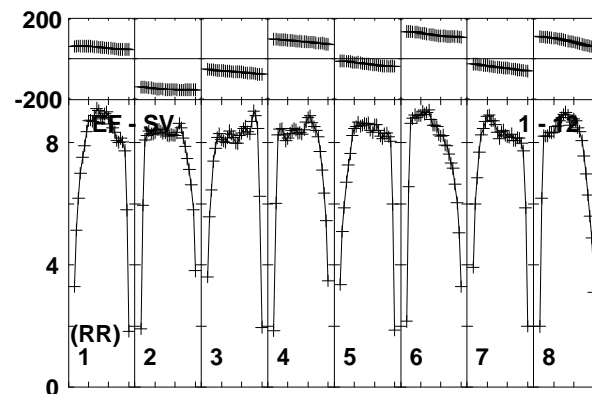
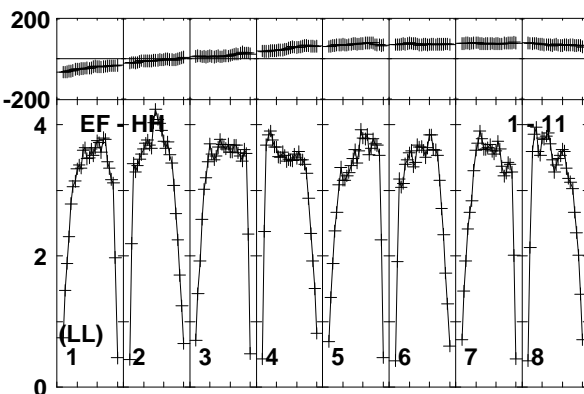
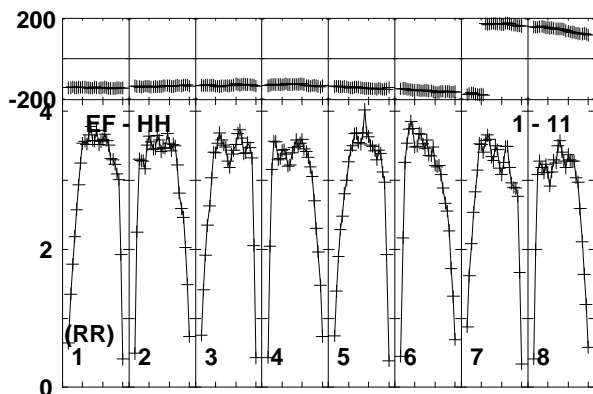
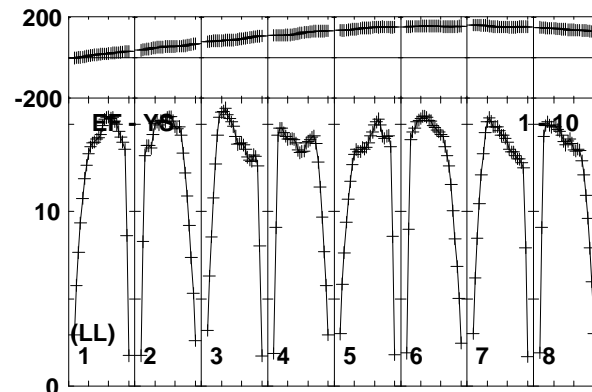
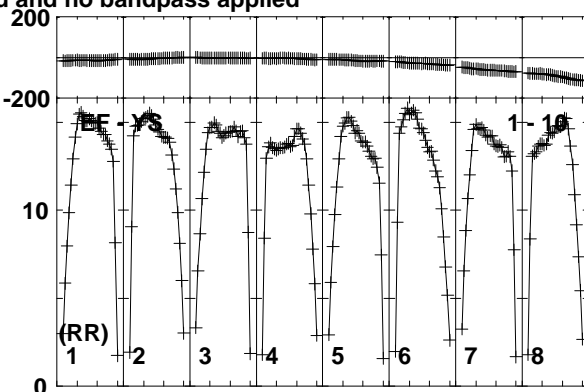
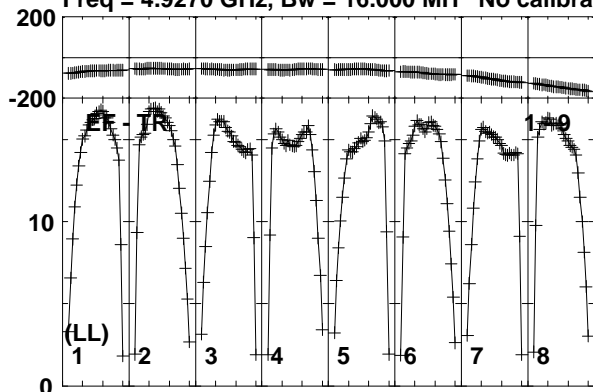

Lower frame: Milli Ampl Jy Top frame: Phas deg  
Vector averaged cross-power spectrum Baseline: EF (01) - TR (09)  
Timerange: 00/05:45:11 to 00/05:46:39

Plot file version 196 created 08-APR-2019 12:09:57

J0815+3635 EM133B.UVDATA.1

Freq = 4.9270 GHz, Bw = 16.000 MH No calibration applied and no bandpass applied

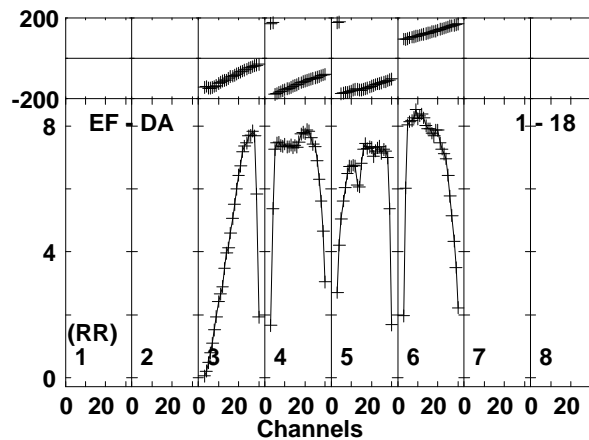
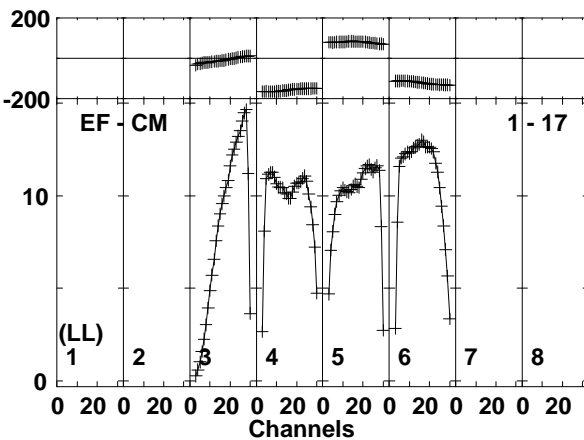
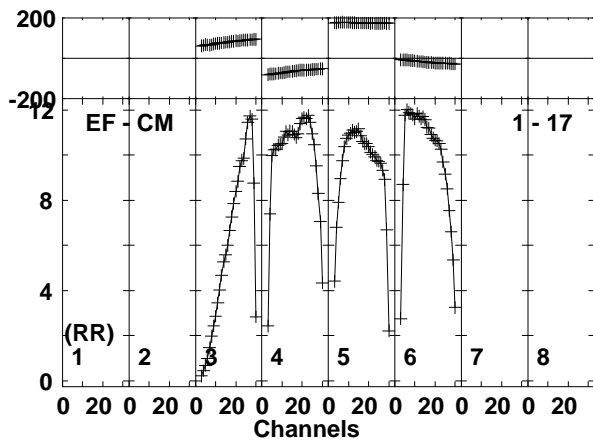
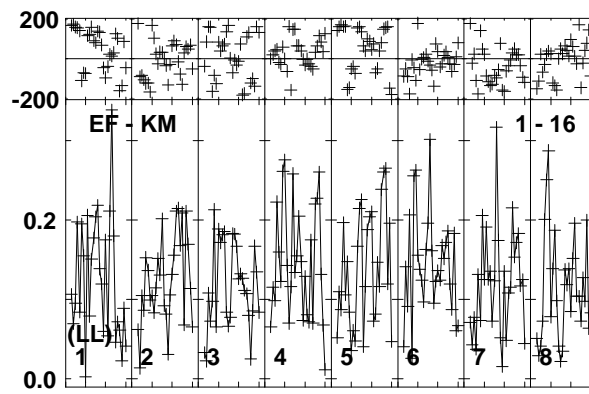
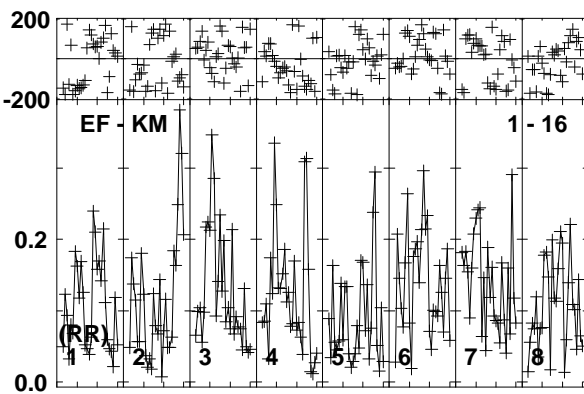
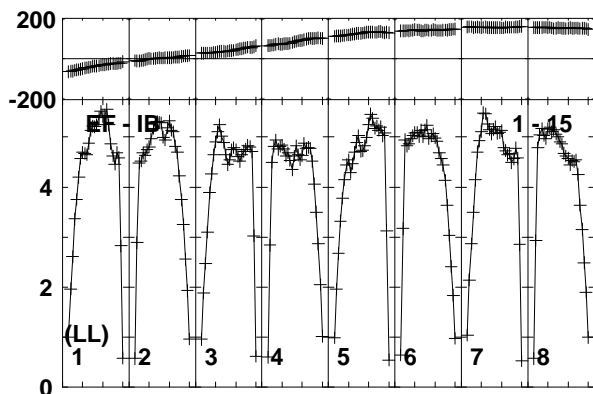
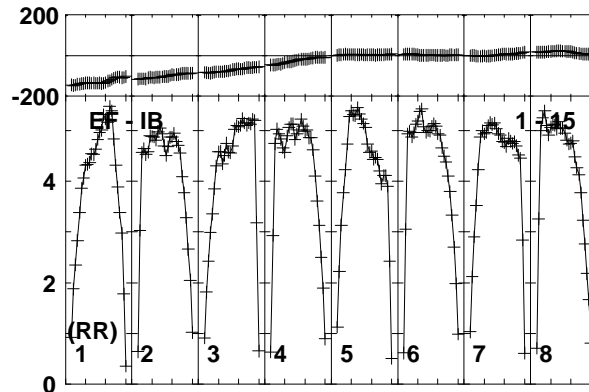
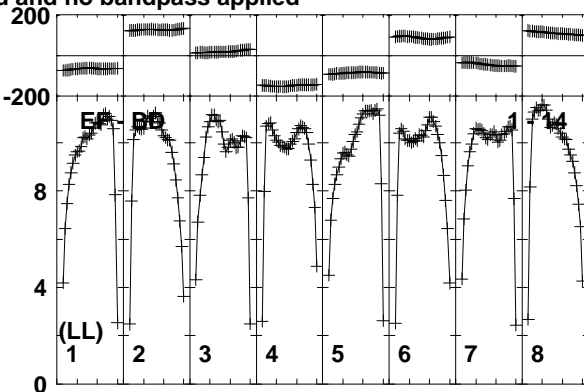
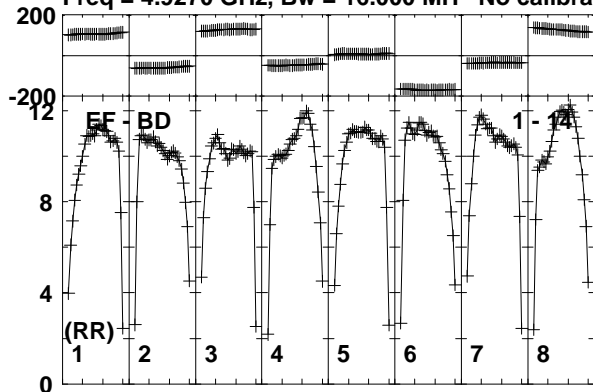

Lower frame: Milli Ampl Jy Top frame: Phas deg  
Vector averaged cross-power spectrum Baseline: EF (01) - BD (14)  
Timerange: 00/05:45:11 to 00/05:46:39

Plot file version 197 created 08-APR-2019 12:09:57

J0815+3635 EM133B.UVDATA.1

Freq = 4.9270 GHz, Bw = 16.000 MH No calibration applied and no bandpass applied

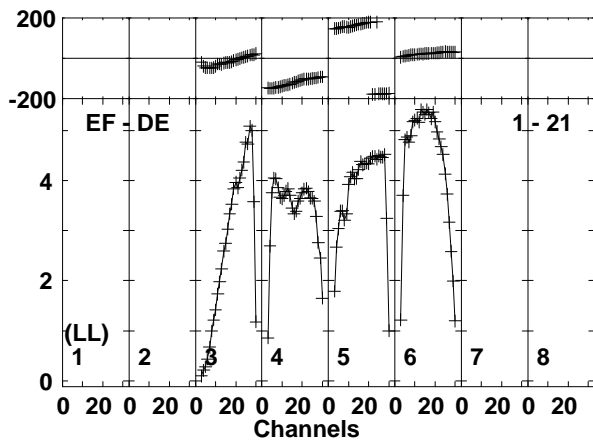
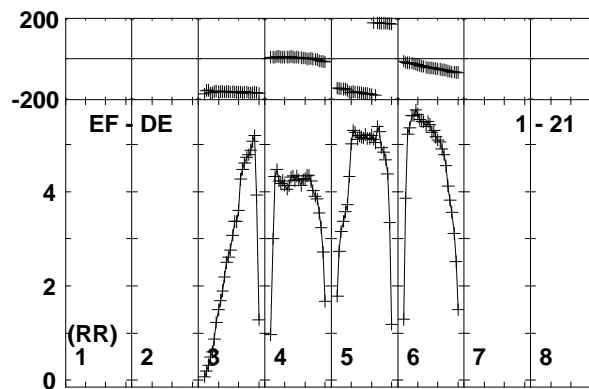
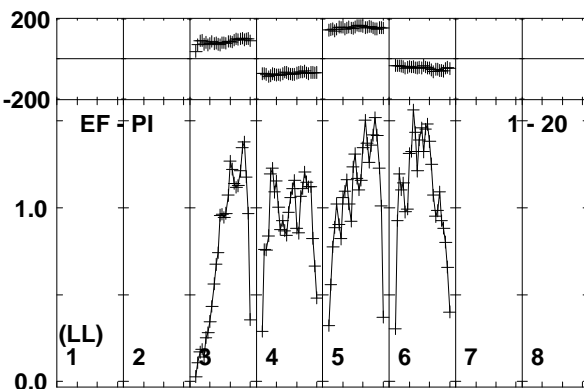
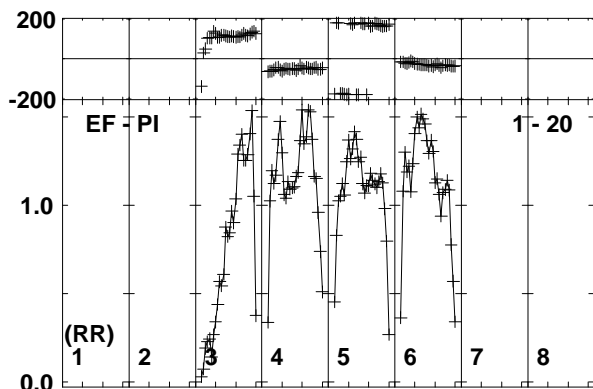
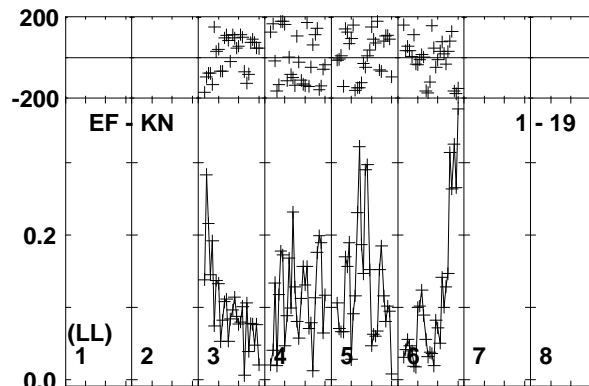
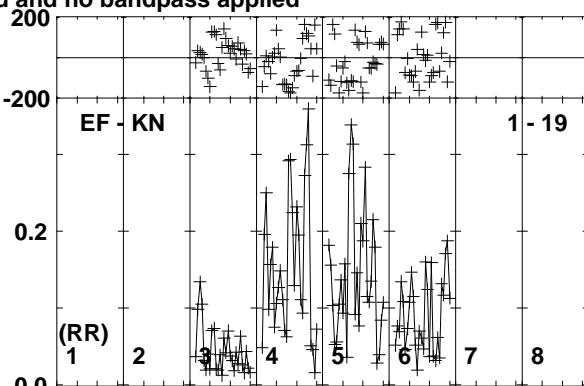
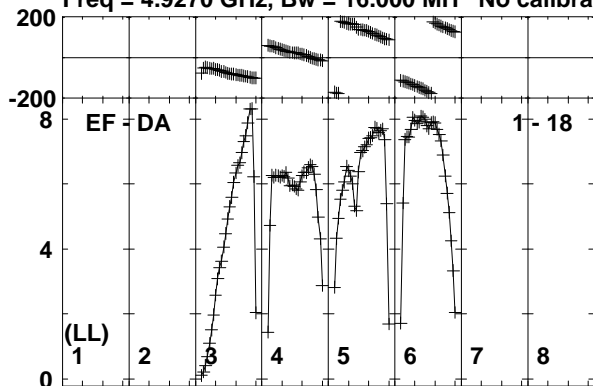

Lower frame: Milli Ampl Jy Top frame: Phas deg  
Vector averaged cross-power spectrum Baseline: EF (01) - DA (18)  
Timerange: 00/05:45:11 to 00/05:46:39

Plot file version 198 created 08-APR-2019 12:09:57

MRK622 EM133B.UVDATA.1

Freq = 4.9270 GHz, Bw = 16.000 MH No calibration applied and no bandpass applied

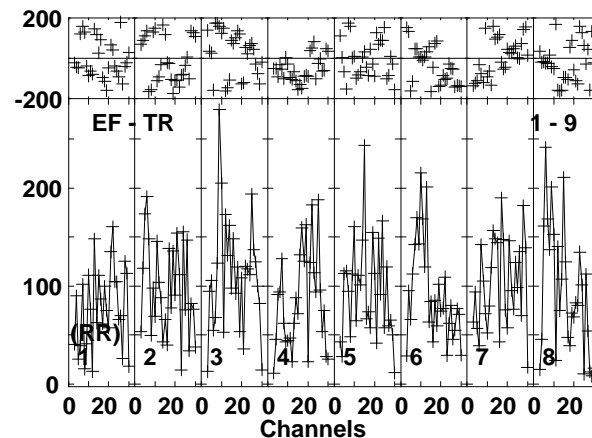
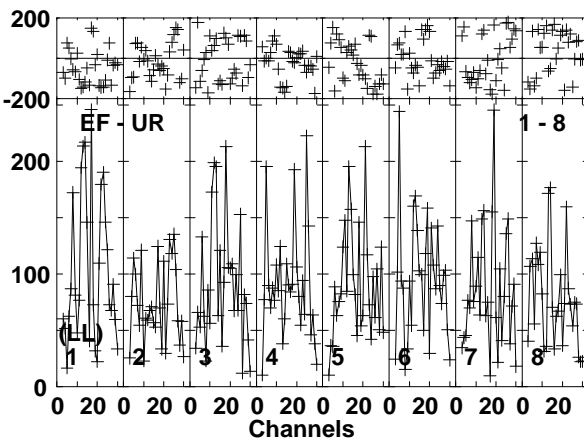
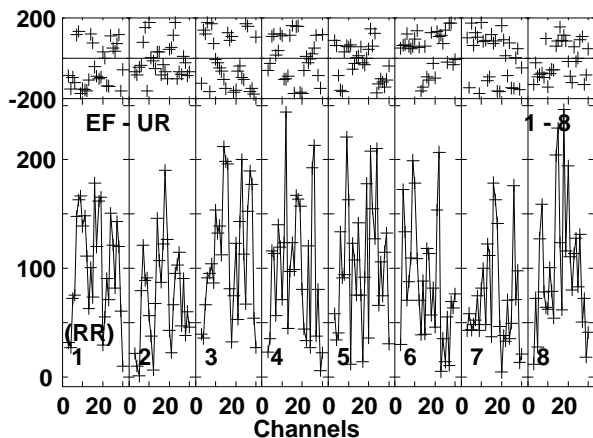
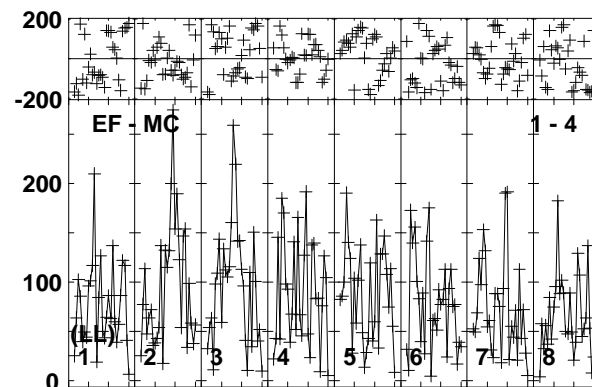
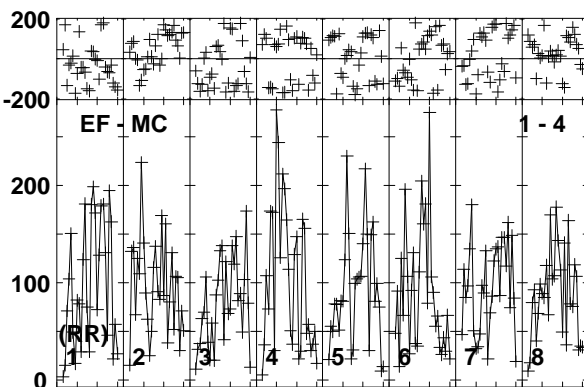
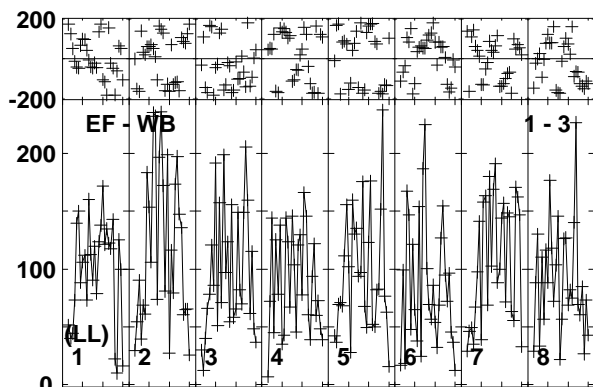
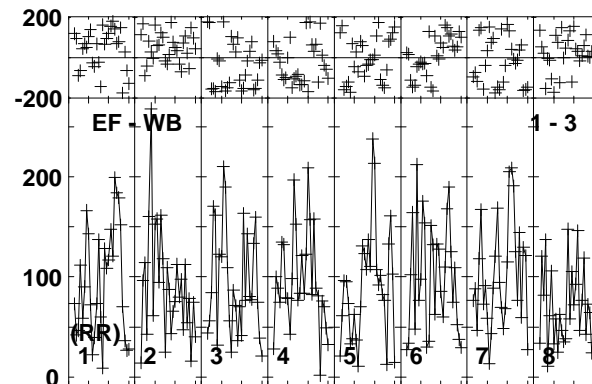
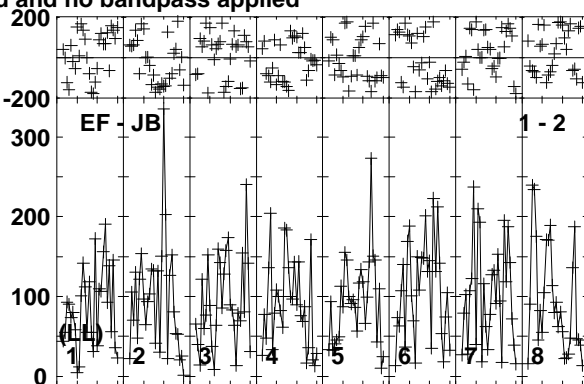
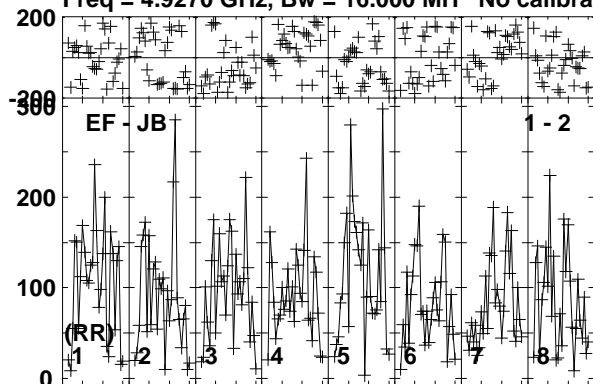

Lower frame: Micro Ampl Jy Top frame: Phas deg  
Vector averaged cross-power spectrum Baseline: EF (01) - JB (02)  
Timerange: 00/05:46:41 to 00/05:50:09

Plot file version 199 created 08-APR-2019 12:09:57

MRK622 EM133B.UVDATA.1

Freq = 4.9270 GHz, Bw = 16.000 MH No calibration applied and no bandpass applied

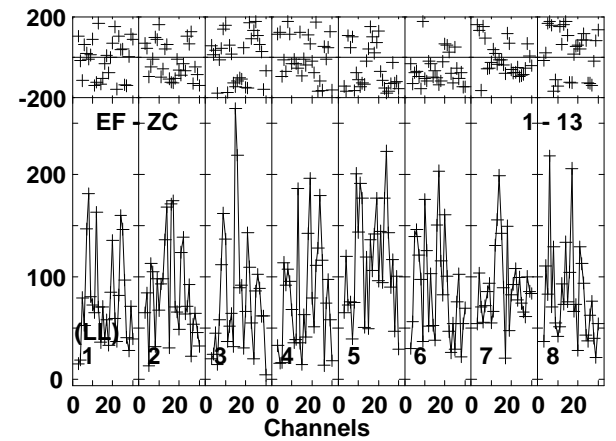
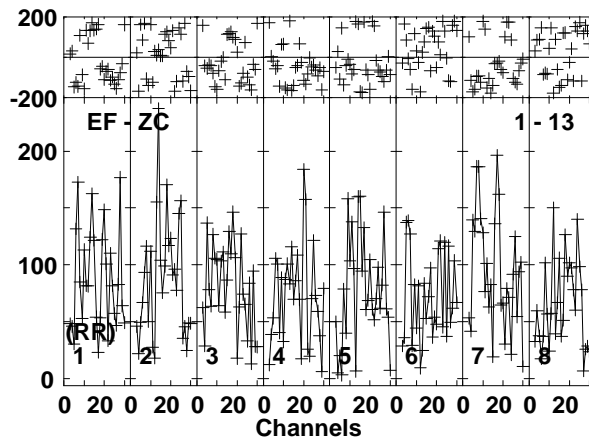
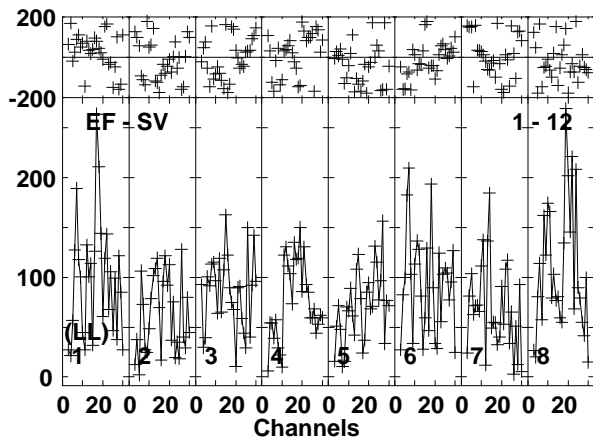
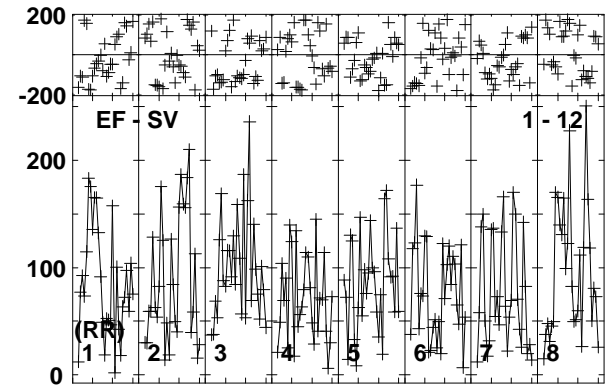
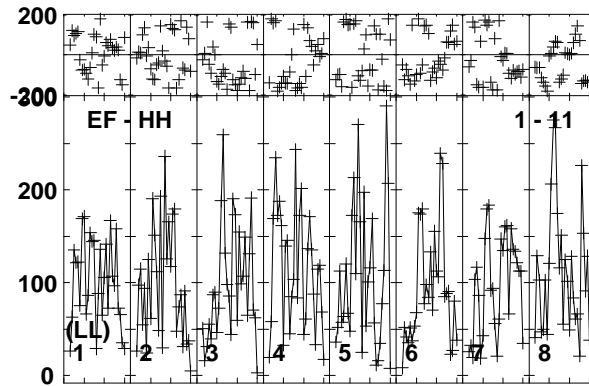
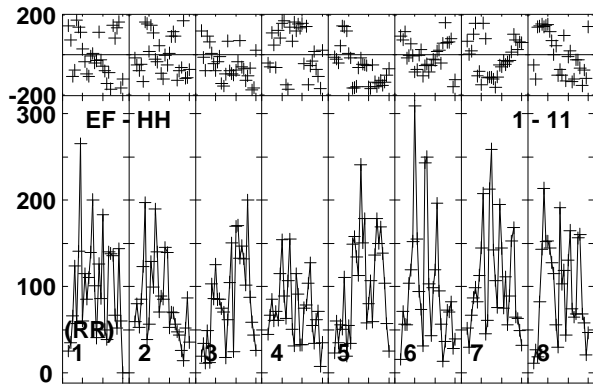
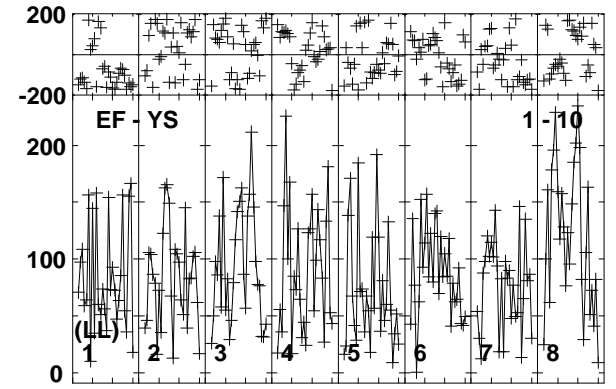
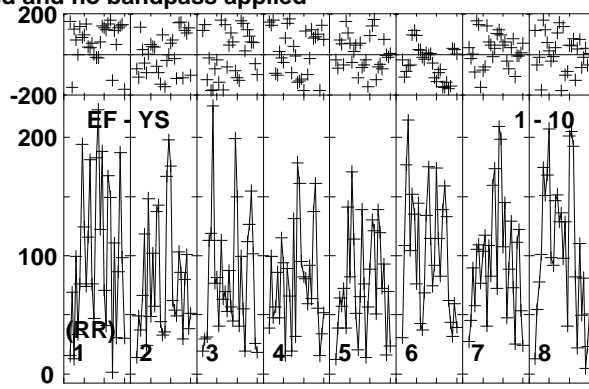
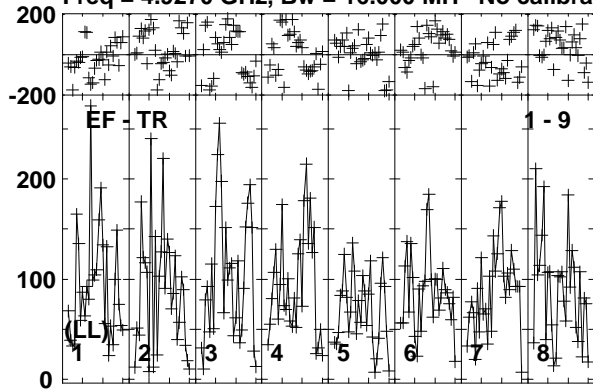

Lower frame: Micro Ampl Jy Top frame: Phas deg  
Vector averaged cross-power spectrum Baseline: EF (01) - TR (09)  
Timerange: 00/05:46:41 to 00/05:50:09

Plot file version 200 created 08-APR-2019 12:09:57

MRK622 EM133B.UVDATA.1

Freq = 4.9270 GHz, Bw = 16.000 MH No calibration applied and no bandpass applied

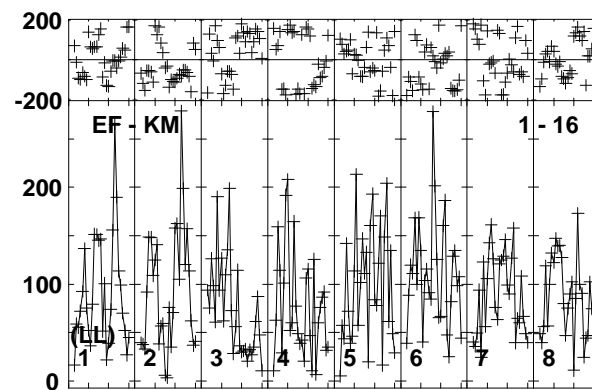
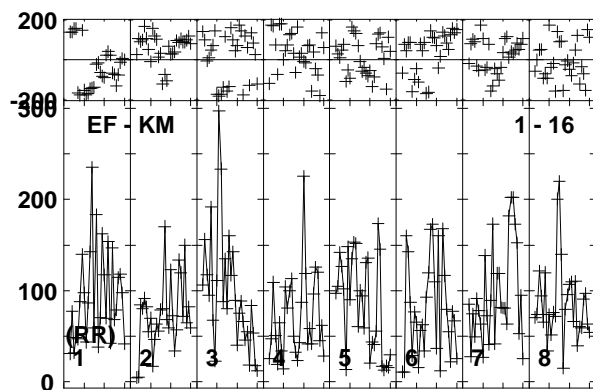
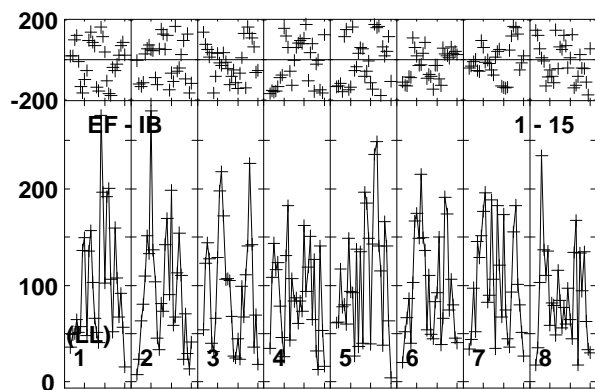
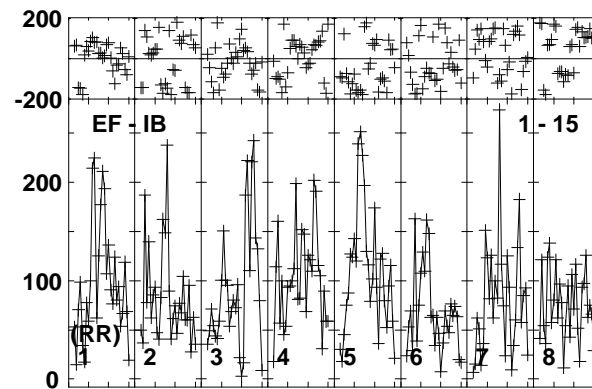
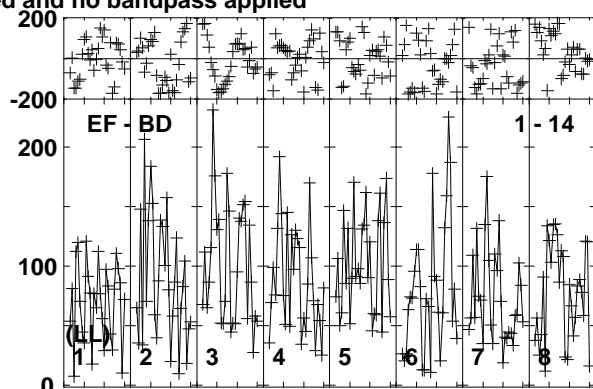
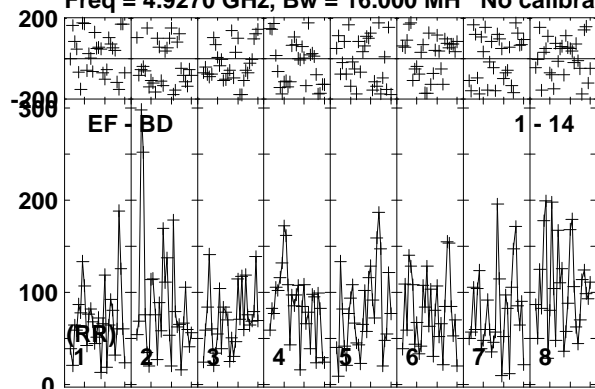

Lower frame: Micro Ampl Jy Top frame: Phas deg  
Vector averaged cross-power spectrum Baseline: EF (01) - BD (14)  
Timerange: 00/05:46:41 to 00/05:50:09



Plot file version 201 created 08-APR-2019 12:09:57

J0815+3635 EM133B.UVDATA.1

Freq = 4.9270 GHz, Bw = 16.000 MH No calibration applied and no bandpass applied

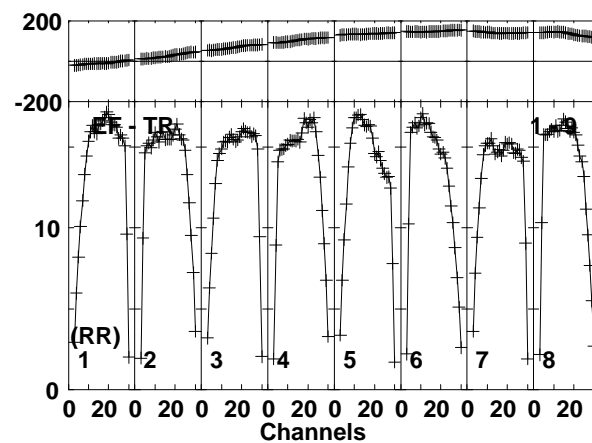
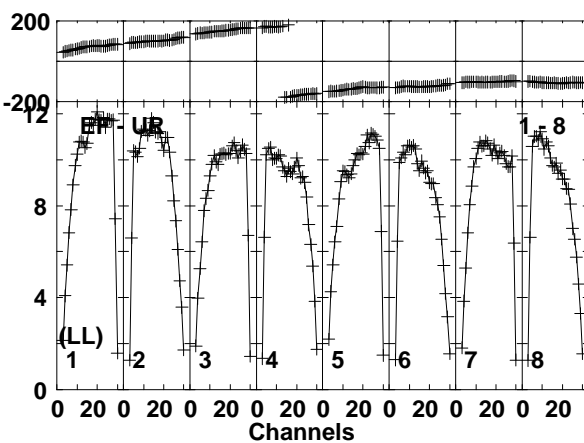
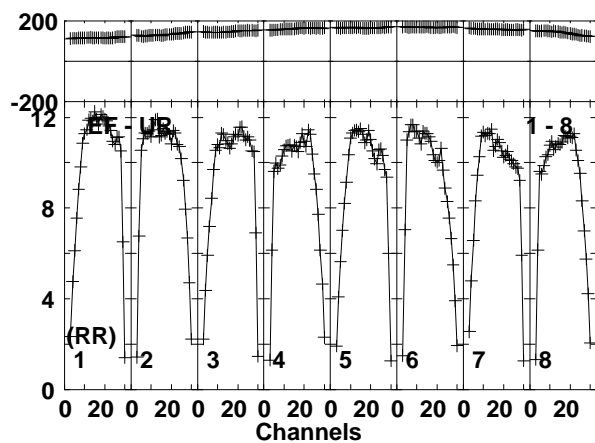
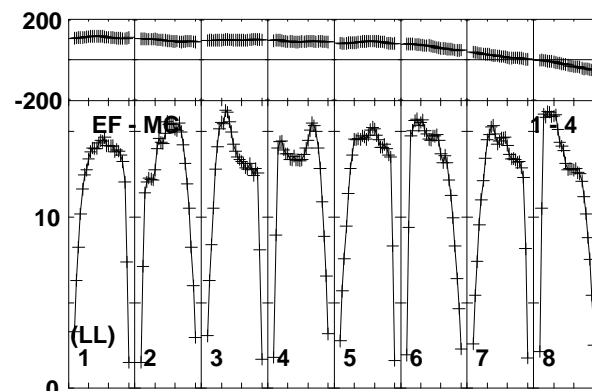
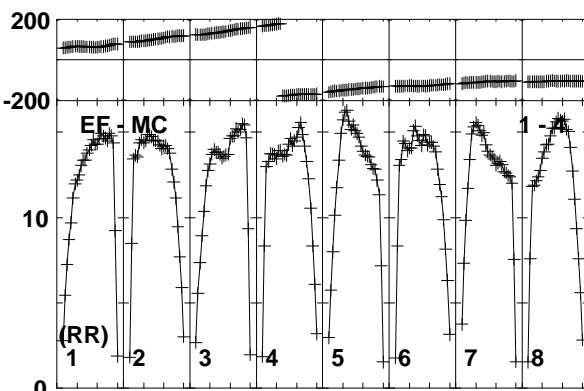
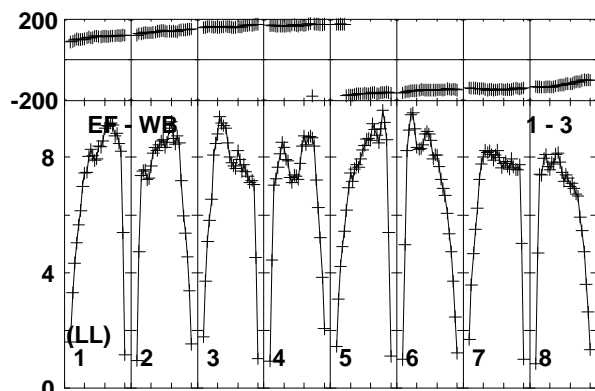
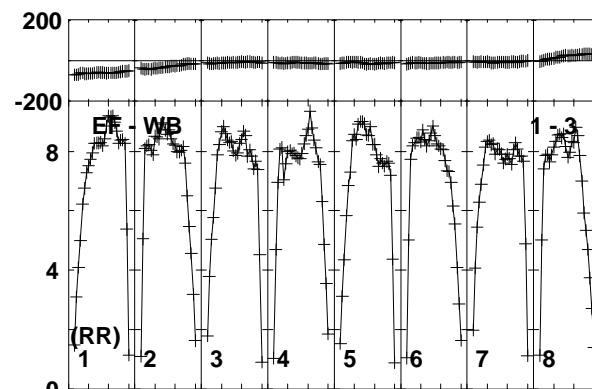
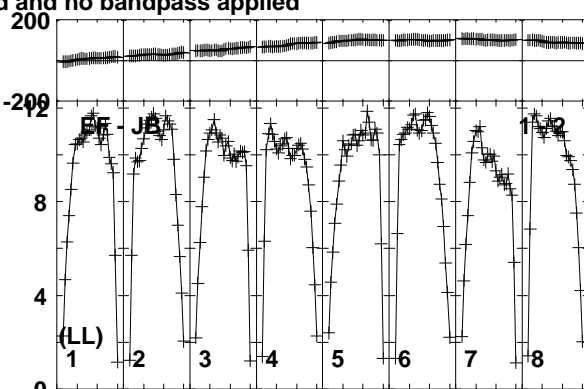
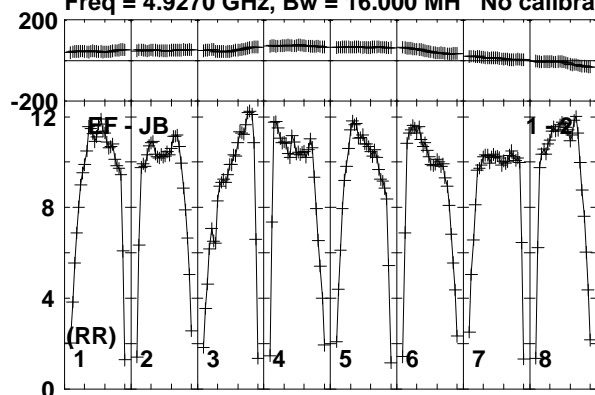

Lower frame: Milli Ampl Jy Top frame: Phas deg  
Vector averaged cross-power spectrum Baseline: EF (01) - JB (02)  
Timerange: 00/05:50:11 to 00/05:51:39

Plot file version 202 created 08-APR-2019 12:09:57

J0815+3635 EM133B.UVDATA.1

Freq = 4.9270 GHz, Bw = 16.000 MH No calibration applied and no bandpass applied

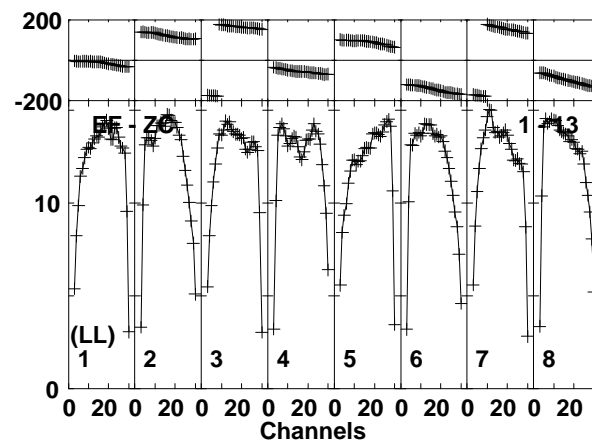
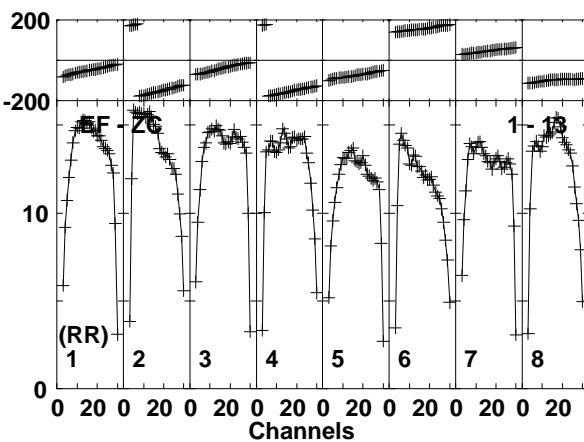
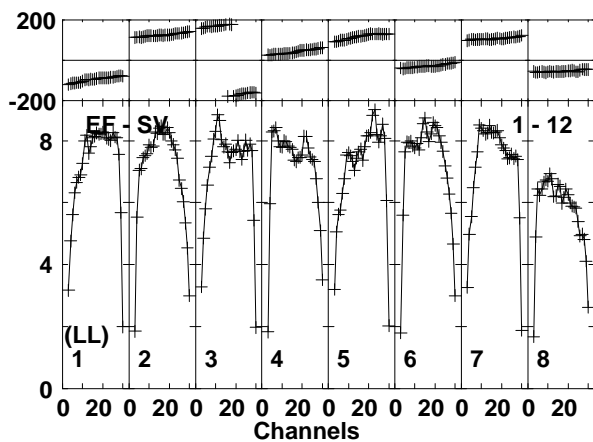
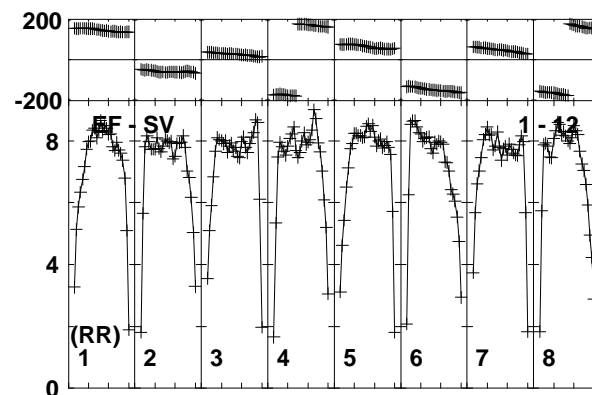
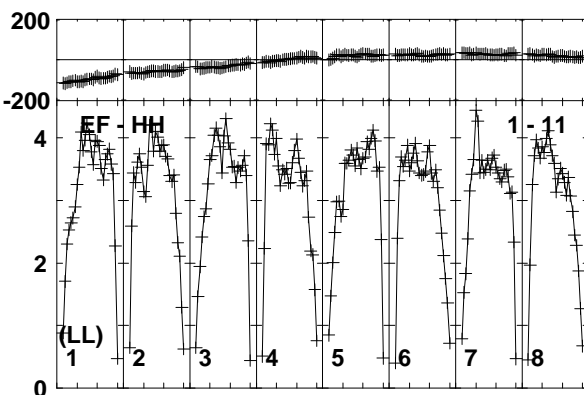
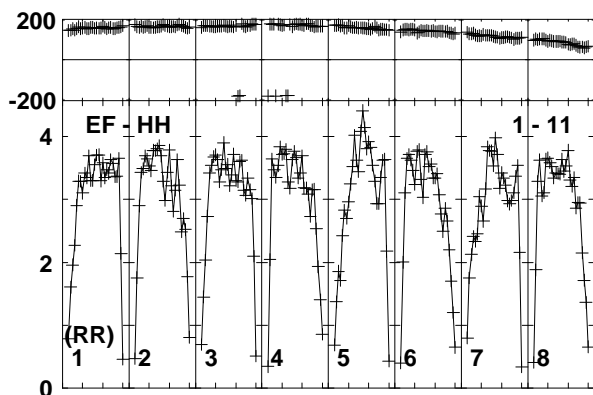
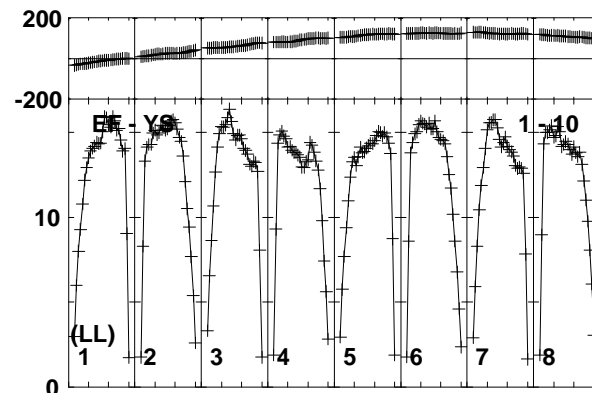
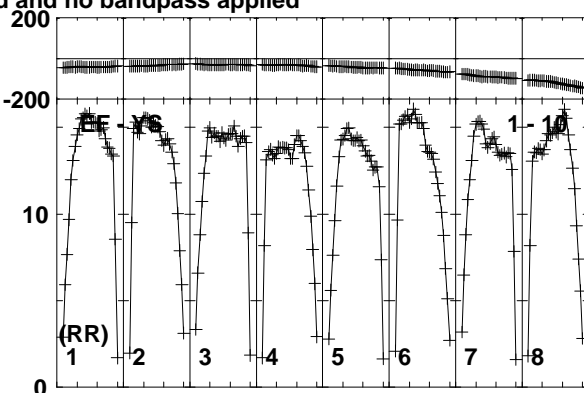
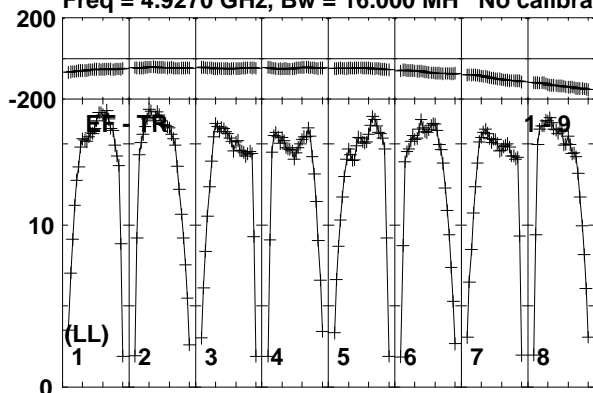

Lower frame: Milli Ampl Jy Top frame: Phas deg  
Vector averaged cross-power spectrum Baseline: EF (01) - TR (09)  
Timerange: 00/05:50:11 to 00/05:51:39

Plot file version 203 created 08-APR-2019 12:09:58

J0815+3635 EM133B.UVDATA.1

Freq = 4.9270 GHz, Bw = 16.000 MH No calibration applied and no bandpass applied

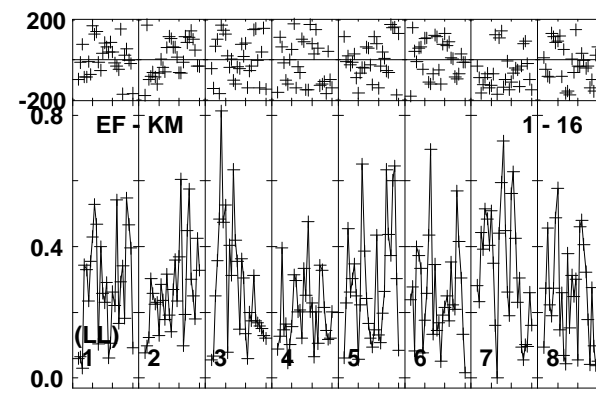
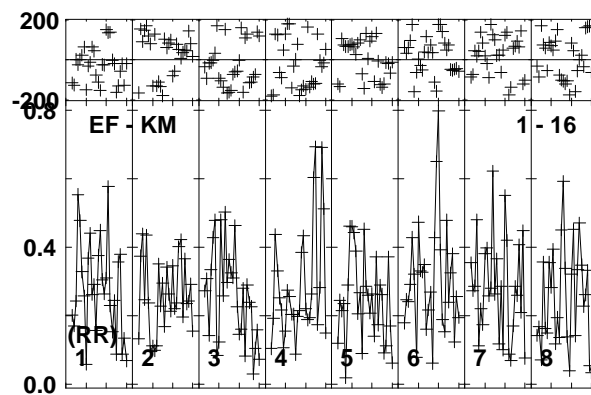
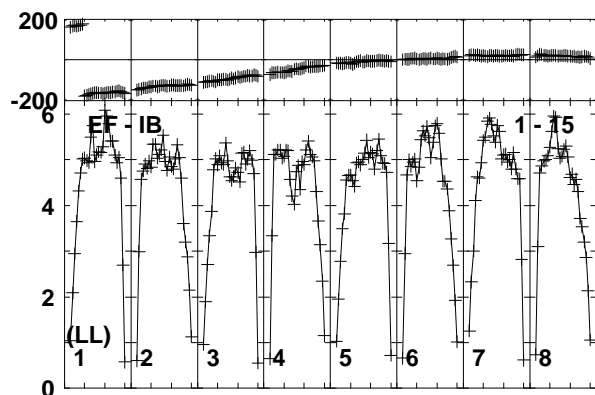
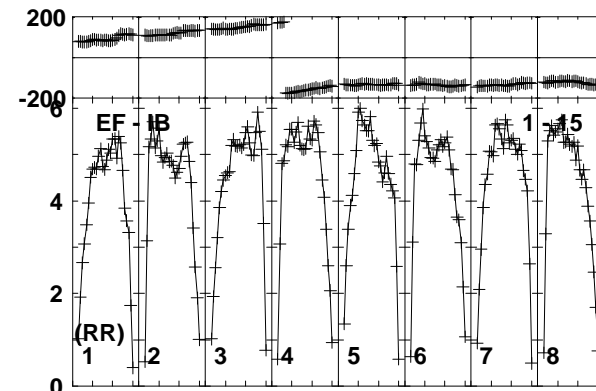
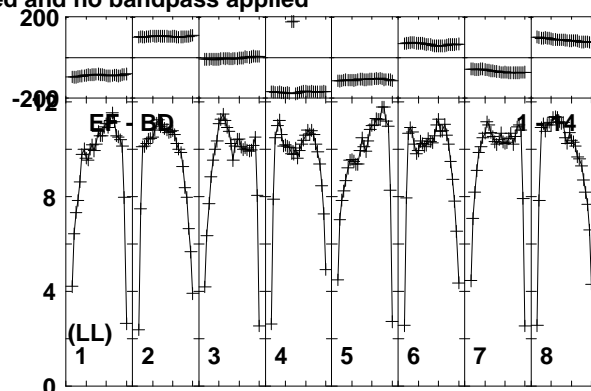
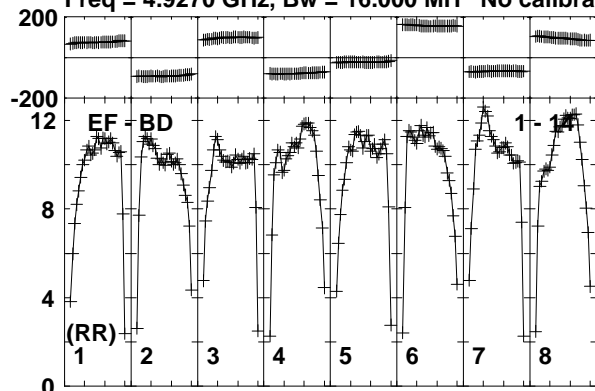

Lower frame: Milli Ampl Jy Top frame: Phas deg  
Vector averaged cross-power spectrum Baseline: EF (01) - BD (14)  
Timerange: 00/05:50:11 to 00/05:51:39

Plot file version 204 created 08-APR-2019 12:09:58

MRK622 EM133B.UVDATA.1

Freq = 4.9270 GHz, Bw = 16.000 MH No calibration applied and no bandpass applied

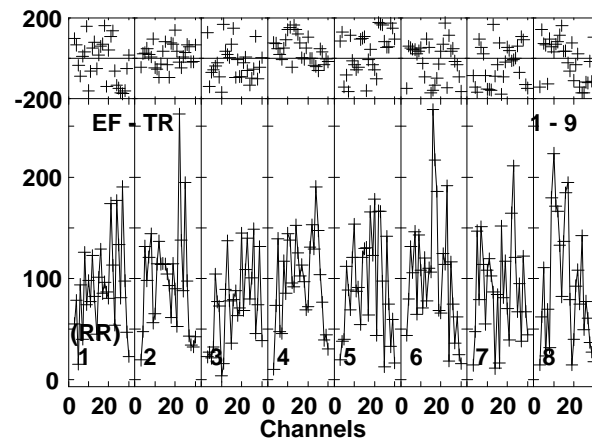
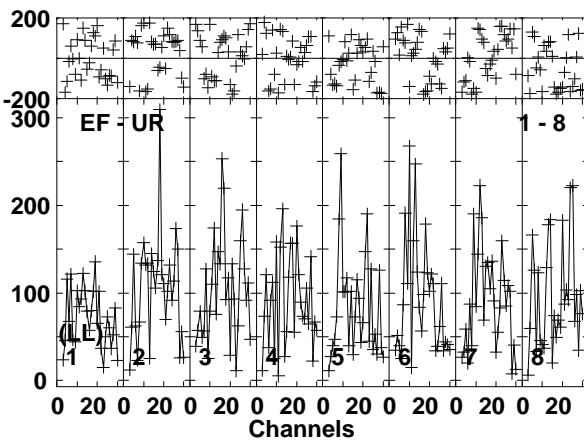
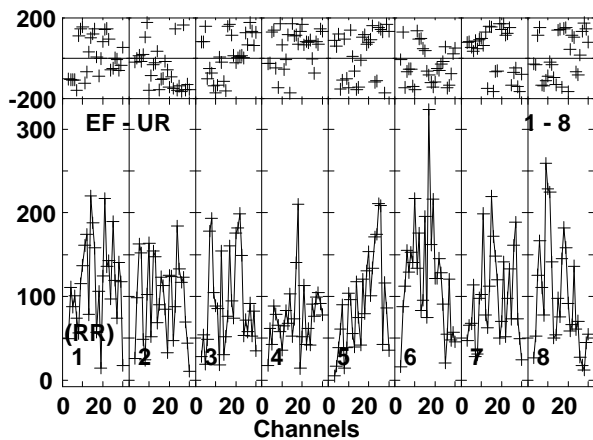
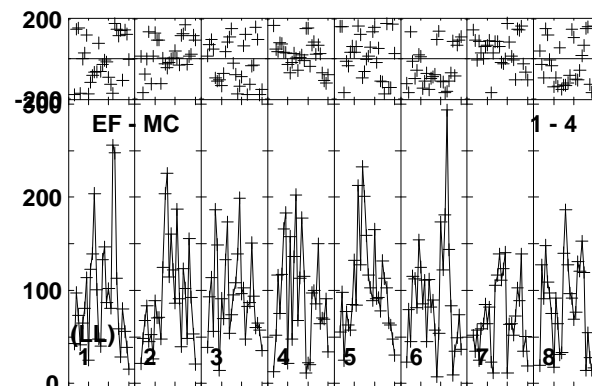
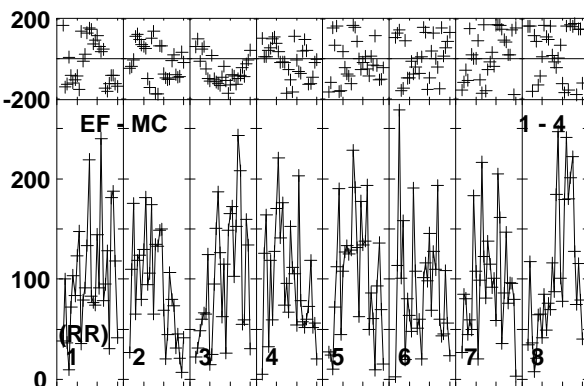
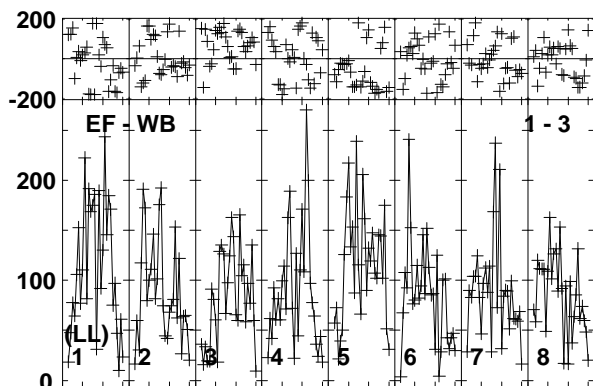
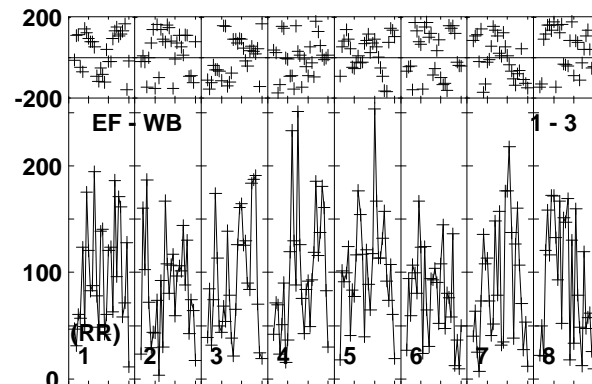
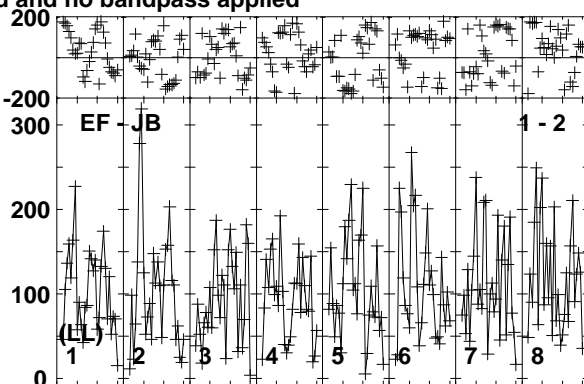
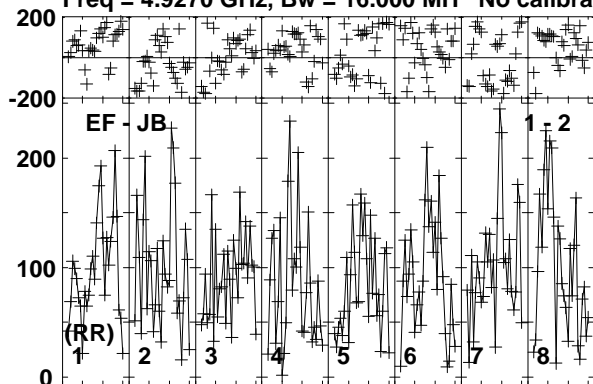

Lower frame: Micro Ampl Jy Top frame: Phas deg  
Vector averaged cross-power spectrum Baseline: EF (01) - JB (02)  
Timerange: 00/05:51:43 to 00/05:55:09

Plot file version 205 created 08-APR-2019 12:09:58  
 MRK622 EM133B.UVDATA.1  
 Freq = 4.9270 GHz, Bw = 16.000 MH No calibration applied and no bandpass applied

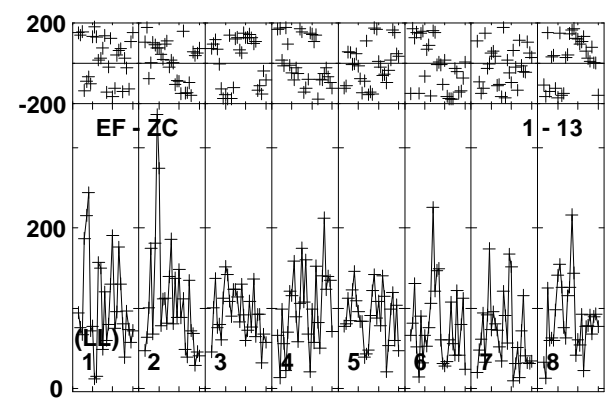
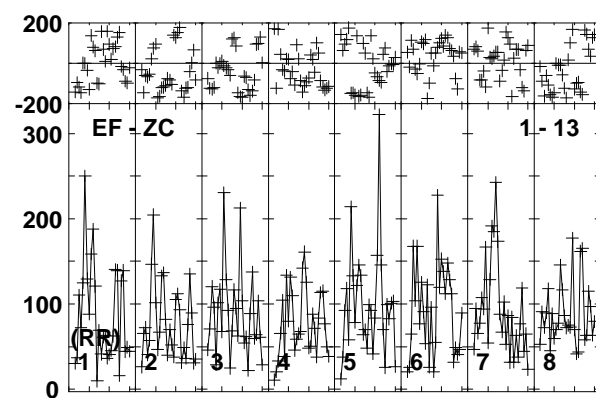
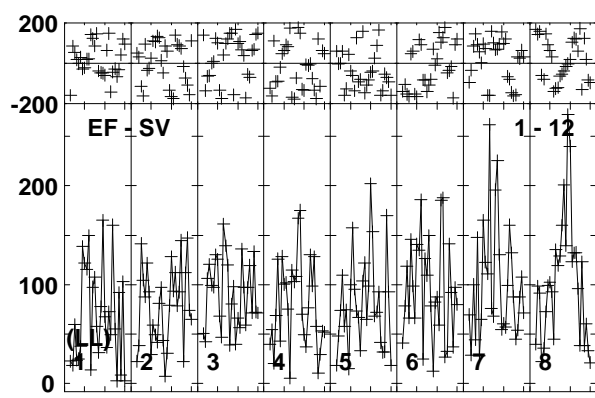
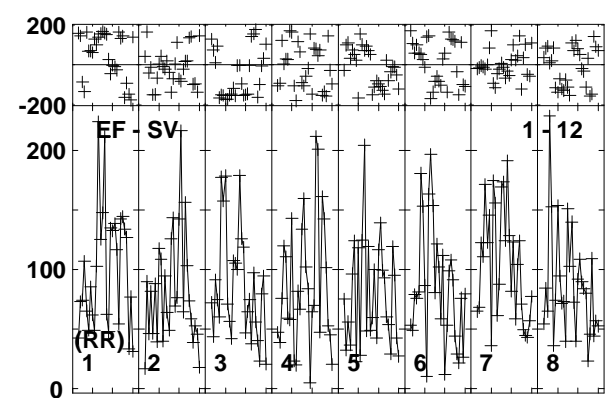
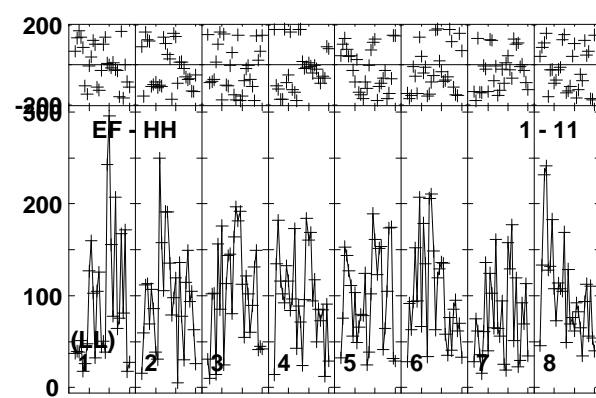
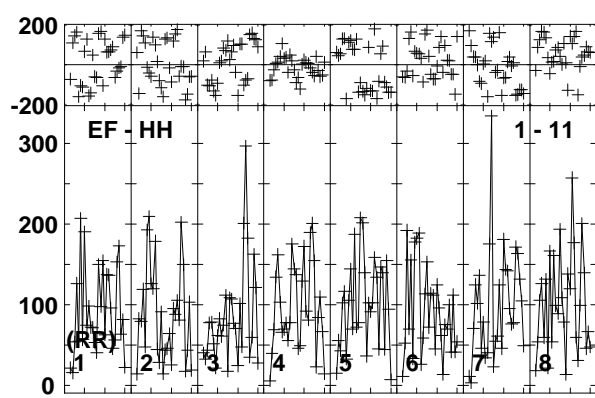
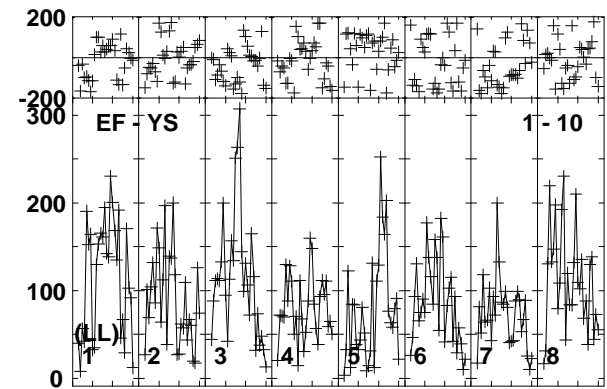
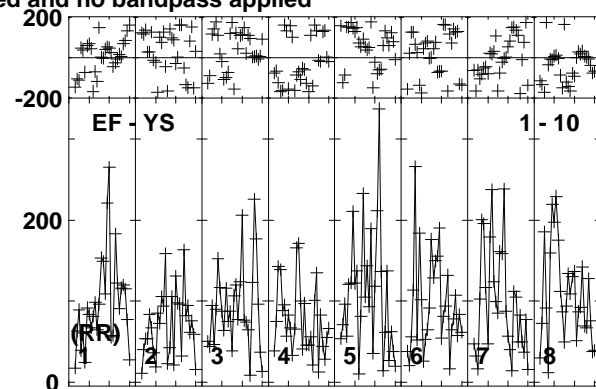
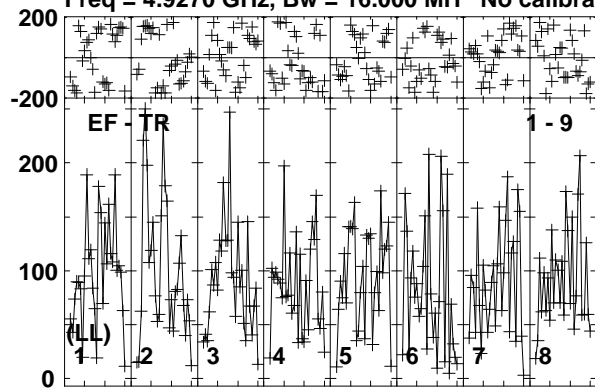

Lower frame: Micro Ampl Jy Top frame: Phas deg  
 Vector averaged cross-power spectrum Baseline: EF (01) - TR (09)  
 Timerange: 00/05:51:43 to 00/05:55:09

Plot file version 206 created 08-APR-2019 12:09:58

MRK622 EM133B.UVDATA.1

Freq = 4.9270 GHz, Bw = 16.000 MH No calibration applied and no bandpass applied

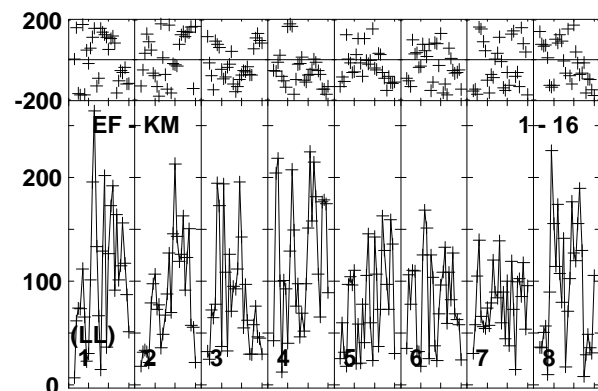
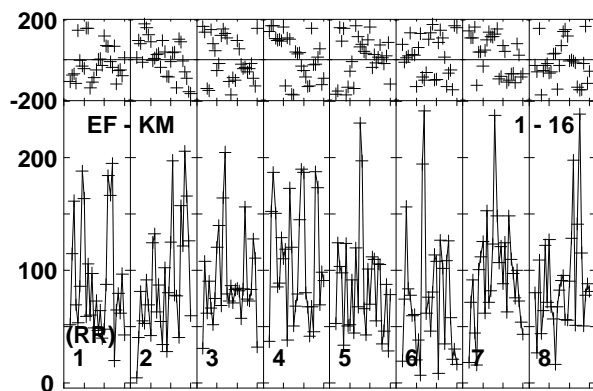
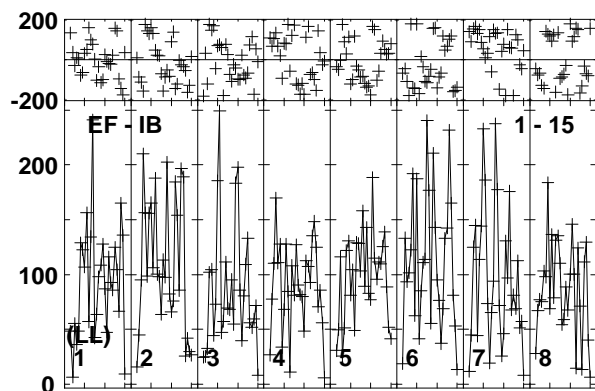
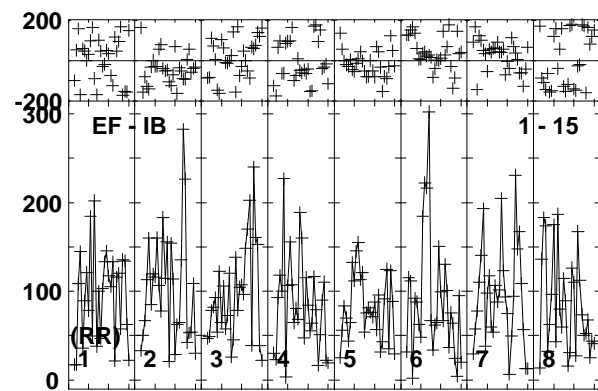
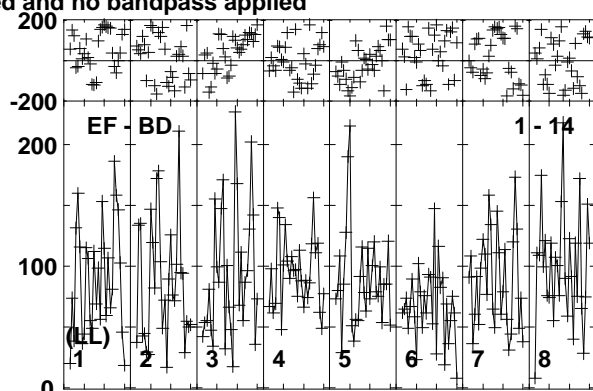
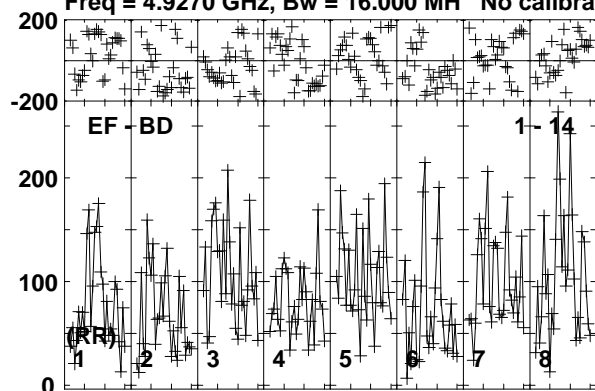

Lower frame: Micro Ampl Jy Top frame: Phas deg  
Vector averaged cross-power spectrum Baseline: EF (01) - BD (14)  
Timerange: 00/05:51:43 to 00/05:55:09

Plot file version 207 created 08-APR-2019 12:09:58

J0815+3635 EM133B.UVDATA.1

Freq = 4.9270 GHz, Bw = 16.000 MH No calibration applied and no bandpass applied

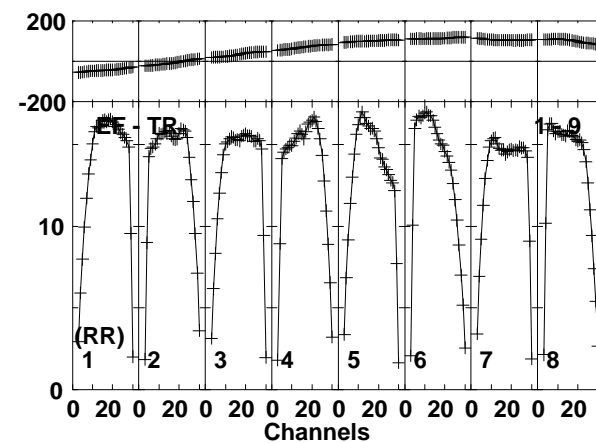
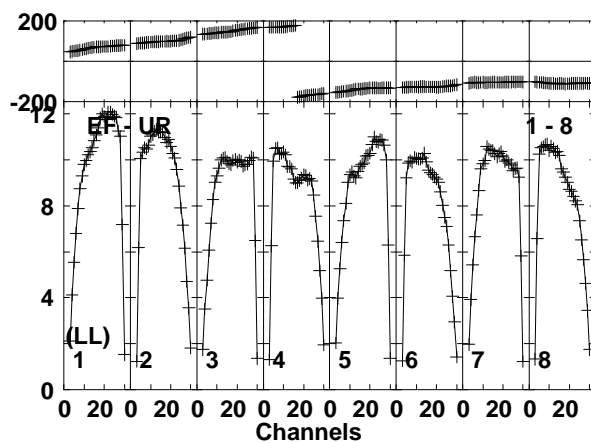
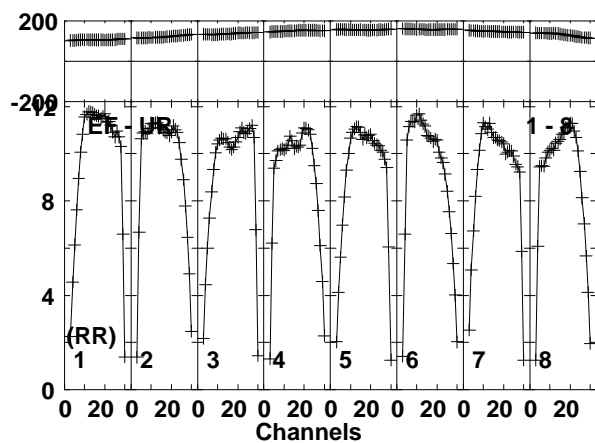
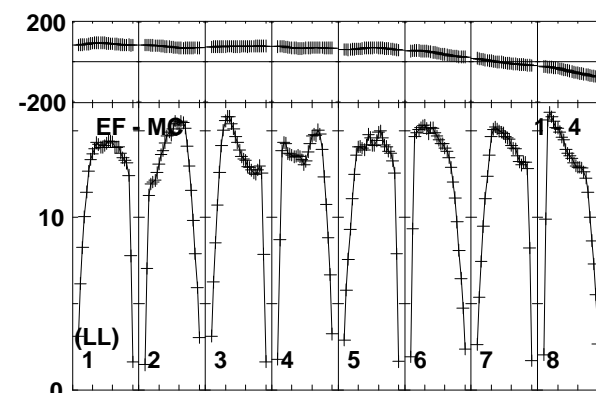
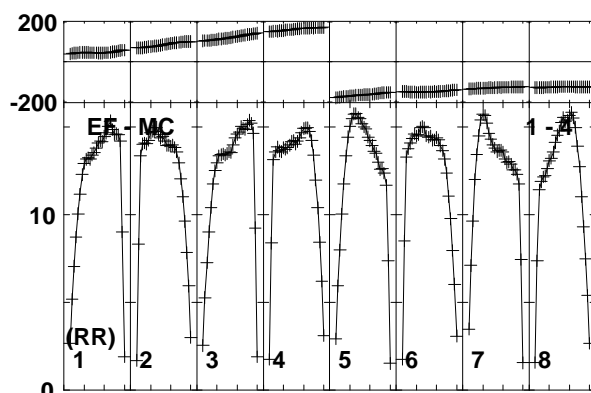
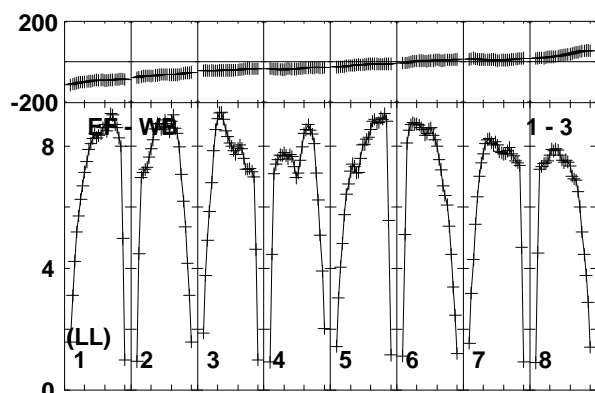
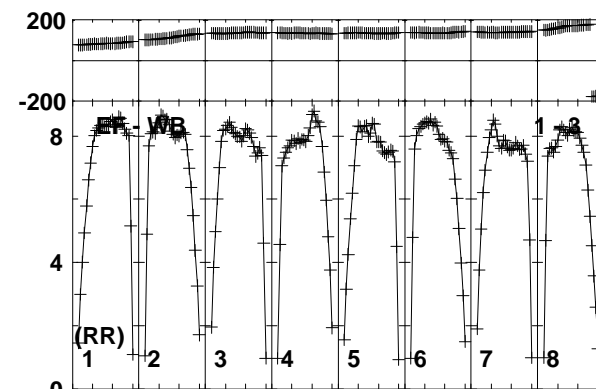
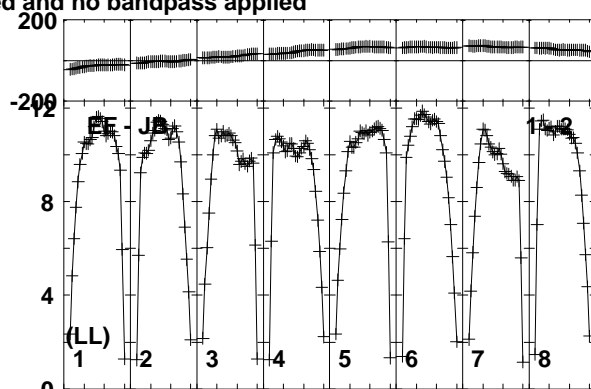
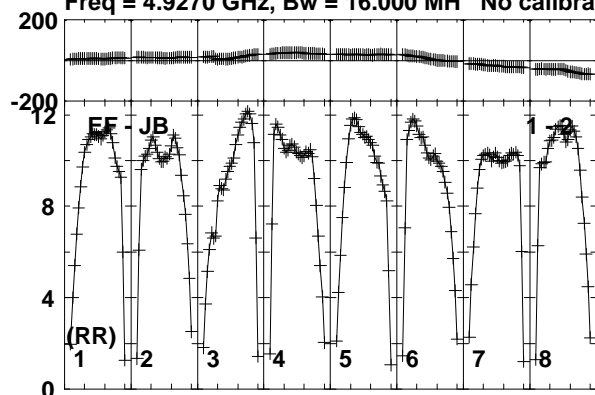

Lower frame: Milli Ampl Jy Top frame: Phas deg  
Vector averaged cross-power spectrum Baseline: EF (01) - JB (02)  
Timerange: 00/05:56:01 to 00/05:57:29

Plot file version 208 created 08-APR-2019 12:09:58

J0815+3635 EM133B.UVDATA.1

Freq = 4.9270 GHz, Bw = 16.000 MH No calibration applied and no bandpass applied

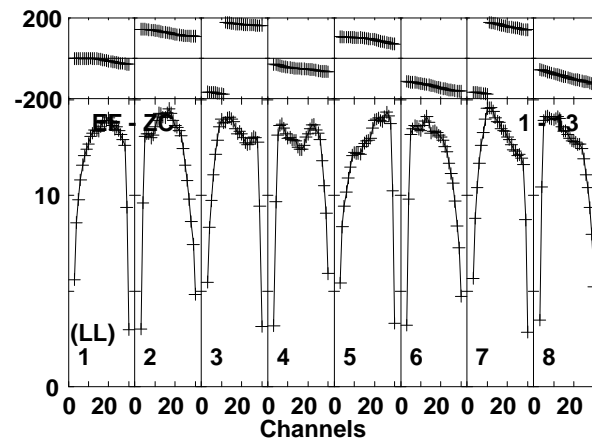
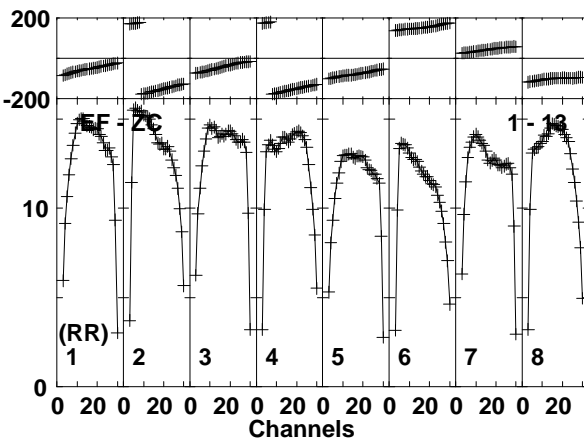
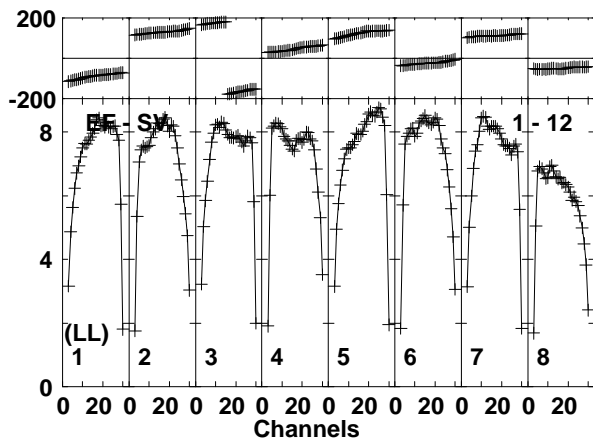
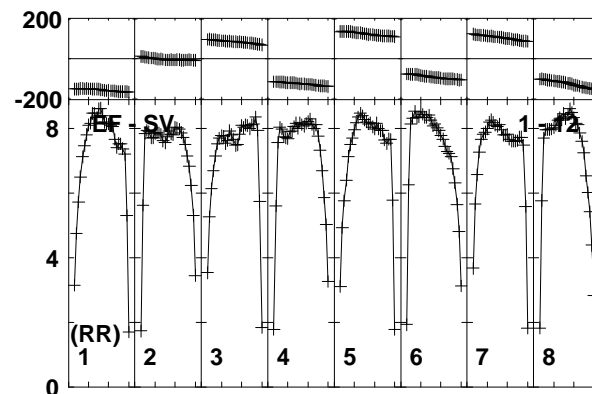
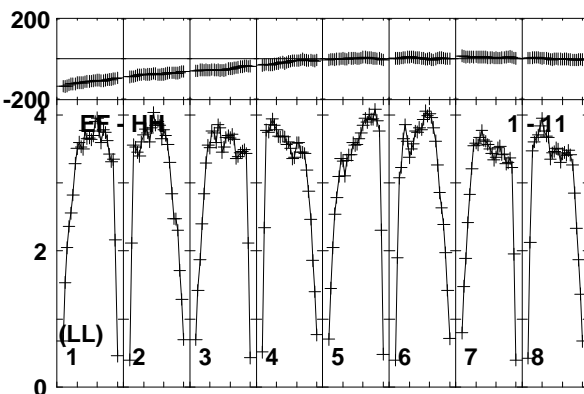
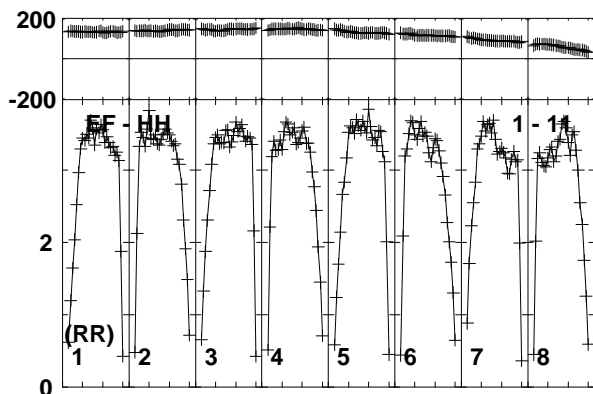
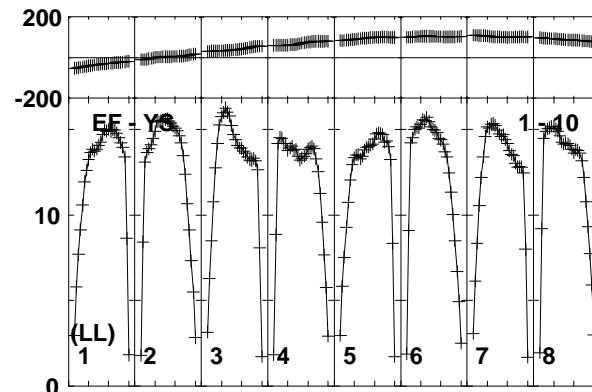
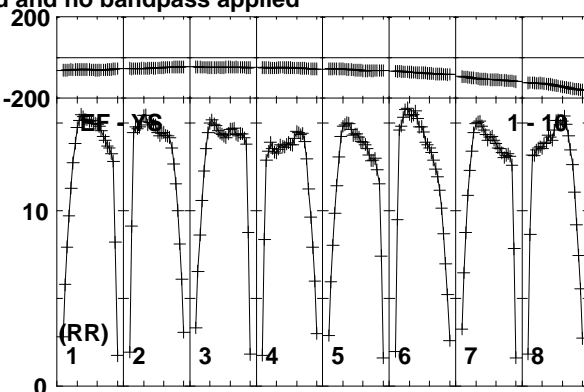
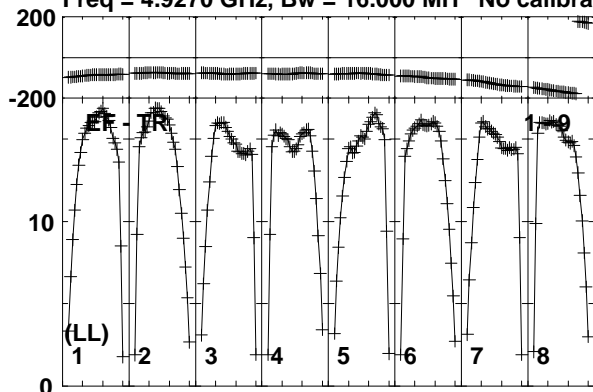

Lower frame: Milli Ampl Jy Top frame: Phas deg  
Vector averaged cross-power spectrum Baseline: EF (01) - TR (09)  
Timerange: 00/05:56:01 to 00/05:57:29



Plot file version 209 created 08-APR-2019 12:09:58

J0815+3635 EM133B.UVDATA.1

Freq = 4.9270 GHz, Bw = 16.000 MH No calibration applied and no bandpass applied

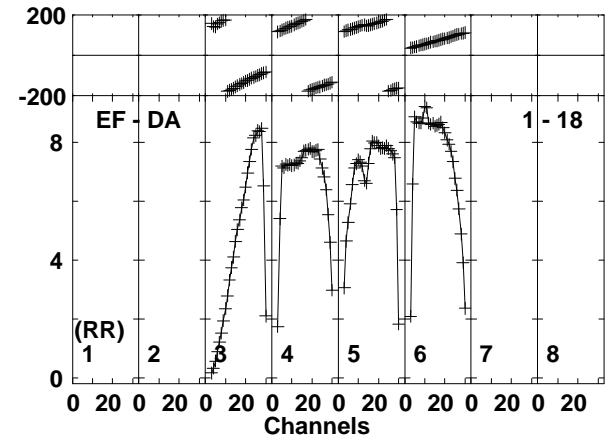
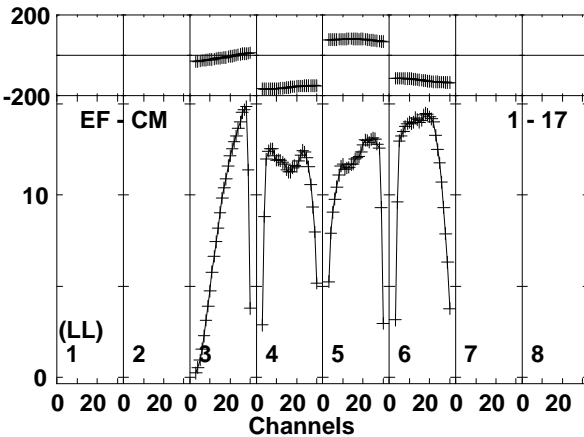
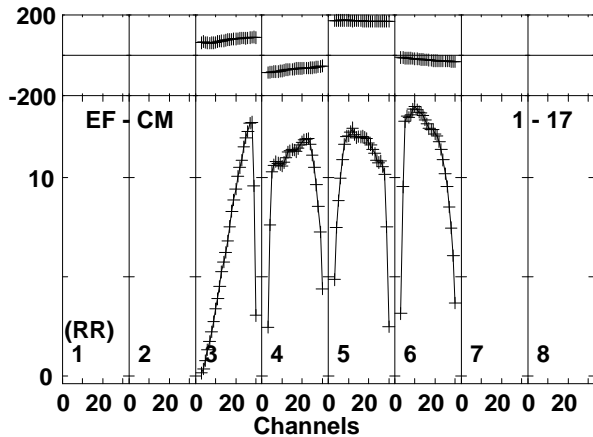
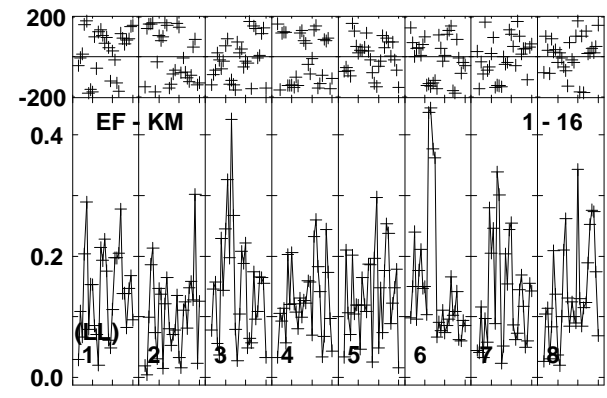
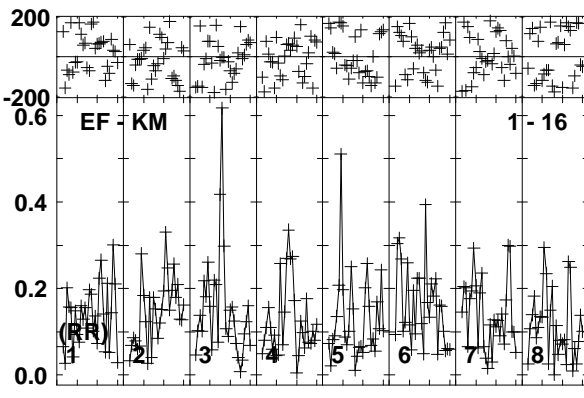
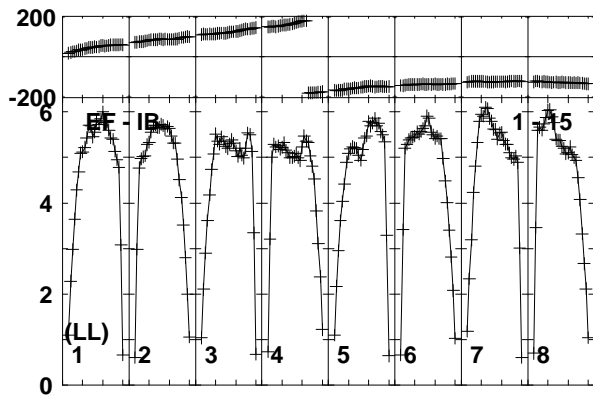
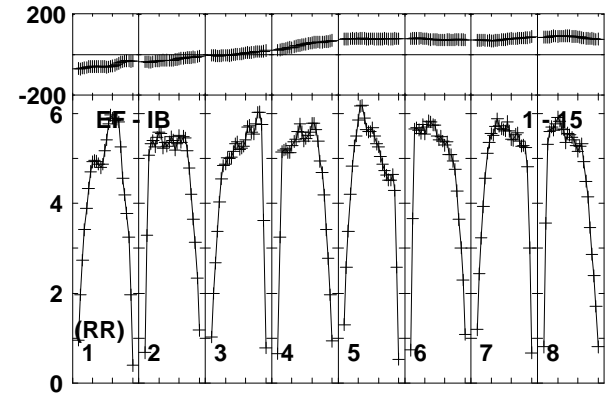
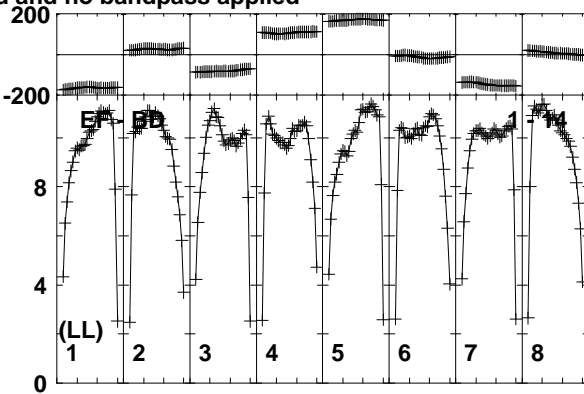
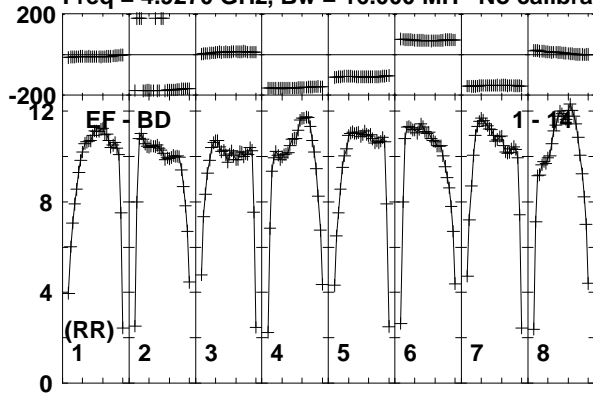

Lower frame: Milli Ampl Jy Top frame: Phas deg  
Vector averaged cross-power spectrum Baseline: EF (01) - BD (14)  
Timerange: 00/05:56:01 to 00/05:57:29

Plot file version 210 created 08-APR-2019 12:09:59

J0815+3635 EM133B.UVDATA.1

Freq = 4.9270 GHz, Bw = 16.000 MH No calibration applied and no bandpass applied

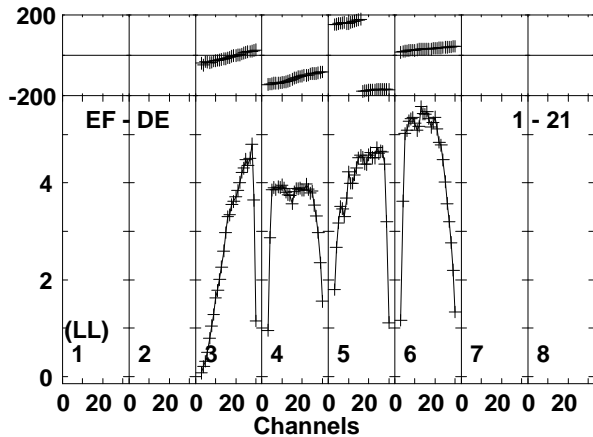
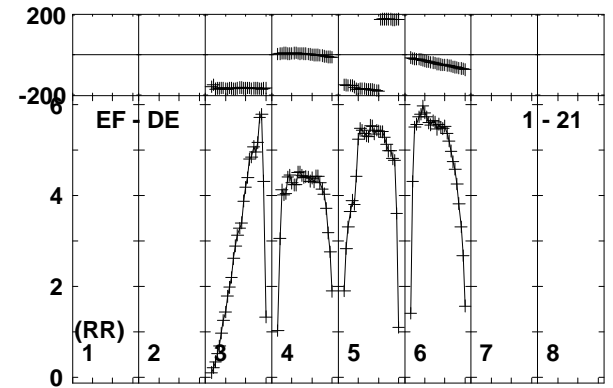
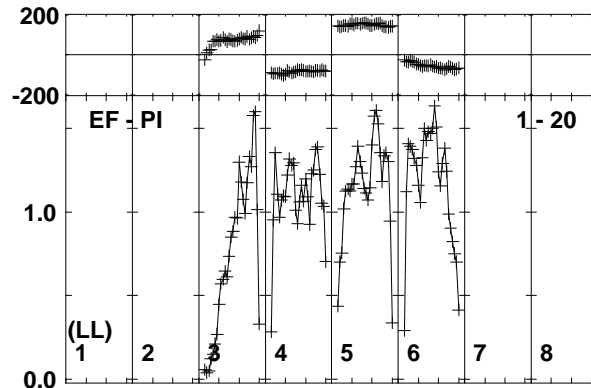
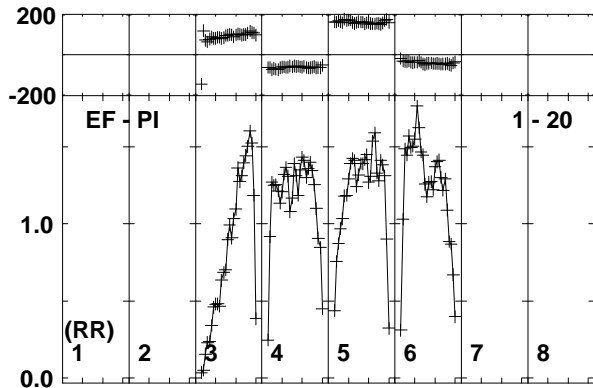
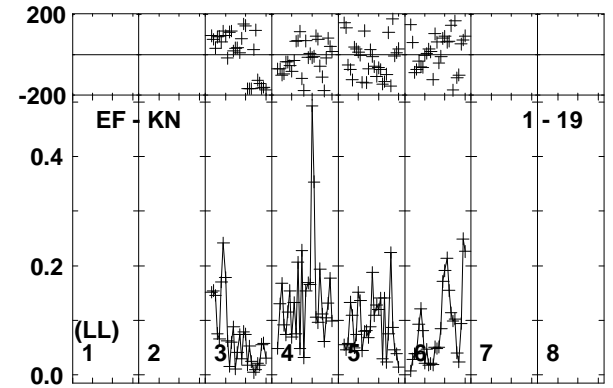
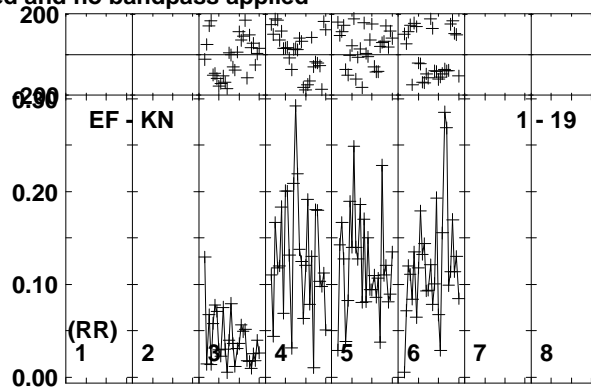
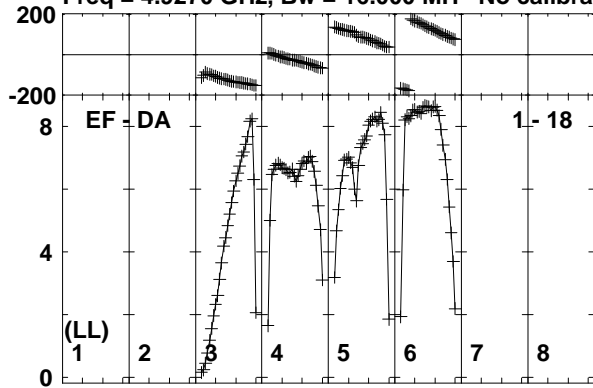

Lower frame: Milli Ampl Jy Top frame: Phas deg  
Vector averaged cross-power spectrum Baseline: EF (01) - DA (18)  
Timerange: 00/05:56:01 to 00/05:57:29

Plot file version 211 created 08-APR-2019 12:09:59

MRK622 EM133B.UVDATA.1

Freq = 4.9270 GHz, Bw = 16.000 MH No calibration applied and no bandpass applied

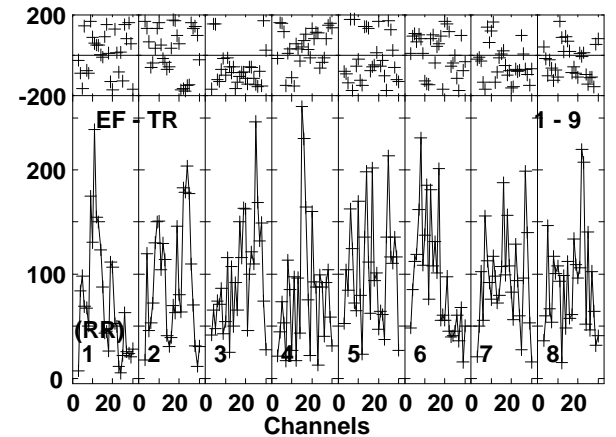
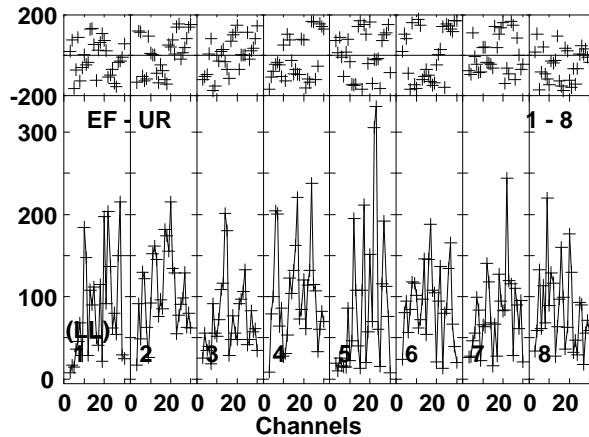
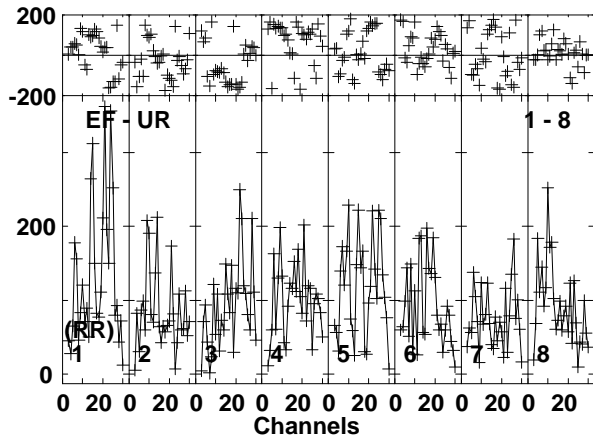
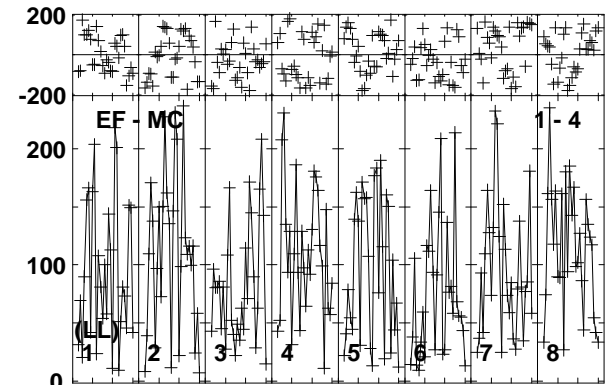
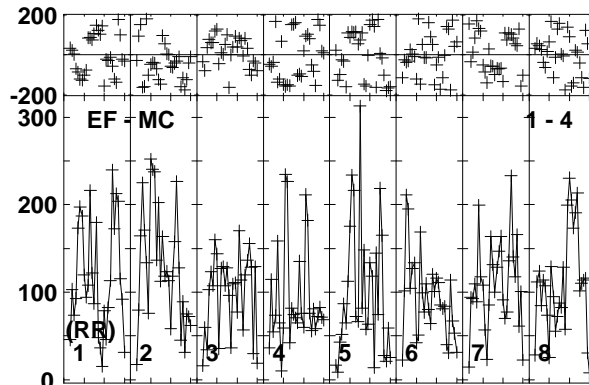
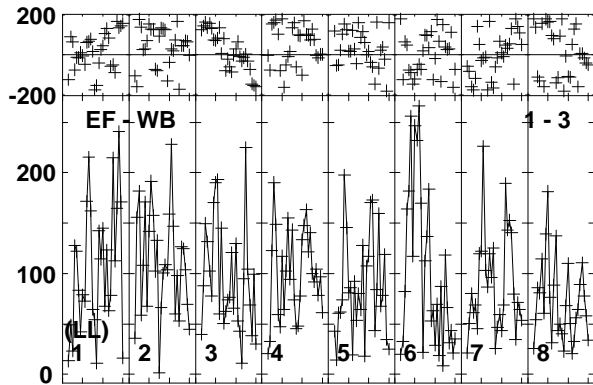
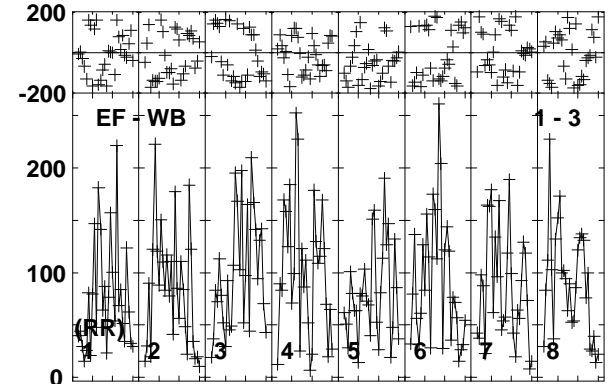
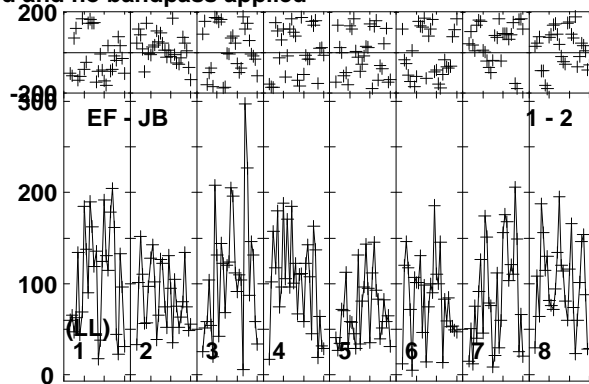
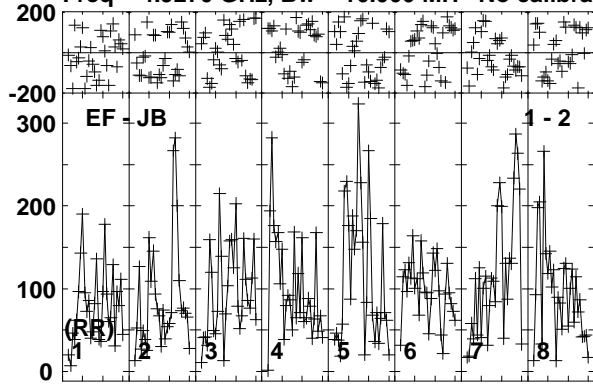

Lower frame: Micro Ampl Jy Top frame: Phas deg  
Vector averaged cross-power spectrum Baseline: EF (01) - JB (02)  
Timerange: 00/05:57:31 to 00/06:00:59

Plot file version 212 created 08-APR-2019 12:09:59

MRK622 EM133B.UVDATA.1

Freq = 4.9270 GHz, Bw = 16.000 MH No calibration applied and no bandpass applied

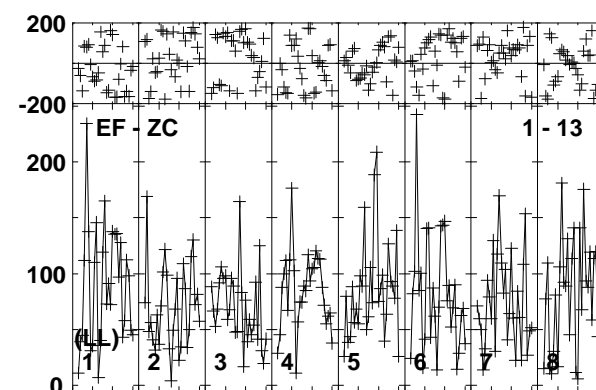
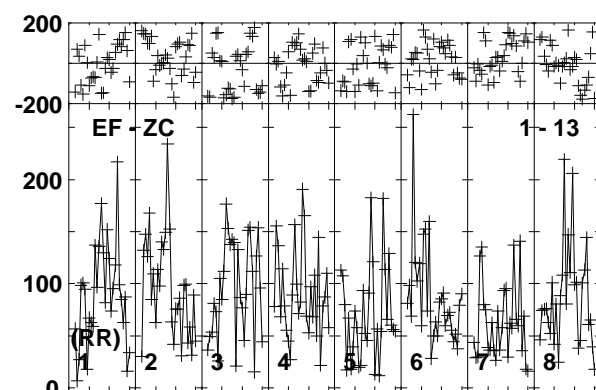
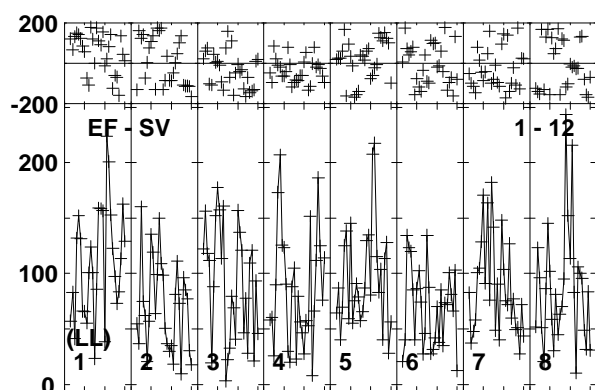
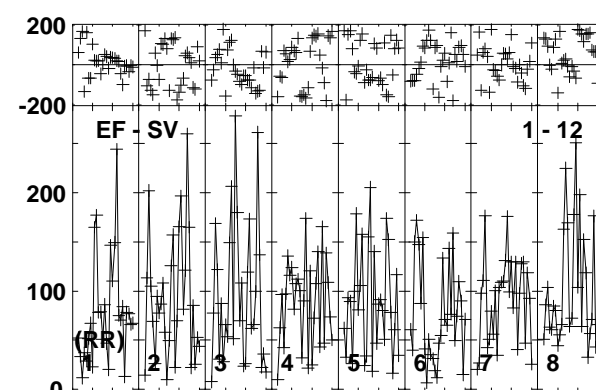
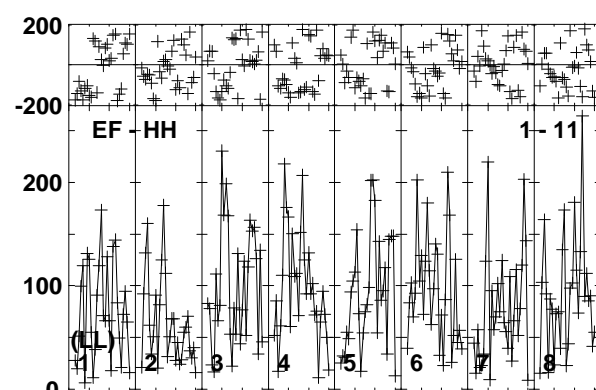
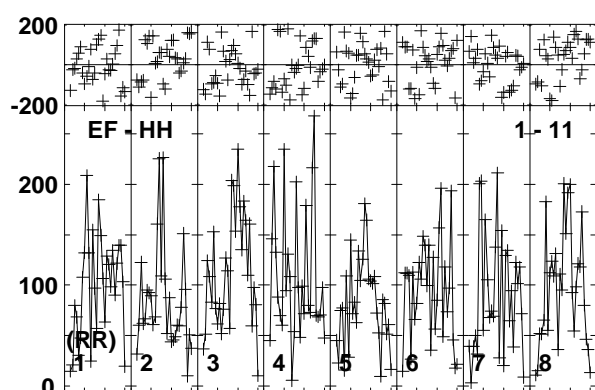
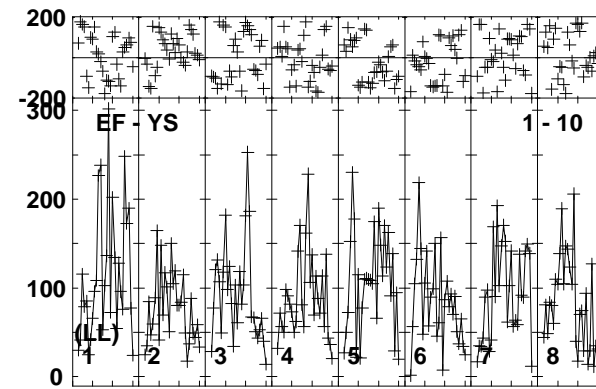
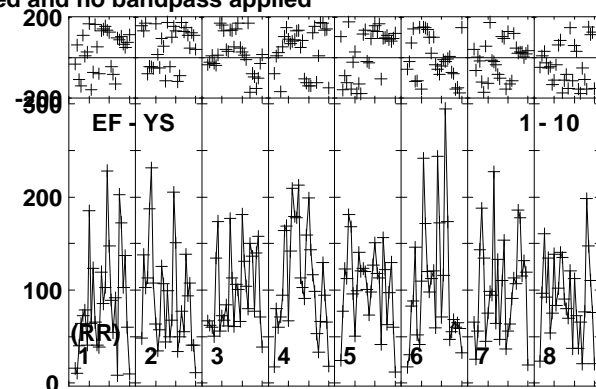
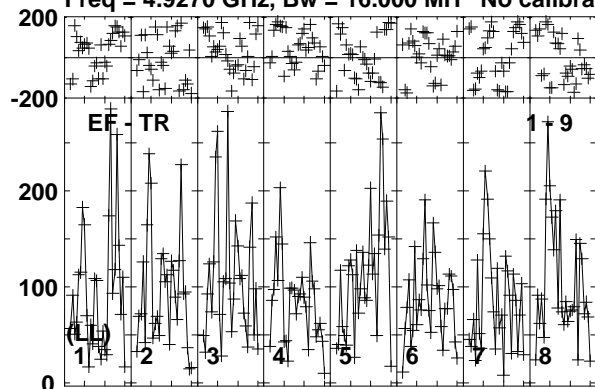

Lower frame: Micro Ampl Jy Top frame: Phas deg  
Vector averaged cross-power spectrum Baseline: EF (01) - TR (09)  
Timerange: 00/05:57:31 to 00/06:00:59

Plot file version 213 created 08-APR-2019 12:09:59

MRK622 EM133B.UVDATA.1

Freq = 4.9270 GHz, Bw = 16.000 MH No calibration applied and no bandpass applied

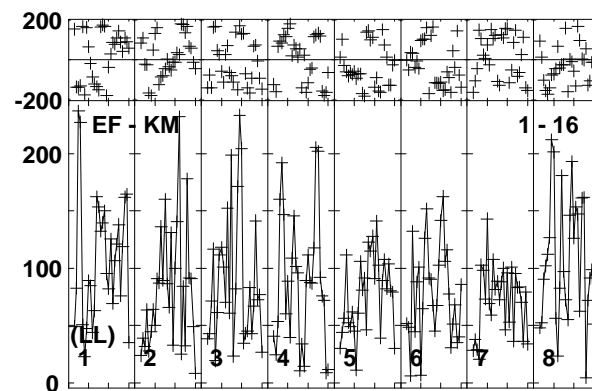
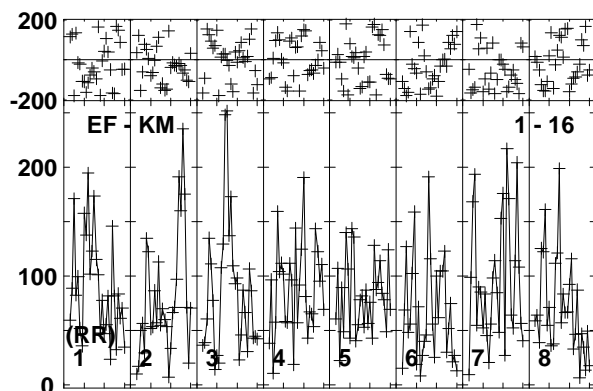
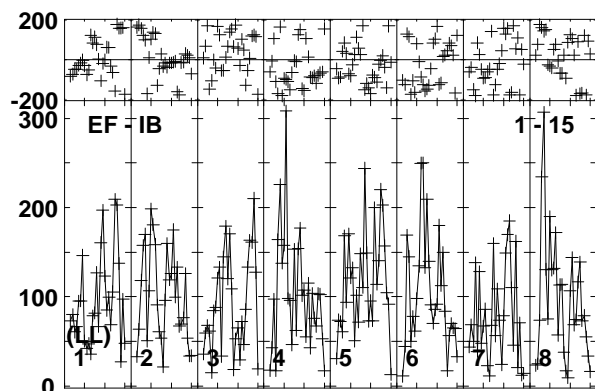
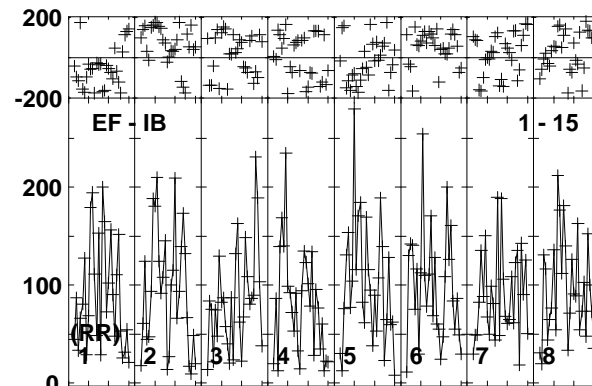
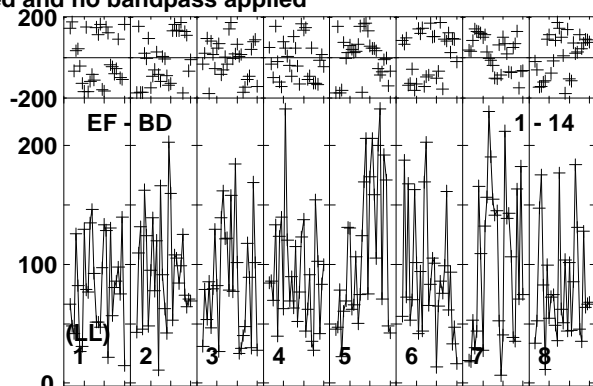
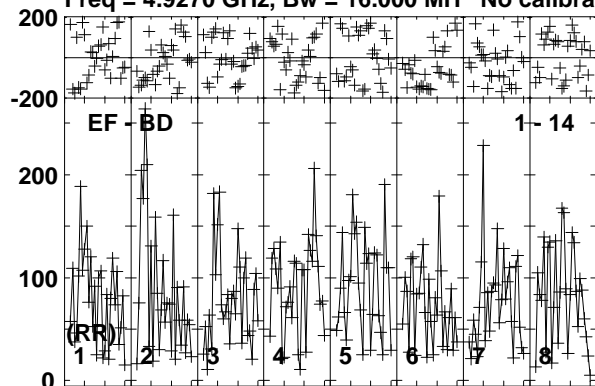

Lower frame: Micro Ampl Jy Top frame: Phas deg  
Vector averaged cross-power spectrum Baseline: EF (01) - BD (14)  
Timerange: 00/05:57:31 to 00/06:00:59

Plot file version 214 created 08-APR-2019 12:09:59

J0815+3635 EM133B.UVDATA.1

Freq = 4.9270 GHz, Bw = 16.000 MH No calibration applied and no bandpass applied

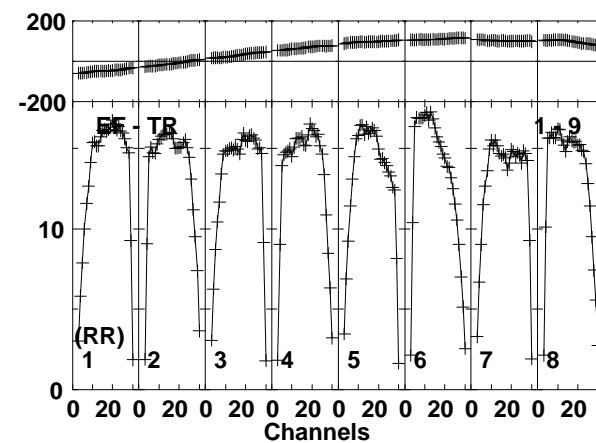
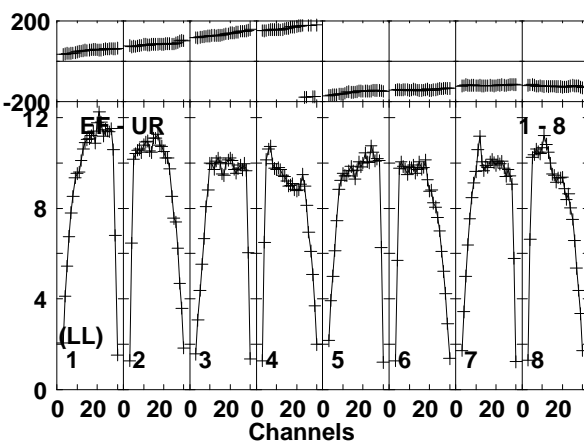
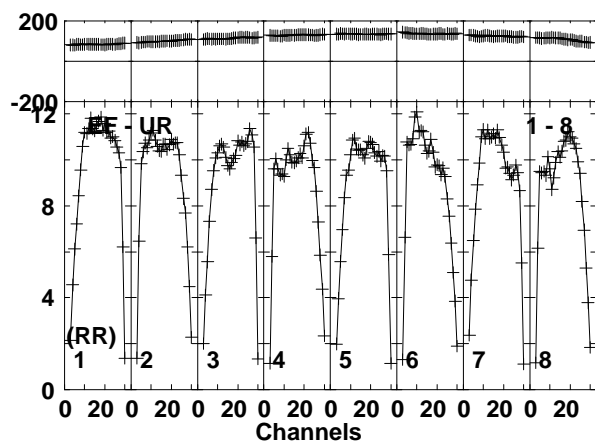
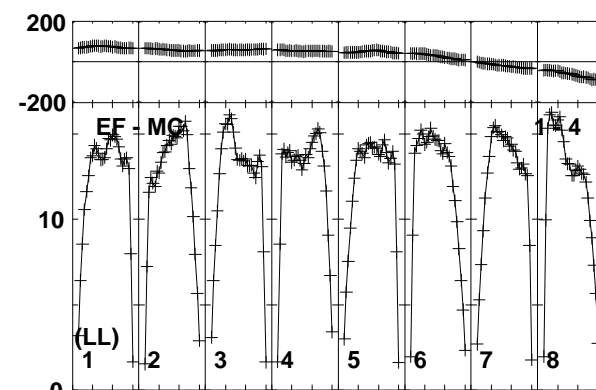
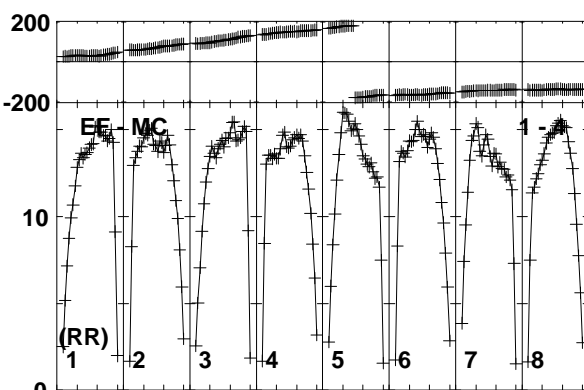
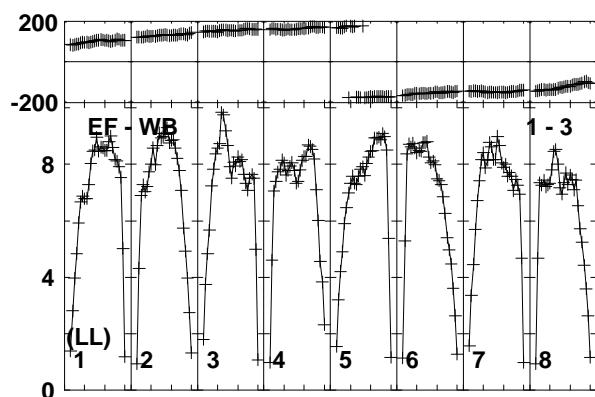
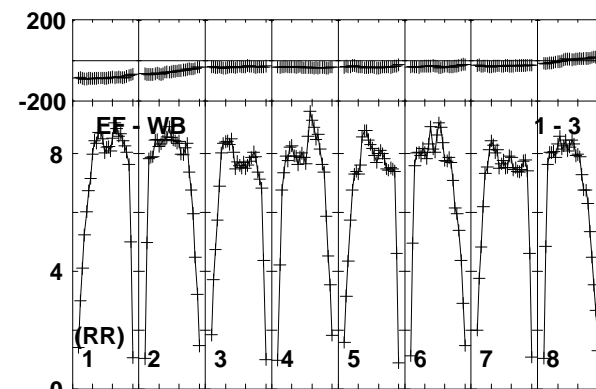
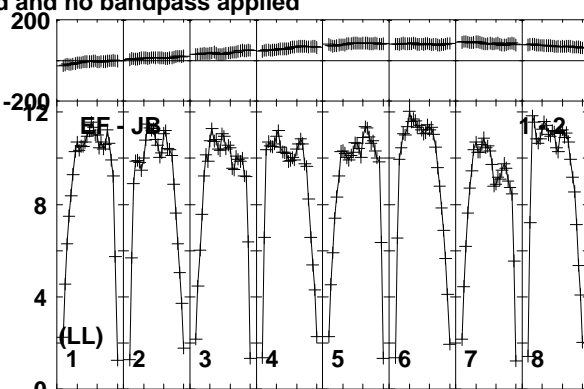
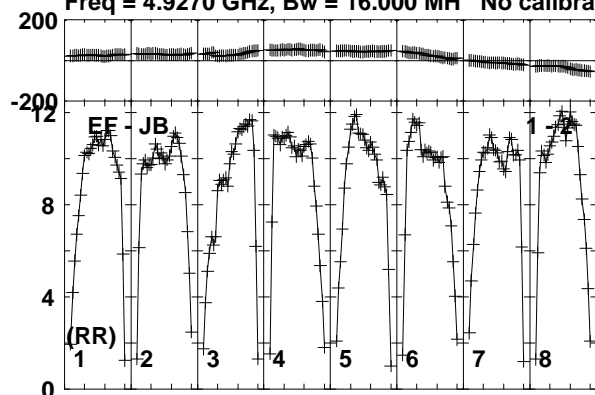

Lower frame: Milli Ampl Jy Top frame: Phas deg  
Vector averaged cross-power spectrum Baseline: EF (01) - JB (02)  
Timerange: 00/06:01:01 to 00/06:02:29

Plot file version 215 created 08-APR-2019 12:09:59

J0815+3635 EM133B.UVDATA.1

Freq = 4.9270 GHz, Bw = 16.000 MH No calibration applied and no bandpass applied

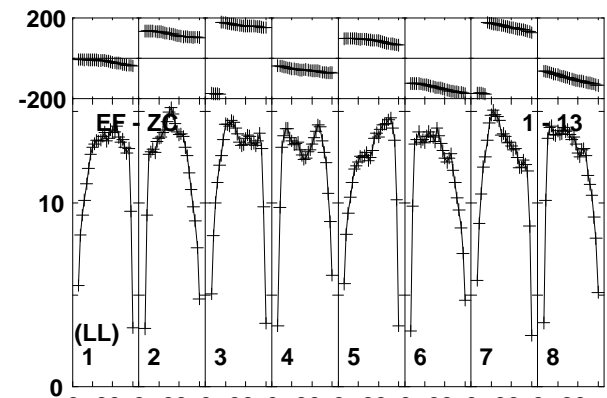
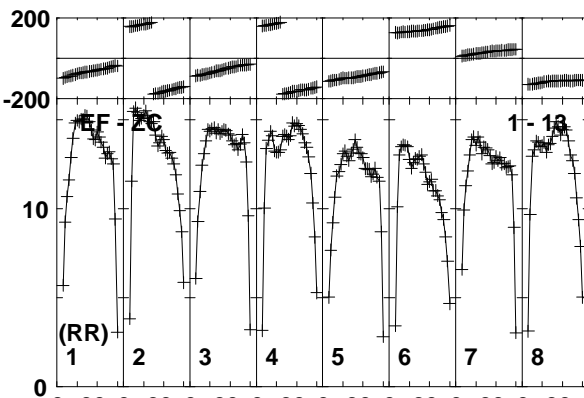
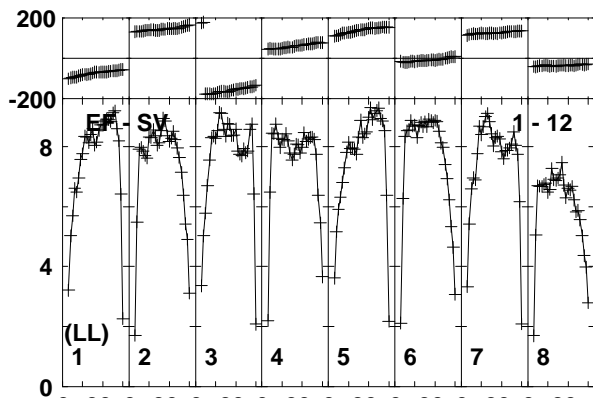
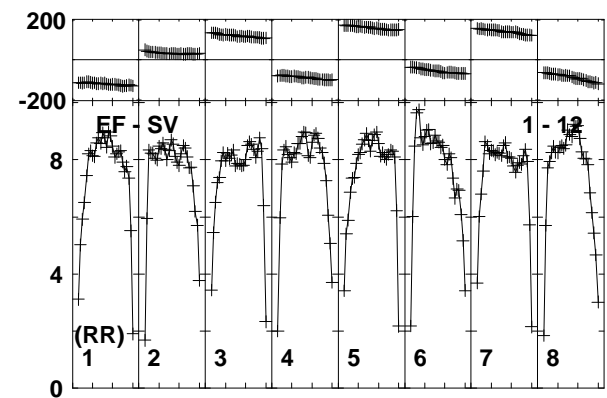
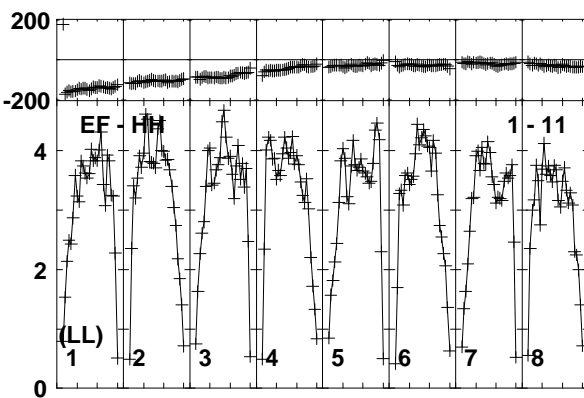
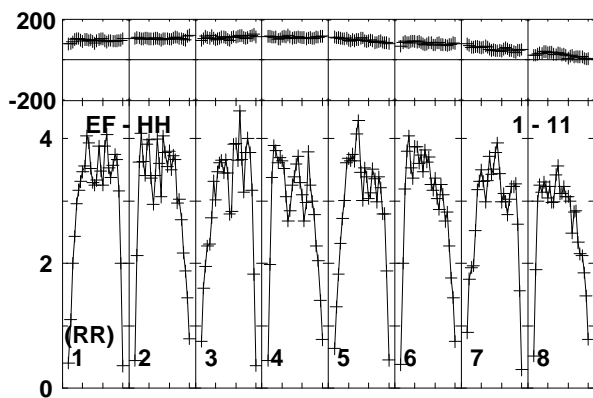
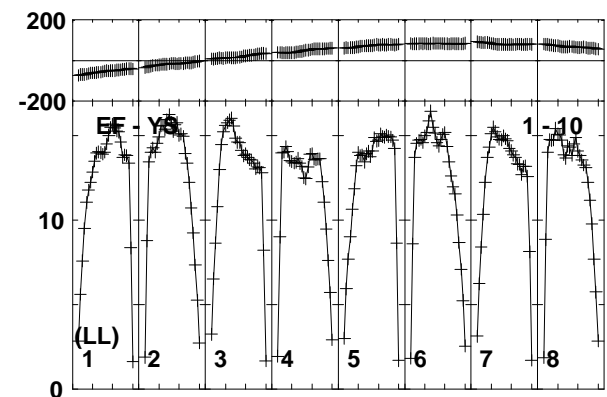
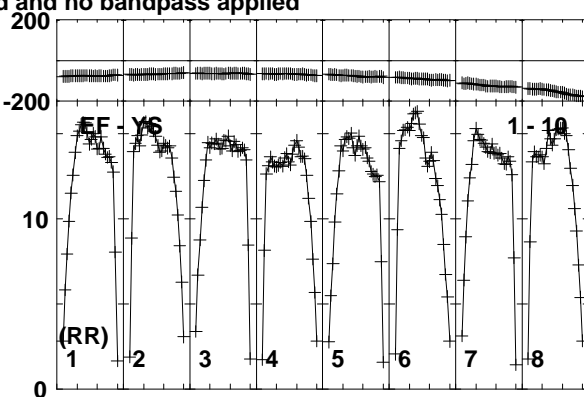
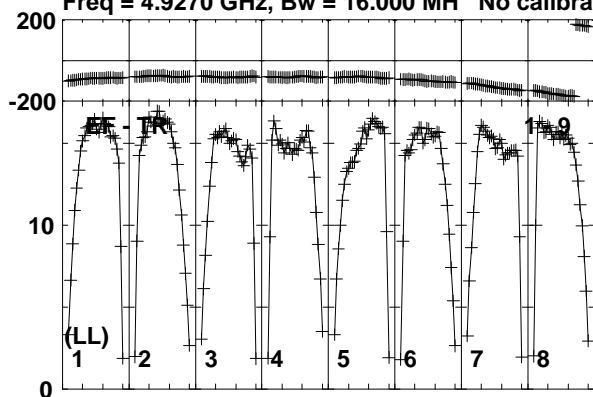

Lower frame: Milli Ampl Jy Top frame: Phas deg  
Vector averaged cross-power spectrum Baseline: EF (01) - TR (09)  
Timerange: 00/06:01:01 to 00/06:02:29

Plot file version 216 created 08-APR-2019 12:09:59

J0815+3635 EM133B.UVDATA.1

Freq = 4.9270 GHz, Bw = 16.000 MH No calibration applied and no bandpass applied

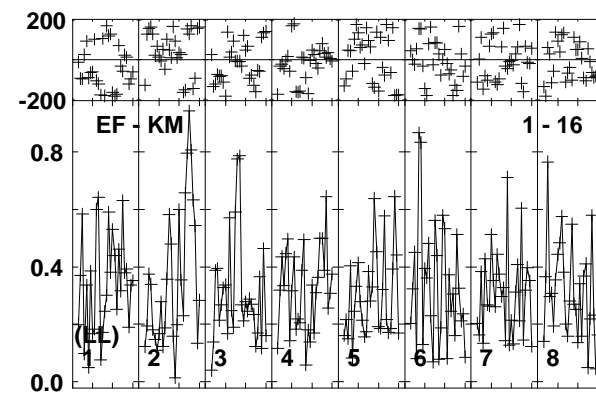
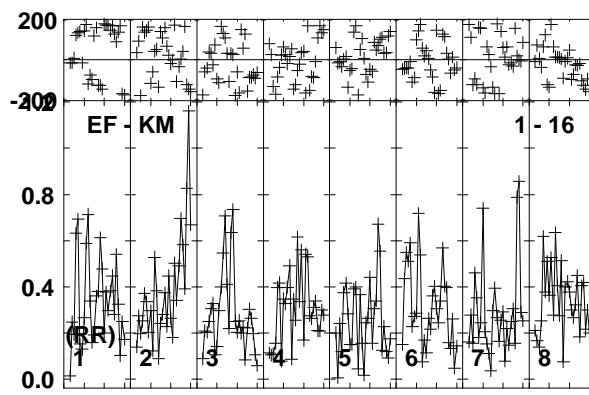
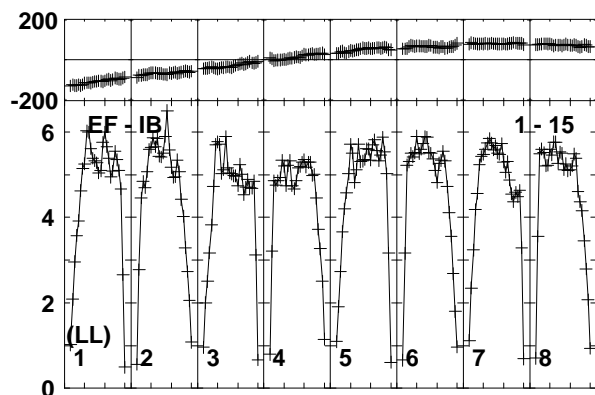
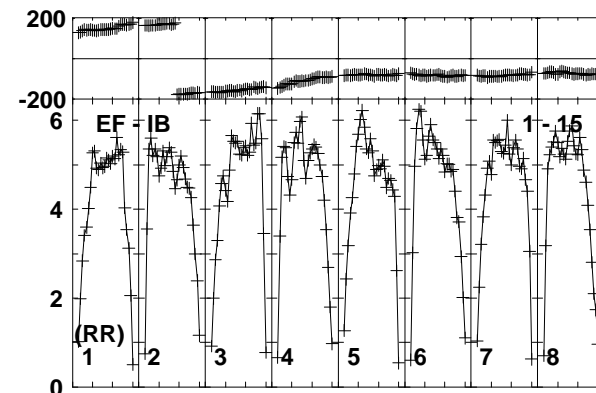
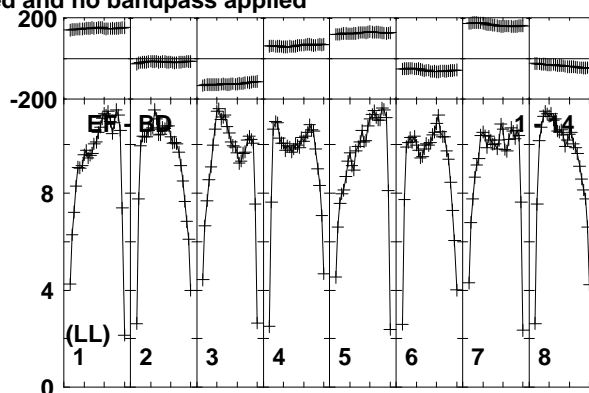
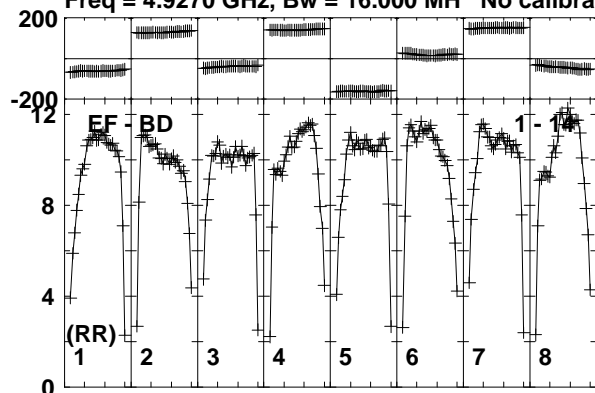

Lower frame: Milli Ampl Jy Top frame: Phas deg  
Vector averaged cross-power spectrum Baseline: EF (01) - BD (14)  
Timerange: 00/06:01:01 to 00/06:02:29



Plot file version 217 created 08-APR-2019 12:10:00

MRK622 EM133B.UVDATA.1

Freq = 4.9270 GHz, Bw = 16.000 MH No calibration applied and no bandpass applied

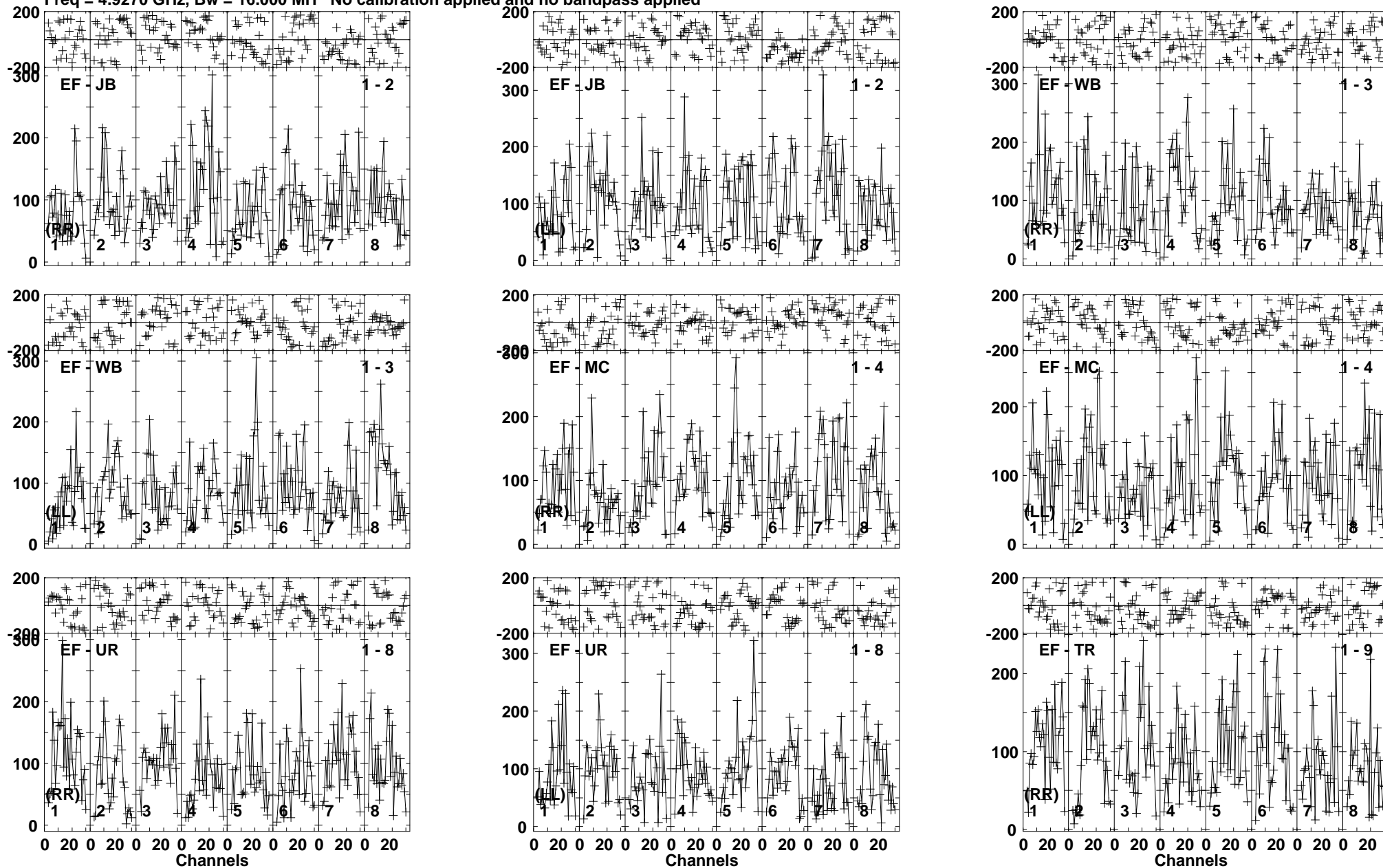

Lower frame: Micro Ampl Jy Top frame: Phas deg  
Vector averaged cross-power spectrum Baseline: EF (01) - JB (02)  
Timerange: 00/06:02:33 to 00/06:05:59

Plot file version 218 created 08-APR-2019 12:10:00

MRK622 EM133B.UVDATA.1

Freq = 4.9270 GHz, Bw = 16.000 MH No calibration applied and no bandpass applied

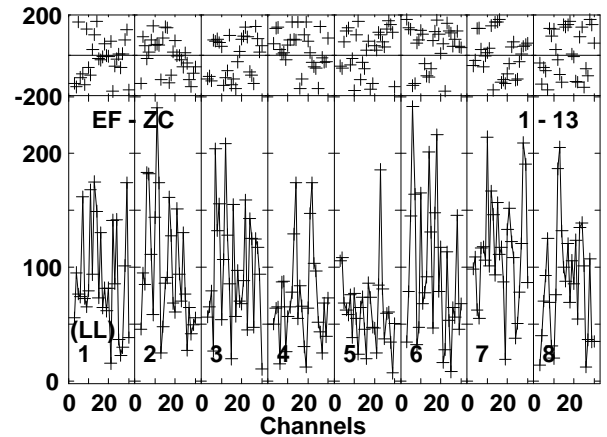
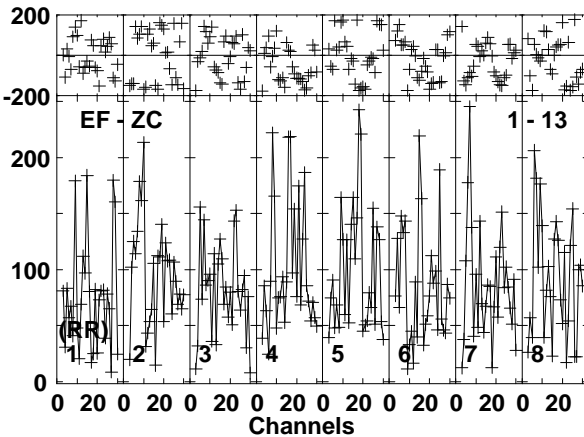
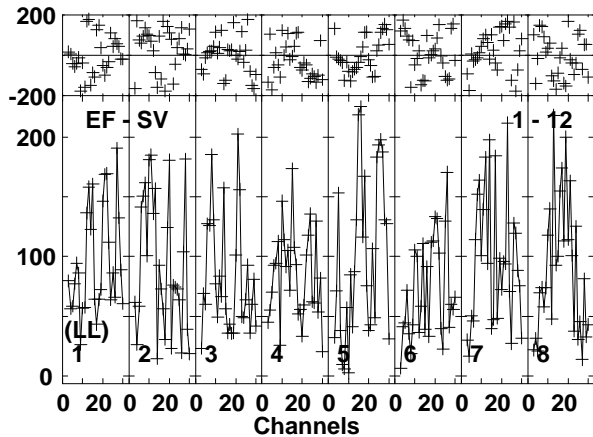
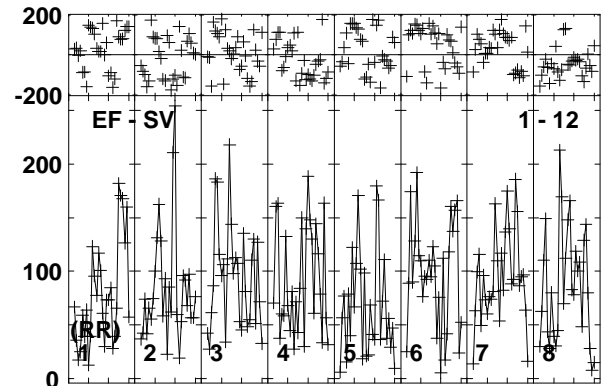
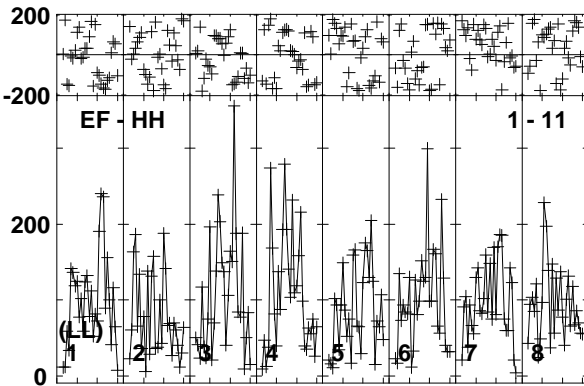
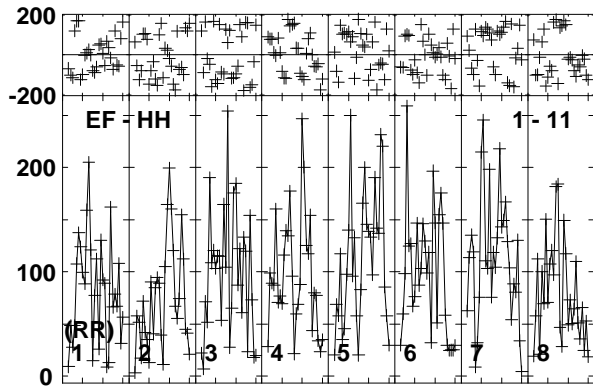
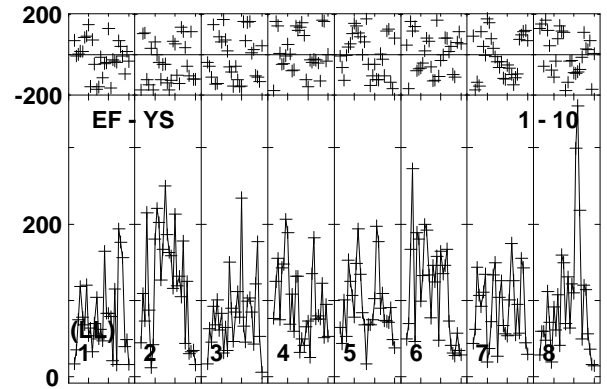
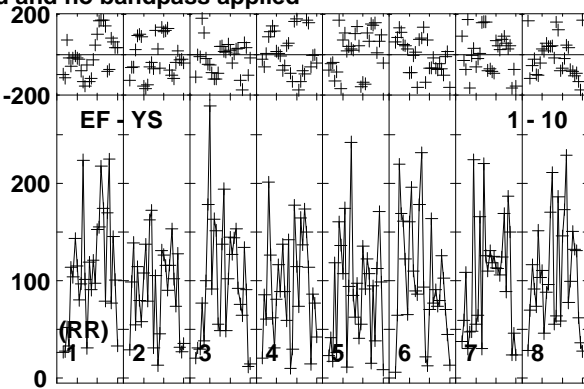
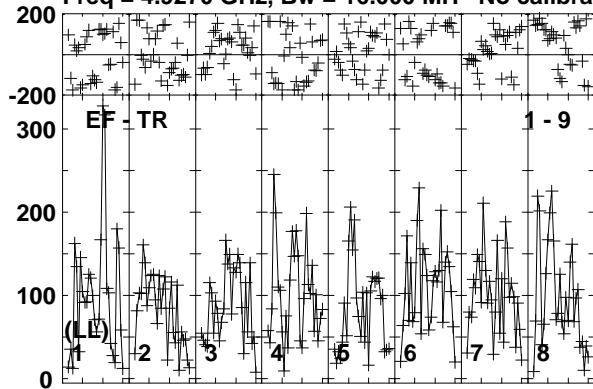

Lower frame: Micro Ampl Jy Top frame: Phas deg  
Vector averaged cross-power spectrum Baseline: EF (01) - TR (09)  
Timerange: 00/06:02:33 to 00/06:05:59

Plot file version 219 created 08-APR-2019 12:10:00

MRK622 EM133B.UVDATA.1

Freq = 4.9270 GHz, Bw = 16.000 MH No calibration applied and no bandpass applied

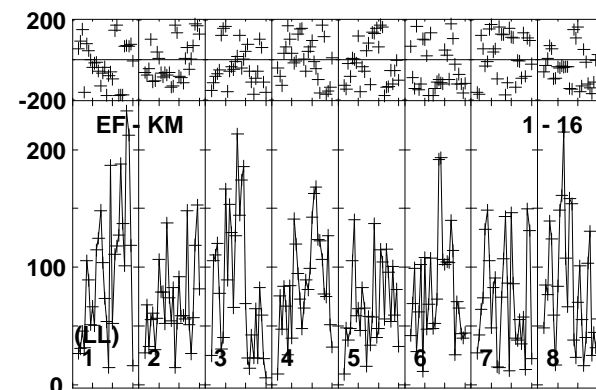
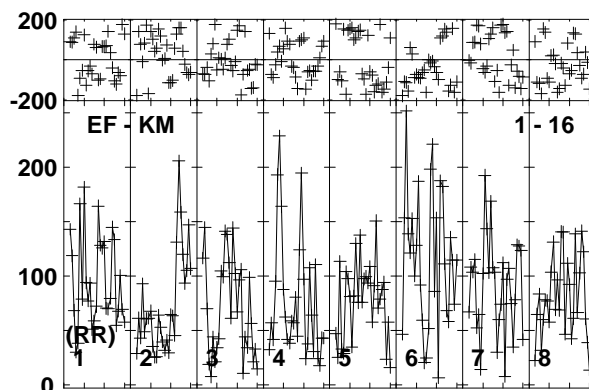
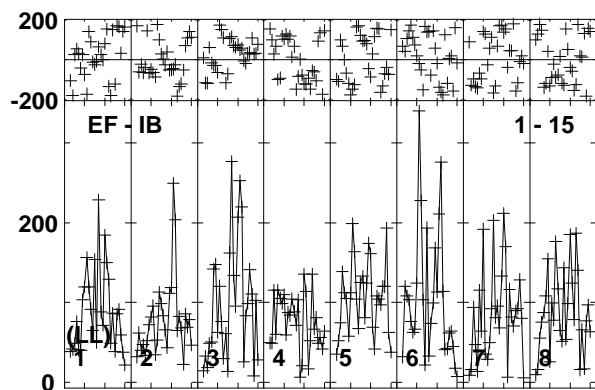
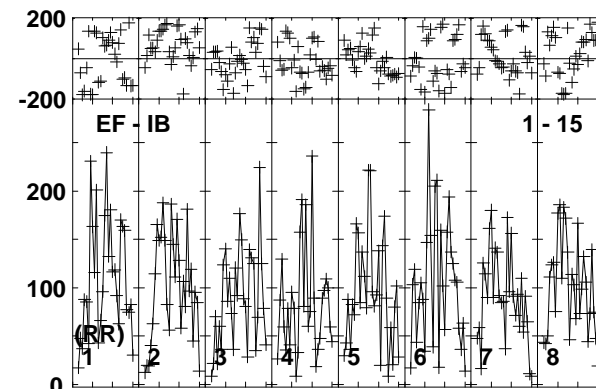
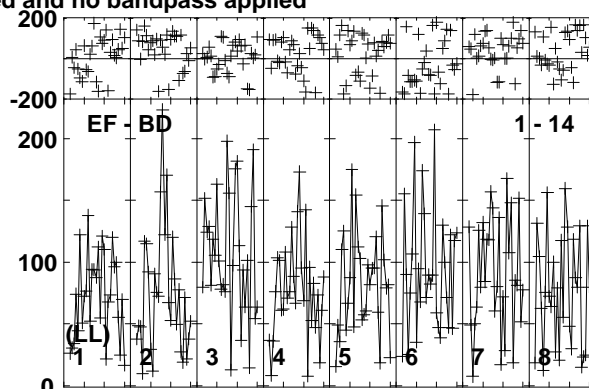
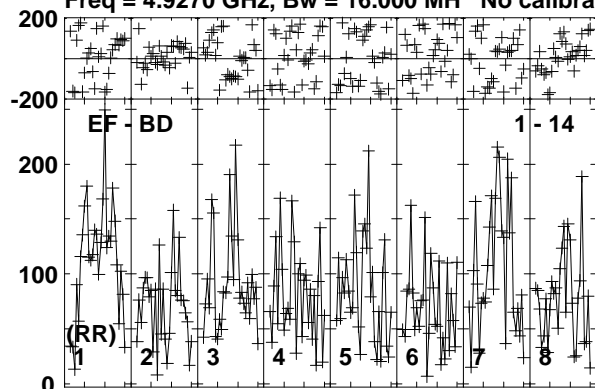

Lower frame: Micro Ampl Jy Top frame: Phas deg  
Vector averaged cross-power spectrum Baseline: EF (01) - BD (14)  
Timerange: 00/06:02:33 to 00/06:05:59

Plot file version 220 created 08-APR-2019 12:10:00

J0815+3635 EM133B.UVDATA.1

Freq = 4.9270 GHz, Bw = 16.000 MH No calibration applied and no bandpass applied

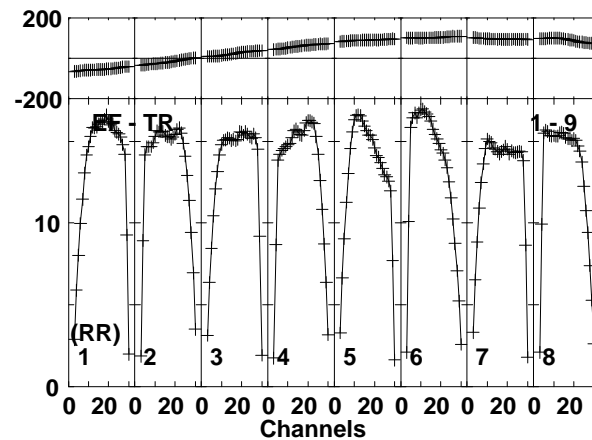
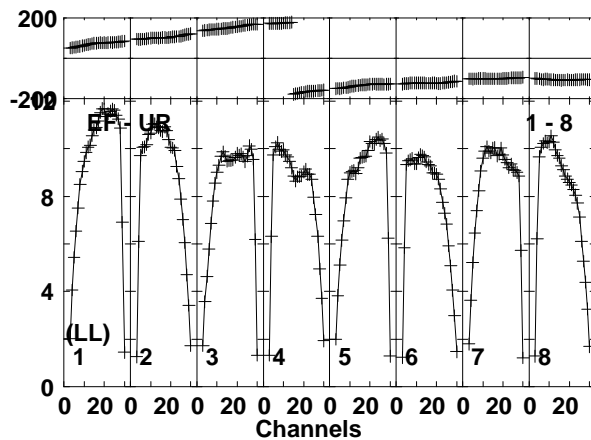
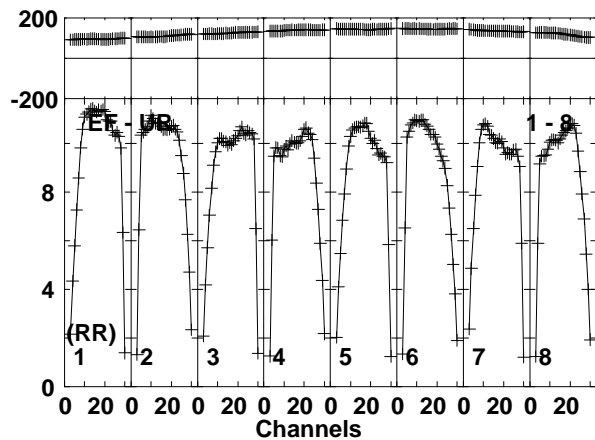
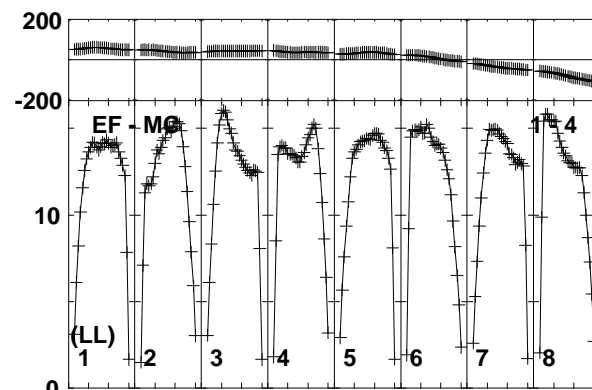
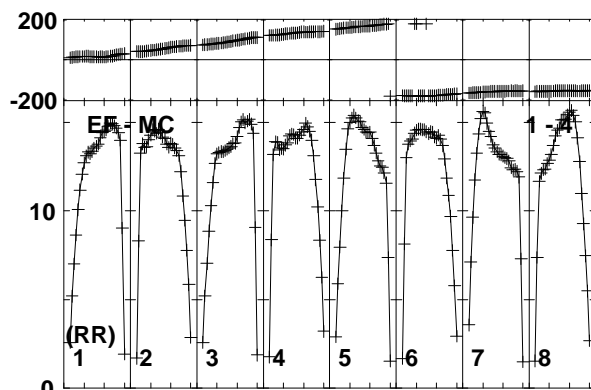
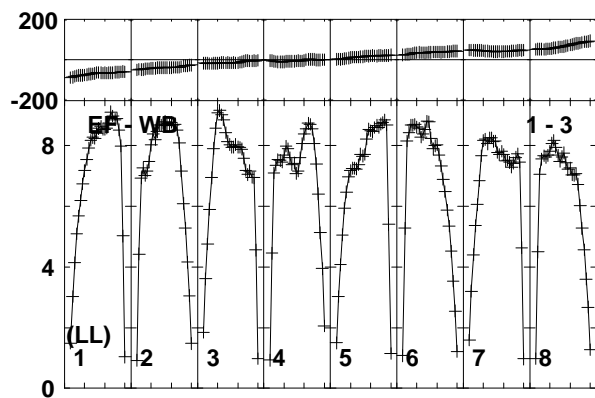
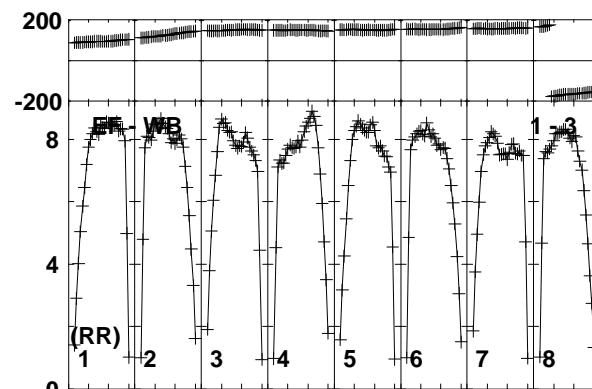
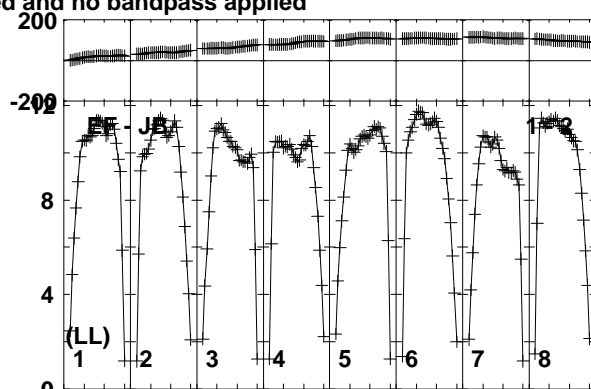
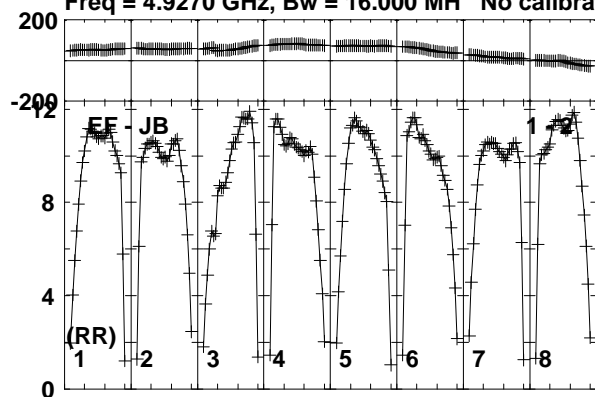

Lower frame: Milli Ampl Jy Top frame: Phas deg  
Vector averaged cross-power spectrum Baseline: EF (01) - JB (02)  
Timerange: 00/06:06:51 to 00/06:08:19

Plot file version 221 created 08-APR-2019 12:10:00

J0815+3635 EM133B.UVDATA.1

Freq = 4.9270 GHz, Bw = 16.000 MH No calibration applied and no bandpass applied

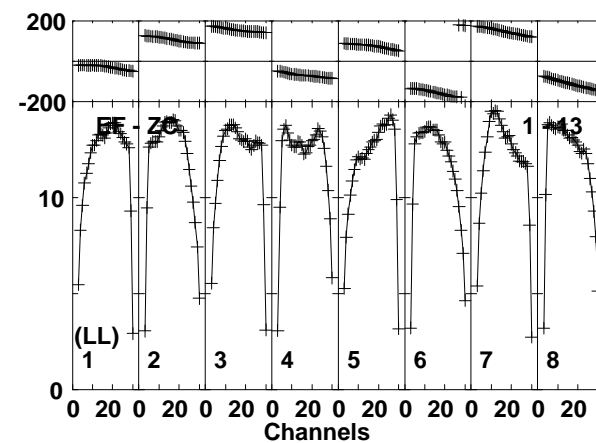
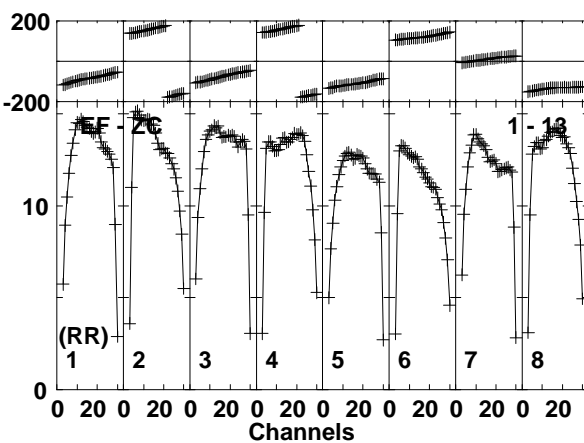
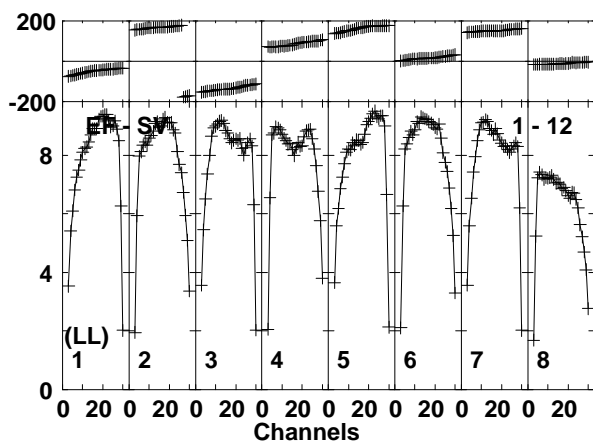
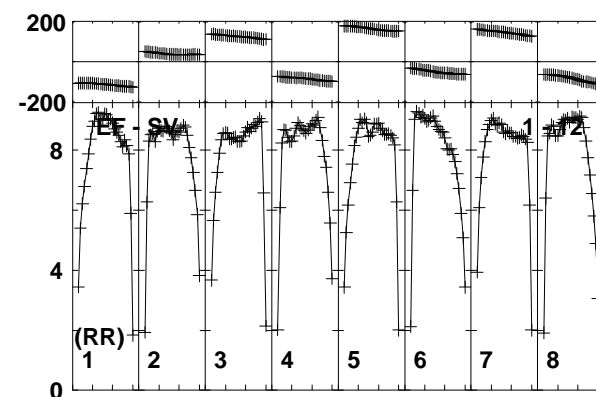
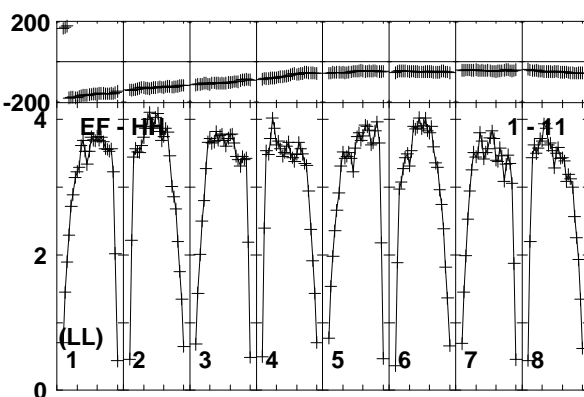
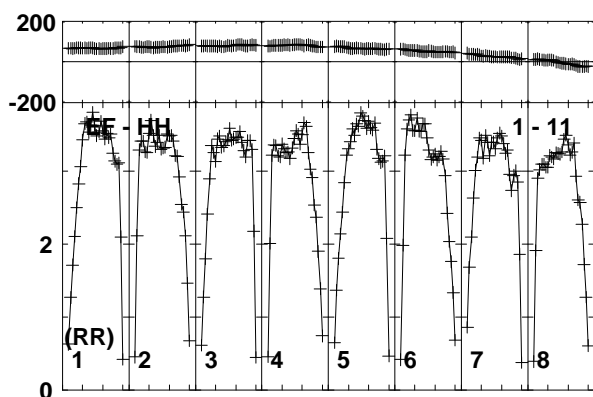
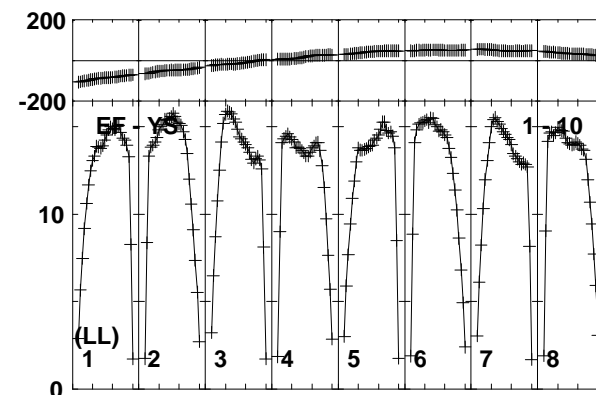
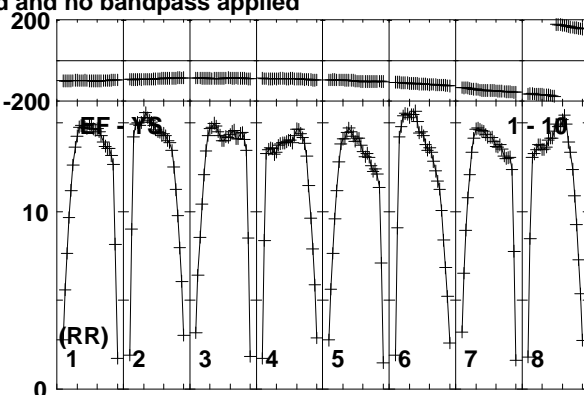
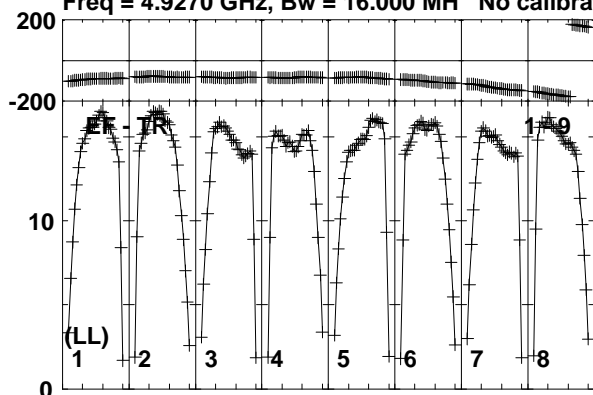

Lower frame: Milli Ampl Jy Top frame: Phas deg  
Vector averaged cross-power spectrum Baseline: EF (01) - TR (09)  
Timerange: 00/06:06:51 to 00/06:08:19

Plot file version 222 created 08-APR-2019 12:10:00

J0815+3635 EM133B.UVDATA.1

Freq = 4.9270 GHz, Bw = 16.000 MH No calibration applied and no bandpass applied

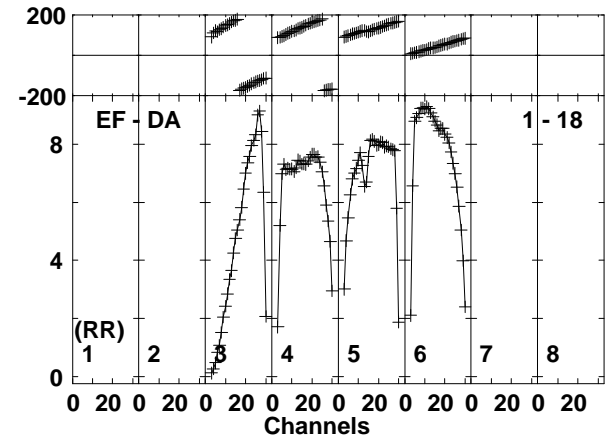
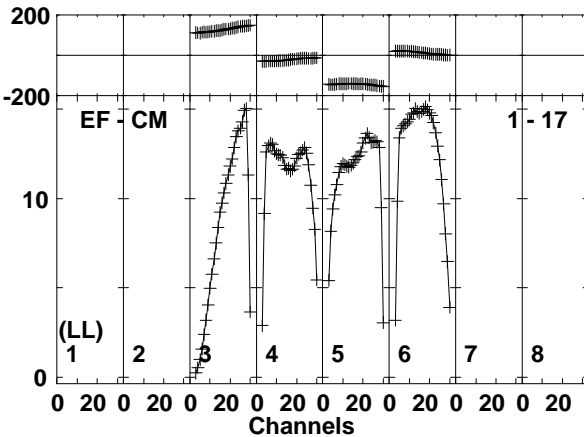
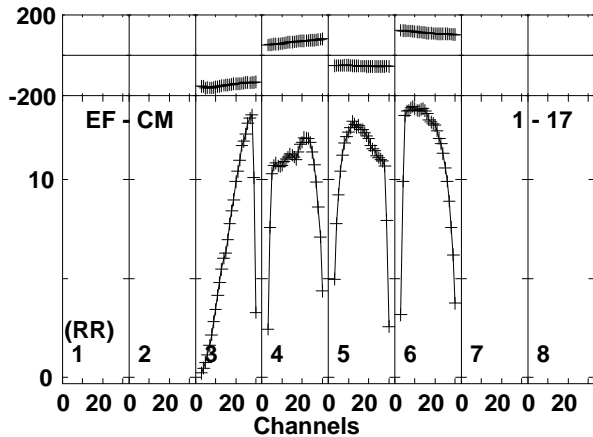
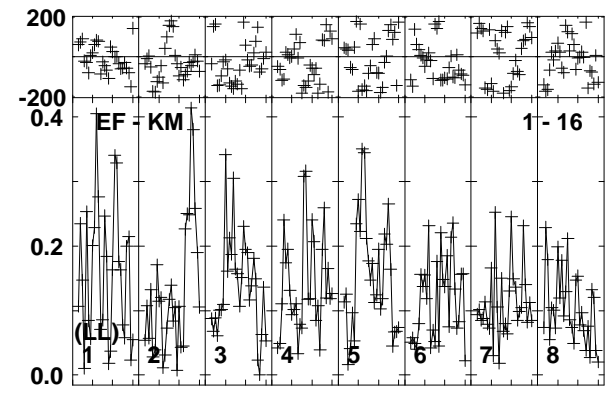
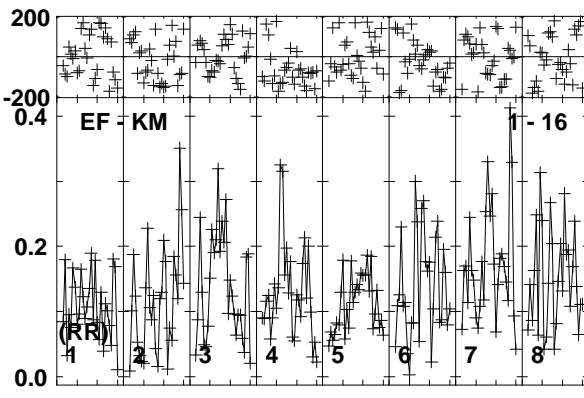
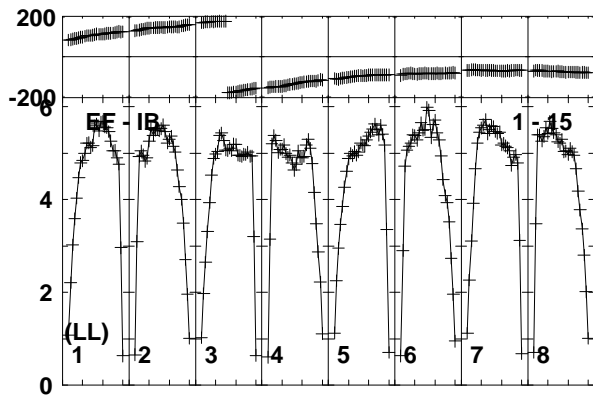
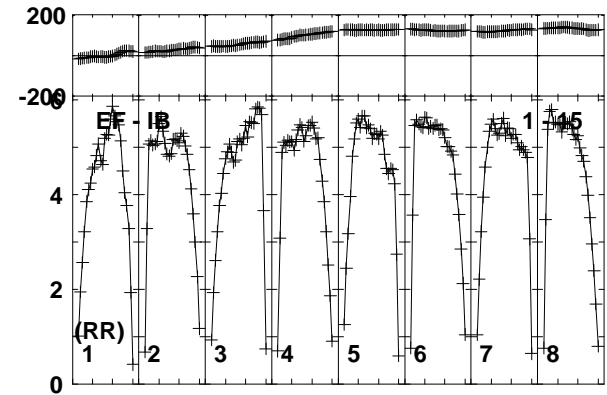
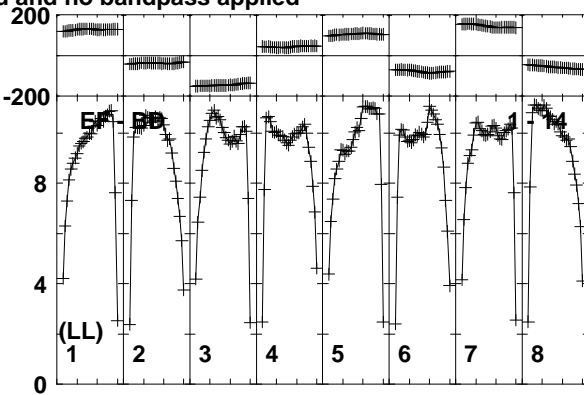
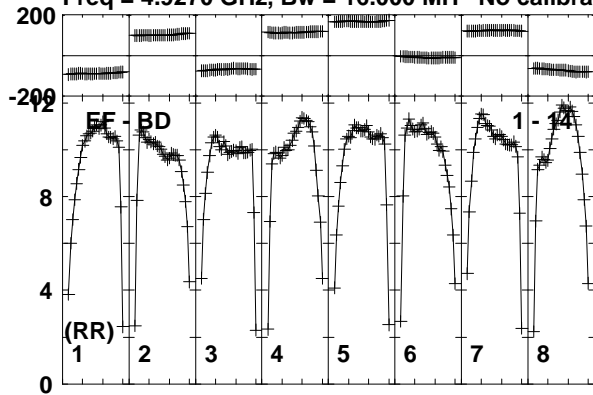

Lower frame: Milli Ampl Jy Top frame: Phas deg  
Vector averaged cross-power spectrum Baseline: EF (01) - BD (14)  
Timerange: 00/06:06:51 to 00/06:08:19

Plot file version 223 created 08-APR-2019 12:10:00

J0815+3635 EM133B.UVDATA.1

Freq = 4.9270 GHz, Bw = 16.000 MH No calibration applied and no bandpass applied

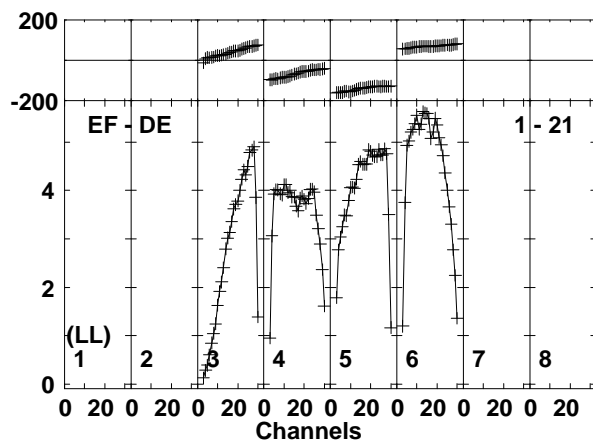
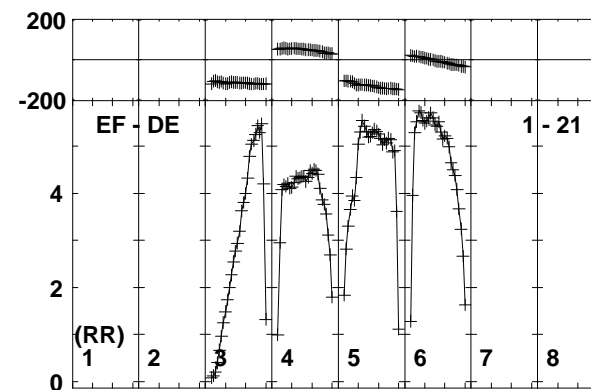
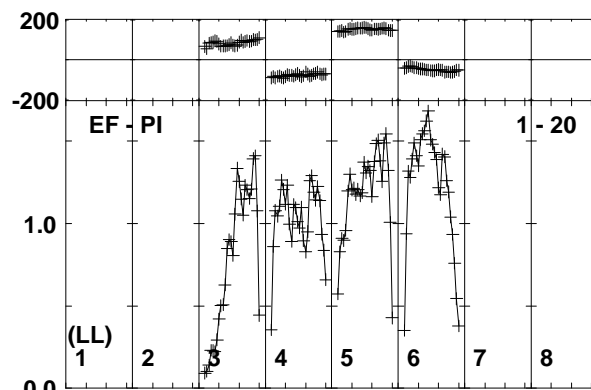
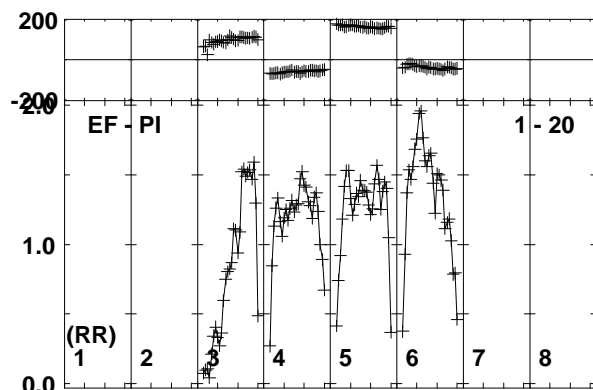
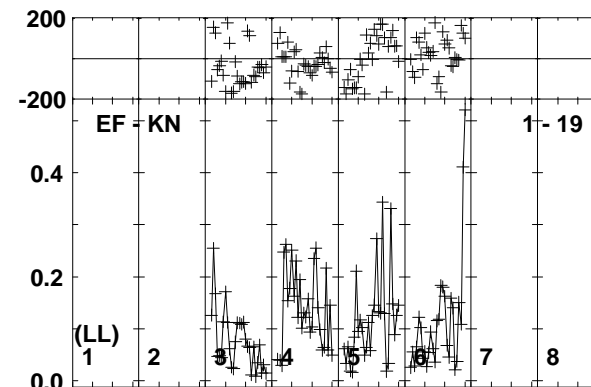
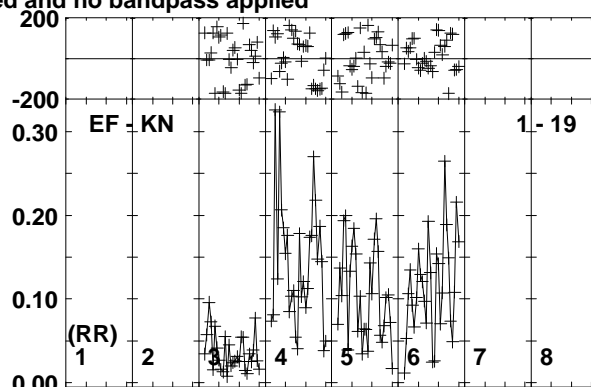
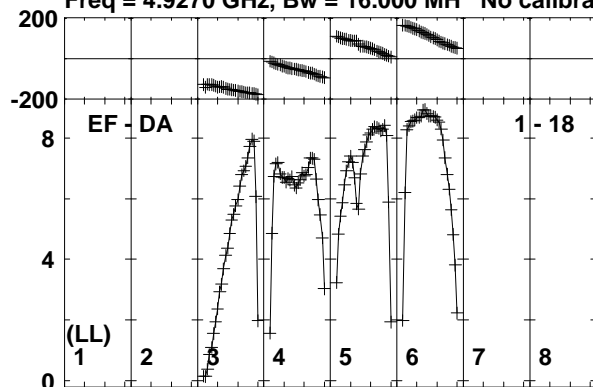

Lower frame: Milli Ampl Jy Top frame: Phas deg  
Vector averaged cross-power spectrum Baseline: EF (01) - DA (18)  
Timerange: 00/06:06:51 to 00/06:08:19

Plot file version 224 created 08-APR-2019 12:10:01

MRK622 EM133B.UVDATA.1

Freq = 4.9270 GHz, Bw = 16.000 MH No calibration applied and no bandpass applied

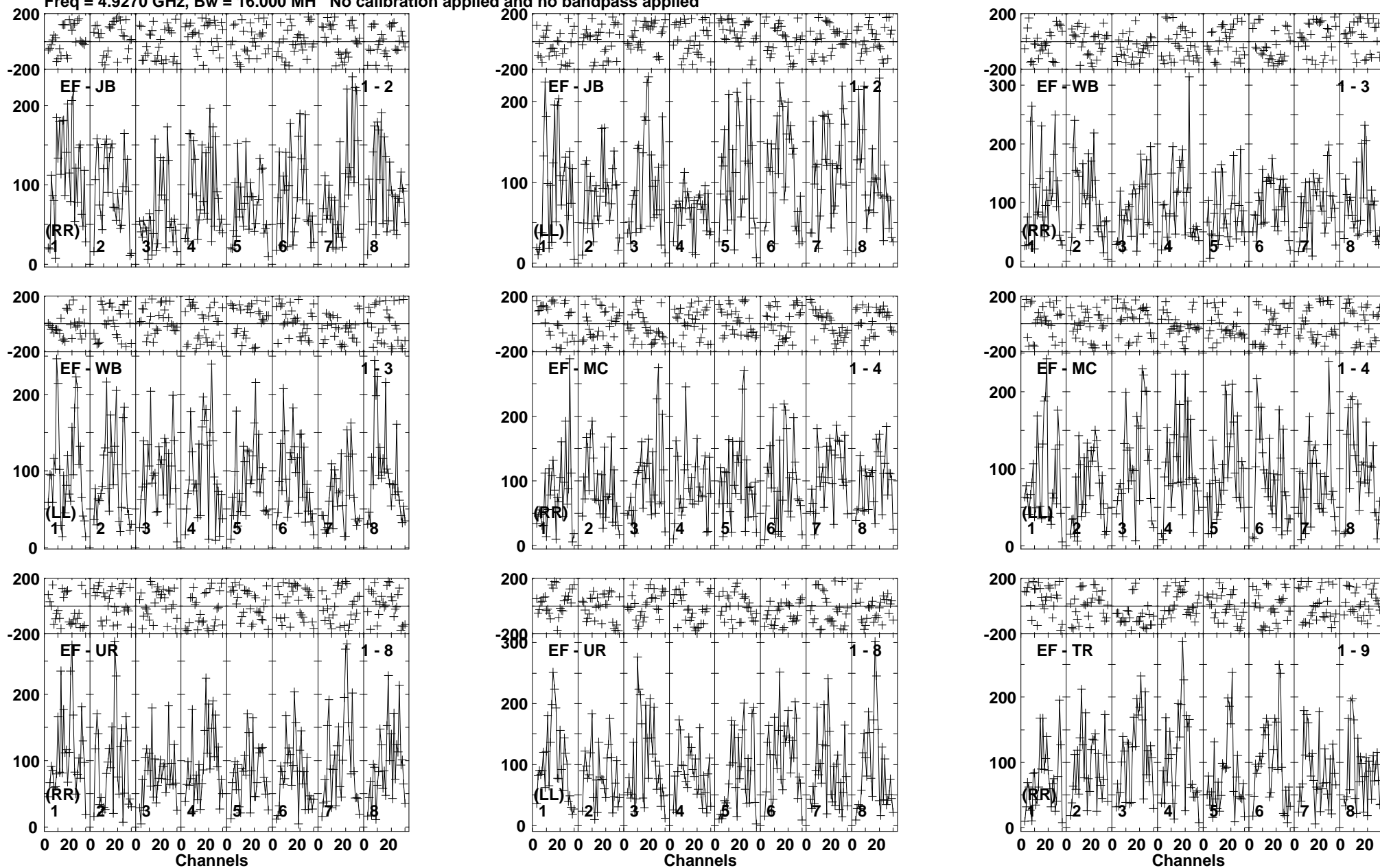

Lower frame: Micro Ampl Jy Top frame: Phas deg  
Vector averaged cross-power spectrum Baseline: EF (01) - JB (02)  
Timerange: 00/06:08:21 to 00/06:11:49



Plot file version 225 created 08-APR-2019 12:10:01

MRK622 EM133B.UVDATA.1

Freq = 4.9270 GHz, Bw = 16.000 MH No calibration applied and no bandpass applied

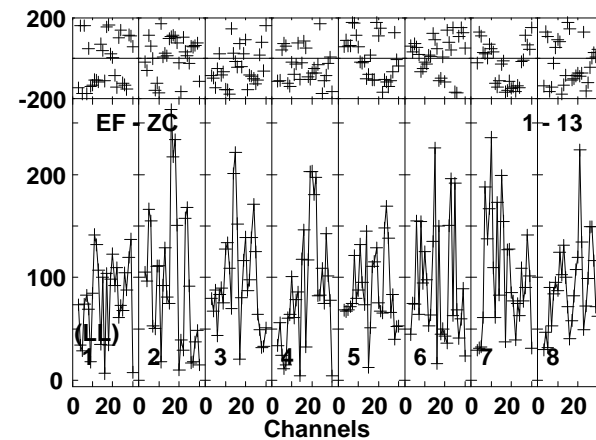
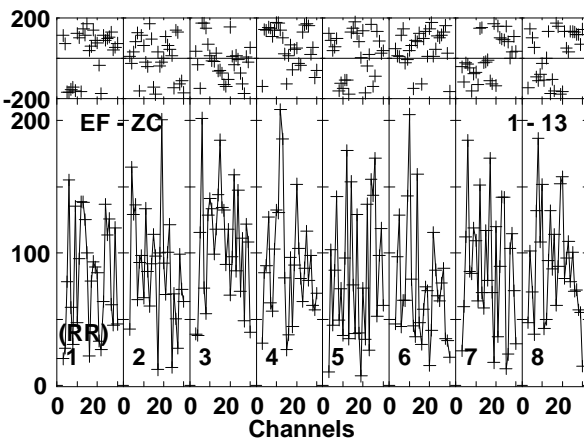
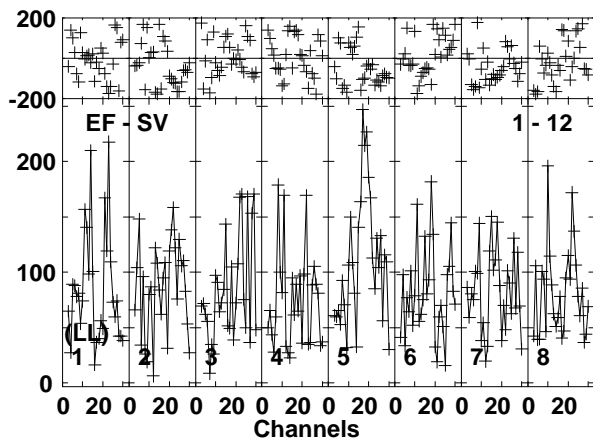
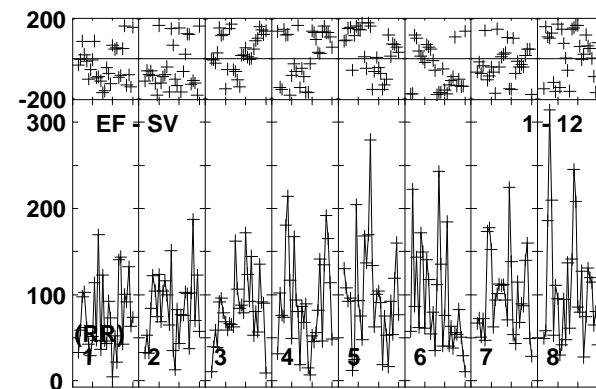
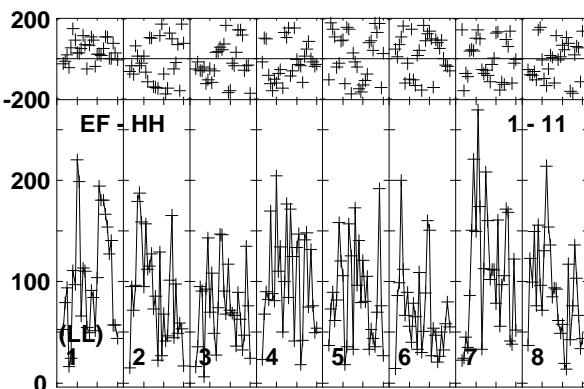
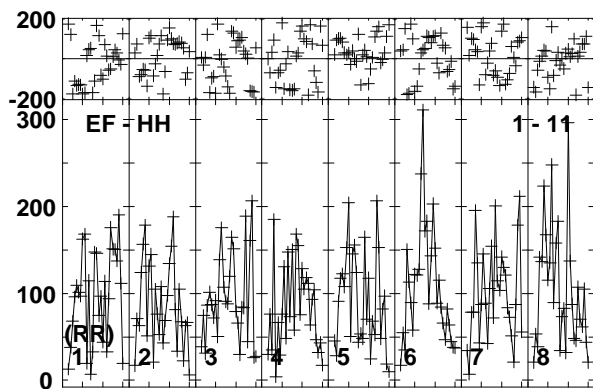
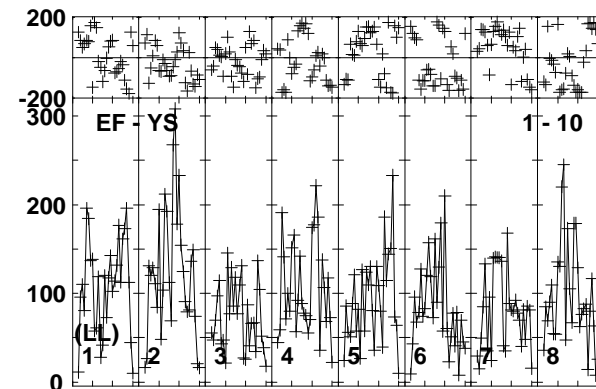
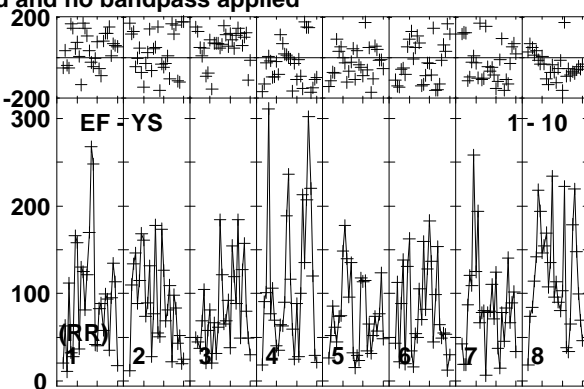
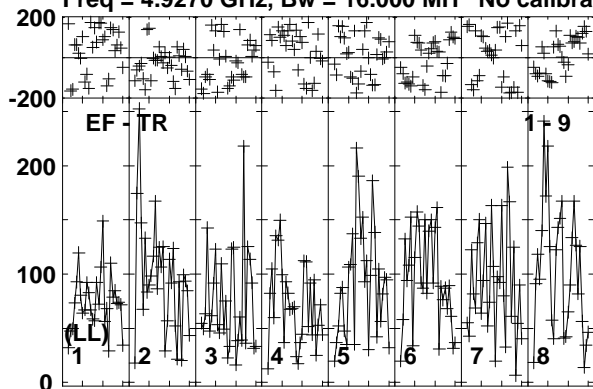

Lower frame: Micro Ampl Jy Top frame: Phas deg  
Vector averaged cross-power spectrum Baseline: EF (01) - TR (09)  
Timerange: 00/06:08:21 to 00/06:11:49

Plot file version 226 created 08-APR-2019 12:10:01

MRK622 EM133B.UVDATA.1

Freq = 4.9270 GHz, Bw = 16.000 MH No calibration applied and no bandpass applied

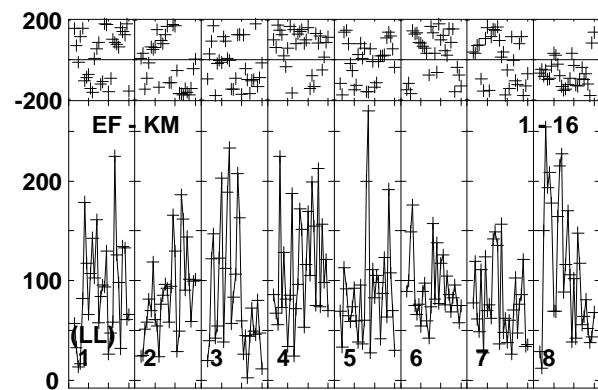
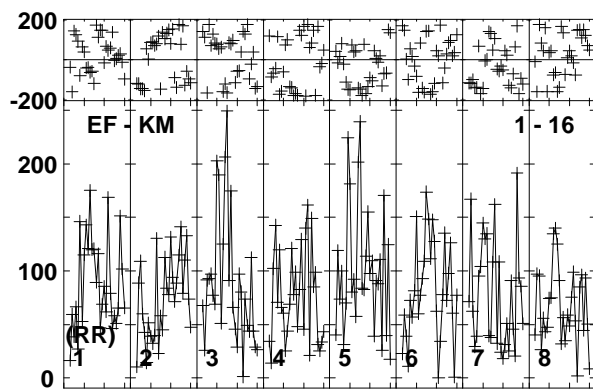
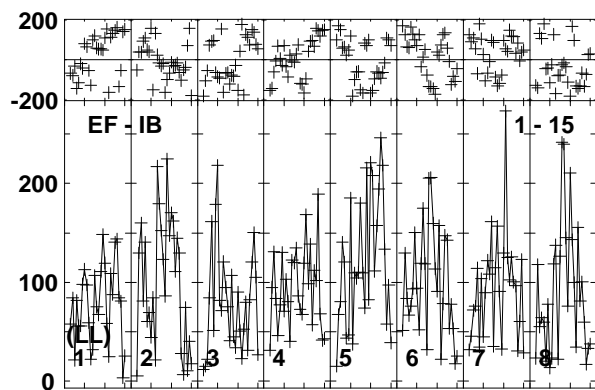
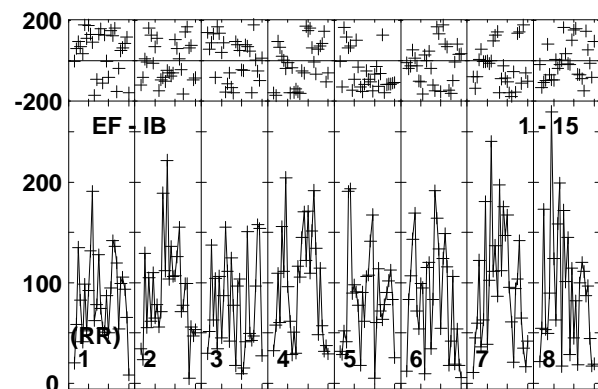
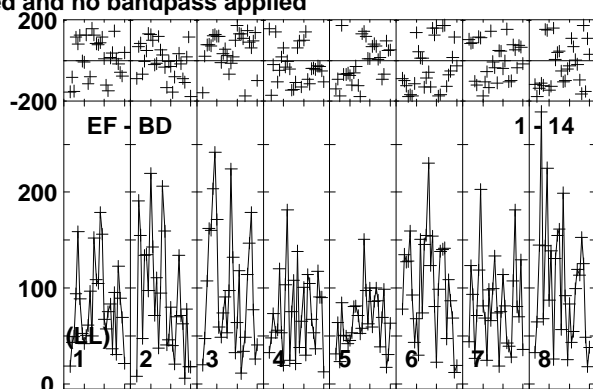
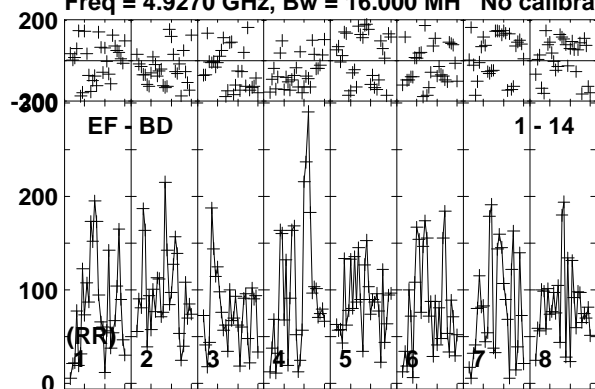

Lower frame: Micro Ampl Jy Top frame: Phas deg  
Vector averaged cross-power spectrum Baseline: EF (01) - BD (14)  
Timerange: 00/06:08:21 to 00/06:11:49

Plot file version 227 created 08-APR-2019 12:10:01

J0815+3635 EM133B.UVDATA.1

Freq = 4.9270 GHz, Bw = 16.000 MH No calibration applied and no bandpass applied

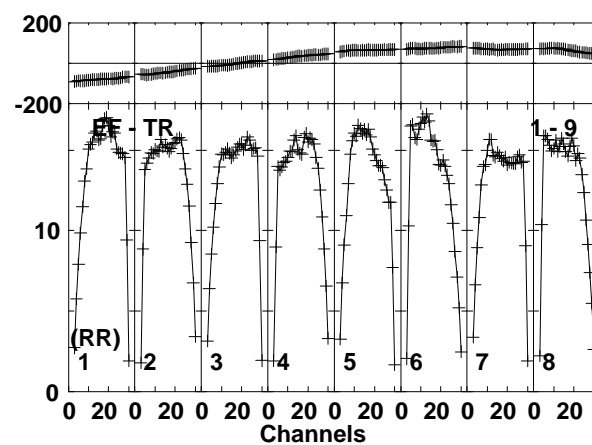
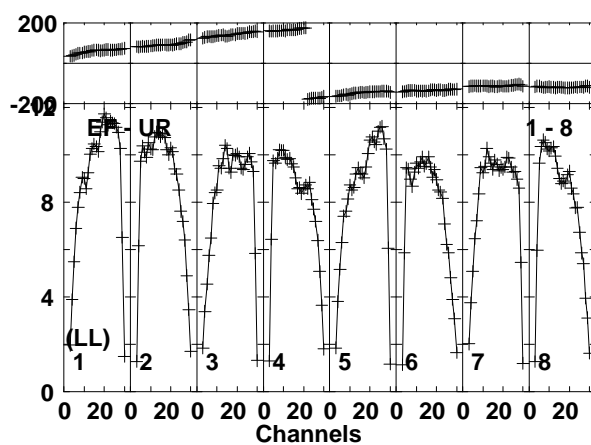
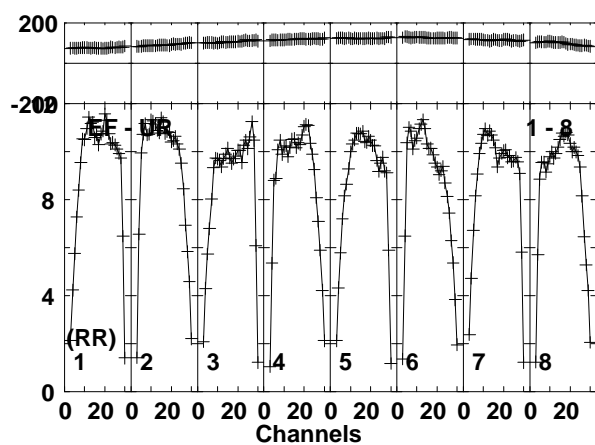
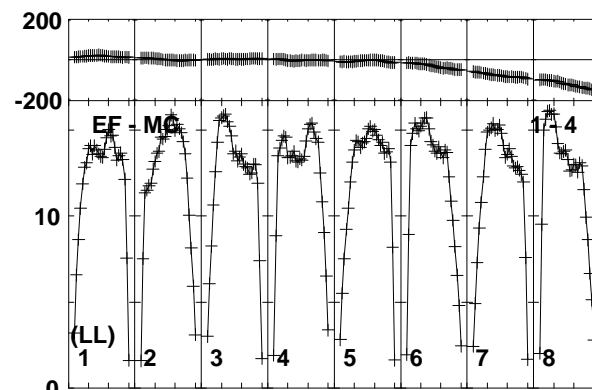
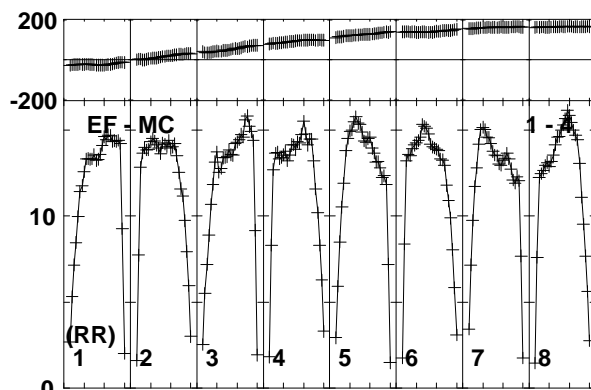
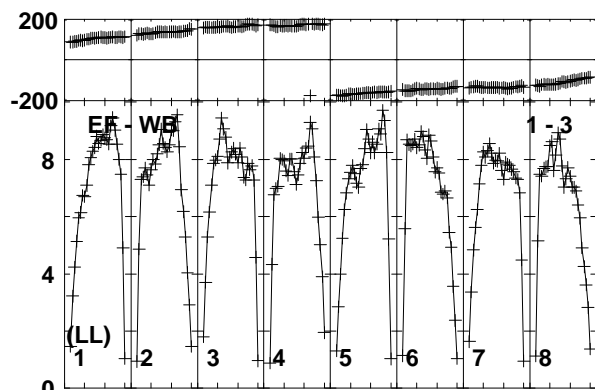
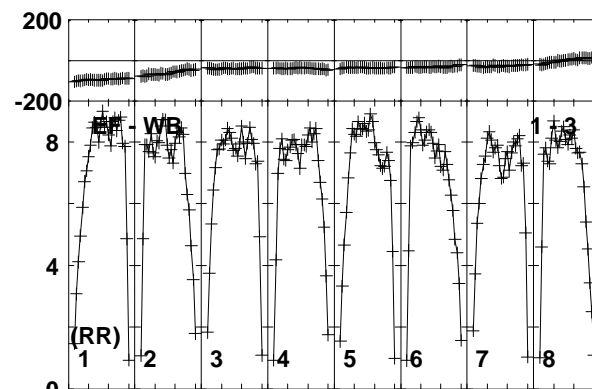
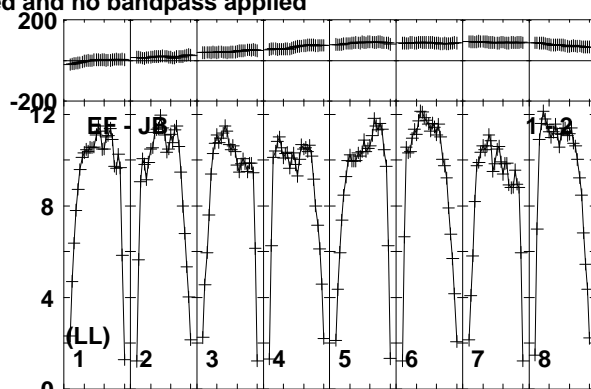
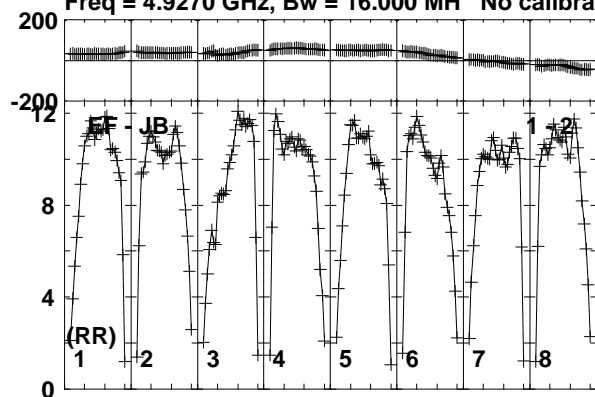

Lower frame: Milli Ampl Jy Top frame: Phas deg  
Vector averaged cross-power spectrum Baseline: EF (01) - JB (02)  
Timerange: 00/06:11:51 to 00/06:13:19

Plot file version 228 created 08-APR-2019 12:10:01

J0815+3635 EM133B.UVDATA.1

Freq = 4.9270 GHz, Bw = 16.000 MH No calibration applied and no bandpass applied

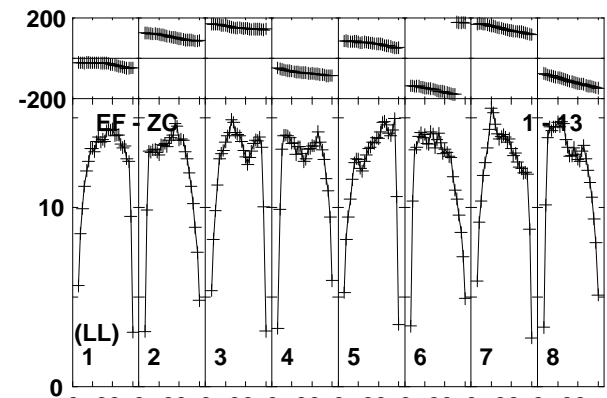
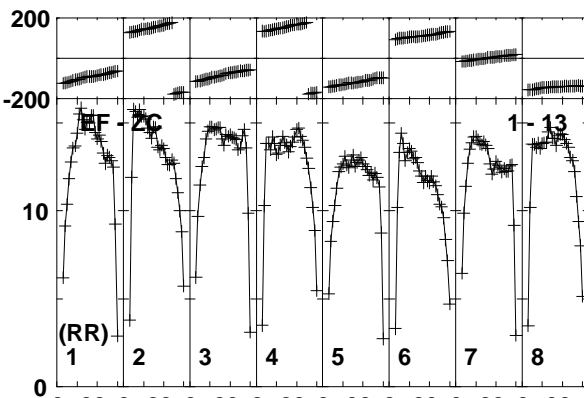
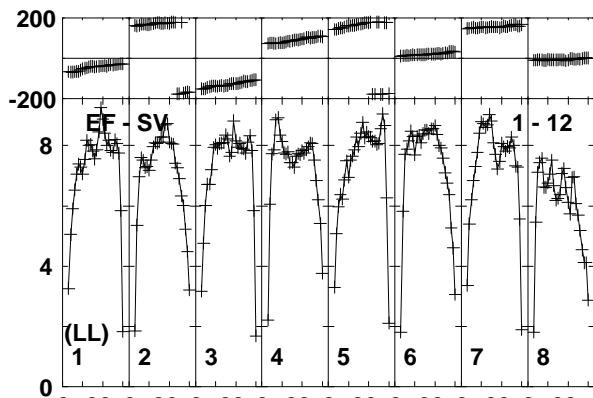
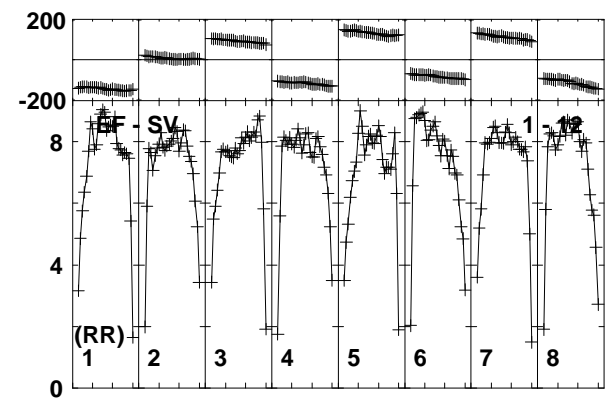
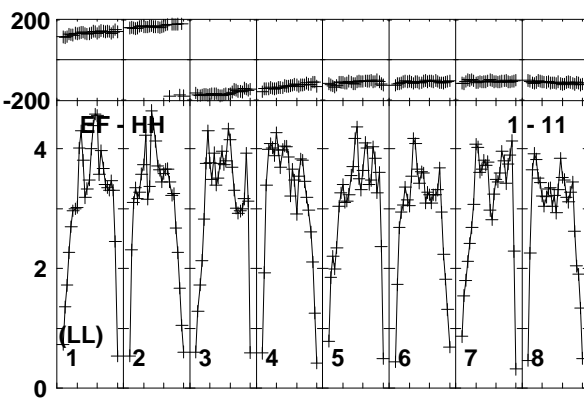
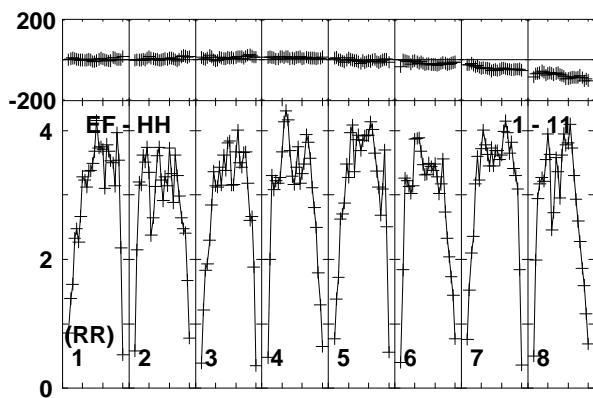
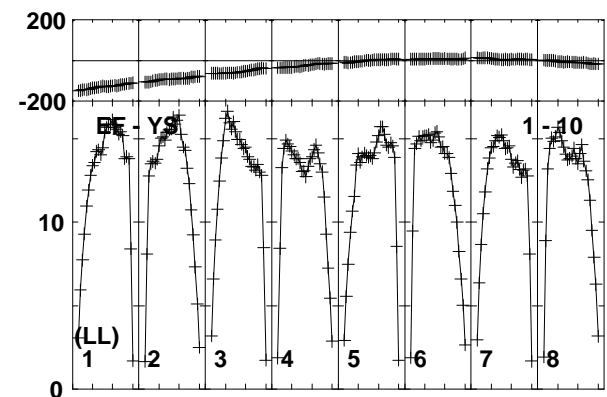
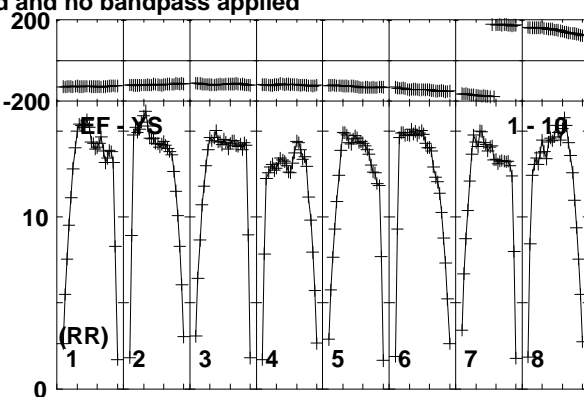
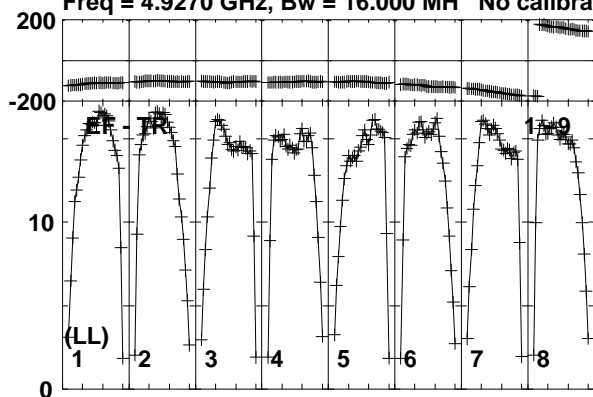

Lower frame: Milli Ampl Jy Top frame: Phas deg  
Vector averaged cross-power spectrum Baseline: EF (01) - TR (09)  
Timerange: 00/06:11:51 to 00/06:13:19

Plot file version 229 created 08-APR-2019 12:10:01

J0815+3635 EM133B.UVDATA.1

Freq = 4.9270 GHz, Bw = 16.000 MH No calibration applied and no bandpass applied

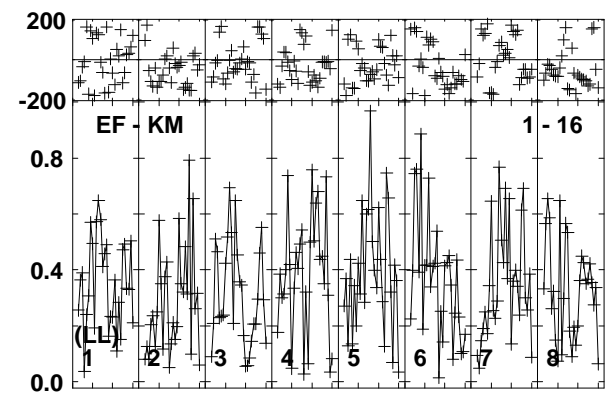
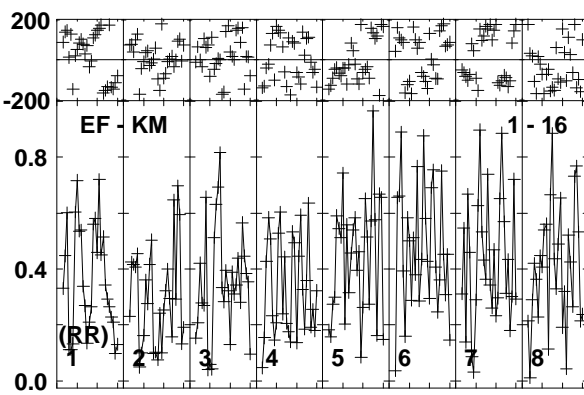
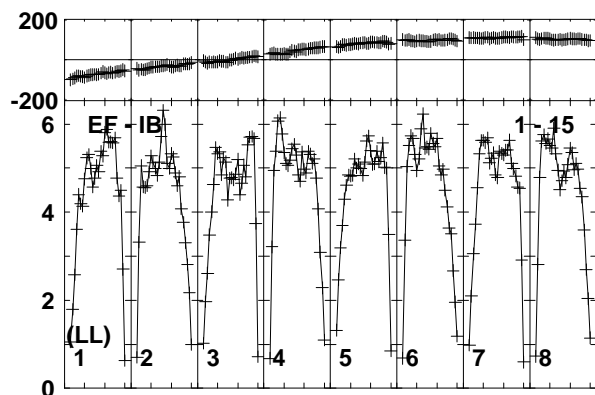
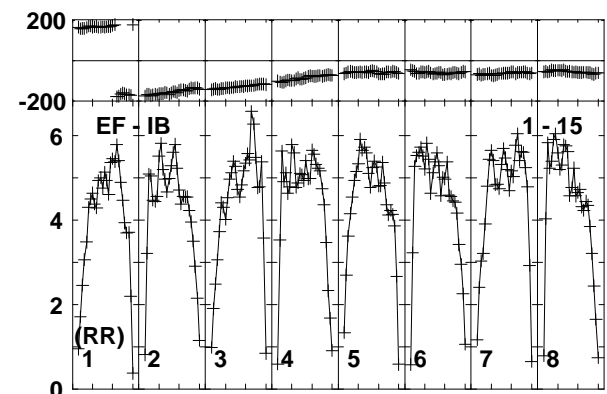
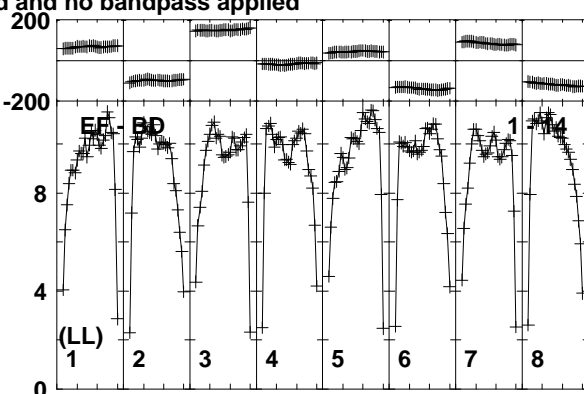
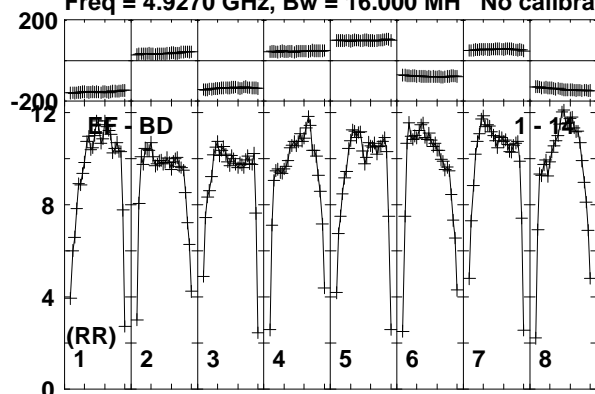

Lower frame: Milli Ampl Jy Top frame: Phas deg  
Vector averaged cross-power spectrum Baseline: EF (01) - BD (14)  
Timerange: 00/06:11:51 to 00/06:13:19

Plot file version 230 created 08-APR-2019 12:10:01

MRK622 EM133B.UVDATA.1

Freq = 4.9270 GHz, Bw = 16.000 MH No calibration applied and no bandpass applied

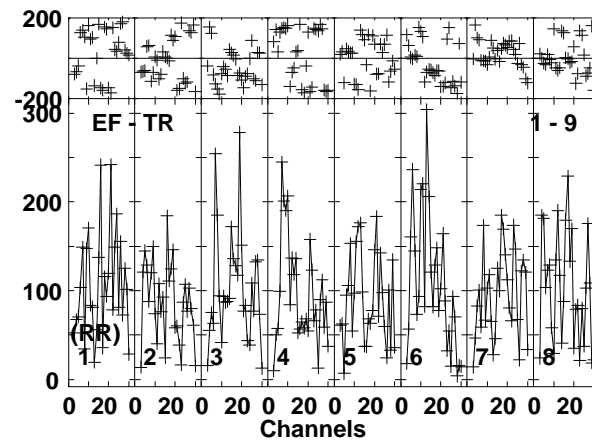
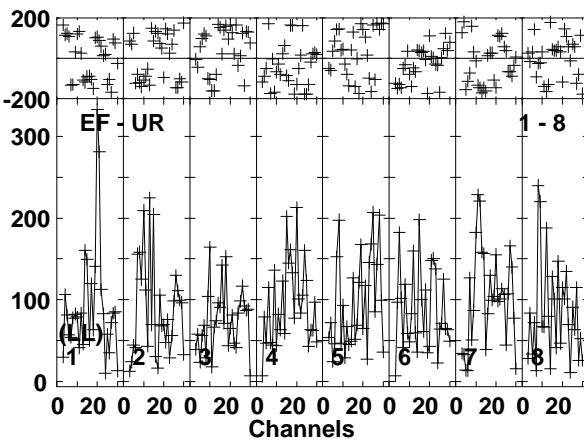
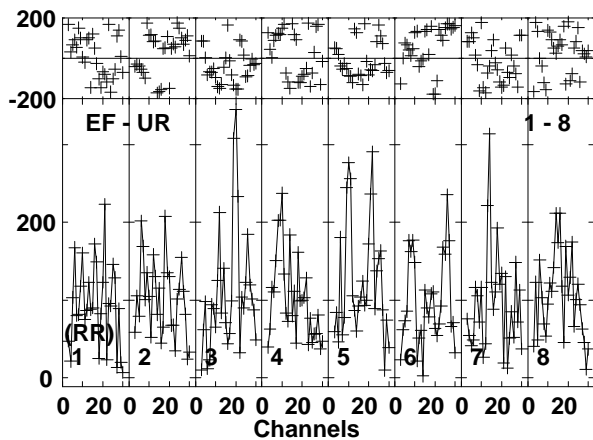
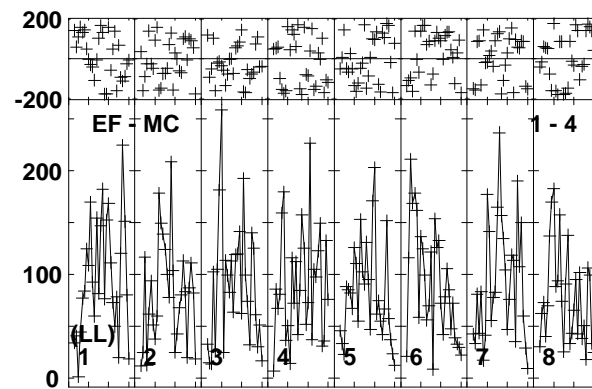
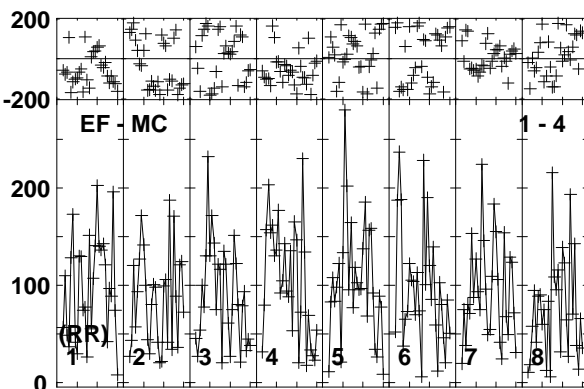
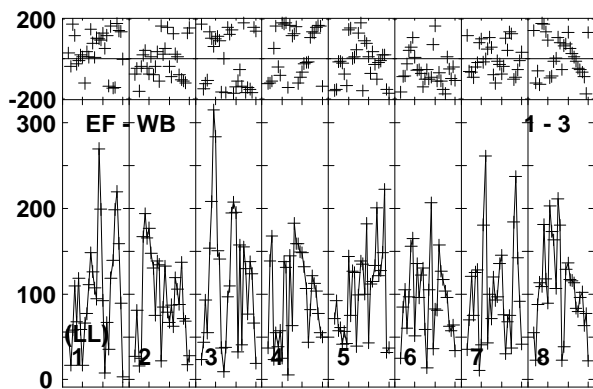
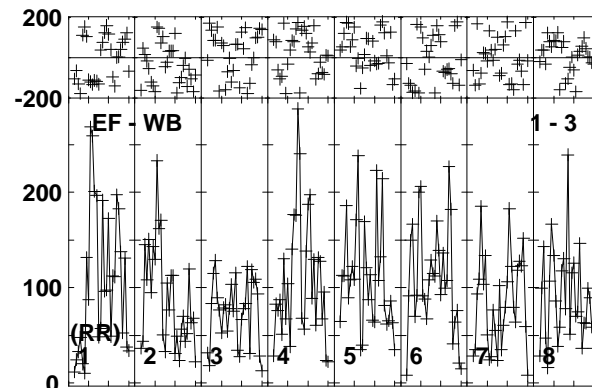
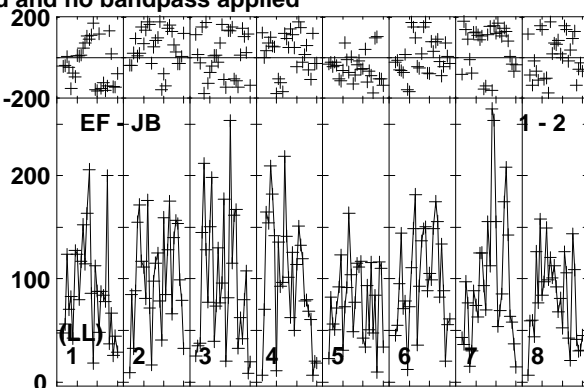
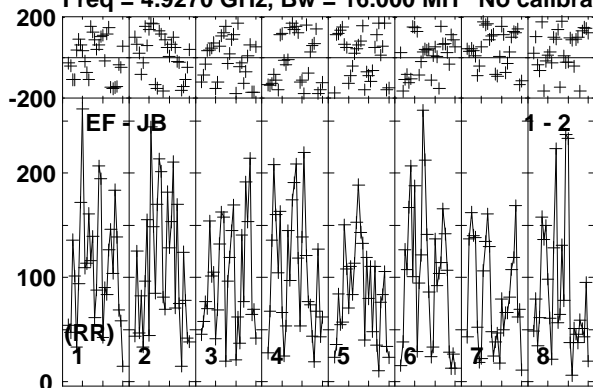

Lower frame: Micro Ampl Jy Top frame: Phas deg  
Vector averaged cross-power spectrum Baseline: EF (01) - JB (02)  
Timerange: 00/06:13:23 to 00/06:16:49

Plot file version 231 created 08-APR-2019 12:10:02

MRK622 EM133B.UVDATA.1

Freq = 4.9270 GHz, Bw = 16.000 MH No calibration applied and no bandpass applied

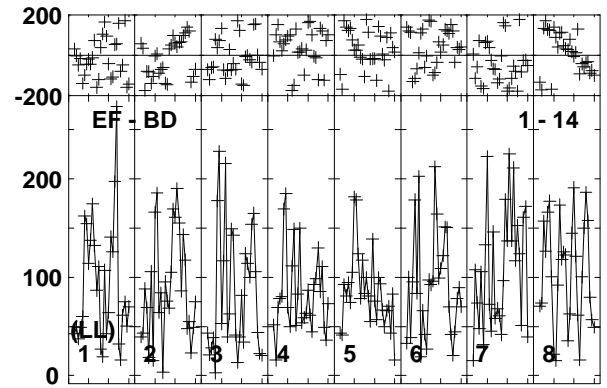
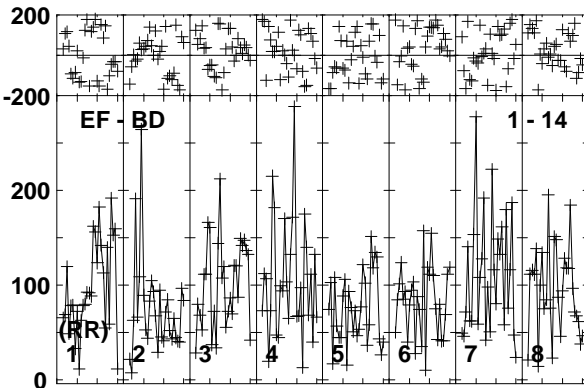
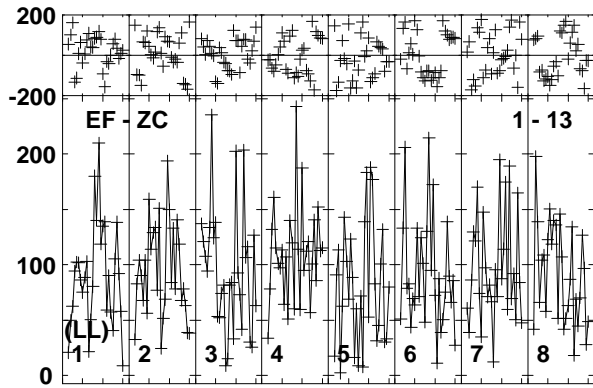
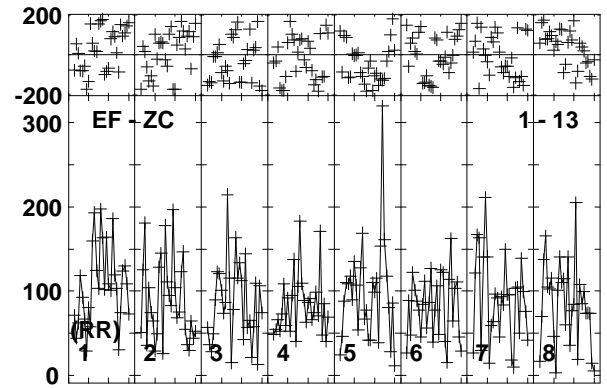
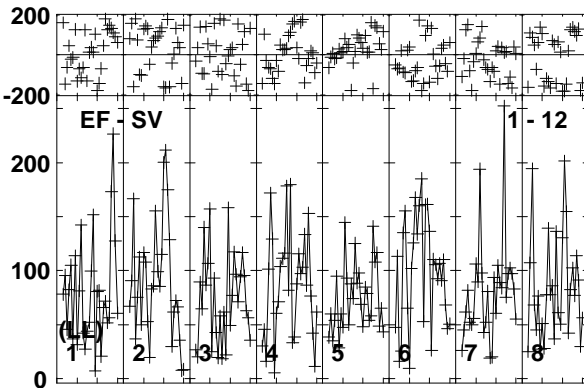
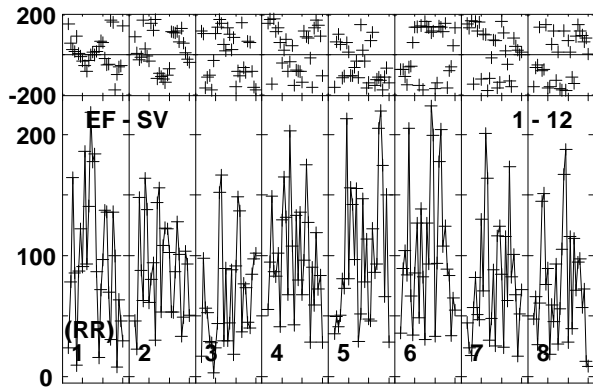
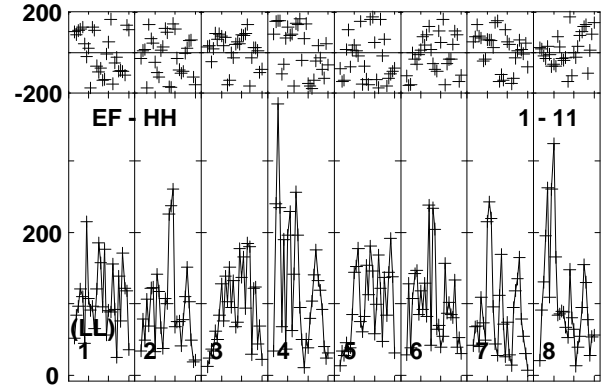
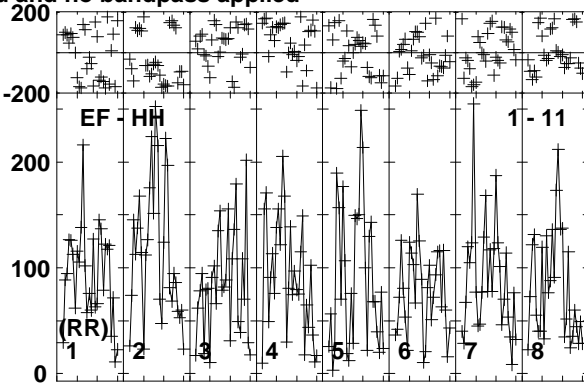
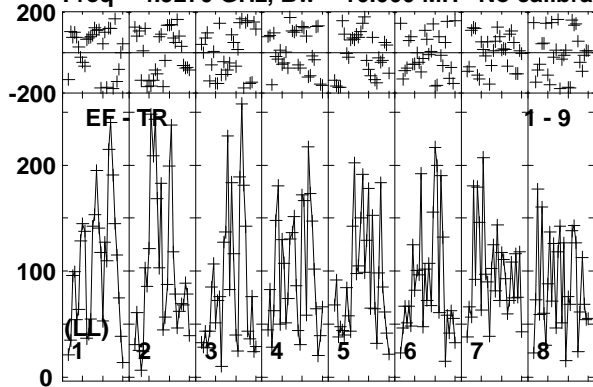

Lower frame: Micro Ampl Jy Top frame: Phas deg  
Vector averaged cross-power spectrum Baseline: EF (01) - TR (09)  
Timerange: 00/06:13:23 to 00/06:16:49

Plot file version 232 created 08-APR-2019 12:10:02

MRK622 EM133B.UVDATA.1

Freq = 4.9270 GHz, Bw = 16.000 MH No calibration applied and no bandpass applied

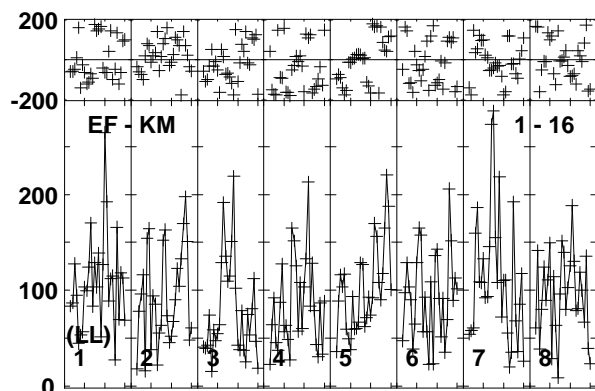
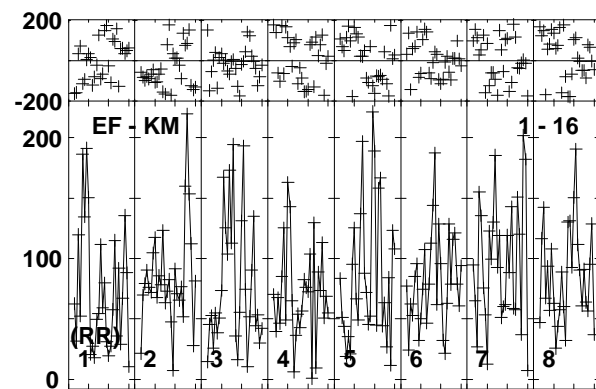
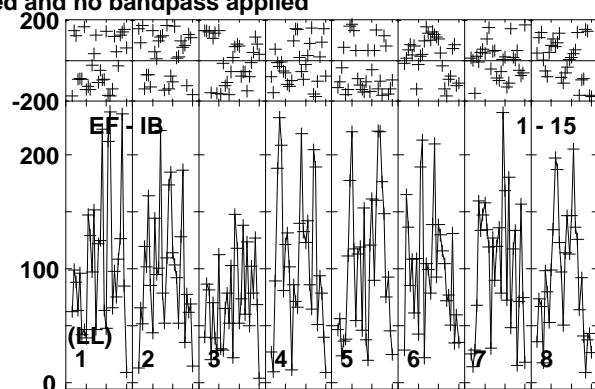
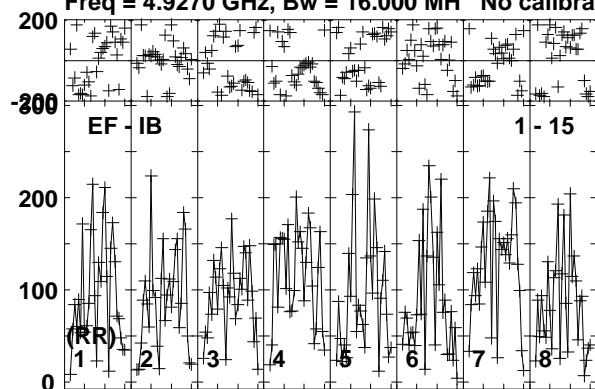

Lower frame: Micro Ampl Jy Top frame: Phas deg  
Vector averaged cross-power spectrum Baseline: EF (01) - IB (15)  
Timerange: 00/06:13:23 to 00/06:16:49



Plot file version 233 created 08-APR-2019 12:10:02

J0815+3635 EM133B.UVDATA.1

Freq = 4.9270 GHz, Bw = 16.000 MH No calibration applied and no bandpass applied

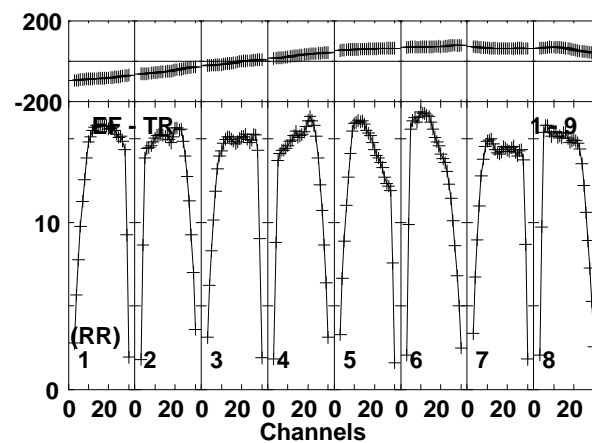
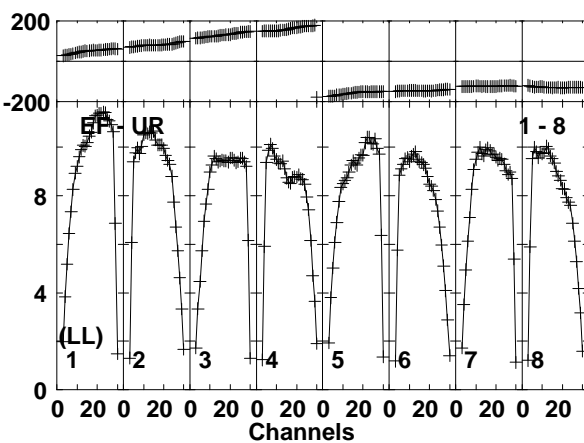
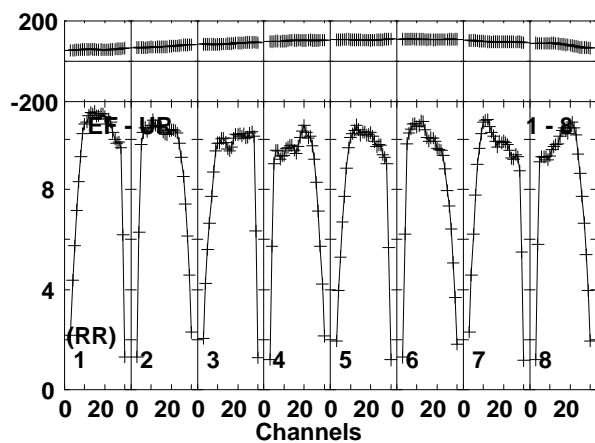
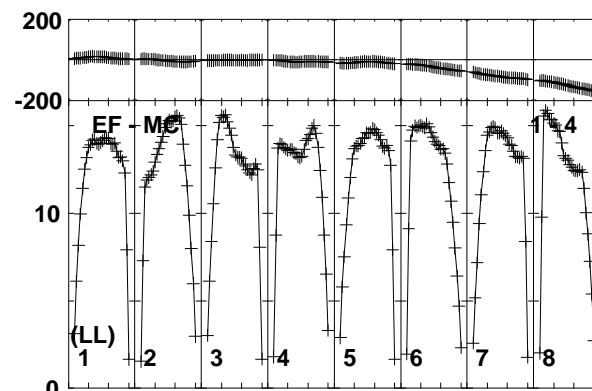
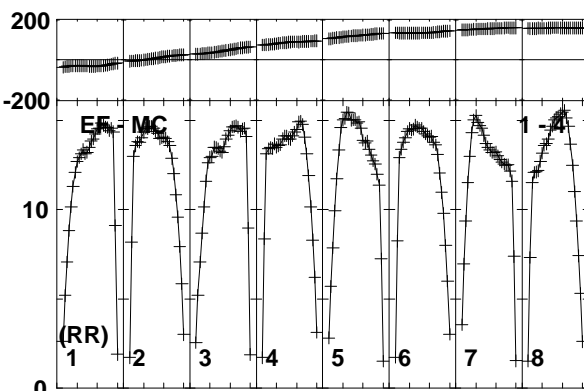
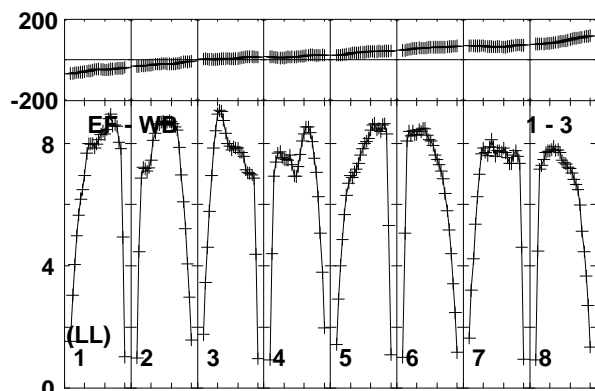
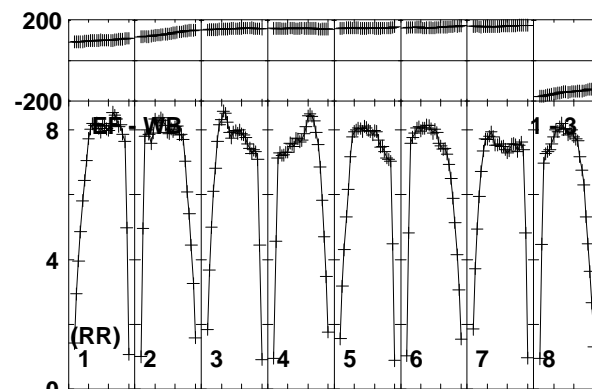
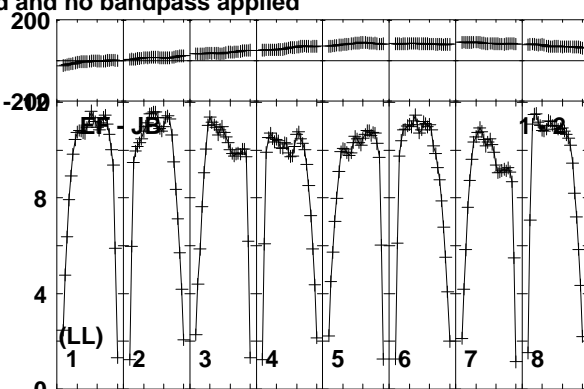
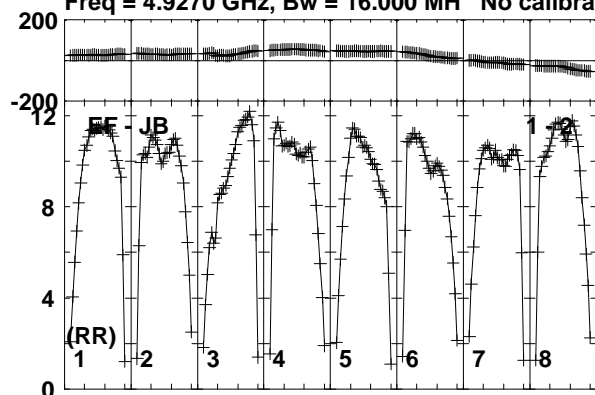

Lower frame: Milli Ampl Jy Top frame: Phas deg  
Vector averaged cross-power spectrum Baseline: EF (01) - JB (02)  
Timerange: 00/06:17:41 to 00/06:19:09

Plot file version 234 created 08-APR-2019 12:10:02

J0815+3635 EM133B.UVDATA.1

Freq = 4.9270 GHz, Bw = 16.000 MH No calibration applied and no bandpass applied

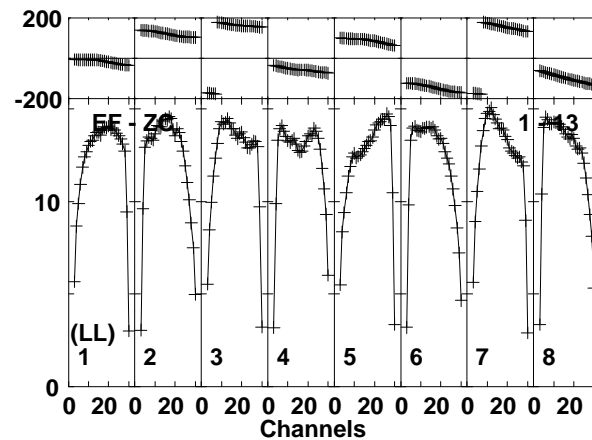
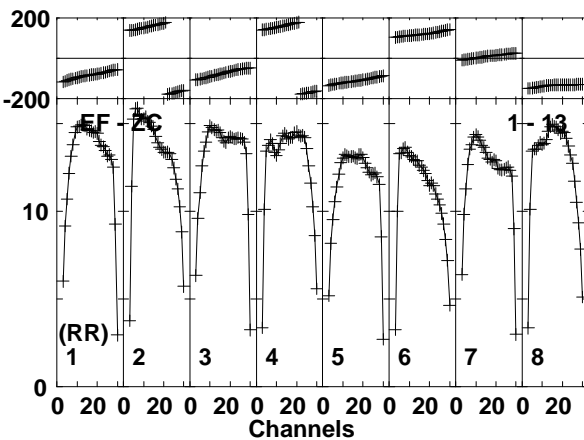
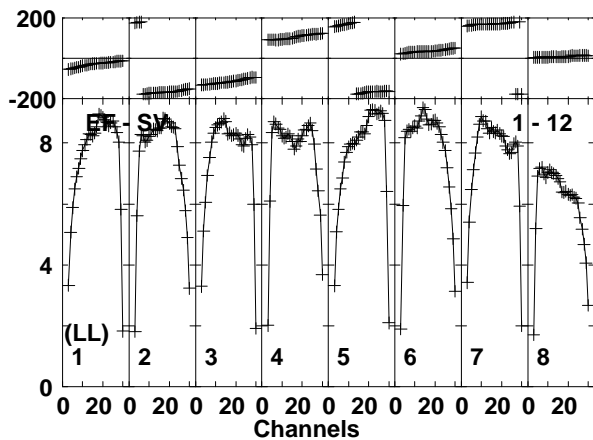
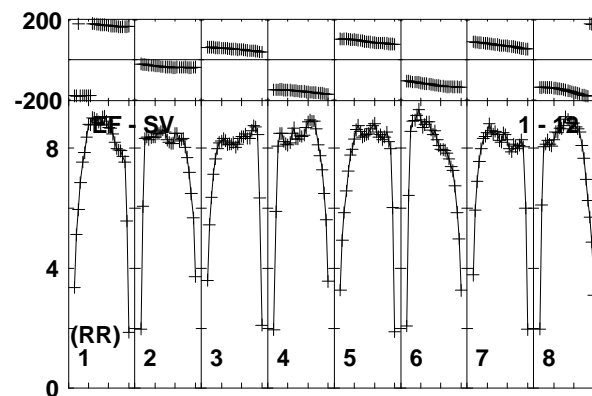
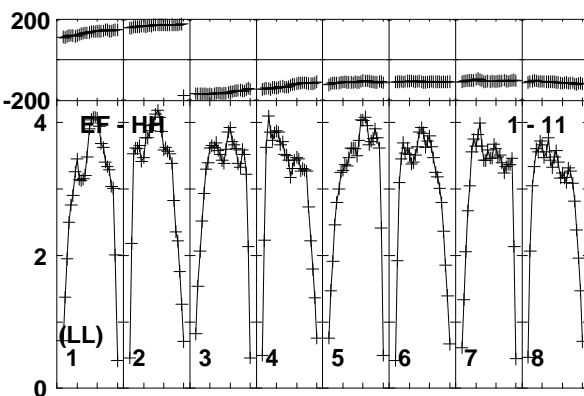
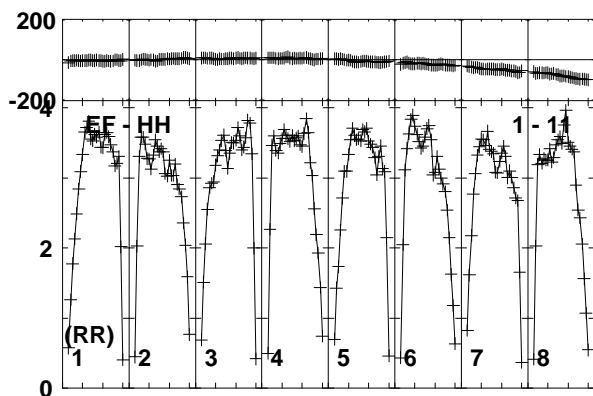
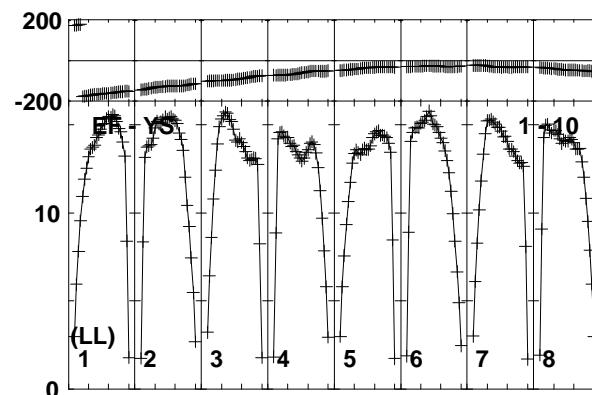
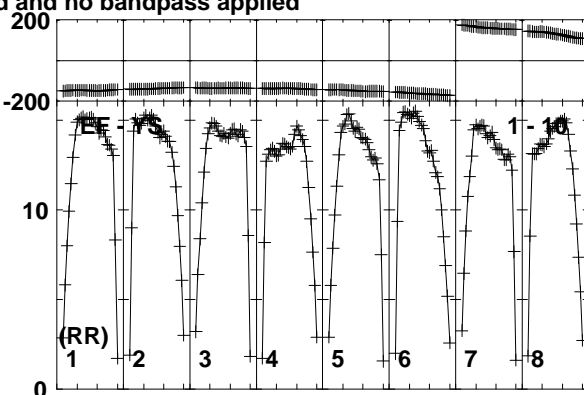
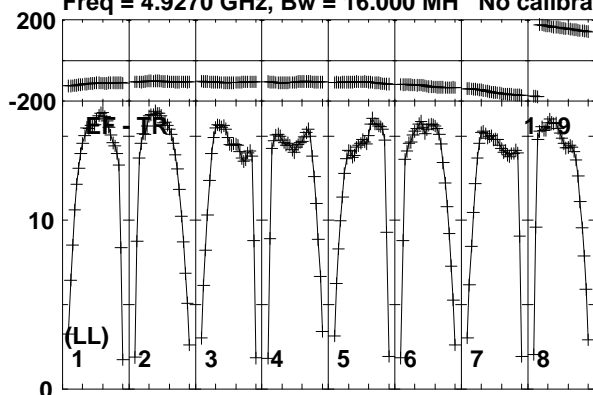

Lower frame: Milli Ampl Jy Top frame: Phas deg  
Vector averaged cross-power spectrum Baseline: EF (01) - TR (09)  
Timerange: 00/06:17:41 to 00/06:19:09

Plot file version 235 created 08-APR-2019 12:10:02

J0815+3635 EM133B.UVDATA.1

Freq = 4.9270 GHz, Bw = 16.000 MH No calibration applied and no bandpass applied

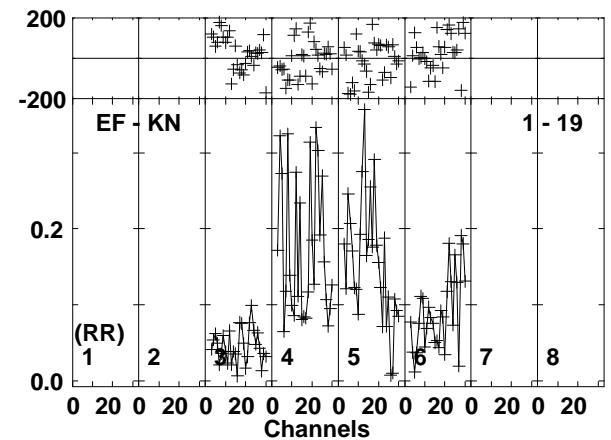
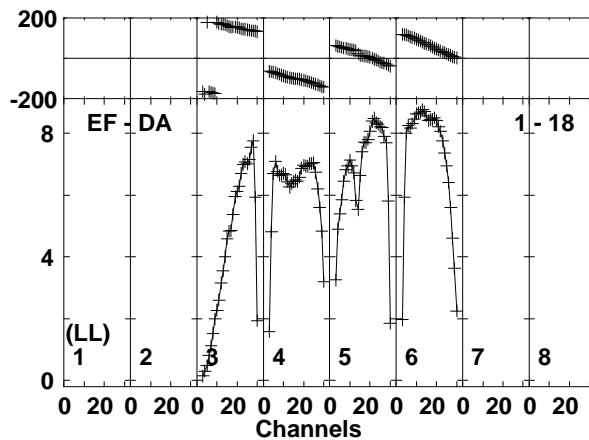
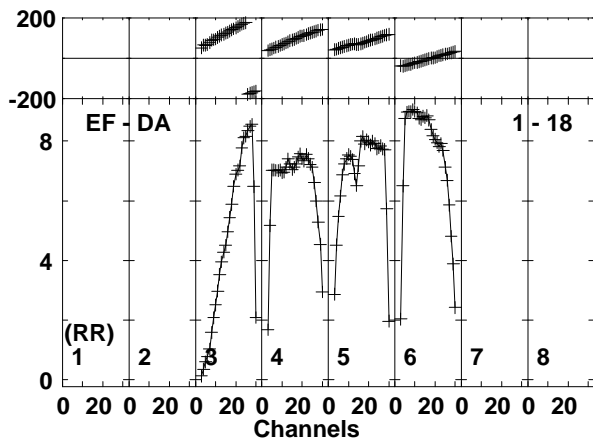
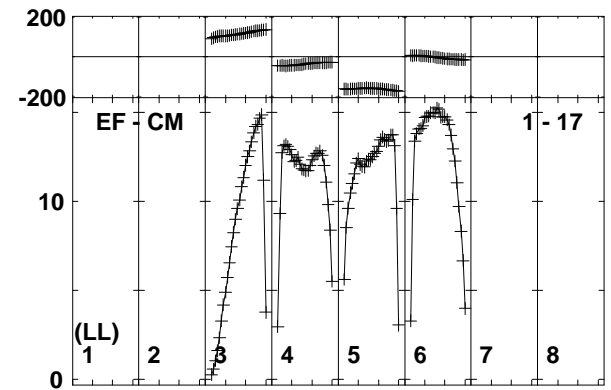
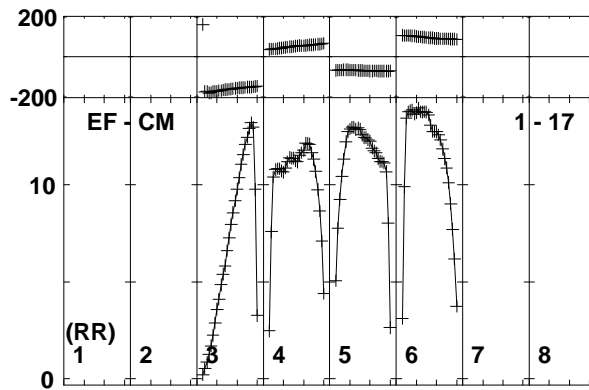
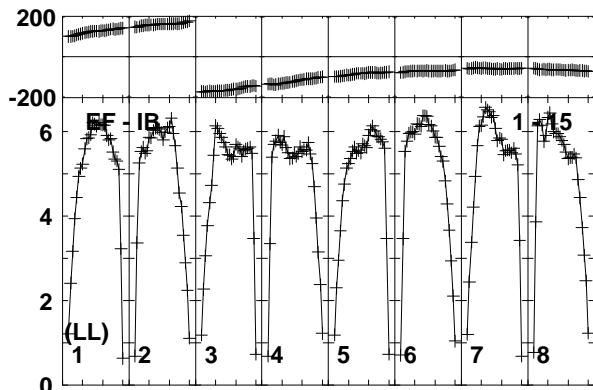
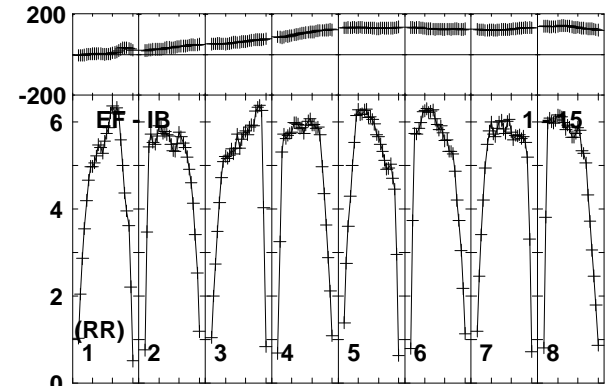
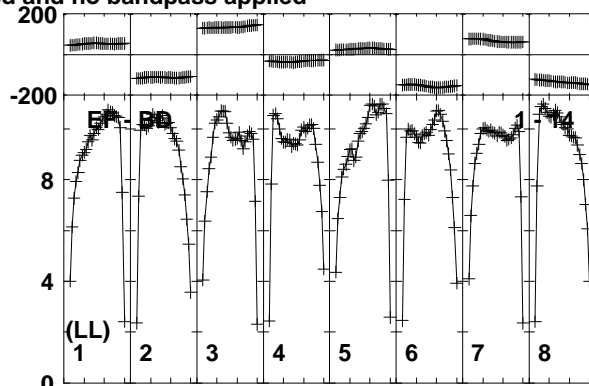
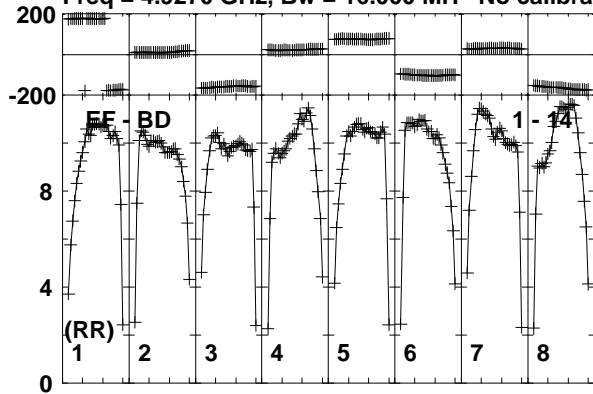

Lower frame: Milli Ampl Jy Top frame: Phas deg  
Vector averaged cross-power spectrum Baseline: EF (01) - BD (14)  
Timerange: 00/06:17:41 to 00/06:19:09

Plot file version 236 created 08-APR-2019 12:10:02

J0815+3635 EM133B.UVDATA.1

Freq = 4.9270 GHz, Bw = 16.000 MH No calibration applied and no bandpass applied

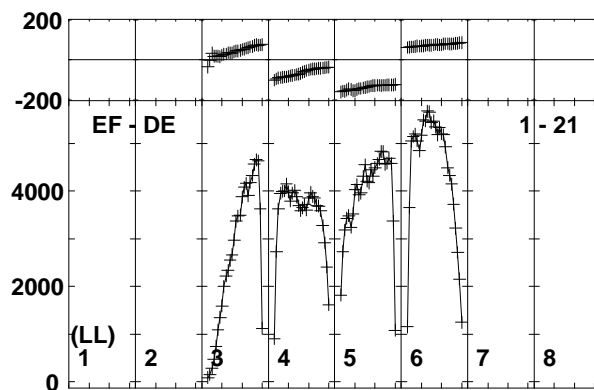
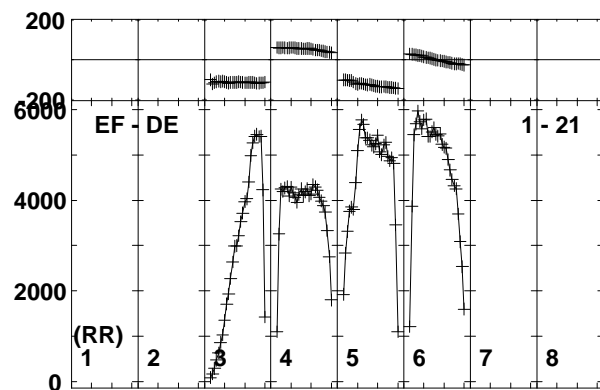
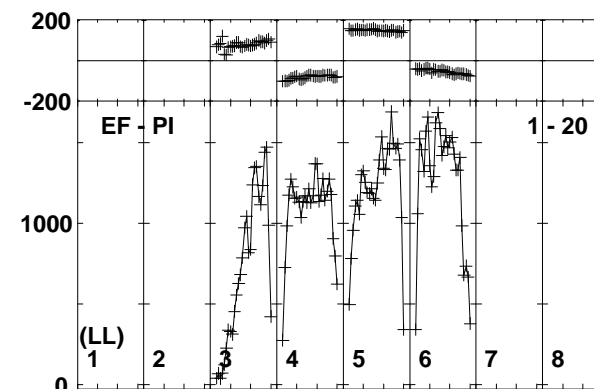
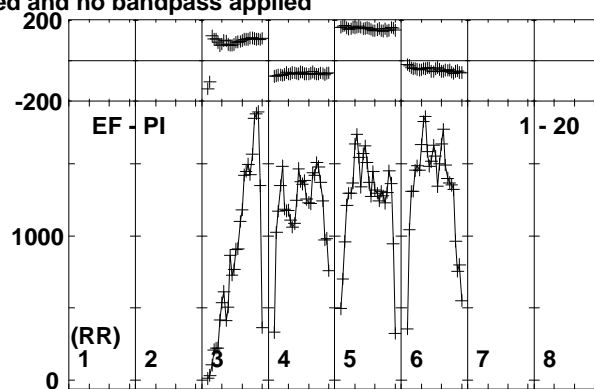
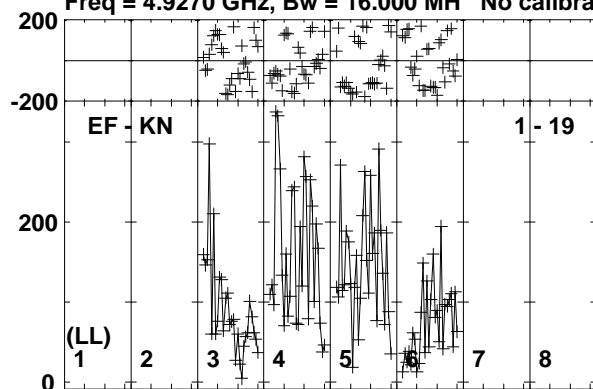

Lower frame: Micro Ampl Jy Top frame: Phas deg  
Vector averaged cross-power spectrum Baseline: EF (01) - KN (19)  
Timerange: 00/06:17:41 to 00/06:19:09

Plot file version 237 created 08-APR-2019 12:10:02

MRK622 EM133B.UVDATA.1

Freq = 4.9270 GHz, Bw = 16.000 MH No calibration applied and no bandpass applied

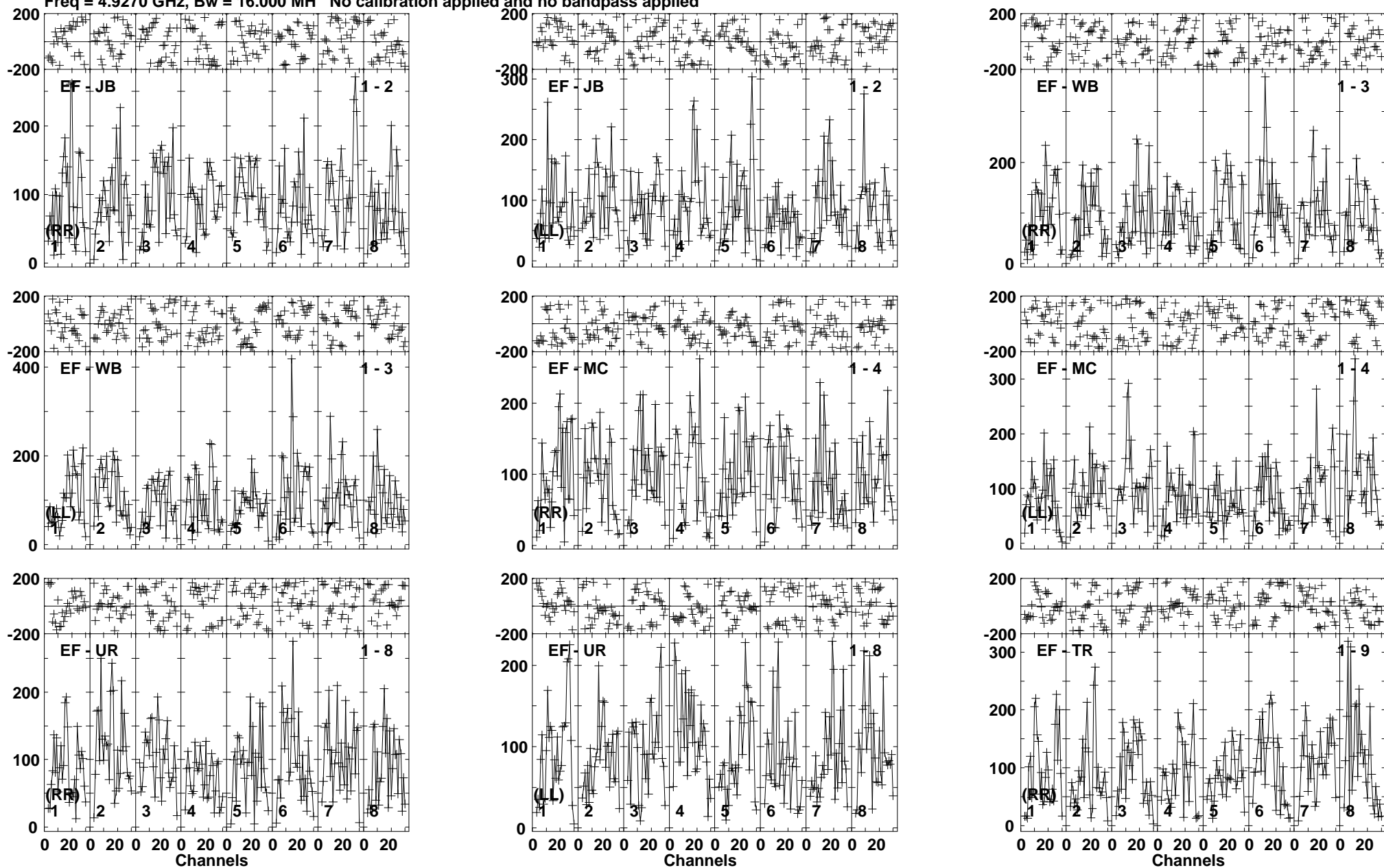

Lower frame: Micro Ampl Jy Top frame: Phas deg  
Vector averaged cross-power spectrum Baseline: EF (01) - JB (02)  
Timerange: 00/06:19:11 to 00/06:22:39

Plot file version 238 created 08-APR-2019 12:10:02

MRK622 EM133B.UVDATA.1

Freq = 4.9270 GHz, Bw = 16.000 MH No calibration applied and no bandpass applied

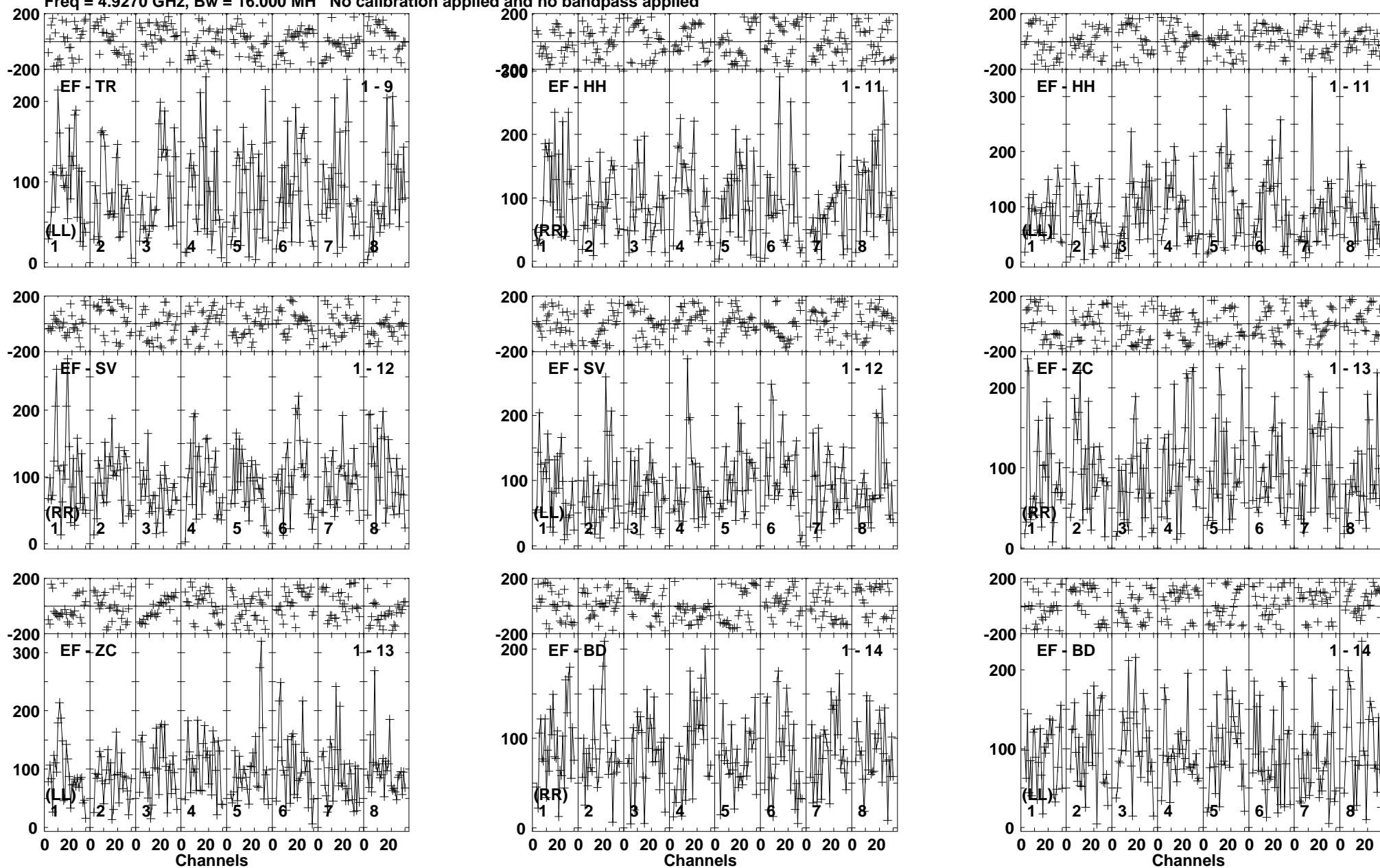

Lower frame: Micro Ampl Jy Top frame: Phas deg  
Vector averaged cross-power spectrum Baseline: EF (01) - TR (09)  
Timerange: 00/06:19:11 to 00/06:22:39

Plot file version 239 created 08-APR-2019 12:10:03

MRK622 EM133B.UVDATA.1

Freq = 4.9270 GHz, Bw = 16.000 MH No calibration applied and no bandpass applied

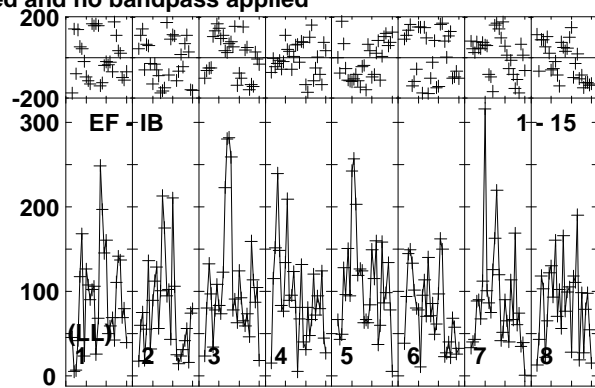
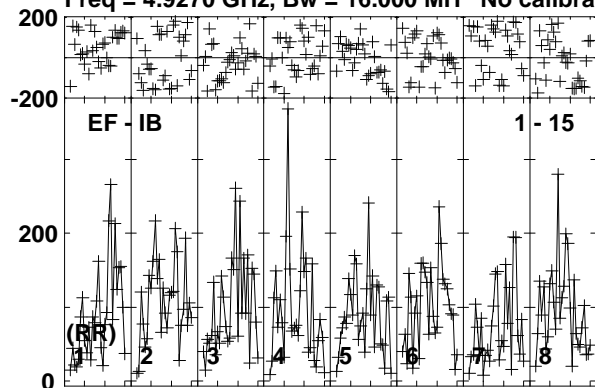

Lower frame: Micro Ampl Jy Top frame: Phas deg  
Vector averaged cross-power spectrum Baseline: EF (01) - IB (15)  
Timerange: 00/06:19:11 to 00/06:22:39

Plot file version 240 created 08-APR-2019 12:10:03

J0815+3635 EM133B.UVDATA.1

Freq = 4.9270 GHz, Bw = 16.000 MH No calibration applied and no bandpass applied

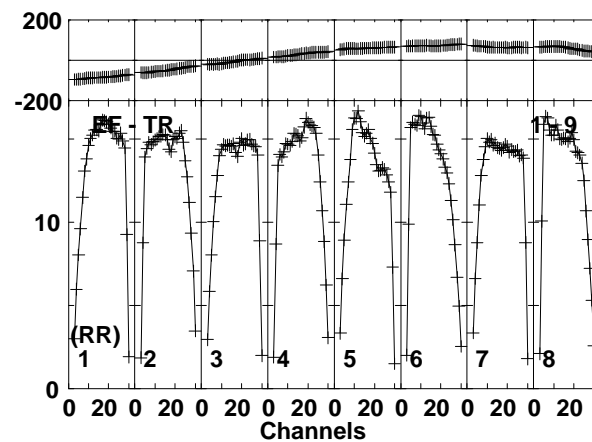
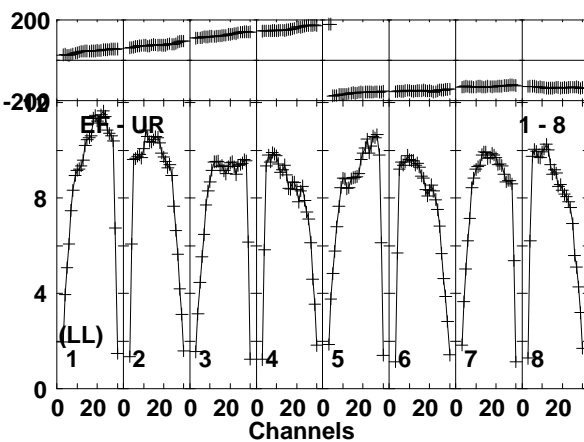
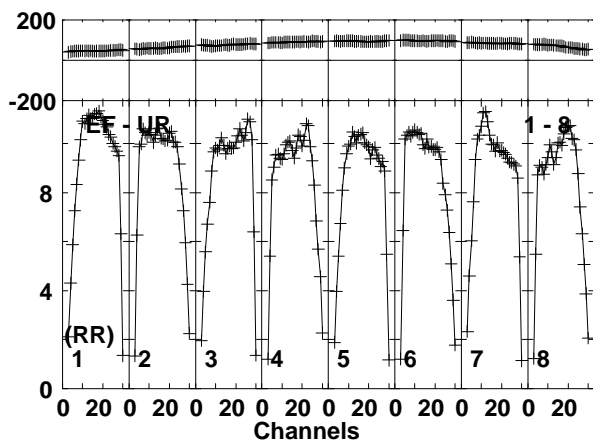
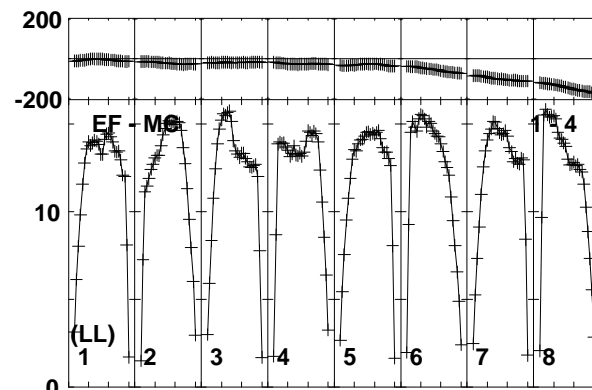
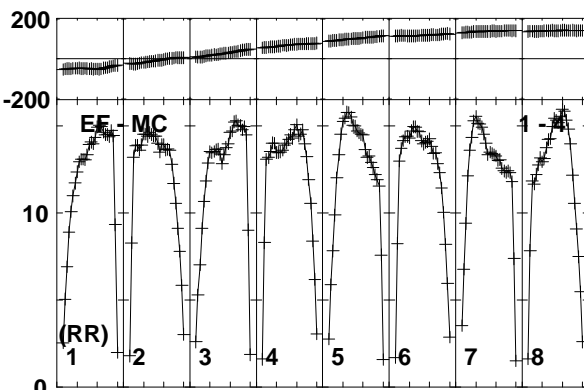
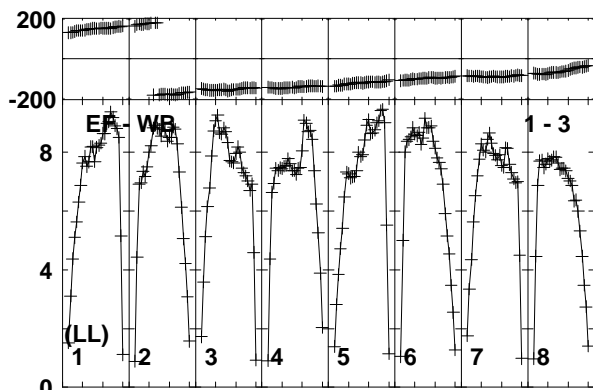
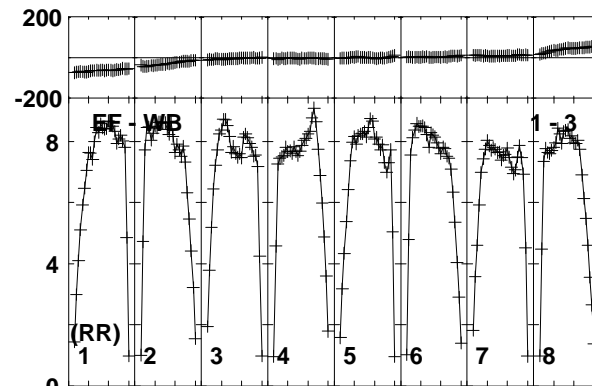
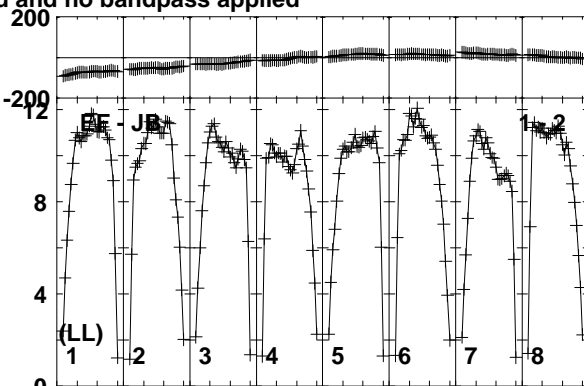
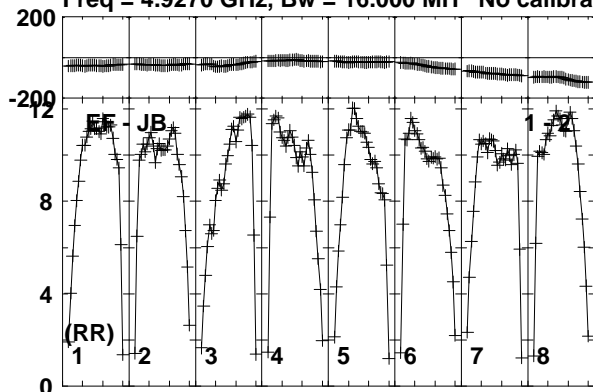

Lower frame: Milli Ampl Jy Top frame: Phas deg  
Vector averaged cross-power spectrum Baseline: EF (01) - JB (02)  
Timerange: 00/06:22:41 to 00/06:24:09



Plot file version 241 created 08-APR-2019 12:10:03

J0815+3635 EM133B.UVDATA.1

Freq = 4.9270 GHz, Bw = 16.000 MH No calibration applied and no bandpass applied

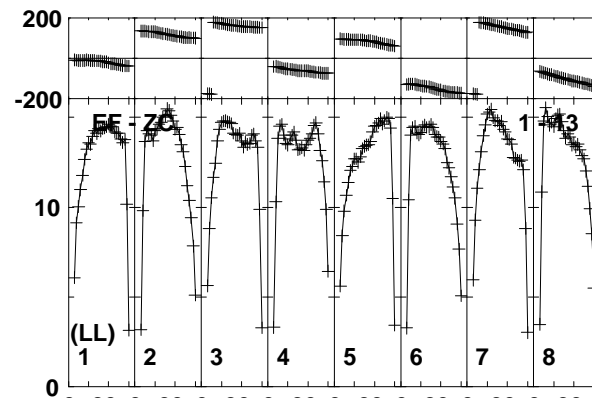
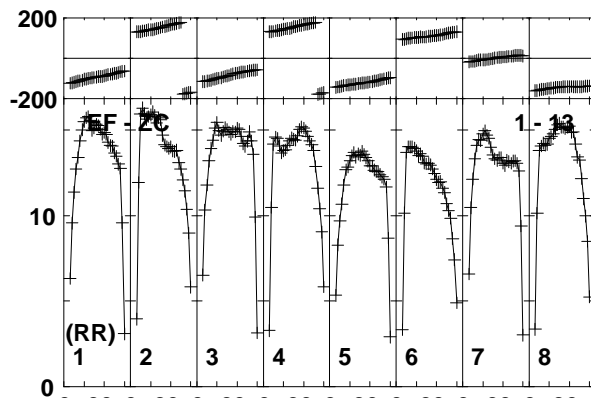
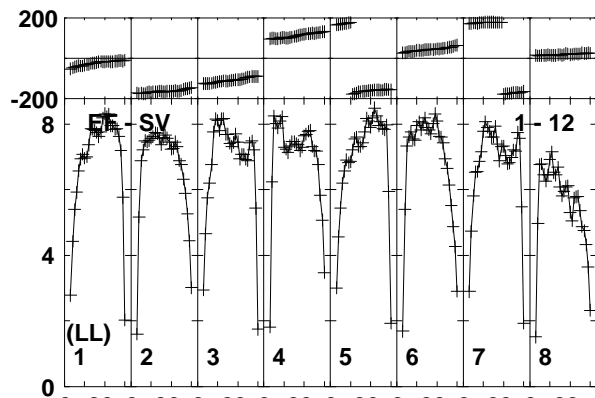
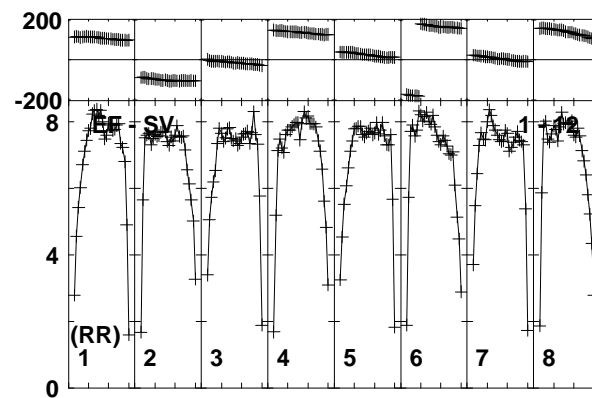
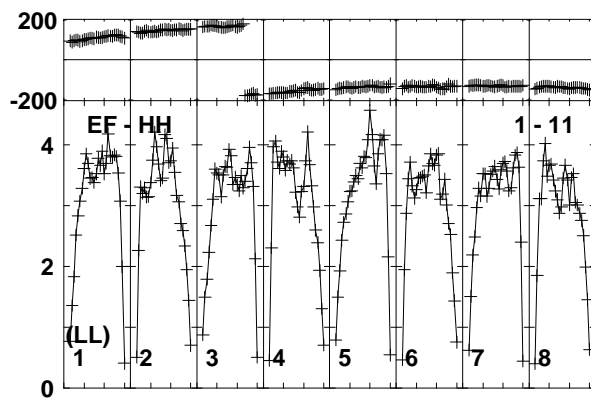
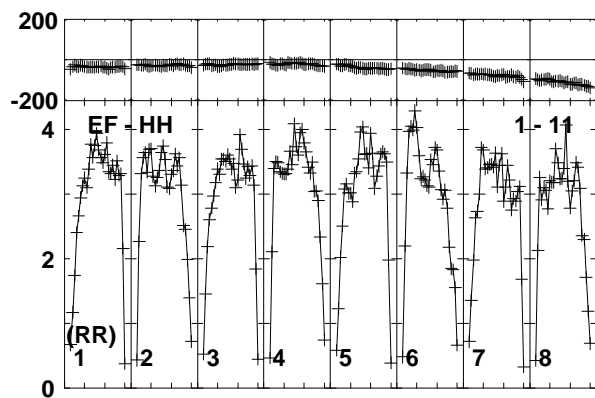
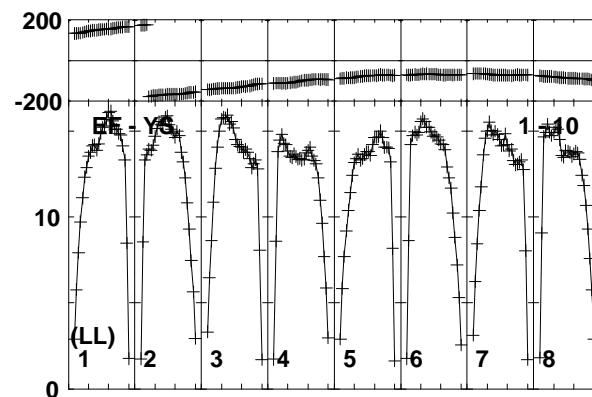
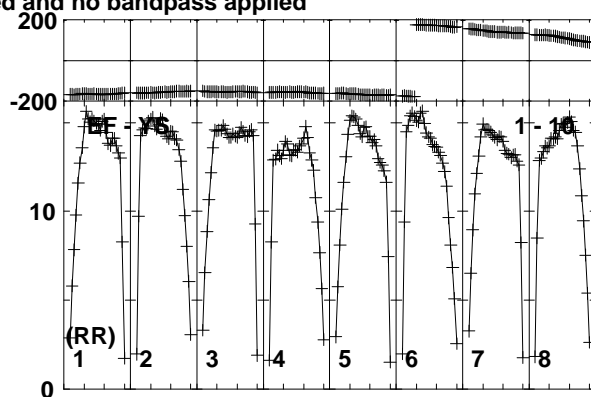
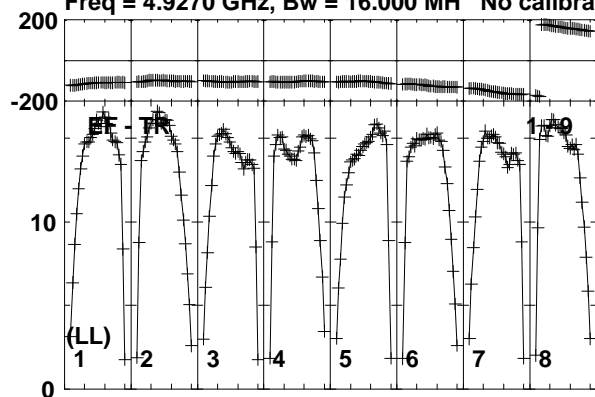

Lower frame: Milli Ampl Jy Top frame: Phas deg  
Vector averaged cross-power spectrum Baseline: EF (01) - TR (09)  
Timerange: 00/06:22:41 to 00/06:24:09

Plot file version 242 created 08-APR-2019 12:10:03

J0815+3635 EM133B.UVDATA.1

Freq = 4.9270 GHz, Bw = 16.000 MH No calibration applied and no bandpass applied

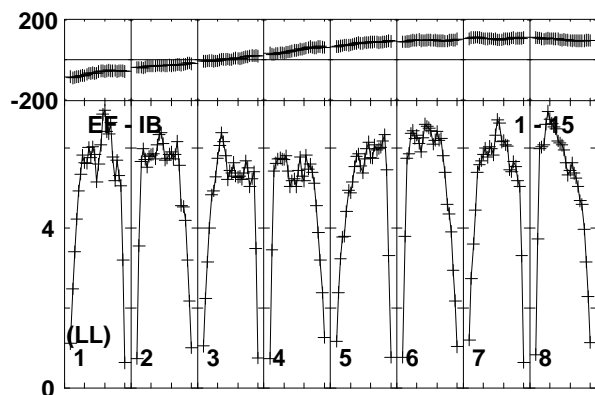
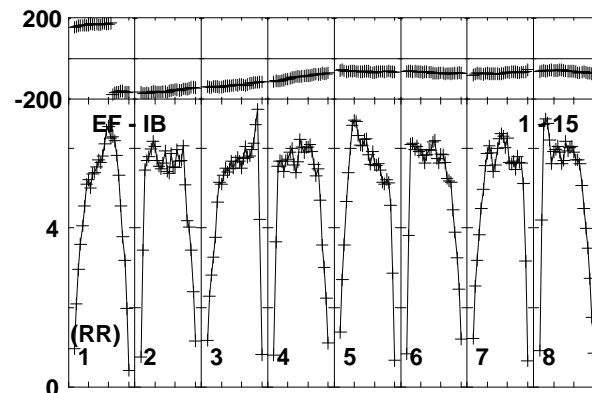
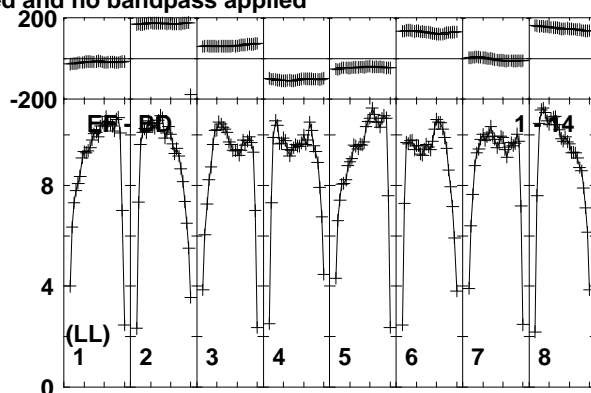
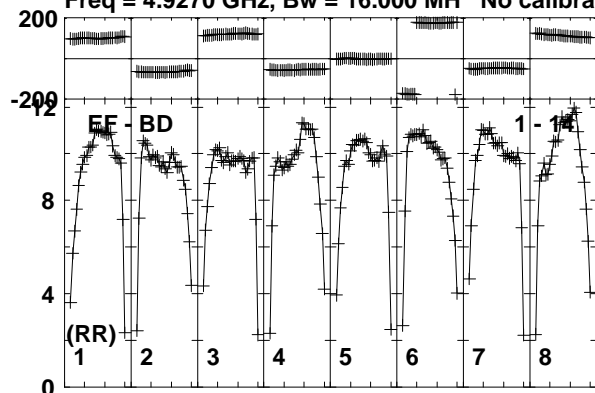

Lower frame: Milli Ampl Jy Top frame: Phas deg  
Vector averaged cross-power spectrum Baseline: EF (01) - BD (14)  
Timerange: 00/06:22:41 to 00/06:24:09

Plot file version 243 created 08-APR-2019 12:10:03

MRK622 EM133B.UVDATA.1

Freq = 4.9270 GHz, Bw = 16.000 MH No calibration applied and no bandpass applied

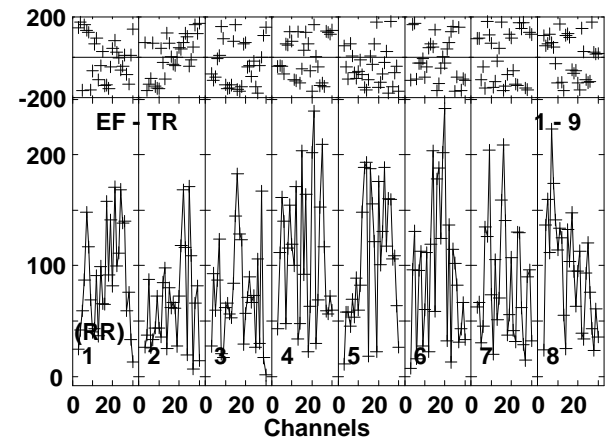
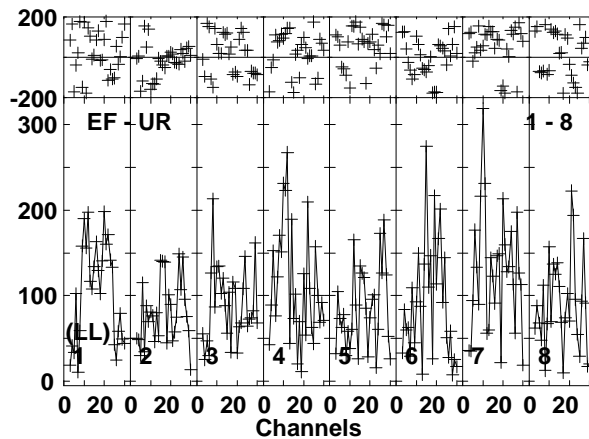
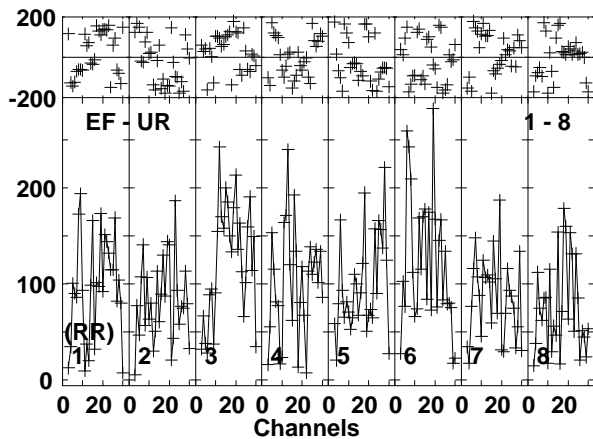
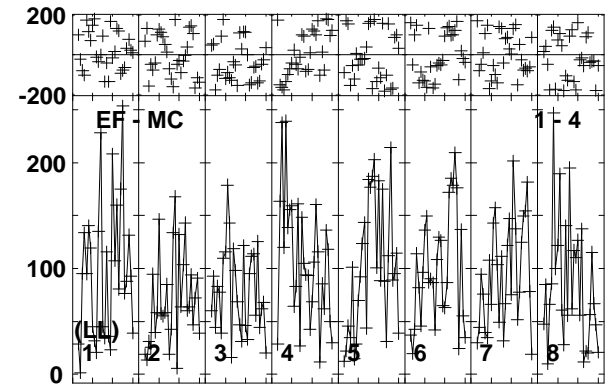
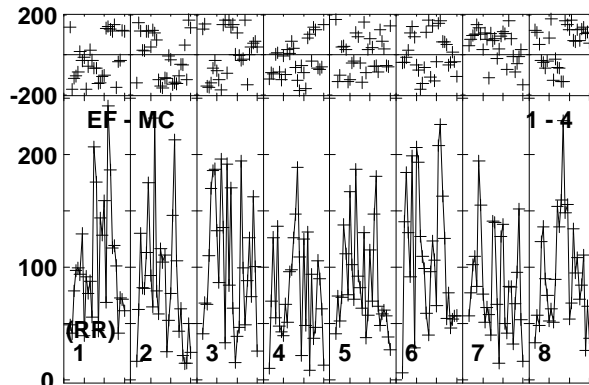
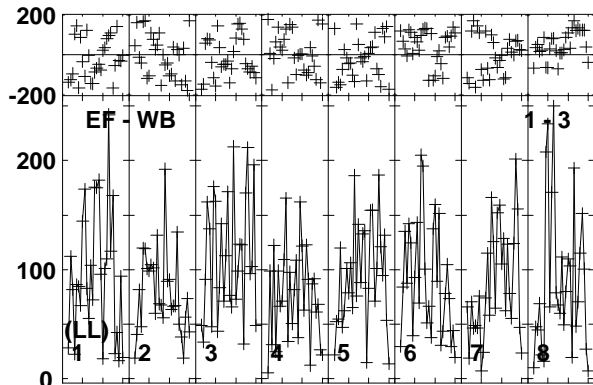
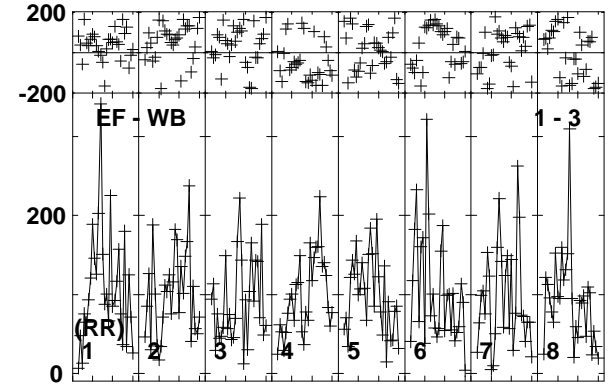
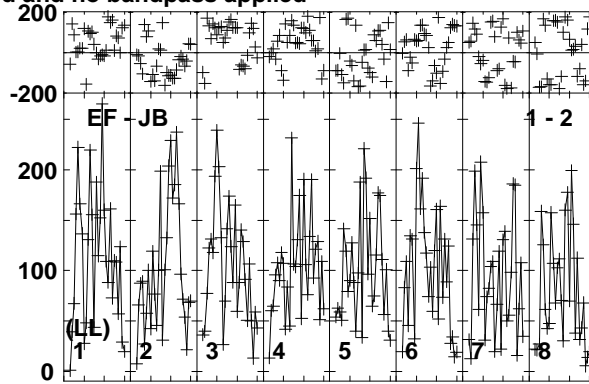
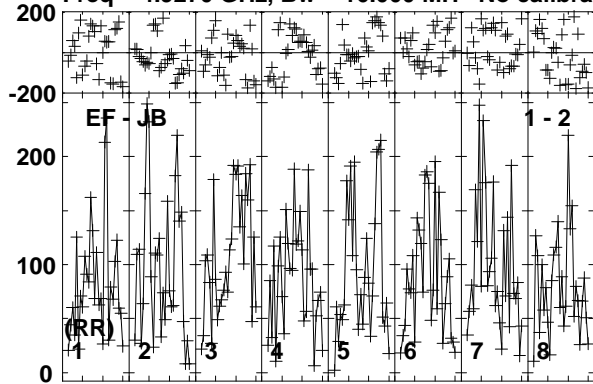

Lower frame: Micro Ampl Jy Top frame: Phas deg  
Vector averaged cross-power spectrum Baseline: EF (01) - JB (02)  
Timerange: 00/06:24:11 to 00/06:27:39

Plot file version 244 created 08-APR-2019 12:10:03

MRK622 EM133B.UVDATA.1

Freq = 4.9270 GHz, Bw = 16.000 MH No calibration applied and no bandpass applied

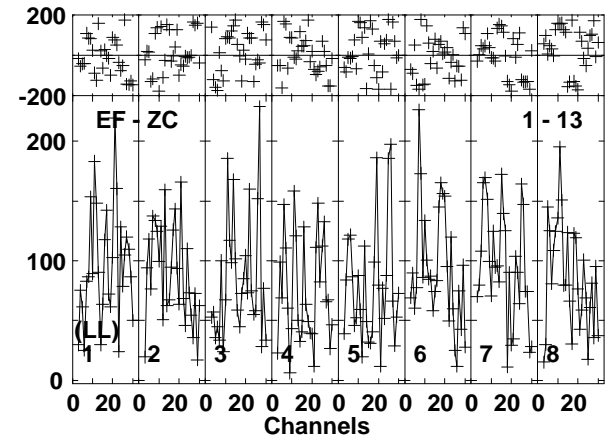
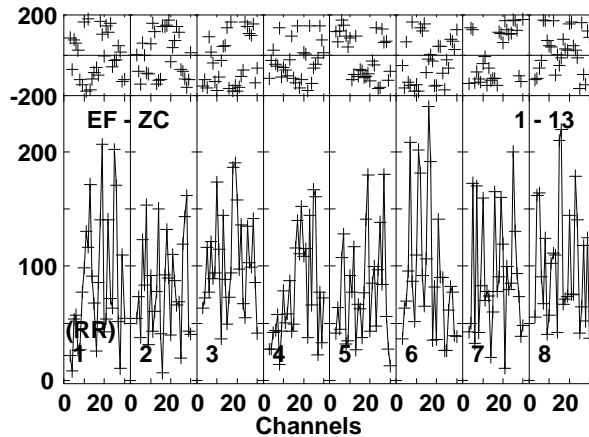
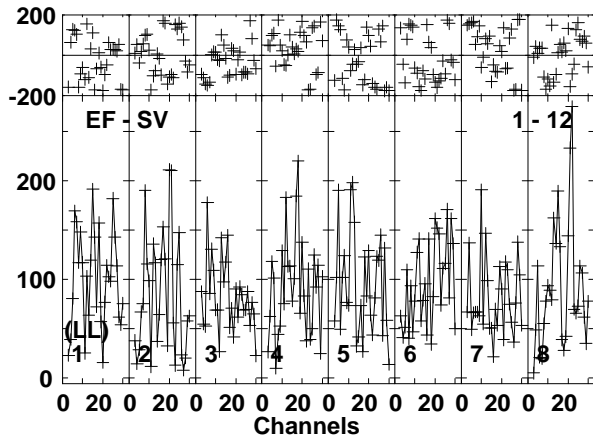
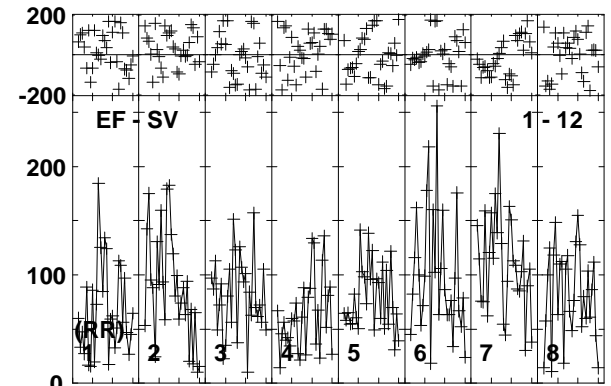
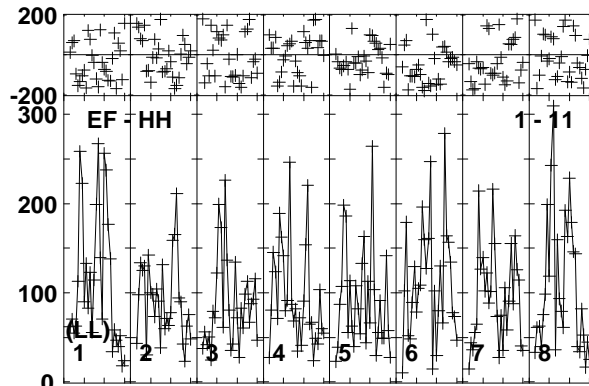
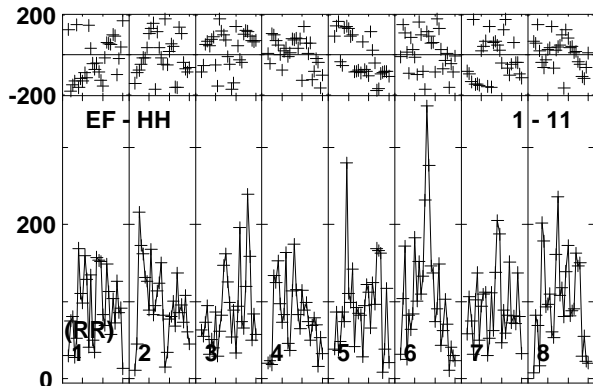
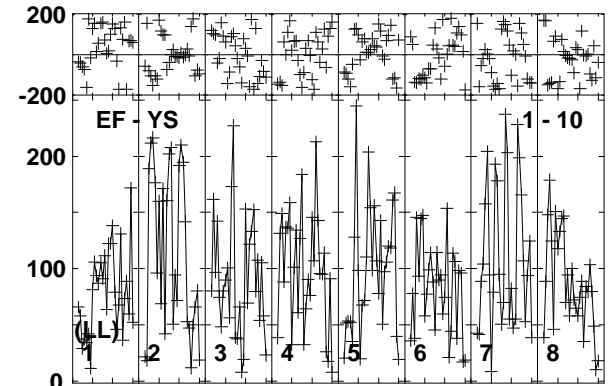
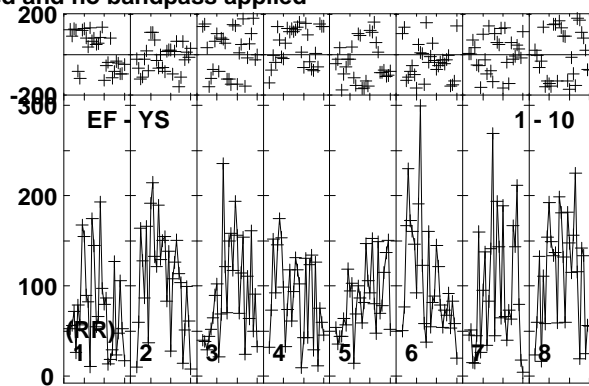
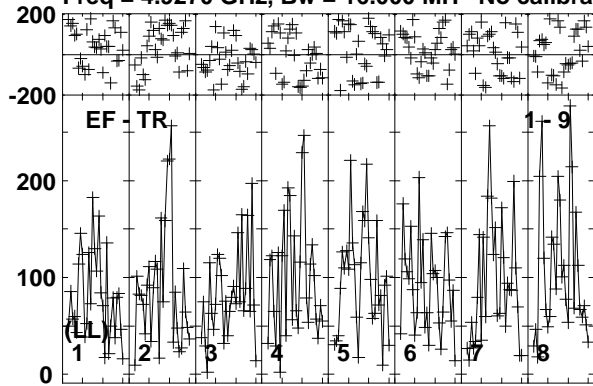

Lower frame: Micro Ampl Jy Top frame: Phas deg  
Vector averaged cross-power spectrum Baseline: EF (01) - TR (09)  
Timerange: 00/06:24:11 to 00/06:27:39

Plot file version 245 created 08-APR-2019 12:10:03

MRK622 EM133B.UVDATA.1

Freq = 4.9270 GHz, Bw = 16.000 MH No calibration applied and no bandpass applied

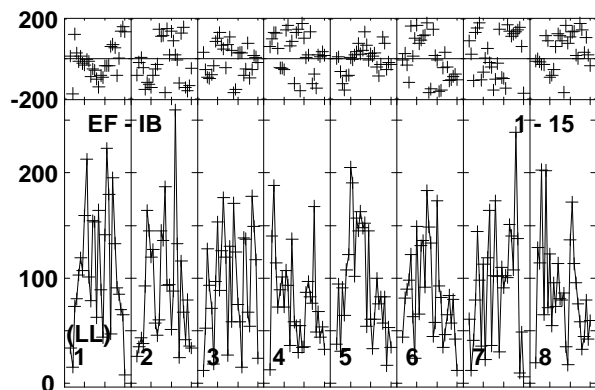
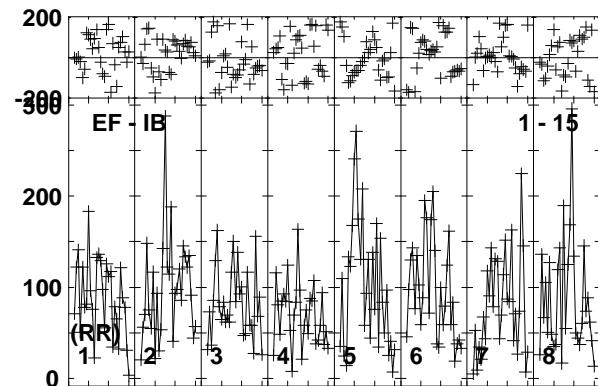
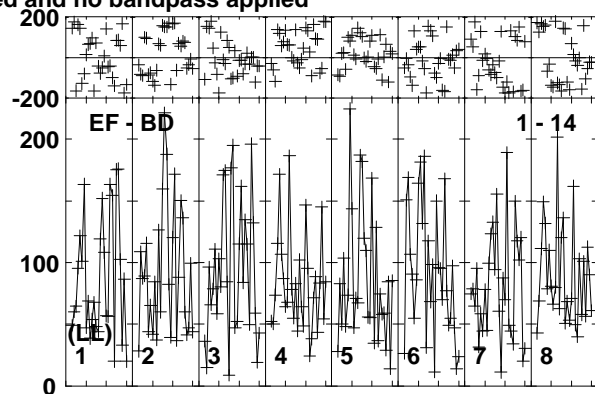
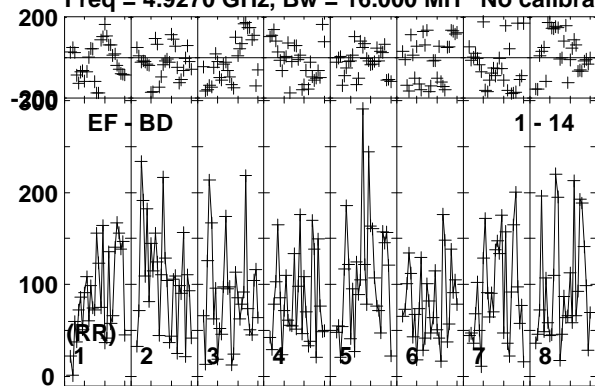

Lower frame: Micro Ampl Jy Top frame: Phas deg  
Vector averaged cross-power spectrum Baseline: EF (01) - BD (14)  
Timerange: 00/06:24:11 to 00/06:27:39

Plot file version 246 created 08-APR-2019 12:10:04

J0815+3635 EM133B.UVDATA.1

Freq = 4.9270 GHz, Bw = 16.000 MH No calibration applied and no bandpass applied

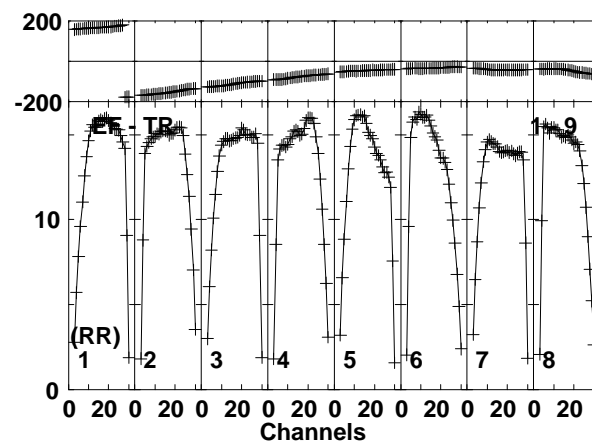
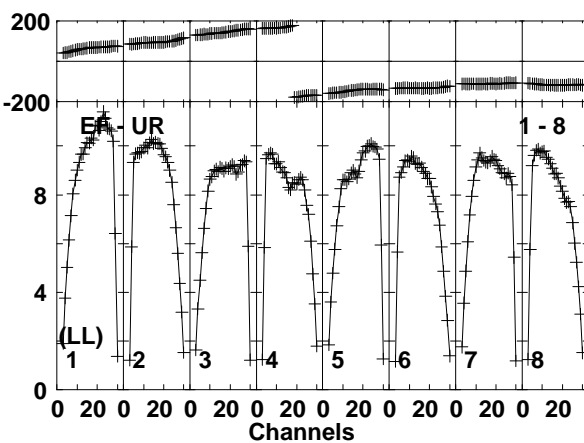
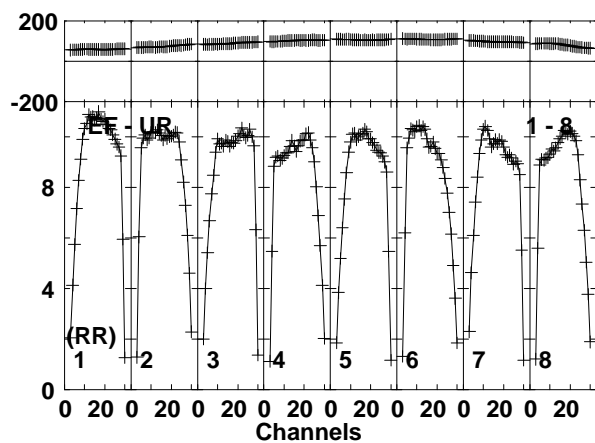
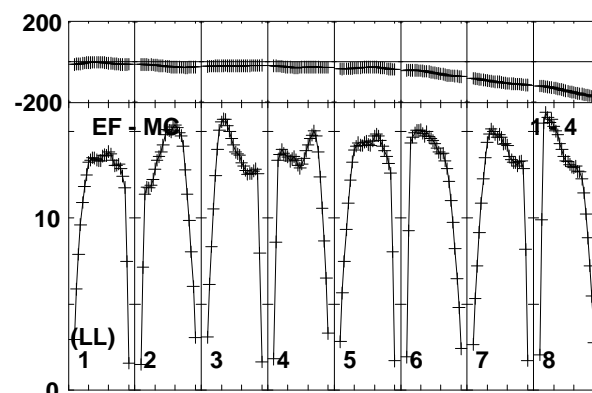
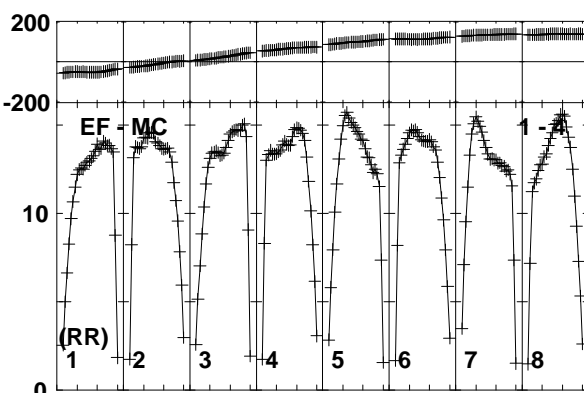
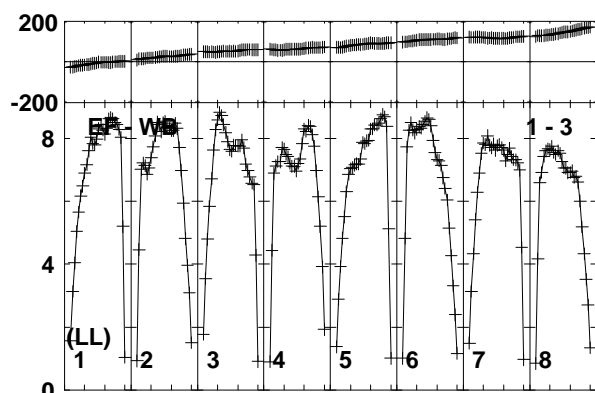
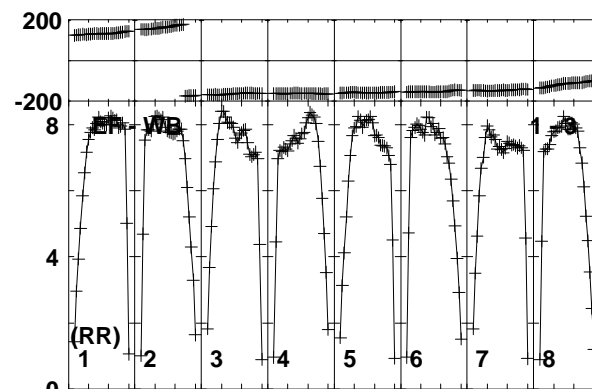
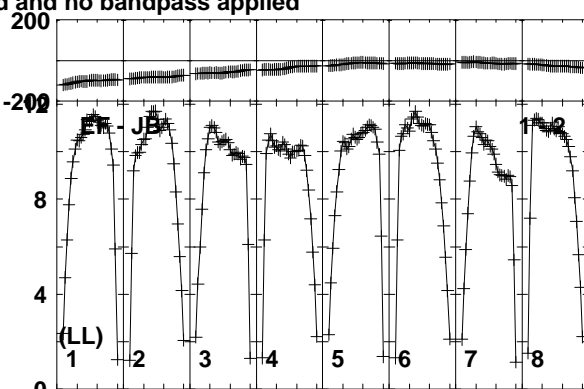
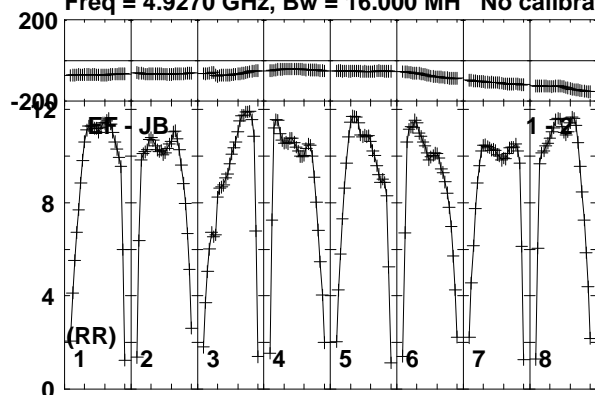

Lower frame: Milli Ampl Jy Top frame: Phas deg  
Vector averaged cross-power spectrum Baseline: EF (01) - JB (02)  
Timerange: 00/06:28:31 to 00/06:29:59

Plot file version 247 created 08-APR-2019 12:10:04

J0815+3635 EM133B.UVDATA.1

Freq = 4.9270 GHz, Bw = 16.000 MH No calibration applied and no bandpass applied

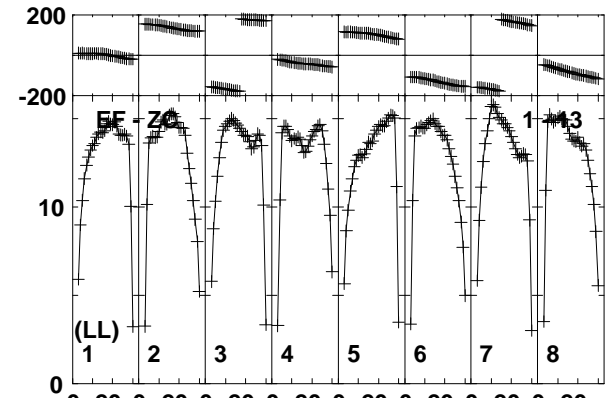
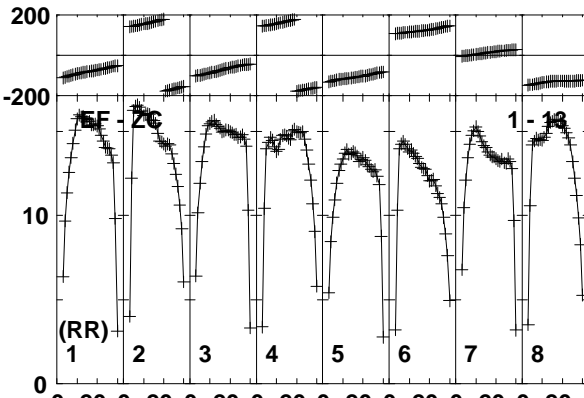
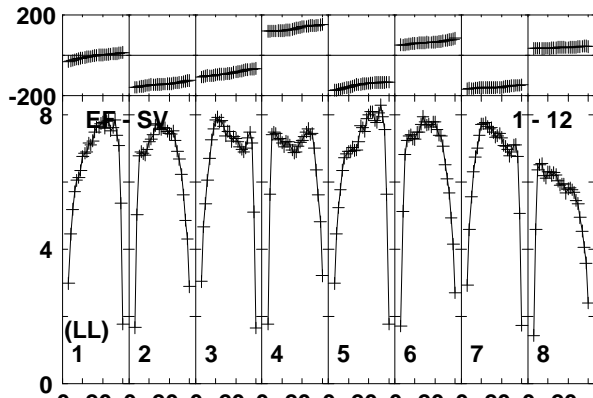
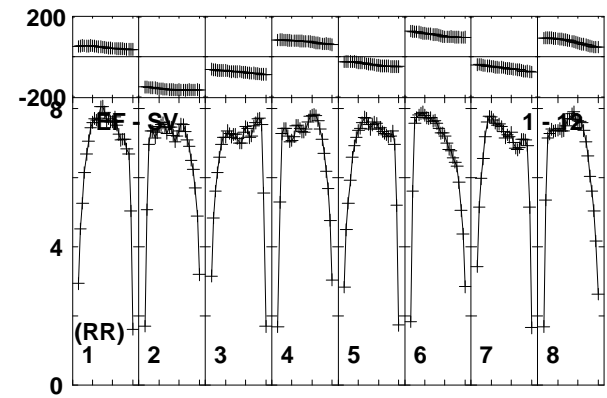
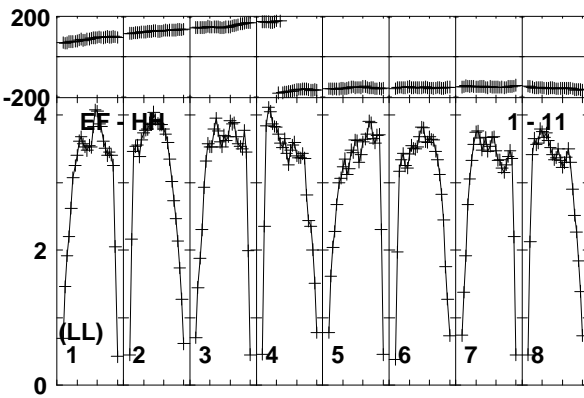
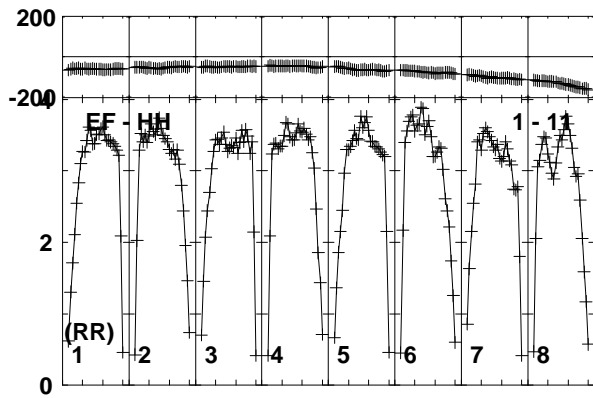
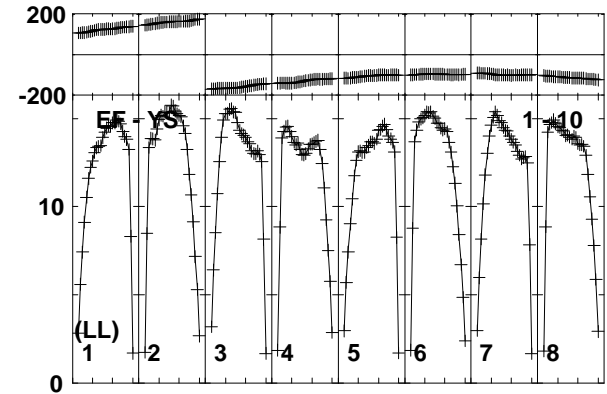
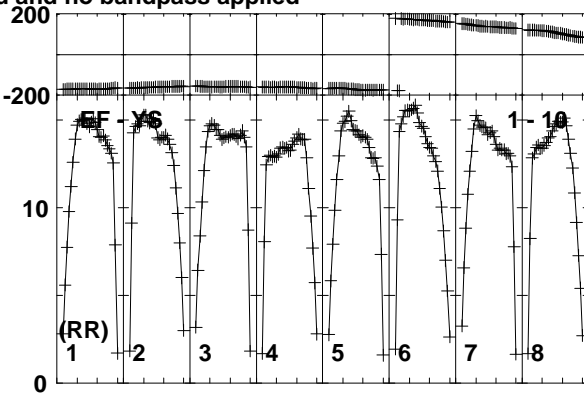
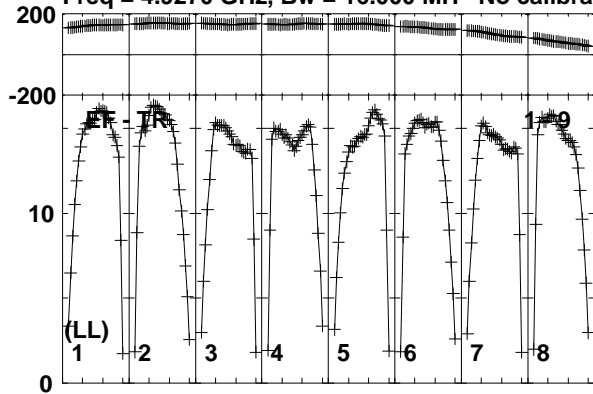

Lower frame: Milli Ampl Jy Top frame: Phas deg  
Vector averaged cross-power spectrum Baseline: EF (01) - TR (09)  
Timerange: 00/06:28:31 to 00/06:29:59

Plot file version 248 created 08-APR-2019 12:10:04

J0815+3635 EM133B.UVDATA.1

Freq = 4.9270 GHz, Bw = 16.000 MH No calibration applied and no bandpass applied

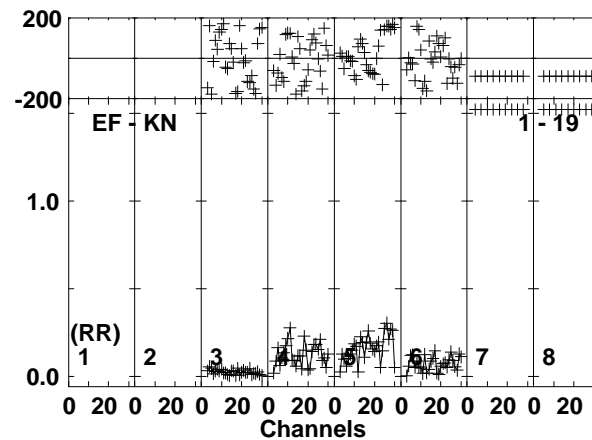
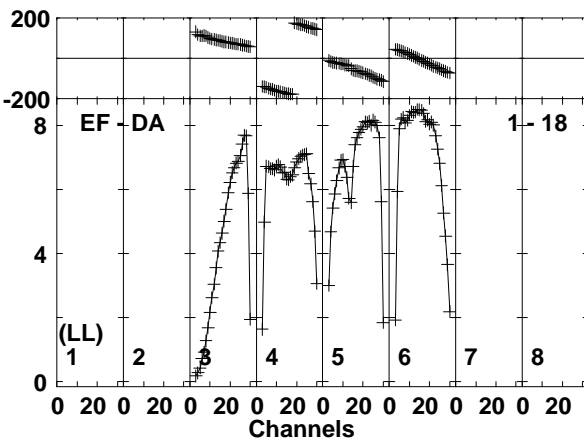
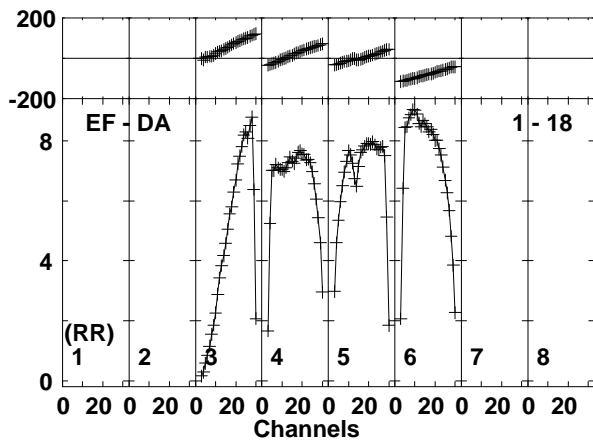
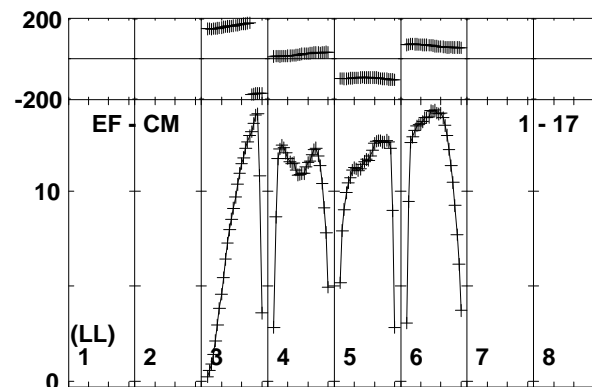
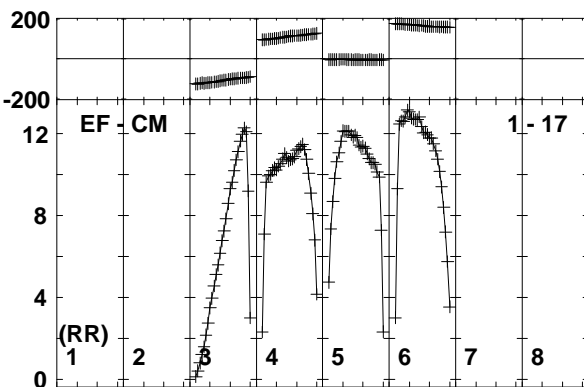
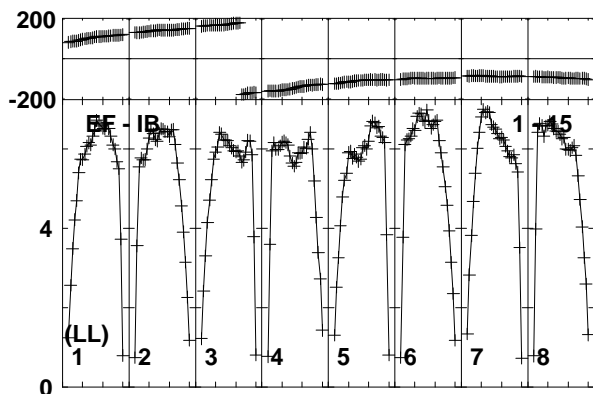
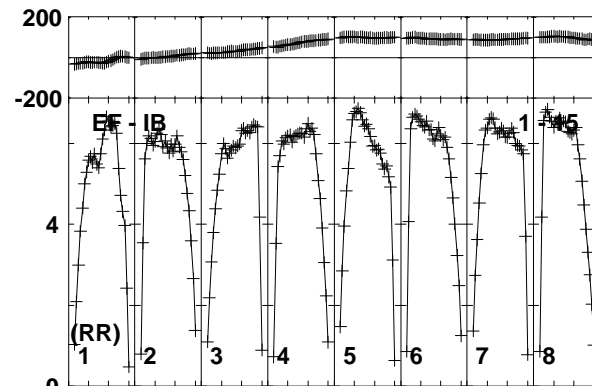
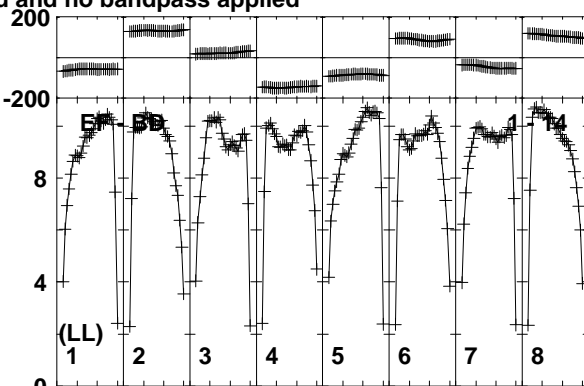
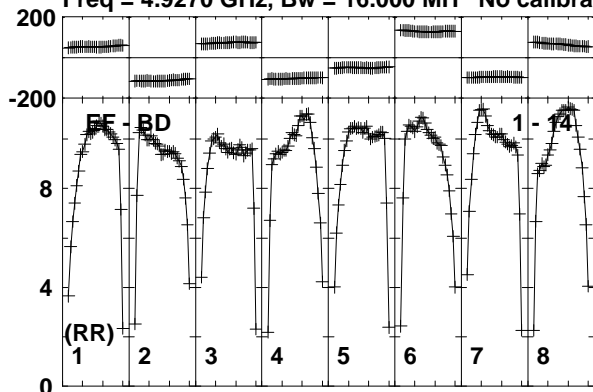

Lower frame: Milli Ampl Jy Top frame: Phas deg  
Vector averaged cross-power spectrum Baseline: EF (01) - BD (14)  
Timerange: 00/06:28:31 to 00/06:29:59



Plot file version 249 created 08-APR-2019 12:10:04

J0815+3635 EM133B.UVDATA.1

Freq = 4.9270 GHz, Bw = 16.000 MH No calibration applied and no bandpass applied

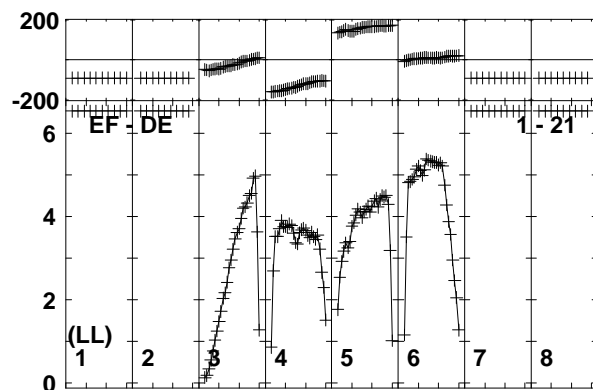
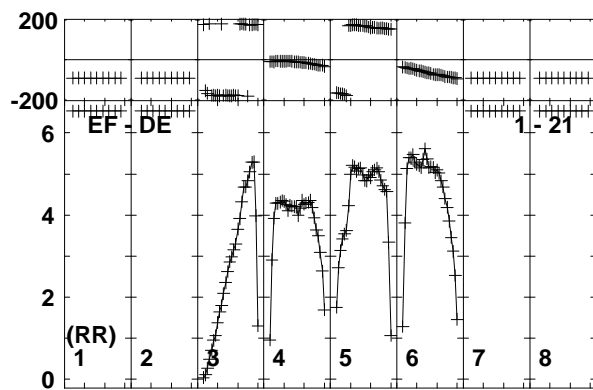
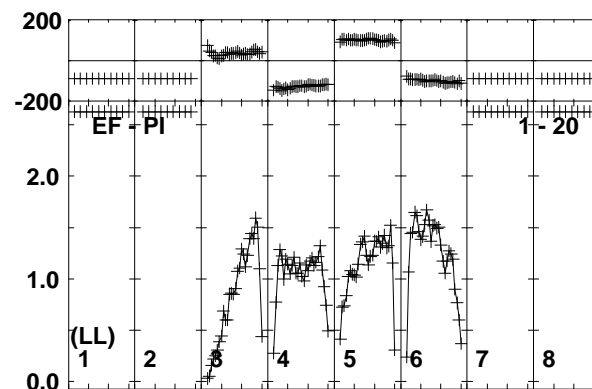
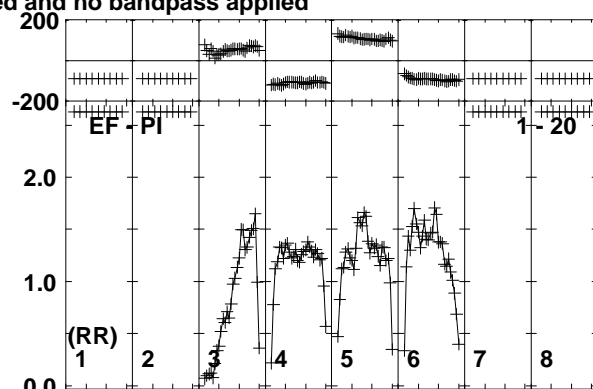
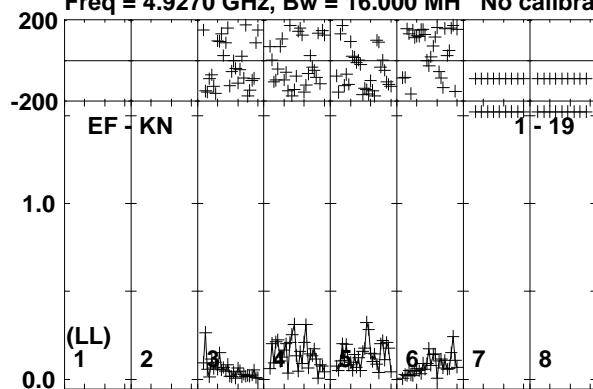

Lower frame: Milli Ampl Jy Top frame: Phas deg  
Vector averaged cross-power spectrum Baseline: EF (01) - KN (19)  
Timerange: 00/06:28:31 to 00/06:29:59

Plot file version 250 created 08-APR-2019 12:10:04

MRK622 EM133B.UVDATA.1

Freq = 4.9270 GHz, Bw = 16.000 MH No calibration applied and no bandpass applied

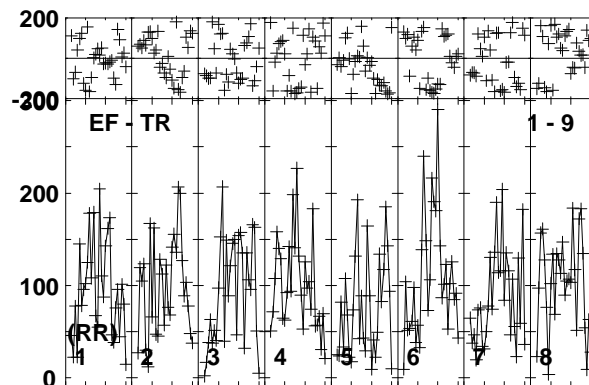
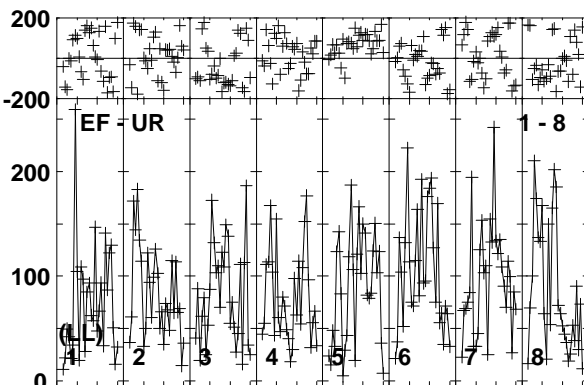
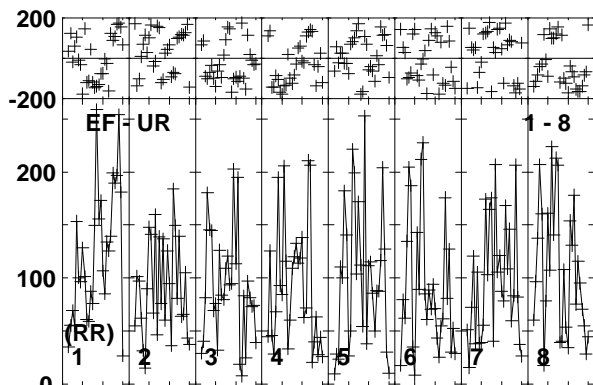
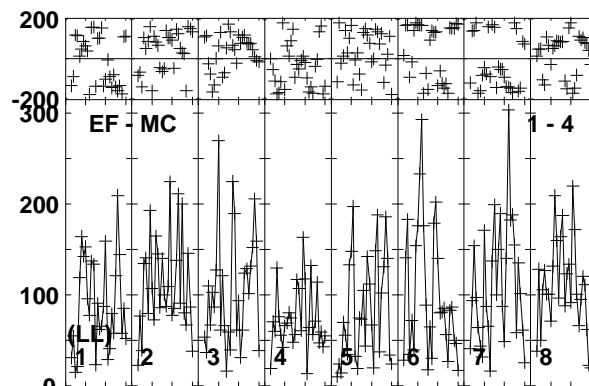
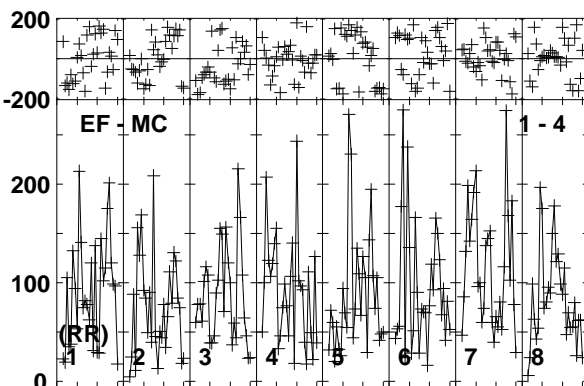
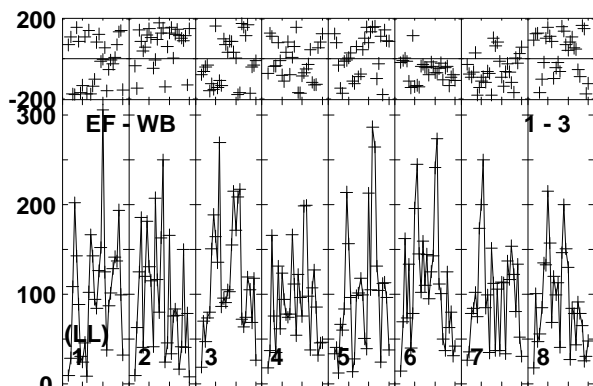
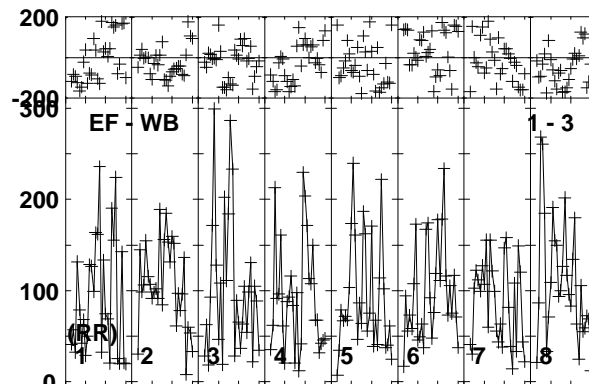
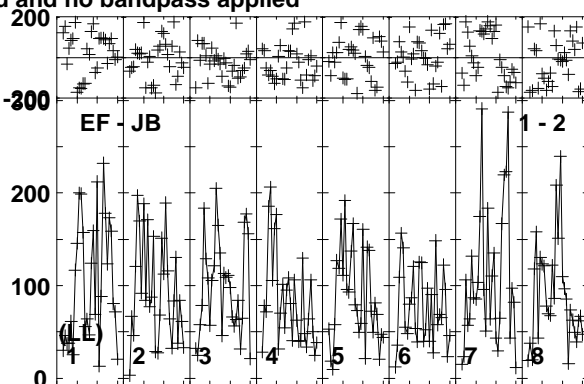
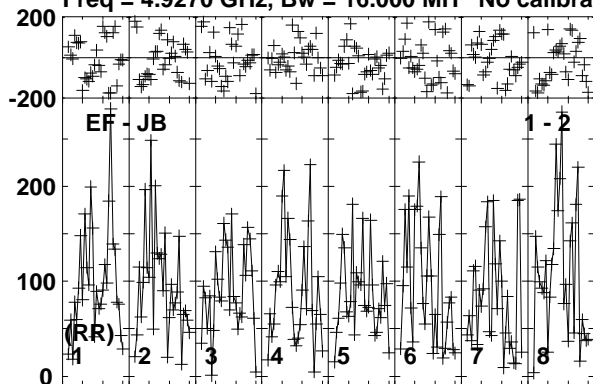

Lower frame: Micro Ampl Jy Top frame: Phas deg  
Vector averaged cross-power spectrum Baseline: EF (01) - JB (02)  
Timerange: 00/06:30:01 to 00/06:33:29

Plot file version 251 created 08-APR-2019 12:10:04

MRK622 EM133B.UVDATA.1

Freq = 4.9270 GHz, Bw = 16.000 MH No calibration applied and no bandpass applied

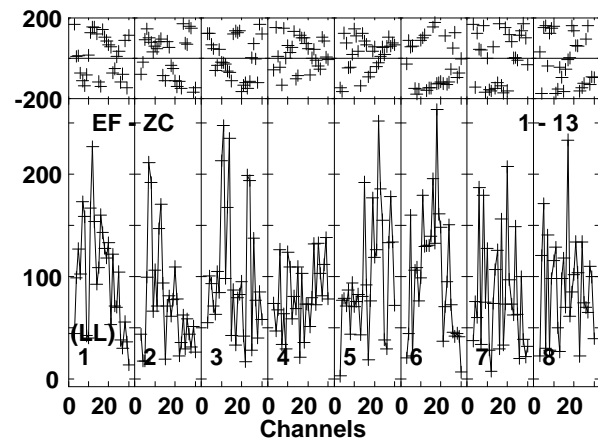
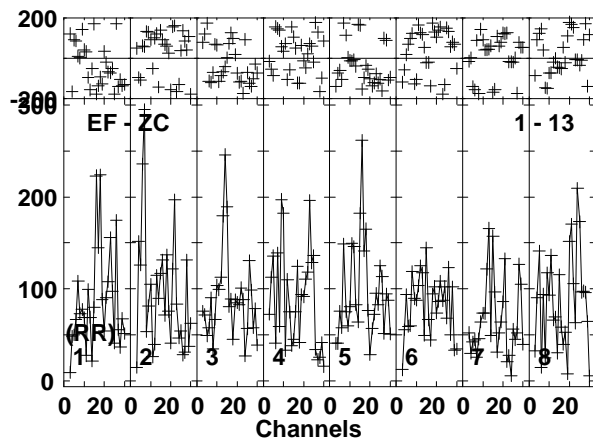
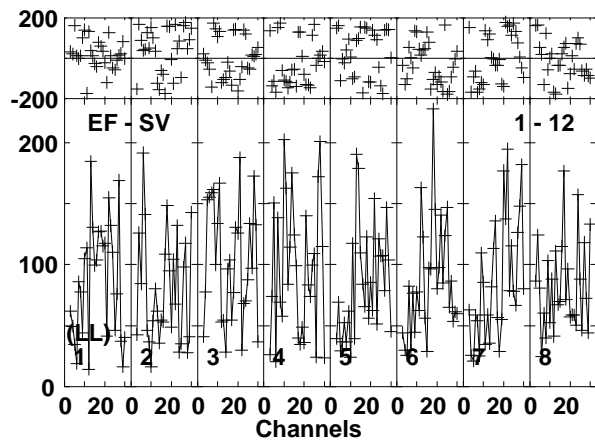
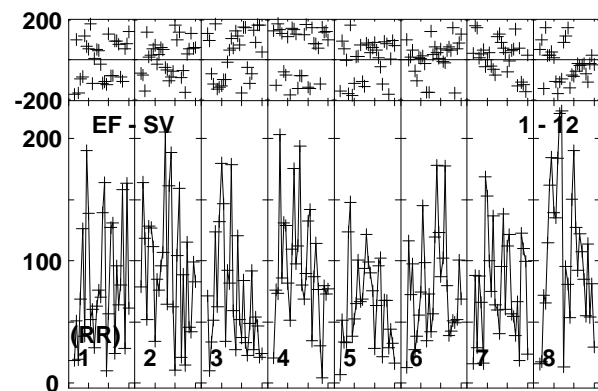
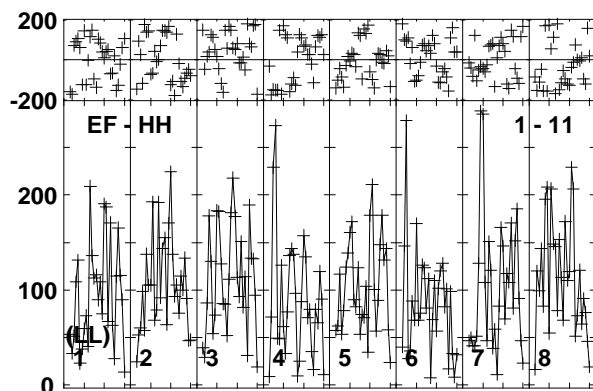
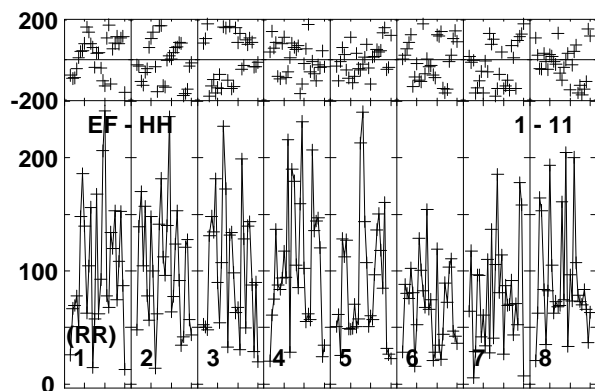
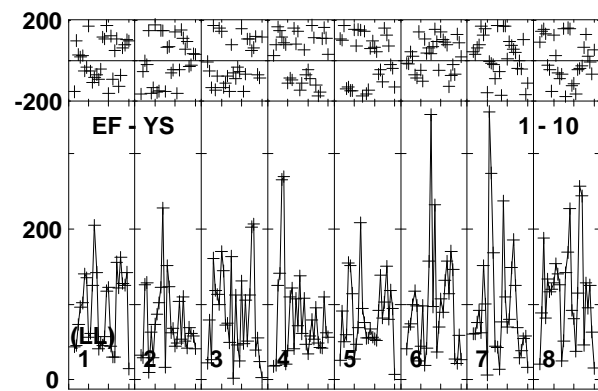
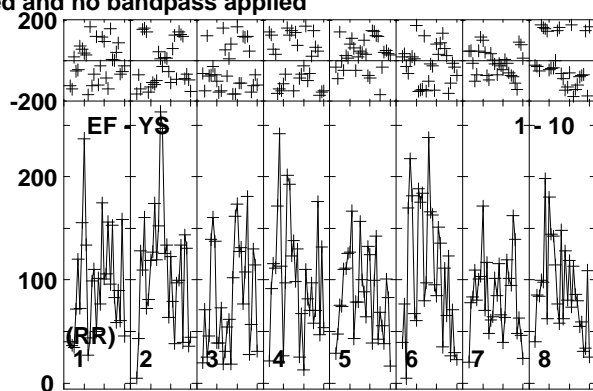
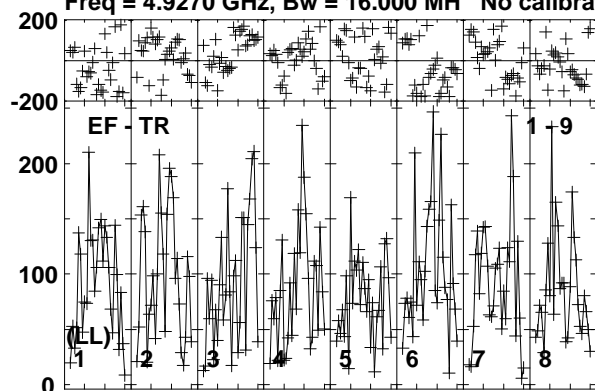

Lower frame: Micro Ampl Jy Top frame: Phas deg  
Vector averaged cross-power spectrum Baseline: EF (01) - TR (09)  
Timerange: 00/06:30:01 to 00/06:33:29

Plot file version 252 created 08-APR-2019 12:10:04

MRK622 EM133B.UVDATA.1

Freq = 4.9270 GHz, Bw = 16.000 MH No calibration applied and no bandpass applied

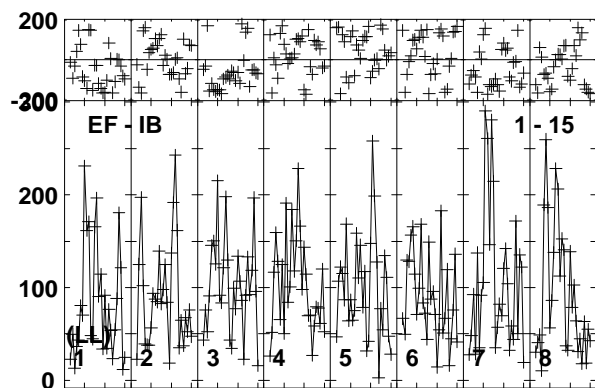
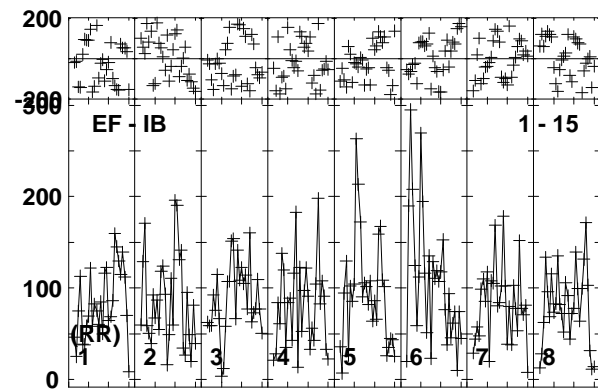
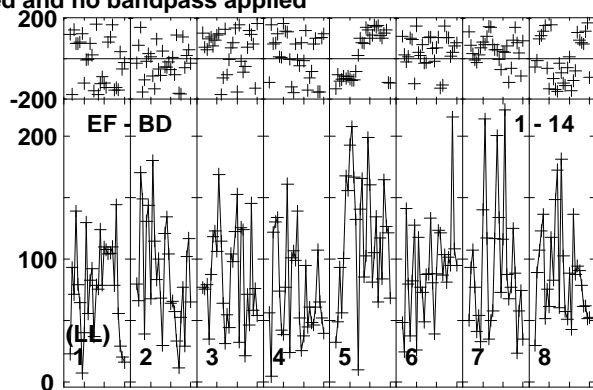
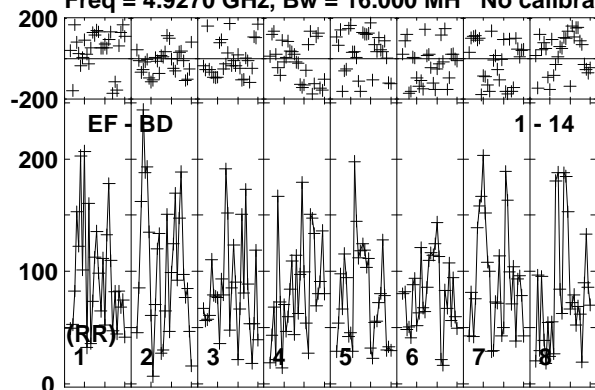

Lower frame: Micro Ampl Jy Top frame: Phas deg  
Vector averaged cross-power spectrum Baseline: EF (01) - BD (14)  
Timerange: 00/06:30:01 to 00/06:33:29

Plot file version 253 created 08-APR-2019 12:10:04

J0815+3635 EM133B.UVDATA.1

Freq = 4.9270 GHz, Bw = 16.000 MH No calibration applied and no bandpass applied

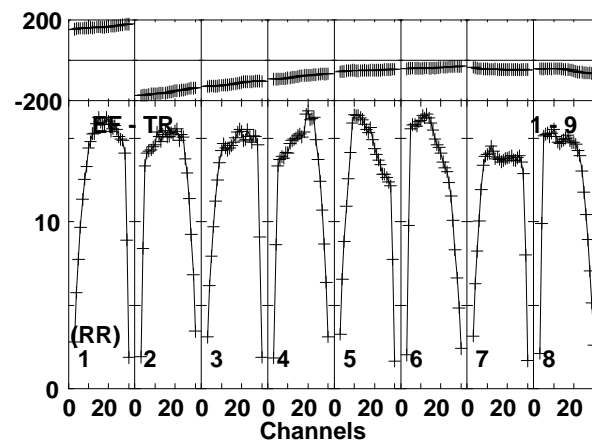
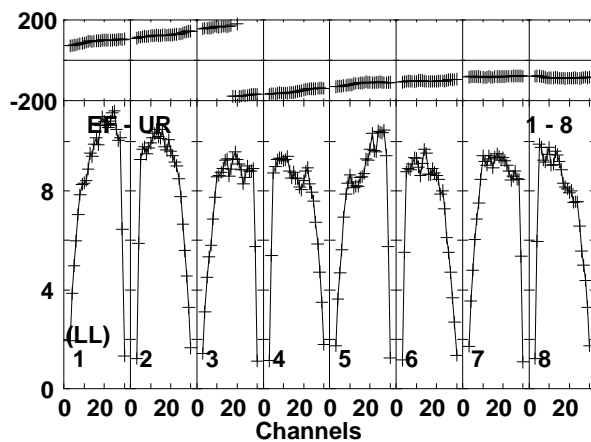
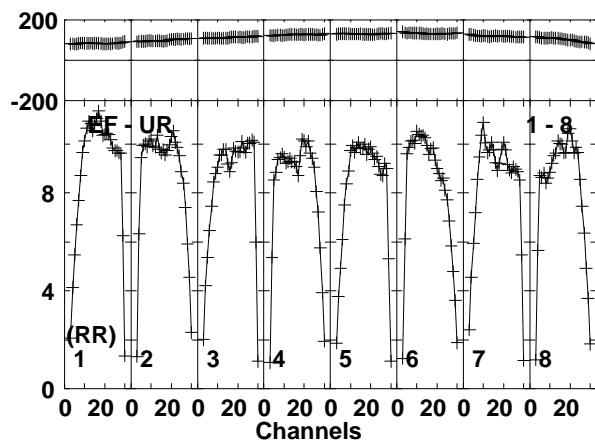
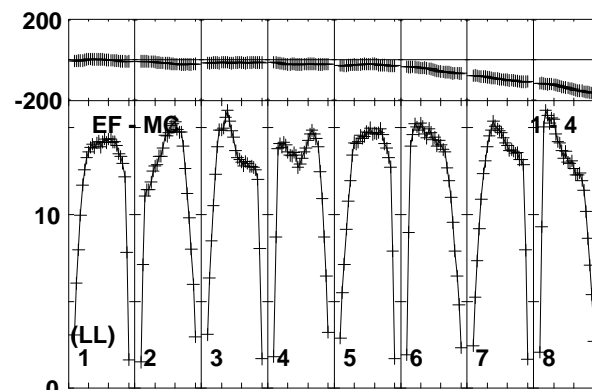
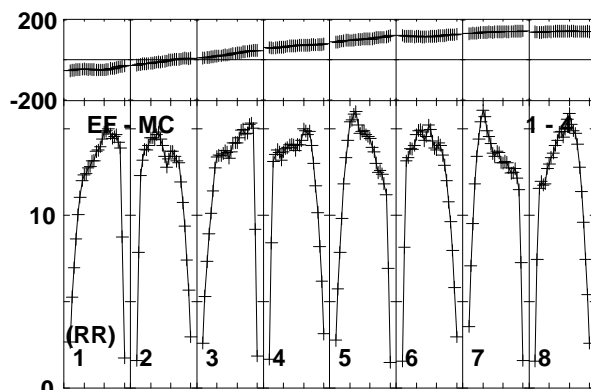
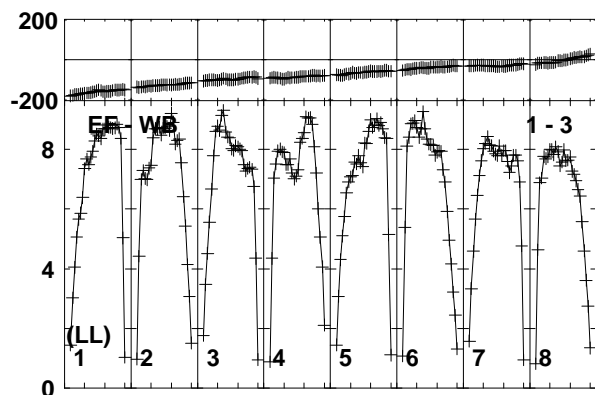
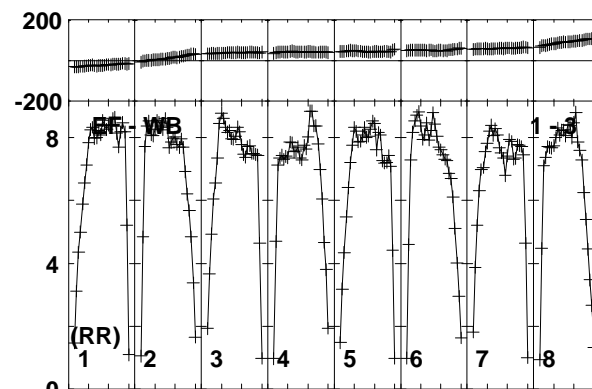
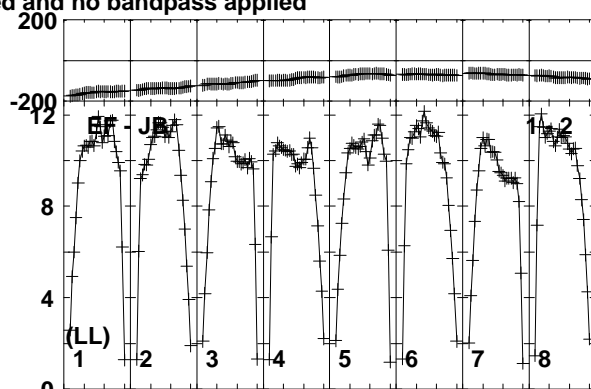
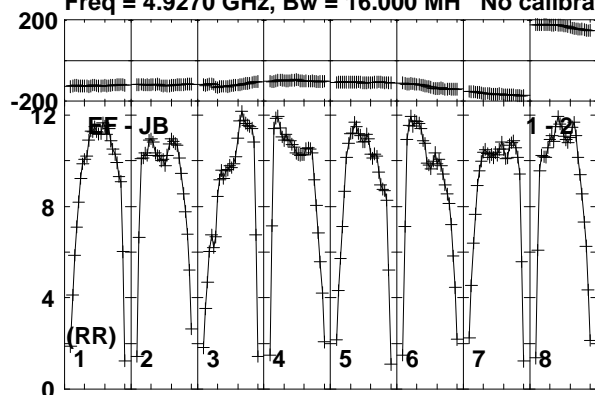

Lower frame: Milli Ampl Jy Top frame: Phas deg  
Vector averaged cross-power spectrum Baseline: EF (01) - JB (02)  
Timerange: 00/06:33:31 to 00/06:34:59

Plot file version 254 created 08-APR-2019 12:10:04

J0815+3635 EM133B.UVDATA.1

Freq = 4.9270 GHz, Bw = 16.000 MH No calibration applied and no bandpass applied

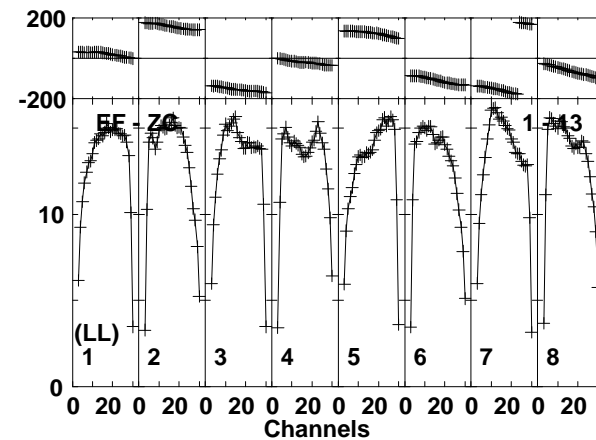
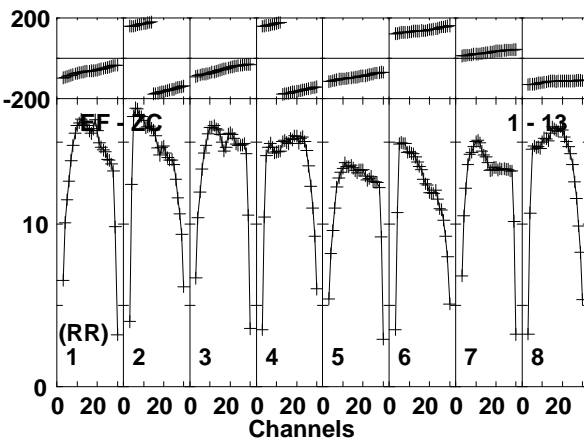
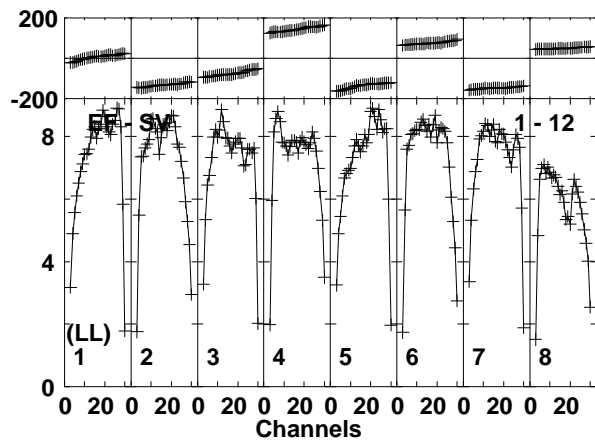
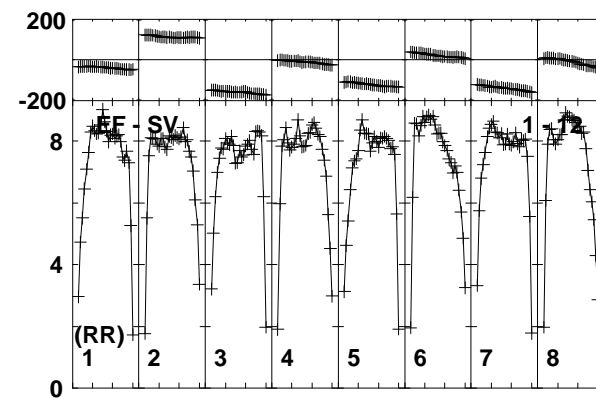
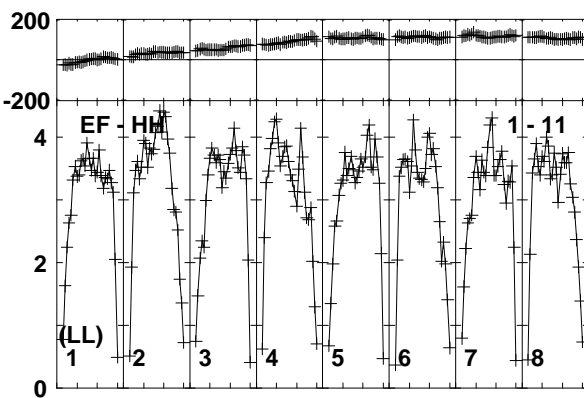
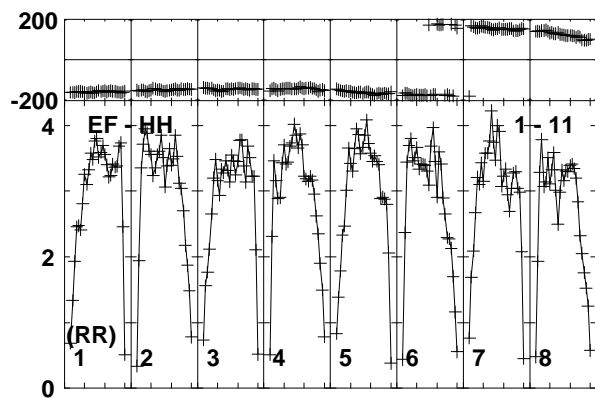
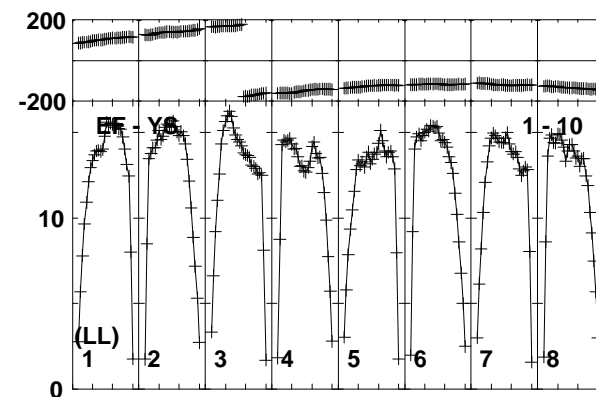
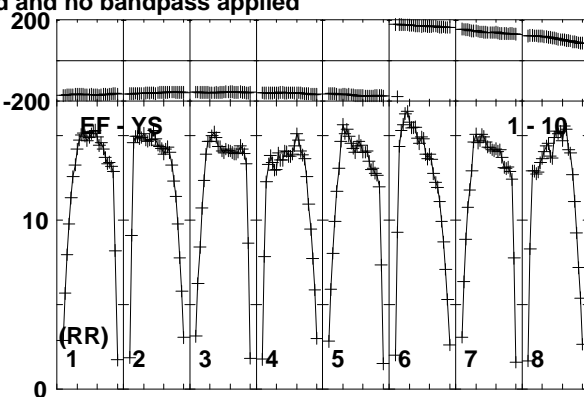
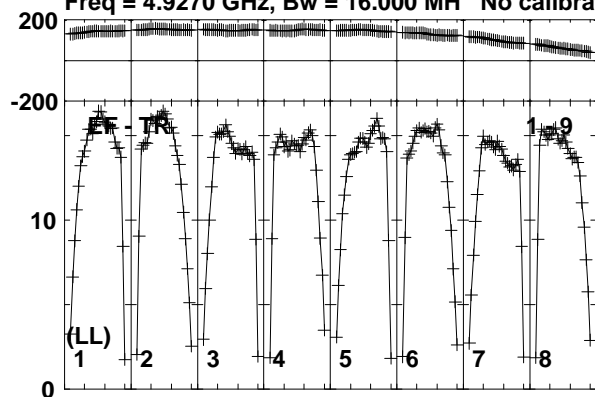

Lower frame: Milli Ampl Jy Top frame: Phas deg  
Vector averaged cross-power spectrum Baseline: EF (01) - TR (09)  
Timerange: 00/06:33:31 to 00/06:34:59

Plot file version 255 created 08-APR-2019 12:10:05

J0815+3635 EM133B.UVDATA.1

Freq = 4.9270 GHz, Bw = 16.000 MH No calibration applied and no bandpass applied

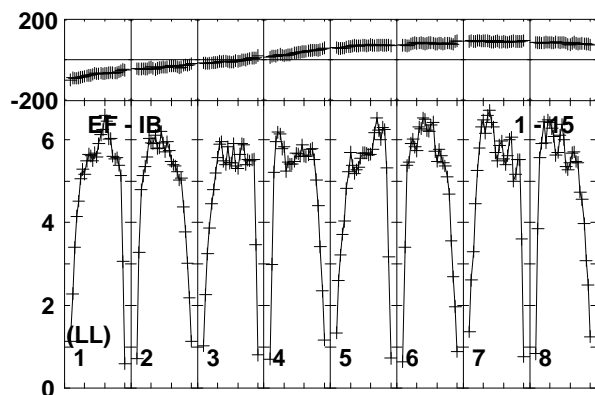
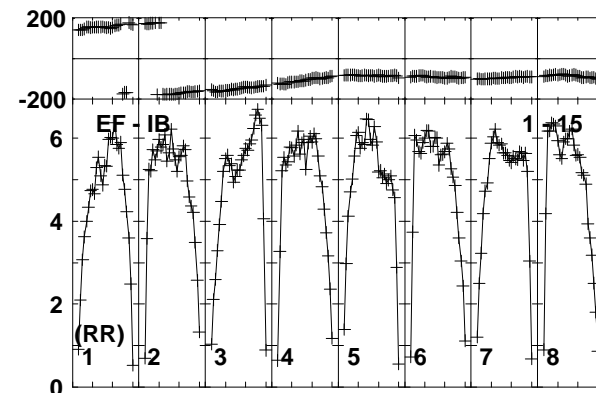
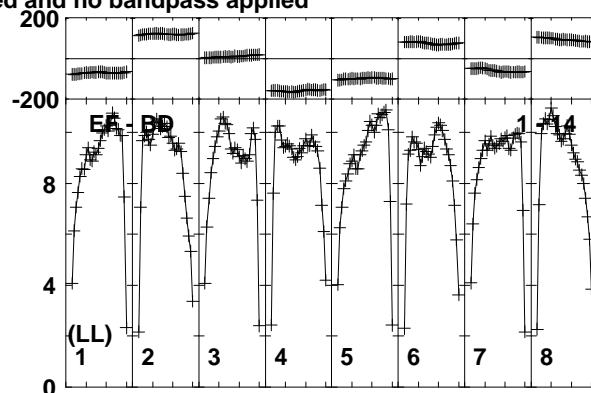
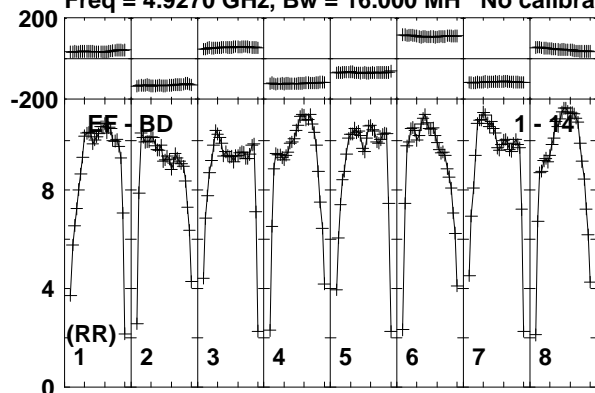

Lower frame: Milli Ampl Jy Top frame: Phas deg  
Vector averaged cross-power spectrum Baseline: EF (01) - BD (14)  
Timerange: 00/06:33:31 to 00/06:34:59

Plot file version 256 created 08-APR-2019 12:10:05

MRK622 EM133B.UVDATA.1

Freq = 4.9270 GHz, Bw = 16.000 MH No calibration applied and no bandpass applied

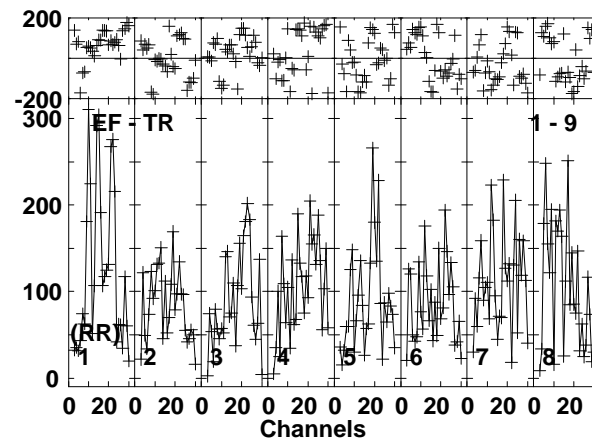
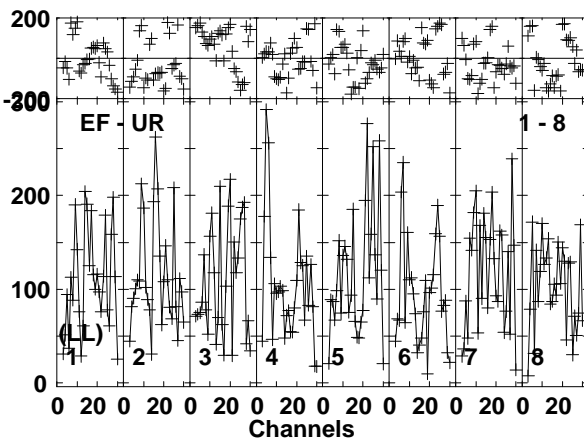
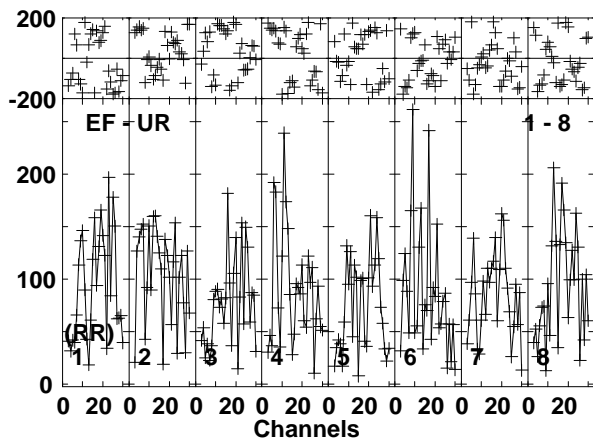
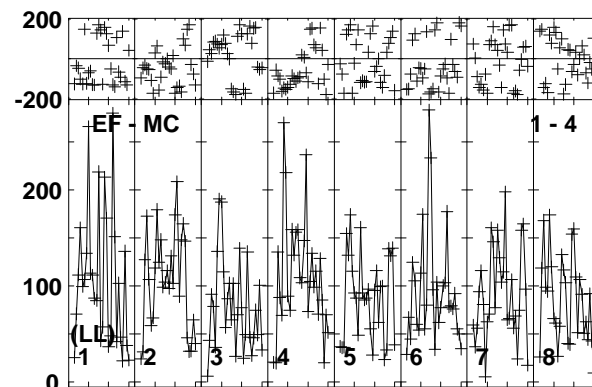
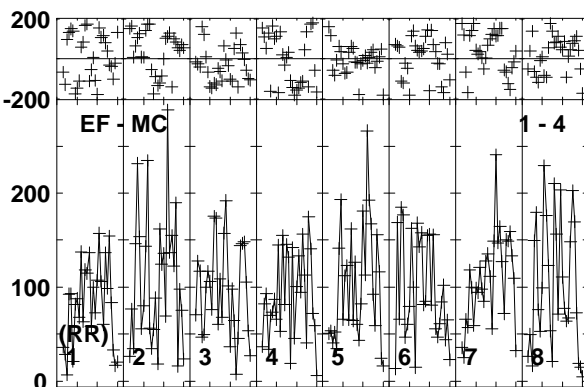
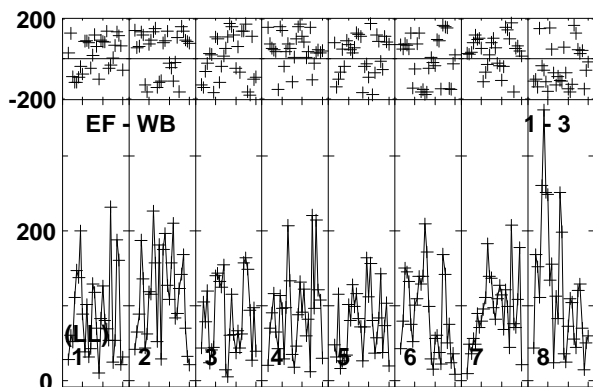
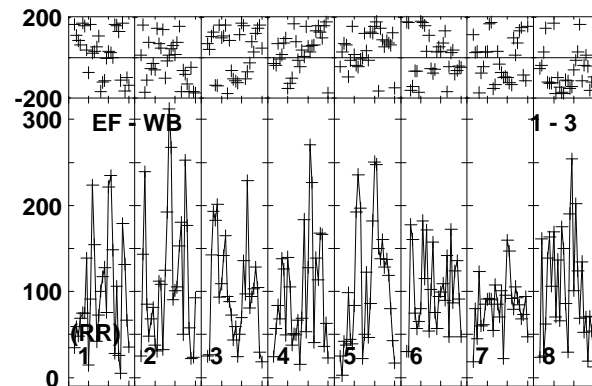
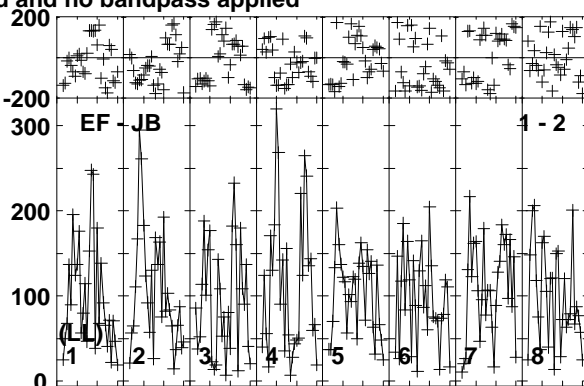
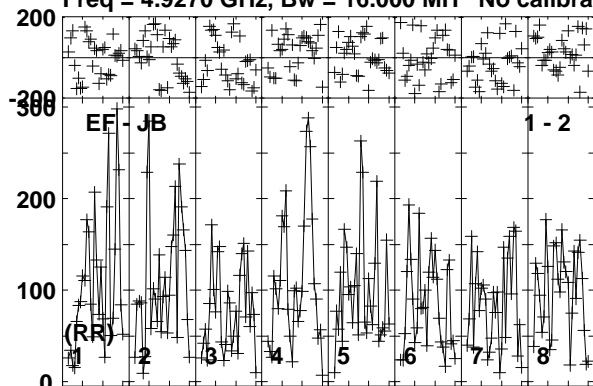

Lower frame: Micro Ampl Jy Top frame: Phas deg  
Vector averaged cross-power spectrum Baseline: EF (01) - JB (02)  
Timerange: 00/06:35:01 to 00/06:38:29



Plot file version 257 created 08-APR-2019 12:10:05

MRK622 EM133B.UVDATA.1

Freq = 4.9270 GHz, Bw = 16.000 MH No calibration applied and no bandpass applied

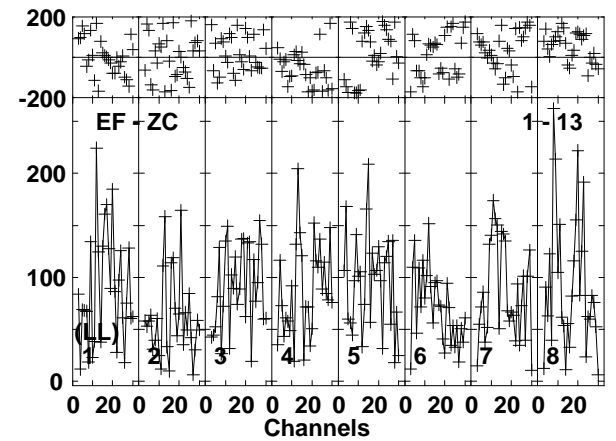
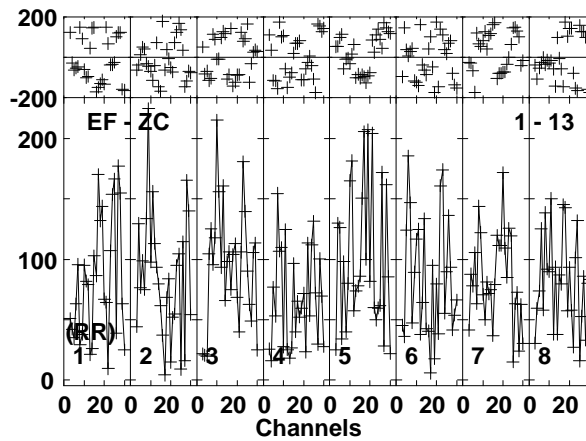
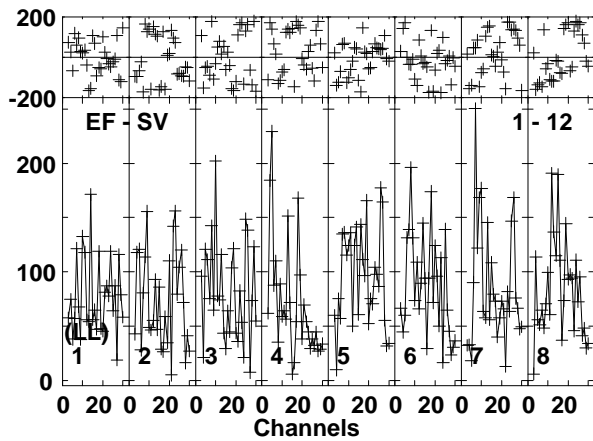
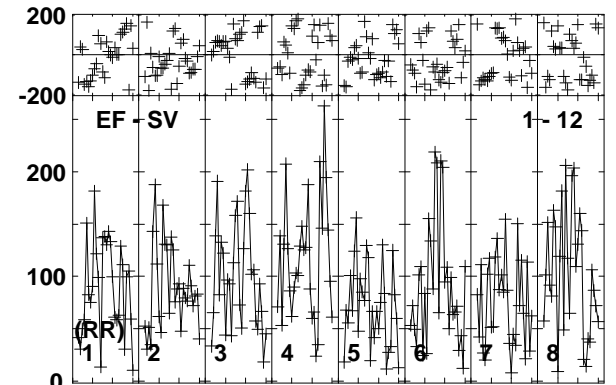
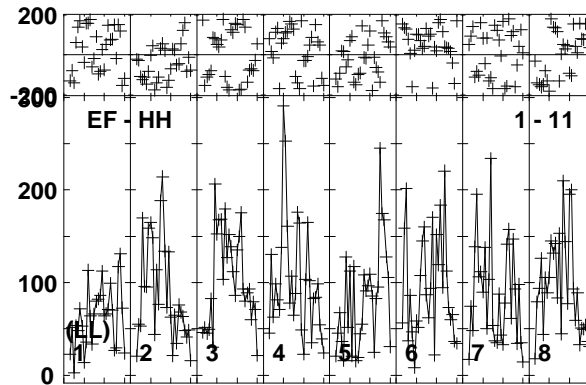
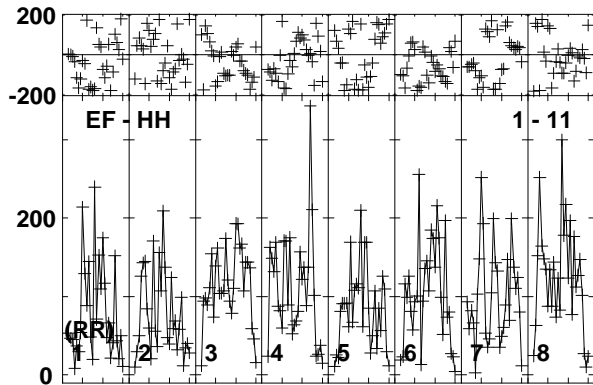
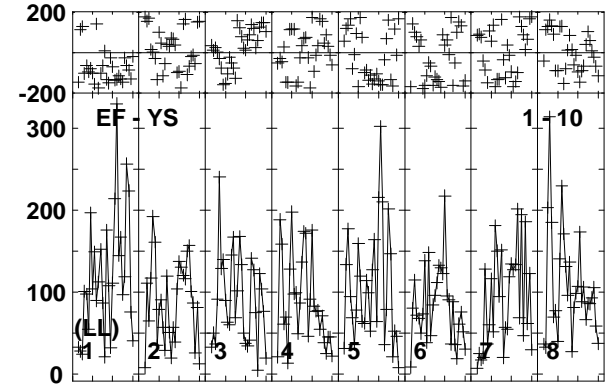
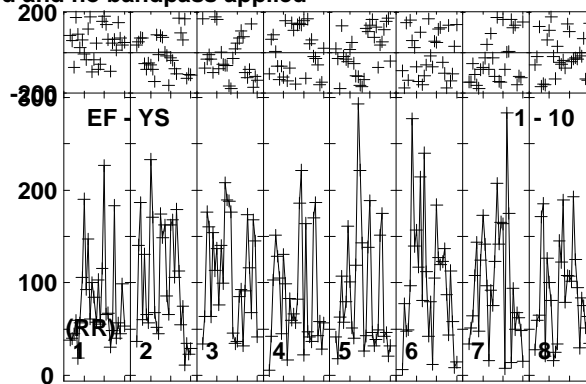
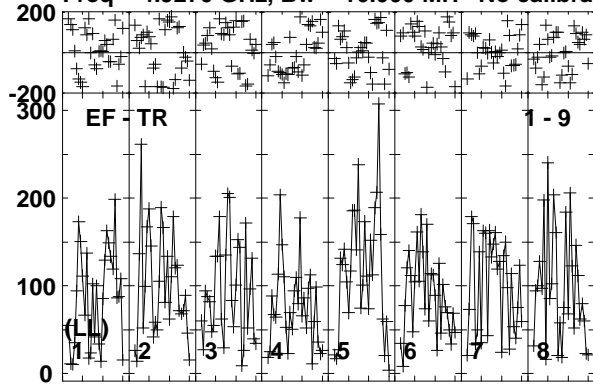

Lower frame: Micro Ampl Jy Top frame: Phas deg  
Vector averaged cross-power spectrum Baseline: EF (01) - TR (09)  
Timerange: 00/06:35:01 to 00/06:38:29

Plot file version 258 created 08-APR-2019 12:10:05

MRK622 EM133B.UVDATA.1

Freq = 4.9270 GHz, Bw = 16.000 MH No calibration applied and no bandpass applied

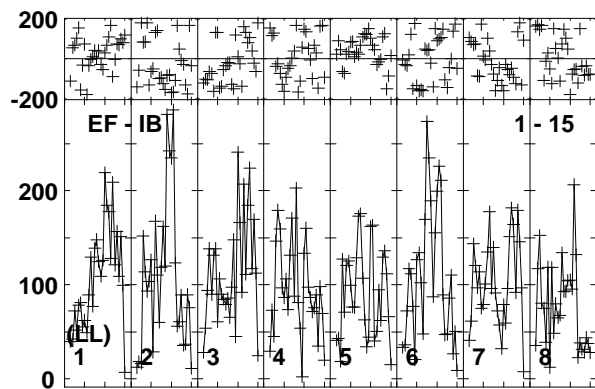
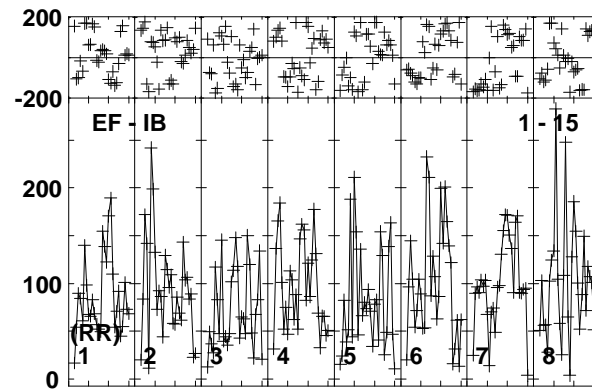
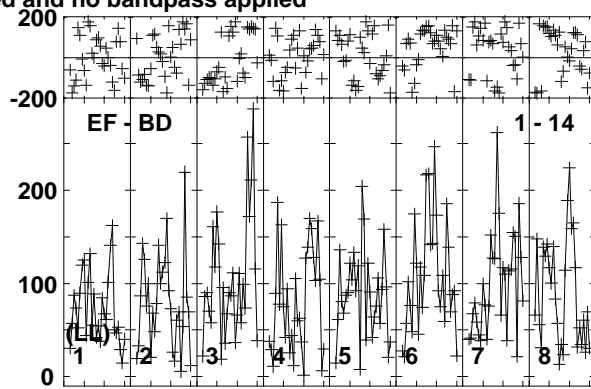
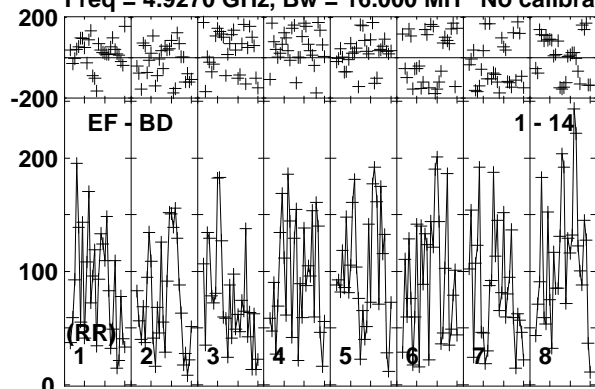

Lower frame: Micro Ampl Jy Top frame: Phas deg  
Vector averaged cross-power spectrum Baseline: EF (01) - BD (14)  
Timerange: 00/06:35:01 to 00/06:38:29

Plot file version 259 created 08-APR-2019 12:10:05

J0815+3635 EM133B.UVDATA.1

Freq = 4.9270 GHz, Bw = 16.000 MH No calibration applied and no bandpass applied

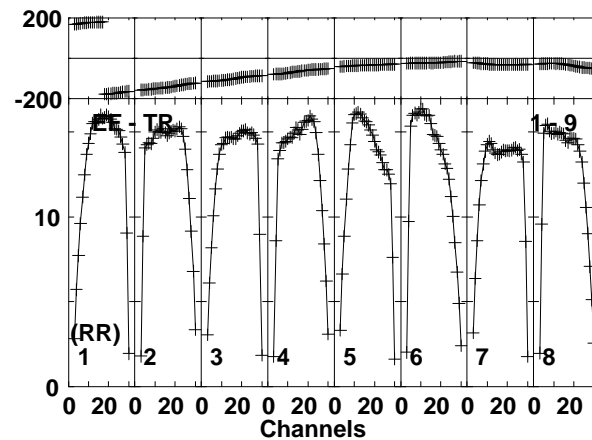
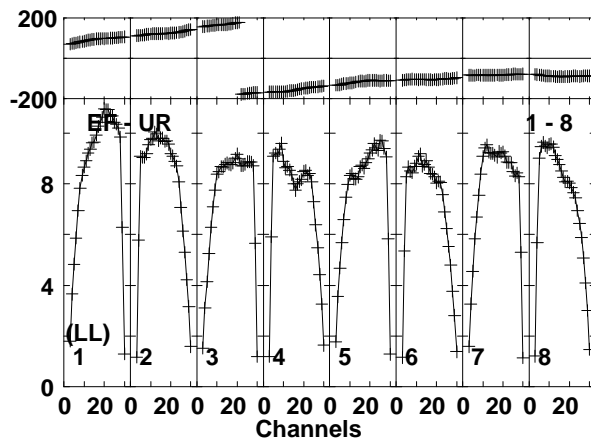
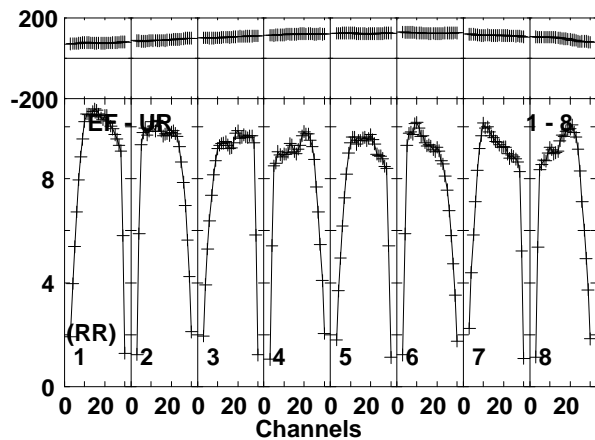
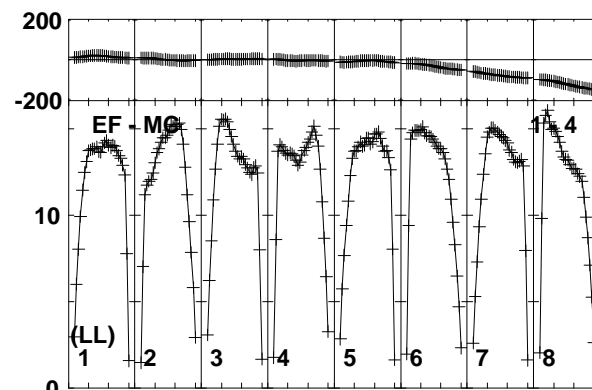
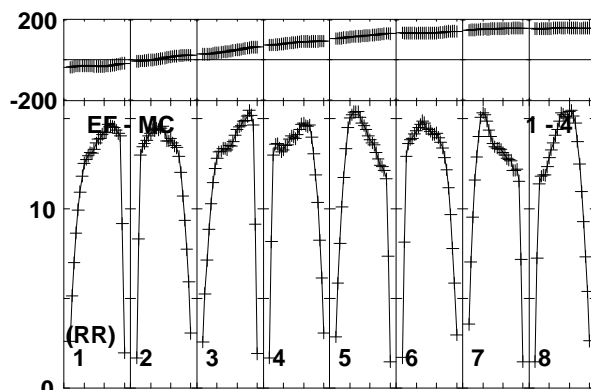
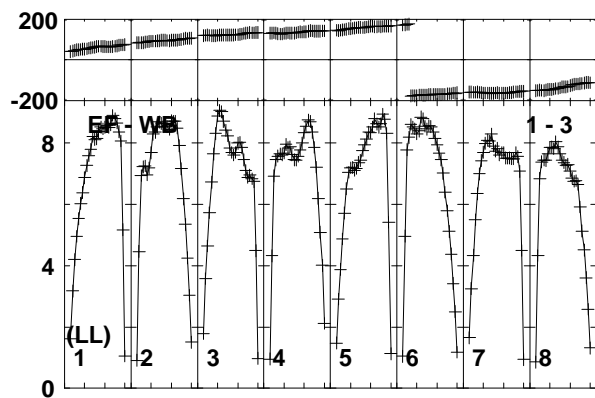
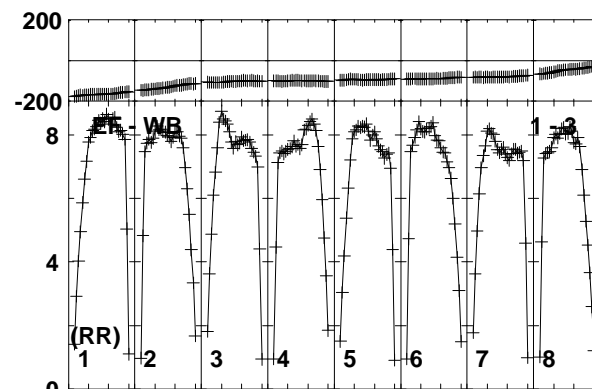
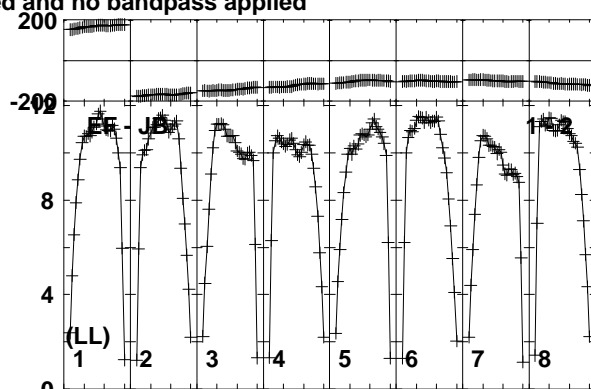
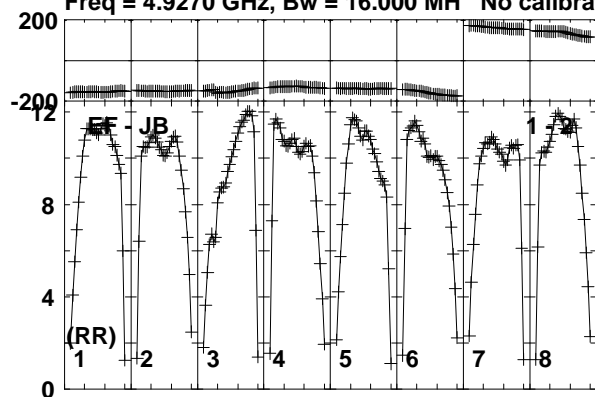

Lower frame: Milli Ampl Jy Top frame: Phas deg  
Vector averaged cross-power spectrum Baseline: EF (01) - JB (02)  
Timerange: 00/06:39:21 to 00/06:40:49

Plot file version 260 created 08-APR-2019 12:10:05

J0815+3635 EM133B.UVDATA.1

Freq = 4.9270 GHz, Bw = 16.000 MH No calibration applied and no bandpass applied

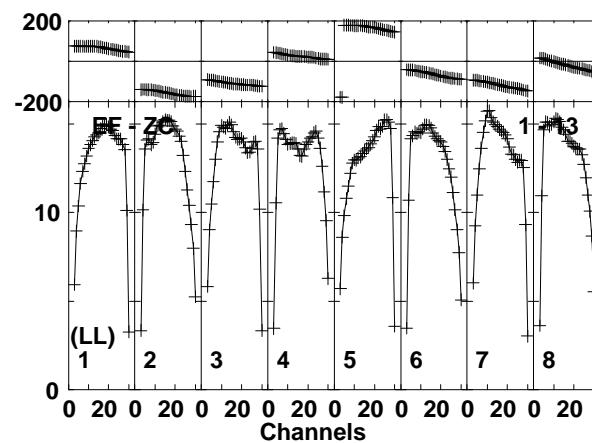
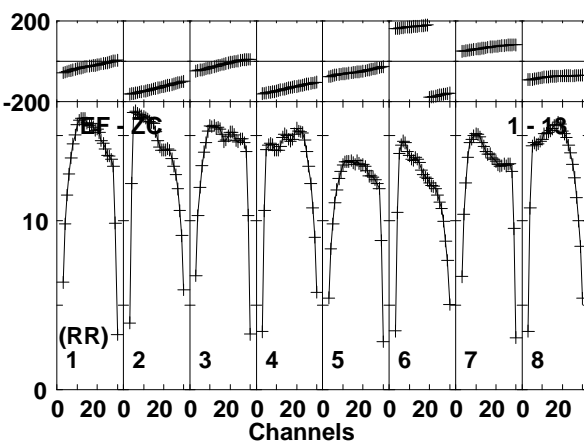
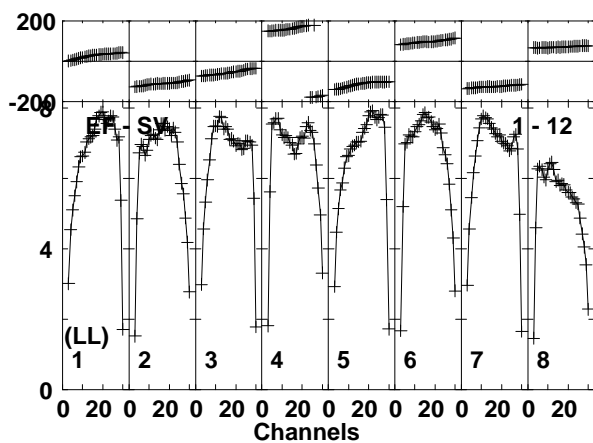
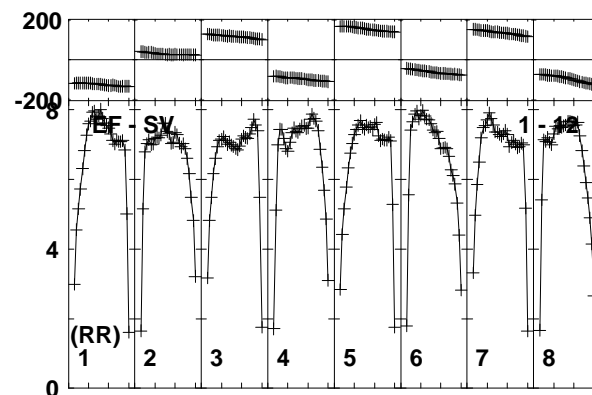
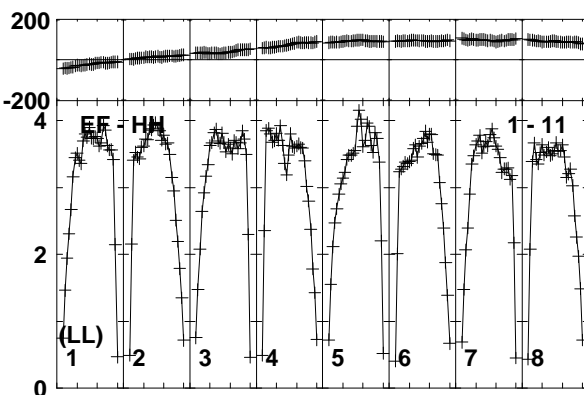
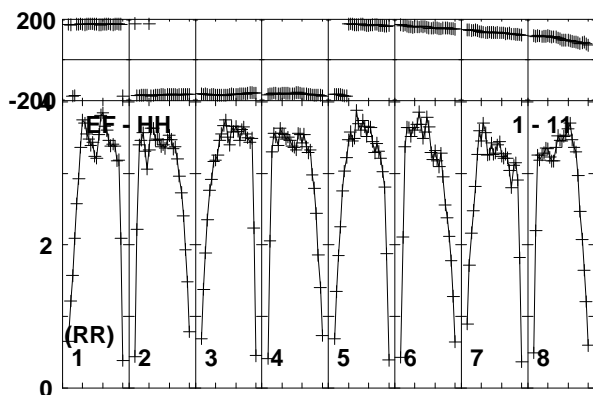
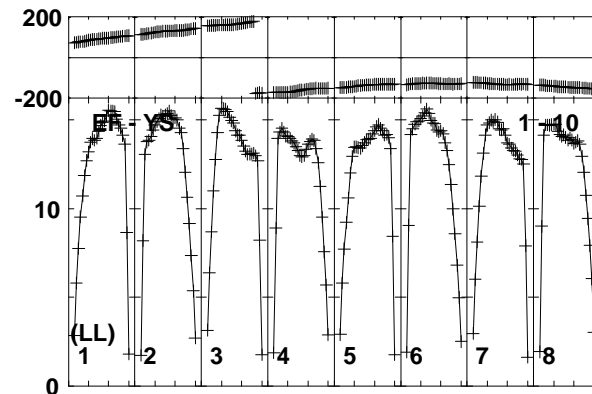
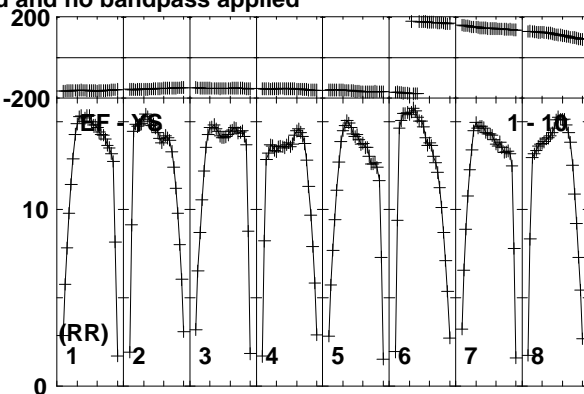
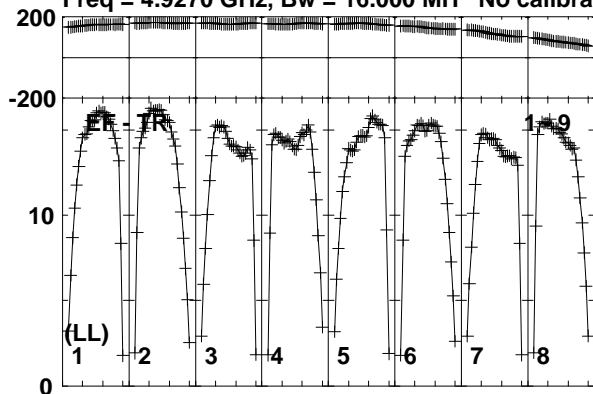

Lower frame: Milli Ampl Jy Top frame: Phas deg  
Vector averaged cross-power spectrum Baseline: EF (01) - TR (09)  
Timerange: 00/06:39:21 to 00/06:40:49

Plot file version 261 created 08-APR-2019 12:10:05

J0815+3635 EM133B.UVDATA.1

Freq = 4.9270 GHz, Bw = 16.000 MH No calibration applied and no bandpass applied

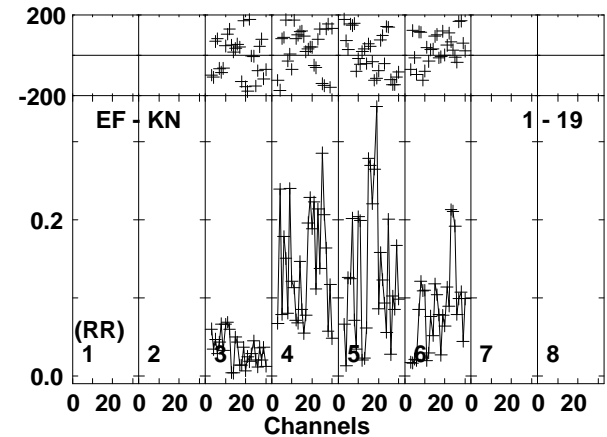
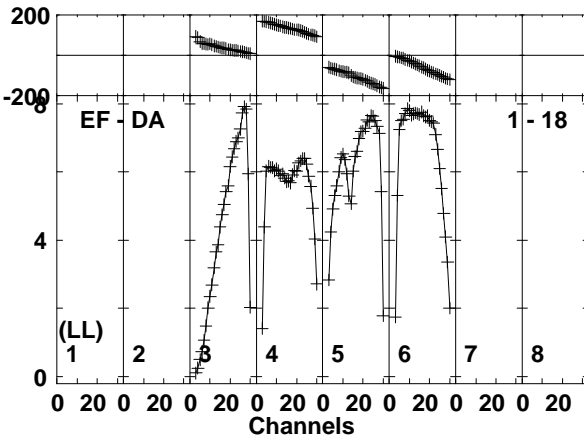
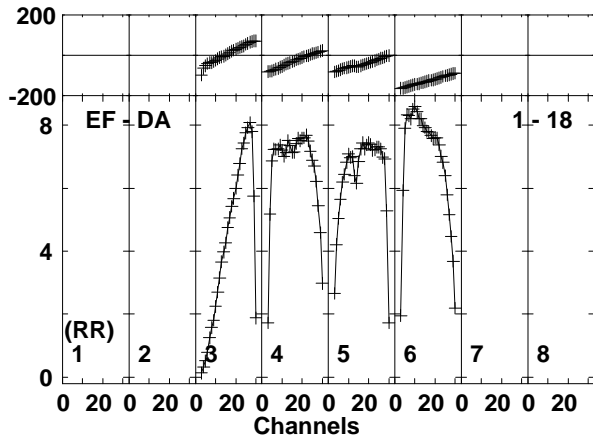
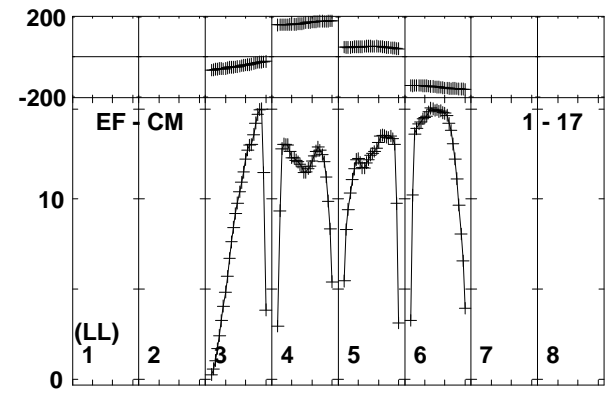
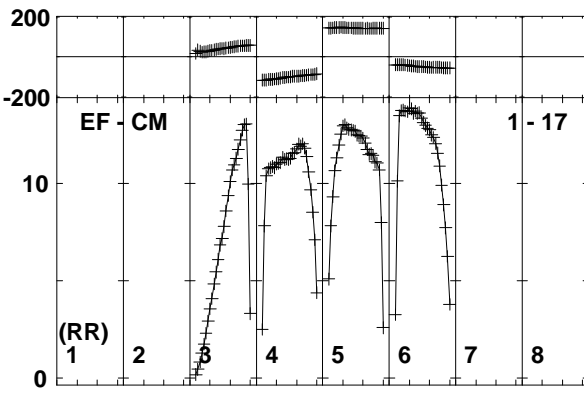
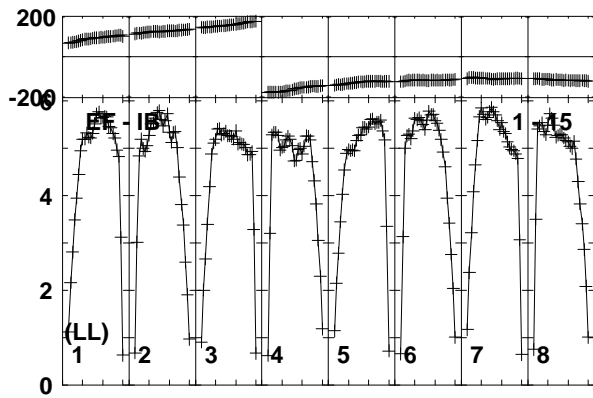
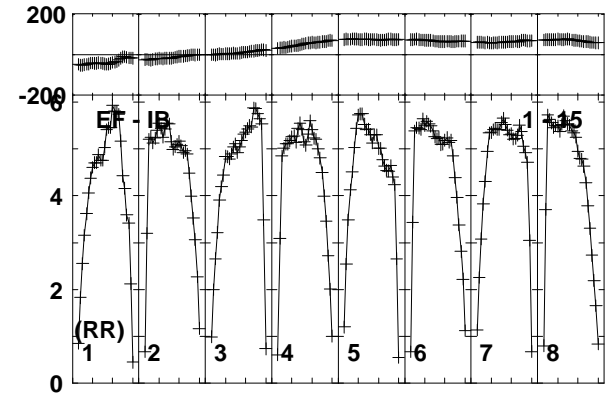
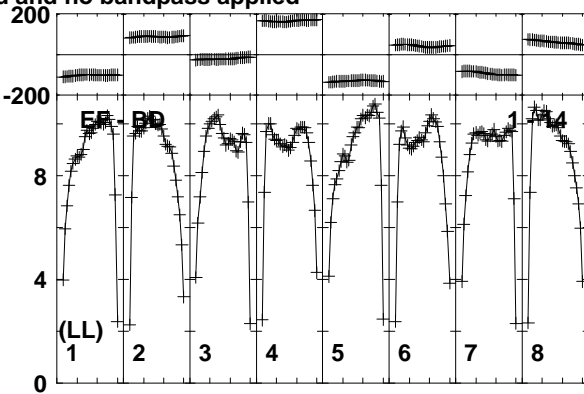
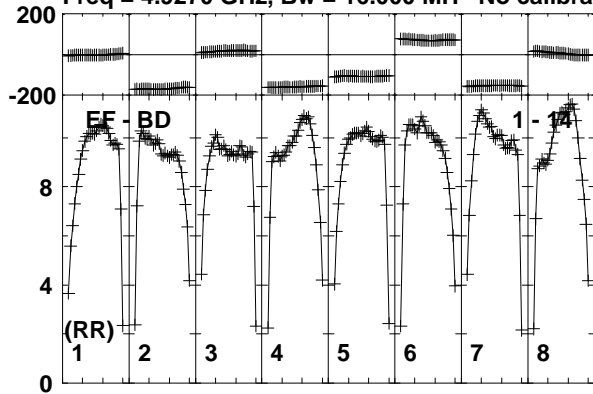

Lower frame: Milli Ampl Jy Top frame: Phas deg  
Vector averaged cross-power spectrum Baseline: EF (01) - BD (14)  
Timerange: 00/06:39:21 to 00/06:40:49

Plot file version 262 created 08-APR-2019 12:10:06

J0815+3635 EM133B.UVDATA.1

Freq = 4.9270 GHz, Bw = 16.000 MH No calibration applied and no bandpass applied

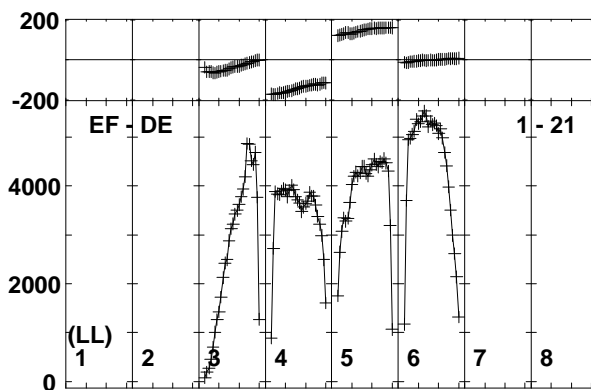
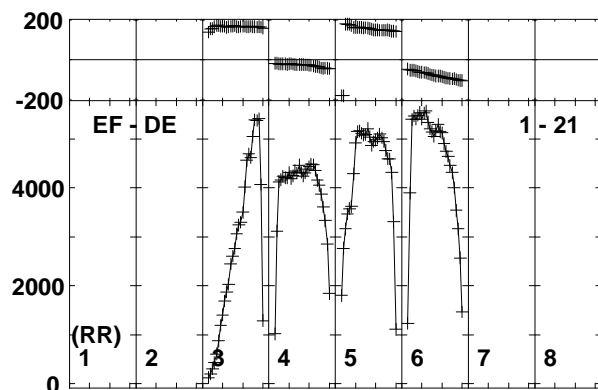
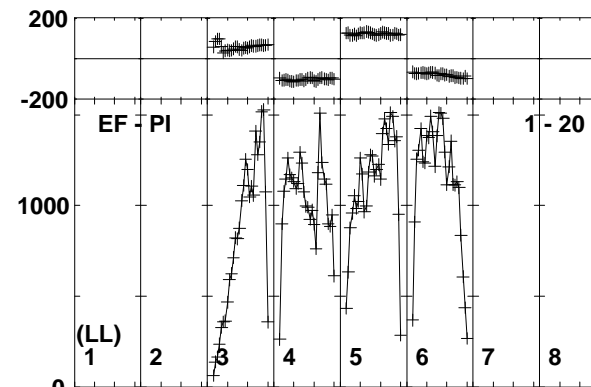
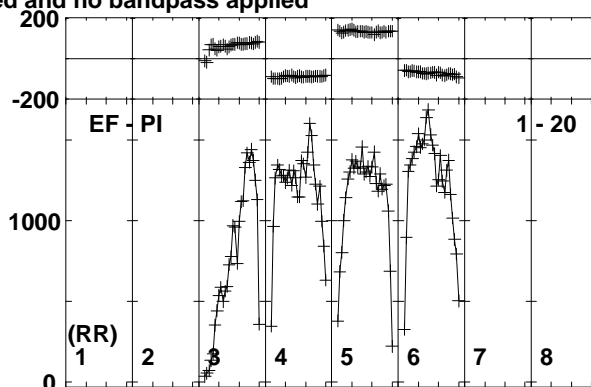
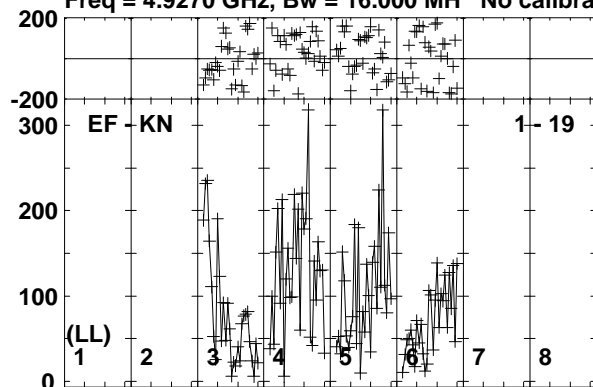

Lower frame: Micro Ampl Jy Top frame: Phas deg  
Vector averaged cross-power spectrum Baseline: EF (01) - KN (19)  
Timerange: 00/06:39:21 to 00/06:40:49

Plot file version 263 created 08-APR-2019 12:10:06

MRK622 EM133B.UVDATA.1

Freq = 4.9270 GHz, Bw = 16.000 MH No calibration applied and no bandpass applied

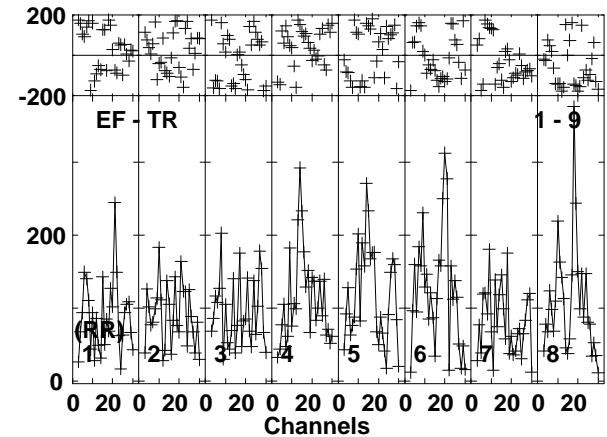
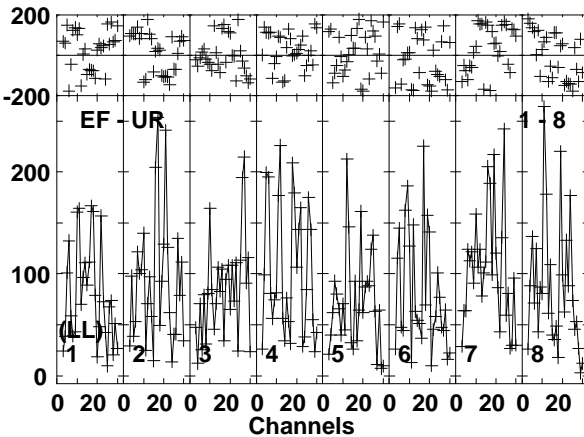
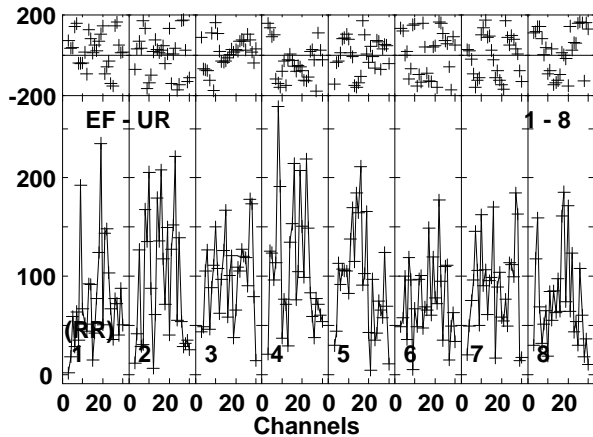
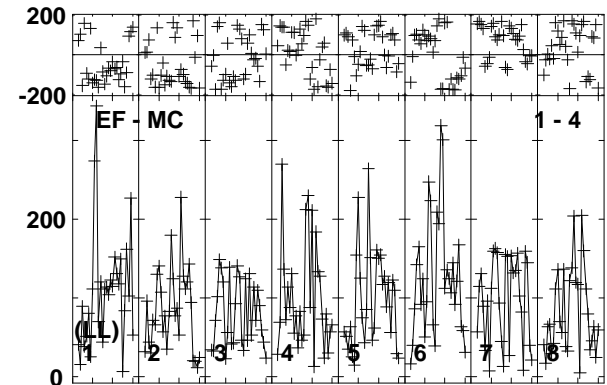
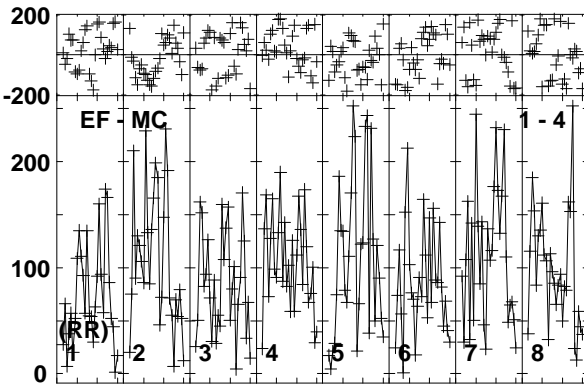
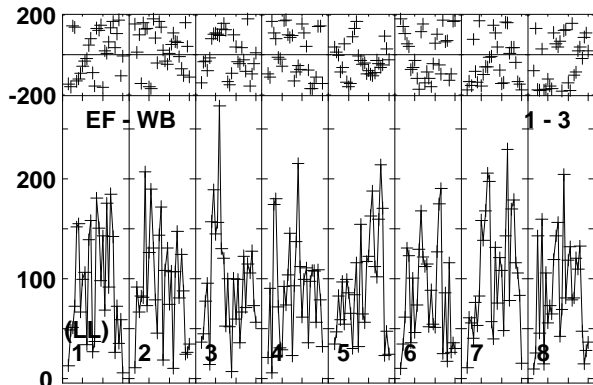
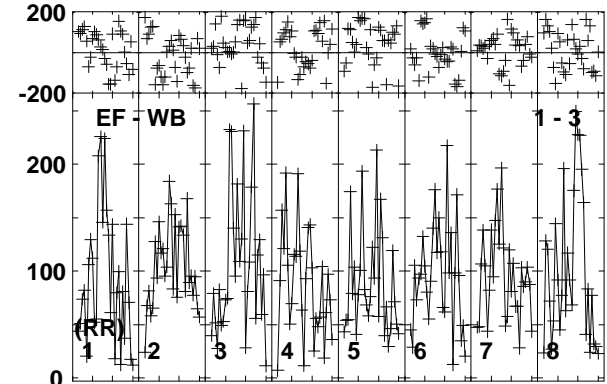
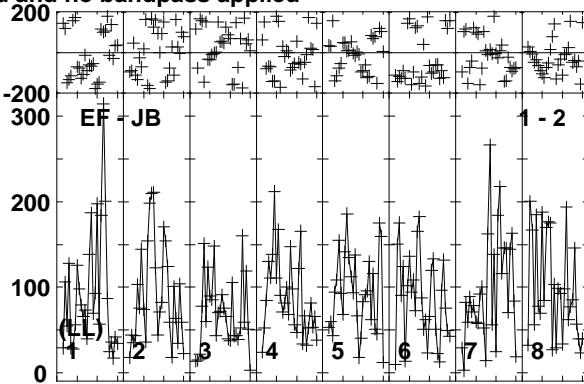
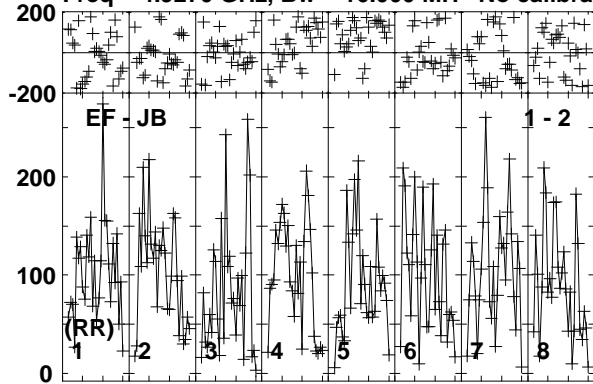

Lower frame: Micro Ampl Jy Top frame: Phas deg  
Vector averaged cross-power spectrum Baseline: EF (01) - JB (02)  
Timerange: 00/06:40:51 to 00/06:44:19

Plot file version 264 created 08-APR-2019 12:10:06

MRK622 EM133B.UVDATA.1

Freq = 4.9270 GHz, Bw = 16.000 MH No calibration applied and no bandpass applied

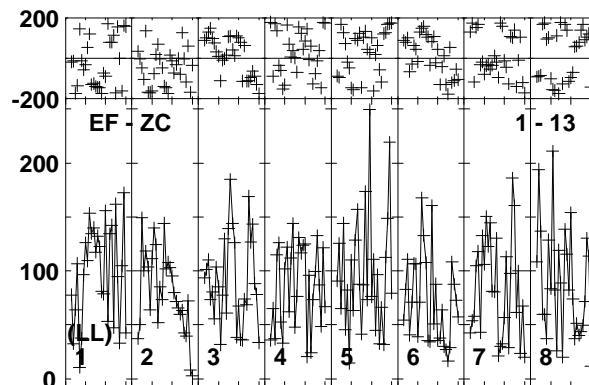
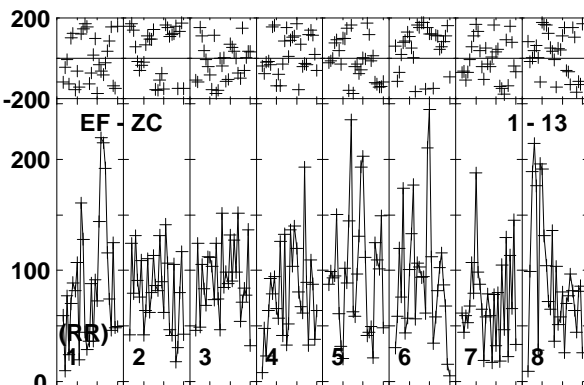
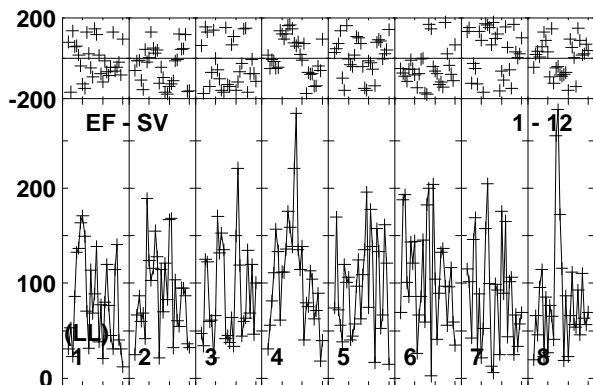
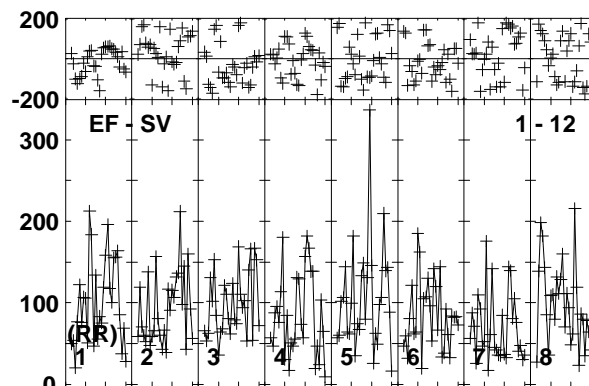
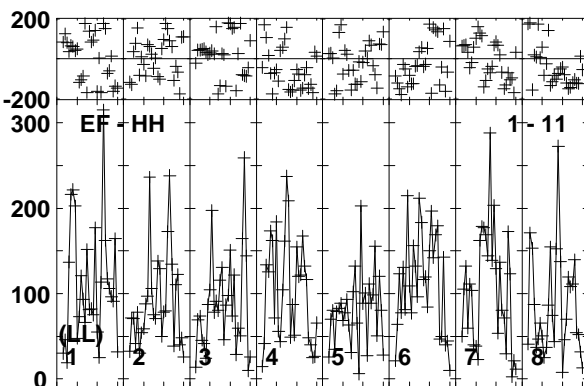
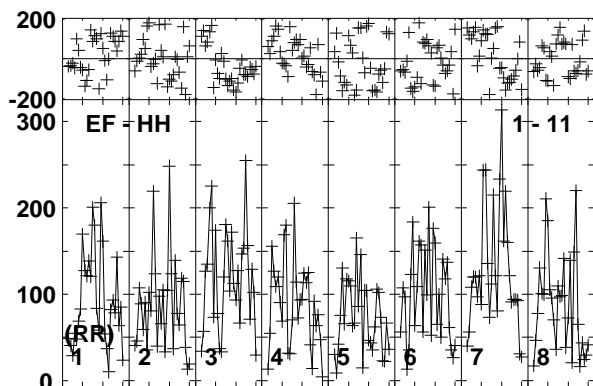
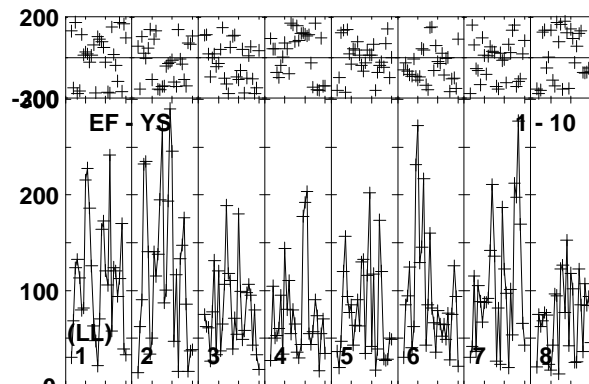
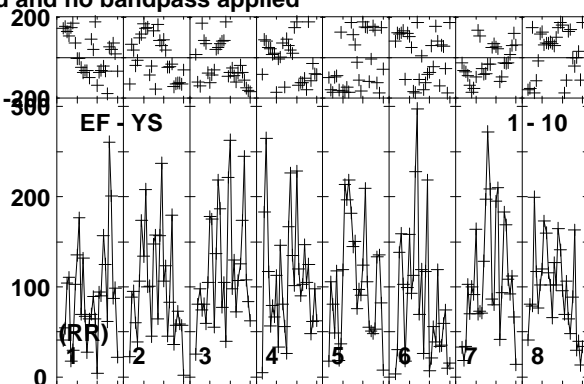
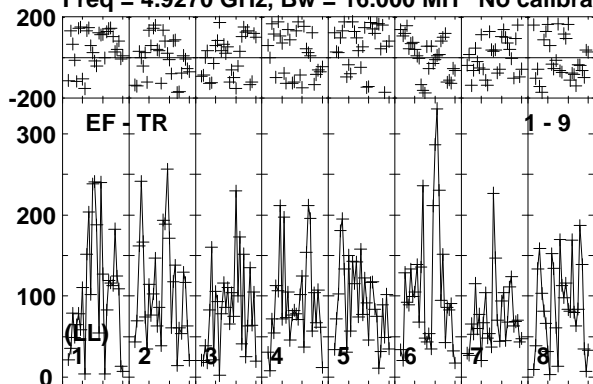

Lower frame: Micro Ampl Jy Top frame: Phas deg  
Vector averaged cross-power spectrum Baseline: EF (01) - TR (09)  
Timerange: 00/06:40:51 to 00/06:44:19



Plot file version 265 created 08-APR-2019 12:10:06

MRK622 EM133B.UVDATA.1

Freq = 4.9270 GHz, Bw = 16.000 MH No calibration applied and no bandpass applied

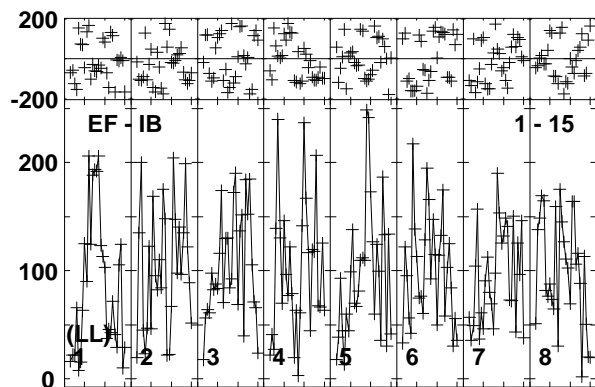
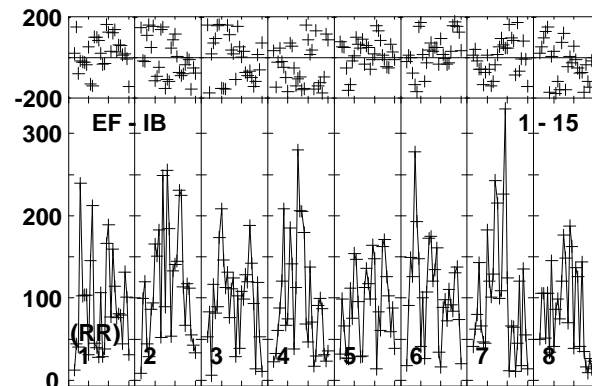
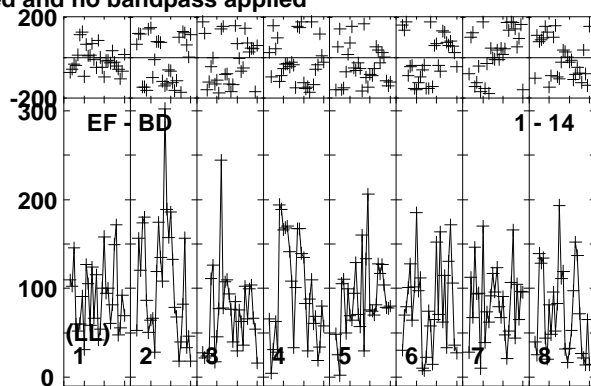
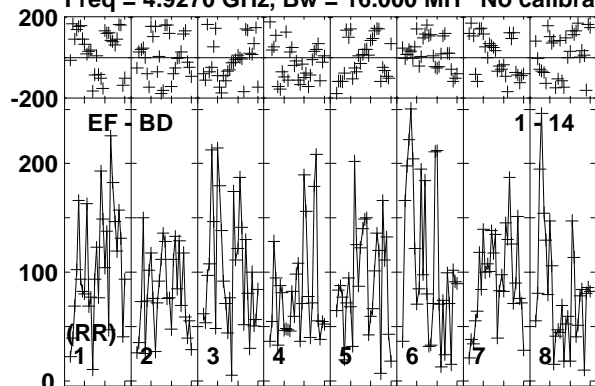

Lower frame: Micro Ampl Jy Top frame: Phas deg  
Vector averaged cross-power spectrum Baseline: EF (01) - BD (14)  
Timerange: 00/06:40:51 to 00/06:44:19

Plot file version 266 created 08-APR-2019 12:10:06

J0815+3635 EM133B.UVDATA.1

Freq = 4.9270 GHz, Bw = 16.000 MH No calibration applied and no bandpass applied

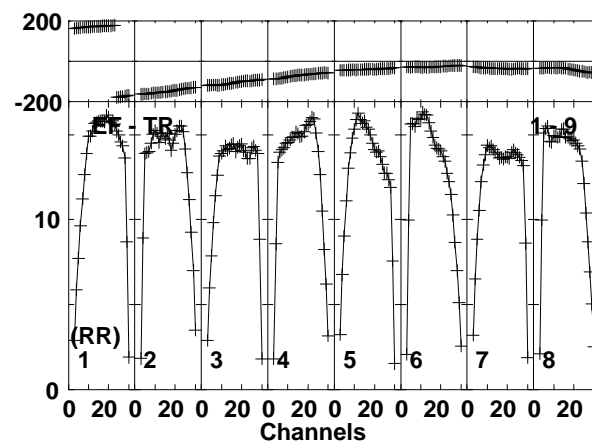
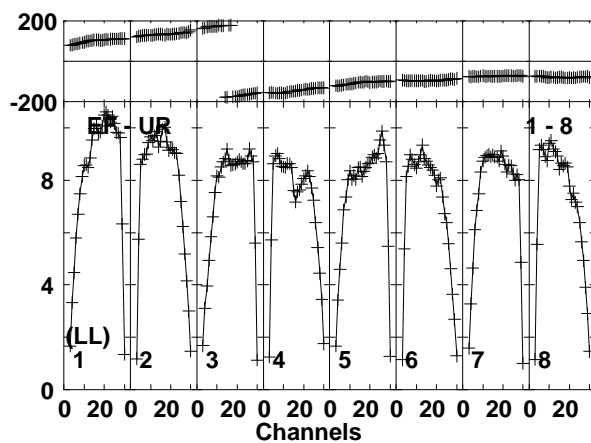
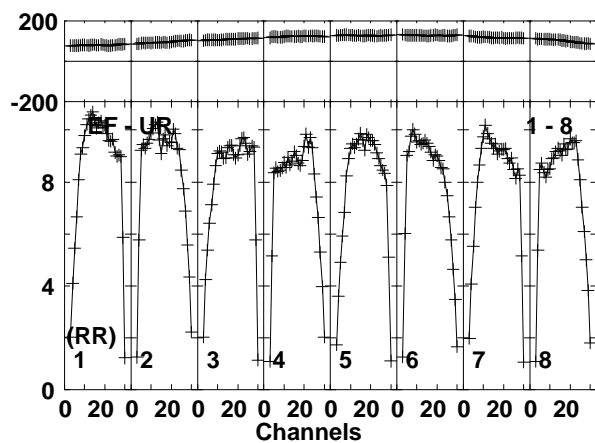
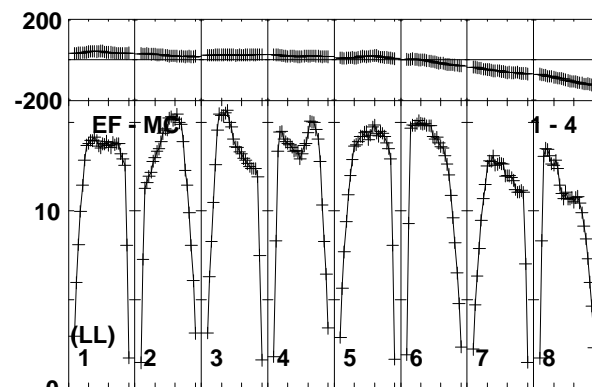
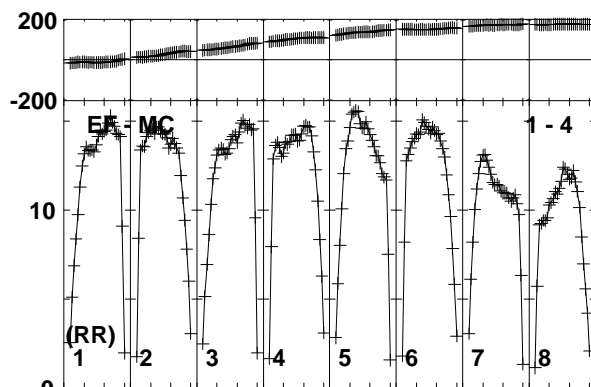
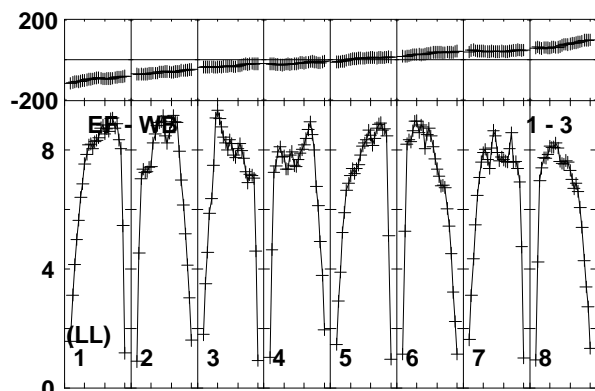
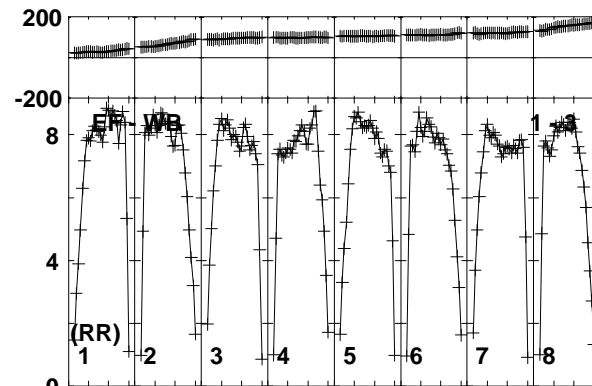
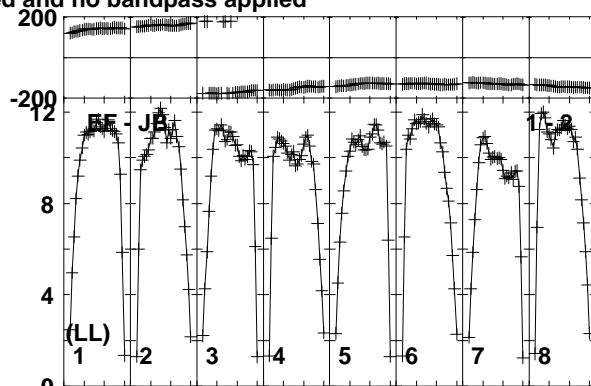
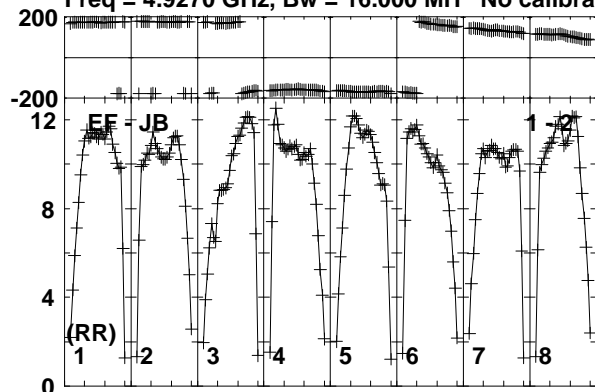

Lower frame: Milli Ampl Jy Top frame: Phas deg  
Vector averaged cross-power spectrum Baseline: EF (01) - JB (02)  
Timerange: 00/06:44:21 to 00/06:45:49

Plot file version 267 created 08-APR-2019 12:10:06

J0815+3635 EM133B.UVDATA.1

Freq = 4.9270 GHz, Bw = 16.000 MH No calibration applied and no bandpass applied

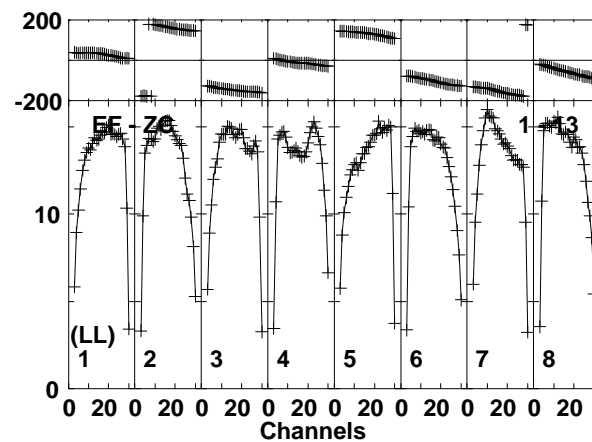
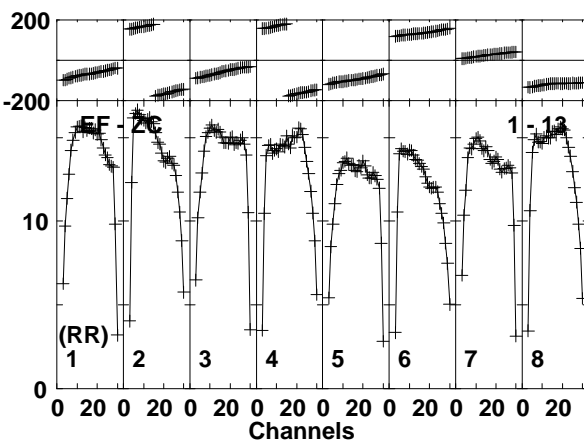
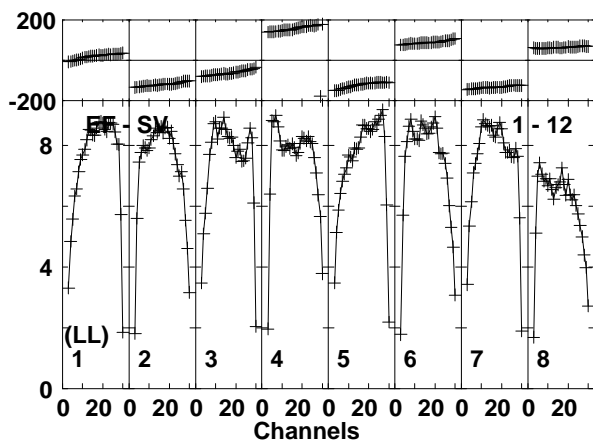
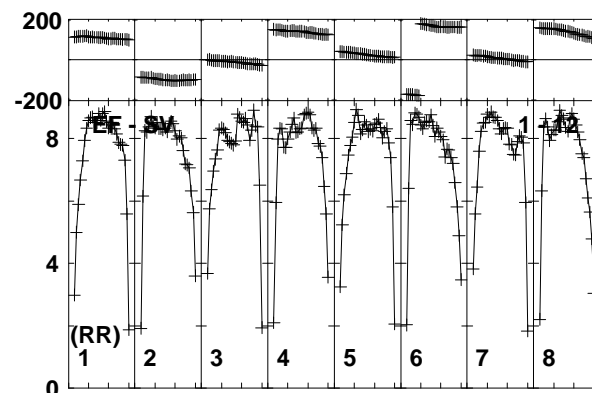
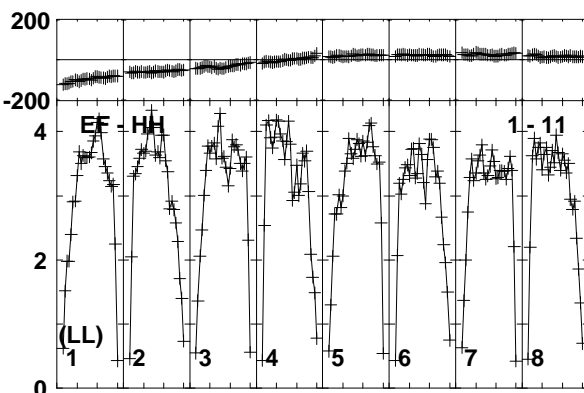
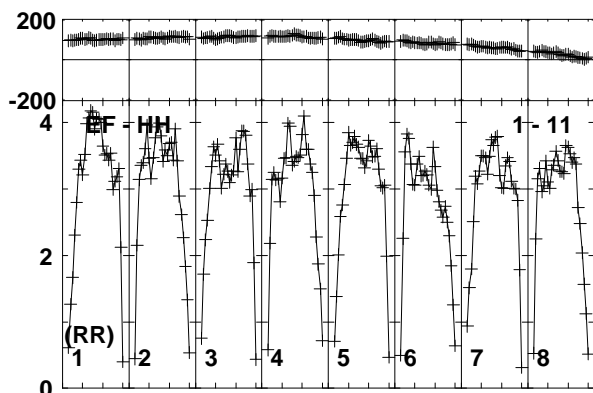
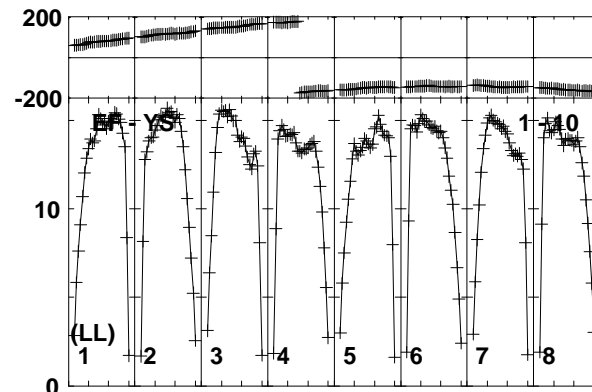
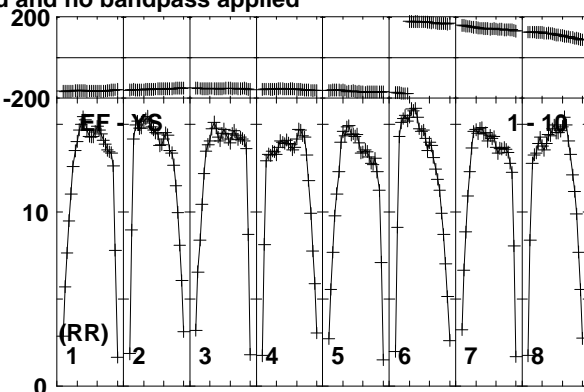
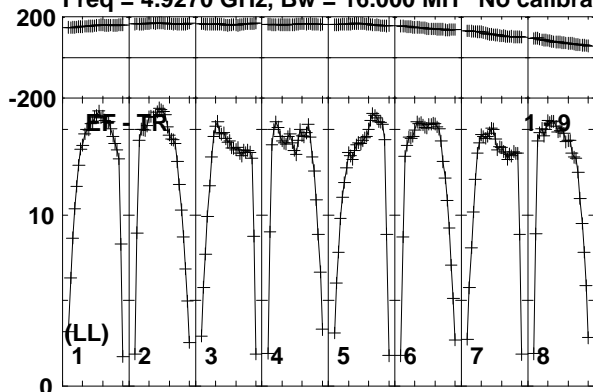

Lower frame: Milli Ampl Jy Top frame: Phas deg  
Vector averaged cross-power spectrum Baseline: EF (01) - TR (09)  
Timerange: 00/06:44:21 to 00/06:45:49

Plot file version 268 created 08-APR-2019 12:10:06

J0815+3635 EM133B.UVDATA.1

Freq = 4.9270 GHz, Bw = 16.000 MH No calibration applied and no bandpass applied

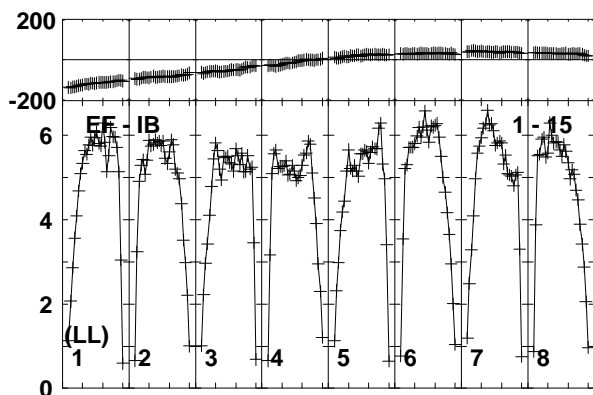
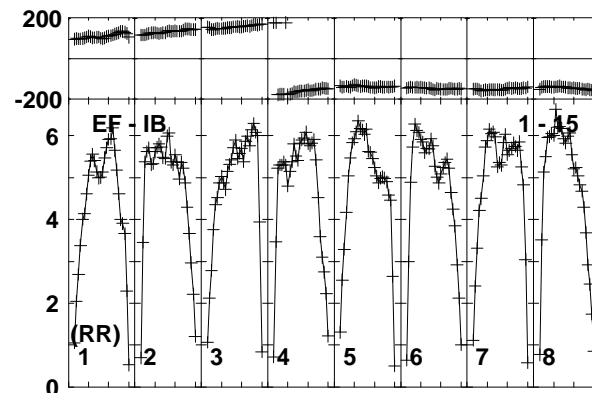
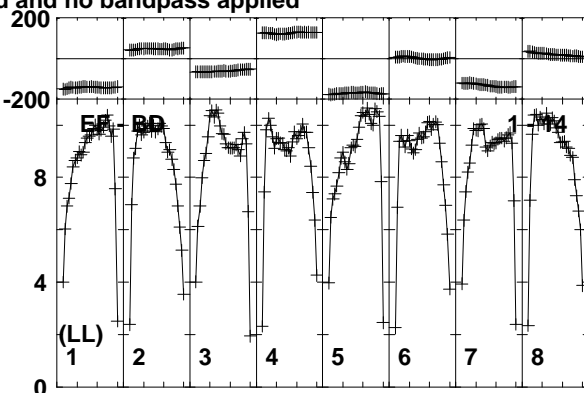
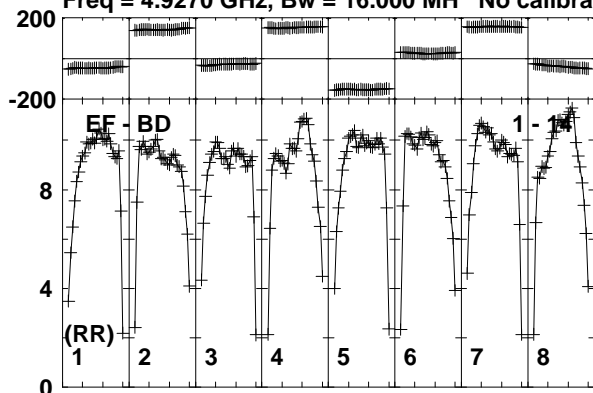

Lower frame: Milli Ampl Jy Top frame: Phas deg  
Vector averaged cross-power spectrum Baseline: EF (01) - BD (14)  
Timerange: 00/06:44:21 to 00/06:45:49

Plot file version 269 created 08-APR-2019 12:10:06

MRK622 EM133B.UVDATA.1

Freq = 4.9270 GHz, Bw = 16.000 MH No calibration applied and no bandpass applied

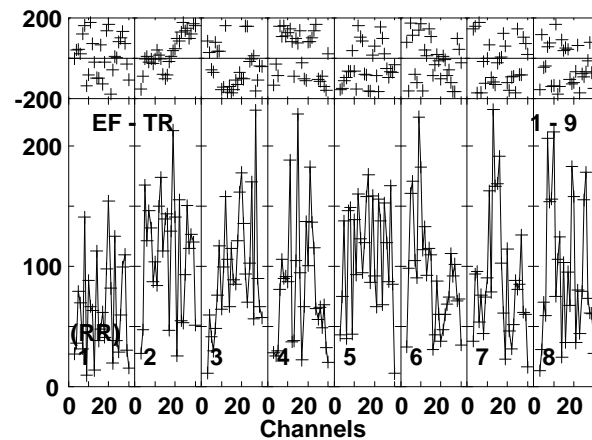
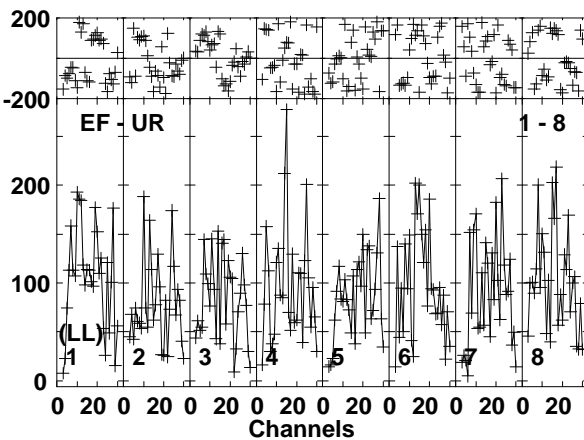
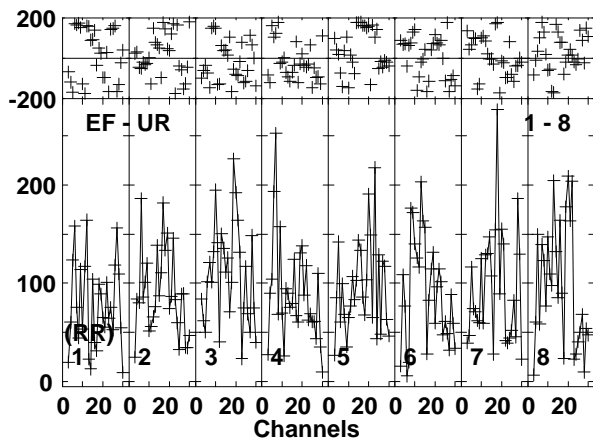
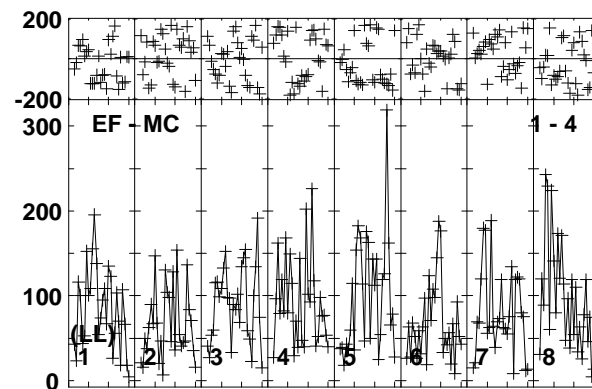
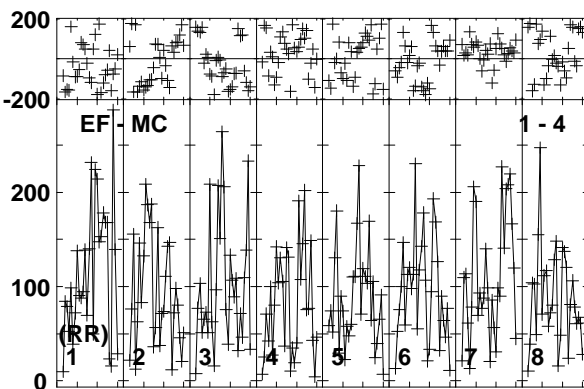
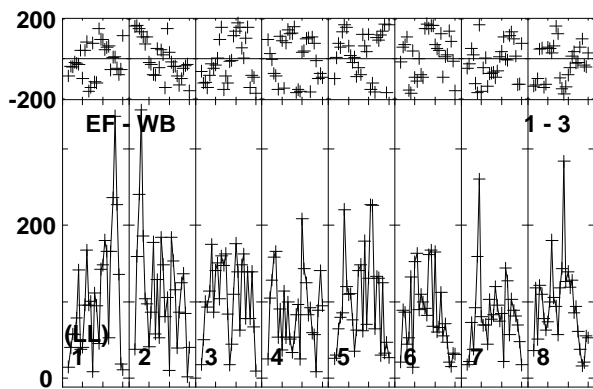
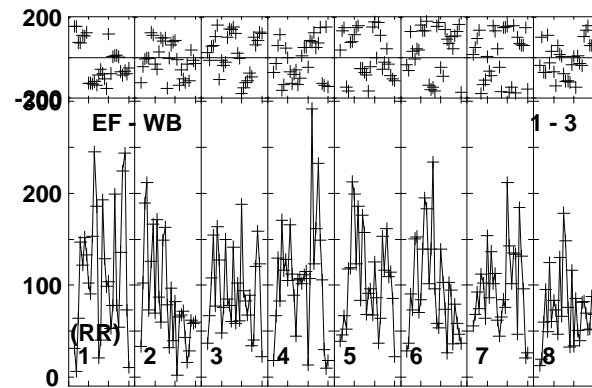
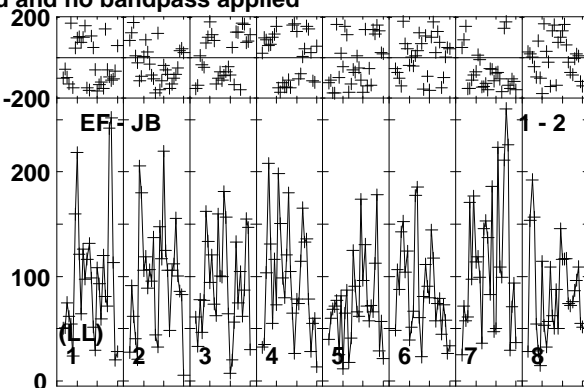
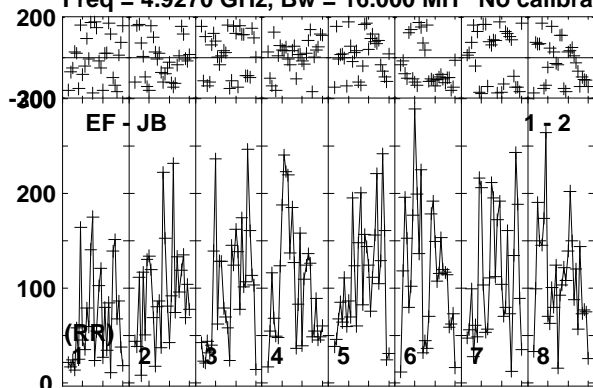

Lower frame: Micro Ampl Jy Top frame: Phas deg  
Vector averaged cross-power spectrum Baseline: EF (01) - JB (02)  
Timerange: 00:06:45:51 to 00:06:49:19

Plot file version 270 created 08-APR-2019 12:10:06

MRK622 EM133B.UVDATA.1

Freq = 4.9270 GHz, Bw = 16.000 MH No calibration applied and no bandpass applied

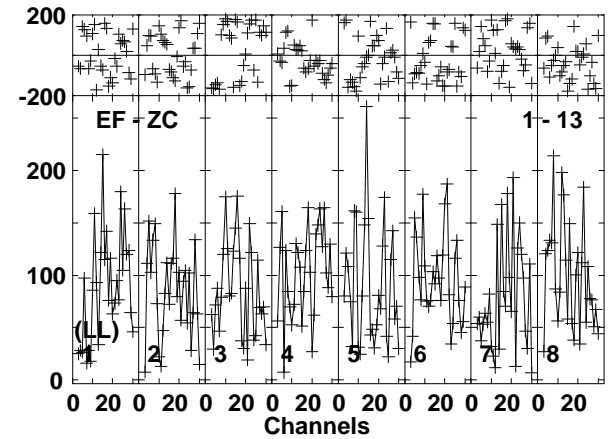
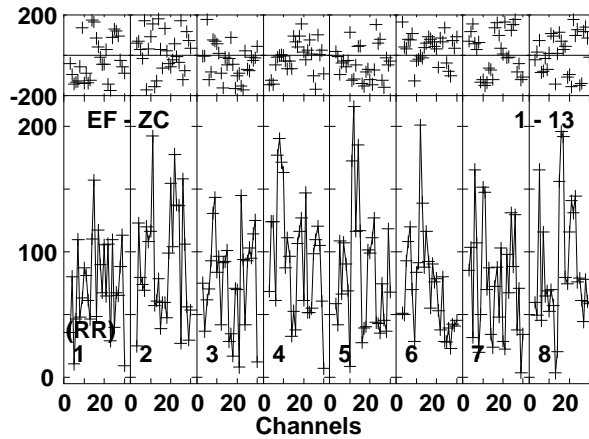
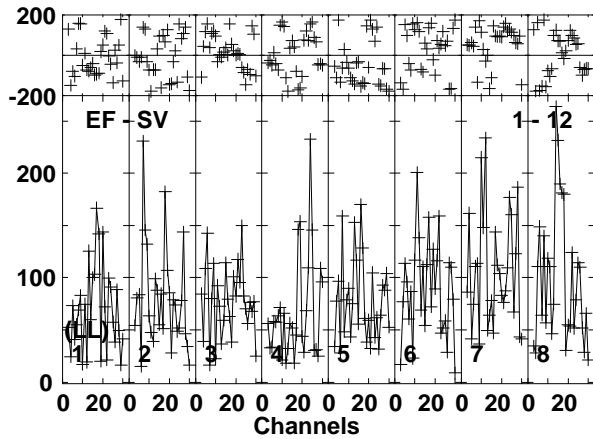
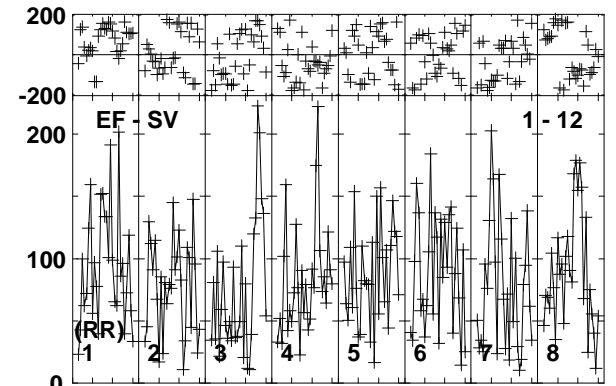
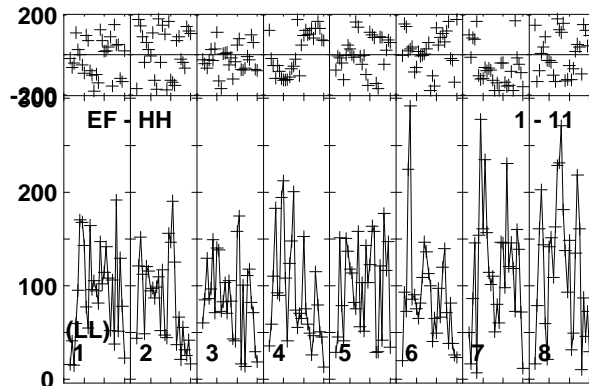
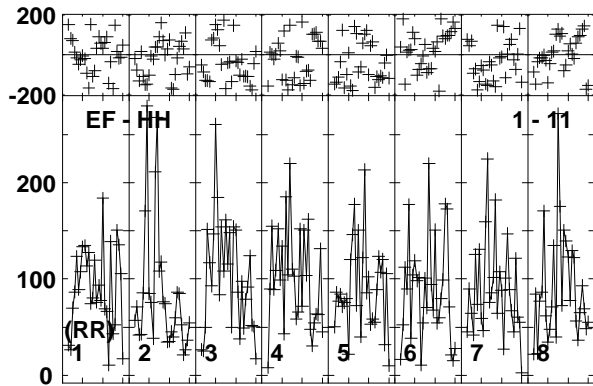
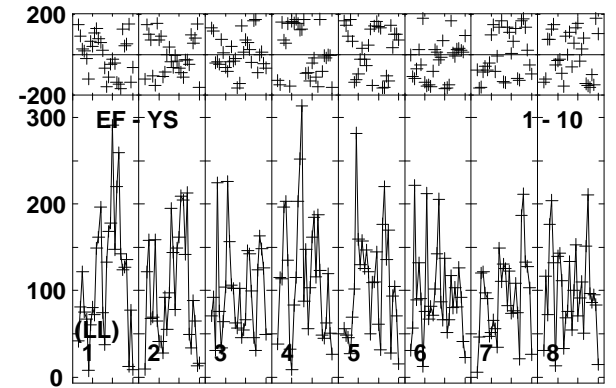
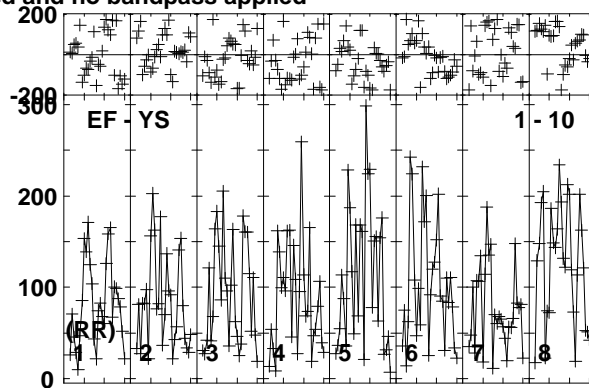
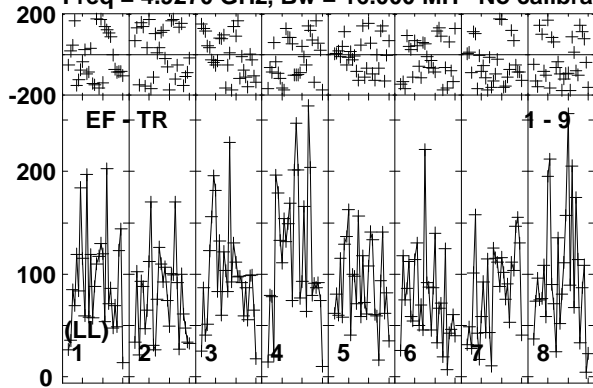

Lower frame: Micro Ampl Jy Top frame: Phas deg  
Vector averaged cross-power spectrum Baseline: EF (01) - TR (09)  
Timerange: 00:06:45:51 to 00:06:49:19

Plot file version 271 created 08-APR-2019 12:10:07

MRK622 EM133B.UVDATA.1

Freq = 4.9270 GHz, Bw = 16.000 MH No calibration applied and no bandpass applied

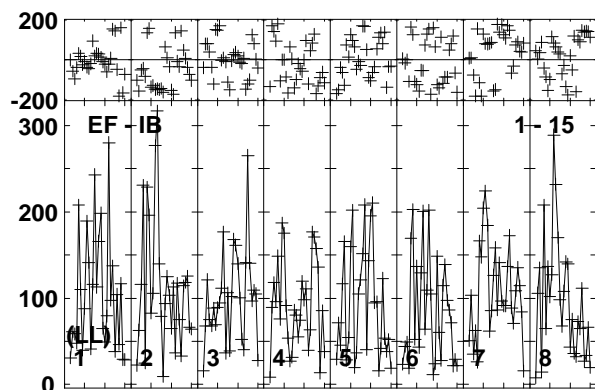
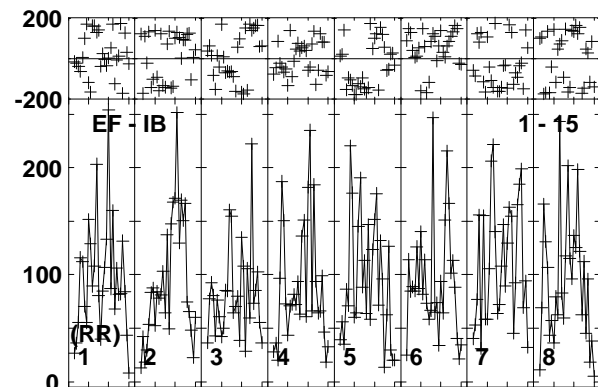
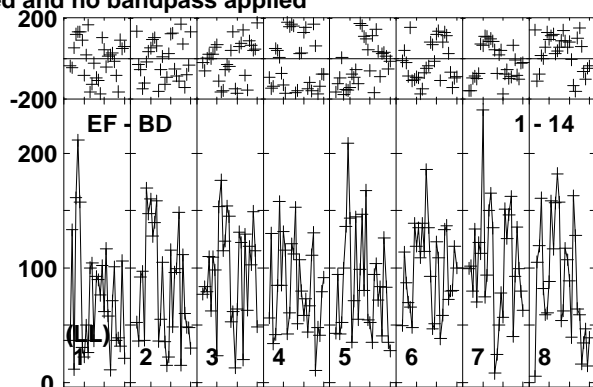
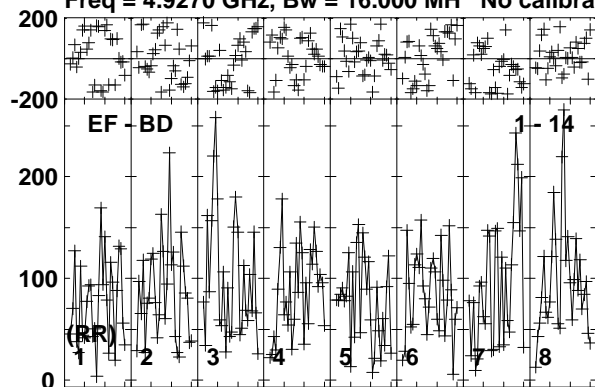

Lower frame: Micro Ampl Jy Top frame: Phas deg  
Vector averaged cross-power spectrum Baseline: EF (01) - BD (14)  
Timerange: 00/06:45:51 to 00/06:49:19

Plot file version 272 created 08-APR-2019 12:10:07

J0815+3635 EM133B.UVDATA.1

Freq = 4.9270 GHz, Bw = 16.000 MH No calibration applied and no bandpass applied

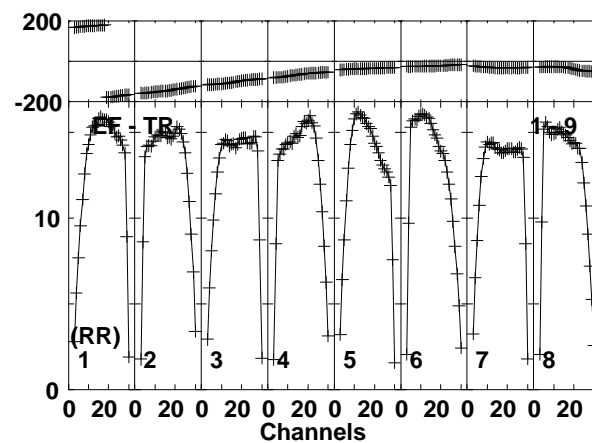
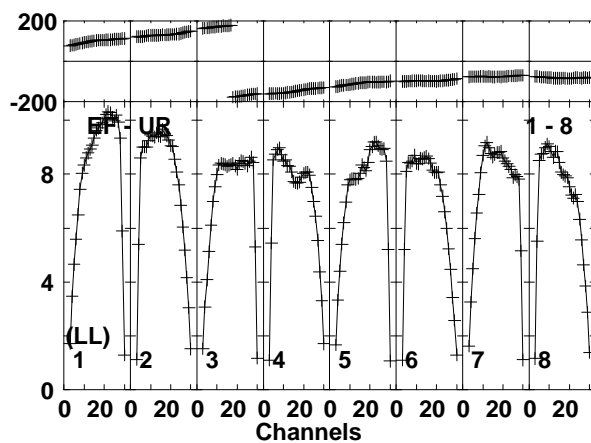
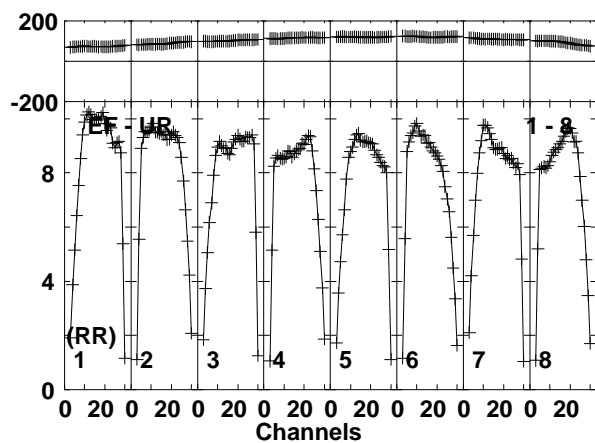
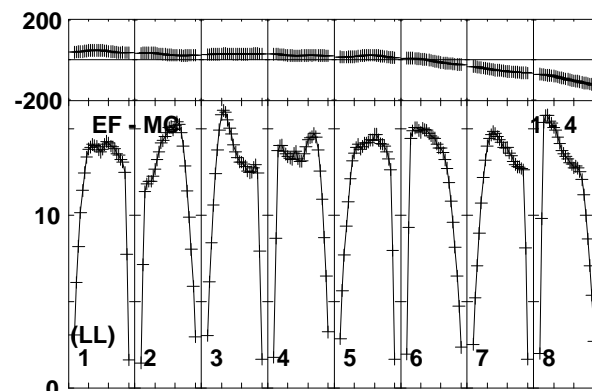
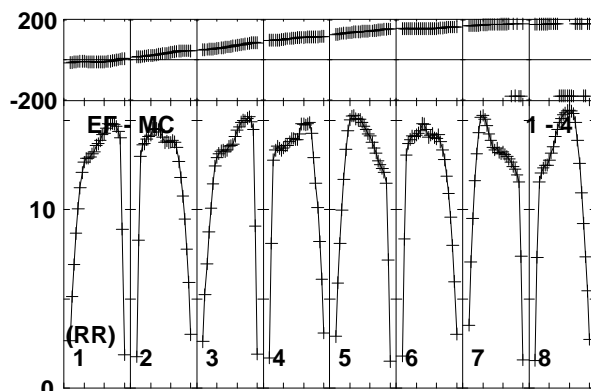
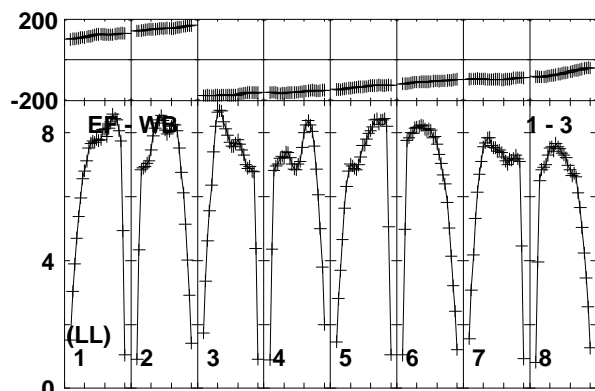
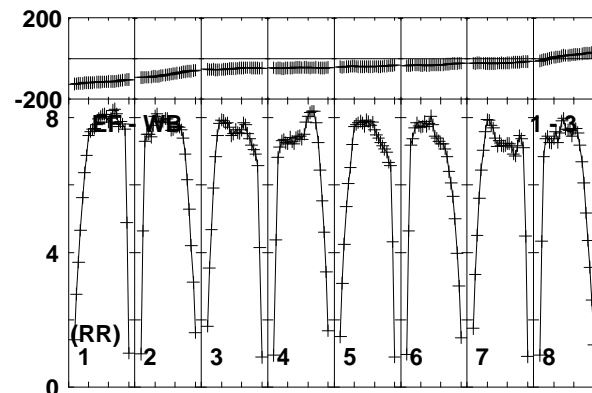
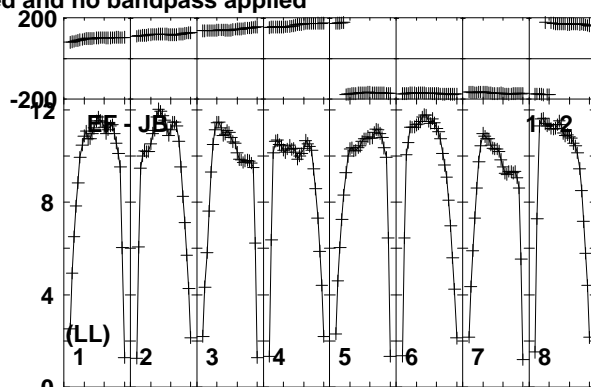
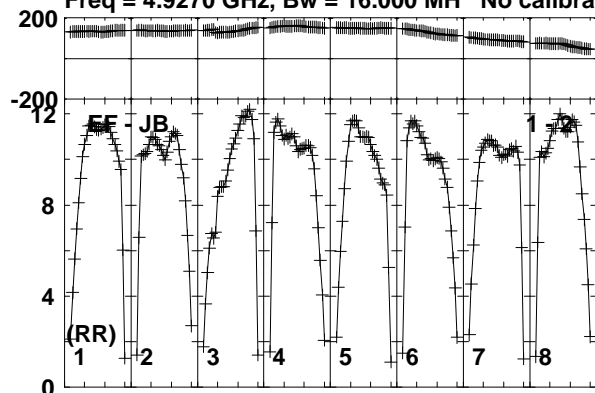

Lower frame: Milli Ampl Jy Top frame: Phas deg  
Vector averaged cross-power spectrum Baseline: EF (01) - JB (02)  
Timerange: 00/06:50:11 to 00/06:51:39



Plot file version 273 created 08-APR-2019 12:10:07

J0815+3635 EM133B.UVDATA.1

Freq = 4.9270 GHz, Bw = 16.000 MH No calibration applied and no bandpass applied

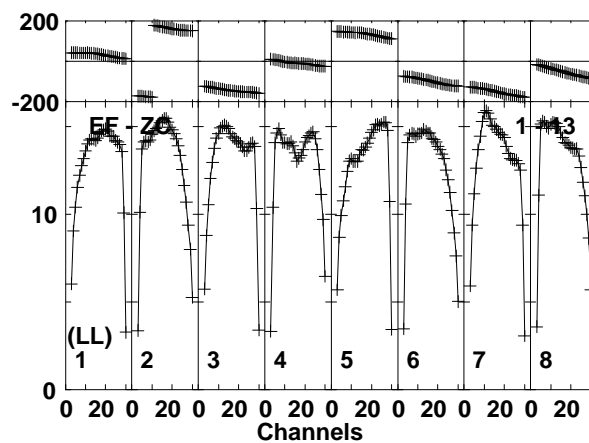
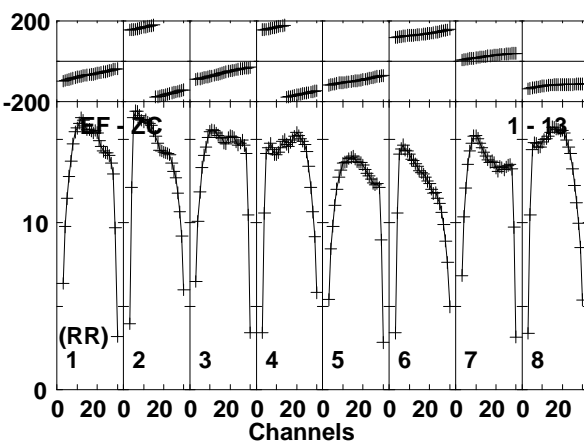
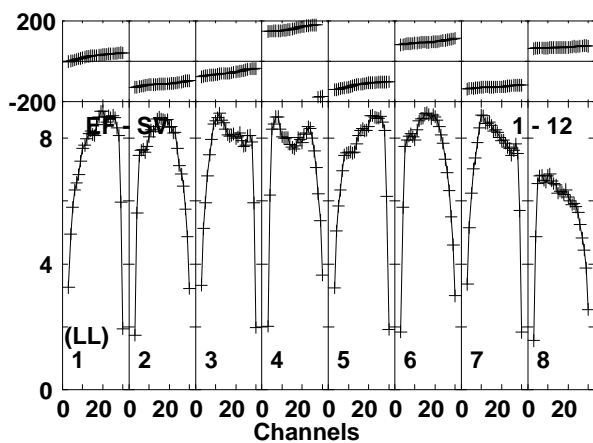
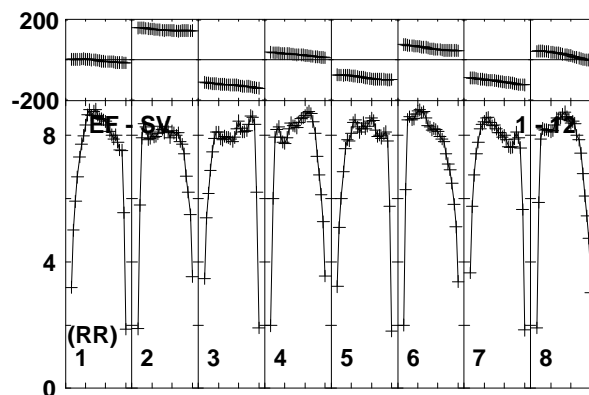
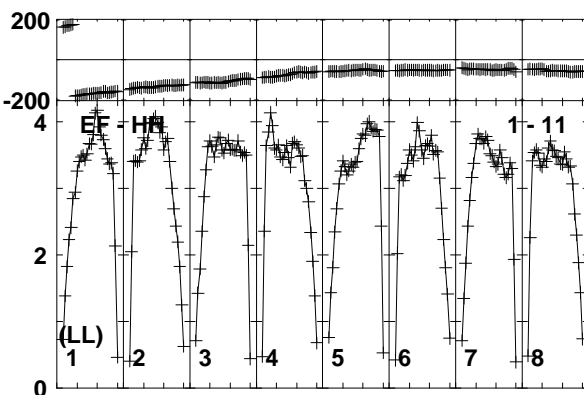
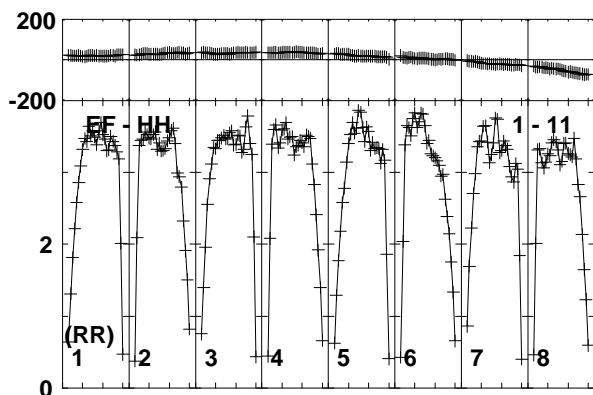
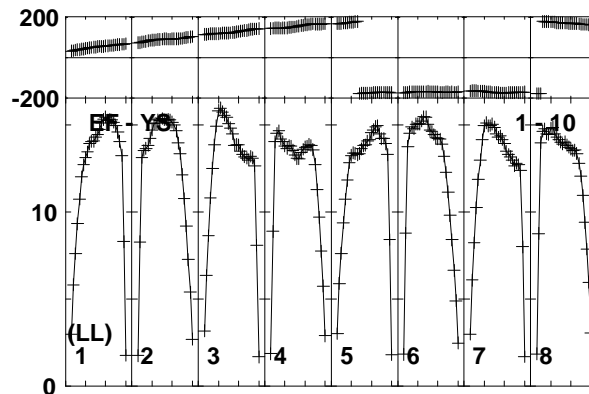
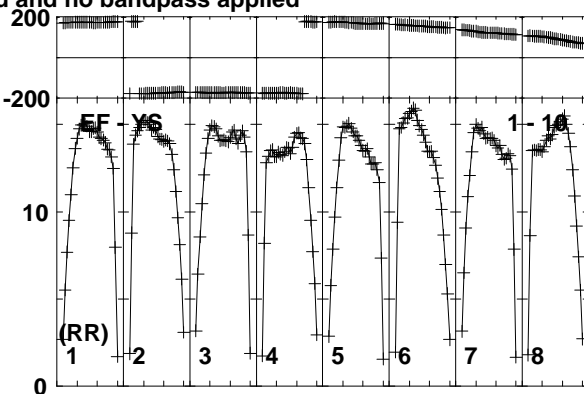
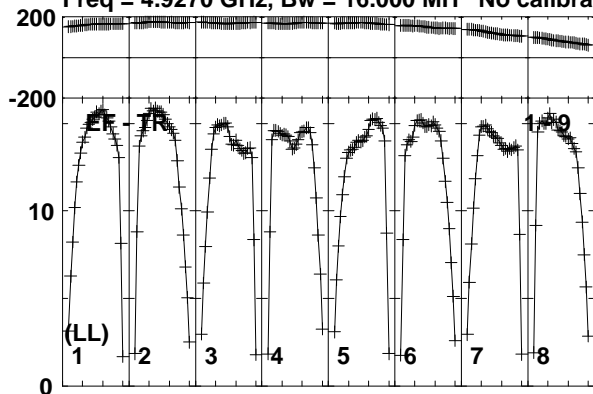

Lower frame: Milli Ampl Jy Top frame: Phas deg  
Vector averaged cross-power spectrum Baseline: EF (01) - TR (09)  
Timerange: 00/06:50:11 to 00/06:51:39

Plot file version 274 created 08-APR-2019 12:10:07

J0815+3635 EM133B.UVDATA.1

Freq = 4.9270 GHz, Bw = 16.000 MH No calibration applied and no bandpass applied

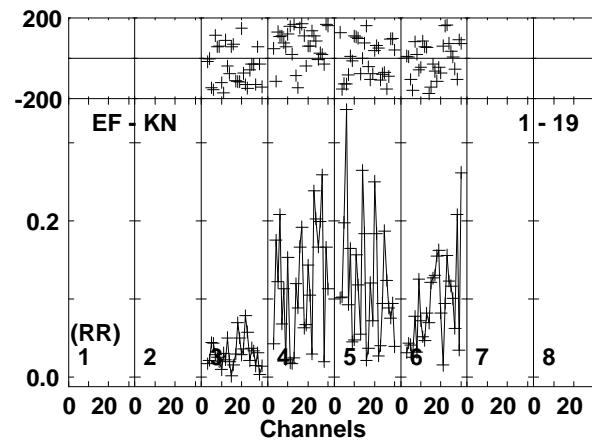
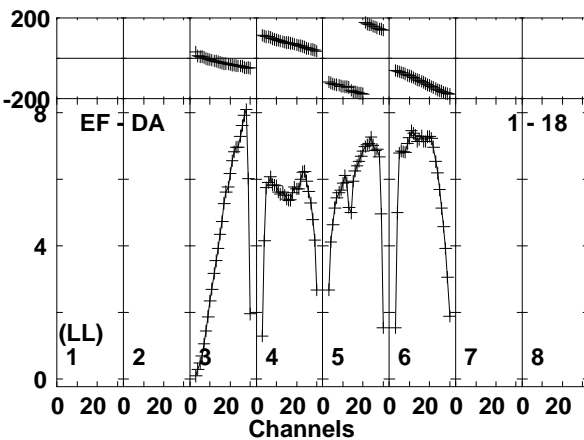
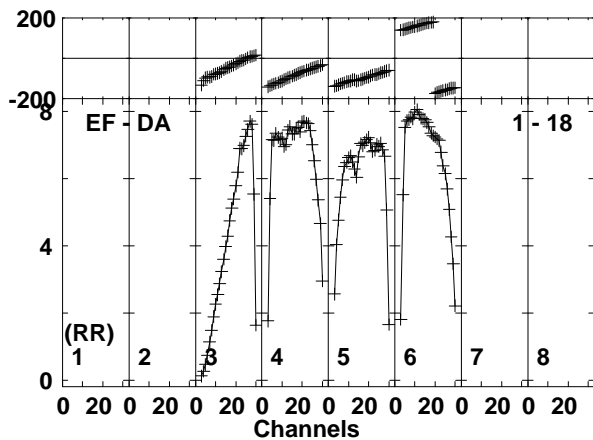
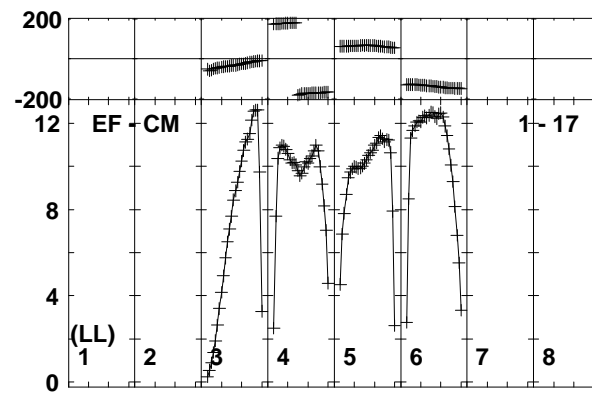
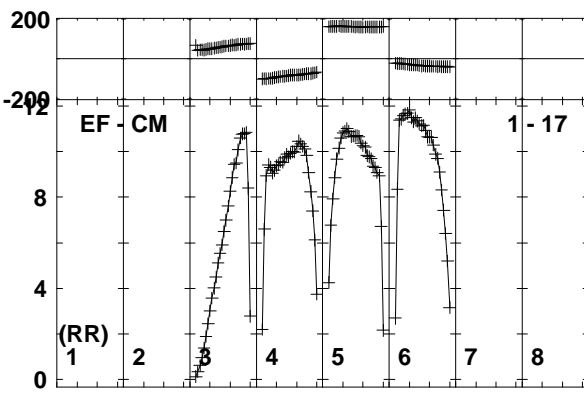
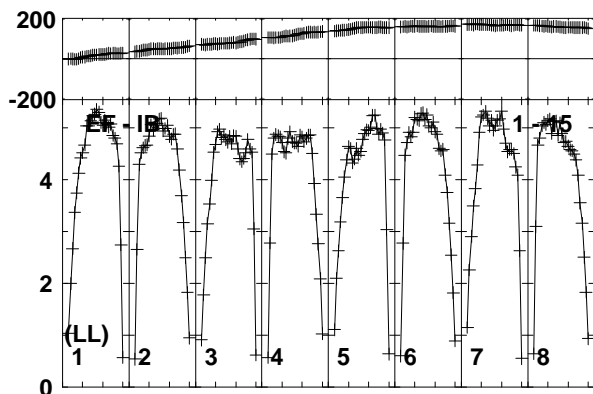
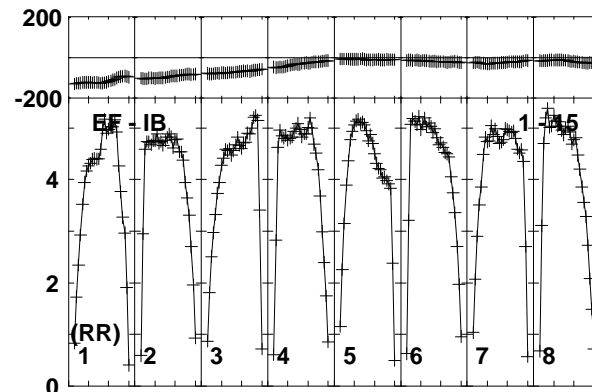
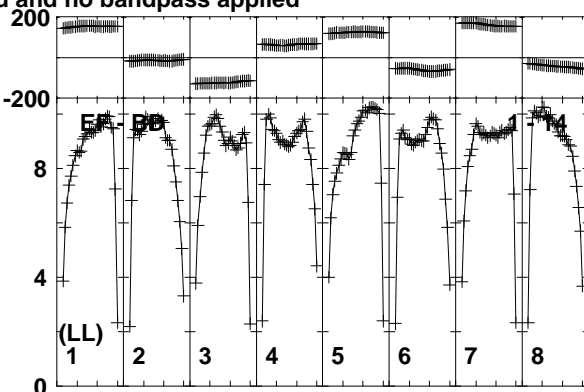
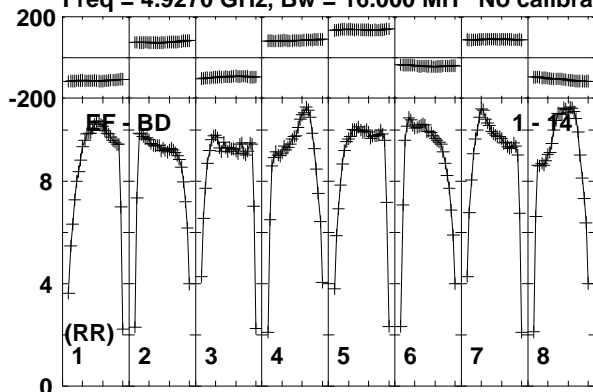

Lower frame: Milli Ampl Jy Top frame: Phas deg  
Vector averaged cross-power spectrum Baseline: EF (01) - BD (14)  
Timerange: 00/06:50:11 to 00/06:51:39

Plot file version 275 created 08-APR-2019 12:10:07

J0815+3635 EM133B.UVDATA.1

Freq = 4.9270 GHz, Bw = 16.000 MH No calibration applied and no bandpass applied

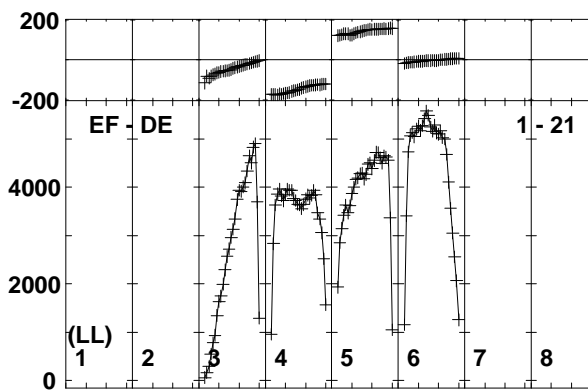
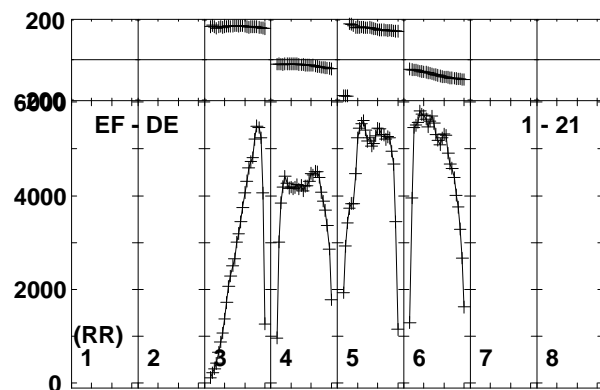
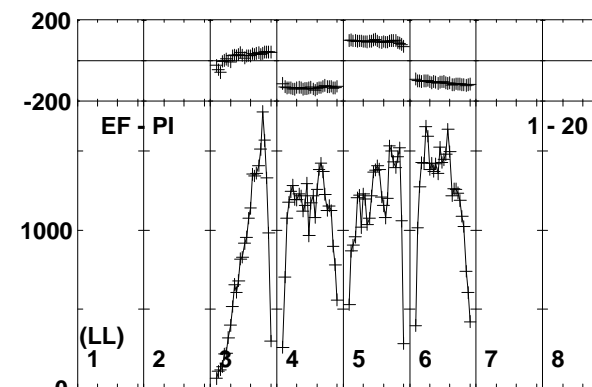
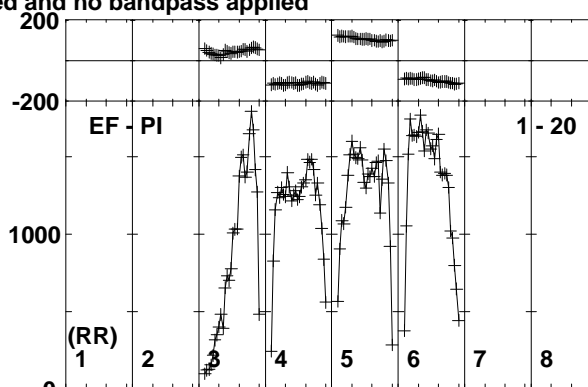
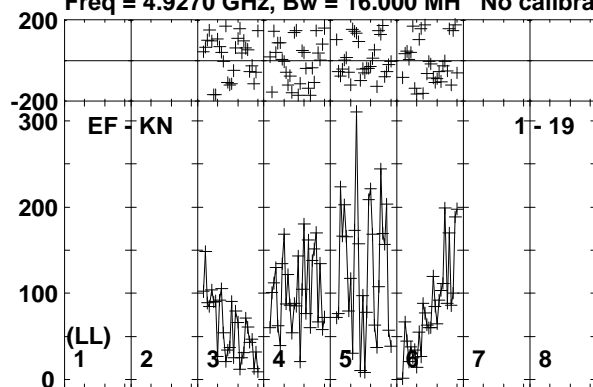

Lower frame: Micro Ampl Jy Top frame: Phas deg  
Vector averaged cross-power spectrum Baseline: EF (01) - KN (19)  
Timerange: 00/06:50:11 to 00/06:51:39

Plot file version 276 created 08-APR-2019 12:10:07

MRK622 EM133B.UVDATA.1

Freq = 4.9270 GHz, Bw = 16.000 MH No calibration applied and no bandpass applied

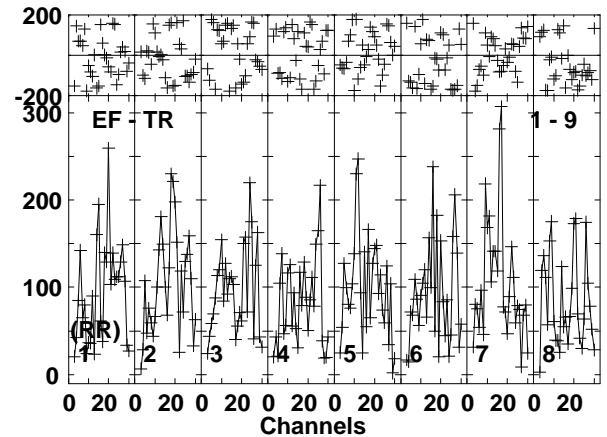
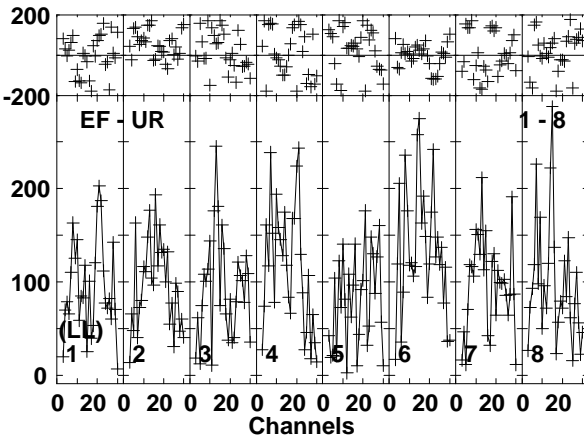
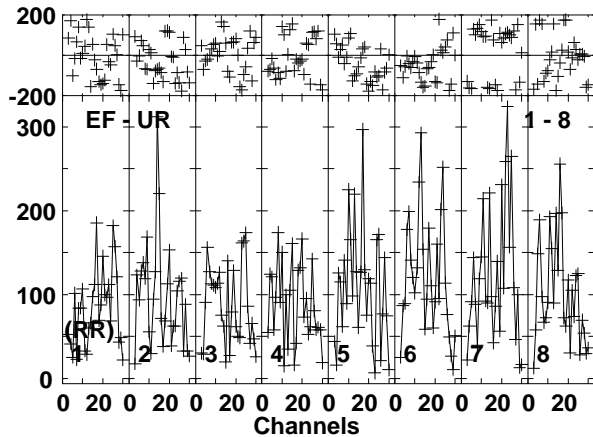
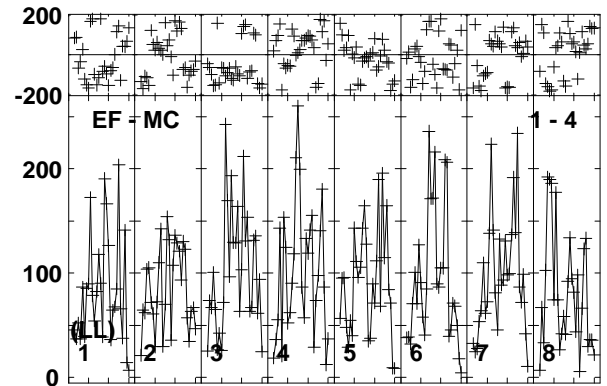
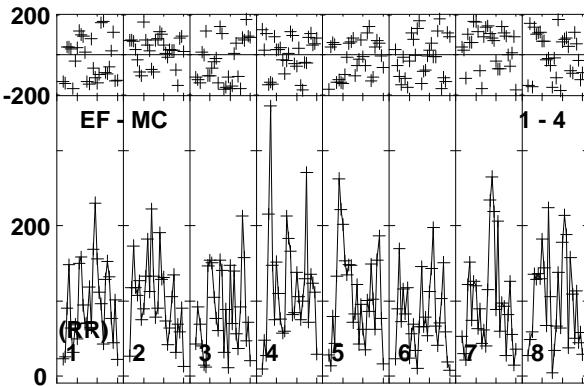
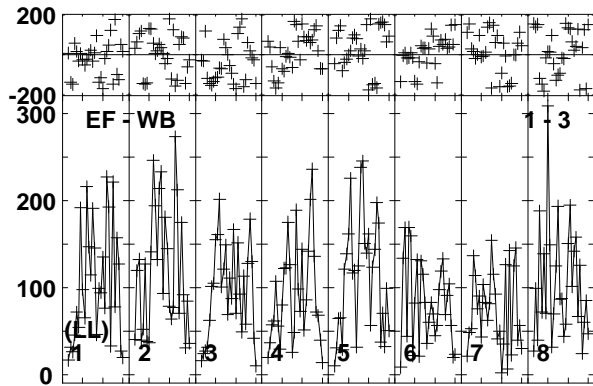
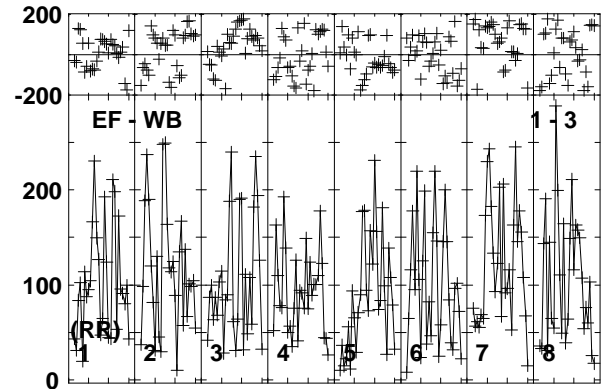
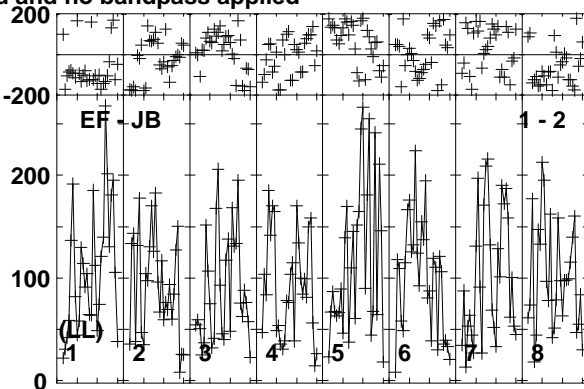
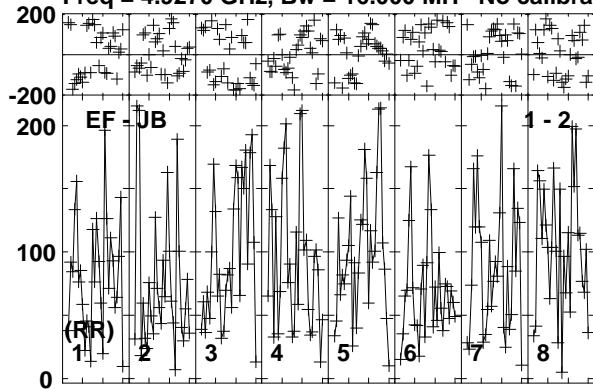

Lower frame: Micro Ampl Jy Top frame: Phas deg  
Vector averaged cross-power spectrum Baseline: EF (01) - JB (02)  
Timerange: 00/06:51:41 to 00/06:55:09

Plot file version 277 created 08-APR-2019 12:10:07

MRK622 EM133B.UVDATA.1

Freq = 4.9270 GHz, Bw = 16.000 MH No calibration applied and no bandpass applied

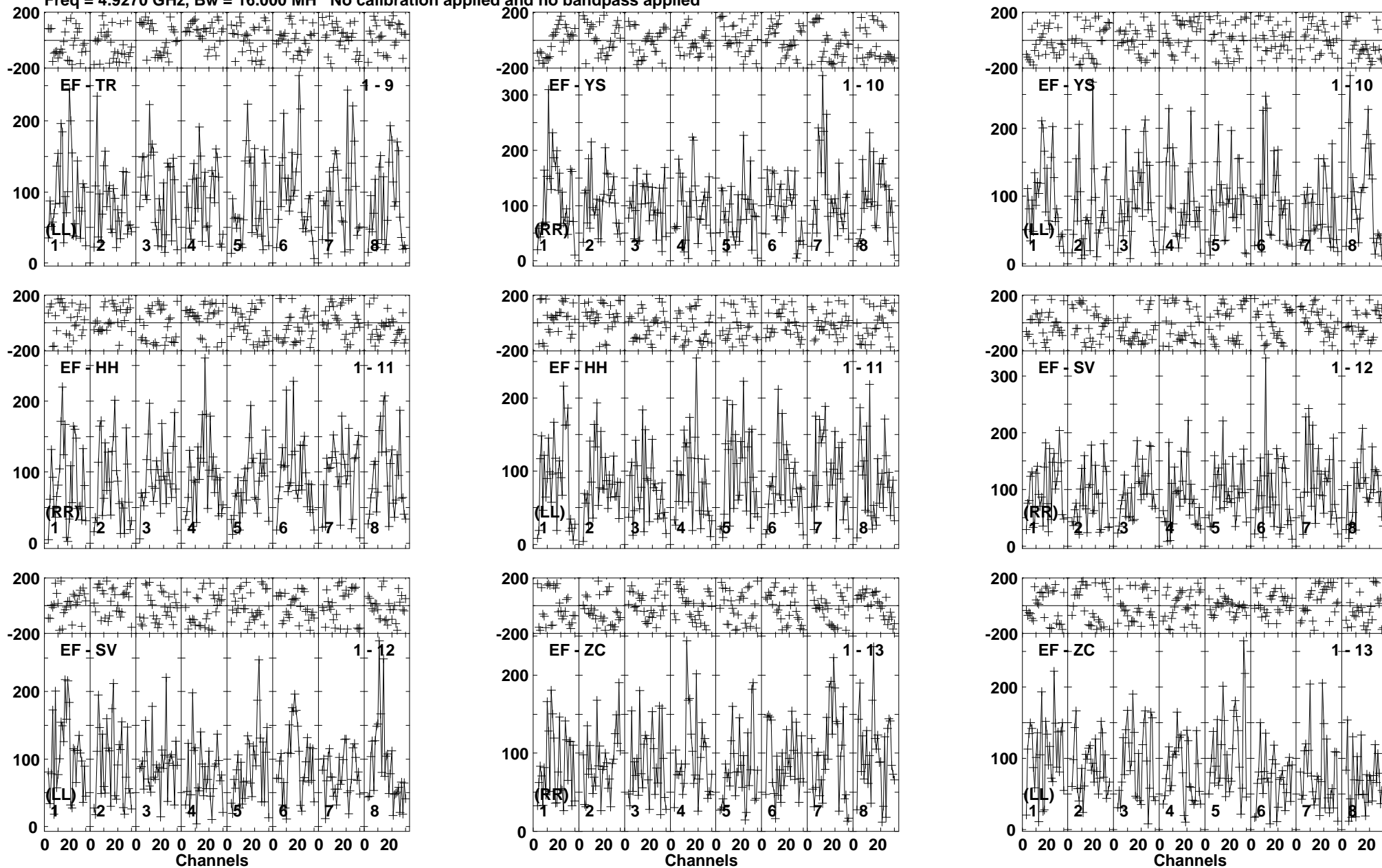

Lower frame: Micro Ampl Jy Top frame: Phas deg  
Vector averaged cross-power spectrum Baseline: EF (01) - TR (09)  
Timerange: 00/06:51:41 to 00/06:55:09

Plot file version 278 created 08-APR-2019 12:10:07

MRK622 EM133B.UVDATA.1

Freq = 4.9270 GHz, Bw = 16.000 MH No calibration applied and no bandpass applied

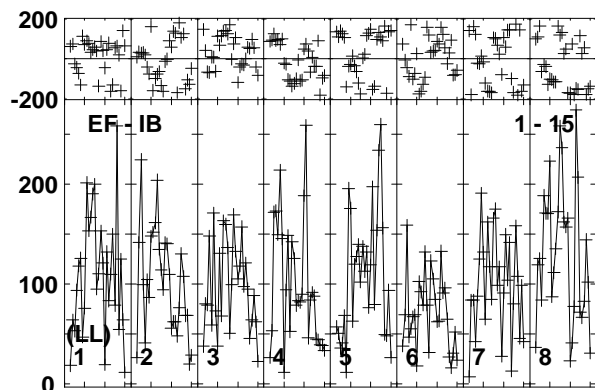
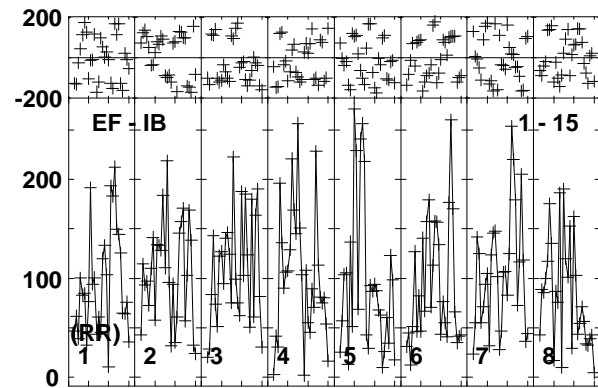
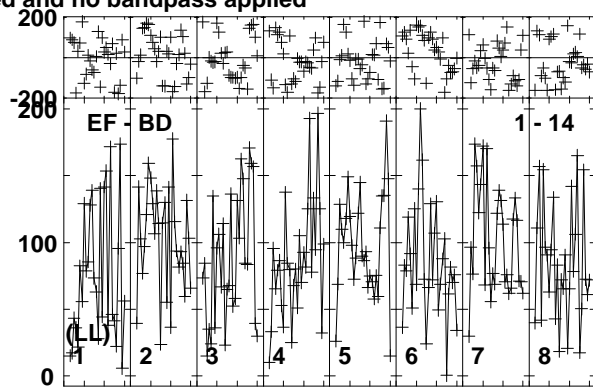
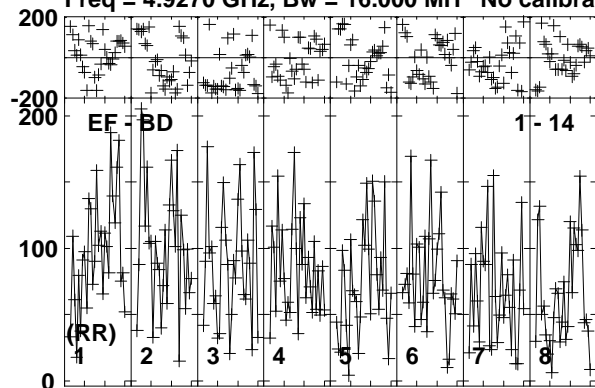

Lower frame: Micro Ampl Jy Top frame: Phas deg  
Vector averaged cross-power spectrum Baseline: EF (01) - BD (14)  
Timerange: 00/06:51:41 to 00/06:55:09

Plot file version 279 created 08-APR-2019 12:10:08

J0815+3635 EM133B.UVDATA.1

Freq = 4.9270 GHz, Bw = 16.000 MH No calibration applied and no bandpass applied

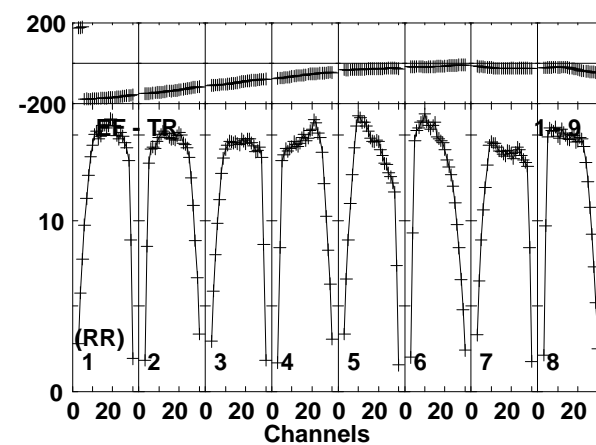
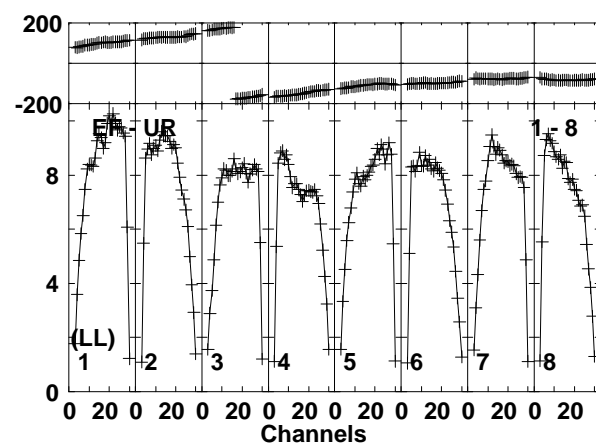
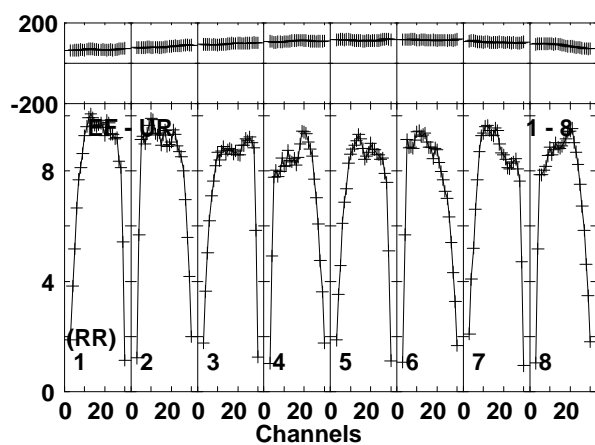
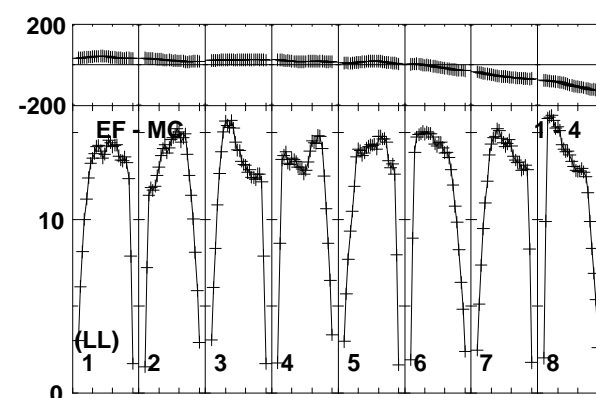
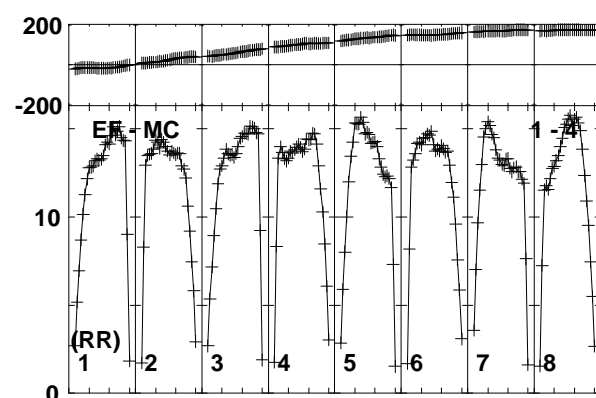
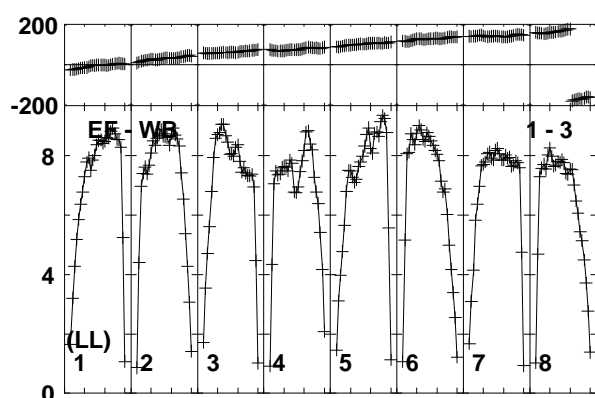
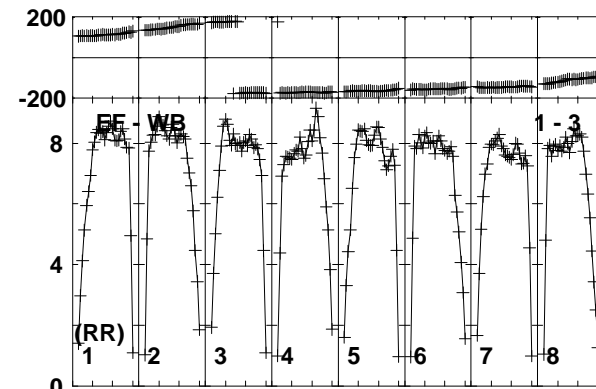
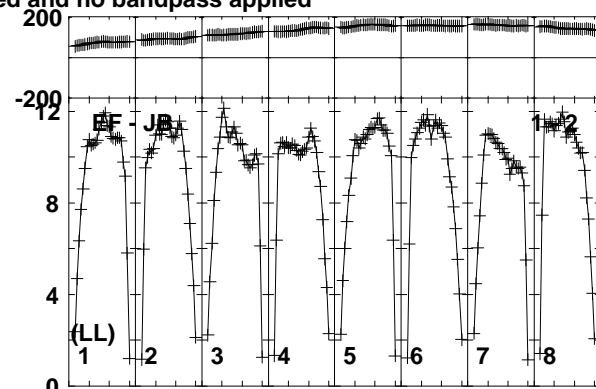
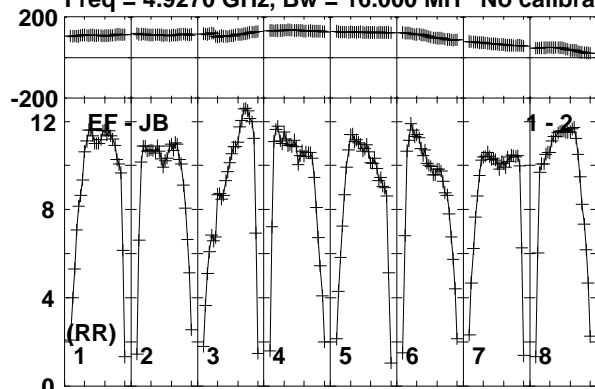

Lower frame: Milli Ampl Jy Top frame: Phas deg  
Vector averaged cross-power spectrum Baseline: EF (01) - JB (02)  
Timerange: 00/06:55:11 to 00/06:56:39

Plot file version 280 created 08-APR-2019 12:10:08

J0815+3635 EM133B.UVDATA.1

Freq = 4.9270 GHz, Bw = 16.000 MH No calibration applied and no bandpass applied

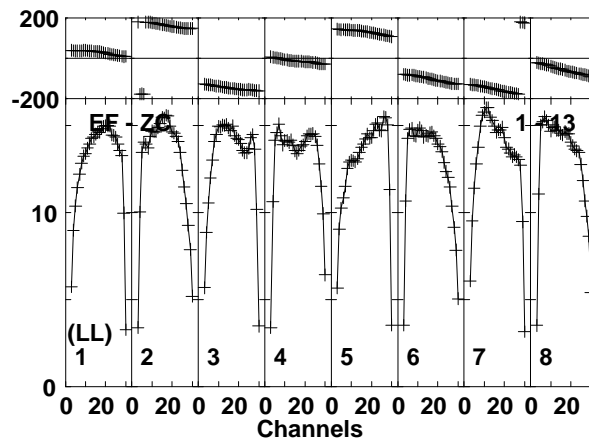
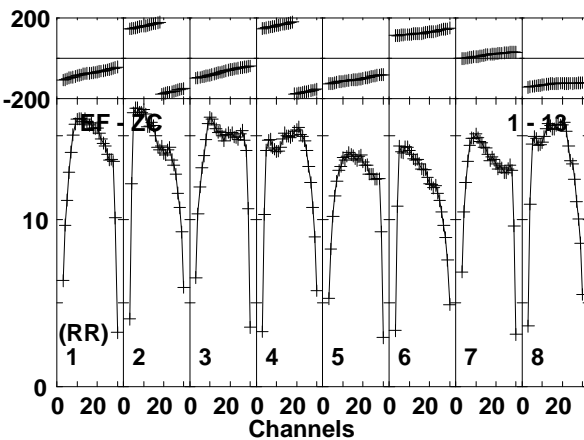
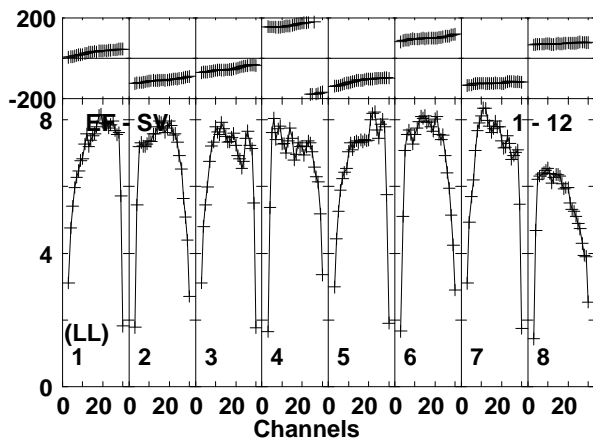
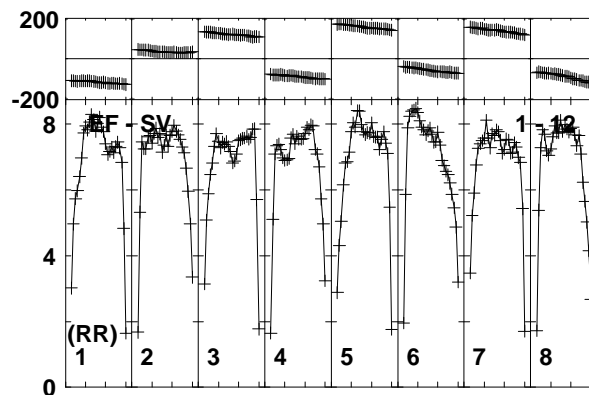
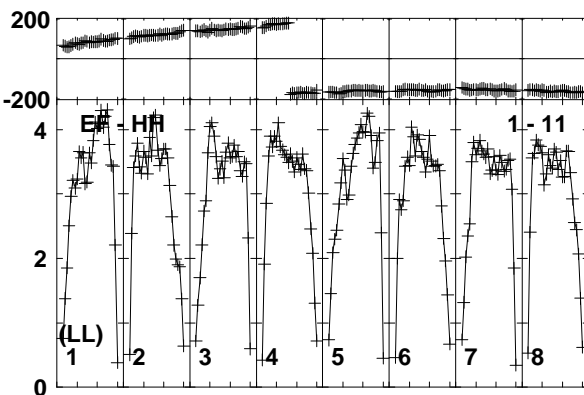
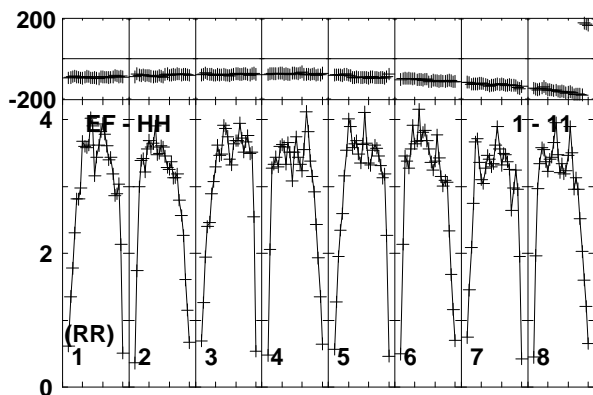
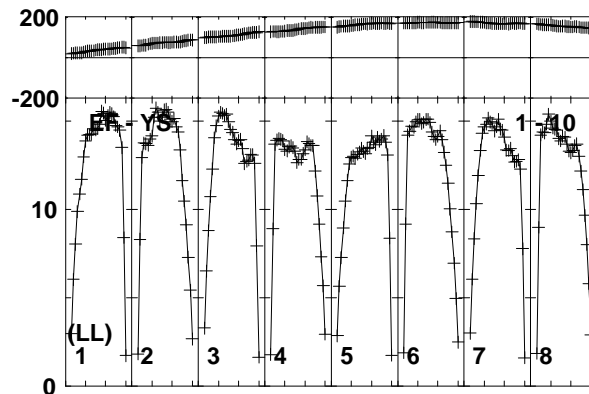
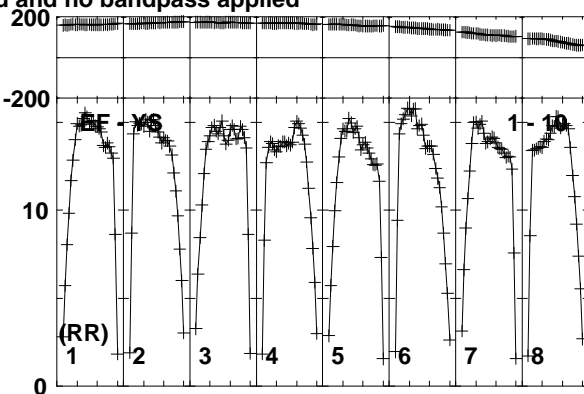
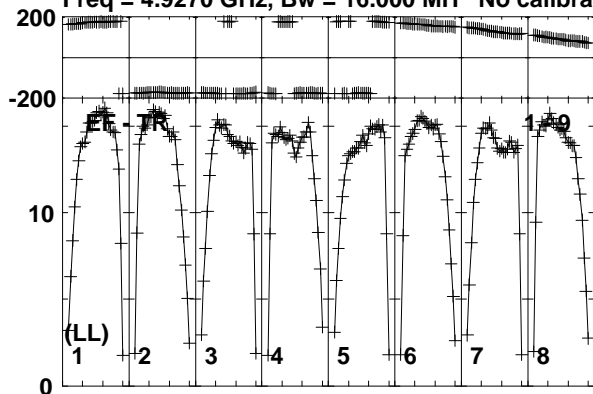

Lower frame: Milli Ampl Jy Top frame: Phas deg  
Vector averaged cross-power spectrum Baseline: EF (01) - TR (09)  
Timerange: 00/06:55:11 to 00/06:56:39



Plot file version 281 created 08-APR-2019 12:10:08

J0815+3635 EM133B.UVDATA.1

Freq = 4.9270 GHz, Bw = 16.000 MH No calibration applied and no bandpass applied

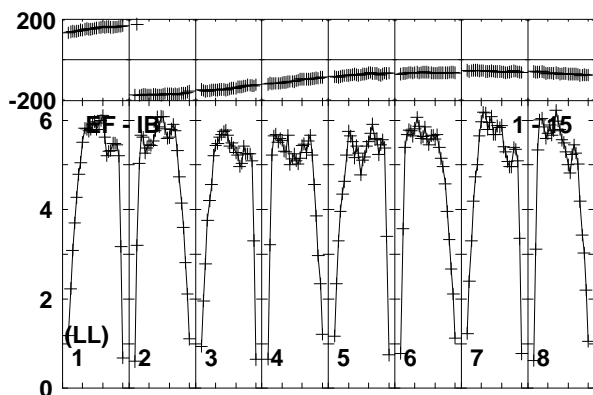
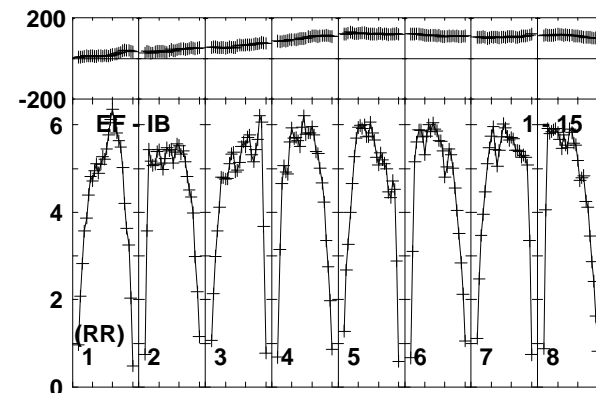
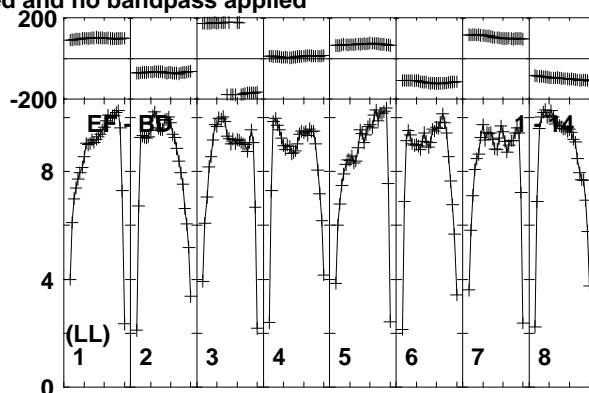
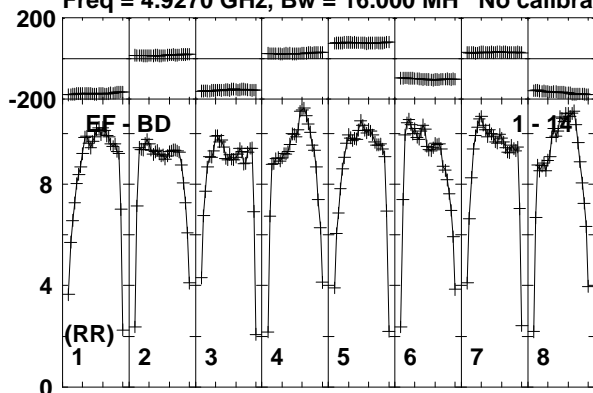

Lower frame: Milli Ampl Jy Top frame: Phas deg  
Vector averaged cross-power spectrum Baseline: EF (01) - BD (14)  
Timerange: 00/06:55:11 to 00/06:56:39

Plot file version 282 created 08-APR-2019 12:10:08

MRK622 EM133B.UVDATA.1

Freq = 4.9270 GHz, Bw = 16.000 MH No calibration applied and no bandpass applied

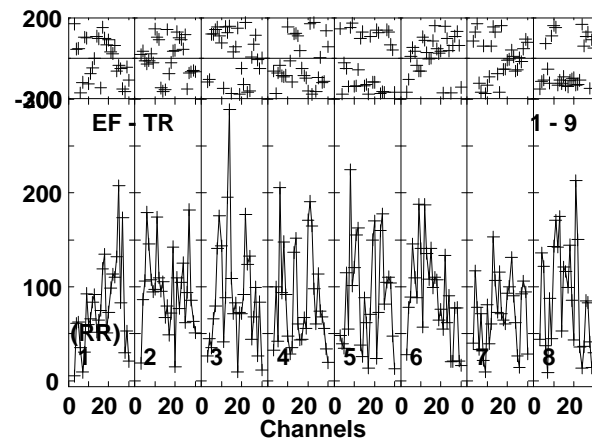
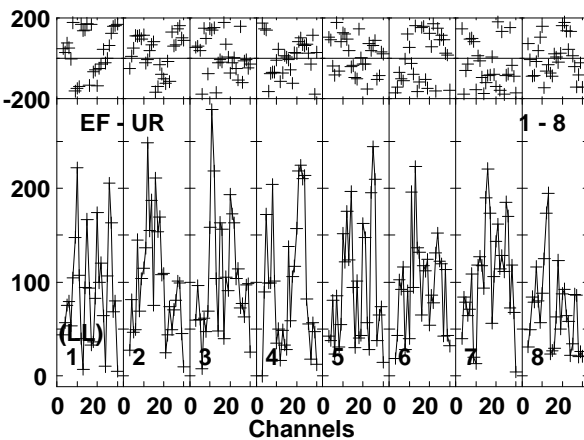
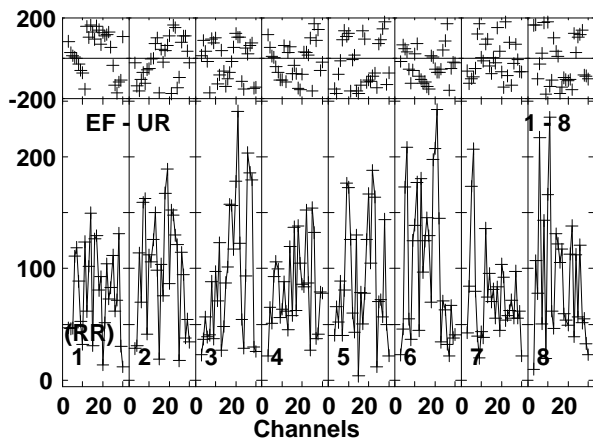
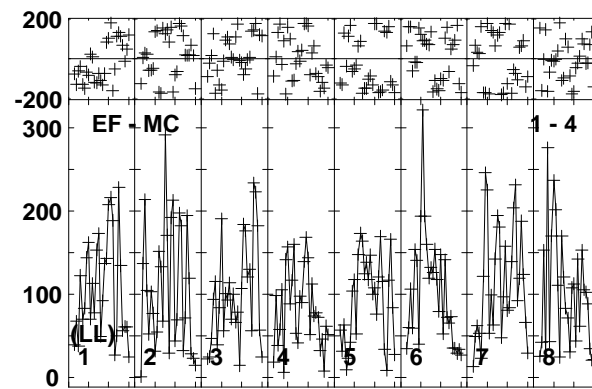
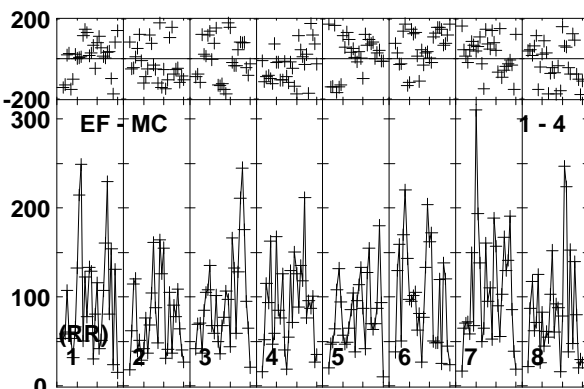
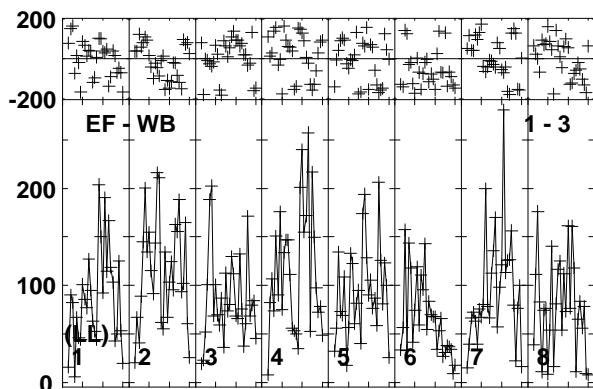
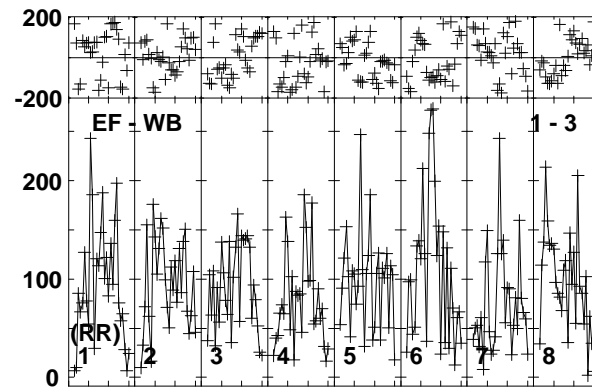
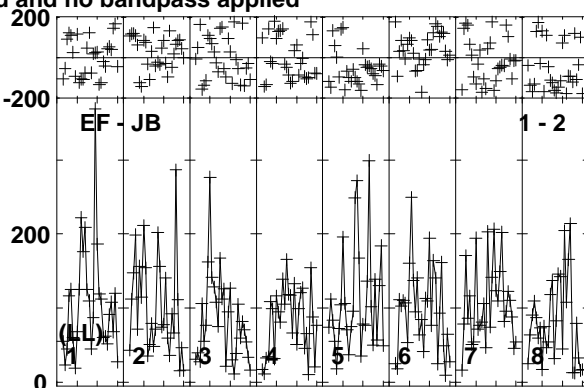
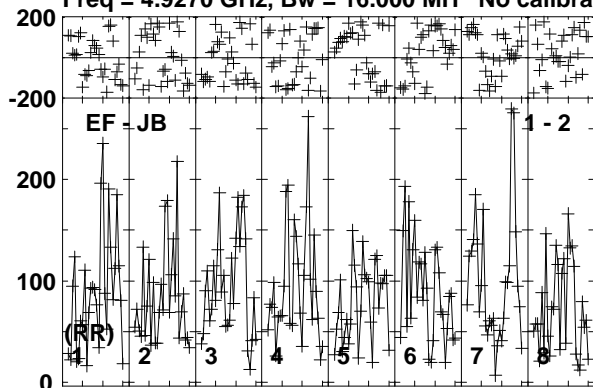

Lower frame: Micro Ampl Jy Top frame: Phas deg  
Vector averaged cross-power spectrum Baseline: EF (01) - JB (02)  
Timerange: 00/06:56:43 to 00/07:00:09

Plot file version 283 created 08-APR-2019 12:10:08

MRK622 EM133B.UVDATA.1

Freq = 4.9270 GHz, Bw = 16.000 MH No calibration applied and no bandpass applied

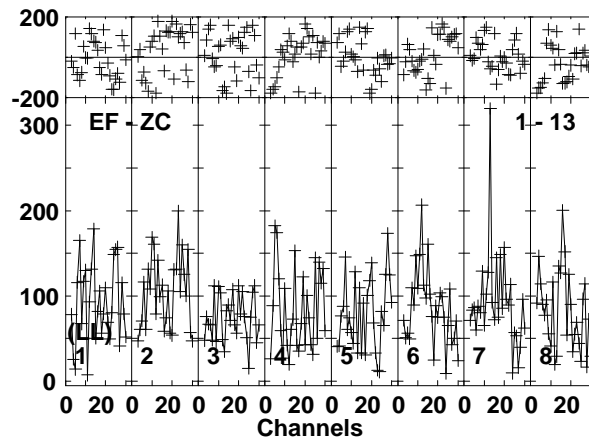
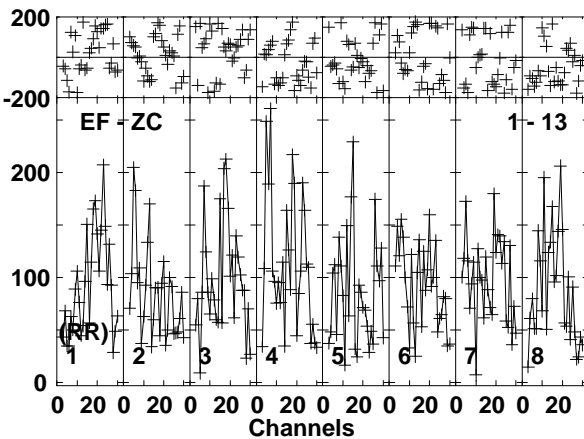
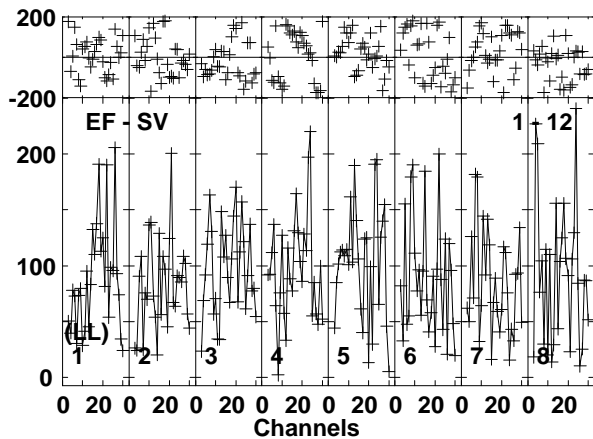
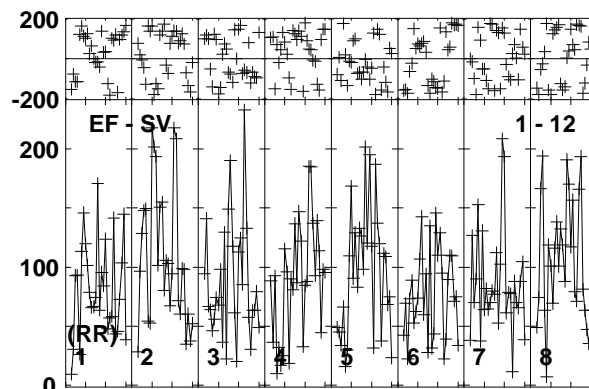
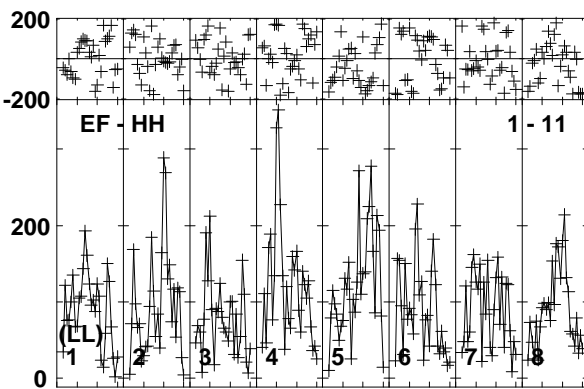
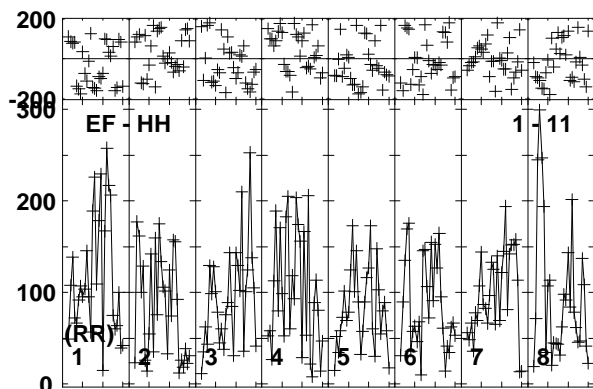
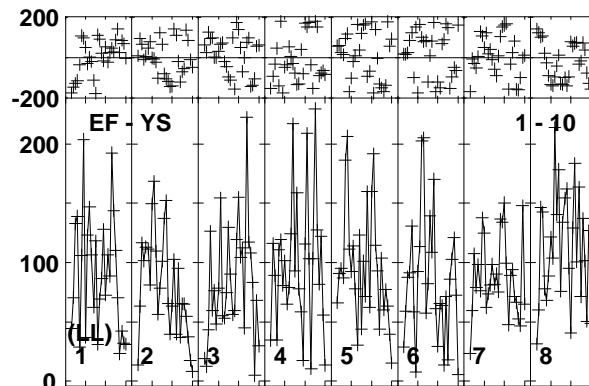
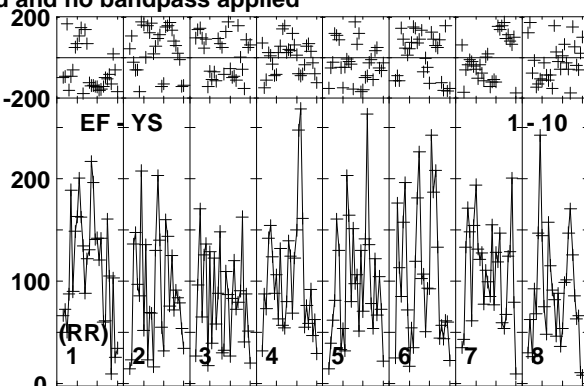
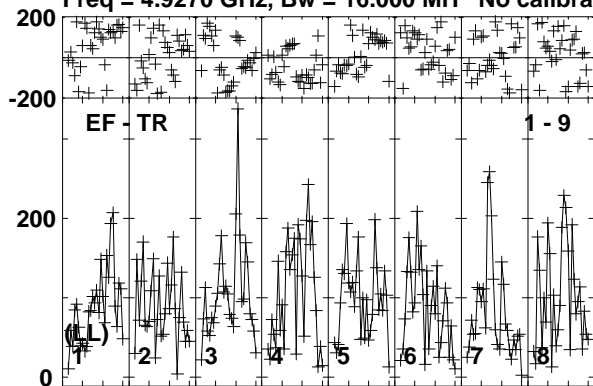

Lower frame: Micro Ampl Jy Top frame: Phas deg  
Vector averaged cross-power spectrum Baseline: EF (01) - TR (09)  
Timerange: 00/06:56:43 to 00/07:00:09

Plot file version 284 created 08-APR-2019 12:10:08

MRK622 EM133B.UVDATA.1

Freq = 4.9270 GHz, Bw = 16.000 MH No calibration applied and no bandpass applied

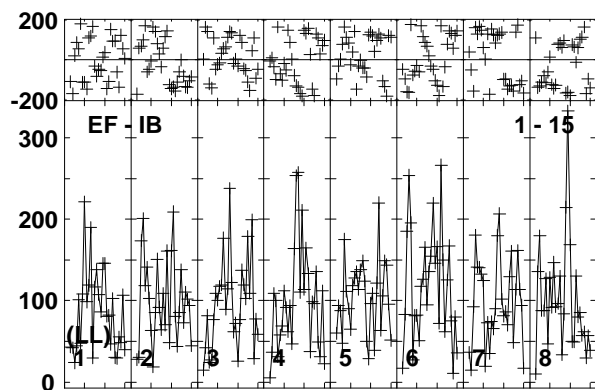
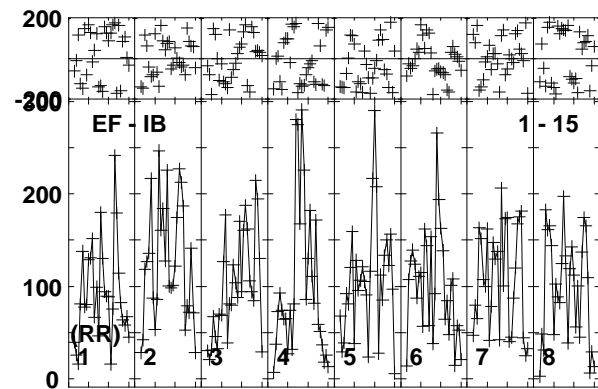
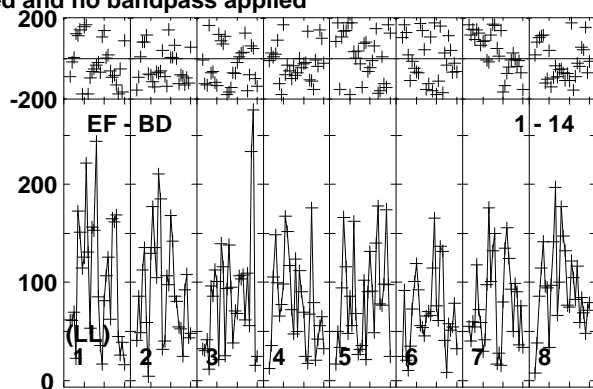
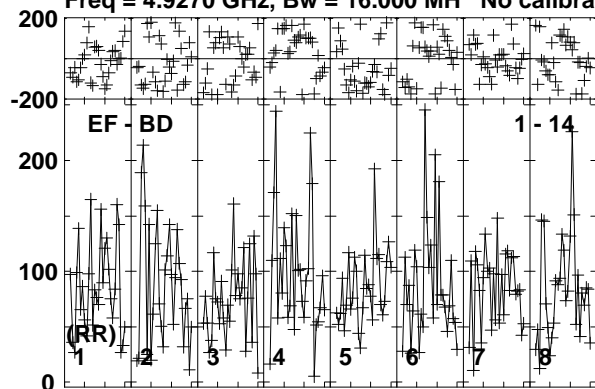

Lower frame: Micro Ampl Jy Top frame: Phas deg  
Vector averaged cross-power spectrum Baseline: EF (01) - BD (14)  
Timerange: 00/06:56:43 to 00/07:00:09

Plot file version 285 created 08-APR-2019 12:10:08

J0815+3635 EM133B.UVDATA.1

Freq = 4.9270 GHz, Bw = 16.000 MH No calibration applied and no bandpass applied

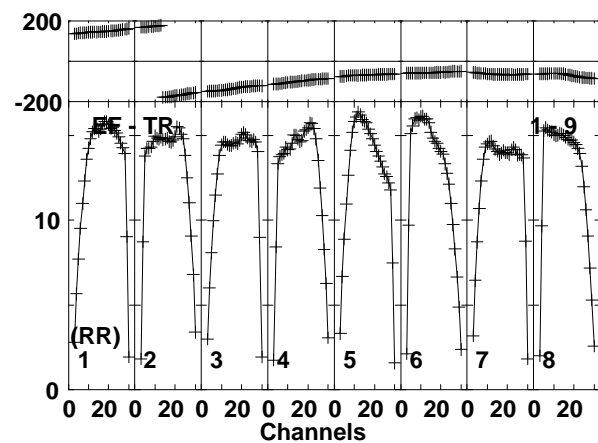
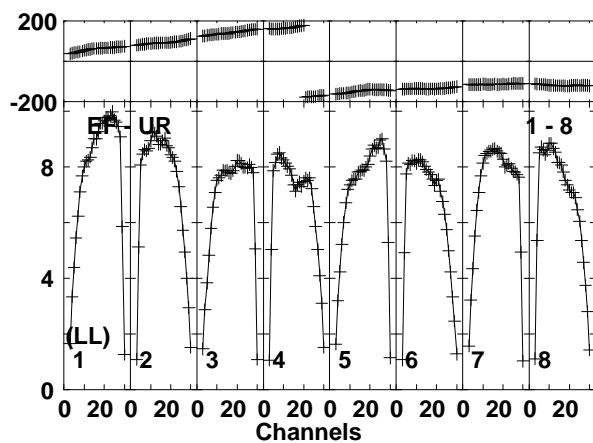
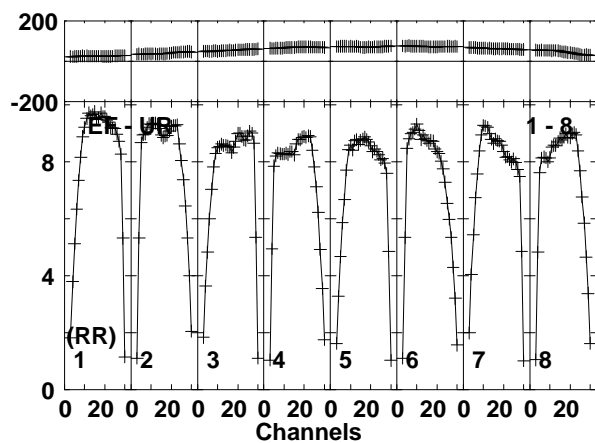
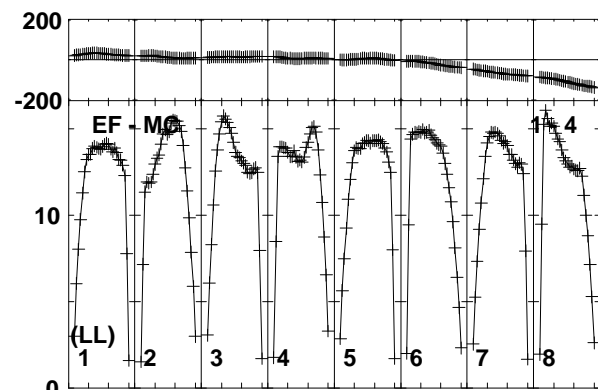
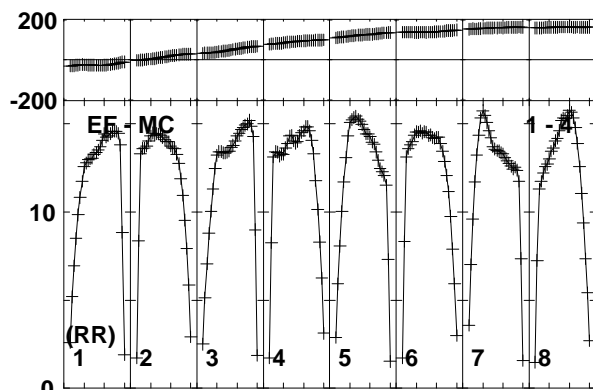
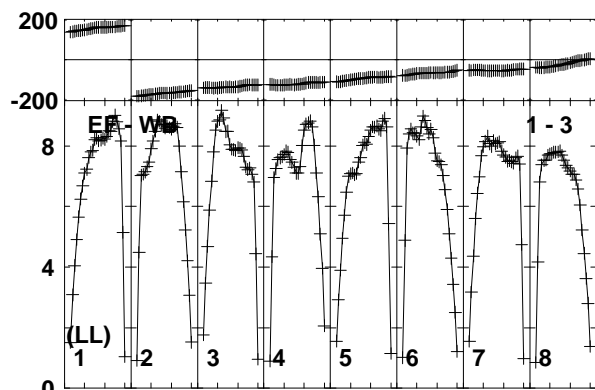
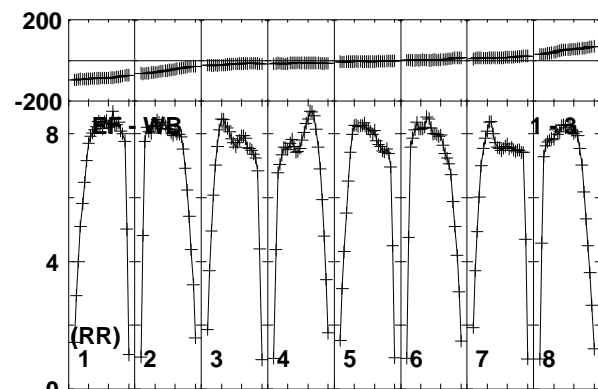
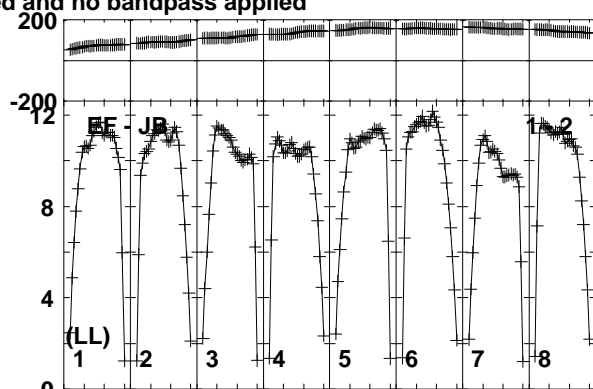
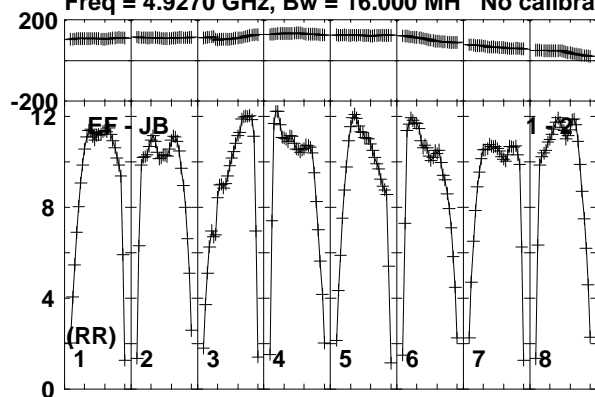

Lower frame: Milli Ampl Jy Top frame: Phas deg  
Vector averaged cross-power spectrum Baseline: EF (01) - JB (02)  
Timerange: 00/07:01:01 to 00/07:02:29

Plot file version 286 created 08-APR-2019 12:10:09

J0815+3635 EM133B.UVDATA.1

Freq = 4.9270 GHz, Bw = 16.000 MH No calibration applied and no bandpass applied

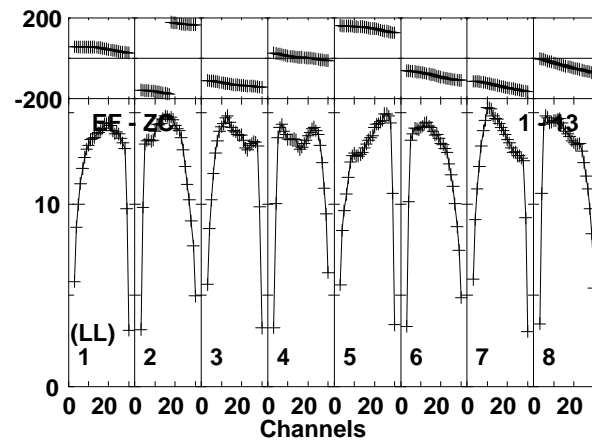
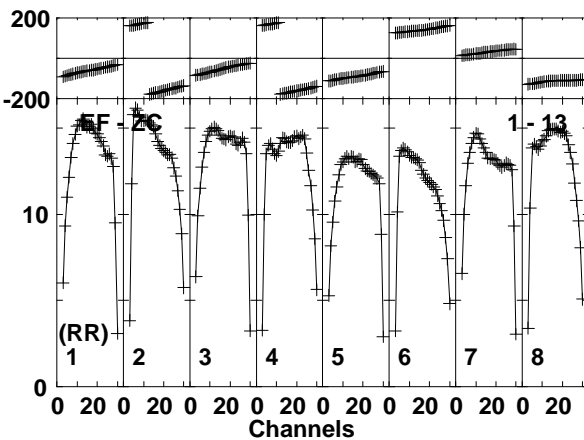
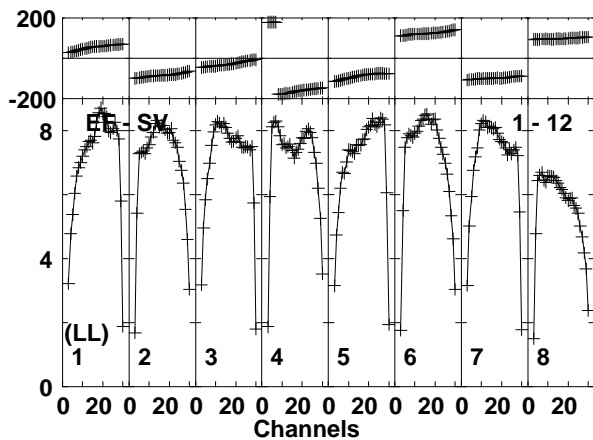
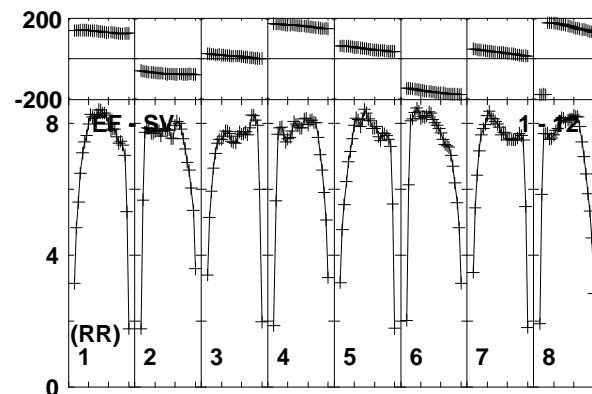
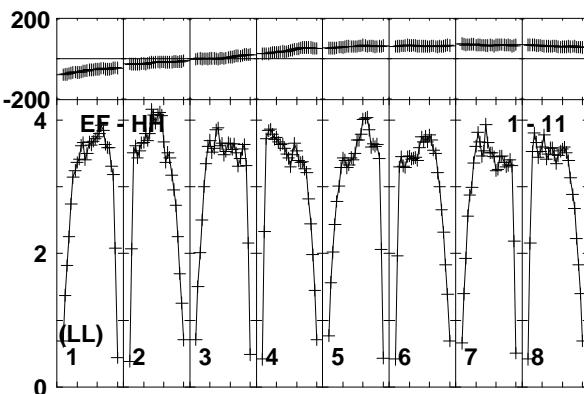
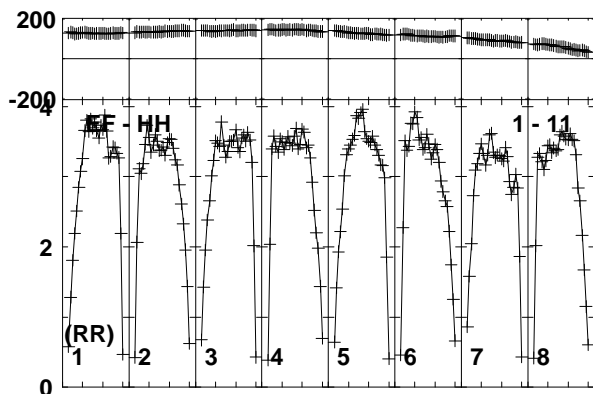
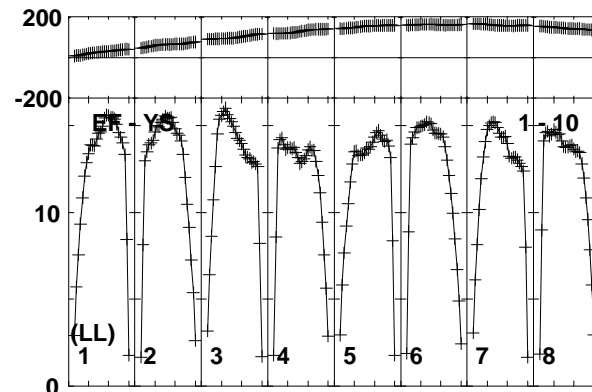
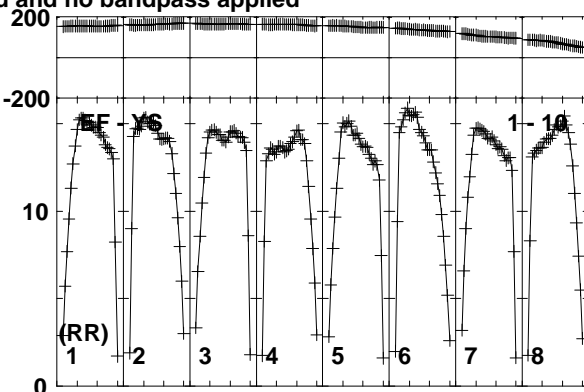
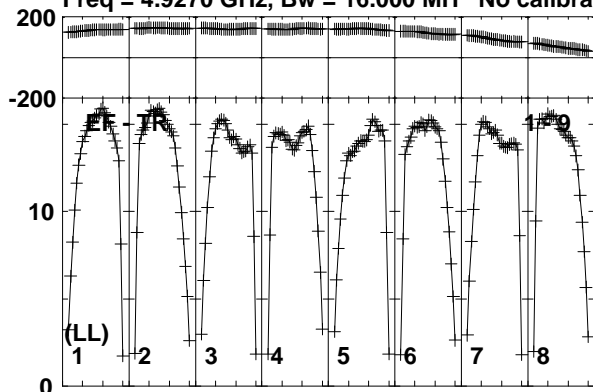

Lower frame: Milli Ampl Jy Top frame: Phas deg  
Vector averaged cross-power spectrum Baseline: EF (01) - TR (09)  
Timerange: 00/07:01:01 to 00/07:02:29

Plot file version 287 created 08-APR-2019 12:10:09

J0815+3635 EM133B.UVDATA.1

Freq = 4.9270 GHz, Bw = 16.000 MH No calibration applied and no bandpass applied

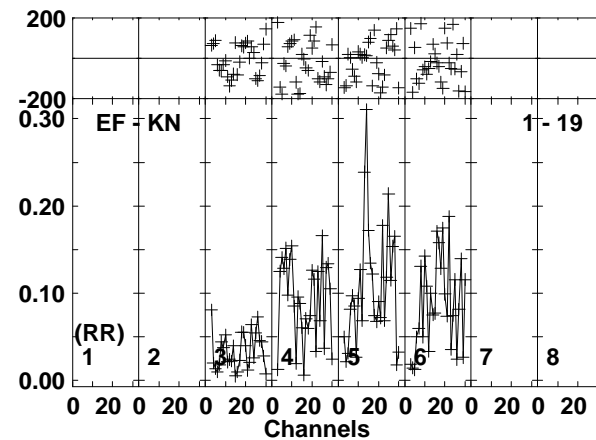
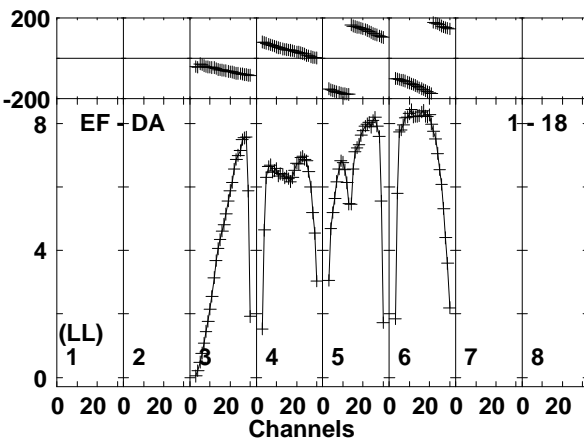
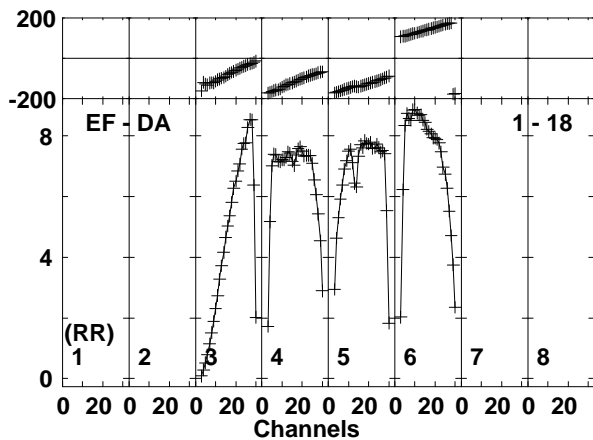
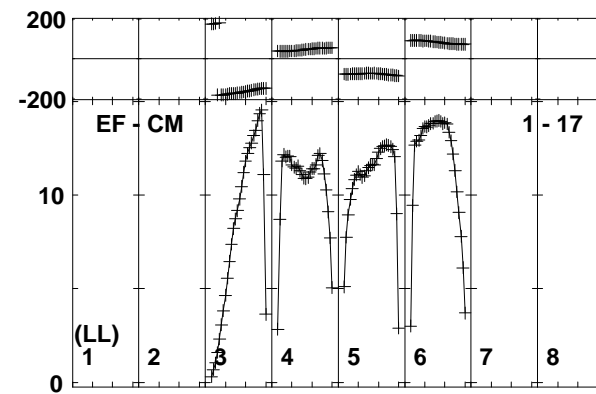
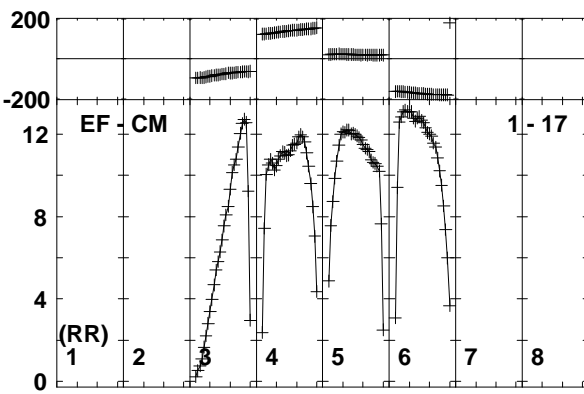
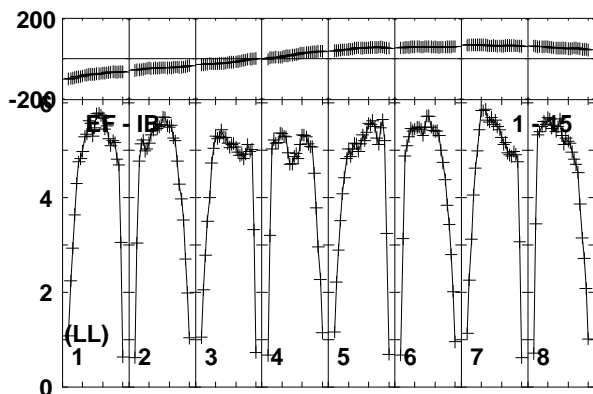
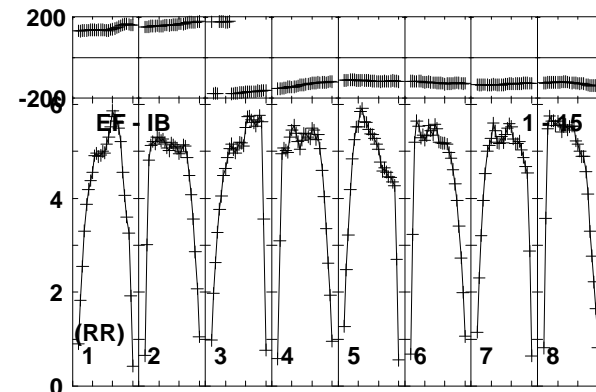
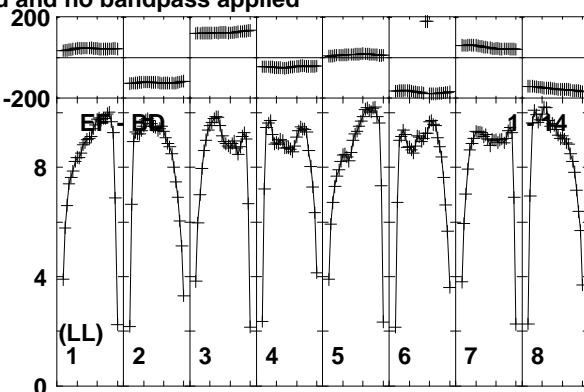
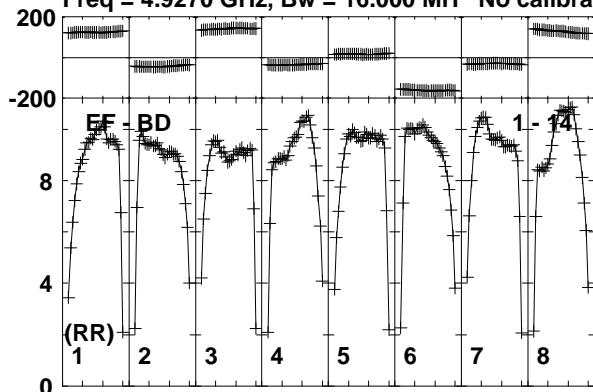

Lower frame: Milli Ampl Jy Top frame: Phas deg  
Vector averaged cross-power spectrum Baseline: EF (01) - BD (14)  
Timerange: 00/07:01:01 to 00/07:02:29

Plot file version 288 created 08-APR-2019 12:10:09

J0815+3635 EM133B.UVDATA.1

Freq = 4.9270 GHz, Bw = 16.000 MH No calibration applied and no bandpass applied

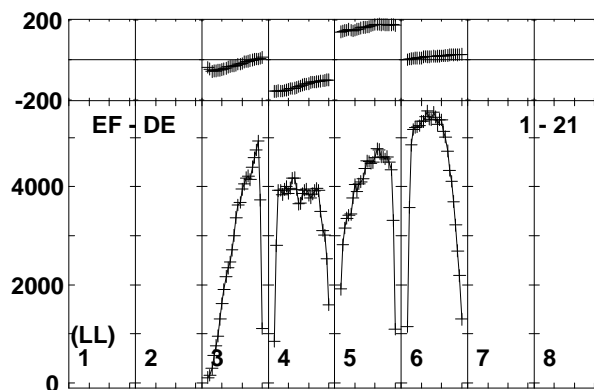
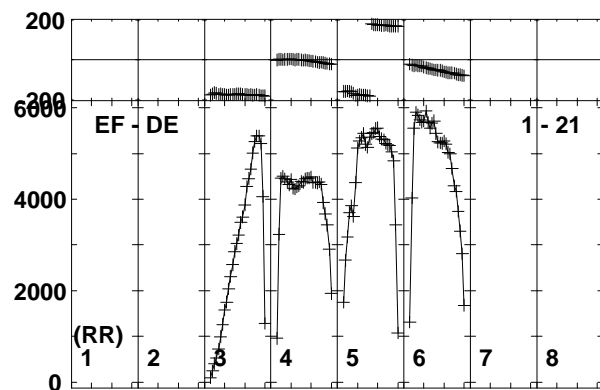
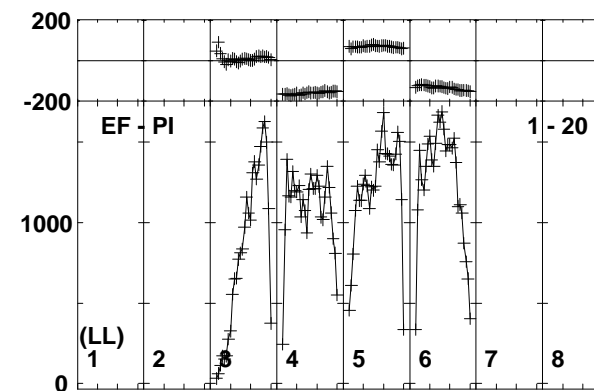
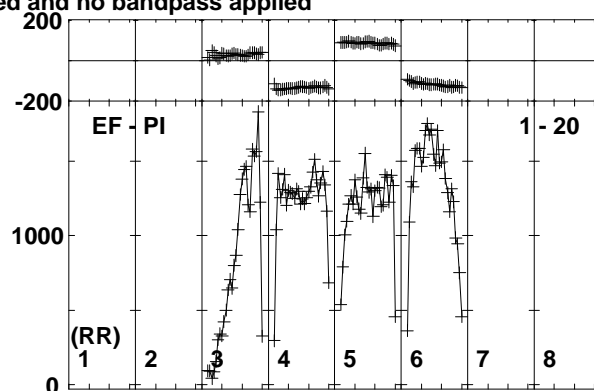
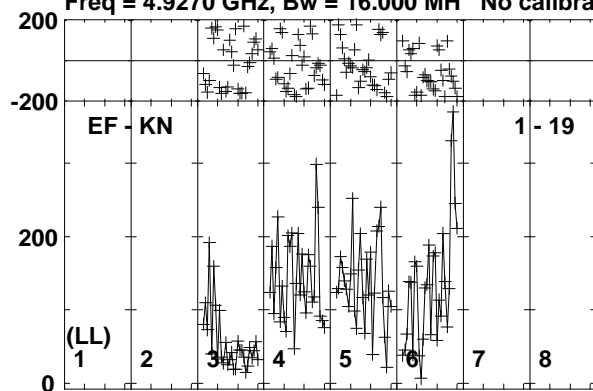

Lower frame: Micro Ampl Jy Top frame: Phas deg  
Vector averaged cross-power spectrum Baseline: EF (01) - KN (19)  
Timerange: 00/07:01:01 to 00/07:02:29



Plot file version 289 created 08-APR-2019 12:10:09

J0927+3902 EM133B.UVDATA.1

Freq = 4.9270 GHz, Bw = 16.000 MH No calibration applied and no bandpass applied

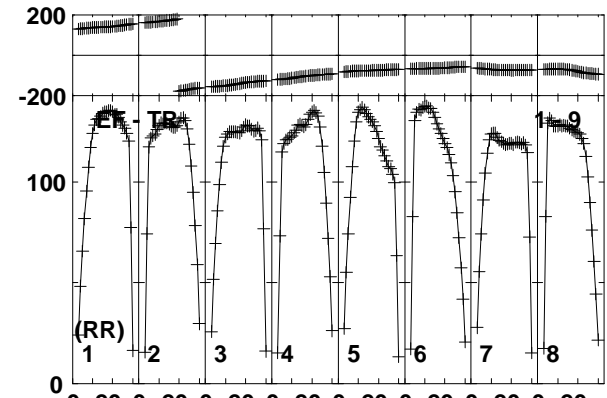
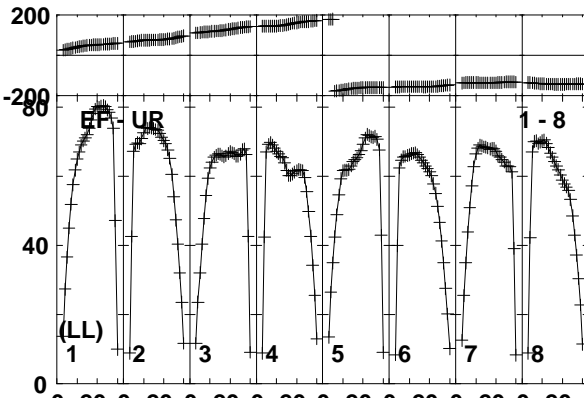
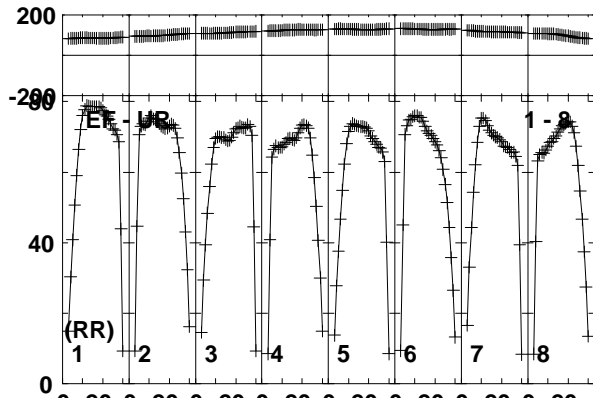
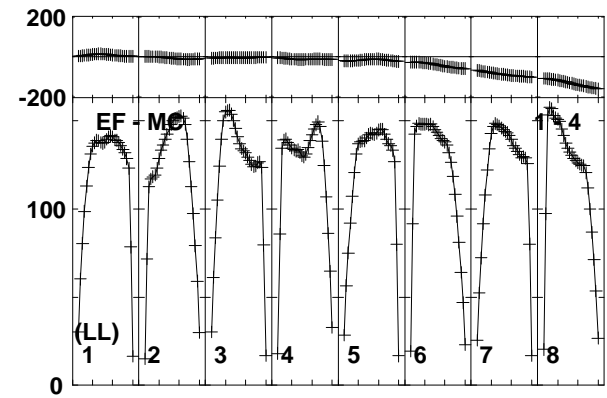
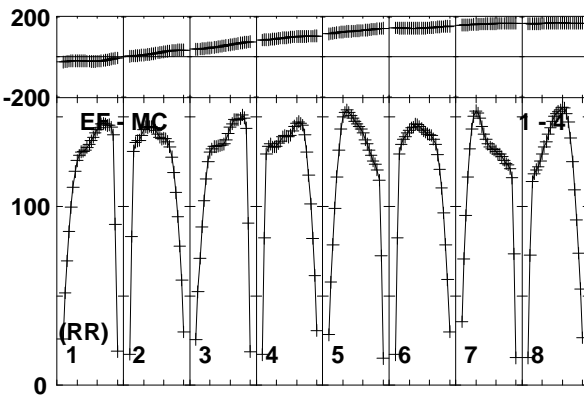
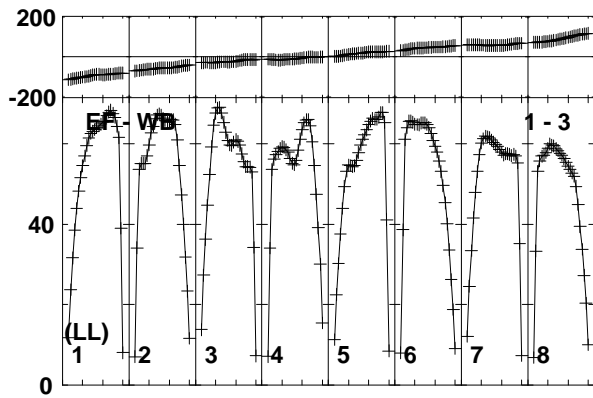
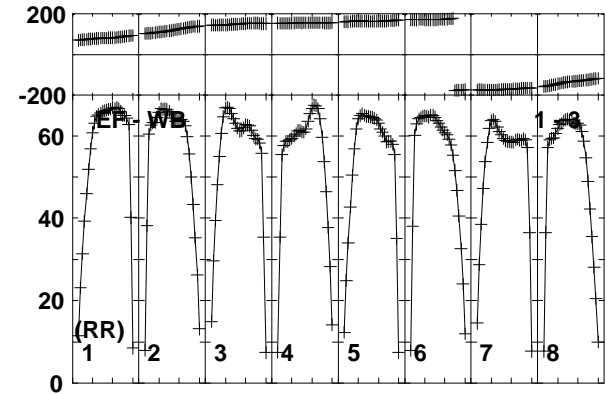
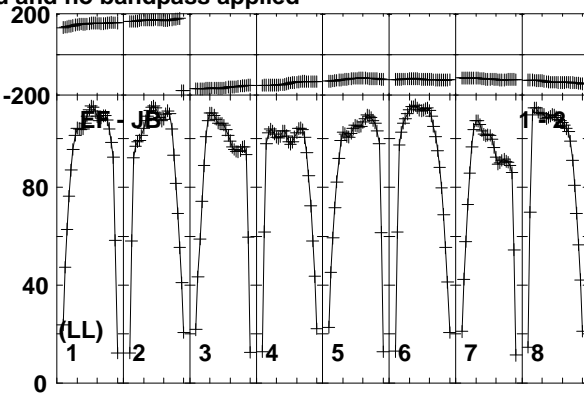
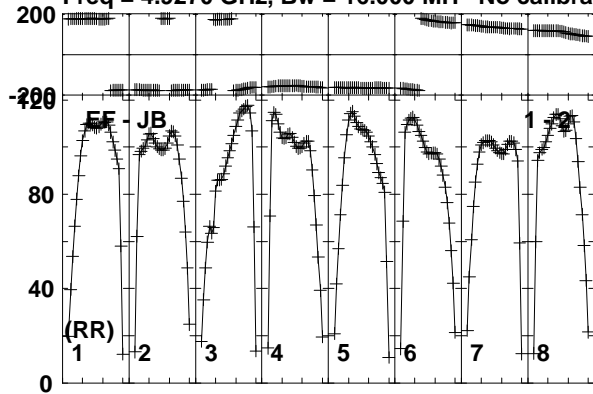

Lower frame: Milli Ampl Jy Top frame: Phas deg  
Vector averaged cross-power spectrum Baseline: EF (01) - JB (02)  
Timerange: 00/07:05:31 to 00/07:09:29

Plot file version 290 created 08-APR-2019 12:10:09

J0927+3902 EM133B.UVDATA.1

Freq = 4.9270 GHz, Bw = 16.000 MH No calibration applied and no bandpass applied

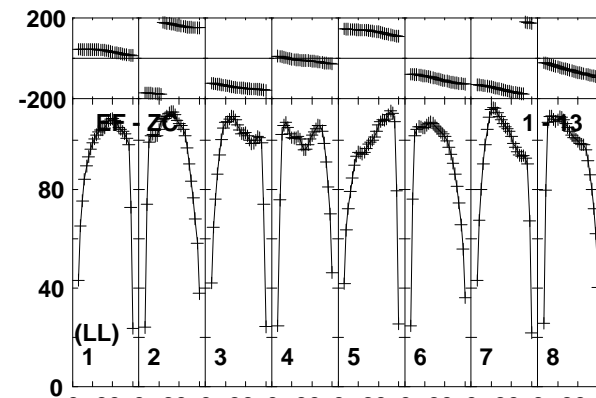
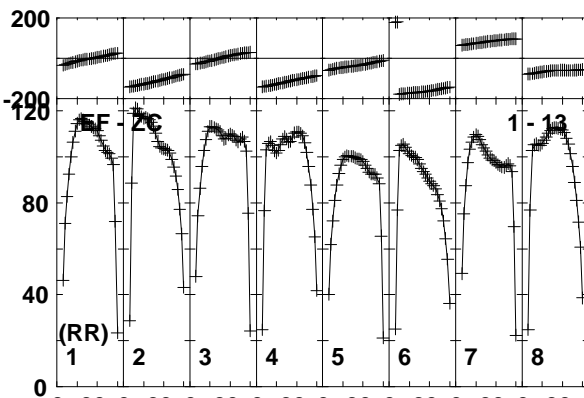
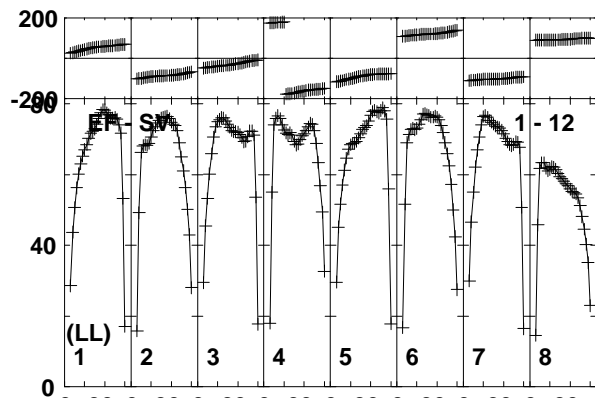
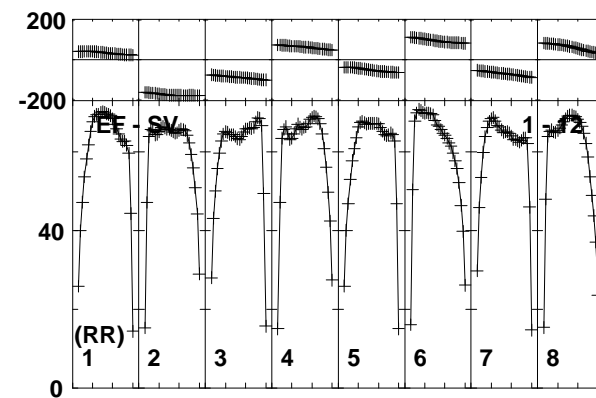
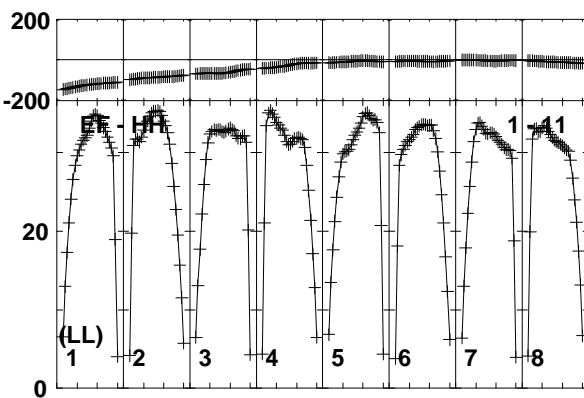
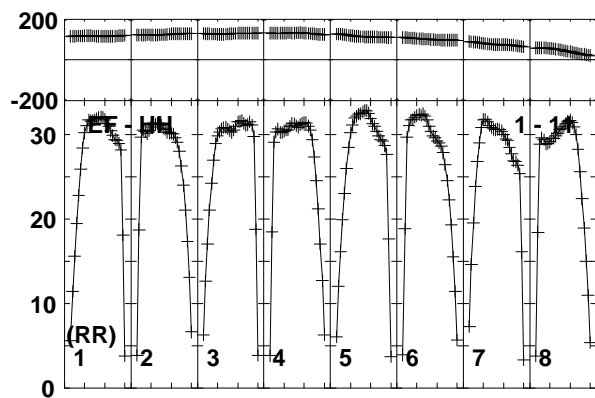
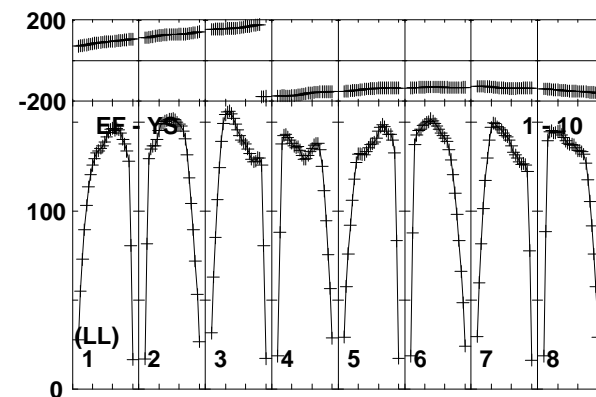
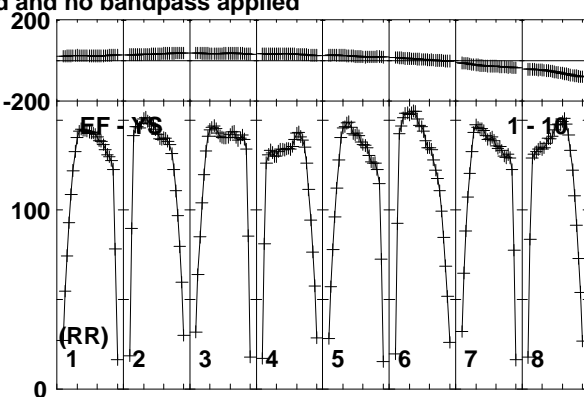
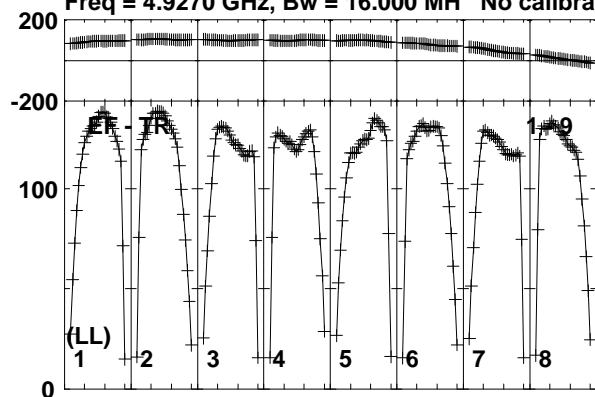

Lower frame: Milli Ampl Jy Top frame: Phas deg  
Vector averaged cross-power spectrum Baseline: EF (01) - TR (09)  
Timerange: 00/07:05:31 to 00/07:09:29

Plot file version 291 created 08-APR-2019 12:10:10

J0927+3902 EM133B.UVDATA.1

Freq = 4.9270 GHz, Bw = 16.000 MH No calibration applied and no bandpass applied

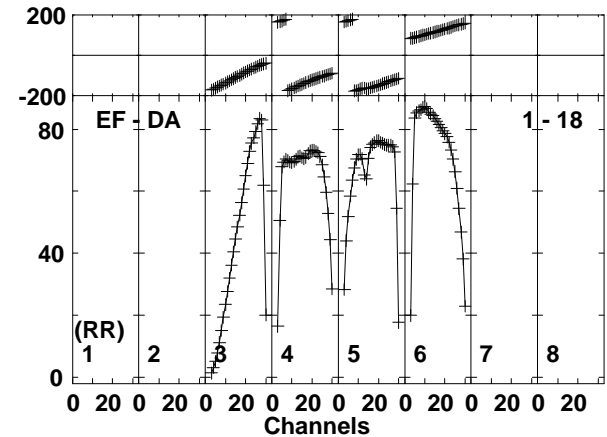
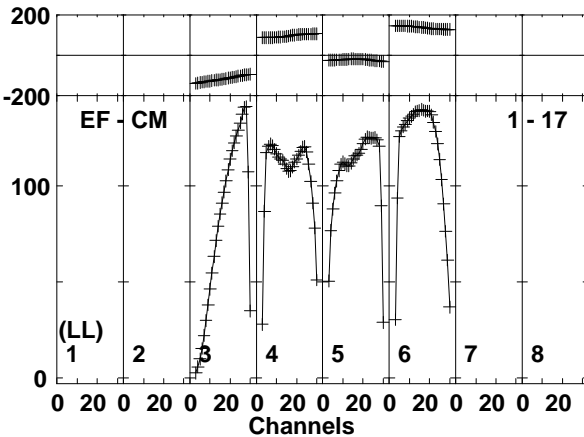
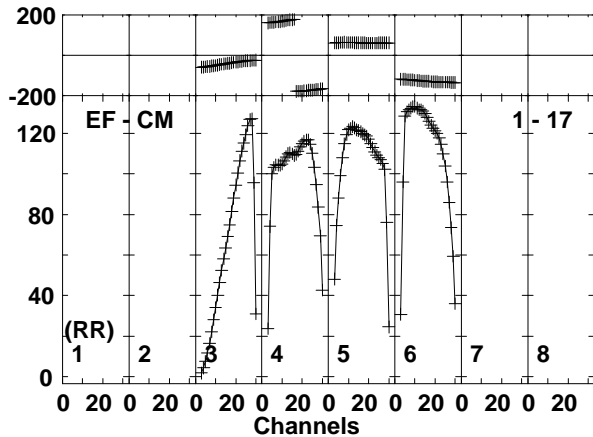
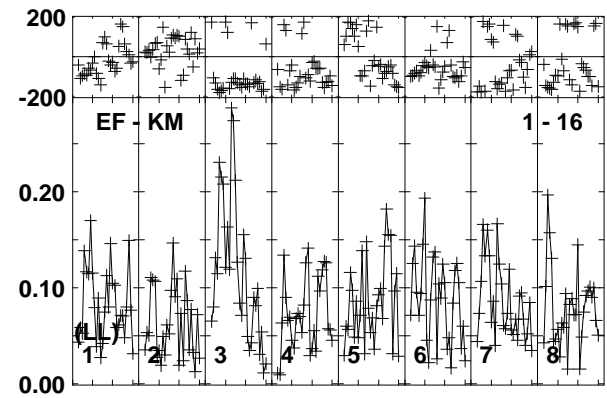
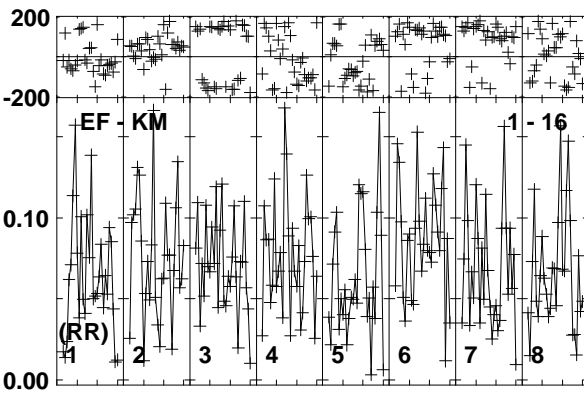
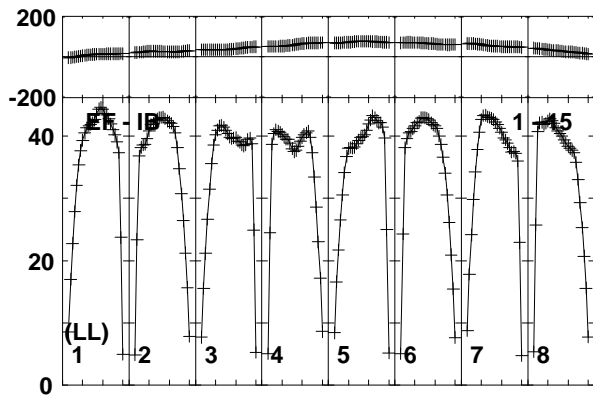
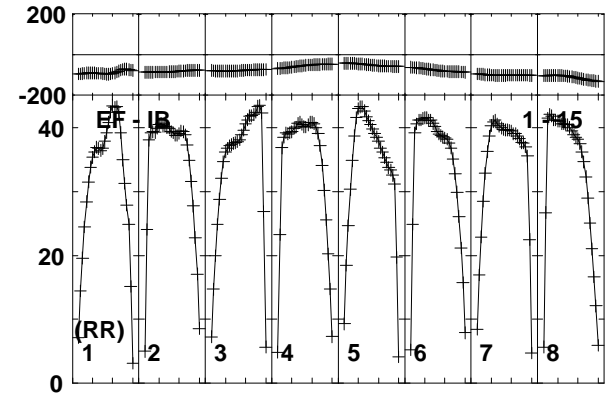
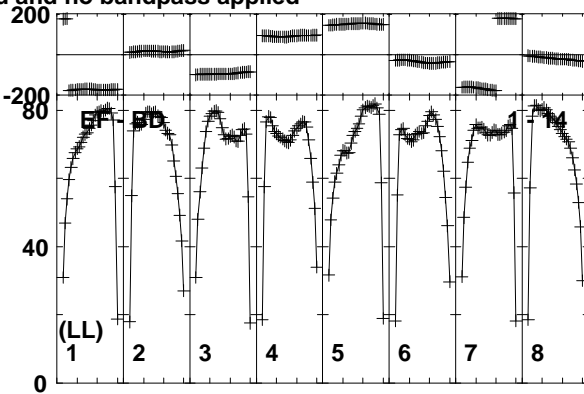
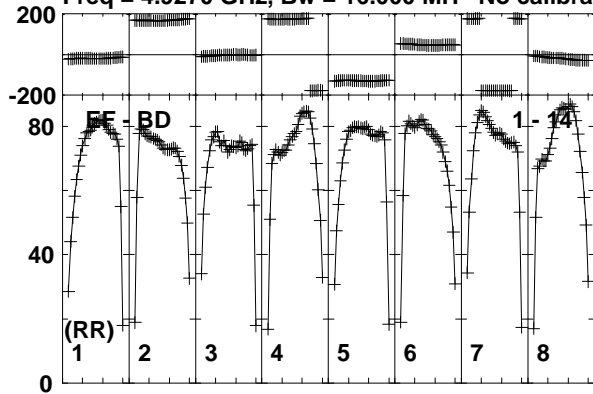

Lower frame: Milli Ampl Jy Top frame: Phas deg  
Vector averaged cross-power spectrum Baseline: EF (01) - BD (14)  
Timerange: 00/07:05:31 to 00/07:09:29

Plot file version 292 created 08-APR-2019 12:10:10

J0927+3902 EM133B.UVDATA.1

Freq = 4.9270 GHz, Bw = 16.000 MH No calibration applied and no bandpass applied

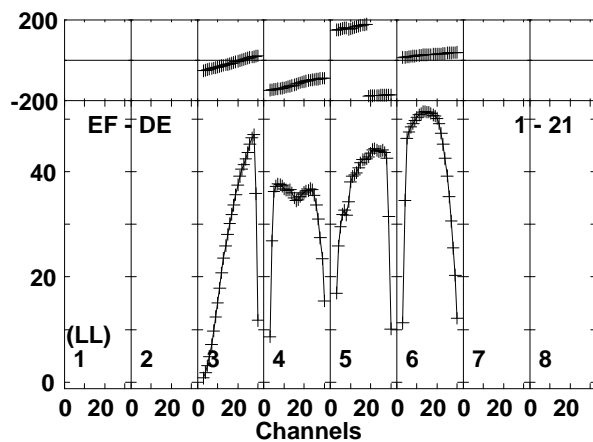
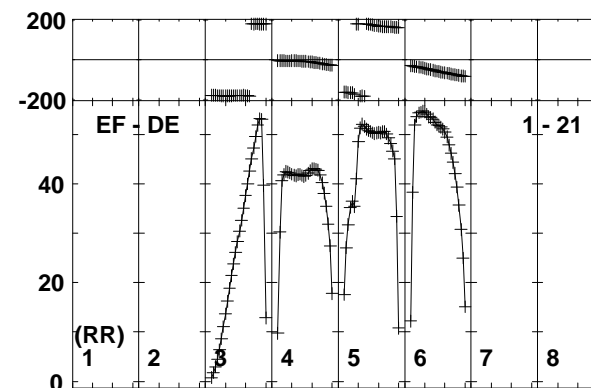
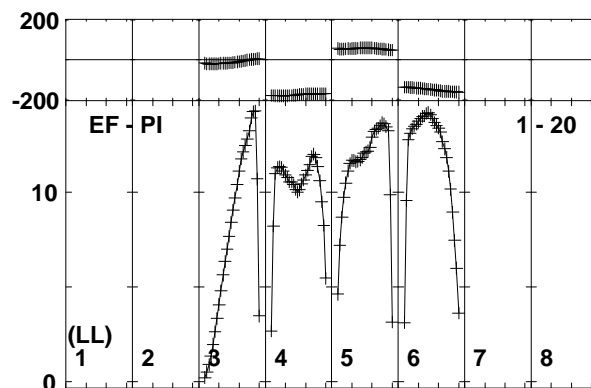
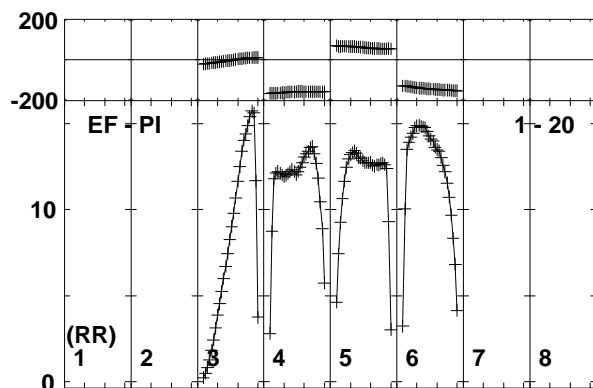
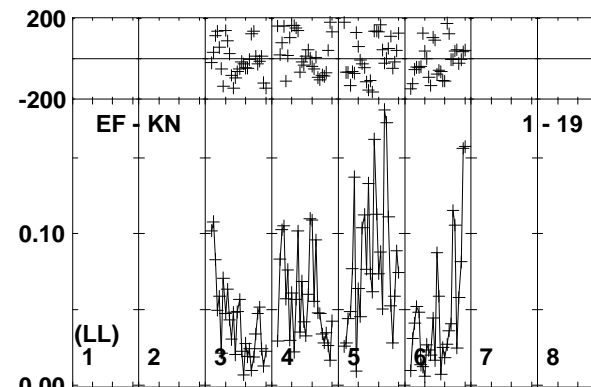
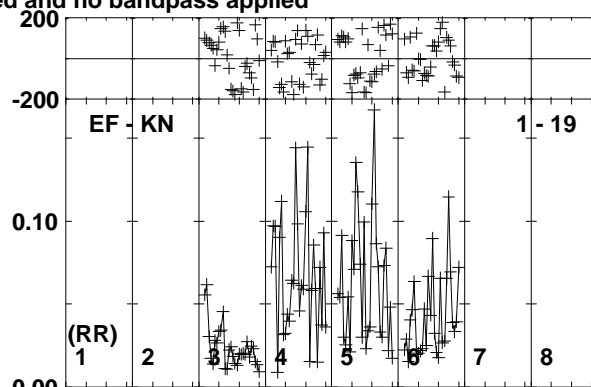
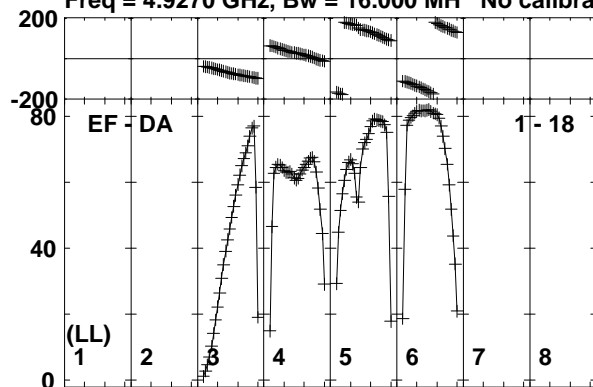

Lower frame: Milli Ampl Jy Top frame: Phas deg  
Vector averaged cross-power spectrum Baseline: EF (01) - DA (18)  
Timerange: 00/07:05:31 to 00/07:09:29

Plot file version 293 created 08-APR-2019 12:10:10

J0815+3635 EM133B.UVDATA.1

Freq = 4.9270 GHz, Bw = 16.000 MH No calibration applied and no bandpass applied

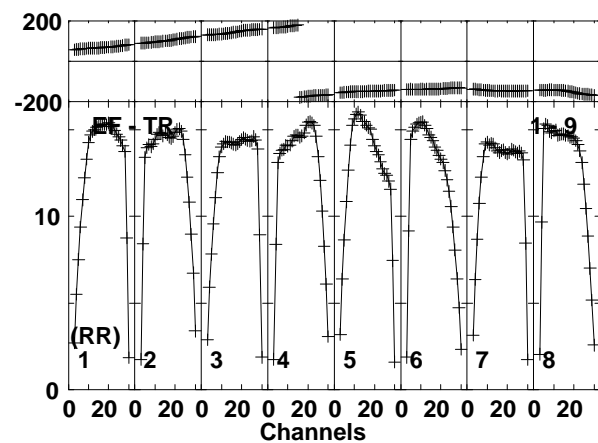
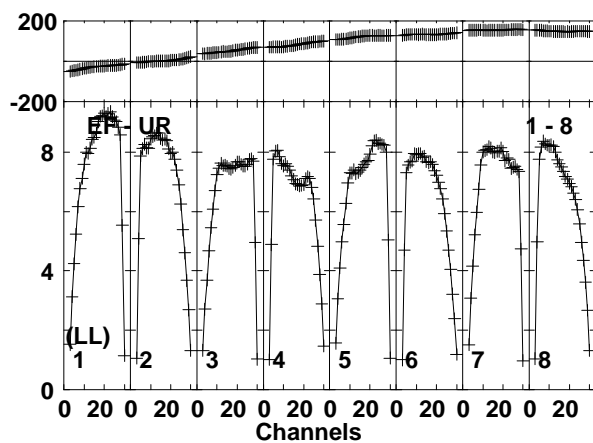
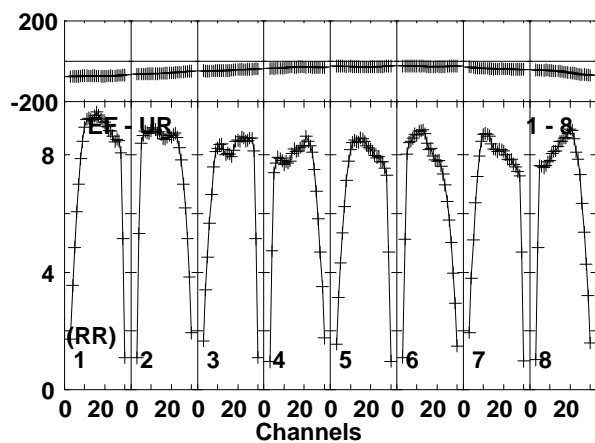
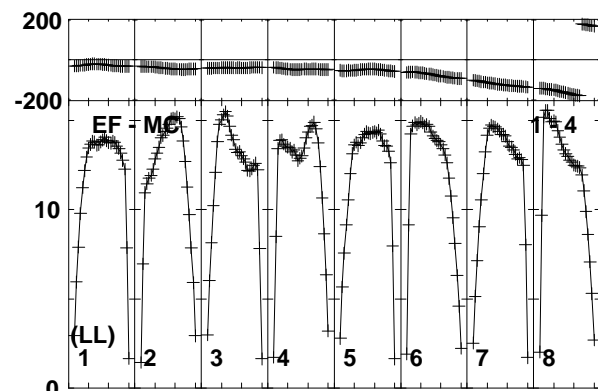
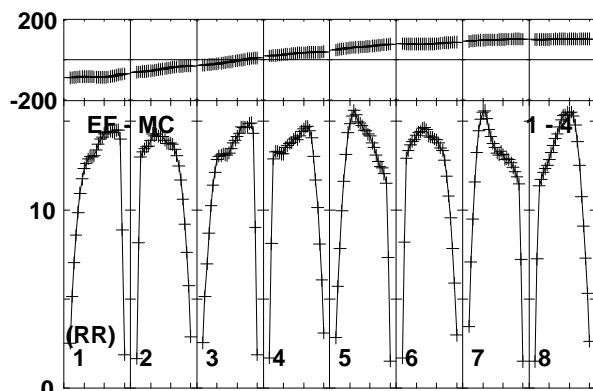
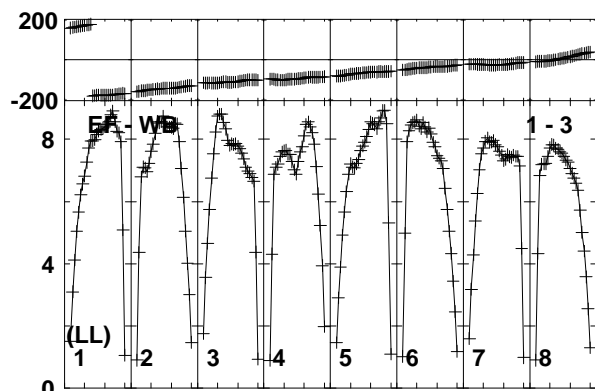
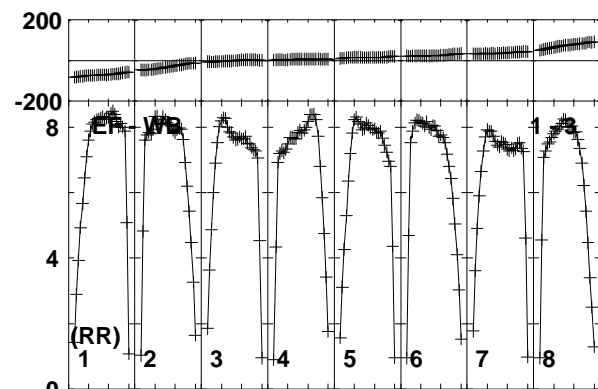
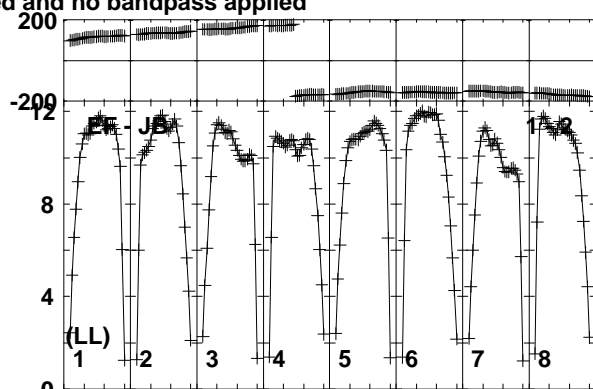
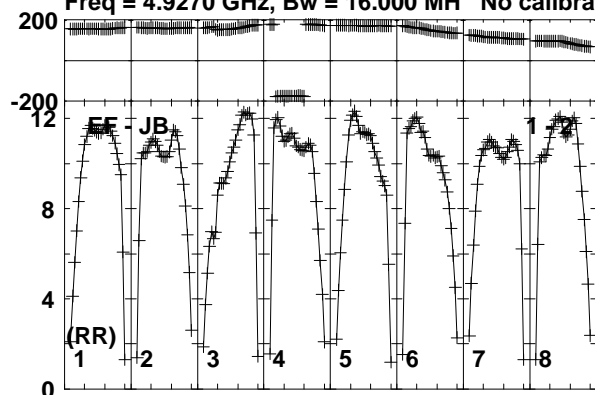

Lower frame: Milli Ampl Jy Top frame: Phas deg  
Vector averaged cross-power spectrum Baseline: EF (01) - JB (02)  
Timerange: 00/07:12:31 to 00/07:14:29

Plot file version 294 created 08-APR-2019 12:10:10

J0815+3635 EM133B.UVDATA.1

Freq = 4.9270 GHz, Bw = 16.000 MH No calibration applied and no bandpass applied

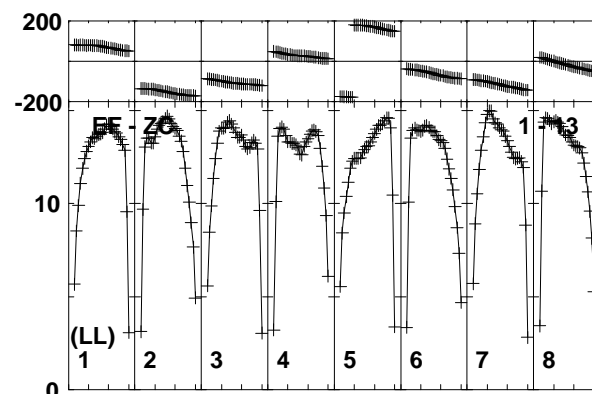
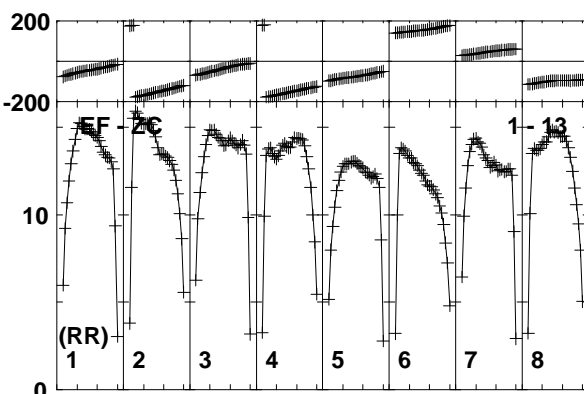
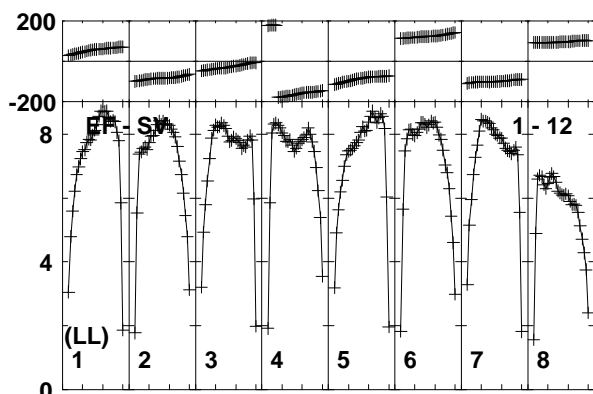
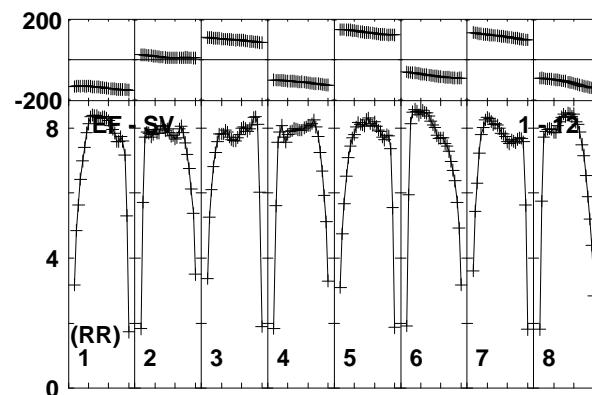
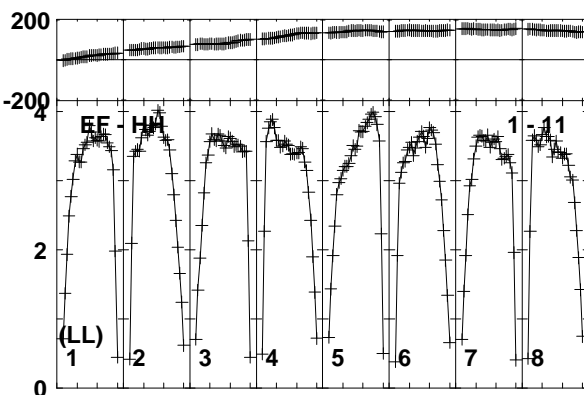
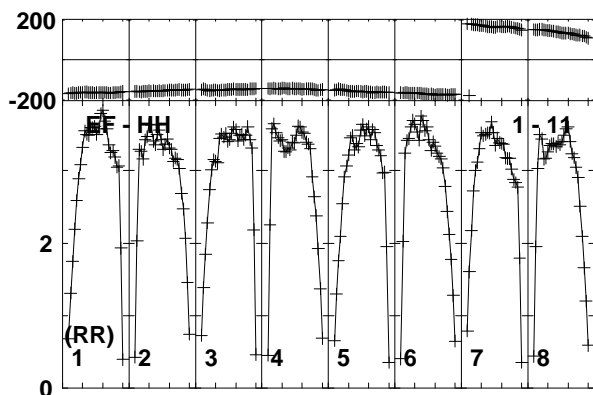
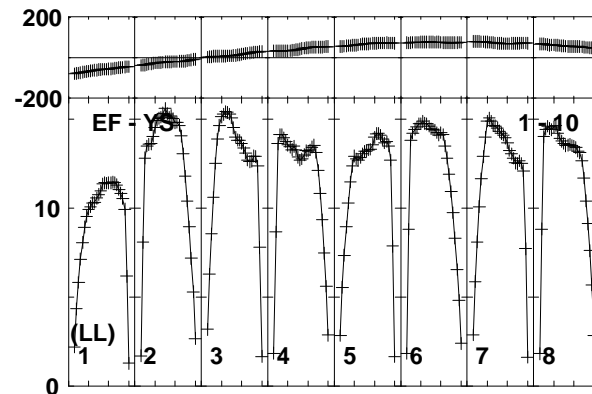
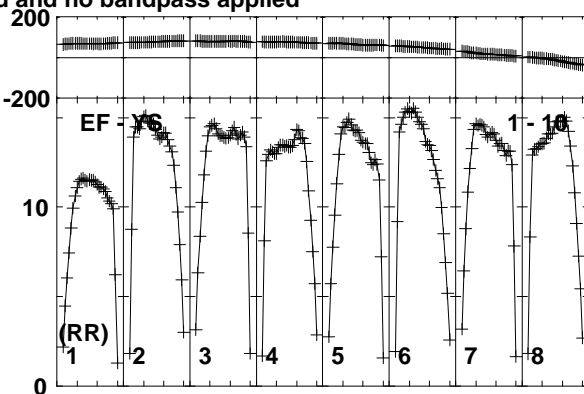
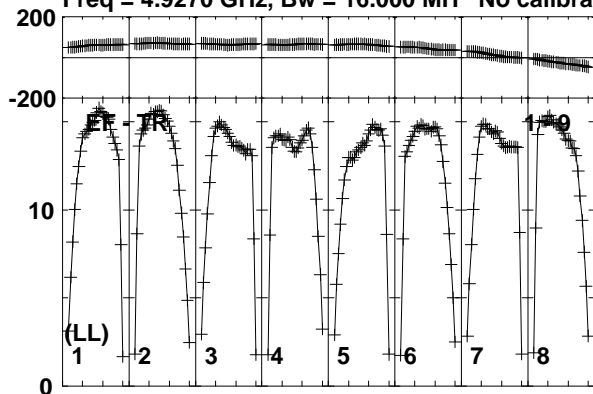

Lower frame: Milli Ampl Jy Top frame: Phas deg  
Vector averaged cross-power spectrum Baseline: EF (01) - TR (09)  
Timerange: 00/07:12:31 to 00/07:14:29

Plot file version 295 created 08-APR-2019 12:10:10

J0815+3635 EM133B.UVDATA.1

Freq = 4.9270 GHz, Bw = 16.000 MH No calibration applied and no bandpass applied

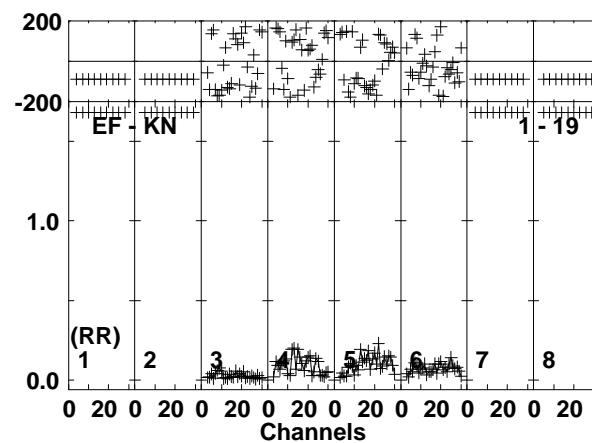
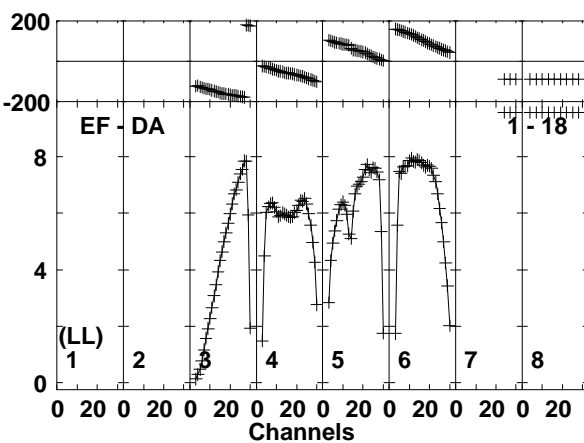
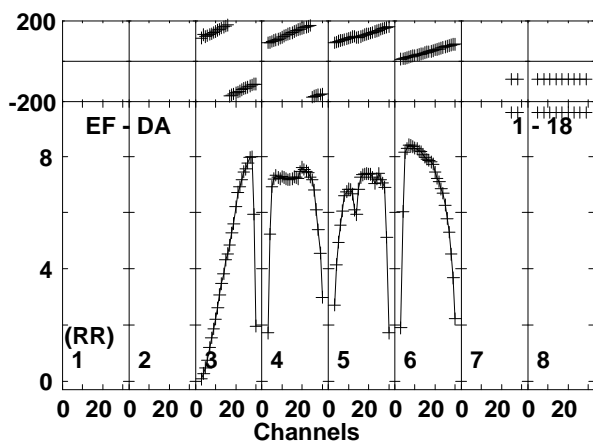
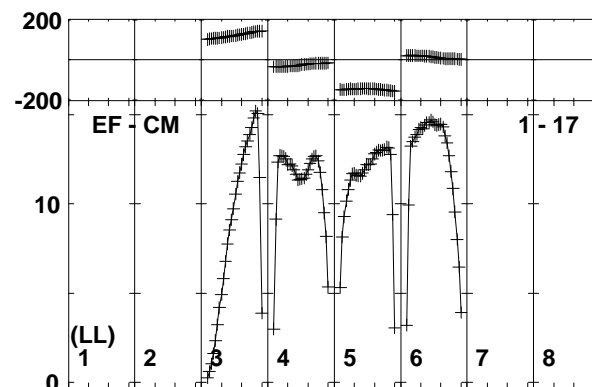
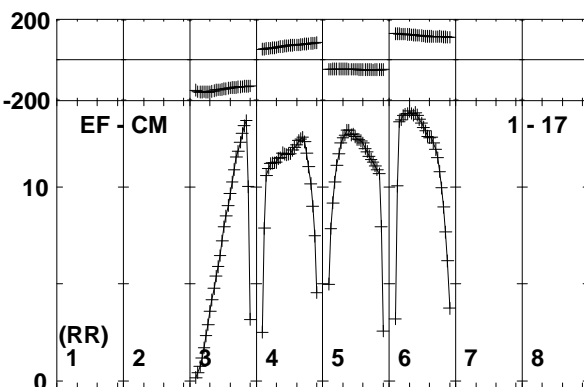
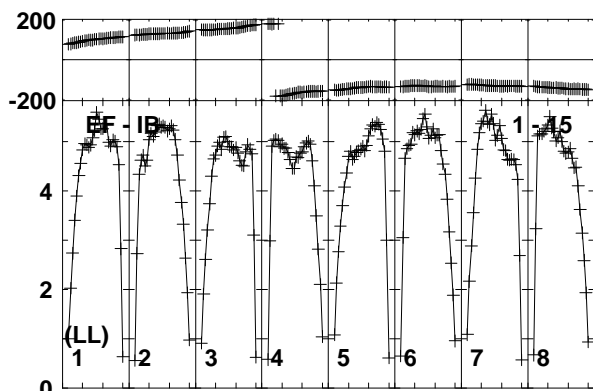
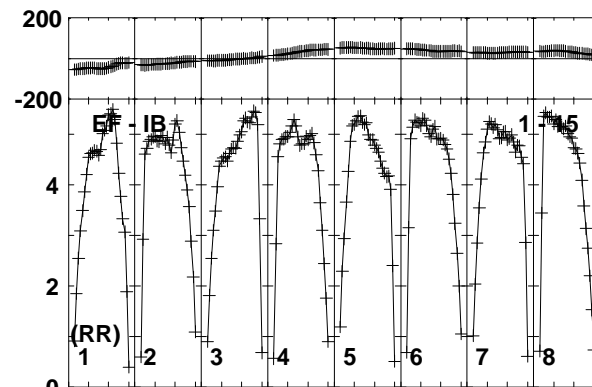
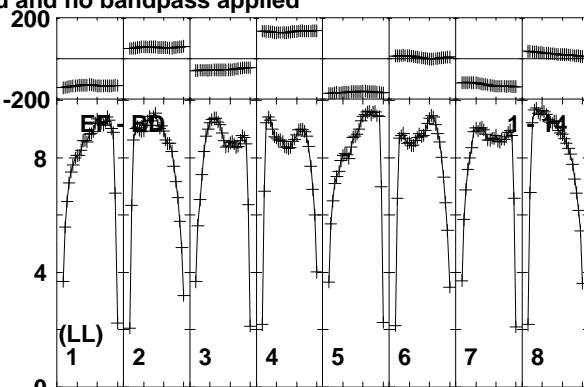
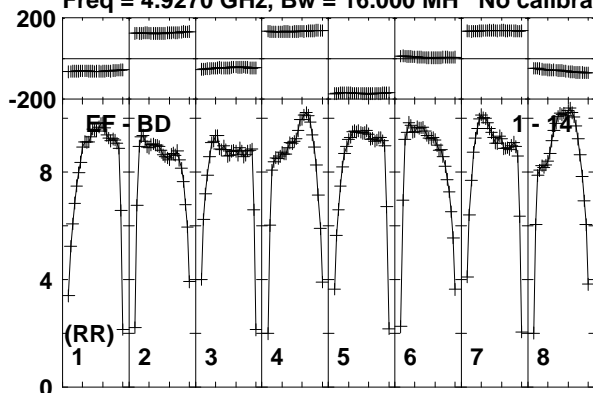

Lower frame: Milli Ampl Jy Top frame: Phas deg  
Vector averaged cross-power spectrum Baseline: EF (01) - BD (14)  
Timerange: 00/07:12:31 to 00/07:14:29

Plot file version 296 created 08-APR-2019 12:10:10

J0815+3635 EM133B.UVDATA.1

Freq = 4.9270 GHz, Bw = 16.000 MH No calibration applied and no bandpass applied

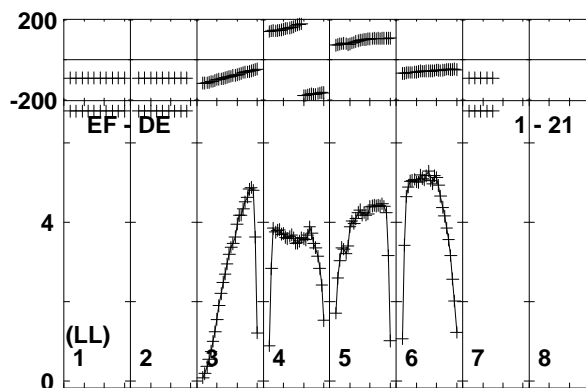
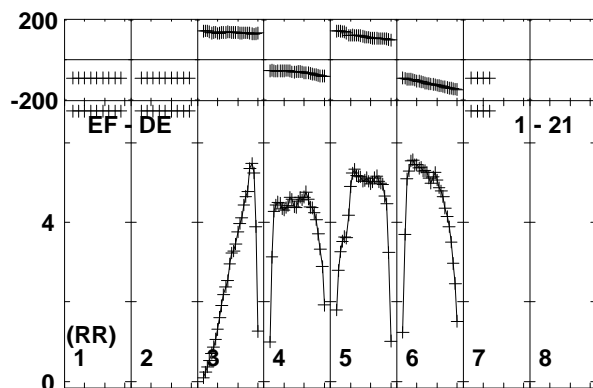
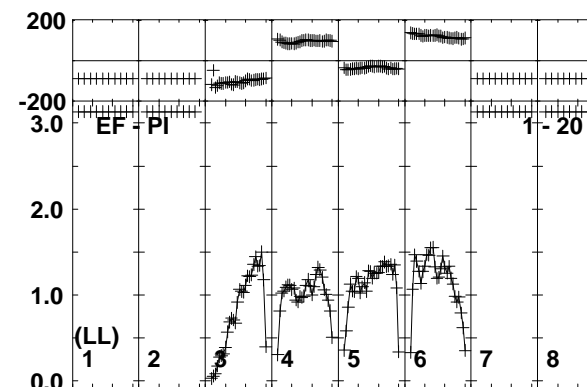
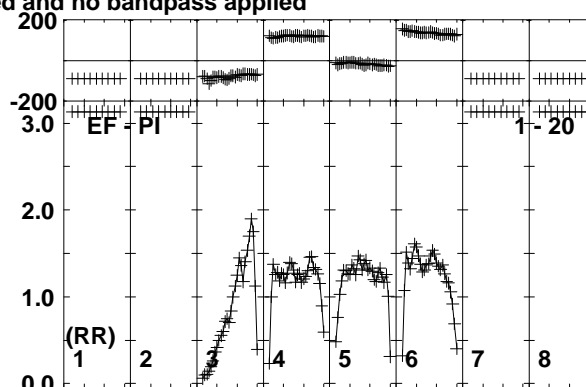
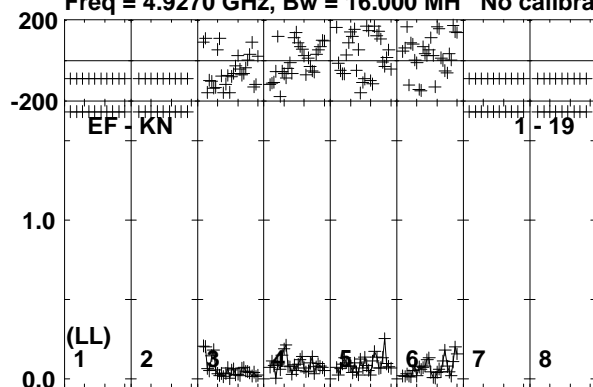

Lower frame: Milli Ampl Jy Top frame: Phas deg  
Vector averaged cross-power spectrum Baseline: EF (01) - KN (19)  
Timerange: 00/07:12:31 to 00/07:14:29



Plot file version 297 created 08-APR-2019 12:10:11

MRK622 EM133B.UVDATA.1

Freq = 4.9270 GHz, Bw = 16.000 MH No calibration applied and no bandpass applied

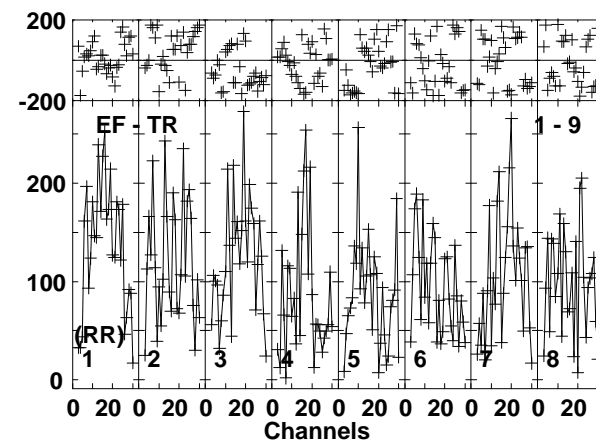
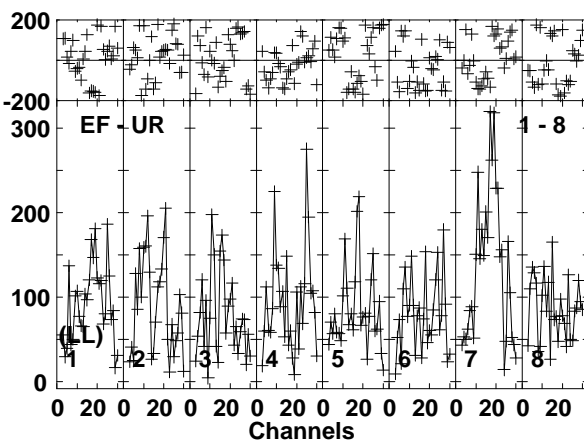
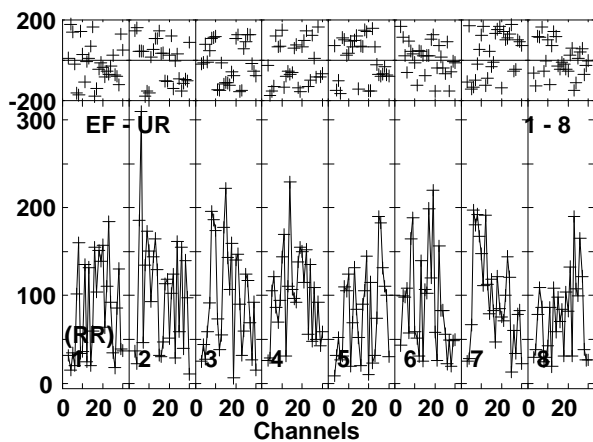
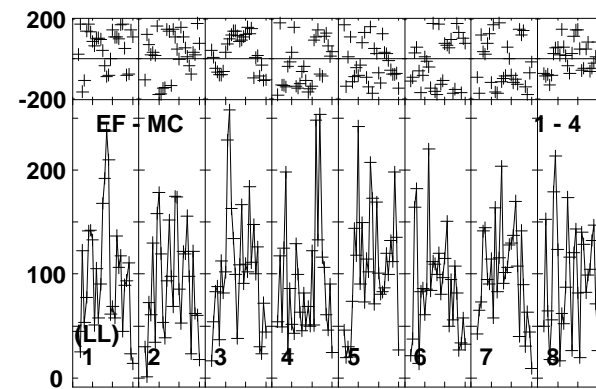
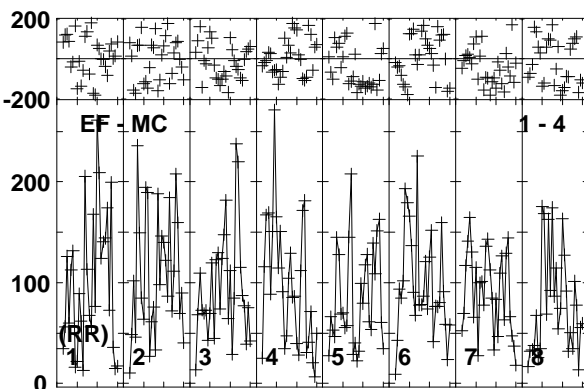
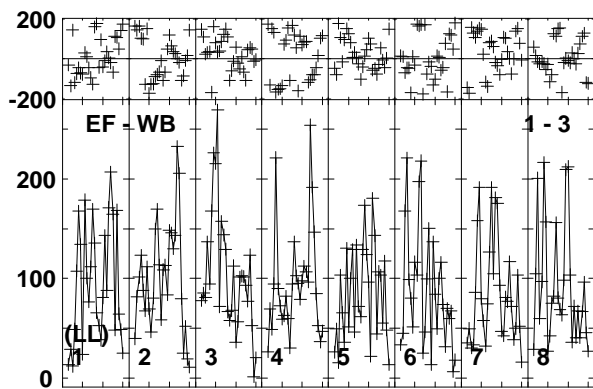
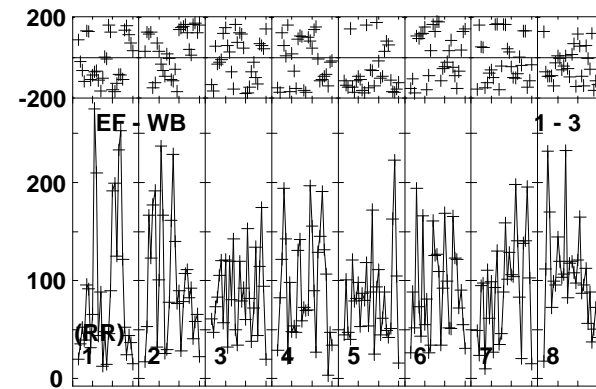
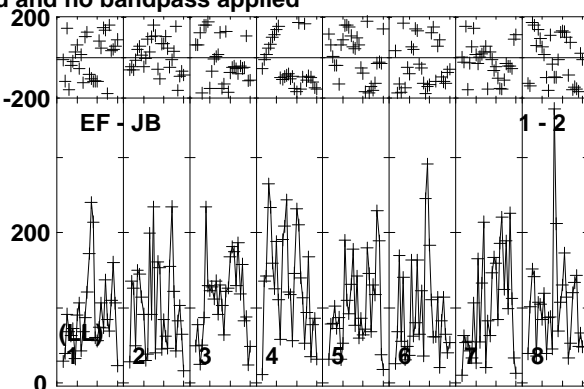
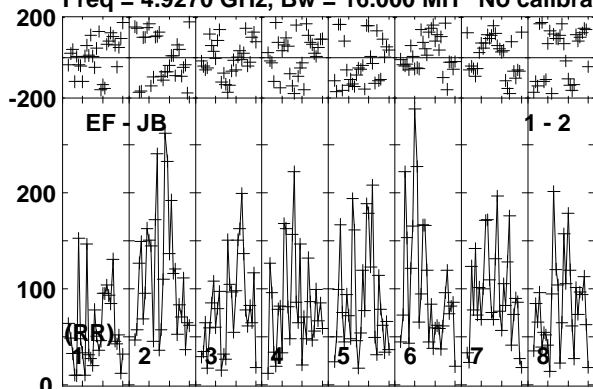

Lower frame: Micro Ampl Jy Top frame: Phas deg  
Vector averaged cross-power spectrum Baseline: EF (01) - JB (02)  
Timerange: 00/07:14:31 to 00/07:17:59

Plot file version 298 created 08-APR-2019 12:10:11  
 MRK622 EM133B.UVDATA.1  
 Freq = 4.9270 GHz, Bw = 16.000 MH No calibration applied and no bandpass applied

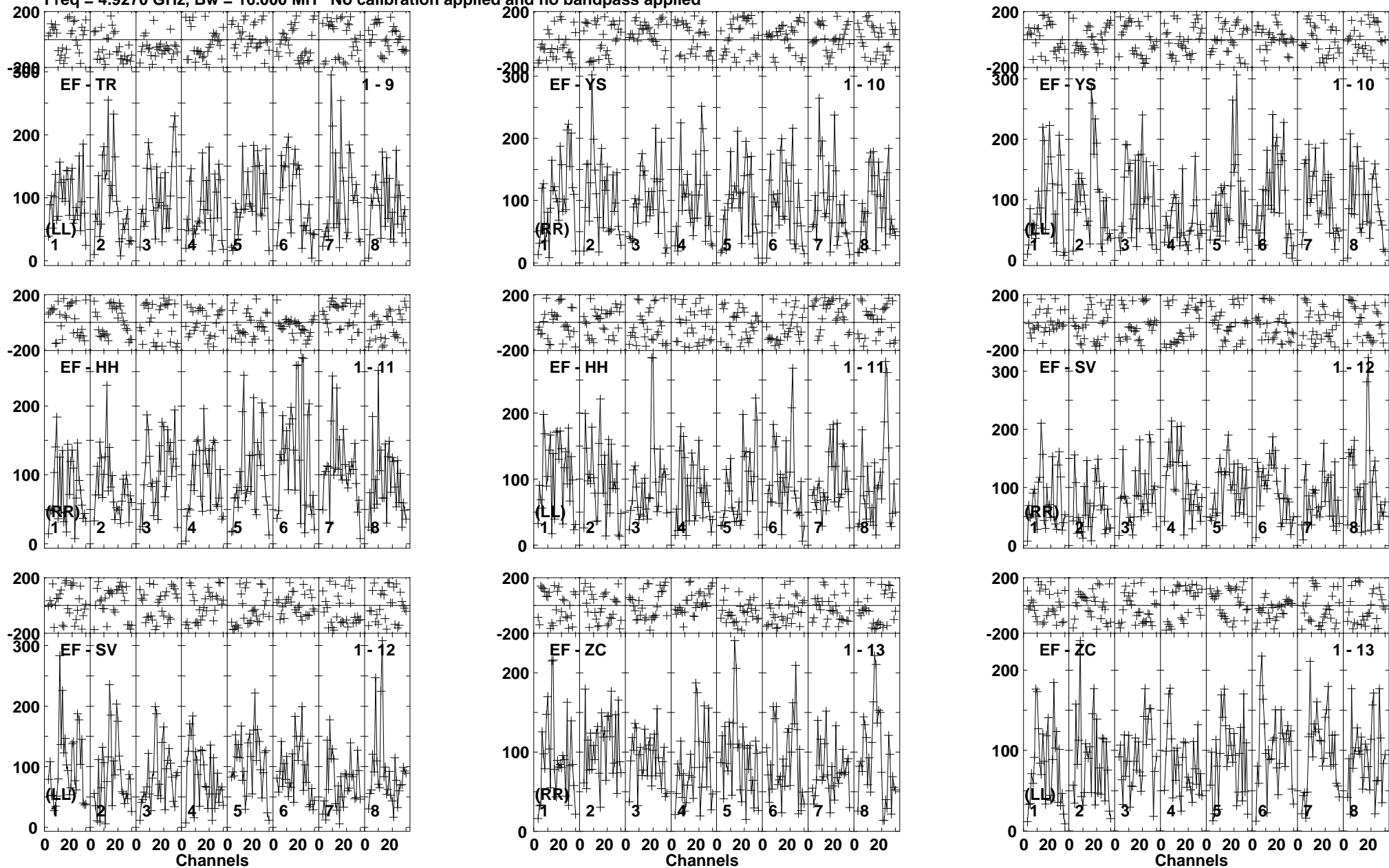

Lower frame: Micro Ampl Jy Top frame: Phas deg  
 Vector averaged cross-power spectrum Baseline: EF (01) - TR (09)  
 Timerange: 00/07:14:31 to 00/07:17:59

Plot file version 299 created 08-APR-2019 12:10:11

MRK622 EM133B.UVDATA.1

Freq = 4.9270 GHz, Bw = 16.000 MH No calibration applied and no bandpass applied

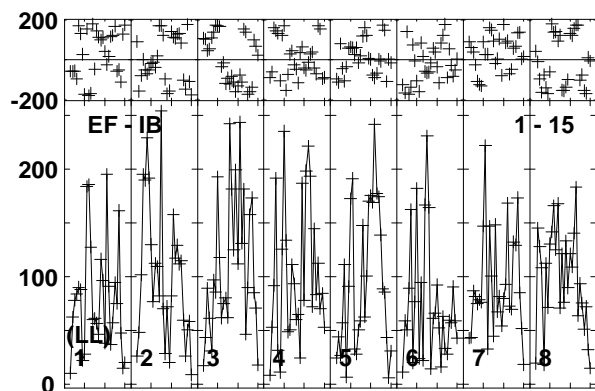
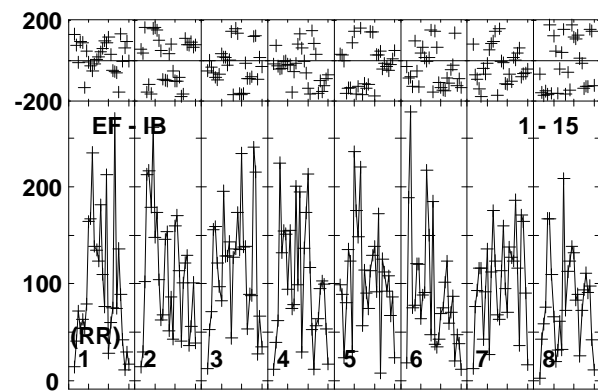
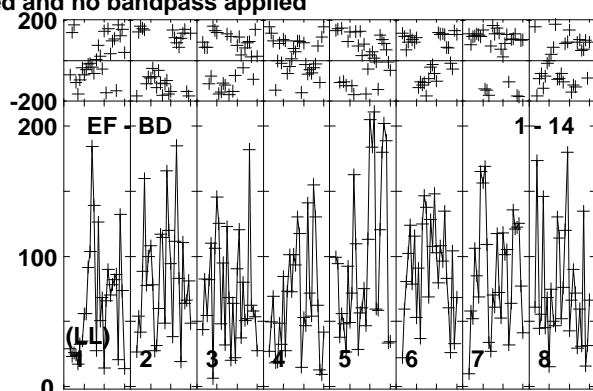
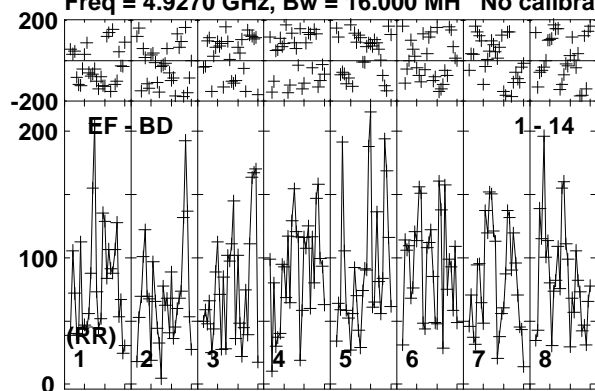

Lower frame: Micro Ampl Jy Top frame: Phas deg  
Vector averaged cross-power spectrum Baseline: EF (01) - BD (14)  
Timerange: 00/07:14:31 to 00/07:17:59

Plot file version 300 created 08-APR-2019 12:10:11

J0815+3635 EM133B.UVDATA.1

Freq = 4.9270 GHz, Bw = 16.000 MH No calibration applied and no bandpass applied

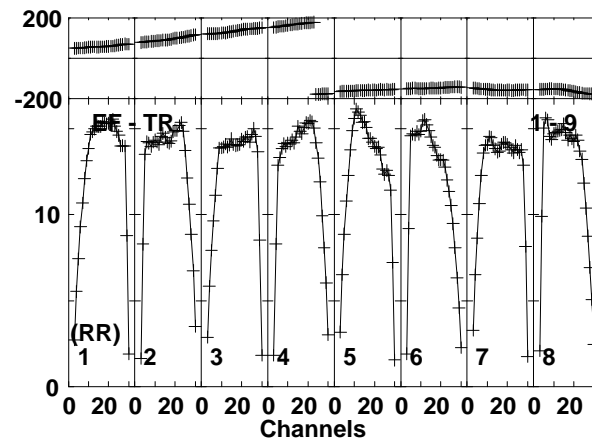
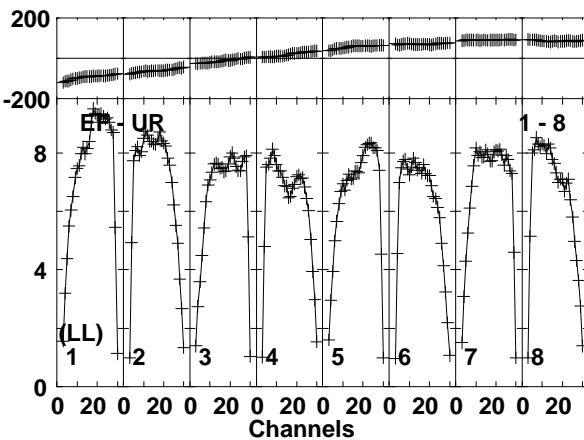
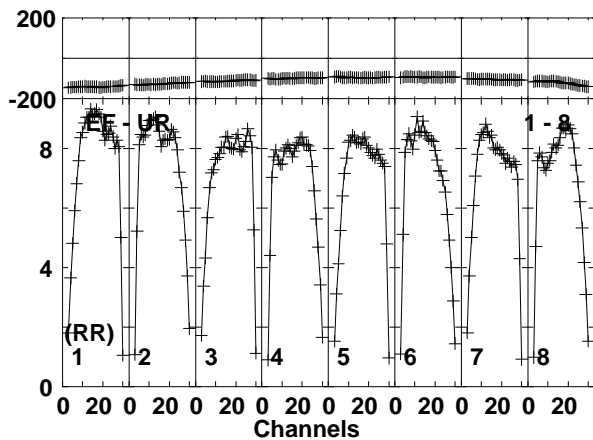
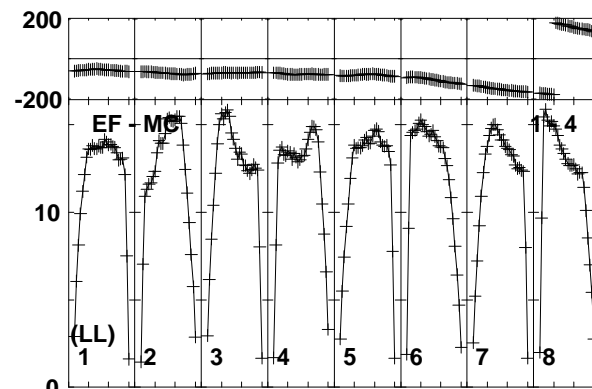
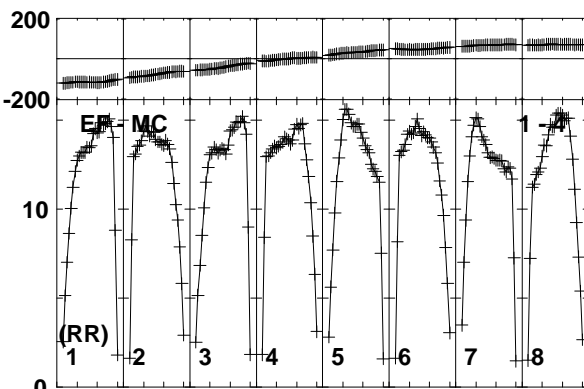
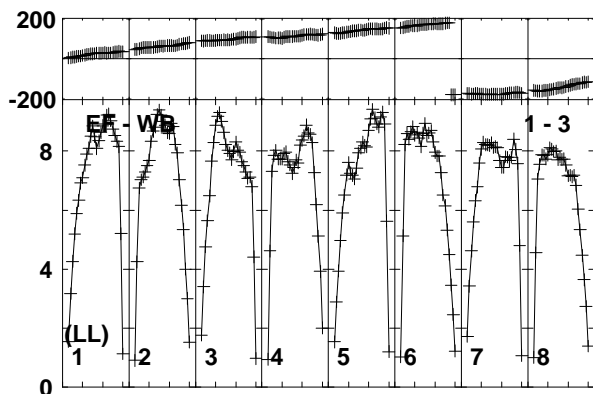
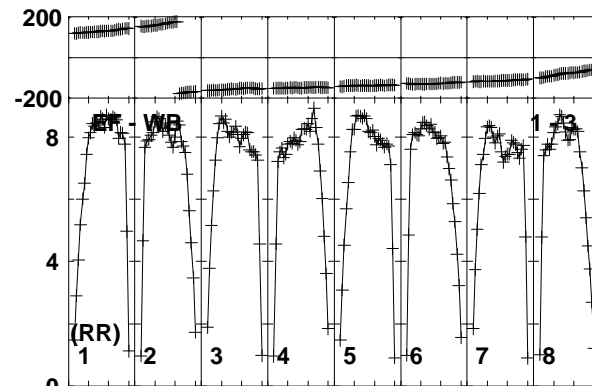
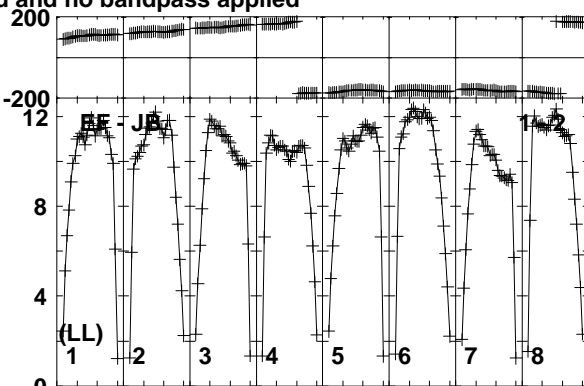
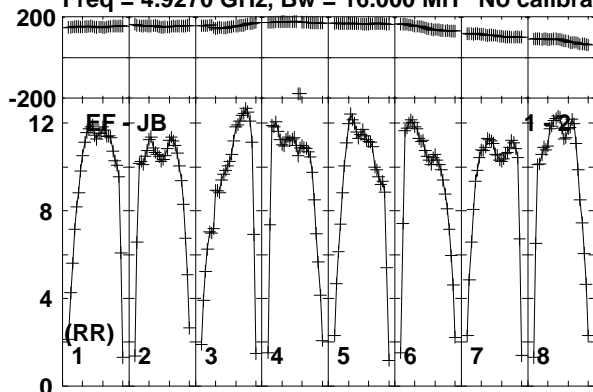

Lower frame: Milli Ampl Jy Top frame: Phas deg  
Vector averaged cross-power spectrum Baseline: EF (01) - JB (02)  
Timerange: 00/07:18:01 to 00/07:19:29

Plot file version 301 created 08-APR-2019 12:10:11

J0815+3635 EM133B.UVDATA.1

Freq = 4.9270 GHz, Bw = 16.000 MH No calibration applied and no bandpass applied

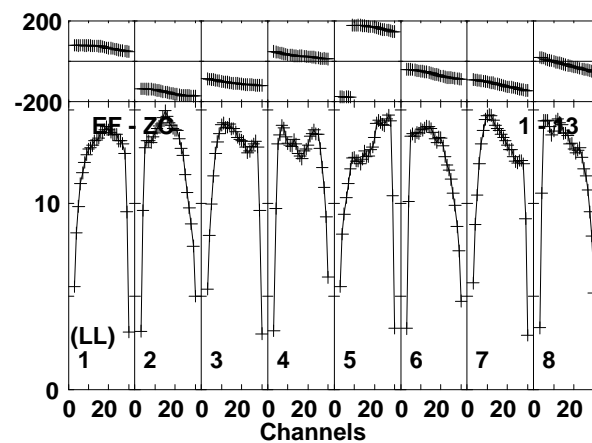
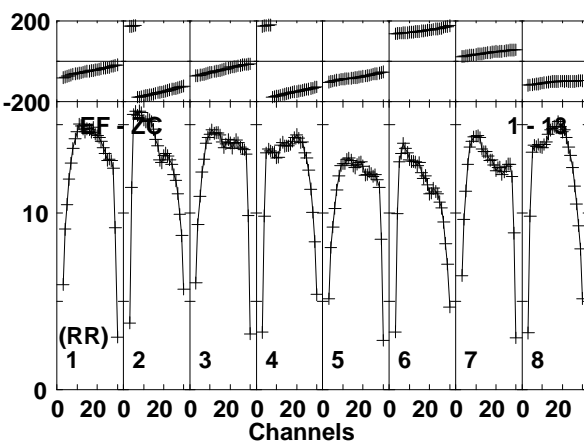
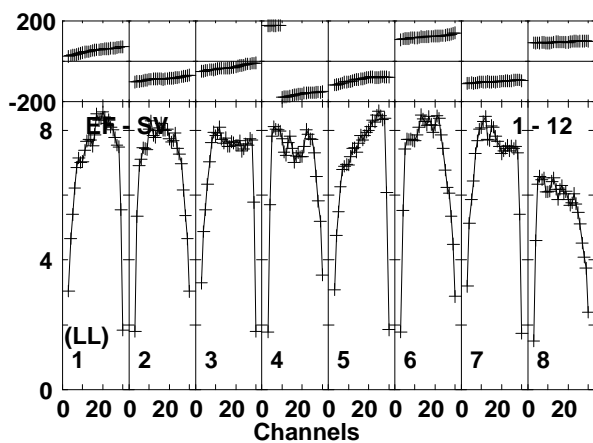
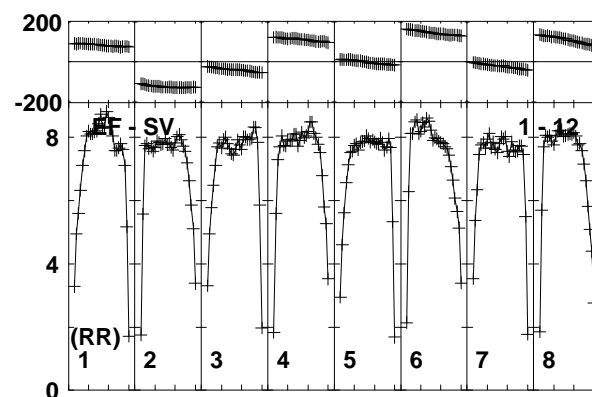
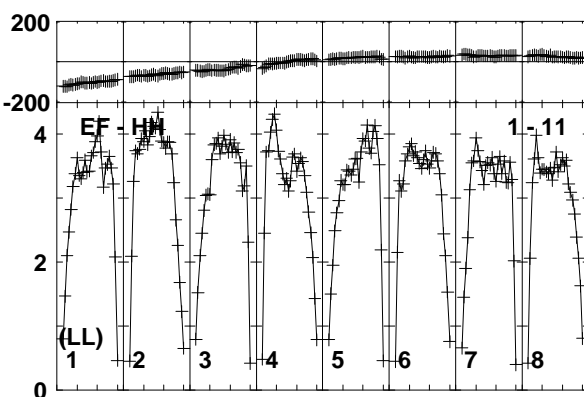
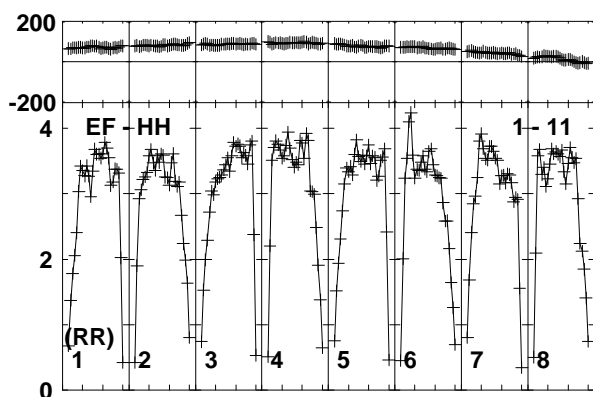
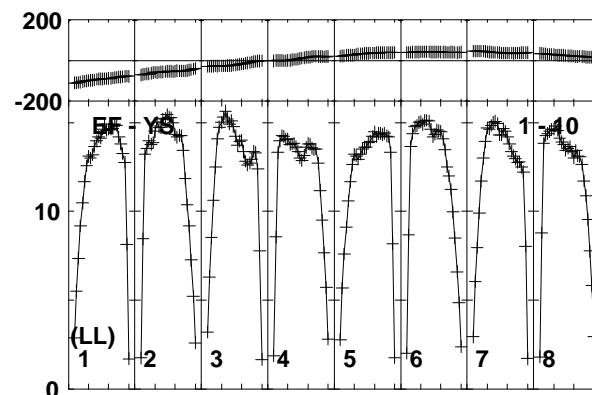
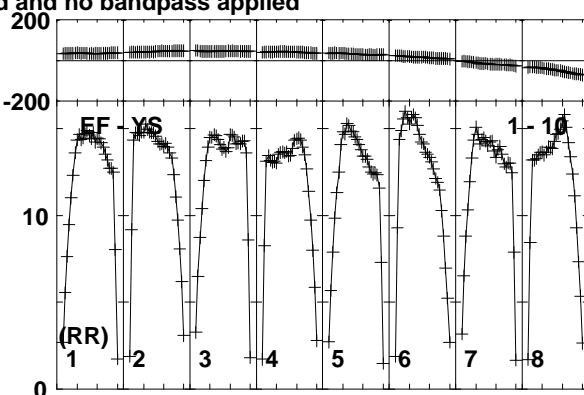
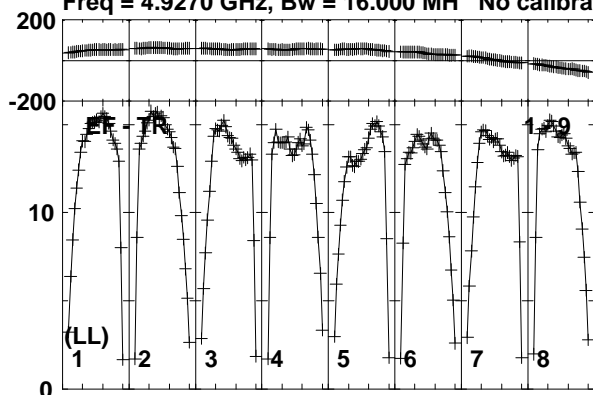

Lower frame: Milli Ampl Jy Top frame: Phas deg  
Vector averaged cross-power spectrum Baseline: EF (01) - TR (09)  
Timerange: 00/07:18:01 to 00/07:19:29

Plot file version 302 created 08-APR-2019 12:10:11

J0815+3635 EM133B.UVDATA.1

Freq = 4.9270 GHz, Bw = 16.000 MH No calibration applied and no bandpass applied

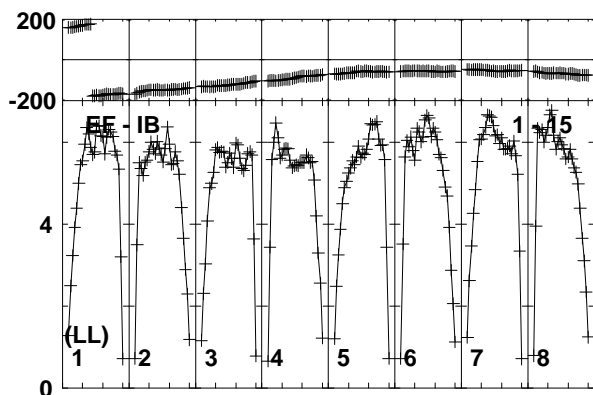
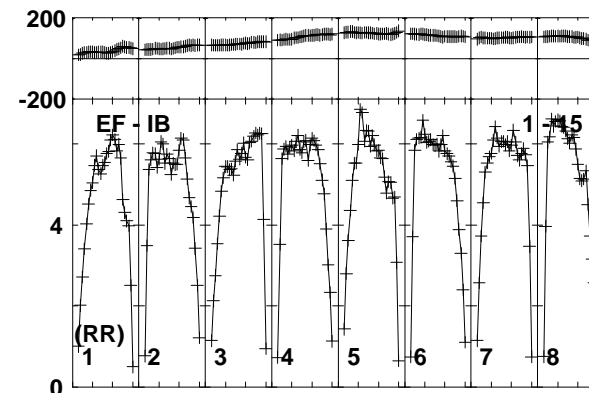
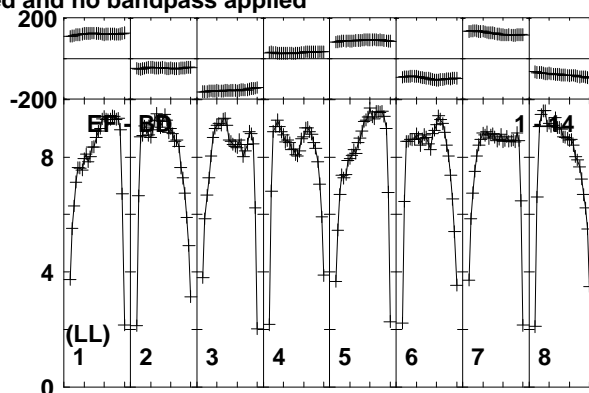
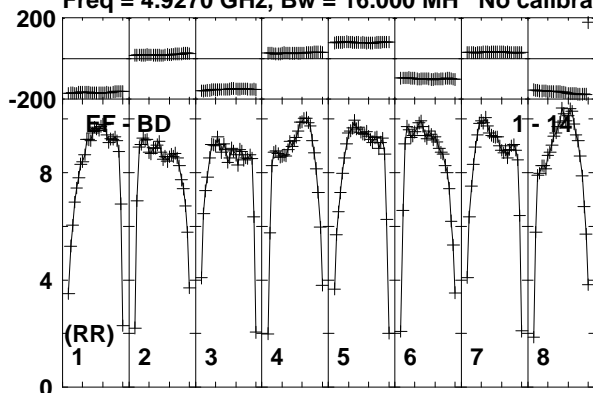

Lower frame: Milli Ampl Jy Top frame: Phas deg  
Vector averaged cross-power spectrum Baseline: EF (01) - BD (14)  
Timerange: 00/07:18:01 to 00/07:19:29

Plot file version 303 created 08-APR-2019 12:10:11

MRK622 EM133B.UVDATA.1

Freq = 4.9270 GHz, Bw = 16.000 MH No calibration applied and no bandpass applied

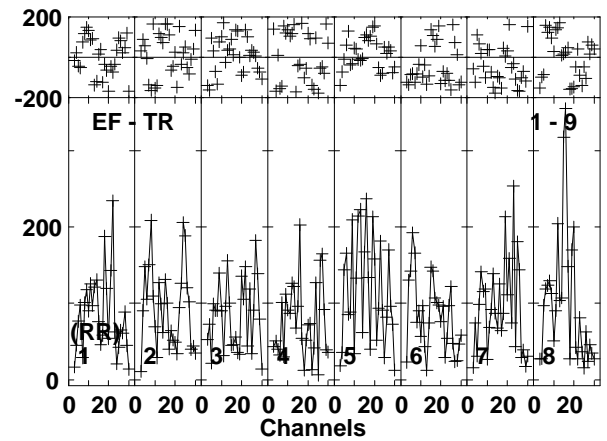
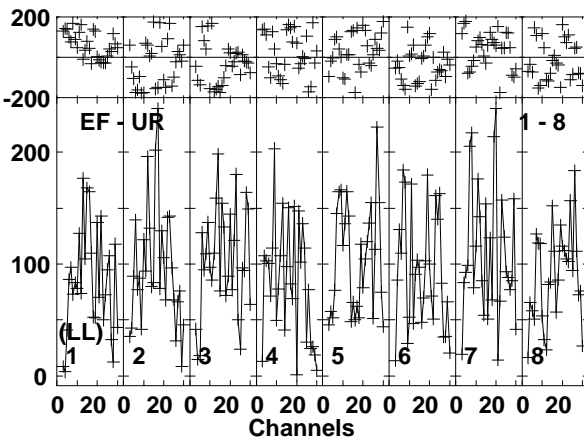
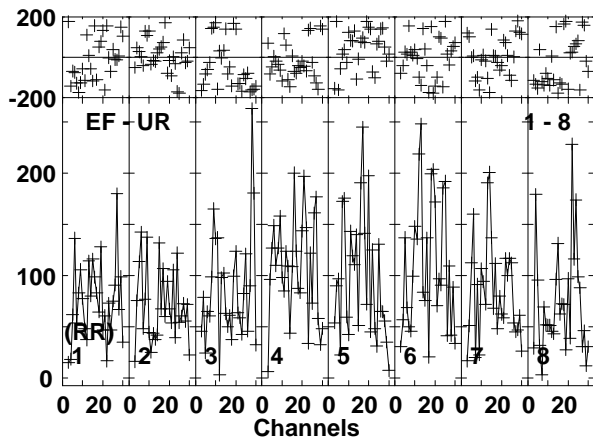
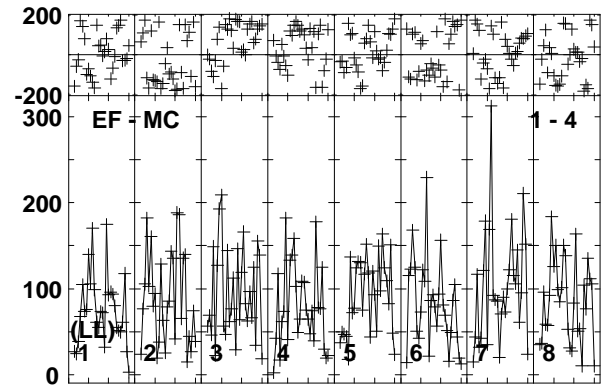
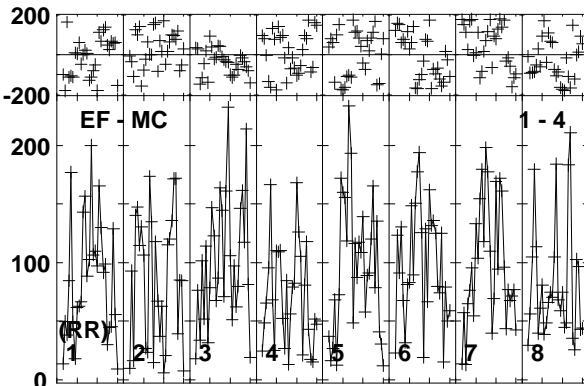
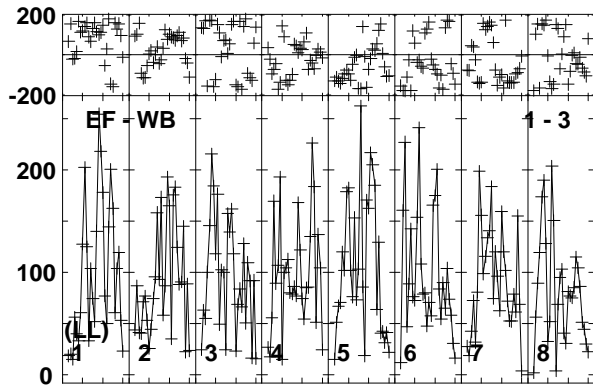
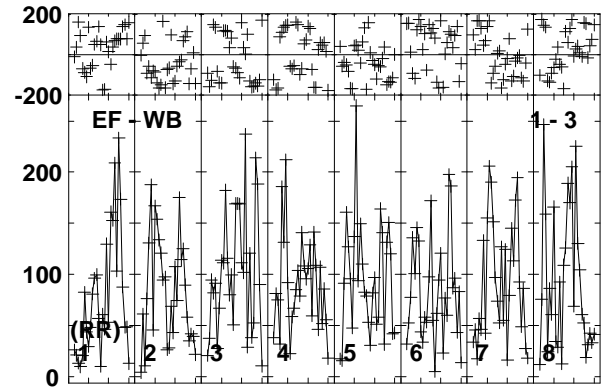
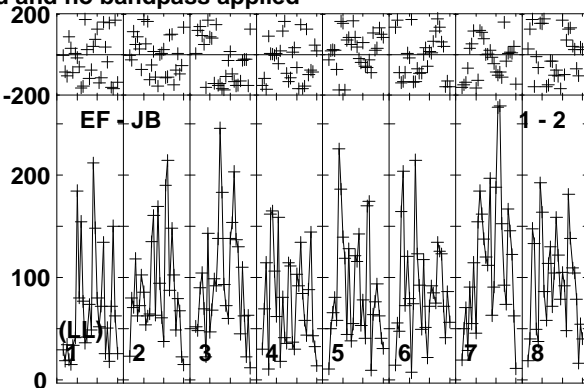
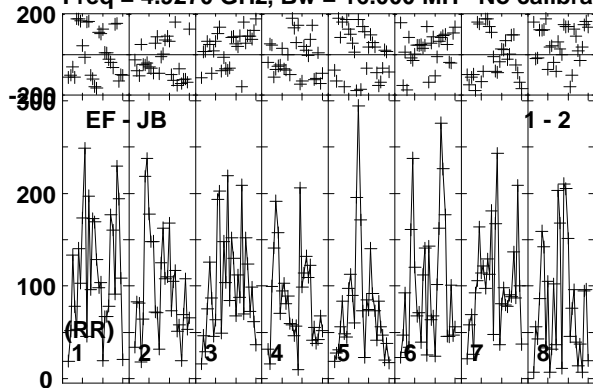

Lower frame: Micro Ampl Jy Top frame: Phas deg  
Vector averaged cross-power spectrum Baseline: EF (01) - JB (02)  
Timerange: 00/07:19:33 to 00/07:22:59

Plot file version 304 created 08-APR-2019 12:10:11

MRK622 EM133B.UVDATA.1

Freq = 4.9270 GHz, Bw = 16.000 MH No calibration applied and no bandpass applied

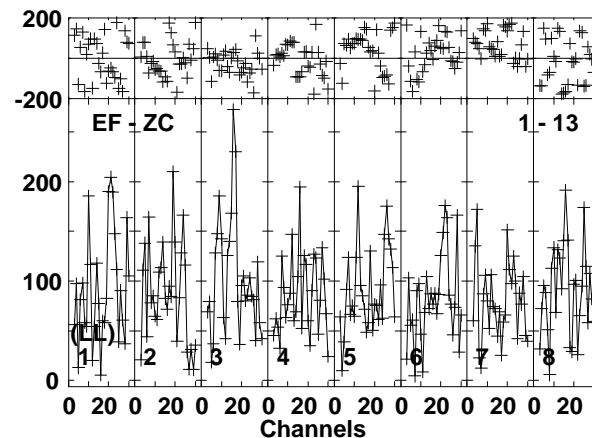
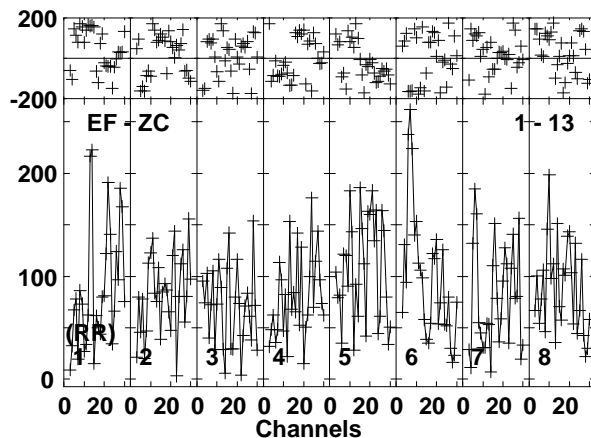
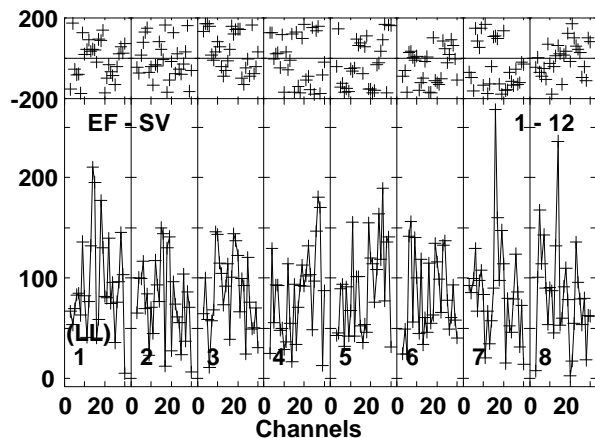
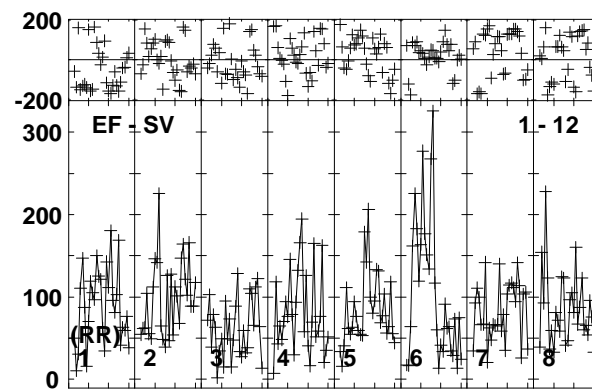
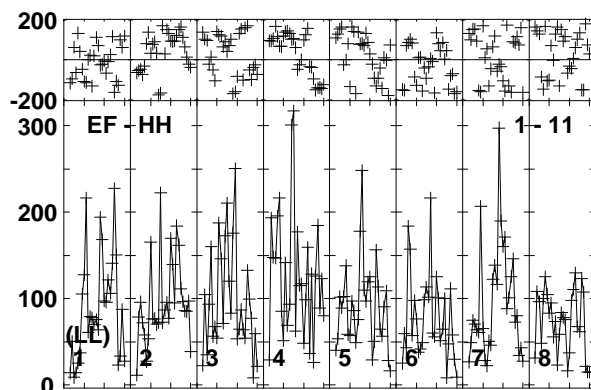
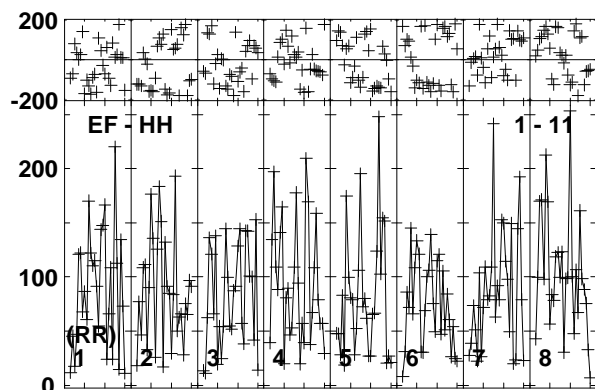
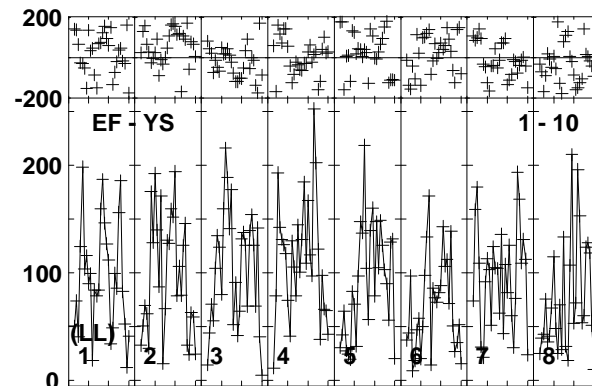
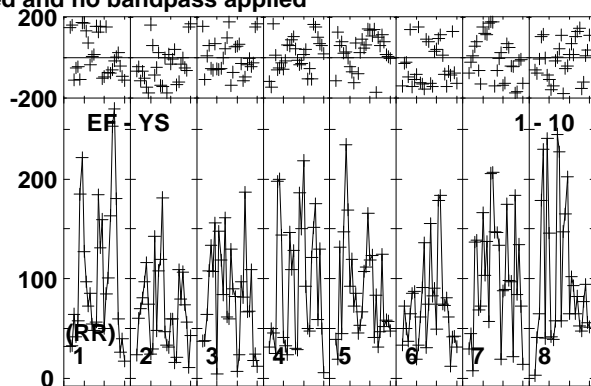
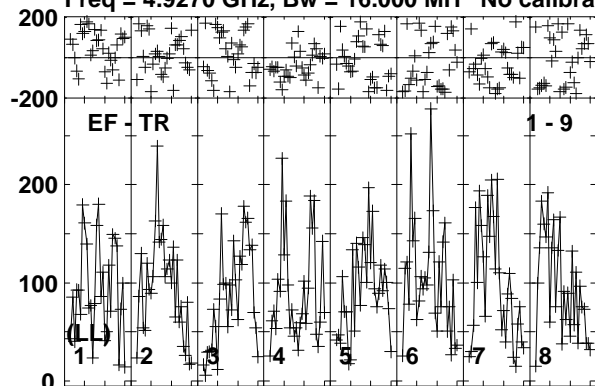

Lower frame: Micro Ampl Jy Top frame: Phas deg  
Vector averaged cross-power spectrum Baseline: EF (01) - TR (09)  
Timerange: 00/07:19:33 to 00/07:22:59



Plot file version 305 created 08-APR-2019 12:10:12

MRK622 EM133B.UVDATA.1

Freq = 4.9270 GHz, Bw = 16.000 MH No calibration applied and no bandpass applied

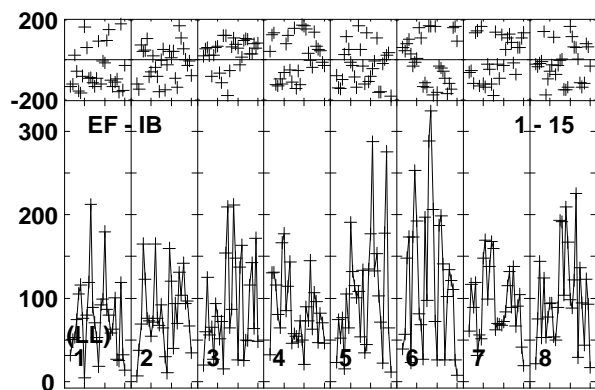
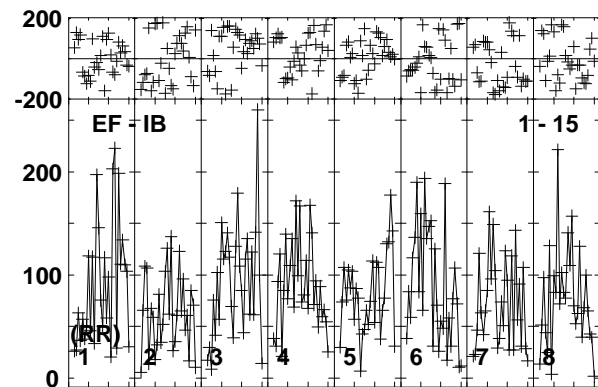
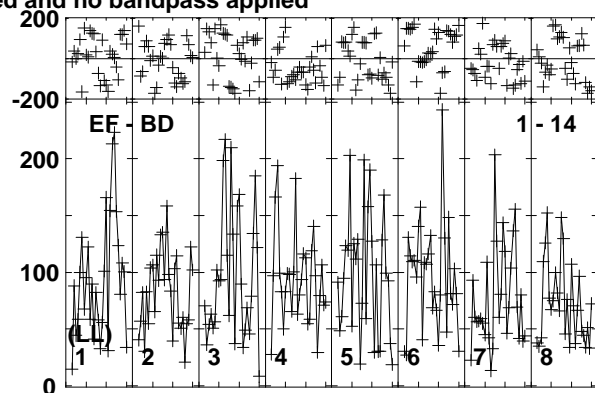
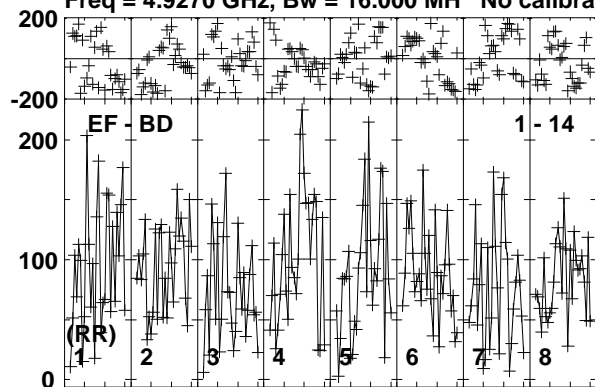

Lower frame: Micro Ampl Jy Top frame: Phas deg  
Vector averaged cross-power spectrum Baseline: EF (01) - BD (14)  
Timerange: 00/07:19:33 to 00/07:22:59

Plot file version 306 created 08-APR-2019 12:10:12

J0815+3635 EM133B.UVDATA.1

Freq = 4.9270 GHz, Bw = 16.000 MH No calibration applied and no bandpass applied

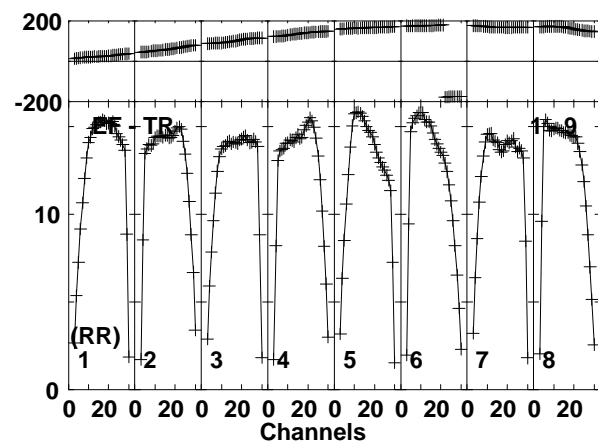
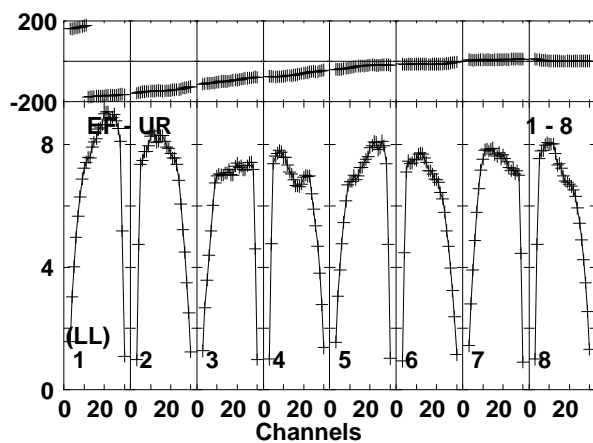
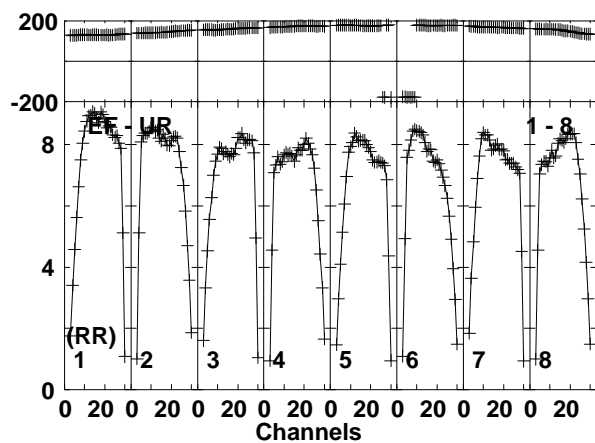
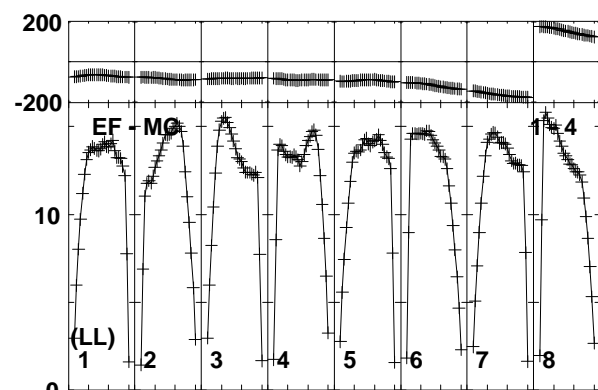
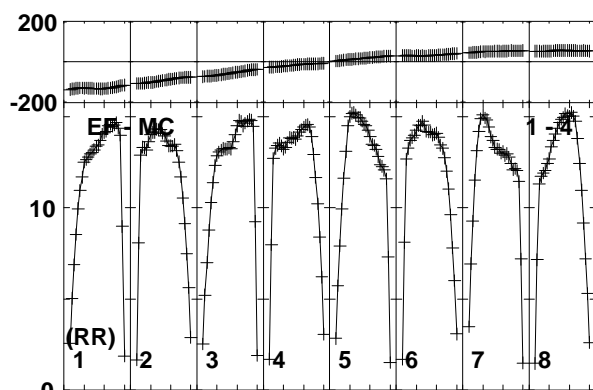
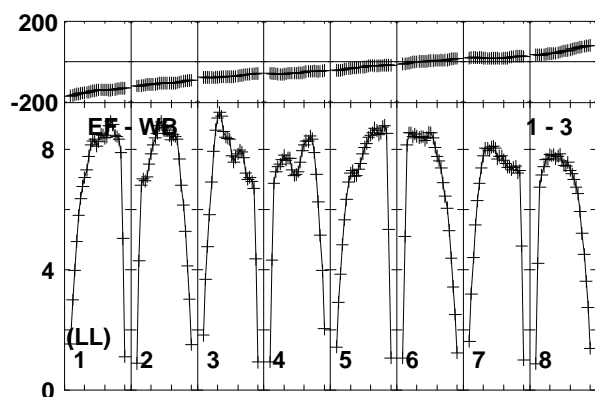
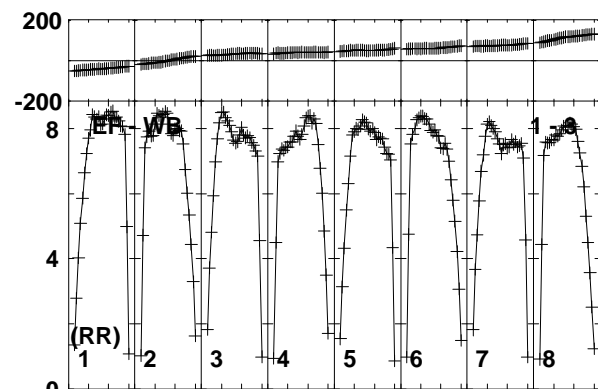
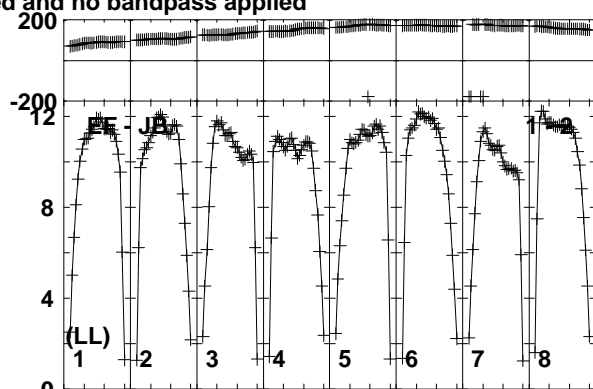
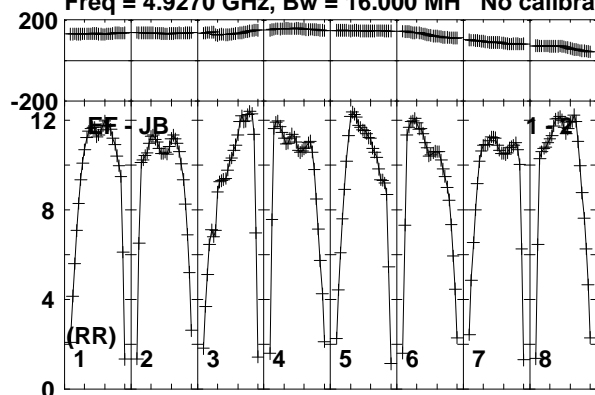

Lower frame: Milli Ampl Jy Top frame: Phas deg  
Vector averaged cross-power spectrum Baseline: EF (01) - JB (02)  
Timerange: 00/07:23:51 to 00/07:25:19

Plot file version 307 created 08-APR-2019 12:10:12

J0815+3635 EM133B.UVDATA.1

Freq = 4.9270 GHz, Bw = 16.000 MH No calibration applied and no bandpass applied

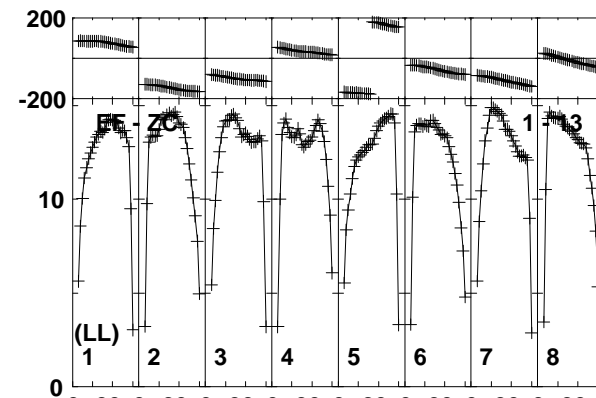
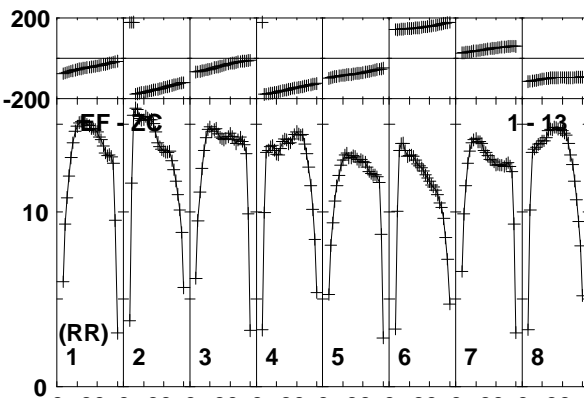
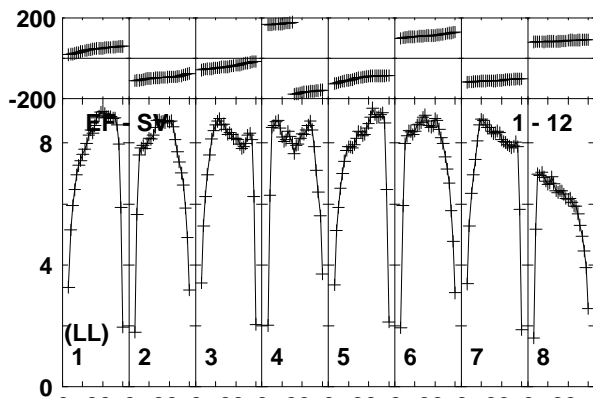
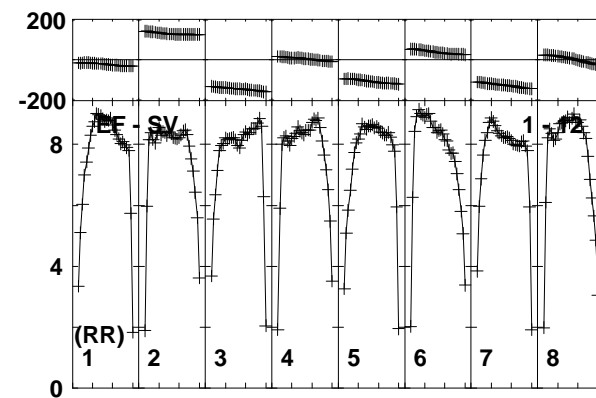
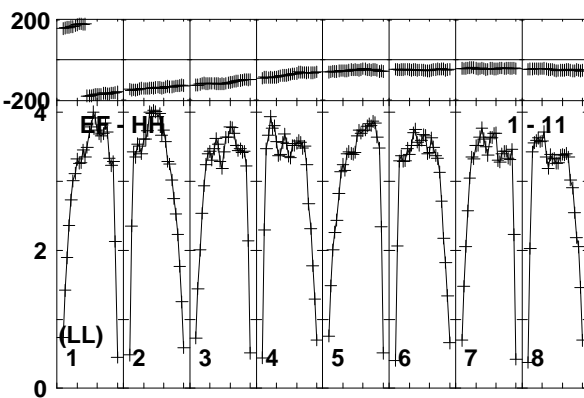
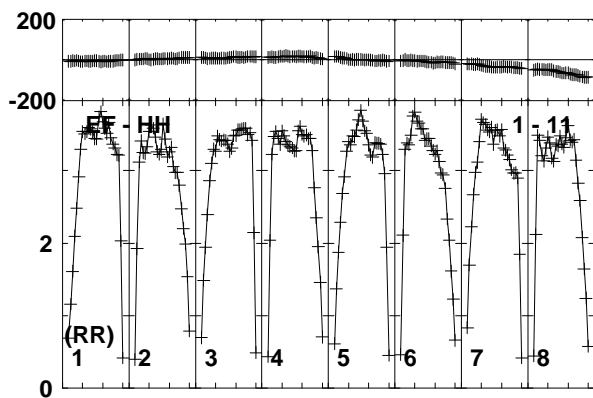
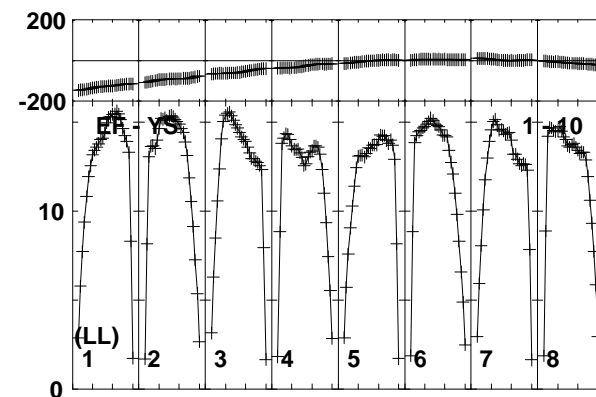
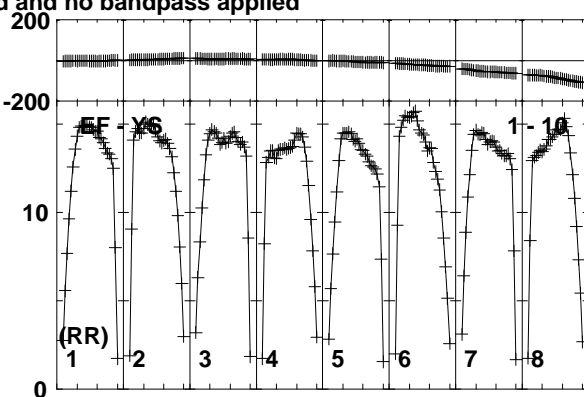
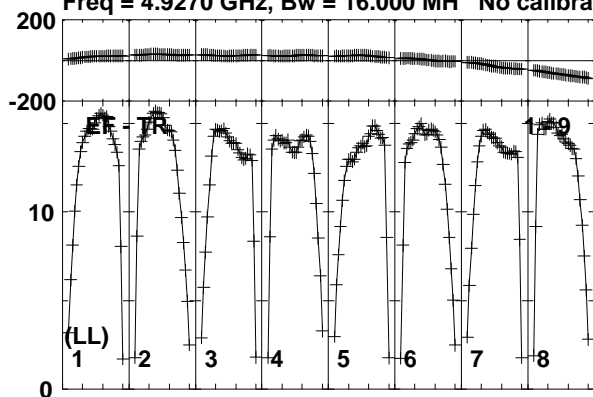

Lower frame: Milli Ampl Jy Top frame: Phas deg  
Vector averaged cross-power spectrum Baseline: EF (01) - TR (09)  
Timerange: 00/07:23:51 to 00/07:25:19

Plot file version 308 created 08-APR-2019 12:10:12

J0815+3635 EM133B.UVDATA.1

Freq = 4.9270 GHz, Bw = 16.000 MH No calibration applied and no bandpass applied

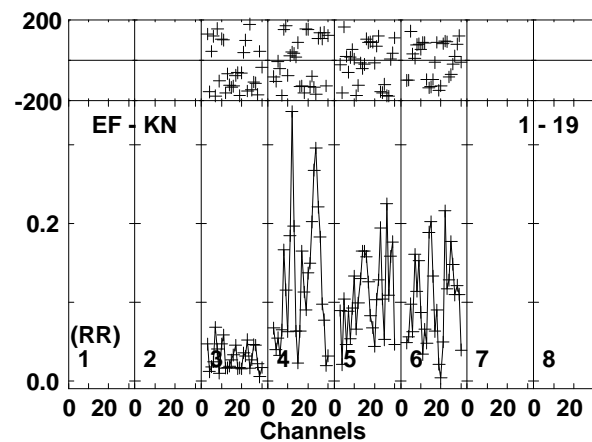
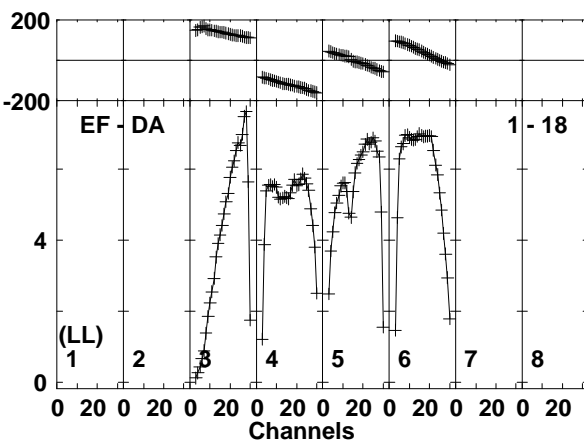
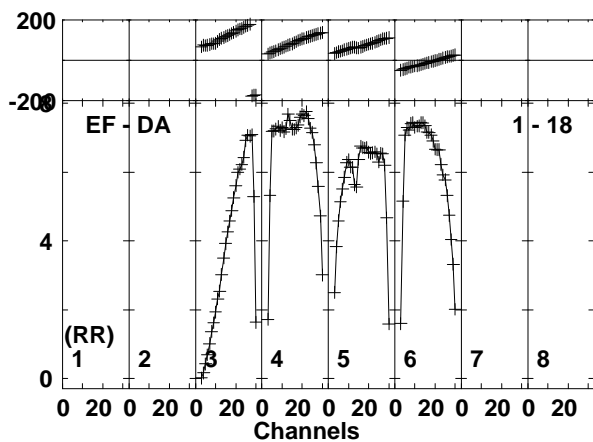
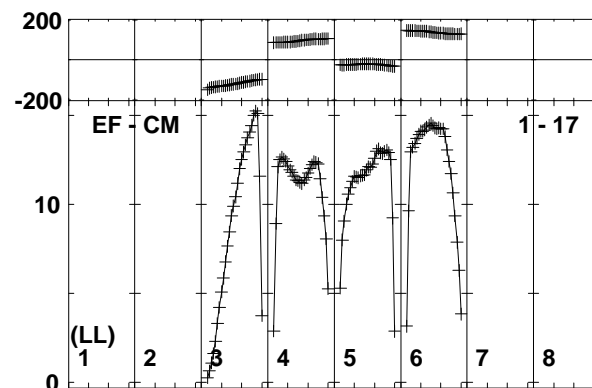
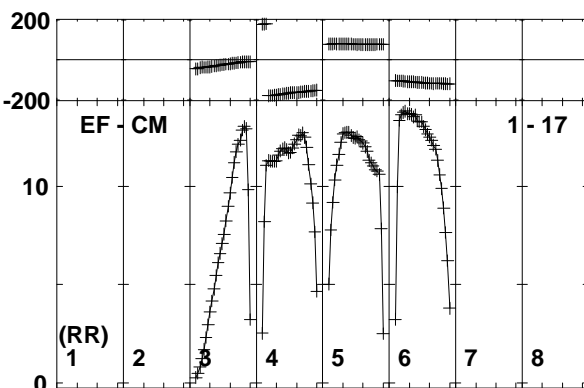
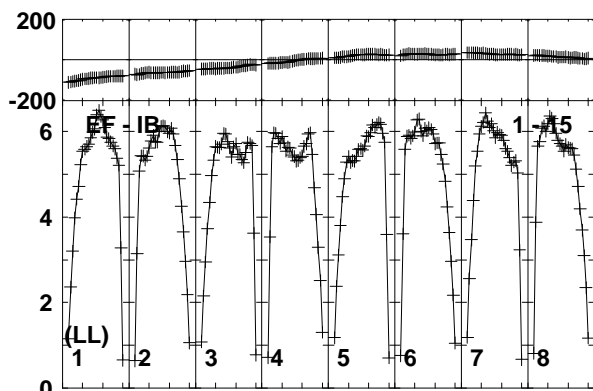
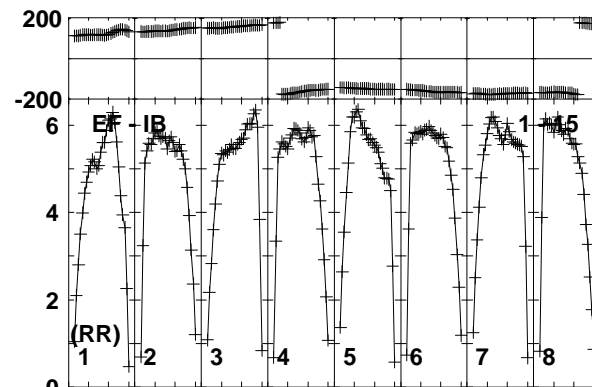
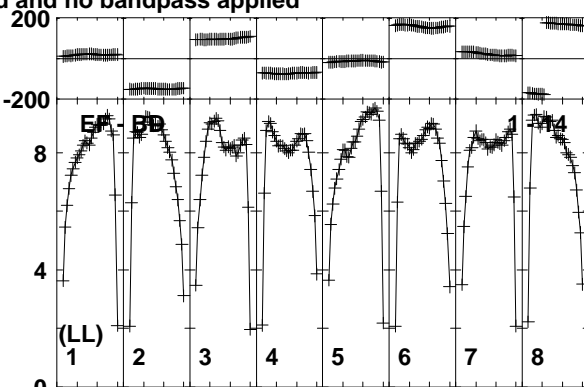
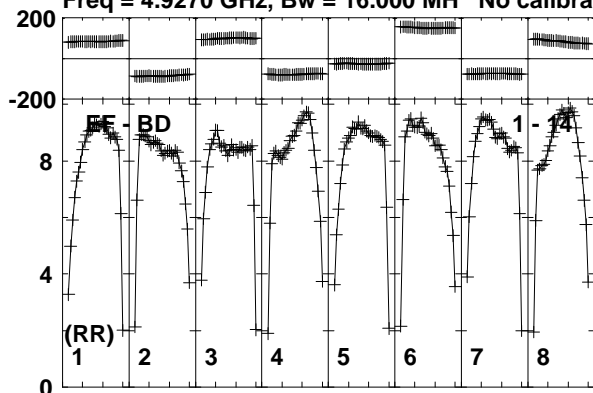

Lower frame: Milli Ampl Jy Top frame: Phas deg  
Vector averaged cross-power spectrum Baseline: EF (01) - BD (14)  
Timerange: 00/07:23:51 to 00/07:25:19

Plot file version 309 created 08-APR-2019 12:10:12

J0815+3635 EM133B.UVDATA.1

Freq = 4.9270 GHz, Bw = 16.000 MH No calibration applied and no bandpass applied

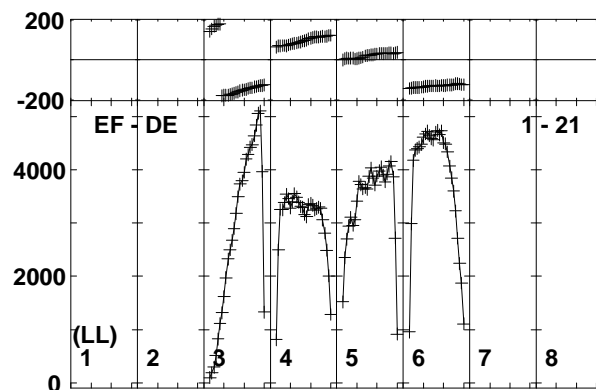
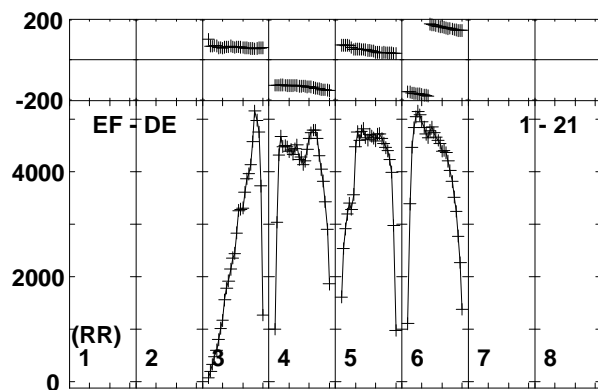
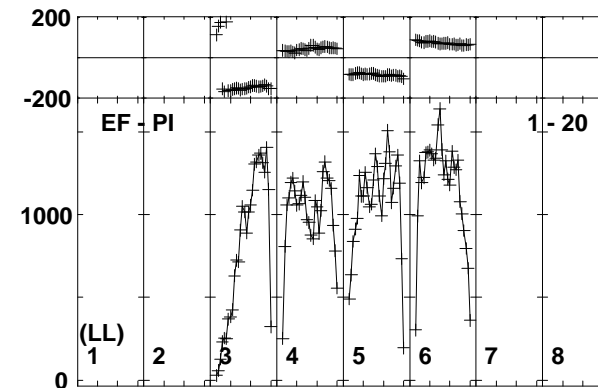
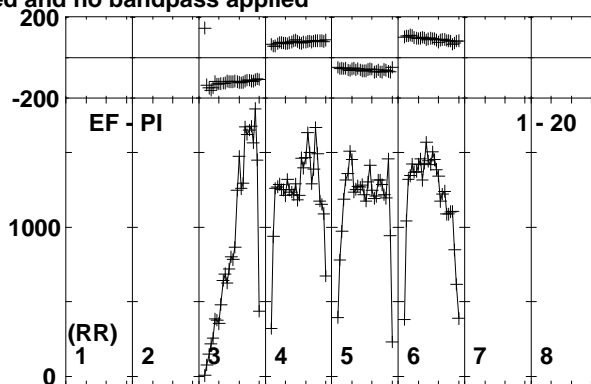
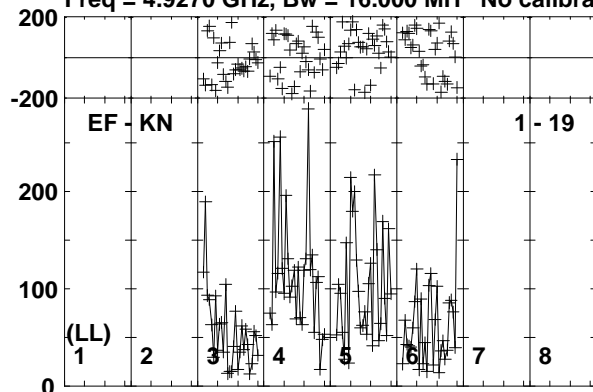

Lower frame: Micro Ampl Jy Top frame: Phas deg  
Vector averaged cross-power spectrum Baseline: EF (01) - KN (19)  
Timerange: 00/07:23:51 to 00/07:25:19

Plot file version 310 created 08-APR-2019 12:10:12

MRK622 EM133B.UVDATA.1

Freq = 4.9270 GHz, Bw = 16.000 MH No calibration applied and no bandpass applied

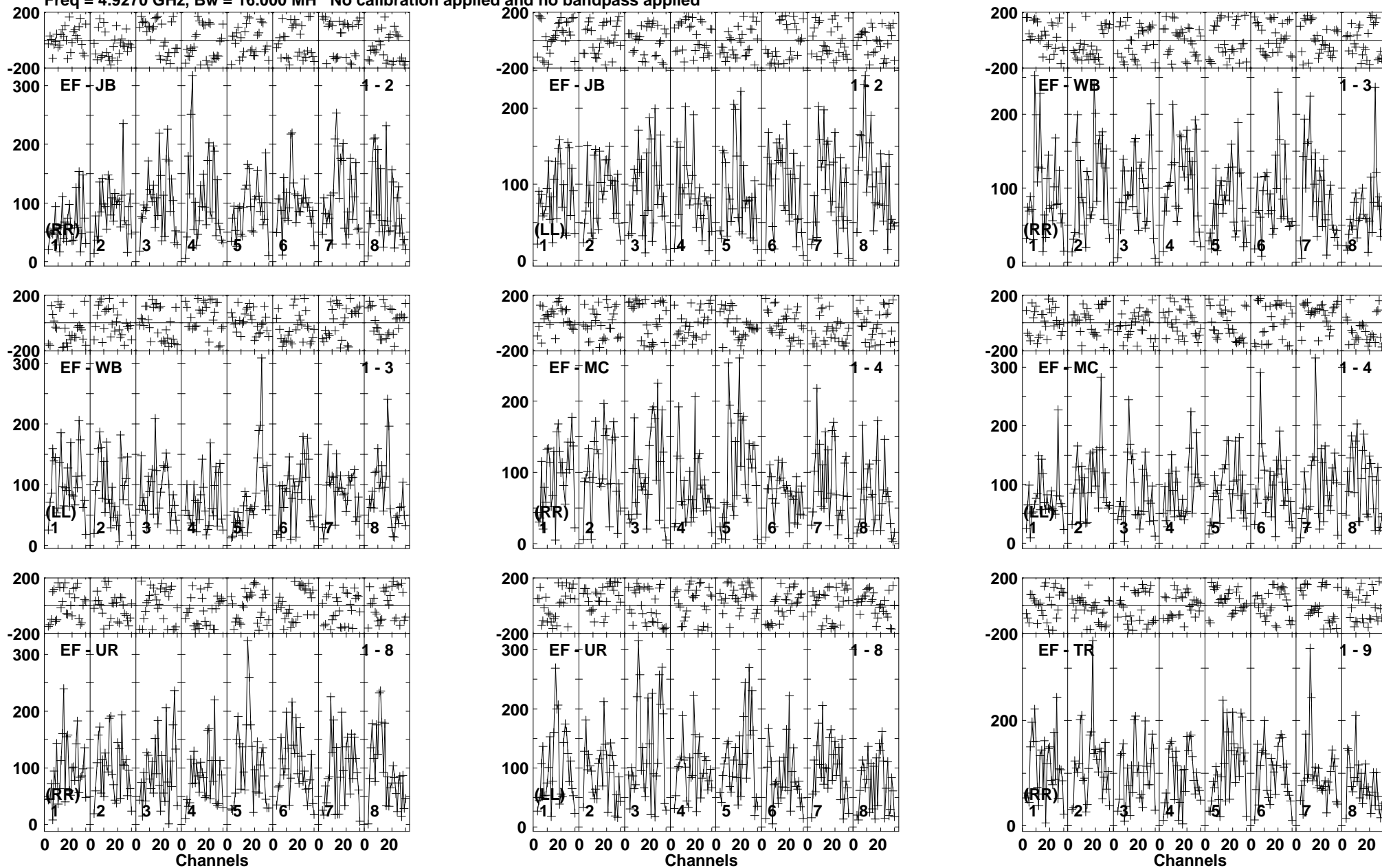

Lower frame: Micro Ampl Jy Top frame: Phas deg  
Vector averaged cross-power spectrum Baseline: EF (01) - JB (02)  
Timerange: 00/07:25:21 to 00/07:28:49

Plot file version 311 created 08-APR-2019 12:10:12

MRK622 EM133B.UVDATA.1

Freq = 4.9270 GHz, Bw = 16.000 MH No calibration applied and no bandpass applied

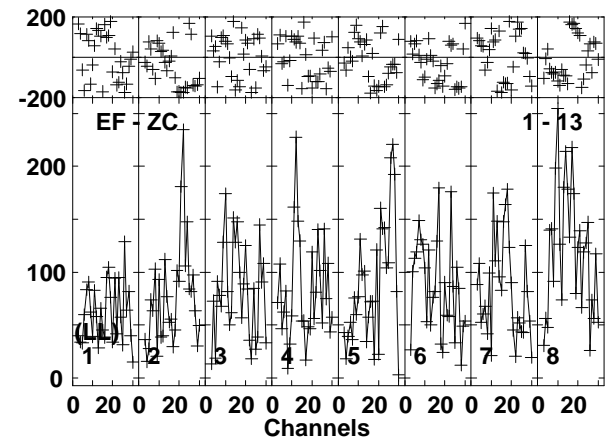
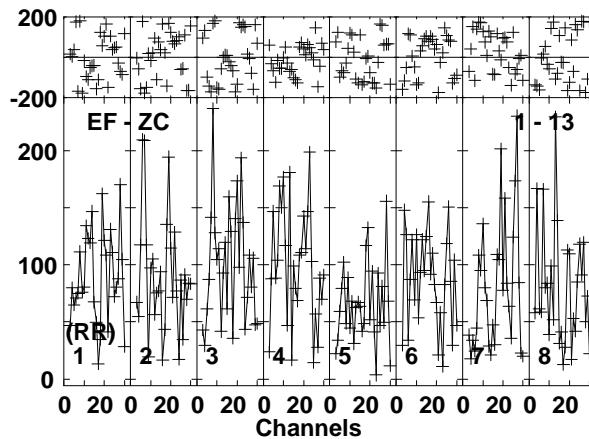
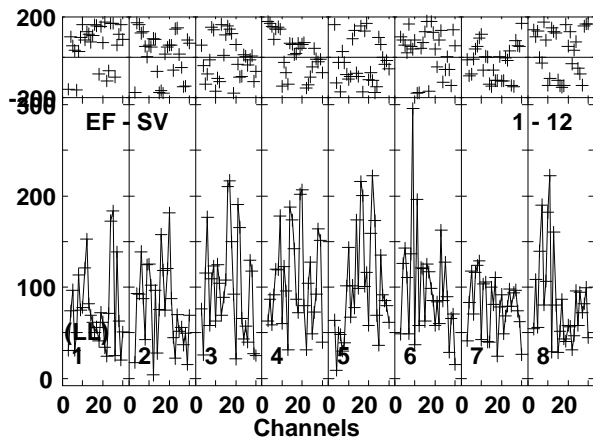
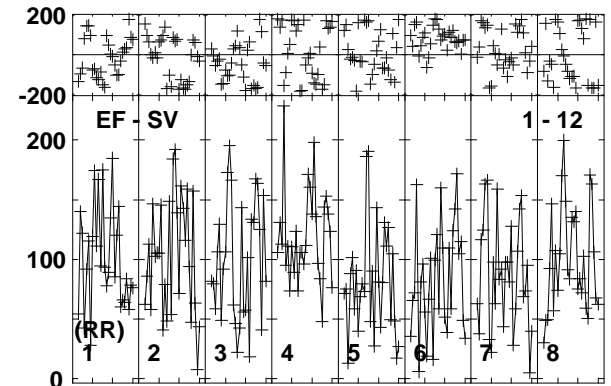
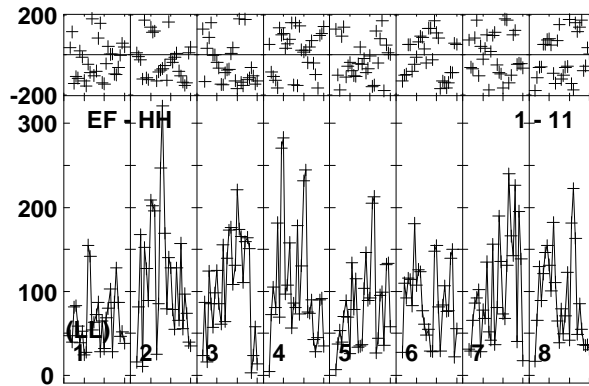
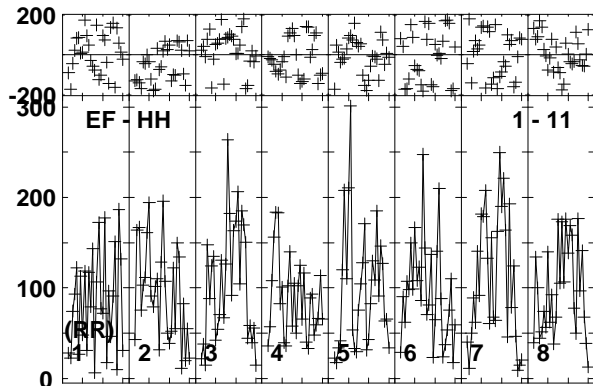
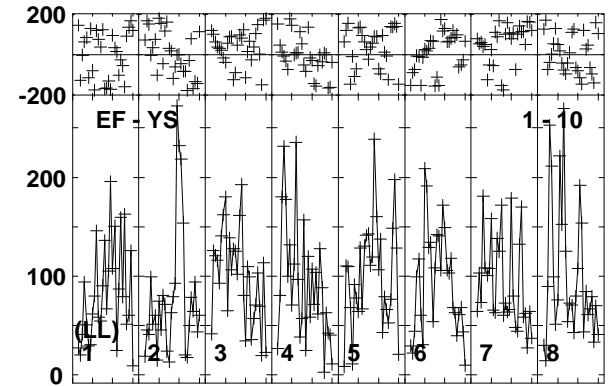
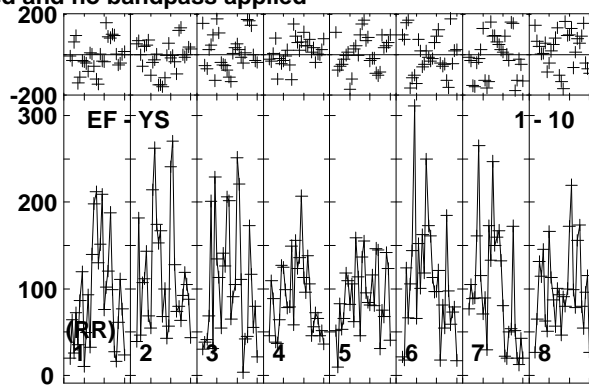
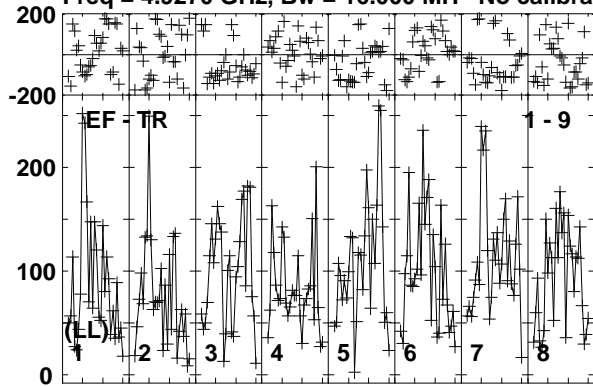

Lower frame: Micro Ampl Jy Top frame: Phas deg  
Vector averaged cross-power spectrum Baseline: EF (01) - TR (09)  
Timerange: 00/07:25:21 to 00/07:28:49

Plot file version 312 created 08-APR-2019 12:10:12

MRK622 EM133B.UVDATA.1

Freq = 4.9270 GHz, Bw = 16.000 MH No calibration applied and no bandpass applied

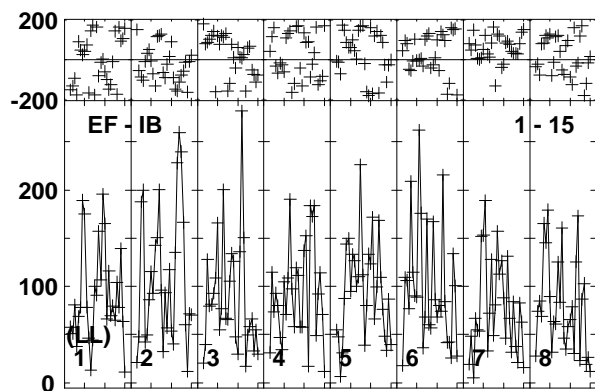
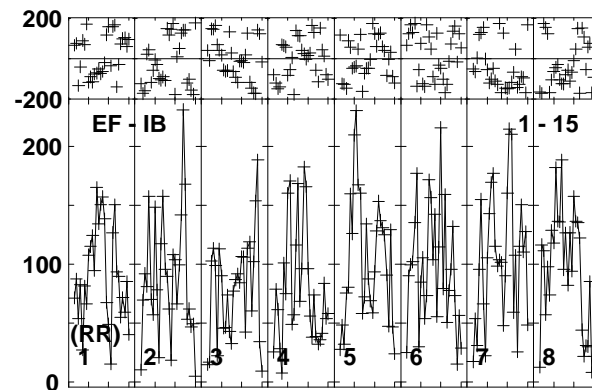
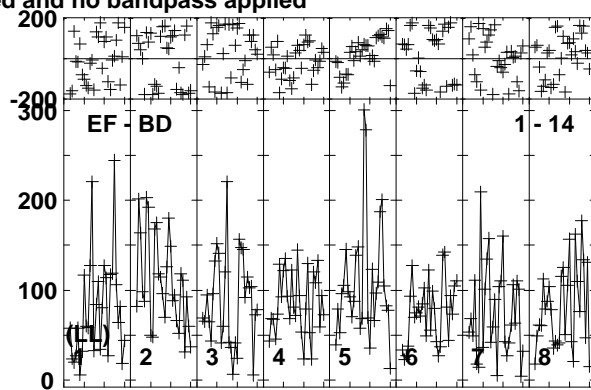
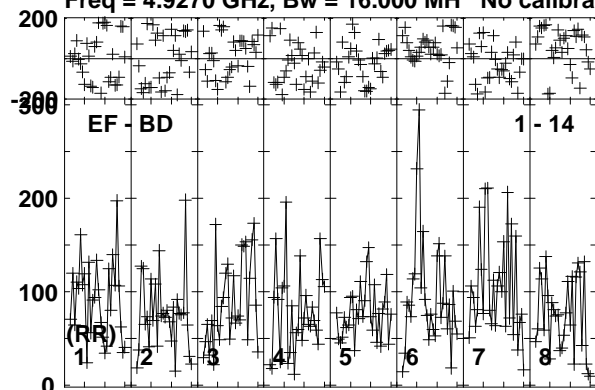

Lower frame: Micro Ampl Jy Top frame: Phas deg  
Vector averaged cross-power spectrum Baseline: EF (01) - BD (14)  
Timerange: 00/07:25:21 to 00/07:28:49



Plot file version 313 created 08-APR-2019 12:10:13

J0815+3635 EM133B.UVDATA.1

Freq = 4.9270 GHz, Bw = 16.000 MH No calibration applied and no bandpass applied

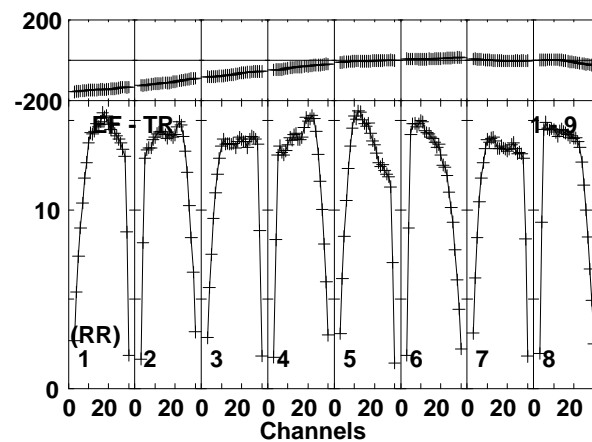
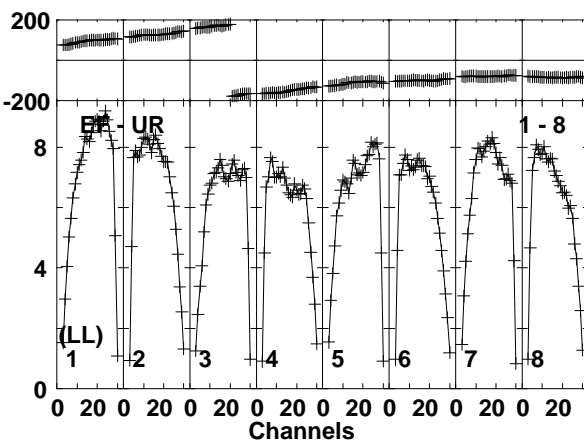
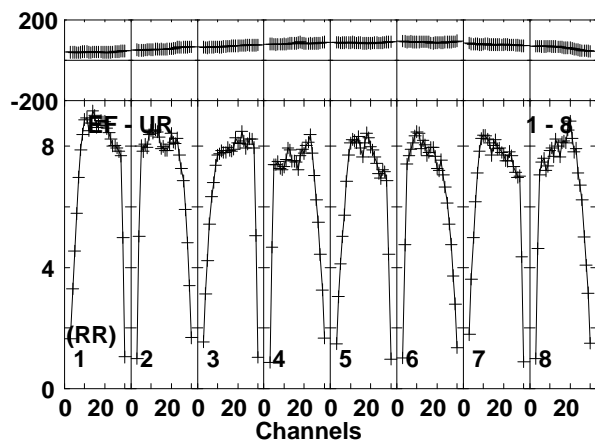
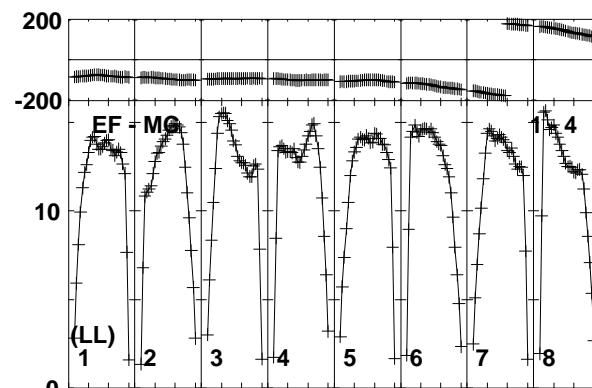
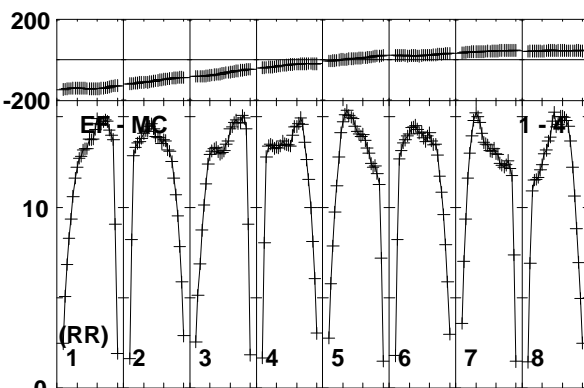
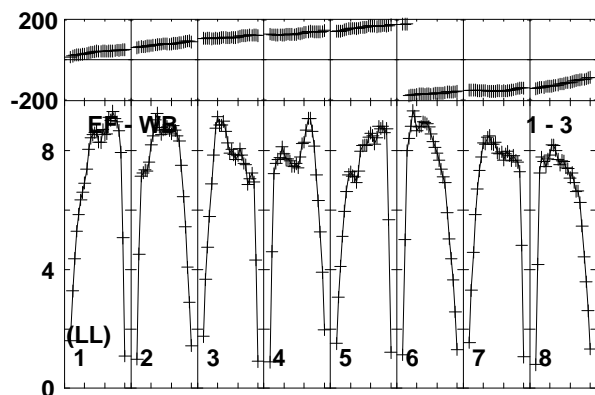
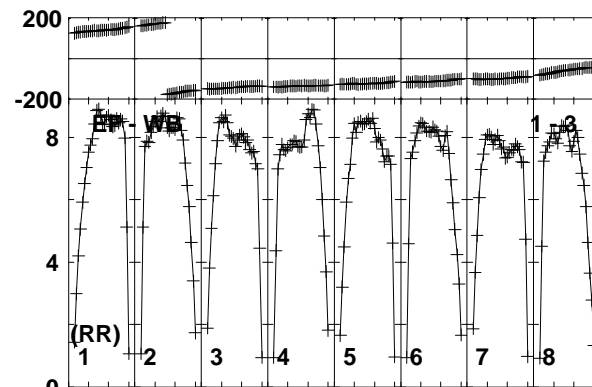
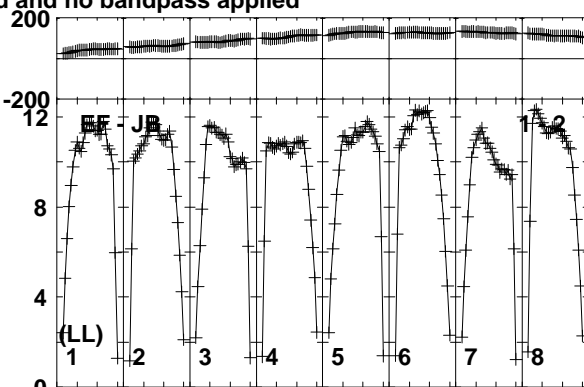
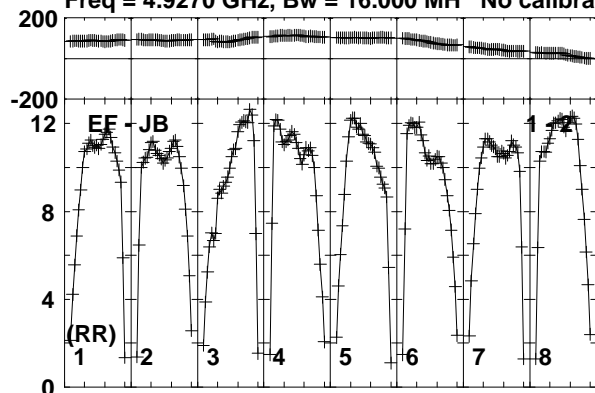

Lower frame: Milli Ampl Jy Top frame: Phas deg  
Vector averaged cross-power spectrum Baseline: EF (01) - JB (02)  
Timerange: 00/07:28:51 to 00/07:30:19

Plot file version 314 created 08-APR-2019 12:10:13

J0815+3635 EM133B.UVDATA.1

Freq = 4.9270 GHz, Bw = 16.000 MH No calibration applied and no bandpass applied

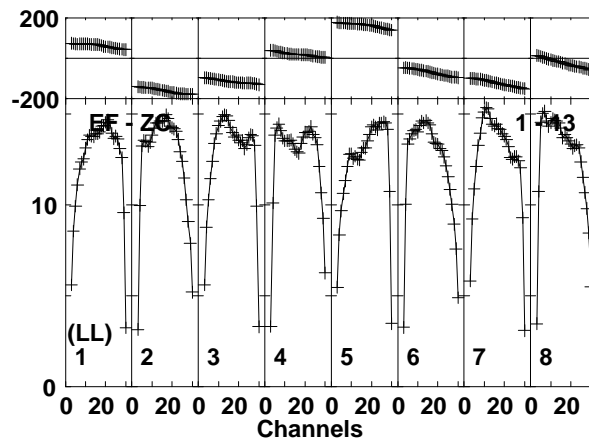
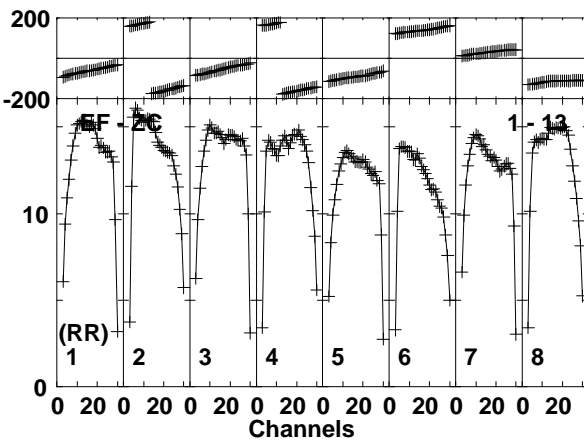
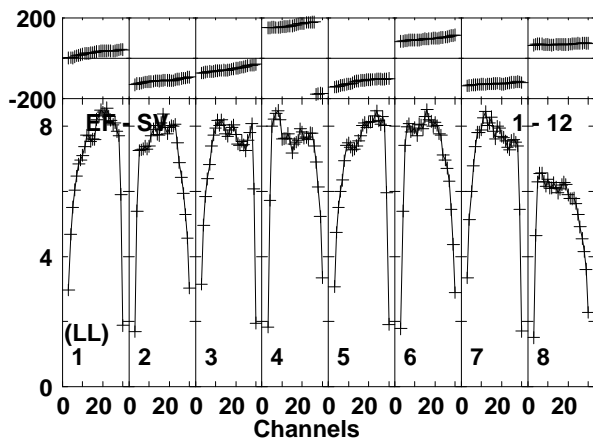
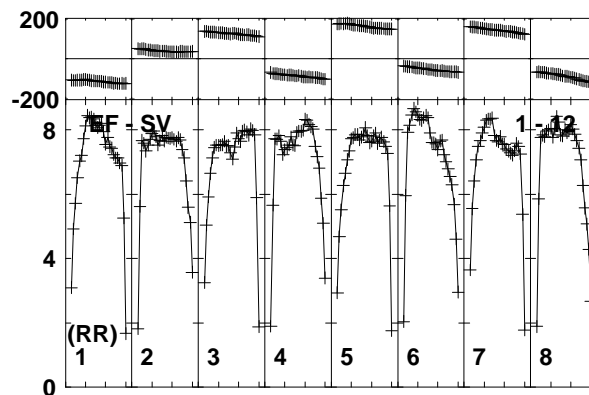
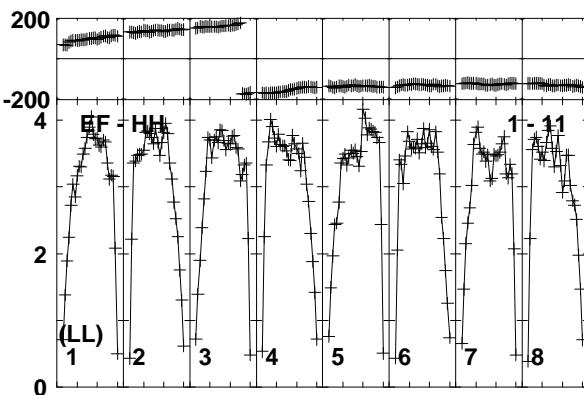
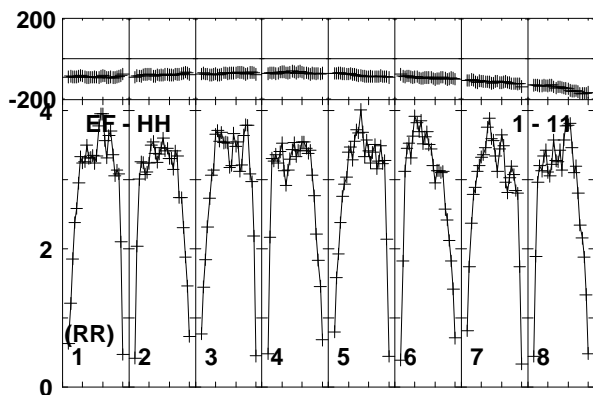
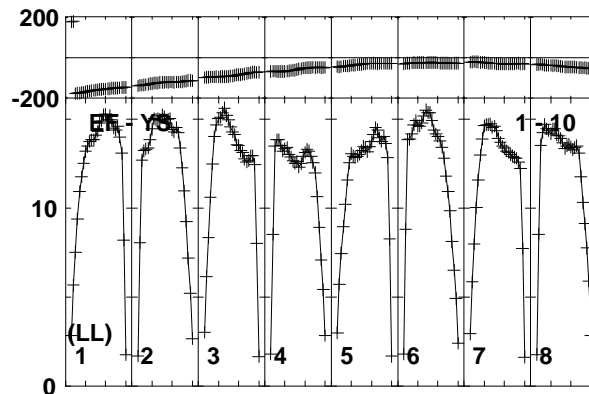
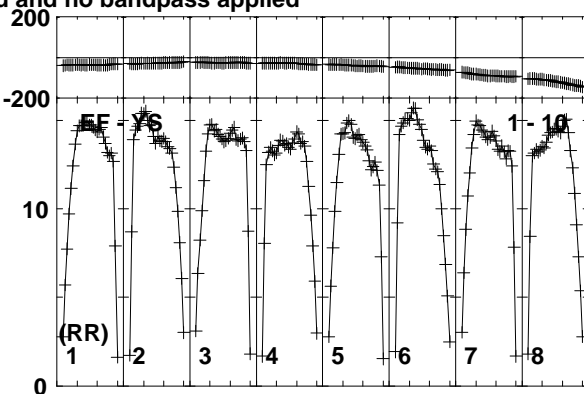
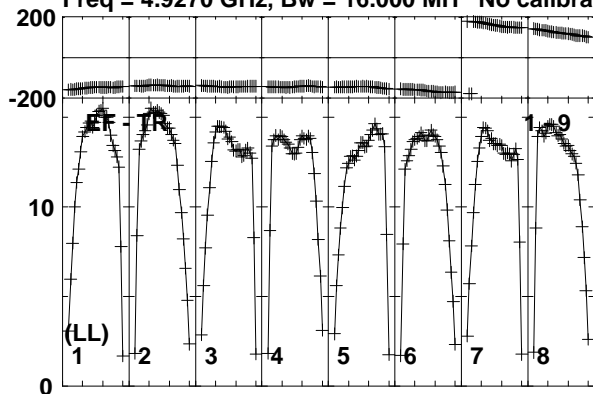

Lower frame: Milli Ampl Jy Top frame: Phas deg  
Vector averaged cross-power spectrum Baseline: EF (01) - TR (09)  
Timerange: 00/07:28:51 to 00/07:30:19

Plot file version 315 created 08-APR-2019 12:10:13

J0815+3635 EM133B.UVDATA.1

Freq = 4.9270 GHz, Bw = 16.000 MH No calibration applied and no bandpass applied

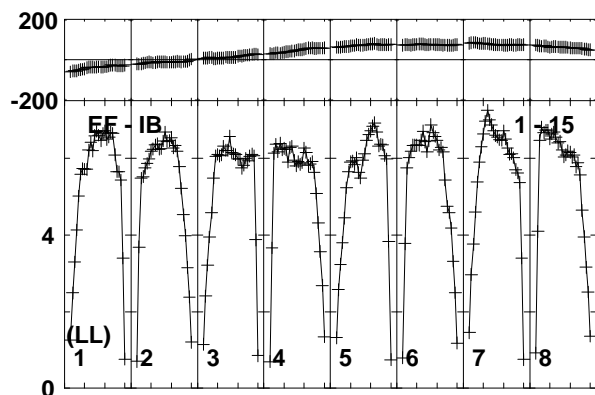
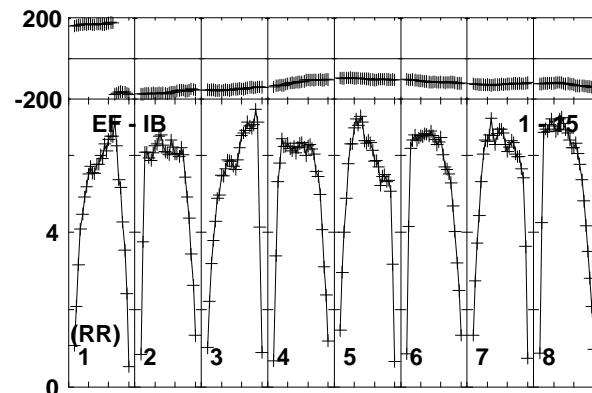
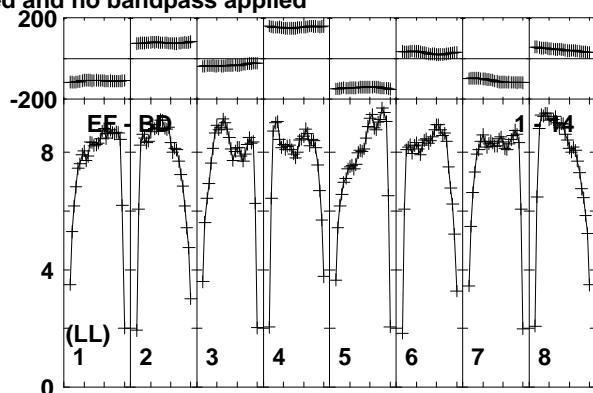
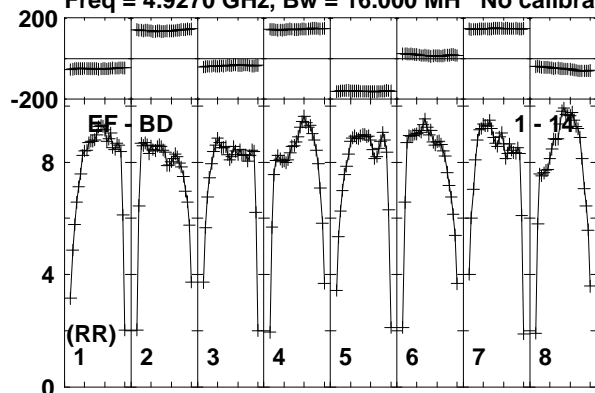

Lower frame: Milli Ampl Jy Top frame: Phas deg  
Vector averaged cross-power spectrum Baseline: EF (01) - BD (14)  
Timerange: 00/07:28:51 to 00/07:30:19

Plot file version 316 created 08-APR-2019 12:10:13

MRK622 EM133B.UVDATA.1

Freq = 4.9270 GHz, Bw = 16.000 MH No calibration applied and no bandpass applied

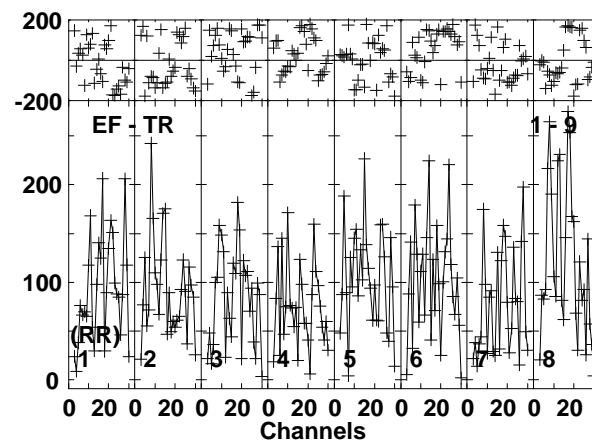
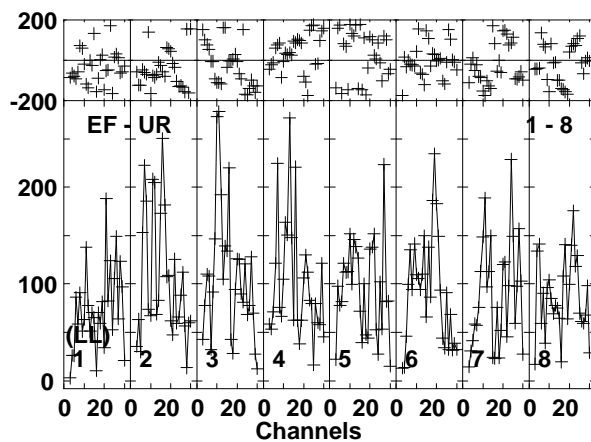
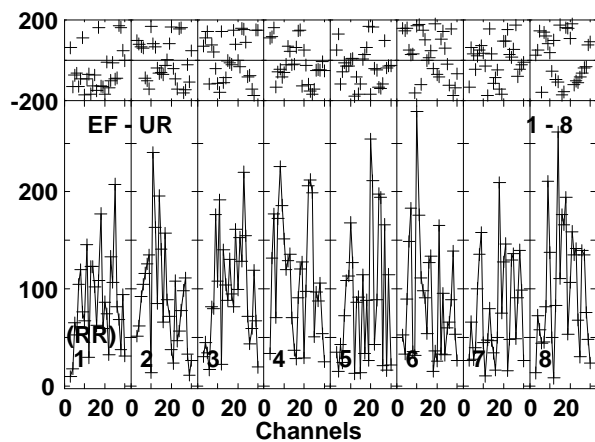
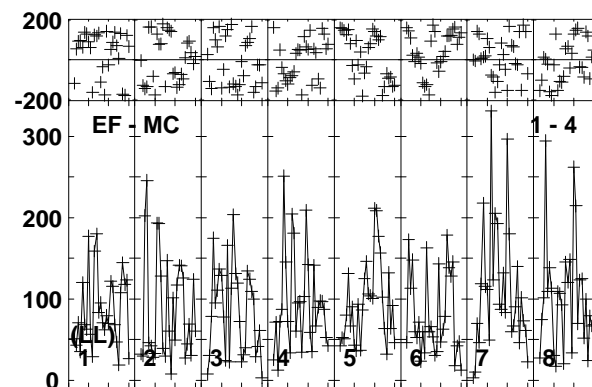
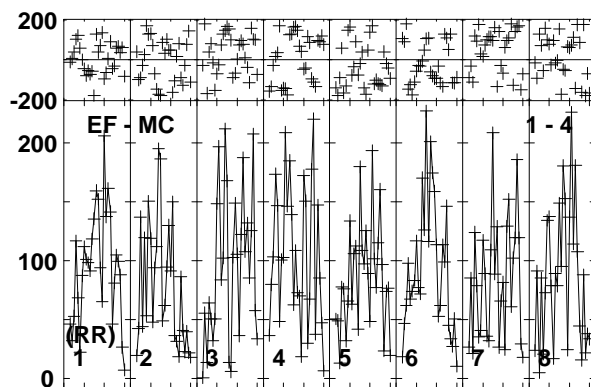
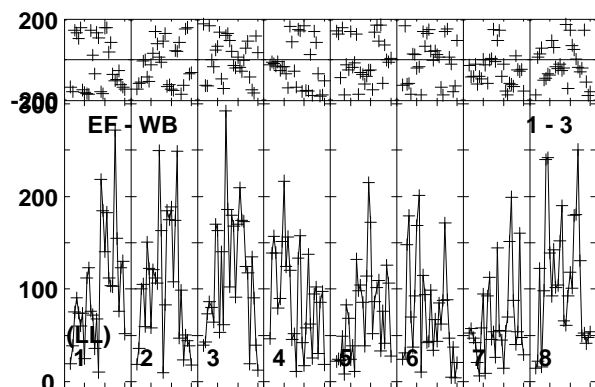
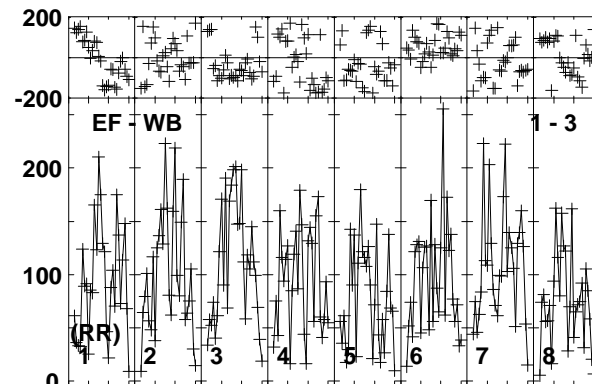
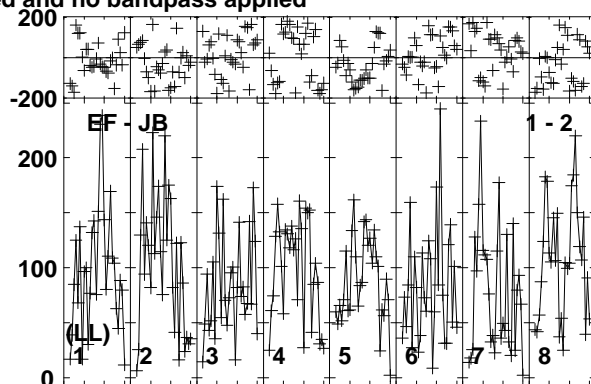
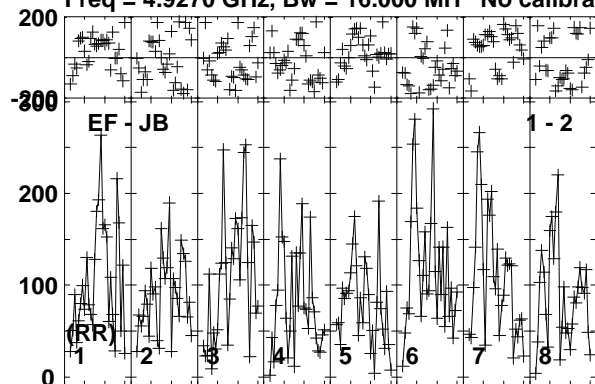

Lower frame: Micro Ampl Jy Top frame: Phas deg  
Vector averaged cross-power spectrum Baseline: EF (01) - JB (02)  
Timerange: 00/07:30:21 to 00/07:33:49

Plot file version 317 created 08-APR-2019 12:10:13

MRK622 EM133B.UVDATA.1

Freq = 4.9270 GHz, Bw = 16.000 MH No calibration applied and no bandpass applied

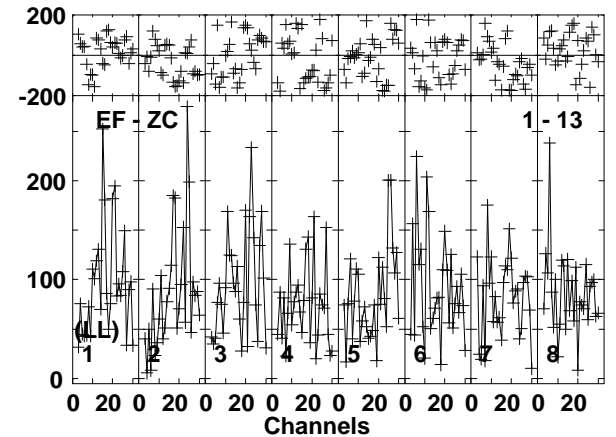
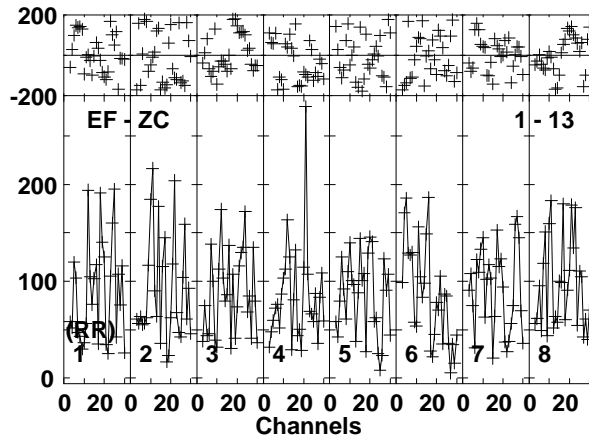
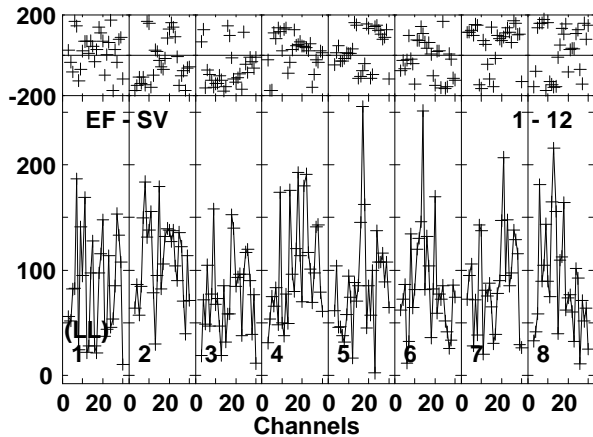
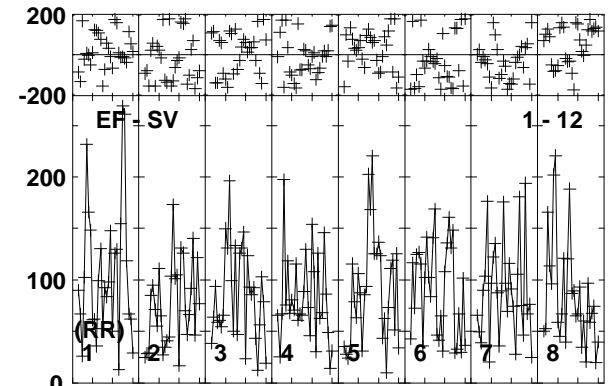
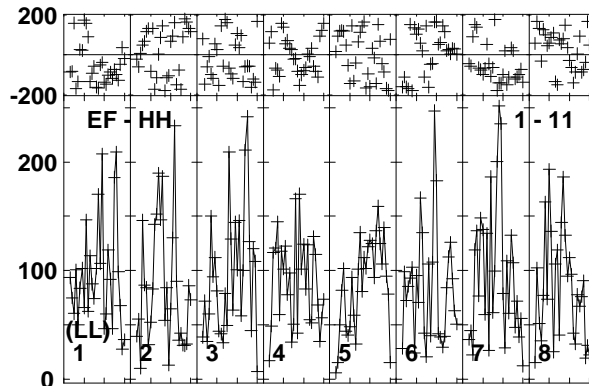
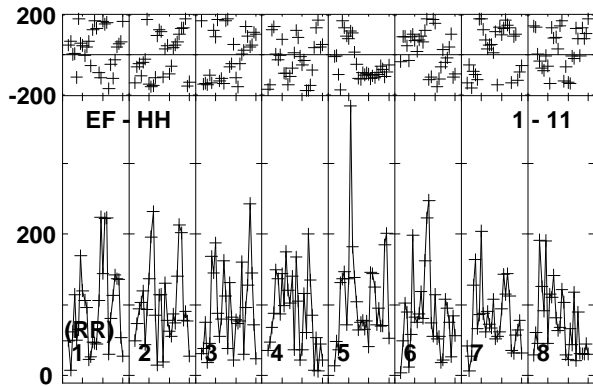
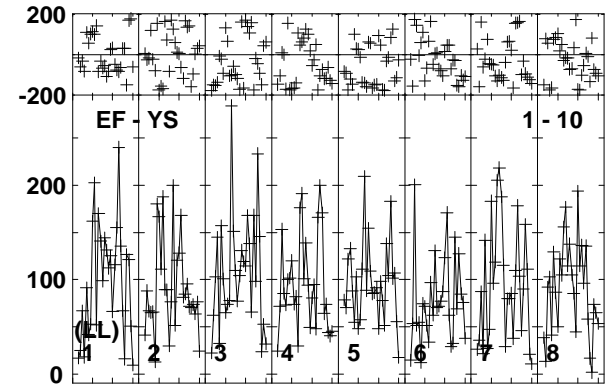
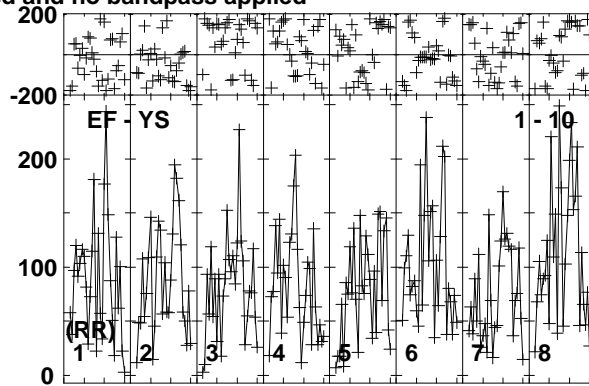
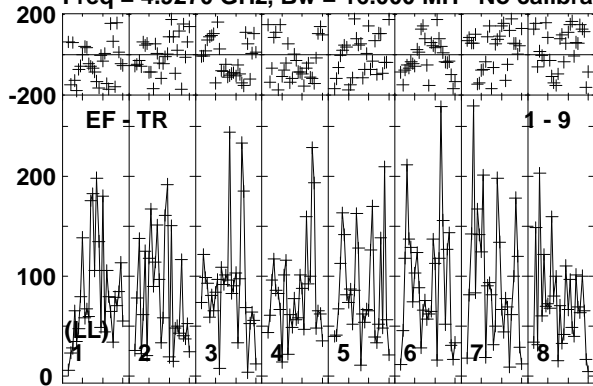

Lower frame: Micro Ampl Jy Top frame: Phas deg  
Vector averaged cross-power spectrum Baseline: EF (01) - TR (09)  
Timerange: 00/07:30:21 to 00/07:33:49

Plot file version 318 created 08-APR-2019 12:10:13

MRK622 EM133B.UVDATA.1

Freq = 4.9270 GHz, Bw = 16.000 MH No calibration applied and no bandpass applied

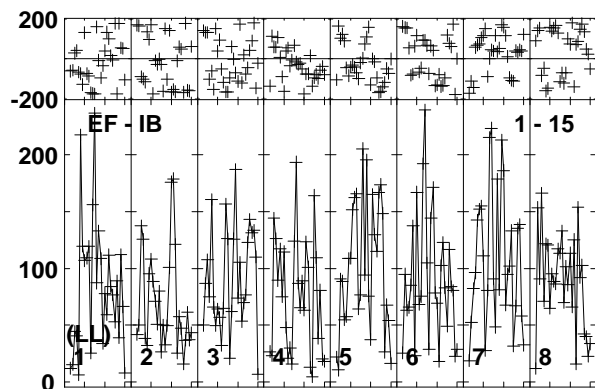
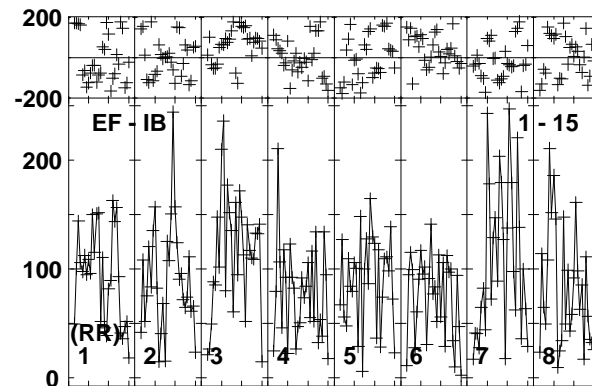
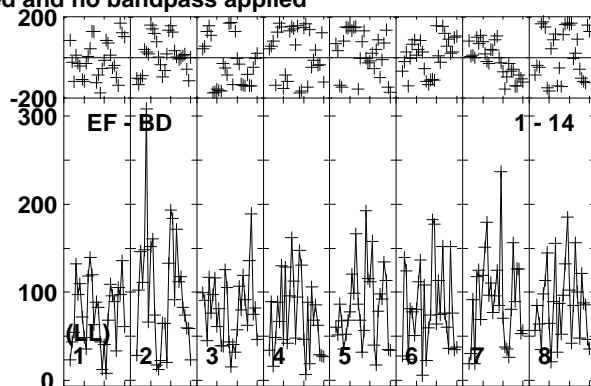
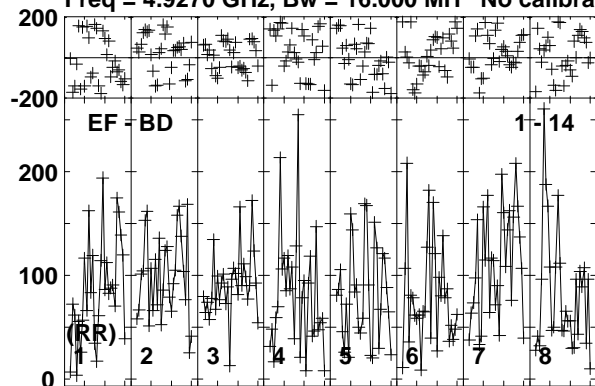

Lower frame: Micro Ampl Jy Top frame: Phas deg  
Vector averaged cross-power spectrum Baseline: EF (01) - BD (14)  
Timerange: 00/07:30:21 to 00/07:33:49

Plot file version 319 created 08-APR-2019 12:10:13

J0815+3635 EM133B.UVDATA.1

Freq = 4.9270 GHz, Bw = 16.000 MH No calibration applied and no bandpass applied

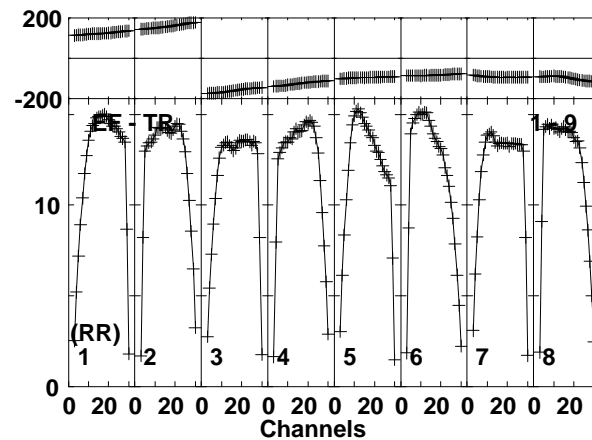
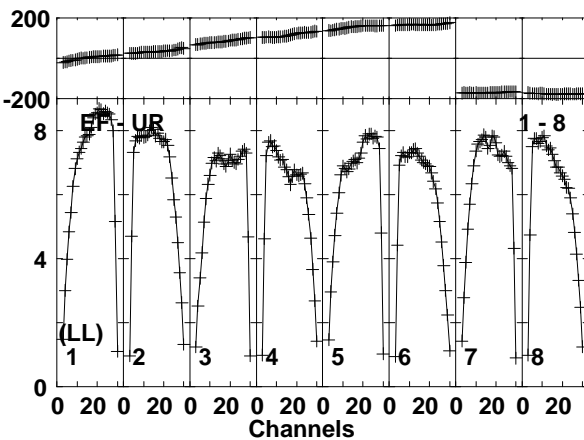
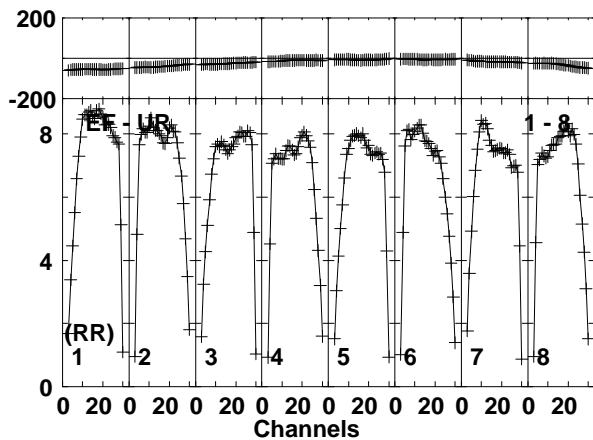
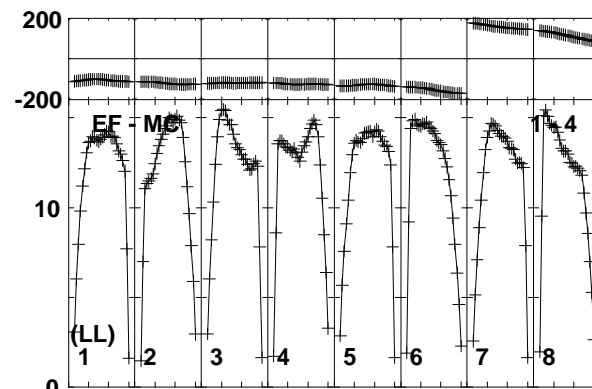
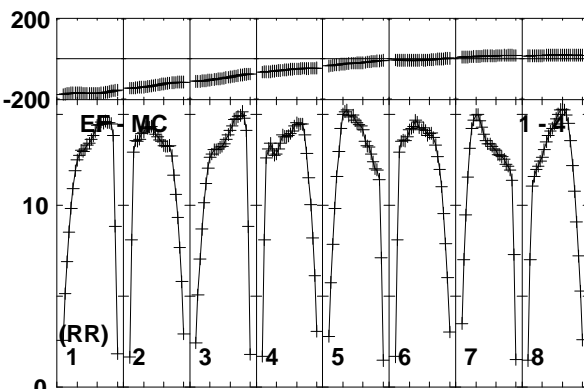
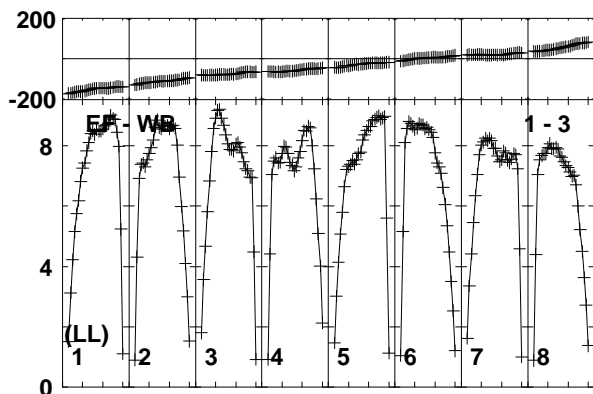
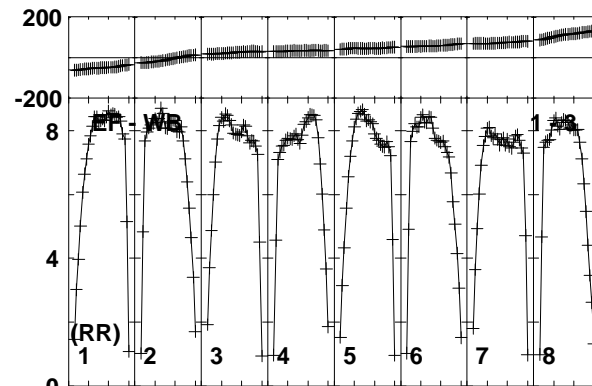
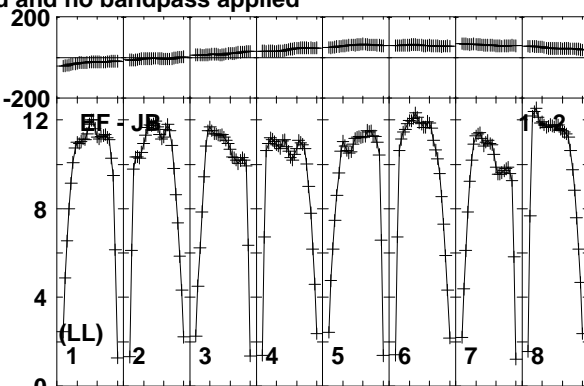
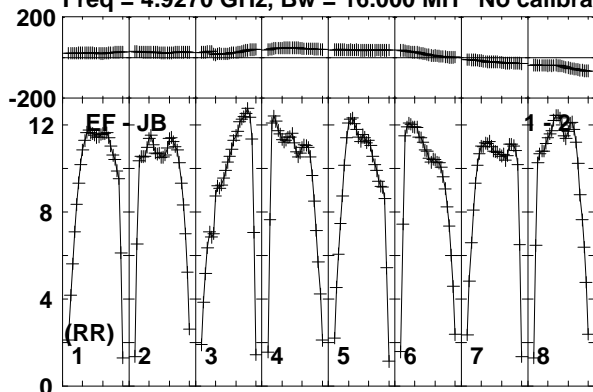

Lower frame: Milli Ampl Jy Top frame: Phas deg  
Vector averaged cross-power spectrum Baseline: EF (01) - JB (02)  
Timerange: 00/07:34:41 to 00/07:36:09

Plot file version 320 created 08-APR-2019 12:10:13

J0815+3635 EM133B.UVDATA.1

Freq = 4.9270 GHz, Bw = 16.000 MH No calibration applied and no bandpass applied

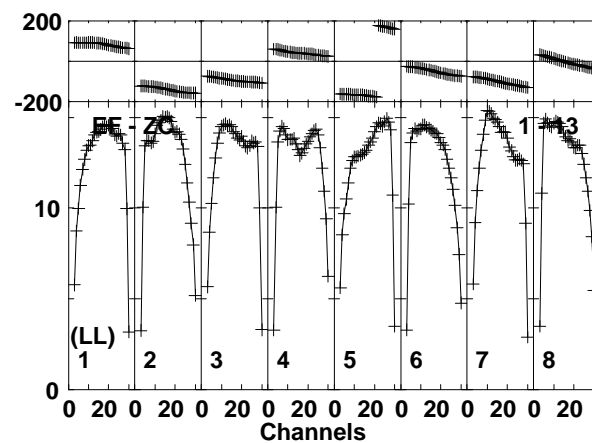
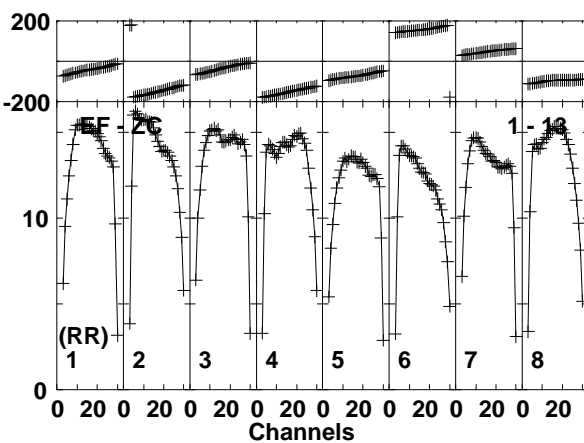
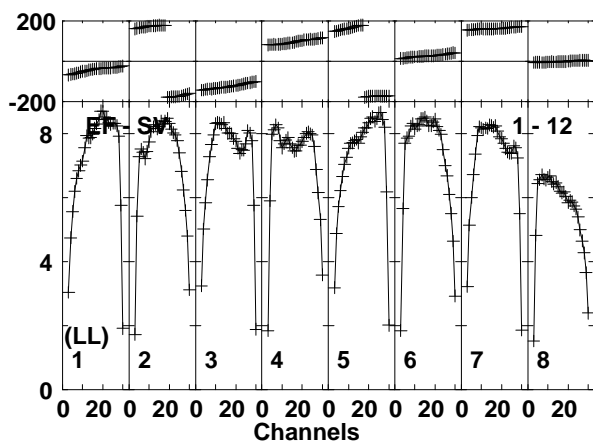
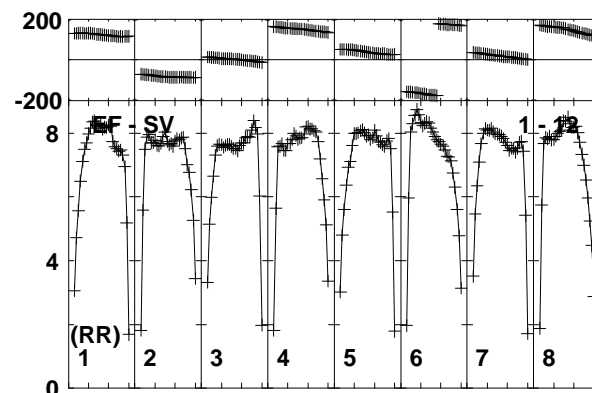
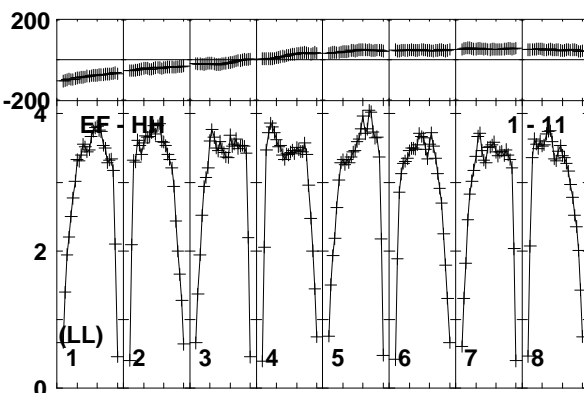
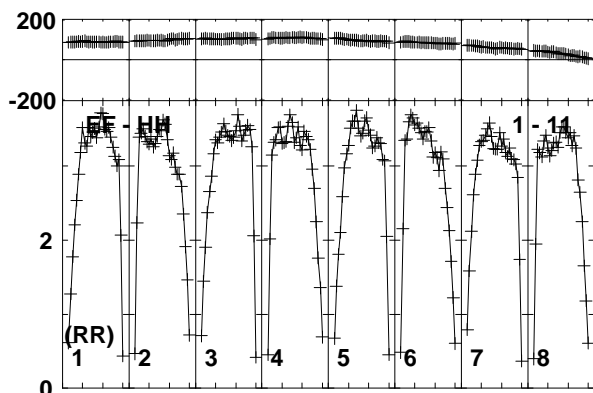
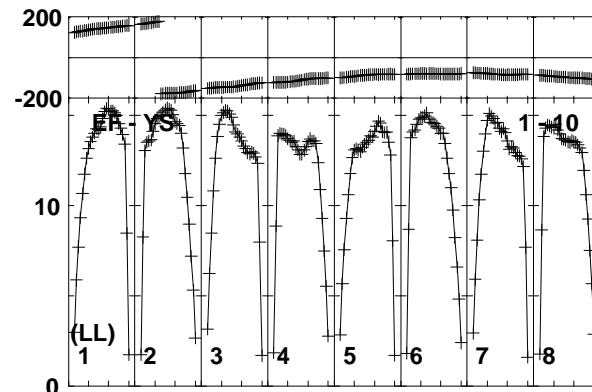
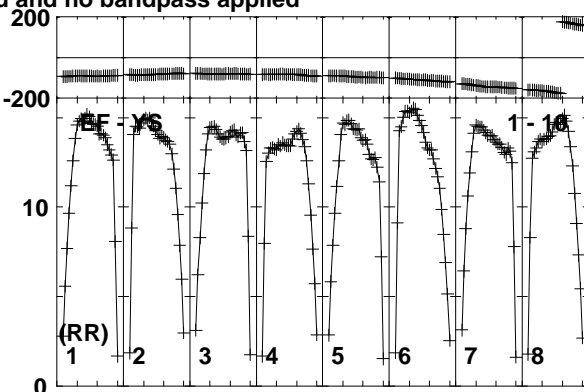
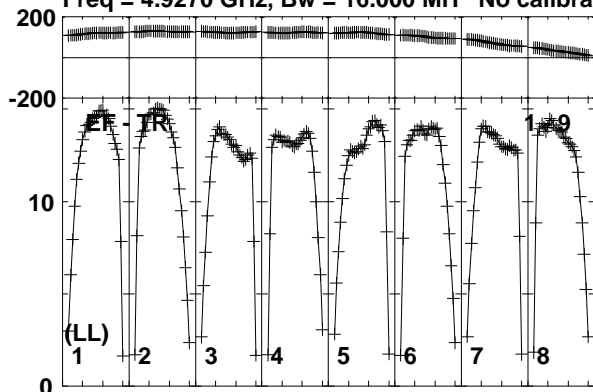

Lower frame: Milli Ampl Jy Top frame: Phas deg  
Vector averaged cross-power spectrum Baseline: EF (01) - TR (09)  
Timerange: 00/07:34:41 to 00/07:36:09



Plot file version 321 created 08-APR-2019 12:10:14

J0815+3635 EM133B.UVDATA.1

Freq = 4.9270 GHz, Bw = 16.000 MH No calibration applied and no bandpass applied

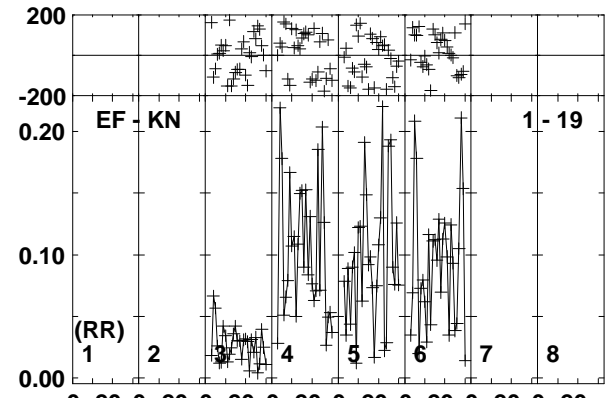
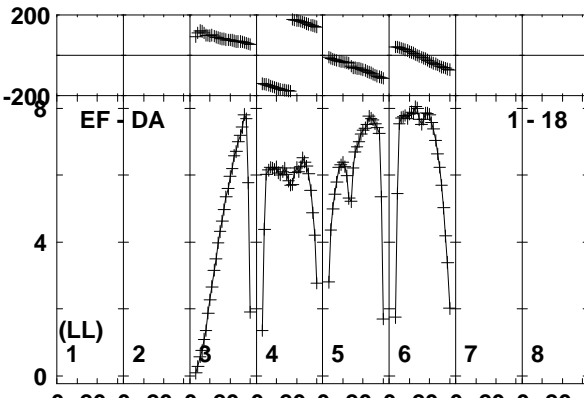
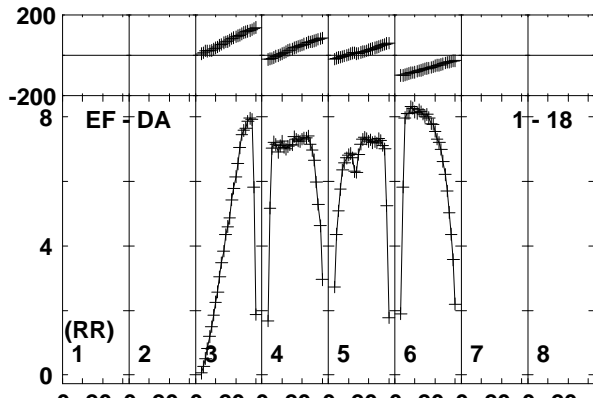
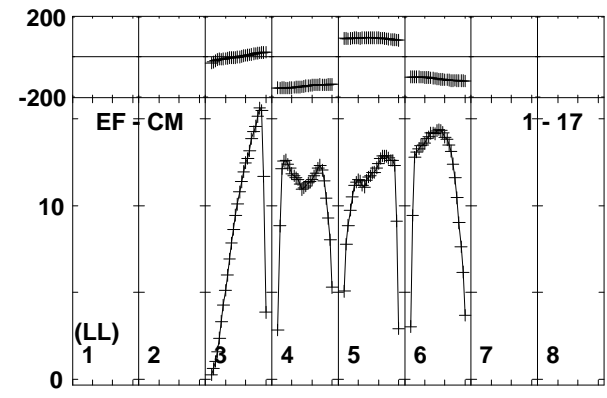
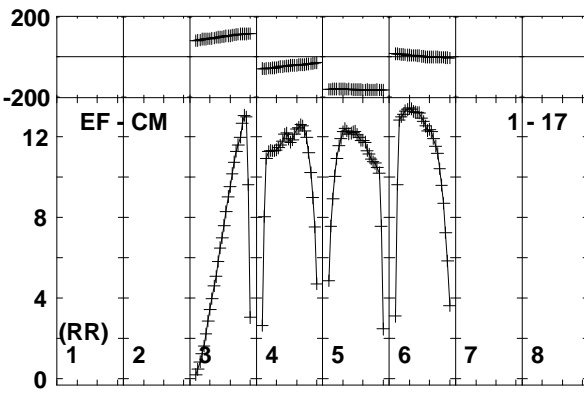
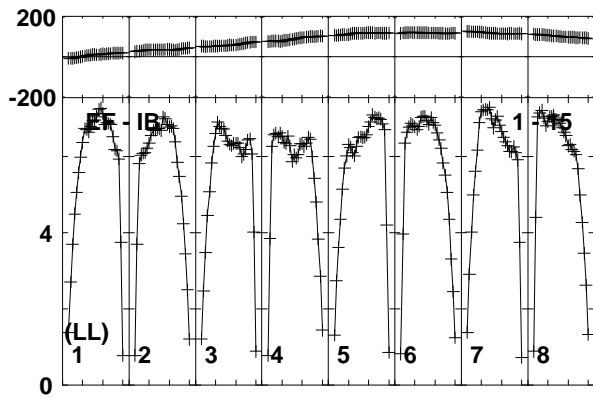
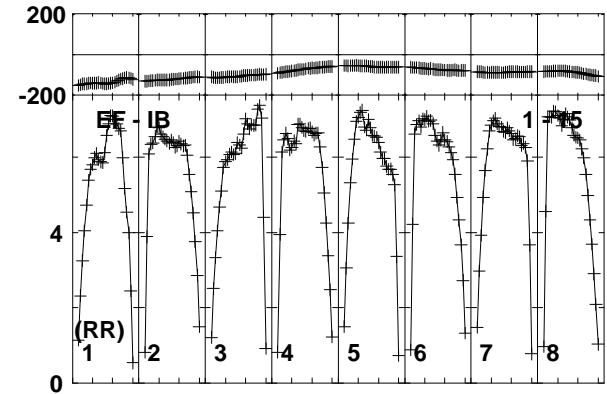
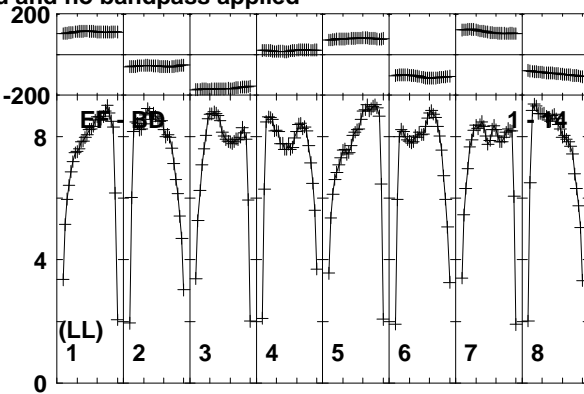
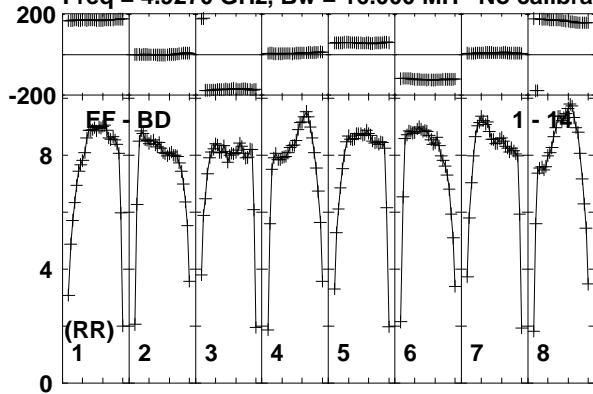

Lower frame: Milli Ampl Jy Top frame: Phas deg  
Vector averaged cross-power spectrum Baseline: EF (01) - BD (14)  
Timerange: 00/07:34:41 to 00/07:36:09

Plot file version 322 created 08-APR-2019 12:10:14

J0815+3635 EM133B.UVDATA.1

Freq = 4.9270 GHz, Bw = 16.000 MH No calibration applied and no bandpass applied

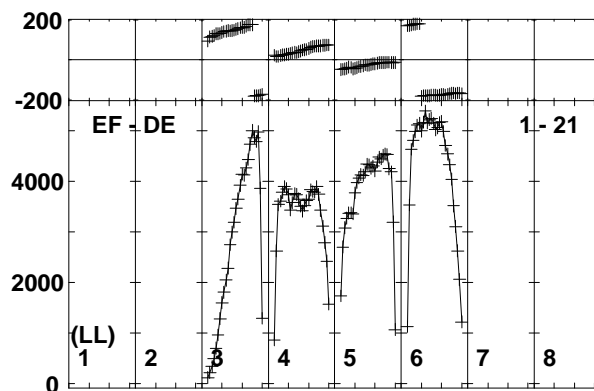
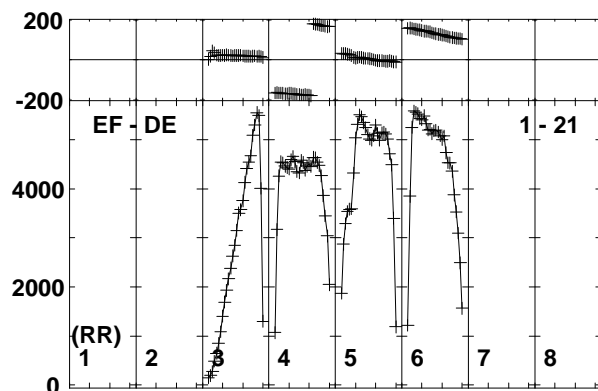
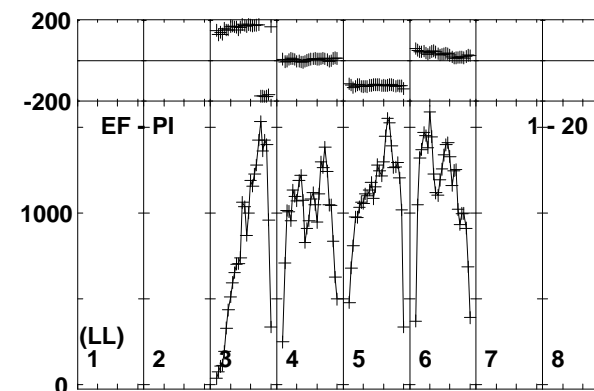
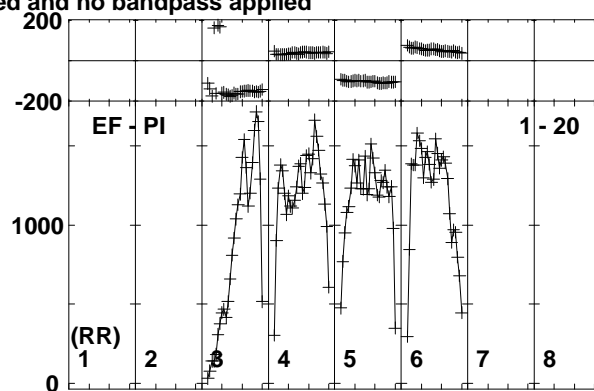
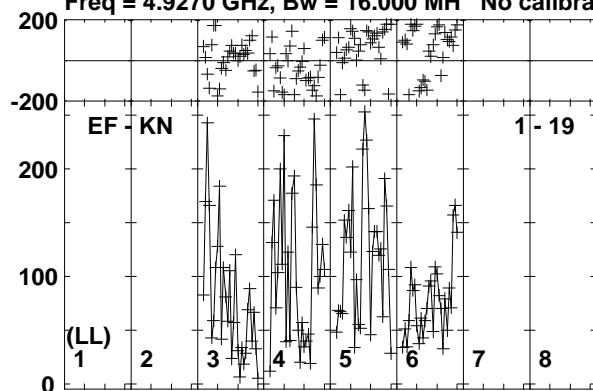

Lower frame: Micro Ampl Jy Top frame: Phas deg  
Vector averaged cross-power spectrum Baseline: EF (01) - KN (19)  
Timerange: 00/07:34:41 to 00/07:36:09

Plot file version 323 created 08-APR-2019 12:10:14

MRK622 EM133B.UVDATA.1

Freq = 4.9270 GHz, Bw = 16.000 MH No calibration applied and no bandpass applied

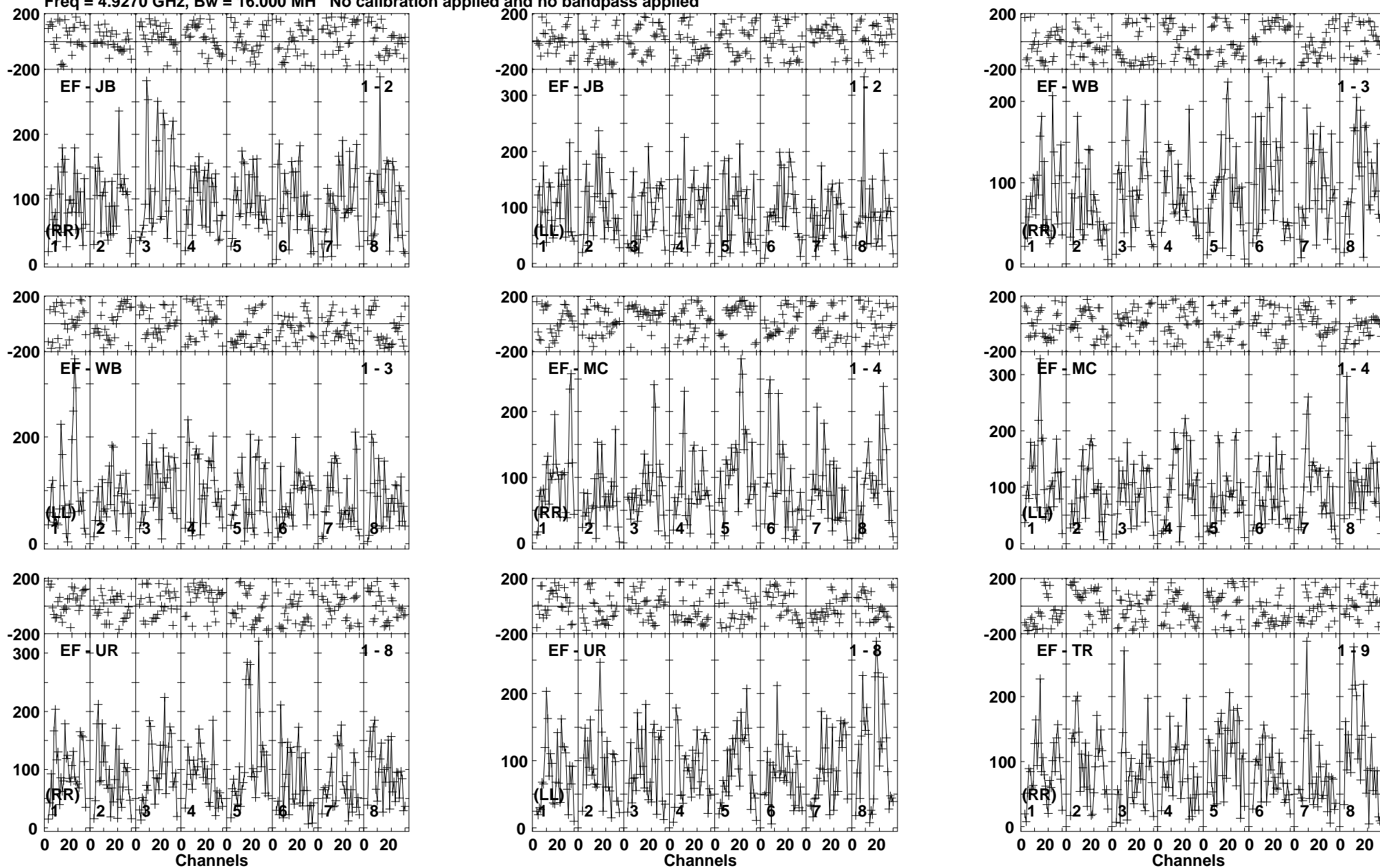

Lower frame: Micro Ampl Jy Top frame: Phas deg  
Vector averaged cross-power spectrum Baseline: EF (01) - JB (02)  
Timerange: 00/07:36:11 to 00/07:39:39

Plot file version 324 created 08-APR-2019 12:10:14

MRK622 EM133B.UVDATA.1

Freq = 4.9270 GHz, Bw = 16.000 MH No calibration applied and no bandpass applied

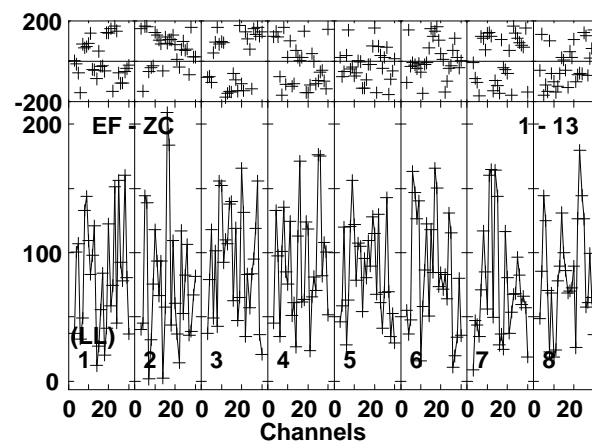
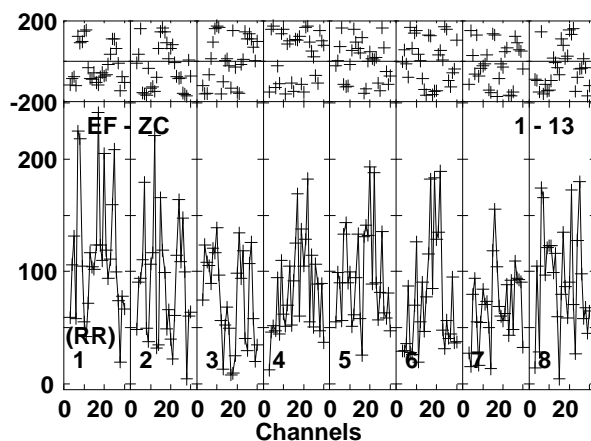
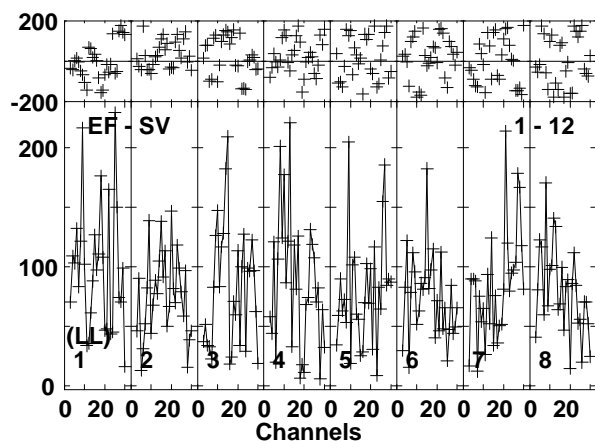
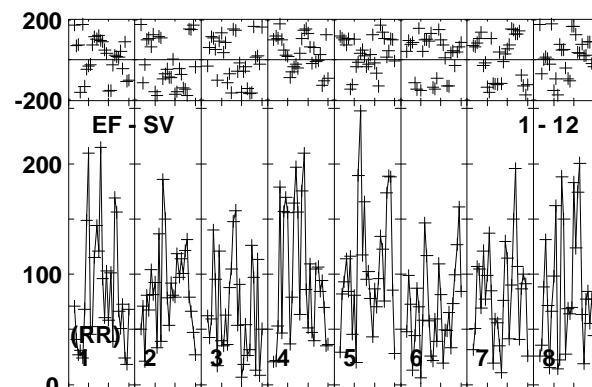
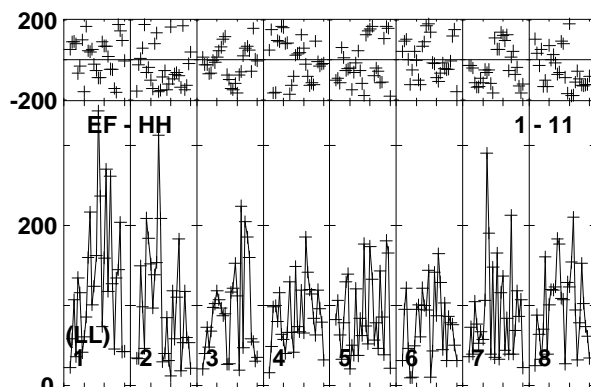
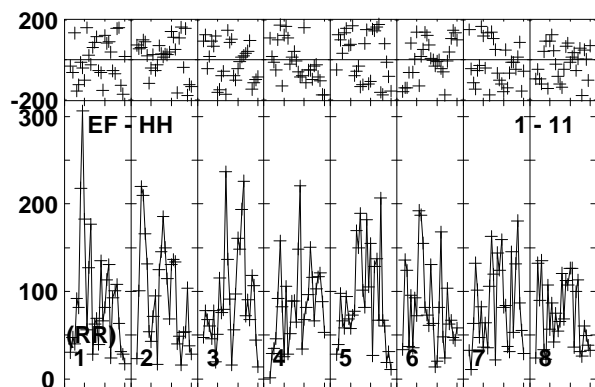
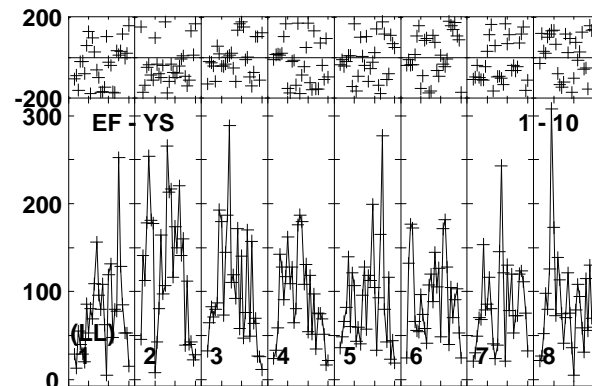
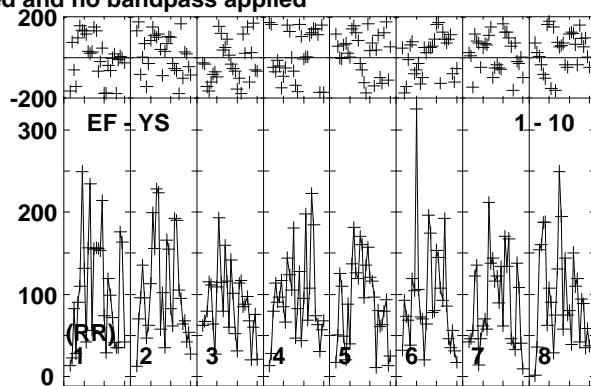
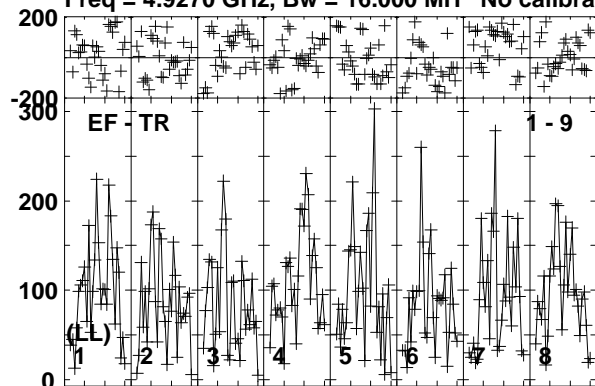

Lower frame: Micro Ampl Jy Top frame: Phas deg  
Vector averaged cross-power spectrum Baseline: EF (01) - TR (09)  
Timerange: 00/07:36:11 to 00/07:39:39

Plot file version 325 created 08-APR-2019 12:10:14

MRK622 EM133B.UVDATA.1

Freq = 4.9270 GHz, Bw = 16.000 MH No calibration applied and no bandpass applied

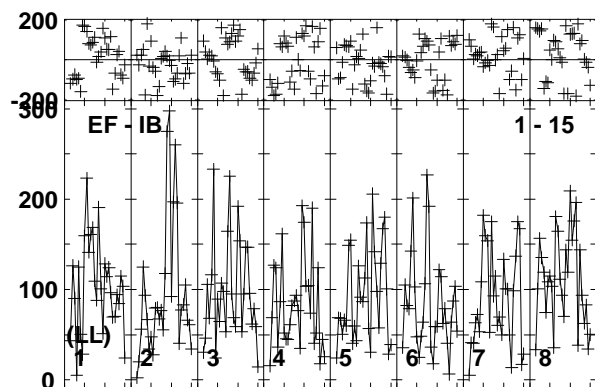
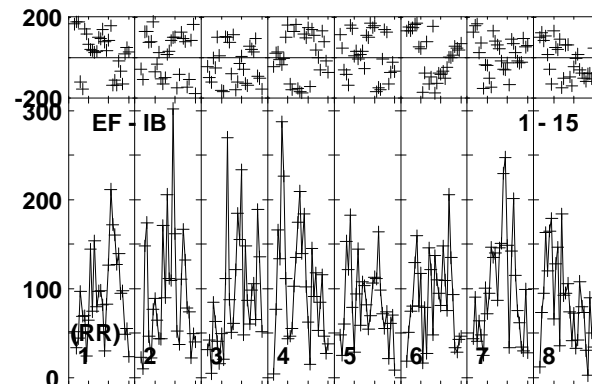
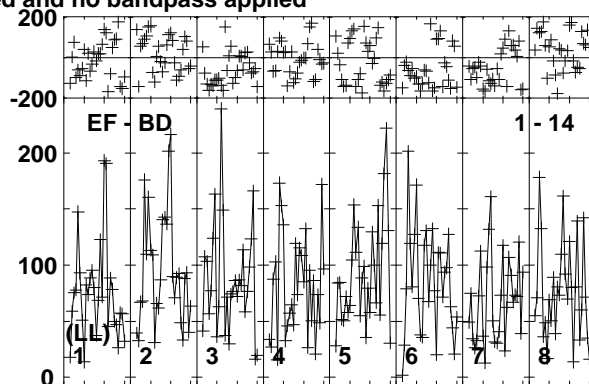
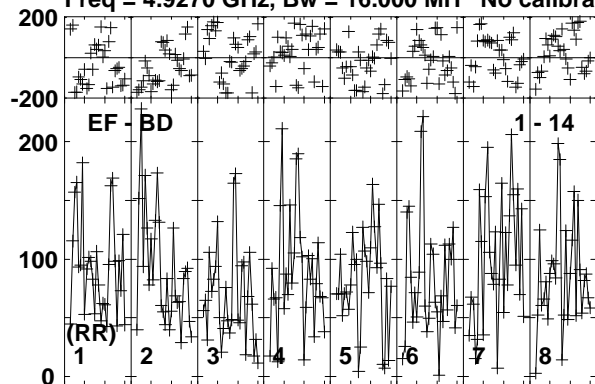

Lower frame: Micro Ampl Jy Top frame: Phas deg  
Vector averaged cross-power spectrum Baseline: EF (01) - BD (14)  
Timerange: 00/07:36:11 to 00/07:39:39

Plot file version 326 created 08-APR-2019 12:10:14

J0815+3635 EM133B.UVDATA.1

Freq = 4.9270 GHz, Bw = 16.000 MH No calibration applied and no bandpass applied

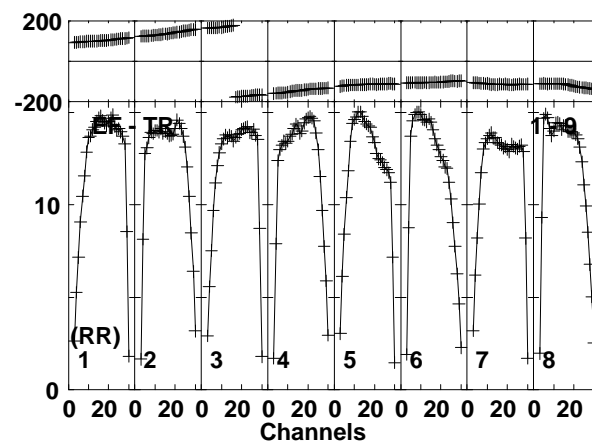
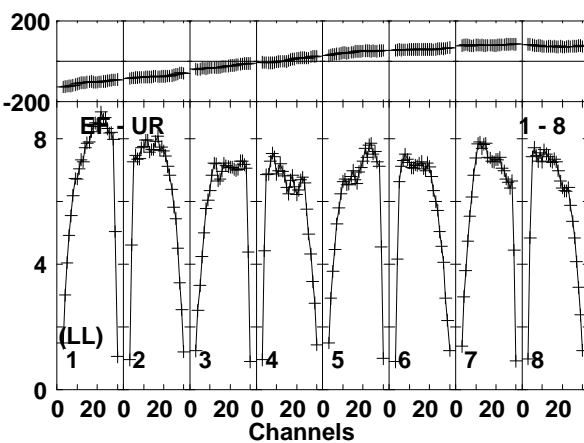
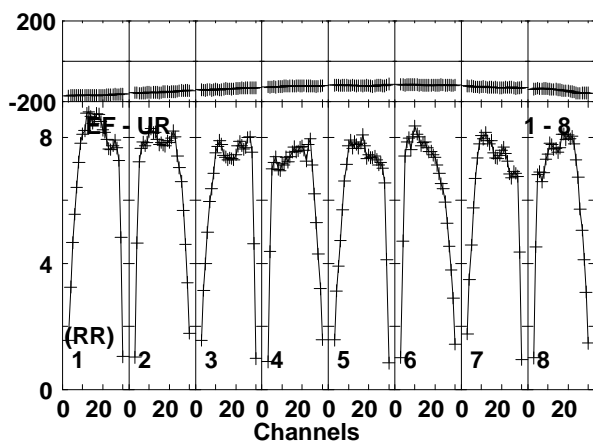
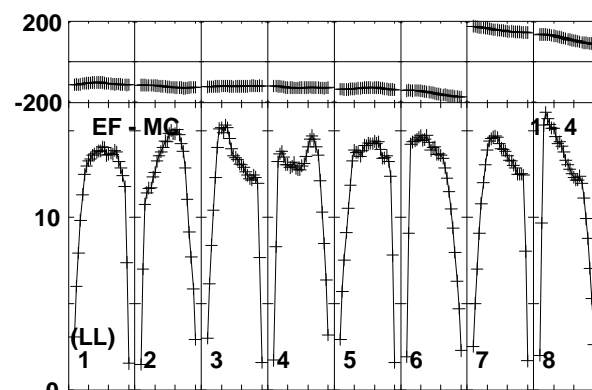
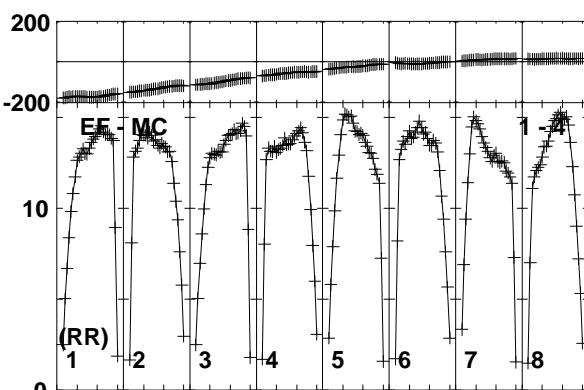
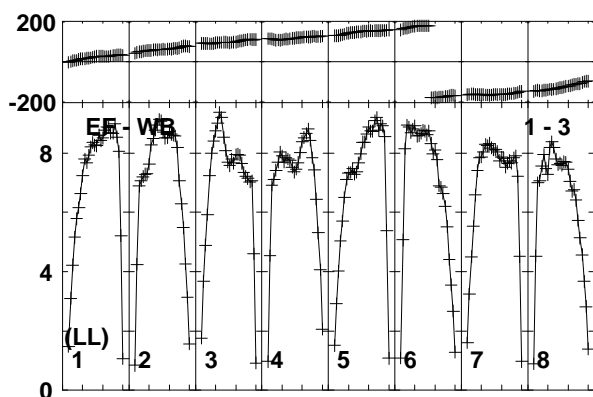
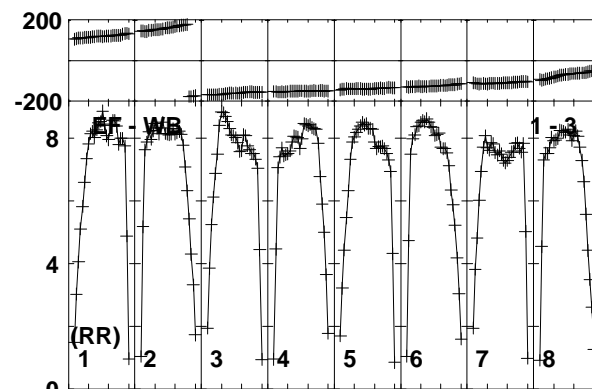
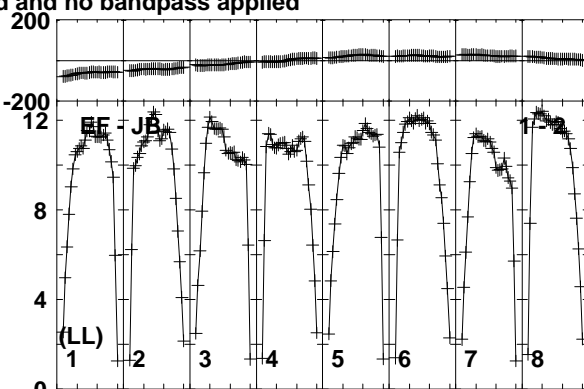
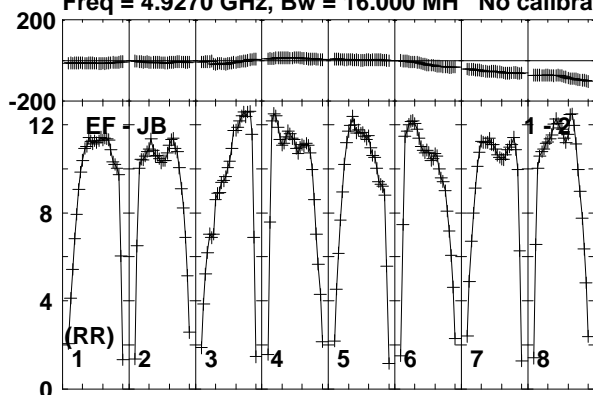

Lower frame: Milli Ampl Jy Top frame: Phas deg  
Vector averaged cross-power spectrum Baseline: EF (01) - JB (02)  
Timerange: 00/07:39:41 to 00/07:41:09

Plot file version 327 created 08-APR-2019 12:10:14

J0815+3635 EM133B.UVDATA.1

Freq = 4.9270 GHz, Bw = 16.000 MH No calibration applied and no bandpass applied

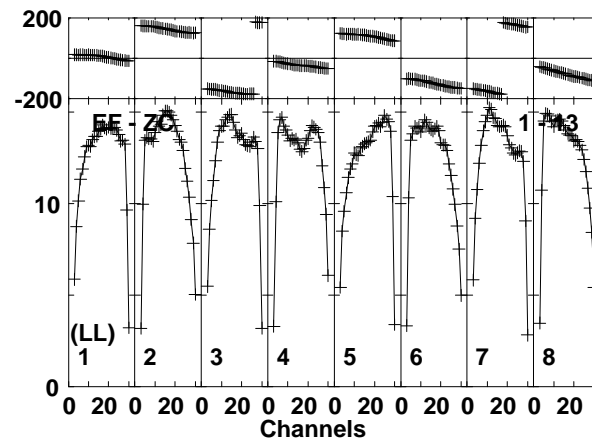
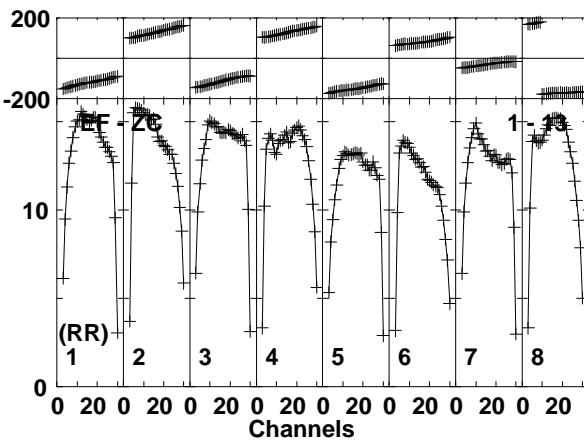
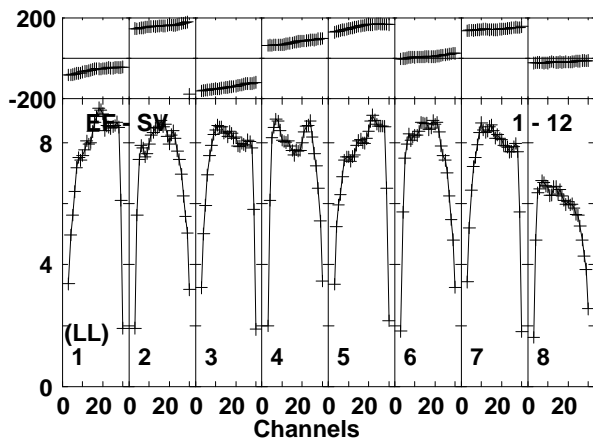
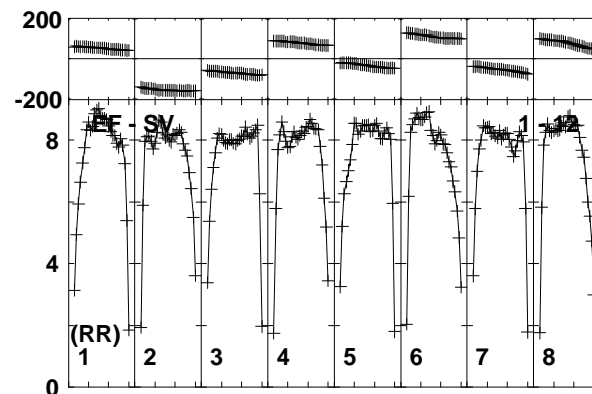
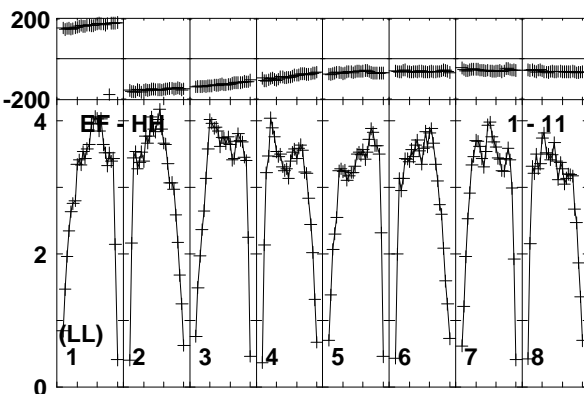
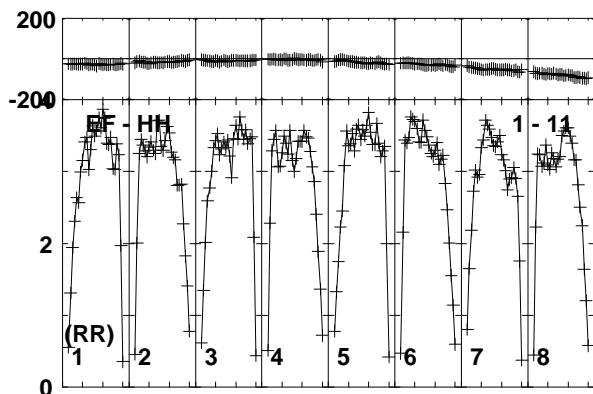
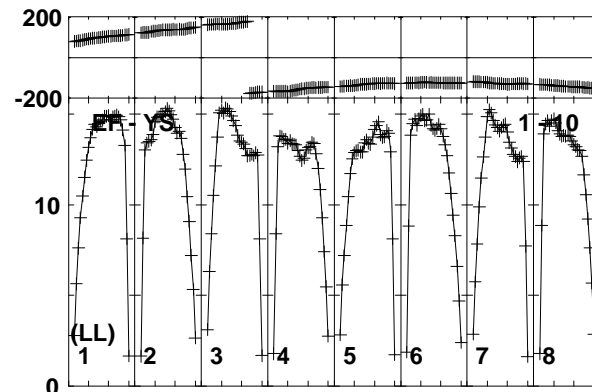
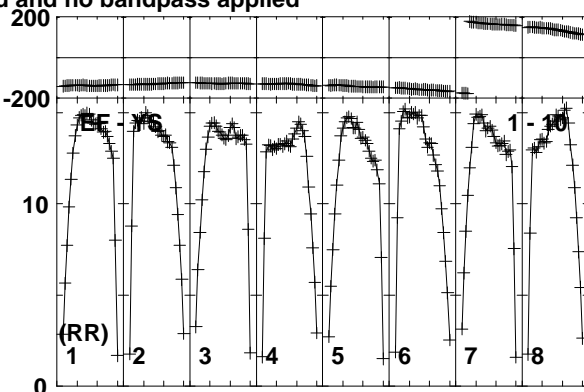
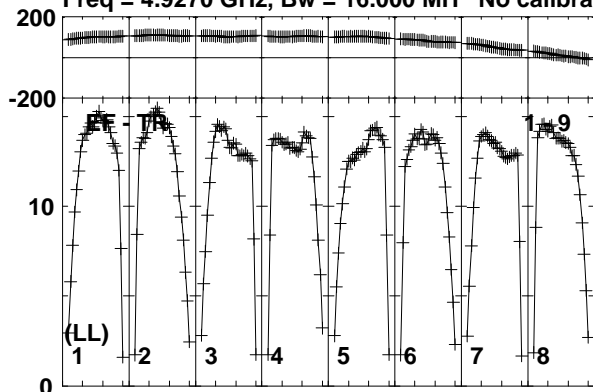

Lower frame: Milli Ampl Jy Top frame: Phas deg  
Vector averaged cross-power spectrum Baseline: EF (01) - TR (09)  
Timerange: 00/07:39:41 to 00/07:41:09

Plot file version 328 created 08-APR-2019 12:10:14

J0815+3635 EM133B.UVDATA.1

Freq = 4.9270 GHz, Bw = 16.000 MH No calibration applied and no bandpass applied

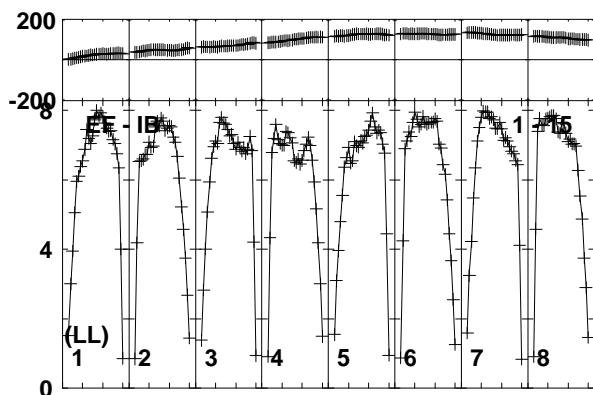
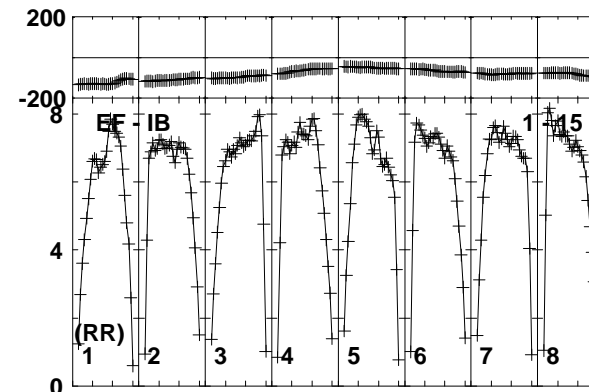
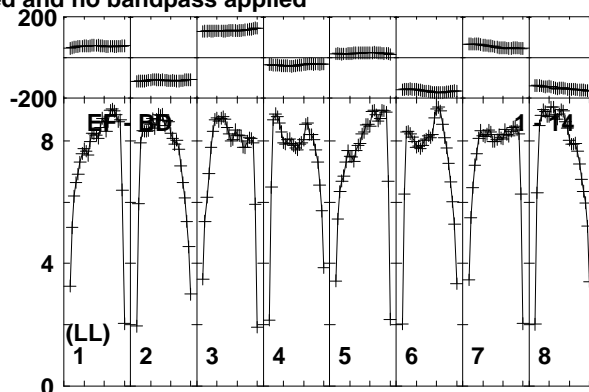
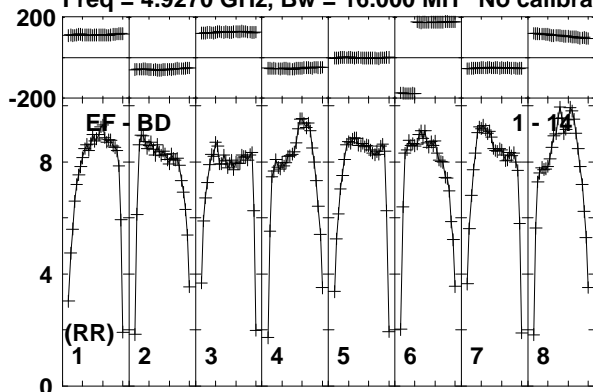

Lower frame: Milli Ampl Jy Top frame: Phas deg  
Vector averaged cross-power spectrum Baseline: EF (01) - BD (14)  
Timerange: 00/07:39:41 to 00/07:41:09



Plot file version 329 created 08-APR-2019 12:10:14

MRK622 EM133B.UVDATA.1

Freq = 4.9270 GHz, Bw = 16.000 MH No calibration applied and no bandpass applied

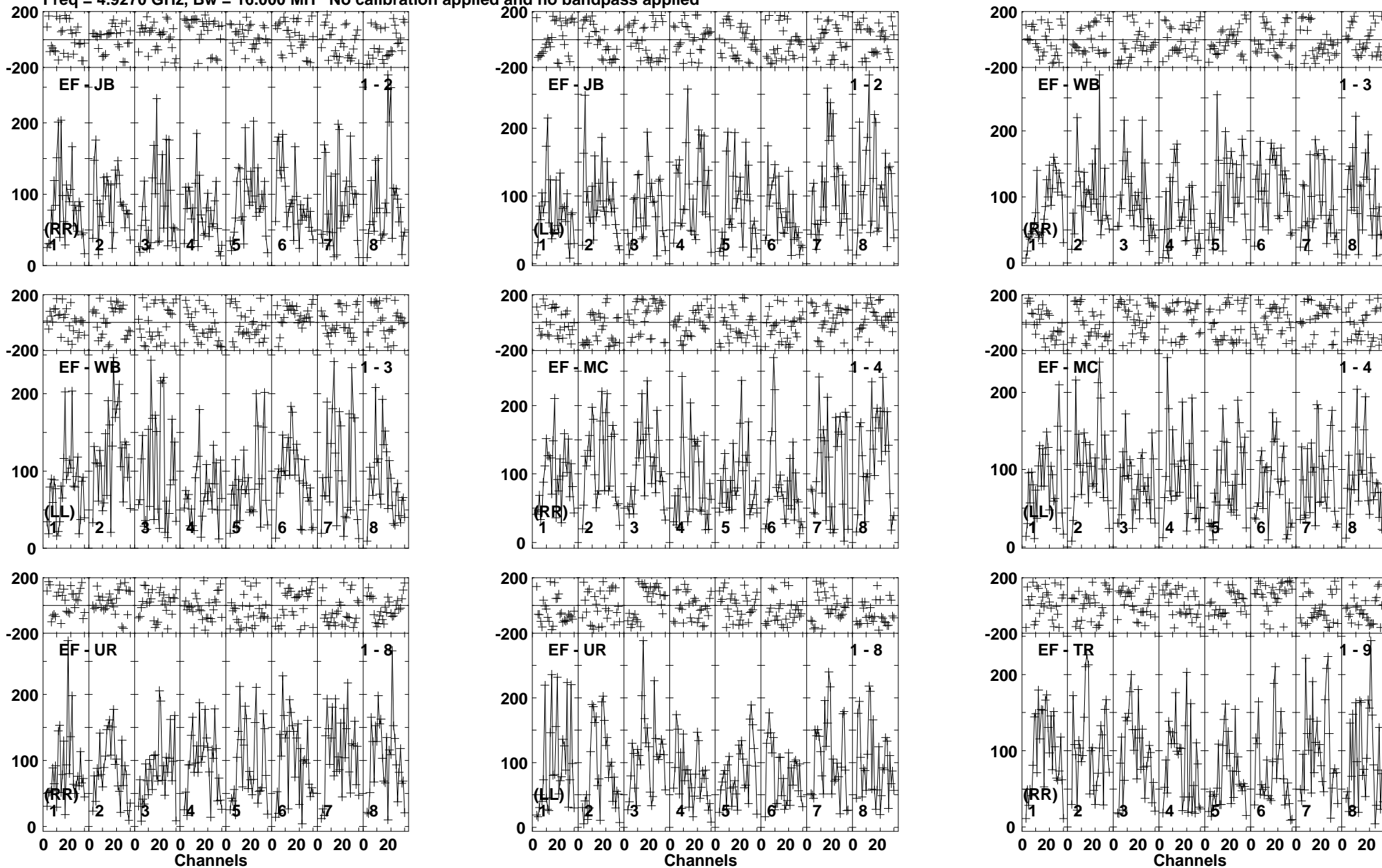

Lower frame: Micro Ampl Jy Top frame: Phas deg  
Vector averaged cross-power spectrum Baseline: EF (01) - JB (02)  
Timerange: 00/07:41:13 to 00/07:44:39

Plot file version 330 created 08-APR-2019 12:10:15

MRK622 EM133B.UVDATA.1

Freq = 4.9270 GHz, Bw = 16.000 MH No calibration applied and no bandpass applied

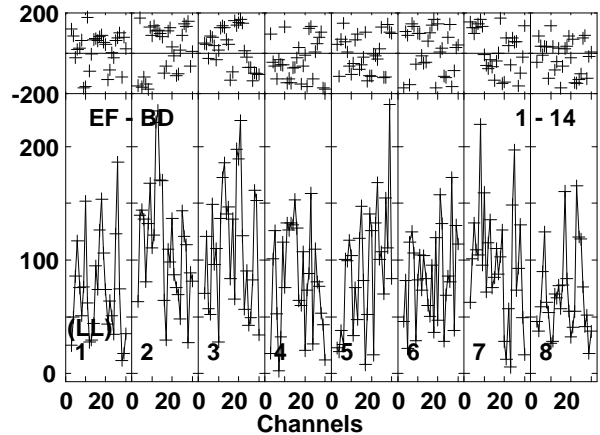
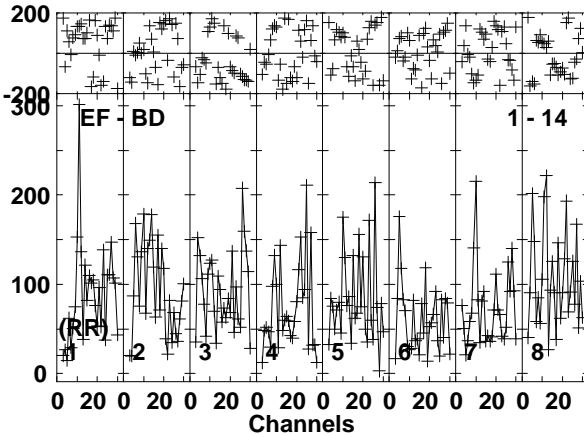
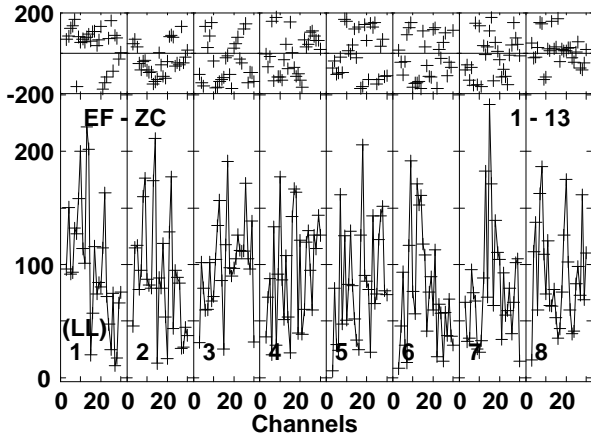
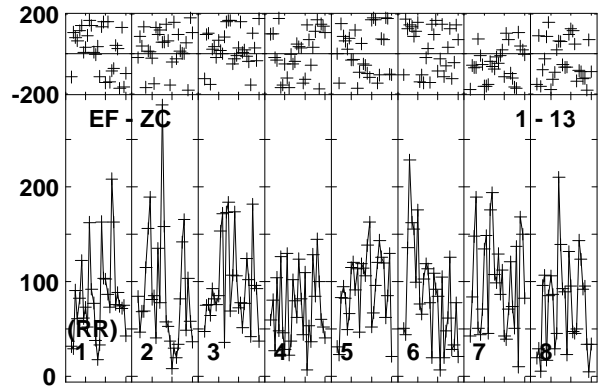
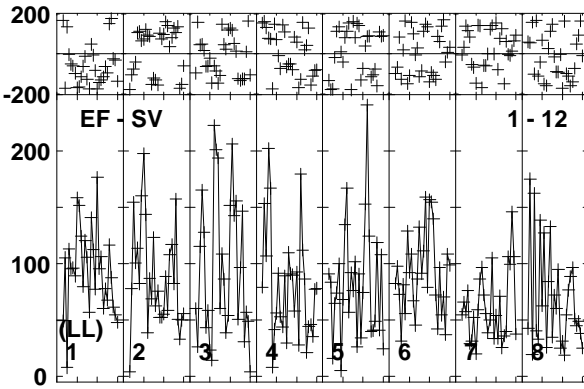
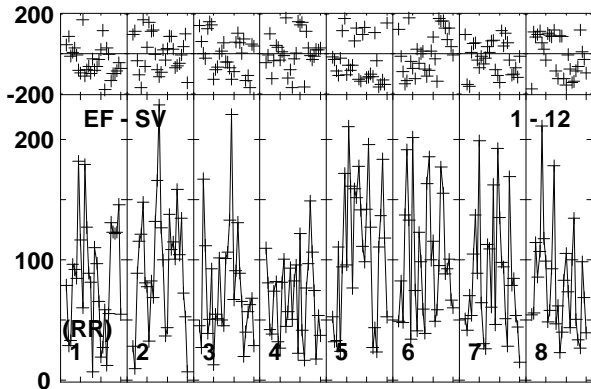
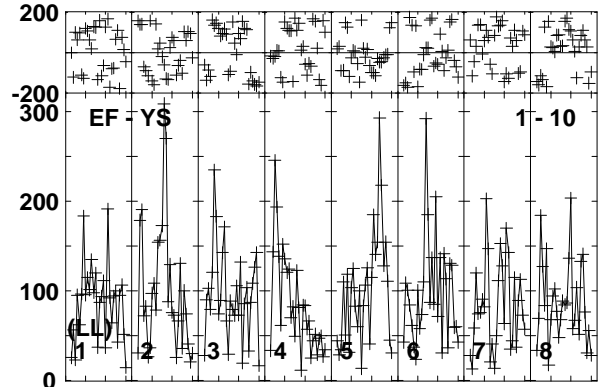
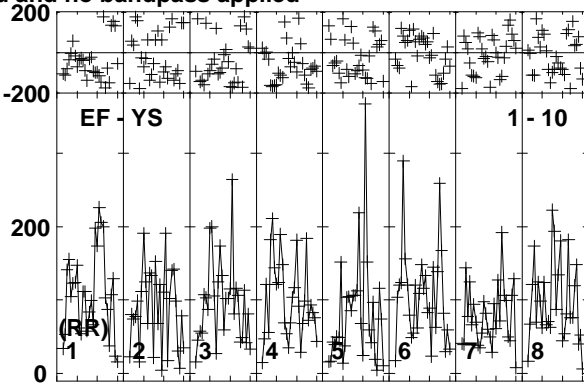
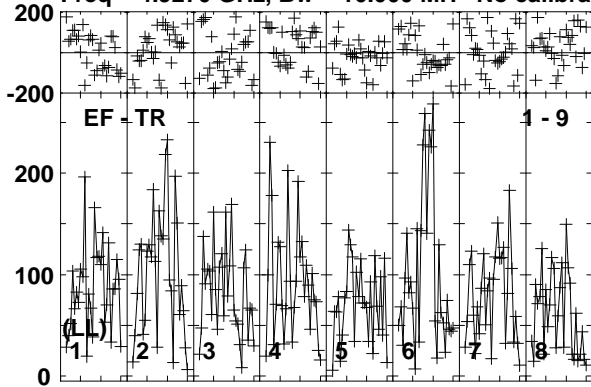

Lower frame: Micro Ampl Jy Top frame: Phas deg  
Vector averaged cross-power spectrum Baseline: EF (01) - TR (09)  
Timerange: 00/07:41:13 to 00/07:44:39

Plot file version 331 created 08-APR-2019 12:10:15

MRK622 EM133B.UVDATA.1

Freq = 4.9270 GHz, Bw = 16.000 MH No calibration applied and no bandpass applied

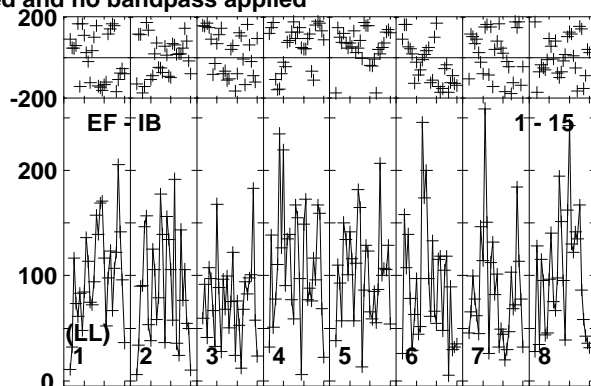
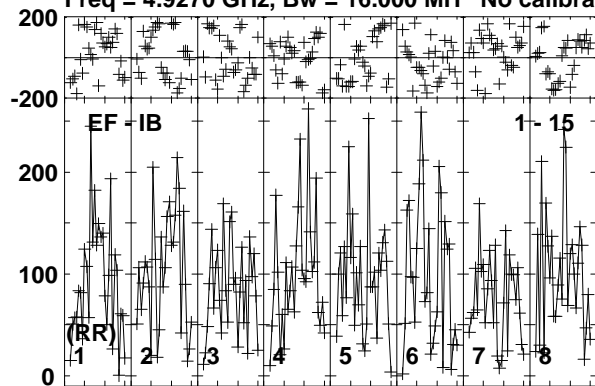

Lower frame: Micro Ampl Jy Top frame: Phas deg  
Vector averaged cross-power spectrum Baseline: EF (01) - IB (15)  
Timerange: 00/07:41:13 to 00/07:44:39

Plot file version 332 created 08-APR-2019 12:10:15

J0815+3635 EM133B.UVDATA.1

Freq = 4.9270 GHz, Bw = 16.000 MH No calibration applied and no bandpass applied

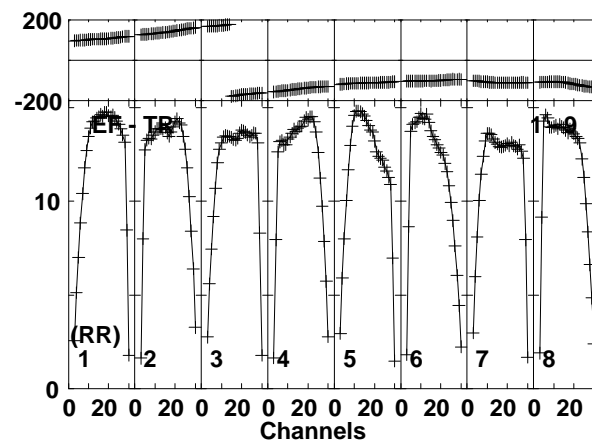
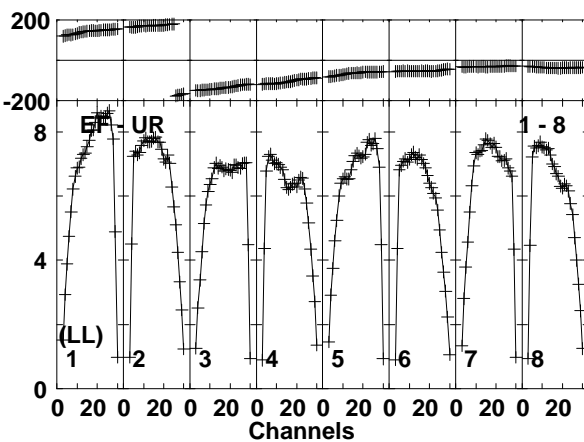
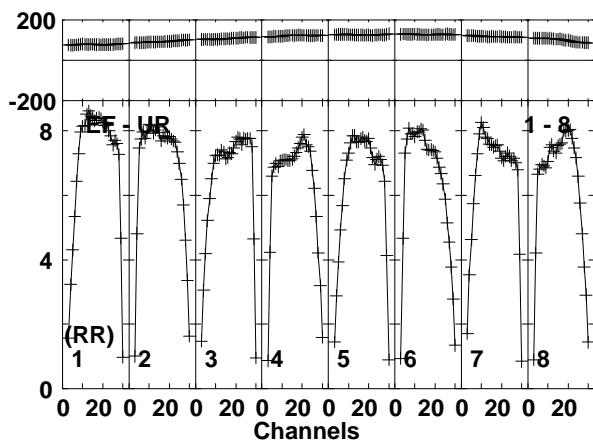
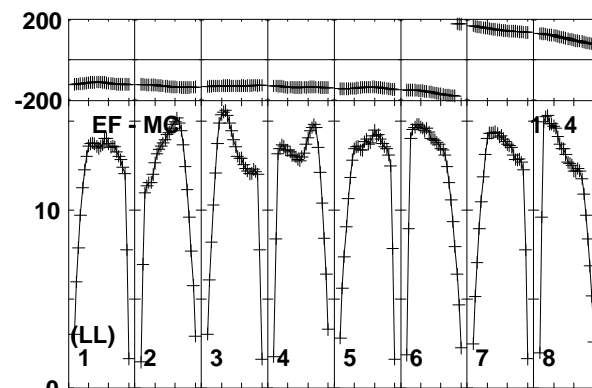
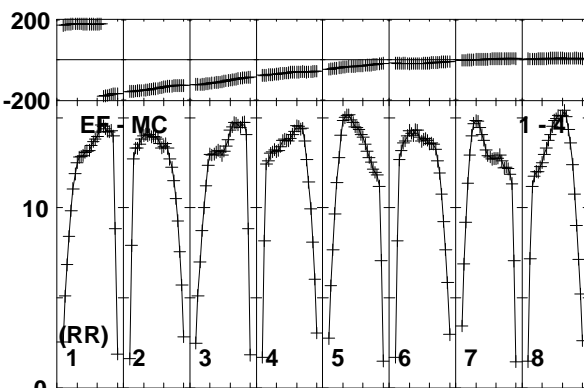
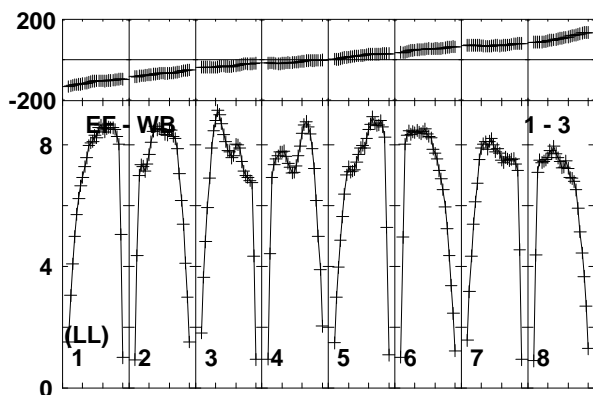
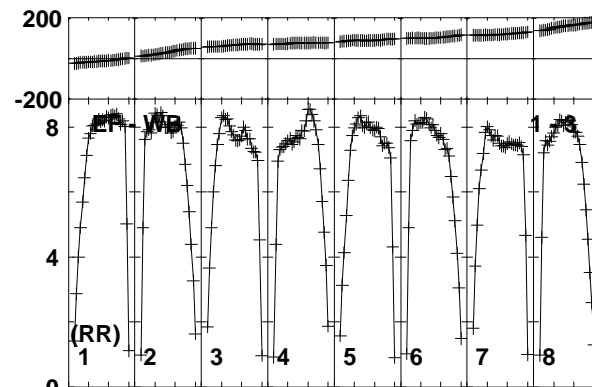
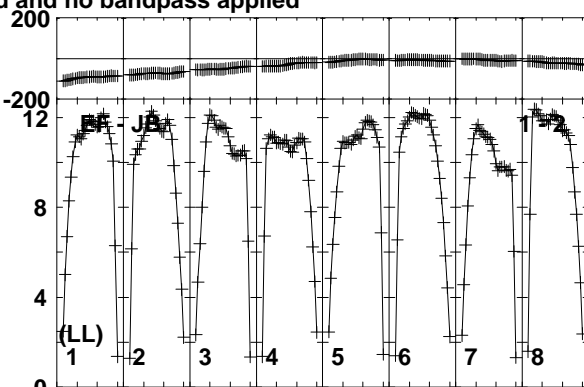
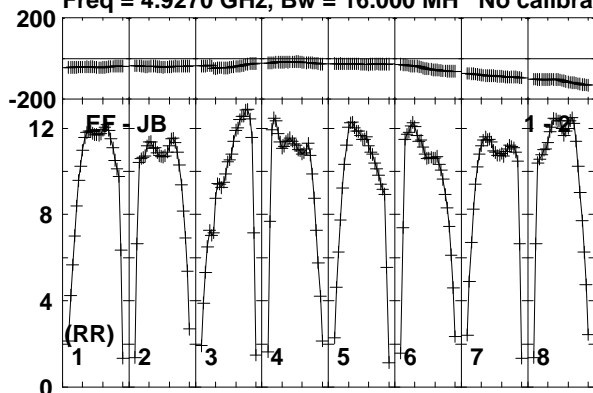

Lower frame: Milli Ampl Jy Top frame: Phas deg  
Vector averaged cross-power spectrum Baseline: EF (01) - JB (02)  
Timerange: 00/07:45:31 to 00/07:46:59

Plot file version 333 created 08-APR-2019 12:10:15

J0815+3635 EM133B.UVDATA.1

Freq = 4.9270 GHz, Bw = 16.000 MH No calibration applied and no bandpass applied

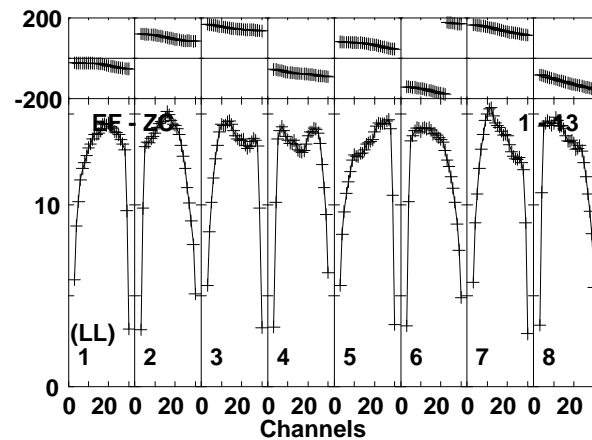
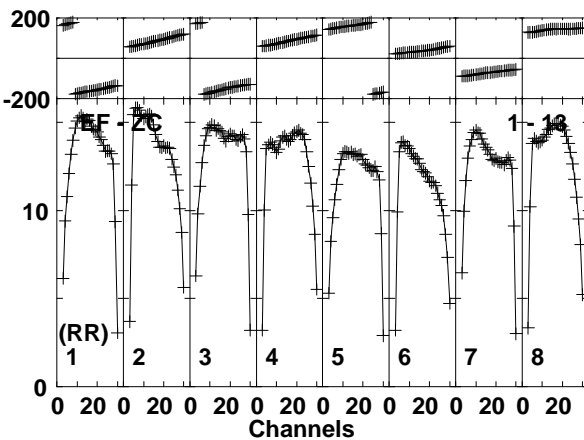
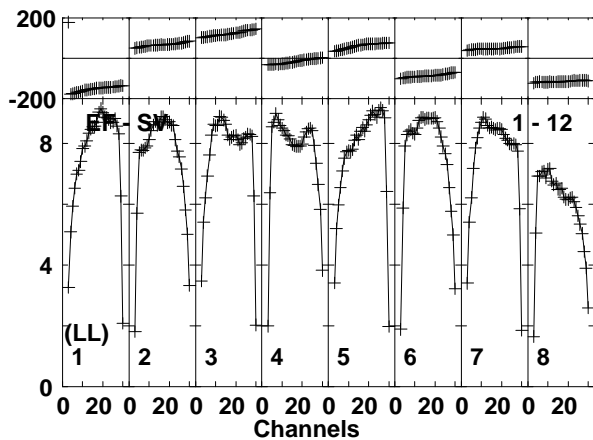
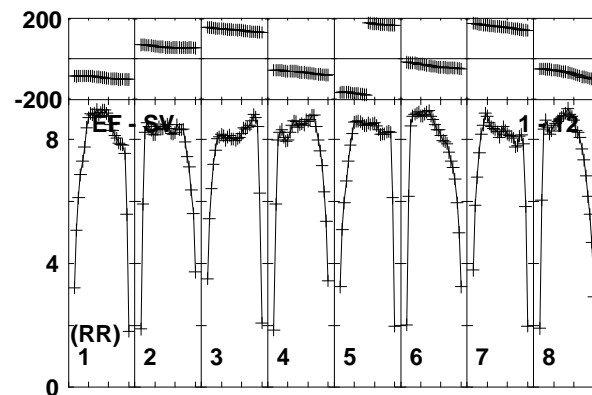
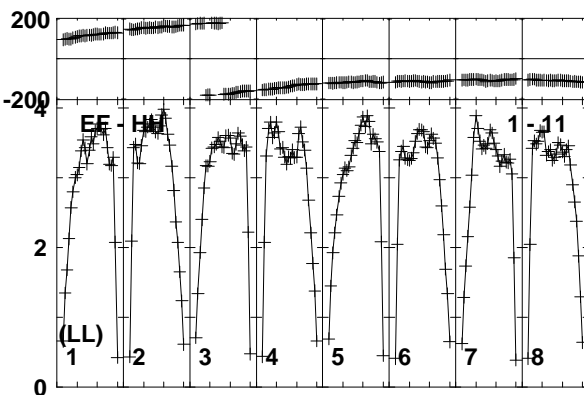
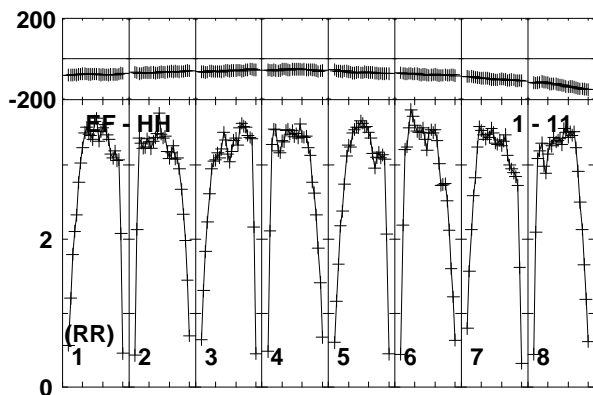
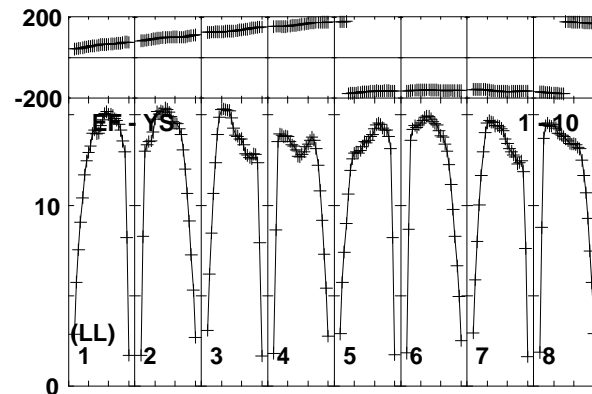
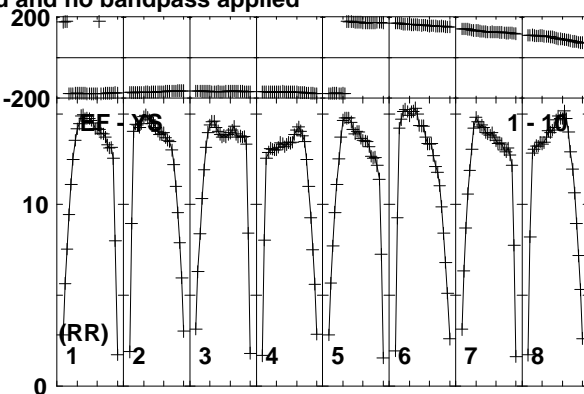
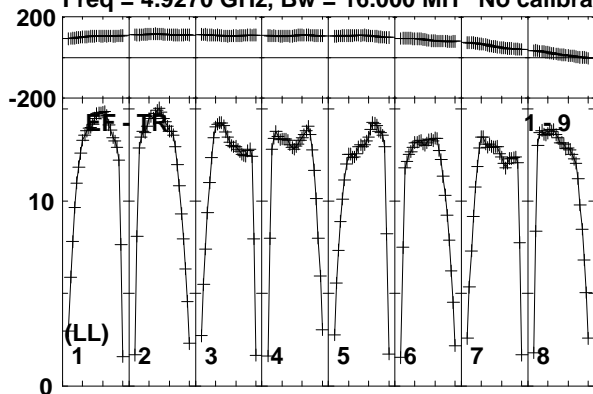

Lower frame: Milli Ampl Jy Top frame: Phas deg  
Vector averaged cross-power spectrum Baseline: EF (01) - TR (09)  
Timerange: 00/07:45:31 to 00/07:46:59

Plot file version 334 created 08-APR-2019 12:10:15

J0815+3635 EM133B.UVDATA.1

Freq = 4.9270 GHz, Bw = 16.000 MH No calibration applied and no bandpass applied

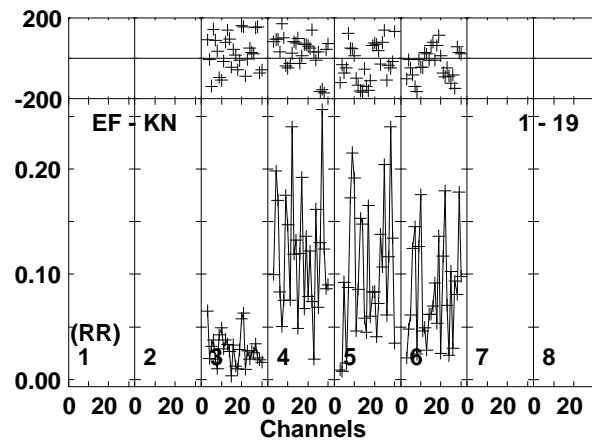
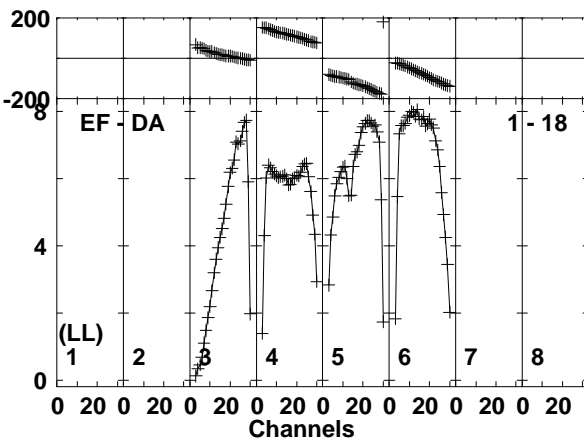
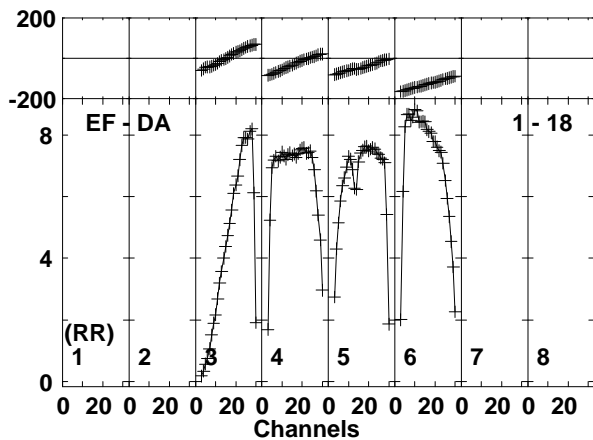
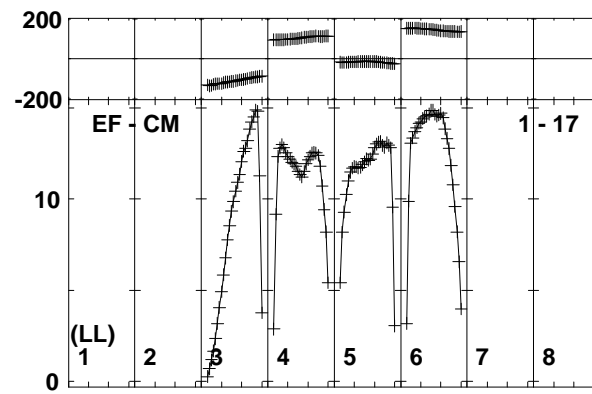
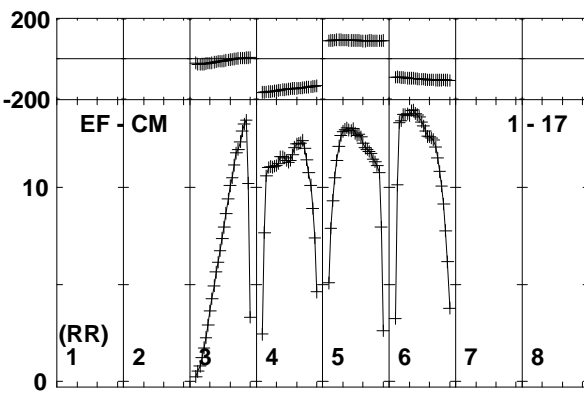
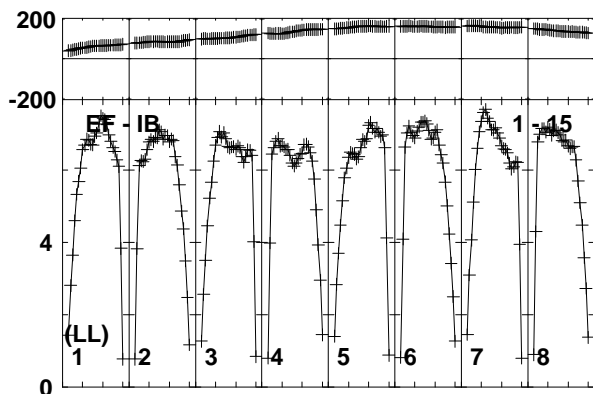
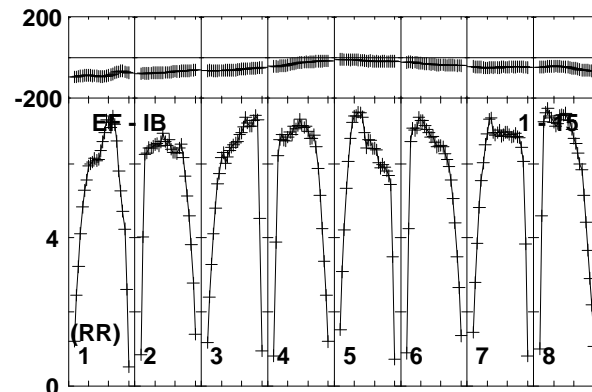
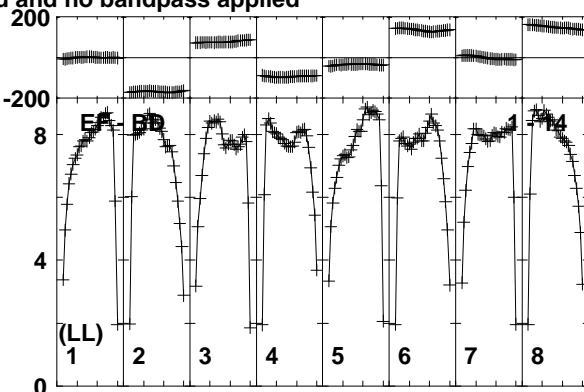
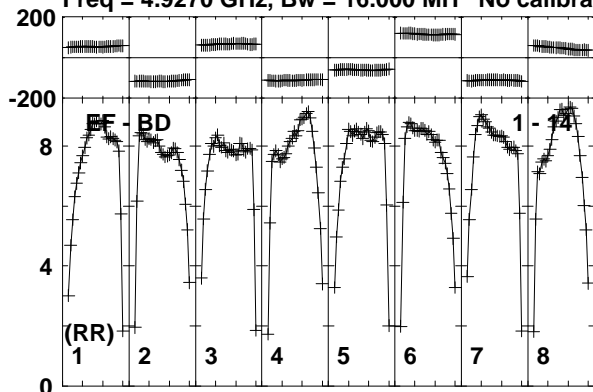

Lower frame: Milli Ampl Jy Top frame: Phas deg  
Vector averaged cross-power spectrum Baseline: EF (01) - BD (14)  
Timerange: 00/07:45:31 to 00/07:46:59

Plot file version 335 created 08-APR-2019 12:10:15

J0815+3635 EM133B.UVDATA.1

Freq = 4.9270 GHz, Bw = 16.000 MH No calibration applied and no bandpass applied

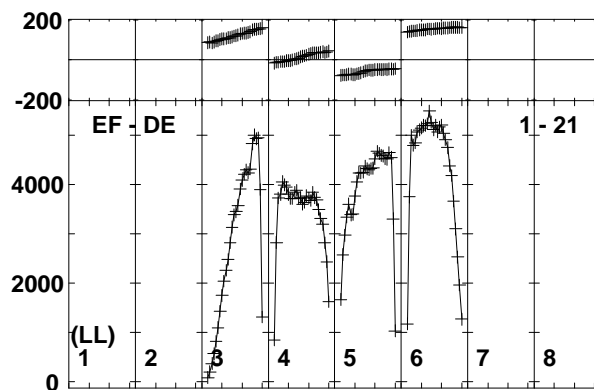
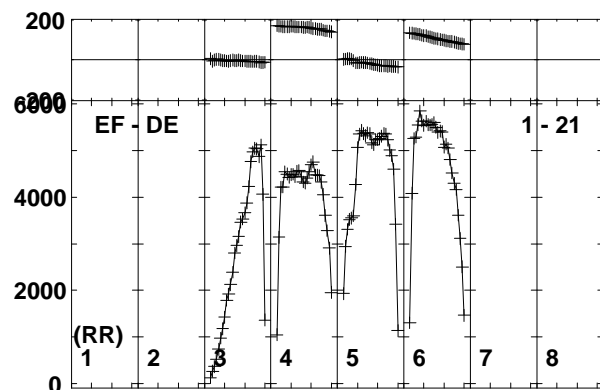
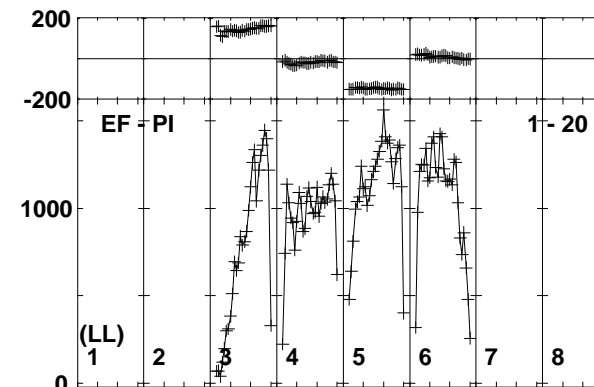
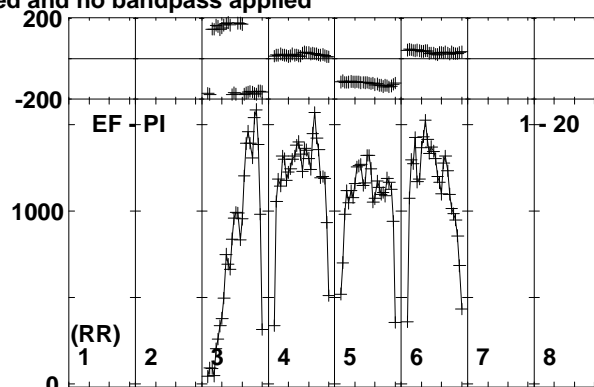
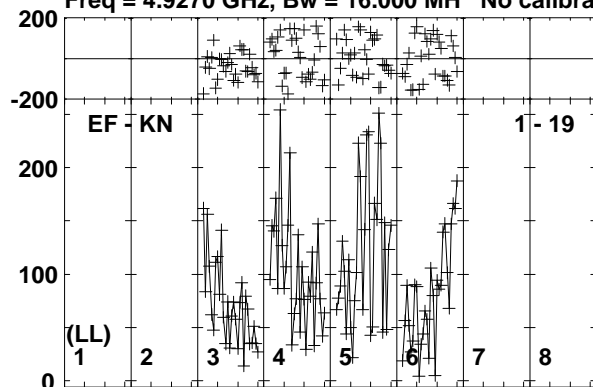

Lower frame: Micro Ampl Jy Top frame: Phas deg  
Vector averaged cross-power spectrum Baseline: EF (01) - KN (19)  
Timerange: 00/07:45:31 to 00/07:46:59

Plot file version 336 created 08-APR-2019 12:10:15

MRK622 EM133B.UVDATA.1

Freq = 4.9270 GHz, Bw = 16.000 MH No calibration applied and no bandpass applied

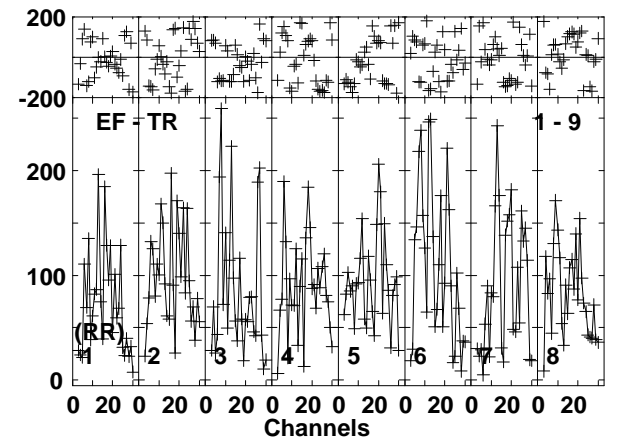
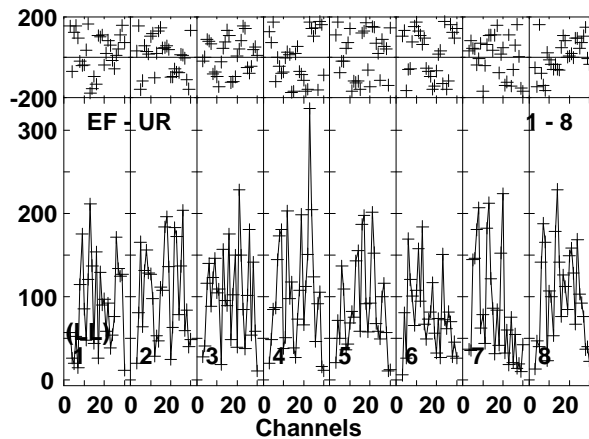
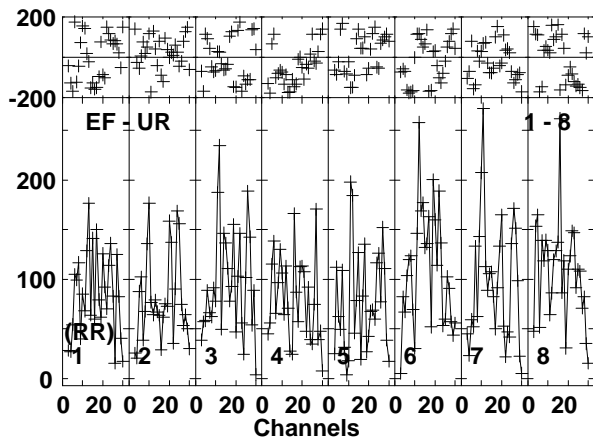
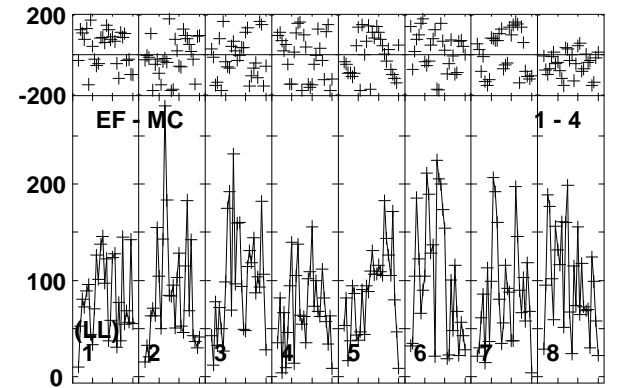
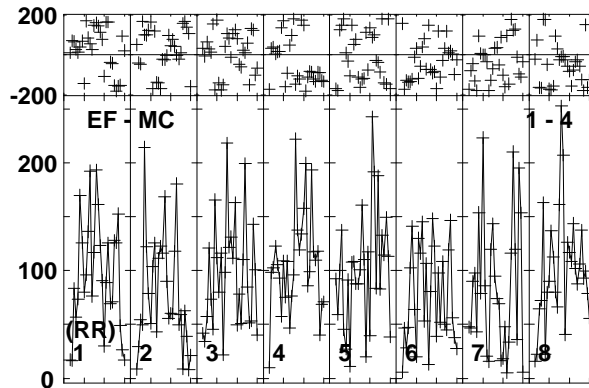
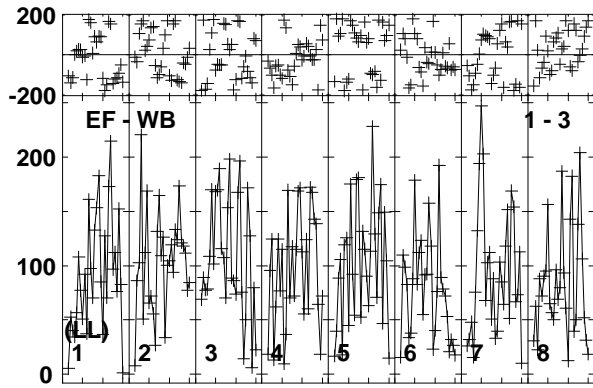
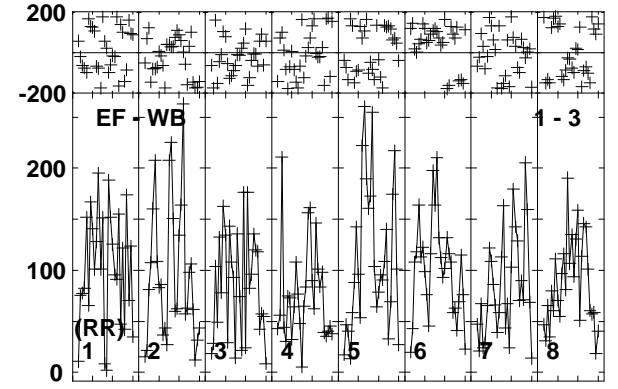
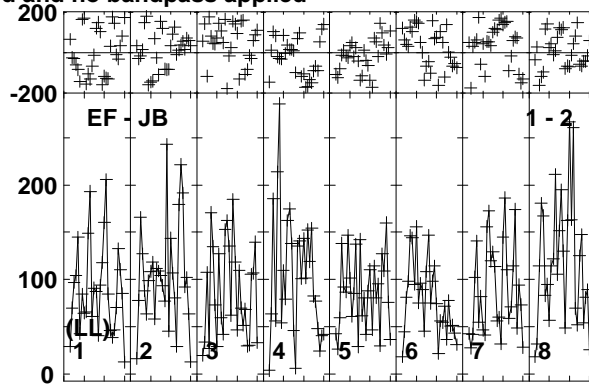
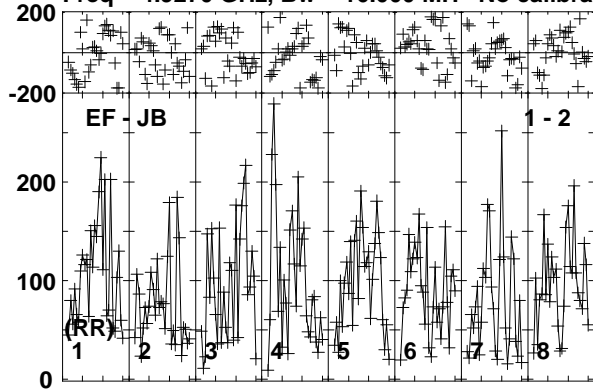

Lower frame: Micro Ampl Jy Top frame: Phas deg  
Vector averaged cross-power spectrum Baseline: EF (01) - JB (02)  
Timerange: 00/07:47:01 to 00/07:50:29



Plot file version 337 created 08-APR-2019 12:10:16

MRK622 EM133B.UVDATA.1

Freq = 4.9270 GHz, Bw = 16.000 MH No calibration applied and no bandpass applied

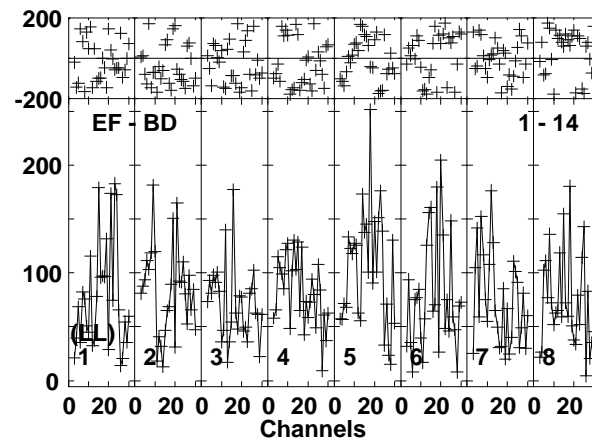
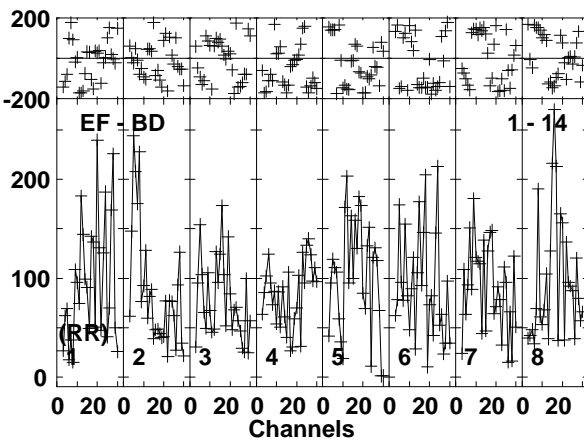
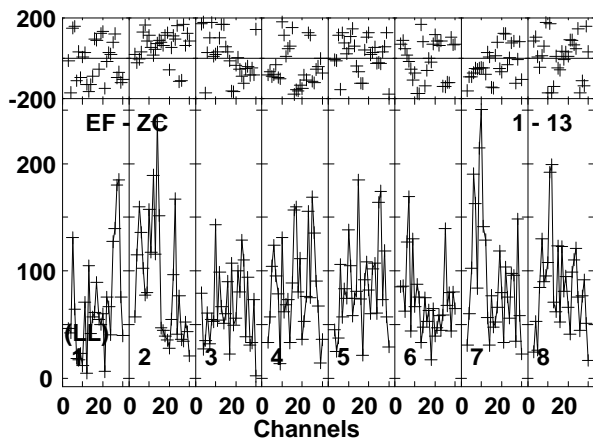
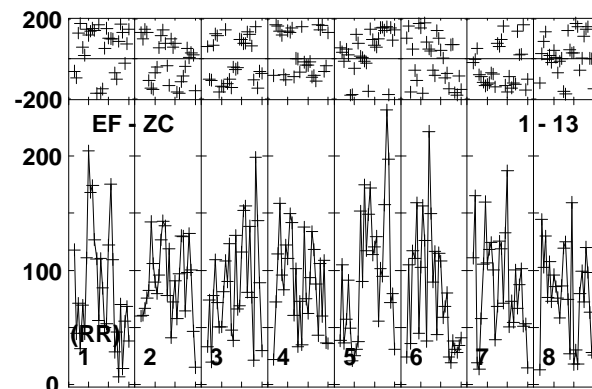
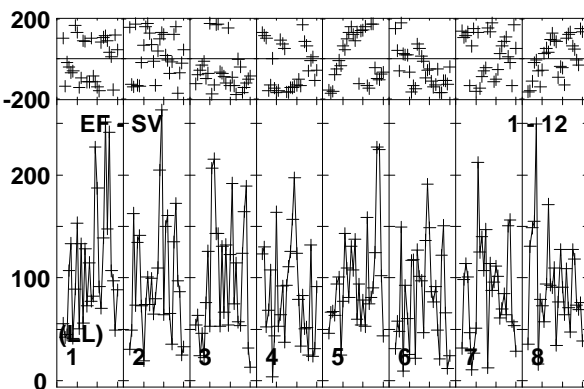
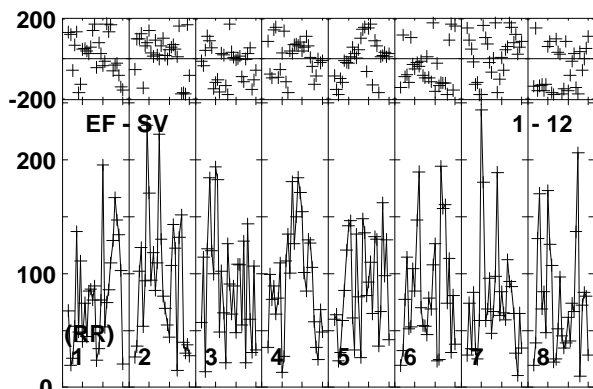
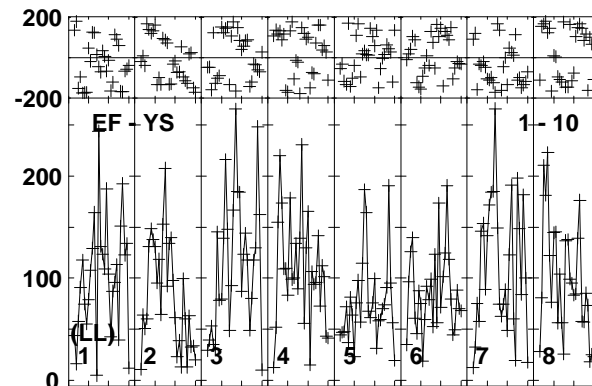
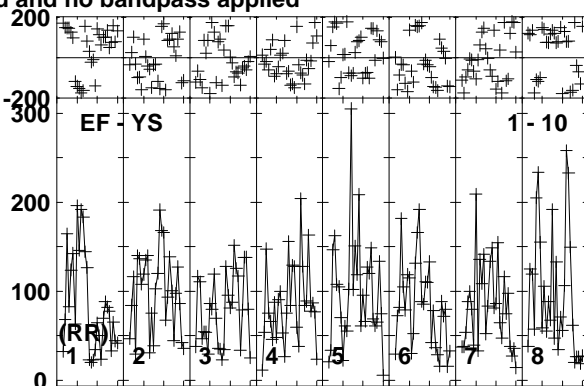
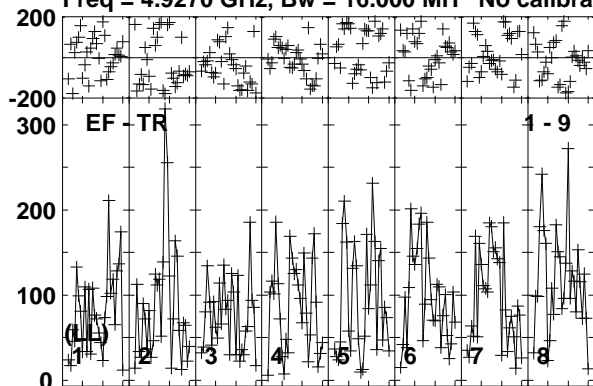

Lower frame: Micro Ampl Jy Top frame: Phas deg  
Vector averaged cross-power spectrum Baseline: EF (01) - TR (09)  
Timerange: 00/07:47:01 to 00/07:50:29

Plot file version 338 created 08-APR-2019 12:10:16

MRK622 EM133B.UVDATA.1

Freq = 4.9270 GHz, Bw = 16.000 MH No calibration applied and no bandpass applied

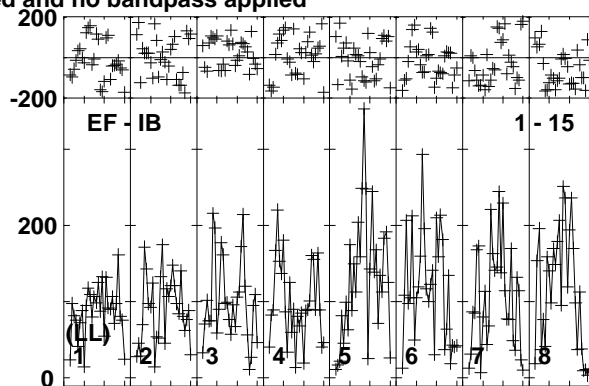
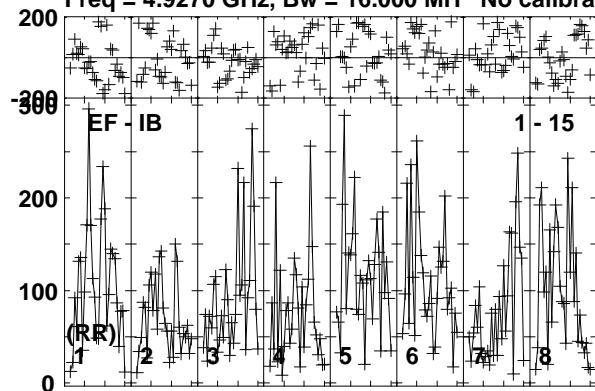

Lower frame: Micro Ampl Jy Top frame: Phas deg  
Vector averaged cross-power spectrum Baseline: EF (01) - IB (15)  
Timerange: 00/07:47:01 to 00/07:50:29

Plot file version 339 created 08-APR-2019 12:10:16

J0815+3635 EM133B.UVDATA.1

Freq = 4.9270 GHz, Bw = 16.000 MH No calibration applied and no bandpass applied

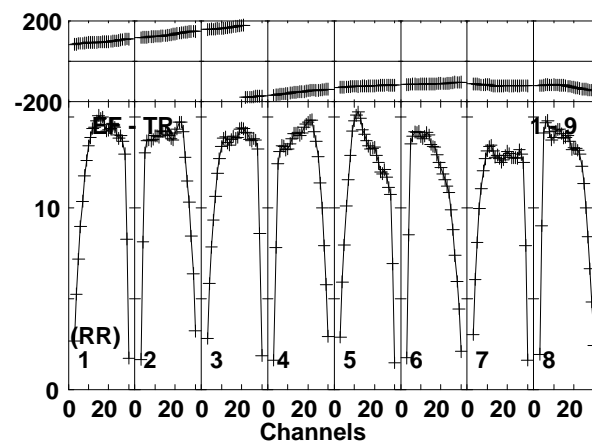
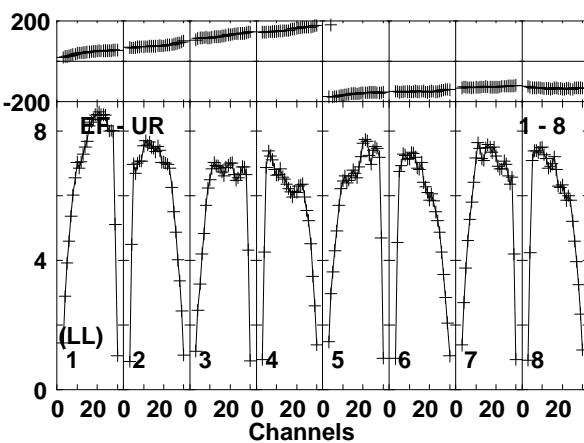
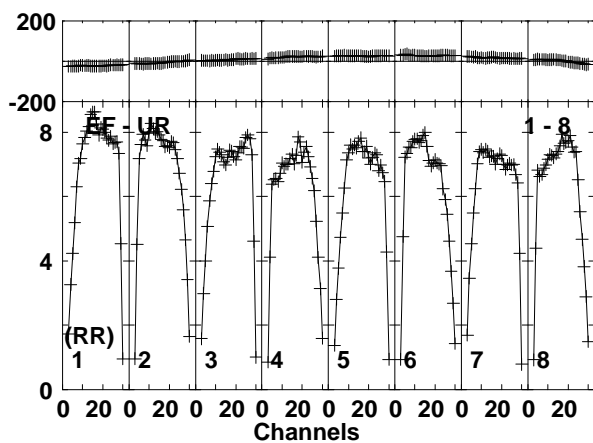
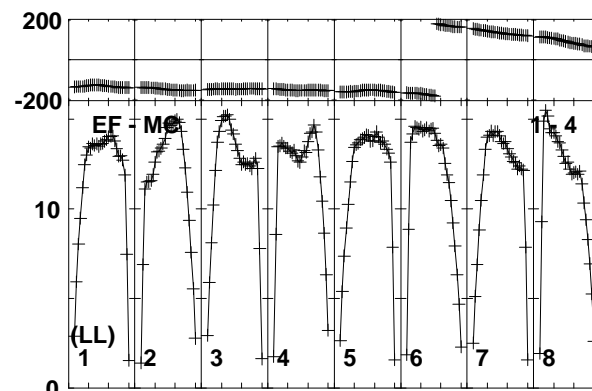
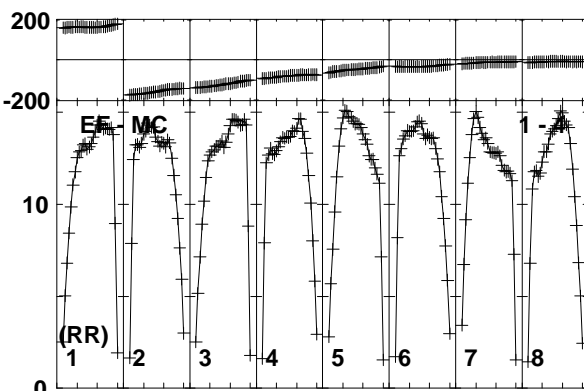
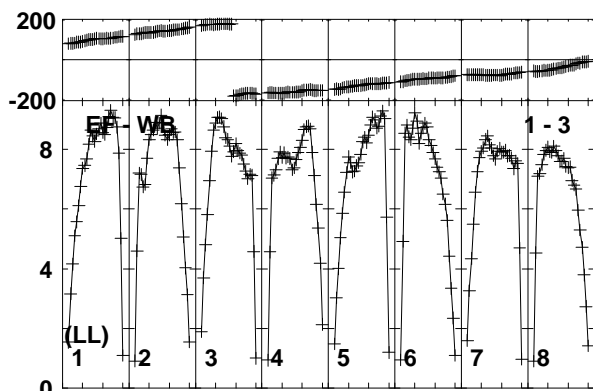
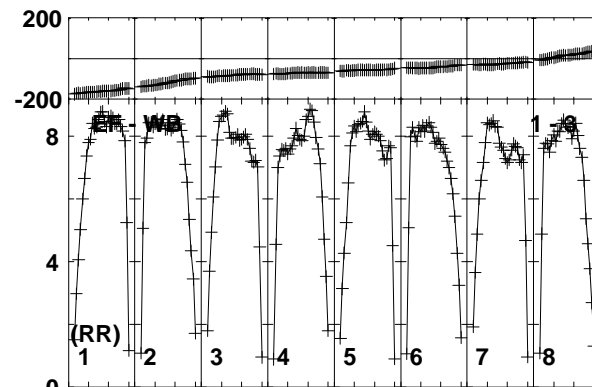
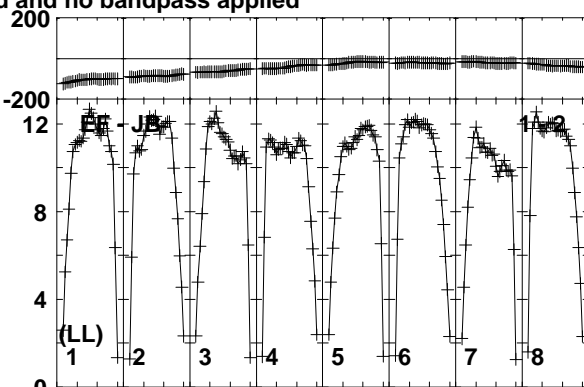
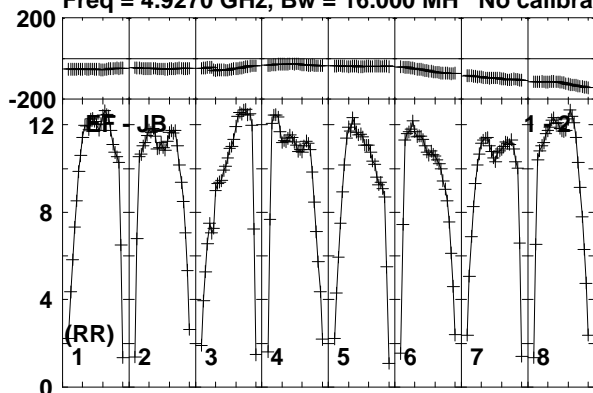

Lower frame: Milli Ampl Jy Top frame: Phas deg  
Vector averaged cross-power spectrum Baseline: EF (01) - JB (02)  
Timerange: 00/07:50:31 to 00/07:51:59

Plot file version 340 created 08-APR-2019 12:10:16

J0815+3635 EM133B.UVDATA.1

Freq = 4.9270 GHz, Bw = 16.000 MH No calibration applied and no bandpass applied

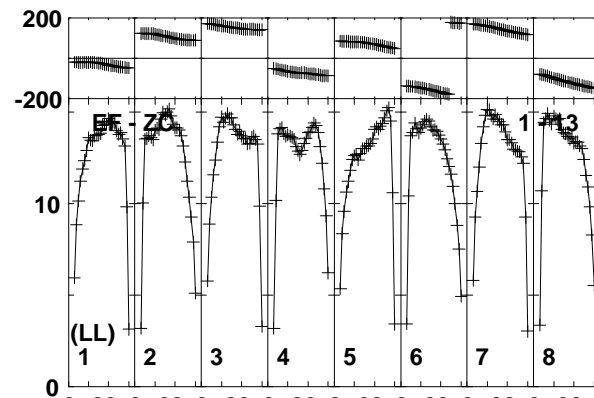
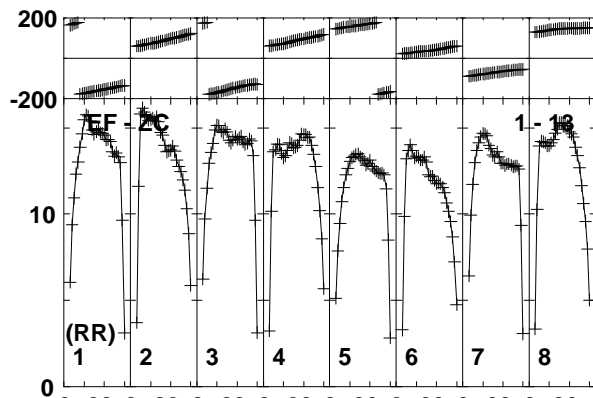
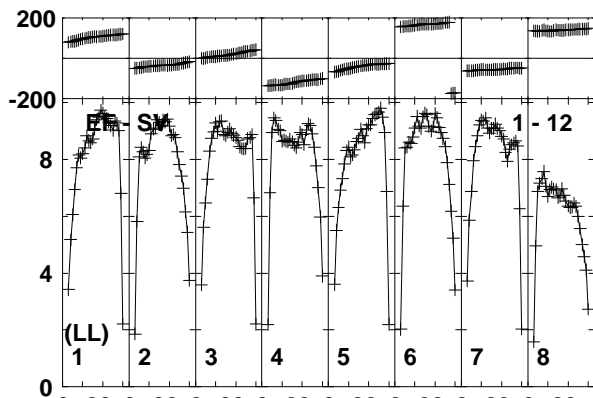
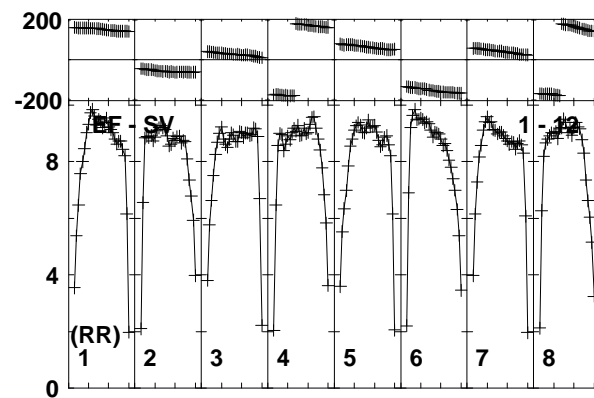
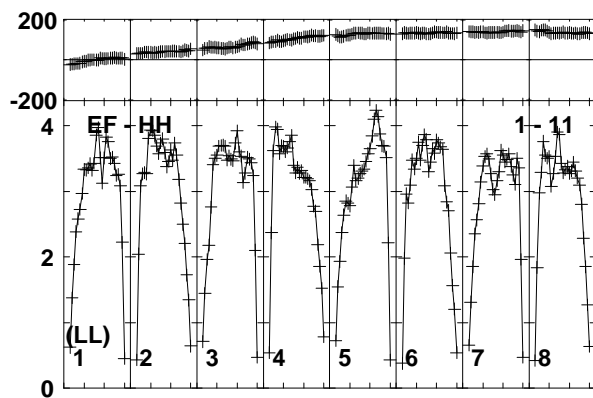
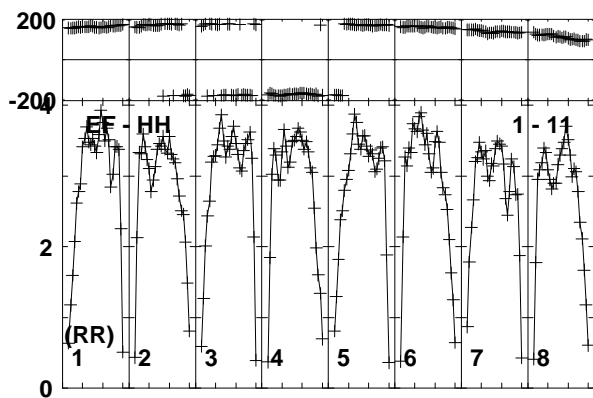
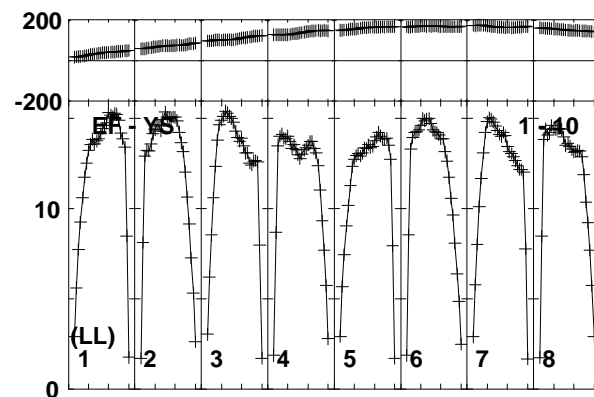
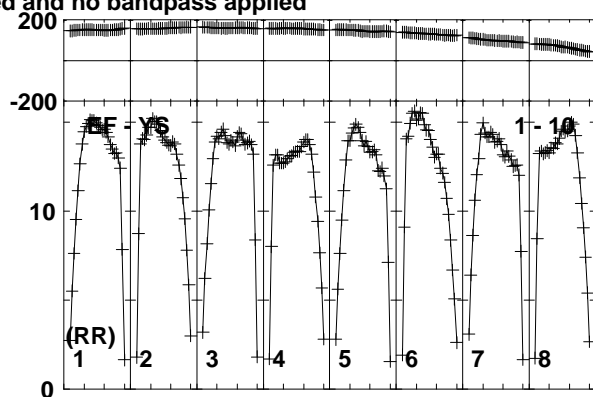
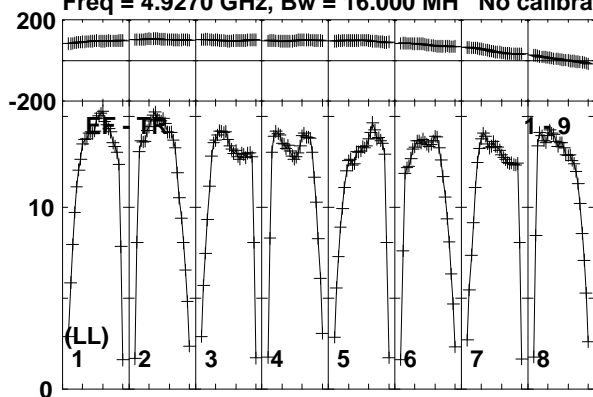

Lower frame: Milli Ampl Jy Top frame: Phas deg  
Vector averaged cross-power spectrum Baseline: EF (01) - TR (09)  
Timerange: 00/07:50:31 to 00/07:51:59

Plot file version 341 created 08-APR-2019 12:10:16

J0815+3635 EM133B.UVDATA.1

Freq = 4.9270 GHz, Bw = 16.000 MH No calibration applied and no bandpass applied

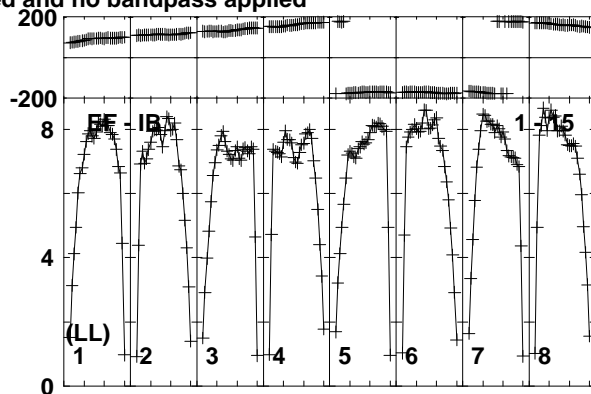
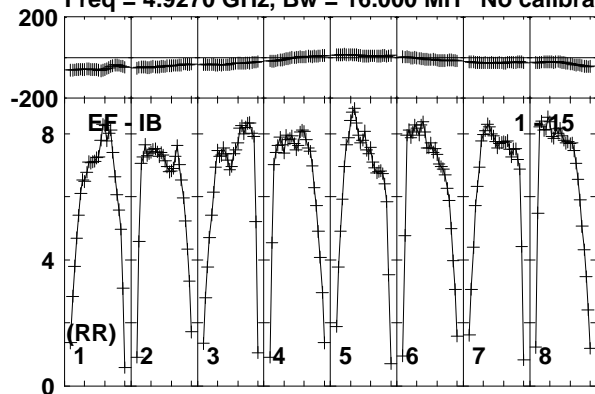

Lower frame: Milli Ampl Jy Top frame: Phas deg  
Vector averaged cross-power spectrum Baseline: EF (01) - IB (15)  
Timerange: 00/07:50:31 to 00/07:51:59

Plot file version 342 created 08-APR-2019 12:10:16

MRK622 EM133B.UVDATA.1

Freq = 4.9270 GHz, Bw = 16.000 MH No calibration applied and no bandpass applied

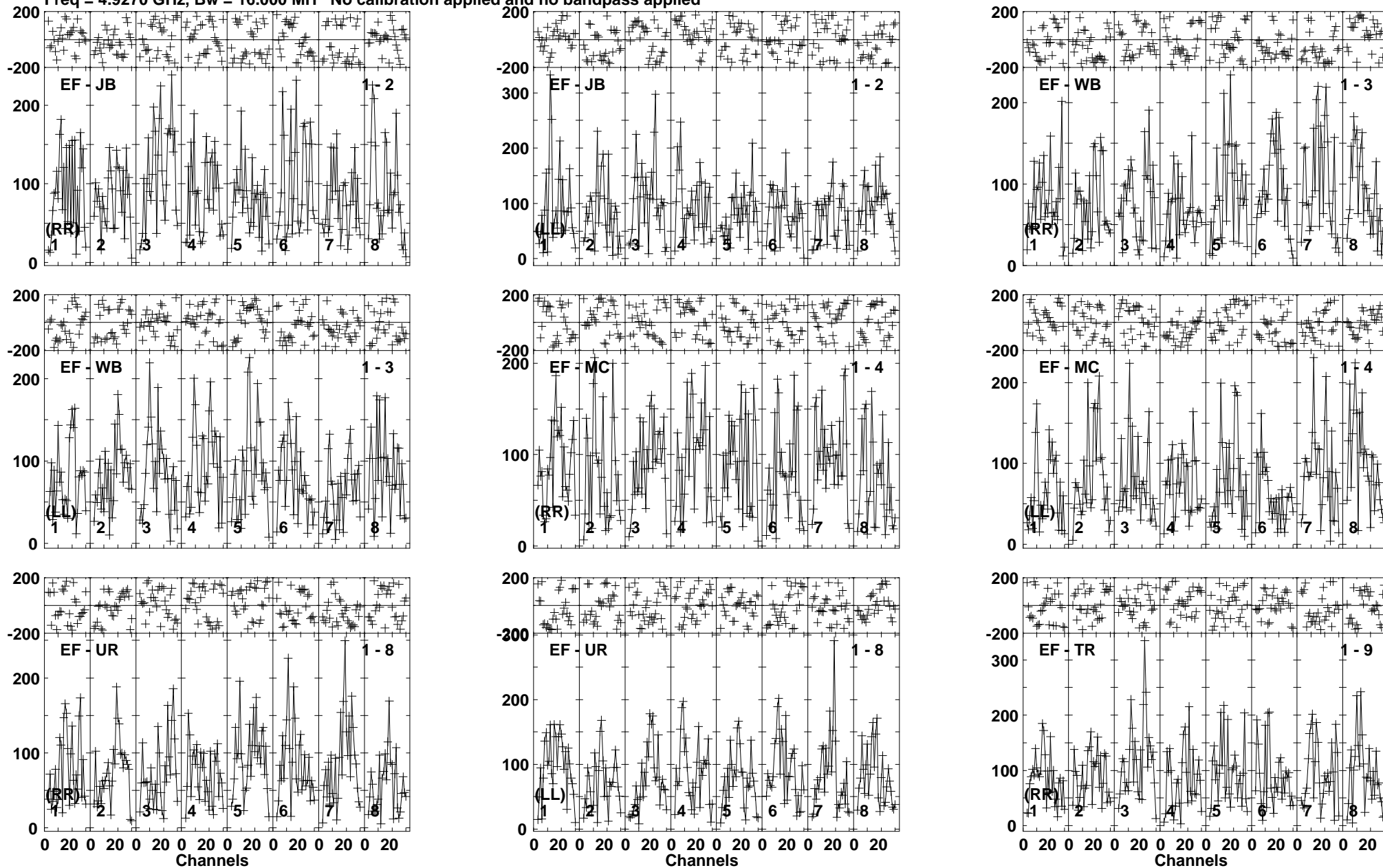

Lower frame: Micro Ampl Jy Top frame: Phas deg  
Vector averaged cross-power spectrum Baseline: EF (01) - JB (02)  
Timerange: 00/07:52:03 to 00/07:55:29

Plot file version 343 created 08-APR-2019 12:10:16

MRK622 EM133B.UVDATA.1

Freq = 4.9270 GHz, Bw = 16.000 MH No calibration applied and no bandpass applied

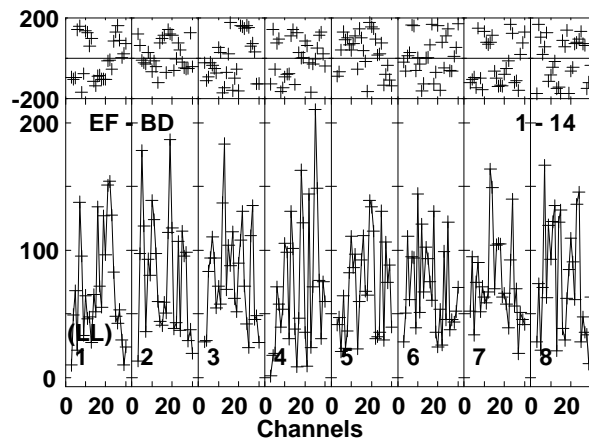
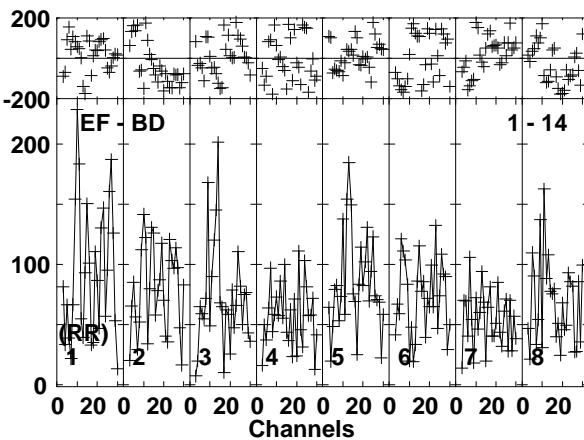
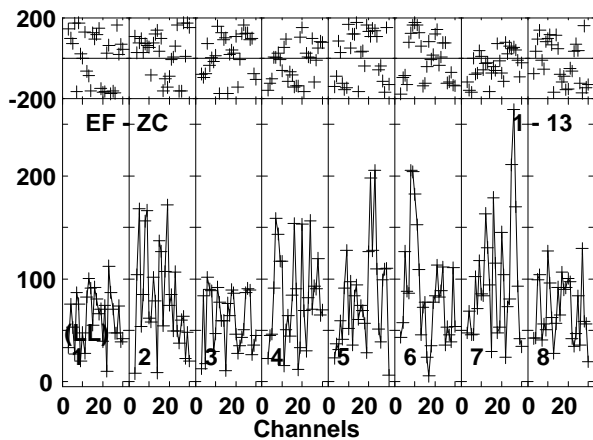
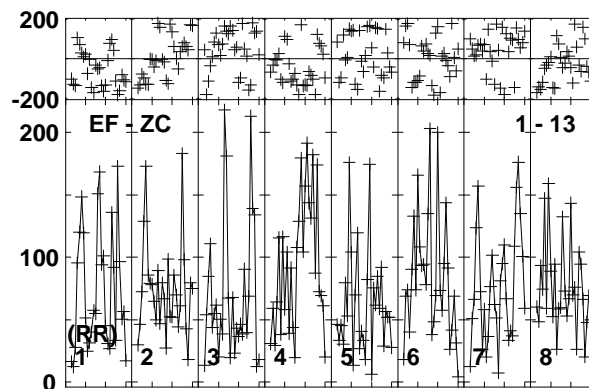
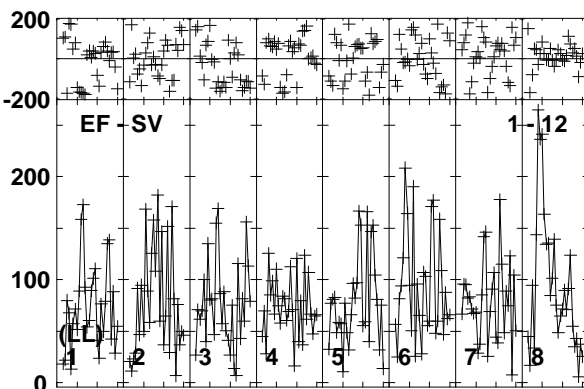
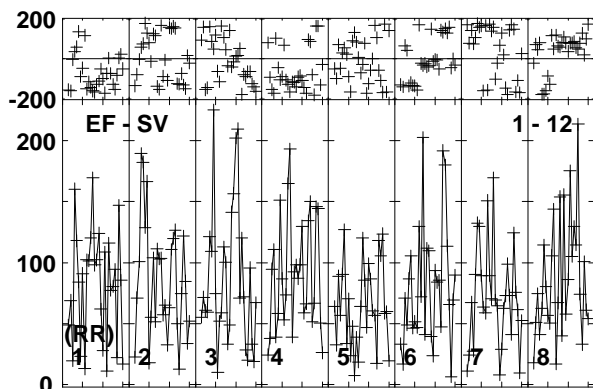
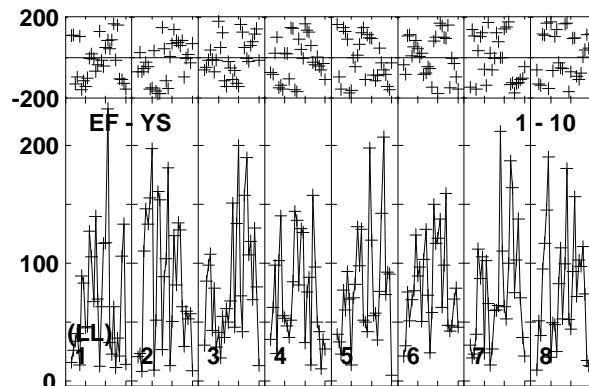
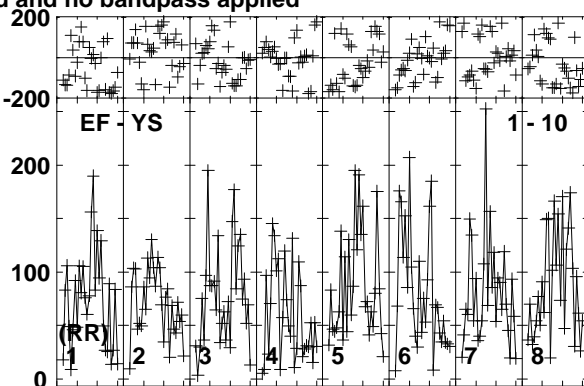
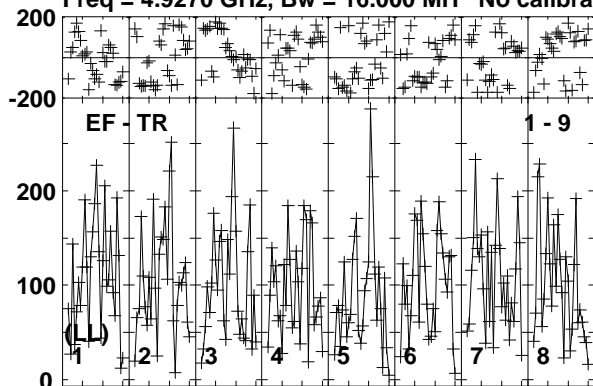

Lower frame: Micro Ampl Jy Top frame: Phas deg  
Vector averaged cross-power spectrum Baseline: EF (01) - TR (09)  
Timerange: 00/07:52:03 to 00/07:55:29

Plot file version 344 created 08-APR-2019 12:10:16

MRK622 EM133B.UVDATA.1

Freq = 4.9270 GHz, Bw = 16.000 MH No calibration applied and no bandpass applied

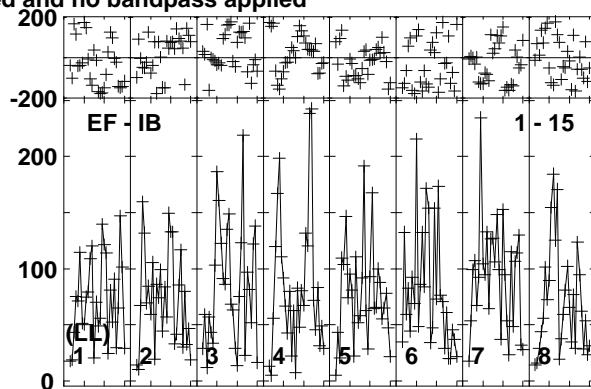
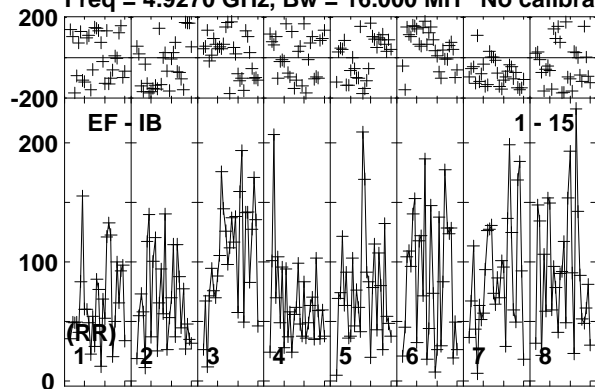

Lower frame: Micro Ampl Jy Top frame: Phas deg  
Vector averaged cross-power spectrum Baseline: EF (01) - IB (15)  
Timerange: 00/07:52:03 to 00/07:55:29



Plot file version 345 created 08-APR-2019 12:10:16

J0815+3635 EM133B.UVDATA.1

Freq = 4.9270 GHz, Bw = 16.000 MH No calibration applied and no bandpass applied

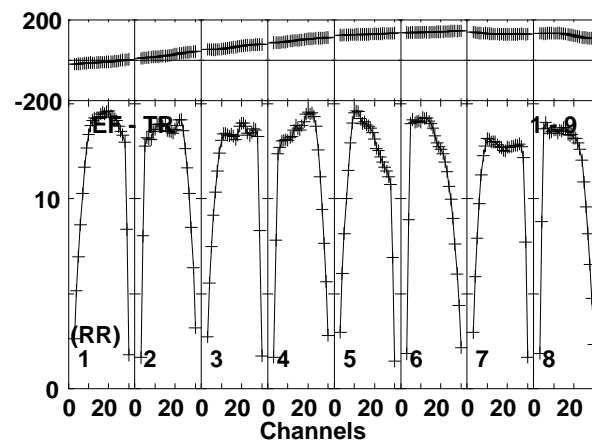
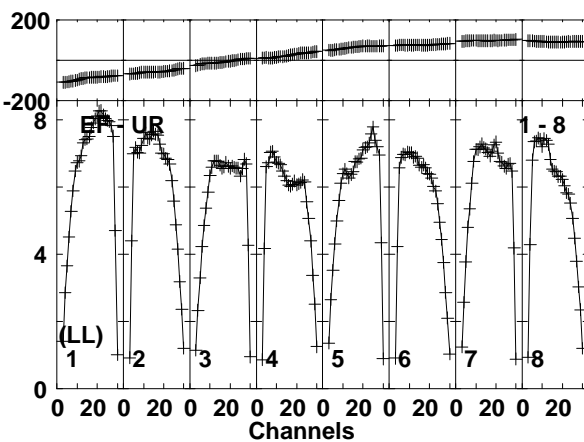
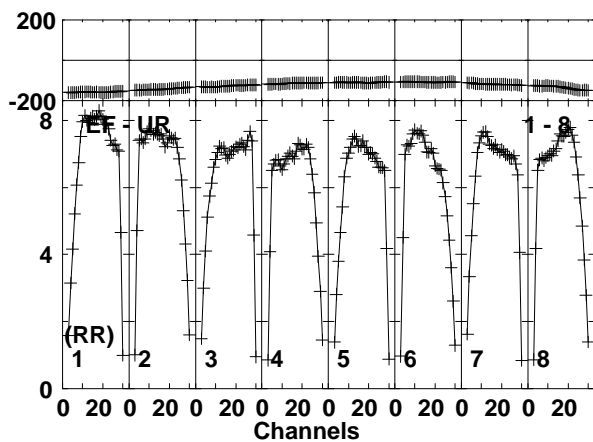
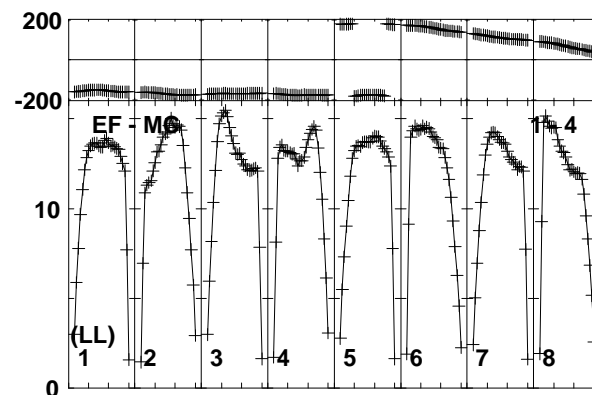
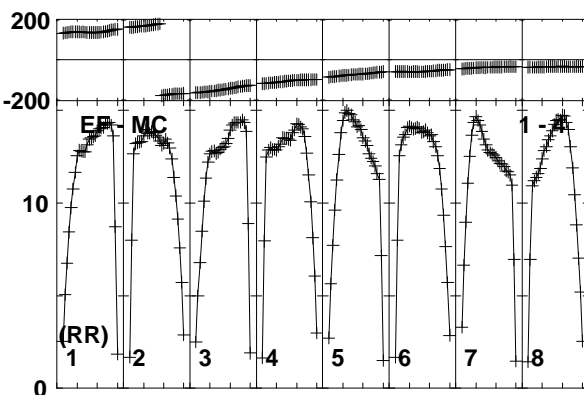
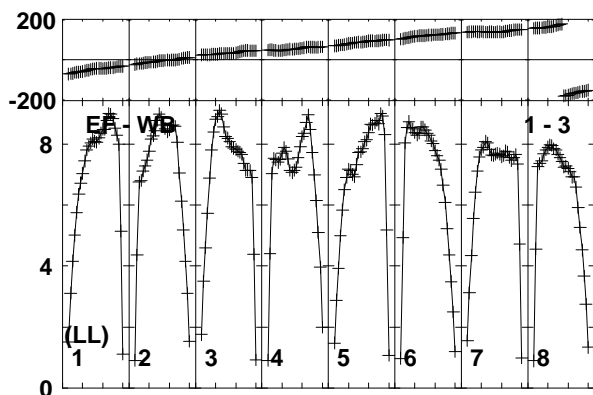
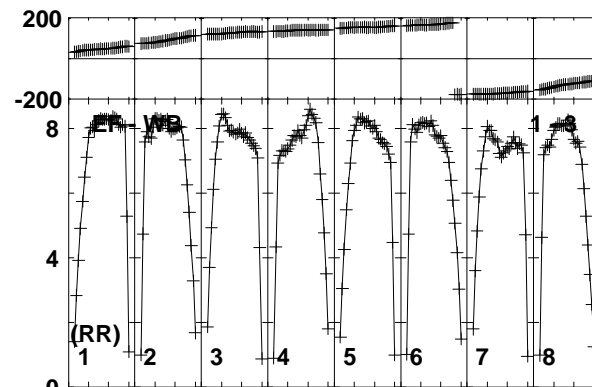
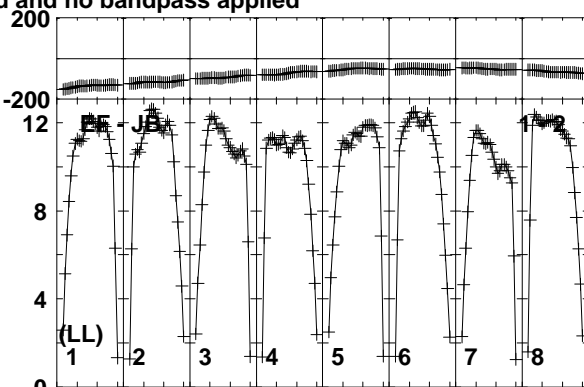
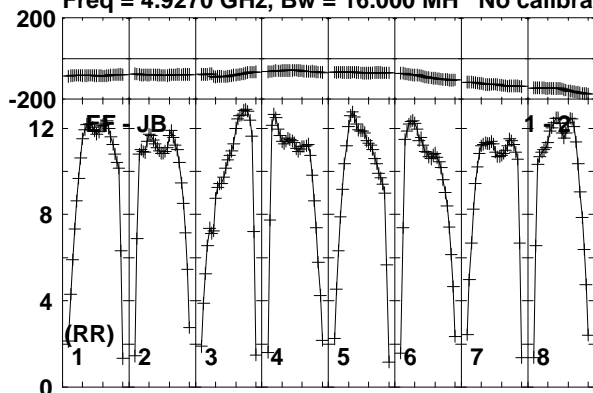

Lower frame: Milli Ampl Jy Top frame: Phas deg  
Vector averaged cross-power spectrum Baseline: EF (01) - JB (02)  
Timerange: 00/07:56:21 to 00/07:57:49

Plot file version 346 created 08-APR-2019 12:10:17

J0815+3635 EM133B.UVDATA.1

Freq = 4.9270 GHz, Bw = 16.000 MH No calibration applied and no bandpass applied

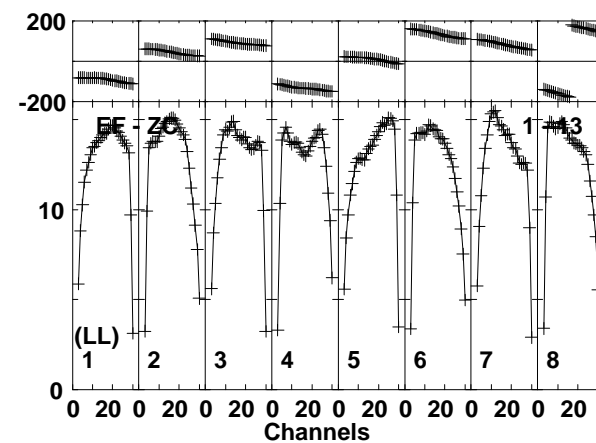
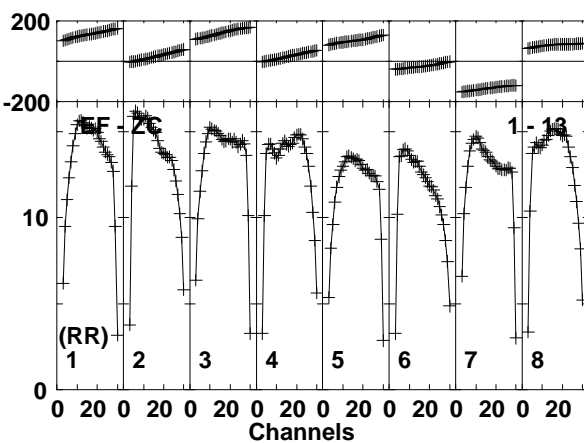
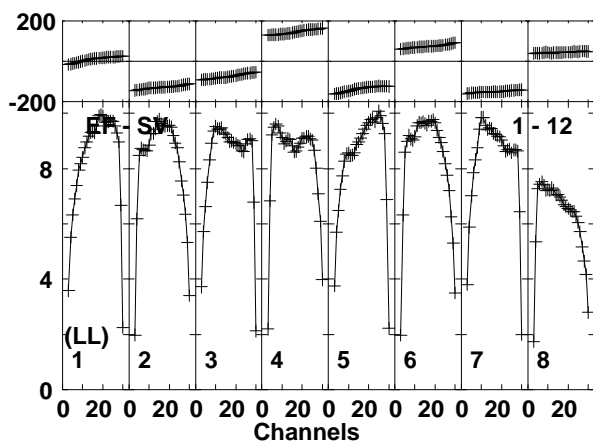
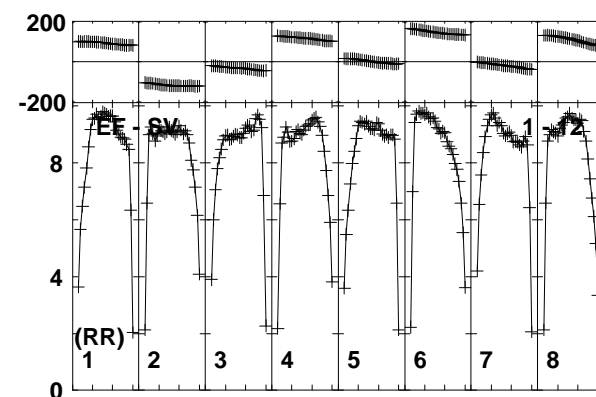
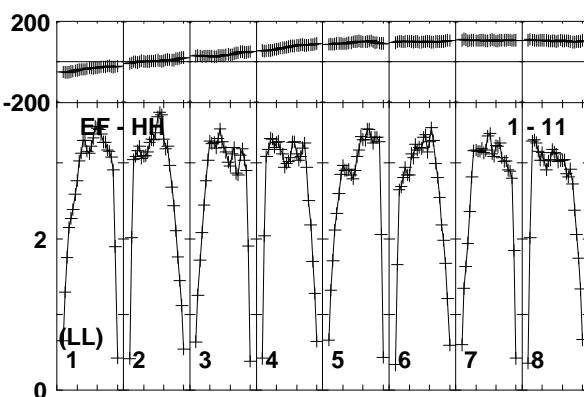
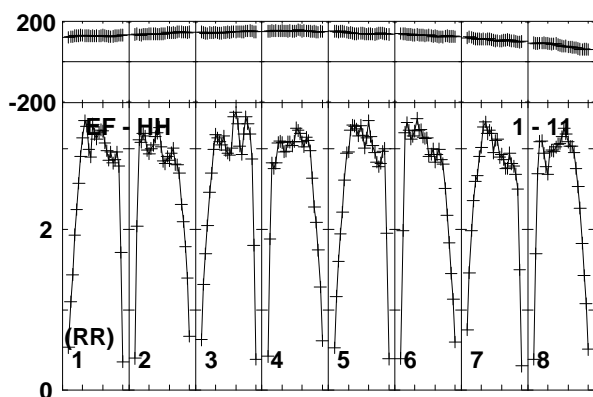
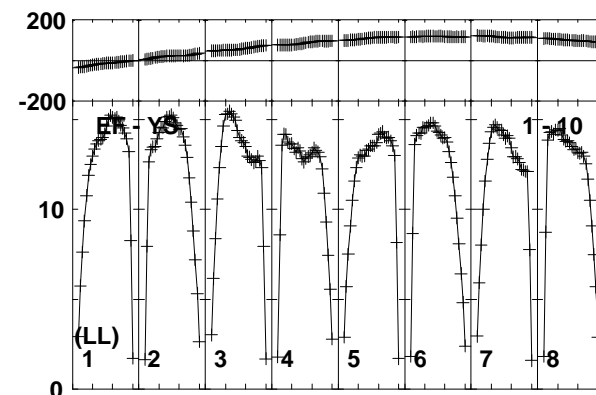
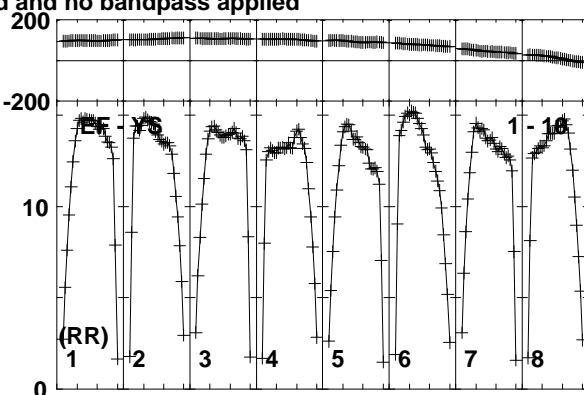
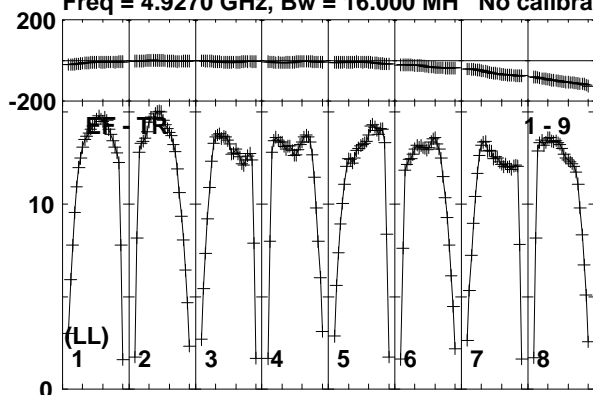

Lower frame: Milli Ampl Jy Top frame: Phas deg  
Vector averaged cross-power spectrum Baseline: EF (01) - TR (09)  
Timerange: 00/07:56:21 to 00/07:57:49

Plot file version 347 created 08-APR-2019 12:10:17

J0815+3635 EM133B.UVDATA.1

Freq = 4.9270 GHz, Bw = 16.000 MH No calibration applied and no bandpass applied

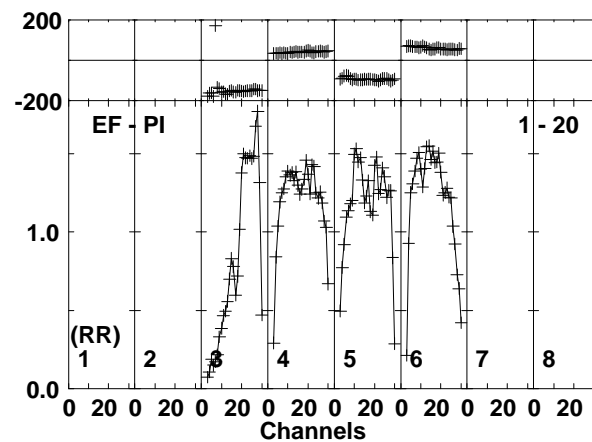
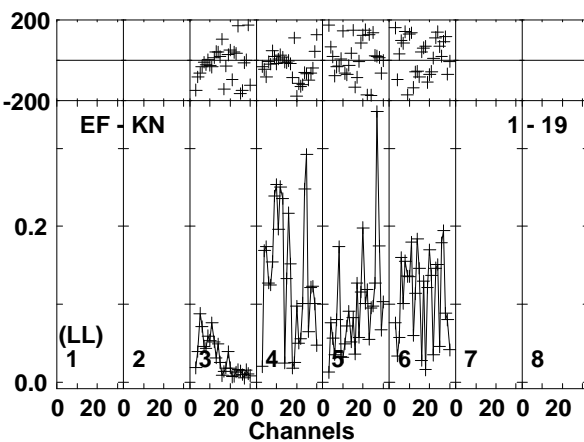
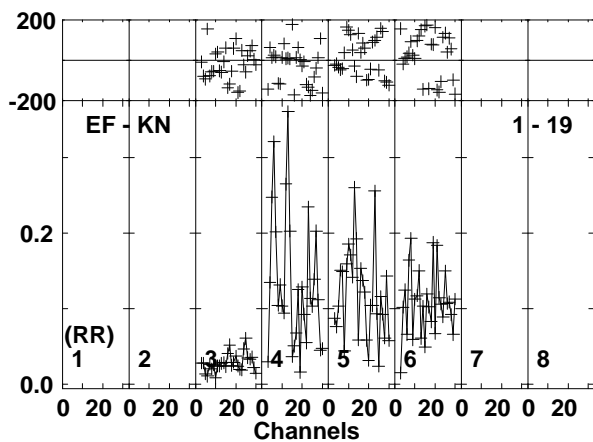
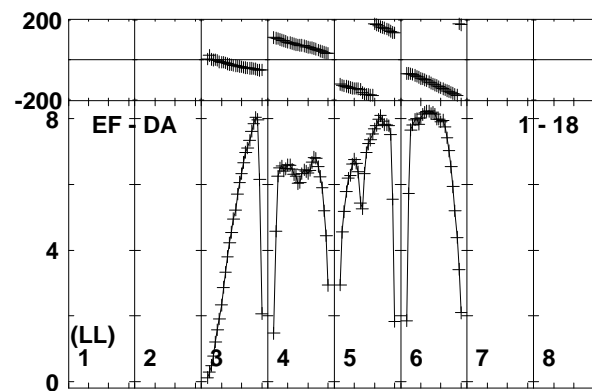
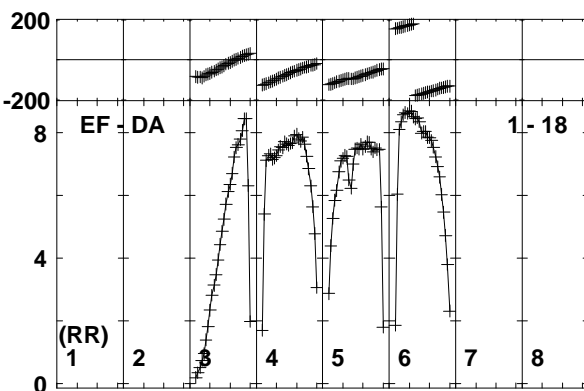
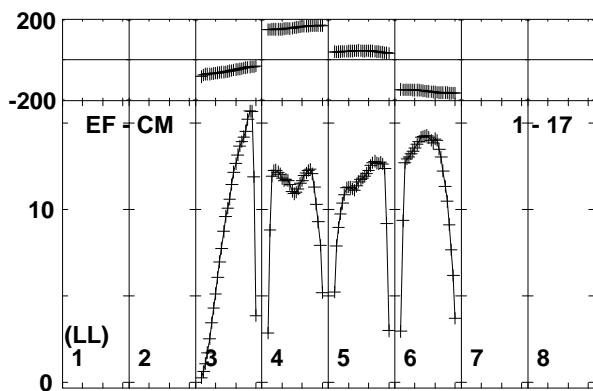
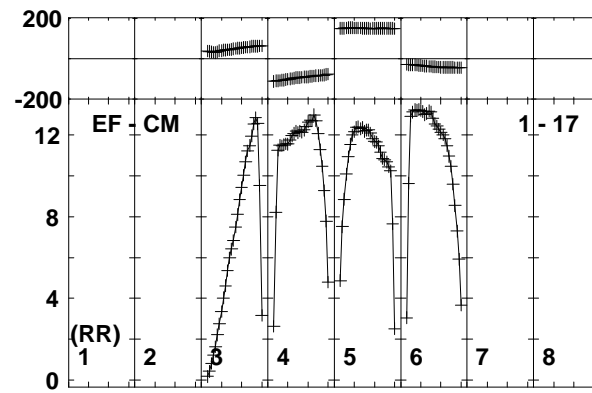
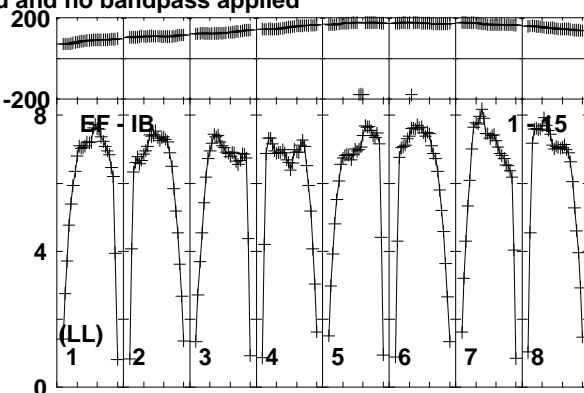
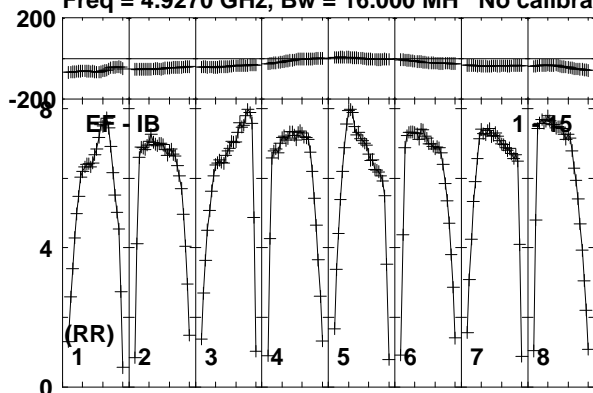

Lower frame: Milli Ampl Jy Top frame: Phas deg  
Vector averaged cross-power spectrum Baseline: EF (01) - IB (15)  
Timerange: 00/07:56:21 to 00/07:57:49

Plot file version 348 created 08-APR-2019 12:10:17

J0815+3635 EM133B.UVDATA.1

Freq = 4.9270 GHz, Bw = 16.000 MH No calibration applied and no bandpass applied

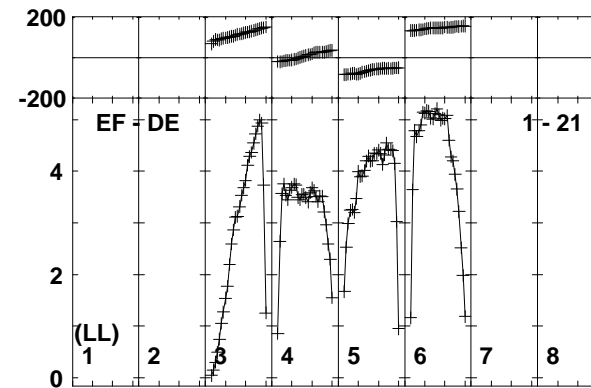
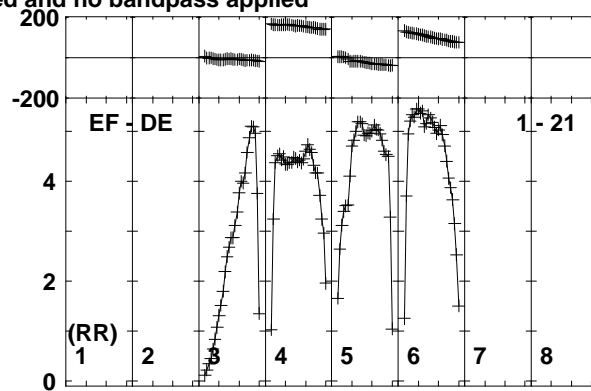
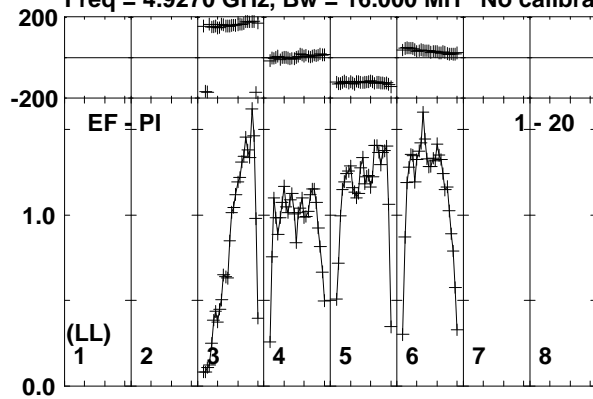

Lower frame: Milli Ampl Jy Top frame: Phas deg  
Vector averaged cross-power spectrum Baseline: EF (01) - PI (20)  
Timerange: 00/07:56:21 to 00/07:57:49

Plot file version 349 created 08-APR-2019 12:10:17

MRK622 EM133B.UVDATA.1

Freq = 4.9270 GHz, Bw = 16.000 MH No calibration applied and no bandpass applied

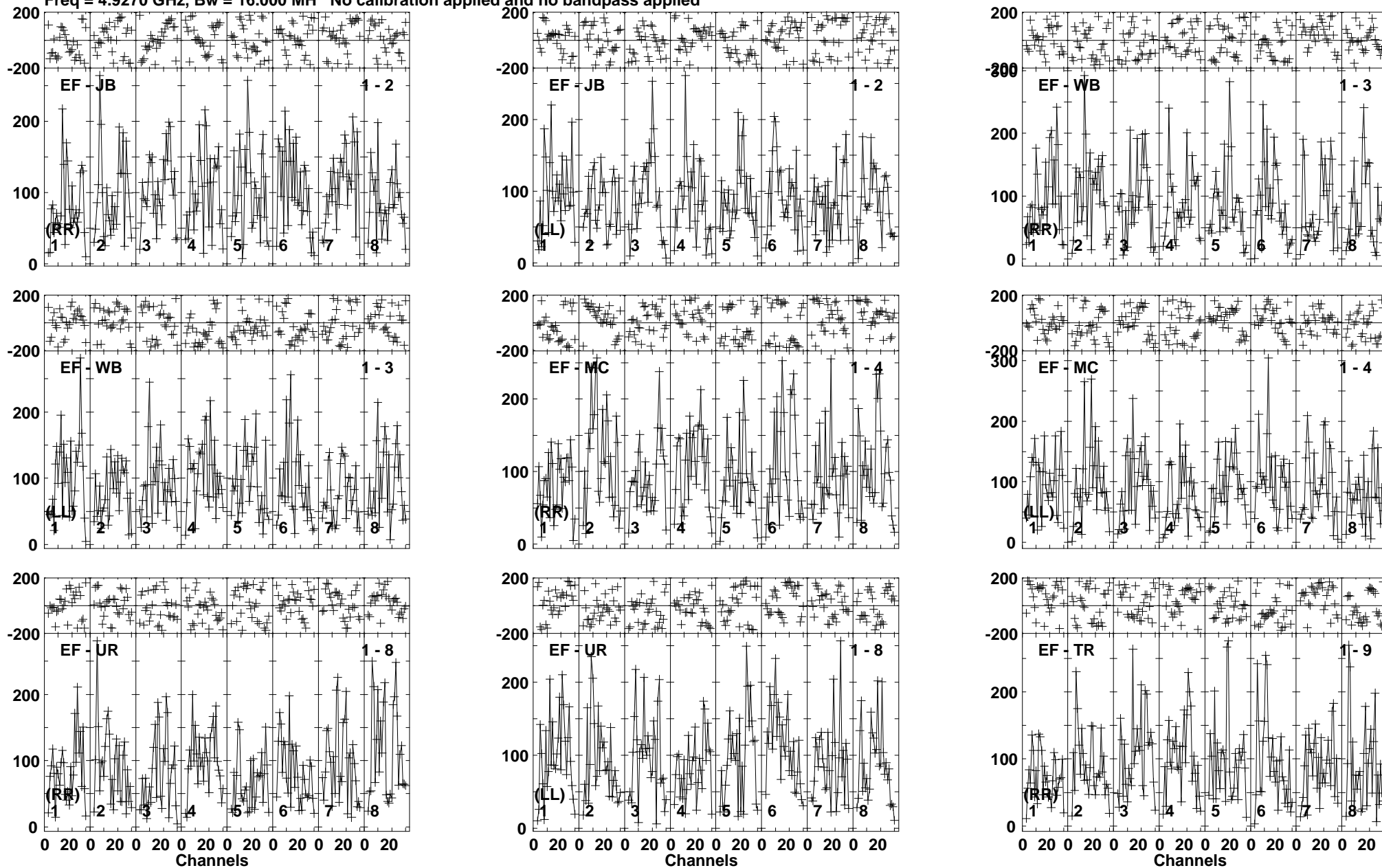

Lower frame: Micro Ampl Jy Top frame: Phas deg  
Vector averaged cross-power spectrum Baseline: EF (01) - JB (02)  
Timerange: 00/07:57:51 to 00/08:01:19

Plot file version 350 created 08-APR-2019 12:10:17

MRK622 EM133B.UVDATA.1

Freq = 4.9270 GHz, Bw = 16.000 MH No calibration applied and no bandpass applied

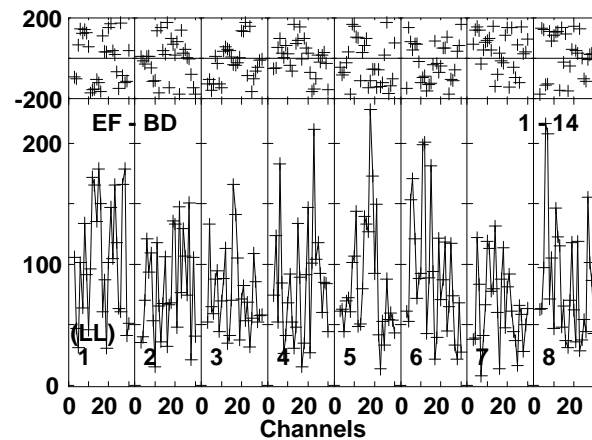
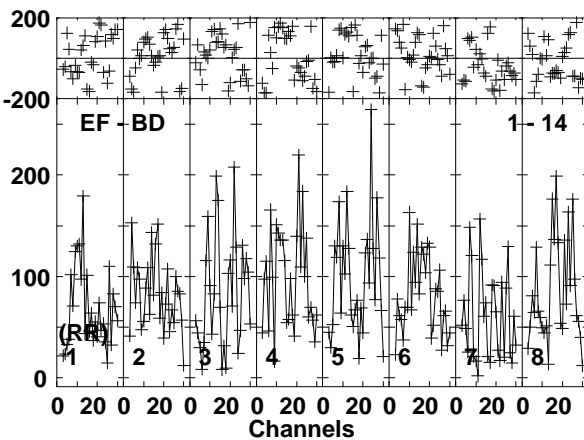
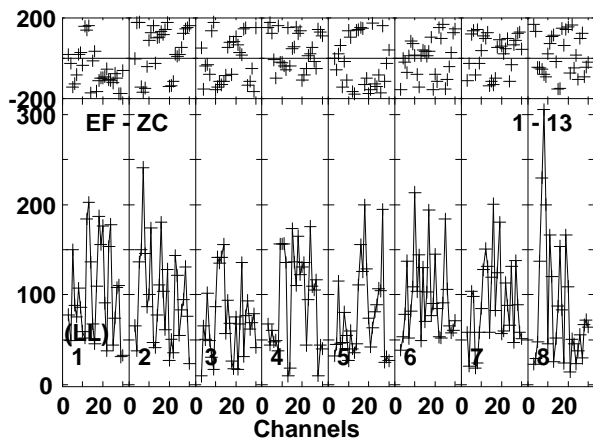
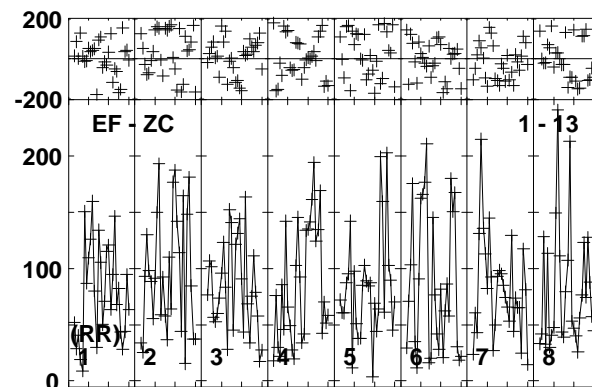
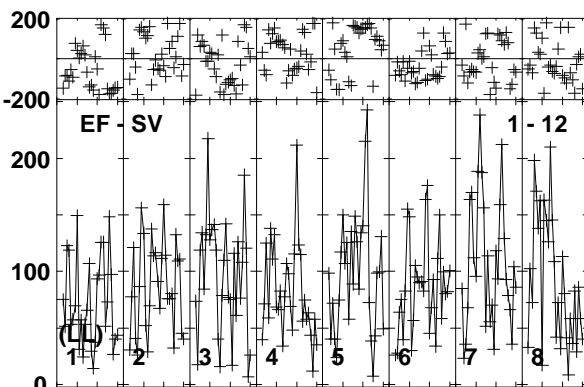
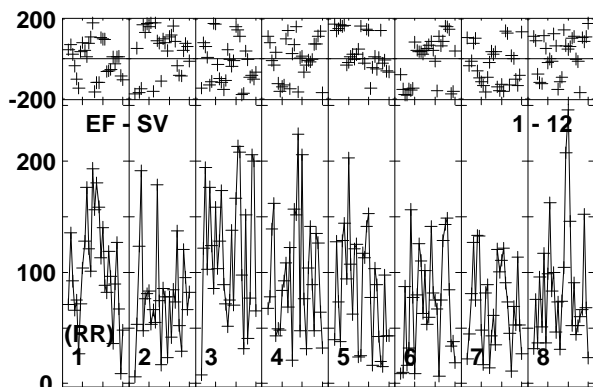
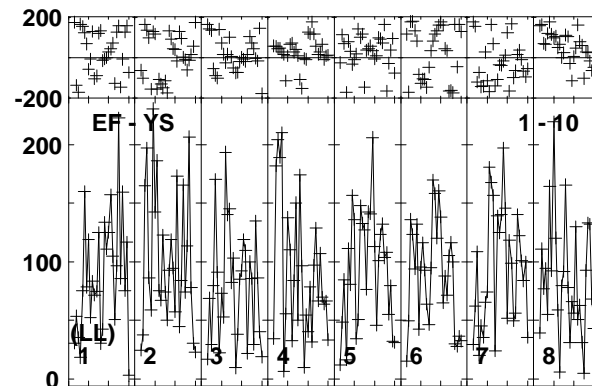
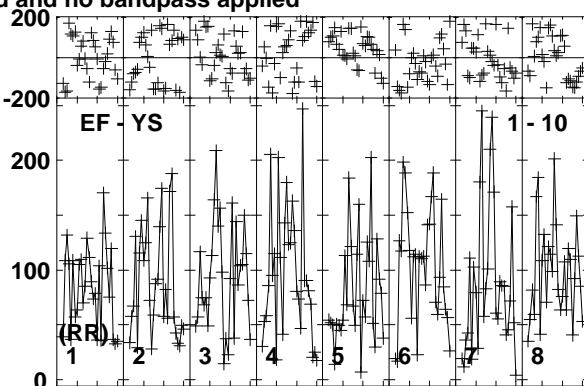
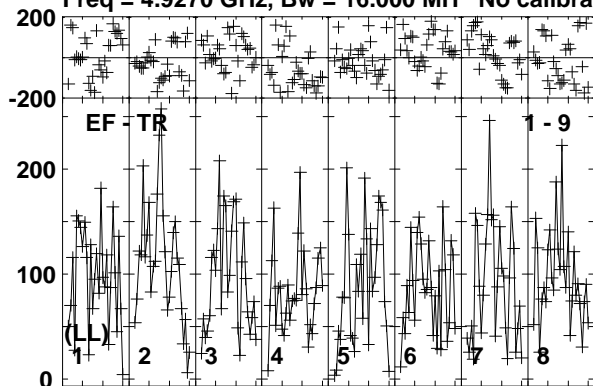

Lower frame: Micro Ampl Jy Top frame: Phas deg  
Vector averaged cross-power spectrum Baseline: EF (01) - TR (09)  
Timerange: 00/07:57:51 to 00/08:01:19

Plot file version 351 created 08-APR-2019 12:10:17

MRK622 EM133B.UVDATA.1

Freq = 4.9270 GHz, Bw = 16.000 MH No calibration applied and no bandpass applied

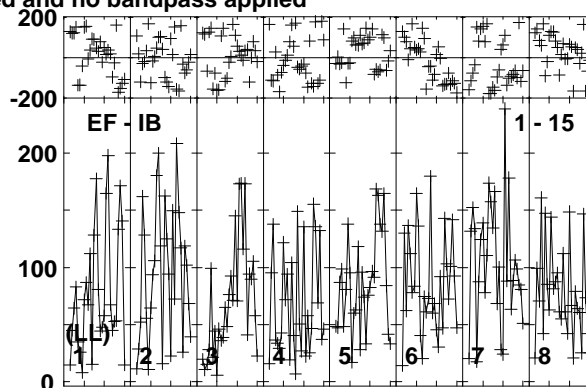
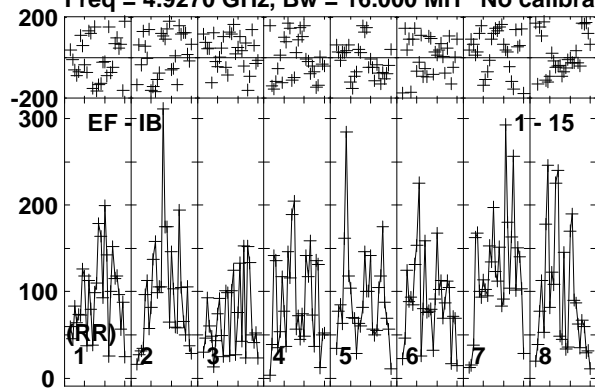

Lower frame: Micro Ampl Jy Top frame: Phas deg  
Vector averaged cross-power spectrum Baseline: EF (01) - IB (15)  
Timerange: 00/07:57:51 to 00/08:01:19

Plot file version 352 created 08-APR-2019 12:10:17

J0815+3635 EM133B.UVDATA.1

Freq = 4.9270 GHz, Bw = 16.000 MH No calibration applied and no bandpass applied

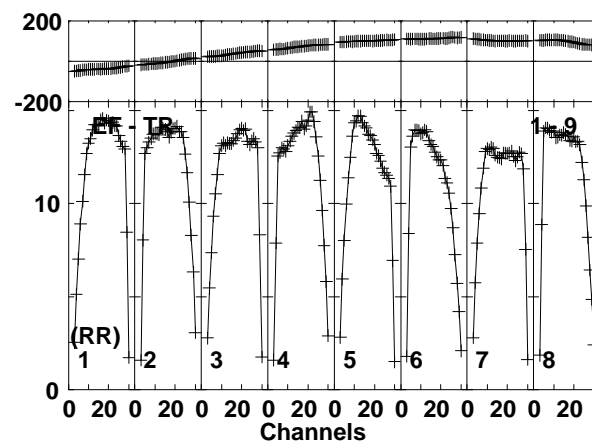
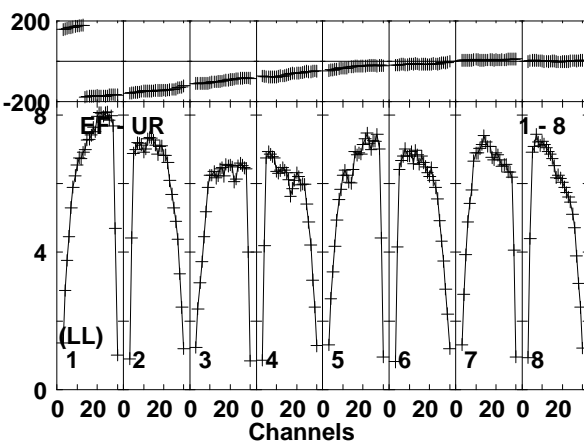
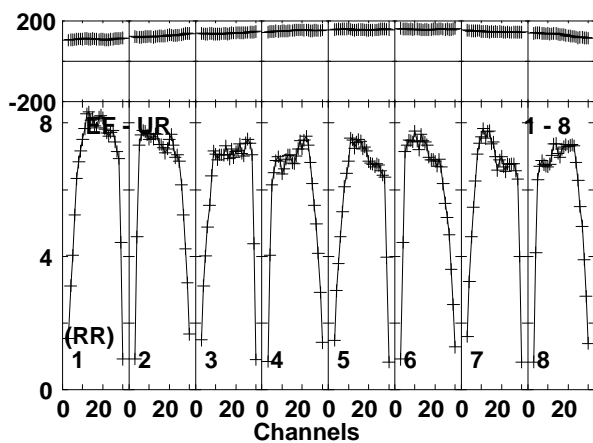
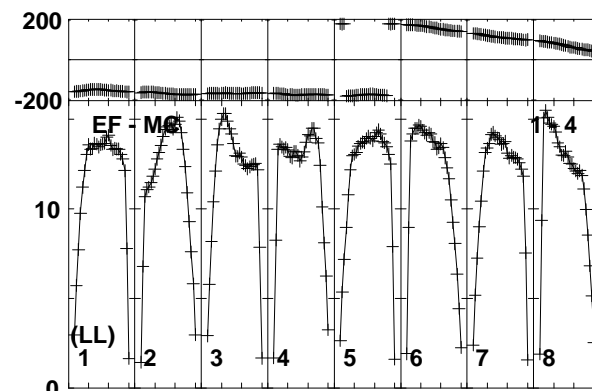
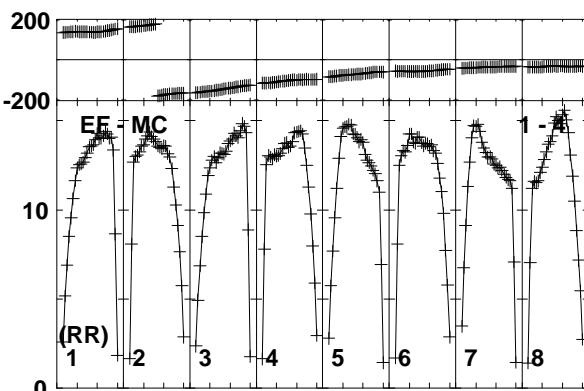
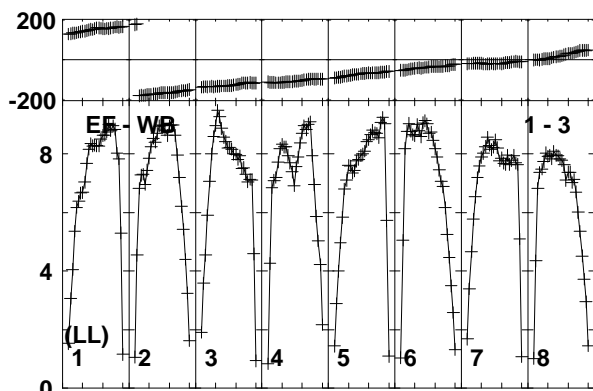
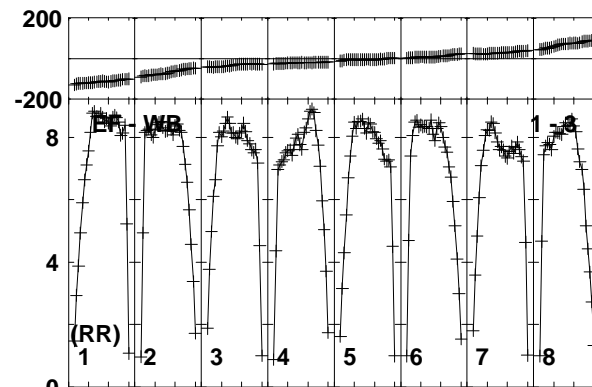
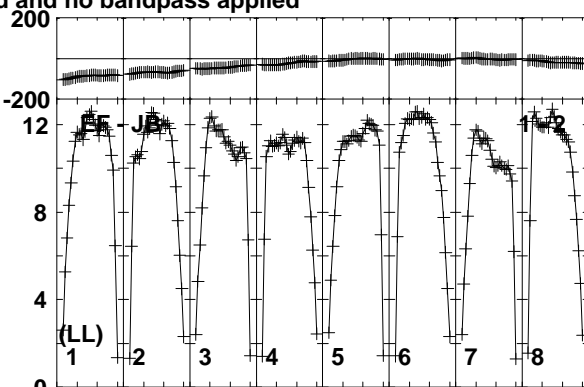
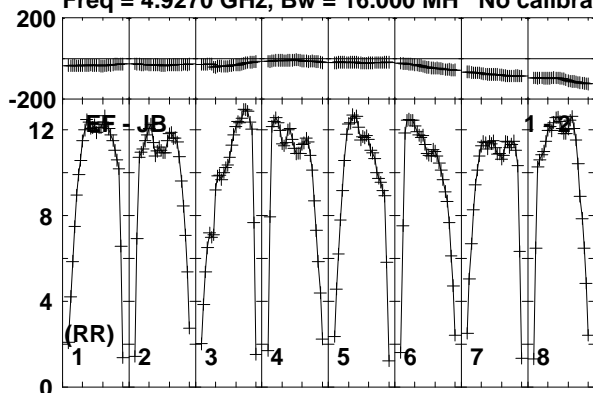

Lower frame: Milli Ampl Jy Top frame: Phas deg  
Vector averaged cross-power spectrum Baseline: EF (01) - JB (02)  
Timerange: 00/08:01:21 to 00/08:02:49



Plot file version 353 created 08-APR-2019 12:10:17

J0815+3635 EM133B.UVDATA.1

Freq = 4.9270 GHz, Bw = 16.000 MH No calibration applied and no bandpass applied

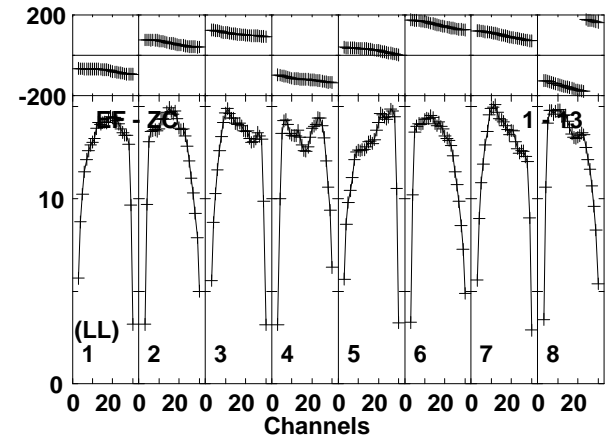
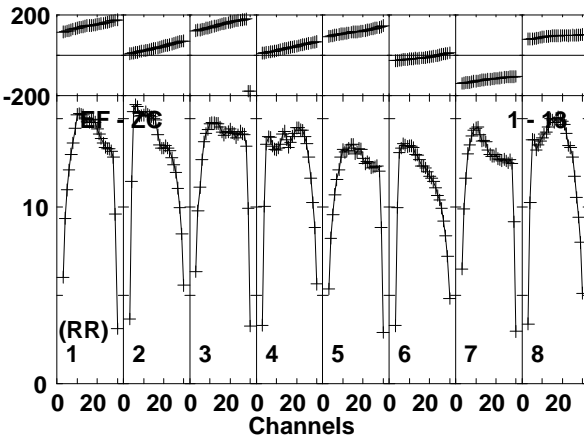
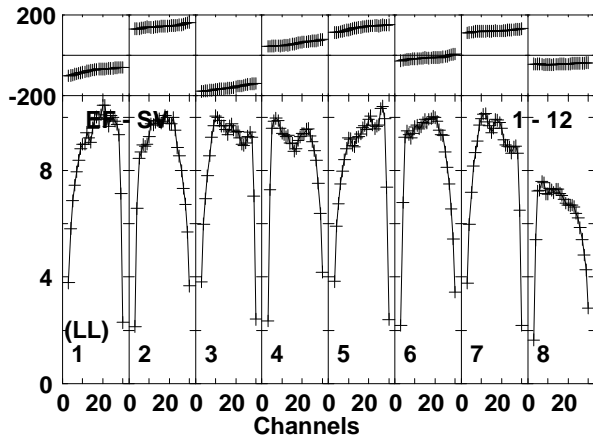
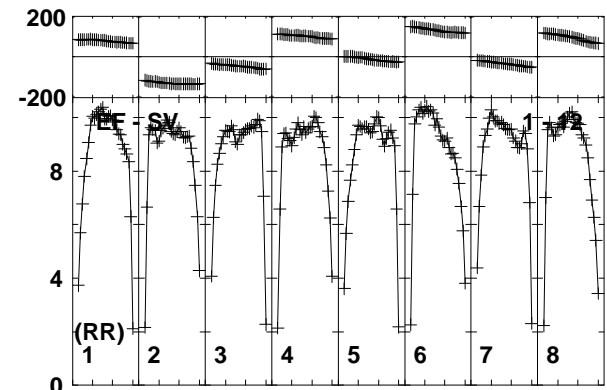
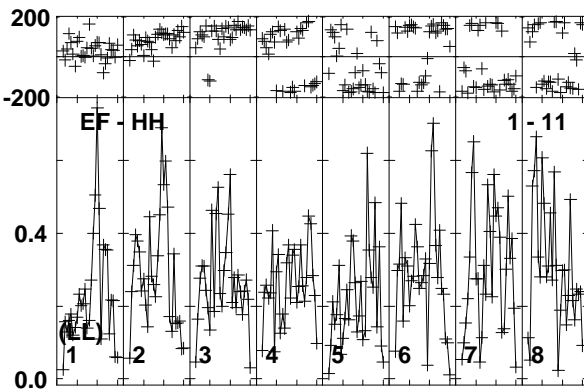
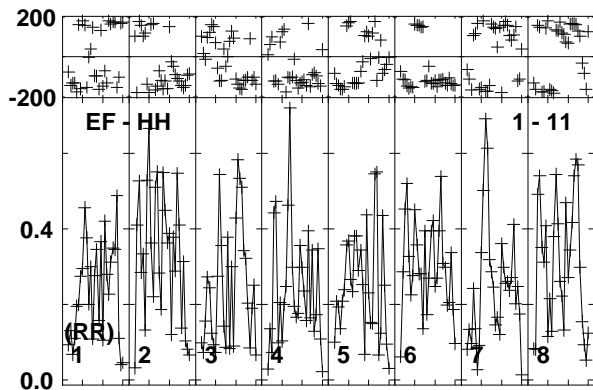
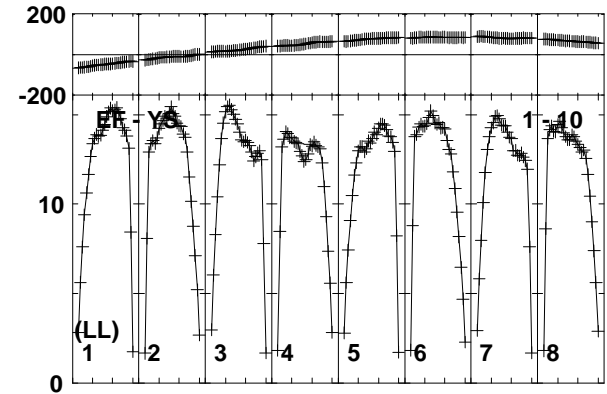
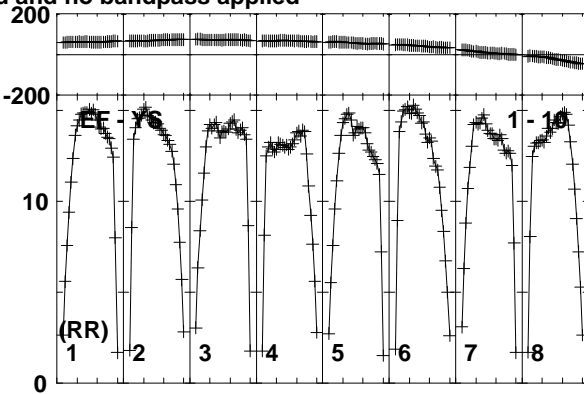
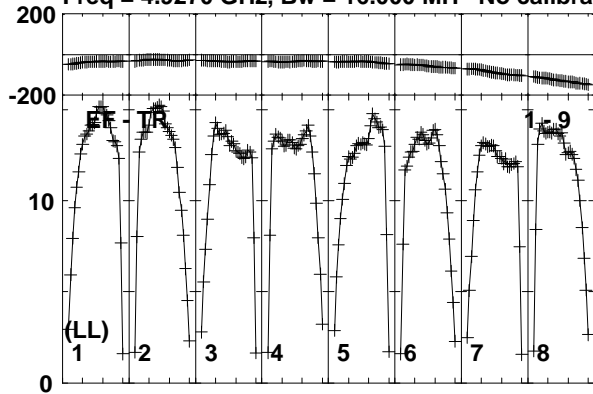

Lower frame: Milli Ampl Jy Top frame: Phas deg  
Vector averaged cross-power spectrum Baseline: EF (01) - TR (09)  
Timerange: 00/08:01:21 to 00/08:02:49

Plot file version 354 created 08-APR-2019 12:10:17

J0815+3635 EM133B.UVDATA.1

Freq = 4.9270 GHz, Bw = 16.000 MH No calibration applied and no bandpass applied

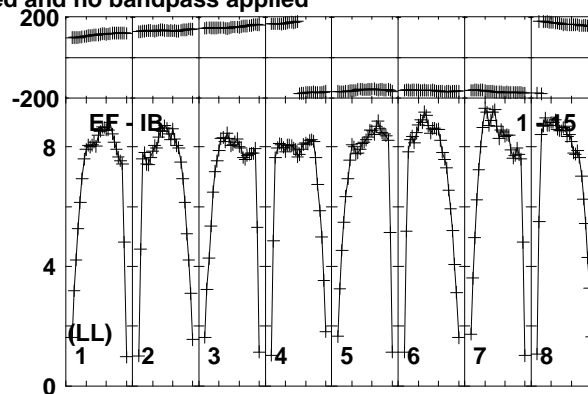
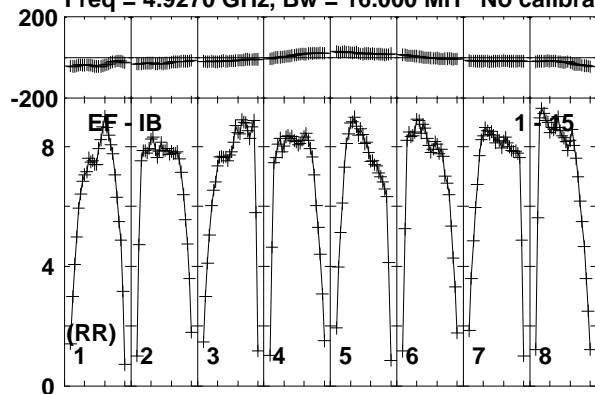

Lower frame: Milli Ampl Jy Top frame: Phas deg  
Vector averaged cross-power spectrum Baseline: EF (01) - IB (15)  
Timerange: 00/08:01:21 to 00/08:02:49

Plot file version 355 created 08-APR-2019 12:10:17

MRK622 EM133B.UVDATA.1

Freq = 4.9270 GHz, Bw = 16.000 MH No calibration applied and no bandpass applied

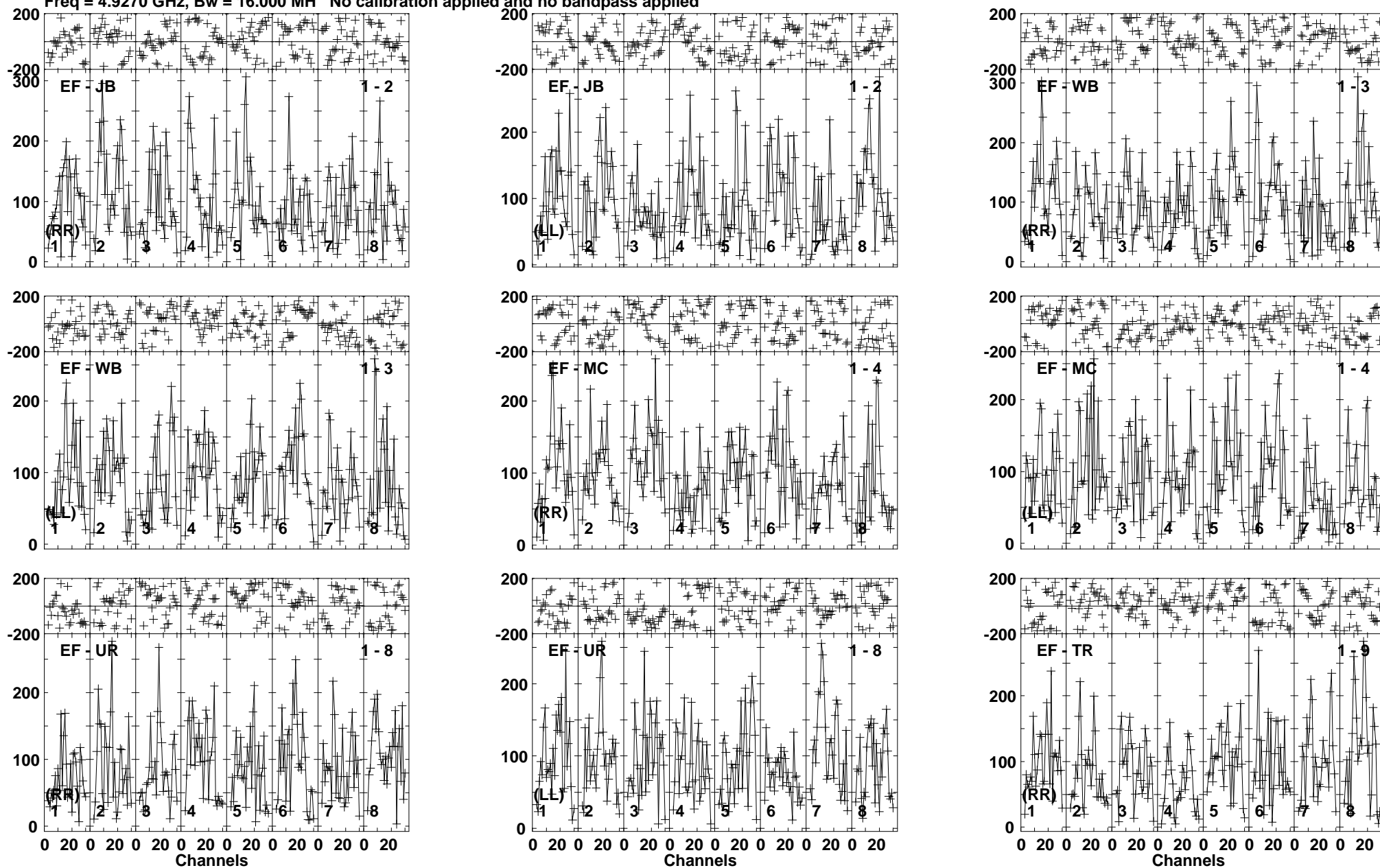

Lower frame: Micro Ampl Jy Top frame: Phas deg  
Vector averaged cross-power spectrum Baseline: EF (01) - JB (02)  
Timerange: 00/08:02:53 to 00/08:06:19

Plot file version 356 created 08-APR-2019 12:10:18

MRK622 EM133B.UVDATA.1

Freq = 4.9270 GHz, Bw = 16.000 MH No calibration applied and no bandpass applied

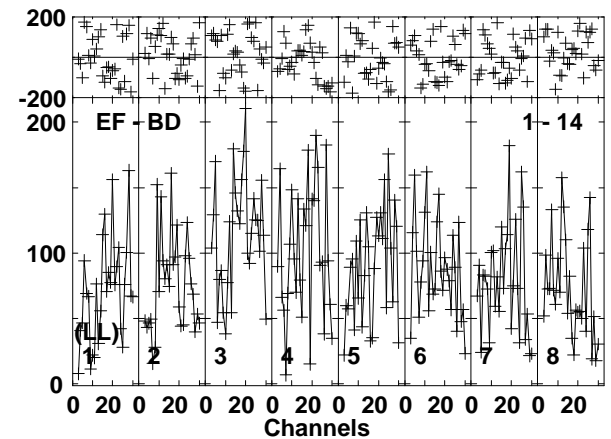
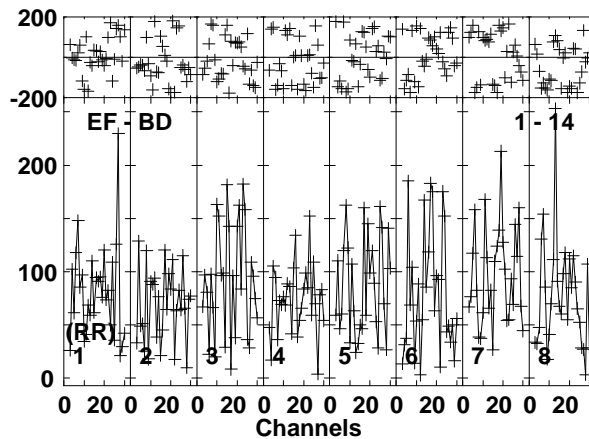
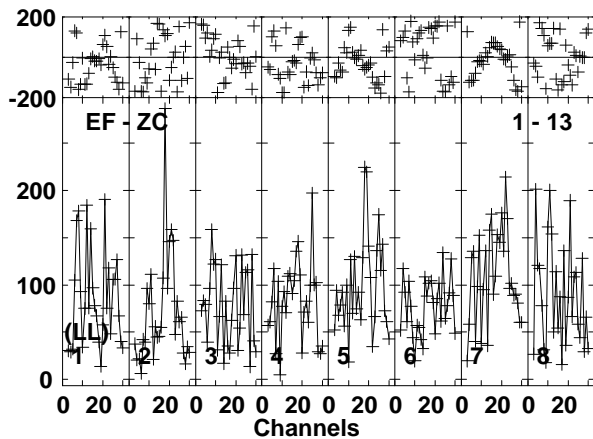
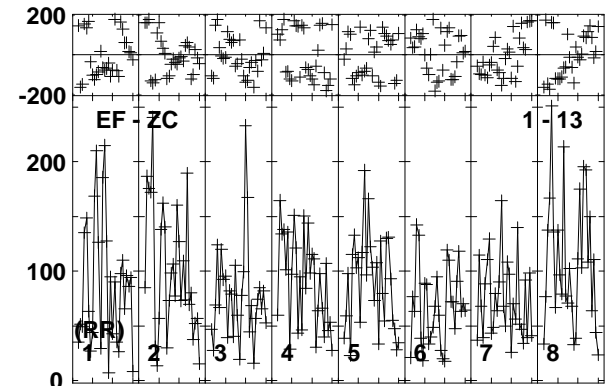
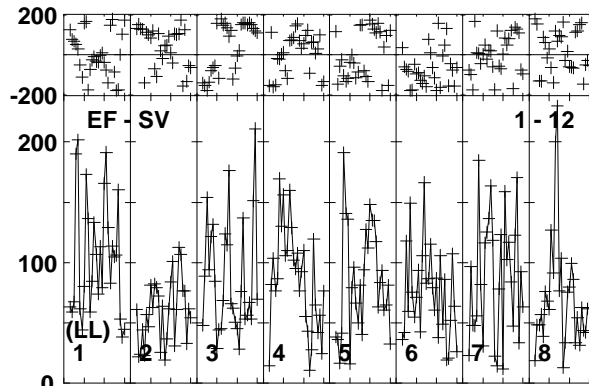
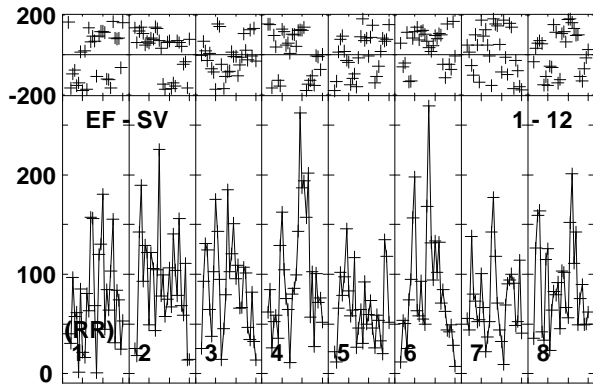
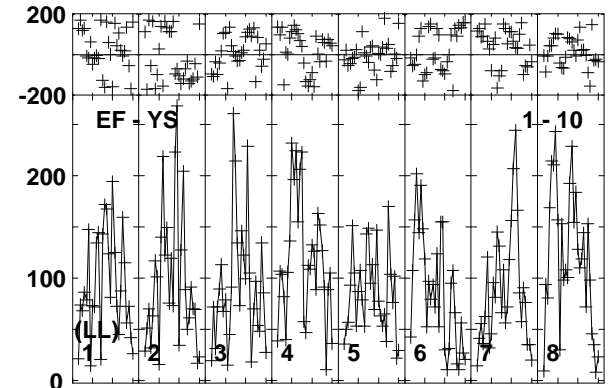
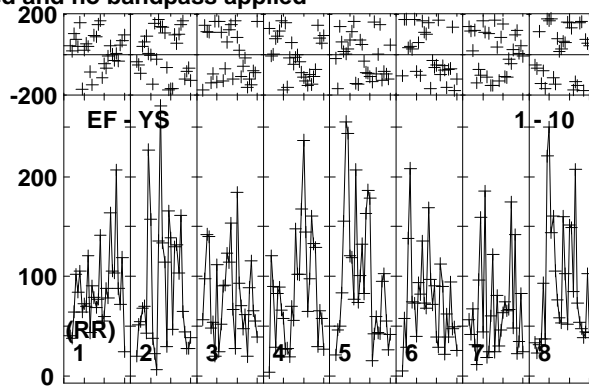
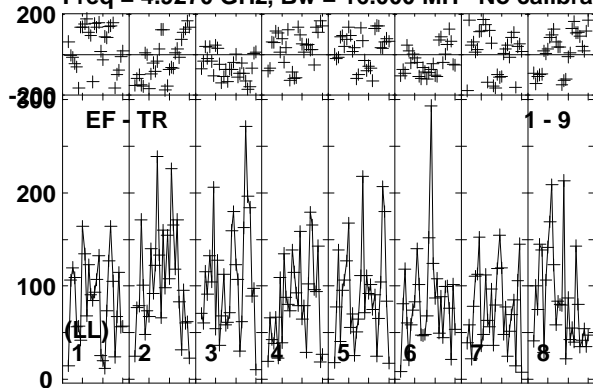

Lower frame: Micro Ampl Jy Top frame: Phas deg  
Vector averaged cross-power spectrum Baseline: EF (01) - TR (09)  
Timerange: 00/08:02:53 to 00/08:06:19

Plot file version 357 created 08-APR-2019 12:10:18

MRK622 EM133B.UVDATA.1

Freq = 4.9270 GHz, Bw = 16.000 MH No calibration applied and no bandpass applied

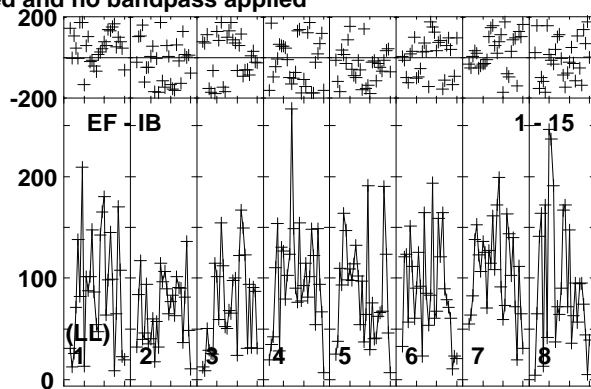
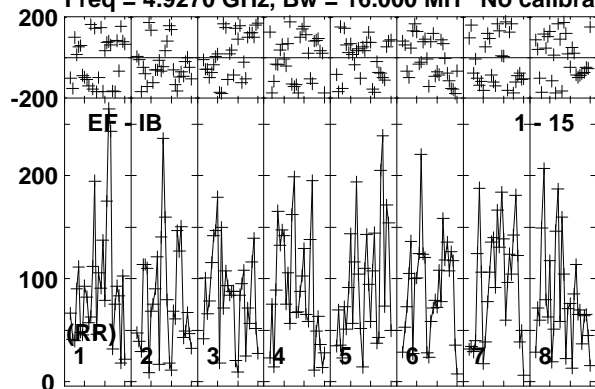

Lower frame: Micro Ampl Jy Top frame: Phas deg  
Vector averaged cross-power spectrum Baseline: EF (01) - IB (15)  
Timerange: 00/08:02:53 to 00/08:06:19

Plot file version 358 created 08-APR-2019 12:10:18

J0815+3635 EM133B.UVDATA.1

Freq = 4.9270 GHz, Bw = 16.000 MH No calibration applied and no bandpass applied

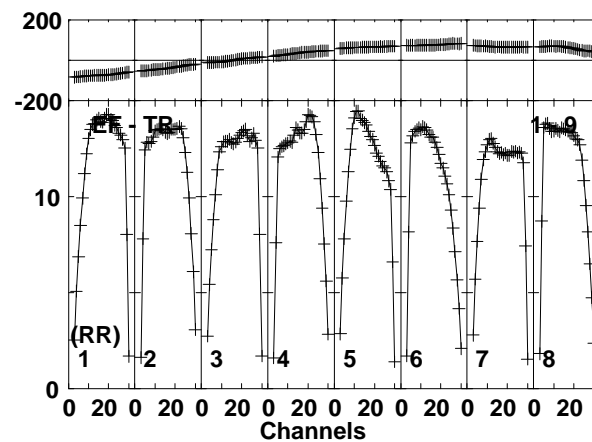
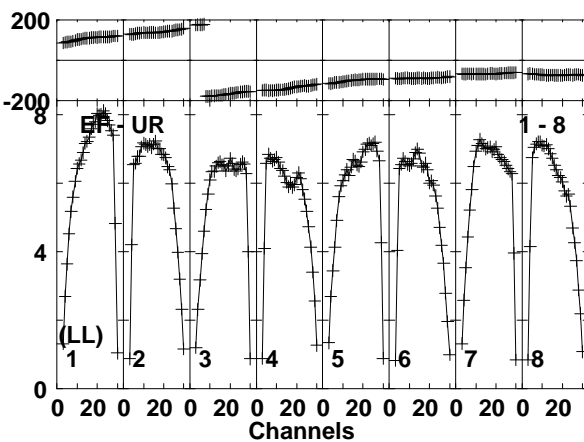
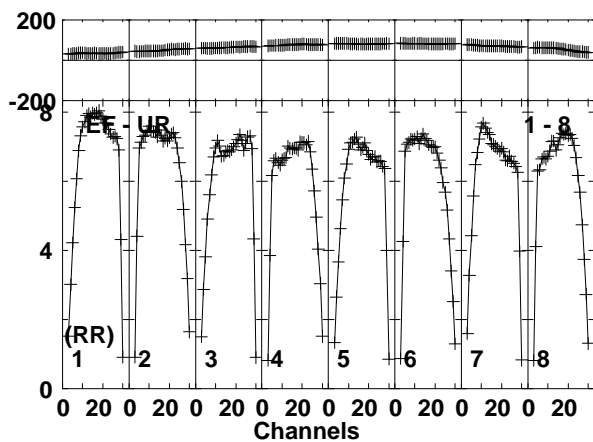
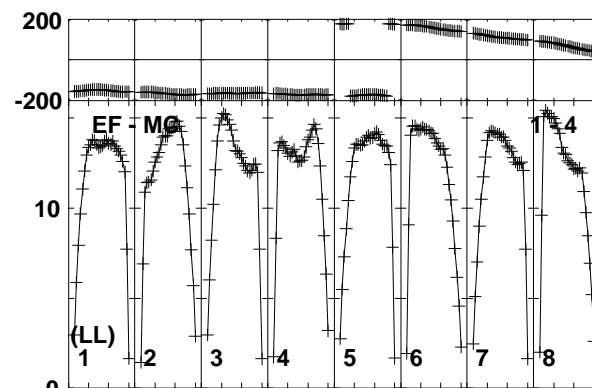
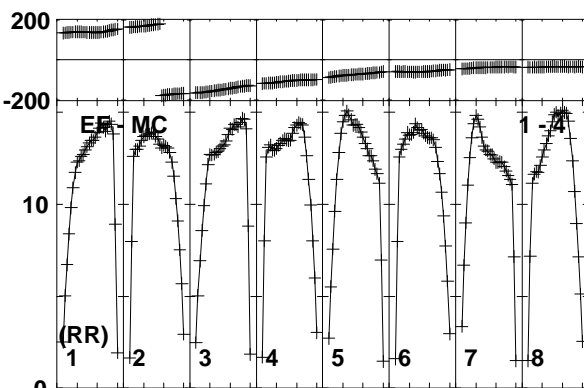
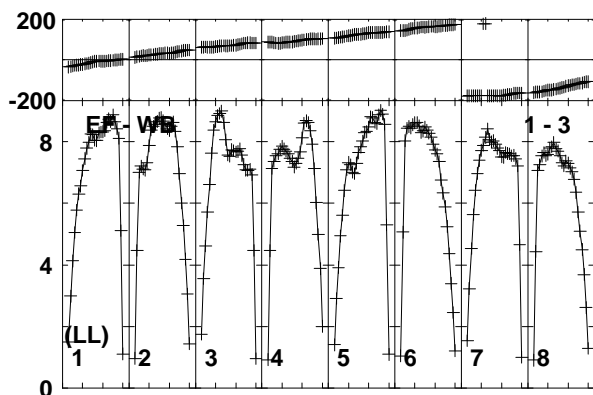
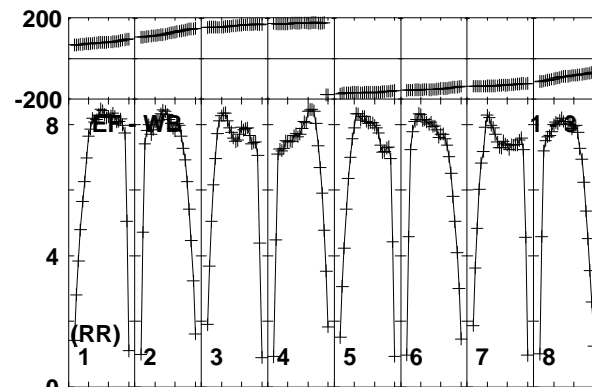
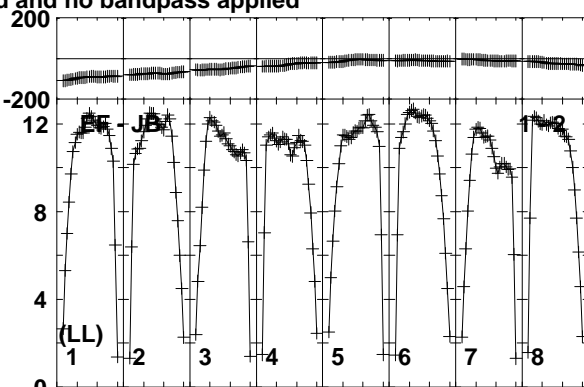
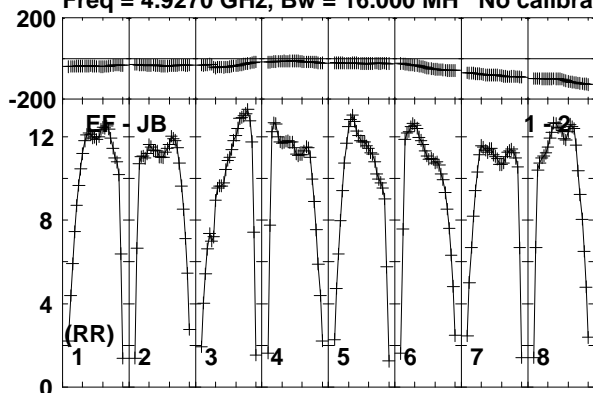

Lower frame: Milli Ampl Jy Top frame: Phas deg  
Vector averaged cross-power spectrum Baseline: EF (01) - JB (02)  
Timerange: 00/08:07:11 to 00/08:08:39

Plot file version 359 created 08-APR-2019 12:10:18

J0815+3635 EM133B.UVDATA.1

Freq = 4.9270 GHz, Bw = 16.000 MH No calibration applied and no bandpass applied

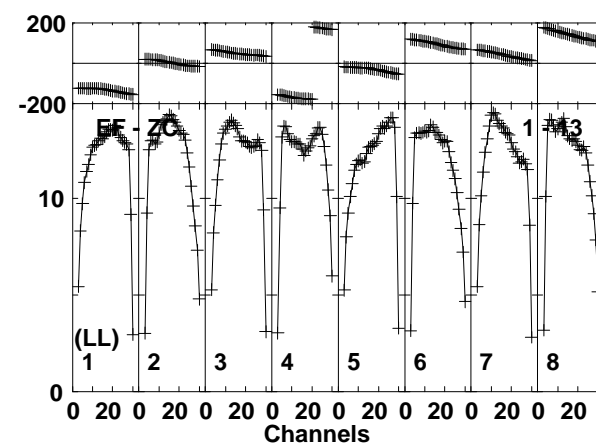
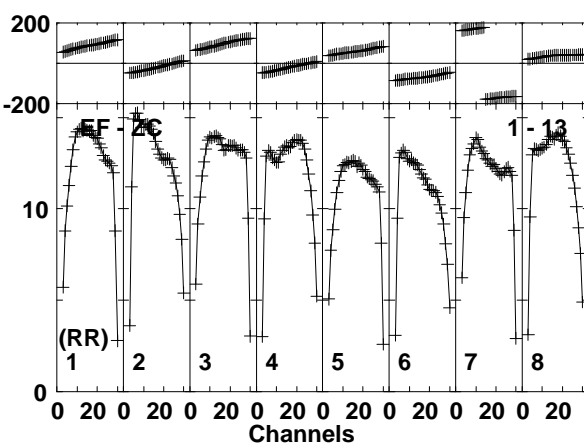
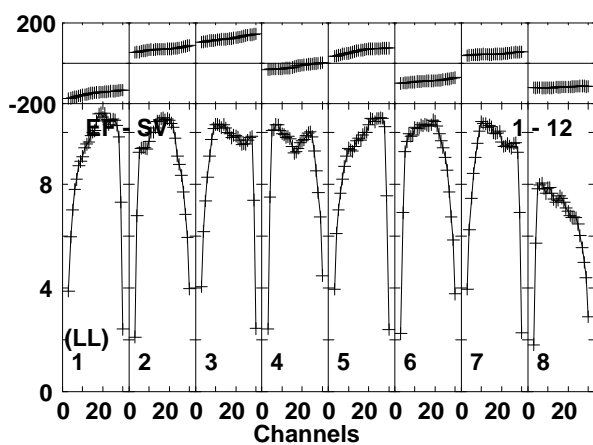
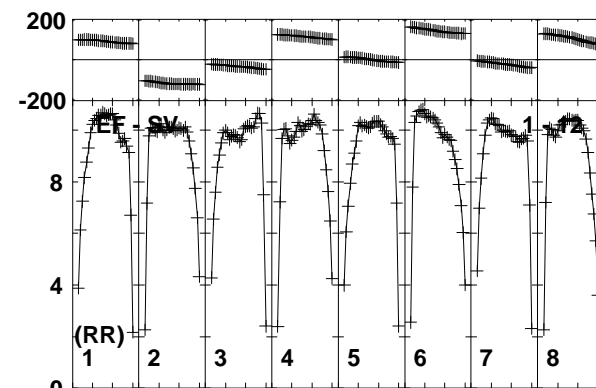
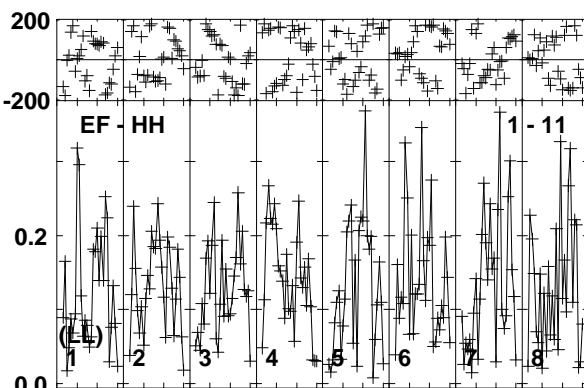
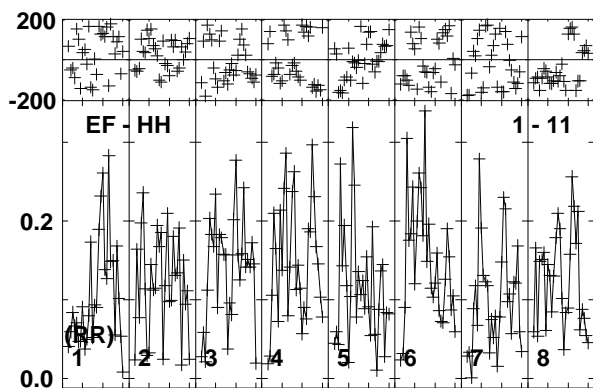
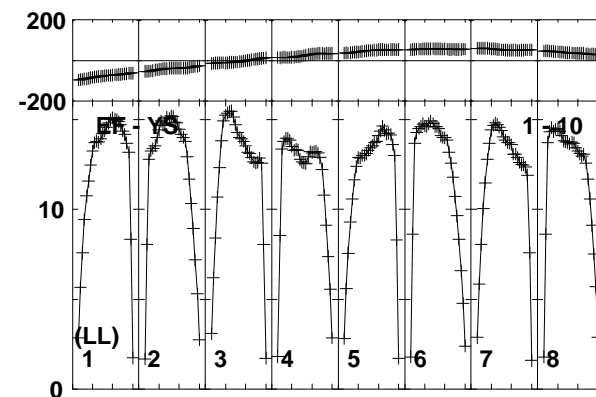
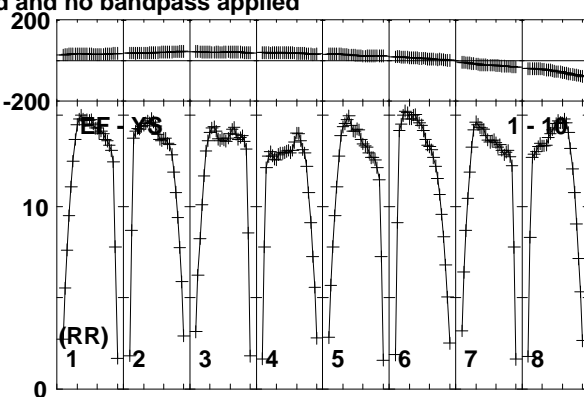
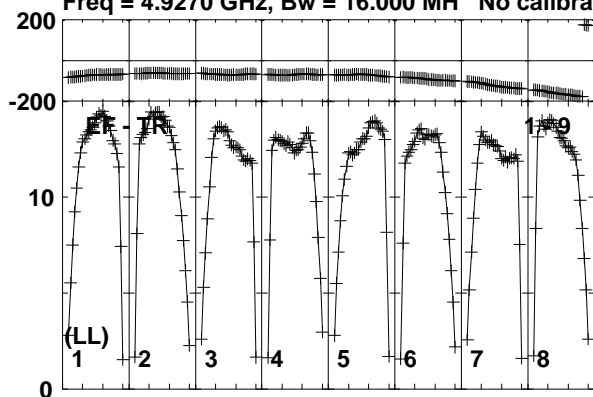

Lower frame: Milli Ampl Jy Top frame: Phas deg  
Vector averaged cross-power spectrum Baseline: EF (01) - TR (09)  
Timerange: 00/08:07:11 to 00/08:08:39

Plot file version 360 created 08-APR-2019 12:10:18

J0815+3635 EM133B.UVDATA.1

Freq = 4.9270 GHz, Bw = 16.000 MH No calibration applied and no bandpass applied

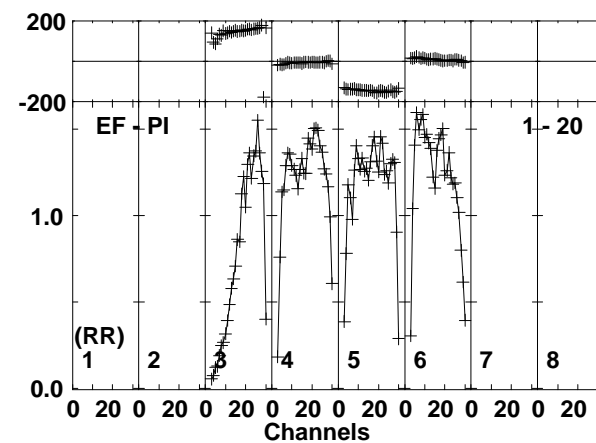
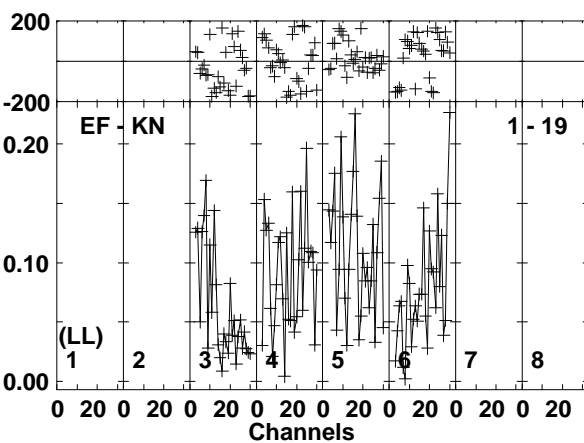
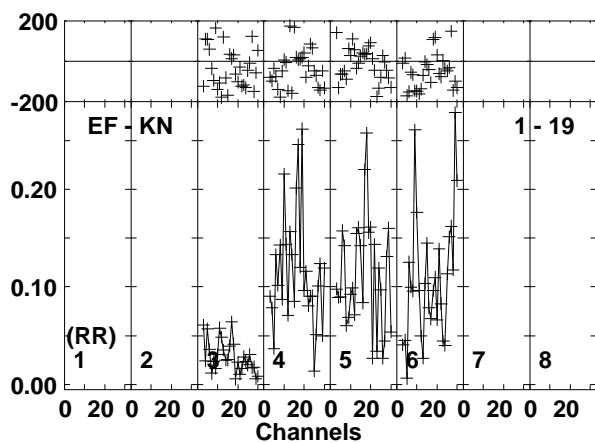
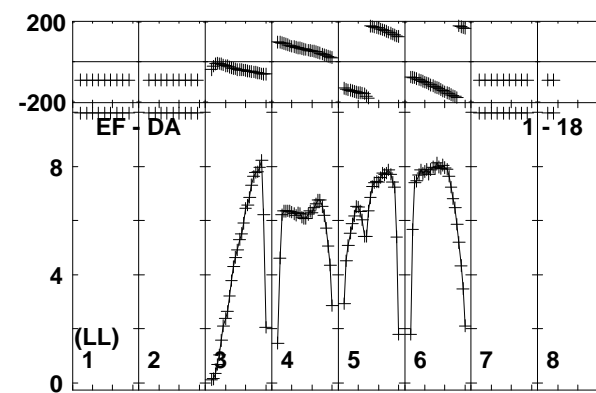
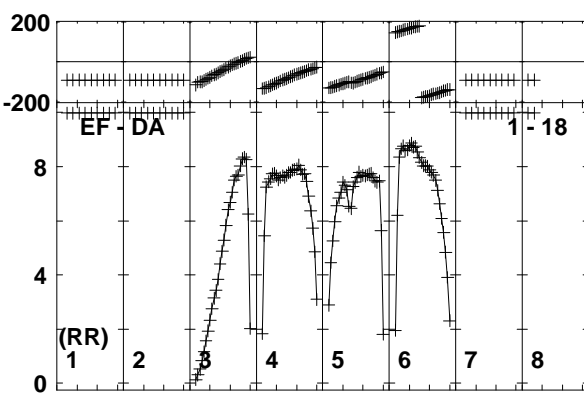
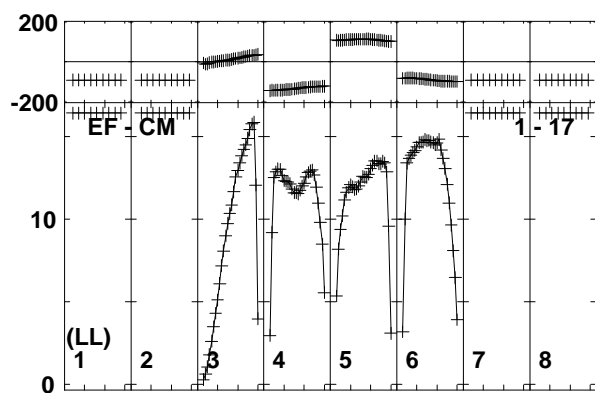
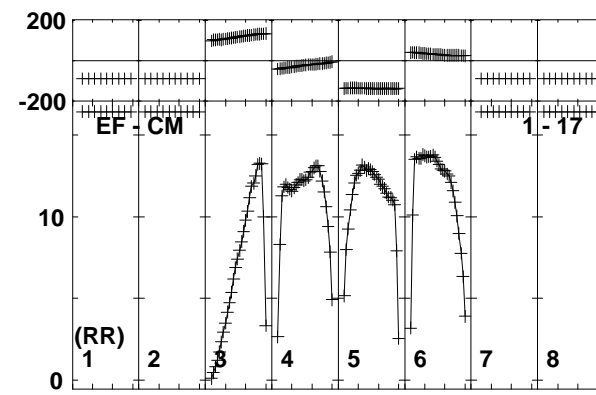
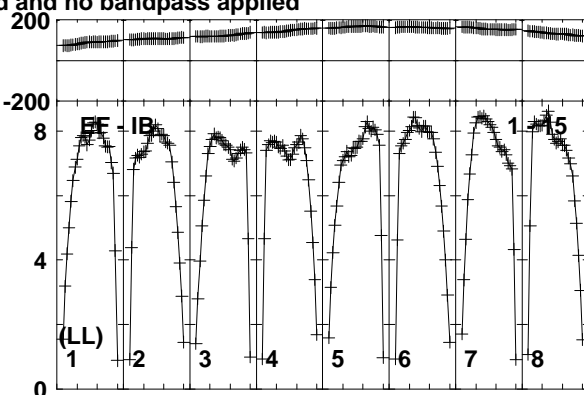
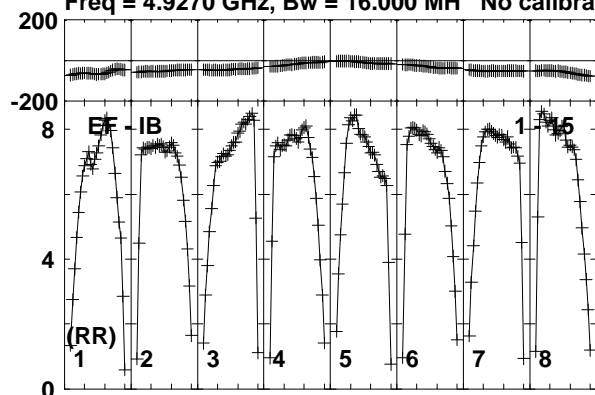

Lower frame: Milli Ampl Jy Top frame: Phas deg  
Vector averaged cross-power spectrum Baseline: EF (01) - IB (15)  
Timerange: 00/08:07:11 to 00/08:08:39



Plot file version 361 created 08-APR-2019 12:10:18

J0815+3635 EM133B.UVDATA.1

Freq = 4.9270 GHz, Bw = 16.000 MH No calibration applied and no bandpass applied

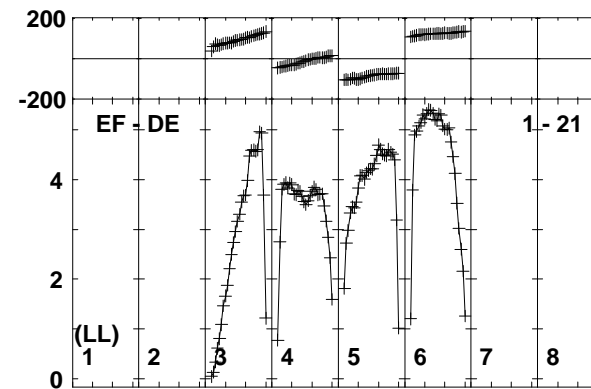
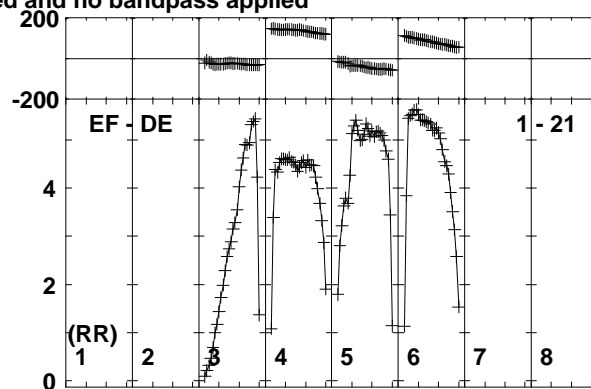
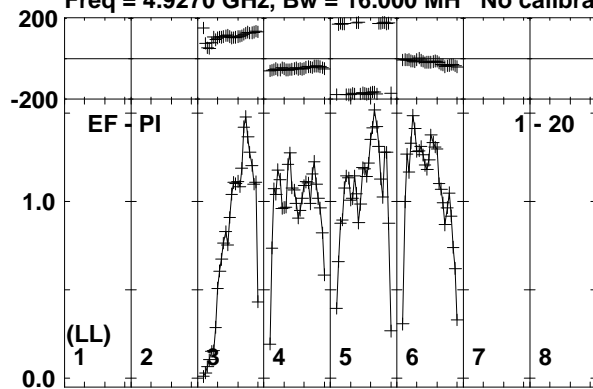

Lower frame: Milli Ampl Jy Top frame: Phas deg  
Vector averaged cross-power spectrum Baseline: EF (01) - PI (20)  
Timerange: 00/08:07:11 to 00/08:08:39

Plot file version 362 created 08-APR-2019 12:10:18

MRK622 EM133B.UVDATA.1

Freq = 4.9270 GHz, Bw = 16.000 MH No calibration applied and no bandpass applied

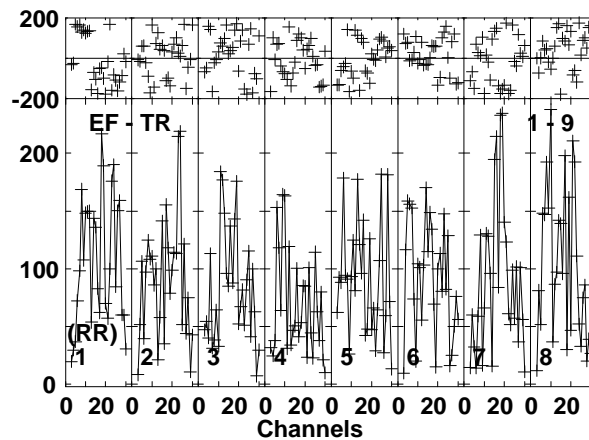
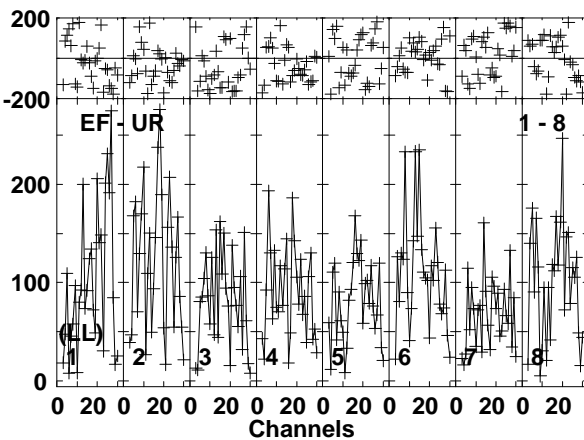
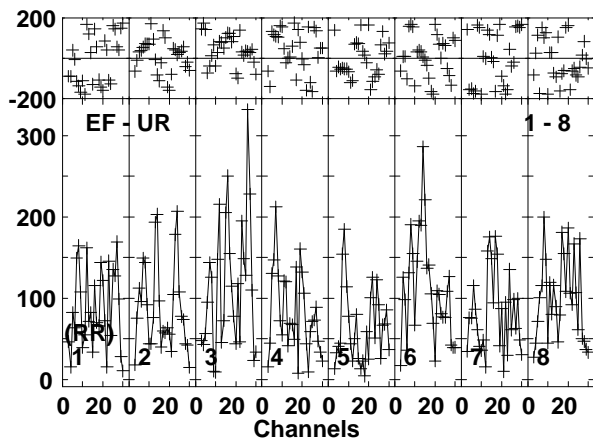
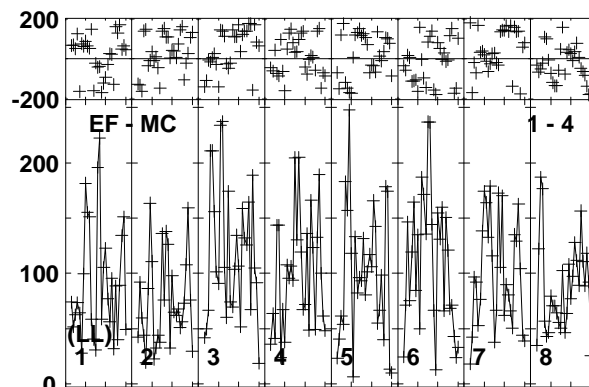
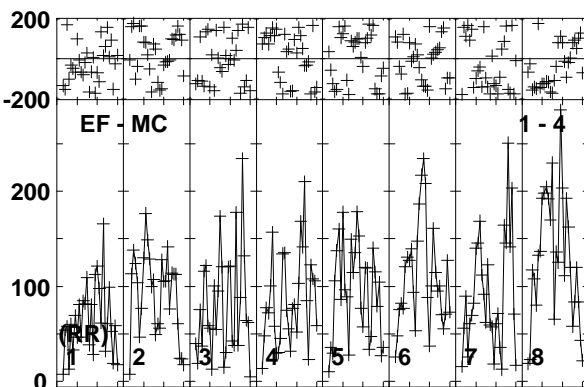
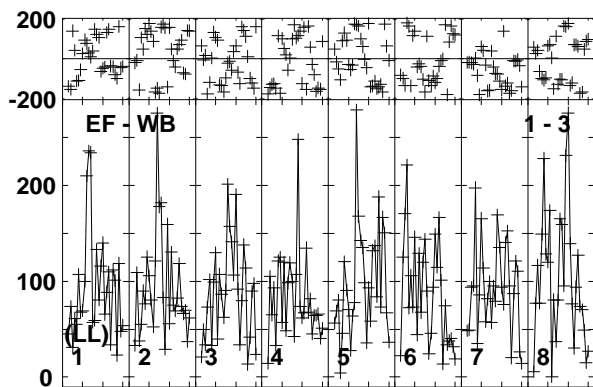
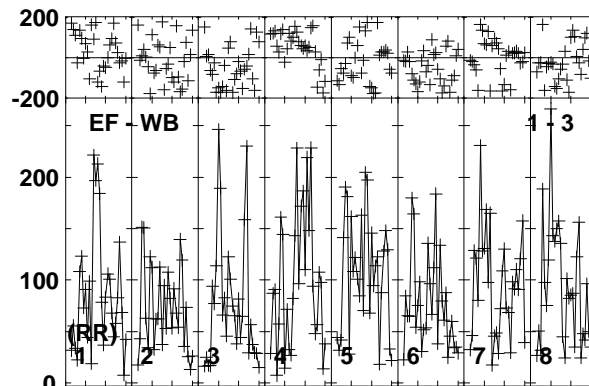
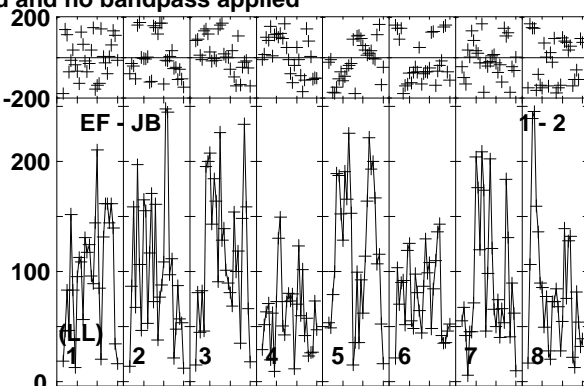
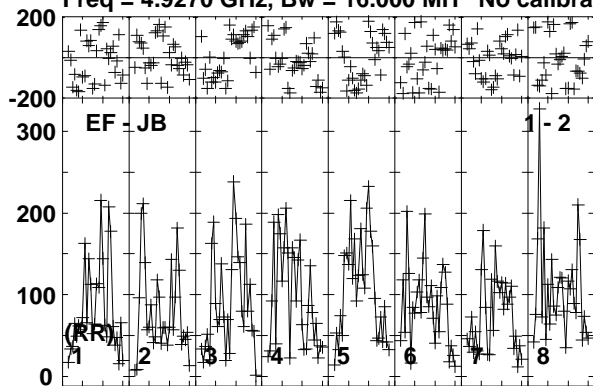

Lower frame: Micro Ampl Jy Top frame: Phas deg  
Vector averaged cross-power spectrum Baseline: EF (01) - JB (02)  
Timerange: 00/08:08:41 to 00/08:12:09

Plot file version 363 created 08-APR-2019 12:10:18

MRK622 EM133B.UVDATA.1

Freq = 4.9270 GHz, Bw = 16.000 MH No calibration applied and no bandpass applied

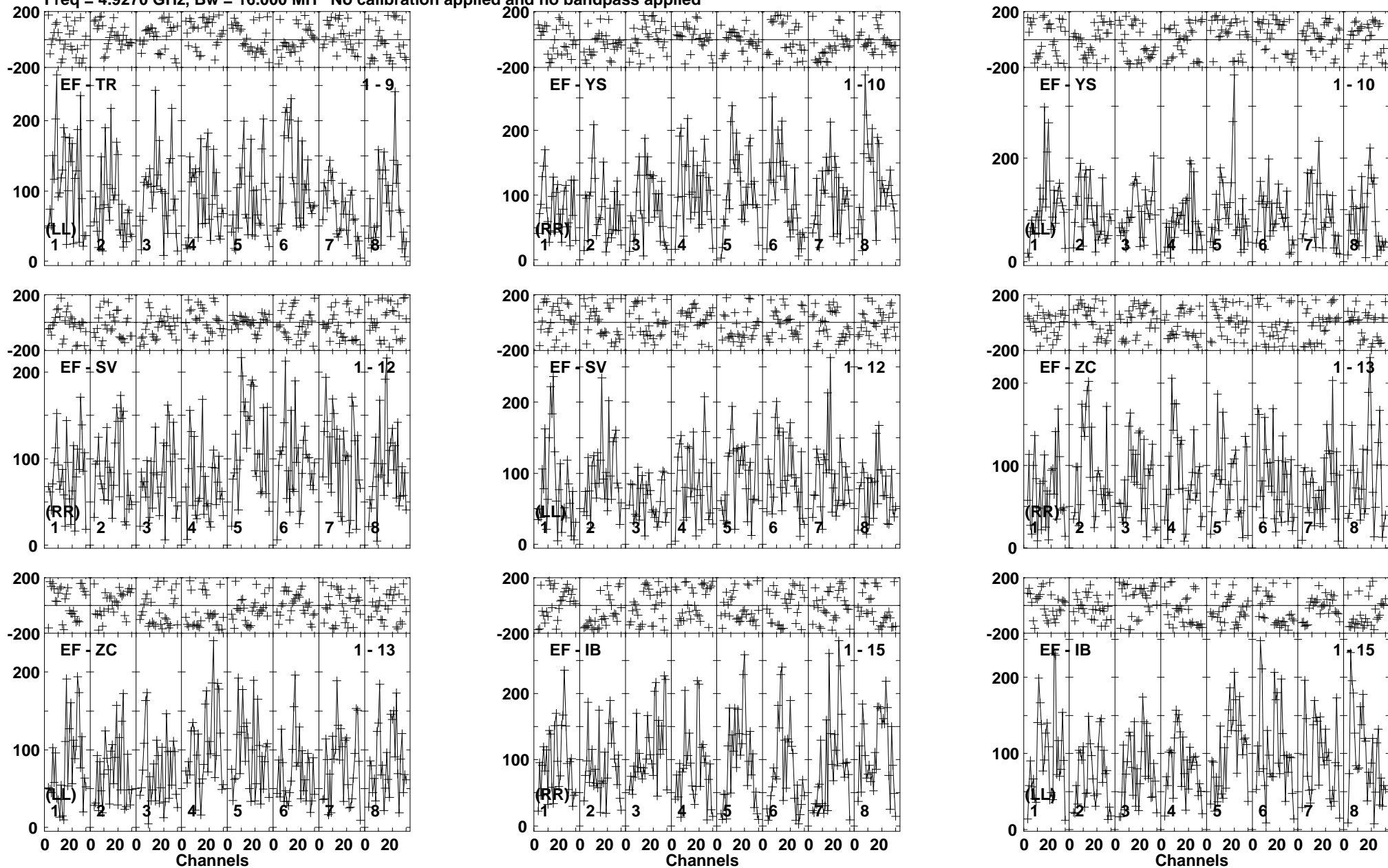

Lower frame: Micro Ampl Jy Top frame: Phas deg  
Vector averaged cross-power spectrum Baseline: EF (01) - TR (09)  
Timerange: 00/08:08:41 to 00/08:12:09

Plot file version 364 created 08-APR-2019 12:10:19

J0815+3635 EM133B.UVDATA.1

Freq = 4.9270 GHz, Bw = 16.000 MH No calibration applied and no bandpass applied

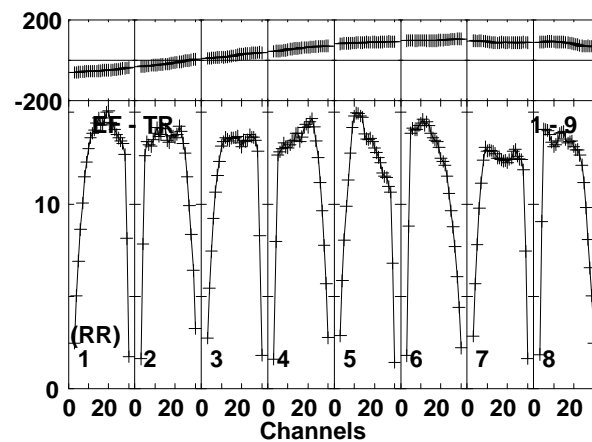
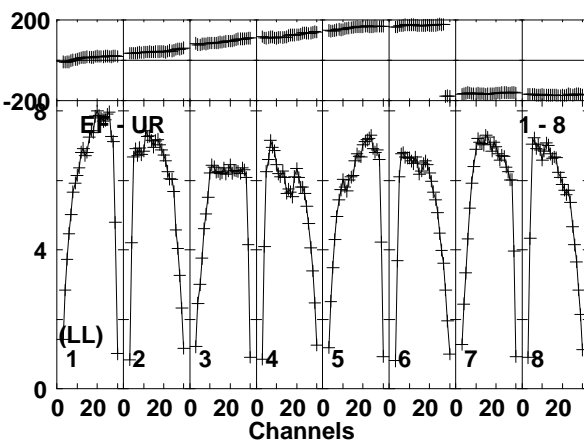
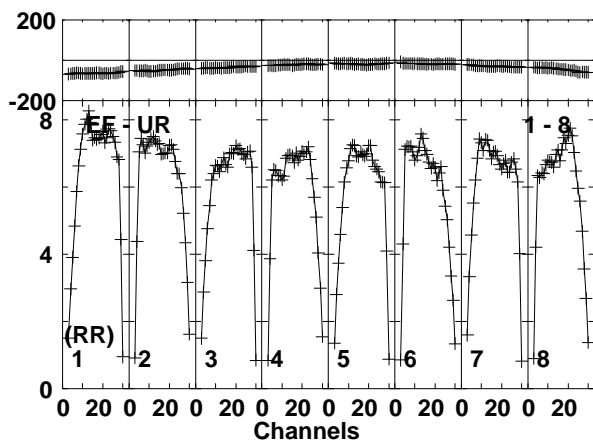
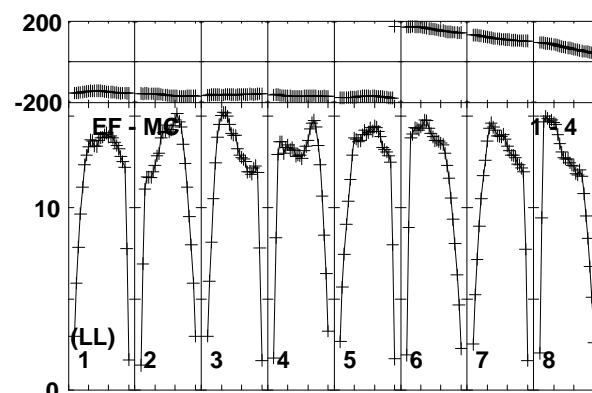
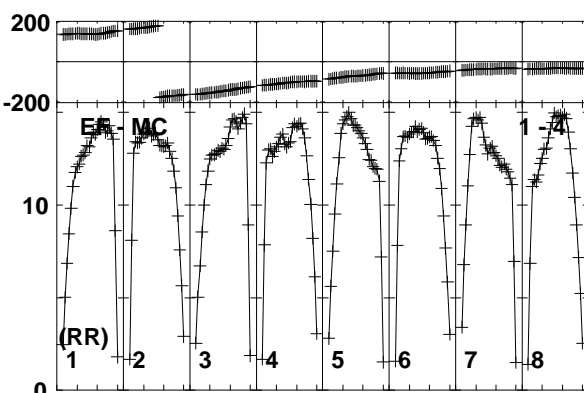
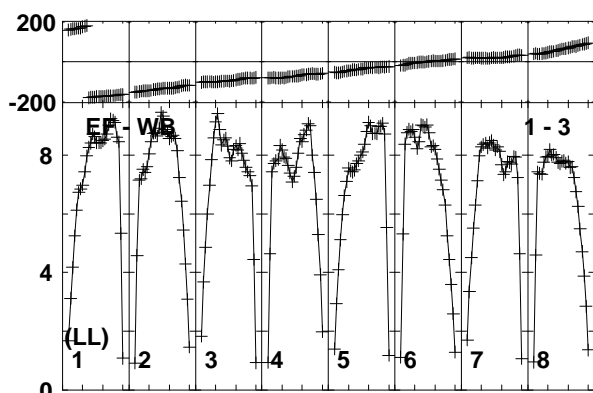
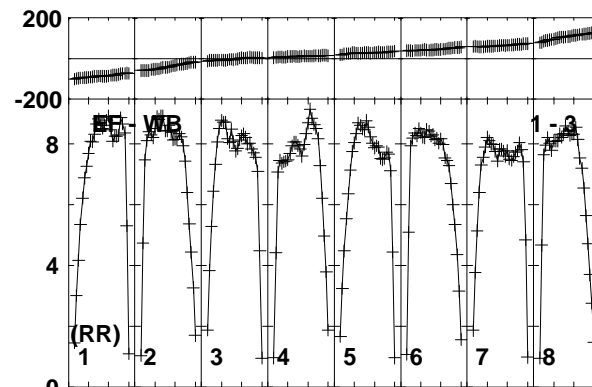
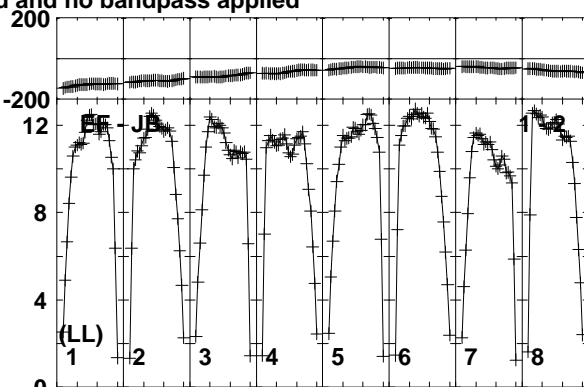
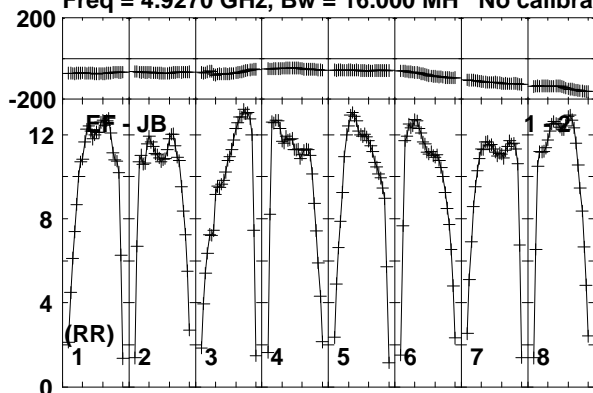

Lower frame: Milli Ampl Jy Top frame: Phas deg  
Vector averaged cross-power spectrum Baseline: EF (01) - JB (02)  
Timerange: 00/08:12:11 to 00/08:13:39

Plot file version 365 created 08-APR-2019 12:10:19

J0815+3635 EM133B.UVDATA.1

Freq = 4.9270 GHz, Bw = 16.000 MH No calibration applied and no bandpass applied

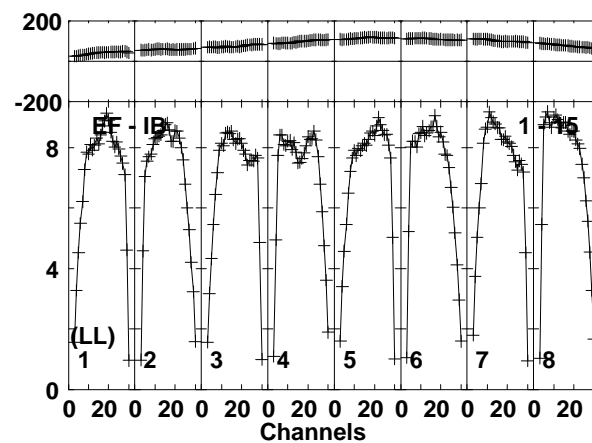
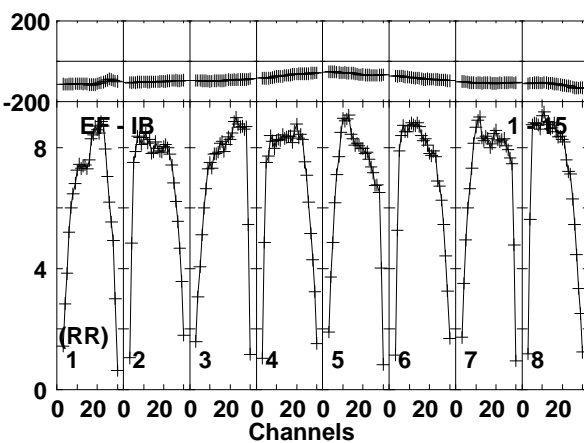
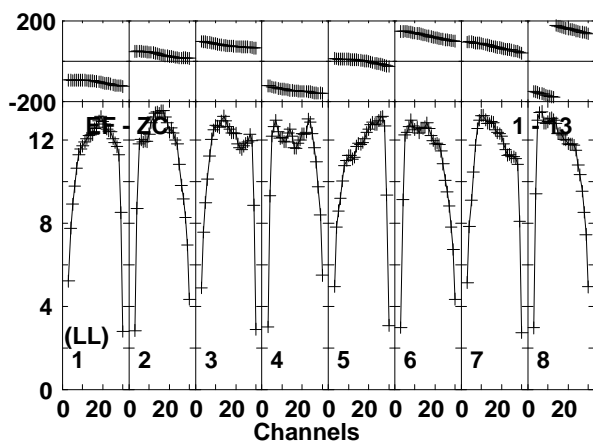
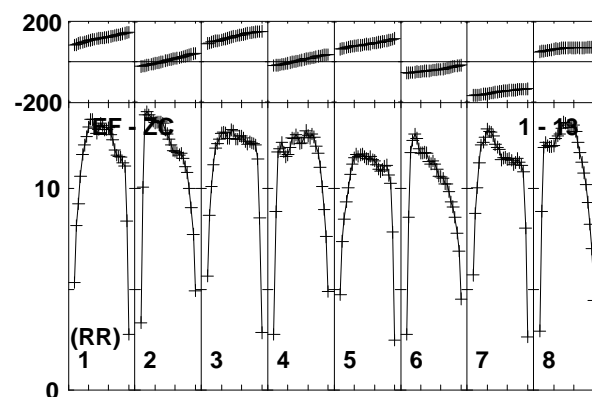
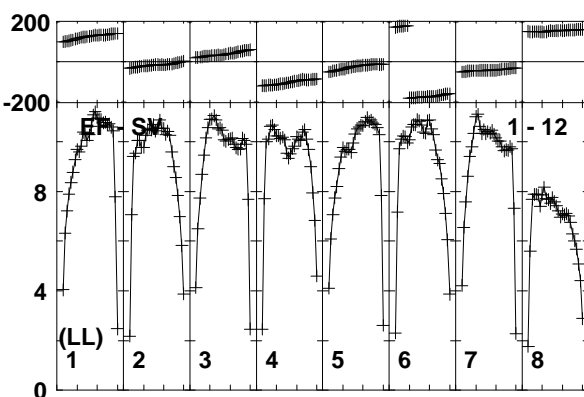
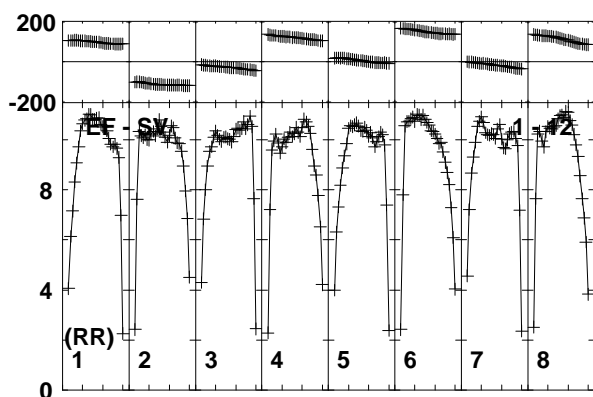
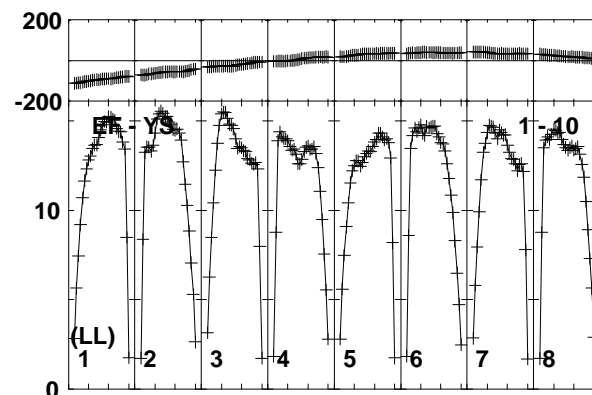
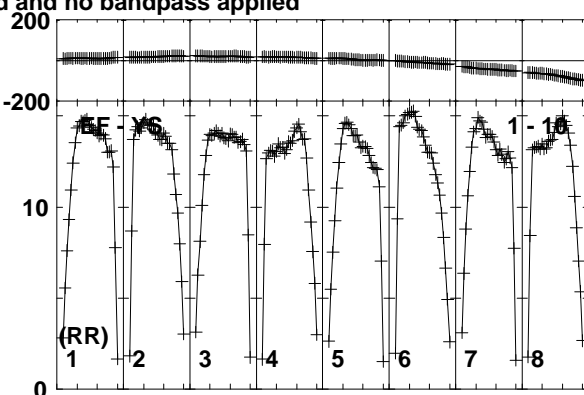
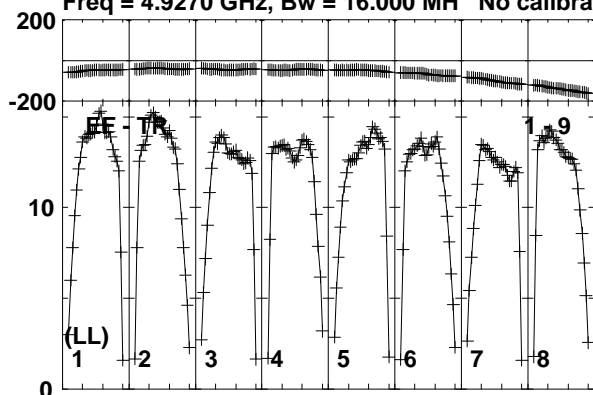

Lower frame: Milli Ampl Jy Top frame: Phas deg  
Vector averaged cross-power spectrum Baseline: EF (01) - TR (09)  
Timerange: 00/08:12:11 to 00/08:13:39

Plot file version 366 created 08-APR-2019 12:10:19

MRK622 EM133B.UVDATA.1

Freq = 4.9270 GHz, Bw = 16.000 MH No calibration applied and no bandpass applied

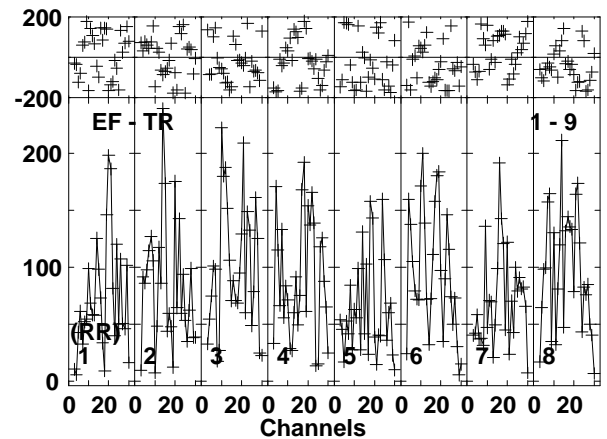
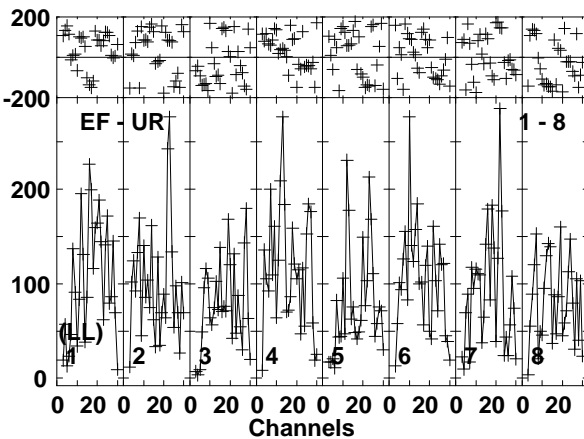
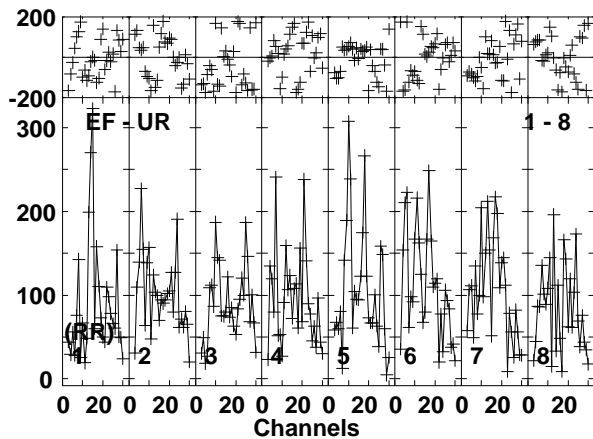
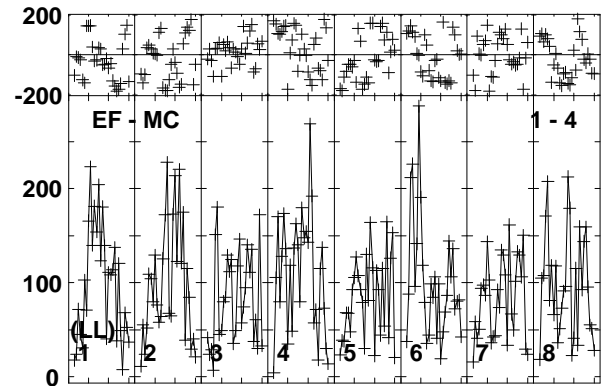
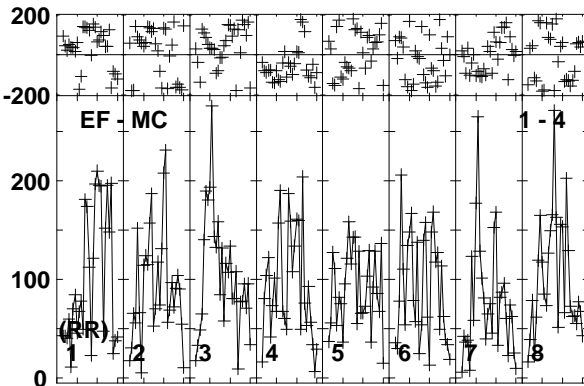
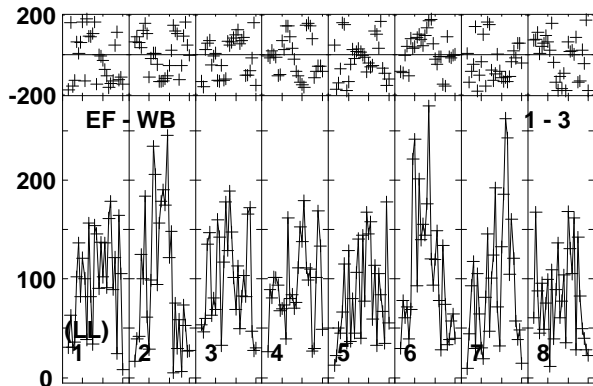
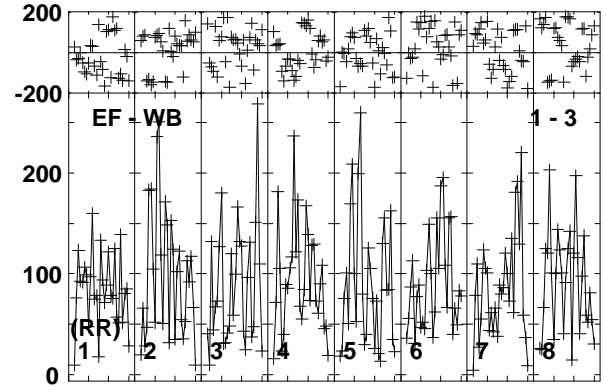
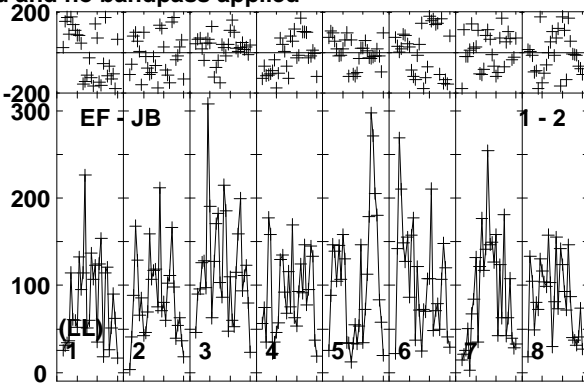
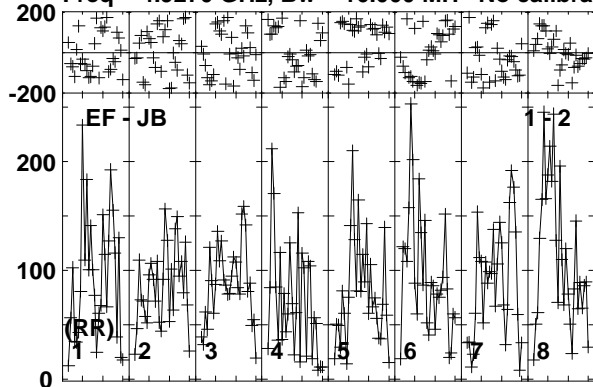

Lower frame: Micro Ampl Jy Top frame: Phas deg  
Vector averaged cross-power spectrum Baseline: EF (01) - JB (02)  
Timerange: 00/08:13:43 to 00/08:17:09

Plot file version 367 created 08-APR-2019 12:10:19

MRK622 EM133B.UVDATA.1

Freq = 4.9270 GHz, Bw = 16.000 MH No calibration applied and no bandpass applied

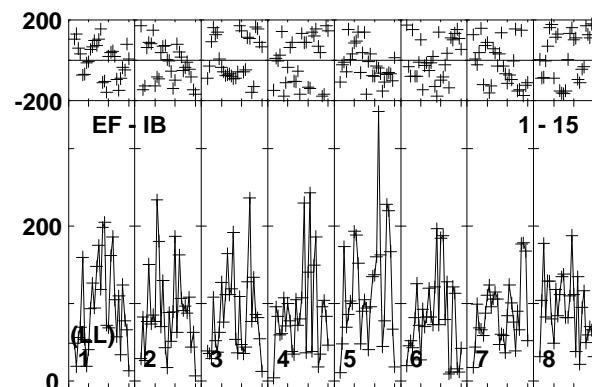
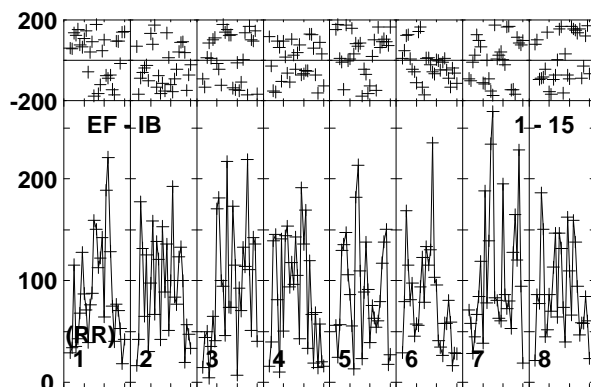
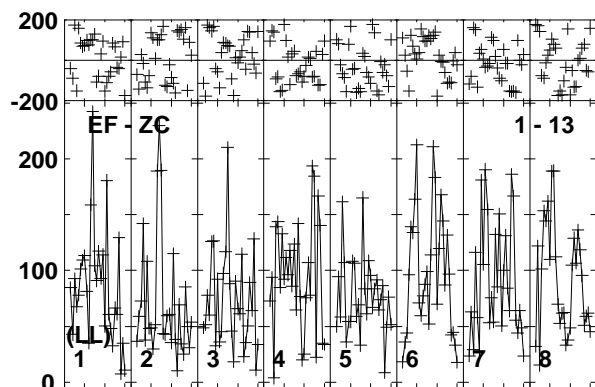
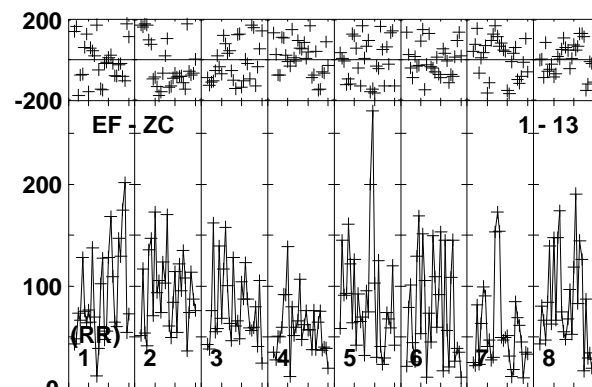
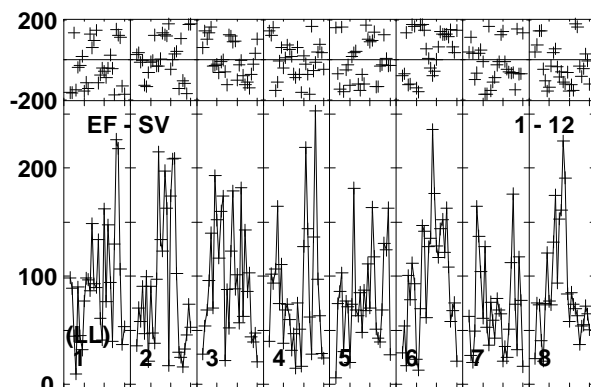
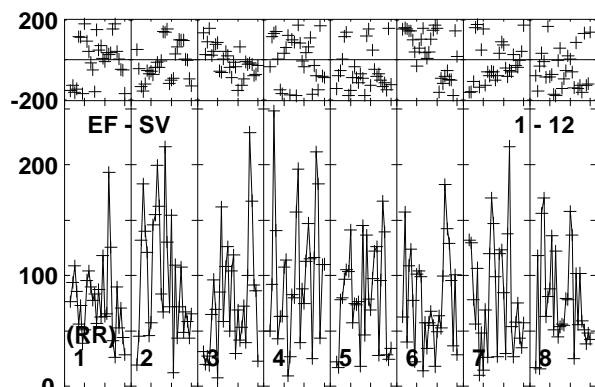
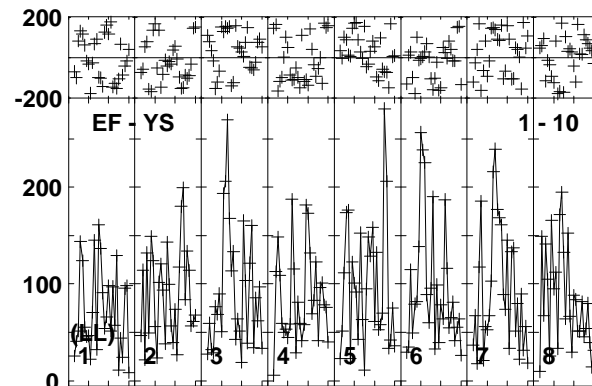
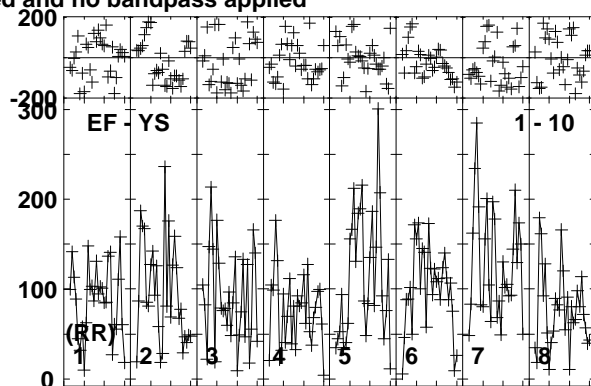
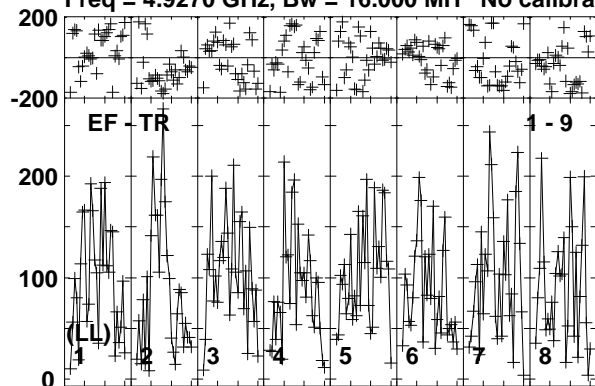

Lower frame: Micro Ampl Jy Top frame: Phas deg  
Vector averaged cross-power spectrum Baseline: EF (01) - TR (09)  
Timerange: 00/08:13:43 to 00/08:17:09

Plot file version 368 created 08-APR-2019 12:10:19

J0815+3635 EM133B.UVDATA.1

Freq = 4.9270 GHz, Bw = 16.000 MH No calibration applied and no bandpass applied

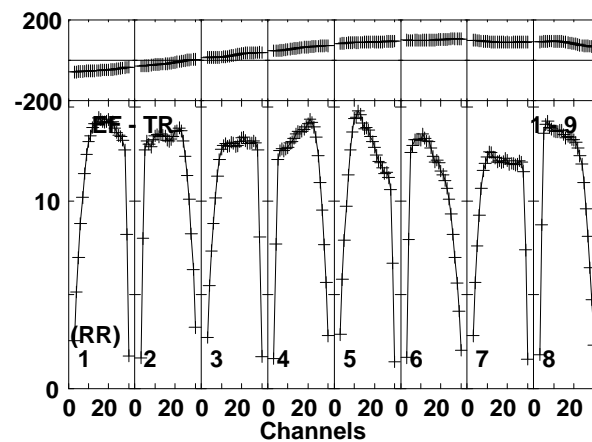
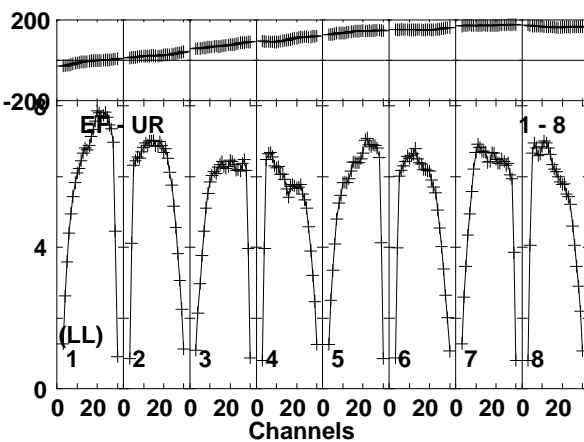
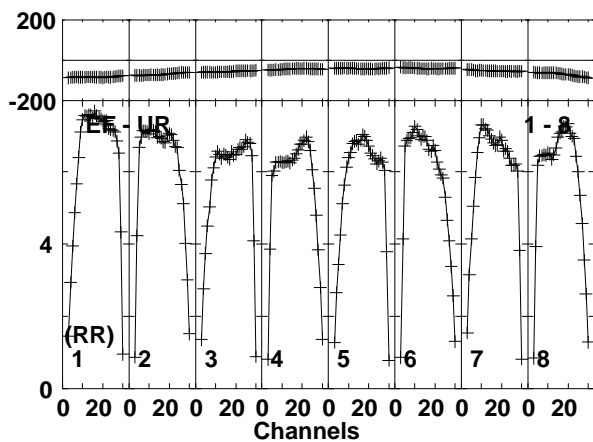
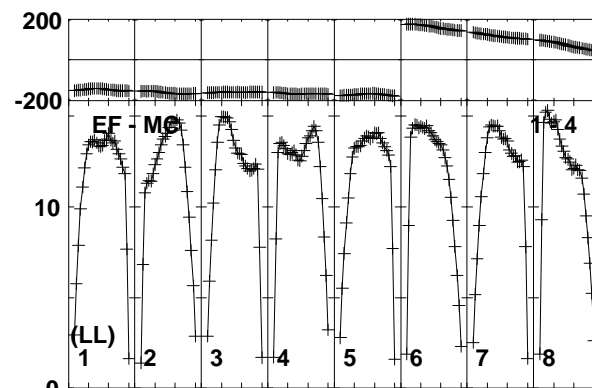
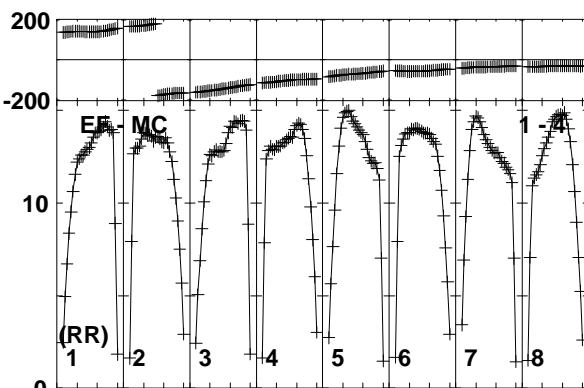
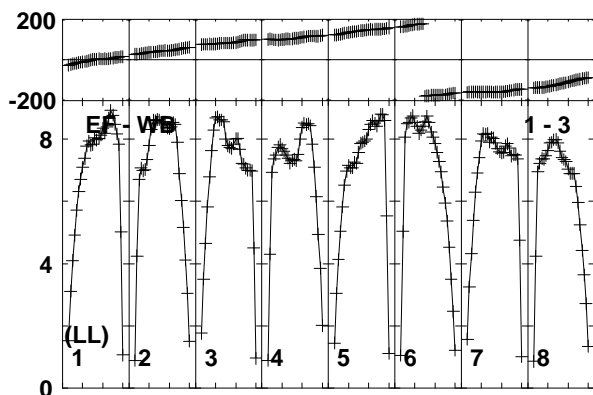
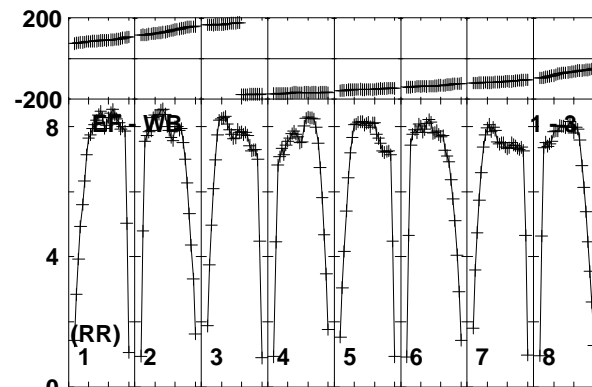
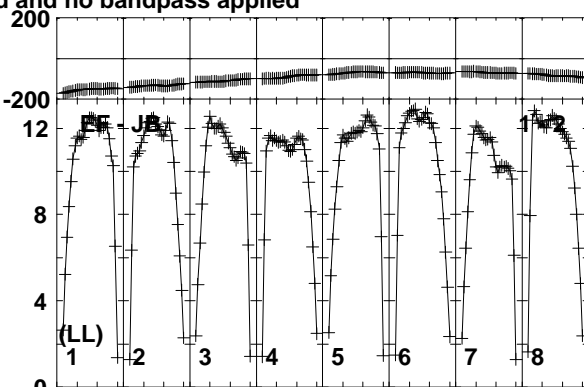
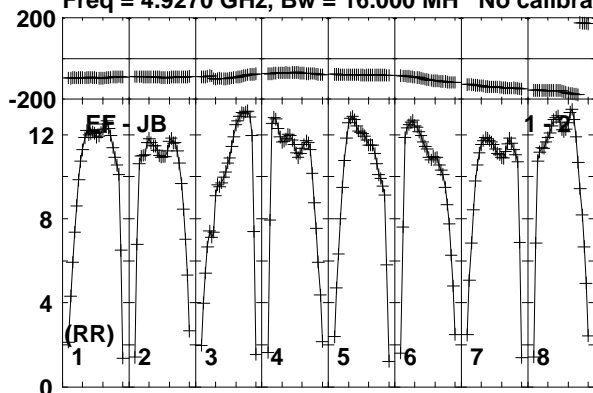

Lower frame: Milli Ampl Jy Top frame: Phas deg  
Vector averaged cross-power spectrum Baseline: EF (01) - JB (02)  
Timerange: 00/08:18:01 to 00/08:19:29



Plot file version 369 created 08-APR-2019 12:10:19

J0815+3635 EM133B.UVDATA.1

Freq = 4.9270 GHz, Bw = 16.000 MH No calibration applied and no bandpass applied

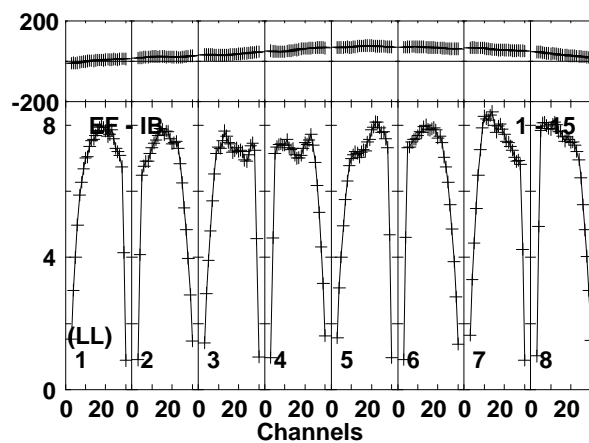
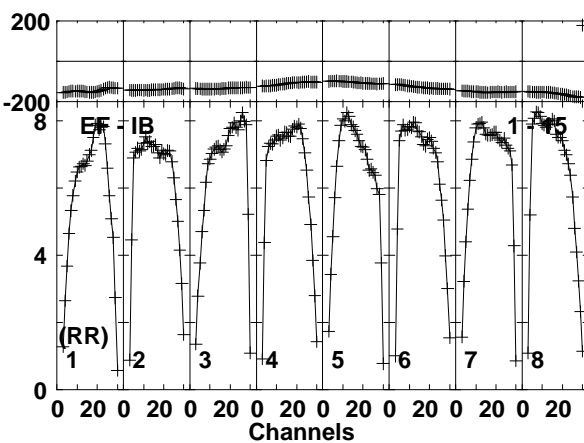
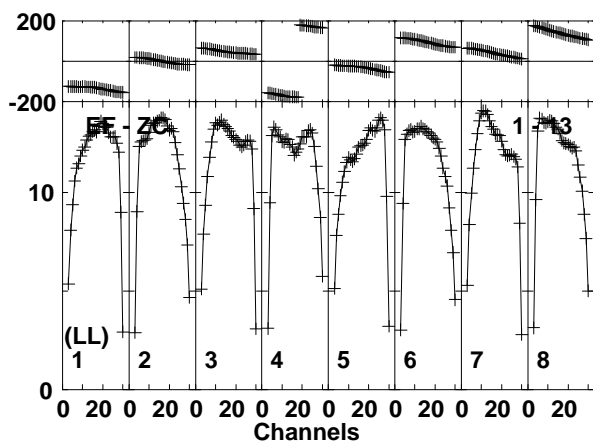
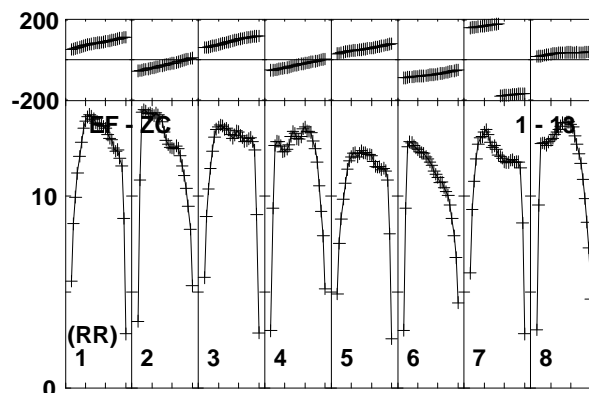
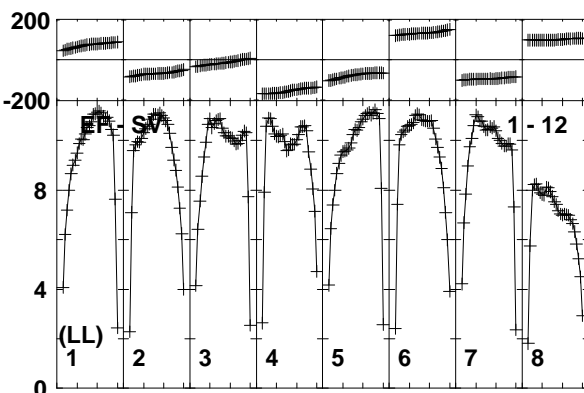
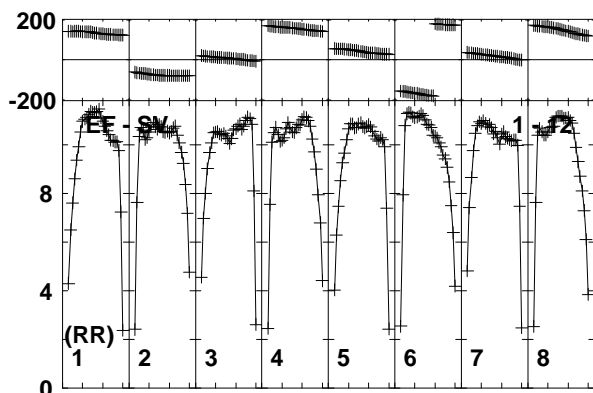
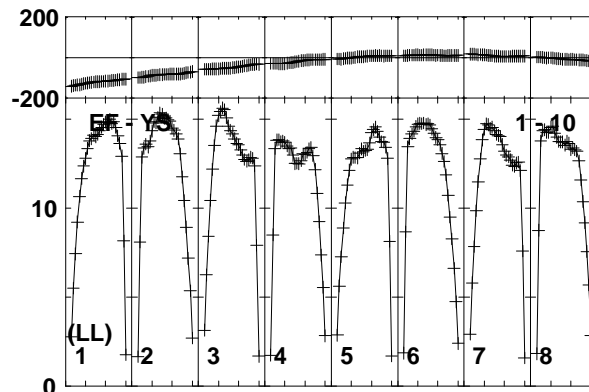
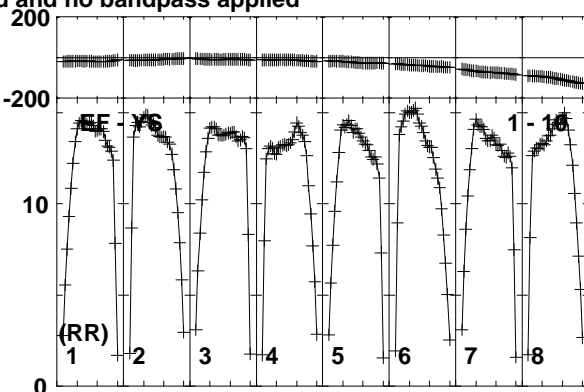
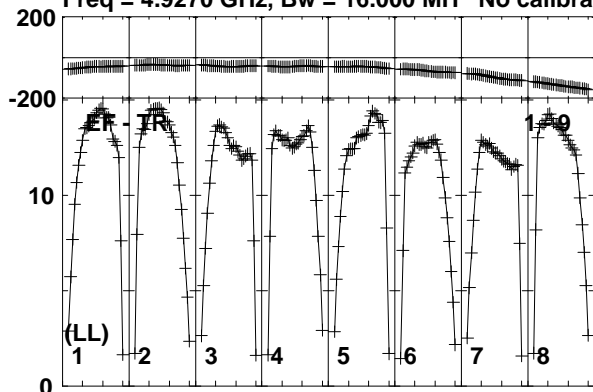

Lower frame: Milli Ampl Jy Top frame: Phas deg  
Vector averaged cross-power spectrum Baseline: EF (01) - TR (09)  
Timerange: 00/08:18:01 to 00/08:19:29

Plot file version 370 created 08-APR-2019 12:10:19

J0815+3635 EM133B.UVDATA.1

Freq = 4.9270 GHz, Bw = 16.000 MH No calibration applied and no bandpass applied

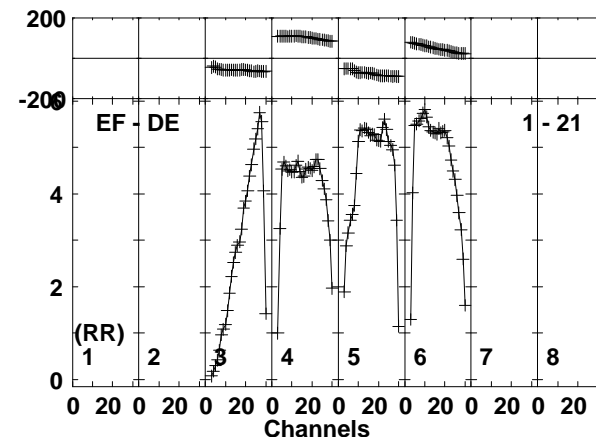
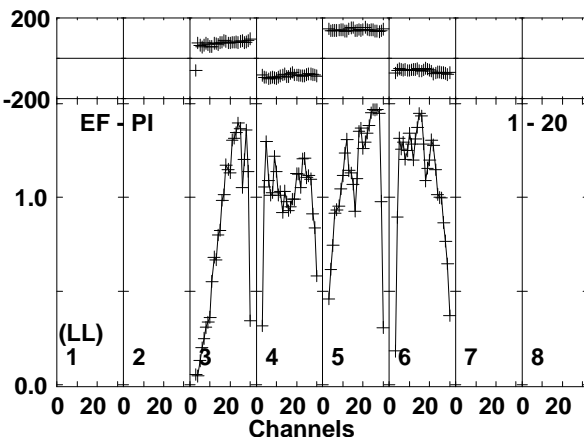
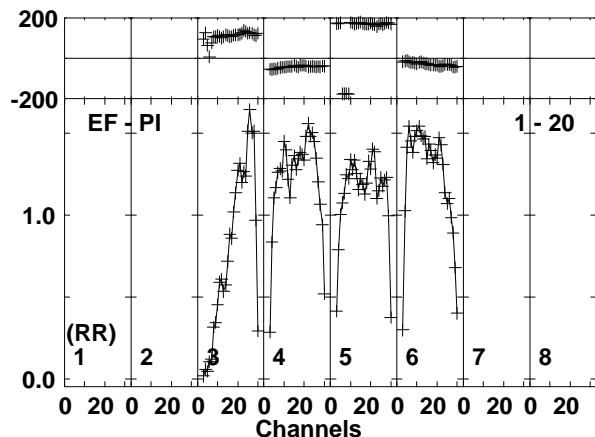
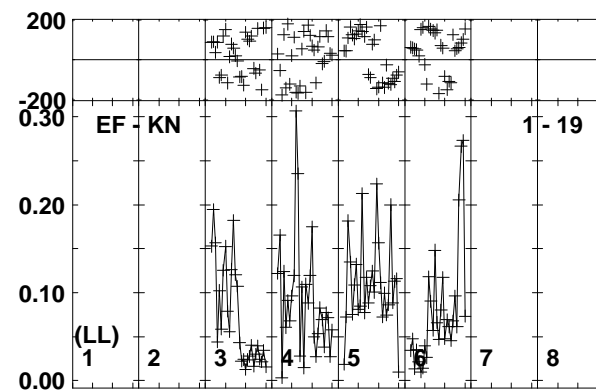
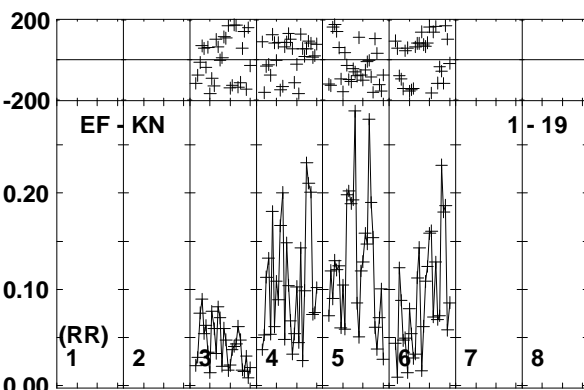
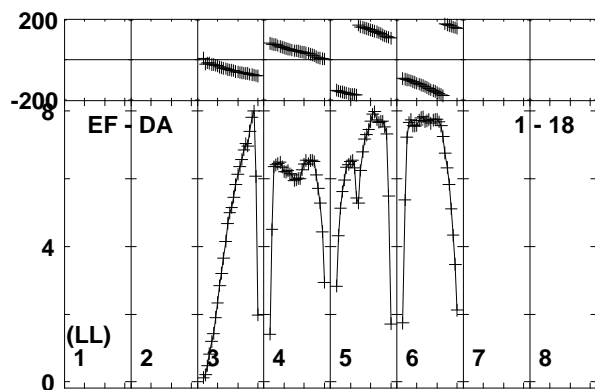
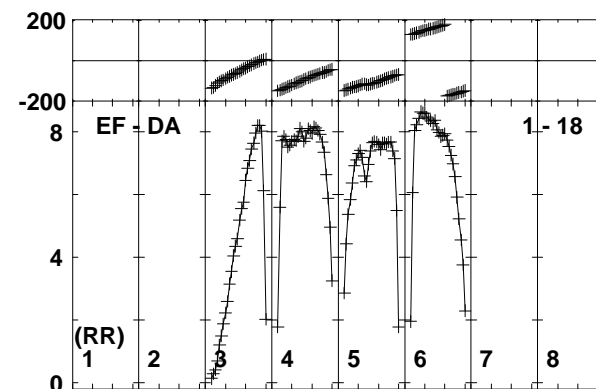
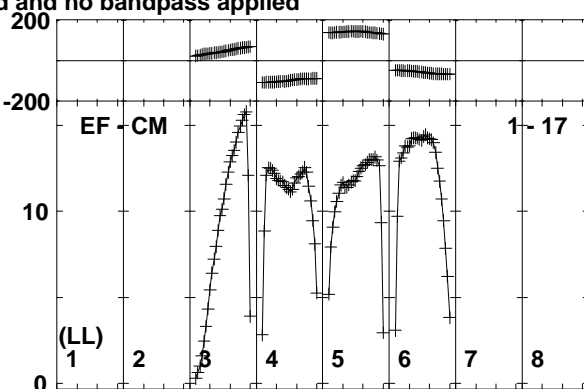
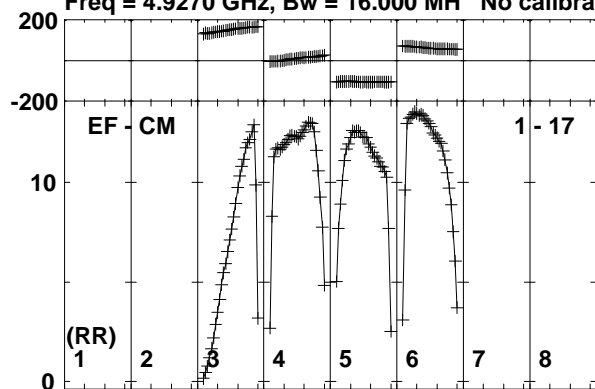

Lower frame: Milli Ampl Jy Top frame: Phas deg  
Vector averaged cross-power spectrum Baseline: EF (01) - CM (17)  
Timerange: 00/08:18:01 to 00/08:19:29

Plot file version 371 created 08-APR-2019 12:10:19  
J0815+3635 EM133B.UVDATA.1  
Freq = 4.9270 GHz, Bw = 16.000 MH No calibration applied and no bandpass applied

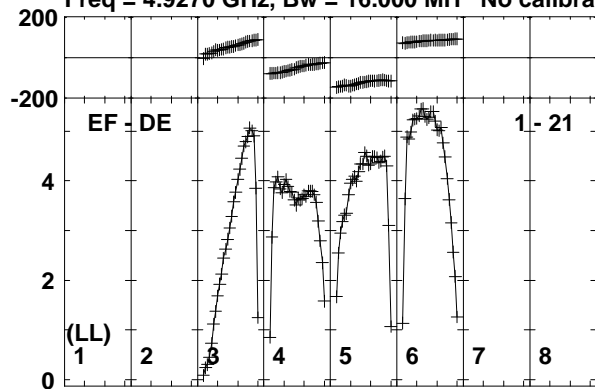

Lower frame: Milli Ampl Jy Top frame: Phas deg  
Vector averaged cross-power spectrum Baseline: EF (01) - DE (21)  
Timerange: 00/08:18:01 to 00/08:19:29

Plot file version 372 created 08-APR-2019 12:10:19

MRK622 EM133B.UVDATA.1

Freq = 4.9270 GHz, Bw = 16.000 MH No calibration applied and no bandpass applied

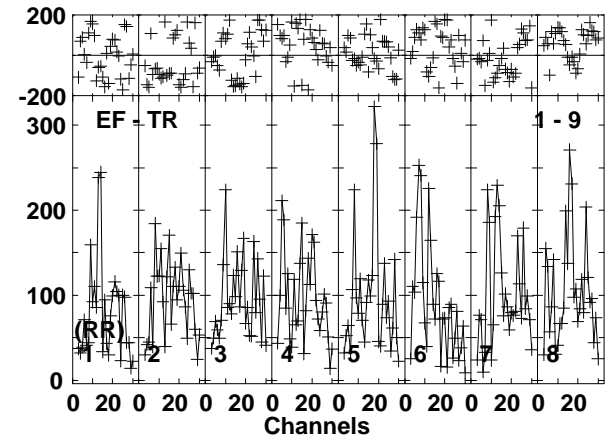
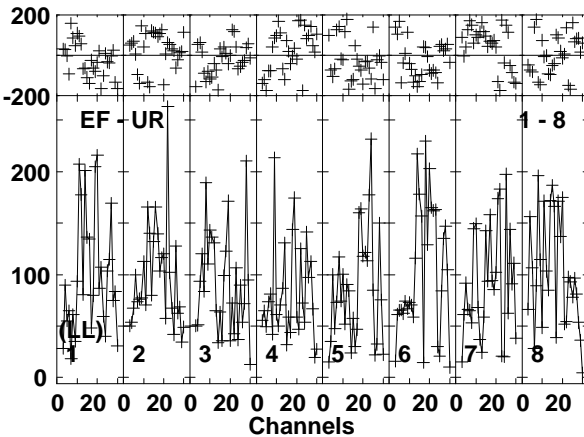
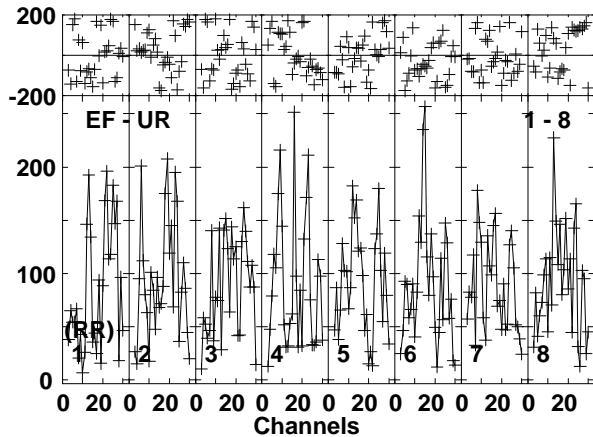
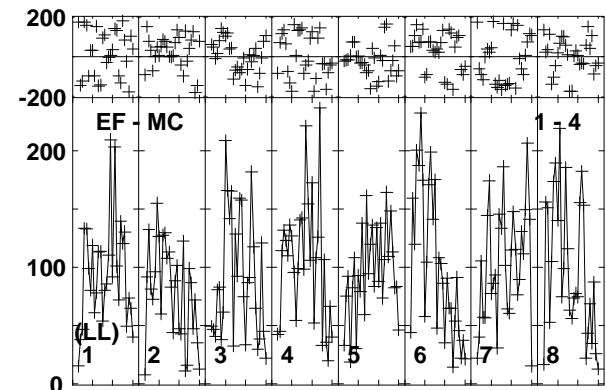
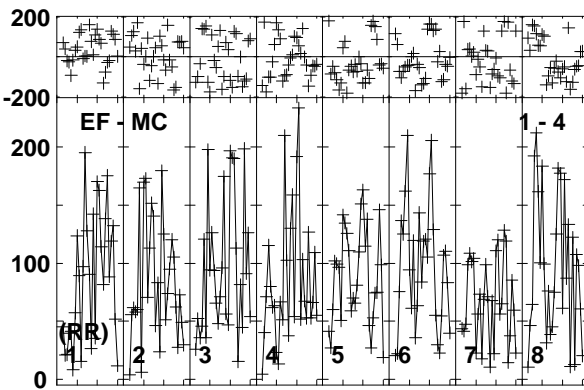
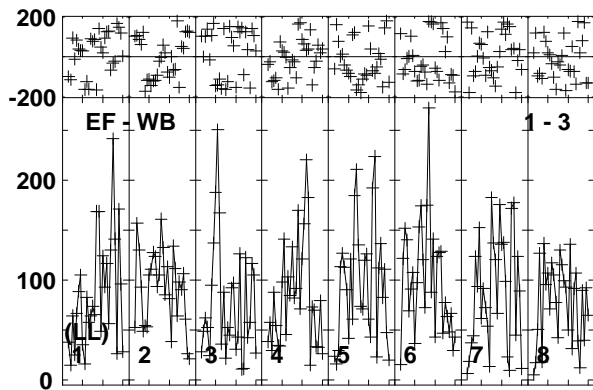
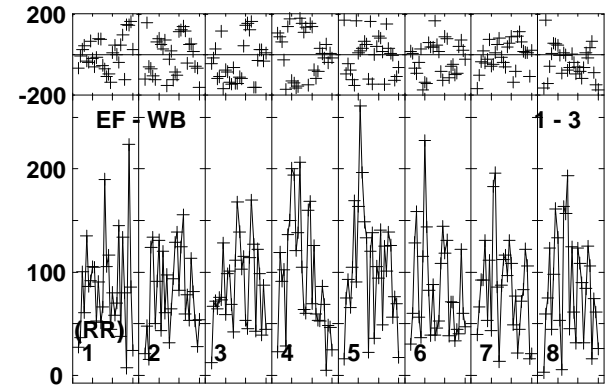
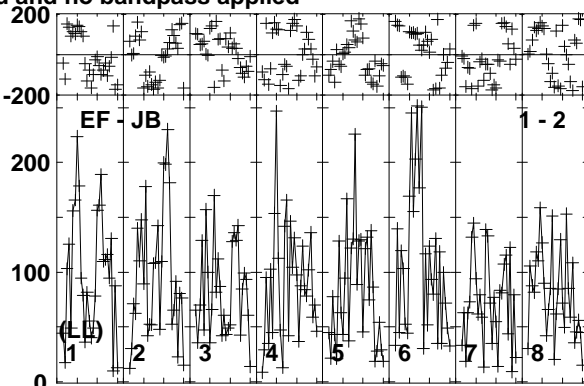
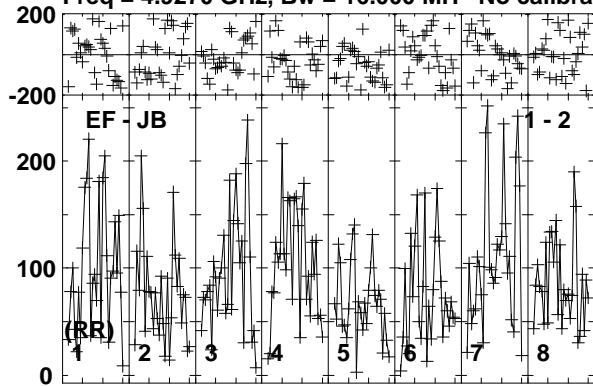

Lower frame: Micro Ampl Jy Top frame: Phas deg  
Vector averaged cross-power spectrum Baseline: EF (01) - JB (02)  
Timerange: 00/08:19:31 to 00/08:22:59

Plot file version 373 created 08-APR-2019 12:10:20

MRK622 EM133B.UVDATA.1

Freq = 4.9270 GHz, Bw = 16.000 MH No calibration applied and no bandpass applied

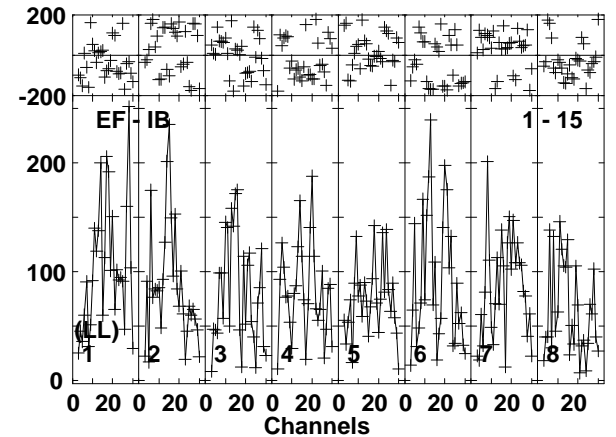
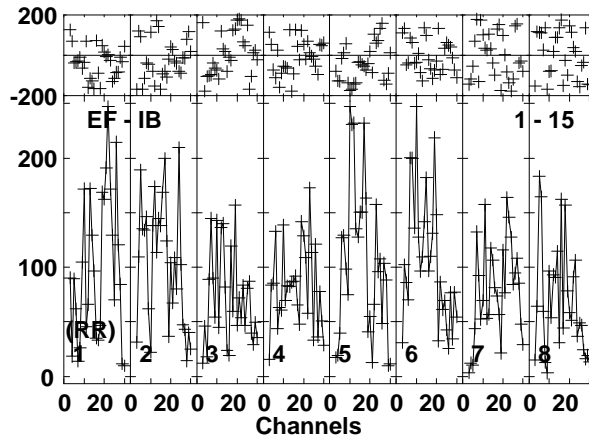
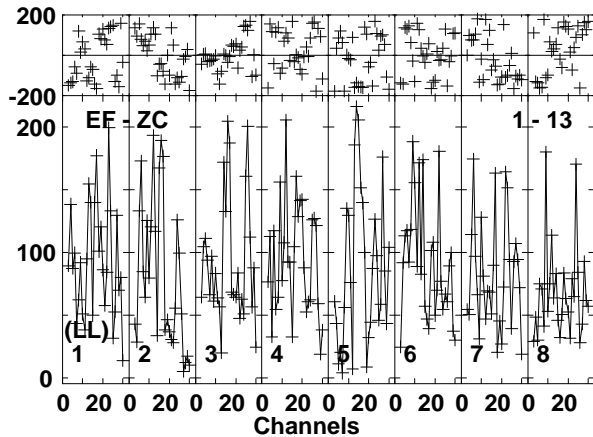
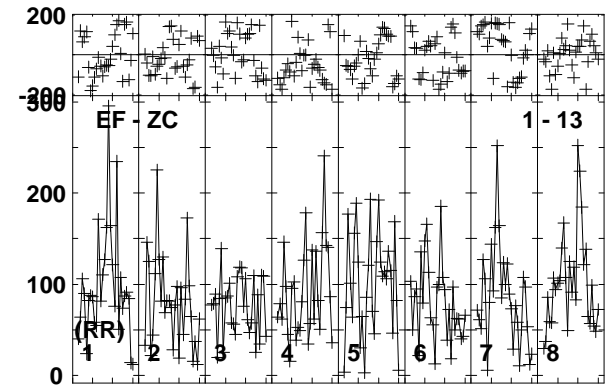
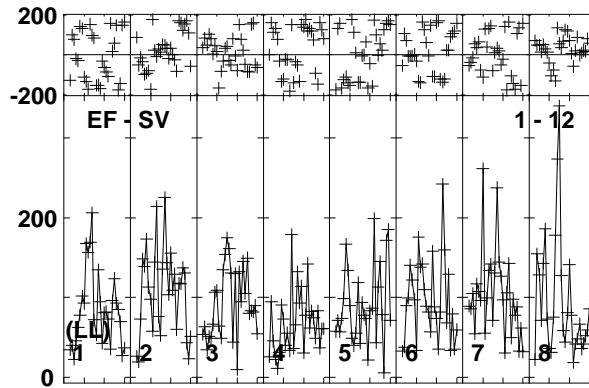
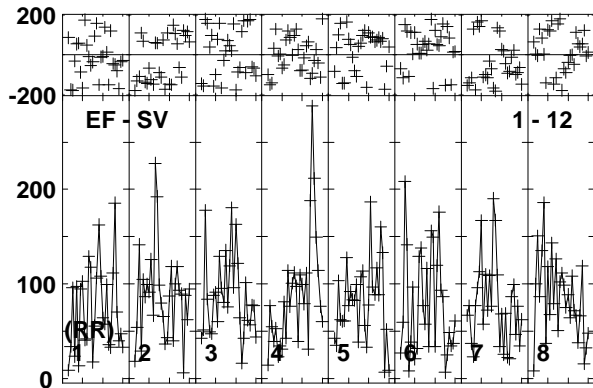
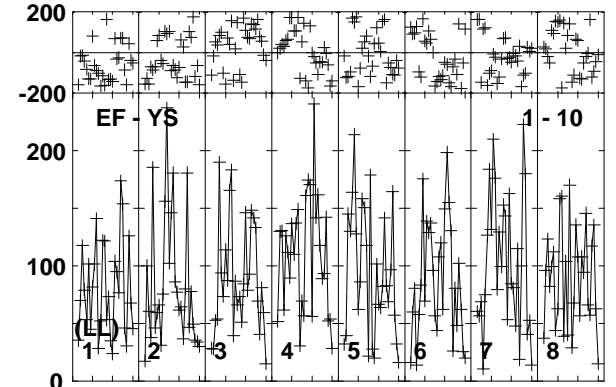
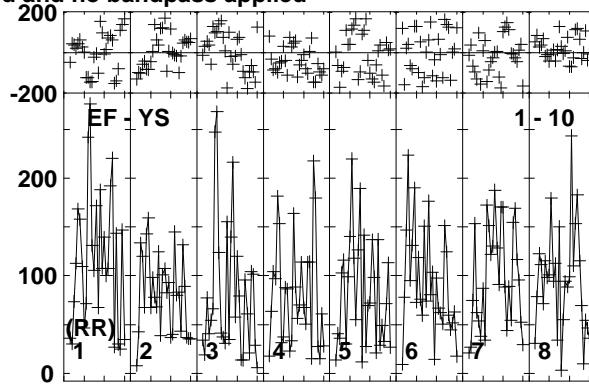
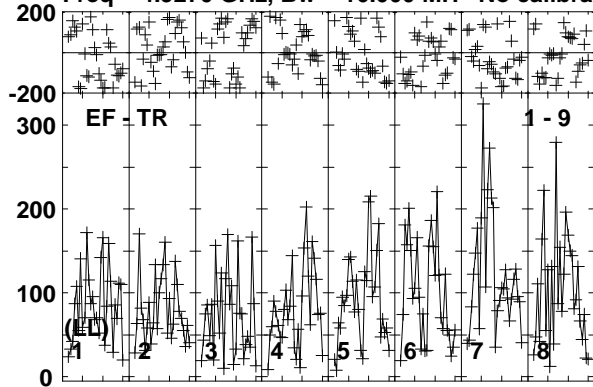

Lower frame: Micro Ampl Jy Top frame: Phas deg  
Vector averaged cross-power spectrum Baseline: EF (01) - TR (09)  
Timerange: 00/08:19:31 to 00/08:22:59

Plot file version 374 created 08-APR-2019 12:10:20

J0815+3635 EM133B.UVDATA.1

Freq = 4.9270 GHz, Bw = 16.000 MH No calibration applied and no bandpass applied

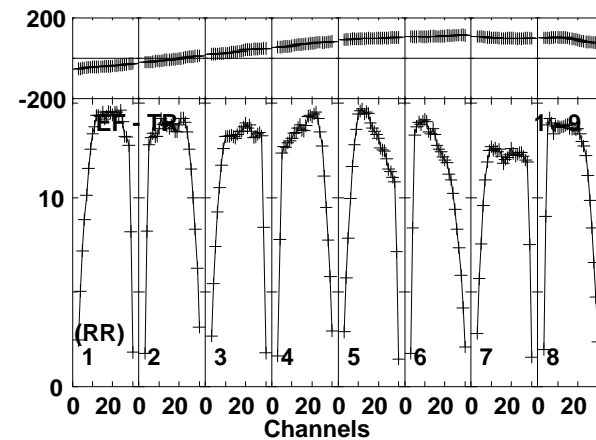
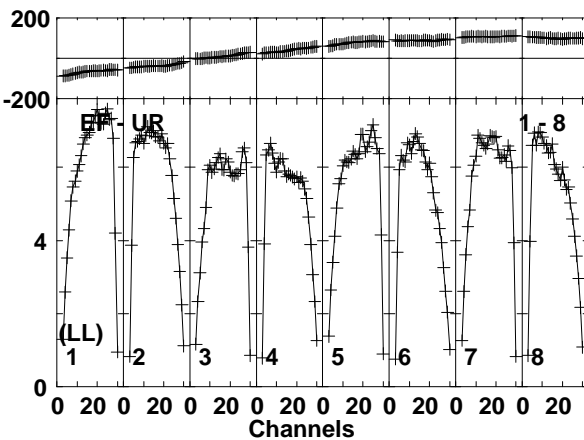
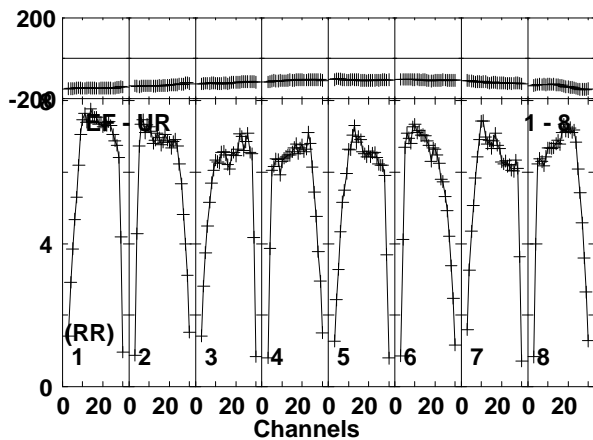
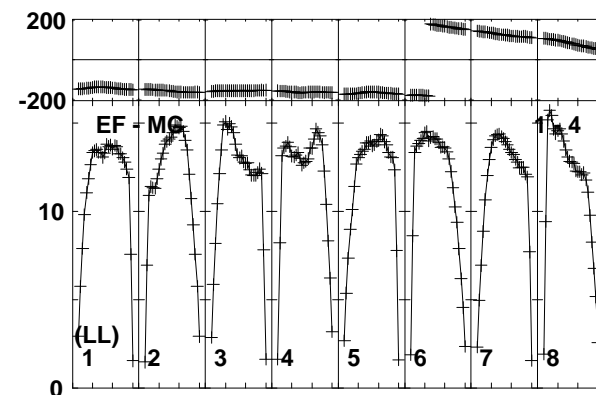
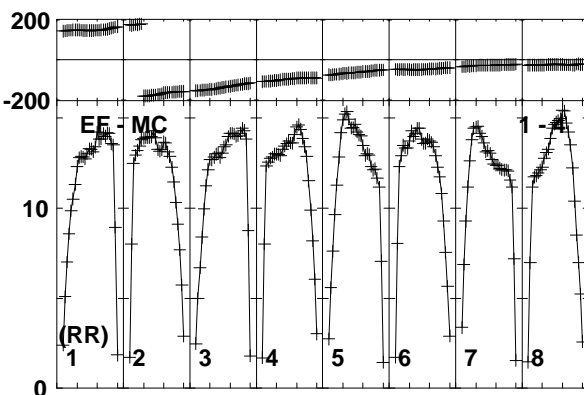
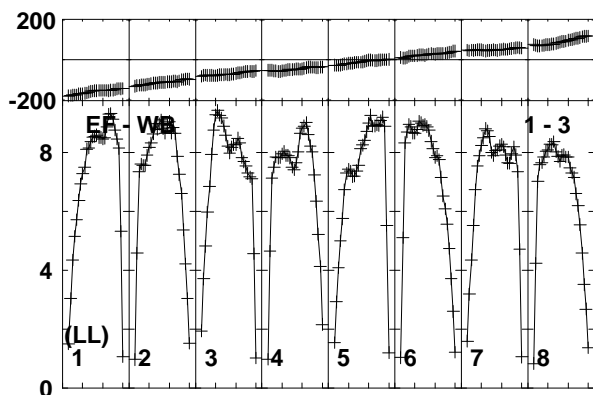
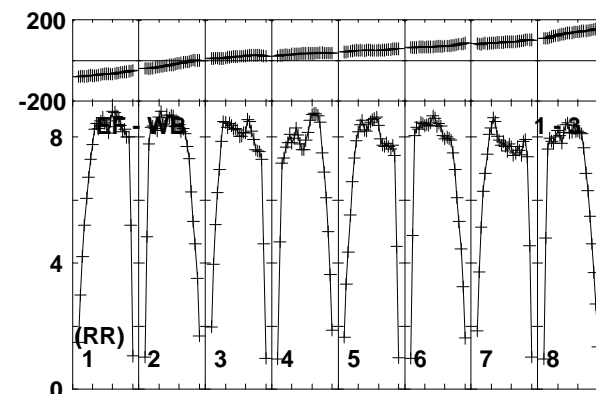
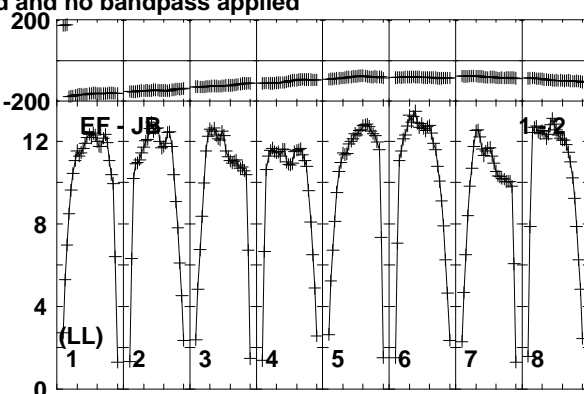
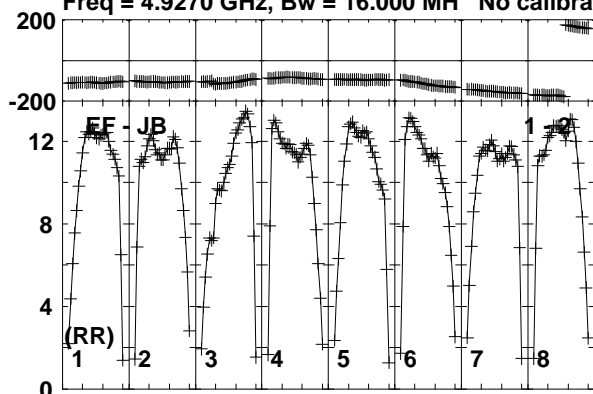

Lower frame: Milli Ampl Jy Top frame: Phas deg  
Vector averaged cross-power spectrum Baseline: EF (01) - JB (02)  
Timerange: 00/08:23:01 to 00/08:24:29

Plot file version 375 created 08-APR-2019 12:10:20

J0815+3635 EM133B.UVDATA.1

Freq = 4.9270 GHz, Bw = 16.000 MH No calibration applied and no bandpass applied

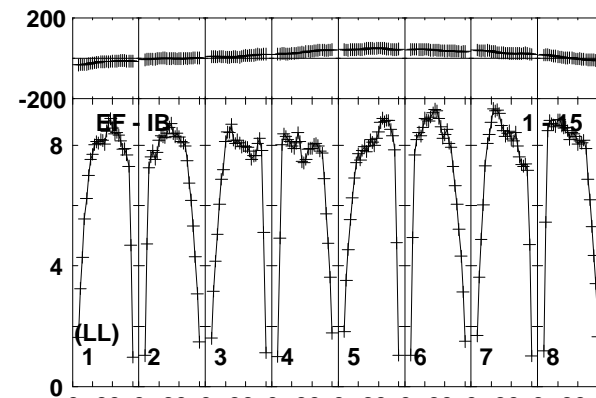
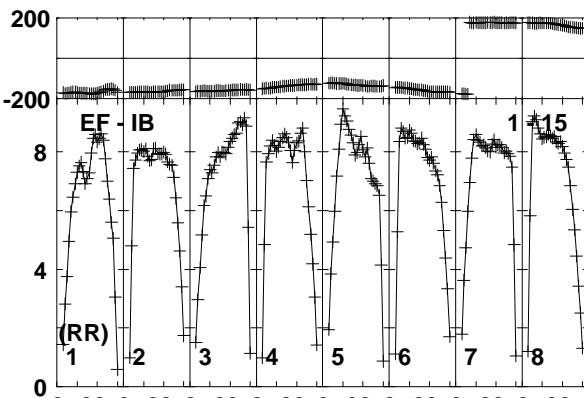
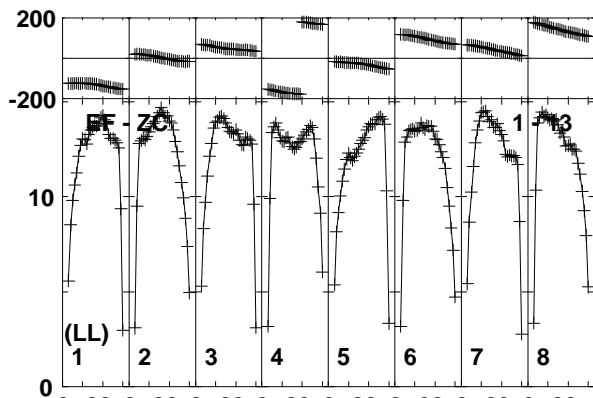
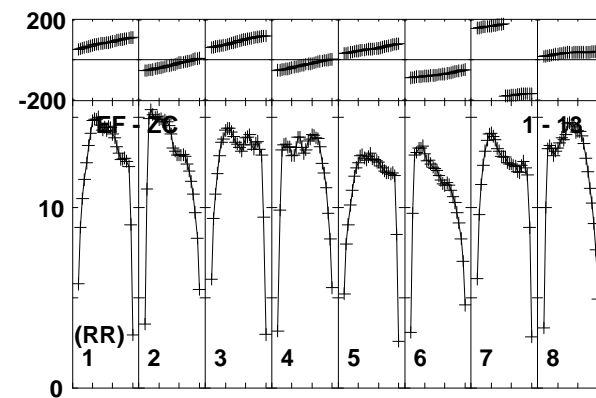
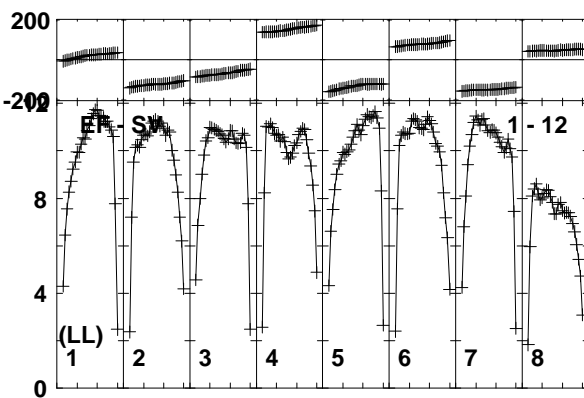
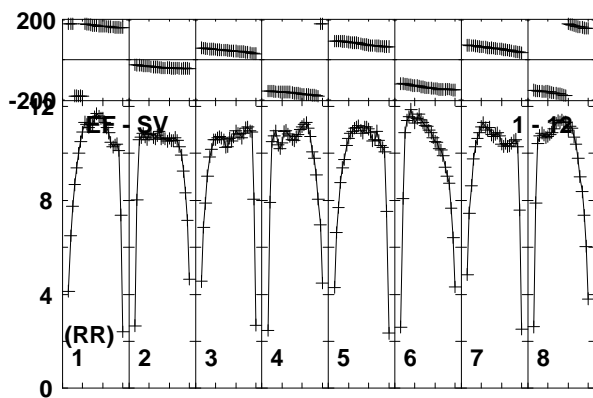
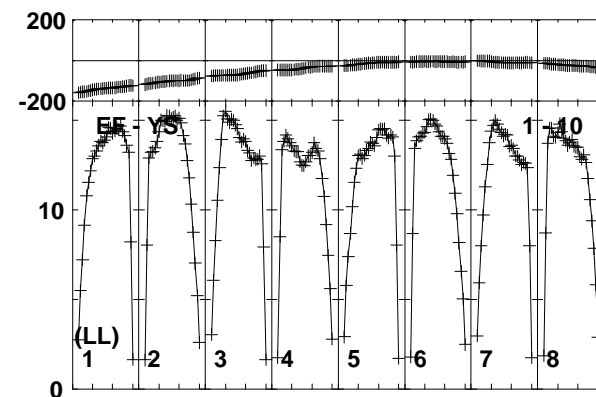
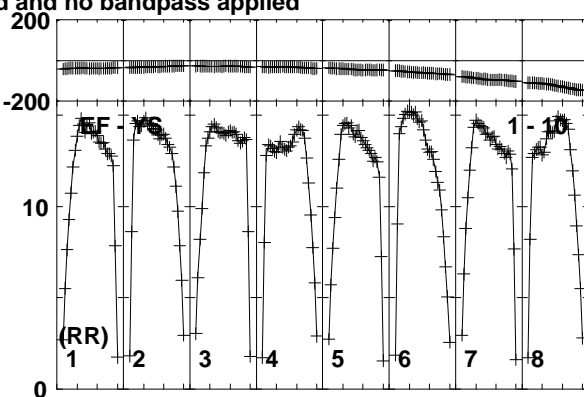
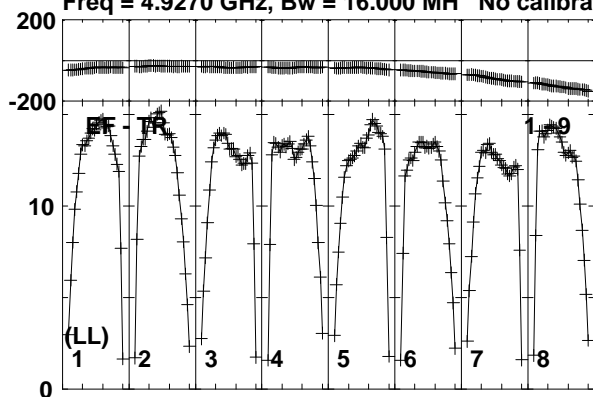

Lower frame: Milli Ampl Jy Top frame: Phas deg  
Vector averaged cross-power spectrum Baseline: EF (01) - TR (09)  
Timerange: 00/08:23:01 to 00/08:24:29

Plot file version 376 created 08-APR-2019 12:10:20

MRK622 EM133B.UVDATA.1

Freq = 4.9270 GHz, Bw = 16.000 MH No calibration applied and no bandpass applied

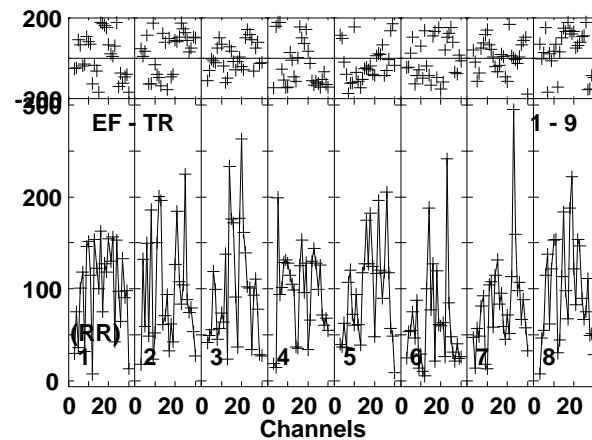
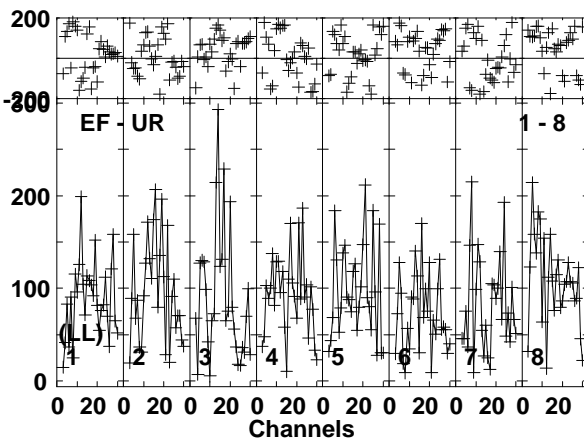
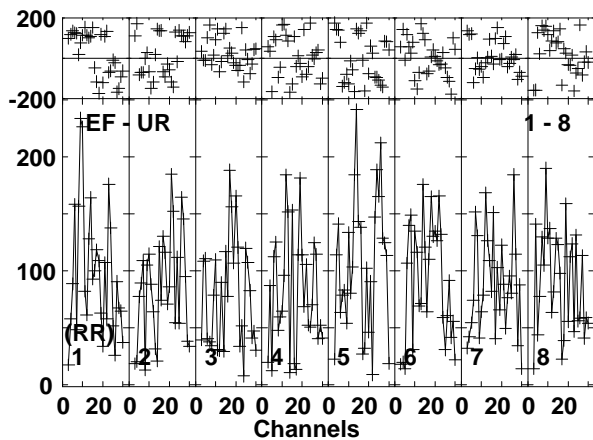
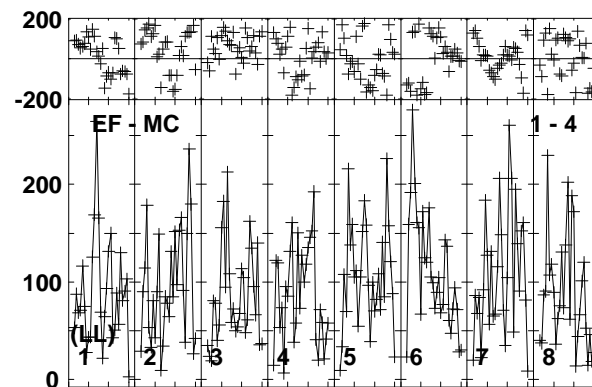
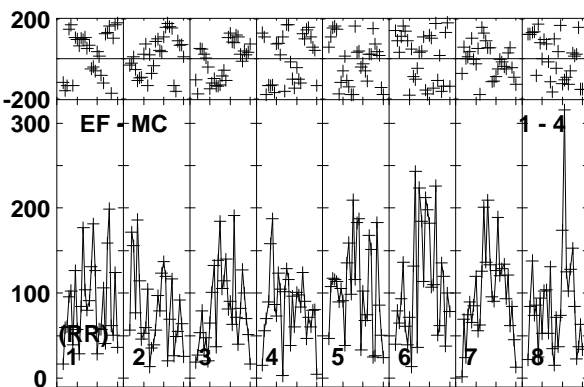
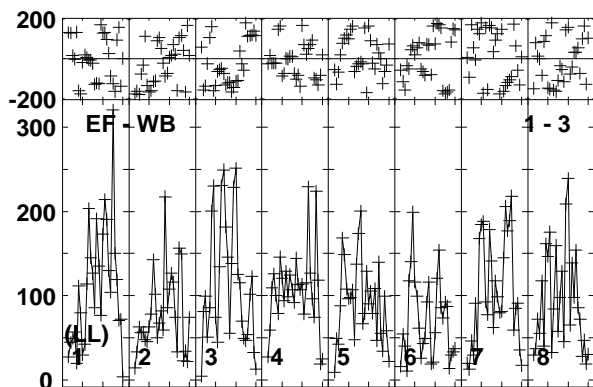
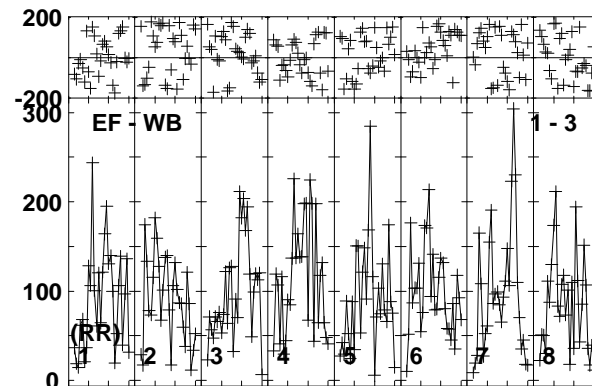
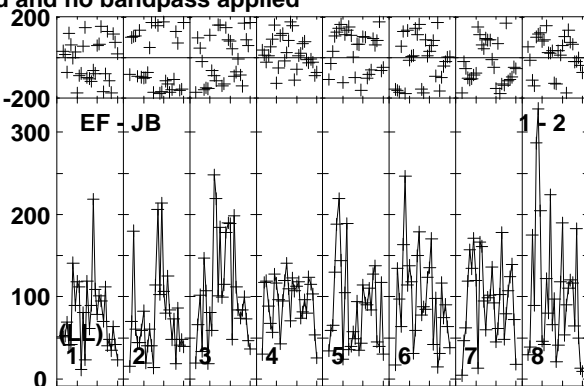
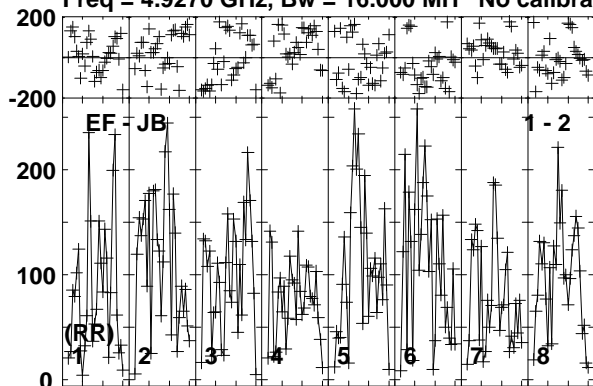

Lower frame: Micro Ampl Jy Top frame: Phas deg  
Vector averaged cross-power spectrum Baseline: EF (01) - JB (02)  
Timerange: 00/08:24:33 to 00/08:27:59



Plot file version 377 created 08-APR-2019 12:10:20

MRK622 EM133B.UVDATA.1

Freq = 4.9270 GHz, Bw = 16.000 MH No calibration applied and no bandpass applied

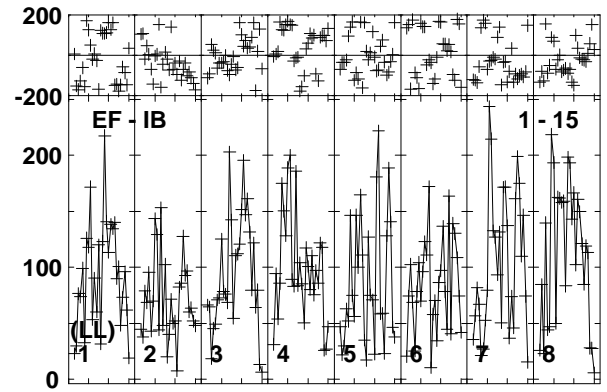
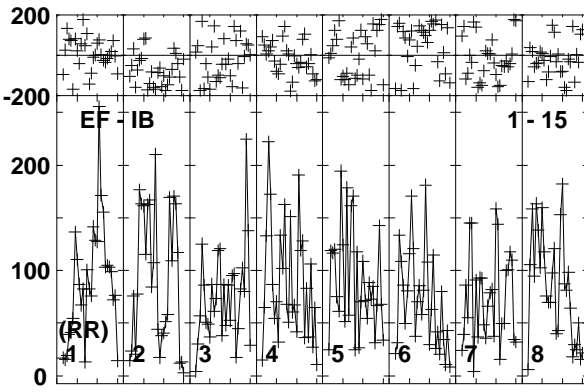
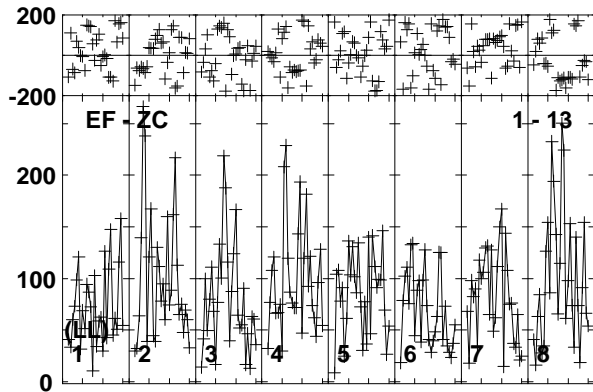
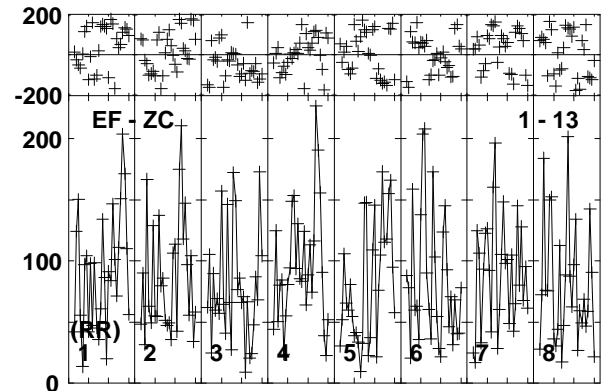
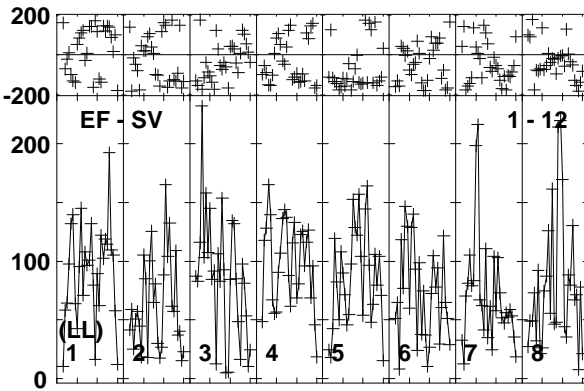
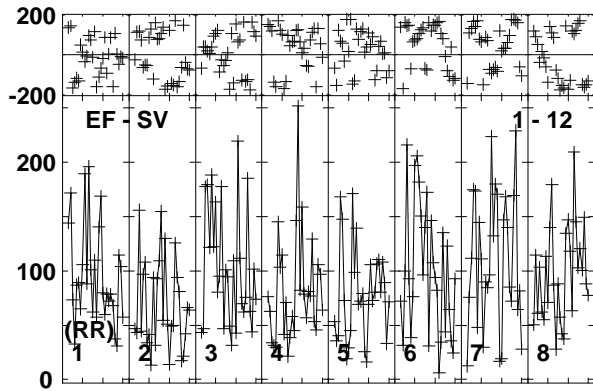
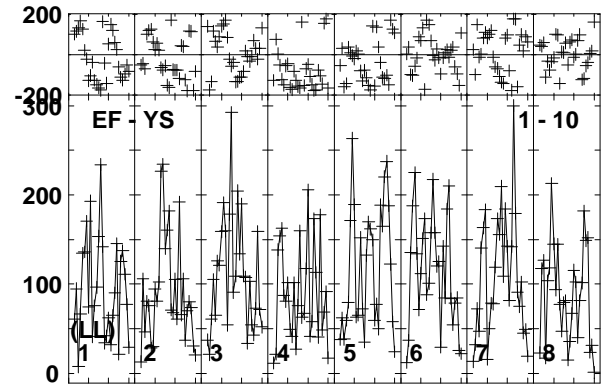
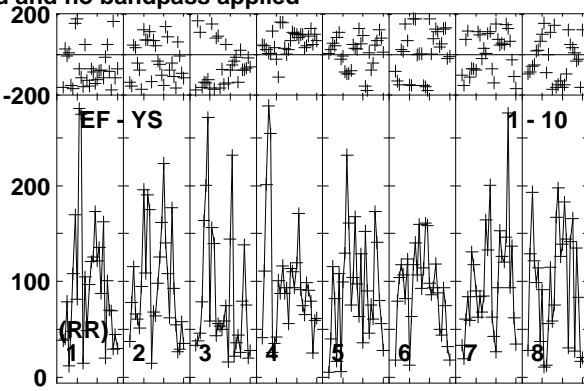
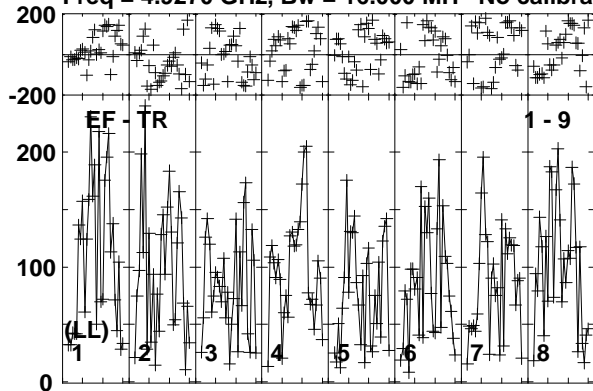

Lower frame: Micro Ampl Jy Top frame: Phas deg  
Vector averaged cross-power spectrum Baseline: EF (01) - TR (09)  
Timerange: 00/08:24:33 to 00/08:27:59

Plot file version 378 created 08-APR-2019 12:10:20

J0815+3635 EM133B.UVDATA.1

Freq = 4.9270 GHz, Bw = 16.000 MH No calibration applied and no bandpass applied

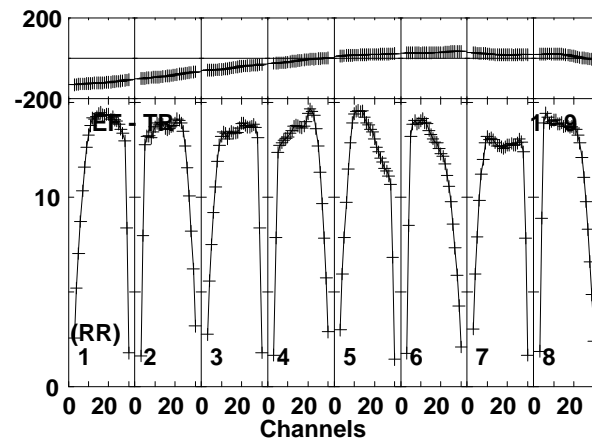
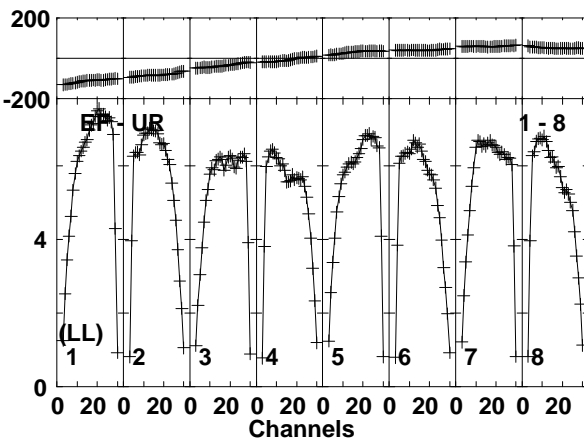
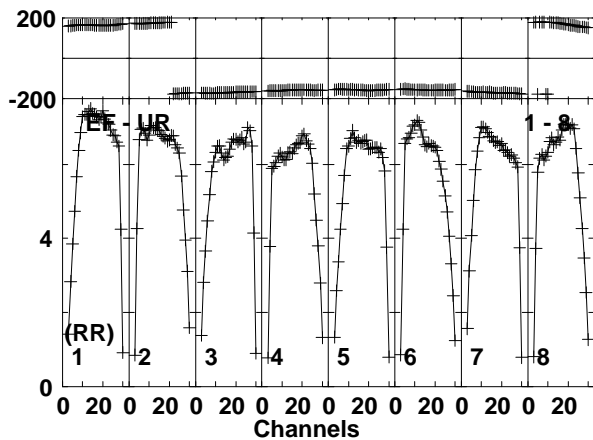
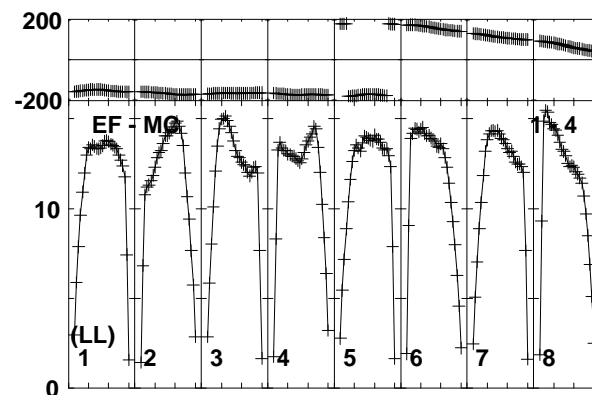
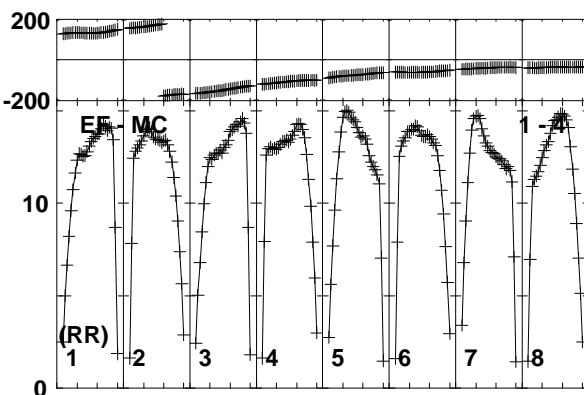
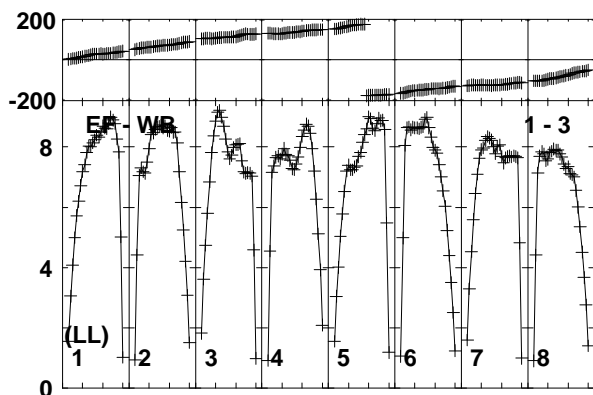
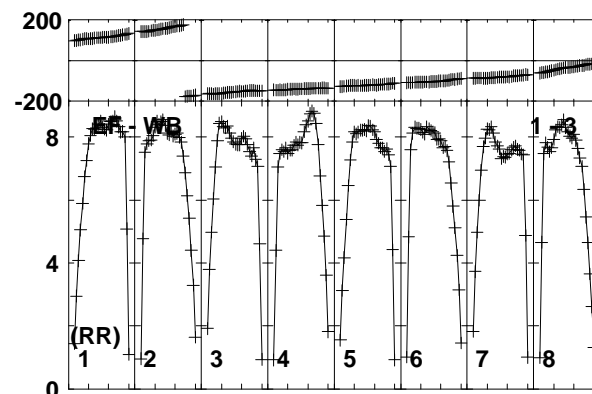
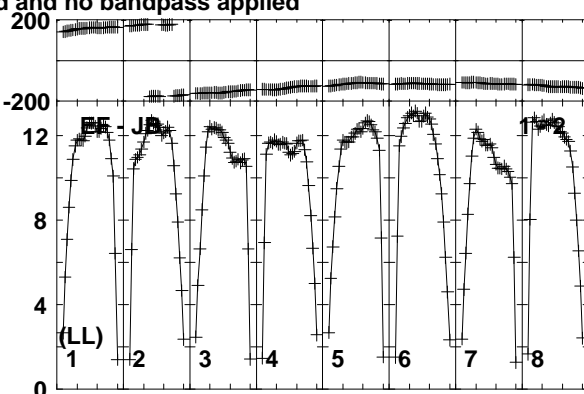
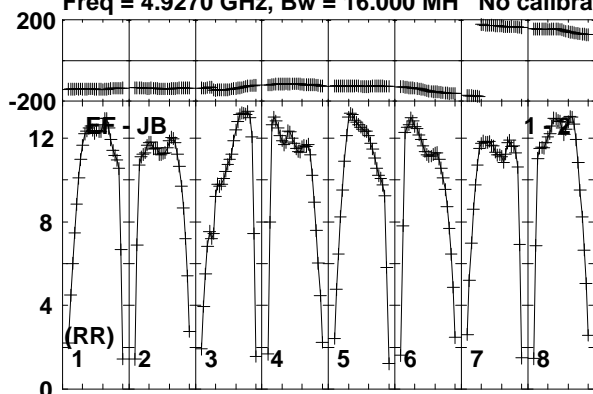

Lower frame: Milli Ampl Jy Top frame: Phas deg  
Vector averaged cross-power spectrum Baseline: EF (01) - JB (02)  
Timerange: 00/08:28:51 to 00/08:30:19

Plot file version 379 created 08-APR-2019 12:10:20

J0815+3635 EM133B.UVDATA.1

Freq = 4.9270 GHz, Bw = 16.000 MH No calibration applied and no bandpass applied

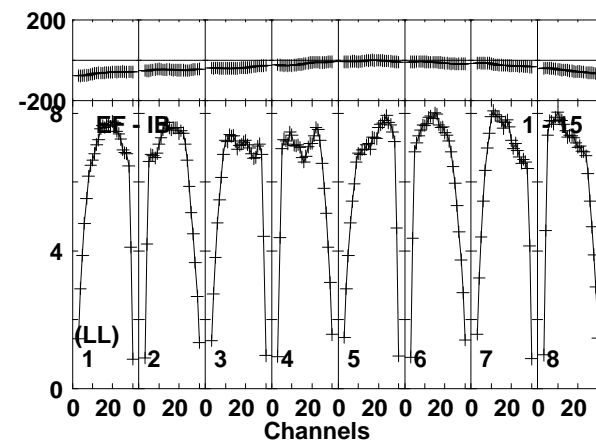
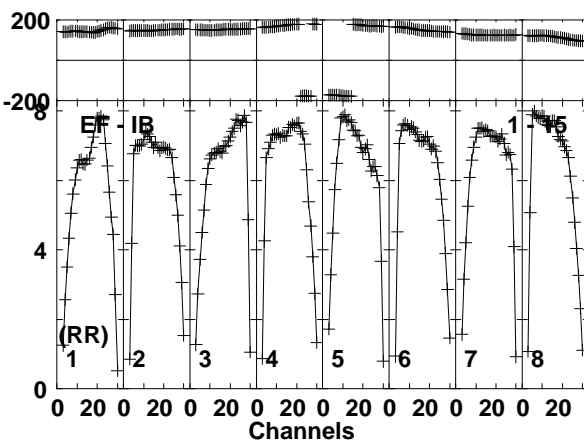
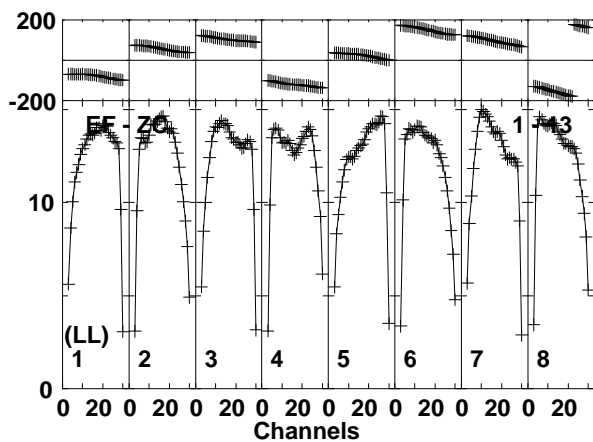
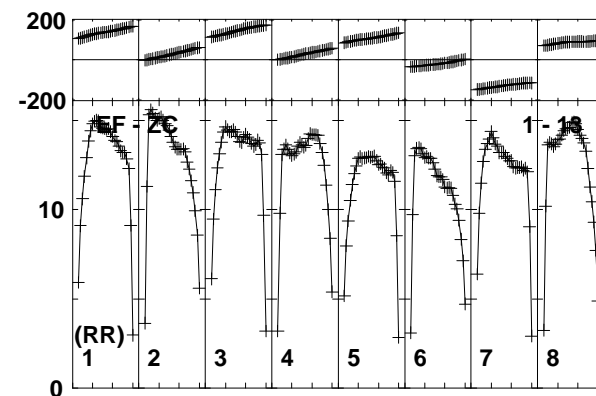
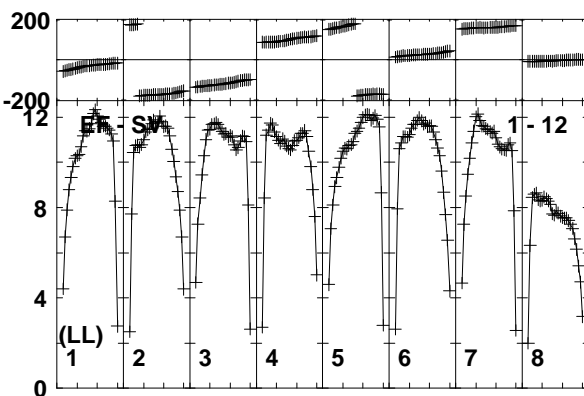
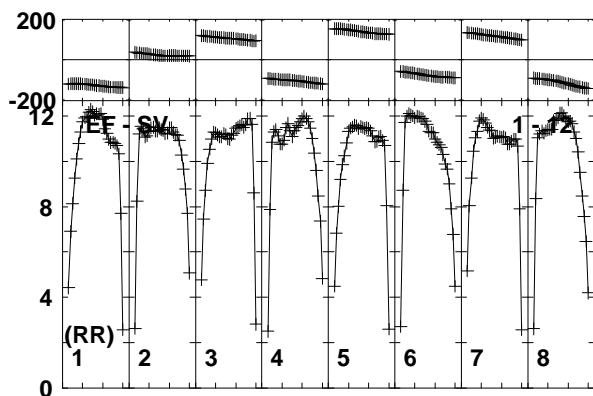
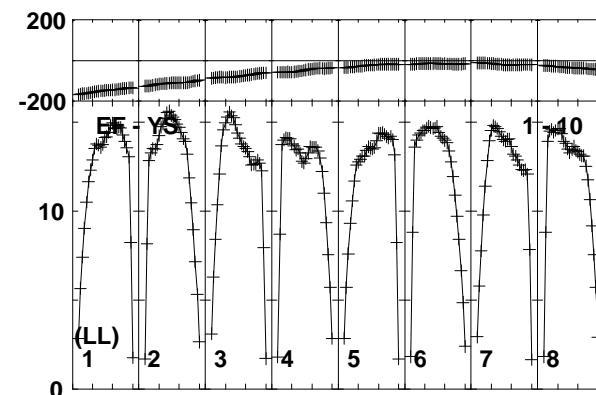
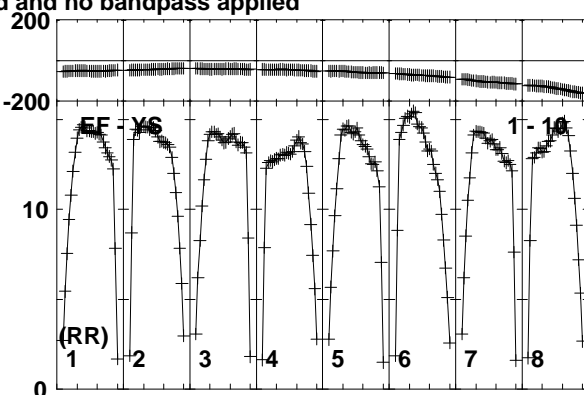
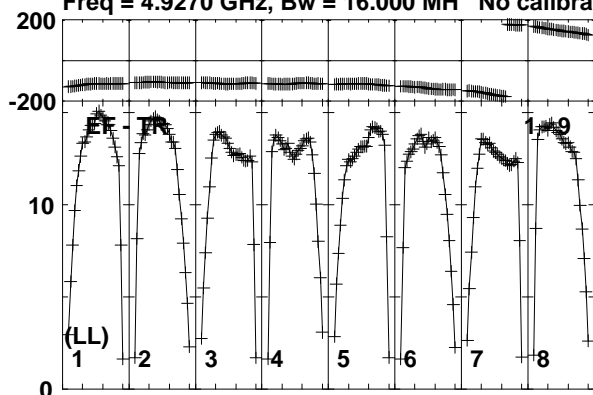

Lower frame: Milli Ampl Jy Top frame: Phas deg  
Vector averaged cross-power spectrum Baseline: EF (01) - TR (09)  
Timerange: 00/08:28:51 to 00/08:30:19

Plot file version 380 created 08-APR-2019 12:10:21

J0815+3635 EM133B.UVDATA.1

Freq = 4.9270 GHz, Bw = 16.000 MH No calibration applied and no bandpass applied

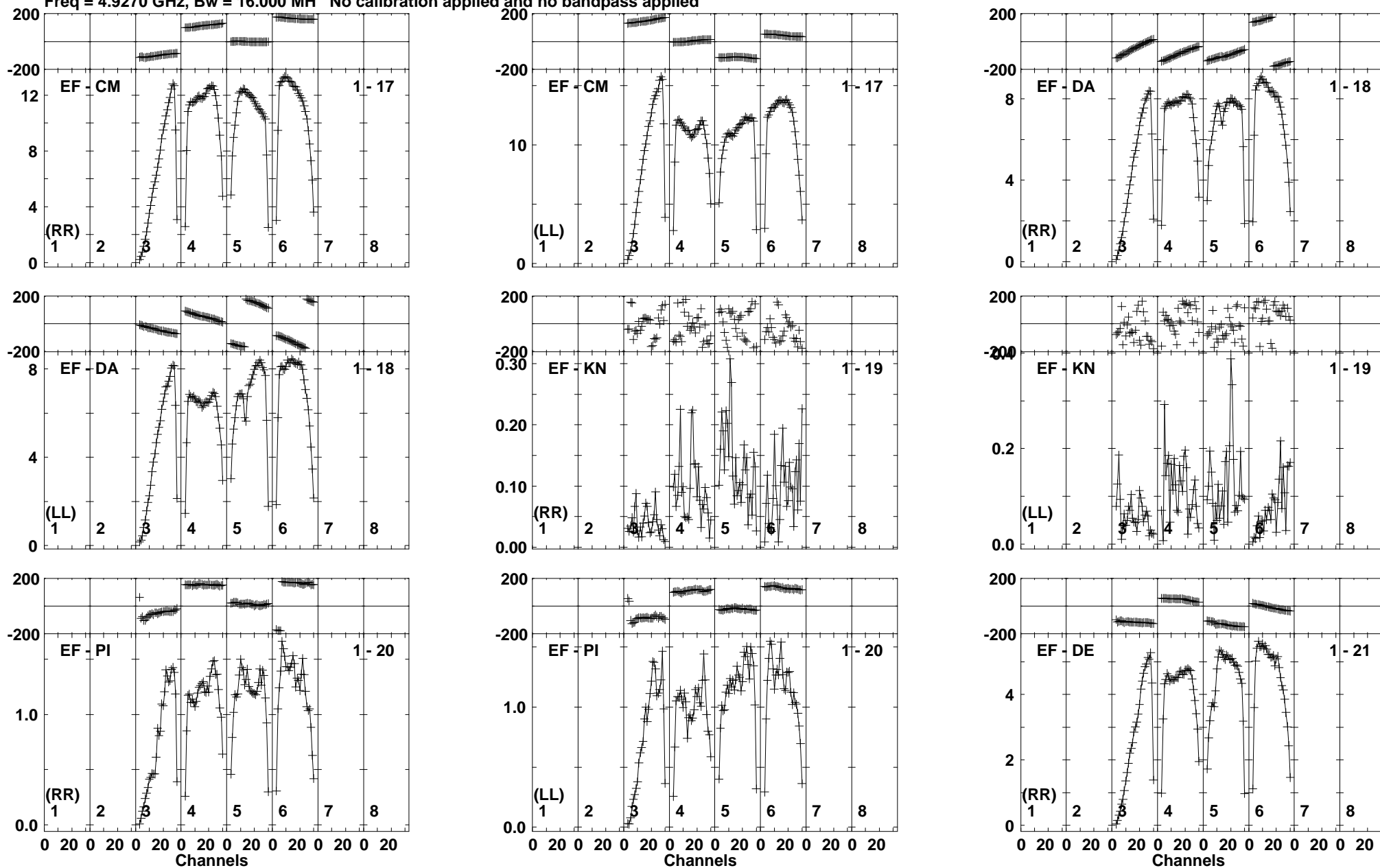

Lower frame: Milli Amply Jy Top frame: Phas deg  
Vector averaged cross-power spectrum Baseline: EF (01) - CM (17)  
Timerange: 00/08:28:51 to 00/08:30:19

Plot file version 381 created 08-APR-2019 12:10:21  
J0815+3635 EM133B.UVDATA.1  
Freq = 4.9270 GHz, Bw = 16.000 MH No calibration applied and no bandpass applied

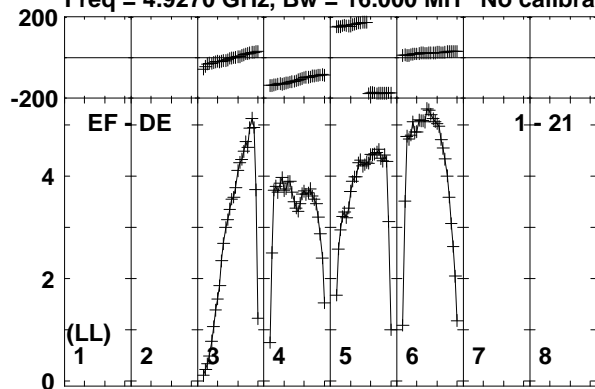

Lower frame: Milli Ampl Jy Top frame: Phas deg  
Vector averaged cross-power spectrum Baseline: EF (01) - DE (21)  
Timerange: 00/08:28:51 to 00/08:30:19

Plot file version 382 created 08-APR-2019 12:10:21

MRK622 EM133B.UVDATA.1

Freq = 4.9270 GHz, Bw = 16.000 MH No calibration applied and no bandpass applied

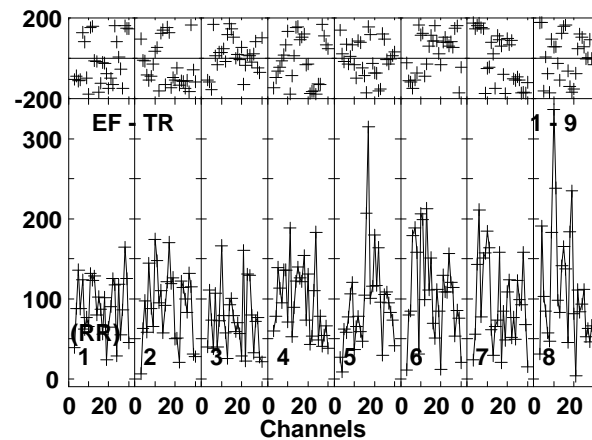
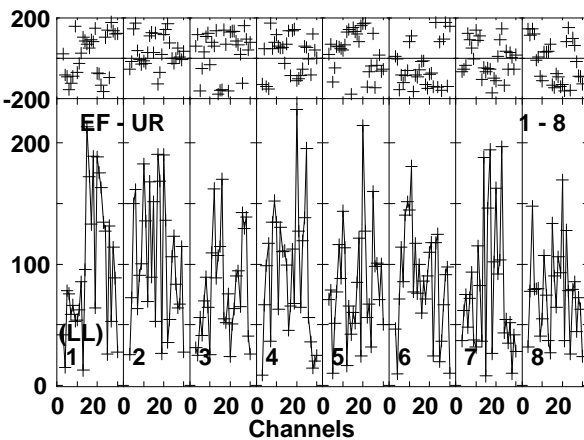
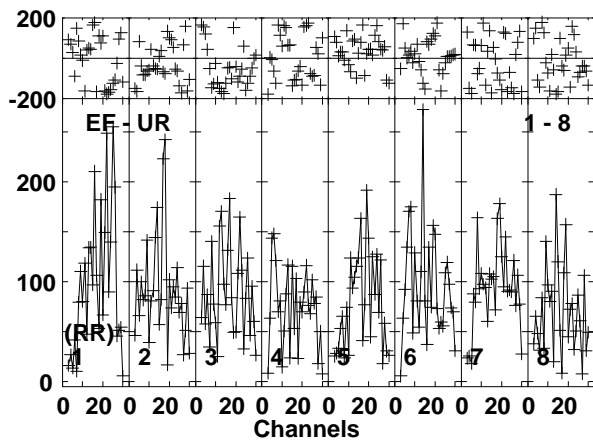
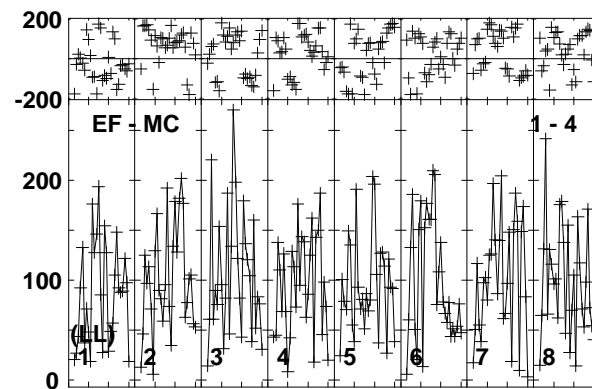
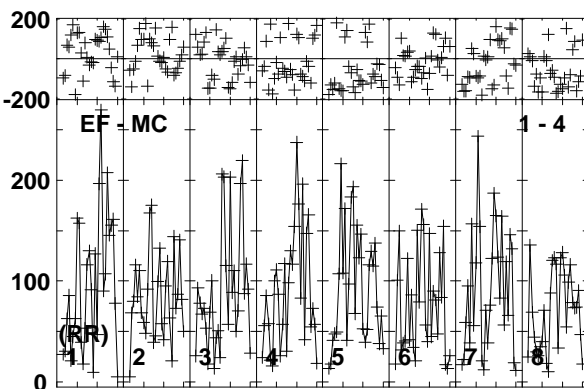
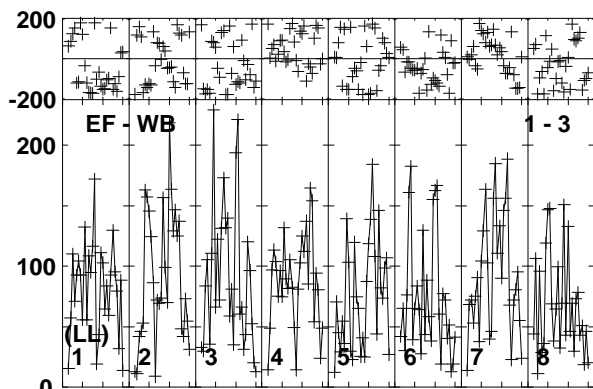
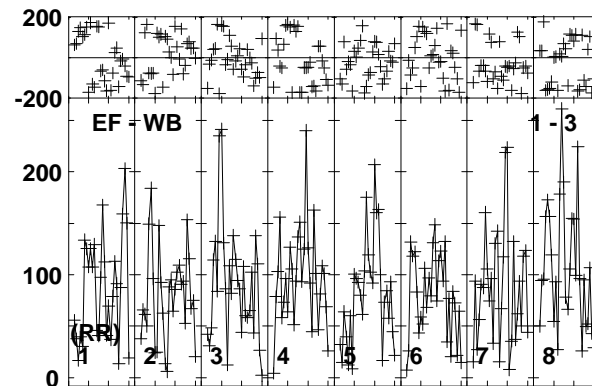
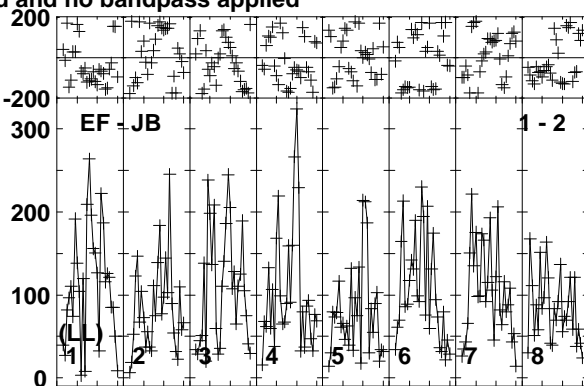
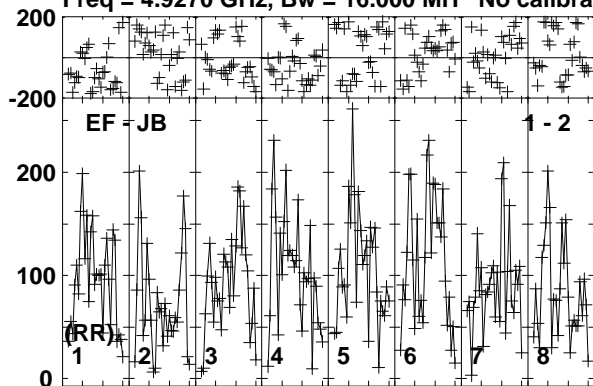

Lower frame: Micro Ampl Jy Top frame: Phas deg  
Vector averaged cross-power spectrum Baseline: EF (01) - JB (02)  
Timerange: 00/08:30:21 to 00/08:33:49

Plot file version 383 created 08-APR-2019 12:10:21

MRK622 EM133B.UVDATA.1

Freq = 4.9270 GHz, Bw = 16.000 MH No calibration applied and no bandpass applied

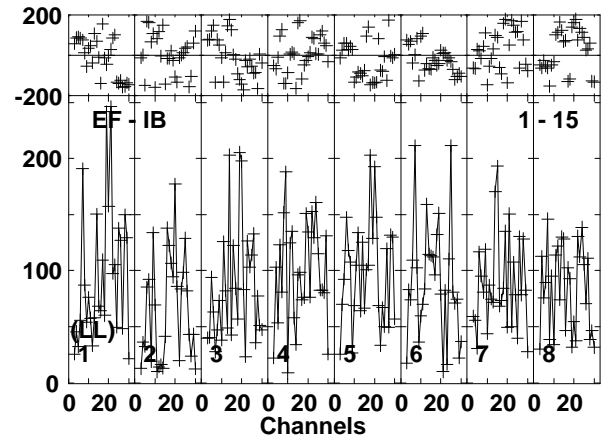
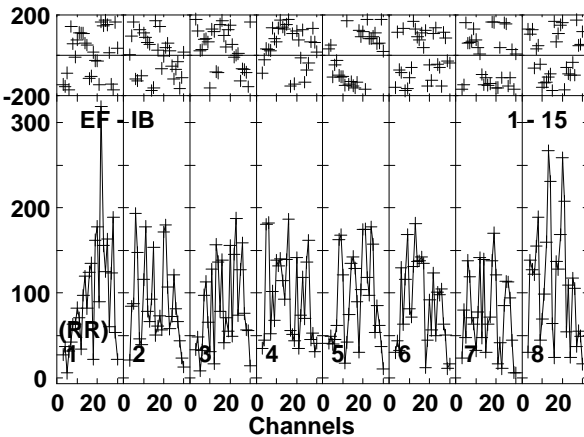
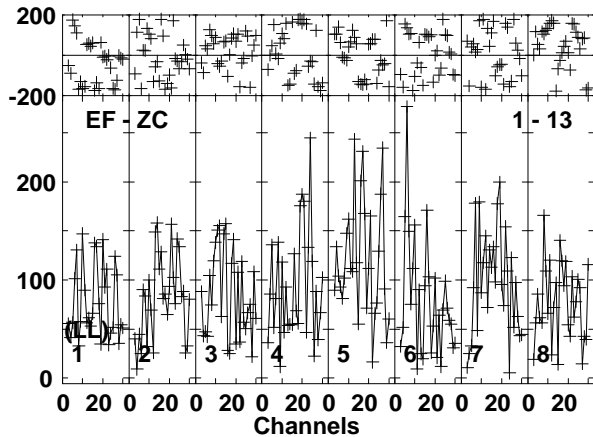
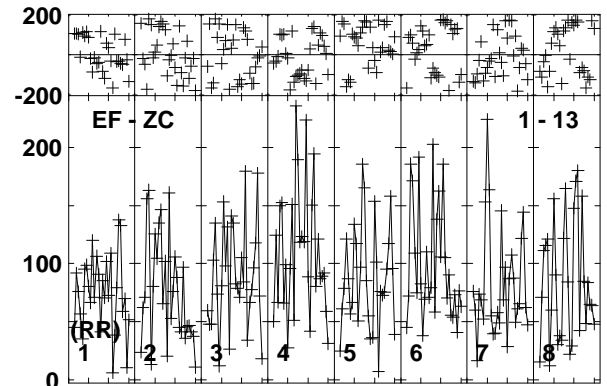
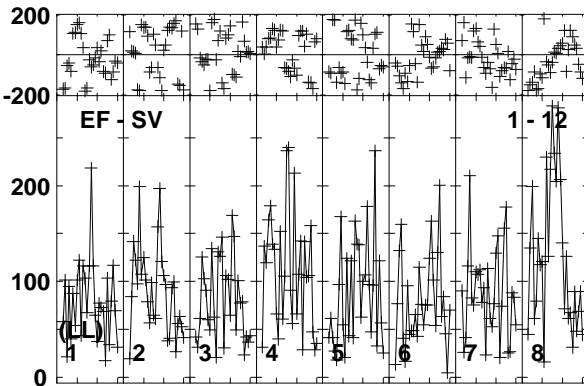
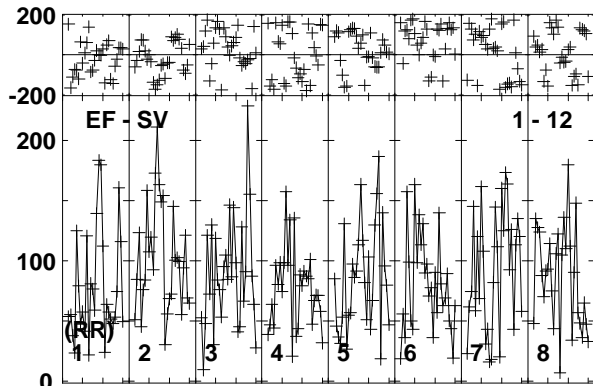
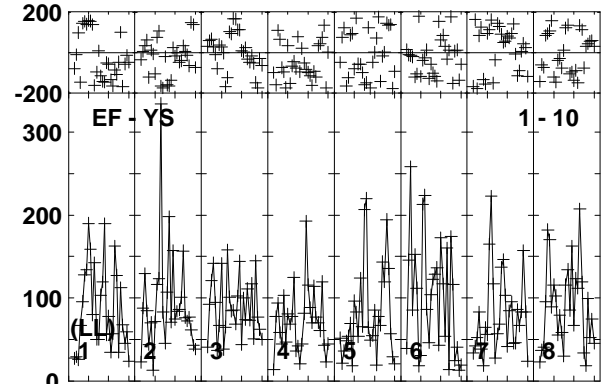
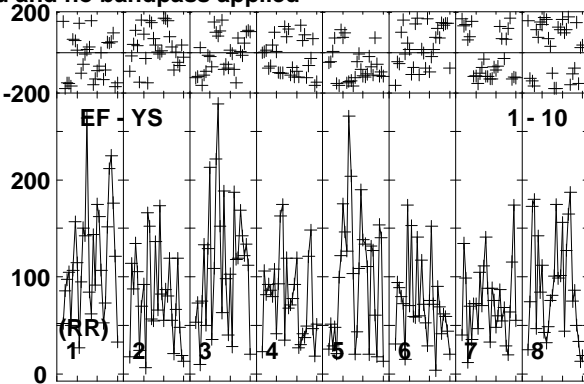
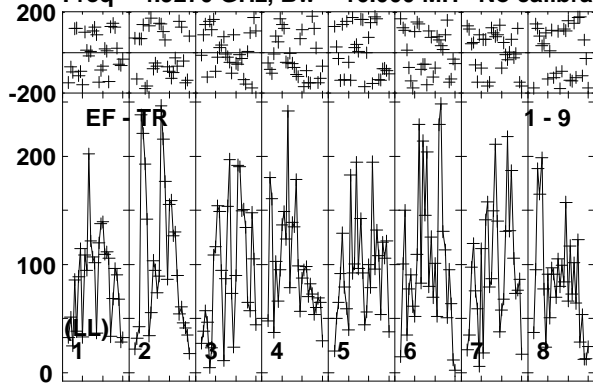

Lower frame: Micro Ampl Jy Top frame: Phas deg  
Vector averaged cross-power spectrum Baseline: EF (01) - TR (09)  
Timerange: 00/08:30:21 to 00/08:33:49

Plot file version 384 created 08-APR-2019 12:10:21

J0815+3635 EM133B.UVDATA.1

Freq = 4.9270 GHz, Bw = 16.000 MH No calibration applied and no bandpass applied

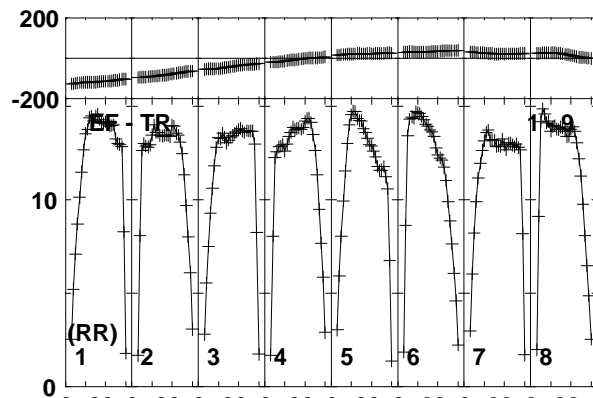
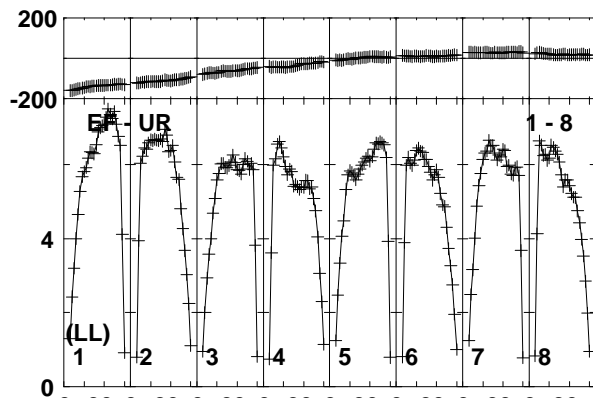
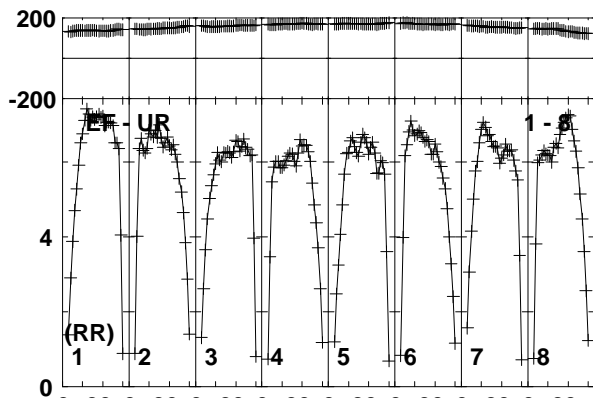
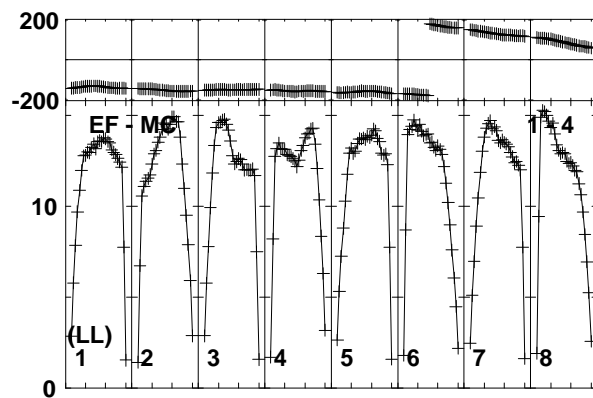
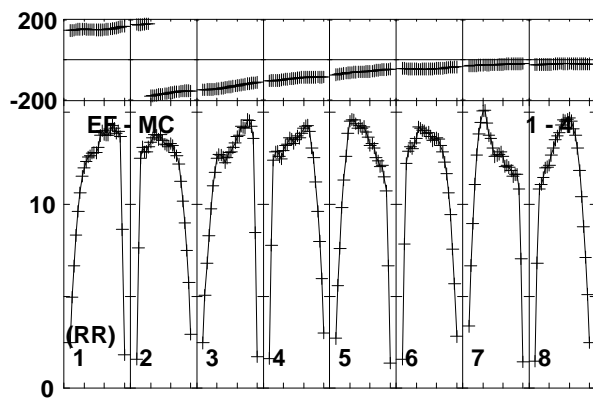
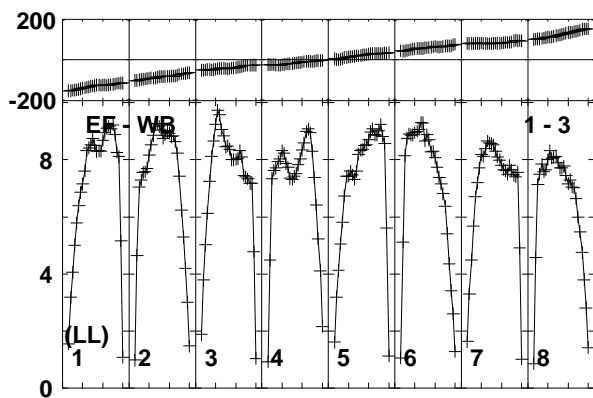
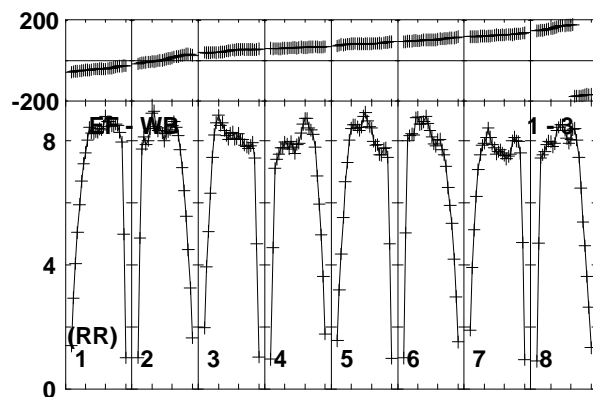
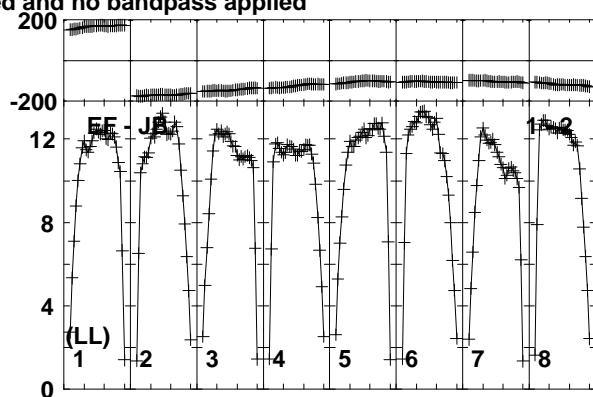
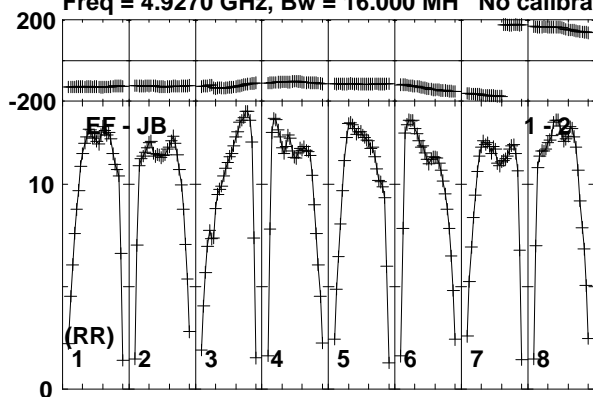

Lower frame: Milli Ampl Jy Top frame: Phas deg  
Vector averaged cross-power spectrum Baseline: EF (01) - JB (02)  
Timerange: 00/08:33:51 to 00/08:35:19



Plot file version 385 created 08-APR-2019 12:10:21

J0815+3635 EM133B.UVDATA.1

Freq = 4.9270 GHz, Bw = 16.000 MH No calibration applied and no bandpass applied

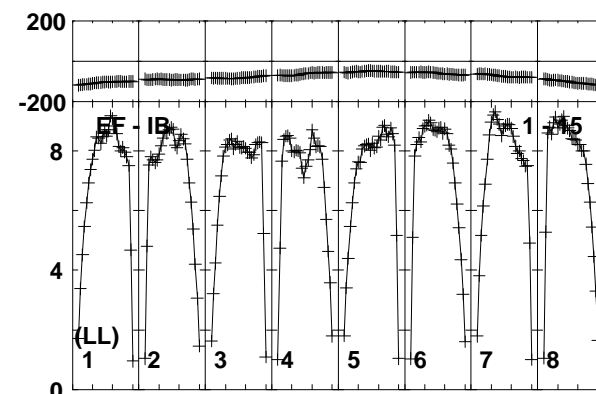
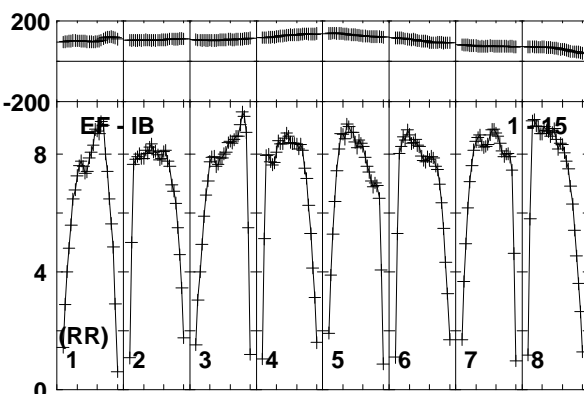
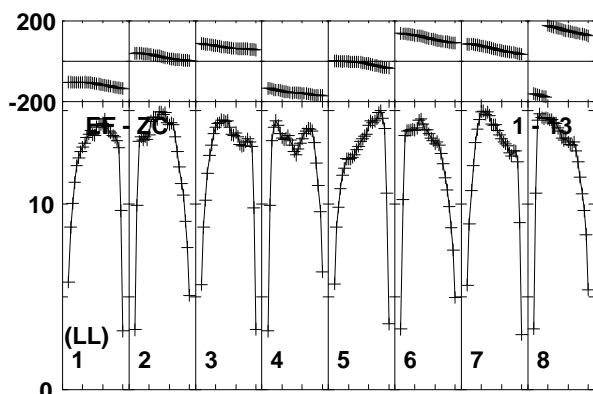
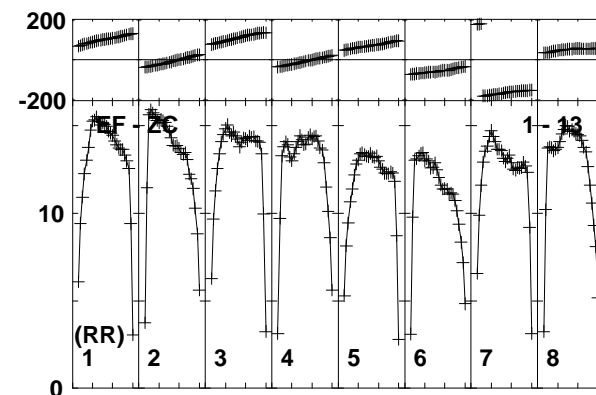
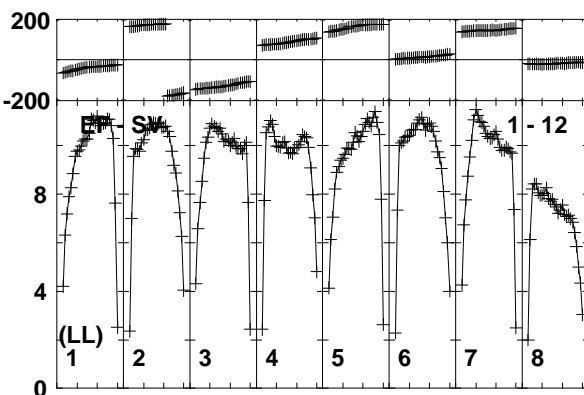
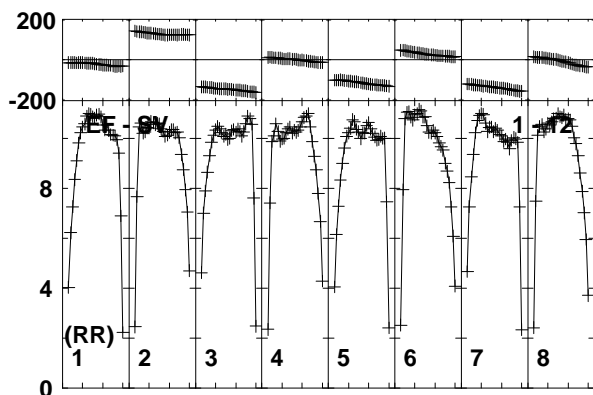
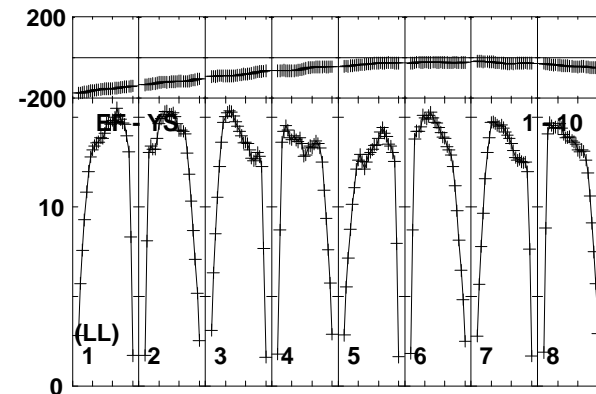
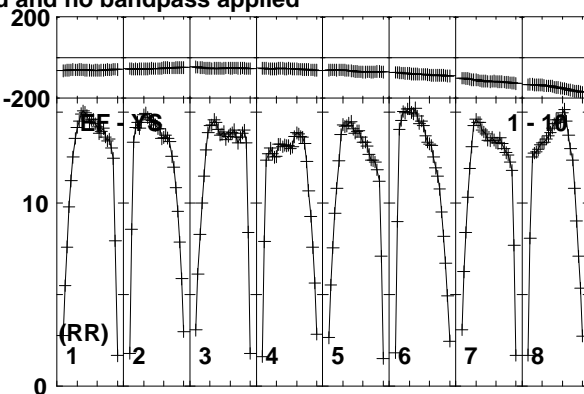
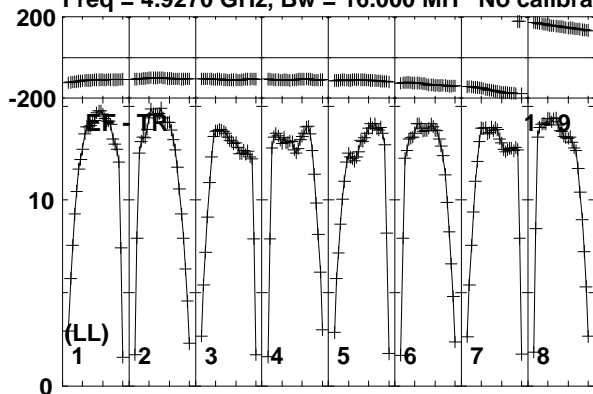

Lower frame: Milli Ampl Jy Top frame: Phas deg  
Vector averaged cross-power spectrum Baseline: EF (01) - TR (09)  
Timerange: 00/08:33:51 to 00/08:35:19

Plot file version 386 created 08-APR-2019 12:10:21

MRK622 EM133B.UVDATA.1

Freq = 4.9270 GHz, Bw = 16.000 MH No calibration applied and no bandpass applied

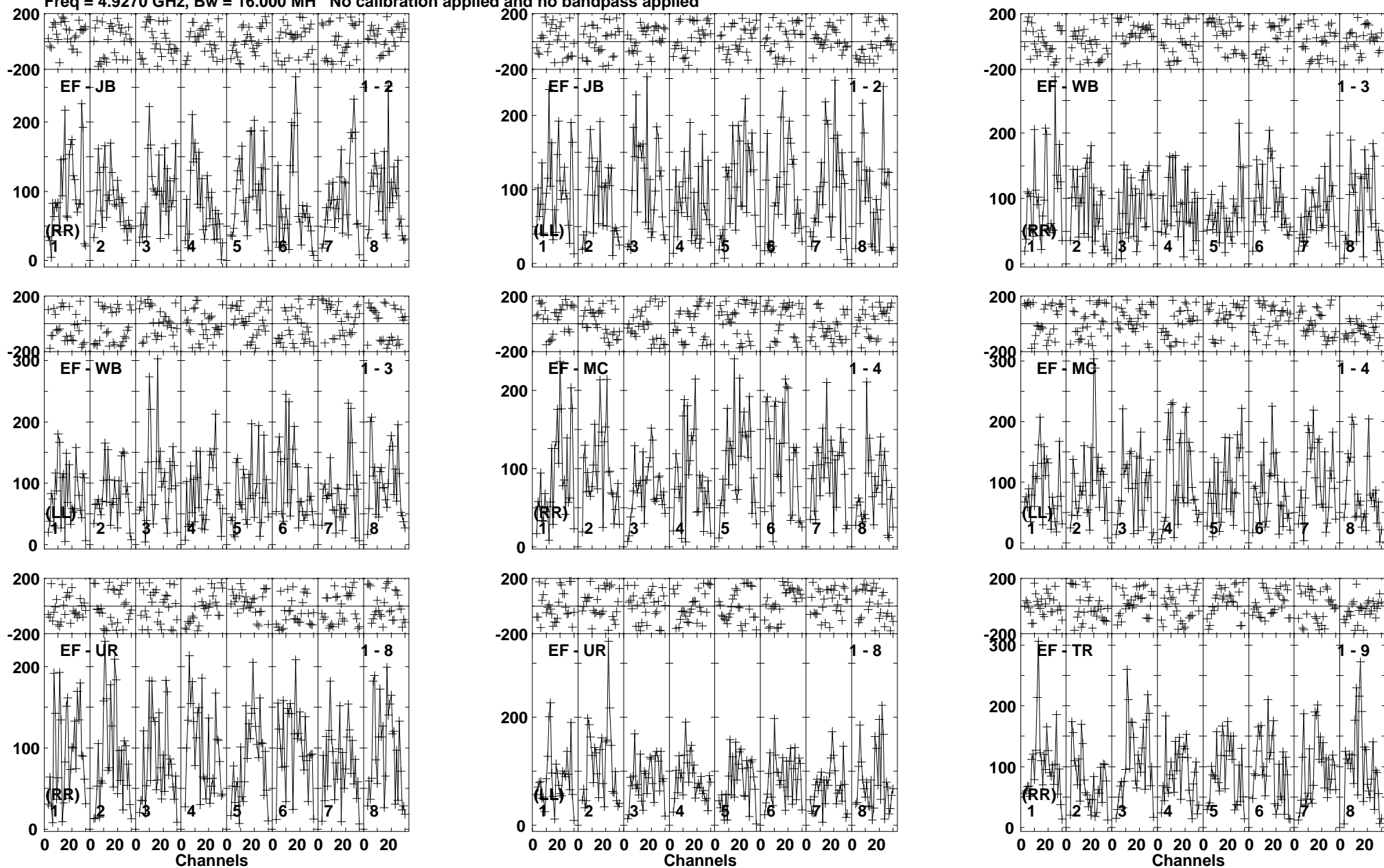

Lower frame: Micro Ampl Jy Top frame: Phas deg  
Vector averaged cross-power spectrum Baseline: EF (01) - JB (02)  
Timerange: 00/08:35:23 to 00/08:38:49

Plot file version 387 created 08-APR-2019 12:10:21

MRK622 EM133B.UVDATA.1

Freq = 4.9270 GHz, Bw = 16.000 MH No calibration applied and no bandpass applied

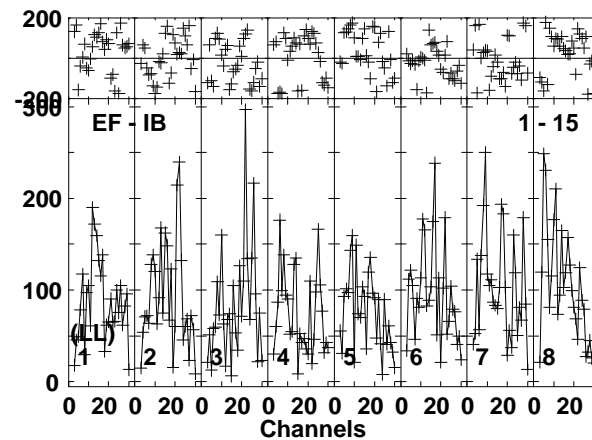
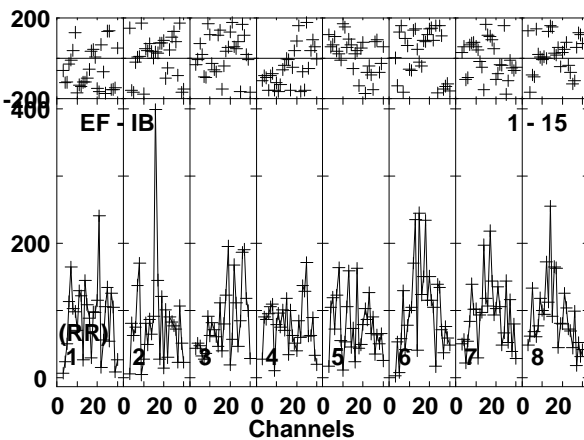
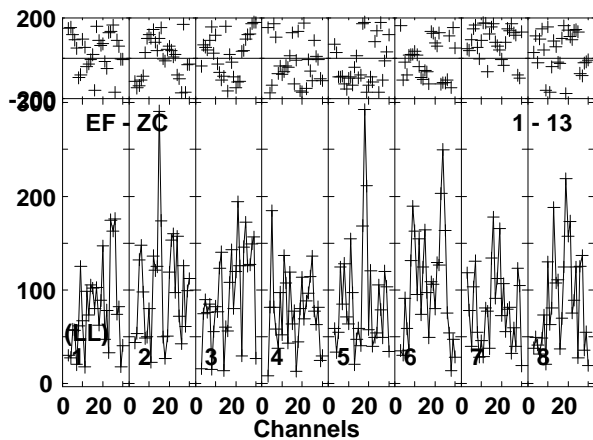
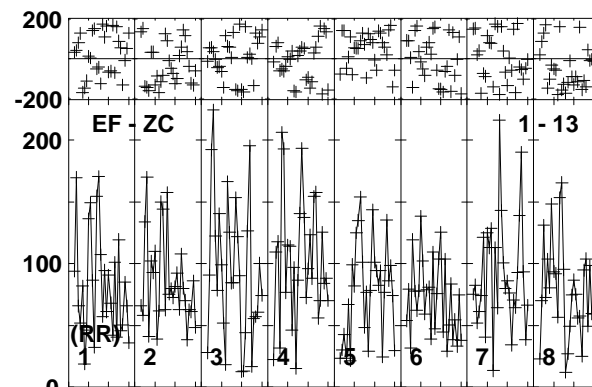
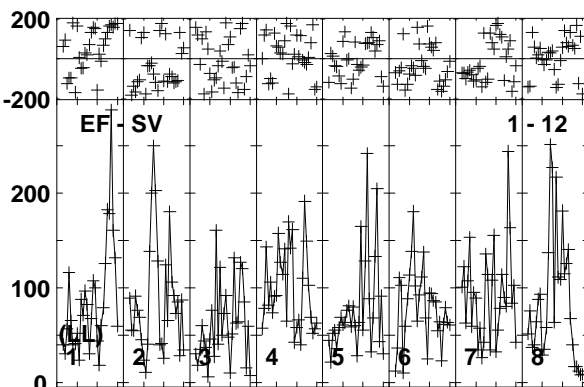
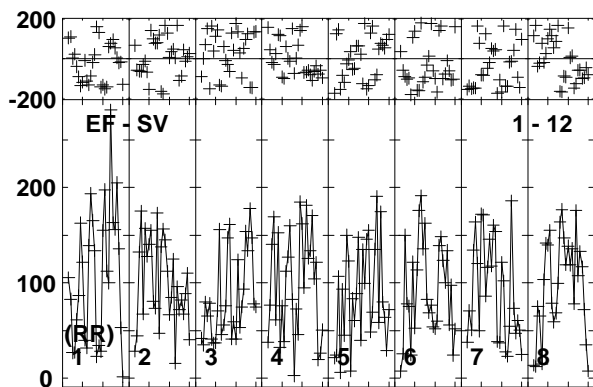
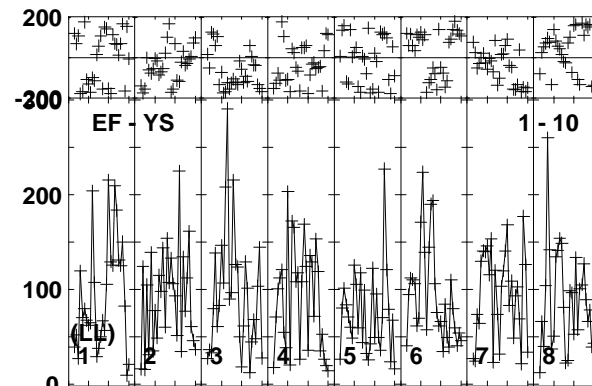
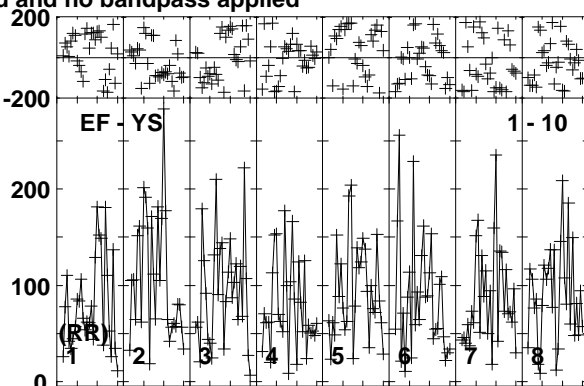
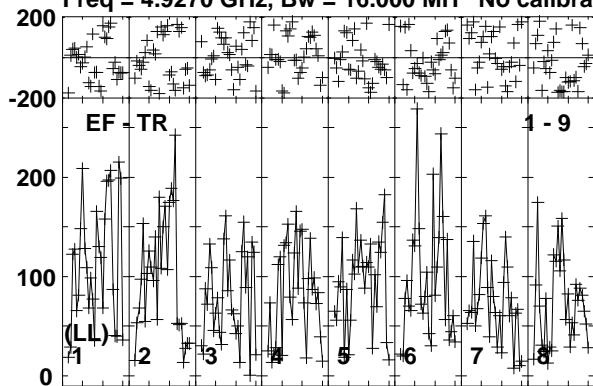

Lower frame: Micro Ampl Jy Top frame: Phas deg  
Vector averaged cross-power spectrum Baseline: EF (01) - TR (09)  
Timerange: 00/08:35:23 to 00/08:38:49

Plot file version 388 created 08-APR-2019 12:10:22

J0815+3635 EM133B.UVDATA.1

Freq = 4.9270 GHz, Bw = 16.000 MH No calibration applied and no bandpass applied

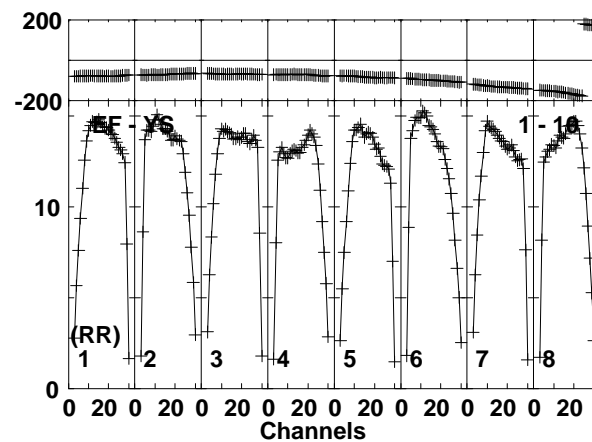
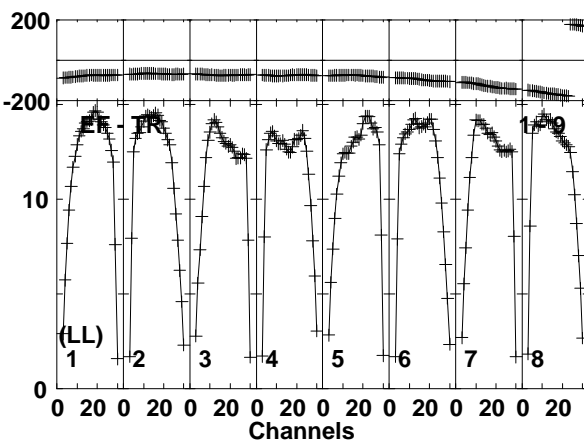
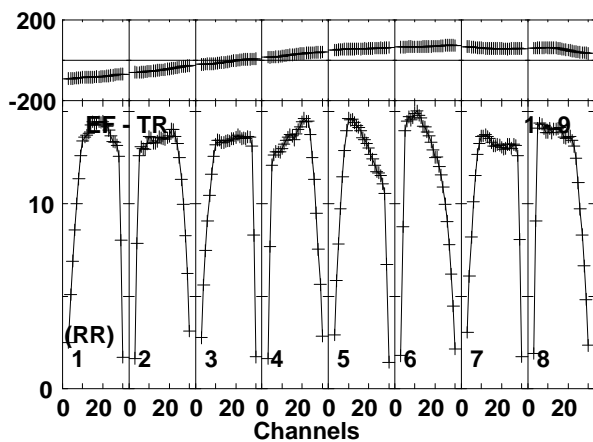
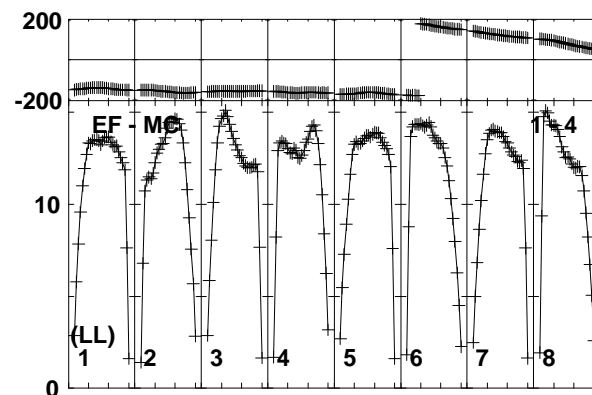
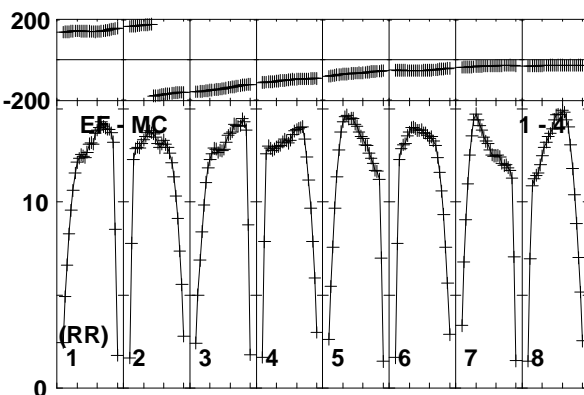
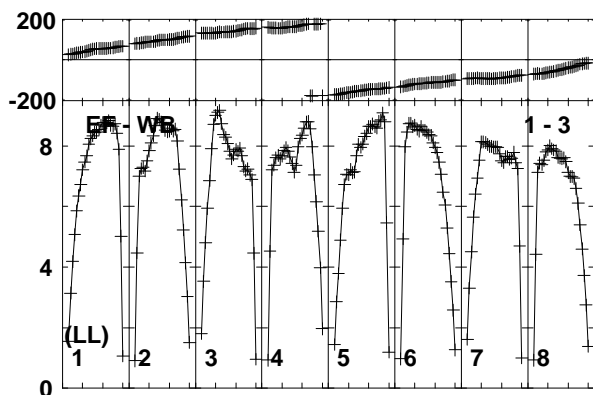
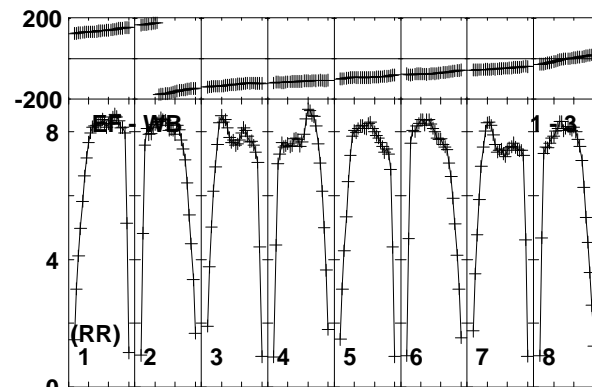
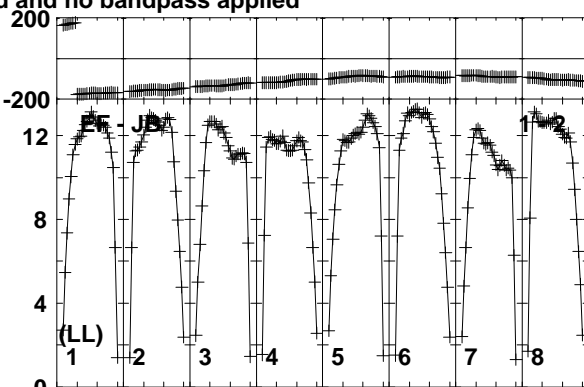
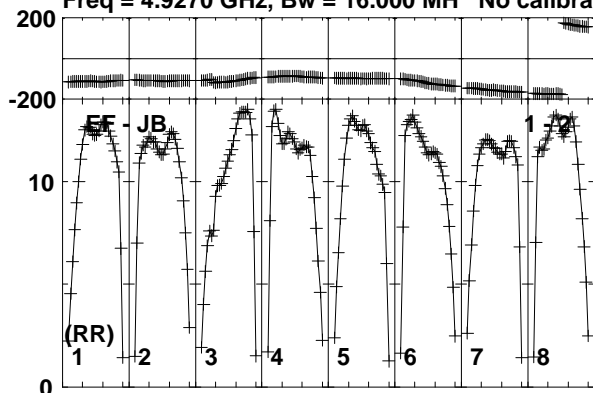

Lower frame: Milli Ampl Jy Top frame: Phas deg  
Vector averaged cross-power spectrum Baseline: EF (01) - JB (02)  
Timerange: 00/08:39:41 to 00/08:41:09

Plot file version 389 created 08-APR-2019 12:10:22

J0815+3635 EM133B.UVDATA.1

Freq = 4.9270 GHz, Bw = 16.000 MH No calibration applied and no bandpass applied

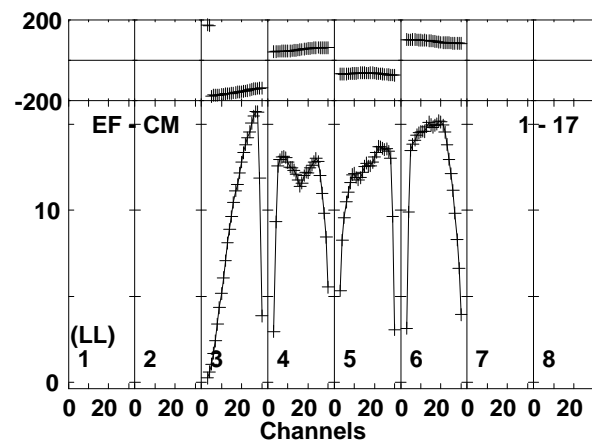
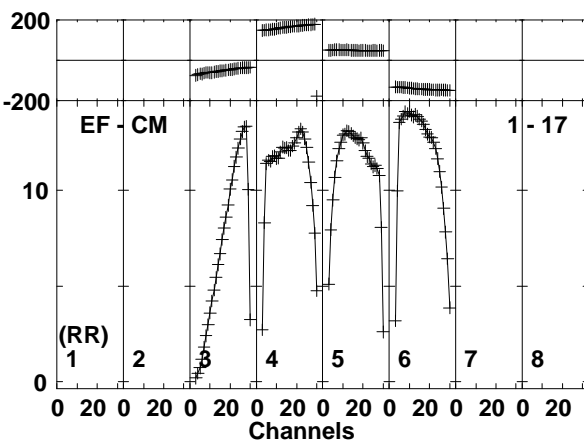
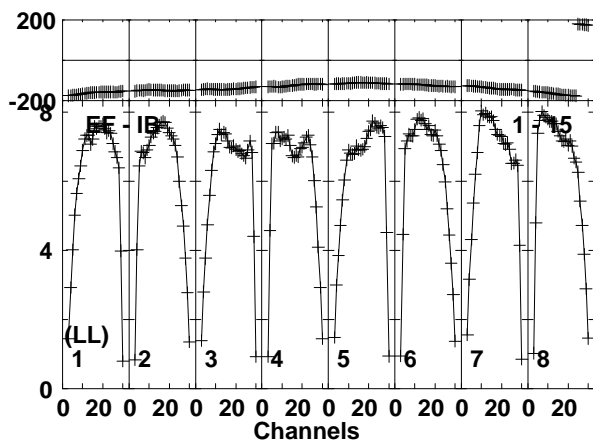
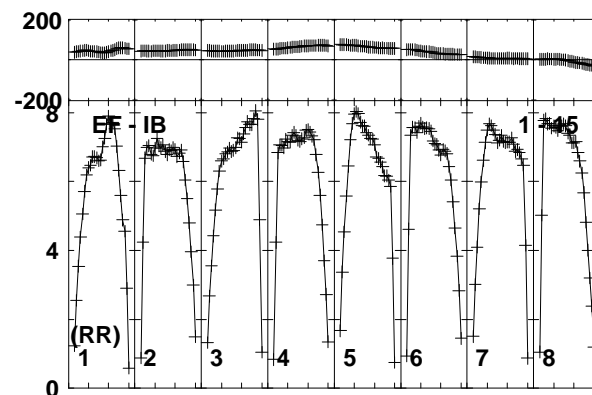
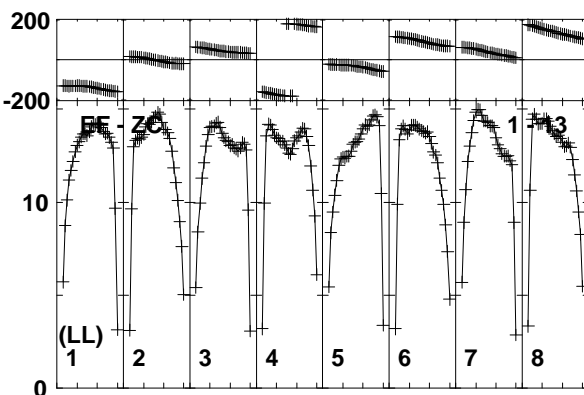
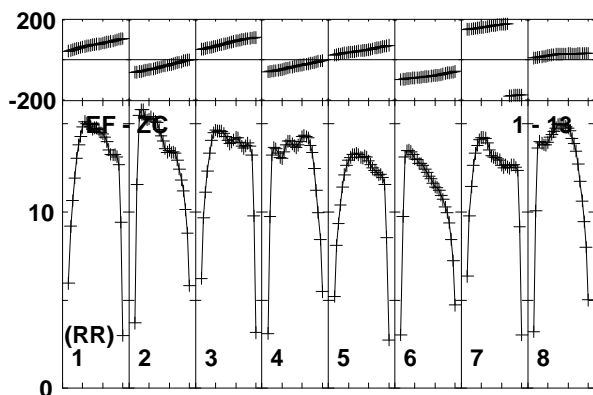
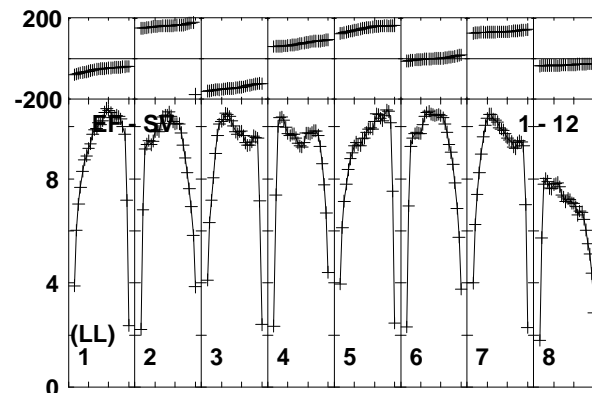
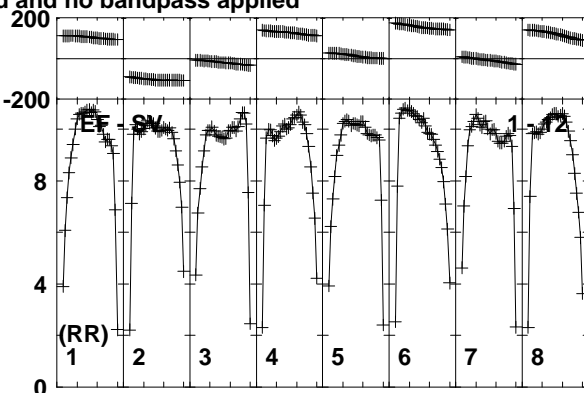
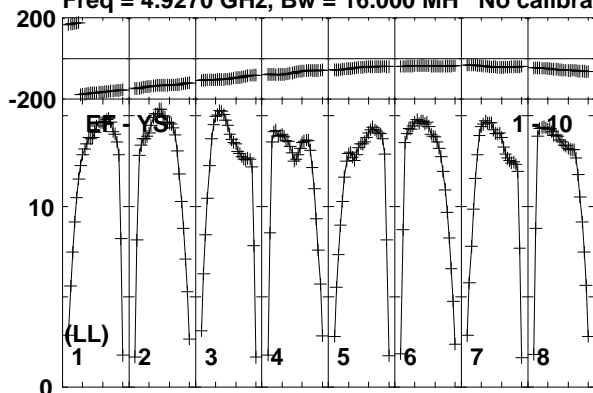

Lower frame: Milli Ampl Jy Top frame: Phas deg  
Vector averaged cross-power spectrum Baseline: EF (01) - YS (10)  
Timerange: 00/08:39:41 to 00/08:41:09

Plot file version 390 created 08-APR-2019 12:10:22

J0815+3635 EM133B.UVDATA.1

Freq = 4.9270 GHz, Bw = 16.000 MH No calibration applied and no bandpass applied

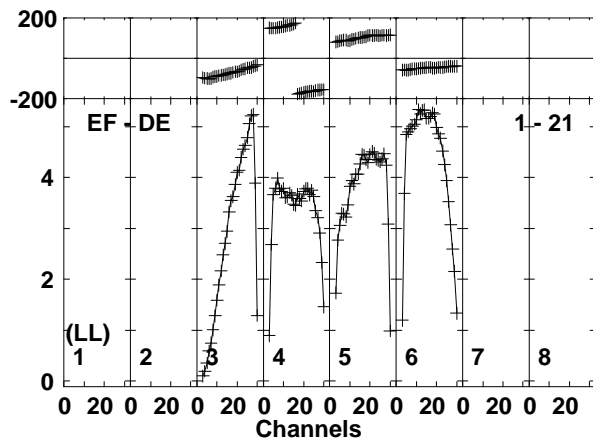
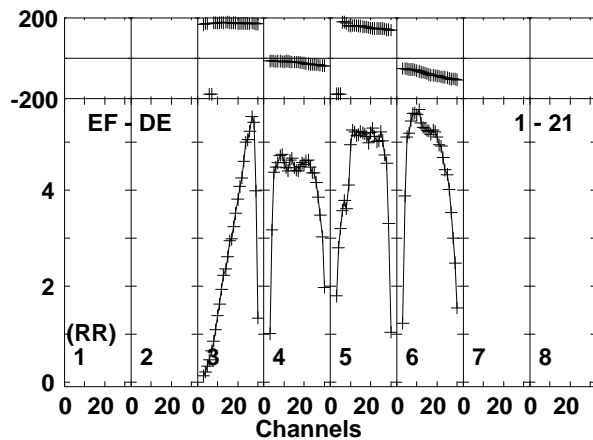
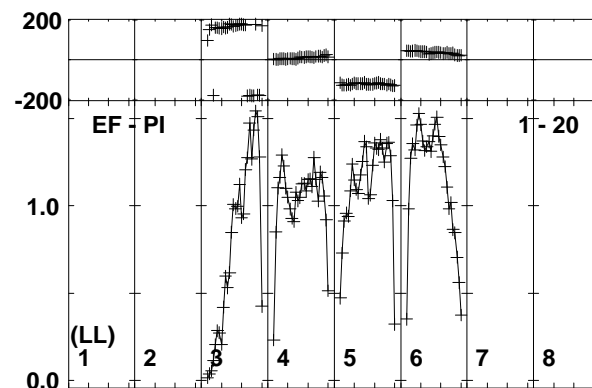
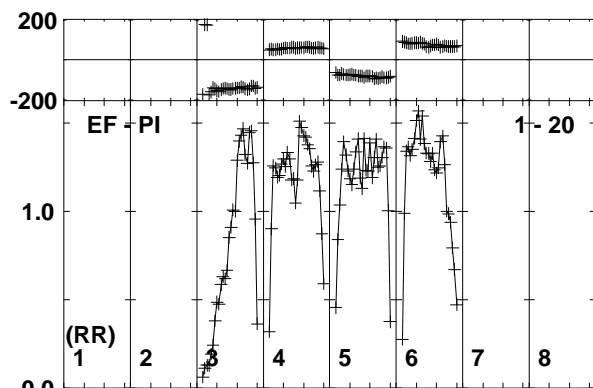
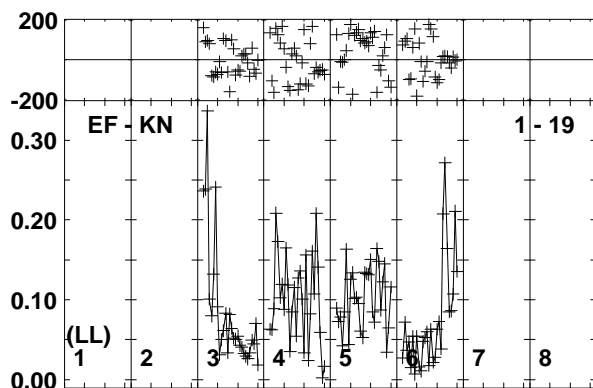
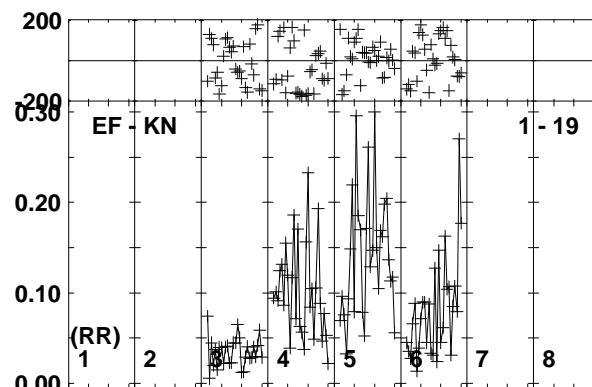
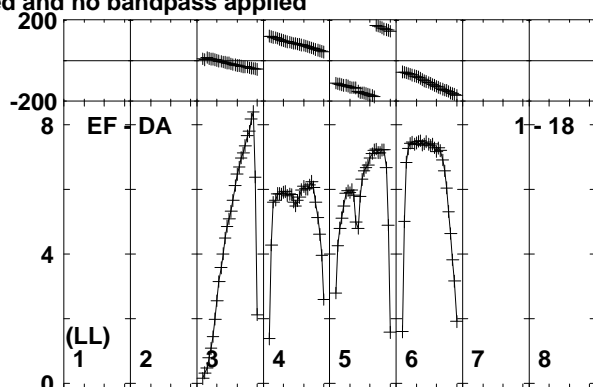
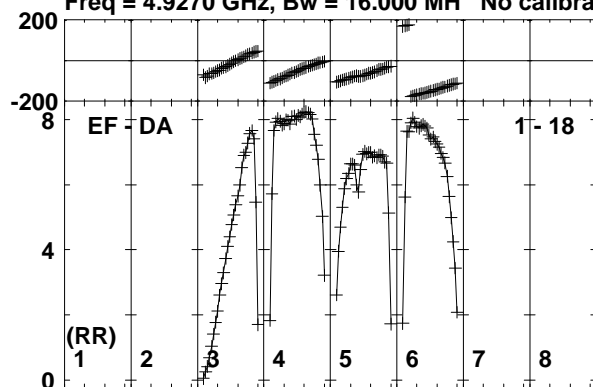

Lower frame: Milli Ampl Jy Top frame: Phas deg  
Vector averaged cross-power spectrum Baseline: EF (01) - DA (18)  
Timerange: 00/08:39:41 to 00/08:41:09

Plot file version 391 created 08-APR-2019 12:10:22

MRK622 EM133B.UVDATA.1

Freq = 4.9270 GHz, Bw = 16.000 MH No calibration applied and no bandpass applied

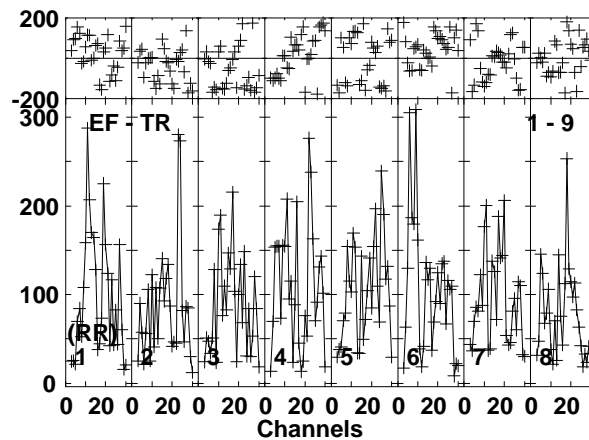
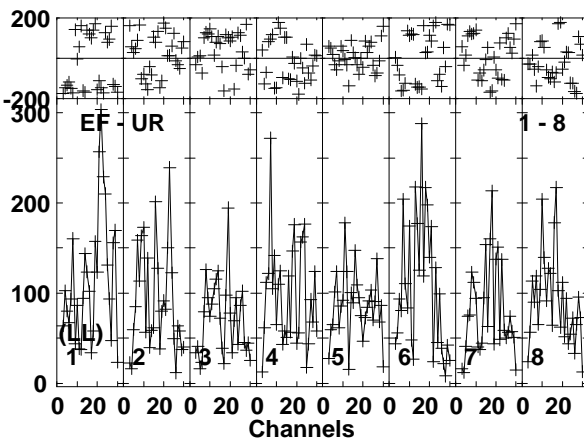
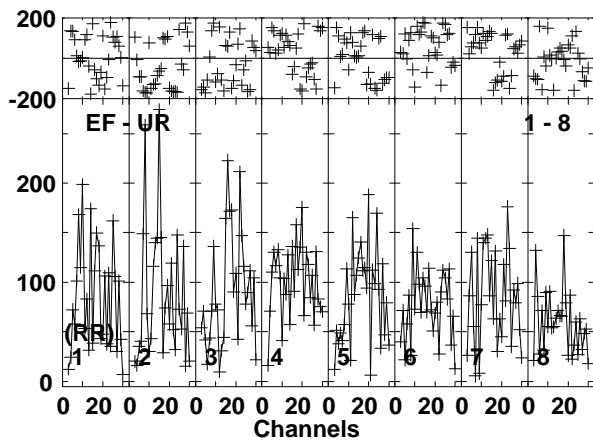
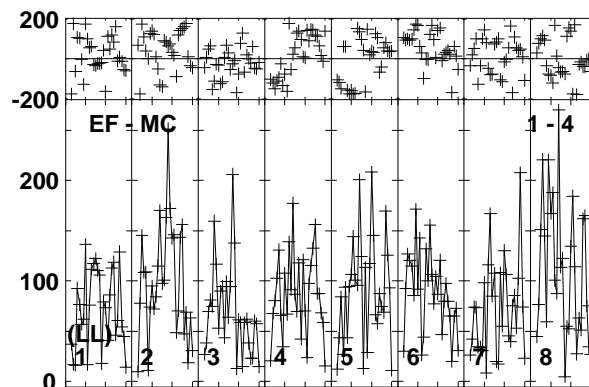
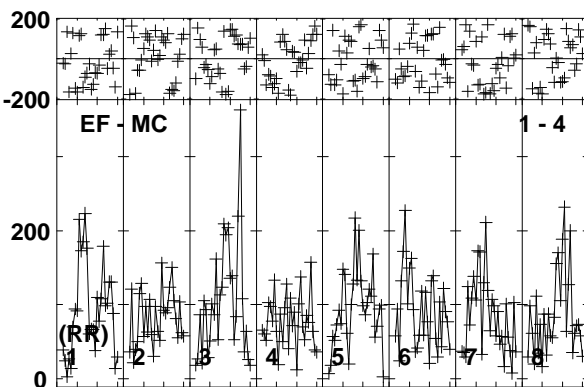
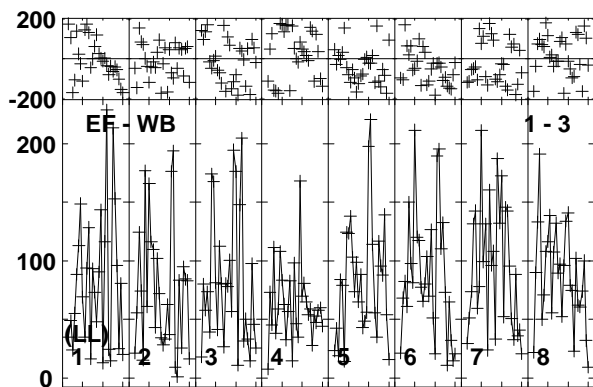
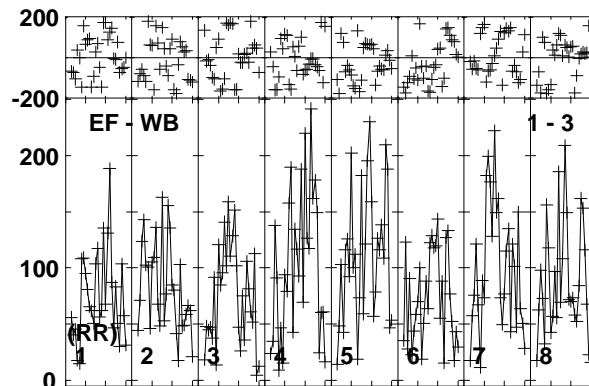
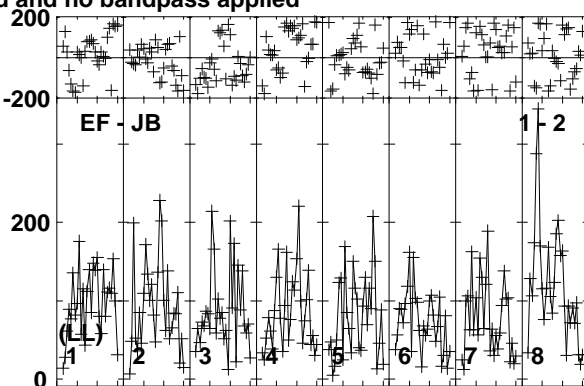
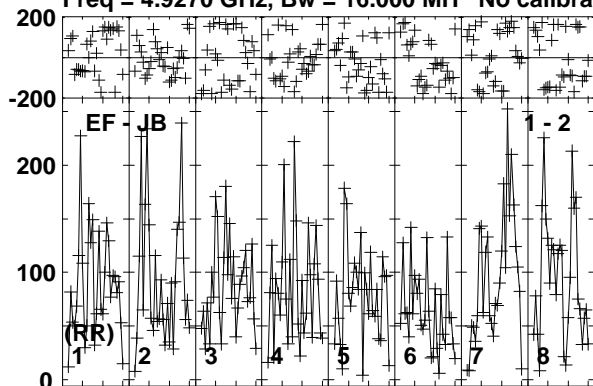

Lower frame: Micro Ampl Jy Top frame: Phas deg  
Vector averaged cross-power spectrum Baseline: EF (01) - JB (02)  
Timerange: 00/08:41:11 to 00/08:44:39

Plot file version 392 created 08-APR-2019 12:10:22

MRK622 EM133B.UVDATA.1

Freq = 4.9270 GHz, Bw = 16.000 MH No calibration applied and no bandpass applied

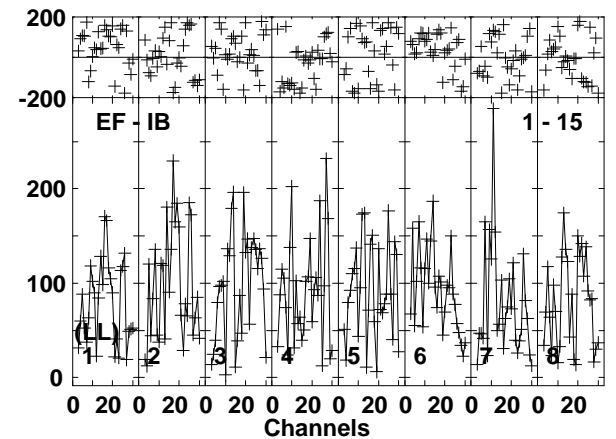
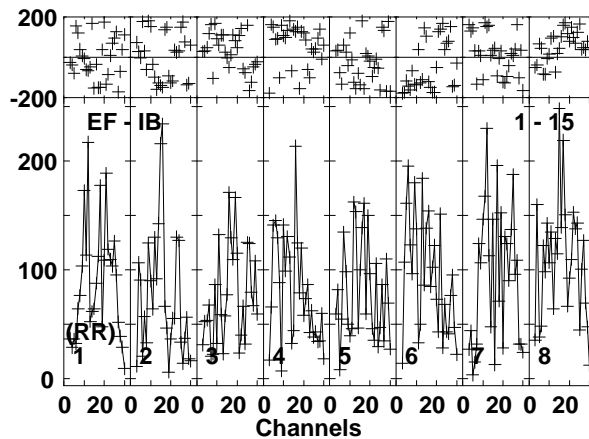
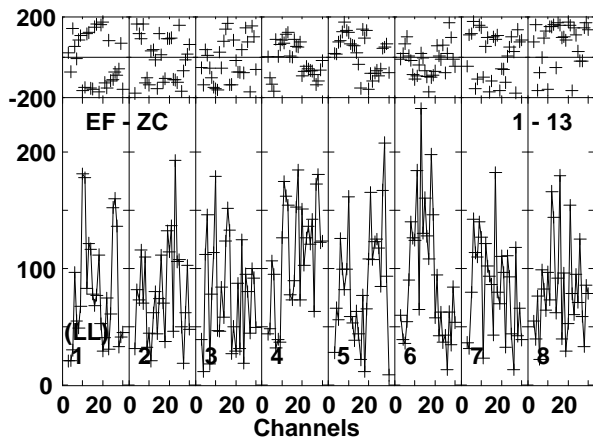
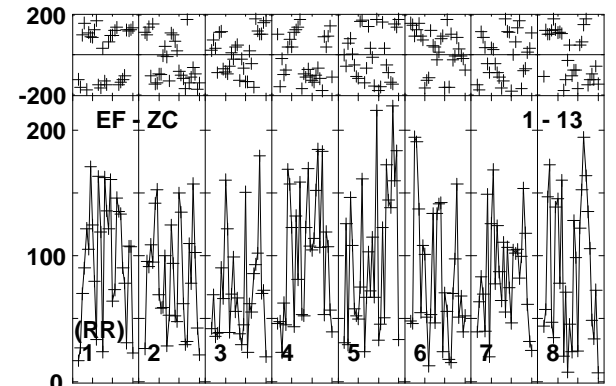
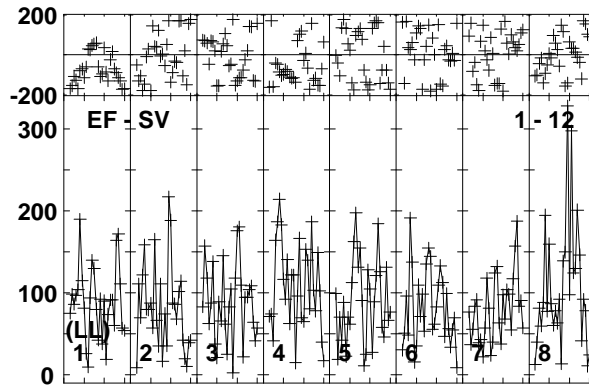
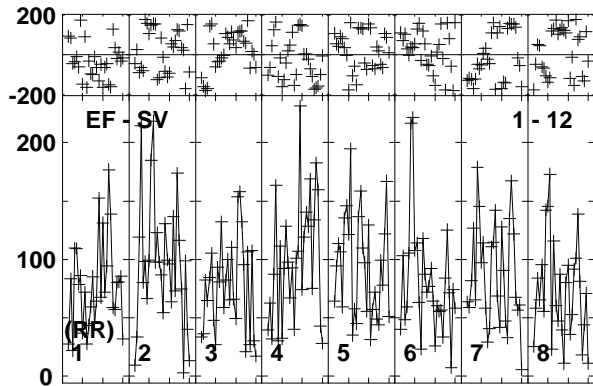
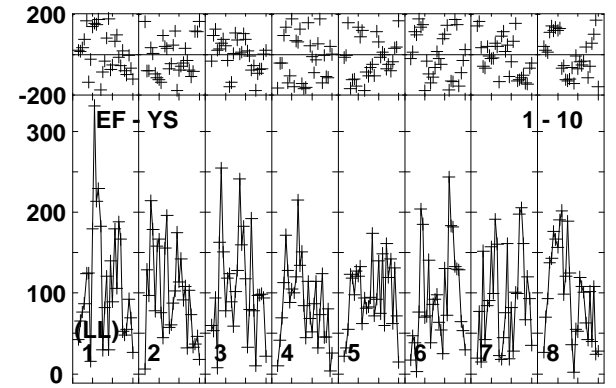
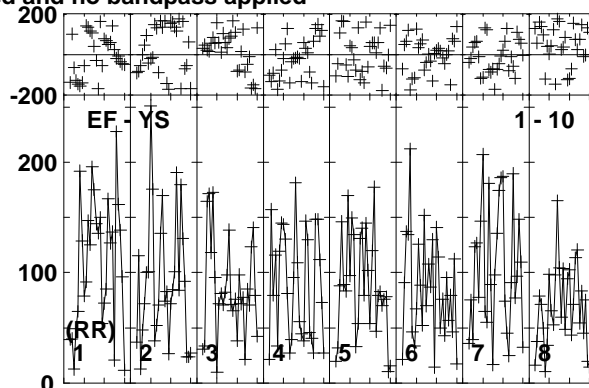
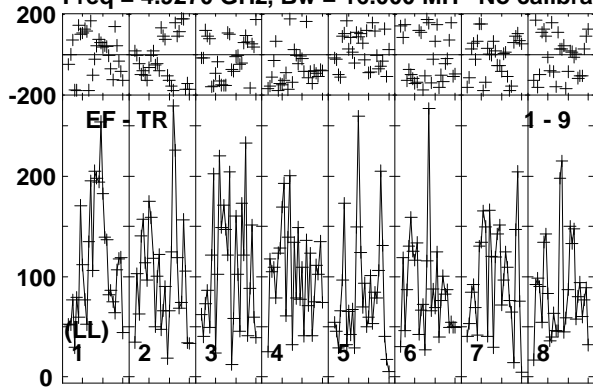

Lower frame: Micro Ampl Jy Top frame: Phas deg  
Vector averaged cross-power spectrum Baseline: EF (01) - TR (09)  
Timerange: 00/08:41:11 to 00/08:44:39



Plot file version 393 created 08-APR-2019 12:10:22

J0815+3635 EM133B.UVDATA.1

Freq = 4.9270 GHz, Bw = 16.000 MH No calibration applied and no bandpass applied

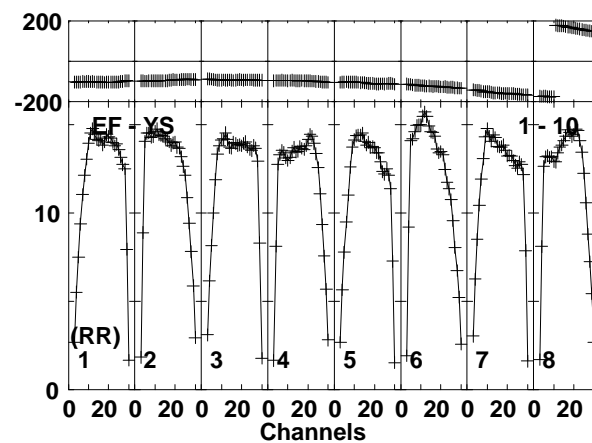
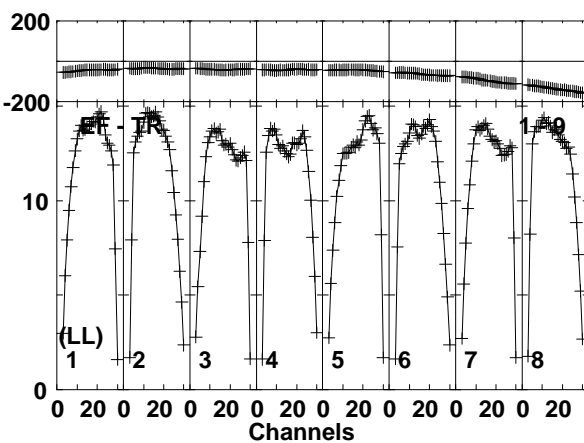
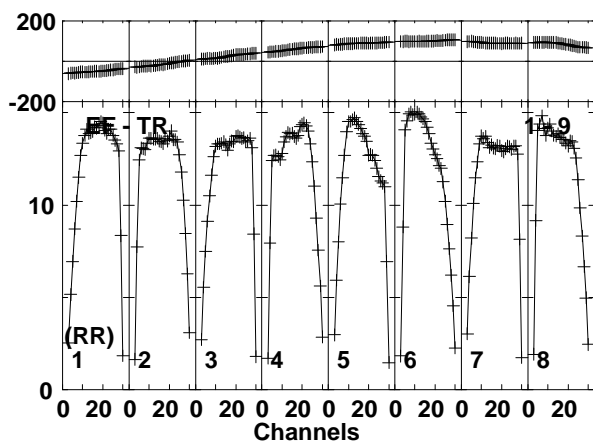
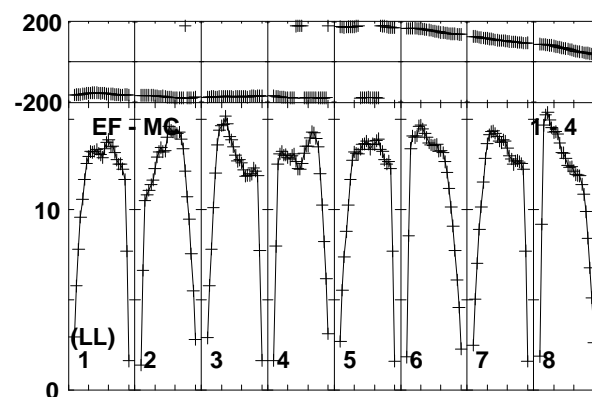
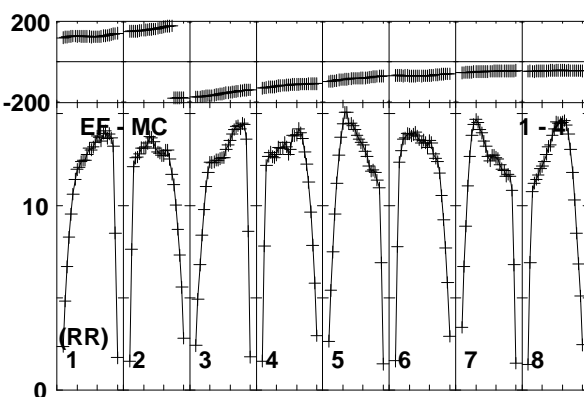
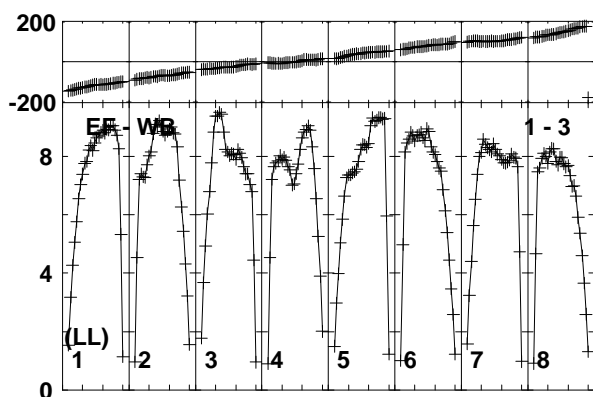
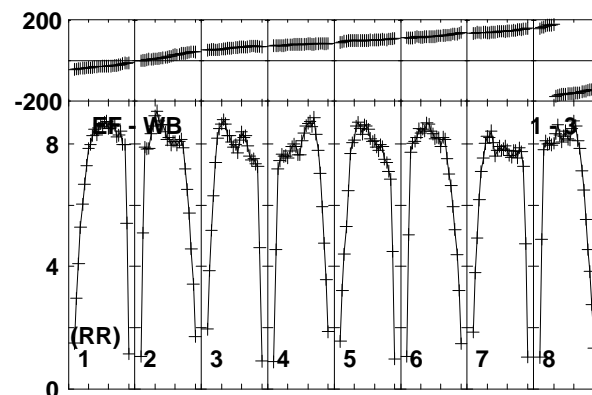
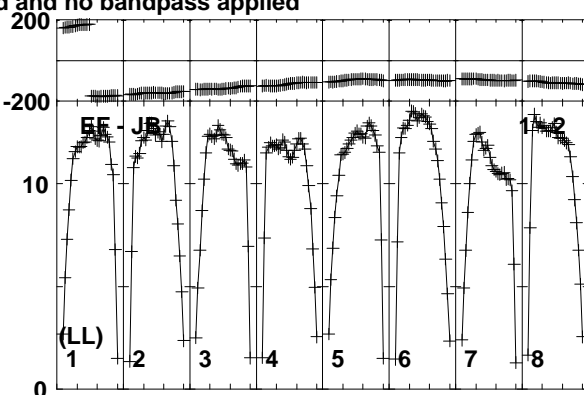
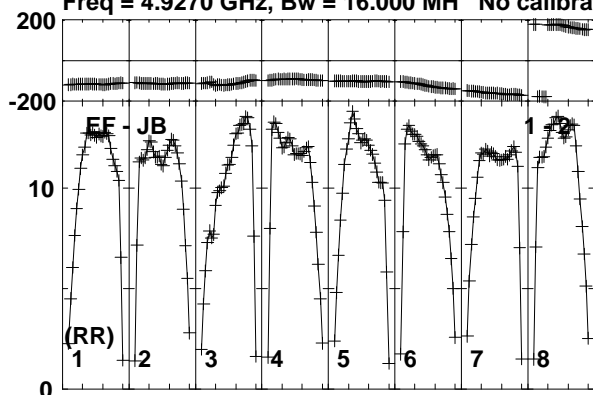

Lower frame: Milli Ampl Jy Top frame: Phas deg  
Vector averaged cross-power spectrum Baseline: EF (01) - JB (02)  
Timerange: 00/08:44:41 to 00/08:46:09

Plot file version 394 created 08-APR-2019 12:10:22

J0815+3635 EM133B.UVDATA.1

Freq = 4.9270 GHz, Bw = 16.000 MH No calibration applied and no bandpass applied

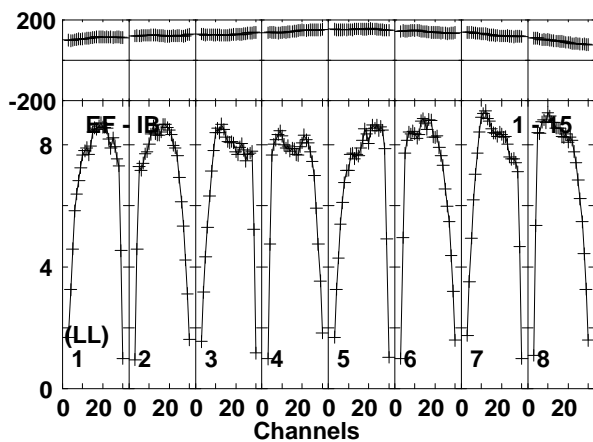
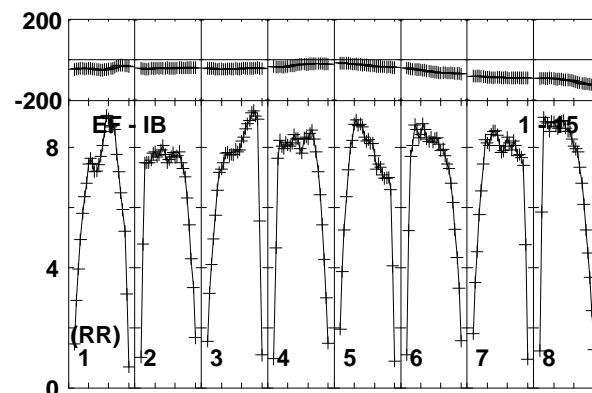
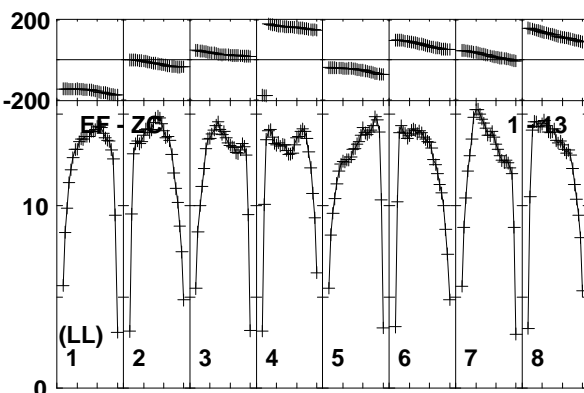
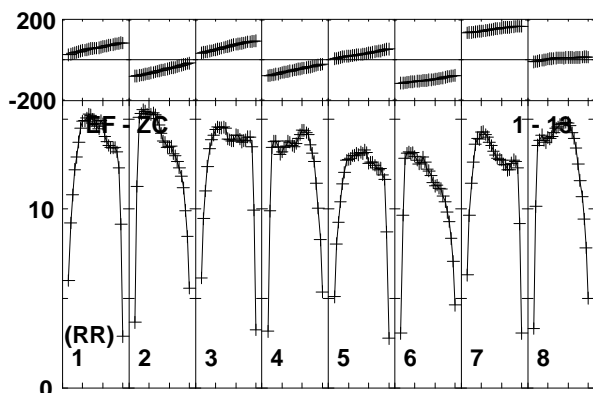
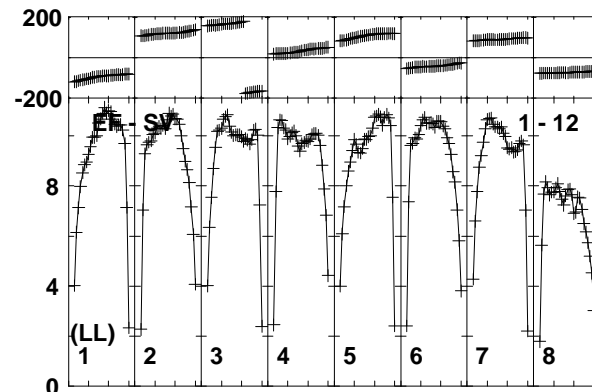
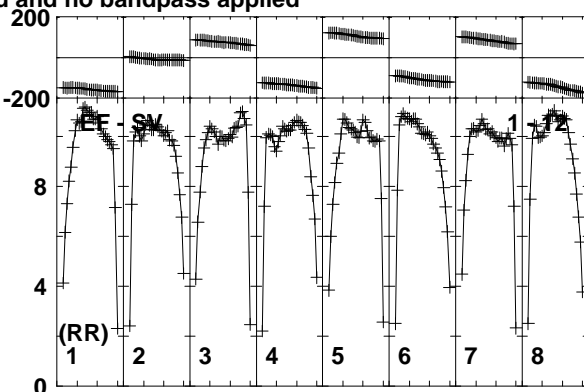
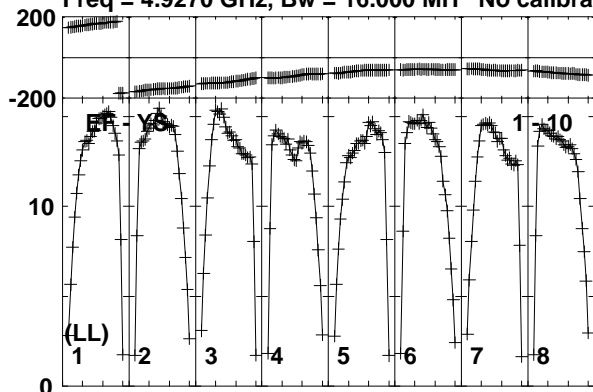

Lower frame: Milli Ampl Jy Top frame: Phas deg  
Vector averaged cross-power spectrum Baseline: EF (01) - YS (10)  
Timerange: 00/08:44:41 to 00/08:46:09

Plot file version 395 created 08-APR-2019 12:10:22

MRK622 EM133B.UVDATA.1

Freq = 4.9270 GHz, Bw = 16.000 MH No calibration applied and no bandpass applied

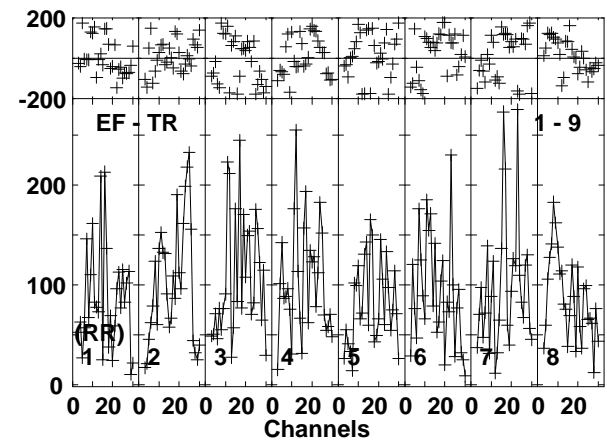
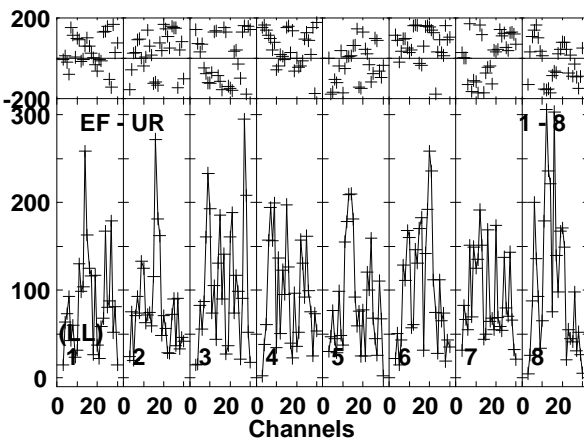
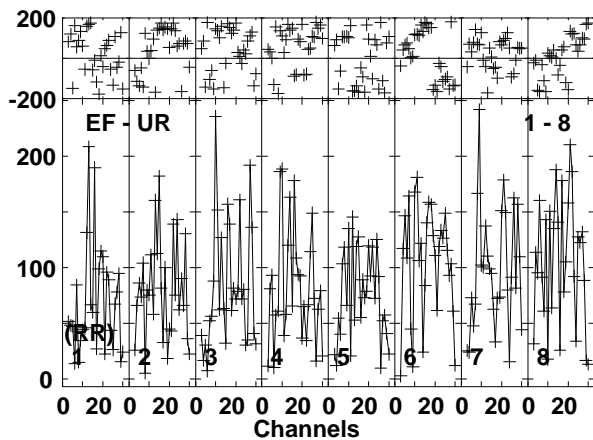
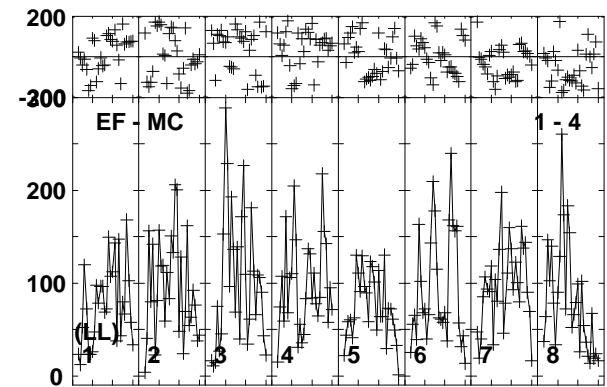
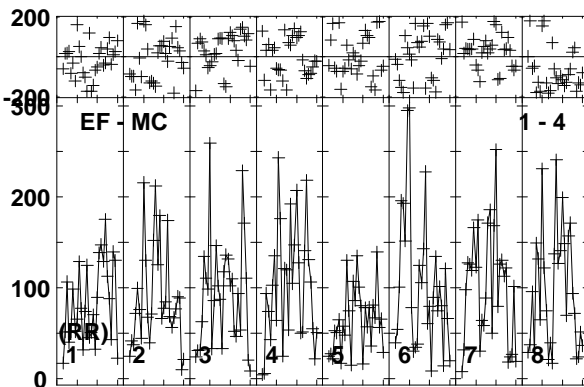
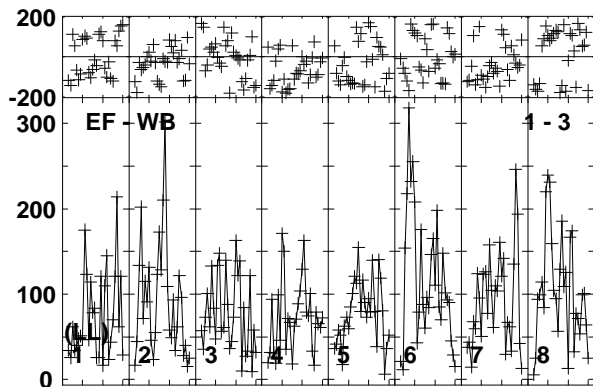
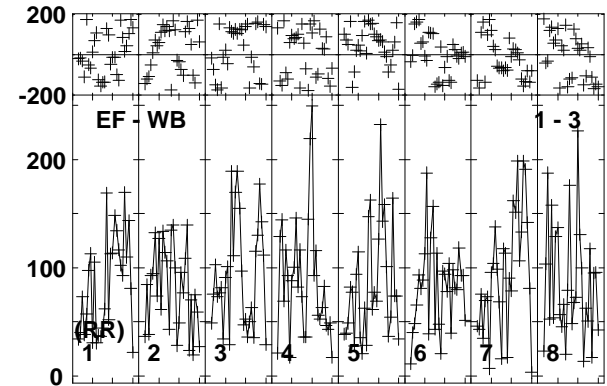
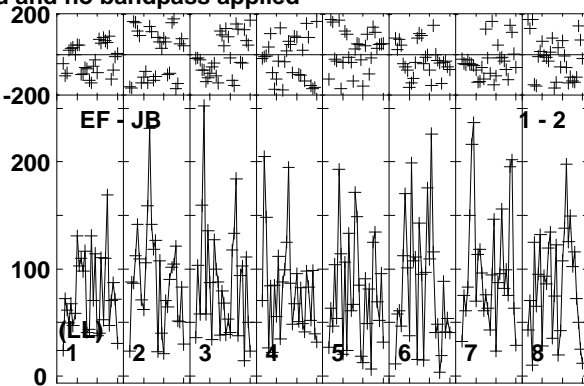
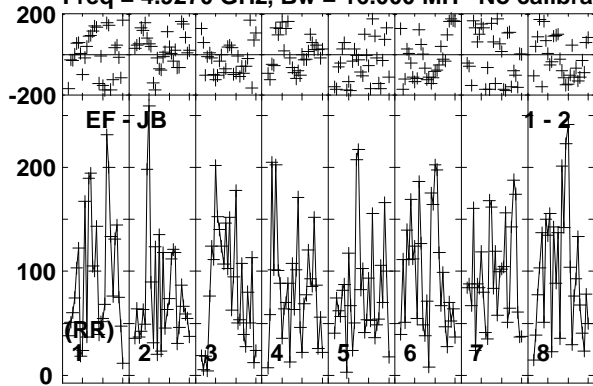

Lower frame: Micro Ampl Jy Top frame: Phas deg  
Vector averaged cross-power spectrum Baseline: EF (01) - JB (02)  
Timerange: 00/08:46:13 to 00/08:49:39

Plot file version 396 created 08-APR-2019 12:10:23

MRK622 EM133B.UVDATA.1

Freq = 4.9270 GHz, Bw = 16.000 MH No calibration applied and no bandpass applied

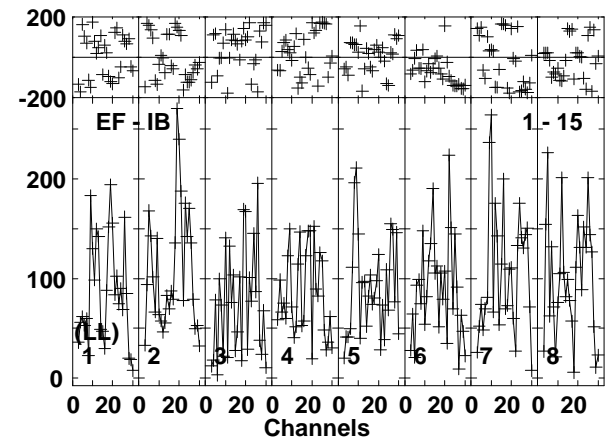
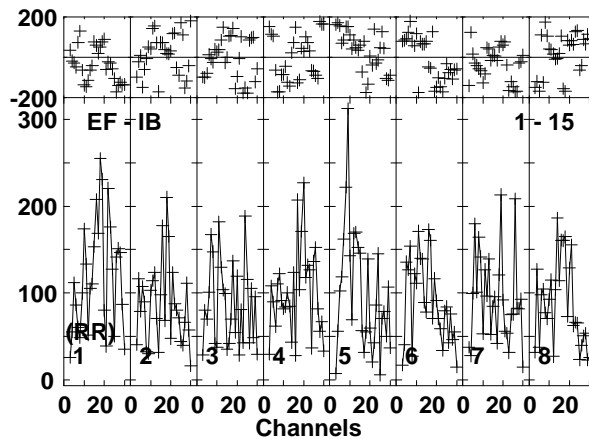
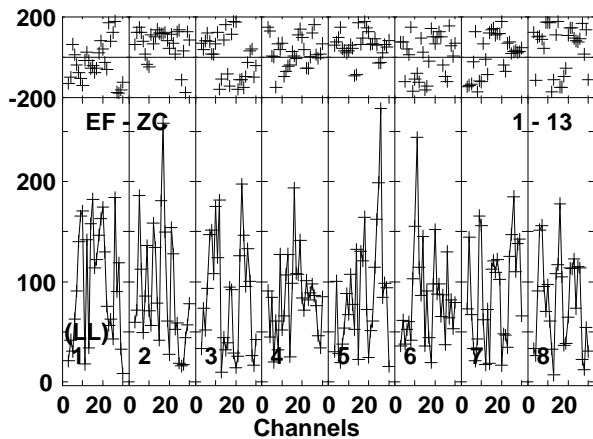
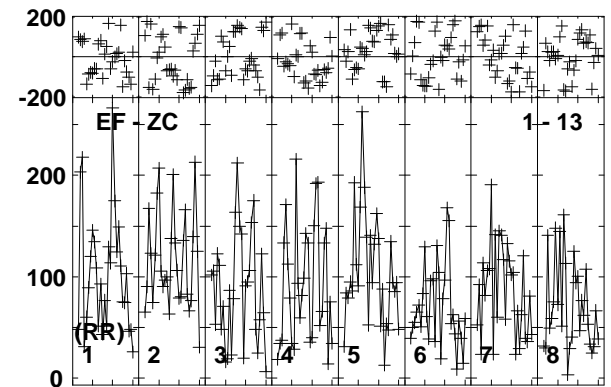
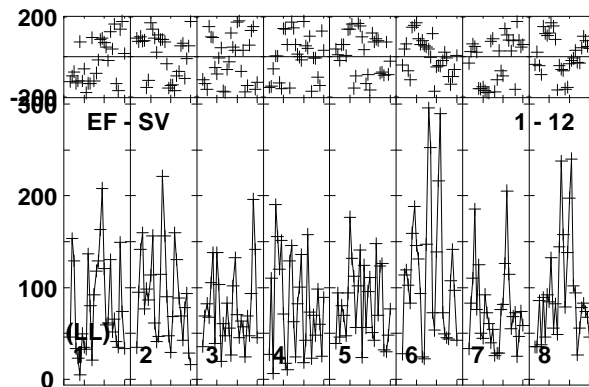
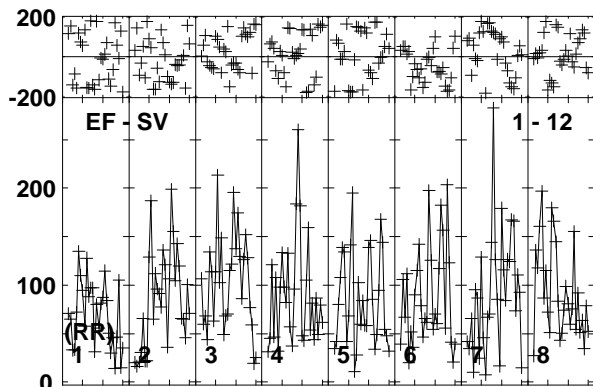
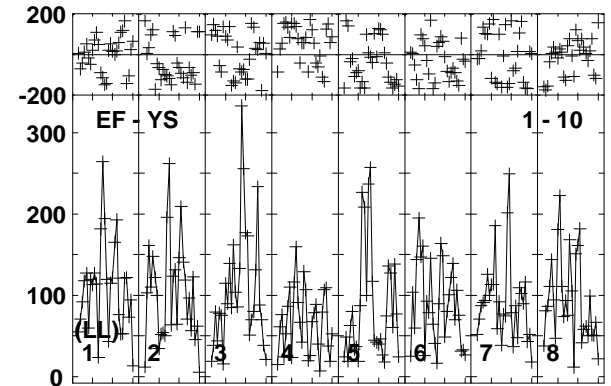
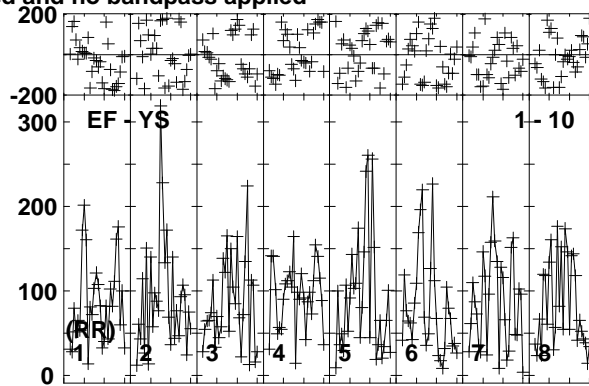
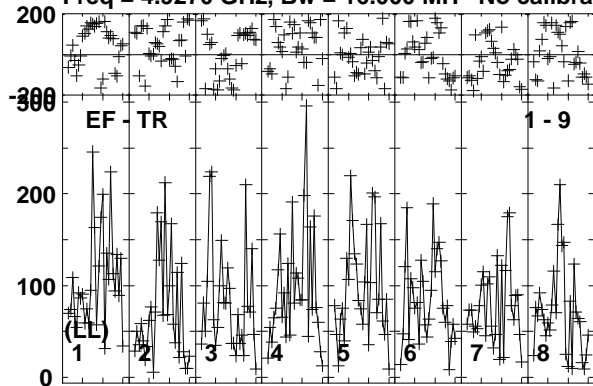

Lower frame: Micro Ampl Jy Top frame: Phas deg  
Vector averaged cross-power spectrum Baseline: EF (01) - TR (09)  
Timerange: 00/08:46:13 to 00/08:49:39

Plot file version 397 created 08-APR-2019 12:10:23

J0815+3635 EM133B.UVDATA.1

Freq = 4.9270 GHz, Bw = 16.000 MH No calibration applied and no bandpass applied

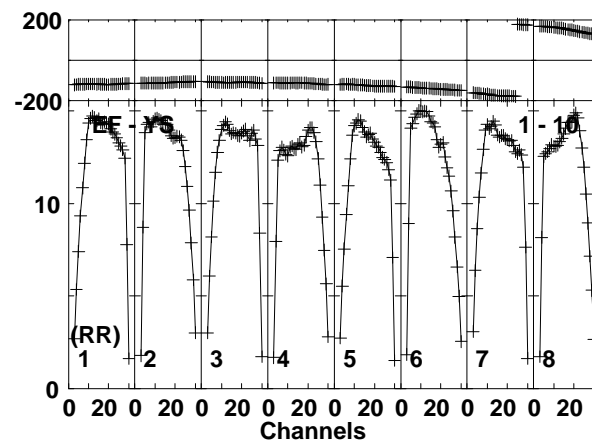
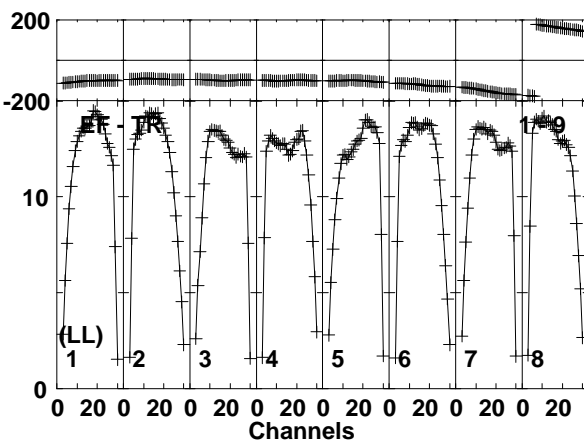
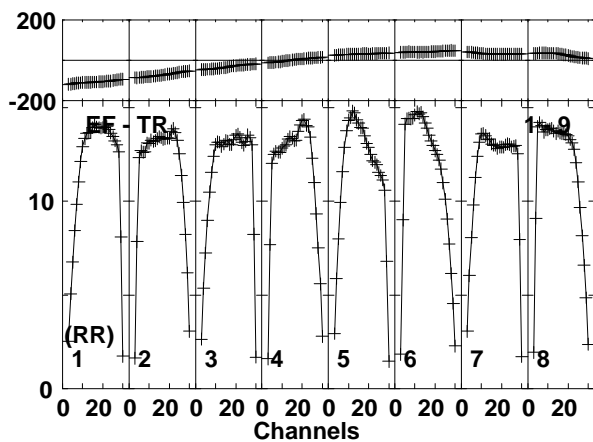
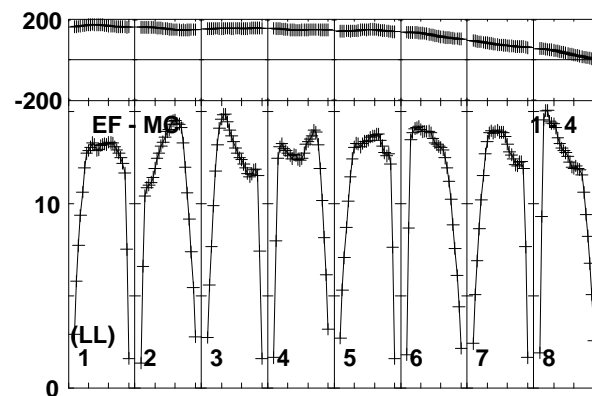
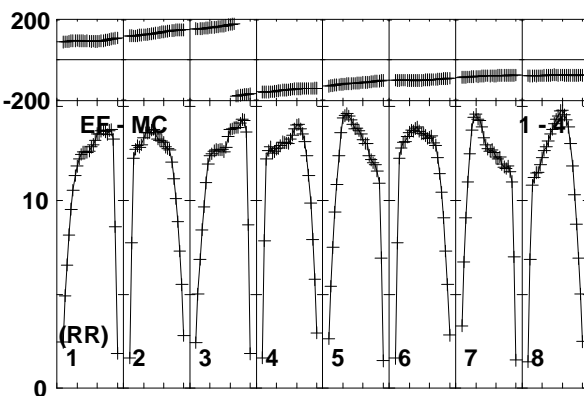
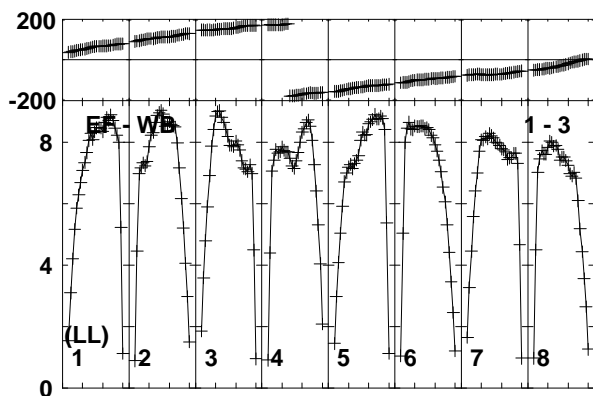
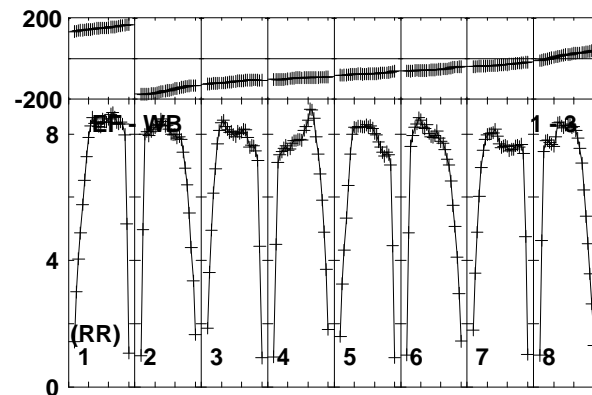
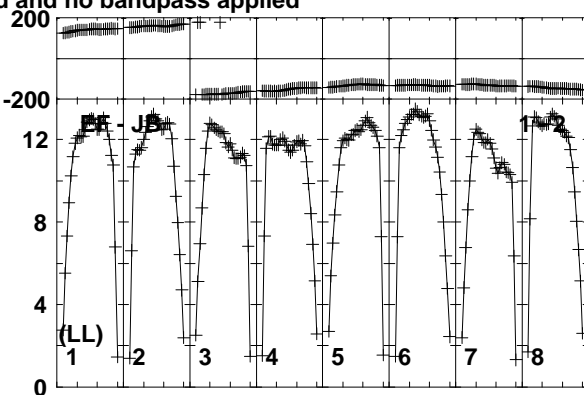
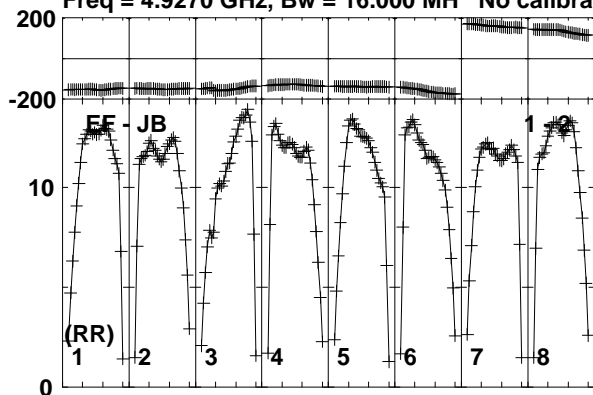

Lower frame: Milli Ampl Jy Top frame: Phas deg  
Vector averaged cross-power spectrum Baseline: EF (01) - JB (02)  
Timerange: 00/08:50:31 to 00/08:51:59

Plot file version 398 created 08-APR-2019 12:10:23

J0815+3635 EM133B.UVDATA.1

Freq = 4.9270 GHz, Bw = 16.000 MH No calibration applied and no bandpass applied

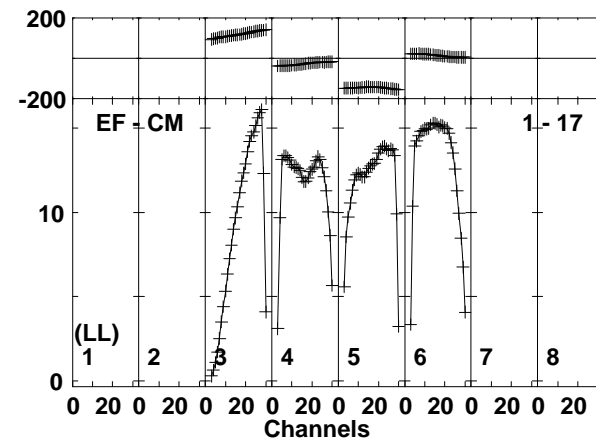
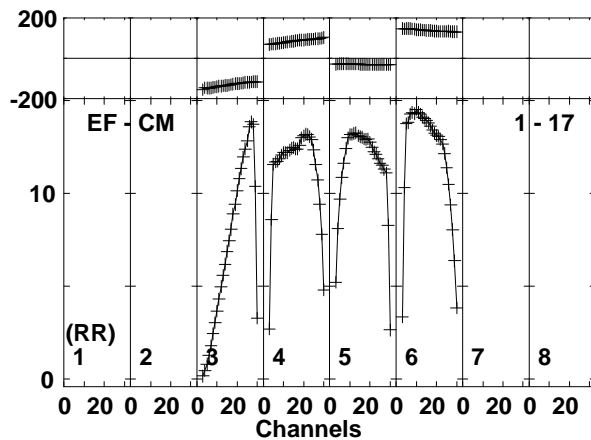
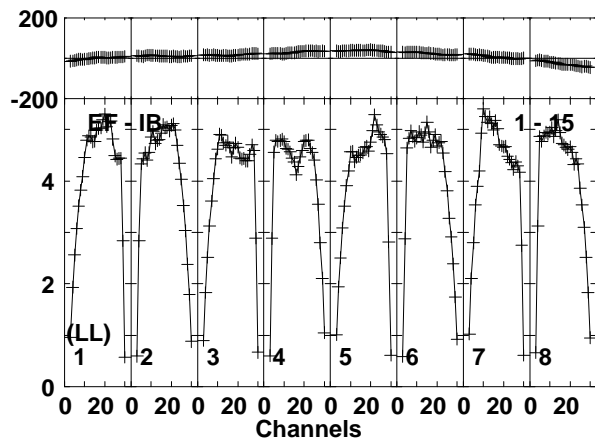
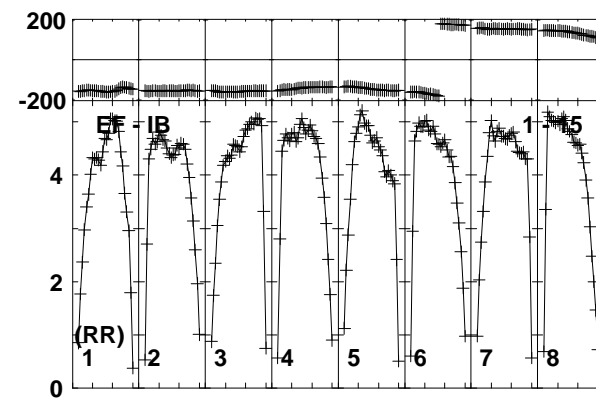
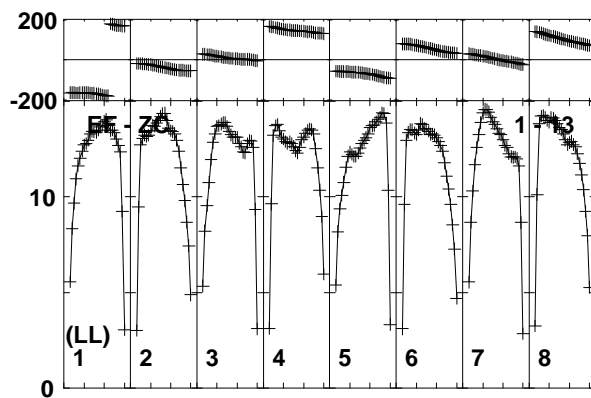
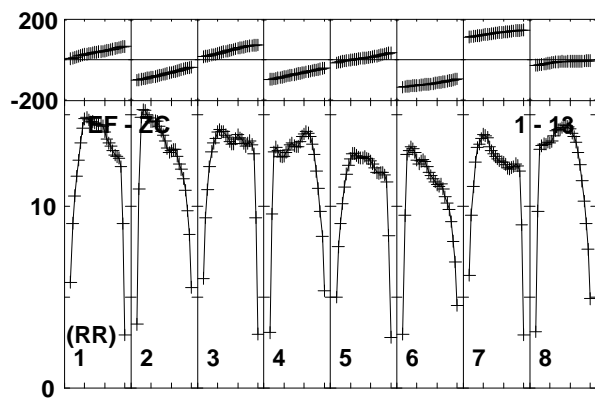
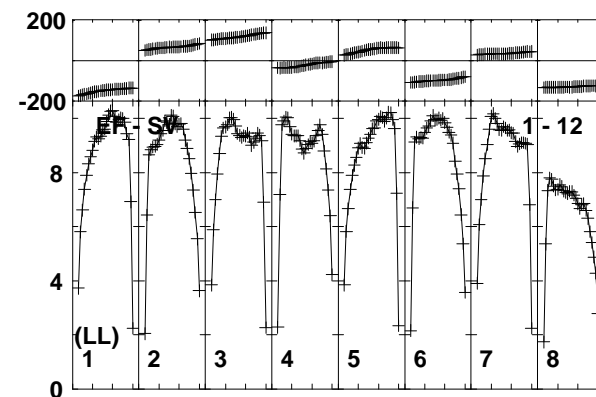
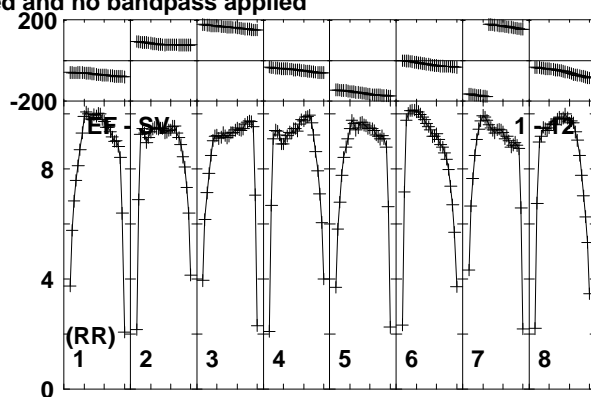
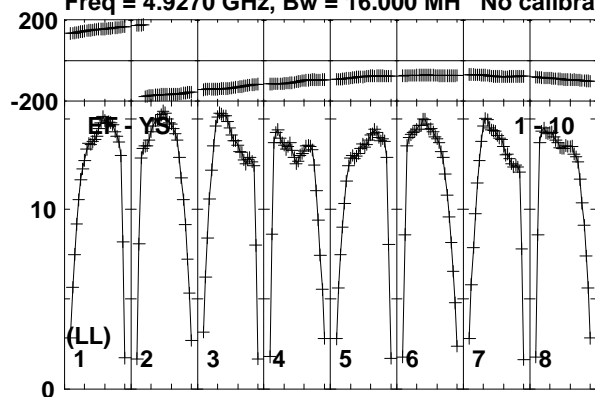

Lower frame: Milli Ampl Jy Top frame: Phas deg  
Vector averaged cross-power spectrum Baseline: EF (01) - YS (10)  
Timerange: 00/08:50:31 to 00/08:51:59

Plot file version 399 created 08-APR-2019 12:10:23

J0815+3635 EM133B.UVDATA.1

Freq = 4.9270 GHz, Bw = 16.000 MH No calibration applied and no bandpass applied

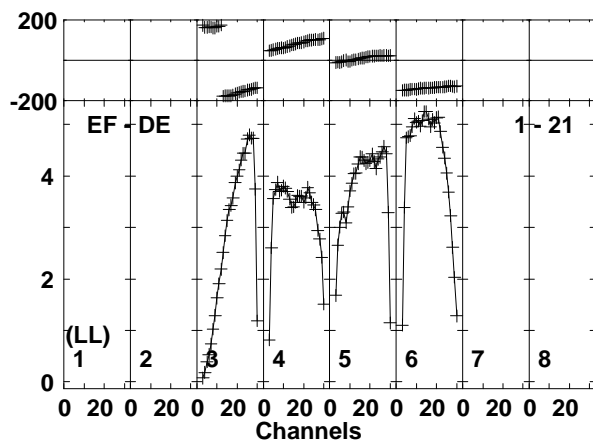
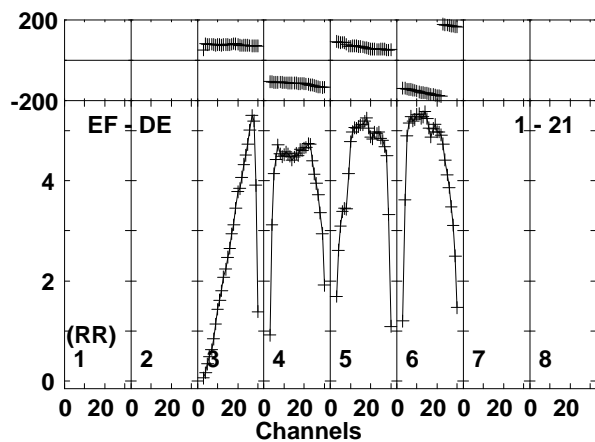
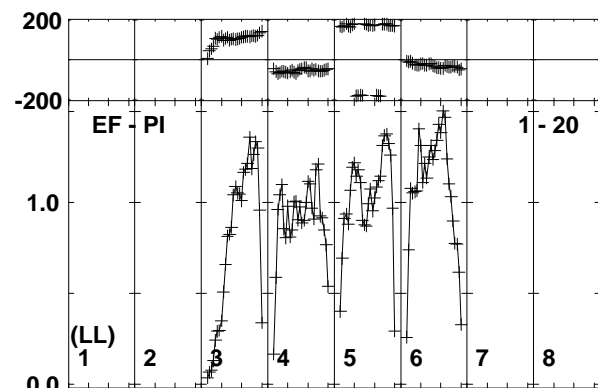
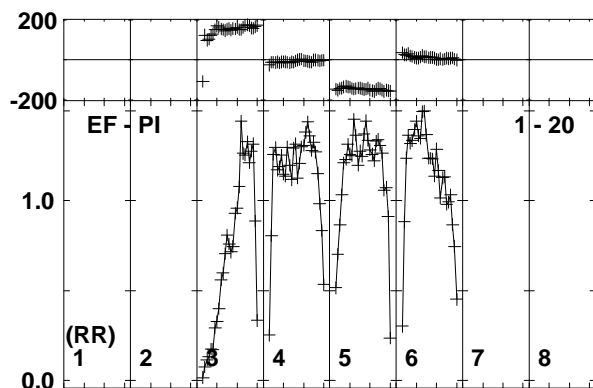
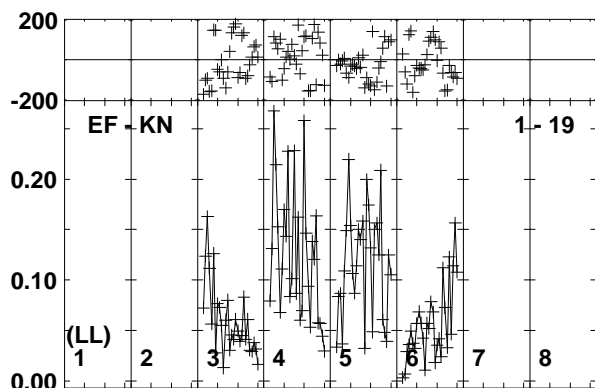
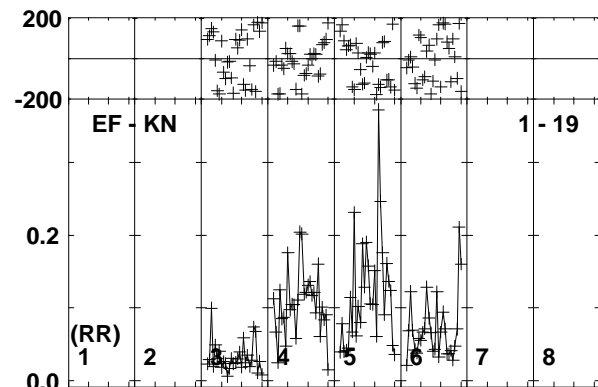
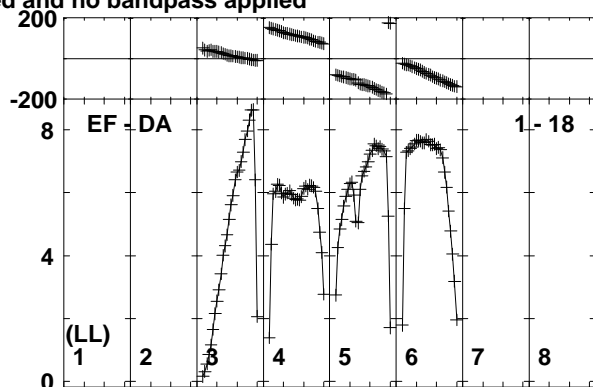
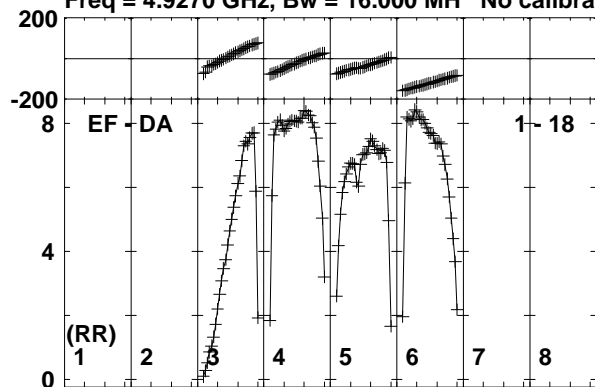

Lower frame: Milli Ampl Jy Top frame: Phas deg  
Vector averaged cross-power spectrum Baseline: EF (01) - DA (18)  
Timerange: 00/08:50:31 to 00/08:51:59

Plot file version 400 created 08-APR-2019 12:10:23

MRK622 EM133B.UVDATA.1

Freq = 4.9270 GHz, Bw = 16.000 MH No calibration applied and no bandpass applied

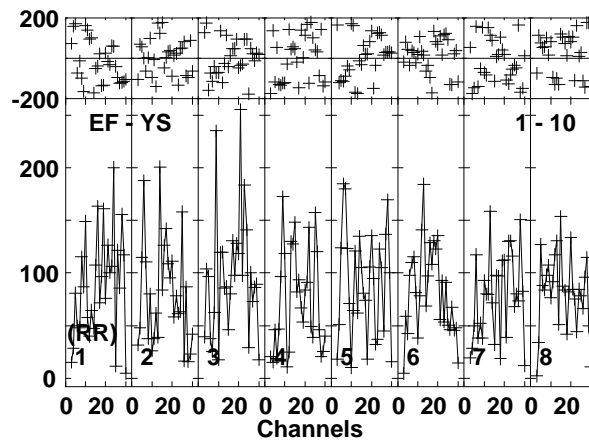
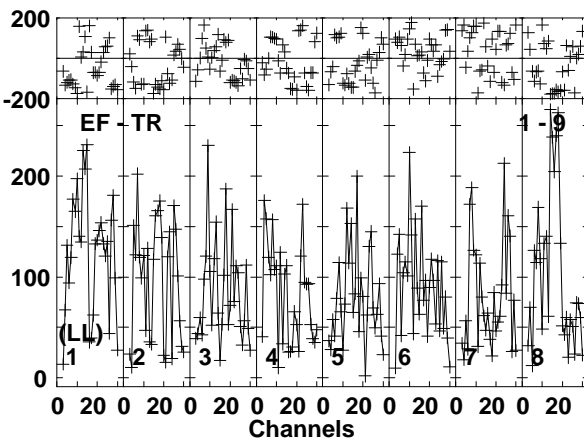
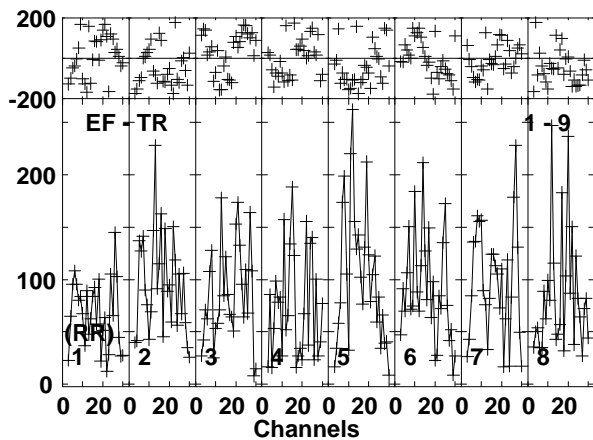
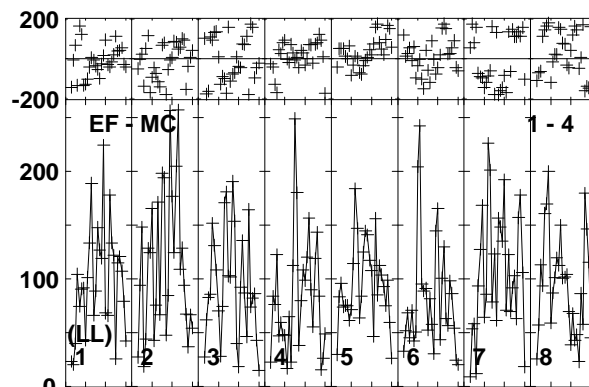
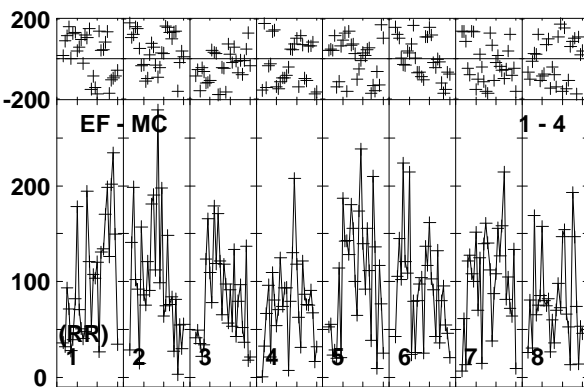
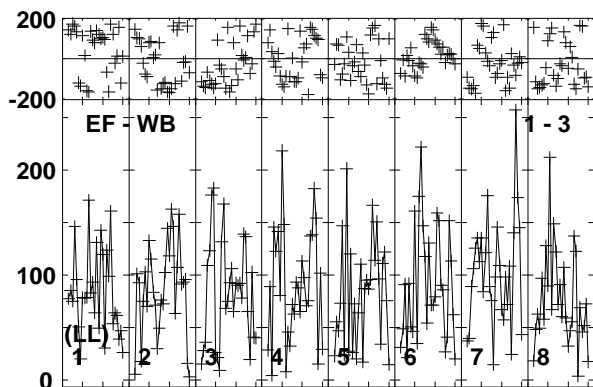
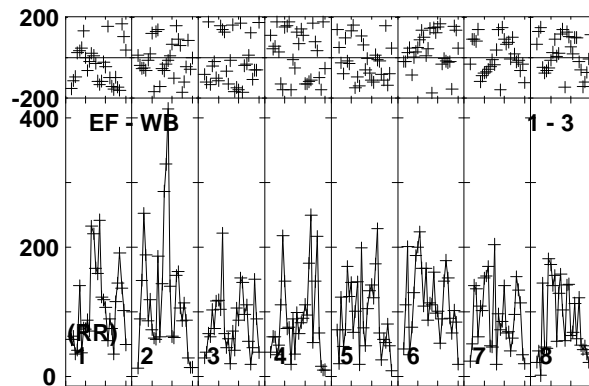
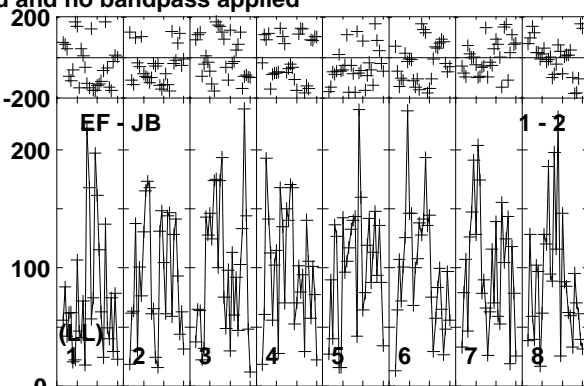
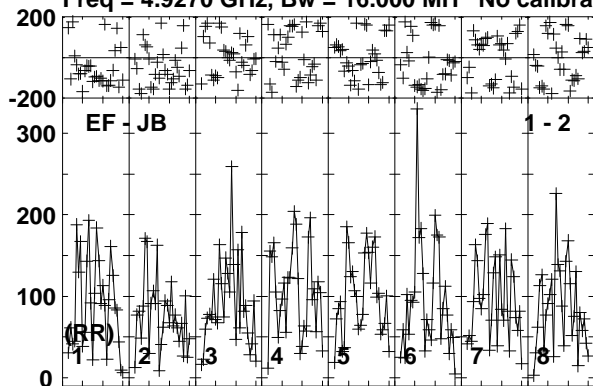

Lower frame: Micro Ampl Jy Top frame: Phas deg  
Vector averaged cross-power spectrum Baseline: EF (01) - JB (02)  
Timerange: 00/08:52:01 to 00/08:55:29



Plot file version 401 created 08-APR-2019 12:10:23

MRK622 EM133B.UVDATA.1

Freq = 4.9270 GHz, Bw = 16.000 MH No calibration applied and no bandpass applied

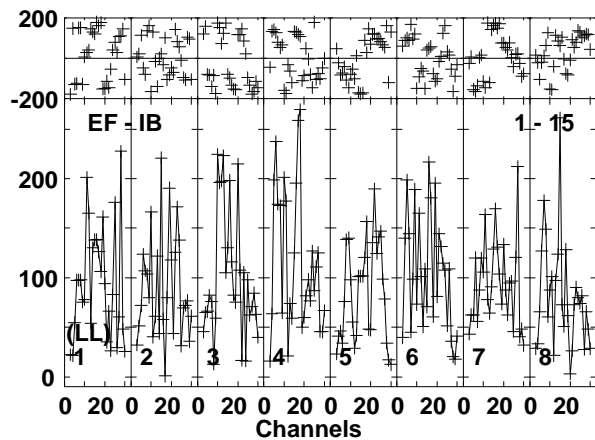
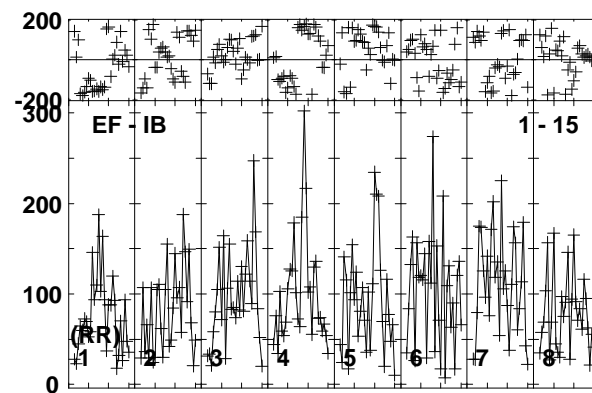
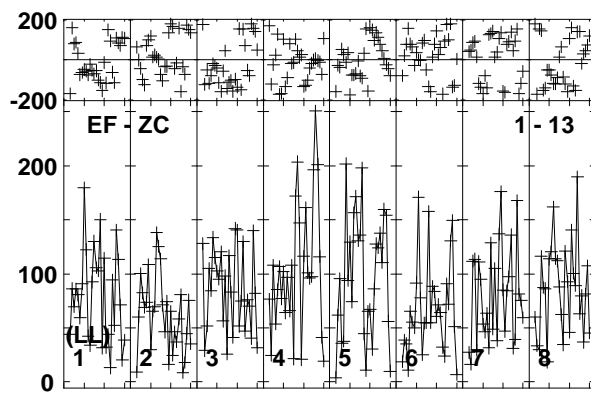
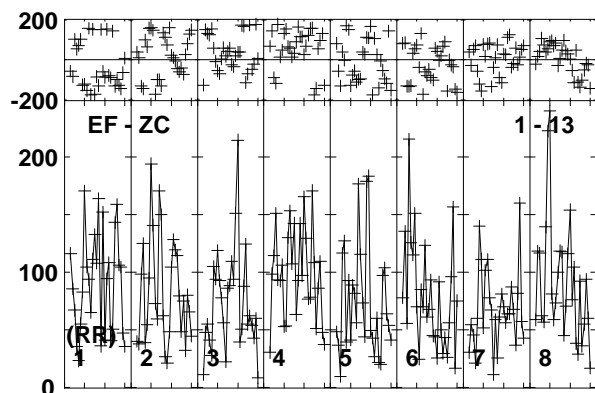
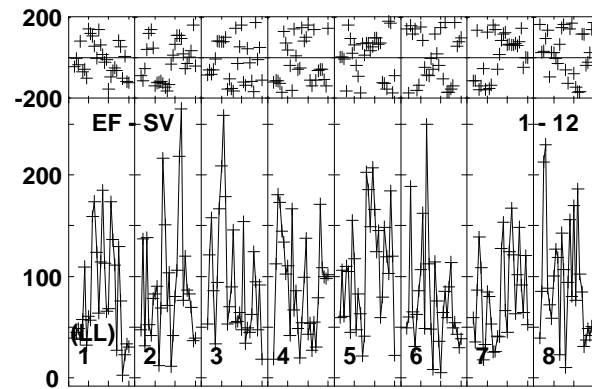
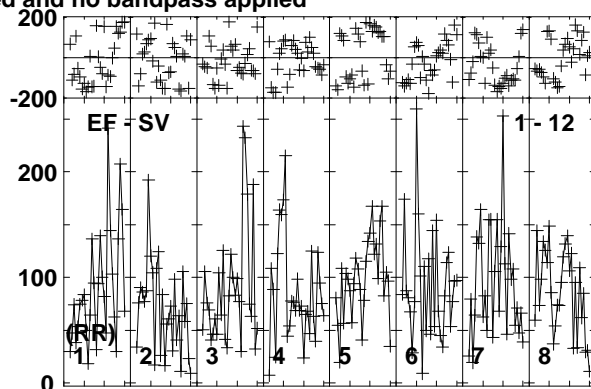
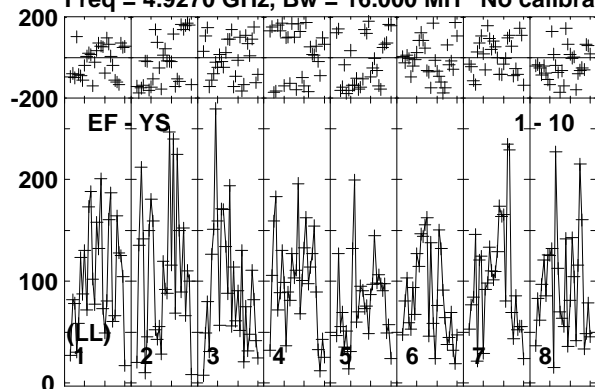

Lower frame: Micro Ampl Jy Top frame: Phas deg  
Vector averaged cross-power spectrum Baseline: EF (01) - YS (10)  
Timerange: 00/08:52:01 to 00/08:55:29

Plot file version 402 created 08-APR-2019 12:10:23

J0815+3635 EM133B.UVDATA.1

Freq = 4.9270 GHz, Bw = 16.000 MH No calibration applied and no bandpass applied

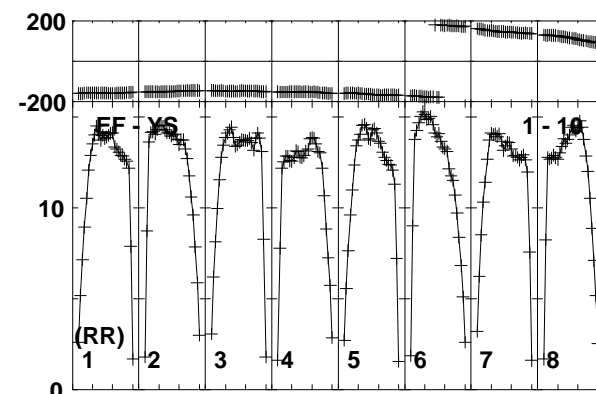
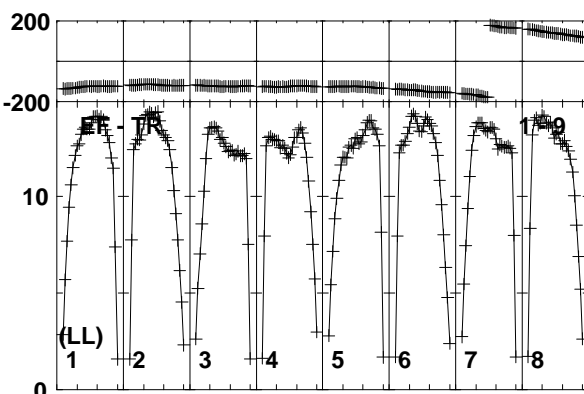
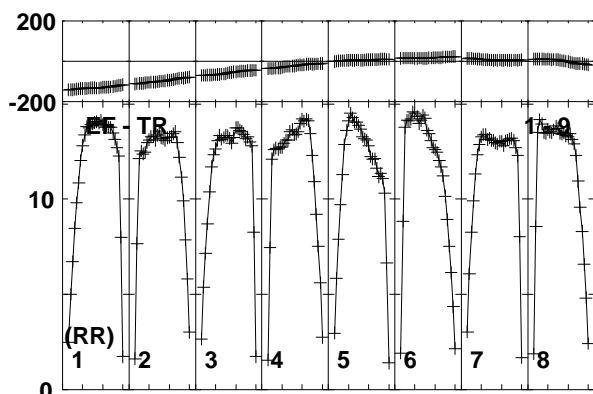
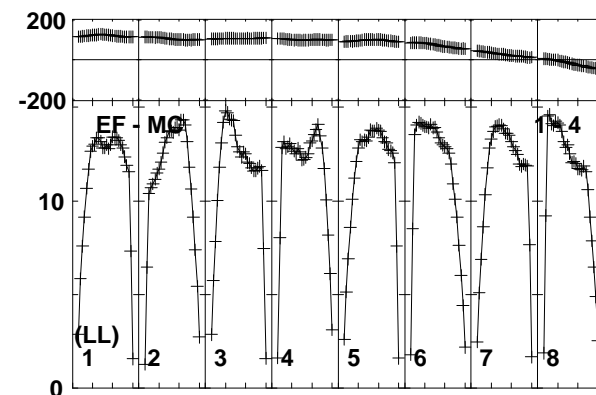
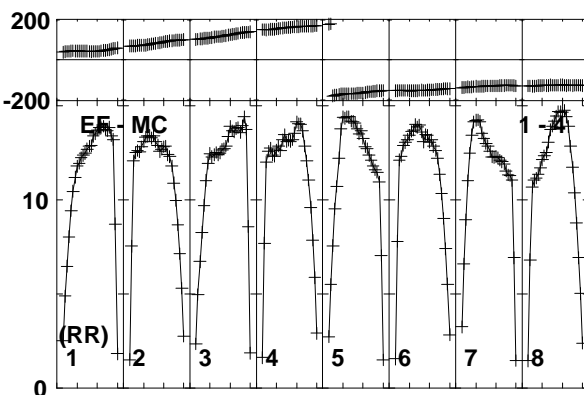
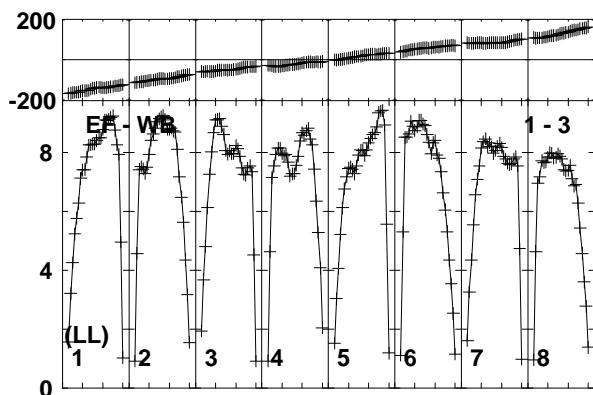
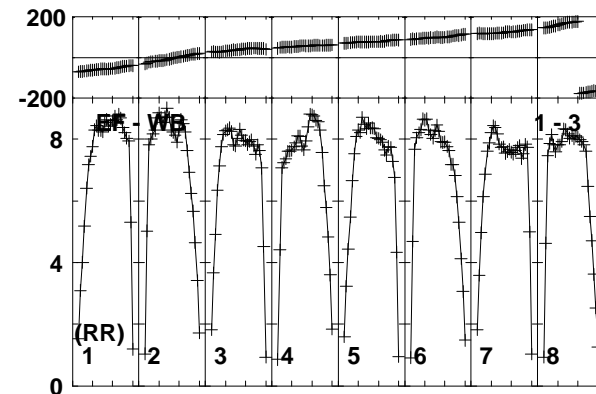
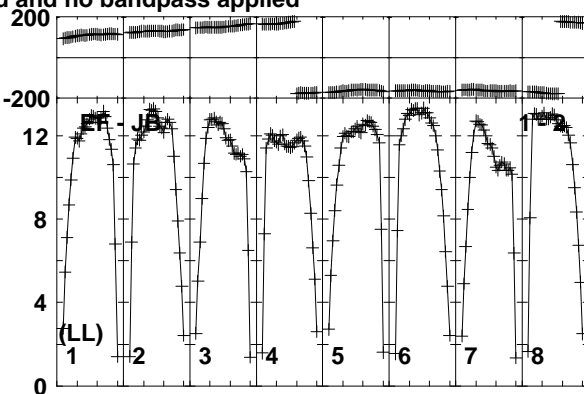
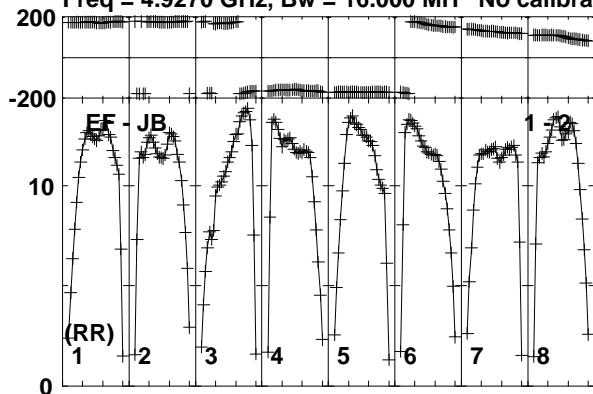

Lower frame: Milli Ampl Jy Top frame: Phas deg  
Vector averaged cross-power spectrum Baseline: EF (01) - JB (02)  
Timerange: 00/08:55:31 to 00/08:56:59

Plot file version 403 created 08-APR-2019 12:10:23

J0815+3635 EM133B.UVDATA.1

Freq = 4.9270 GHz, Bw = 16.000 MH No calibration applied and no bandpass applied

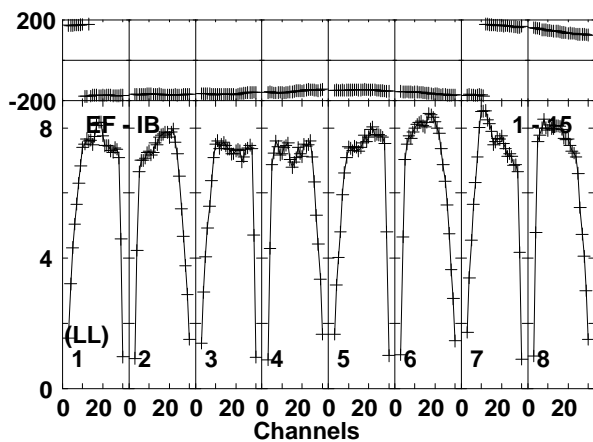
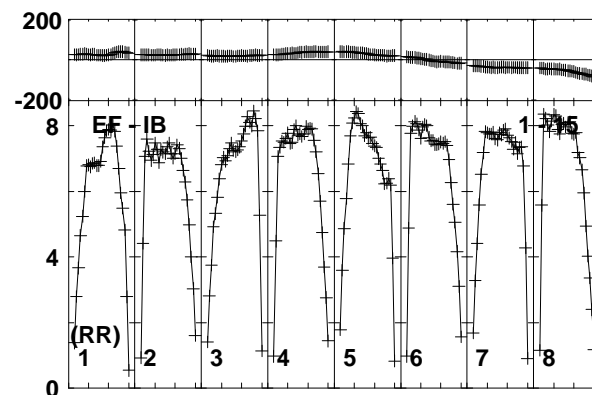
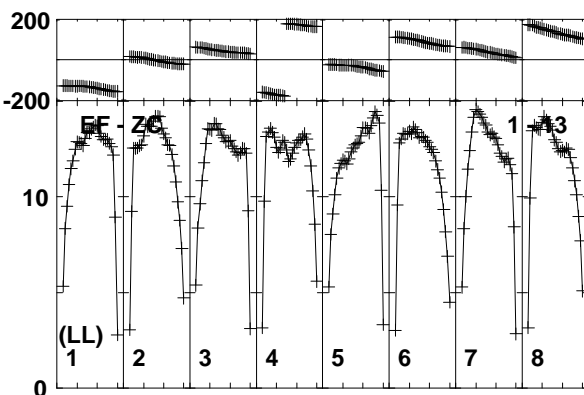
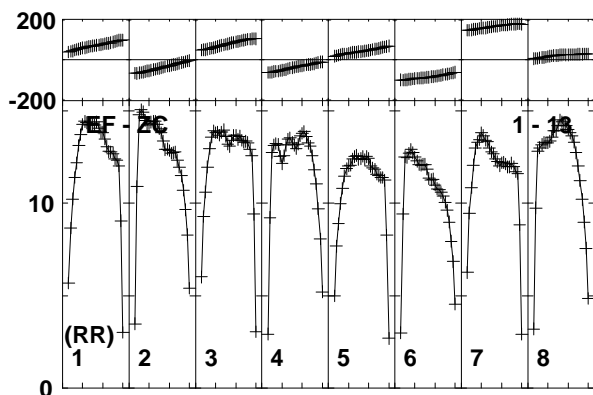
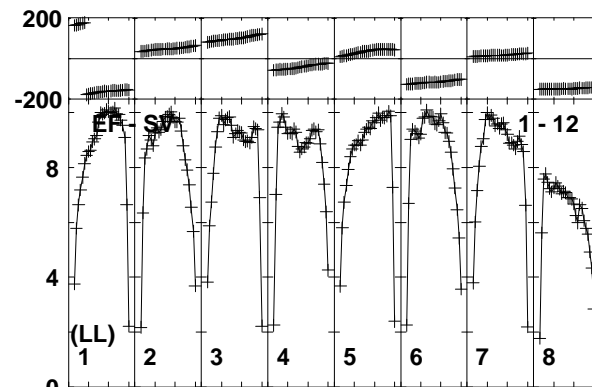
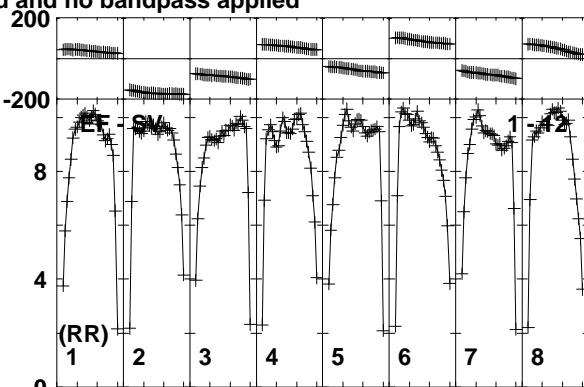
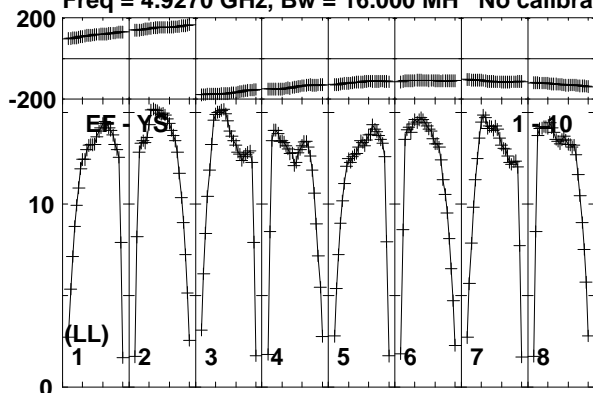

Lower frame: Milli Ampl Jy Top frame: Phas deg  
Vector averaged cross-power spectrum Baseline: EF (01) - YS (10)  
Timerange: 00/08:55:31 to 00/08:56:59

Plot file version 404 created 08-APR-2019 12:10:24

MRK622 EM133B.UVDATA.1

Freq = 4.9270 GHz, Bw = 16.000 MH No calibration applied and no bandpass applied

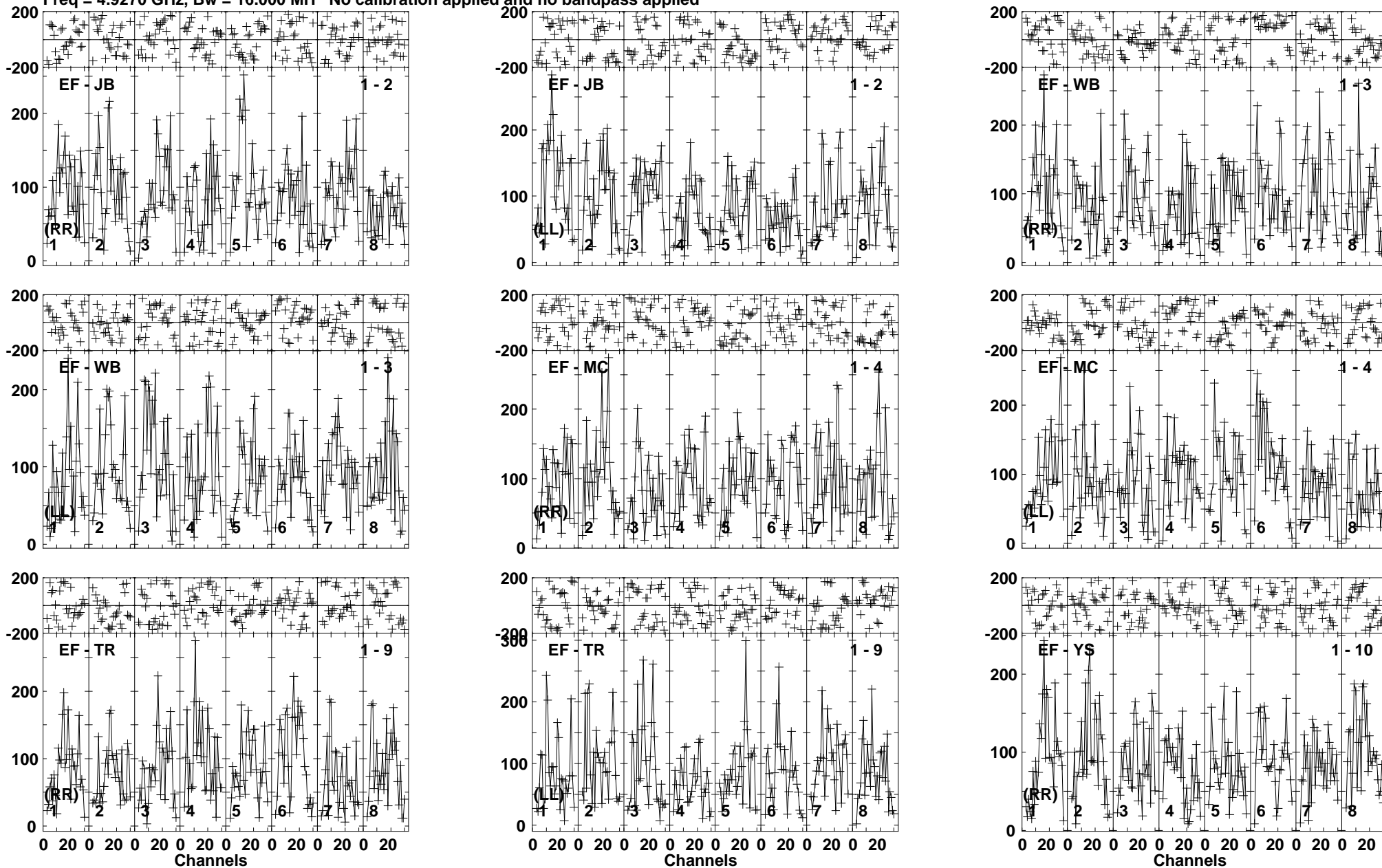

Lower frame: Micro Ampl Jy Top frame: Phas deg  
Vector averaged cross-power spectrum Baseline: EF (01) - JB (02)  
Timerange: 00/08:57:03 to 00/09:00:29

Plot file version 405 created 08-APR-2019 12:10:24

MRK622 EM133B.UVDATA.1

Freq = 4.9270 GHz, Bw = 16.000 MH No calibration applied and no bandpass applied

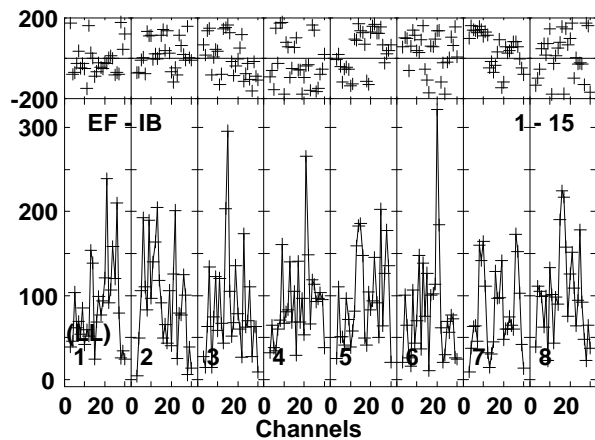
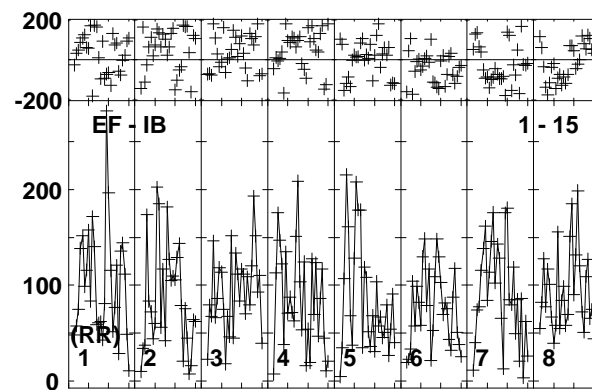
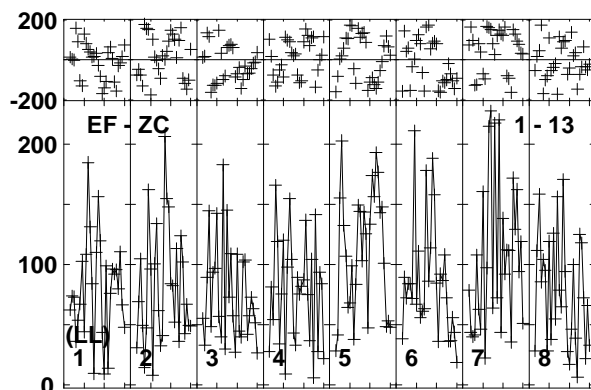
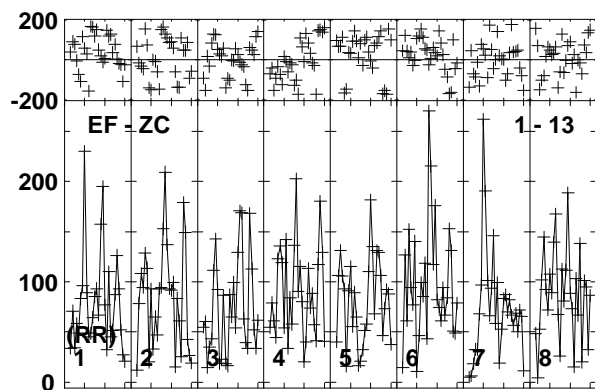
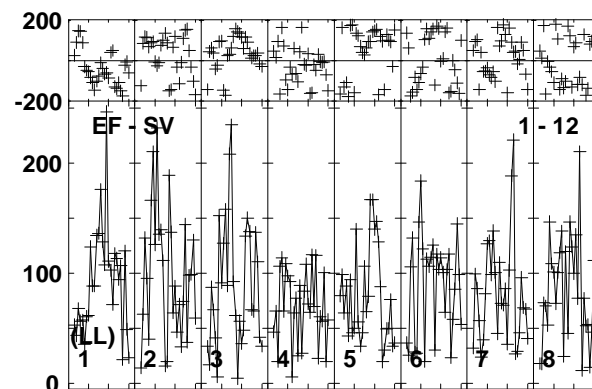
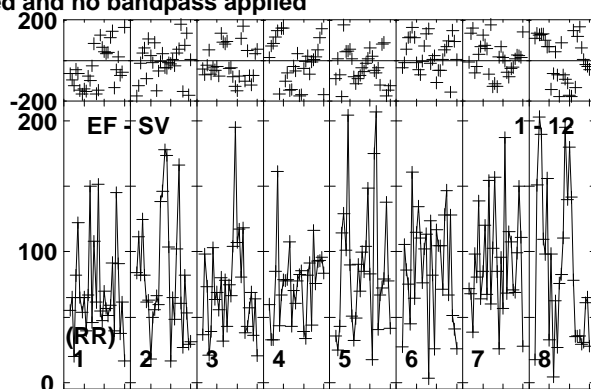
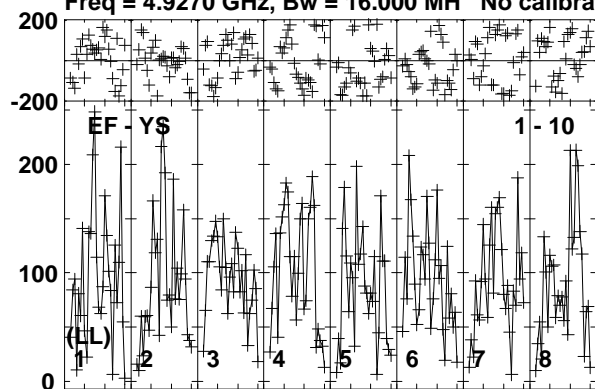

Lower frame: Micro Ampl Jy Top frame: Phas deg  
Vector averaged cross-power spectrum Baseline: EF (01) - YS (10)  
Timerange: 00/08:57:03 to 00/09:00:29

Plot file version 406 created 08-APR-2019 12:10:24

J0815+3635 EM133B.UVDATA.1

Freq = 4.9270 GHz, Bw = 16.000 MH No calibration applied and no bandpass applied

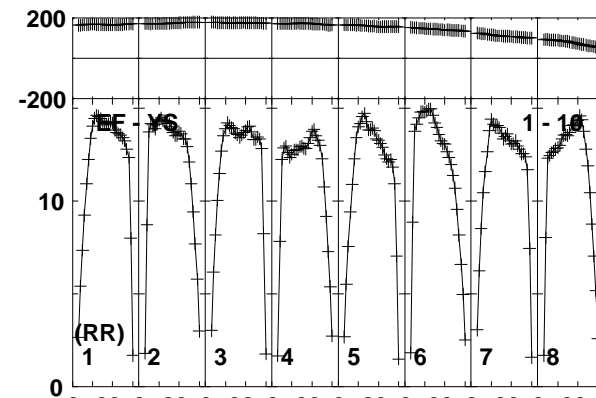
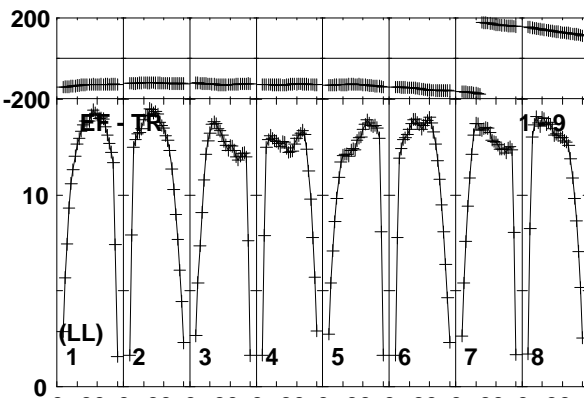
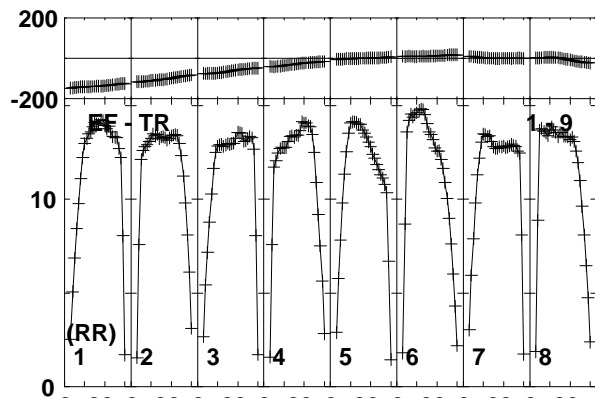
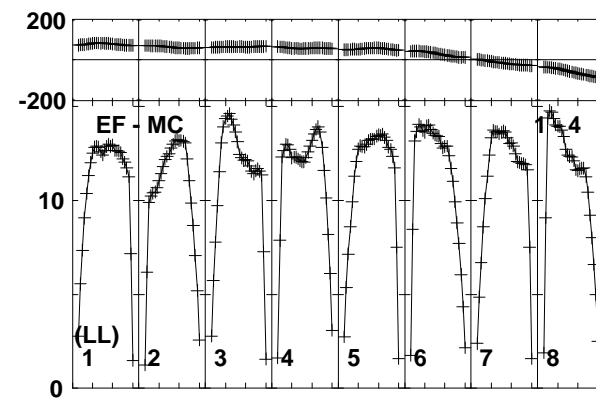
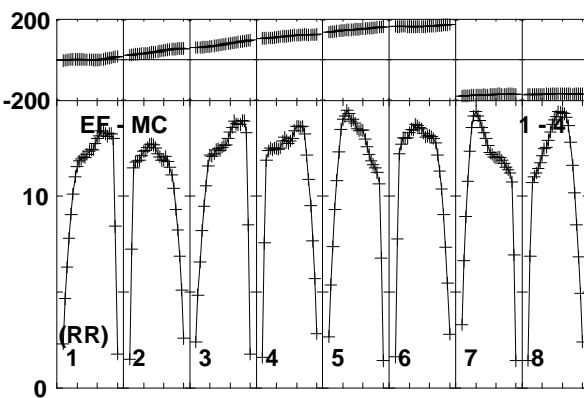
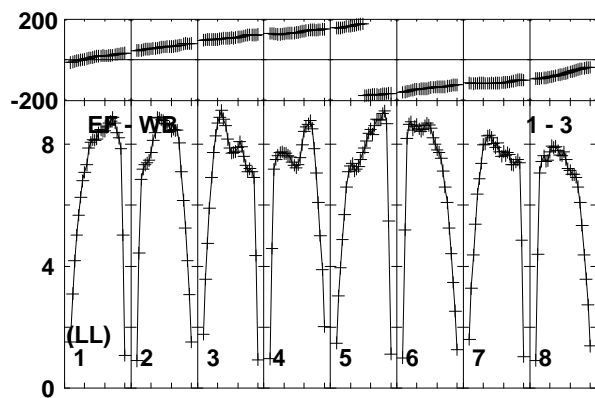
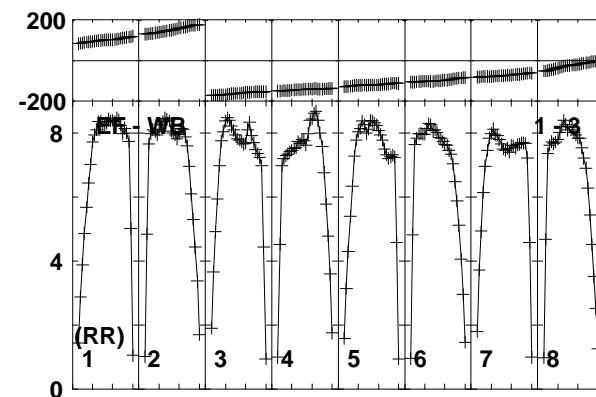
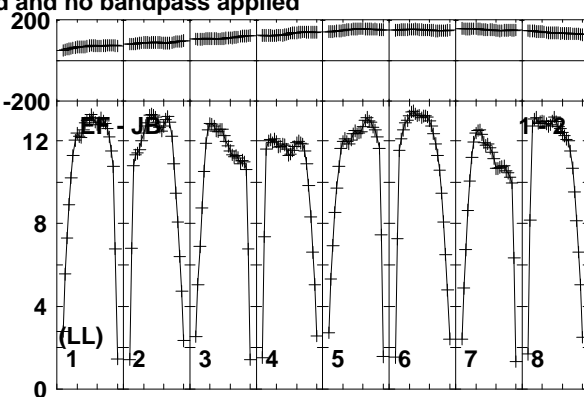
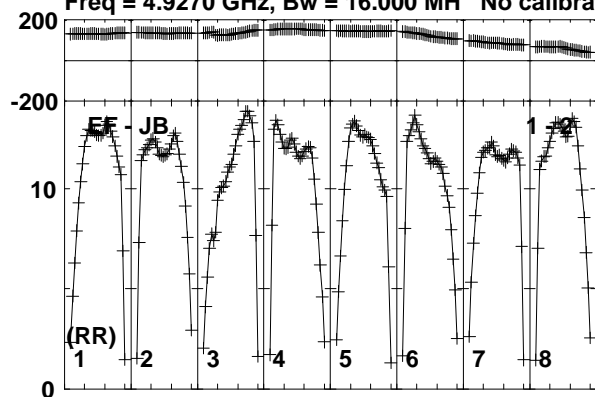

Lower frame: Milli Ampl Jy Top frame: Phas deg  
Vector averaged cross-power spectrum Baseline: EF (01) - JB (02)  
Timerange: 00/09:01:21 to 00/09:02:49

Plot file version 407 created 08-APR-2019 12:10:24

J0815+3635 EM133B.UVDATA.1

Freq = 4.9270 GHz, Bw = 16.000 MH No calibration applied and no bandpass applied

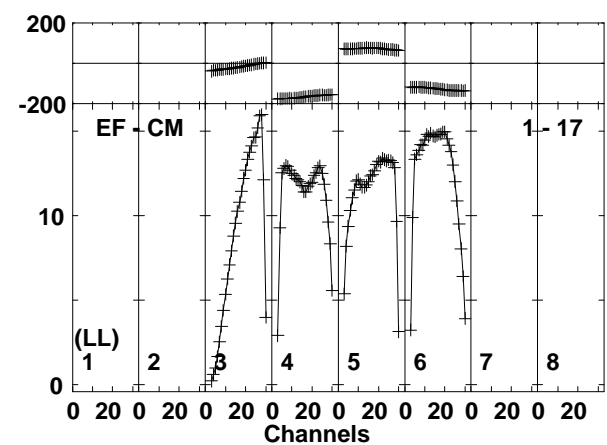
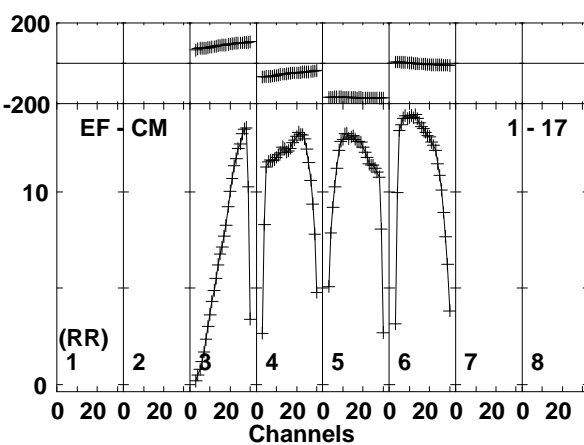
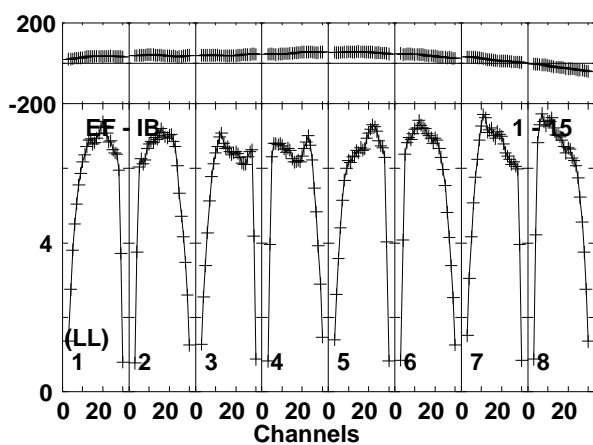
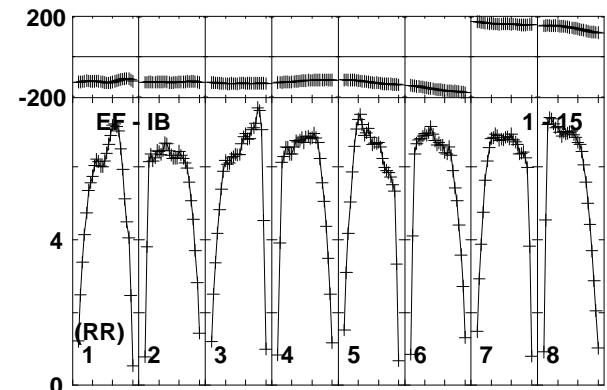
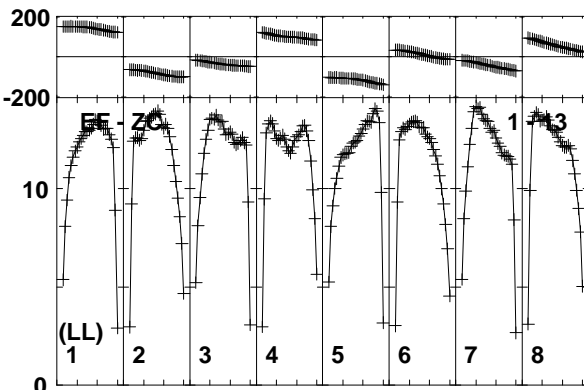
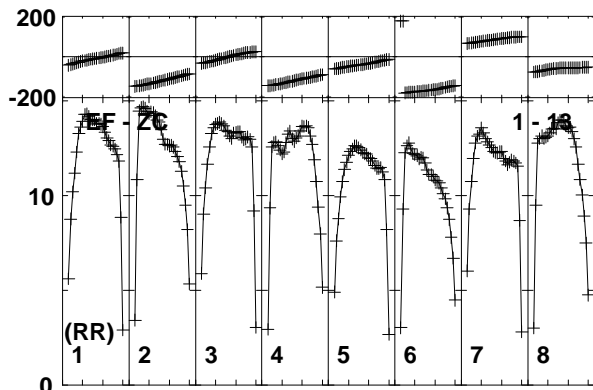
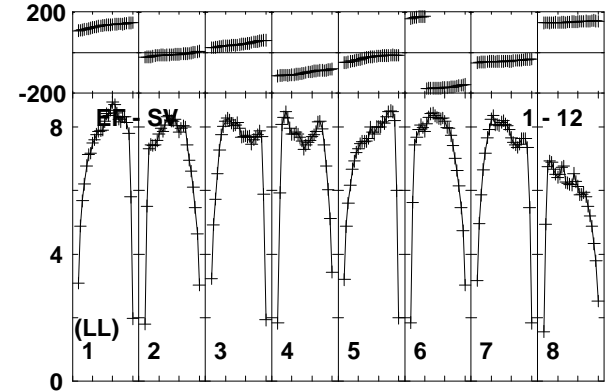
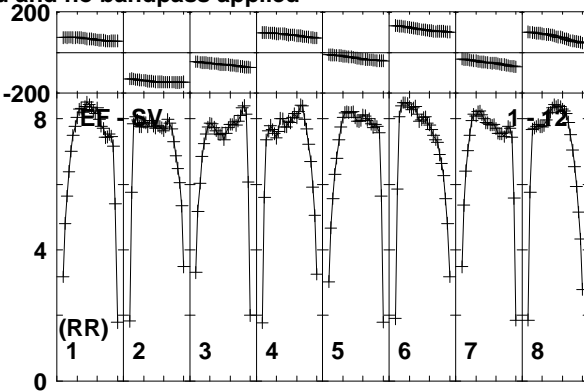
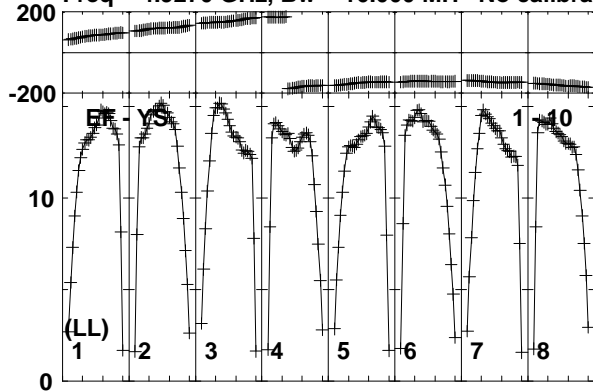

Lower frame: Milli Ampl Jy Top frame: Phas deg  
Vector averaged cross-power spectrum Baseline: EF (01) - YS (10)  
Timerange: 00/09:01:21 to 00/09:02:49

Plot file version 408 created 08-APR-2019 12:10:24

J0815+3635 EM133B.UVDATA.1

Freq = 4.9270 GHz, Bw = 16.000 MH No calibration applied and no bandpass applied

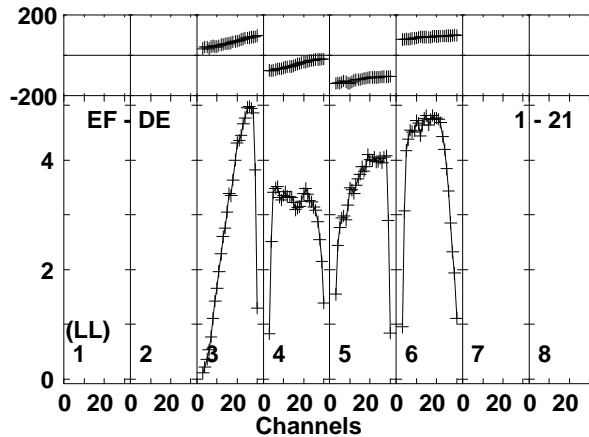
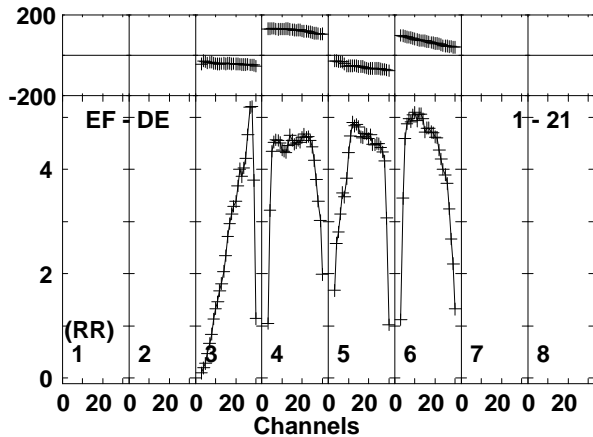
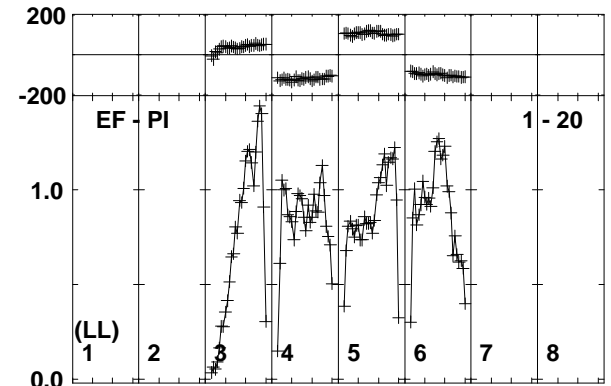
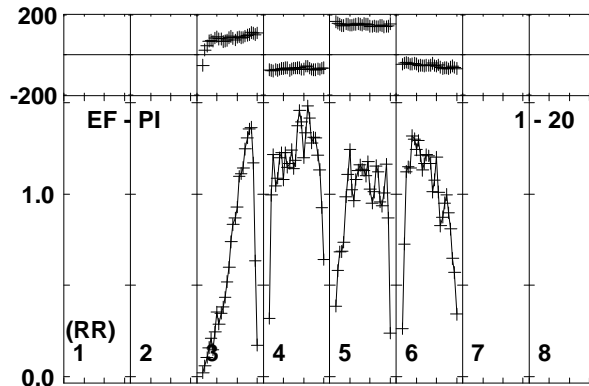
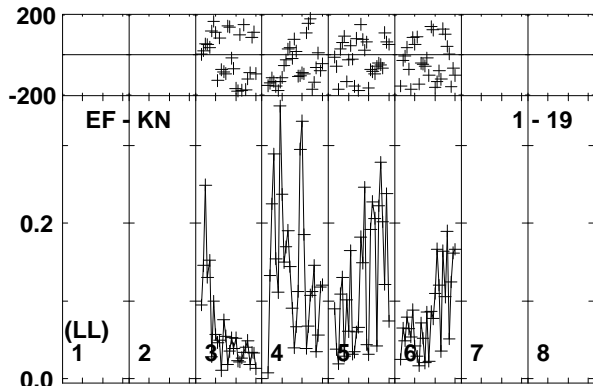
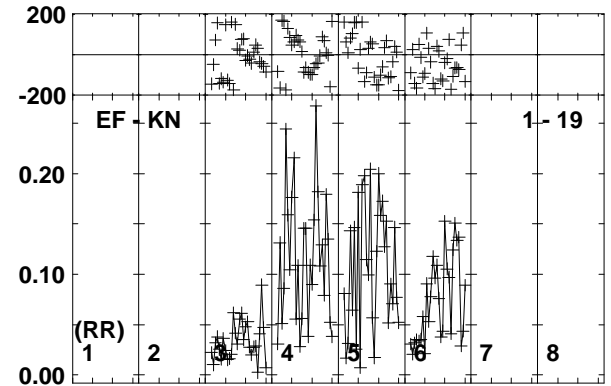
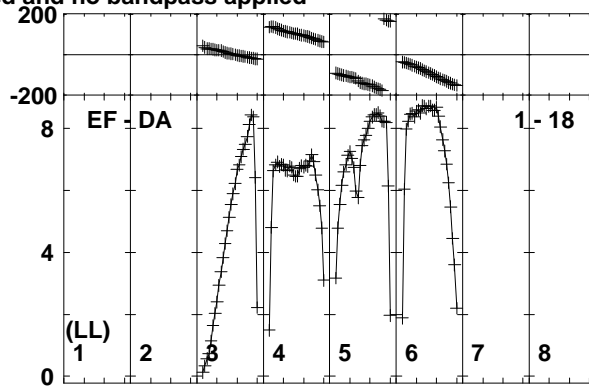
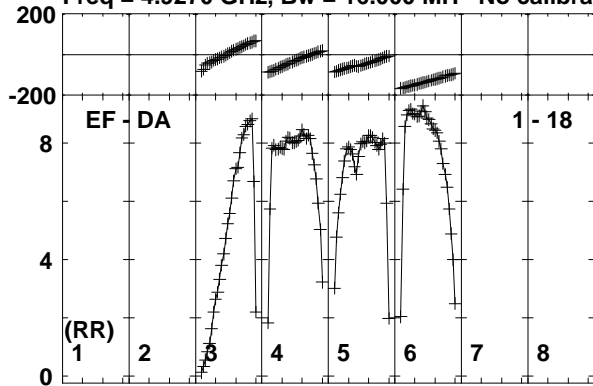

Lower frame: Milli Ampl Jy Top frame: Phas deg  
Vector averaged cross-power spectrum Baseline: EF (01) - DA (18)  
Timerange: 00/09:01:21 to 00/09:02:49



Plot file version 409 created 08-APR-2019 12:10:24

MRK622 EM133B.UVDATA.1

Freq = 4.9270 GHz, Bw = 16.000 MH No calibration applied and no bandpass applied

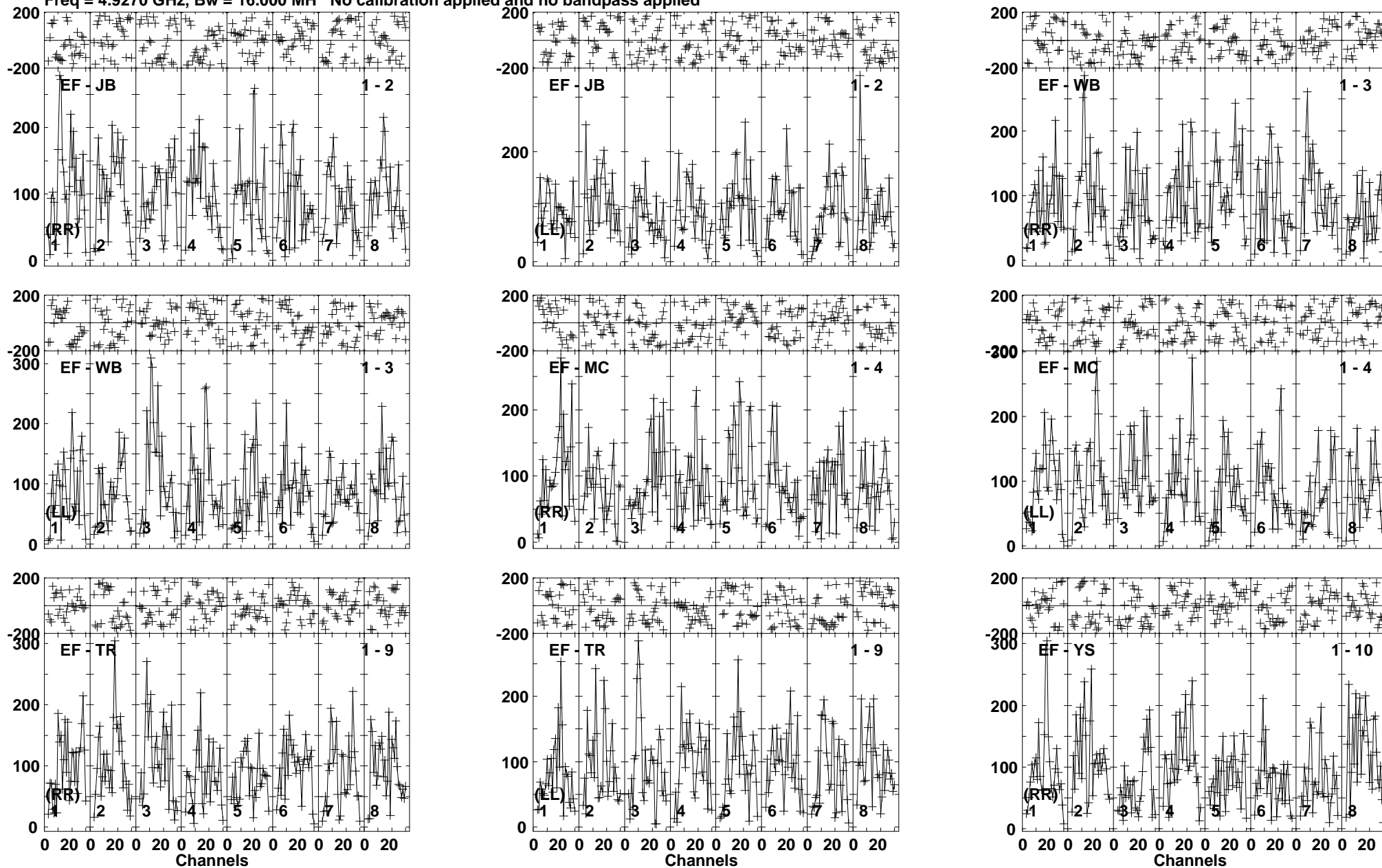

Lower frame: Micro Ampl Jy Top frame: Phas deg  
Vector averaged cross-power spectrum Baseline: EF (01) - JB (02)  
Timerange: 00/09:02:51 to 00/09:06:19

Plot file version 410 created 08-APR-2019 12:10:24

MRK622 EM133B.UVDATA.1

Freq = 4.9270 GHz, Bw = 16.000 MH No calibration applied and no bandpass applied

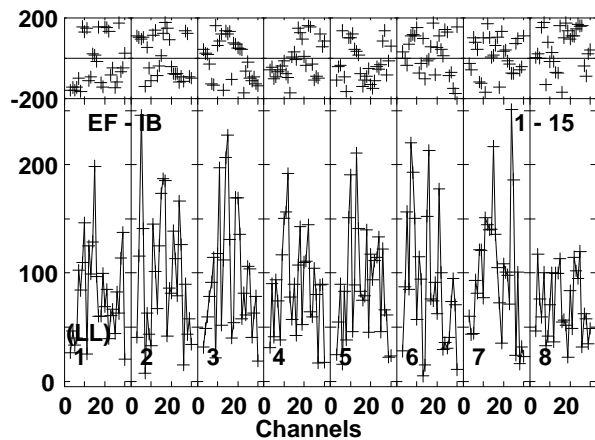
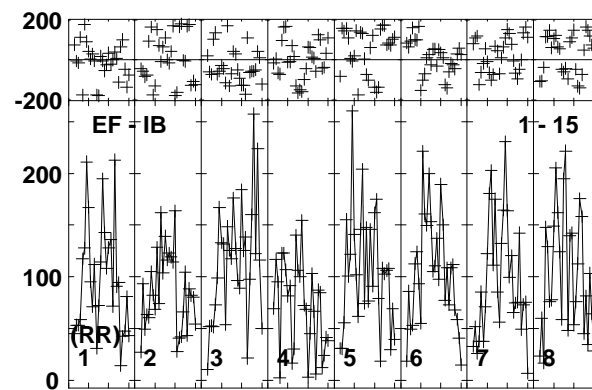
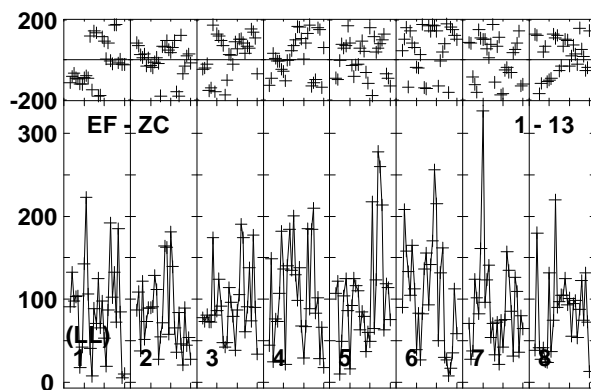
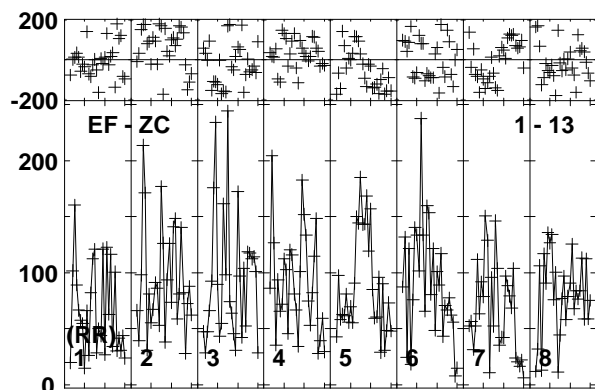
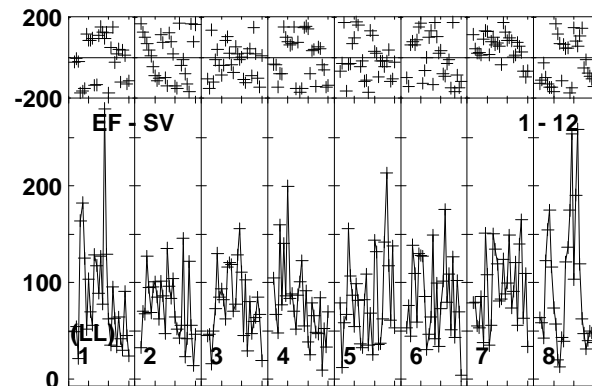
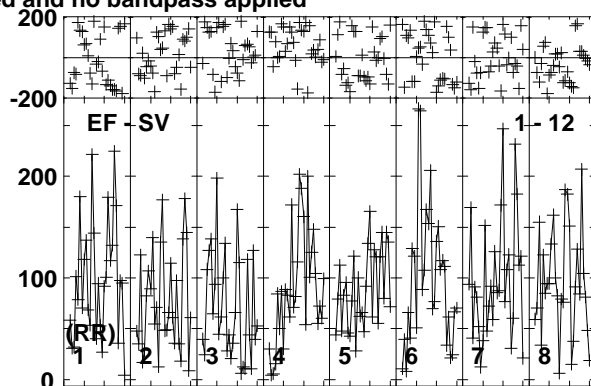
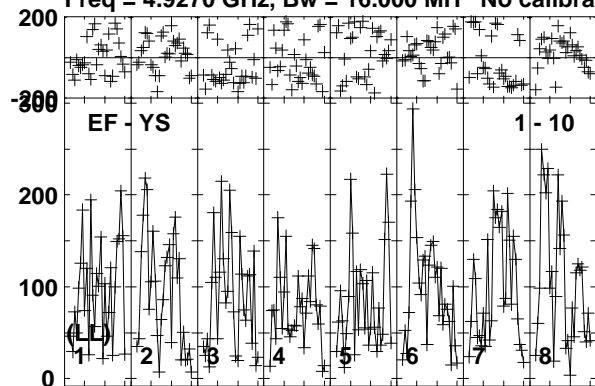

Lower frame: Micro Ampl Jy Top frame: Phas deg  
Vector averaged cross-power spectrum Baseline: EF (01) - YS (10)  
Timerange: 00/09:02:51 to 00/09:06:19

Plot file version 411 created 08-APR-2019 12:10:25

J0815+3635 EM133B.UVDATA.1

Freq = 4.9270 GHz, Bw = 16.000 MH No calibration applied and no bandpass applied

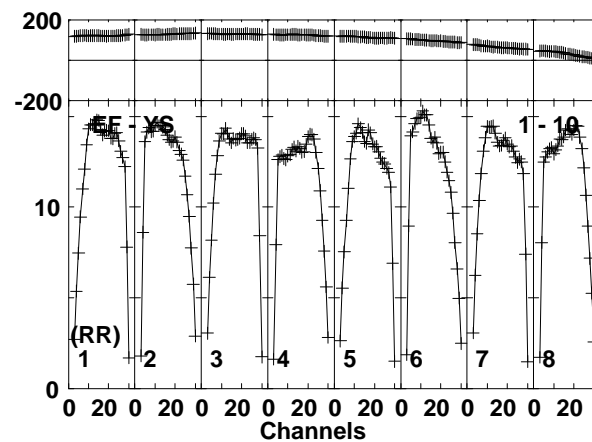
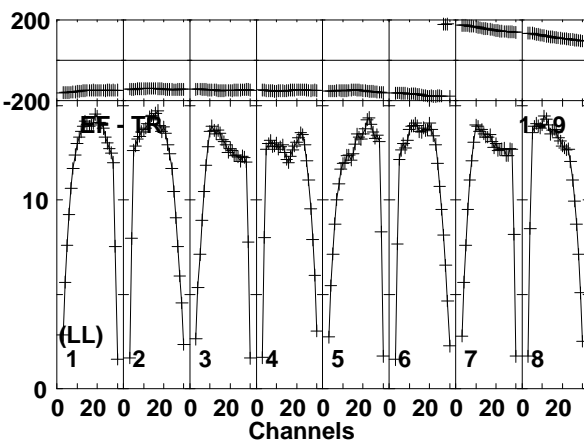
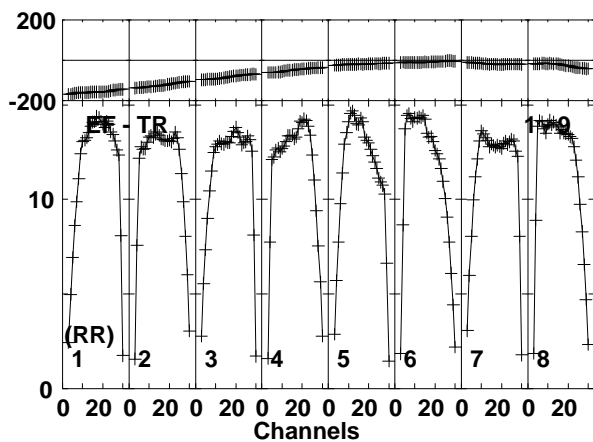
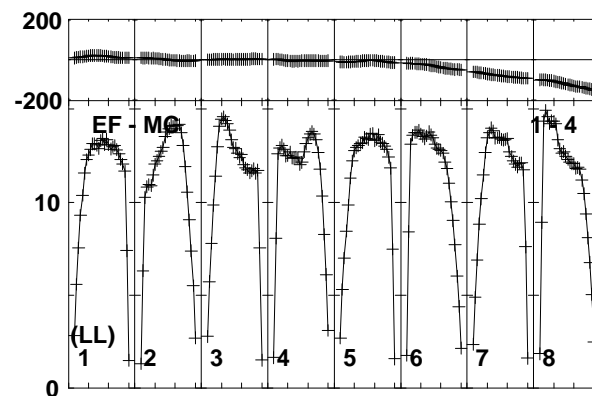
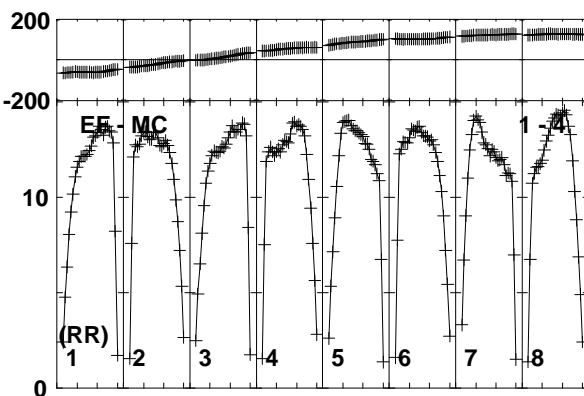
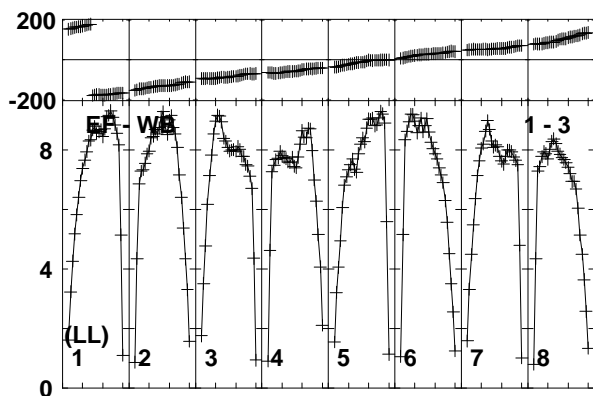
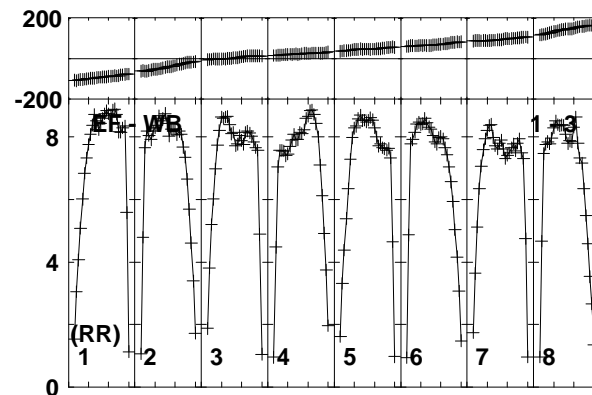
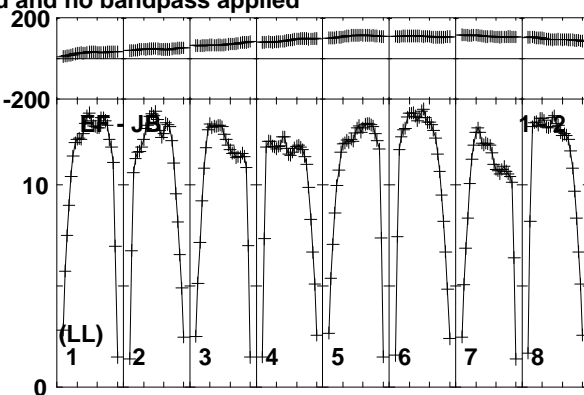
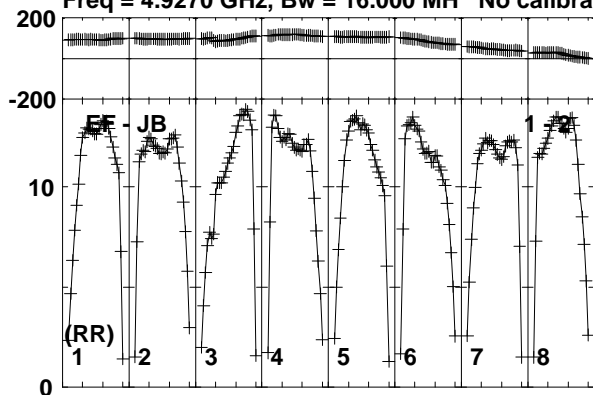

Lower frame: Milli Ampl Jy Top frame: Phas deg  
Vector averaged cross-power spectrum Baseline: EF (01) - JB (02)  
Timerange: 00/09:06:21 to 00/09:07:49

Plot file version 412 created 08-APR-2019 12:10:25

J0815+3635 EM133B.UVDATA.1

Freq = 4.9270 GHz, Bw = 16.000 MH No calibration applied and no bandpass applied

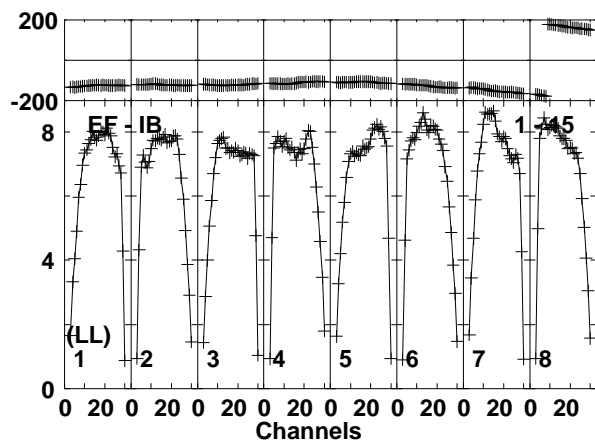
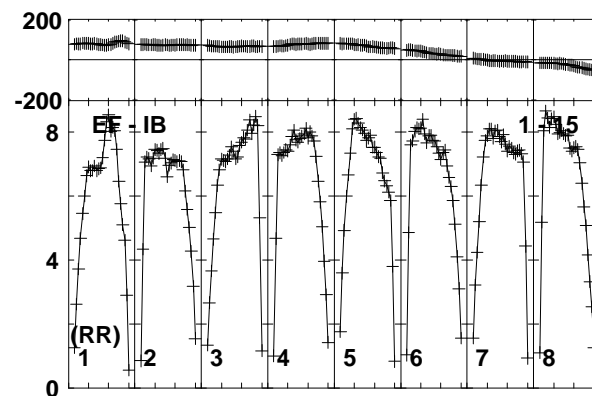
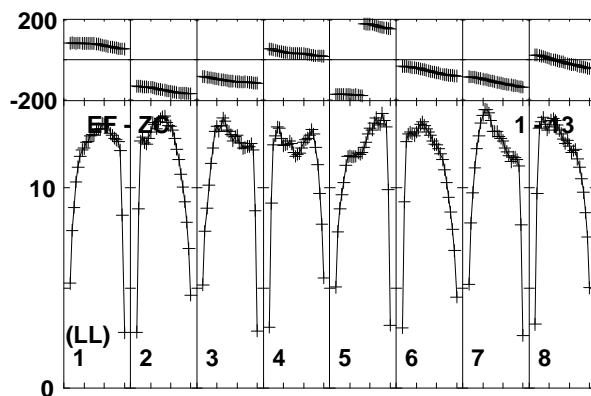
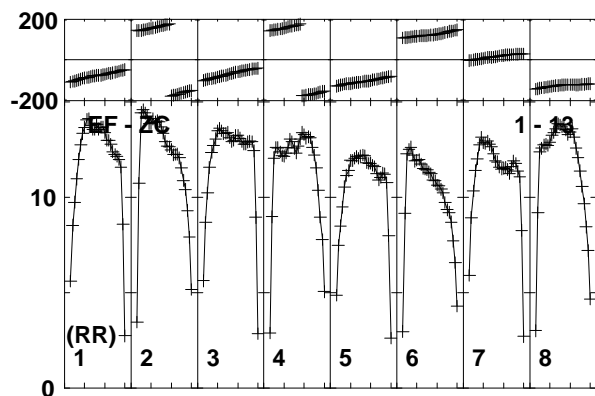
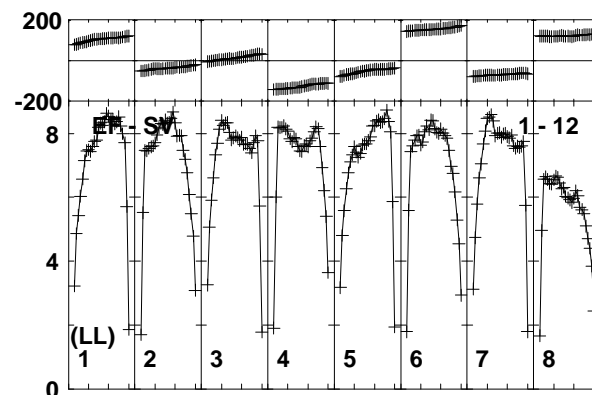
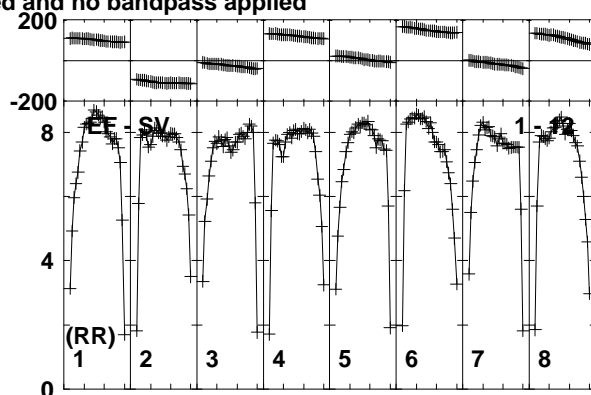
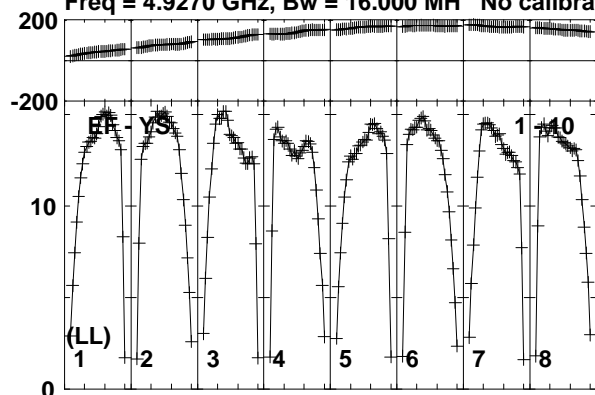

Lower frame: Milli Ampl Jy Top frame: Phas deg  
Vector averaged cross-power spectrum Baseline: EF (01) - YS (10)  
Timerange: 00/09:06:21 to 00/09:07:49

Plot file version 413 created 08-APR-2019 12:10:25

MRK622 EM133B.UVDATA.1

Freq = 4.9270 GHz, Bw = 16.000 MH No calibration applied and no bandpass applied

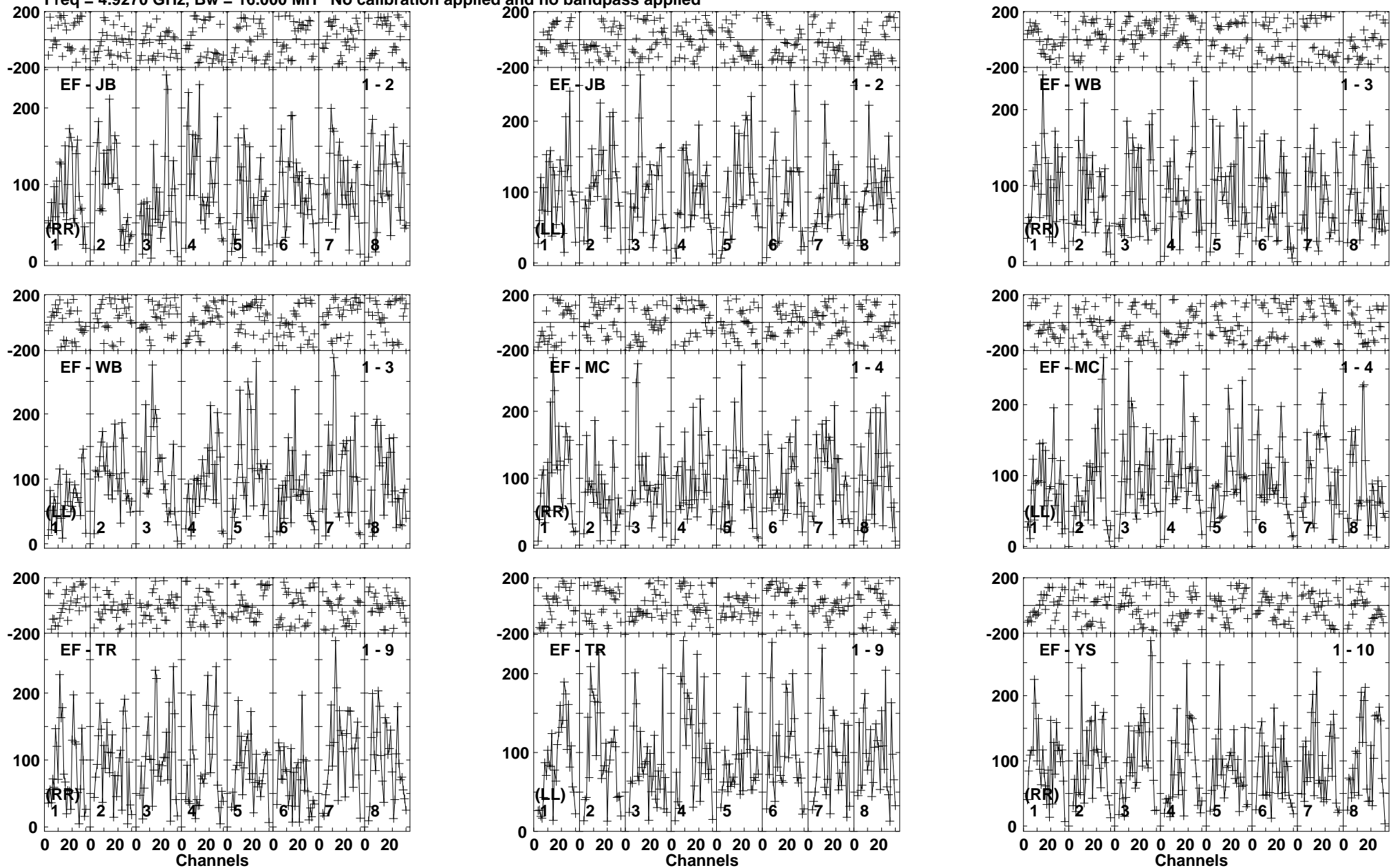

Lower frame: Micro Ampl Jy Top frame: Phas deg  
Vector averaged cross-power spectrum Baseline: EF (01) - JB (02)  
Timerange: 00/09:07:53 to 00/09:11:19

Plot file version 414 created 08-APR-2019 12:10:25

MRK622 EM133B.UVDATA.1

Freq = 4.9270 GHz, Bw = 16.000 MH No calibration applied and no bandpass applied

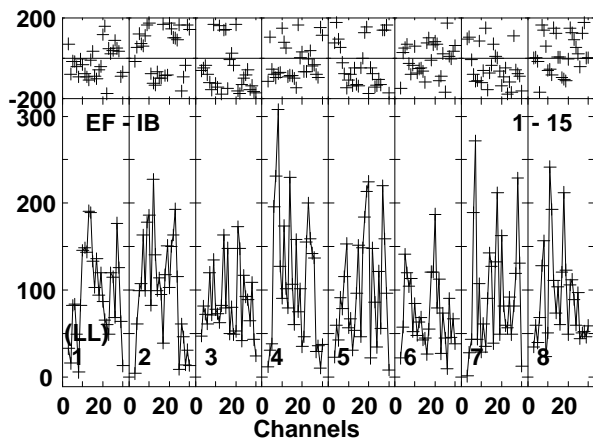
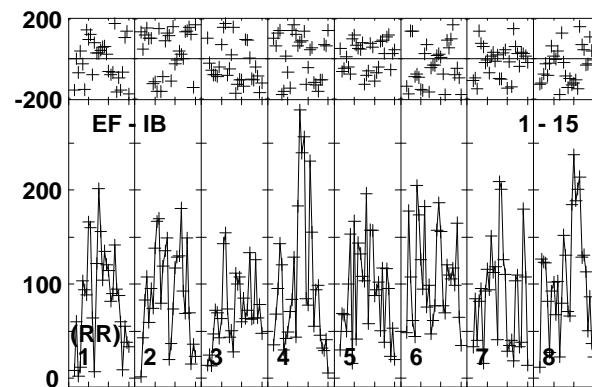
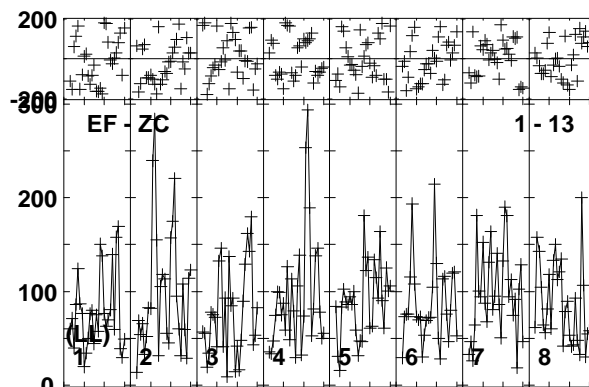
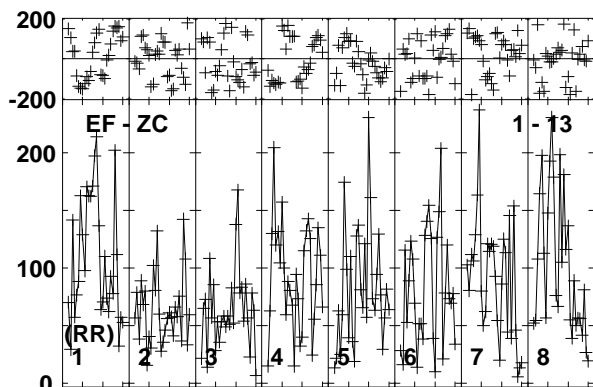
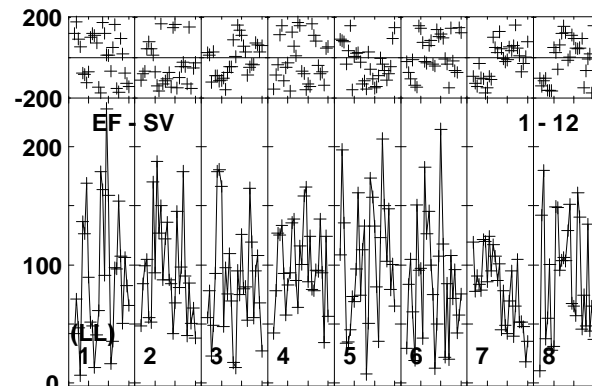
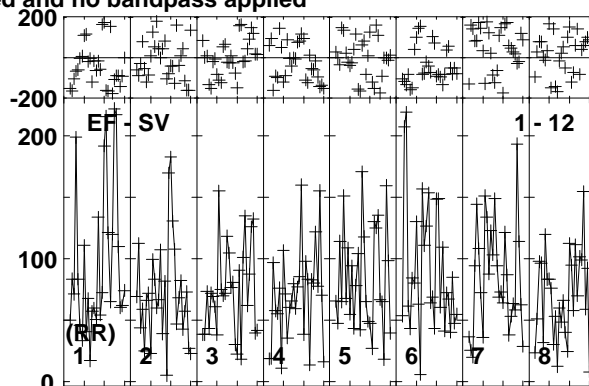
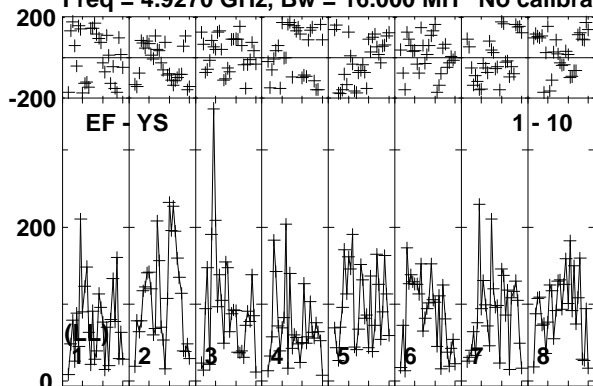

Lower frame: Micro Ampl Jy Top frame: Phas deg  
Vector averaged cross-power spectrum Baseline: EF (01) - YS (10)  
Timerange: 00/09:07:53 to 00/09:11:19

Plot file version 415 created 08-APR-2019 12:10:25

J0815+3635 EM133B.UVDATA.1

Freq = 4.9270 GHz, Bw = 16.000 MH No calibration applied and no bandpass applied

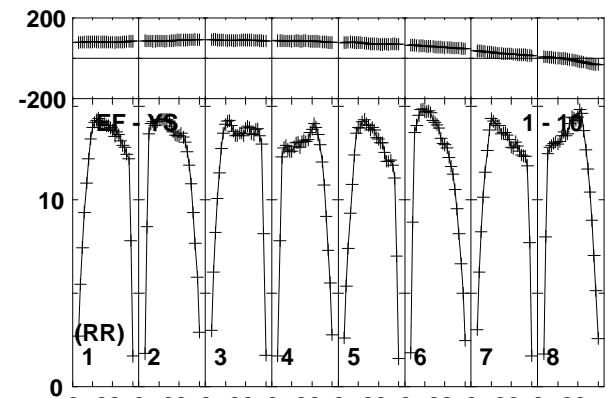
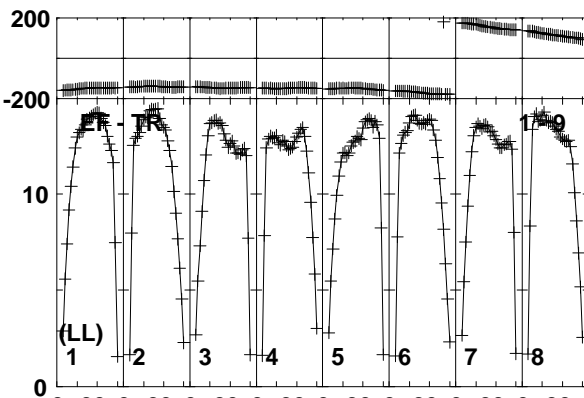
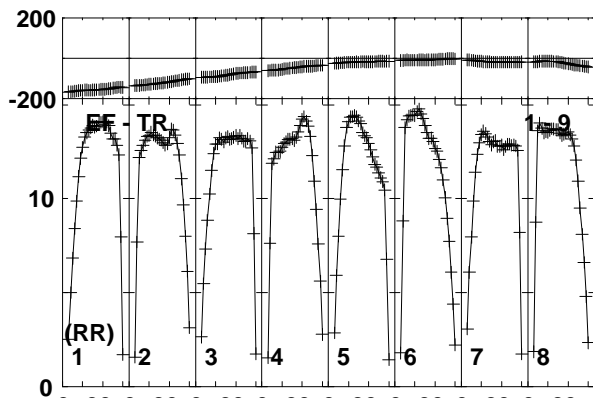
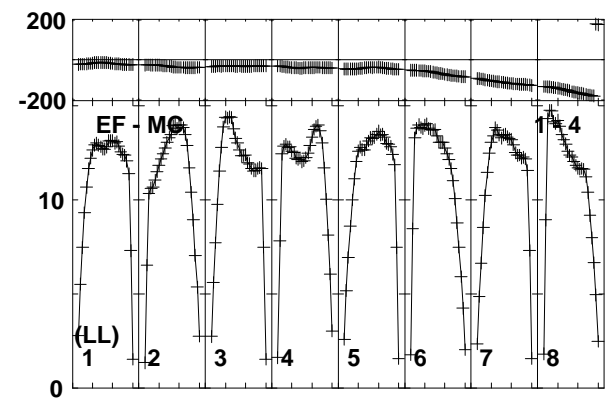
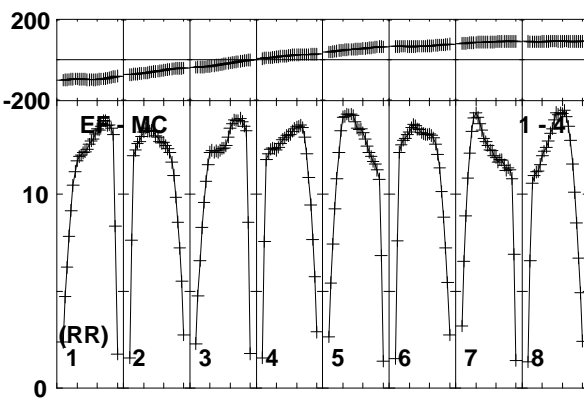
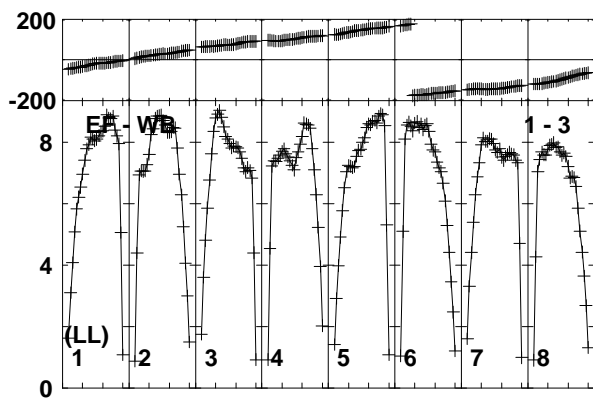
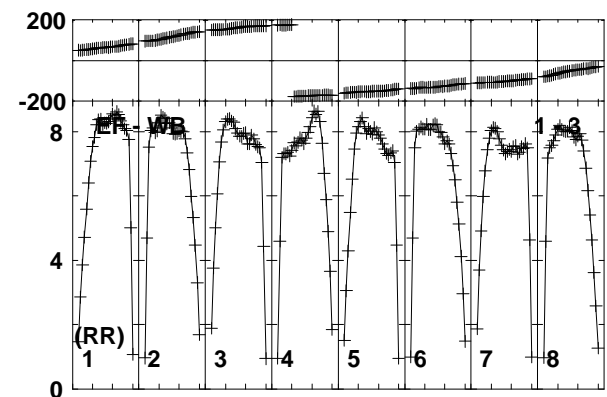
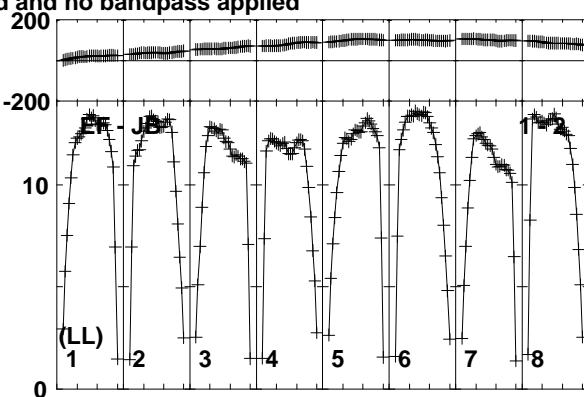
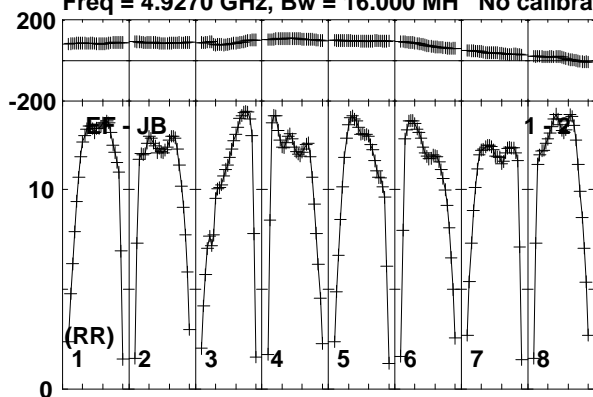

Lower frame: Milli Ampl Jy Top frame: Phas deg  
Vector averaged cross-power spectrum Baseline: EF (01) - JB (02)  
Timerange: 00/09:12:11 to 00/09:13:39

Plot file version 416 created 08-APR-2019 12:10:25

J0815+3635 EM133B.UVDATA.1

Freq = 4.9270 GHz, Bw = 16.000 MH No calibration applied and no bandpass applied

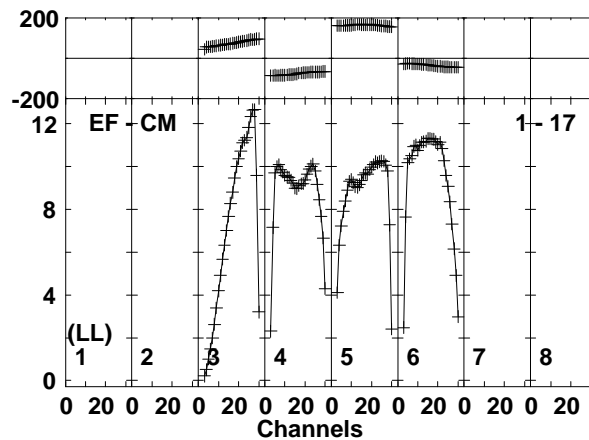
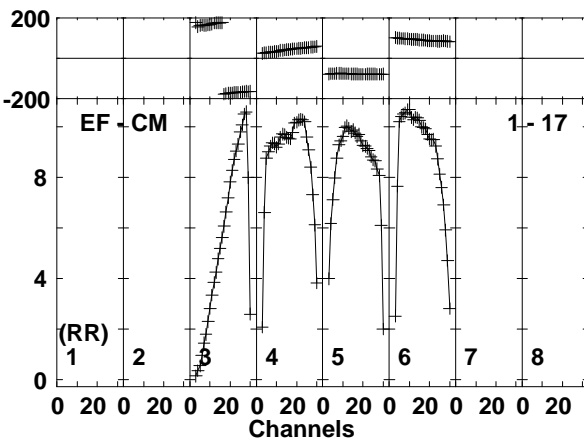
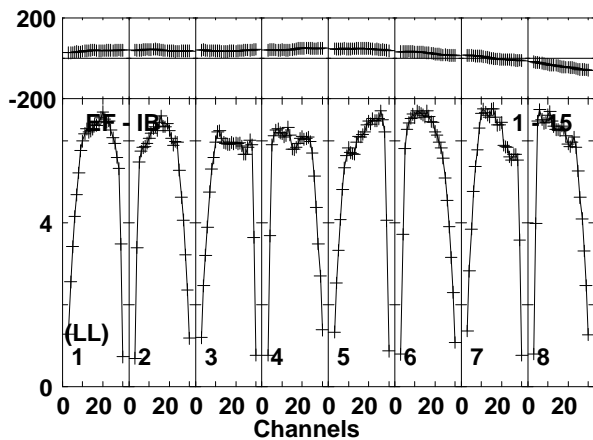
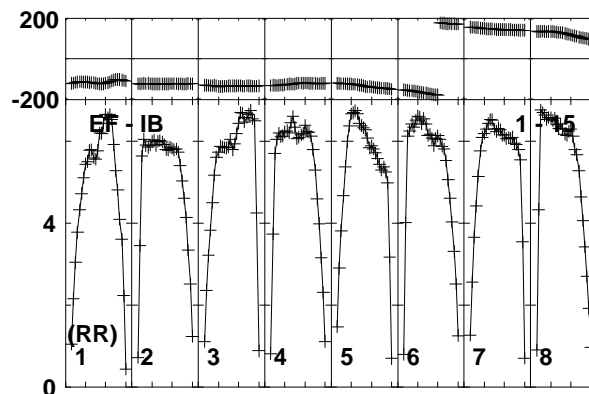
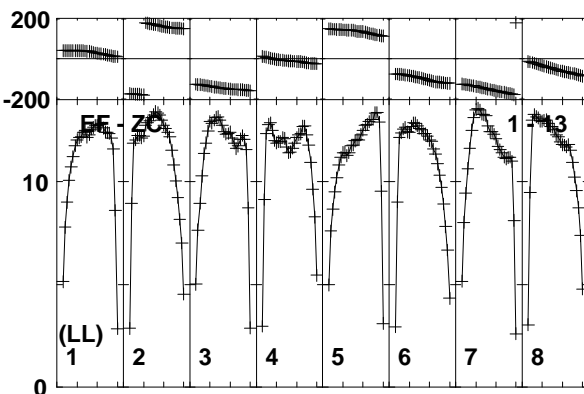
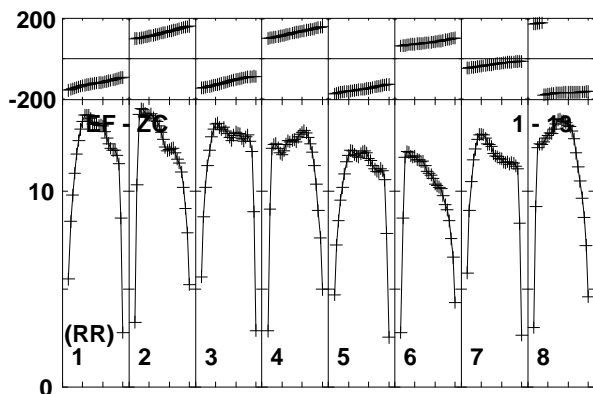
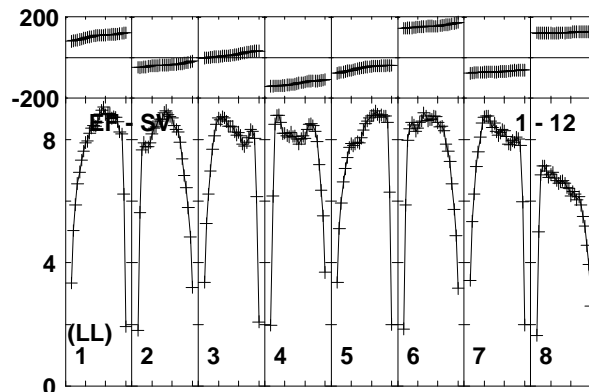
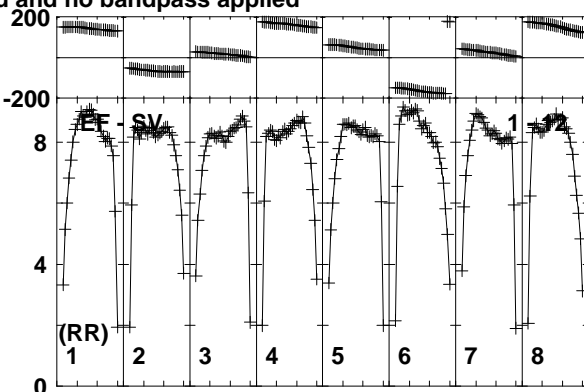
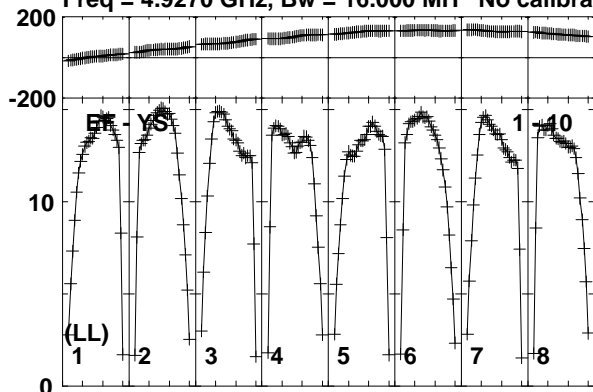

Lower frame: Milli Ampl Jy Top frame: Phas deg  
Vector averaged cross-power spectrum Baseline: EF (01) - YS (10)  
Timerange: 00/09:12:11 to 00/09:13:39



Plot file version 417 created 08-APR-2019 12:10:25

J0815+3635 EM133B.UVDATA.1

Freq = 4.9270 GHz, Bw = 16.000 MH No calibration applied and no bandpass applied

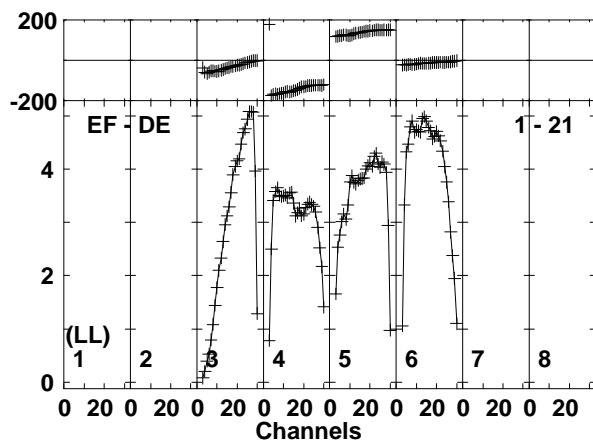
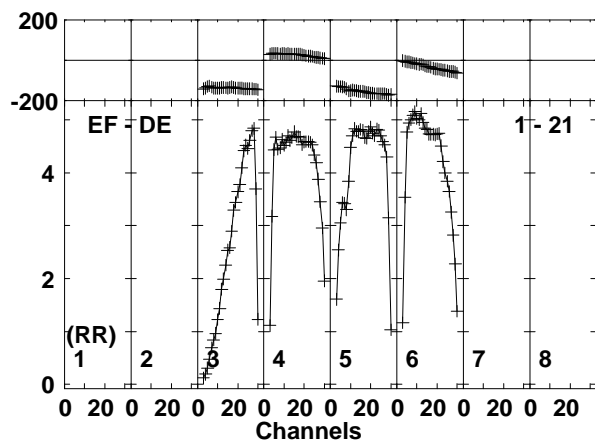
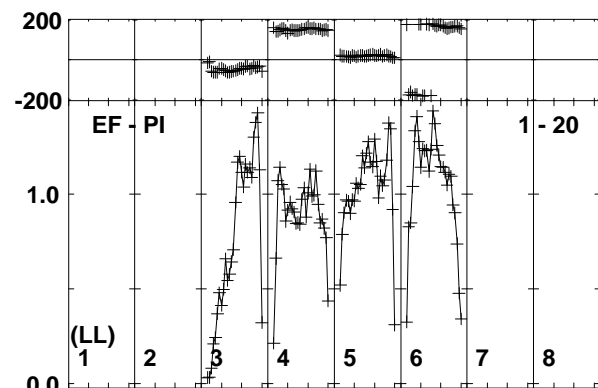
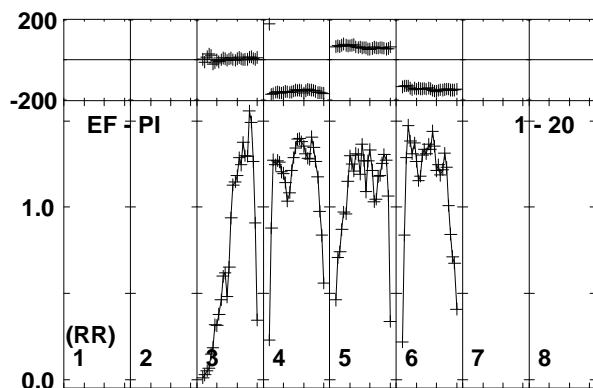
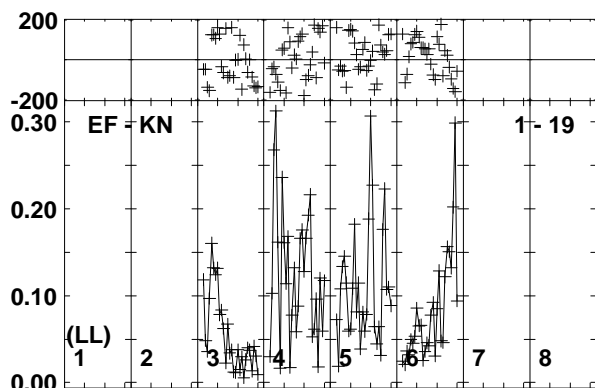
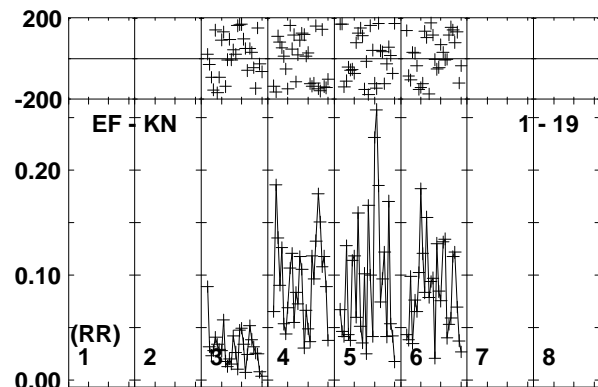
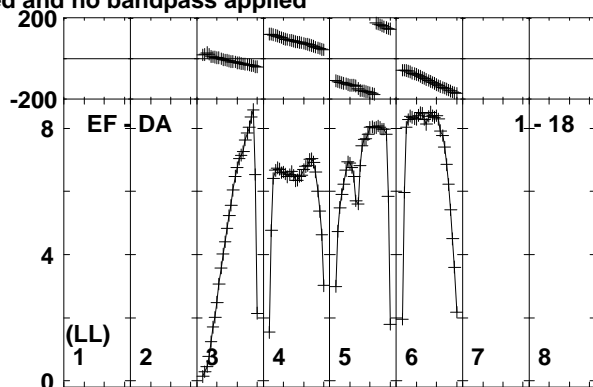
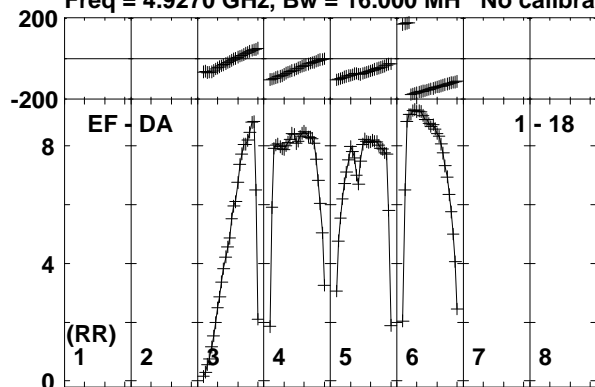

Lower frame: Milli Ampl Jy Top frame: Phas deg  
Vector averaged cross-power spectrum Baseline: EF (01) - DA (18)  
Timerange: 00/09:12:11 to 00/09:13:39

Plot file version 418 created 08-APR-2019 12:10:25

MRK622 EM133B.UVDATA.1

Freq = 4.9270 GHz, Bw = 16.000 MH No calibration applied and no bandpass applied

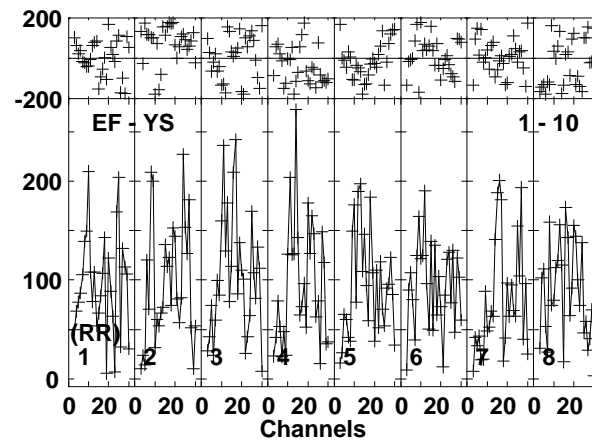
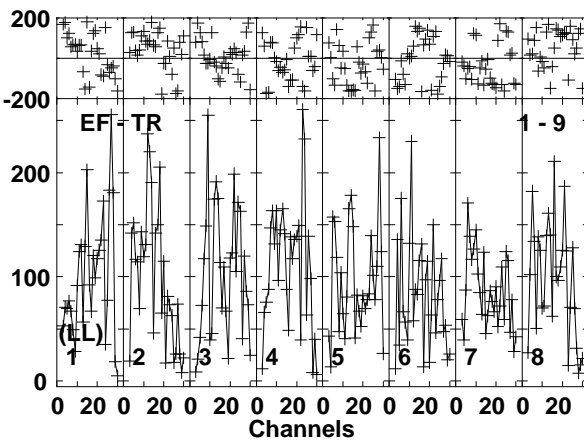
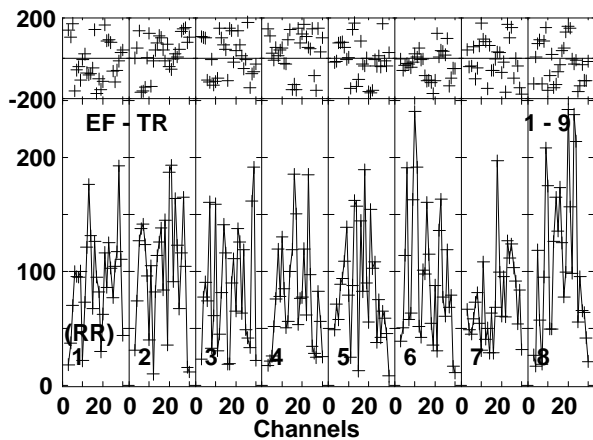
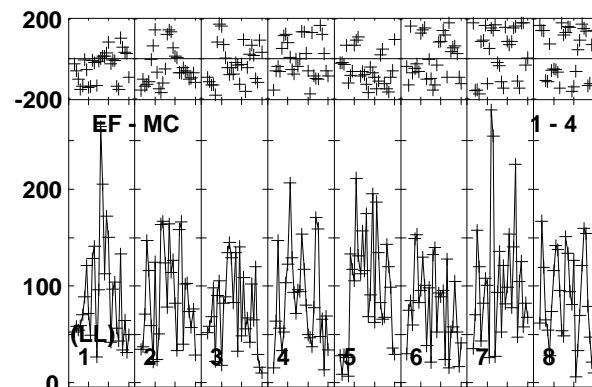
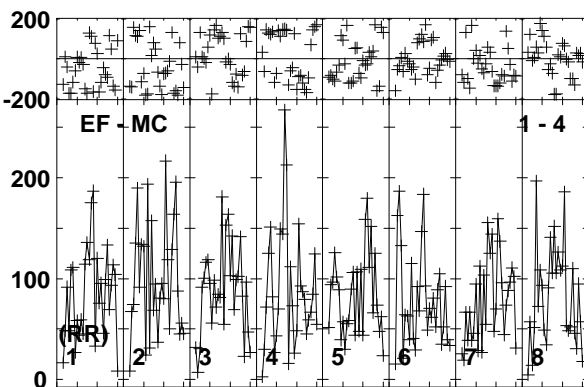
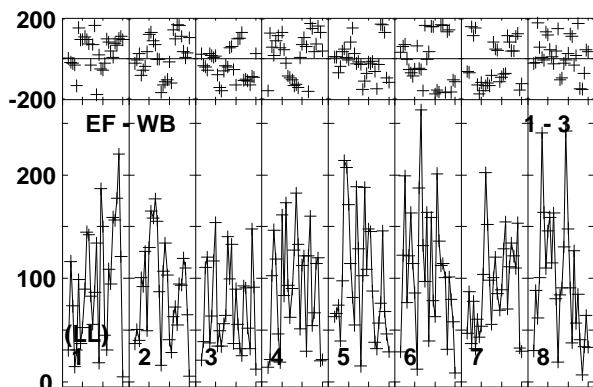
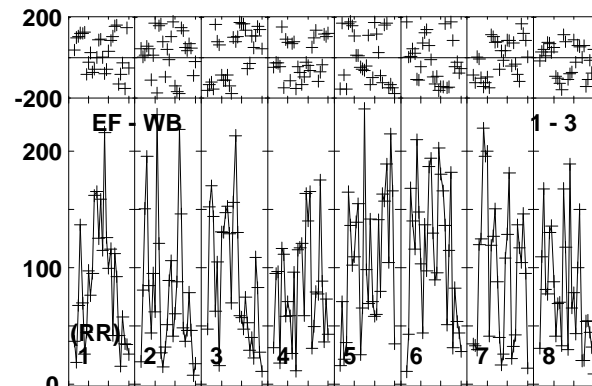
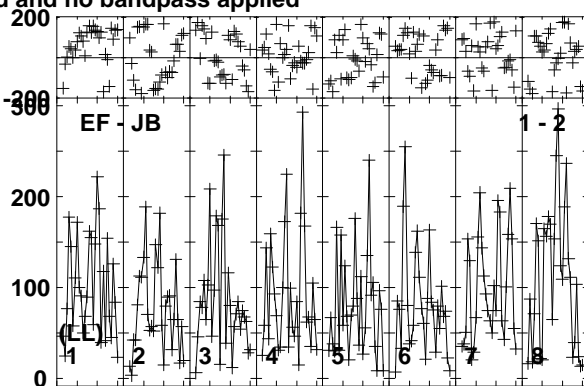
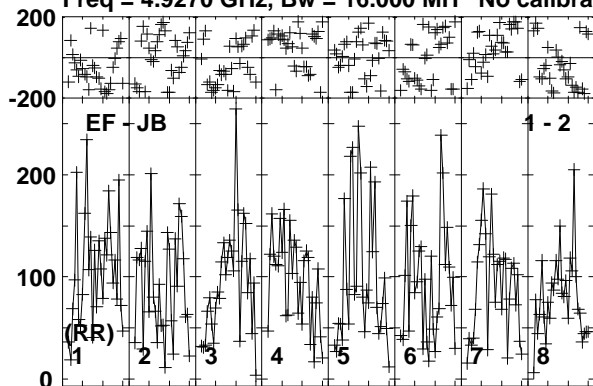

Lower frame: Micro Ampl Jy Top frame: Phas deg  
Vector averaged cross-power spectrum Baseline: EF (01) - JB (02)  
Timerange: 00/09:13:41 to 00/09:17:09

Plot file version 419 created 08-APR-2019 12:10:26

MRK622 EM133B.UVDATA.1

Freq = 4.9270 GHz, Bw = 16.000 MH No calibration applied and no bandpass applied

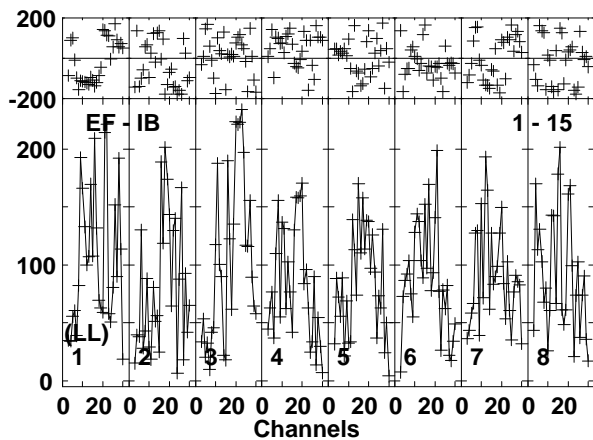
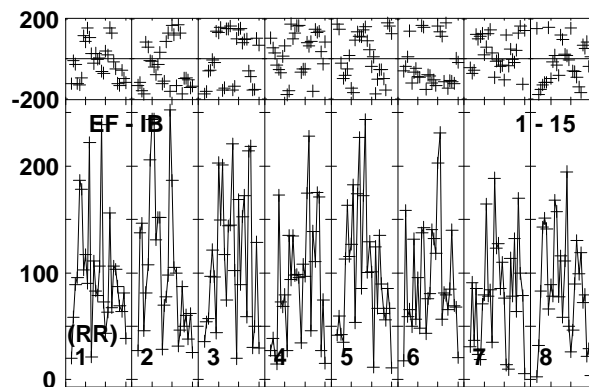
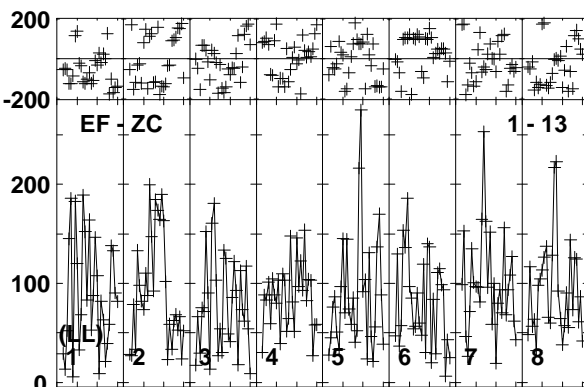
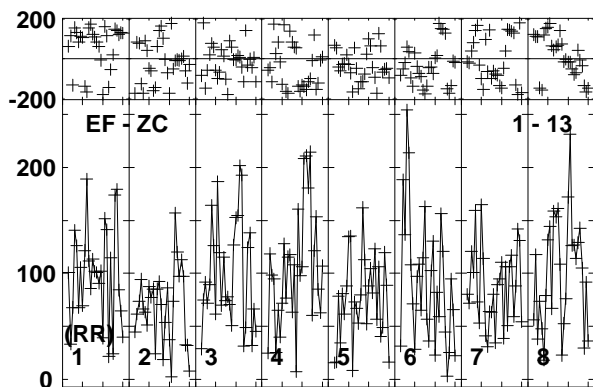
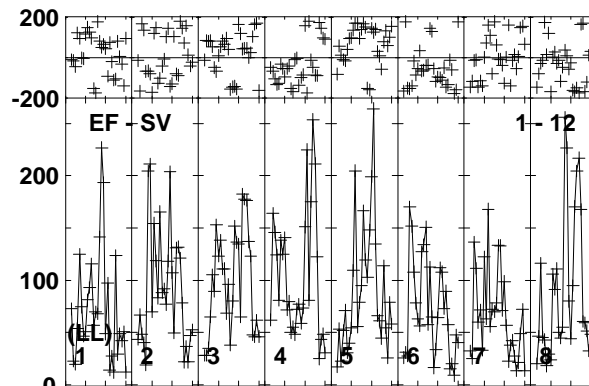
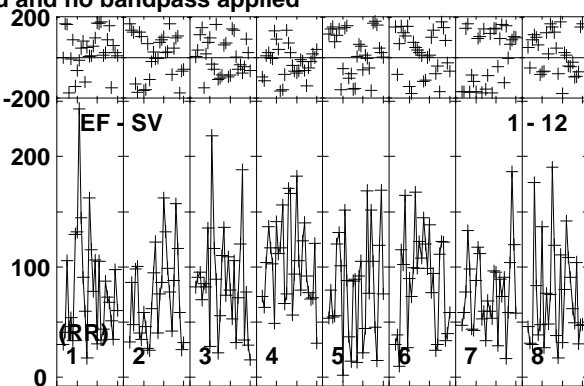
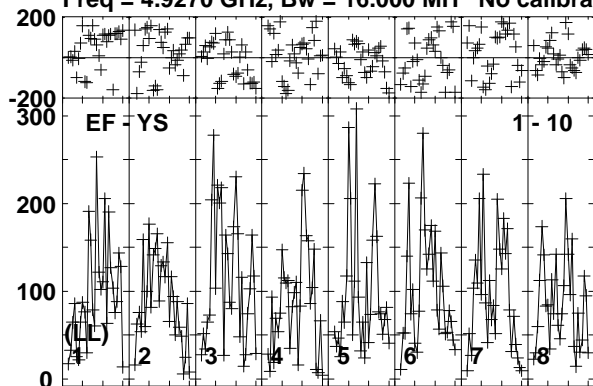

Lower frame: Micro Ampl Jy Top frame: Phas deg  
Vector averaged cross-power spectrum Baseline: EF (01) - YS (10)  
Timerange: 00/09:13:41 to 00/09:17:09

Plot file version 420 created 08-APR-2019 12:10:26

J0815+3635 EM133B.UVDATA.1

Freq = 4.9270 GHz, Bw = 16.000 MH No calibration applied and no bandpass applied

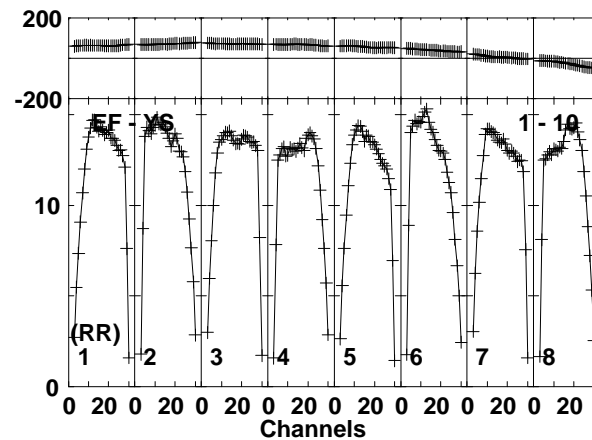
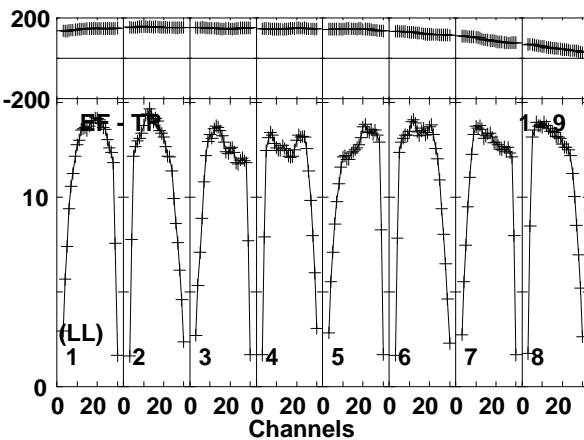
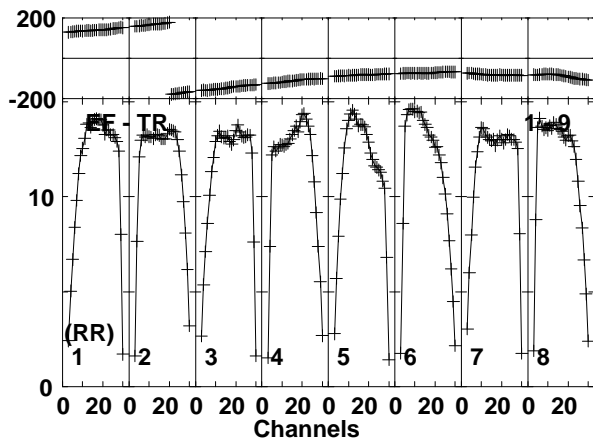
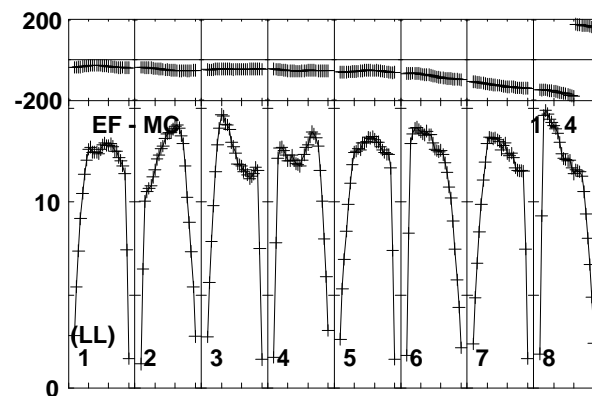
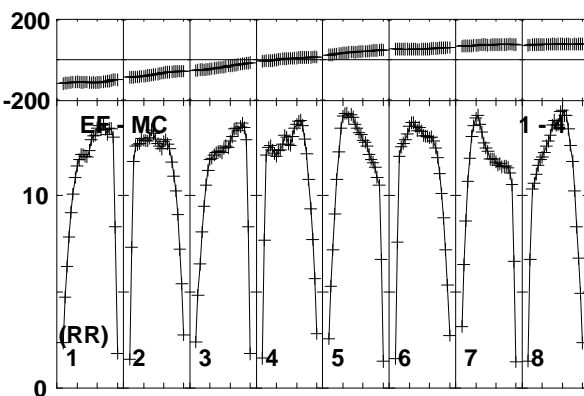
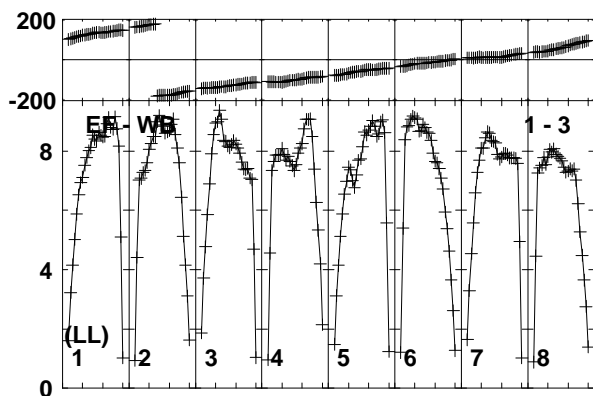
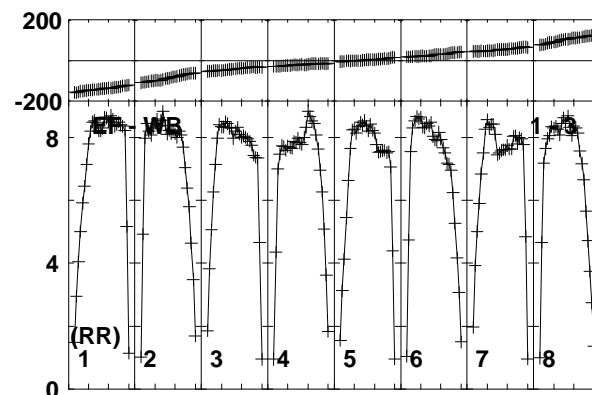
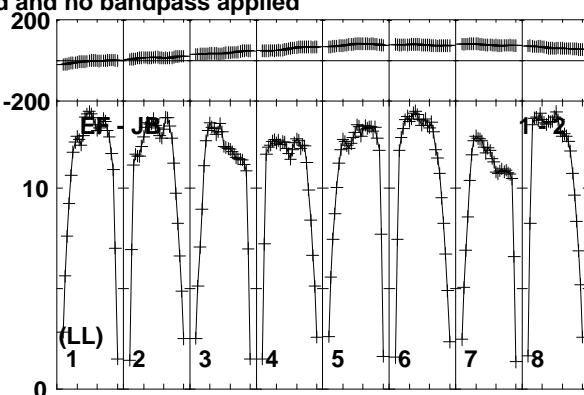
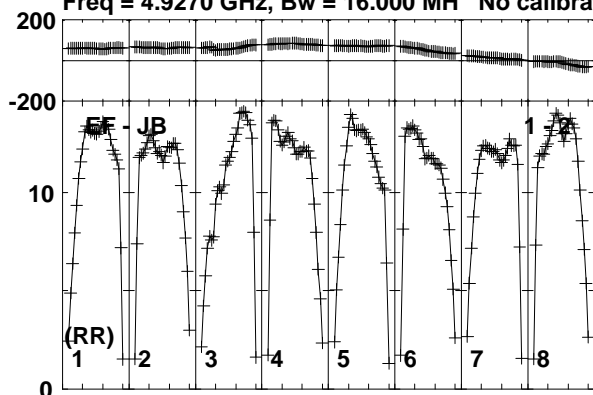

Lower frame: Milli Ampl Jy Top frame: Phas deg  
Vector averaged cross-power spectrum Baseline: EF (01) - JB (02)  
Timerange: 00/09:17:11 to 00/09:18:39

Plot file version 421 created 08-APR-2019 12:10:26

J0815+3635 EM133B.UVDATA.1

Freq = 4.9270 GHz, Bw = 16.000 MH No calibration applied and no bandpass applied

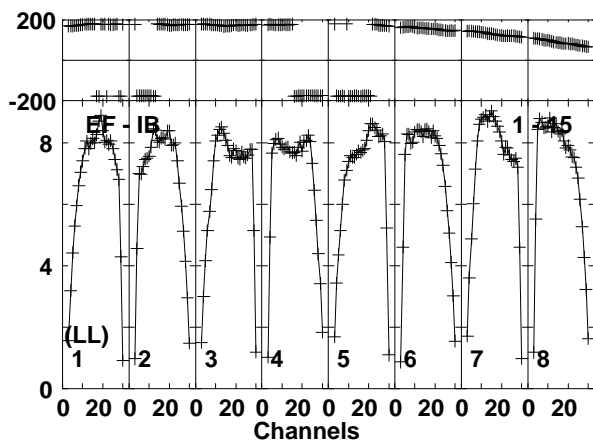
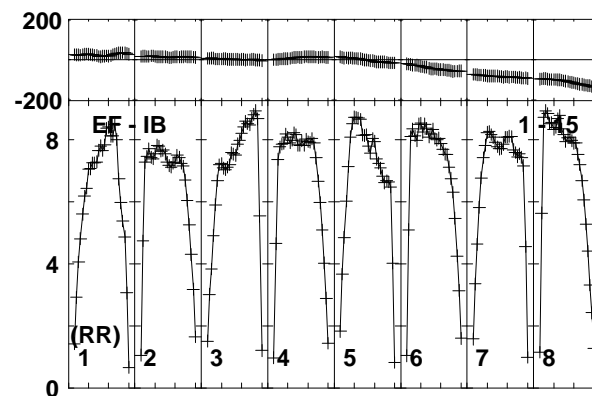
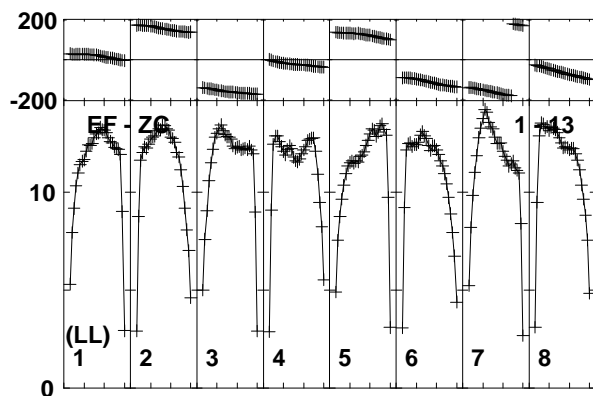
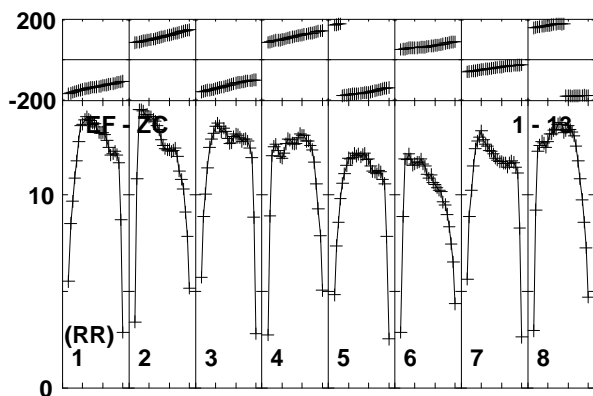
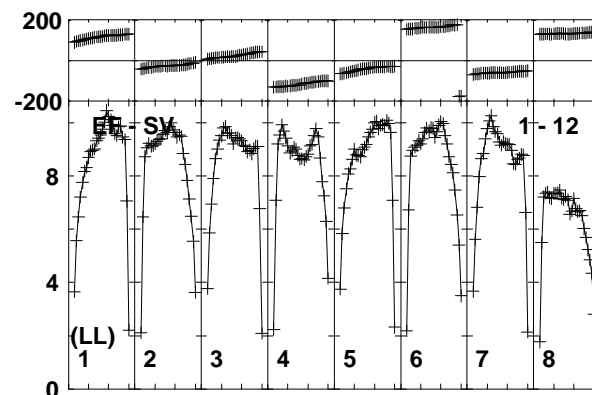
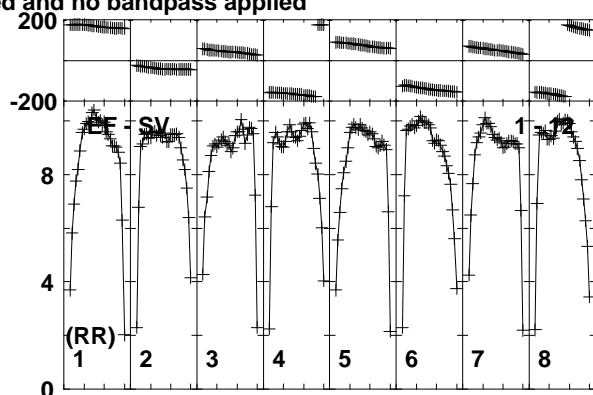
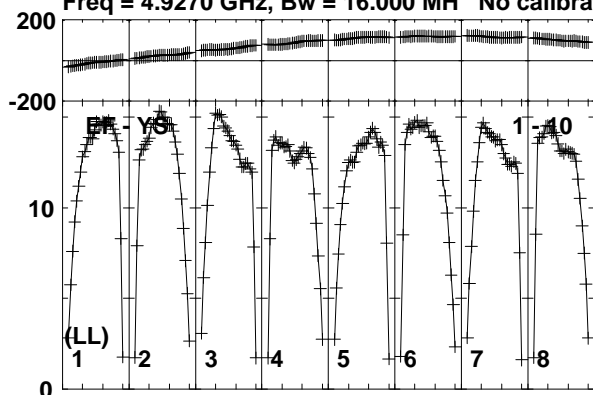

Lower frame: Milli Ampl Jy Top frame: Phas deg  
Vector averaged cross-power spectrum Baseline: EF (01) - YS (10)  
Timerange: 00/09:17:11 to 00/09:18:39

Plot file version 422 created 08-APR-2019 12:10:26

MRK622 EM133B.UVDATA.1

Freq = 4.9270 GHz, Bw = 16.000 MH No calibration applied and no bandpass applied

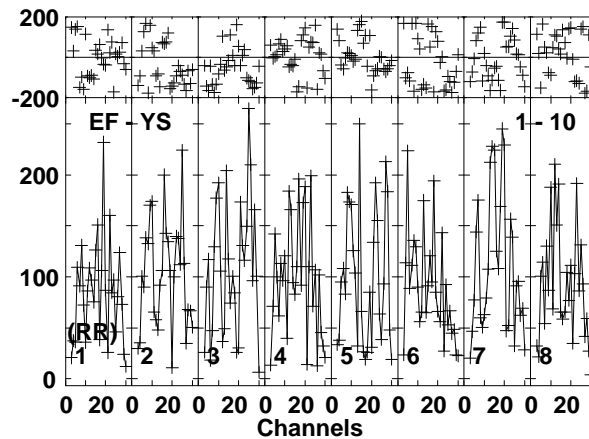
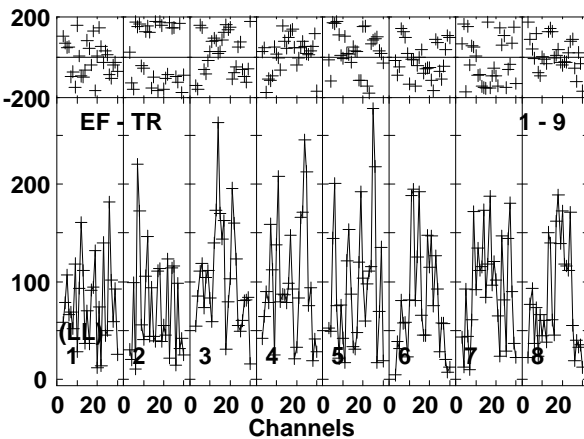
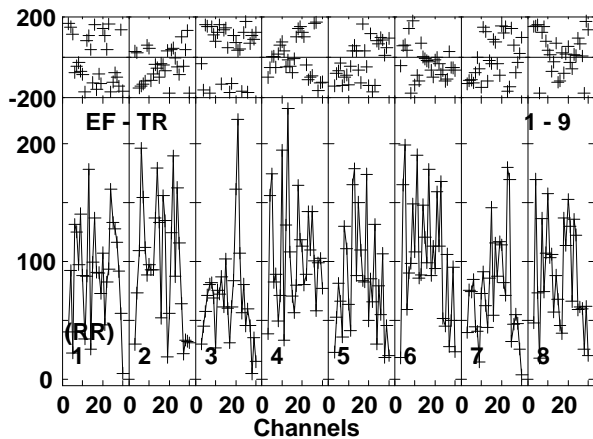
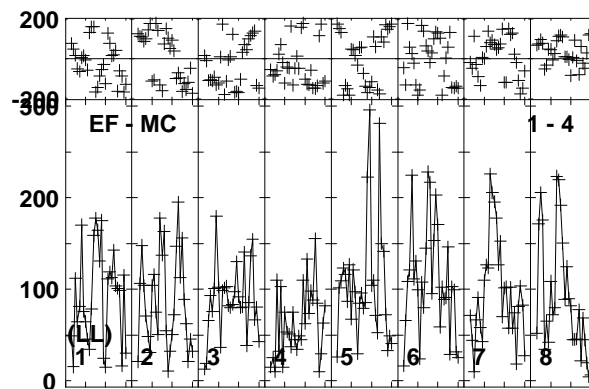
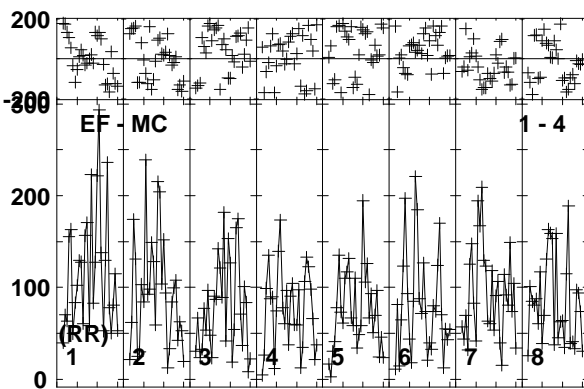
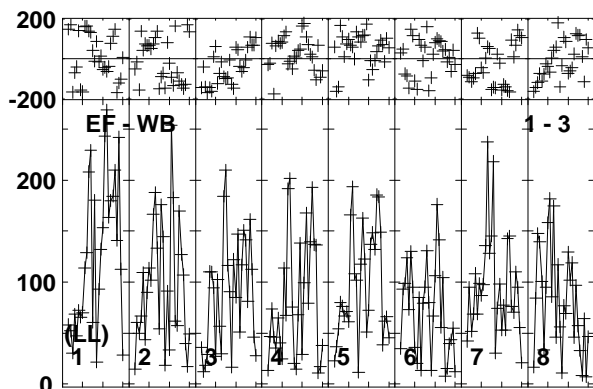
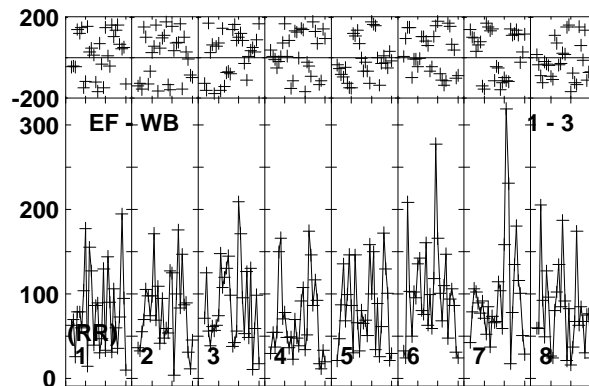
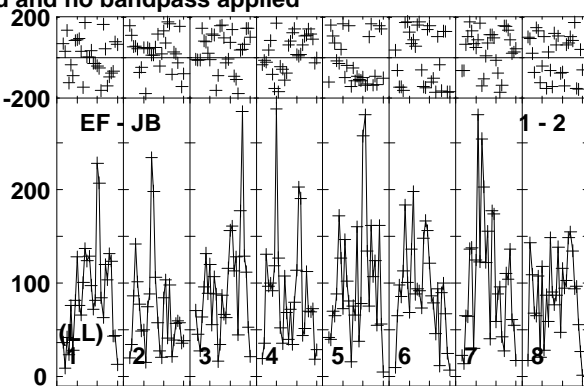
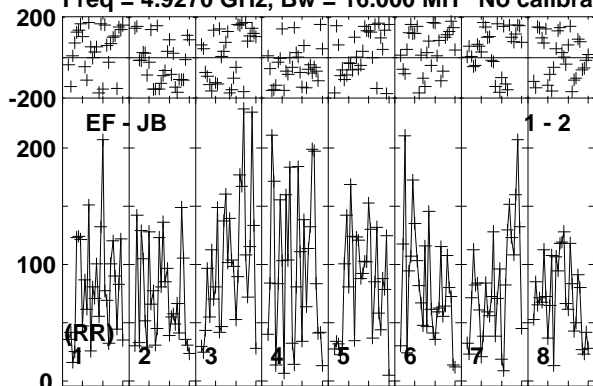

Lower frame: Micro Ampl Jy Top frame: Phas deg  
Vector averaged cross-power spectrum Baseline: EF (01) - JB (02)  
Timerange: 00/09:18:43 to 00/09:22:09

Plot file version 423 created 08-APR-2019 12:10:26

MRK622 EM133B.UVDATA.1

Freq = 4.9270 GHz, Bw = 16.000 MH No calibration applied and no bandpass applied

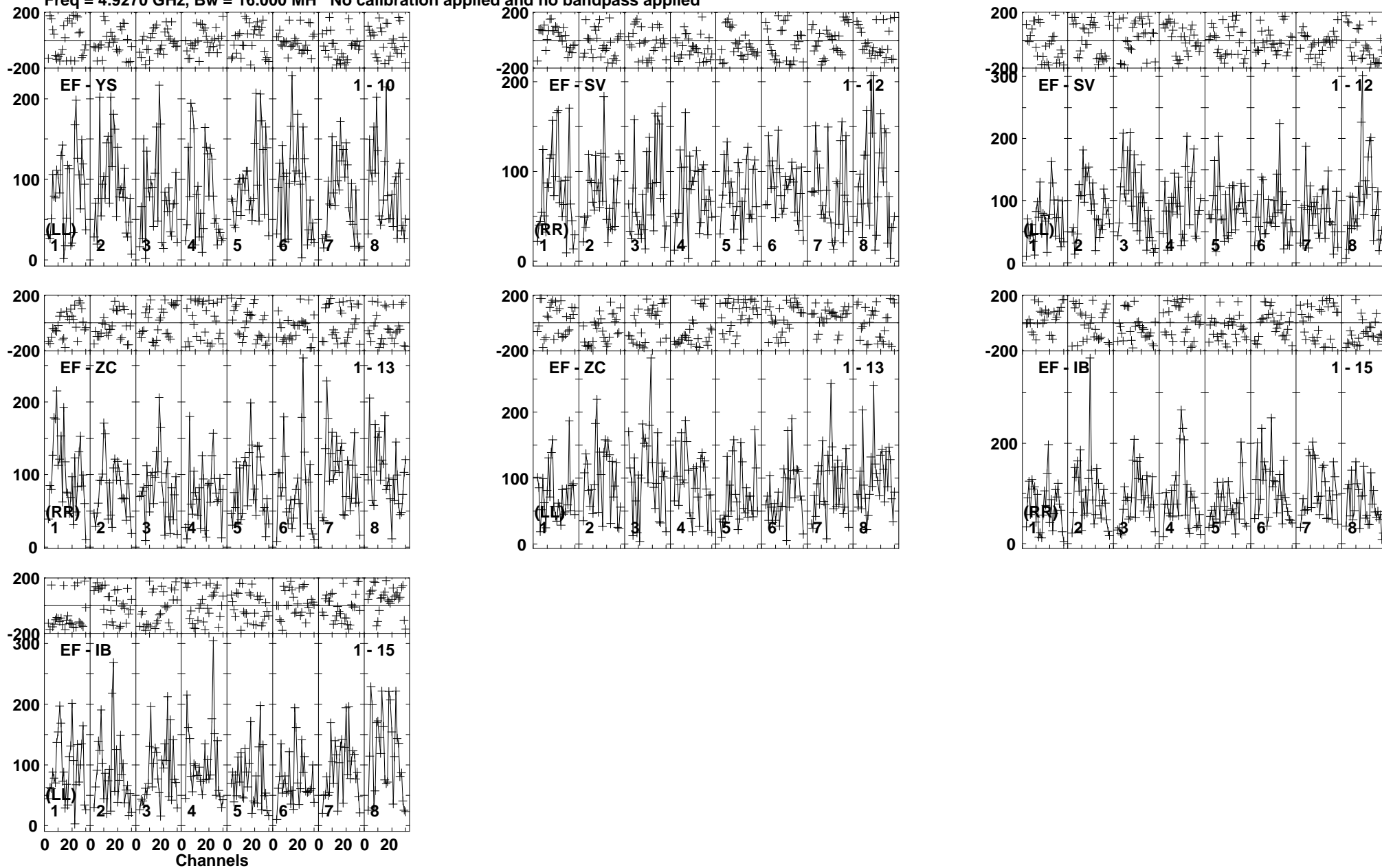

Lower frame: Micro Ampl Jy Top frame: Phas deg  
Vector averaged cross-power spectrum Baseline: EF (01) - YS (10)  
Timerange: 00/09:18:43 to 00/09:22:09

Plot file version 424 created 08-APR-2019 12:10:26

J0815+3635 EM133B.UVDATA.1

Freq = 4.9270 GHz, Bw = 16.000 MH No calibration applied and no bandpass applied

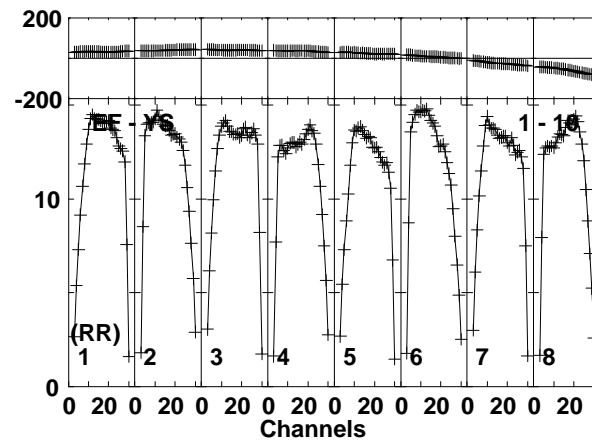
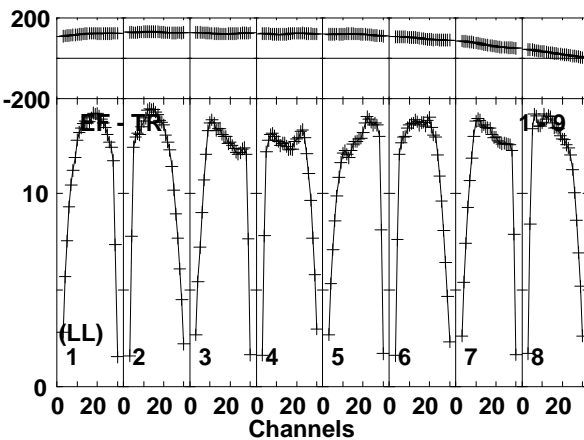
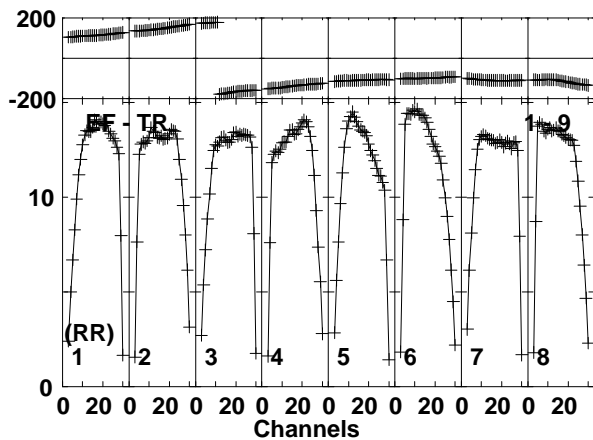
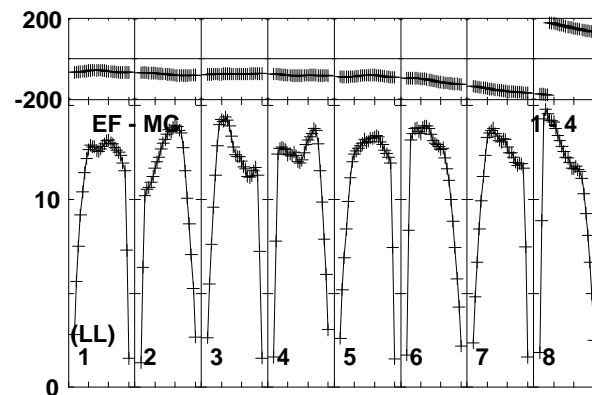
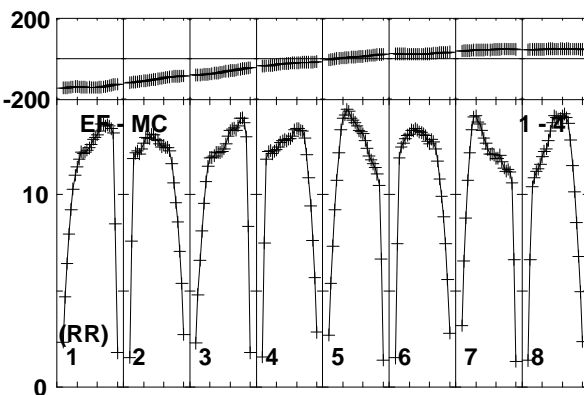
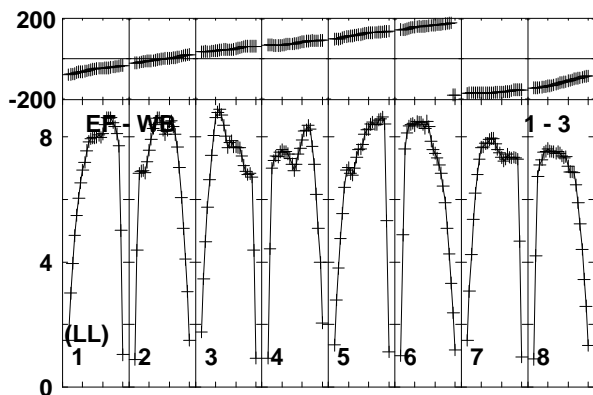
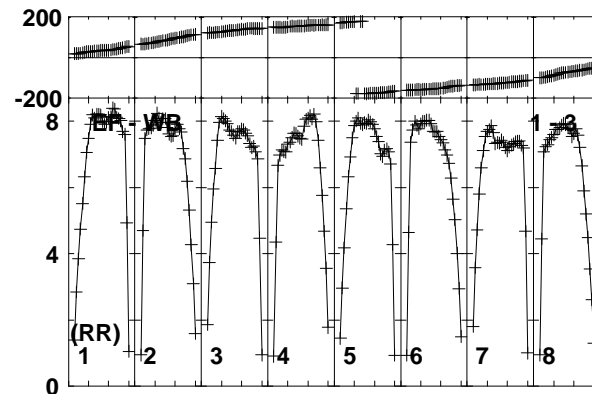
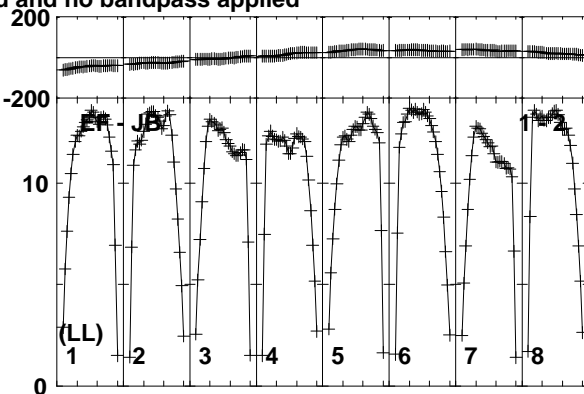
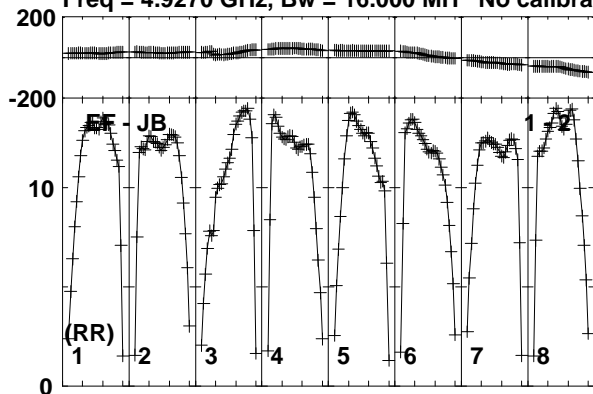

Lower frame: Milli Ampl Jy Top frame: Phas deg  
Vector averaged cross-power spectrum Baseline: EF (01) - JB (02)  
Timerange: 00/09:23:01 to 00/09:24:29



Plot file version 425 created 08-APR-2019 12:10:26

J0815+3635 EM133B.UVDATA.1

Freq = 4.9270 GHz, Bw = 16.000 MH No calibration applied and no bandpass applied

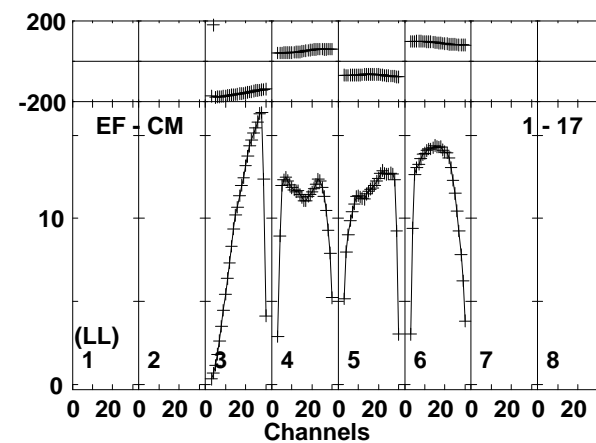
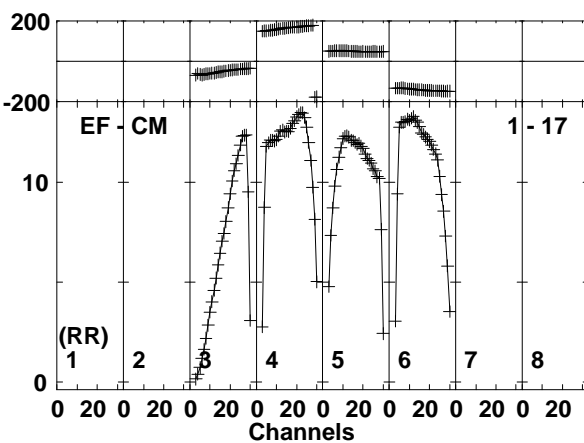
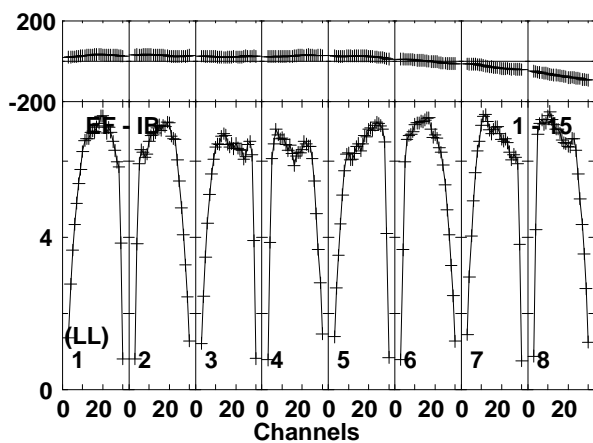
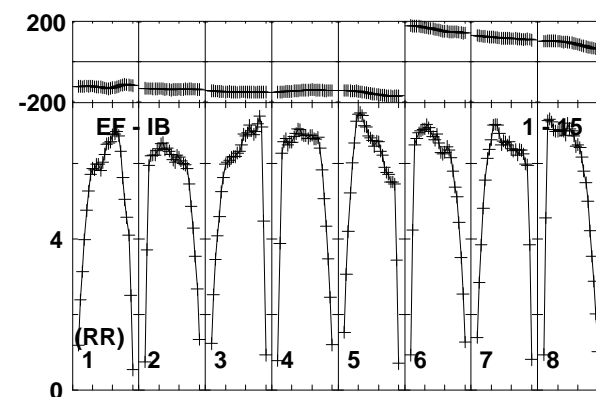
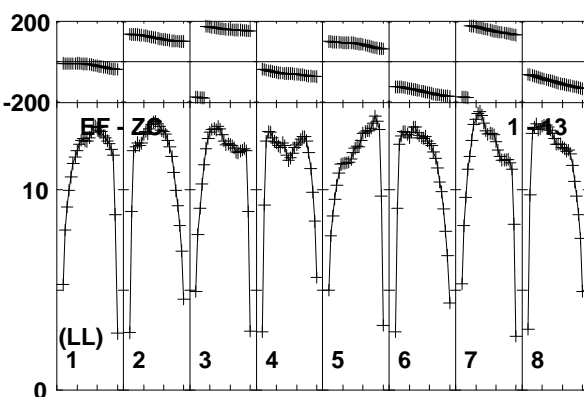
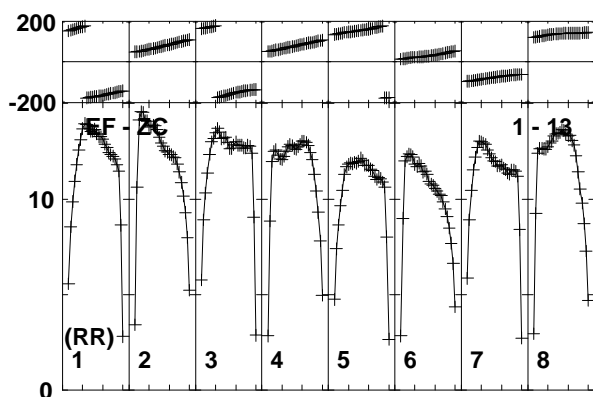
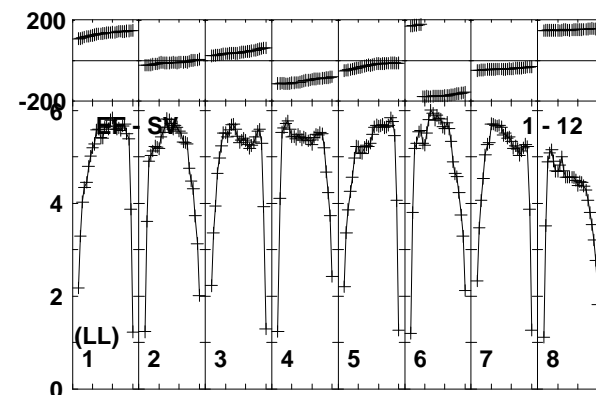
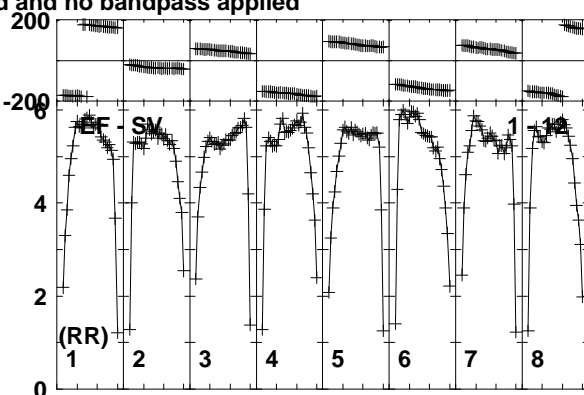
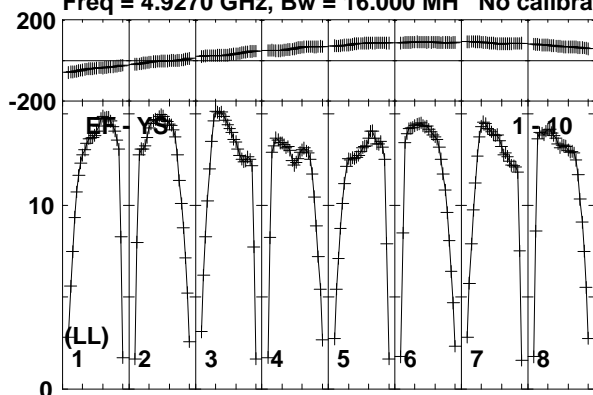

Lower frame: Milli Ampl Jy Top frame: Phas deg  
Vector averaged cross-power spectrum Baseline: EF (01) - YS (10)  
Timerange: 00/09:23:01 to 00/09:24:29

Plot file version 426 created 08-APR-2019 12:10:26

J0815+3635 EM133B.UVDATA.1

Freq = 4.9270 GHz, Bw = 16.000 MH No calibration applied and no bandpass applied

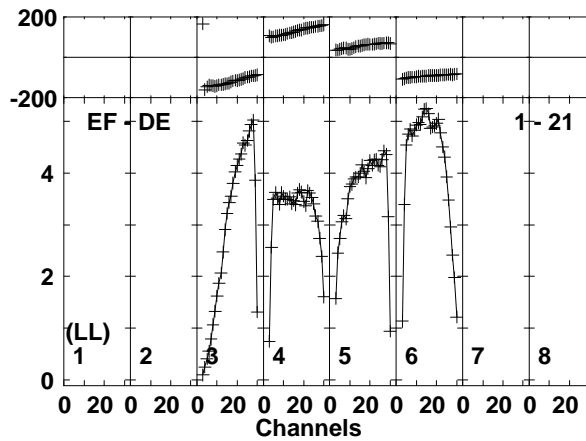
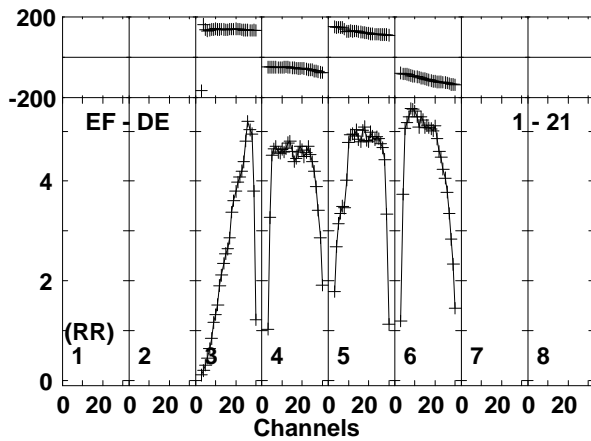
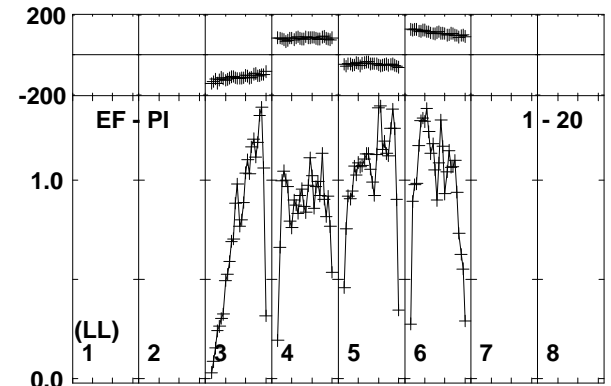
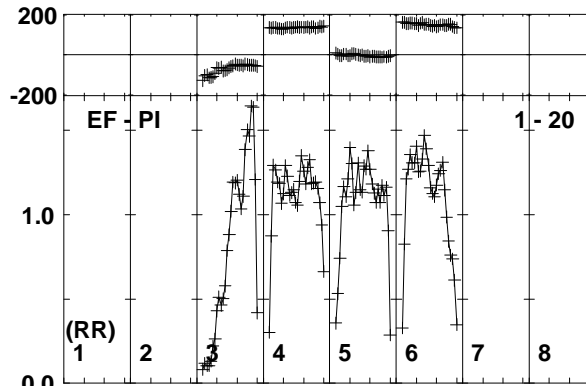
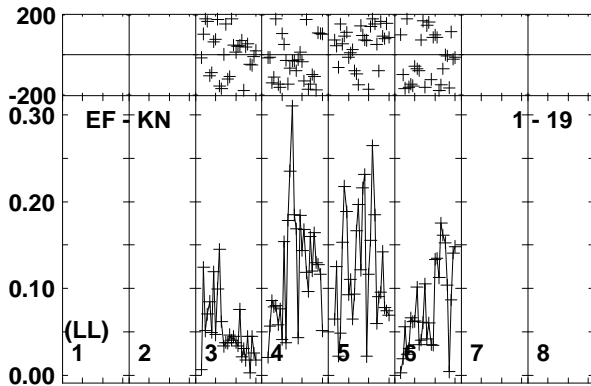
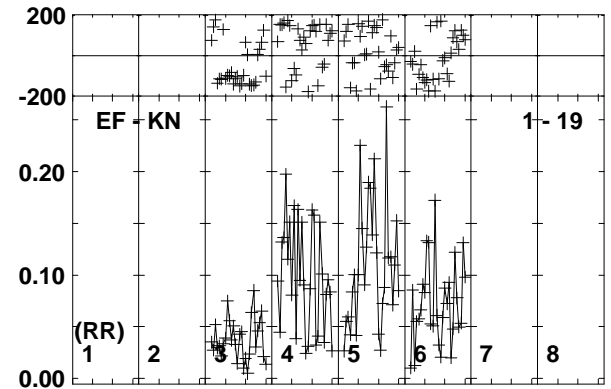
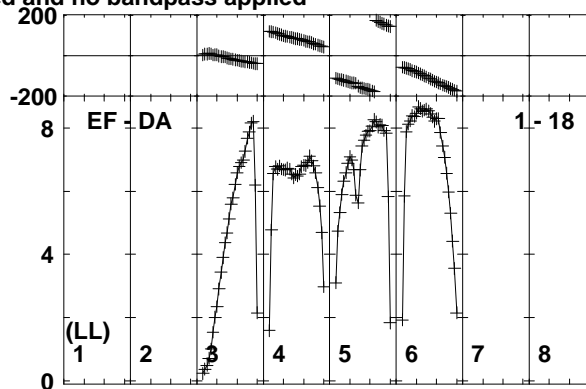
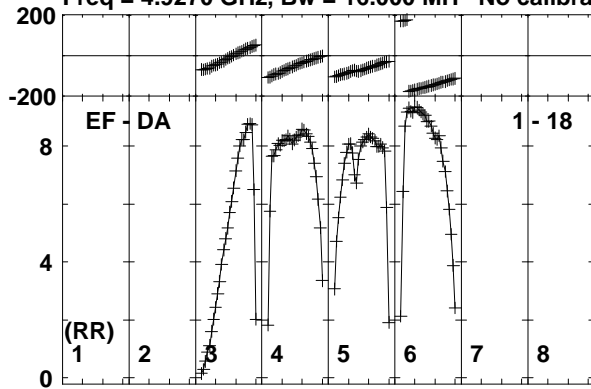

Lower frame: Milli Ampl Jy Top frame: Phas deg  
Vector averaged cross-power spectrum Baseline: EF (01) - DA (18)  
Timerange: 00/09:23:01 to 00/09:24:29

Plot file version 427 created 08-APR-2019 12:10:27

MRK622 EM133B.UVDATA.1

Freq = 4.9270 GHz, Bw = 16.000 MH No calibration applied and no bandpass applied

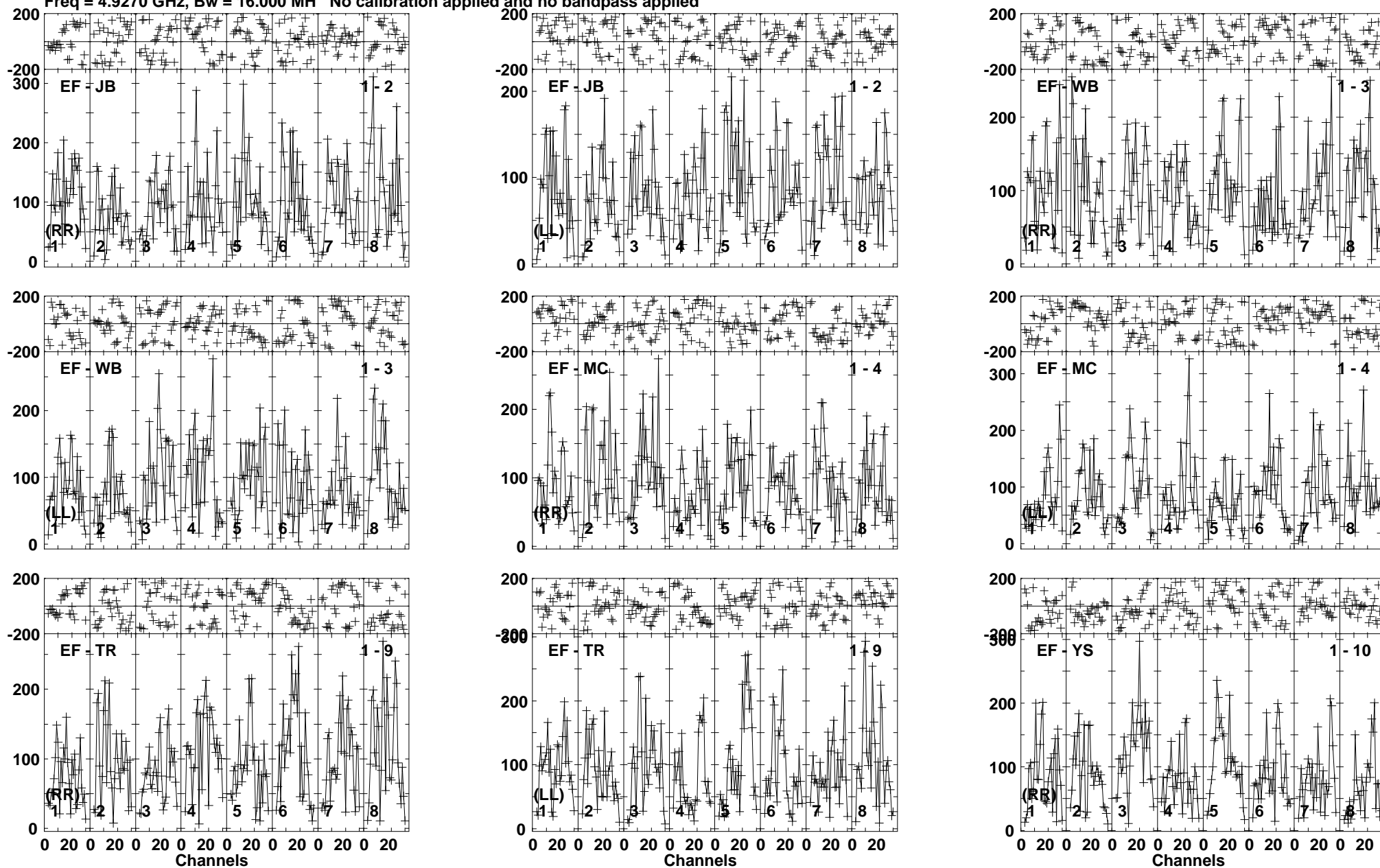

Lower frame: Micro Ampl Jy Top frame: Phas deg  
Vector averaged cross-power spectrum Baseline: EF (01) - JB (02)  
Timerange: 00/09:24:31 to 00/09:27:59

Plot file version 428 created 08-APR-2019 12:10:27

MRK622 EM133B.UVDATA.1

Freq = 4.9270 GHz, Bw = 16.000 MH No calibration applied and no bandpass applied

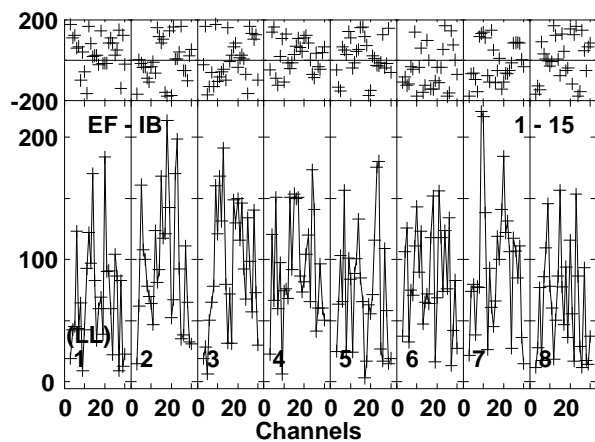
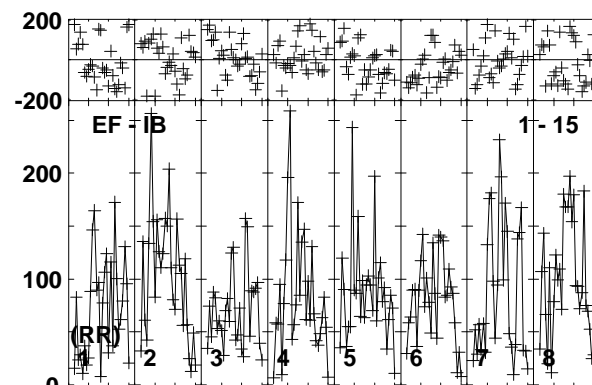
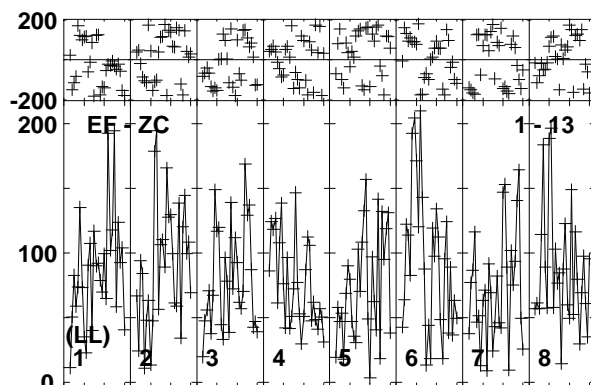
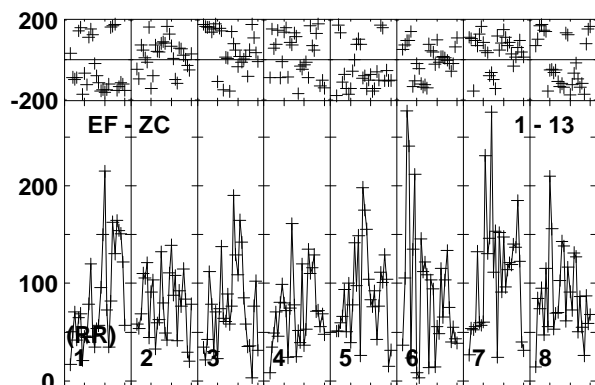
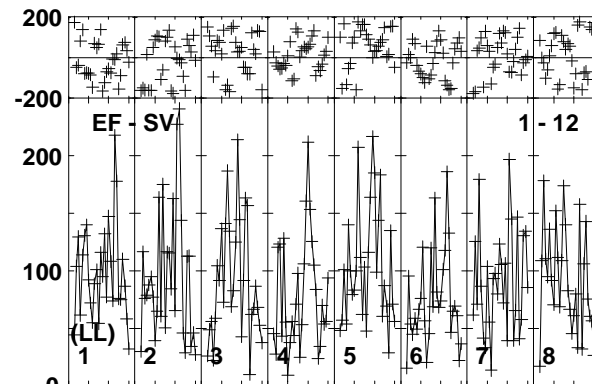
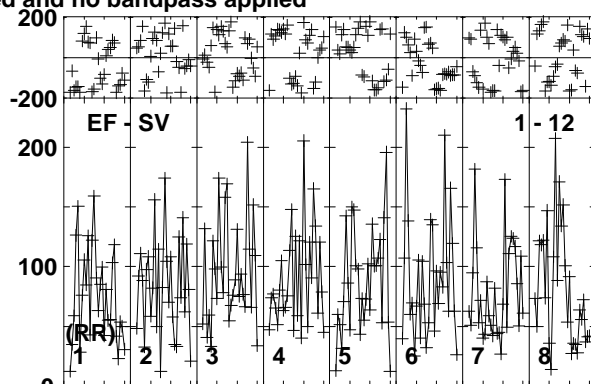
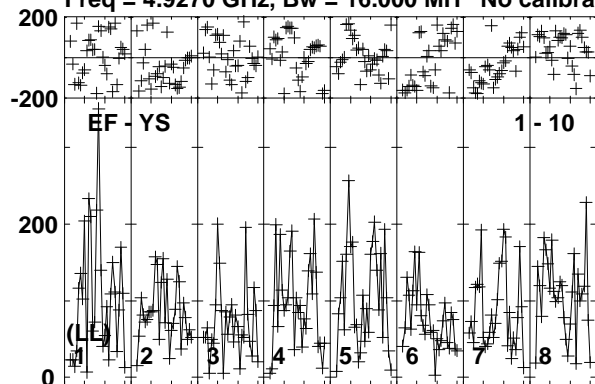

Lower frame: Micro Ampl Jy Top frame: Phas deg  
Vector averaged cross-power spectrum Baseline: EF (01) - YS (10)  
Timerange: 00/09:24:31 to 00/09:27:59

Plot file version 429 created 08-APR-2019 12:10:27

J0815+3635 EM133B.UVDATA.1

Freq = 4.9270 GHz, Bw = 16.000 MH No calibration applied and no bandpass applied

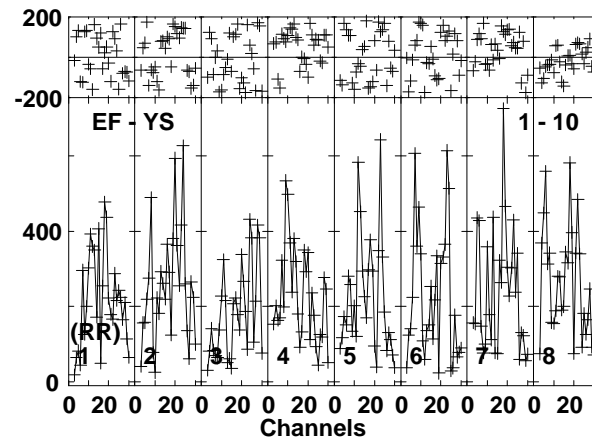
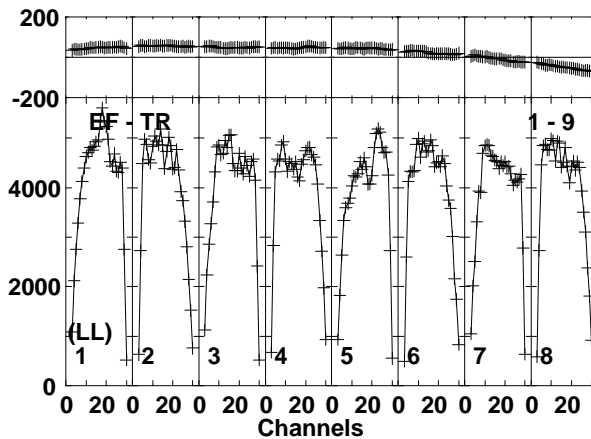
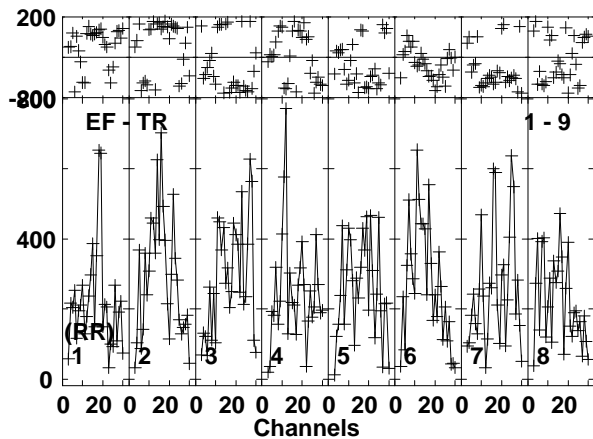
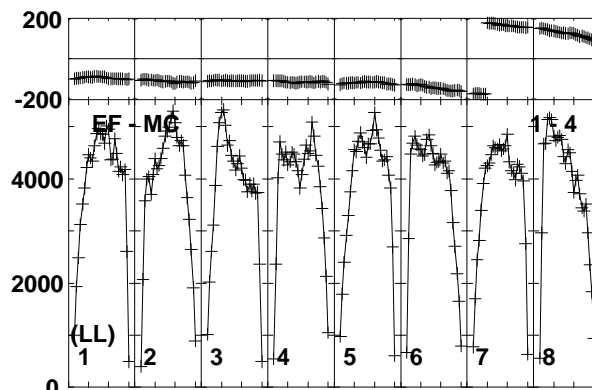
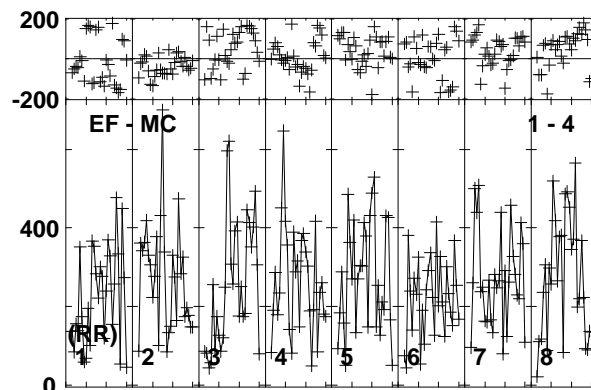
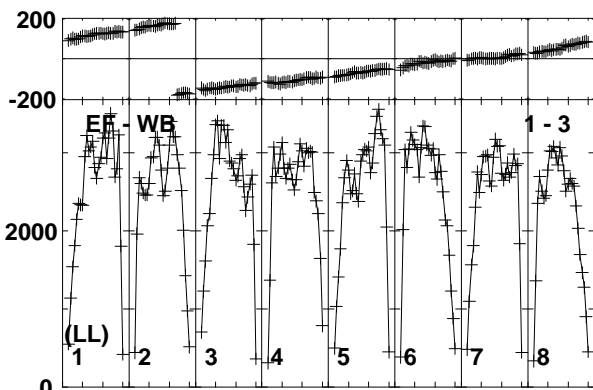
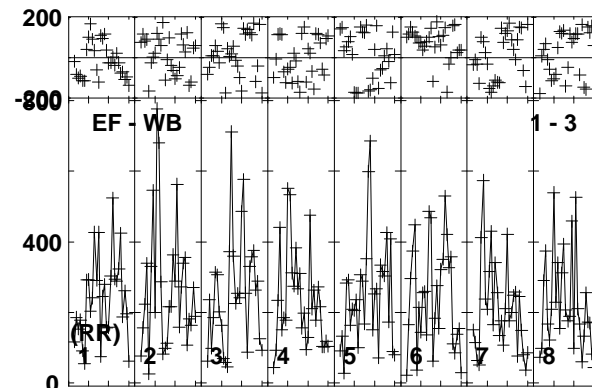
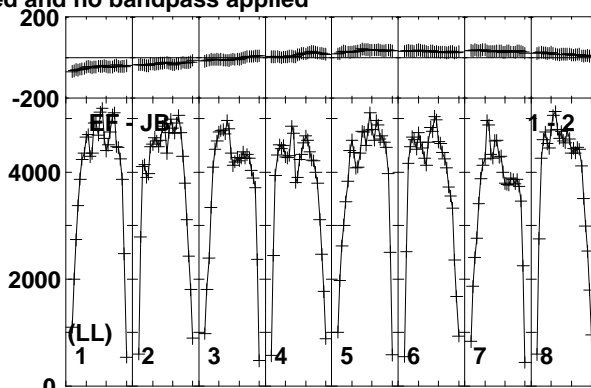
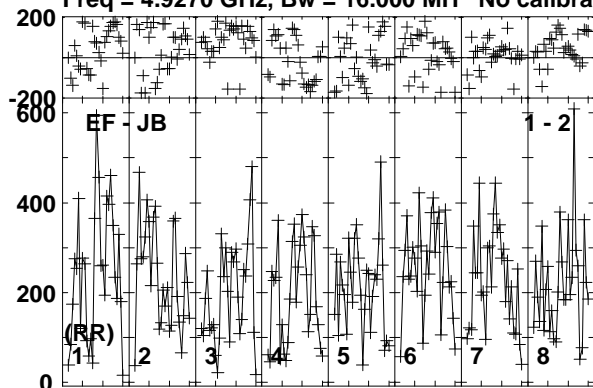

Lower frame: Micro Ampl Jy Top frame: Phas deg  
Vector averaged cross-power spectrum Baseline: EF (01) - JB (02)  
Timerange: 00/09:28:01 to 00/09:29:29

Plot file version 430 created 08-APR-2019 12:10:27

J0815+3635 EM133B.UVDATA.1

Freq = 4.9270 GHz, Bw = 16.000 MH No calibration applied and no bandpass applied

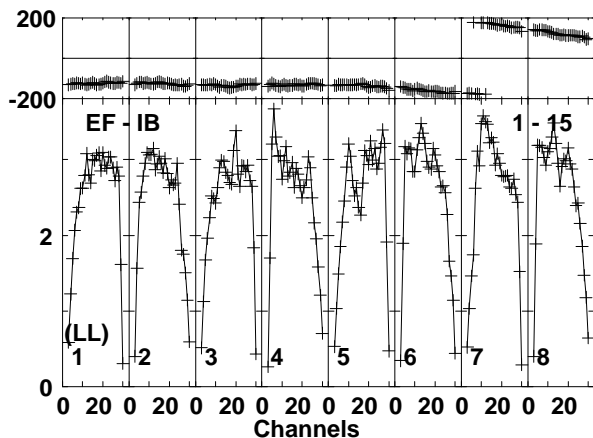
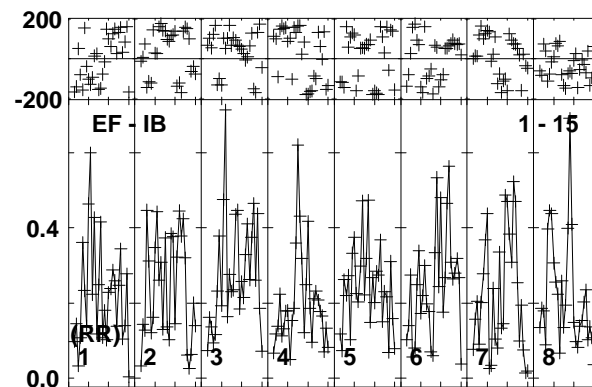
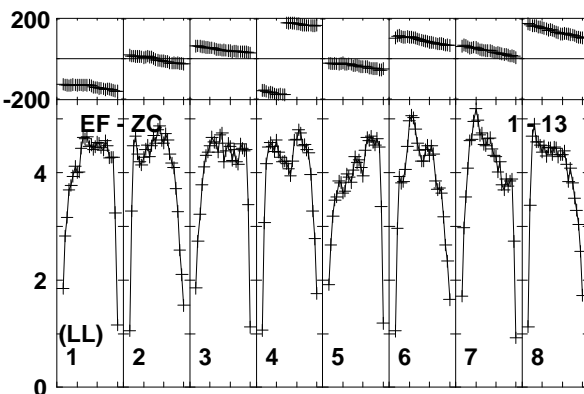
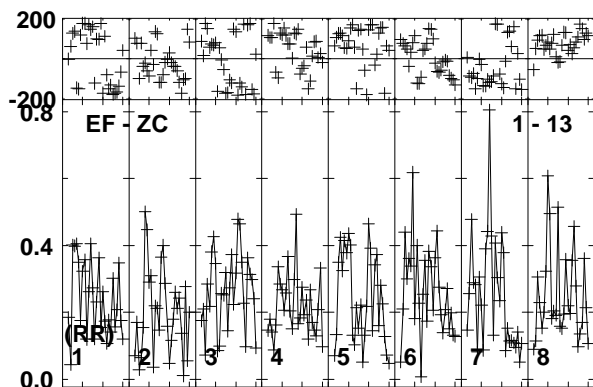
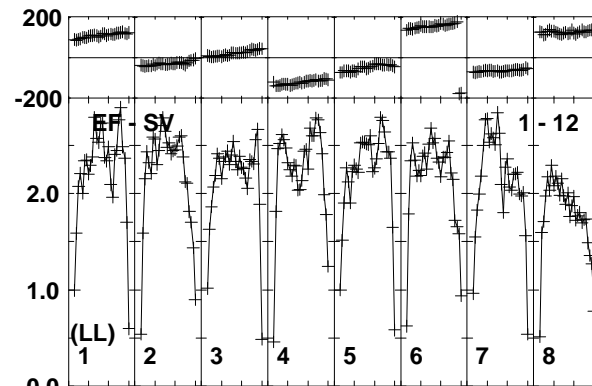
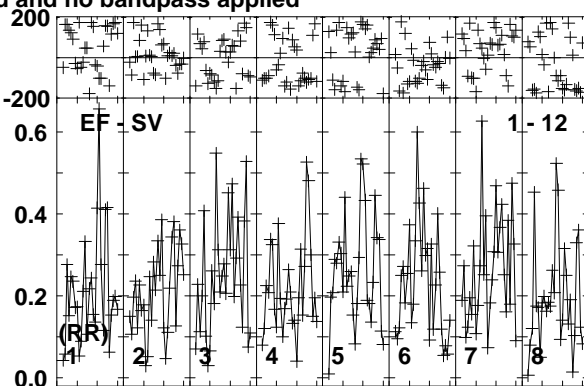
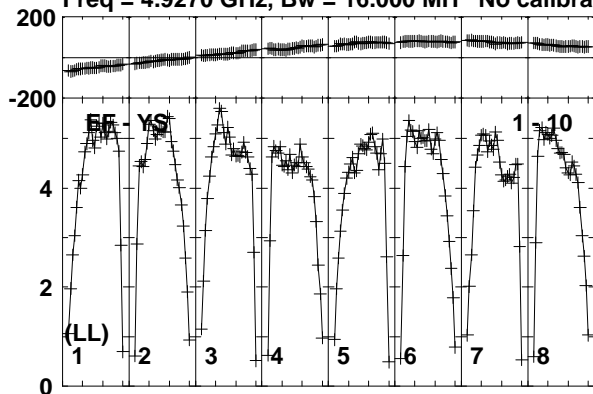

Lower frame: Milli Ampl Jy Top frame: Phas deg  
Vector averaged cross-power spectrum Baseline: EF (01) - YS (10)  
Timerange: 00/09:28:01 to 00/09:29:29

Plot file version 431 created 08-APR-2019 12:10:27

MRK622 EM133B.UVDATA.1

Freq = 4.9270 GHz, Bw = 16.000 MH No calibration applied and no bandpass applied

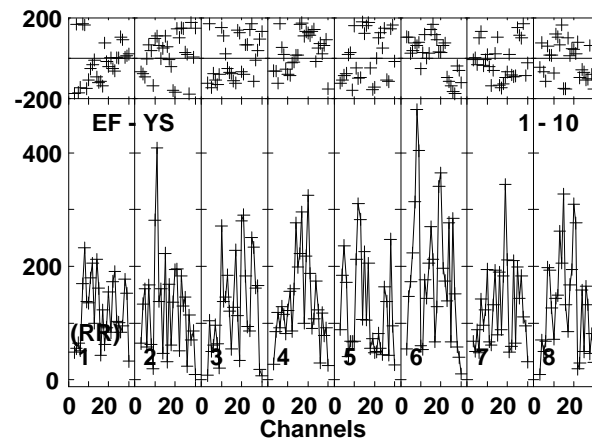
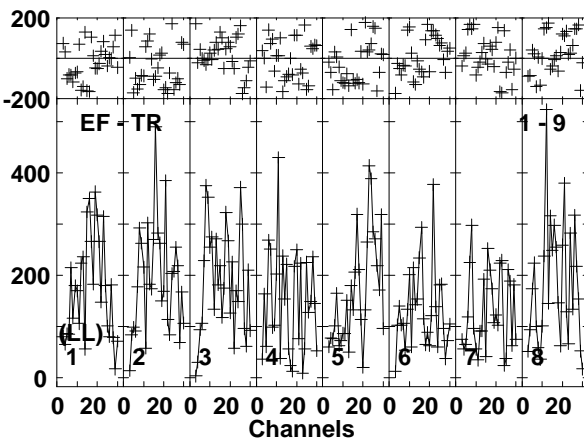
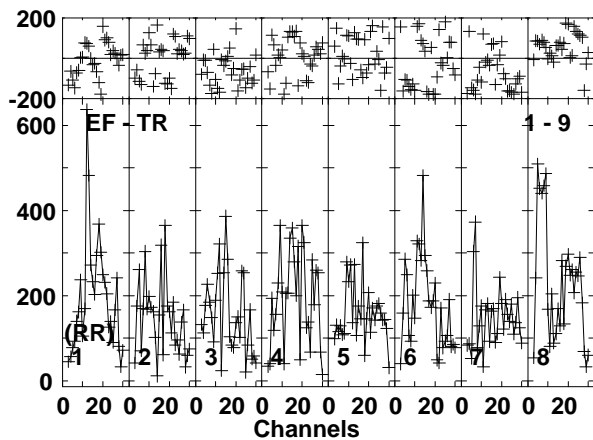
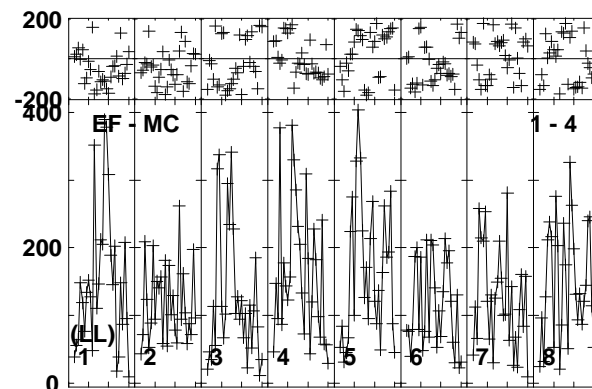
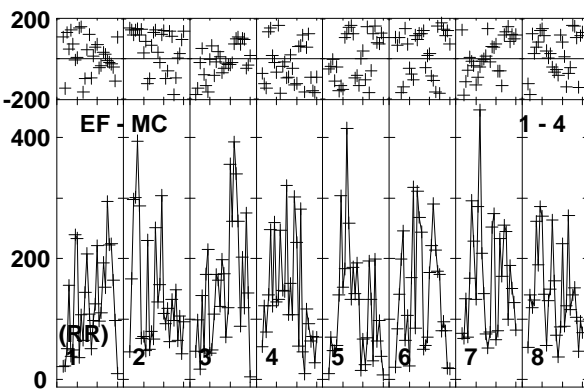
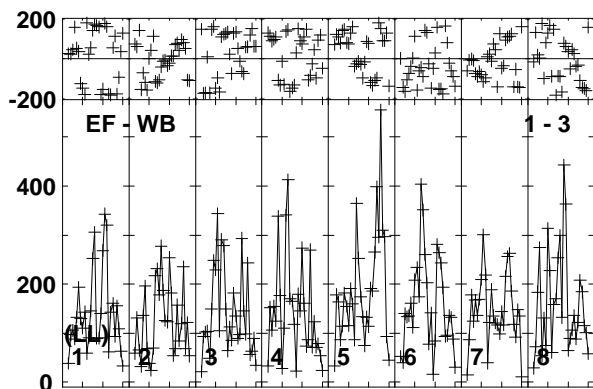
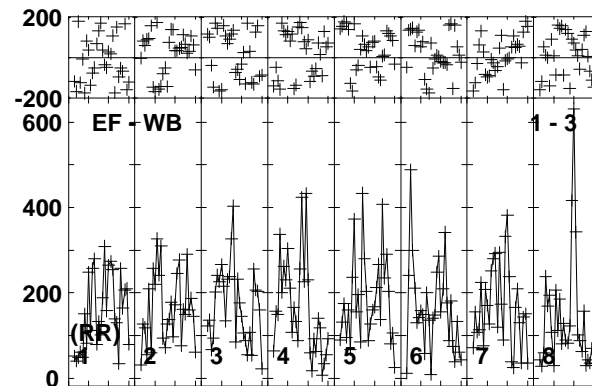
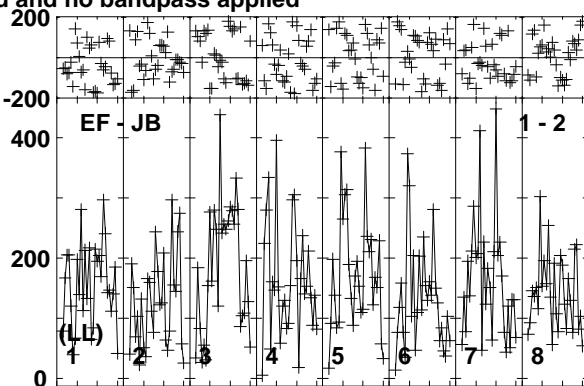
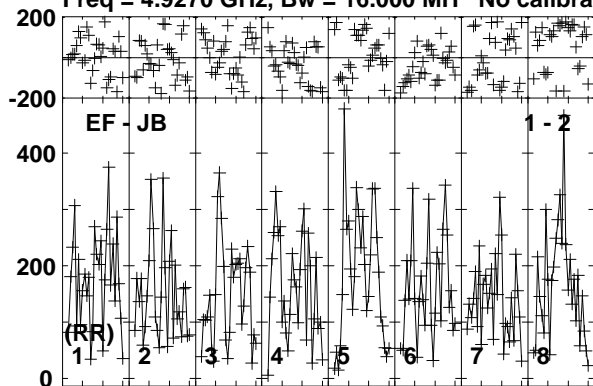

Lower frame: Micro Ampl Jy Top frame: Phas deg  
Vector averaged cross-power spectrum Baseline: EF (01) - JB (02)  
Timerange: 00/09:29:33 to 00/09:32:59

Plot file version 432 created 08-APR-2019 12:10:27

MRK622 EM133B.UVDATA.1

Freq = 4.9270 GHz, Bw = 16.000 MH No calibration applied and no bandpass applied

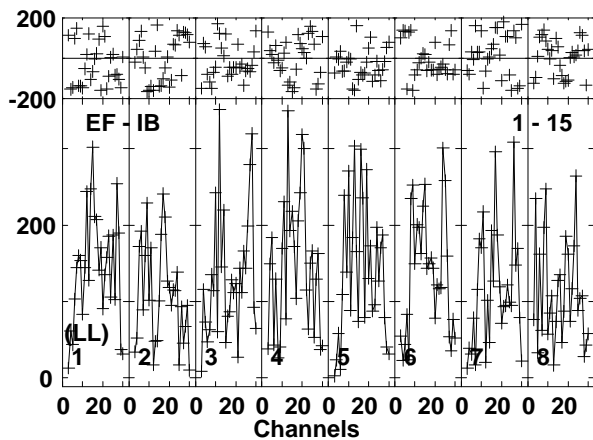
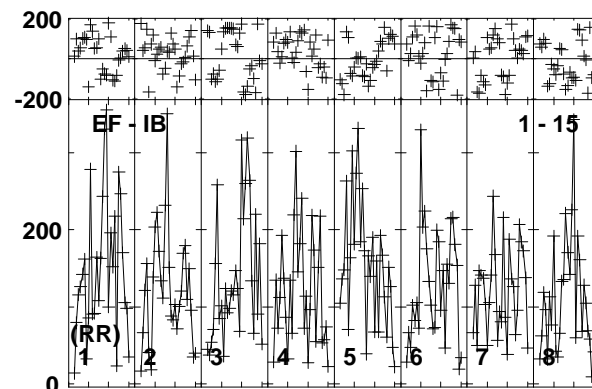
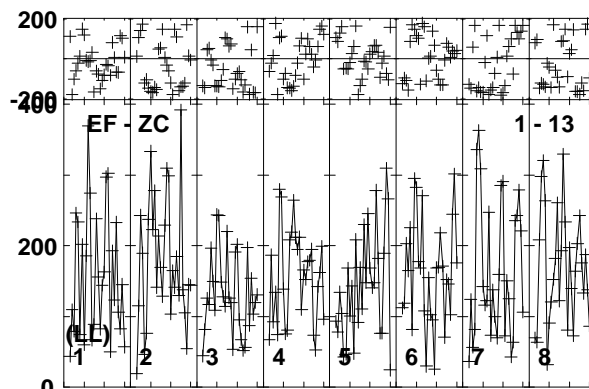
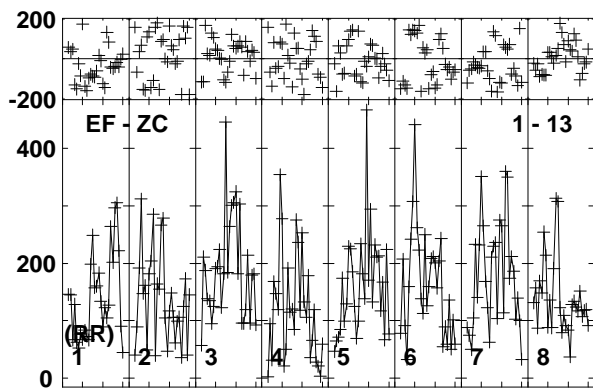
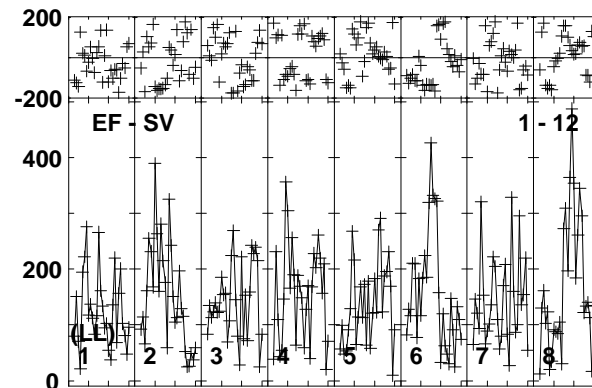
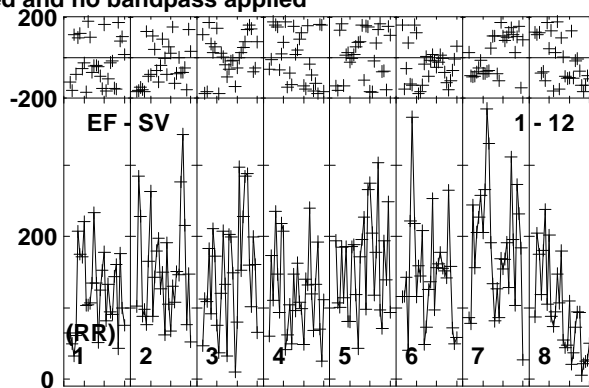
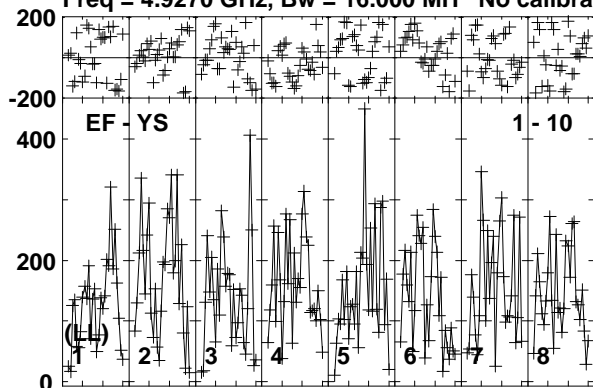

Lower frame: Micro Ampl Jy Top frame: Phas deg  
Vector averaged cross-power spectrum Baseline: EF (01) - YS (10)  
Timerange: 00/09:29:33 to 00/09:32:59



Plot file version 433 created 08-APR-2019 12:10:27

J0815+3635 EM133B.UVDATA.1

Freq = 4.9270 GHz, Bw = 16.000 MH No calibration applied and no bandpass applied

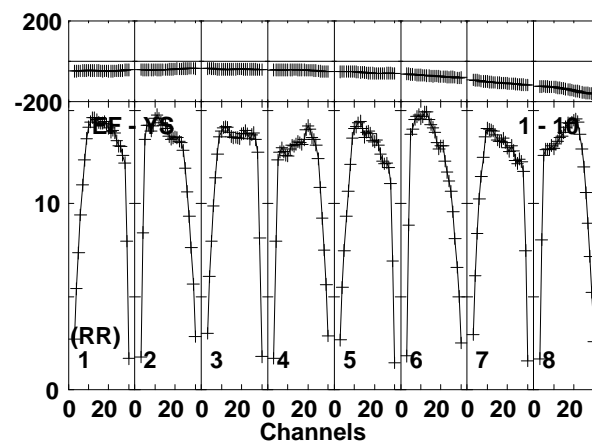
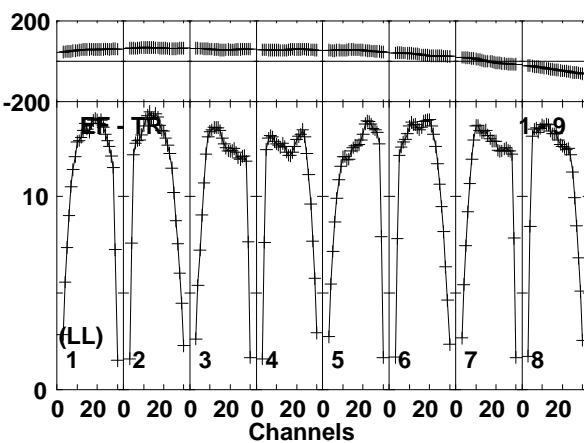
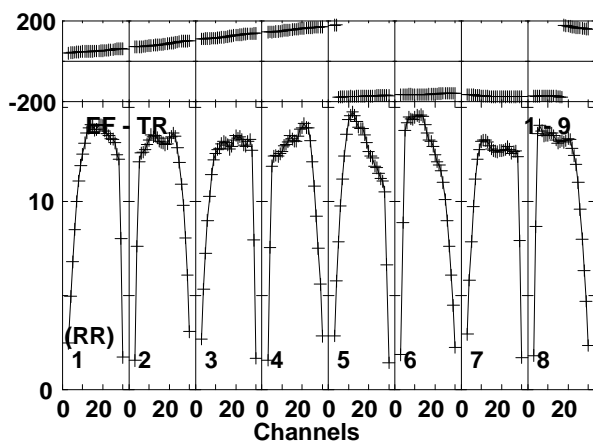
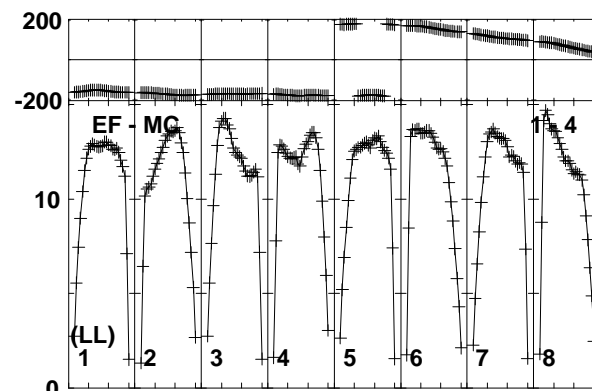
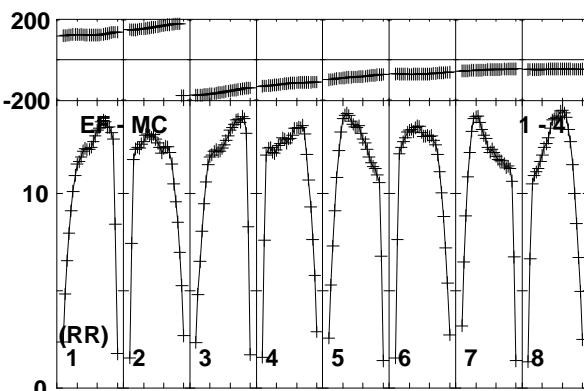
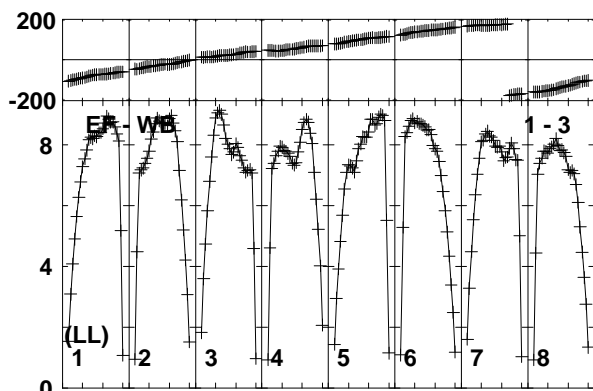
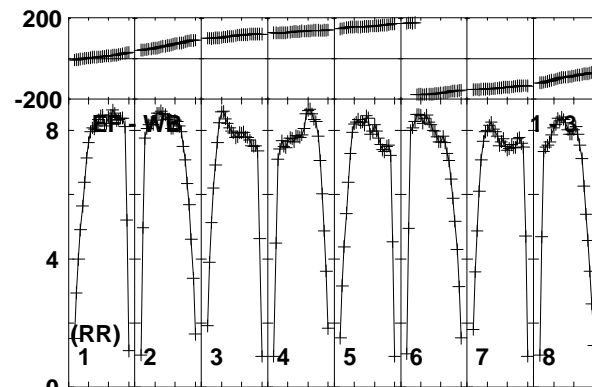
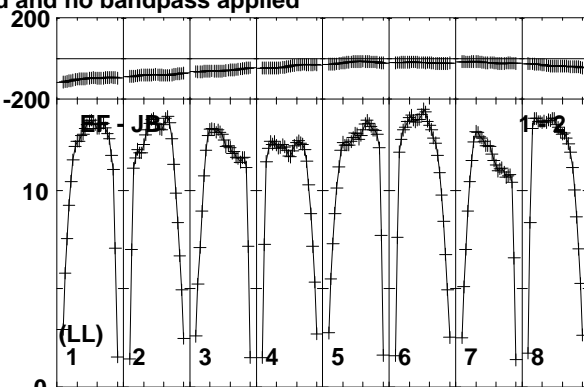
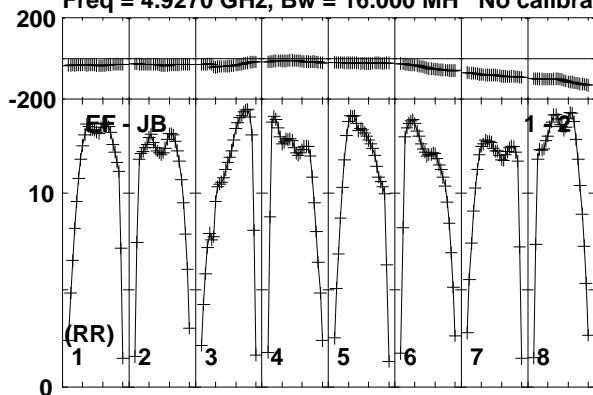

Lower frame: Milli Ampl Jy Top frame: Phas deg  
Vector averaged cross-power spectrum Baseline: EF (01) - JB (02)  
Timerange: 00/09:33:51 to 00/09:35:19

Plot file version 434 created 08-APR-2019 12:10:28

J0815+3635 EM133B.UVDATA.1

Freq = 4.9270 GHz, Bw = 16.000 MH No calibration applied and no bandpass applied

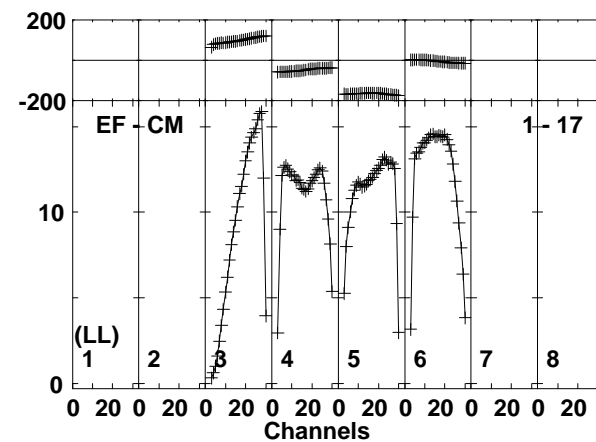
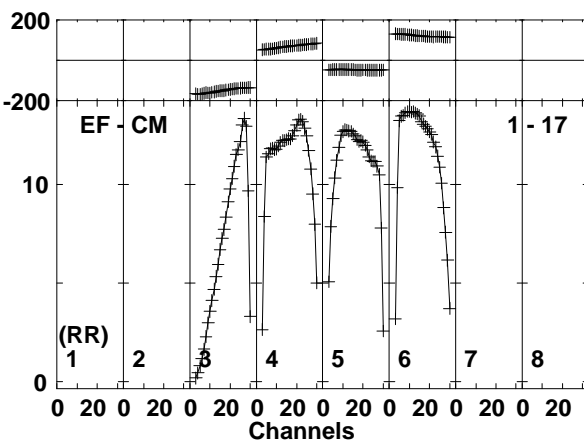
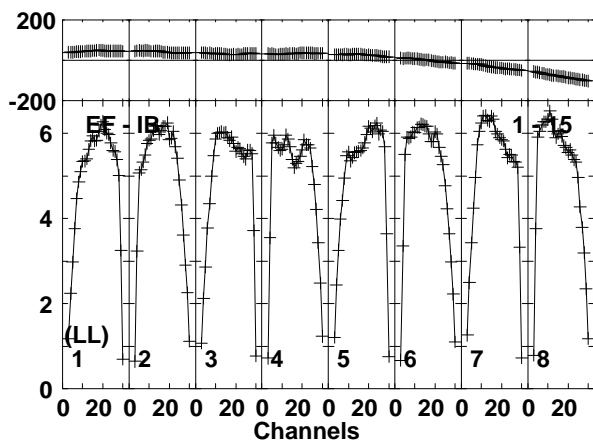
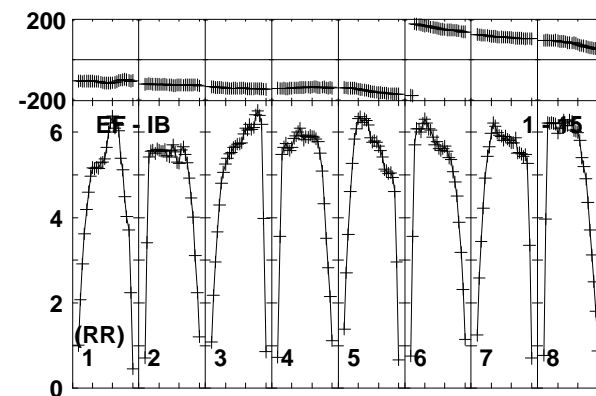
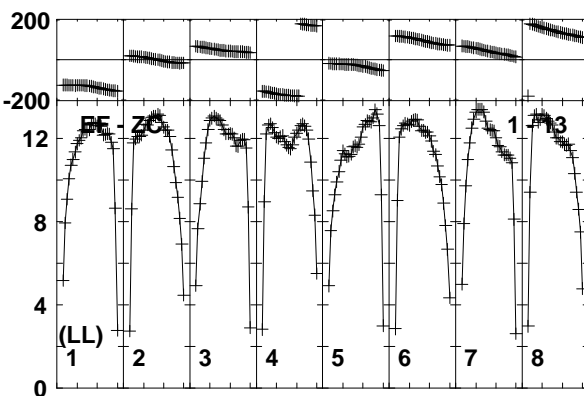
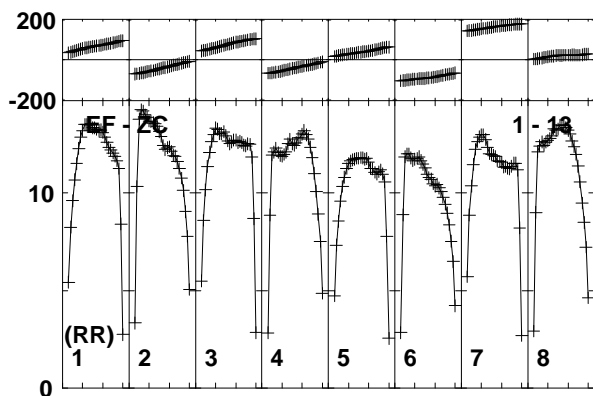
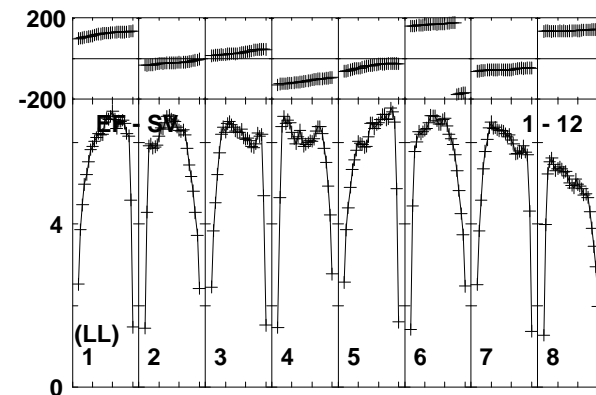
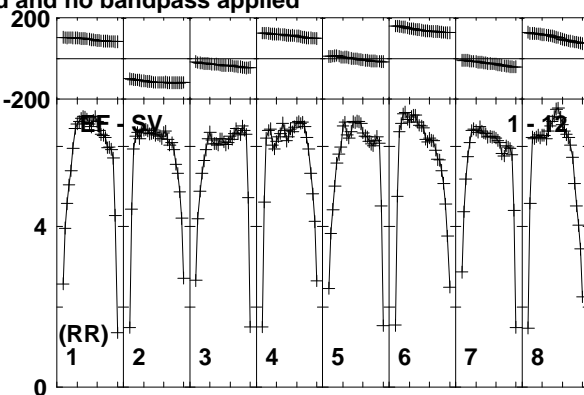
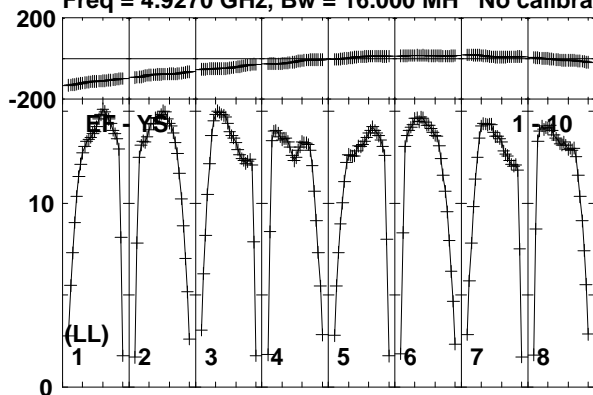

Lower frame: Milli Ampl Jy Top frame: Phas deg  
Vector averaged cross-power spectrum Baseline: EF (01) - YS (10)  
Timerange: 00/09:33:51 to 00/09:35:19

Plot file version 435 created 08-APR-2019 12:10:28

J0815+3635 EM133B.UVDATA.1

Freq = 4.9270 GHz, Bw = 16.000 MH No calibration applied and no bandpass applied

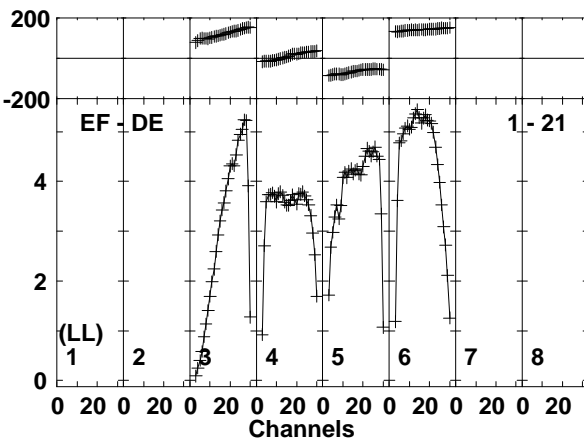
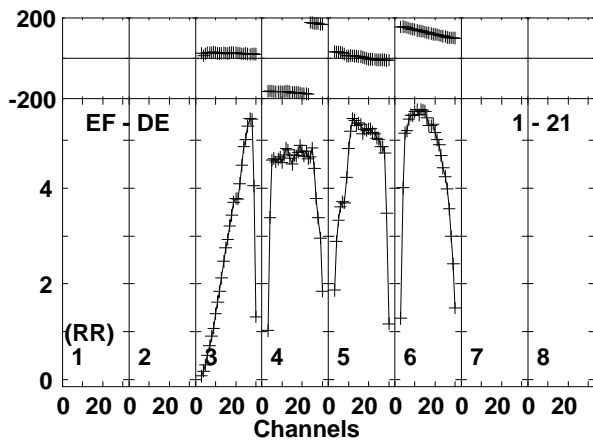
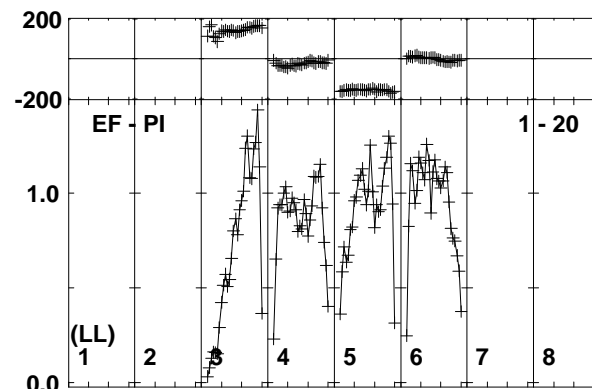
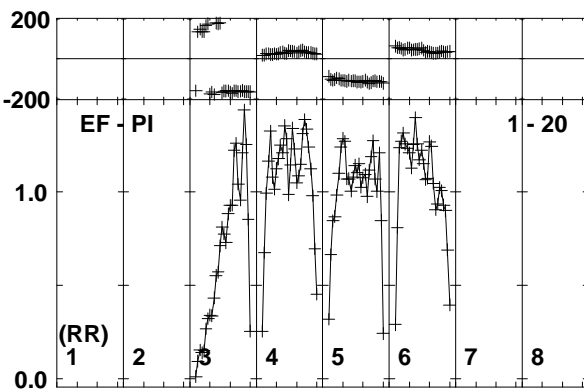
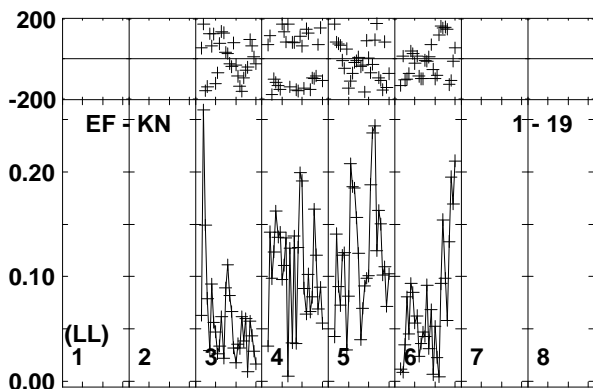
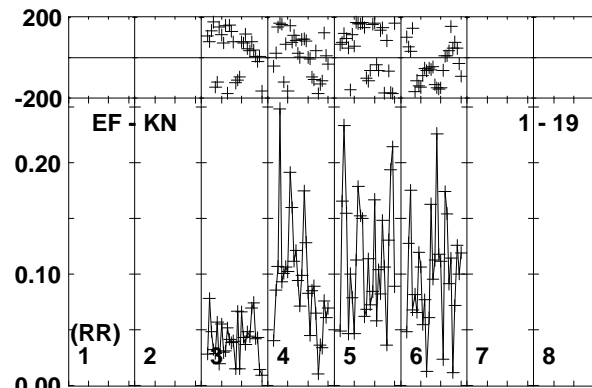
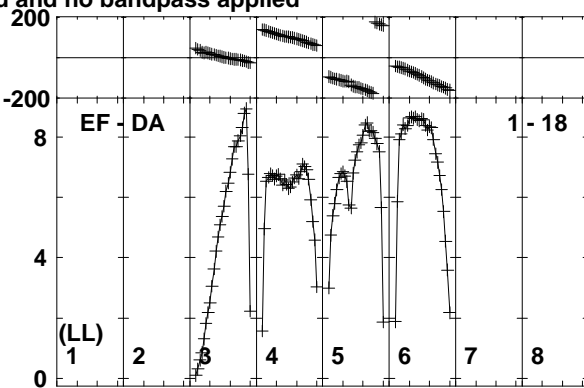
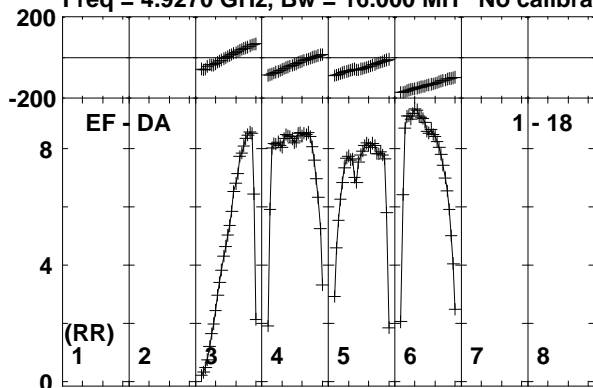

Lower frame: Milli Ampl Jy Top frame: Phas deg  
Vector averaged cross-power spectrum Baseline: EF (01) - DA (18)  
Timerange: 00/09:33:51 to 00/09:35:19

Plot file version 436 created 08-APR-2019 12:10:28

MRK622 EM133B.UVDATA.1

Freq = 4.9270 GHz, Bw = 16.000 MH No calibration applied and no bandpass applied

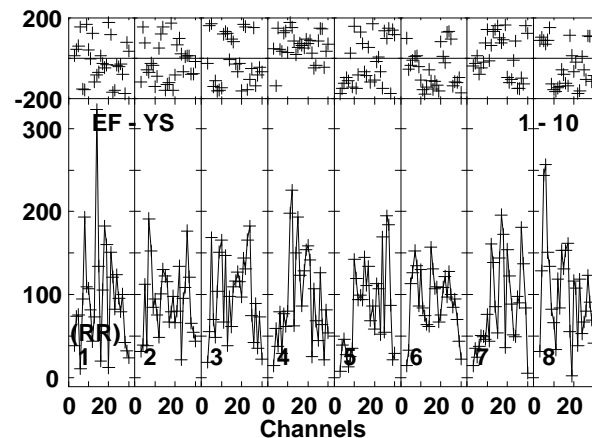
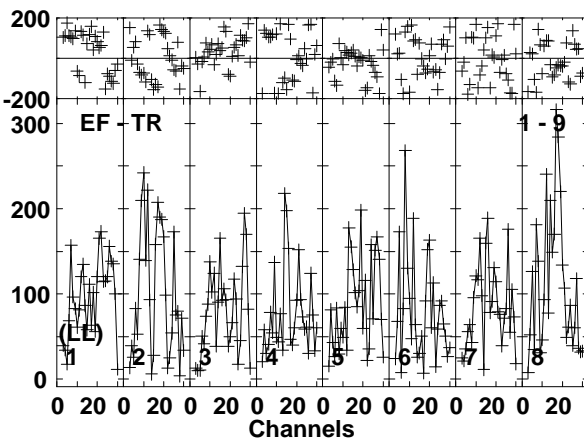
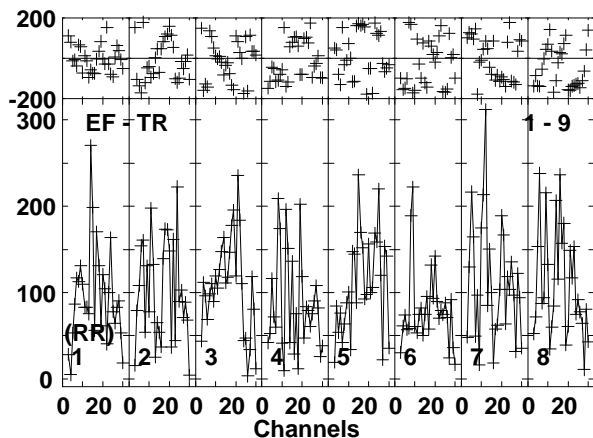
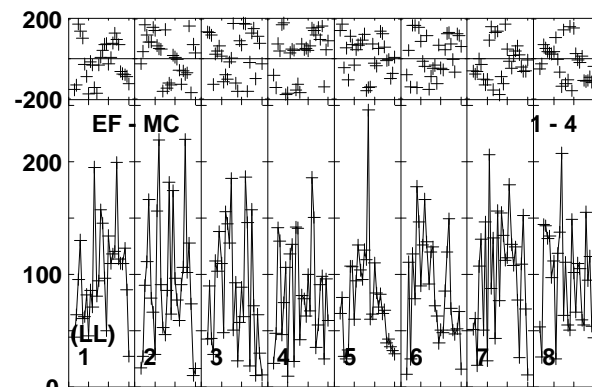
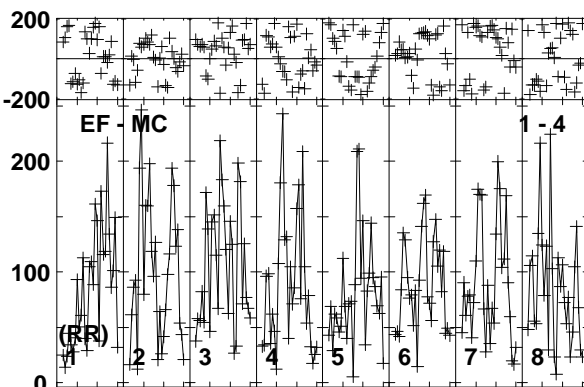
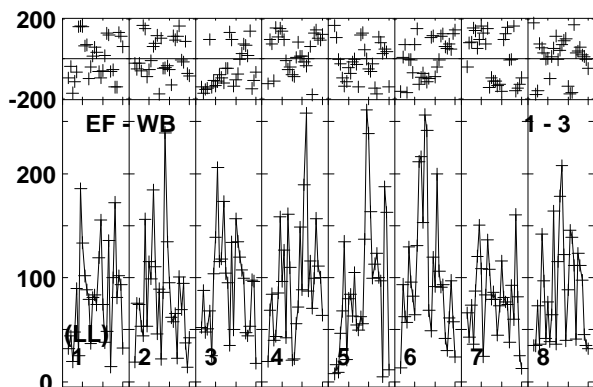
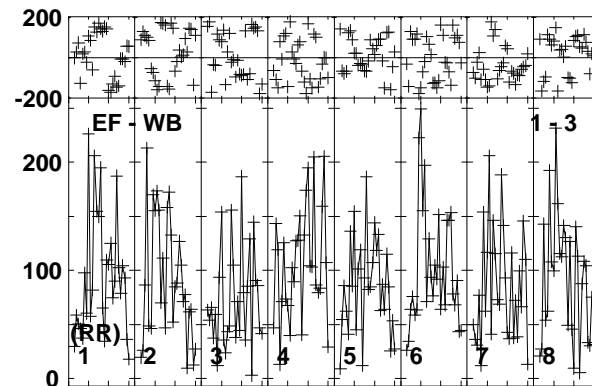
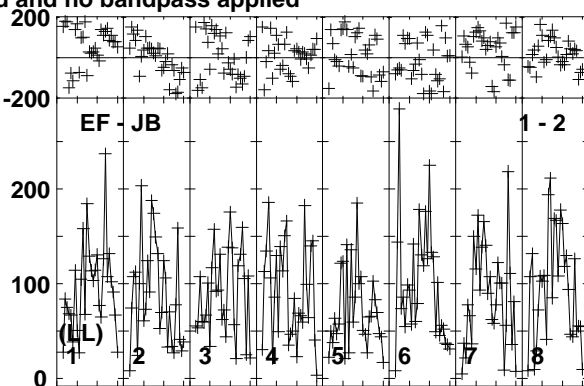
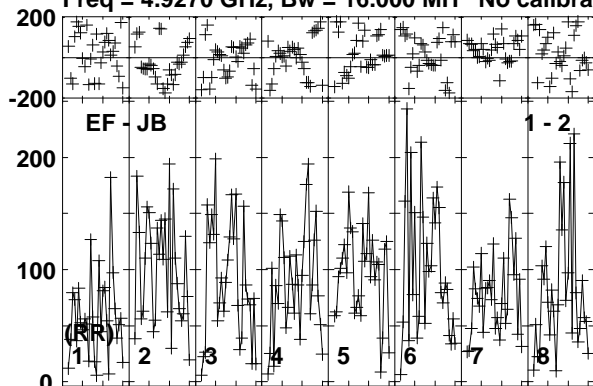

Lower frame: Micro Ampl Jy Top frame: Phas deg  
Vector averaged cross-power spectrum Baseline: EF (01) - JB (02)  
Timerange: 00/09:35:21 to 00/09:38:49

Plot file version 437 created 08-APR-2019 12:10:28

MRK622 EM133B.UVDATA.1

Freq = 4.9270 GHz, Bw = 16.000 MH No calibration applied and no bandpass applied

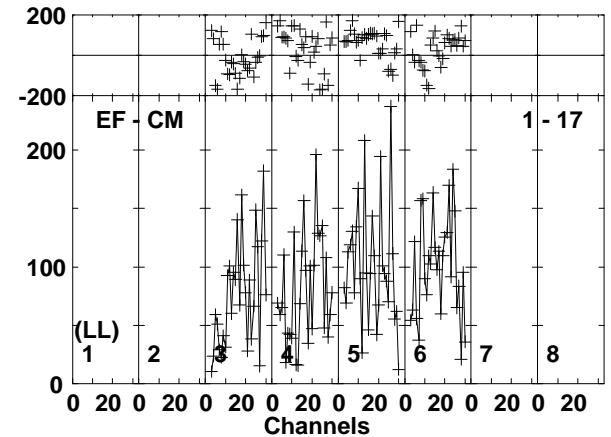
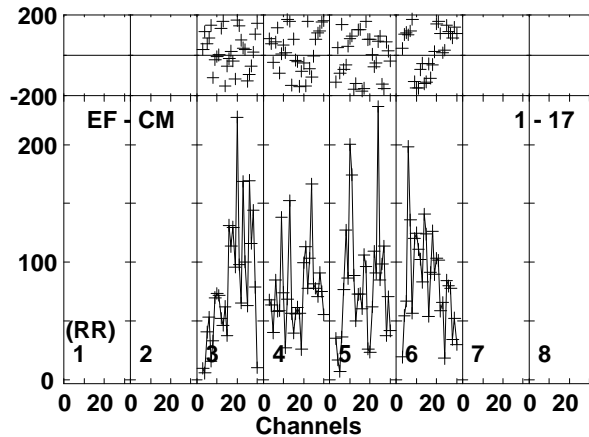
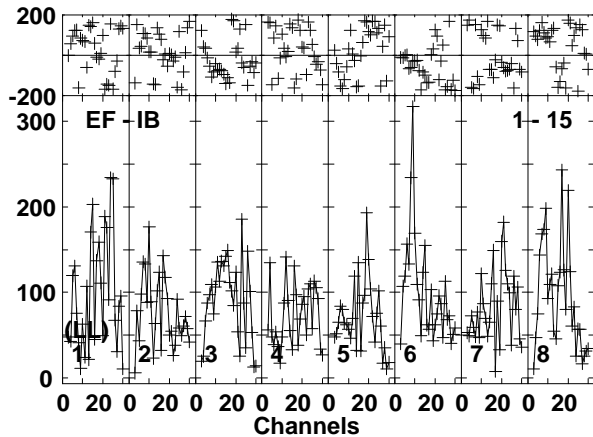
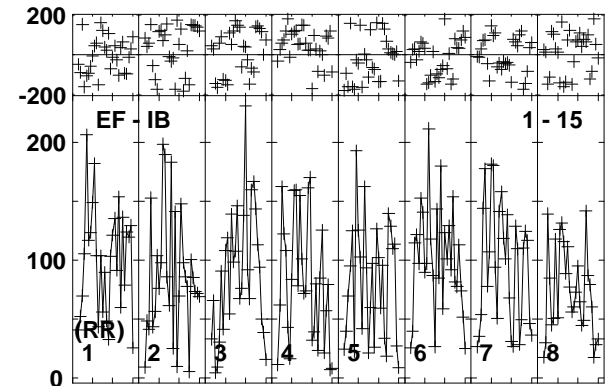
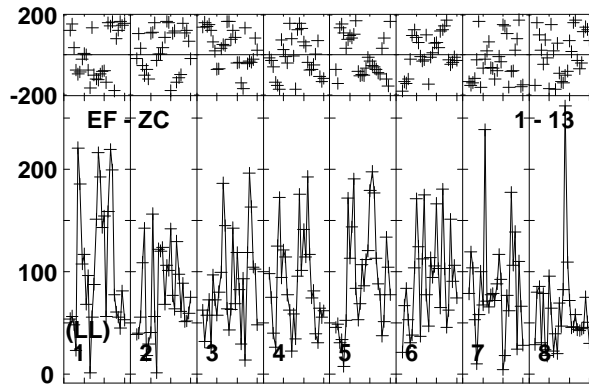
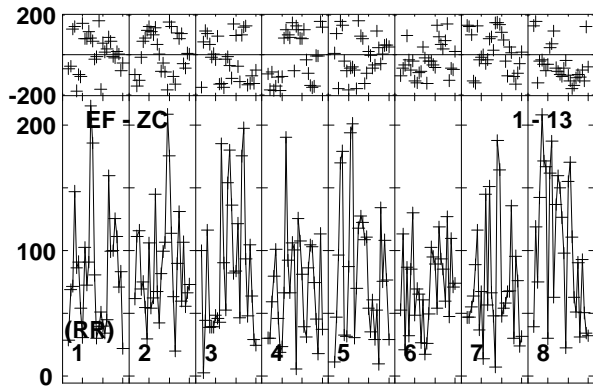
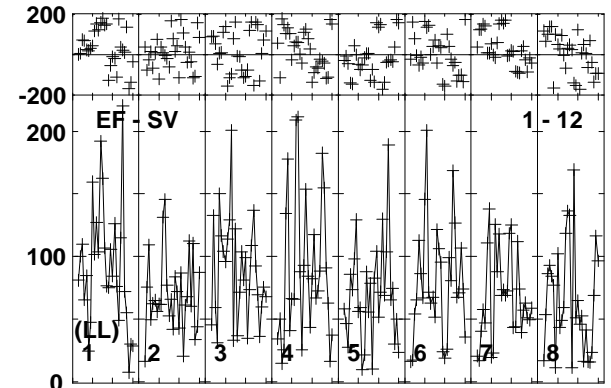
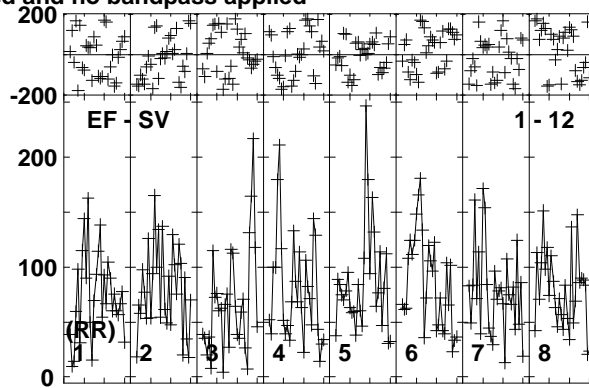
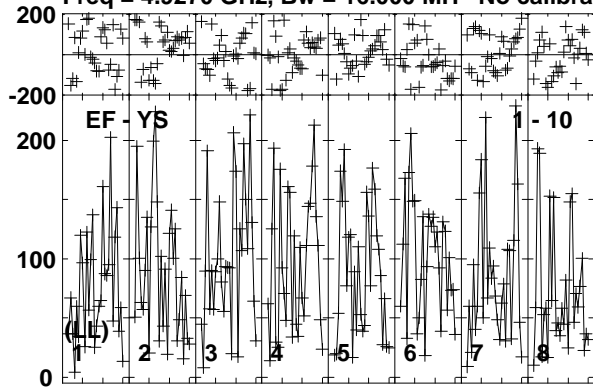

Lower frame: Micro Ampl Jy Top frame: Phas deg  
Vector averaged cross-power spectrum Baseline: EF (01) - YS (10)  
Timerange: 00/09:35:21 to 00/09:38:49

Plot file version 438 created 08-APR-2019 12:10:28

MRK622 EM133B.UVDATA.1

Freq = 4.9270 GHz, Bw = 16.000 MH No calibration applied and no bandpass applied

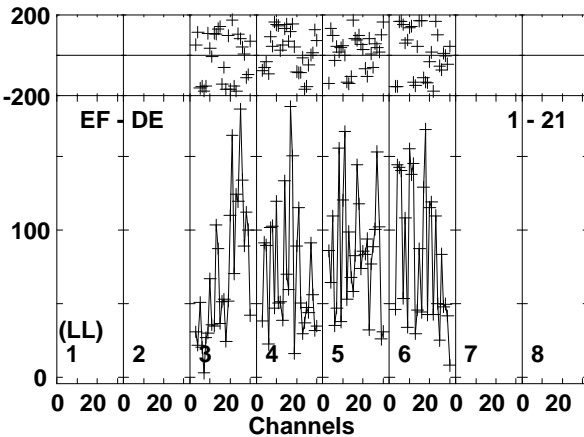
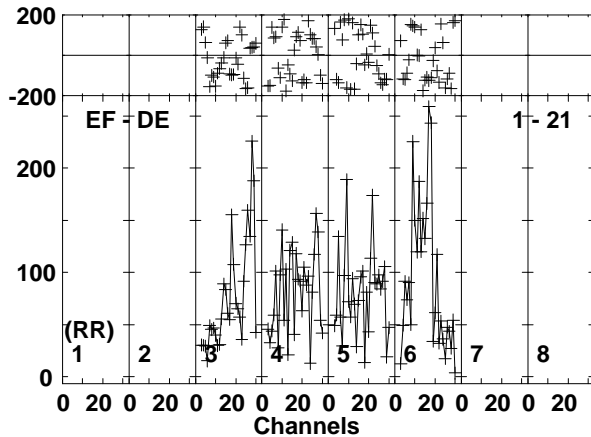
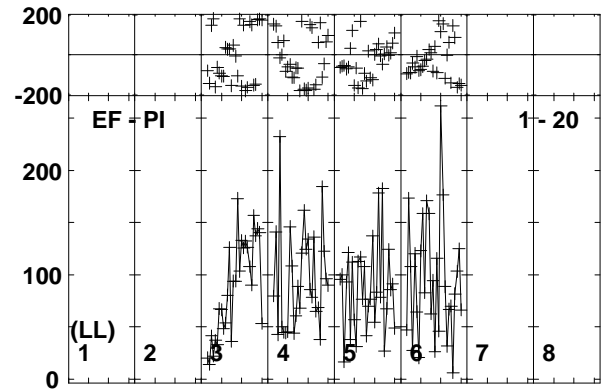
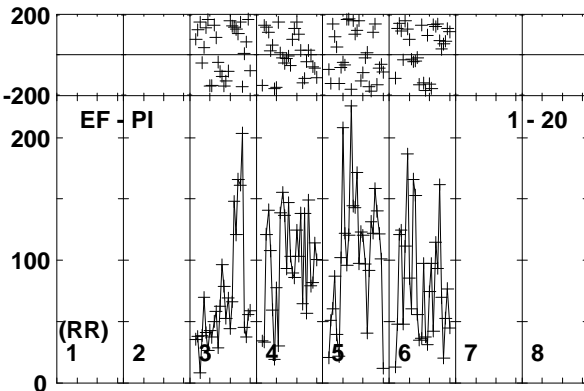
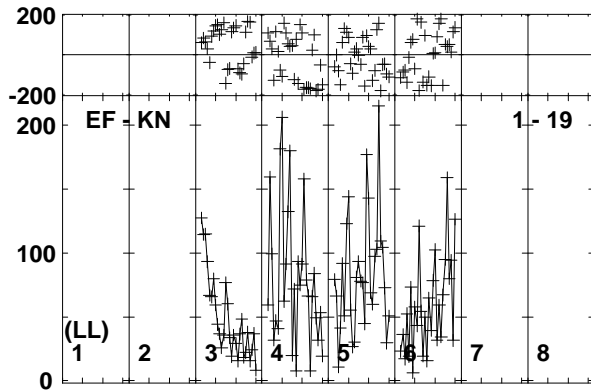
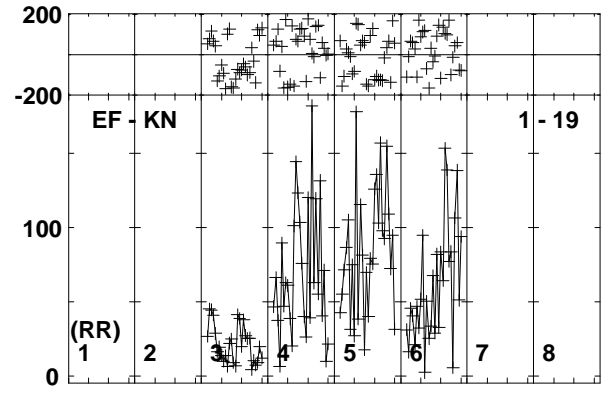
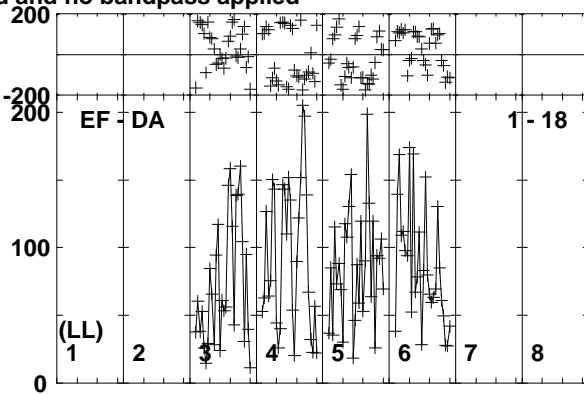
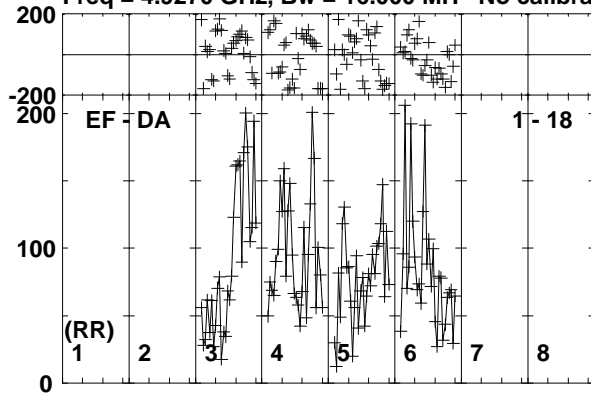

Lower frame: Micro Ampl Jy Top frame: Phas deg  
Vector averaged cross-power spectrum Baseline: EF (01) - DA (18)  
Timerange: 00/09:35:21 to 00/09:38:49

Plot file version 439 created 08-APR-2019 12:10:28

J0815+3635 EM133B.UVDATA.1

Freq = 4.9270 GHz, Bw = 16.000 MH No calibration applied and no bandpass applied

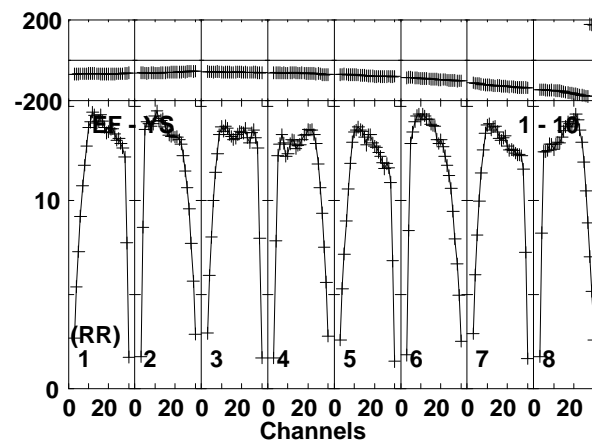
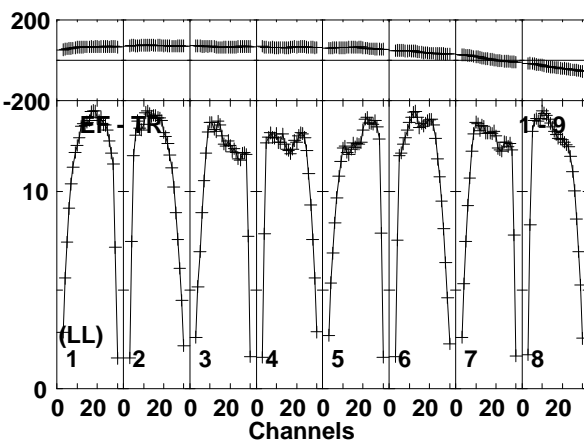
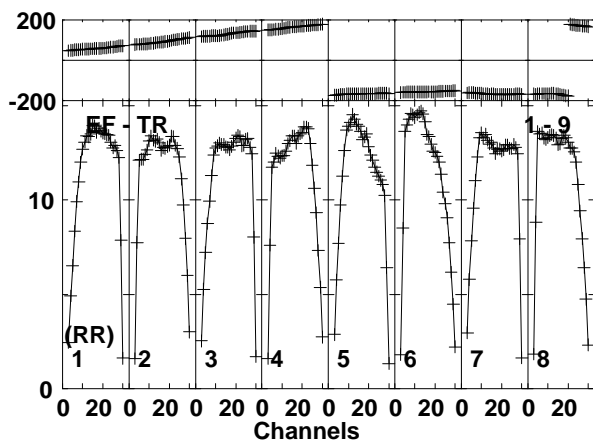
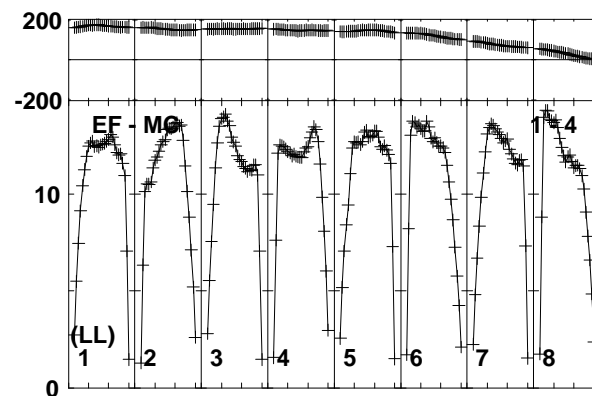
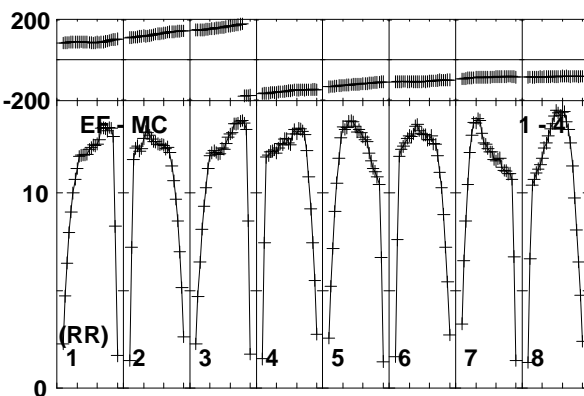
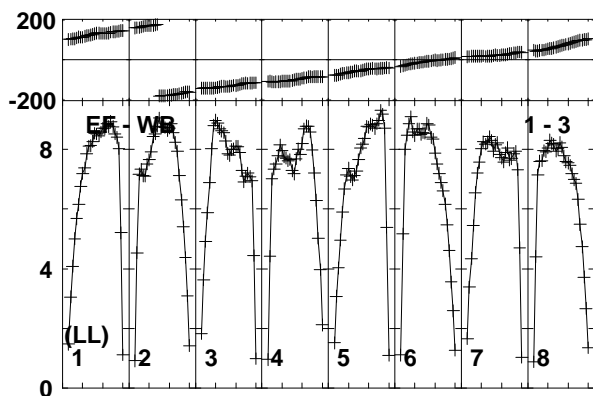
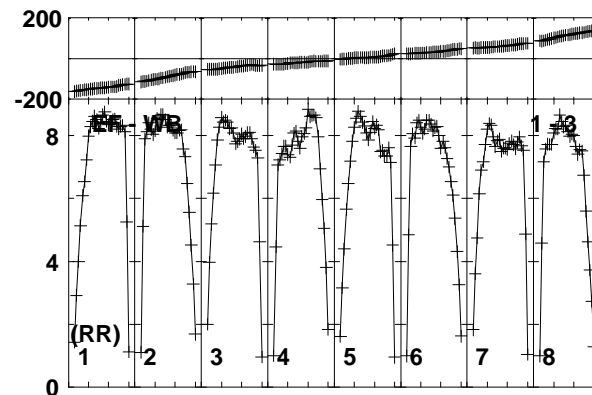
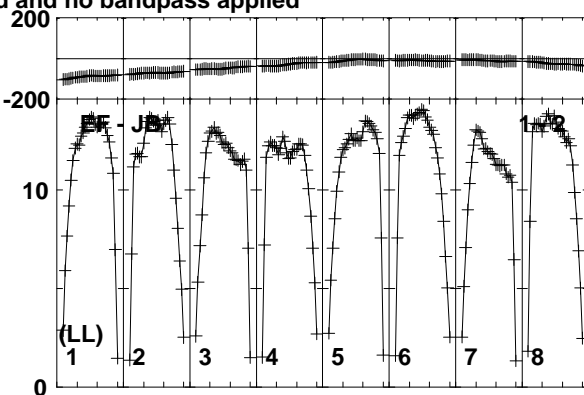
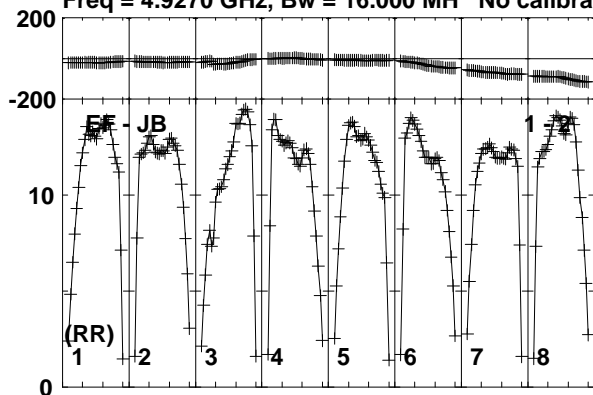

Lower frame: Milli Ampl Jy Top frame: Phas deg  
Vector averaged cross-power spectrum Baseline: EF (01) - JB (02)  
Timerange: 00/09:38:51 to 00/09:40:19

Plot file version 440 created 08-APR-2019 12:10:29

J0815+3635 EM133B.UVDATA.1

Freq = 4.9270 GHz, Bw = 16.000 MH No calibration applied and no bandpass applied

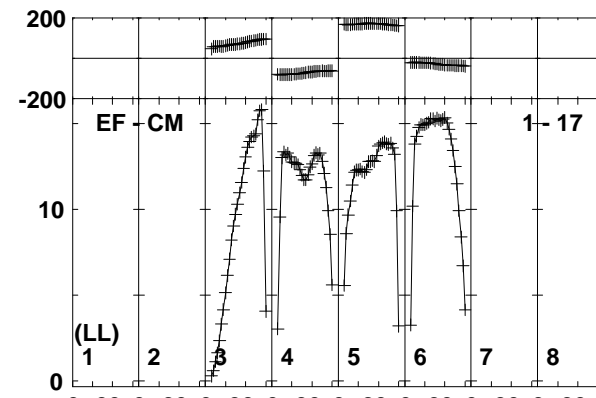
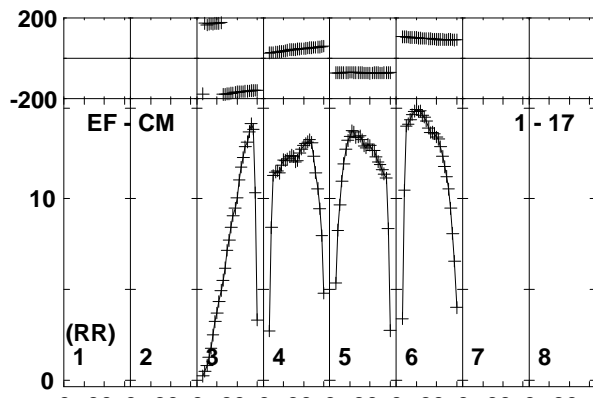
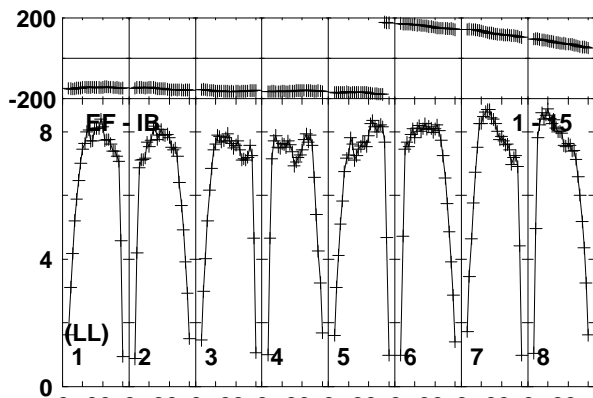
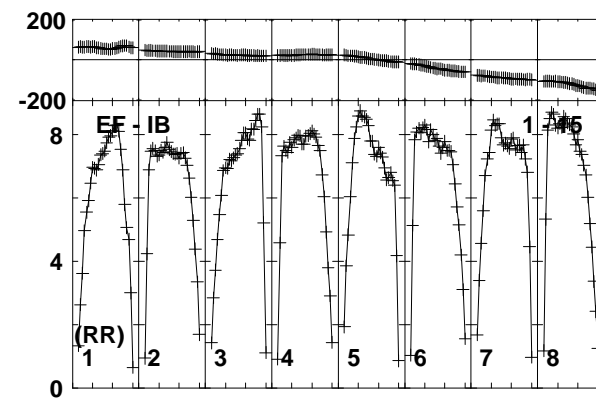
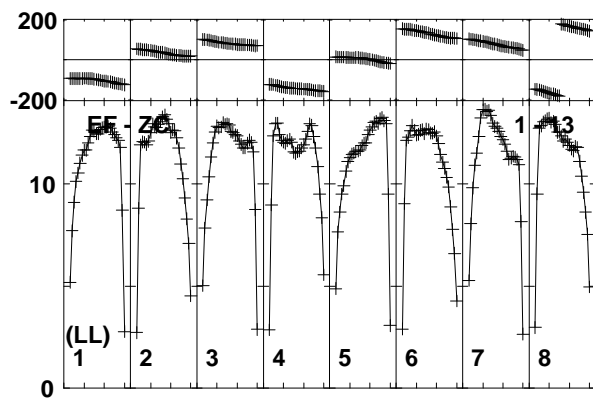
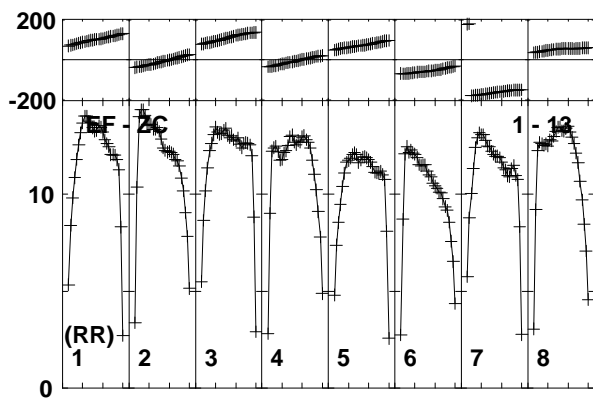
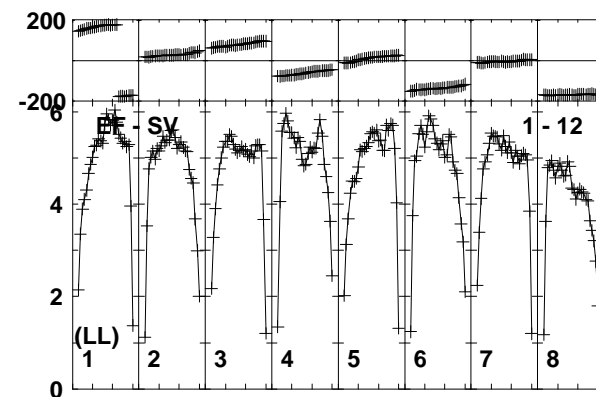
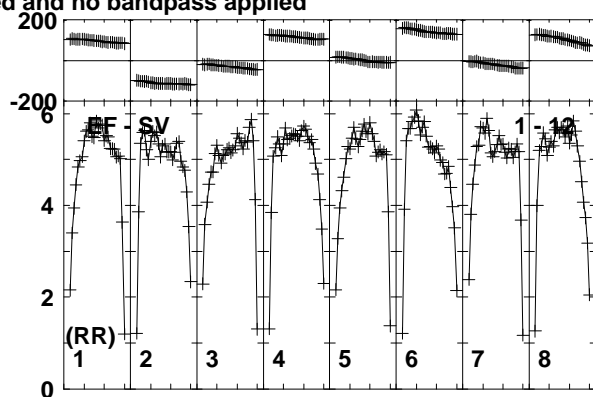
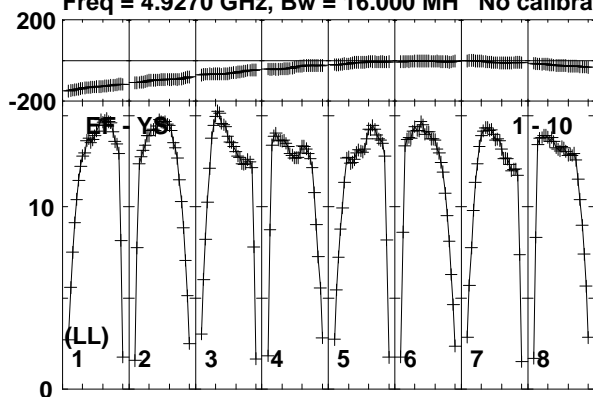

Lower frame: Milli Ampl Jy Top frame: Phas deg  
Vector averaged cross-power spectrum Baseline: EF (01) - YS (10)  
Timerange: 00/09:38:51 to 00/09:40:19



Plot file version 441 created 08-APR-2019 12:10:29

J0815+3635 EM133B.UVDATA.1

Freq = 4.9270 GHz, Bw = 16.000 MH No calibration applied and no bandpass applied

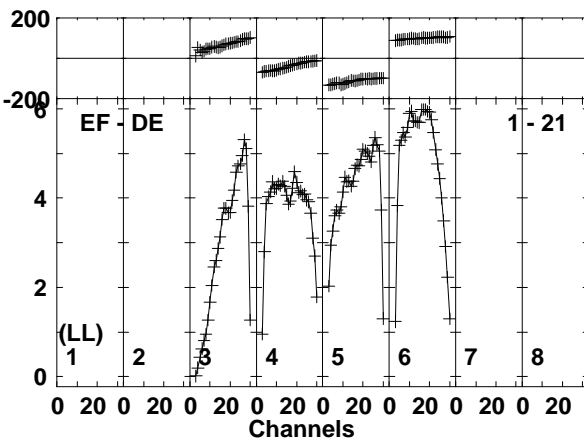
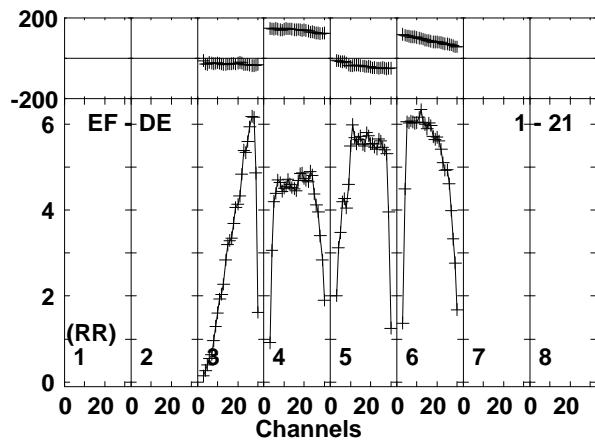
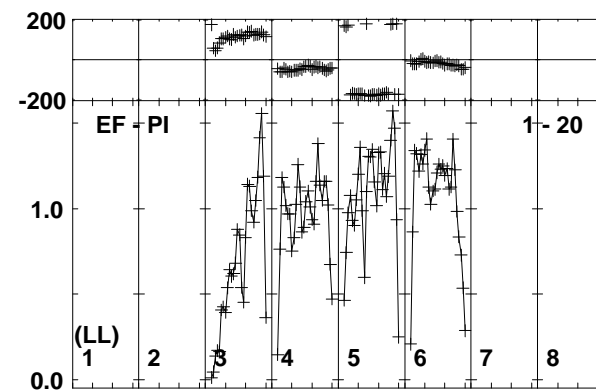
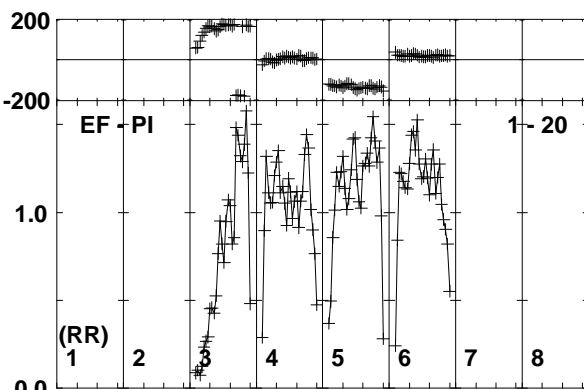
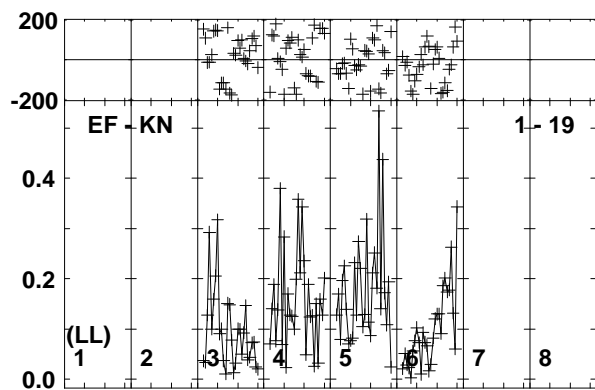
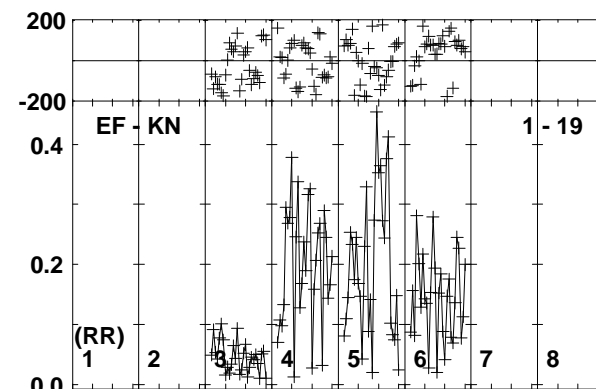
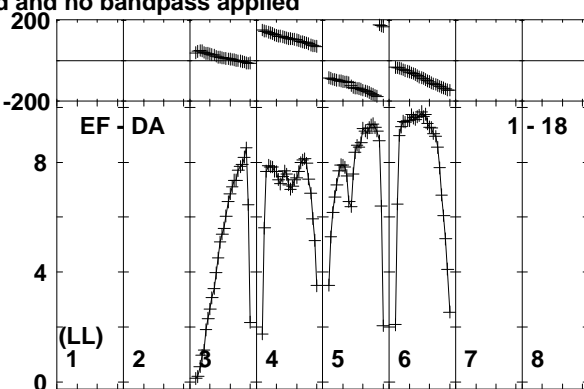
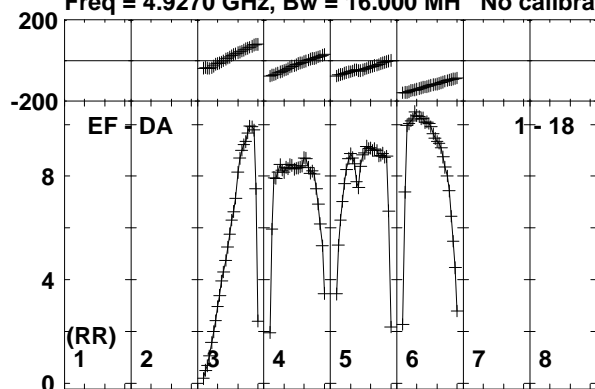

Lower frame: Milli Ampl Jy Top frame: Phas deg  
Vector averaged cross-power spectrum Baseline: EF (01) - DA (18)  
Timerange: 00/09:38:51 to 00/09:40:19

Plot file version 442 created 08-APR-2019 12:10:29

MRK622 EM133B.UVDATA.1

Freq = 4.9270 GHz, Bw = 16.000 MH No calibration applied and no bandpass applied

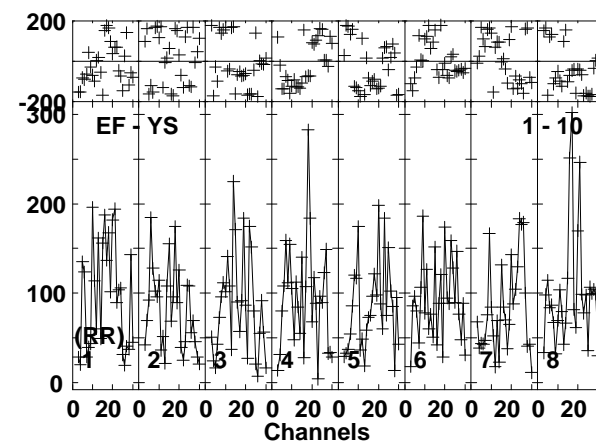
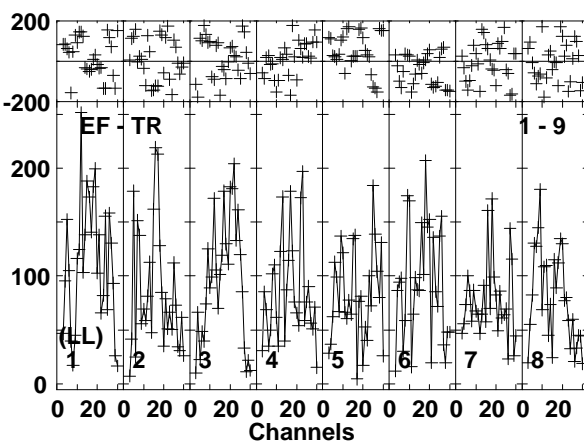
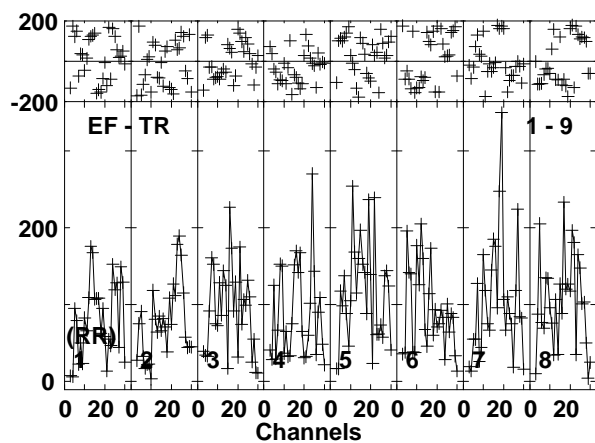
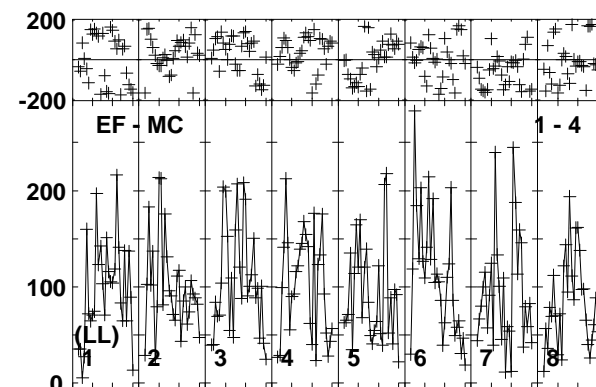
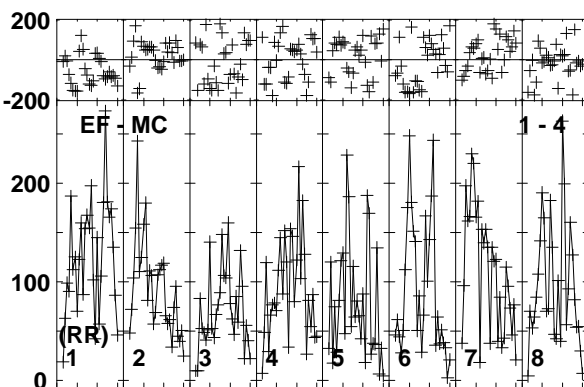
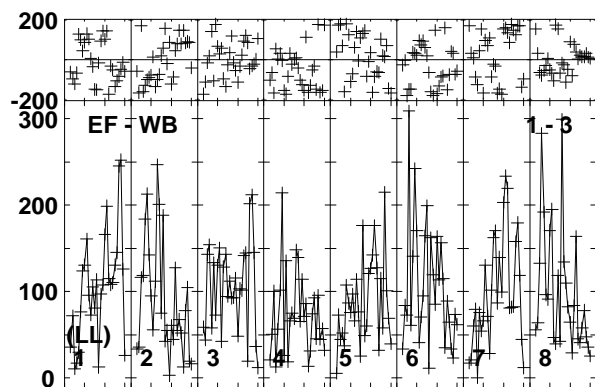
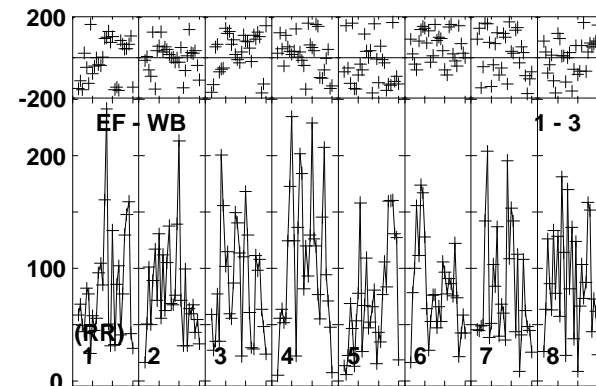
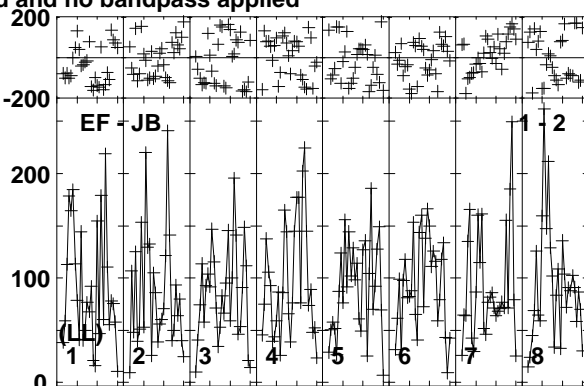
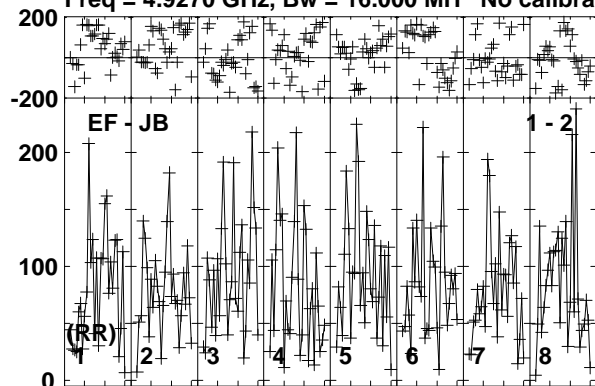

Lower frame: Micro Ampl Jy Top frame: Phas deg  
Vector averaged cross-power spectrum Baseline: EF (01) - JB (02)  
Timerange: 00/09:40:21 to 00/09:43:49

Plot file version 443 created 08-APR-2019 12:10:29

MRK622 EM133B.UVDATA.1

Freq = 4.9270 GHz, Bw = 16.000 MH No calibration applied and no bandpass applied

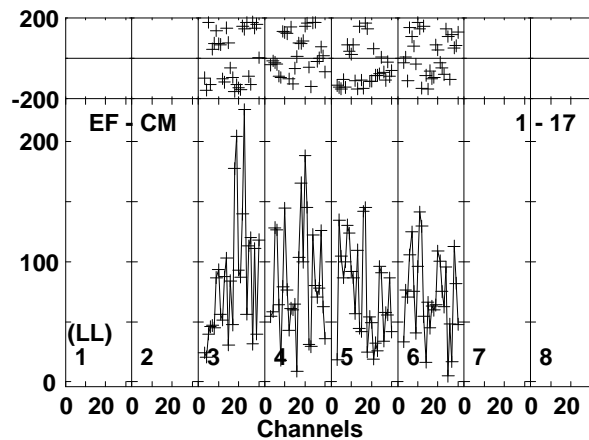
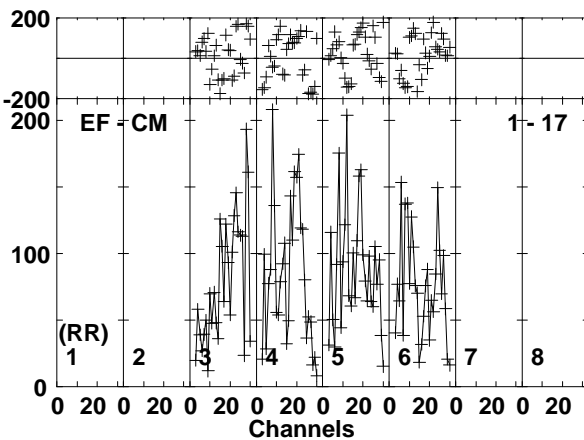
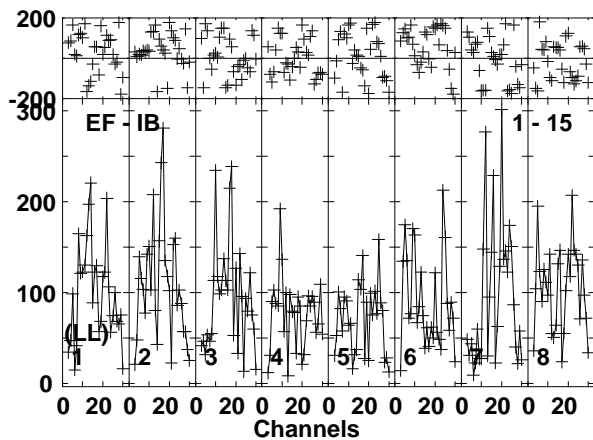
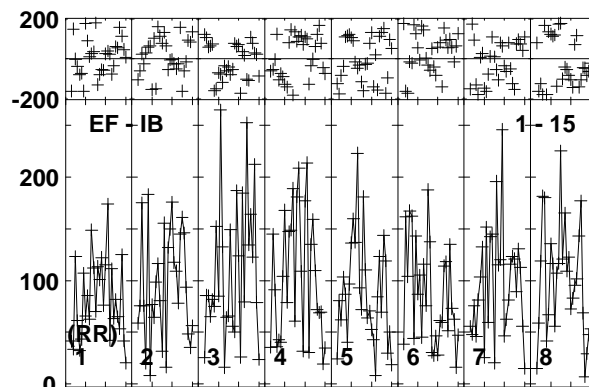
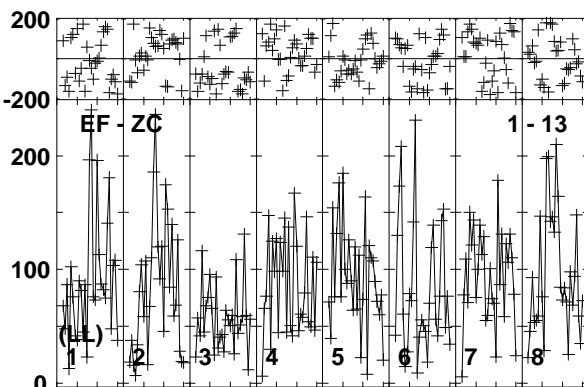
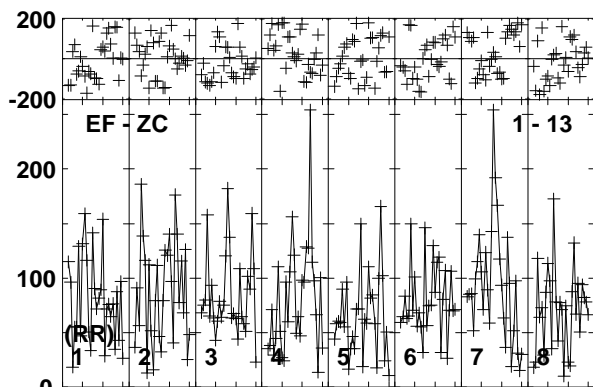
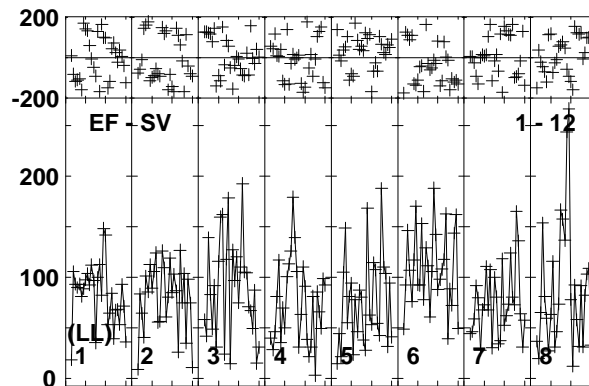
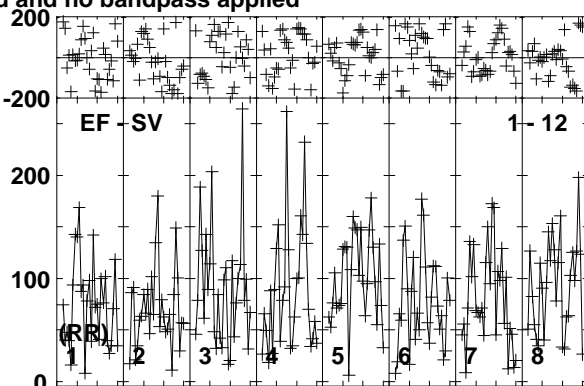
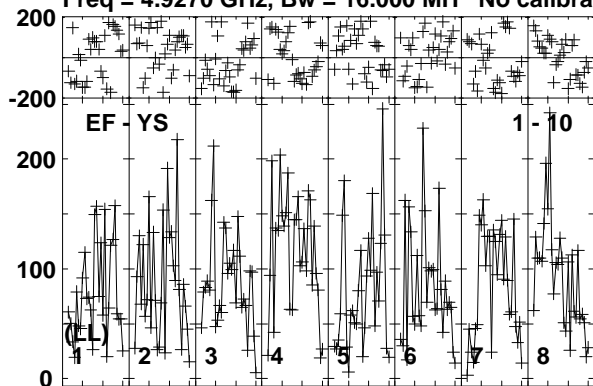

Lower frame: Micro Ampl Jy Top frame: Phas deg  
Vector averaged cross-power spectrum Baseline: EF (01) - YS (10)  
Timerange: 00/09:40:21 to 00/09:43:49

Plot file version 444 created 08-APR-2019 12:10:29

MRK622 EM133B.UVDATA.1

Freq = 4.9270 GHz, Bw = 16.000 MH No calibration applied and no bandpass applied

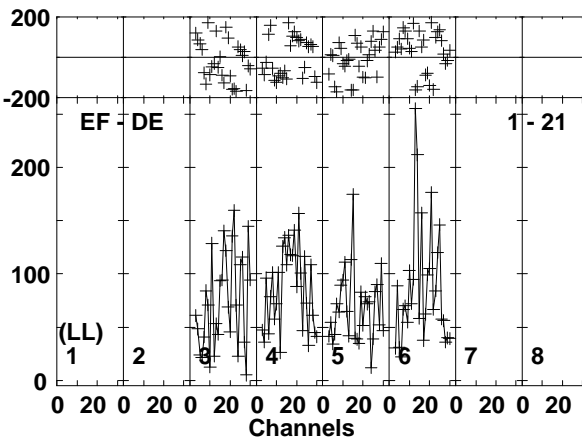
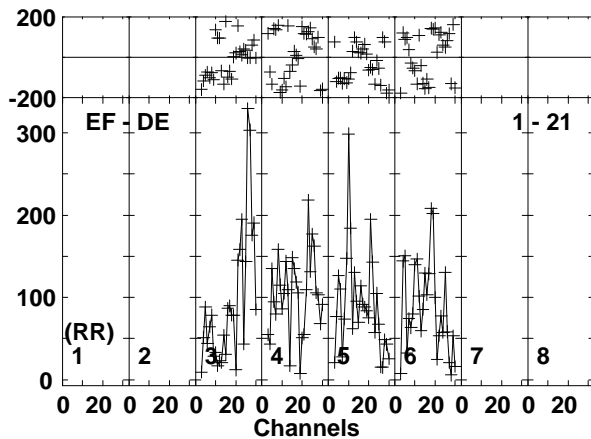
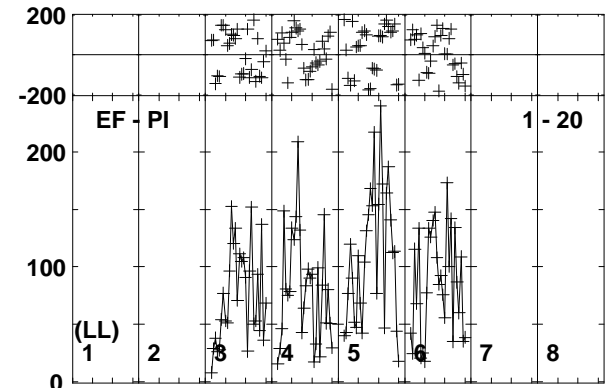
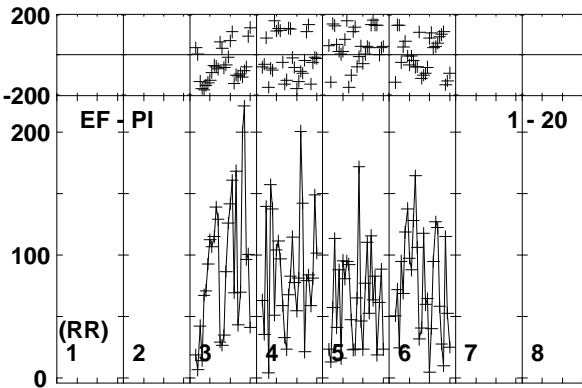
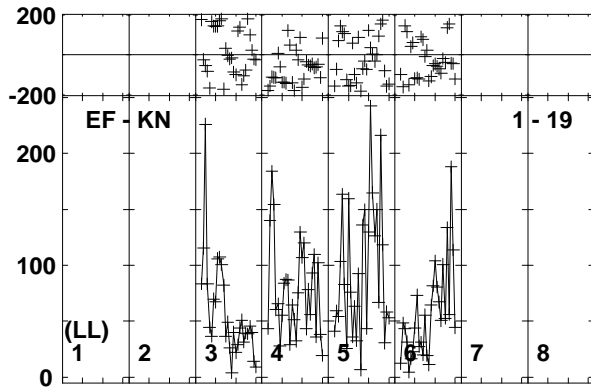
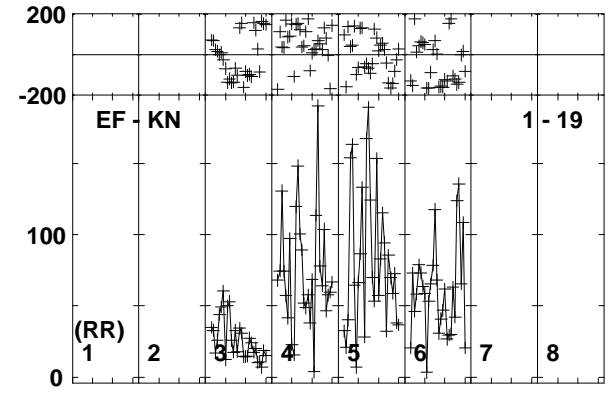
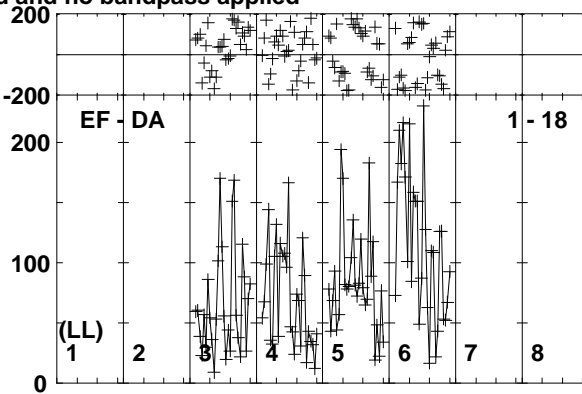
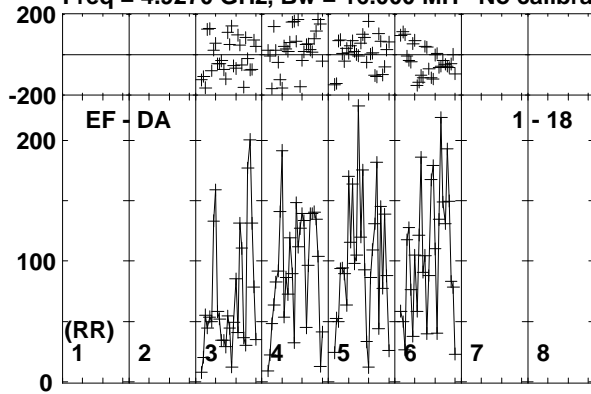

Lower frame: Micro Ampl Jy Top frame: Phas deg  
Vector averaged cross-power spectrum Baseline: EF (01) - DA (18)  
Timerange: 00/09:40:21 to 00/09:43:49

Plot file version 445 created 08-APR-2019 12:10:29

J0815+3635 EM133B.UVDATA.1

Freq = 4.9270 GHz, Bw = 16.000 MH No calibration applied and no bandpass applied

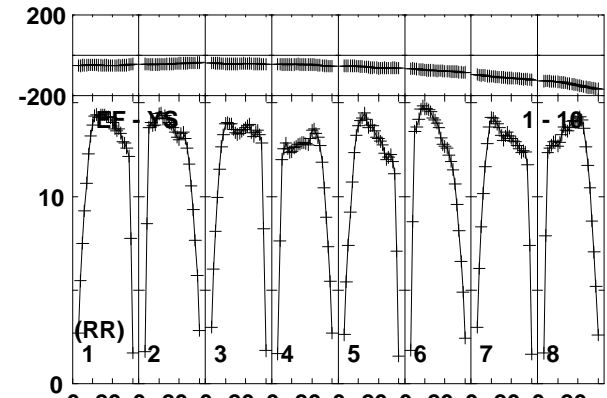
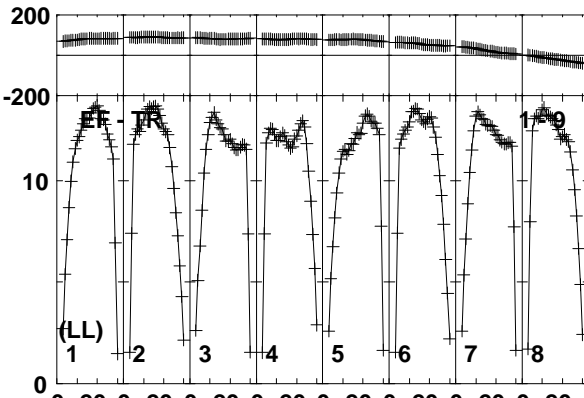
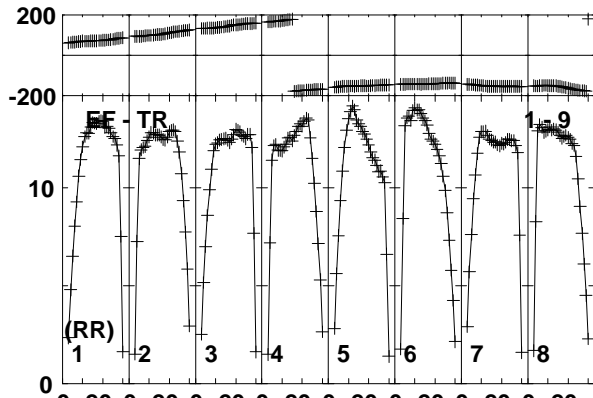
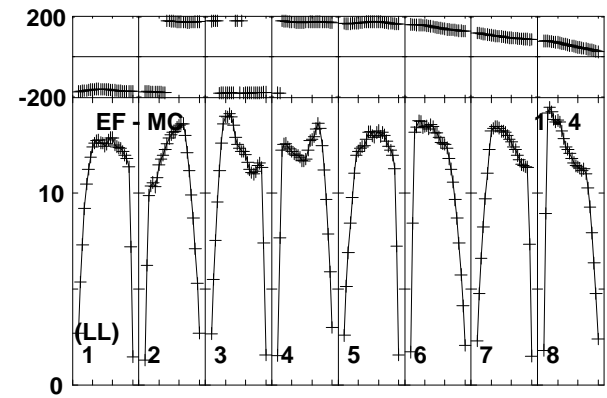
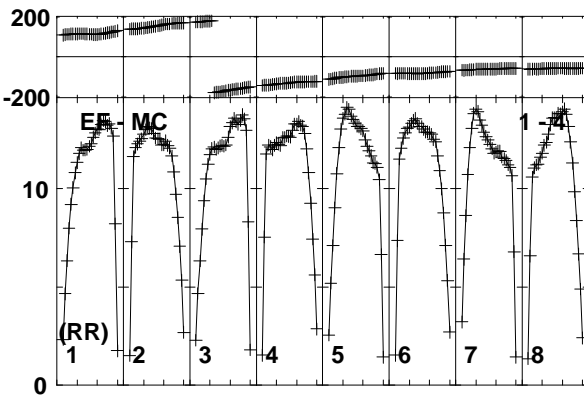
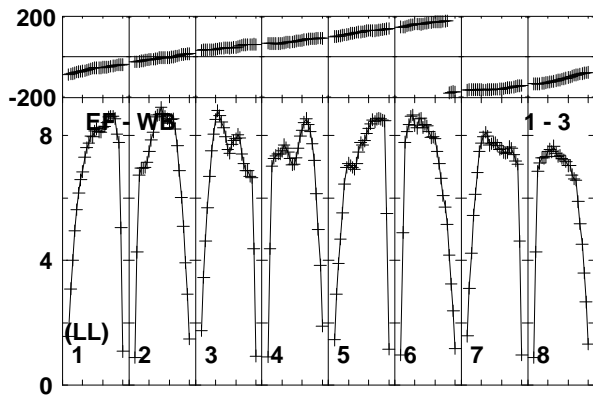
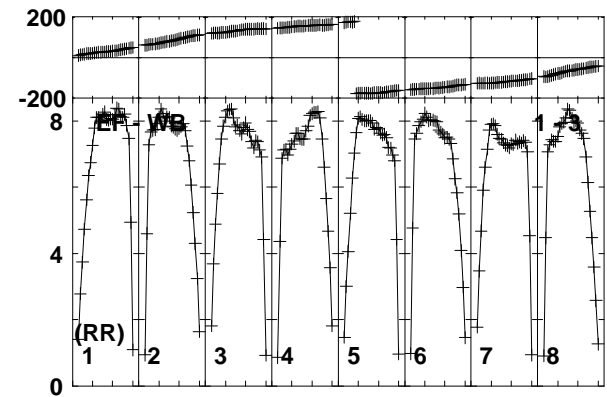
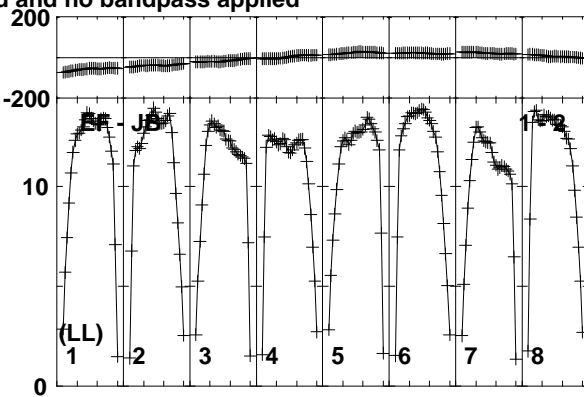
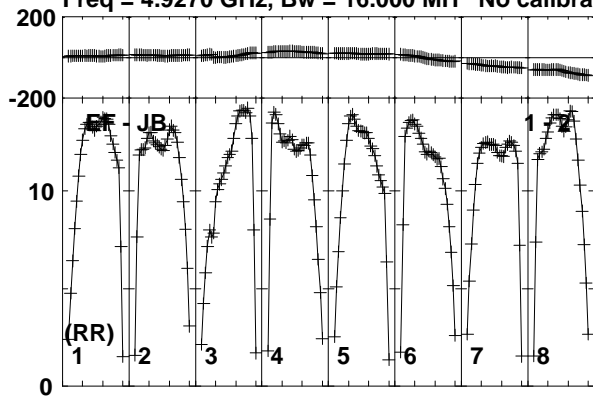

Lower frame: Milli Ampl Jy Top frame: Phas deg  
Vector averaged cross-power spectrum Baseline: EF (01) - JB (02)  
Timerange: 00/09:44:41 to 00/09:46:09

Plot file version 446 created 08-APR-2019 12:10:30

J0815+3635 EM133B.UVDATA.1

Freq = 4.9270 GHz, Bw = 16.000 MH No calibration applied and no bandpass applied

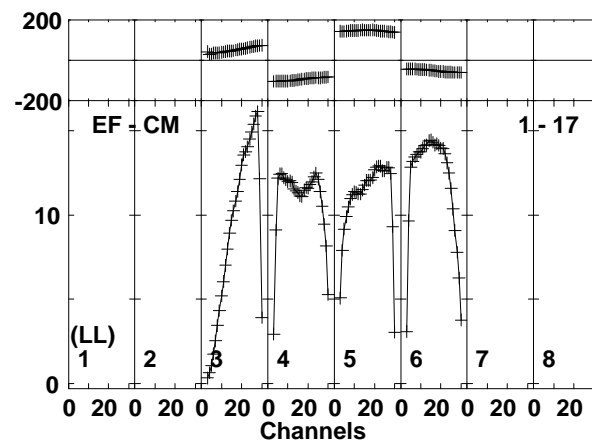
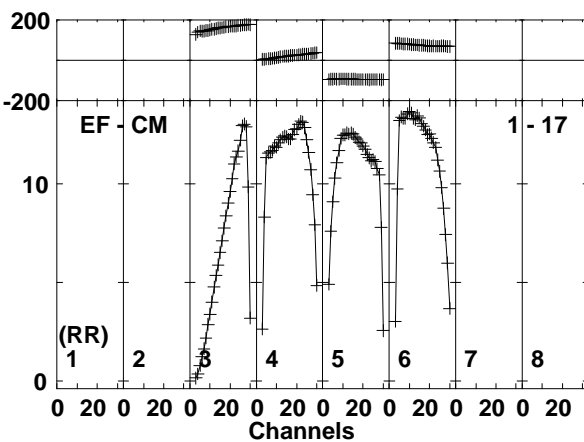
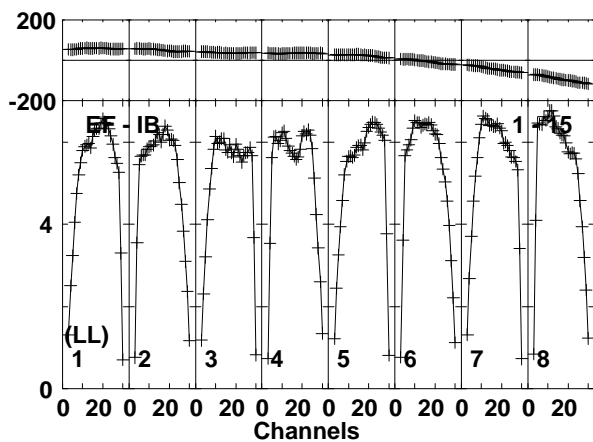
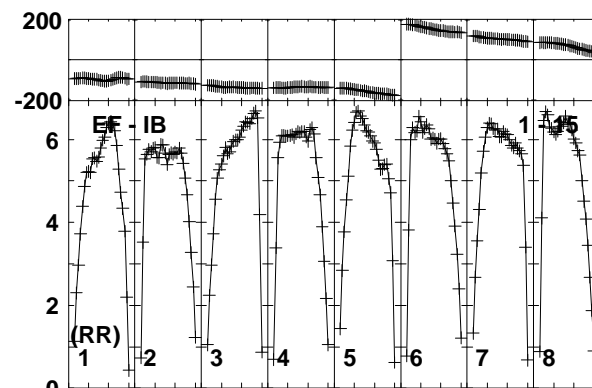
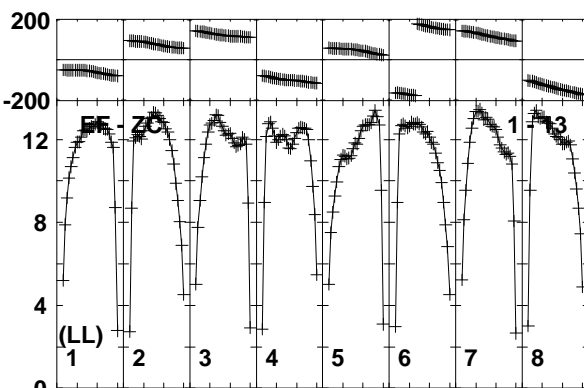
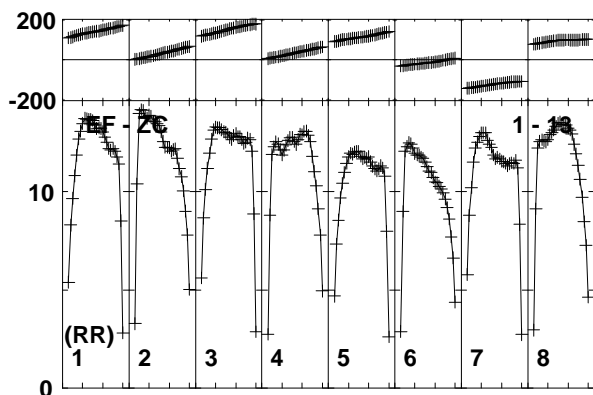
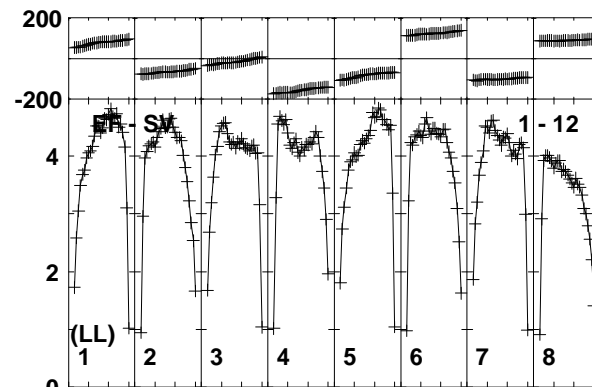
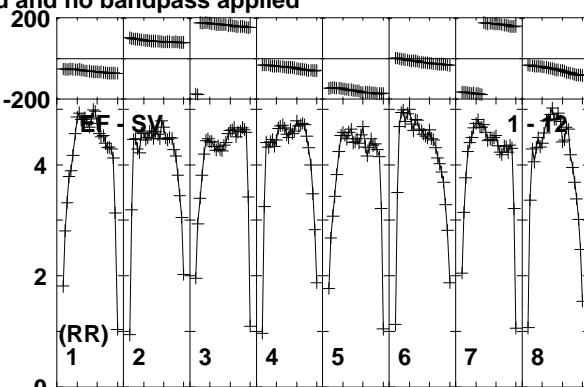
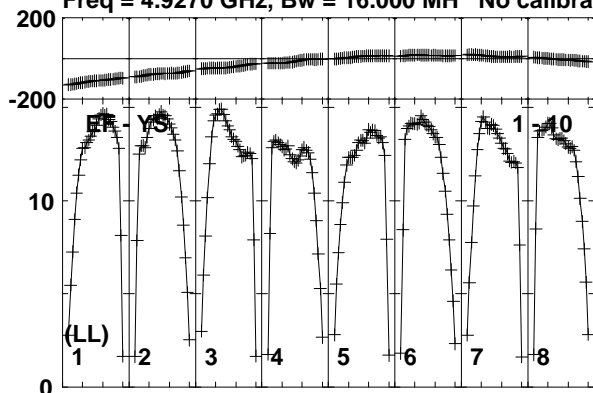

Lower frame: Milli Ampl Jy Top frame: Phas deg  
Vector averaged cross-power spectrum Baseline: EF (01) - YS (10)  
Timerange: 00/09:44:41 to 00/09:46:09

Plot file version 447 created 08-APR-2019 12:10:30

J0815+3635 EM133B.UVDATA.1

Freq = 4.9270 GHz, Bw = 16.000 MH No calibration applied and no bandpass applied

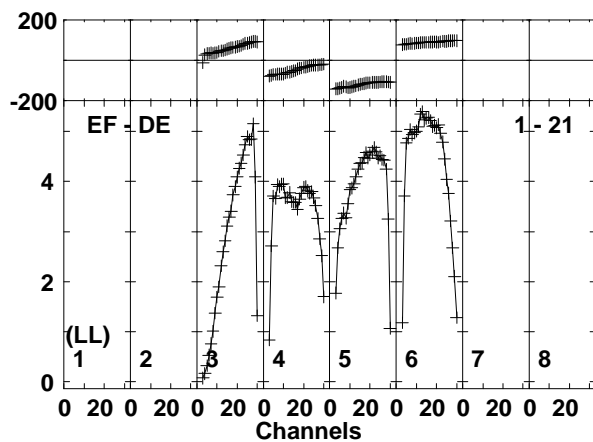
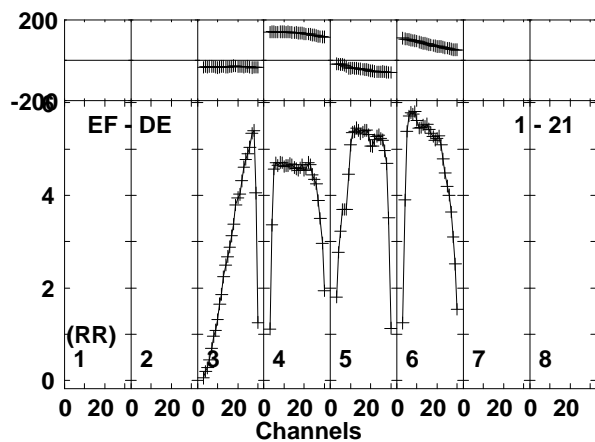
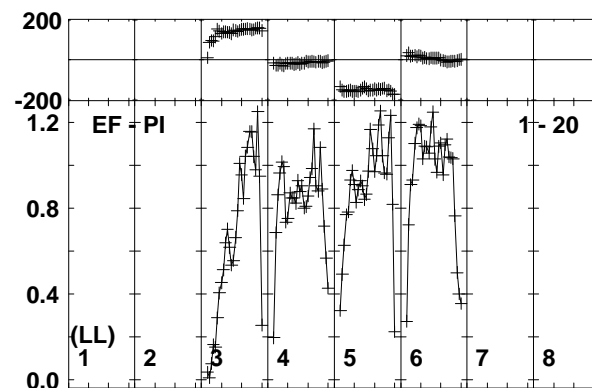
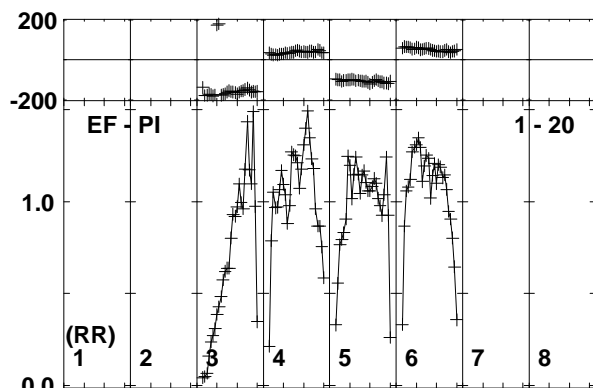
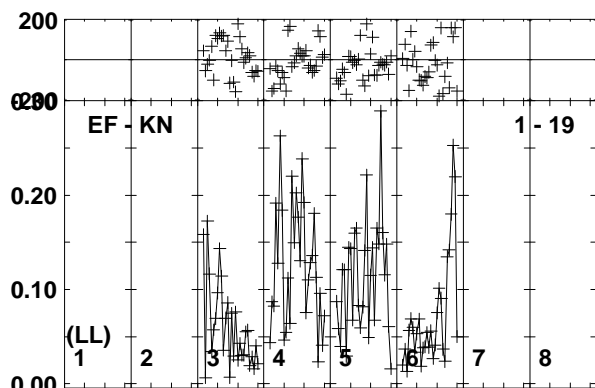
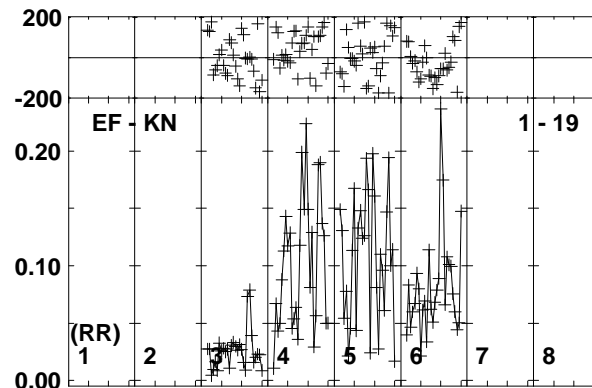
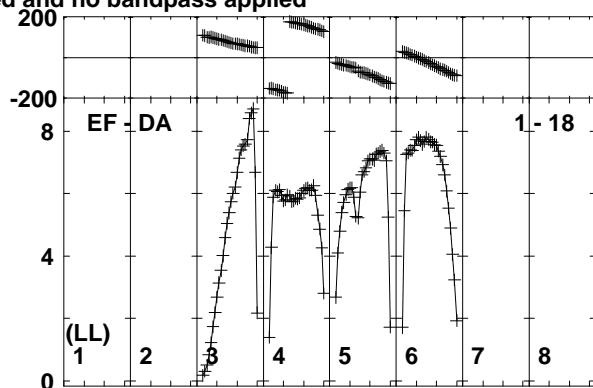
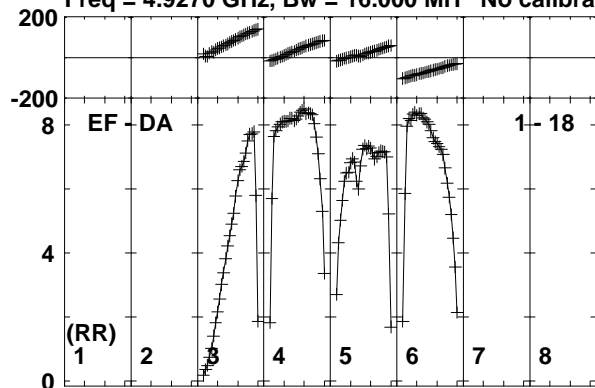

Lower frame: Milli Ampl Jy Top frame: Phas deg  
Vector averaged cross-power spectrum Baseline: EF (01) - DA (18)  
Timerange: 00/09:44:41 to 00/09:46:09

Plot file version 448 created 08-APR-2019 12:10:30

MRK622 EM133B.UVDATA.1

Freq = 4.9270 GHz, Bw = 16.000 MH No calibration applied and no bandpass applied

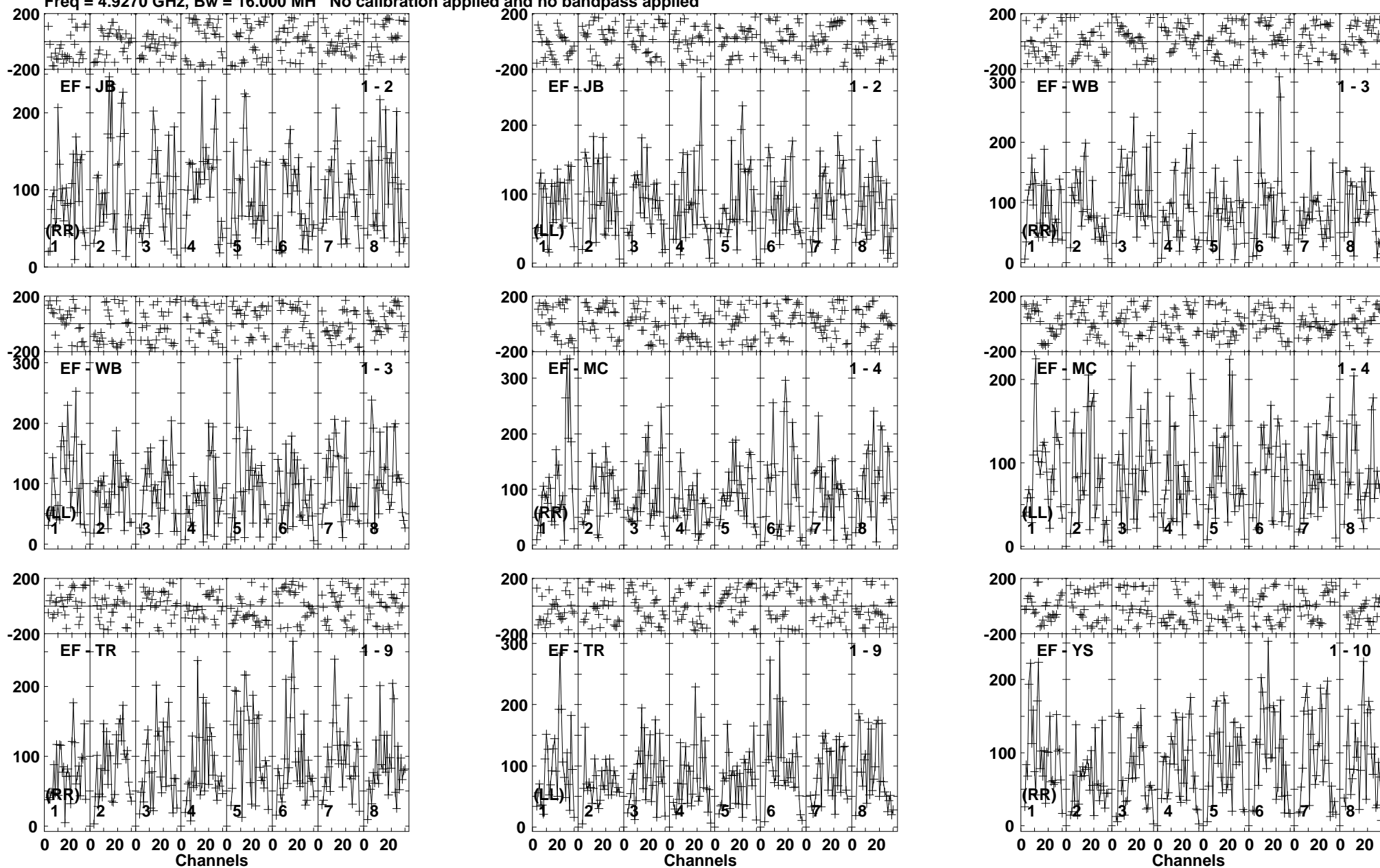

Lower frame: Micro Ampl Jy Top frame: Phas deg  
Vector averaged cross-power spectrum Baseline: EF (01) - JB (02)  
Timerange: 00/09:46:11 to 00/09:49:39



Plot file version 449 created 08-APR-2019 12:10:30

MRK622 EM133B.UVDATA.1

Freq = 4.9270 GHz, Bw = 16.000 MH No calibration applied and no bandpass applied

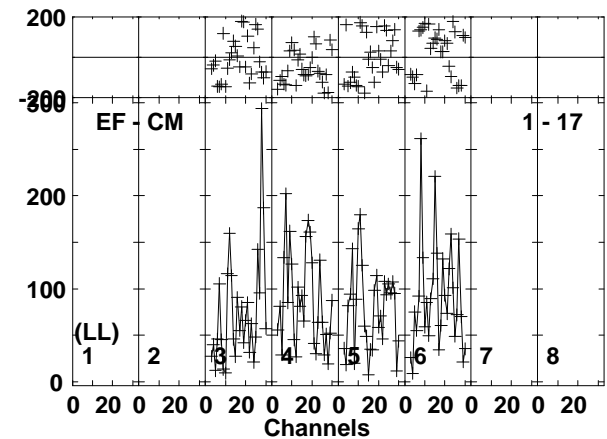
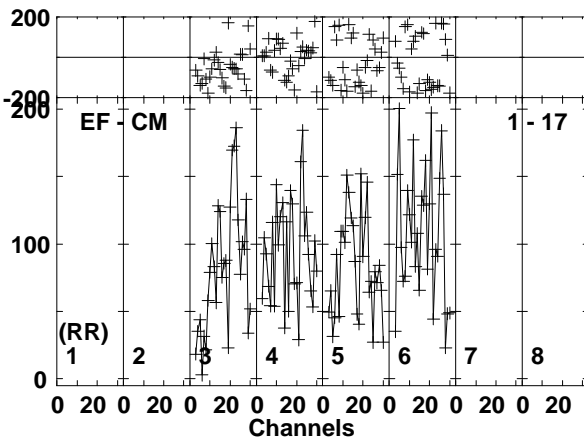
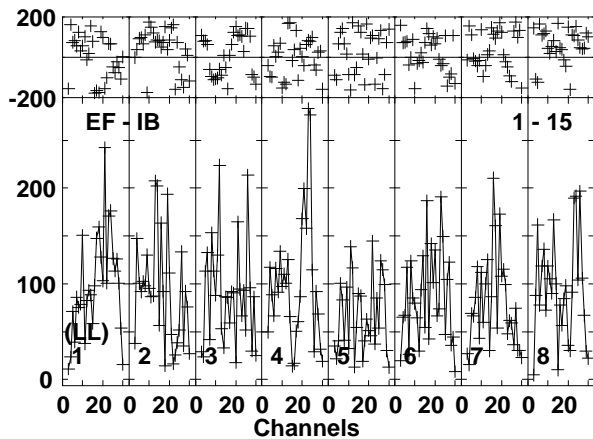
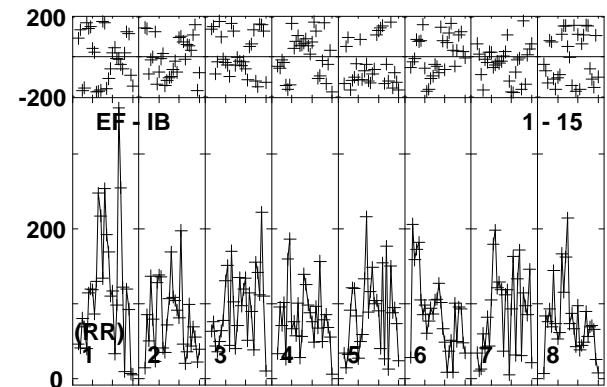
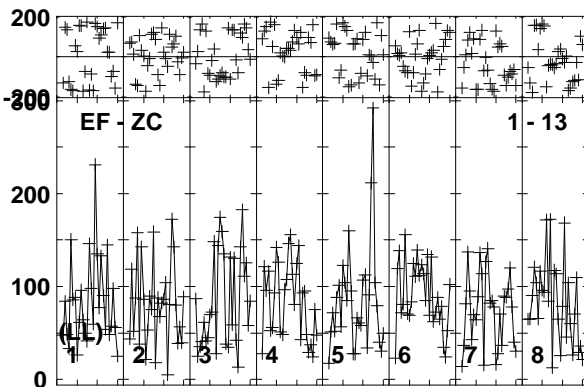
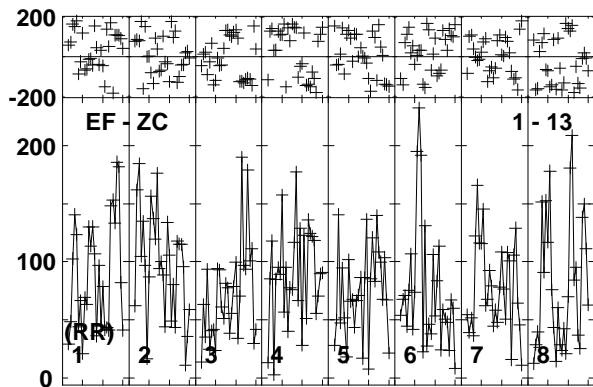
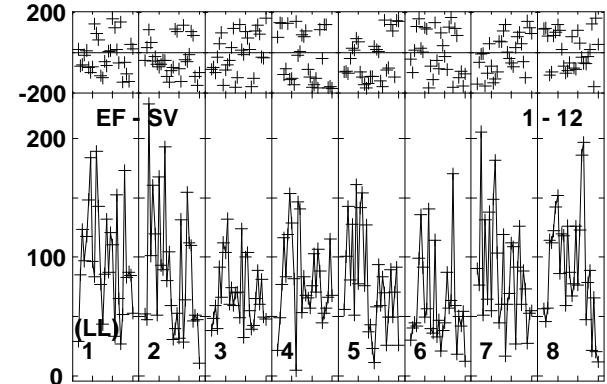
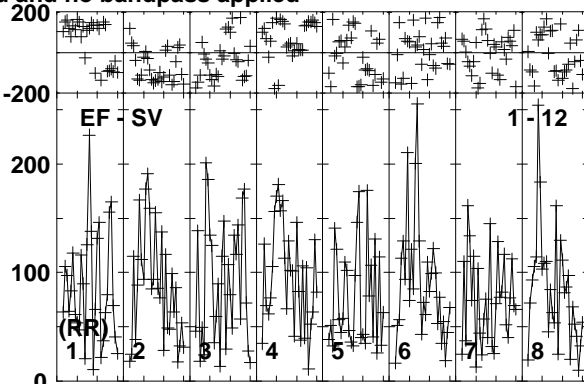
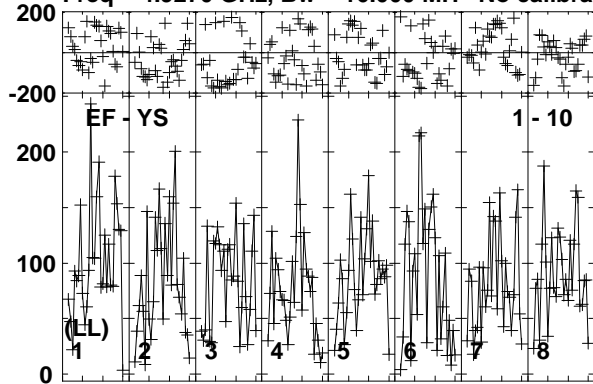

Lower frame: Micro Ampl Jy Top frame: Phas deg  
Vector averaged cross-power spectrum Baseline: EF (01) - YS (10)  
Timerange: 00/09:46:11 to 00/09:49:39

Plot file version 450 created 08-APR-2019 12:10:30

MRK622 EM133B.UVDATA.1

Freq = 4.9270 GHz, Bw = 16.000 MH No calibration applied and no bandpass applied

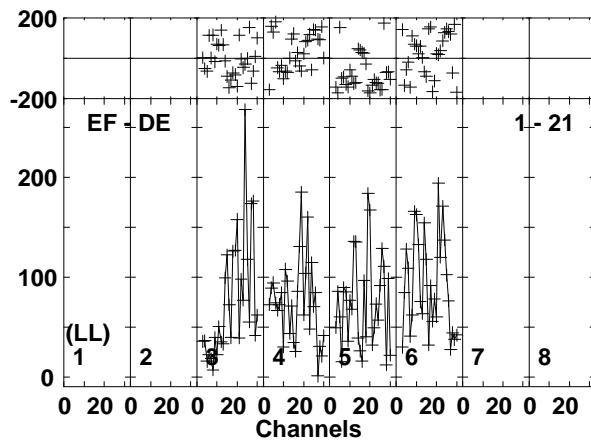
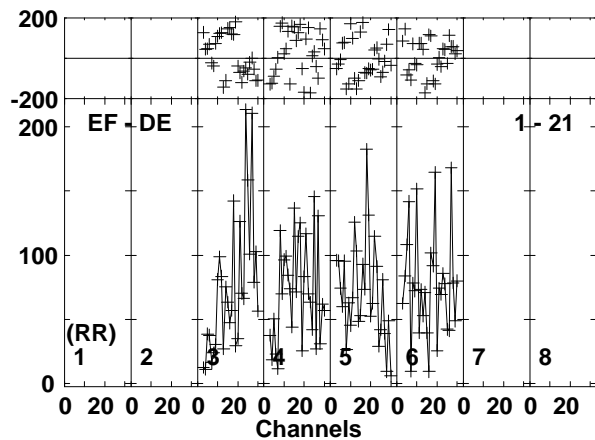
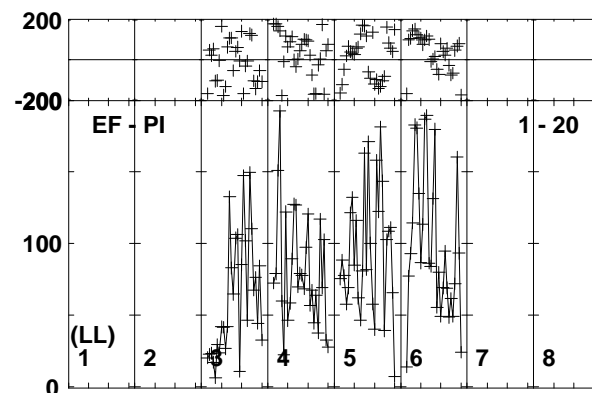
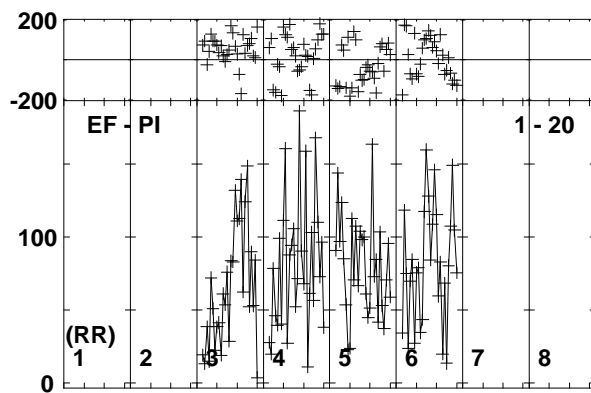
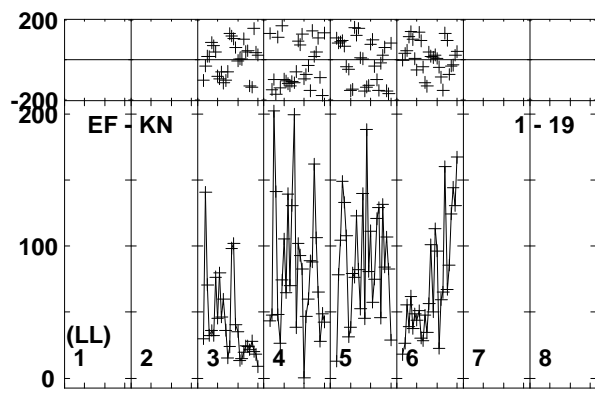
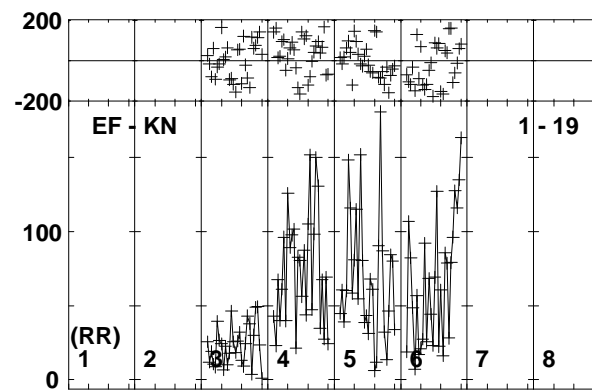
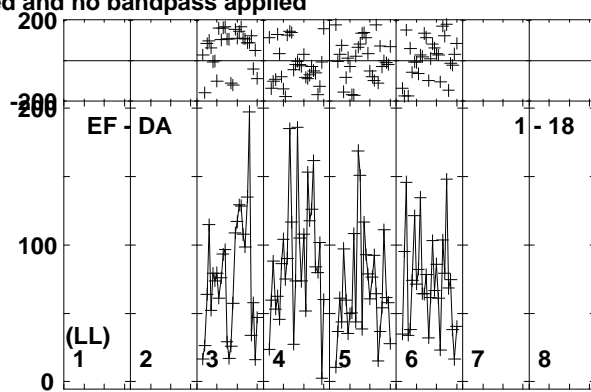
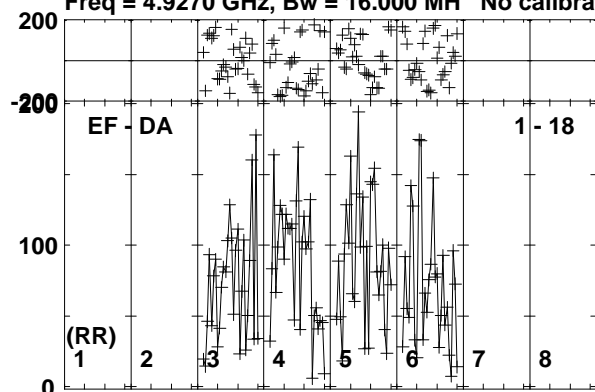

Lower frame: Micro Ampl Jy Top frame: Phas deg  
Vector averaged cross-power spectrum Baseline: EF (01) - DA (18)  
Timerange: 00/09:46:11 to 00/09:49:39

Plot file version 451 created 08-APR-2019 12:10:30

J0815+3635 EM133B.UVDATA.1

Freq = 4.9270 GHz, Bw = 16.000 MH No calibration applied and no bandpass applied

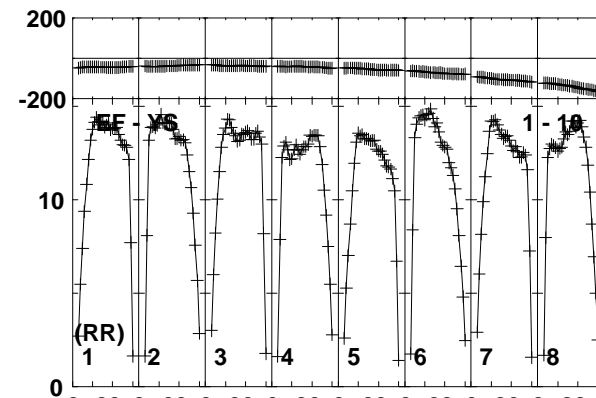
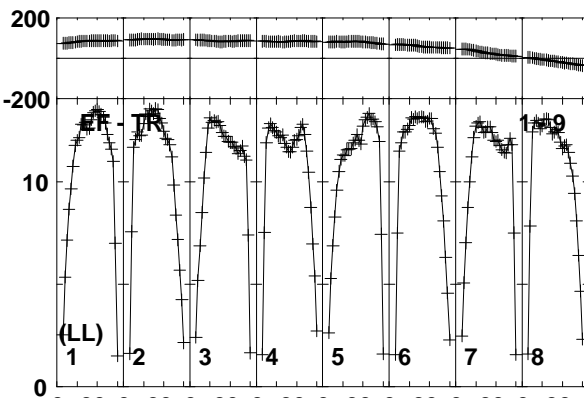
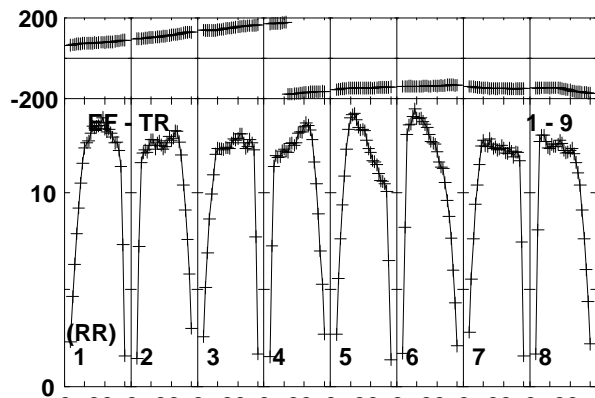
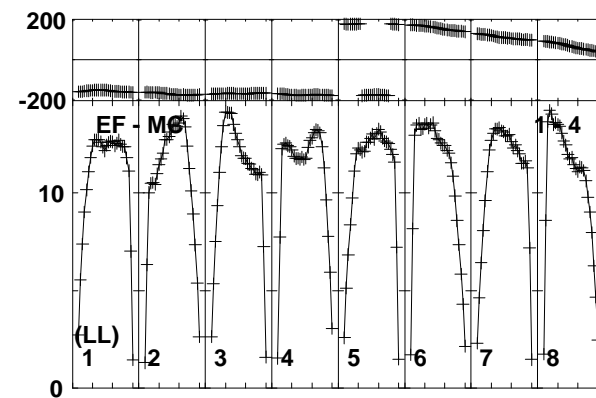
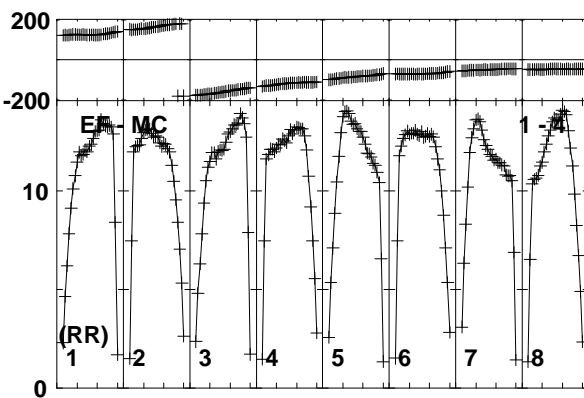
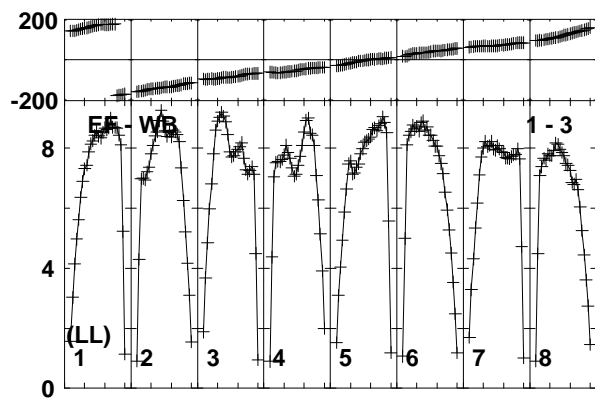
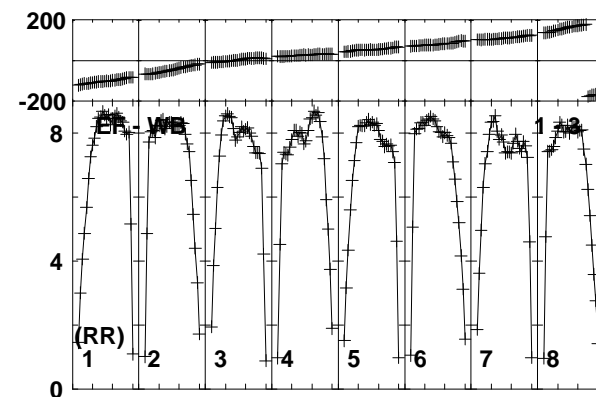
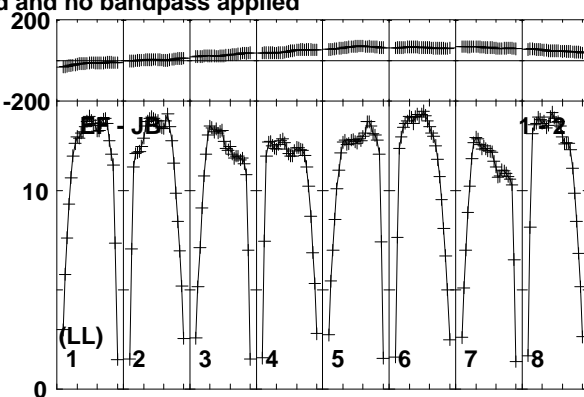
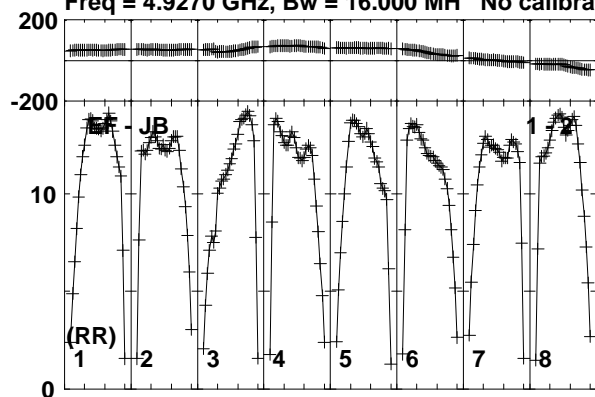

Lower frame: Milli Ampl Jy Top frame: Phas deg  
Vector averaged cross-power spectrum Baseline: EF (01) - JB (02)  
Timerange: 00/09:49:41 to 00/09:51:09

Plot file version 452 created 08-APR-2019 12:10:31

J0815+3635 EM133B.UVDATA.1

Freq = 4.9270 GHz, Bw = 16.000 MH No calibration applied and no bandpass applied

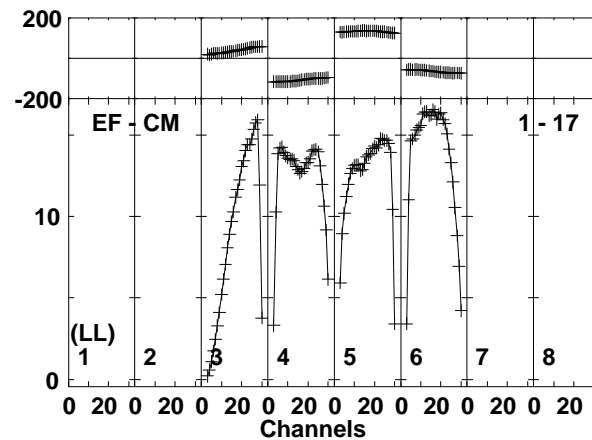
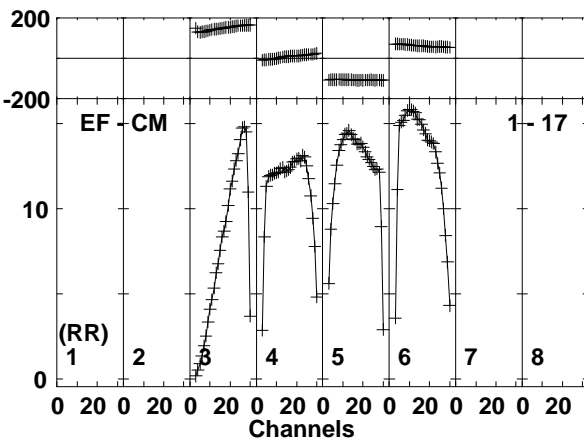
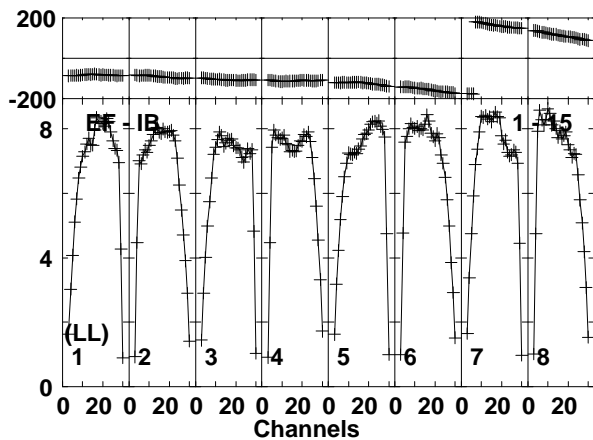
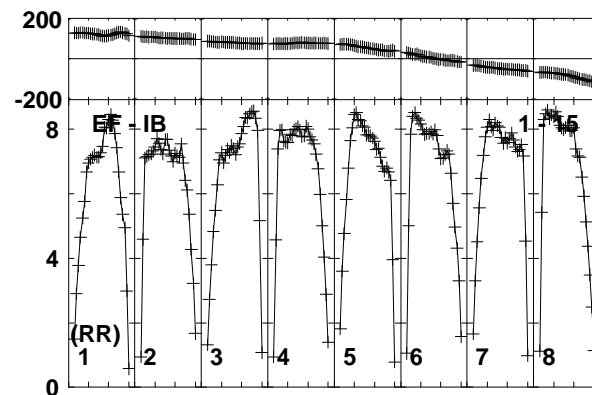
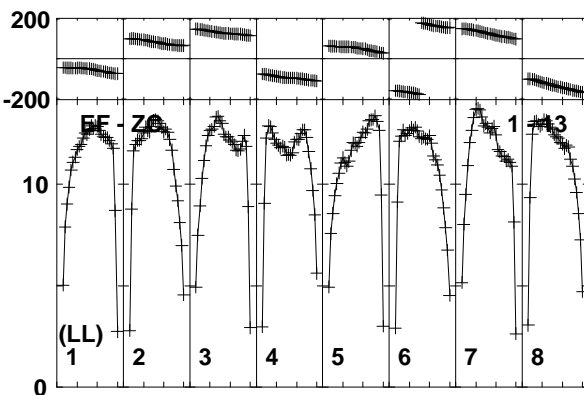
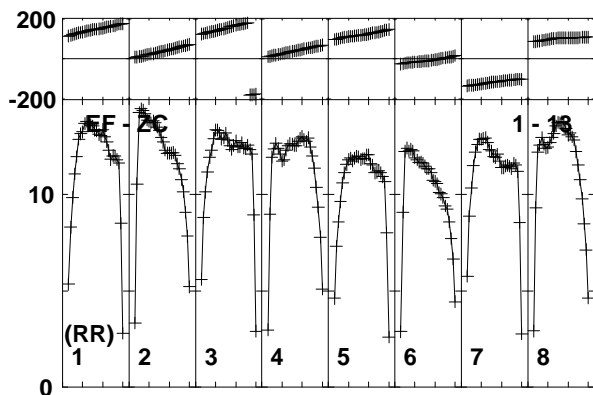
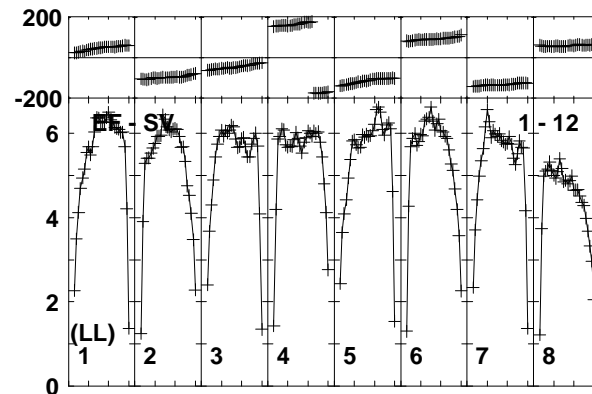
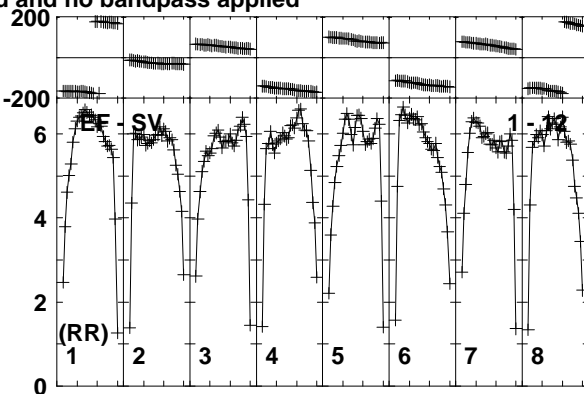
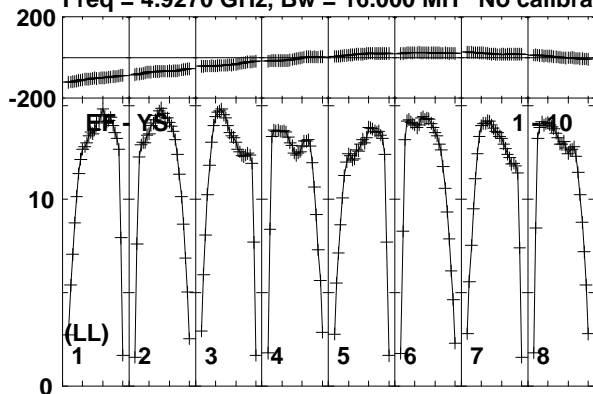

Lower frame: Milli Ampl Jy Top frame: Phas deg  
Vector averaged cross-power spectrum Baseline: EF (01) - YS (10)  
Timerange: 00:09:49:41 to 00:09:51:09

Plot file version 453 created 08-APR-2019 12:10:31

J0815+3635 EM133B.UVDATA.1

Freq = 4.9270 GHz, Bw = 16.000 MH No calibration applied and no bandpass applied

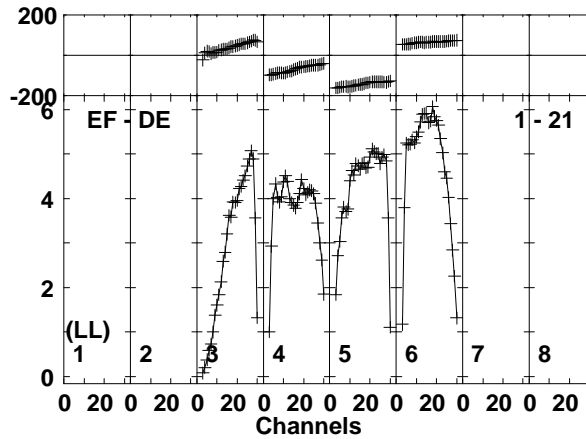
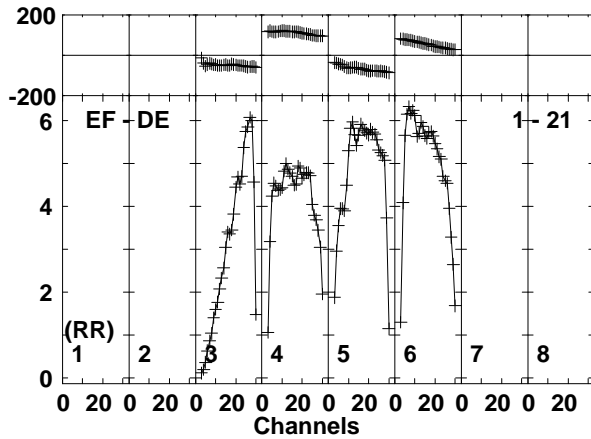
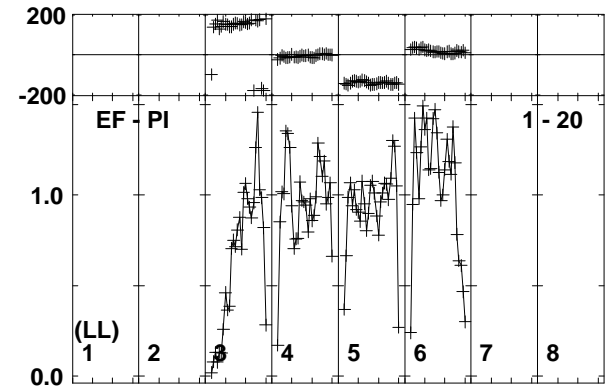
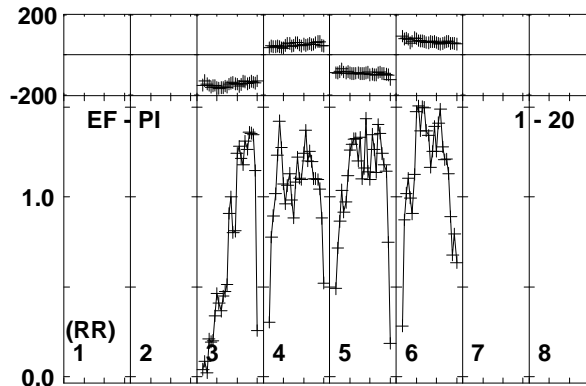
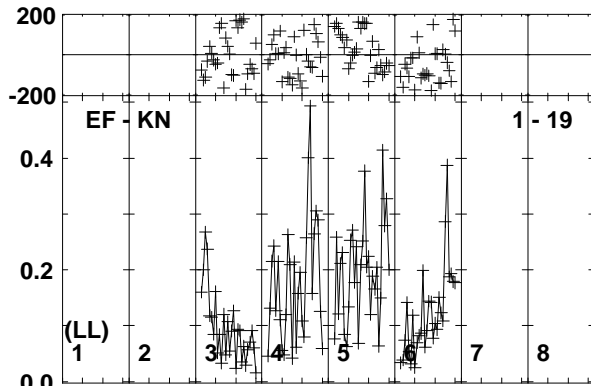
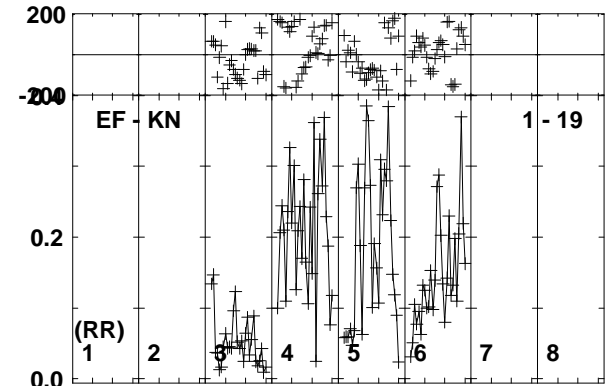
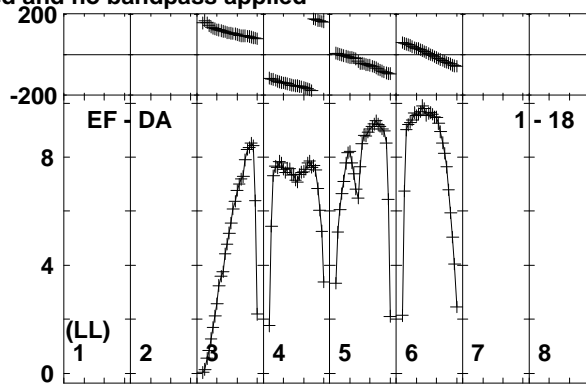
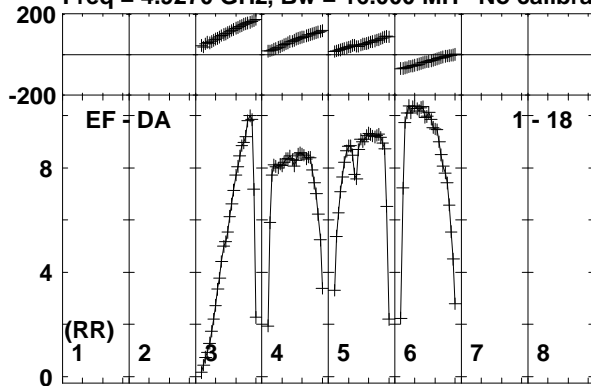

Lower frame: Milli Ampl Jy Top frame: Phas deg  
Vector averaged cross-power spectrum Baseline: EF (01) - DA (18)  
Timerange: 00/09:49:41 to 00/09:51:09

Plot file version 454 created 08-APR-2019 12:10:31

MRK622 EM133B.UVDATA.1

Freq = 4.9270 GHz, Bw = 16.000 MH No calibration applied and no bandpass applied

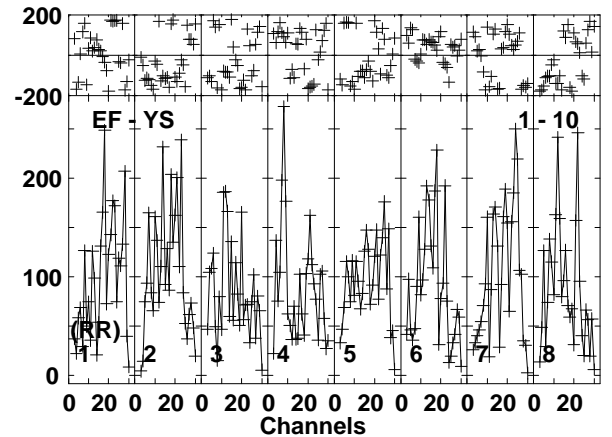
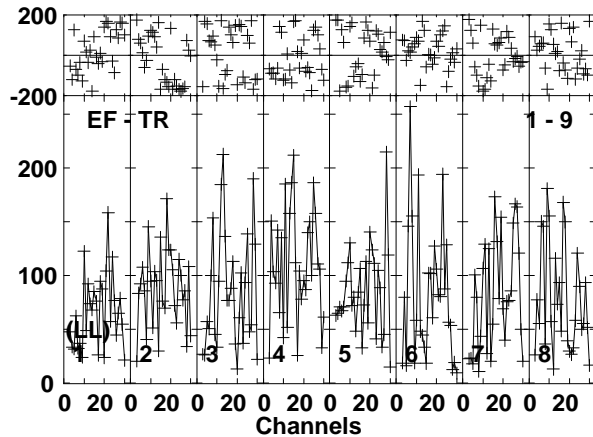
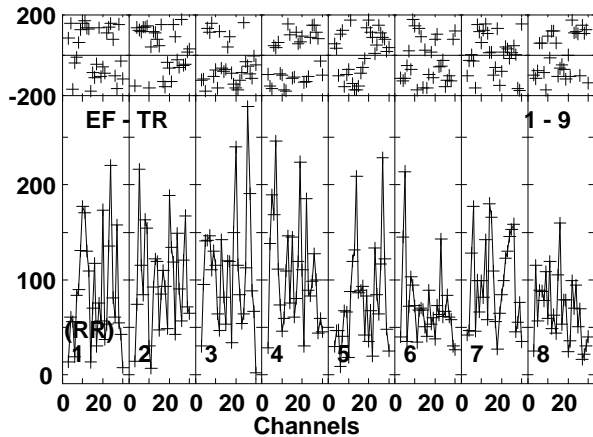
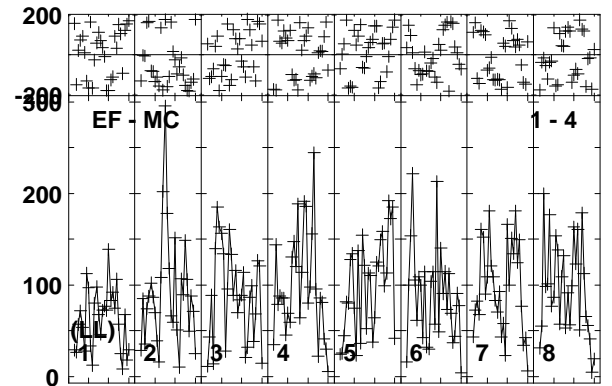
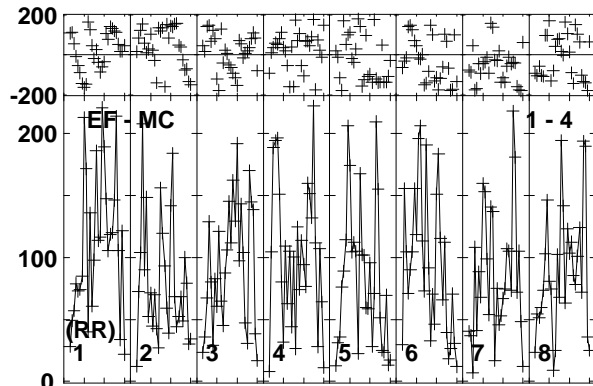
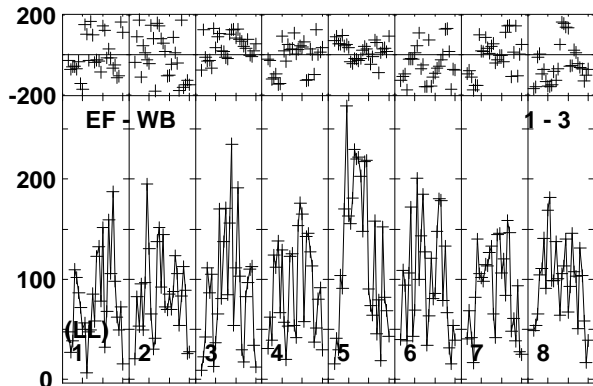
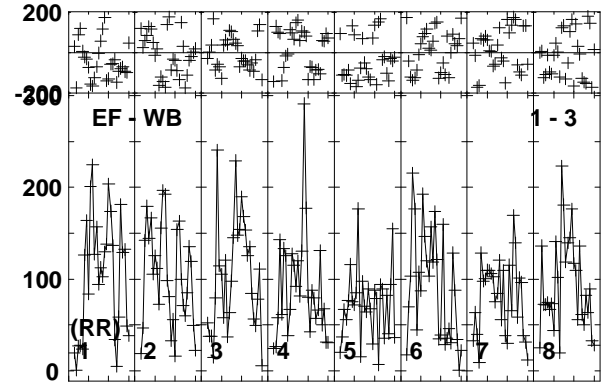
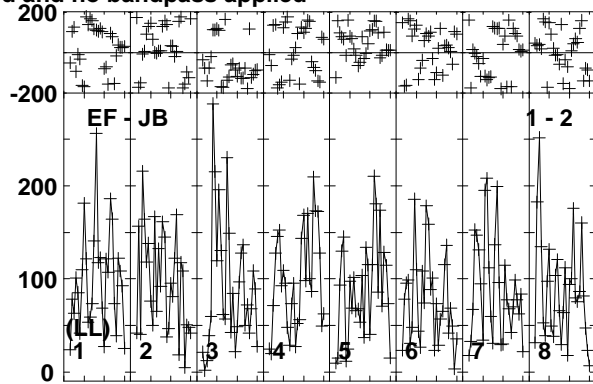
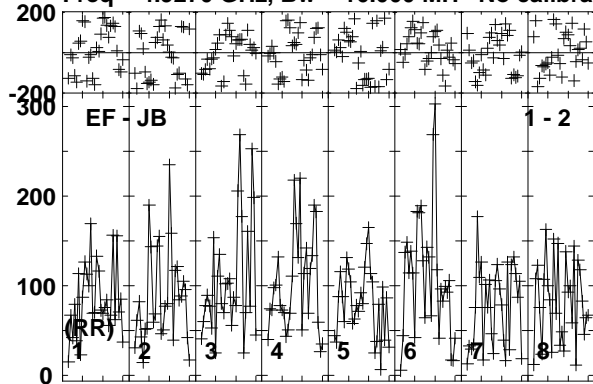

Lower frame: Micro Ampl Jy Top frame: Phas deg  
Vector averaged cross-power spectrum Baseline: EF (01) - JB (02)  
Timerange: 00/09:51:13 to 00/09:54:39

Plot file version 455 created 08-APR-2019 12:10:31

MRK622 EM133B.UVDATA.1

Freq = 4.9270 GHz, Bw = 16.000 MH No calibration applied and no bandpass applied

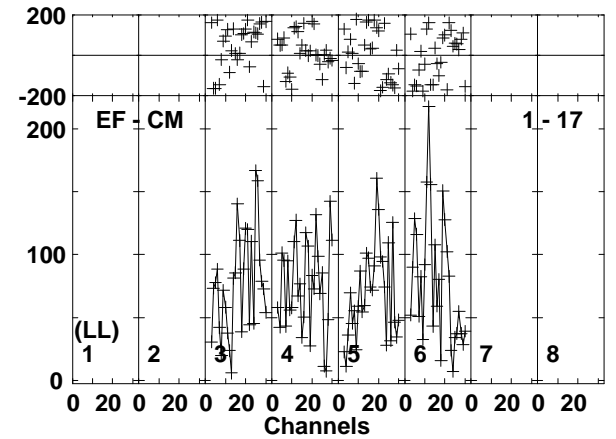
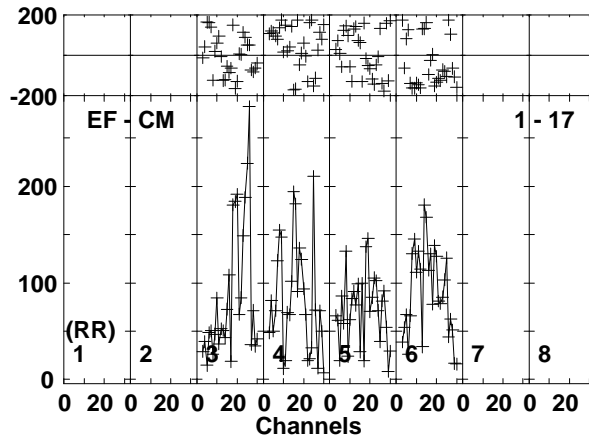
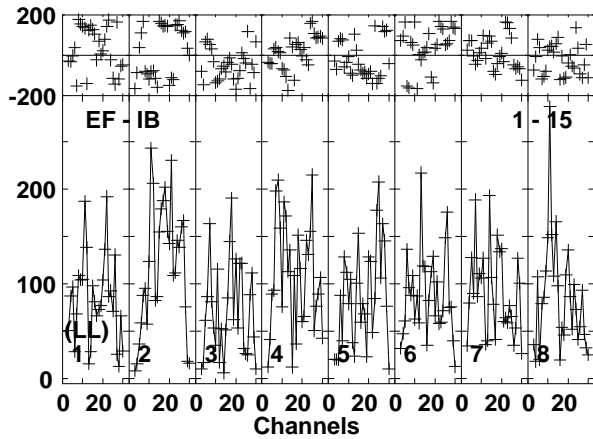
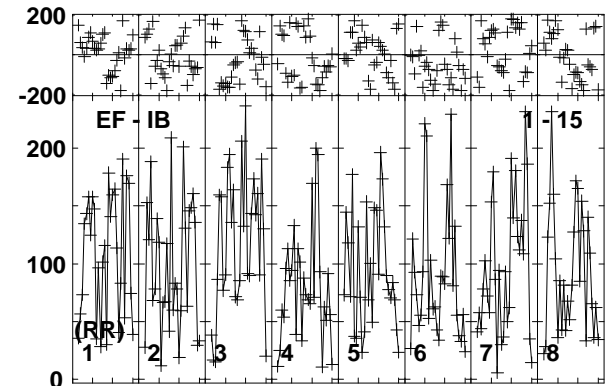
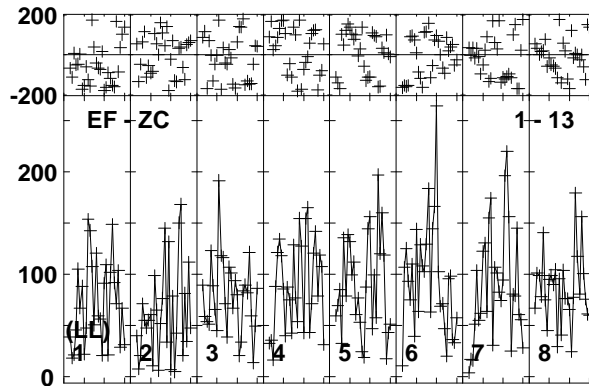
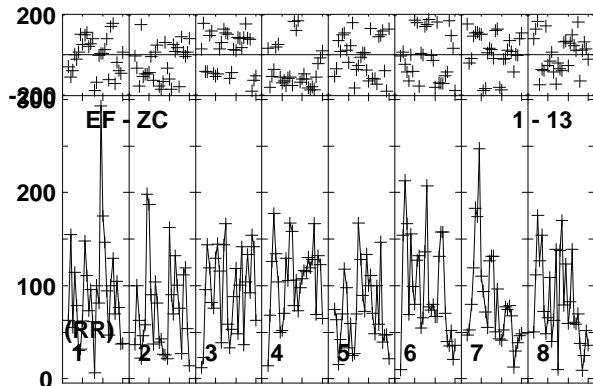
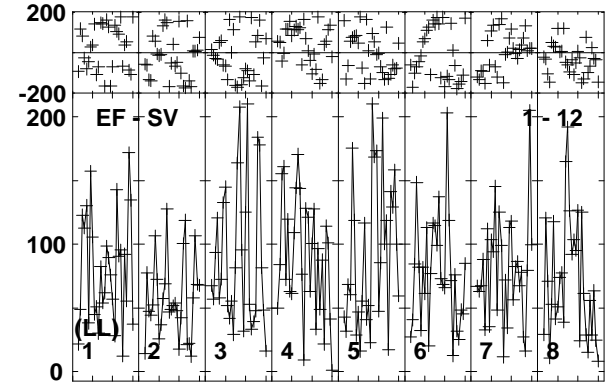
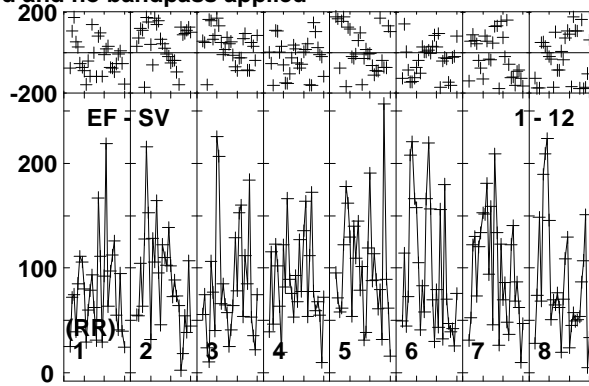
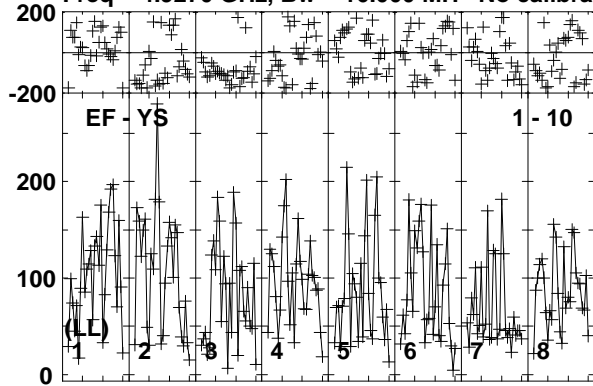

Lower frame: Micro Ampl Jy Top frame: Phas deg  
Vector averaged cross-power spectrum Baseline: EF (01) - YS (10)  
Timerange: 00/09:51:13 to 00/09:54:39

Plot file version 456 created 08-APR-2019 12:10:31

MRK622 EM133B.UVDATA.1

Freq = 4.9270 GHz, Bw = 16.000 MH No calibration applied and no bandpass applied

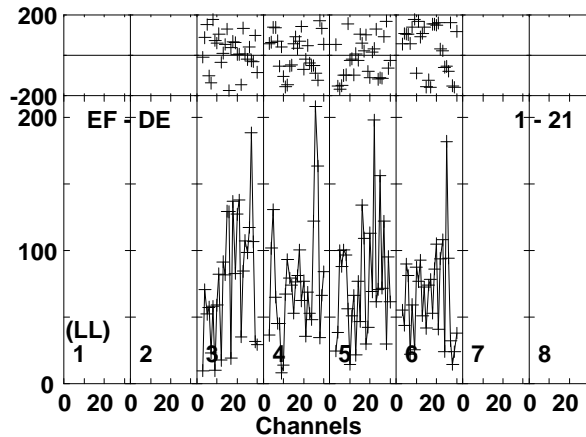
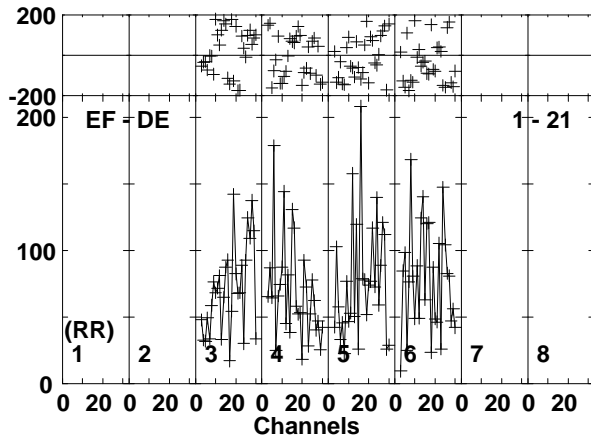
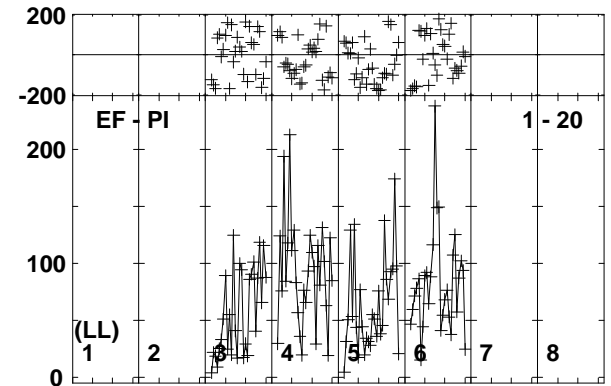
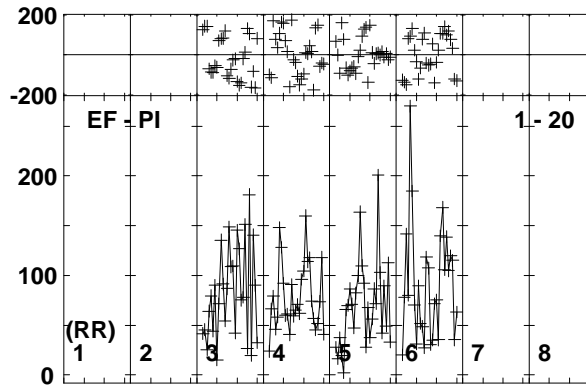
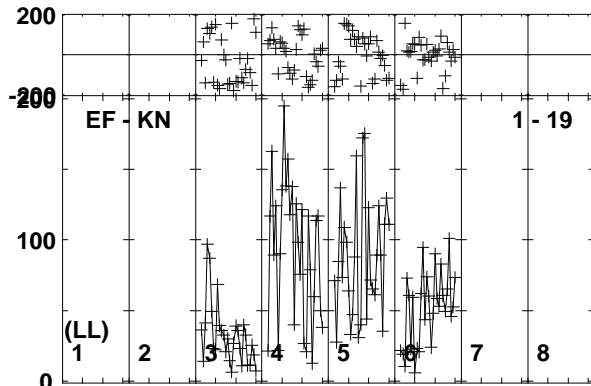
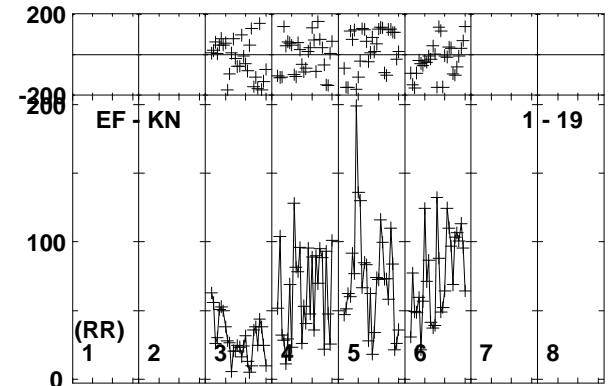
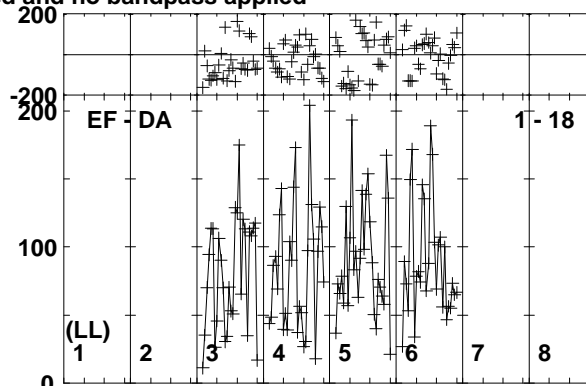
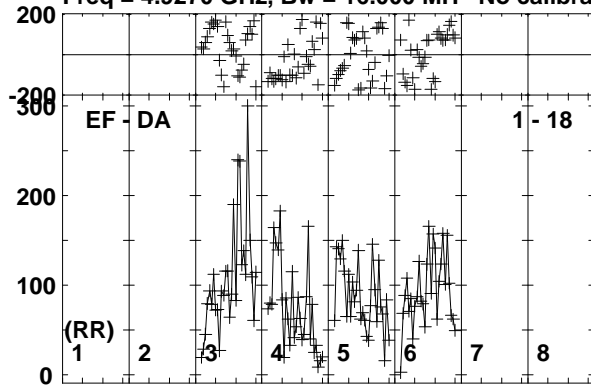

Lower frame: Micro Ampl Jy Top frame: Phas deg  
Vector averaged cross-power spectrum Baseline: EF (01) - DA (18)  
Timerange: 00/09:51:13 to 00/09:54:39



Plot file version 457 created 08-APR-2019 12:10:31

J0815+3635 EM133B.UVDATA.1

Freq = 4.9270 GHz, Bw = 16.000 MH No calibration applied and no bandpass applied

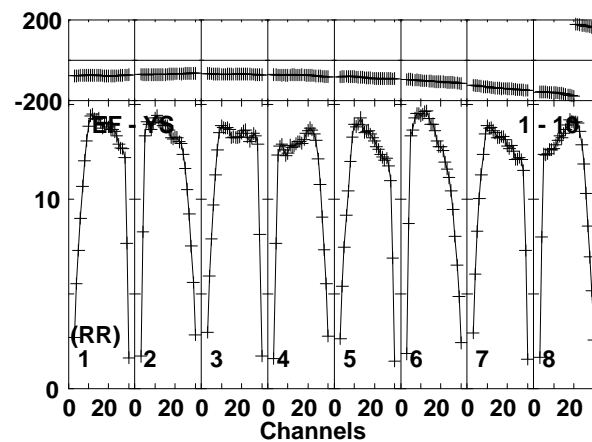
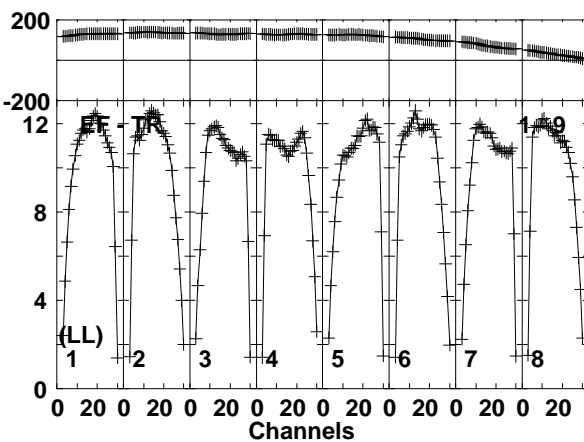
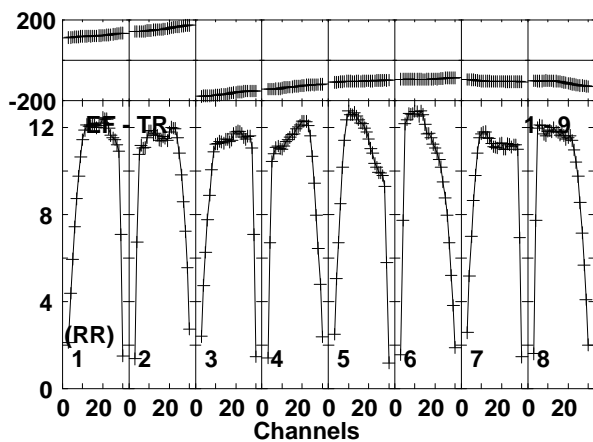
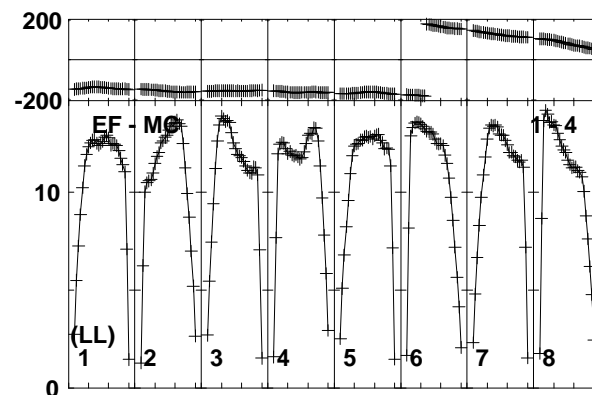
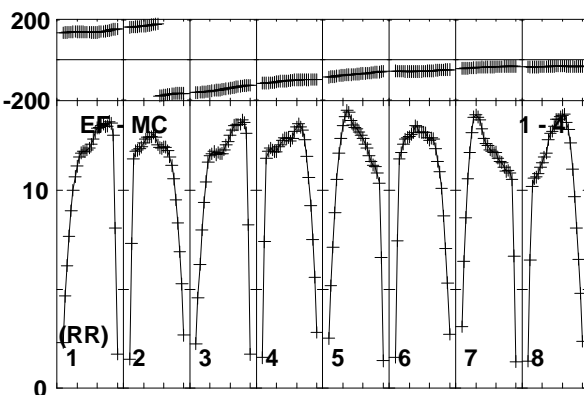
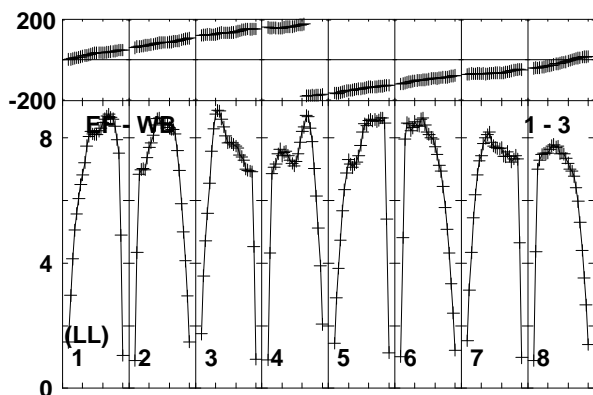
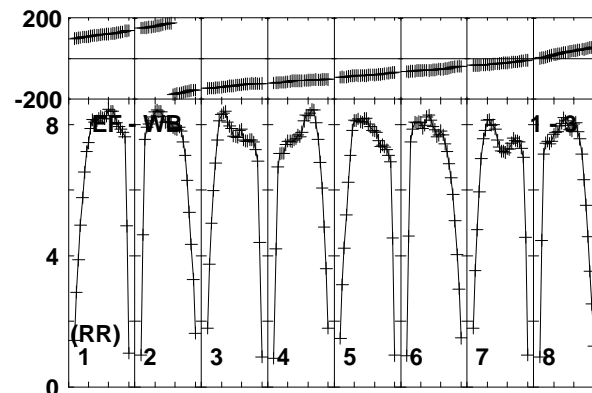
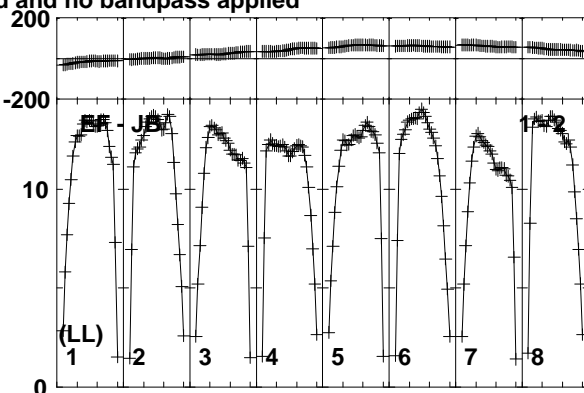
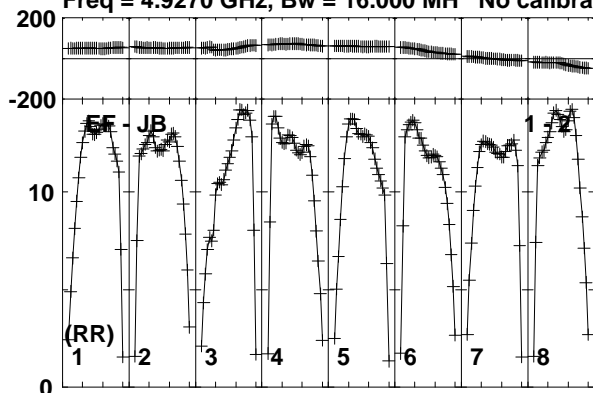

Lower frame: Milli Ampl Jy Top frame: Phas deg  
Vector averaged cross-power spectrum Baseline: EF (01) - JB (02)  
Timerange: 00/09:55:31 to 00/09:56:59

Plot file version 458 created 08-APR-2019 12:10:32

J0815+3635 EM133B.UVDATA.1

Freq = 4.9270 GHz, Bw = 16.000 MH No calibration applied and no bandpass applied

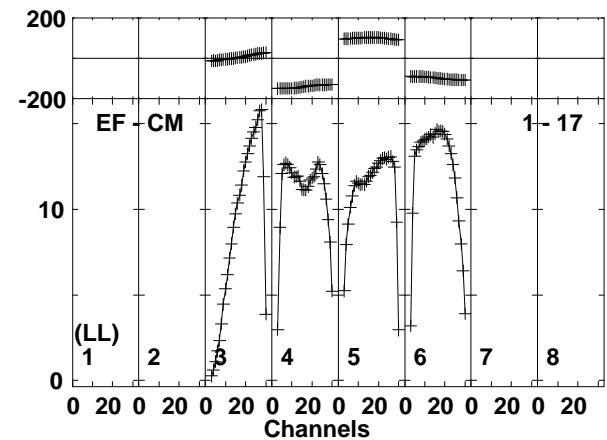
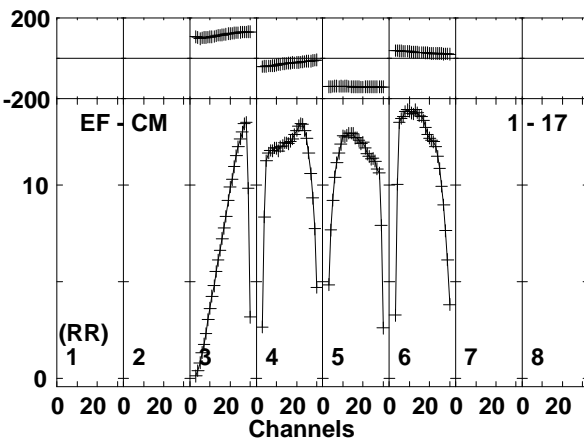
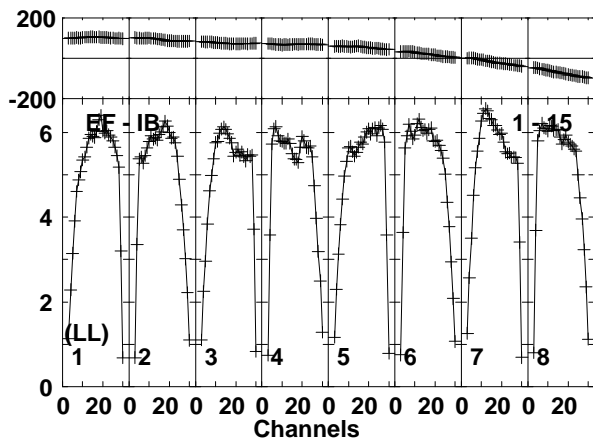
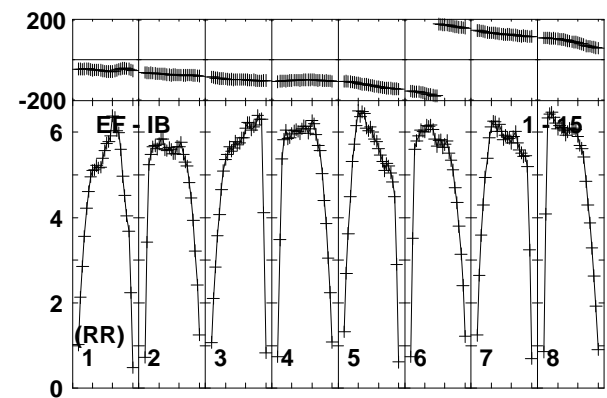
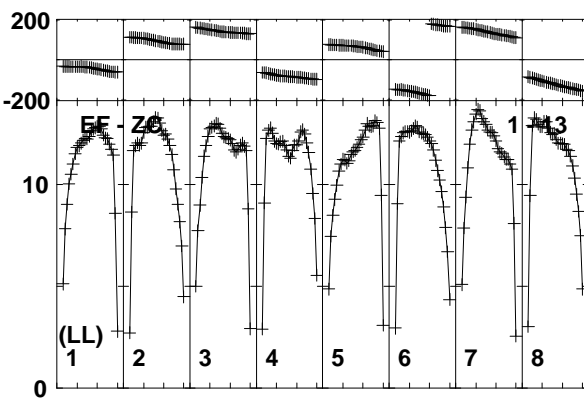
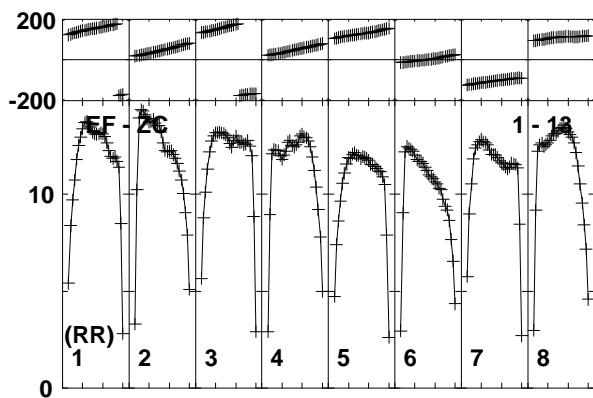
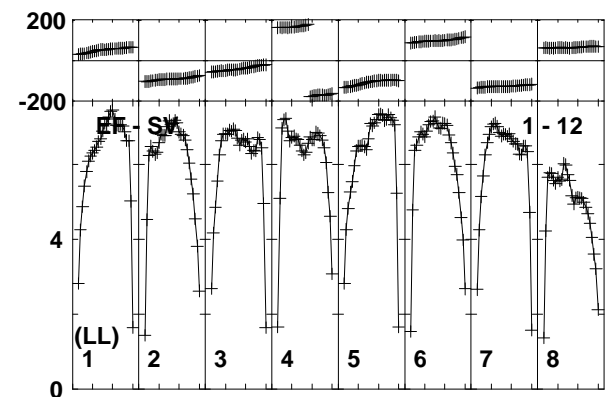
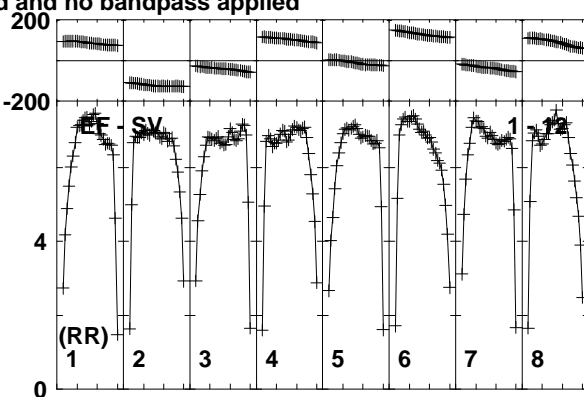
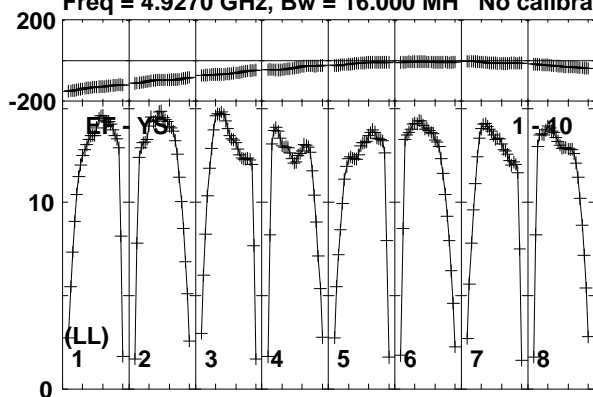

Lower frame: Milli Ampl Jy Top frame: Phas deg  
Vector averaged cross-power spectrum Baseline: EF (01) - YS (10)  
Timerange: 00/09:55:31 to 00/09:56:59

Plot file version 459 created 08-APR-2019 12:10:32

J0815+3635 EM133B.UVDATA.1

Freq = 4.9270 GHz, Bw = 16.000 MH No calibration applied and no bandpass applied

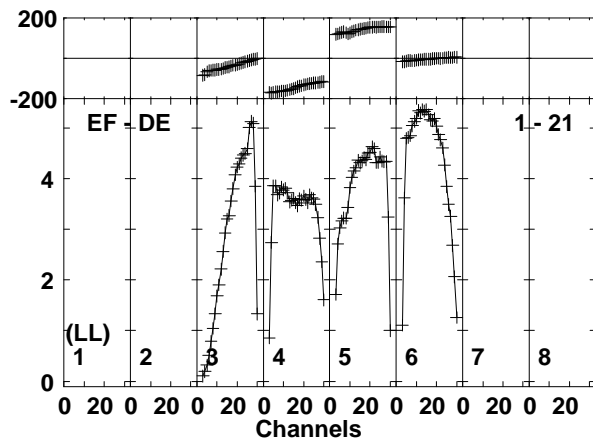
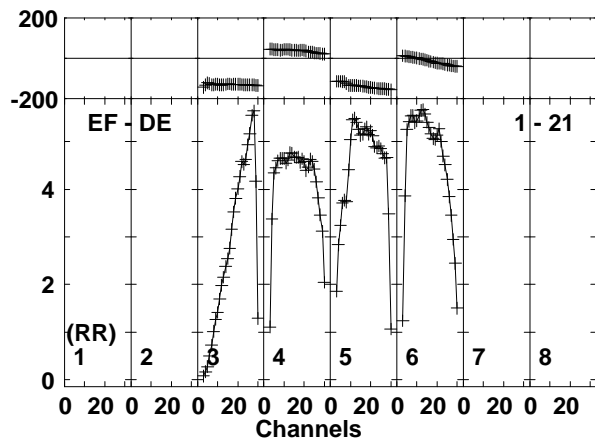
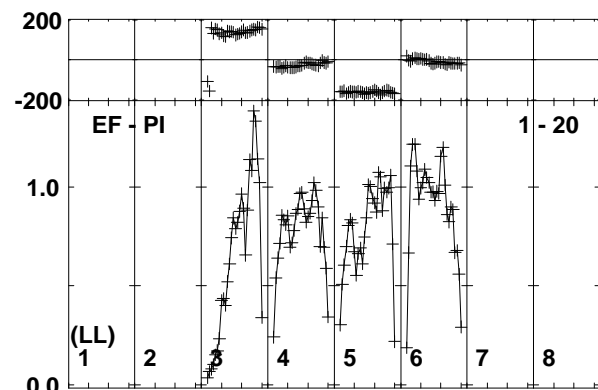
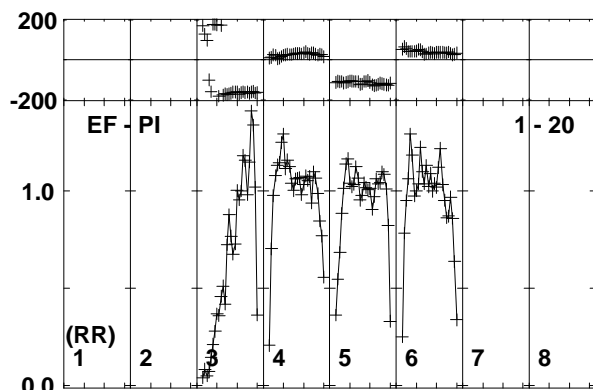
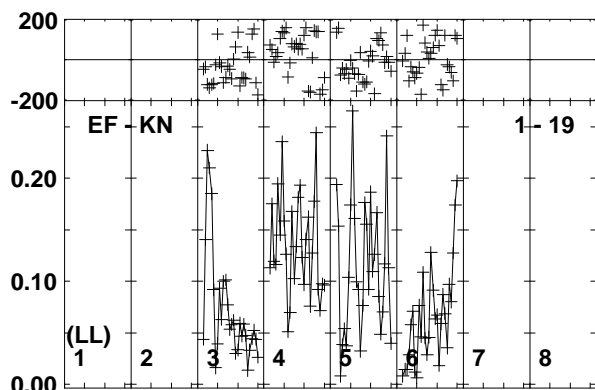
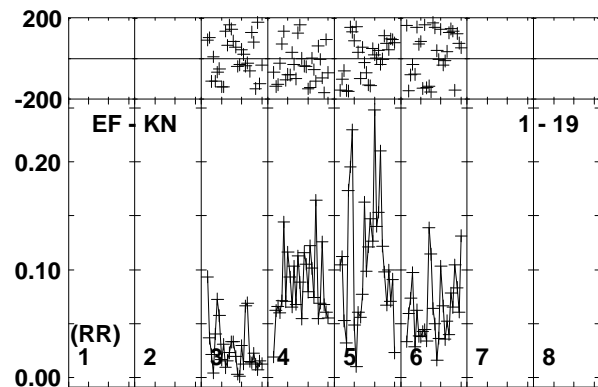
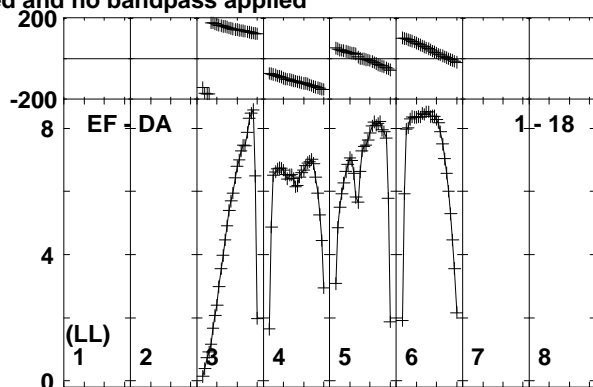
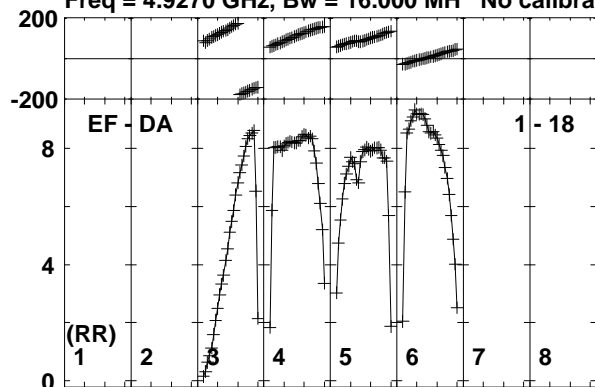

Lower frame: Milli Ampl Jy Top frame: Phas deg  
Vector averaged cross-power spectrum Baseline: EF (01) - DA (18)  
Timerange: 00/09:55:31 to 00/09:56:59

Plot file version 460 created 08-APR-2019 12:10:32

MRK622 EM133B.UVDATA.1

Freq = 4.9270 GHz, Bw = 16.000 MH No calibration applied and no bandpass applied

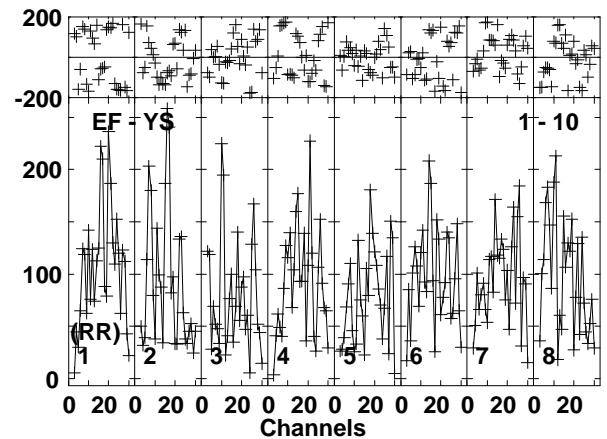
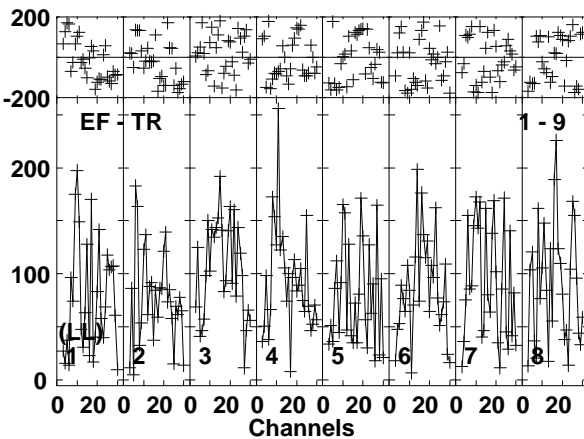
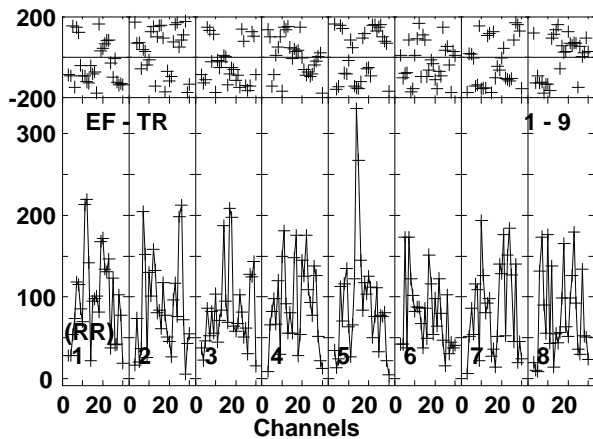
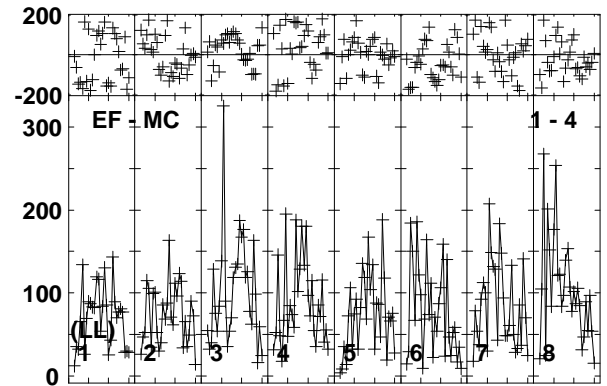
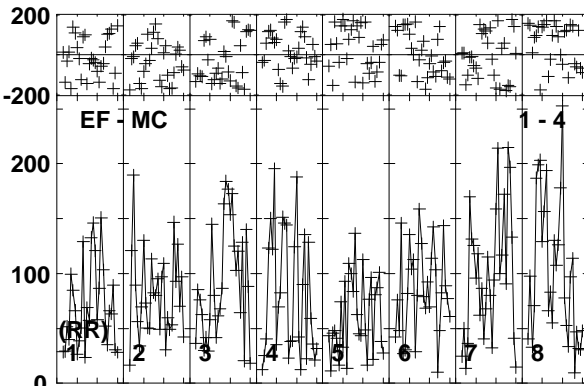
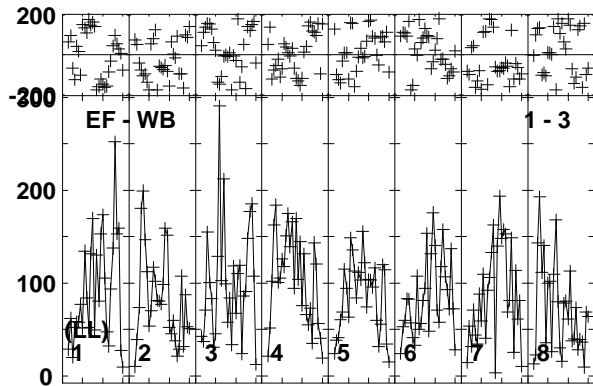
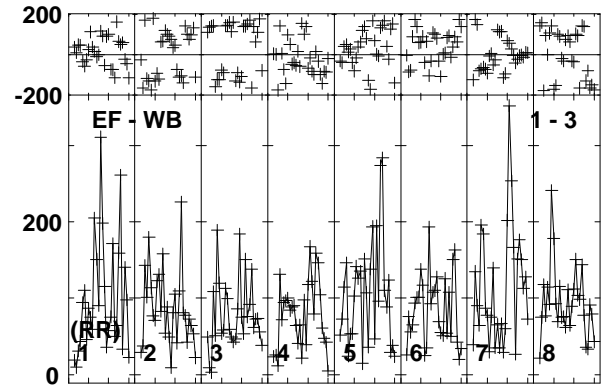
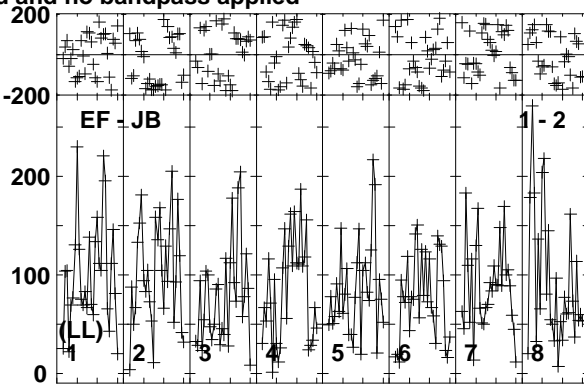
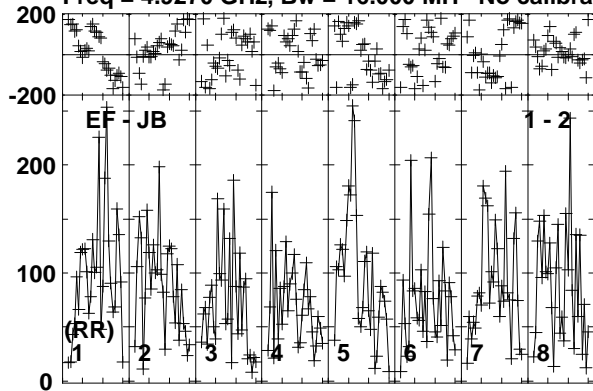

Lower frame: Micro Ampl Jy Top frame: Phas deg  
Vector averaged cross-power spectrum Baseline: EF (01) - JB (02)  
Timerange: 00/09:57:01 to 00/10:00:29

Plot file version 461 created 08-APR-2019 12:10:32

MRK622 EM133B.UVDATA.1

Freq = 4.9270 GHz, Bw = 16.000 MH No calibration applied and no bandpass applied

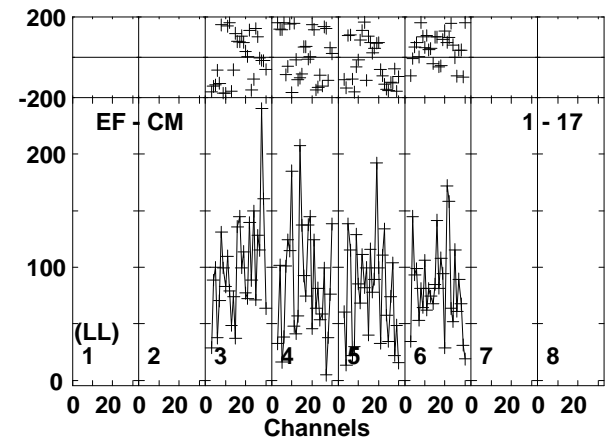
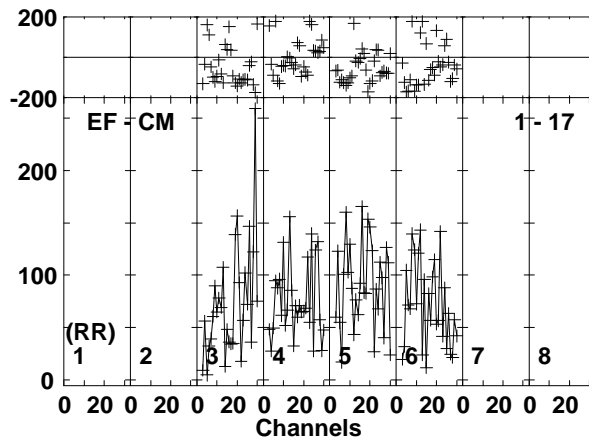
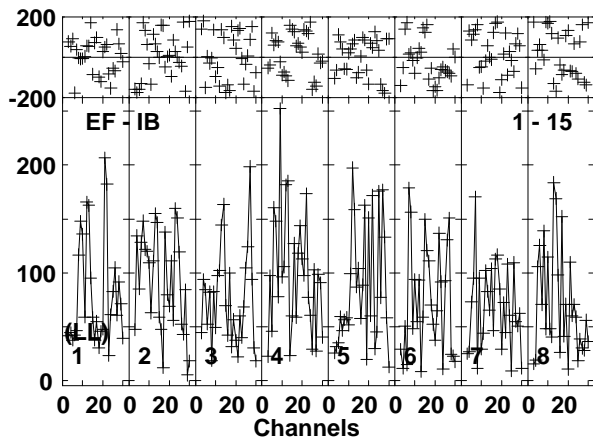
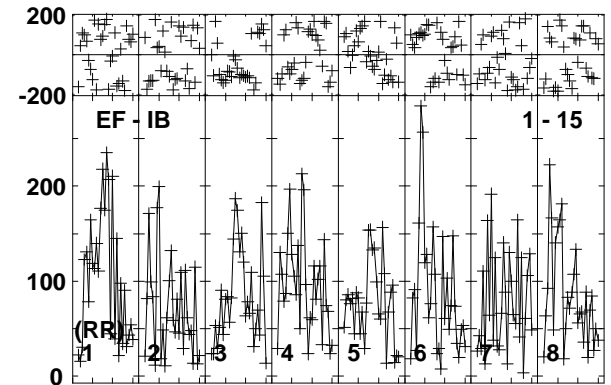
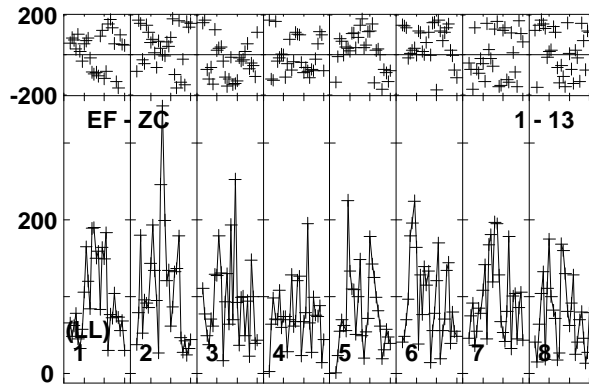
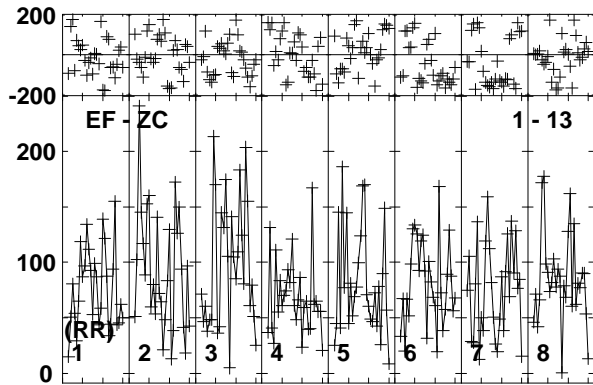
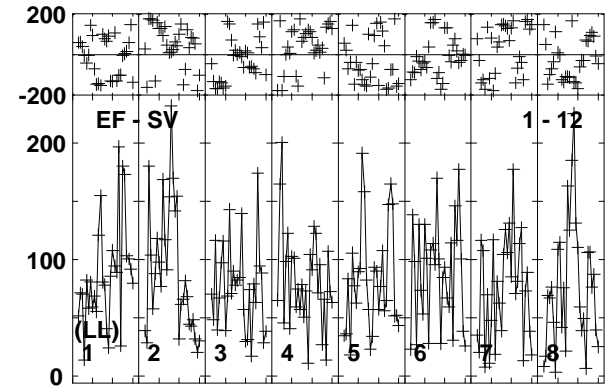
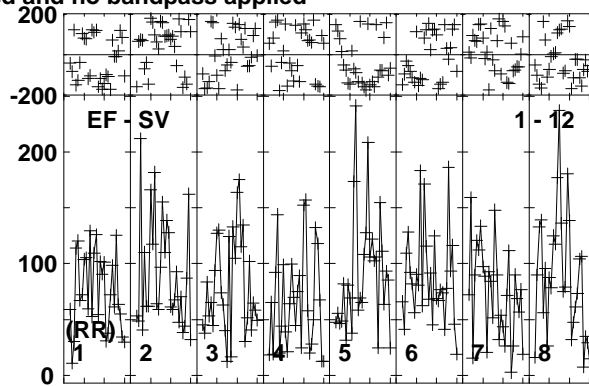
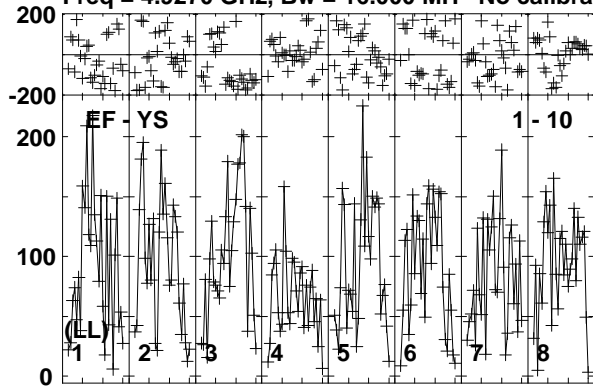

Lower frame: Micro Ampl Jy Top frame: Phas deg  
Vector averaged cross-power spectrum Baseline: EF (01) - YS (10)  
Timerange: 00/09:57:01 to 00/10:00:29

Plot file version 462 created 08-APR-2019 12:10:32

MRK622 EM133B.UVDATA.1

Freq = 4.9270 GHz, Bw = 16.000 MH No calibration applied and no bandpass applied

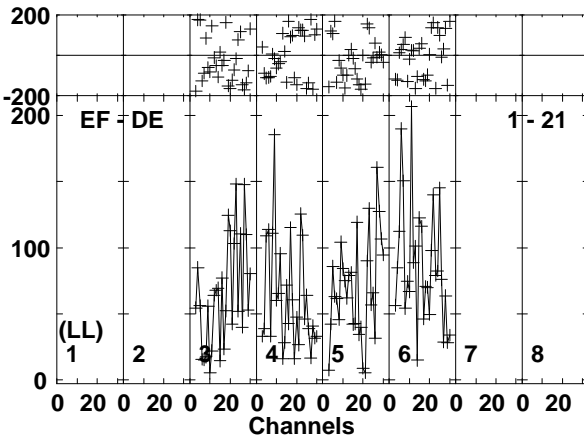
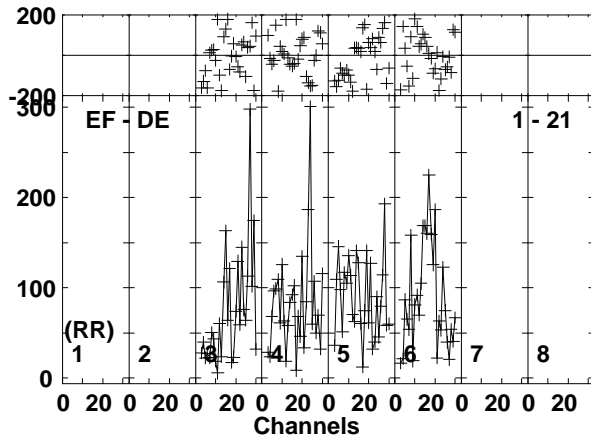
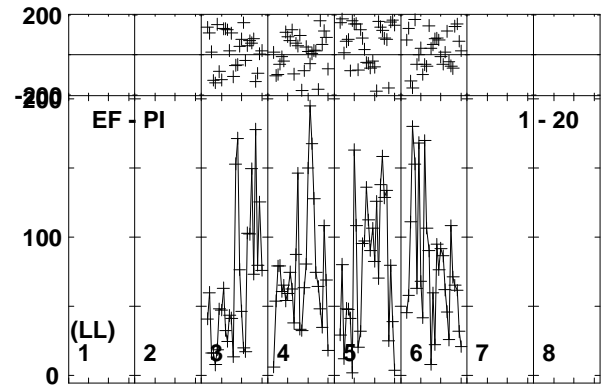
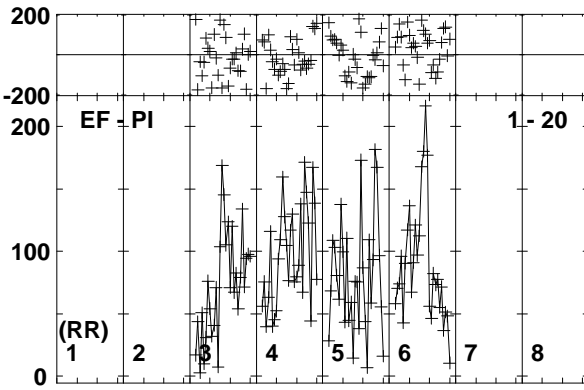
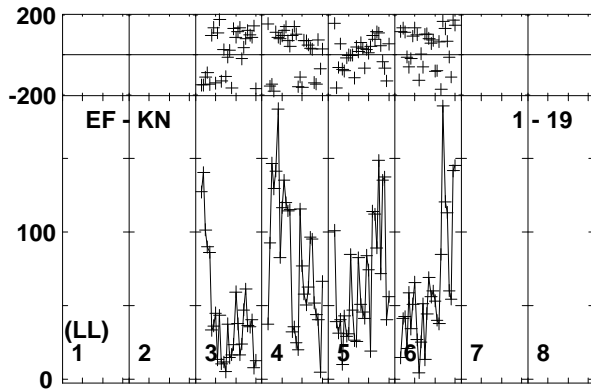
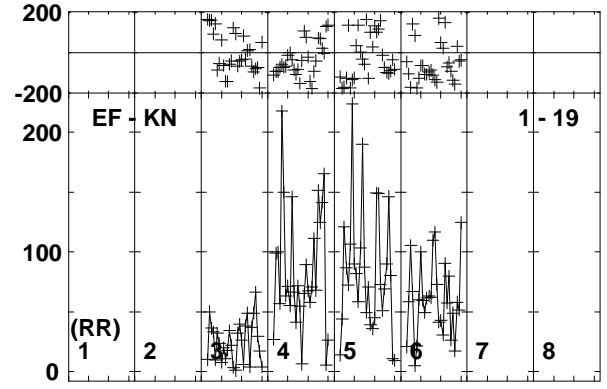
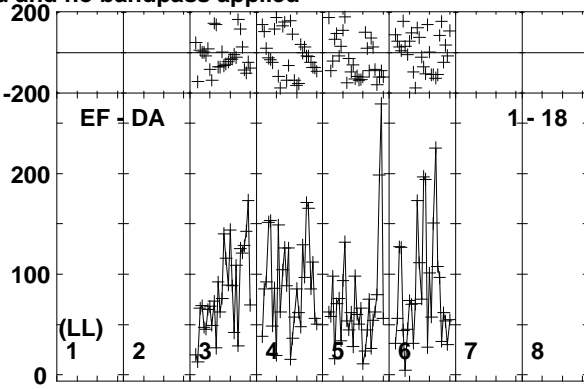
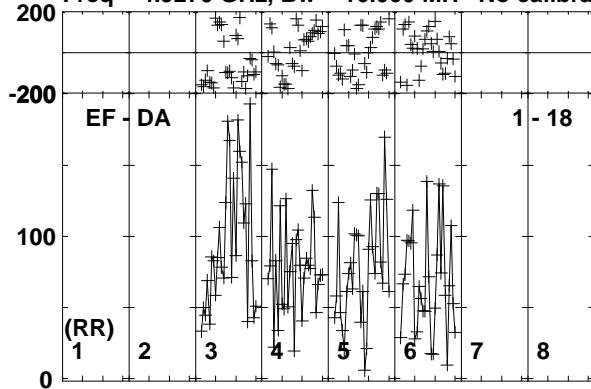

Lower frame: Micro Ampl Jy Top frame: Phas deg  
Vector averaged cross-power spectrum Baseline: EF (01) - DA (18)  
Timerange: 00/09:57:01 to 00/10:00:29

Plot file version 463 created 08-APR-2019 12:10:32

J0815+3635 EM133B.UVDATA.1

Freq = 4.9270 GHz, Bw = 16.000 MH No calibration applied and no bandpass applied

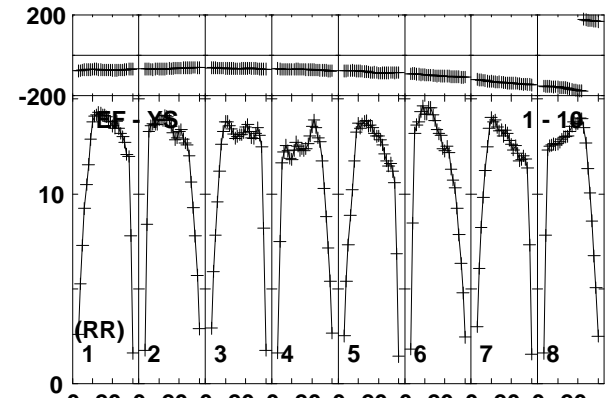
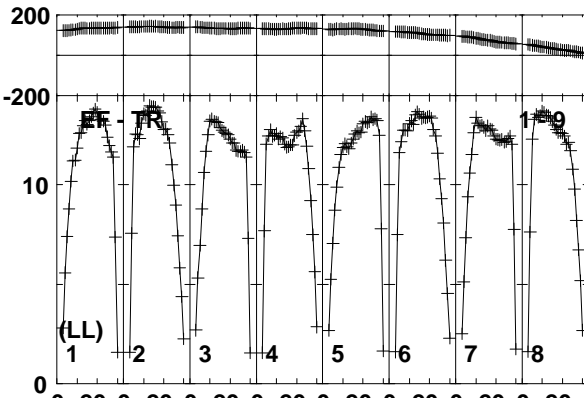
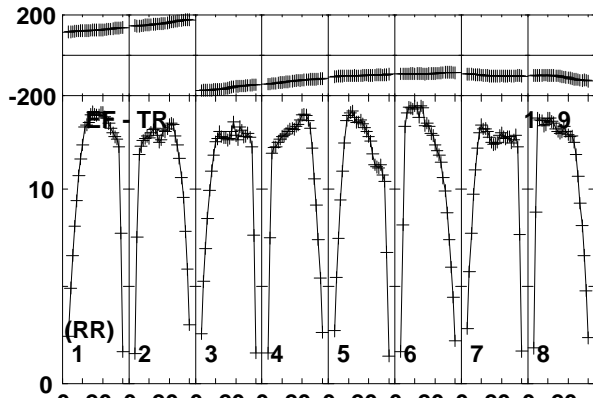
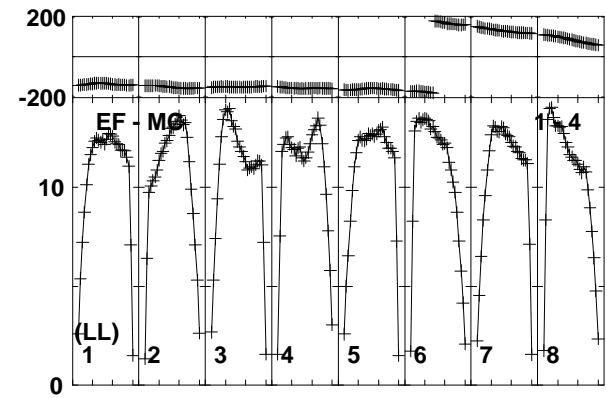
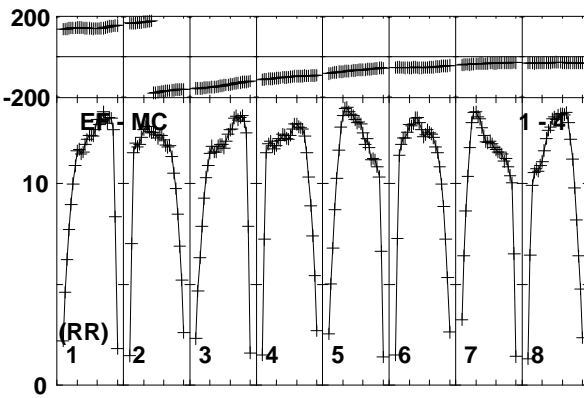
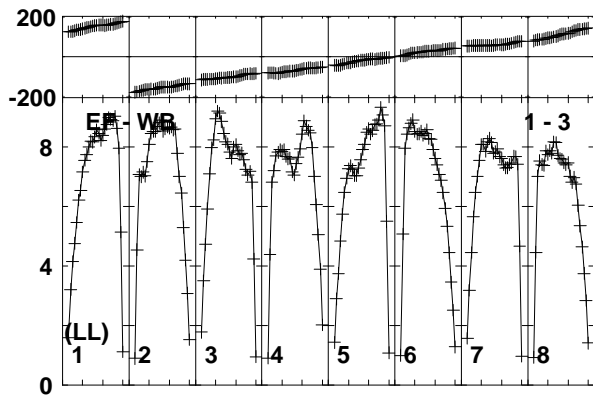
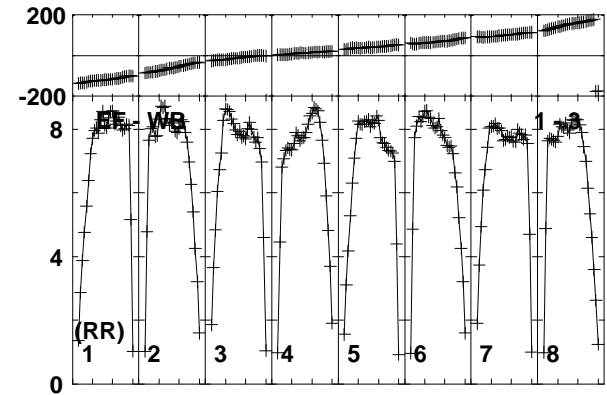
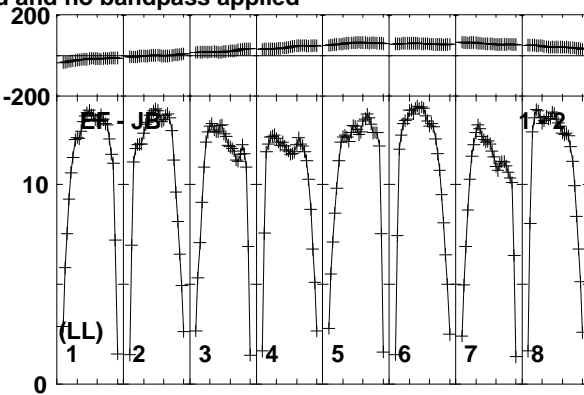
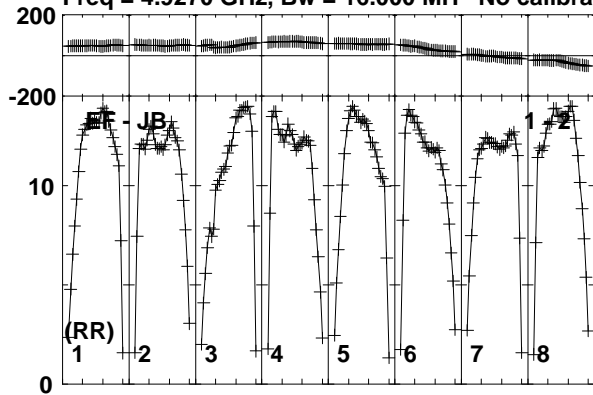

Lower frame: Milli Ampl Jy Top frame: Phas deg  
Vector averaged cross-power spectrum Baseline: EF (01) - JB (02)  
Timerange: 00/10:00:31 to 00/10:01:59

Plot file version 464 created 08-APR-2019 12:10:33

J0815+3635 EM133B.UVDATA.1

Freq = 4.9270 GHz, Bw = 16.000 MH No calibration applied and no bandpass applied

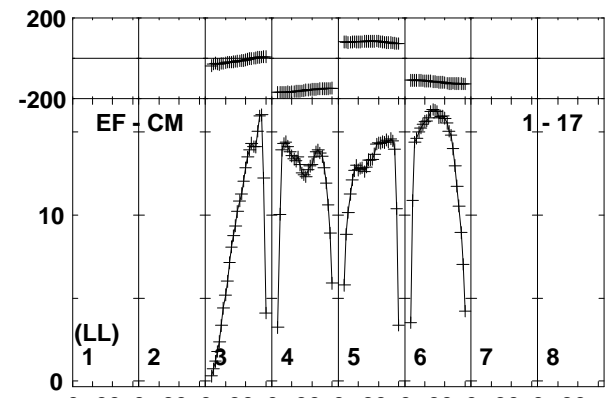
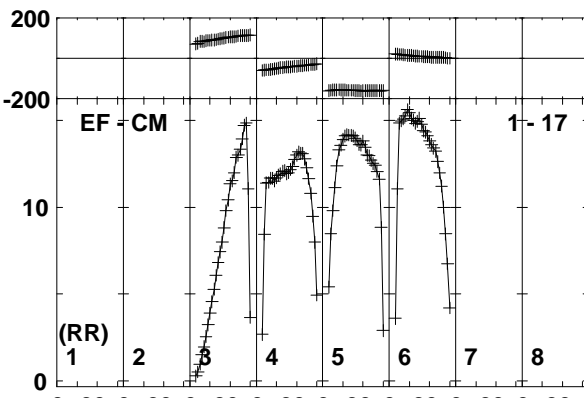
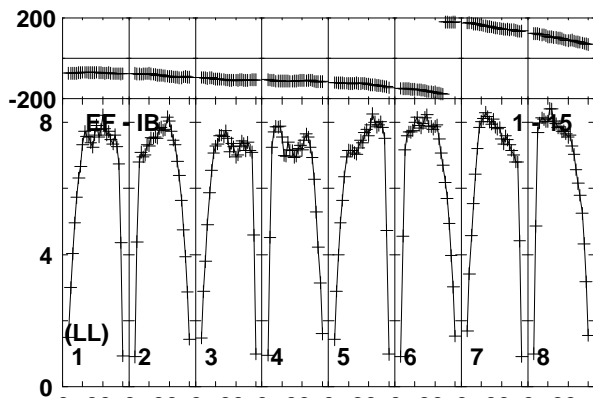
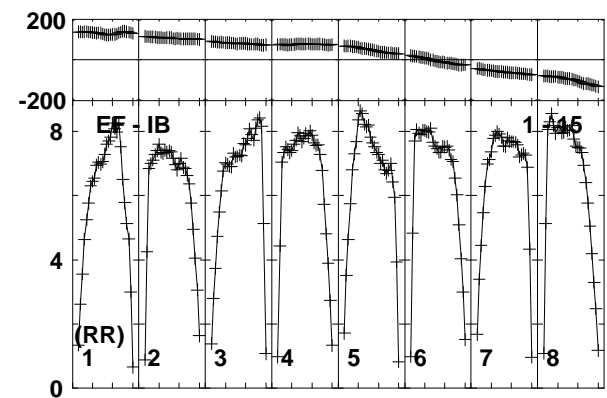
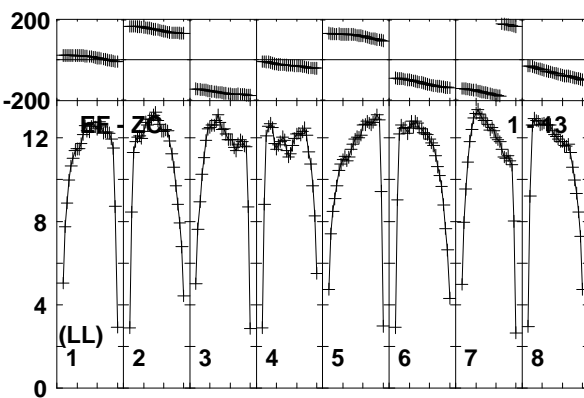
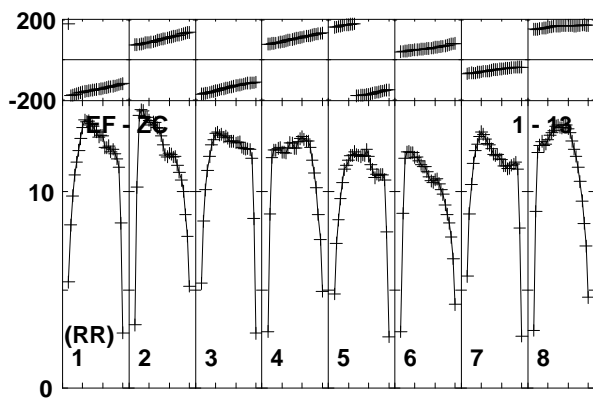
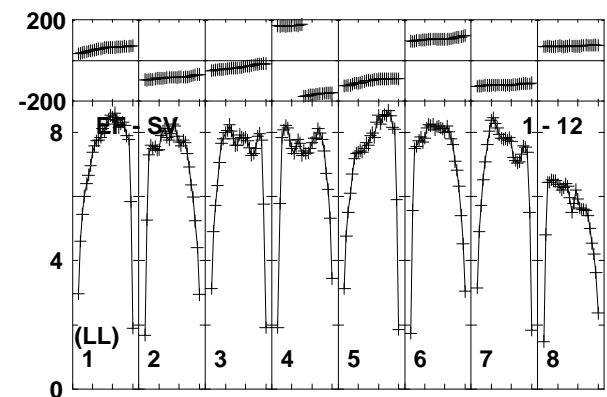
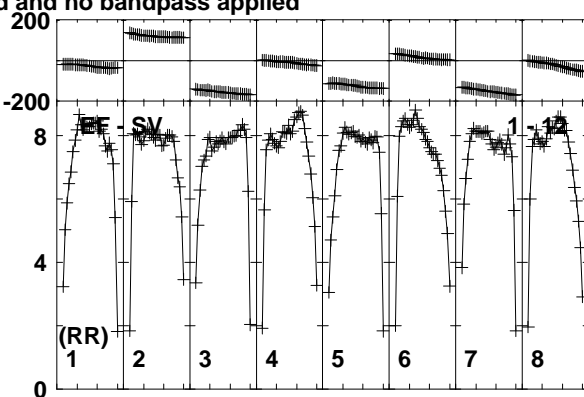
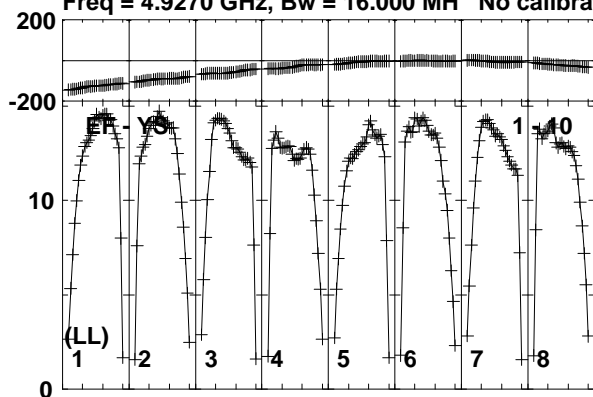

Lower frame: Milli Ampl Jy Top frame: Phas deg  
Vector averaged cross-power spectrum Baseline: EF (01) - YS (10)  
Timerange: 00/10:00:31 to 00/10:01:59



Plot file version 465 created 08-APR-2019 12:10:33

J0815+3635 EM133B.UVDATA.1

Freq = 4.9270 GHz, Bw = 16.000 MH No calibration applied and no bandpass applied

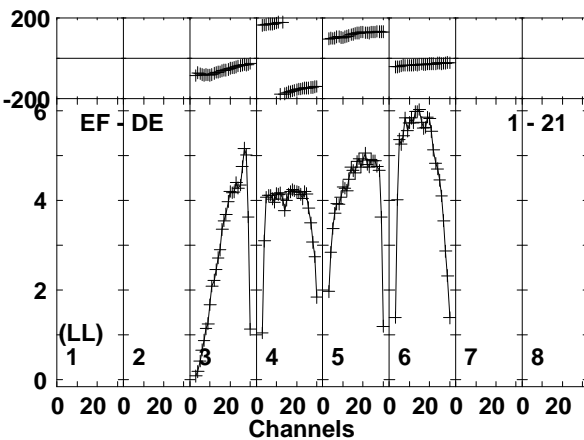
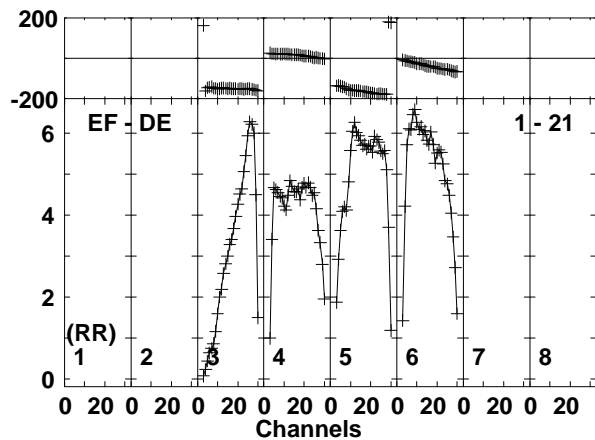
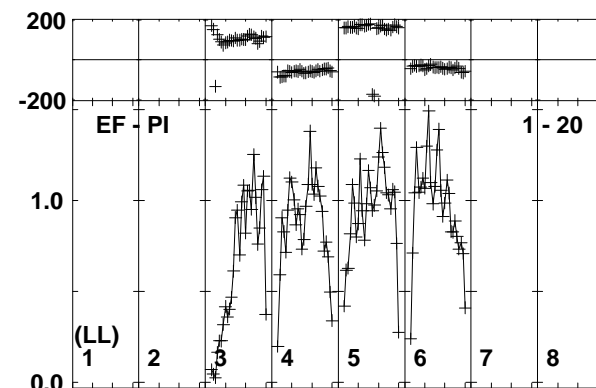
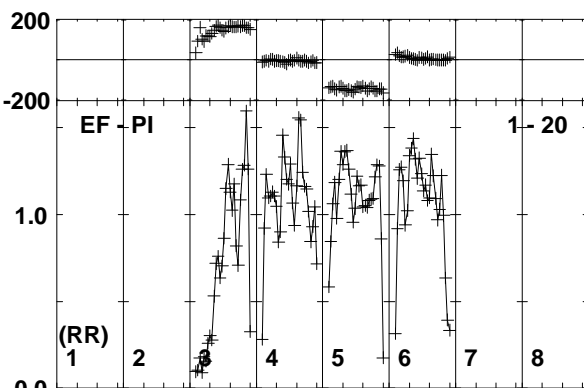
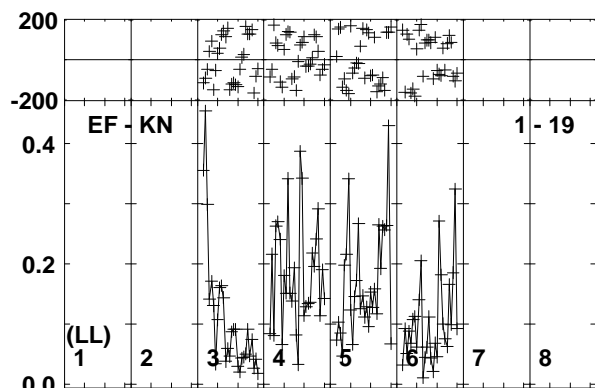
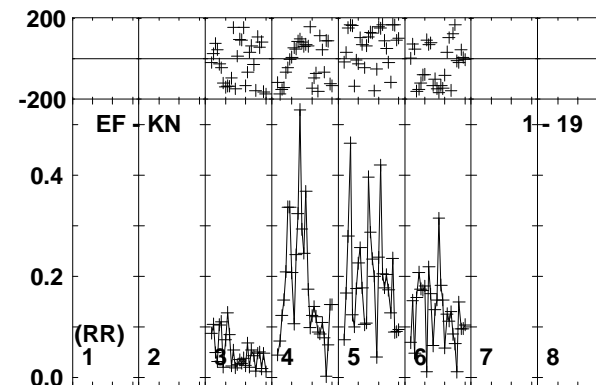
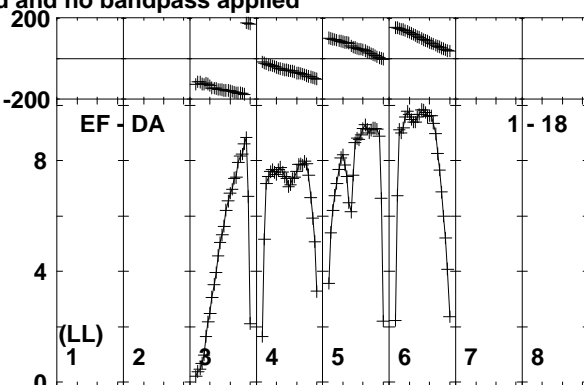
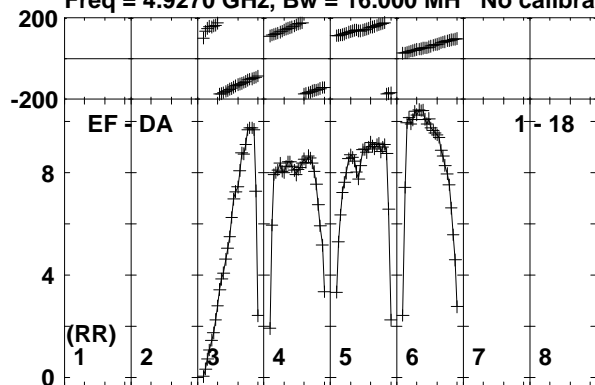

Lower frame: Milli Ampl Jy Top frame: Phas deg  
Vector averaged cross-power spectrum Baseline: EF (01) - DA (18)  
Timerange: 00/10/00:31 to 00/10/01:59

Plot file version 466 created 08-APR-2019 12:10:33

MRK622 EM133B.UVDATA.1

Freq = 4.9270 GHz, Bw = 16.000 MH No calibration applied and no bandpass applied

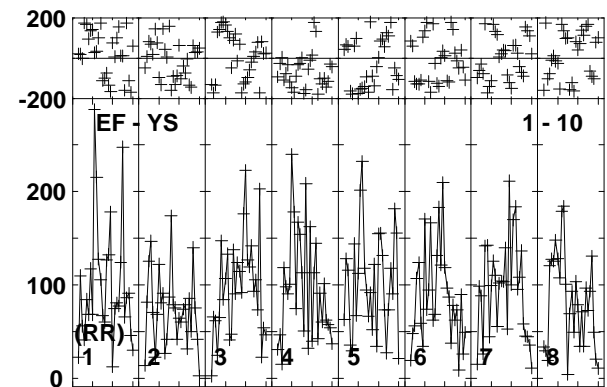
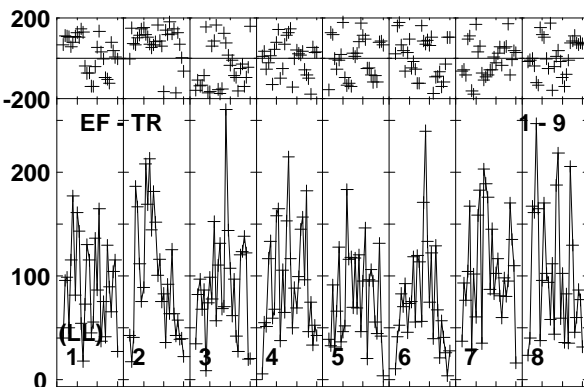
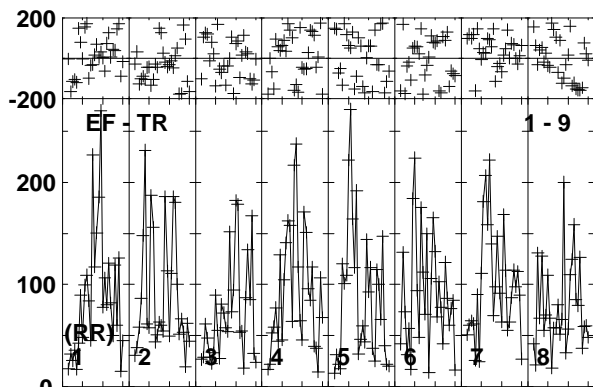
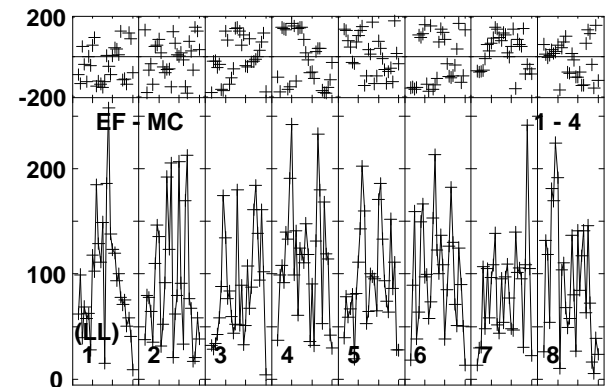
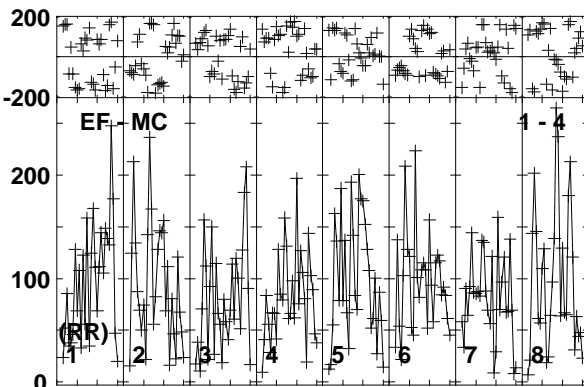
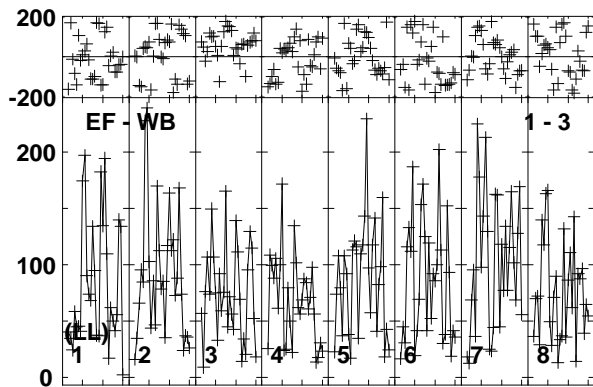
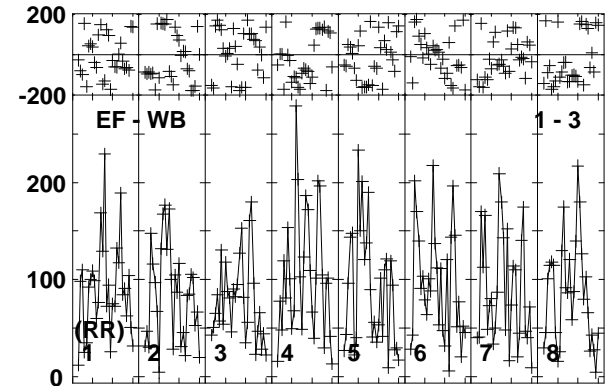
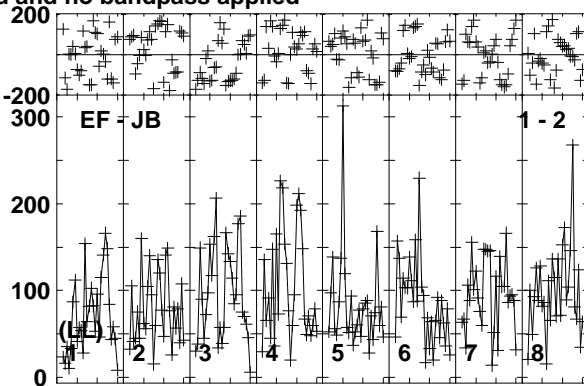
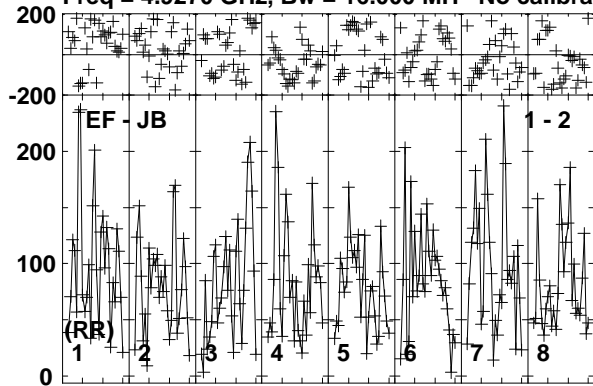

Lower frame: Micro Ampl Jy Top frame: Phas deg  
Vector averaged cross-power spectrum Baseline: EF (01) - JB (02)  
Timerange: 00/10:02:03 to 00/10:05:29

Plot file version 467 created 08-APR-2019 12:10:33

MRK622 EM133B.UVDATA.1

Freq = 4.9270 GHz, Bw = 16.000 MH No calibration applied and no bandpass applied

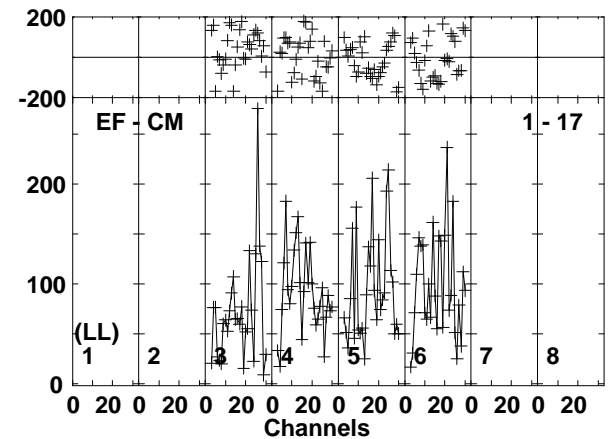
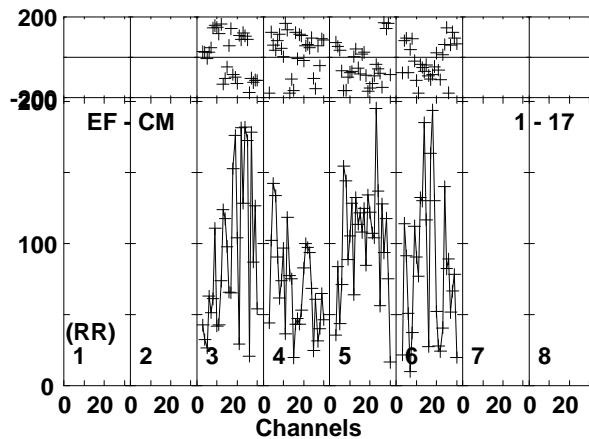
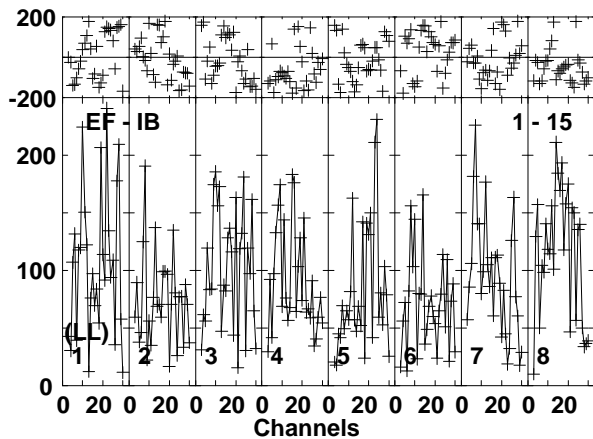
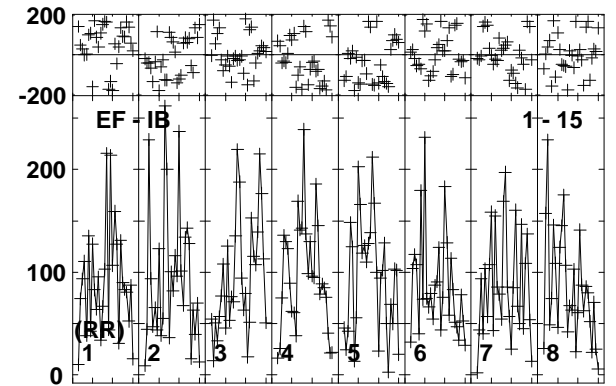
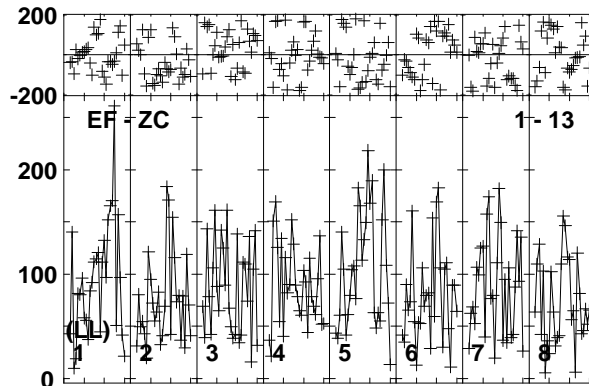
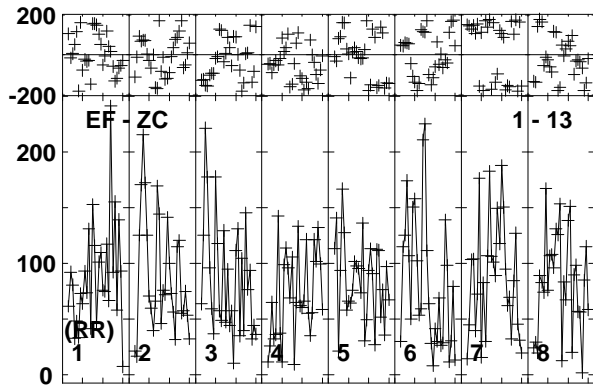
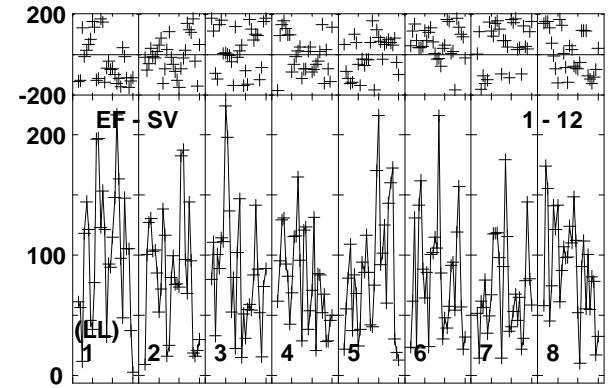
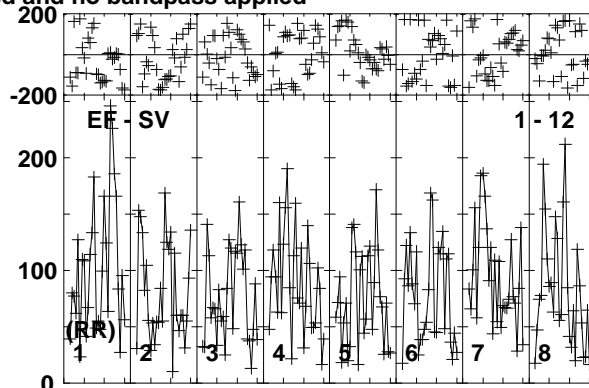
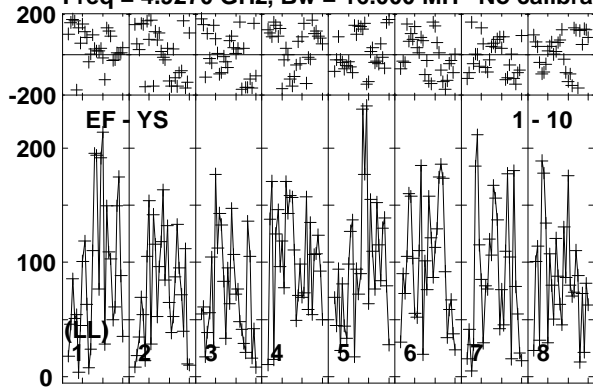

Lower frame: Micro Ampl Jy Top frame: Phas deg  
Vector averaged cross-power spectrum Baseline: EF (01) - YS (10)  
Timerange: 00/10:02:03 to 00/10:05:29

Plot file version 468 created 08-APR-2019 12:10:33

MRK622 EM133B.UVDATA.1

Freq = 4.9270 GHz, Bw = 16.000 MH No calibration applied and no bandpass applied

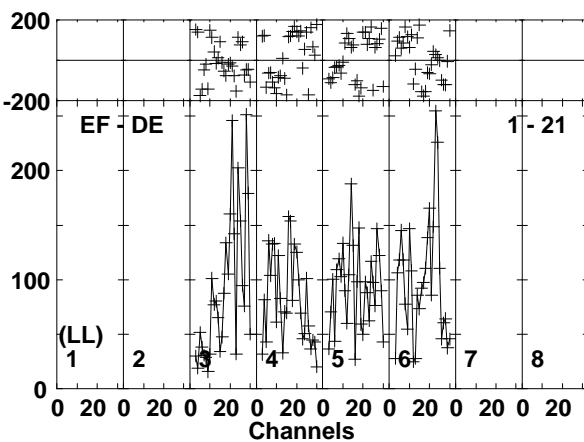
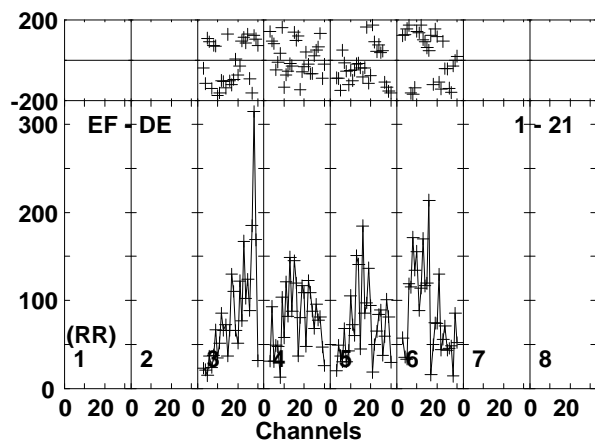
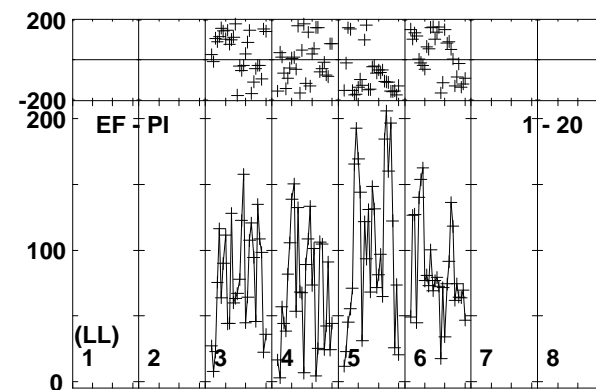
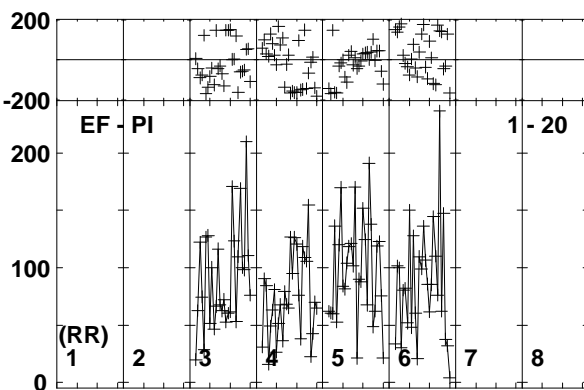
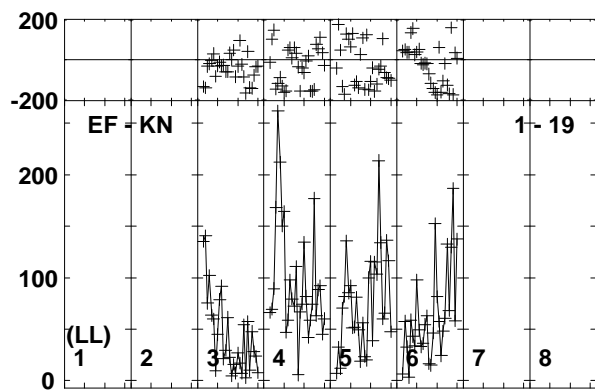
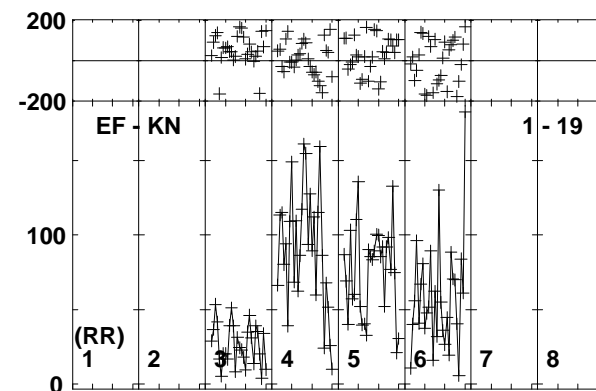
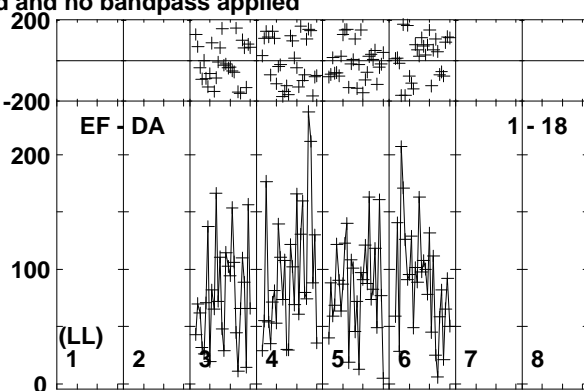
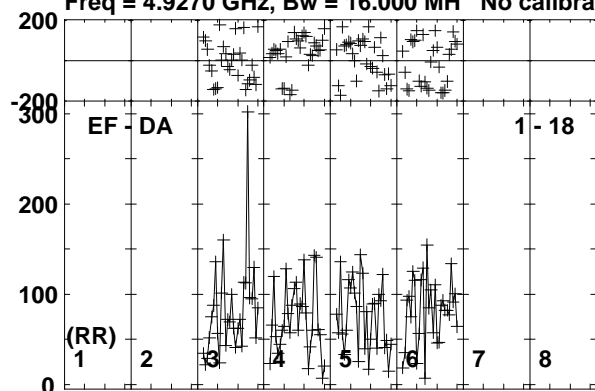

Lower frame: Micro Ampl Jy Top frame: Phas deg  
Vector averaged cross-power spectrum Baseline: EF (01) - DA (18)  
Timerange: 00/10:02:03 to 00/10:05:29

Plot file version 469 created 08-APR-2019 12:10:33

J0815+3635 EM133B.UVDATA.1

Freq = 4.9270 GHz, Bw = 16.000 MH No calibration applied and no bandpass applied

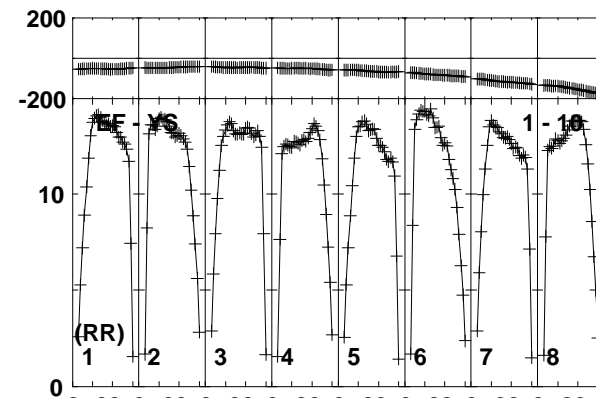
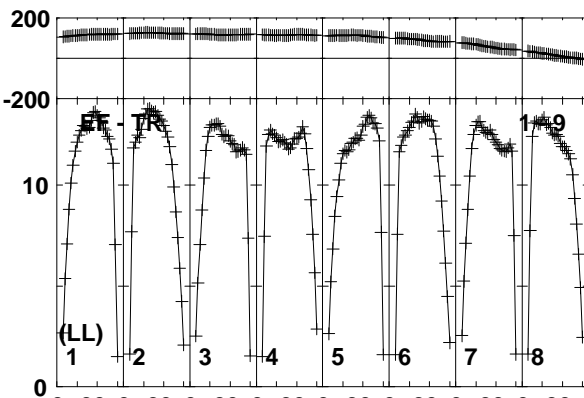
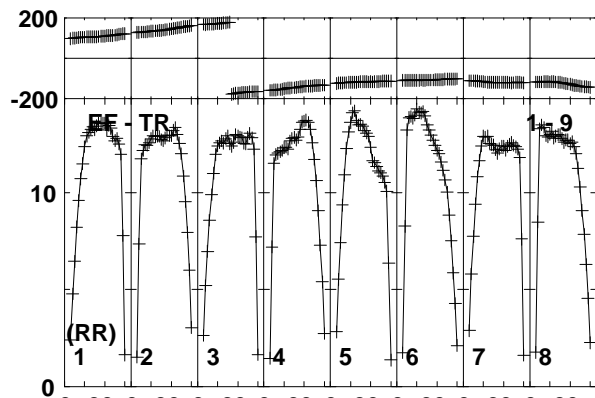
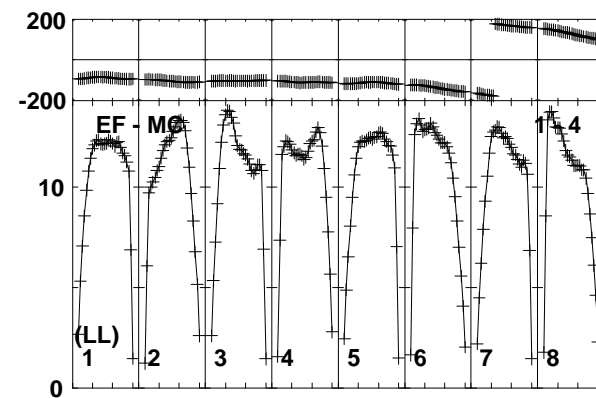
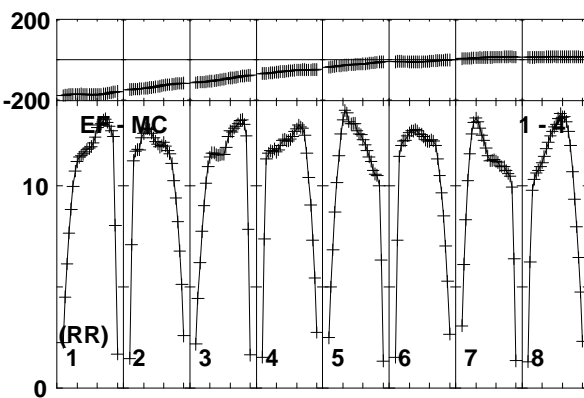
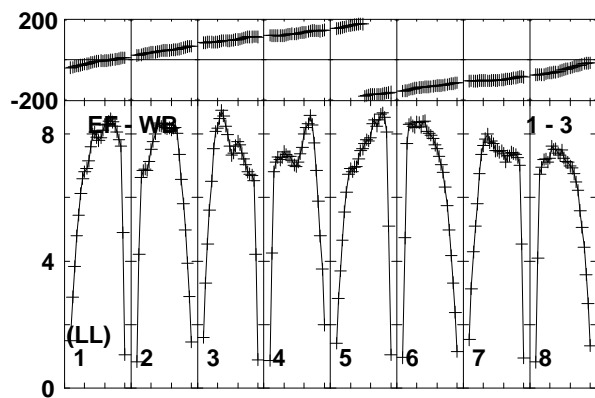
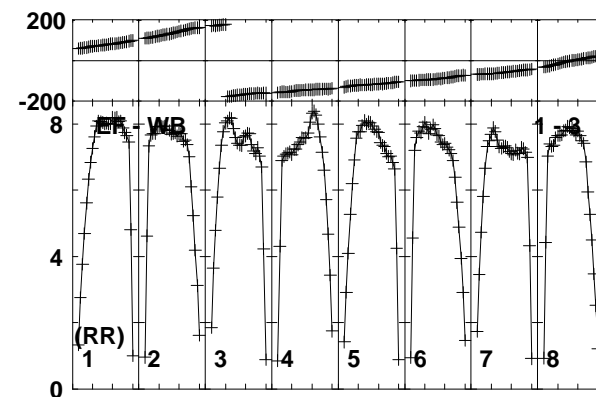
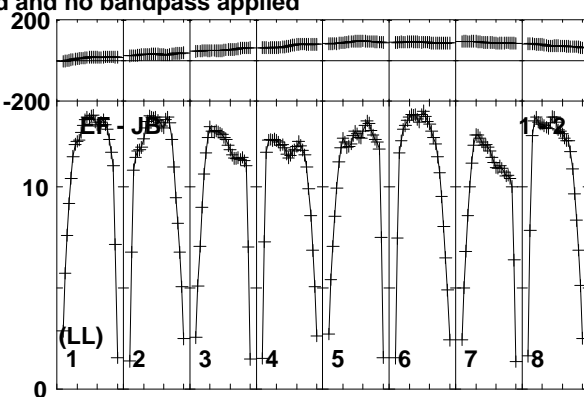
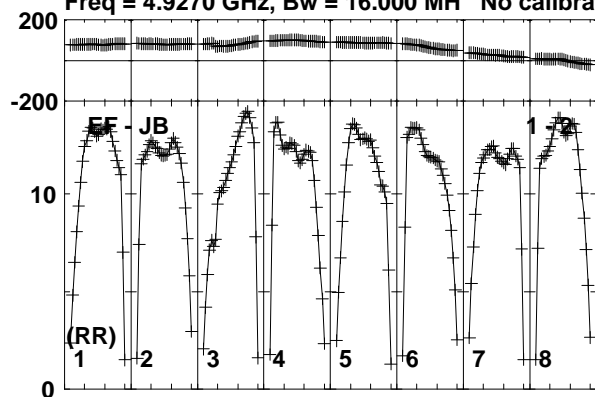

Lower frame: Milli Ampl Jy Top frame: Phas deg  
Vector averaged cross-power spectrum Baseline: EF (01) - JB (02)  
Timerange: 00/10/06:21 to 00/10/07:49

Plot file version 470 created 08-APR-2019 12:10:34

J0815+3635 EM133B.UVDATA.1

Freq = 4.9270 GHz, Bw = 16.000 MH No calibration applied and no bandpass applied

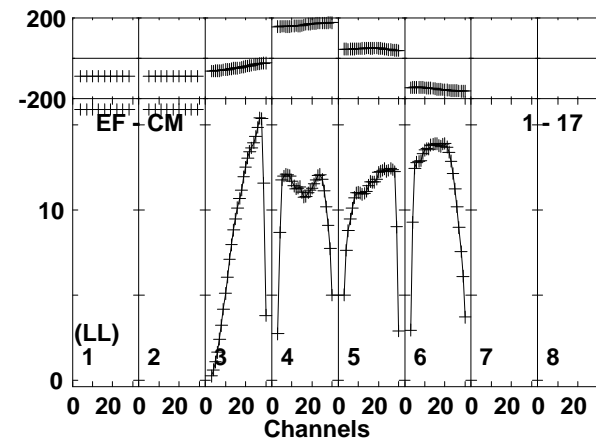
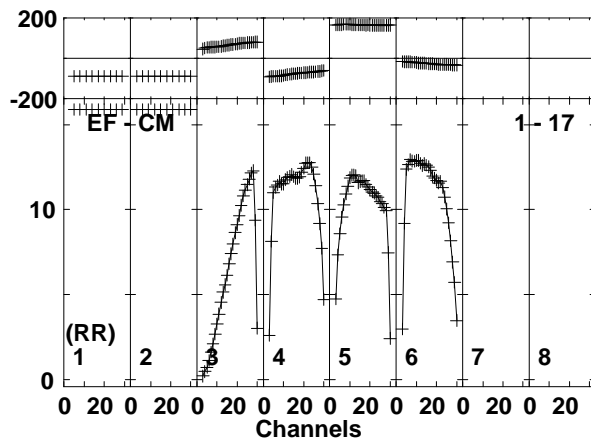
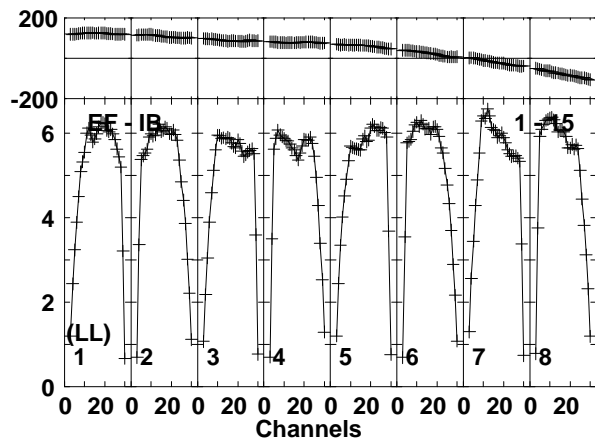
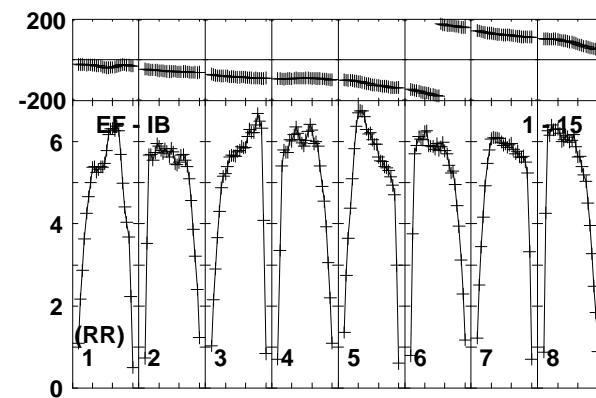
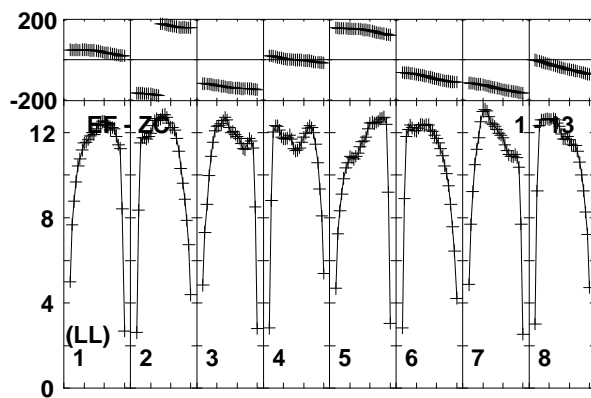
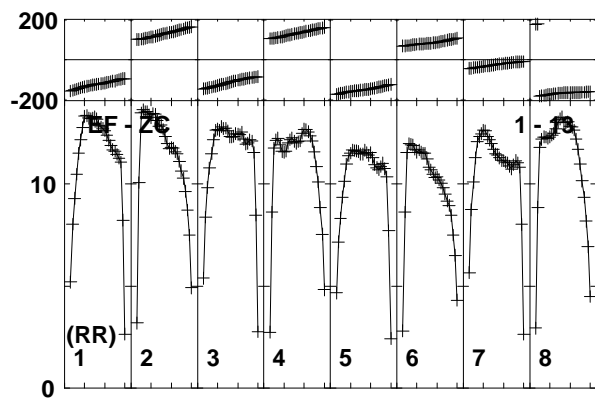
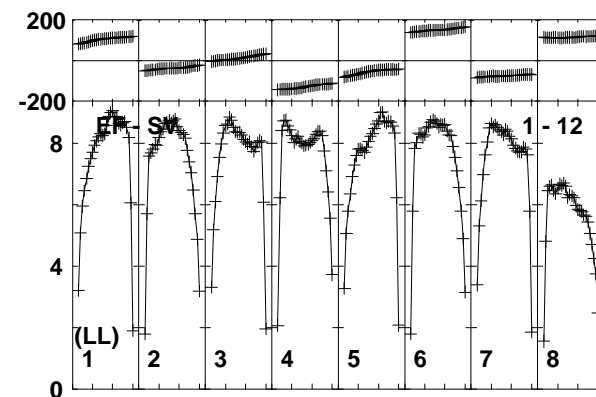
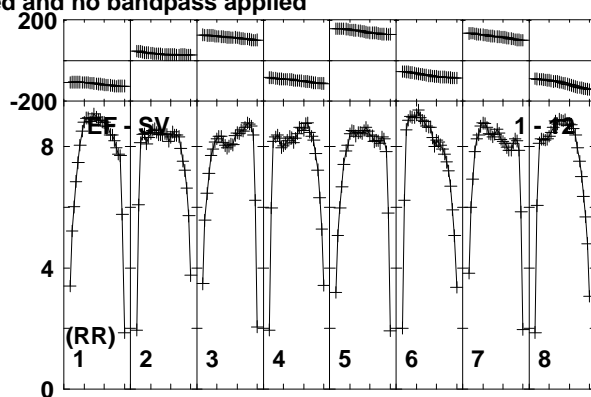
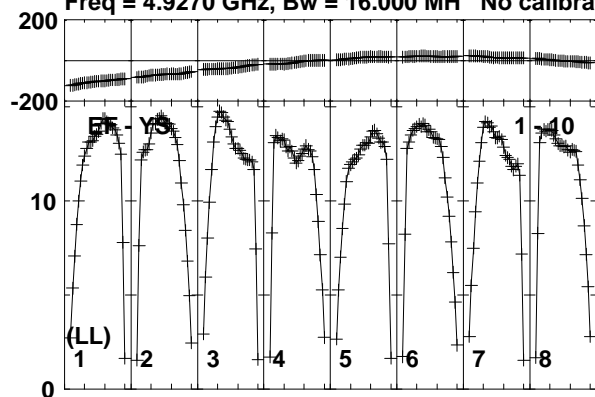

Lower frame: Milli Ampl Jy Top frame: Phas deg  
Vector averaged cross-power spectrum Baseline: EF (01) - YS (10)  
Timerange: 00/10:06:21 to 00/10:07:49

Plot file version 471 created 08-APR-2019 12:10:34

J0815+3635 EM133B.UVDATA.1

Freq = 4.9270 GHz, Bw = 16.000 MH No calibration applied and no bandpass applied

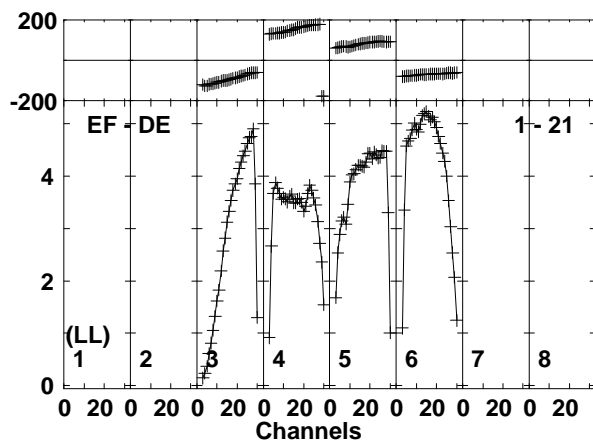
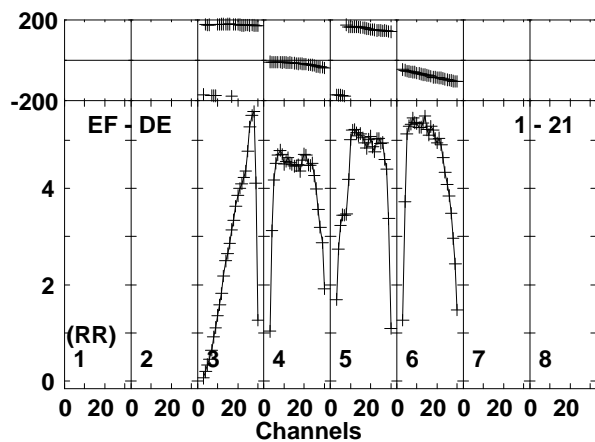
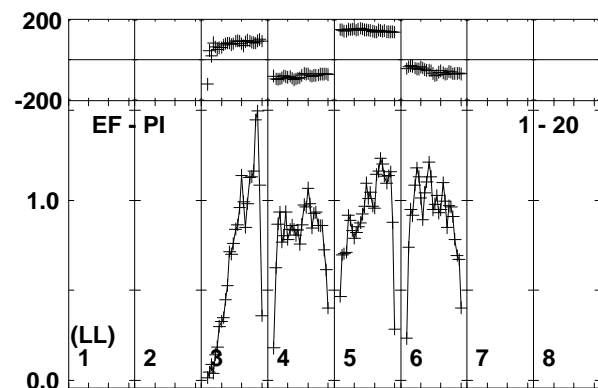
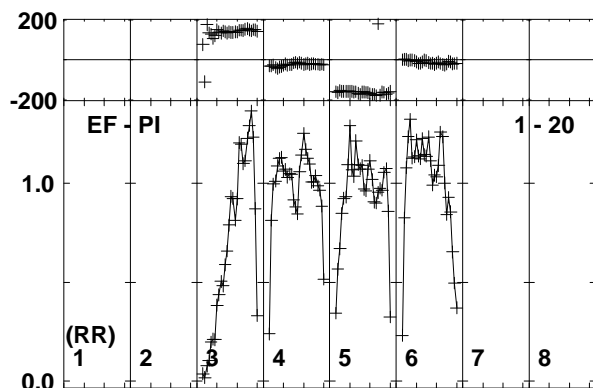
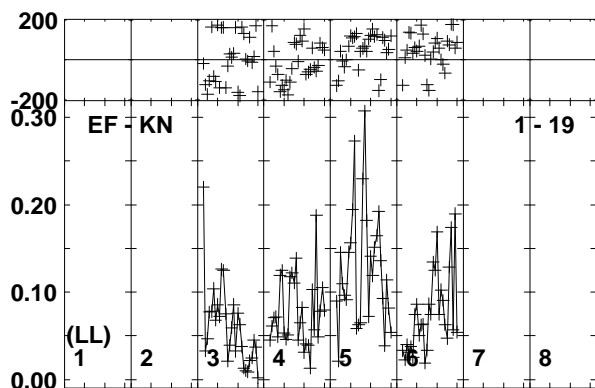
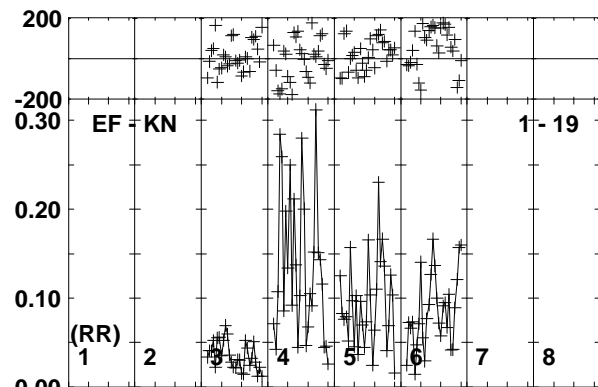
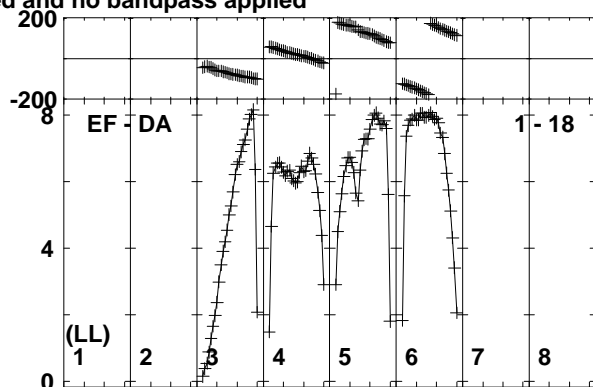
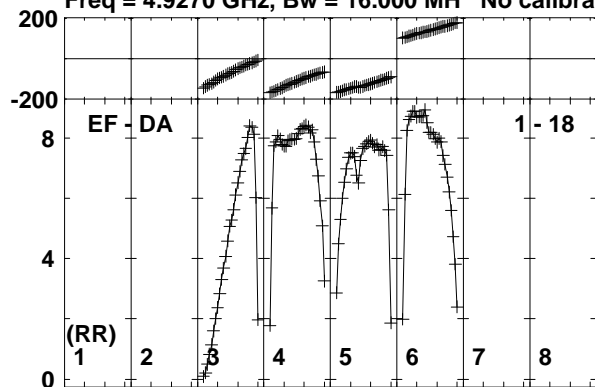

Lower frame: Milli Ampl Jy Top frame: Phas deg  
Vector averaged cross-power spectrum Baseline: EF (01) - DA (18)  
Timerange: 00/10:06:21 to 00/10:07:49

Plot file version 472 created 08-APR-2019 12:10:34

MRK622 EM133B.UVDATA.1

Freq = 4.9270 GHz, Bw = 16.000 MH No calibration applied and no bandpass applied

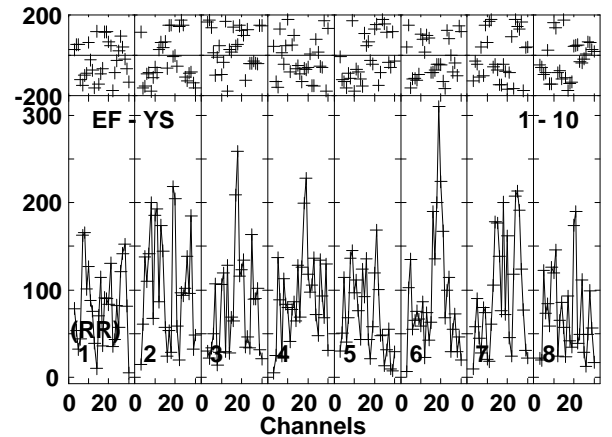
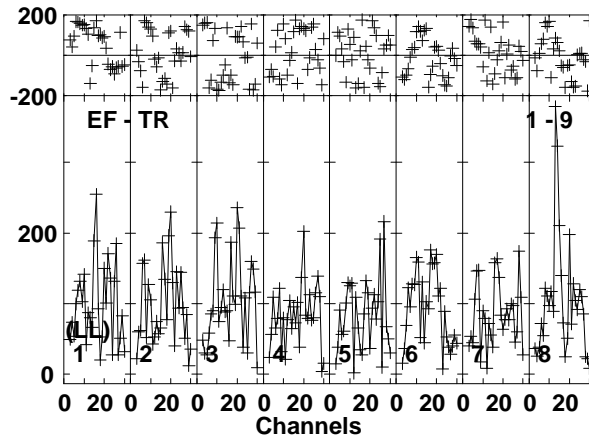
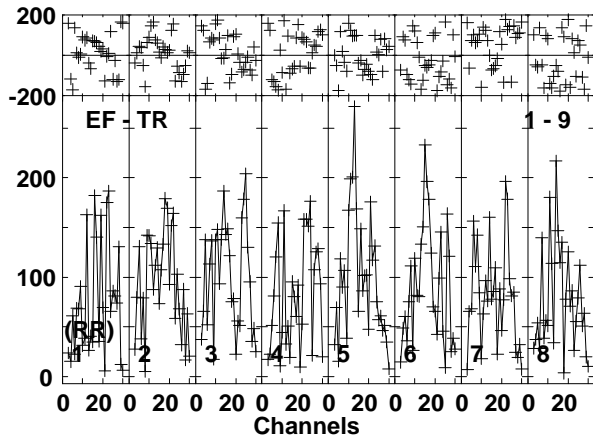
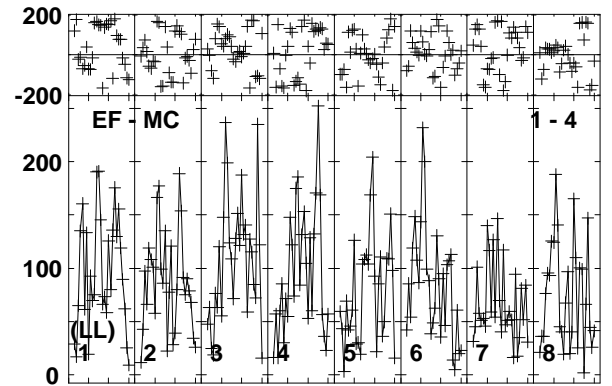
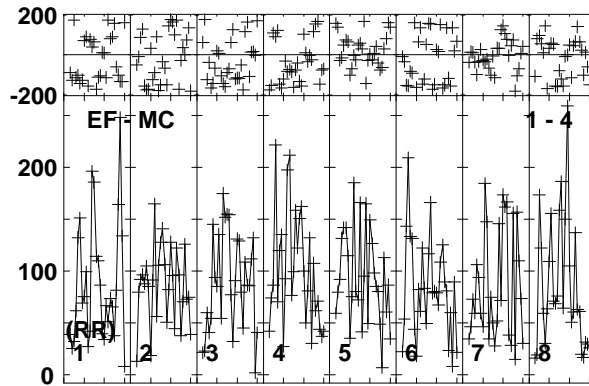
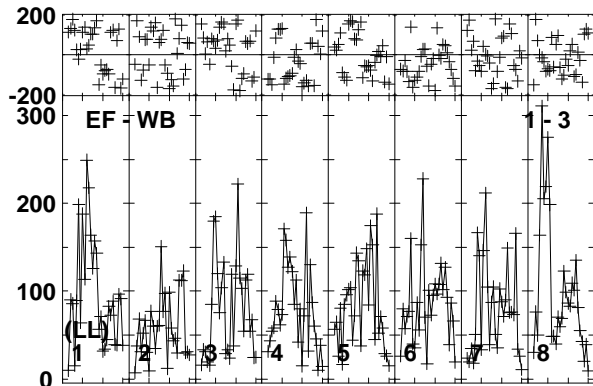
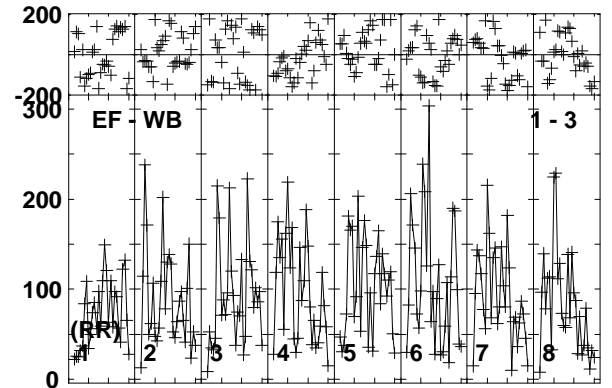
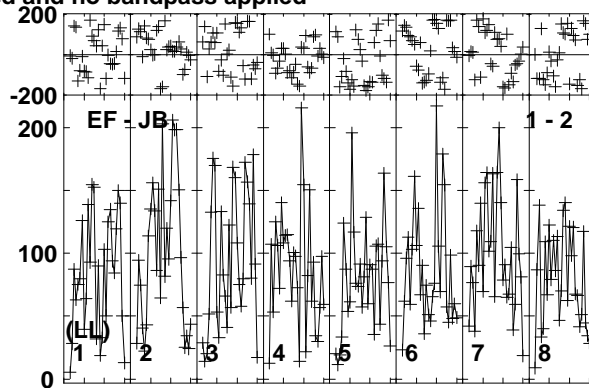
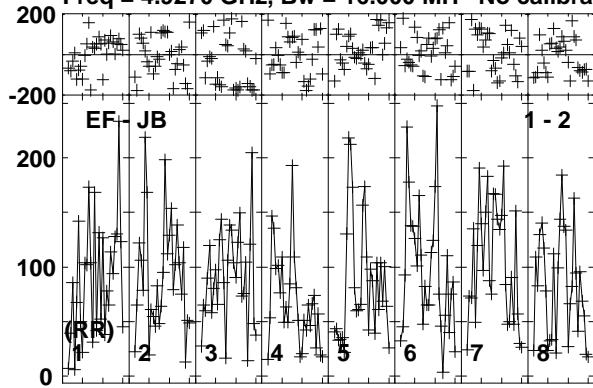

Lower frame: Micro Ampl Jy Top frame: Phas deg  
Vector averaged cross-power spectrum Baseline: EF (01) - JB (02)  
Timerange: 00/10:07:51 to 00/10:11:19



Plot file version 473 created 08-APR-2019 12:10:34

MRK622 EM133B.UVDATA.1

Freq = 4.9270 GHz, Bw = 16.000 MH No calibration applied and no bandpass applied

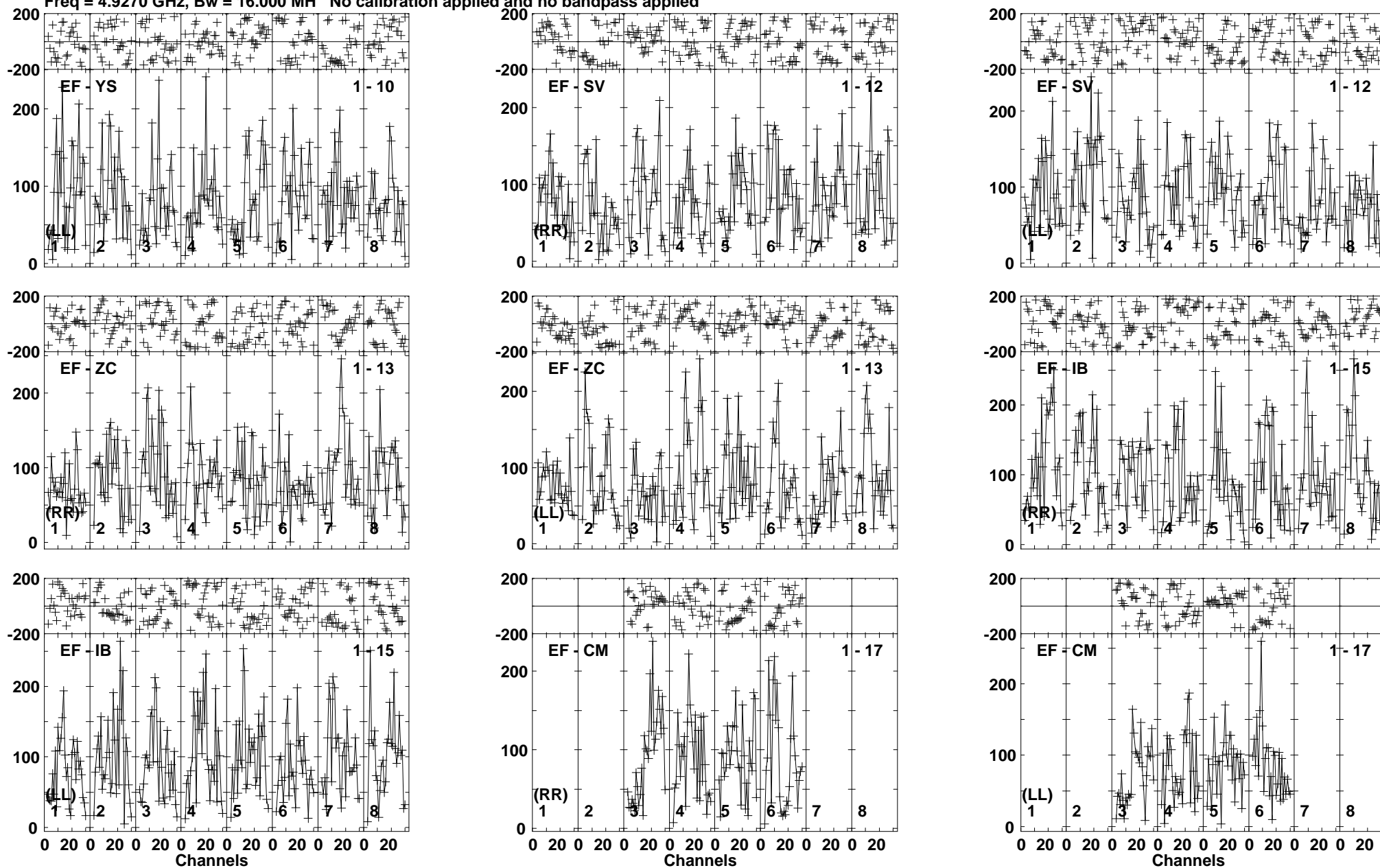

Lower frame: Micro Ampl Jy Top frame: Phas deg  
Vector averaged cross-power spectrum Baseline: EF (01) - YS (10)  
Timerange: 00/10:07:51 to 00/10:11:19

Plot file version 474 created 08-APR-2019 12:10:34

MRK622 EM133B.UVDATA.1

Freq = 4.9270 GHz, Bw = 16.000 MH No calibration applied and no bandpass applied

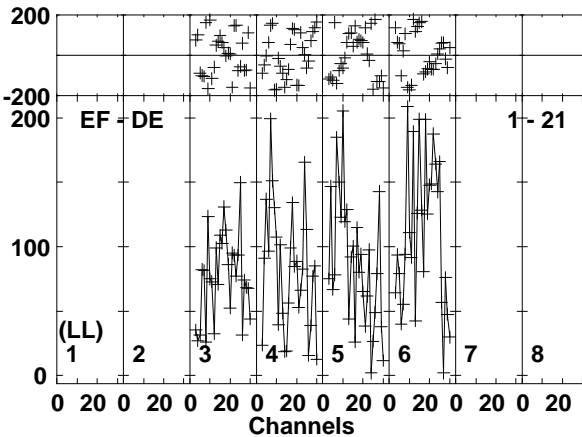
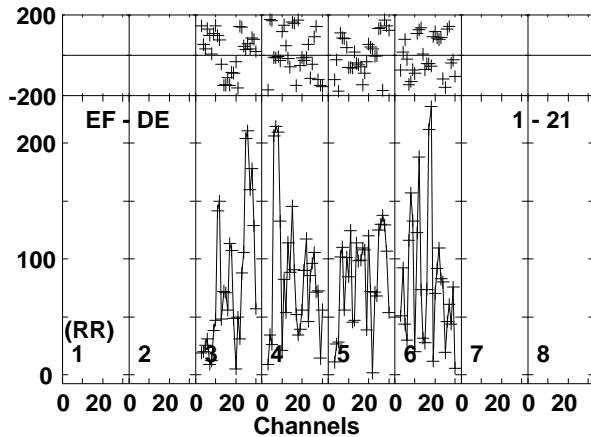
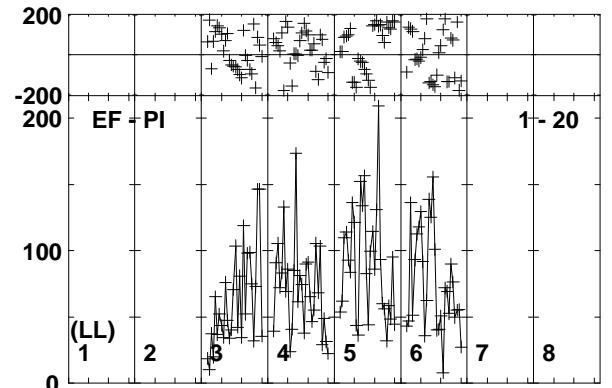
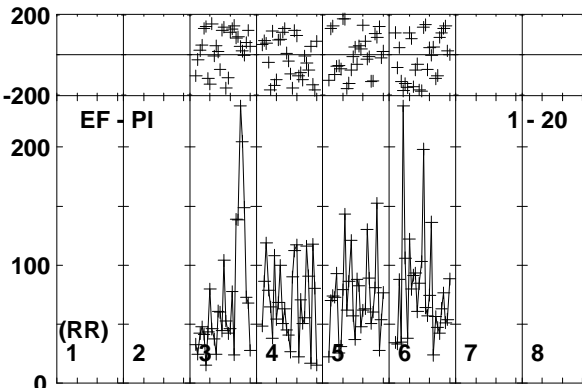
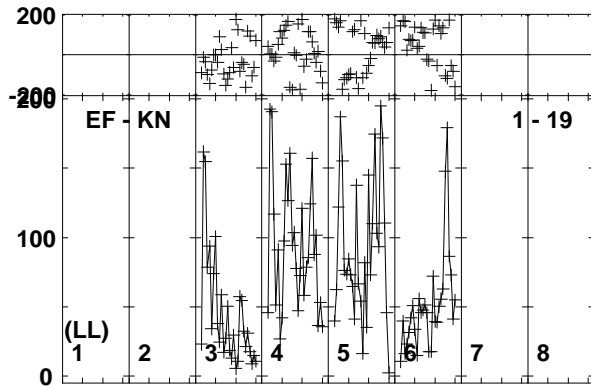
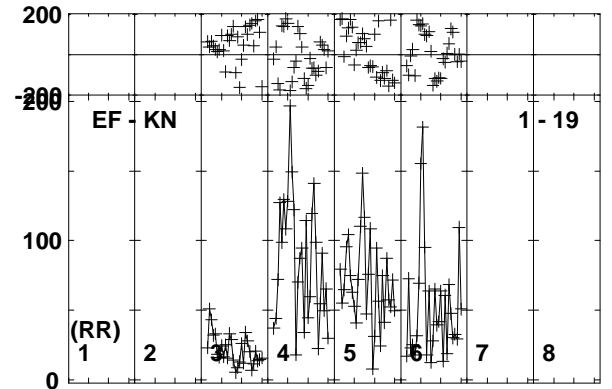
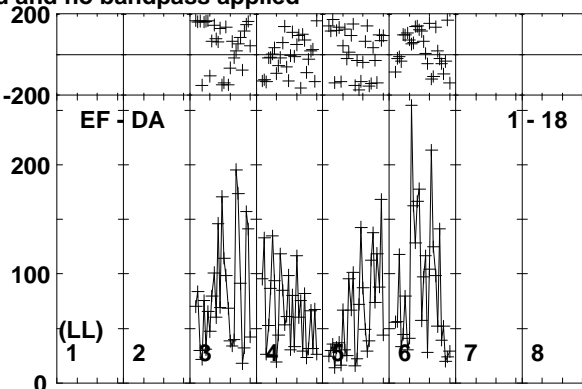
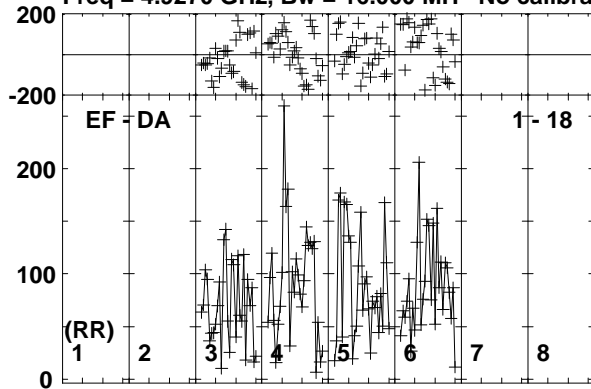

Lower frame: Micro Ampl Jy Top frame: Phas deg  
Vector averaged cross-power spectrum Baseline: EF (01) - DA (18)  
Timerange: 00/10:07:51 to 00/10:11:19

Plot file version 475 created 08-APR-2019 12:10:34

J0815+3635 EM133B.UVDATA.1

Freq = 4.9270 GHz, Bw = 16.000 MH No calibration applied and no bandpass applied

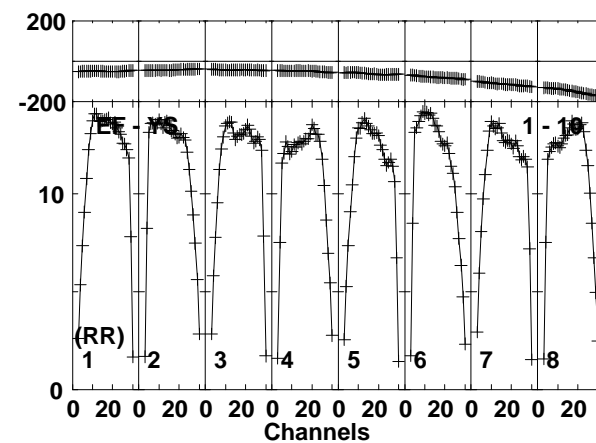
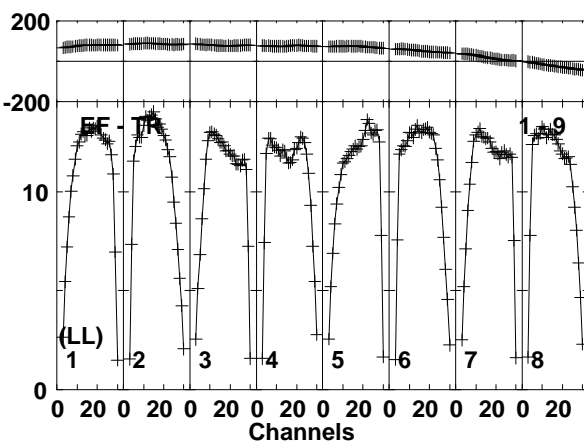
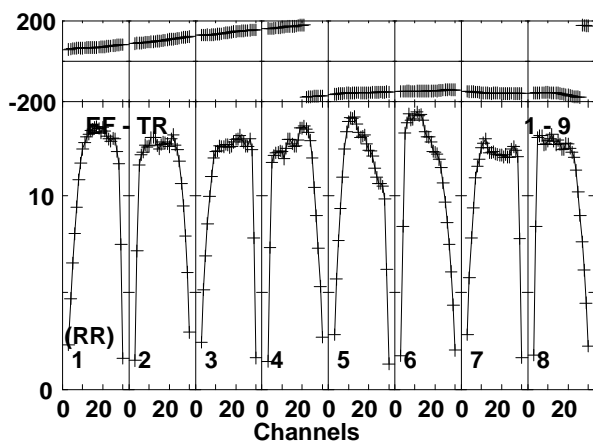
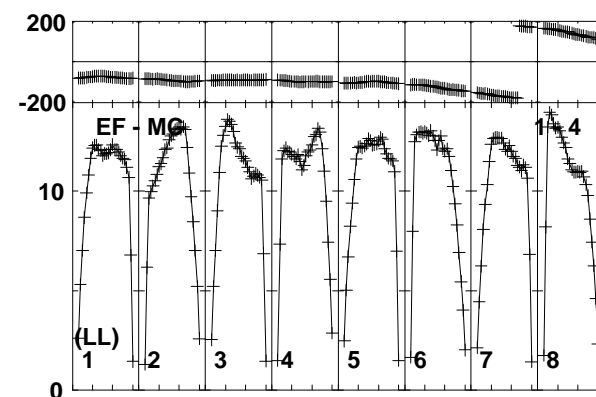
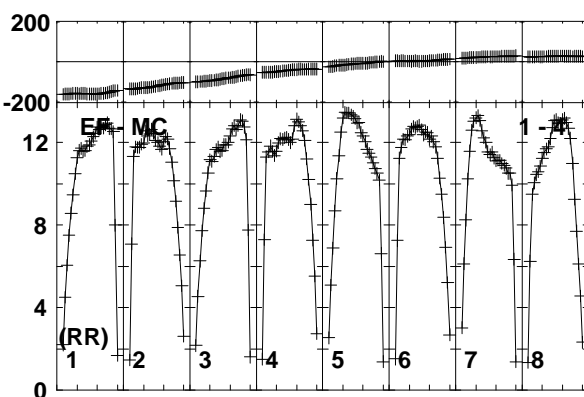
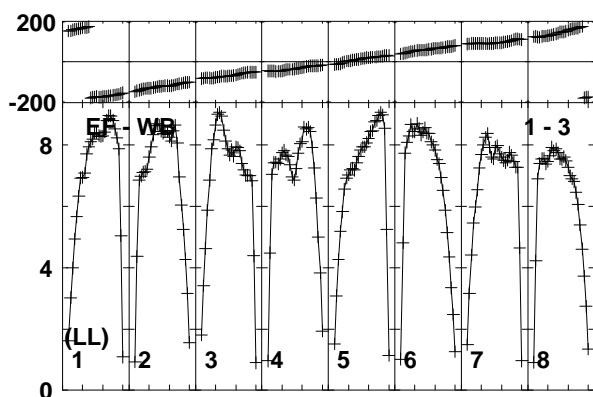
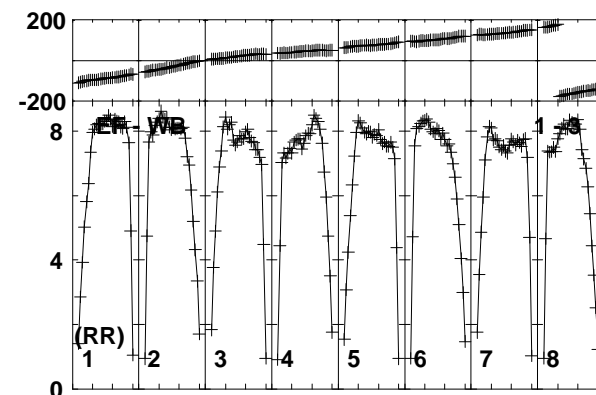
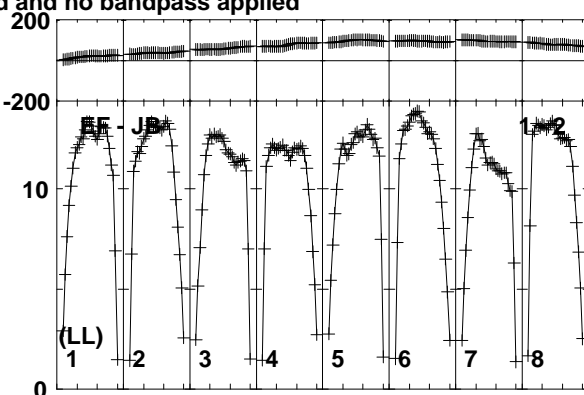
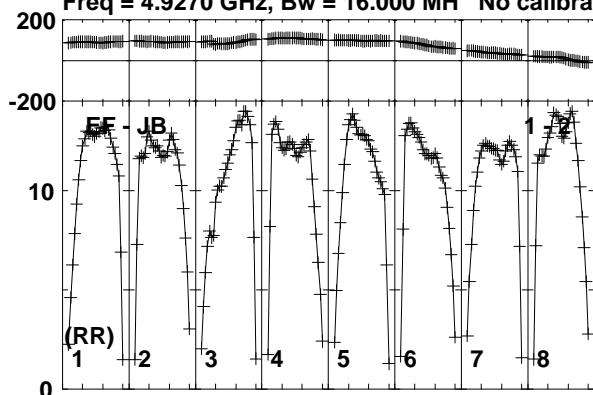

Lower frame: Milli Ampl Jy Top frame: Phas deg  
Vector averaged cross-power spectrum Baseline: EF (01) - JB (02)  
Timerange: 00/10:11:21 to 00/10:12:49

Plot file version 476 created 08-APR-2019 12:10:34

J0815+3635 EM133B.UVDATA.1

Freq = 4.9270 GHz, Bw = 16.000 MH No calibration applied and no bandpass applied

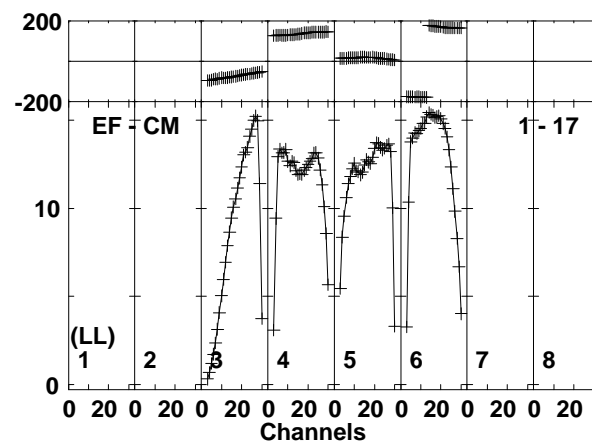
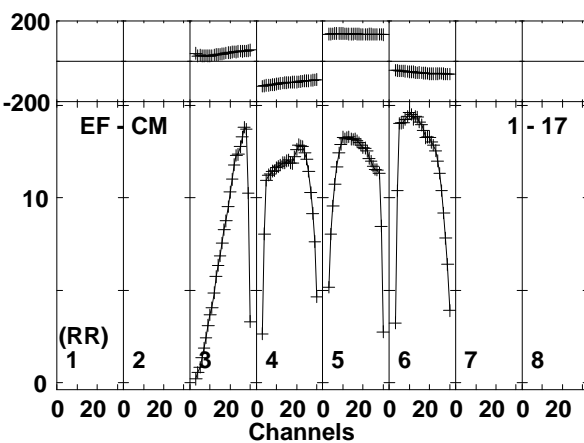
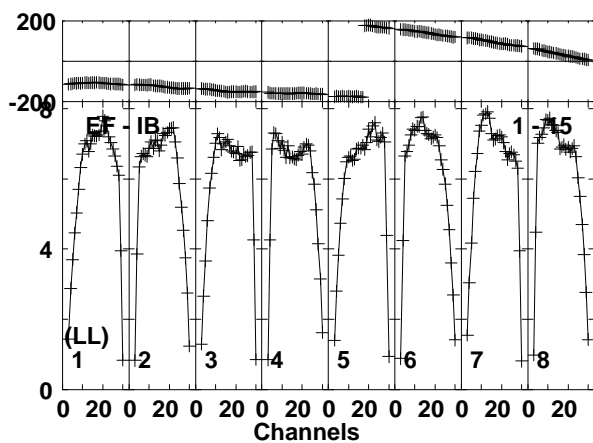
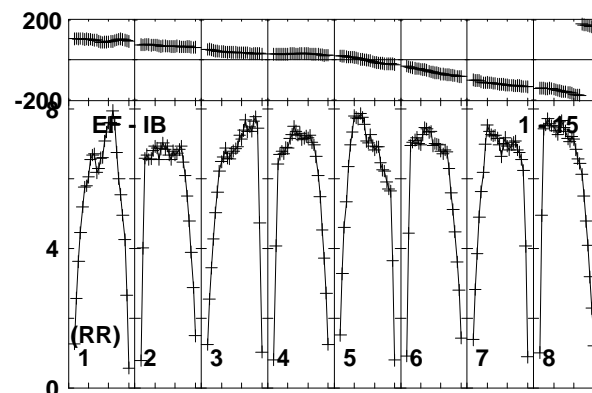
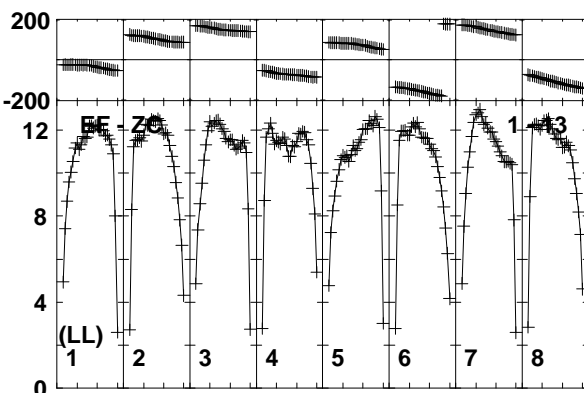
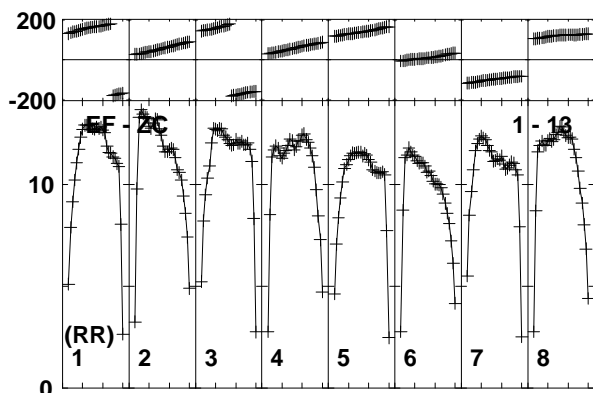
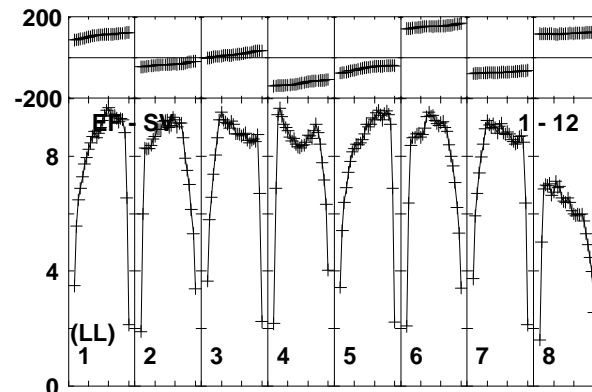
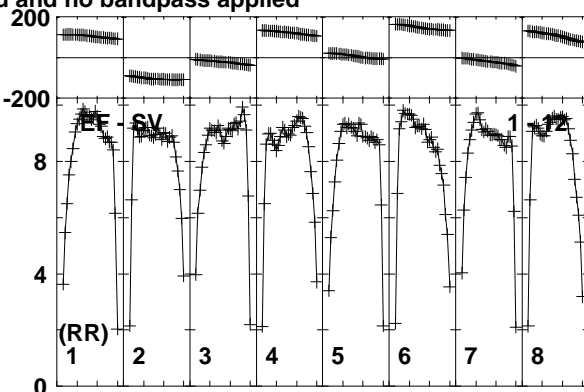
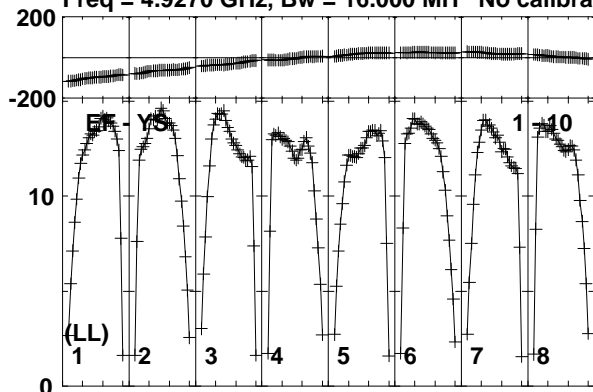

Lower frame: Milli Ampl Jy Top frame: Phas deg  
Vector averaged cross-power spectrum Baseline: EF (01) - YS (10)  
Timerange: 00/10:11:21 to 00/10:12:49

Plot file version 477 created 08-APR-2019 12:10:35

J0815+3635 EM133B.UVDATA.1

Freq = 4.9270 GHz, Bw = 16.000 MH No calibration applied and no bandpass applied

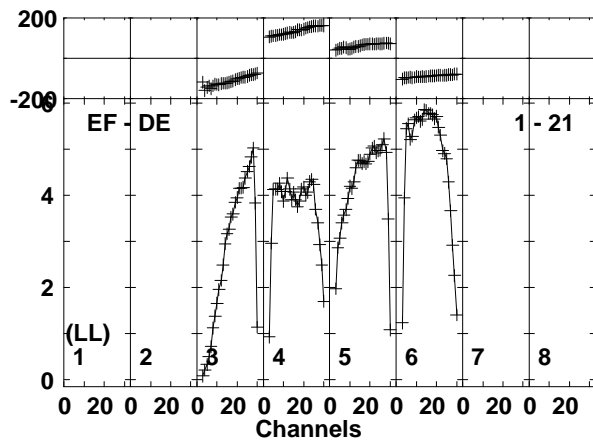
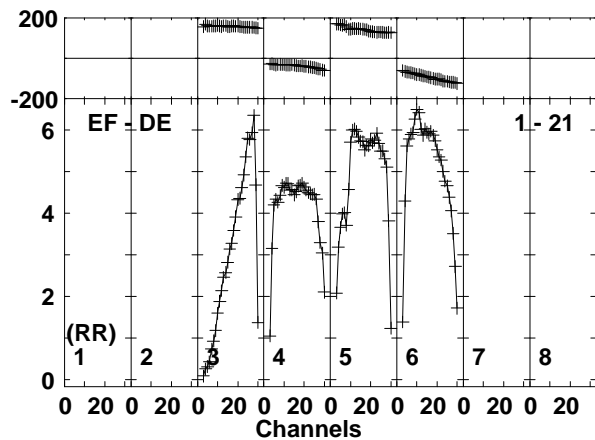
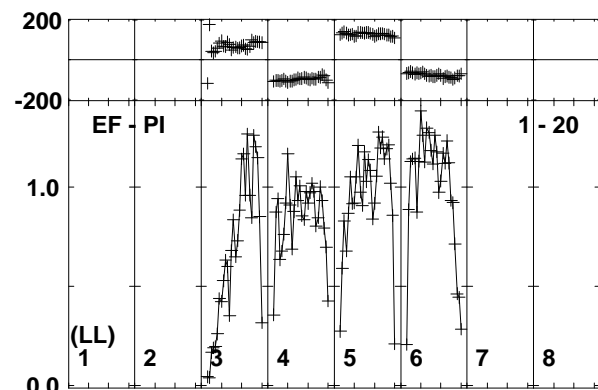
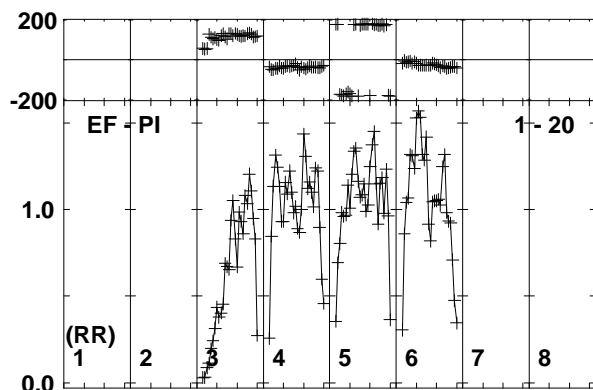
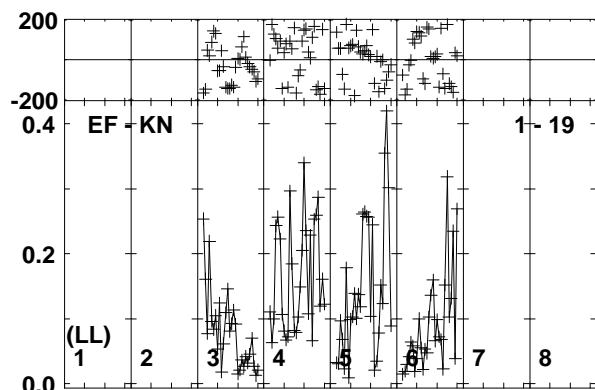
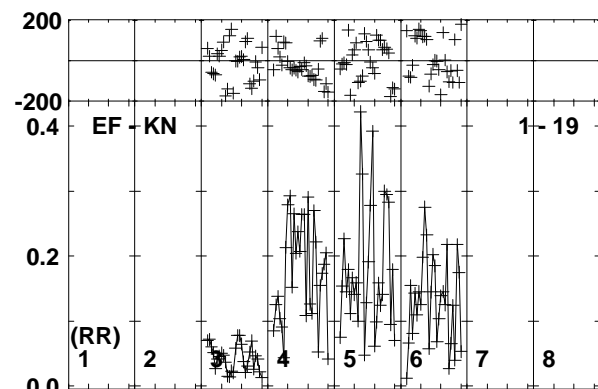
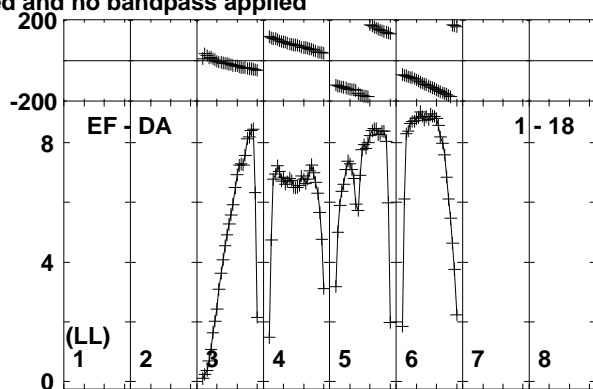
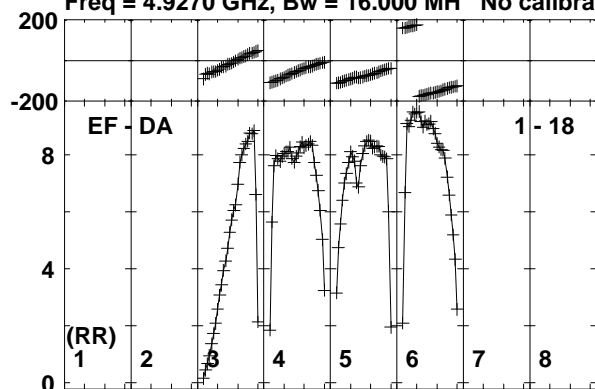

Lower frame: Milli Ampl Jy Top frame: Phas deg  
Vector averaged cross-power spectrum Baseline: EF (01) - DA (18)  
Timerange: 00/10:11:21 to 00/10:12:49

Plot file version 478 created 08-APR-2019 12:10:35

MRK622 EM133B.UVDATA.1

Freq = 4.9270 GHz, Bw = 16.000 MH No calibration applied and no bandpass applied

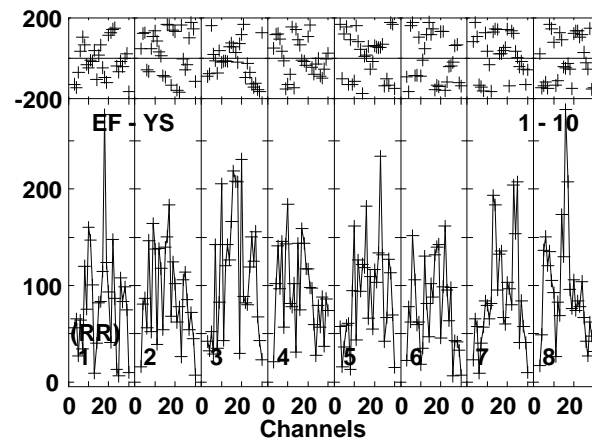
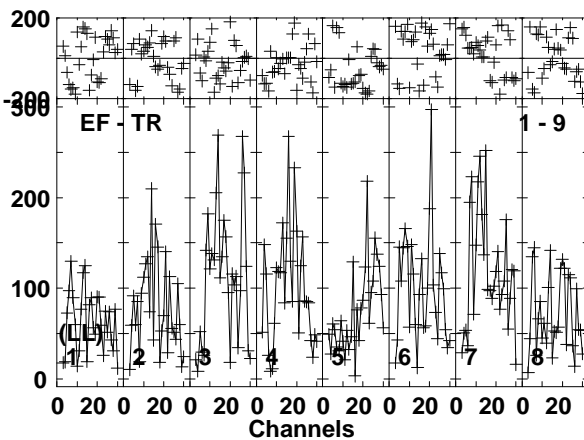
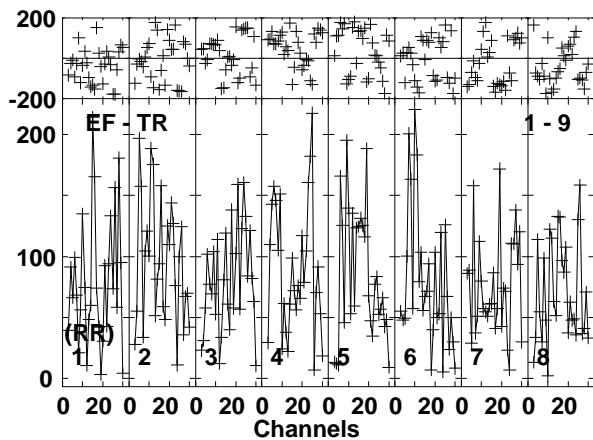
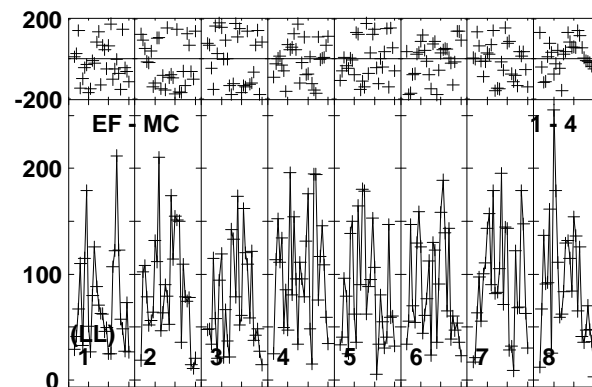
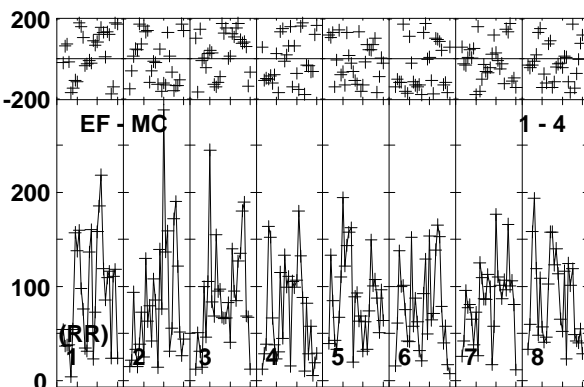
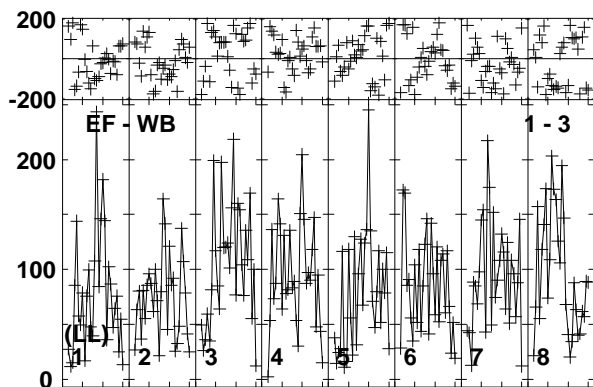
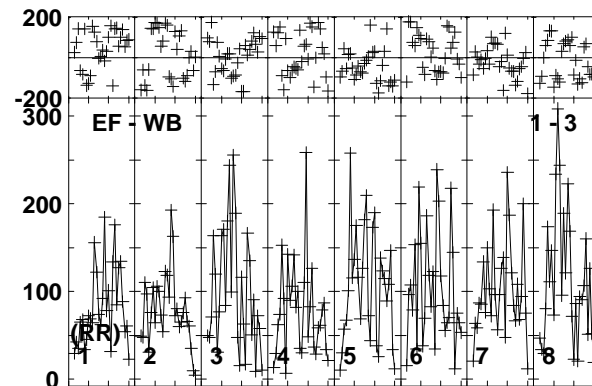
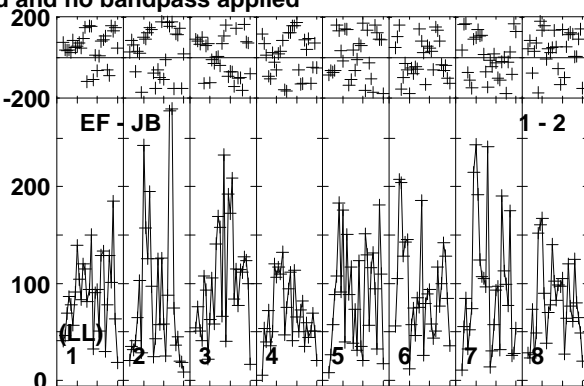
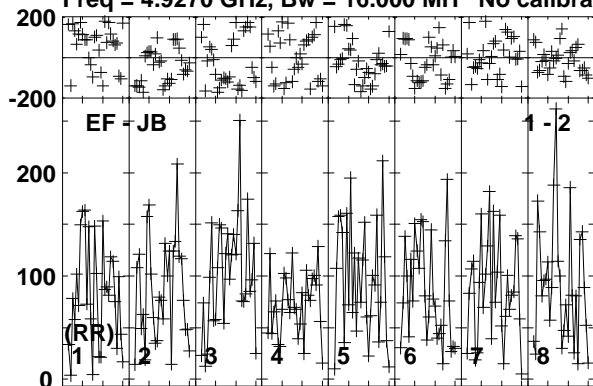

Lower frame: Micro Ampl Jy Top frame: Phas deg  
Vector averaged cross-power spectrum Baseline: EF (01) - JB (02)  
Timerange: 00/10:12:53 to 00/10:16:19

Plot file version 479 created 08-APR-2019 12:10:35

MRK622 EM133B.UVDATA.1

Freq = 4.9270 GHz, Bw = 16.000 MH No calibration applied and no bandpass applied

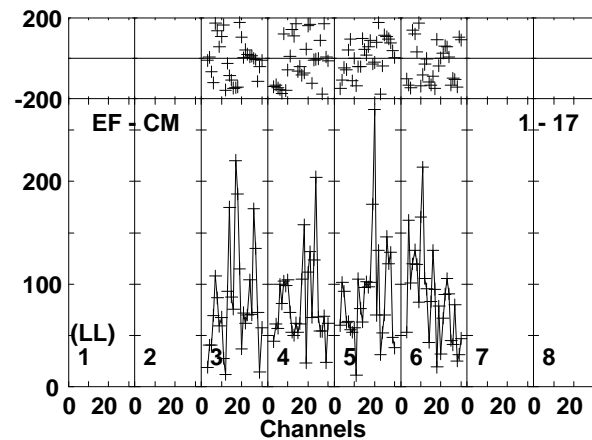
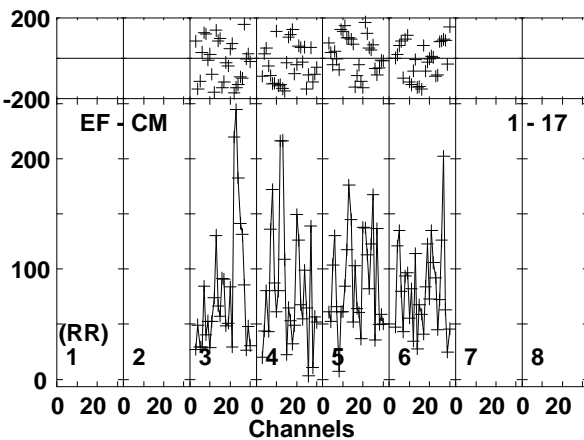
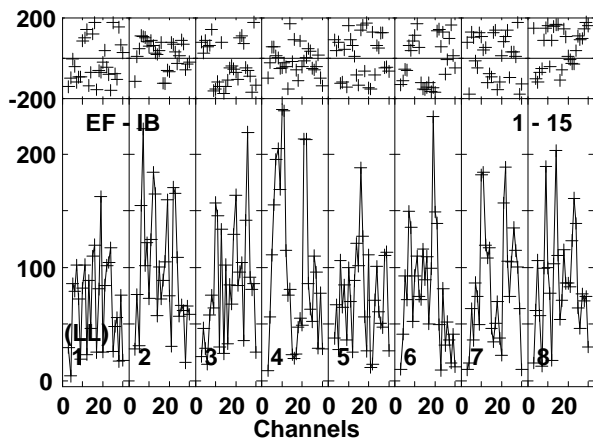
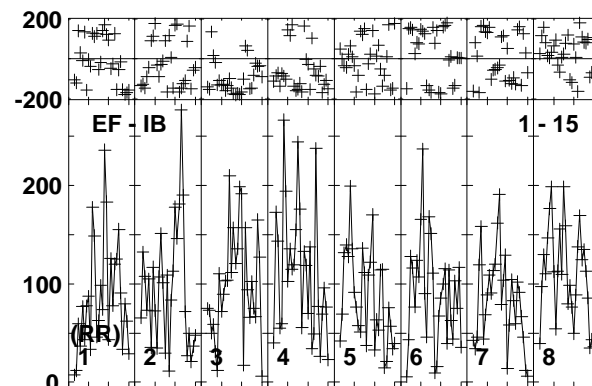
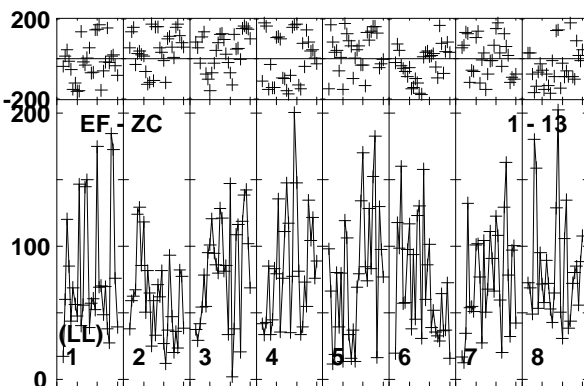
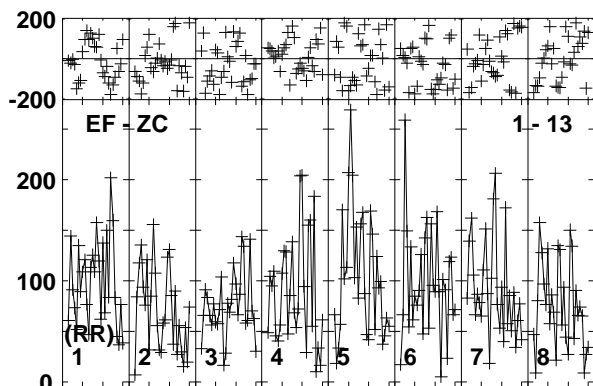
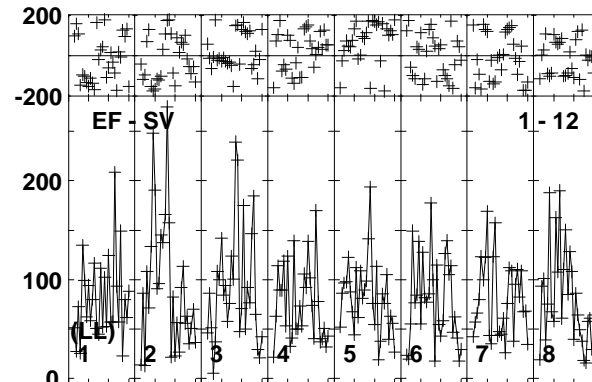
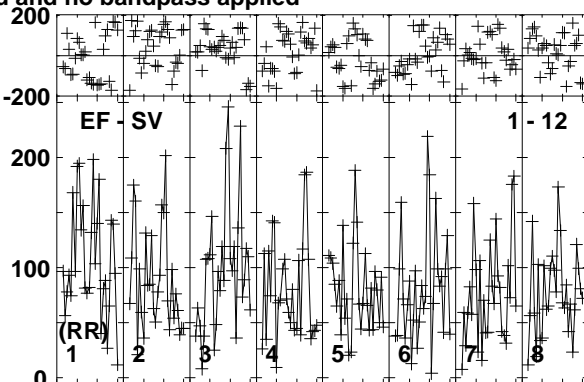
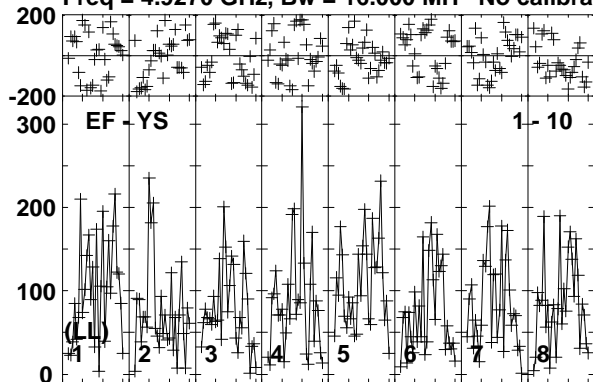

Lower frame: Micro Ampl Jy Top frame: Phas deg  
Vector averaged cross-power spectrum Baseline: EF (01) - YS (10)  
Timerange: 00/10:12:53 to 00/10:16:19

Plot file version 480 created 08-APR-2019 12:10:35

MRK622 EM133B.UVDATA.1

Freq = 4.9270 GHz, Bw = 16.000 MH No calibration applied and no bandpass applied

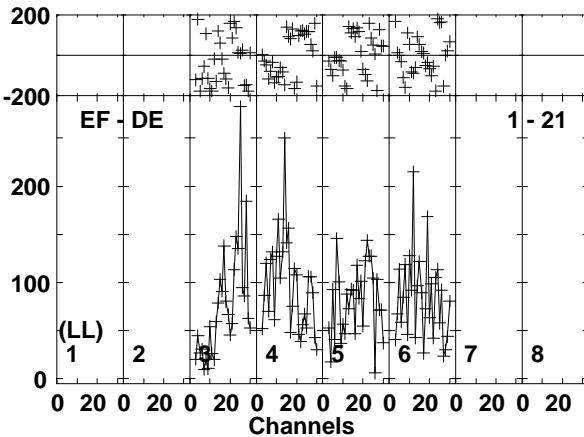
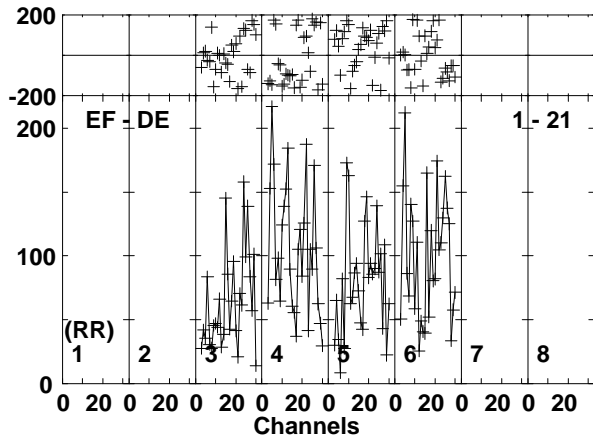
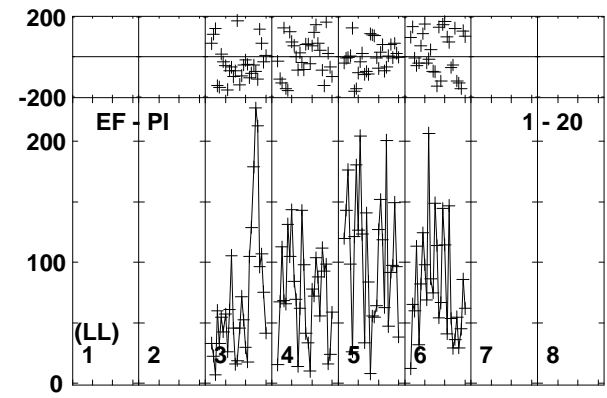
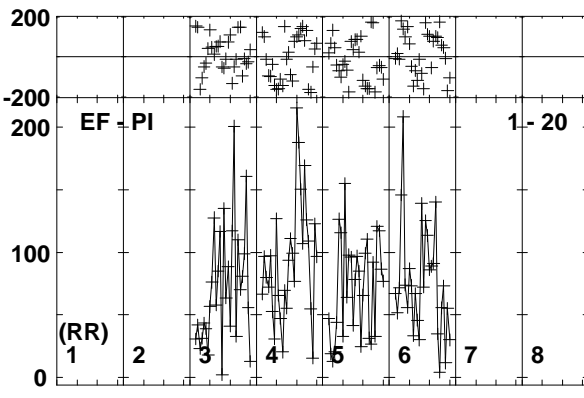
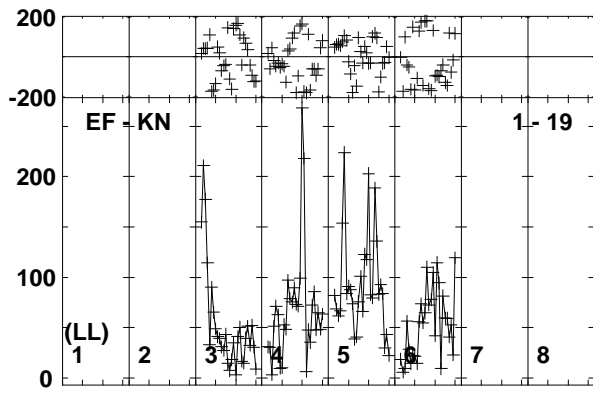
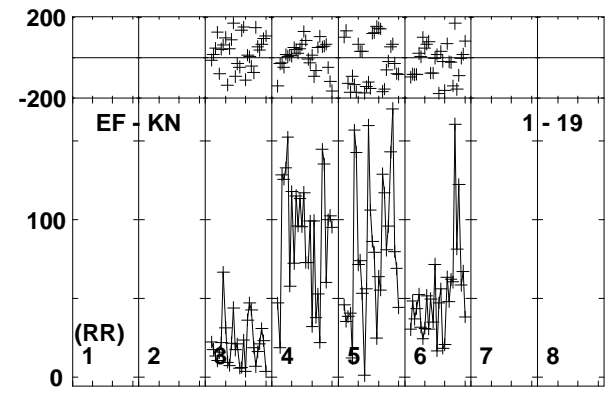
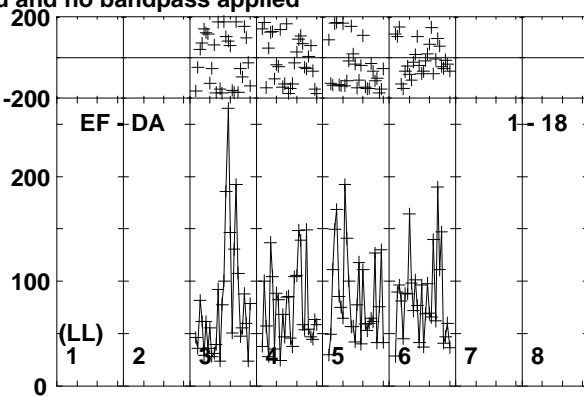
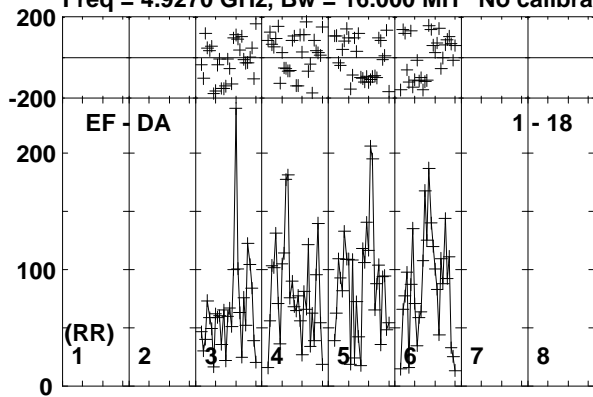

Lower frame: Micro Ampl Jy Top frame: Phas deg  
Vector averaged cross-power spectrum Baseline: EF (01) - DA (18)  
Timerange: 00/10:12:53 to 00/10:16:19



Plot file version 481 created 08-APR-2019 12:10:35

J0815+3635 EM133B.UVDATA.1

Freq = 4.9270 GHz, Bw = 16.000 MH No calibration applied and no bandpass applied

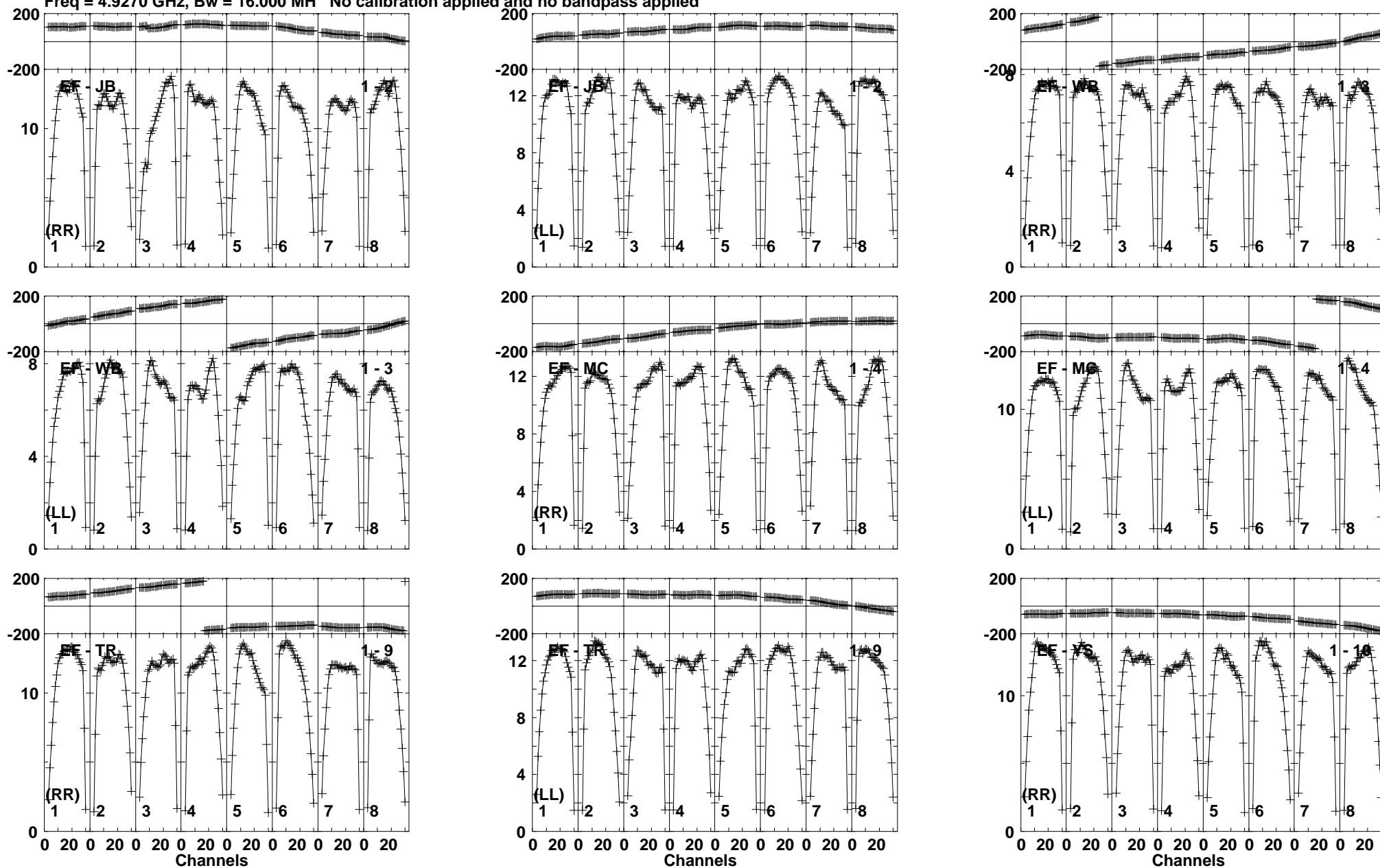

Lower frame: Milli Ampl Jy Top frame: Phas deg  
Vector averaged cross-power spectrum Baseline: EF (01) - JB (02)  
Timerange: 00/10:17:11 to 00/10:18:39

Plot file version 482 created 08-APR-2019 12:10:35

J0815+3635 EM133B.UVDATA.1

Freq = 4.9270 GHz, Bw = 16.000 MH No calibration applied and no bandpass applied

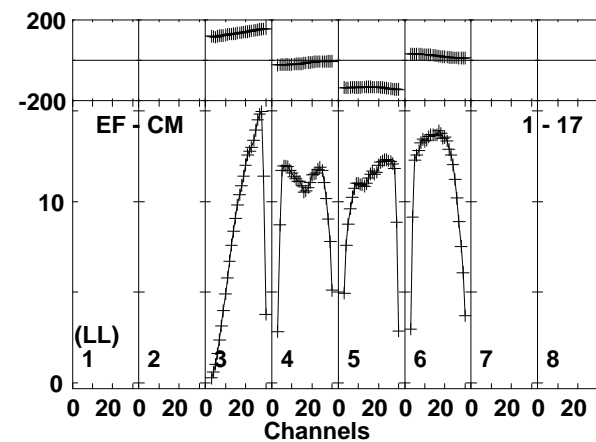
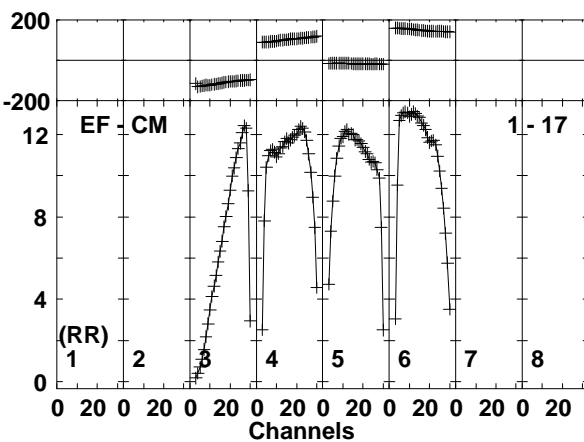
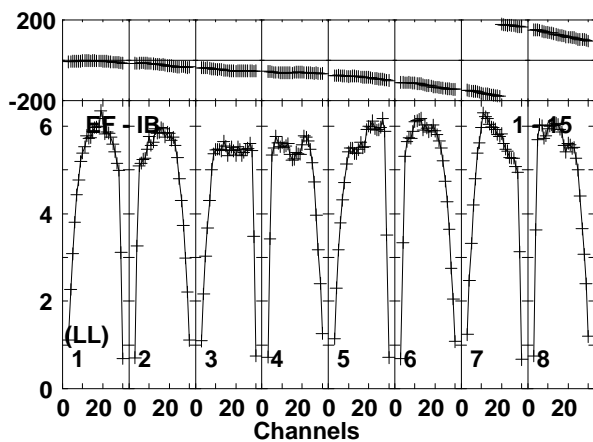
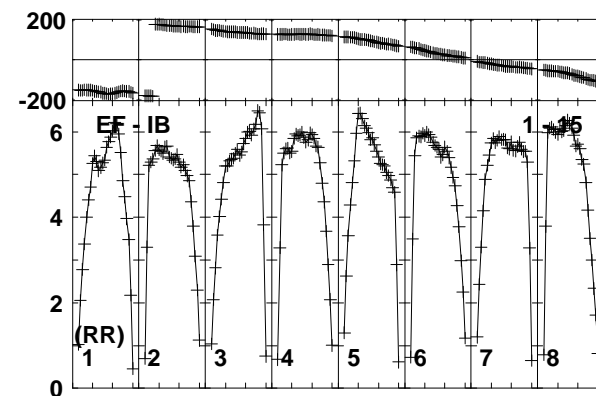
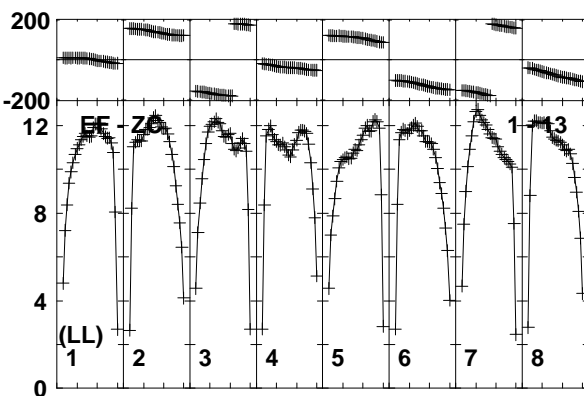
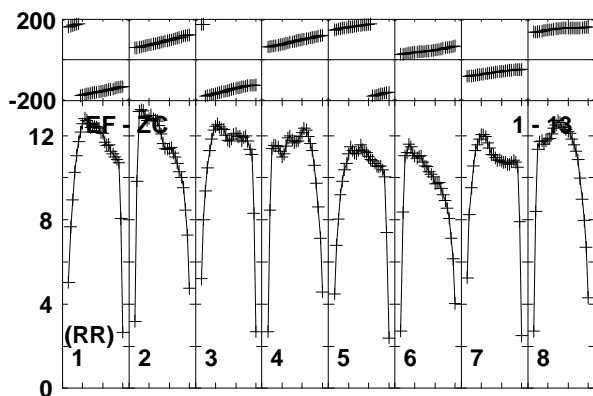
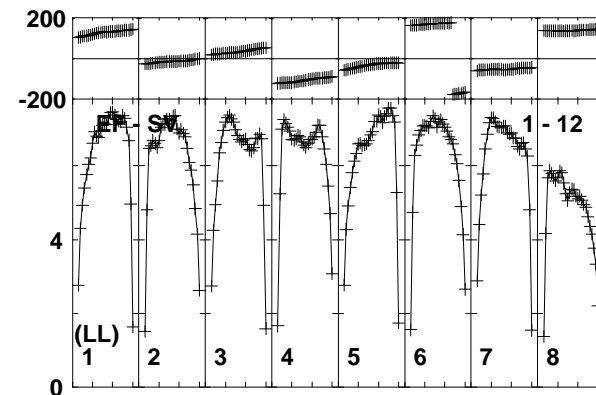
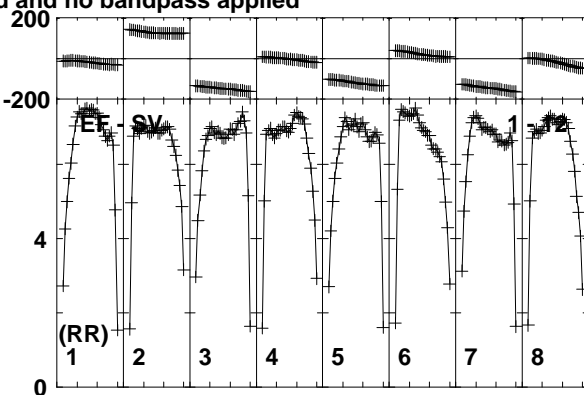
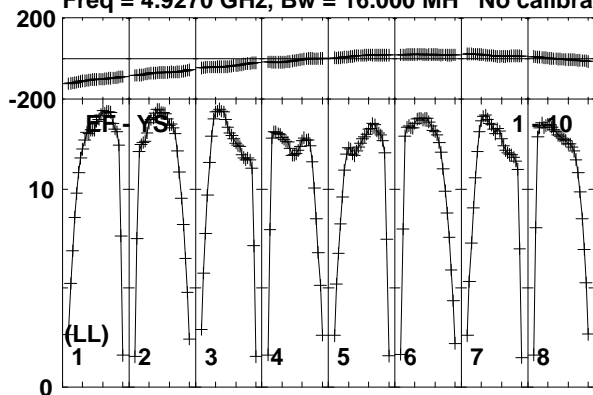

Lower frame: Milli Ampl Jy Top frame: Phas deg  
Vector averaged cross-power spectrum Baseline: EF (01) - YS (10)  
Timerange: 00/10:17:11 to 00/10:18:39

Plot file version 483 created 08-APR-2019 12:10:36

J0815+3635 EM133B.UVDATA.1

Freq = 4.9270 GHz, Bw = 16.000 MH No calibration applied and no bandpass applied

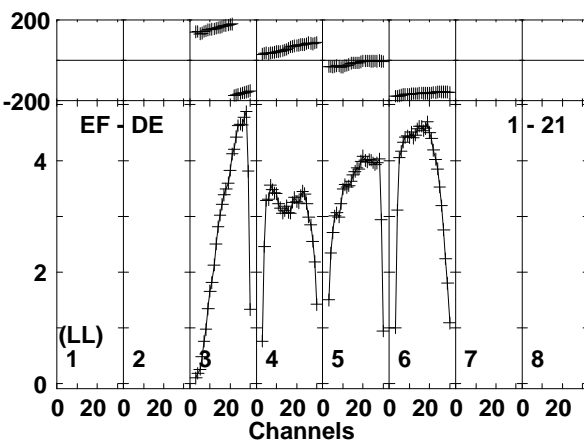
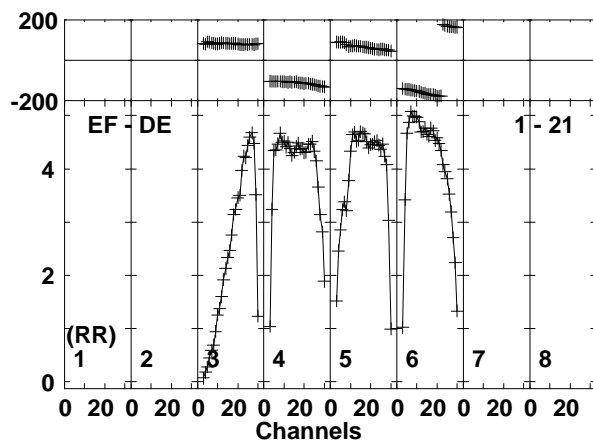
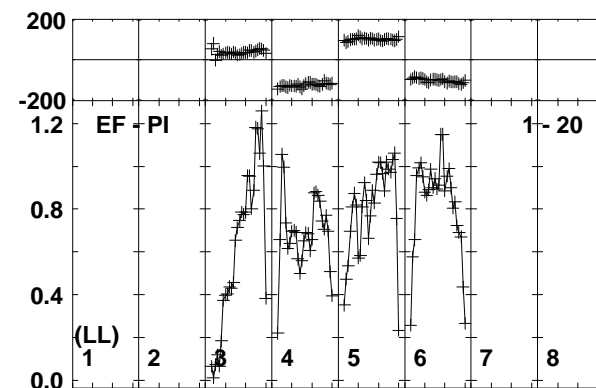
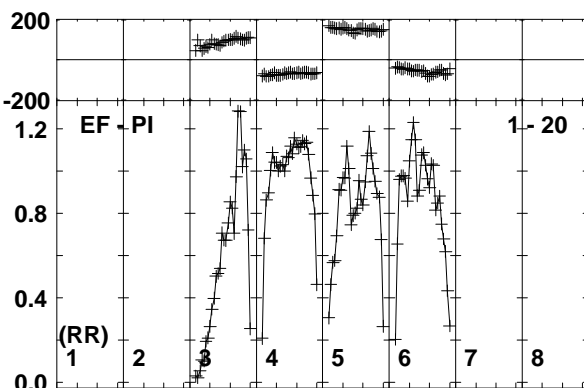
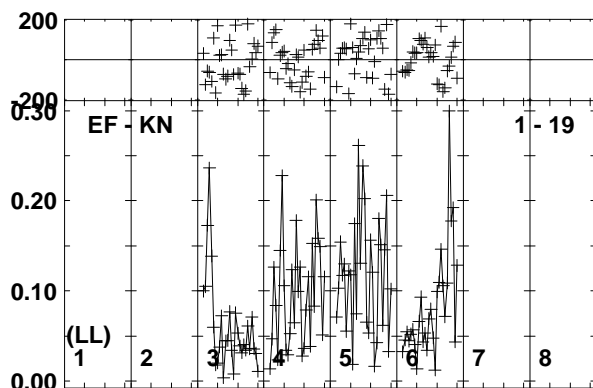
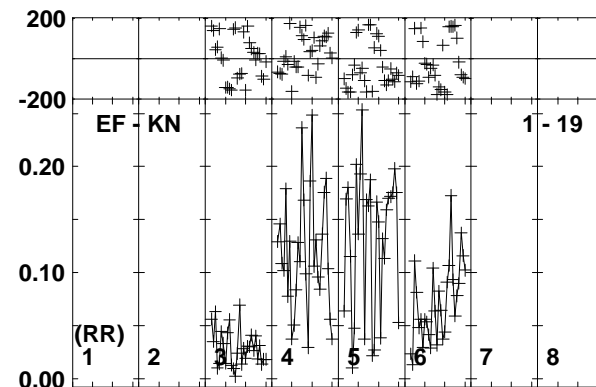
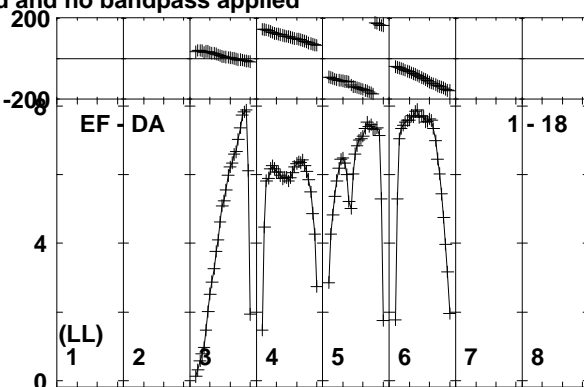
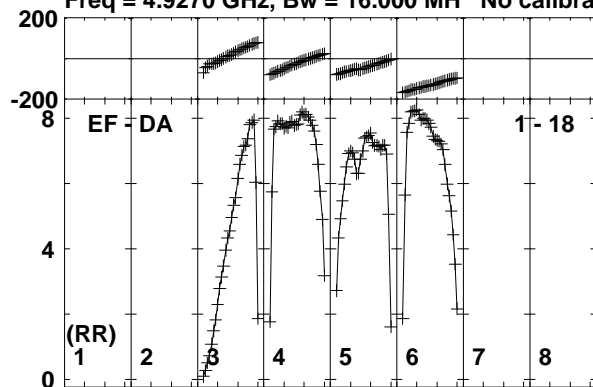

Lower frame: Milli Ampl Jy Top frame: Phas deg  
Vector averaged cross-power spectrum Baseline: EF (01) - DA (18)  
Timerange: 00/10:17:11 to 00/10:18:39

Plot file version 484 created 08-APR-2019 12:10:36

MRK622 EM133B.UVDATA.1

Freq = 4.9270 GHz, Bw = 16.000 MH No calibration applied and no bandpass applied

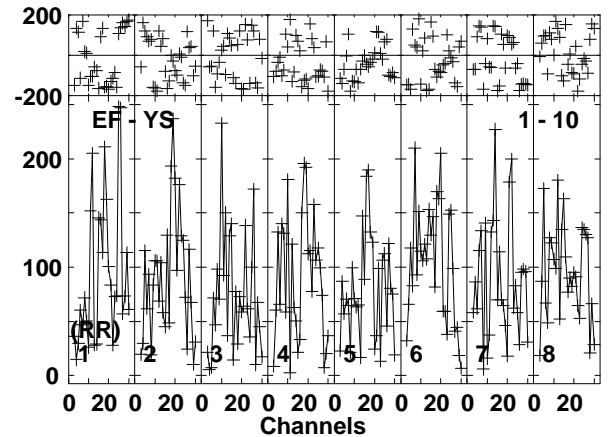
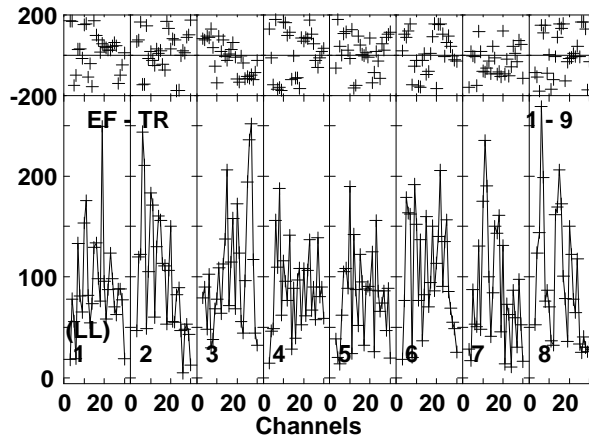
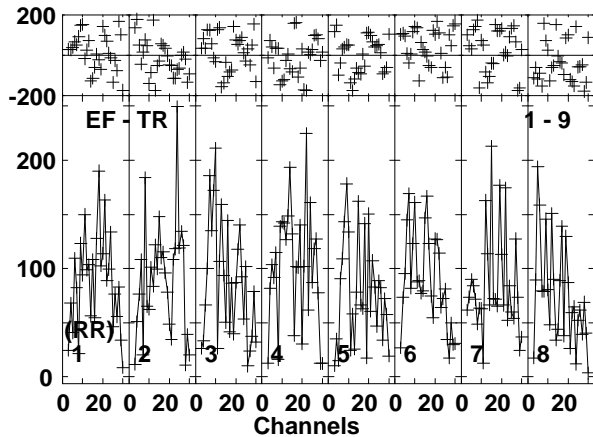
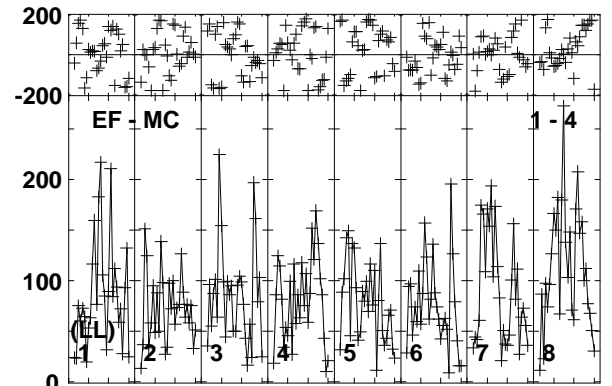
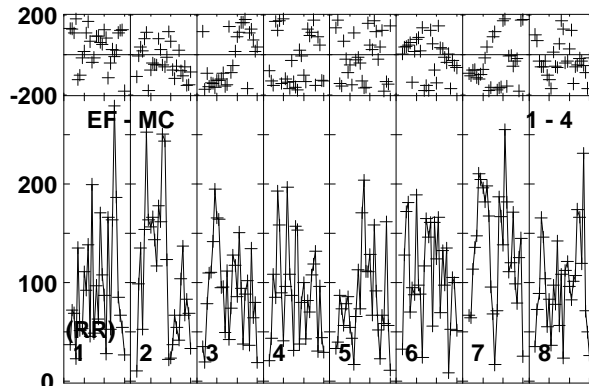
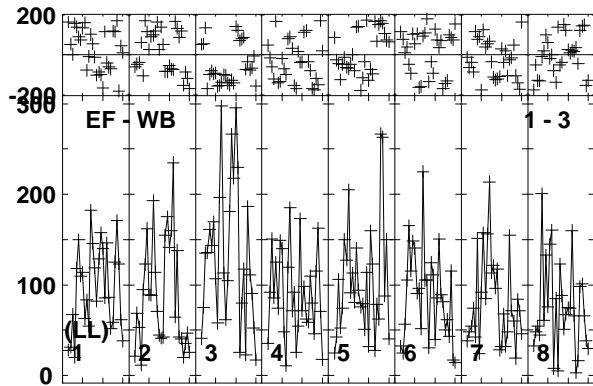
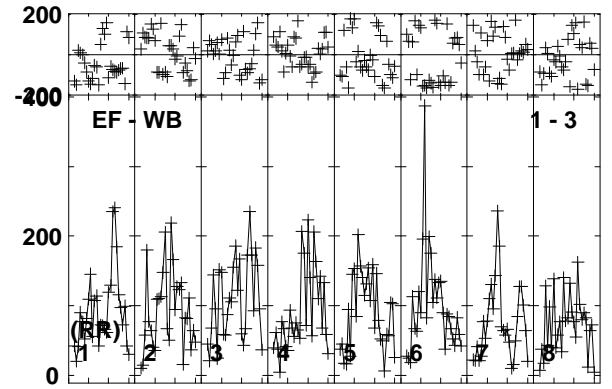
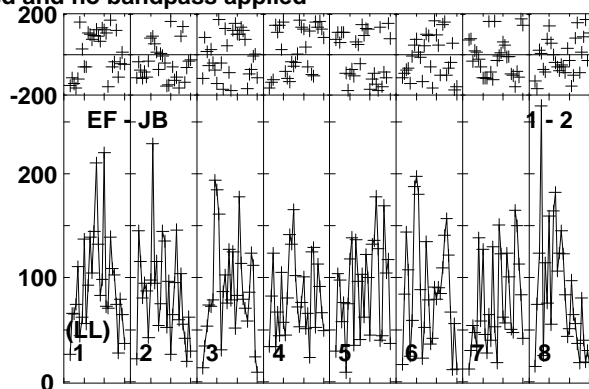
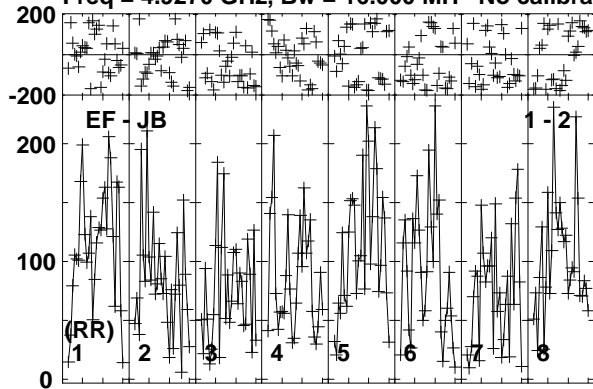

Lower frame: Micro Ampl Jy Top frame: Phas deg  
Vector averaged cross-power spectrum Baseline: EF (01) - JB (02)  
Timerange: 00/10:18:41 to 00/10:22:09

Plot file version 485 created 08-APR-2019 12:10:36

MRK622 EM133B.UVDATA.1

Freq = 4.9270 GHz, Bw = 16.000 MH No calibration applied and no bandpass applied

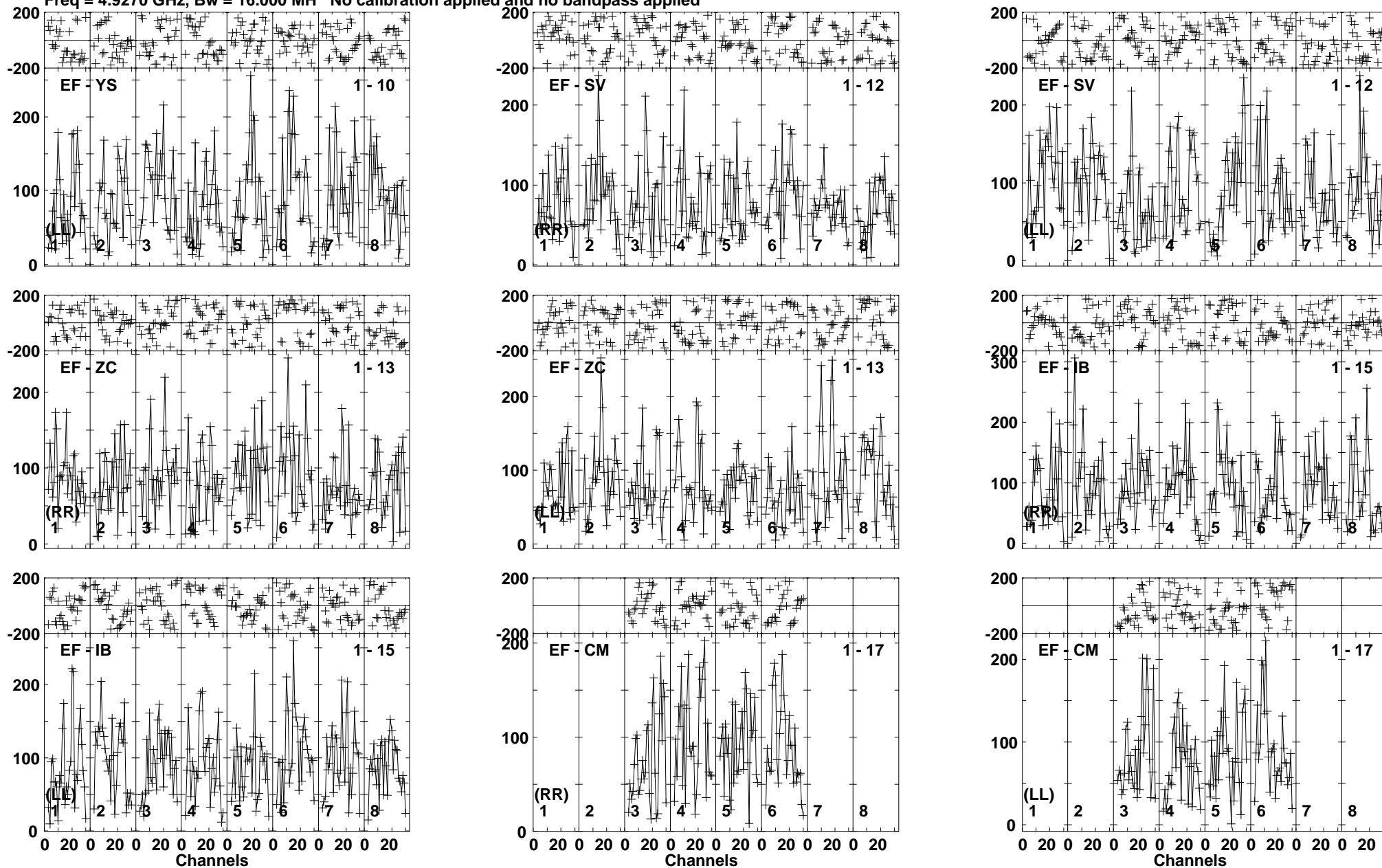

Lower frame: Micro Ampl Jy Top frame: Phas deg  
Vector averaged cross-power spectrum Baseline: EF (01) - YS (10)  
Timerange: 00/10:18:41 to 00/10:22:09

Plot file version 486 created 08-APR-2019 12:10:36

MRK622 EM133B.UVDATA.1

Freq = 4.9270 GHz, Bw = 16.000 MH No calibration applied and no bandpass applied

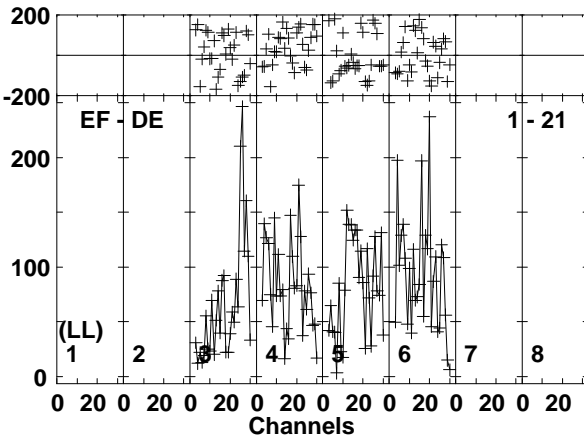
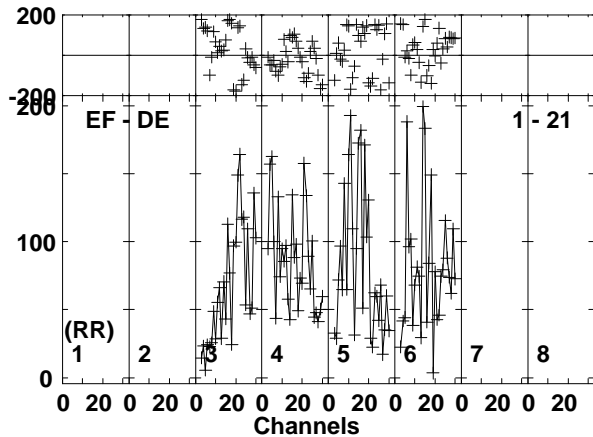
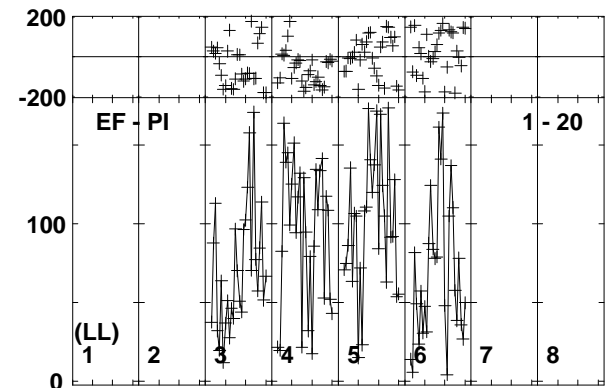
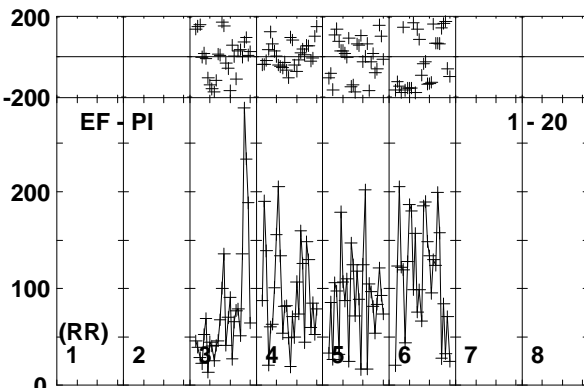
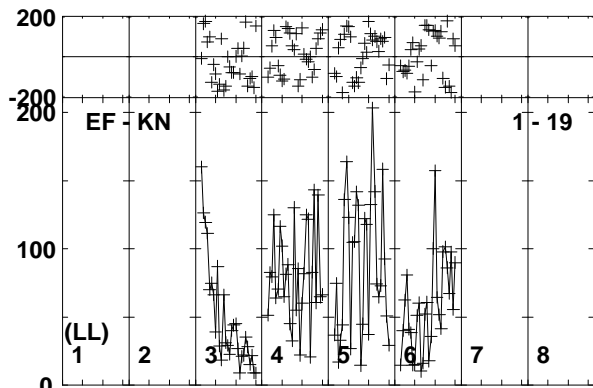
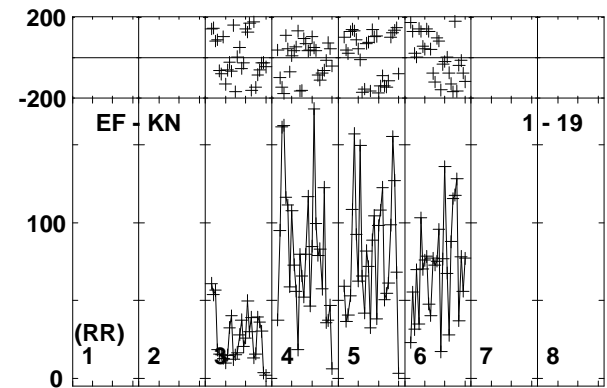
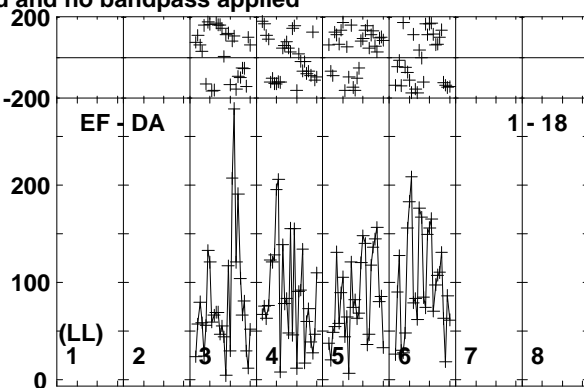
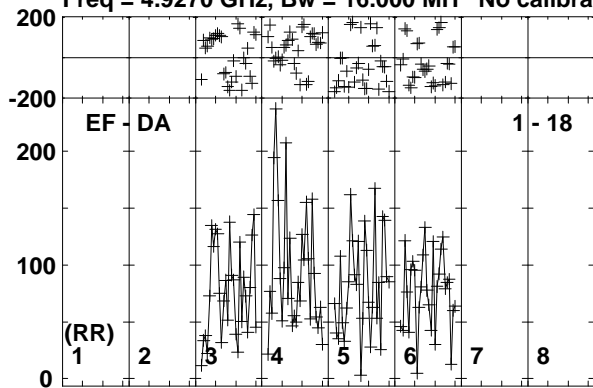

Lower frame: Micro Ampl Jy Top frame: Phas deg  
Vector averaged cross-power spectrum Baseline: EF (01) - DA (18)  
Timerange: 00/10:18:41 to 00/10:22:09

Plot file version 487 created 08-APR-2019 12:10:36

J0815+3635 EM133B.UVDATA.1

Freq = 4.9270 GHz, Bw = 16.000 MH No calibration applied and no bandpass applied

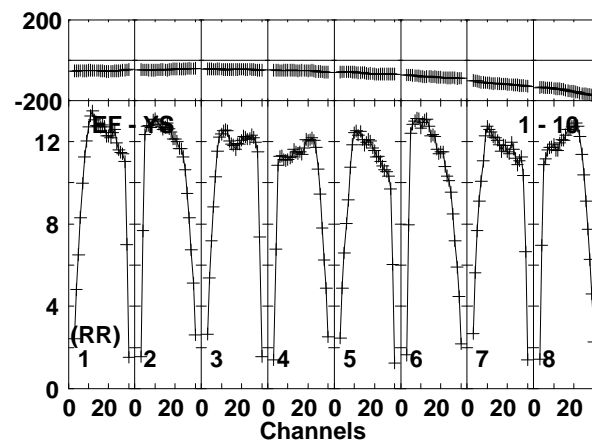
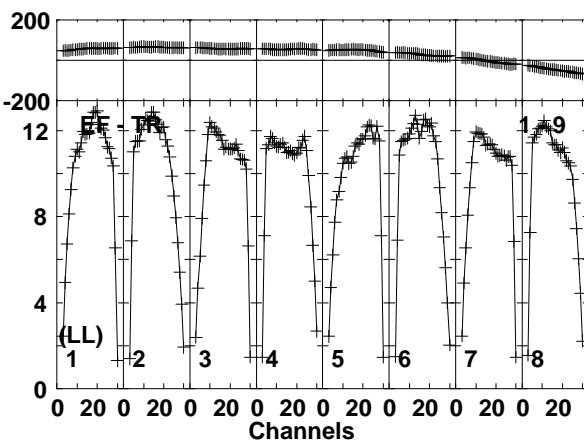
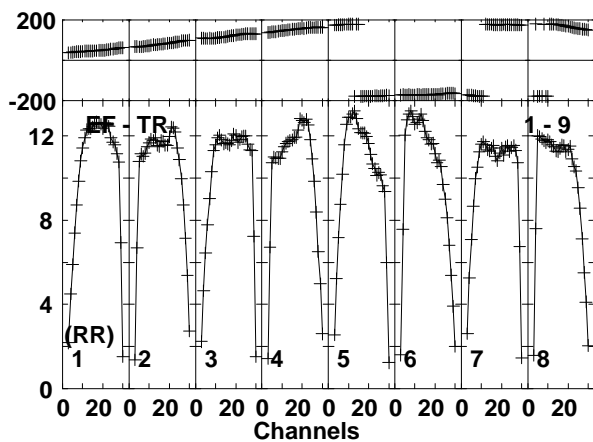
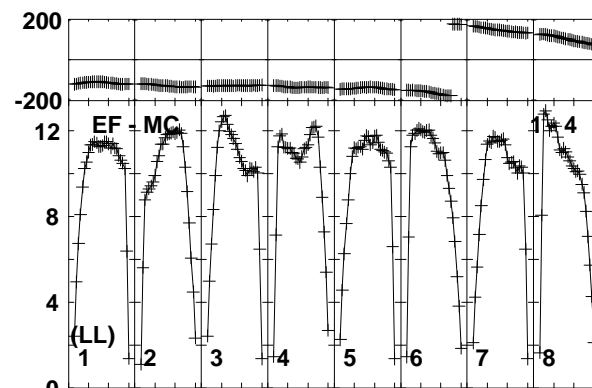
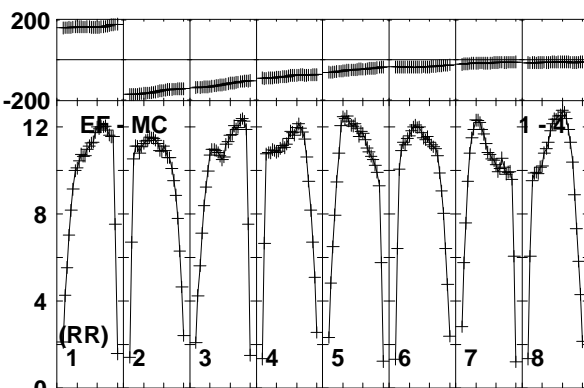
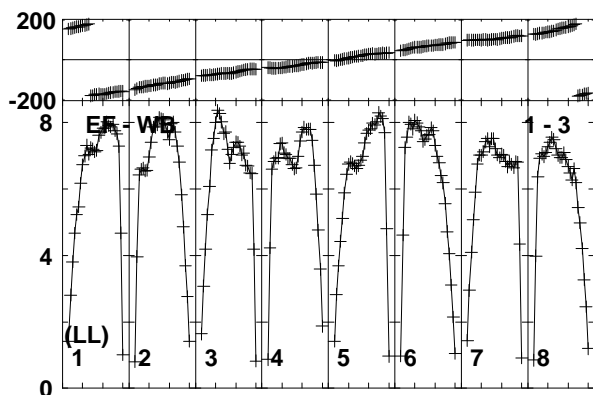
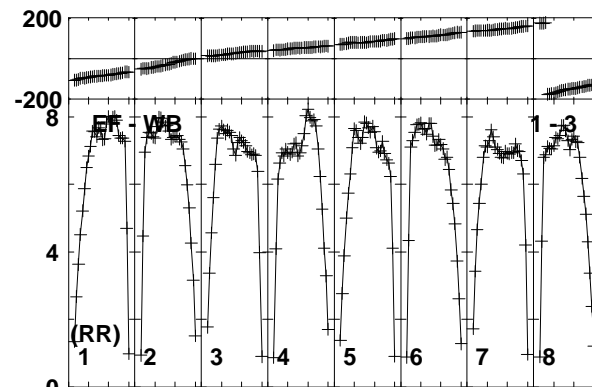
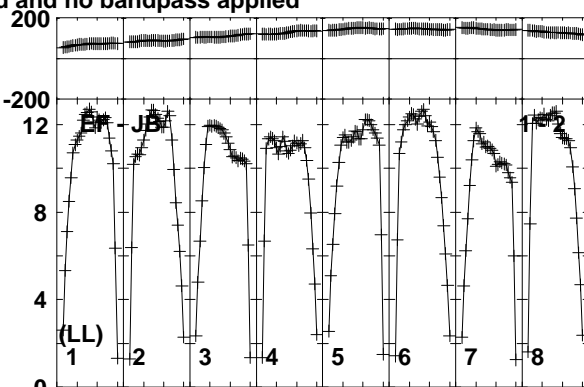
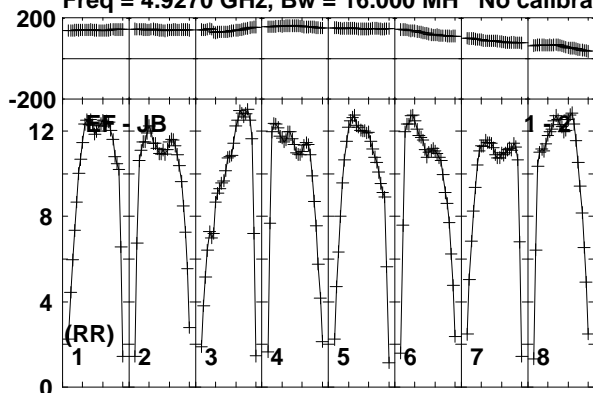

Lower frame: Milli Ampl Jy Top frame: Phas deg  
Vector averaged cross-power spectrum Baseline: EF (01) - JB (02)  
Timerange: 00/10/22:11 to 00/10/23:39

Plot file version 488 created 08-APR-2019 12:10:36

J0815+3635 EM133B.UVDATA.1

Freq = 4.9270 GHz, Bw = 16.000 MH No calibration applied and no bandpass applied

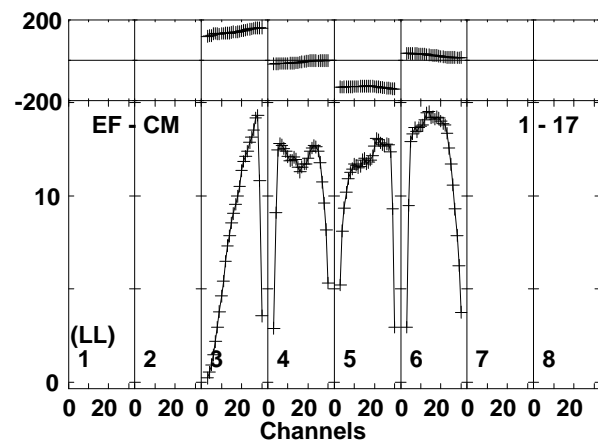
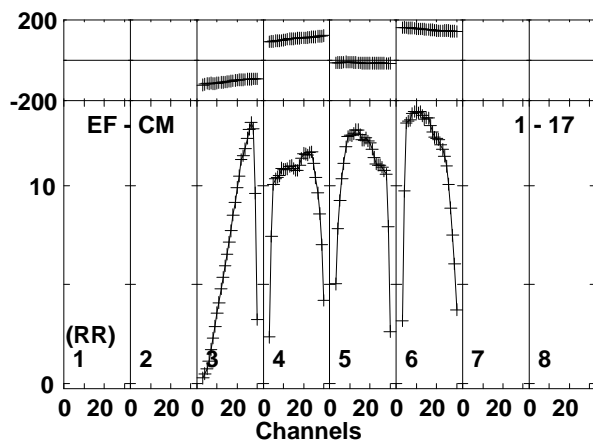
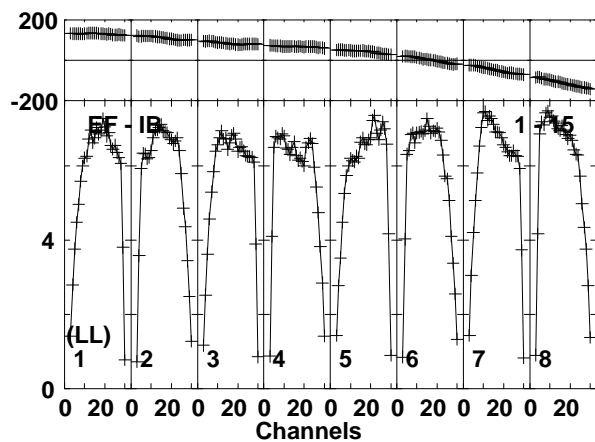
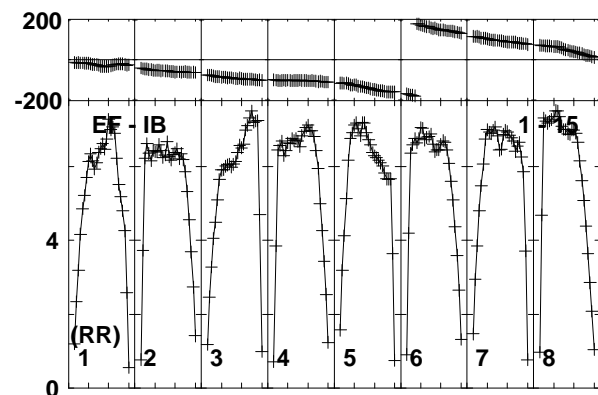
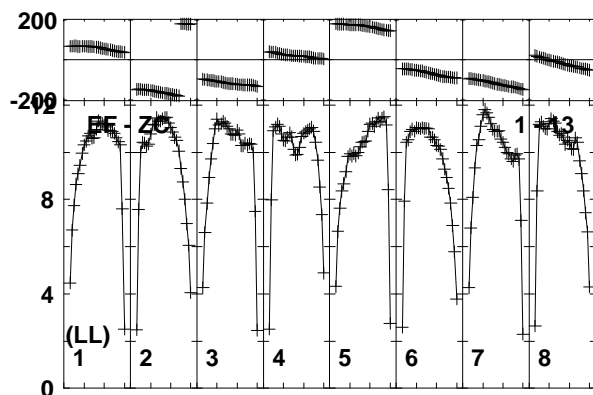
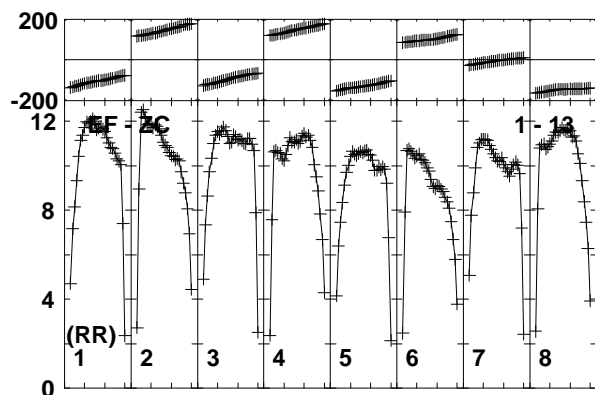
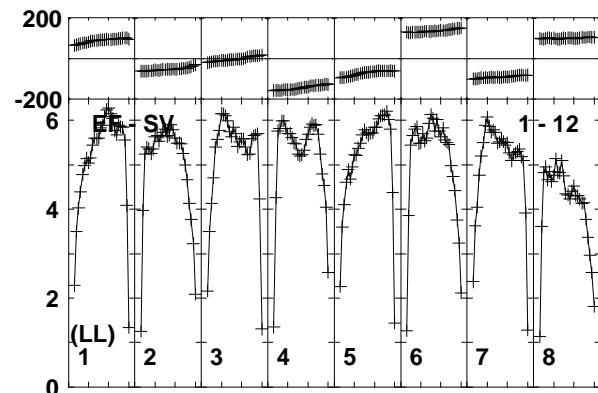
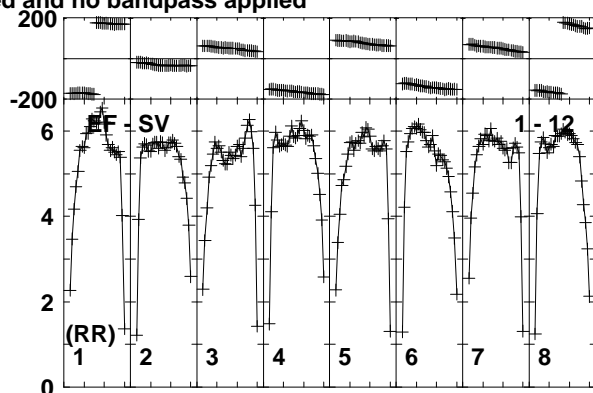
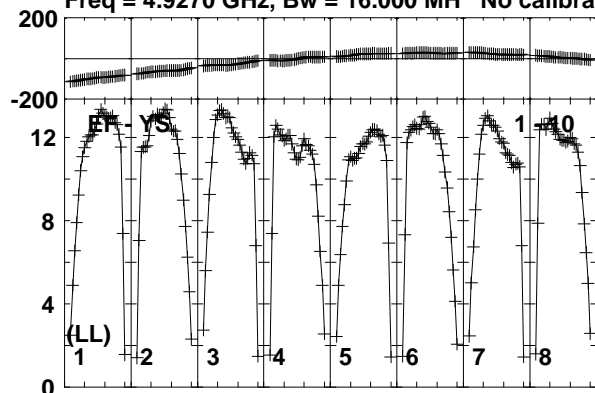

Lower frame: Milli Ampl Jy Top frame: Phas deg  
Vector averaged cross-power spectrum Baseline: EF (01) - YS (10)  
Timerange: 00/10:22:11 to 00/10:23:39



Plot file version 489 created 08-APR-2019 12:10:37

J0815+3635 EM133B.UVDATA.1

Freq = 4.9270 GHz, Bw = 16.000 MH No calibration applied and no bandpass applied

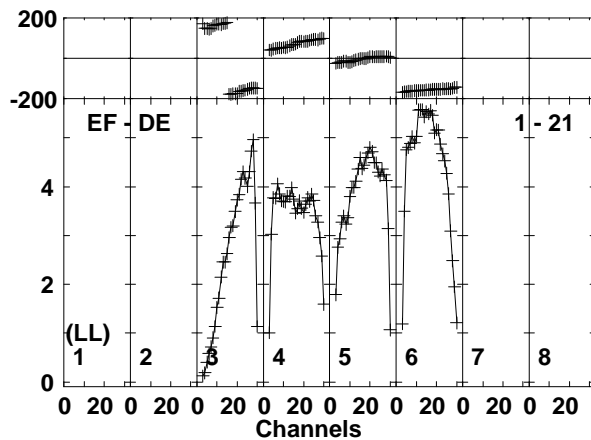
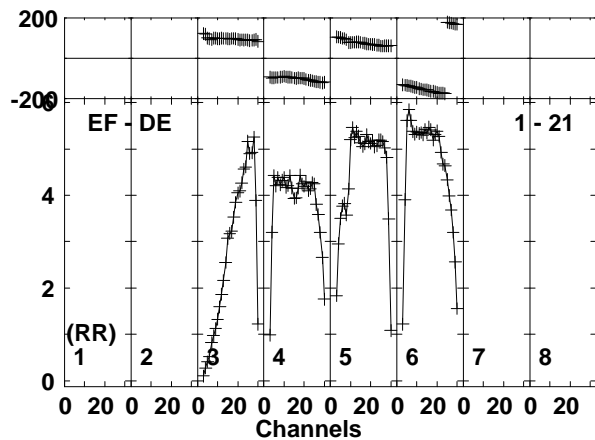
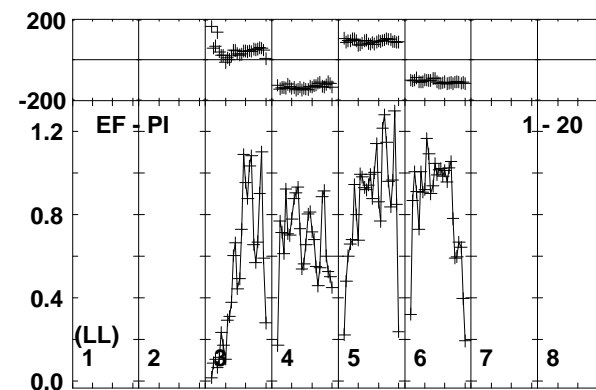
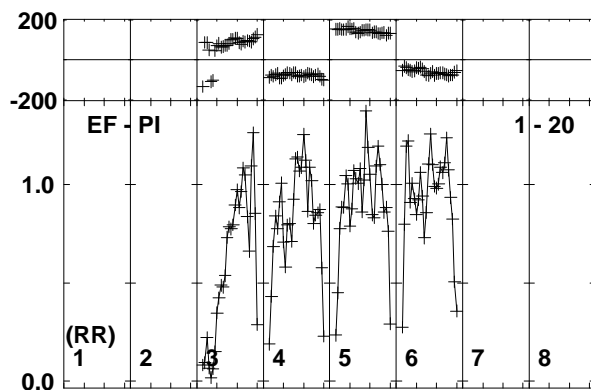
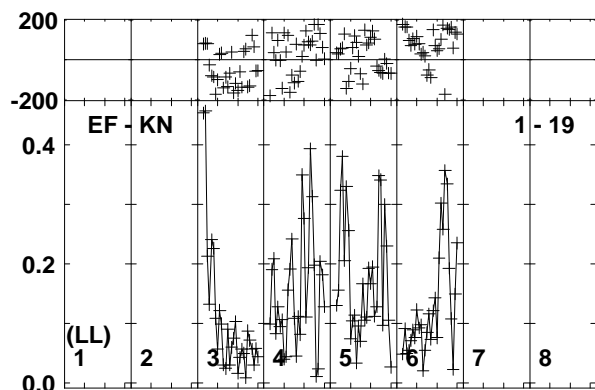
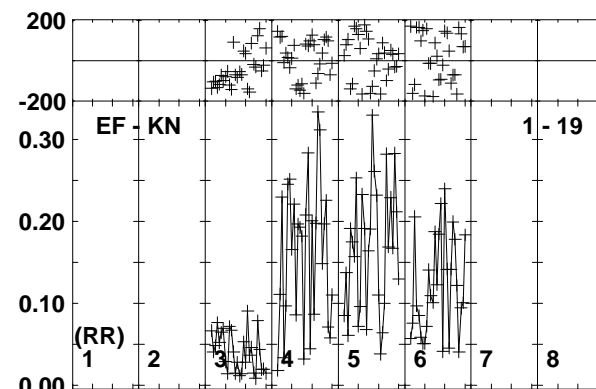
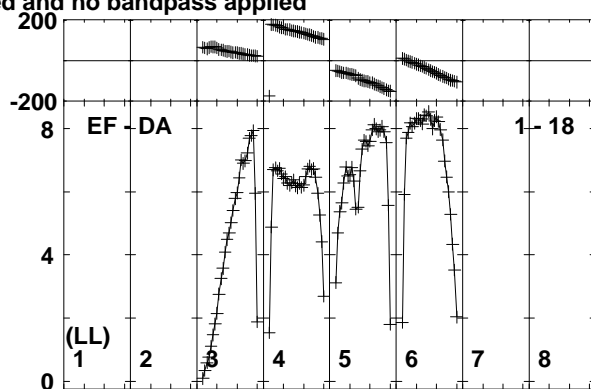
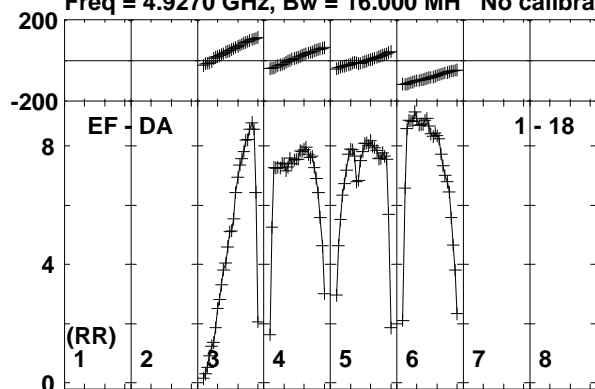

Lower frame: Milli Ampl Jy Top frame: Phas deg  
Vector averaged cross-power spectrum Baseline: EF (01) - DA (18)  
Timerange: 00/10:22:11 to 00/10:23:39

Plot file version 490 created 08-APR-2019 12:10:37

MRK622 EM133B.UVDATA.1

Freq = 4.9270 GHz, Bw = 16.000 MH No calibration applied and no bandpass applied

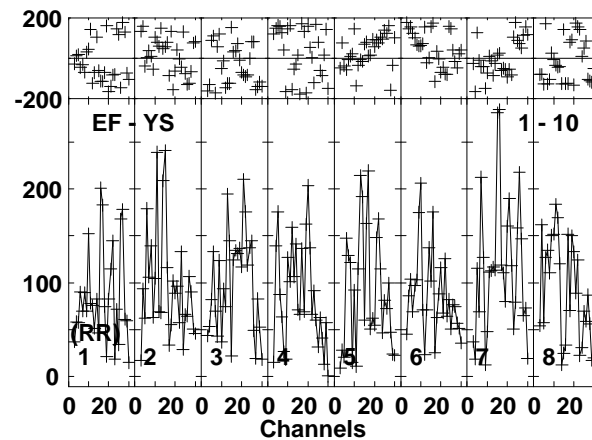
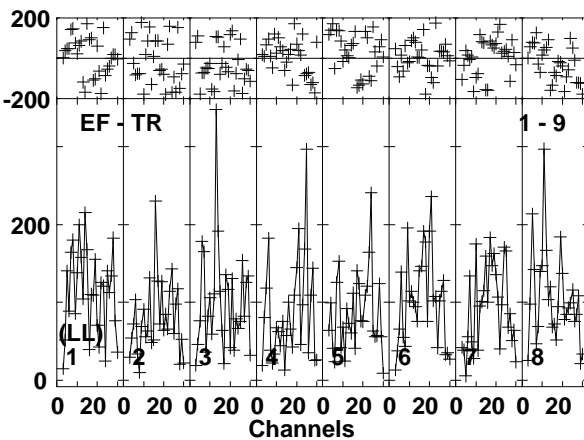
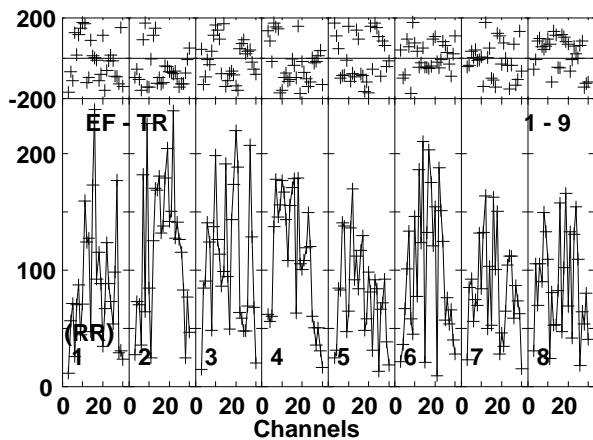
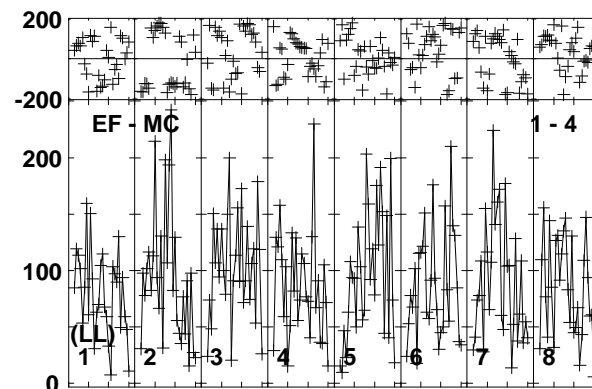
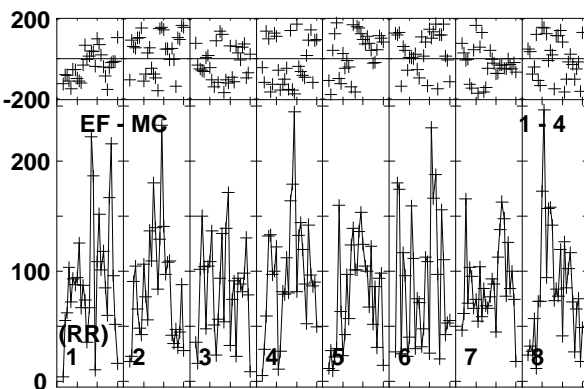
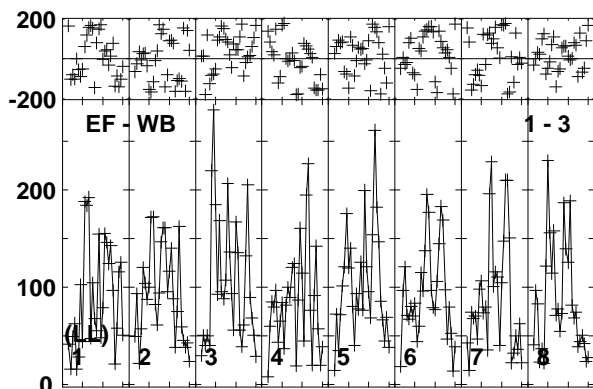
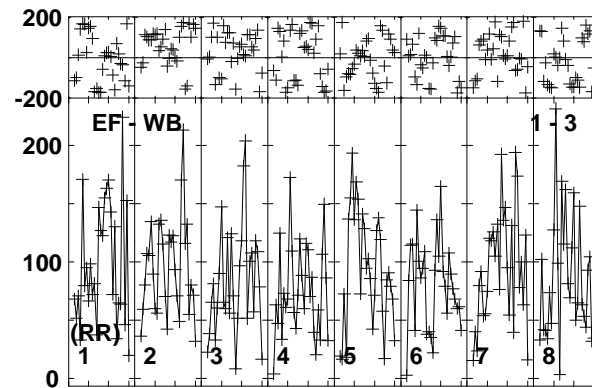
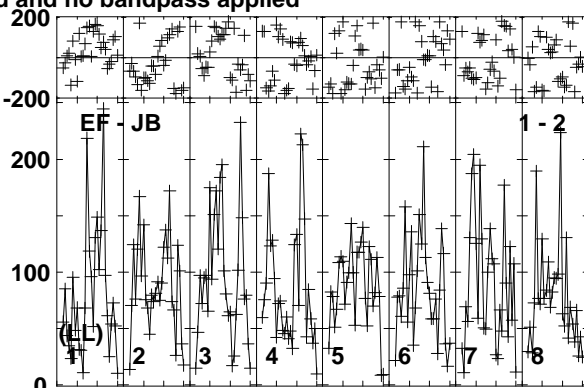
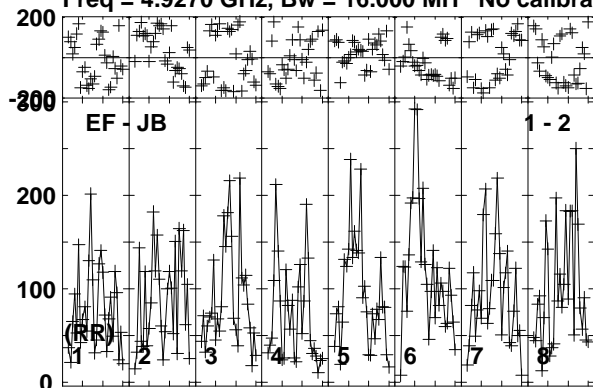

Lower frame: Micro Ampl Jy Top frame: Phas deg  
Vector averaged cross-power spectrum Baseline: EF (01) - JB (02)  
Timerange: 00/10:23:43 to 00/10:27:09

Plot file version 491 created 08-APR-2019 12:10:37

MRK622 EM133B.UVDATA.1

Freq = 4.9270 GHz, Bw = 16.000 MH No calibration applied and no bandpass applied

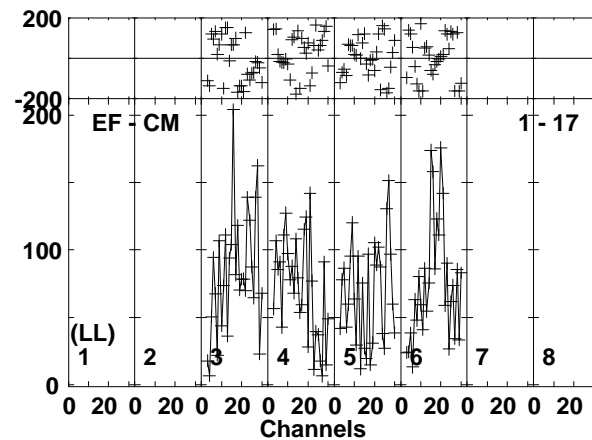
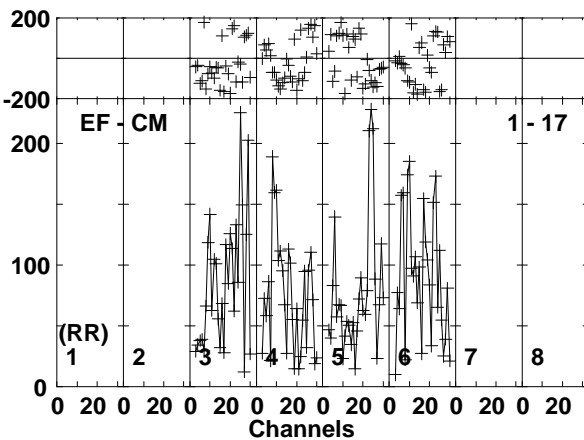
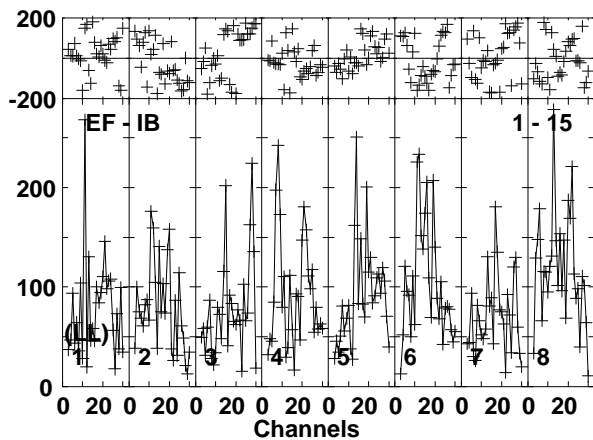
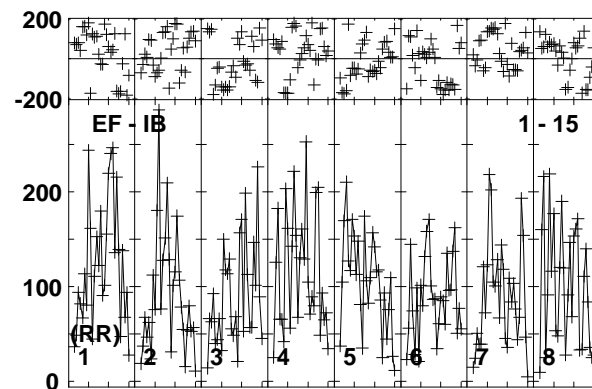
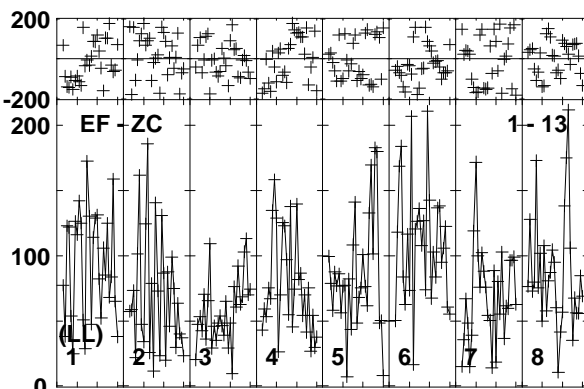
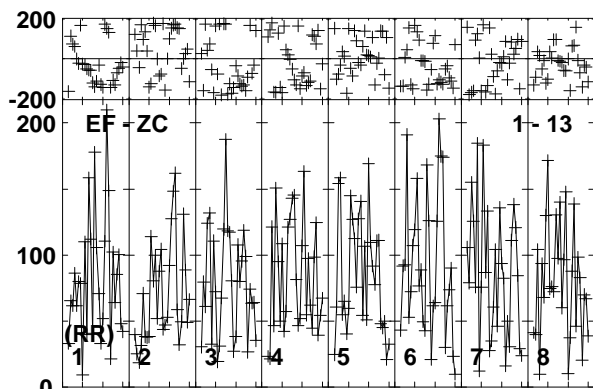
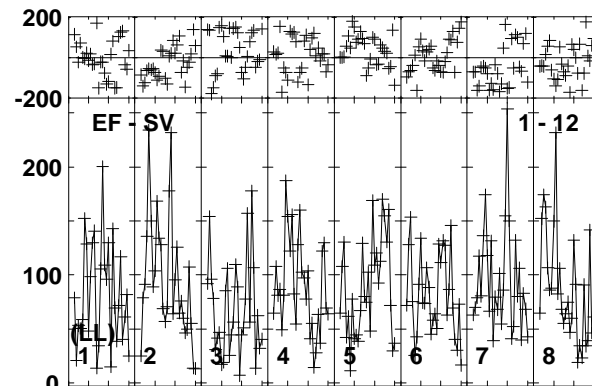
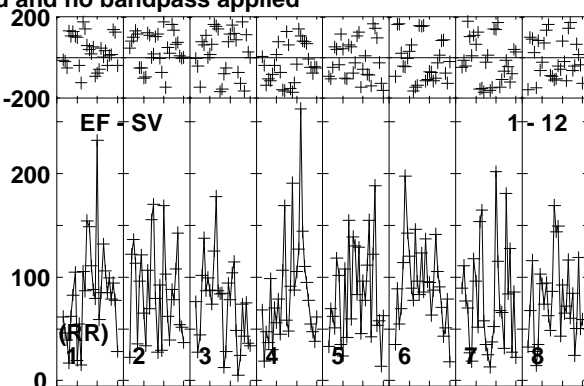
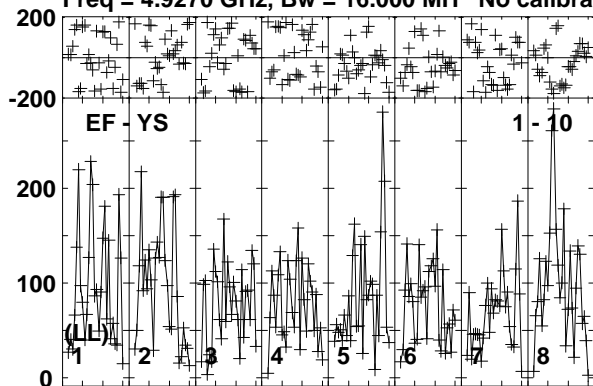

Lower frame: Micro Ampl Jy Top frame: Phas deg  
Vector averaged cross-power spectrum Baseline: EF (01) - YS (10)  
Timerange: 00/10:23:43 to 00/10:27:09

Plot file version 492 created 08-APR-2019 12:10:37

MRK622 EM133B.UVDATA.1

Freq = 4.9270 GHz, Bw = 16.000 MH No calibration applied and no bandpass applied

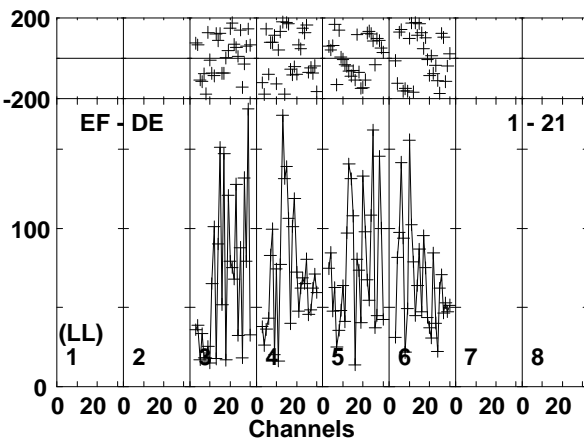
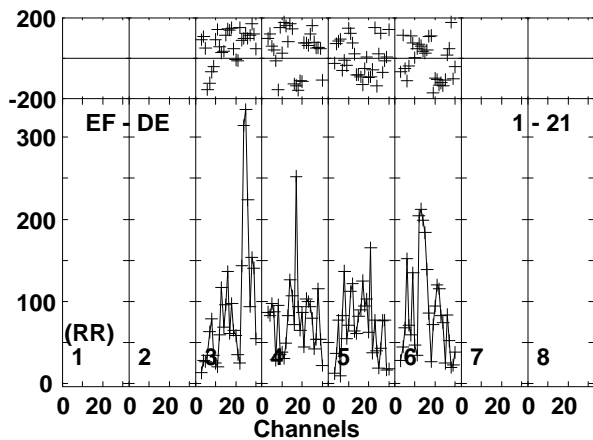
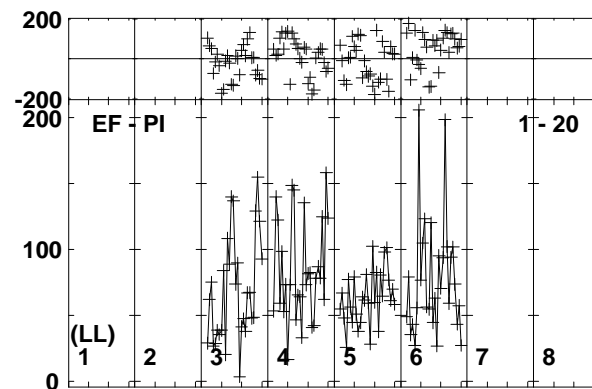
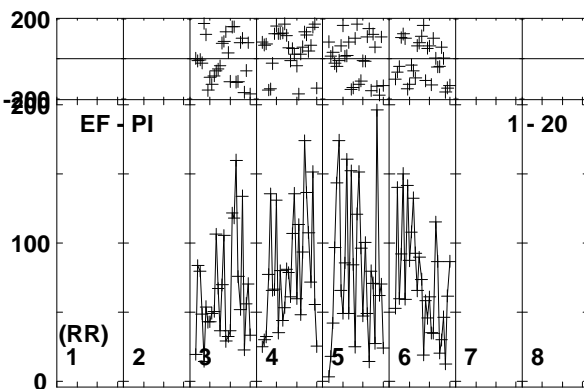
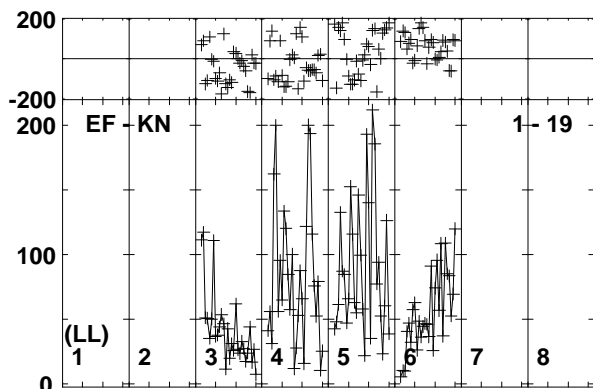
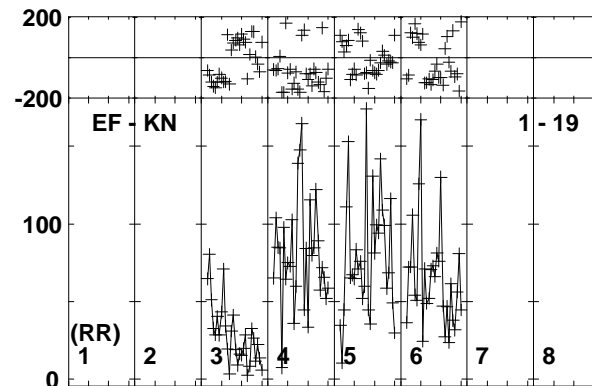
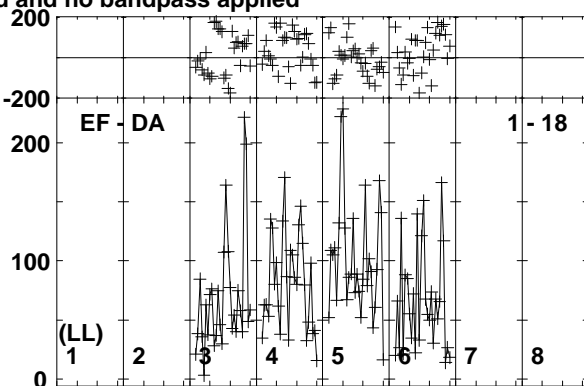
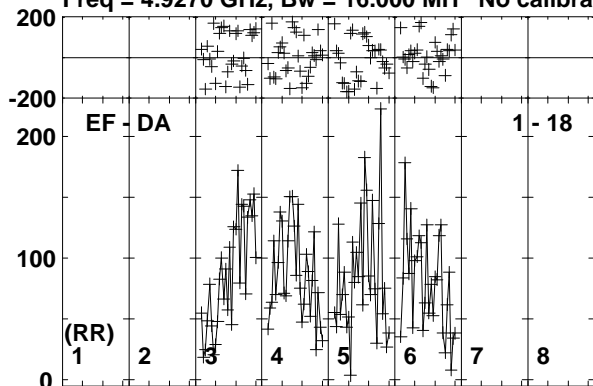

Lower frame: Micro Ampl Jy Top frame: Phas deg  
Vector averaged cross-power spectrum Baseline: EF (01) - DA (18)  
Timerange: 00/10:23:43 to 00/10:27:09

Plot file version 493 created 08-APR-2019 12:10:37

J0815+3635 EM133B.UVDATA.1

Freq = 4.9270 GHz, Bw = 16.000 MH No calibration applied and no bandpass applied

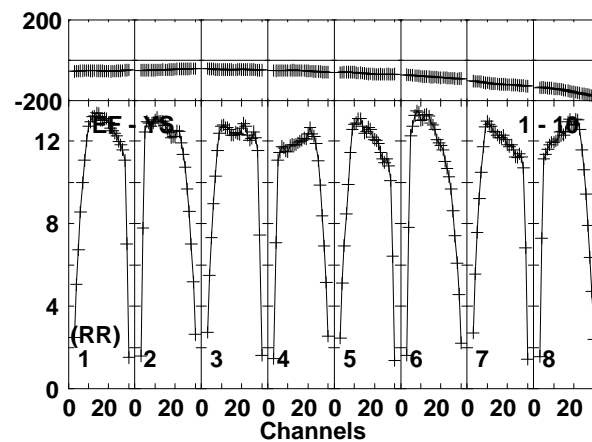
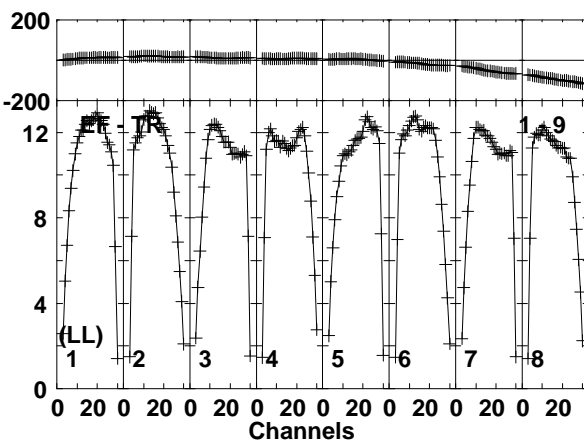
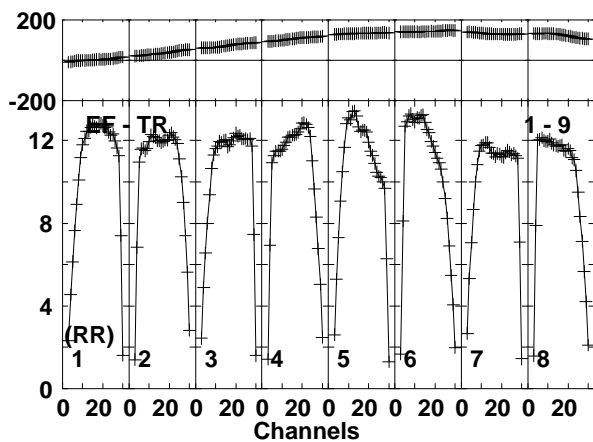
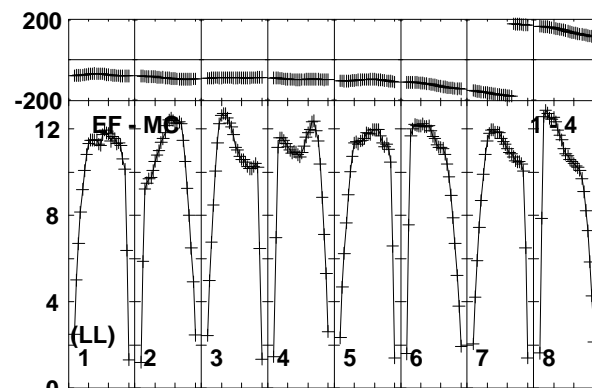
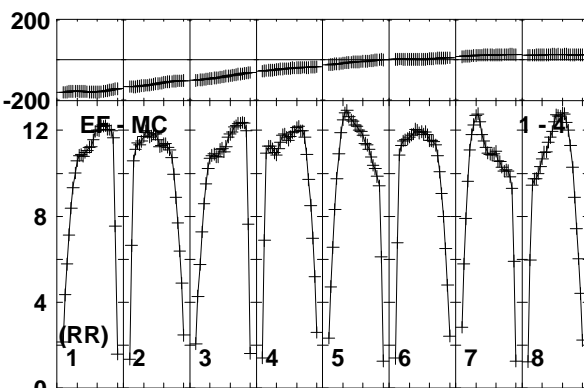
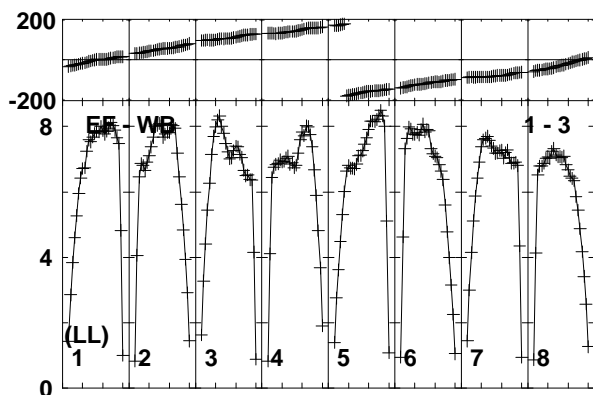
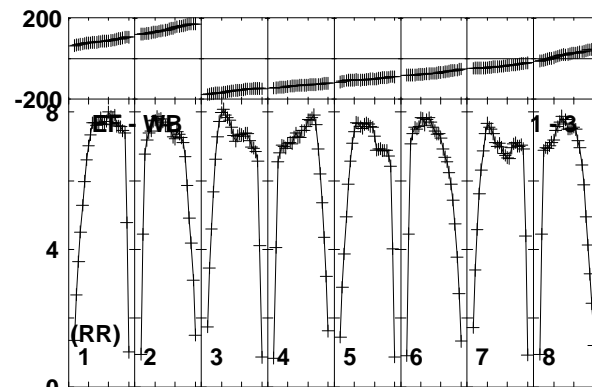
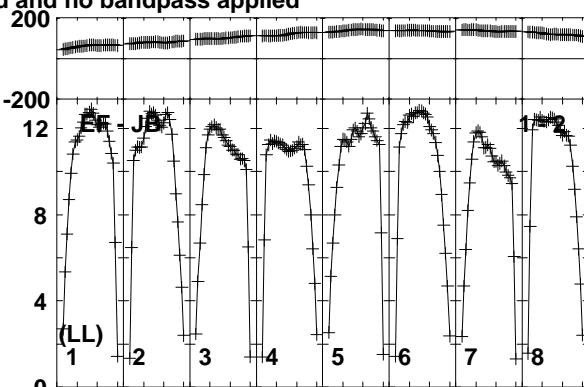
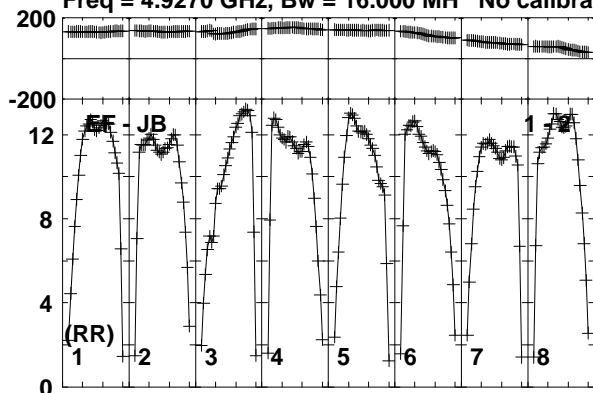

Lower frame: Milli Ampl Jy Top frame: Phas deg  
Vector averaged cross-power spectrum Baseline: EF (01) - JB (02)  
Timerange: 00/10:28:01 to 00/10:29:29

Plot file version 494 created 08-APR-2019 12:10:37

J0815+3635 EM133B.UVDATA.1

Freq = 4.9270 GHz, Bw = 16.000 MH No calibration applied and no bandpass applied

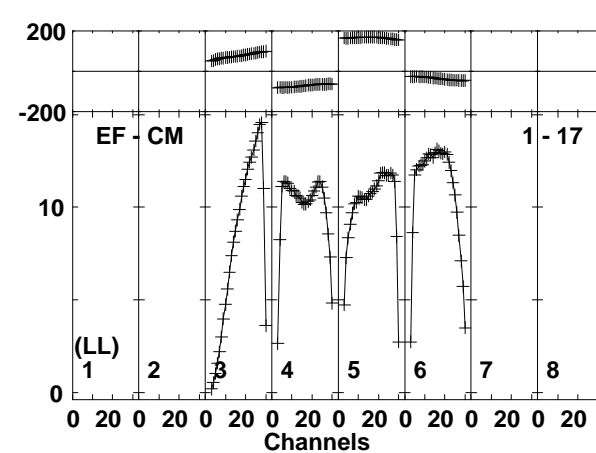
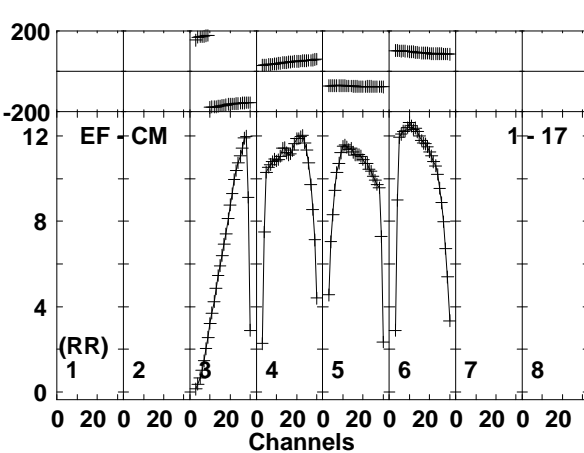
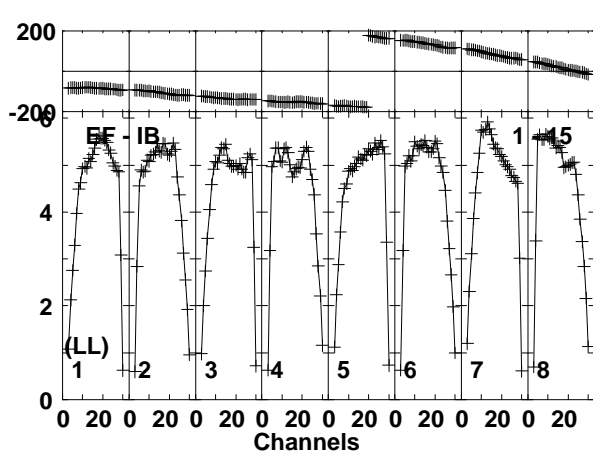
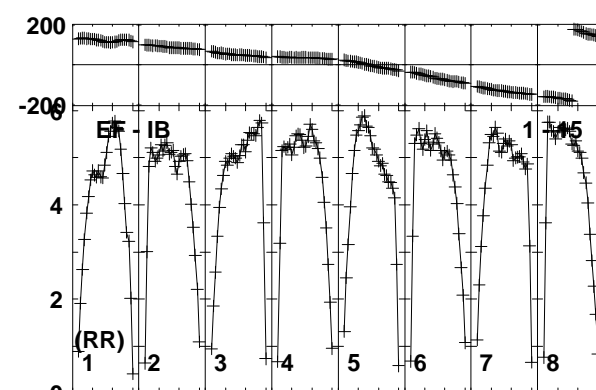
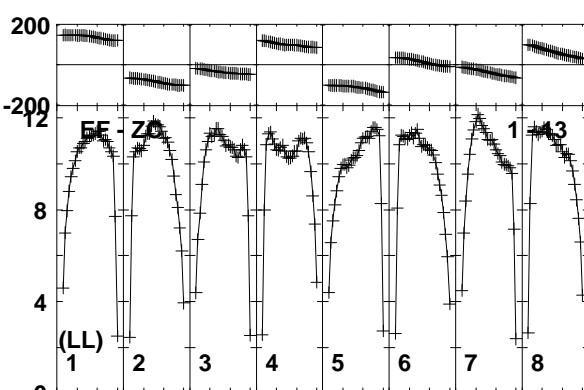
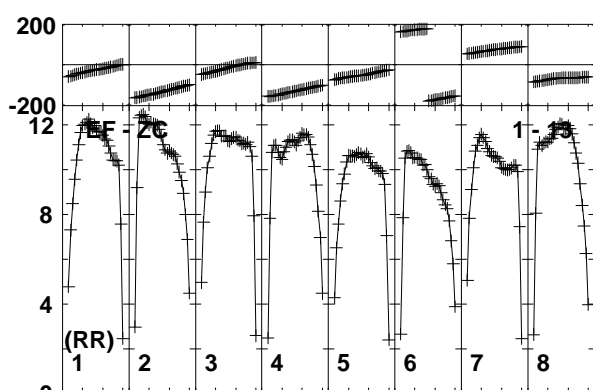
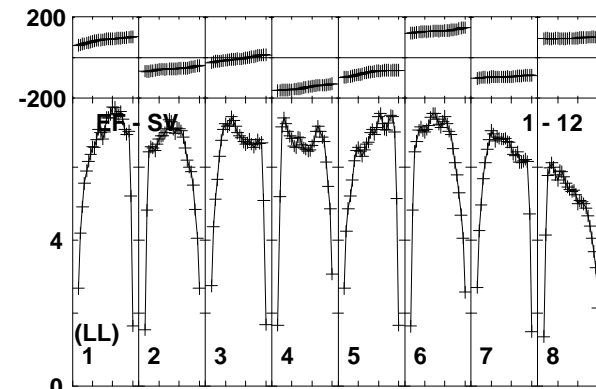
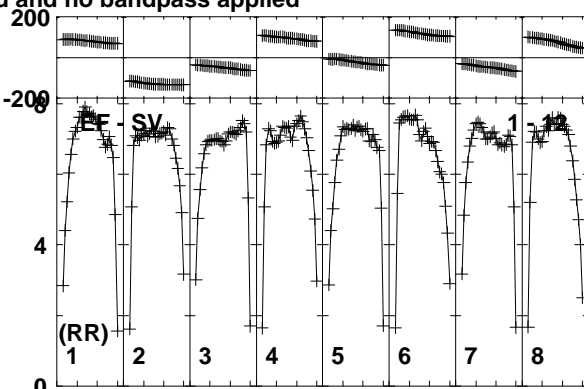
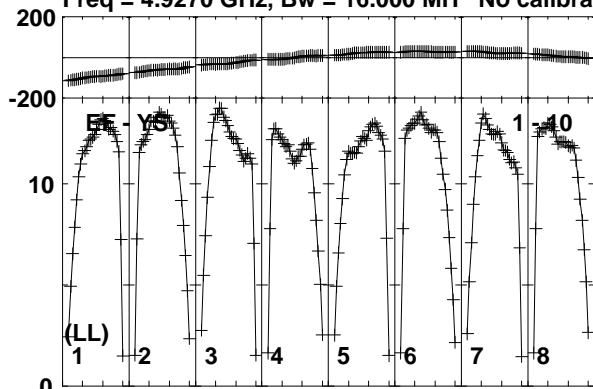

Lower frame: Milli Ampl Jy Top frame: Phas deg  
Vector averaged cross-power spectrum Baseline: EF (01) - YS (10)  
Timerange: 00/10:28:01 to 00/10:29:29

Plot file version 495 created 08-APR-2019 12:10:37

J0815+3635 EM133B.UVDATA.1

Freq = 4.9270 GHz, Bw = 16.000 MH No calibration applied and no bandpass applied

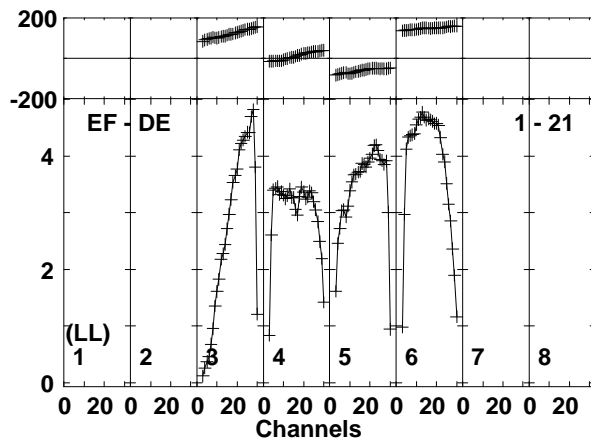
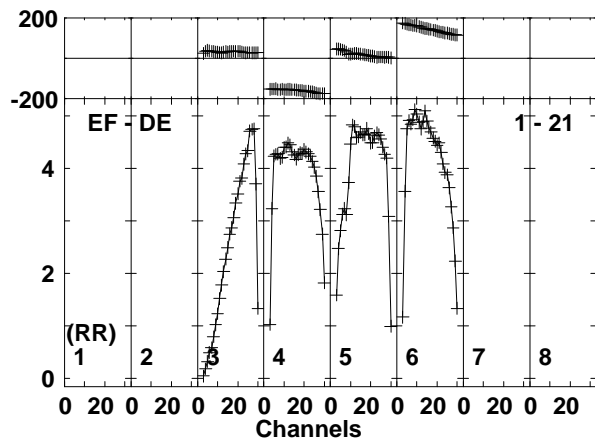
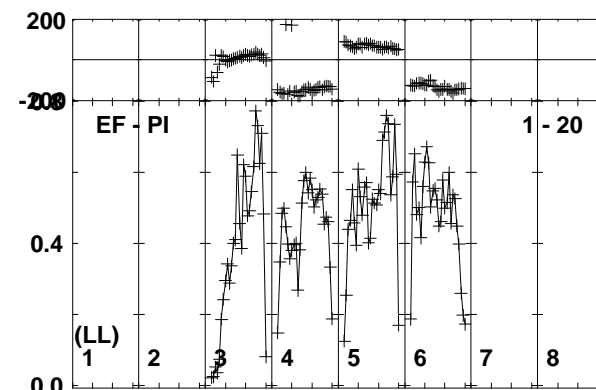
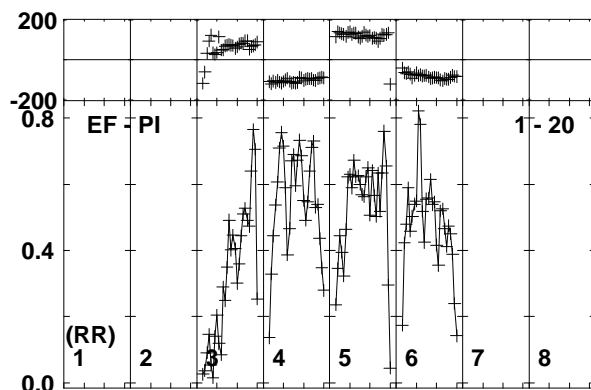
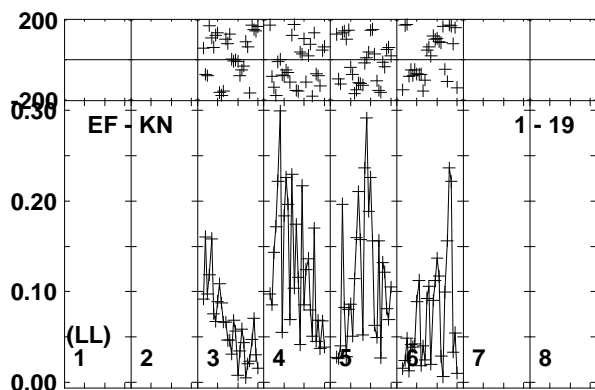
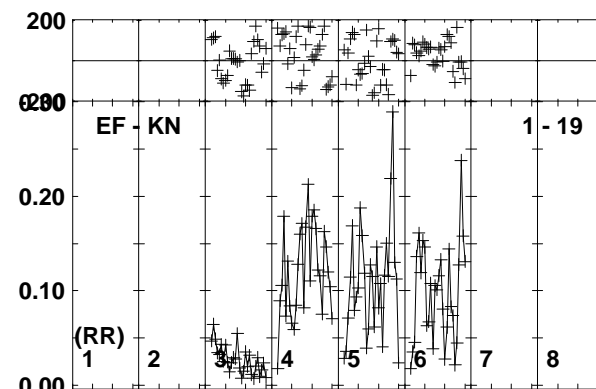
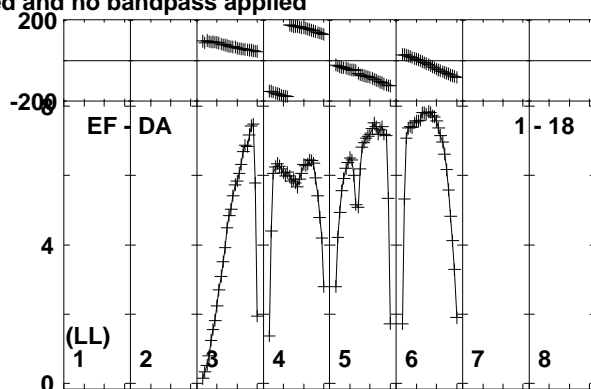
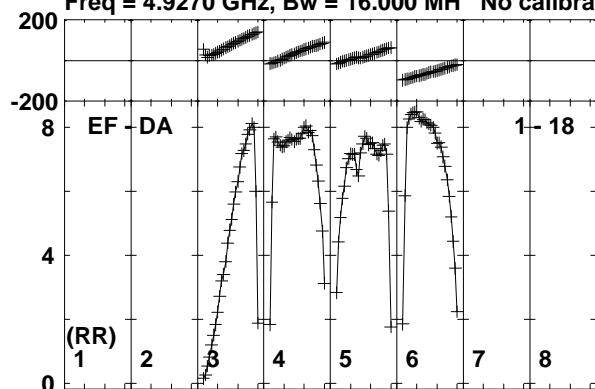

Lower frame: Milli Ampl Jy Top frame: Phas deg  
Vector averaged cross-power spectrum Baseline: EF (01) - DA (18)  
Timerange: 00/10:28:01 to 00/10:29:29

Plot file version 496 created 08-APR-2019 12:10:38

MRK622 EM133B.UVDATA.1

Freq = 4.9270 GHz, Bw = 16.000 MH No calibration applied and no bandpass applied

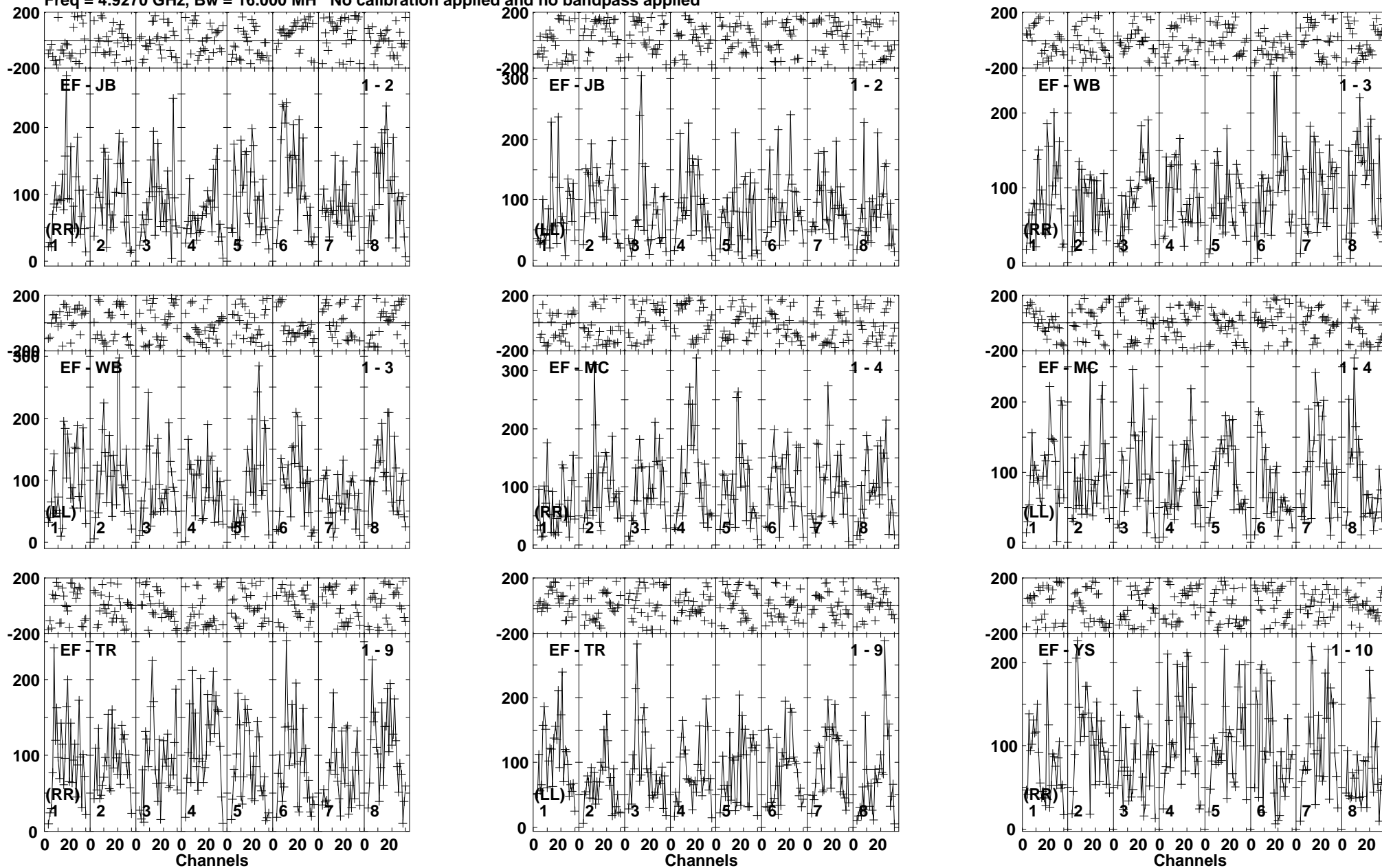

Lower frame: Micro Ampl Jy Top frame: Phas deg  
Vector averaged cross-power spectrum Baseline: EF (01) - JB (02)  
Timerange: 00/10:29:31 to 00/10:32:59



Plot file version 497 created 08-APR-2019 12:10:38

MRK622 EM133B.UVDATA.1

Freq = 4.9270 GHz, Bw = 16.000 MH No calibration applied and no bandpass applied

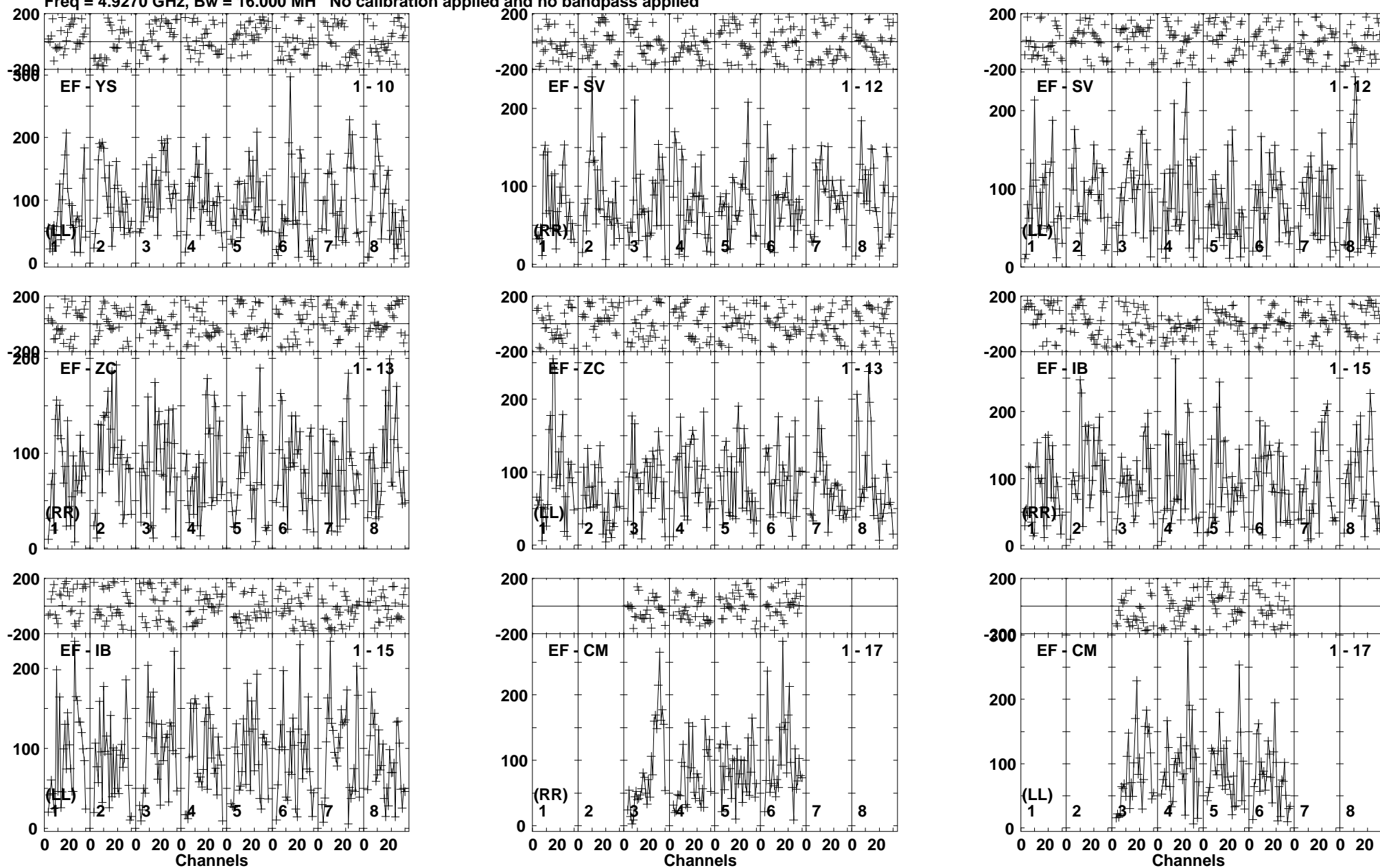

Lower frame: Micro Ampl Jy Top frame: Phas deg  
Vector averaged cross-power spectrum Baseline: EF (01) - YS (10)  
Timerange: 00/10:29:31 to 00/10:32:59

Plot file version 498 created 08-APR-2019 12:10:38

MRK622 EM133B.UVDATA.1

Freq = 4.9270 GHz, Bw = 16.000 MH No calibration applied and no bandpass applied

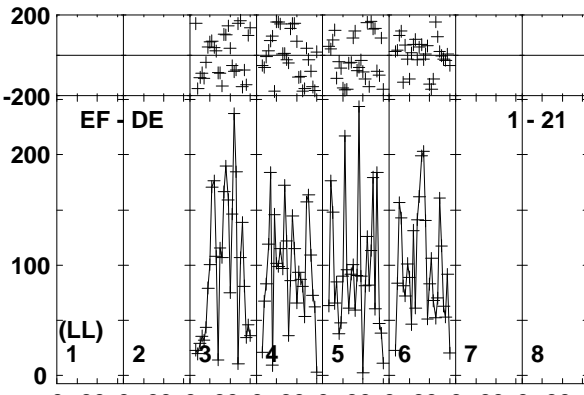
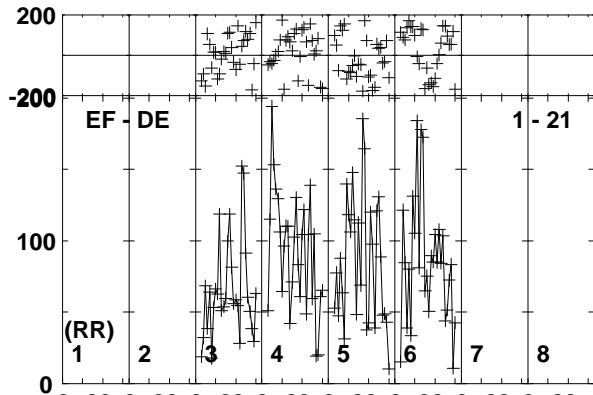
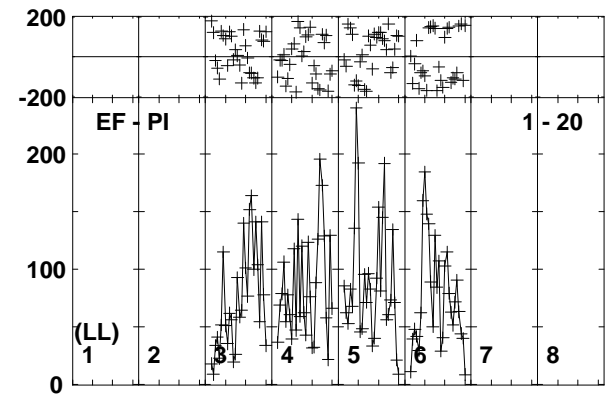
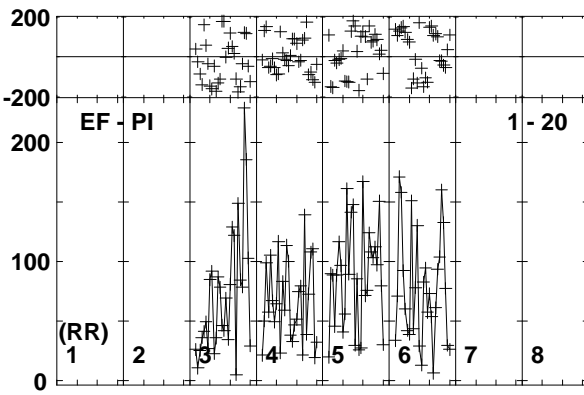
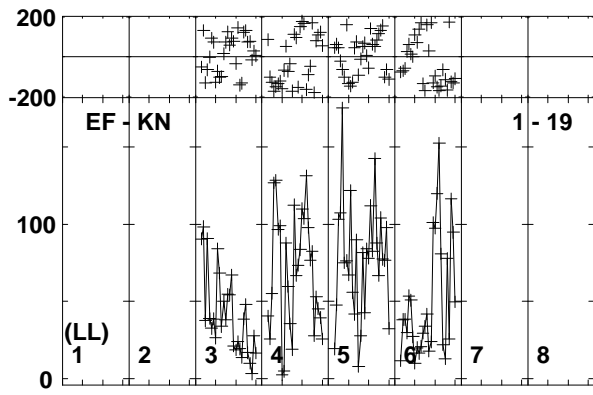
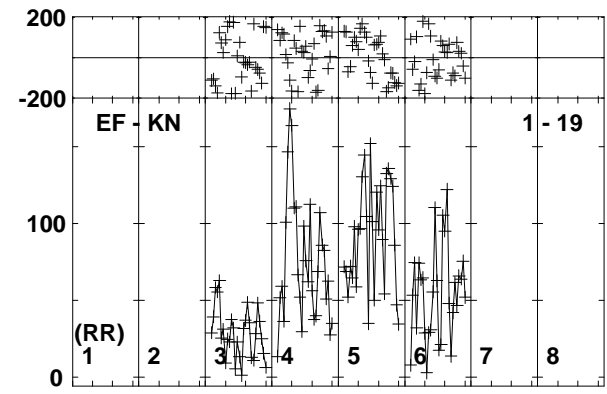
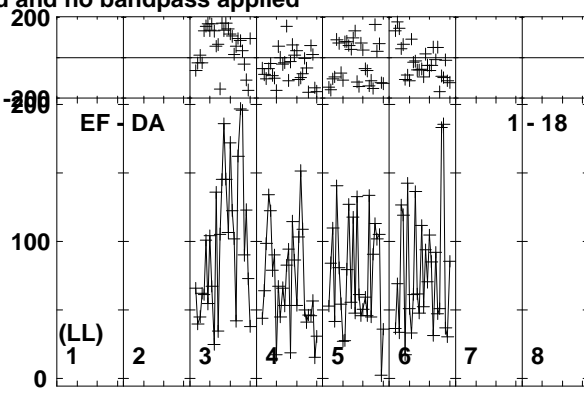
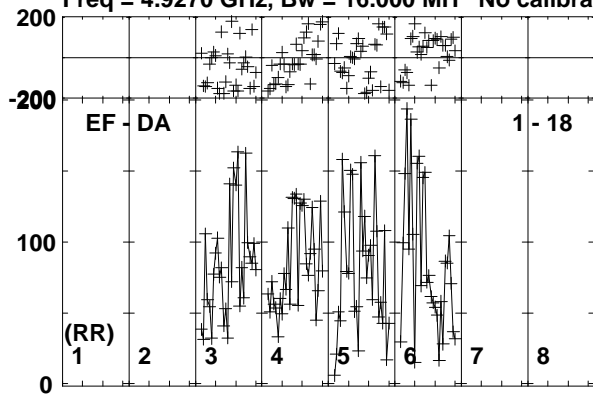

Lower frame: Micro Ampl Jy Top frame: Phas deg  
Vector averaged cross-power spectrum Baseline: EF (01) - DA (18)  
Timerange: 00/10:29:31 to 00/10:32:59

Plot file version 499 created 08-APR-2019 12:10:38

J0815+3635 EM133B.UVDATA.1

Freq = 4.9270 GHz, Bw = 16.000 MH No calibration applied and no bandpass applied

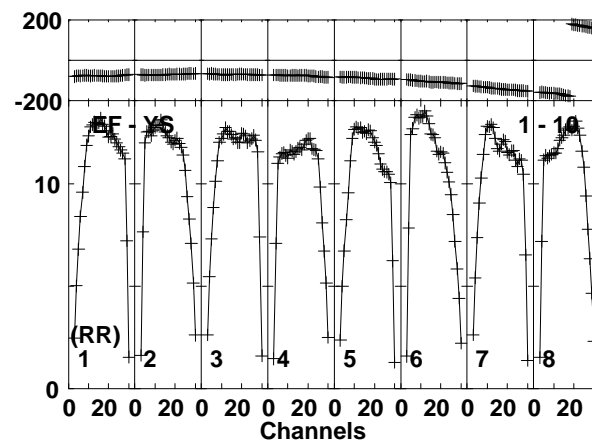
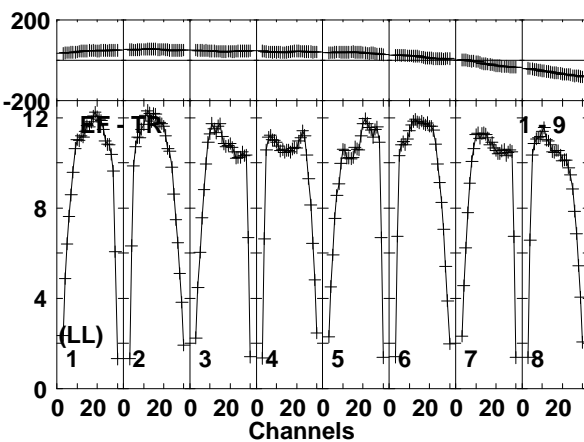
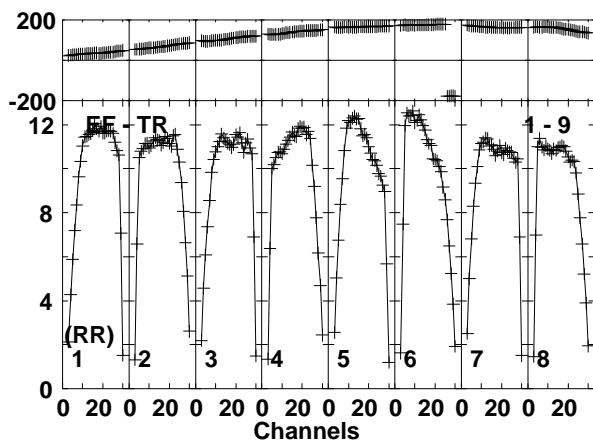
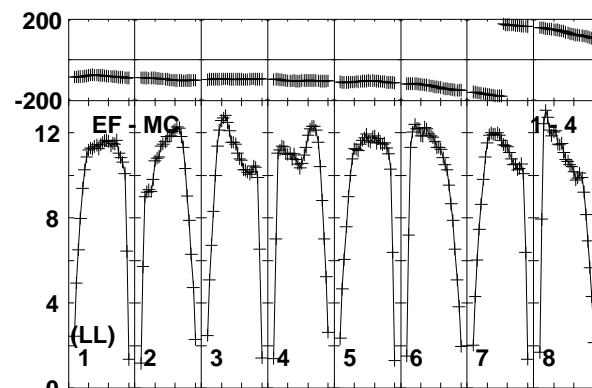
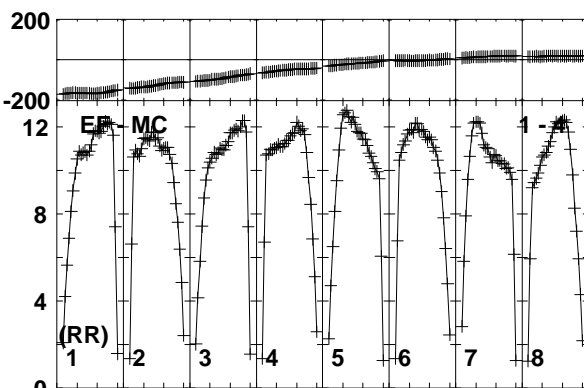
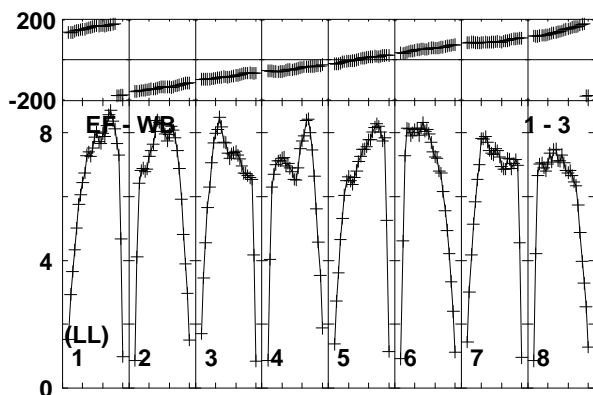
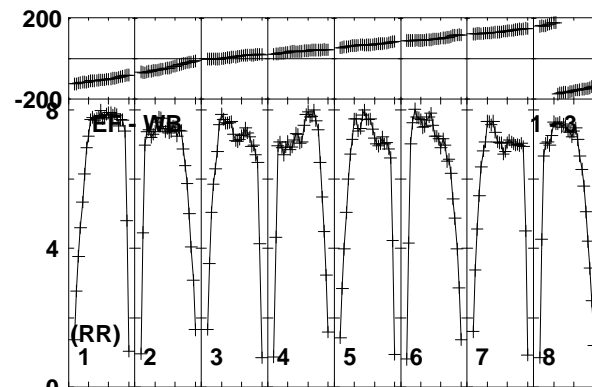
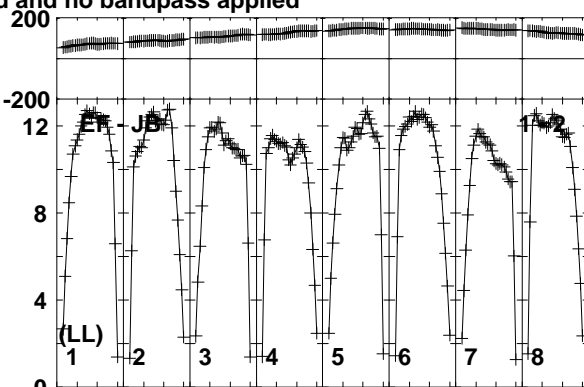
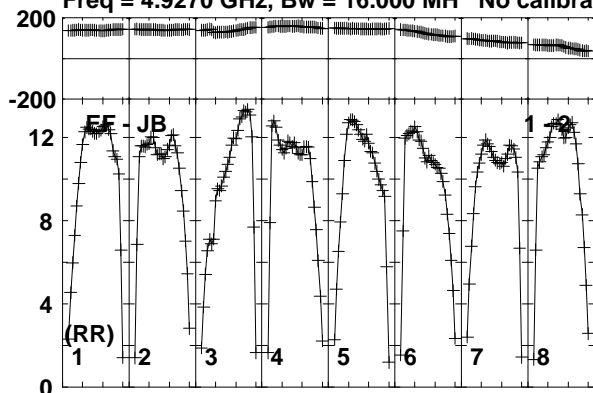

Lower frame: Milli Ampl Jy Top frame: Phas deg  
Vector averaged cross-power spectrum Baseline: EF (01) - JB (02)  
Timerange: 00/10:33:01 to 00/10:34:29

Plot file version 500 created 08-APR-2019 12:10:38

J0815+3635 EM133B.UVDATA.1

Freq = 4.9270 GHz, Bw = 16.000 MH No calibration applied and no bandpass applied

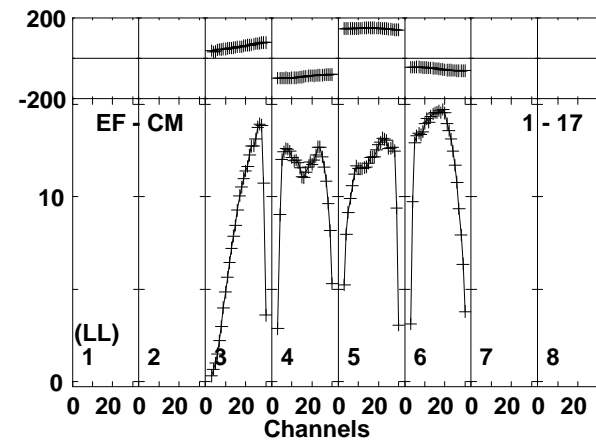
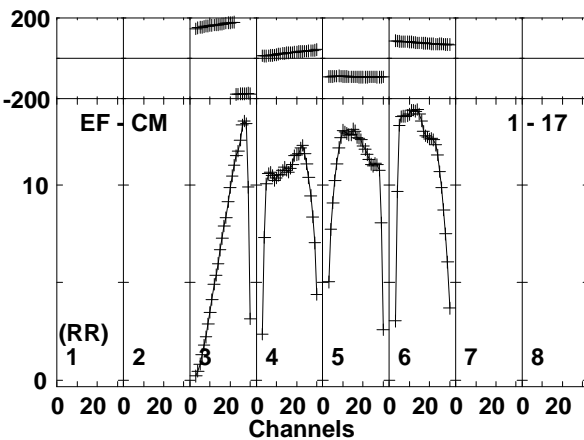
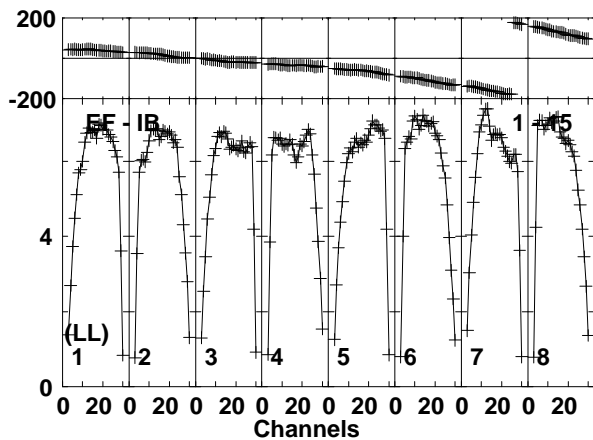
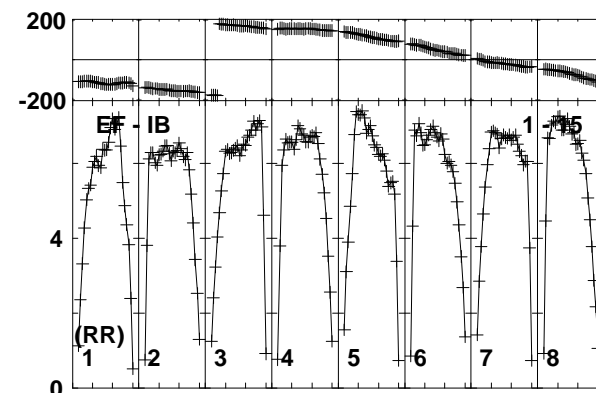
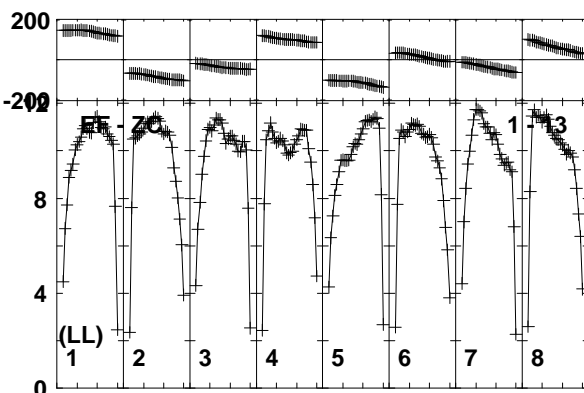
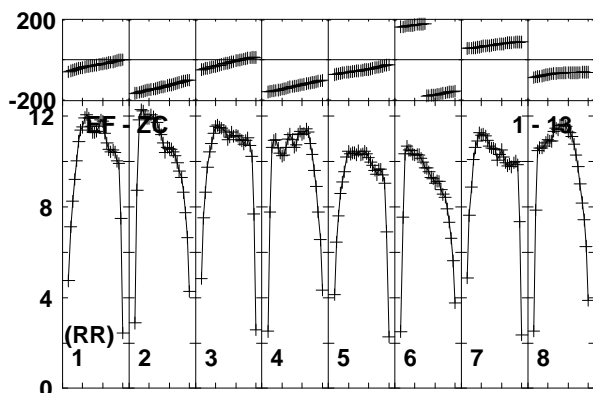
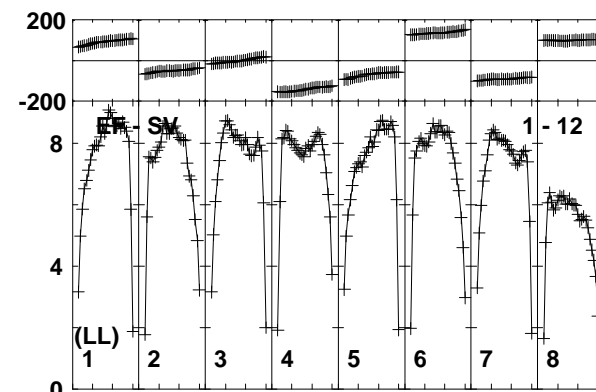
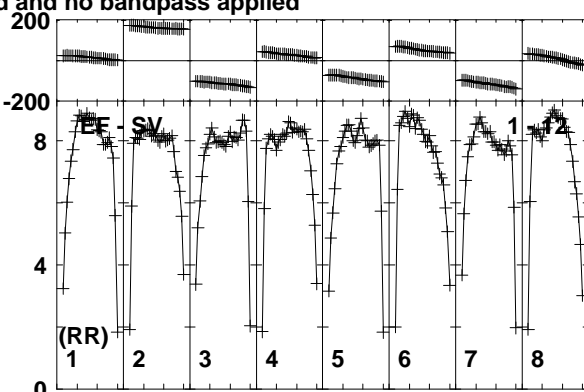
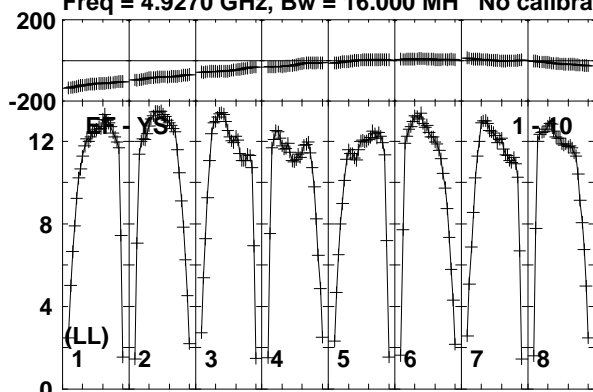

Lower frame: Milli Ampl Jy Top frame: Phas deg  
Vector averaged cross-power spectrum Baseline: EF (01) - YS (10)  
Timerange: 00/10:33:01 to 00/10:34:29

Plot file version 501 created 08-APR-2019 12:10:38

J0815+3635 EM133B.UVDATA.1

Freq = 4.9270 GHz, Bw = 16.000 MH No calibration applied and no bandpass applied

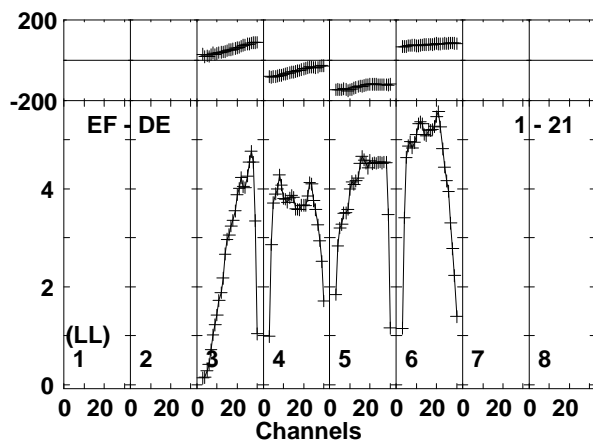
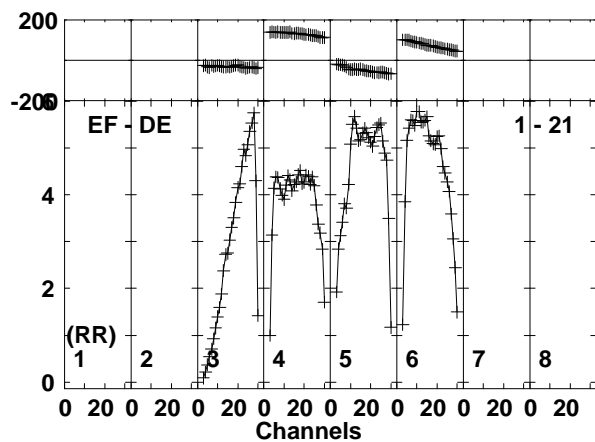
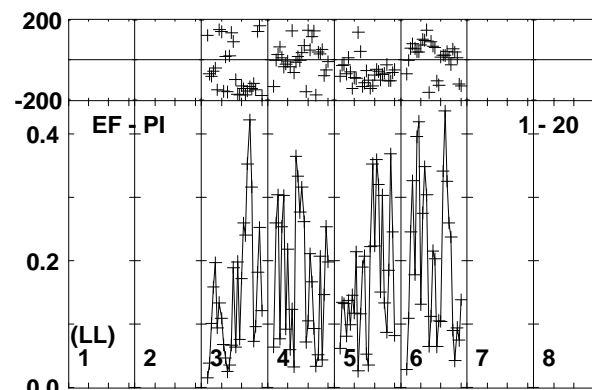
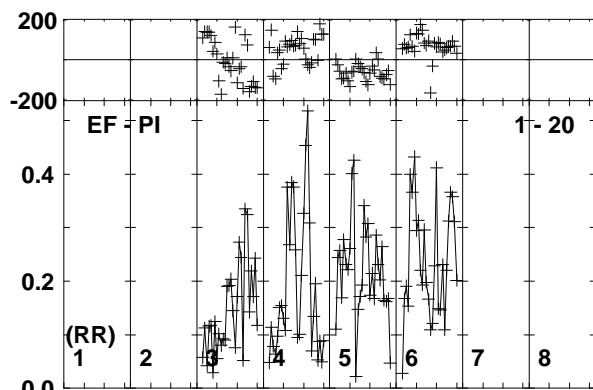
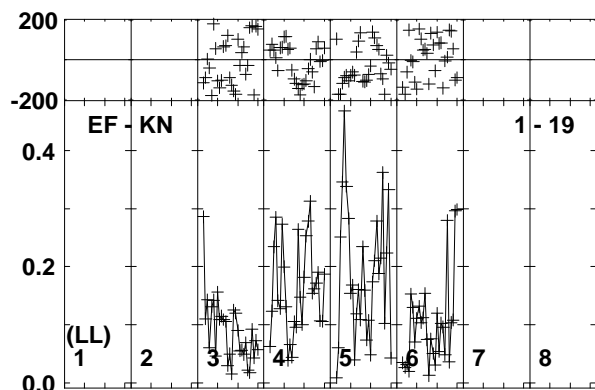
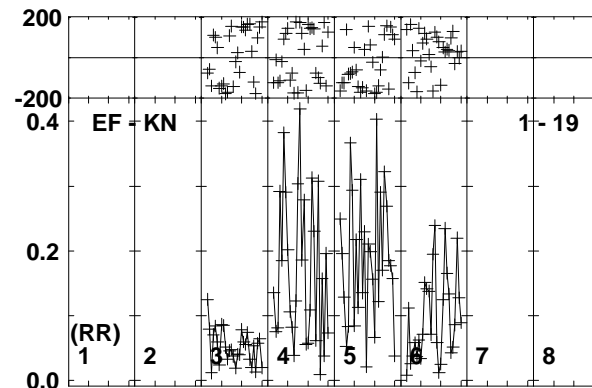
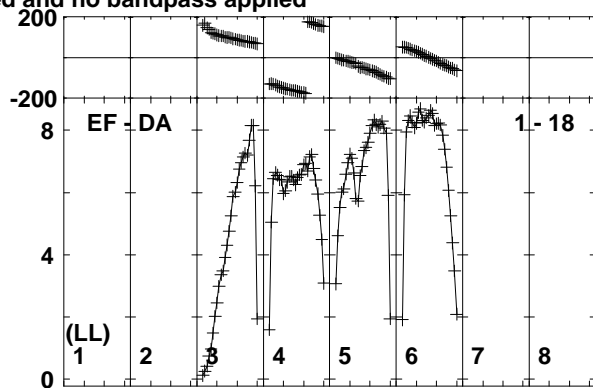
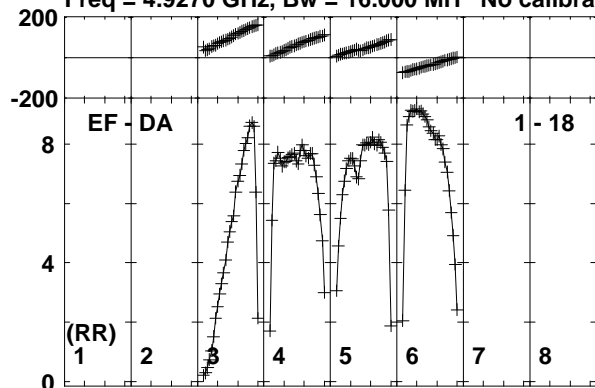

Lower frame: Milli Ampl Jy Top frame: Phas deg  
Vector averaged cross-power spectrum Baseline: EF (01) - DA (18)  
Timerange: 00/10:33:01 to 00/10:34:29

Plot file version 502 created 08-APR-2019 12:10:39

MRK622 EM133B.UVDATA.1

Freq = 4.9270 GHz, Bw = 16.000 MH No calibration applied and no bandpass applied

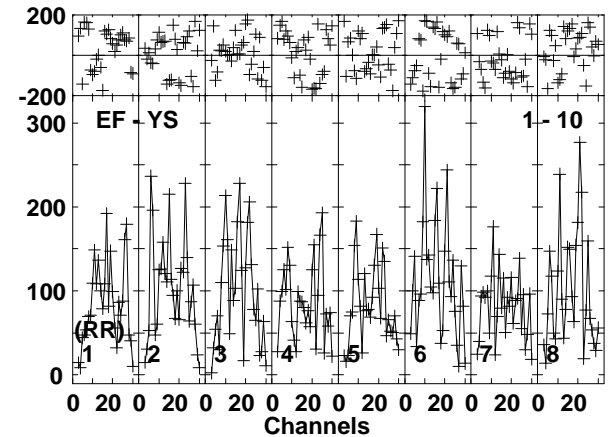
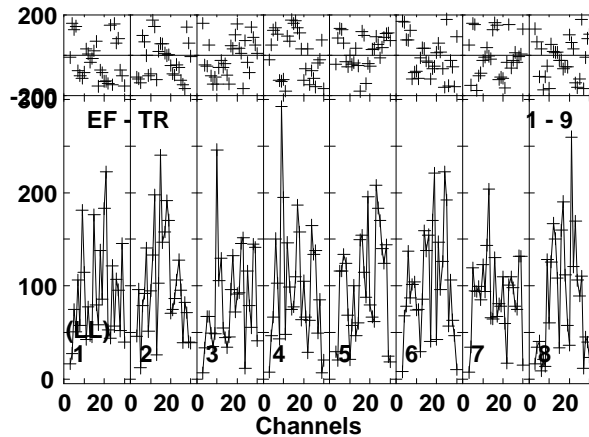
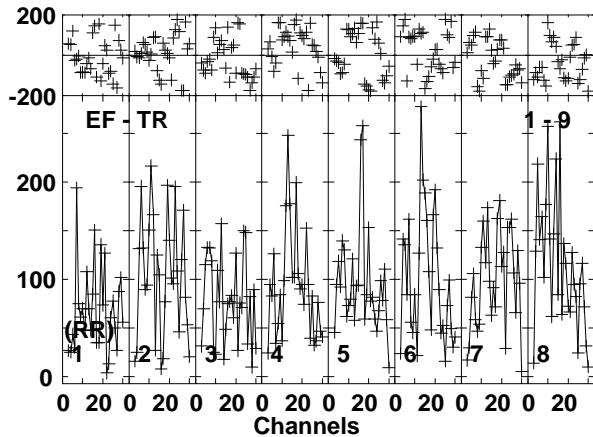
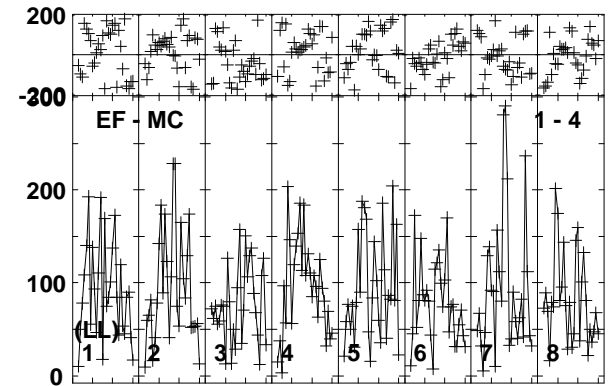
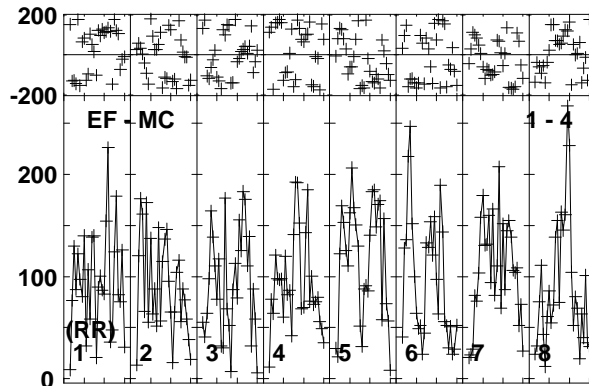
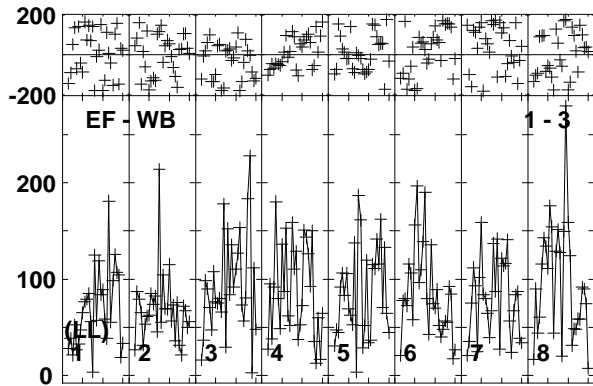
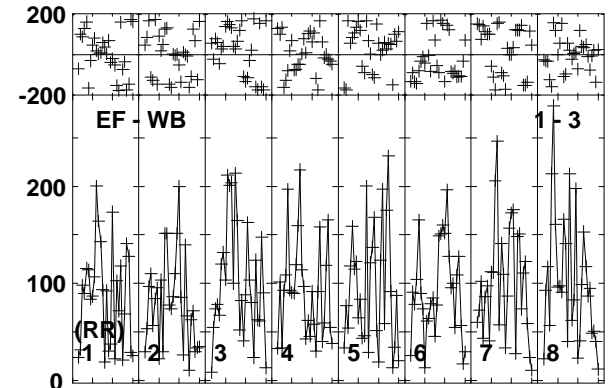
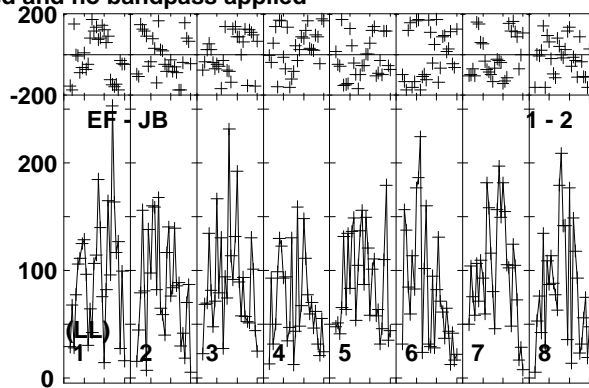
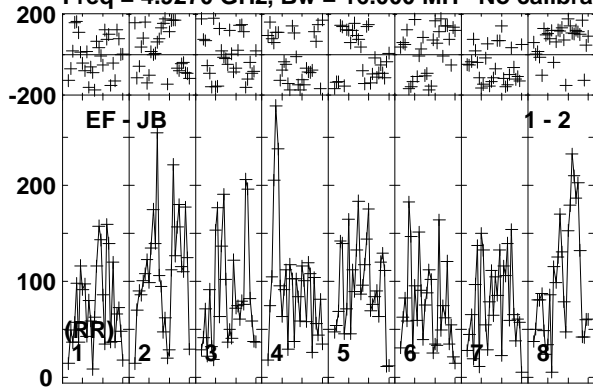

Lower frame: Micro Ampl Jy Top frame: Phas deg  
Vector averaged cross-power spectrum Baseline: EF (01) - JB (02)  
Timerange: 00/10:34:33 to 00/10:37:59

Plot file version 503 created 08-APR-2019 12:10:39

MRK622 EM133B.UVDATA.1

Freq = 4.9270 GHz, Bw = 16.000 MH No calibration applied and no bandpass applied

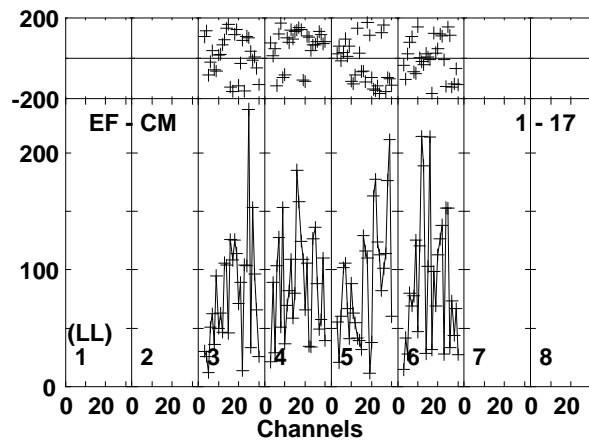
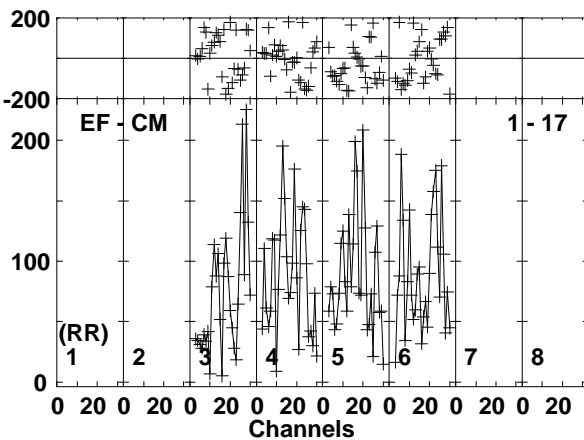
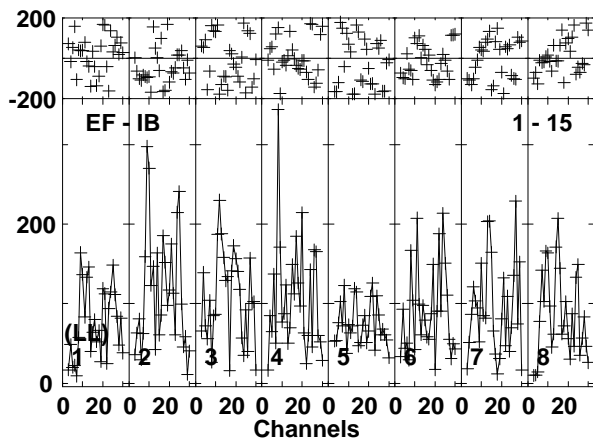
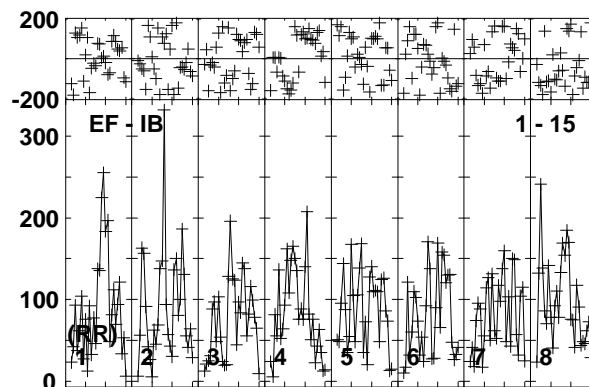
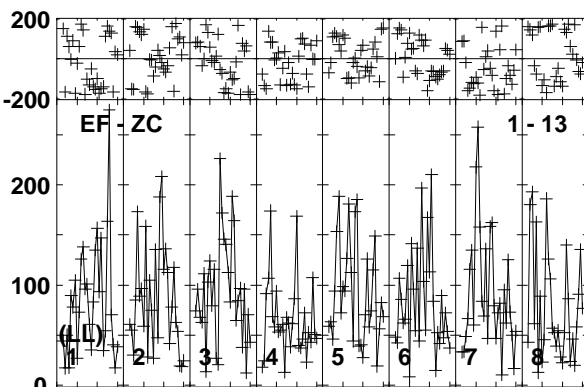
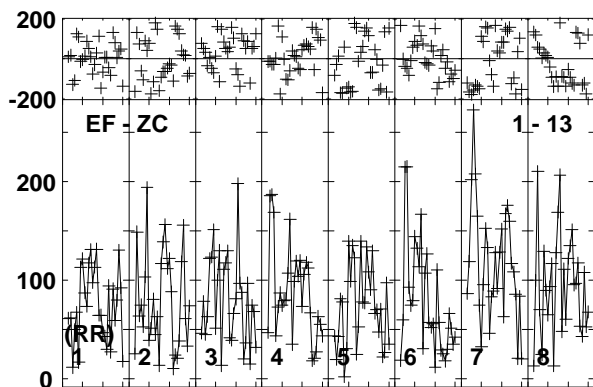
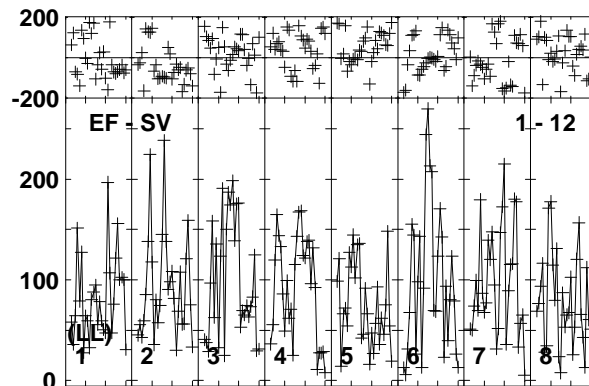
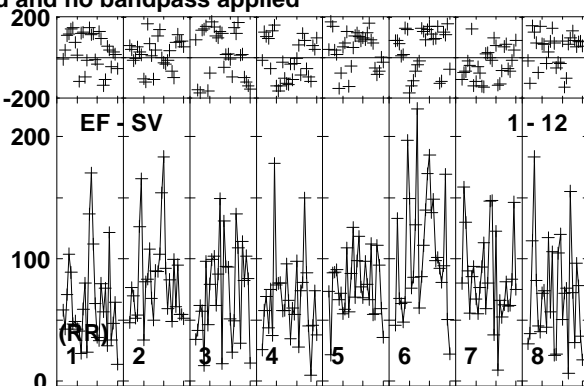
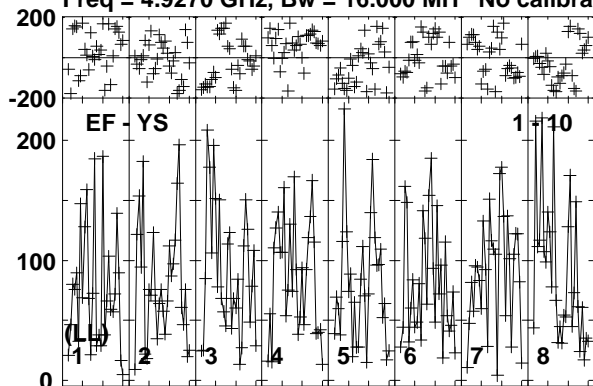

Lower frame: Micro Ampl Jy Top frame: Phas deg  
Vector averaged cross-power spectrum Baseline: EF (01) - YS (10)  
Timerange: 00/10:34:33 to 00/10:37:59

Plot file version 504 created 08-APR-2019 12:10:39

MRK622 EM133B.UVDATA.1

Freq = 4.9270 GHz, Bw = 16.000 MH No calibration applied and no bandpass applied

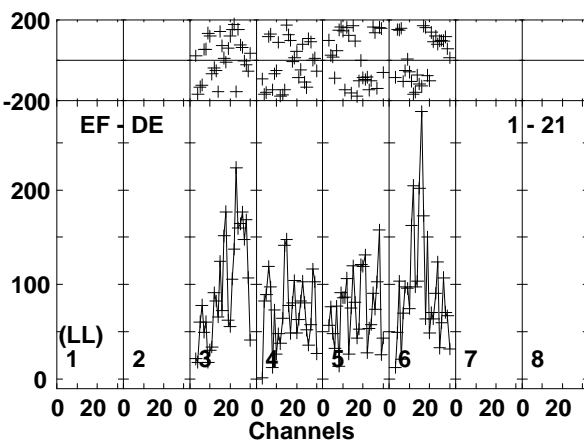
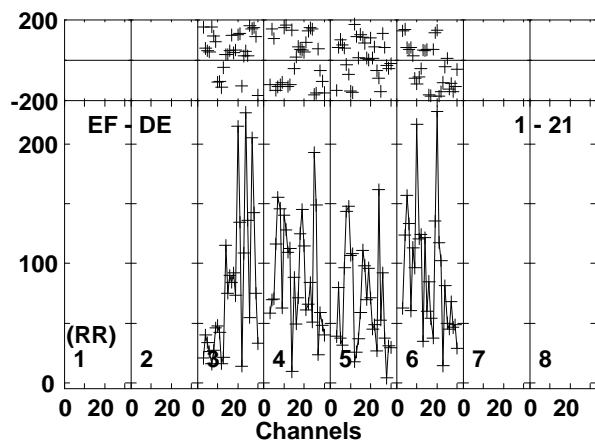
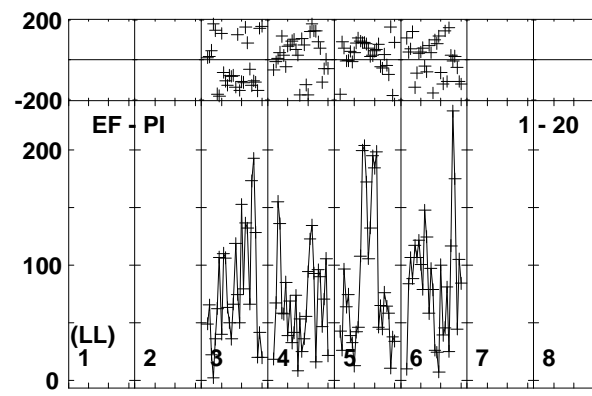
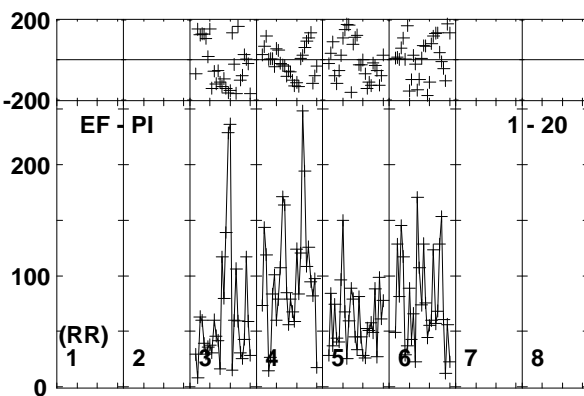
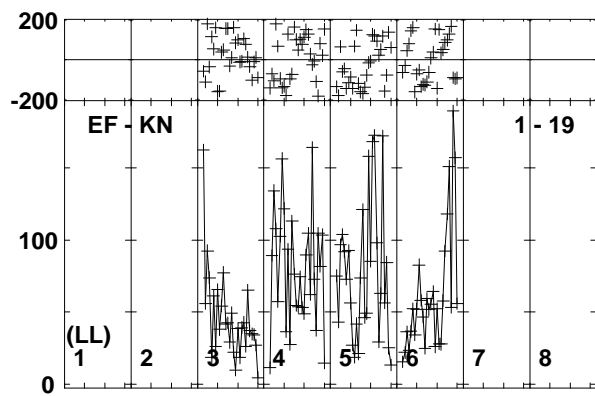
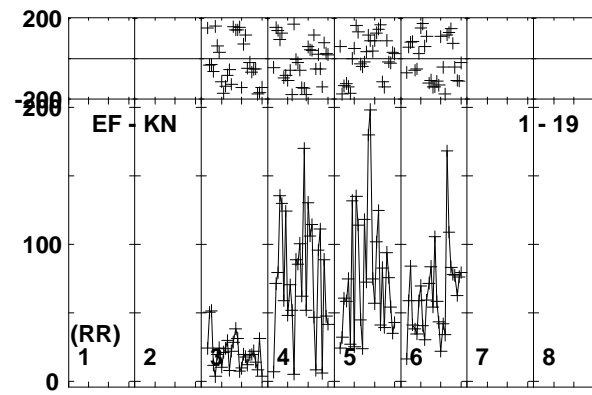
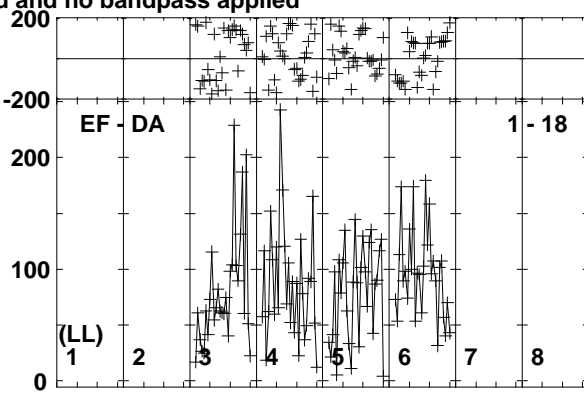
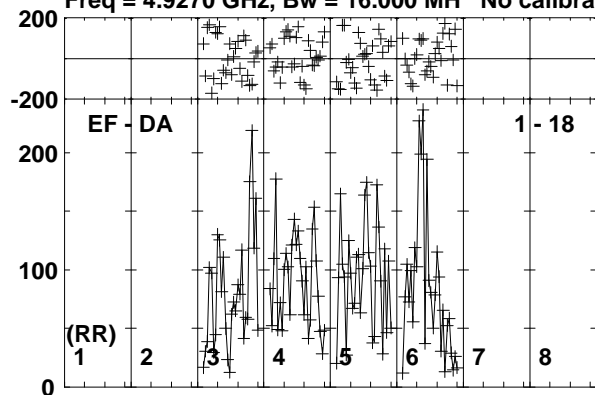

Lower frame: Micro Ampl Jy Top frame: Phas deg  
Vector averaged cross-power spectrum Baseline: EF (01) - DA (18)  
Timerange: 00/10:34:33 to 00/10:37:59



Plot file version 505 created 08-APR-2019 12:10:39

J0815+3635 EM133B.UVDATA.1

Freq = 4.9270 GHz, Bw = 16.000 MH No calibration applied and no bandpass applied

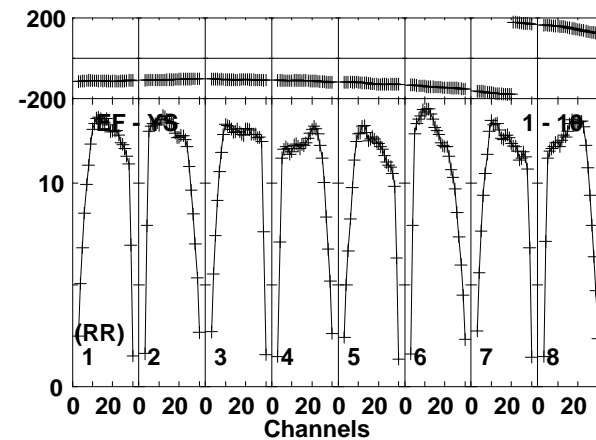
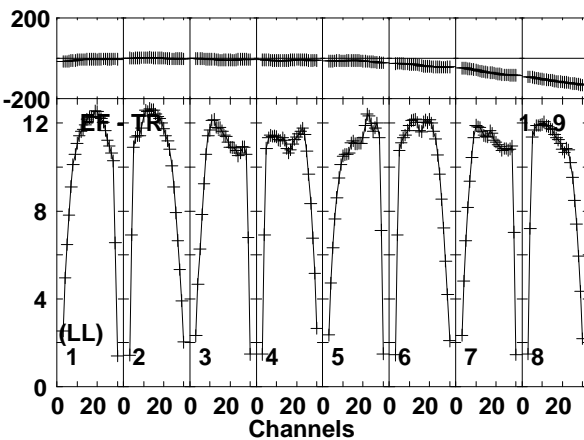
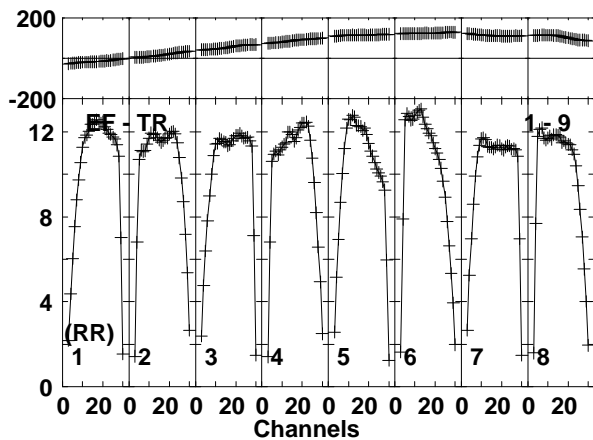
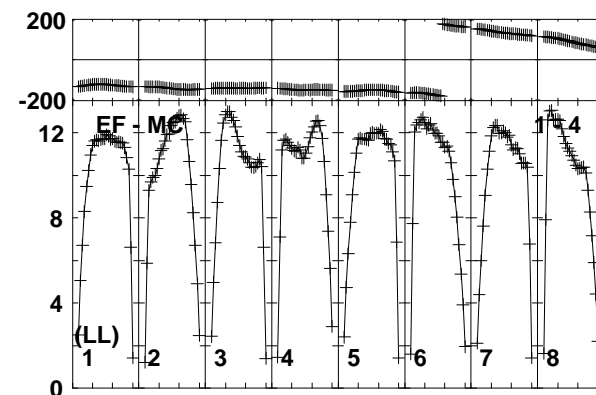
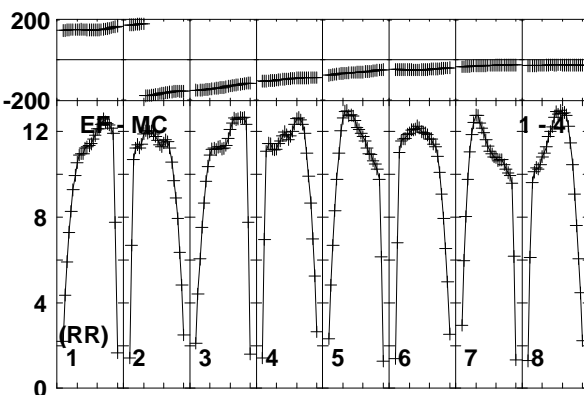
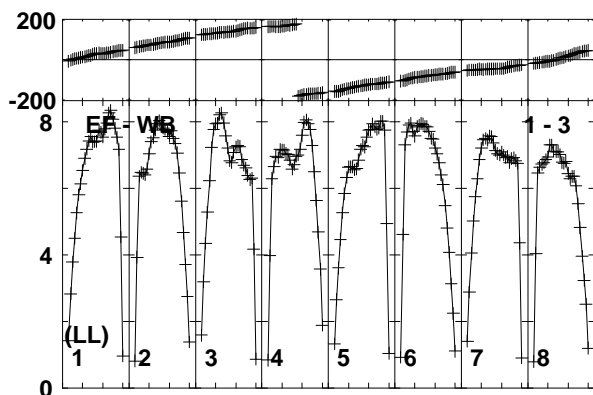
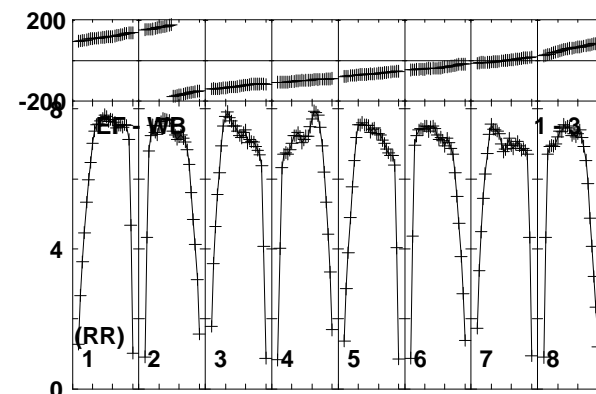
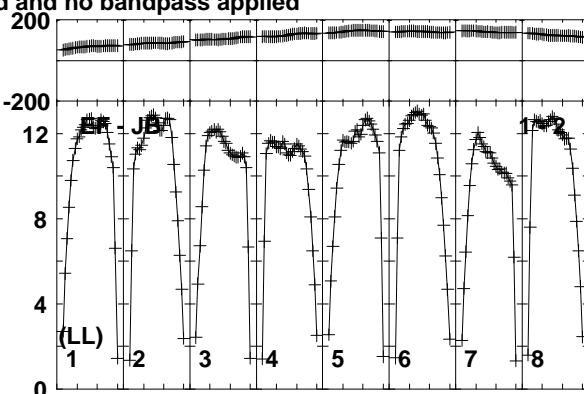
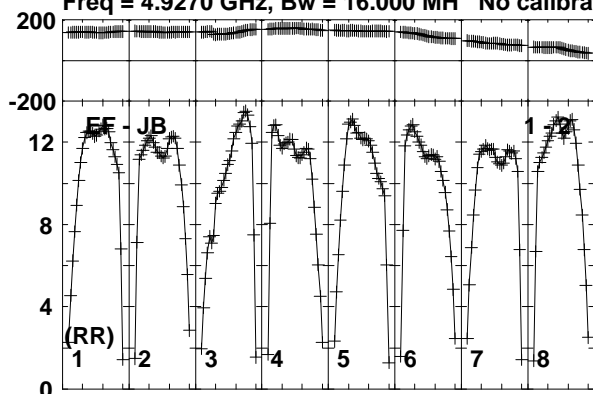

Lower frame: Milli Ampl Jy Top frame: Phas deg  
Vector averaged cross-power spectrum Baseline: EF (01) - JB (02)  
Timerange: 00/10:38:51 to 00/10:40:19

Plot file version 506 created 08-APR-2019 12:10:39

J0815+3635 EM133B.UVDATA.1

Freq = 4.9270 GHz, Bw = 16.000 MH No calibration applied and no bandpass applied

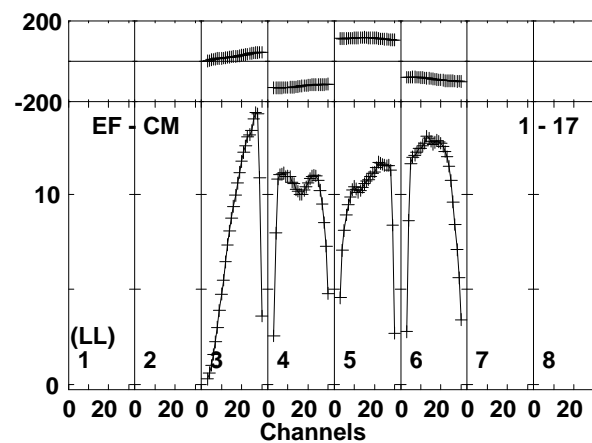
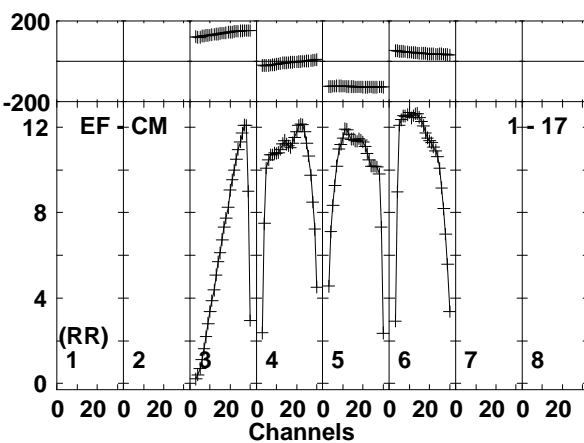
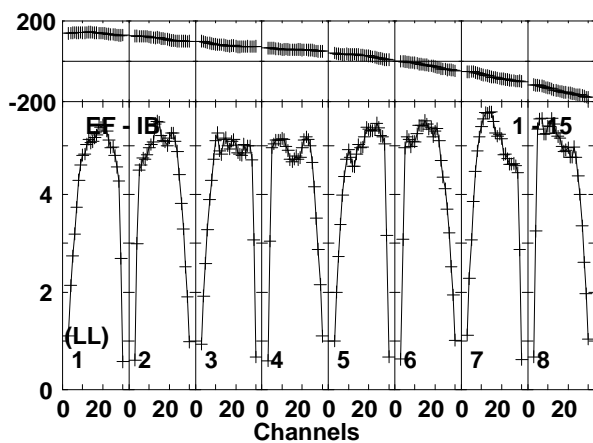
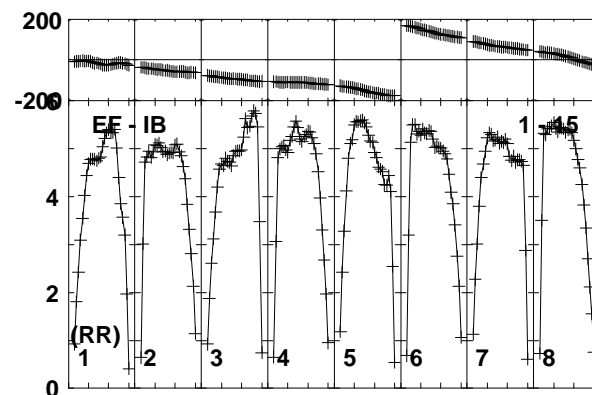
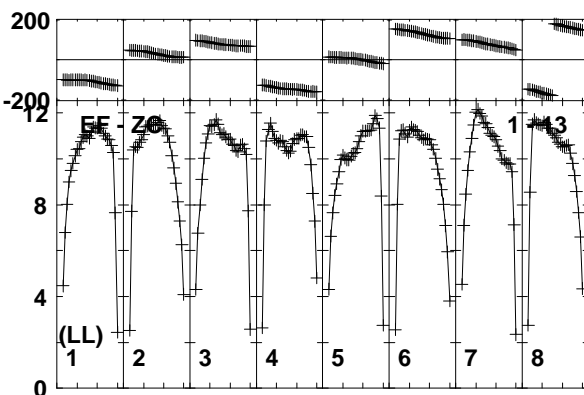
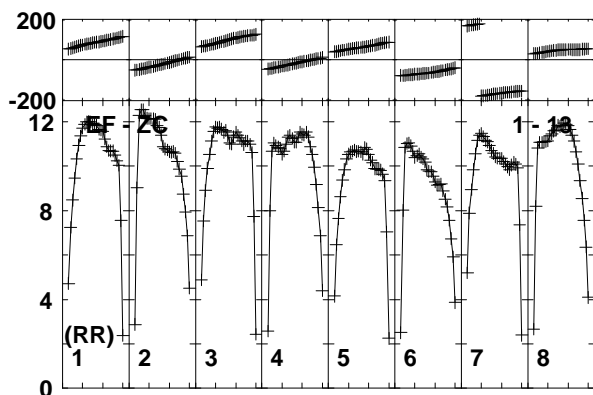
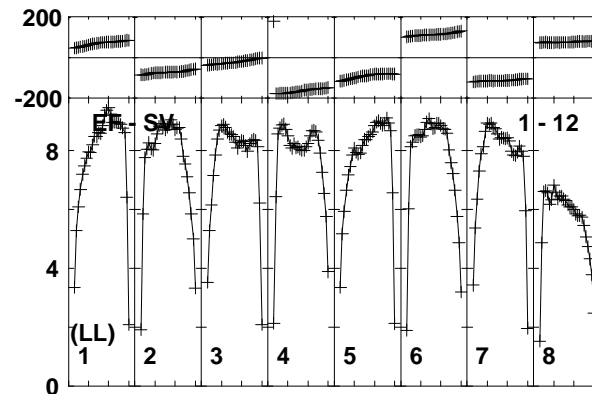
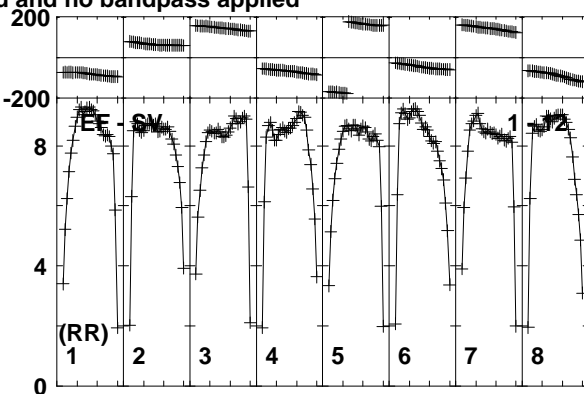
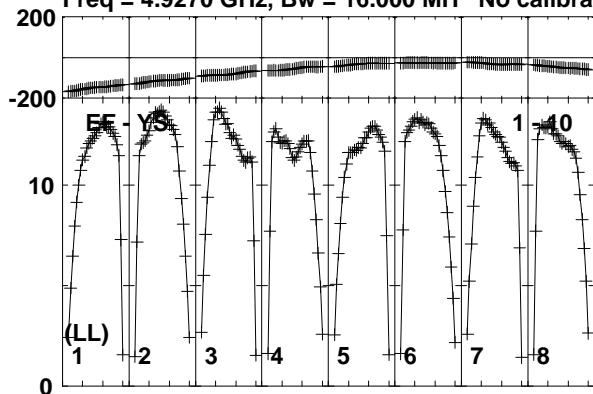

Lower frame: Milli Ampl Jy Top frame: Phas deg  
Vector averaged cross-power spectrum Baseline: EF (01) - YS (10)  
Timerange: 00/10:38:51 to 00/10:40:19

Plot file version 507 created 08-APR-2019 12:10:39

J0815+3635 EM133B.UVDATA.1

Freq = 4.9270 GHz, Bw = 16.000 MH No calibration applied and no bandpass applied

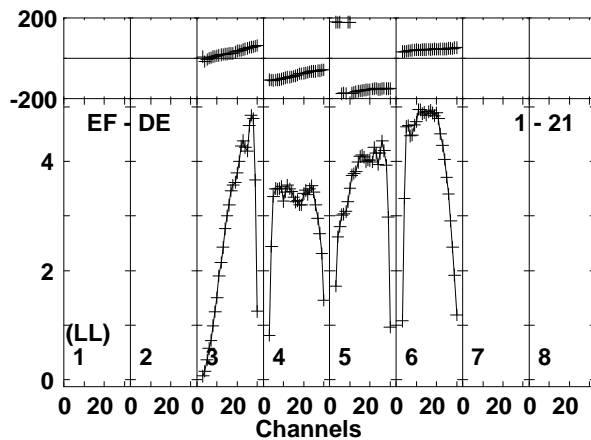
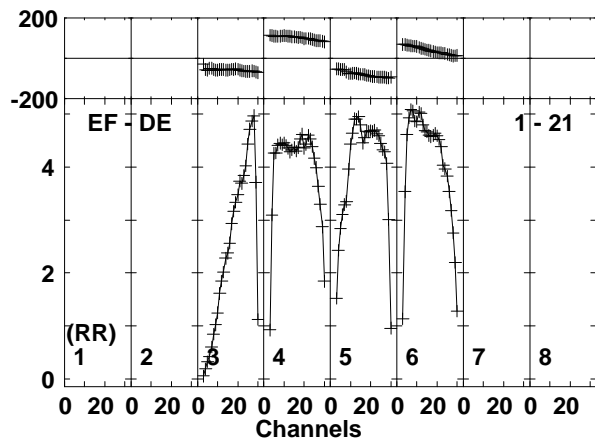
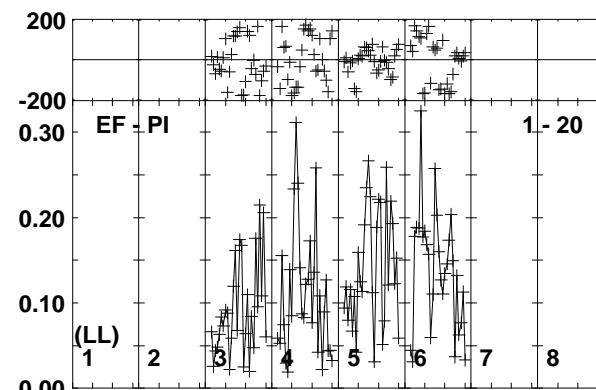
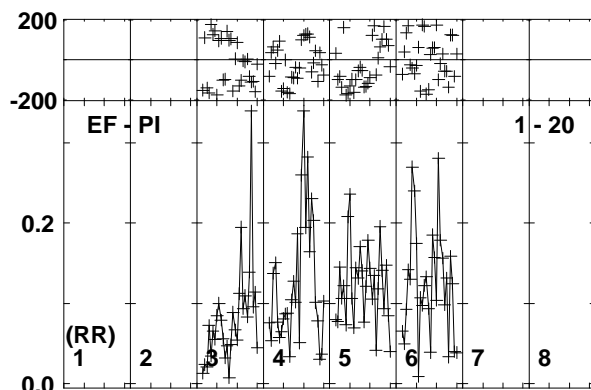
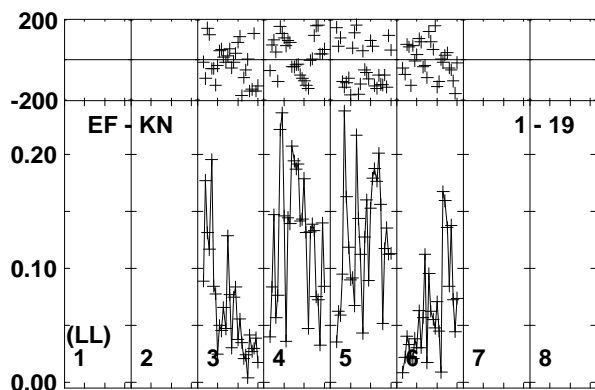
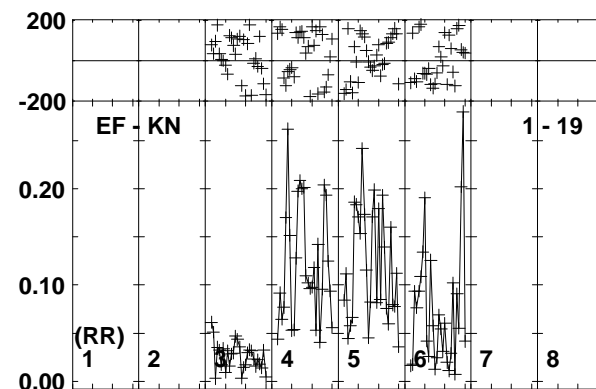
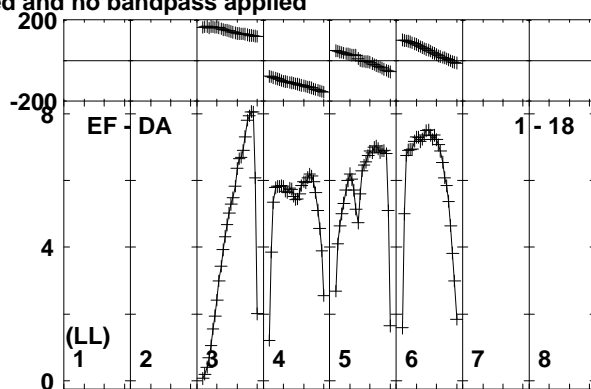
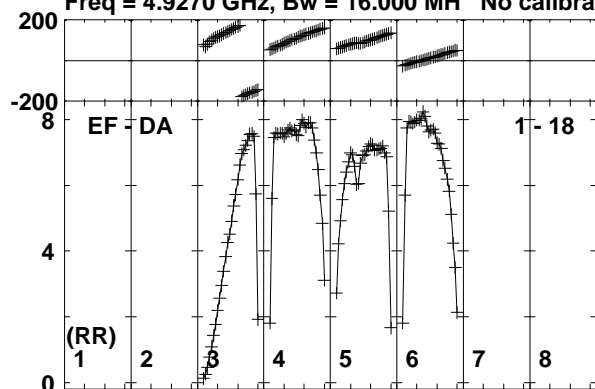

Lower frame: Milli Ampl Jy Top frame: Phas deg  
Vector averaged cross-power spectrum Baseline: EF (01) - DA (18)  
Timerange: 00/10:38:51 to 00/10:40:19

Plot file version 508 created 08-APR-2019 12:10:39

MRK622 EM133B.UVDATA.1

Freq = 4.9270 GHz, Bw = 16.000 MH No calibration applied and no bandpass applied

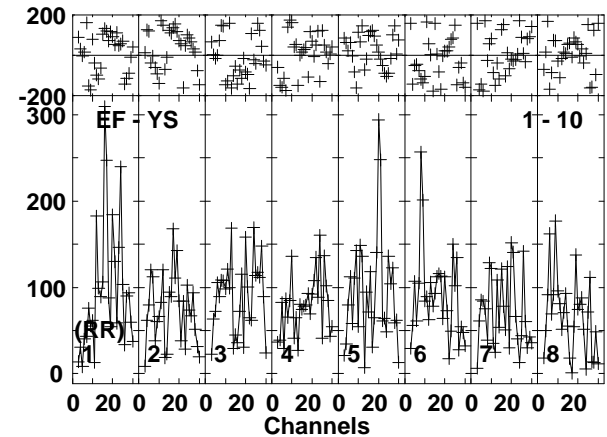
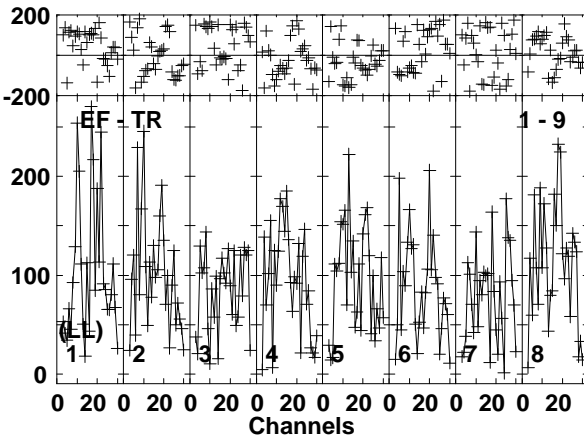
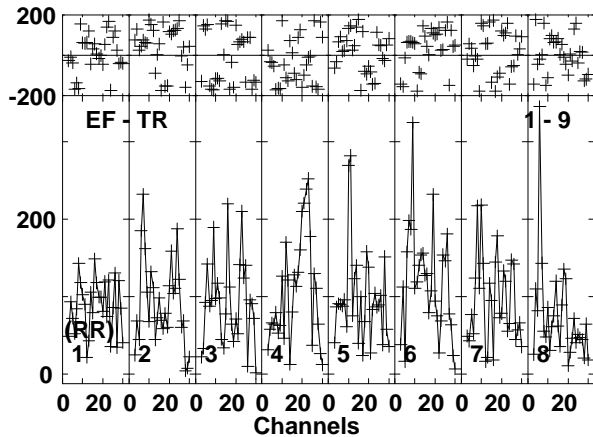
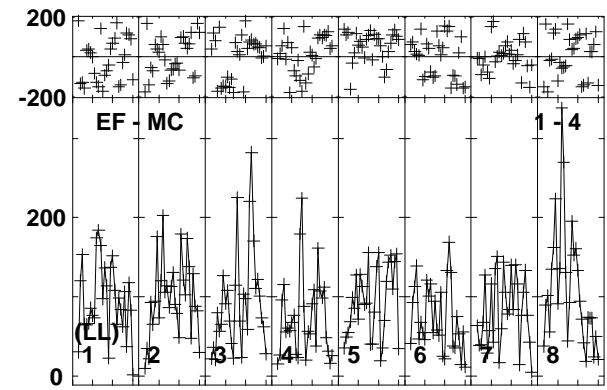
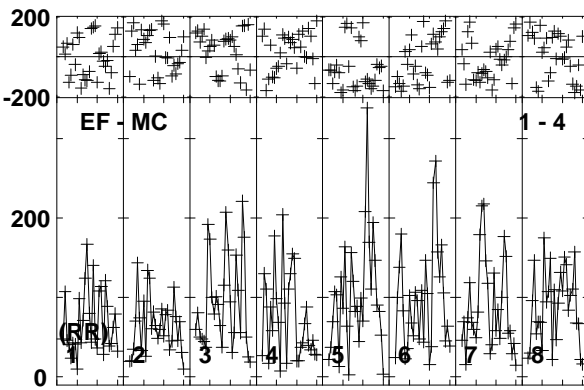
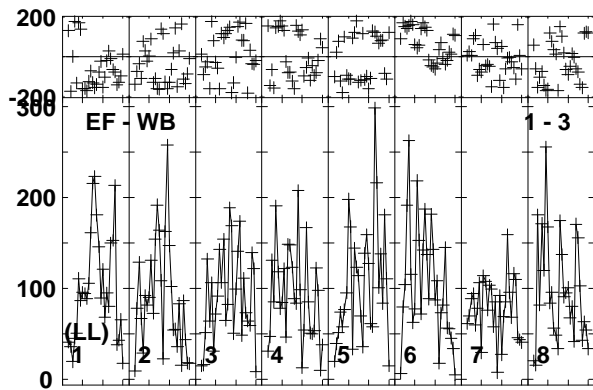
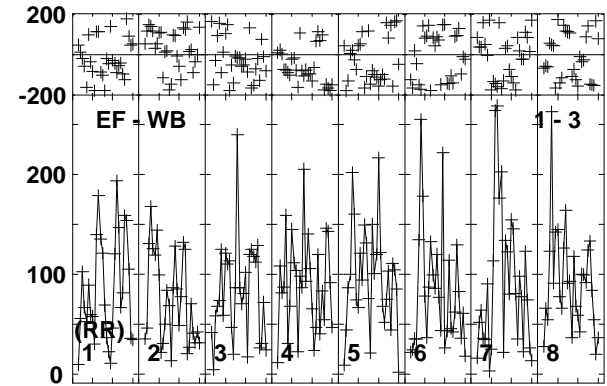
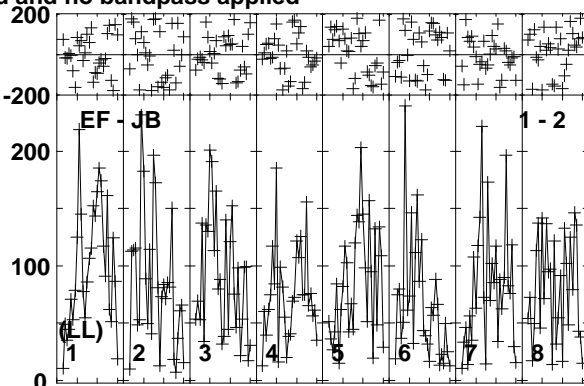
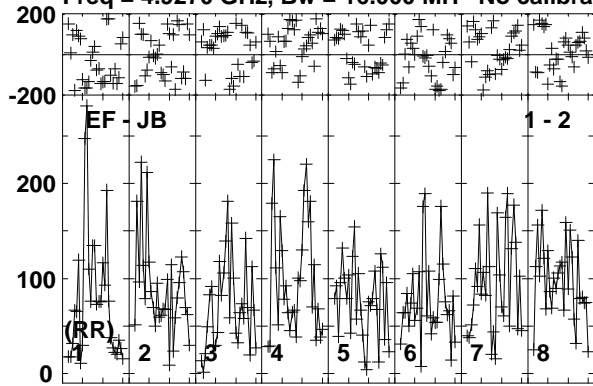

Lower frame: Micro Ampl Jy Top frame: Phas deg  
Vector averaged cross-power spectrum Baseline: EF (01) - JB (02)  
Timerange: 00/10:40:21 to 00/10:43:49

Plot file version 509 created 08-APR-2019 12:10:40

MRK622 EM133B.UVDATA.1

Freq = 4.9270 GHz, Bw = 16.000 MH No calibration applied and no bandpass applied

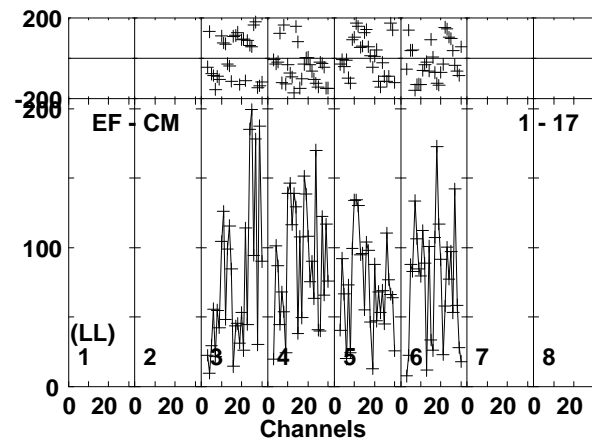
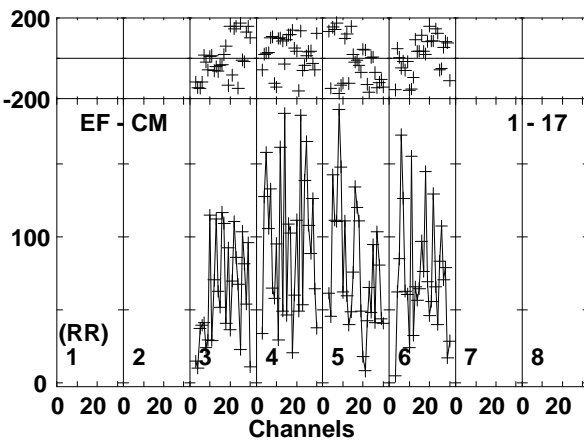
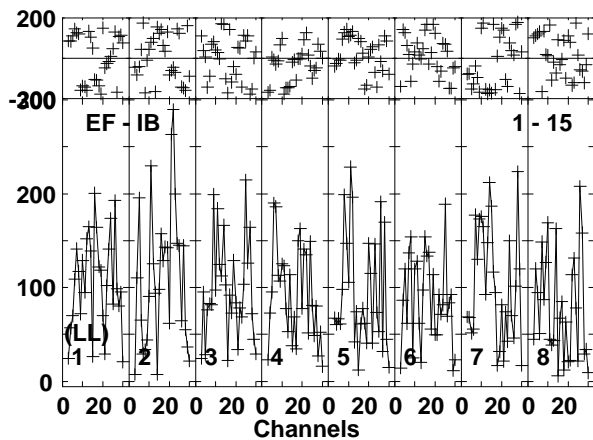
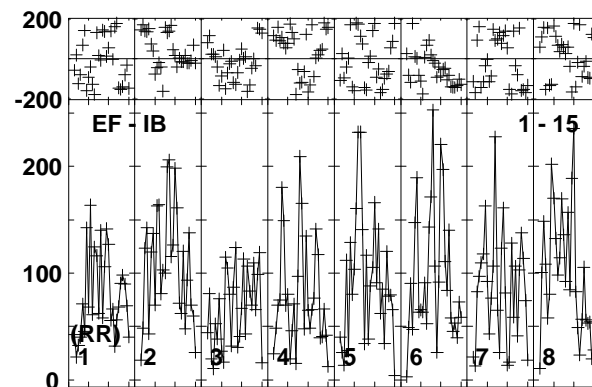
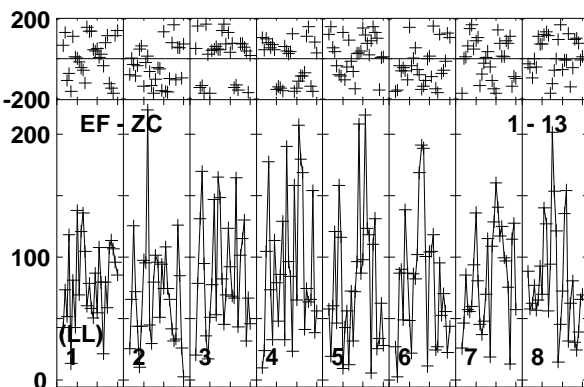
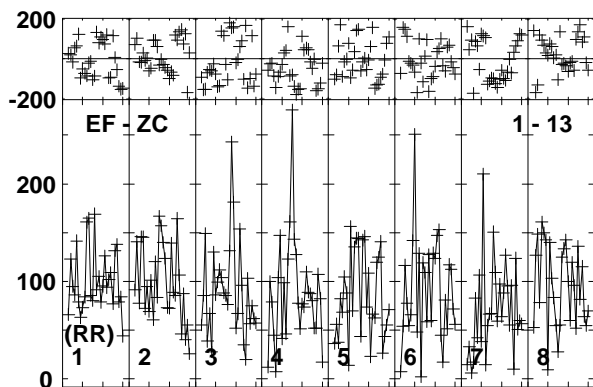
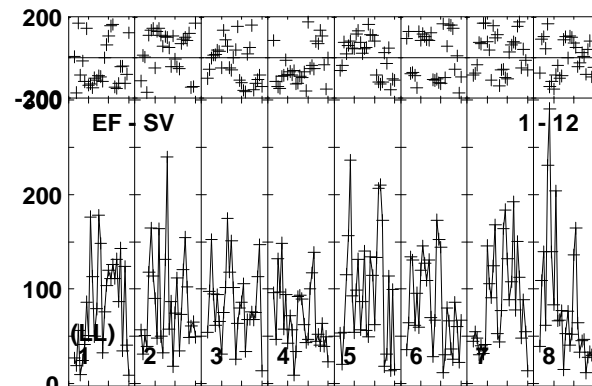
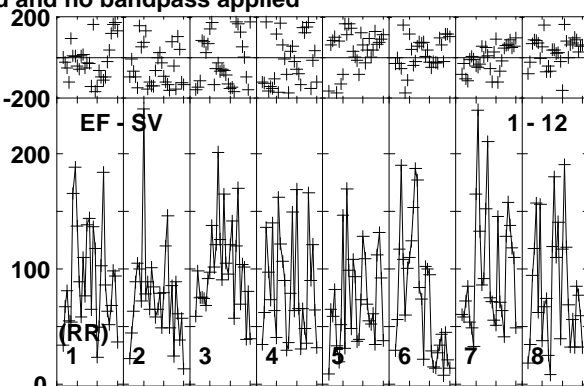
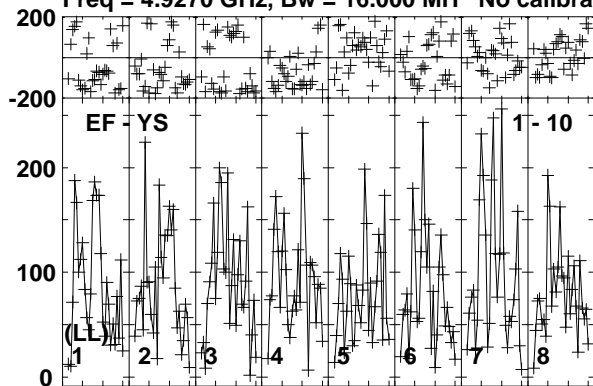

Lower frame: Micro Ampl Jy Top frame: Phas deg  
Vector averaged cross-power spectrum Baseline: EF (01) - YS (10)  
Timerange: 00/10:40:21 to 00/10:43:49

Plot file version 510 created 08-APR-2019 12:10:40

MRK622 EM133B.UVDATA.1

Freq = 4.9270 GHz, Bw = 16.000 MH No calibration applied and no bandpass applied

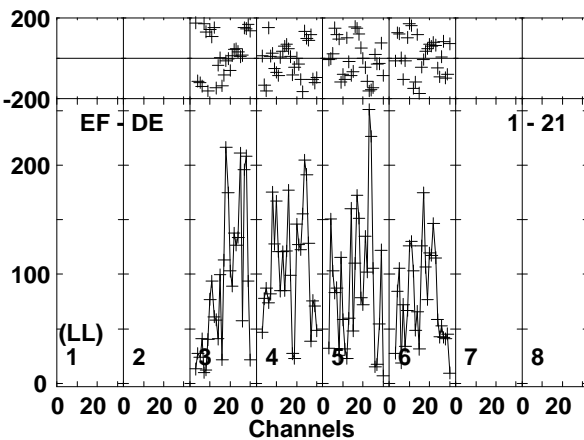
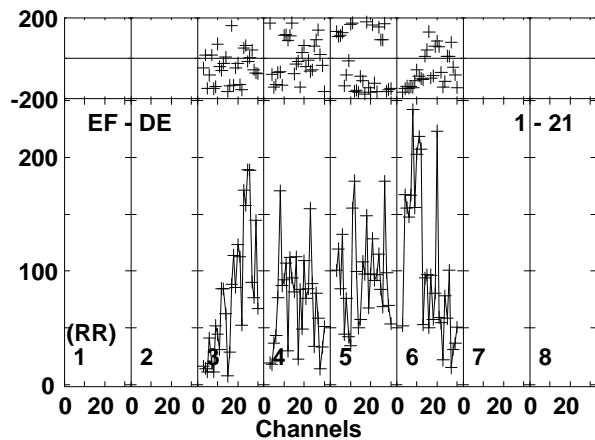
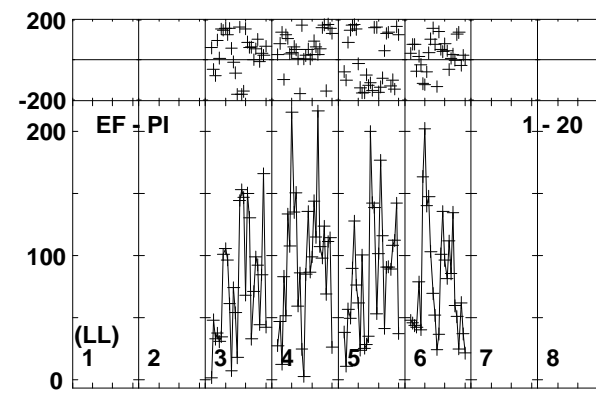
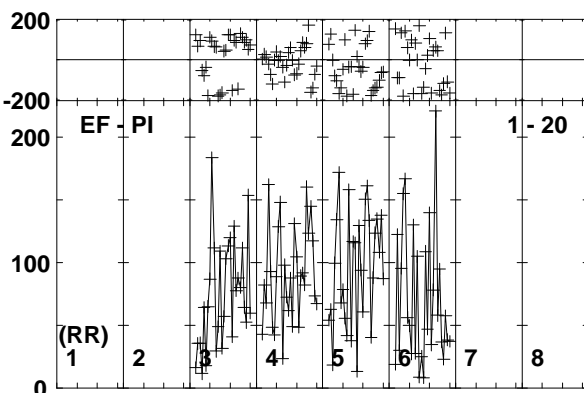
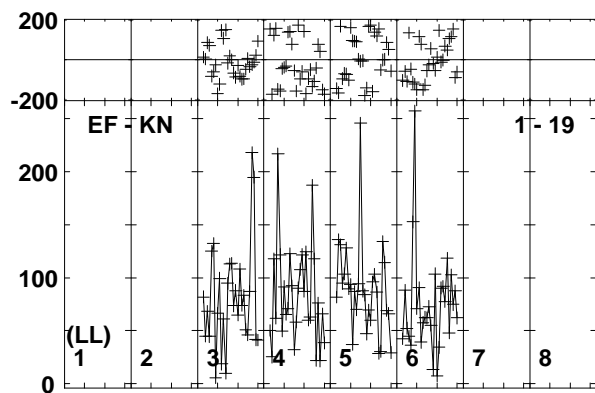
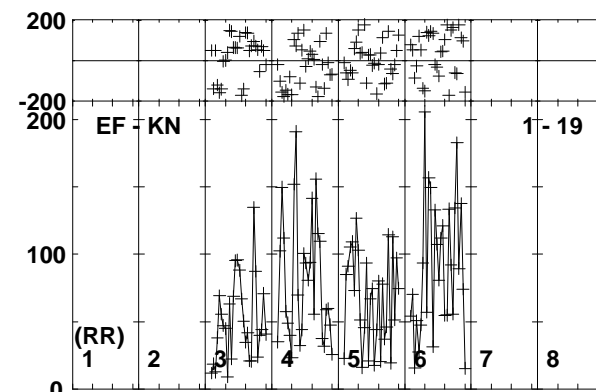
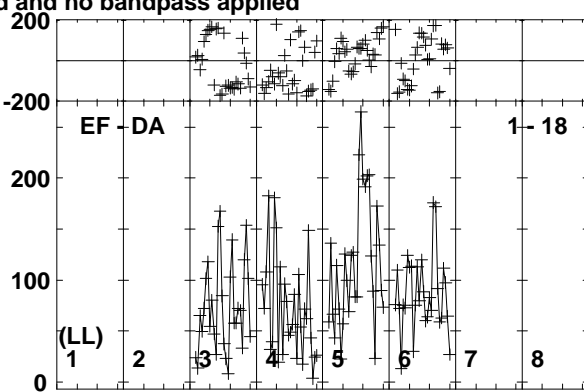
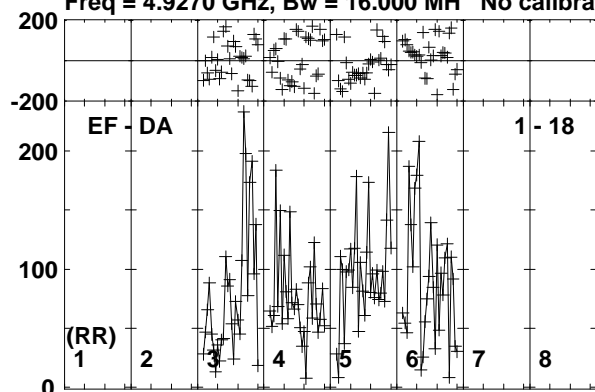

Lower frame: Micro Ampl Jy Top frame: Phas deg  
Vector averaged cross-power spectrum Baseline: EF (01) - DA (18)  
Timerange: 00/10:40:21 to 00/10:43:49

Plot file version 511 created 08-APR-2019 12:10:40

J0815+3635 EM133B.UVDATA.1

Freq = 4.9270 GHz, Bw = 16.000 MH No calibration applied and no bandpass applied

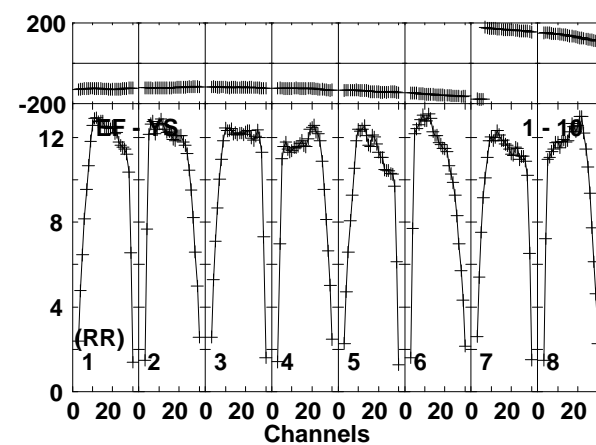
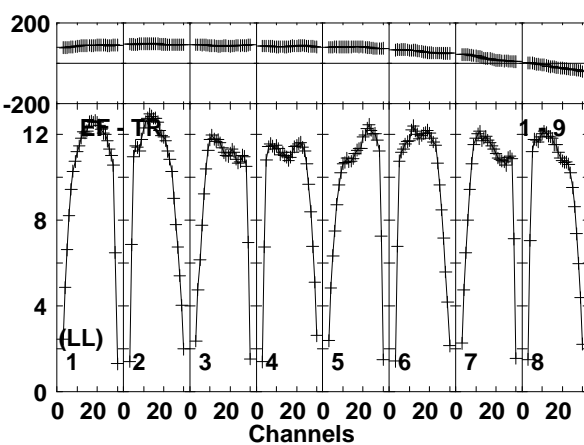
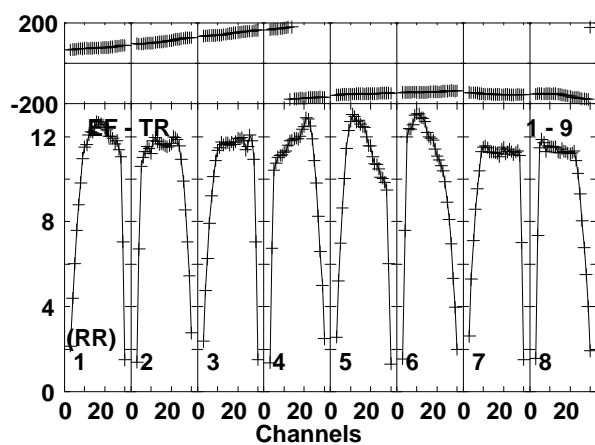
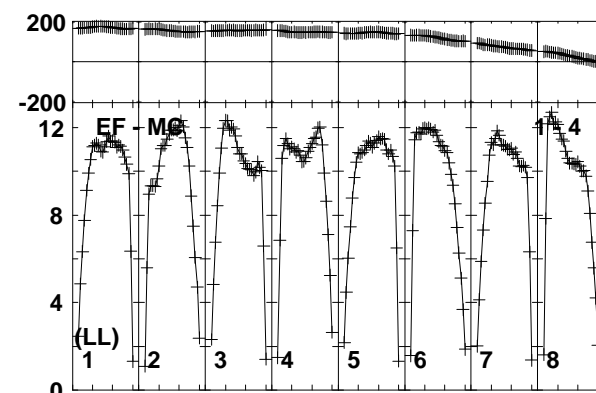
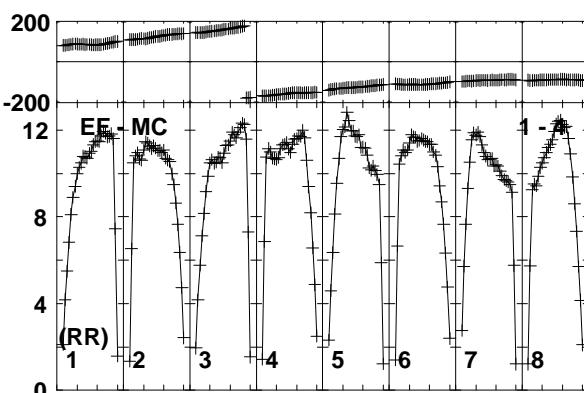
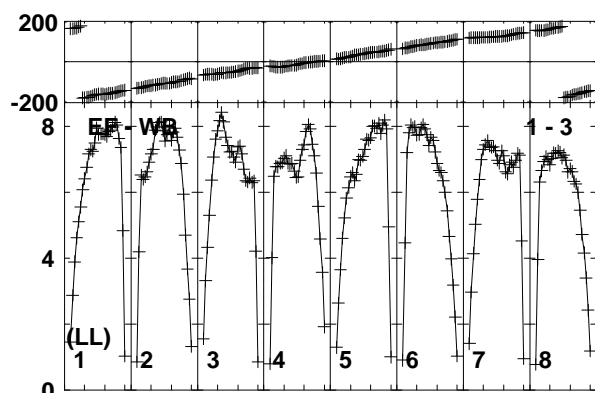
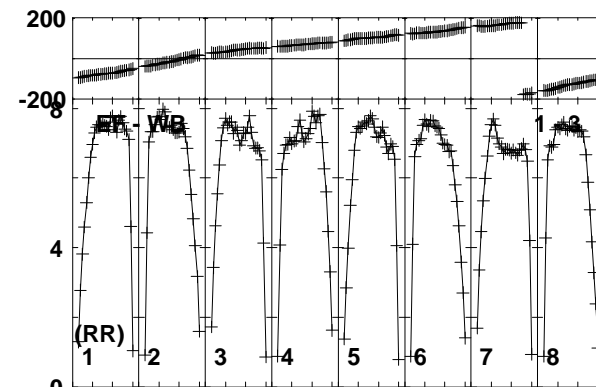
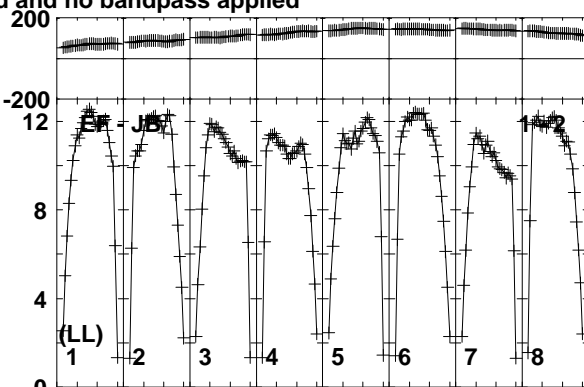
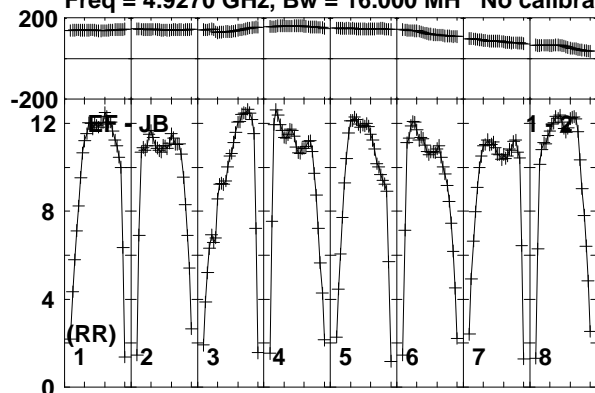

Lower frame: Milli Ampl Jy Top frame: Phas deg  
Vector averaged cross-power spectrum Baseline: EF (01) - JB (02)  
Timerange: 00/10:43:51 to 00/10:45:19

Plot file version 512 created 08-APR-2019 12:10:40

J0815+3635 EM133B.UVDATA.1

Freq = 4.9270 GHz, Bw = 16.000 MH No calibration applied and no bandpass applied

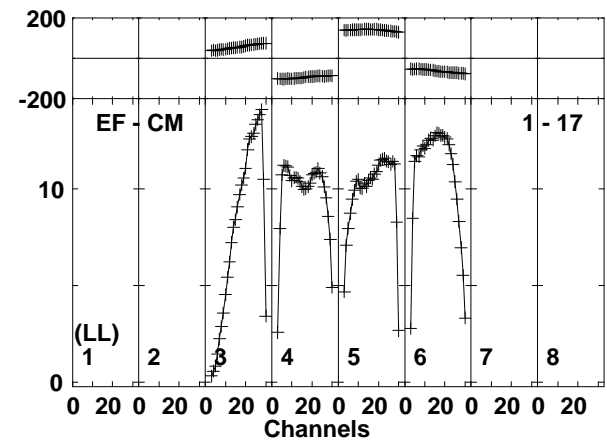
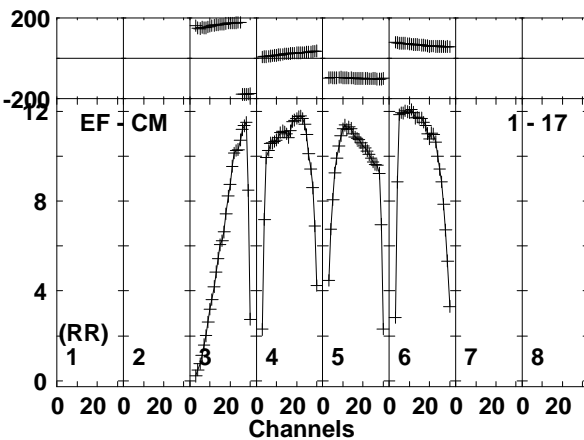
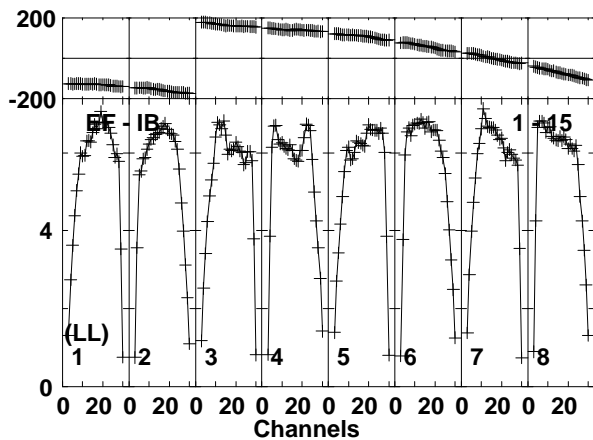
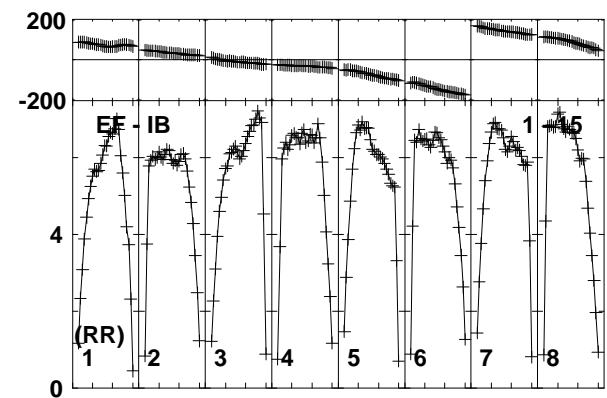
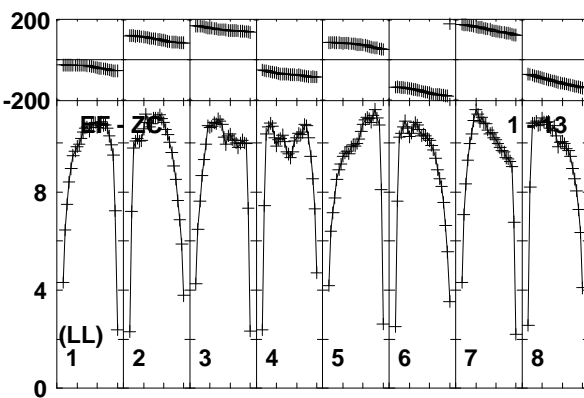
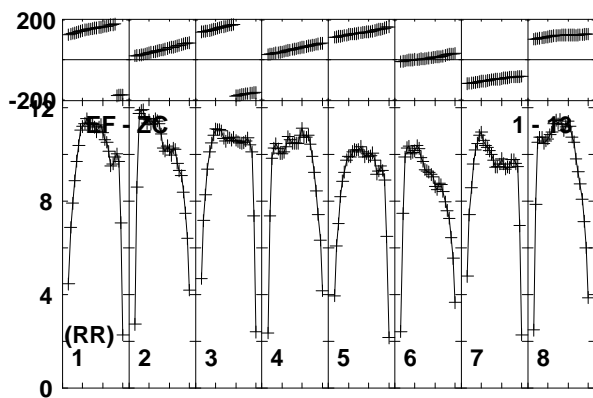
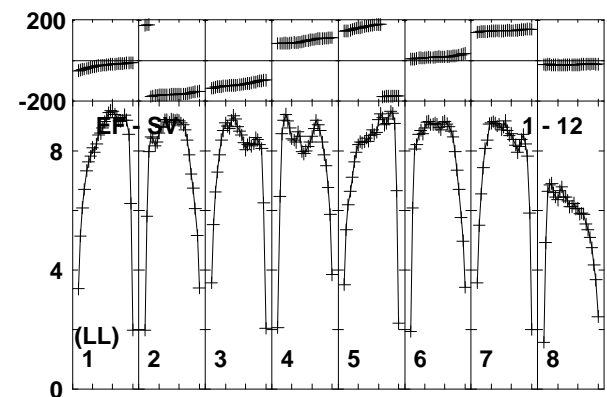
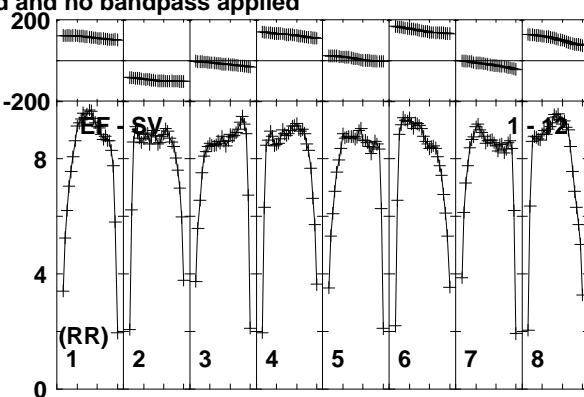
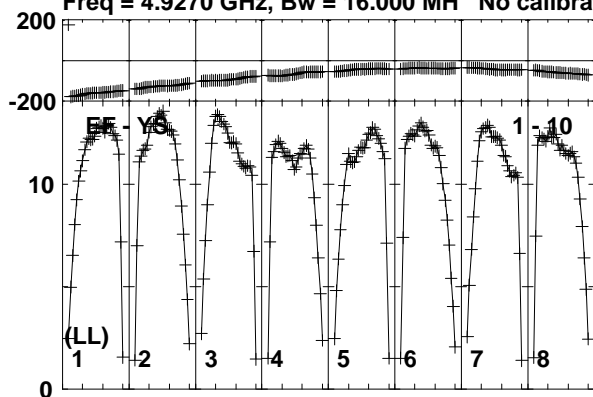

Lower frame: Milli Ampl Jy Top frame: Phas deg  
Vector averaged cross-power spectrum Baseline: EF (01) - YS (10)  
Timerange: 00/10:43:51 to 00/10:45:19



Plot file version 513 created 08-APR-2019 12:10:40

J0815+3635 EM133B.UVDATA.1

Freq = 4.9270 GHz, Bw = 16.000 MH No calibration applied and no bandpass applied

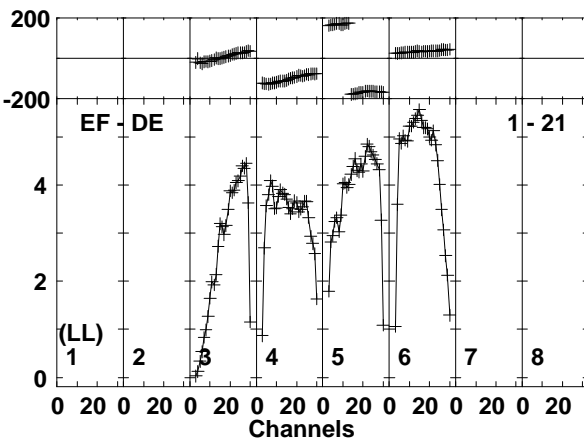
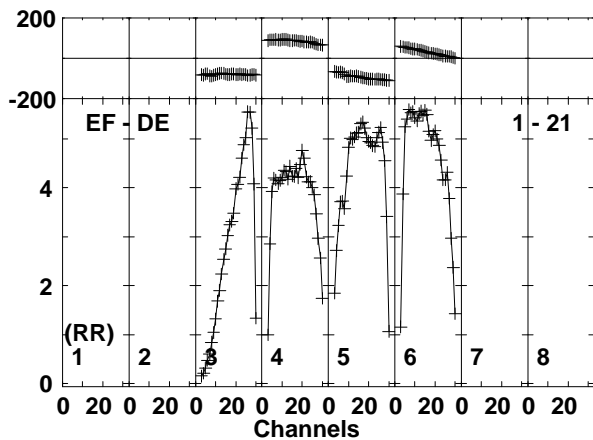
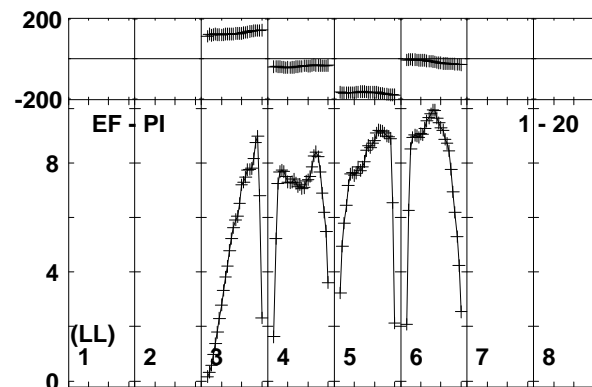
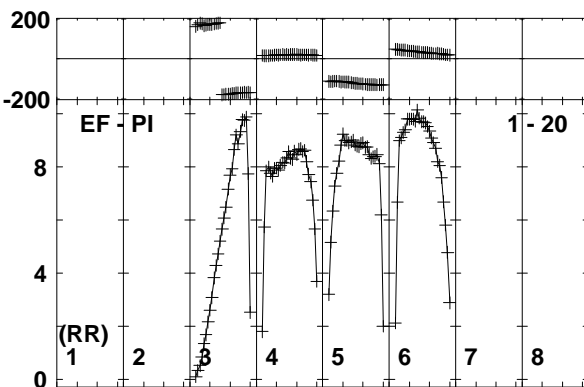
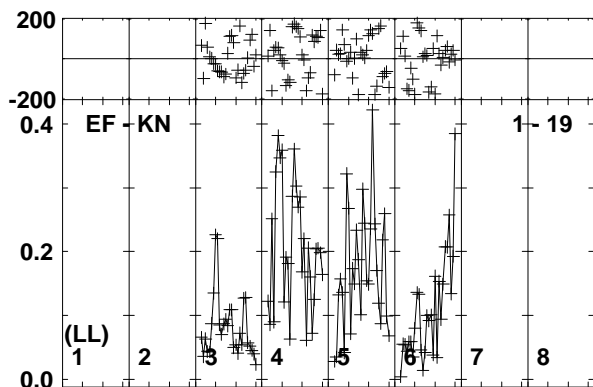
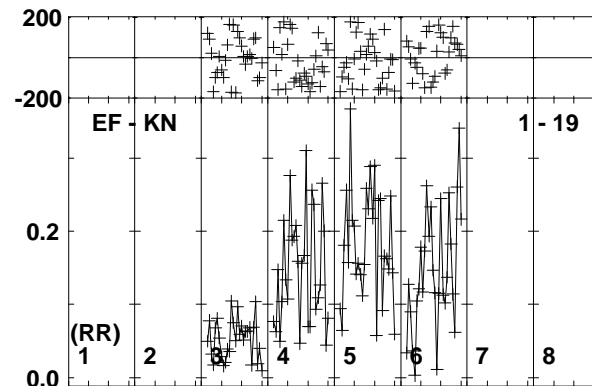
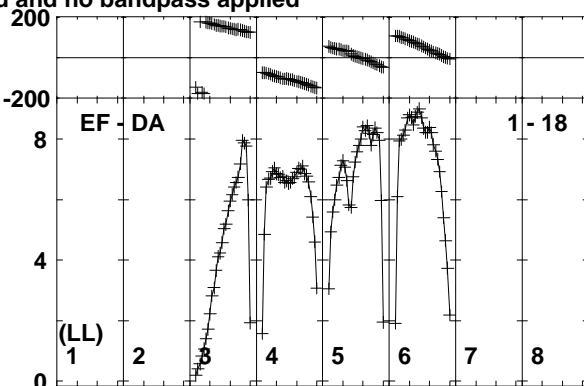
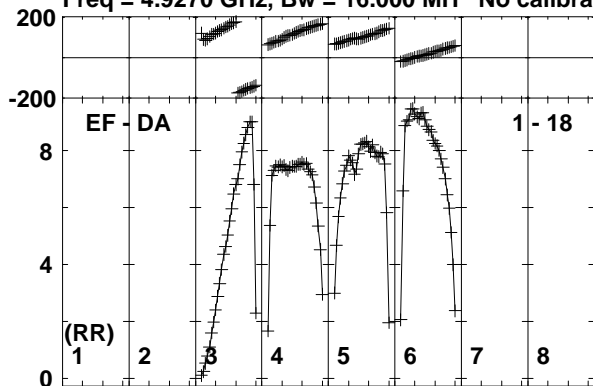

Lower frame: Milli Ampl Jy Top frame: Phas deg  
Vector averaged cross-power spectrum Baseline: EF (01) - DA (18)  
Timerange: 00/10:43:51 to 00/10:45:19

Plot file version 514 created 08-APR-2019 12:10:40

MRK622 EM133B.UVDATA.1

Freq = 4.9270 GHz, Bw = 16.000 MH No calibration applied and no bandpass applied

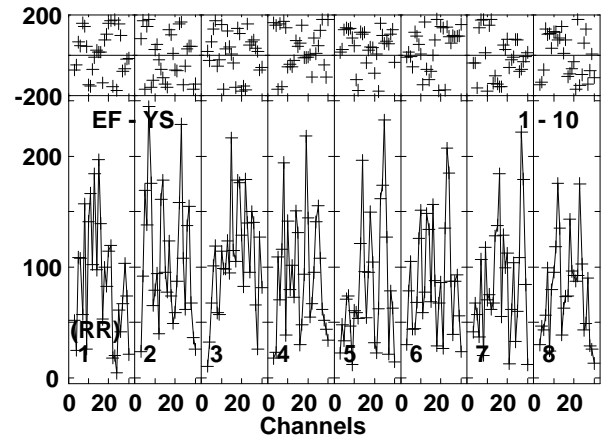
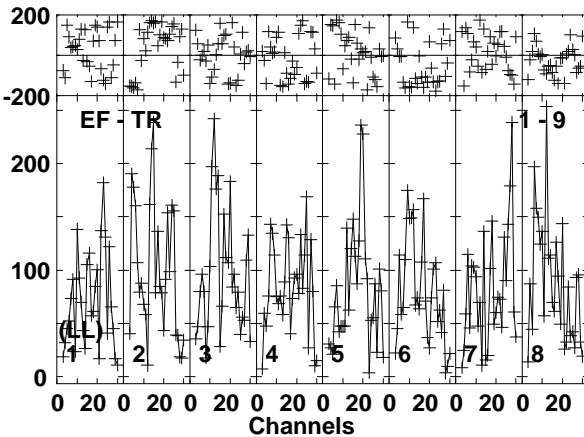
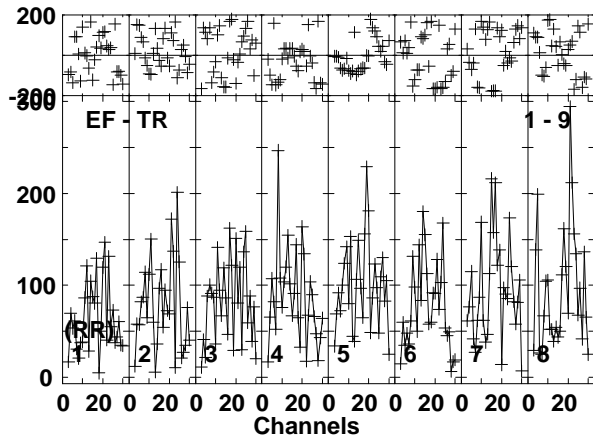
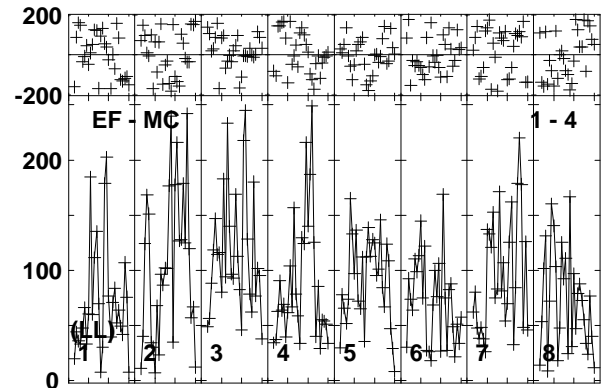
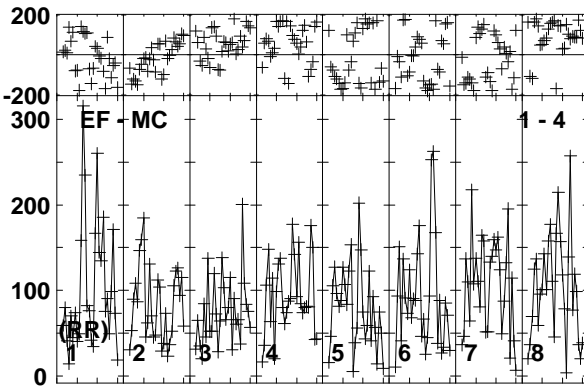
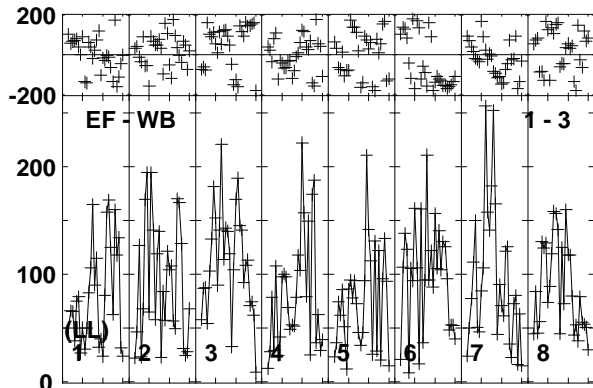
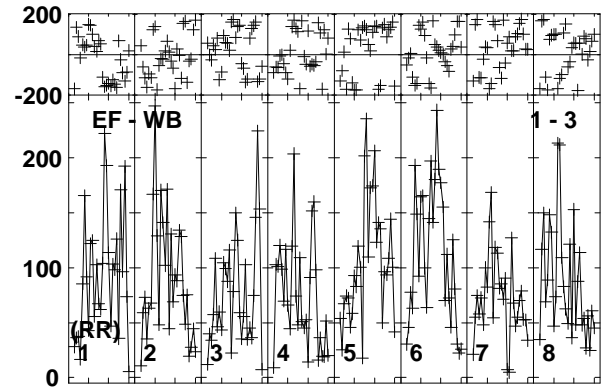
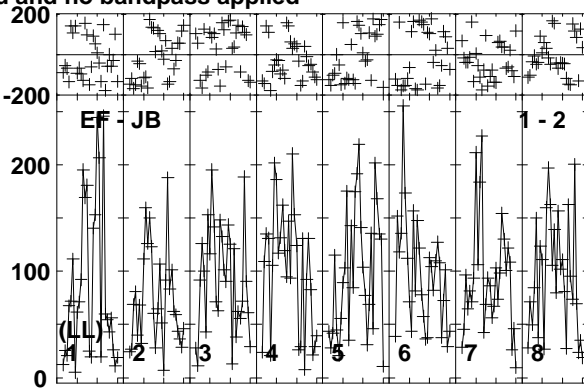
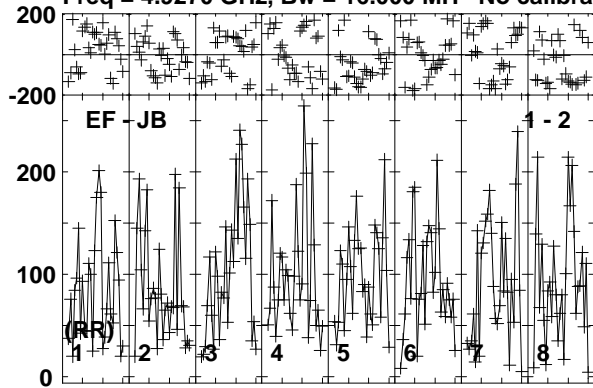

Lower frame: Micro Ampl Jy Top frame: Phas deg  
Vector averaged cross-power spectrum Baseline: EF (01) - JB (02)  
Timerange: 00/10:45:23 to 00/10:48:49

Plot file version 515 created 08-APR-2019 12:10:41

MRK622 EM133B.UVDATA.1

Freq = 4.9270 GHz, Bw = 16.000 MH No calibration applied and no bandpass applied

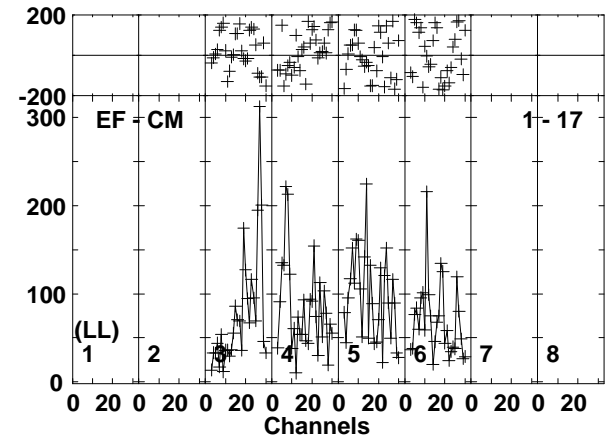
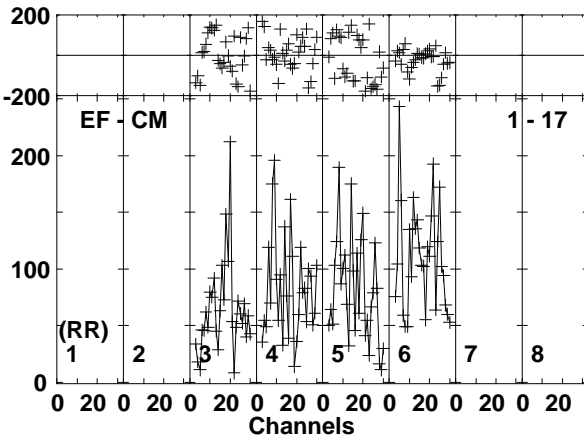
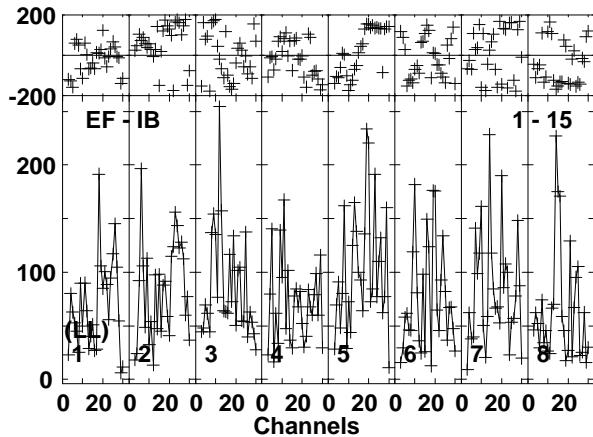
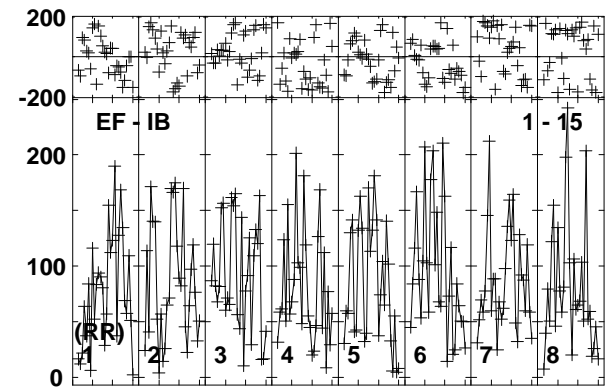
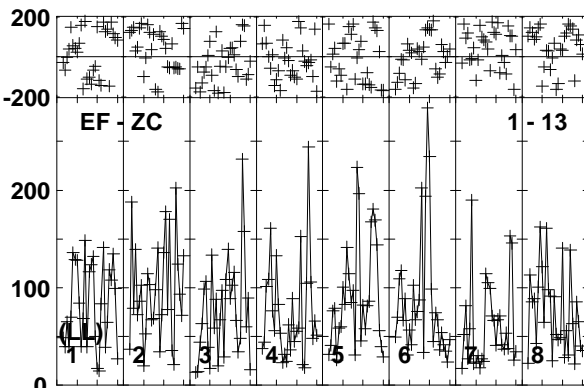
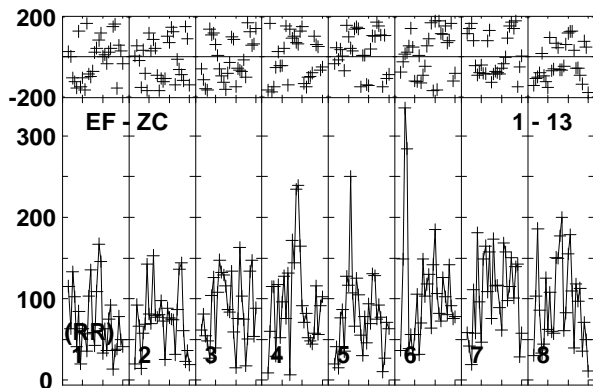
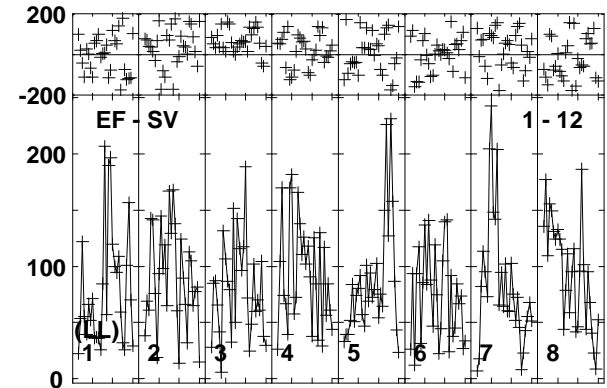
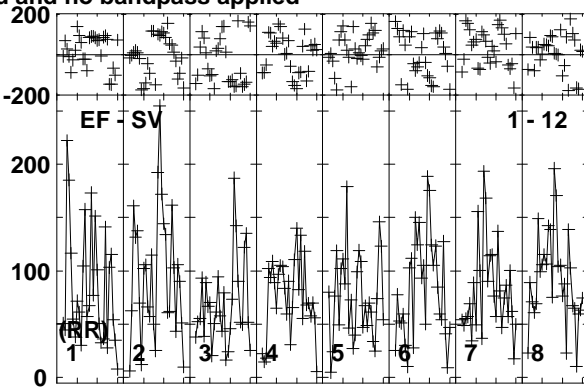
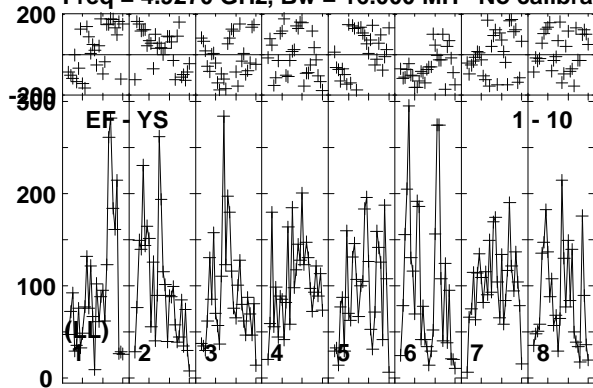

Lower frame: Micro Ampl Jy Top frame: Phas deg  
Vector averaged cross-power spectrum Baseline: EF (01) - YS (10)  
Timerange: 00/10:45:23 to 00/10:48:49

Plot file version 516 created 08-APR-2019 12:10:41

MRK622 EM133B.UVDATA.1

Freq = 4.9270 GHz, Bw = 16.000 MH No calibration applied and no bandpass applied

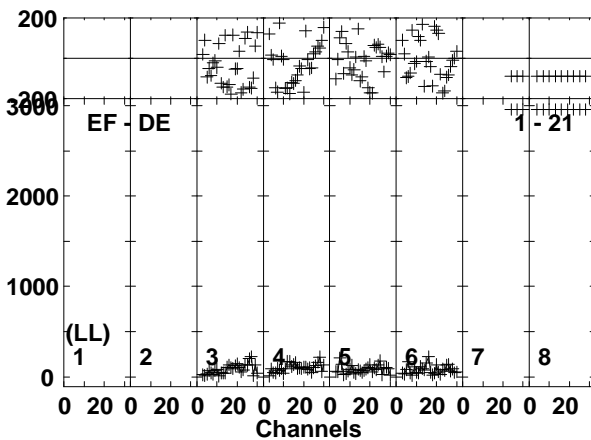
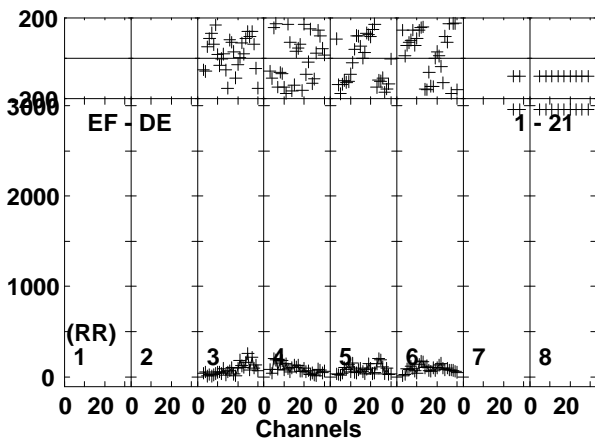
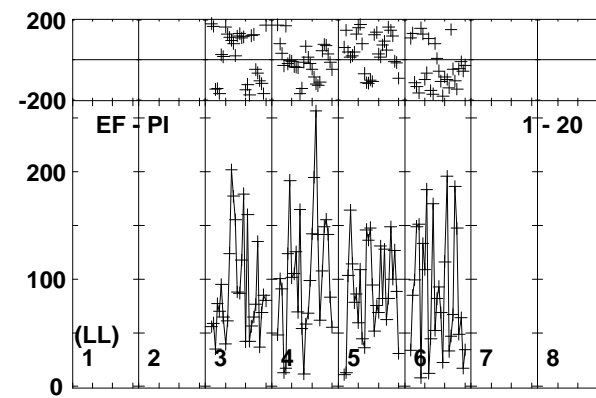
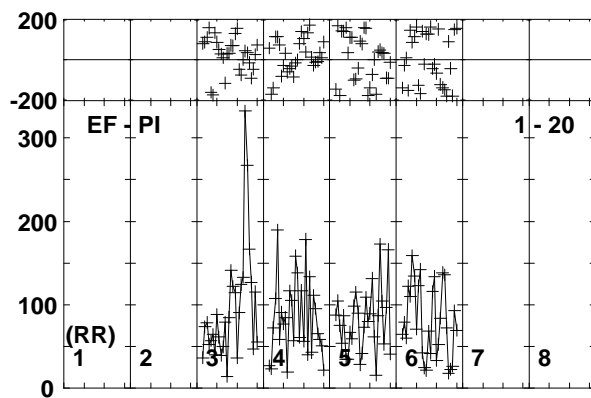
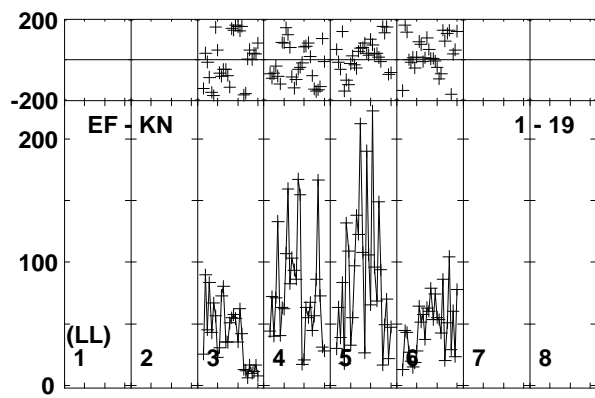
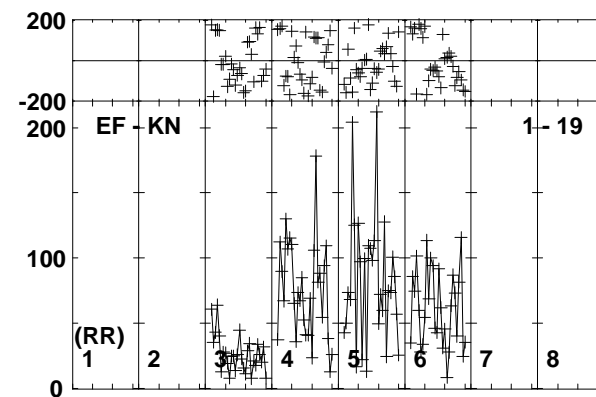
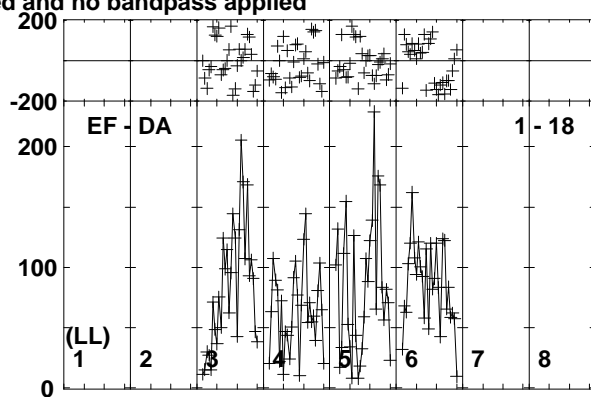
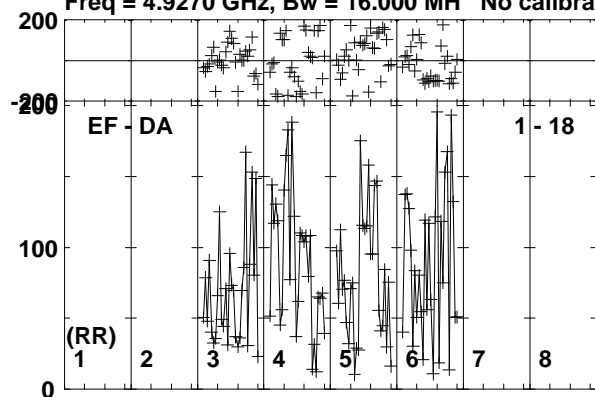

Lower frame: Micro Ampl Jy Top frame: Phas deg  
Vector averaged cross-power spectrum Baseline: EF (01) - DA (18)  
Timerange: 00/10:45:23 to 00/10:48:49

Plot file version 517 created 08-APR-2019 12:10:41

J0815+3635 EM133B.UVDATA.1

Freq = 4.9270 GHz, Bw = 16.000 MH No calibration applied and no bandpass applied

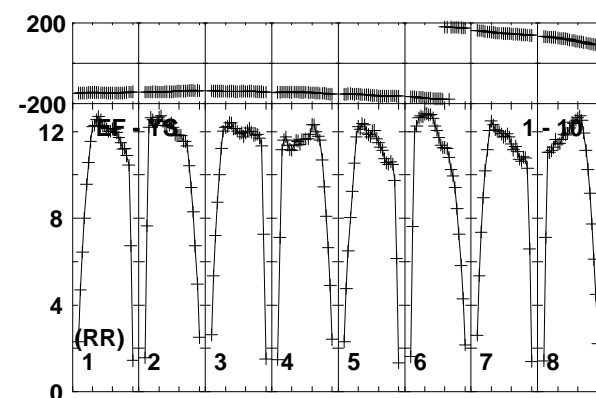
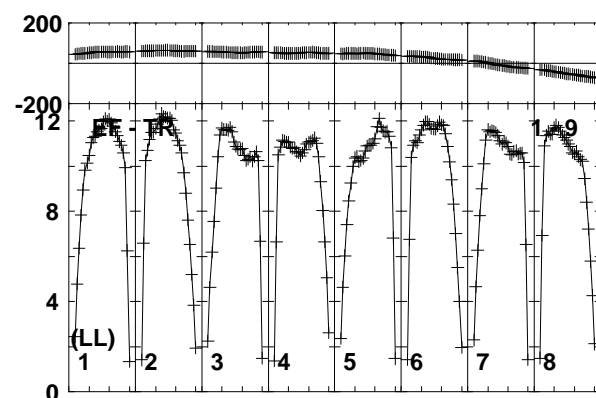
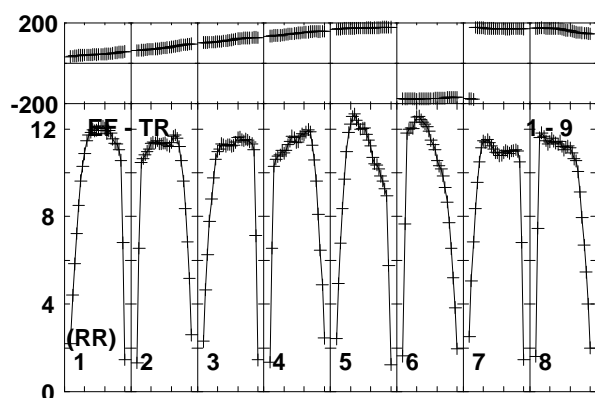
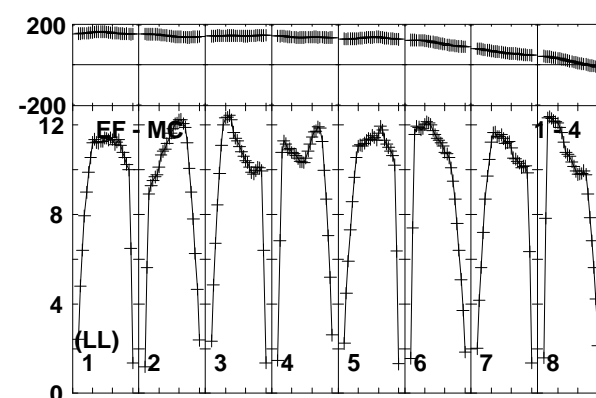
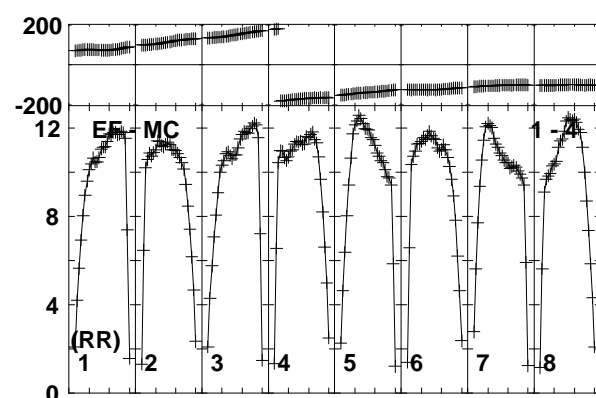
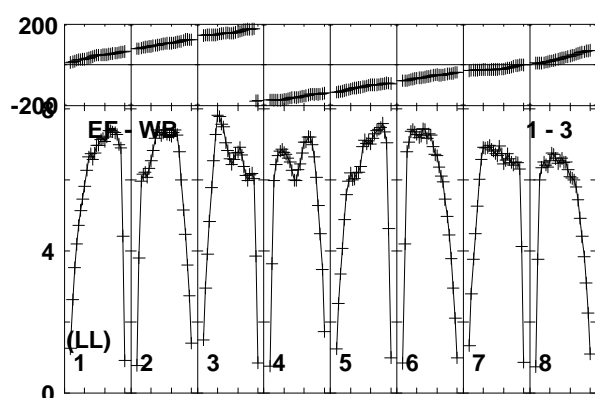
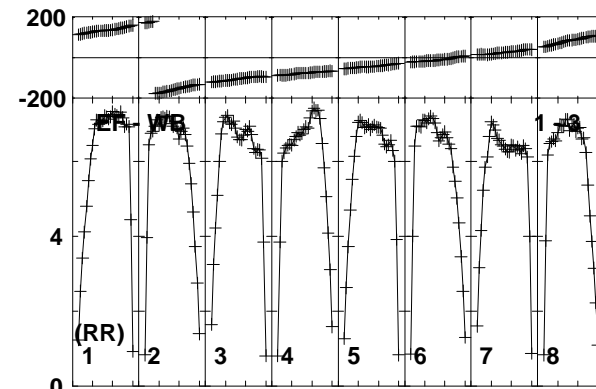
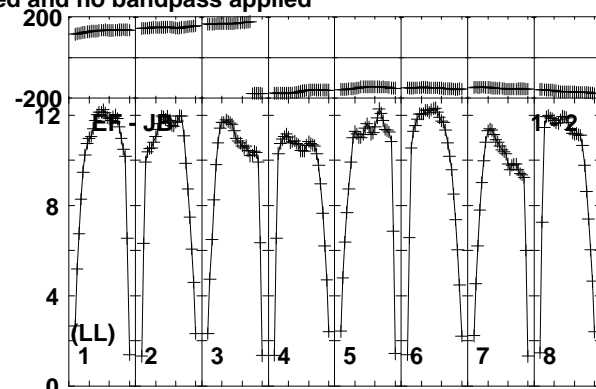
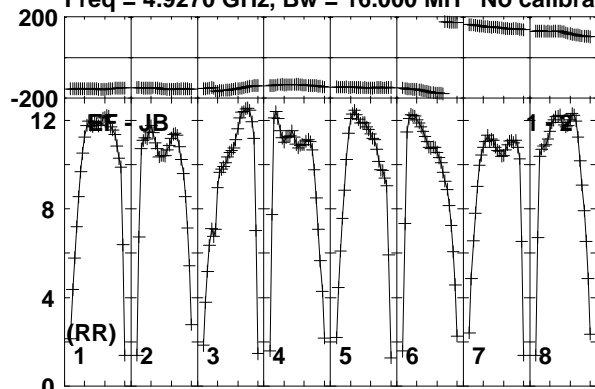

Lower frame: Milli Ampl Jy Top frame: Phas deg  
Vector averaged cross-power spectrum Baseline: EF (01) - JB (02)  
Timerange: 00/10:49:41 to 00/10:51:09

Plot file version 518 created 08-APR-2019 12:10:41

J0815+3635 EM133B.UVDATA.1

Freq = 4.9270 GHz, Bw = 16.000 MH No calibration applied and no bandpass applied

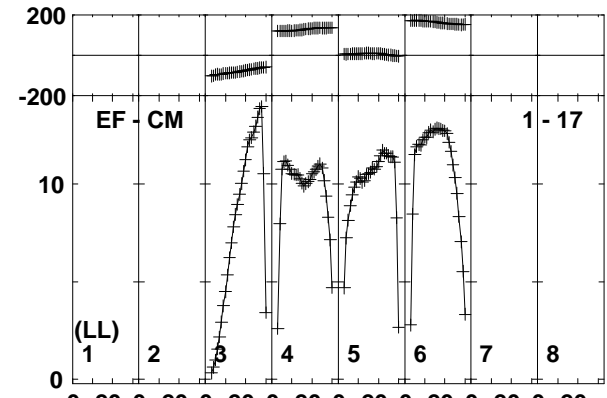
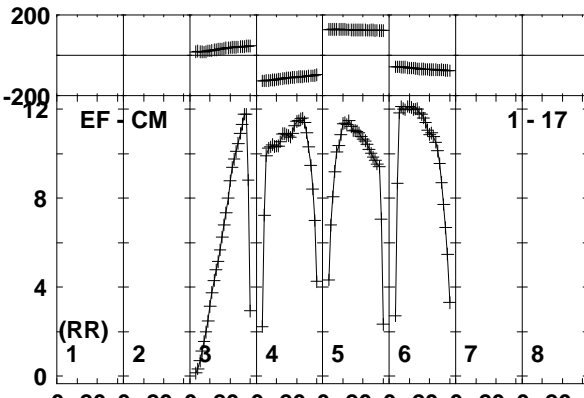
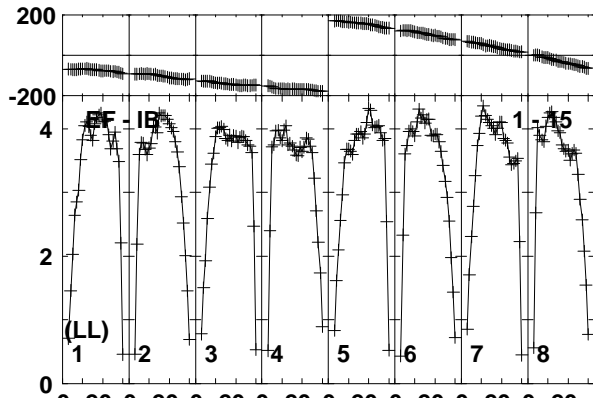
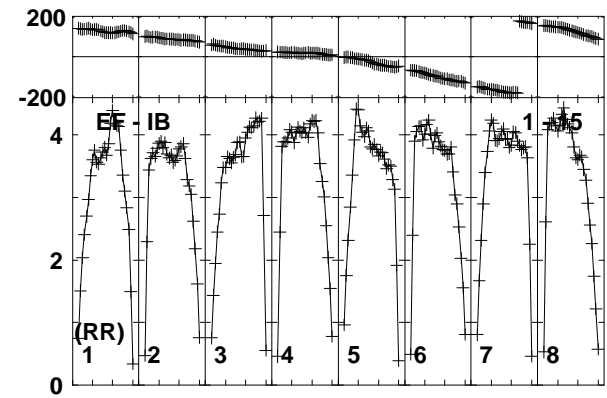
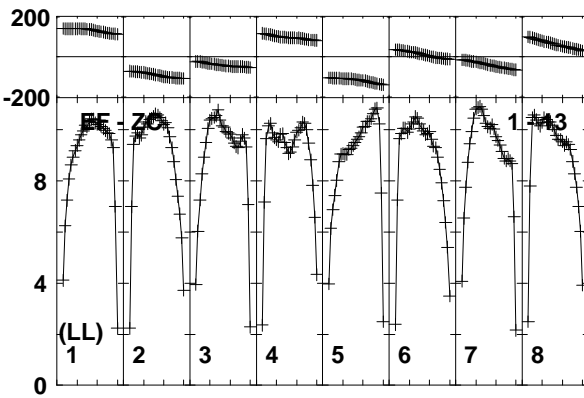
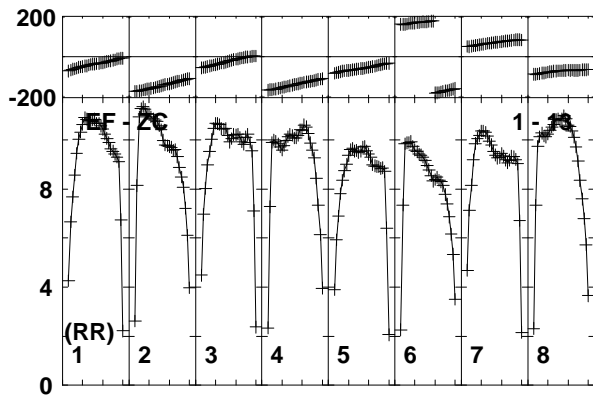
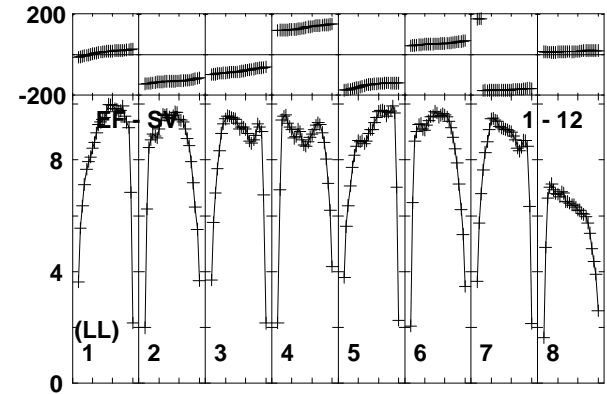
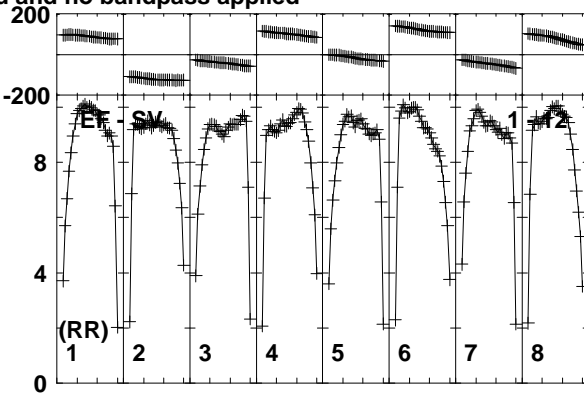
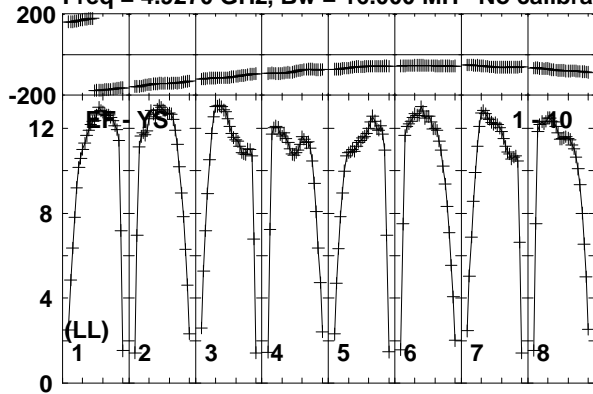

Lower frame: Milli Ampl Jy Top frame: Phas deg  
Vector averaged cross-power spectrum Baseline: EF (01) - YS (10)  
Timerange: 00/10:49:41 to 00/10:51:09

Plot file version 519 created 08-APR-2019 12:10:41

J0815+3635 EM133B.UVDATA.1

Freq = 4.9270 GHz, Bw = 16.000 MH No calibration applied and no bandpass applied

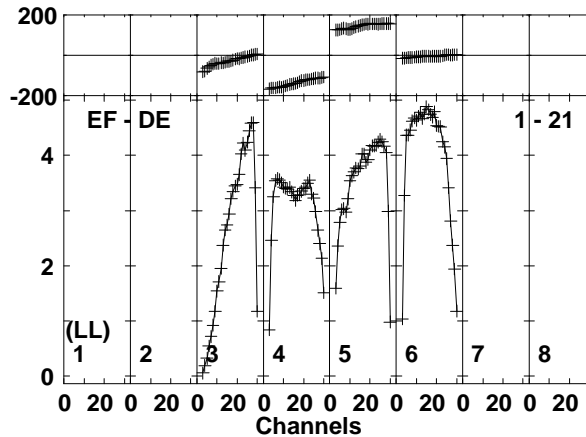
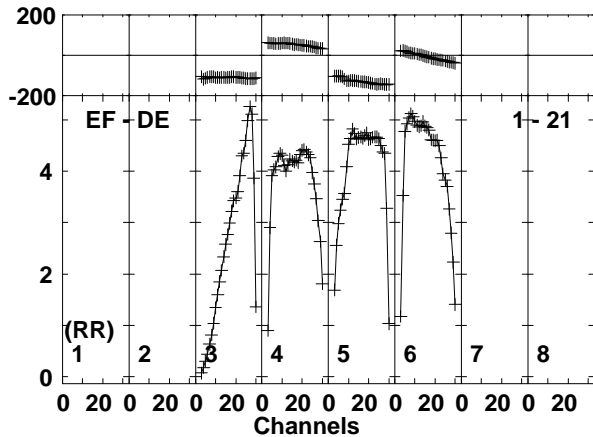
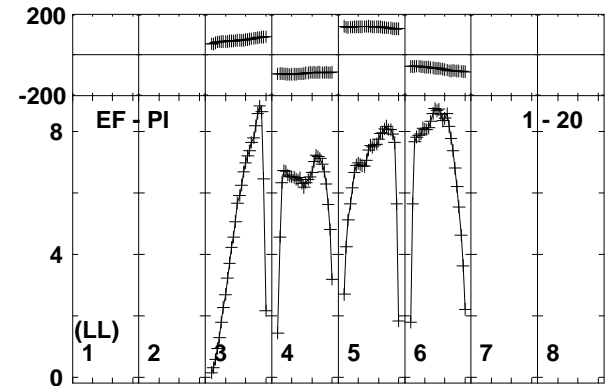
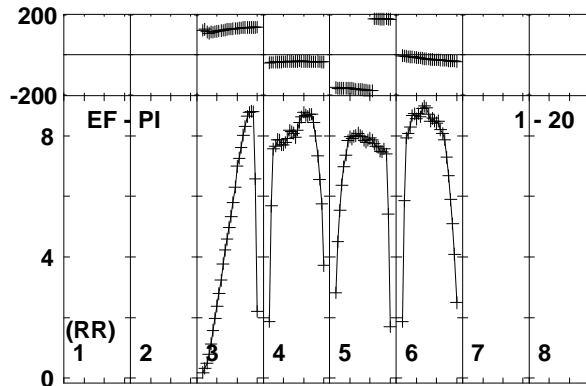
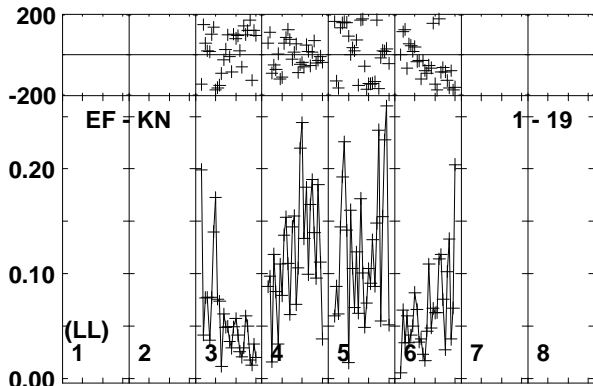
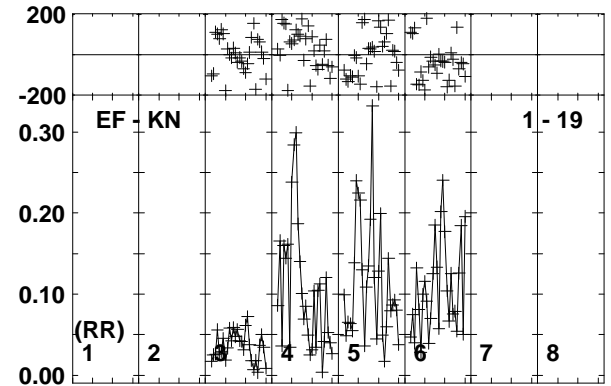
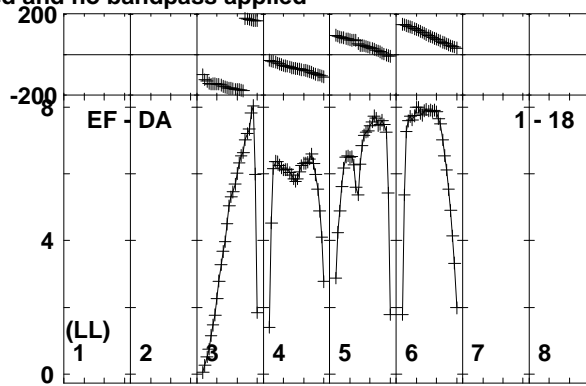
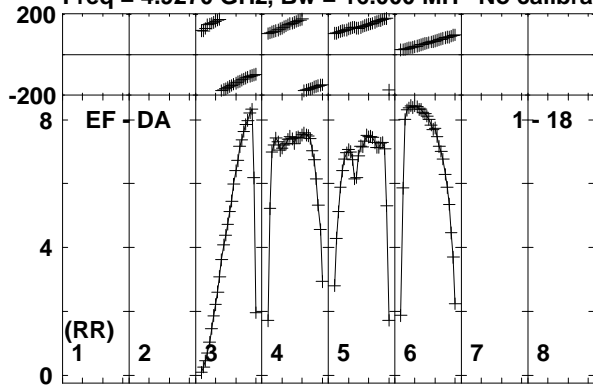

Lower frame: Milli Ampl Jy Top frame: Phas deg  
Vector averaged cross-power spectrum Baseline: EF (01) - DA (18)  
Timerange: 00/10:49:41 to 00/10:51:09





Plot file version 521 created 08-APR-2019 12:10:42

MRK622 EM133B.UVDATA.1

Freq = 4.9270 GHz, Bw = 16.000 MH No calibration applied and no bandpass applied

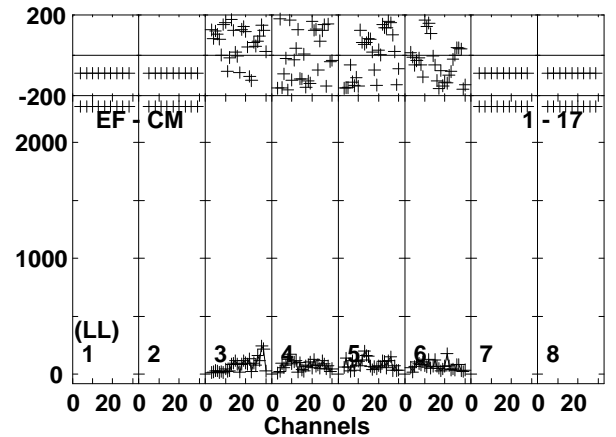
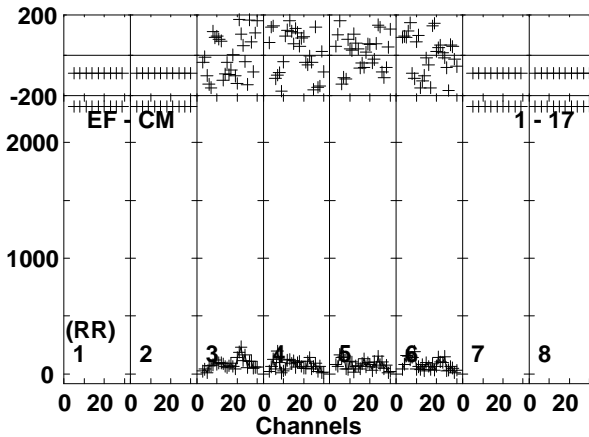
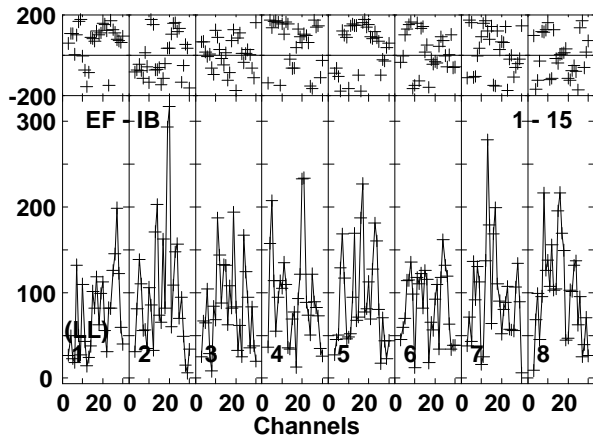
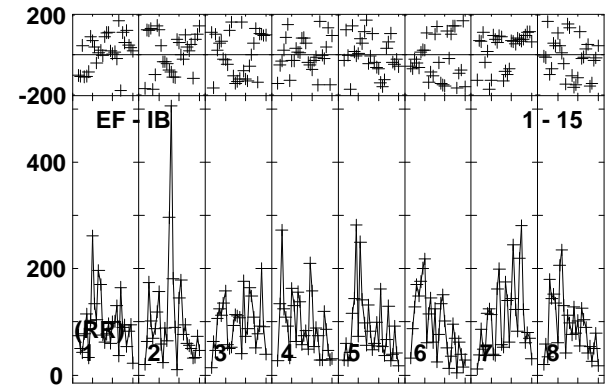
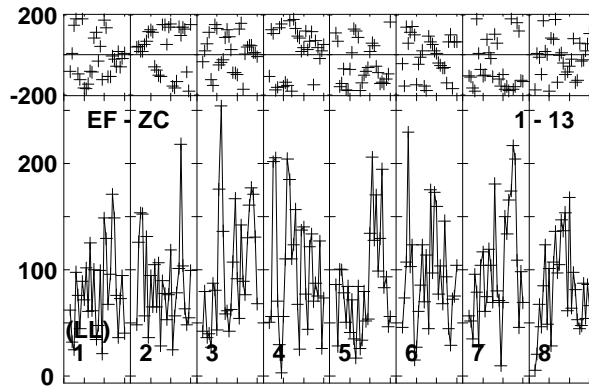
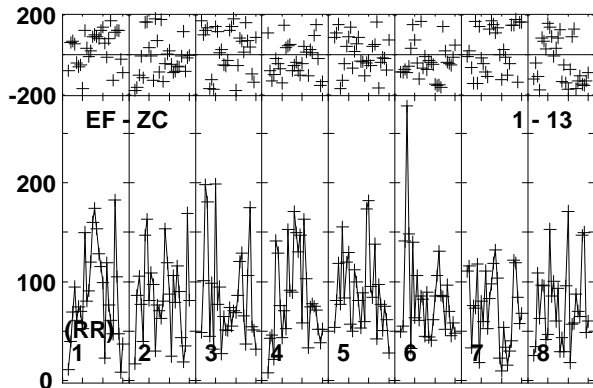
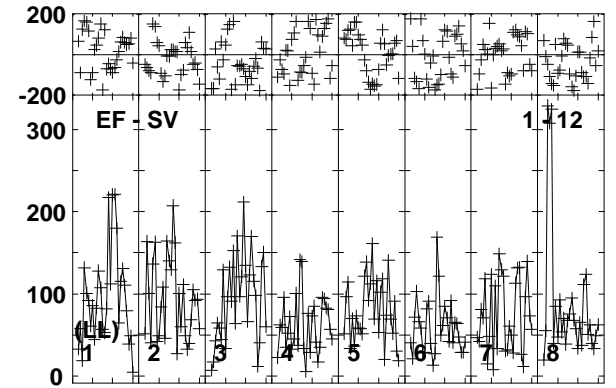
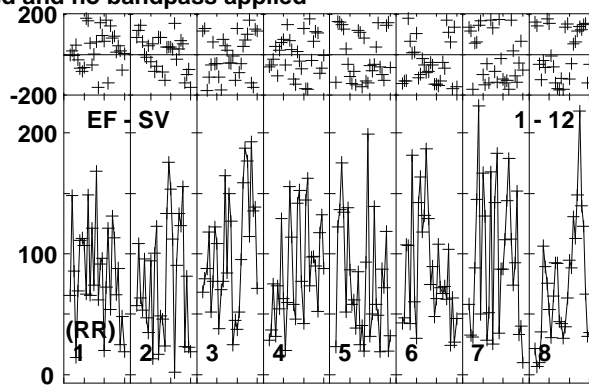
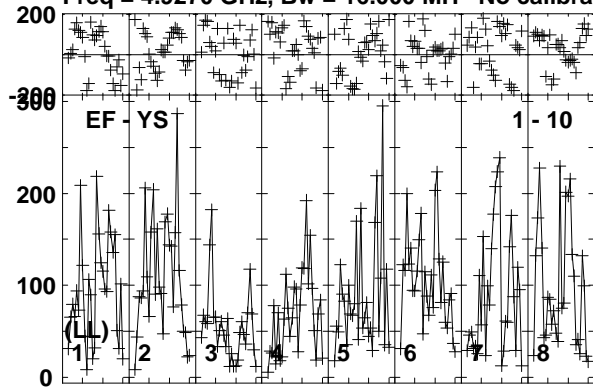

Lower frame: Micro Ampl Jy Top frame: Phas deg  
Vector averaged cross-power spectrum Baseline: EF (01) - YS (10)  
Timerange: 00/10:51:11 to 00/10:54:39

Plot file version 522 created 08-APR-2019 12:10:42

MRK622 EM133B.UVDATA.1

Freq = 4.9270 GHz, Bw = 16.000 MH No calibration applied and no bandpass applied

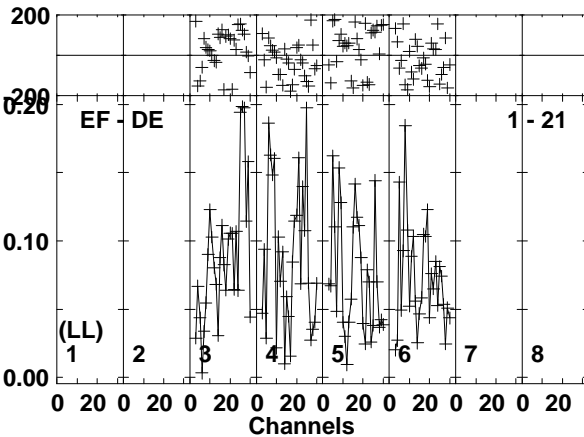
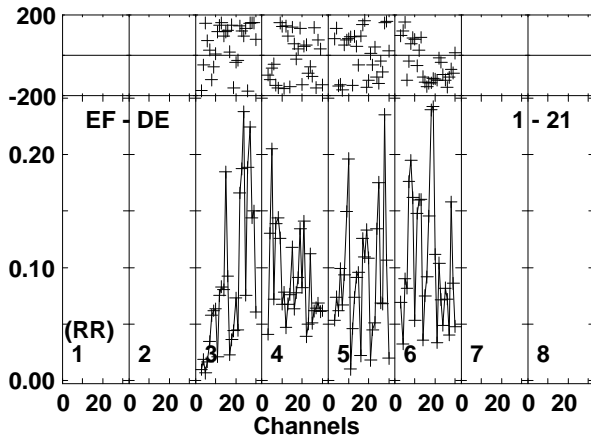
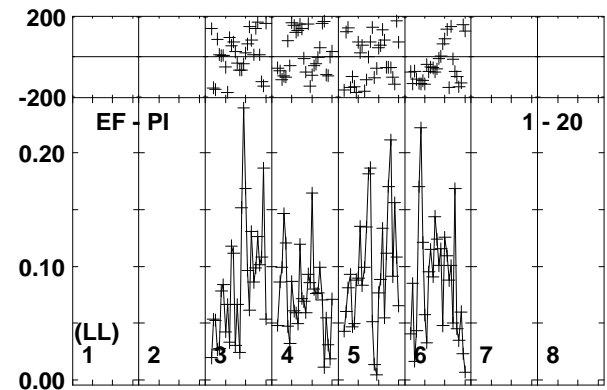
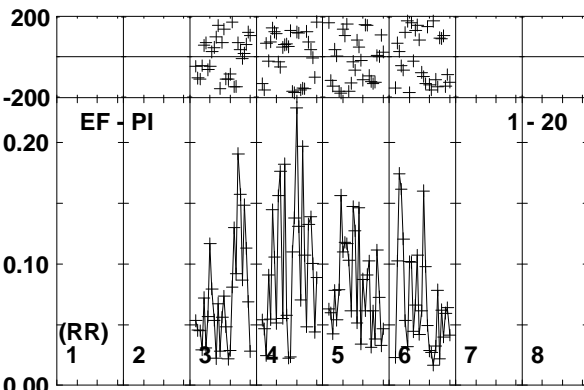
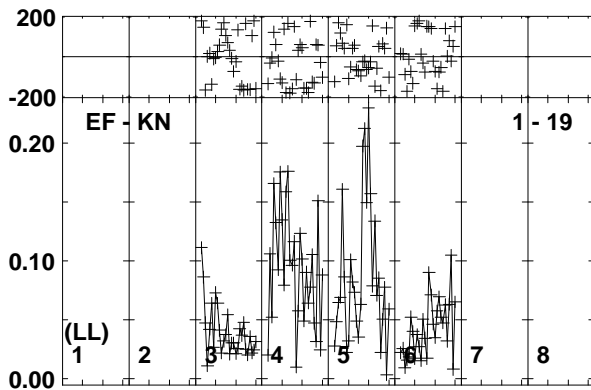
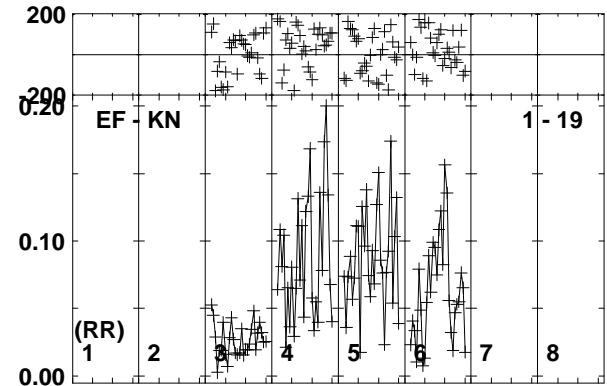
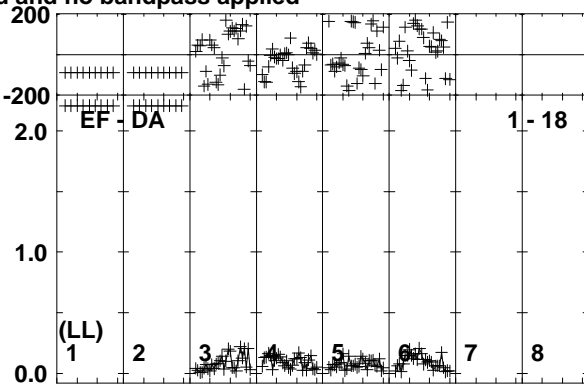
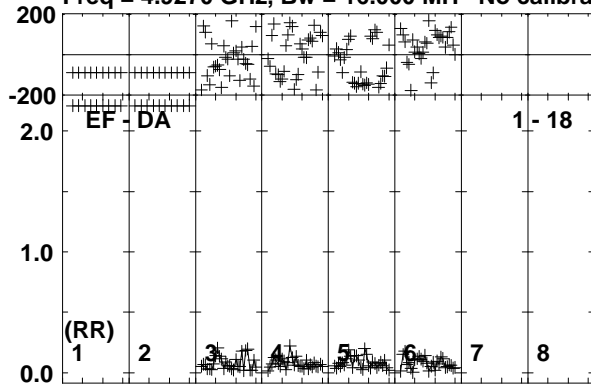

Lower frame: Milli Ampl Jy Top frame: Phas deg  
Vector averaged cross-power spectrum Baseline: EF (01) - DA (18)  
Timerange: 00/10:51:11 to 00/10:54:39

Plot file version 523 created 08-APR-2019 12:10:42

J0815+3635 EM133B.UVDATA.1

Freq = 4.9270 GHz, Bw = 16.000 MH No calibration applied and no bandpass applied

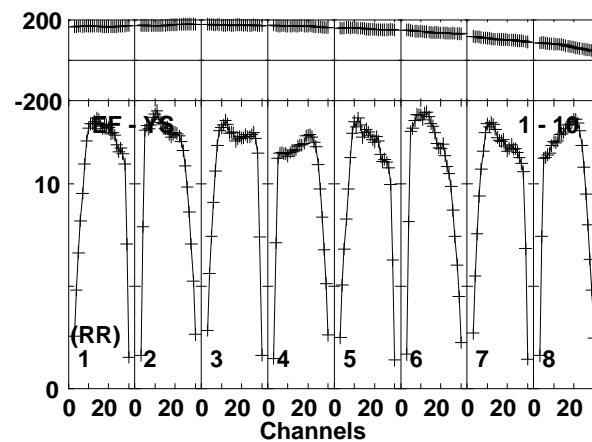
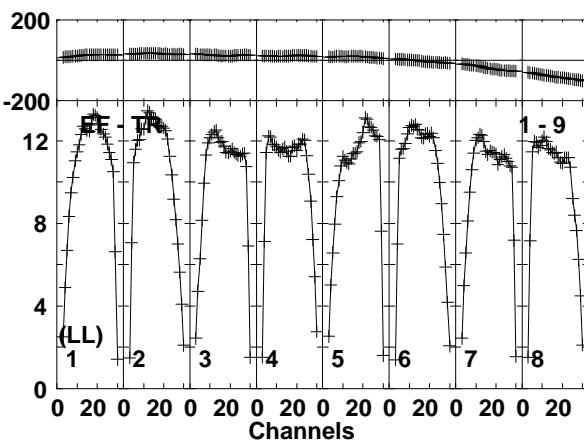
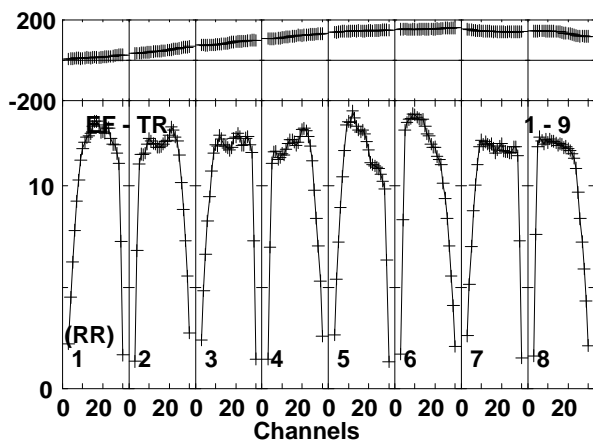
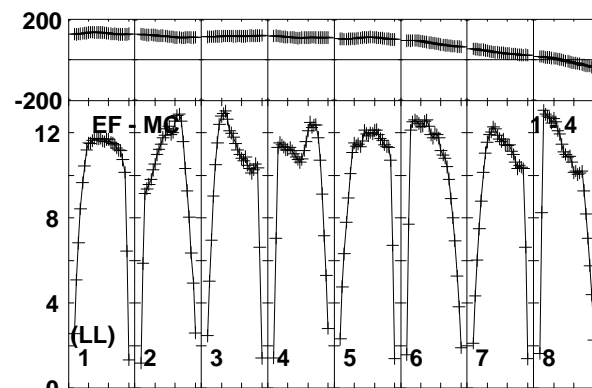
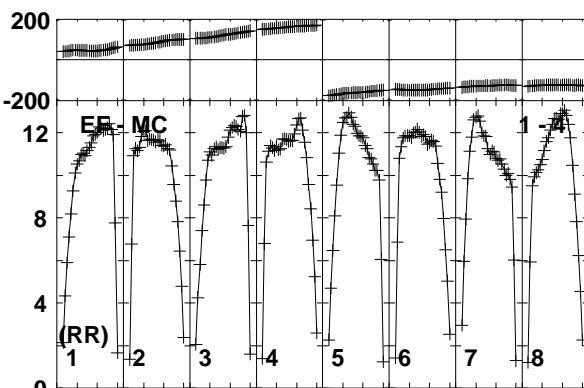
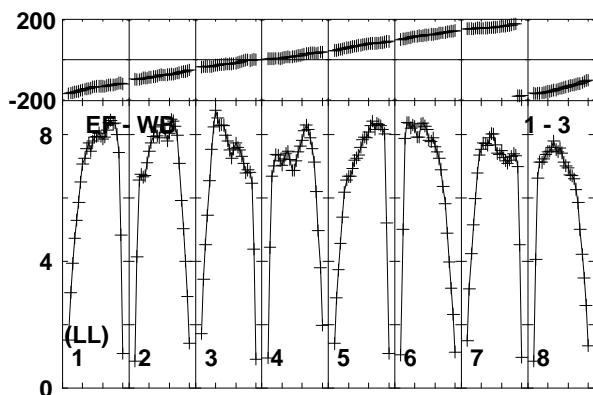
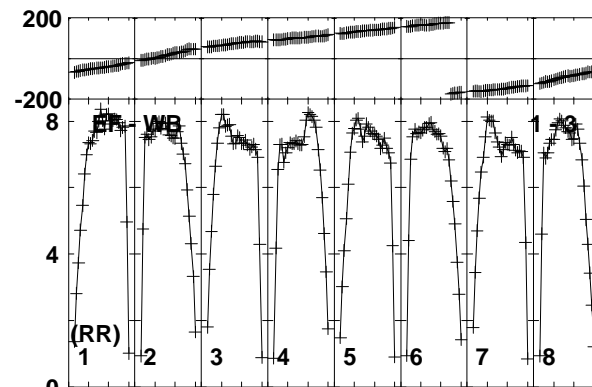
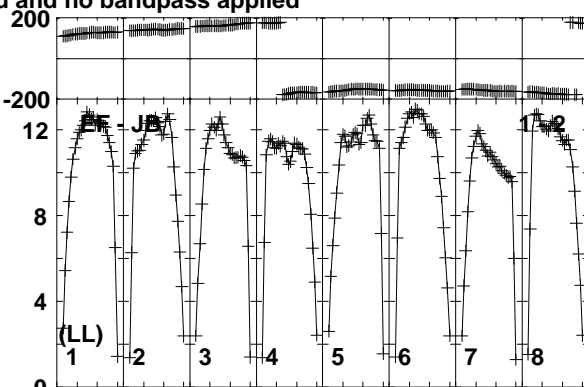
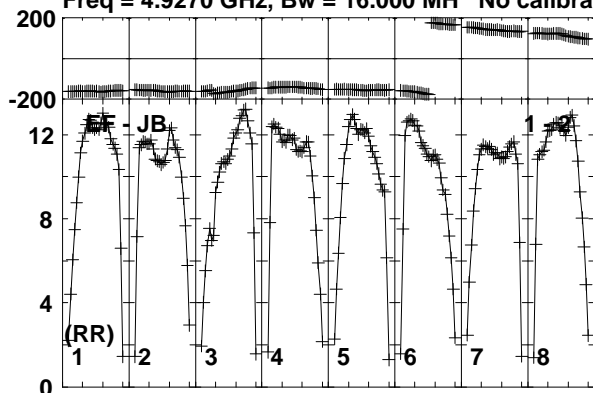

Lower frame: Milli Ampl Jy Top frame: Phas deg  
Vector averaged cross-power spectrum Baseline: EF (01) - JB (02)  
Timerange: 00/10:54:41 to 00/10:56:09

Plot file version 524 created 08-APR-2019 12:10:42

J0815+3635 EM133B.UVDATA.1

Freq = 4.9270 GHz, Bw = 16.000 MH No calibration applied and no bandpass applied

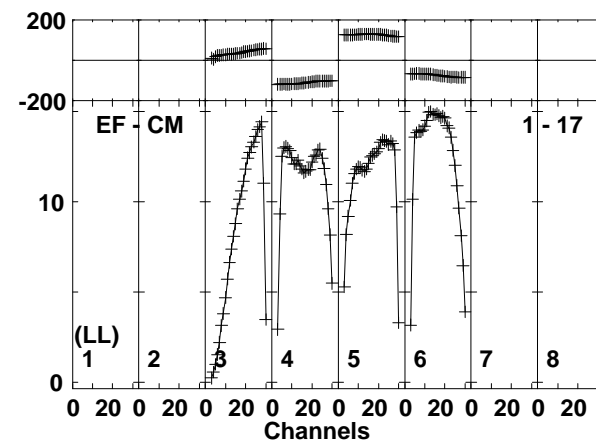
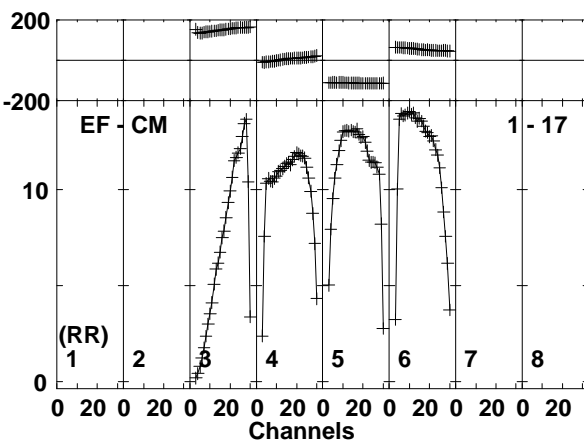
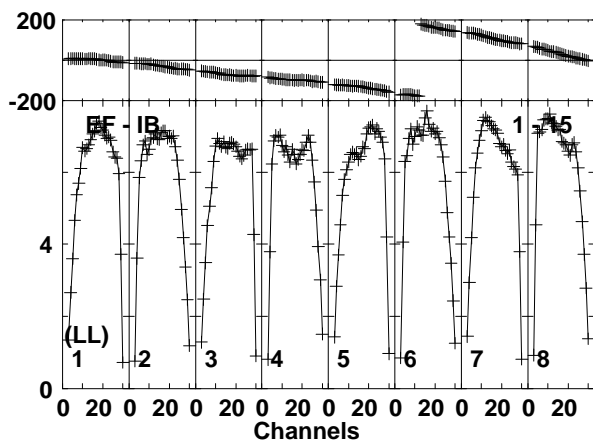
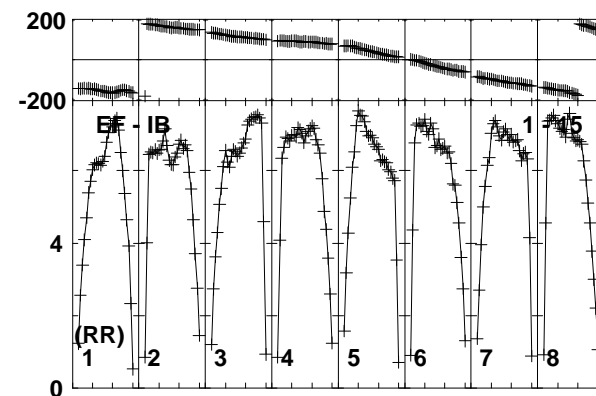
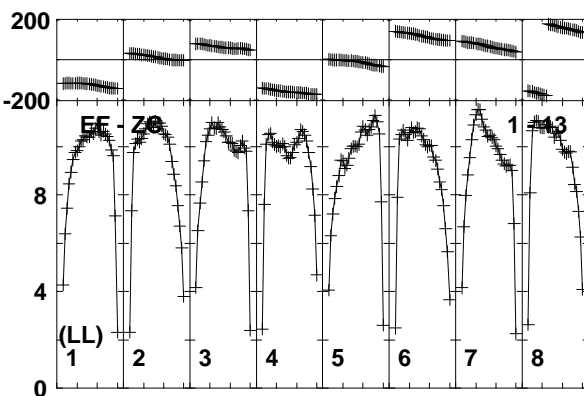
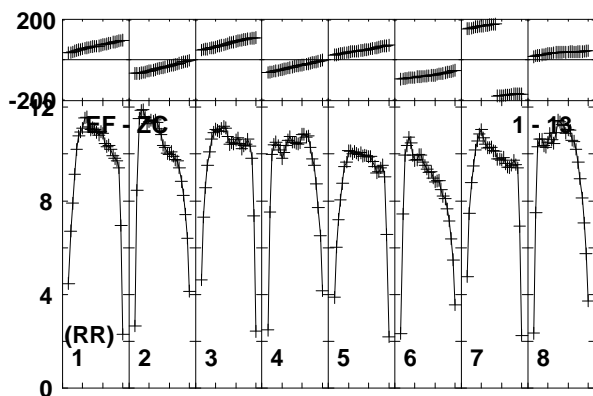
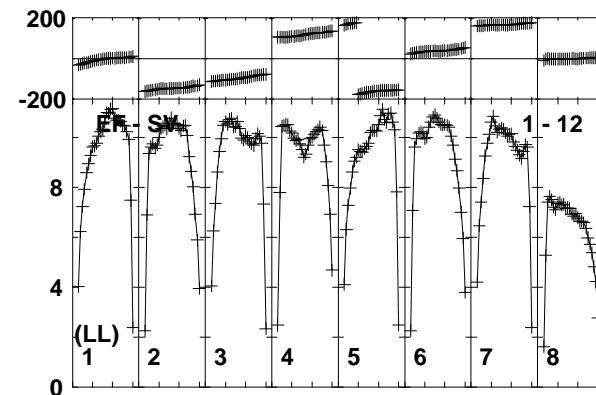
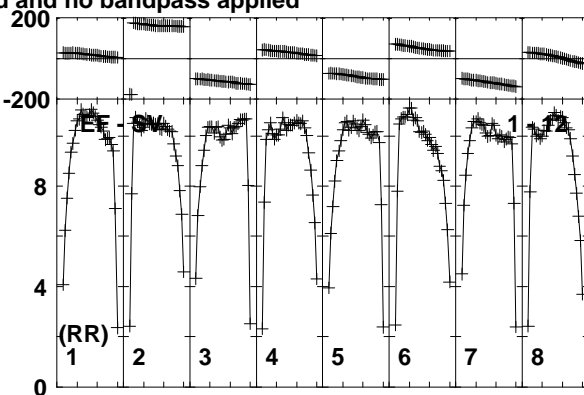
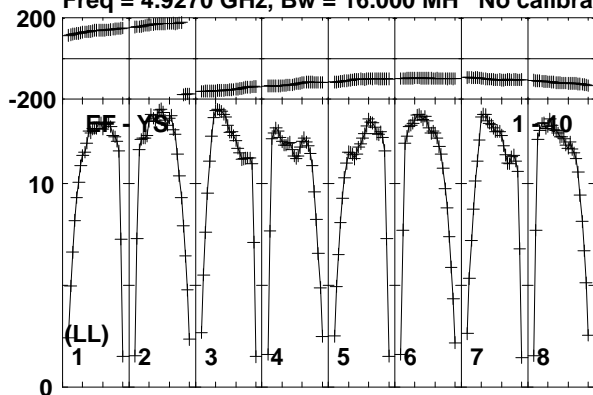

Lower frame: Milli Ampl Jy Top frame: Phas deg  
Vector averaged cross-power spectrum Baseline: EF (01) - YS (10)  
Timerange: 00/10:54:41 to 00/10:56:09

Plot file version 525 created 08-APR-2019 12:10:42

J0815+3635 EM133B.UVDATA.1

Freq = 4.9270 GHz, Bw = 16.000 MH No calibration applied and no bandpass applied

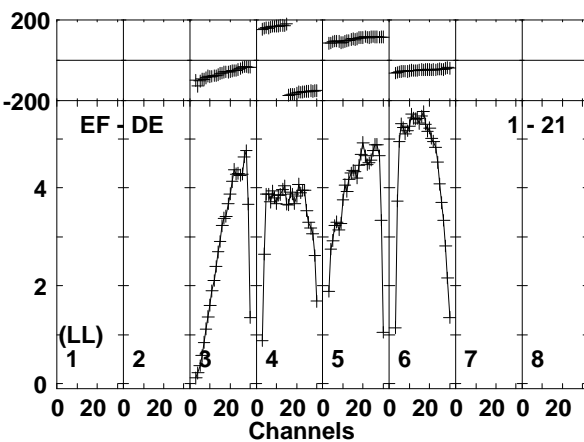
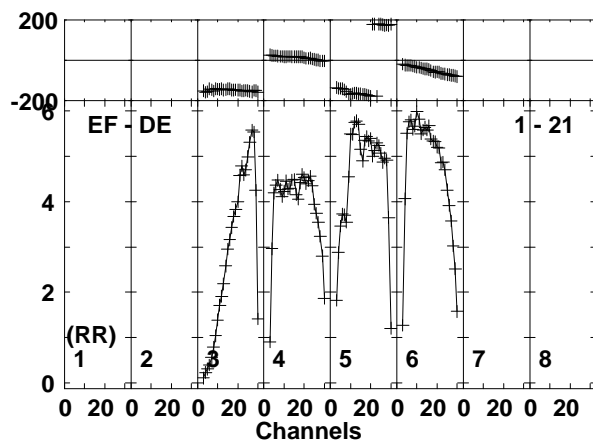
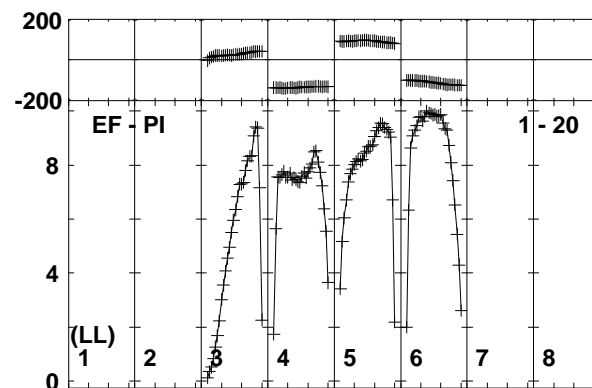
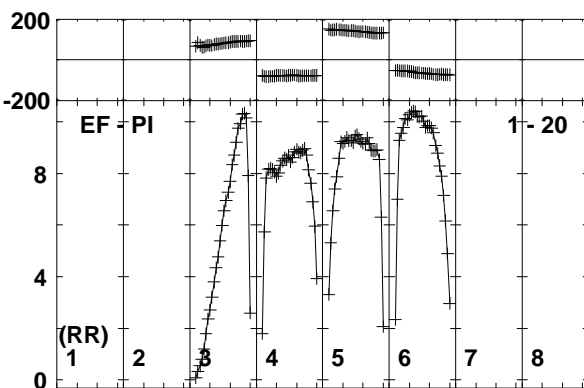
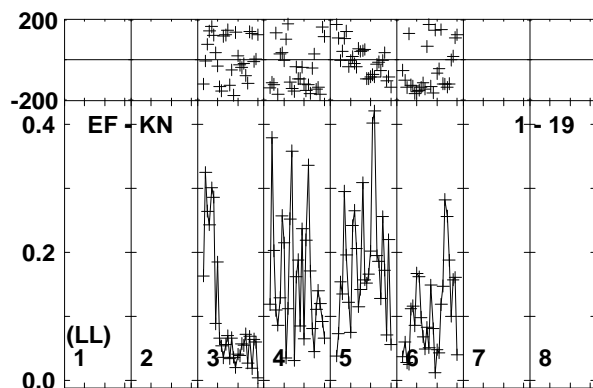
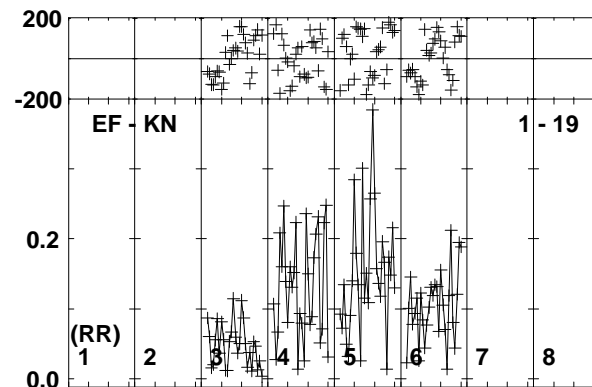
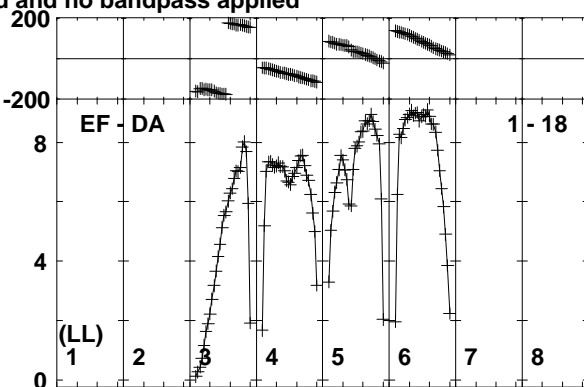
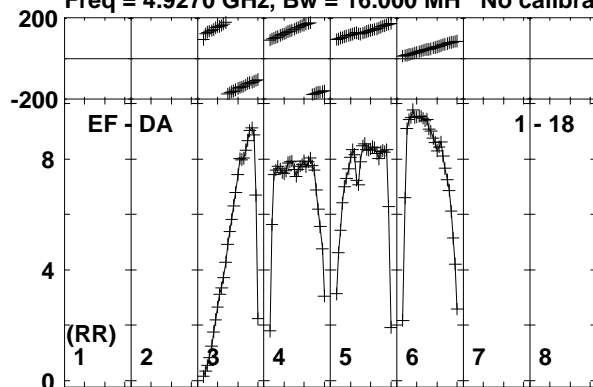

Lower frame: Milli Ampl Jy Top frame: Phas deg  
Vector averaged cross-power spectrum Baseline: EF (01) - DA (18)  
Timerange: 00/10:54:41 to 00/10:56:09

Plot file version 526 created 08-APR-2019 12:10:42  
 J0927+3902 EM133B.UVDATA.1  
 Freq = 4.9270 GHz, Bw = 16.000 MH No calibration applied and no bandpass applied

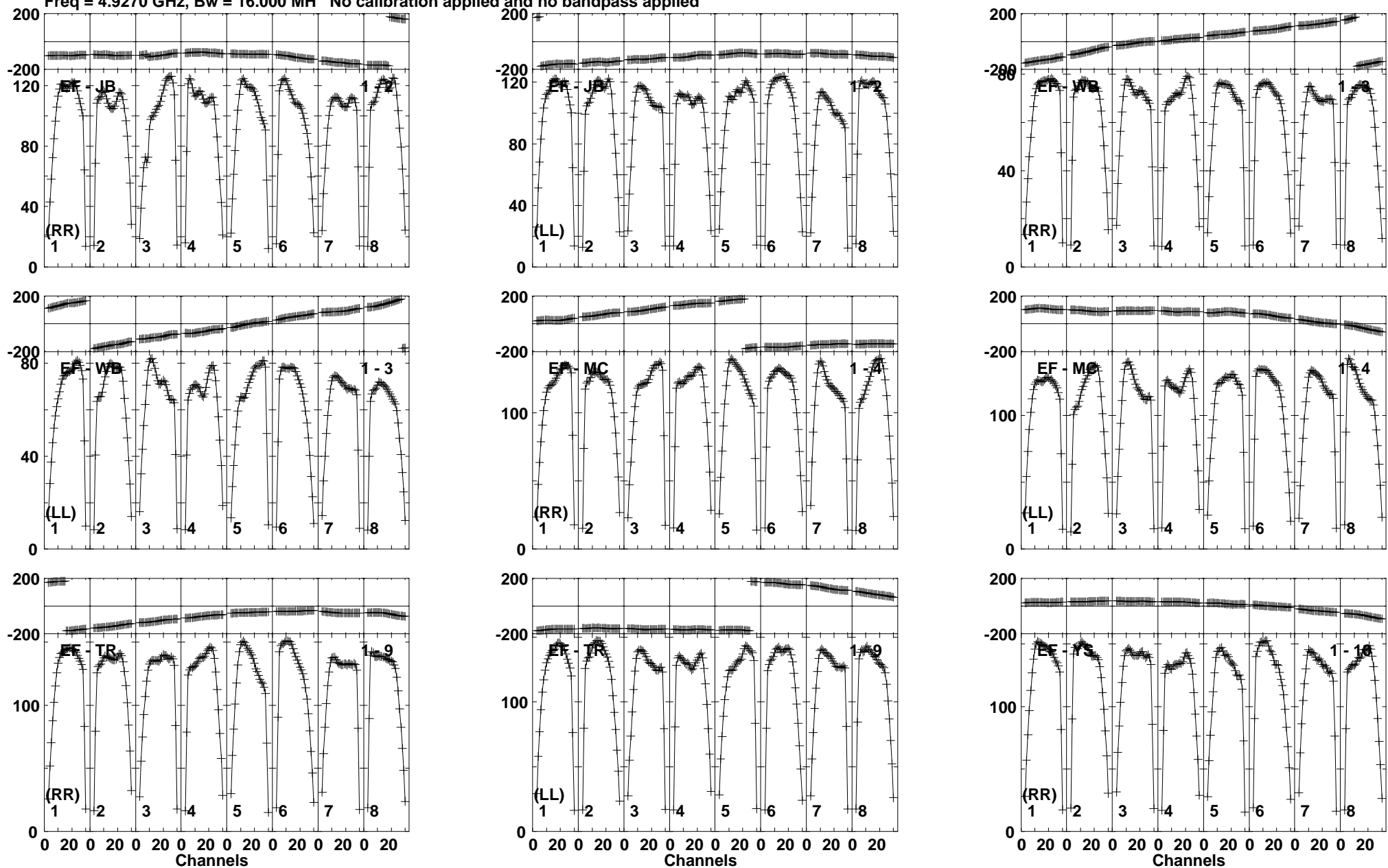

Lower frame: Milli Ampl Jy Top frame: Phas deg  
 Vector averaged cross-power spectrum Baseline: EF (01) - JB (02)  
 Timerange: 00/10:56:13 to 00/10:59:59

Plot file version 527 created 08-APR-2019 12:10:43

J0927+3902 EM133B.UVDATA.1

Freq = 4.9270 GHz, Bw = 16.000 MH No calibration applied and no bandpass applied

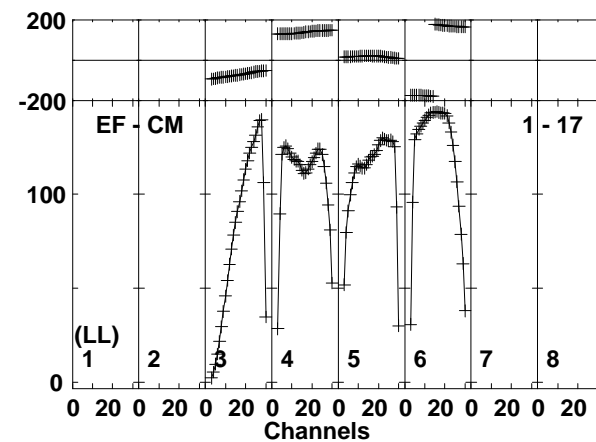
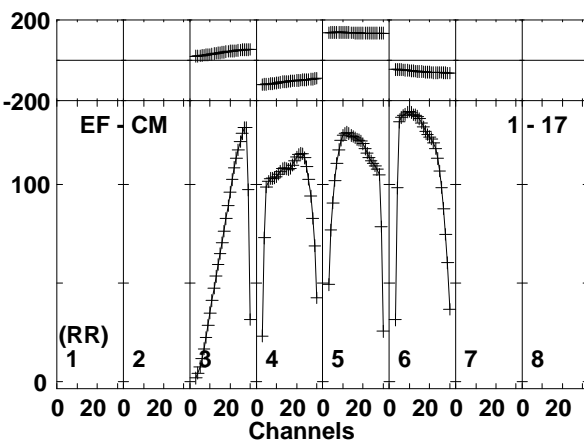
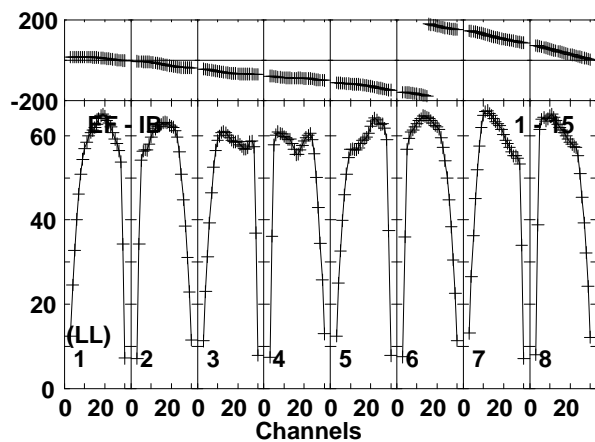
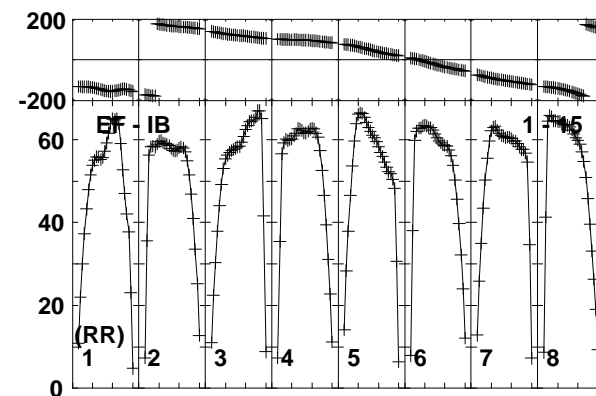
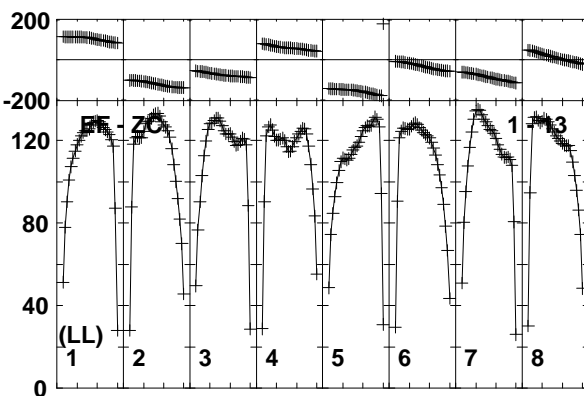
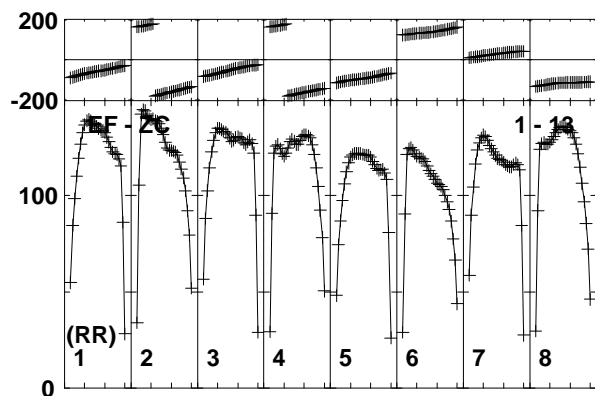
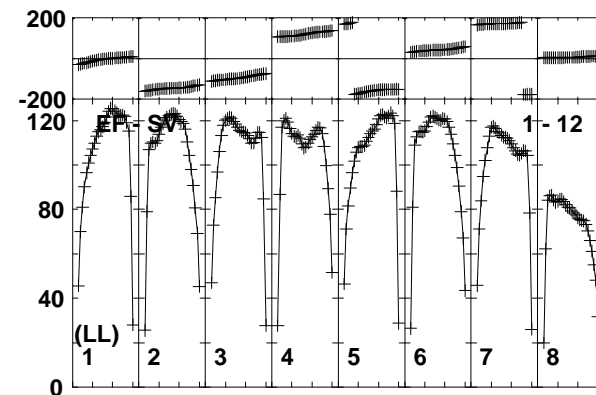
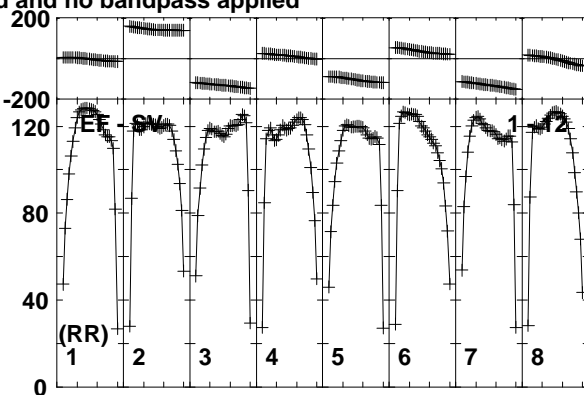
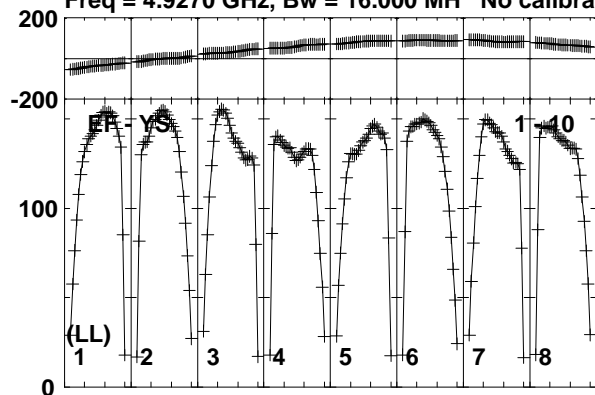

Lower frame: Milli Ampl Jy Top frame: Phas deg  
Vector averaged cross-power spectrum Baseline: EF (01) - YS (10)  
Timerange: 00/10:56:13 to 00/10:59:59

Plot file version 528 created 08-APR-2019 12:10:43

J0927+3902 EM133B.UVDATA.1

Freq = 4.9270 GHz, Bw = 16.000 MH No calibration applied and no bandpass applied

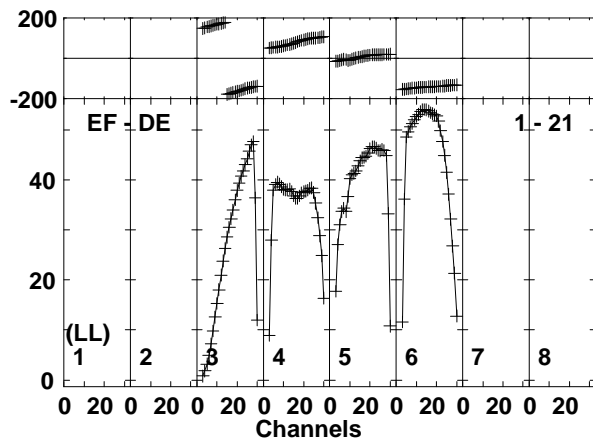
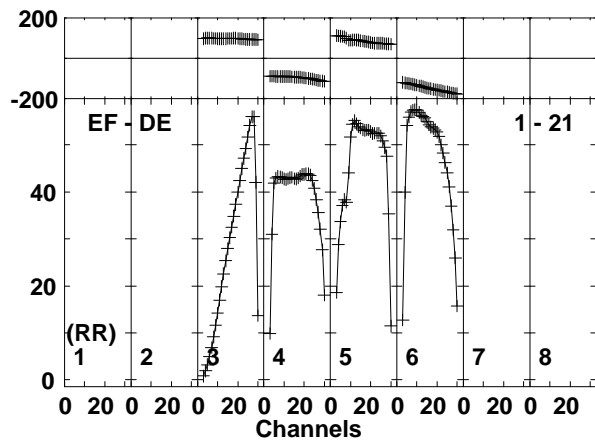
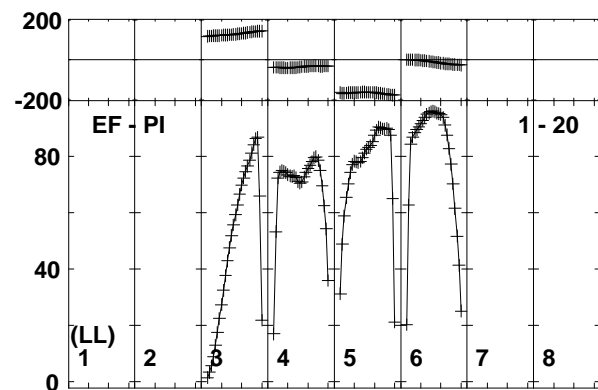
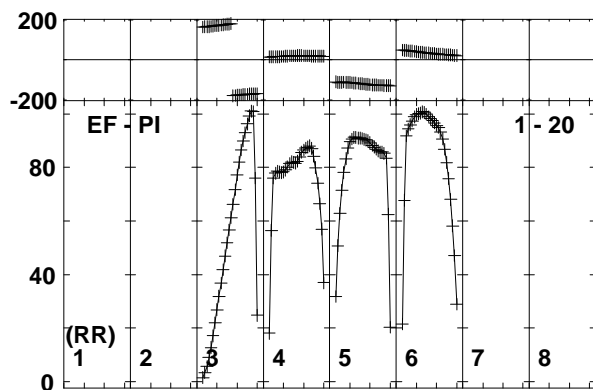
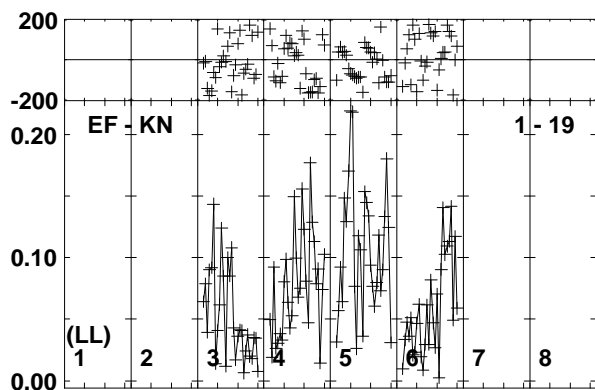
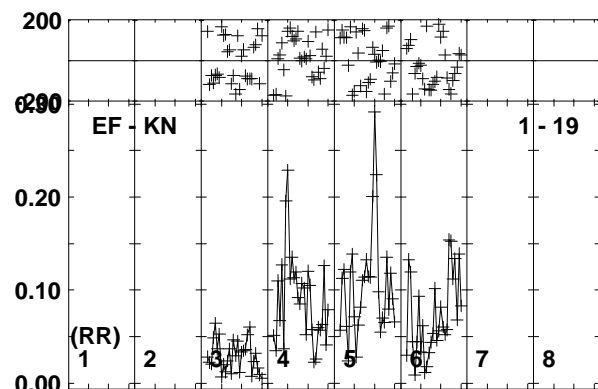
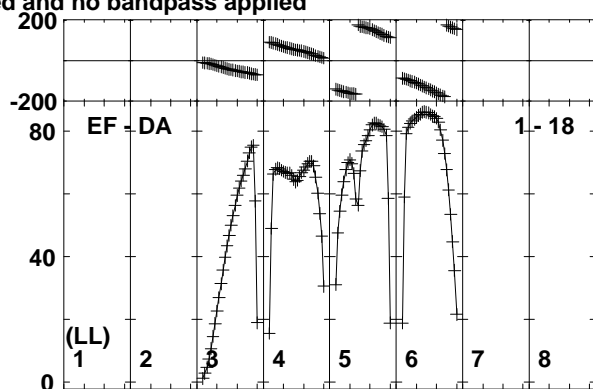
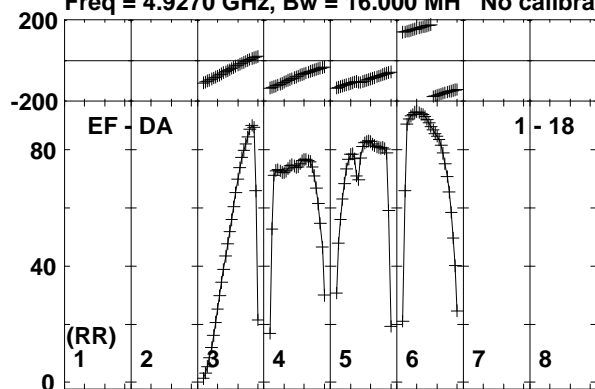

Lower frame: Milli Ampl Jy Top frame: Phas deg  
Vector averaged cross-power spectrum Baseline: EF (01) - DA (18)  
Timerange: 00/10:56:13 to 00/10:59:59