

Plot file version 1 created 08-AUG-2008 16:58:13

J0209+13 EO006B.UVDATA.1

Freq = 1.5950 GHz, Bw = 16.000 MH No calibration applied and no bandpass applied

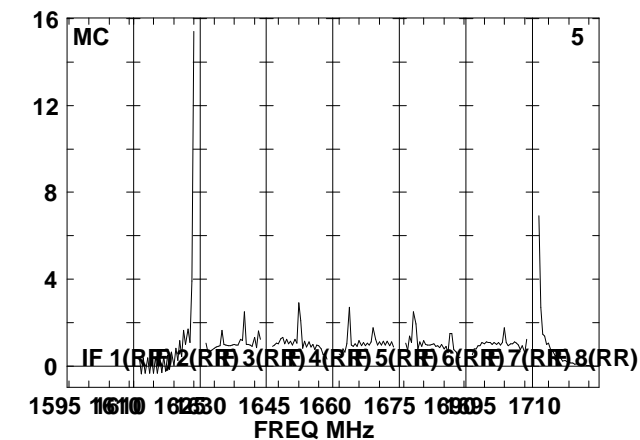
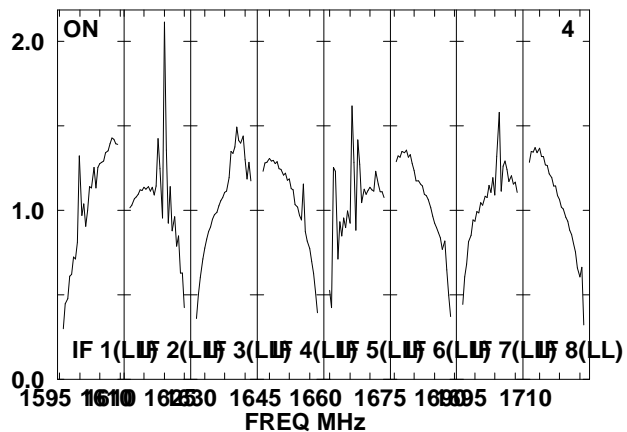
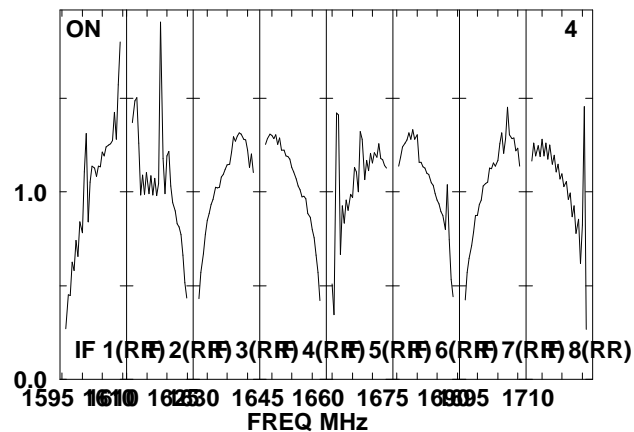
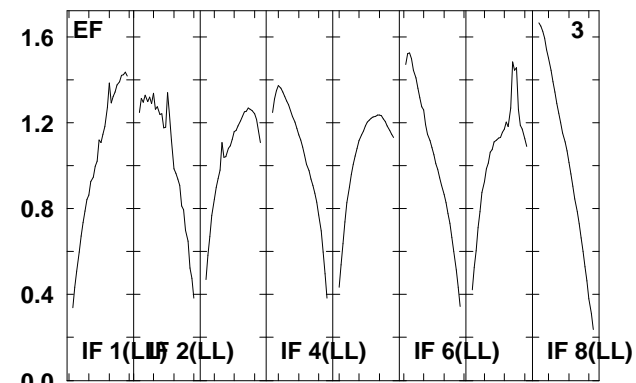
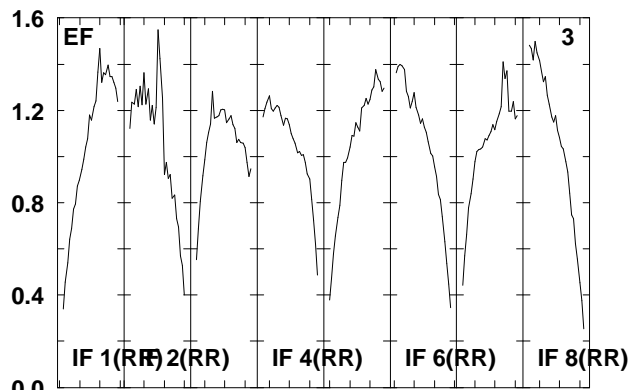
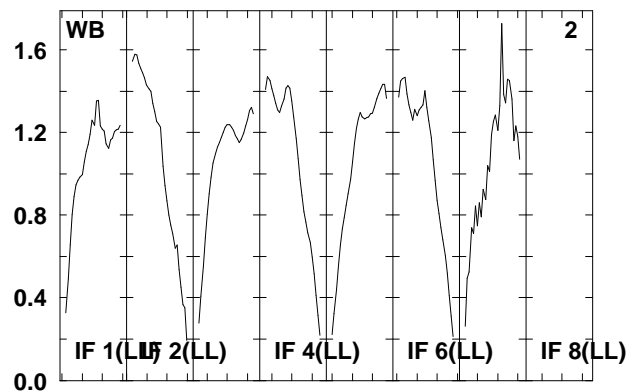
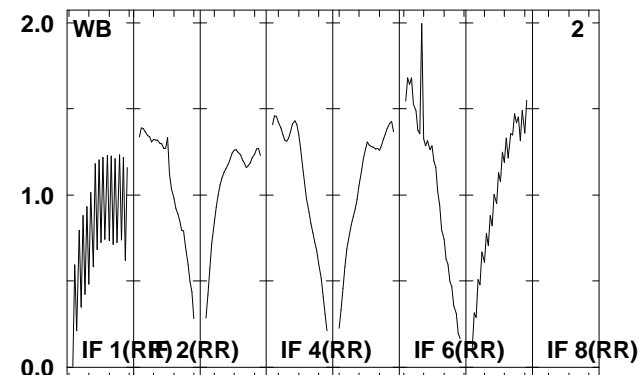
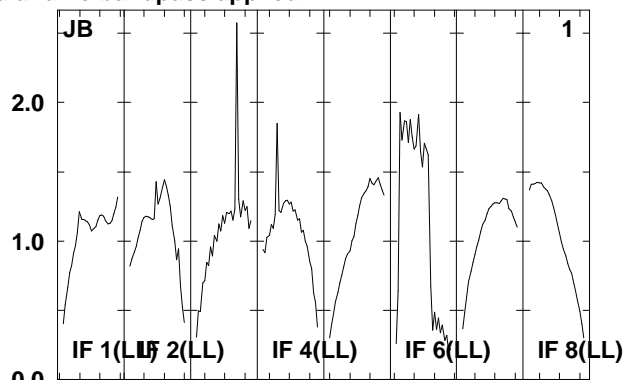
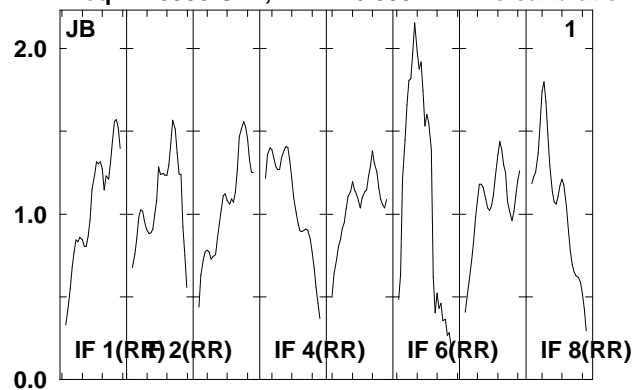

Lower frame: Real Jy  
Total-power spectrum Antenna: \*  
Timerange: 00/03:30:07 to 00/03:31:51

Plot file version 2 created 08-AUG-2008 16:58:13

J0209+13 EO006B.UVDATA.1

Freq = 1.5950 GHz, Bw = 16.000 MH No calibration applied and no bandpass applied

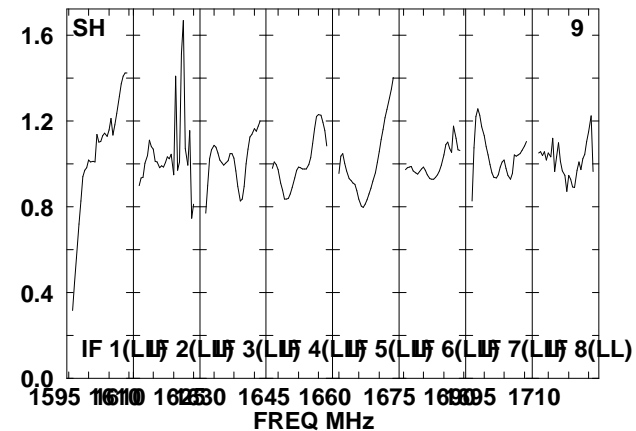
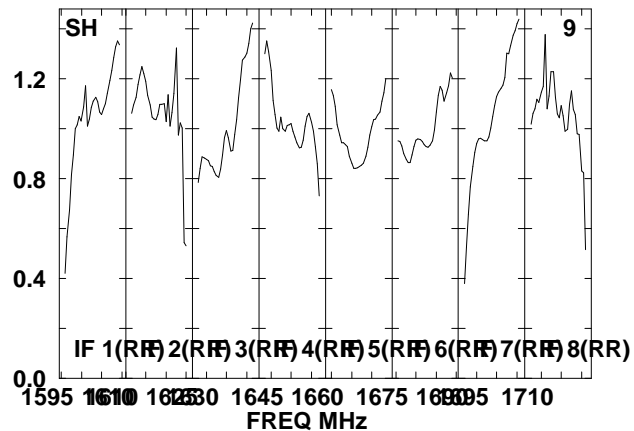
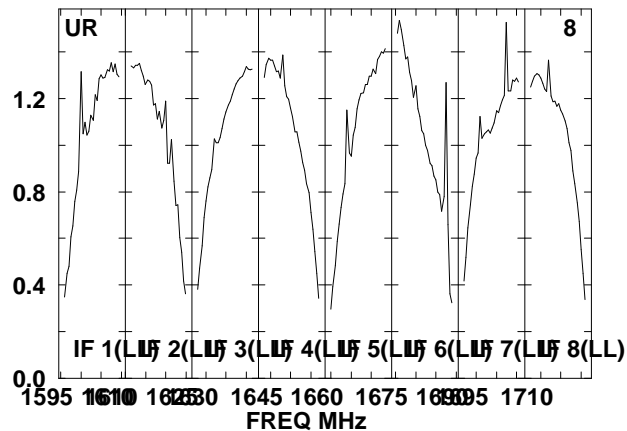
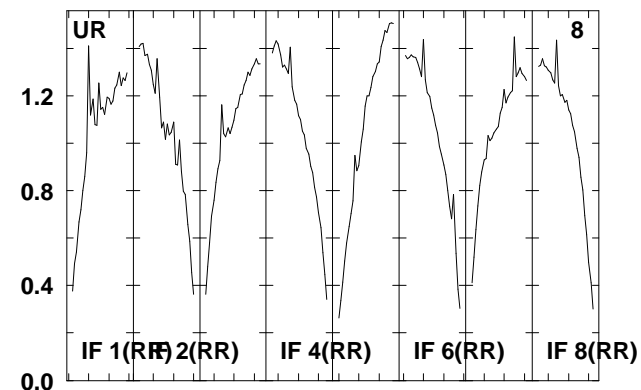
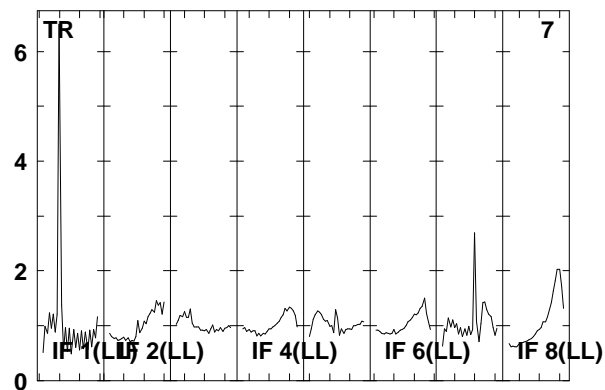
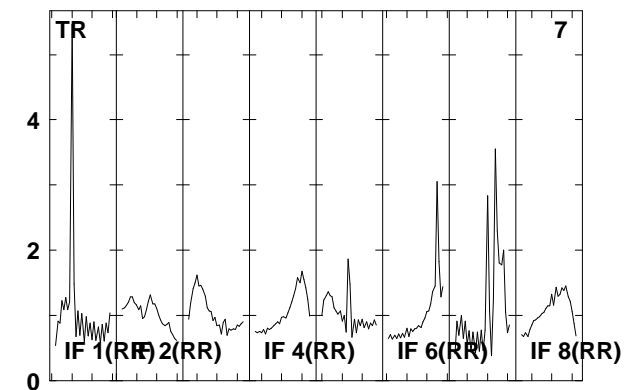
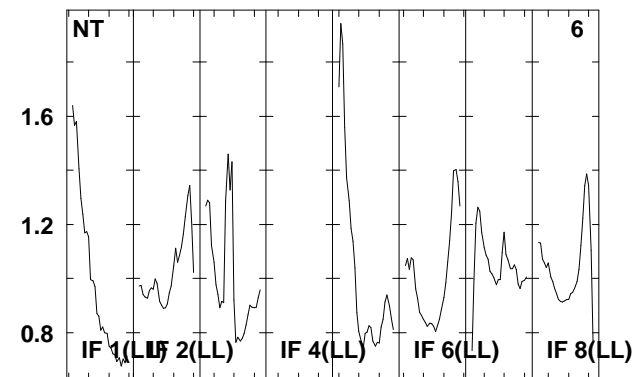
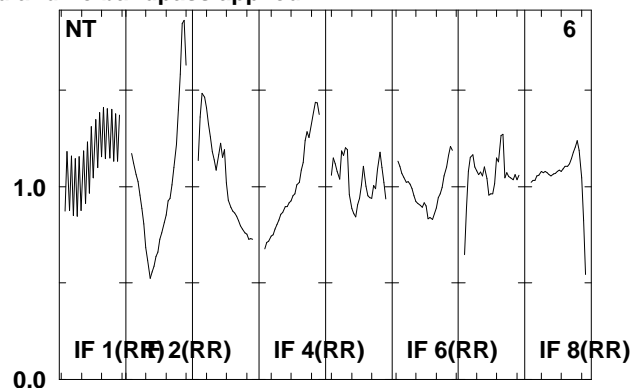
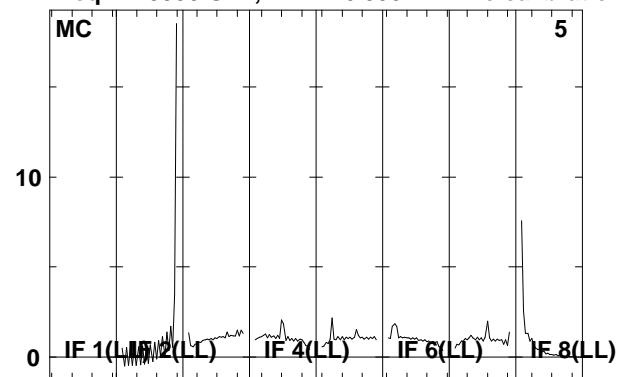

Lower frame: Real Jy

Total-power spectrum Antenna: \*

Timerange: 00/03:30:07 to 00/03:31:51

Plot file version 3 created 08-AUG-2008 16:58:13

J0209+13 EO006B.UVDATA.1

Freq = 1.5950 GHz, Bw = 16.000 MH No calibration applied and no bandpass applied

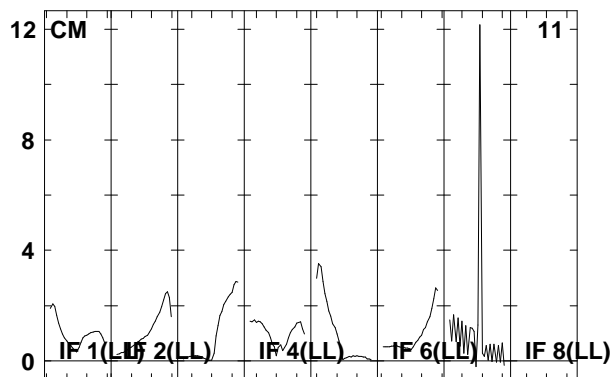
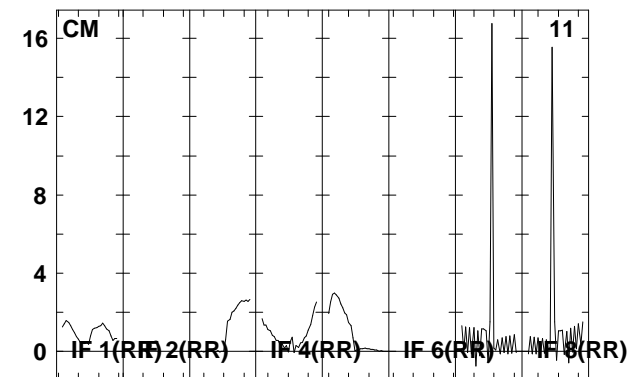
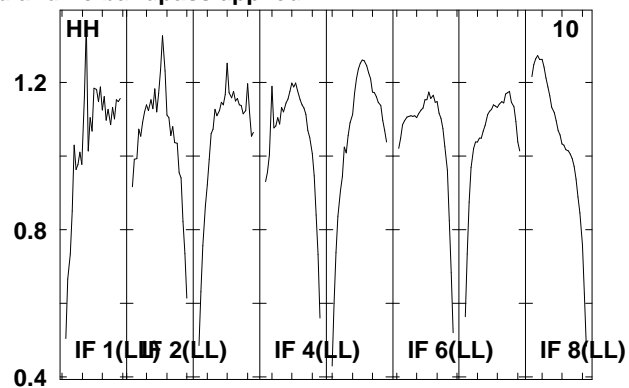
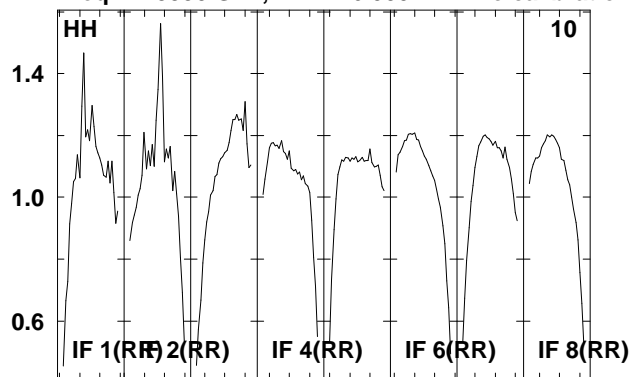

Lower frame: Real Jy  
Total-power spectrum Antenna: \*  
Timerange: 00/03:30:07 to 00/03:31:51

Plot file version 4 created 08-AUG-2008 16:58:14

J021348 EO006B.UVDATA.1

Freq = 1.5950 GHz, Bw = 16.000 MH No calibration applied and no bandpass applied

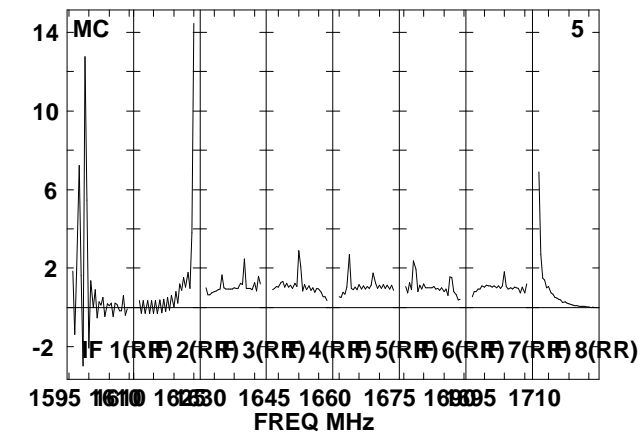
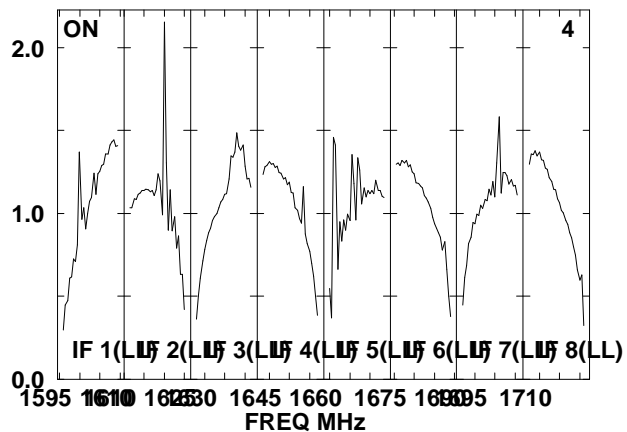
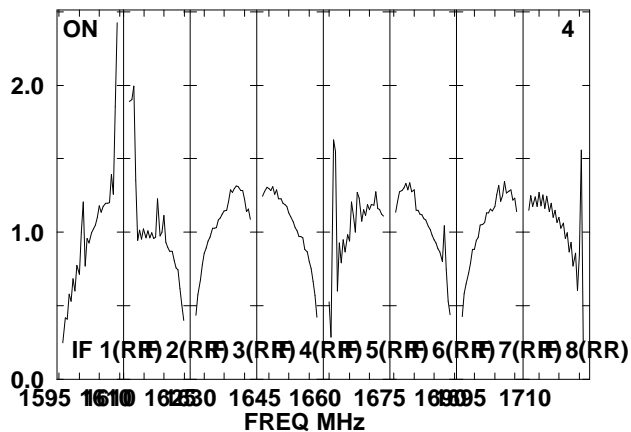
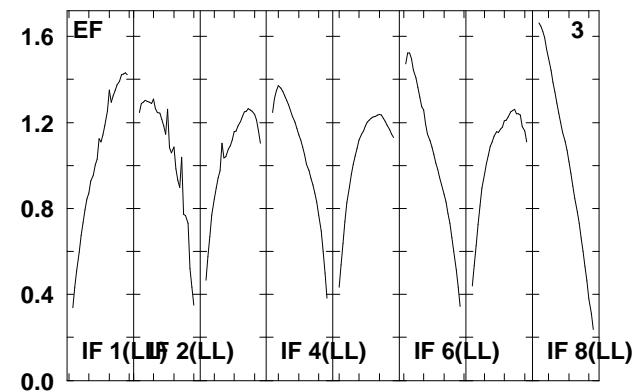
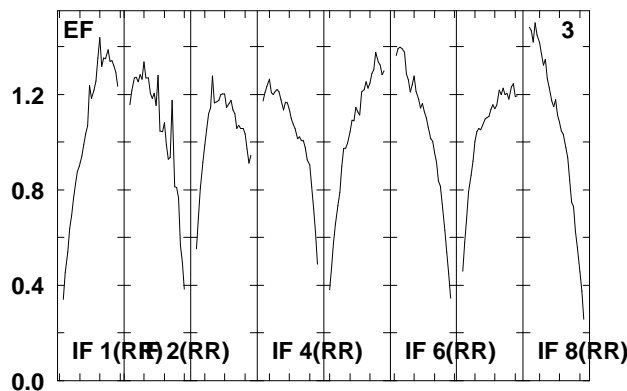
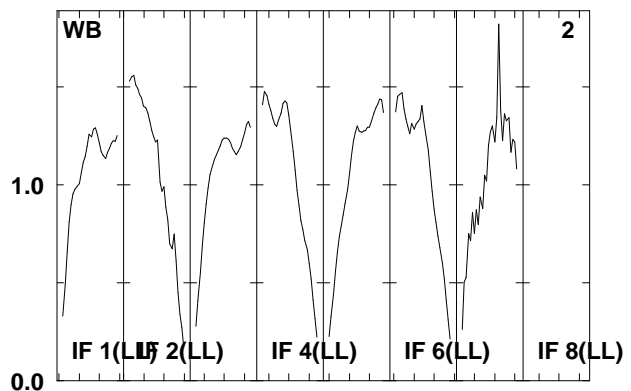
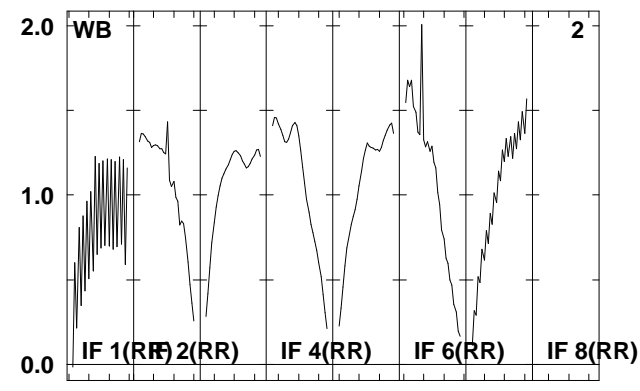
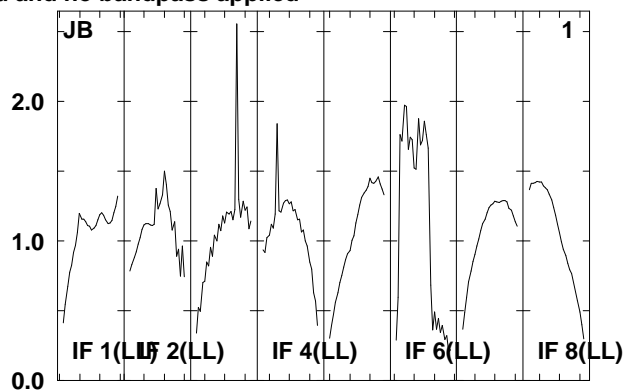
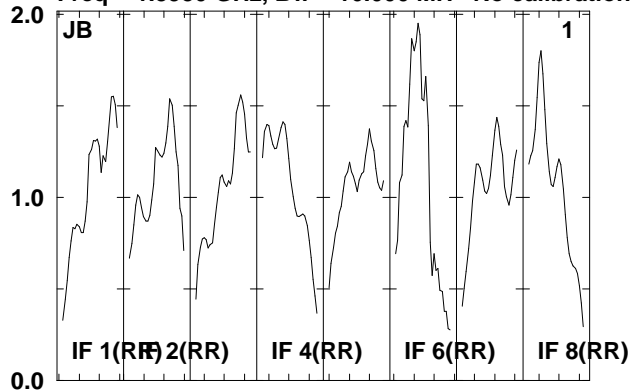

Lower frame: Real Jy  
Total-power spectrum Antenna: \*  
Timerange: 00/03:32:31 to 00/03:37:07



Plot file version 5 created 08-AUG-2008 16:58:15

J021348 EO06B.UVDATA.1

Freq = 1.5950 GHz, Bw = 16.000 MH No calibration applied and no bandpass applied

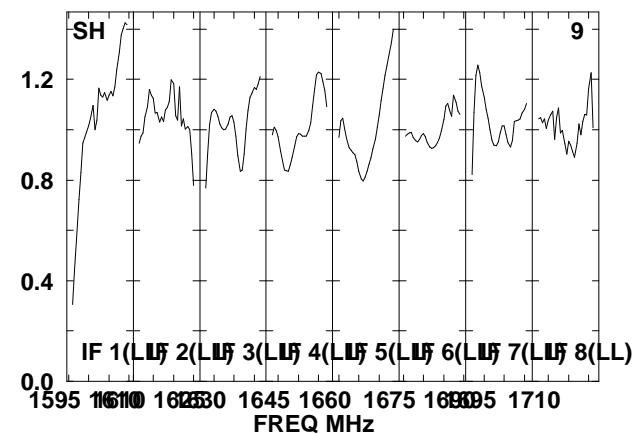
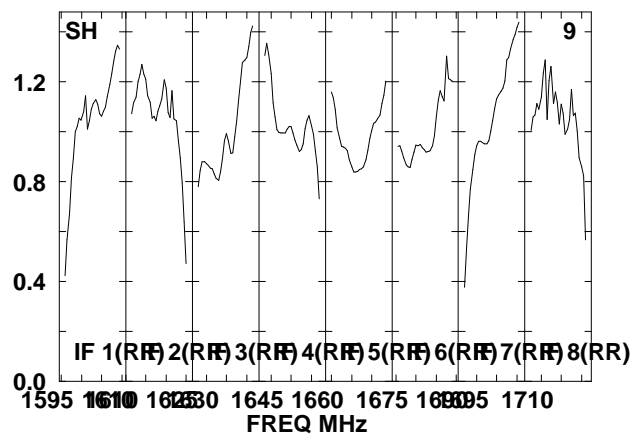
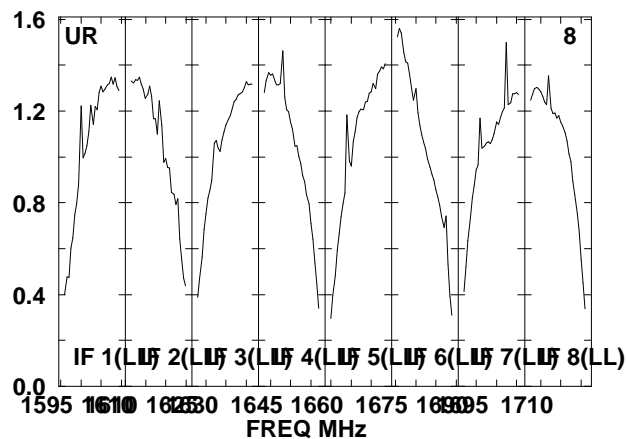
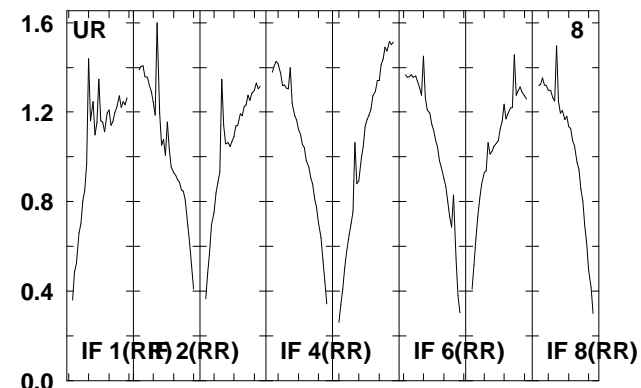
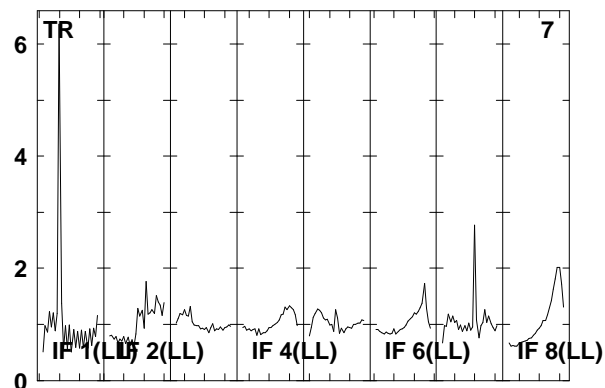
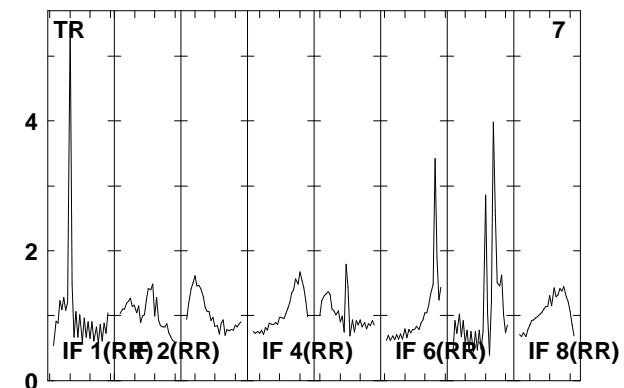
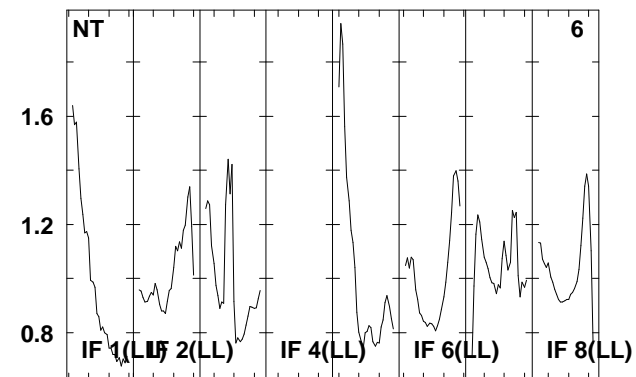
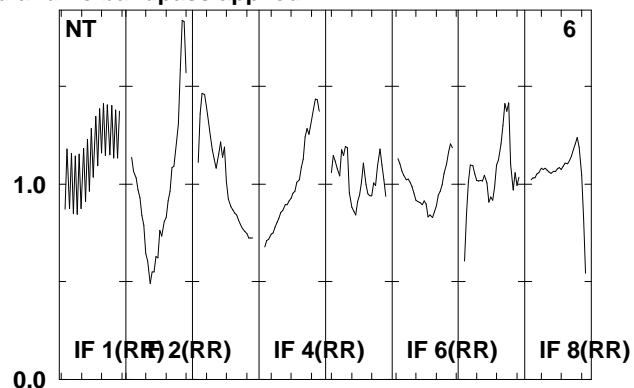
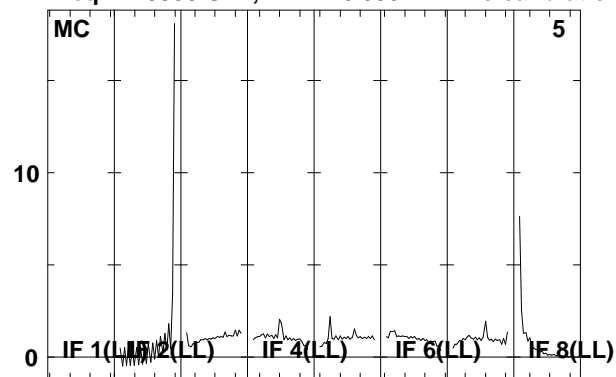

Lower frame: Real Jy

Total-power spectrum Antenna: \*

Timerange: 00/03:32:31 to 00/03:37:07

Plot file version 6 created 08-AUG-2008 16:58:15

J021348 EO006B.UVDATA.1

Freq = 1.5950 GHz, Bw = 16.000 MH No calibration applied and no bandpass applied

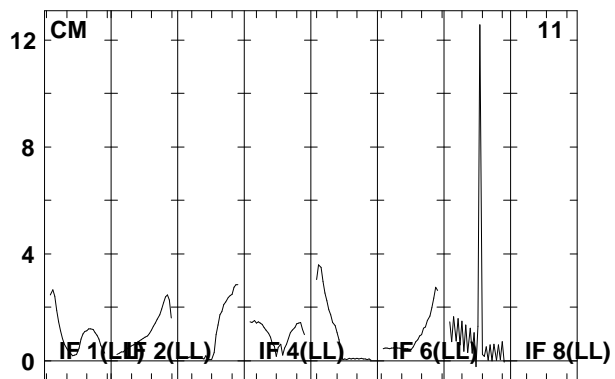
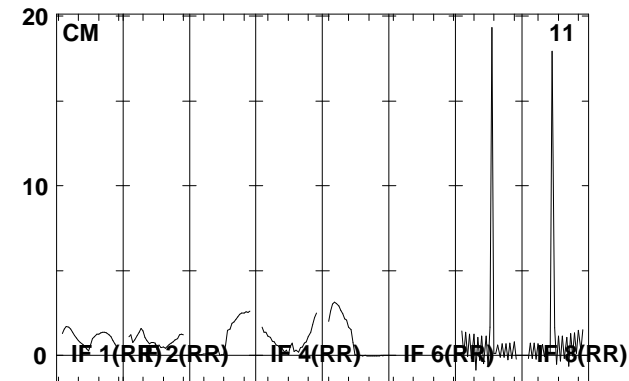
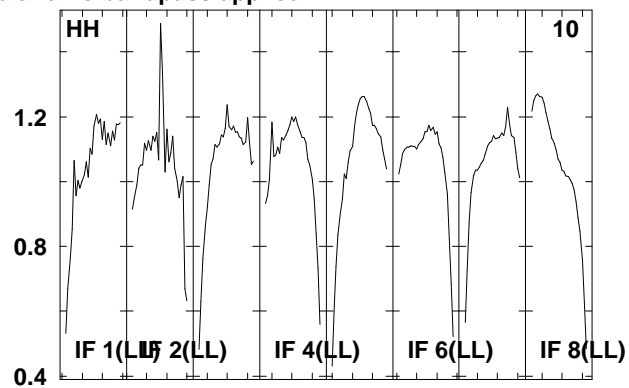
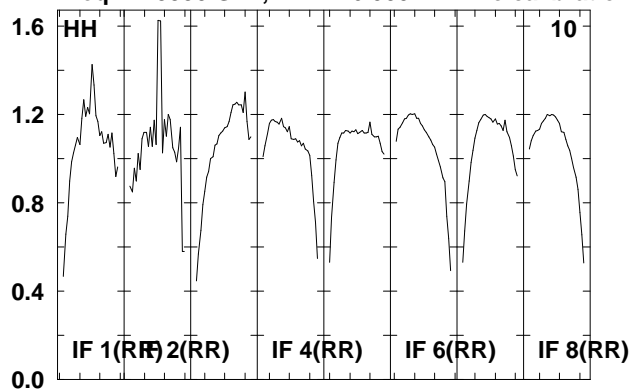

Lower frame: Real Jy  
Total-power spectrum Antenna: \*  
Timerange: 00/03:32:31 to 00/03:37:07

Plot file version 7 created 08-AUG-2008 16:58:16

J0209+13 EO006B.UVDATA.1

Freq = 1.5950 GHz, Bw = 16.000 MH No calibration applied and no bandpass applied

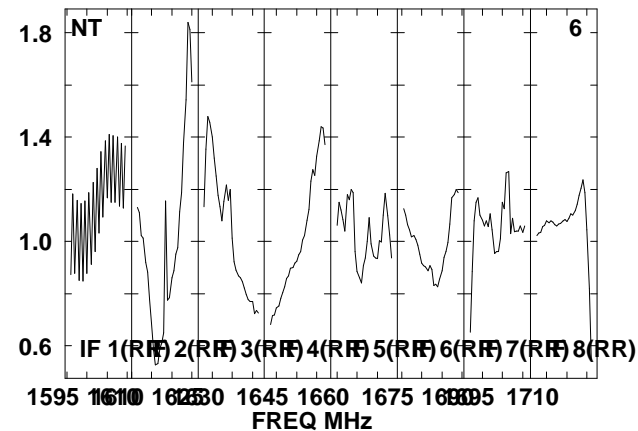
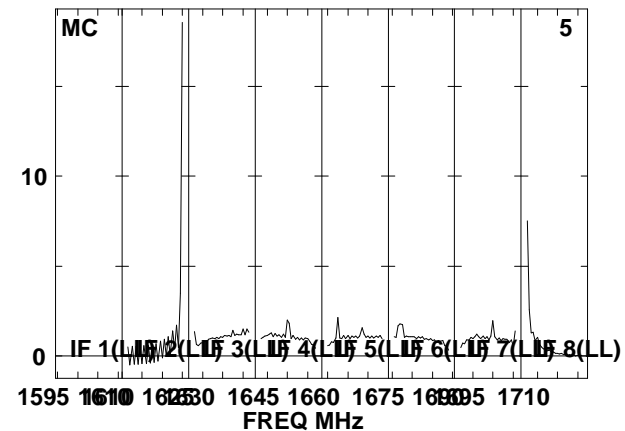
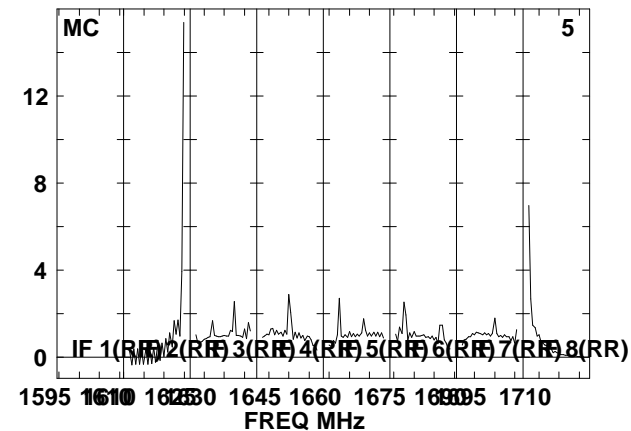
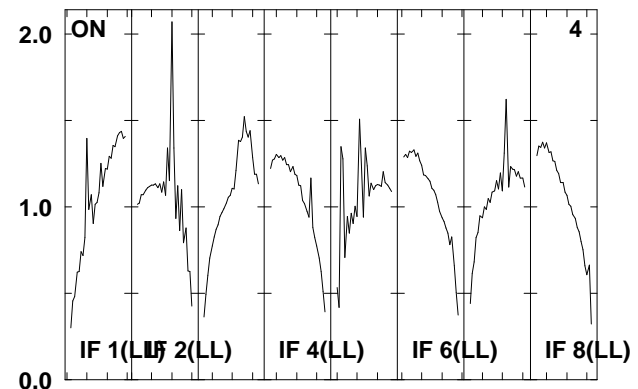
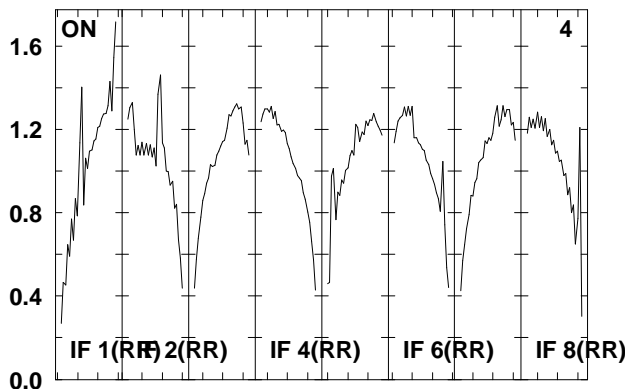
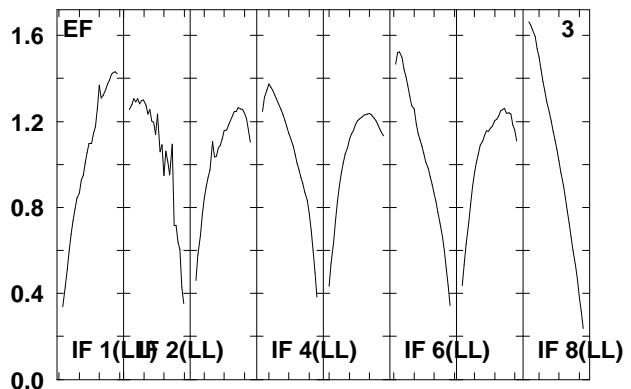
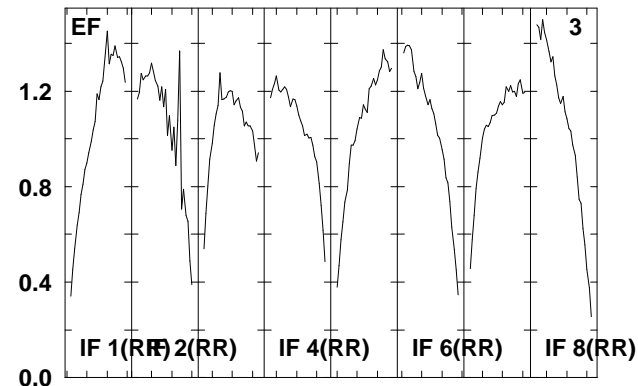
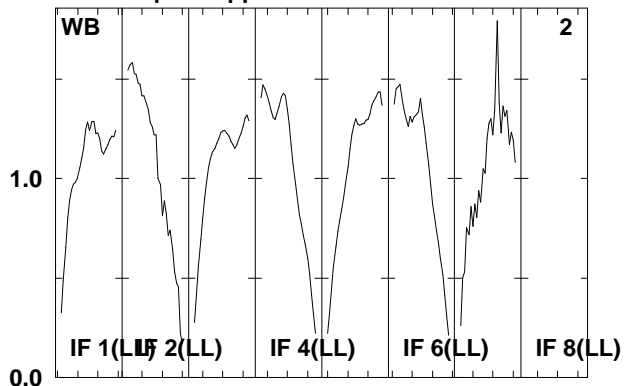
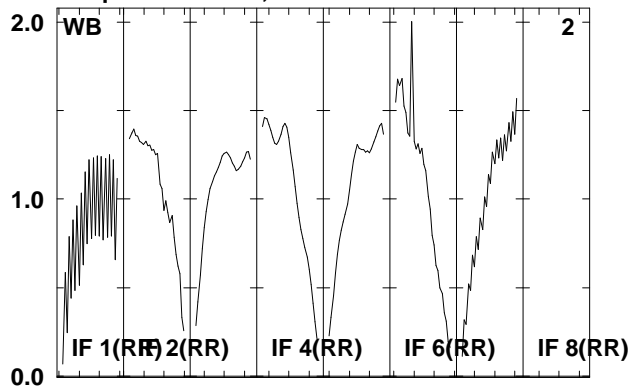

Lower frame: Real Jy  
Total-power spectrum Antenna: \*  
Timerange: 00/03:37:43 to 00/03:39:19

Plot file version 8 created 08-AUG-2008 16:58:16  
 J0209+13 EO06B.UVDATA.1  
 Freq = 1.5950 GHz, Bw = 16.000 MH No calibration applied and no bandpass applied

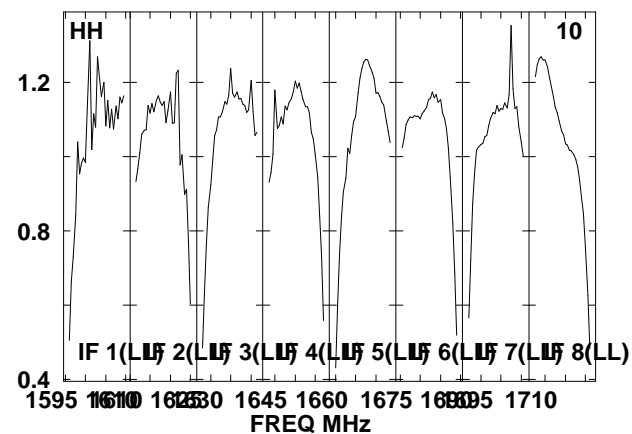
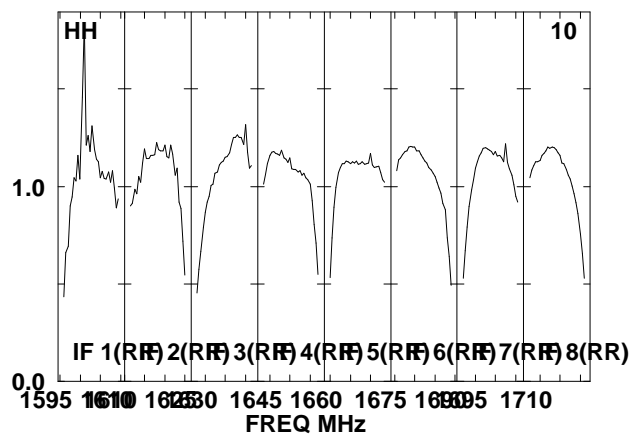
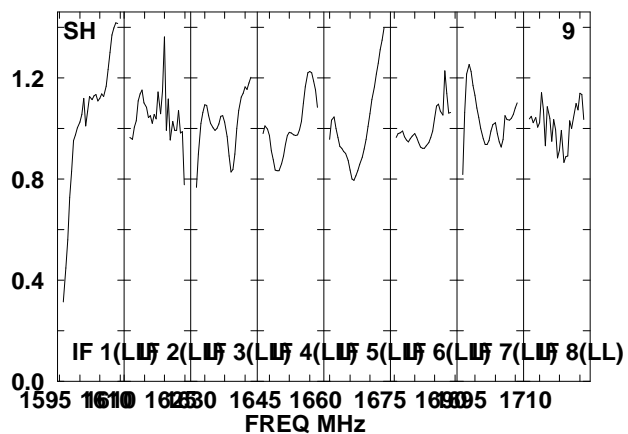
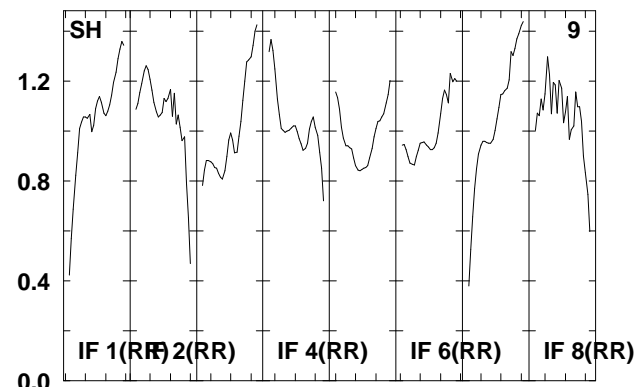
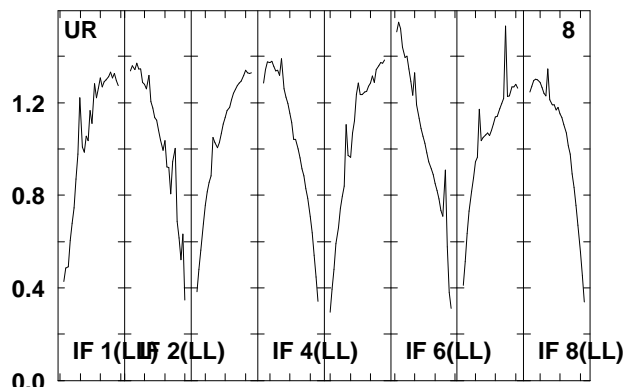
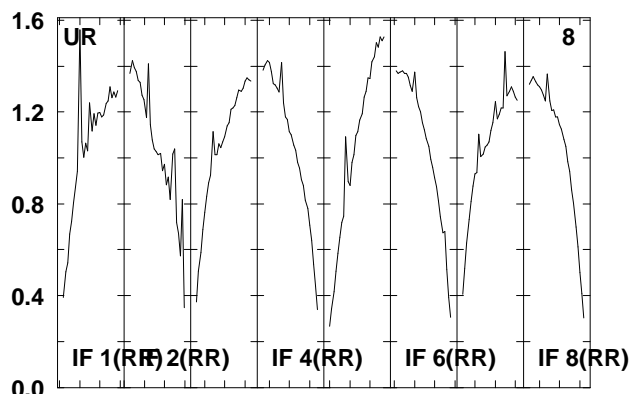
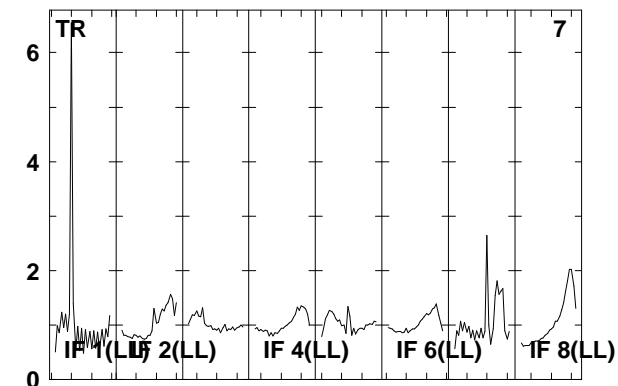
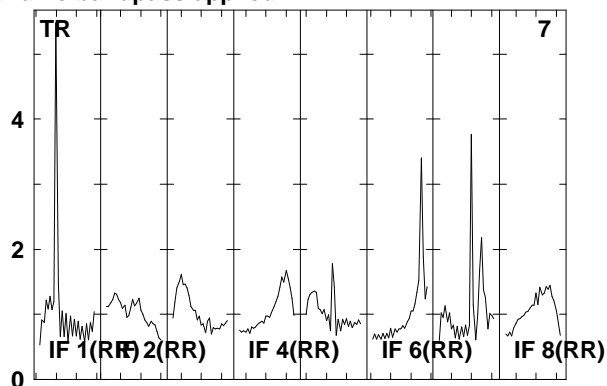
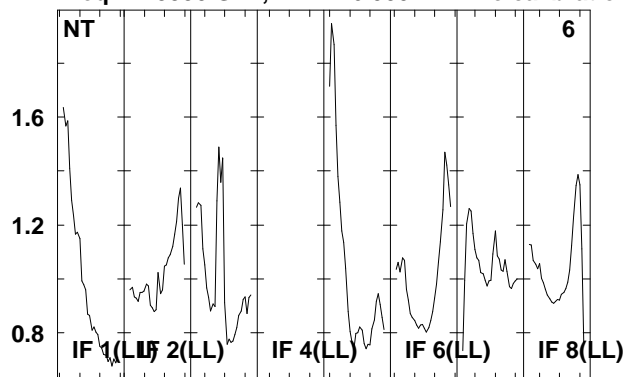

Lower frame: Real Jy  
 Total-power spectrum Antenna: \*  
 Timerange: 00/03:37:43 to 00/03:39:19

Plot file version 9 created 08-AUG-2008 16:58:17

J0209+13 EO006B.UVDATA.1

Freq = 1.5950 GHz, Bw = 16.000 MH No calibration applied and no bandpass applied

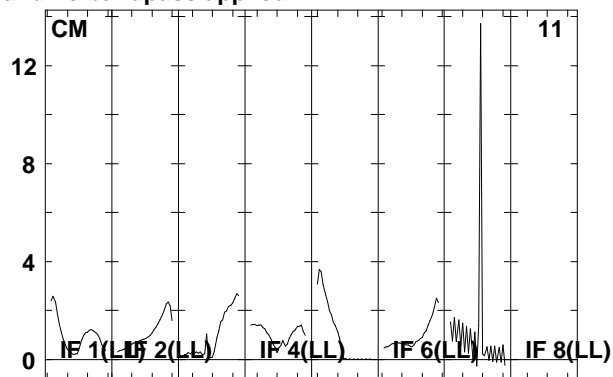
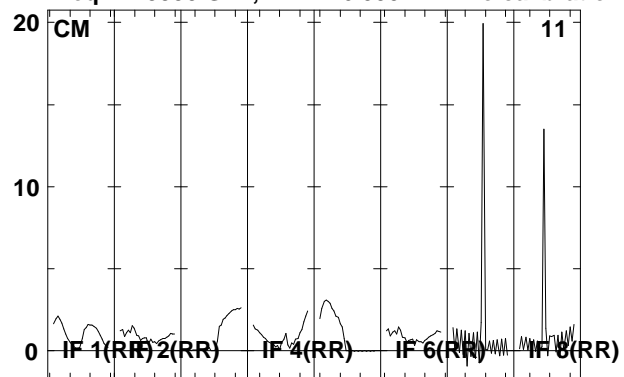

Lower frame: Real Jy  
Total-power spectrum Antenna: \*  
Timerange: 00/03:37:43 to 00/03:39:19

Plot file version 10 created 08-AUG-2008 16:58:17

J021348 EO006B.UVDATA.1

Freq = 1.5950 GHz, Bw = 16.000 MH No calibration applied and no bandpass applied

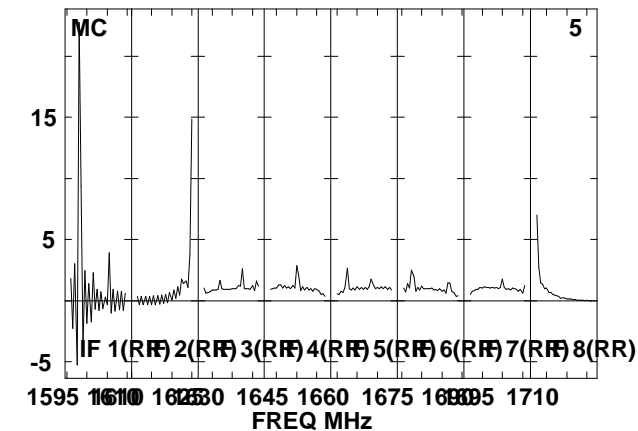
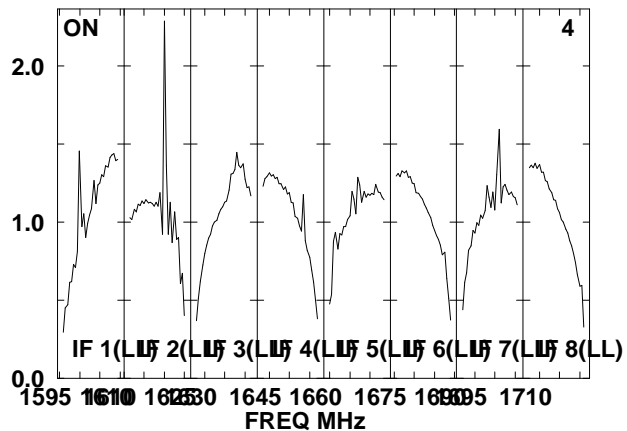
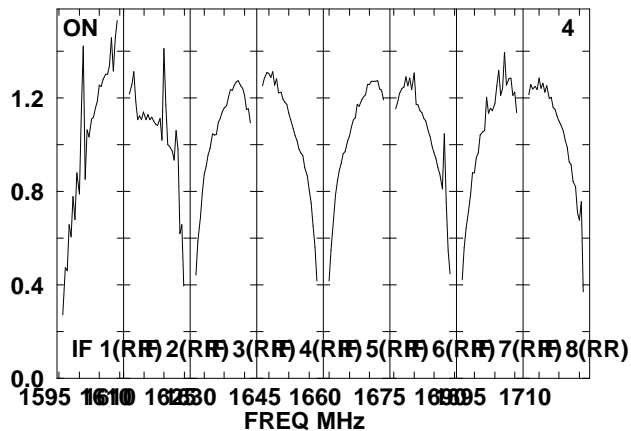
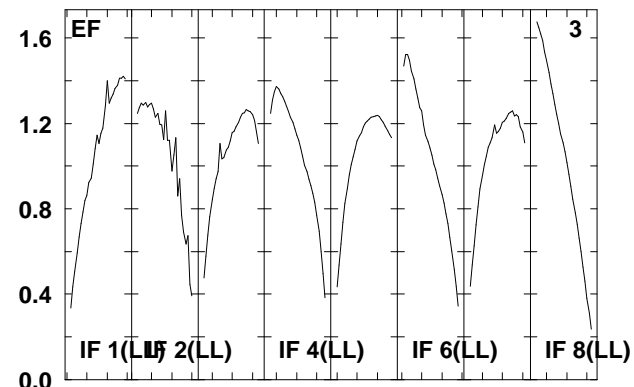
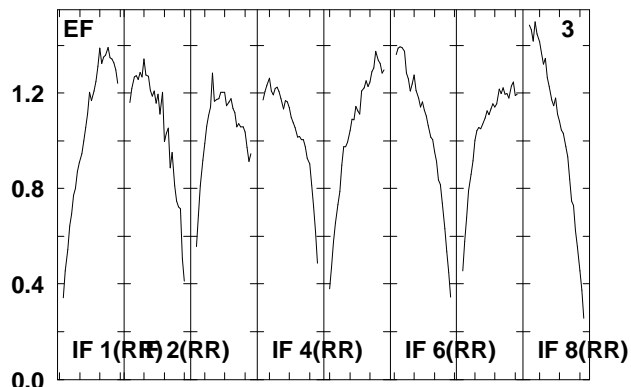
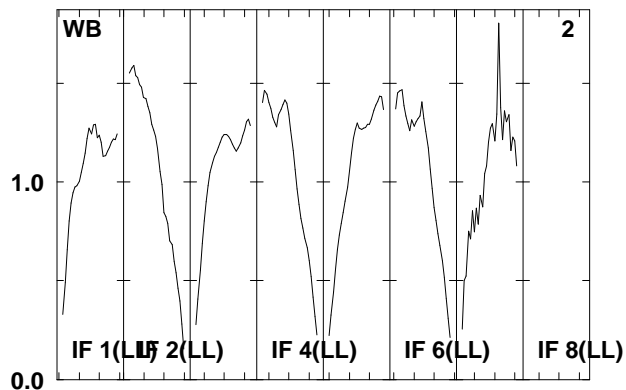
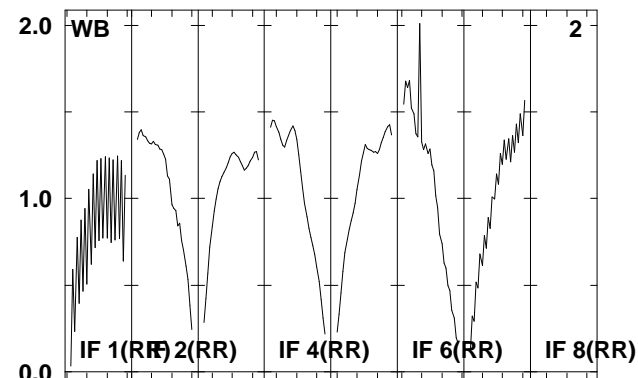
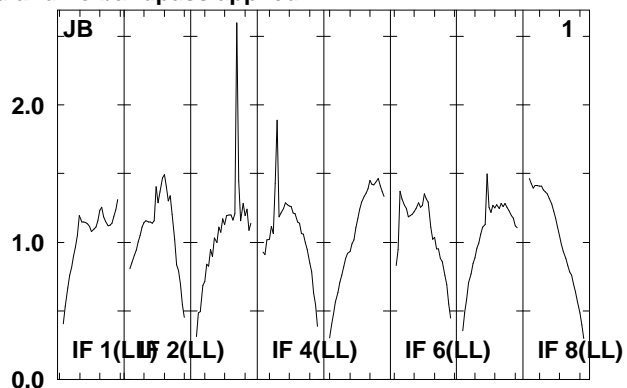
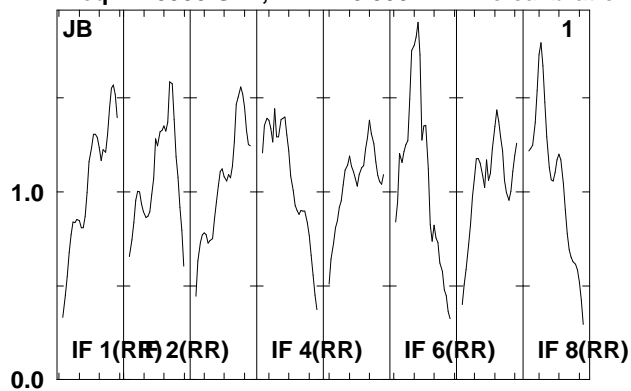

Lower frame: Real Jy  
Total-power spectrum Antenna: \*  
Timerange: 00/03:39:51 to 00/03:44:27

Plot file version 11 created 08-AUG-2008 16:58:18

J021348 EO006B.UVDATA.1

Freq = 1.5950 GHz, Bw = 16.000 MH No calibration applied and no bandpass applied

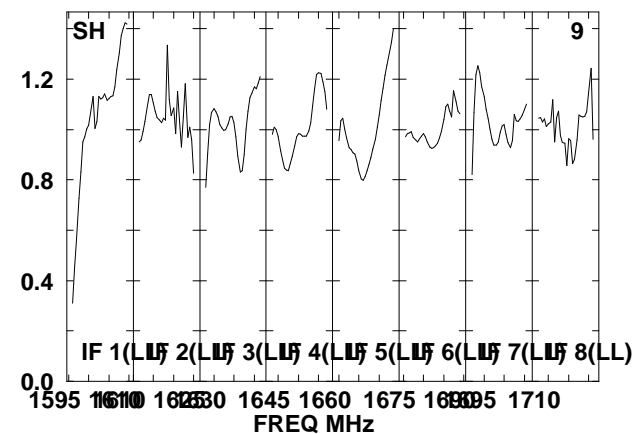
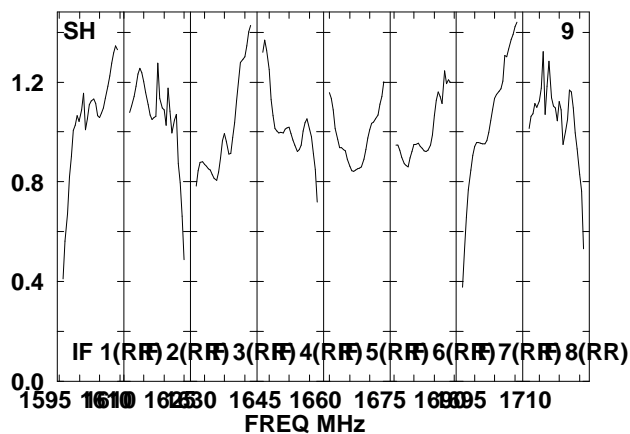
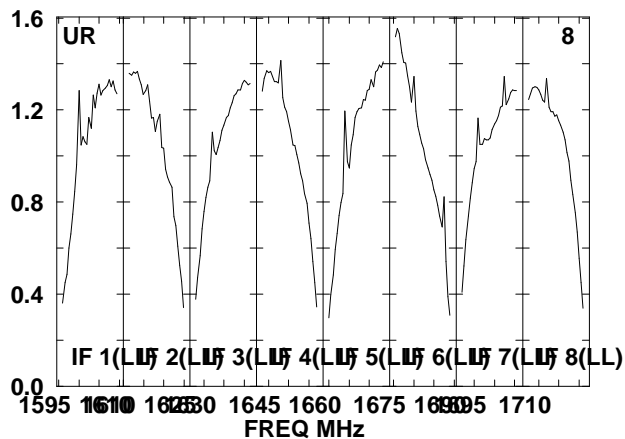
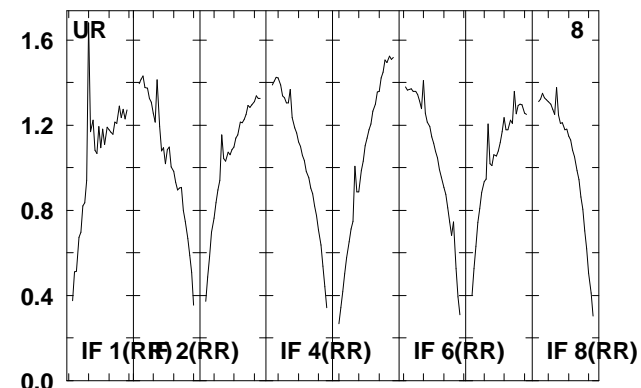
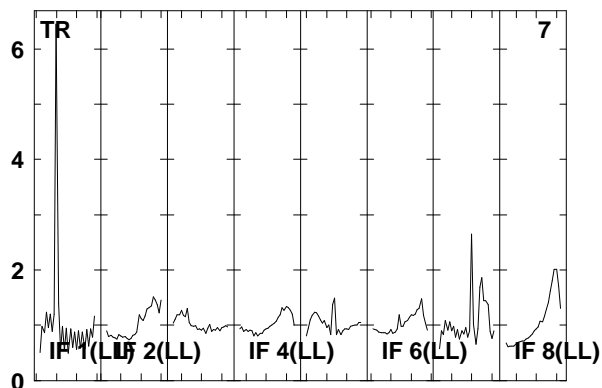
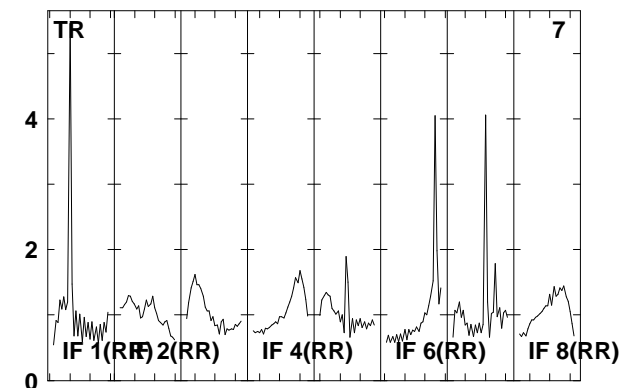
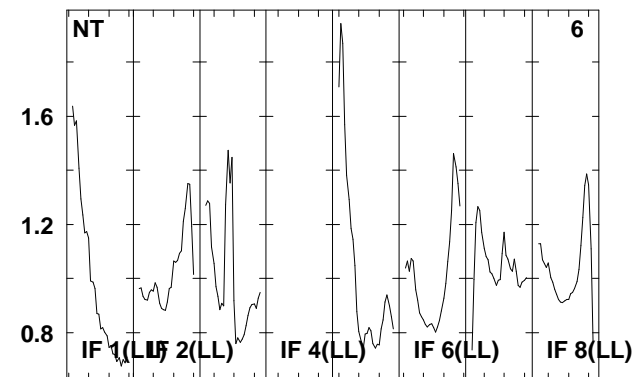
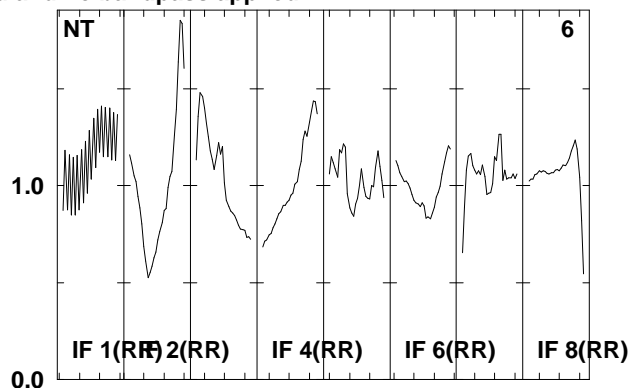
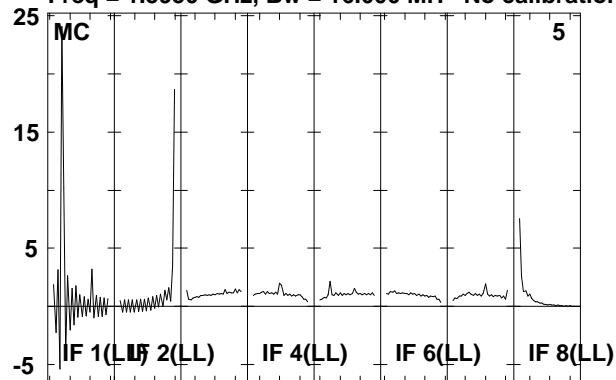

Lower frame: Real Jy

Total-power spectrum Antenna: \*

Timerange: 00/03:39:51 to 00/03:44:27

Plot file version 12 created 08-AUG-2008 16:58:19

J021348 EO006B.UVDATA.1

Freq = 1.5950 GHz, Bw = 16.000 MH No calibration applied and no bandpass applied

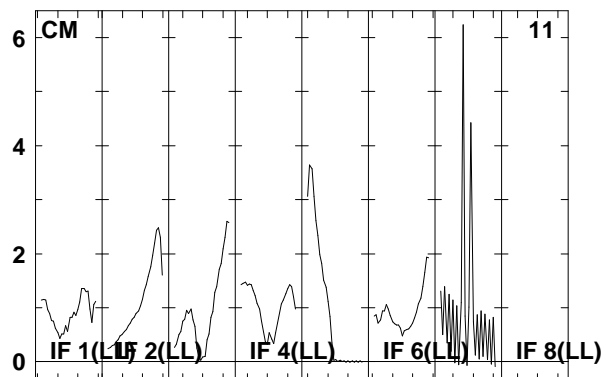
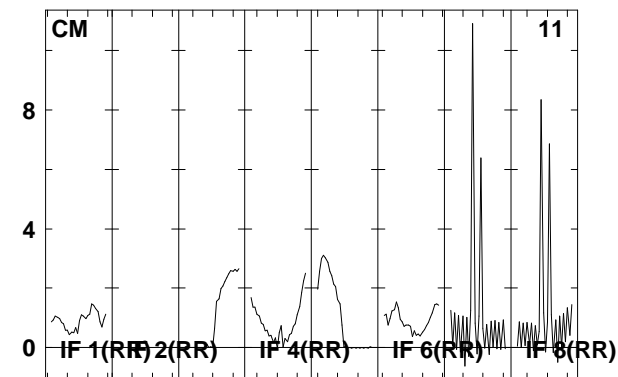
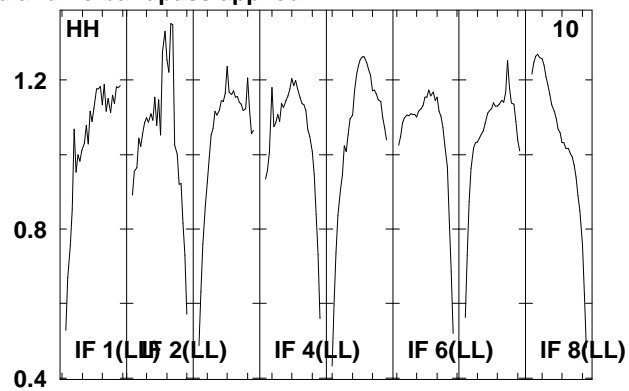
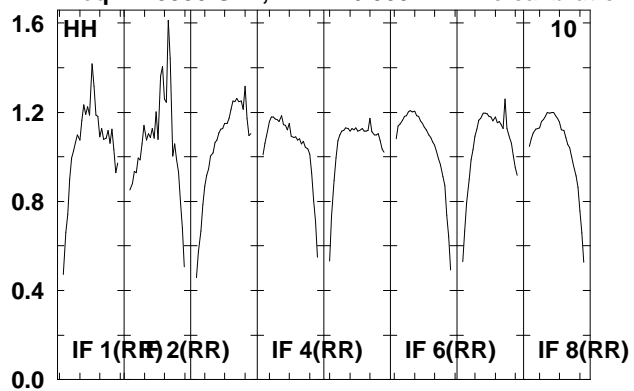

Lower frame: Real Jy  
Total-power spectrum Antenna: \*  
Timerange: 00/03:39:51 to 00/03:44:27



Plot file version 13 created 08-AUG-2008 16:58:19

J0209+13 EO006B.UVDATA.1

Freq = 1.5950 GHz, Bw = 16.000 MH No calibration applied and no bandpass applied

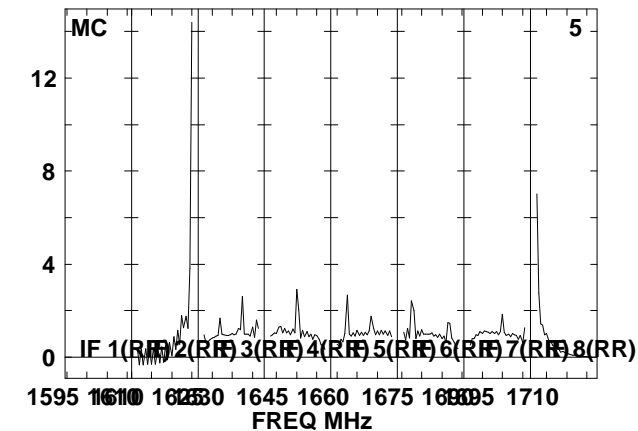
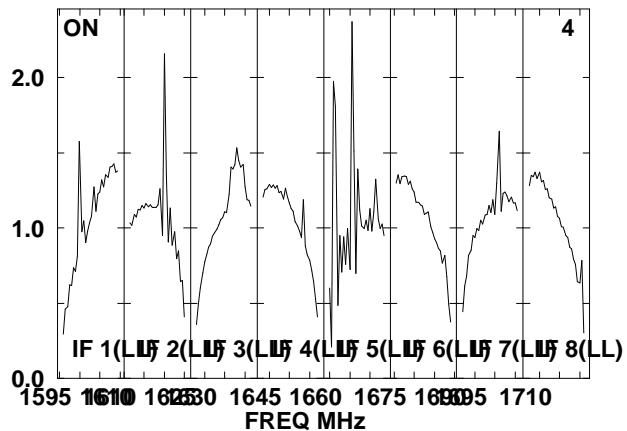
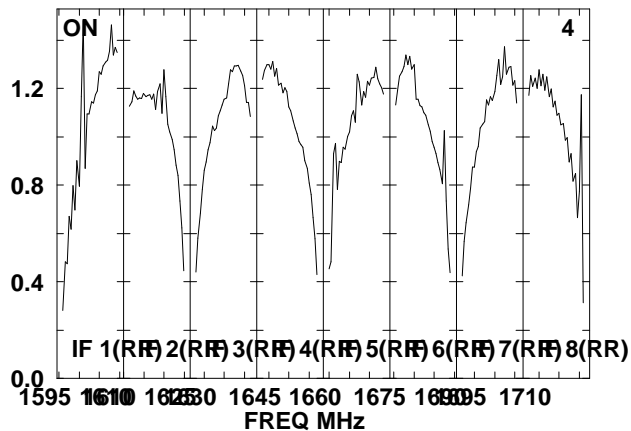
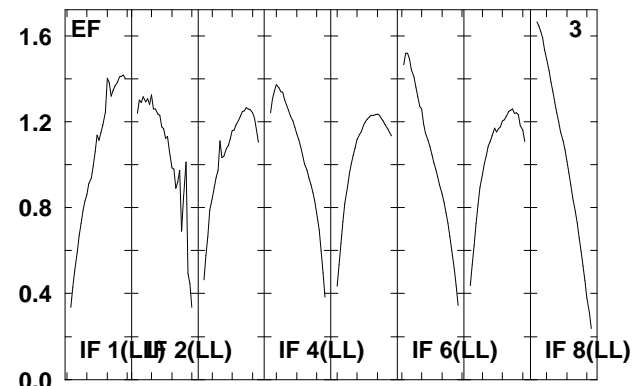
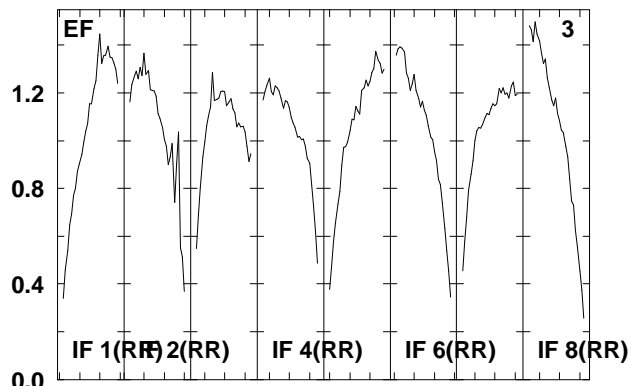
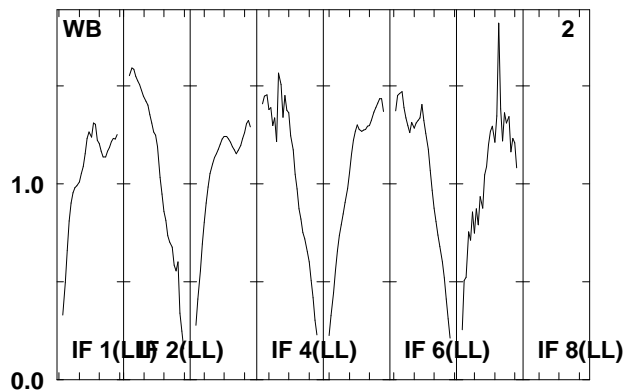
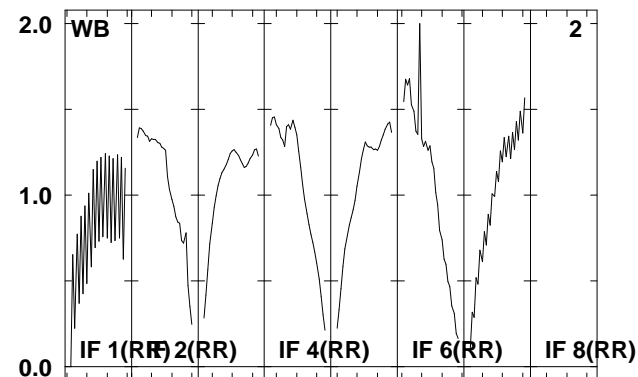
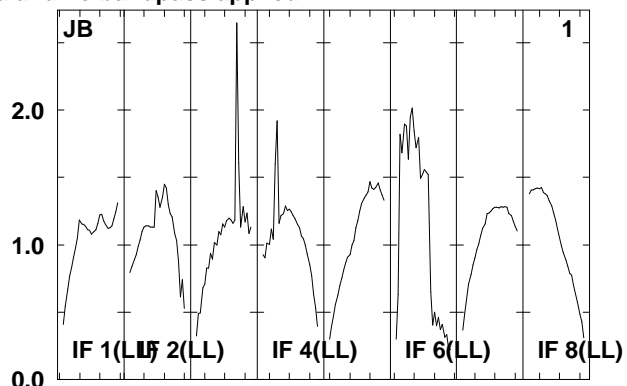
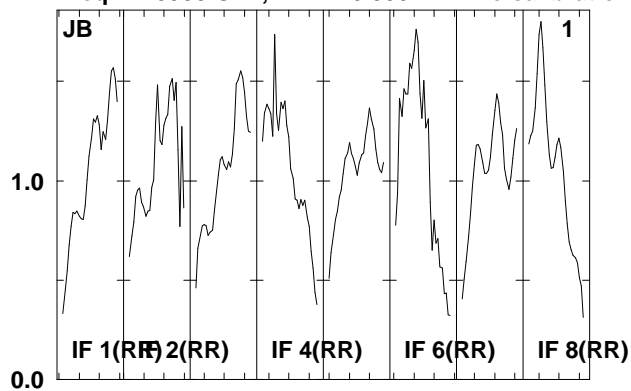

Lower frame: Real Jy

Total-power spectrum Antenna: \*

Timerange: 00/03:45:03 to 00/03:46:39

Plot file version 14 created 08-AUG-2008 16:58:20

J0209+13 EO006B.UVDATA.1

Freq = 1.5950 GHz, Bw = 16.000 MH No calibration applied and no bandpass applied

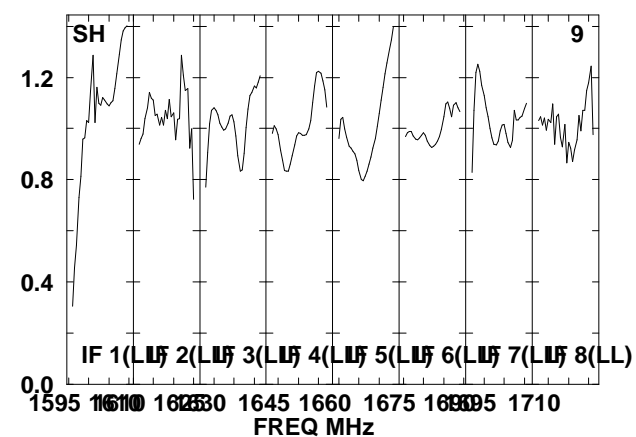
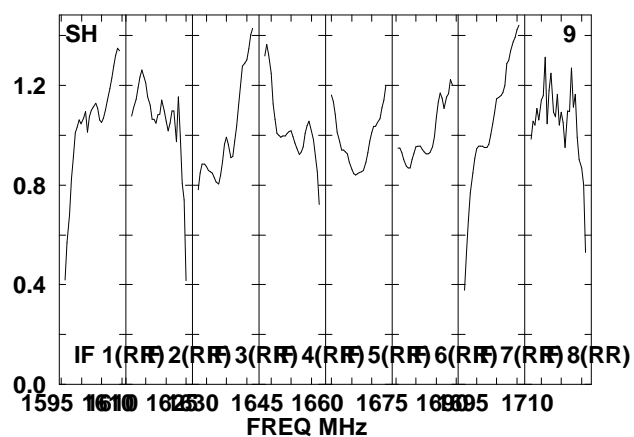
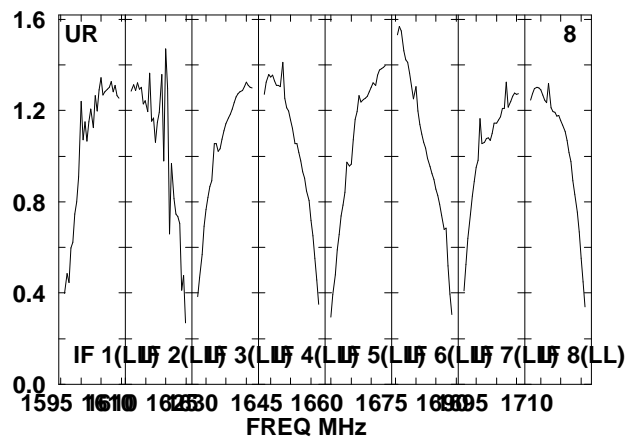
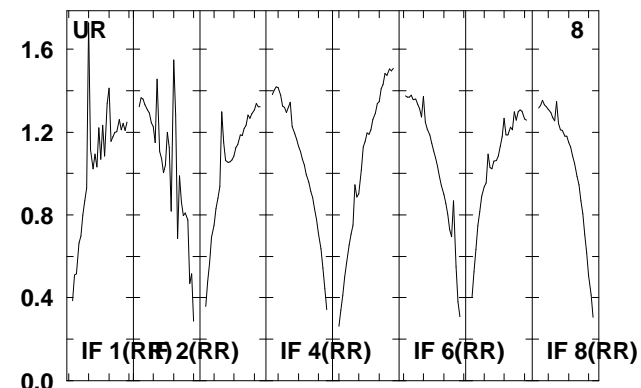
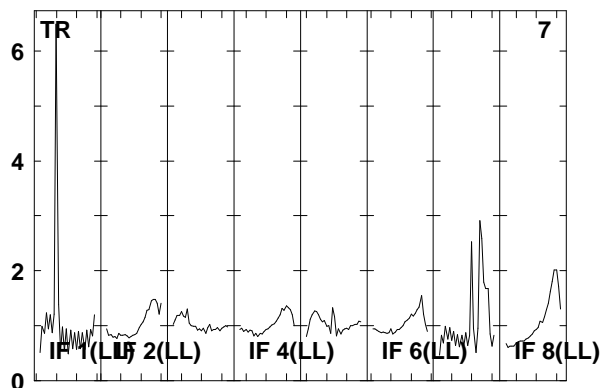
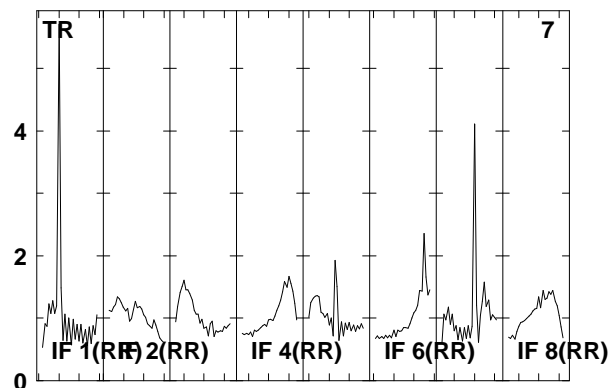
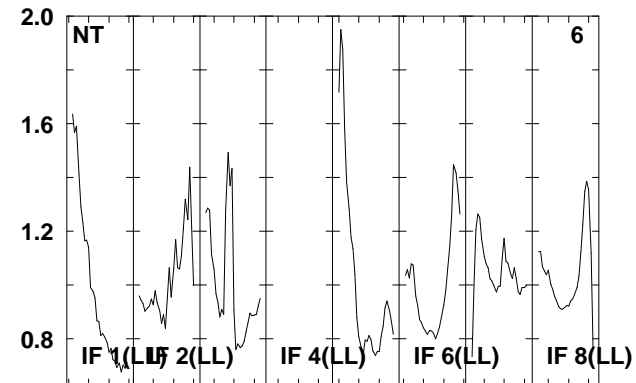
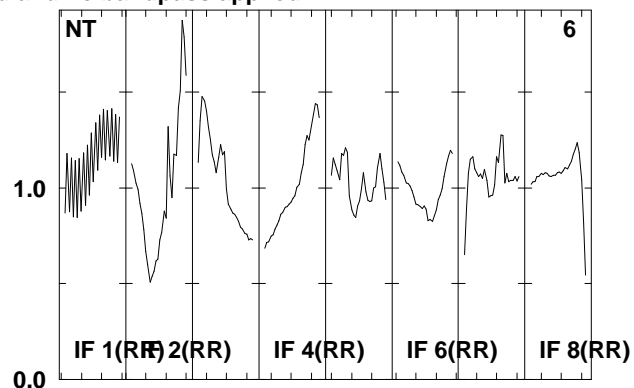
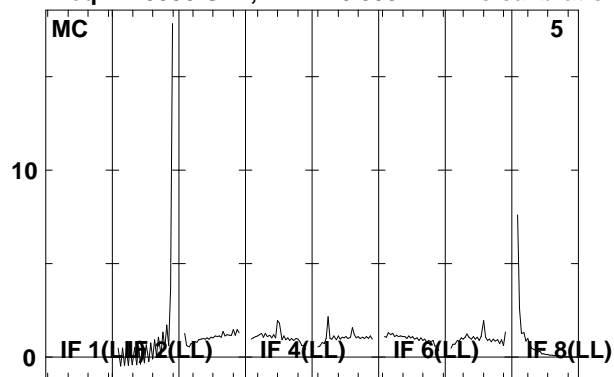

Lower frame: Real Jy  
Total-power spectrum Antenna: \*  
Timerange: 00/03:45:03 to 00/03:46:39

Plot file version 15 created 08-AUG-2008 16:58:20

J0209+13 EO06B.UVDATA.1

Freq = 1.5950 GHz, Bw = 16.000 MH No calibration applied and no bandpass applied

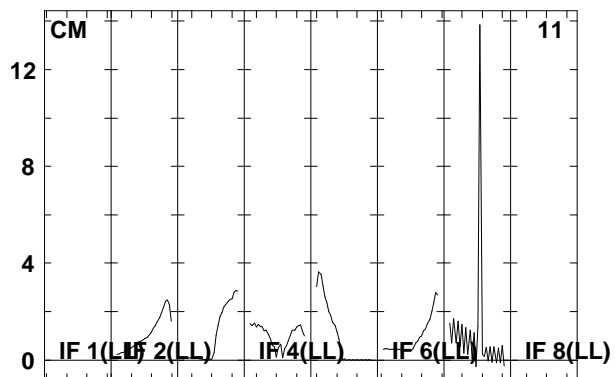
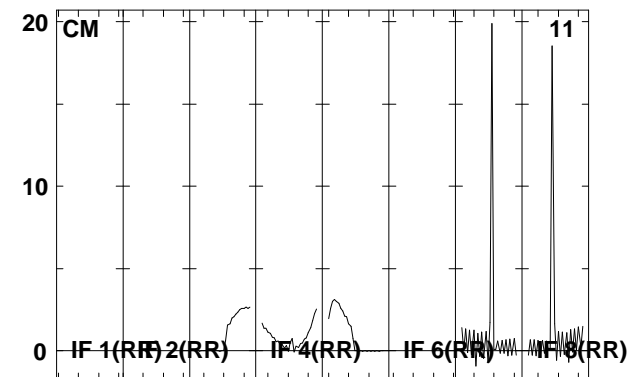
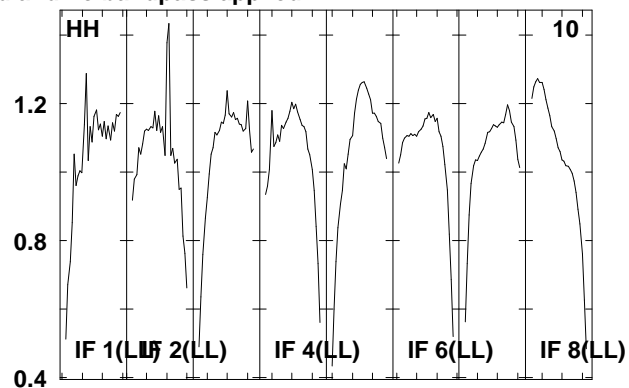
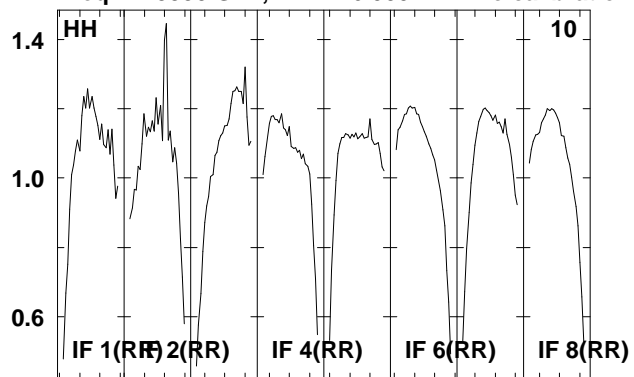

Lower frame: Real Jy  
Total-power spectrum Antenna: \*  
Timerange: 00/03:45:03 to 00/03:46:39

Plot file version 16 created 08-AUG-2008 16:58:20

J021348 EO006B.UVDATA.1

Freq = 1.5950 GHz, Bw = 16.000 MH No calibration applied and no bandpass applied

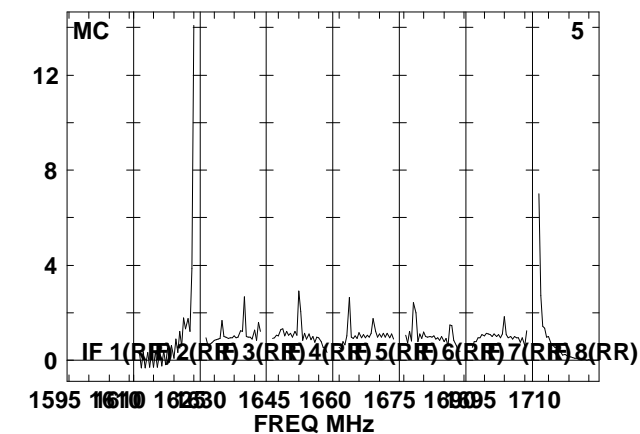
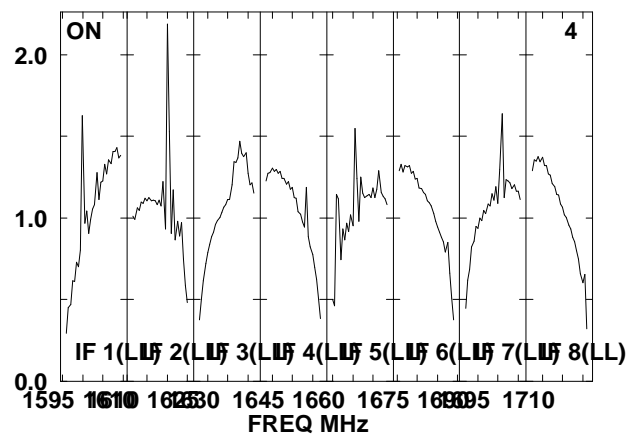
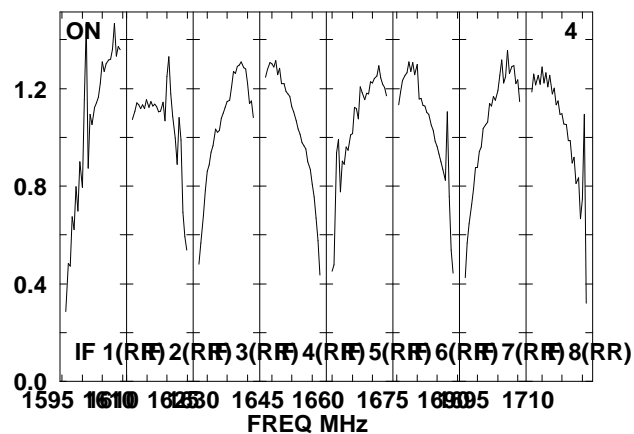
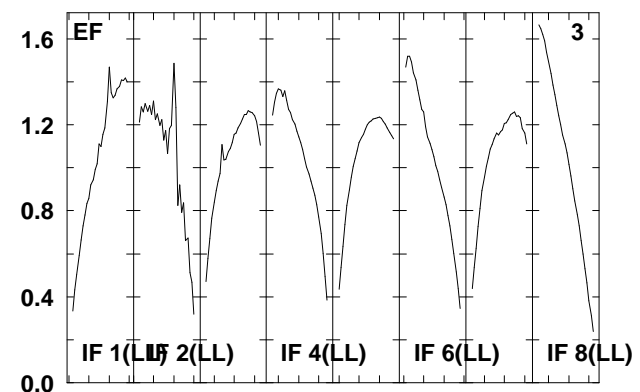
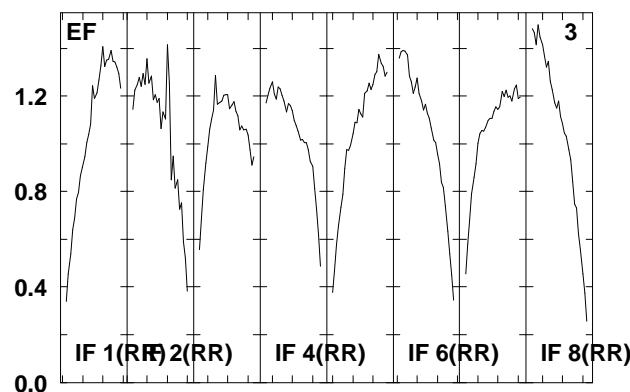
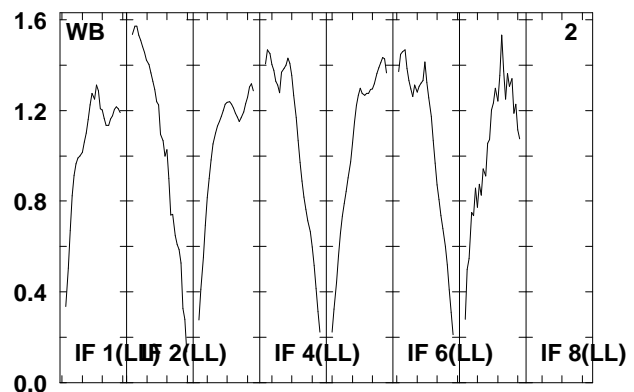
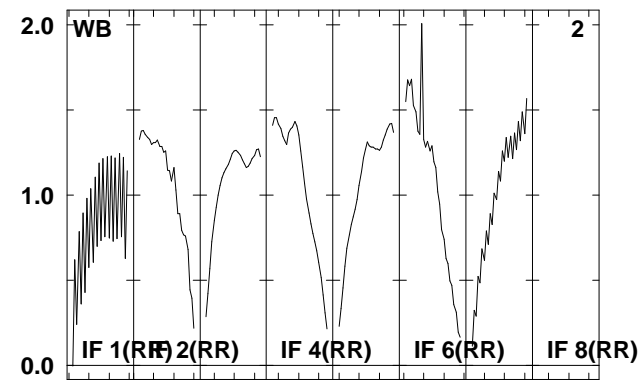
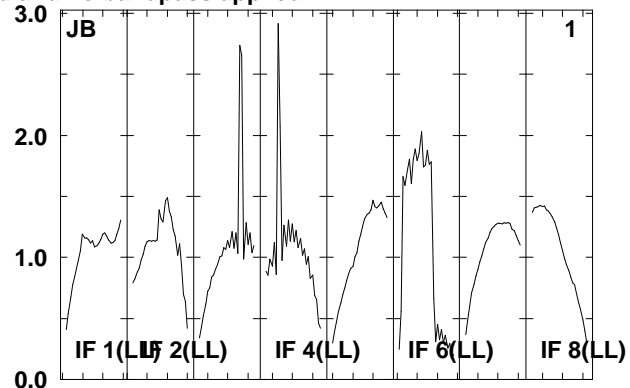
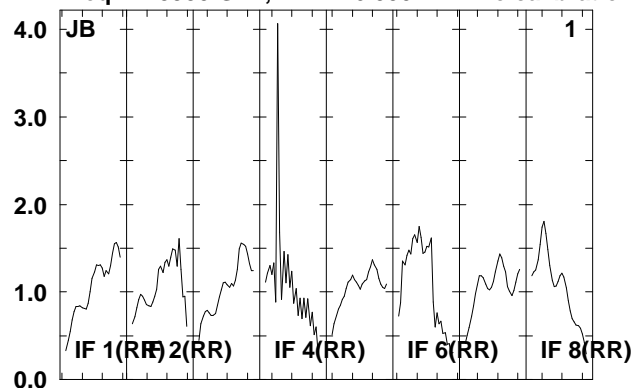

Lower frame: Real Jy  
Total-power spectrum Antenna: \*  
Timerange: 00/03:47:11 to 00/03:51:47

Plot file version 17 created 08-AUG-2008 16:58:21

J021348 EO06B.UVDATA.1

Freq = 1.5950 GHz, Bw = 16.000 MH No calibration applied and no bandpass applied

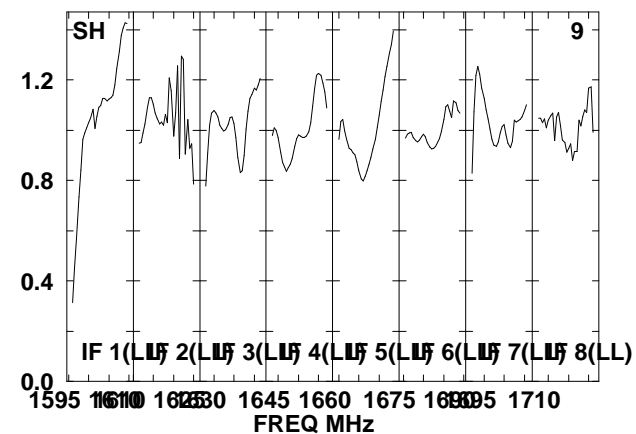
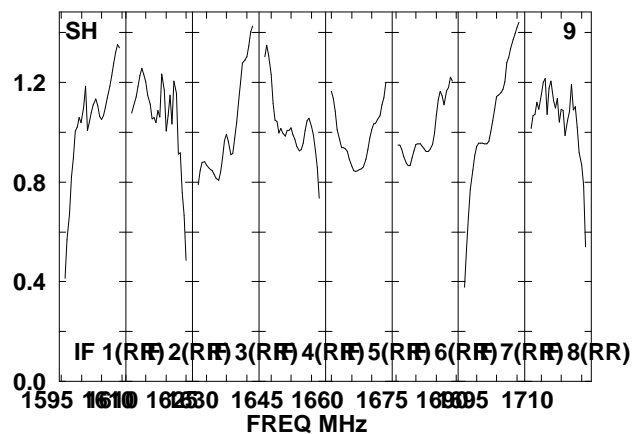
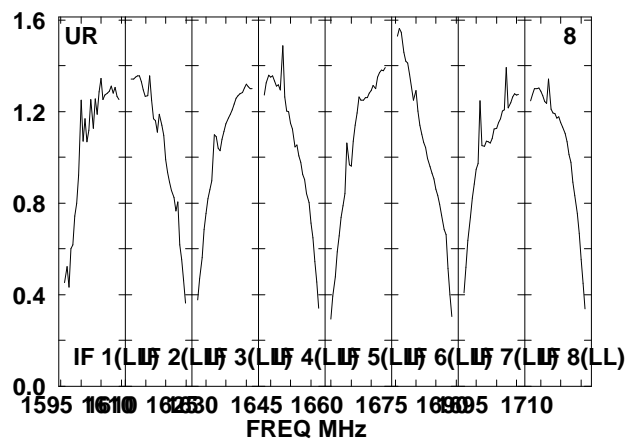
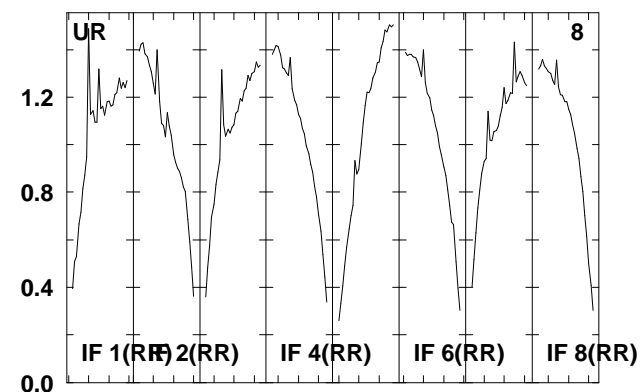
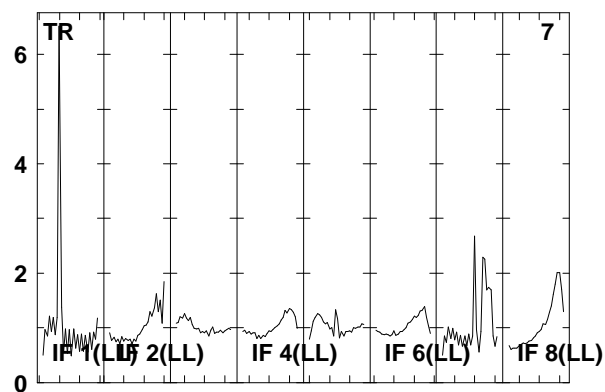
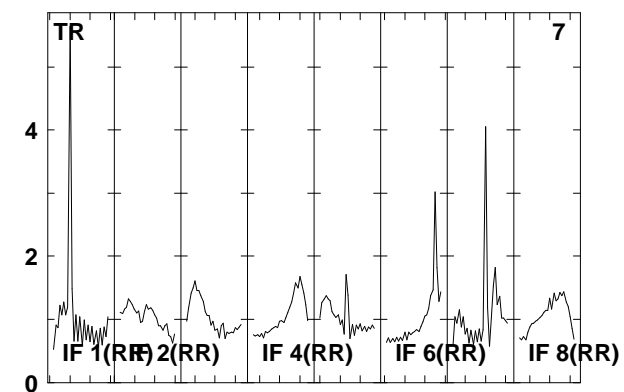
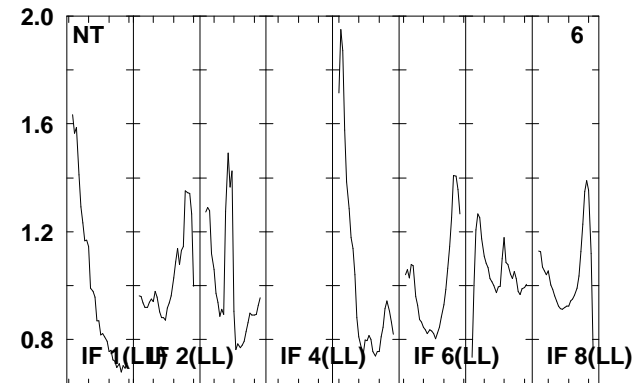
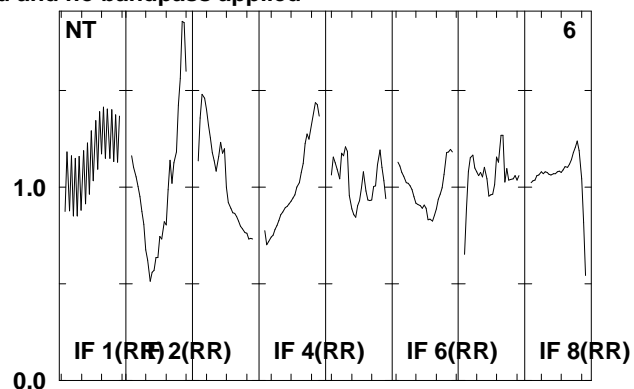
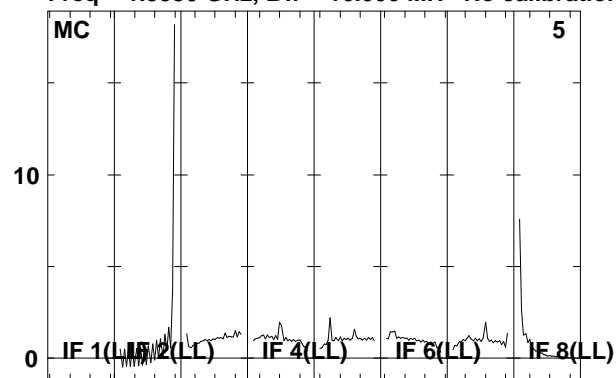

Lower frame: Real Jy

Total-power spectrum Antenna: \*

Timerange: 00/03:47:11 to 00/03:51:47

Plot file version 18 created 08-AUG-2008 16:58:22

J021348 EO006B.UVDATA.1

Freq = 1.5950 GHz, Bw = 16.000 MH No calibration applied and no bandpass applied

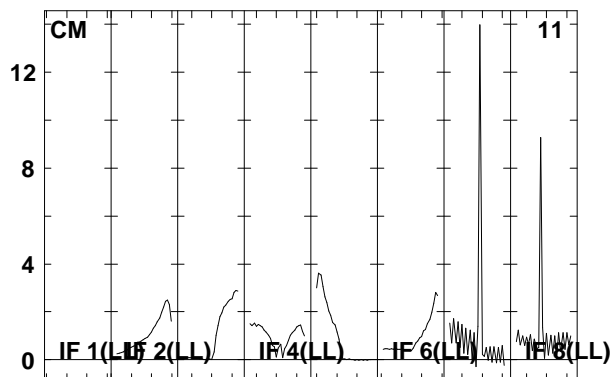
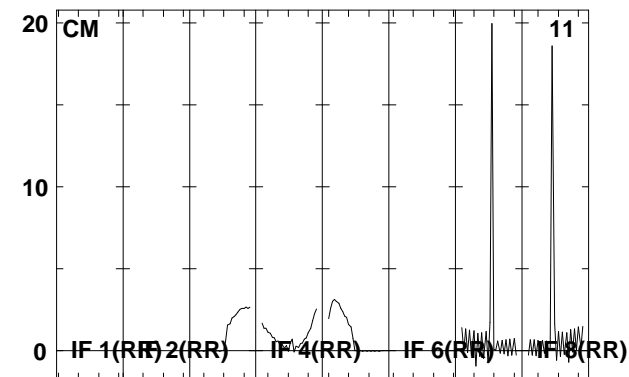
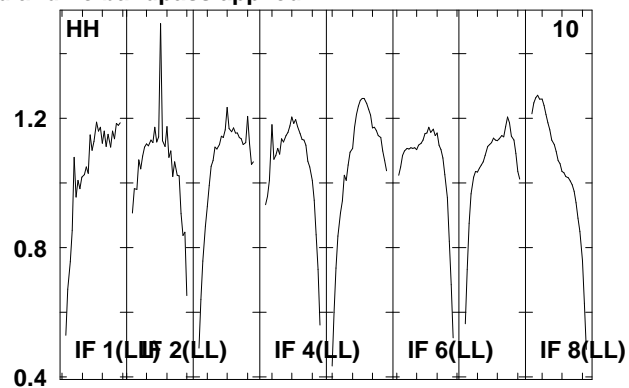
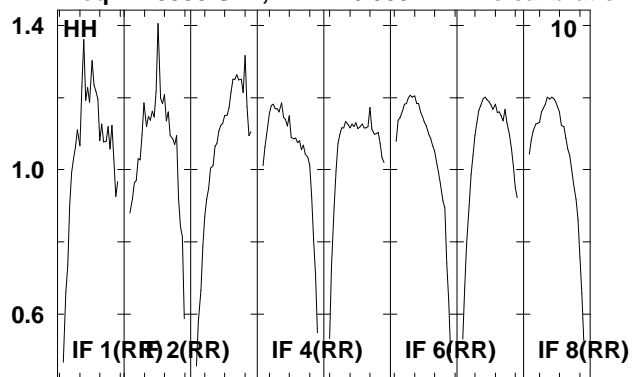

Lower frame: Real Jy  
Total-power spectrum Antenna: \*  
Timerange: 00/03:47:11 to 00/03:51:47

Plot file version 19 created 08-AUG-2008 16:58:22

J0209+13 E0006B.UVDATA.1

Freq = 1.5950 GHz, Bw = 16.000 MH No calibration applied and no bandpass applied

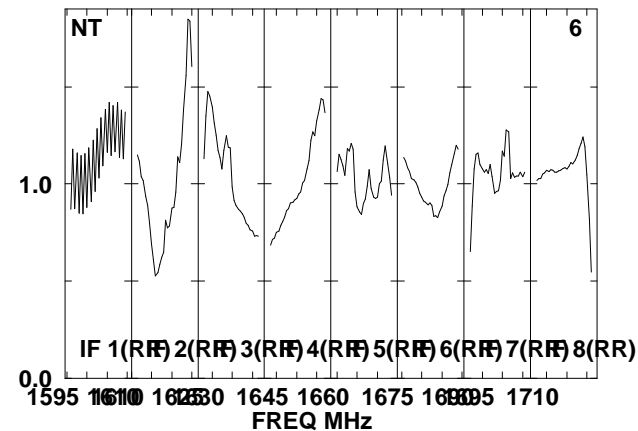
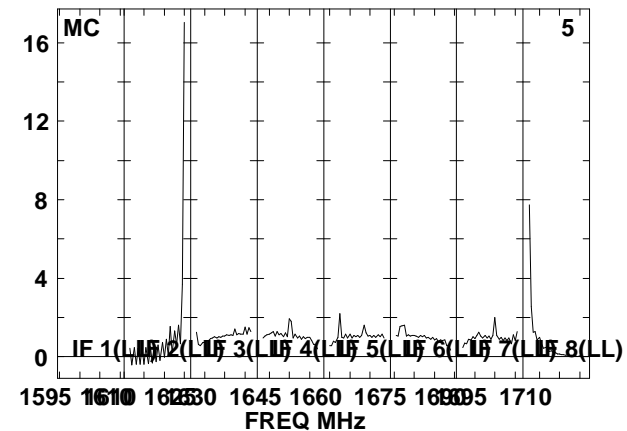
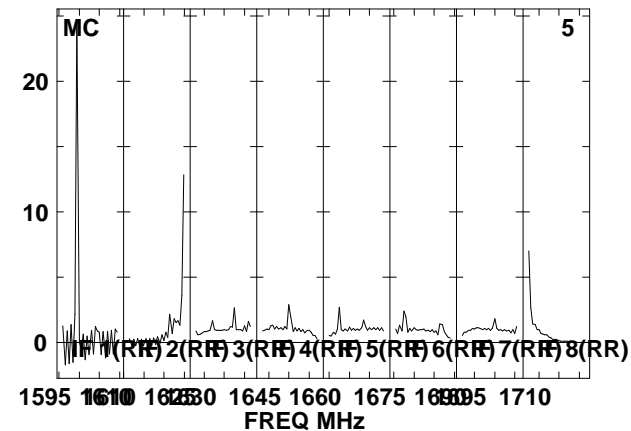
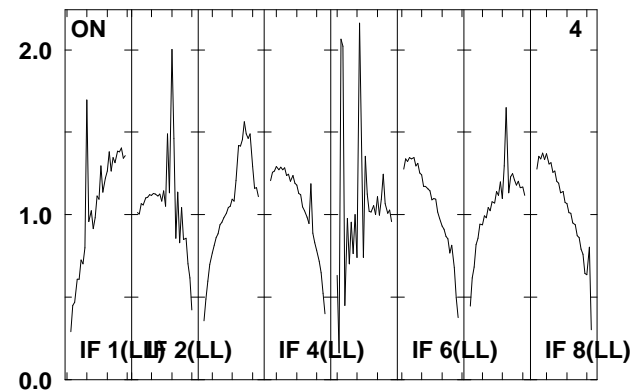
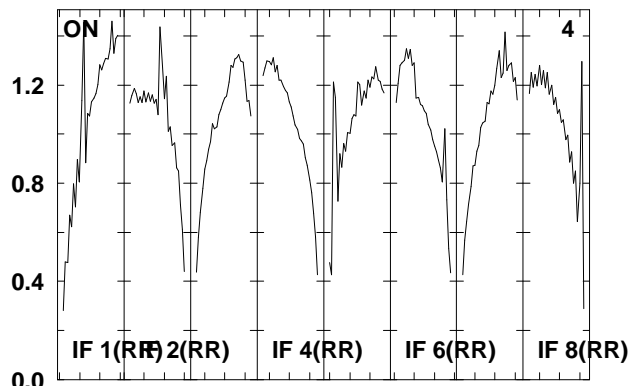
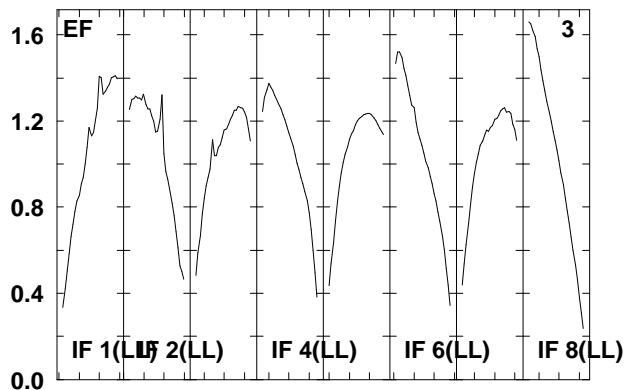
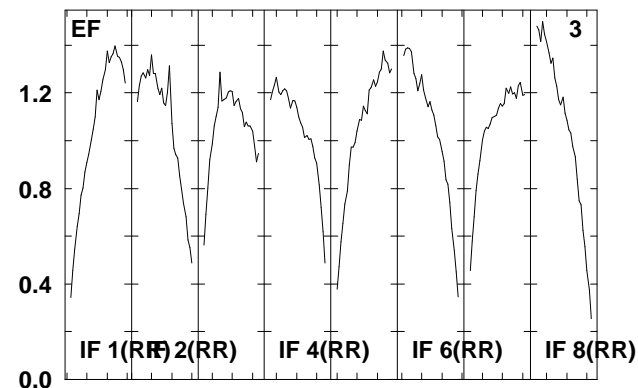
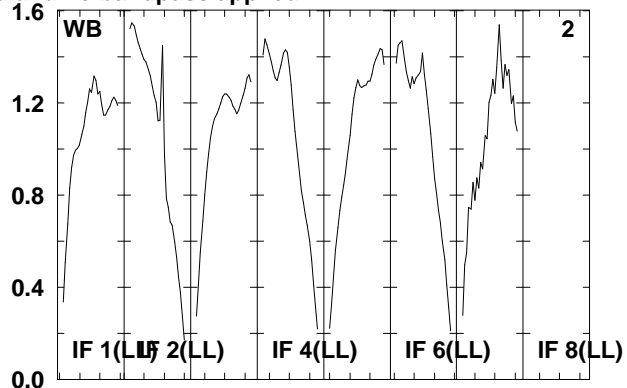
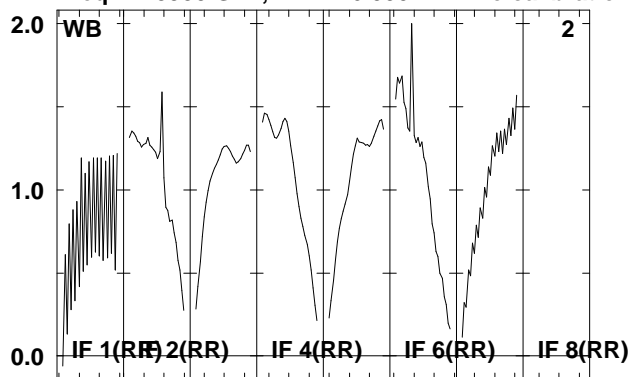

Lower frame: Real Jy  
Total-power spectrum Antenna: \*  
Timerange: 00/03:52:23 to 00/03:53:59

Plot file version 20 created 08-AUG-2008 16:58:23

J0209+13 EO06B.UVDATA.1

Freq = 1.5950 GHz, Bw = 16.000 MH No calibration applied and no bandpass applied

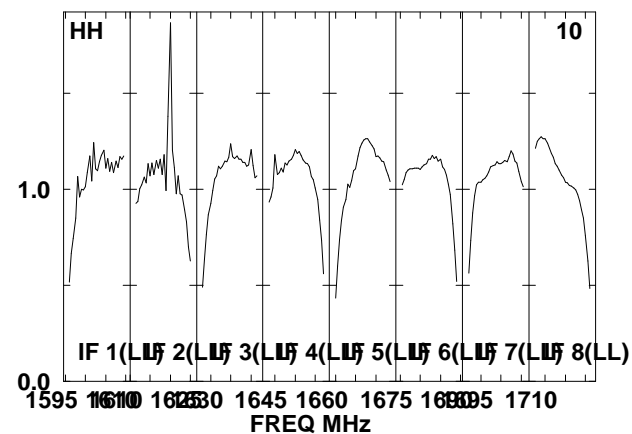
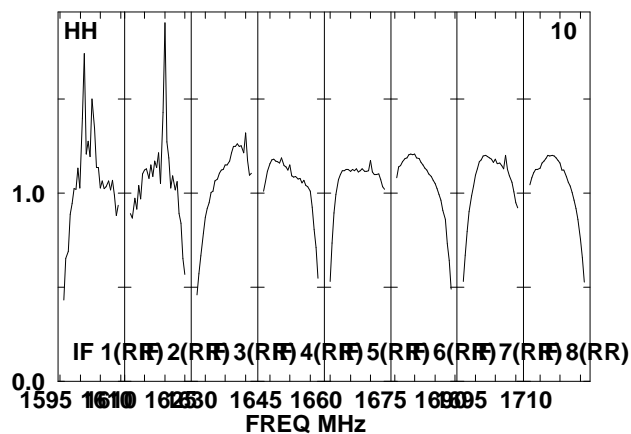
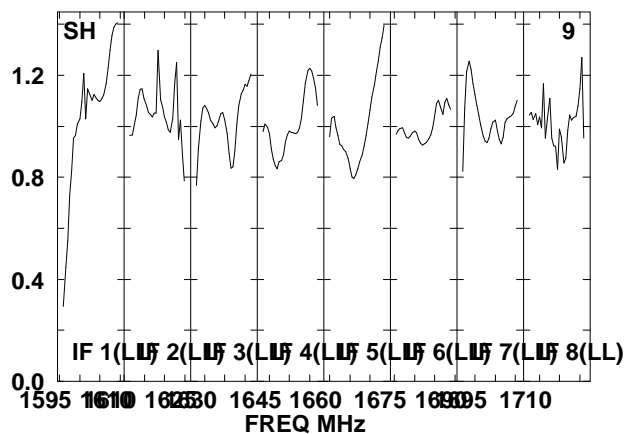
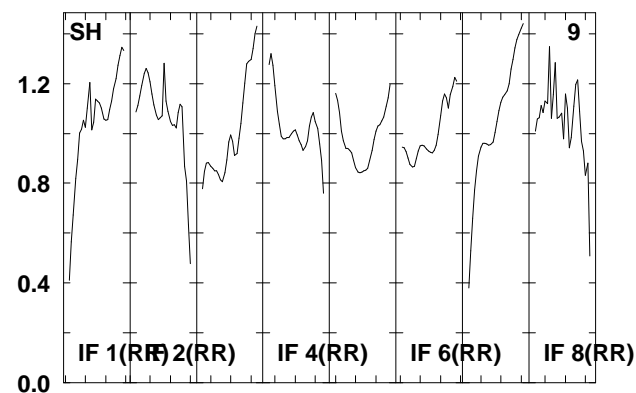
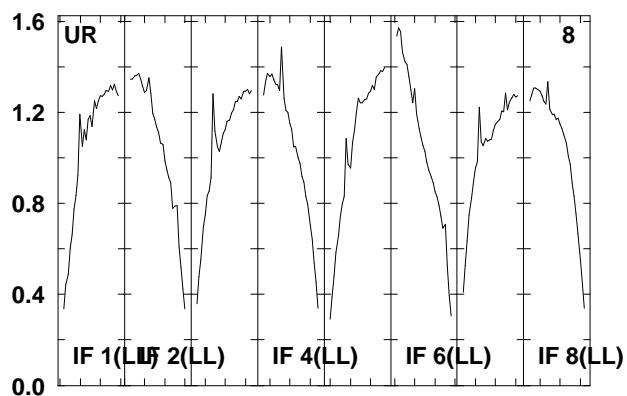
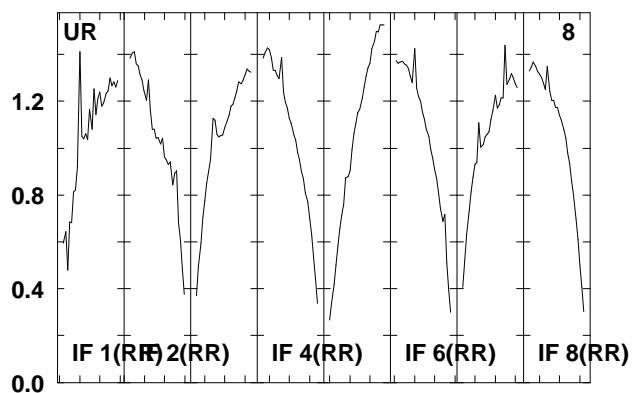
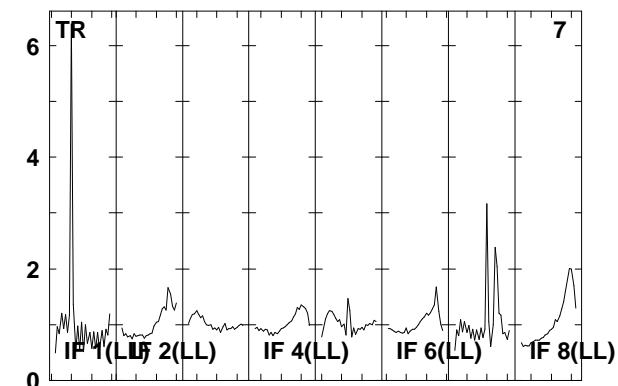
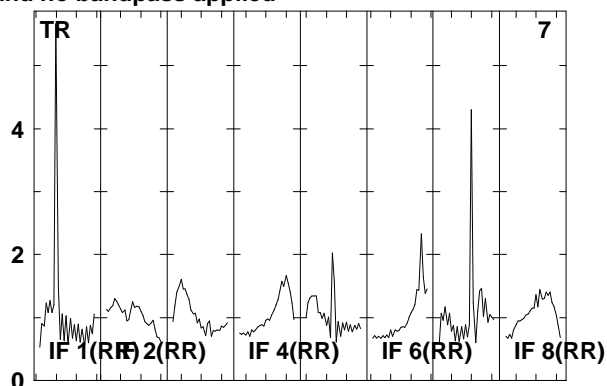
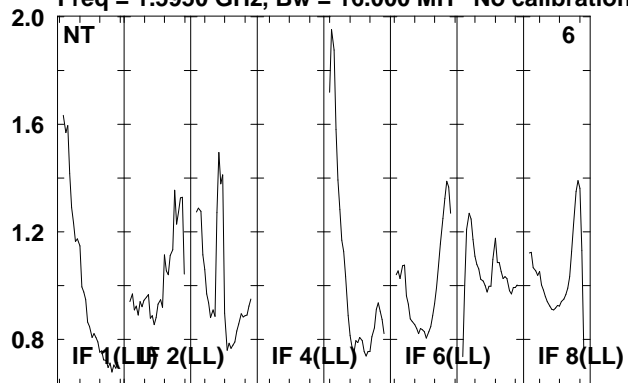

Lower frame: Real Jy

Total-power spectrum Antenna: \*

Timerange: 00/03:52:23 to 00/03:53:59



Plot file version 21 created 08-AUG-2008 16:58:23

J0209+13 EO006B.UVDATA.1

Freq = 1.5950 GHz, Bw = 16.000 MH No calibration applied and no bandpass applied

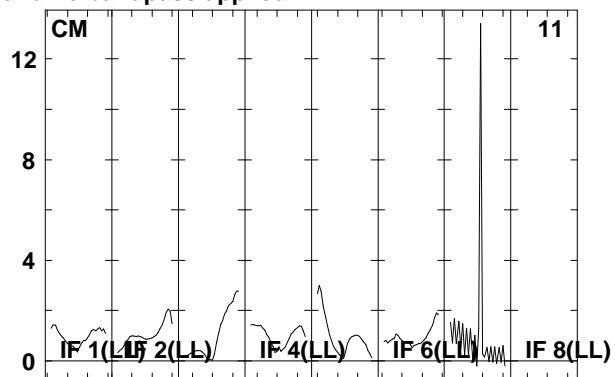
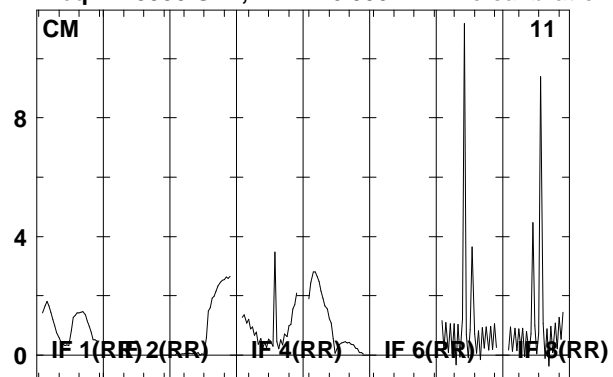

Lower frame: Real Jy  
Total-power spectrum Antenna: \*  
Timerange: 00/03:52:23 to 00/03:53:59

Plot file version 22 created 08-AUG-2008 16:58:24

J021348 EO006B.UVDATA.1

Freq = 1.5950 GHz, Bw = 16.000 MH No calibration applied and no bandpass applied

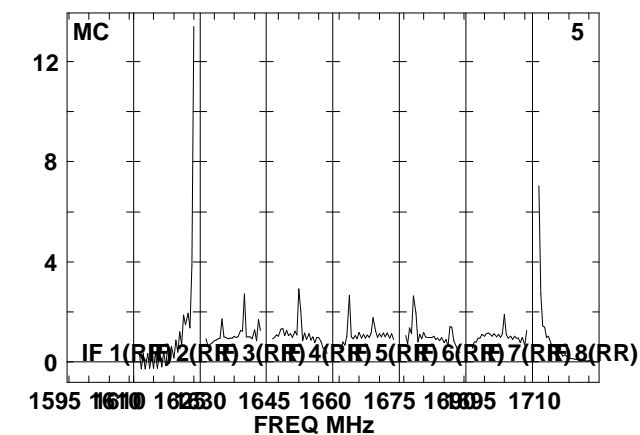
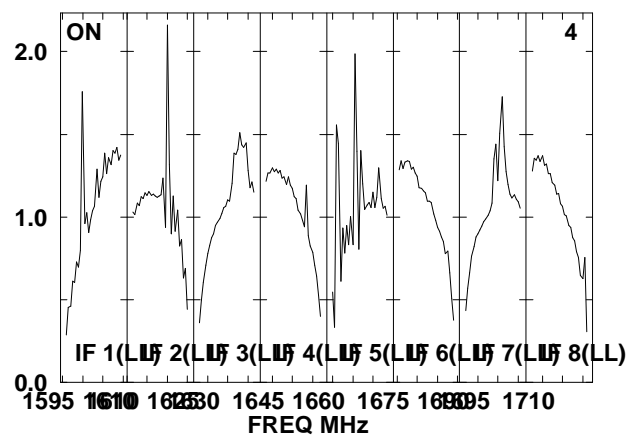
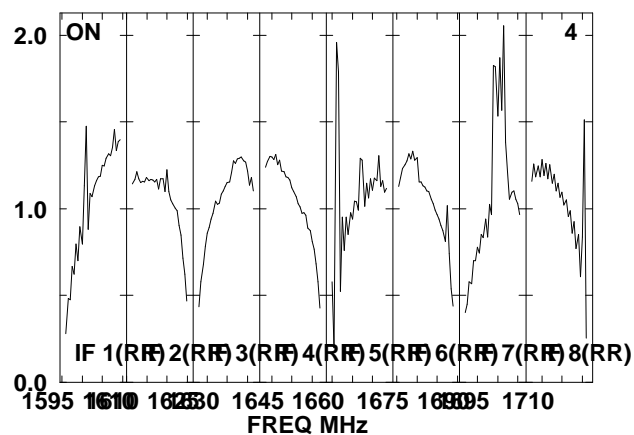
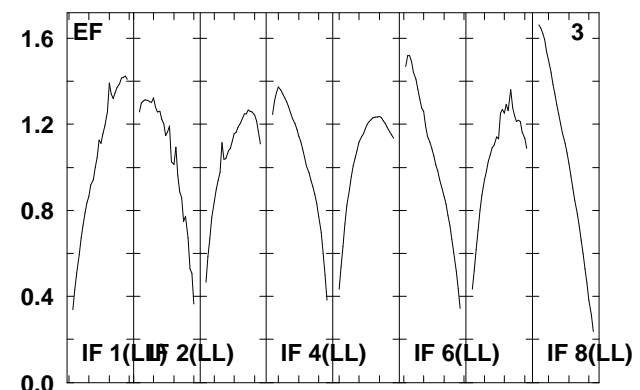
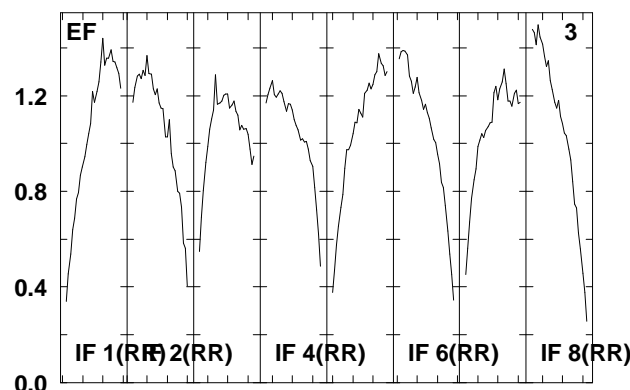
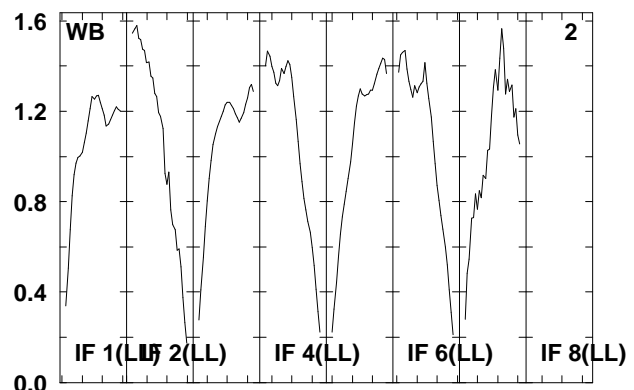
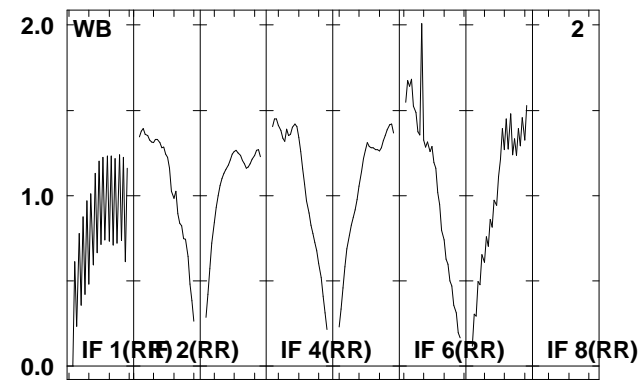
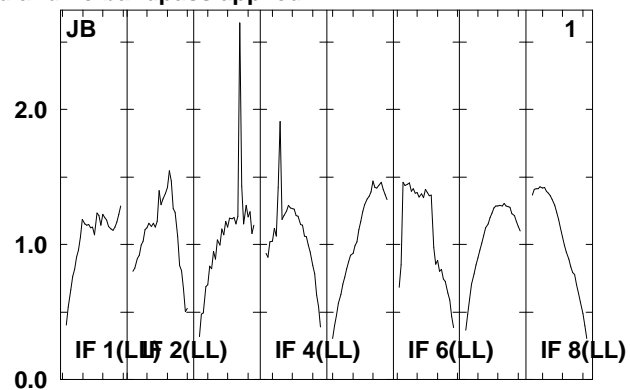
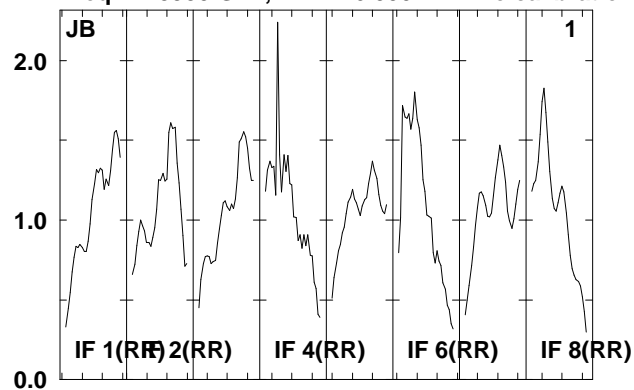

Lower frame: Real Jy  
Total-power spectrum Antenna: \*  
Timerange: 00/03:54:35 to 00/03:59:07

Plot file version 23 created 08-AUG-2008 16:58:25

J021348 EO06B.UVDATA.1

Freq = 1.5950 GHz, Bw = 16.000 MH No calibration applied and no bandpass applied

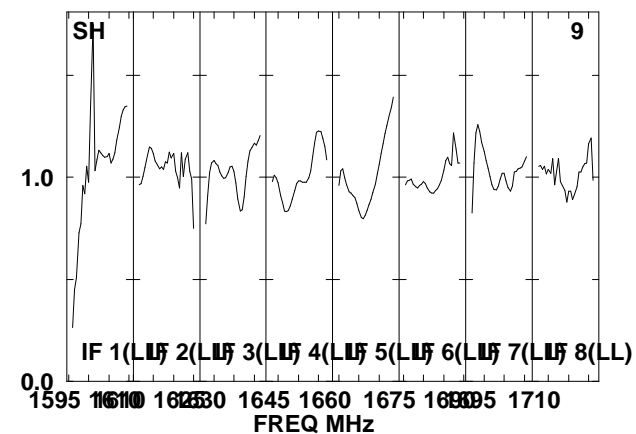
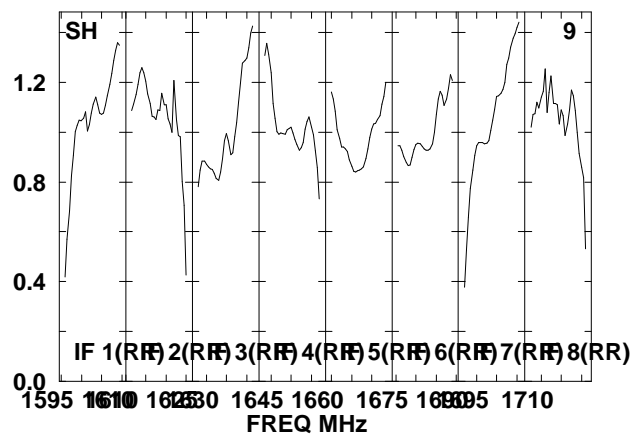
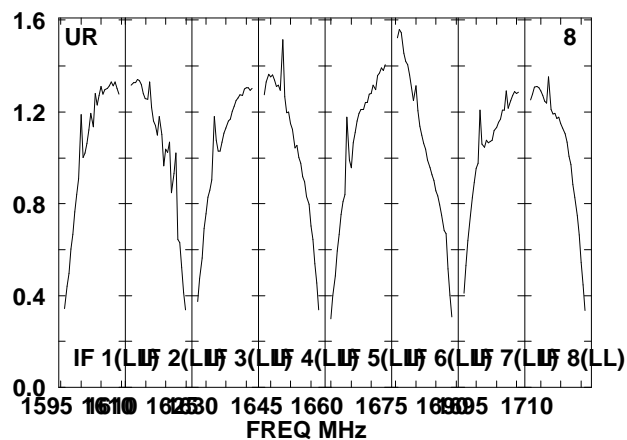
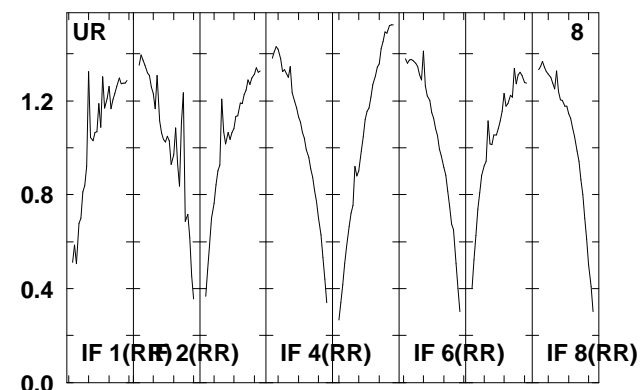
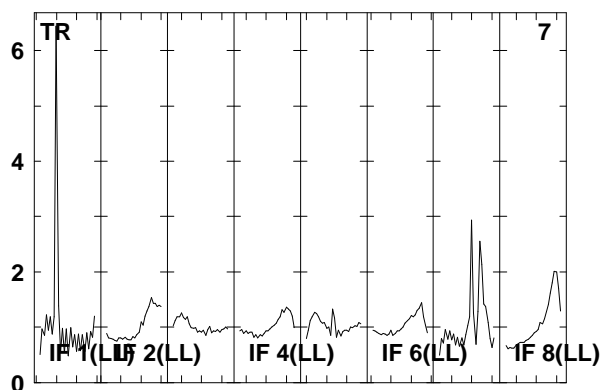
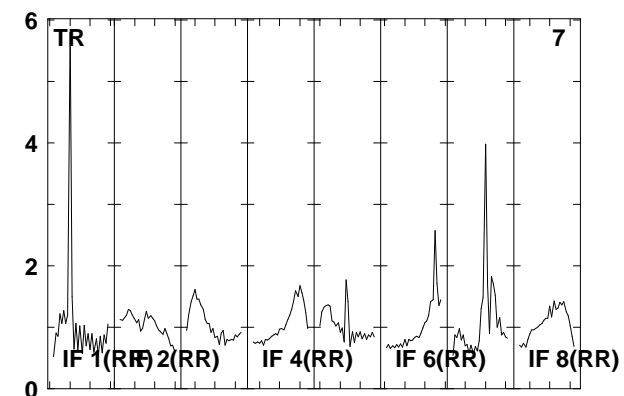
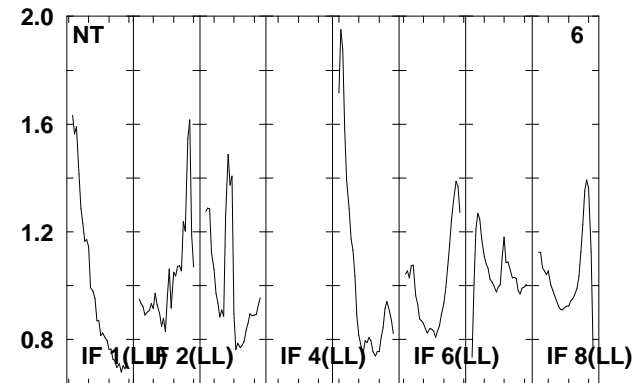
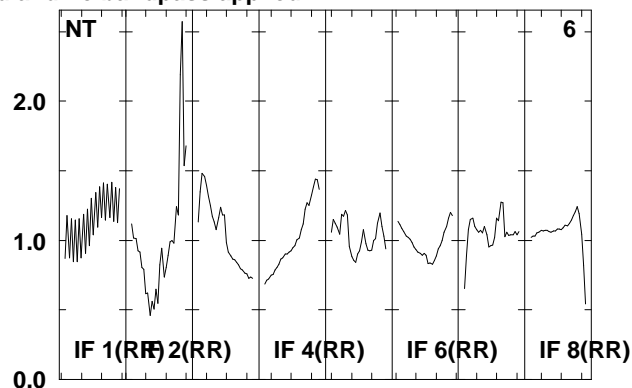
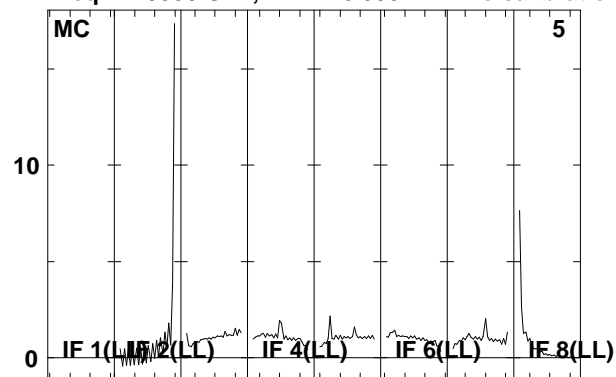

Lower frame: Real Jy

Total-power spectrum Antenna: \*

Timerange: 00/03:54:35 to 00/03:59:07

Plot file version 24 created 08-AUG-2008 16:58:25

J021348 EO006B.UVDATA.1

Freq = 1.5950 GHz, Bw = 16.000 MH No calibration applied and no bandpass applied

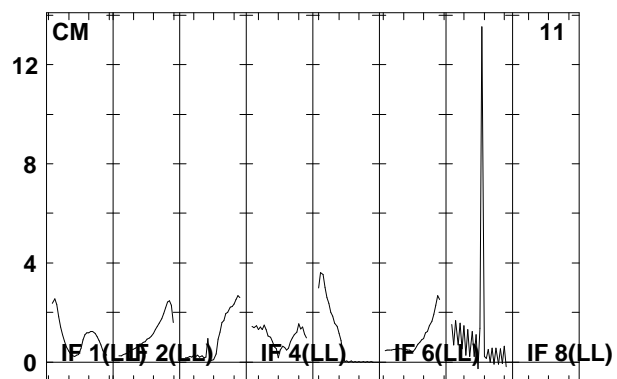
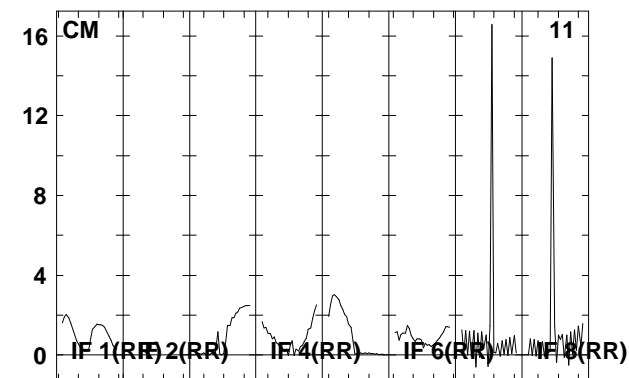
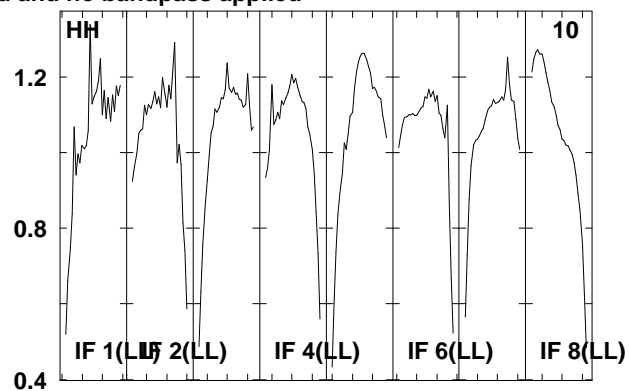
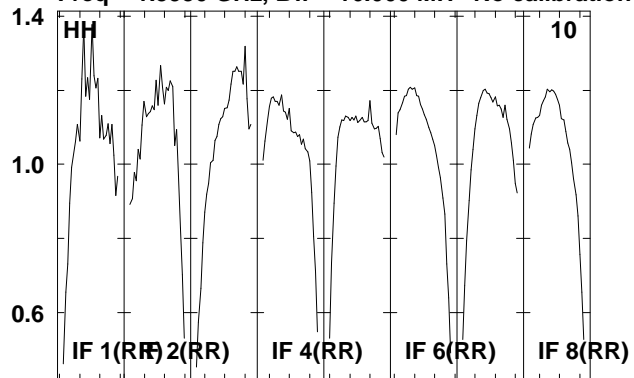

Lower frame: Real Jy  
Total-power spectrum Antenna: \*  
Timerange: 00/03:54:35 to 00/03:59:07

Plot file version 25 created 08-AUG-2008 16:58:26

J0209+13 EO006B.UVDATA.1

Freq = 1.5950 GHz, Bw = 16.000 MH No calibration applied and no bandpass applied

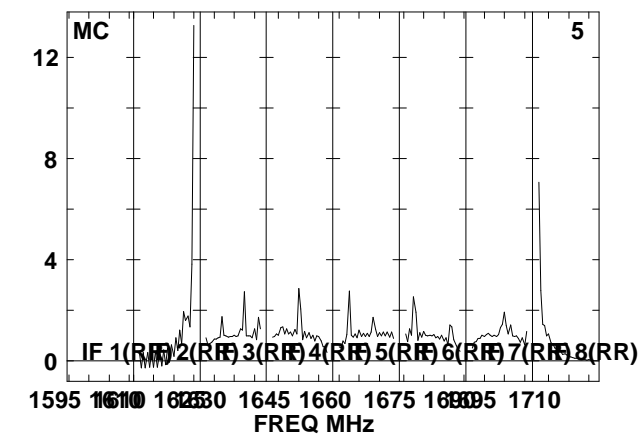
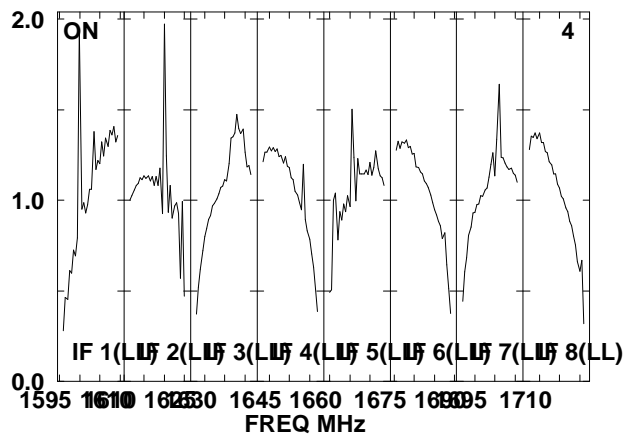
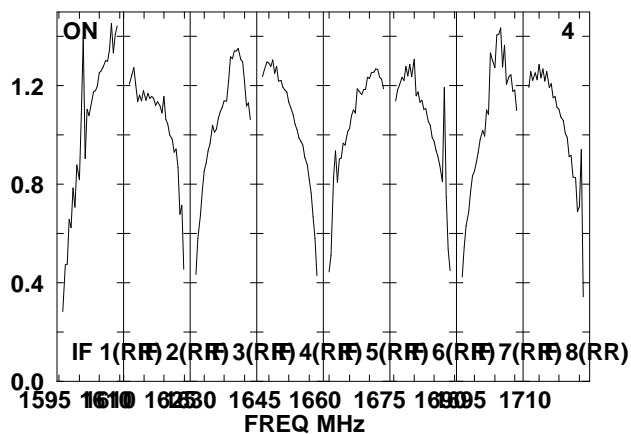
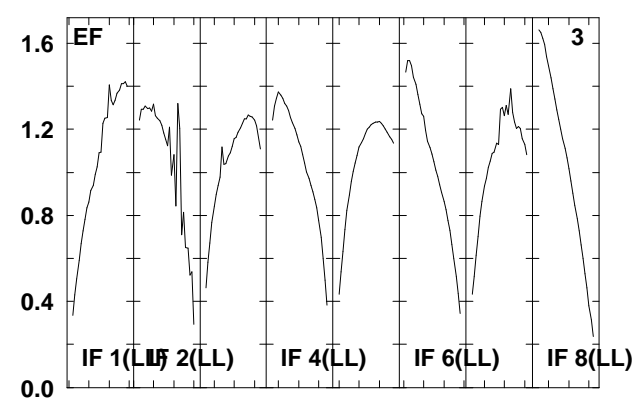
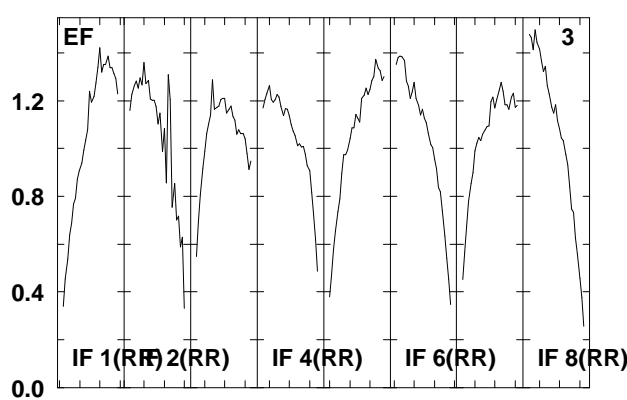
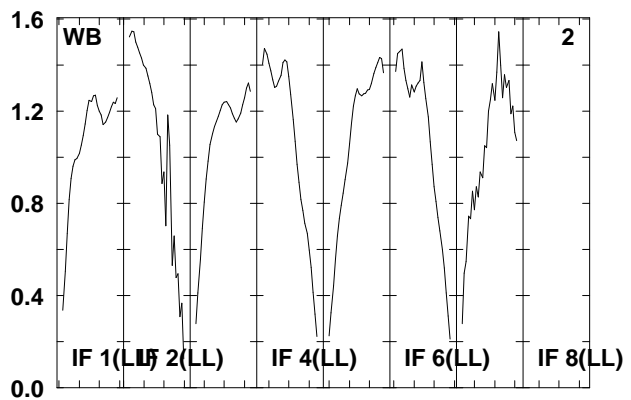
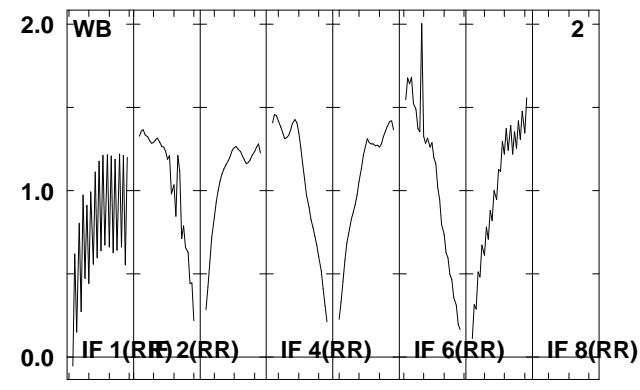
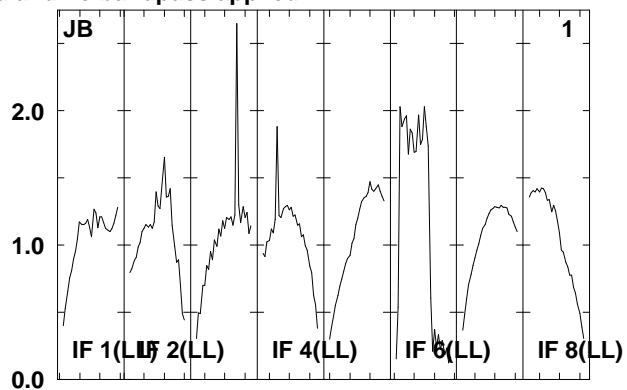
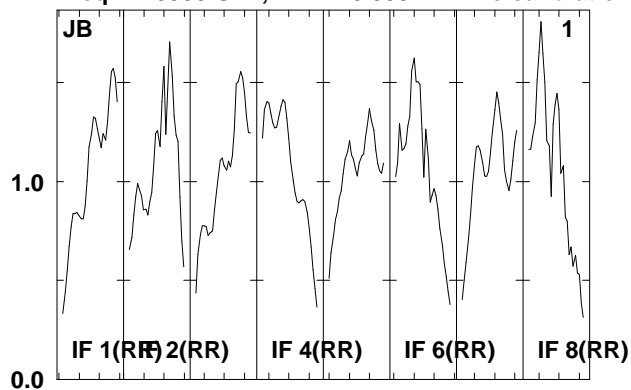

Lower frame: Real Jy  
Total-power spectrum Antenna: \*  
Timerange: 00/03:59:43 to 00/04:01:11

Plot file version 26 created 08-AUG-2008 16:58:26

J0209+13 EO006B.UVDATA.1

Freq = 1.5950 GHz, Bw = 16.000 MH No calibration applied and no bandpass applied

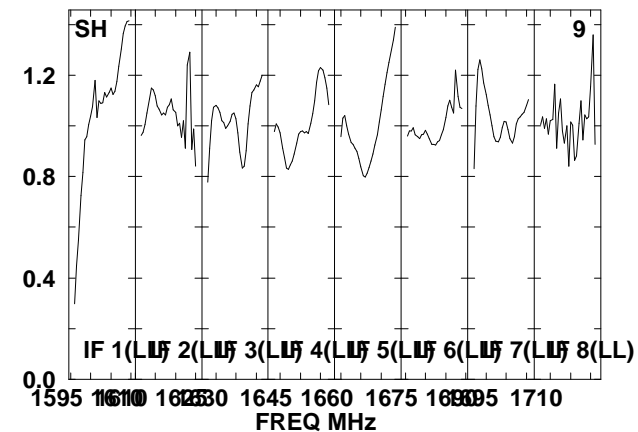
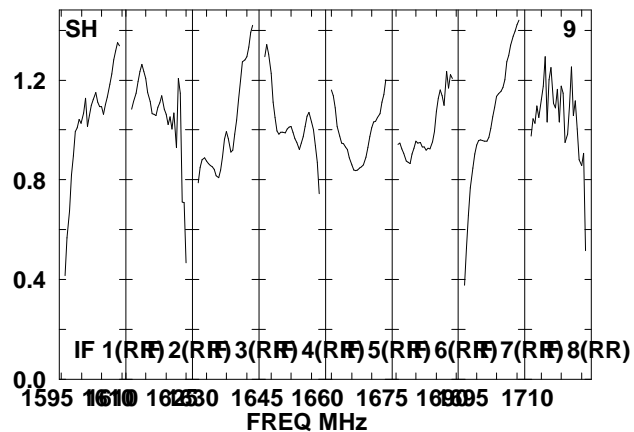
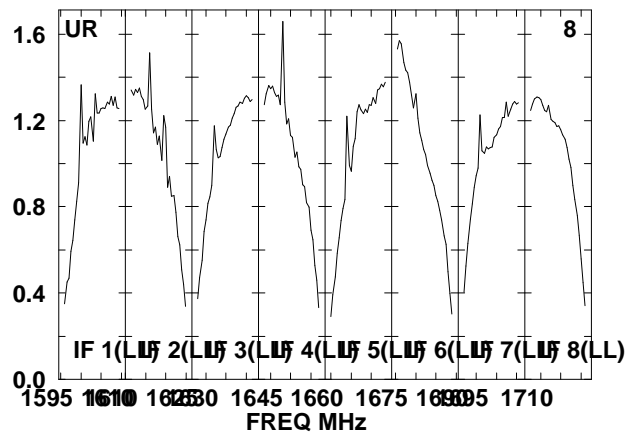
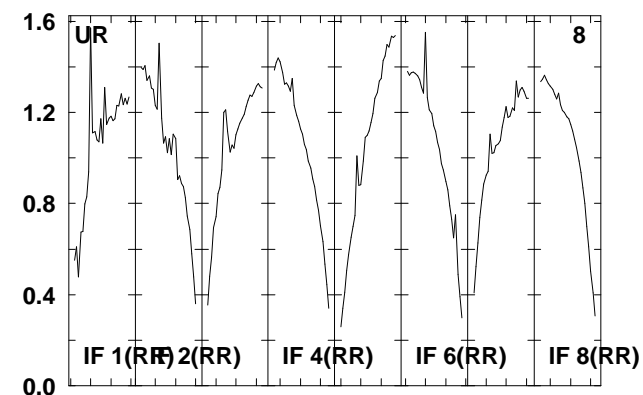
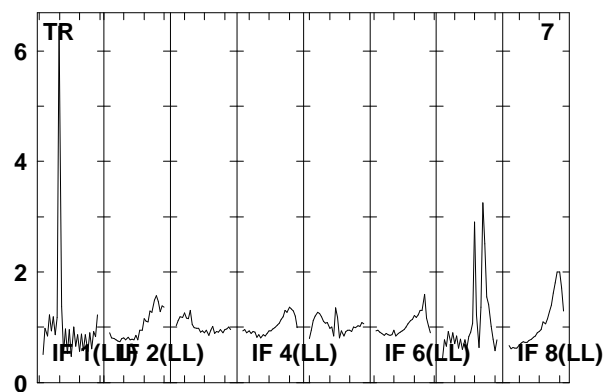
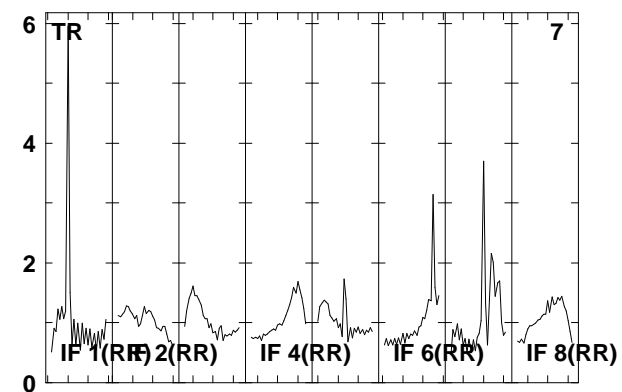
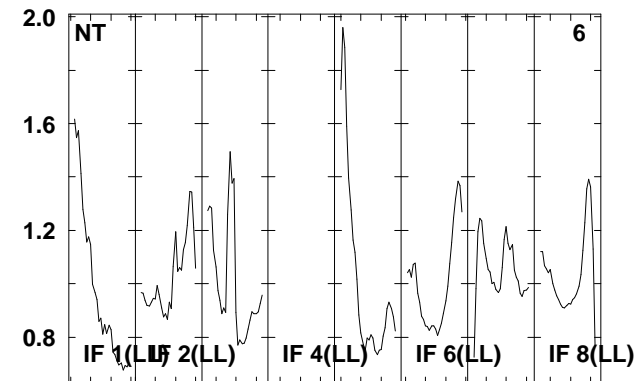
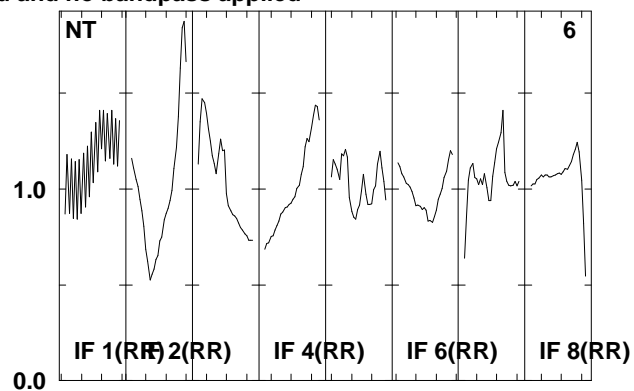
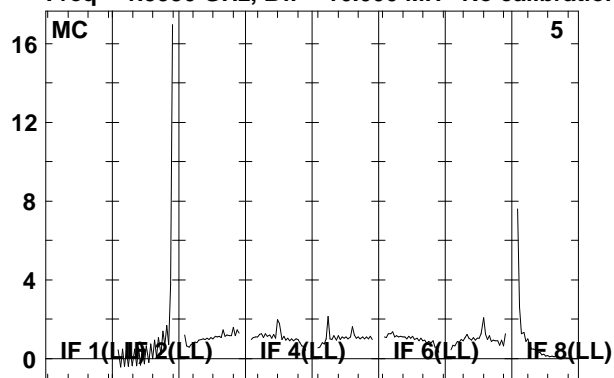

Lower frame: Real Jy

Total-power spectrum Antenna: \*

Timerange: 00/03:59:43 to 00/04:01:11

Plot file version 27 created 08-AUG-2008 16:58:27

J0209+13 EO06B.UVDATA.1

Freq = 1.5950 GHz, Bw = 16.000 MH No calibration applied and no bandpass applied

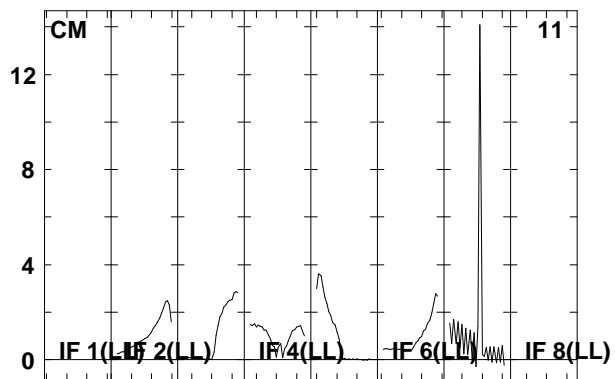
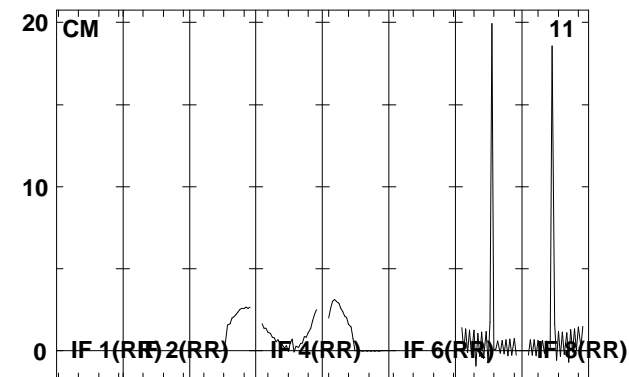
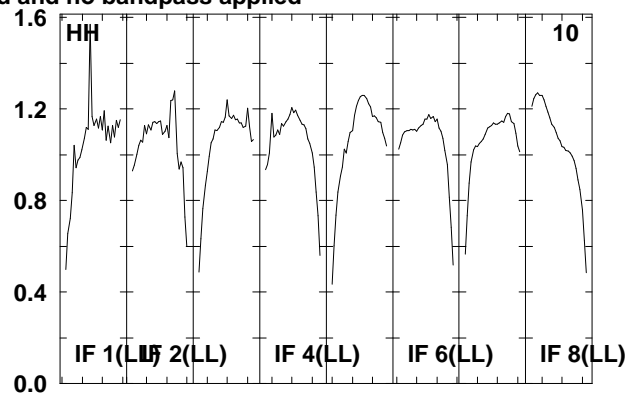
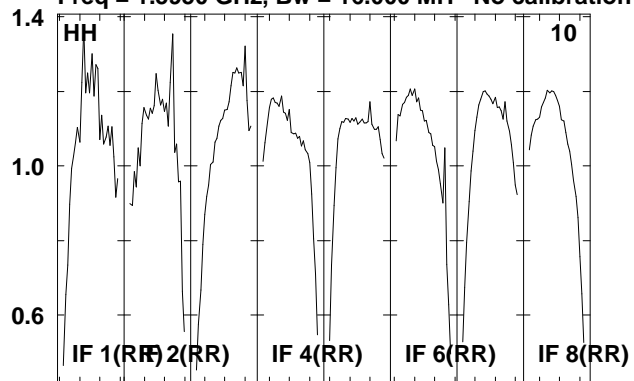

Lower frame: Real Jy  
Total-power spectrum Antenna: \*  
Timerange: 00/03:59:43 to 00/04:01:11

Plot file version 28 created 08-AUG-2008 16:58:27

J021348 EO006B.UVDATA.1

Freq = 1.5950 GHz, Bw = 16.000 MH No calibration applied and no bandpass applied

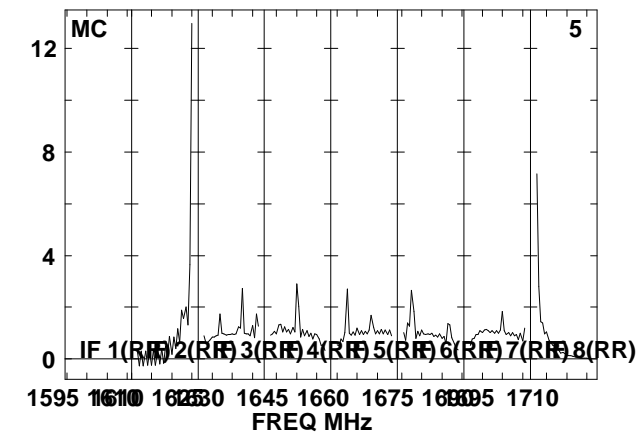
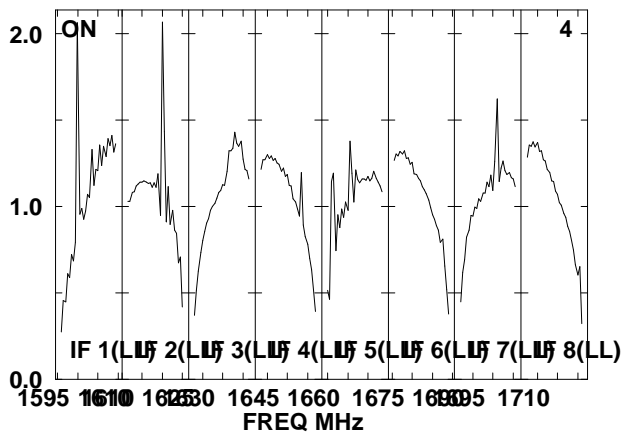
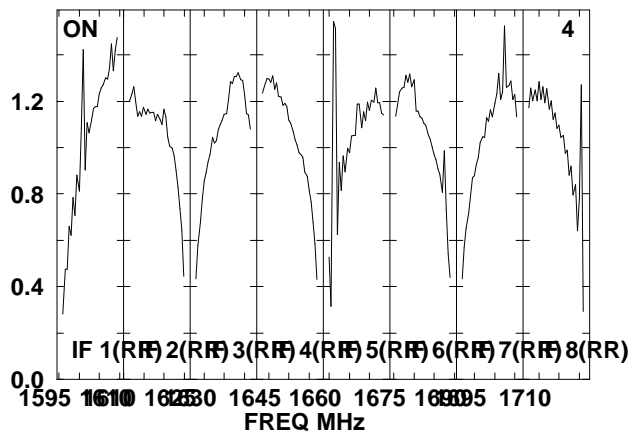
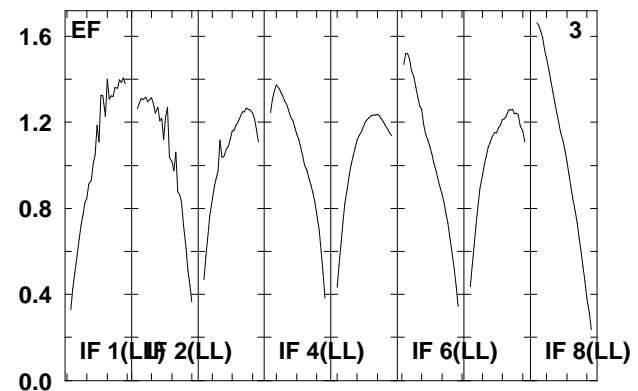
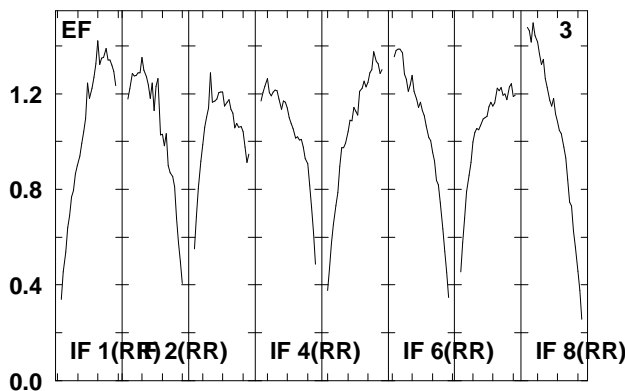
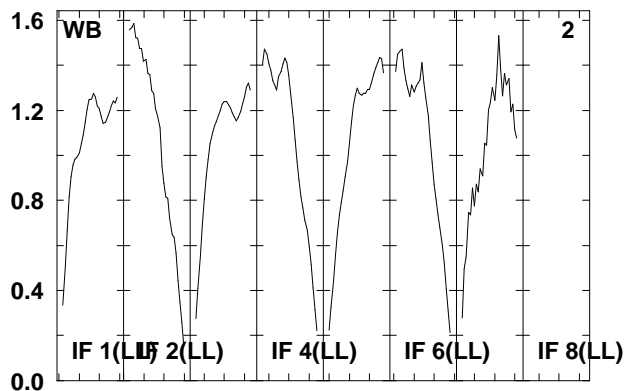
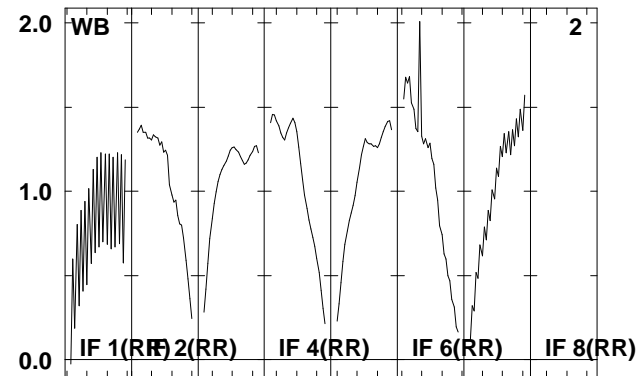
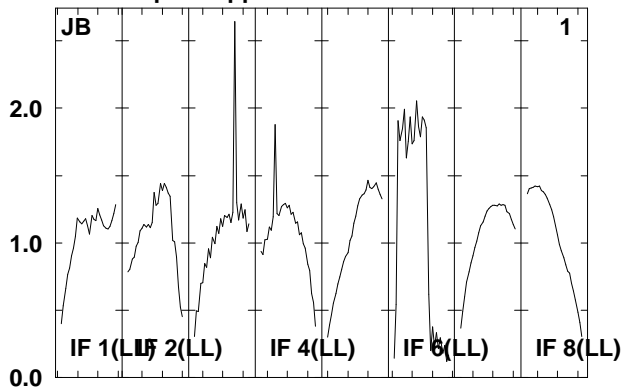
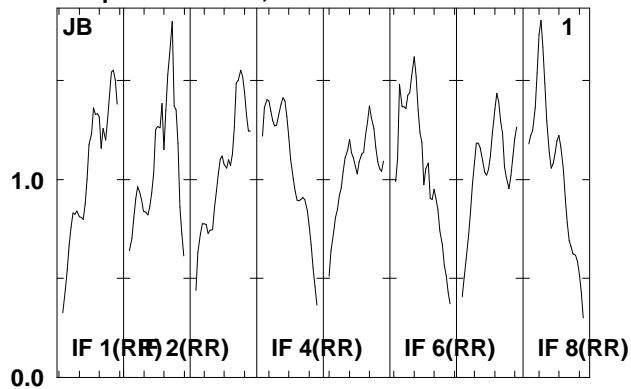

Lower frame: Real Jy  
Total-power spectrum Antenna: \*  
Timerange: 00/04:01:53 to 00/04:06:29



Plot file version 29 created 08-AUG-2008 16:58:28

J021348 EO006B.UVDATA.1

Freq = 1.5950 GHz, Bw = 16.000 MH No calibration applied and no bandpass applied

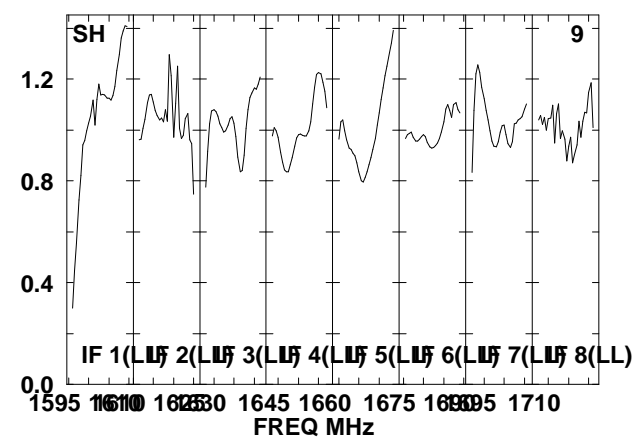
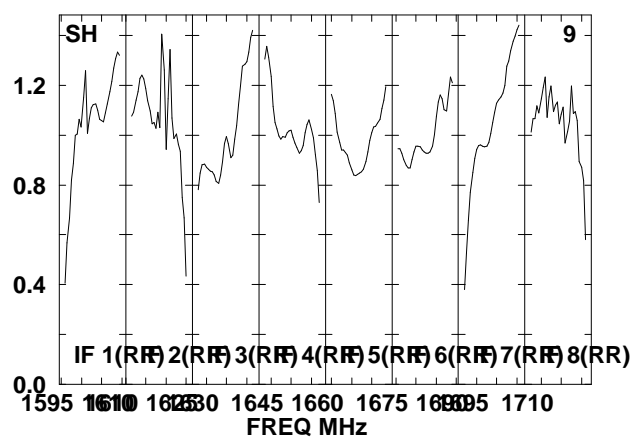
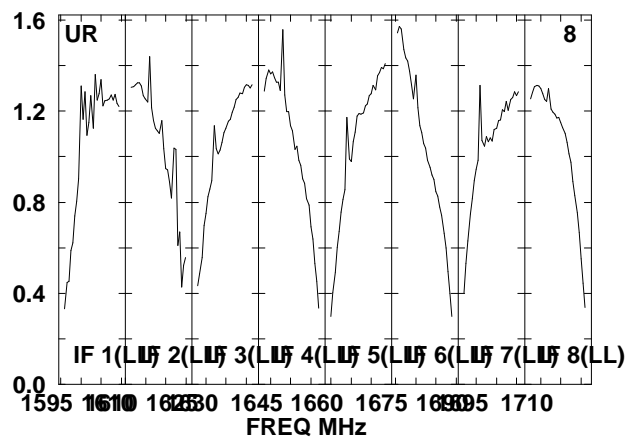
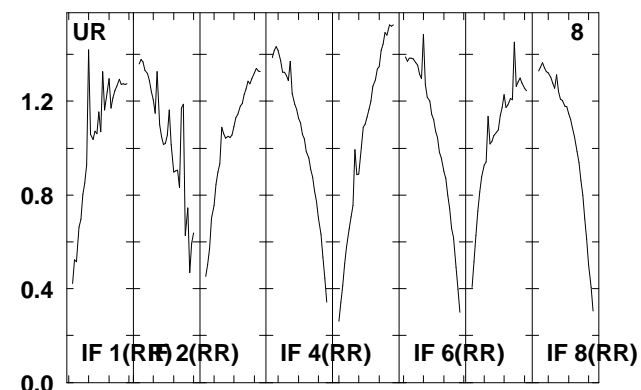
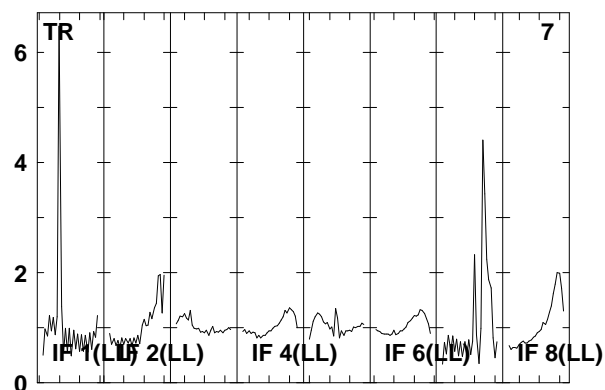
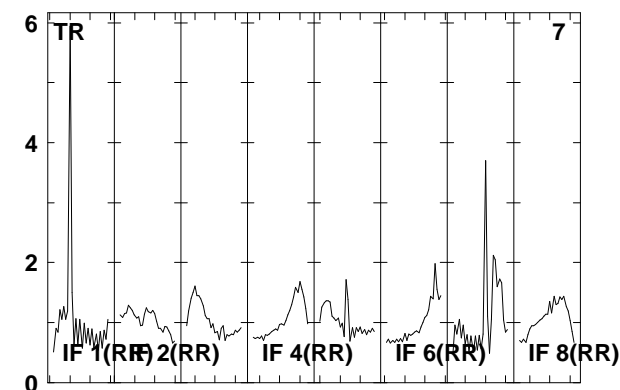
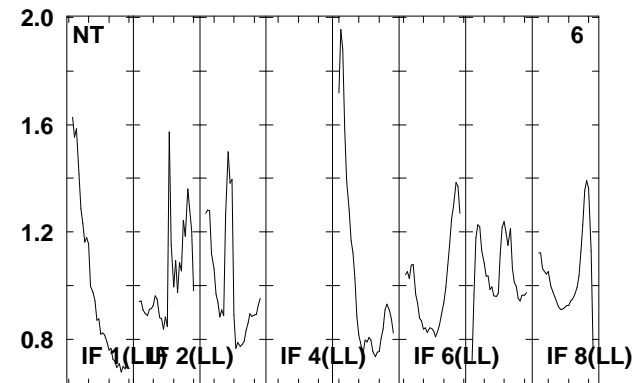
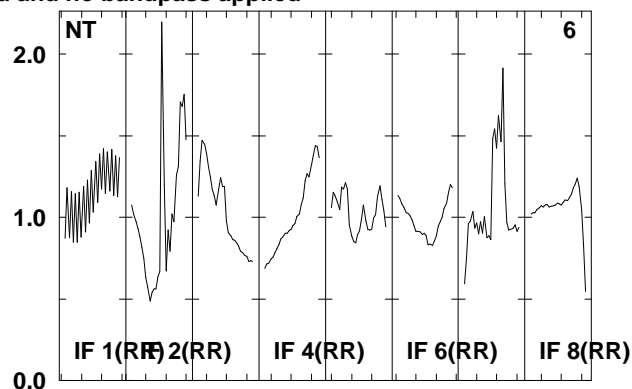
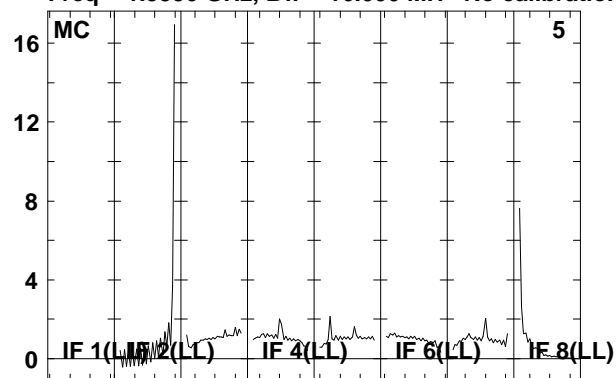

Lower frame: Real Jy

Total-power spectrum Antenna: \*

Timerange: 00/04:01:53 to 00/04:06:29

Plot file version 30 created 08-AUG-2008 16:58:28

J021348 EO006B.UVDATA.1

Freq = 1.5950 GHz, Bw = 16.000 MH No calibration applied and no bandpass applied

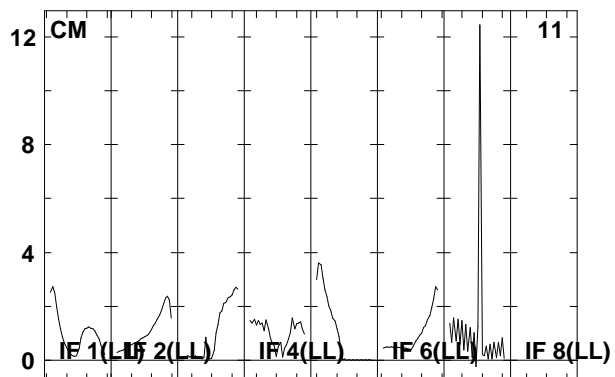
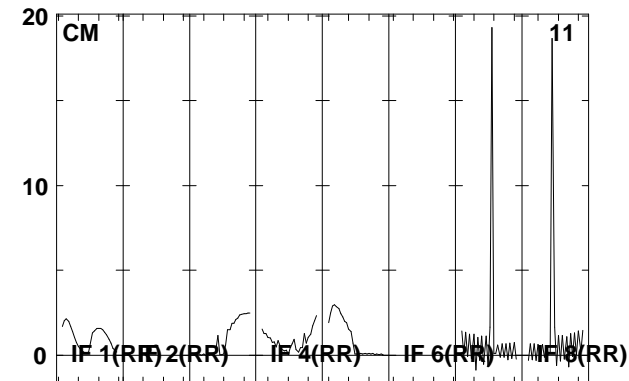
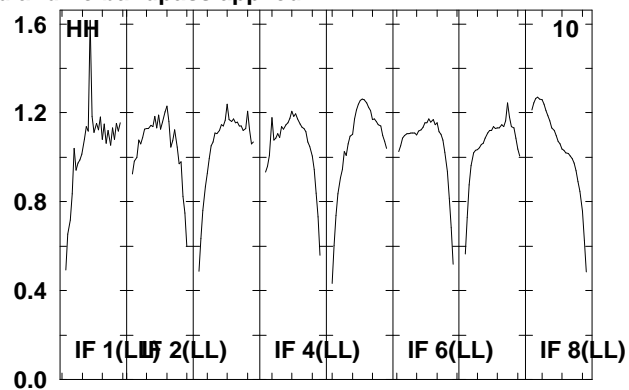
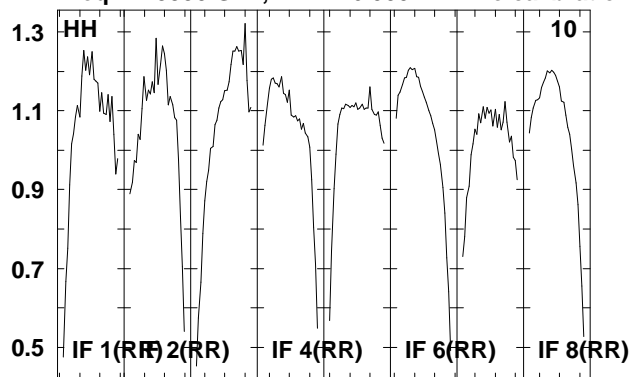

Lower frame: Real Jy  
Total-power spectrum Antenna: \*  
Timerange: 00/04:01:53 to 00/04:06:29

Plot file version 31 created 08-AUG-2008 16:58:29

J0209+13 EO006B.UVDATA.1

Freq = 1.5950 GHz, Bw = 16.000 MH No calibration applied and no bandpass applied

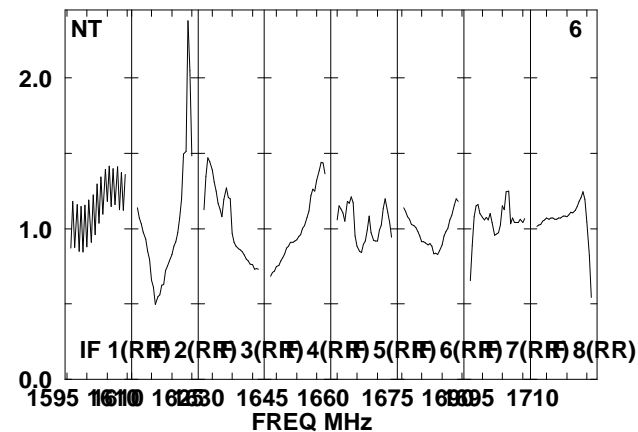
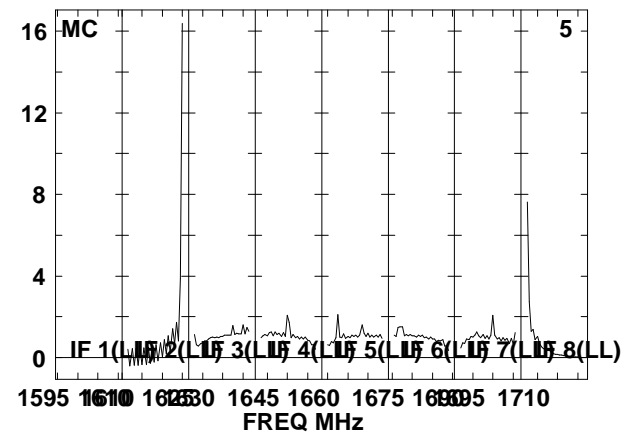
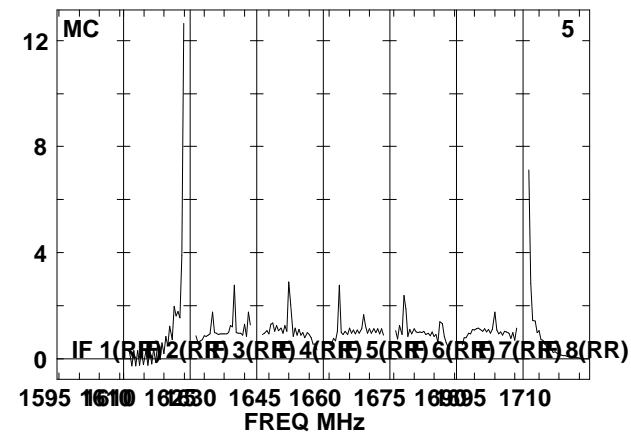
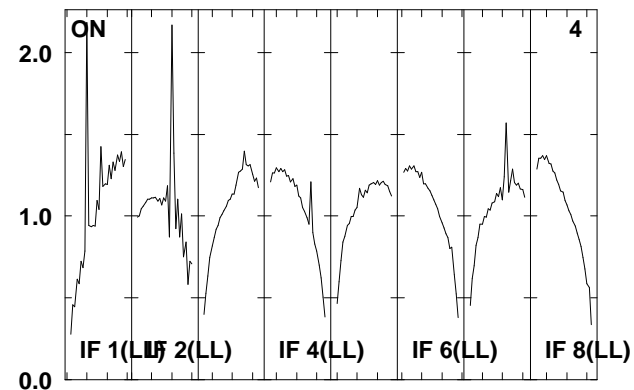
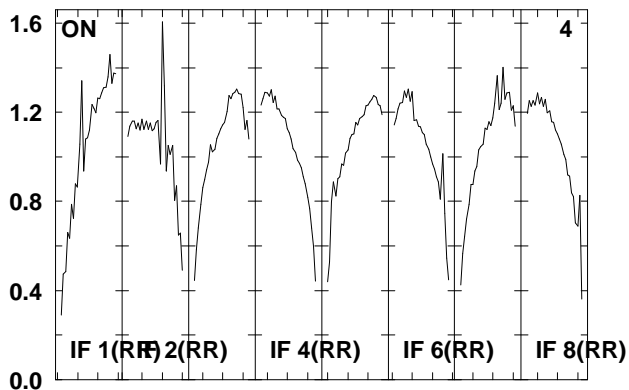
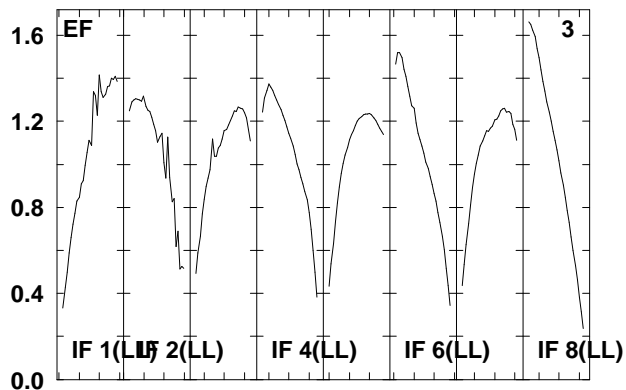
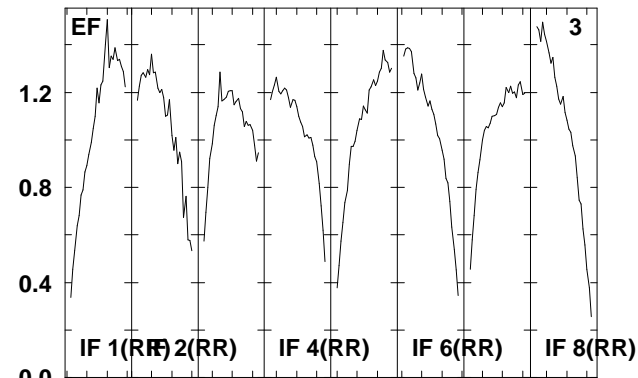
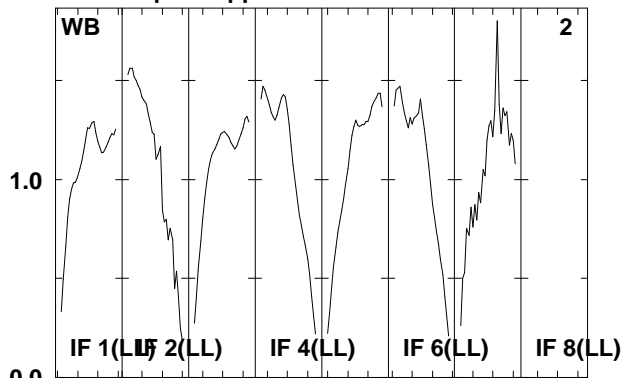
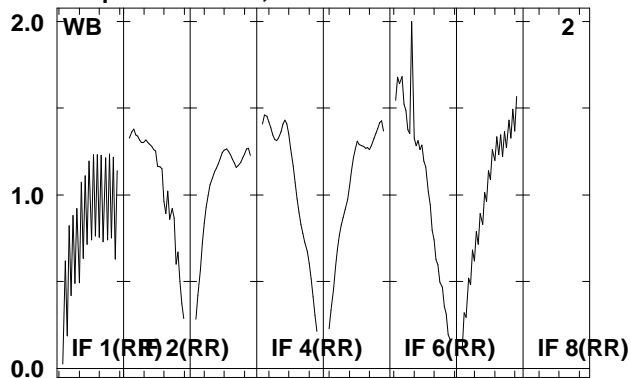

Lower frame: Real Jy  
Total-power spectrum Antenna: \*  
Timerange: 00/04:07:05 to 00/04:08:37

Plot file version 32 created 08-AUG-2008 16:58:29

J0209+13 EO06B.UVDATA.1

Freq = 1.5950 GHz, Bw = 16.000 MH No calibration applied and no bandpass applied

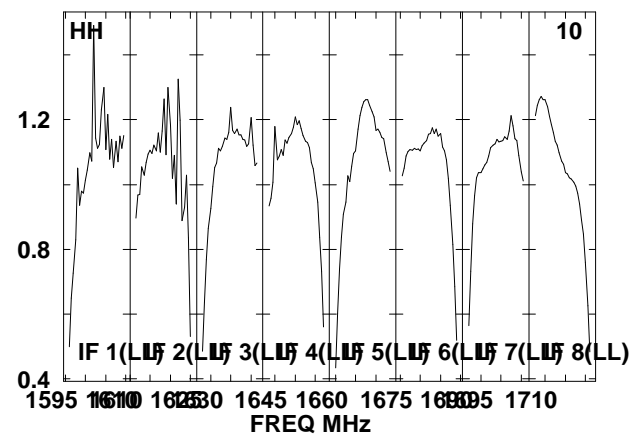
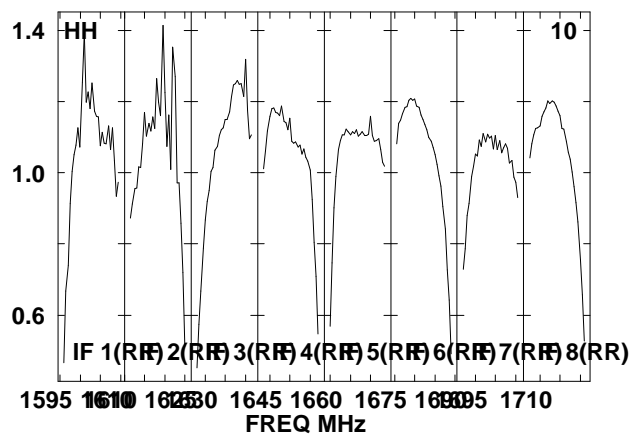
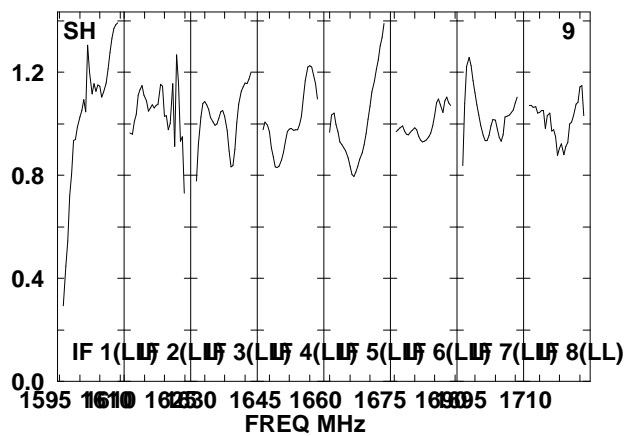
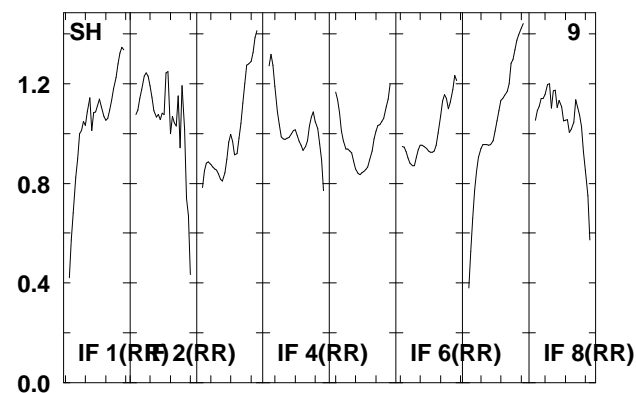
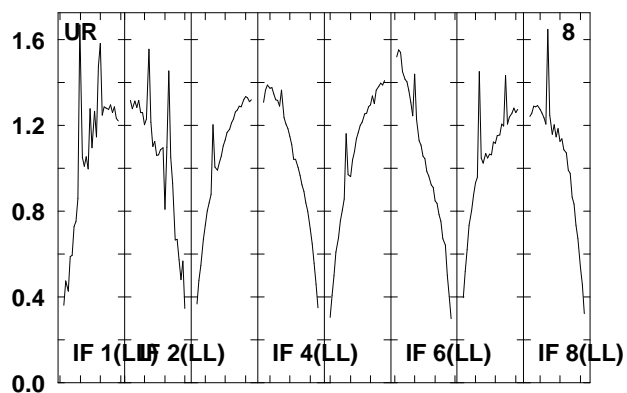
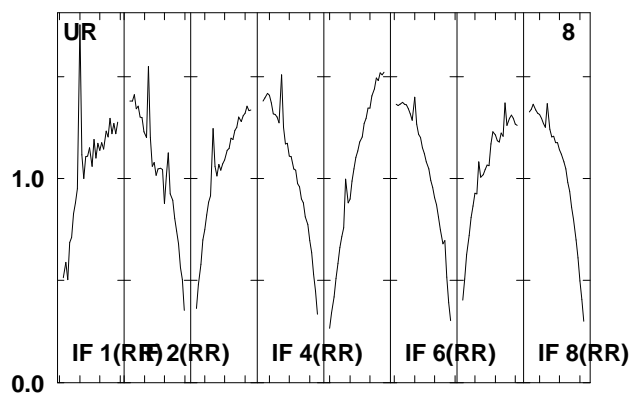
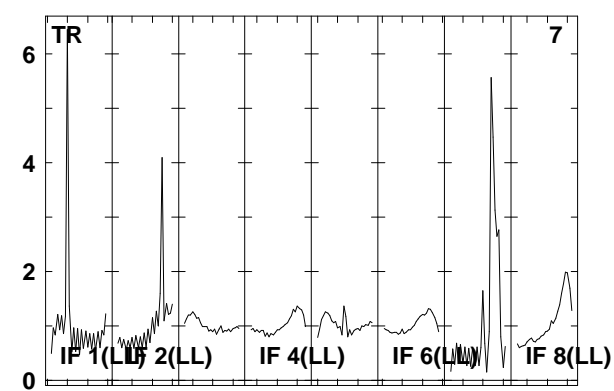
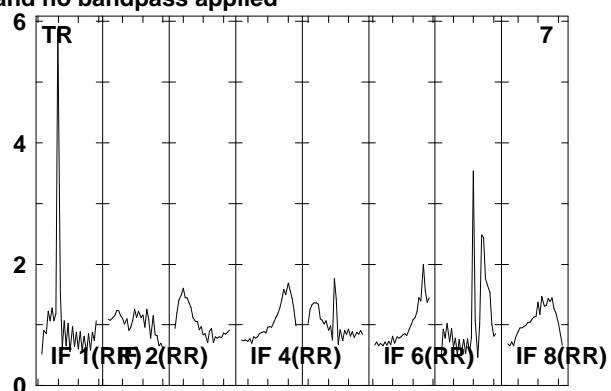
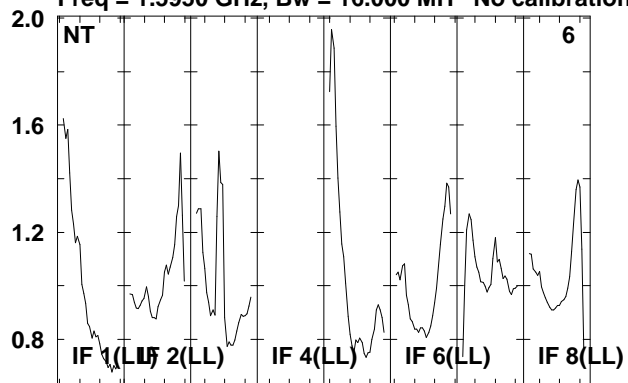

Lower frame: Real Jy  
Total-power spectrum Antenna: \*  
Timerange: 00/04:07:05 to 00/04:08:37

Plot file version 33 created 08-AUG-2008 16:58:30

J0209+13 EO006B.UVDATA.1

Freq = 1.5950 GHz, Bw = 16.000 MH No calibration applied and no bandpass applied

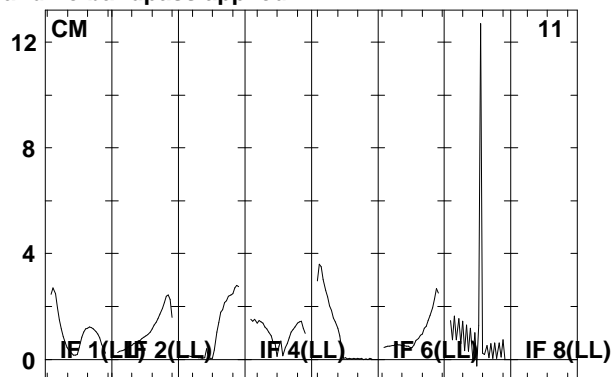
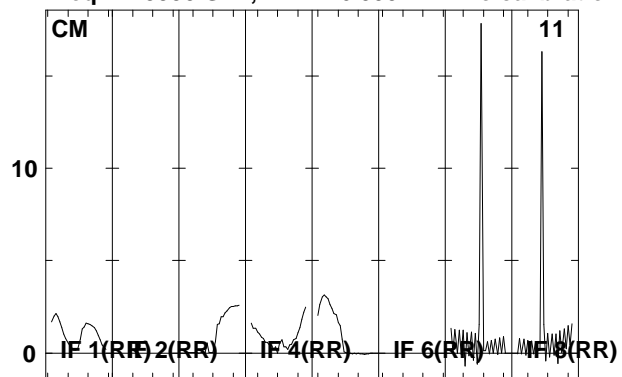

Lower frame: Real Jy  
Total-power spectrum Antenna: \*  
Timerange: 00/04:07:05 to 00/04:08:37

Plot file version 34 created 08-AUG-2008 16:58:30

J021348 EO006B.UVDATA.1

Freq = 1.5950 GHz, Bw = 16.000 MH No calibration applied and no bandpass applied

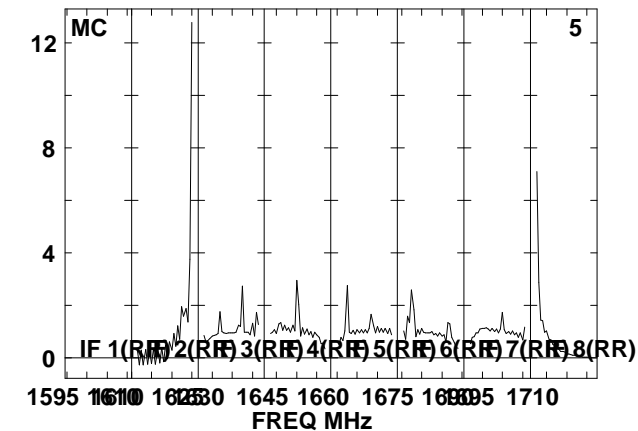
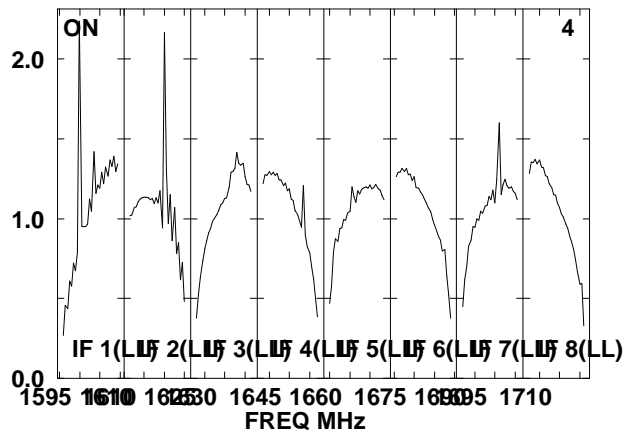
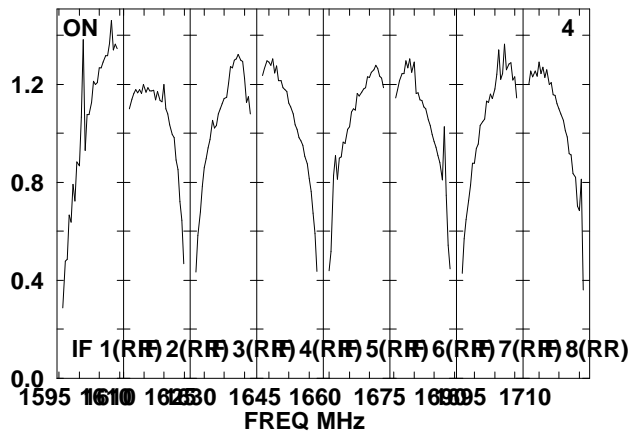
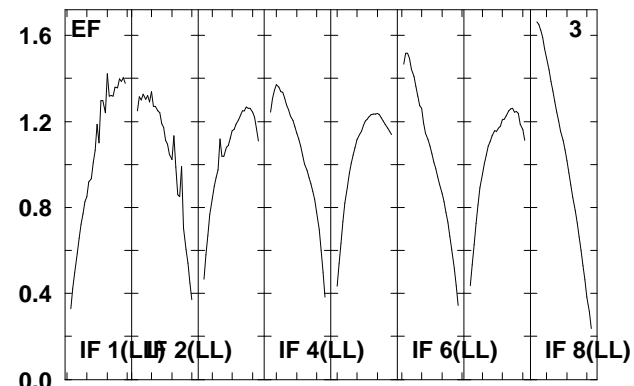
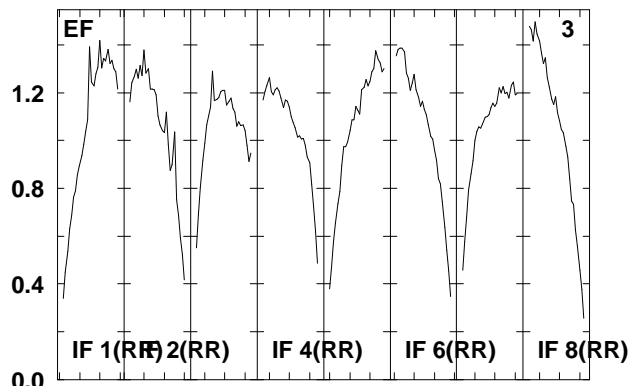
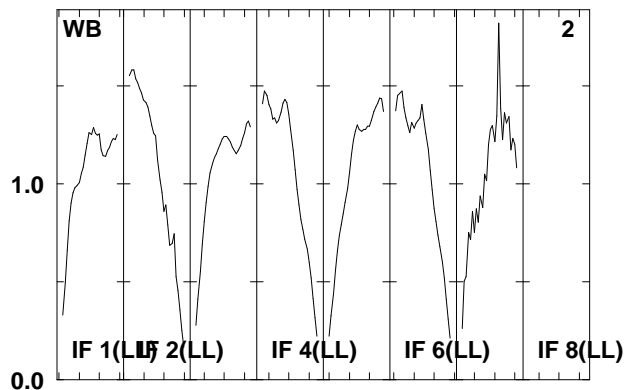
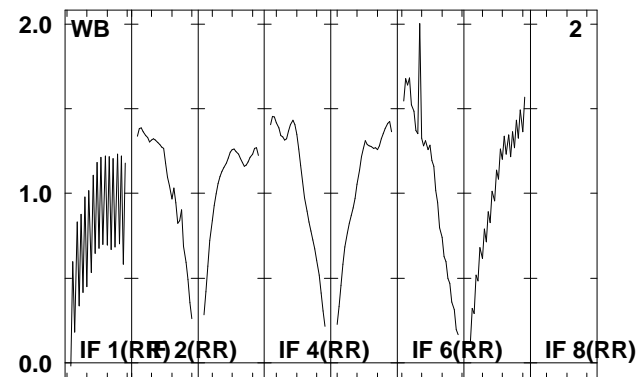
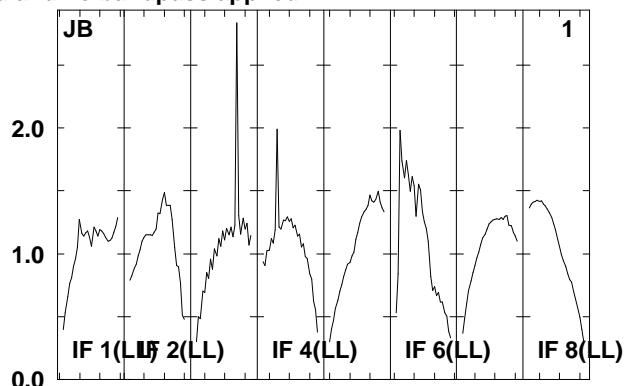
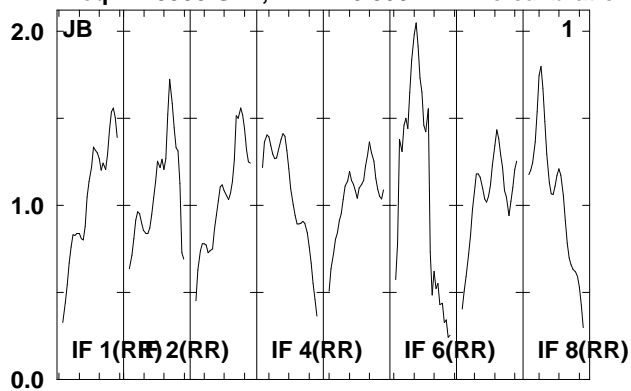

Lower frame: Real Jy  
Total-power spectrum Antenna: \*  
Timerange: 00/04:09:13 to 00/04:13:49

Plot file version 35 created 08-AUG-2008 16:58:31

J021348 EO06B.UVDATA.1

Freq = 1.5950 GHz, Bw = 16.000 MH No calibration applied and no bandpass applied

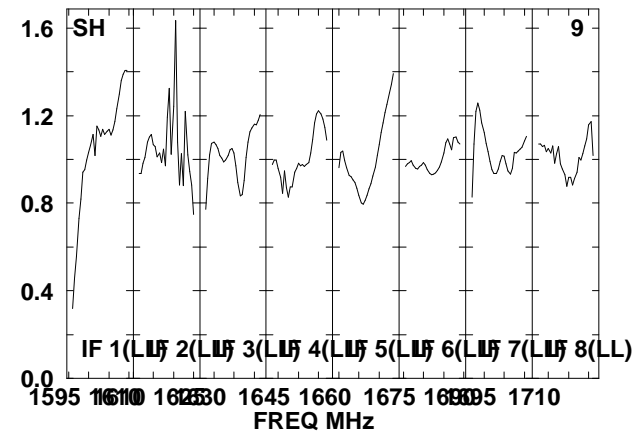
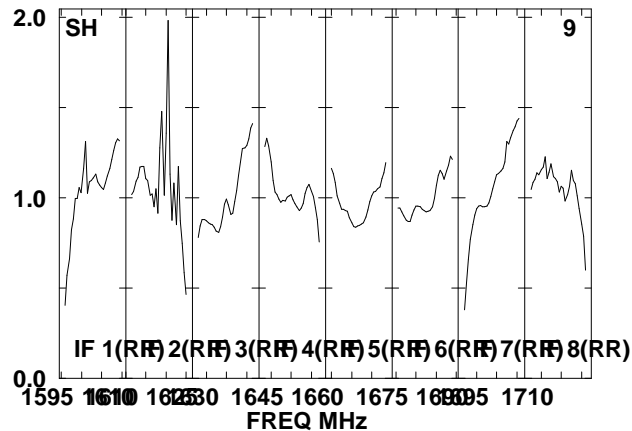
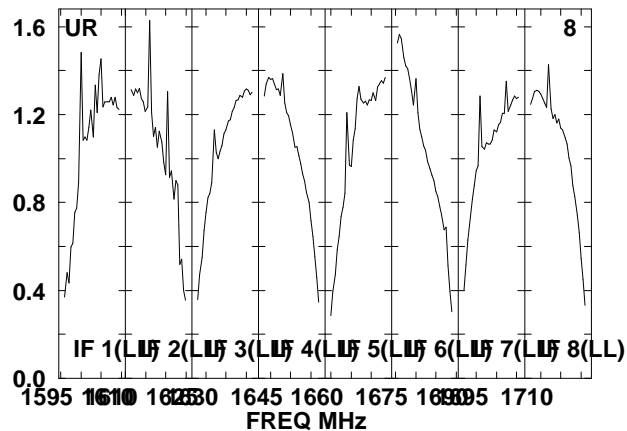
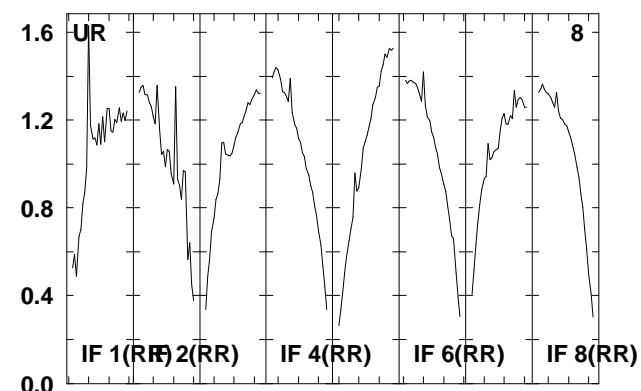
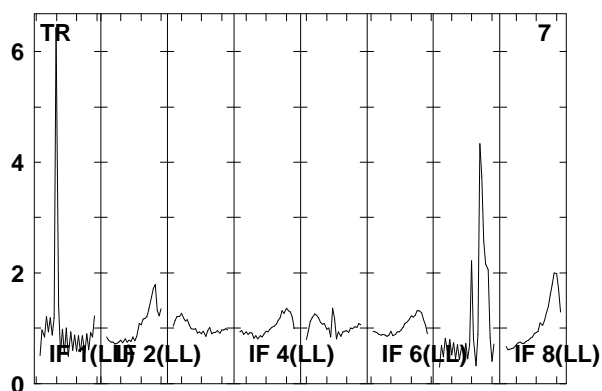
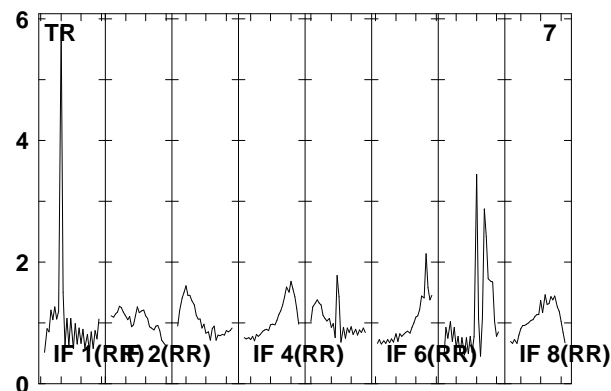
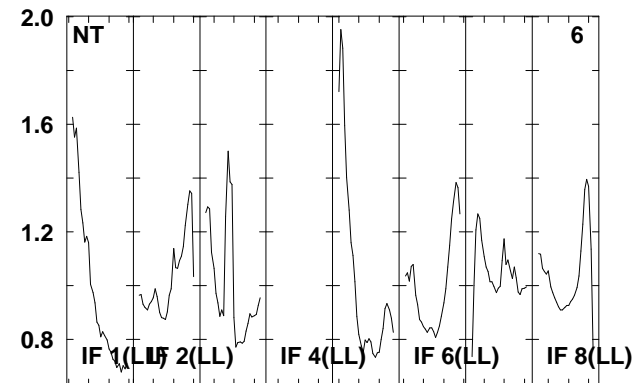
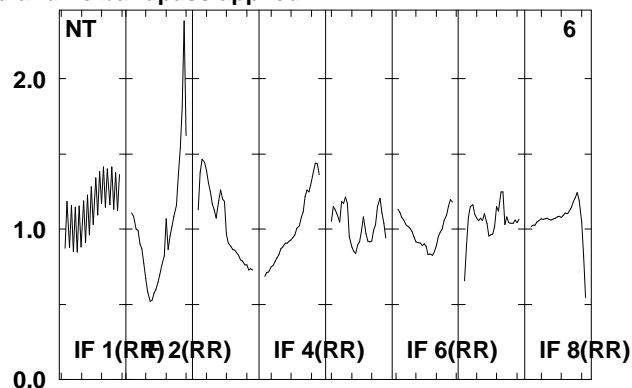
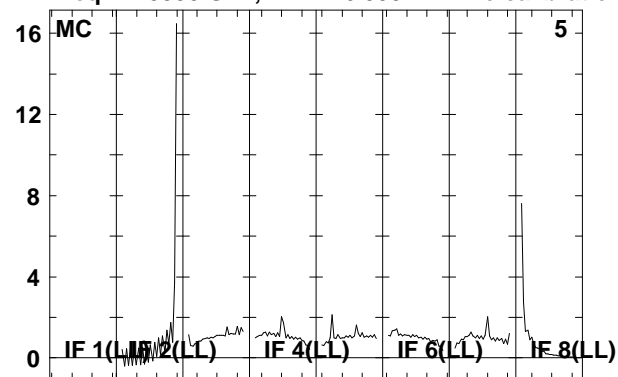

Lower frame: Real Jy

Total-power spectrum Antenna: \*

Timerange: 00/04:09:13 to 00/04:13:49

Plot file version 36 created 08-AUG-2008 16:58:32

J021348 EO006B.UVDATA.1

Freq = 1.5950 GHz, Bw = 16.000 MH No calibration applied and no bandpass applied

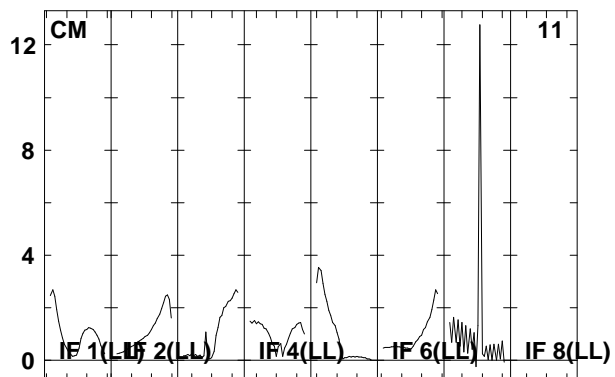
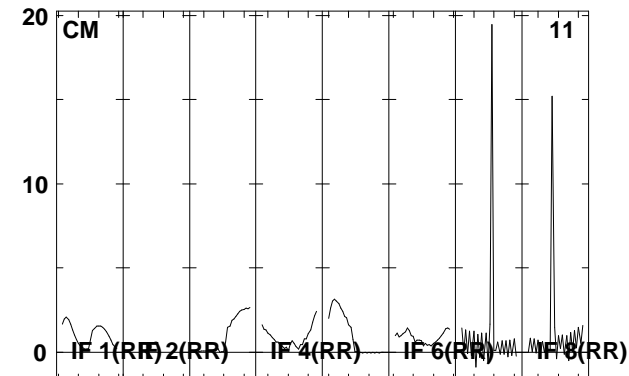
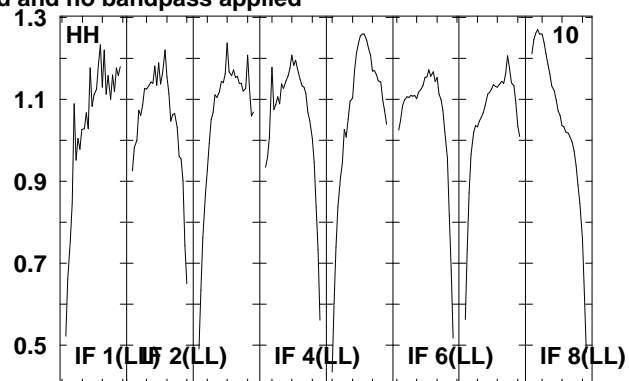
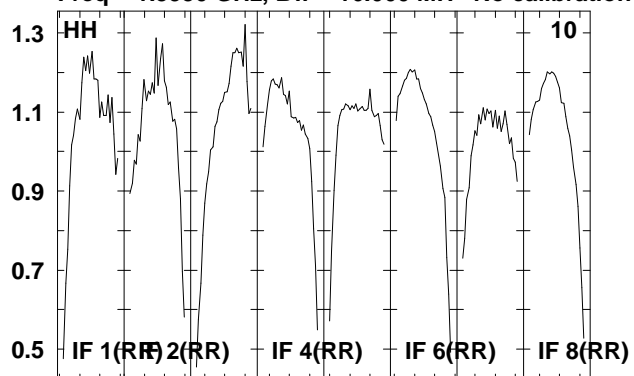

Lower frame: Real Jy  
Total-power spectrum Antenna: \*  
Timerange: 00/04:09:13 to 00/04:13:49



Plot file version 37 created 08-AUG-2008 16:58:32

J0209+13 EO006B.UVDATA.1

Freq = 1.5950 GHz, Bw = 16.000 MH No calibration applied and no bandpass applied

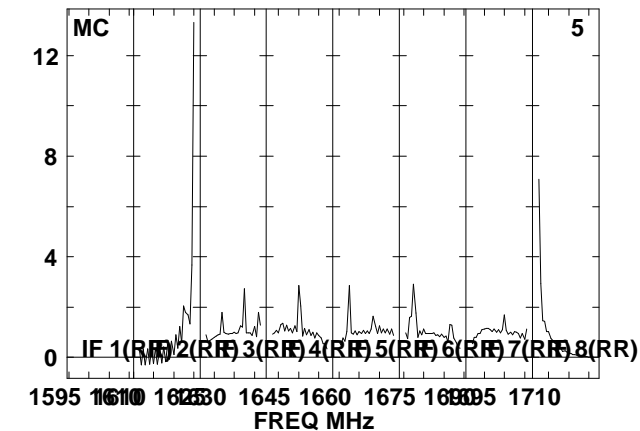
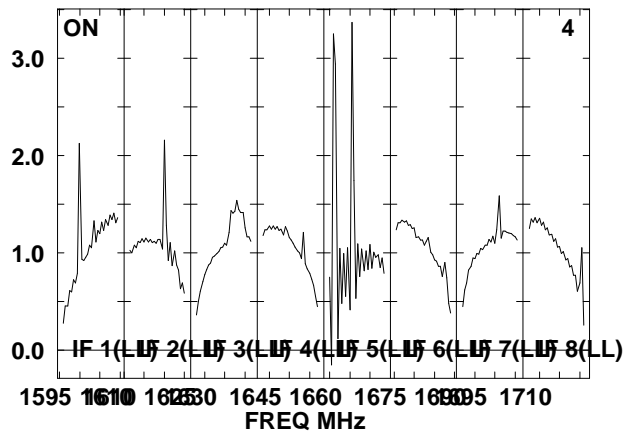
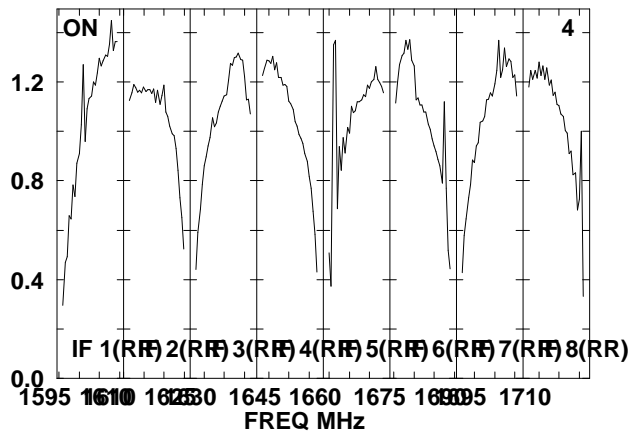
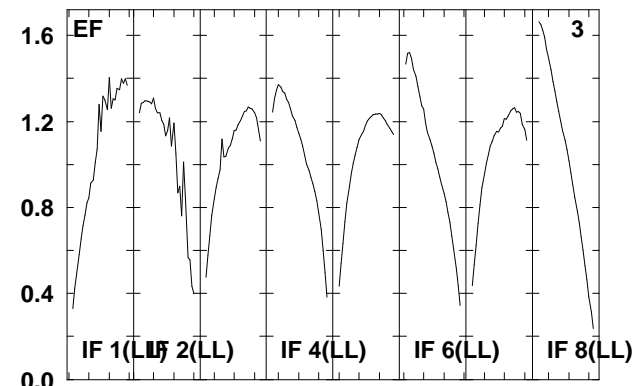
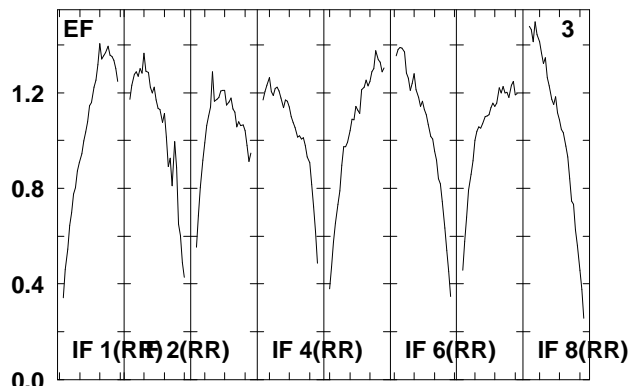
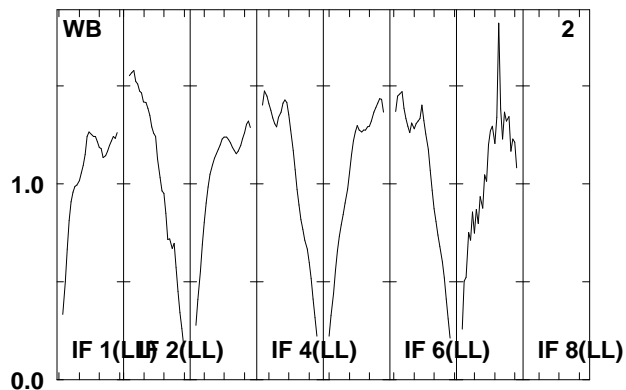
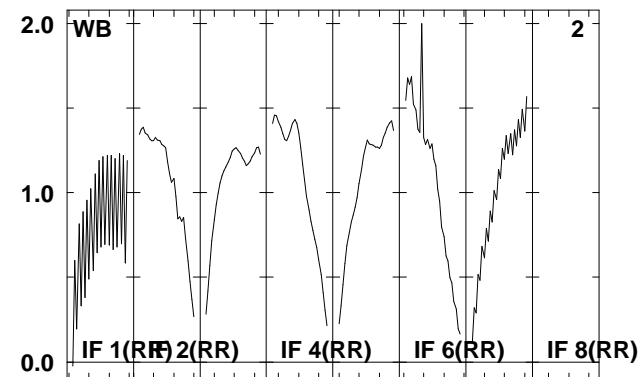
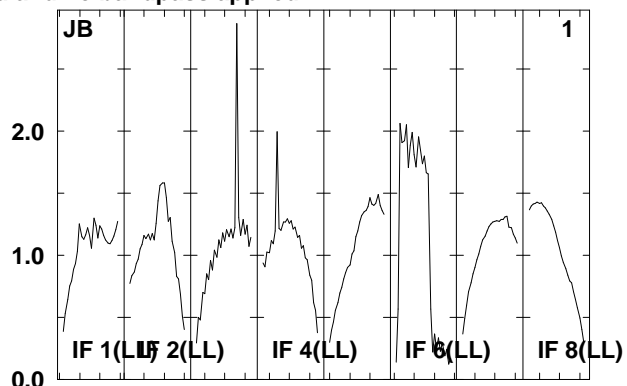
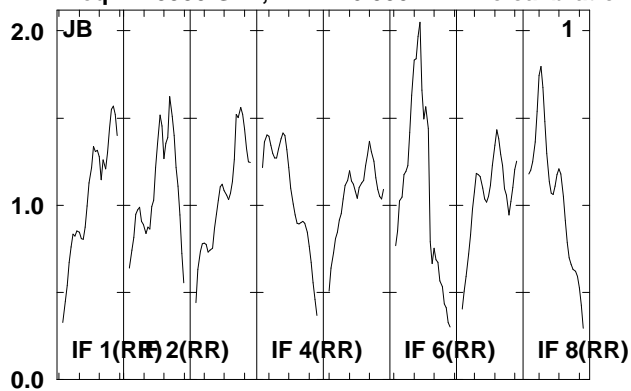

Lower frame: Real Jy  
Total-power spectrum Antenna: \*  
Timerange: 00/04:14:21 to 00/04:15:57

Plot file version 38 created 08-AUG-2008 16:58:33

J0209+13 EO006B.UVDATA.1

Freq = 1.5950 GHz, Bw = 16.000 MH No calibration applied and no bandpass applied

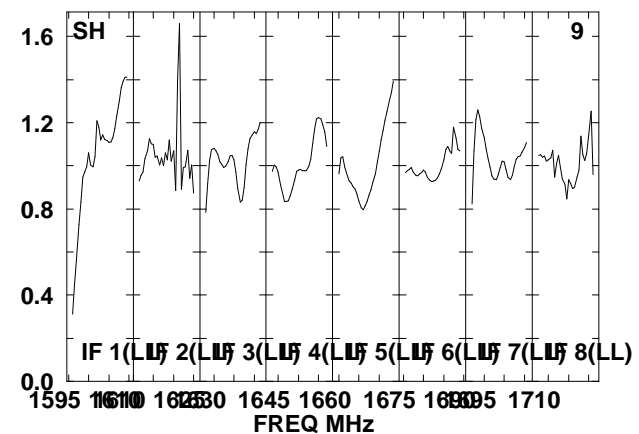
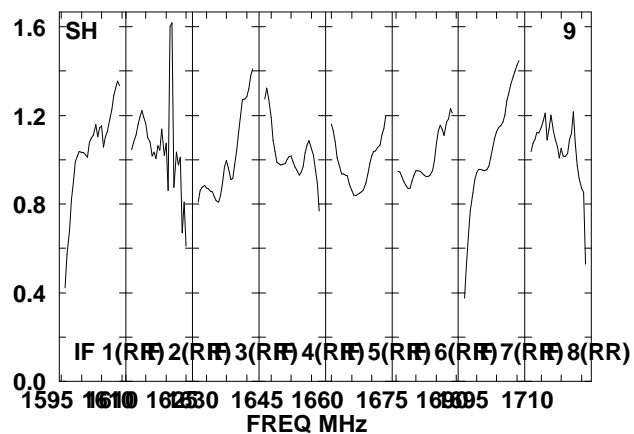
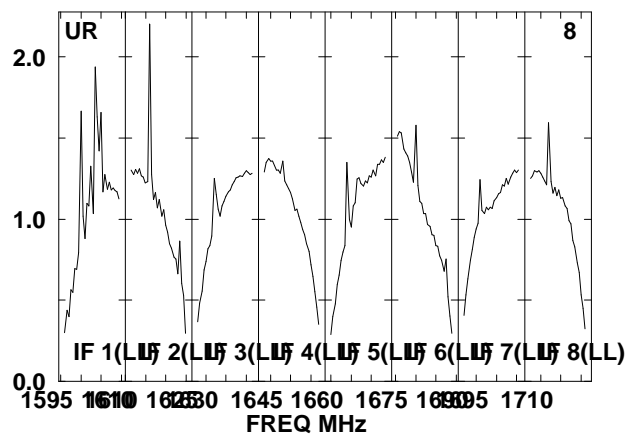
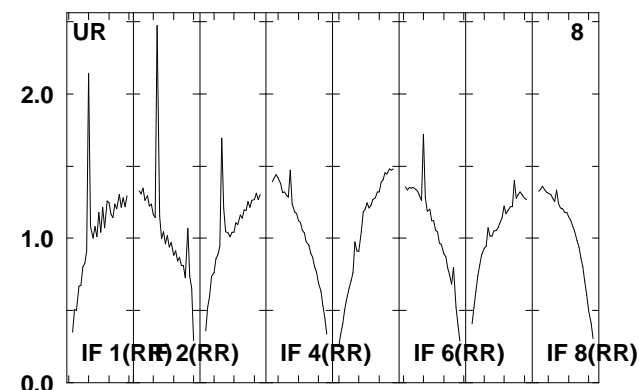
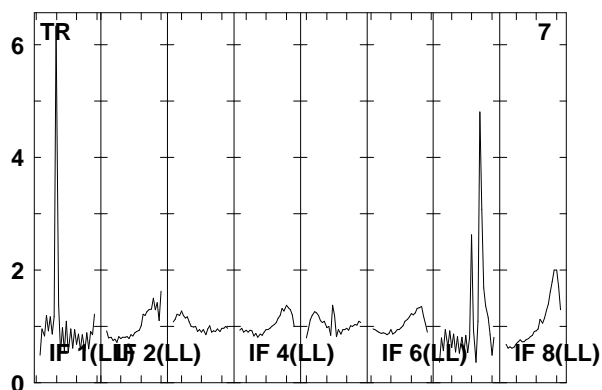
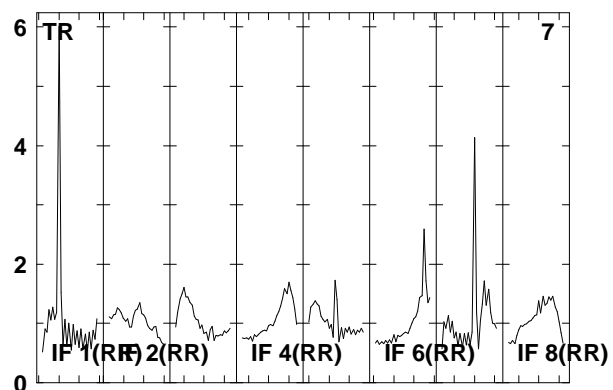
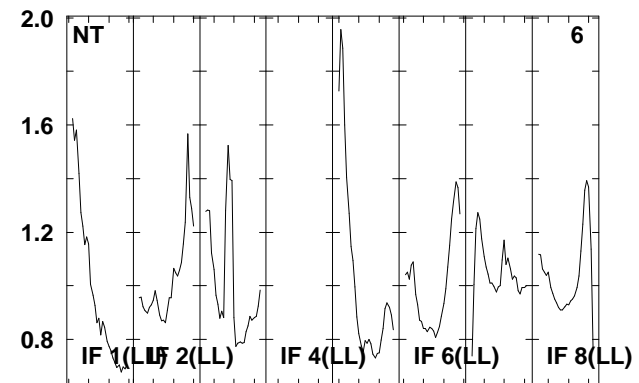
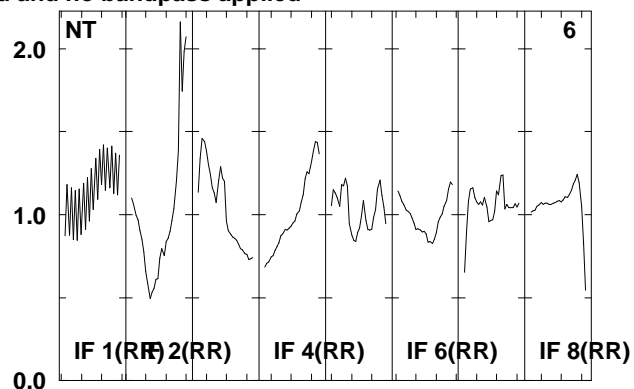
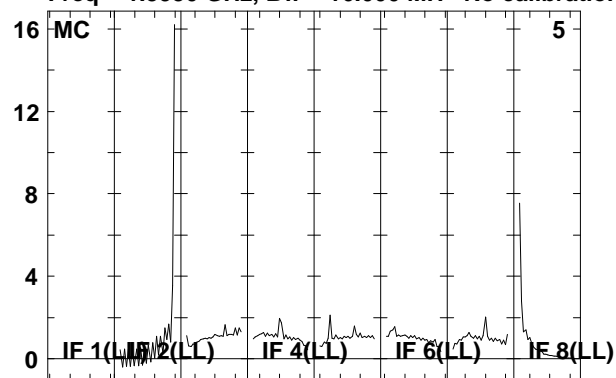

Lower frame: Real Jy

Total-power spectrum Antenna: \*

Timerange: 00/04:14:21 to 00/04:15:57

Plot file version 39 created 08-AUG-2008 16:58:33

J0209+13 EO06B.UVDATA.1

Freq = 1.5950 GHz, Bw = 16.000 MH No calibration applied and no bandpass applied

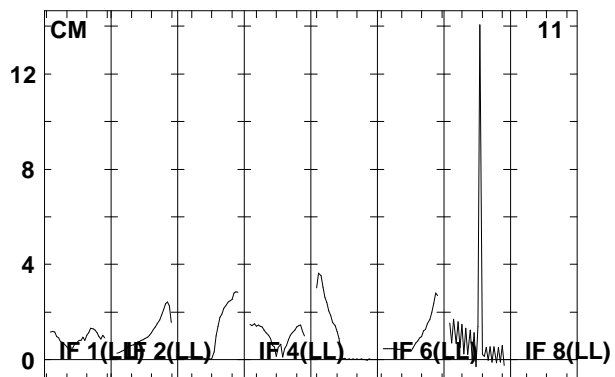
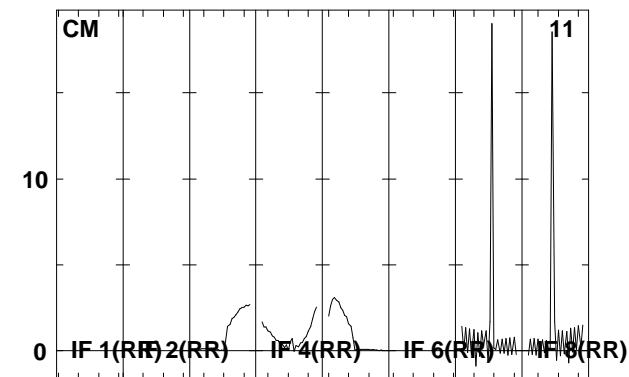
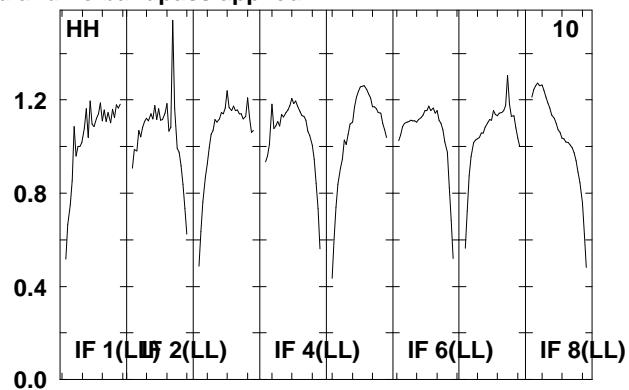
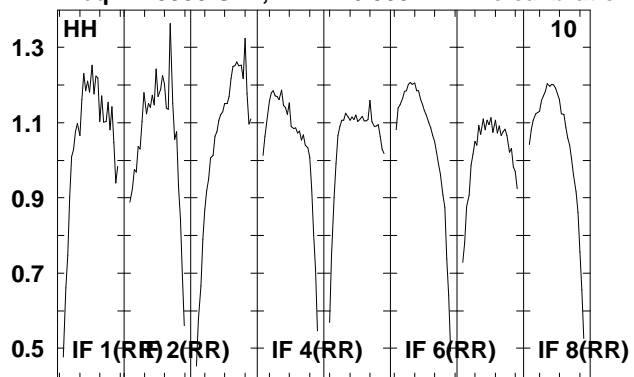

Lower frame: Real Jy  
Total-power spectrum Antenna: \*  
Timerange: 00/04:14:21 to 00/04:15:57

Plot file version 40 created 08-AUG-2008 16:58:34

J021348 EO006B.UVDATA.1

Freq = 1.5950 GHz, Bw = 16.000 MH No calibration applied and no bandpass applied

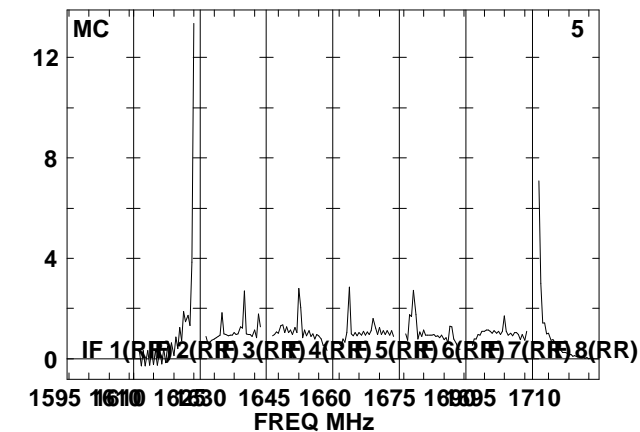
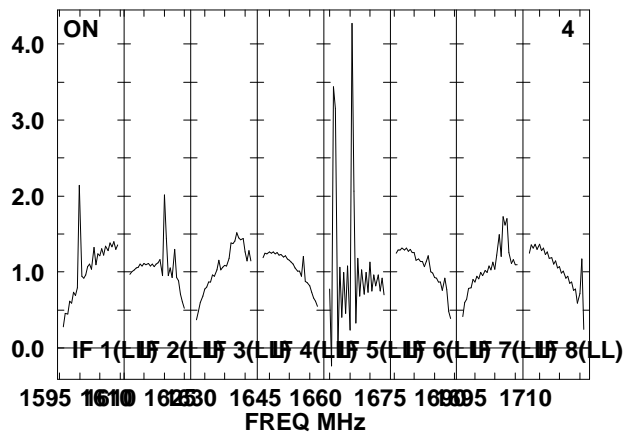
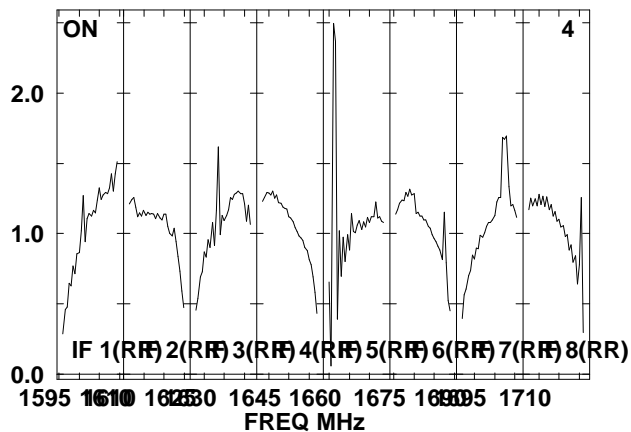
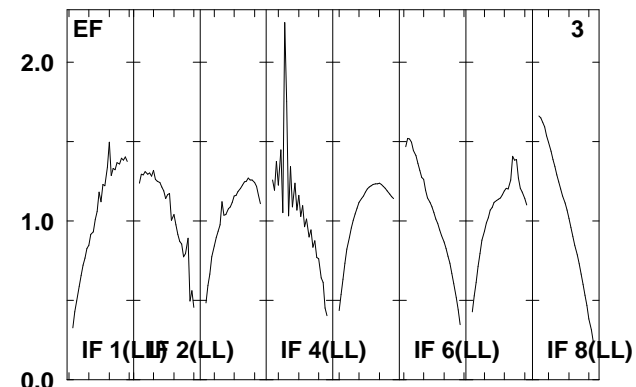
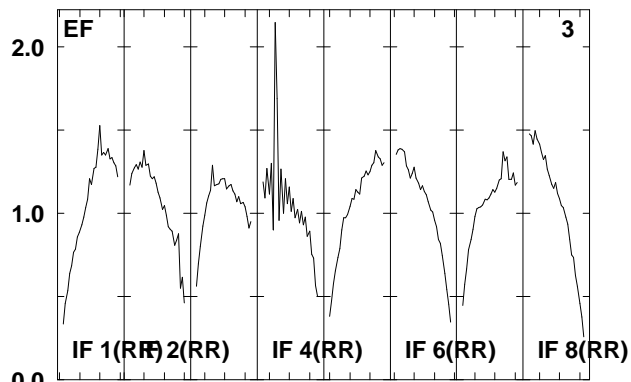
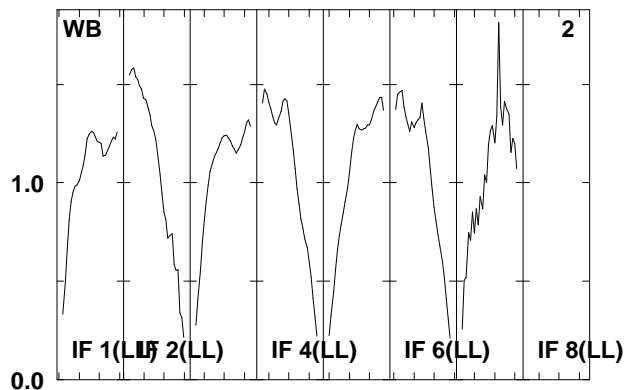
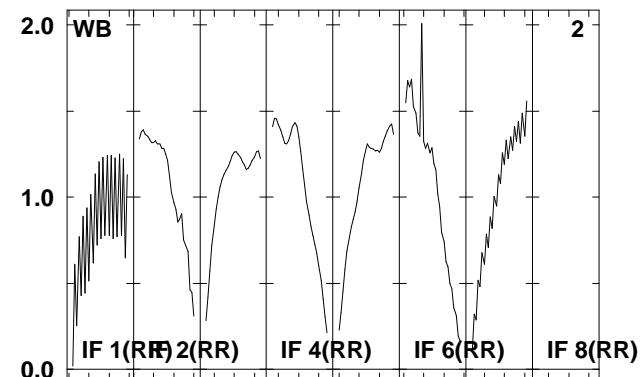
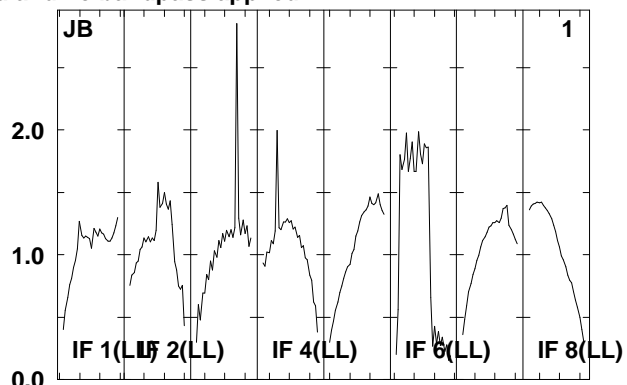
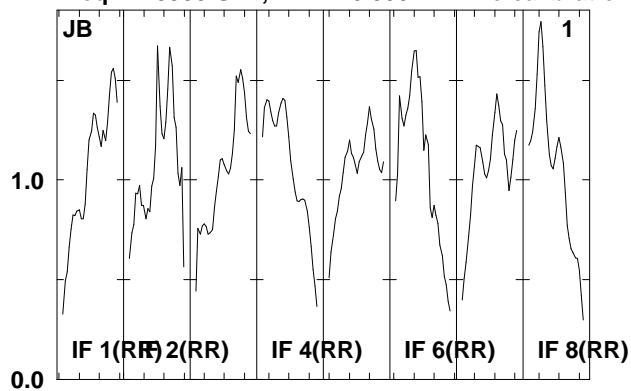

Lower frame: Real Jy  
Total-power spectrum Antenna: \*  
Timerange: 00/04:16:33 to 00/04:21:09

Plot file version 41 created 08-AUG-2008 16:58:34

J021348 EO06B.UVDATA.1

Freq = 1.5950 GHz, Bw = 16.000 MH No calibration applied and no bandpass applied

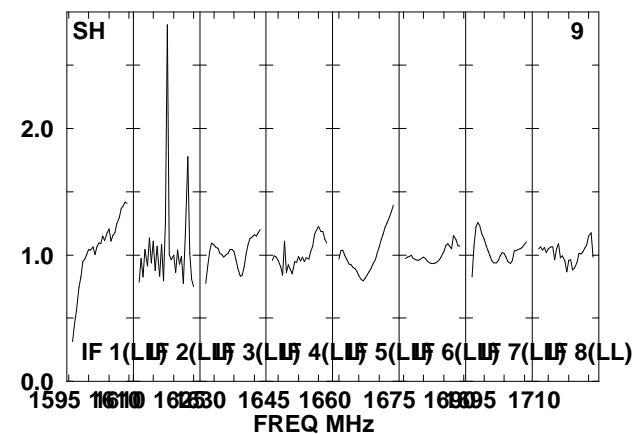
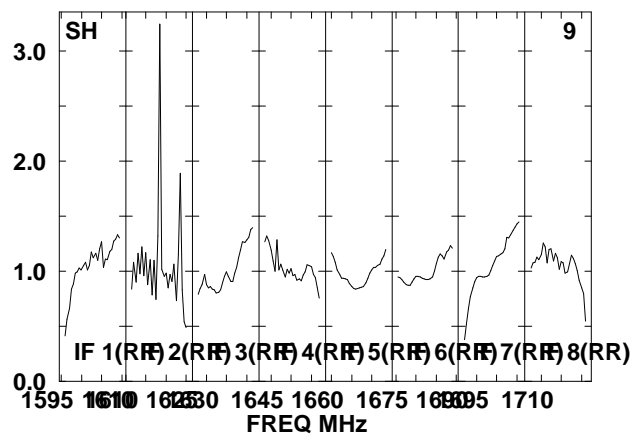
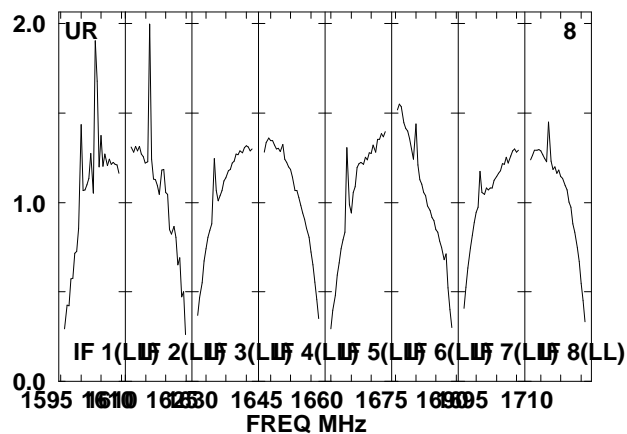
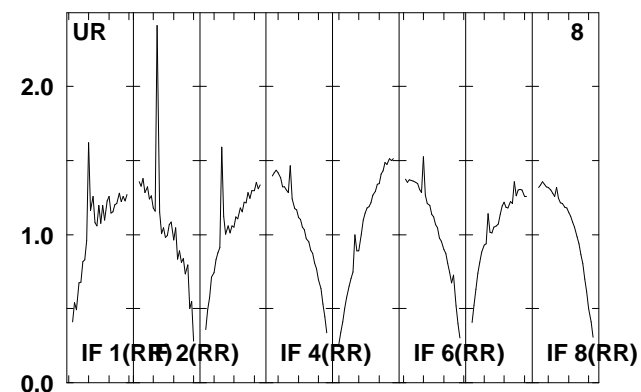
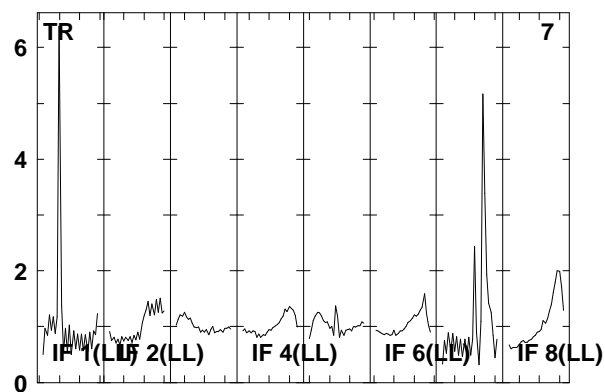
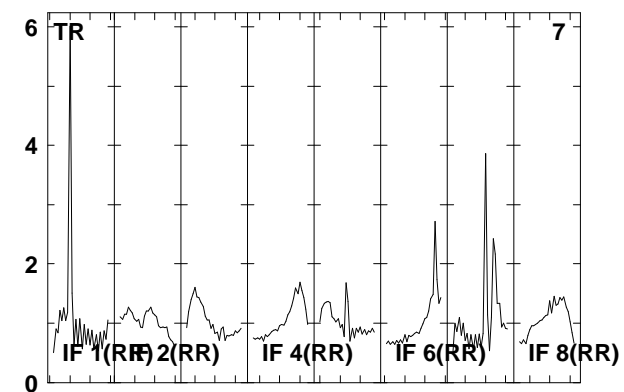
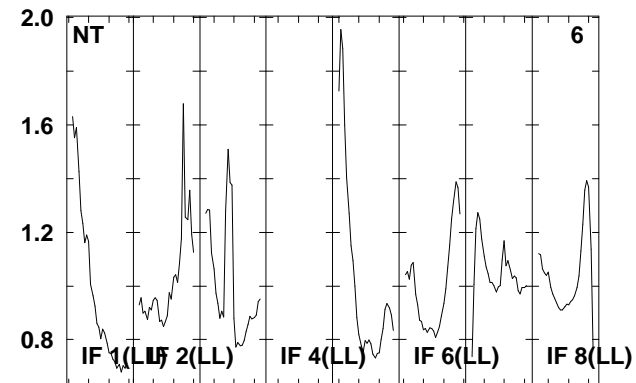
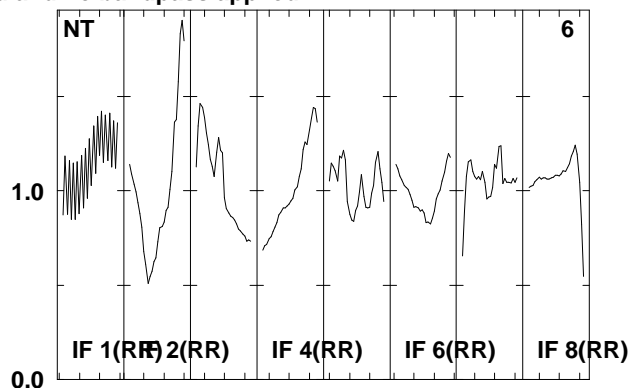
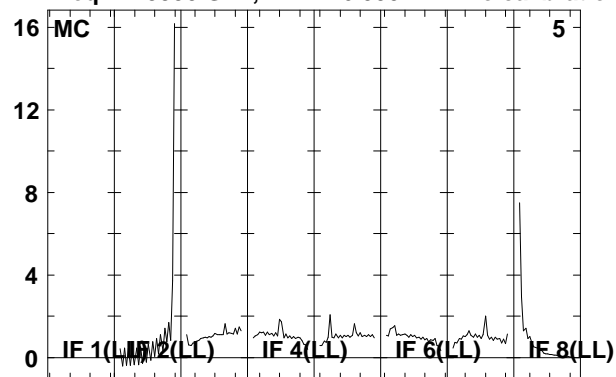

Lower frame: Real Jy

Total-power spectrum Antenna: \*

Timerange: 00/04:16:33 to 00/04:21:09

Plot file version 42 created 08-AUG-2008 16:58:35

J021348 EO006B.UVDATA.1

Freq = 1.5950 GHz, Bw = 16.000 MH No calibration applied and no bandpass applied

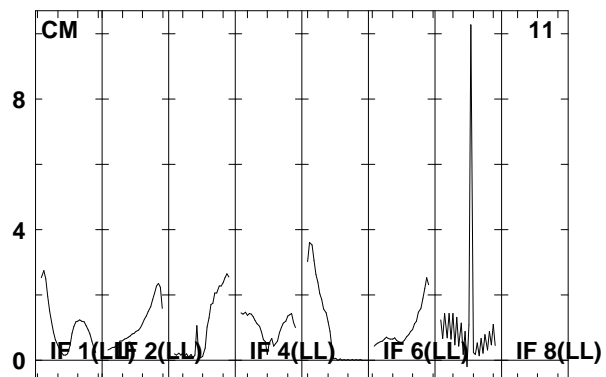
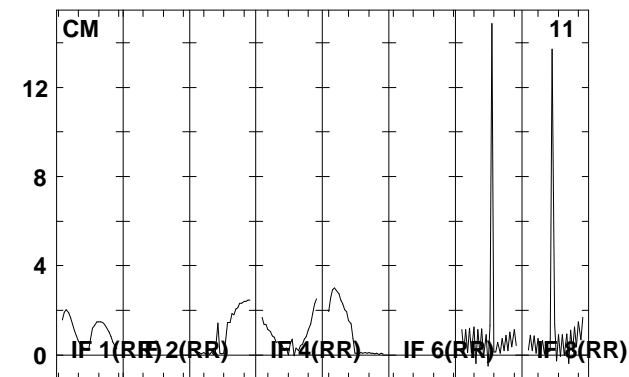
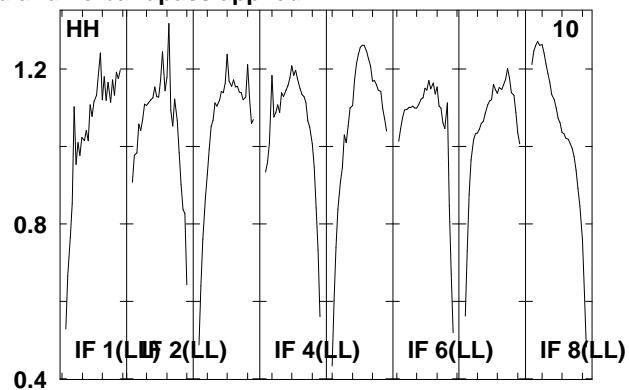
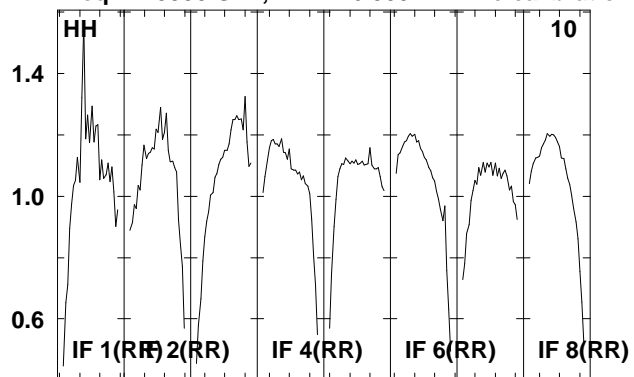

Lower frame: Real Jy  
Total-power spectrum Antenna: \*  
Timerange: 00/04:16:33 to 00/04:21:09

Plot file version 43 created 08-AUG-2008 16:58:35

J0209+13 EO006B.UVDATA.1

Freq = 1.5950 GHz, Bw = 16.000 MH No calibration applied and no bandpass applied

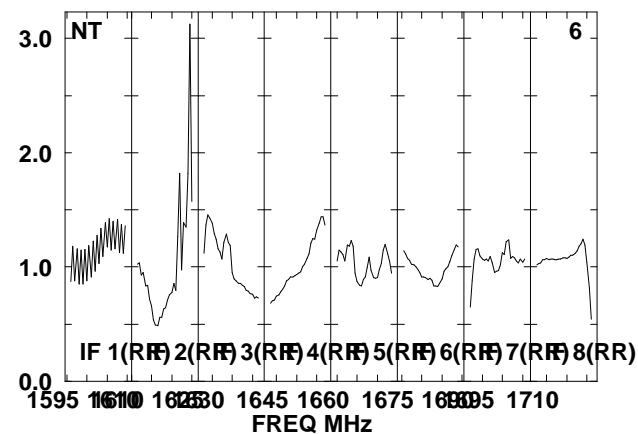
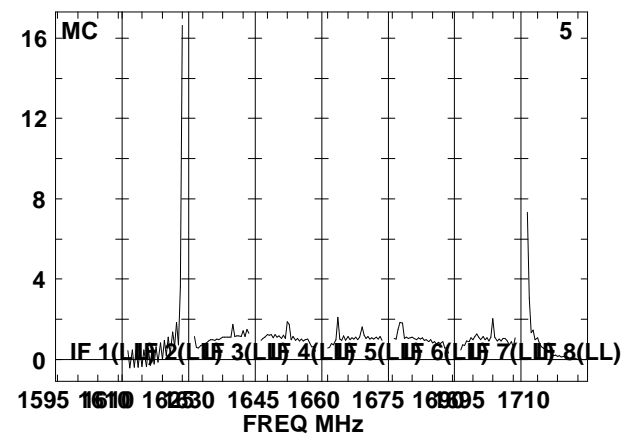
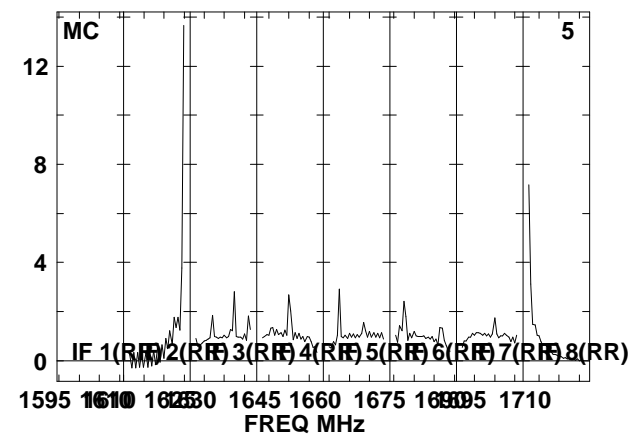
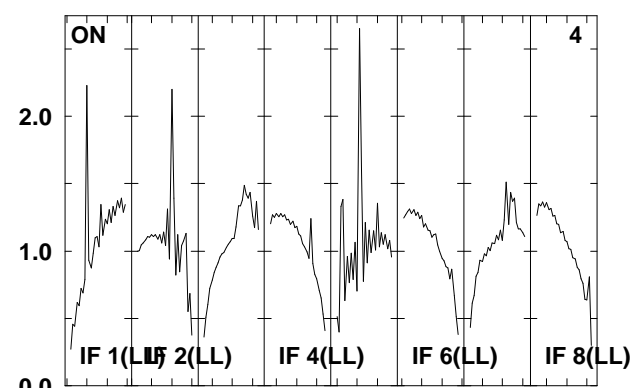
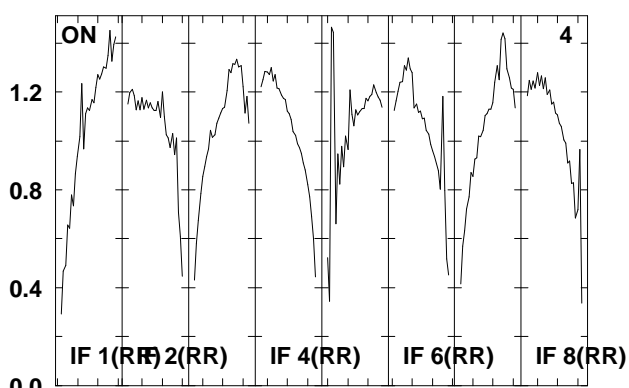
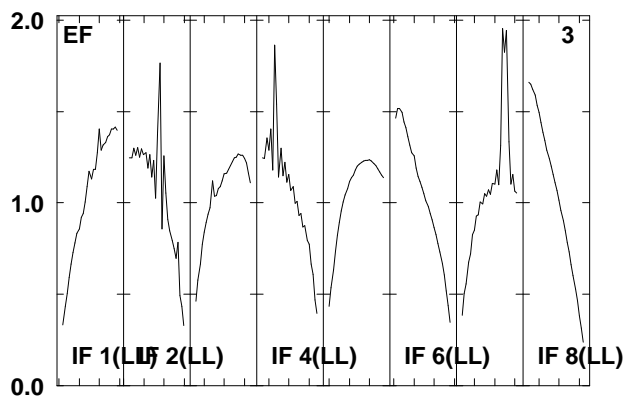
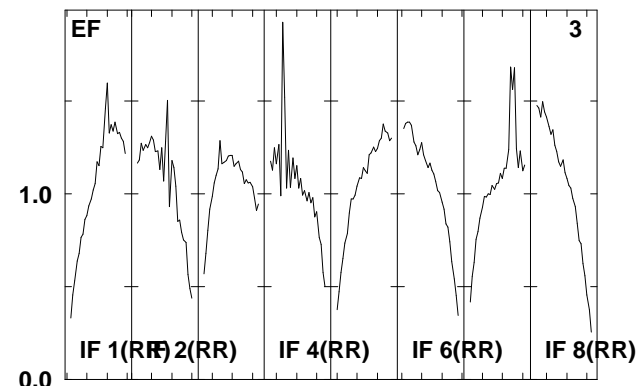
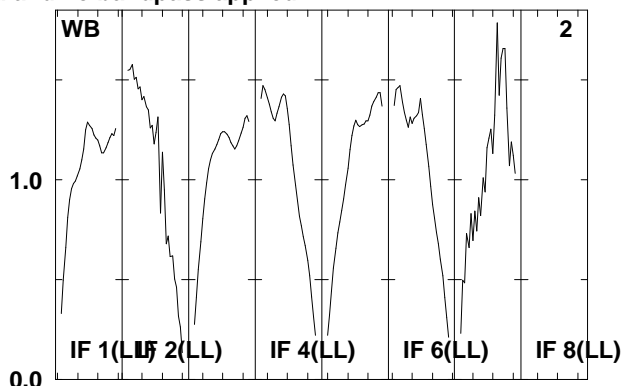
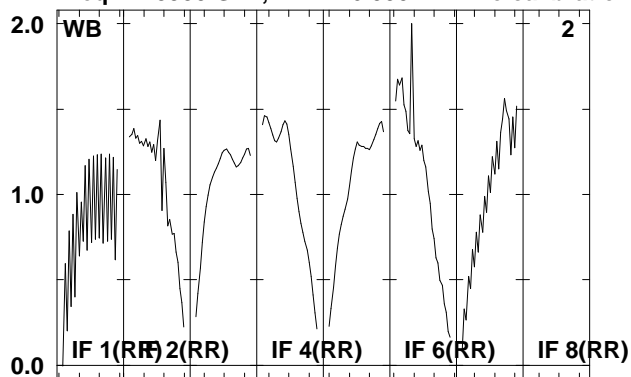

Lower frame: Real Jy  
Total-power spectrum Antenna: \*  
Timerange: 00/04:21:45 to 00/04:23:17

Plot file version 44 created 08-AUG-2008 16:58:36

J0209+13 EO006B.UVDATA.1

Freq = 1.5950 GHz, Bw = 16.000 MH No calibration applied and no bandpass applied

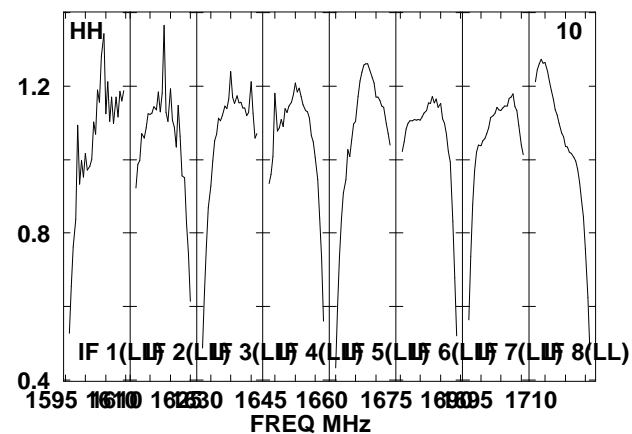
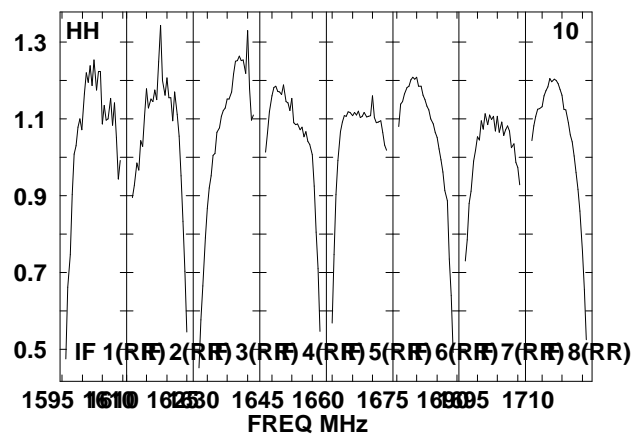
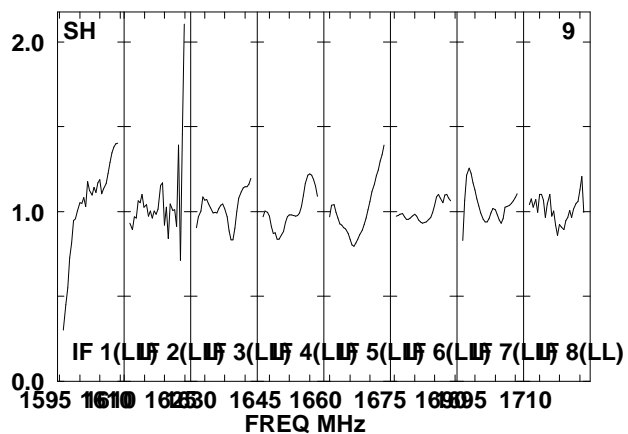
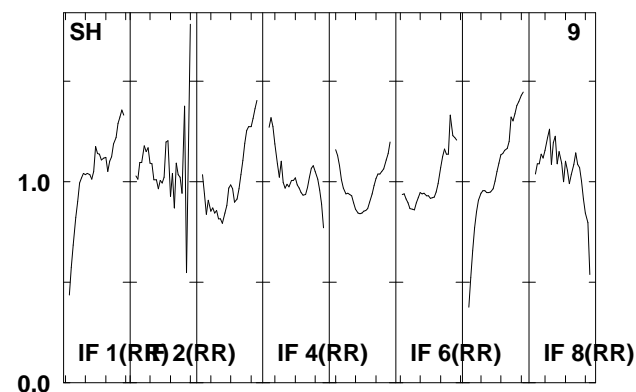
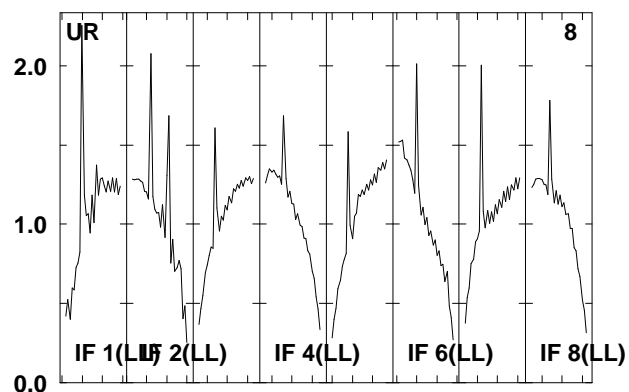
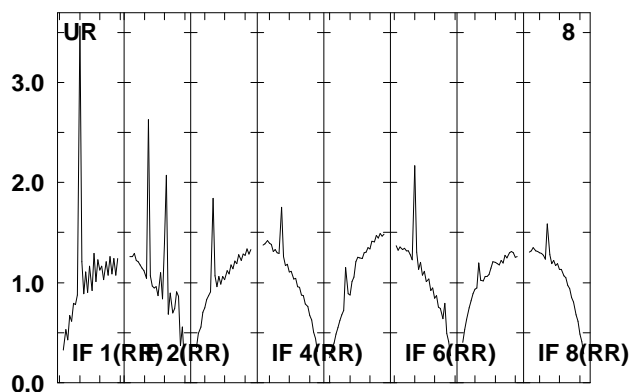
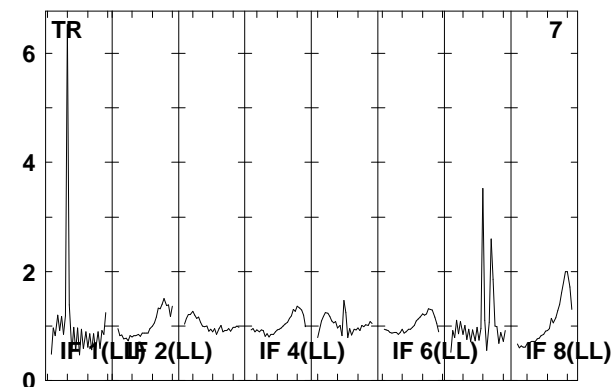
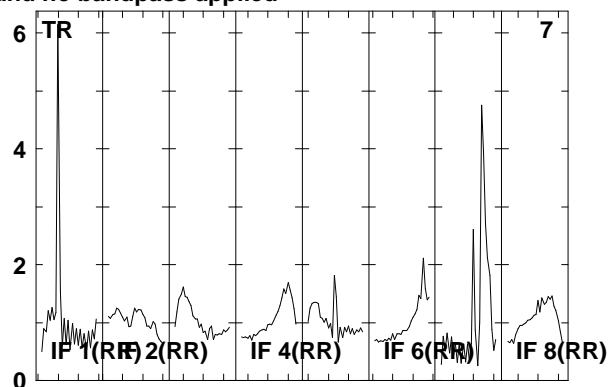
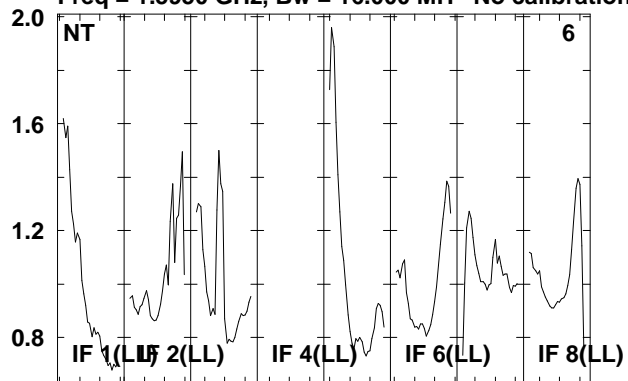

Lower frame: Real Jy  
Total-power spectrum Antenna: \*  
Timerange: 00/04:21:45 to 00/04:23:17



Plot file version 45 created 08-AUG-2008 16:58:36

J0209+13 EO006B.UVDATA.1

Freq = 1.5950 GHz, Bw = 16.000 MH No calibration applied and no bandpass applied

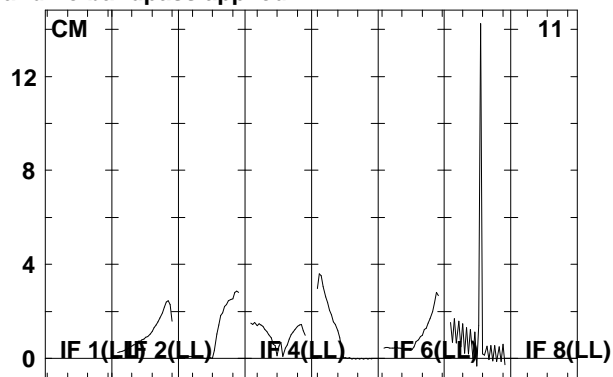
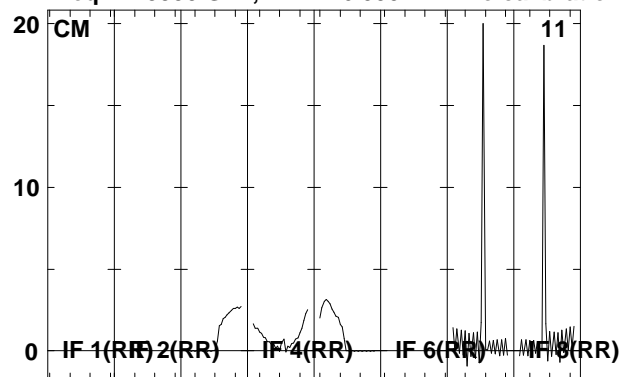

Lower frame: Real Jy  
Total-power spectrum Antenna: \*  
Timerange: 00/04:21:45 to 00/04:23:17

Plot file version 46 created 08-AUG-2008 16:58:37

J021348 EO006B.UVDATA.1

Freq = 1.5950 GHz, Bw = 16.000 MH No calibration applied and no bandpass applied

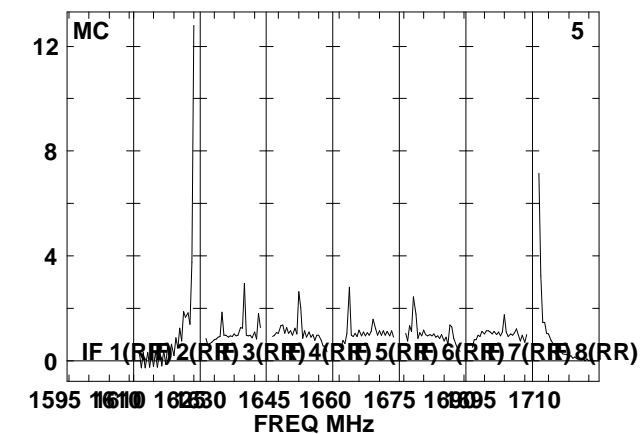
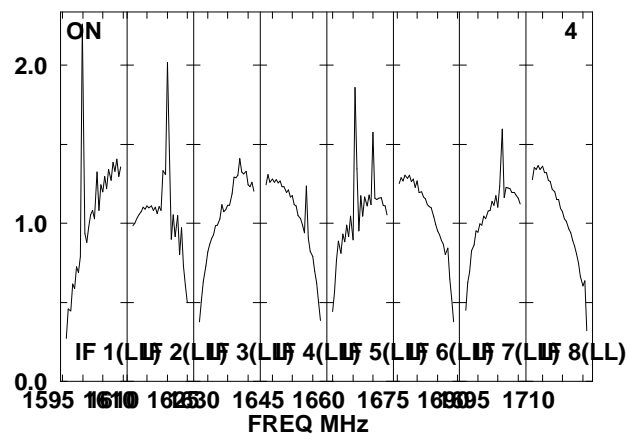
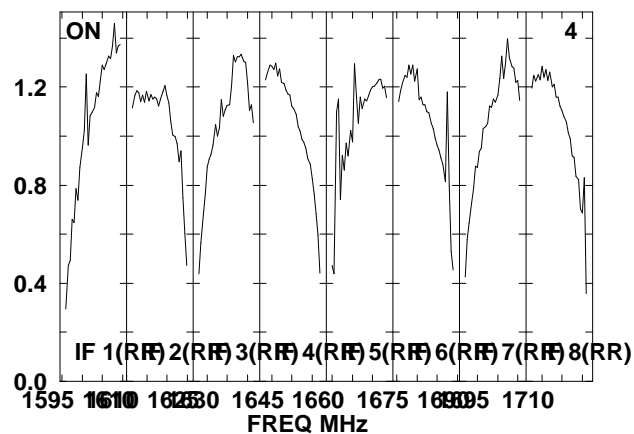
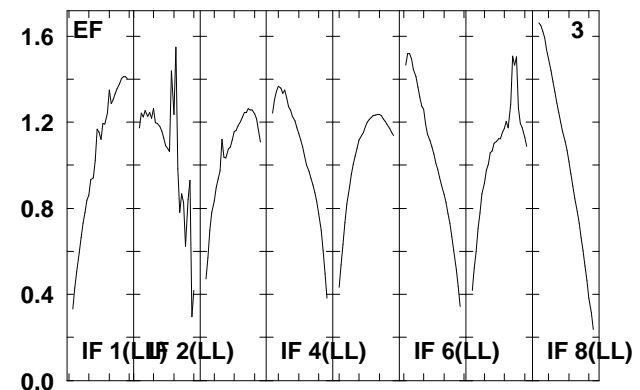
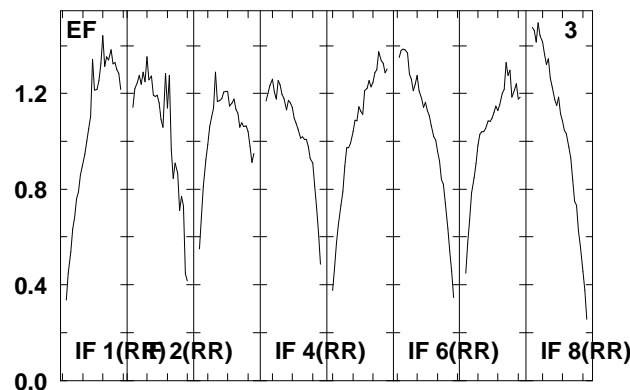
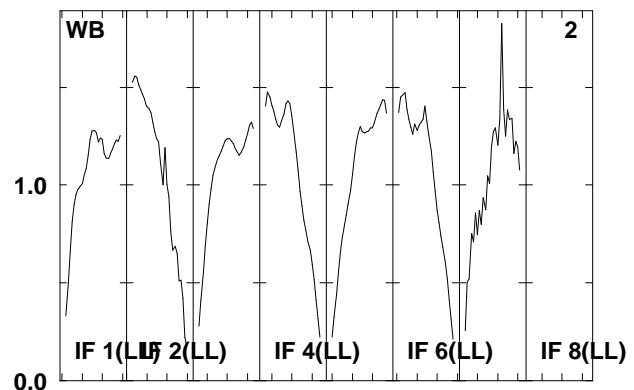
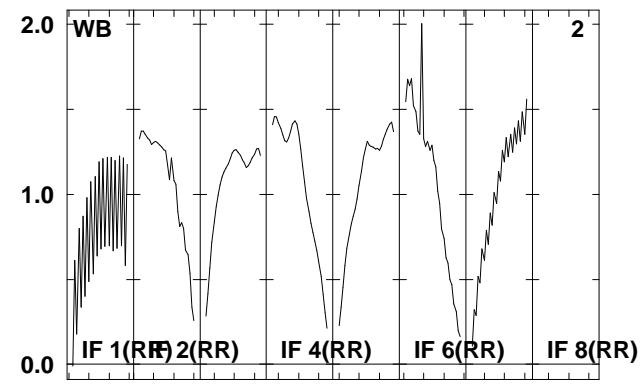
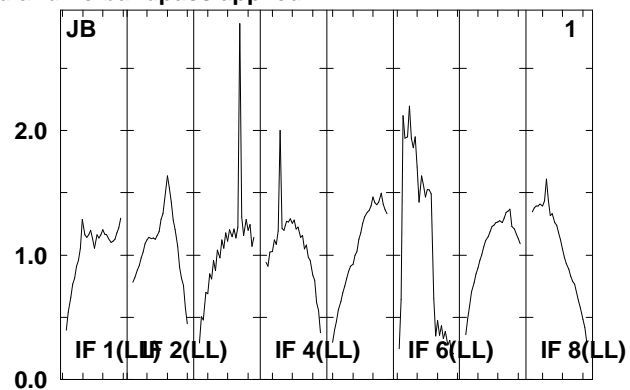
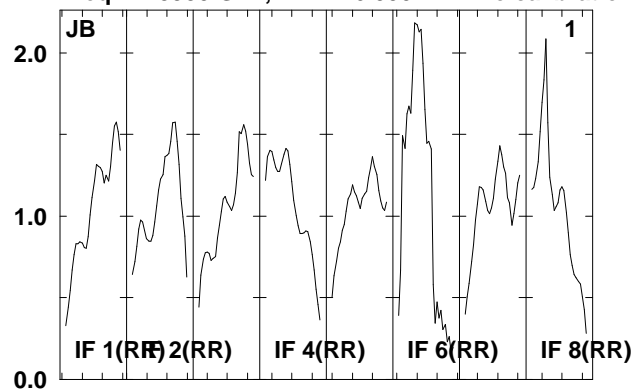

Lower frame: Real Jy  
Total-power spectrum Antenna: \*  
Timerange: 00/04:23:53 to 00/04:28:29

Plot file version 47 created 08-AUG-2008 16:58:37

J021348 EO006B.UVDATA.1

Freq = 1.5950 GHz, Bw = 16.000 MH No calibration applied and no bandpass applied

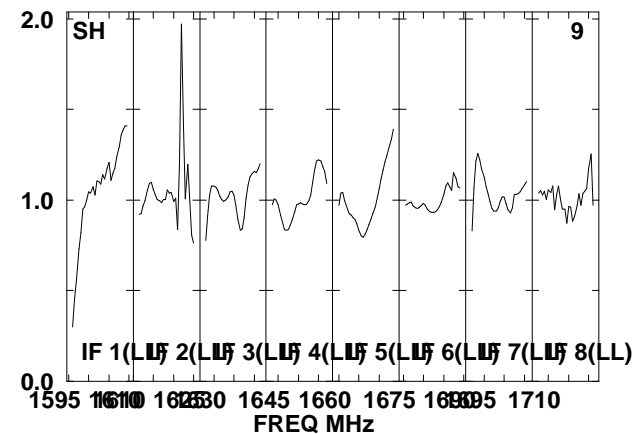
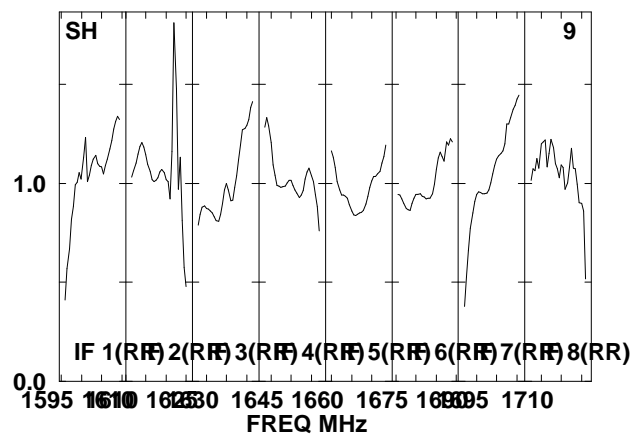
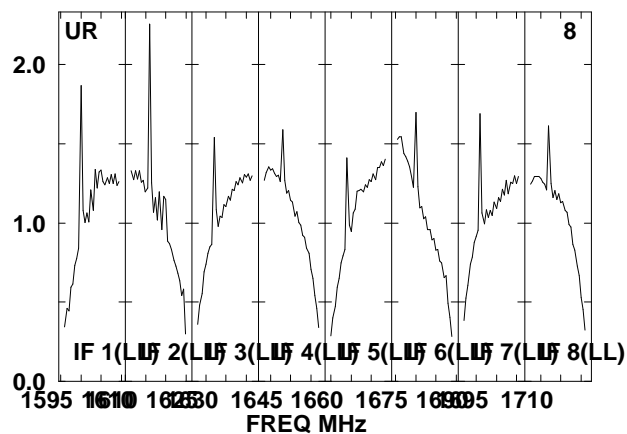
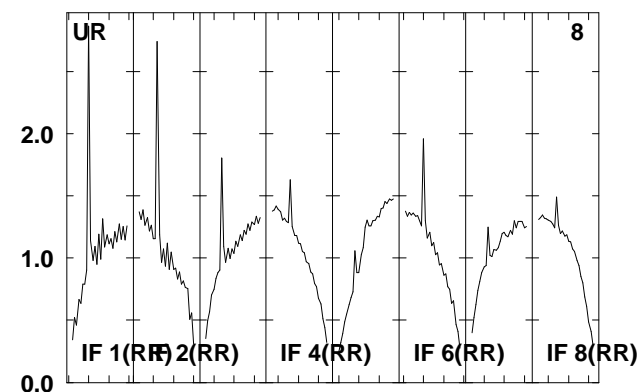
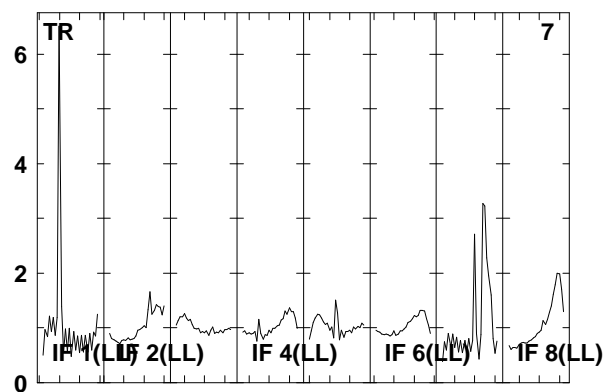
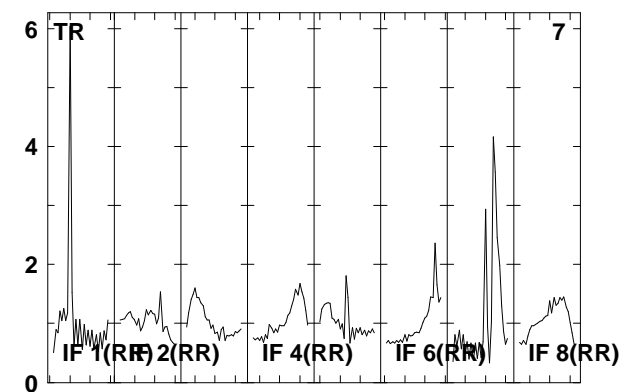
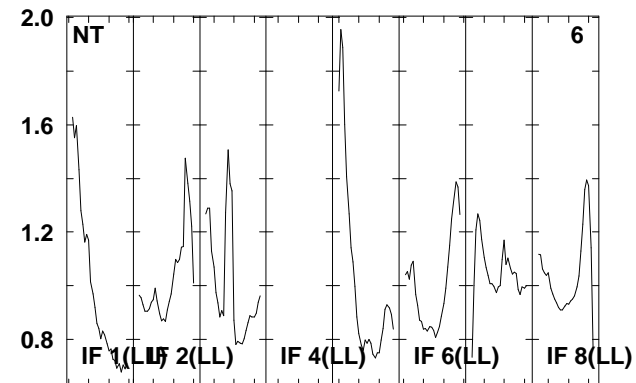
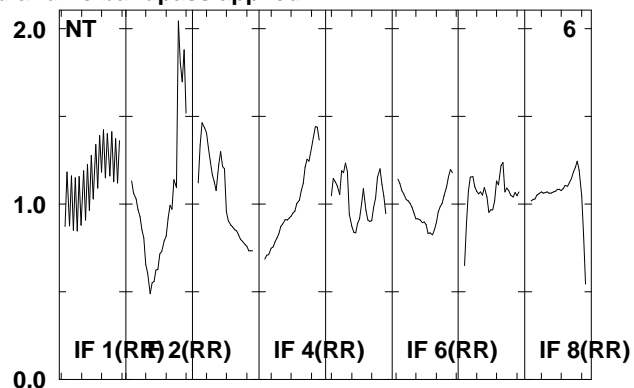
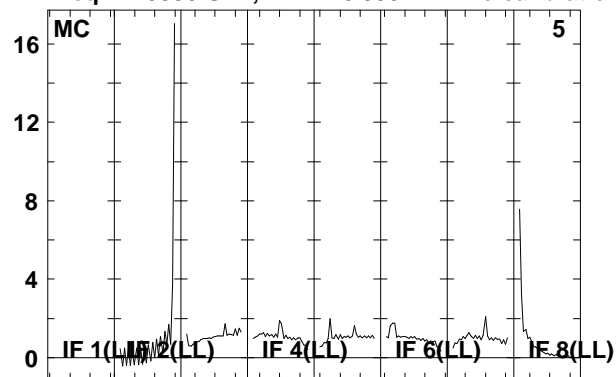

Lower frame: Real Jy

Total-power spectrum Antenna: \*

Timerange: 00/04:23:53 to 00/04:28:29

Plot file version 48 created 08-AUG-2008 16:58:38

J021348 EO006B.UVDATA.1

Freq = 1.5950 GHz, Bw = 16.000 MH No calibration applied and no bandpass applied

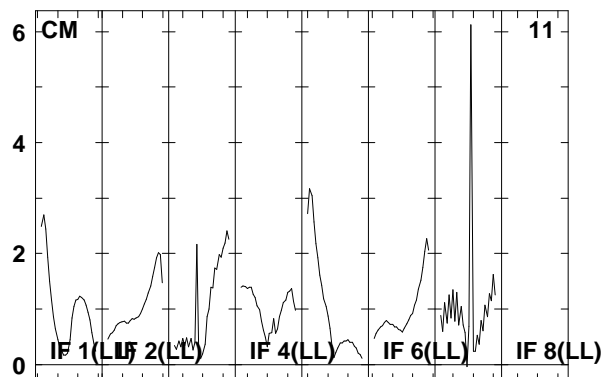
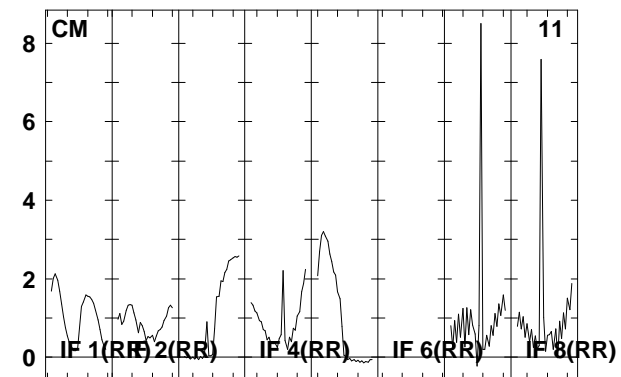
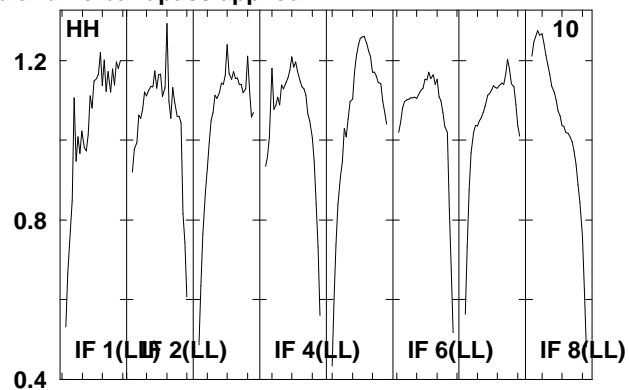
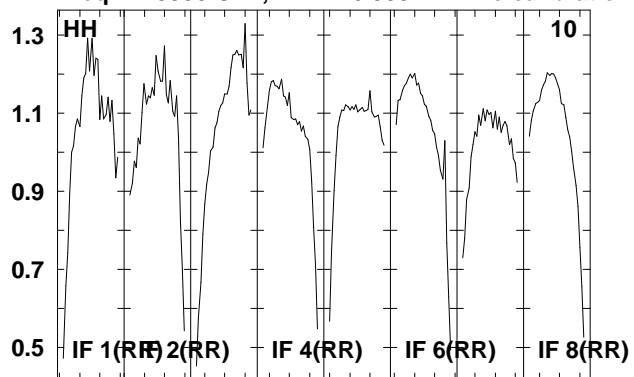

Lower frame: Real Jy  
Total-power spectrum Antenna: \*  
Timerange: 00/04:23:53 to 00/04:28:29

Plot file version 49 created 08-AUG-2008 16:58:39

J0209+13 EO006B.UVDATA.1

Freq = 1.5950 GHz, Bw = 16.000 MH No calibration applied and no bandpass applied

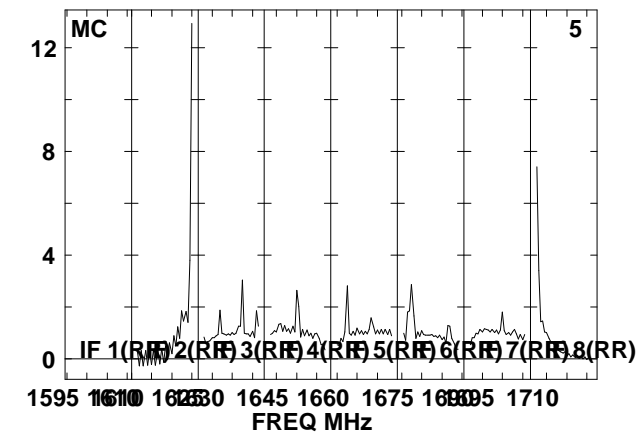
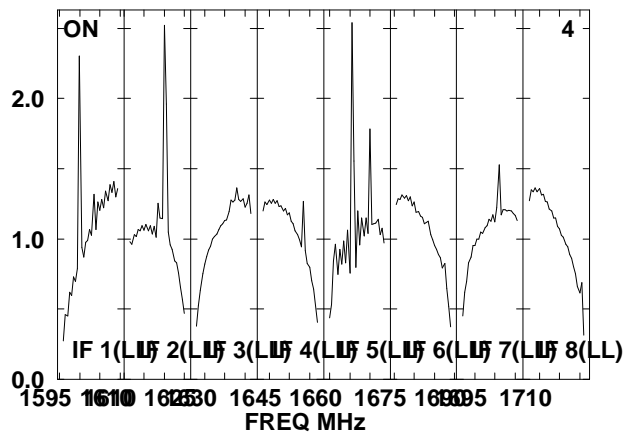
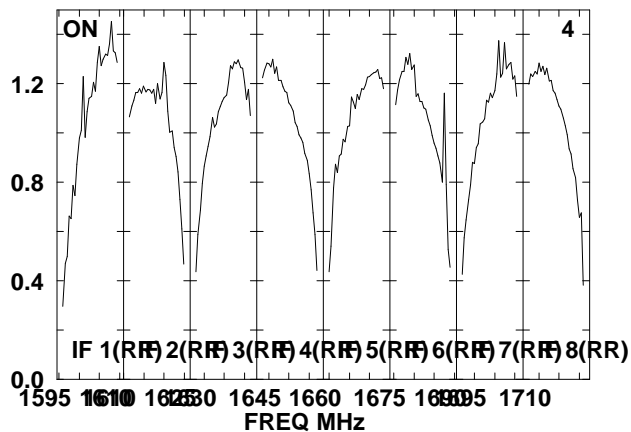
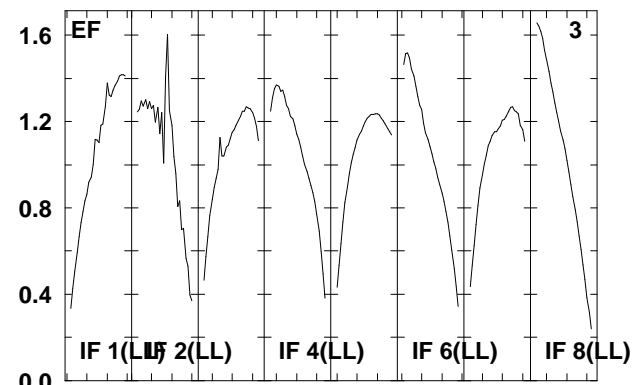
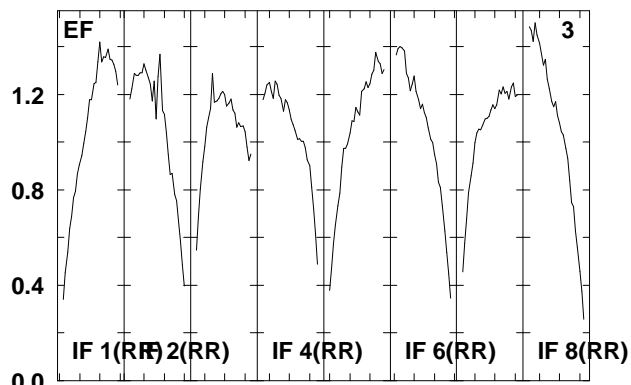
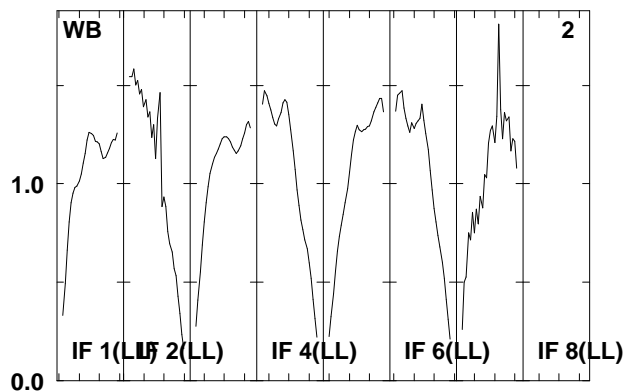
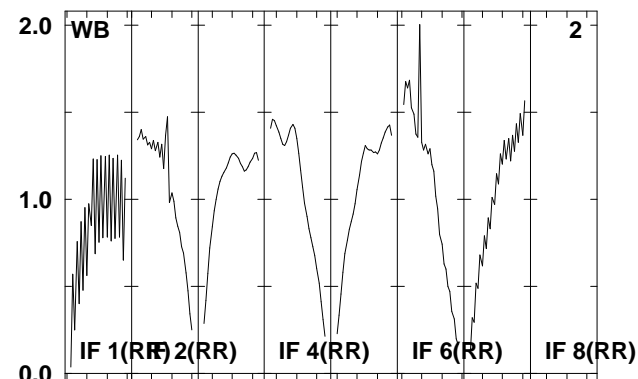
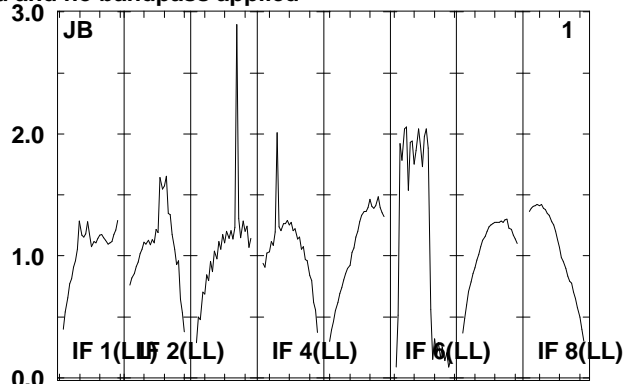
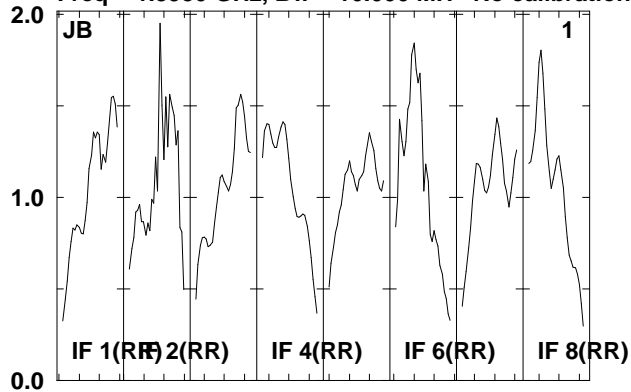

Lower frame: Real Jy  
Total-power spectrum Antenna: \*  
Timerange: 00/04:29:01 to 00/04:30:33

Plot file version 50 created 08-AUG-2008 16:58:39

J0209+13 EO006B.UVDATA.1

Freq = 1.5950 GHz, Bw = 16.000 MH No calibration applied and no bandpass applied

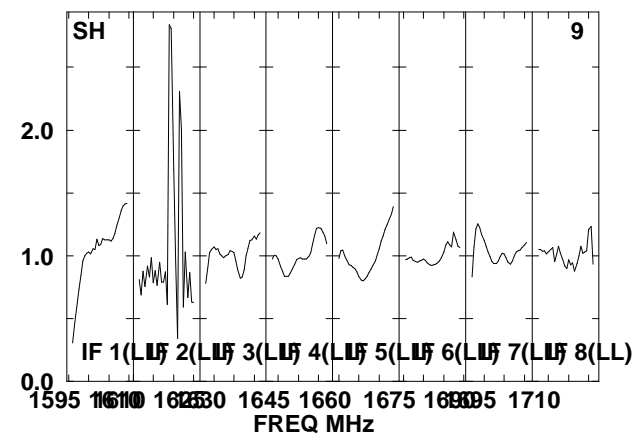
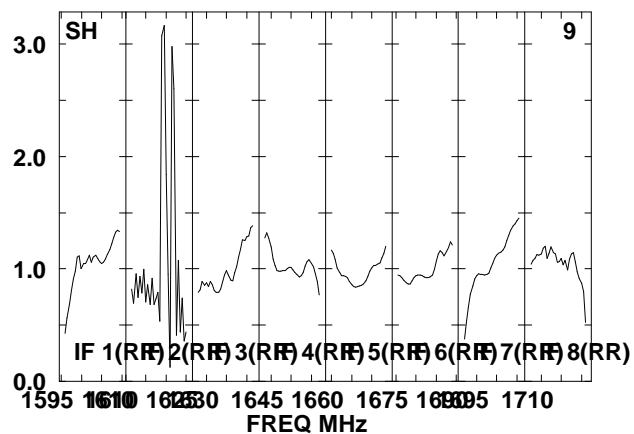
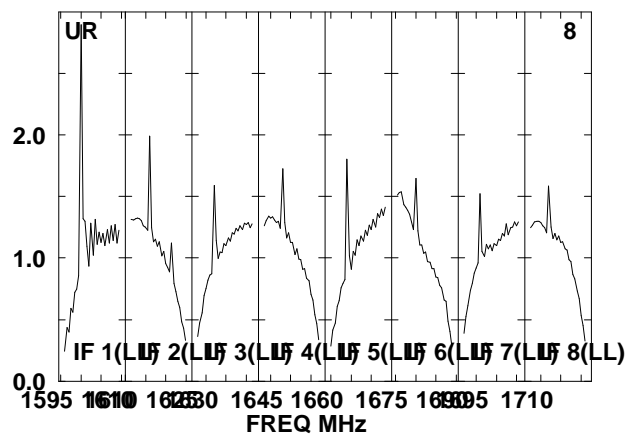
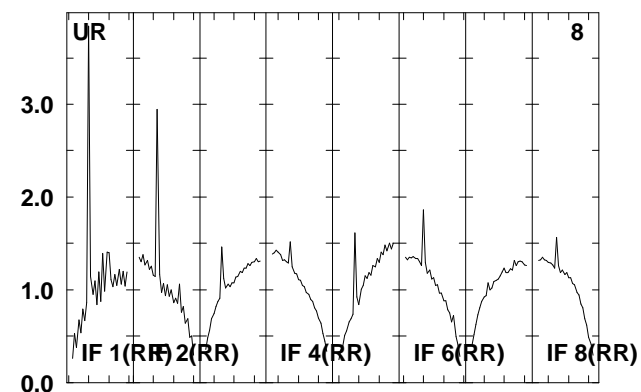
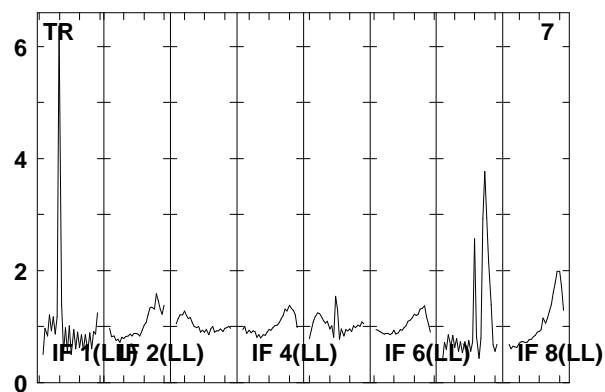
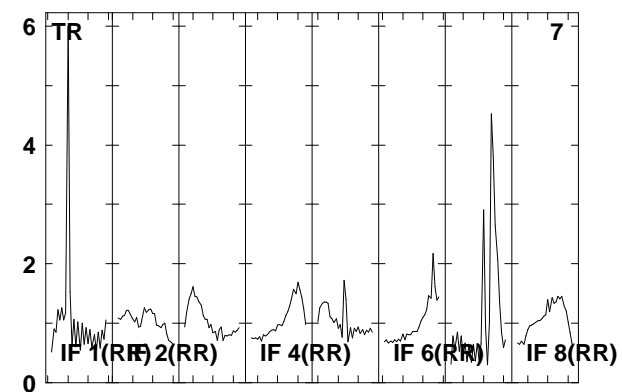
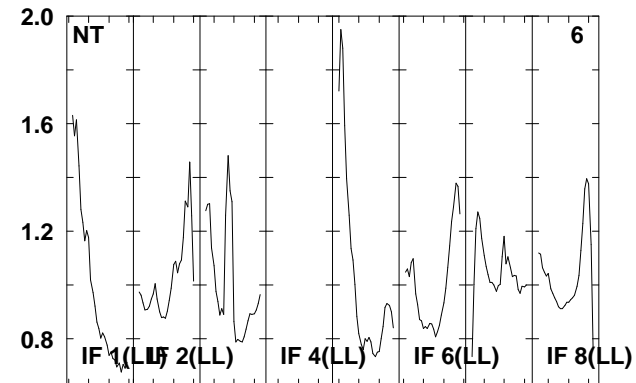
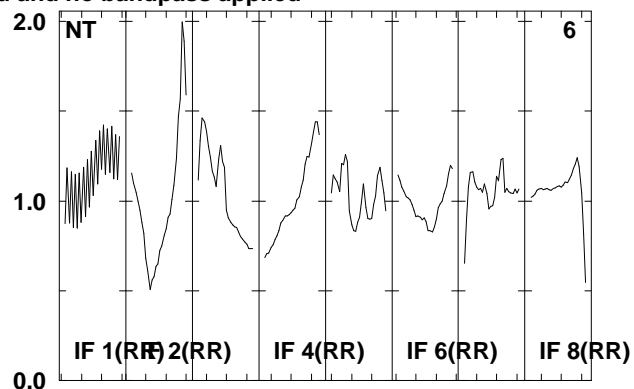
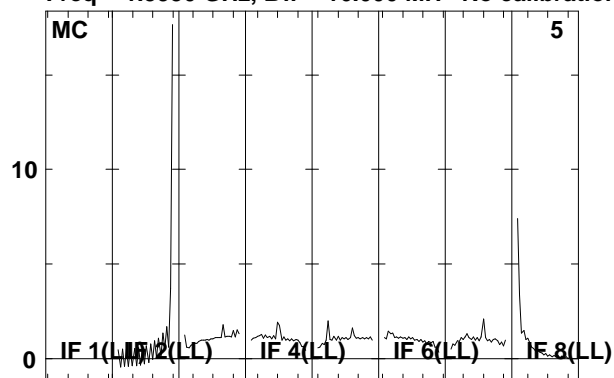

Lower frame: Real Jy

Total-power spectrum Antenna: \*

Timerange: 00/04:29:01 to 00/04:30:33

Plot file version 51 created 08-AUG-2008 16:58:40

J0209+13 EO006B.UVDATA.1

Freq = 1.5950 GHz, Bw = 16.000 MH No calibration applied and no bandpass applied

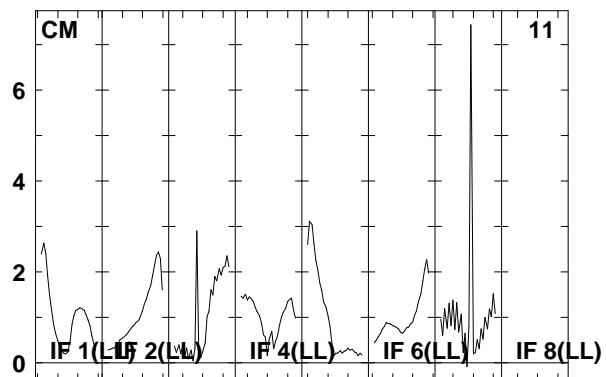
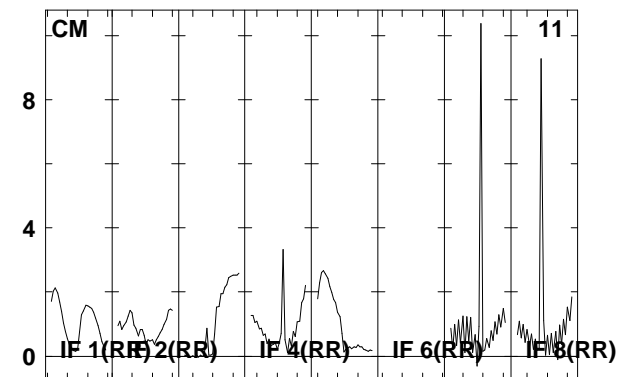
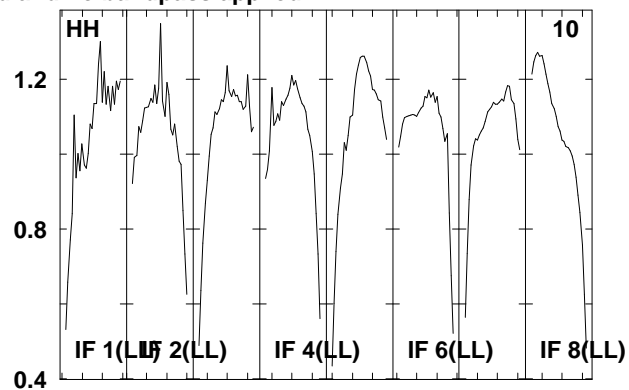
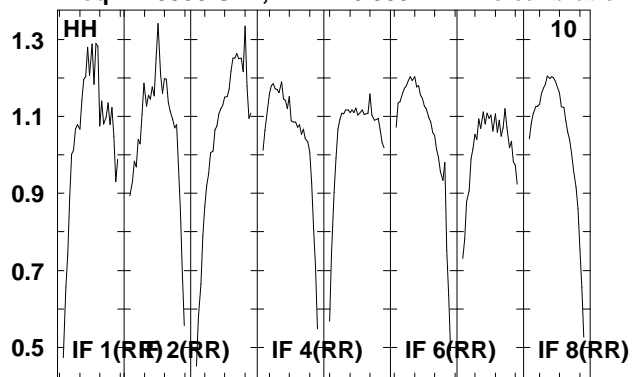

Lower frame: Real Jy  
Total-power spectrum Antenna: \*  
Timerange: 00/04:29:01 to 00/04:30:33

Plot file version 52 created 08-AUG-2008 16:58:40

J021348 EO006B.UVDATA.1

Freq = 1.5950 GHz, Bw = 16.000 MH No calibration applied and no bandpass applied

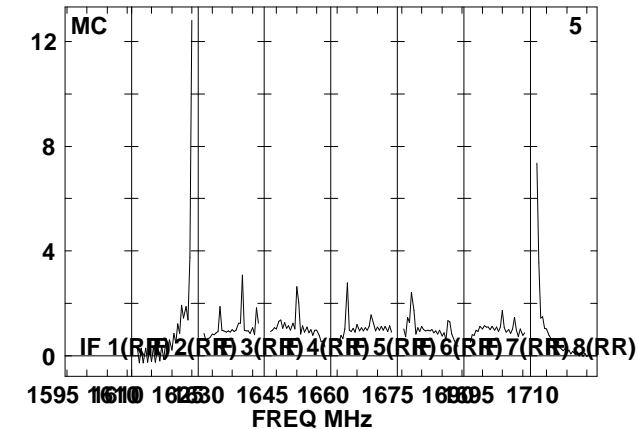
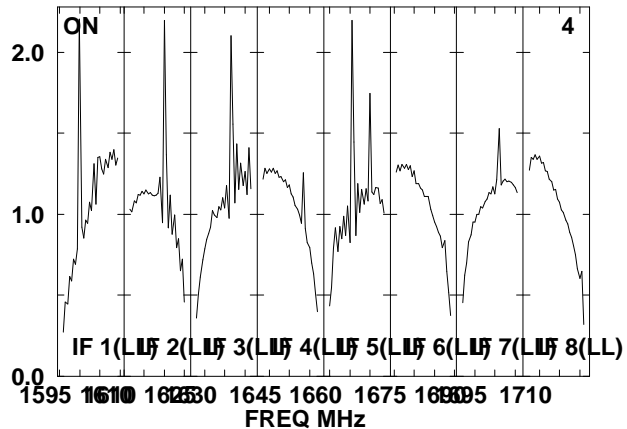
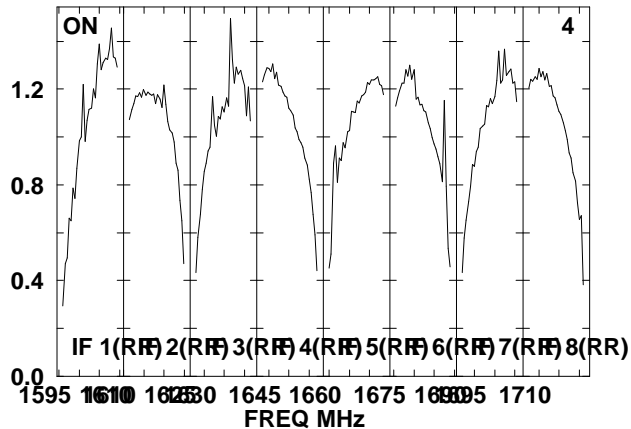
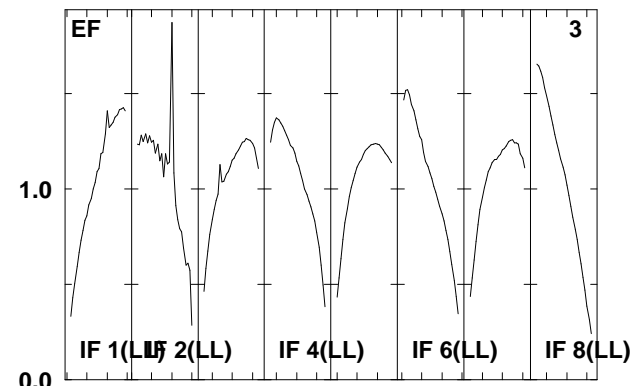
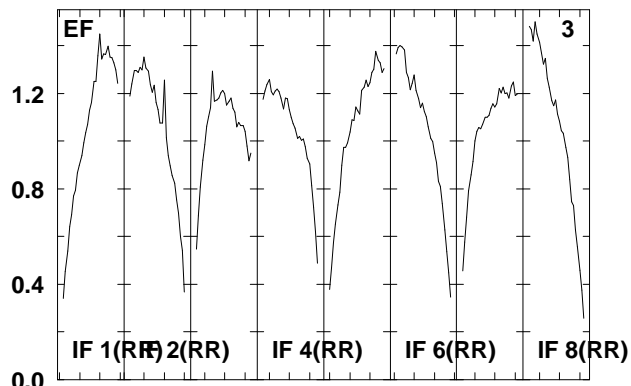
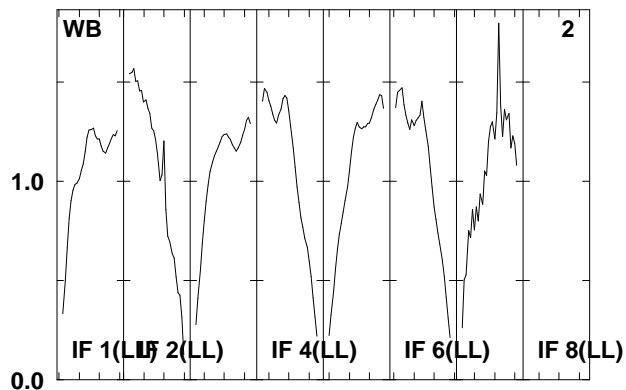
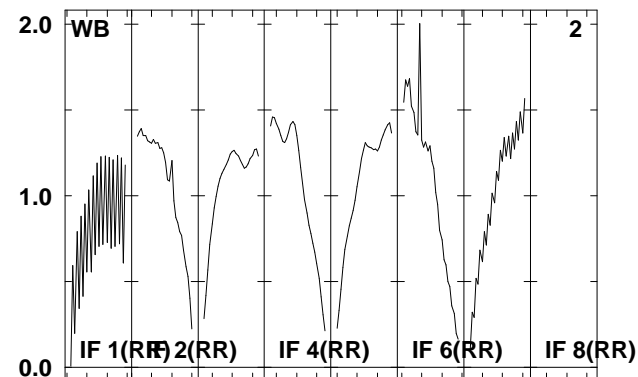
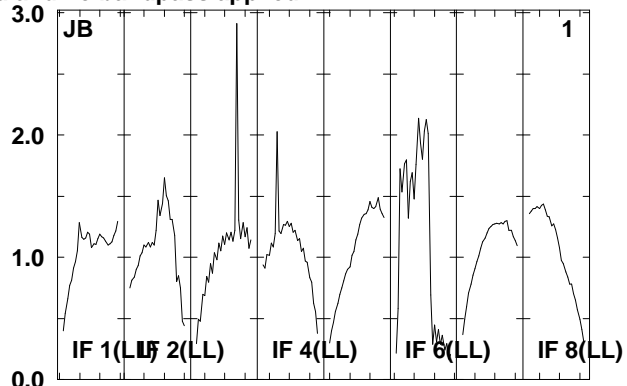
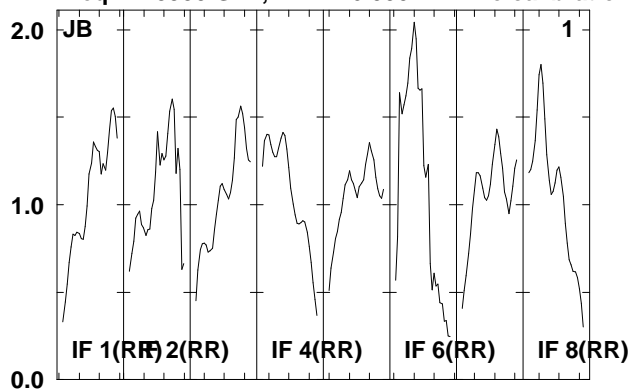

Lower frame: Real Jy  
Total-power spectrum Antenna: \*  
Timerange: 00/04:31:21 to 00/04:35:41



Plot file version 53 created 08-AUG-2008 16:58:41

J021348 EO006B.UVDATA.1

Freq = 1.5950 GHz, Bw = 16.000 MH No calibration applied and no bandpass applied

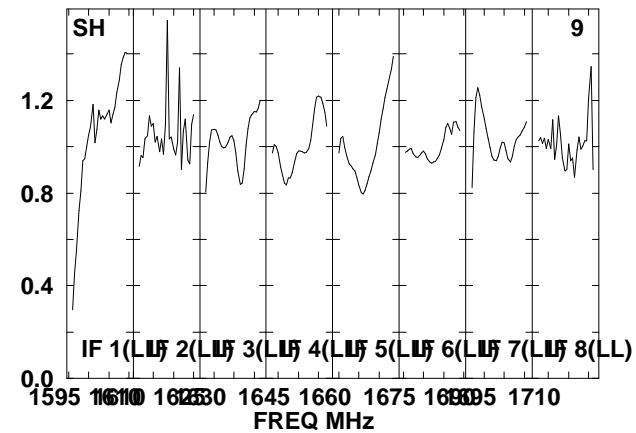
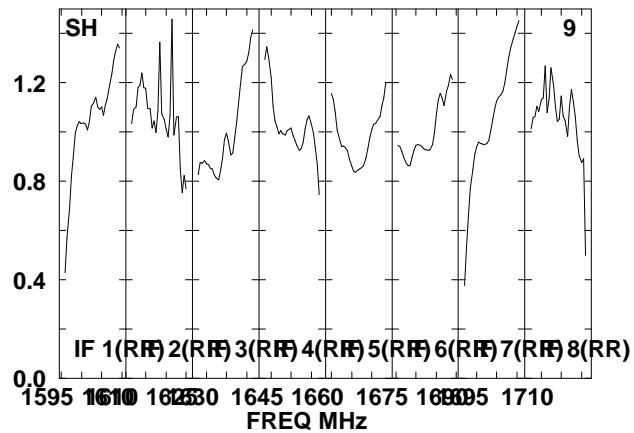
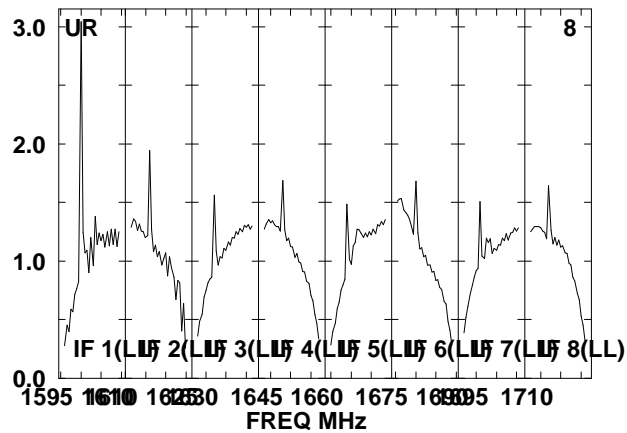
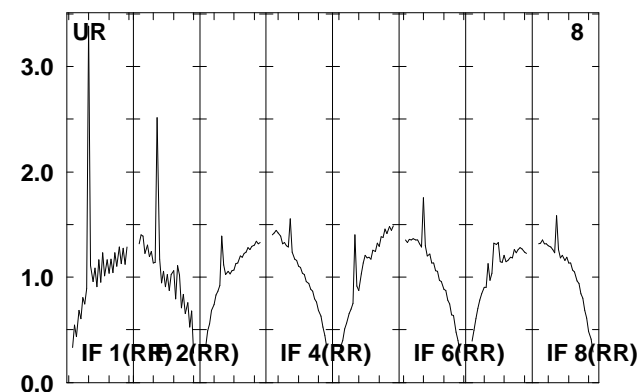
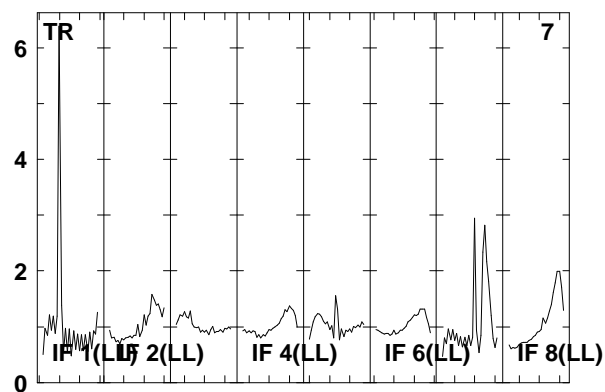
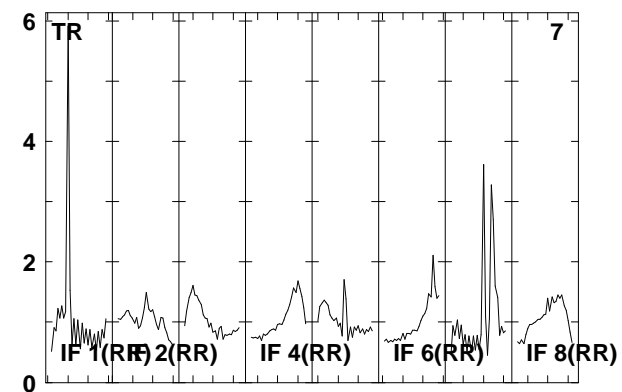
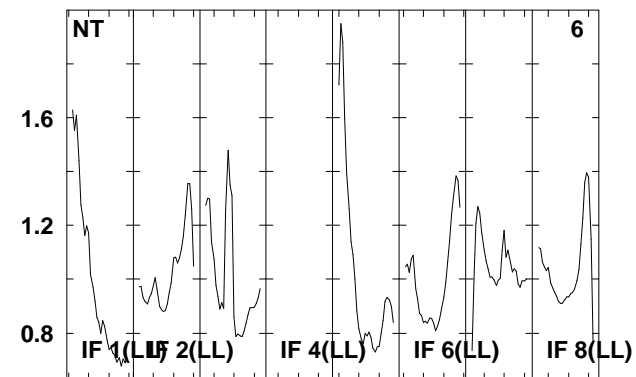
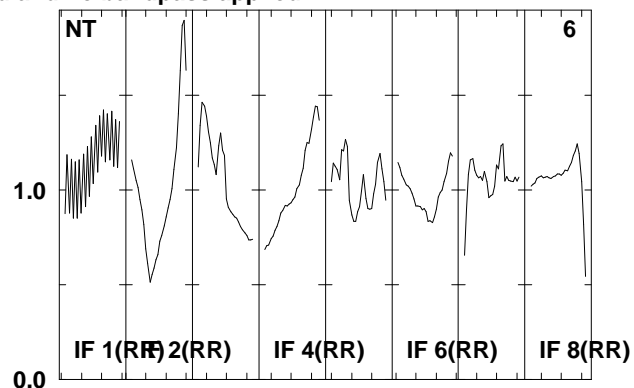
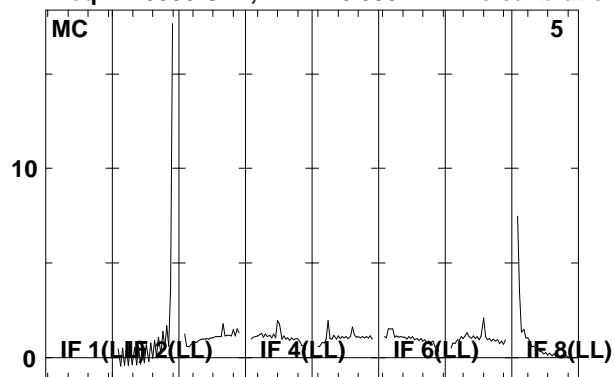

Lower frame: Real Jy

Total-power spectrum Antenna: \*

Timerange: 00/04:31:21 to 00/04:35:41

Plot file version 54 created 08-AUG-2008 16:58:42

J021348 EO006B.UVDATA.1

Freq = 1.5950 GHz, Bw = 16.000 MH No calibration applied and no bandpass applied

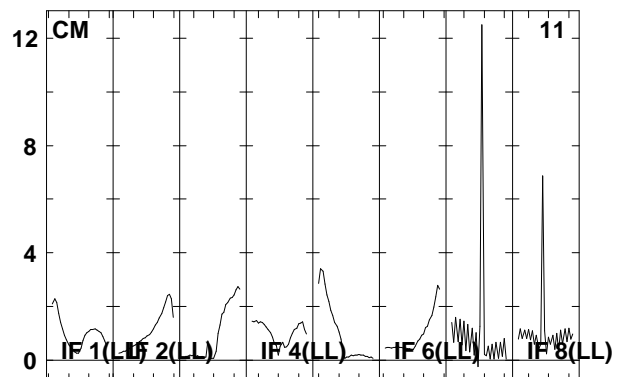
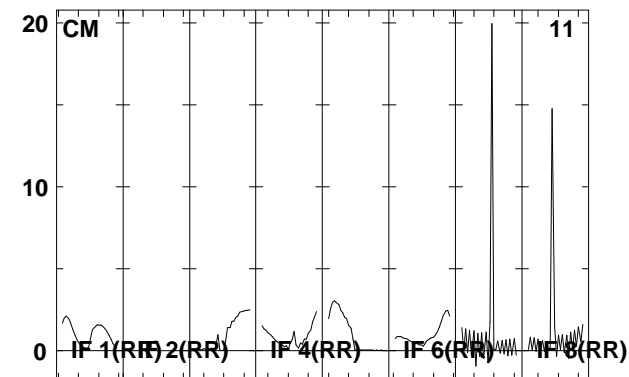
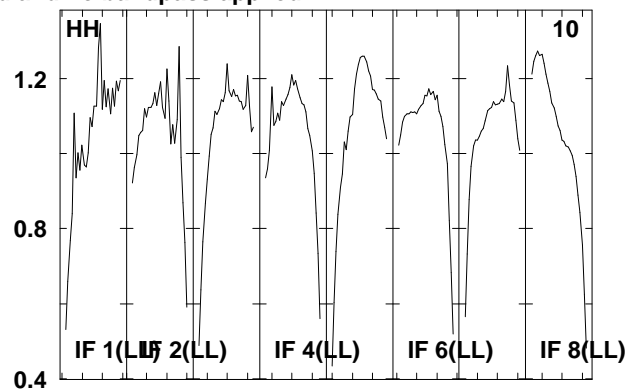
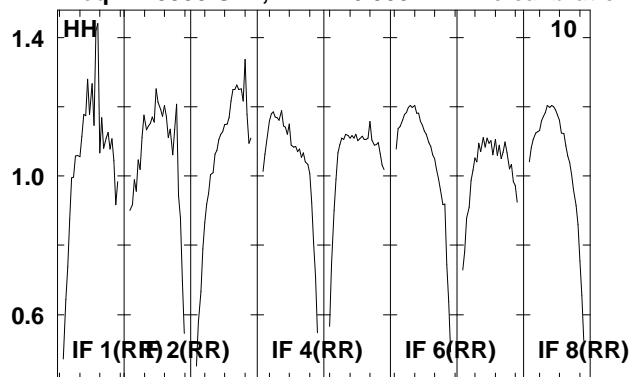

Lower frame: Real Jy  
Total-power spectrum Antenna: \*  
Timerange: 00/04:31:21 to 00/04:35:41

Plot file version 55 created 08-AUG-2008 16:58:42

J0209+13 EO006B.UVDATA.1

Freq = 1.5950 GHz, Bw = 16.000 MH No calibration applied and no bandpass applied

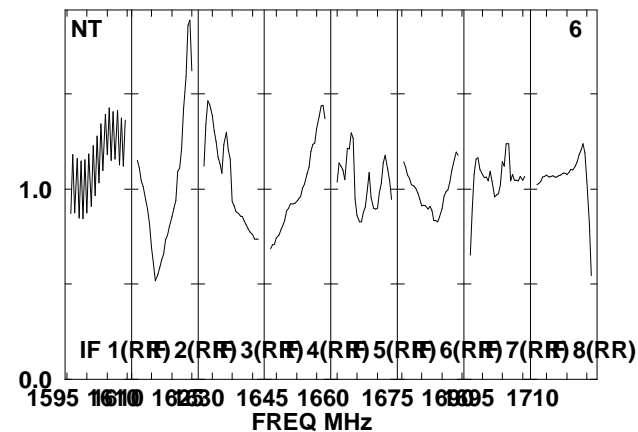
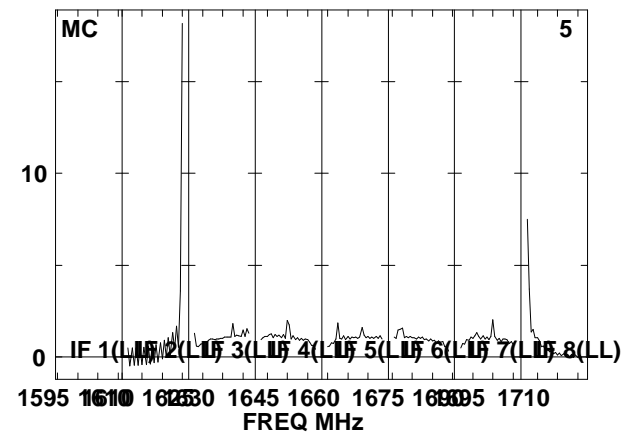
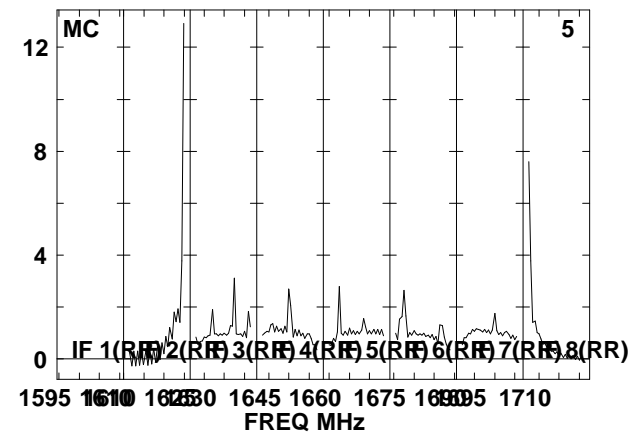
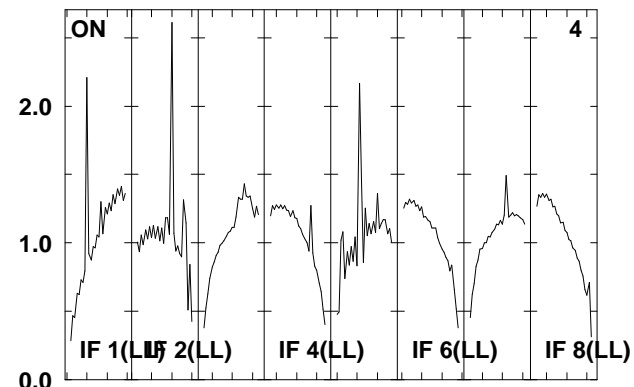
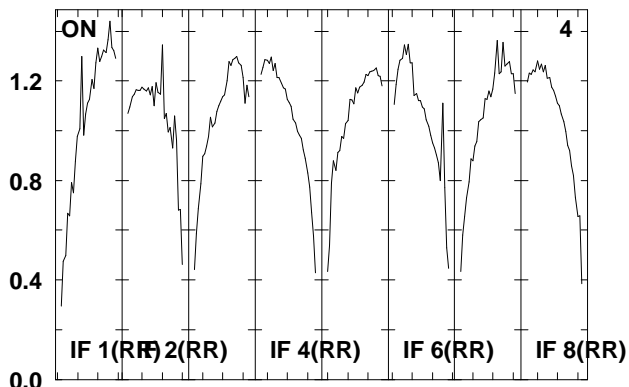
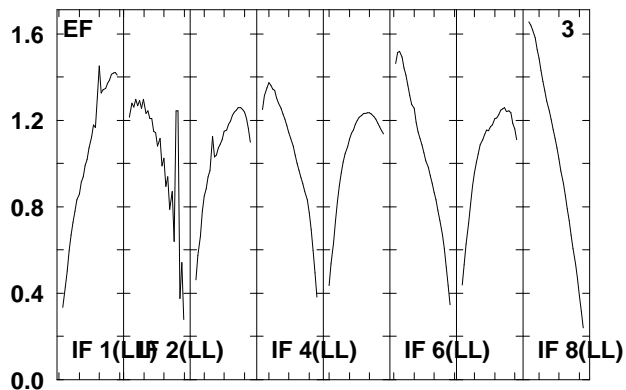
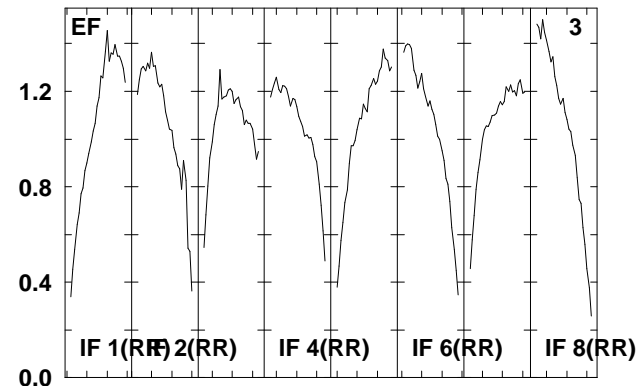
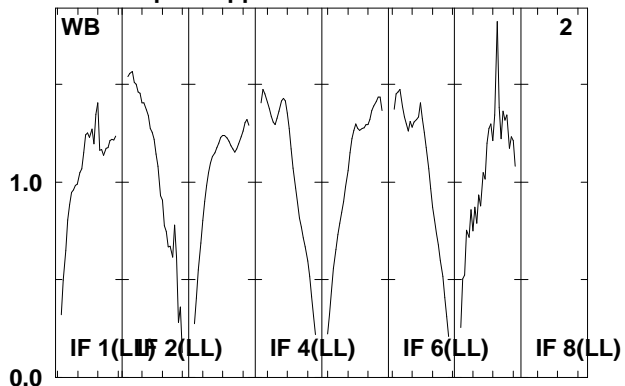
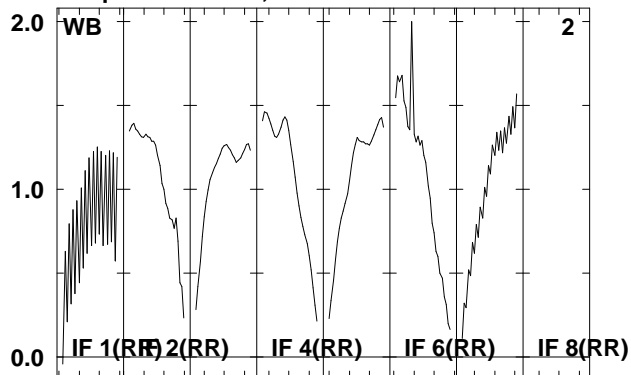

Lower frame: Real Jy  
Total-power spectrum Antenna: \*  
Timerange: 00/04:36:23 to 00/04:37:51

Plot file version 56 created 08-AUG-2008 16:58:42  
 J0209+13 EO06B.UVDATA.1  
 Freq = 1.5950 GHz, Bw = 16.000 MH No calibration applied and no bandpass applied

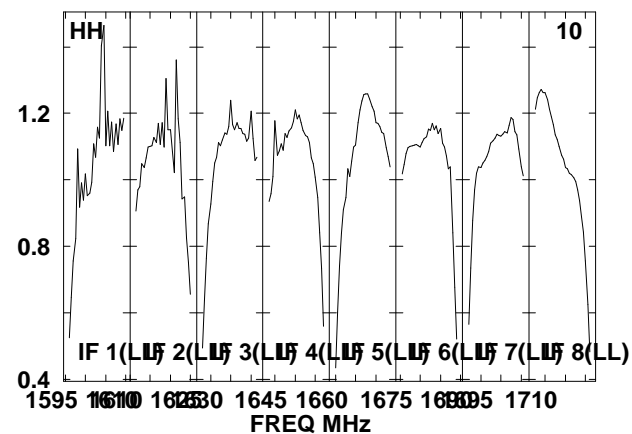
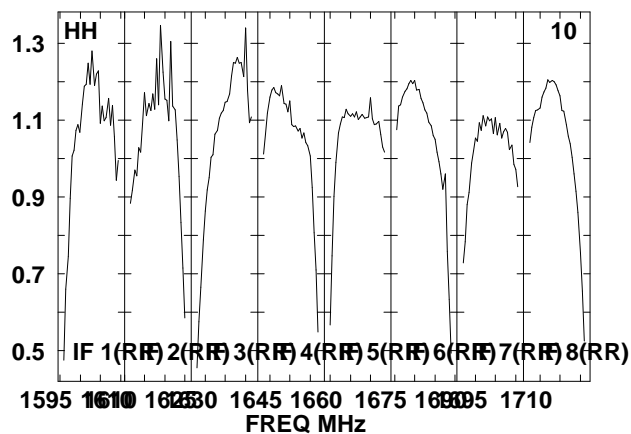
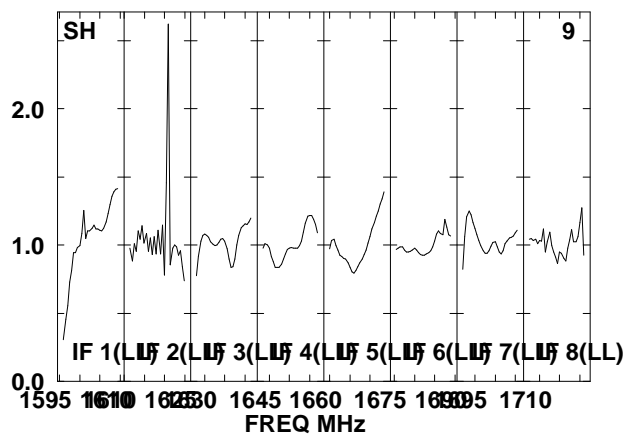
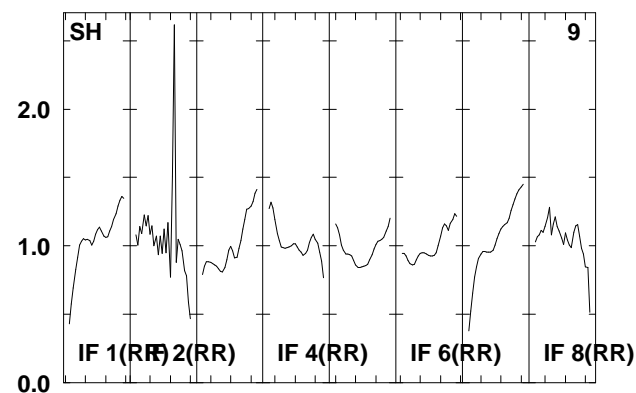
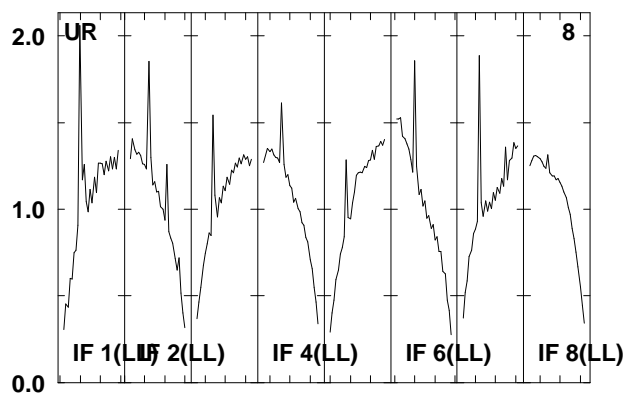
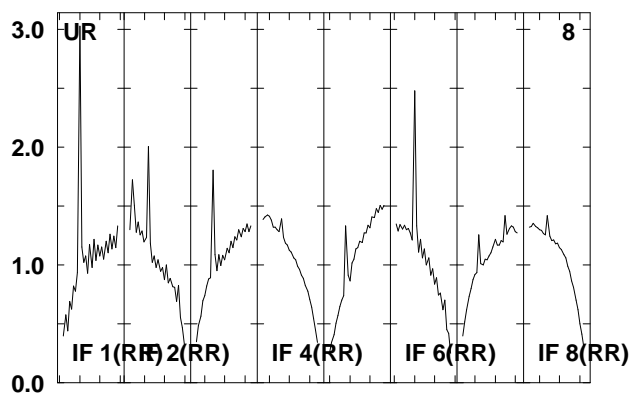
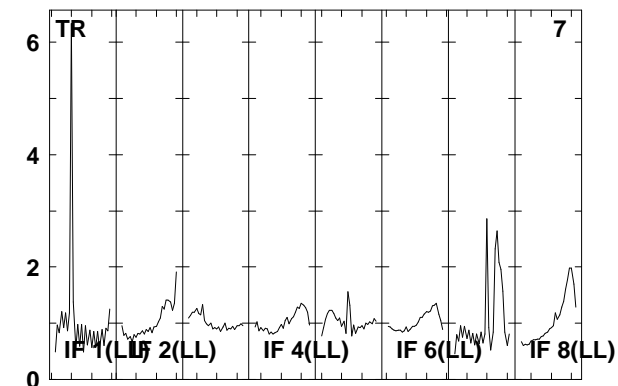
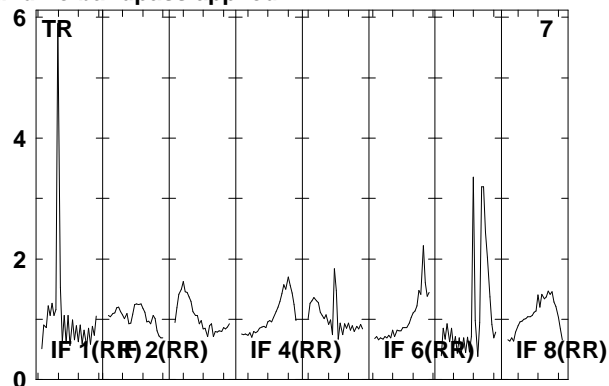
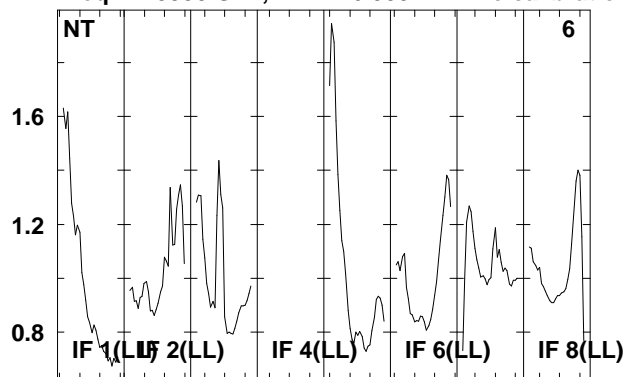

Lower frame: Real Jy  
 Total-power spectrum Antenna: \*  
 Timerange: 00/04:36:23 to 00/04:37:51

Plot file version 57 created 08-AUG-2008 16:58:43

J0209+13 EO006B.UVDATA.1

Freq = 1.5950 GHz, Bw = 16.000 MH No calibration applied and no bandpass applied

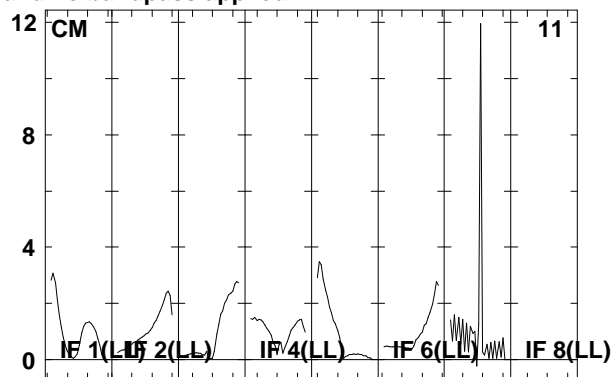
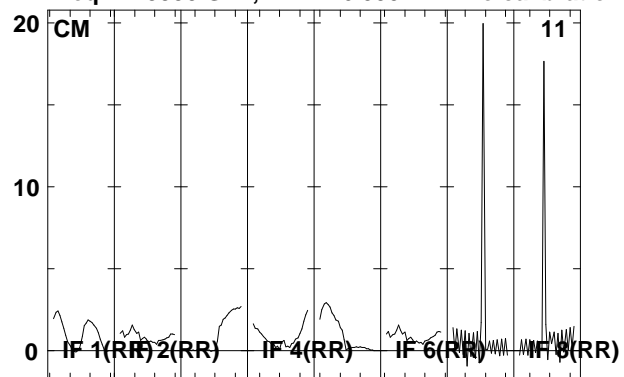

Lower frame: Real Jy  
Total-power spectrum Antenna: \*  
Timerange: 00/04:36:23 to 00/04:37:51

Plot file version 58 created 08-AUG-2008 16:58:43

J021348 EO006B.UVDATA.1

Freq = 1.5950 GHz, Bw = 16.000 MH No calibration applied and no bandpass applied

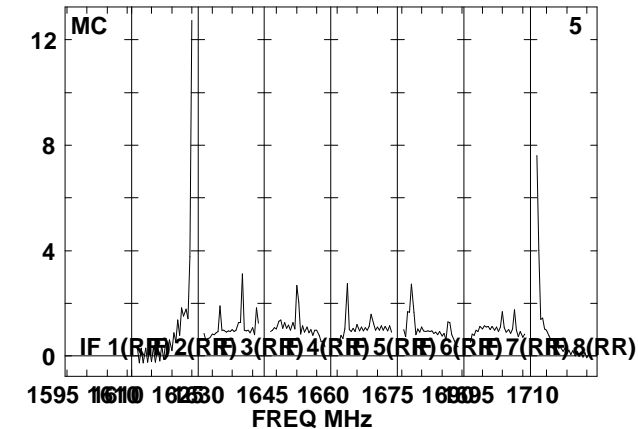
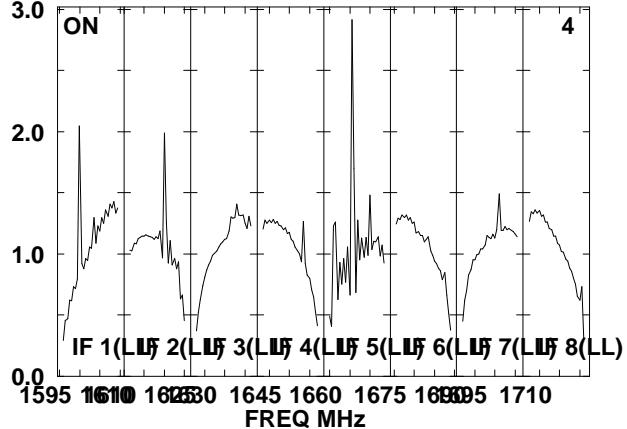
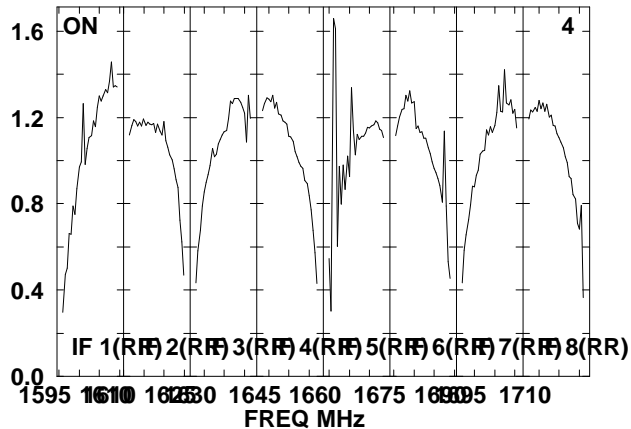
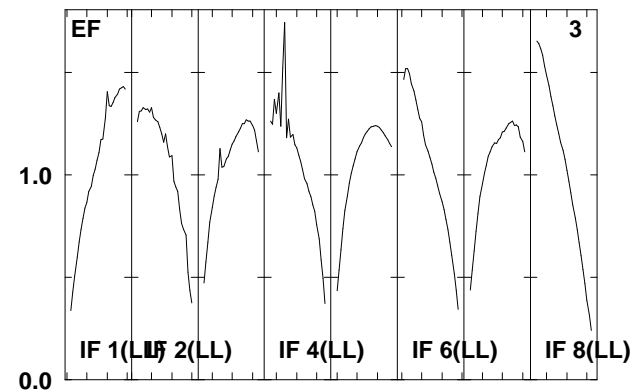
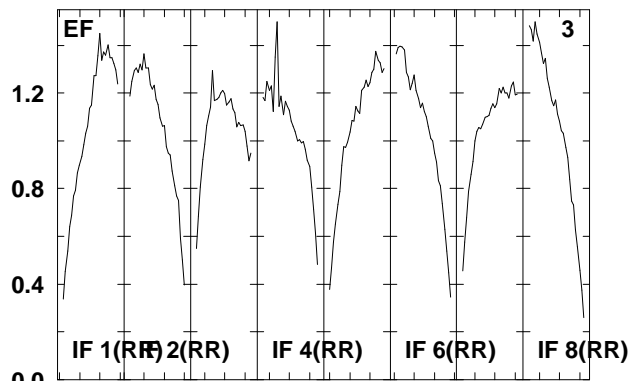
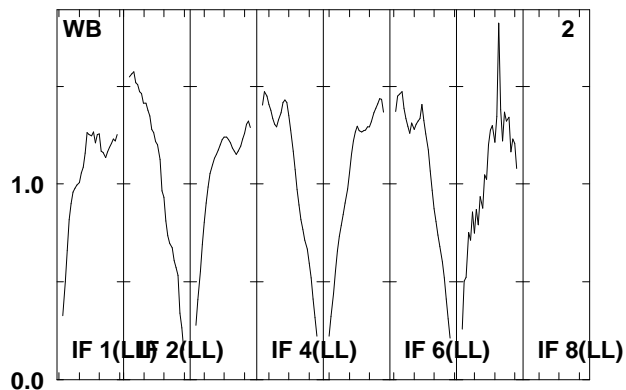
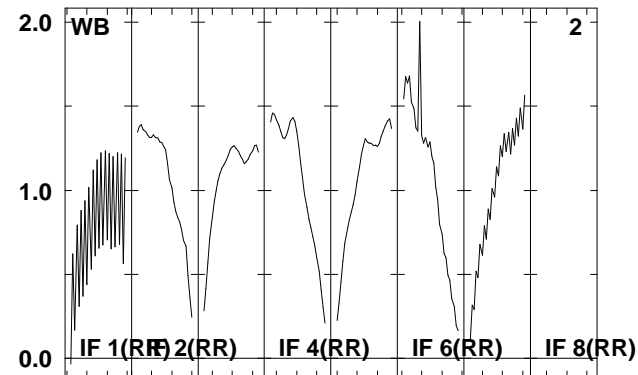
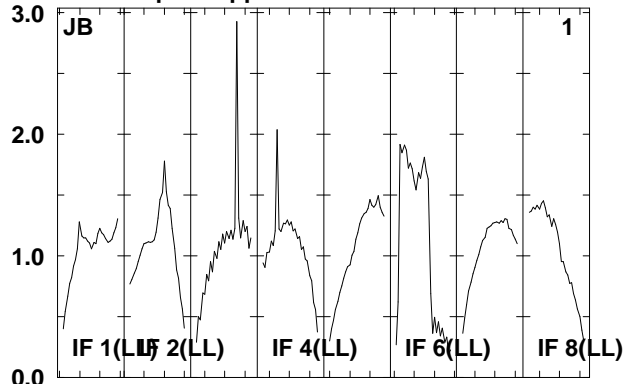
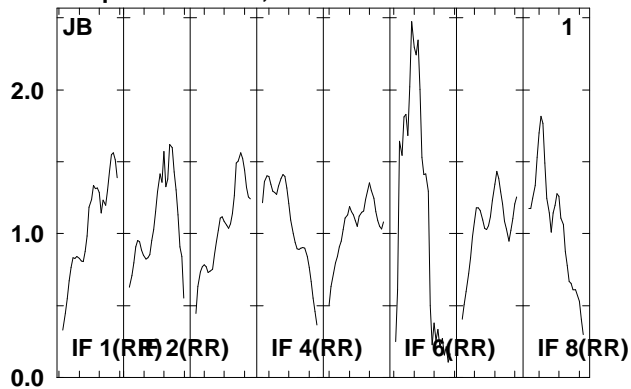

Lower frame: Real Jy  
Total-power spectrum Antenna: \*  
Timerange: 00/04:38:33 to 00/04:43:09

Plot file version 59 created 08-AUG-2008 16:58:44

J021348 EO006B.UVDATA.1

Freq = 1.5950 GHz, Bw = 16.000 MH No calibration applied and no bandpass applied

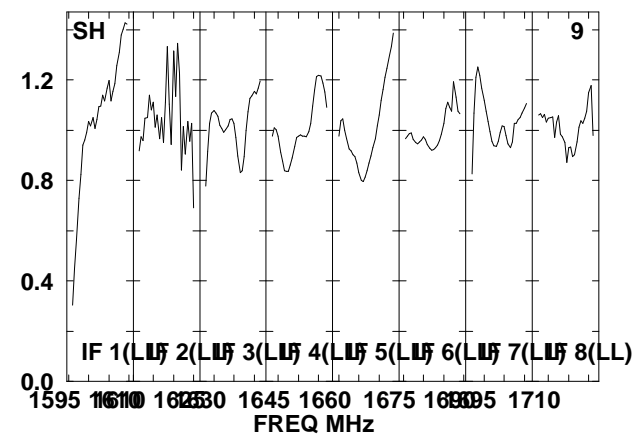
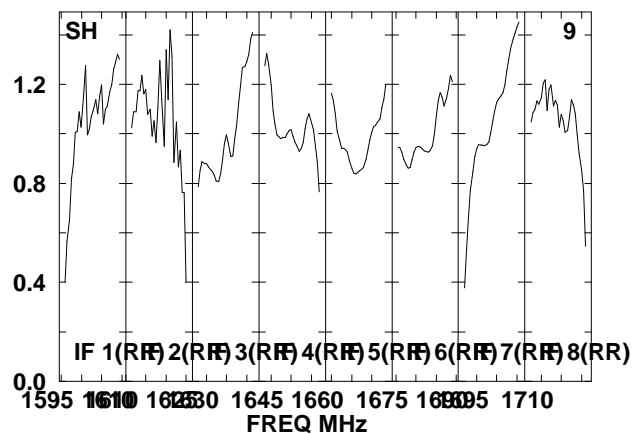
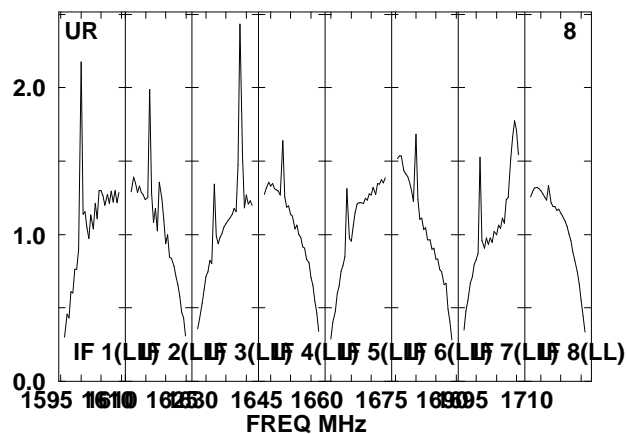
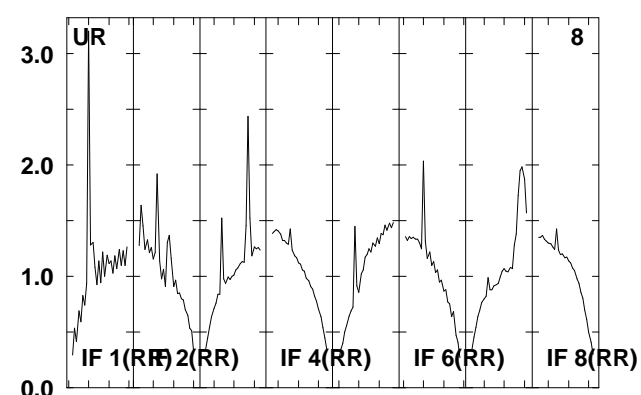
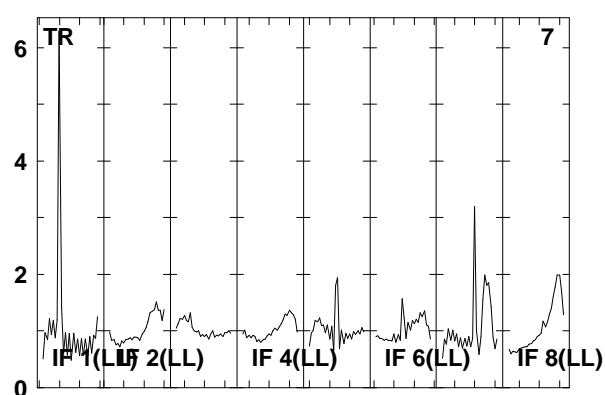
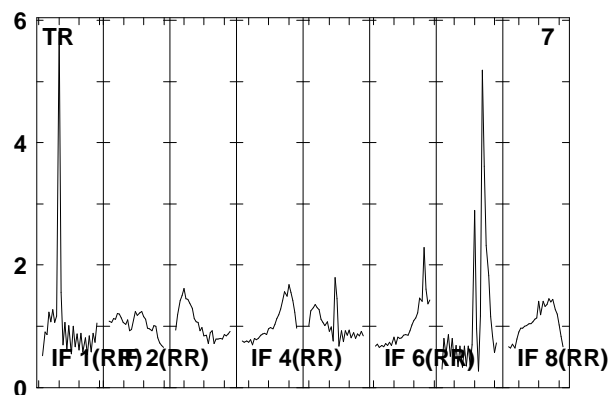
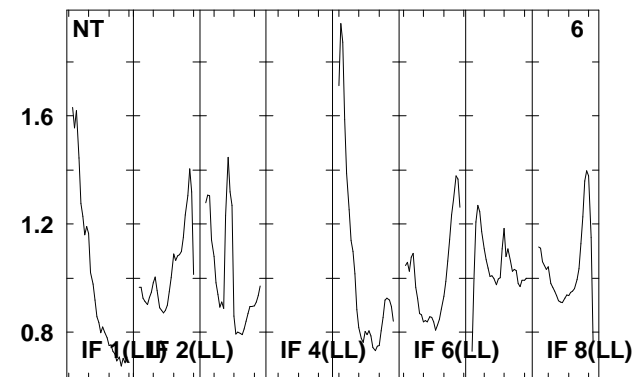
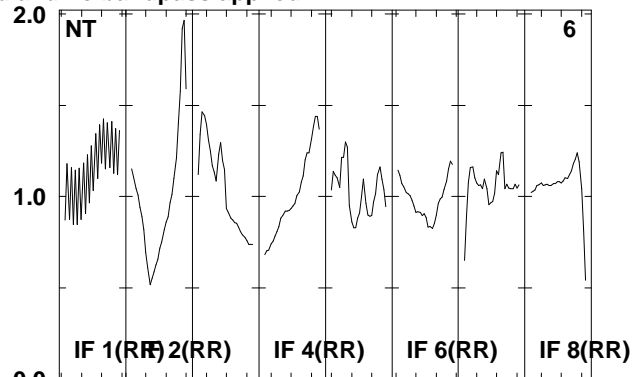
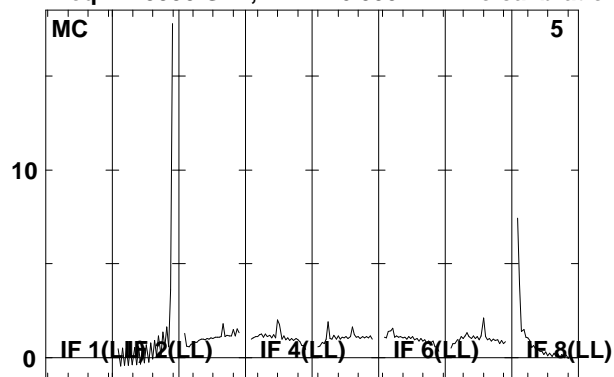

Lower frame: Real Jy  
Total-power spectrum Antenna: \*  
Timerange: 00/04:38:33 to 00/04:43:09

Plot file version 60 created 08-AUG-2008 16:58:45

J021348 EO006B.UVDATA.1

Freq = 1.5950 GHz, Bw = 16.000 MH No calibration applied and no bandpass applied

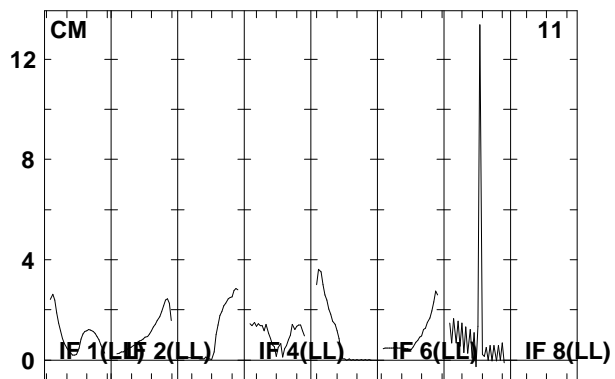
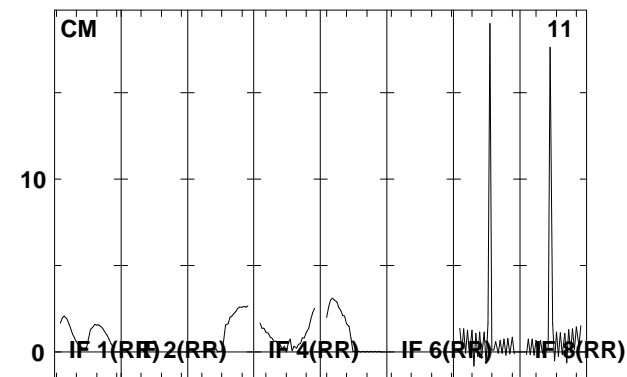
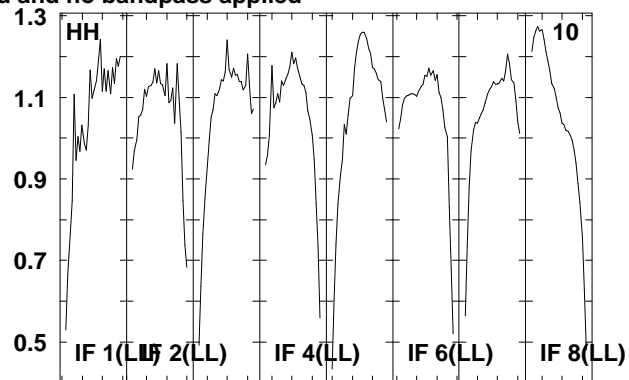
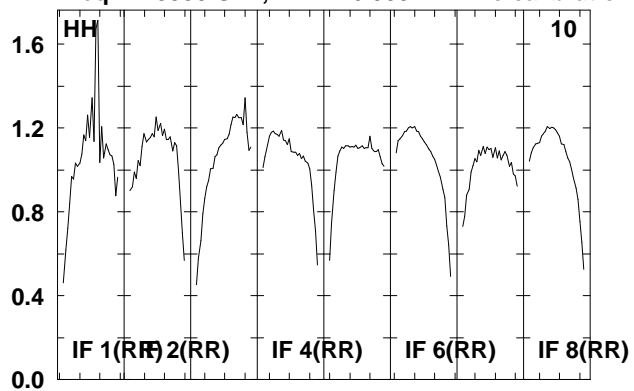

Lower frame: Real Jy  
Total-power spectrum Antenna: \*  
Timerange: 00/04:38:33 to 00/04:43:09



Plot file version 61 created 08-AUG-2008 16:58:45

J0209+13 EO006B.UVDATA.1

Freq = 1.5950 GHz, Bw = 16.000 MH No calibration applied and no bandpass applied

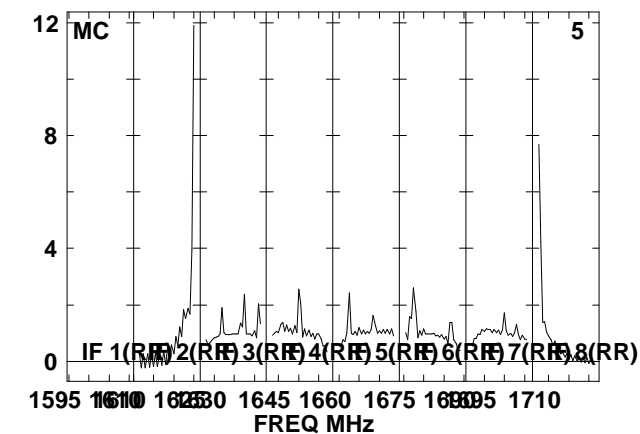
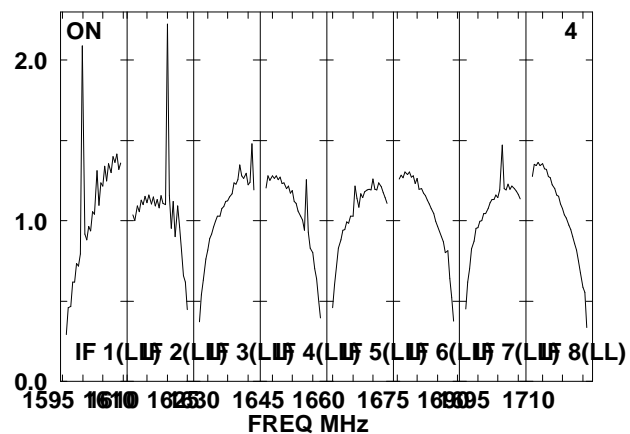
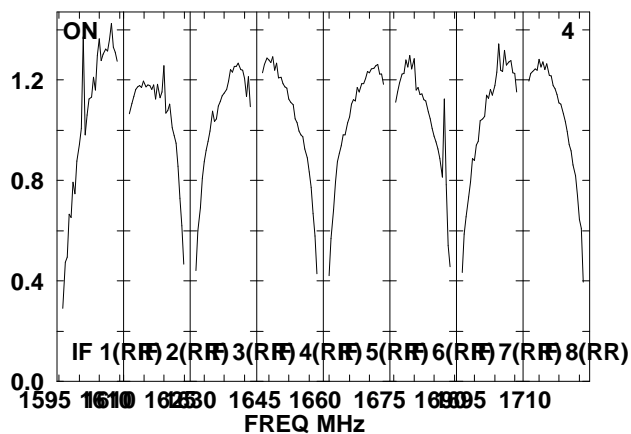
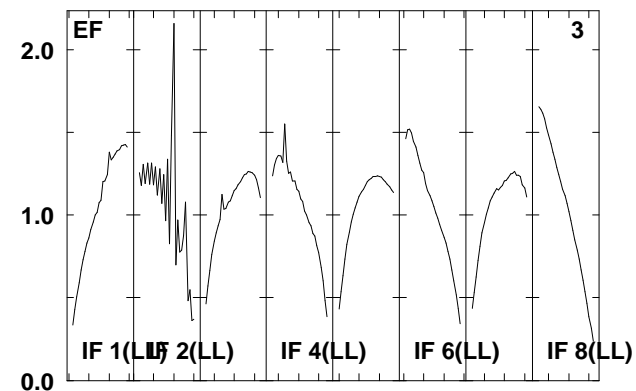
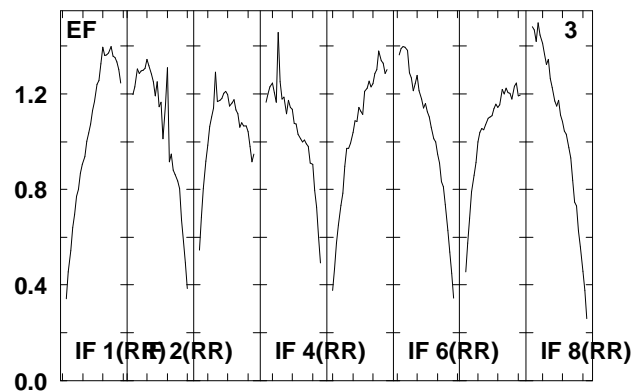
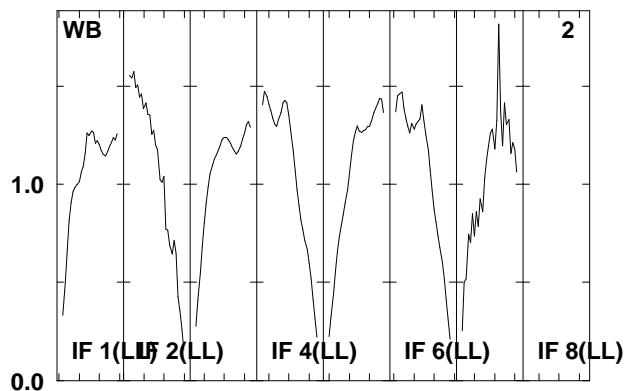
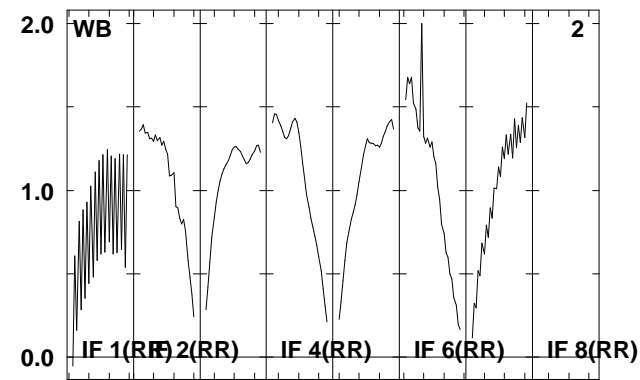
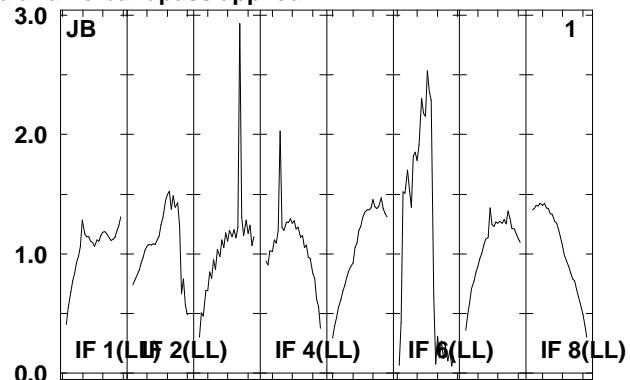
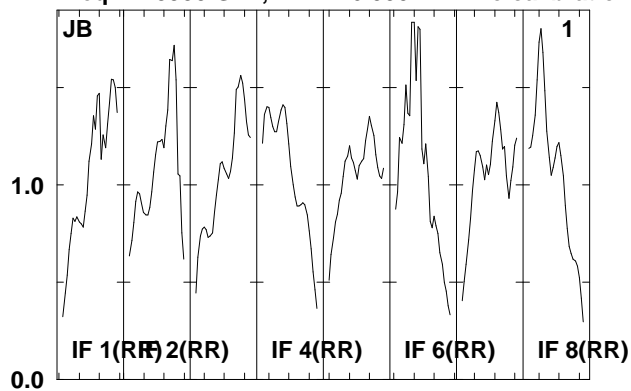

Lower frame: Real Jy  
Total-power spectrum Antenna: \*  
Timerange: 00/04:43:41 to 00/04:45:17

Plot file version 62 created 08-AUG-2008 16:58:45

J0209+13 EO006B.UVDATA.1

Freq = 1.5950 GHz, Bw = 16.000 MH No calibration applied and no bandpass applied

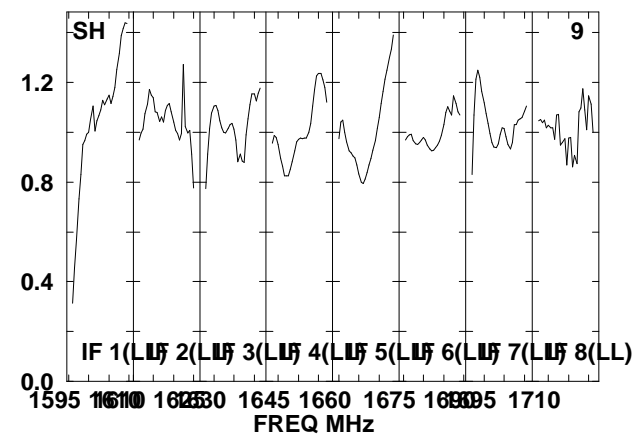
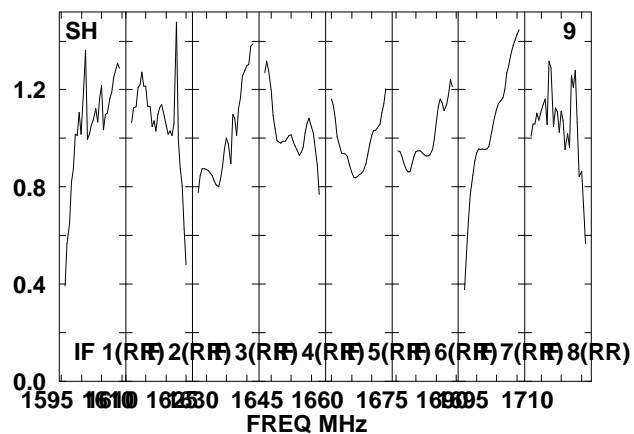
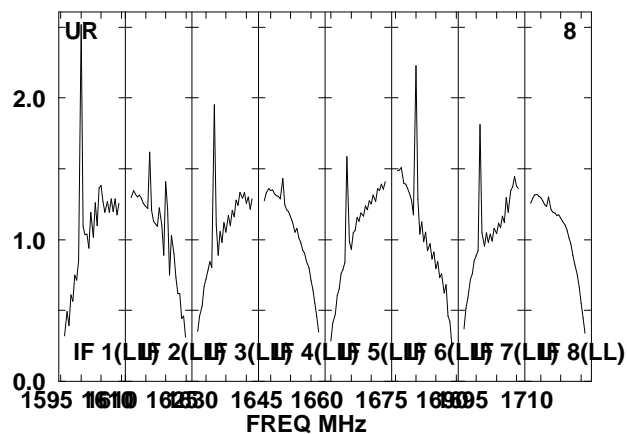
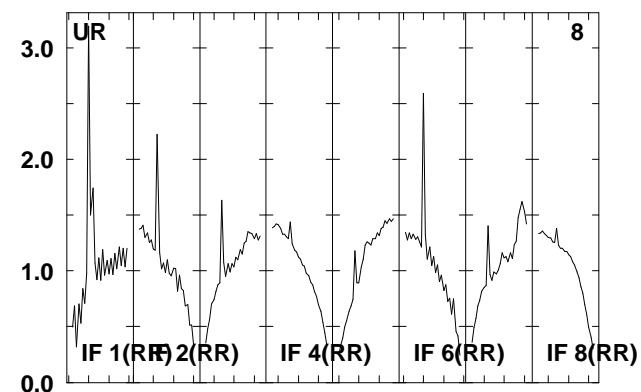
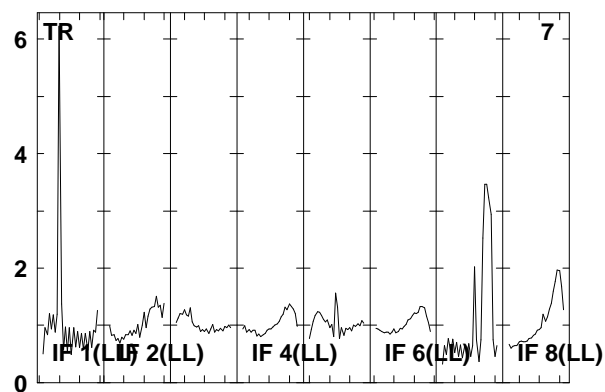
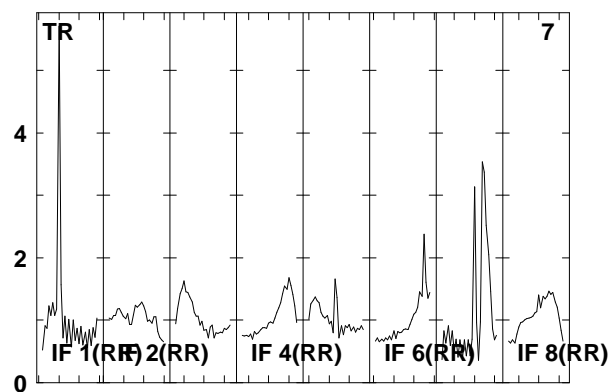
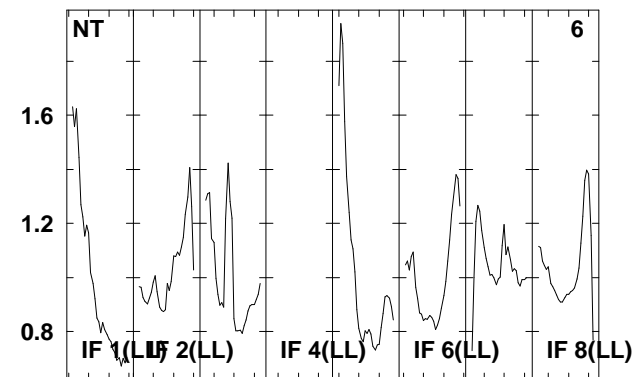
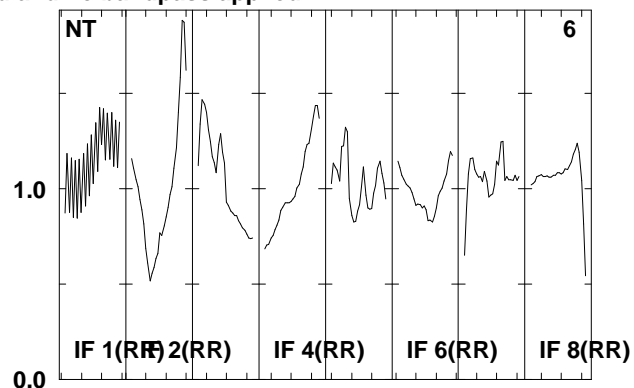
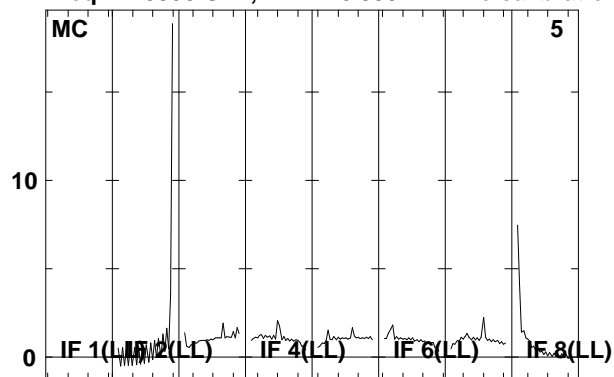

Lower frame: Real Jy

Total-power spectrum Antenna: \*

Timerange: 00/04:43:41 to 00/04:45:17

Plot file version 63 created 08-AUG-2008 16:58:46

J0209+13 EO06B.UVDATA.1

Freq = 1.5950 GHz, Bw = 16.000 MH No calibration applied and no bandpass applied

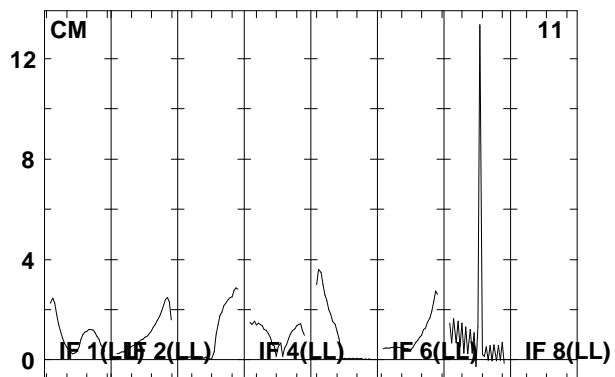
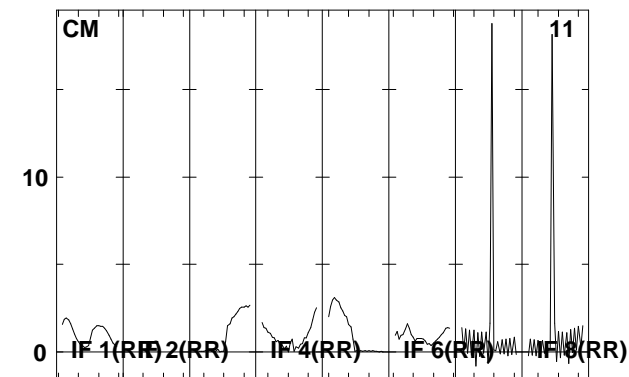
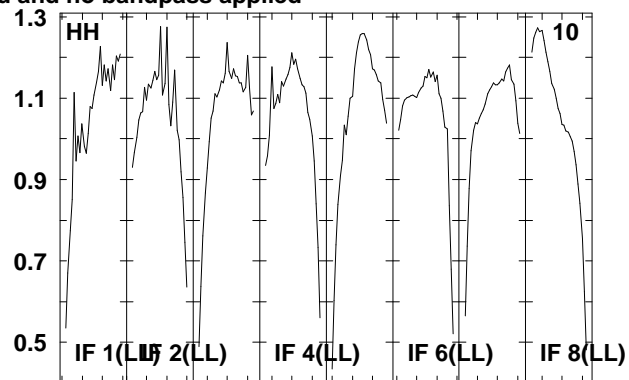
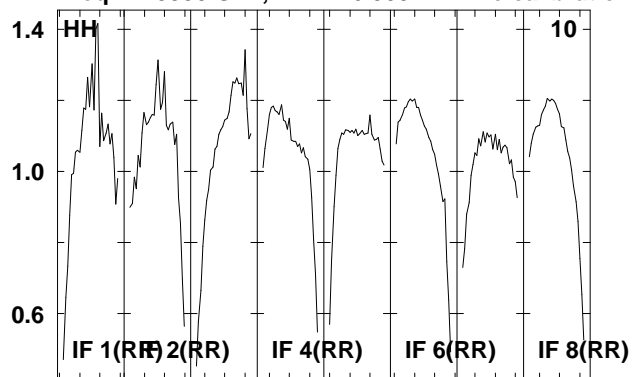

Lower frame: Real Jy  
Total-power spectrum Antenna: \*  
Timerange: 00/04:43:41 to 00/04:45:17

Plot file version 64 created 08-AUG-2008 16:58:46

J021348 EO006B.UVDATA.1

Freq = 1.5950 GHz, Bw = 16.000 MH No calibration applied and no bandpass applied

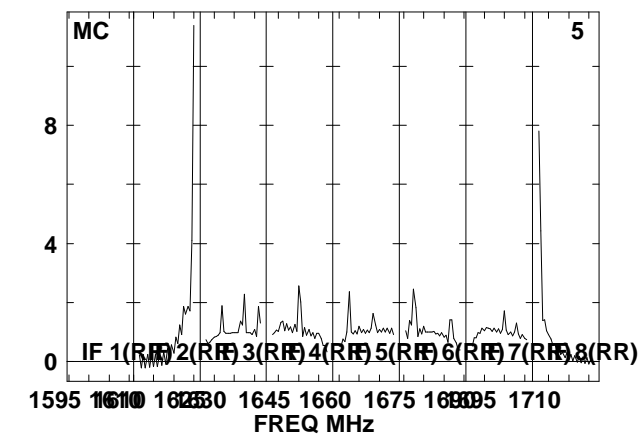
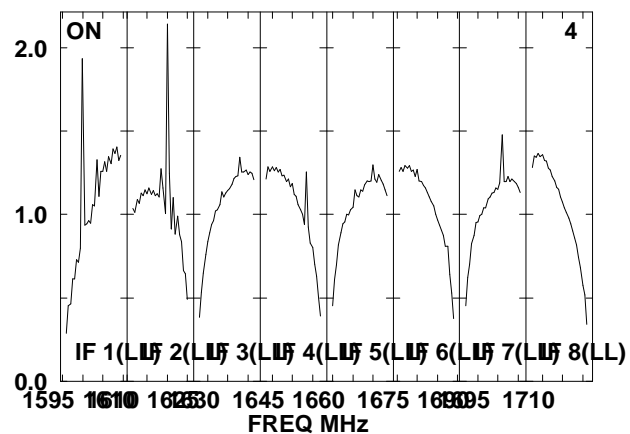
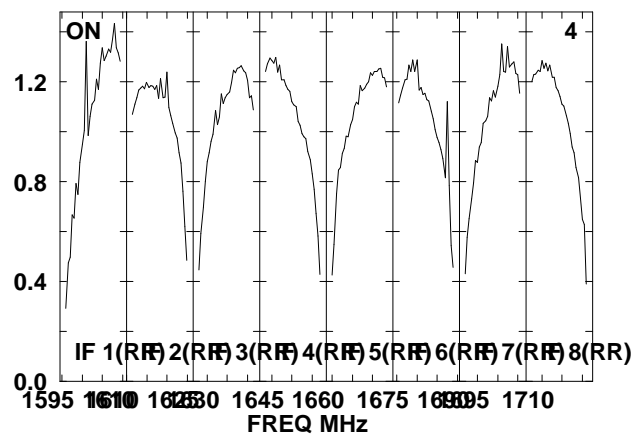
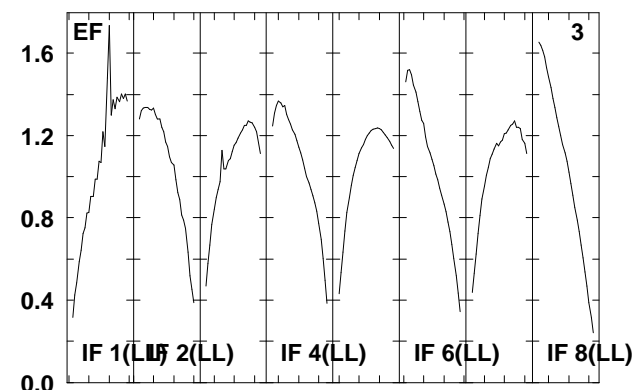
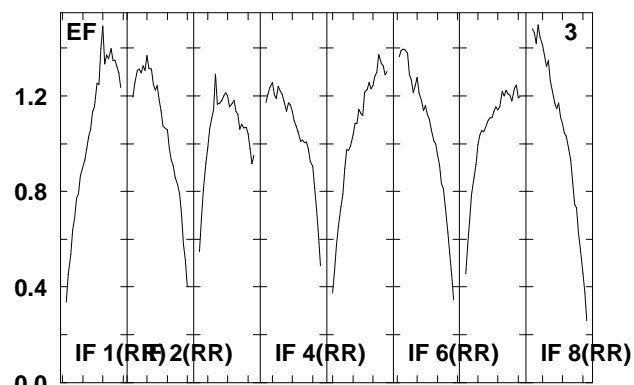
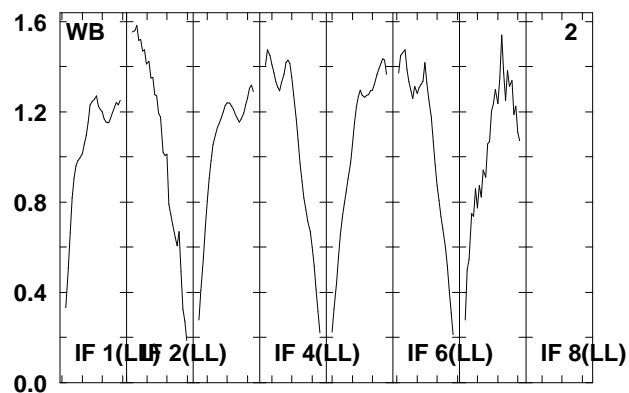
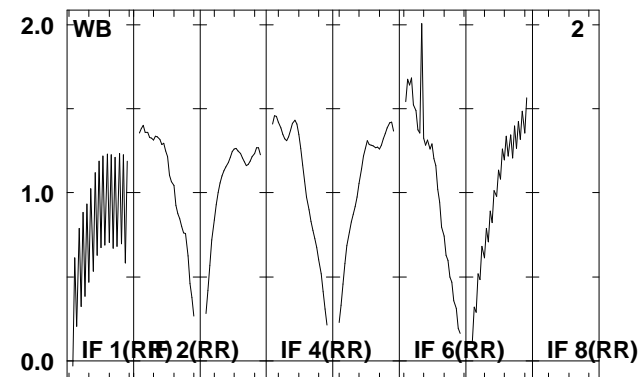
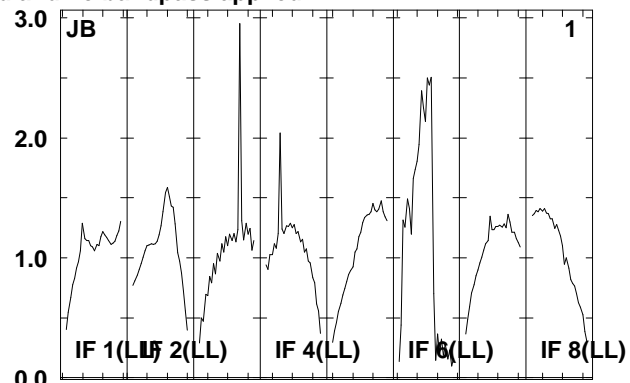
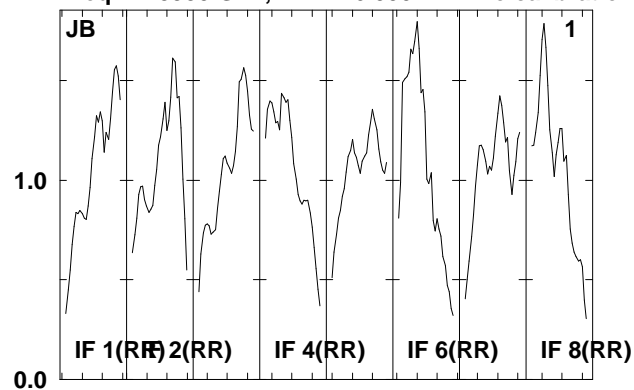

Lower frame: Real Jy  
Total-power spectrum Antenna: \*  
Timerange: 00/04:45:53 to 00/04:50:29

Plot file version 65 created 08-AUG-2008 16:58:47

J021348 EO06B.UVDATA.1

Freq = 1.5950 GHz, Bw = 16.000 MH No calibration applied and no bandpass applied

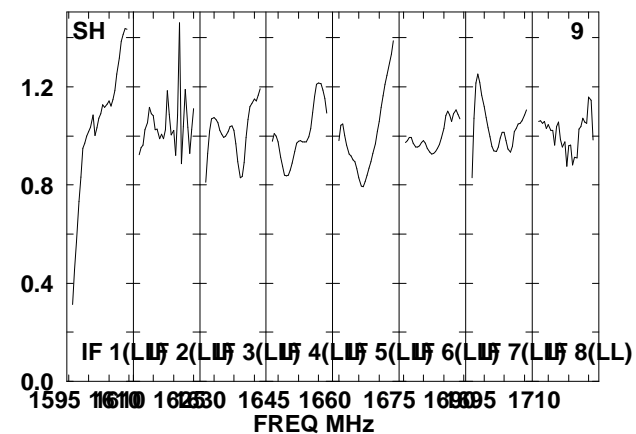
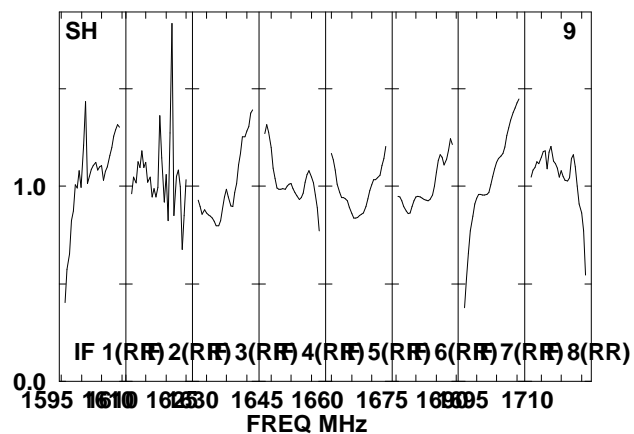
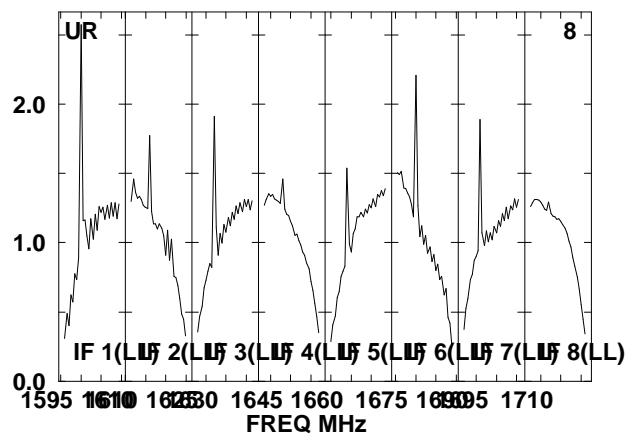
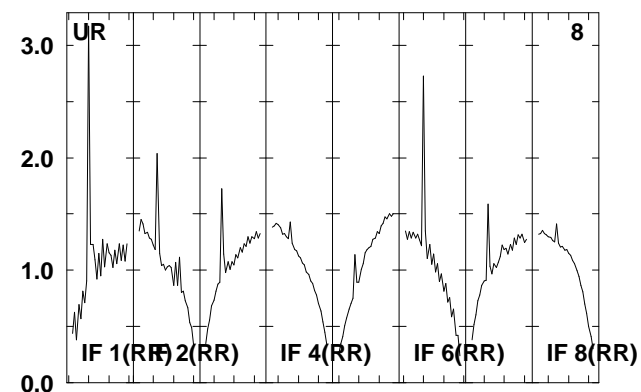
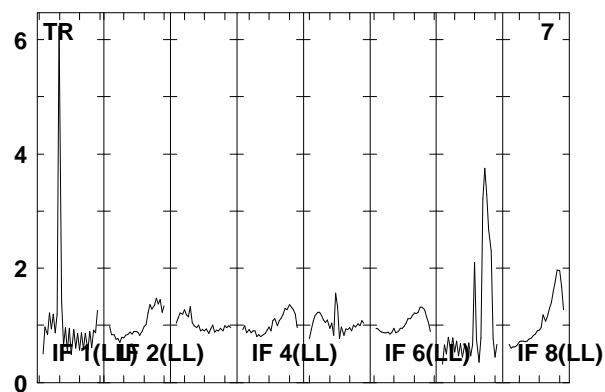
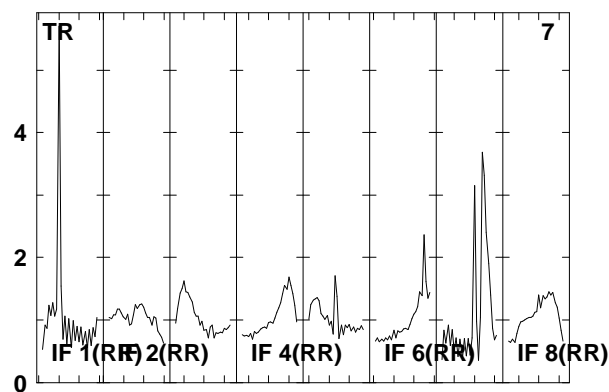
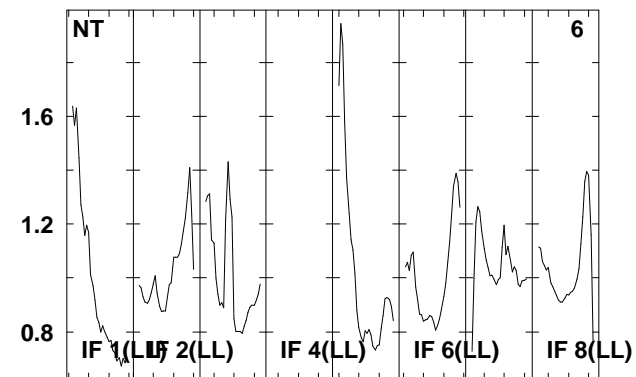
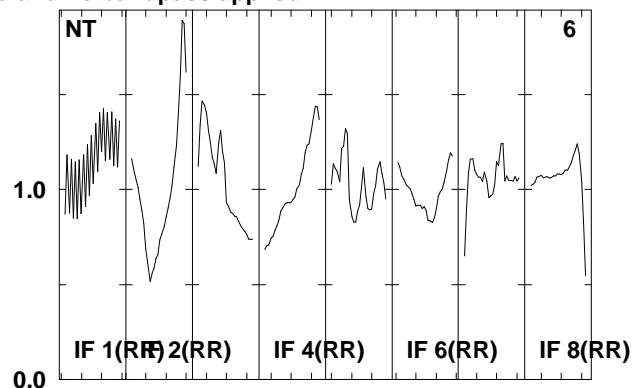
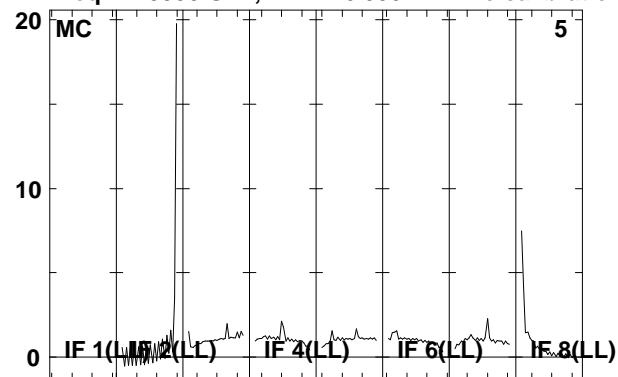

Lower frame: Real Jy  
Total-power spectrum Antenna: \*  
Timerange: 00/04:45:53 to 00/04:50:29

Plot file version 66 created 08-AUG-2008 16:58:47

J021348 EO006B.UVDATA.1

Freq = 1.5950 GHz, Bw = 16.000 MH No calibration applied and no bandpass applied

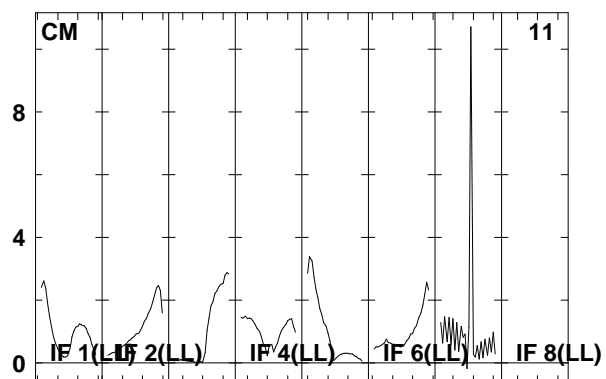
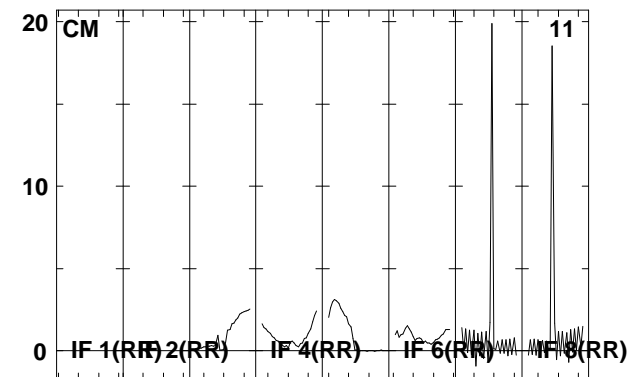
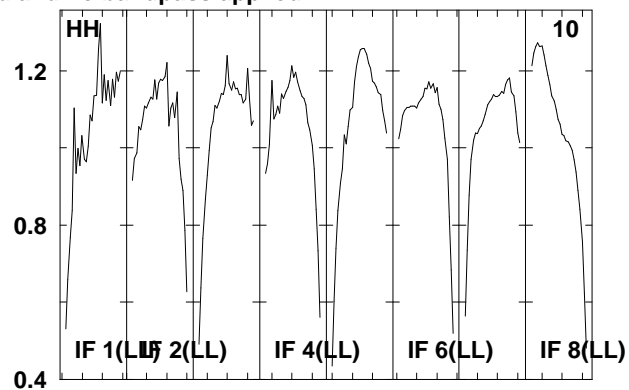
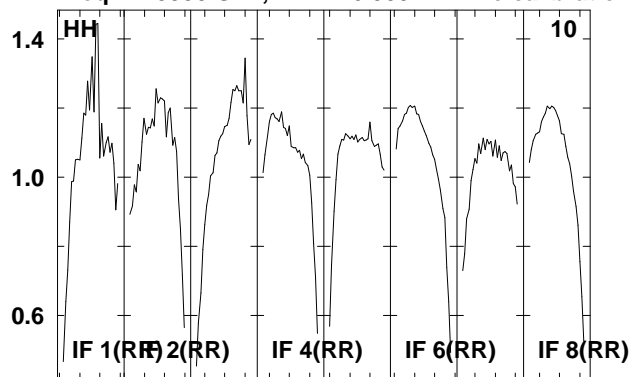

Lower frame: Real Jy  
Total-power spectrum Antenna: \*  
Timerange: 00/04:45:53 to 00/04:50:29

Plot file version 67 created 08-AUG-2008 16:58:47

J0209+13 EO006B.UVDATA.1

Freq = 1.5950 GHz, Bw = 16.000 MH No calibration applied and no bandpass applied

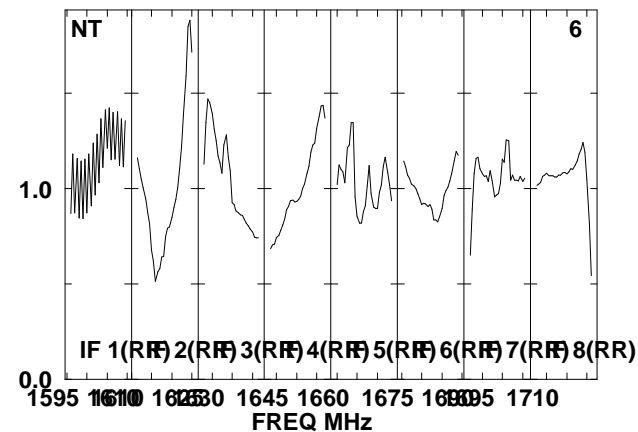
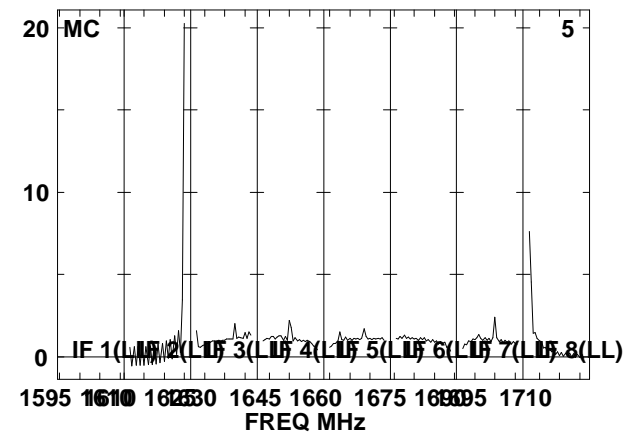
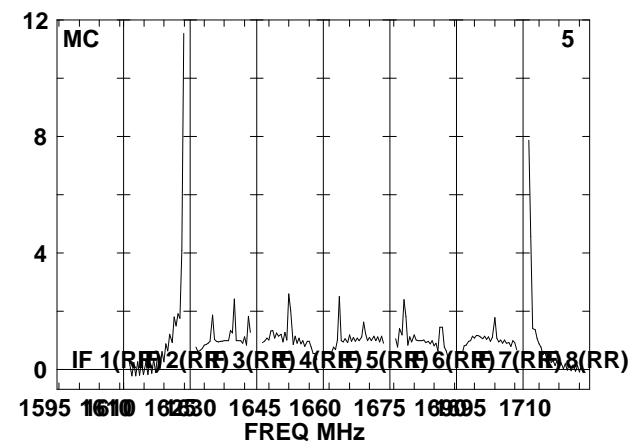
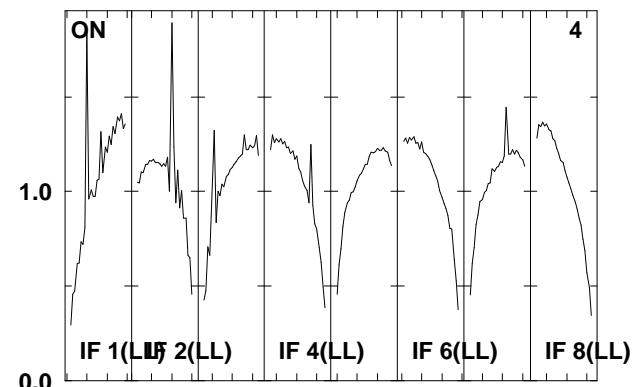
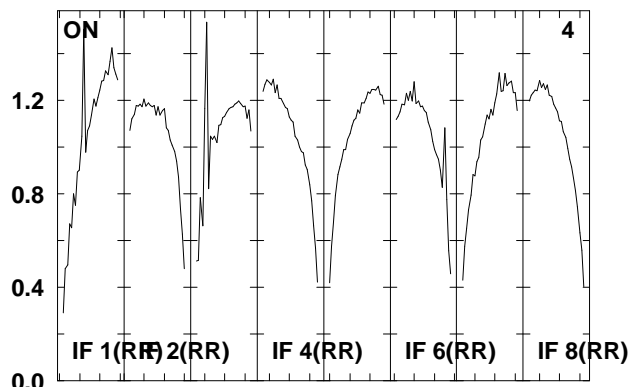
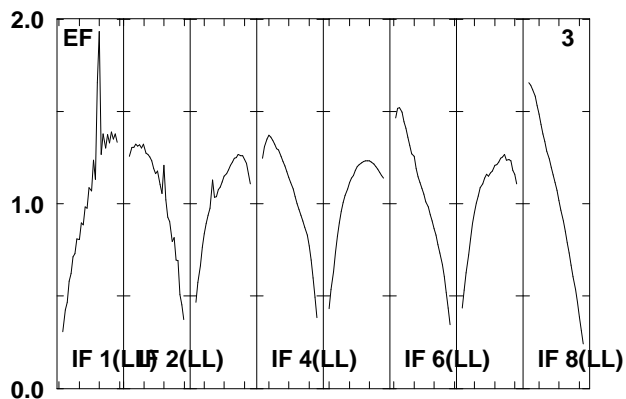
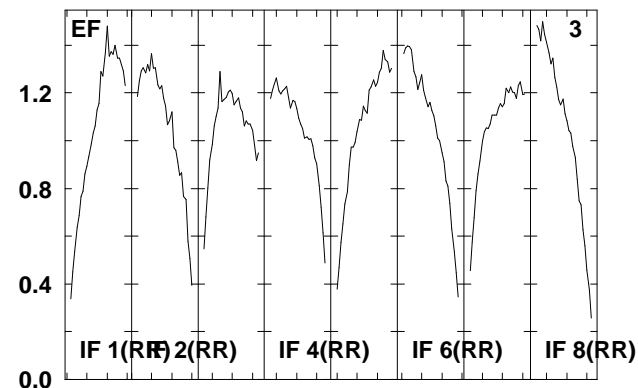
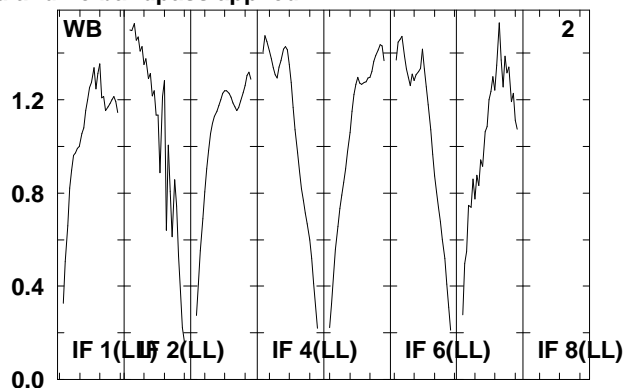
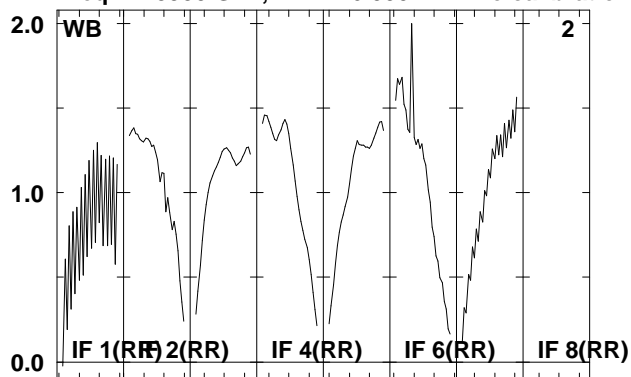

Lower frame: Real Jy  
Total-power spectrum Antenna: \*  
Timerange: 00/04:51:01 to 00/04:52:37

Plot file version 68 created 08-AUG-2008 16:58:48  
 J0209+13 EO06B.UVDATA.1  
 Freq = 1.5950 GHz, Bw = 16.000 MH No calibration applied and no bandpass applied

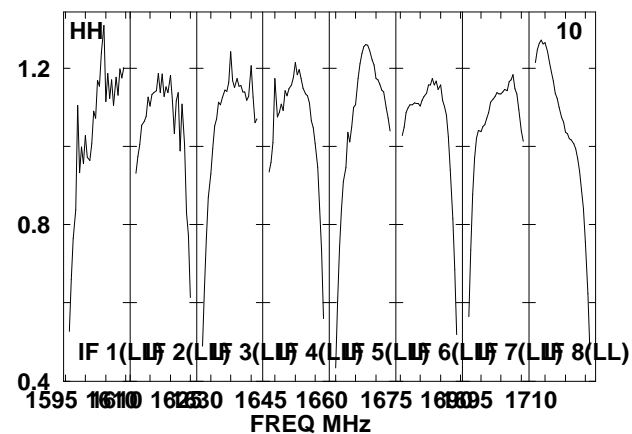
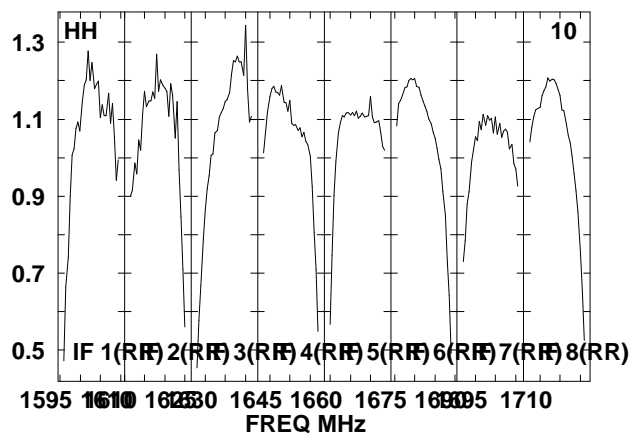
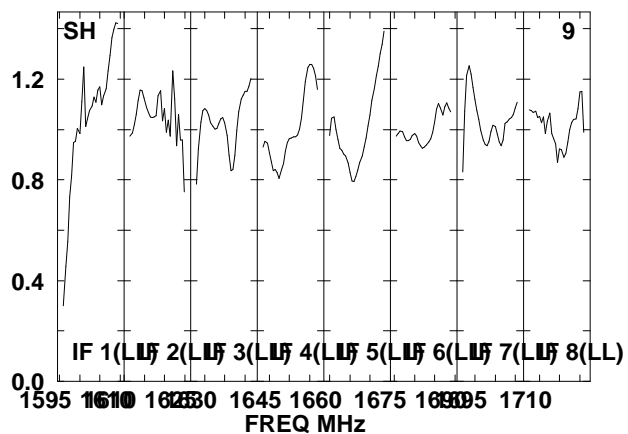
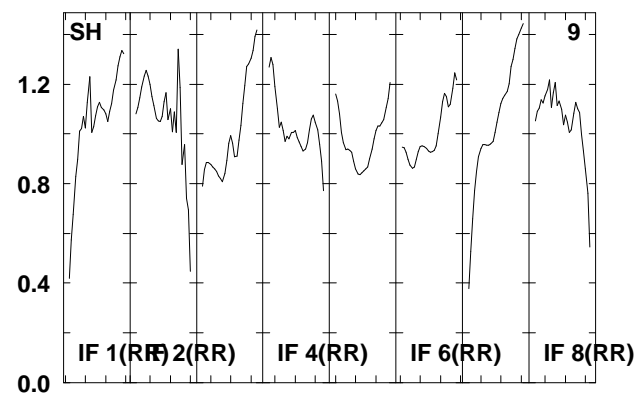
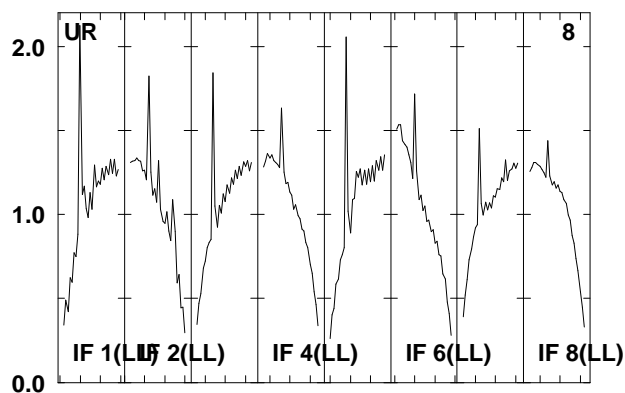
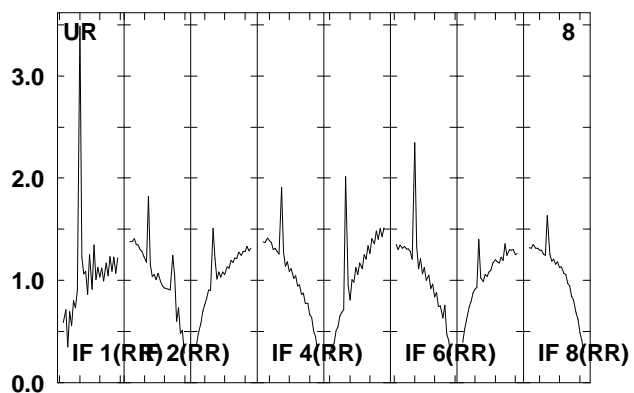
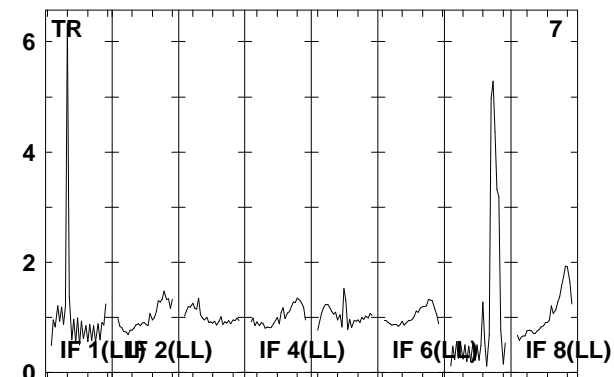
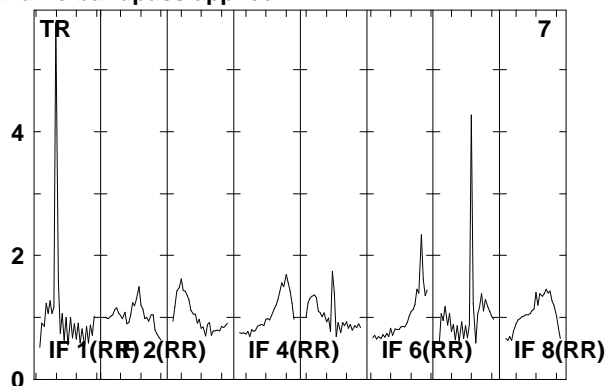
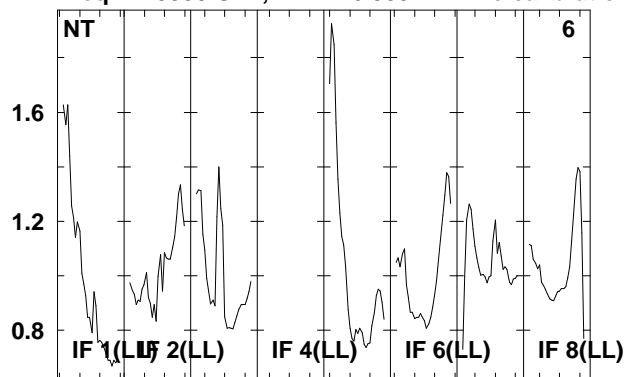

Lower frame: Real Jy  
 Total-power spectrum Antenna: \*  
 Timerange: 00/04:51:01 to 00/04:52:37



Plot file version 69 created 08-AUG-2008 16:58:48

J0209+13 EO006B.UVDATA.1

Freq = 1.5950 GHz, Bw = 16.000 MH No calibration applied and no bandpass applied

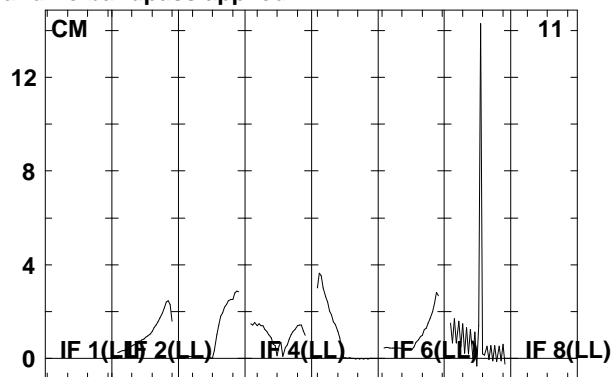
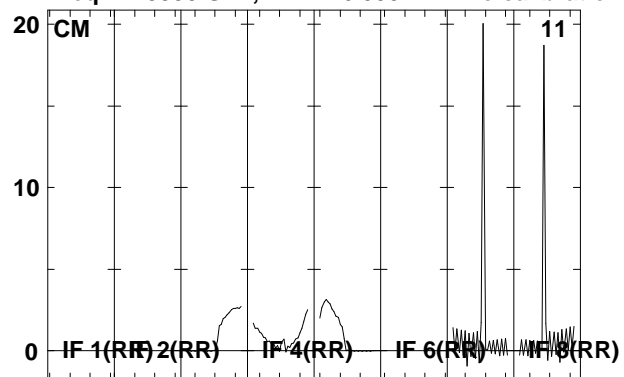

Lower frame: Real Jy  
Total-power spectrum Antenna: \*  
Timerange: 00/04:51:01 to 00/04:52:37

Plot file version 70 created 08-AUG-2008 16:58:48

J021348 EO006B.UVDATA.1

Freq = 1.5950 GHz, Bw = 16.000 MH No calibration applied and no bandpass applied

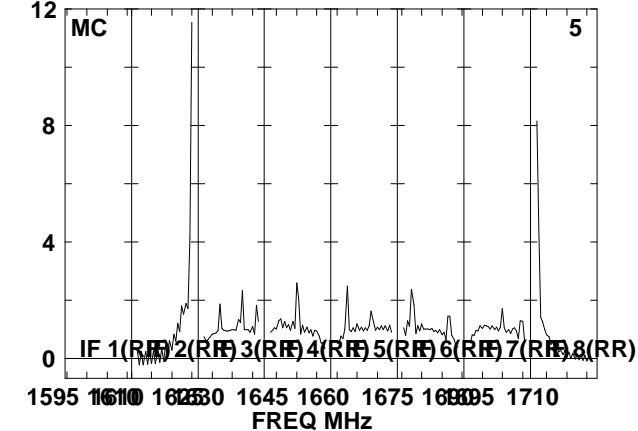
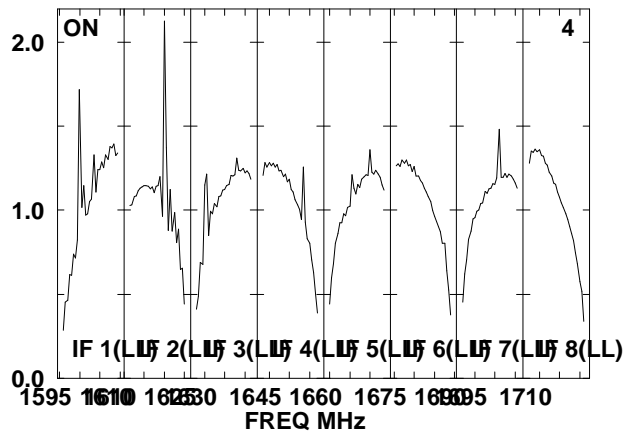
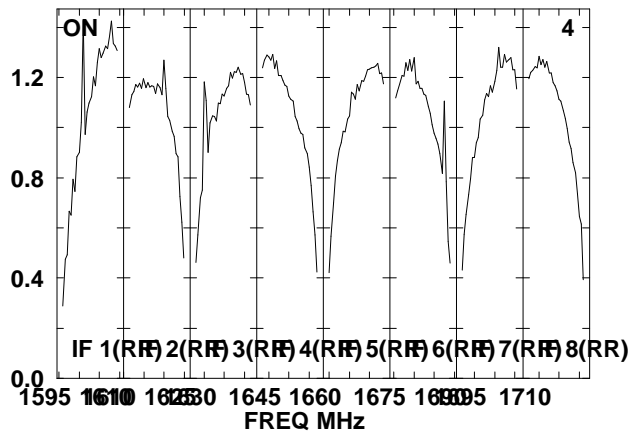
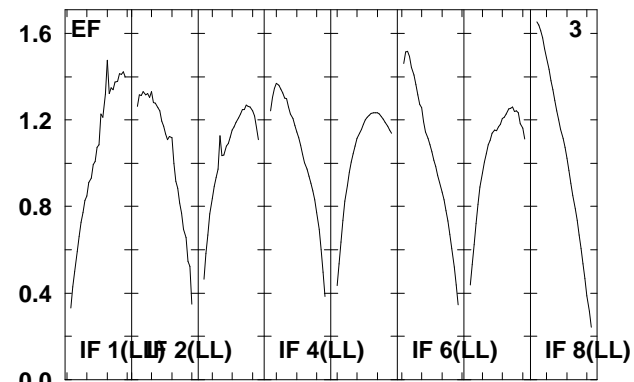
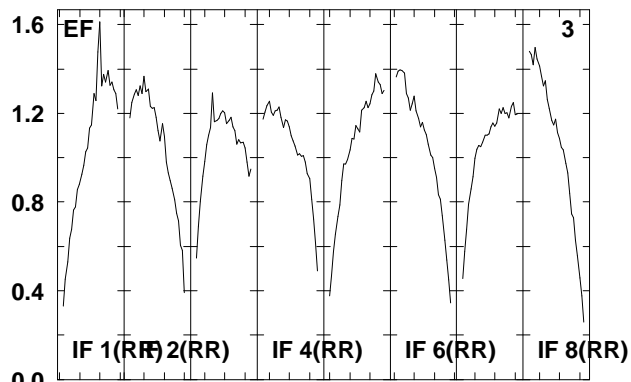
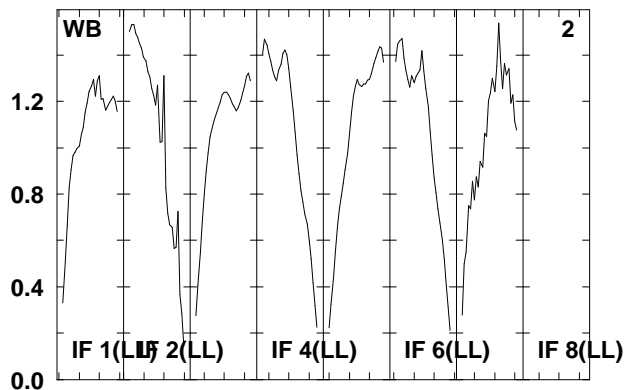
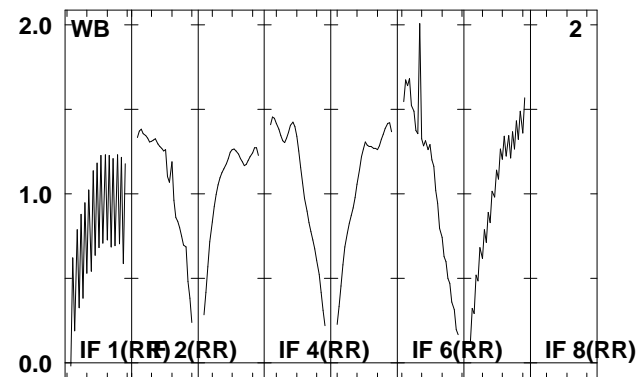
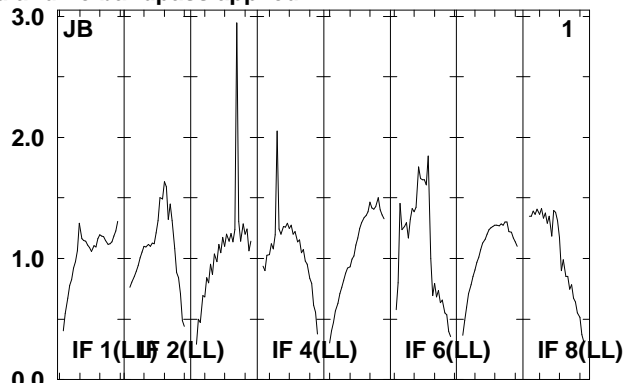
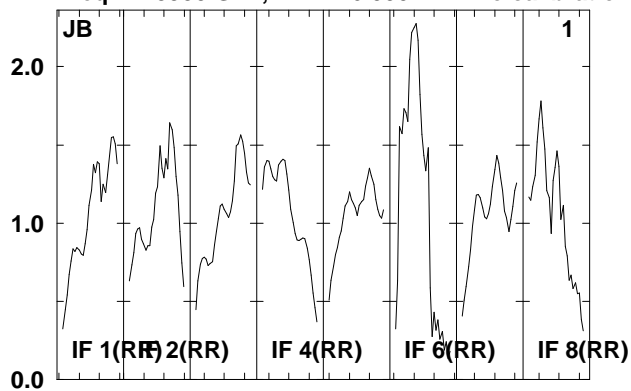

Lower frame: Real Jy  
Total-power spectrum Antenna: \*  
Timerange: 00/04:53:13 to 00/04:57:49

Plot file version 71 created 08-AUG-2008 16:58:49

J021348 EO06B.UVDATA.1

Freq = 1.5950 GHz, Bw = 16.000 MH No calibration applied and no bandpass applied

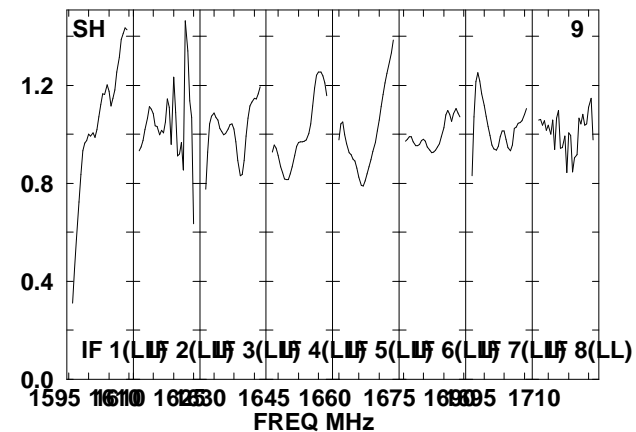
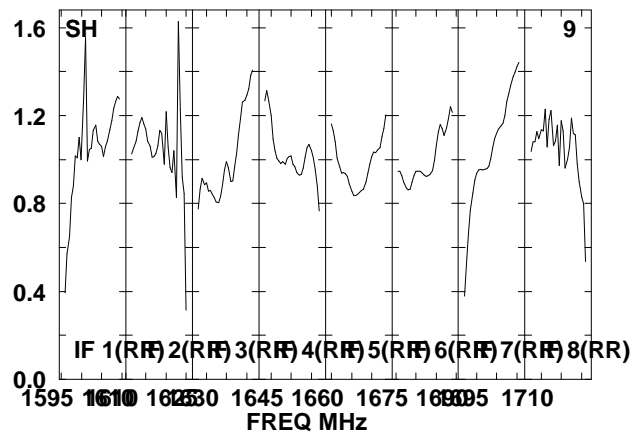
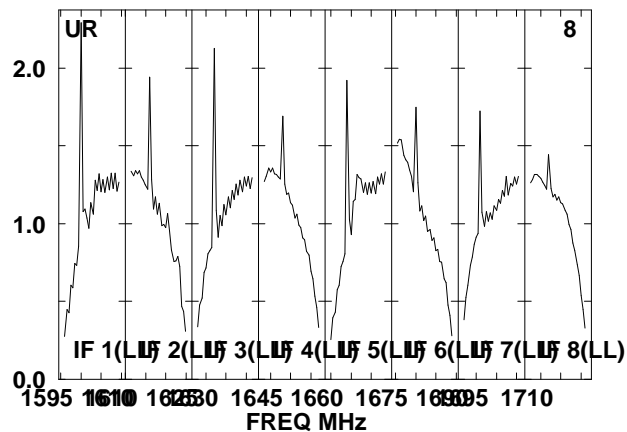
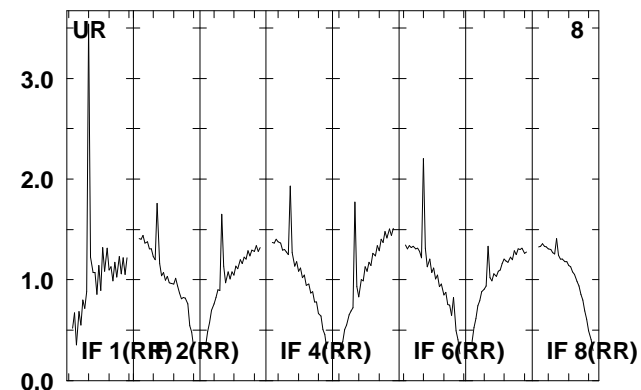
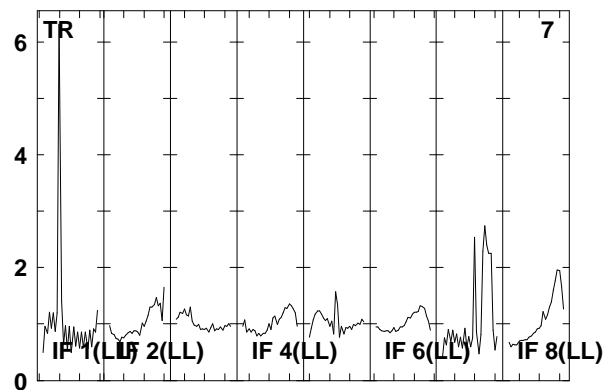
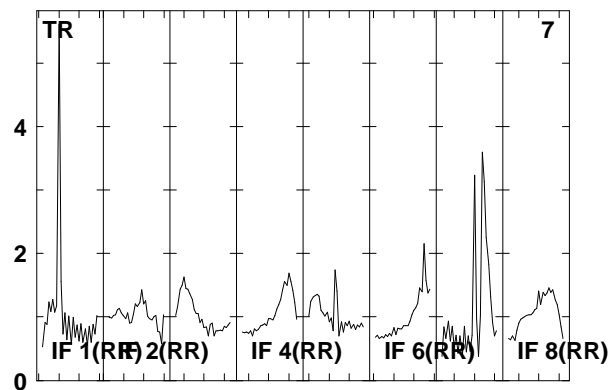
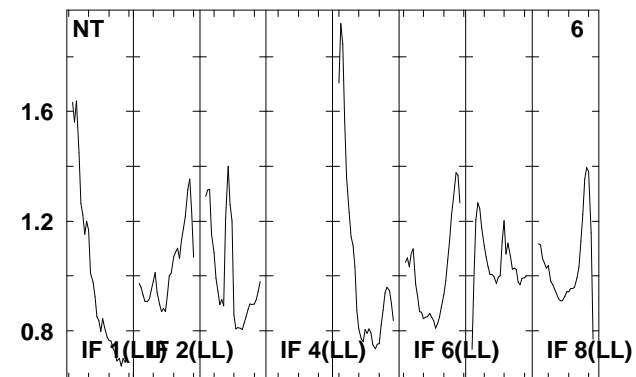
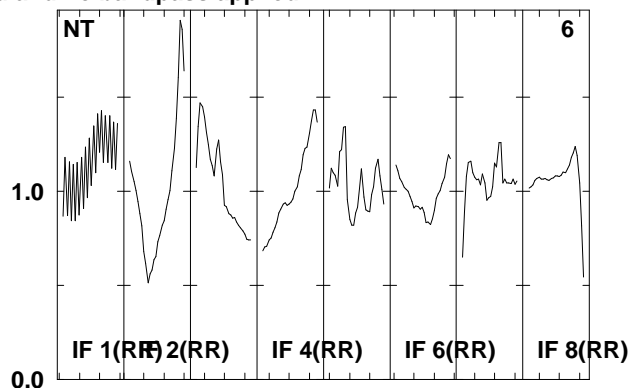
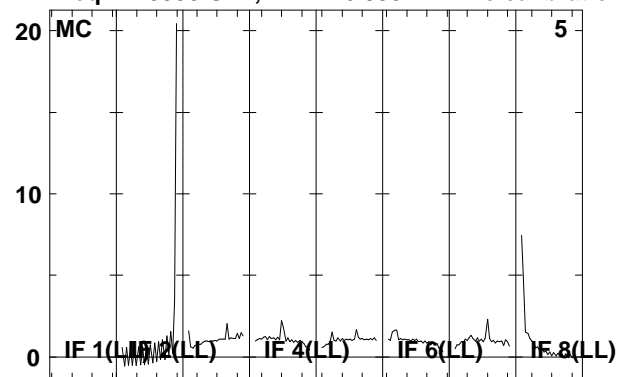

Lower frame: Real Jy  
Total-power spectrum Antenna: \*  
Timerange: 00/04:53:13 to 00/04:57:49

Plot file version 72 created 08-AUG-2008 16:58:50

J021348 EO006B.UVDATA.1

Freq = 1.5950 GHz, Bw = 16.000 MH No calibration applied and no bandpass applied

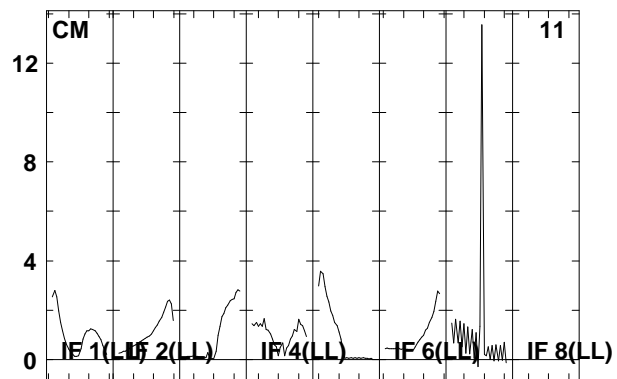
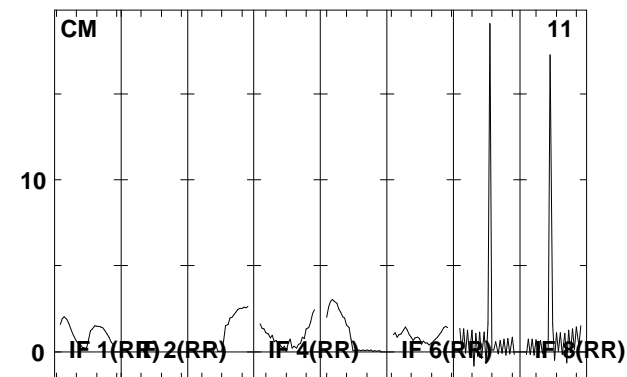
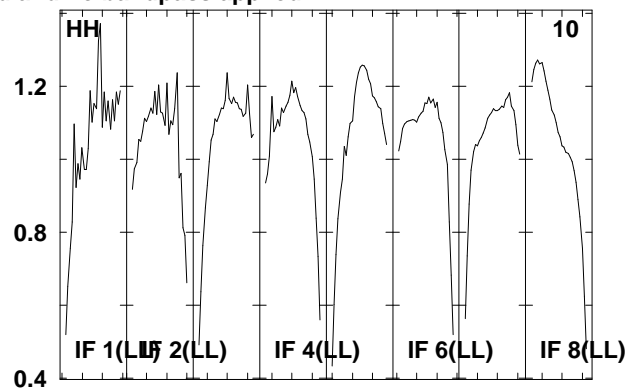
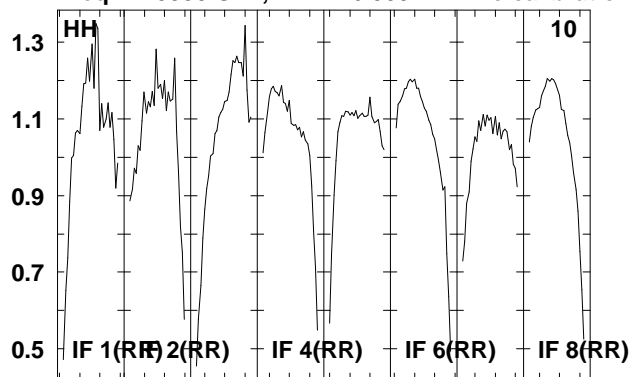

Lower frame: Real Jy  
Total-power spectrum Antenna: \*  
Timerange: 00/04:53:13 to 00/04:57:49

Plot file version 73 created 08-AUG-2008 16:58:50

J0209+13 EO006B.UVDATA.1

Freq = 1.5950 GHz, Bw = 16.000 MH No calibration applied and no bandpass applied

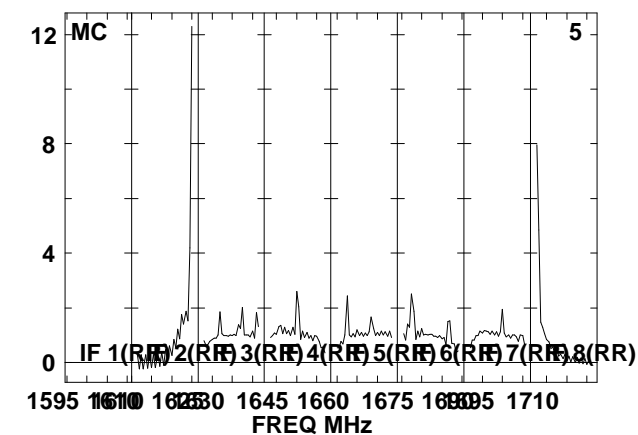
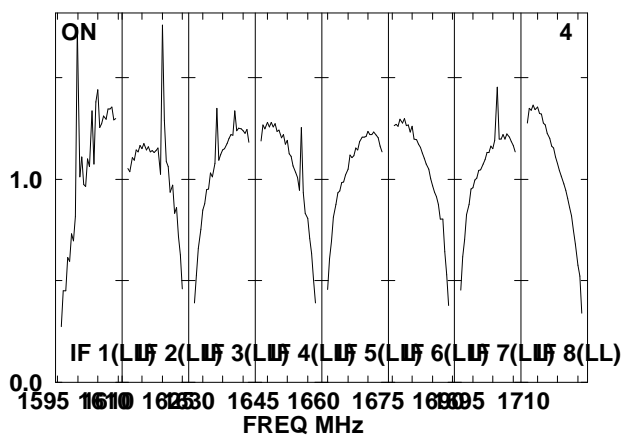
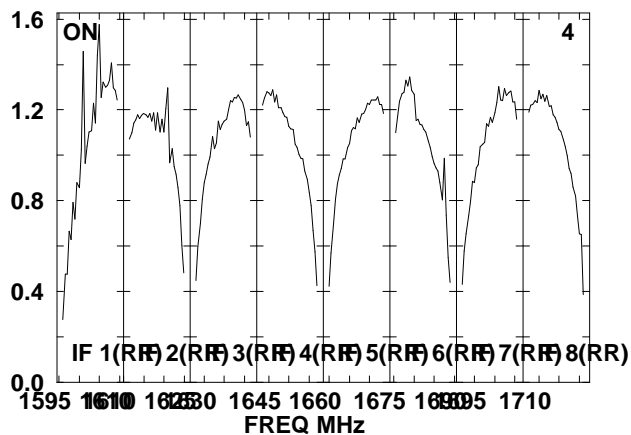
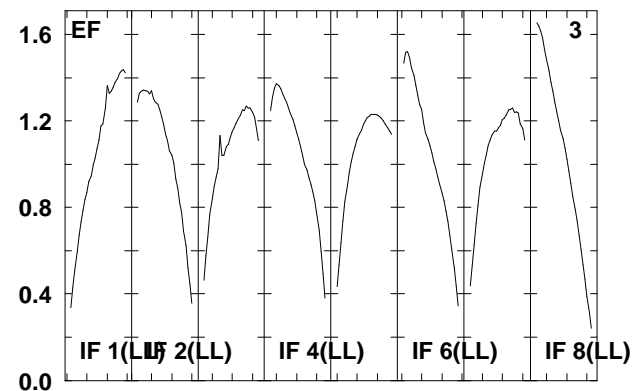
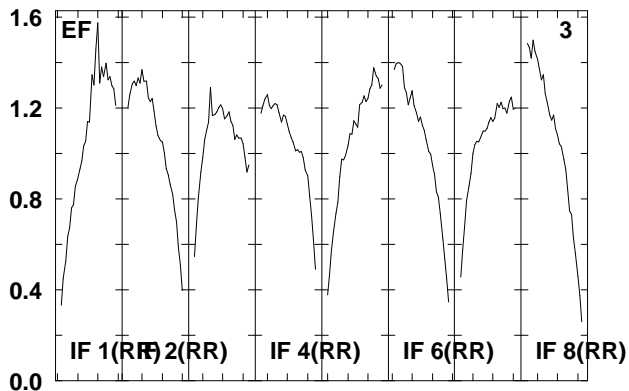
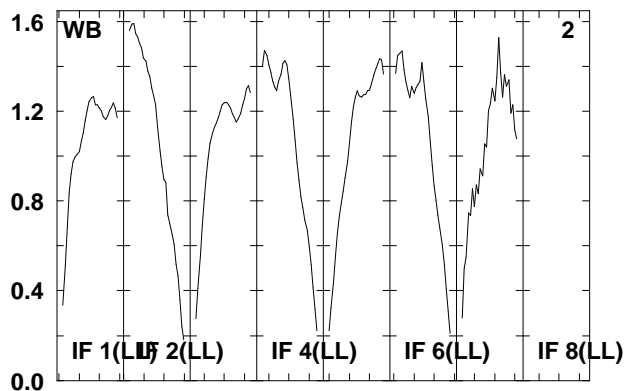
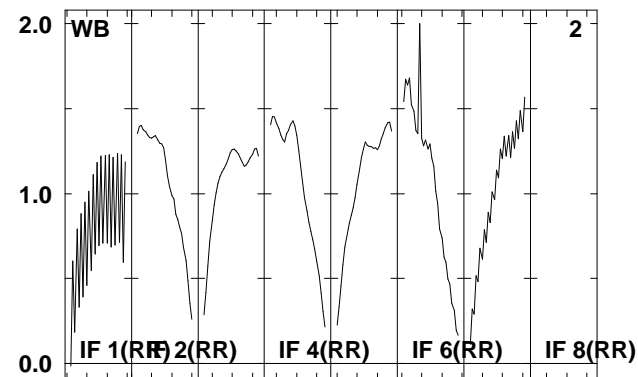
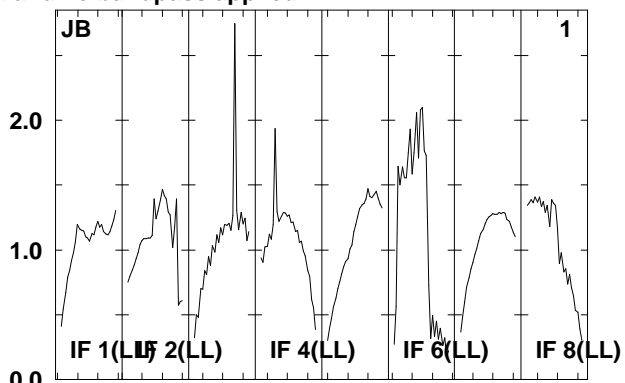
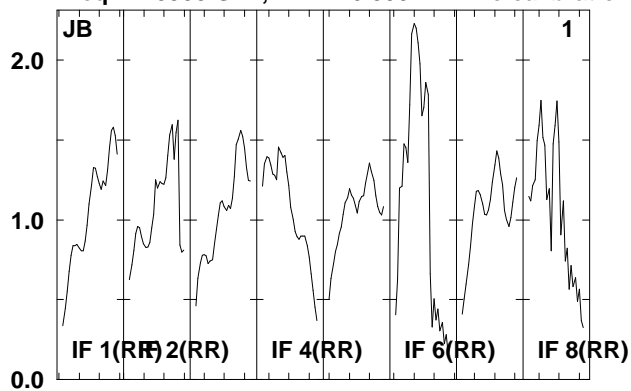

Lower frame: Real Jy  
Total-power spectrum Antenna: \*  
Timerange: 00/04:58:21 to 00/04:59:57

Plot file version 74 created 08-AUG-2008 16:58:51

J0209+13 EO006B.UVDATA.1

Freq = 1.5950 GHz, Bw = 16.000 MH No calibration applied and no bandpass applied

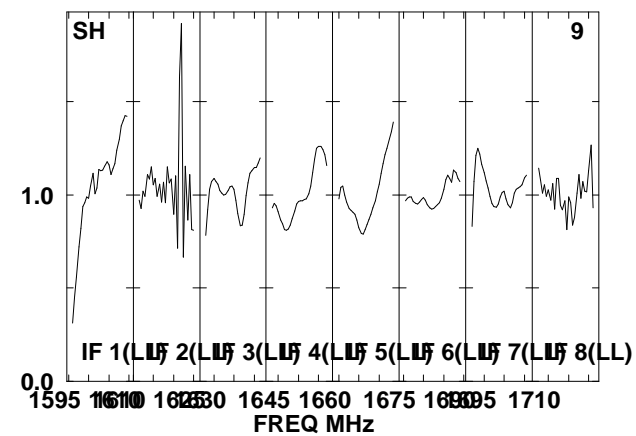
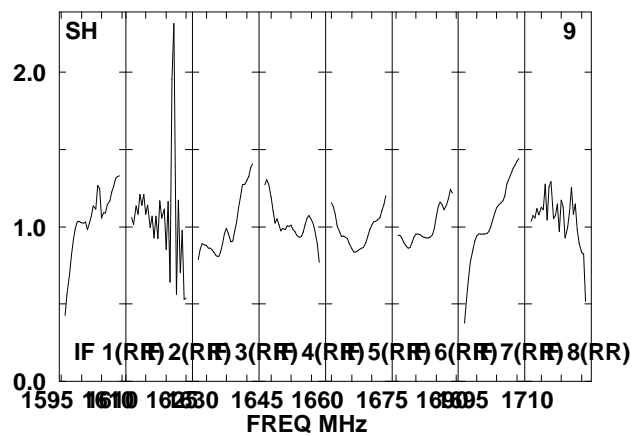
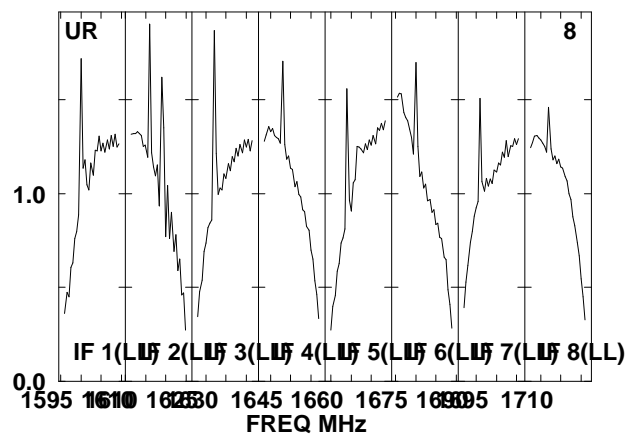
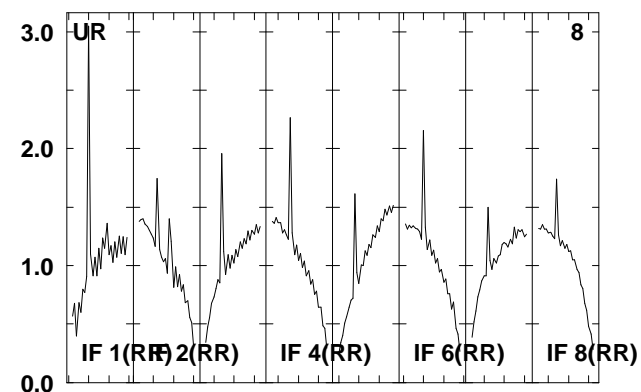
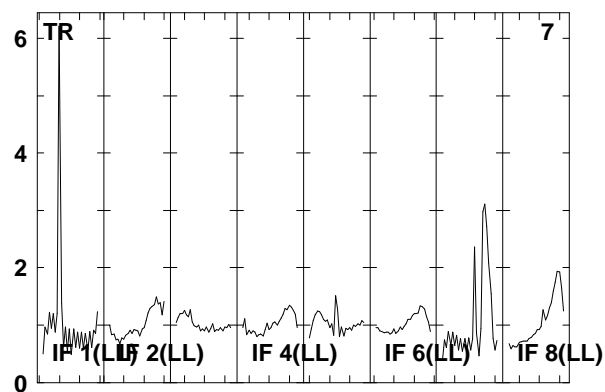
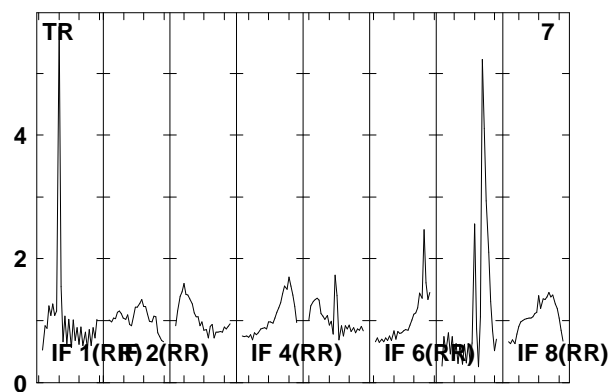
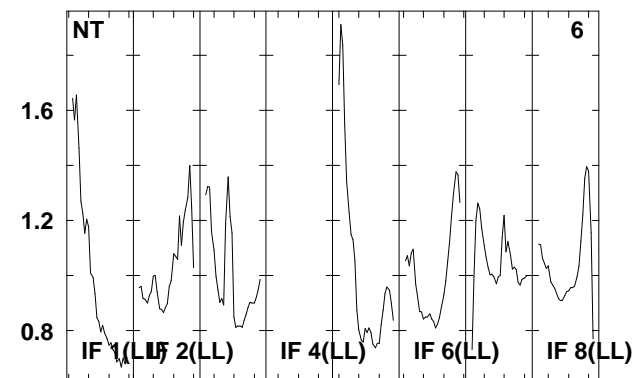
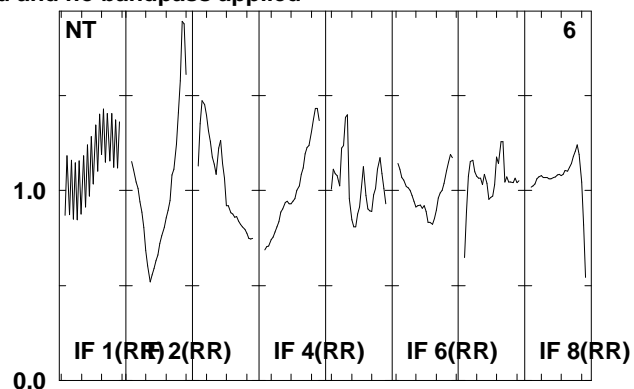
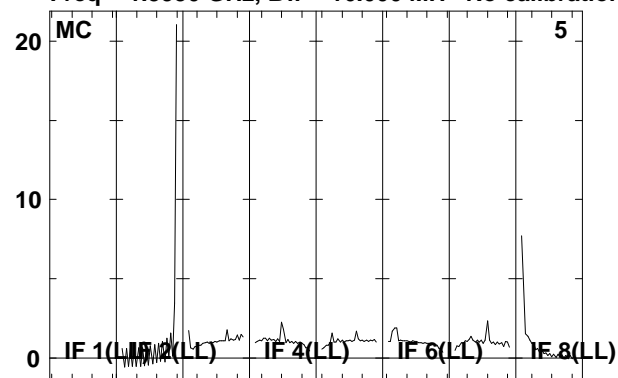

Lower frame: Real Jy

Total-power spectrum Antenna: \*

Timerange: 00/04:58:21 to 00/04:59:57

Plot file version 75 created 08-AUG-2008 16:58:51

J0209+13 EO006B.UVDATA.1

Freq = 1.5950 GHz, Bw = 16.000 MH No calibration applied and no bandpass applied

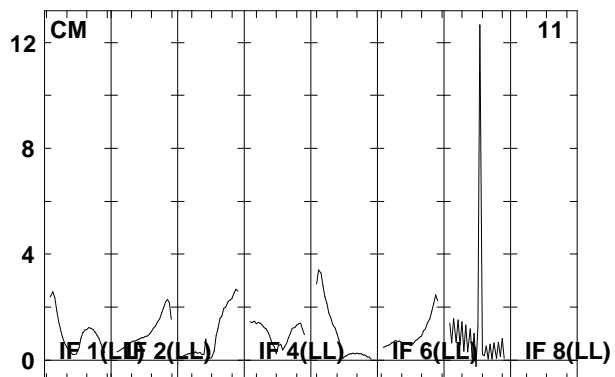
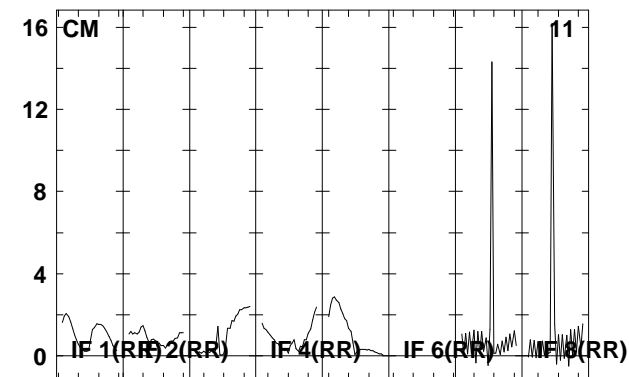
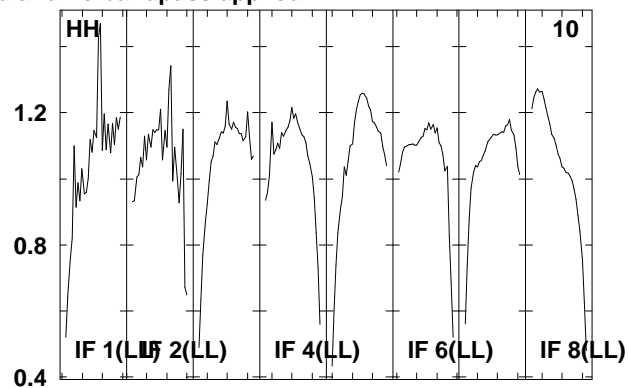
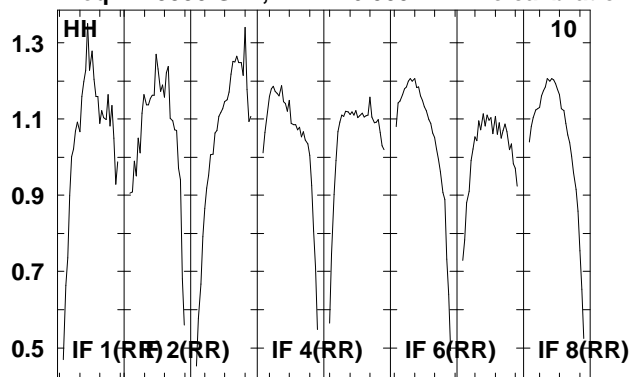

Lower frame: Real Jy  
Total-power spectrum Antenna: \*  
Timerange: 00/04:58:21 to 00/04:59:57

Plot file version 76 created 08-AUG-2008 16:58:52

J021348 EO006B.UVDATA.1

Freq = 1.5950 GHz, Bw = 16.000 MH No calibration applied and no bandpass applied

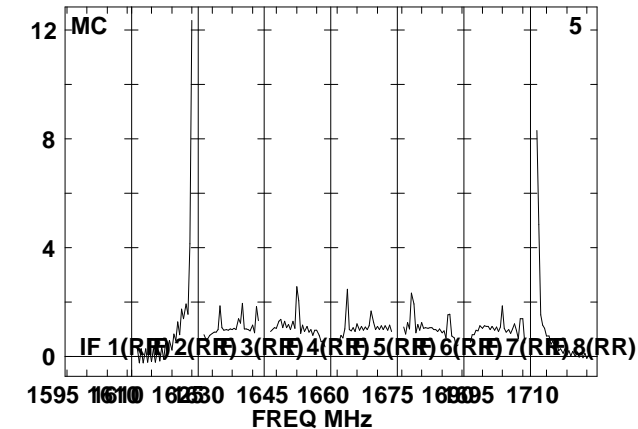
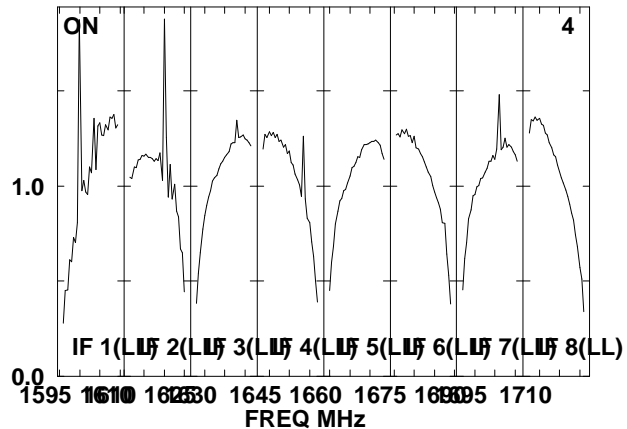
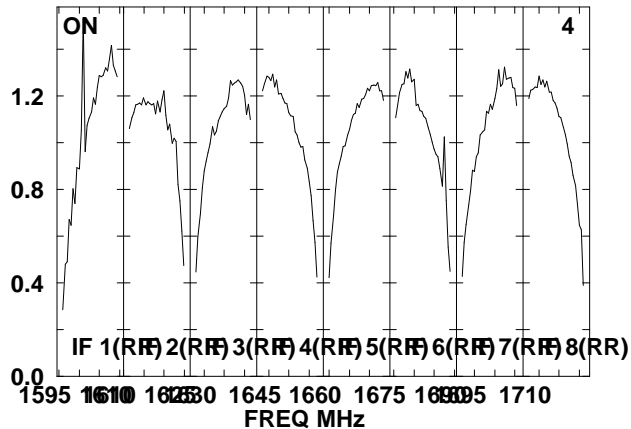
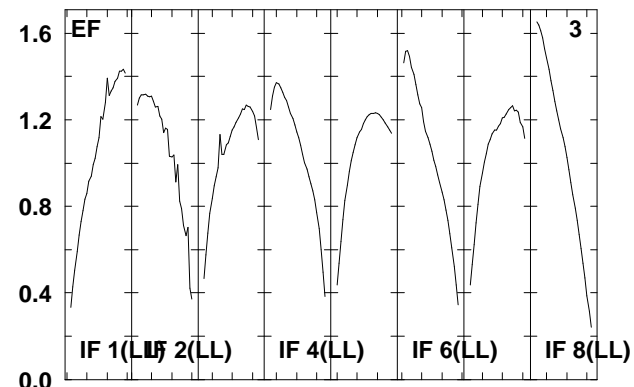
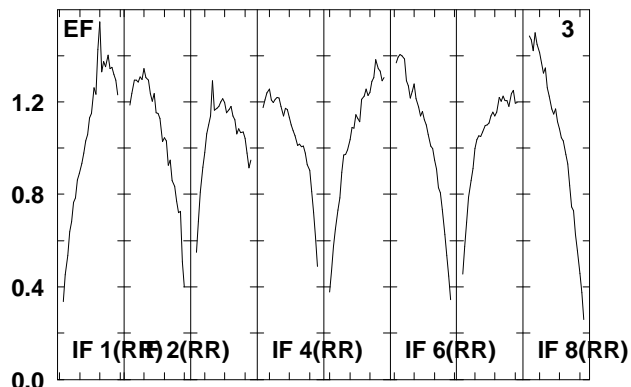
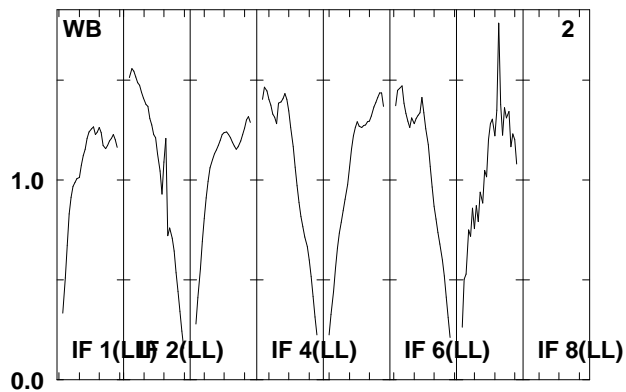
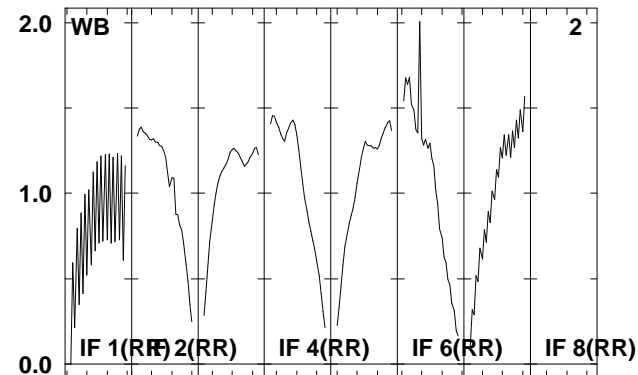
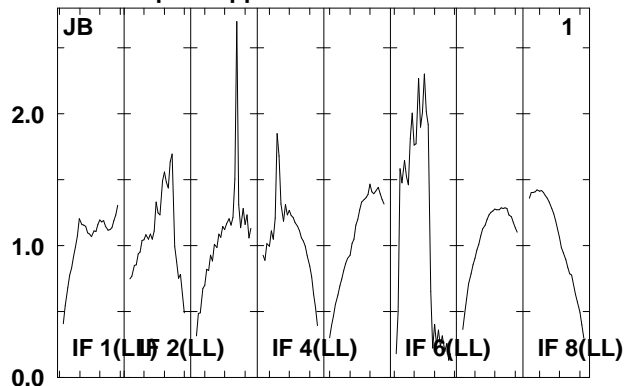
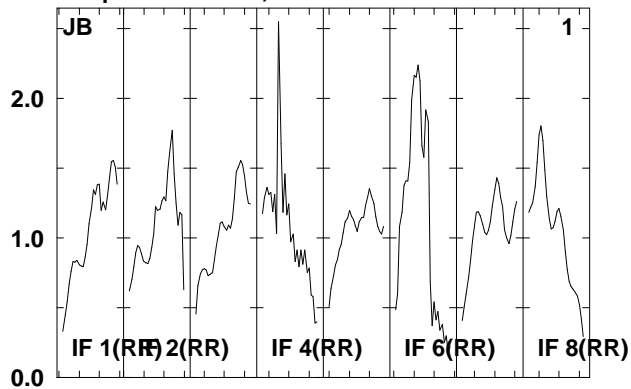

Lower frame: Real Jy  
Total-power spectrum Antenna: \*  
Timerange: 00/05:00:33 to 00/05:05:01



Plot file version 77 created 08-AUG-2008 16:58:52

J021348 EO06B.UVDATA.1

Freq = 1.5950 GHz, Bw = 16.000 MH No calibration applied and no bandpass applied

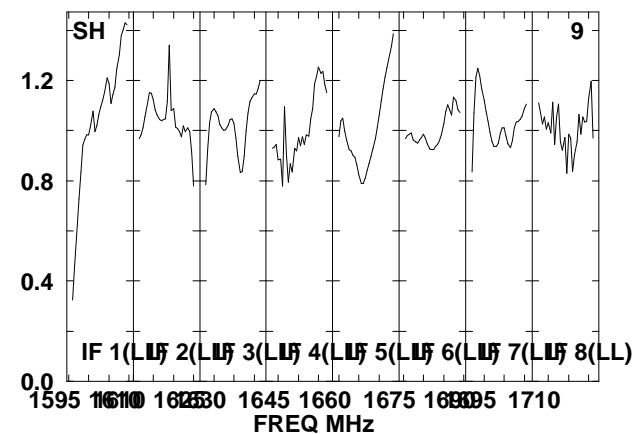
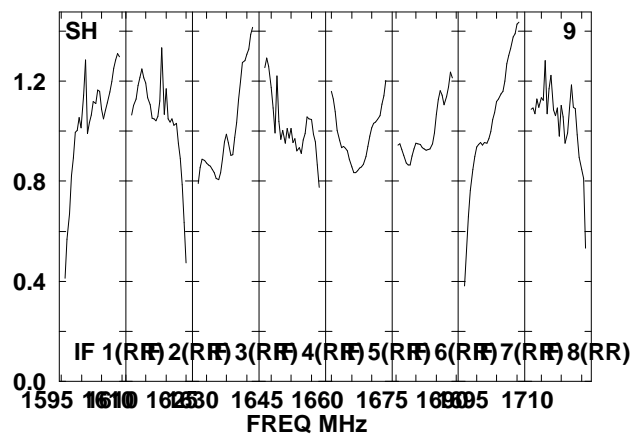
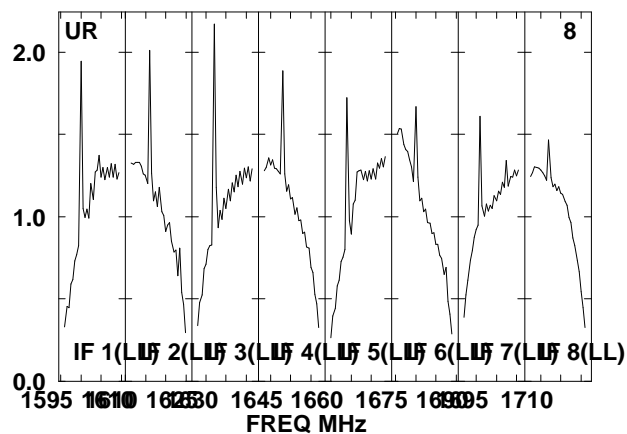
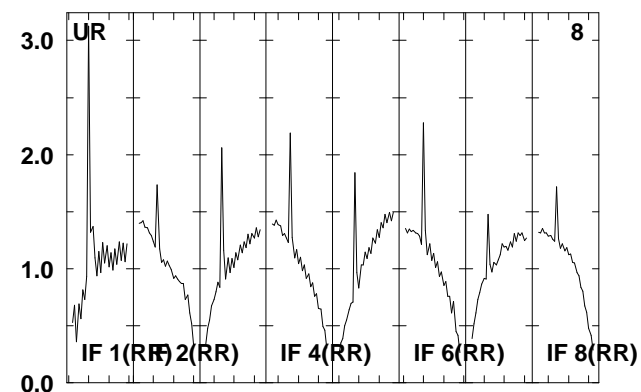
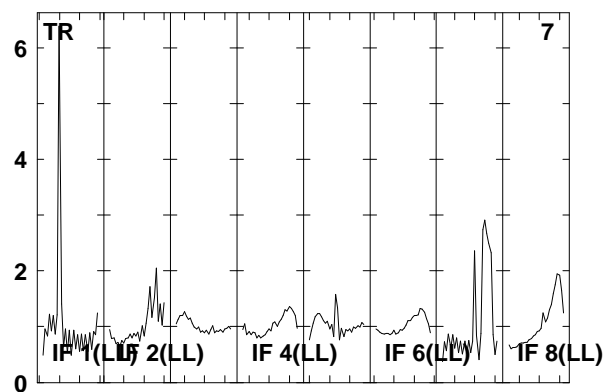
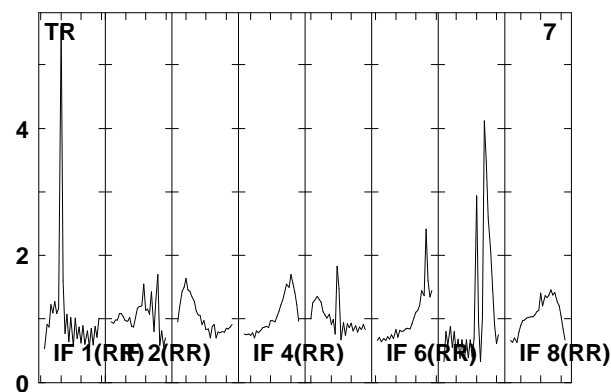
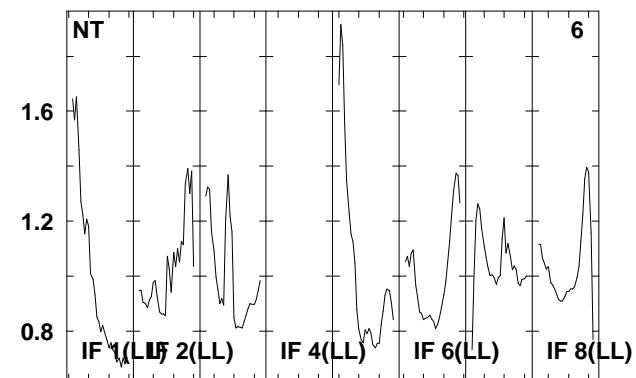
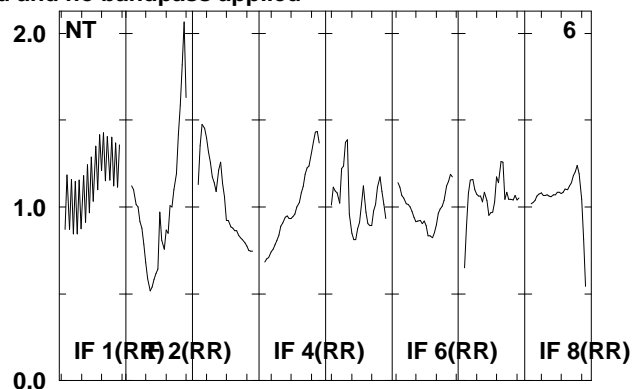
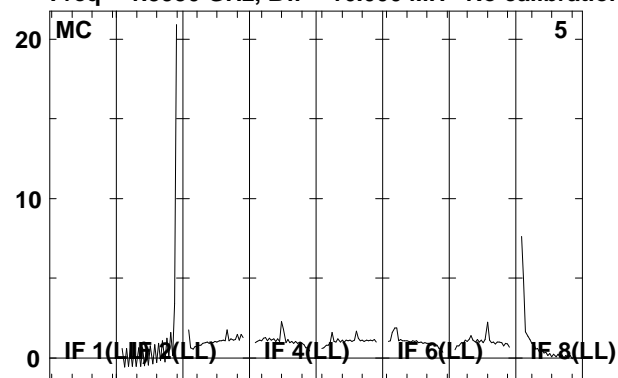

Lower frame: Real Jy

Total-power spectrum Antenna: \*

Timerange: 00/05:00:33 to 00/05:05:01

Plot file version 78 created 08-AUG-2008 16:58:53

J021348 EO006B.UVDATA.1

Freq = 1.5950 GHz, Bw = 16.000 MH No calibration applied and no bandpass applied

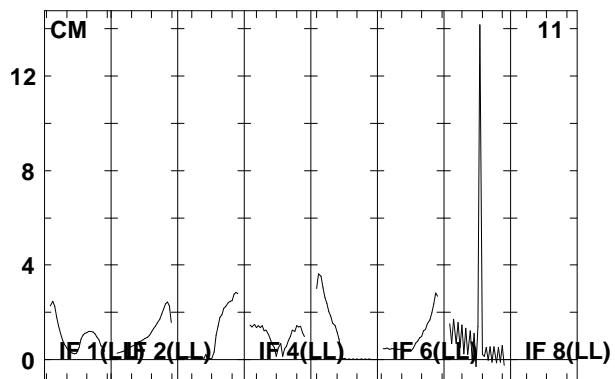
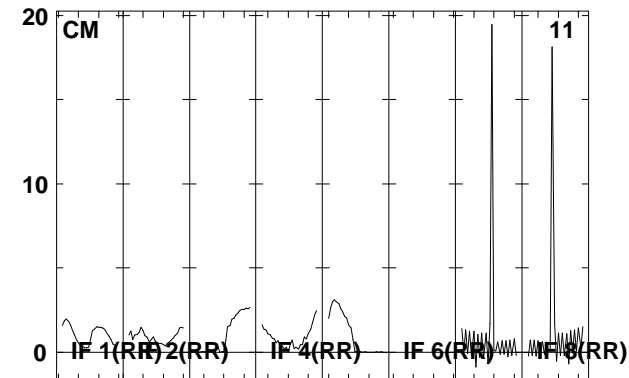
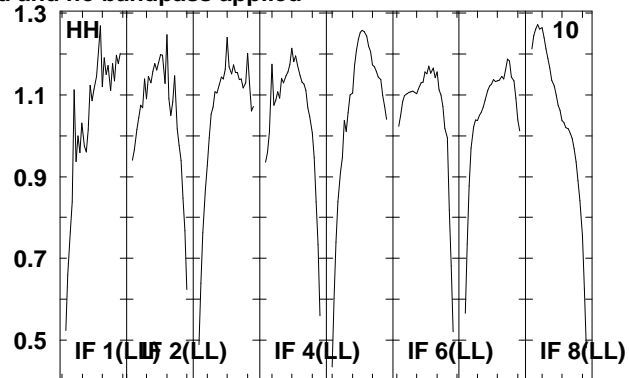
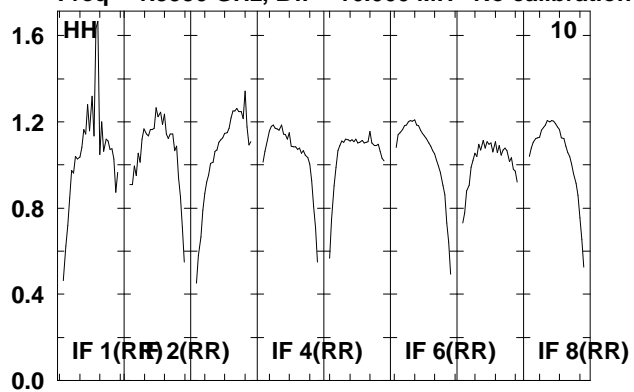

Lower frame: Real Jy  
Total-power spectrum Antenna: \*  
Timerange: 00/05:00:33 to 00/05:05:01

Plot file version 79 created 08-AUG-2008 16:58:54

J0209+13 EO006B.UVDATA.1

Freq = 1.5950 GHz, Bw = 16.000 MH No calibration applied and no bandpass applied

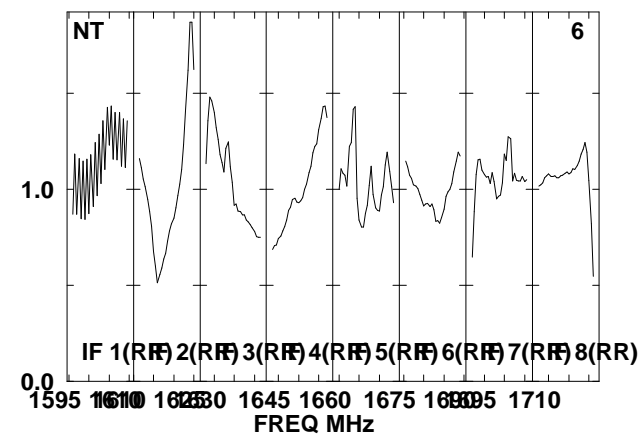
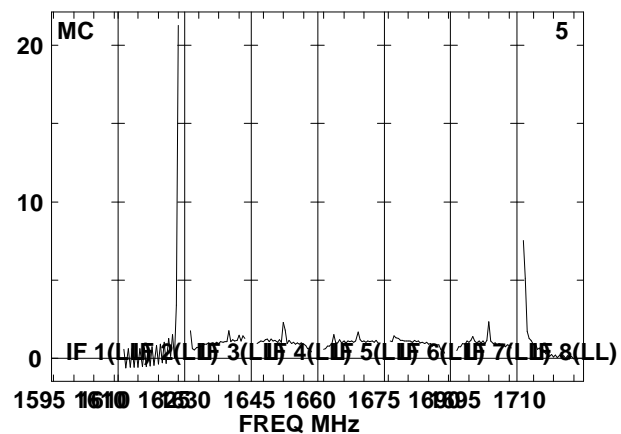
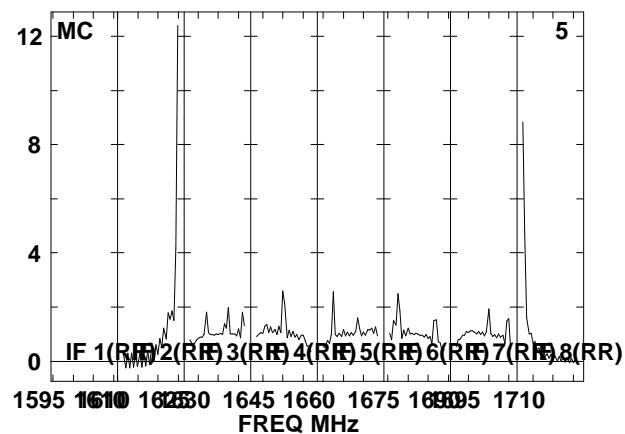
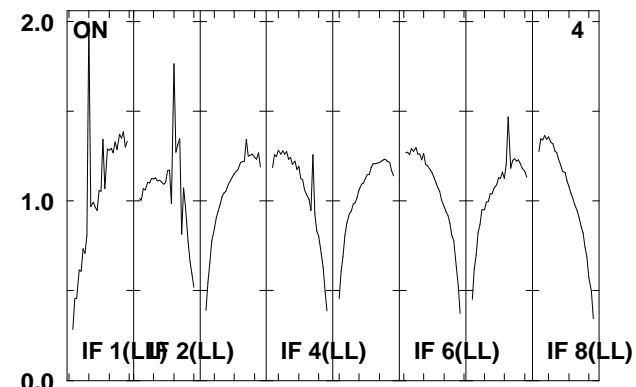
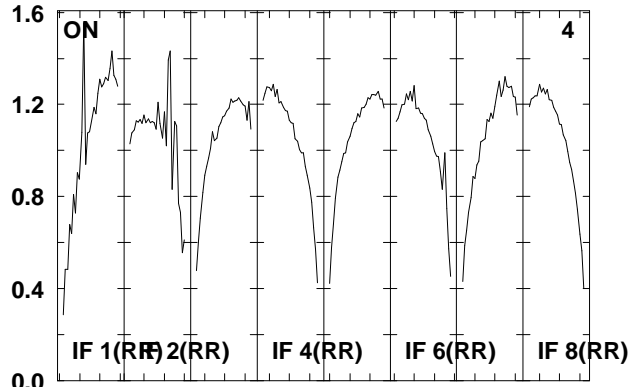
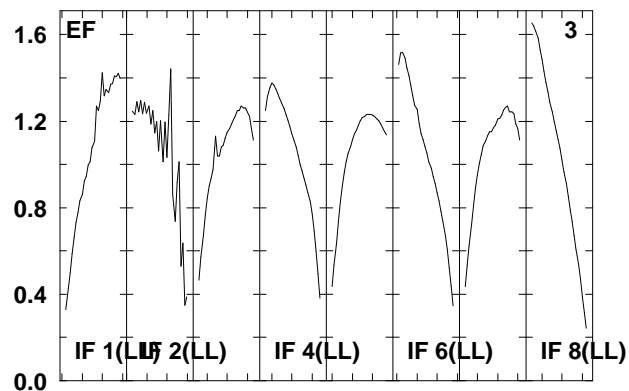
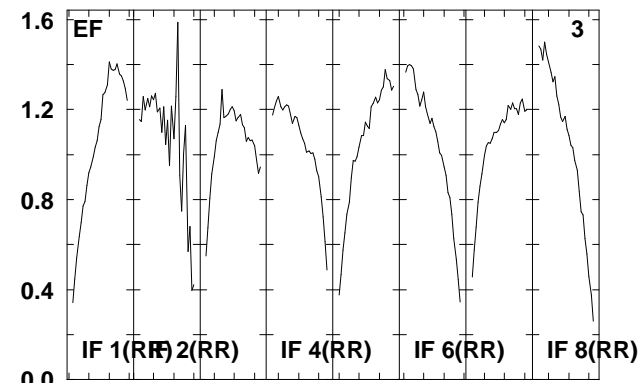
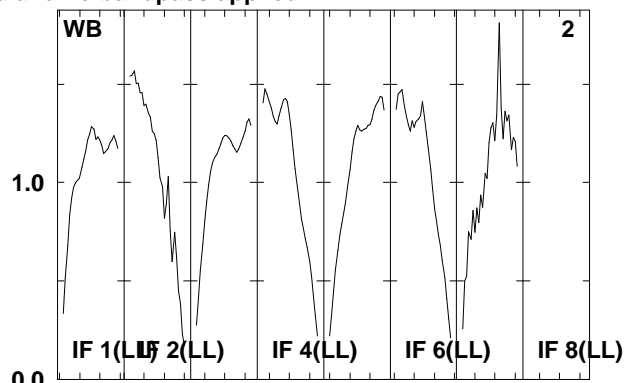
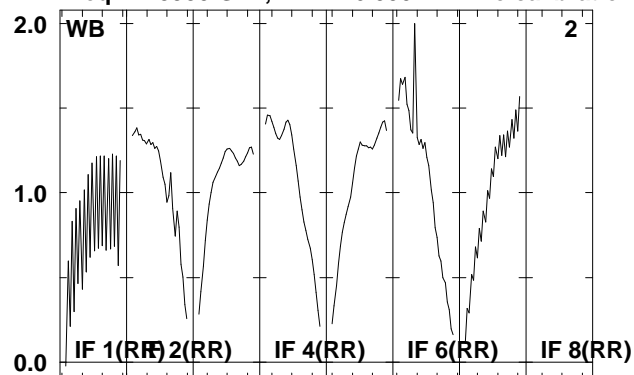

Lower frame: Real Jy  
Total-power spectrum Antenna: \*  
Timerange: 00/05:05:43 to 00/05:07:11

Plot file version 80 created 08-AUG-2008 16:58:54  
 J0209+13 EO06B.UVDATA.1  
 Freq = 1.5950 GHz, Bw = 16.000 MH No calibration applied and no bandpass applied

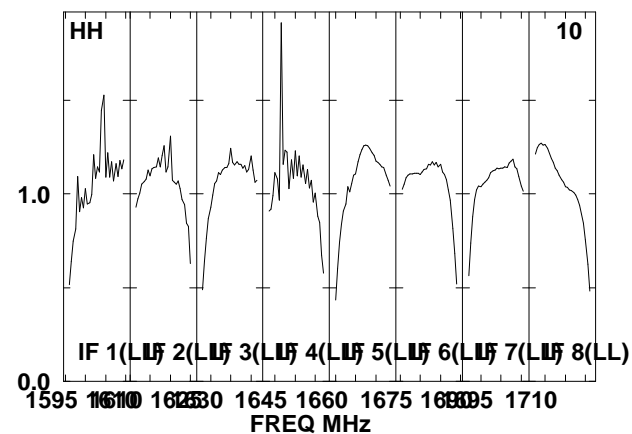
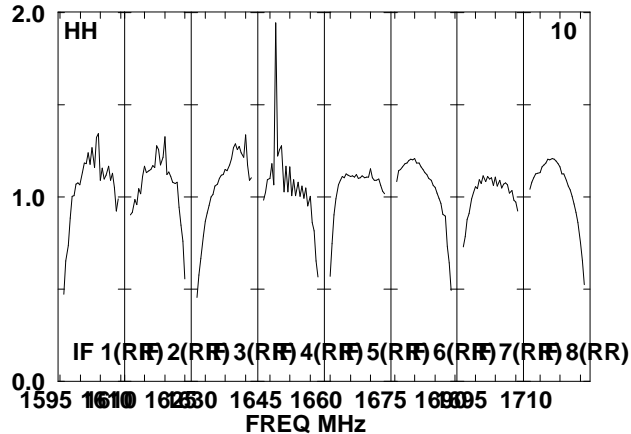
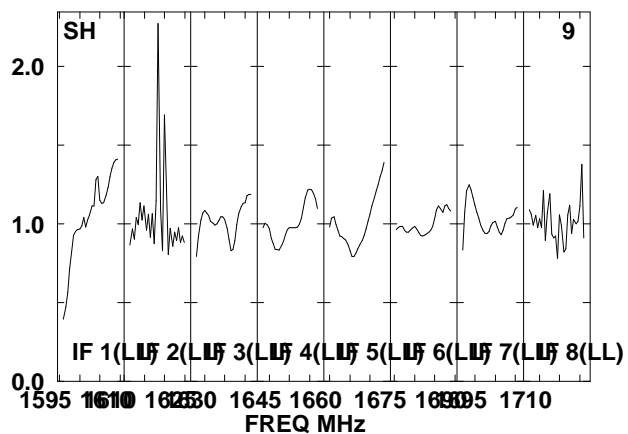
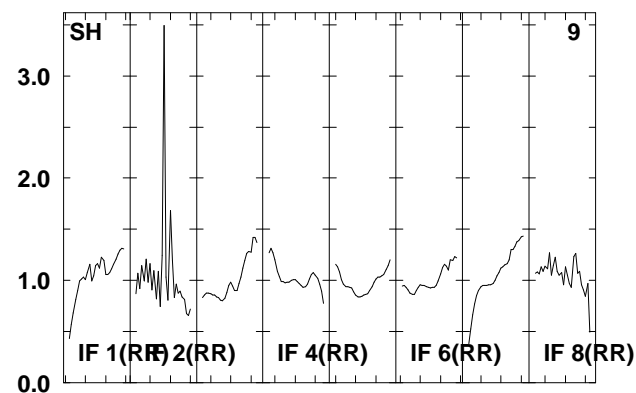
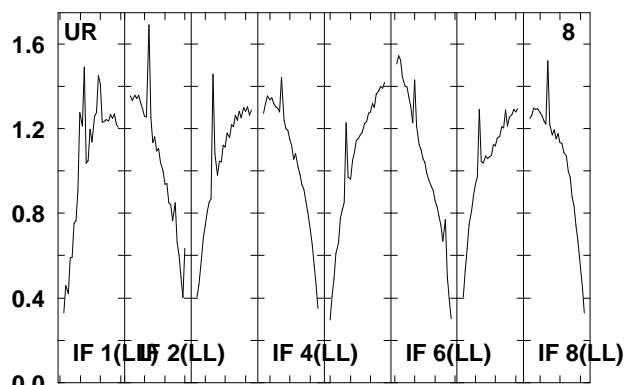
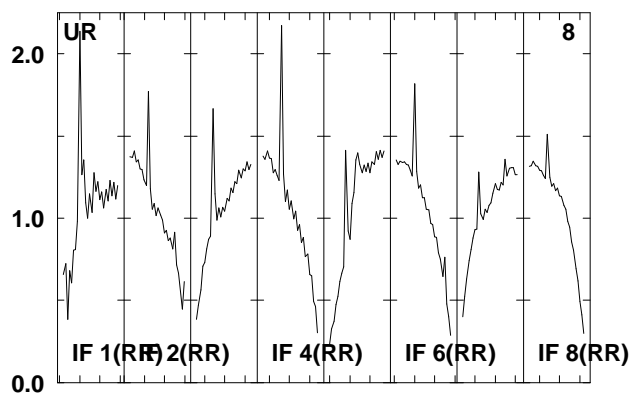
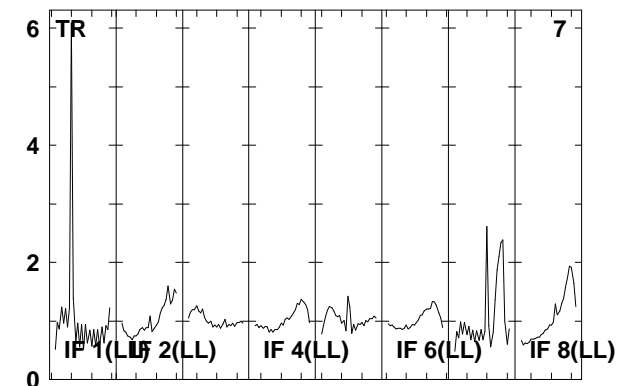
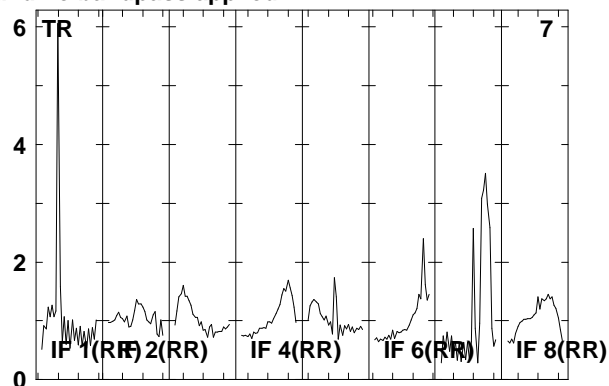
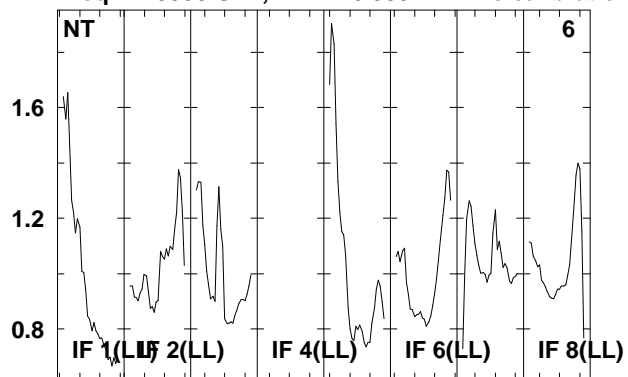

Lower frame: Real Jy  
 Total-power spectrum Antenna: \*  
 Timerange: 00/05:05:43 to 00/05:07:11

Plot file version 81 created 08-AUG-2008 16:58:55

J0209+13 EO006B.UVDATA.1

Freq = 1.5950 GHz, Bw = 16.000 MH No calibration applied and no bandpass applied

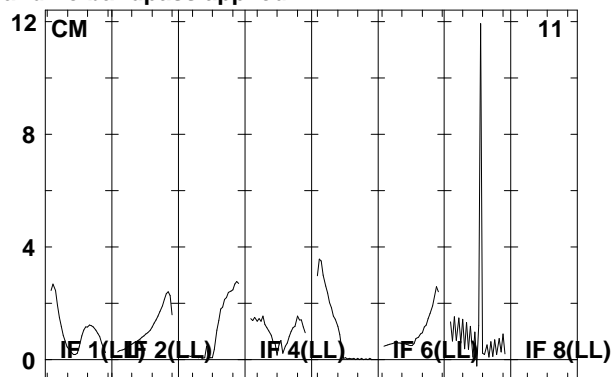
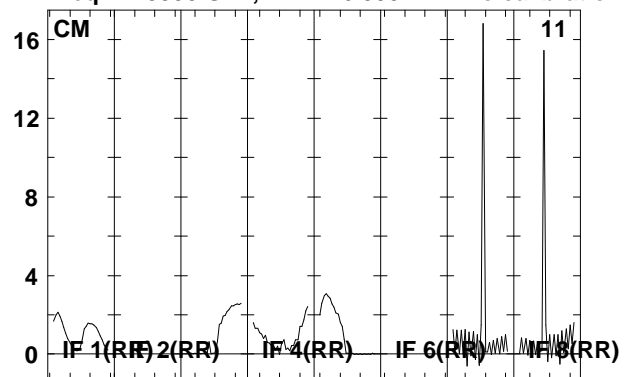

Lower frame: Real Jy  
Total-power spectrum Antenna: \*  
Timerange: 00/05:05:43 to 00/05:07:11

Plot file version 82 created 08-AUG-2008 16:58:55

J021348 EO006B.UVDATA.1

Freq = 1.5950 GHz, Bw = 16.000 MH No calibration applied and no bandpass applied

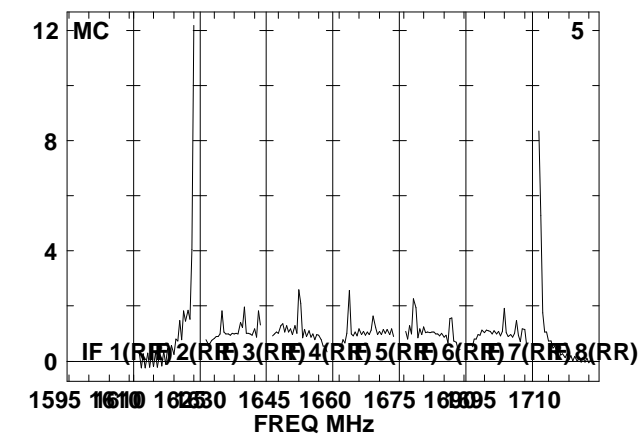
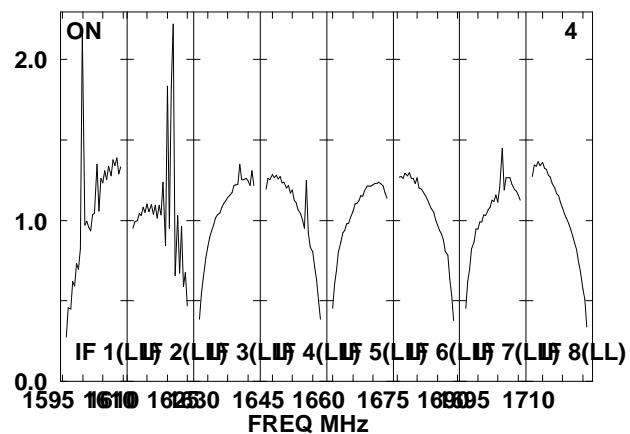
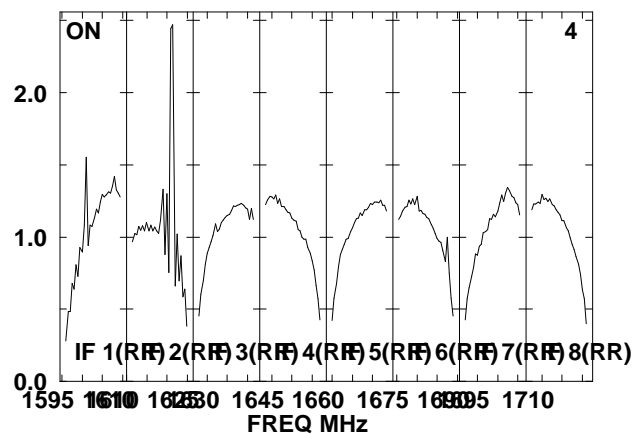
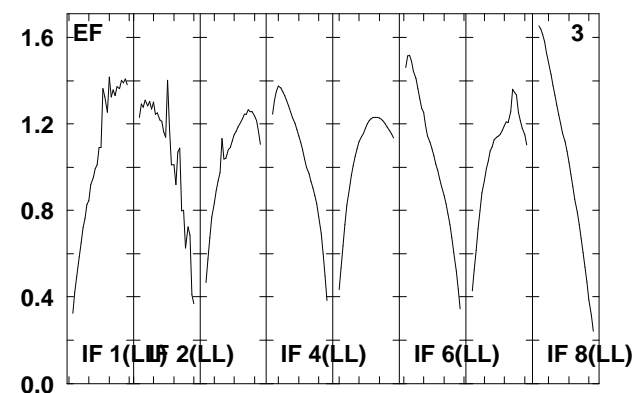
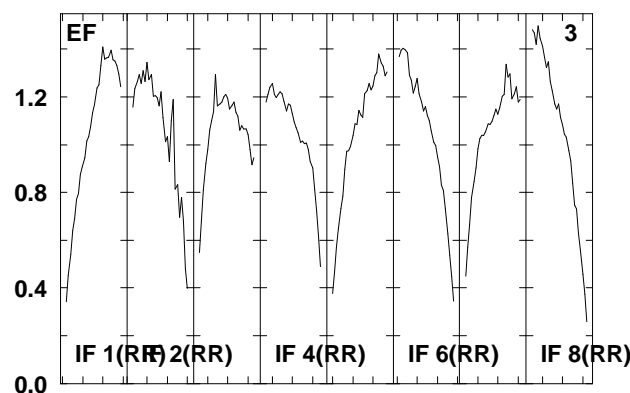
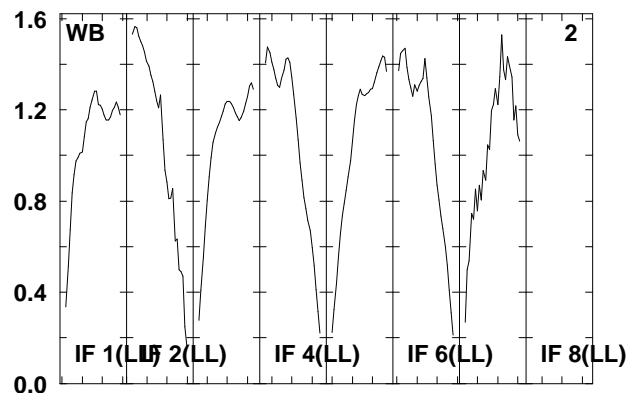
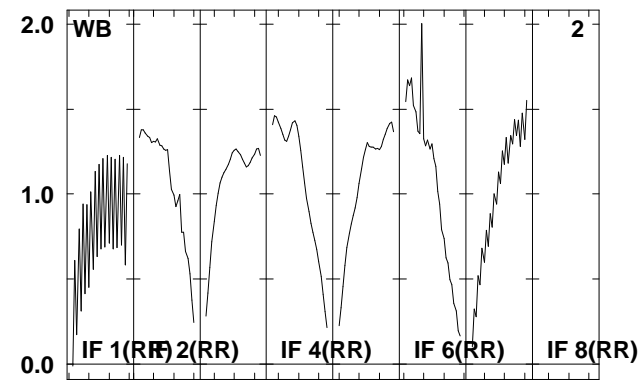
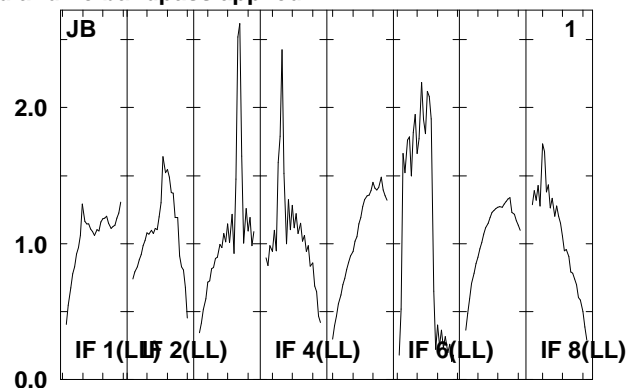
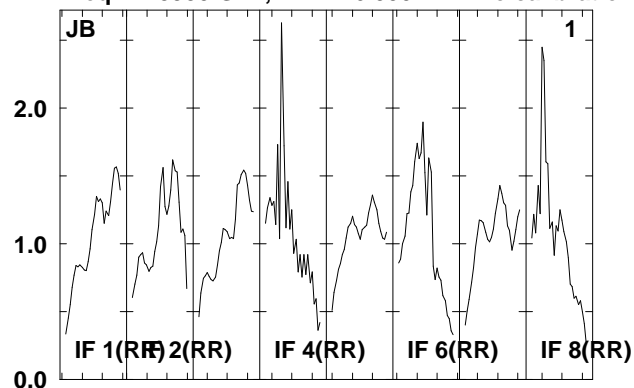

Lower frame: Real Jy  
Total-power spectrum Antenna: \*  
Timerange: 00/05:07:53 to 00/05:12:29

Plot file version 83 created 08-AUG-2008 16:58:56

J021348 EO006B.UVDATA.1

Freq = 1.5950 GHz, Bw = 16.000 MH No calibration applied and no bandpass applied

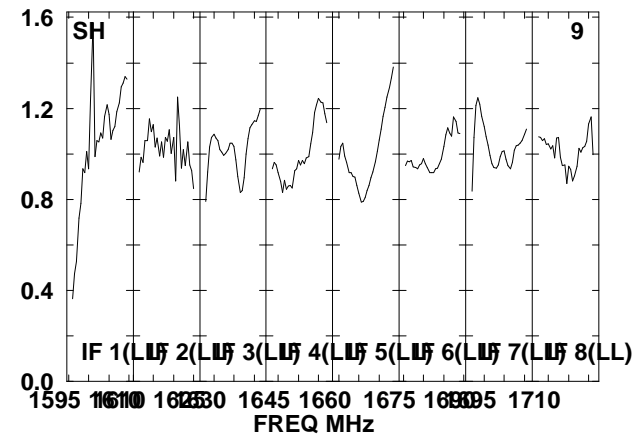
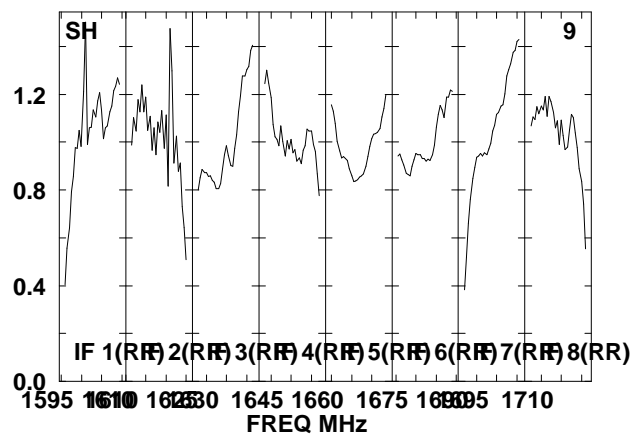
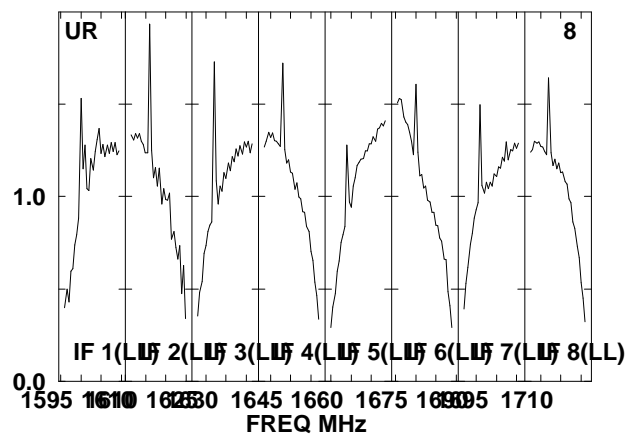
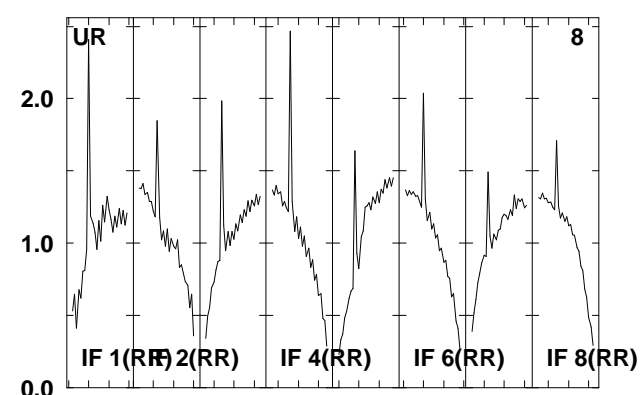
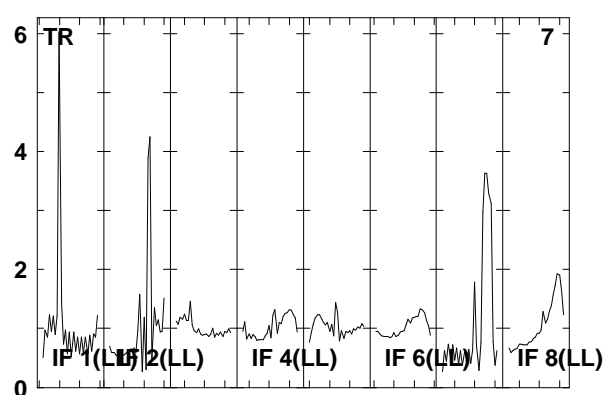
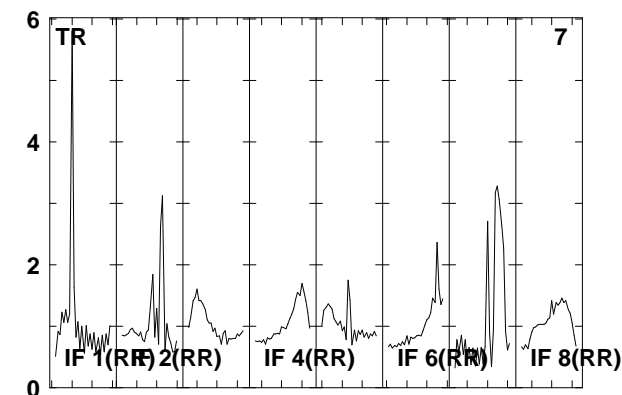
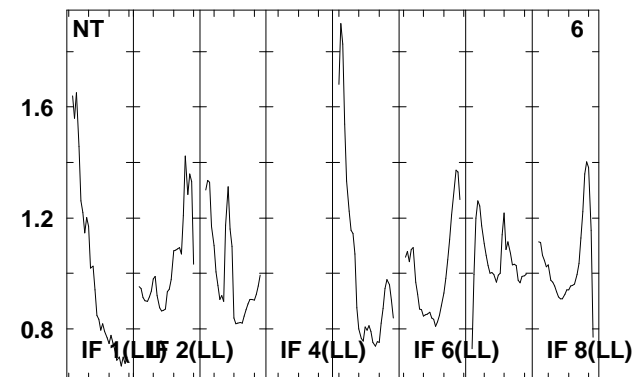
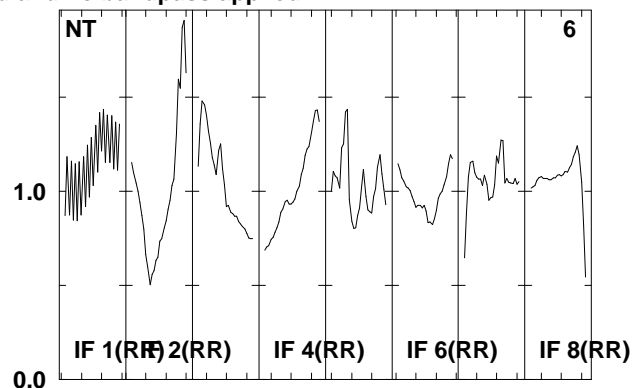
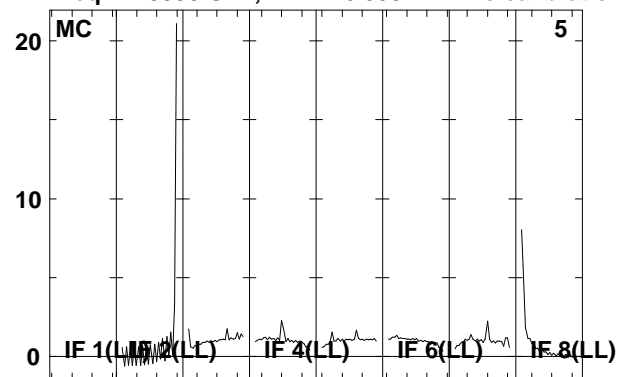

Lower frame: Real Jy

Total-power spectrum Antenna: \*

Timerange: 00/05:07:53 to 00/05:12:29

Plot file version 84 created 08-AUG-2008 16:58:57

J021348 EO006B.UVDATA.1

Freq = 1.5950 GHz, Bw = 16.000 MH No calibration applied and no bandpass applied

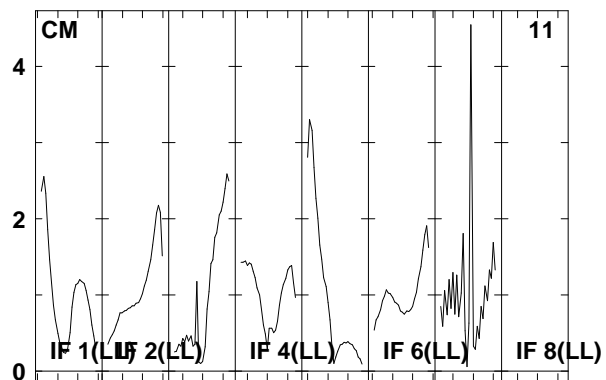
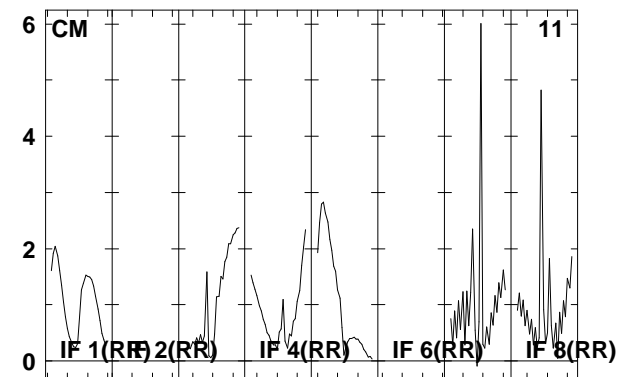
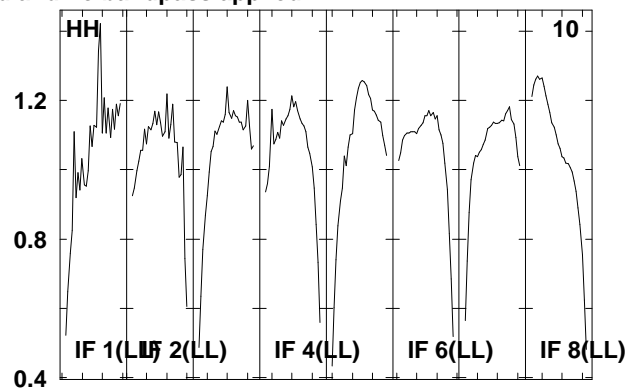
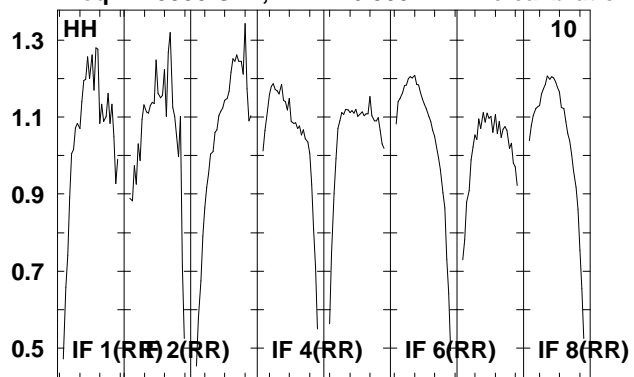

Lower frame: Real Jy  
Total-power spectrum Antenna: \*  
Timerange: 00/05:07:53 to 00/05:12:29



Plot file version 85 created 08-AUG-2008 16:58:57

J0209+13 EO006B.UVDATA.1

Freq = 1.5950 GHz, Bw = 16.000 MH No calibration applied and no bandpass applied

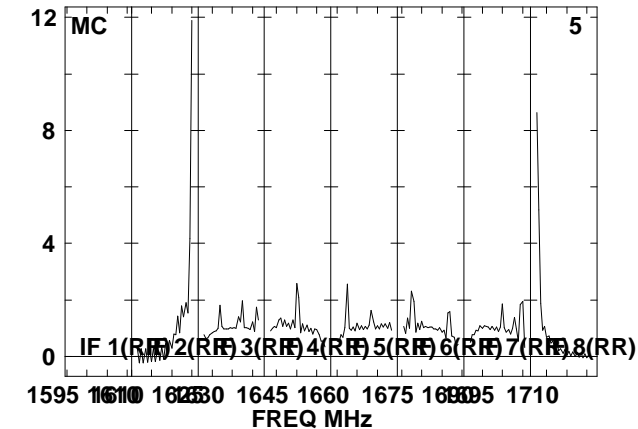
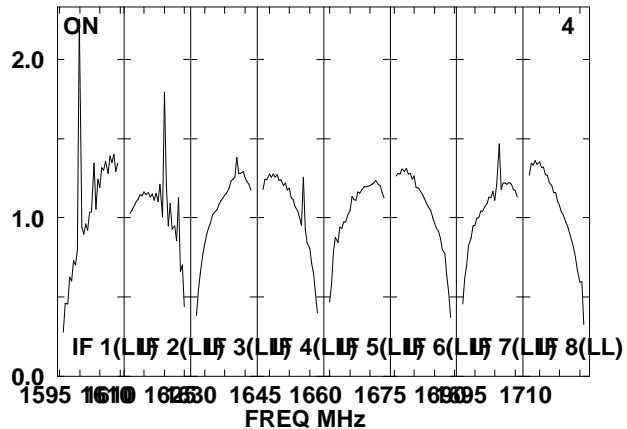
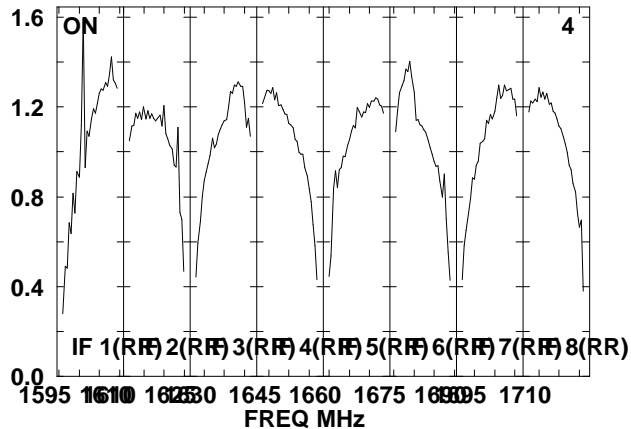
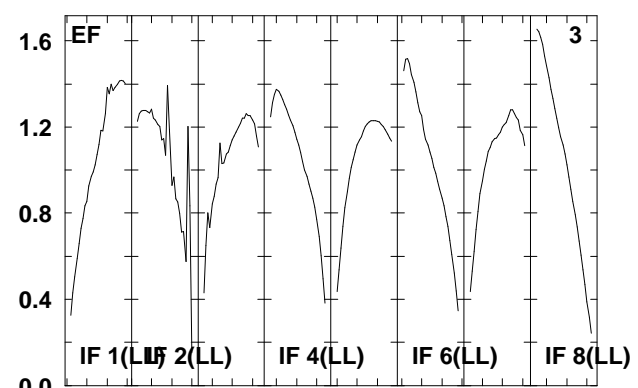
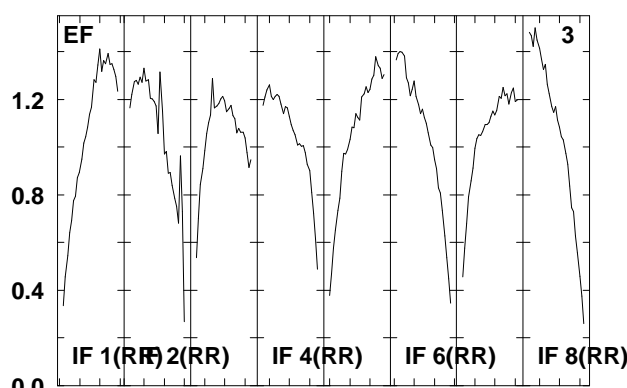
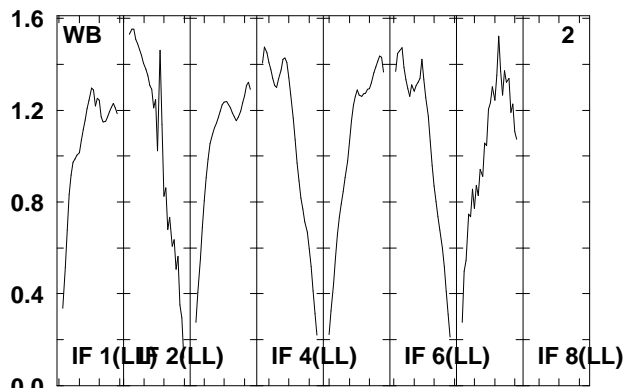
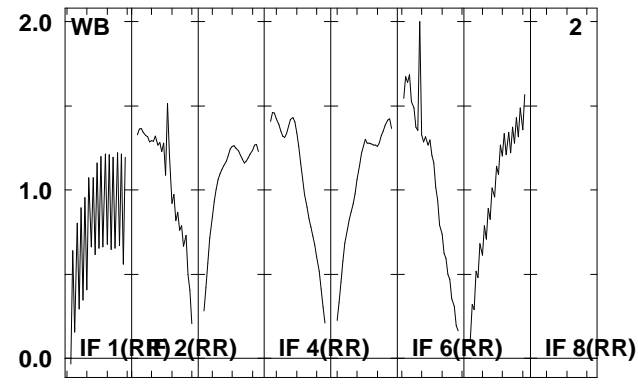
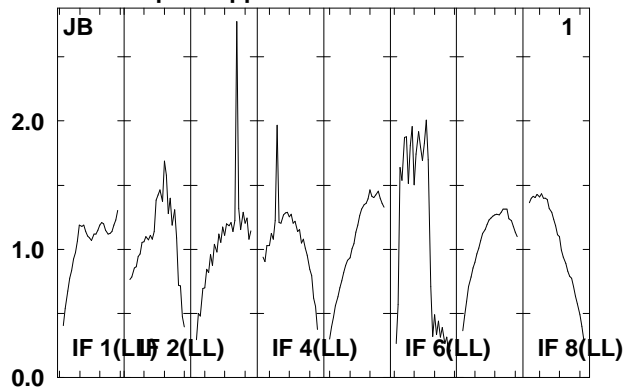
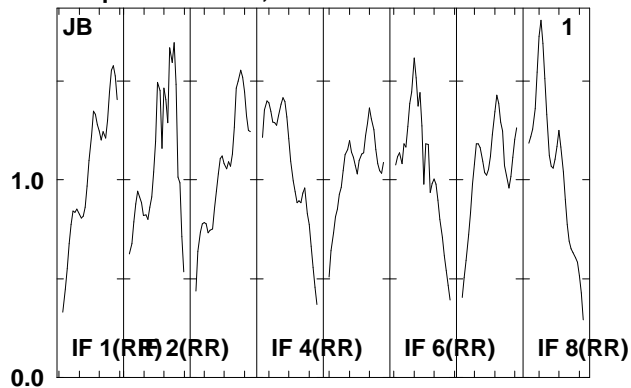

Lower frame: Real Jy  
Total-power spectrum Antenna: \*  
Timerange: 00/05:13:01 to 00/05:14:37

Plot file version 86 created 08-AUG-2008 16:58:57

J0209+13 EO006B.UVDATA.1

Freq = 1.5950 GHz, Bw = 16.000 MH No calibration applied and no bandpass applied

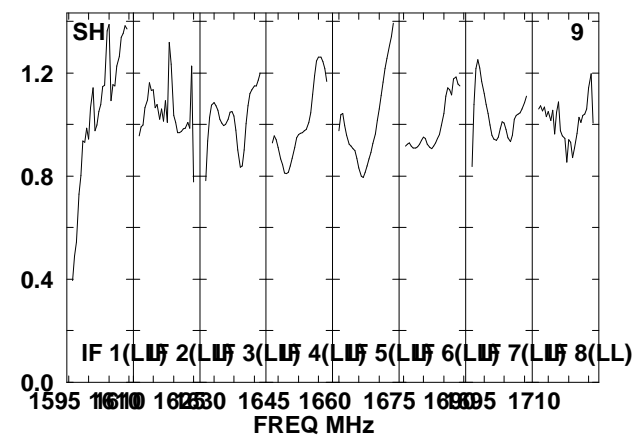
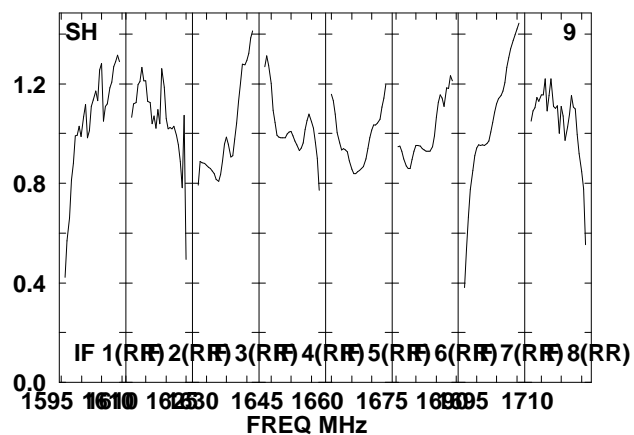
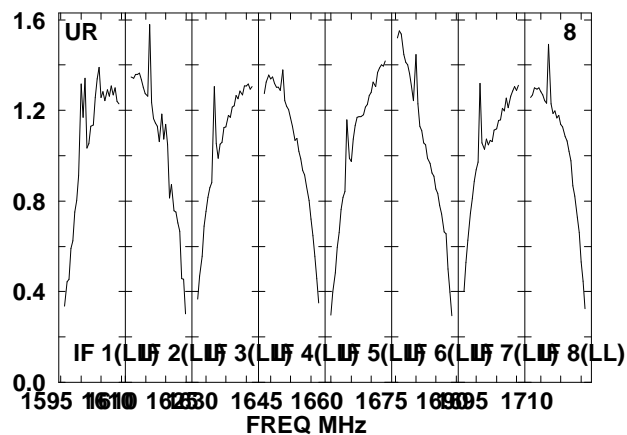
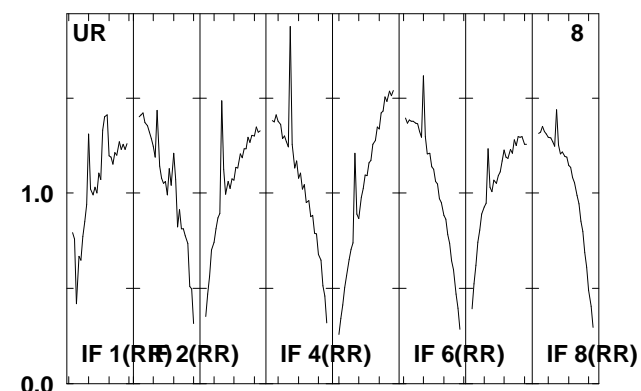
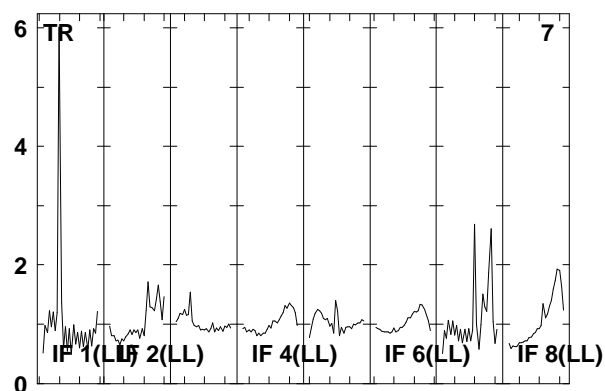
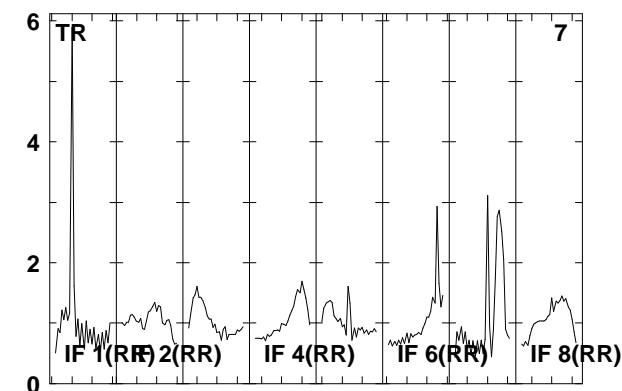
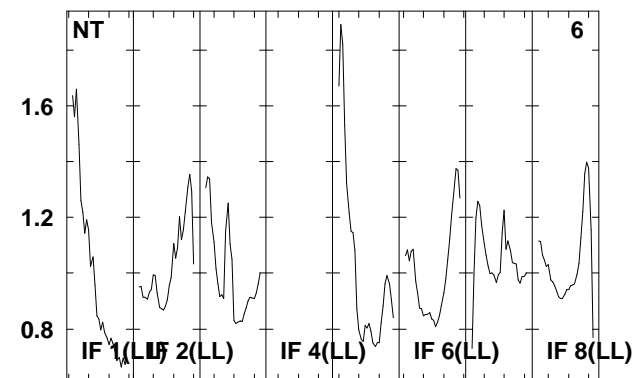
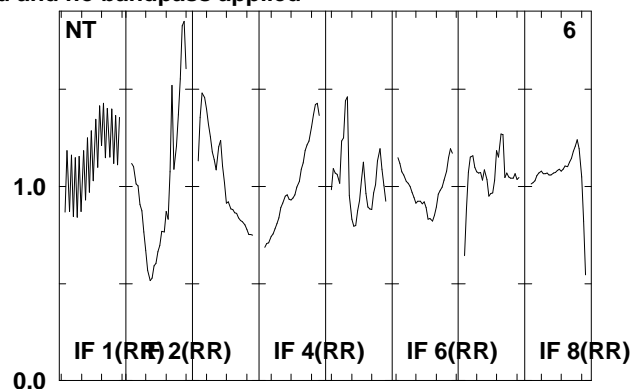
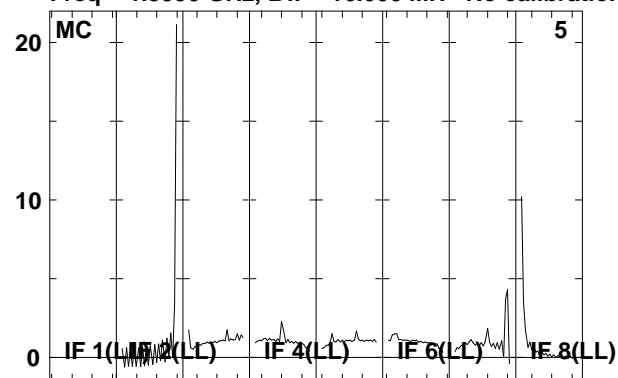

Lower frame: Real Jy

Total-power spectrum Antenna: \*

Timerange: 00/05:13:01 to 00/05:14:37

Plot file version 87 created 08-AUG-2008 16:58:57

J0209+13 EO006B.UVDATA.1

Freq = 1.5950 GHz, Bw = 16.000 MH No calibration applied and no bandpass applied

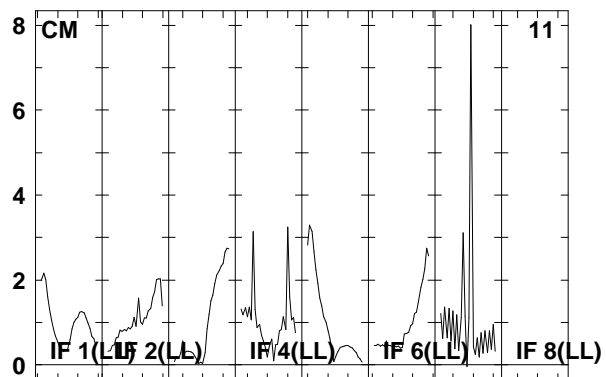
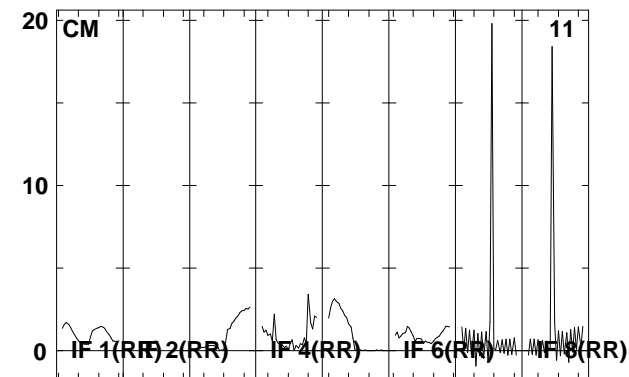
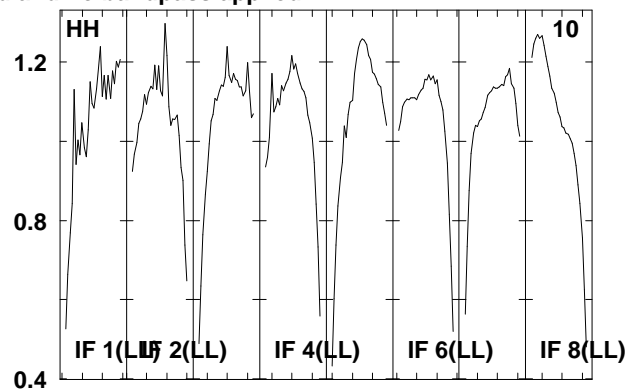
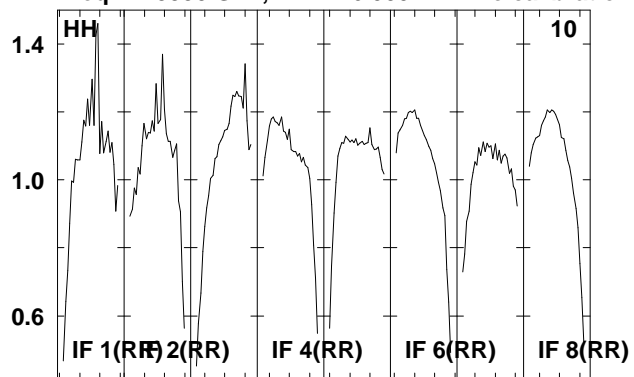

Lower frame: Real Jy  
Total-power spectrum Antenna: \*  
Timerange: 00/05:13:01 to 00/05:14:37

Plot file version 88 created 08-AUG-2008 16:58:58

J021348 EO006B.UVDATA.1

Freq = 1.5950 GHz, Bw = 16.000 MH No calibration applied and no bandpass applied

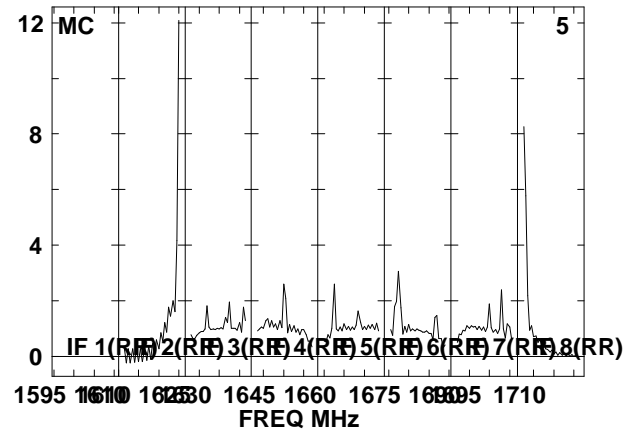
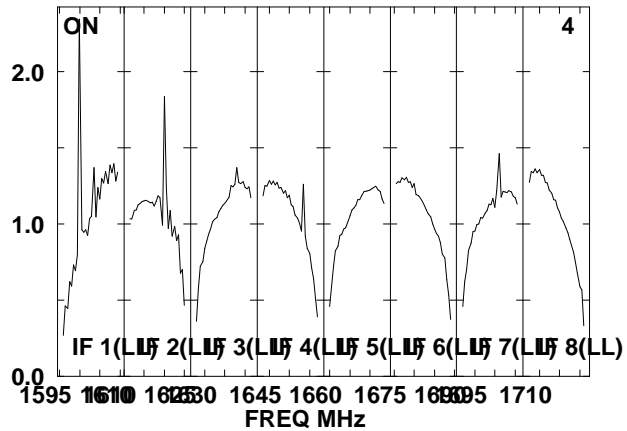
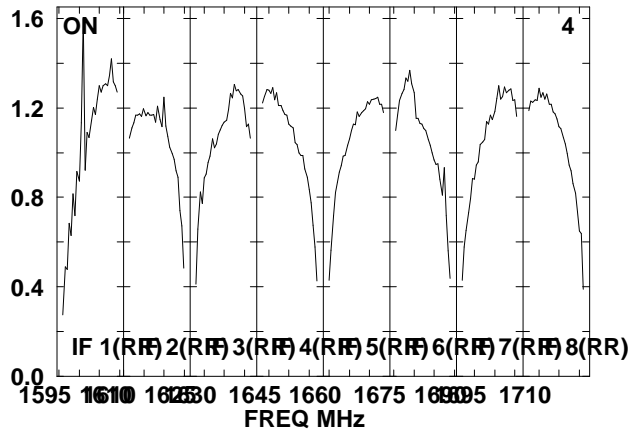
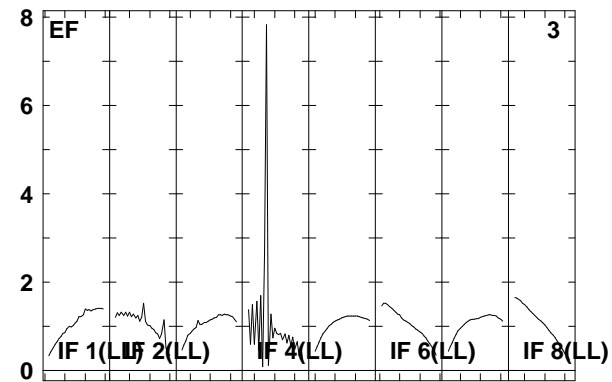
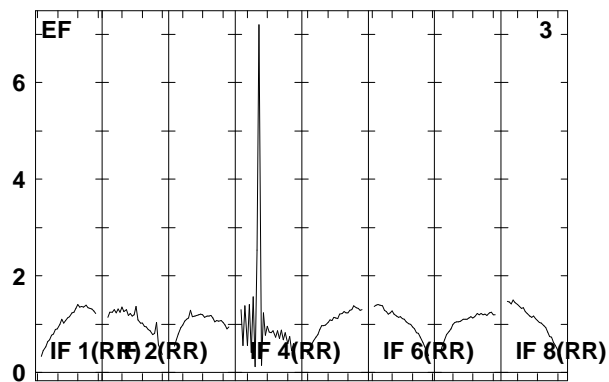
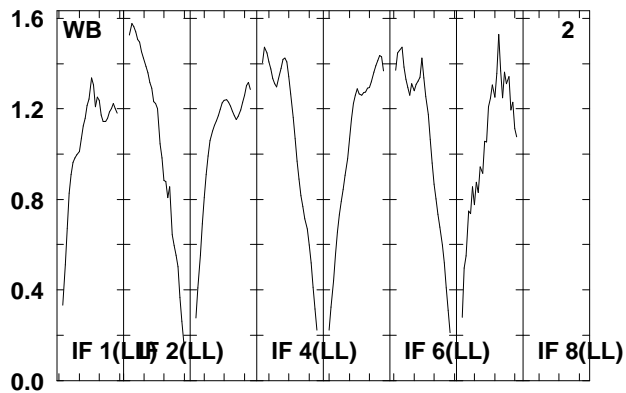
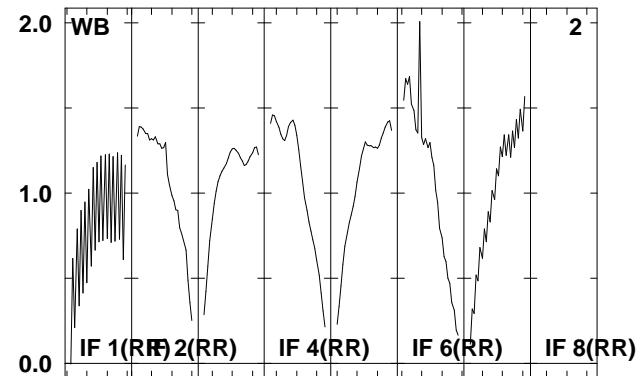
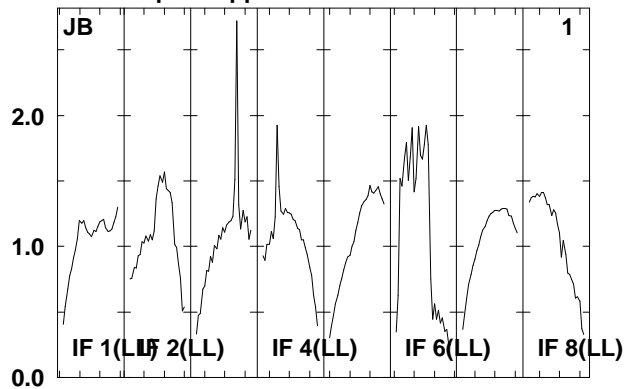
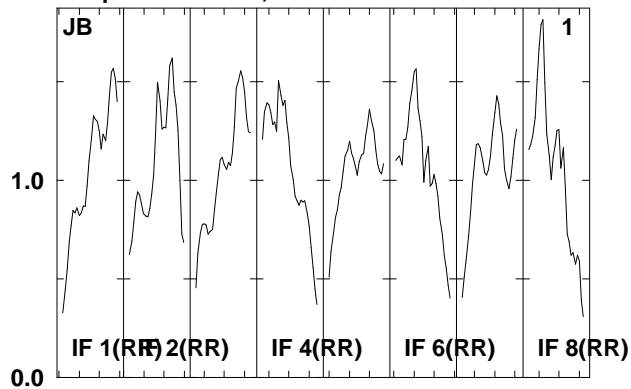

Lower frame: Real Jy

Total-power spectrum Antenna: \*

Timerange: 00/05:15:13 to 00/05:19:49

Plot file version 89 created 08-AUG-2008 16:58:58

J021348 EO006B.UVDATA.1

Freq = 1.5950 GHz, Bw = 16.000 MH No calibration applied and no bandpass applied

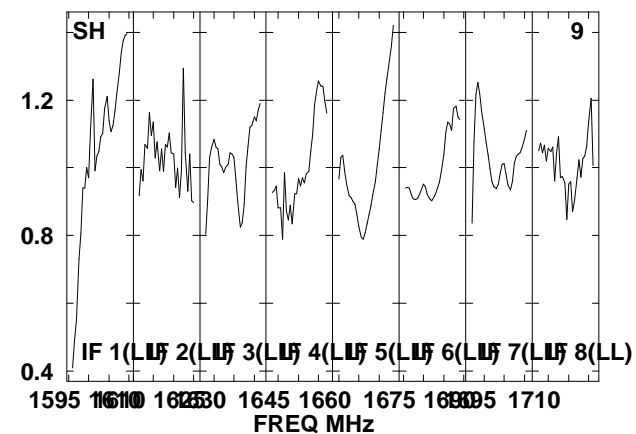
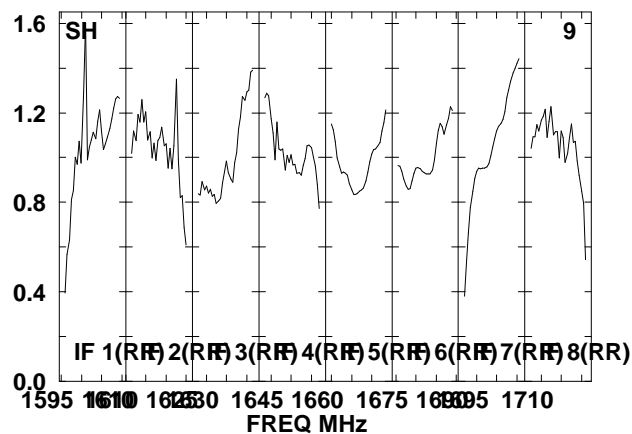
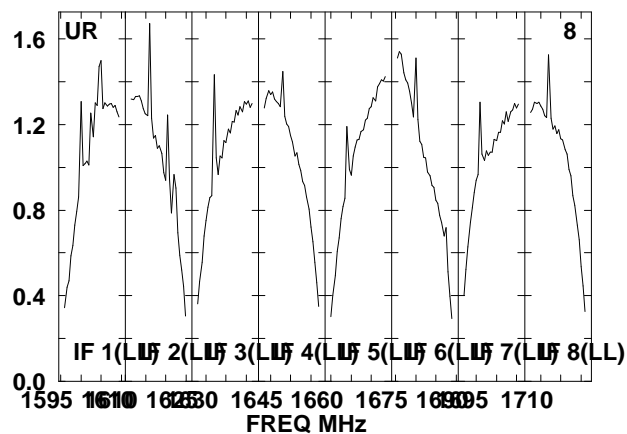
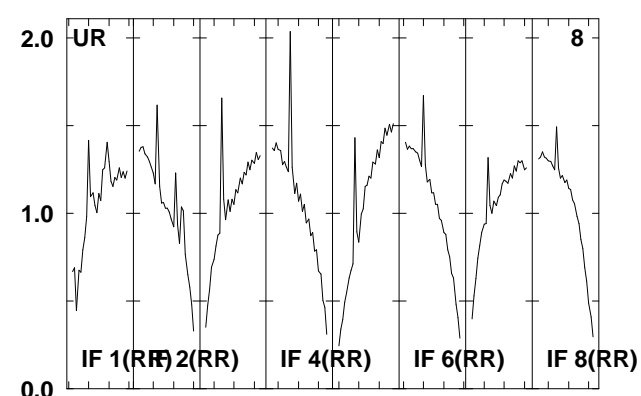
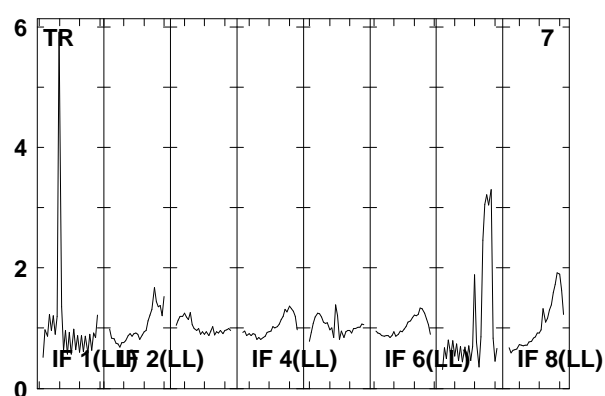
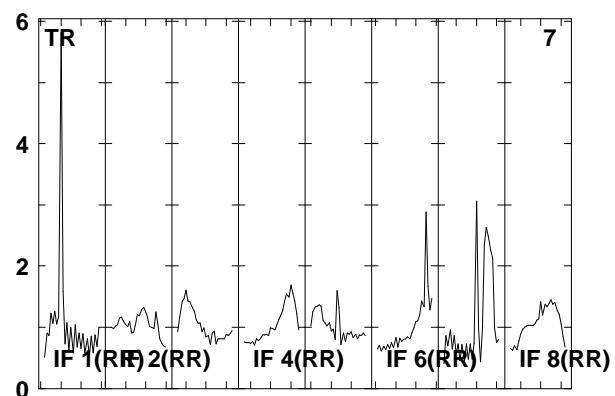
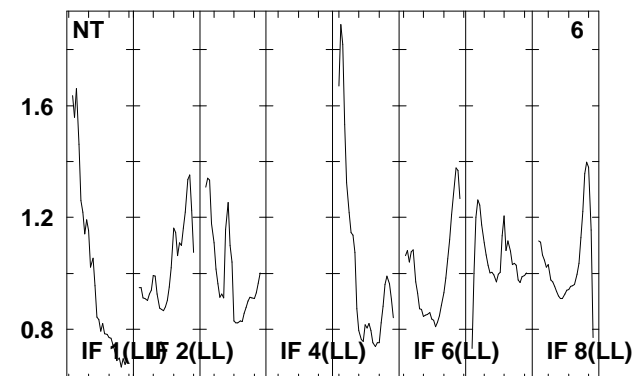
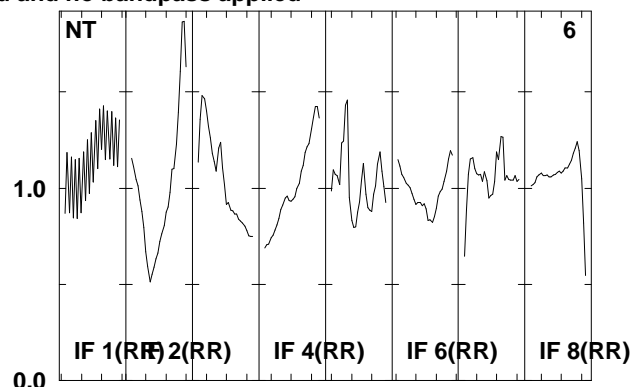
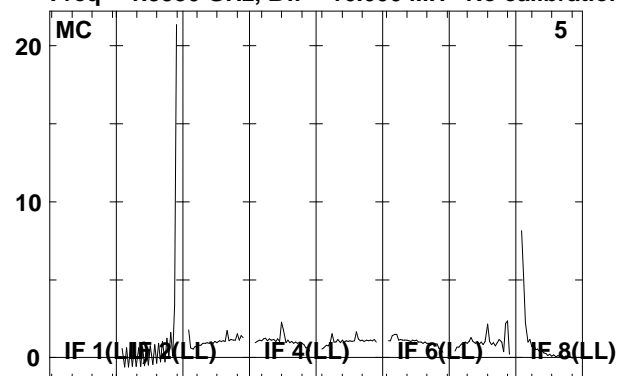

Lower frame: Real Jy

Total-power spectrum Antenna: \*

Timerange: 00/05:15:13 to 00/05:19:49

Plot file version 90 created 08-AUG-2008 16:58:59

J021348 EO006B.UVDATA.1

Freq = 1.5950 GHz, Bw = 16.000 MH No calibration applied and no bandpass applied

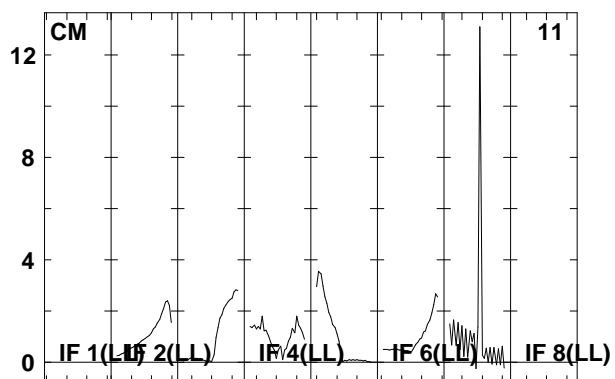
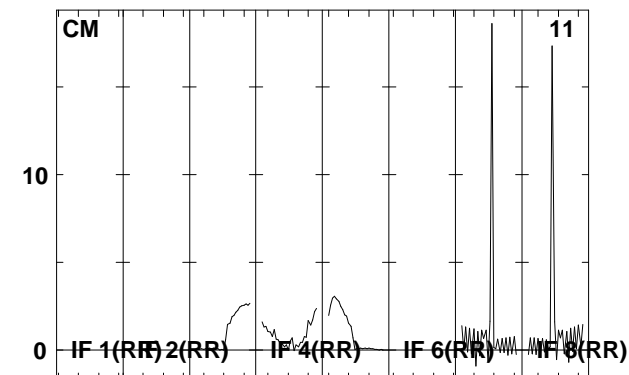
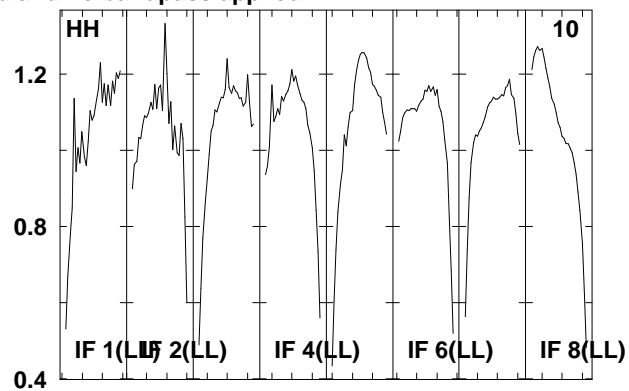
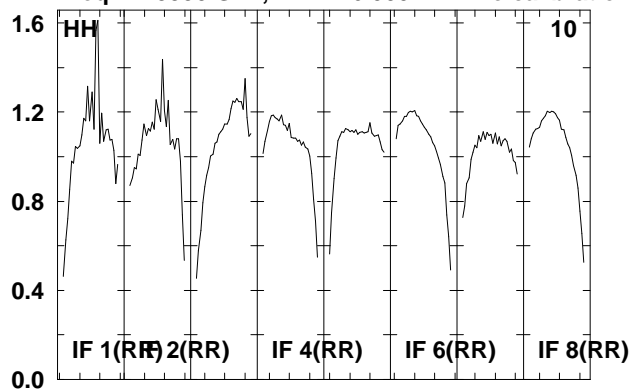

Lower frame: Real Jy  
Total-power spectrum Antenna: \*  
Timerange: 00/05:15:13 to 00/05:19:49

Plot file version 91 created 08-AUG-2008 16:59:00

J0209+13 EO006B.UVDATA.1

Freq = 1.5950 GHz, Bw = 16.000 MH No calibration applied and no bandpass applied

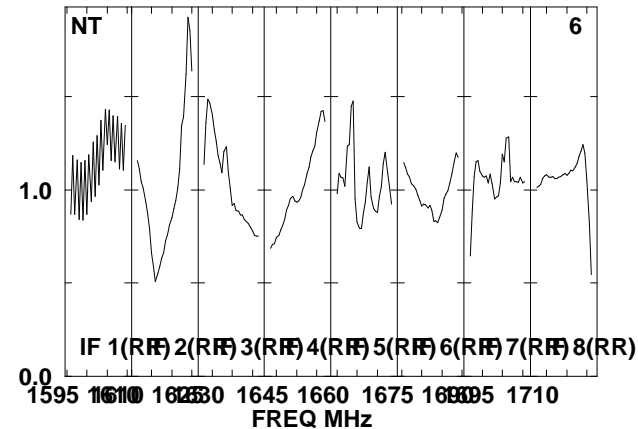
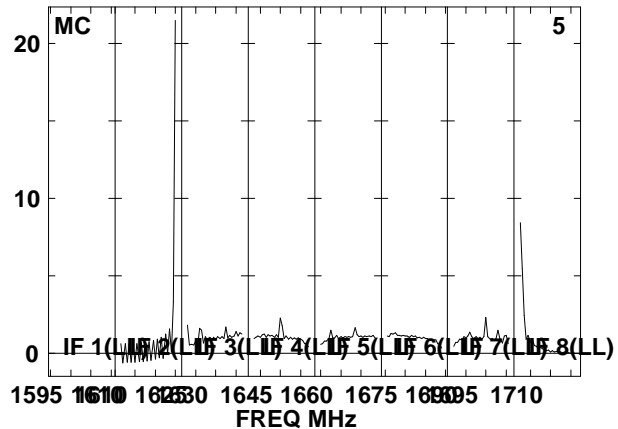
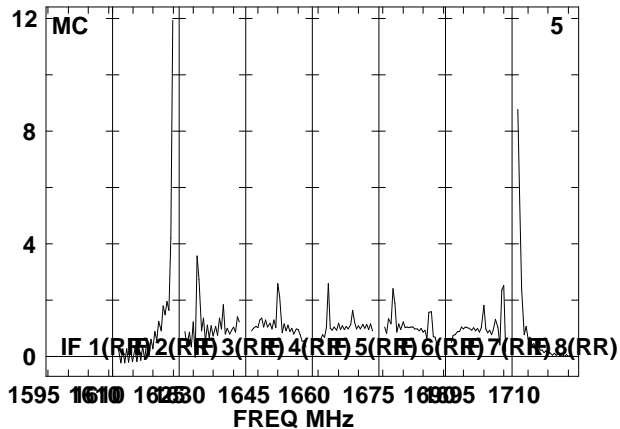
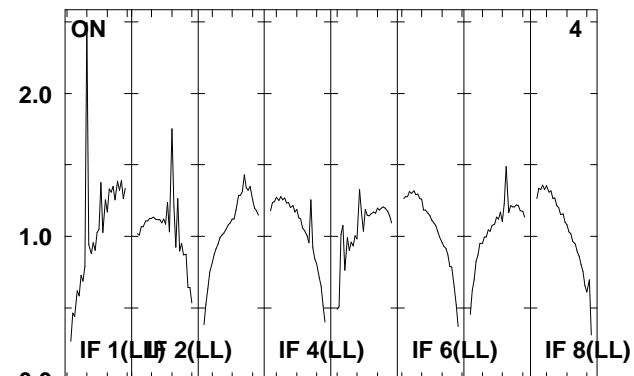
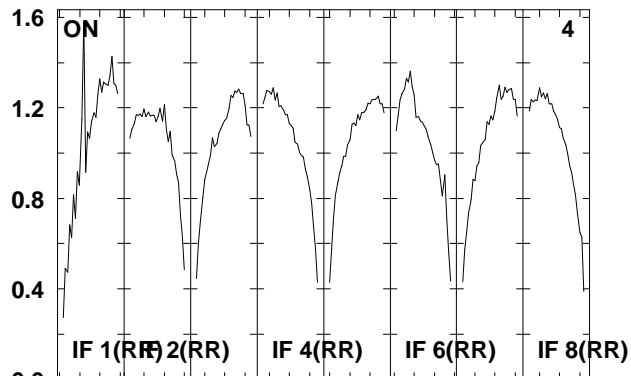
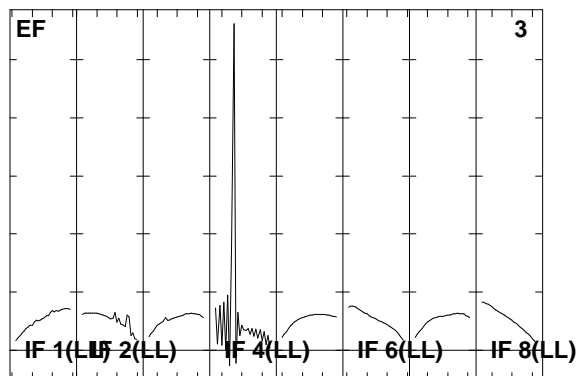
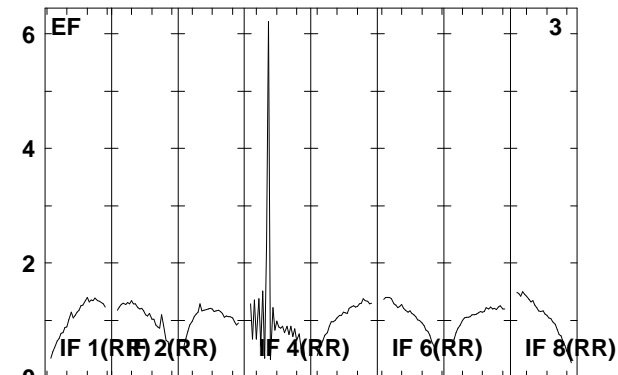
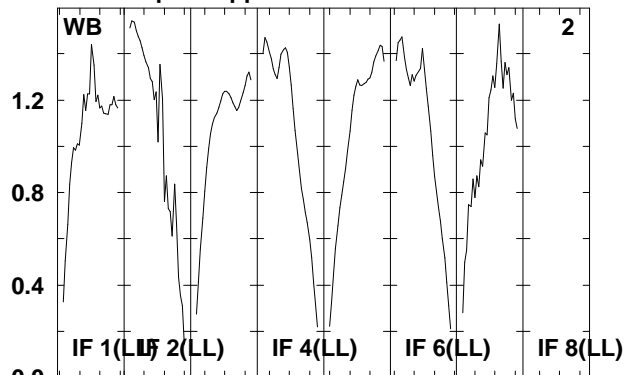
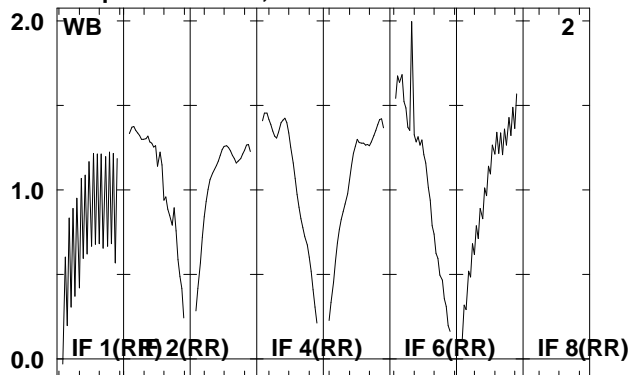

Lower frame: Real Jy  
Total-power spectrum Antenna: \*  
Timerange: 00/05:20:21 to 00/05:21:57

Plot file version 92 created 08-AUG-2008 16:59:00  
 J0209+13 EO006B.UVDATA.1  
 Freq = 1.5950 GHz, Bw = 16.000 MH No calibration applied and no bandpass applied

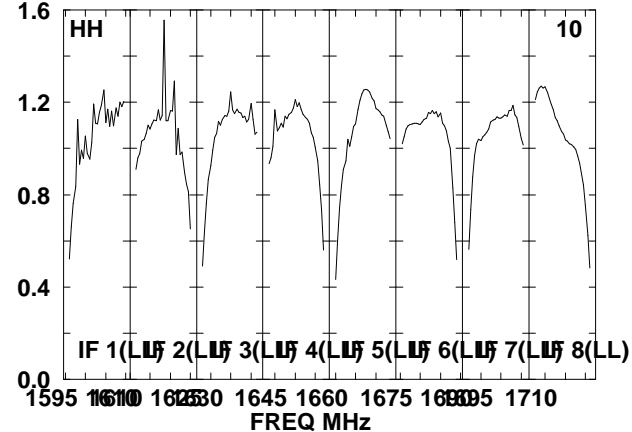
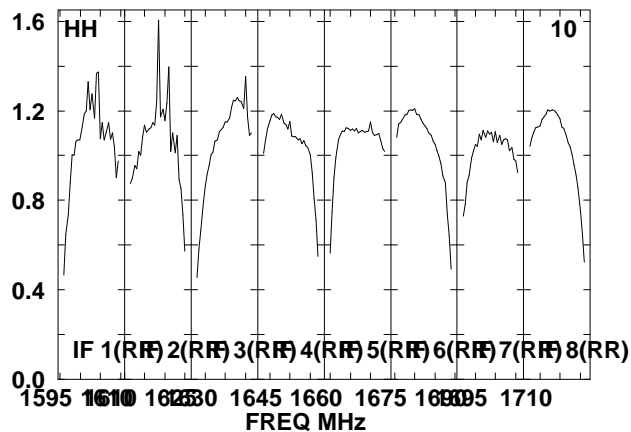
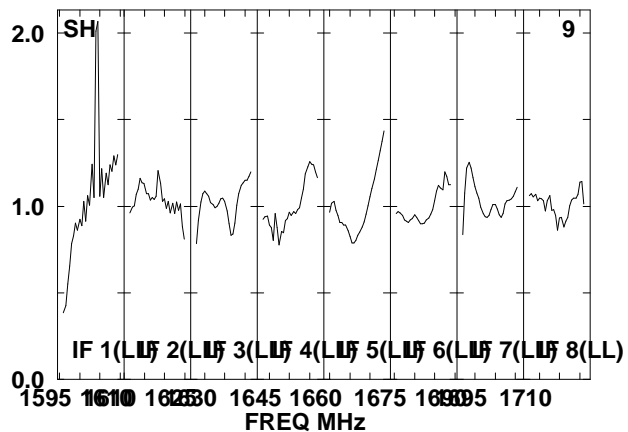
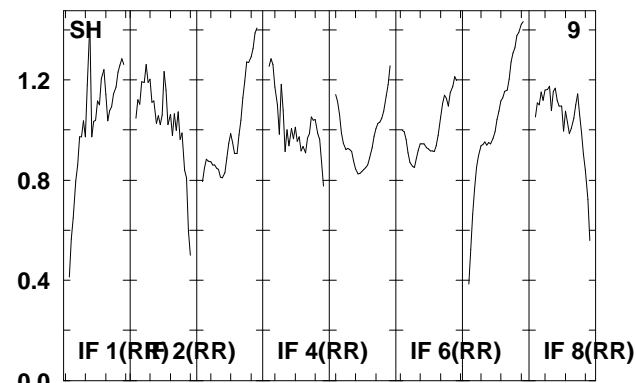
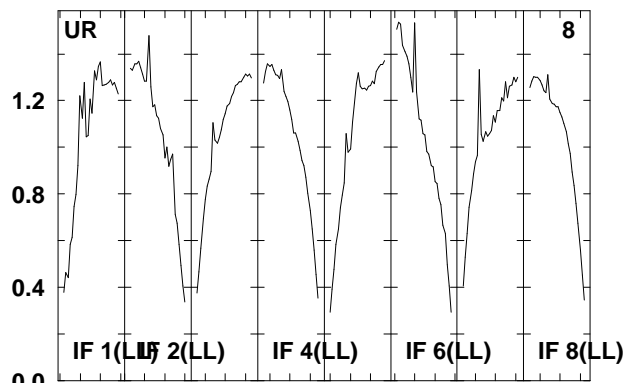
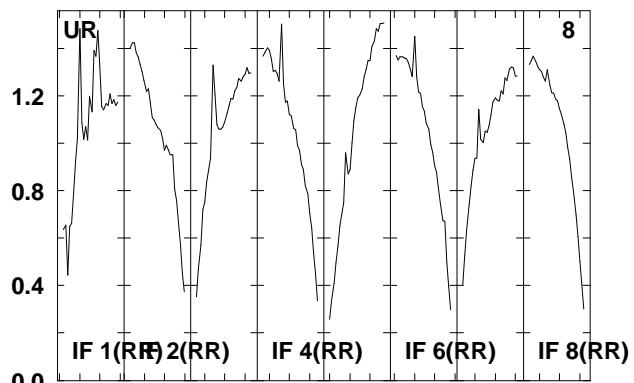
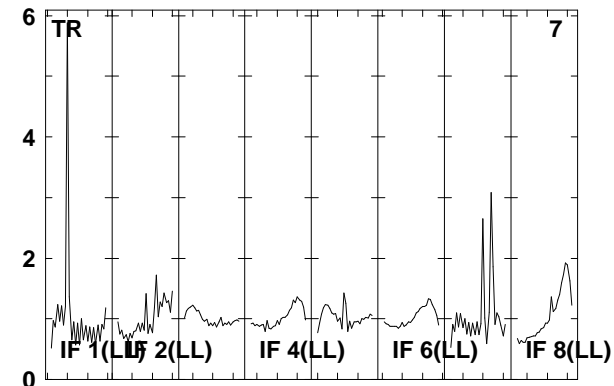
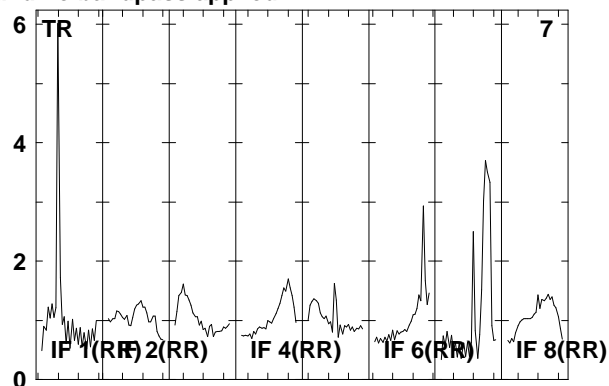
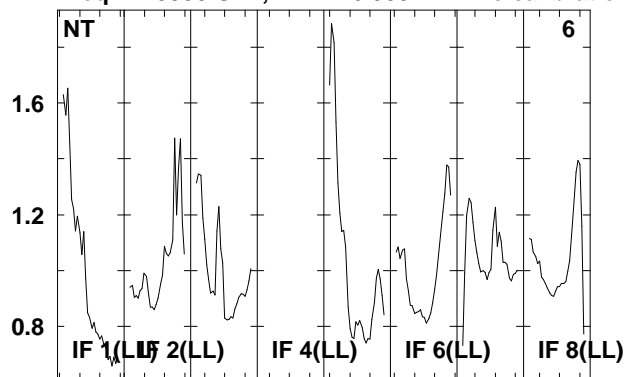

Lower frame: Real Jy  
 Total-power spectrum Antenna: \*  
 Timerange: 00/05:20:21 to 00/05:21:57



Plot file version 93 created 08-AUG-2008 16:59:00

J0209+13 EO006B.UVDATA.1

Freq = 1.5950 GHz, Bw = 16.000 MH No calibration applied and no bandpass applied

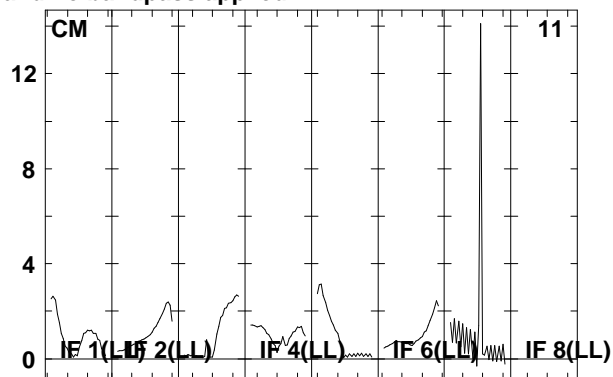
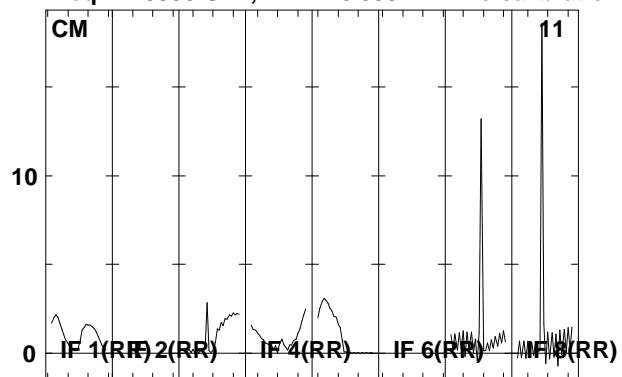

Lower frame: Real Jy  
Total-power spectrum Antenna: \*  
Timerange: 00/05:20:21 to 00/05:21:57

Plot file version 94 created 08-AUG-2008 16:59:01

J021348 EO006B.UVDATA.1

Freq = 1.5950 GHz, Bw = 16.000 MH No calibration applied and no bandpass applied

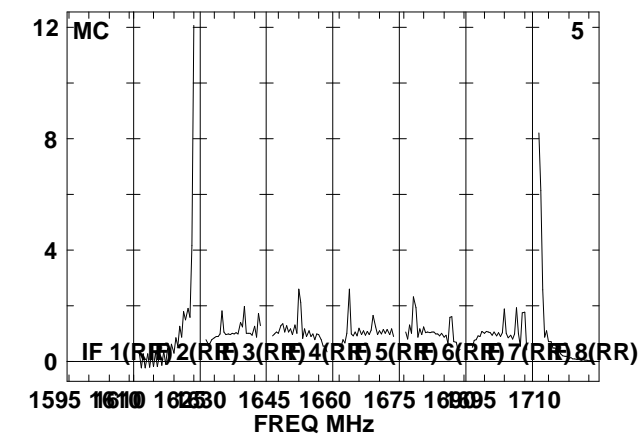
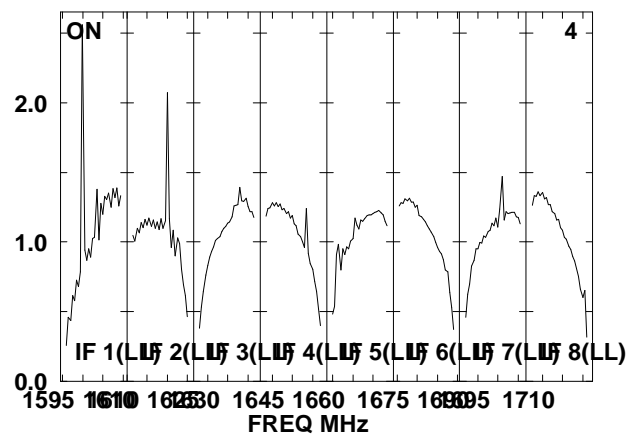
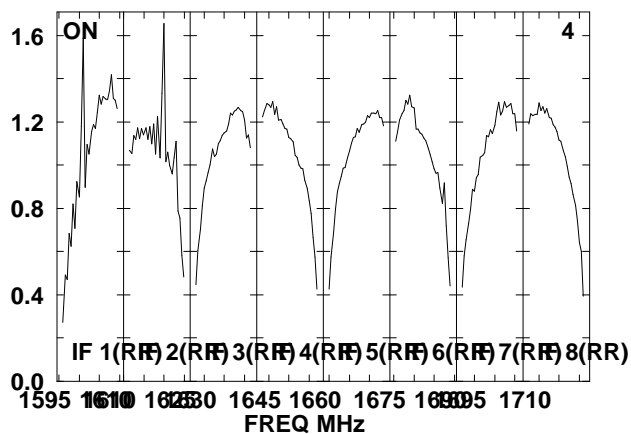
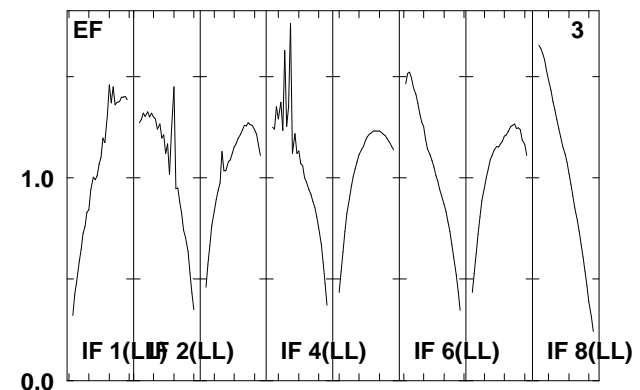
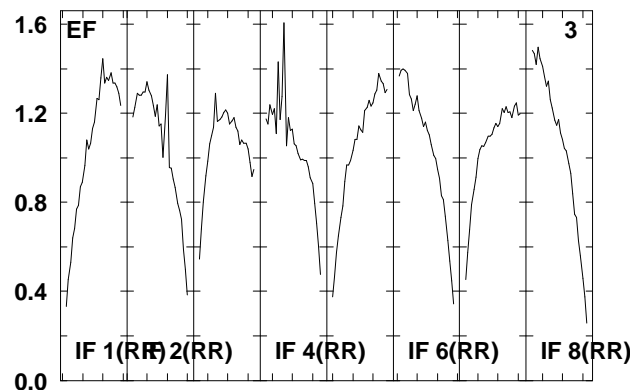
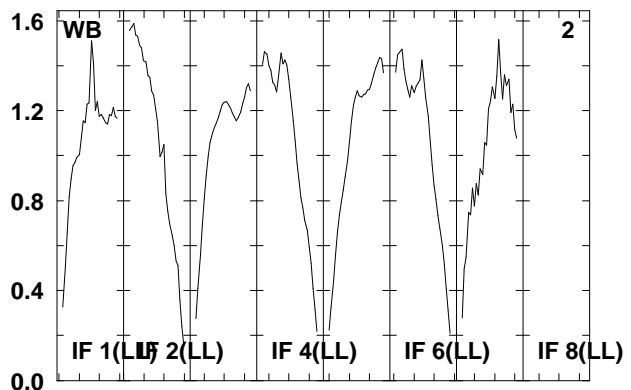
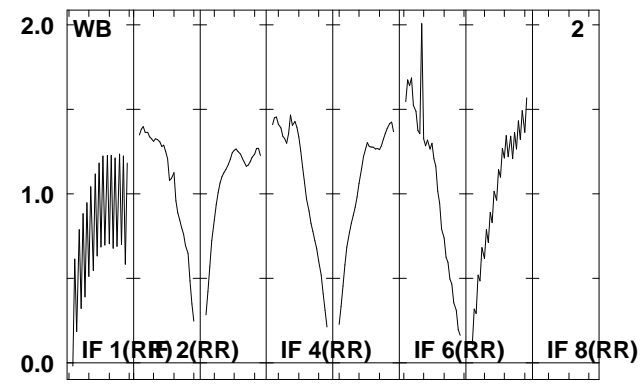
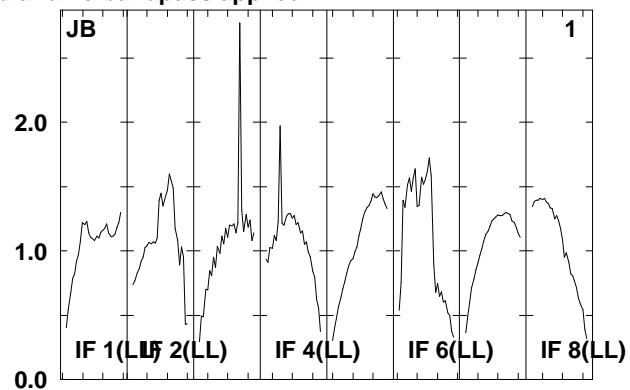
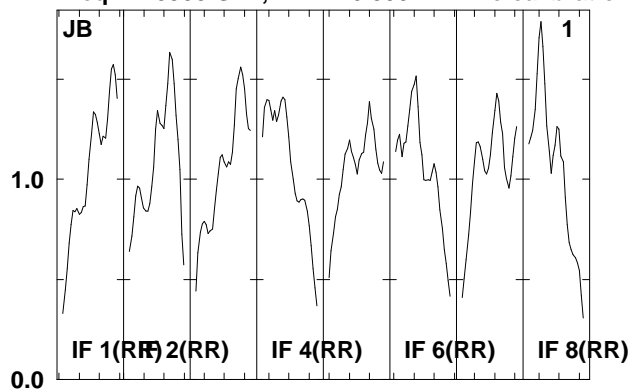

Lower frame: Real Jy  
Total-power spectrum Antenna: \*  
Timerange: 00/05:22:41 to 00/05:27:01

Plot file version 95 created 08-AUG-2008 16:59:01  
 J021348 EO06B.UVDATA.1  
 Freq = 1.5950 GHz, Bw = 16.000 MH No calibration applied and no bandpass applied

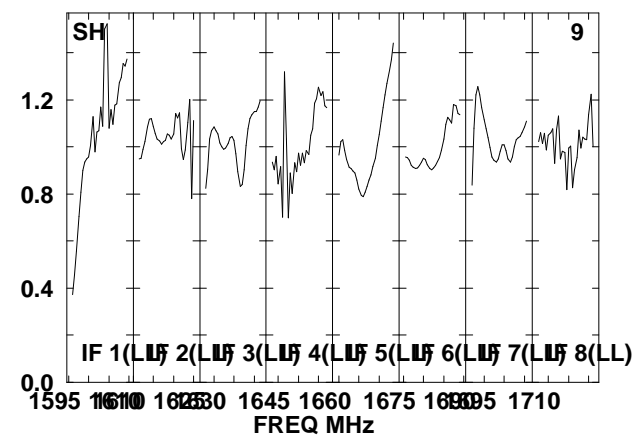
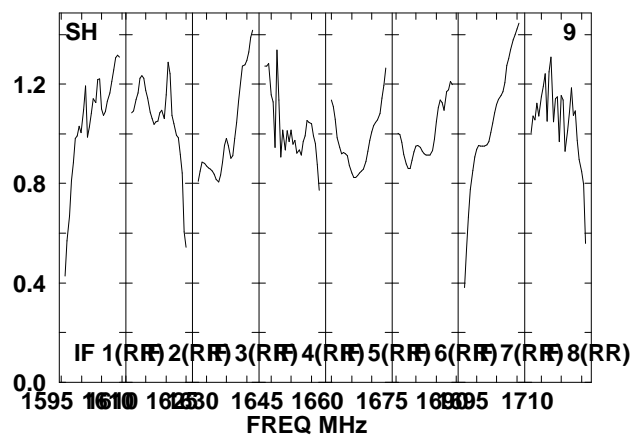
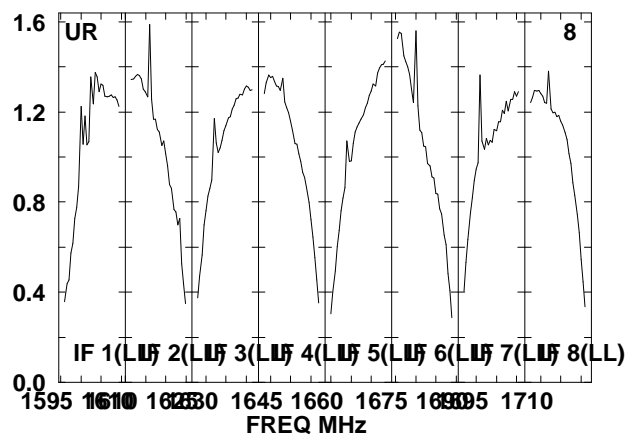
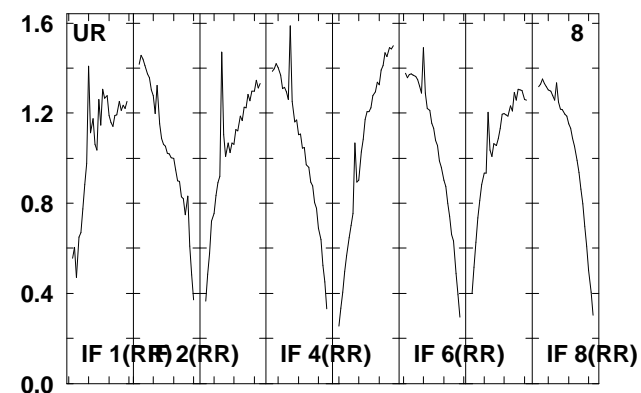
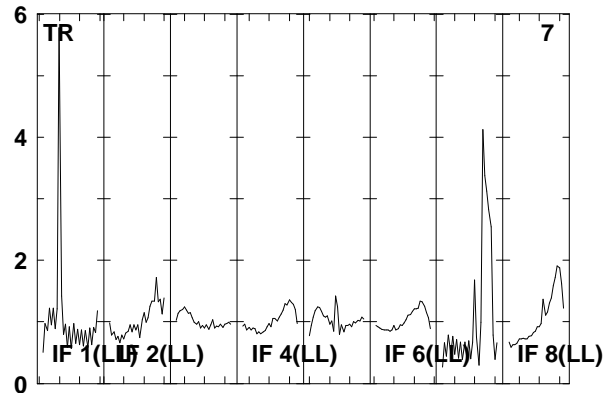
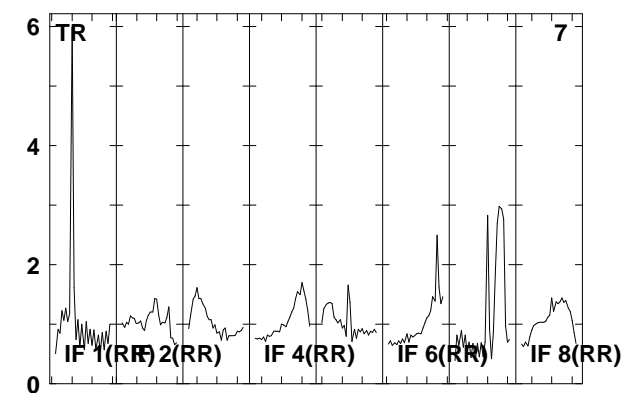
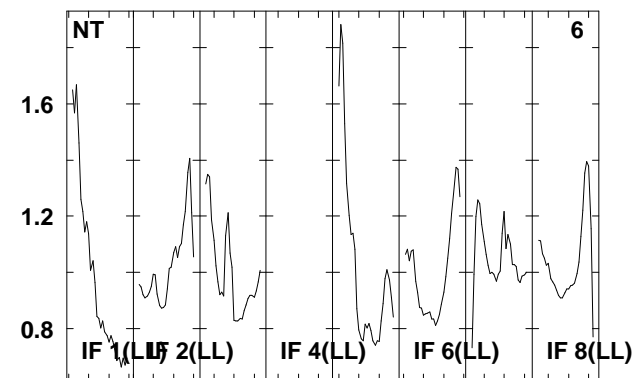
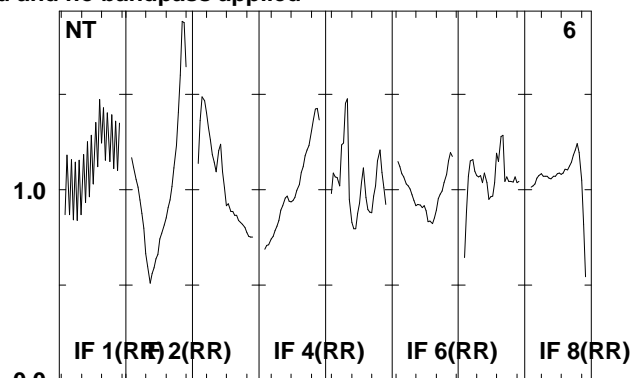
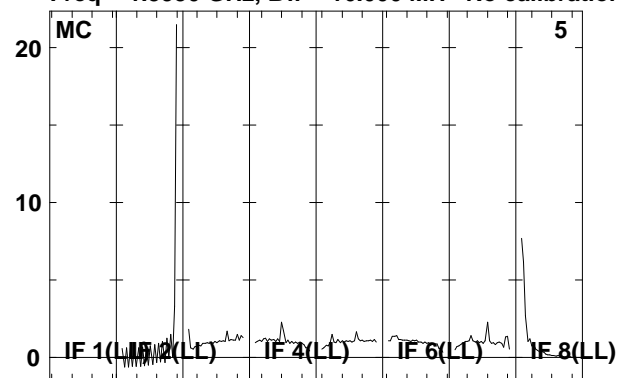

Lower frame: Real Jy  
 Total-power spectrum Antenna: \*  
 Timerange: 00/05:22:41 to 00/05:27:01

Plot file version 96 created 08-AUG-2008 16:59:02

J021348 EO006B.UVDATA.1

Freq = 1.5950 GHz, Bw = 16.000 MH No calibration applied and no bandpass applied

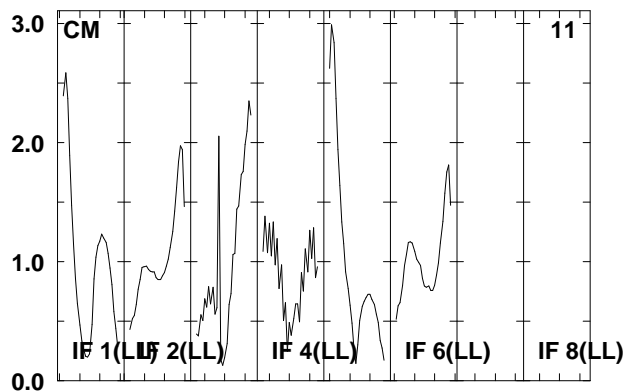
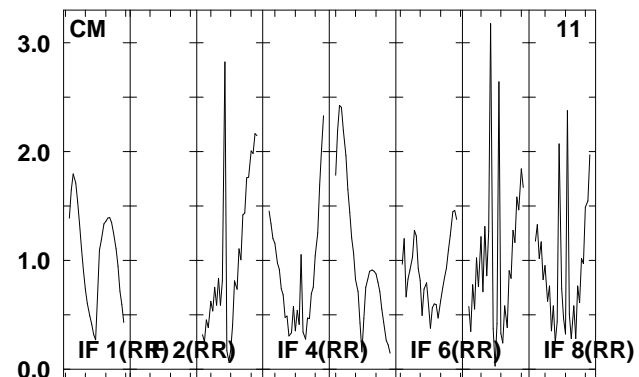
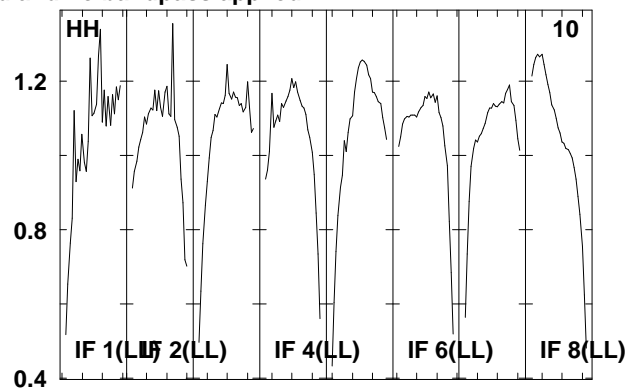
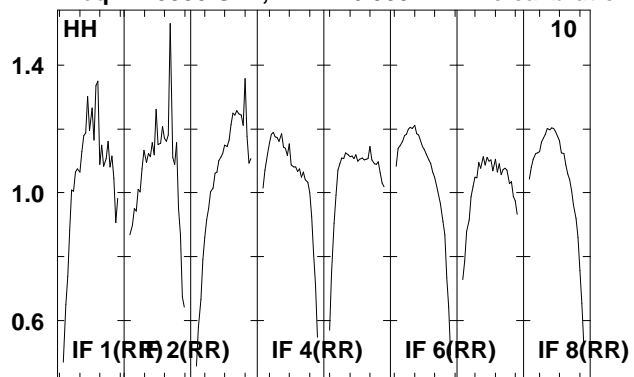

Lower frame: Real Jy  
Total-power spectrum Antenna: \*  
Timerange: 00/05:22:41 to 00/05:27:01

Plot file version 97 created 08-AUG-2008 16:59:02

J0209+13 EO006B.UVDATA.1

Freq = 1.5950 GHz, Bw = 16.000 MH No calibration applied and no bandpass applied

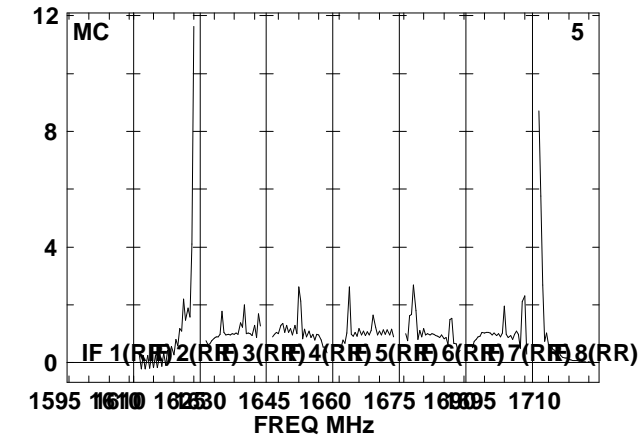
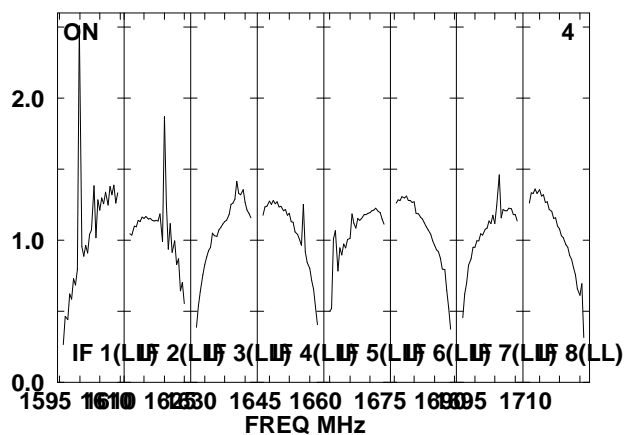
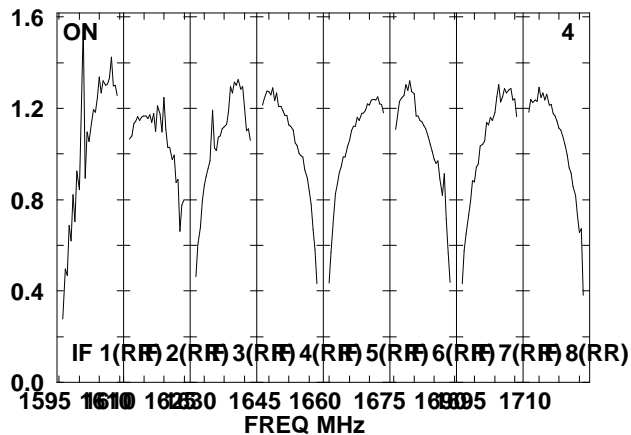
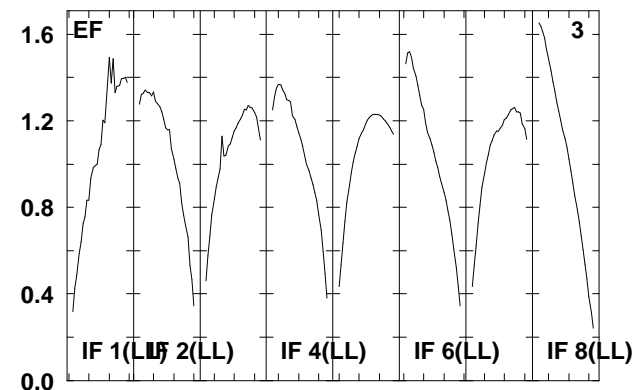
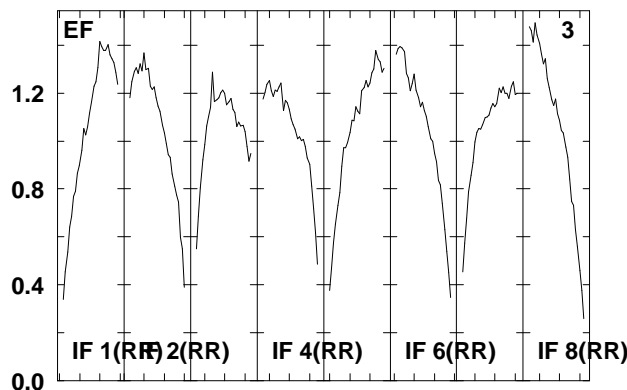
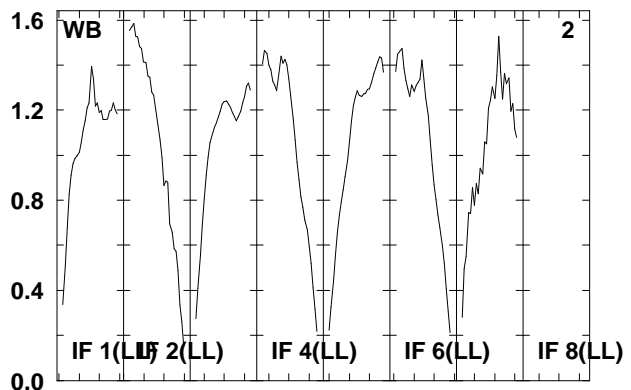
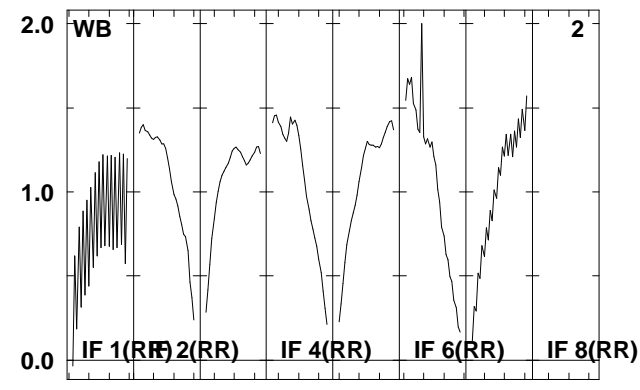
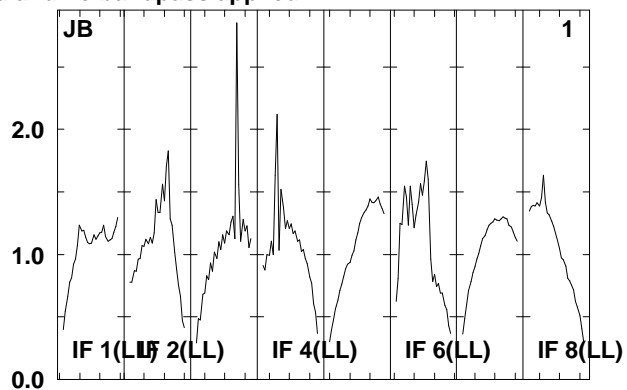
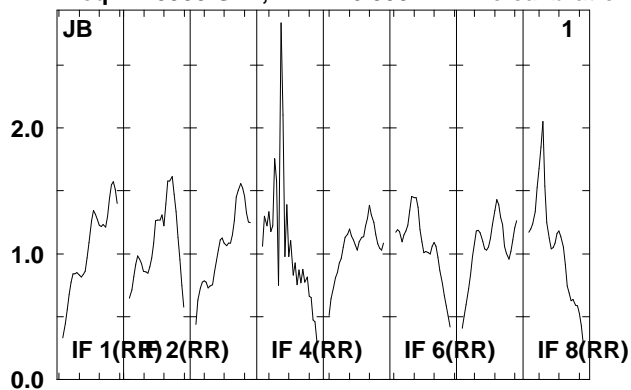

Lower frame: Real Jy  
Total-power spectrum Antenna: \*  
Timerange: 00/05:27:45 to 00/05:29:17

Plot file version 98 created 08-AUG-2008 16:59:03

J0209+13 EO006B.UVDATA.1

Freq = 1.5950 GHz, Bw = 16.000 MH No calibration applied and no bandpass applied

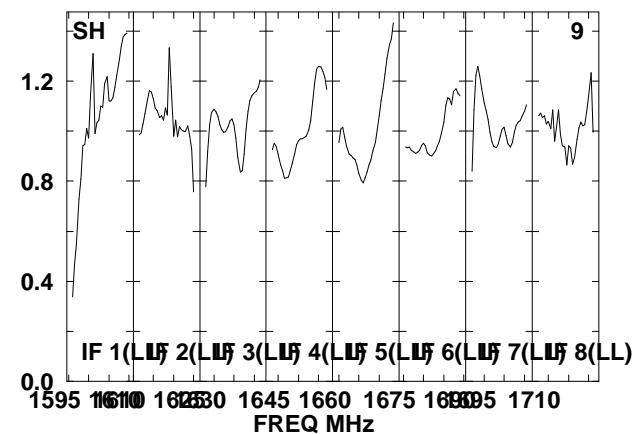
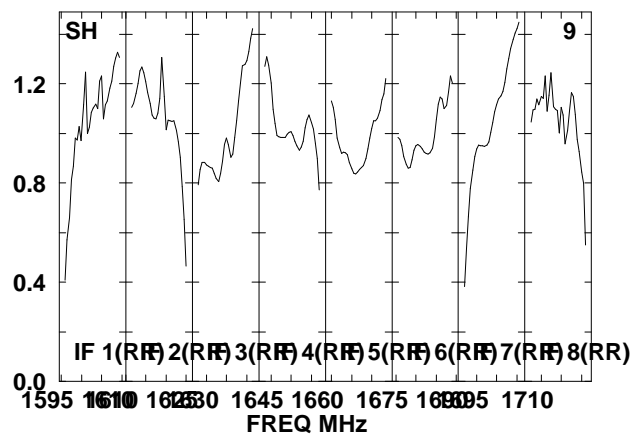
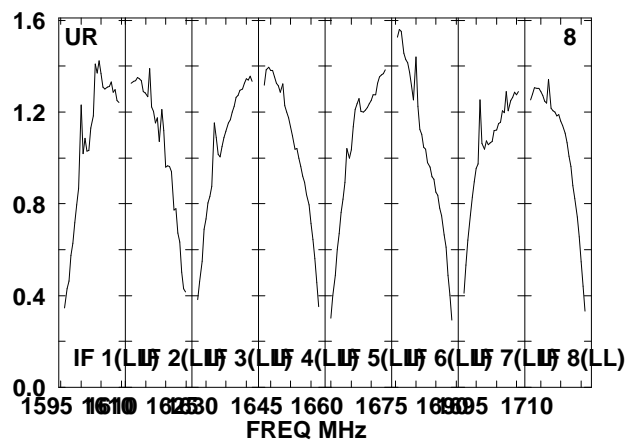
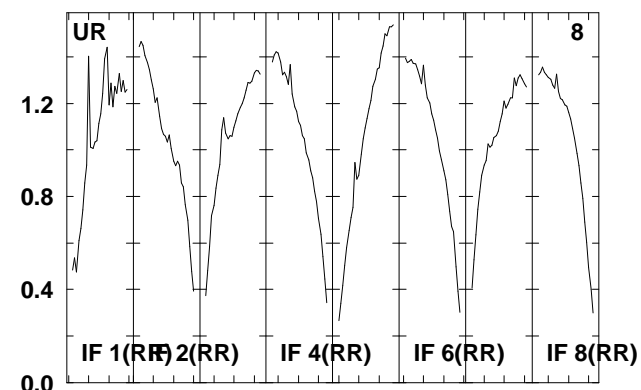
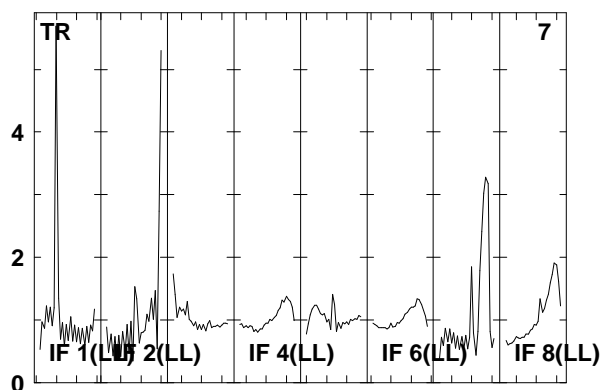
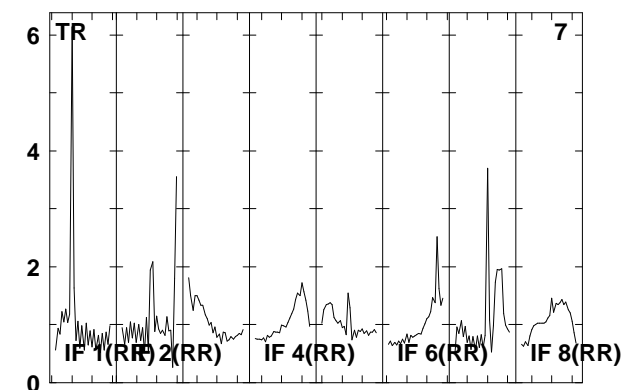
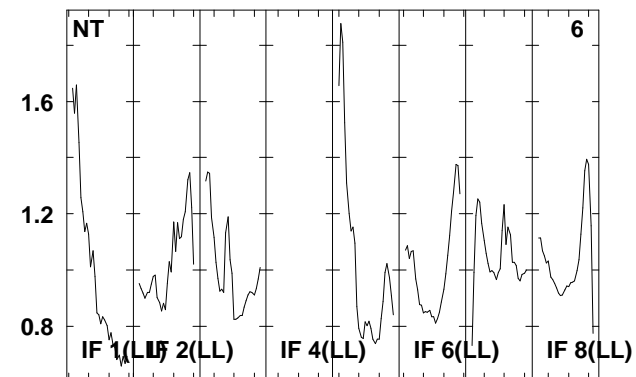
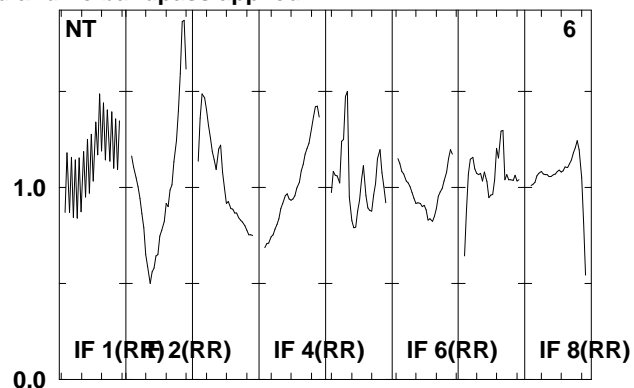
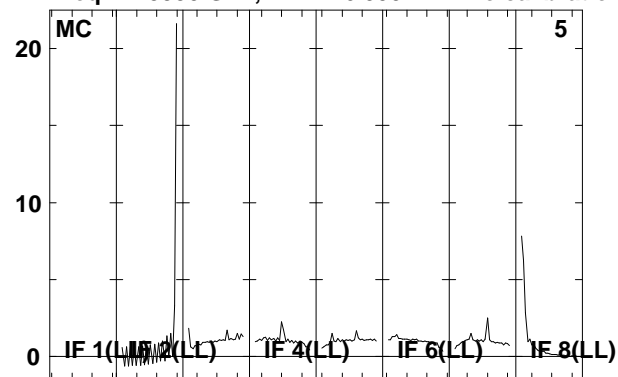

Lower frame: Real Jy

Total-power spectrum Antenna: \*

Timerange: 00/05:27:45 to 00/05:29:17

Plot file version 99 created 08-AUG-2008 16:59:03

J0209+13 EO006B.UVDATA.1

Freq = 1.5950 GHz, Bw = 16.000 MH No calibration applied and no bandpass applied

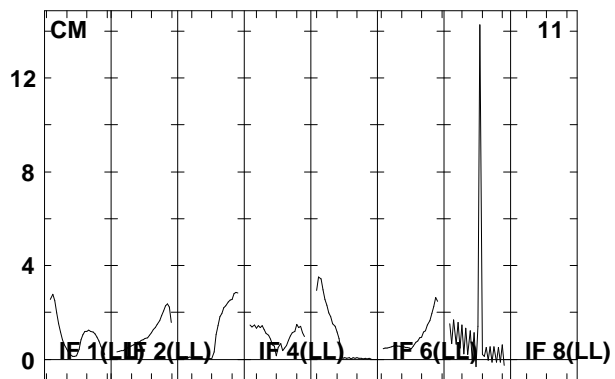
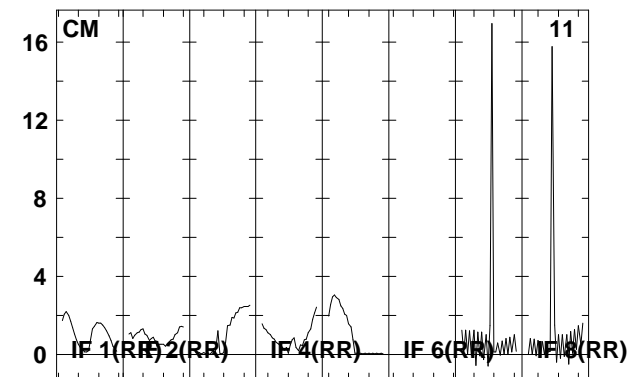
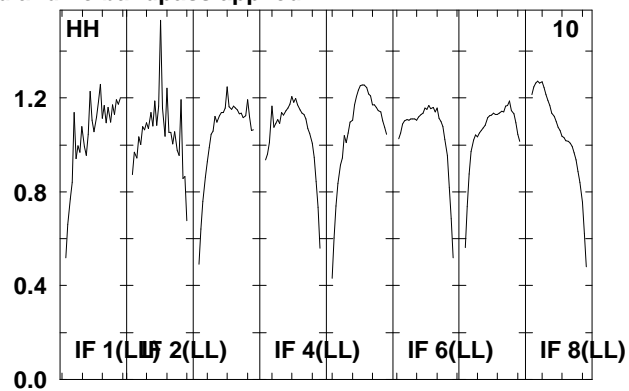
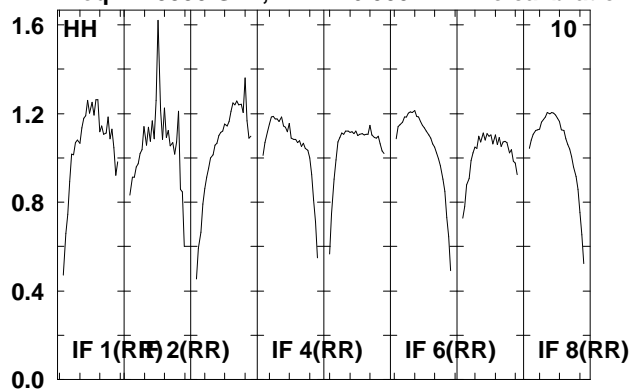

Lower frame: Real Jy  
Total-power spectrum Antenna: \*  
Timerange: 00/05:27:45 to 00/05:29:17

Plot file version 100 created 08-AUG-2008 16:59:04

J021348 EO006B.UVDATA.1

Freq = 1.5950 GHz, Bw = 16.000 MH No calibration applied and no bandpass applied

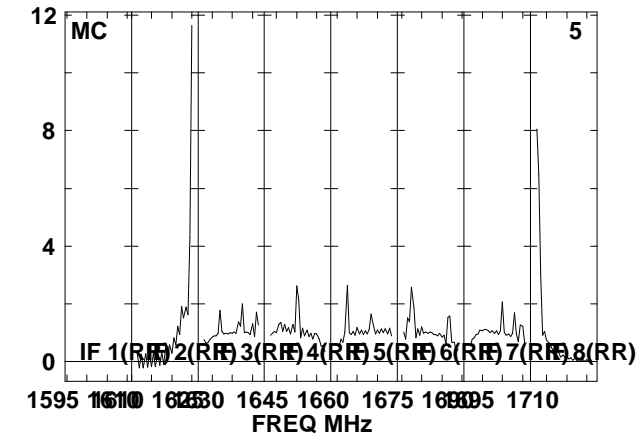
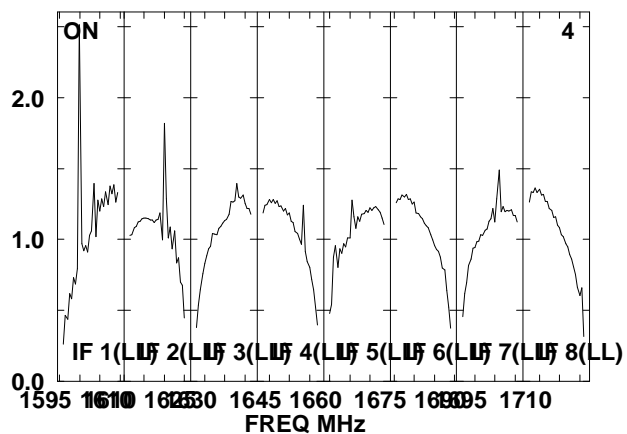
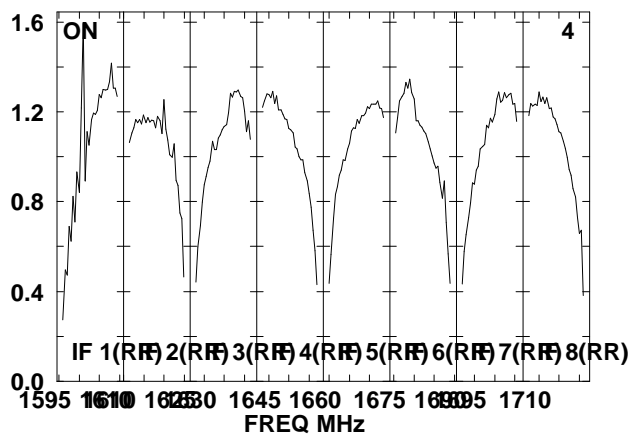
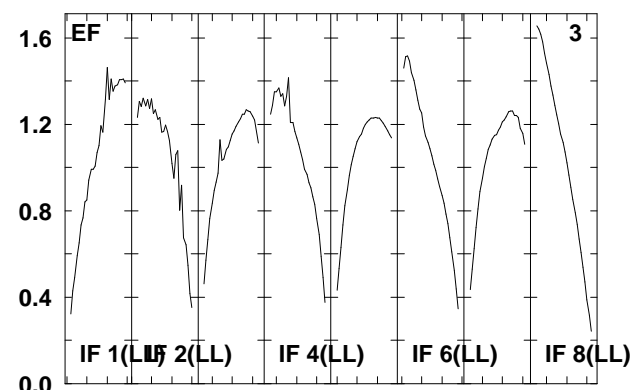
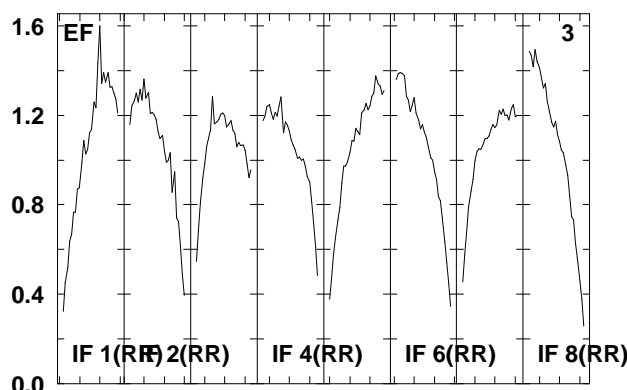
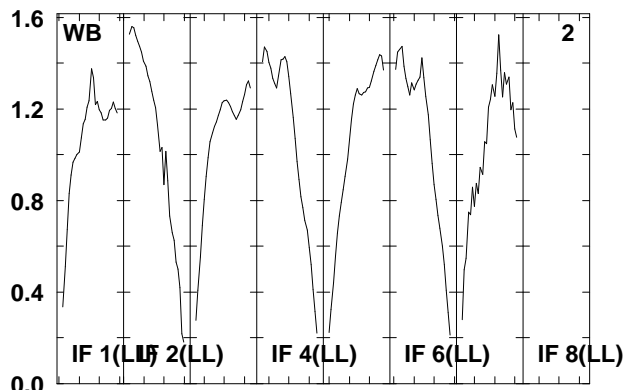
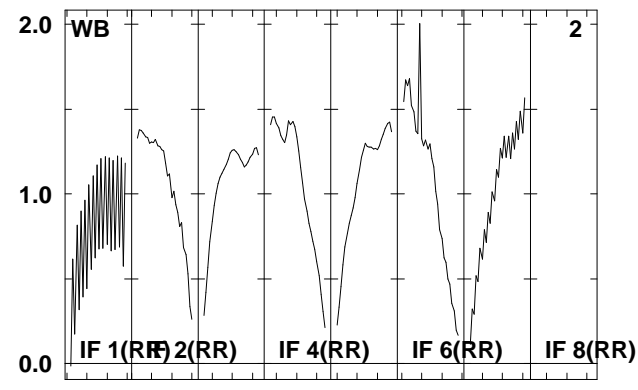
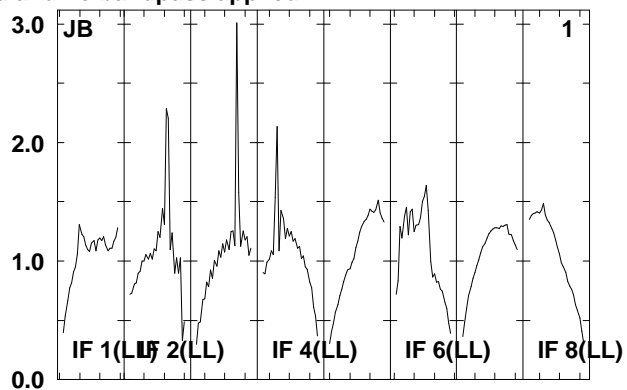
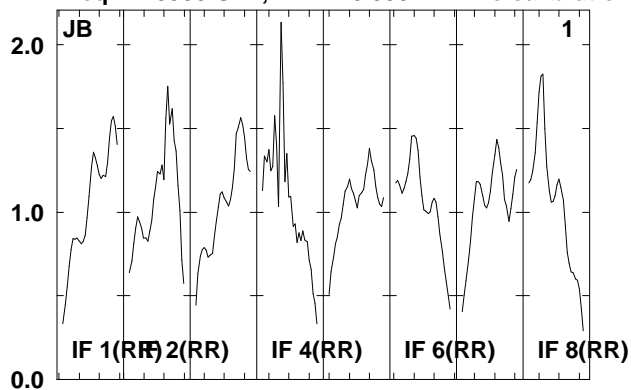

Lower frame: Real Jy  
Total-power spectrum Antenna: \*  
Timerange: 00/05:29:57 to 00/05:34:21



Plot file version 101 created 08-AUG-2008 16:59:04

J021348 EO06B.UVDATA.1

Freq = 1.5950 GHz, Bw = 16.000 MH No calibration applied and no bandpass applied

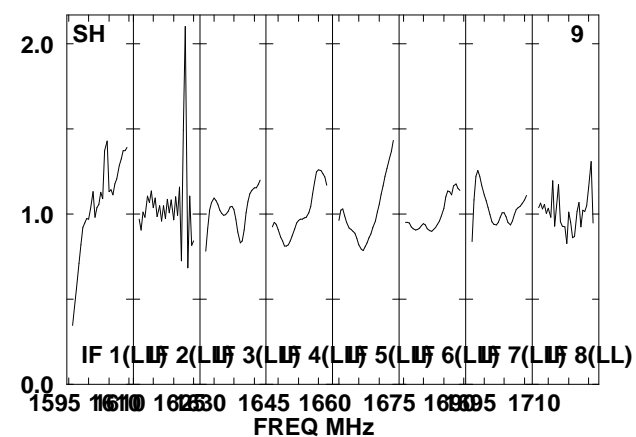
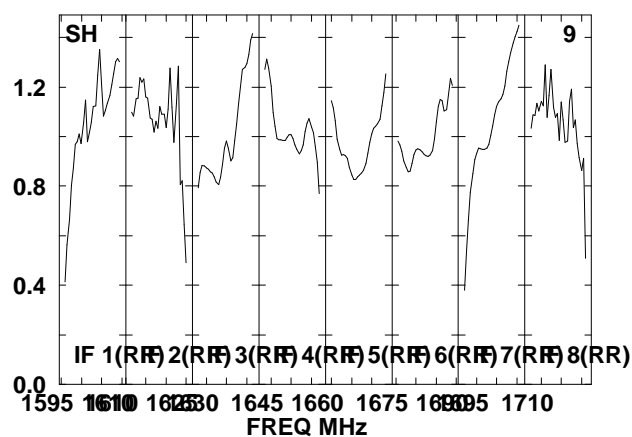
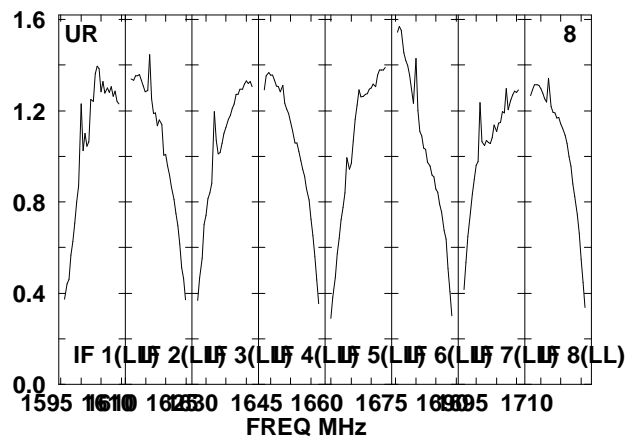
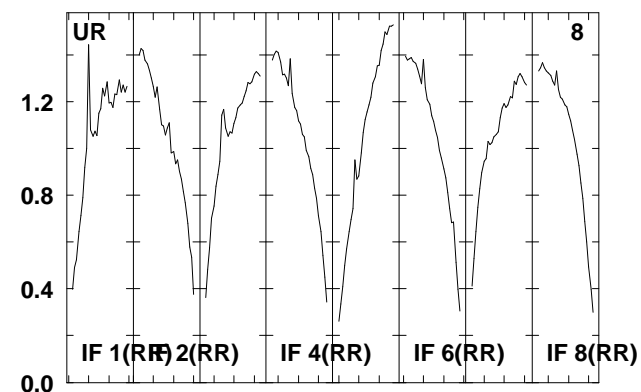
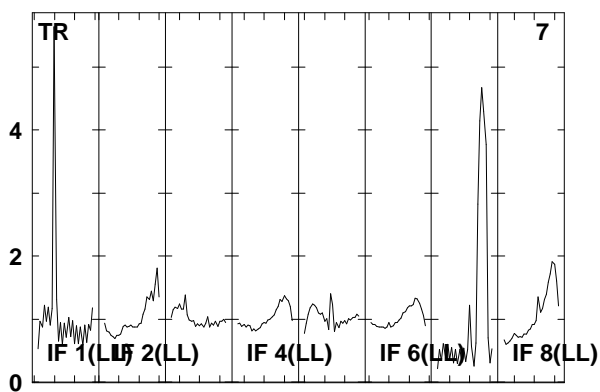
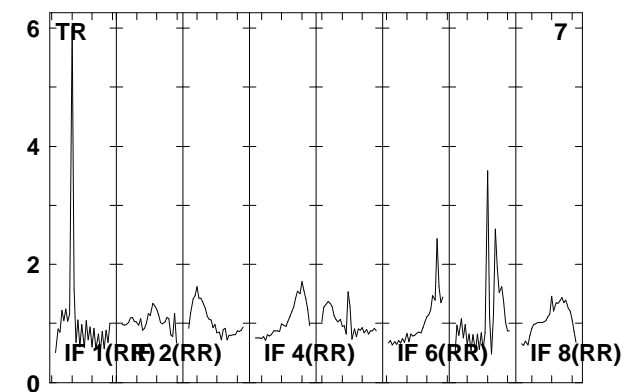
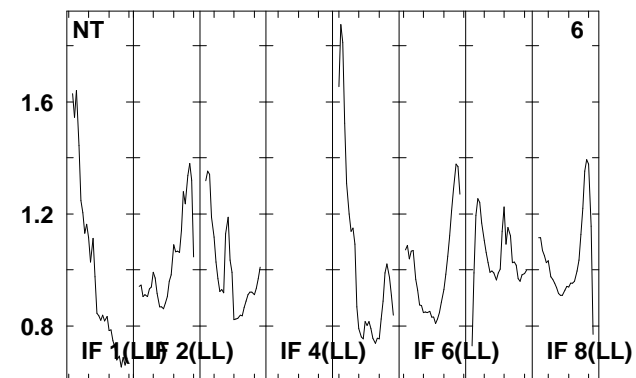
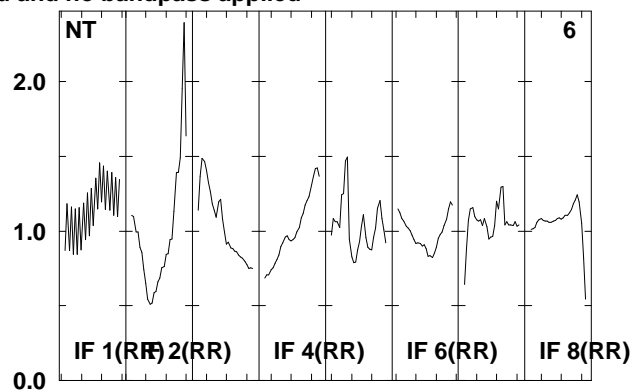
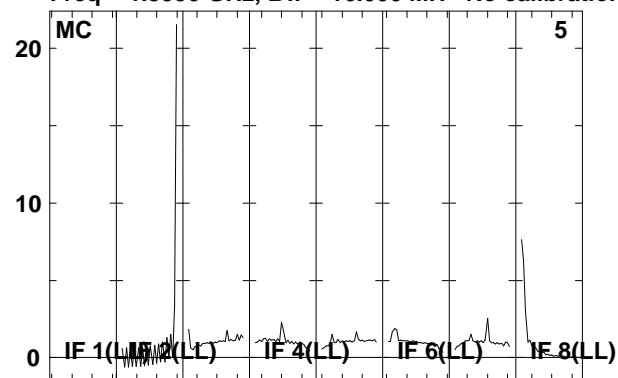

Lower frame: Real Jy

Total-power spectrum Antenna: \*

Timerange: 00/05:29:57 to 00/05:34:21

Plot file version 102 created 08-AUG-2008 16:59:05

J021348 EO006B.UVDATA.1

Freq = 1.5950 GHz, Bw = 16.000 MH No calibration applied and no bandpass applied

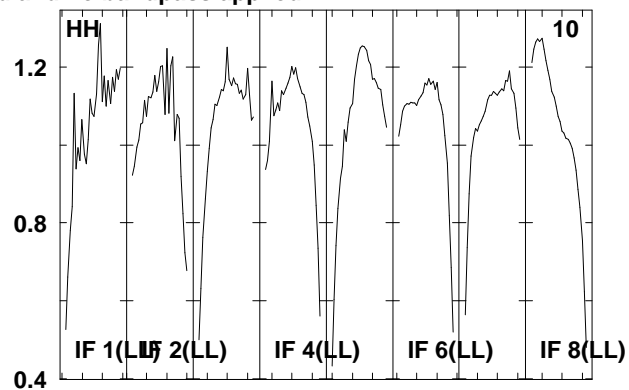
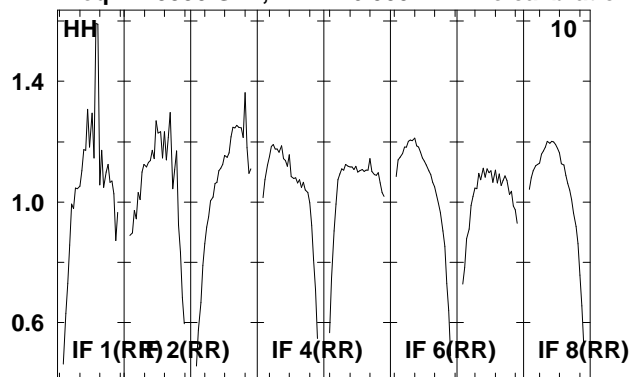

Lower frame: Real Jy  
Total-power spectrum Antenna: \*  
Timerange: 00/05:29:57 to 00/05:34:21

Plot file version 103 created 08-AUG-2008 16:59:06

J0209+13 EO006B.UVDATA.1

Freq = 1.5950 GHz, Bw = 16.000 MH No calibration applied and no bandpass applied

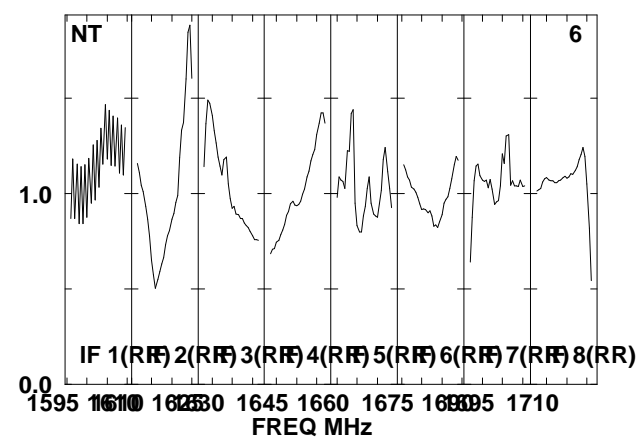
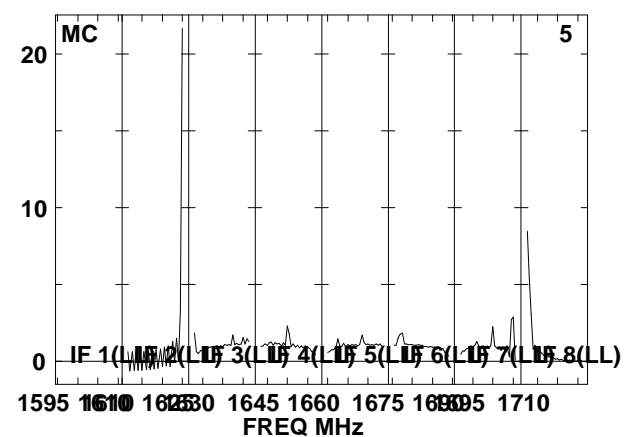
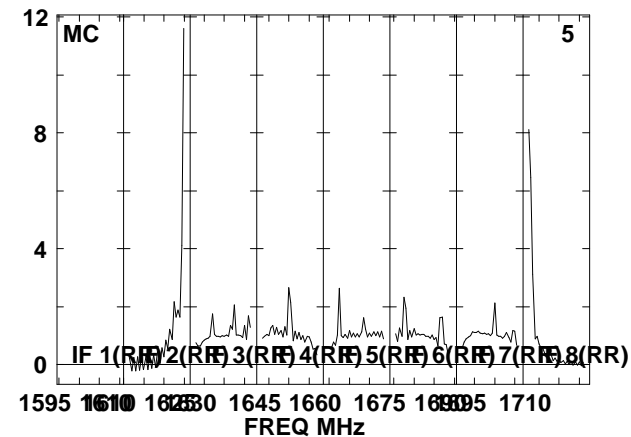
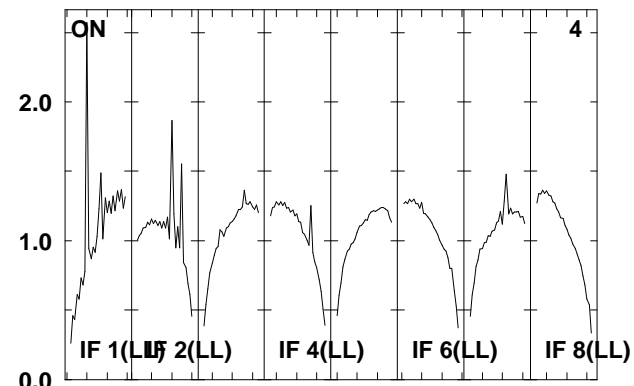
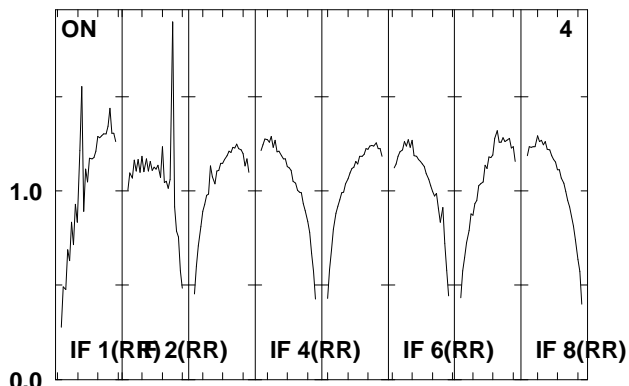
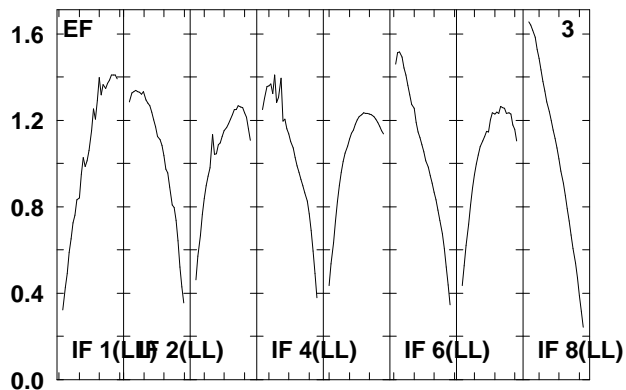
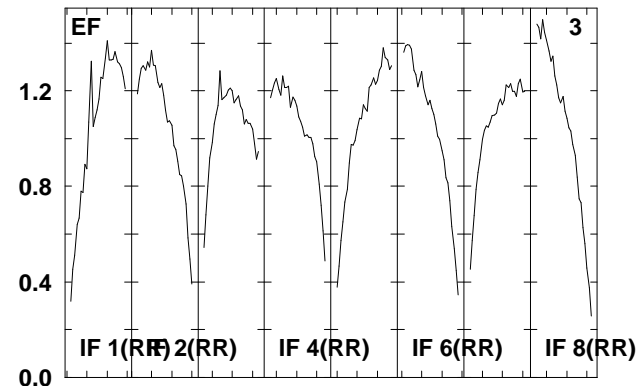
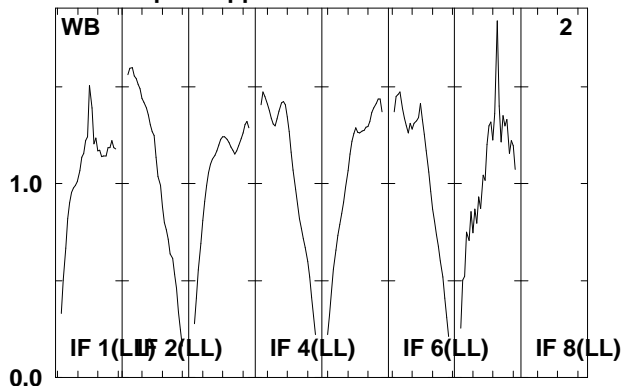
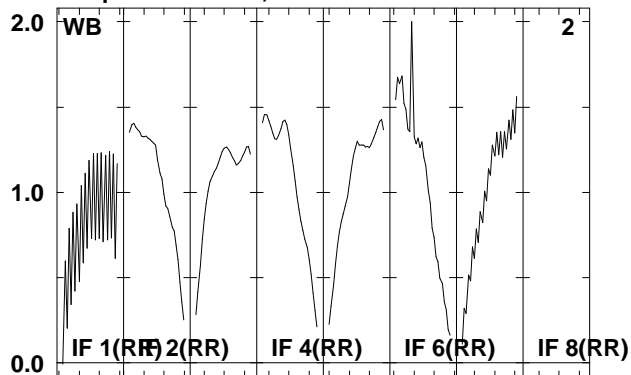

Lower frame: Real Jy  
Total-power spectrum Antenna: \*  
Timerange: 00/05:35:01 to 00/05:36:37

Plot file version 104 created 08-AUG-2008 16:59:06

J0209+13 EO06B.UVDATA.1

Freq = 1.5950 GHz, Bw = 16.000 MH No calibration applied and no bandpass applied

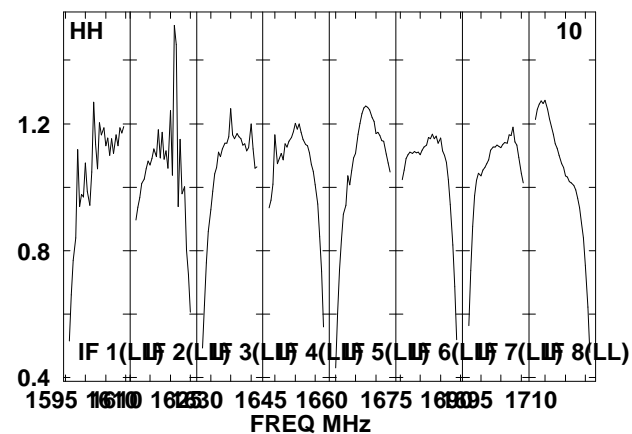
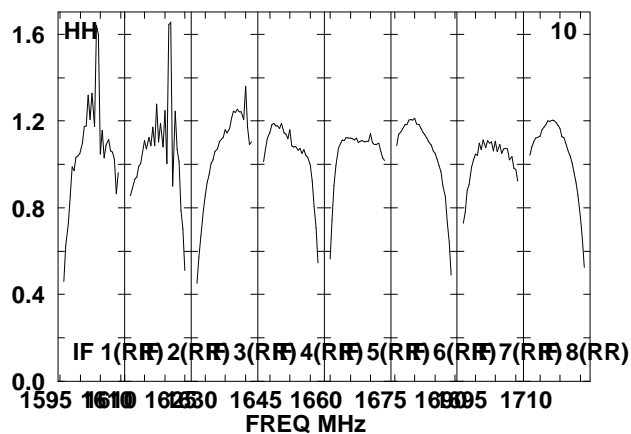
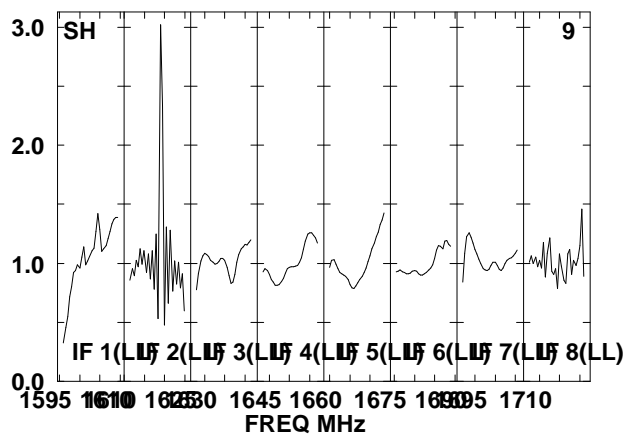
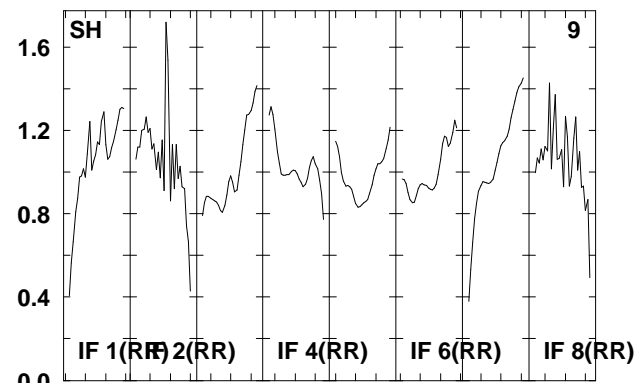
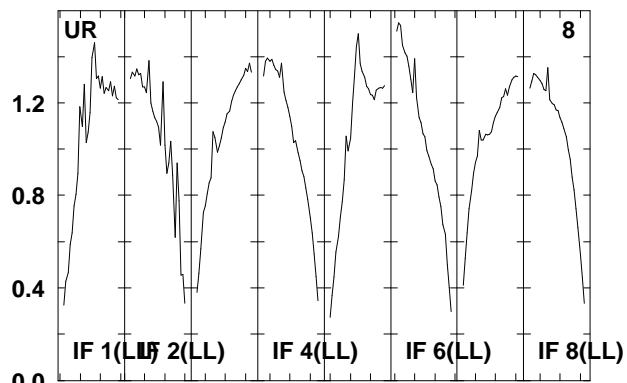
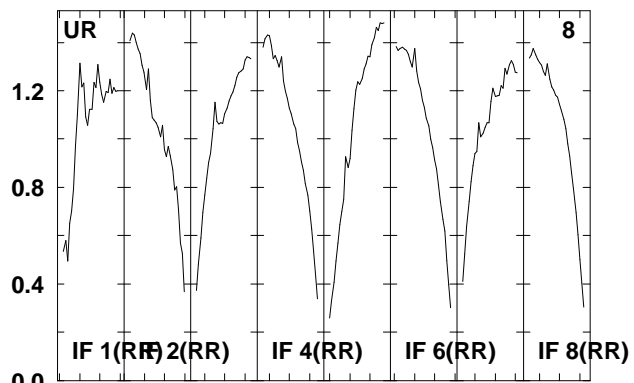
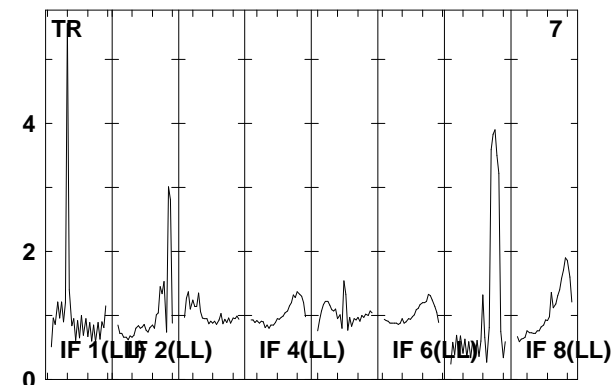
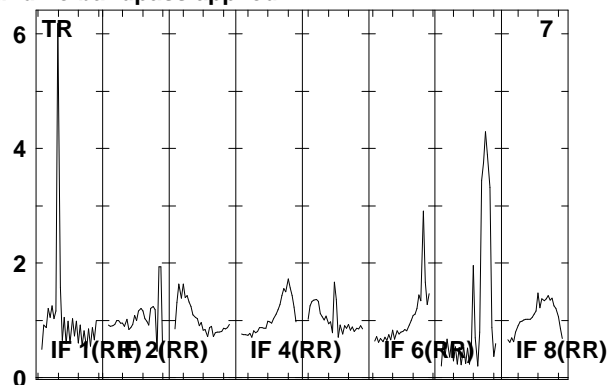
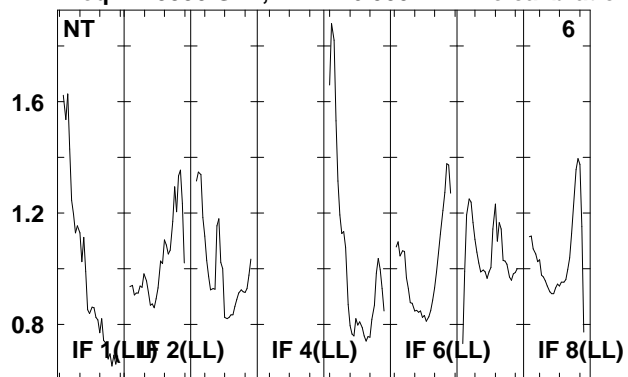

Lower frame: Real Jy

Total-power spectrum Antenna: \*

Timerange: 00/05:35:01 to 00/05:36:37

Plot file version 105 created 08-AUG-2008 16:59:06

J0209+13 EO006B.UVDATA.1

Freq = 1.5950 GHz, Bw = 16.000 MH No calibration applied and no bandpass applied

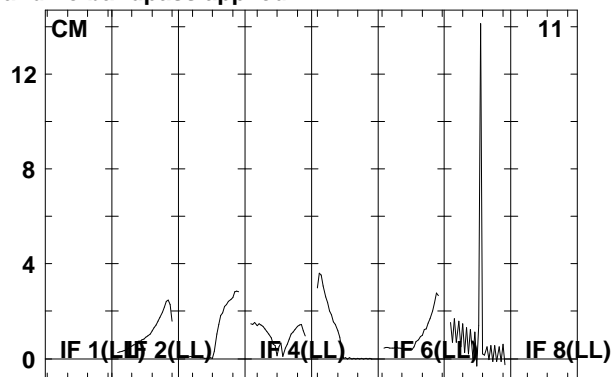
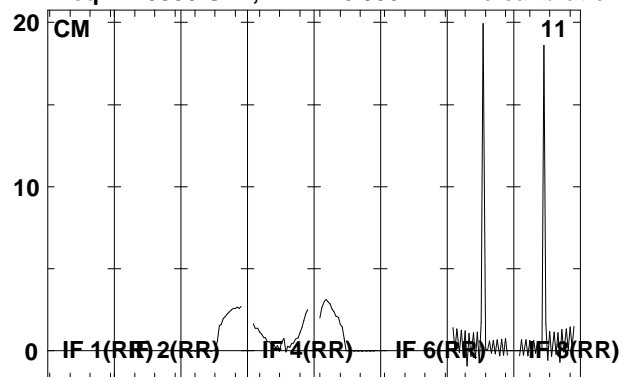

Lower frame: Real Jy  
Total-power spectrum Antenna: \*  
Timerange: 00/05:35:01 to 00/05:36:37

Plot file version 106 created 08-AUG-2008 16:59:07

J021348 EO006B.UVDATA.1

Freq = 1.5950 GHz, Bw = 16.000 MH No calibration applied and no bandpass applied

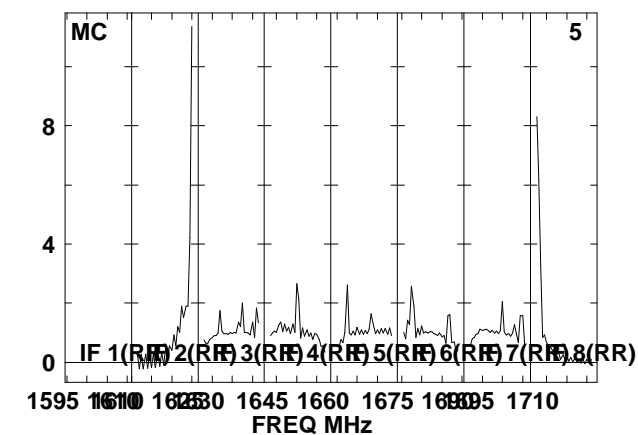
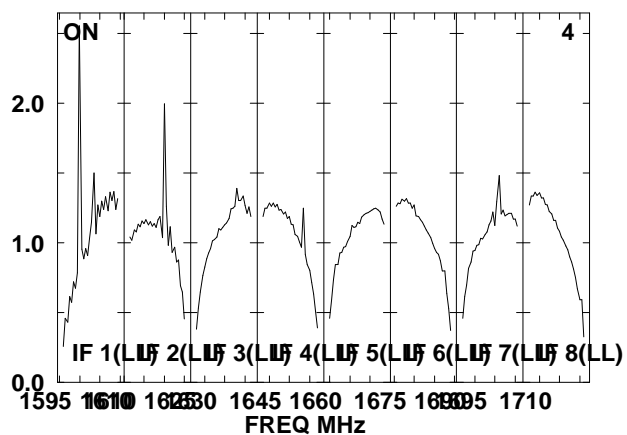
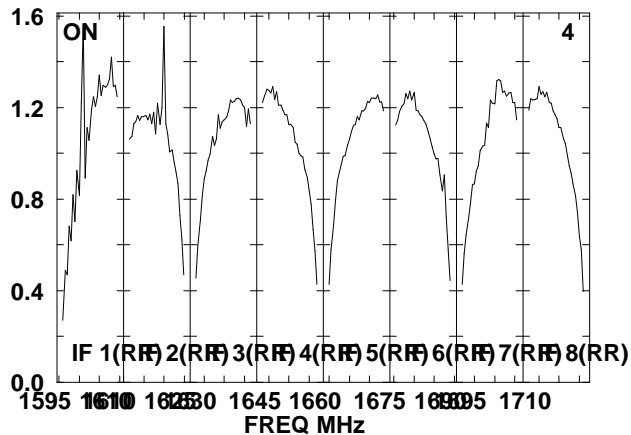
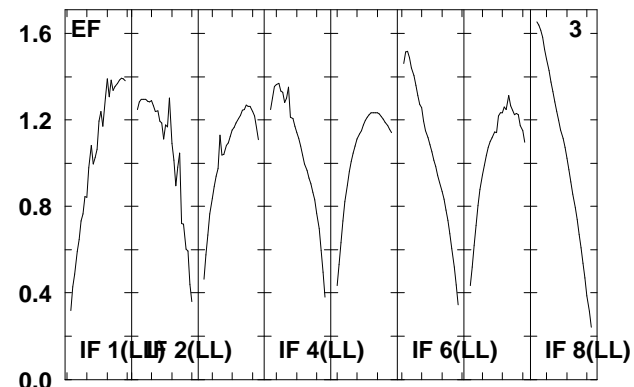
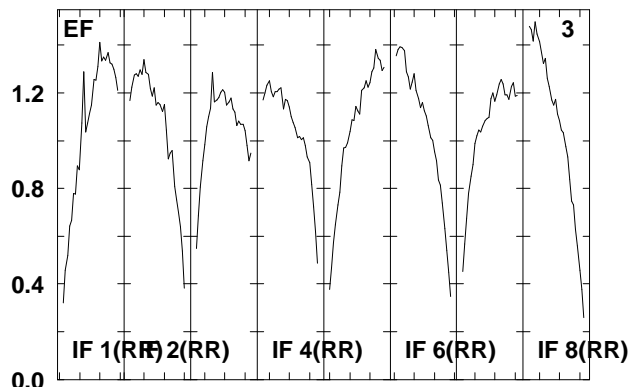
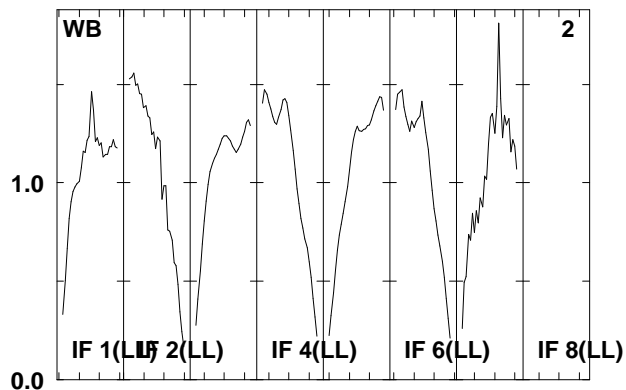
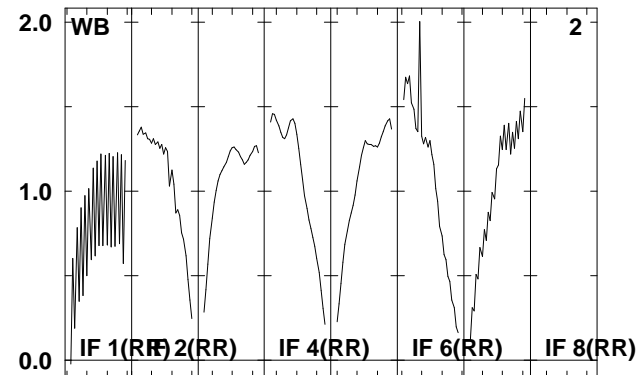
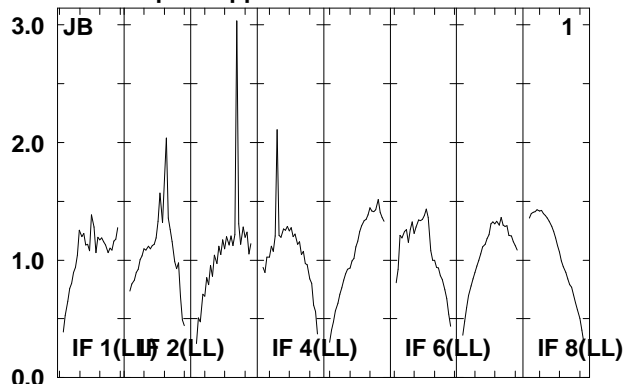
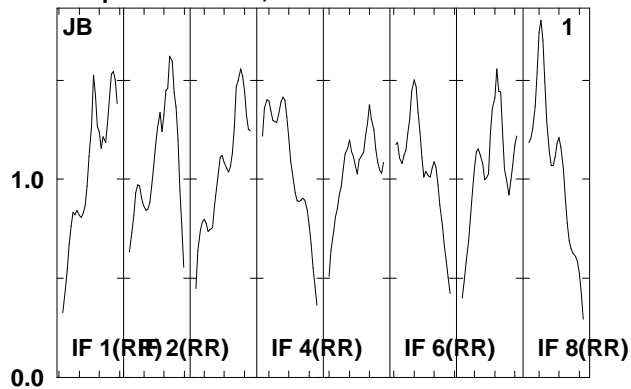

Lower frame: Real Jy  
Total-power spectrum Antenna: \*  
Timerange: 00/05:37:13 to 00/05:41:49

Plot file version 107 created 08-AUG-2008 16:59:07

J021348 EO06B.UVDATA.1

Freq = 1.5950 GHz, Bw = 16.000 MH No calibration applied and no bandpass applied

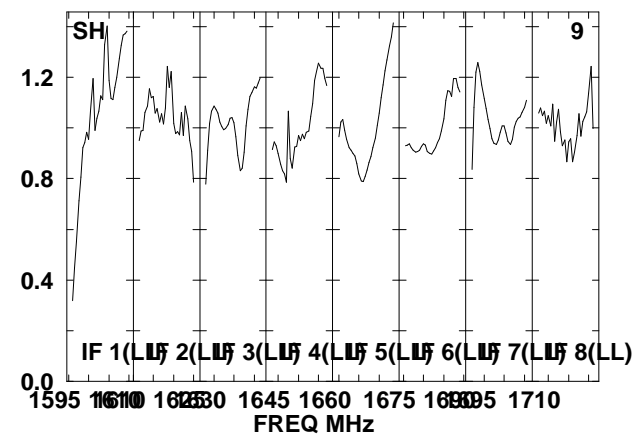
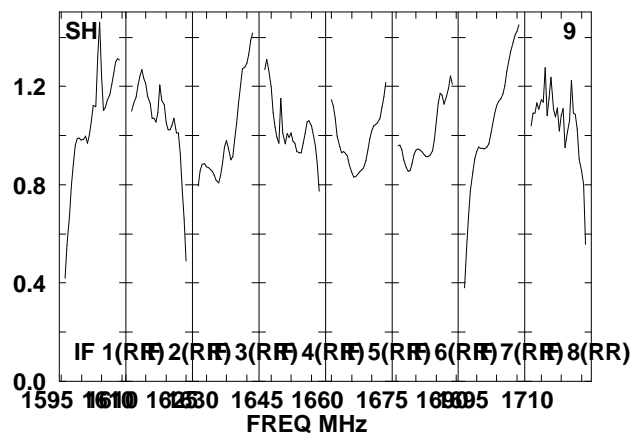
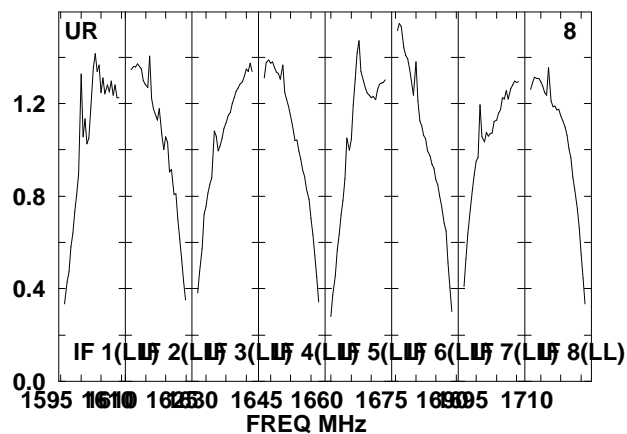
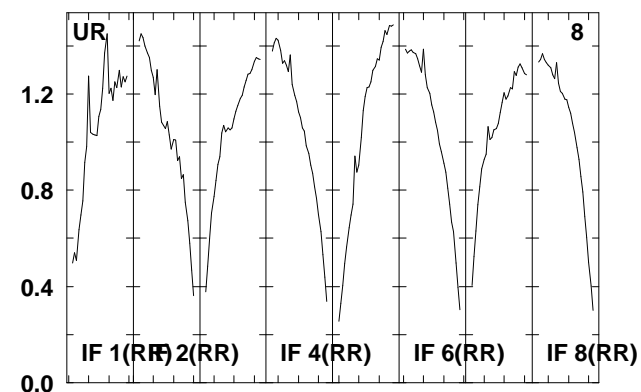
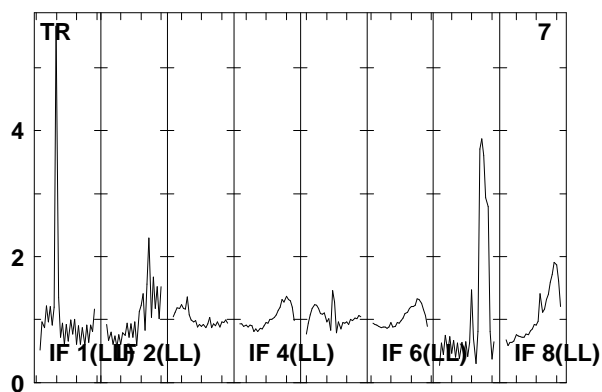
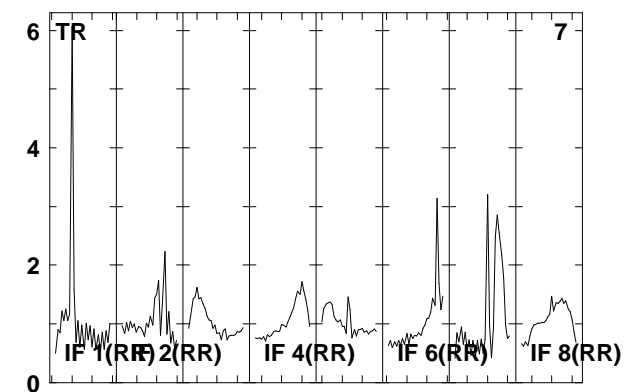
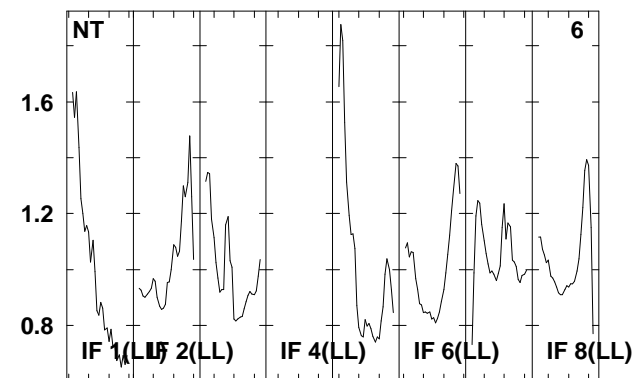
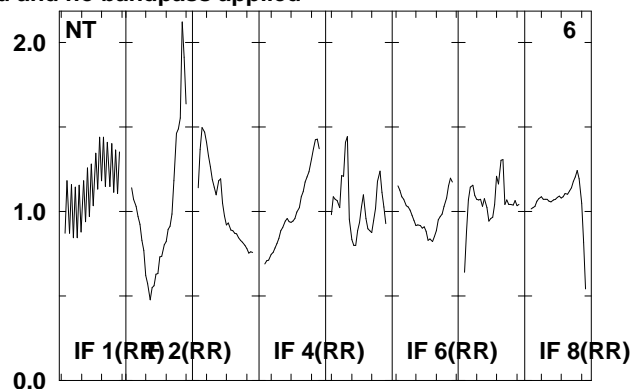
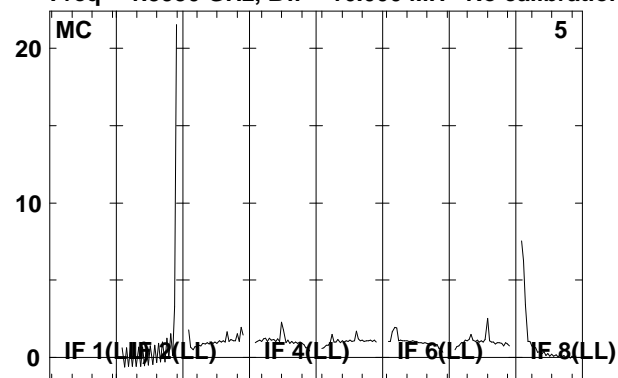

Lower frame: Real Jy

Total-power spectrum Antenna: \*

Timerange: 00/05:37:13 to 00/05:41:49

Plot file version 108 created 08-AUG-2008 16:59:08

J021348 EO006B.UVDATA.1

Freq = 1.5950 GHz, Bw = 16.000 MH No calibration applied and no bandpass applied

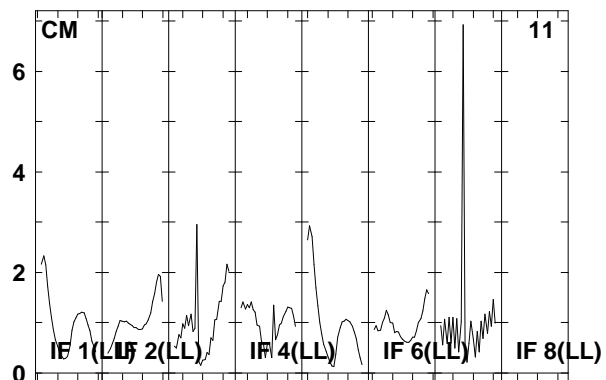
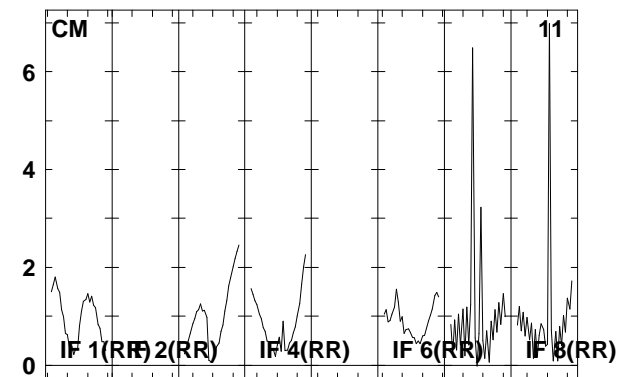
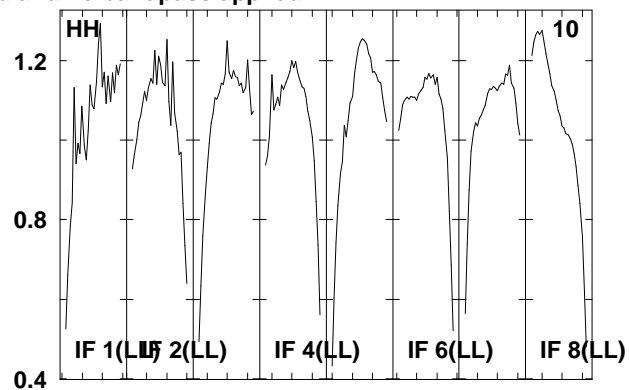
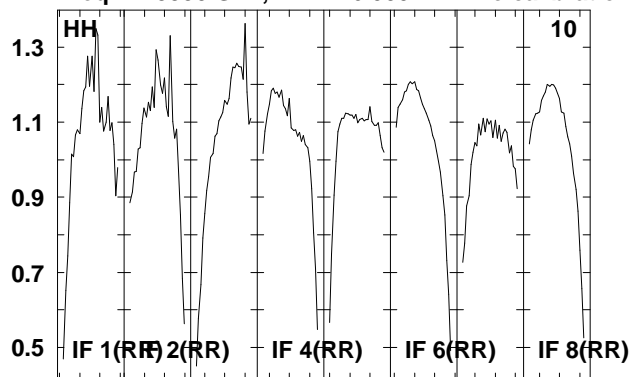

Lower frame: Real Jy  
Total-power spectrum Antenna: \*  
Timerange: 00/05:37:13 to 00/05:41:49



Plot file version 109 created 08-AUG-2008 16:59:09

J0209+13 EO006B.UVDATA.1

Freq = 1.5950 GHz, Bw = 16.000 MH No calibration applied and no bandpass applied

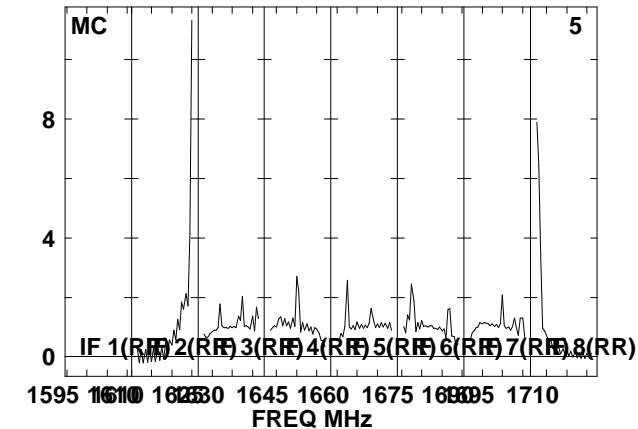
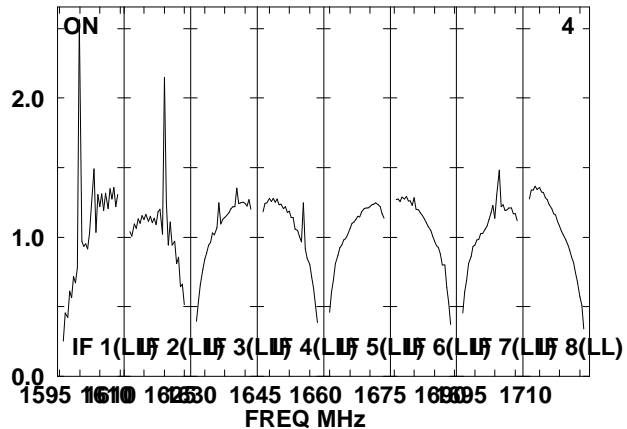
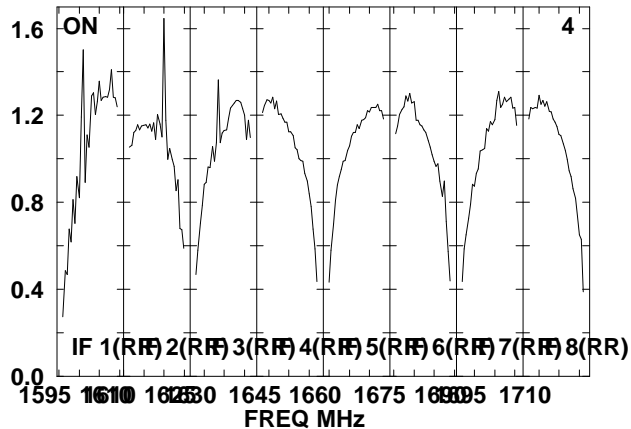
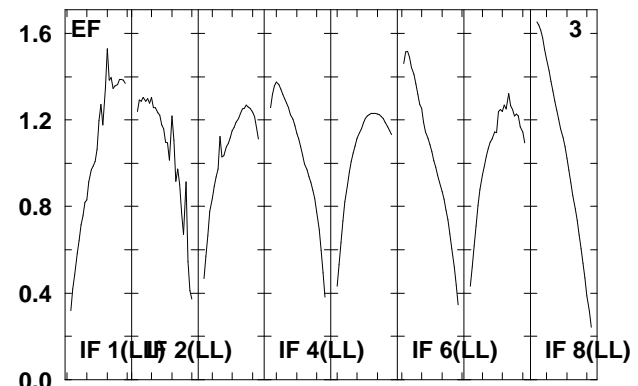
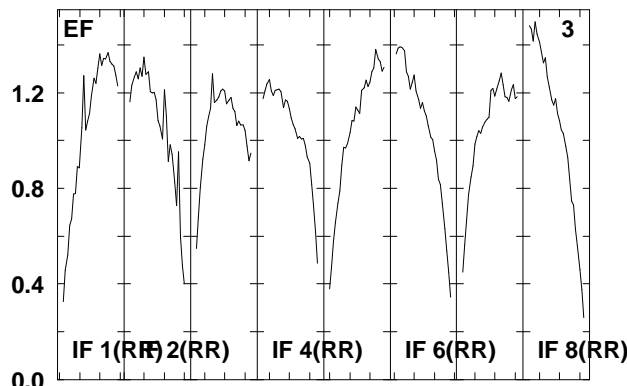
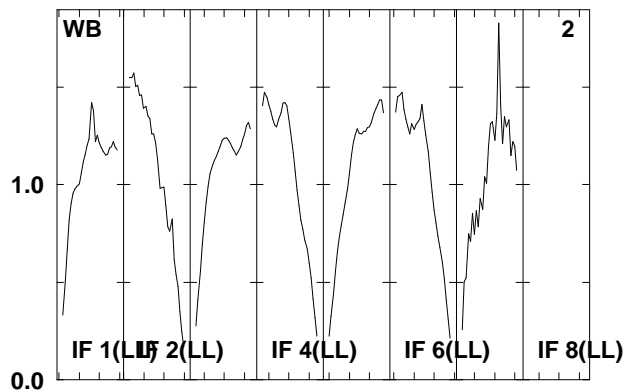
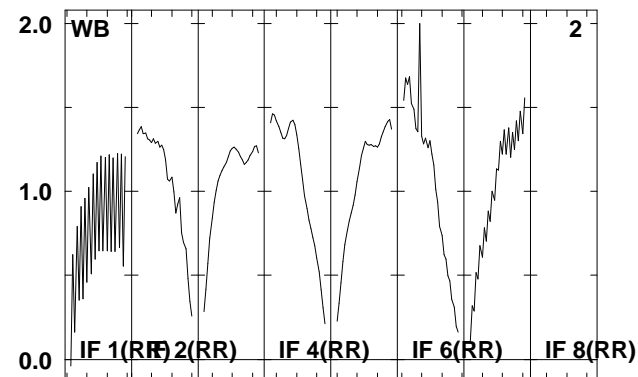
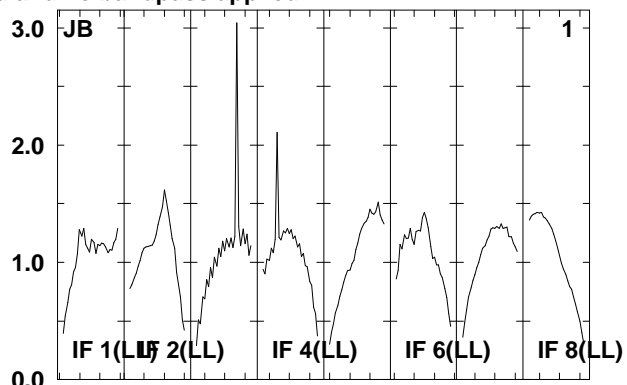
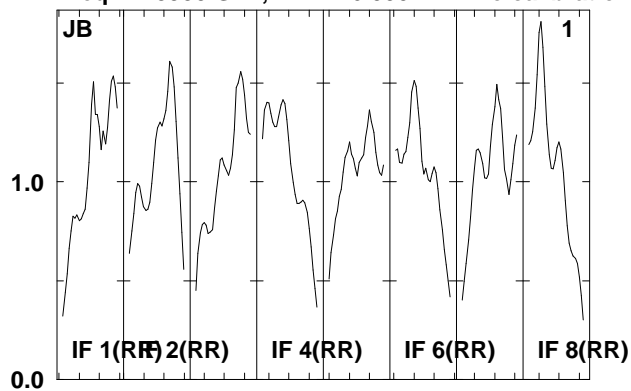

Lower frame: Real Jy  
Total-power spectrum Antenna: \*  
Timerange: 00/05:42:27 to 00/05:43:51

Plot file version 110 created 08-AUG-2008 16:59:09

J0209+13 EO006B.UVDATA.1

Freq = 1.5950 GHz, Bw = 16.000 MH No calibration applied and no bandpass applied

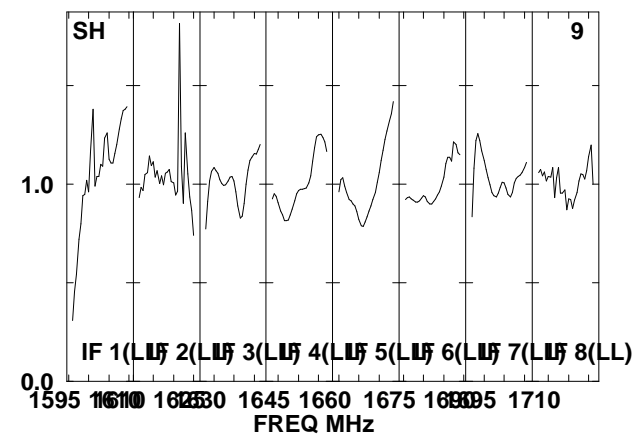
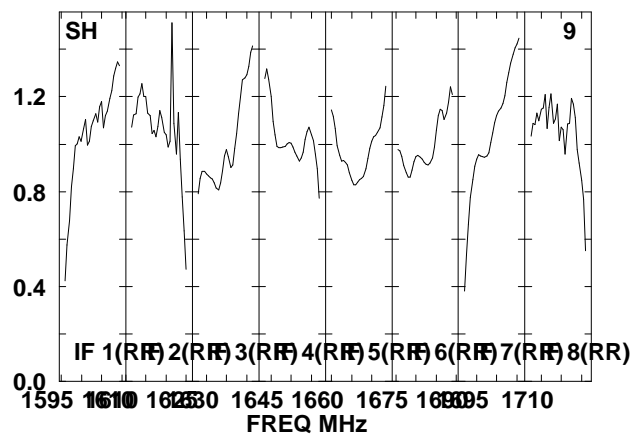
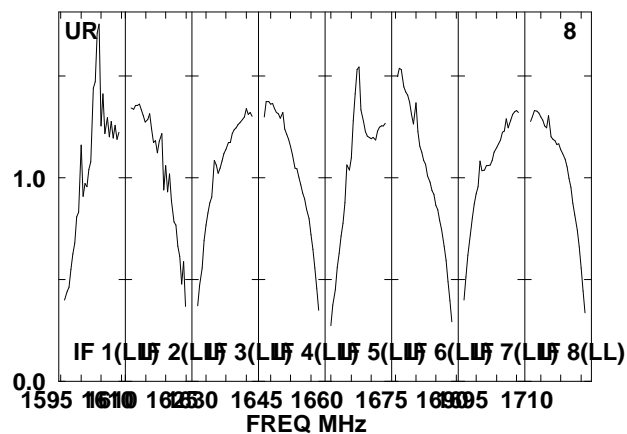
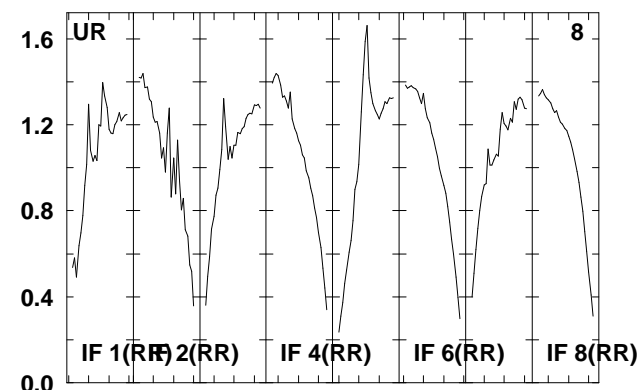
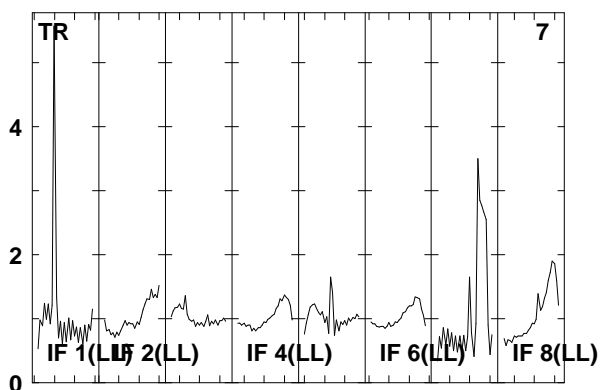
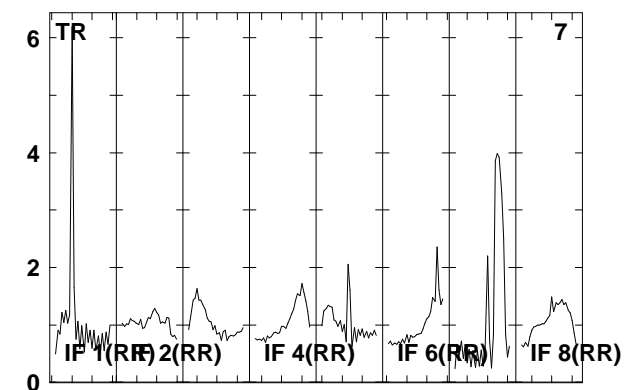
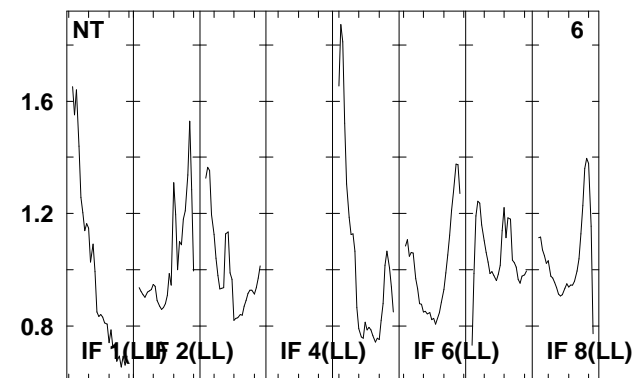
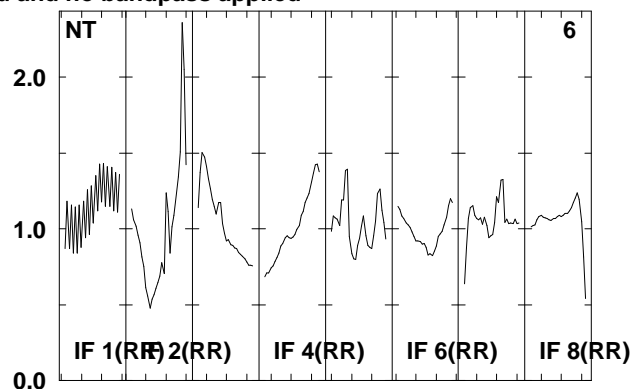
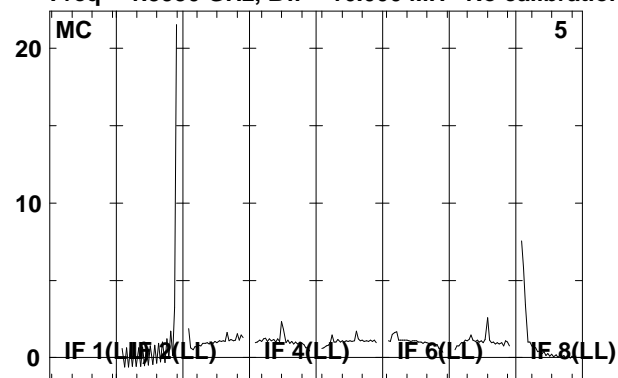

Lower frame: Real Jy

Total-power spectrum Antenna: \*

Timerange: 00/05:42:27 to 00/05:43:51

Plot file version 111 created 08-AUG-2008 16:59:10

J0209+13 EO006B.UVDATA.1

Freq = 1.5950 GHz, Bw = 16.000 MH No calibration applied and no bandpass applied

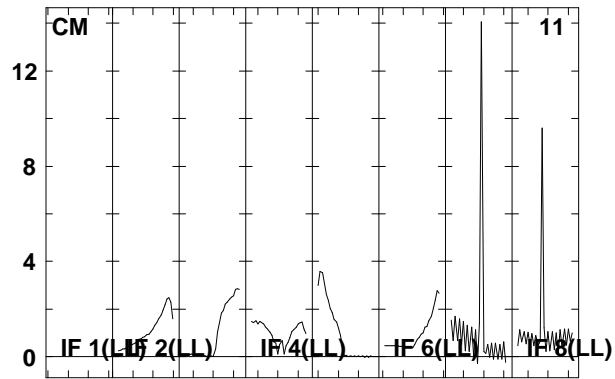
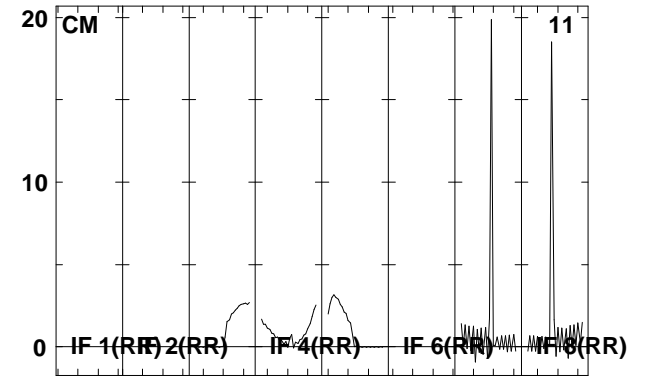
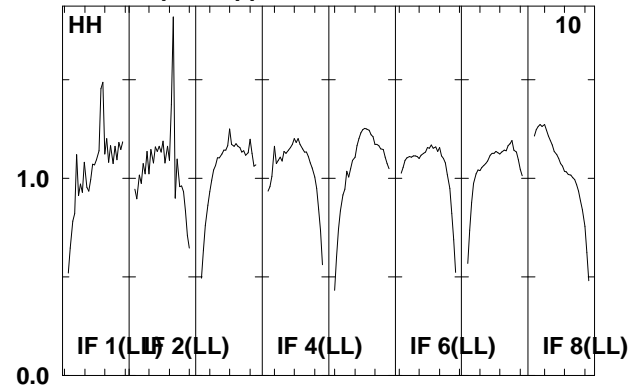
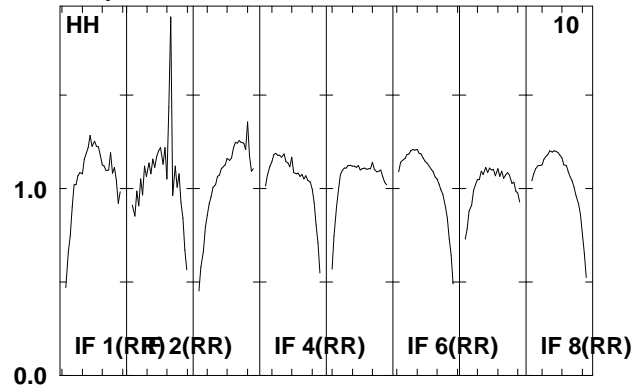

Lower frame: Real Jy  
Total-power spectrum Antenna: \*  
Timerange: 00/05:42:27 to 00/05:43:51

Plot file version 112 created 08-AUG-2008 16:59:10

J021348 EO006B.UVDATA.1

Freq = 1.5950 GHz, Bw = 16.000 MH No calibration applied and no bandpass applied

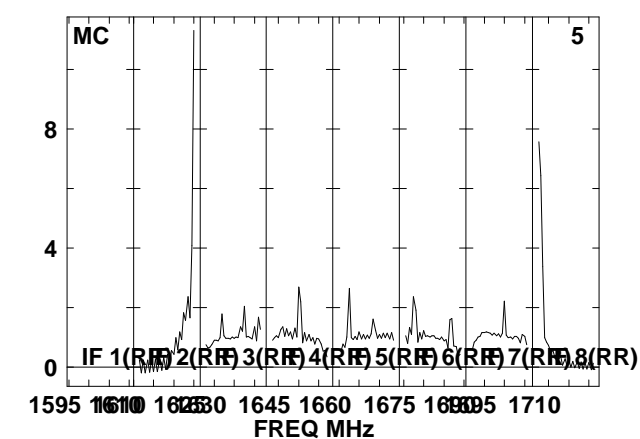
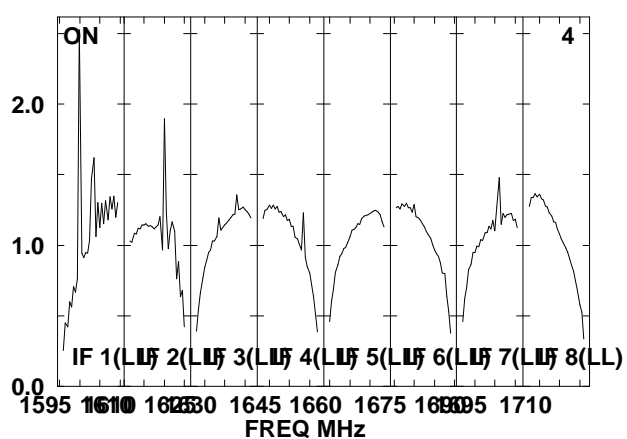
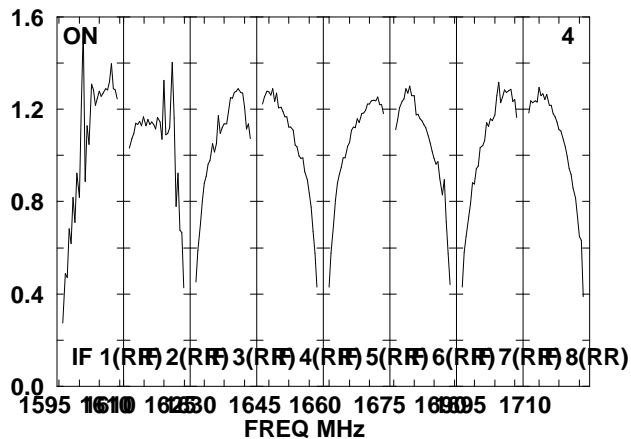
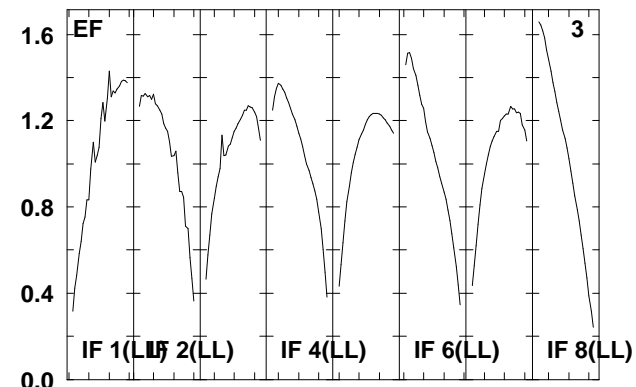
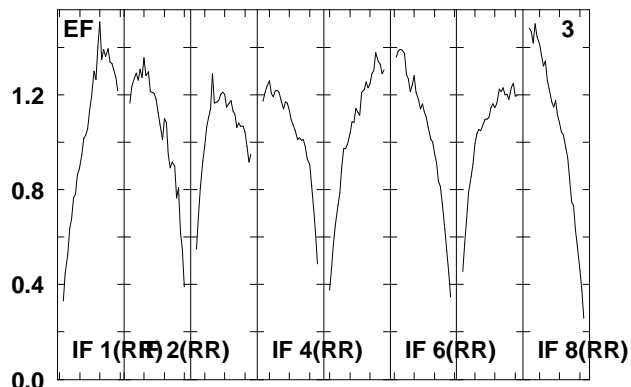
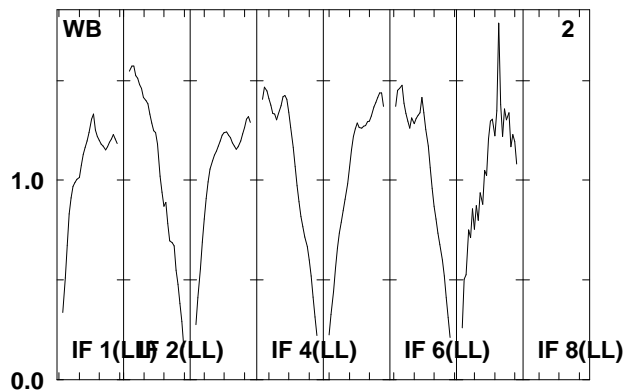
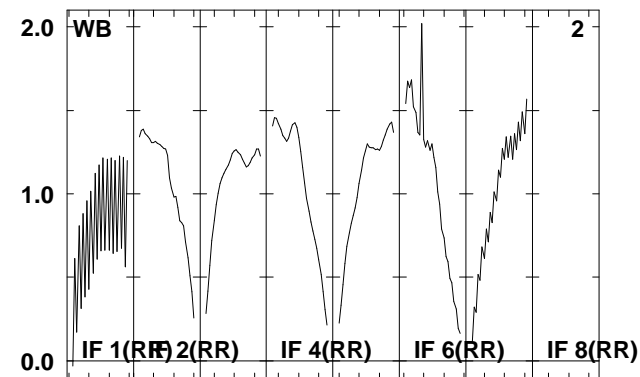
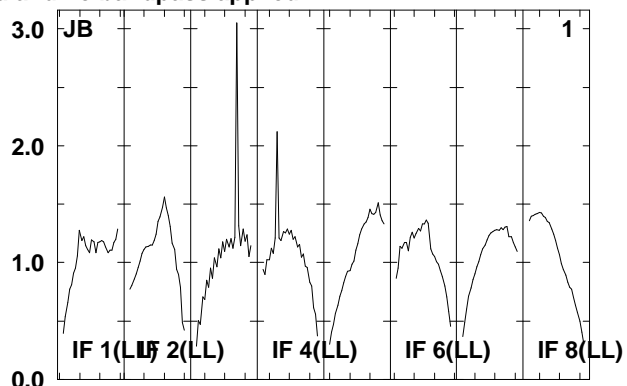
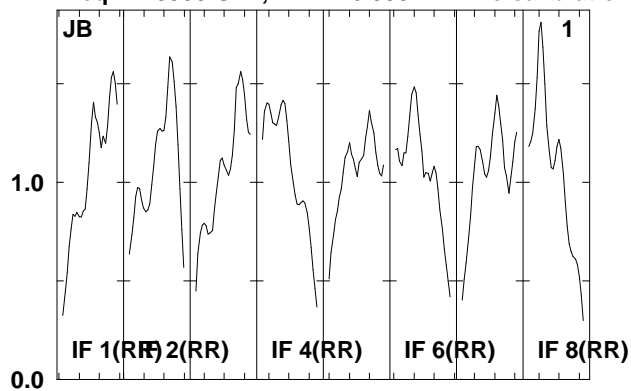

Lower frame: Real Jy  
Total-power spectrum Antenna: \*  
Timerange: 00/05:44:33 to 00/05:49:01

Plot file version 113 created 08-AUG-2008 16:59:11

J021348 EO006B.UVDATA.1

Freq = 1.5950 GHz, Bw = 16.000 MH No calibration applied and no bandpass applied

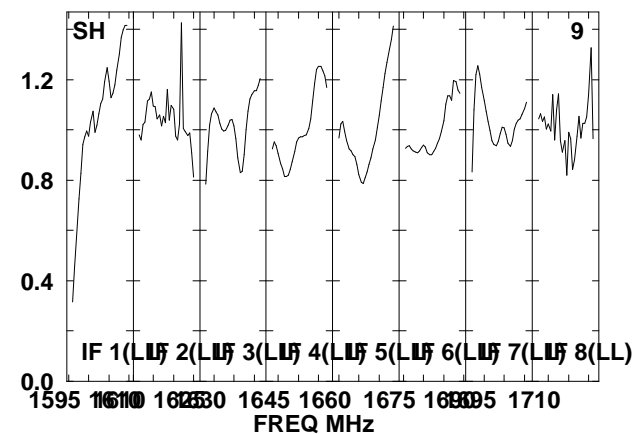
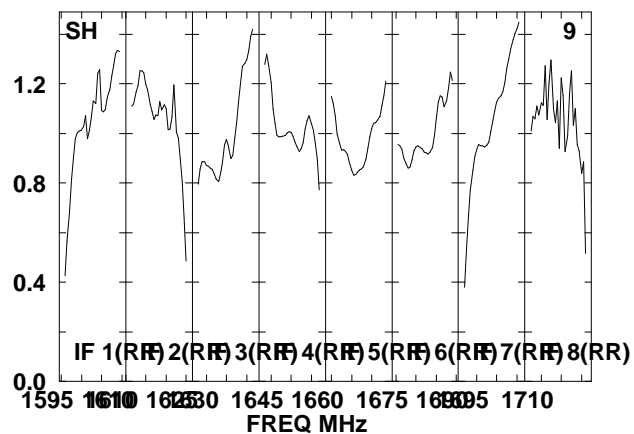
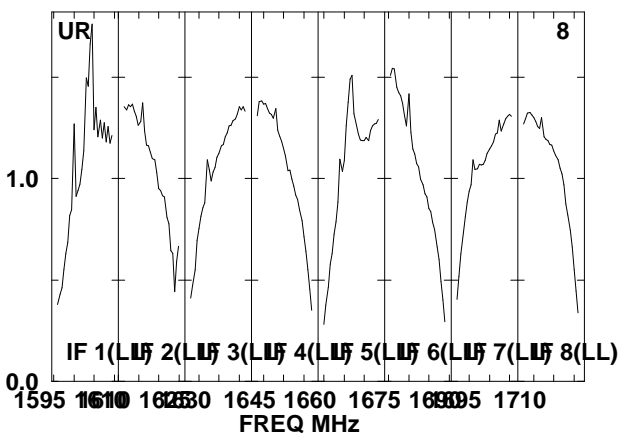
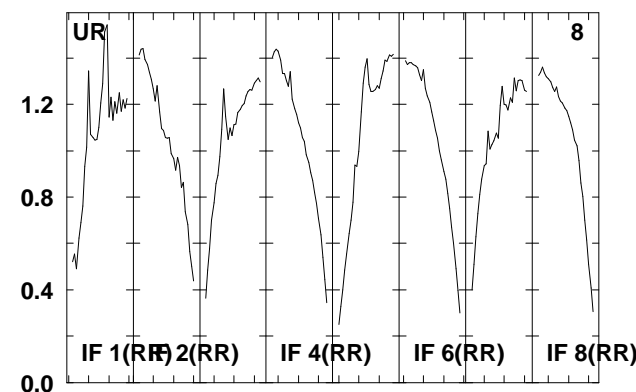
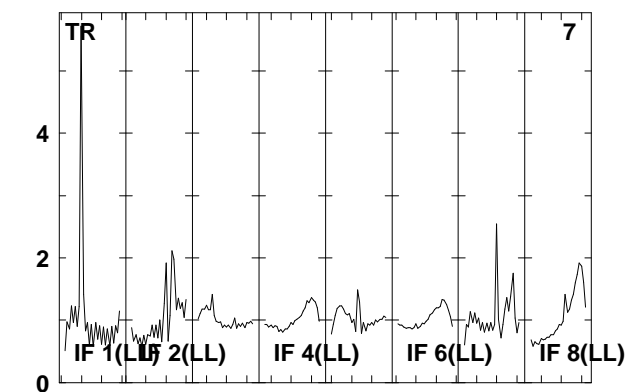
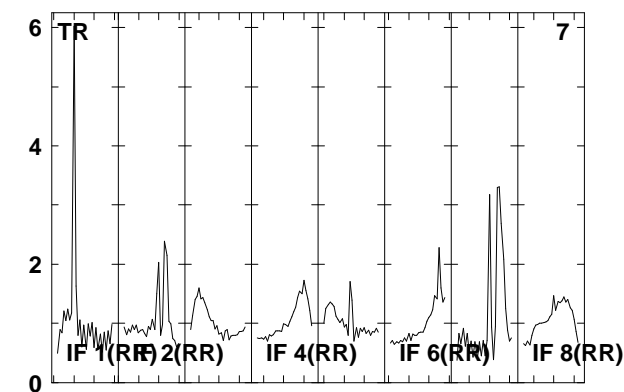
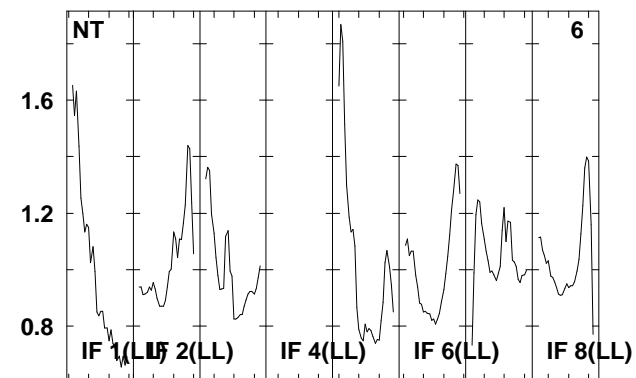
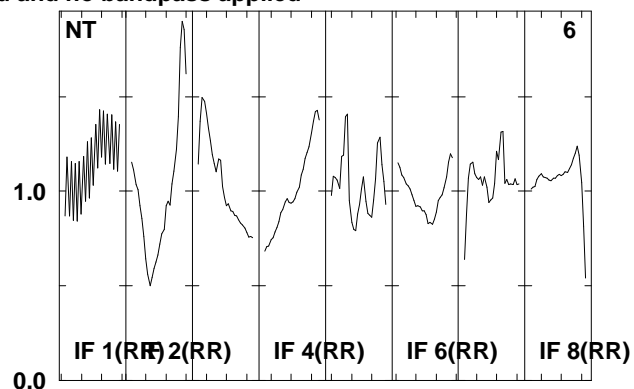
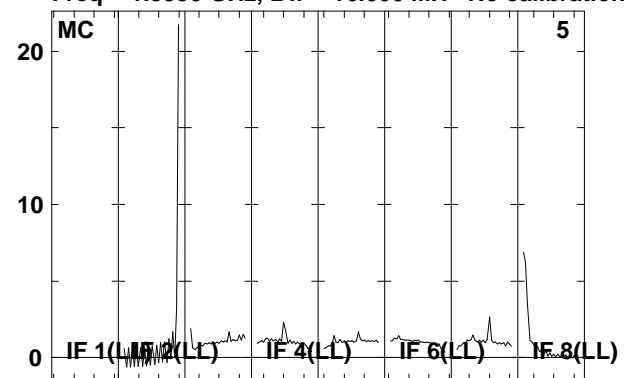

Lower frame: Real Jy

Total-power spectrum Antenna: \*

Timerange: 00/05:44:33 to 00/05:49:01

Plot file version 114 created 08-AUG-2008 16:59:12

J021348 EO006B.UVDATA.1

Freq = 1.5950 GHz, Bw = 16.000 MH No calibration applied and no bandpass applied

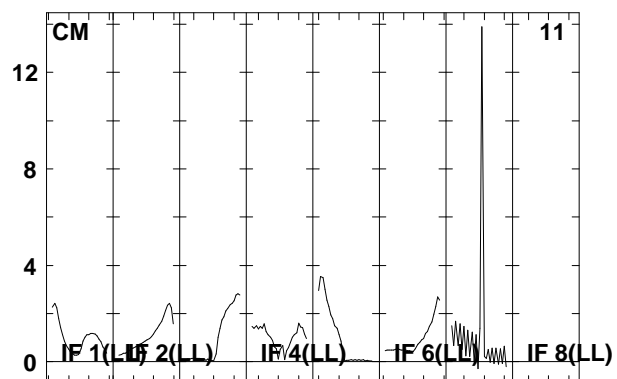
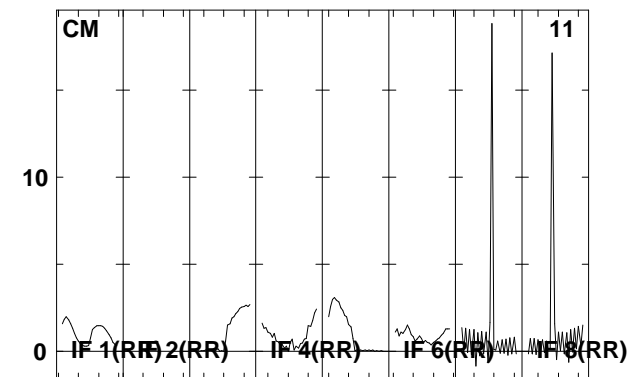
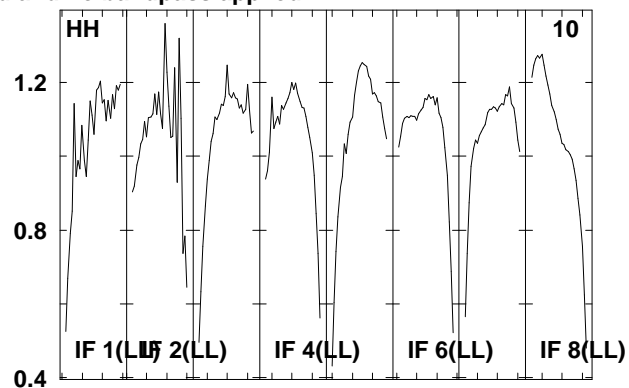
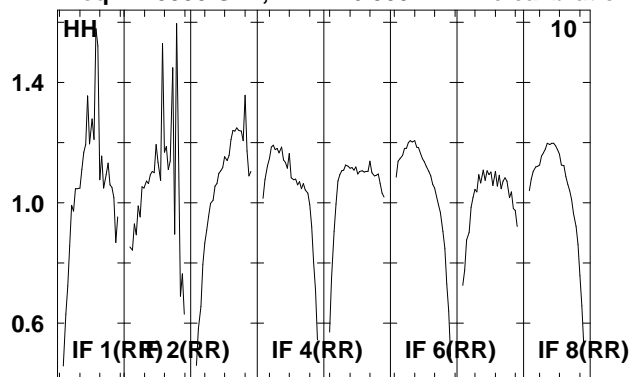

Lower frame: Real Jy  
Total-power spectrum Antenna: \*  
Timerange: 00/05:44:33 to 00/05:49:01

Plot file version 115 created 08-AUG-2008 16:59:12

J0209+13 EO006B.UVDATA.1

Freq = 1.5950 GHz, Bw = 16.000 MH No calibration applied and no bandpass applied

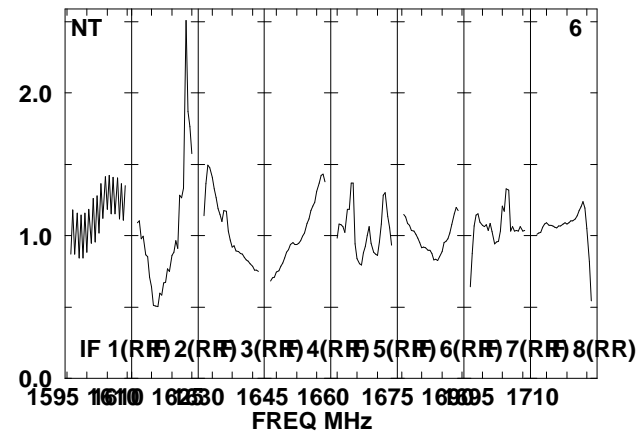
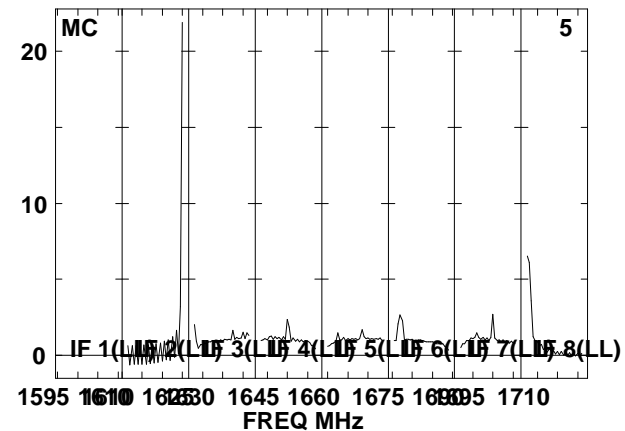
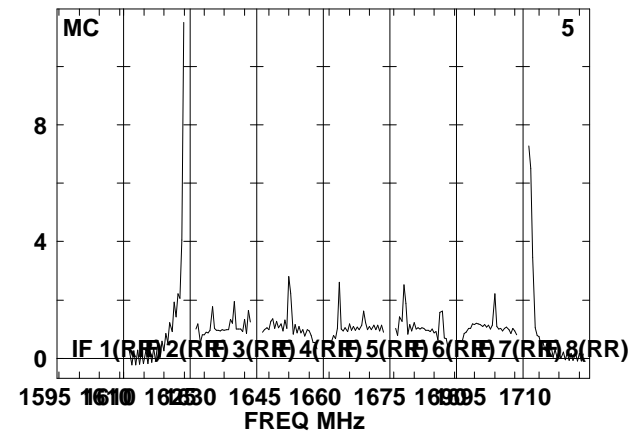
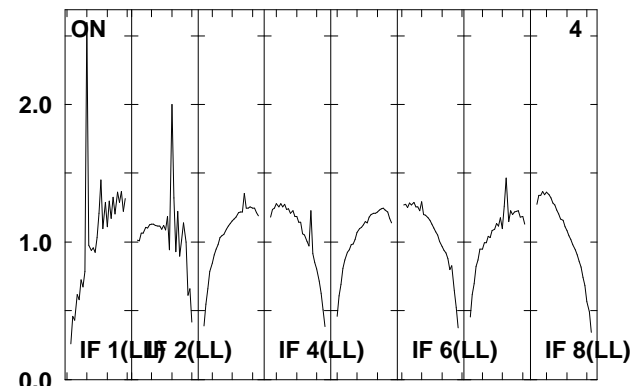
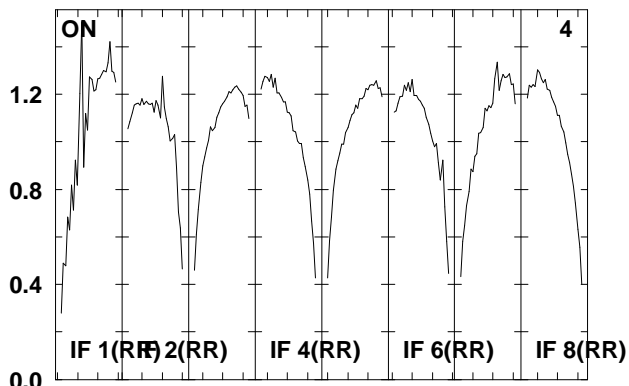
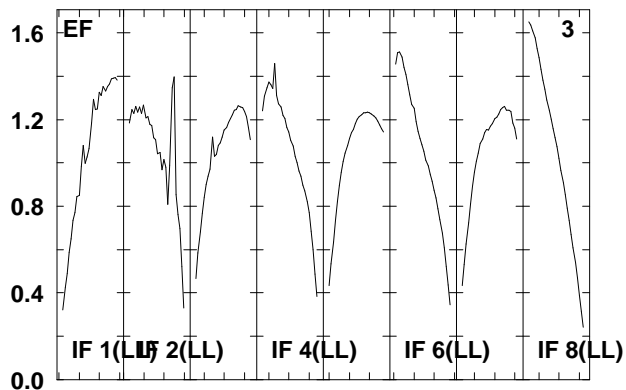
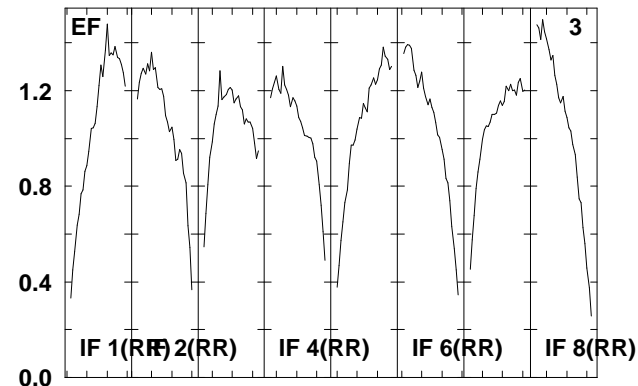
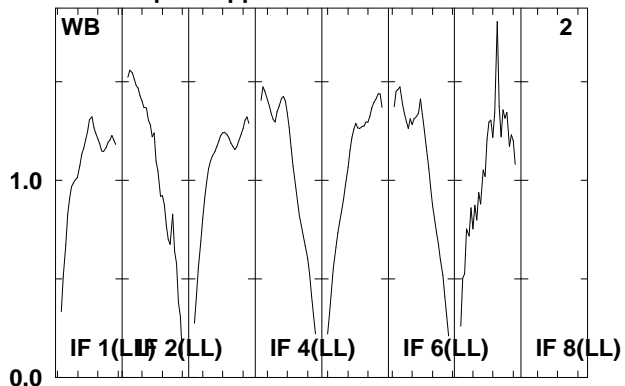
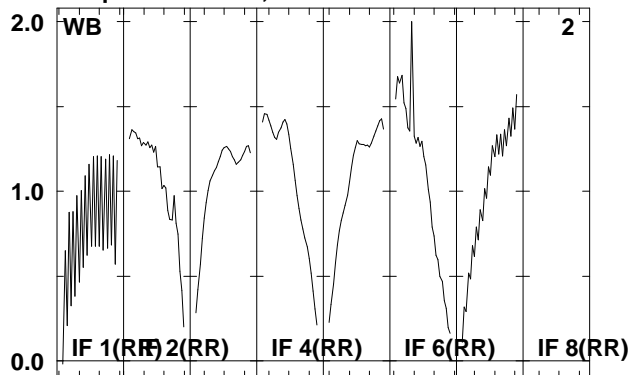

Lower frame: Real Jy  
Total-power spectrum Antenna: \*  
Timerange: 00/05:49:43 to 00/05:51:11

Plot file version 116 created 08-AUG-2008 16:59:13

J0209+13 EO06B.UVDATA.1

Freq = 1.5950 GHz, Bw = 16.000 MH No calibration applied and no bandpass applied

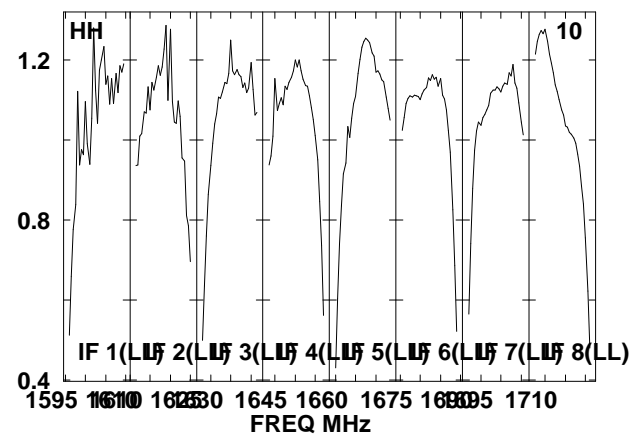
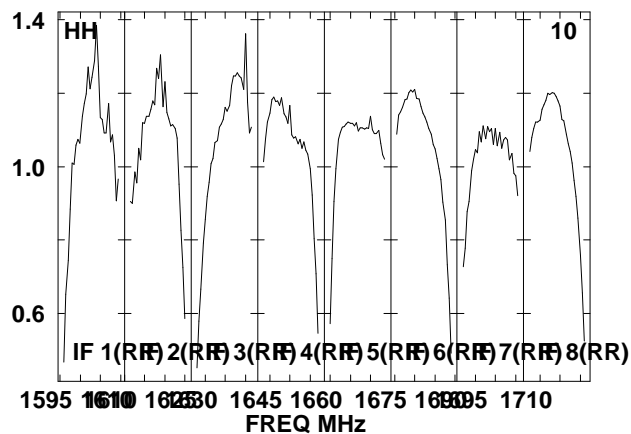
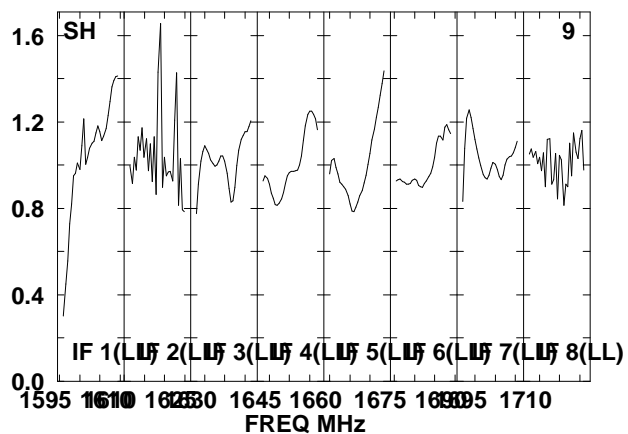
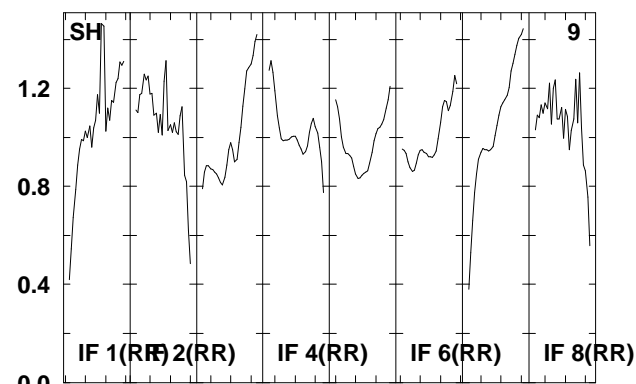
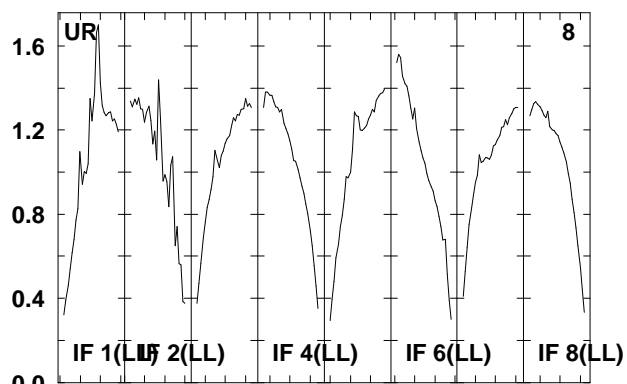
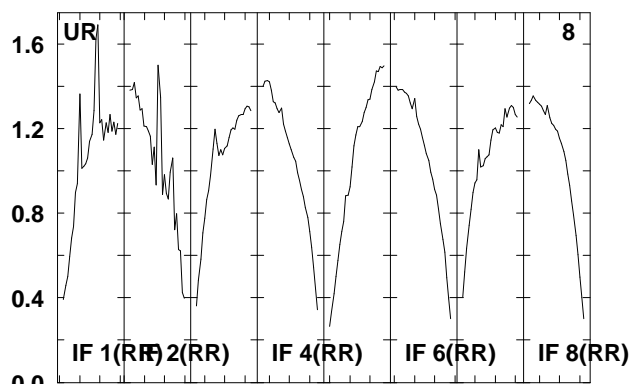
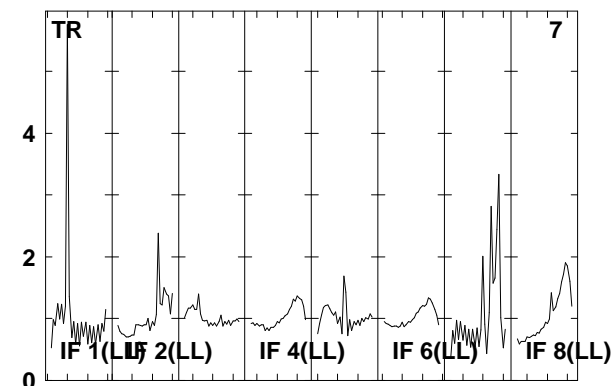
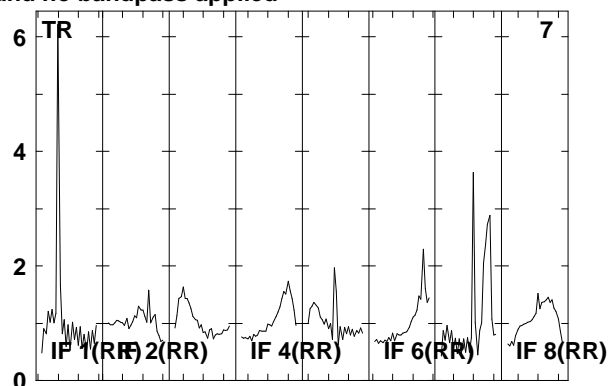
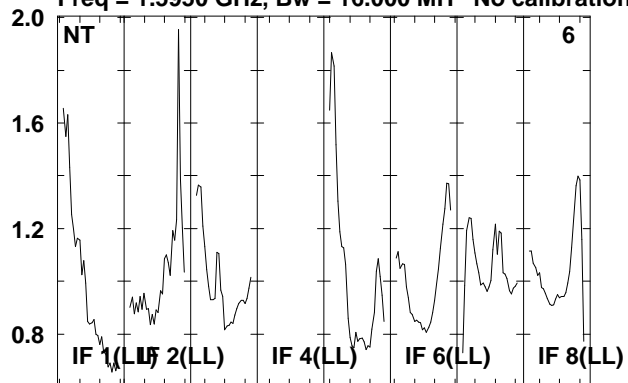

Lower frame: Real Jy  
Total-power spectrum Antenna: \*  
Timerange: 00/05:49:43 to 00/05:51:11



Plot file version 117 created 08-AUG-2008 16:59:13

J0209+13 EO006B.UVDATA.1

Freq = 1.5950 GHz, Bw = 16.000 MH No calibration applied and no bandpass applied

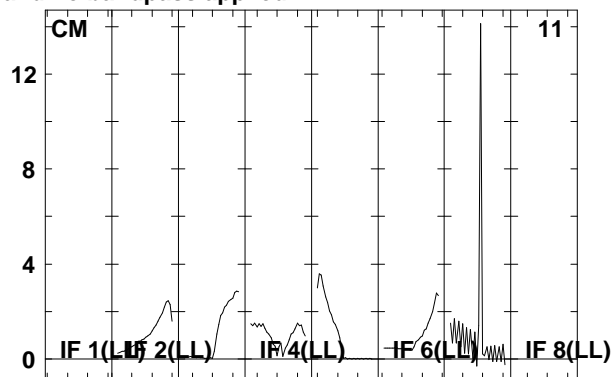
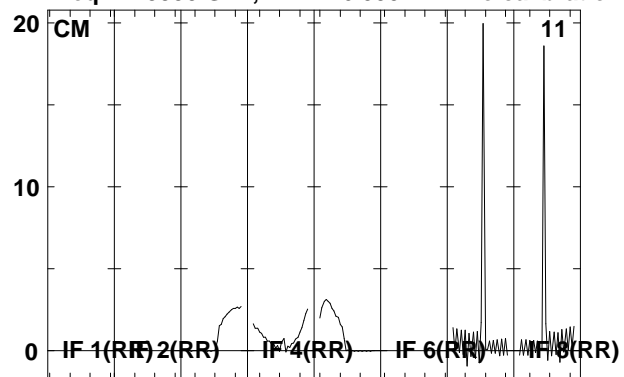

Lower frame: Real Jy  
Total-power spectrum Antenna: \*  
Timerange: 00/05:49:43 to 00/05:51:11

Plot file version 118 created 08-AUG-2008 16:59:13

J021348 EO006B.UVDATA.1

Freq = 1.5950 GHz, Bw = 16.000 MH No calibration applied and no bandpass applied

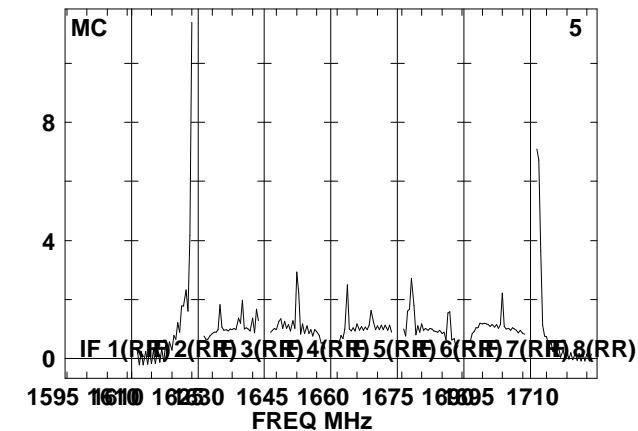
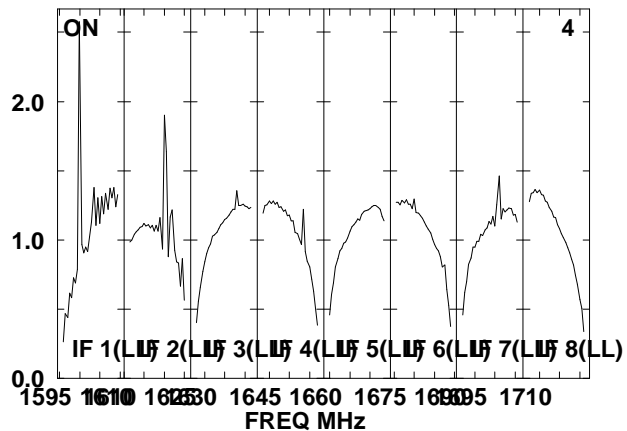
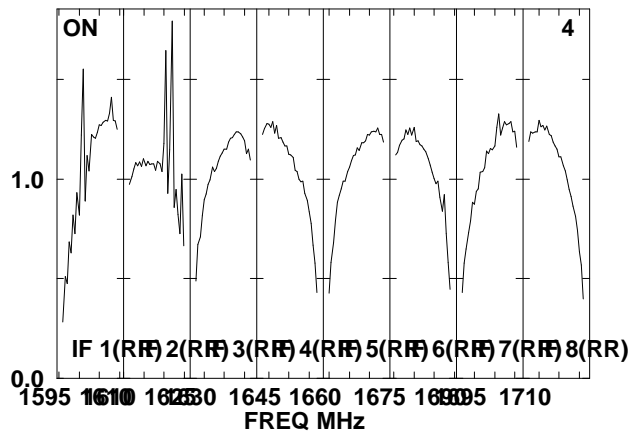
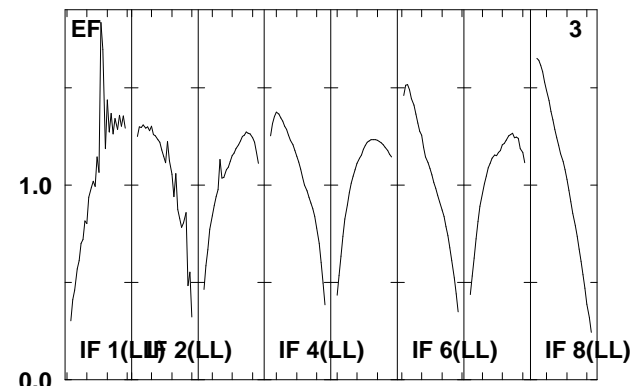
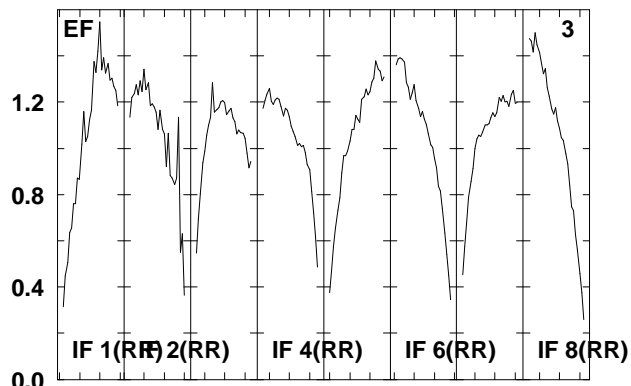
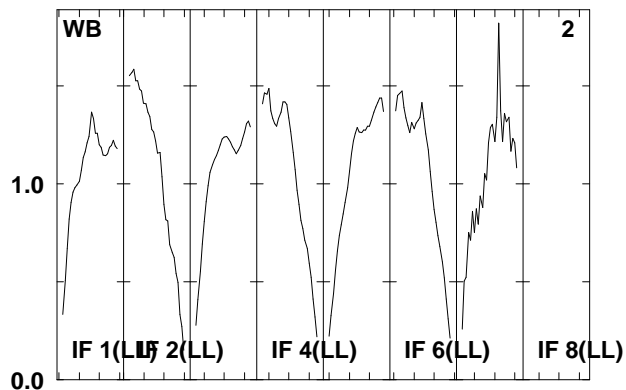
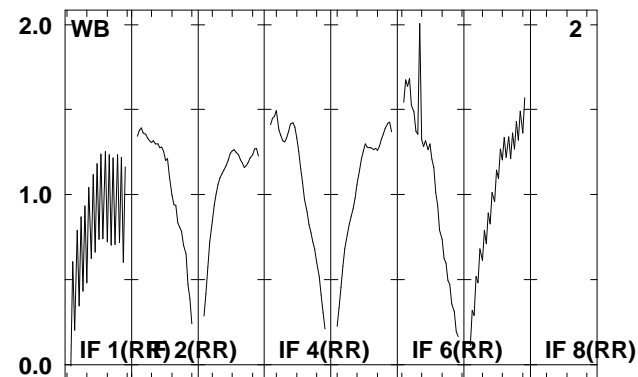
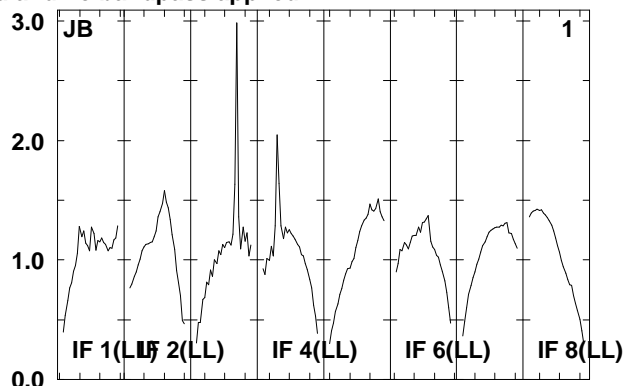
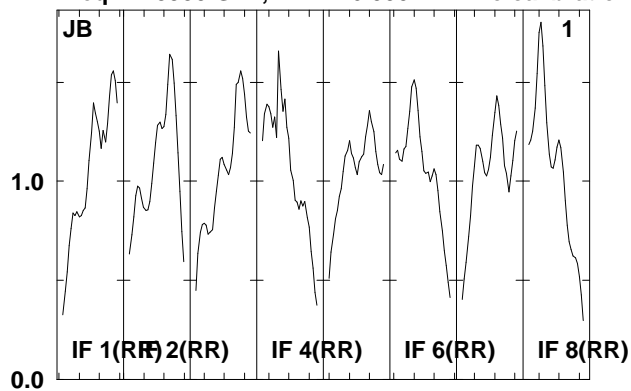

Lower frame: Real Jy  
Total-power spectrum Antenna: \*  
Timerange: 00/05:51:57 to 00/05:56:29

Plot file version 119 created 08-AUG-2008 16:59:14

J021348 EO006B.UVDATA.1

Freq = 1.5950 GHz, Bw = 16.000 MH No calibration applied and no bandpass applied

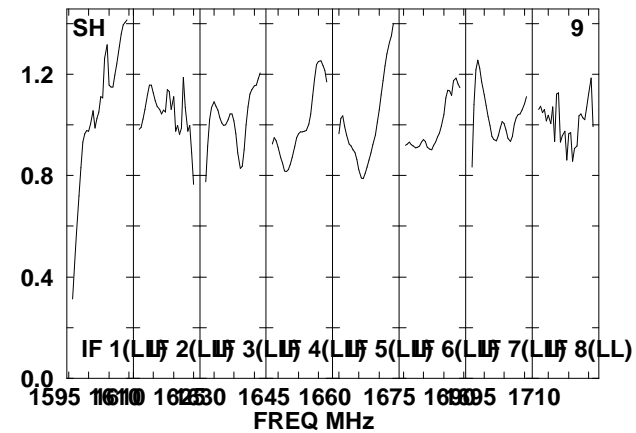
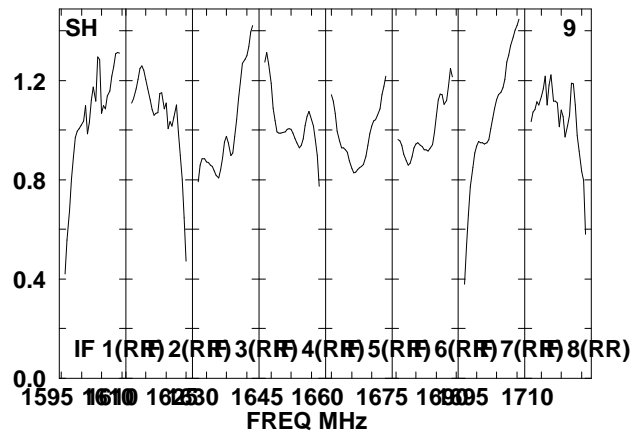
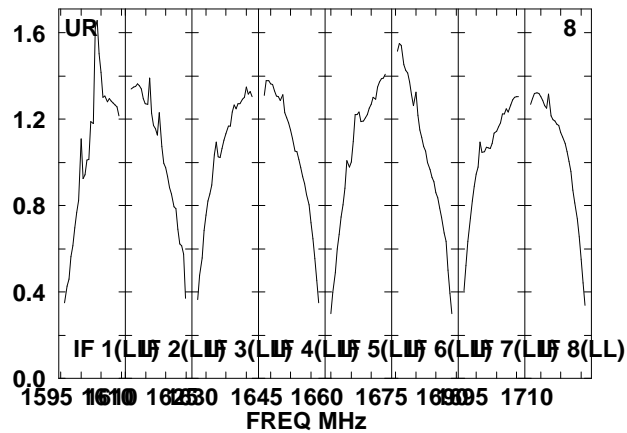
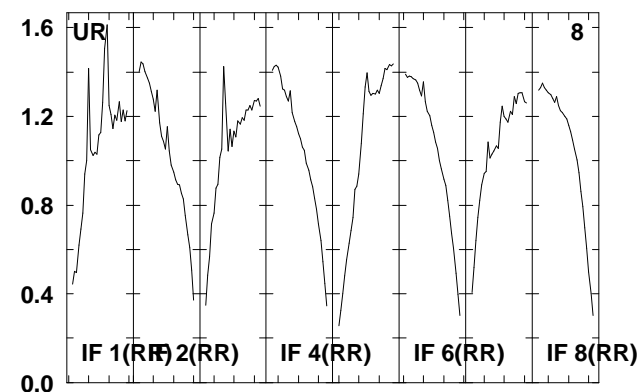
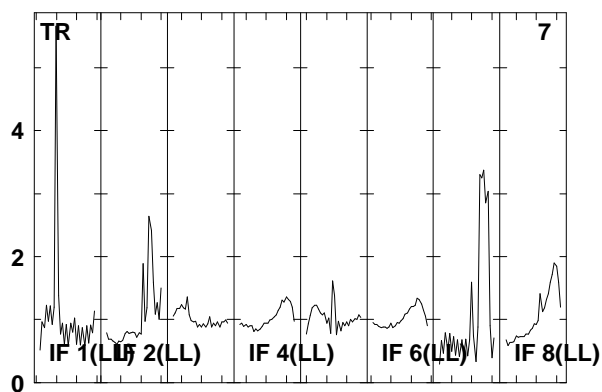
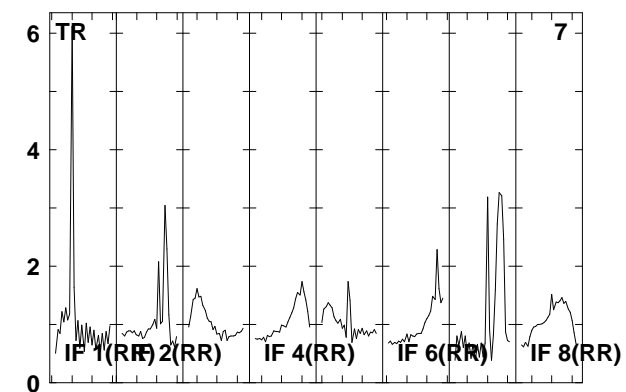
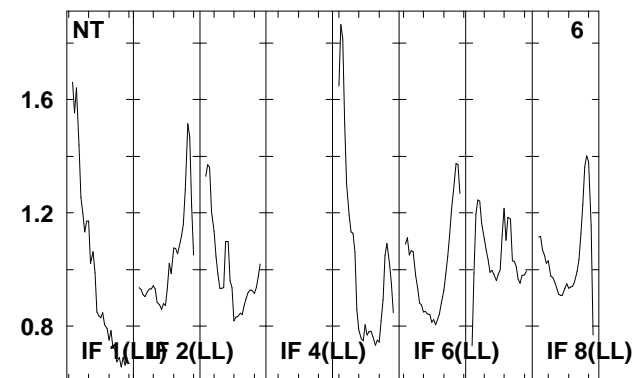
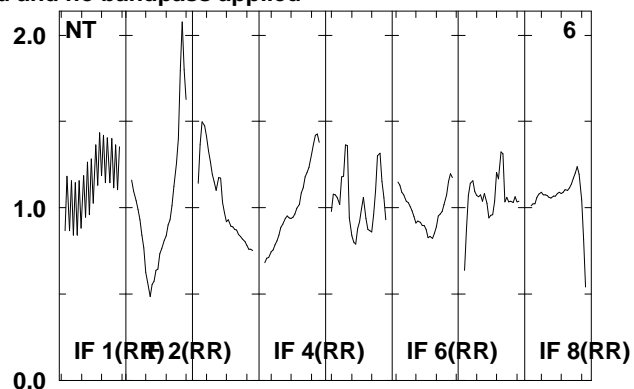
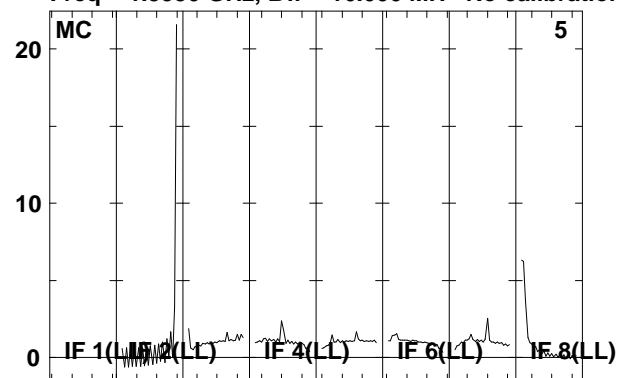

Lower frame: Real Jy

Total-power spectrum Antenna: \*

Timerange: 00/05:51:57 to 00/05:56:29

Plot file version 120 created 08-AUG-2008 16:59:15

J021348 EO006B.UVDATA.1

Freq = 1.5950 GHz, Bw = 16.000 MH No calibration applied and no bandpass applied

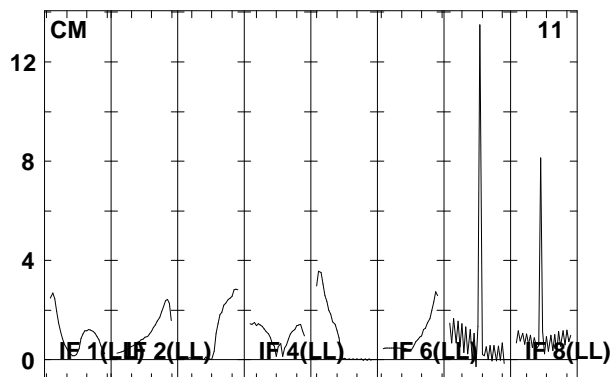
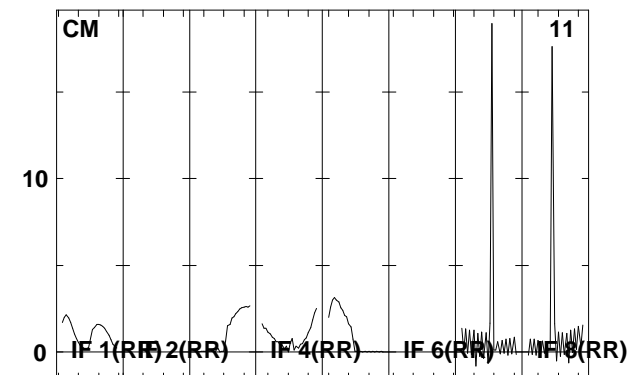
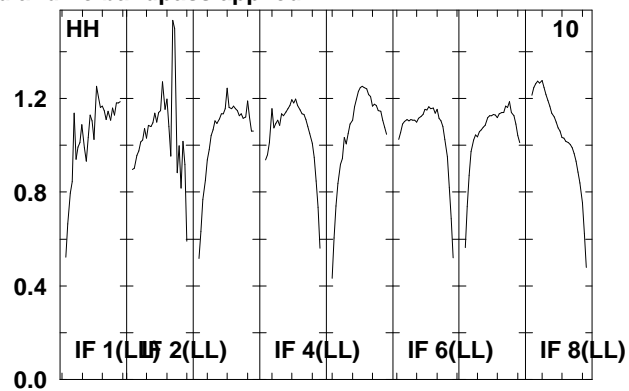
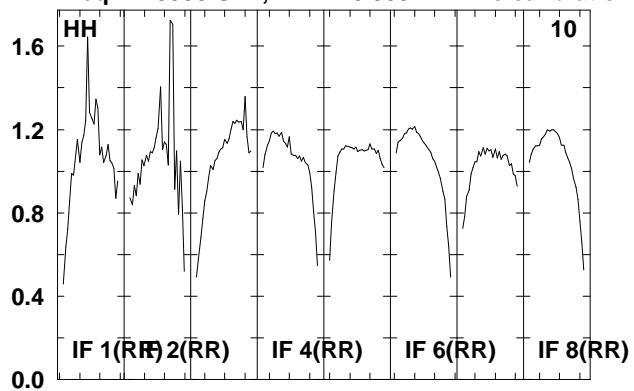

Lower frame: Real Jy  
Total-power spectrum Antenna: \*  
Timerange: 00/05:51:57 to 00/05:56:29

Plot file version 121 created 08-AUG-2008 16:59:15

J0209+13 EO006B.UVDATA.1

Freq = 1.5950 GHz, Bw = 16.000 MH No calibration applied and no bandpass applied

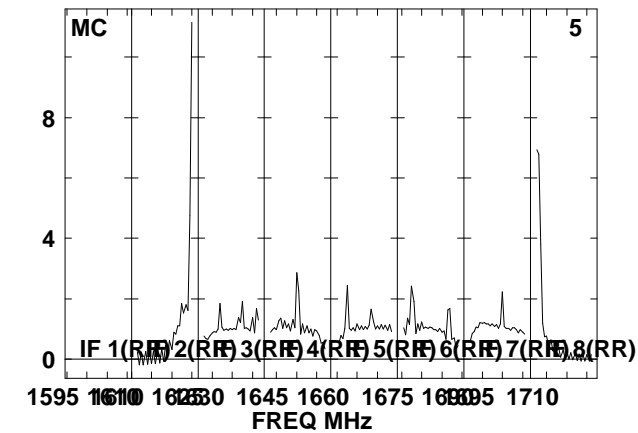
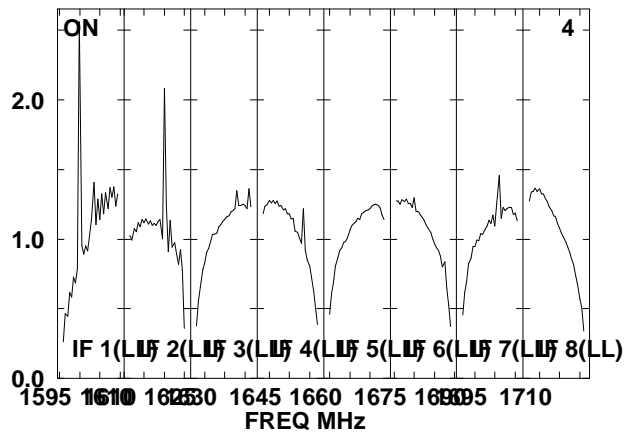
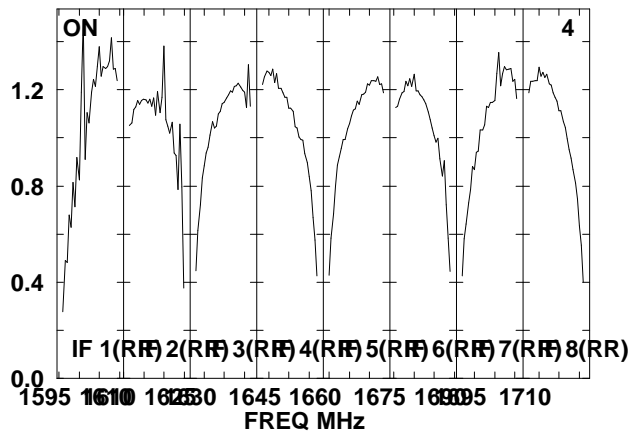
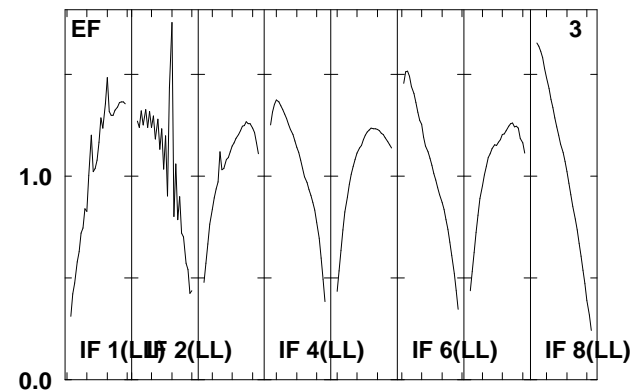
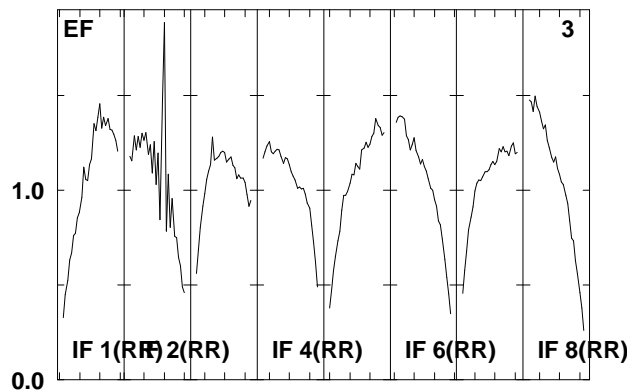
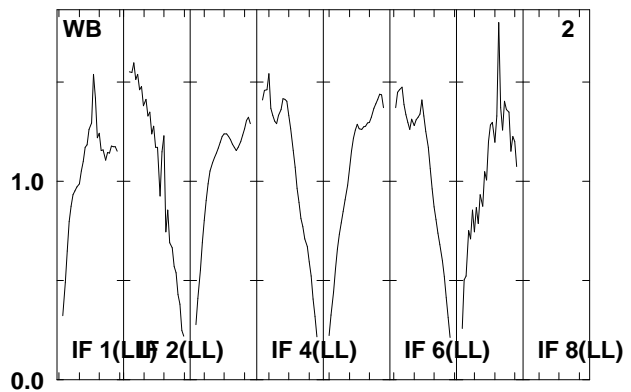
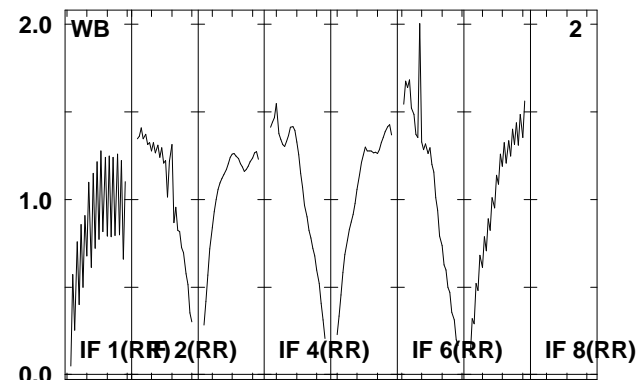
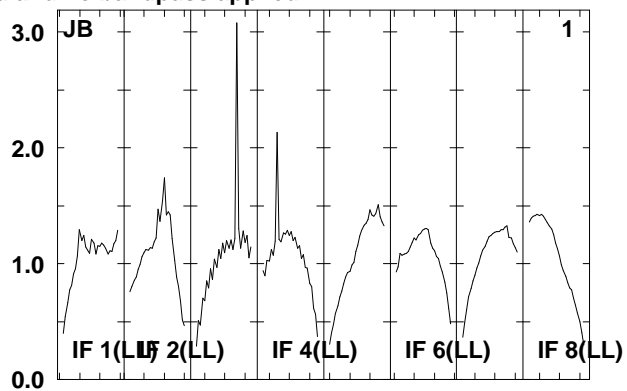
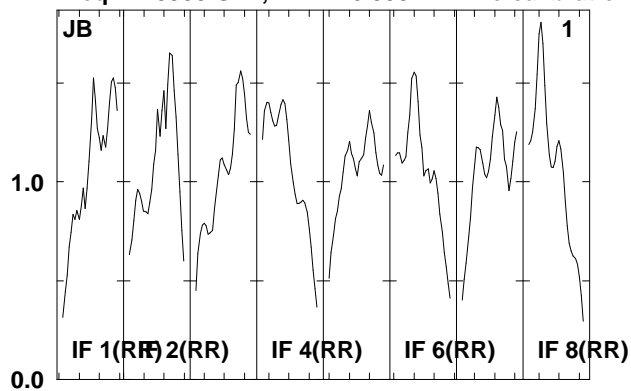

Lower frame: Real Jy  
Total-power spectrum Antenna: \*  
Timerange: 00/05:57:01 to 00/05:58:37

Plot file version 122 created 08-AUG-2008 16:59:16

J0209+13 EO006B.UVDATA.1

Freq = 1.5950 GHz, Bw = 16.000 MH No calibration applied and no bandpass applied

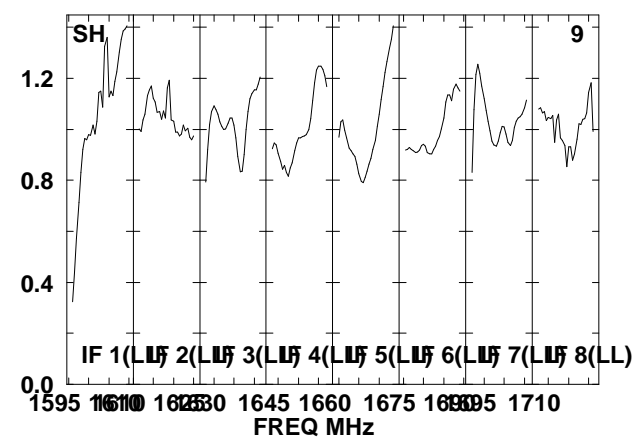
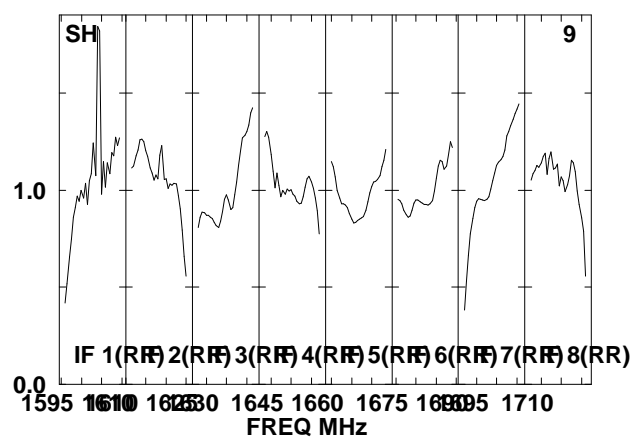
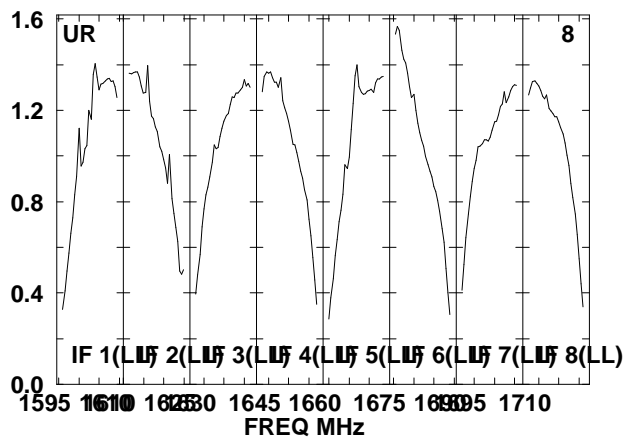
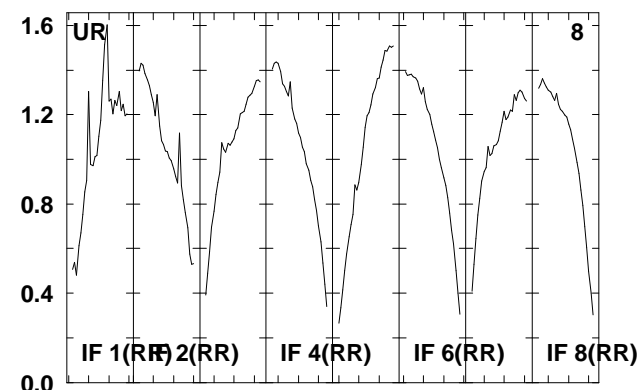
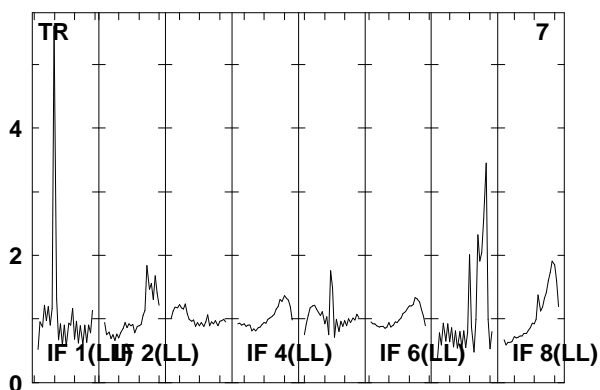
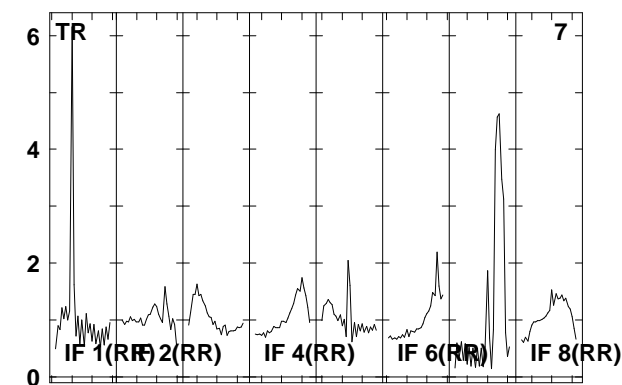
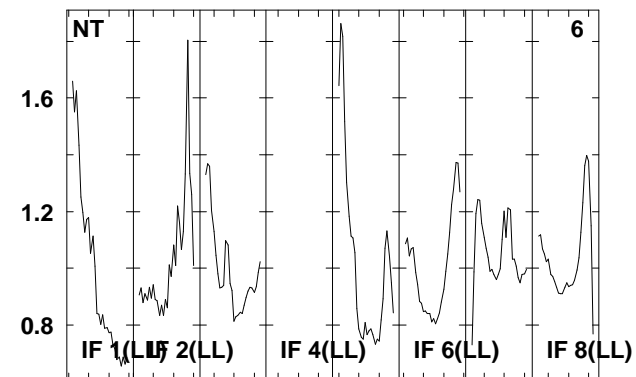
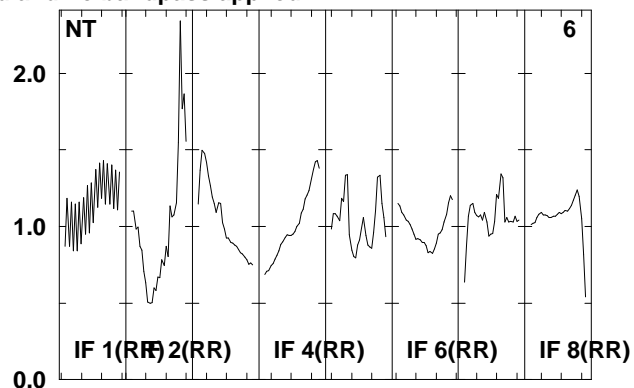
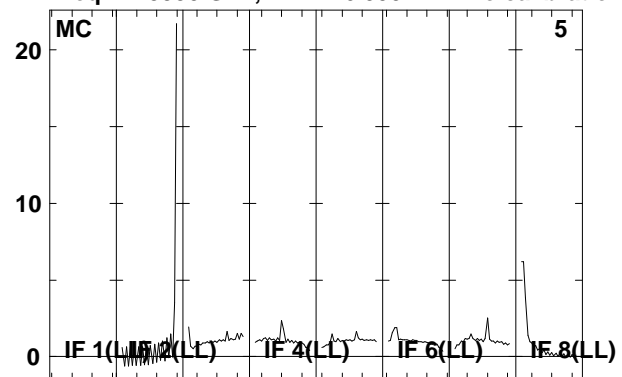

Lower frame: Real Jy

Total-power spectrum Antenna: \*

Timerange: 00/05:57:01 to 00/05:58:37

Plot file version 123 created 08-AUG-2008 16:59:16

J0209+13 EO006B.UVDATA.1

Freq = 1.5950 GHz, Bw = 16.000 MH No calibration applied and no bandpass applied

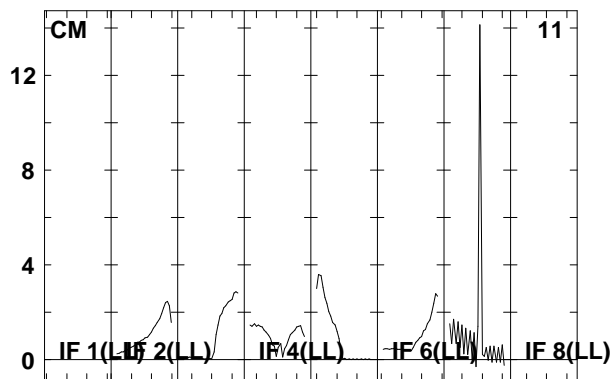
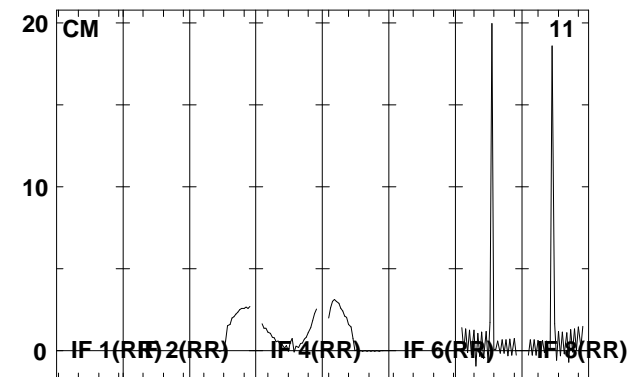
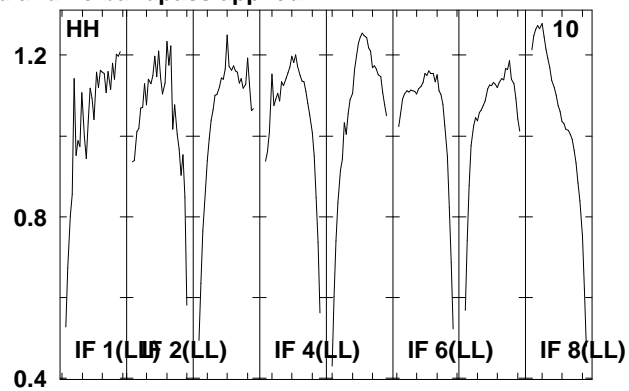
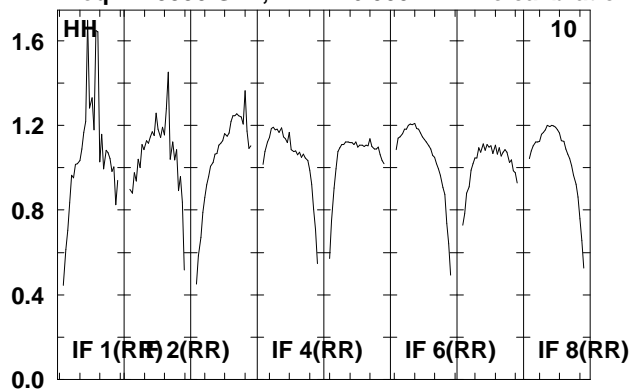

Lower frame: Real Jy  
Total-power spectrum Antenna: \*  
Timerange: 00/05:57:01 to 00/05:58:37

Plot file version 124 created 08-AUG-2008 16:59:17

J021348 EO006B.UVDATA.1

Freq = 1.5950 GHz, Bw = 16.000 MH No calibration applied and no bandpass applied

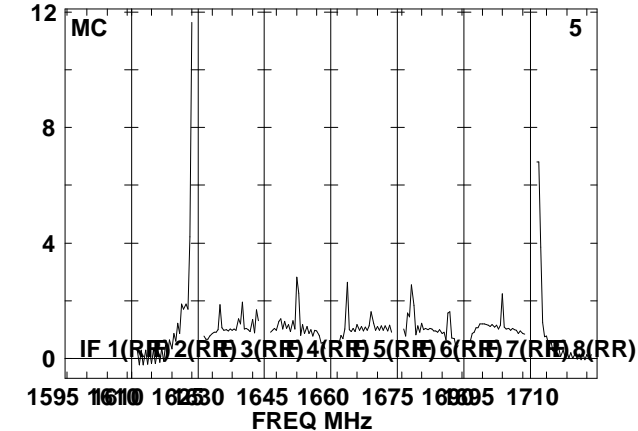
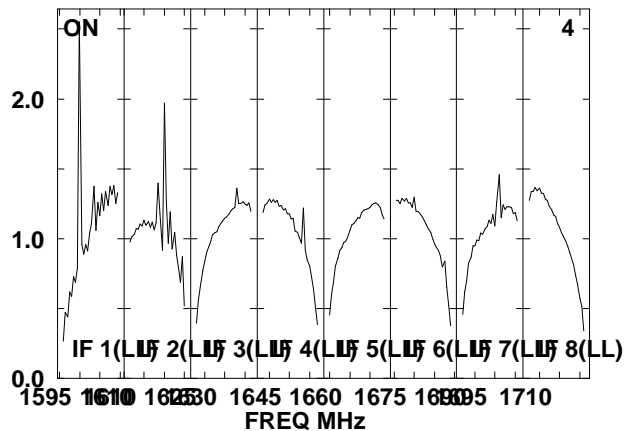
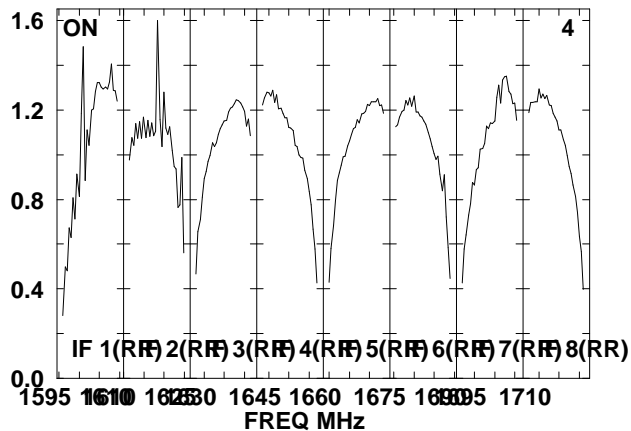
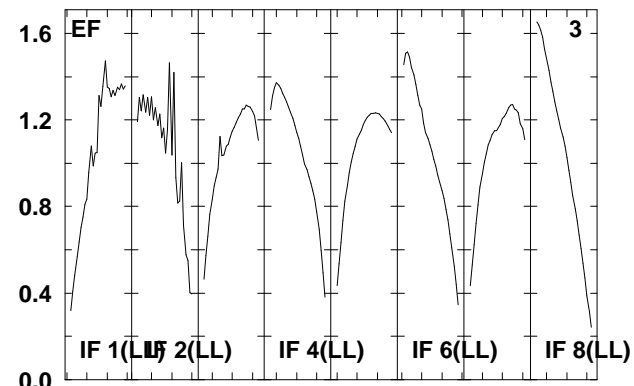
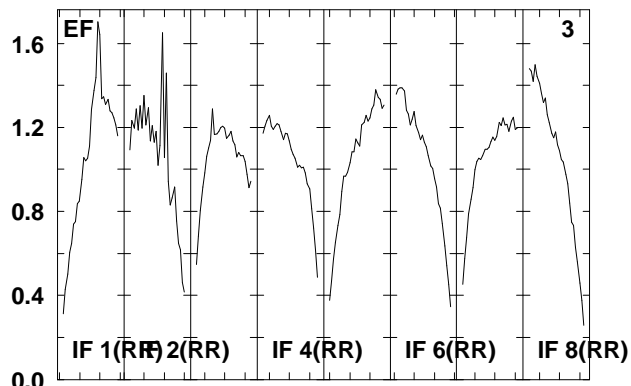
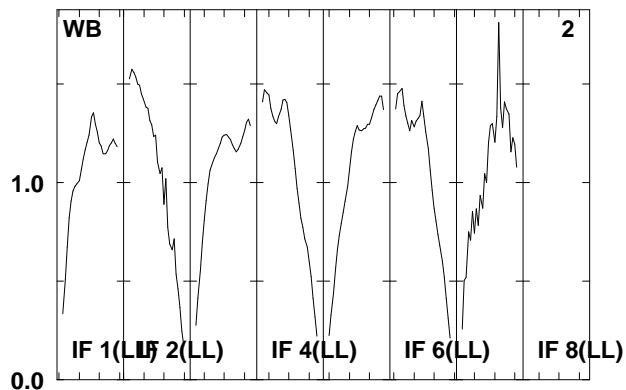
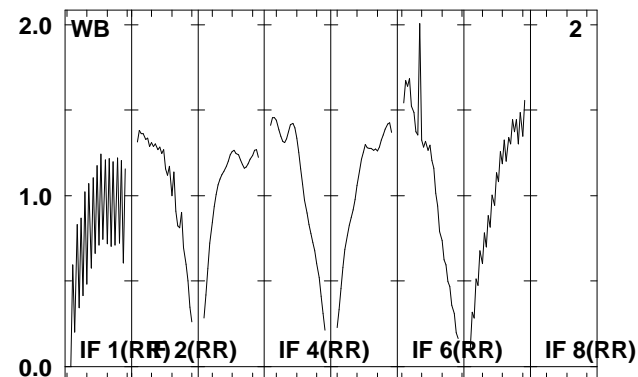
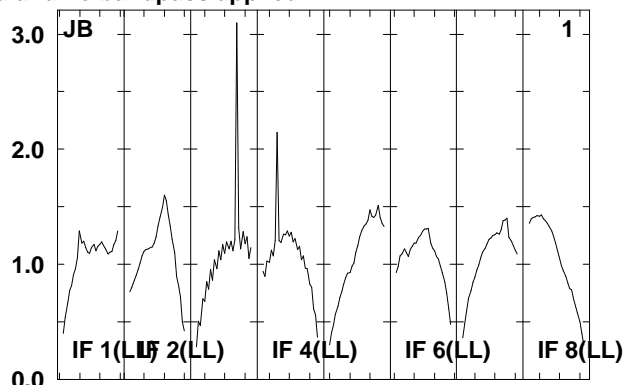
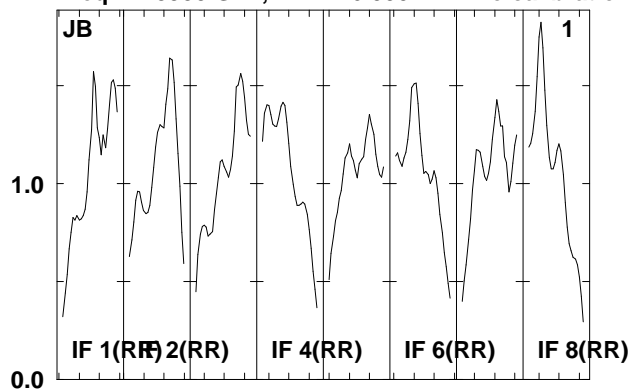

Lower frame: Real Jy

Total-power spectrum Antenna: \*

Timerange: 00/05:59:13 to 00/06:03:49



Plot file version 125 created 08-AUG-2008 16:59:18

J021348 EO006B.UVDATA.1

Freq = 1.5950 GHz, Bw = 16.000 MH No calibration applied and no bandpass applied

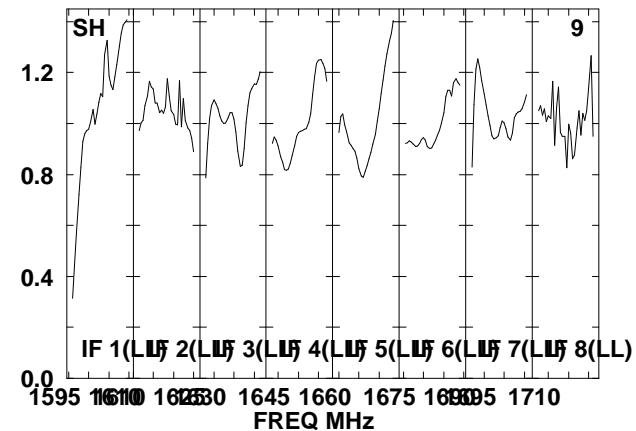
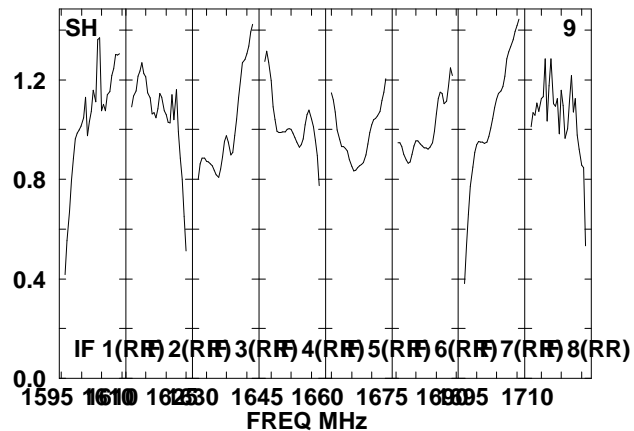
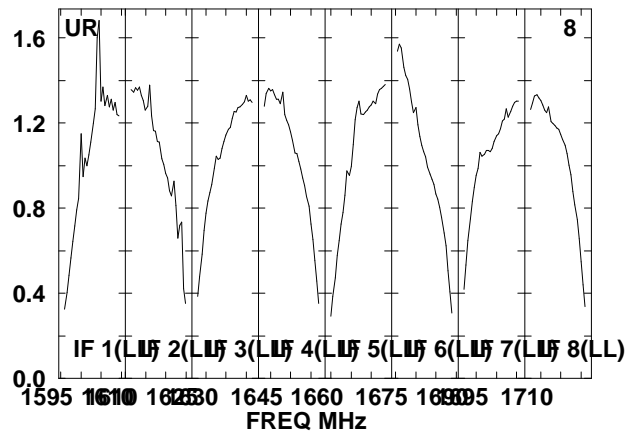
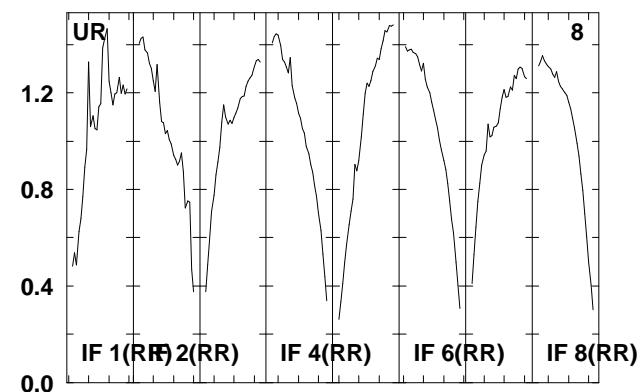
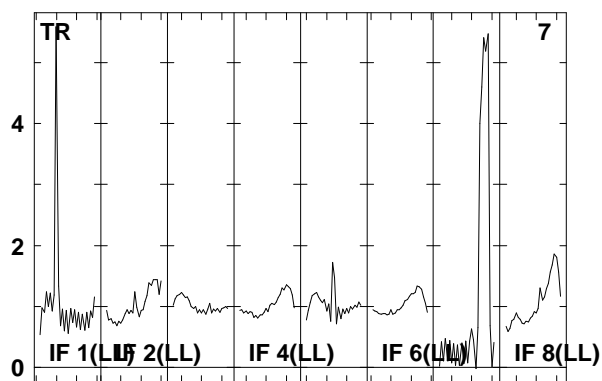
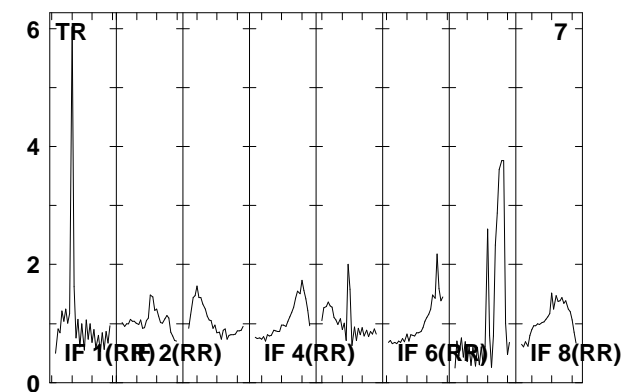
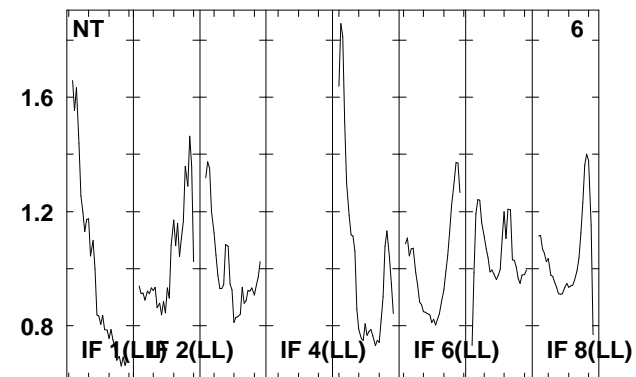
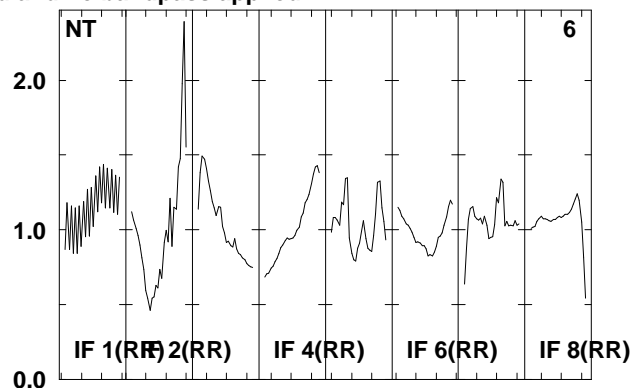
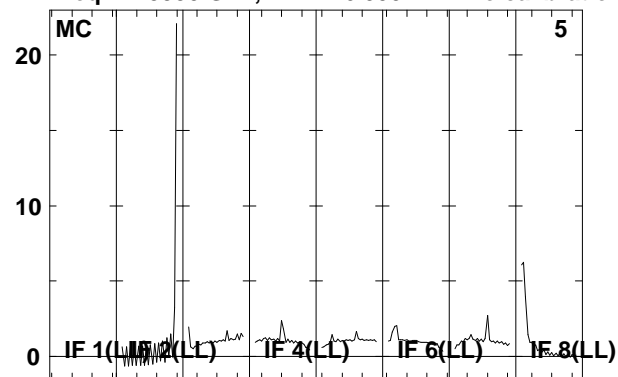

Lower frame: Real Jy

Total-power spectrum Antenna: \*

Timerange: 00/05:59:13 to 00/06:03:49

Plot file version 126 created 08-AUG-2008 16:59:19

J021348 EO006B.UVDATA.1

Freq = 1.5950 GHz, Bw = 16.000 MH No calibration applied and no bandpass applied

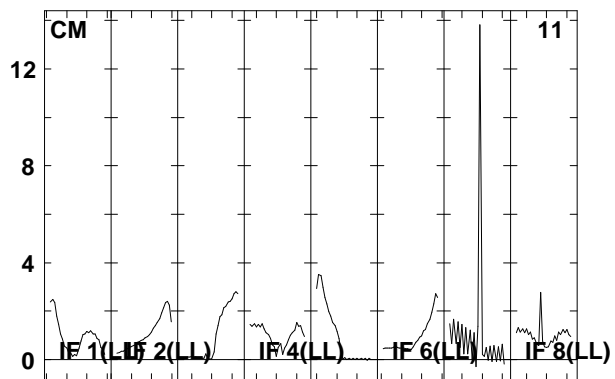
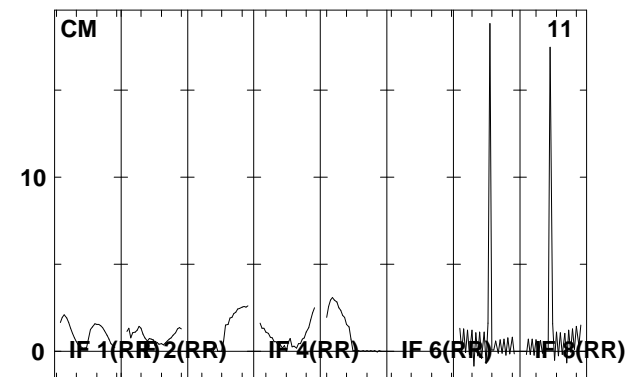
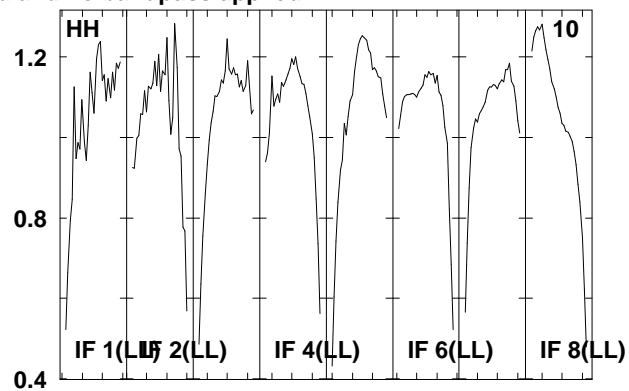
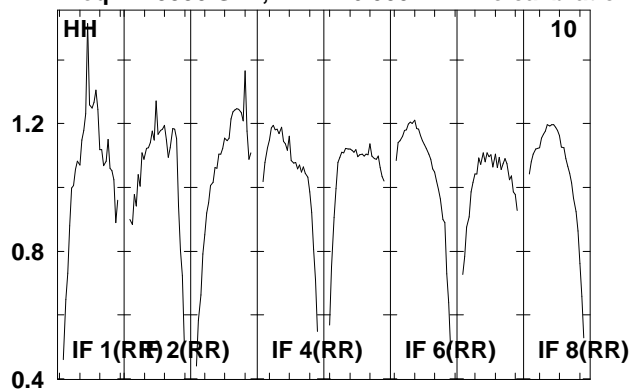

Lower frame: Real Jy  
Total-power spectrum Antenna: \*  
Timerange: 00/05:59:13 to 00/06:03:49

Plot file version 127 created 08-AUG-2008 16:59:19

J0209+13 EO006B.UVDATA.1

Freq = 1.5950 GHz, Bw = 16.000 MH No calibration applied and no bandpass applied

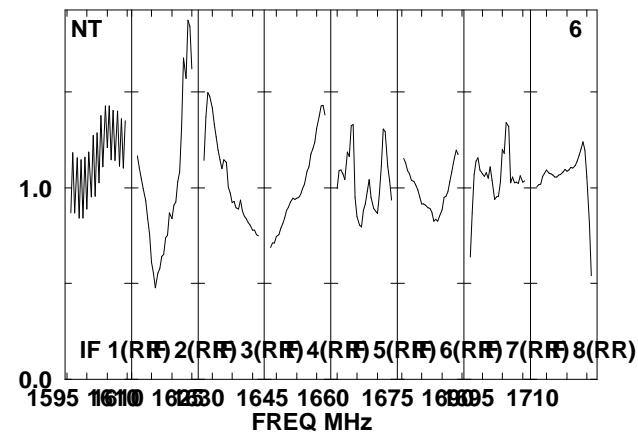
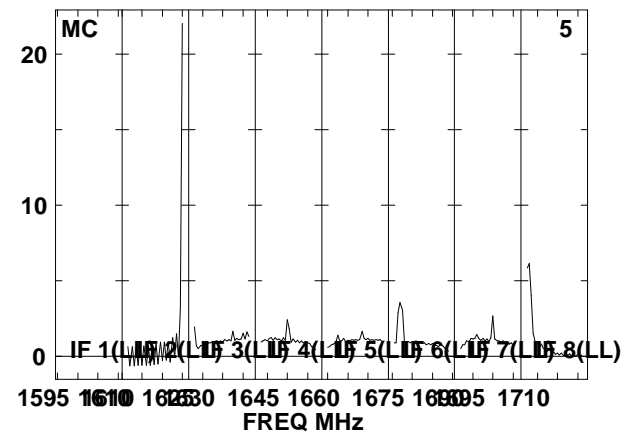
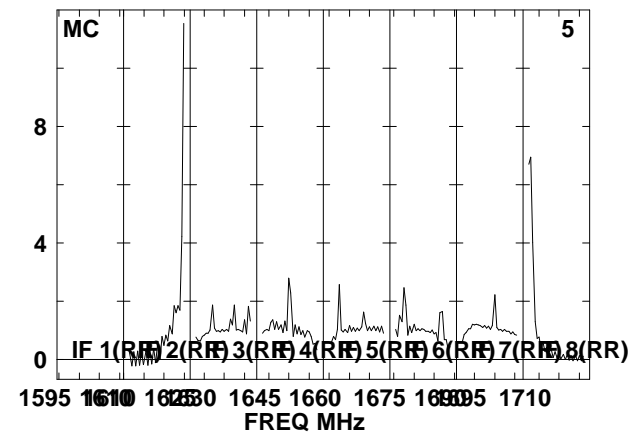
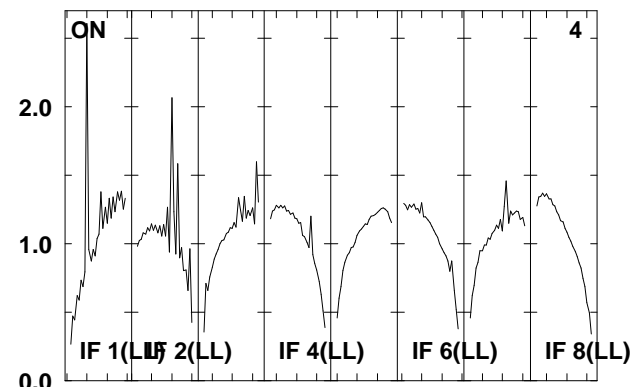
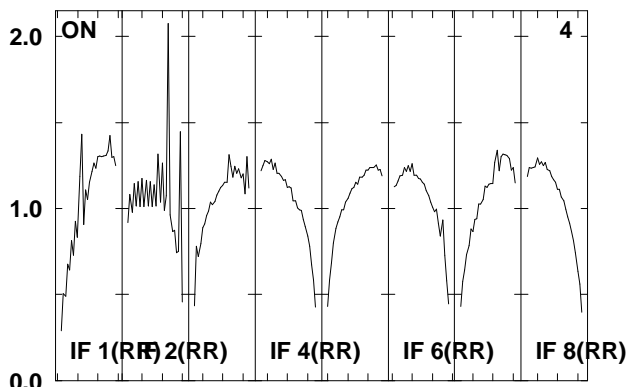
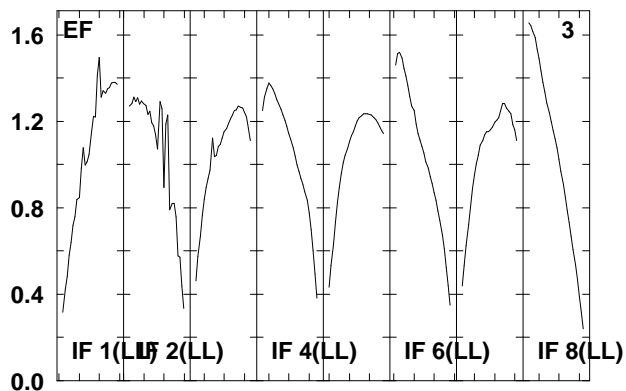
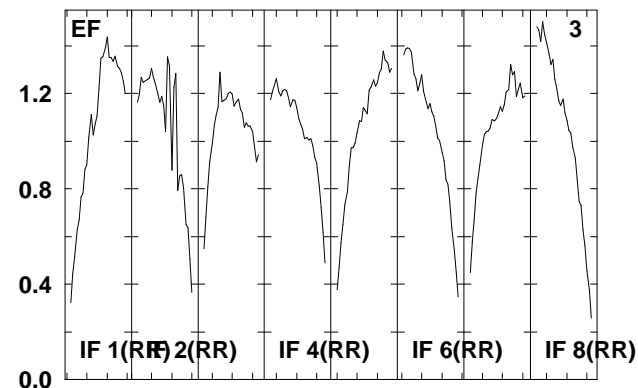
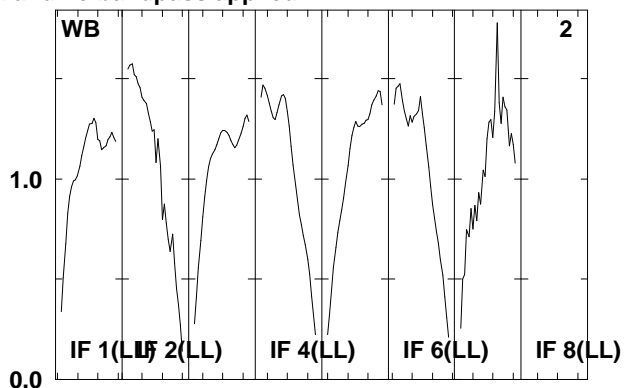
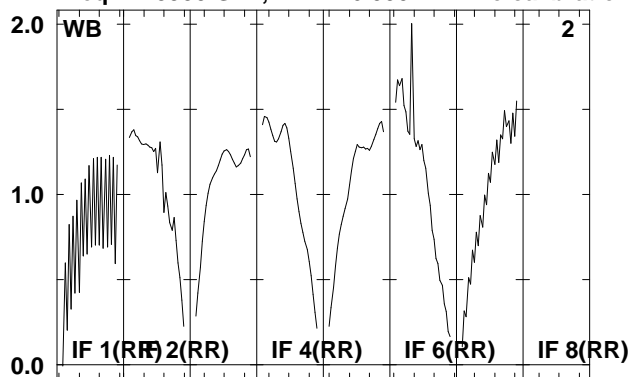

Lower frame: Real Jy  
Total-power spectrum Antenna: \*  
Timerange: 00/06:04:21 to 00/06:05:57

Plot file version 128 created 08-AUG-2008 16:59:20

J0209+13 EO06B.UVDATA.1

Freq = 1.5950 GHz, Bw = 16.000 MH No calibration applied and no bandpass applied

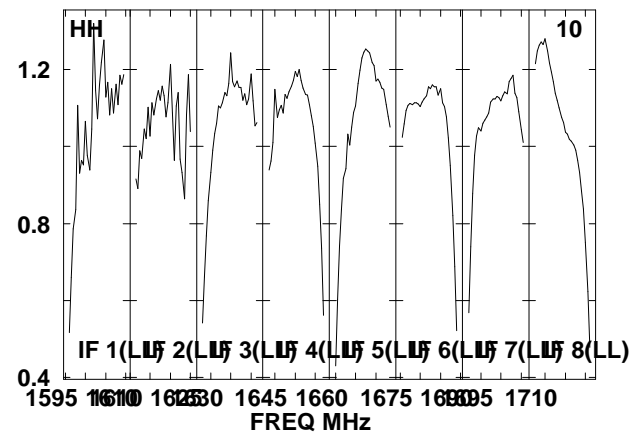
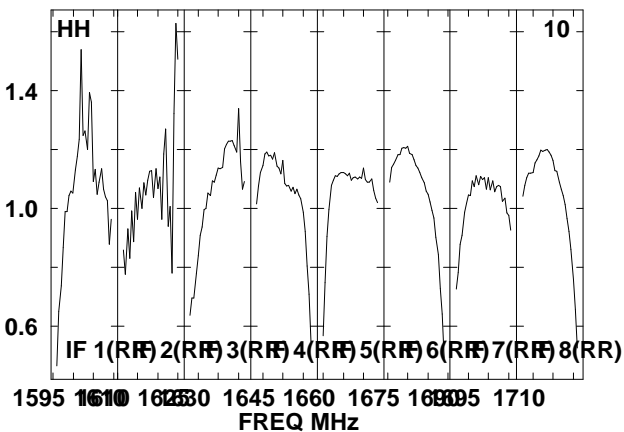
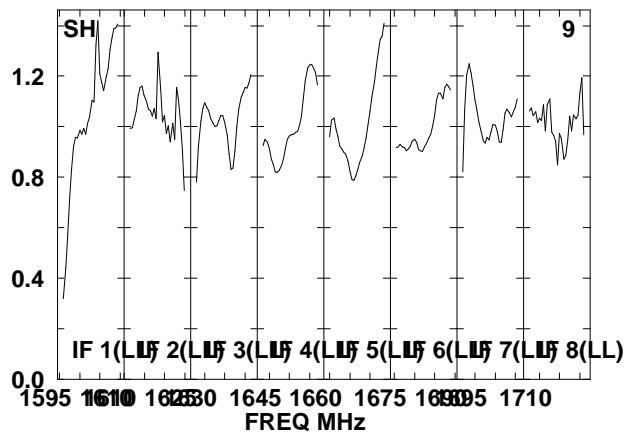
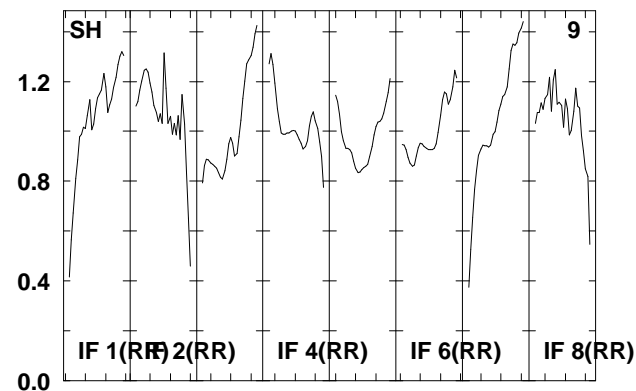
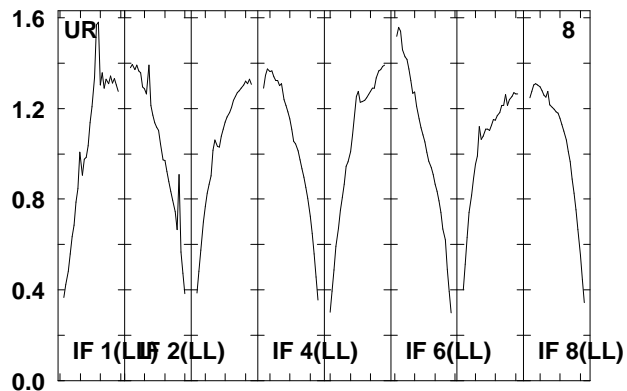
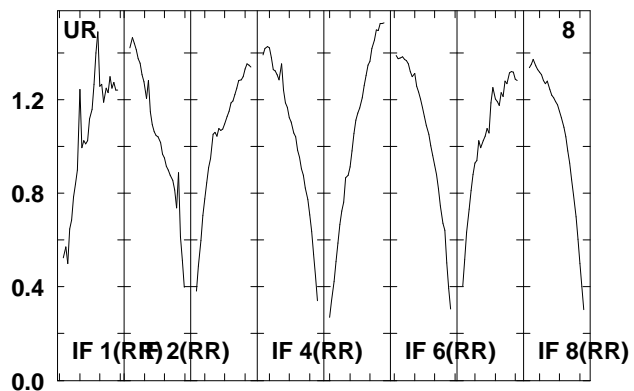
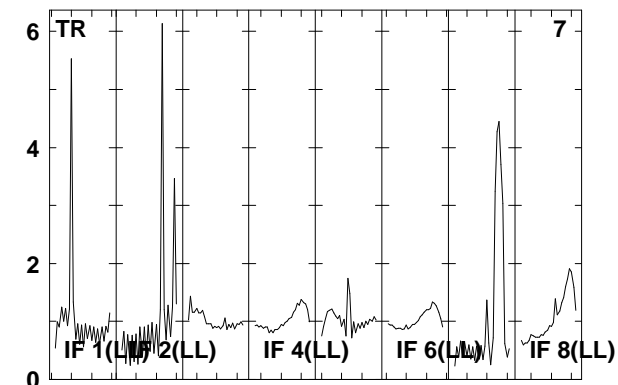
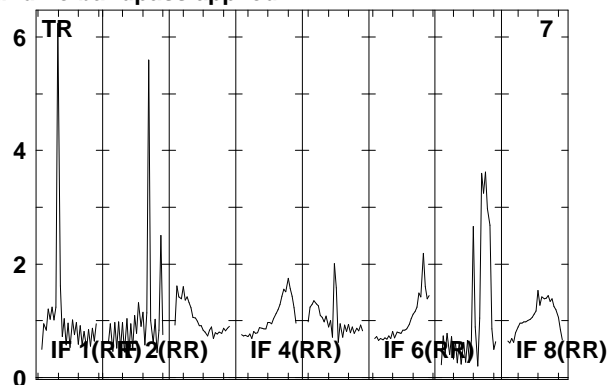
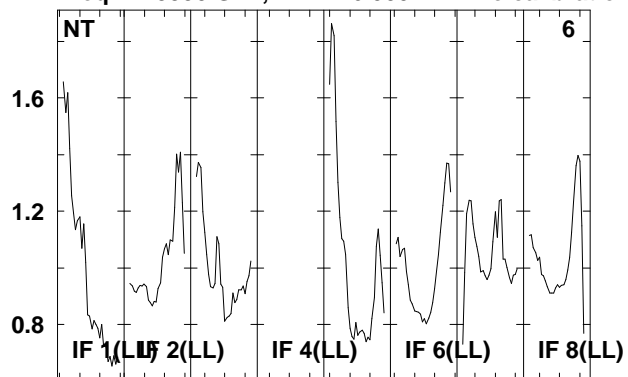

Lower frame: Real Jy  
Total-power spectrum Antenna: \*  
Timerange: 00/06:04:21 to 00/06:05:57

Plot file version 129 created 08-AUG-2008 16:59:20

J0209+13 EO006B.UVDATA.1

Freq = 1.5950 GHz, Bw = 16.000 MH No calibration applied and no bandpass applied

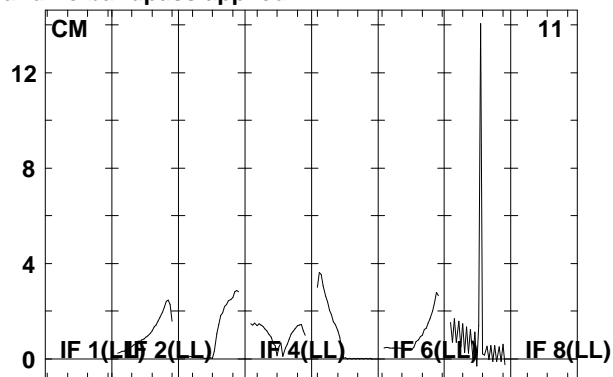
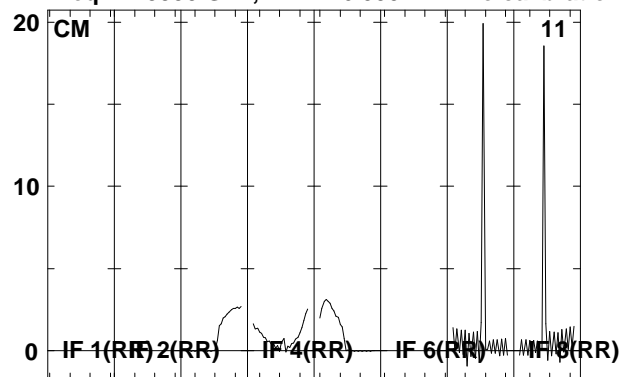

Lower frame: Real Jy  
Total-power spectrum Antenna: \*  
Timerange: 00/06:04:21 to 00/06:05:57

Plot file version 130 created 08-AUG-2008 16:59:20

J021348 EO006B.UVDATA.1

Freq = 1.5950 GHz, Bw = 16.000 MH No calibration applied and no bandpass applied

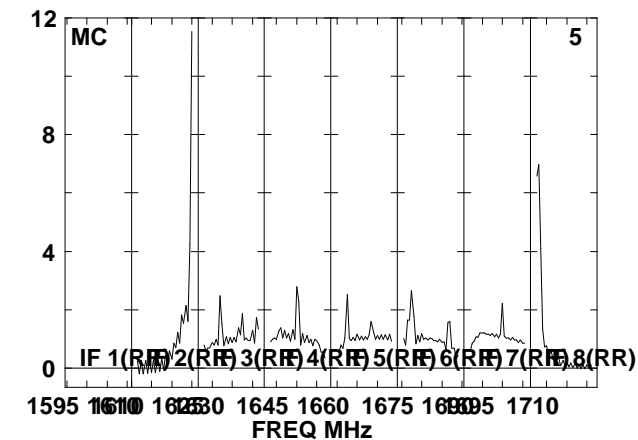
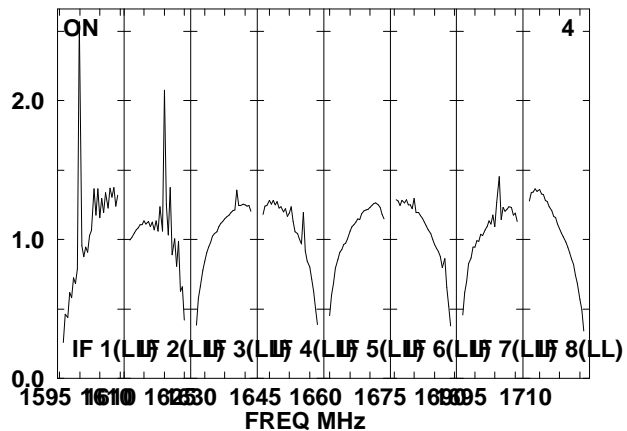
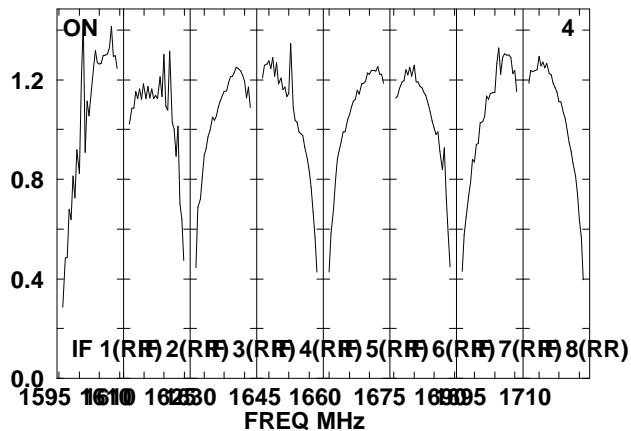
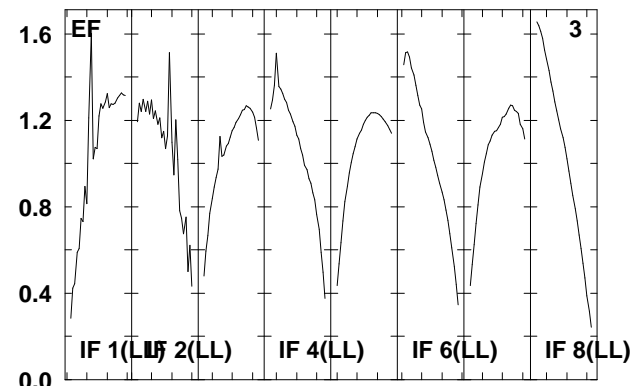
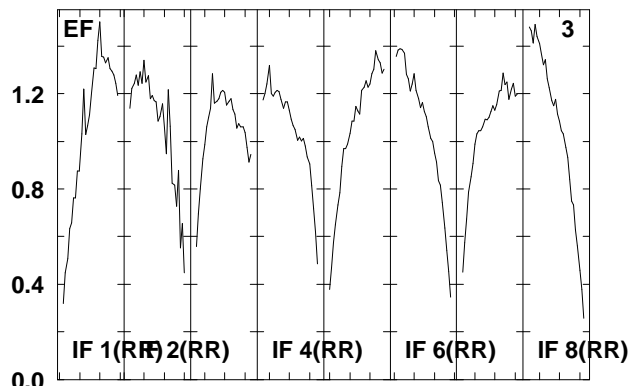
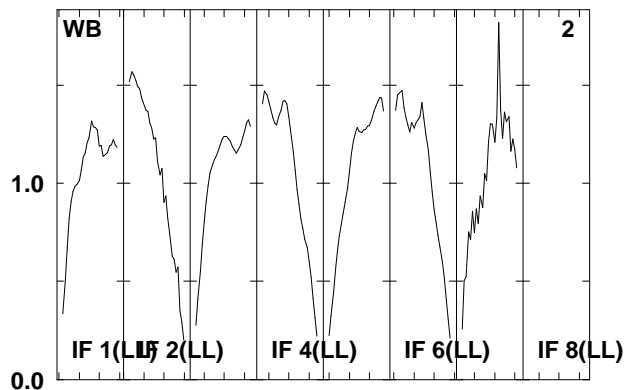
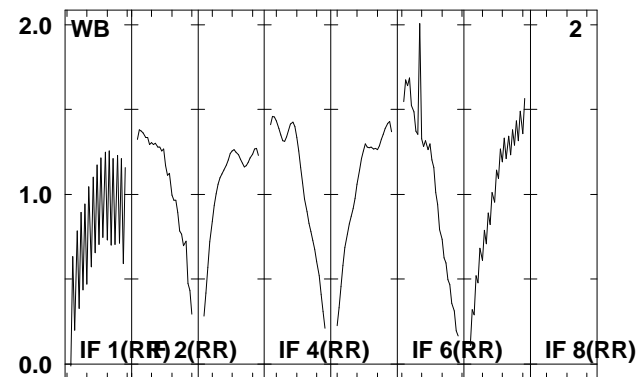
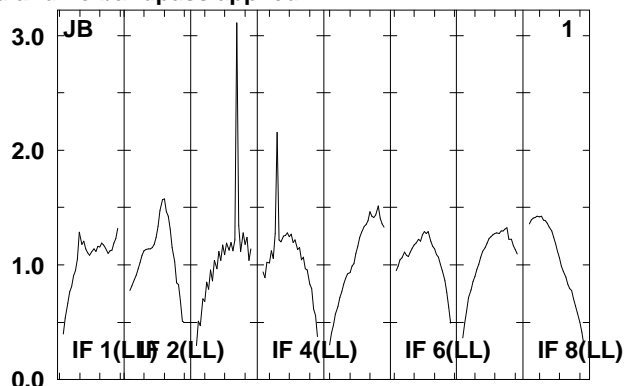
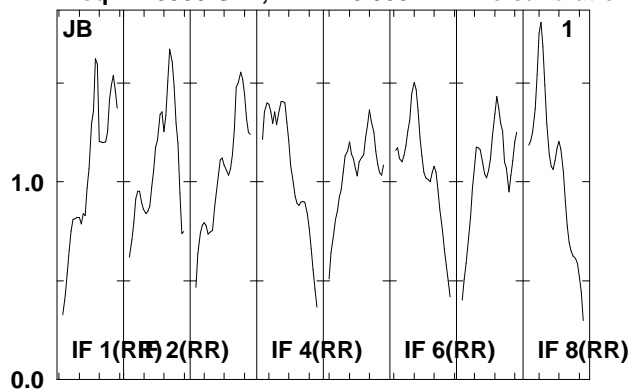

Lower frame: Real Jy  
Total-power spectrum Antenna: \*  
Timerange: 00/06:06:33 to 00/06:11:09

Plot file version 131 created 08-AUG-2008 16:59:21

J021348 EO006B.UVDATA.1

Freq = 1.5950 GHz, Bw = 16.000 MH No calibration applied and no bandpass applied

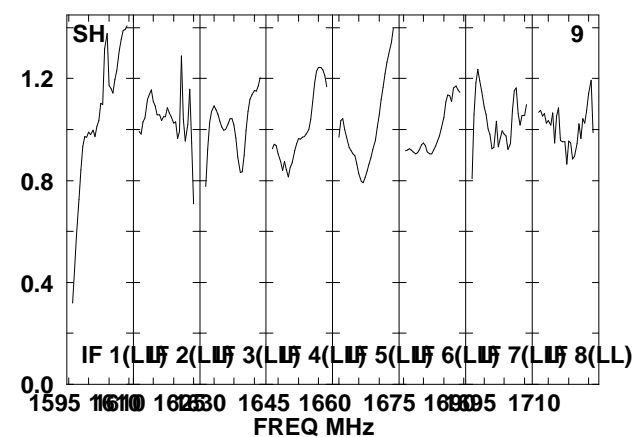
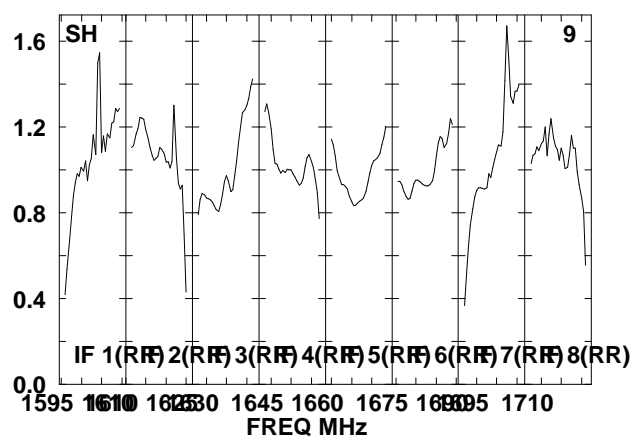
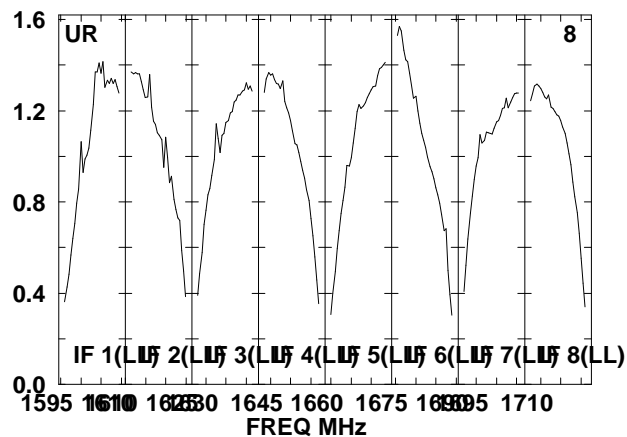
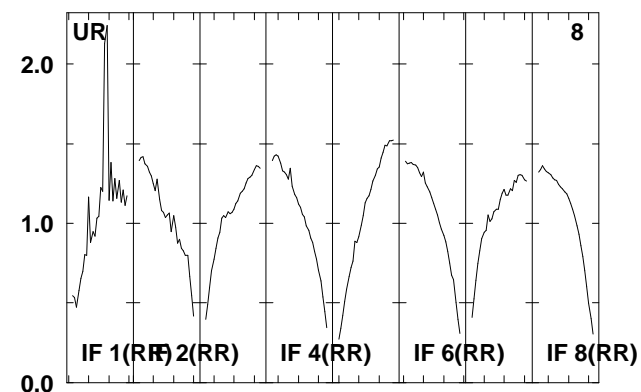
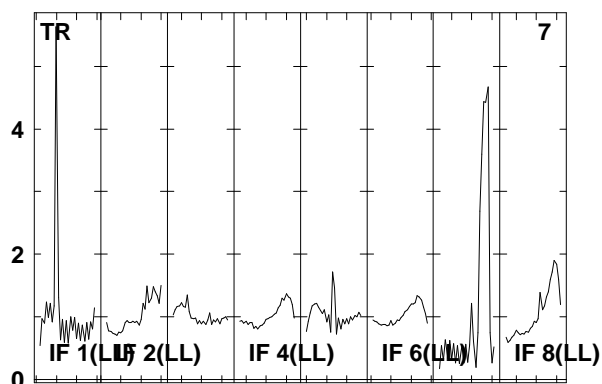
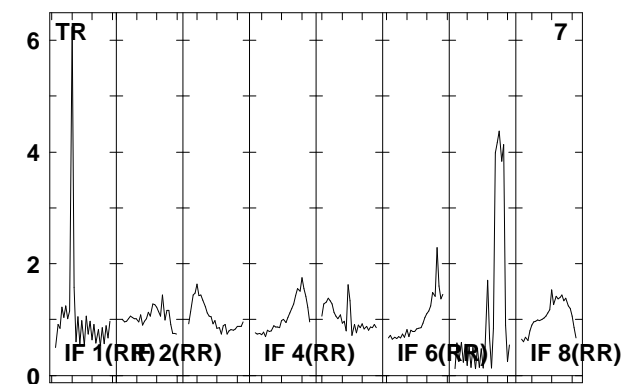
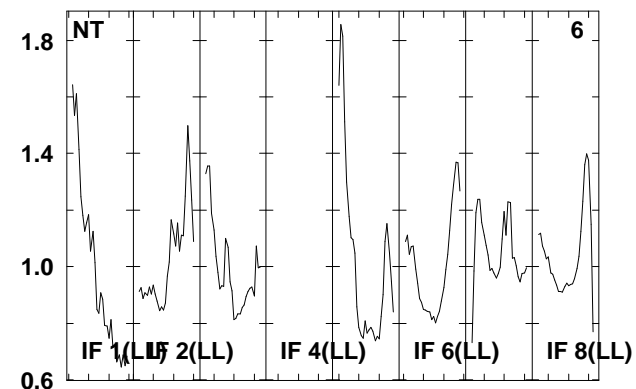
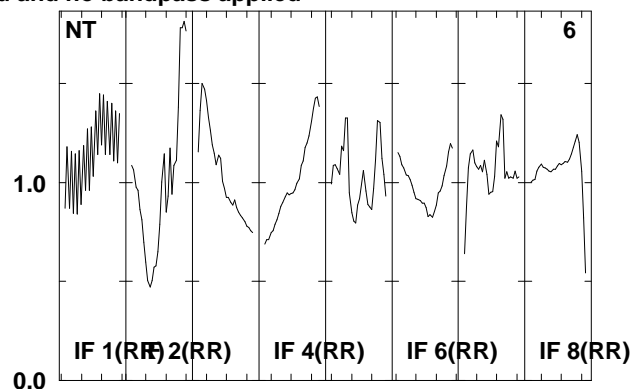
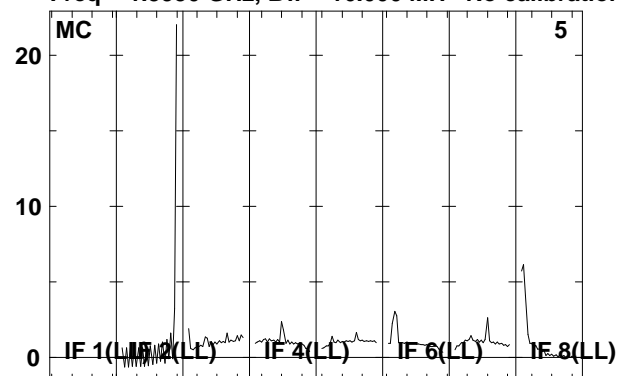

Lower frame: Real Jy

Total-power spectrum Antenna: \*

Timerange: 00/06:06:33 to 00/06:11:09

Plot file version 132 created 08-AUG-2008 16:59:22

J021348 EO006B.UVDATA.1

Freq = 1.5950 GHz, Bw = 16.000 MH No calibration applied and no bandpass applied

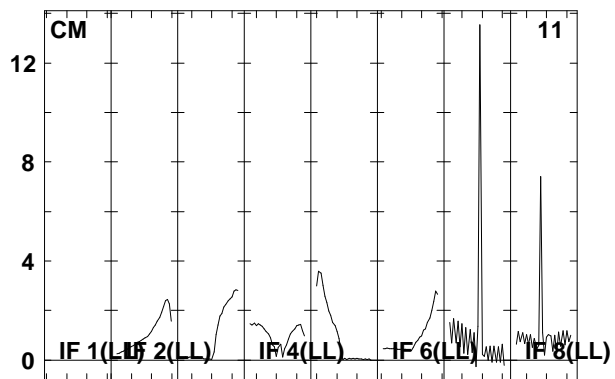
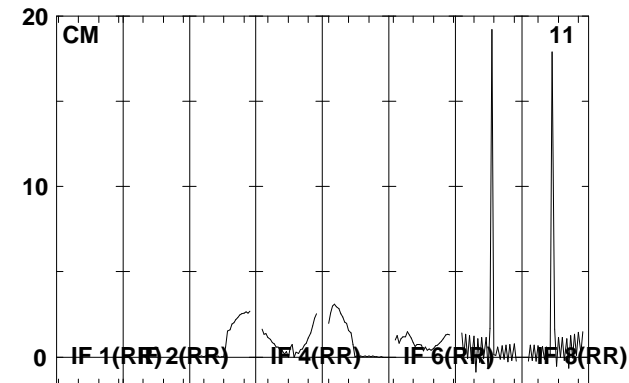
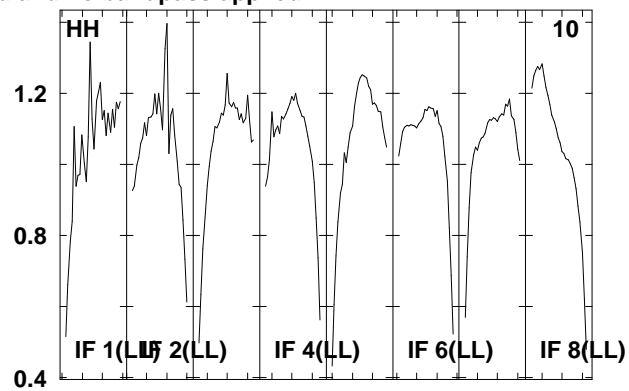
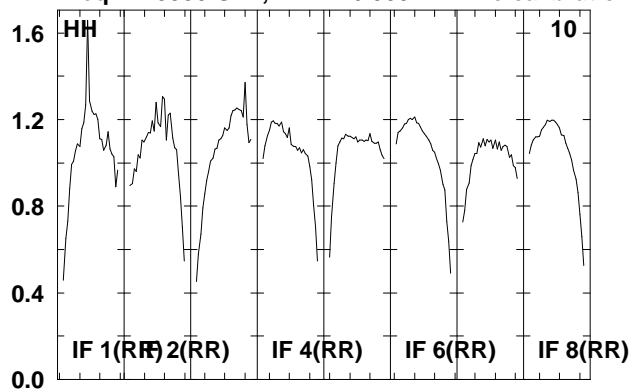

Lower frame: Real Jy  
Total-power spectrum Antenna: \*  
Timerange: 00/06:06:33 to 00/06:11:09



Plot file version 133 created 08-AUG-2008 16:59:23

J0209+13 EO006B.UVDATA.1

Freq = 1.5950 GHz, Bw = 16.000 MH No calibration applied and no bandpass applied

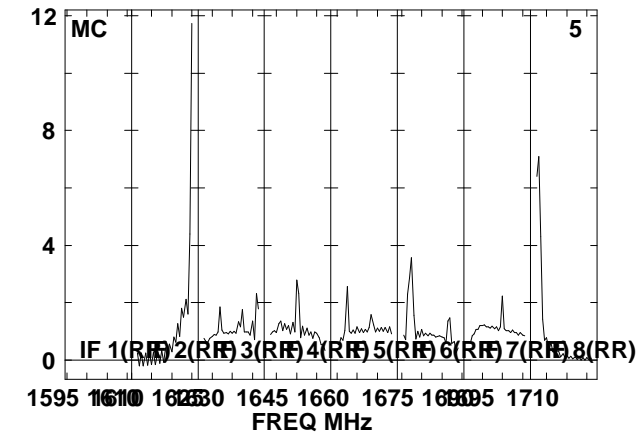
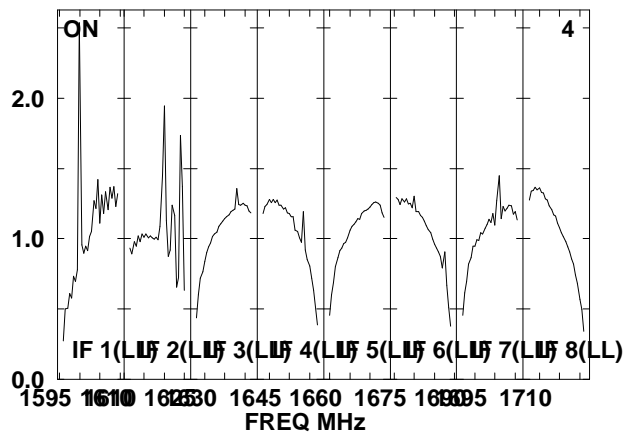
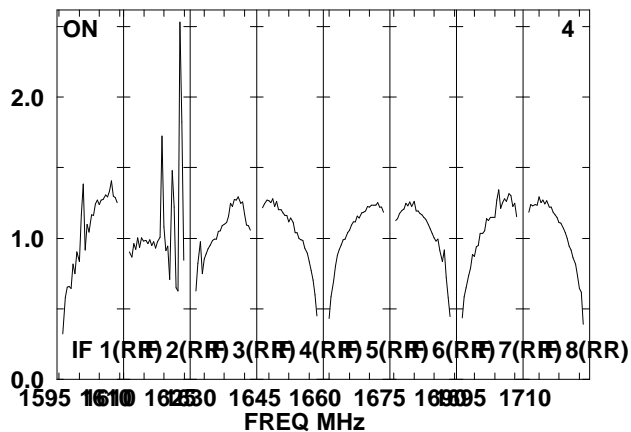
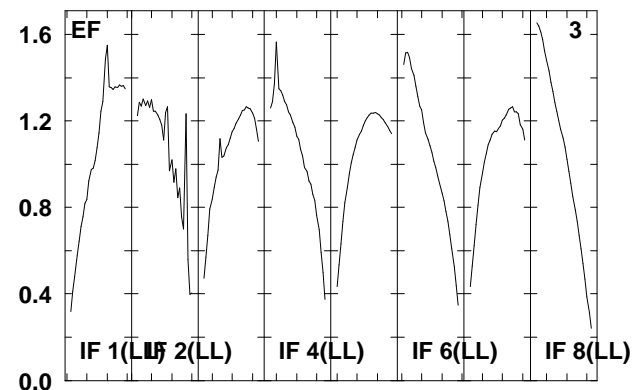
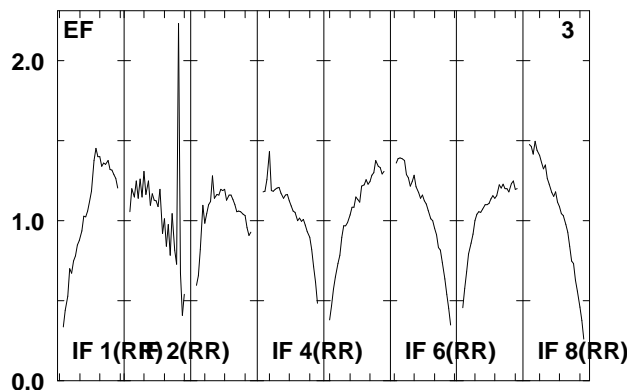
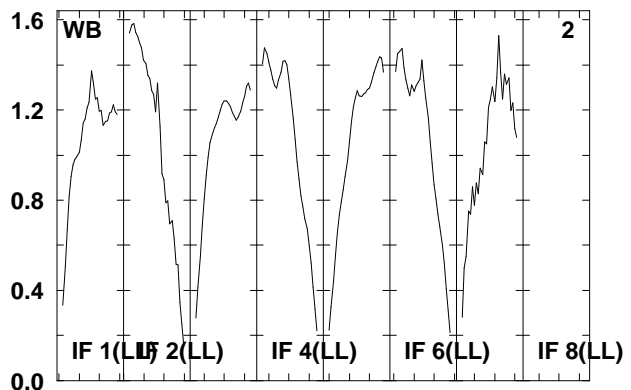
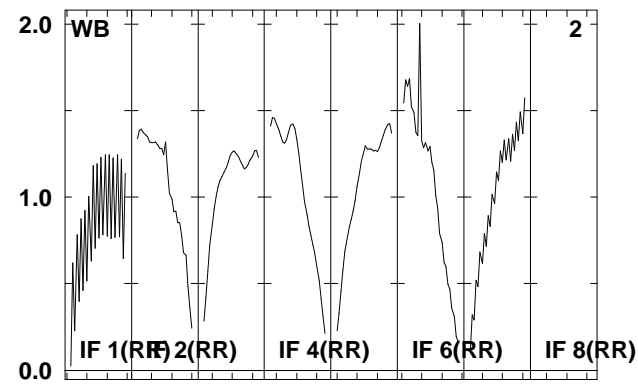
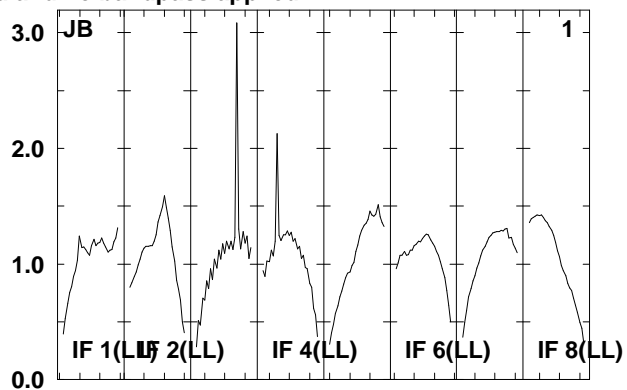
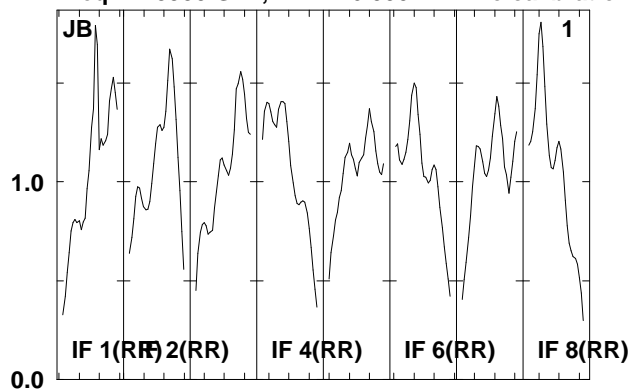

Lower frame: Real Jy  
Total-power spectrum Antenna: \*  
Timerange: 00/06:11:41 to 00/06:13:17

Plot file version 134 created 08-AUG-2008 16:59:23

J0209+13 EO006B.UVDATA.1

Freq = 1.5950 GHz, Bw = 16.000 MH No calibration applied and no bandpass applied

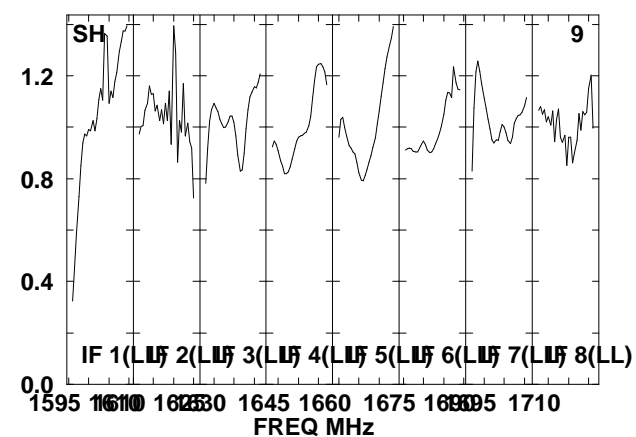
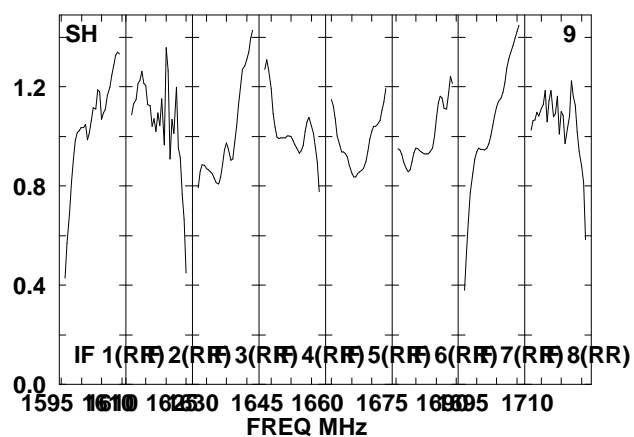
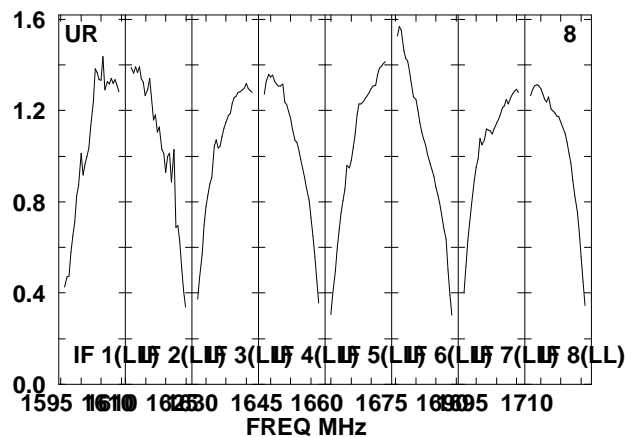
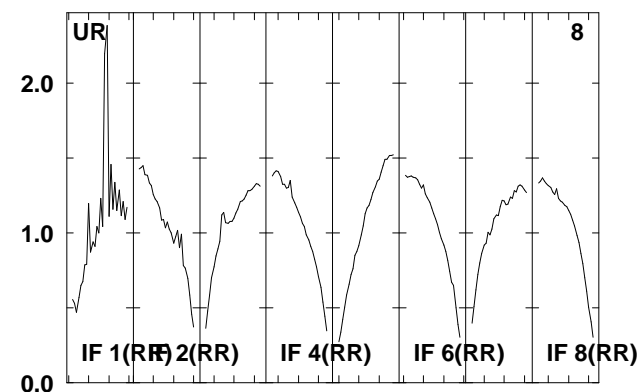
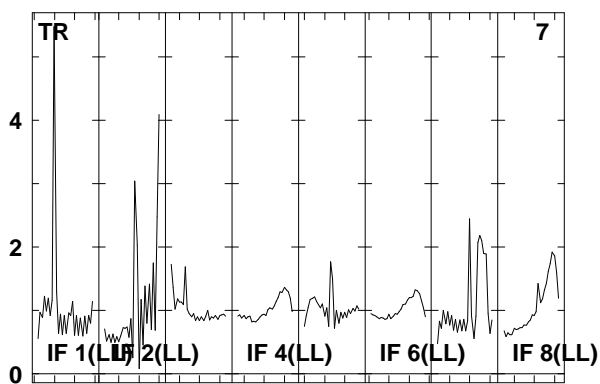
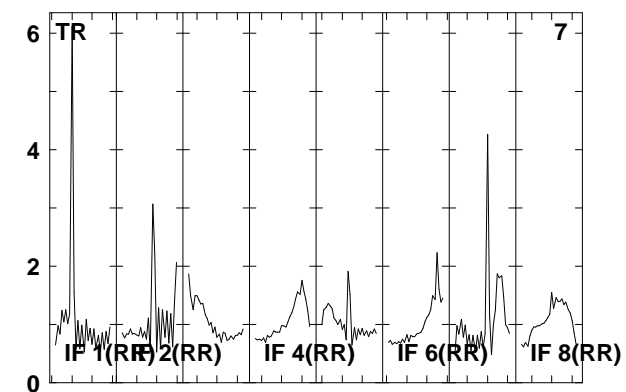
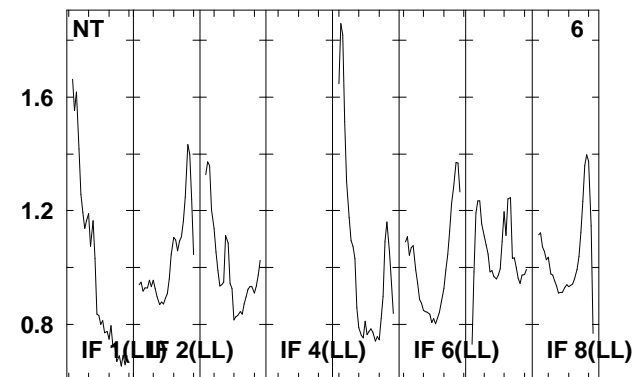
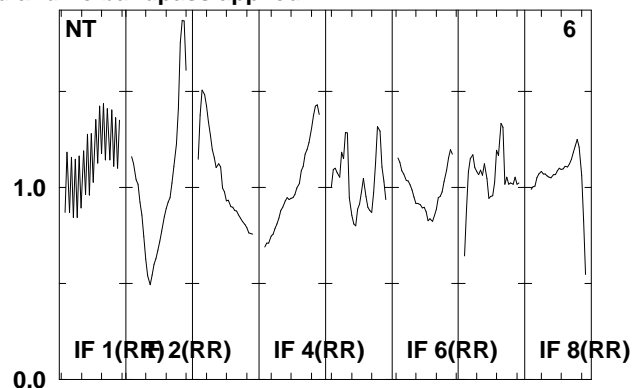
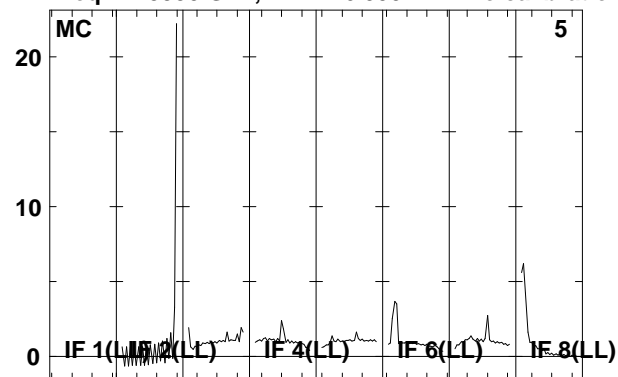

Lower frame: Real Jy

Total-power spectrum Antenna: \*

Timerange: 00/06:11:41 to 00/06:13:17

Plot file version 135 created 08-AUG-2008 16:59:24

J0209+13 EO006B.UVDATA.1

Freq = 1.5950 GHz, Bw = 16.000 MH No calibration applied and no bandpass applied

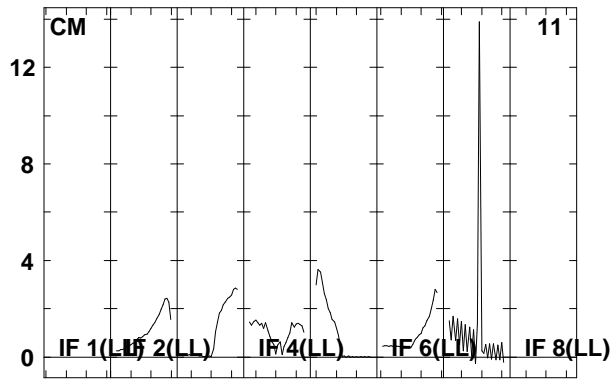
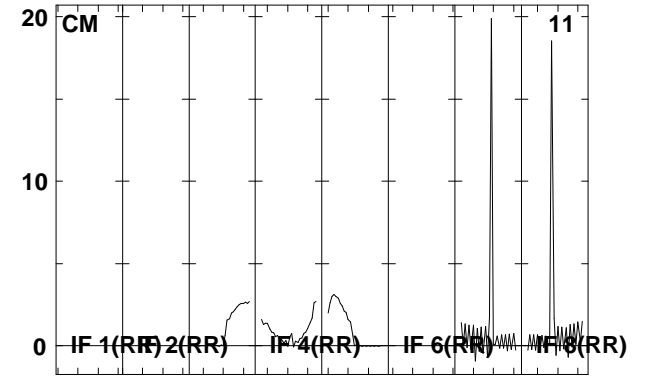
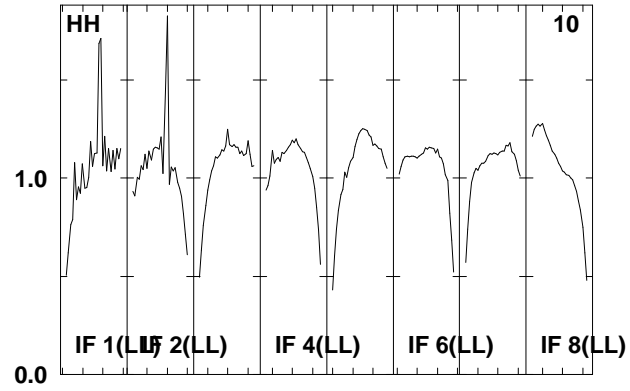
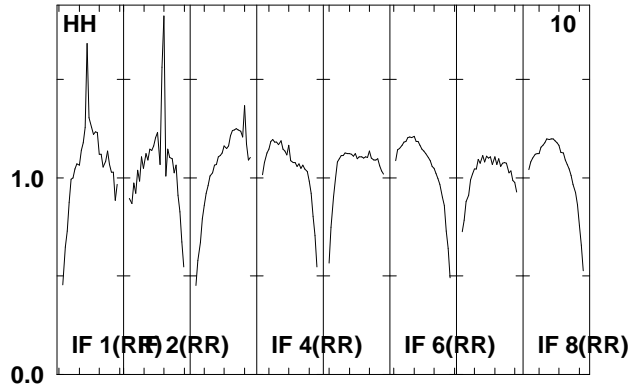

Lower frame: Real Jy  
Total-power spectrum Antenna: \*  
Timerange: 00/06:11:41 to 00/06:13:17

Plot file version 136 created 08-AUG-2008 16:59:24

J021348 EO006B.UVDATA.1

Freq = 1.5950 GHz, Bw = 16.000 MH No calibration applied and no bandpass applied

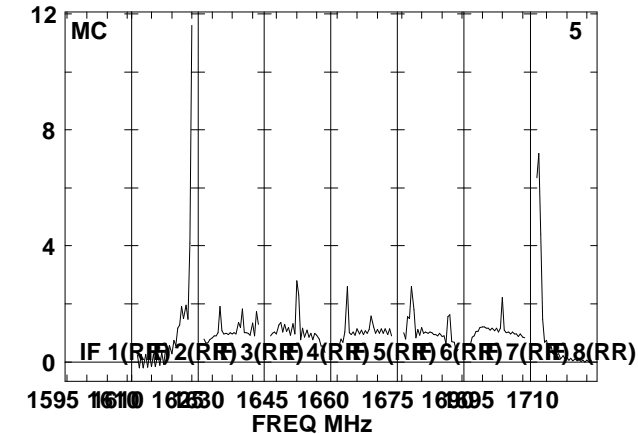
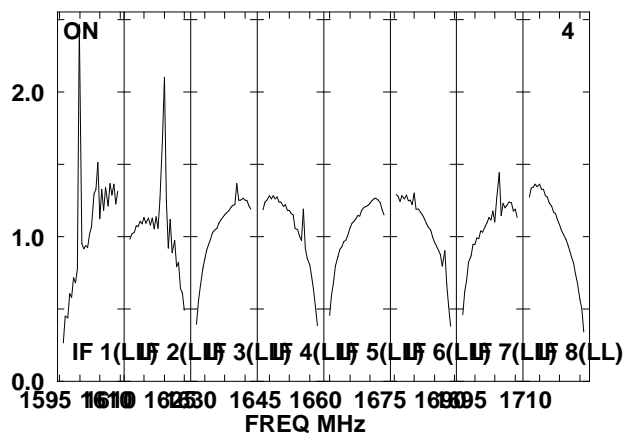
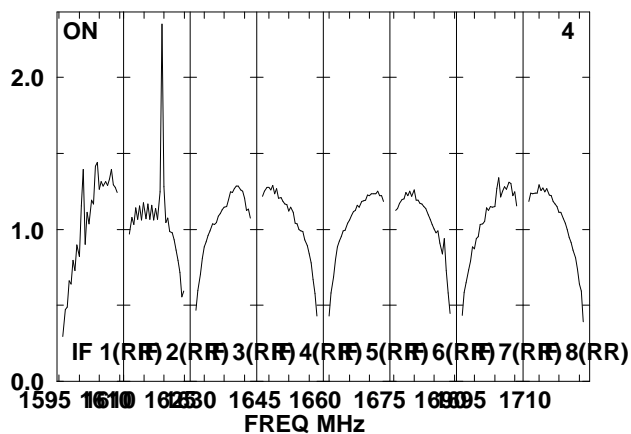
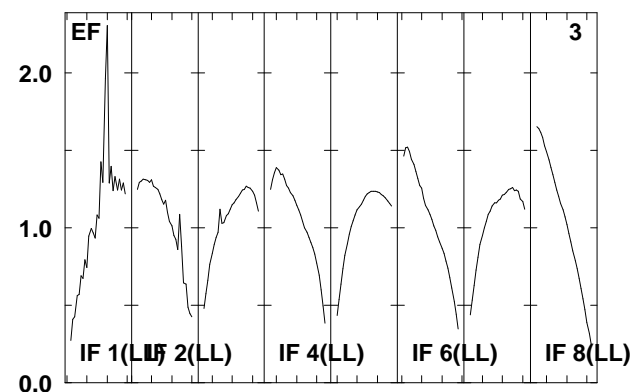
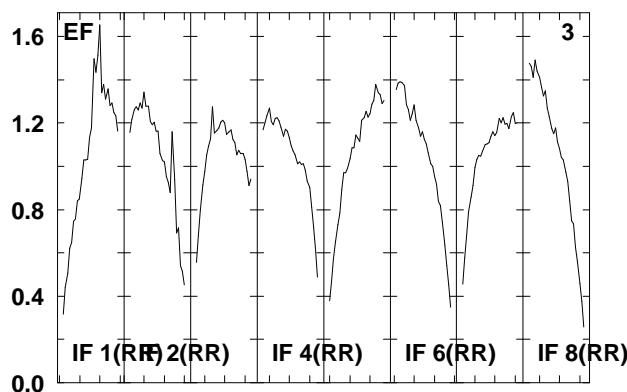
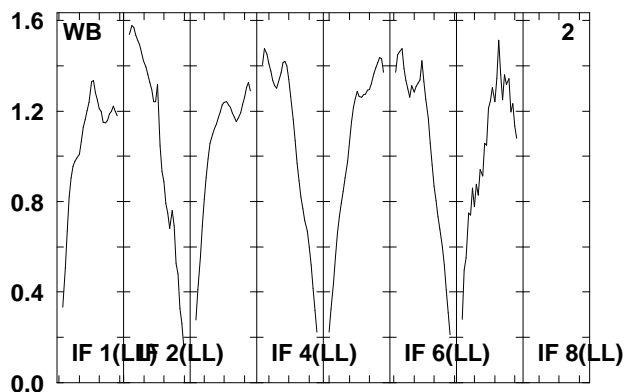
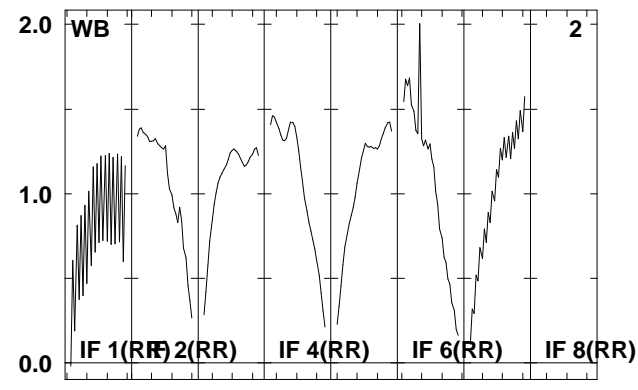
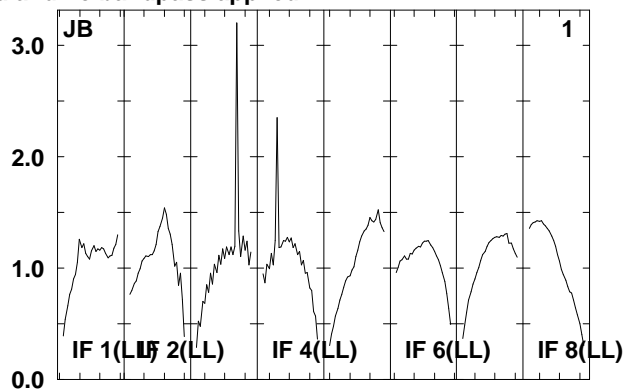
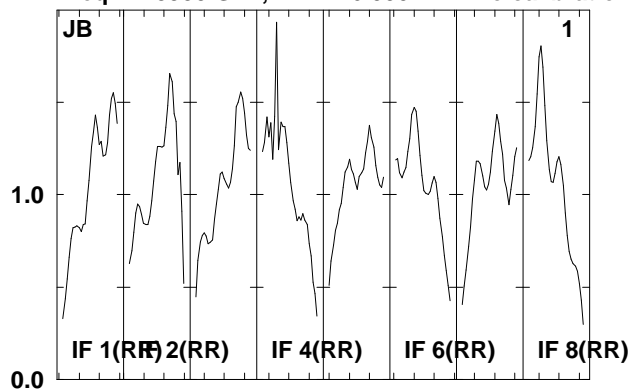

Lower frame: Real Jy  
Total-power spectrum Antenna: \*  
Timerange: 00/06:13:53 to 00/06:18:29

Plot file version 137 created 08-AUG-2008 16:59:25

J021348 EO006B.UVDATA.1

Freq = 1.5950 GHz, Bw = 16.000 MH No calibration applied and no bandpass applied

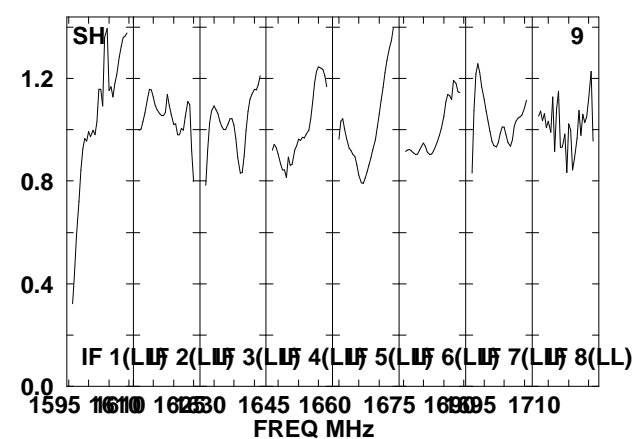
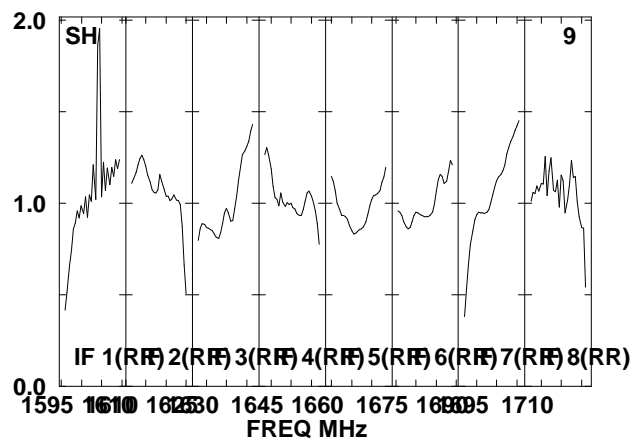
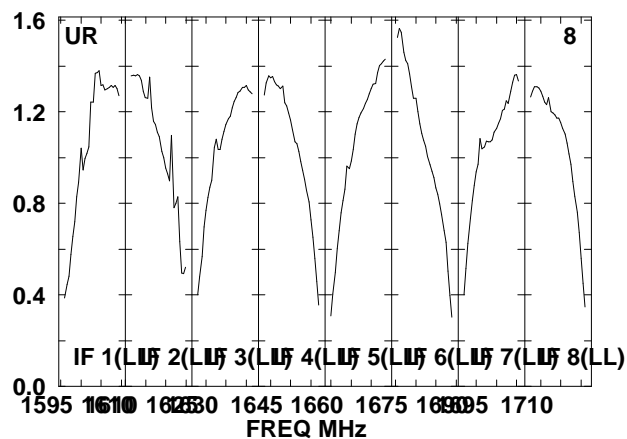
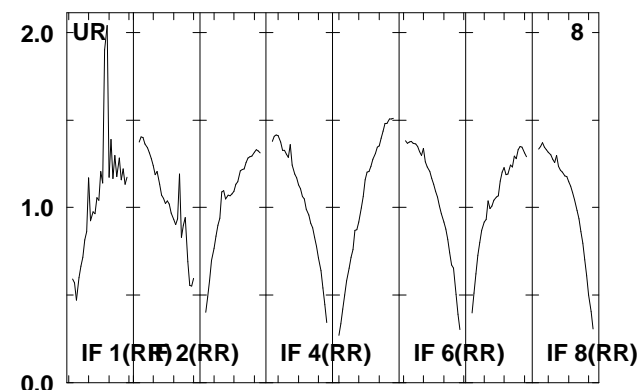
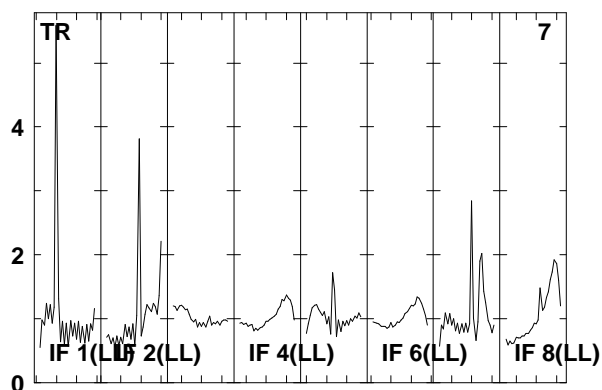
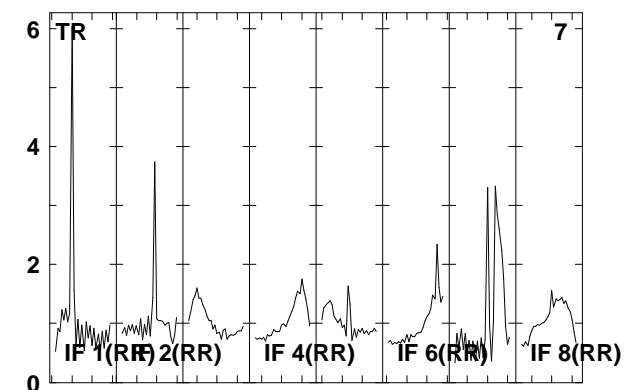
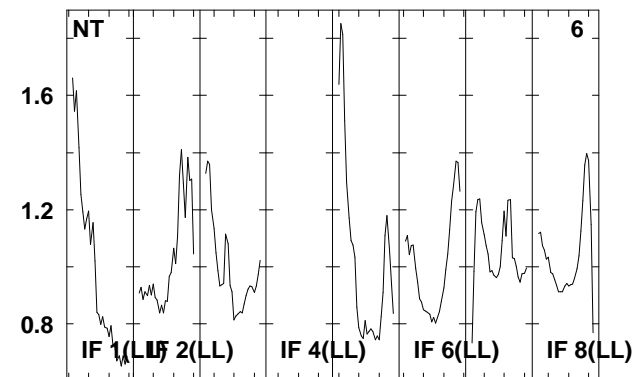
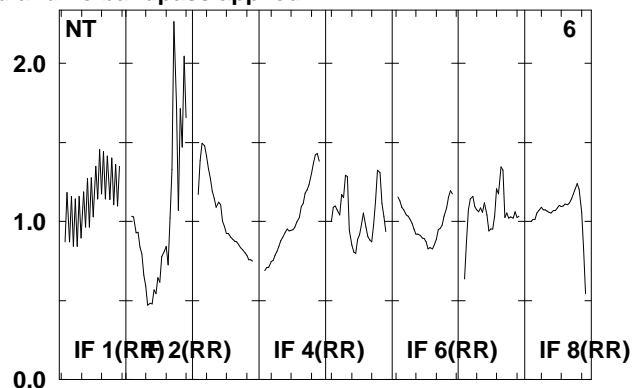
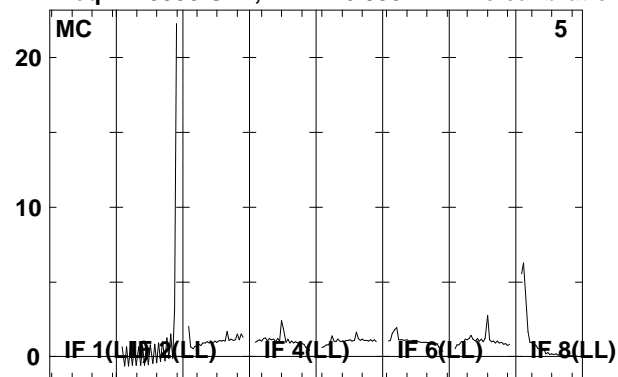

Lower frame: Real Jy

Total-power spectrum Antenna: \*

Timerange: 00/06:13:53 to 00/06:18:29

Plot file version 138 created 08-AUG-2008 16:59:25

J021348 EO006B.UVDATA.1

Freq = 1.5950 GHz, Bw = 16.000 MH No calibration applied and no bandpass applied

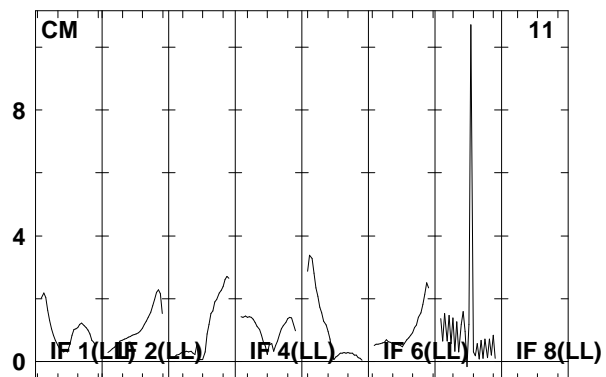
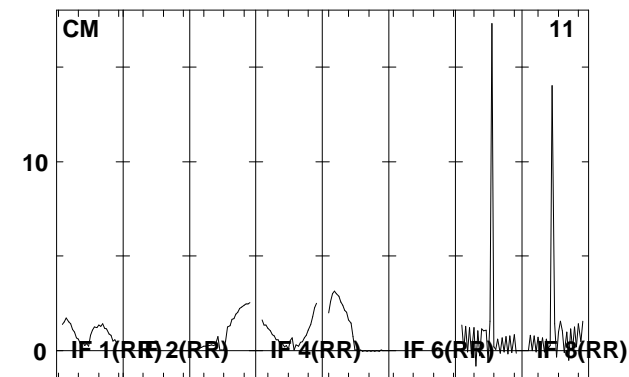
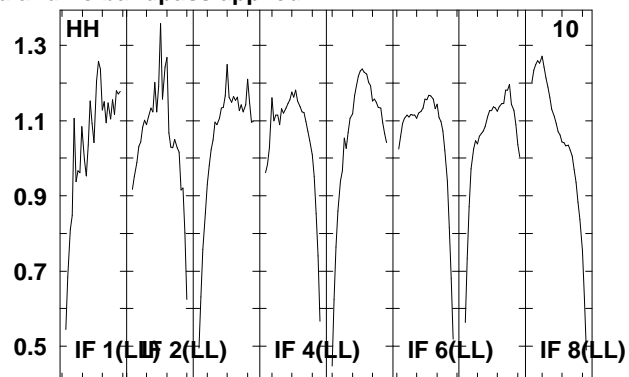
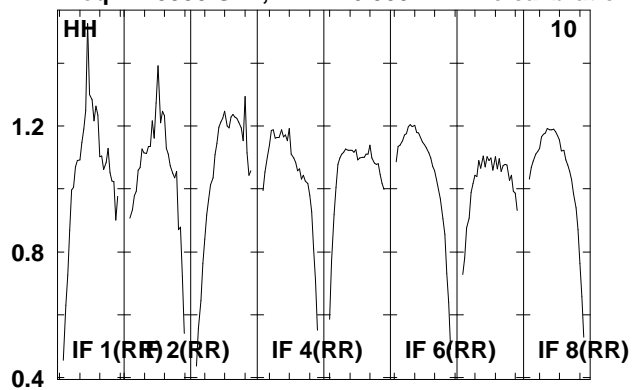

Lower frame: Real Jy  
Total-power spectrum Antenna: \*  
Timerange: 00/06:13:53 to 00/06:18:29

Plot file version 139 created 08-AUG-2008 16:59:26

J0209+13 EO006B.UVDATA.1

Freq = 1.5950 GHz, Bw = 16.000 MH No calibration applied and no bandpass applied

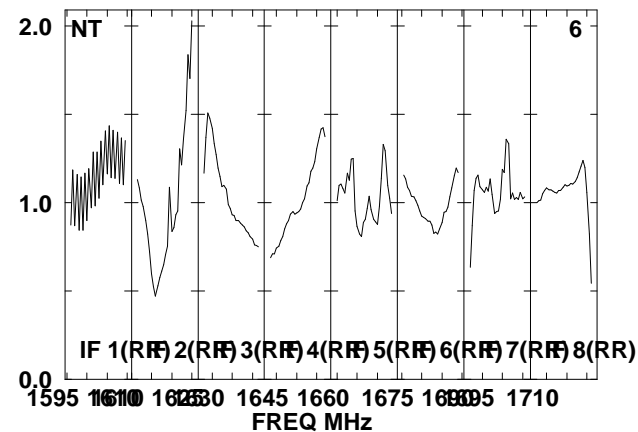
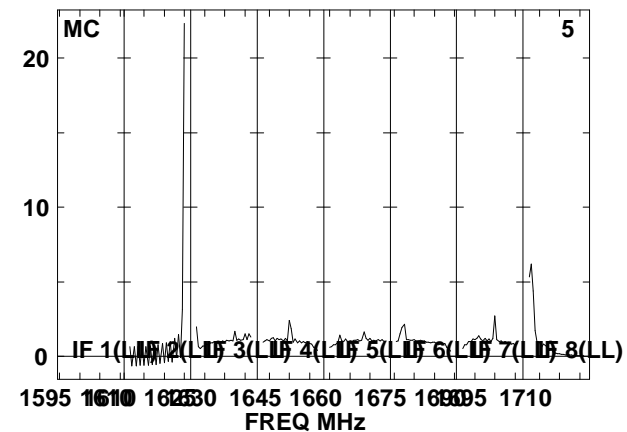
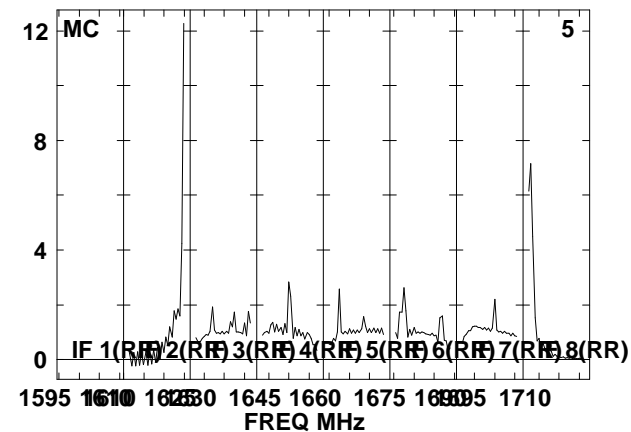
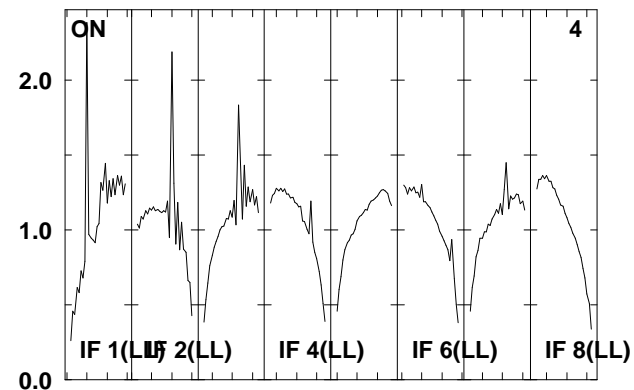
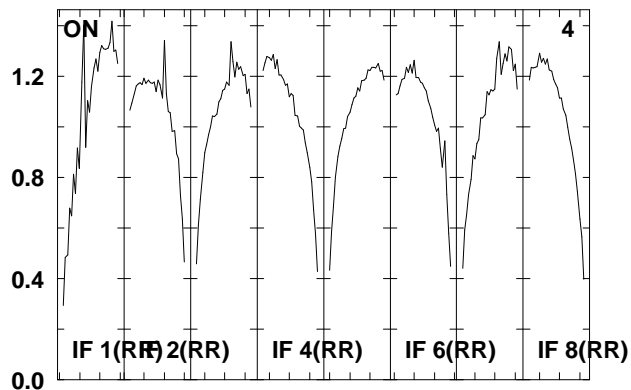
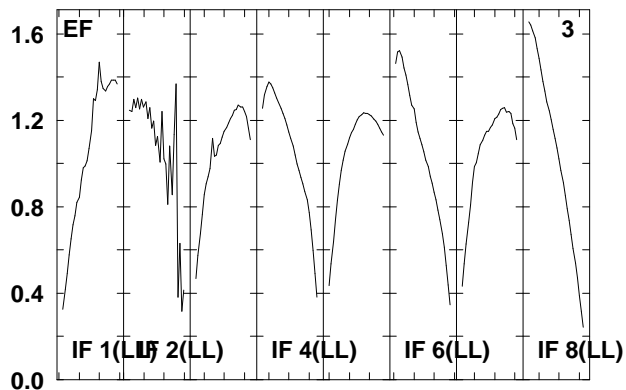
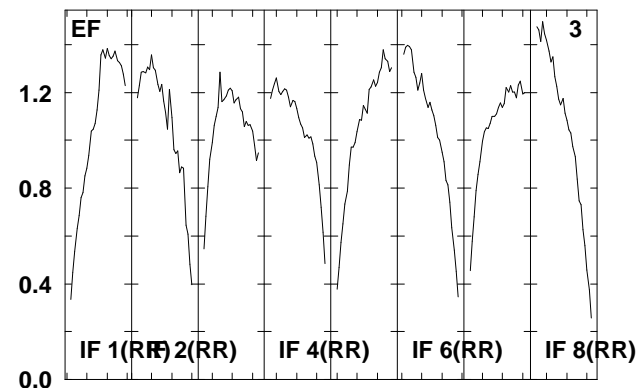
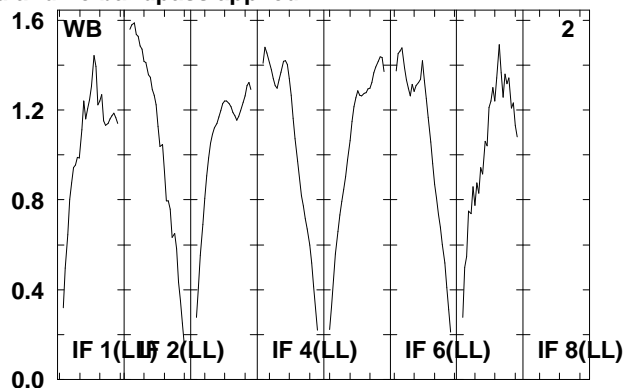
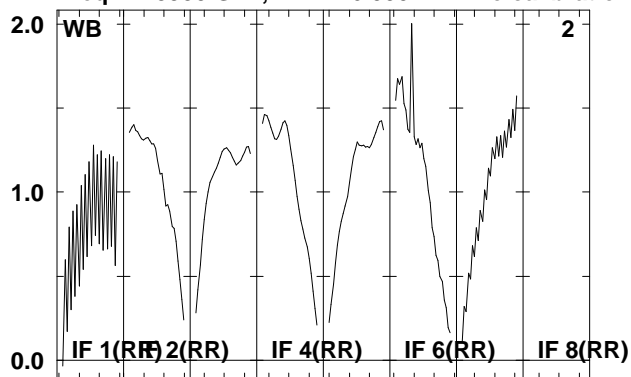

Lower frame: Real Jy

Total-power spectrum Antenna: \*

Timerange: 00/06:19:11 to 00/06:20:31

Plot file version 140 created 08-AUG-2008 16:59:26

J0209+13 EO06B.UVDATA.1

Freq = 1.5950 GHz, Bw = 16.000 MH No calibration applied and no bandpass applied

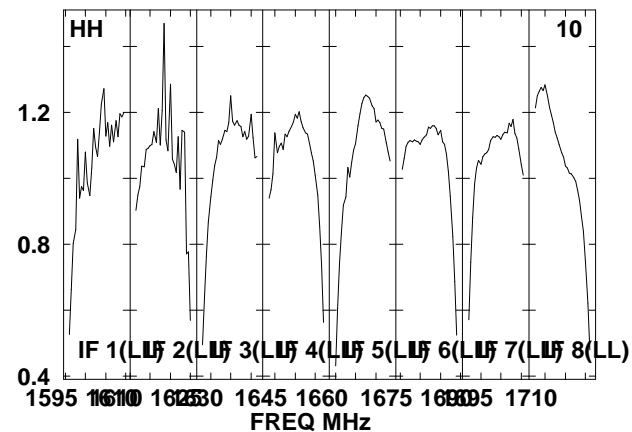
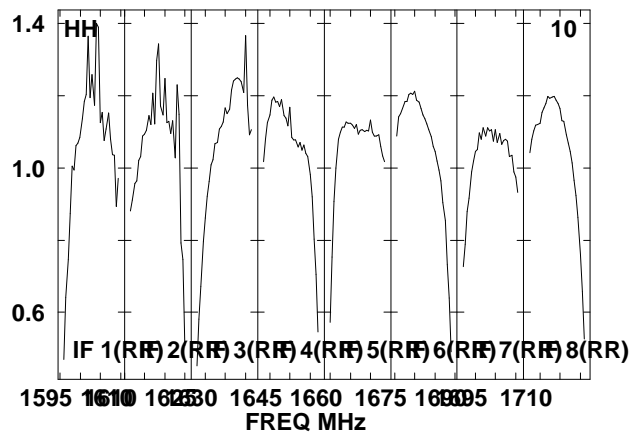
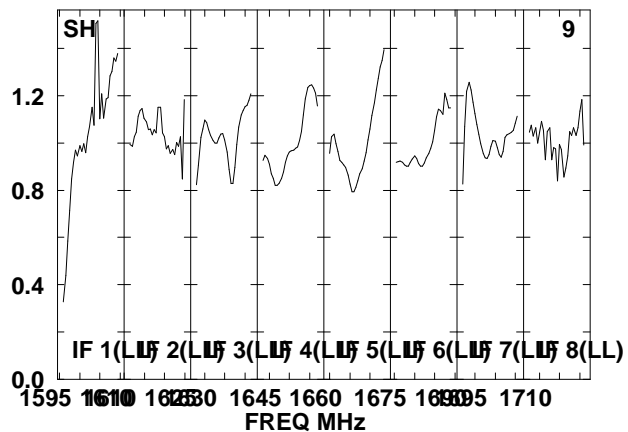
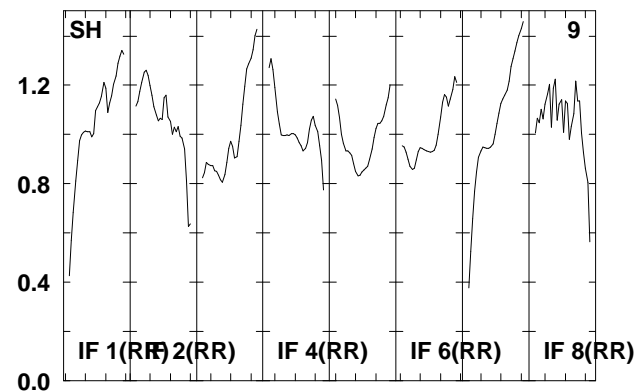
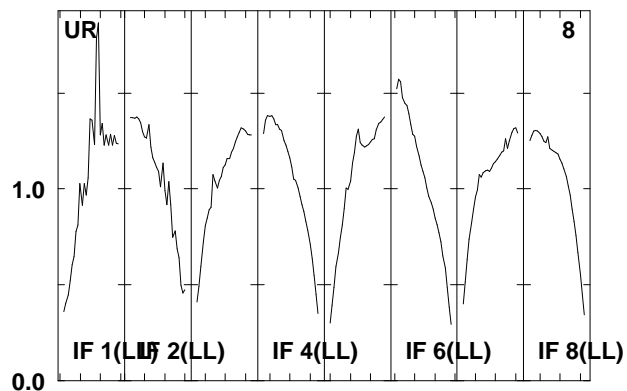
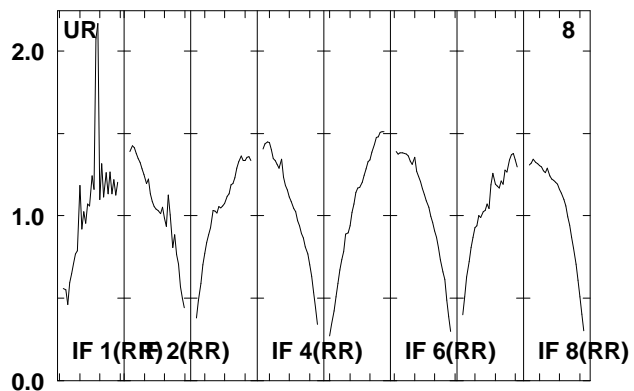
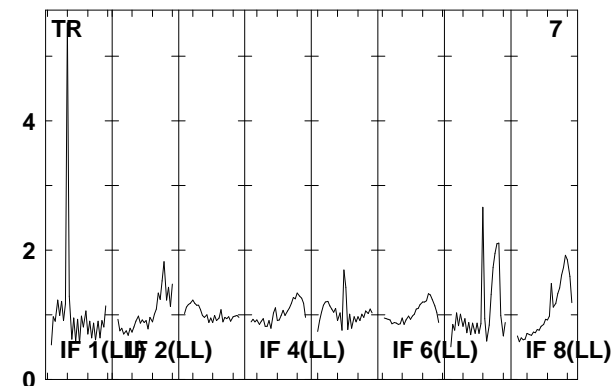
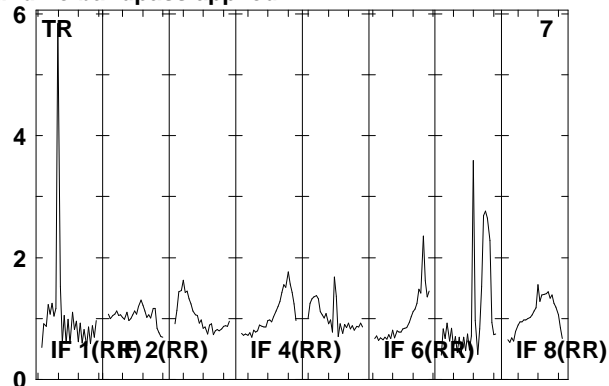
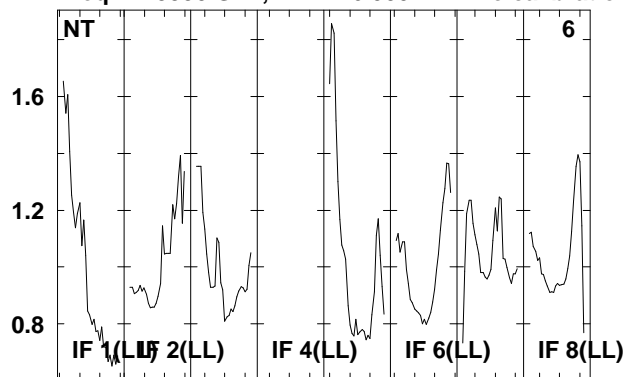

Lower frame: Real Jy  
Total-power spectrum Antenna: \*  
Timerange: 00/06:19:11 to 00/06:20:31



Plot file version 141 created 08-AUG-2008 16:59:26

J0209+13 EO006B.UVDATA.1

Freq = 1.5950 GHz, Bw = 16.000 MH No calibration applied and no bandpass applied

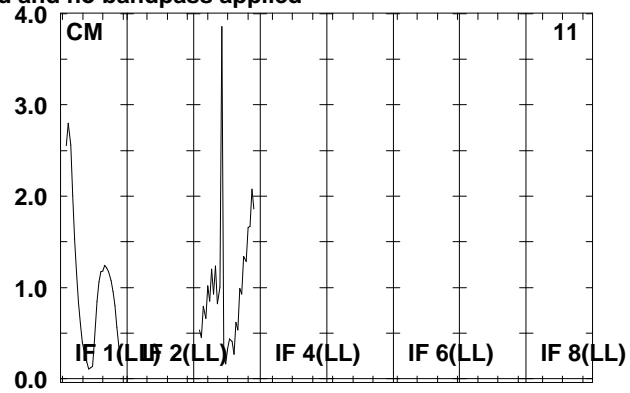
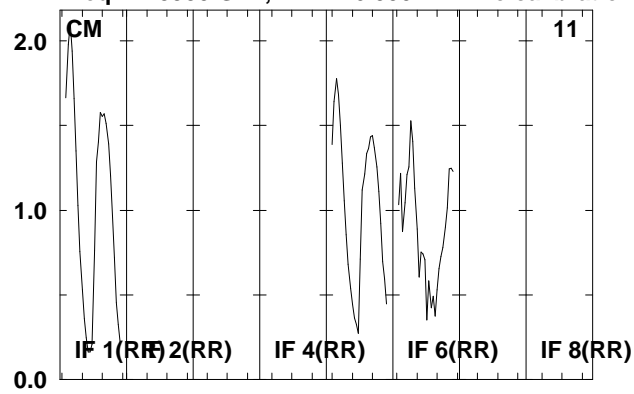

Lower frame: Real Jy  
Total-power spectrum Antenna: \*  
Timerange: 00/06:19:11 to 00/06:20:31

Plot file version 142 created 08-AUG-2008 16:59:27

J021348 EO06B.UVDATA.1

Freq = 1.5950 GHz, Bw = 16.000 MH No calibration applied and no bandpass applied

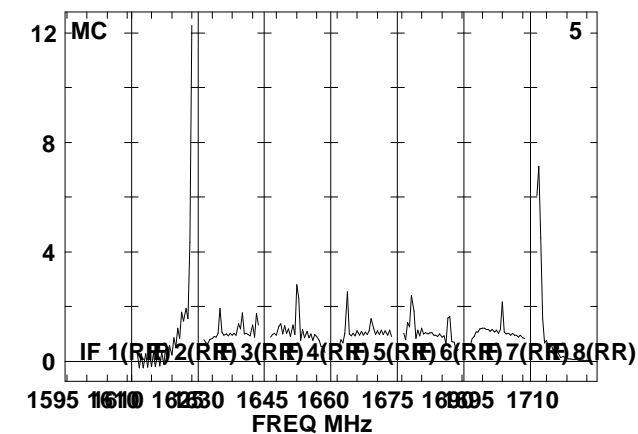
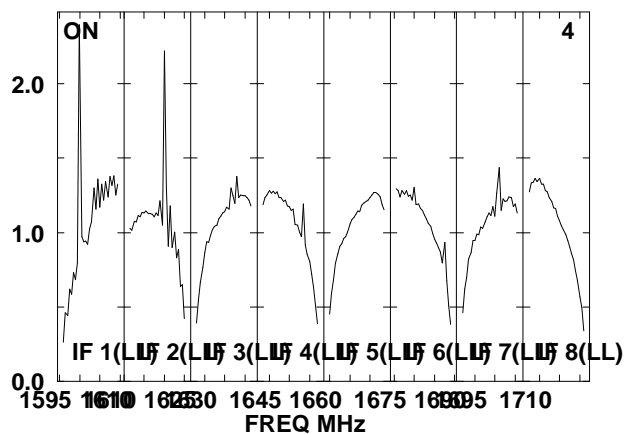
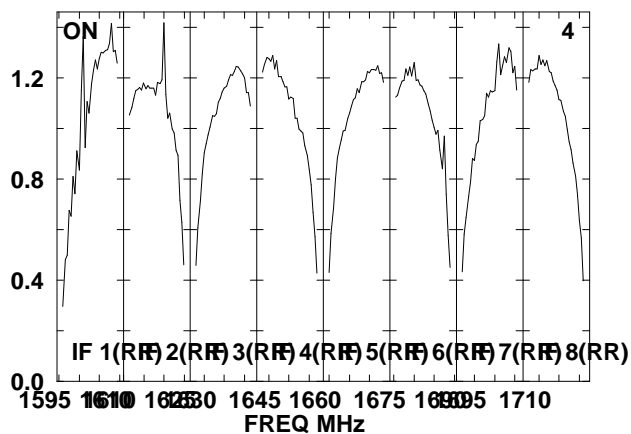
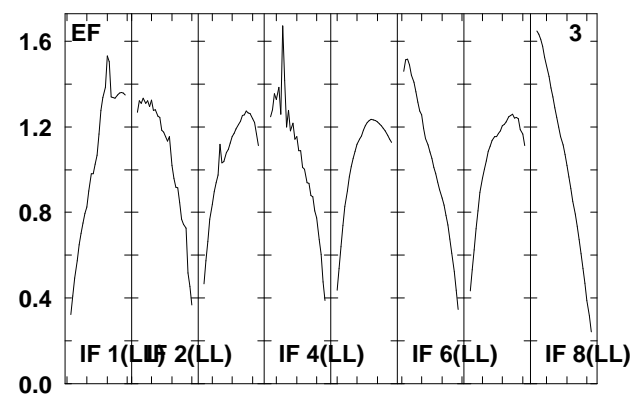
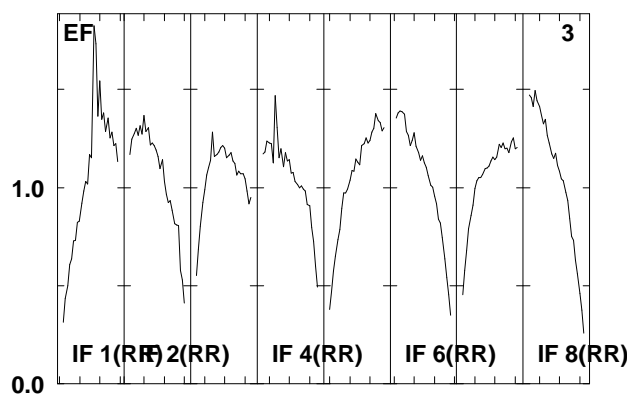
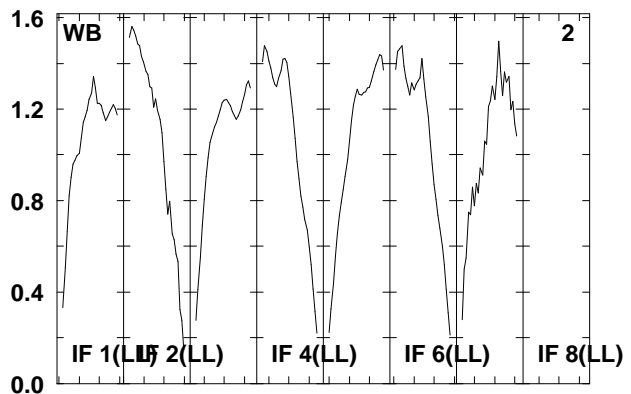
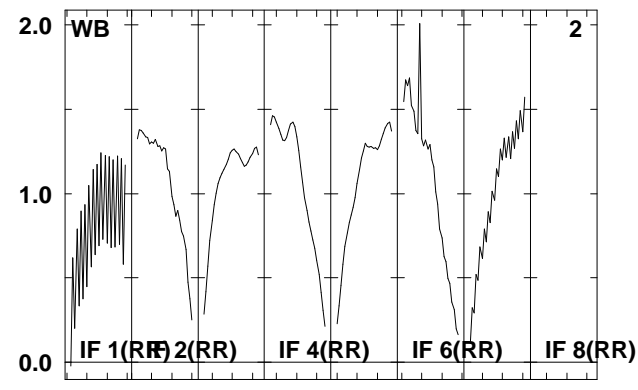
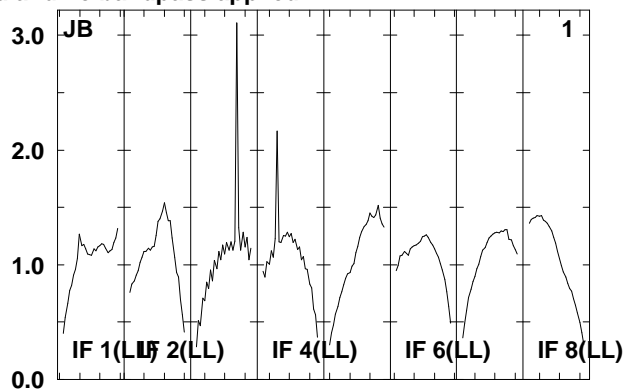
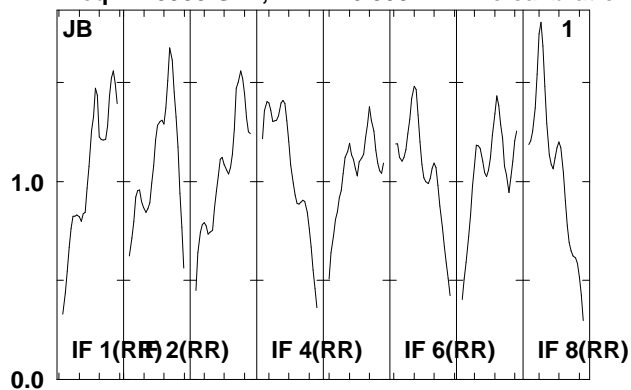

Lower frame: Real Jy  
Total-power spectrum Antenna: \*  
Timerange: 00/06:21:13 to 00/06:25:49

Plot file version 143 created 08-AUG-2008 16:59:27

J021348 EO006B.UVDATA.1

Freq = 1.5950 GHz, Bw = 16.000 MH No calibration applied and no bandpass applied

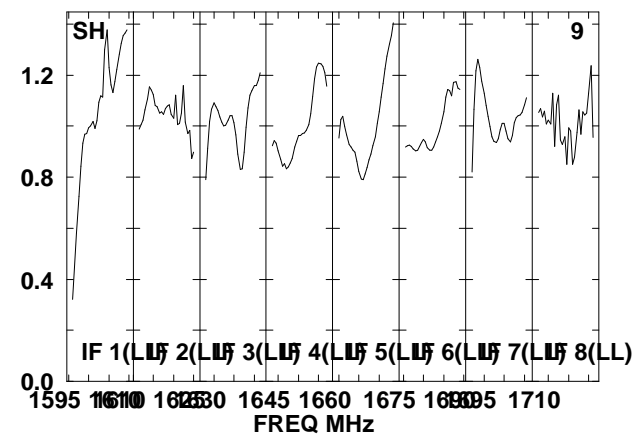
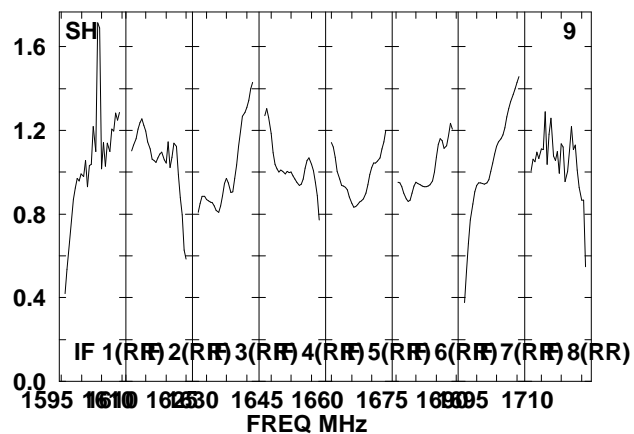
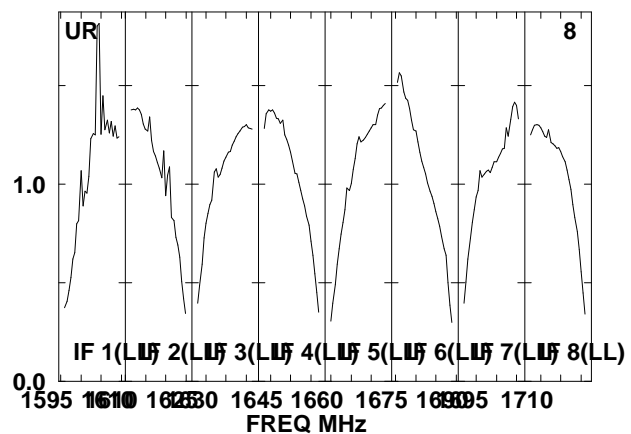
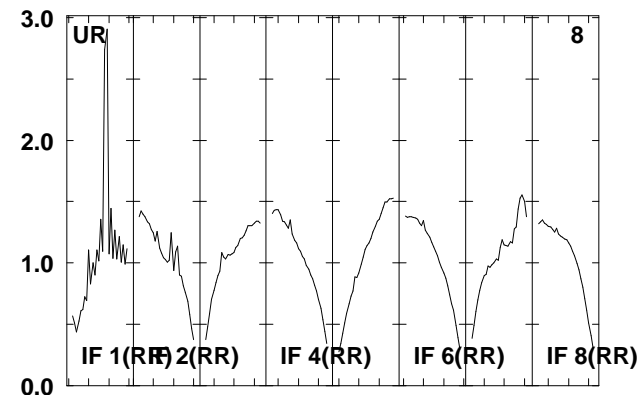
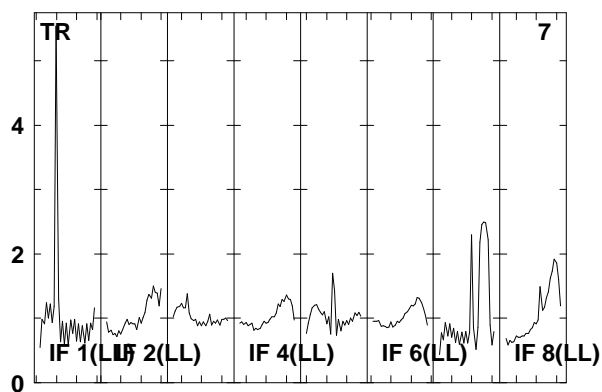
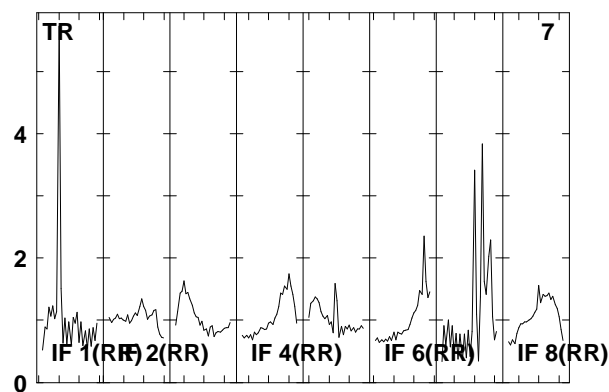
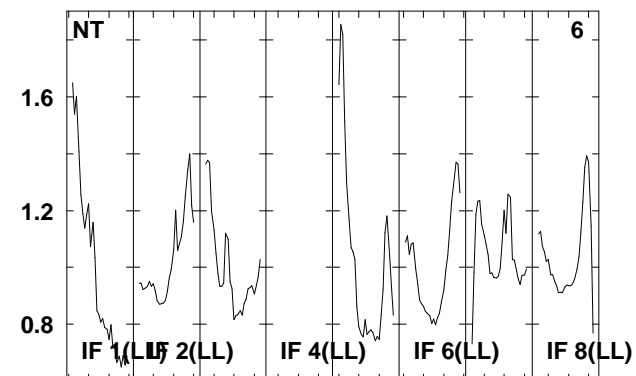
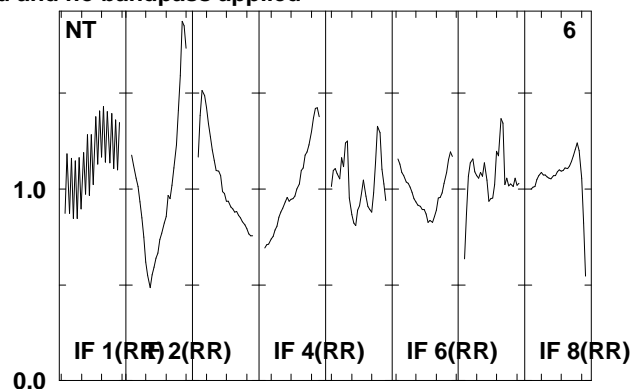
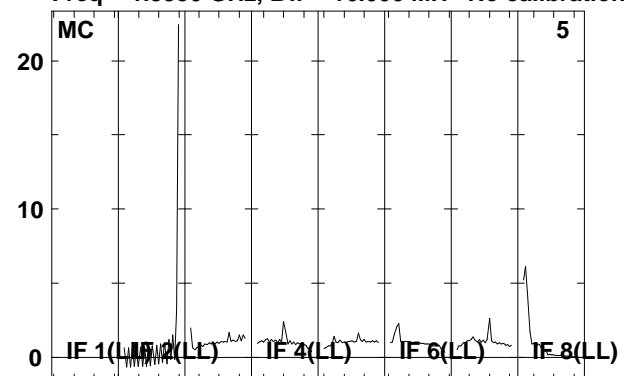

Lower frame: Real Jy

Total-power spectrum Antenna: \*

Timerange: 00/06:21:13 to 00/06:25:49

Plot file version 144 created 08-AUG-2008 16:59:28

J021348 EO006B.UVDATA.1

Freq = 1.5950 GHz, Bw = 16.000 MH No calibration applied and no bandpass applied

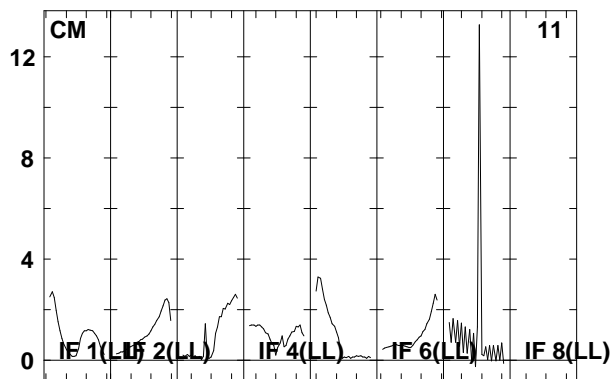
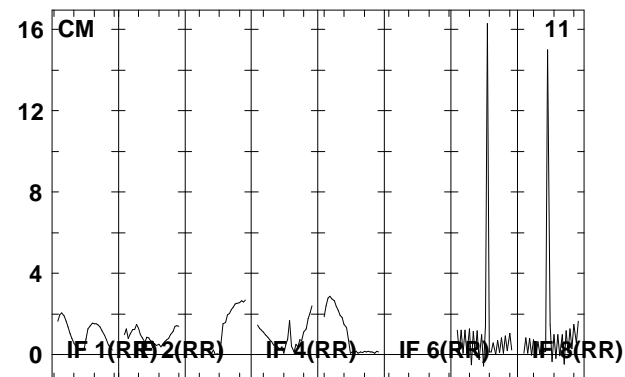
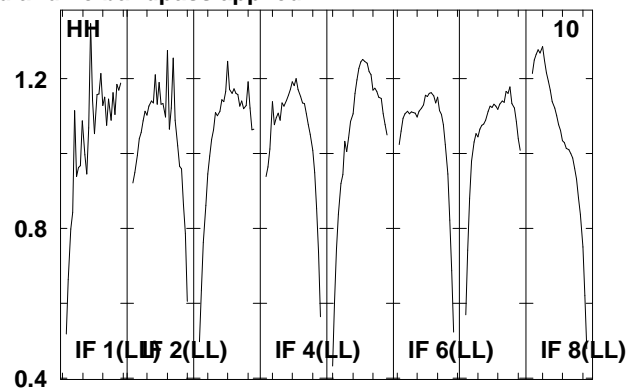
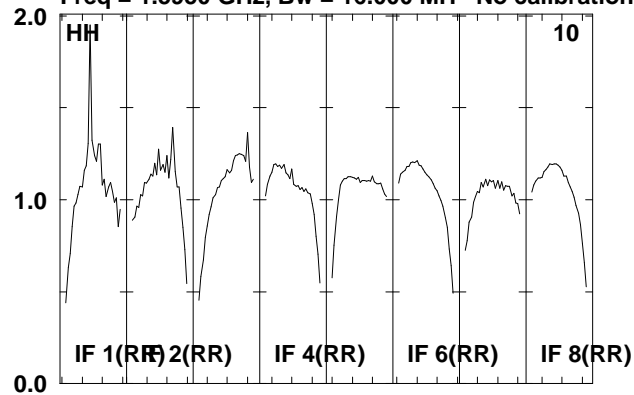

Lower frame: Real Jy  
Total-power spectrum Antenna: \*  
Timerange: 00/06:21:13 to 00/06:25:49

Plot file version 145 created 08-AUG-2008 16:59:28

J0209+13 EO006B.UVDATA.1

Freq = 1.5950 GHz, Bw = 16.000 MH No calibration applied and no bandpass applied

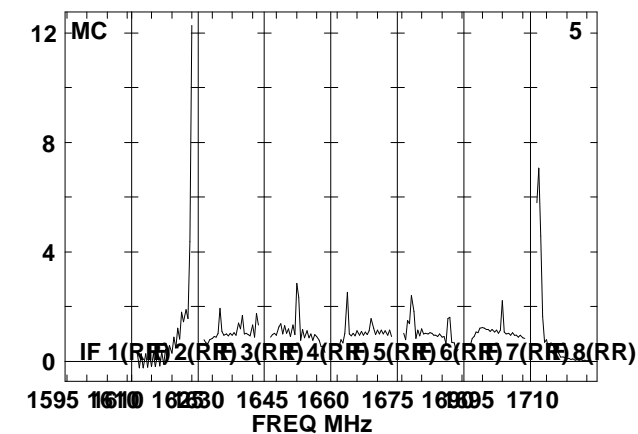
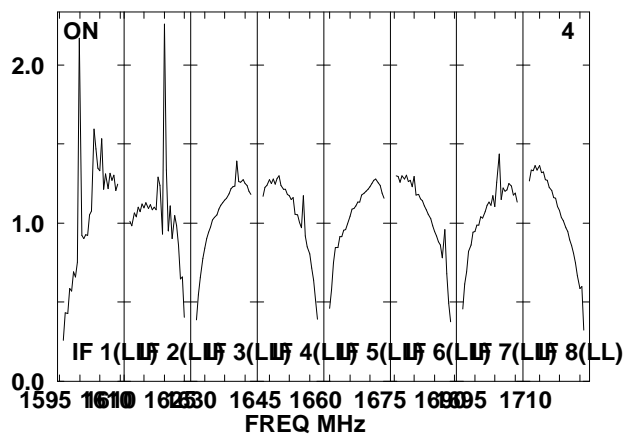
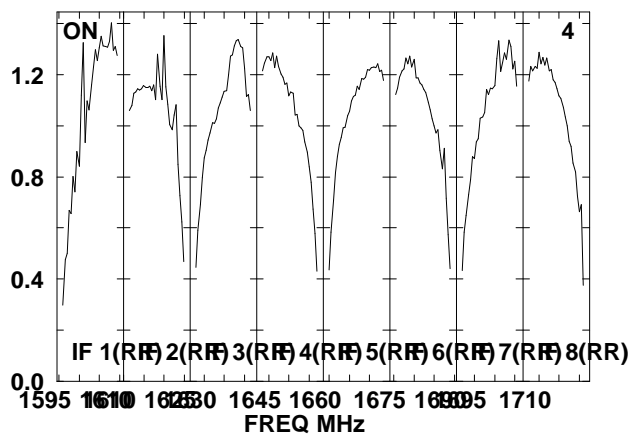
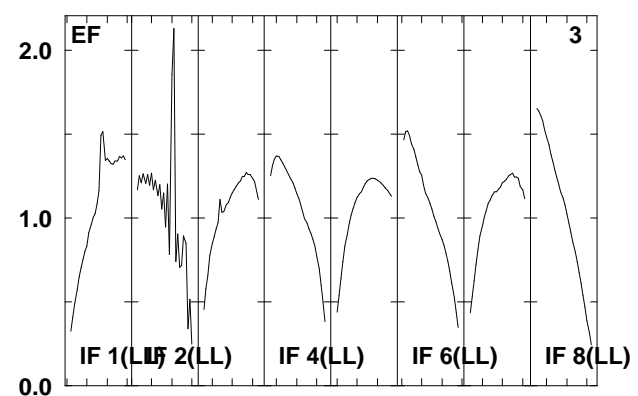
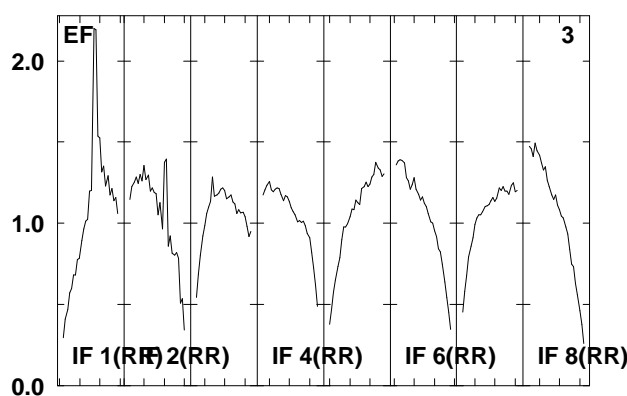
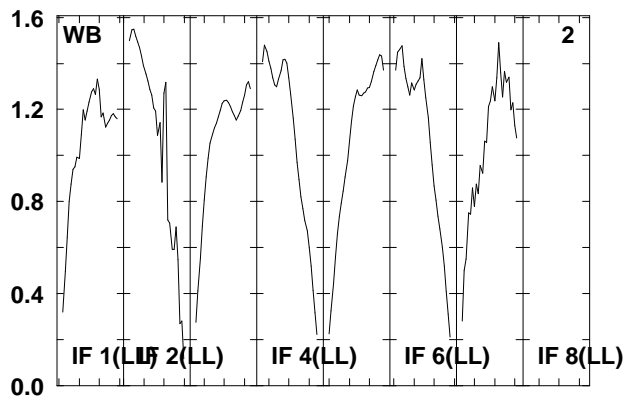
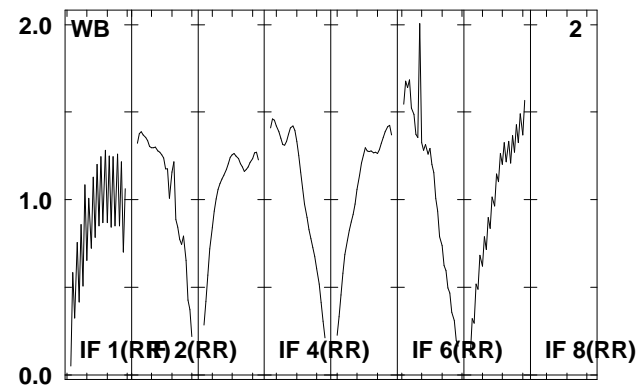
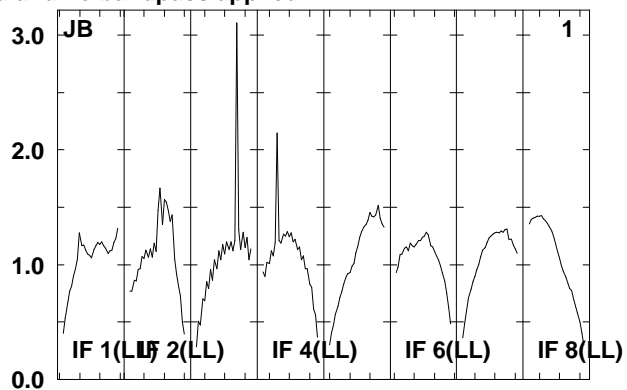
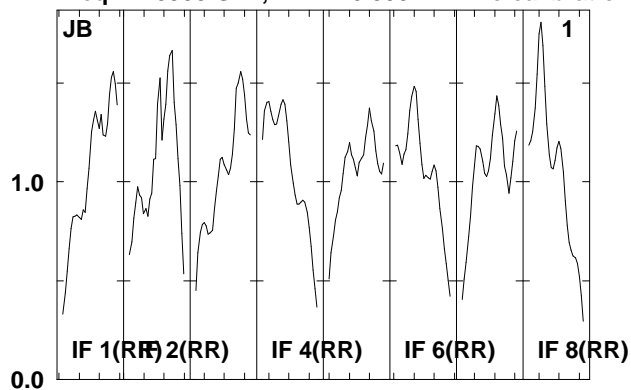

Lower frame: Real Jy  
Total-power spectrum Antenna: \*  
Timerange: 00/06:26:21 to 00/06:27:57

Plot file version 146 created 08-AUG-2008 16:59:29

J0209+13 EO006B.UVDATA.1

Freq = 1.5950 GHz, Bw = 16.000 MH No calibration applied and no bandpass applied

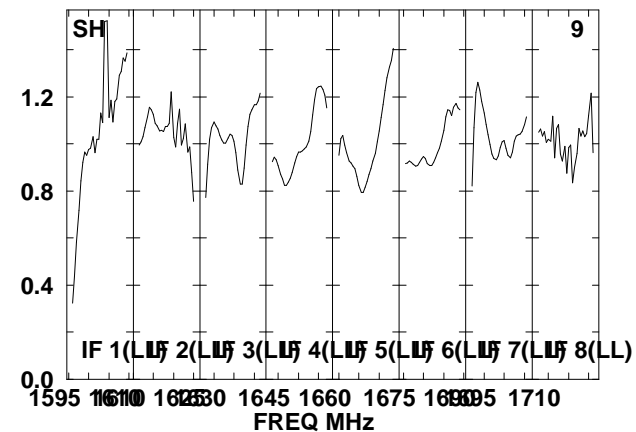
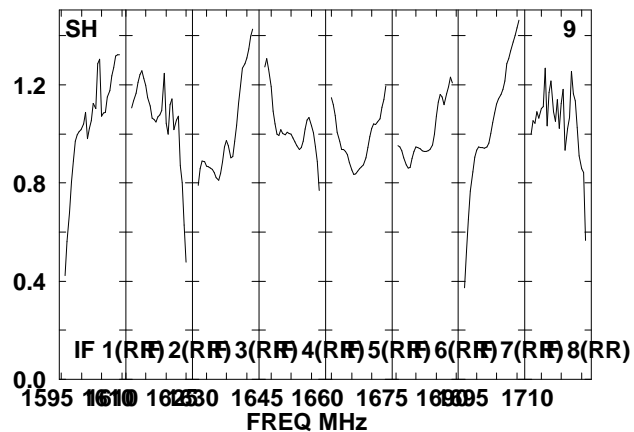
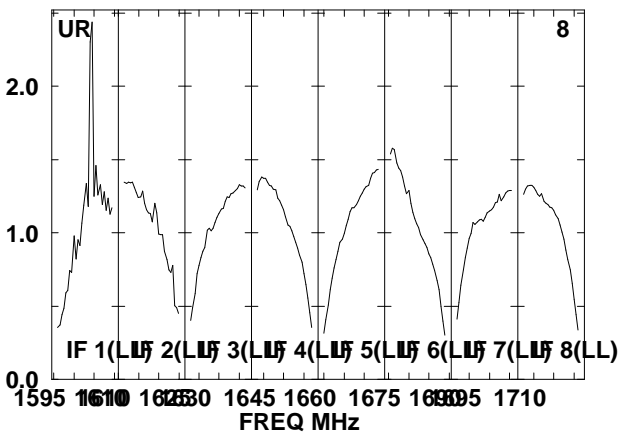
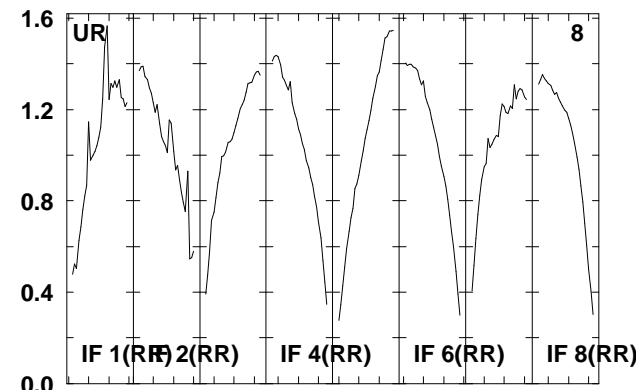
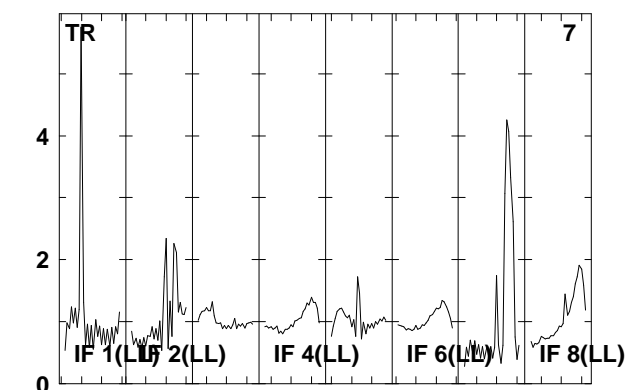
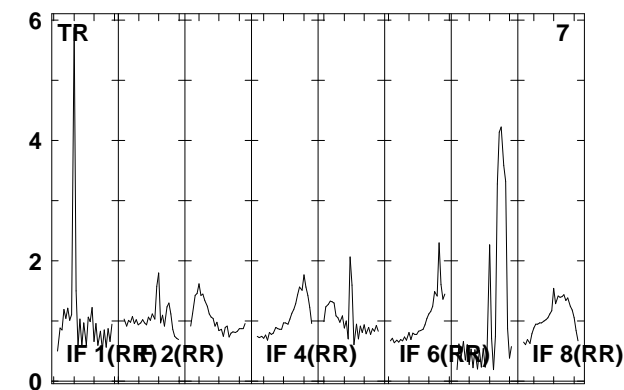
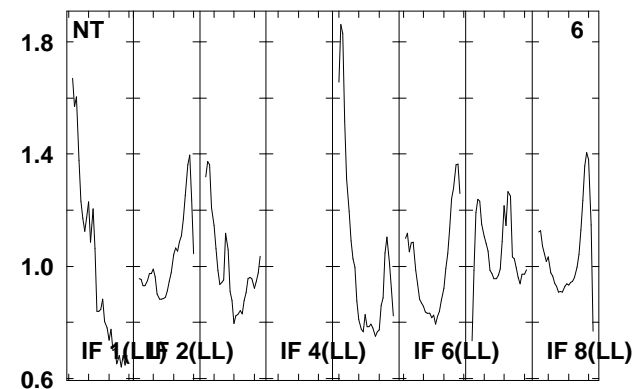
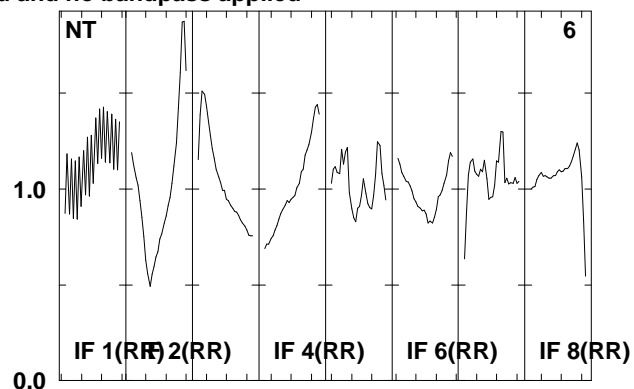
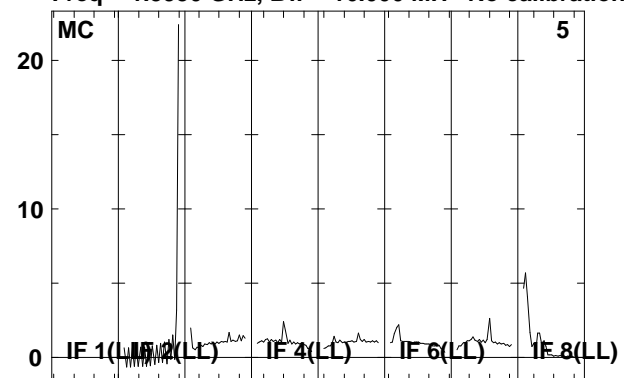

Lower frame: Real Jy  
Total-power spectrum Antenna: \*  
Timerange: 00/06:26:21 to 00/06:27:57

Plot file version 147 created 08-AUG-2008 16:59:29

J0209+13 EO006B.UVDATA.1

Freq = 1.5950 GHz, Bw = 16.000 MH No calibration applied and no bandpass applied

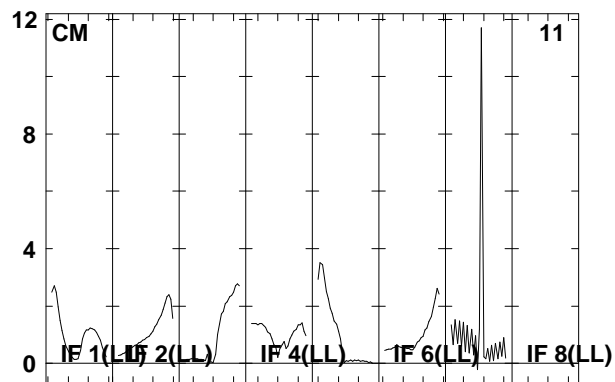
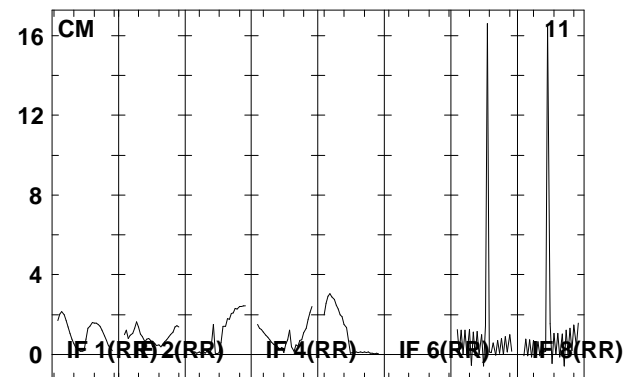
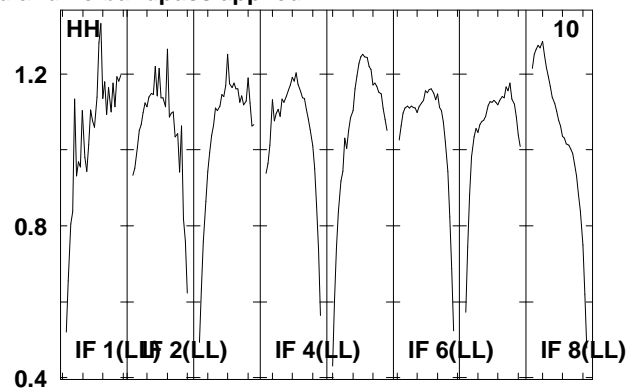
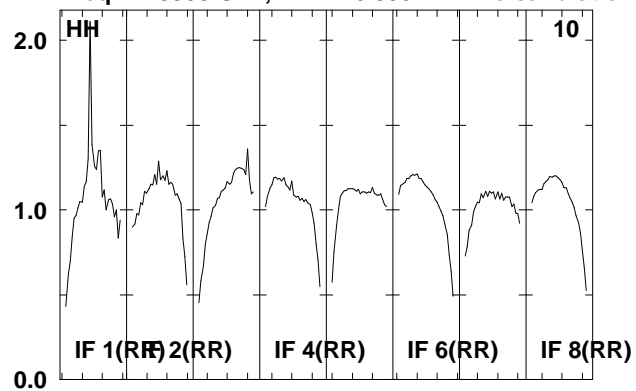

Lower frame: Real Jy  
Total-power spectrum Antenna: \*  
Timerange: 00/06:26:21 to 00/06:27:57

Plot file version 148 created 08-AUG-2008 16:59:29

J0237+28 EO006B.UVDATA.1

Freq = 1.5950 GHz, Bw = 16.000 MH No calibration applied and no bandpass applied

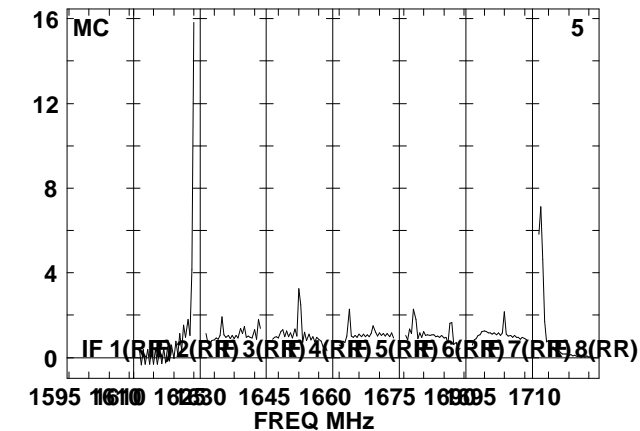
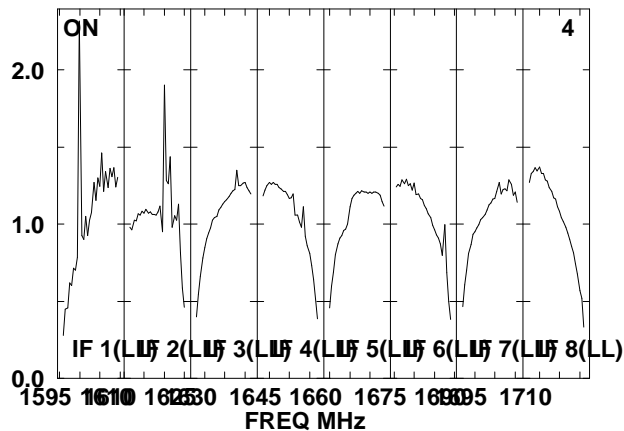
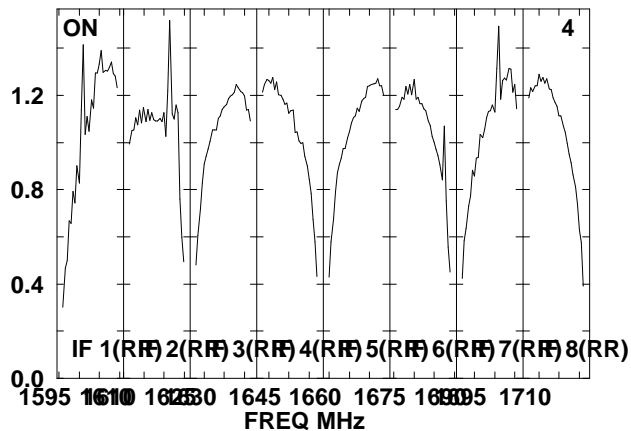
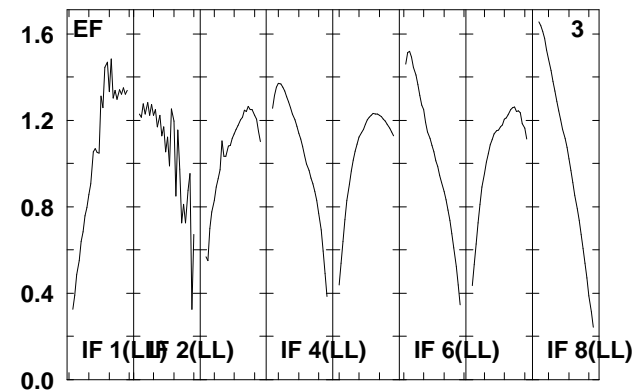
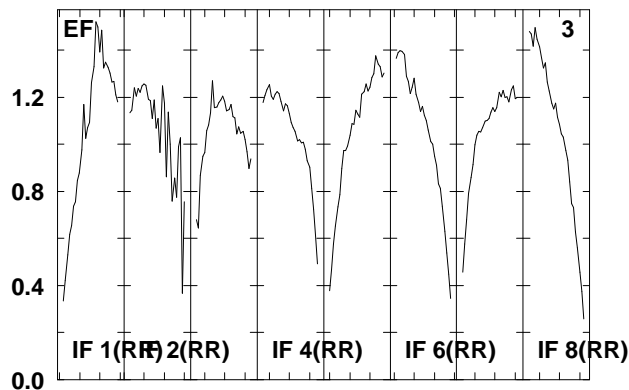
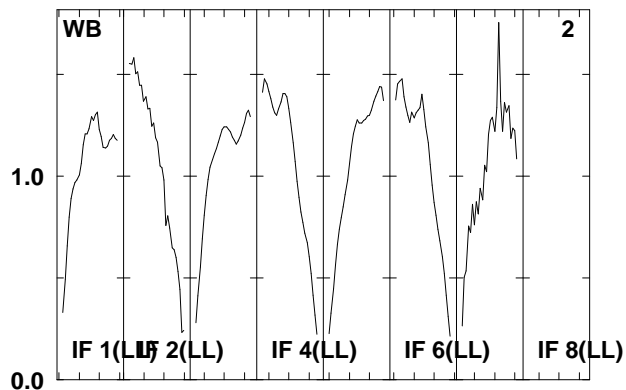
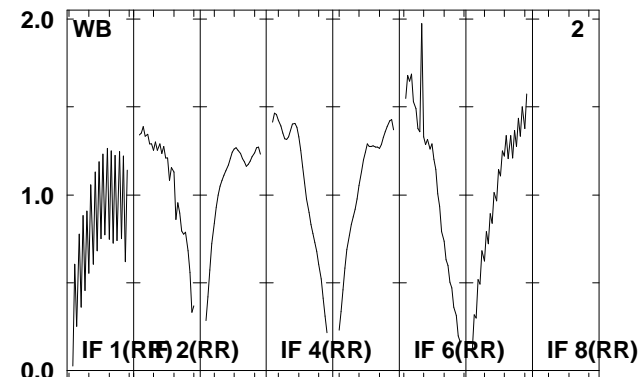
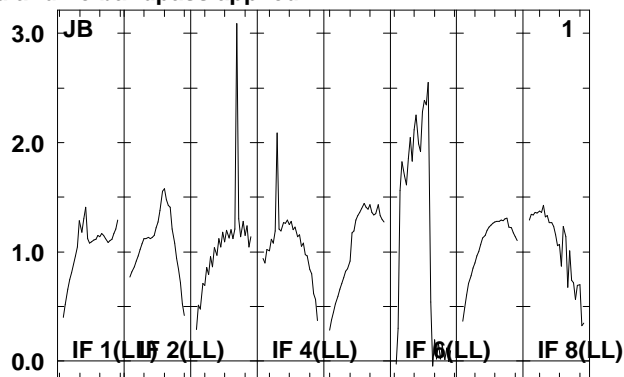
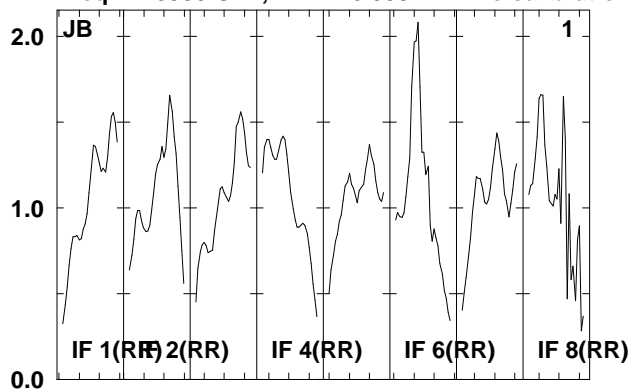

Lower frame: Real Jy  
Total-power spectrum Antenna: \*  
Timerange: 00/06:29:53 to 00/06:35:21



Plot file version 149 created 08-AUG-2008 16:59:30

J0237+28 EO006B.UVDATA.1

Freq = 1.5950 GHz, Bw = 16.000 MH No calibration applied and no bandpass applied

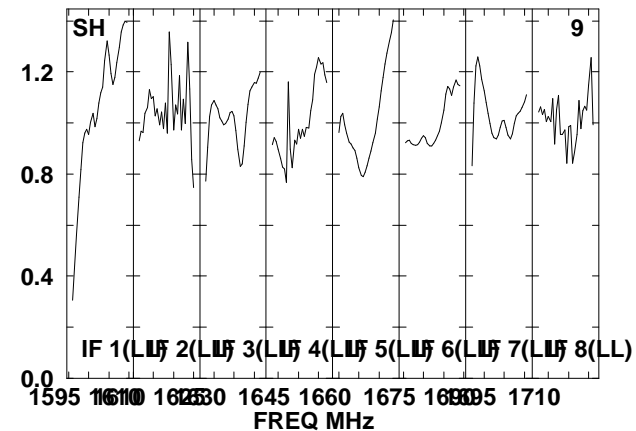
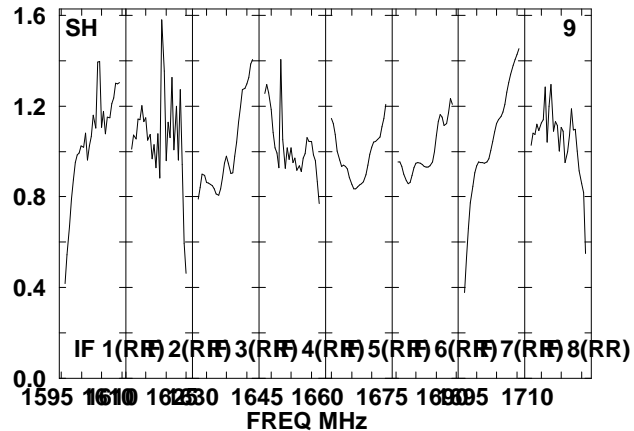
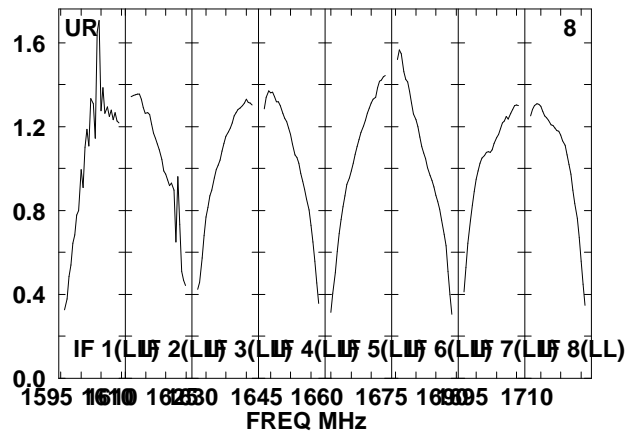
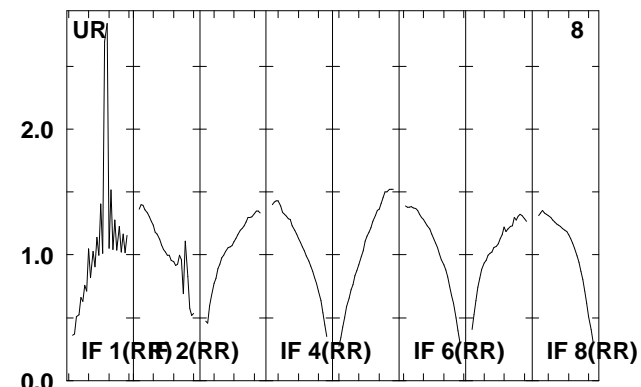
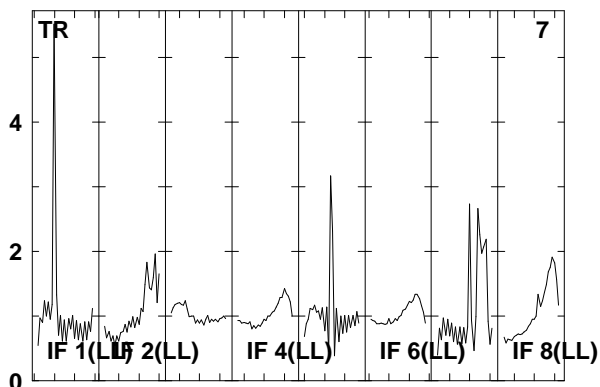
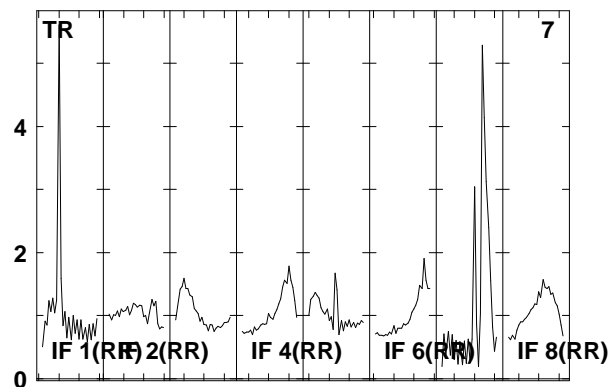
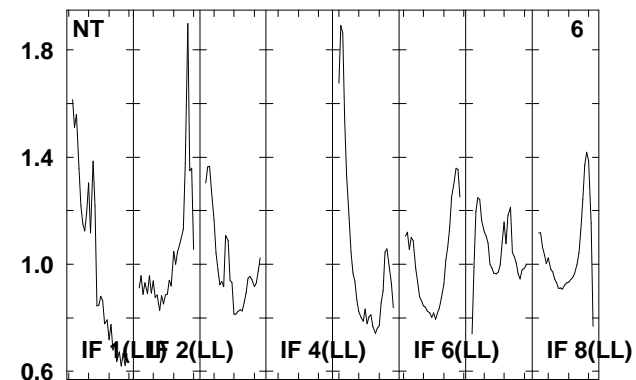
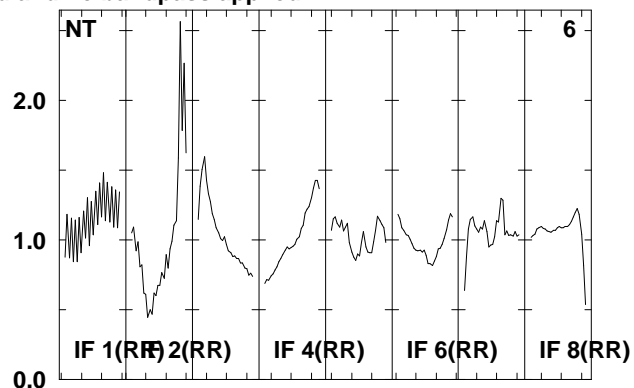
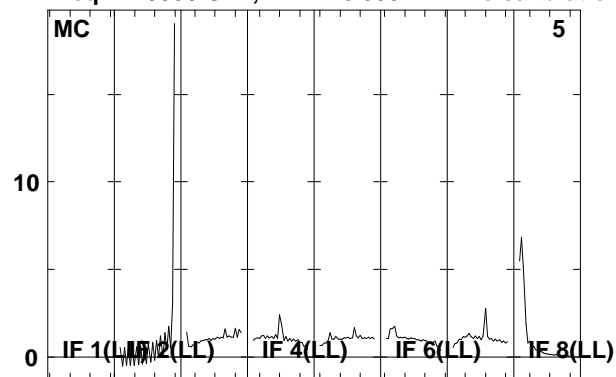

Lower frame: Real Jy

Total-power spectrum Antenna: \*

Timerange: 00/06:29:53 to 00/06:35:21

Plot file version 150 created 08-AUG-2008 16:59:31

J0237+28 EO006B.UVDATA.1

Freq = 1.5950 GHz, Bw = 16.000 MH No calibration applied and no bandpass applied

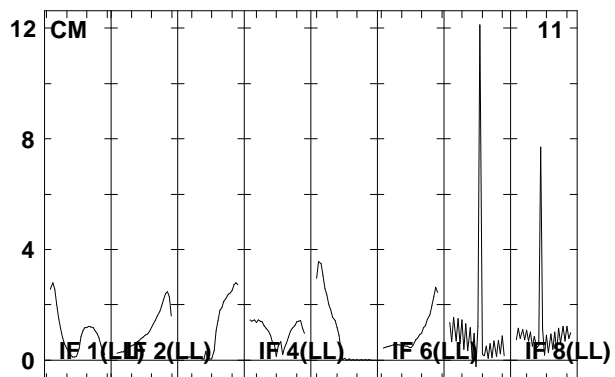
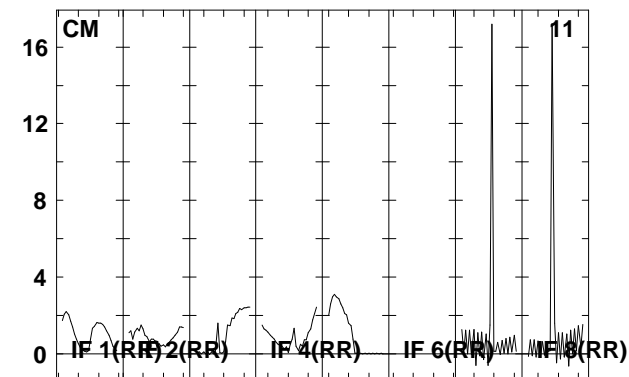
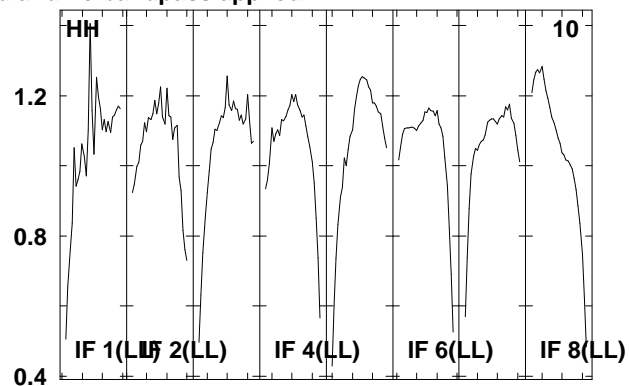
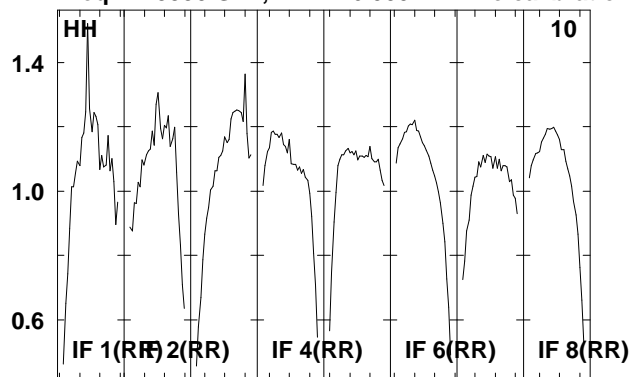

Lower frame: Real Jy  
Total-power spectrum Antenna: \*  
Timerange: 00/06:29:53 to 00/06:35:21

Plot file version 151 created 08-AUG-2008 16:59:32

J0204+15 EO006B.UVDATA.1

Freq = 1.5950 GHz, Bw = 16.000 MH No calibration applied and no bandpass applied

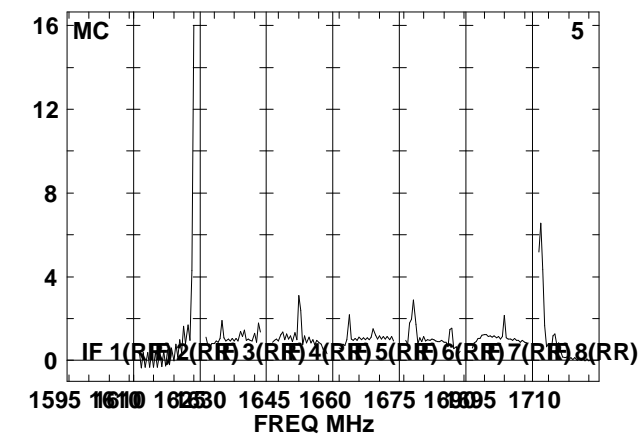
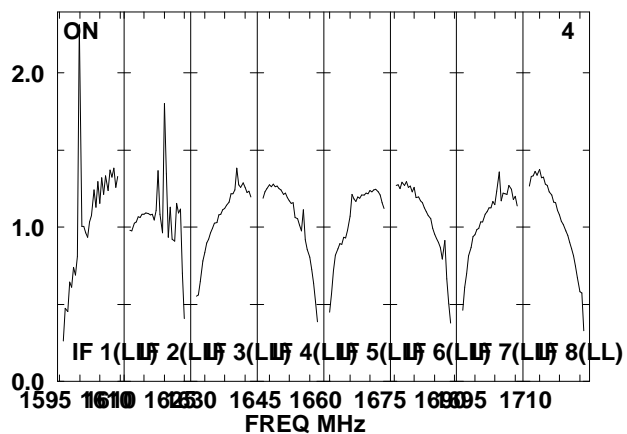
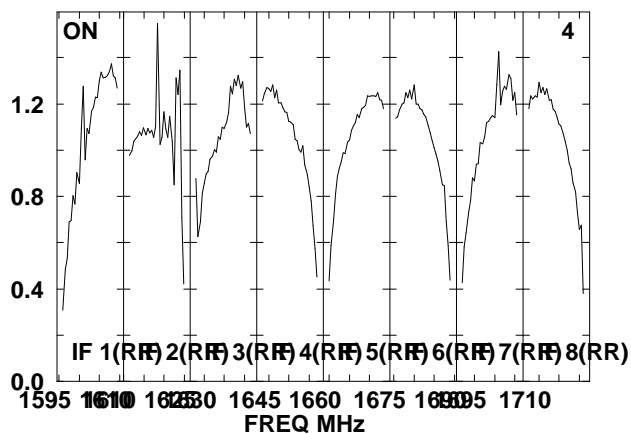
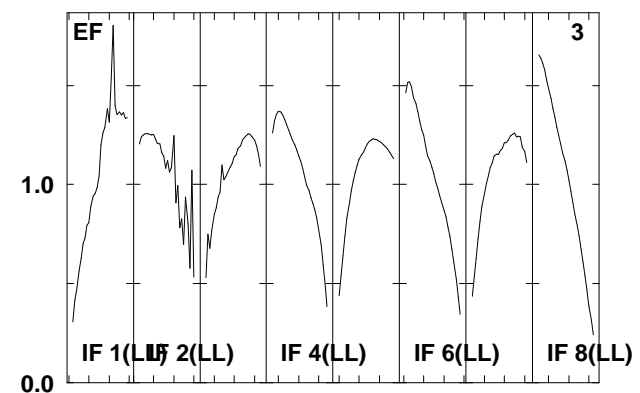
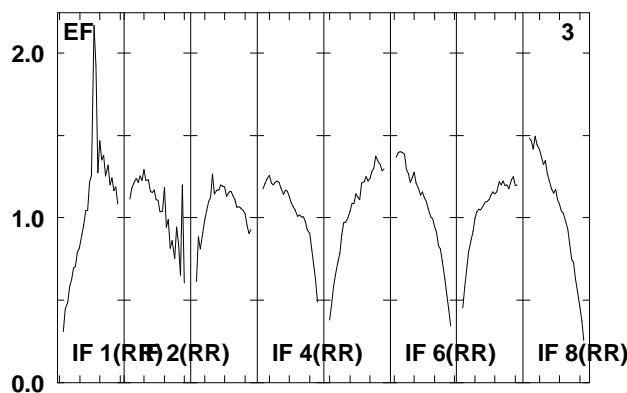
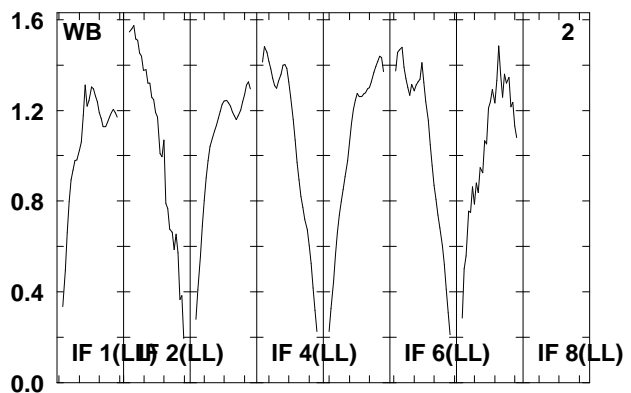
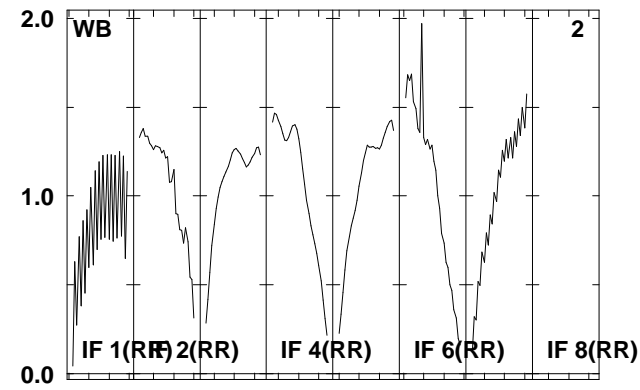
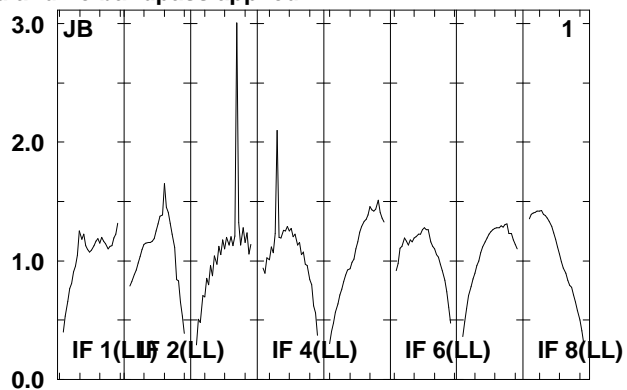
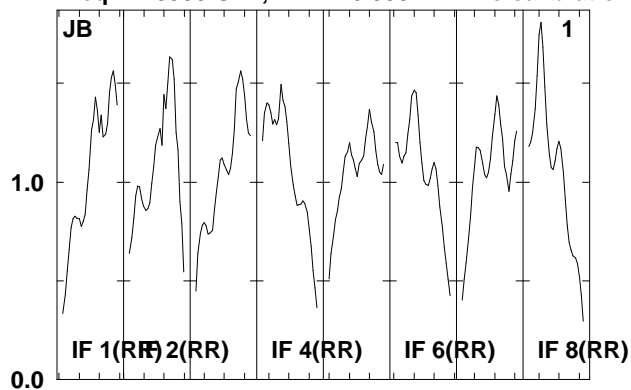

Lower frame: Real Jy  
Total-power spectrum Antenna: \*  
Timerange: 00/06:36:05 to 00/06:41:57

Plot file version 152 created 08-AUG-2008 16:59:32

J0204+15 EO006B.UVDATA.1

Freq = 1.5950 GHz, Bw = 16.000 MH No calibration applied and no bandpass applied

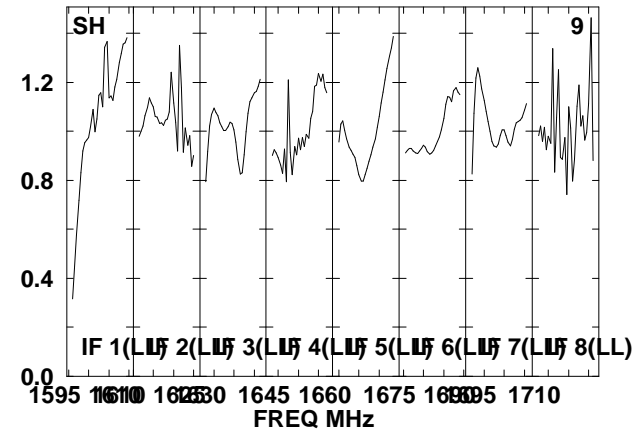
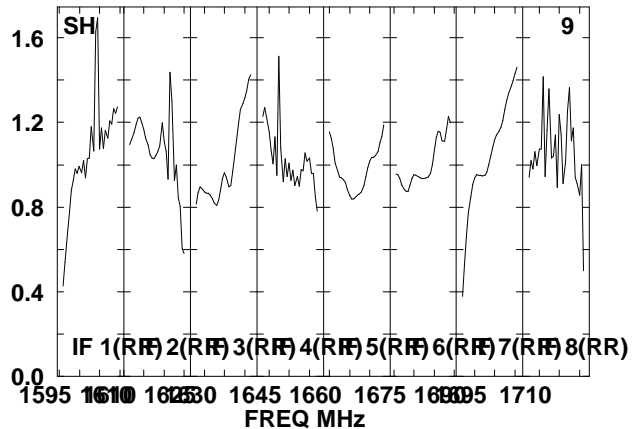
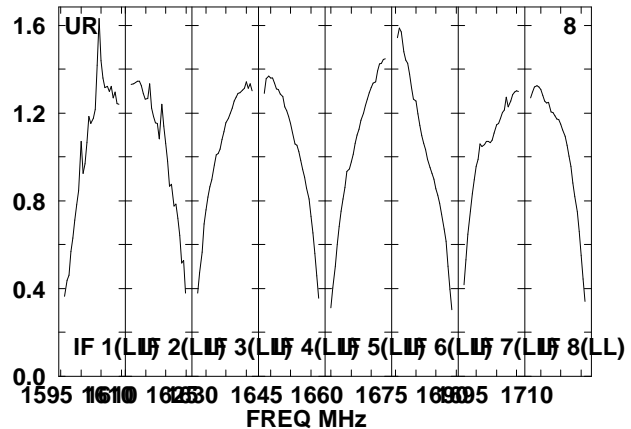
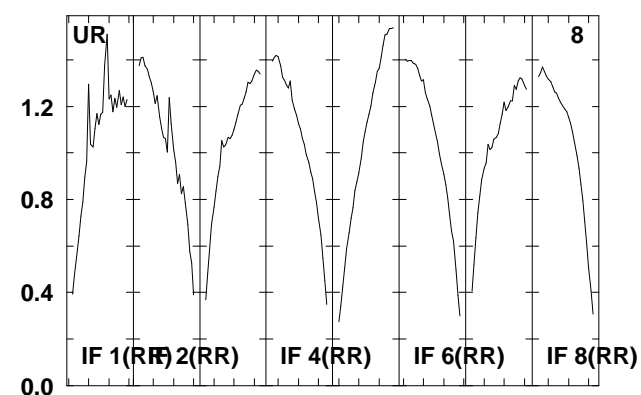
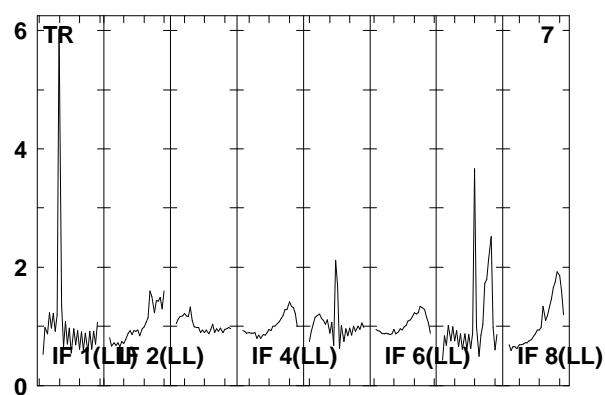
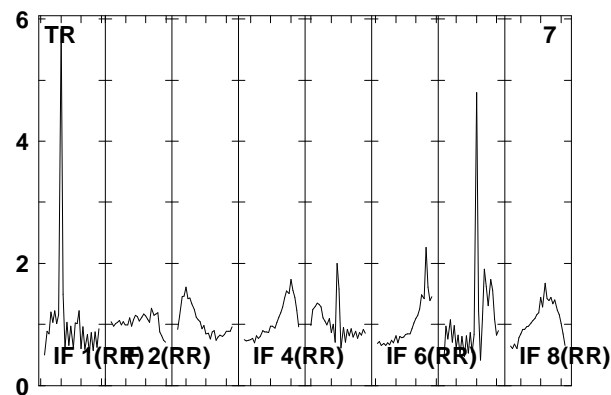
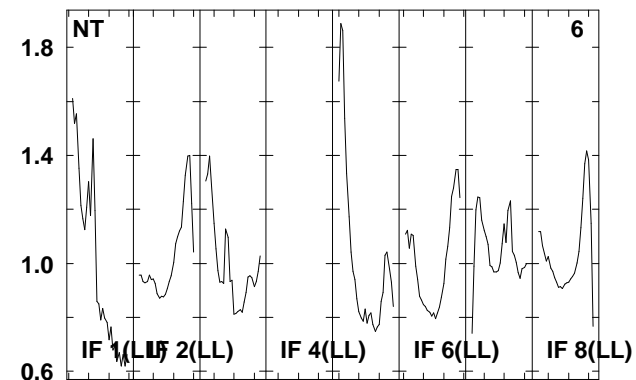
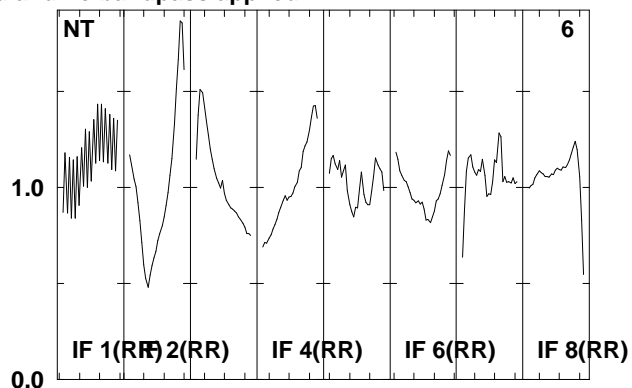
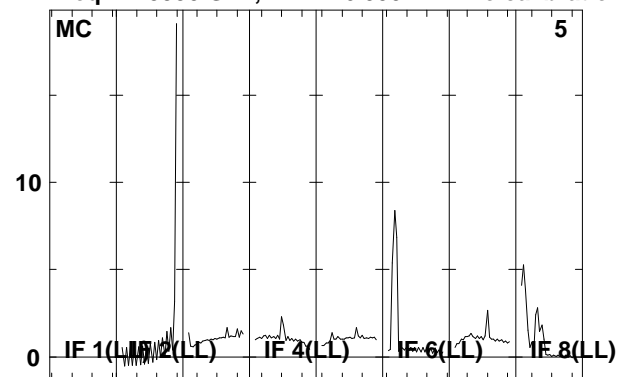

Lower frame: Real Jy  
Total-power spectrum Antenna: \*  
Timerange: 00/06:36:05 to 00/06:41:57

Plot file version 153 created 08-AUG-2008 16:59:33

J0204+15 EO006B.UVDATA.1

Freq = 1.5950 GHz, Bw = 16.000 MH No calibration applied and no bandpass applied

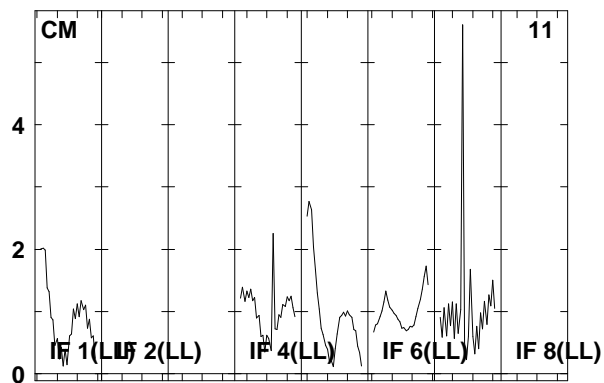
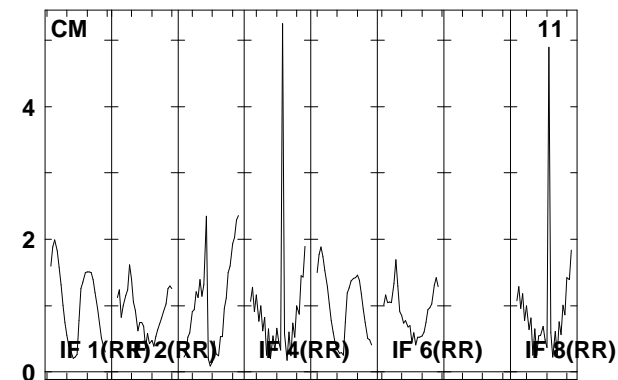
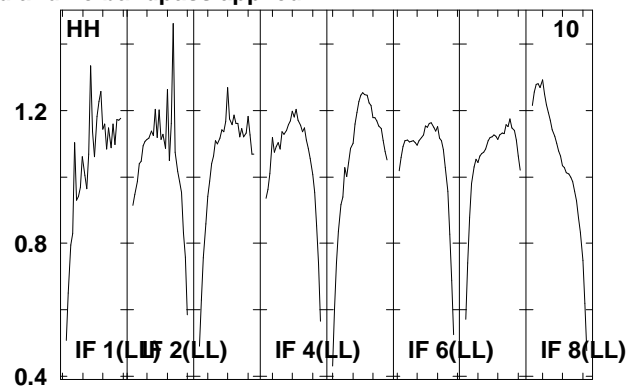
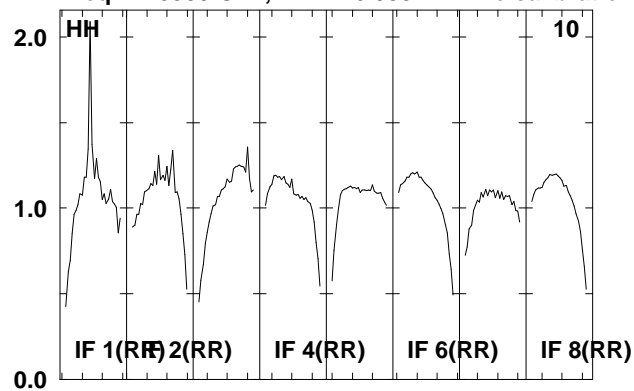

Lower frame: Real Jy  
Total-power spectrum Antenna: \*  
Timerange: 00/06:36:05 to 00/06:41:57

Plot file version 154 created 08-AUG-2008 16:59:34

J0209+13 EO006B.UVDATA.1

Freq = 1.5950 GHz, Bw = 16.000 MH No calibration applied and no bandpass applied

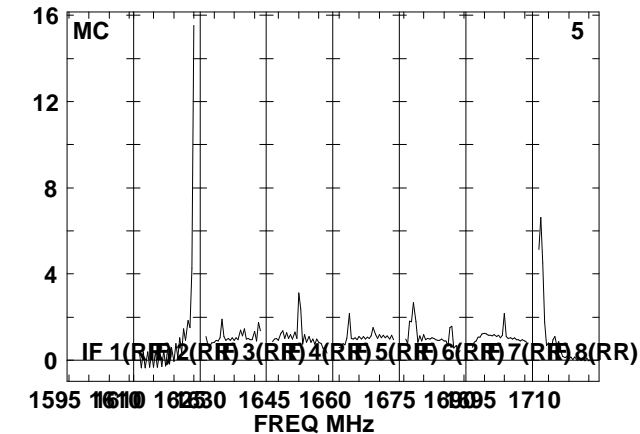
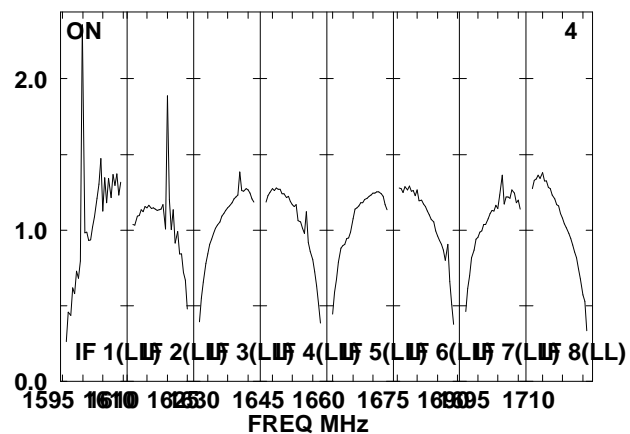
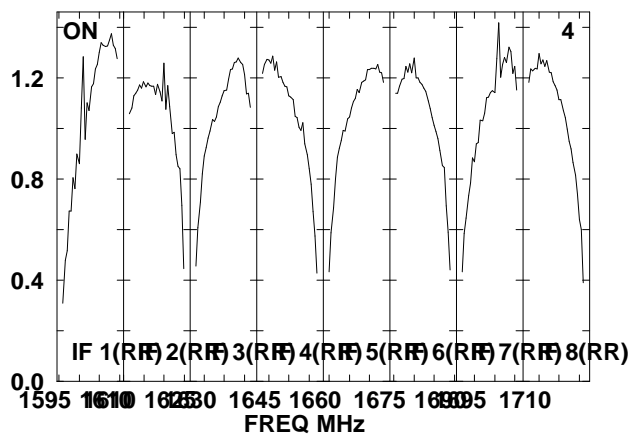
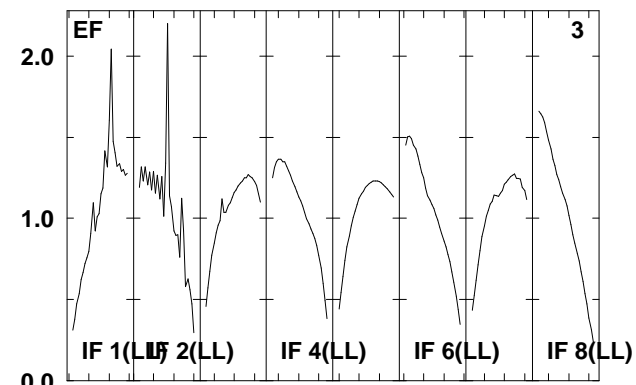
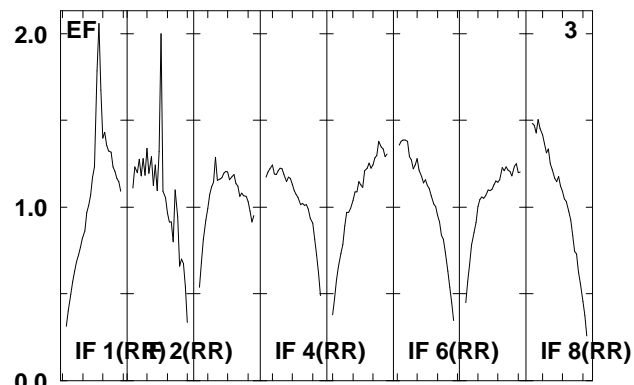
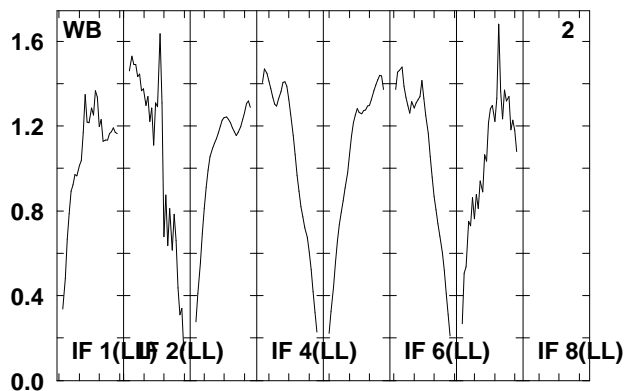
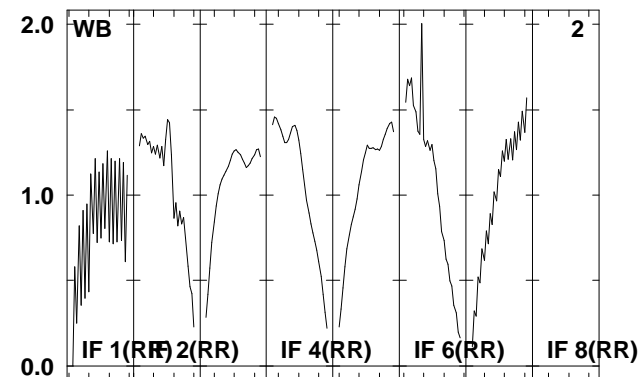
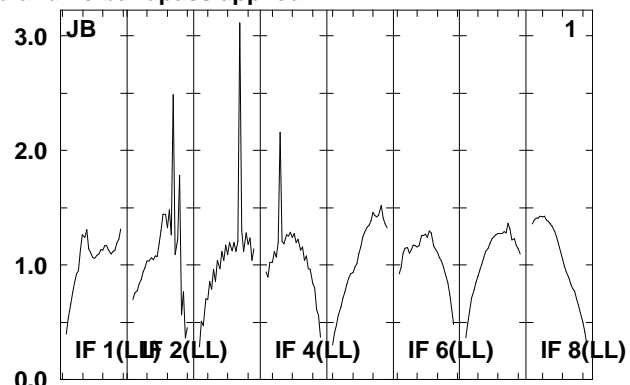
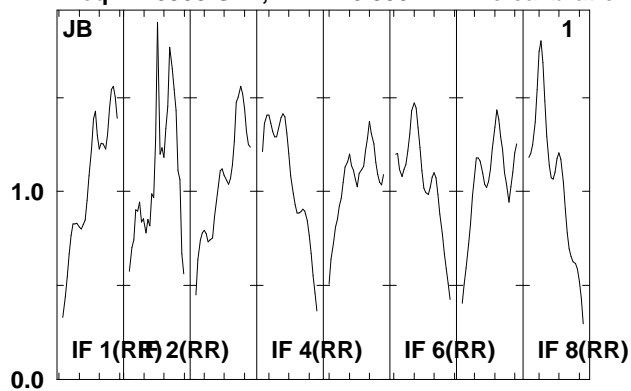

Lower frame: Real Jy  
Total-power spectrum Antenna: \*  
Timerange: 00/06:43:41 to 00/06:45:17

Plot file version 155 created 08-AUG-2008 16:59:34

J0209+13 EO006B.UVDATA.1

Freq = 1.5950 GHz, Bw = 16.000 MH No calibration applied and no bandpass applied

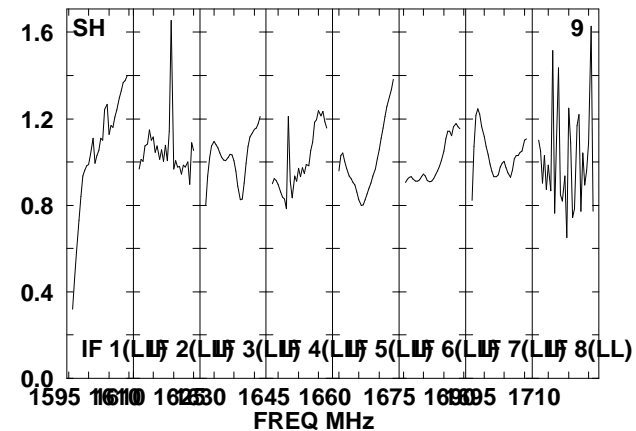
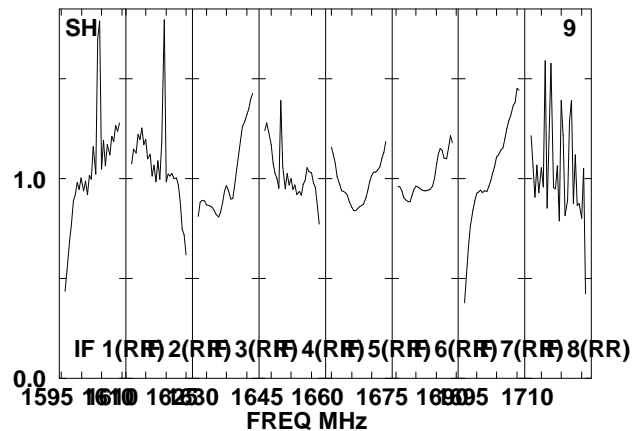
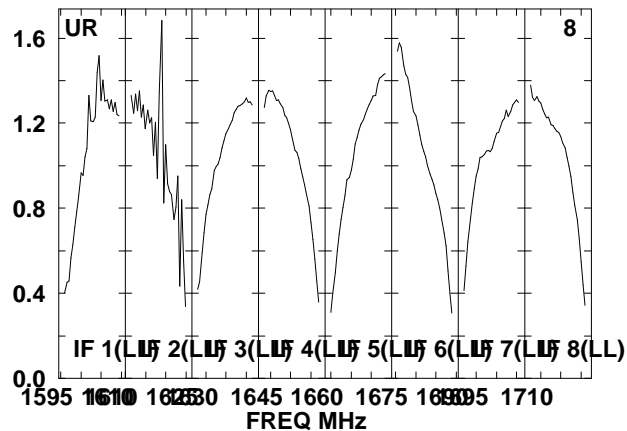
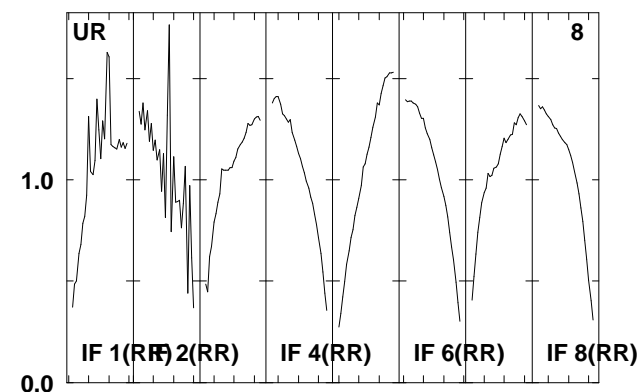
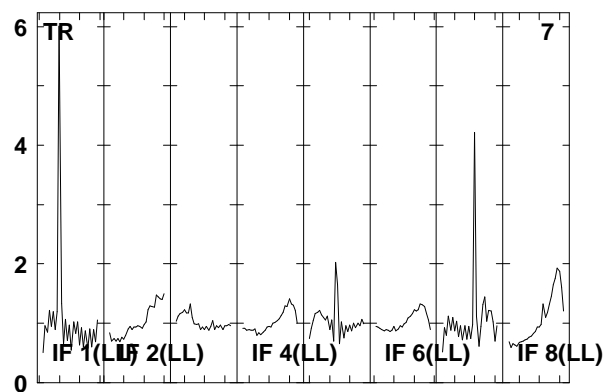
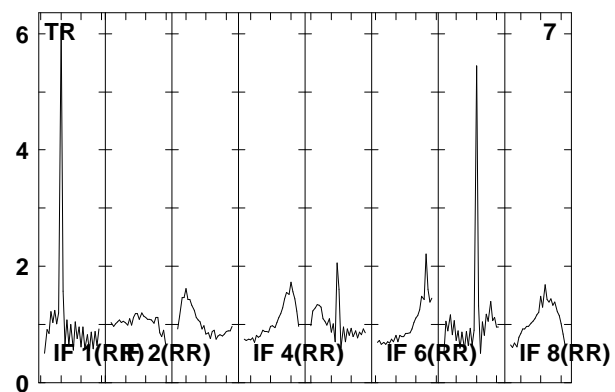
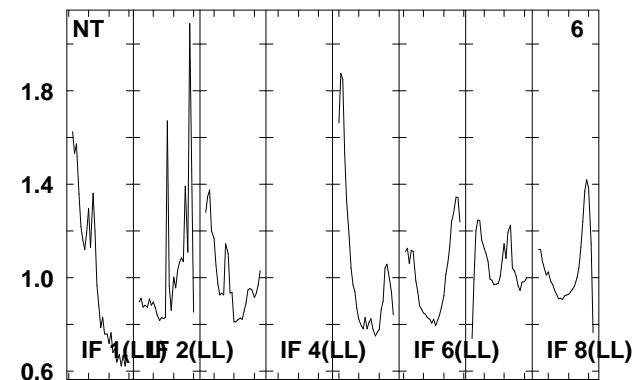
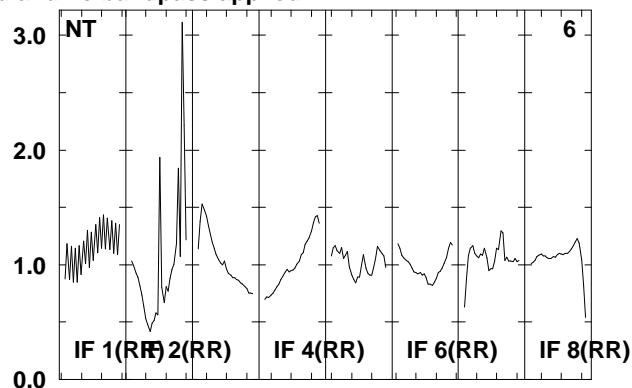
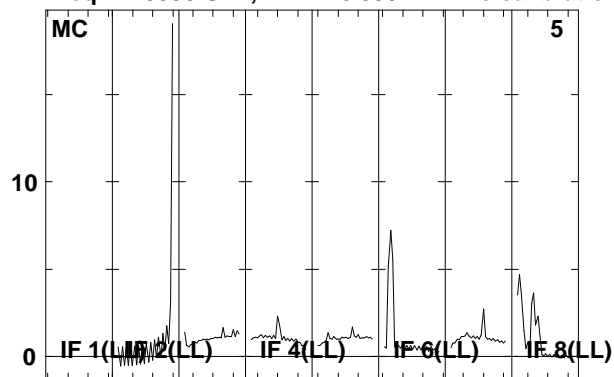

Lower frame: Real Jy

Total-power spectrum Antenna: \*

Timerange: 00/06:43:41 to 00/06:45:17

Plot file version 156 created 08-AUG-2008 16:59:35

J0209+13 EO006B.UVDATA.1

Freq = 1.5950 GHz, Bw = 16.000 MH No calibration applied and no bandpass applied

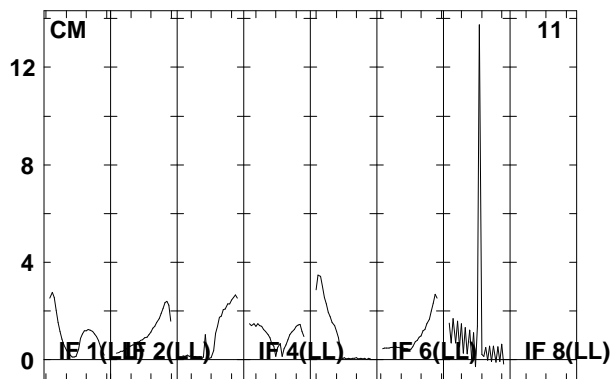
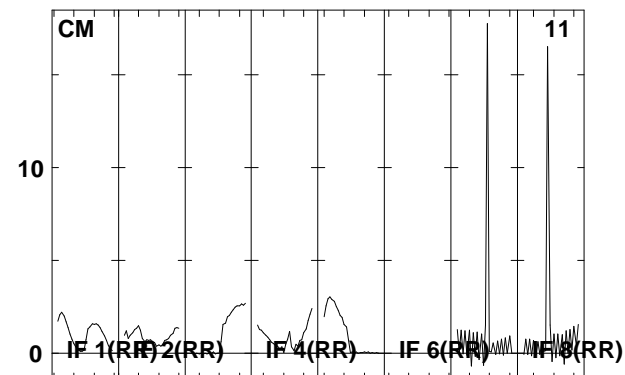
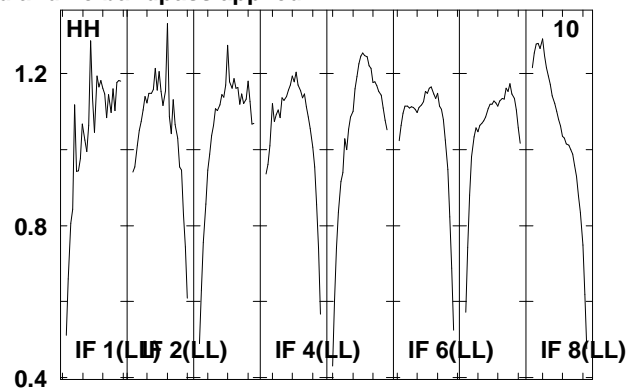
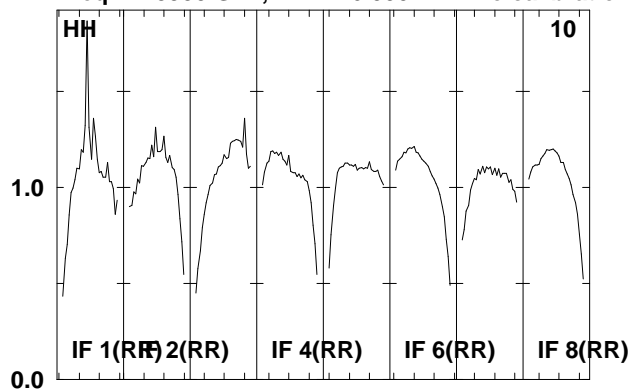

Lower frame: Real Jy  
Total-power spectrum Antenna: \*  
Timerange: 00/06:43:41 to 00/06:45:17



Plot file version 157 created 08-AUG-2008 16:59:35

J021348 EO006B.UVDATA.1

Freq = 1.5950 GHz, Bw = 16.000 MH No calibration applied and no bandpass applied

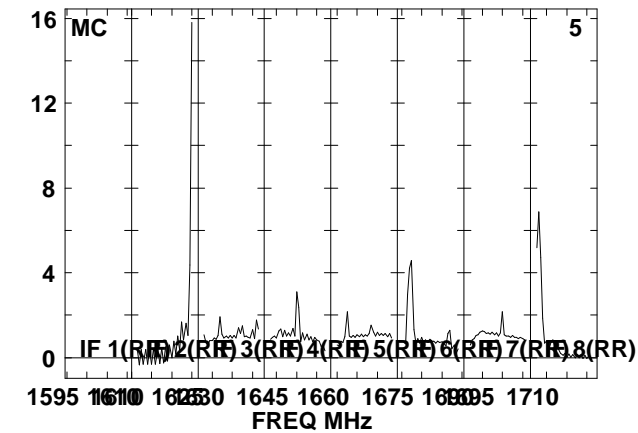
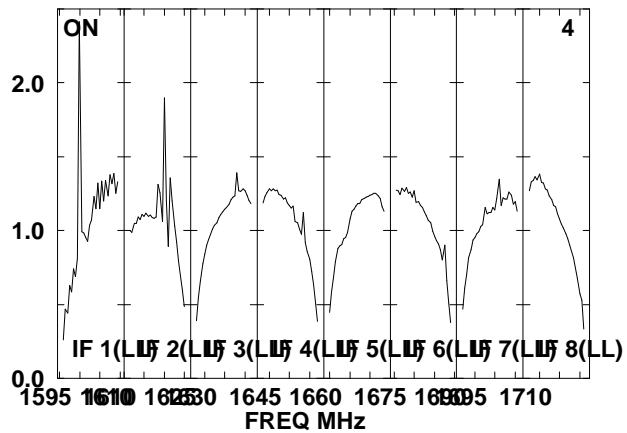
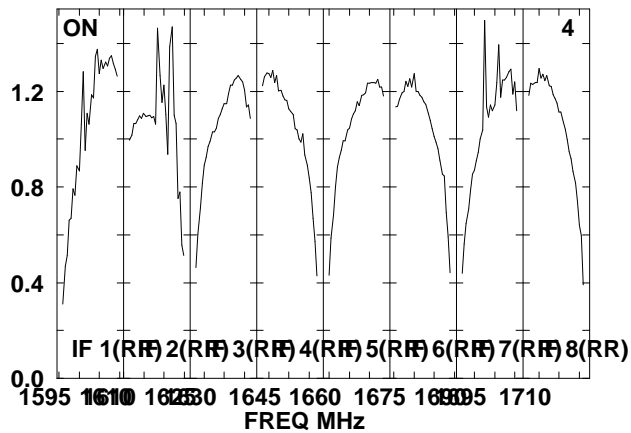
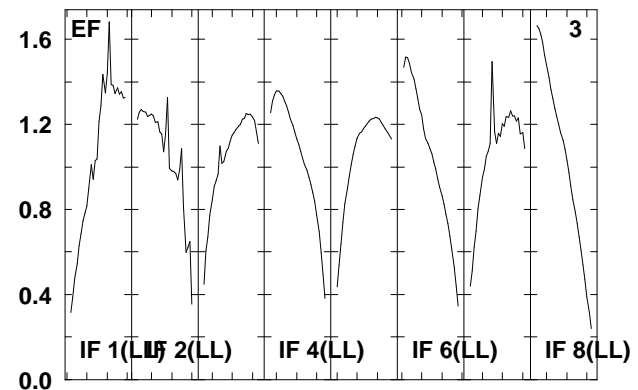
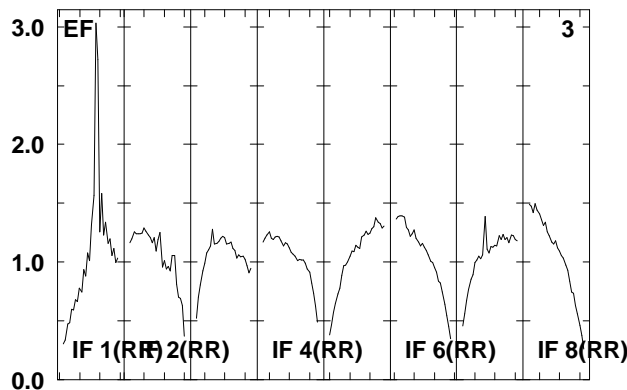
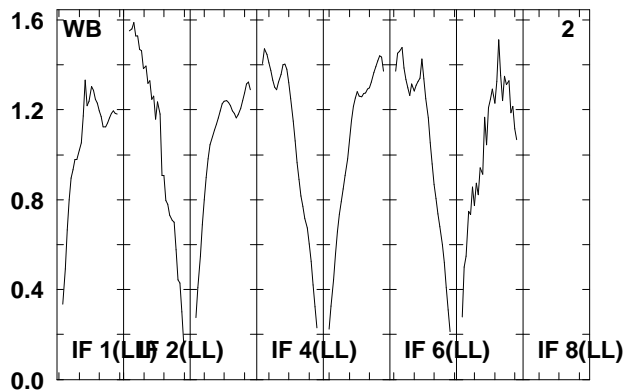
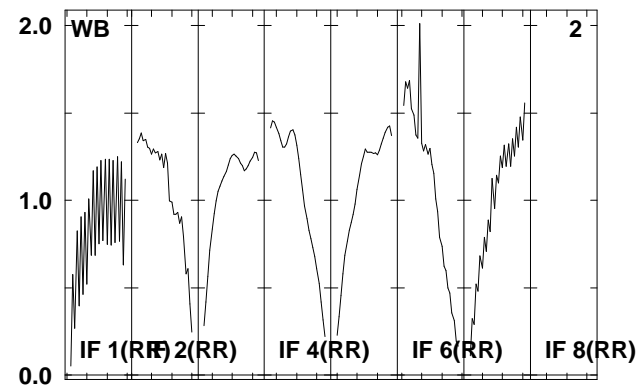
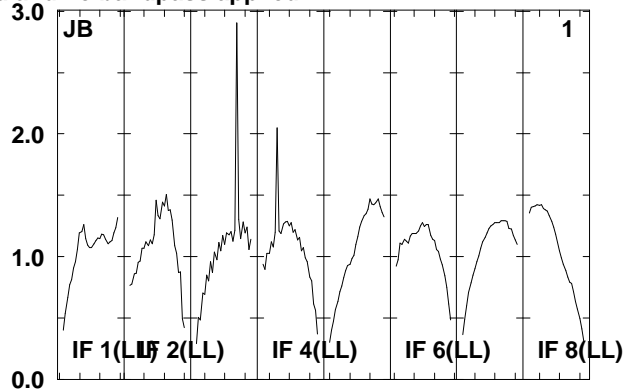
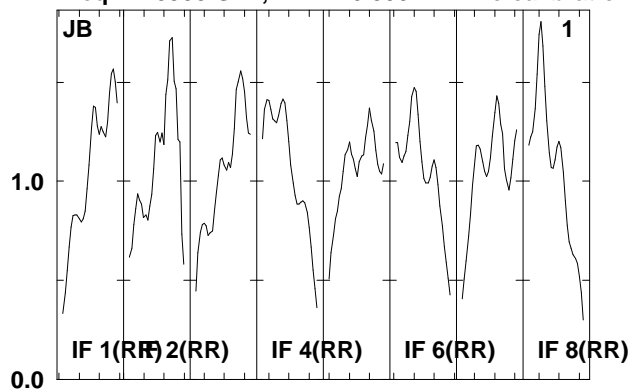

Lower frame: Real Jy  
Total-power spectrum Antenna: \*  
Timerange: 00/06:45:53 to 00/06:50:29

Plot file version 158 created 08-AUG-2008 16:59:36

J021348 EO06B.UVDATA.1

Freq = 1.5950 GHz, Bw = 16.000 MH No calibration applied and no bandpass applied

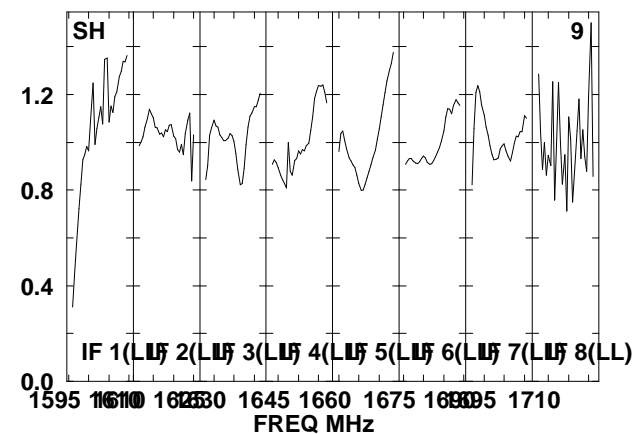
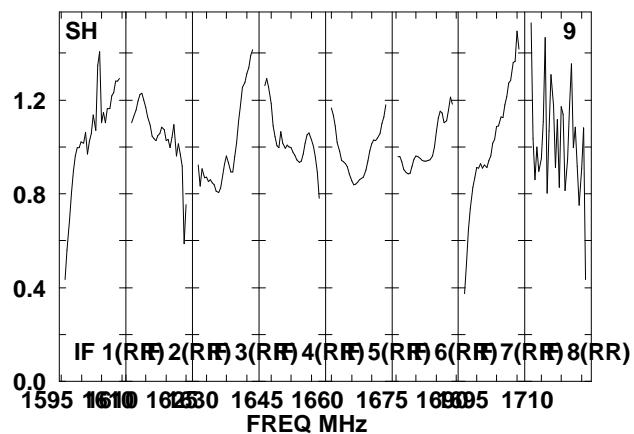
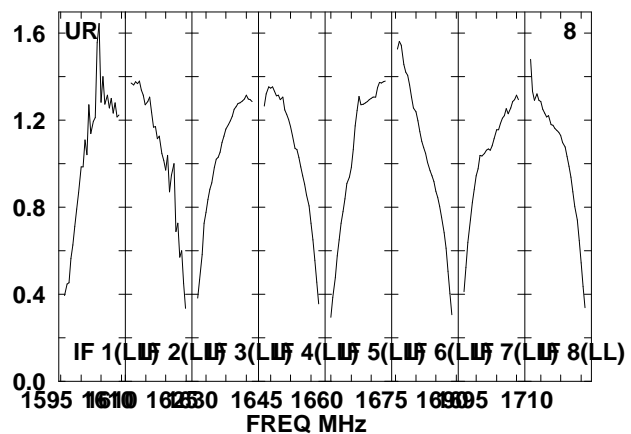
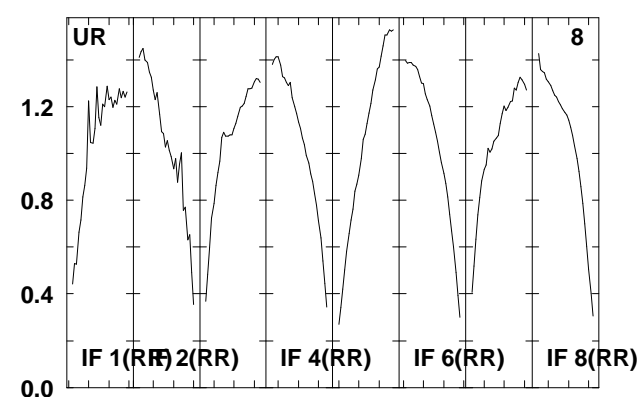
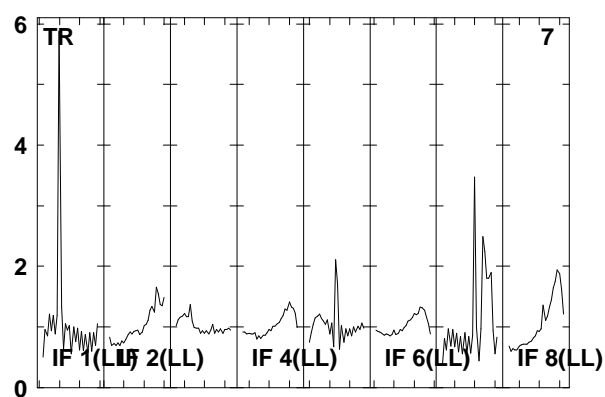
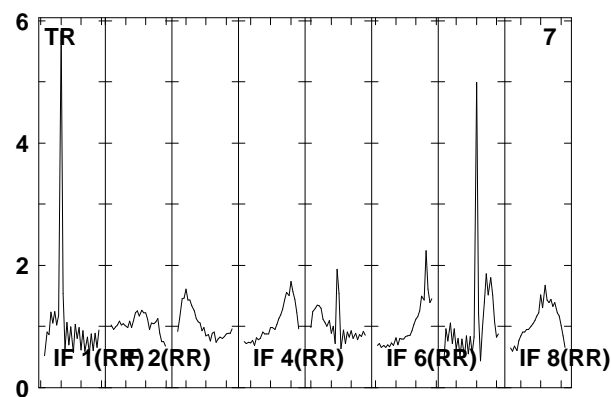
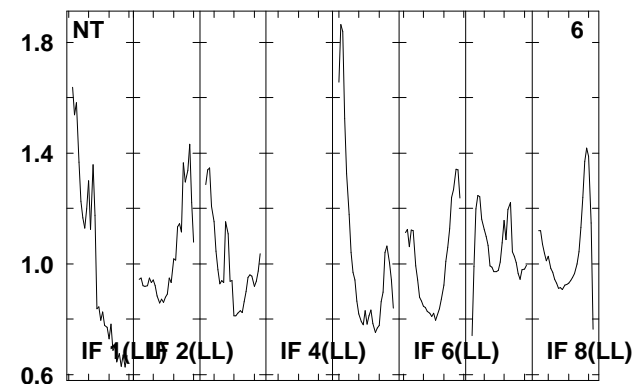
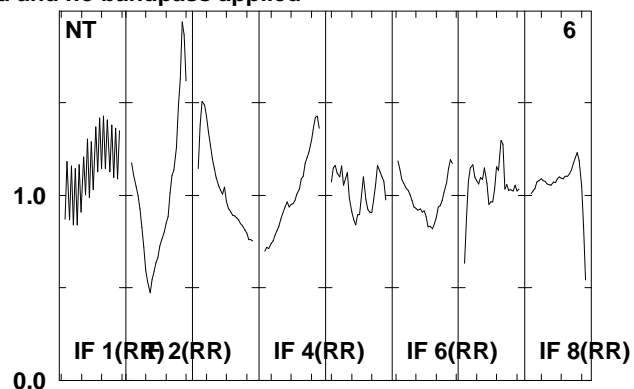
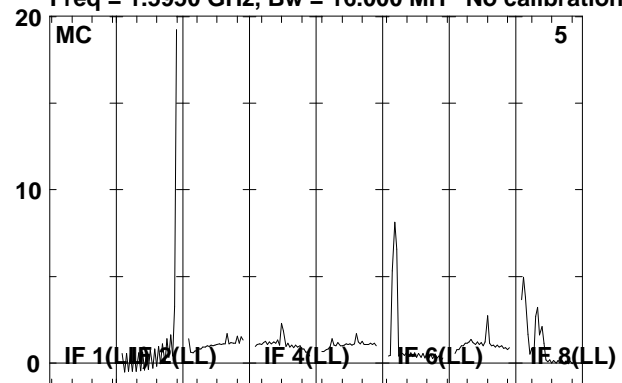

Lower frame: Real Jy

Total-power spectrum Antenna: \*

Timerange: 00/06:45:53 to 00/06:50:29

Plot file version 159 created 08-AUG-2008 16:59:37

J021348 EO006B.UVDATA.1

Freq = 1.5950 GHz, Bw = 16.000 MH No calibration applied and no bandpass applied

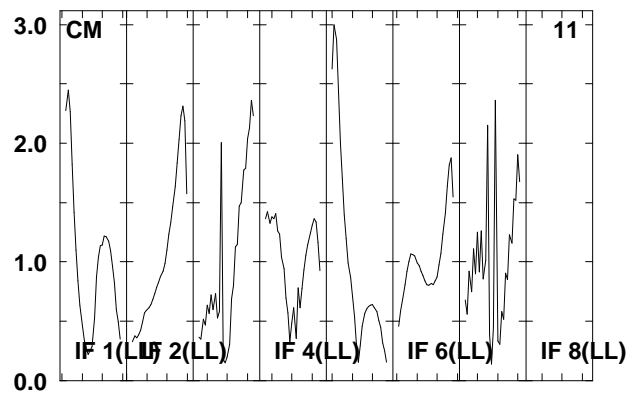
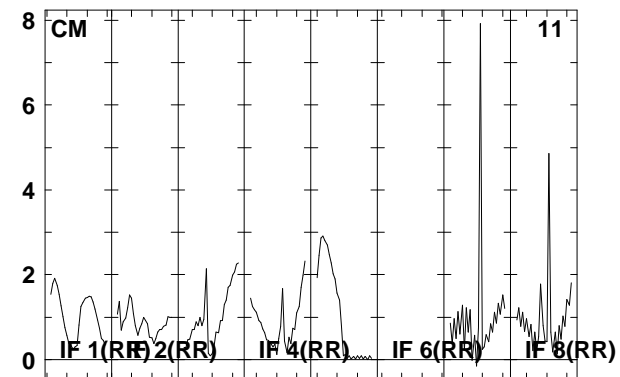
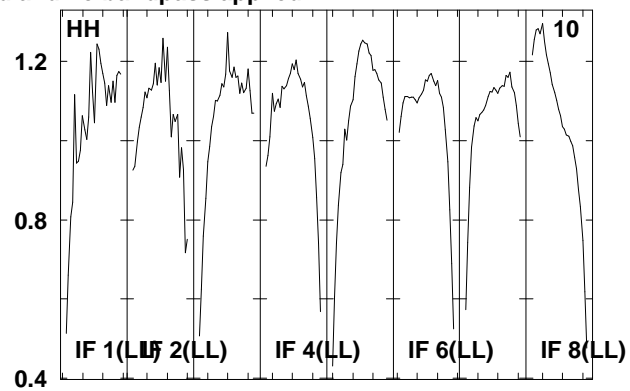
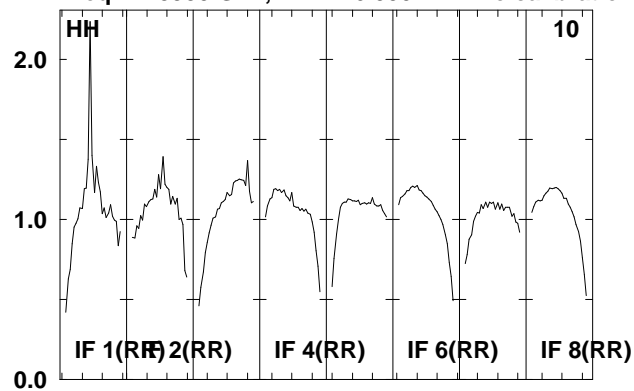

Lower frame: Real Jy  
Total-power spectrum Antenna: \*  
Timerange: 00/06:45:53 to 00/06:50:29

Plot file version 160 created 08-AUG-2008 16:59:37

J0209+13 EO006B.UVDATA.1

Freq = 1.5950 GHz, Bw = 16.000 MH No calibration applied and no bandpass applied

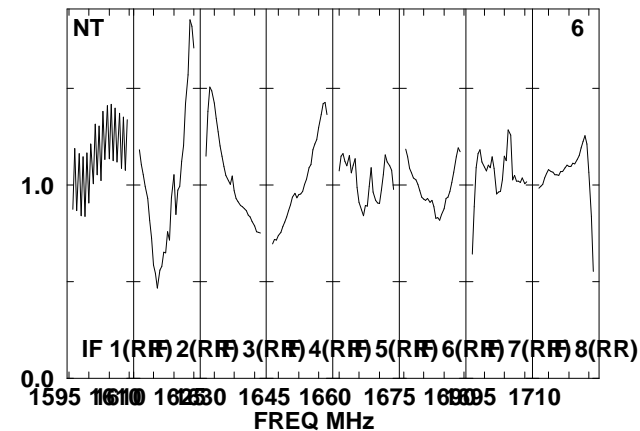
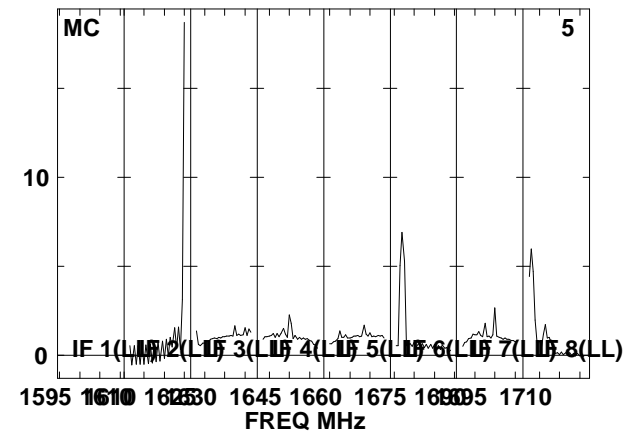
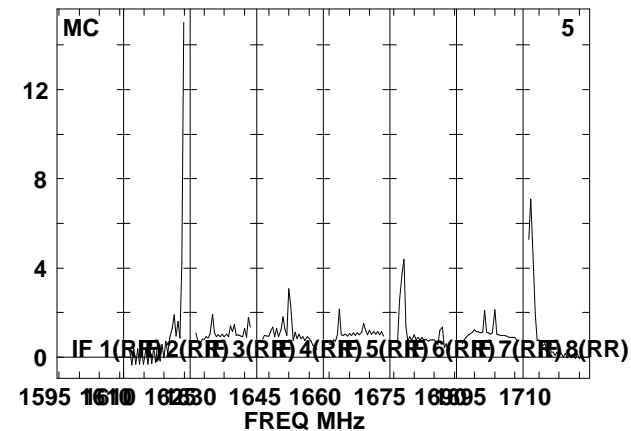
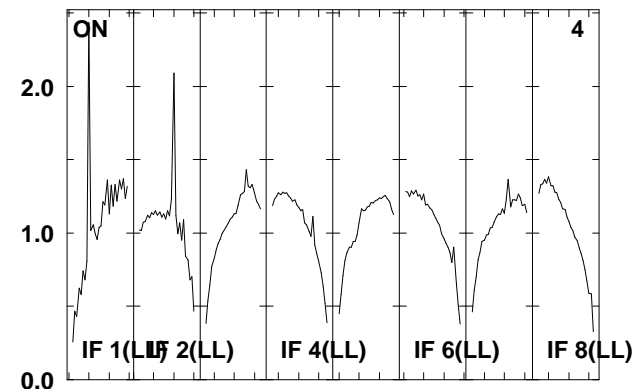
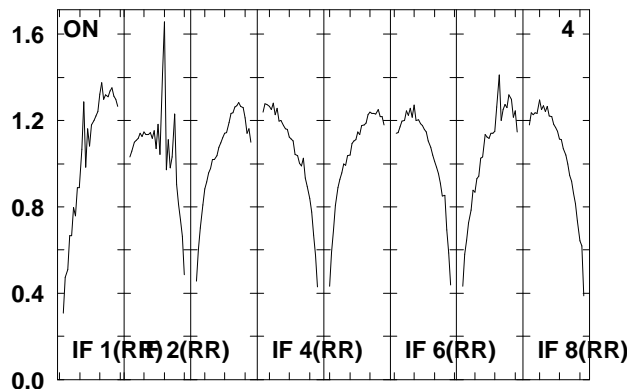
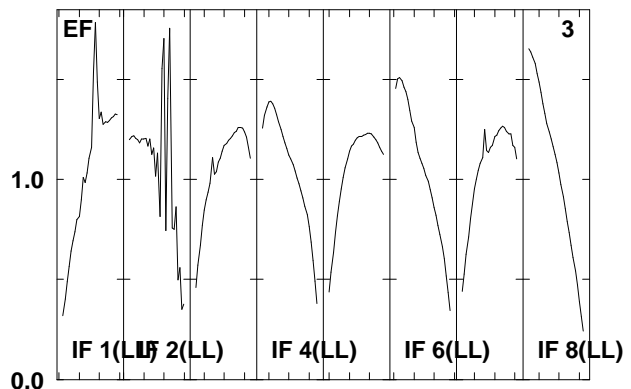
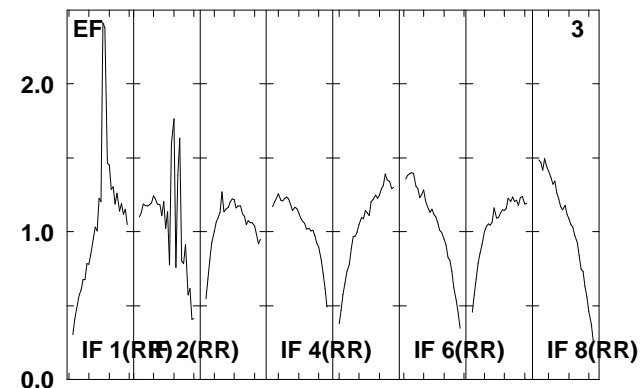
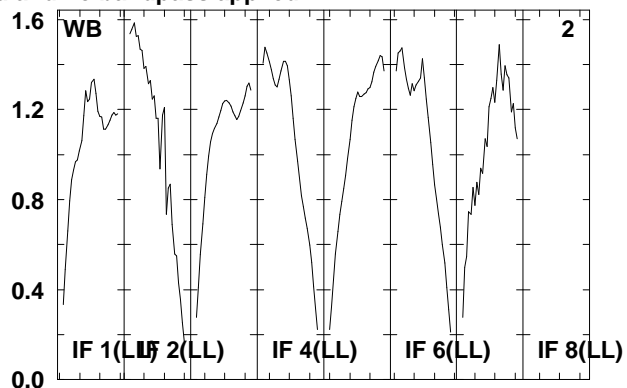
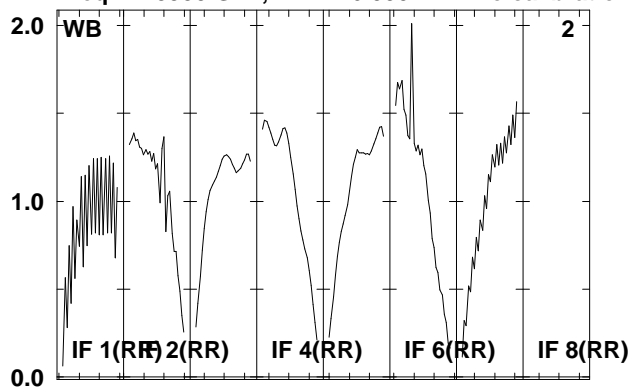

Lower frame: Real Jy  
Total-power spectrum Antenna: \*  
Timerange: 00/06:51:01 to 00/06:52:37

Plot file version 161 created 08-AUG-2008 16:59:38  
 J0209+13 EO06B.UVDATA.1  
 Freq = 1.5950 GHz, Bw = 16.000 MH No calibration applied and no bandpass applied

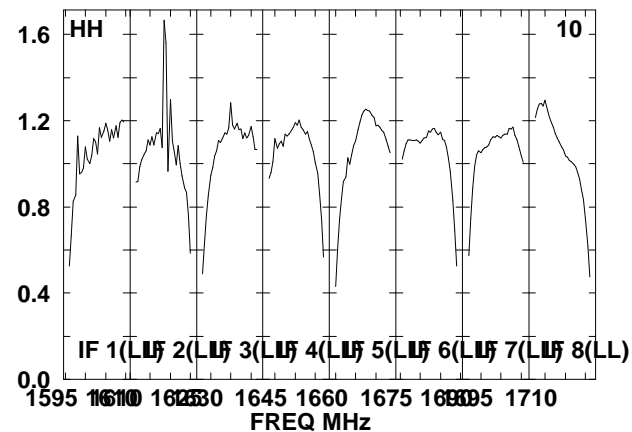
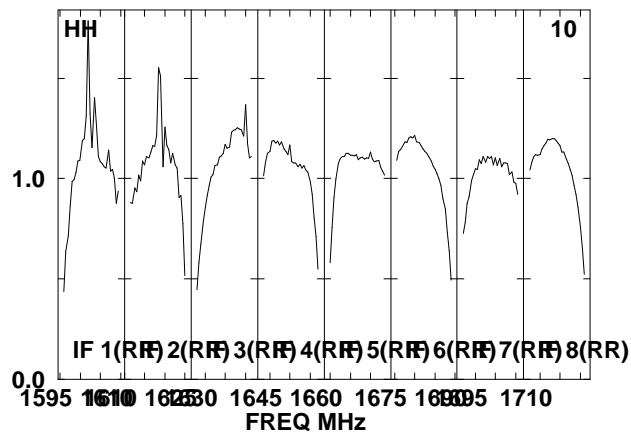
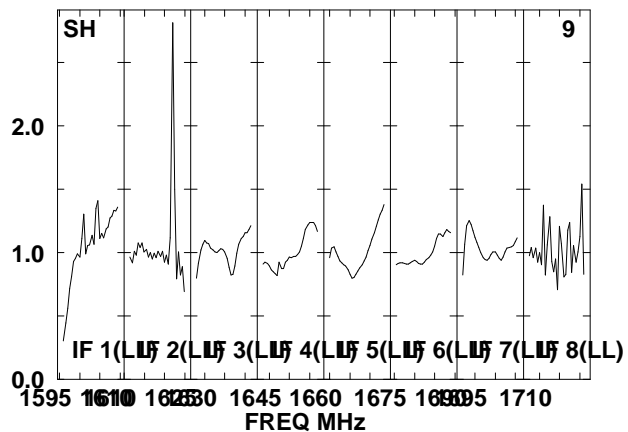
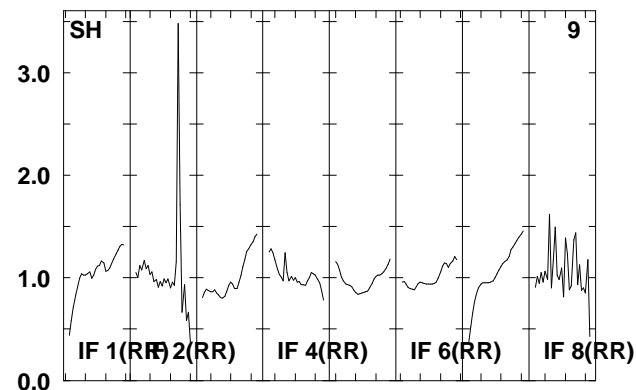
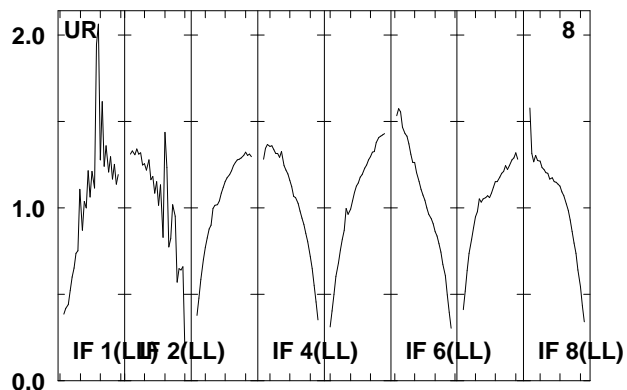
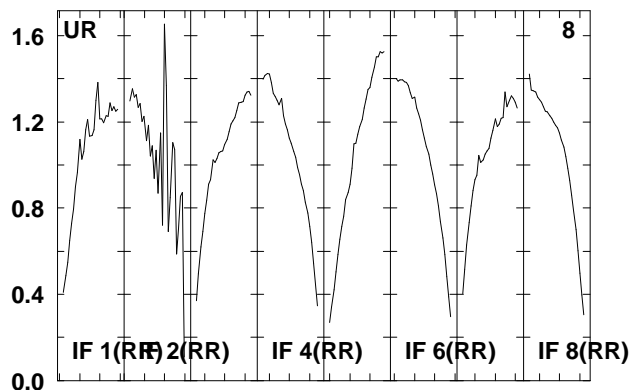
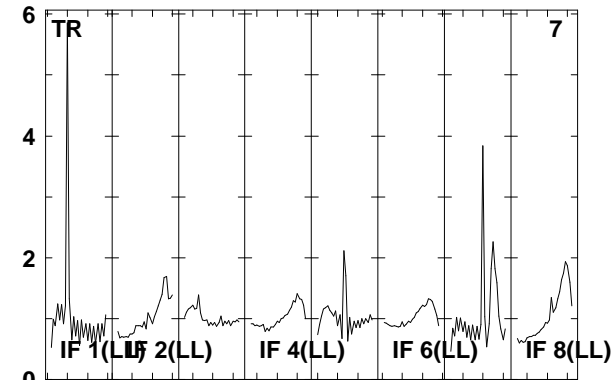
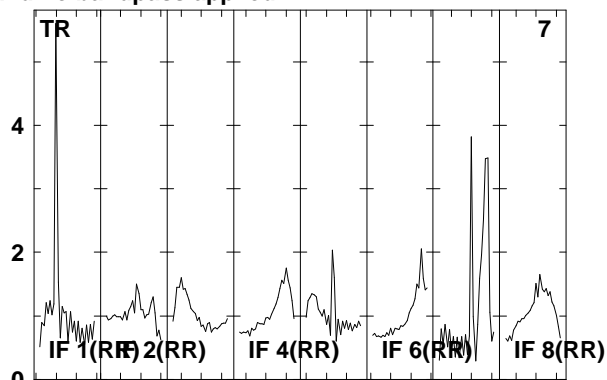
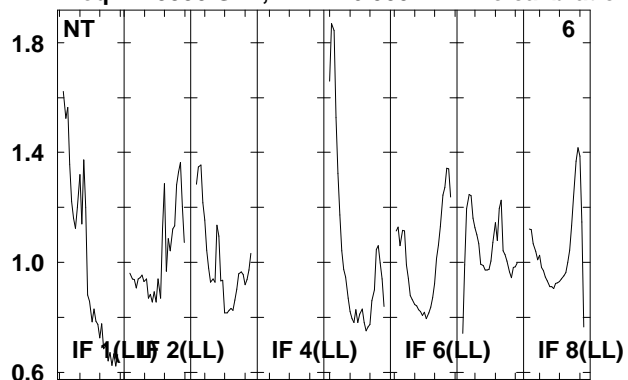

Lower frame: Real Jy  
 Total-power spectrum Antenna: \*  
 Timerange: 00/06:51:01 to 00/06:52:37

Plot file version 162 created 08-AUG-2008 16:59:38

J0209+13 EO006B.UVDATA.1

Freq = 1.5950 GHz, Bw = 16.000 MH No calibration applied and no bandpass applied

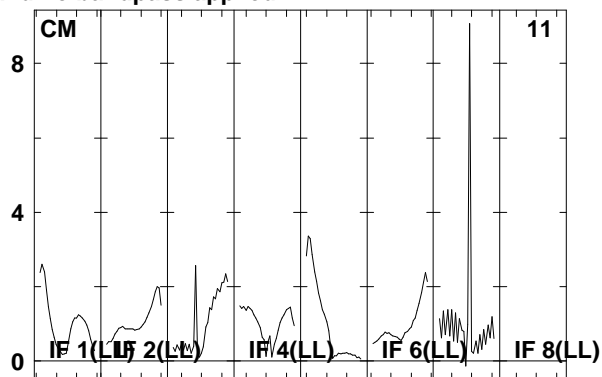
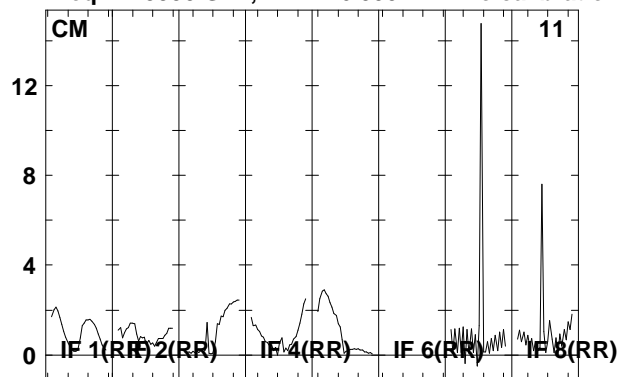

Lower frame: Real Jy  
Total-power spectrum Antenna: \*  
Timerange: 00/06:51:01 to 00/06:52:37

Plot file version 163 created 08-AUG-2008 16:59:38

J021348 EO006B.UVDATA.1

Freq = 1.5950 GHz, Bw = 16.000 MH No calibration applied and no bandpass applied

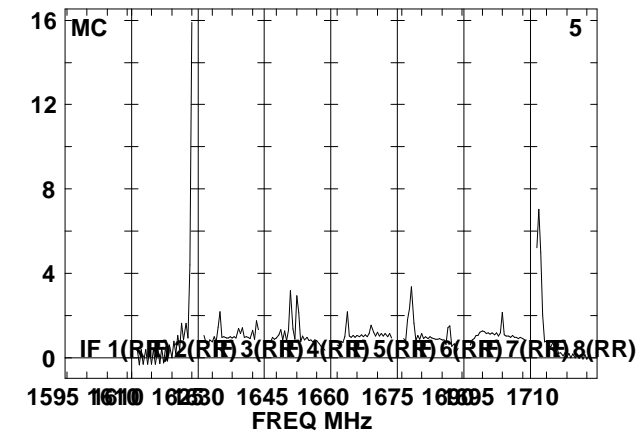
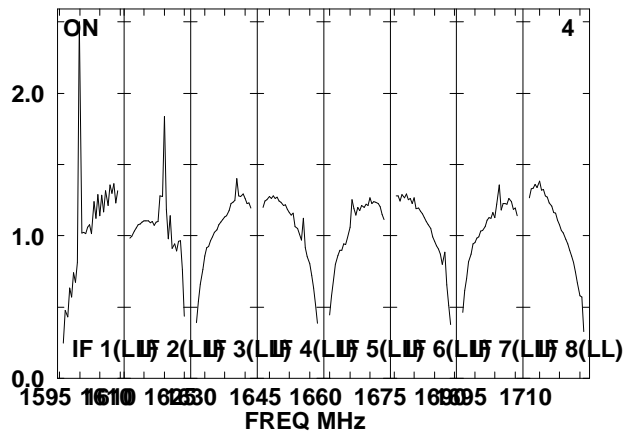
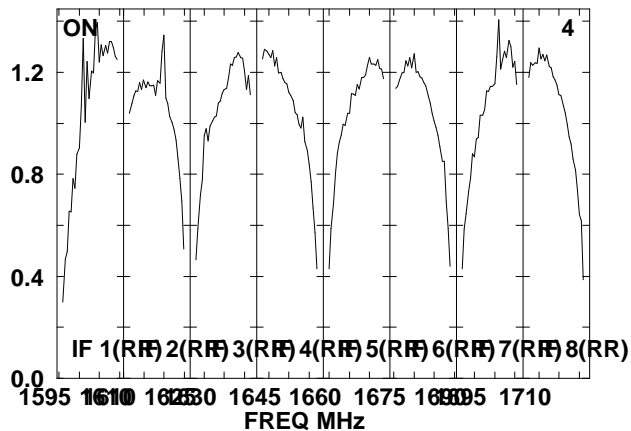
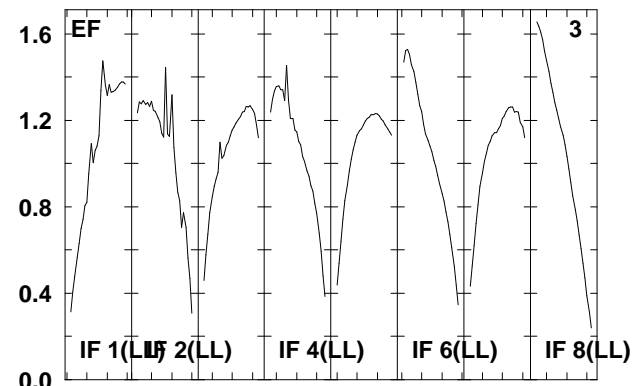
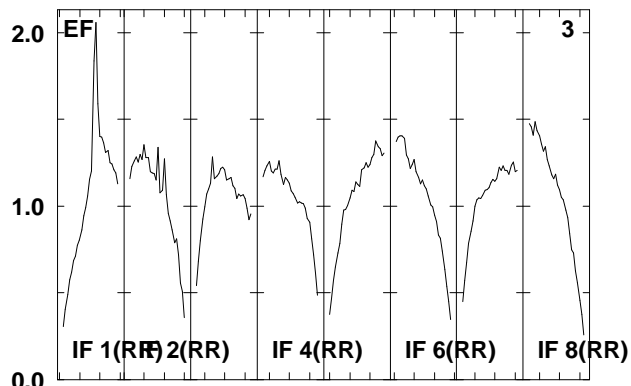
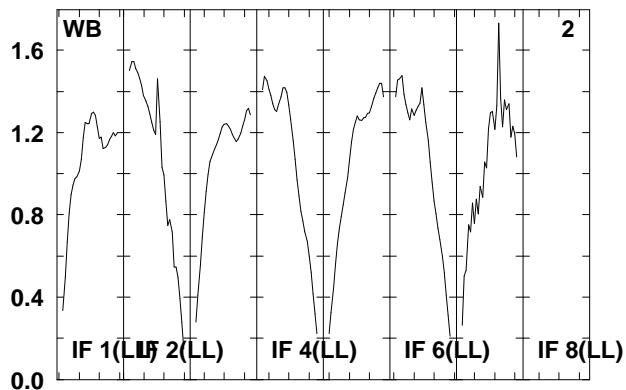
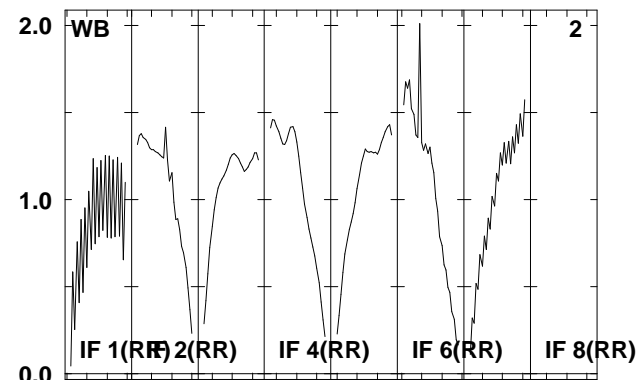
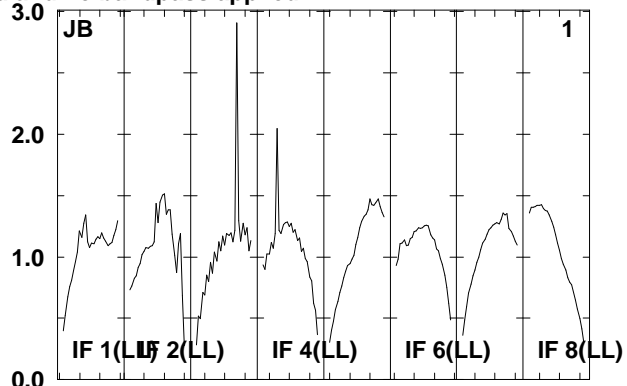
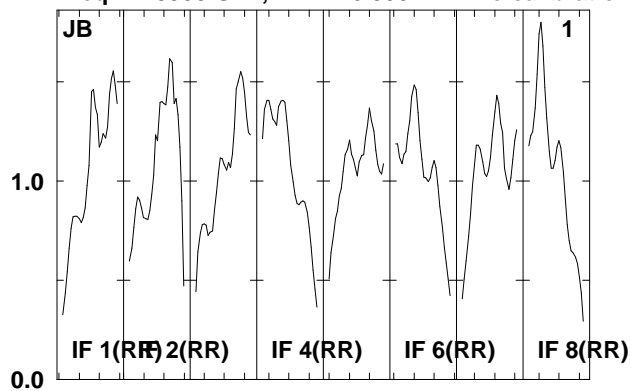

Lower frame: Real Jy  
Total-power spectrum Antenna: \*  
Timerange: 00/06:53:13 to 00/06:57:49

Plot file version 164 created 08-AUG-2008 16:59:39

J021348 EO006B.UVDATA.1

Freq = 1.5950 GHz, Bw = 16.000 MH No calibration applied and no bandpass applied

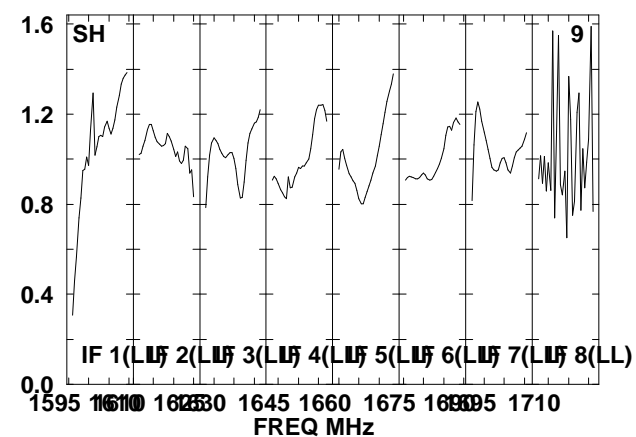
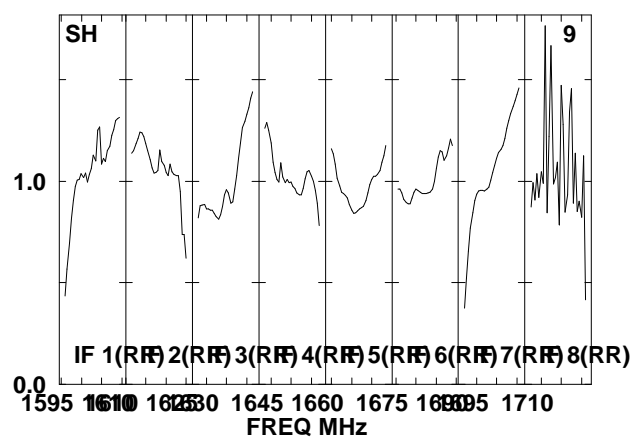
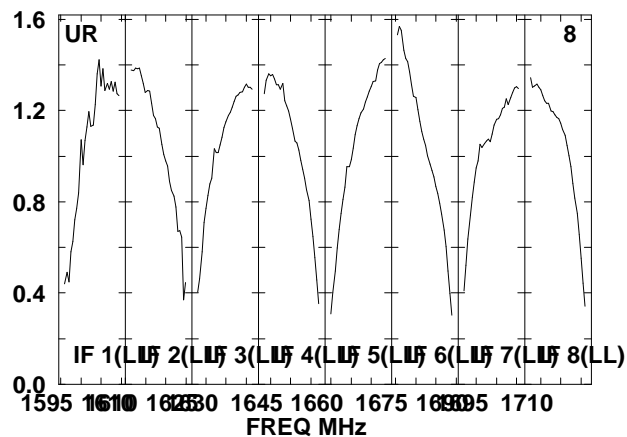
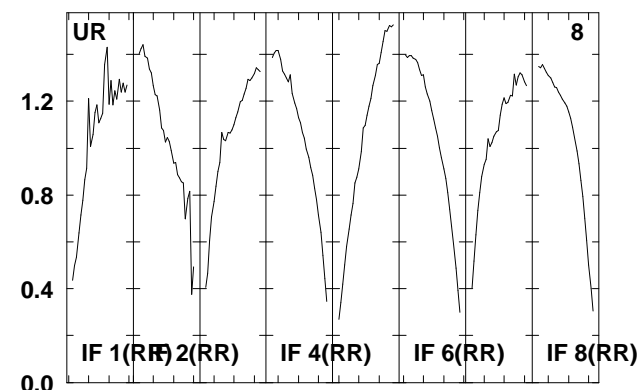
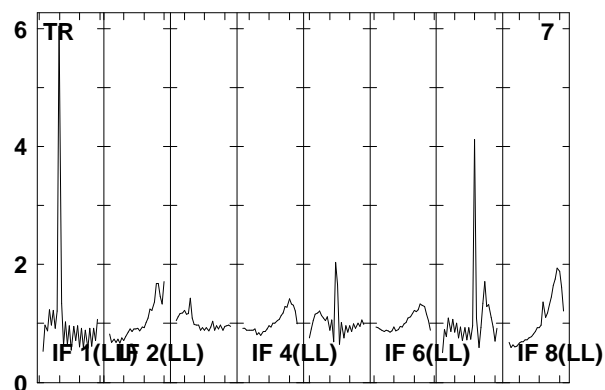
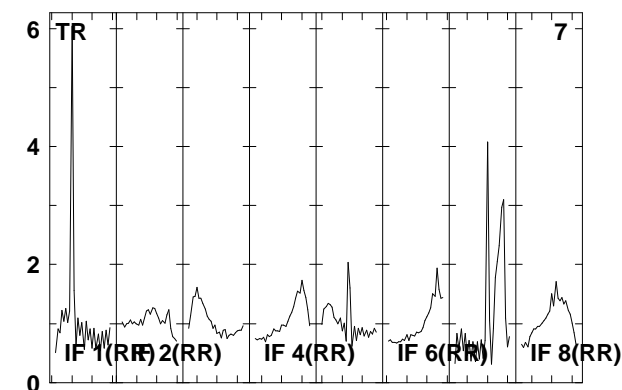
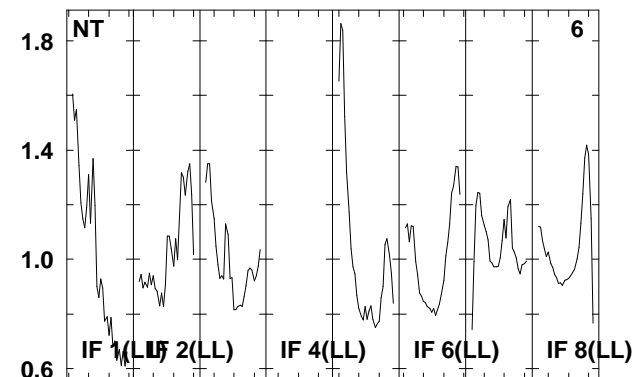
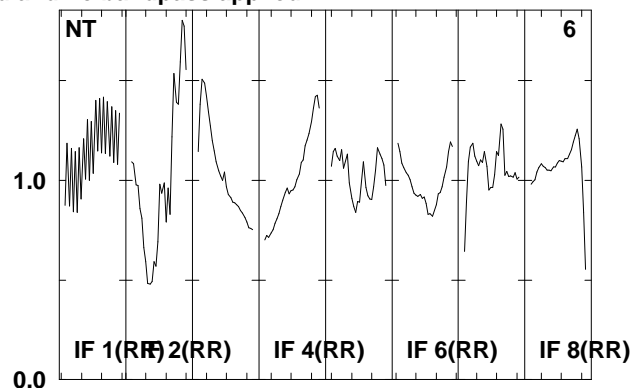
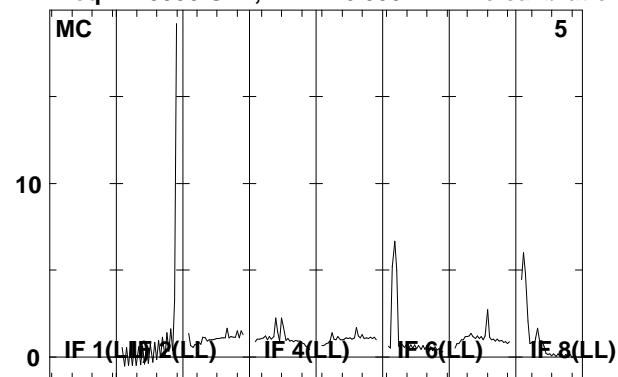

Lower frame: Real Jy

Total-power spectrum Antenna: \*

Timerange: 00/06:53:13 to 00/06:57:49



Plot file version 165 created 08-AUG-2008 16:59:40

J021348 EO006B.UVDATA.1

Freq = 1.5950 GHz, Bw = 16.000 MH No calibration applied and no bandpass applied

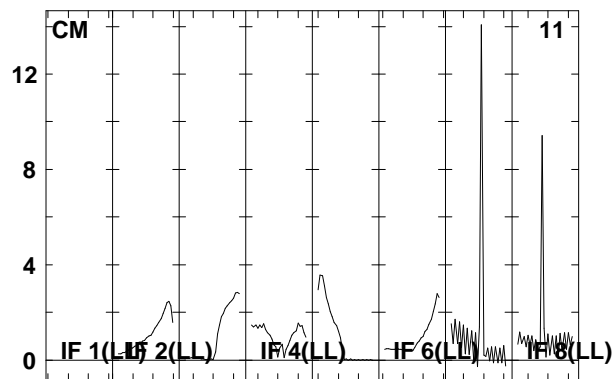
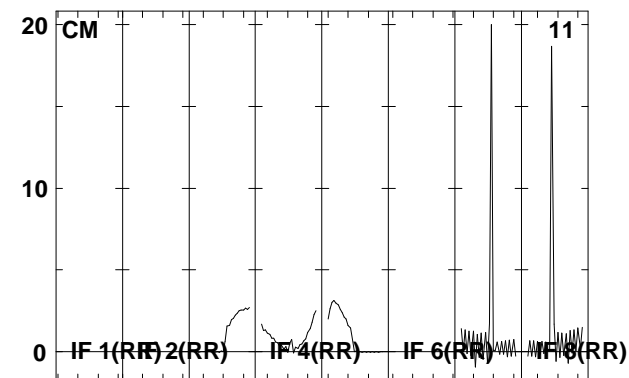
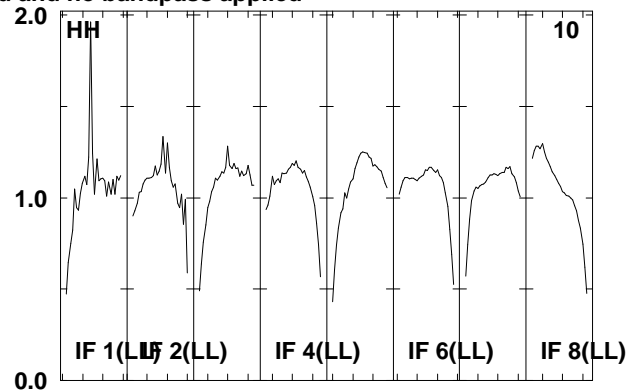
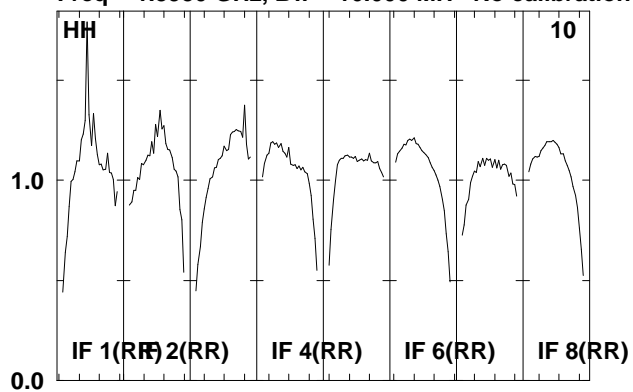

Lower frame: Real Jy  
Total-power spectrum Antenna: \*  
Timerange: 00/06:53:13 to 00/06:57:49

Plot file version 166 created 08-AUG-2008 16:59:41

J0209+13 EO006B.UVDATA.1

Freq = 1.5950 GHz, Bw = 16.000 MH No calibration applied and no bandpass applied

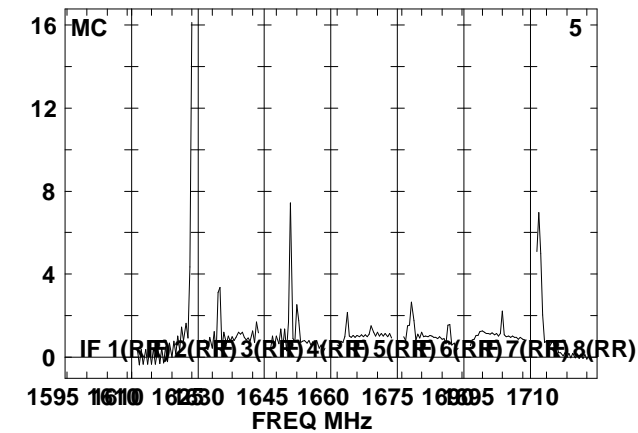
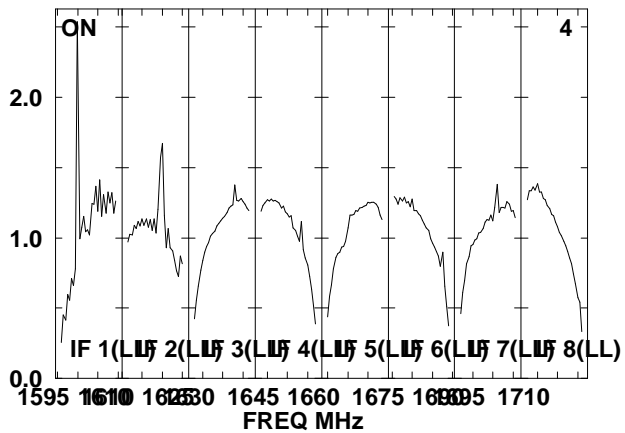
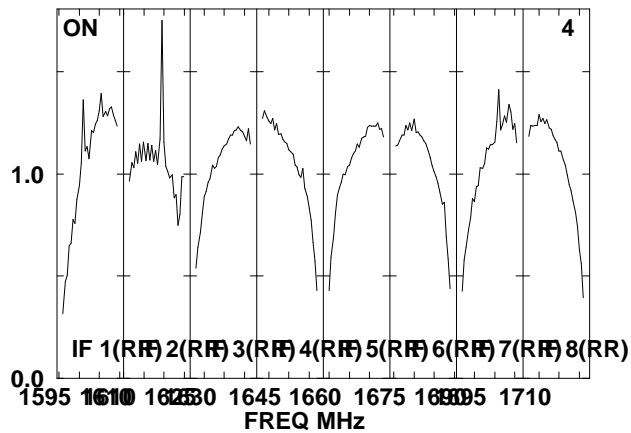
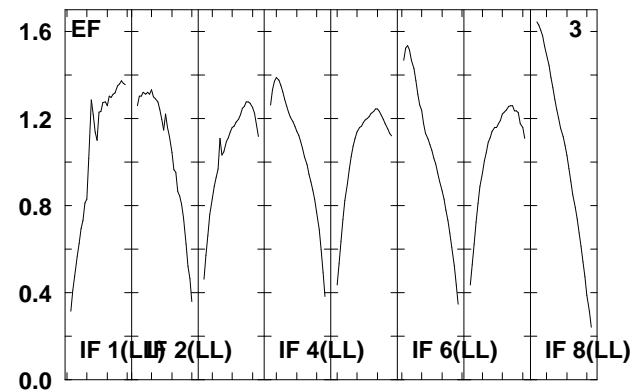
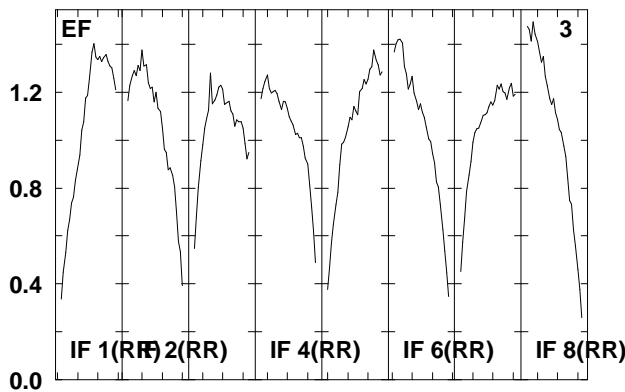
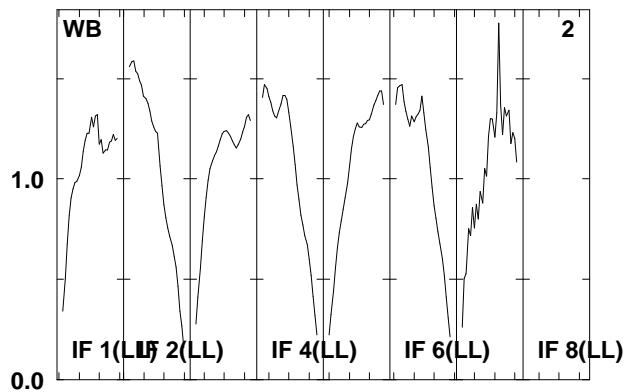
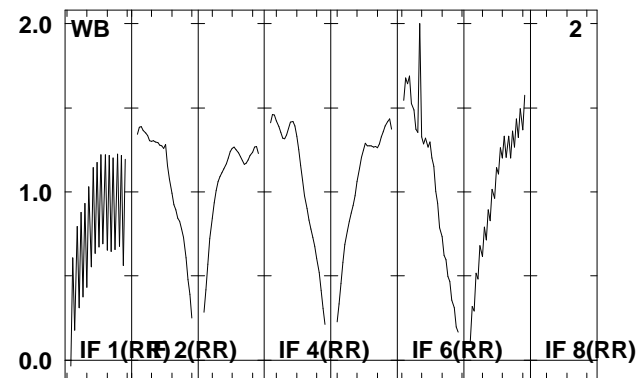
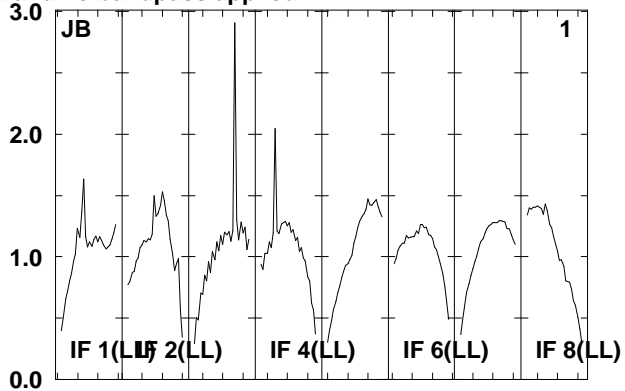
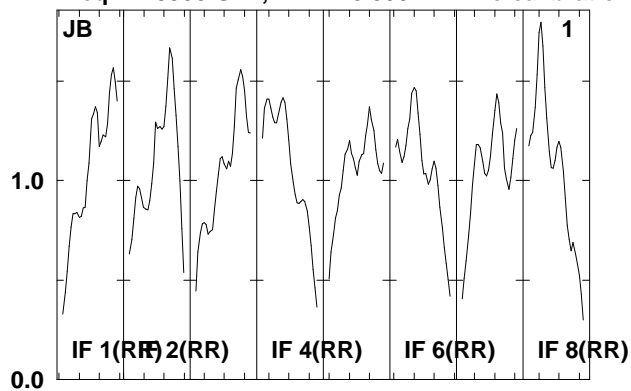

Lower frame: Real Jy  
Total-power spectrum Antenna: \*  
Timerange: 00/06:58:21 to 00/06:59:57

Plot file version 167 created 08-AUG-2008 16:59:41

J0209+13 EO006B.UVDATA.1

Freq = 1.5950 GHz, Bw = 16.000 MH No calibration applied and no bandpass applied

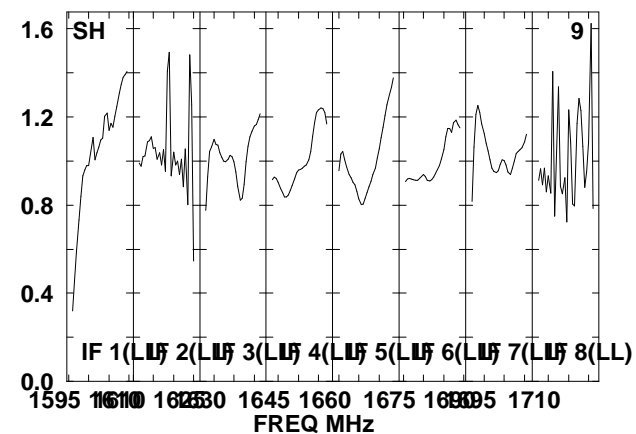
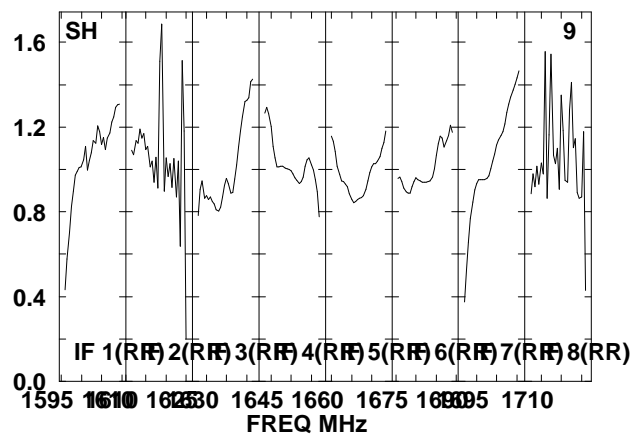
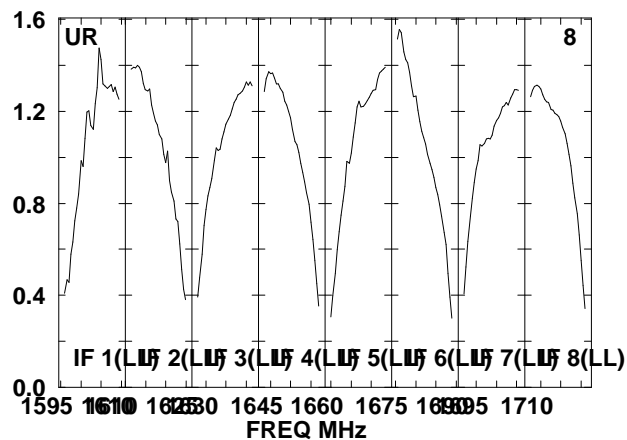
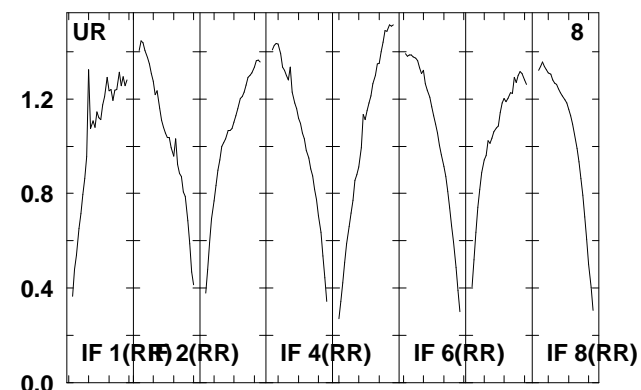
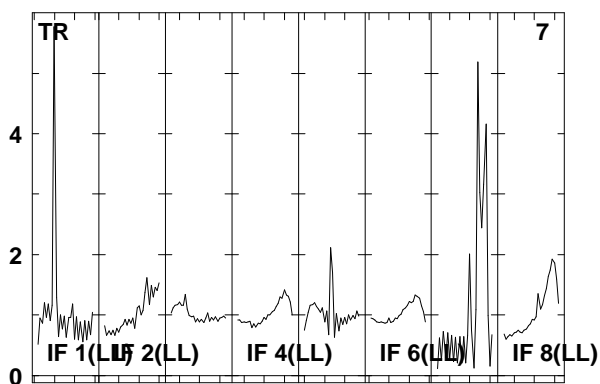
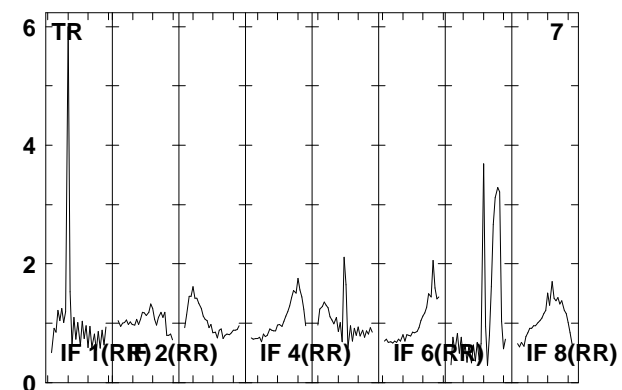
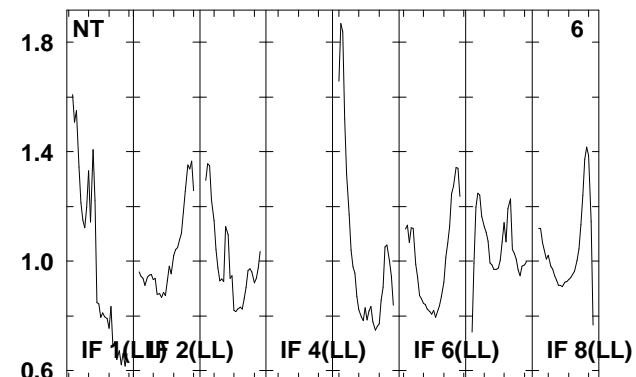
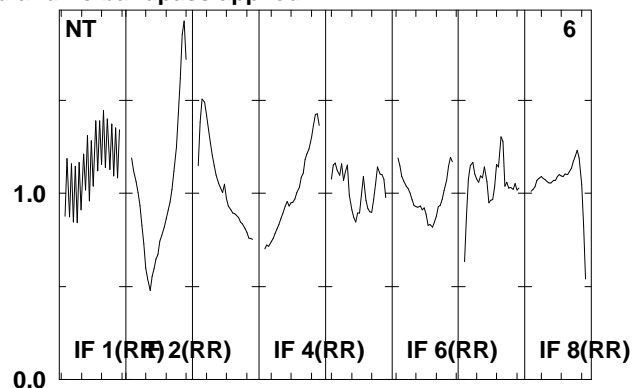
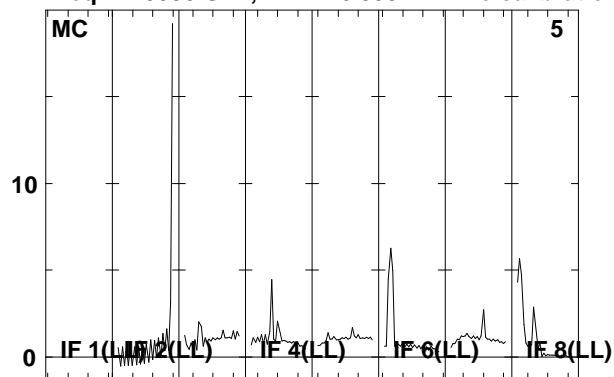

Lower frame: Real Jy

Total-power spectrum Antenna: \*

Timerange: 00/06:58:21 to 00/06:59:57

Plot file version 168 created 08-AUG-2008 16:59:41

J0209+13 EO006B.UVDATA.1

Freq = 1.5950 GHz, Bw = 16.000 MH No calibration applied and no bandpass applied

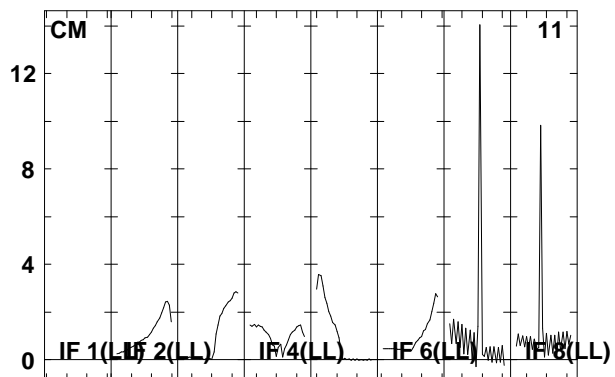
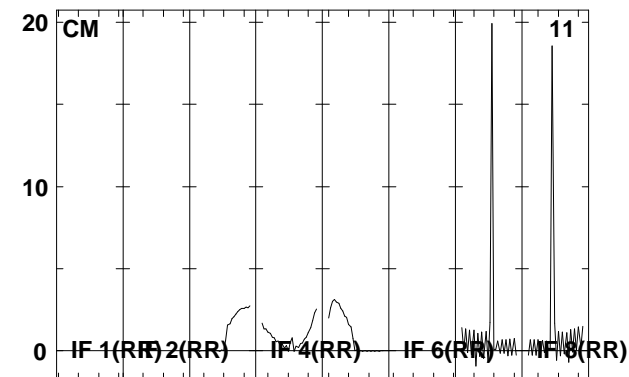
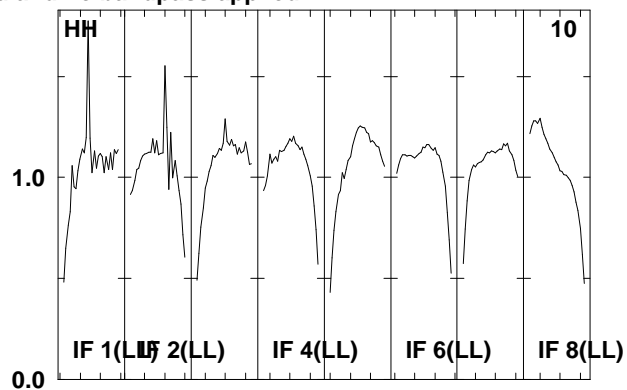
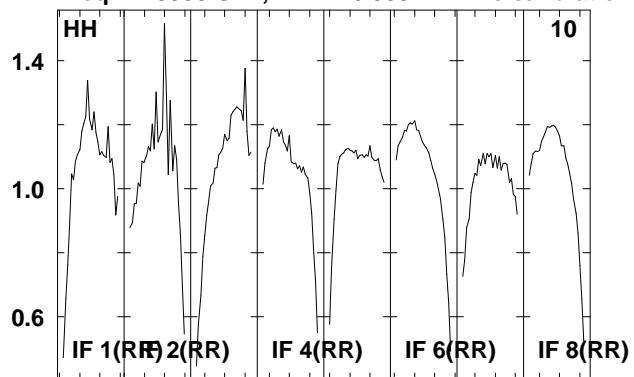

Lower frame: Real Jy  
Total-power spectrum Antenna: \*  
Timerange: 00/06:58:21 to 00/06:59:57

Plot file version 169 created 08-AUG-2008 16:59:41

J021348 EO006B.UVDATA.1

Freq = 1.5950 GHz, Bw = 16.000 MH No calibration applied and no bandpass applied

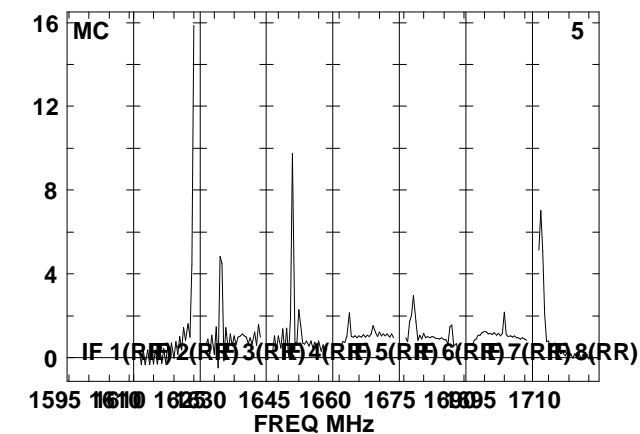
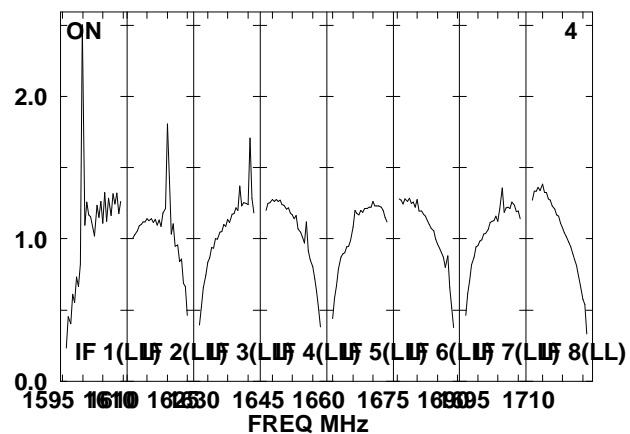
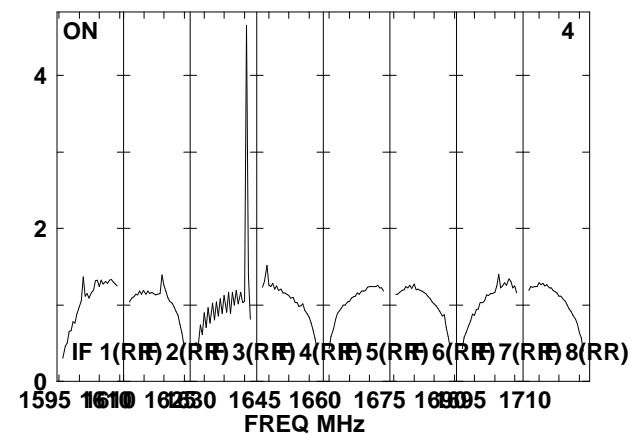
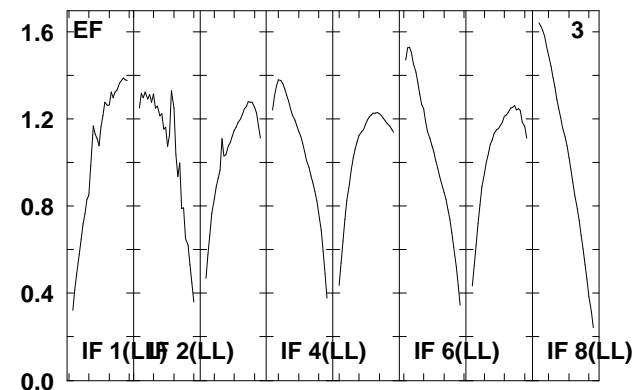
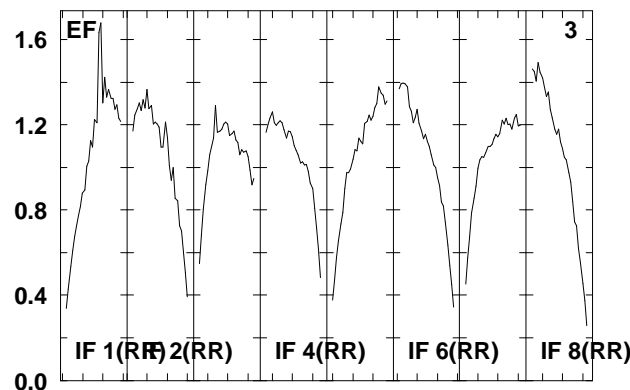
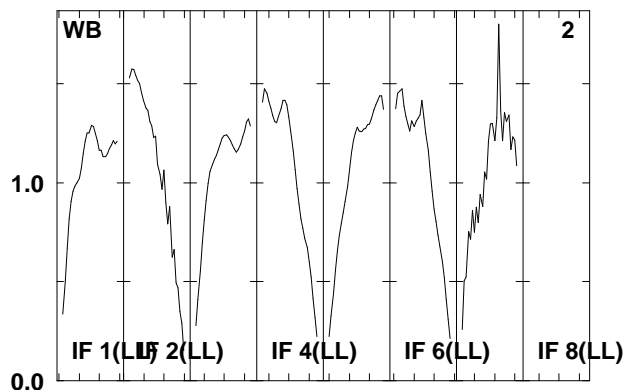
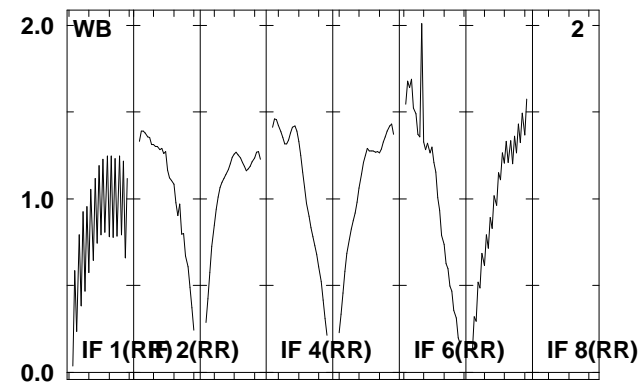
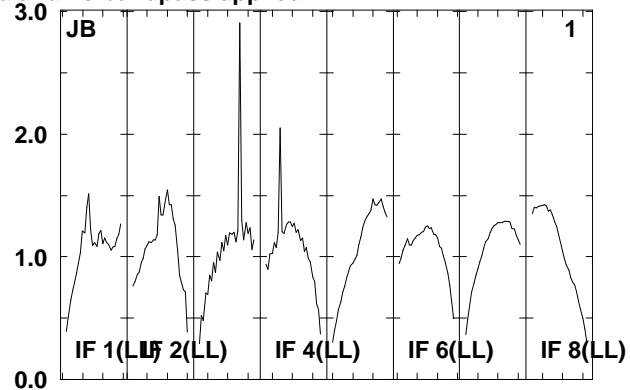
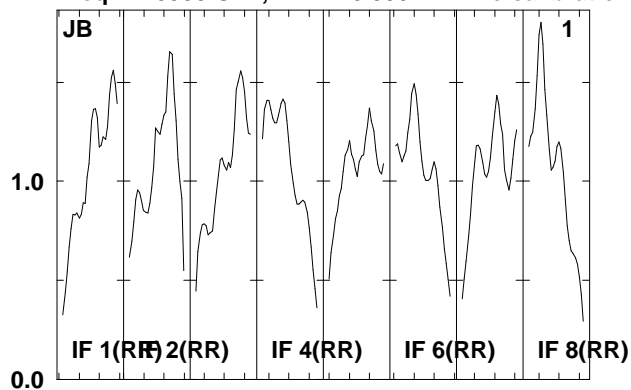

Lower frame: Real Jy  
Total-power spectrum Antenna: \*  
Timerange: 00/07:00:33 to 00/07:05:09

Plot file version 170 created 08-AUG-2008 16:59:42

J021348 EO06B.UVDATA.1

Freq = 1.5950 GHz, Bw = 16.000 MH No calibration applied and no bandpass applied

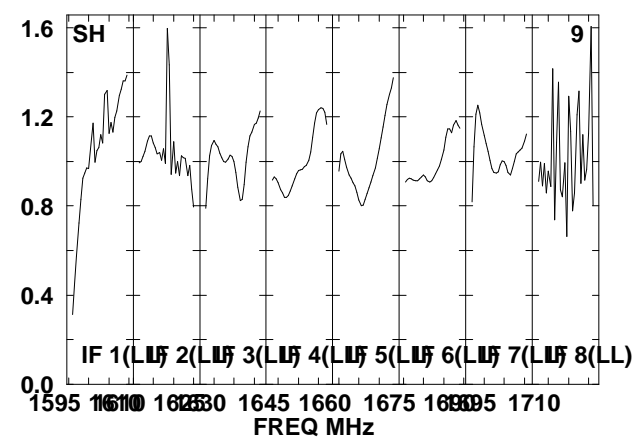
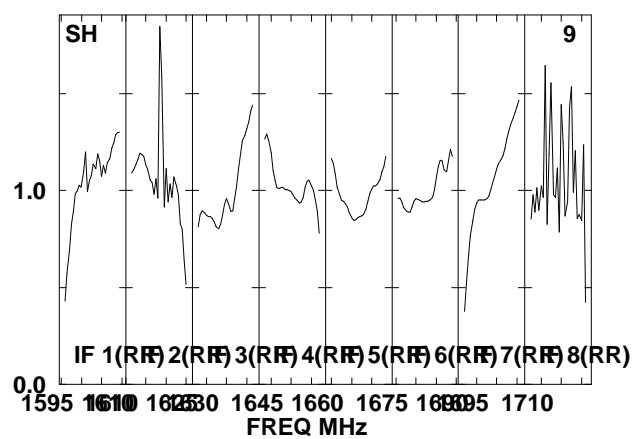
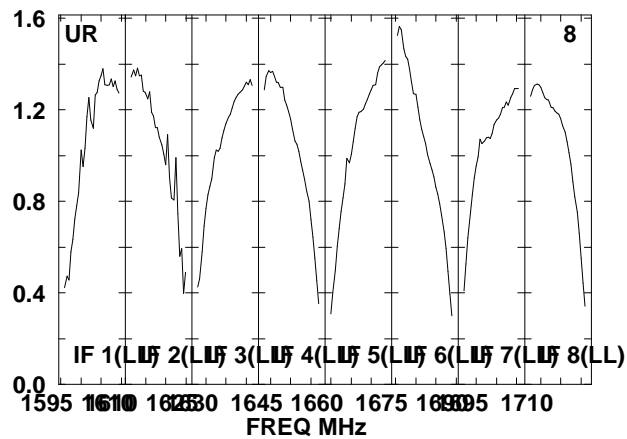
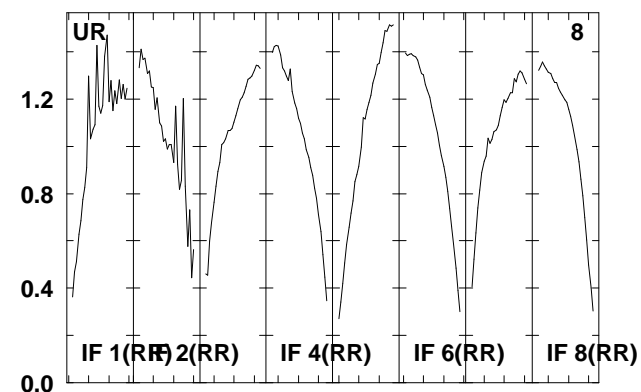
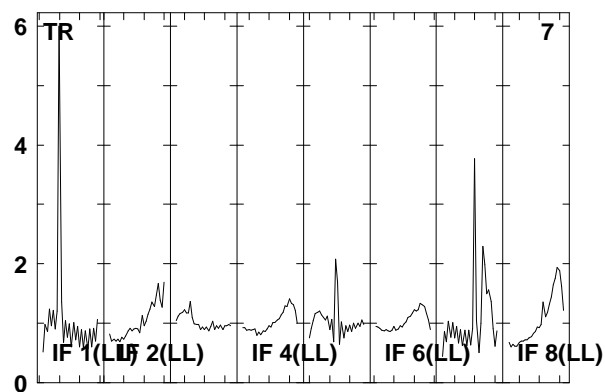
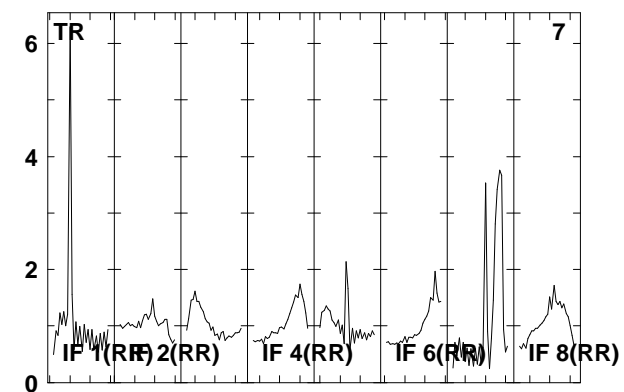
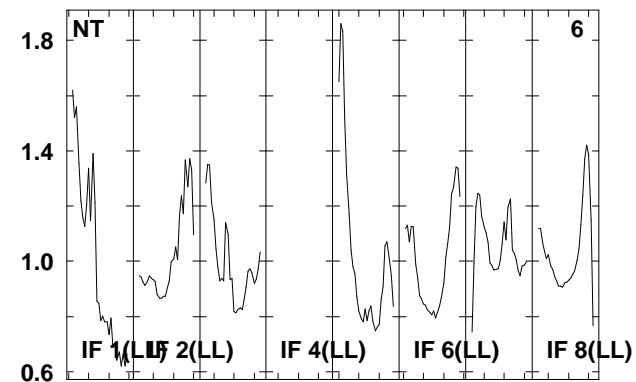
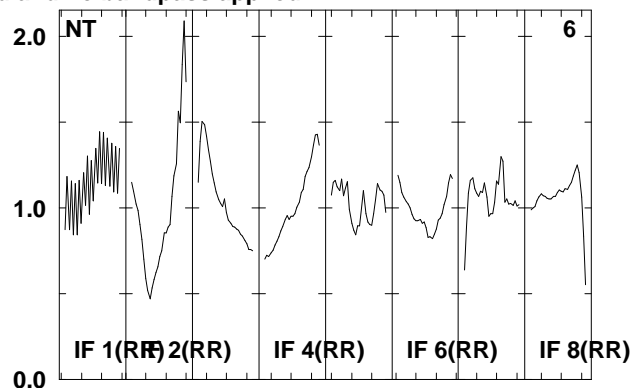
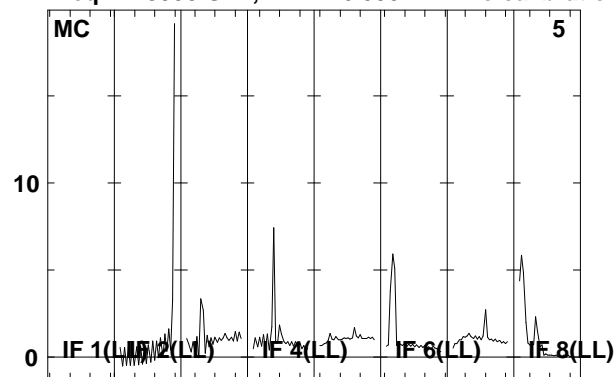

Lower frame: Real Jy

Total-power spectrum Antenna: \*

Timerange: 00/07:00:33 to 00/07:05:09

Plot file version 171 created 08-AUG-2008 16:59:43

J021348 EO006B.UVDATA.1

Freq = 1.5950 GHz, Bw = 16.000 MH No calibration applied and no bandpass applied

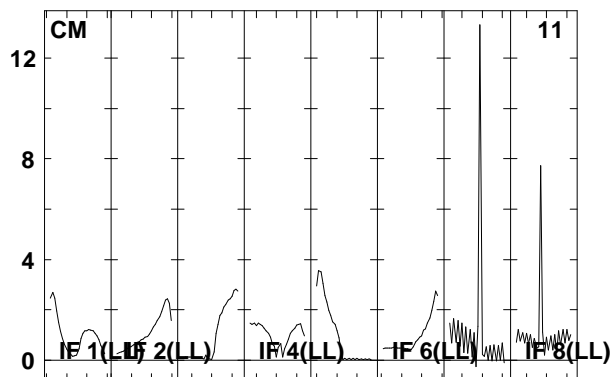
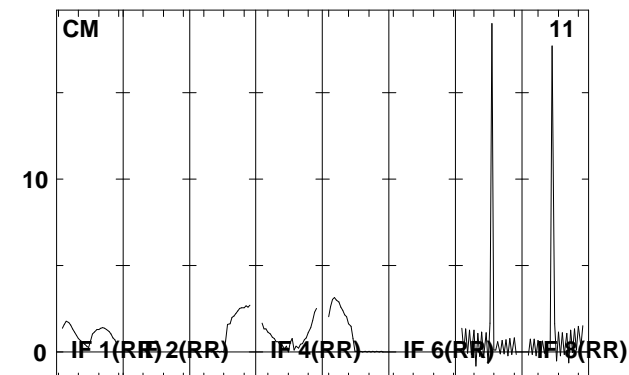
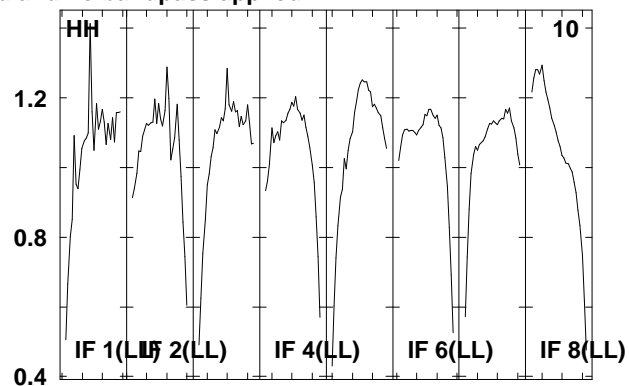
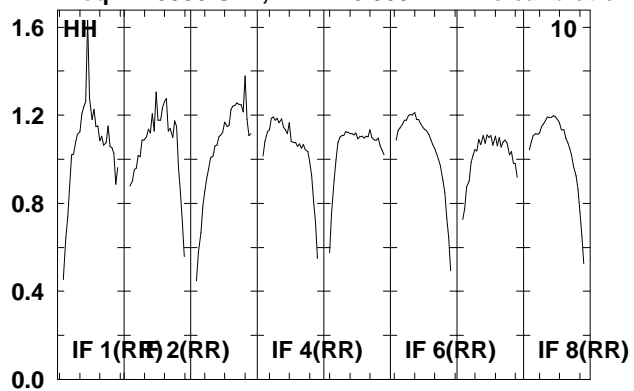

Lower frame: Real Jy  
Total-power spectrum Antenna: \*  
Timerange: 00/07:00:33 to 00/07:05:09

Plot file version 172 created 08-AUG-2008 16:59:43

J0209+13 E0006B.UVDATA.1

Freq = 1.5950 GHz, Bw = 16.000 MH No calibration applied and no bandpass applied

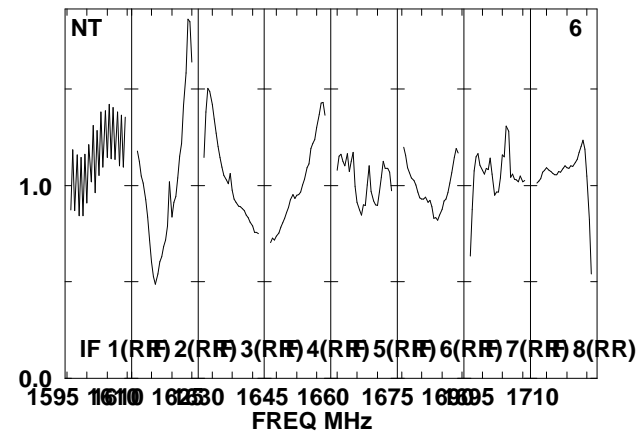
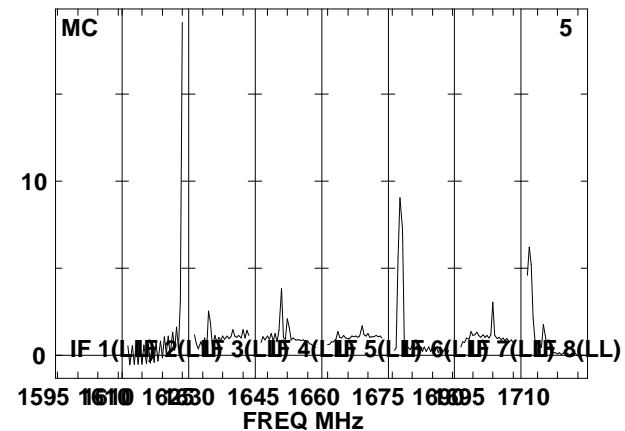
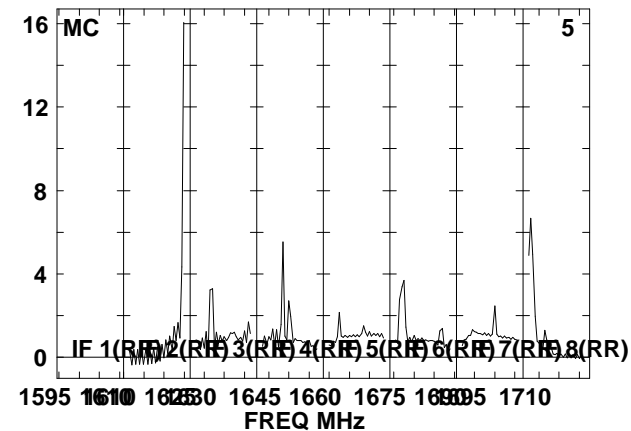
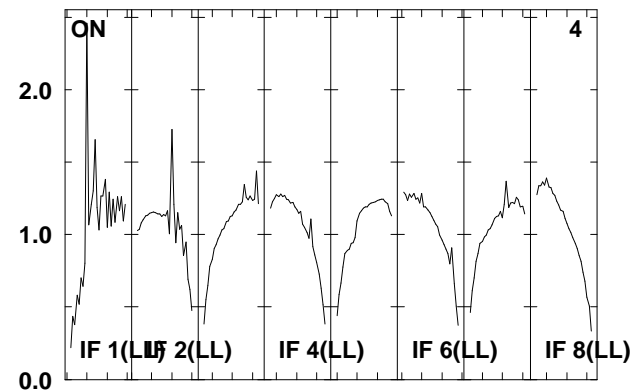
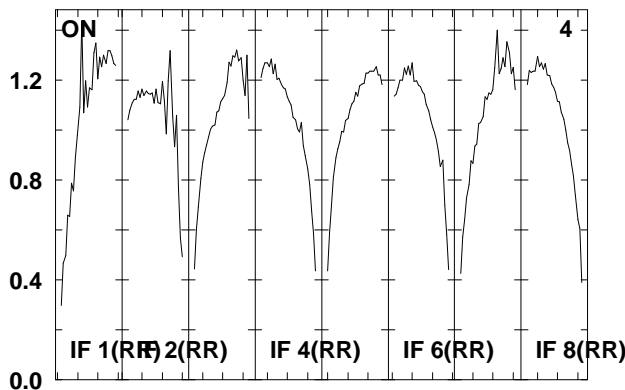
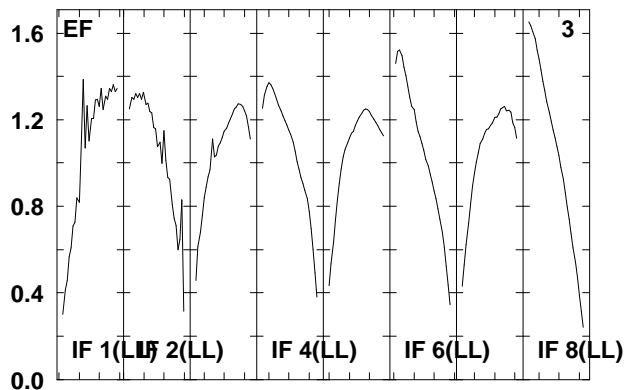
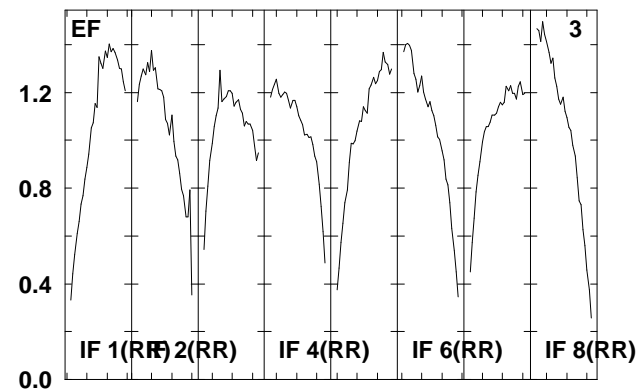
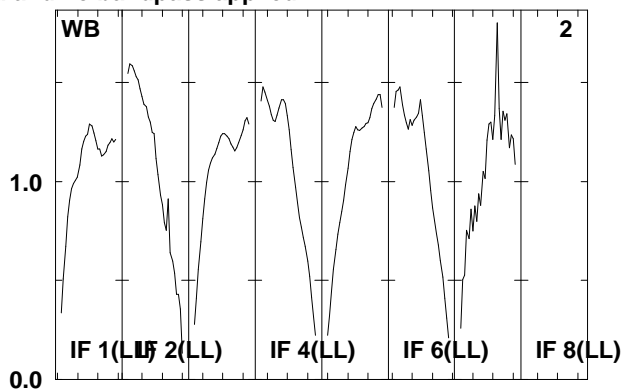
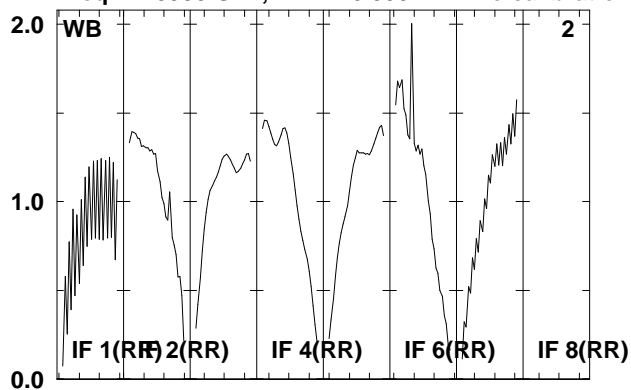

Lower frame: Real Jy  
Total-power spectrum Antenna: \*  
Timerange: 00/07:05:45 to 00/07:07:17



Plot file version 173 created 08-AUG-2008 16:59:43

J0209+13 EO06B.UVDATA.1

Freq = 1.5950 GHz, Bw = 16.000 MH No calibration applied and no bandpass applied

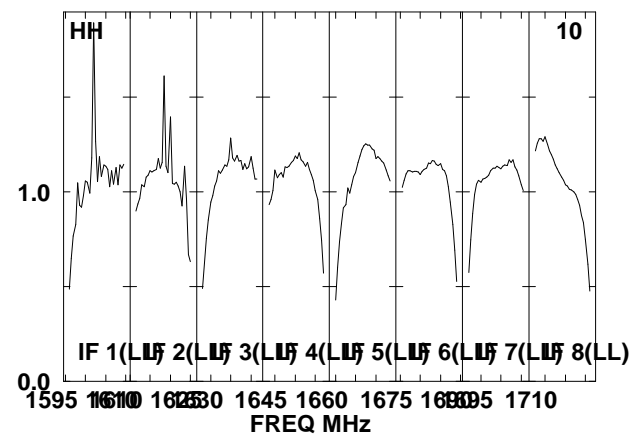
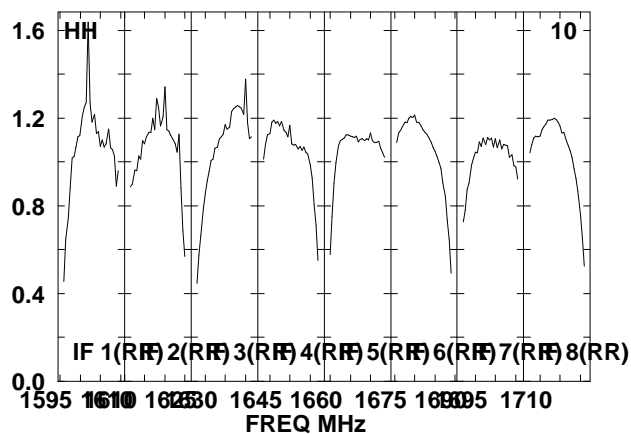
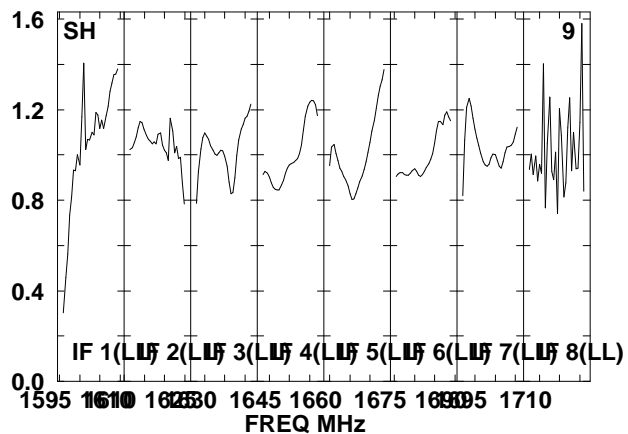
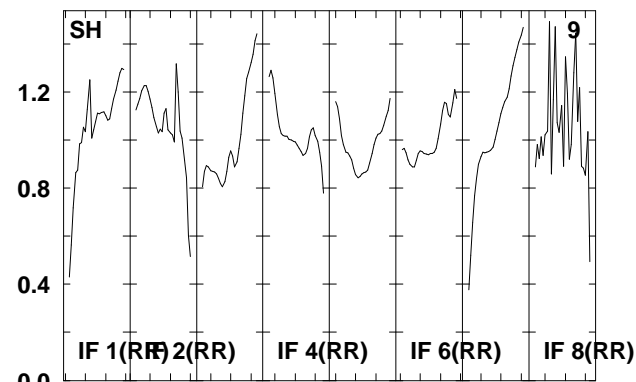
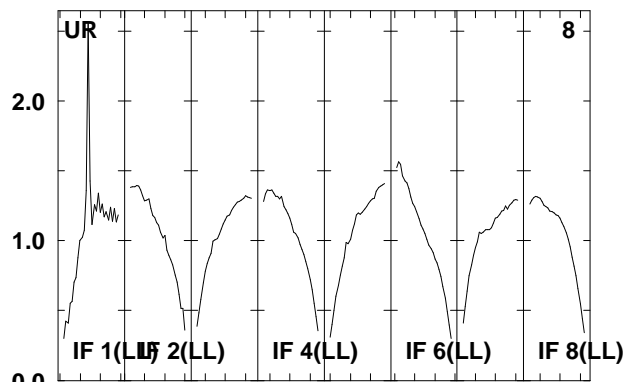
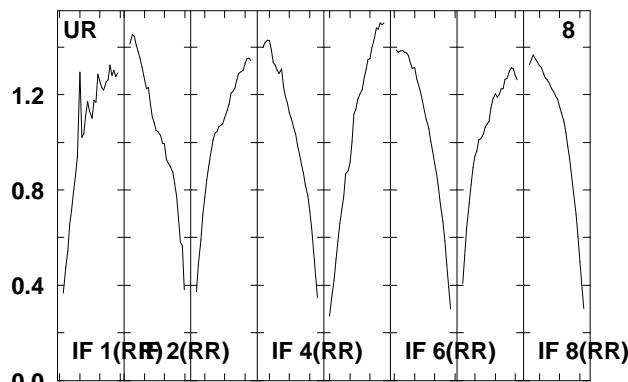
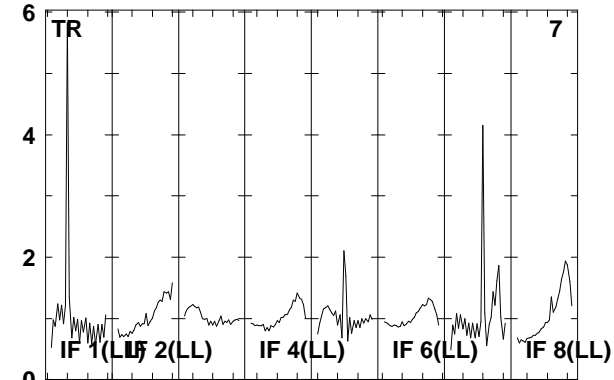
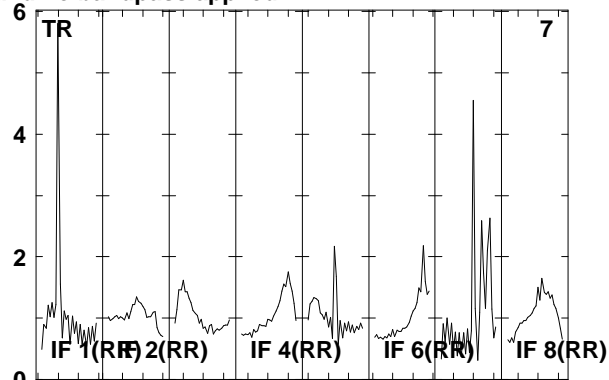
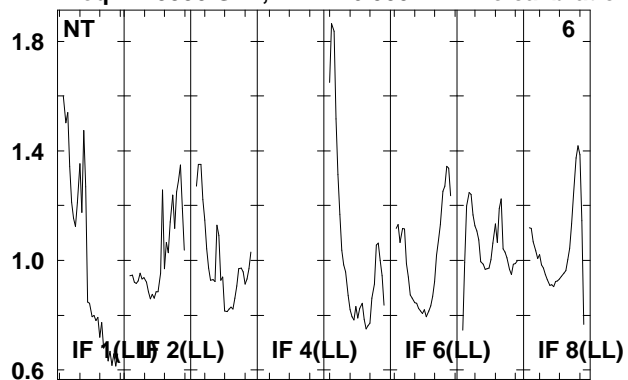

Lower frame: Real Jy  
Total-power spectrum Antenna: \*  
Timerange: 00/07:05:45 to 00/07:07:17

Plot file version 174 created 08-AUG-2008 16:59:43

J0209+13 EO006B.UVDATA.1

Freq = 1.5950 GHz, Bw = 16.000 MH No calibration applied and no bandpass applied

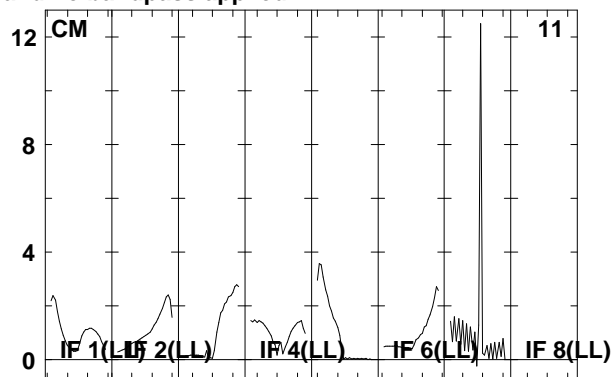
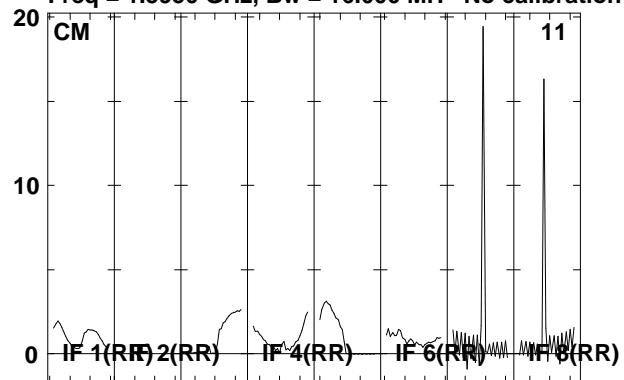

Lower frame: Real Jy  
Total-power spectrum Antenna: \*  
Timerange: 00/07:05:45 to 00/07:07:17

Plot file version 175 created 08-AUG-2008 16:59:44

J021348 EO06B.UVDATA.1

Freq = 1.5950 GHz, Bw = 16.000 MH No calibration applied and no bandpass applied

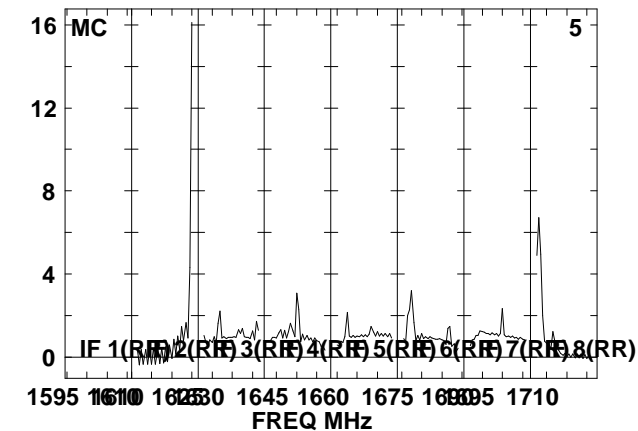
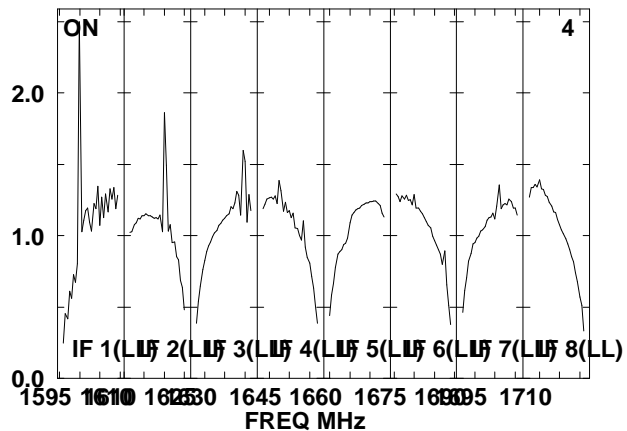
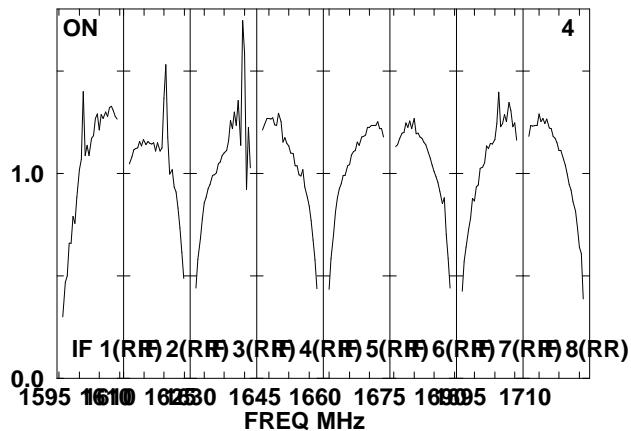
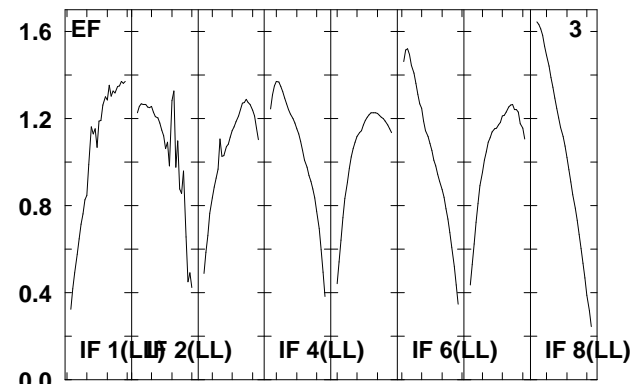
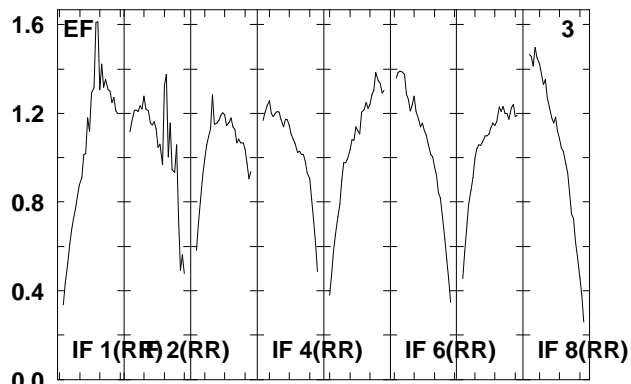
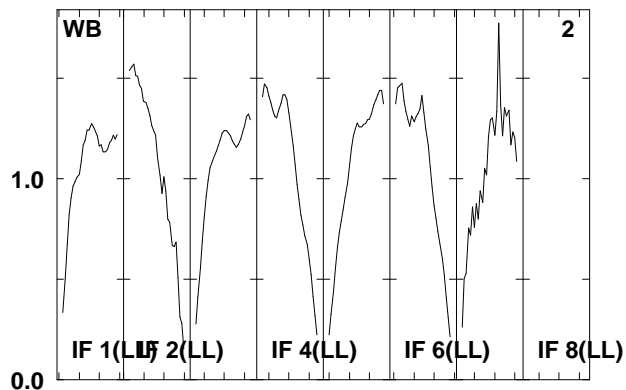
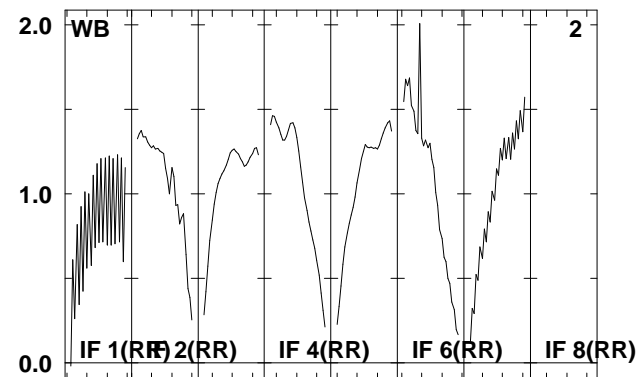
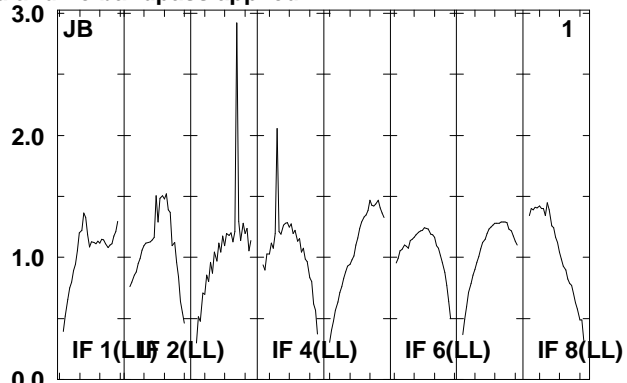
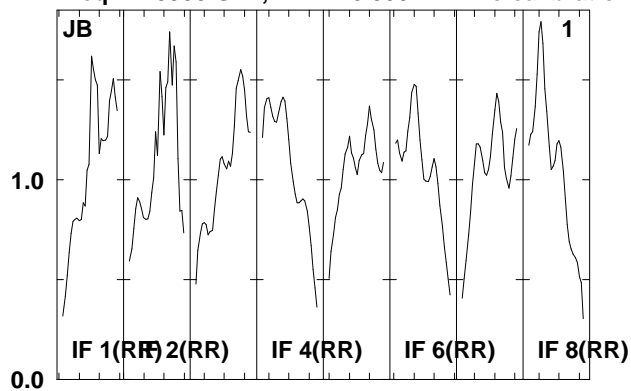

Lower frame: Real Jy  
Total-power spectrum Antenna: \*  
Timerange: 00/07:07:53 to 00/07:12:21

Plot file version 176 created 08-AUG-2008 16:59:45

J021348 EO06B.UVDATA.1

Freq = 1.5950 GHz, Bw = 16.000 MH No calibration applied and no bandpass applied

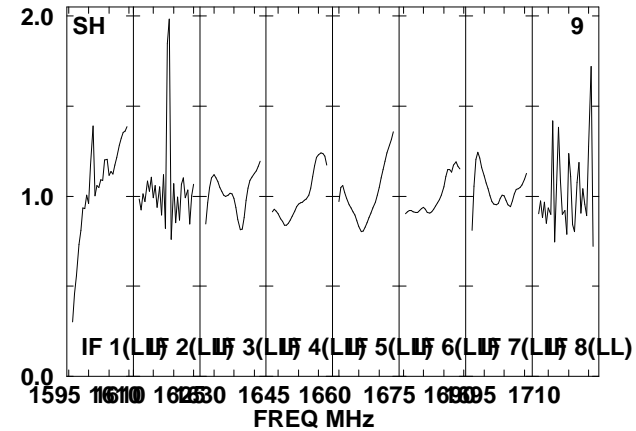
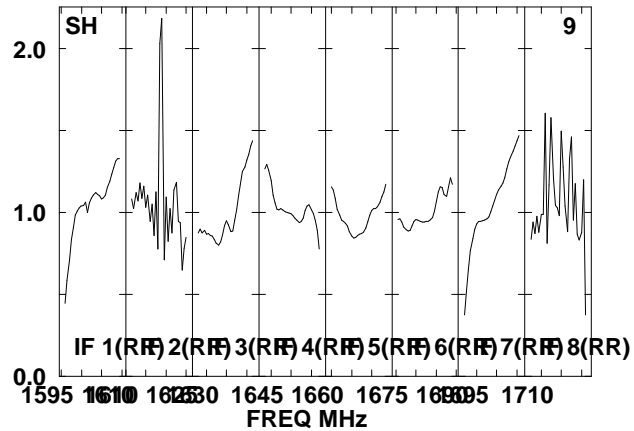
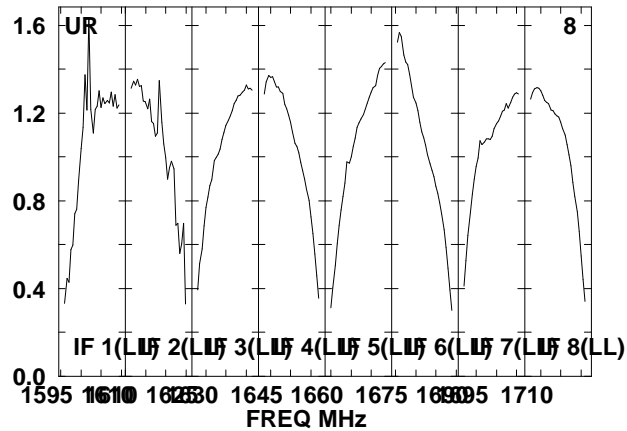
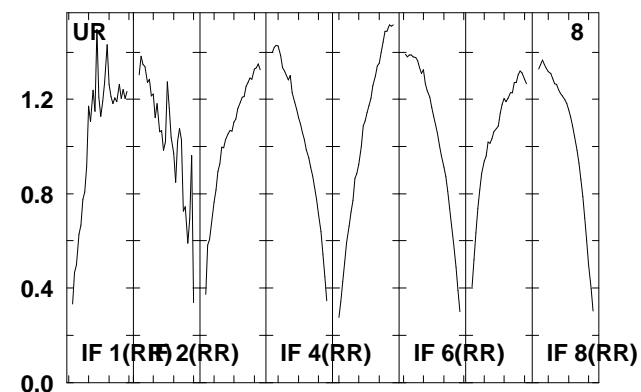
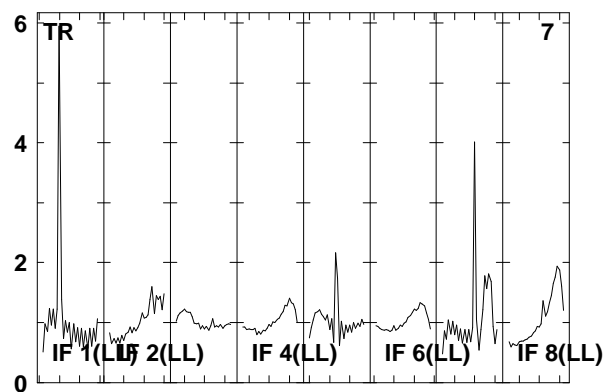
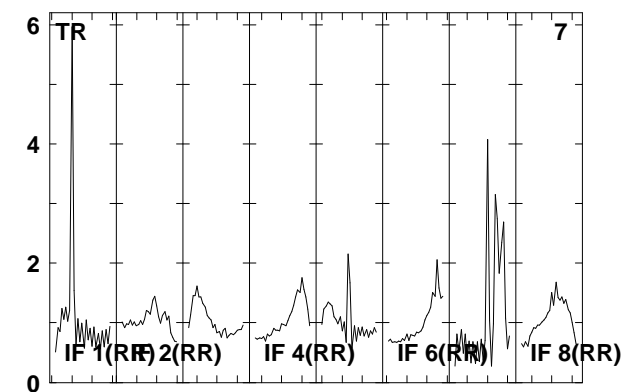
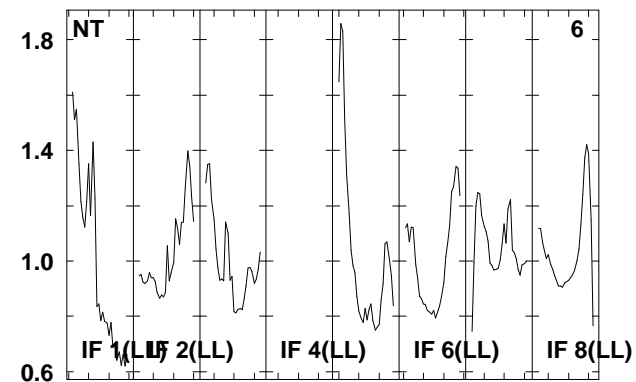
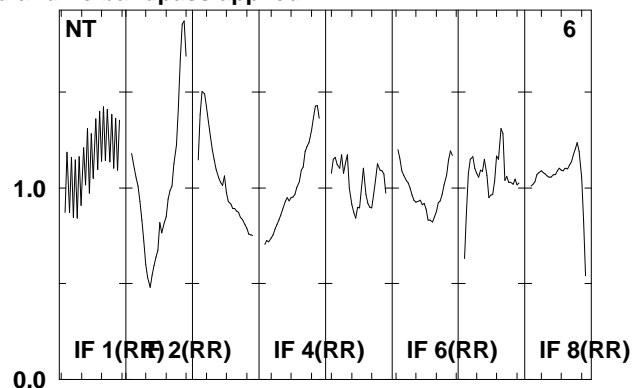
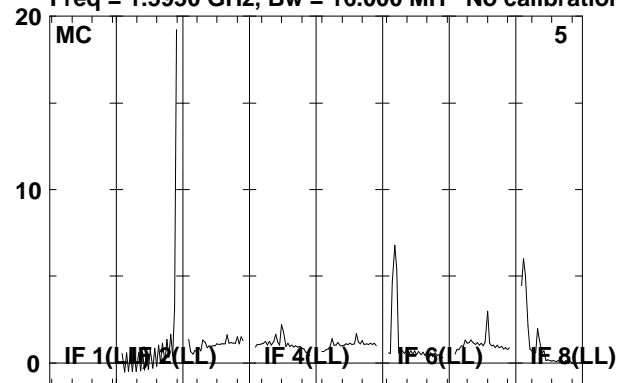

Lower frame: Real Jy  
Total-power spectrum Antenna: \*  
Timerange: 00/07:07:53 to 00/07:12:21

Plot file version 177 created 08-AUG-2008 16:59:46

J021348 EO006B.UVDATA.1

Freq = 1.5950 GHz, Bw = 16.000 MH No calibration applied and no bandpass applied

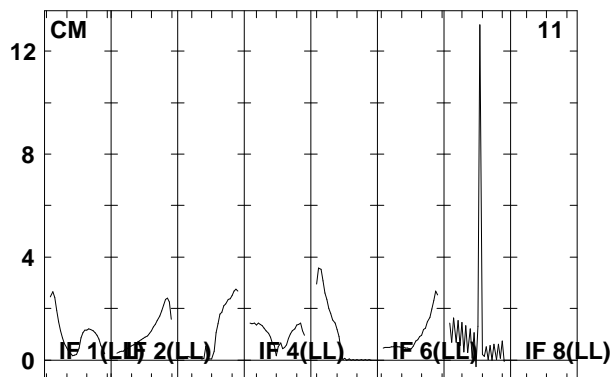
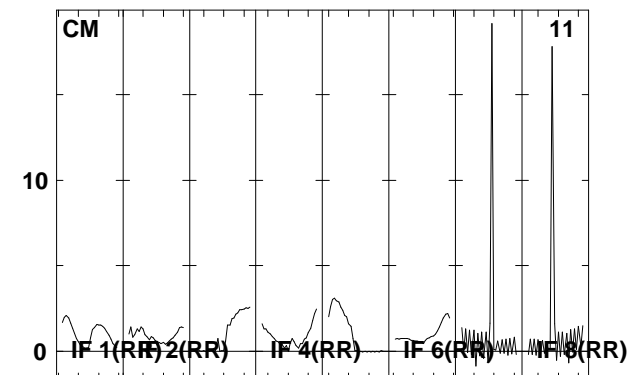
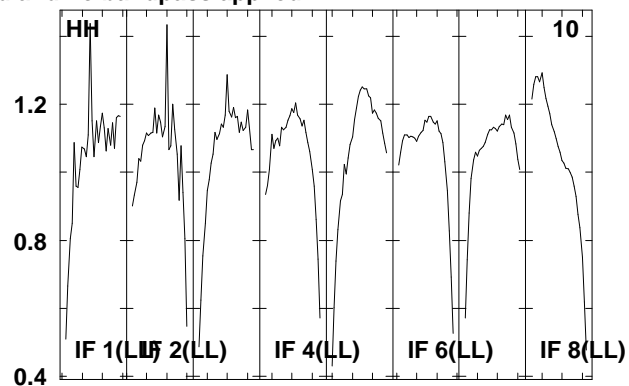
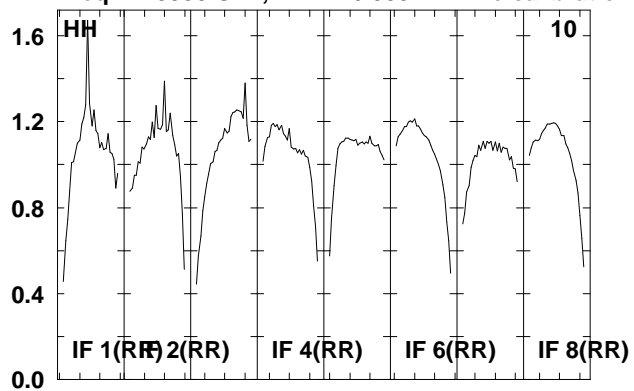

Lower frame: Real Jy  
Total-power spectrum Antenna: \*  
Timerange: 00/07:07:53 to 00/07:12:21

Plot file version 178 created 08-AUG-2008 16:59:46

J0209+13 EO006B.UVDATA.1

Freq = 1.5950 GHz, Bw = 16.000 MH No calibration applied and no bandpass applied

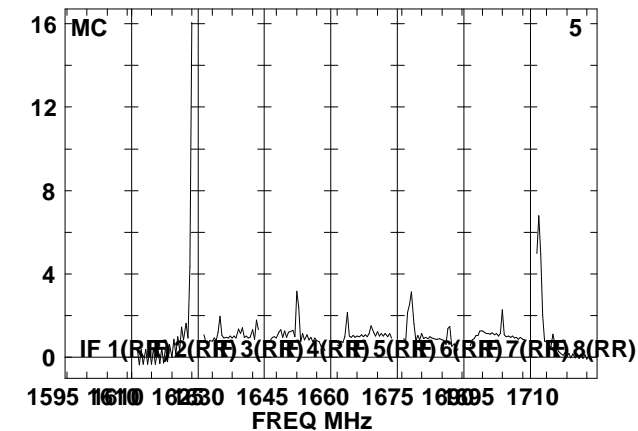
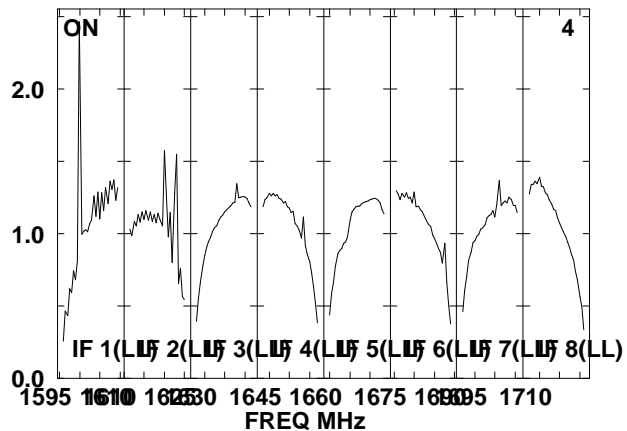
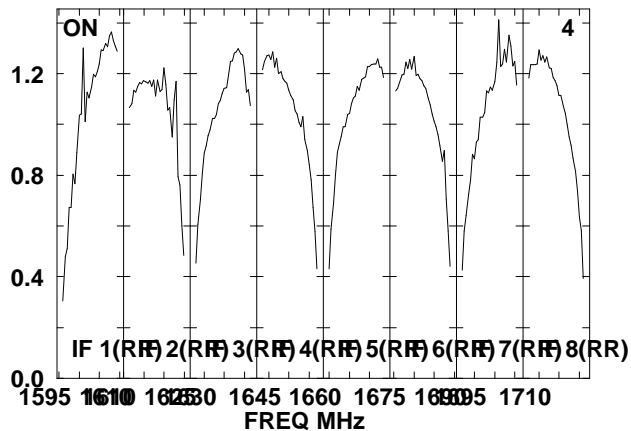
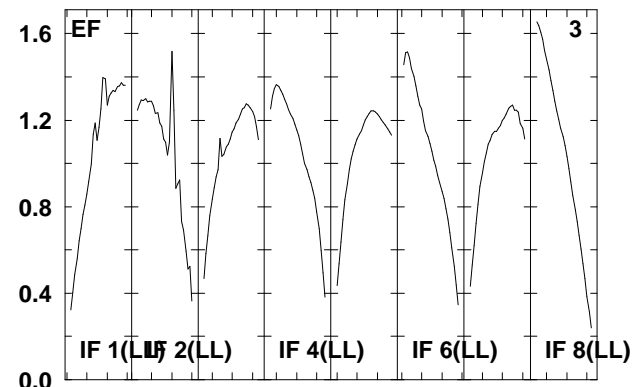
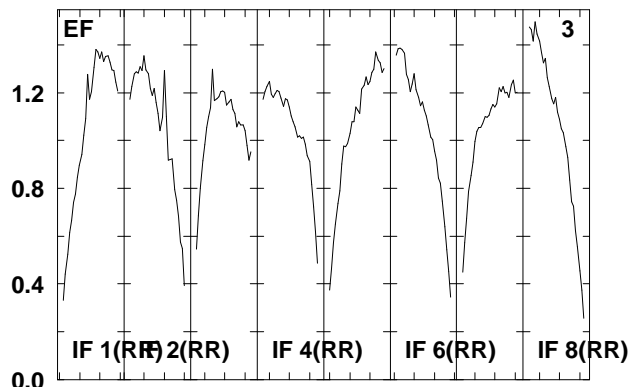
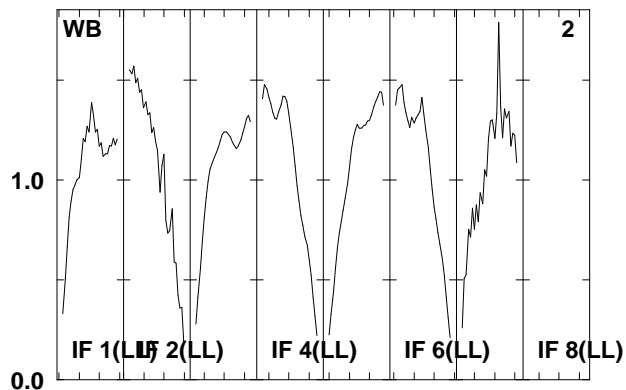
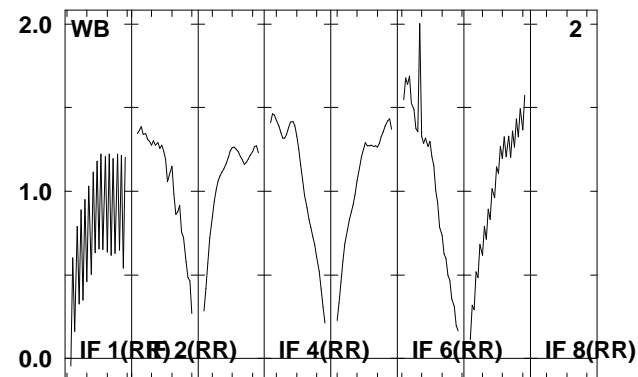
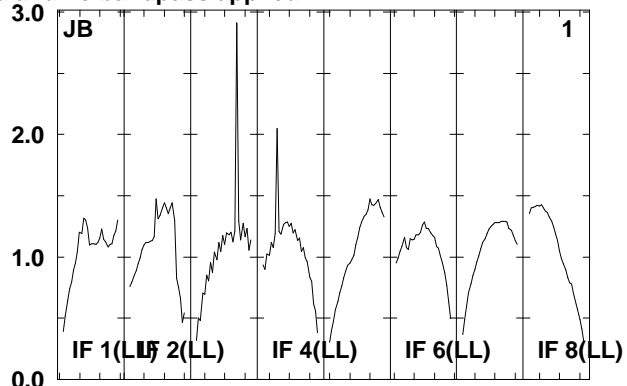
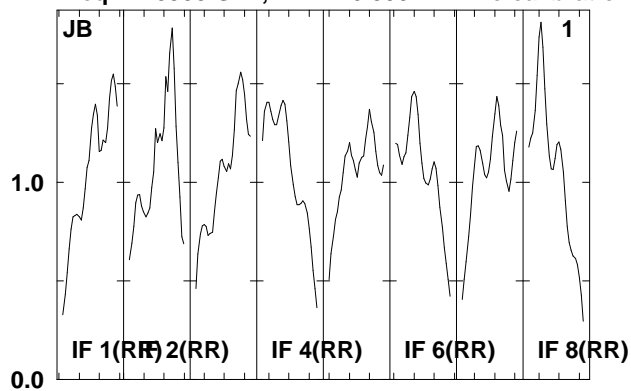

Lower frame: Real Jy  
Total-power spectrum Antenna: \*  
Timerange: 00/07:13:03 to 00/07:14:31

Plot file version 179 created 08-AUG-2008 16:59:46

J0209+13 EO006B.UVDATA.1

Freq = 1.5950 GHz, Bw = 16.000 MH No calibration applied and no bandpass applied

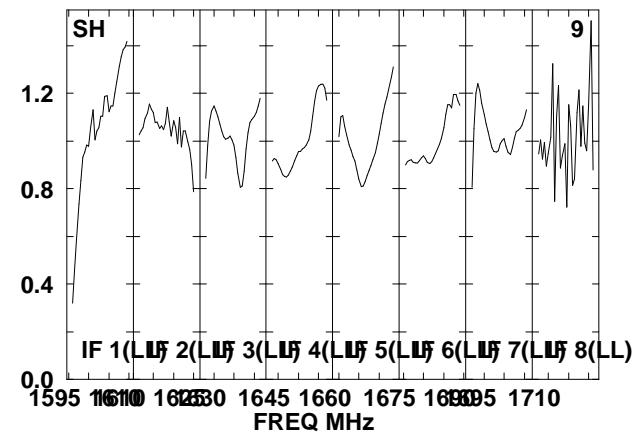
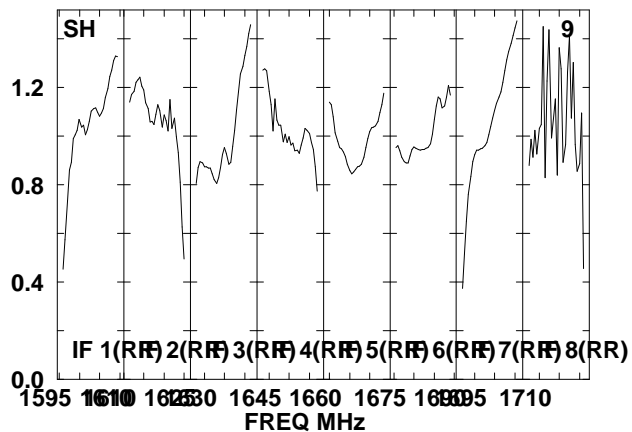
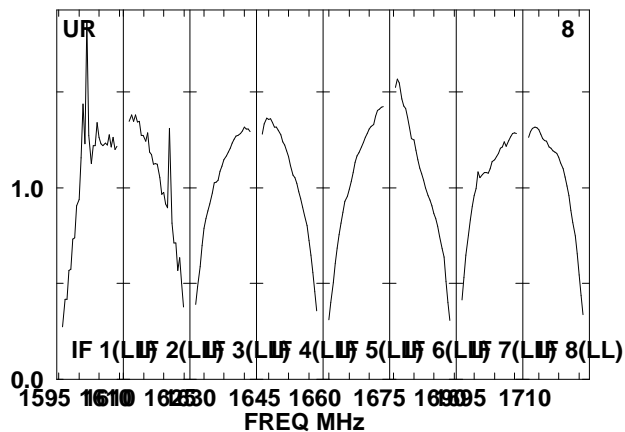
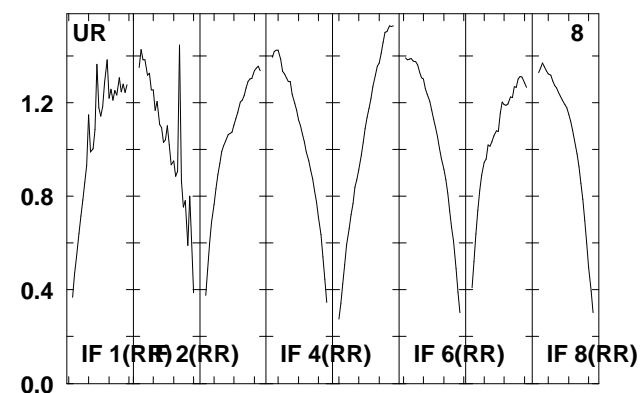
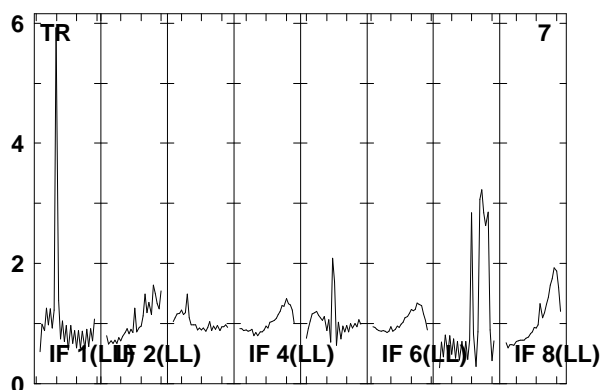
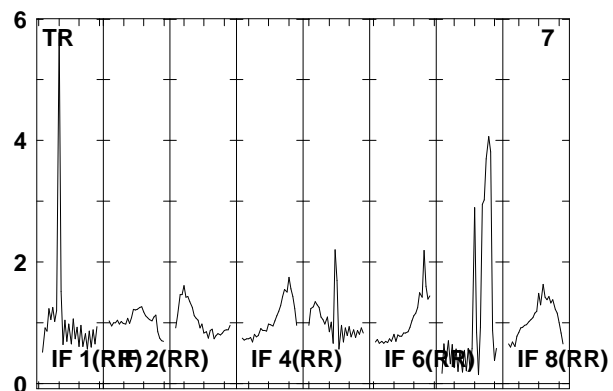
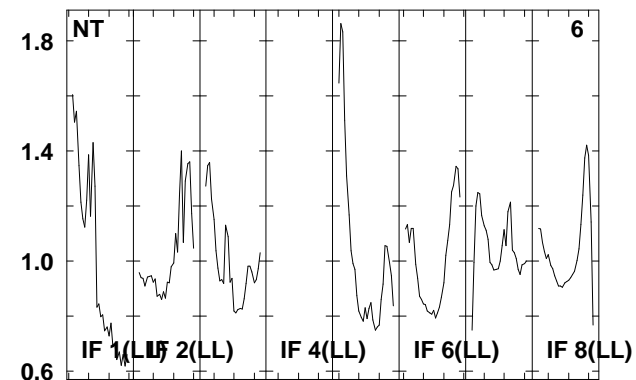
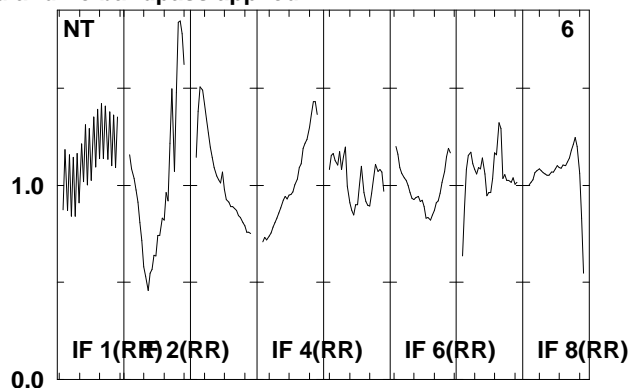
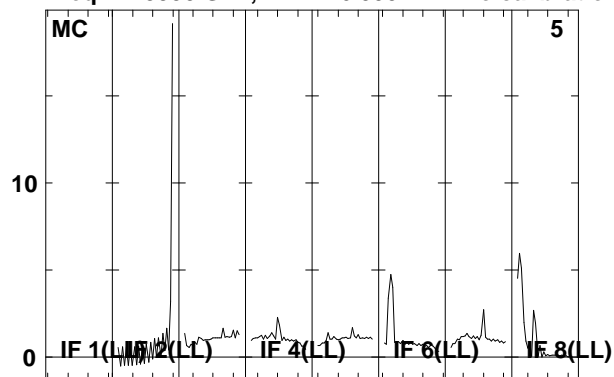

Lower frame: Real Jy

Total-power spectrum Antenna: \*

Timerange: 00/07:13:03 to 00/07:14:31

Plot file version 180 created 08-AUG-2008 16:59:47

J0209+13 EO006B.UVDATA.1

Freq = 1.5950 GHz, Bw = 16.000 MH No calibration applied and no bandpass applied

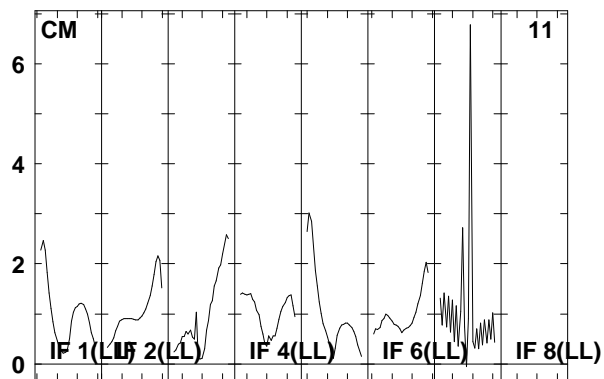
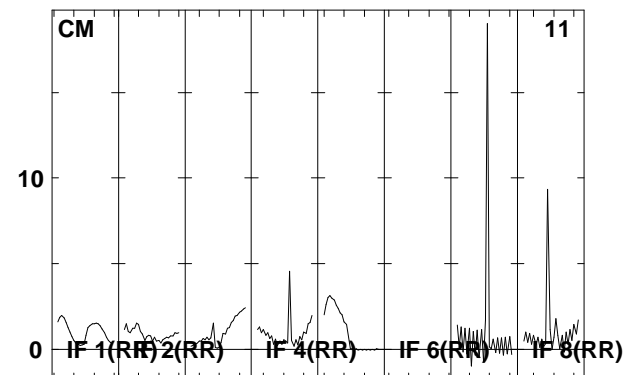
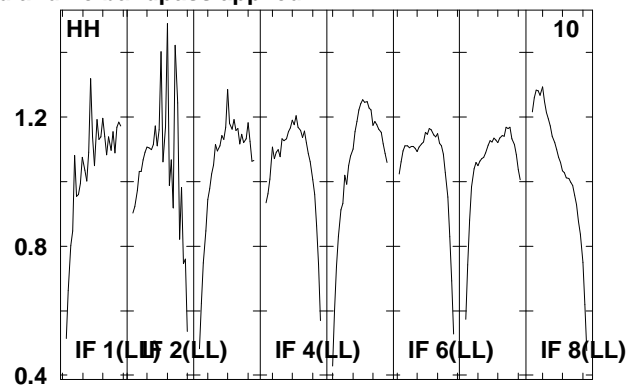
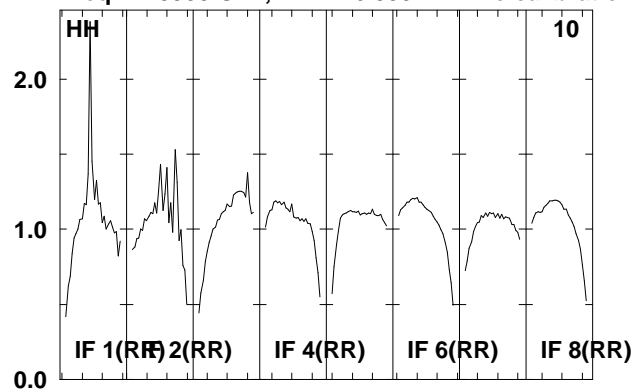

Lower frame: Real Jy  
Total-power spectrum Antenna: \*  
Timerange: 00/07:13:03 to 00/07:14:31



Plot file version 181 created 08-AUG-2008 16:59:47

J021348 EO006B.UVDATA.1

Freq = 1.5950 GHz, Bw = 16.000 MH No calibration applied and no bandpass applied

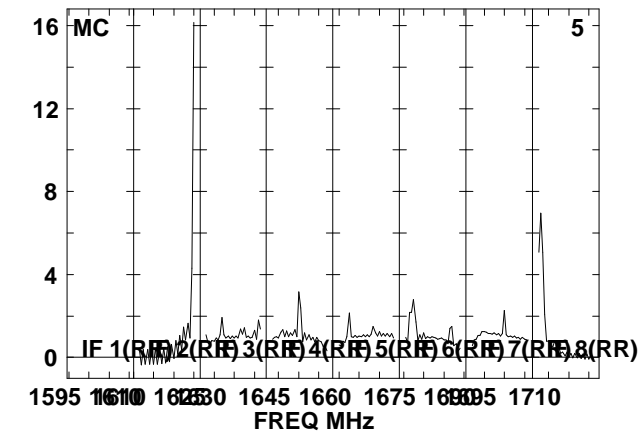
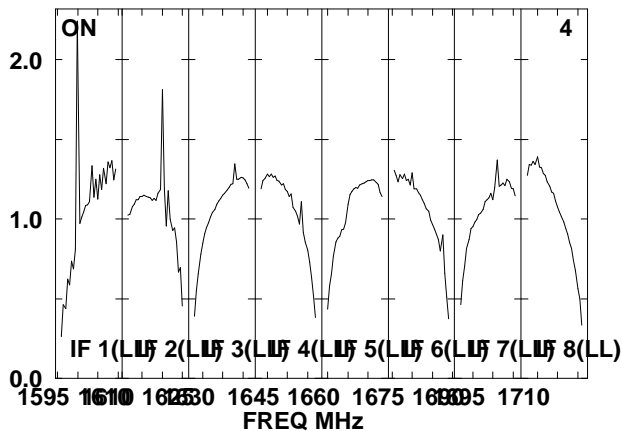
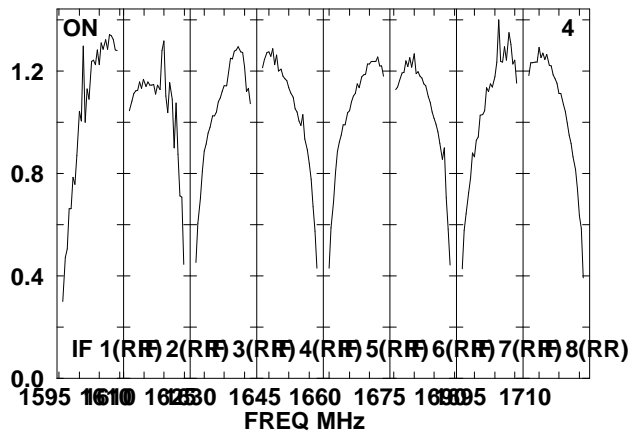
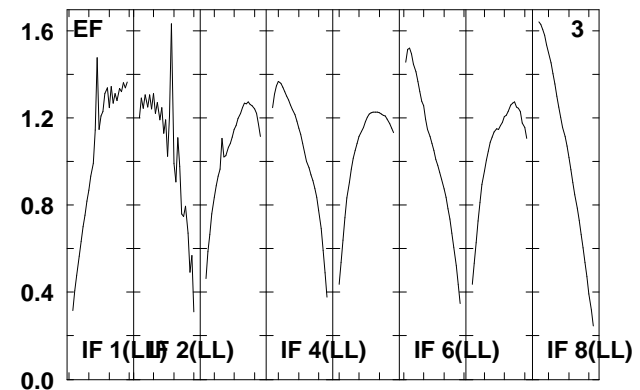
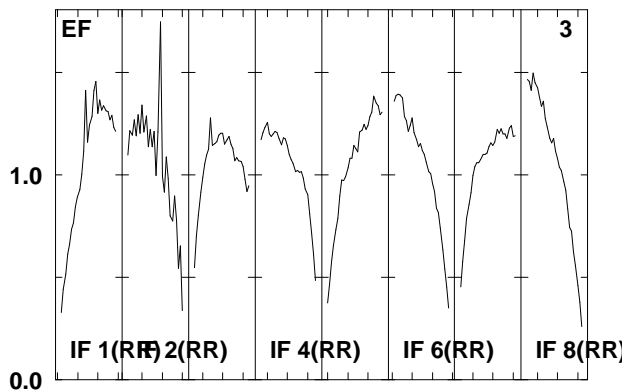
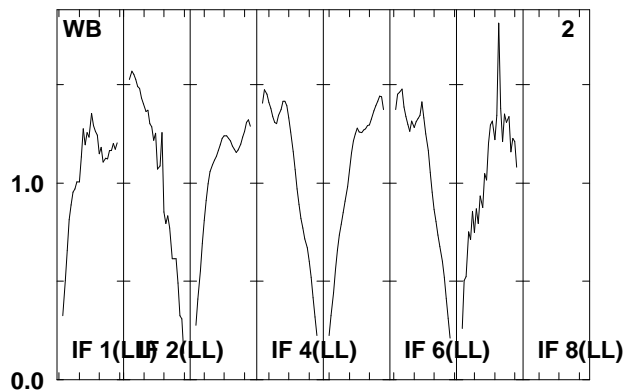
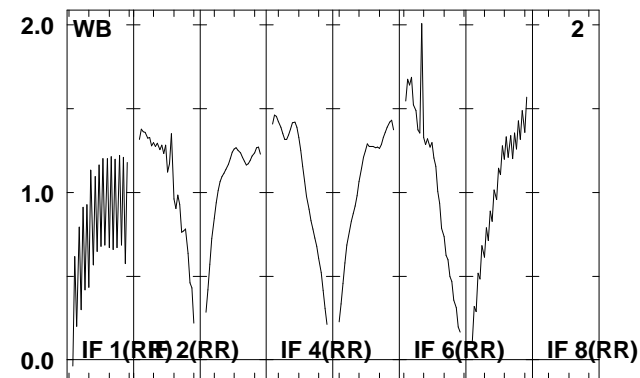
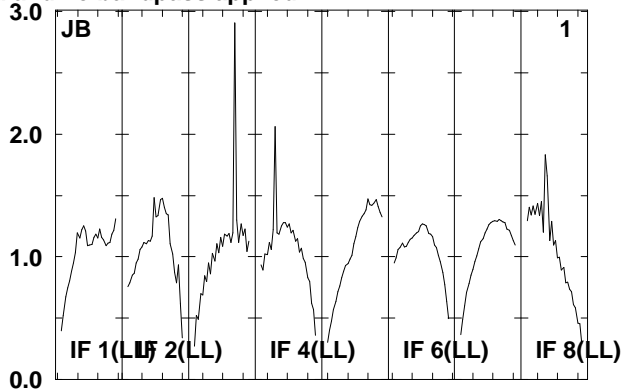
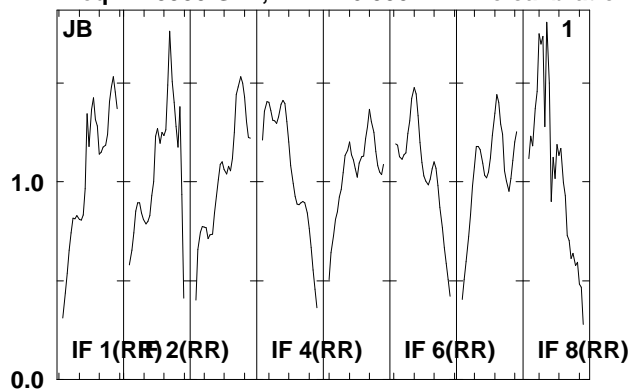

Lower frame: Real Jy  
Total-power spectrum Antenna: \*  
Timerange: 00/07:15:13 to 00/07:19:49

Plot file version 182 created 08-AUG-2008 16:59:48

J021348 EO06B.UVDATA.1

Freq = 1.5950 GHz, Bw = 16.000 MH No calibration applied and no bandpass applied

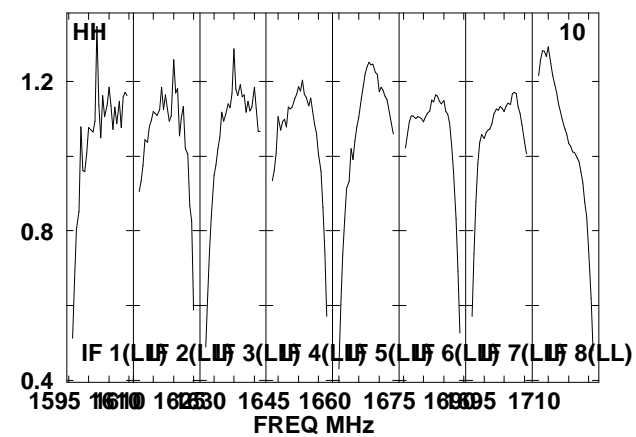
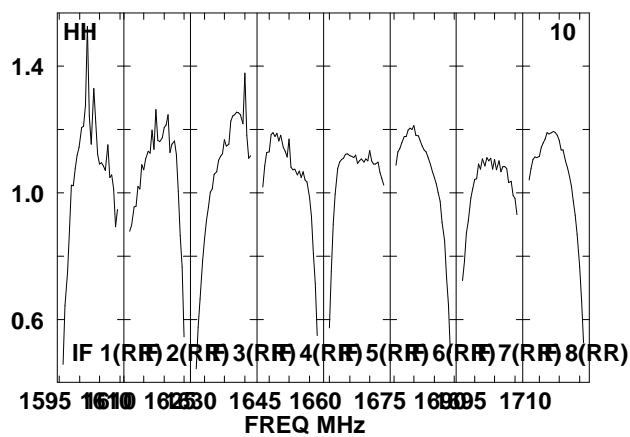
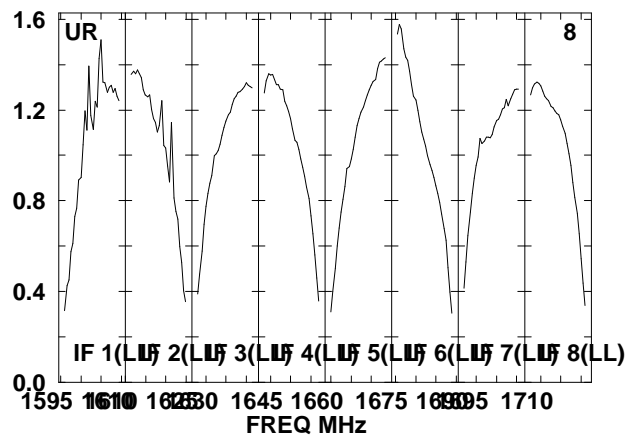
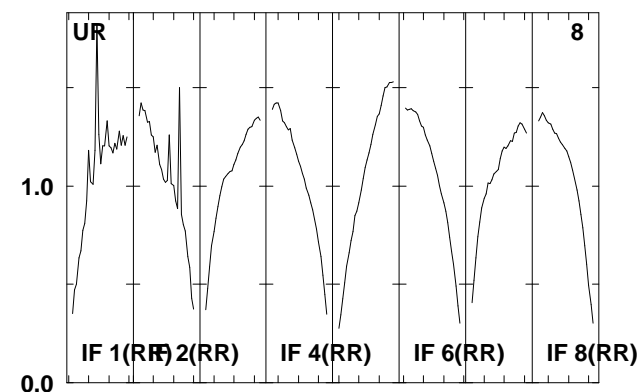
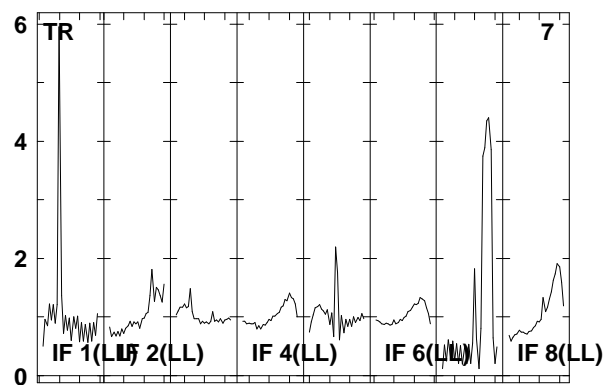
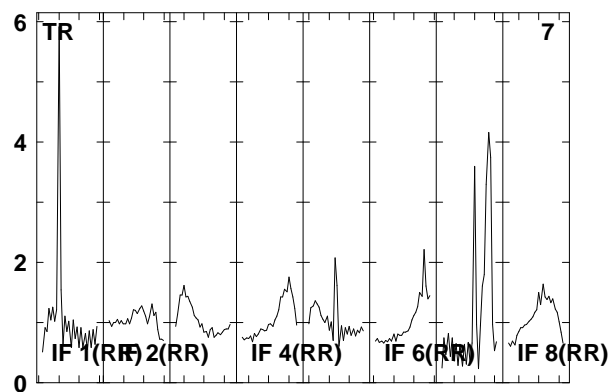
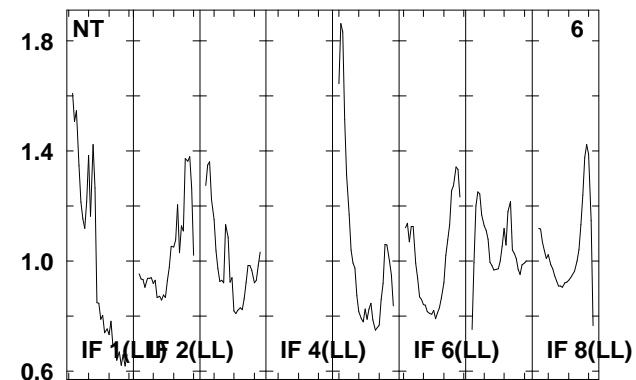
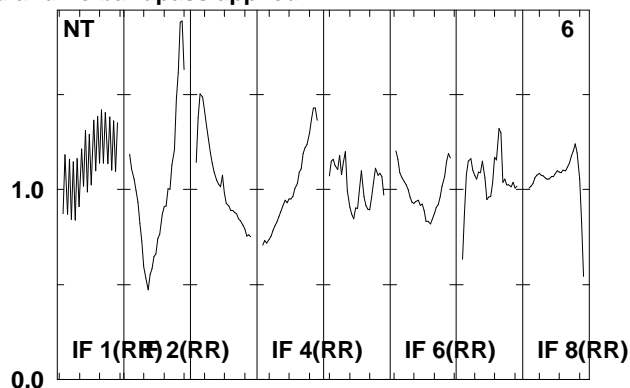
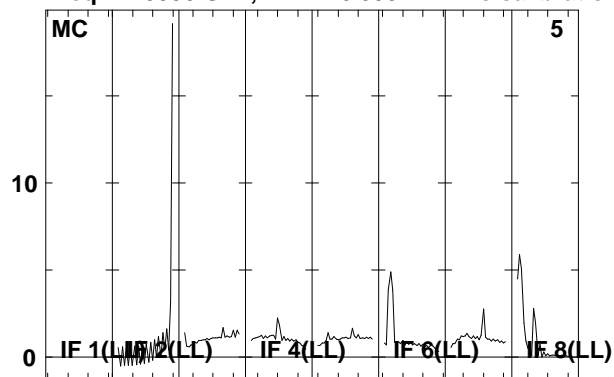

Lower frame: Real Jy  
Total-power spectrum Antenna: \*  
Timerange: 00/07:15:13 to 00/07:19:49

Plot file version 183 created 08-AUG-2008 16:59:49

J021348 EO006B.UVDATA.1

Freq = 1.5950 GHz, Bw = 16.000 MH No calibration applied and no bandpass applied

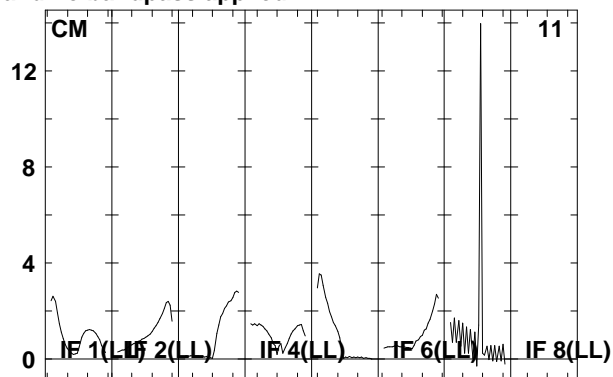
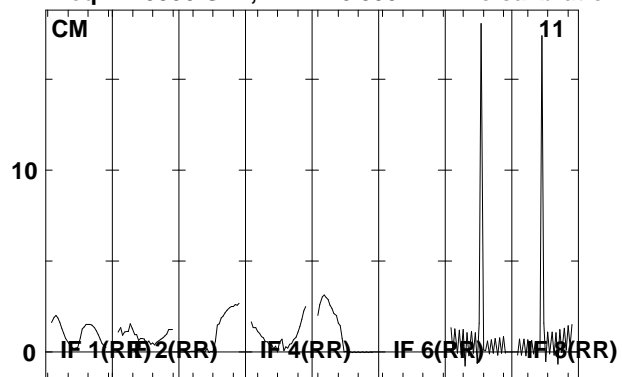

Lower frame: Real Jy  
Total-power spectrum Antenna: \*  
Timerange: 00/07:15:13 to 00/07:19:49

Plot file version 184 created 08-AUG-2008 16:59:49

J0209+13 EO006B.UVDATA.1

Freq = 1.5950 GHz, Bw = 16.000 MH No calibration applied and no bandpass applied

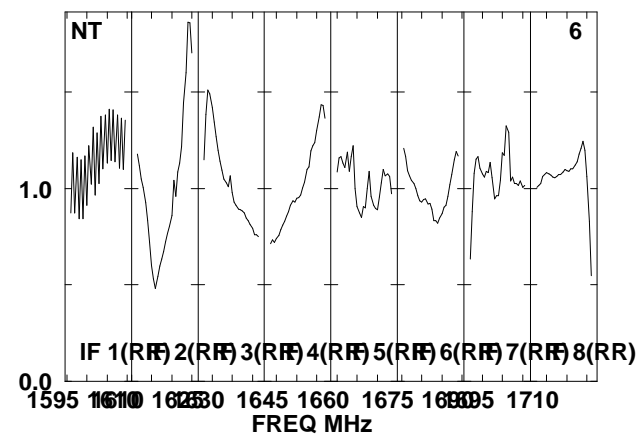
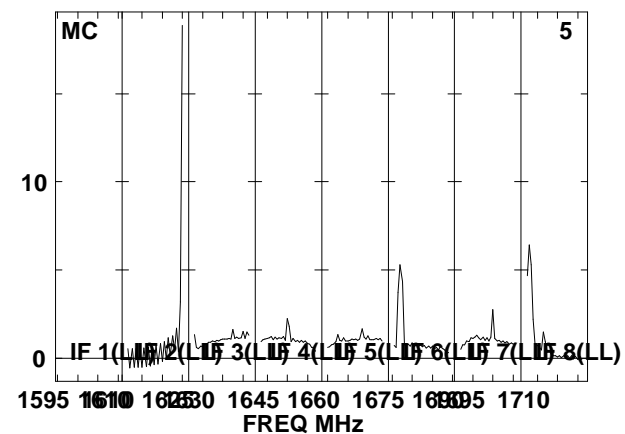
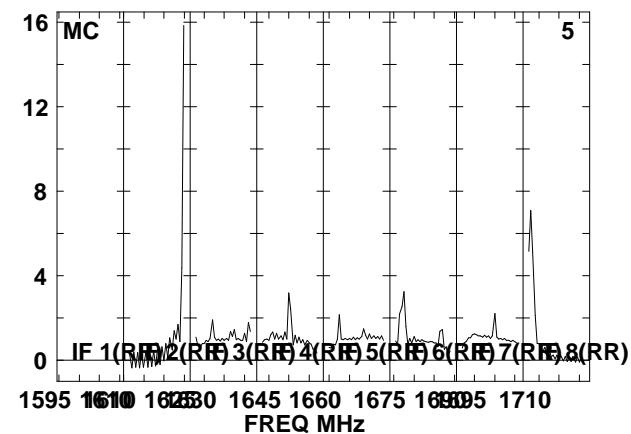
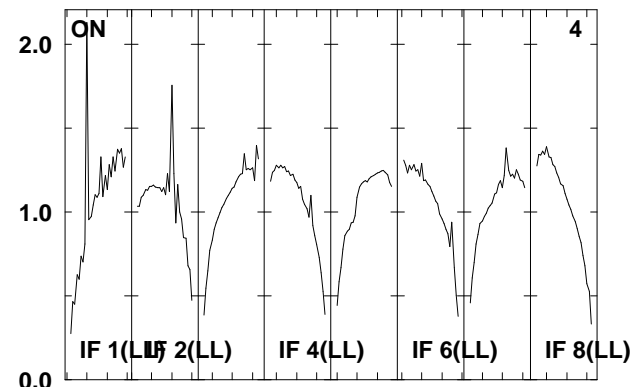
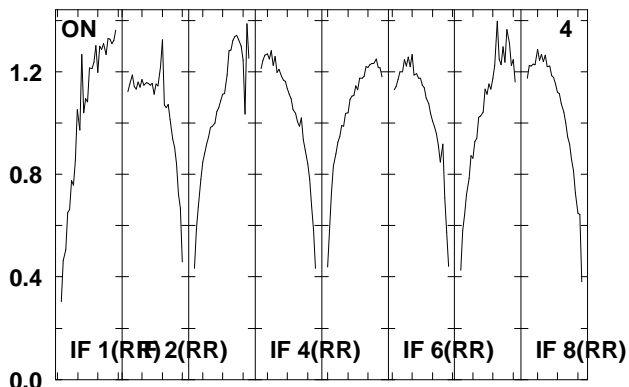
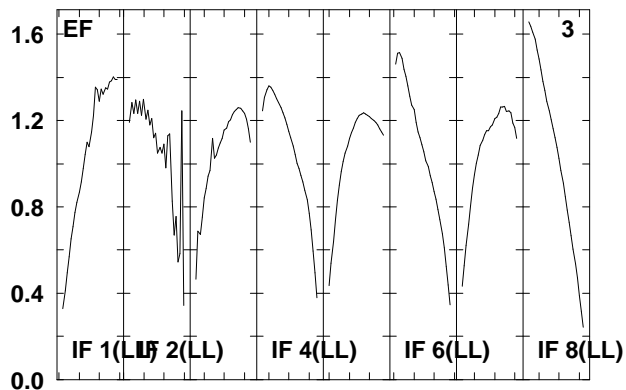
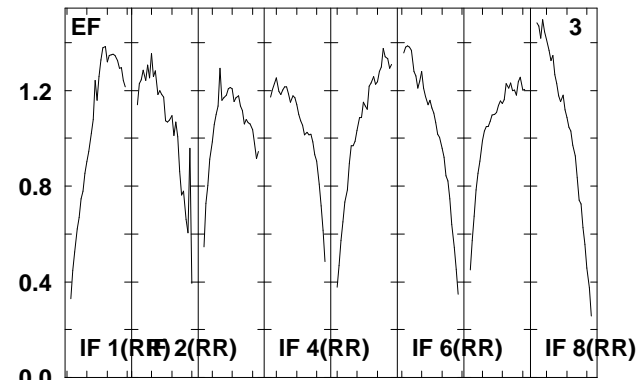
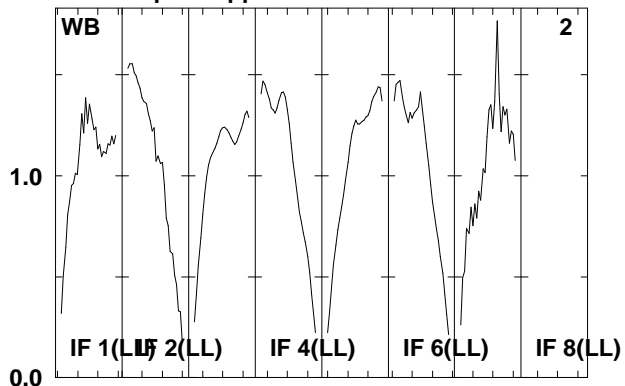
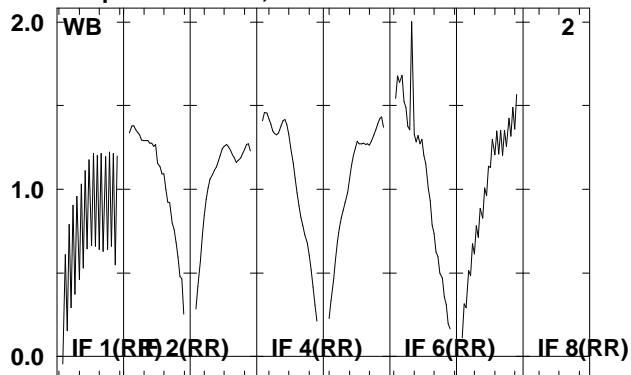

Lower frame: Real Jy

Total-power spectrum Antenna: \*

Timerange: 00/07:20:21 to 00/07:21:57

Plot file version 185 created 08-AUG-2008 16:59:50

J0209+13 EO06B.UVDATA.1

Freq = 1.5950 GHz, Bw = 16.000 MH No calibration applied and no bandpass applied

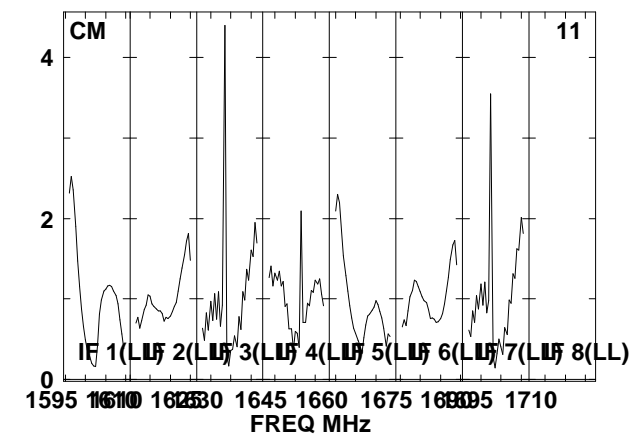
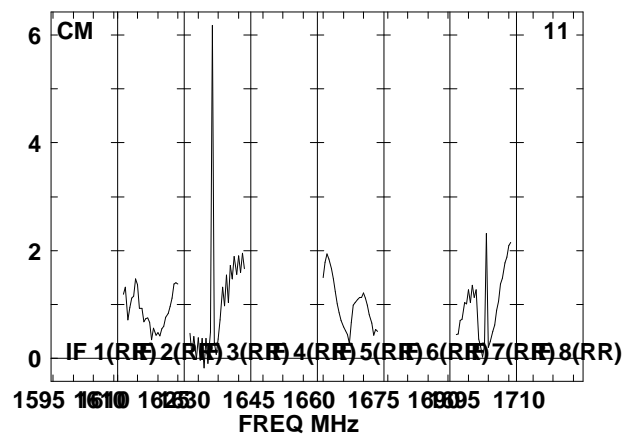
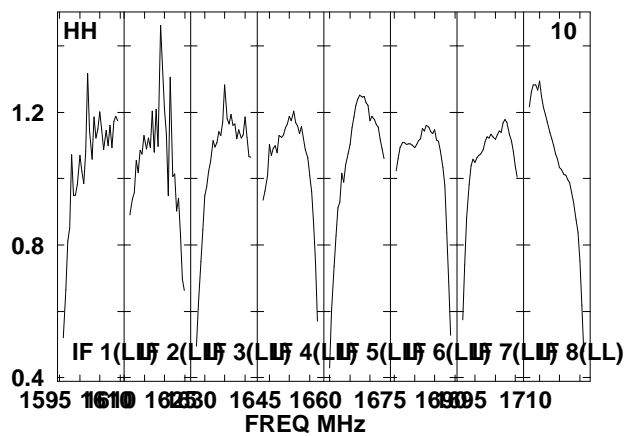
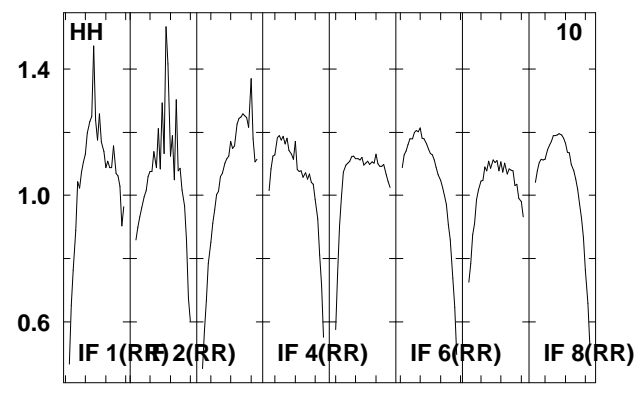
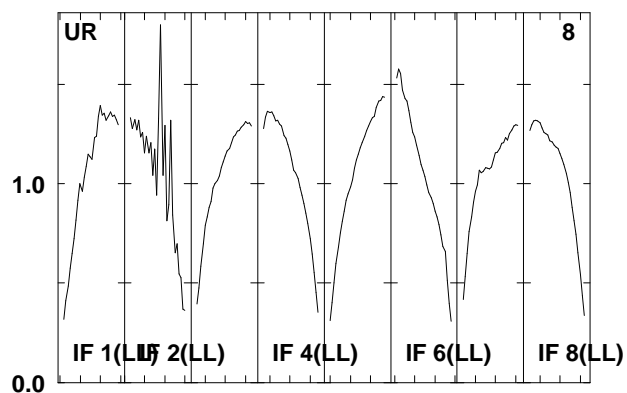
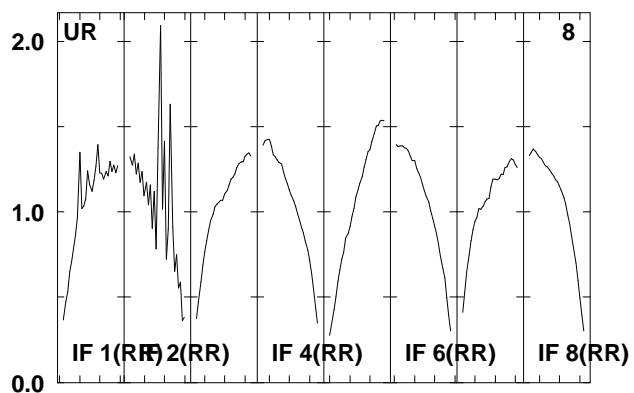
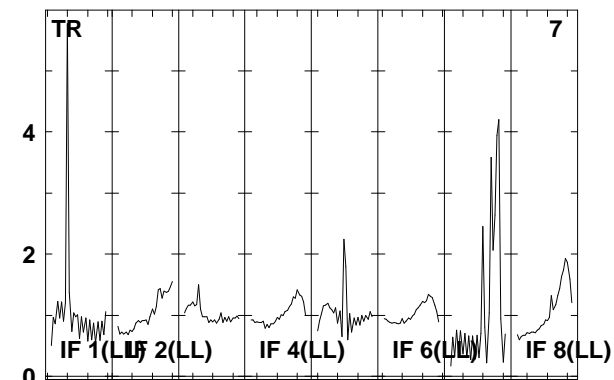
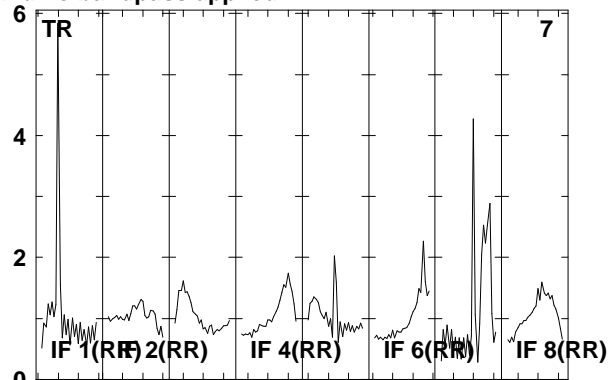
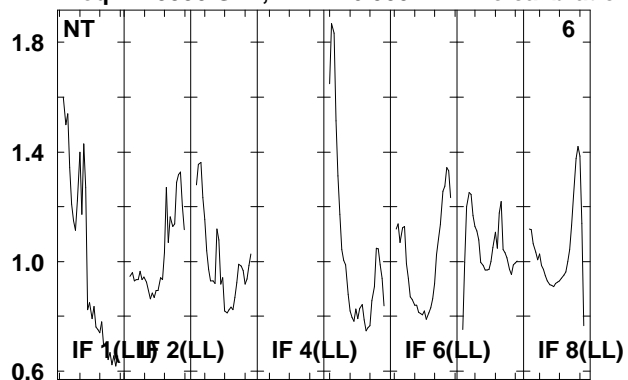

Lower frame: Real Jy  
Total-power spectrum Antenna: \*  
Timerange: 00/07:20:21 to 00/07:21:57

Plot file version 186 created 08-AUG-2008 16:59:50

J021348 EO006B.UVDATA.1

Freq = 1.5950 GHz, Bw = 16.000 MH No calibration applied and no bandpass applied

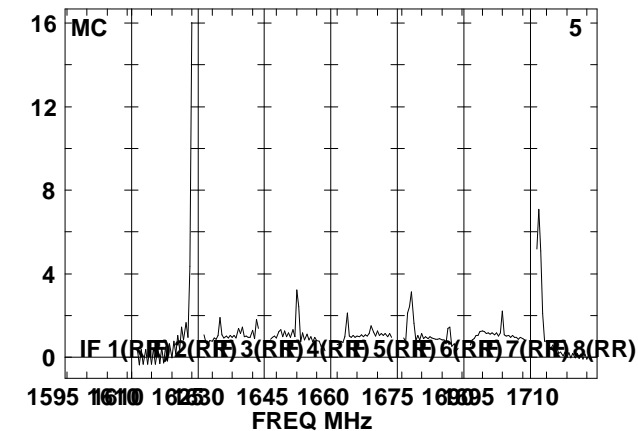
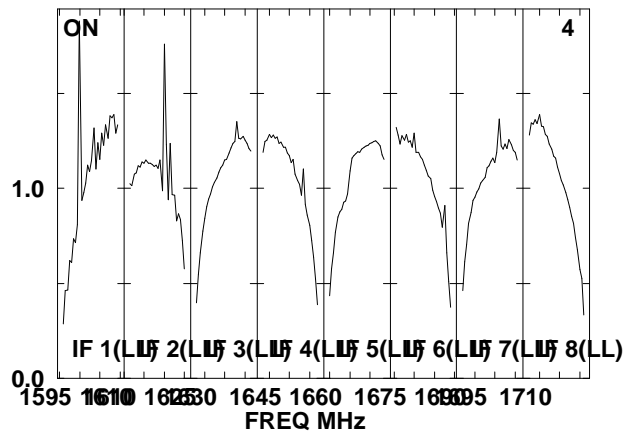
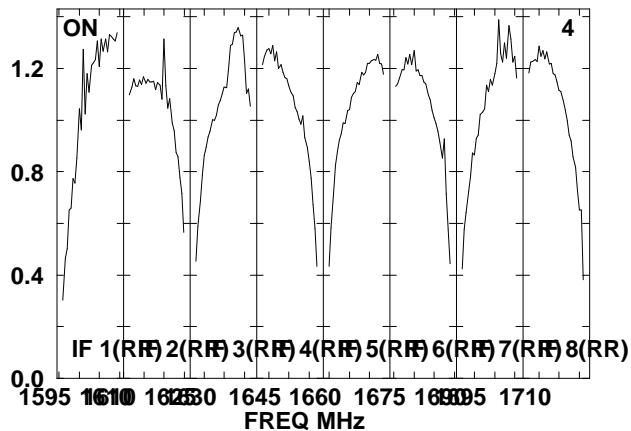
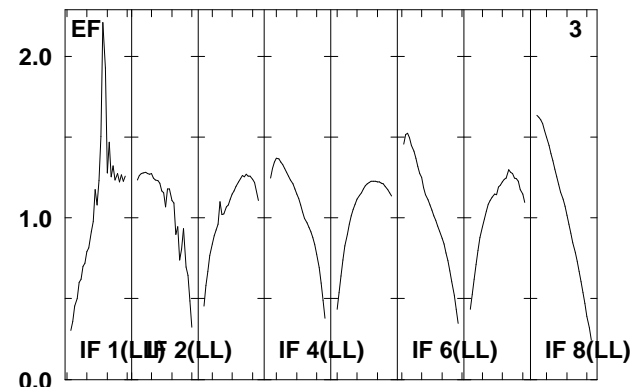
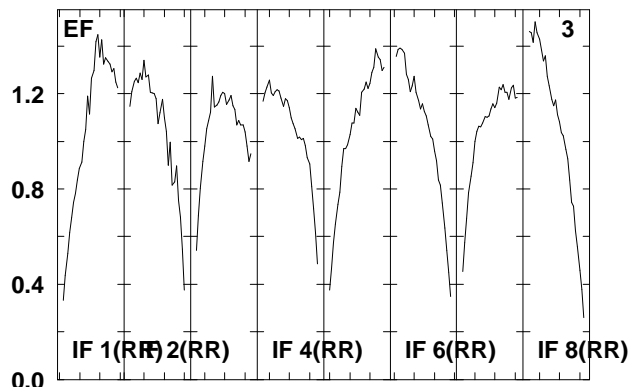
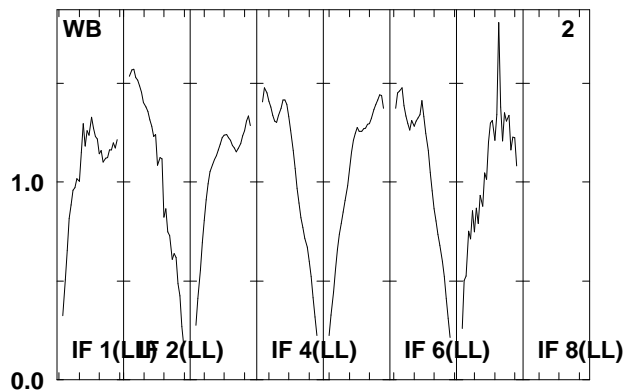
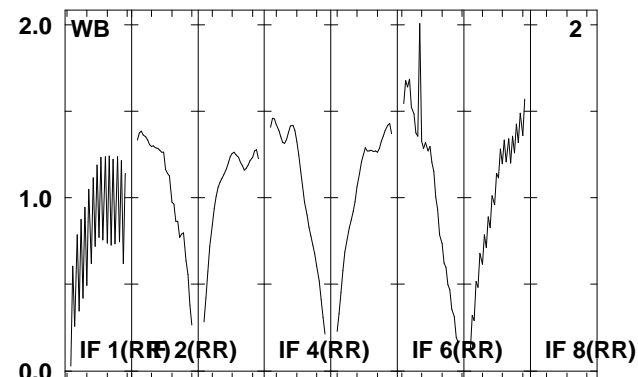
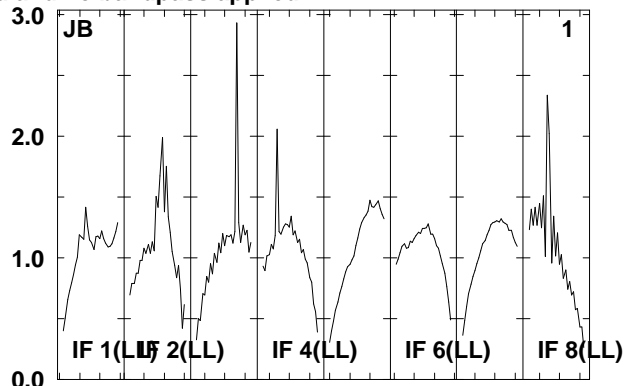
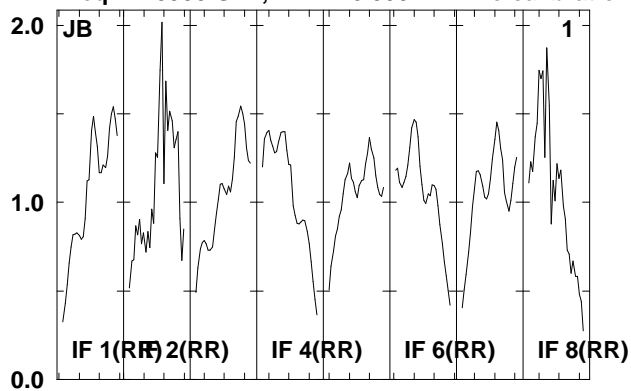

Lower frame: Real Jy  
Total-power spectrum Antenna: \*  
Timerange: 00/07:22:33 to 00/07:27:09

Plot file version 187 created 08-AUG-2008 16:59:51

J021348 EO06B.UVDATA.1

Freq = 1.5950 GHz, Bw = 16.000 MH No calibration applied and no bandpass applied

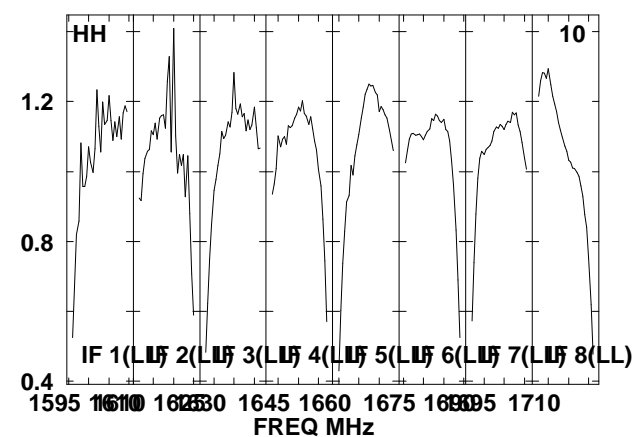
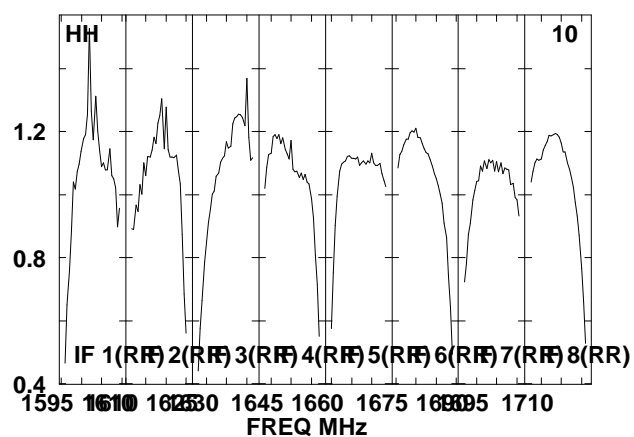
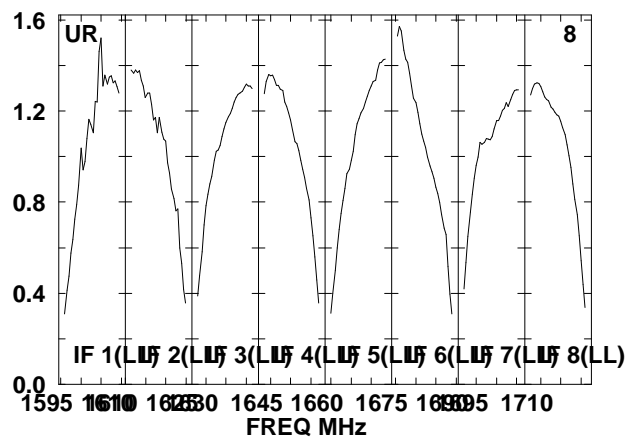
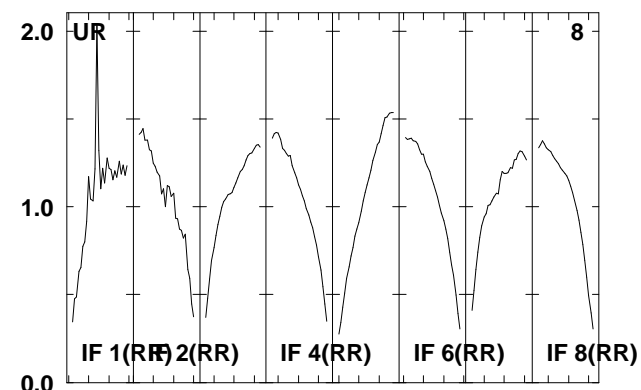
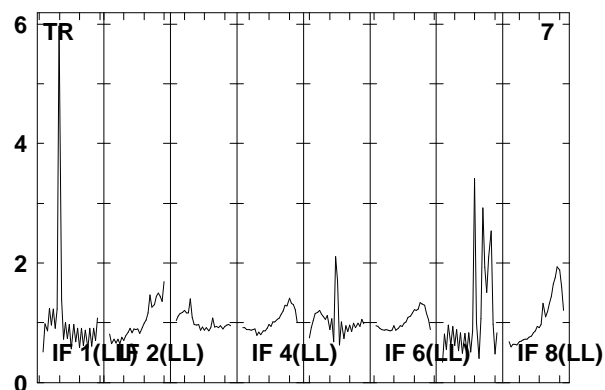
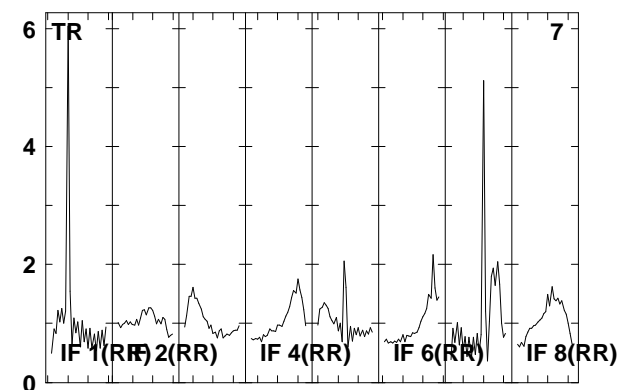
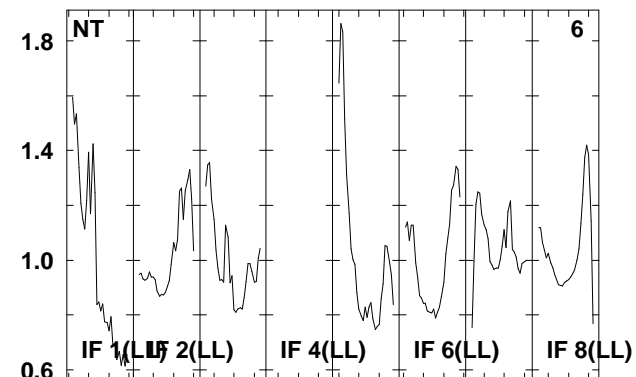
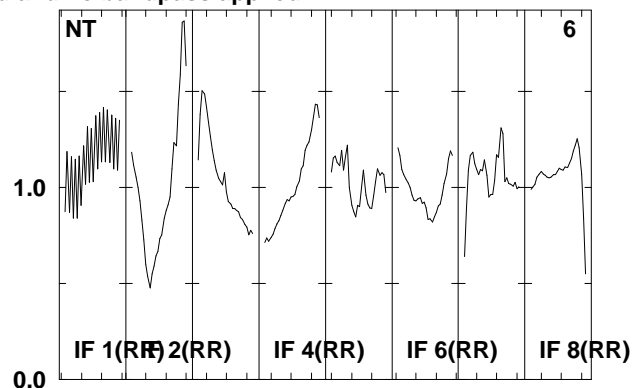
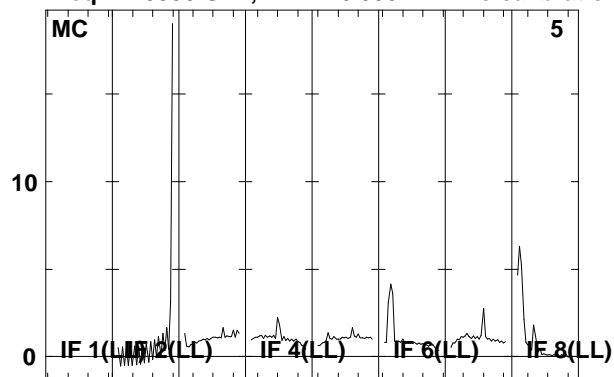

Lower frame: Real Jy

Total-power spectrum Antenna: \*

Timerange: 00/07:22:33 to 00/07:27:09

Plot file version 188 created 08-AUG-2008 16:59:51

J021348 EO006B.UVDATA.1

Freq = 1.5950 GHz, Bw = 16.000 MH No calibration applied and no bandpass applied

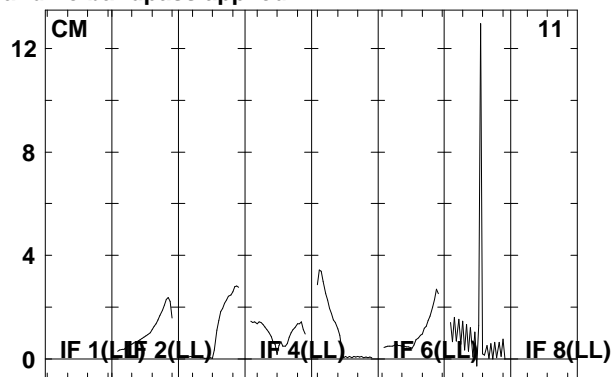
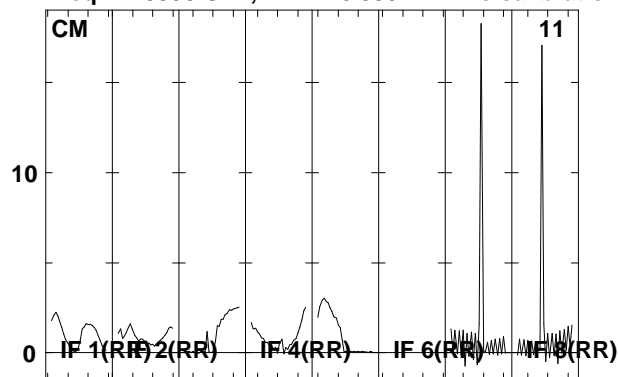

Lower frame: Real Jy  
Total-power spectrum Antenna: \*  
Timerange: 00/07:22:33 to 00/07:27:09



Plot file version 189 created 08-AUG-2008 16:59:53

J0209+13 EO006B.UVDATA.1

Freq = 1.5950 GHz, Bw = 16.000 MH No calibration applied and no bandpass applied

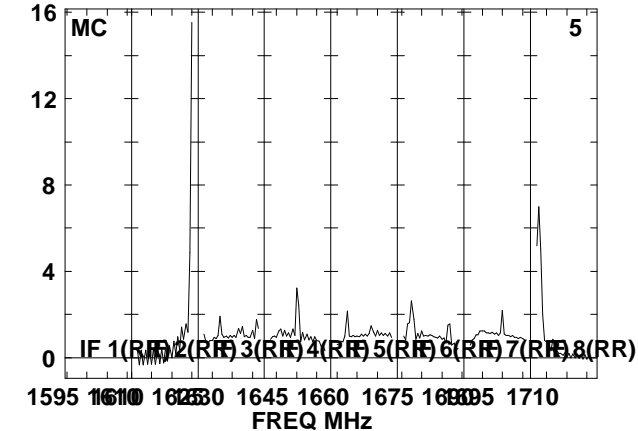
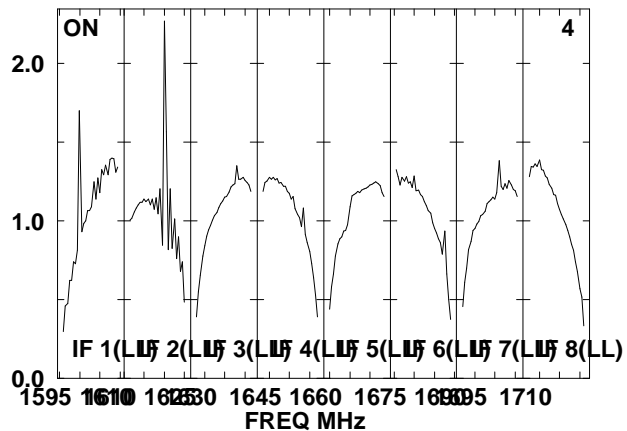
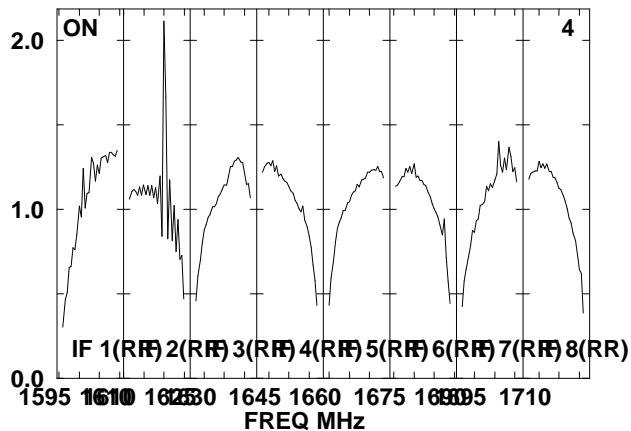
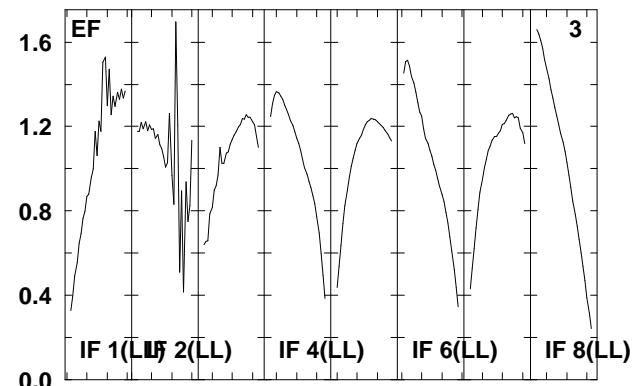
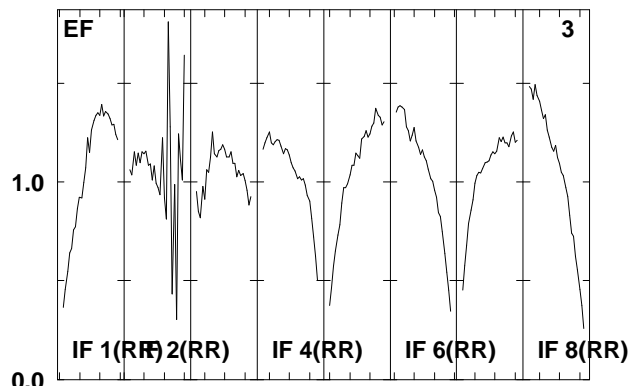
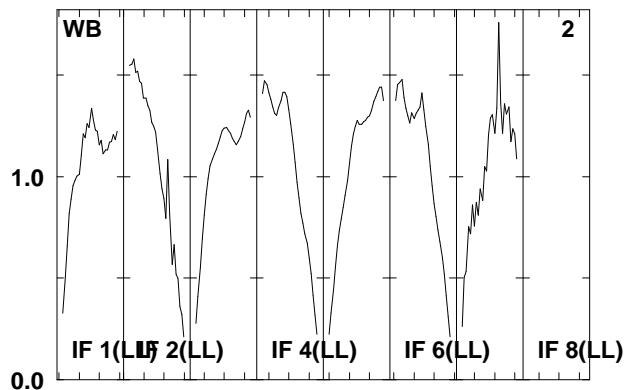
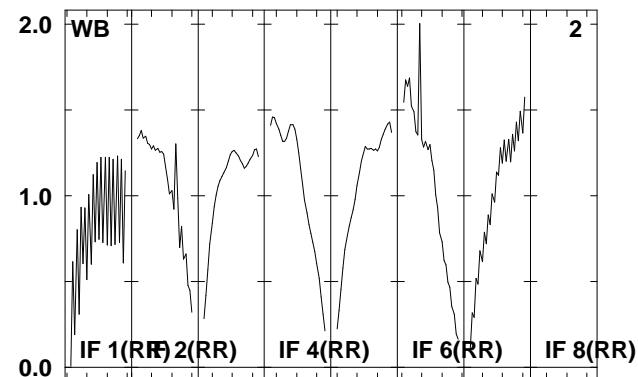
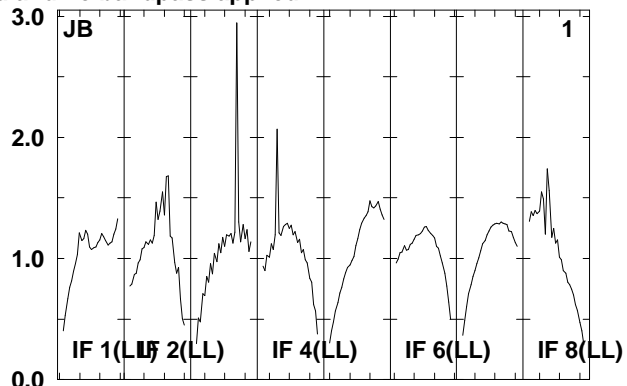
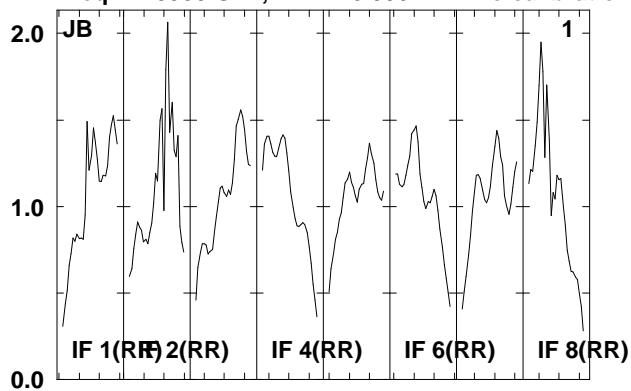

Lower frame: Real Jy  
Total-power spectrum Antenna: \*  
Timerange: 00/07:27:41 to 00/07:29:17

Plot file version 190 created 08-AUG-2008 16:59:53

J0209+13 EO006B.UVDATA.1

Freq = 1.5950 GHz, Bw = 16.000 MH No calibration applied and no bandpass applied

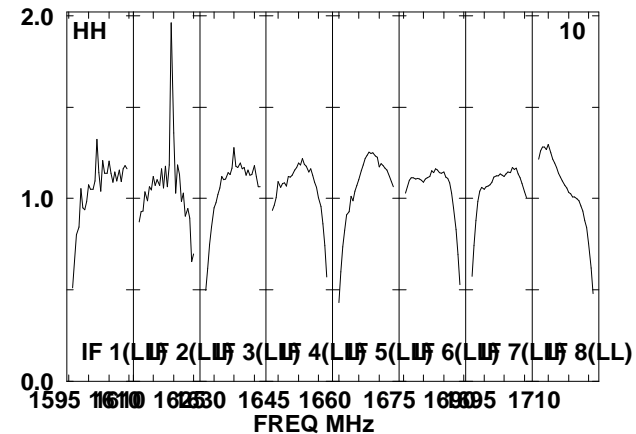
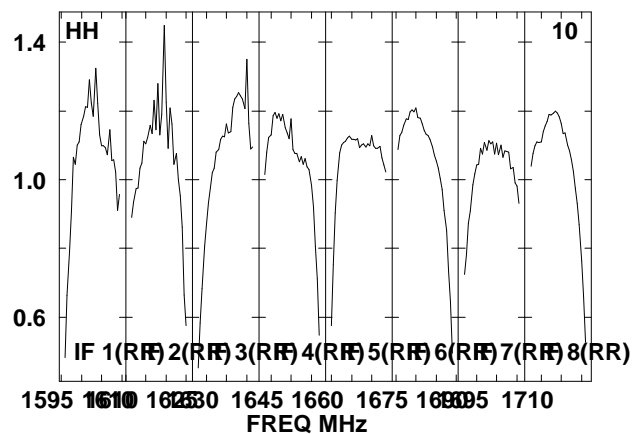
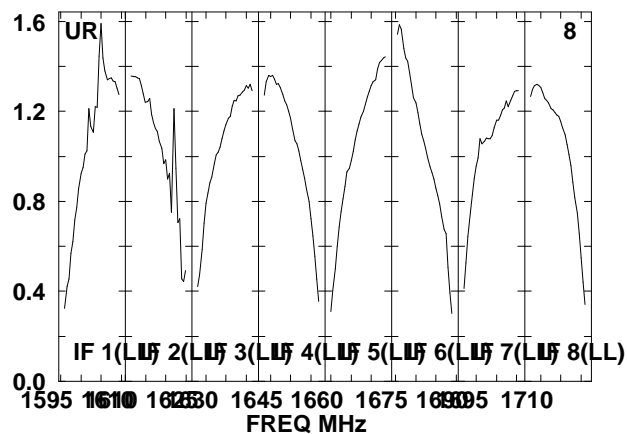
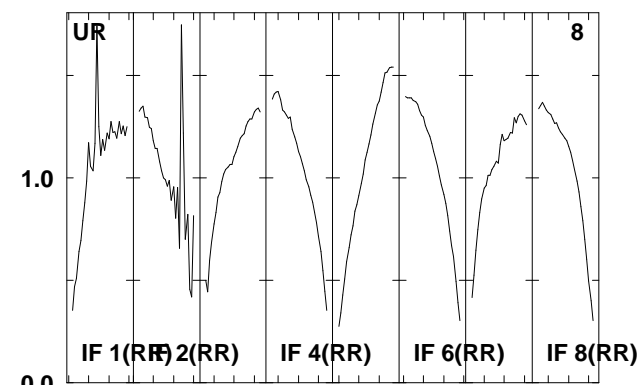
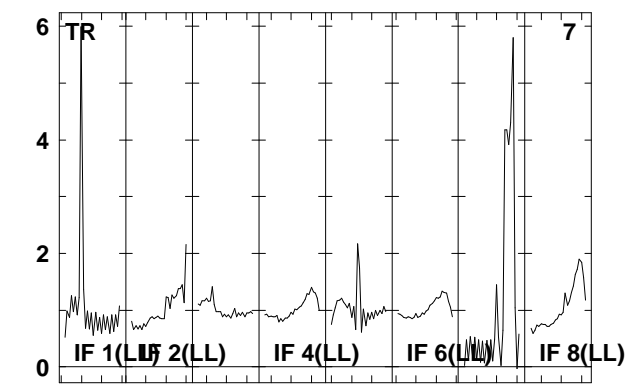
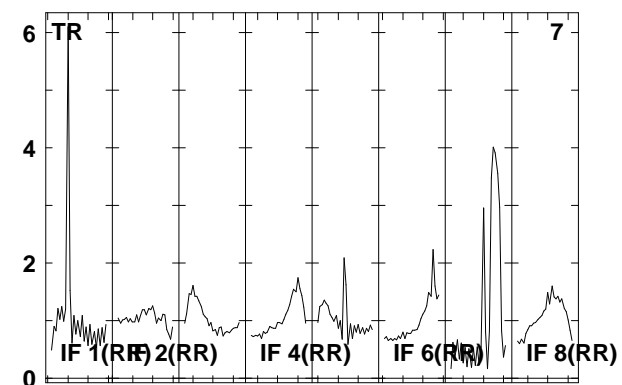
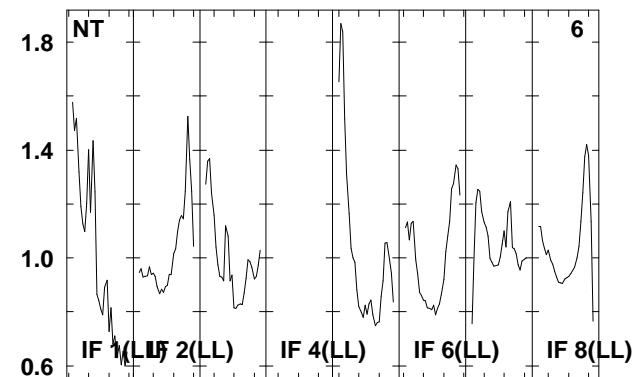
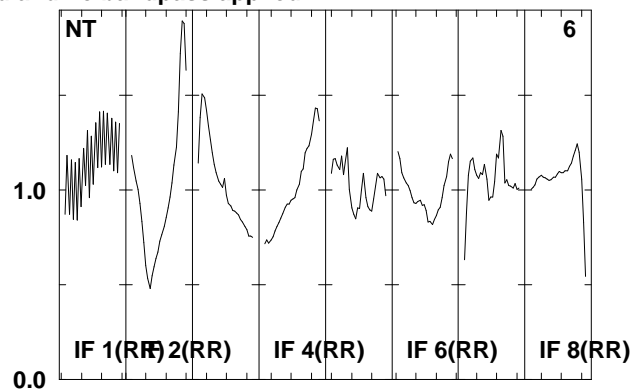
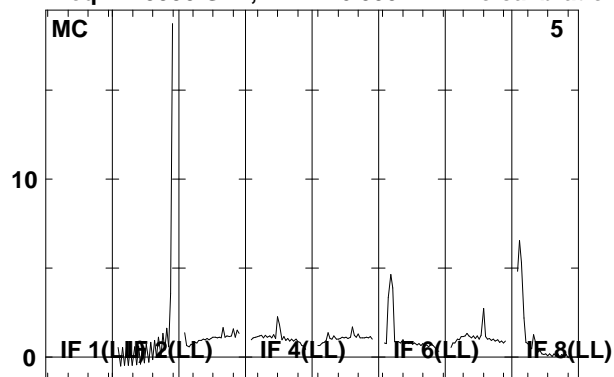

Lower frame: Real Jy  
Total-power spectrum Antenna: \*  
Timerange: 00/07:27:41 to 00/07:29:17

Plot file version 191 created 08-AUG-2008 16:59:53

J0209+13 EO006B.UVDATA.1

Freq = 1.5950 GHz, Bw = 16.000 MH No calibration applied and no bandpass applied

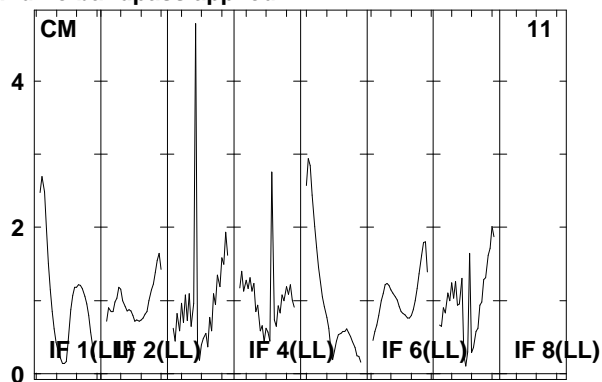
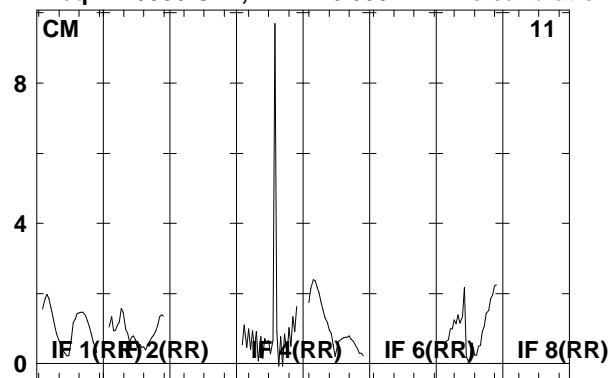

Lower frame: Real Jy  
Total-power spectrum Antenna: \*  
Timerange: 00/07:27:41 to 00/07:29:17

Plot file version 192 created 08-AUG-2008 16:59:54

J021348 EO006B.UVDATA.1

Freq = 1.5950 GHz, Bw = 16.000 MH No calibration applied and no bandpass applied

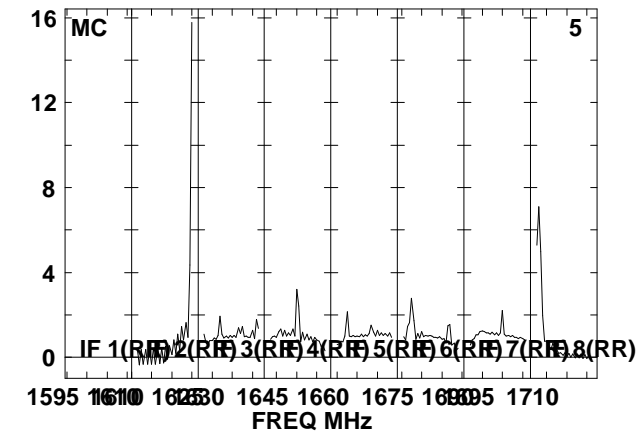
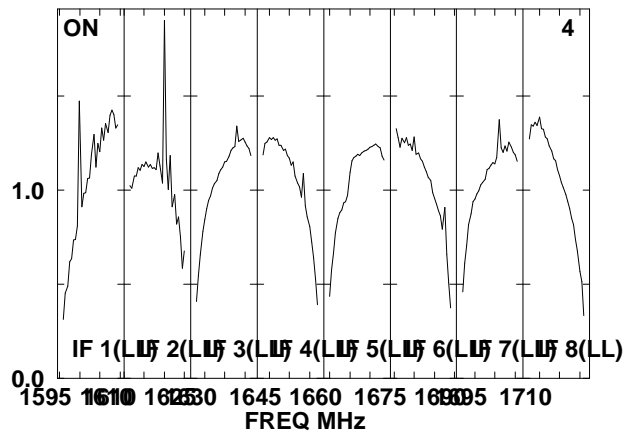
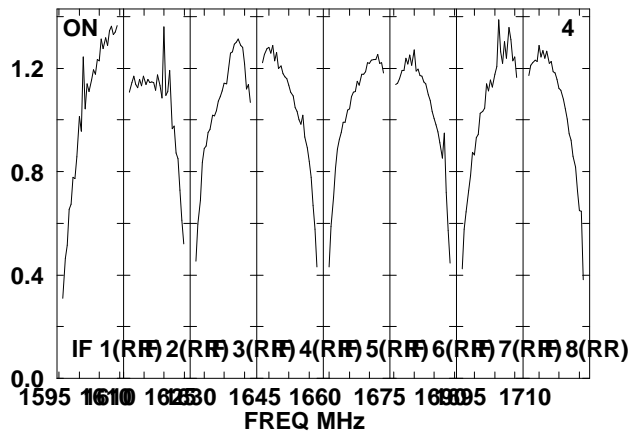
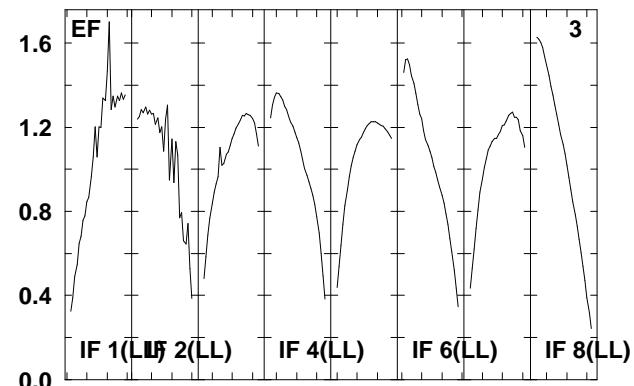
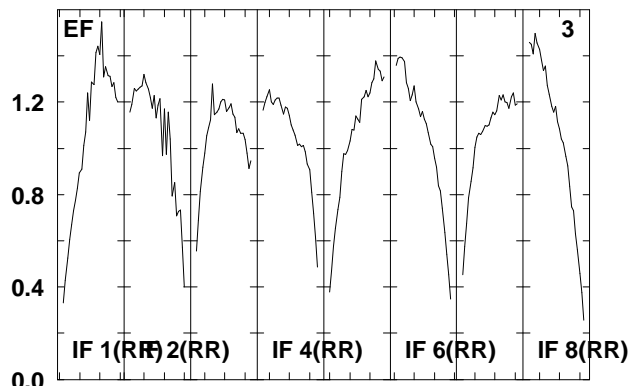
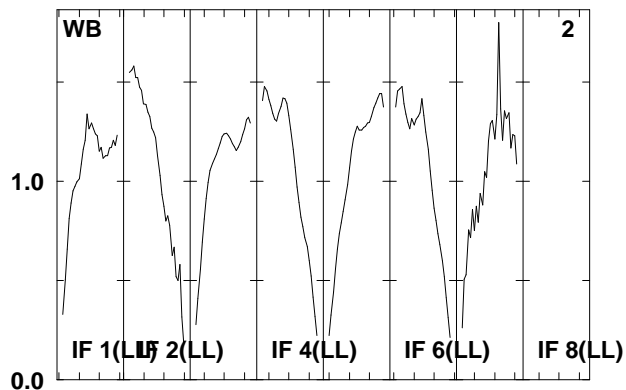
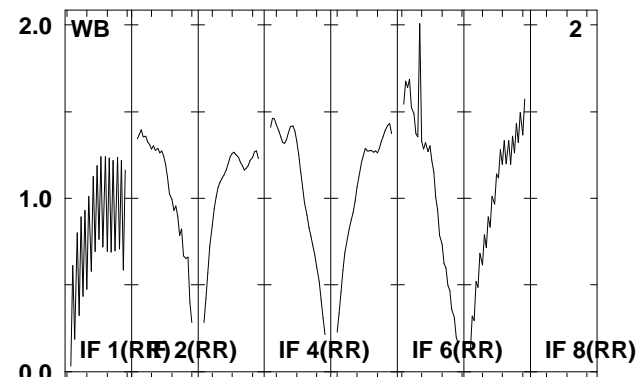
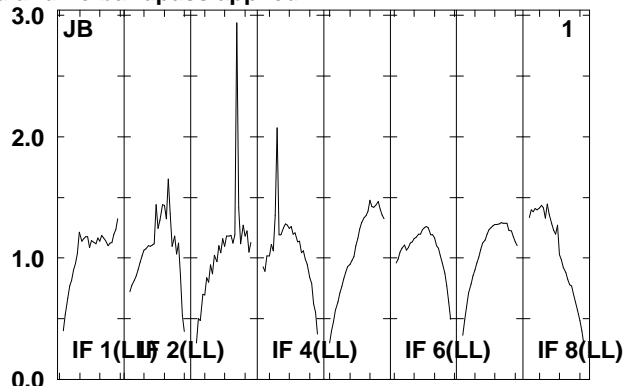
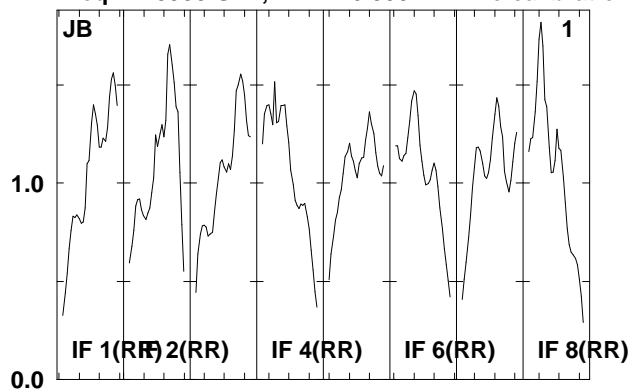

Lower frame: Real Jy  
Total-power spectrum Antenna: \*  
Timerange: 00/07:29:53 to 00/07:34:29

Plot file version 193 created 08-AUG-2008 16:59:55

J021348 EO06B.UVDATA.1

Freq = 1.5950 GHz, Bw = 16.000 MH No calibration applied and no bandpass applied

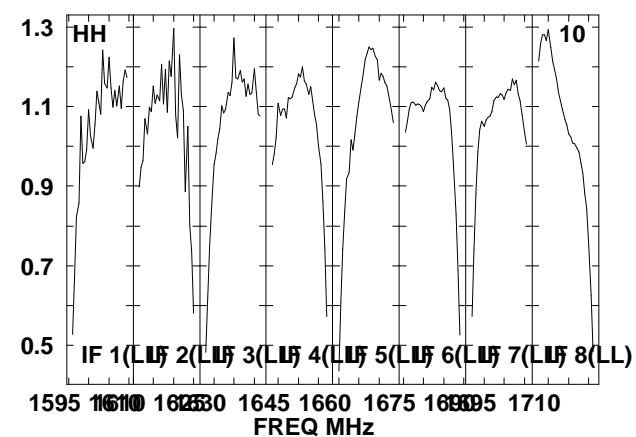
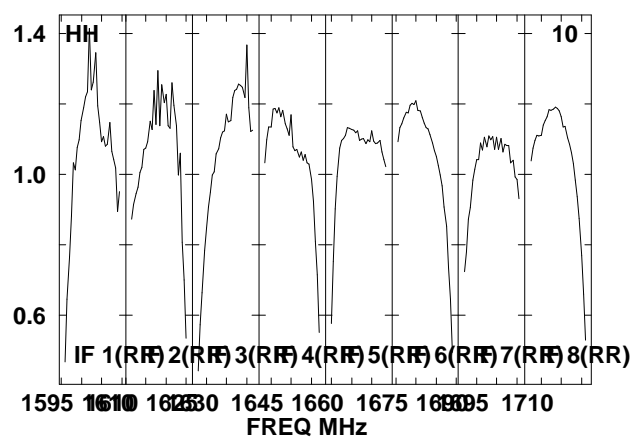
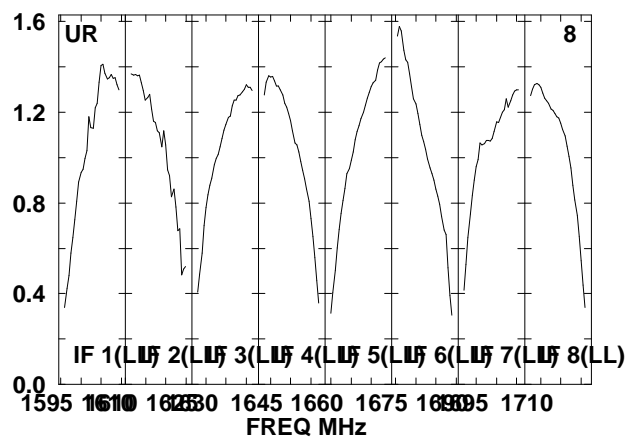
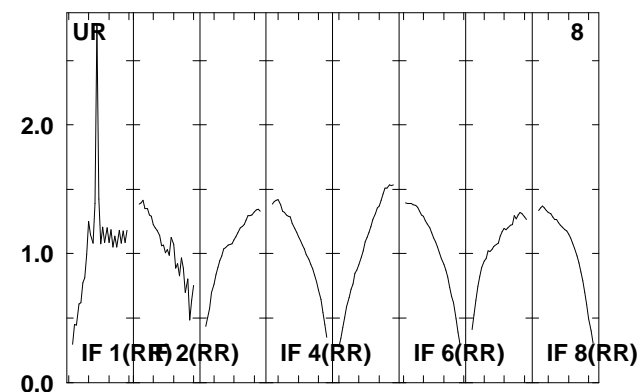
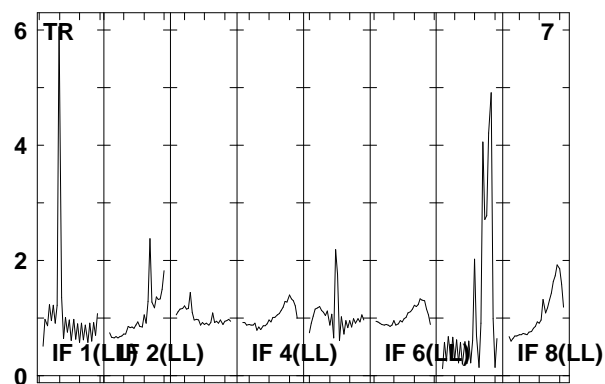
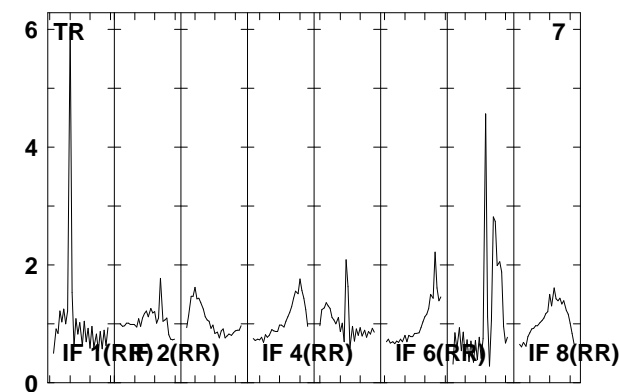
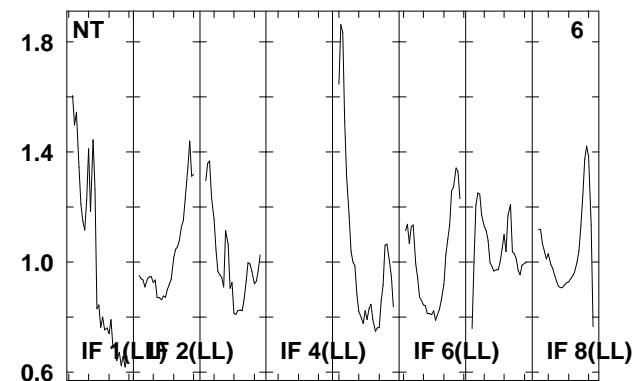
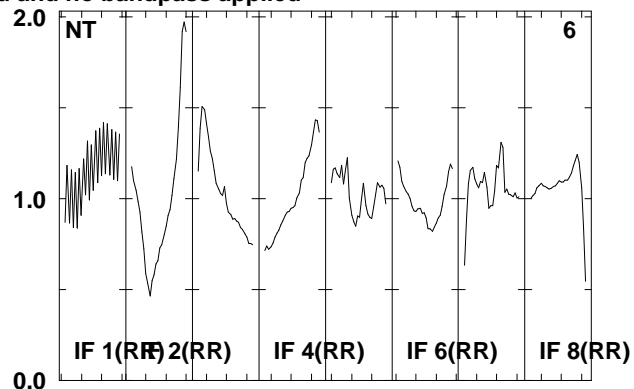
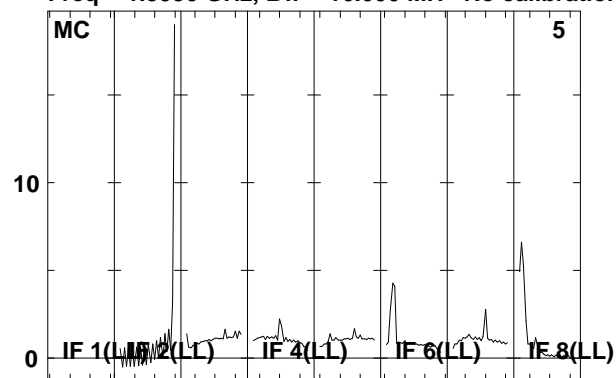

Lower frame: Real Jy  
Total-power spectrum Antenna: \*  
Timerange: 00/07:29:53 to 00/07:34:29

Plot file version 194 created 08-AUG-2008 16:59:56

J021348 EO006B.UVDATA.1

Freq = 1.5950 GHz, Bw = 16.000 MH No calibration applied and no bandpass applied

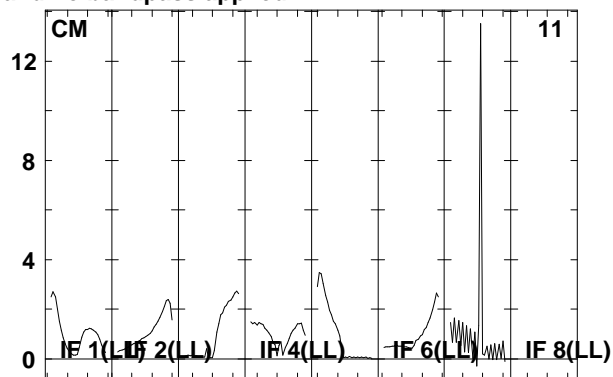
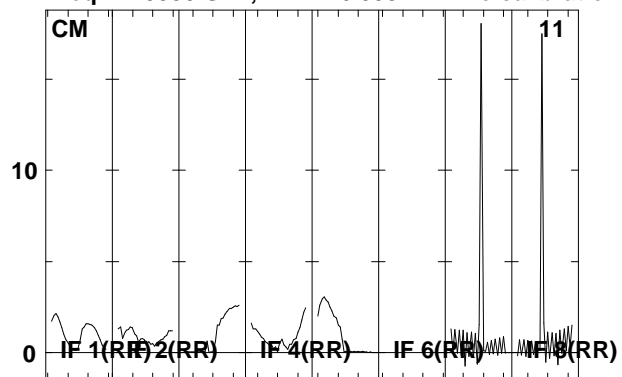

Lower frame: Real Jy  
Total-power spectrum Antenna: \*  
Timerange: 00/07:29:53 to 00/07:34:29

Plot file version 195 created 08-AUG-2008 16:59:57

J0209+13 EO006B.UVDATA.1

Freq = 1.5950 GHz, Bw = 16.000 MH No calibration applied and no bandpass applied

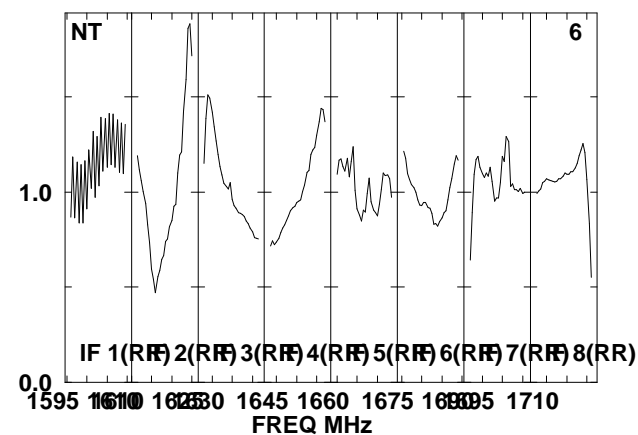
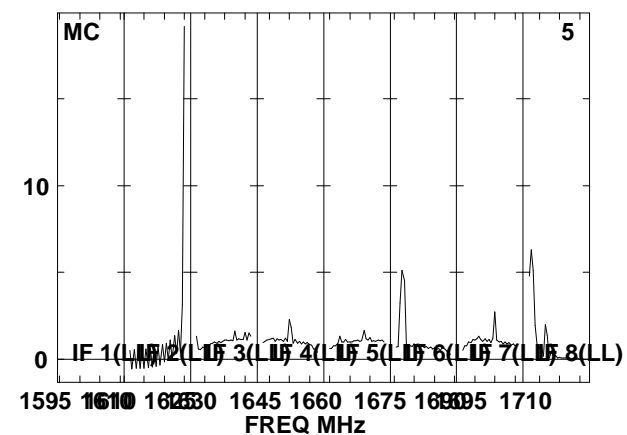
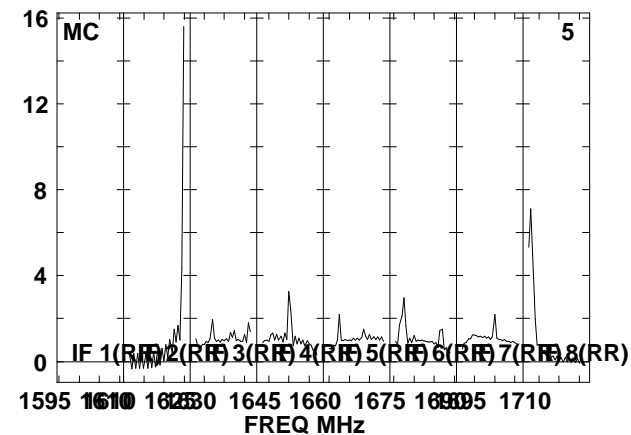
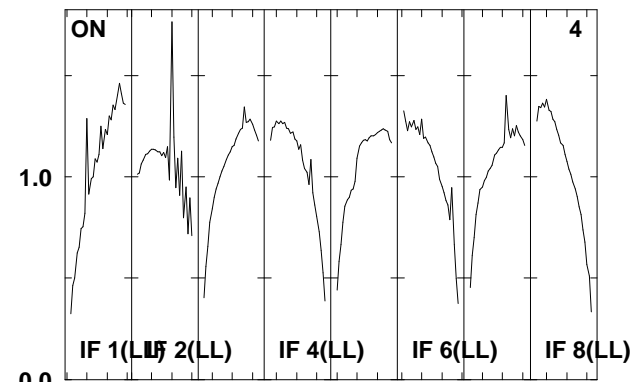
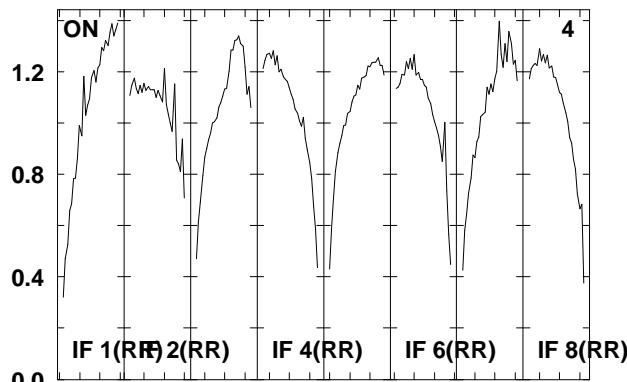
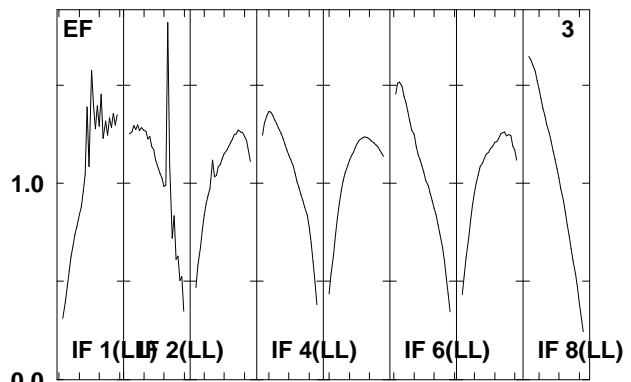
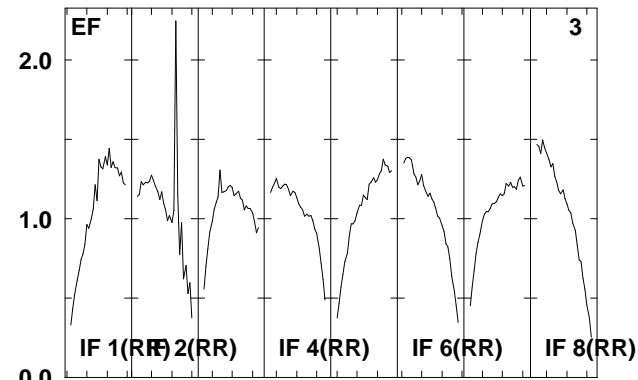
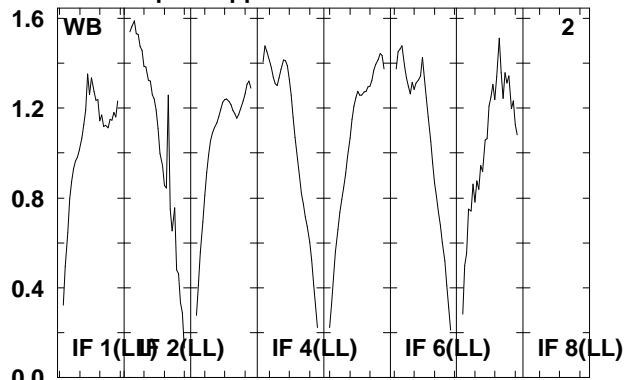
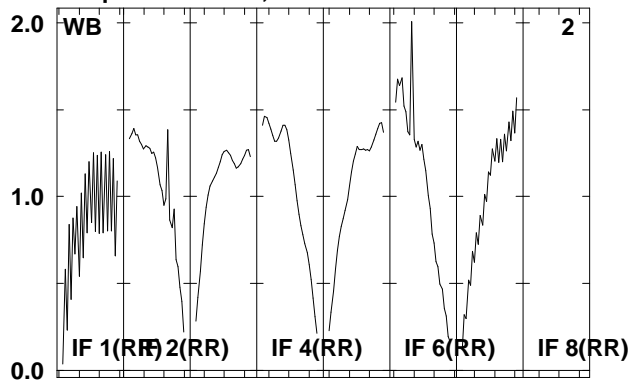

Lower frame: Real Jy  
Total-power spectrum Antenna: \*  
Timerange: 00/07:35:05 to 00/07:36:37

Plot file version 196 created 08-AUG-2008 16:59:58

J0209+13 EO06B.UVDATA.1

Freq = 1.5950 GHz, Bw = 16.000 MH No calibration applied and no bandpass applied

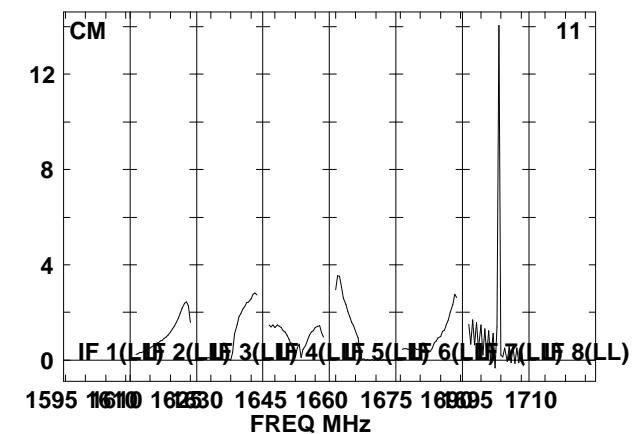
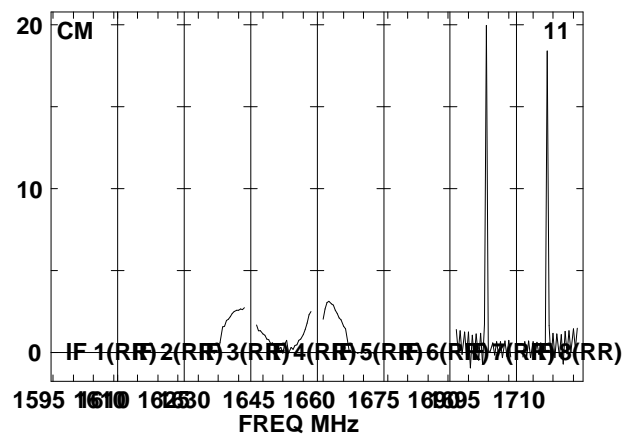
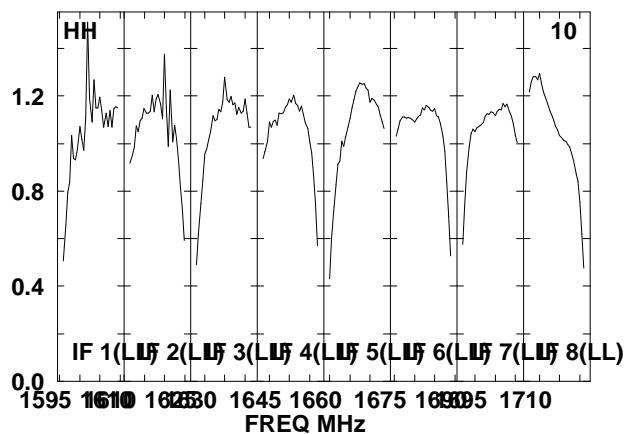
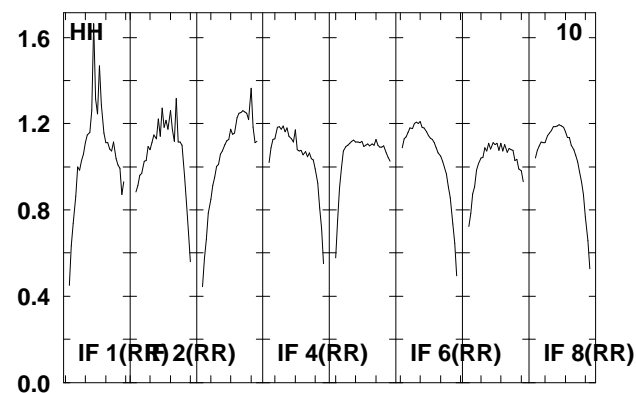
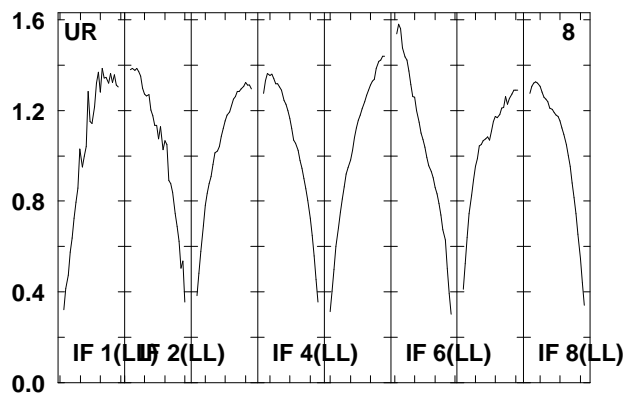
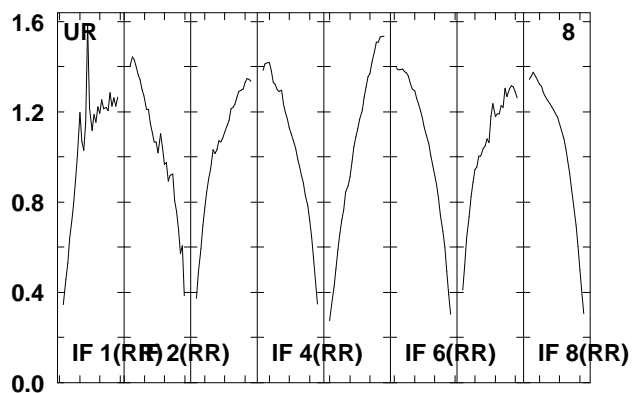
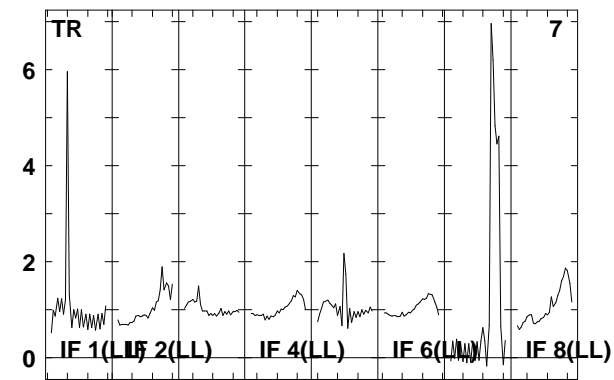
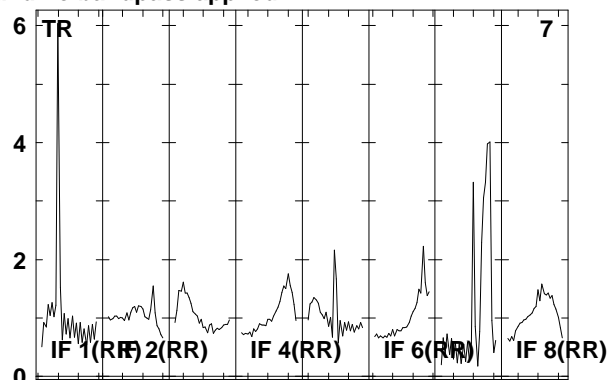
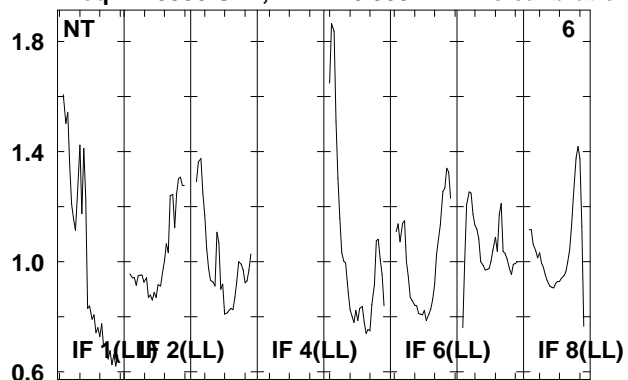

Lower frame: Real Jy  
Total-power spectrum Antenna: \*  
Timerange: 00/07:35:05 to 00/07:36:37



Plot file version 197 created 08-AUG-2008 16:59:58

J021348 EO006B.UVDATA.1

Freq = 1.5950 GHz, Bw = 16.000 MH No calibration applied and no bandpass applied

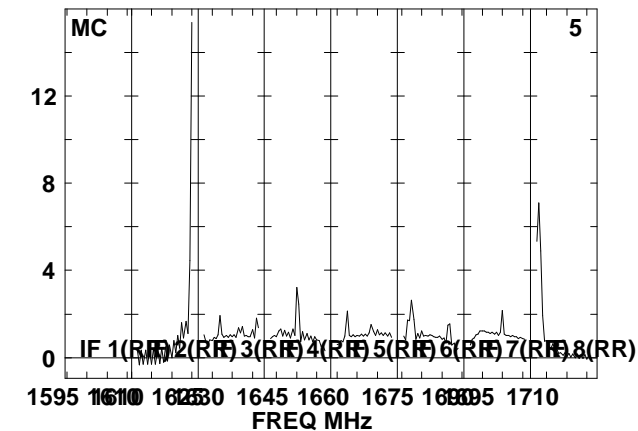
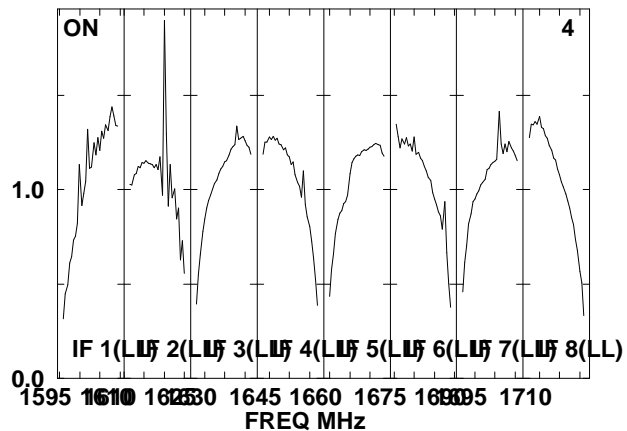
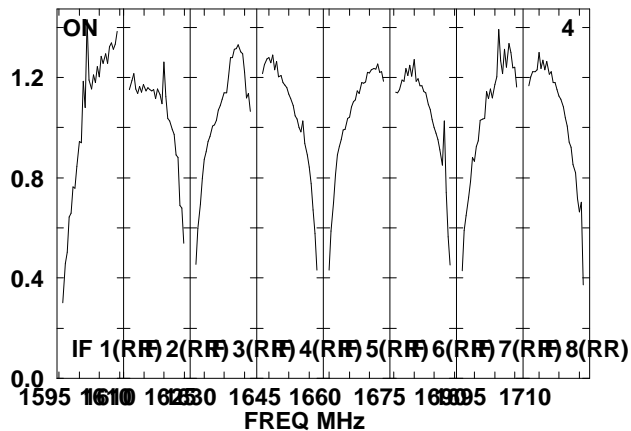
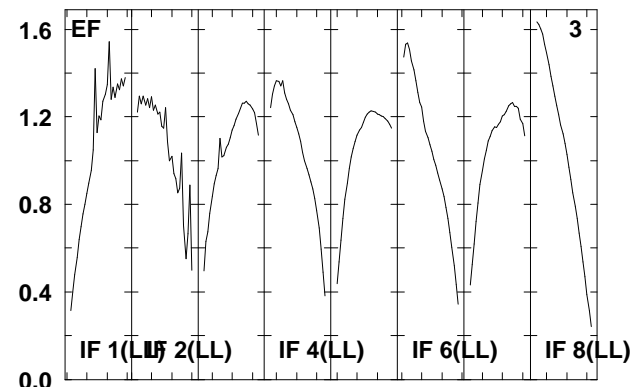
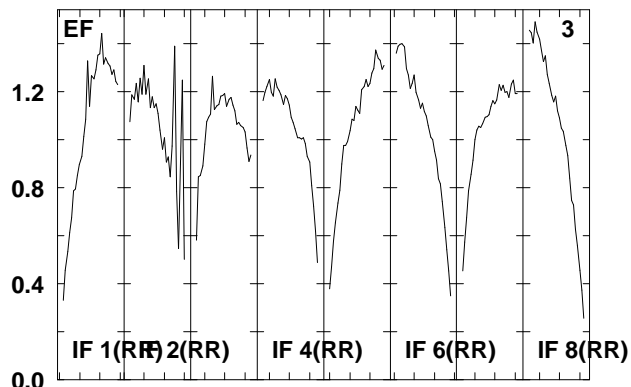
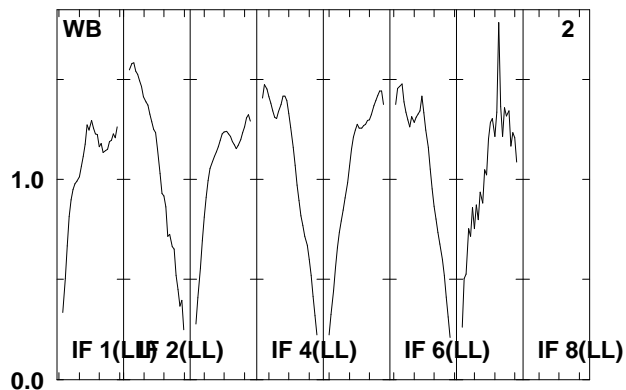
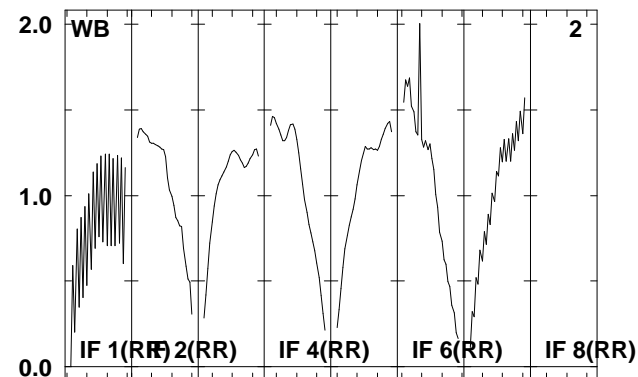
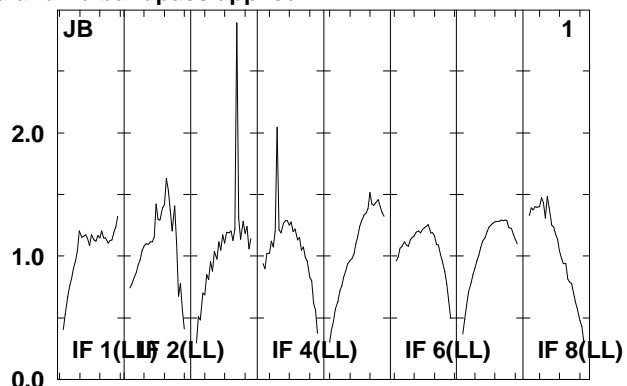
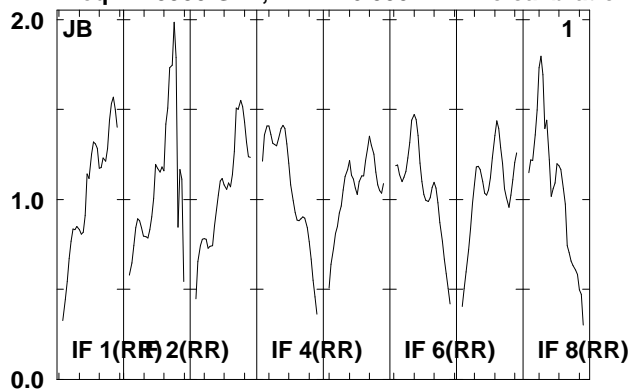

Lower frame: Real Jy  
Total-power spectrum Antenna: \*  
Timerange: 00/07:37:13 to 00/07:41:41

Plot file version 198 created 08-AUG-2008 16:59:59

J021348 EO006B.UVDATA.1

Freq = 1.5950 GHz, Bw = 16.000 MH No calibration applied and no bandpass applied

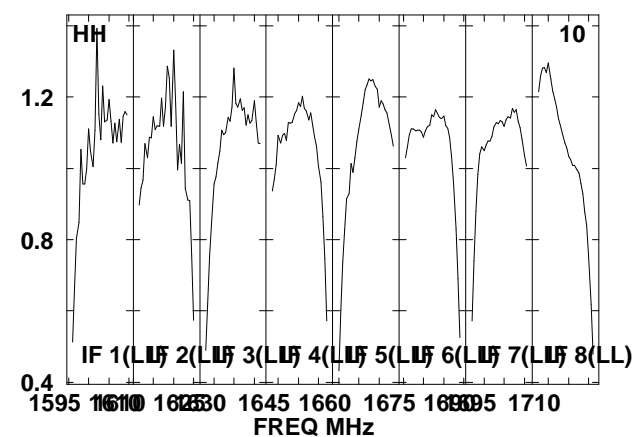
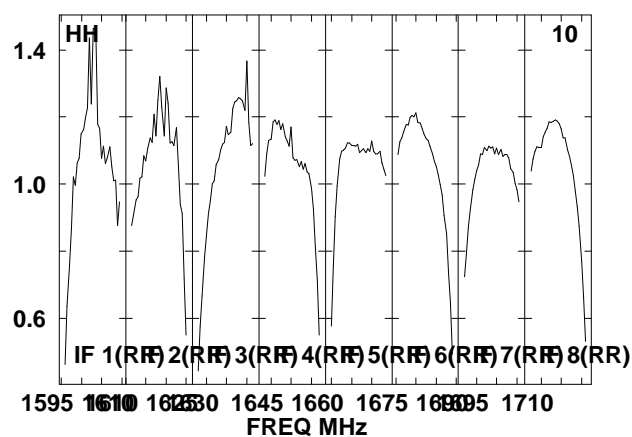
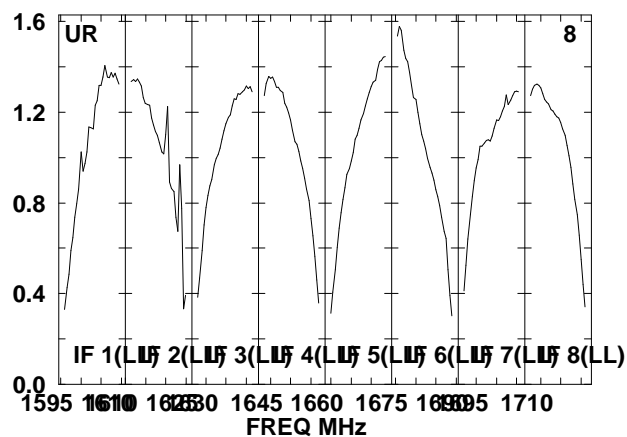
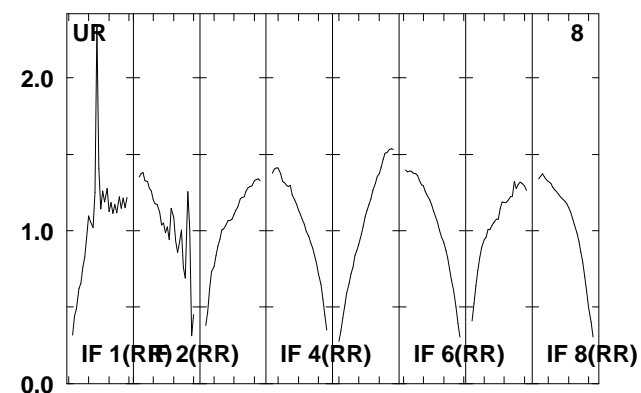
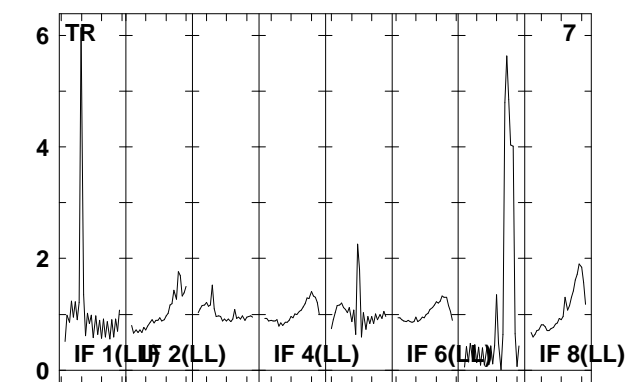
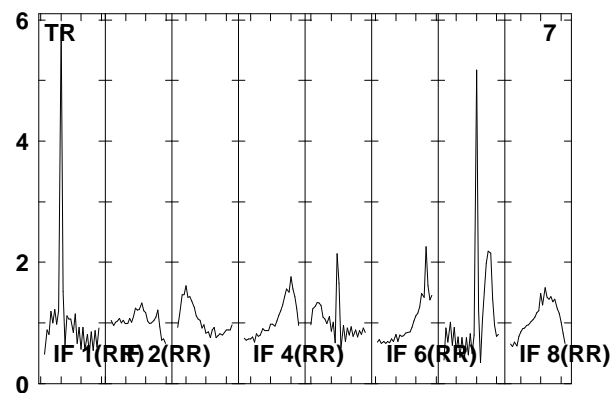
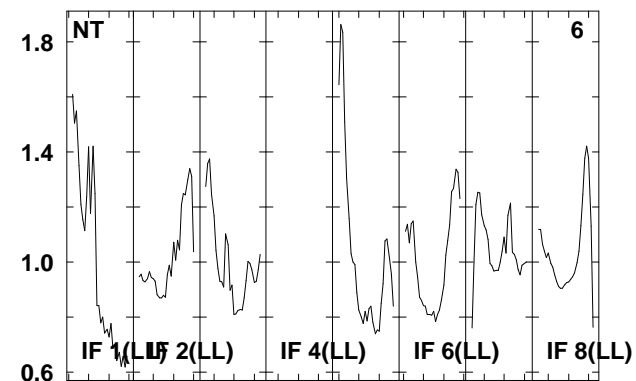
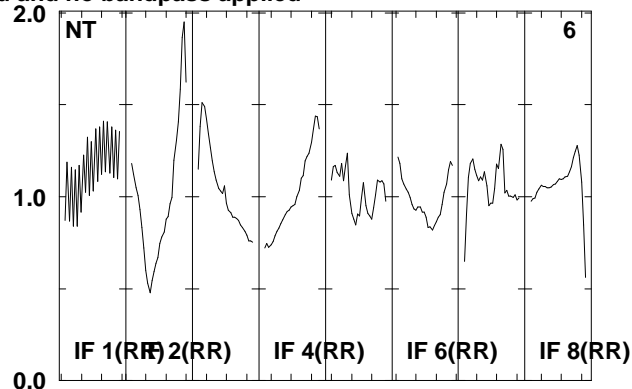
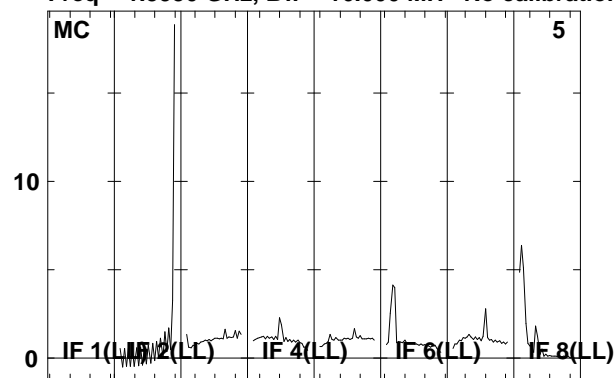

Lower frame: Real Jy  
Total-power spectrum Antenna: \*  
Timerange: 00/07:37:13 to 00/07:41:41

Plot file version 199 created 08-AUG-2008 17:00:00

J021348 EO006B.UVDATA.1

Freq = 1.5950 GHz, Bw = 16.000 MH No calibration applied and no bandpass applied

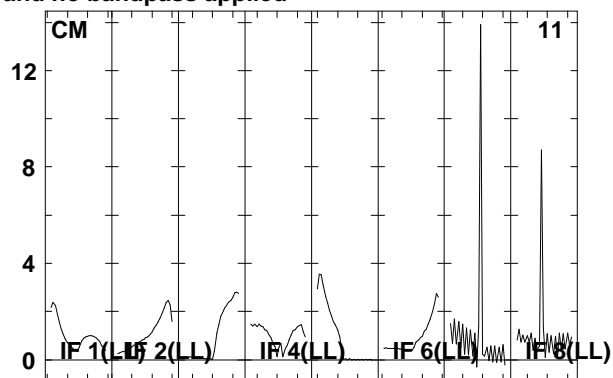
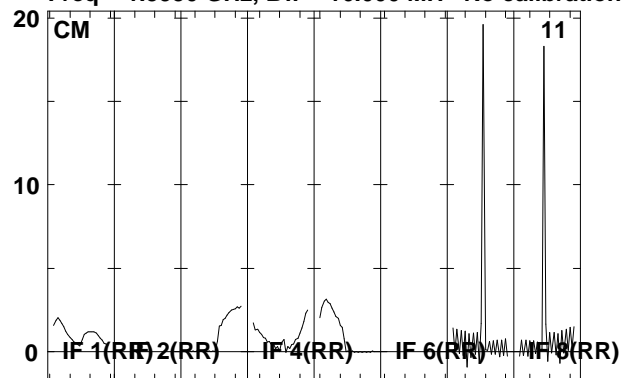

Lower frame: Real Jy  
Total-power spectrum Antenna: \*  
Timerange: 00/07:37:13 to 00/07:41:41

Plot file version 200 created 08-AUG-2008 17:00:00

J0209+13 EO006B.UVDATA.1

Freq = 1.5950 GHz, Bw = 16.000 MH No calibration applied and no bandpass applied

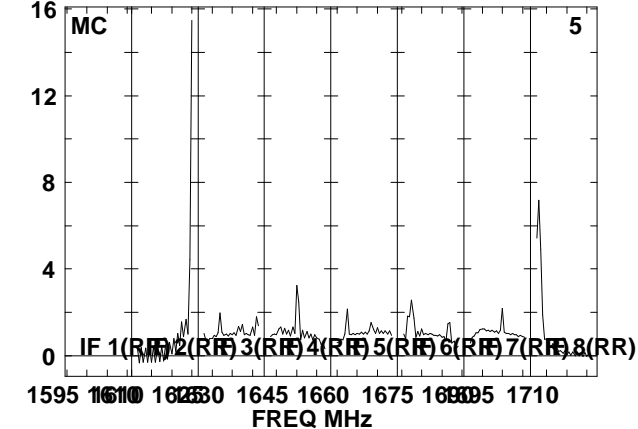
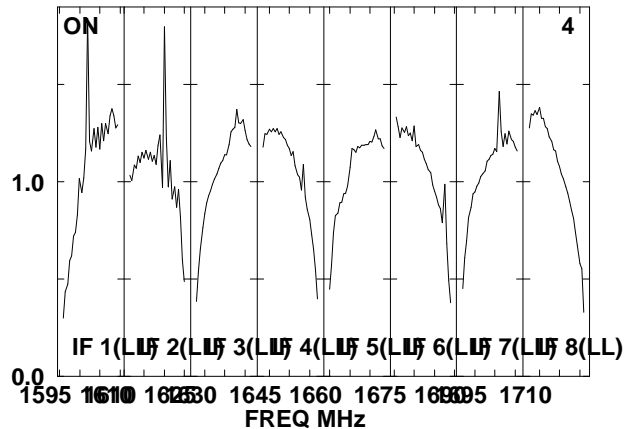
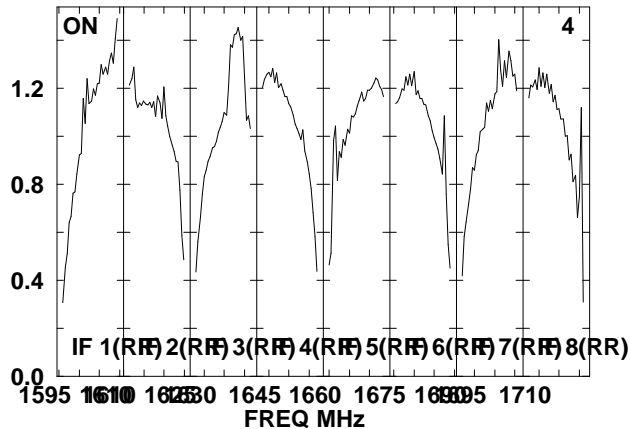
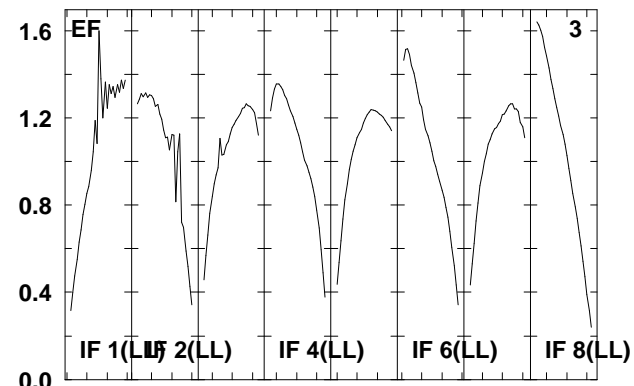
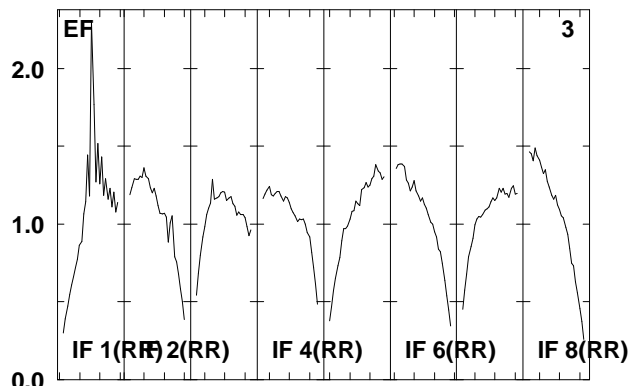
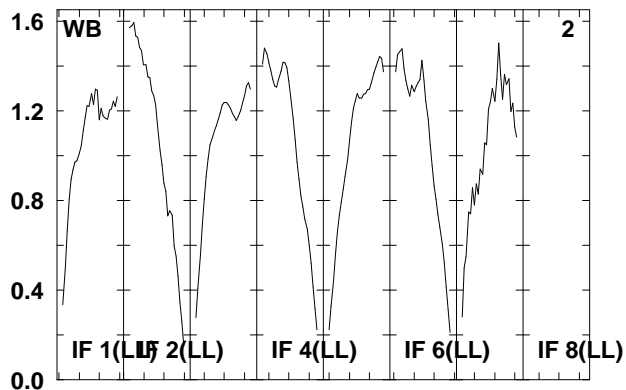
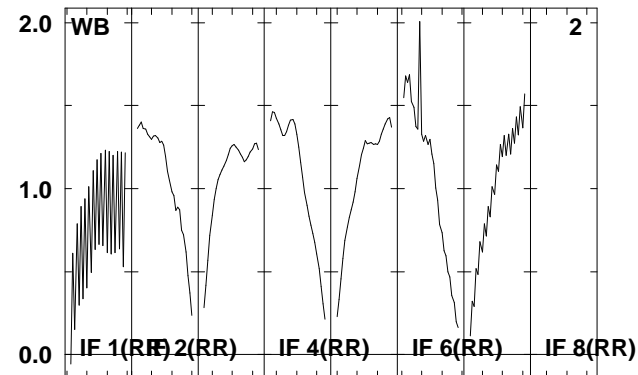
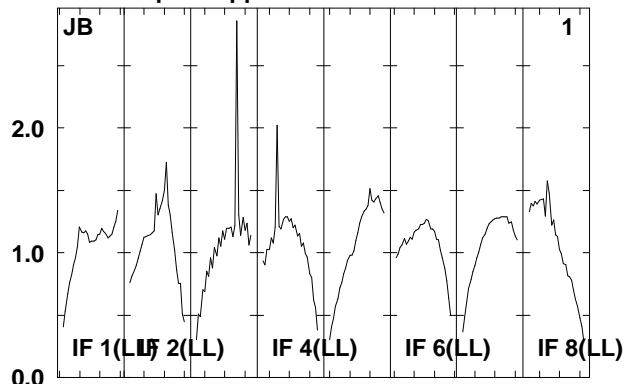
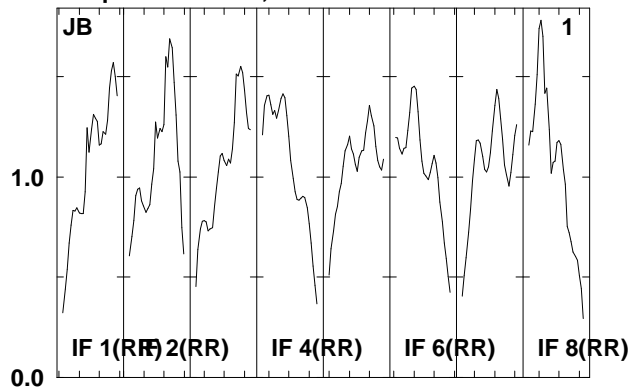

Lower frame: Real Jy

Total-power spectrum Antenna: \*

Timerange: 00/07:42:21 to 00/07:43:53

Plot file version 201 created 08-AUG-2008 17:00:00

J0209+13 EO006B.UVDATA.1

Freq = 1.5950 GHz, Bw = 16.000 MH No calibration applied and no bandpass applied

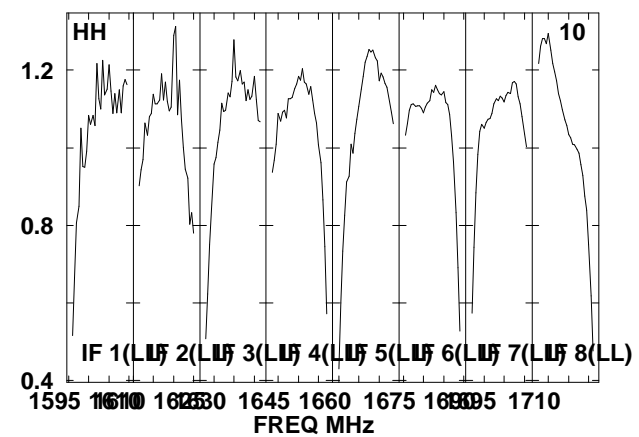
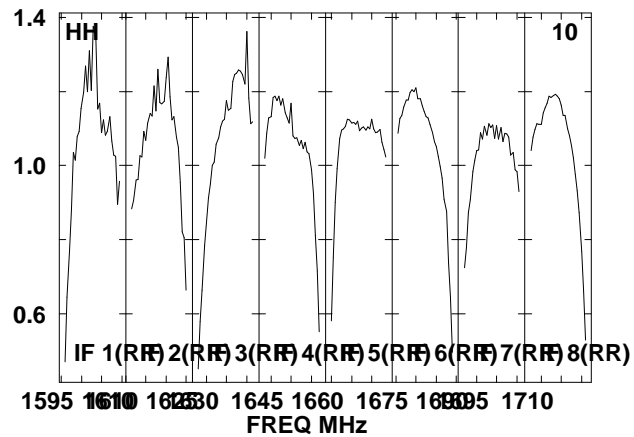
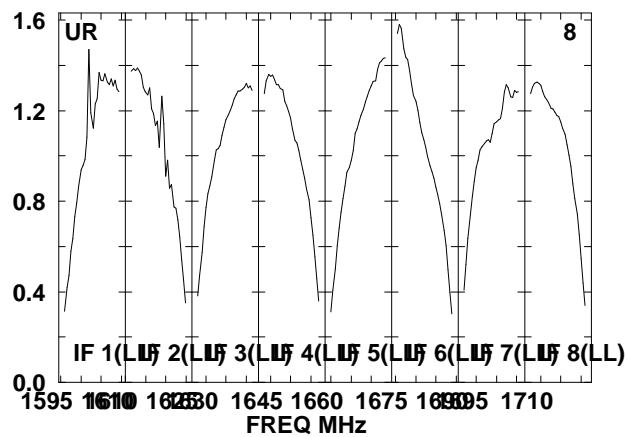
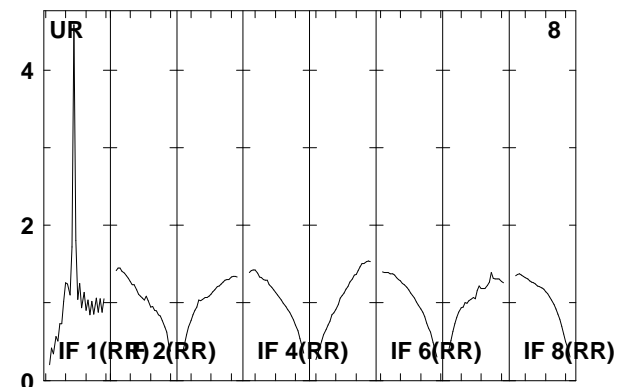
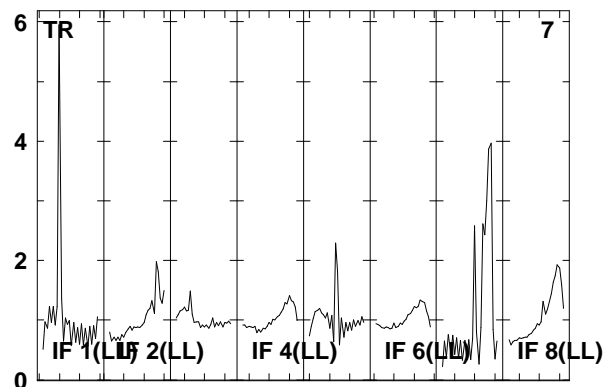
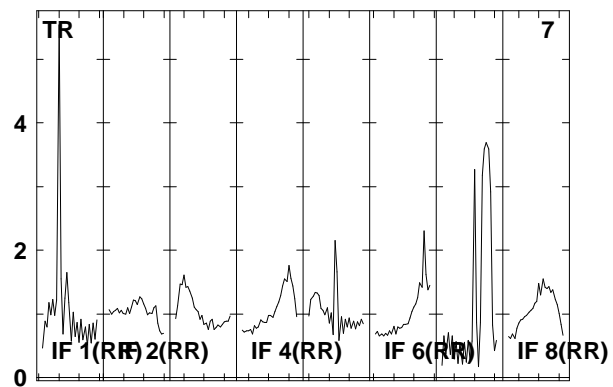
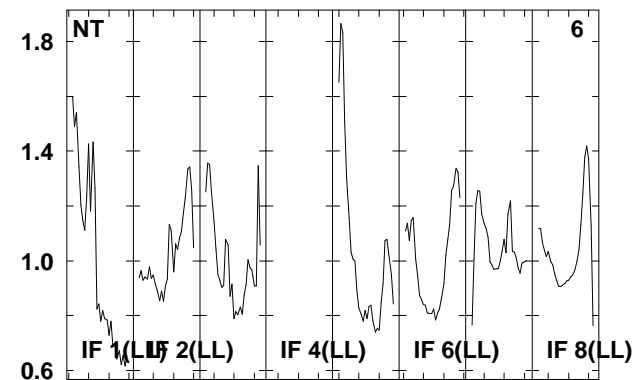
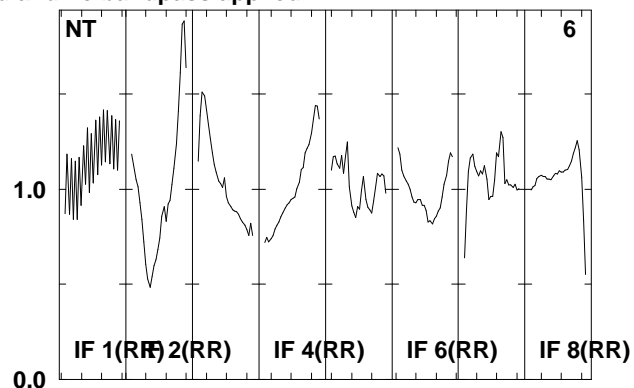
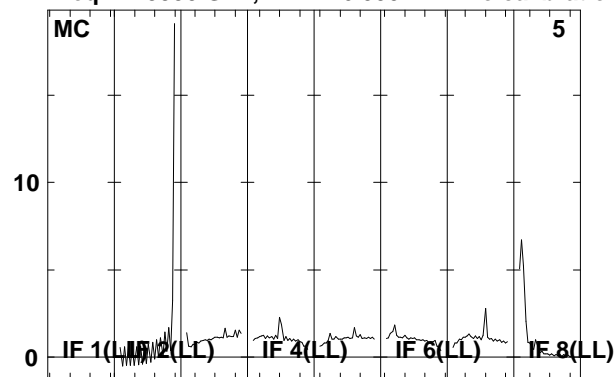

Lower frame: Real Jy

Total-power spectrum Antenna: \*

Timerange: 00/07:42:21 to 00/07:43:53

Plot file version 202 created 08-AUG-2008 17:00:01

J0209+13 EO006B.UVDATA.1

Freq = 1.5950 GHz, Bw = 16.000 MH No calibration applied and no bandpass applied

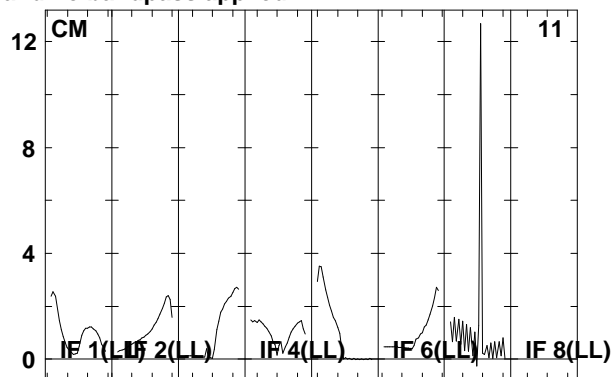
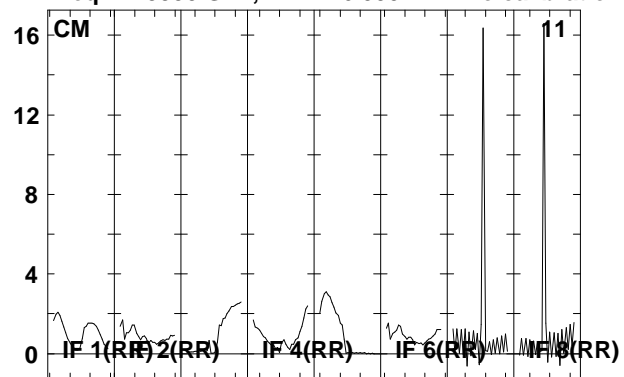

Lower frame: Real Jy  
Total-power spectrum Antenna: \*  
Timerange: 00/07:42:21 to 00/07:43:53

Plot file version 203 created 08-AUG-2008 17:00:01

J021348 EO006B.UVDATA.1

Freq = 1.5950 GHz, Bw = 16.000 MH No calibration applied and no bandpass applied

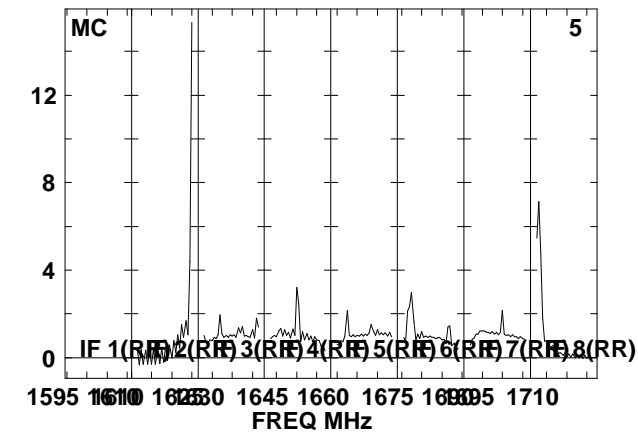
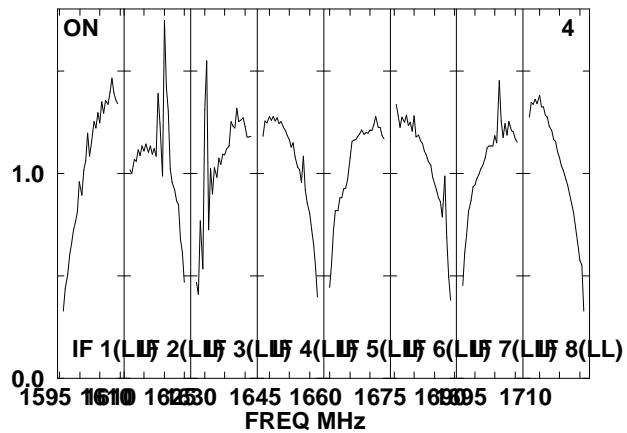
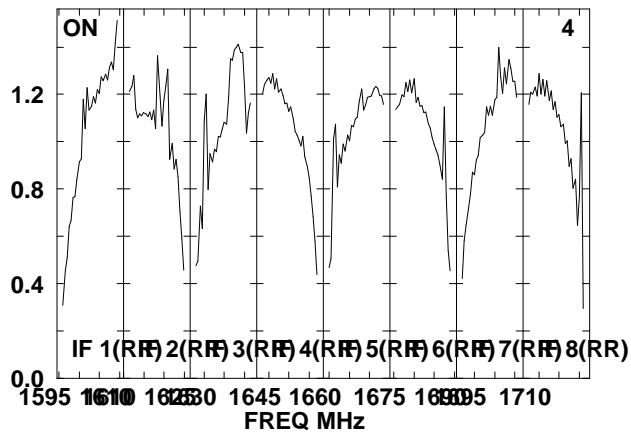
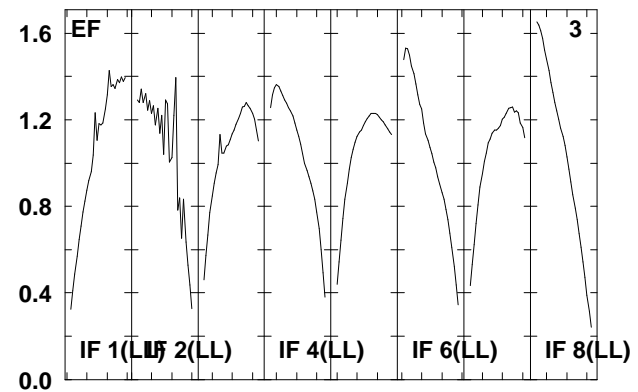
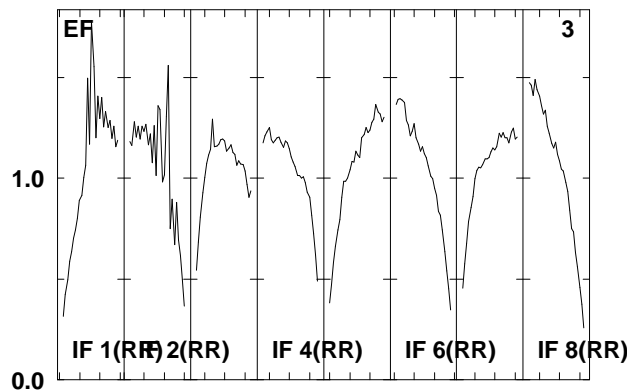
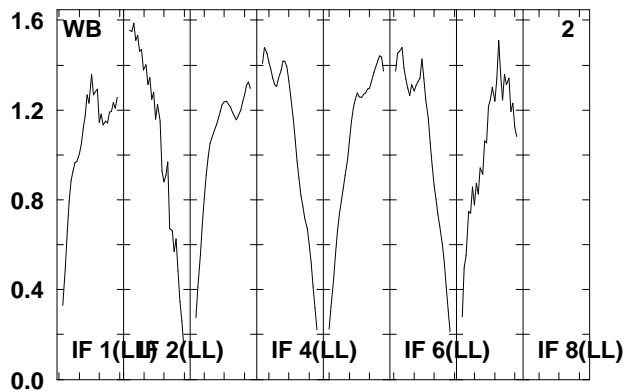
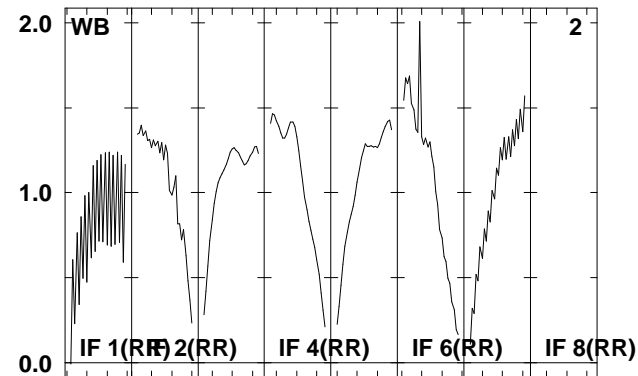
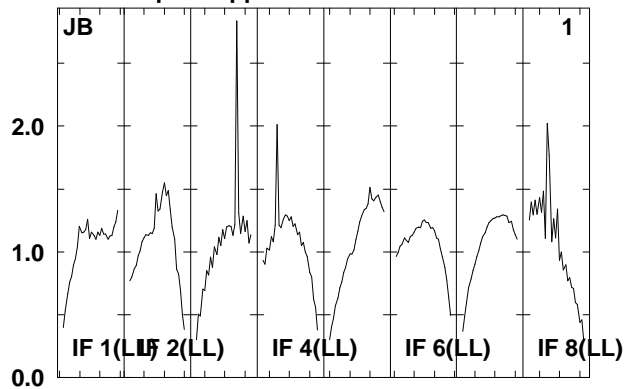
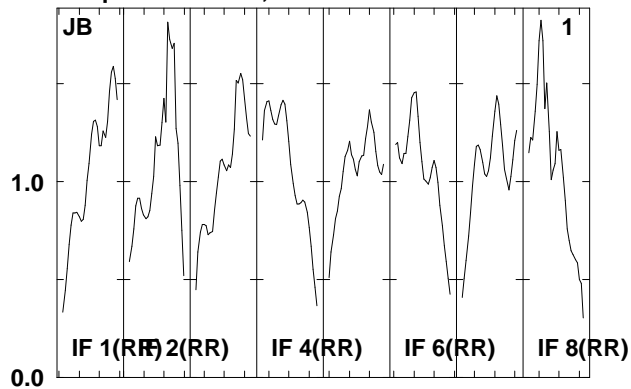

Lower frame: Real Jy  
Total-power spectrum Antenna: \*  
Timerange: 00/07:44:33 to 00/07:49:09

Plot file version 204 created 08-AUG-2008 17:00:01

J021348 EO06B.UVDATA.1

Freq = 1.5950 GHz, Bw = 16.000 MH No calibration applied and no bandpass applied

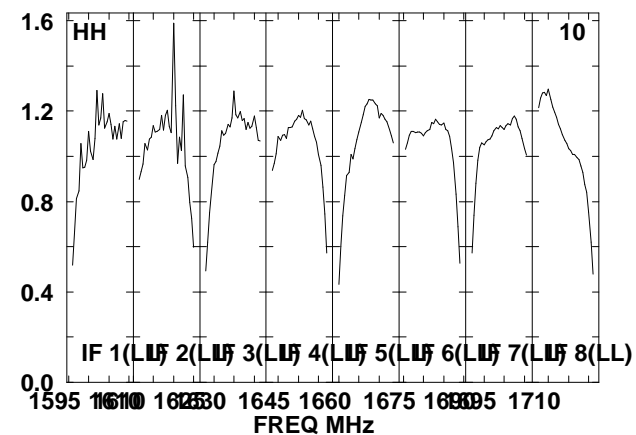
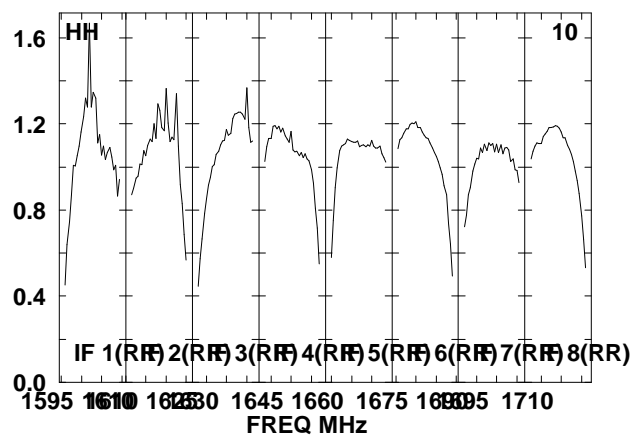
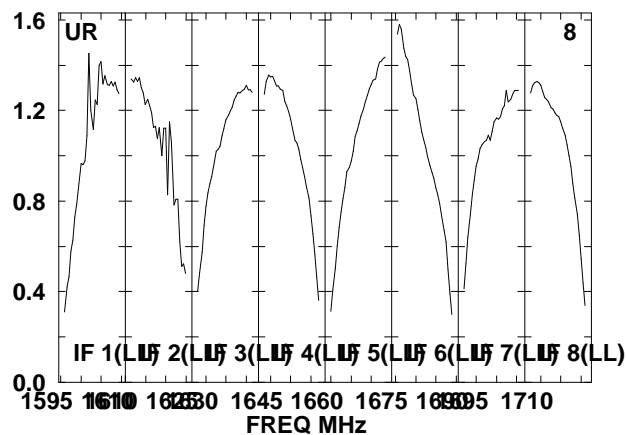
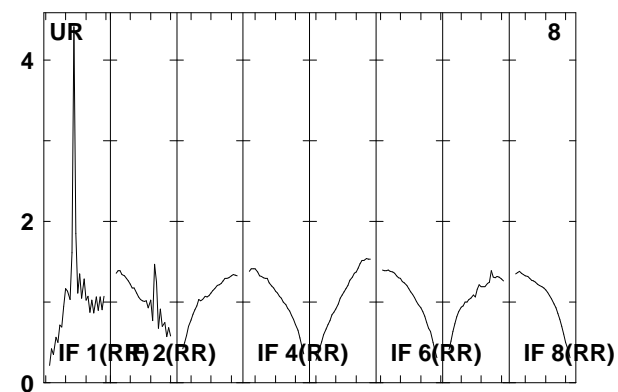
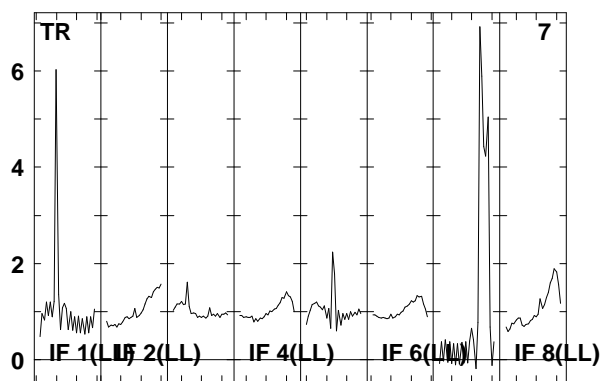
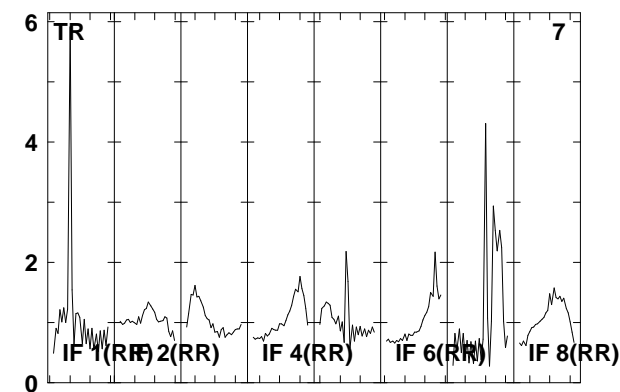
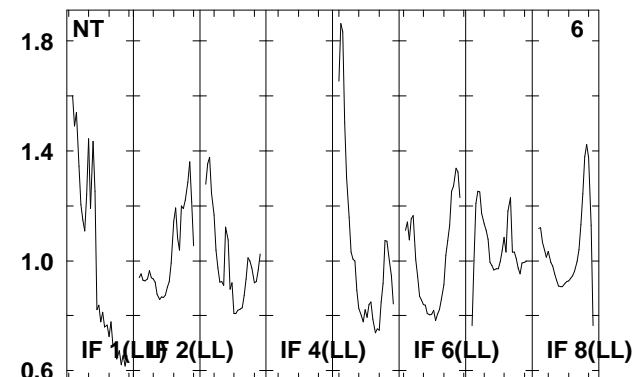
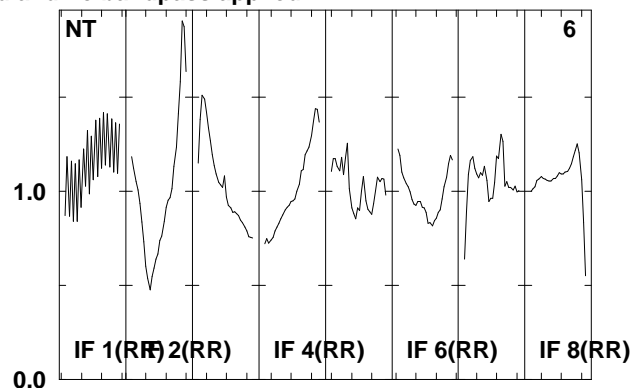
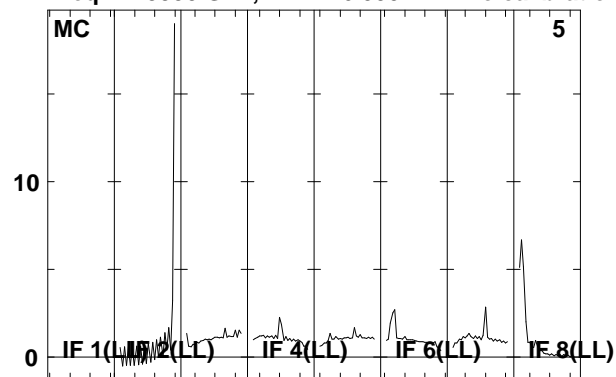

Lower frame: Real Jy  
Total-power spectrum Antenna: \*  
Timerange: 00/07:44:33 to 00/07:49:09



Plot file version 205 created 08-AUG-2008 17:00:02

J021348 EO006B.UVDATA.1

Freq = 1.5950 GHz, Bw = 16.000 MH No calibration applied and no bandpass applied

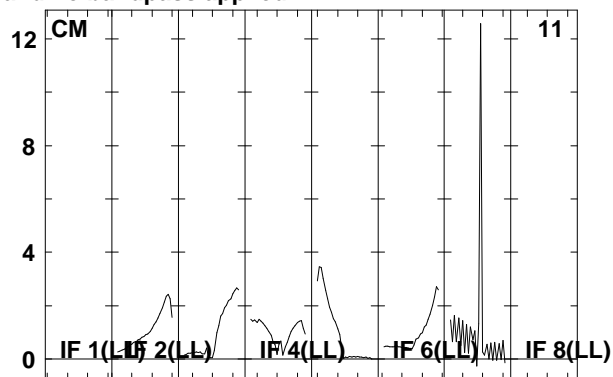
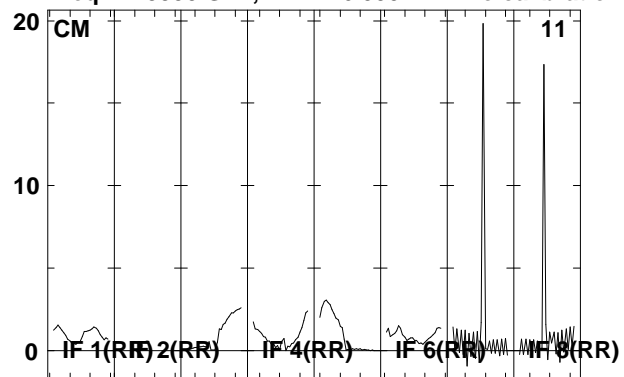

Lower frame: Real Jy  
Total-power spectrum Antenna: \*  
Timerange: 00/07:44:33 to 00/07:49:09

Plot file version 206 created 08-AUG-2008 17:00:03

J0209+13 E0006B.UVDATA.1

Freq = 1.5950 GHz, Bw = 16.000 MH No calibration applied and no bandpass applied

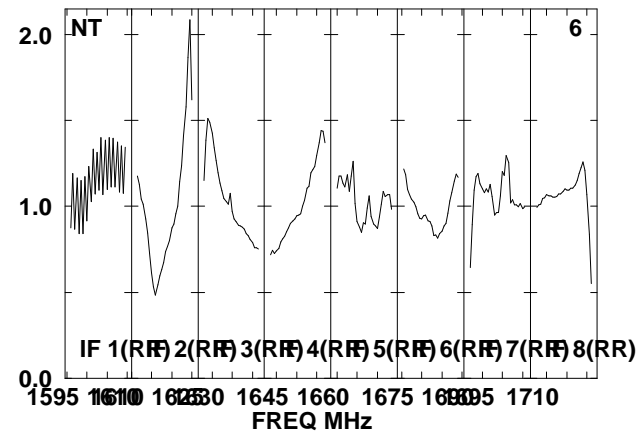
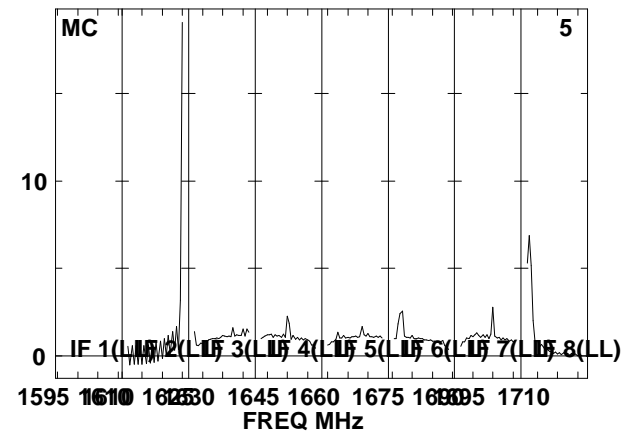
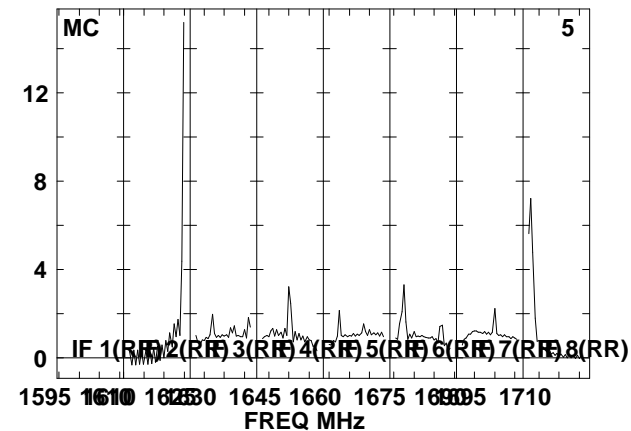
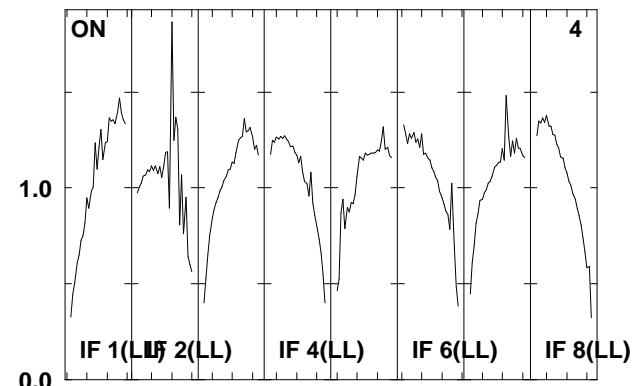
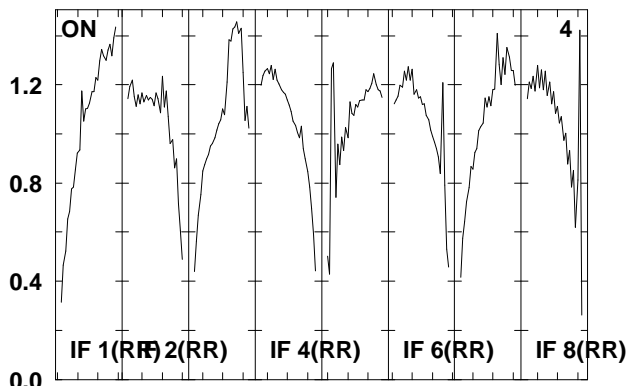
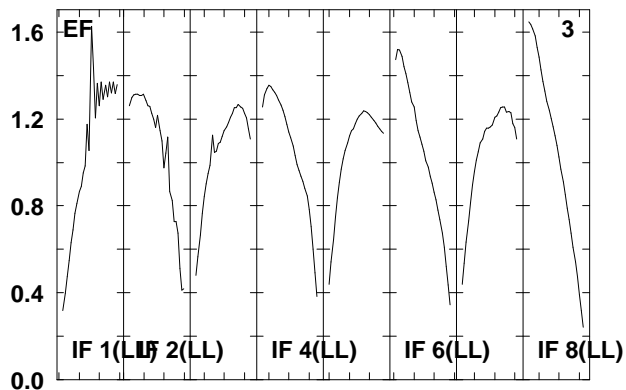
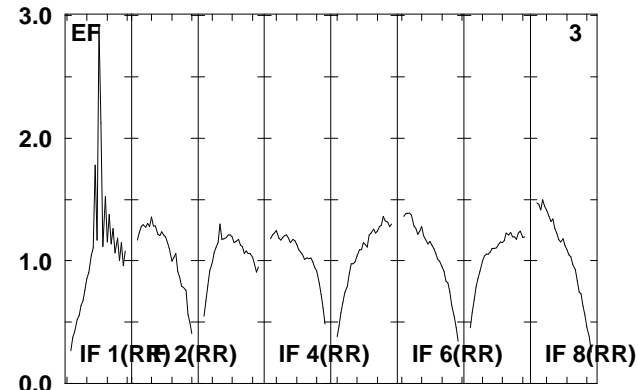
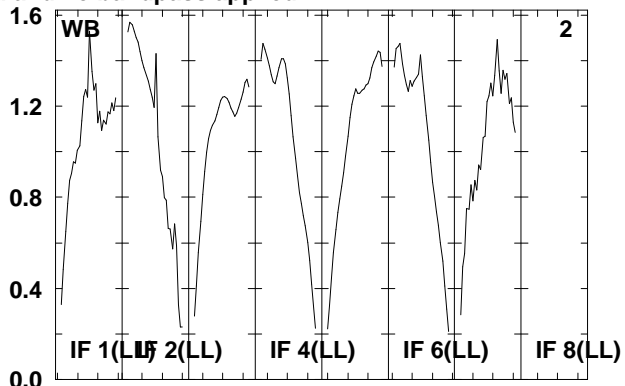
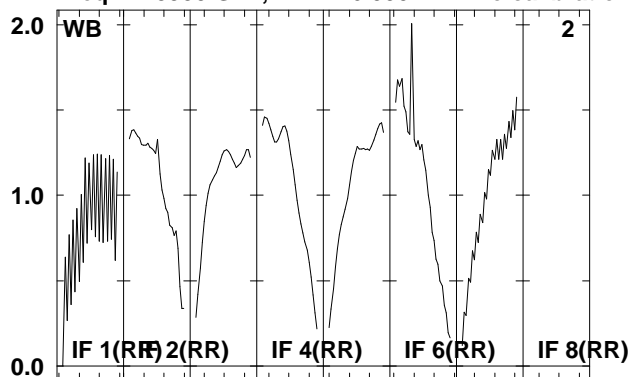

Lower frame: Real Jy

Total-power spectrum Antenna: \*

Timerange: 00/07:49:41 to 00/07:51:17

Plot file version 207 created 08-AUG-2008 17:00:03

J0209+13 EO06B.UVDATA.1

Freq = 1.5950 GHz, Bw = 16.000 MH No calibration applied and no bandpass applied

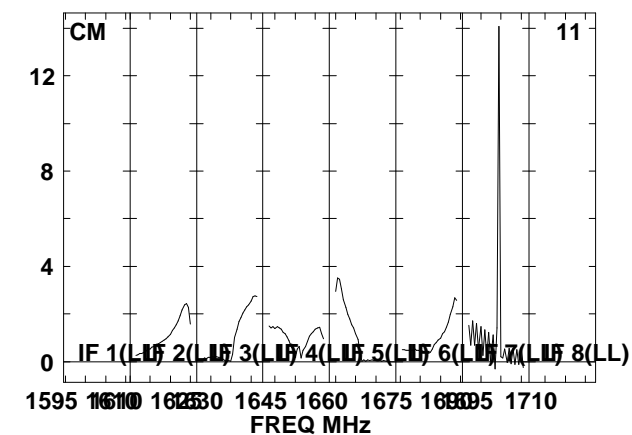
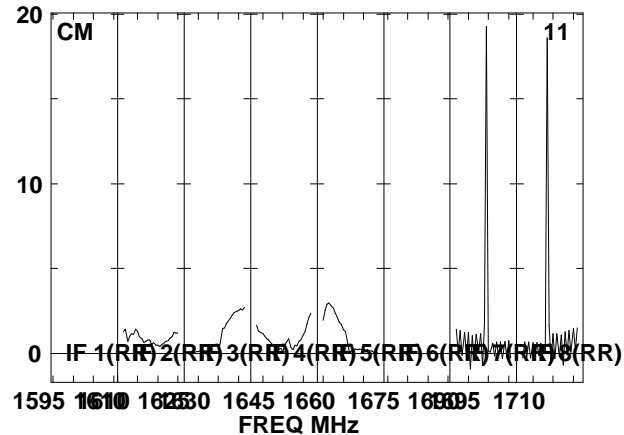
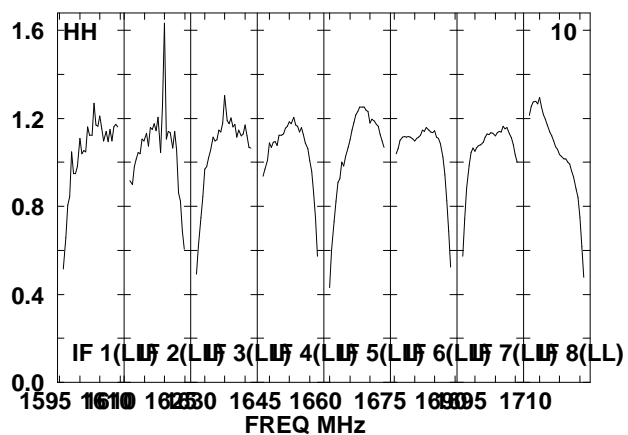
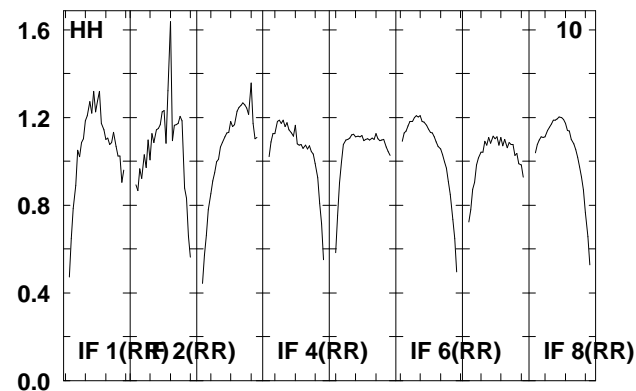
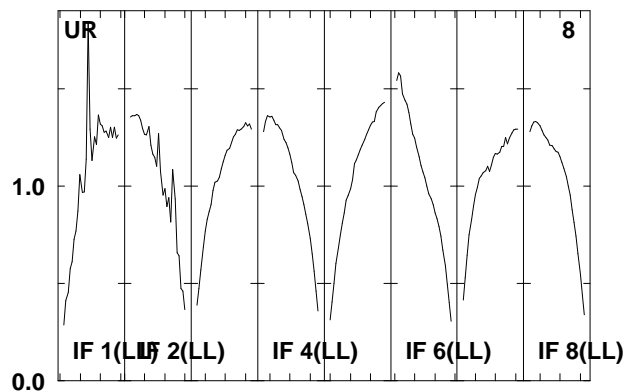
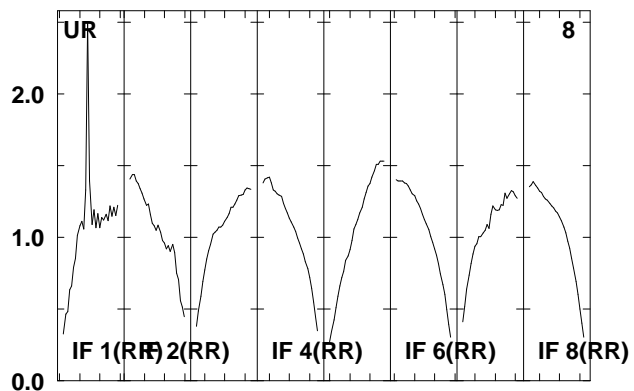
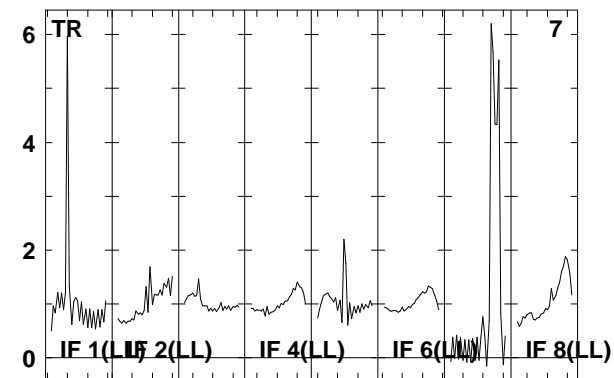
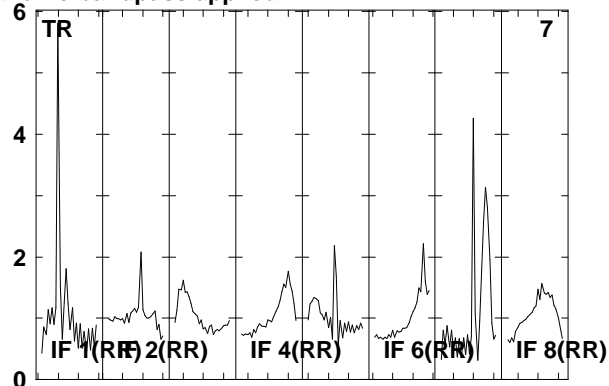
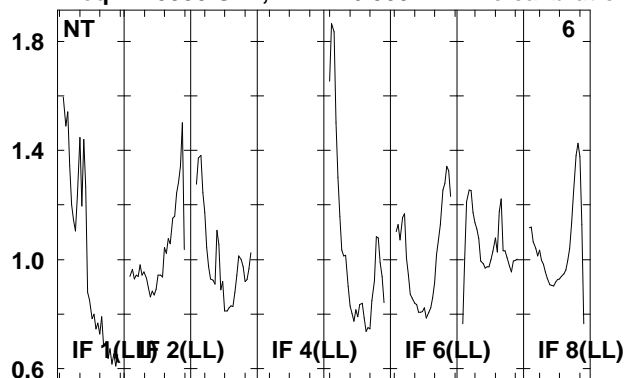

Lower frame: Real Jy  
Total-power spectrum Antenna: \*  
Timerange: 00/07:49:41 to 00/07:51:17

Plot file version 208 created 08-AUG-2008 17:00:04

J021348 EO006B.UVDATA.1

Freq = 1.5950 GHz, Bw = 16.000 MH No calibration applied and no bandpass applied

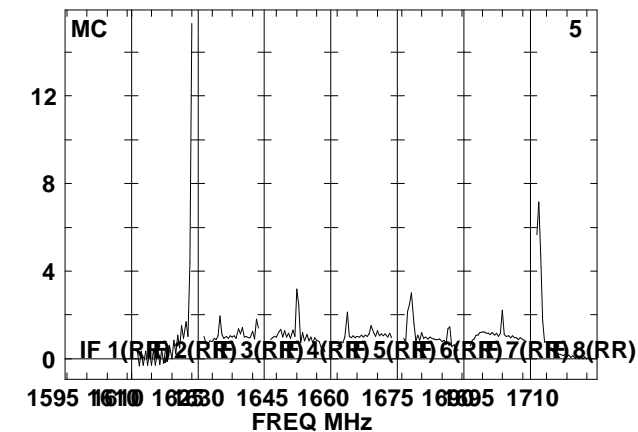
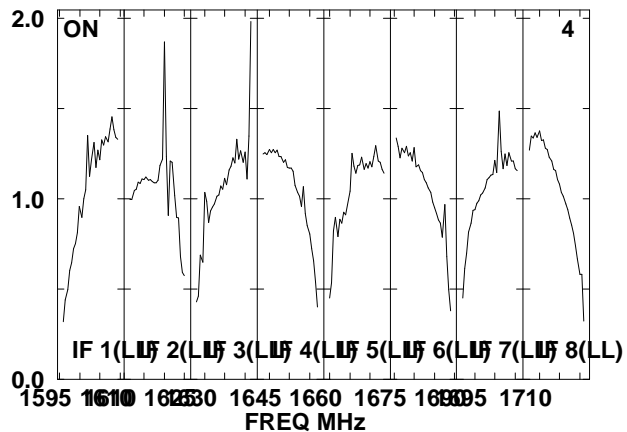
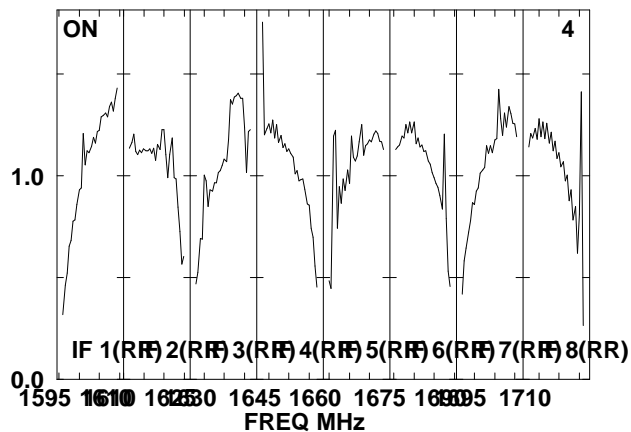
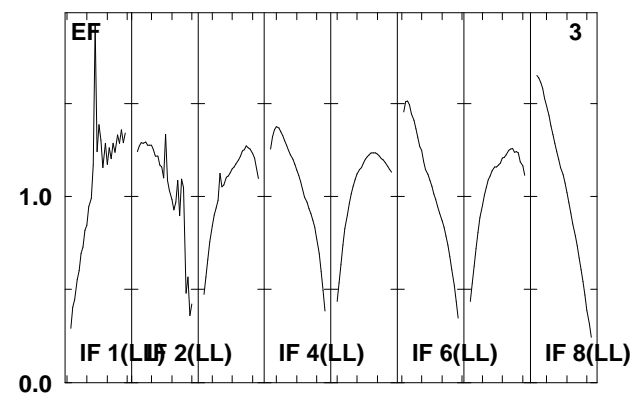
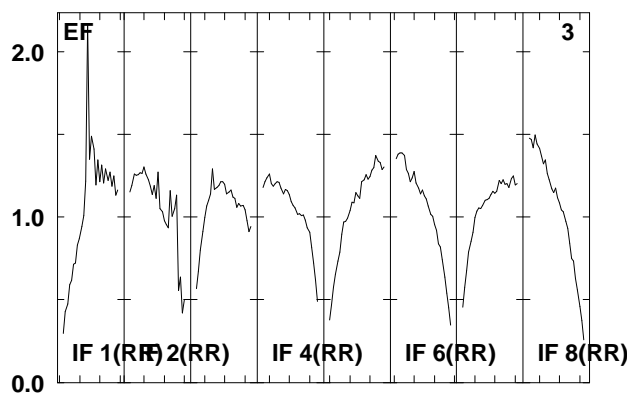
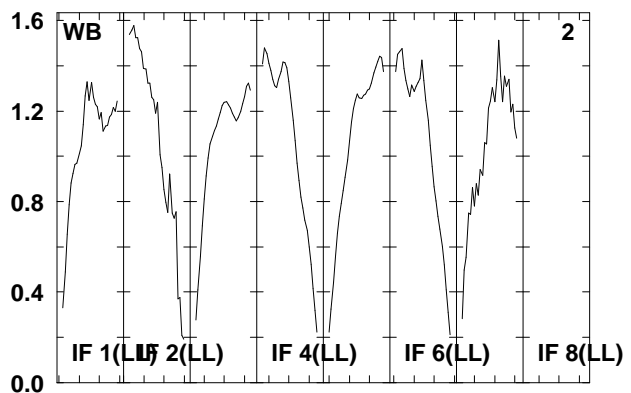
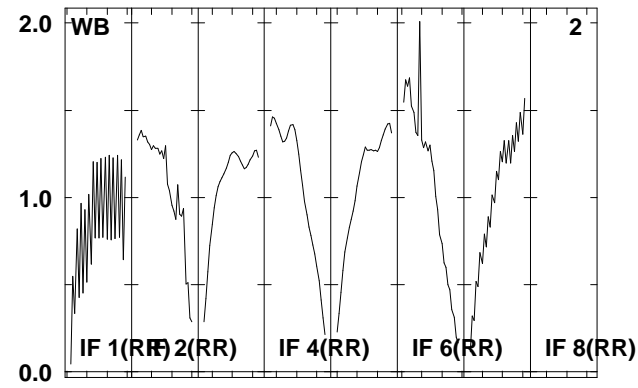
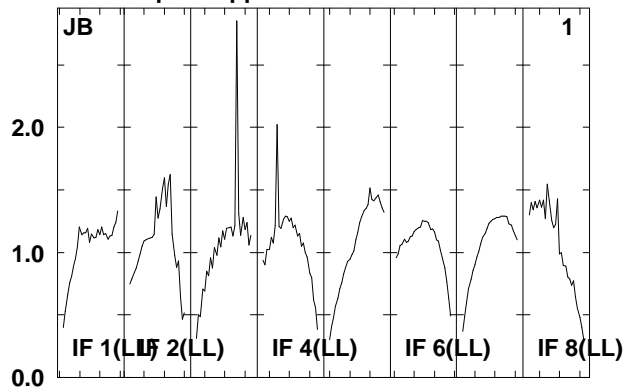
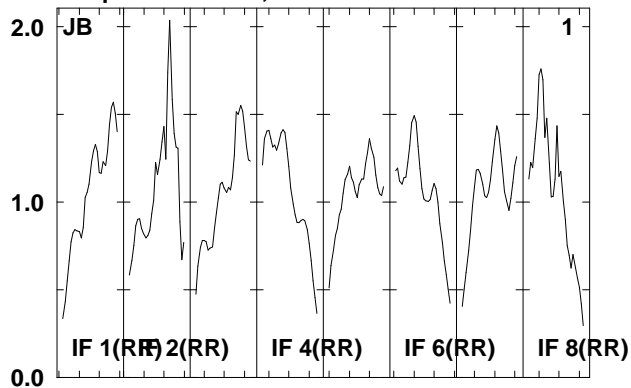

Lower frame: Real Jy

Total-power spectrum Antenna: \*

Timerange: 00/07:51:53 to 00/07:56:29

Plot file version 209 created 08-AUG-2008 17:00:04

J021348 EO06B.UVDATA.1

Freq = 1.5950 GHz, Bw = 16.000 MH No calibration applied and no bandpass applied

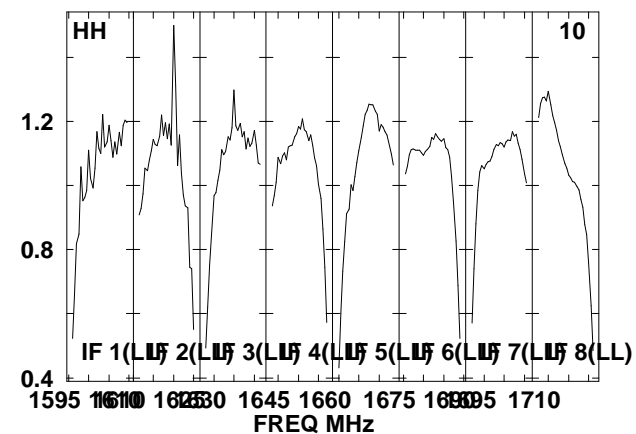
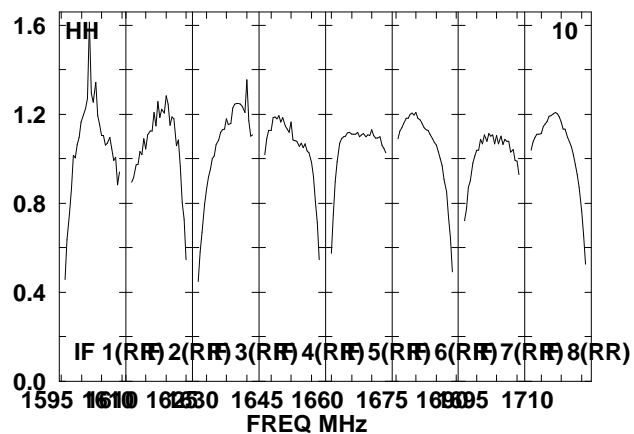
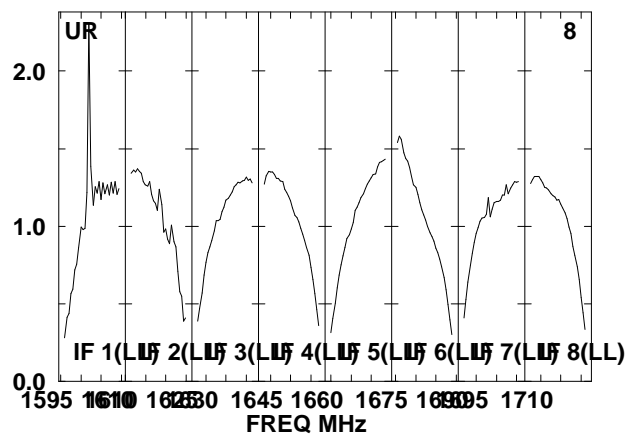
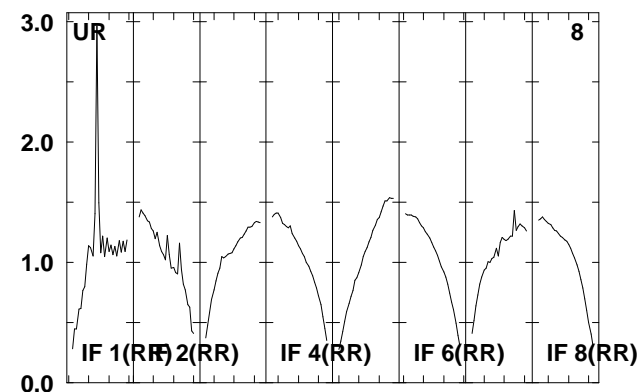
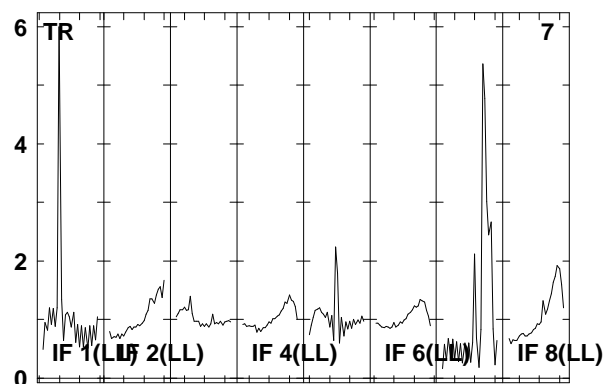
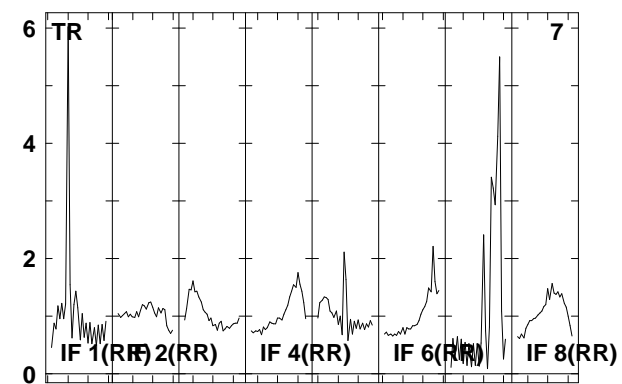
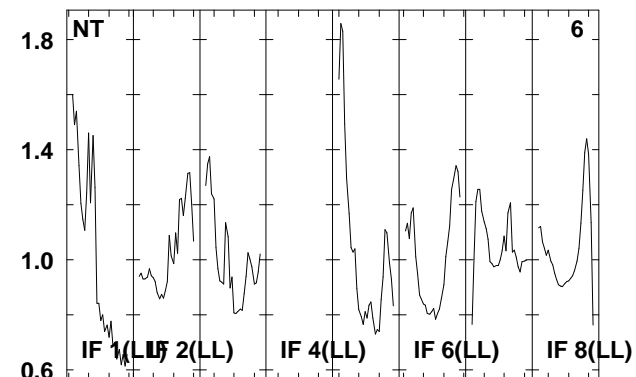
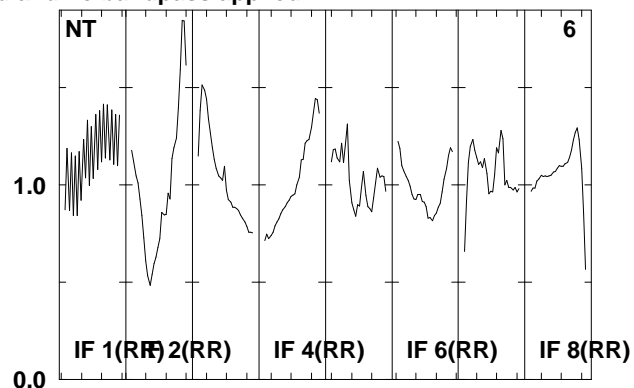
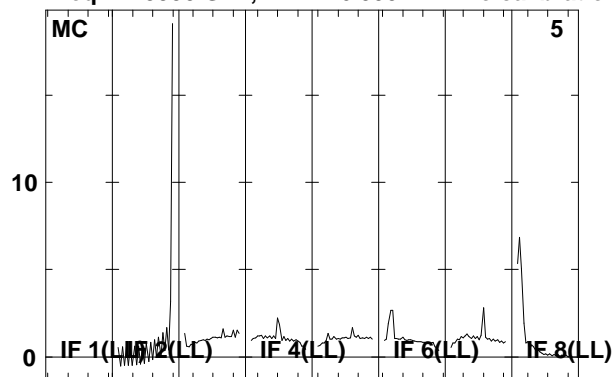

Lower frame: Real Jy  
Total-power spectrum Antenna: \*  
Timerange: 00/07:51:53 to 00/07:56:29

Plot file version 210 created 08-AUG-2008 17:00:05

J021348 EO006B.UVDATA.1

Freq = 1.5950 GHz, Bw = 16.000 MH No calibration applied and no bandpass applied

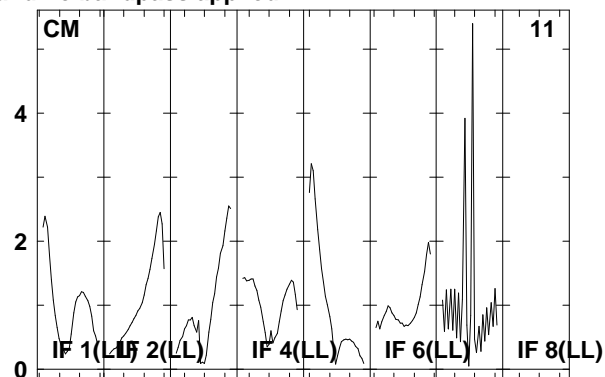
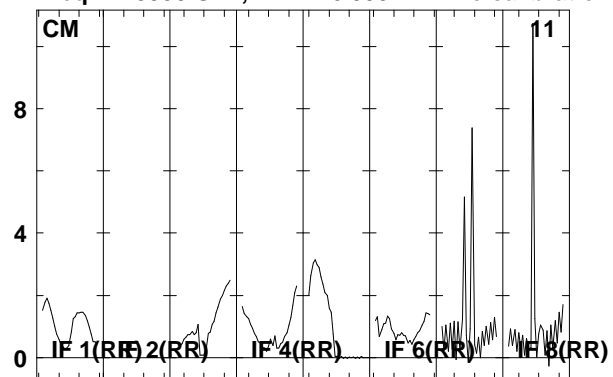

Lower frame: Real Jy  
Total-power spectrum Antenna: \*  
Timerange: 00/07:51:53 to 00/07:56:29

Plot file version 211 created 08-AUG-2008 17:00:06

J0209+13 EO006B.UVDATA.1

Freq = 1.5950 GHz, Bw = 16.000 MH No calibration applied and no bandpass applied

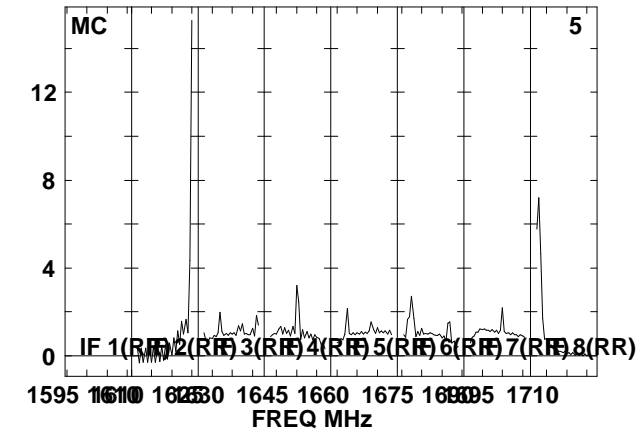
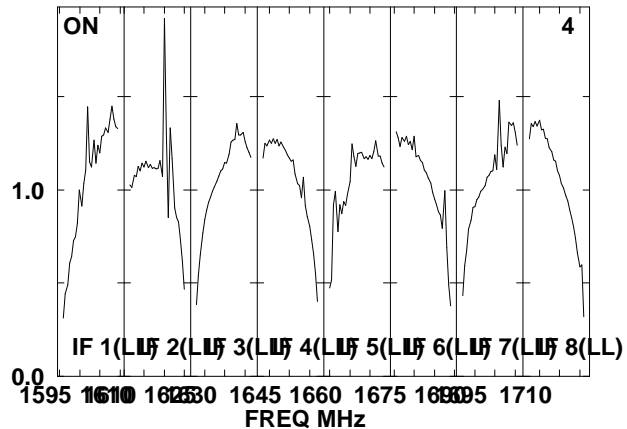
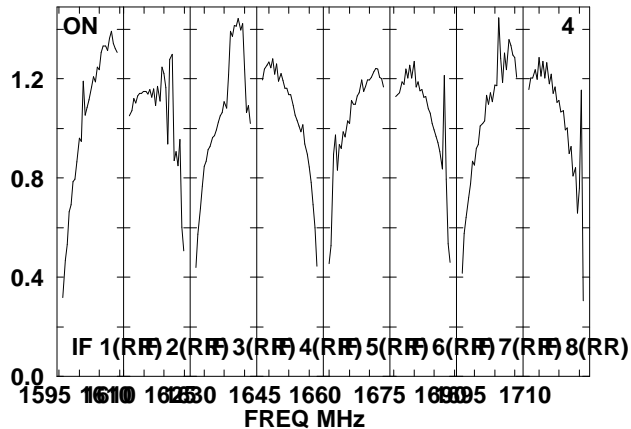
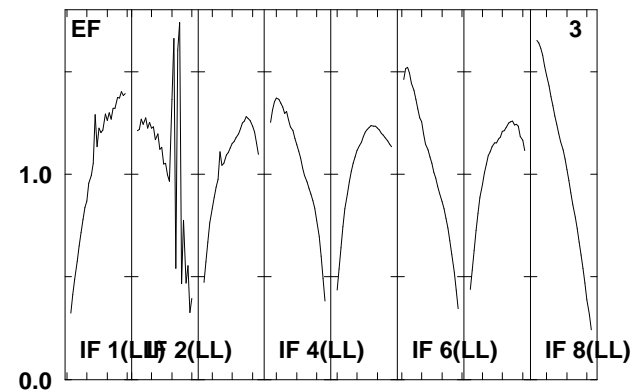
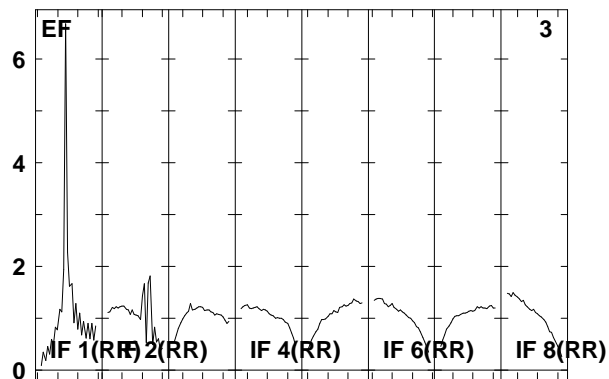
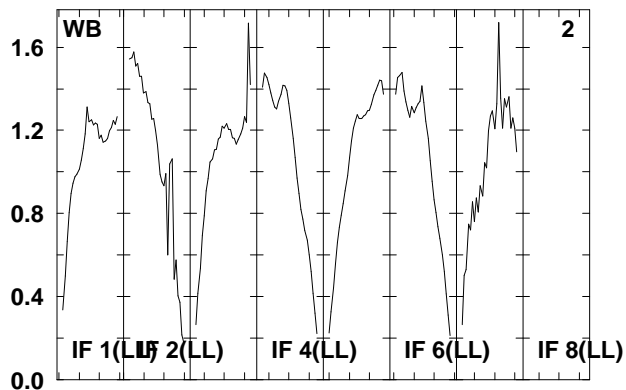
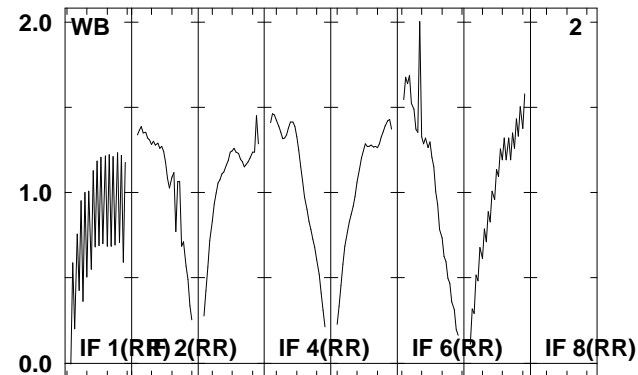
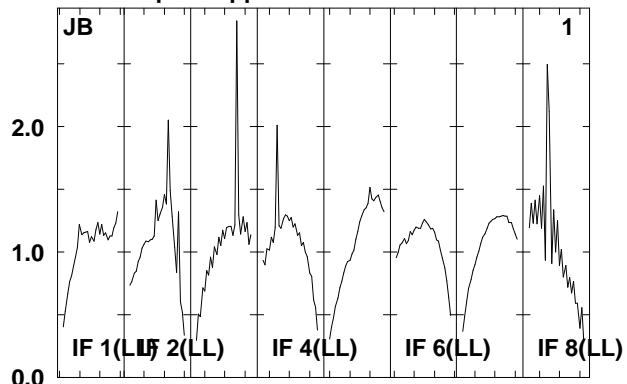
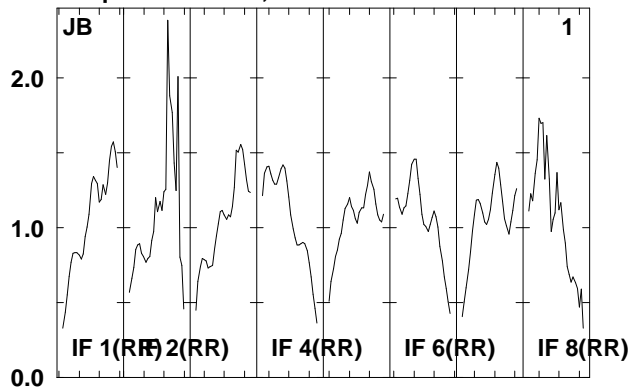

Lower frame: Real Jy  
Total-power spectrum Antenna: \*  
Timerange: 00/07:57:01 to 00/07:58:33

Plot file version 212 created 08-AUG-2008 17:00:06

J0209+13 EO006B.UVDATA.1

Freq = 1.5950 GHz, Bw = 16.000 MH No calibration applied and no bandpass applied

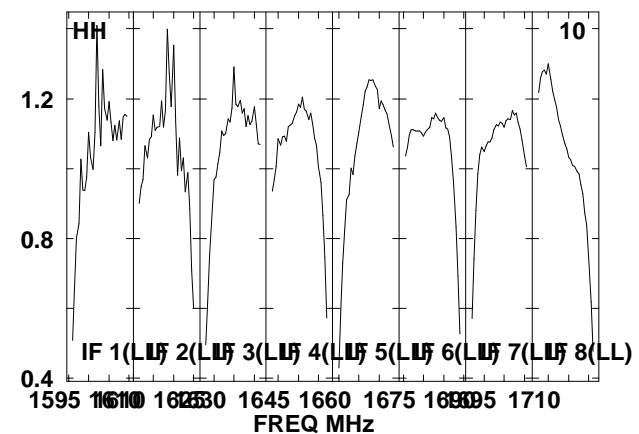
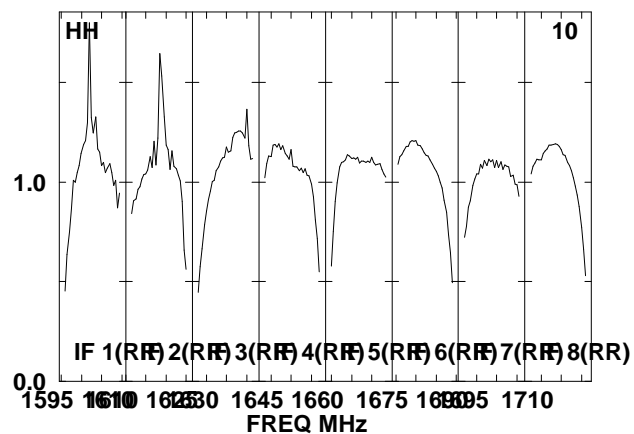
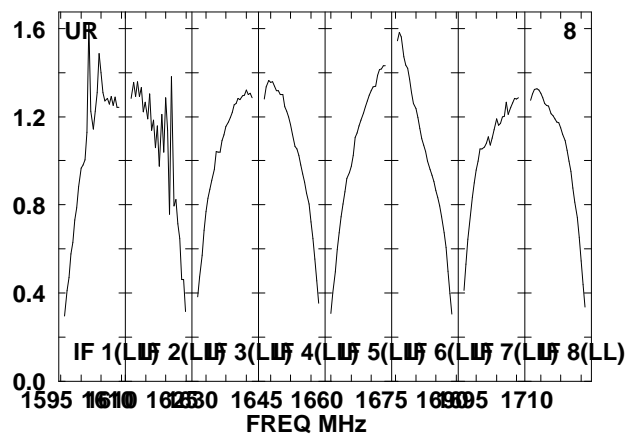
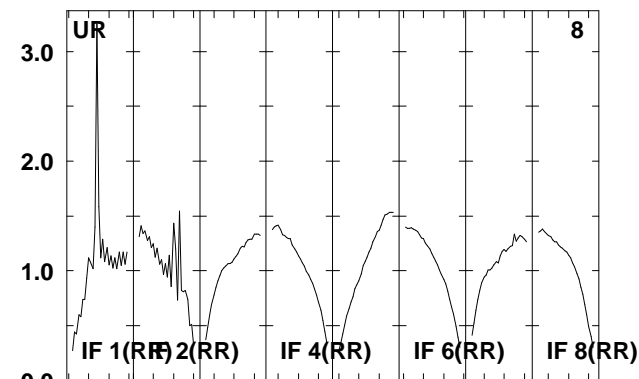
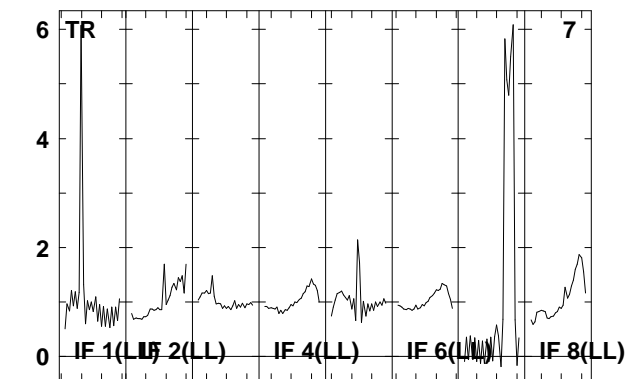
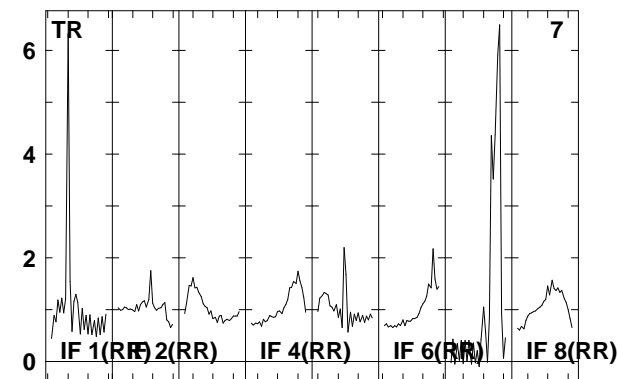
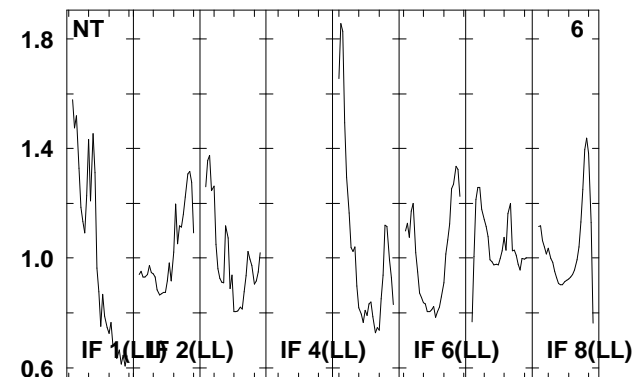
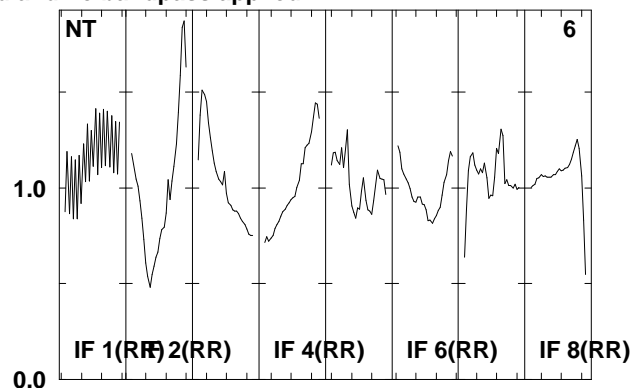
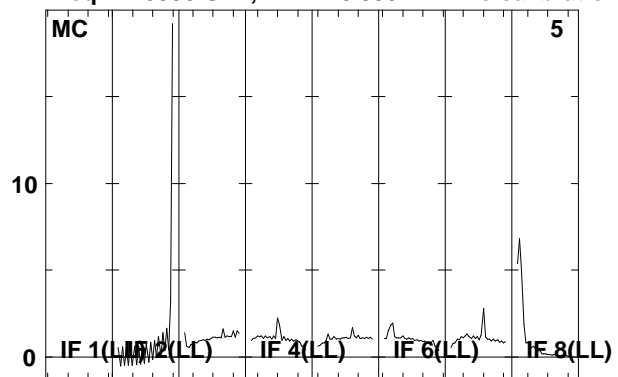

Lower frame: Real Jy  
Total-power spectrum Antenna: \*  
Timerange: 00/07:57:01 to 00/07:58:33



Plot file version 213 created 08-AUG-2008 17:00:06

J021348 EO006B.UVDATA.1

Freq = 1.5950 GHz, Bw = 16.000 MH No calibration applied and no bandpass applied

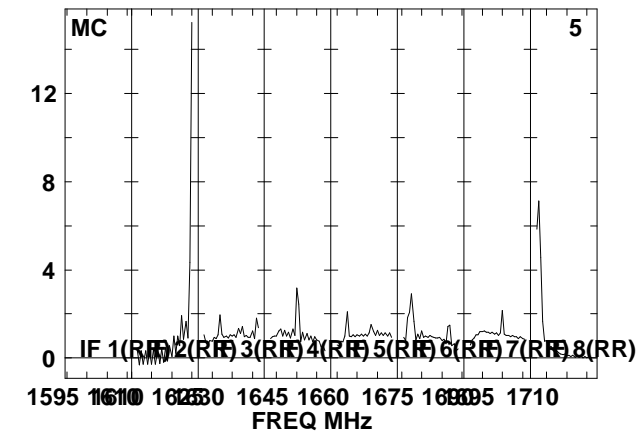
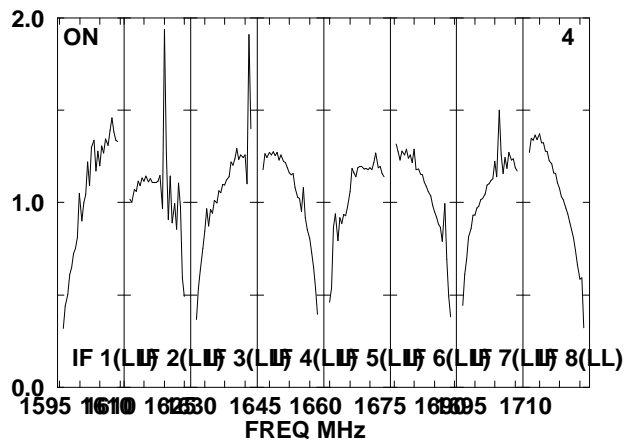
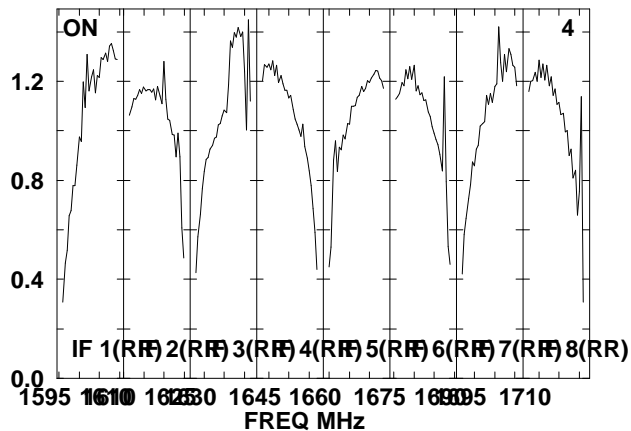
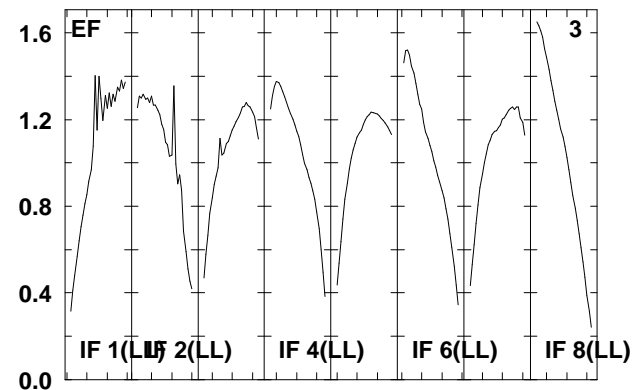
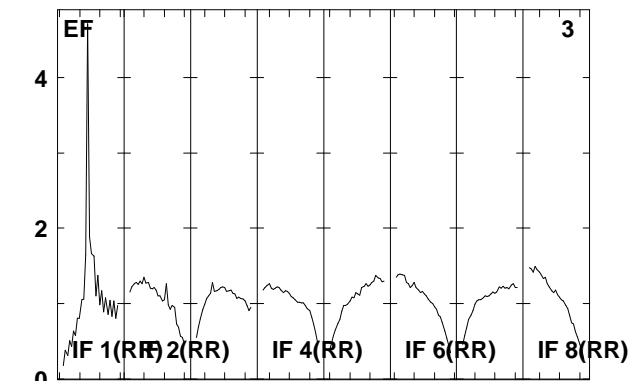
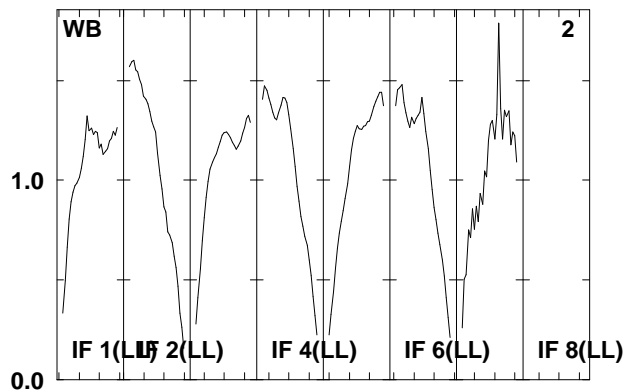
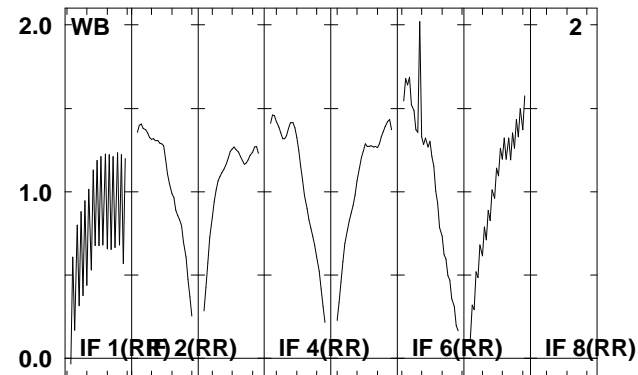
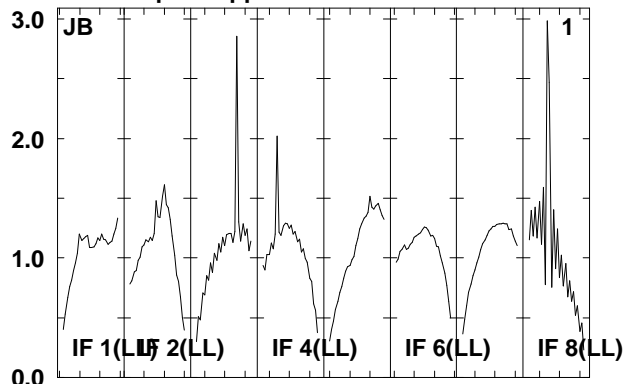
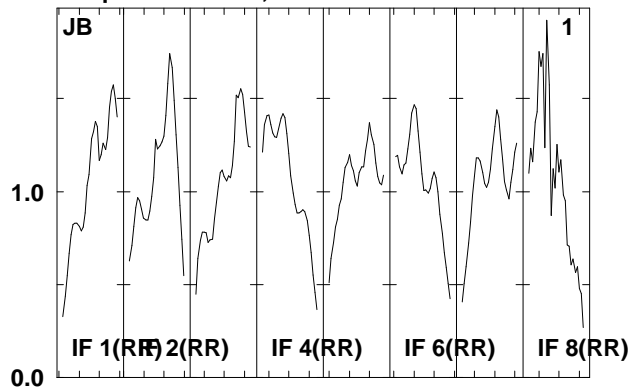

Lower frame: Real Jy  
Total-power spectrum Antenna: \*  
Timerange: 00/07:59:13 to 00/08:03:49

Plot file version 214 created 08-AUG-2008 17:00:07

J021348 EO006B.UVDATA.1

Freq = 1.5950 GHz, Bw = 16.000 MH No calibration applied and no bandpass applied

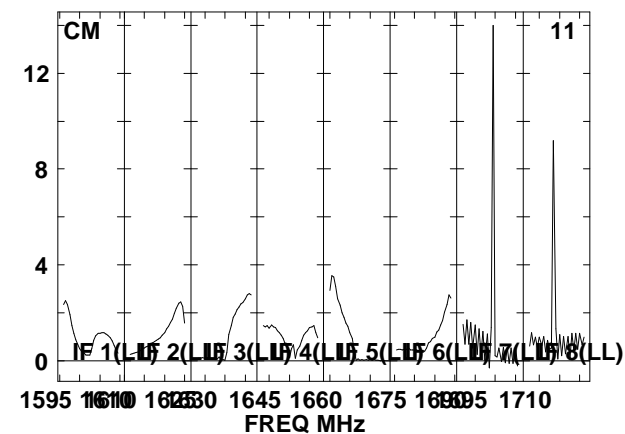
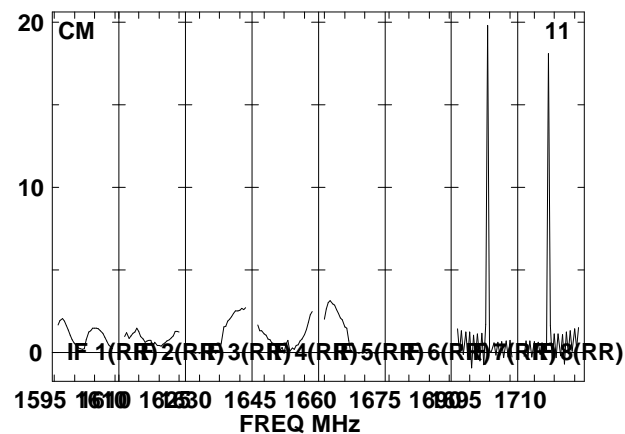
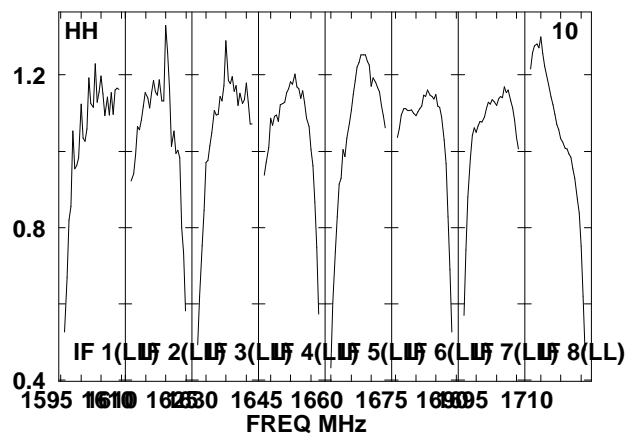
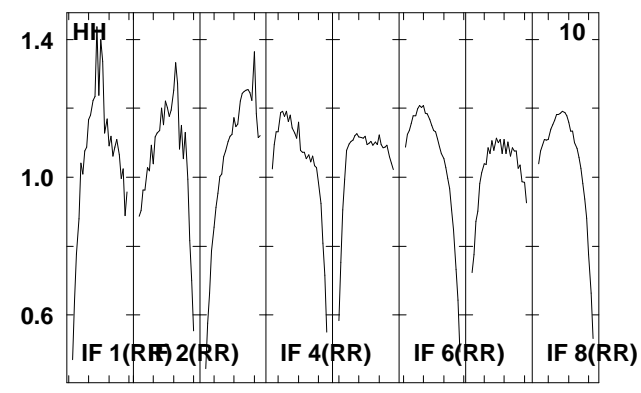
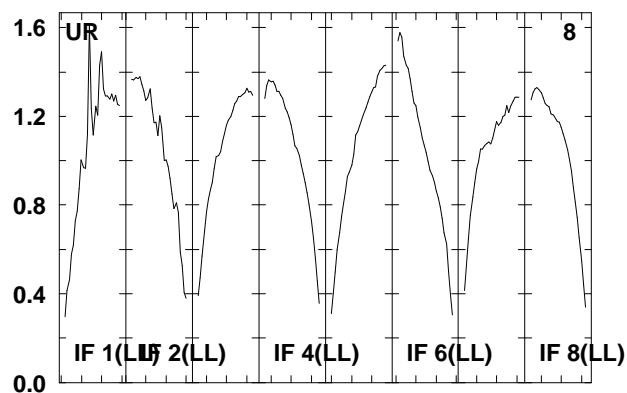
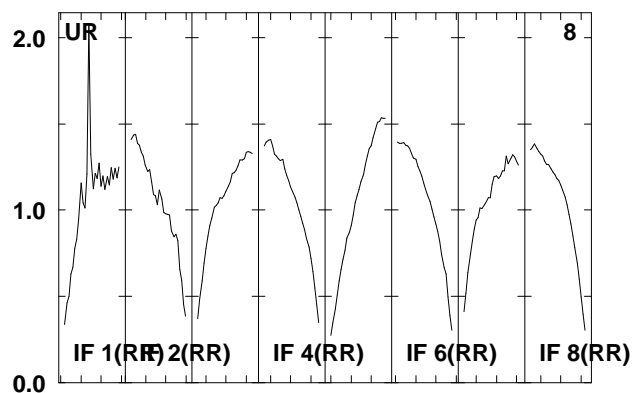
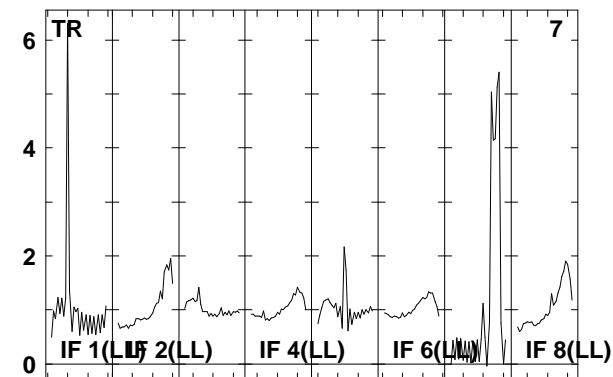
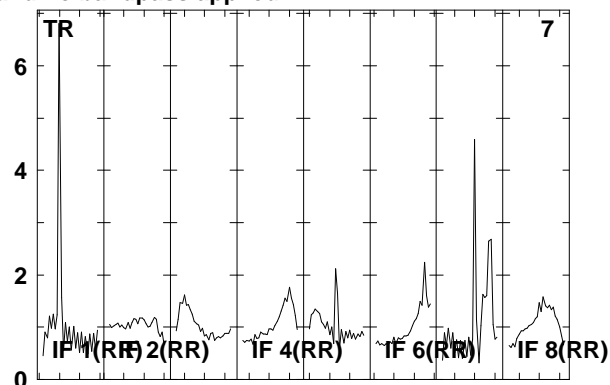
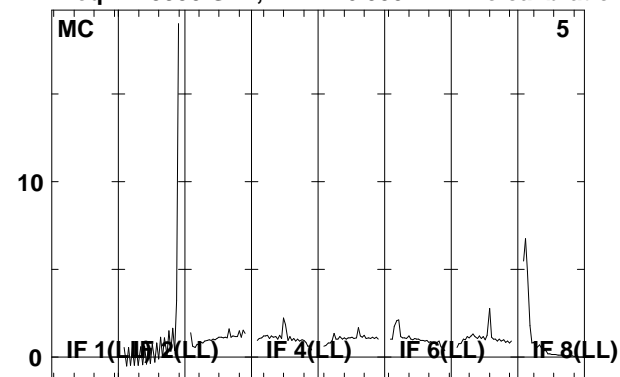

Lower frame: Real Jy  
Total-power spectrum Antenna: \*  
Timerange: 00/07:59:13 to 00/08:03:49

Plot file version 215 created 08-AUG-2008 17:00:09

J0209+13 EO006B.UVDATA.1

Freq = 1.5950 GHz, Bw = 16.000 MH No calibration applied and no bandpass applied

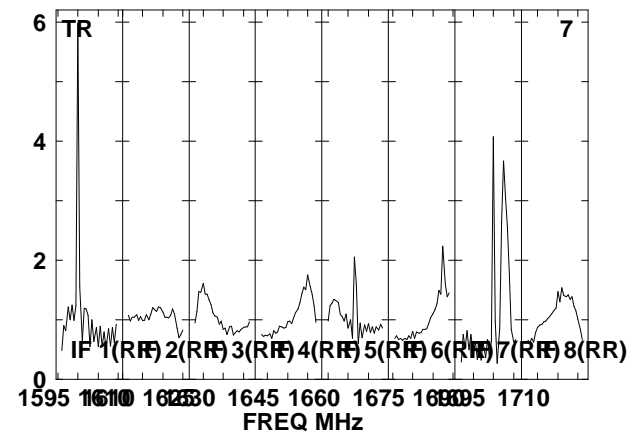
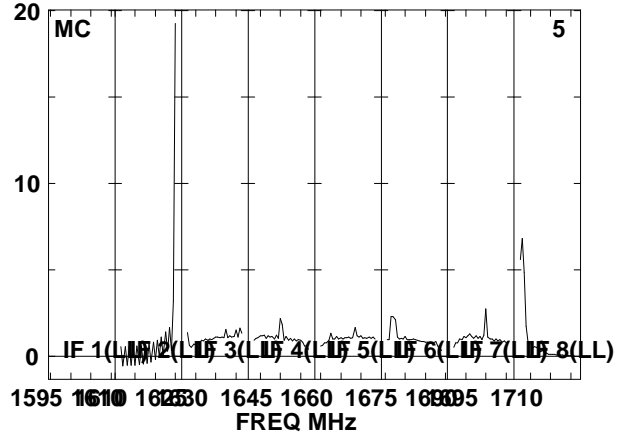
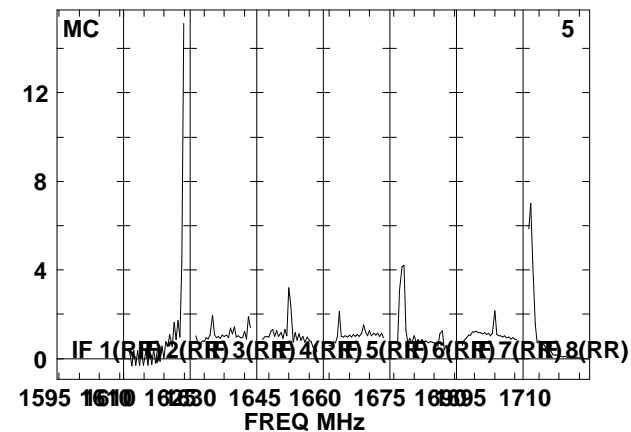
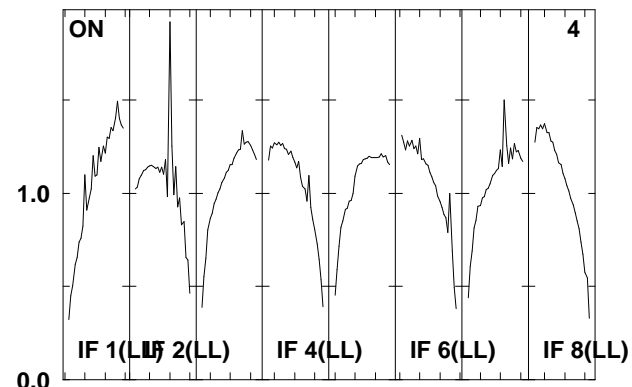
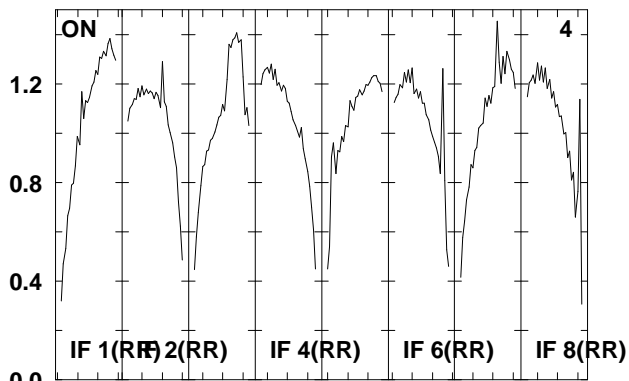
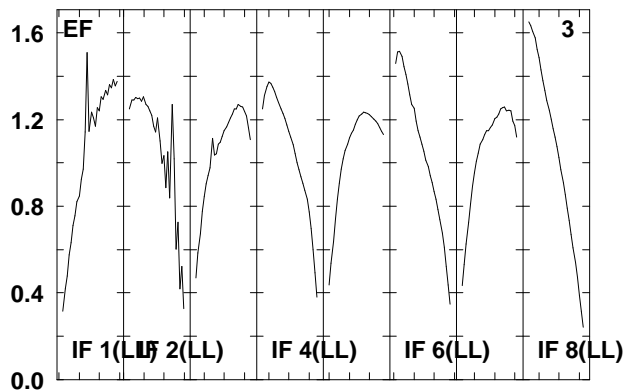
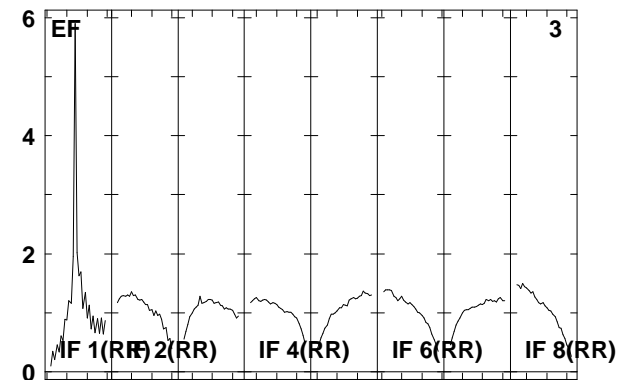
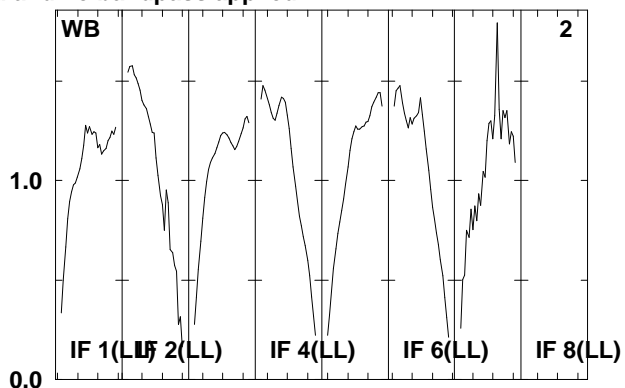
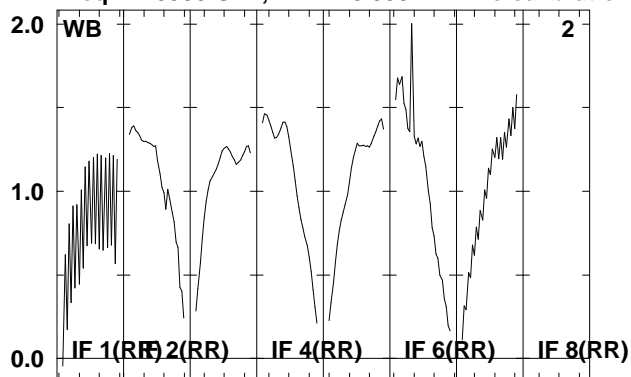

Lower frame: Real Jy  
Total-power spectrum Antenna: \*  
Timerange: 00/08:04:35 to 00/08:05:51

Plot file version 216 created 08-AUG-2008 17:00:09

J0209+13 EO006B.UVDATA.1

Freq = 1.5950 GHz, Bw = 16.000 MH No calibration applied and no bandpass applied

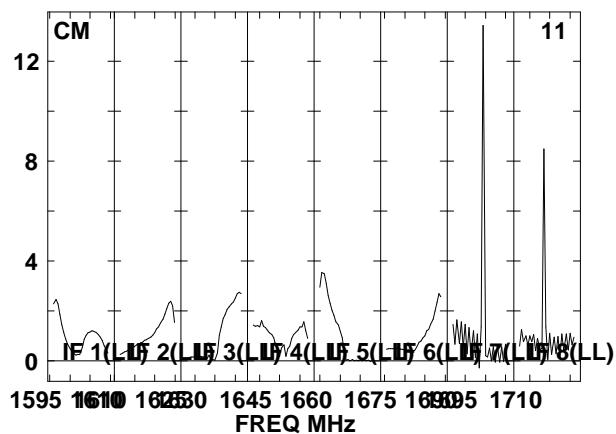
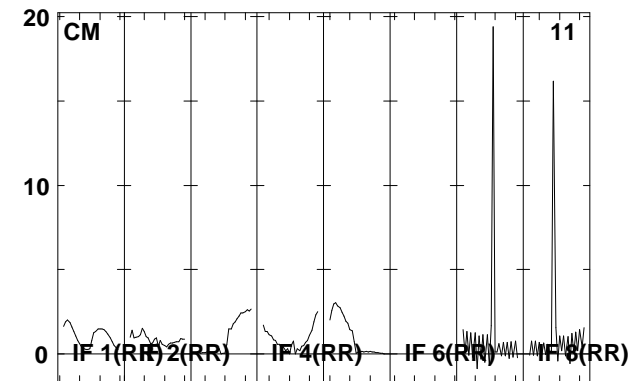
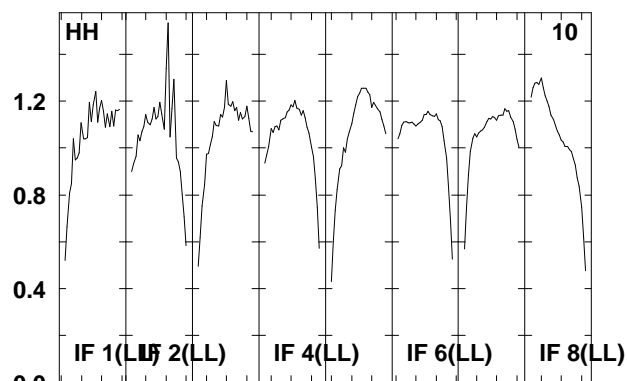
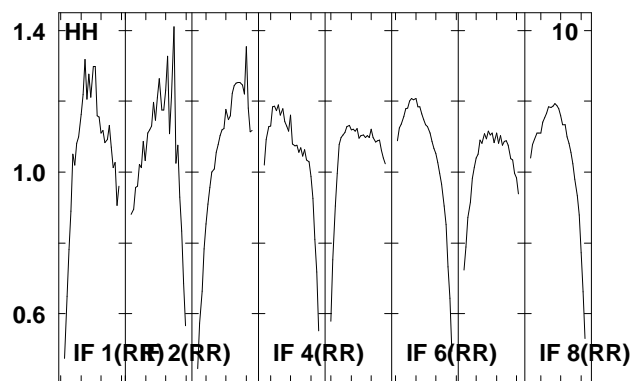
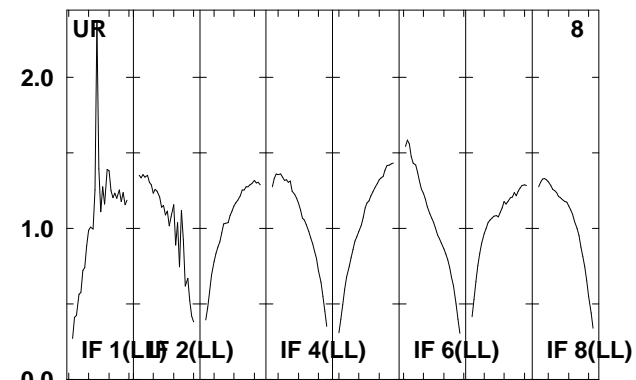
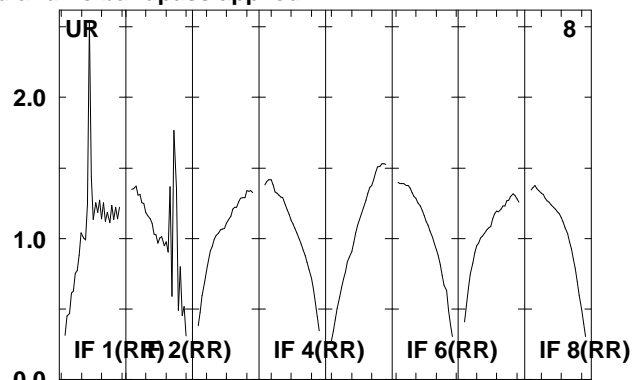
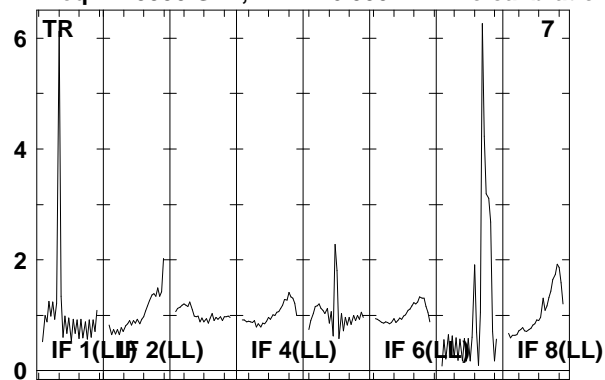

Lower frame: Real Jy

Total-power spectrum Antenna: \*

Timerange: 00/08:04:35 to 00/08:05:51

Plot file version 217 created 08-AUG-2008 17:00:09

J021348 EO006B.UVDATA.1

Freq = 1.5950 GHz, Bw = 16.000 MH No calibration applied and no bandpass applied

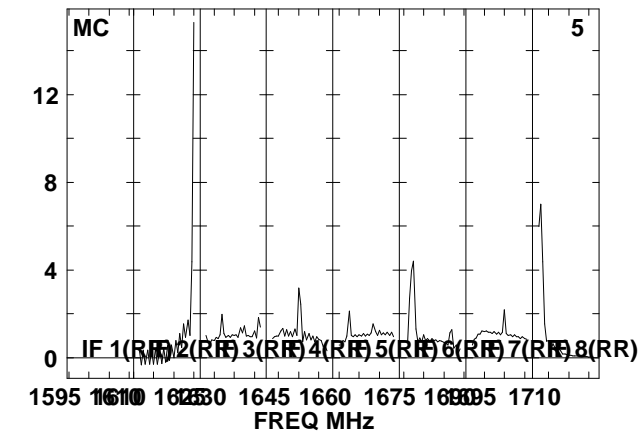
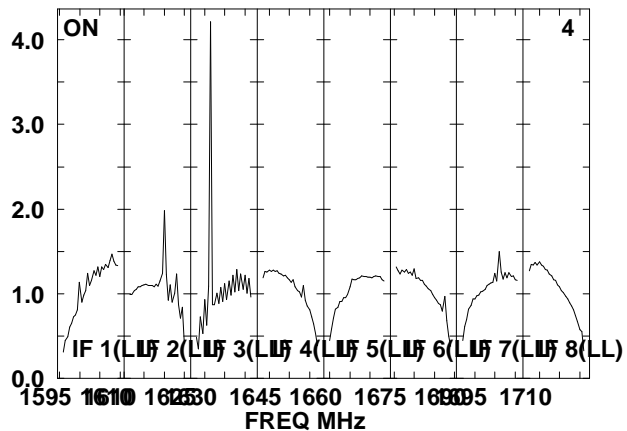
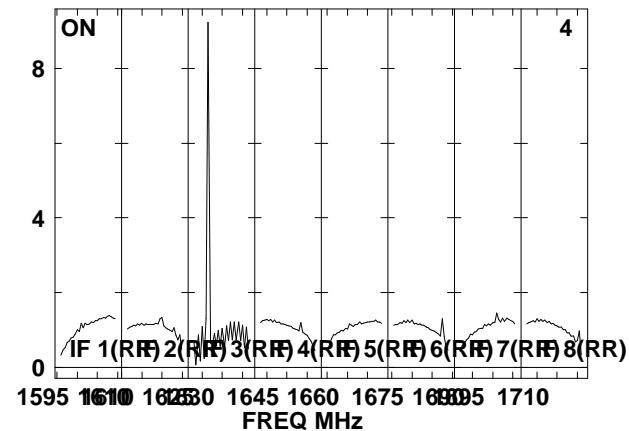
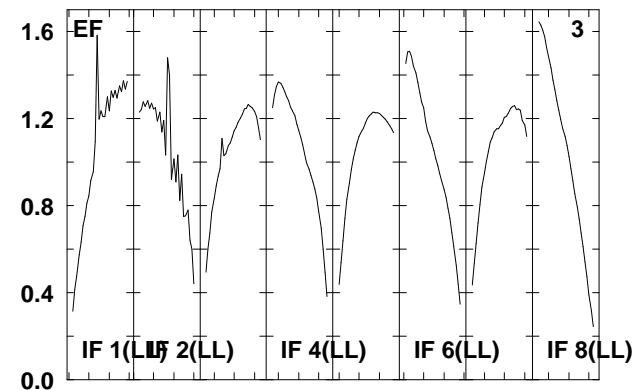
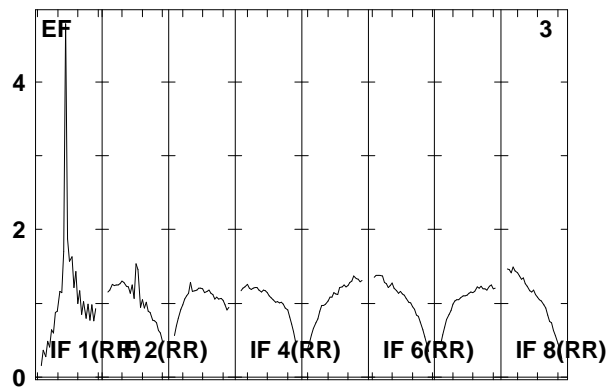
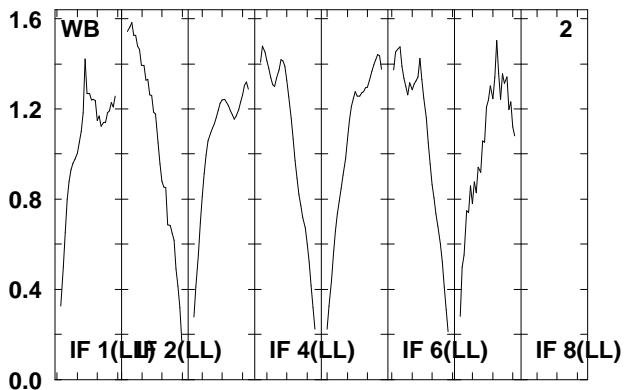
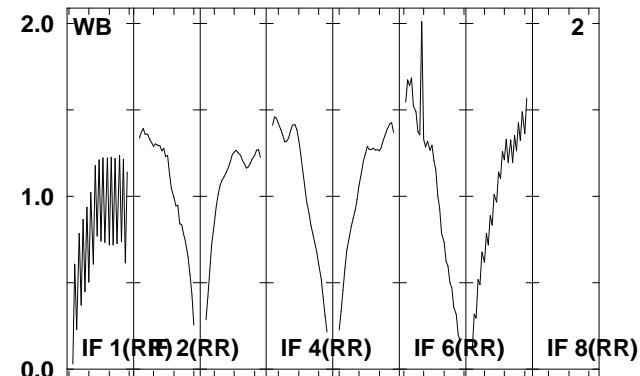
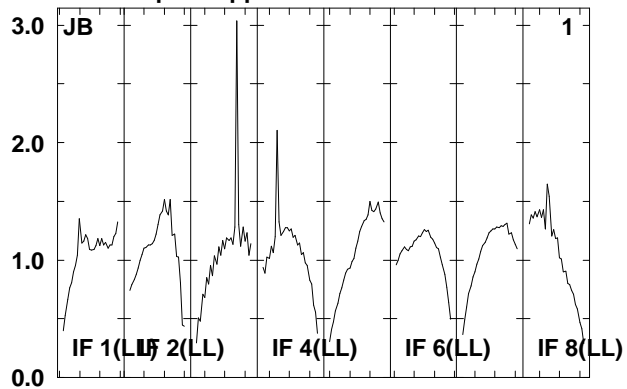
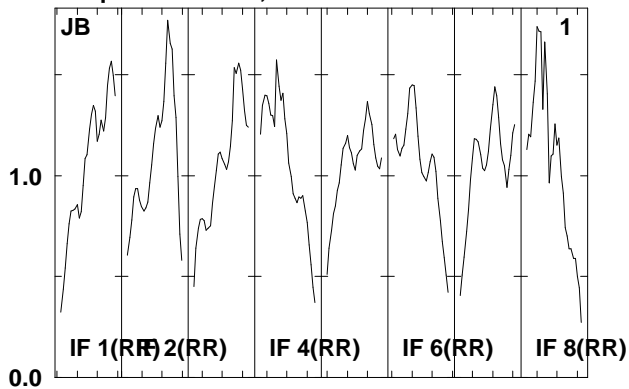

Lower frame: Real Jy  
Total-power spectrum Antenna: \*  
Timerange: 00/08:06:33 to 00/08:11:09

Plot file version 218 created 08-AUG-2008 17:00:10

J021348 EO006B.UVDATA.1

Freq = 1.5950 GHz, Bw = 16.000 MH No calibration applied and no bandpass applied

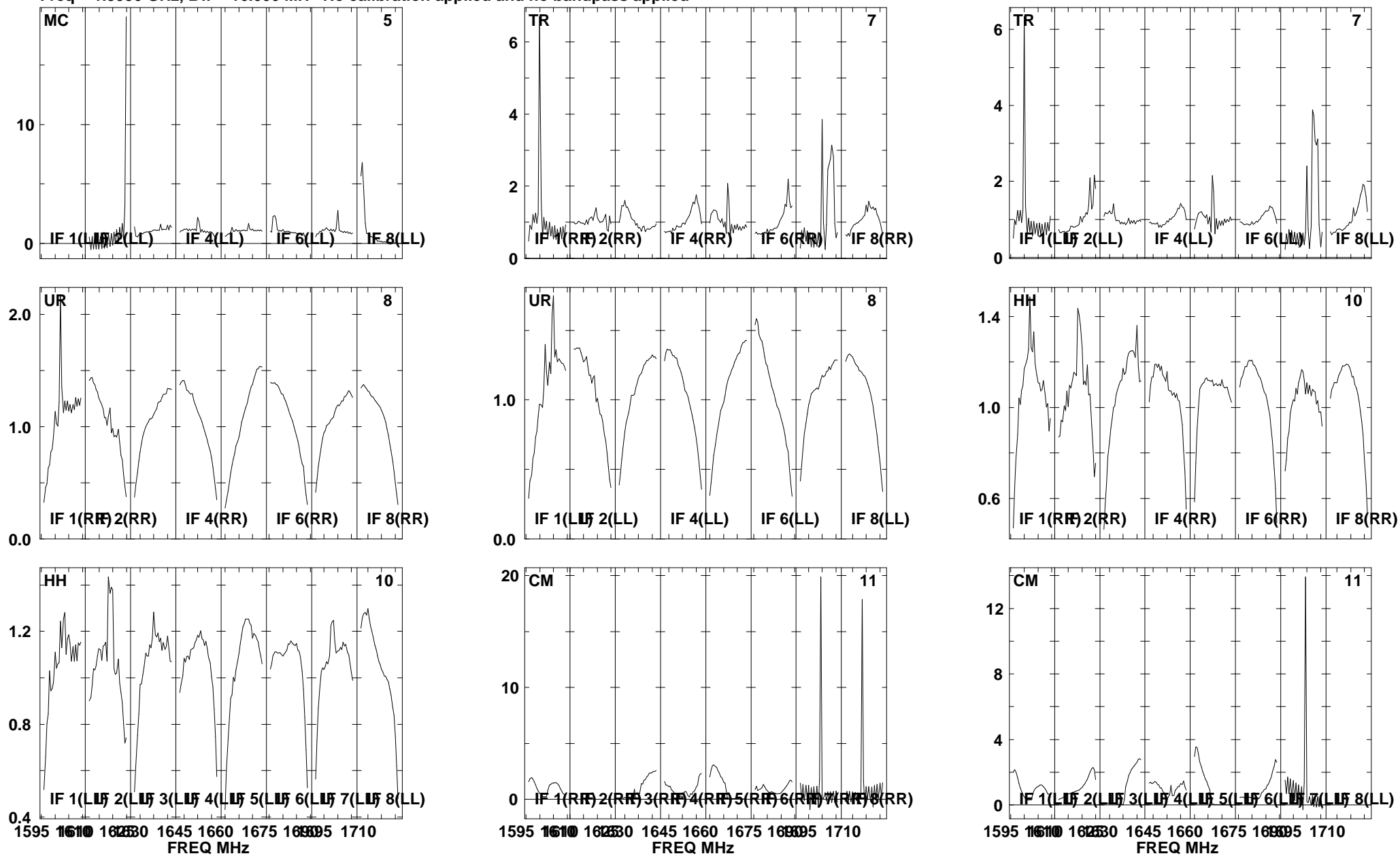

Lower frame: Real Jy  
Total-power spectrum Antenna: \*  
Timerange: 00/08:06:33 to 00/08:11:09

Plot file version 219 created 08-AUG-2008 17:00:11

J0209+13 EO006B.UVDATA.1

Freq = 1.5950 GHz, Bw = 16.000 MH No calibration applied and no bandpass applied

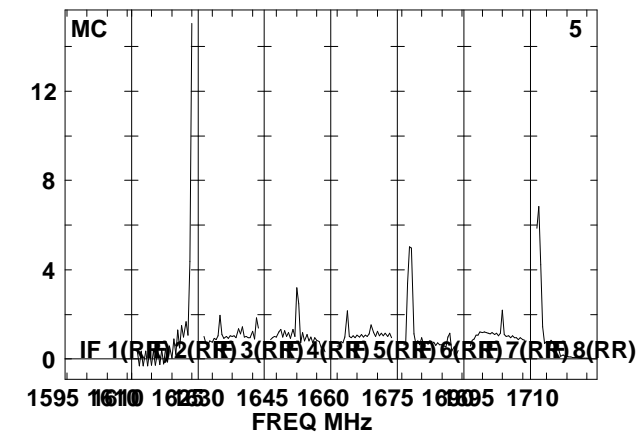
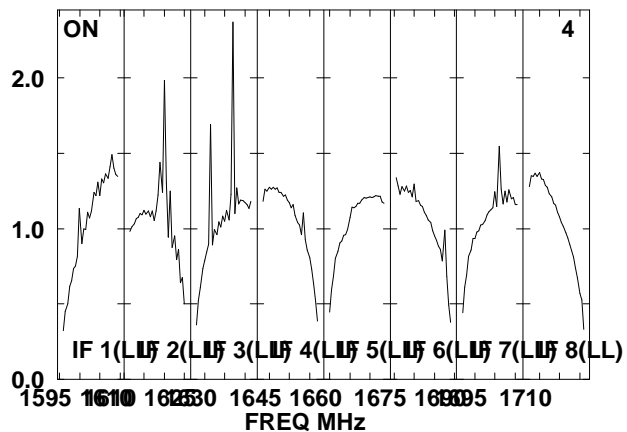
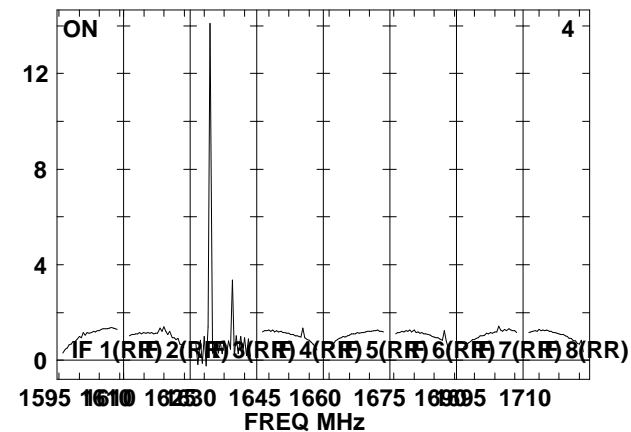
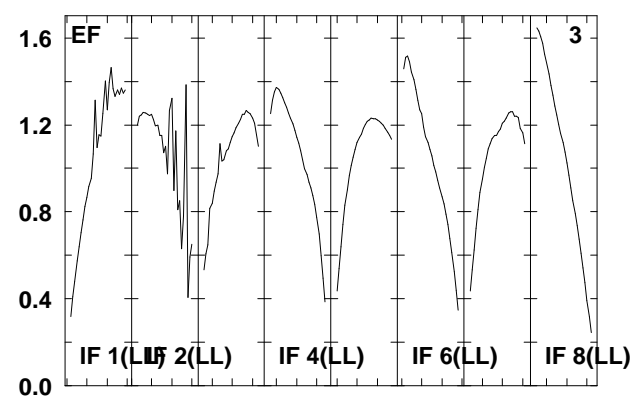
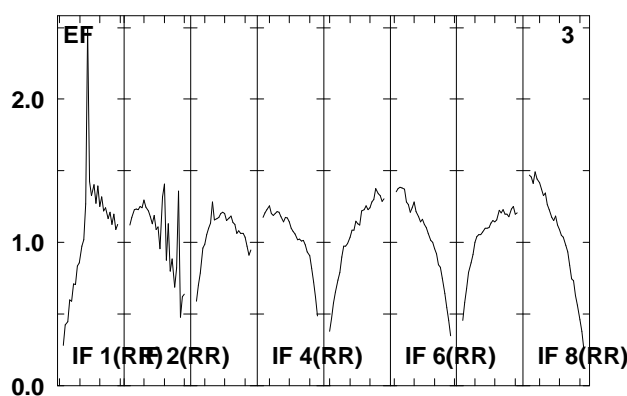
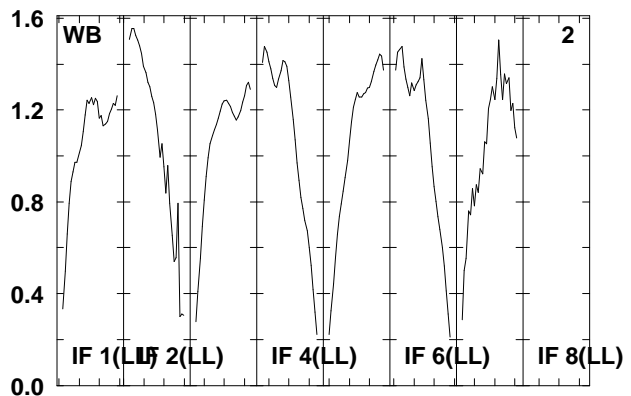
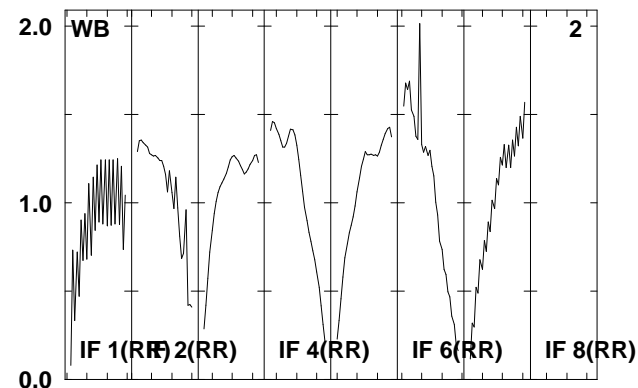
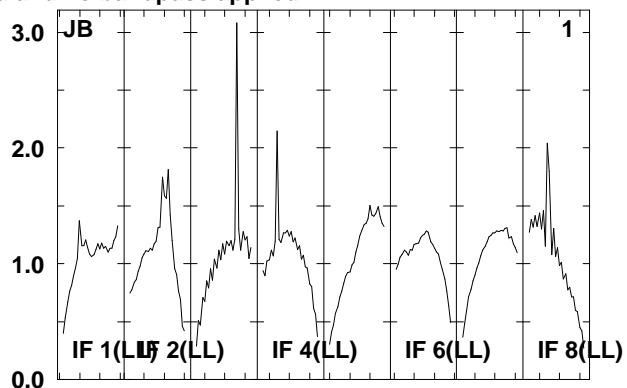
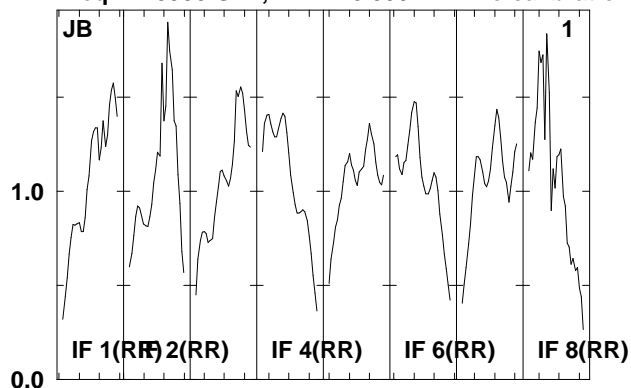

Lower frame: Real Jy  
Total-power spectrum Antenna: \*  
Timerange: 00/08:11:45 to 00/08:13:17

Plot file version 220 created 08-AUG-2008 17:00:11

J0209+13 EO006B.UVDATA.1

Freq = 1.5950 GHz, Bw = 16.000 MH No calibration applied and no bandpass applied

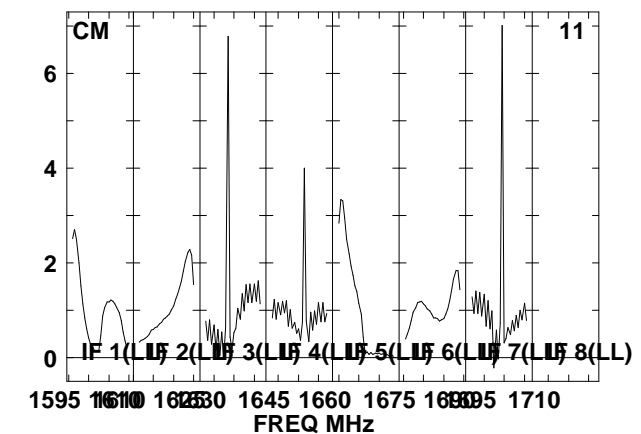
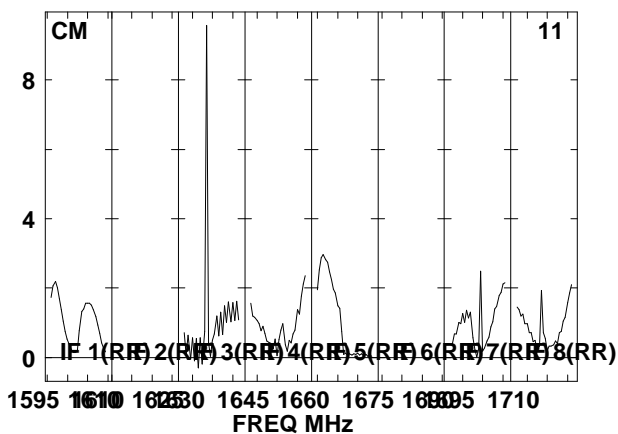
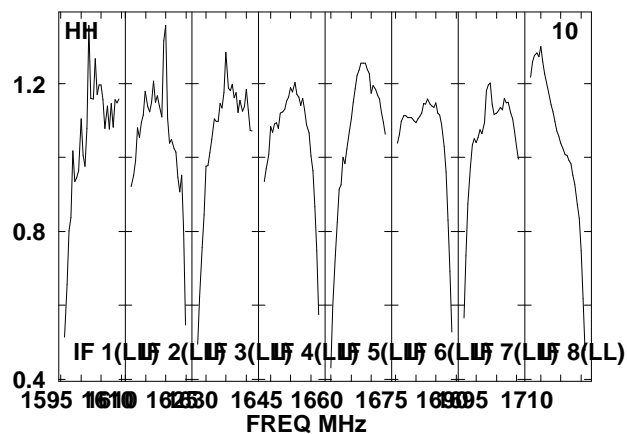
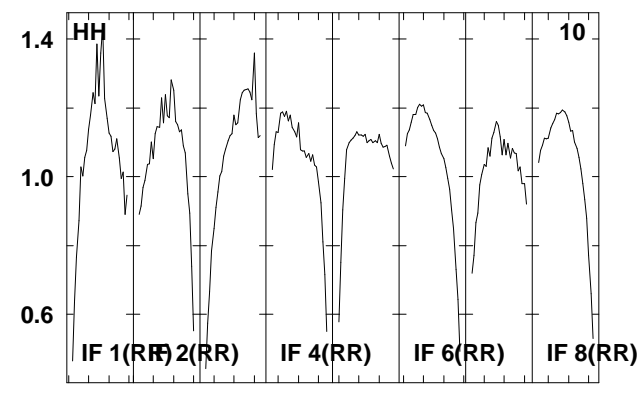
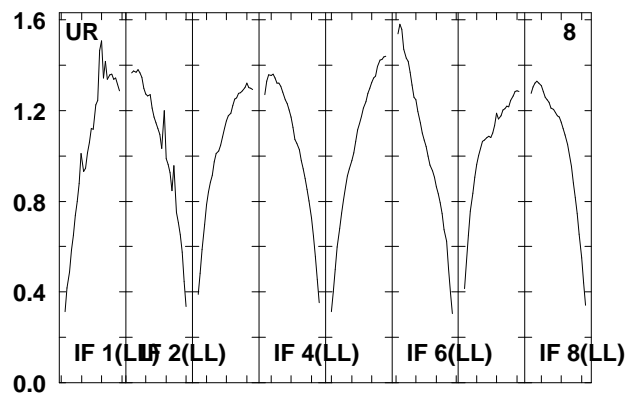
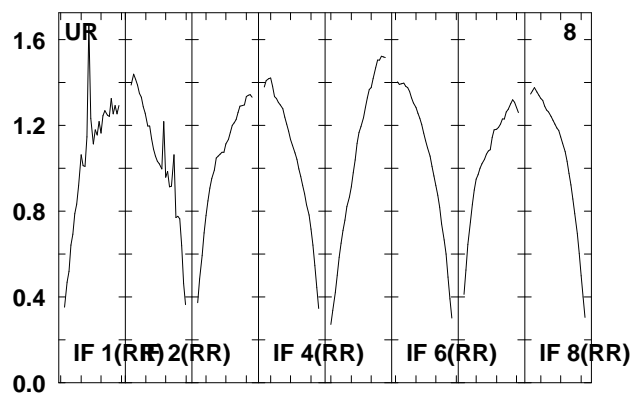
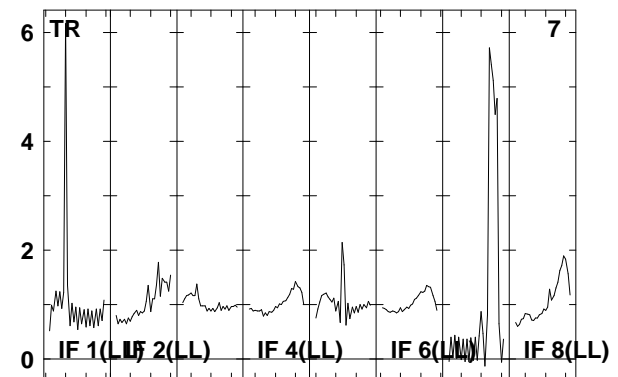
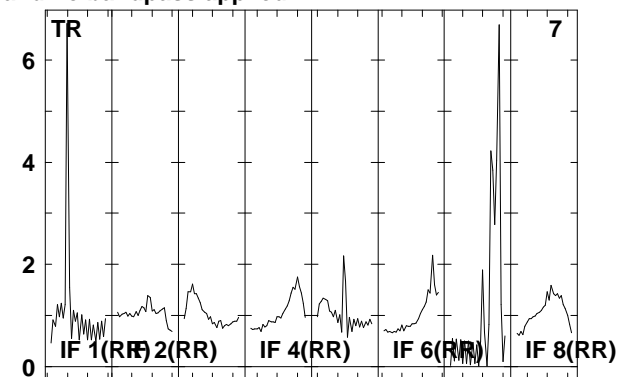
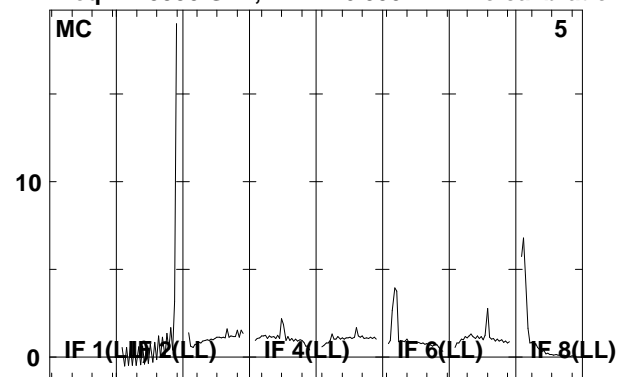

Lower frame: Real Jy

Total-power spectrum Antenna: \*

Timerange: 00/08:11:45 to 00/08:13:17



Plot file version 221 created 08-AUG-2008 17:00:12

J021348 EO006B.UVDATA.1

Freq = 1.5950 GHz, Bw = 16.000 MH No calibration applied and no bandpass applied

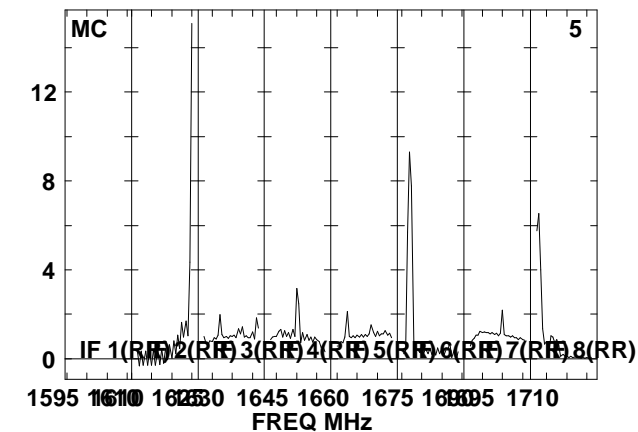
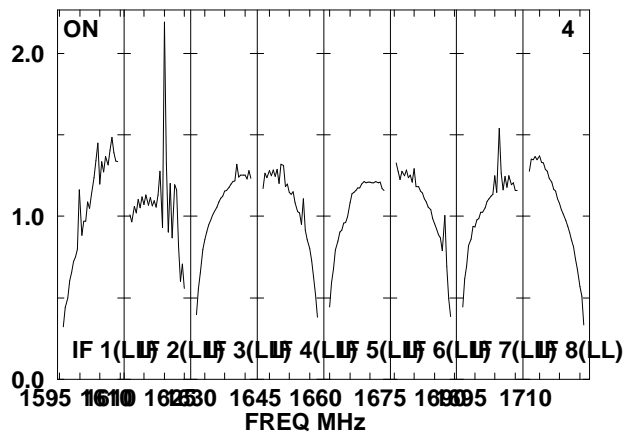
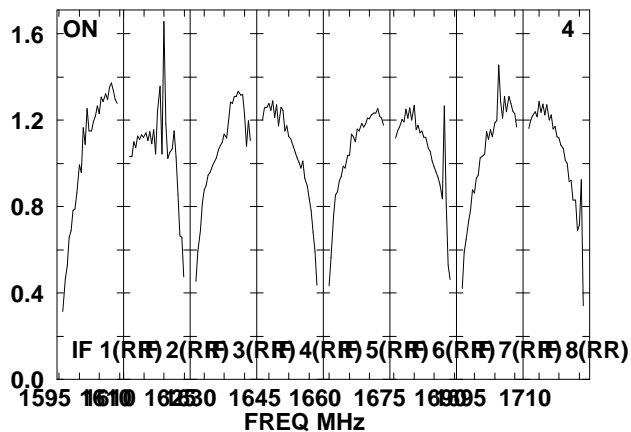
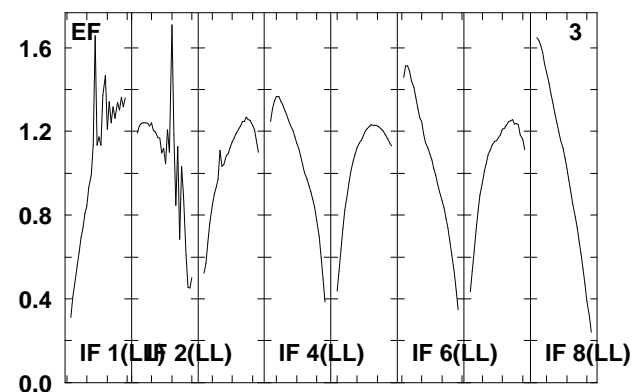
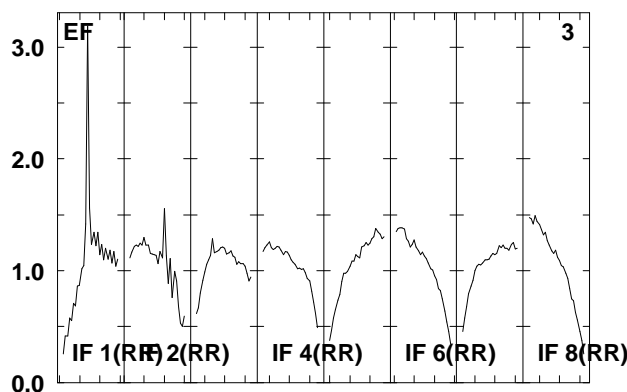
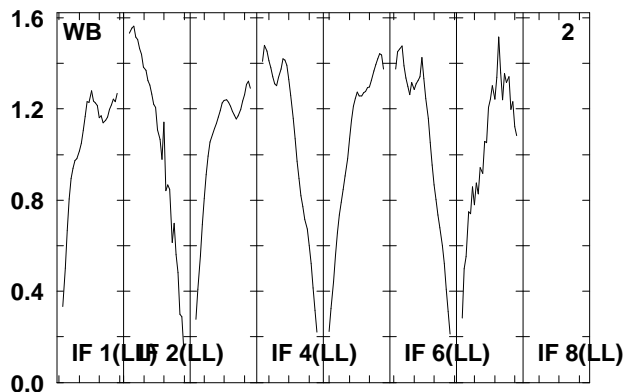
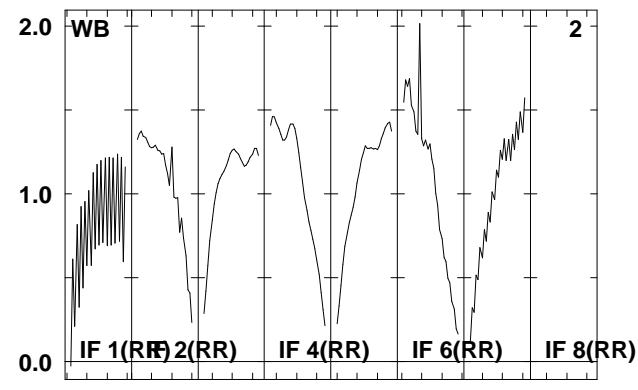
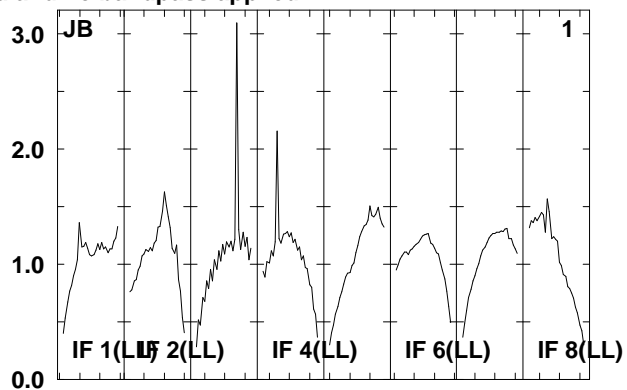
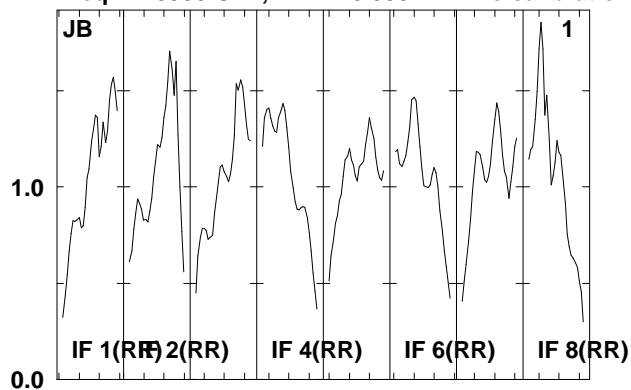

Lower frame: Real Jy  
Total-power spectrum Antenna: \*  
Timerange: 00/08:13:57 to 00/08:18:21

Plot file version 222 created 08-AUG-2008 17:00:13

J021348 EO006B.UVDATA.1

Freq = 1.5950 GHz, Bw = 16.000 MH No calibration applied and no bandpass applied

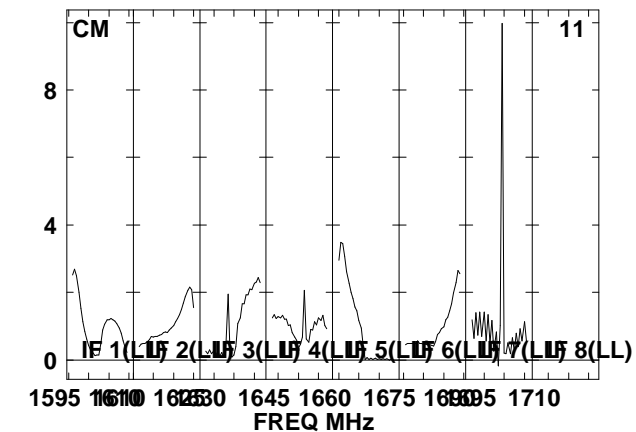
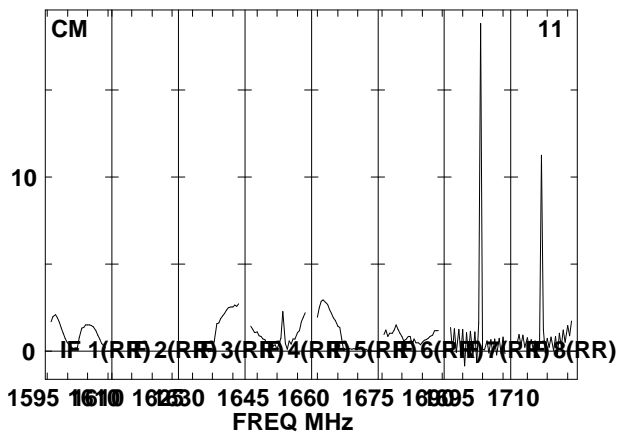
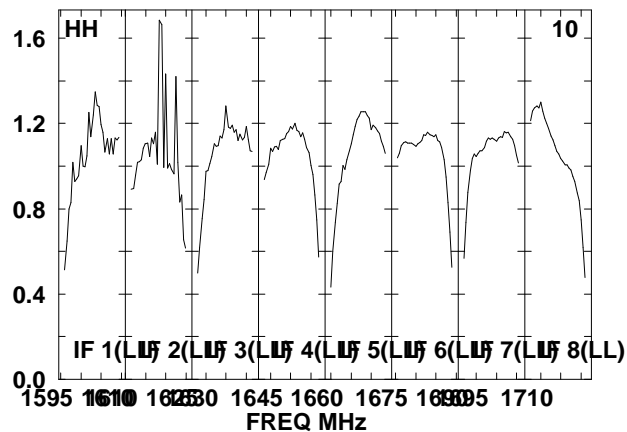
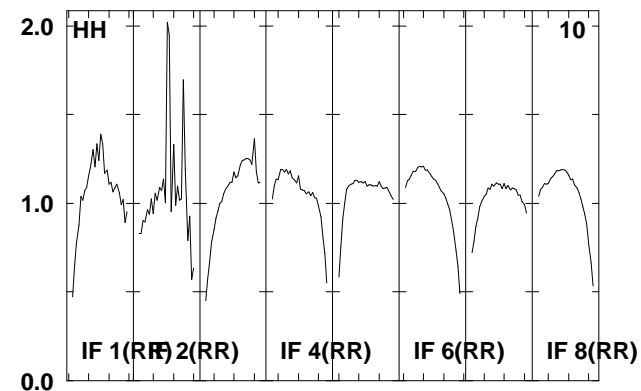
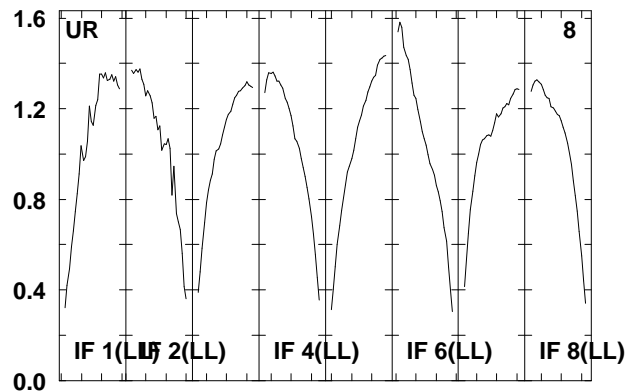
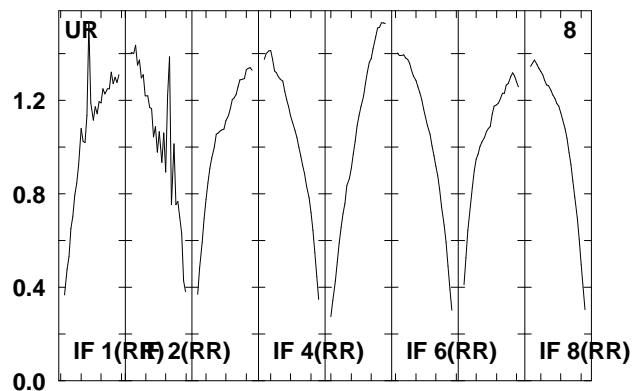
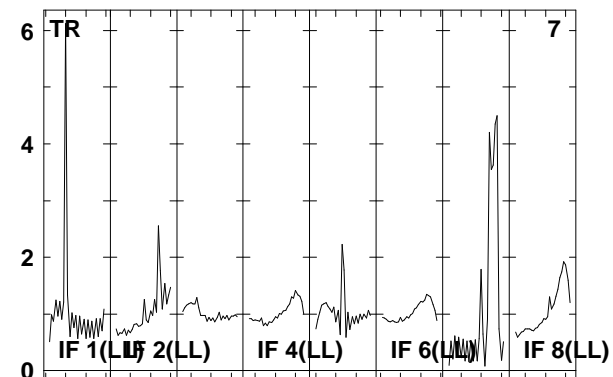
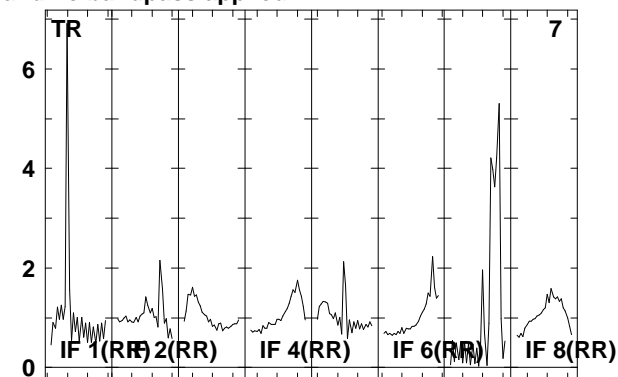
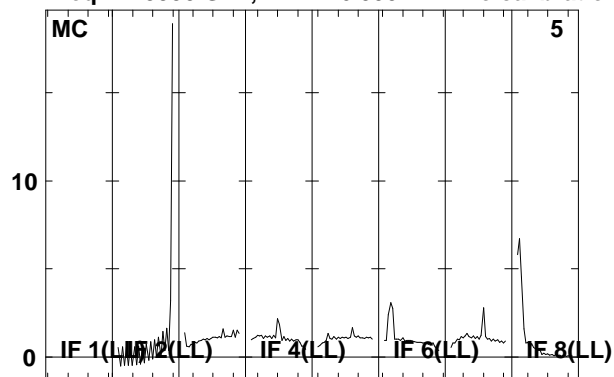

Lower frame: Real Jy

Total-power spectrum Antenna: \*

Timerange: 00/08:13:57 to 00/08:18:21

Plot file version 223 created 08-AUG-2008 17:00:14

J0209+13 EO006B.UVDATA.1

Freq = 1.5950 GHz, Bw = 16.000 MH No calibration applied and no bandpass applied

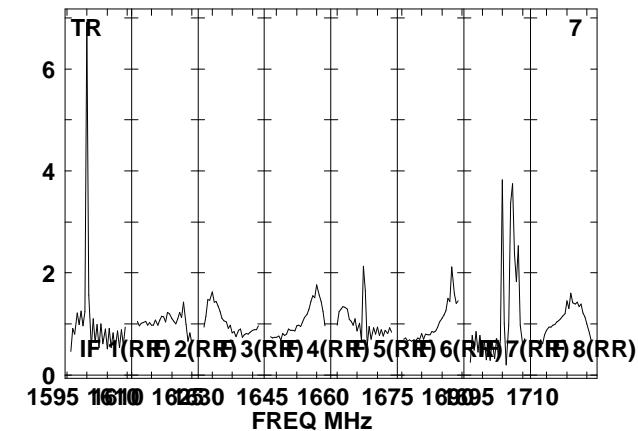
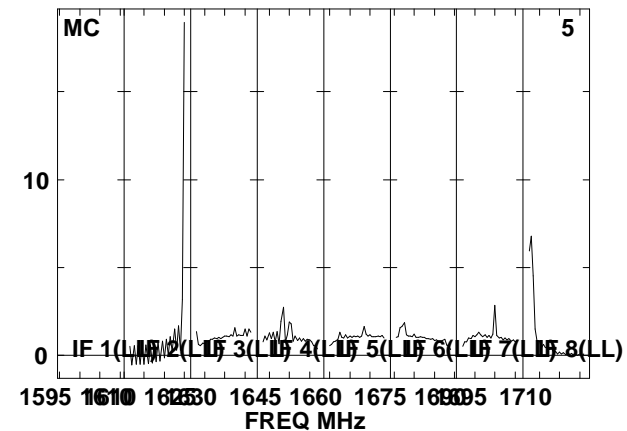
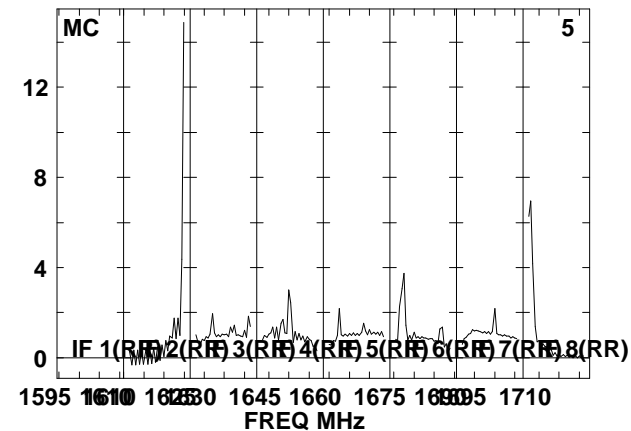
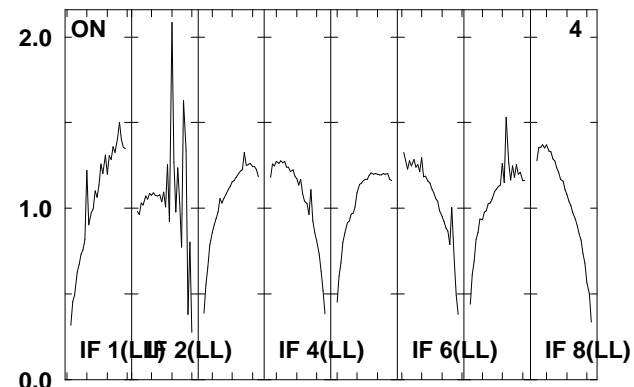
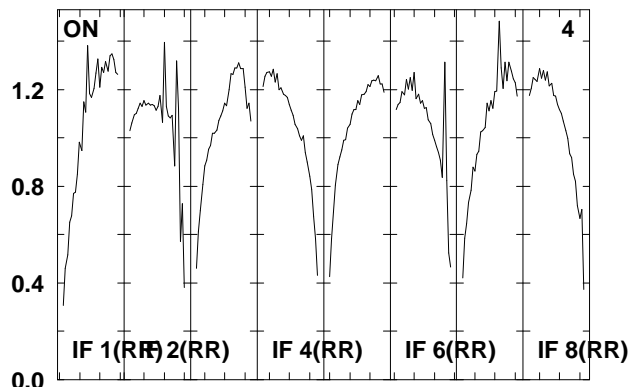
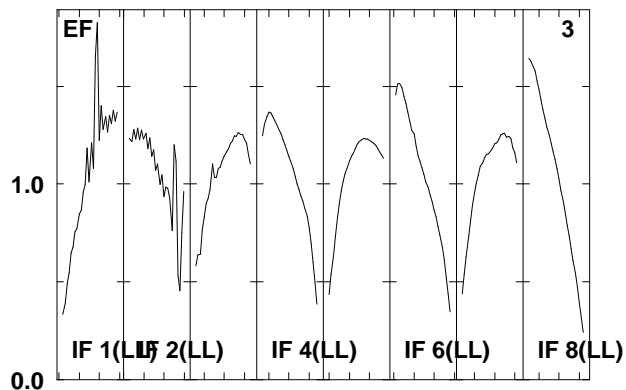
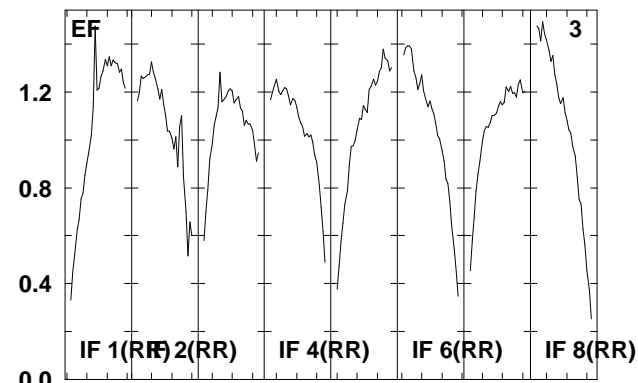
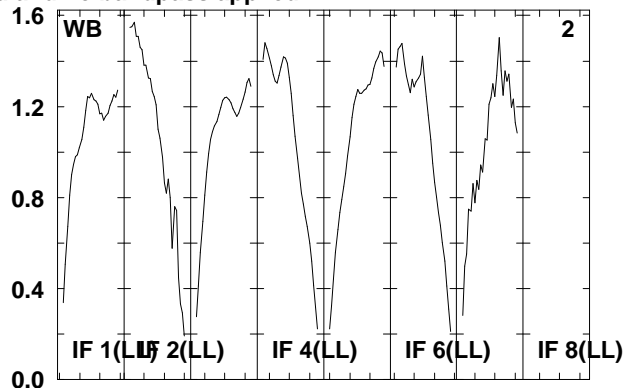
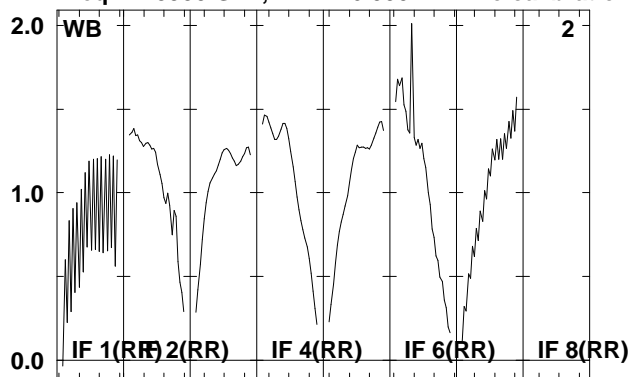

Lower frame: Real Jy

Total-power spectrum Antenna: \*

Timerange: 00/08:19:01 to 00/08:20:37

Plot file version 224 created 08-AUG-2008 17:00:14

J0209+13 EO006B.UVDATA.1

Freq = 1.5950 GHz, Bw = 16.000 MH No calibration applied and no bandpass applied

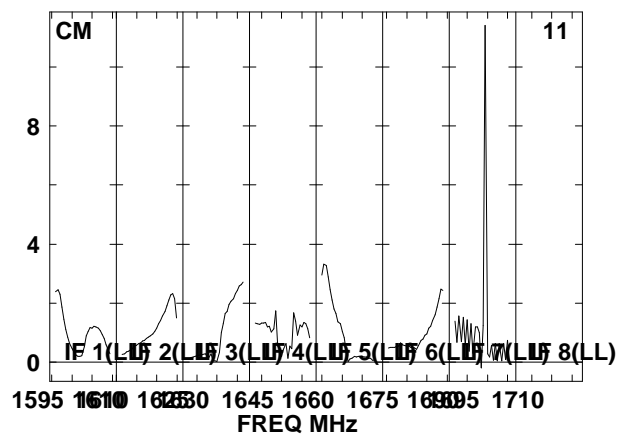
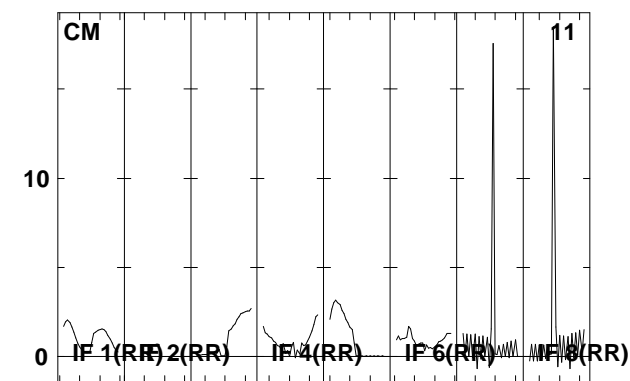
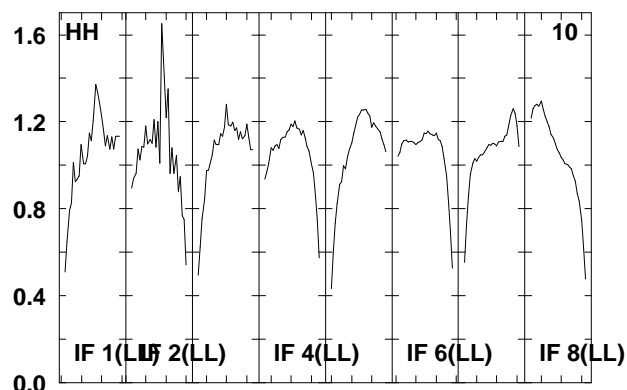
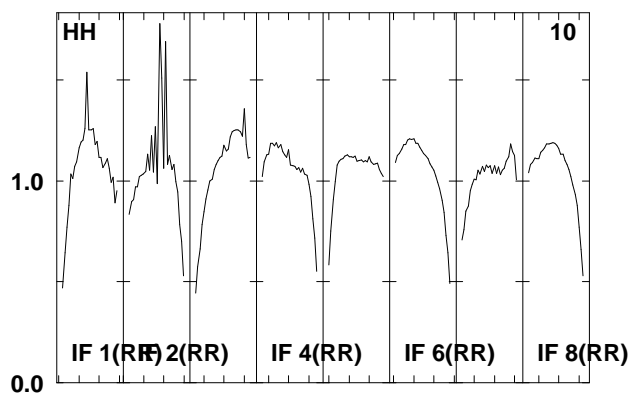
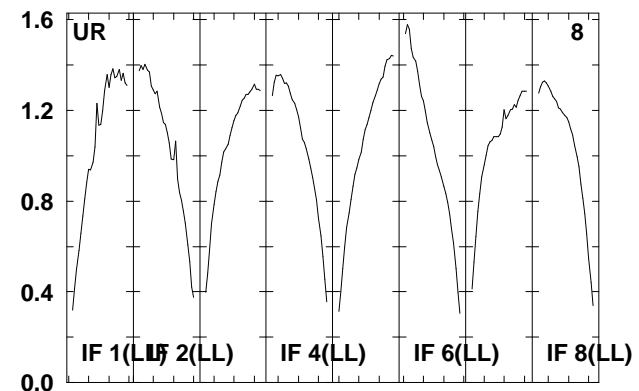
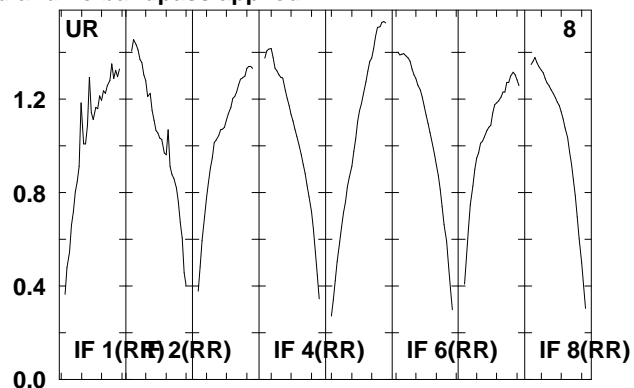
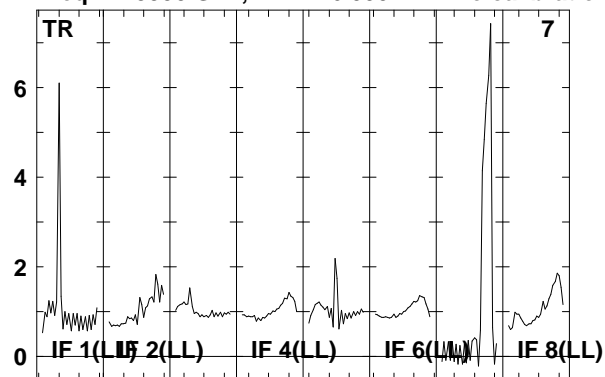

Lower frame: Real Jy

Total-power spectrum Antenna: \*

Timerange: 00/08:19:01 to 00/08:20:37

Plot file version 225 created 08-AUG-2008 17:00:14

J021348 EO006B.UVDATA.1

Freq = 1.5950 GHz, Bw = 16.000 MH No calibration applied and no bandpass applied

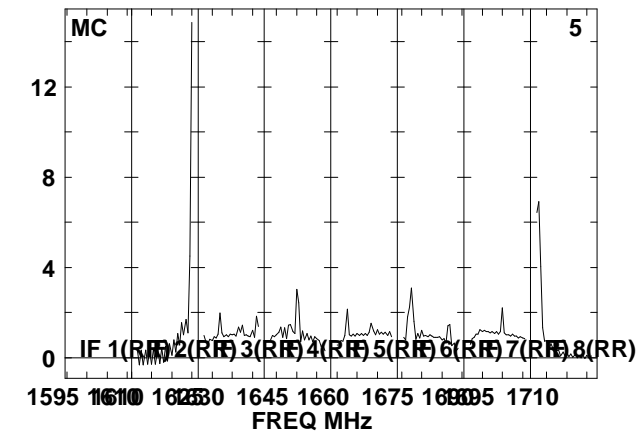
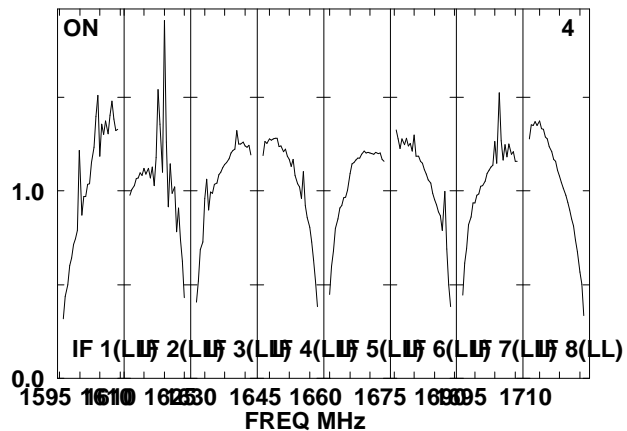
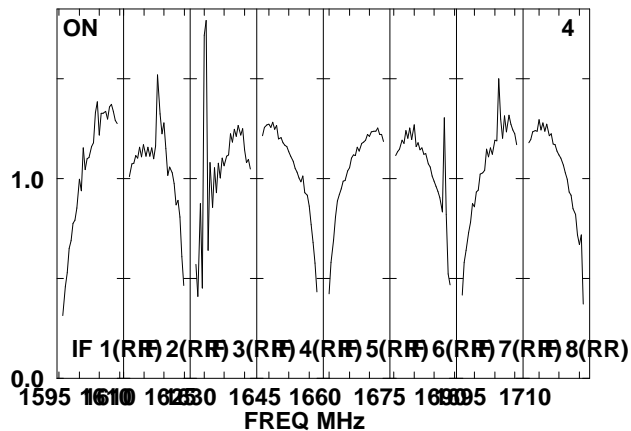
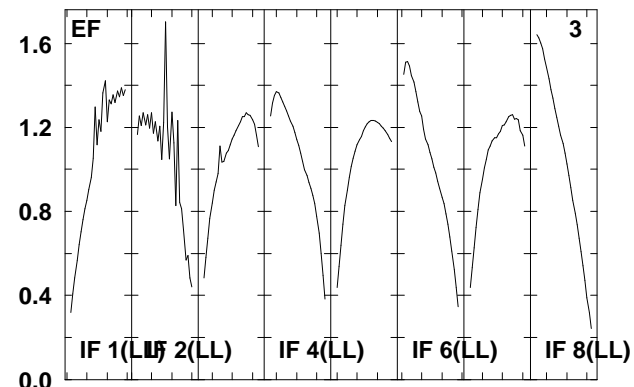
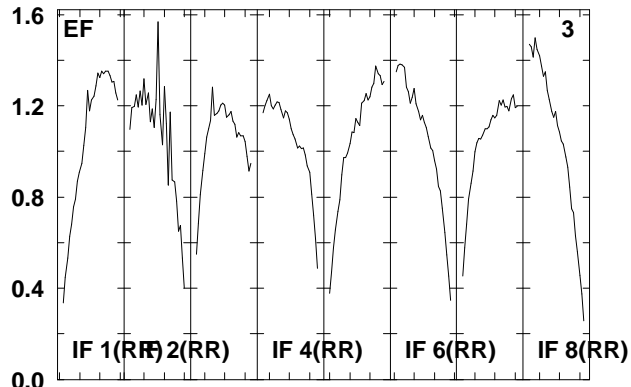
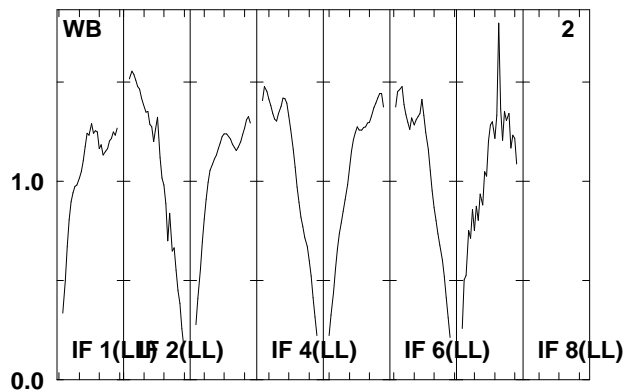
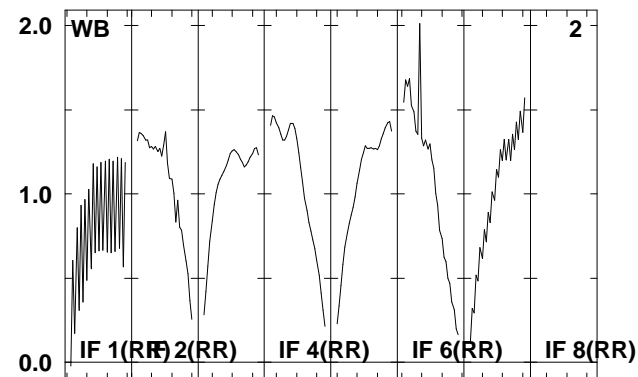
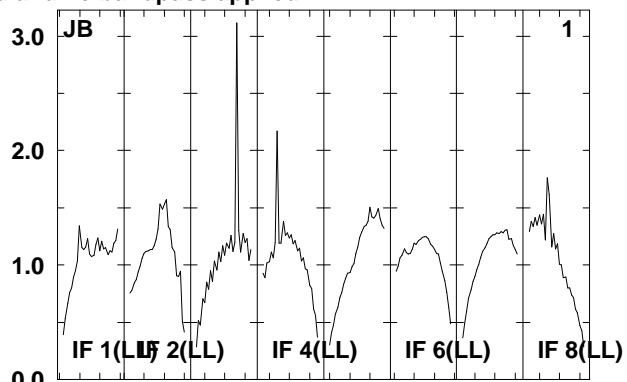
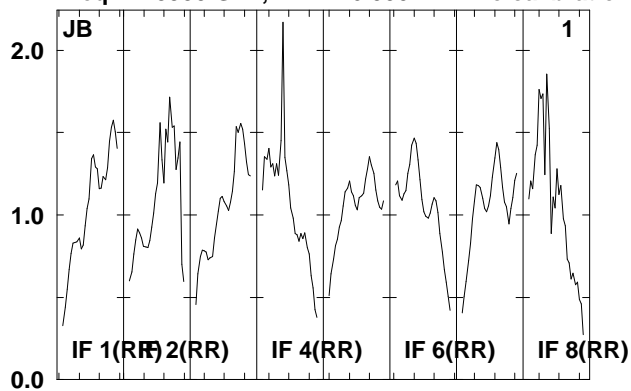

Lower frame: Real Jy  
Total-power spectrum Antenna: \*  
Timerange: 00/08:21:17 to 00/08:25:41

Plot file version 226 created 08-AUG-2008 17:00:15

J021348 EO006B.UVDATA.1

Freq = 1.5950 GHz, Bw = 16.000 MH No calibration applied and no bandpass applied

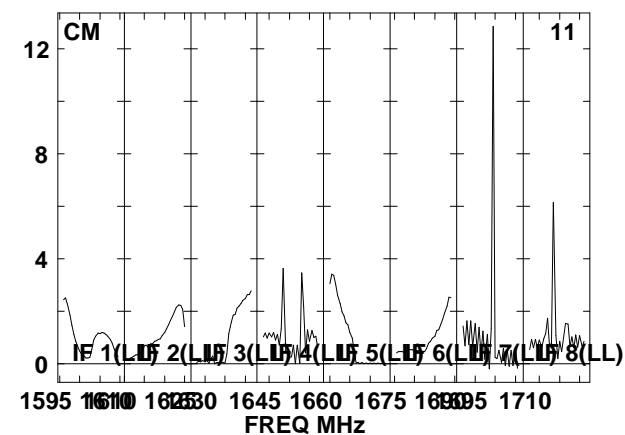
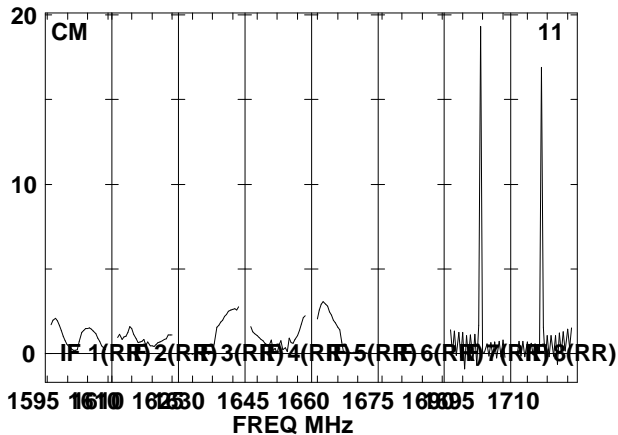
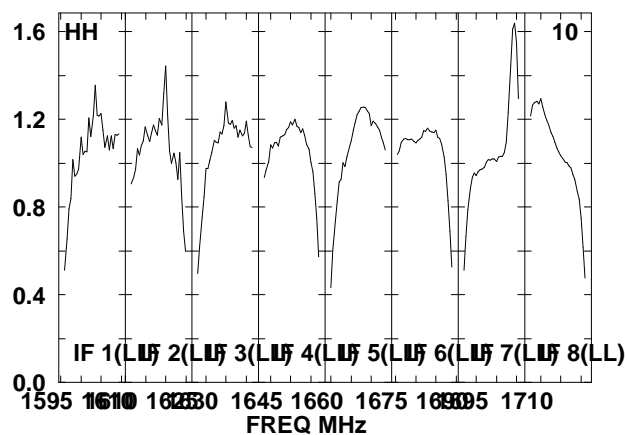
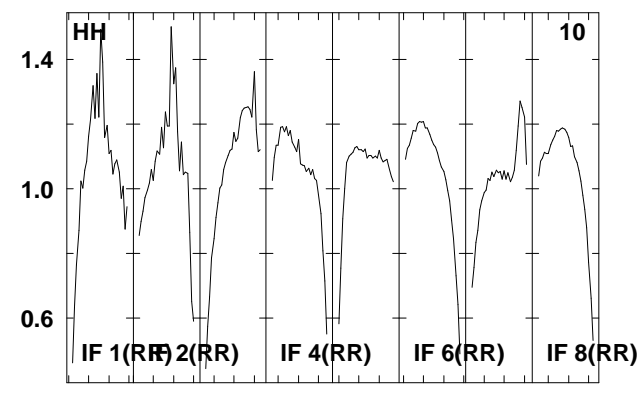
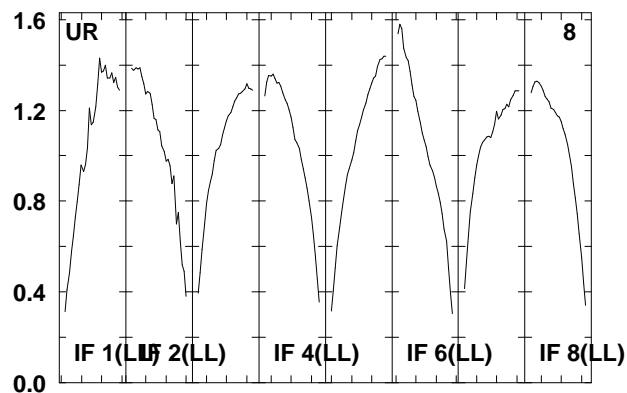
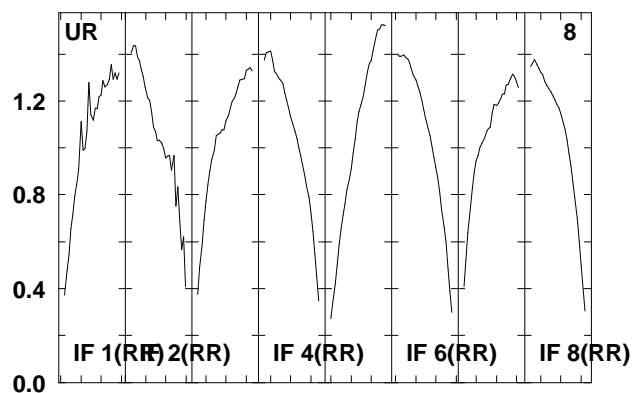
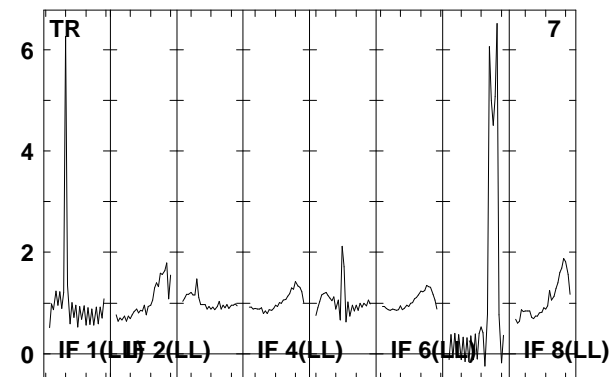
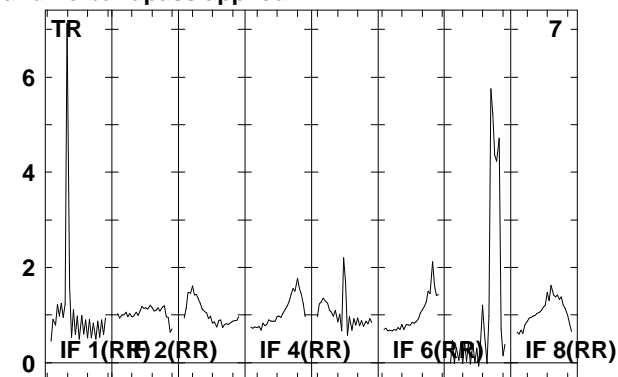
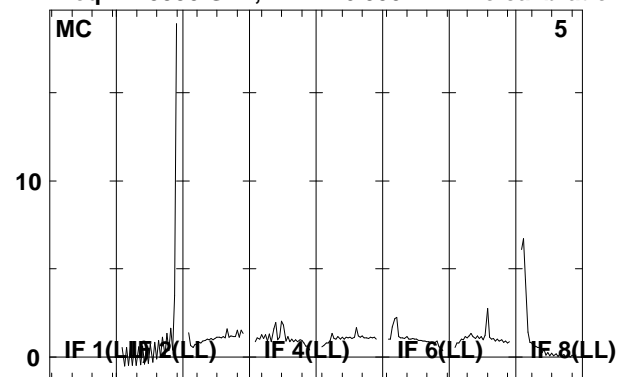

Lower frame: Real Jy  
Total-power spectrum Antenna: \*  
Timerange: 00/08:21:17 to 00/08:25:41

Plot file version 227 created 08-AUG-2008 17:00:16

J0209+13 EO006B.UVDATA.1

Freq = 1.5950 GHz, Bw = 16.000 MH No calibration applied and no bandpass applied

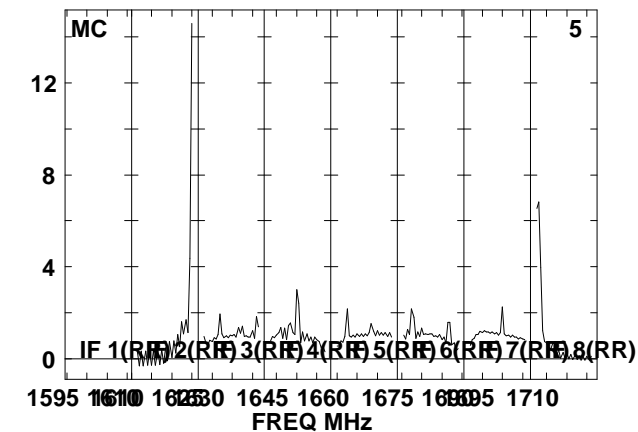
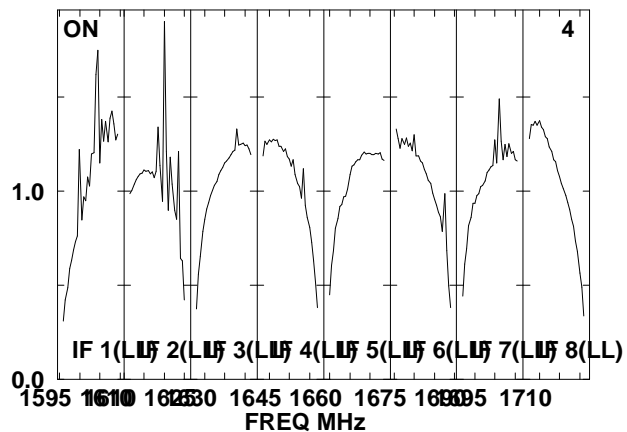
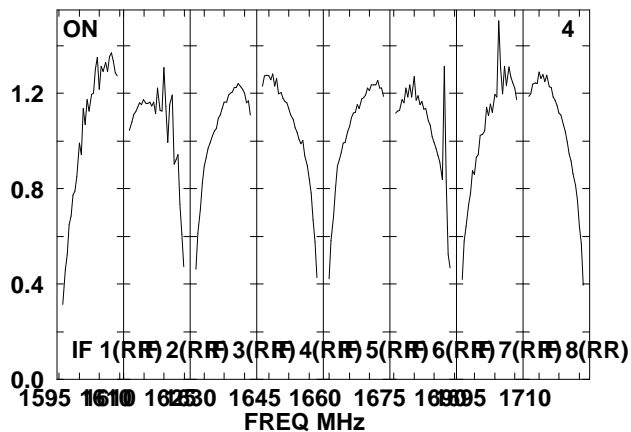
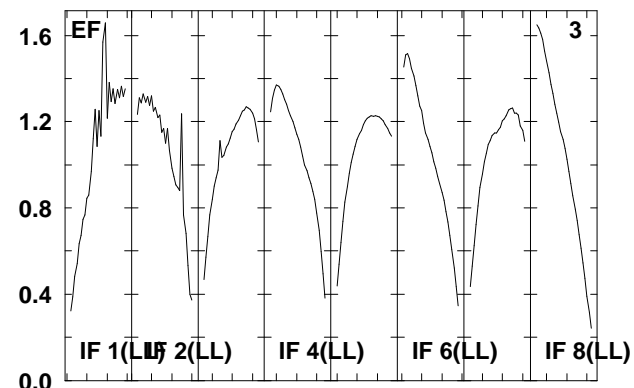
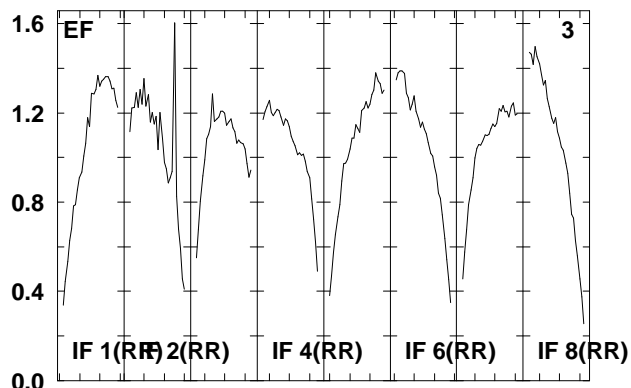
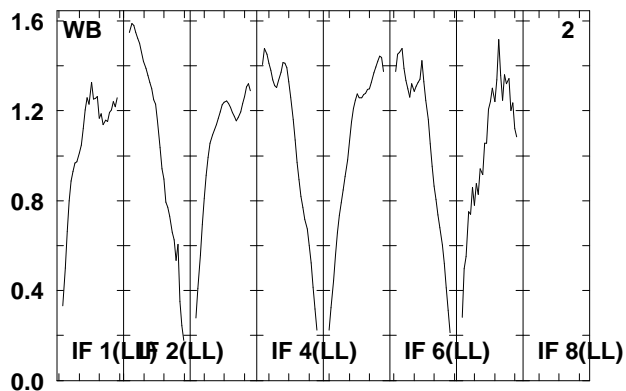
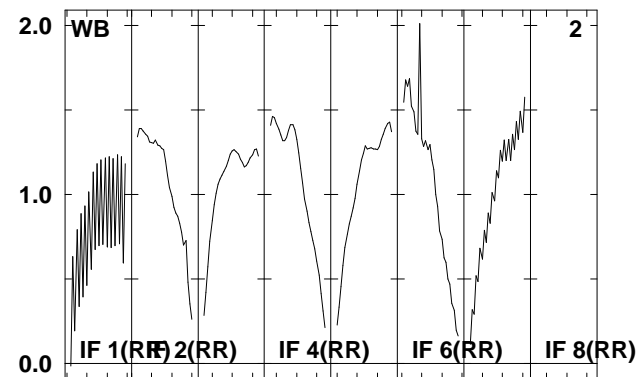
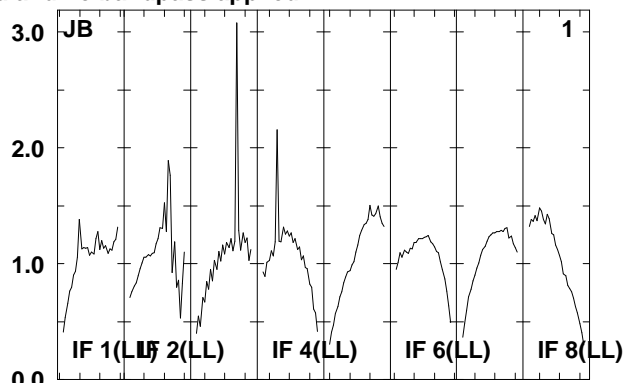
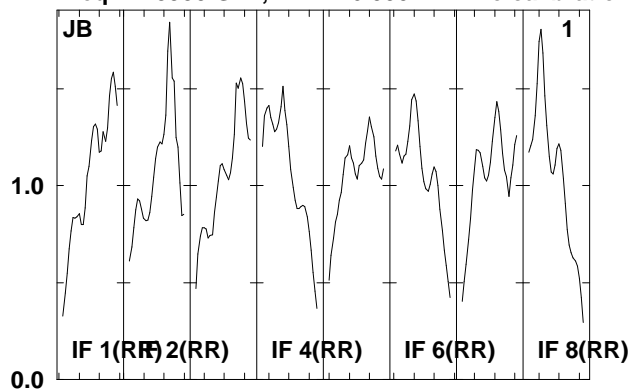

Lower frame: Real Jy

Total-power spectrum Antenna: \*

Timerange: 00/08:26:21 to 00/08:27:53

Plot file version 228 created 08-AUG-2008 17:00:16

J0209+13 EO006B.UVDATA.1

Freq = 1.5950 GHz, Bw = 16.000 MH No calibration applied and no bandpass applied

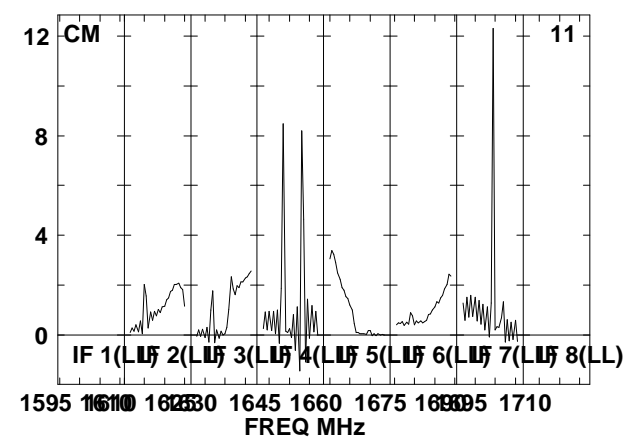
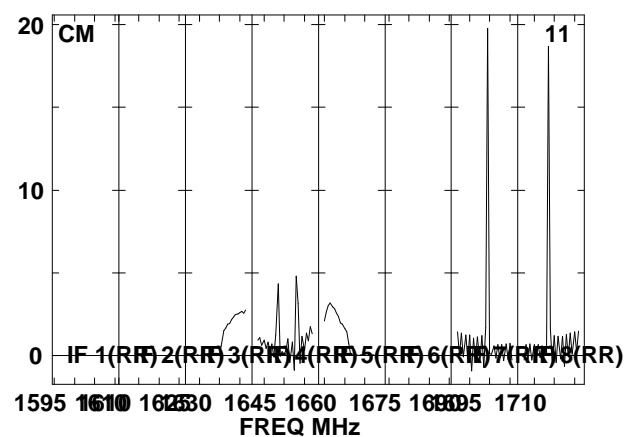
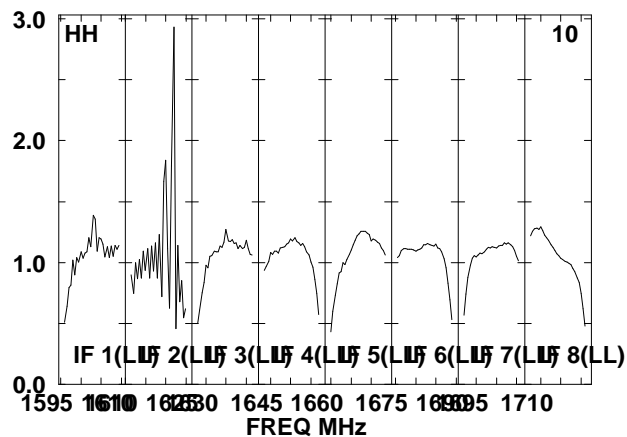
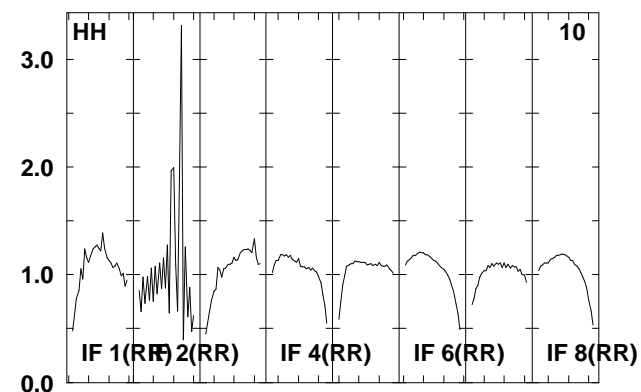
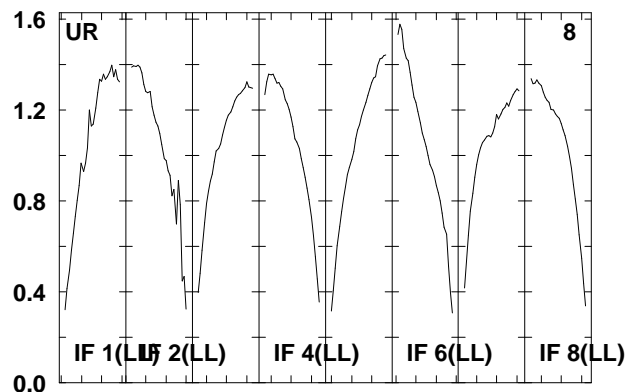
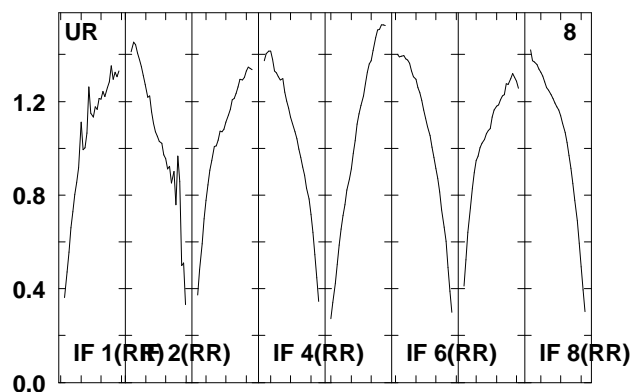
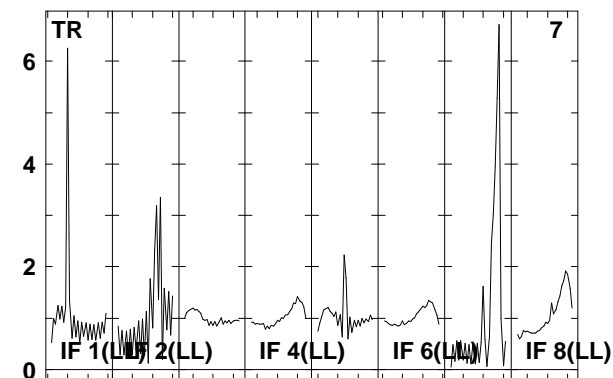
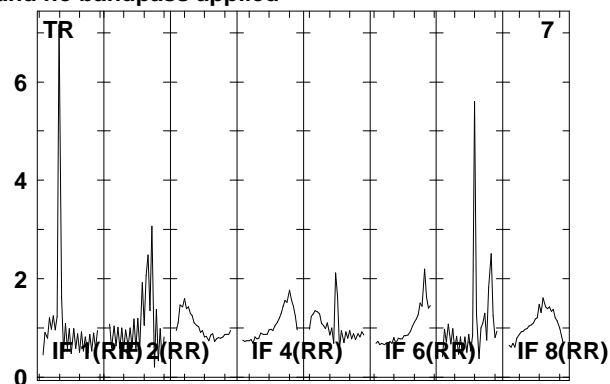
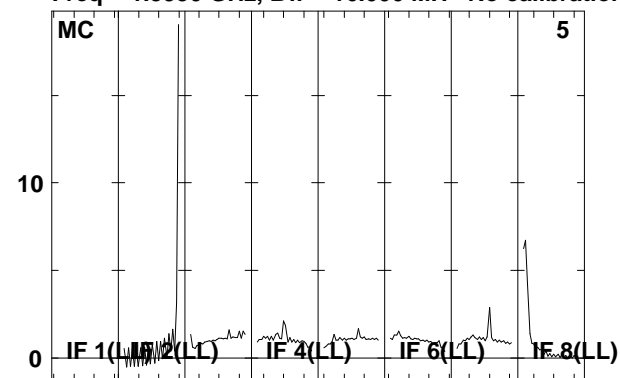

Lower frame: Real Jy

Total-power spectrum Antenna: \*

Timerange: 00/08:26:21 to 00/08:27:53



Plot file version 229 created 08-AUG-2008 17:00:17

J021348 EO006B.UVDATA.1

Freq = 1.5950 GHz, Bw = 16.000 MH No calibration applied and no bandpass applied

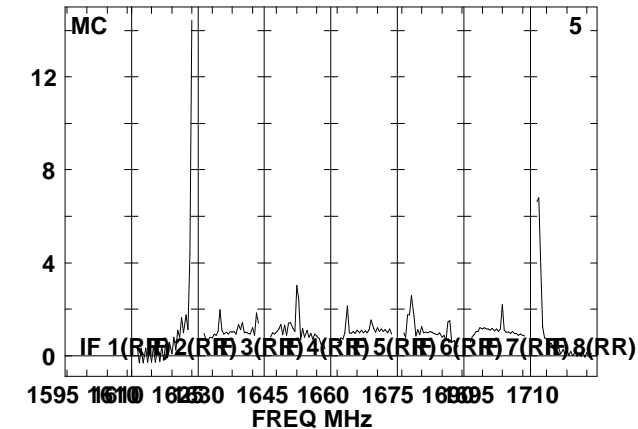
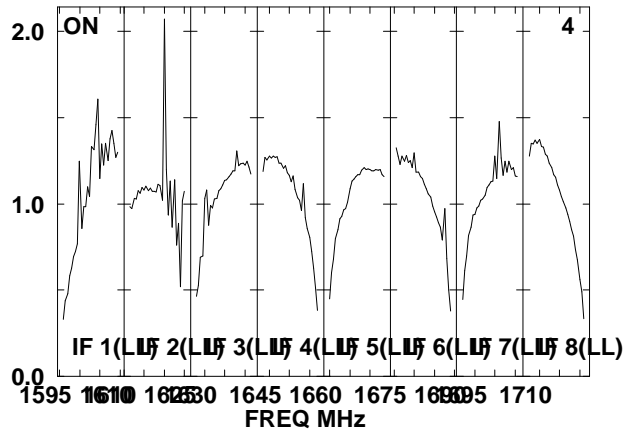
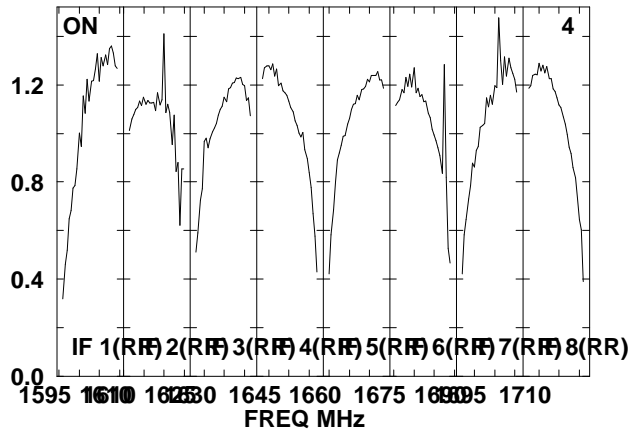
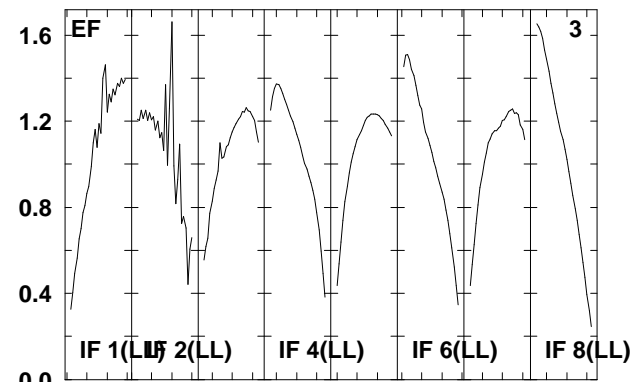
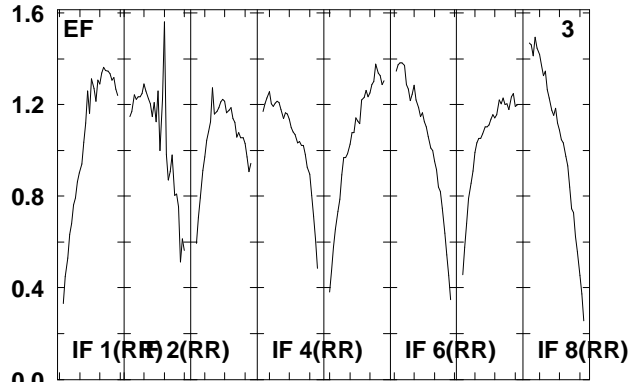
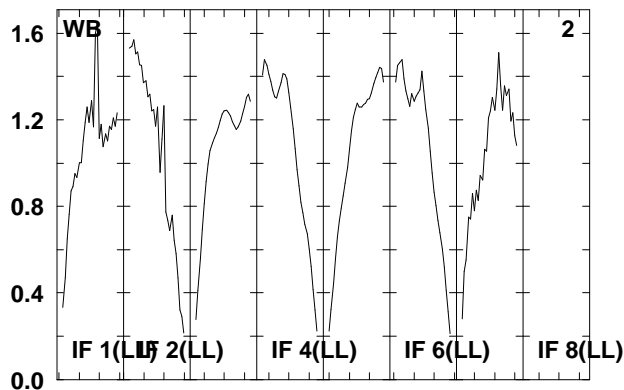
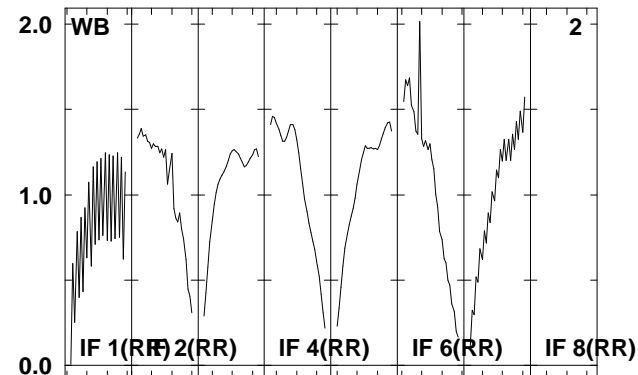
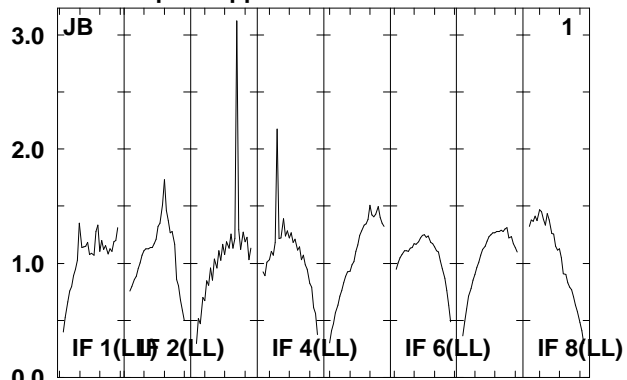
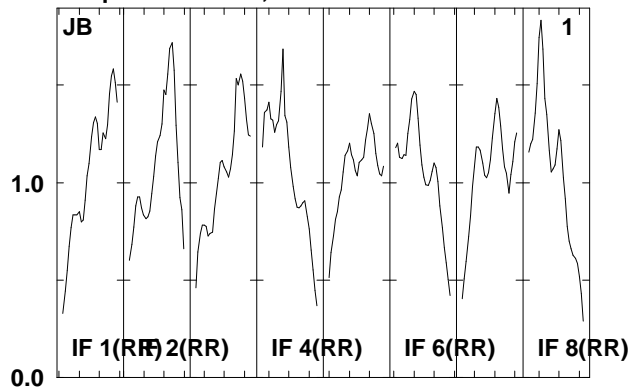

Lower frame: Real Jy

Total-power spectrum Antenna: \*

Timerange: 00/08:28:33 to 00/08:33:09

Plot file version 230 created 08-AUG-2008 17:00:18

J021348 EO006B.UVDATA.1

Freq = 1.5950 GHz, Bw = 16.000 MH No calibration applied and no bandpass applied

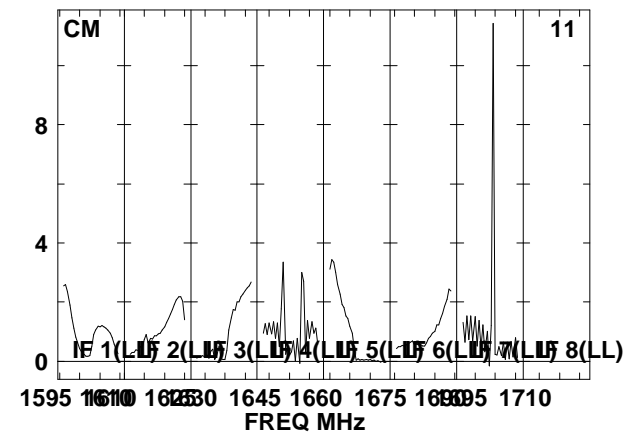
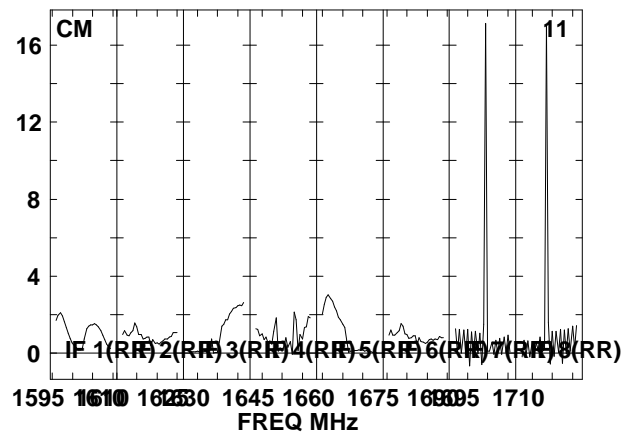
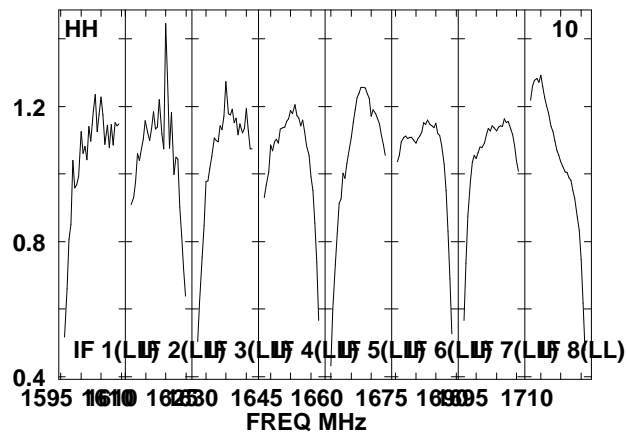
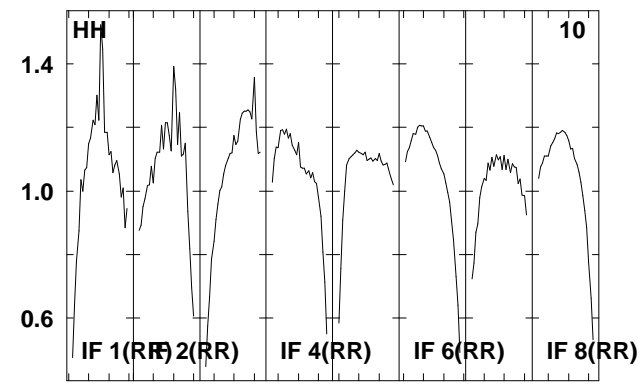
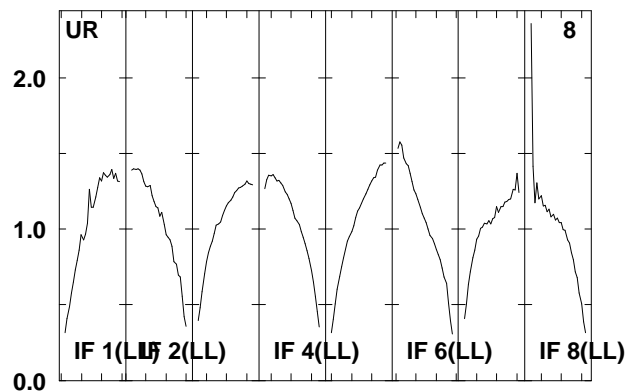
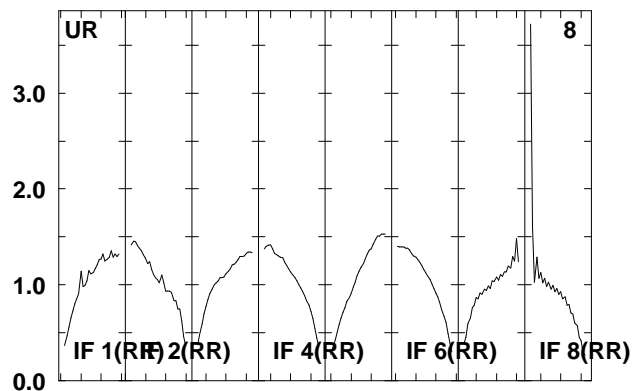
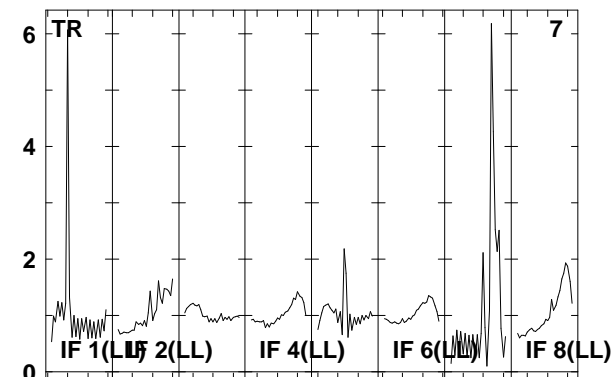
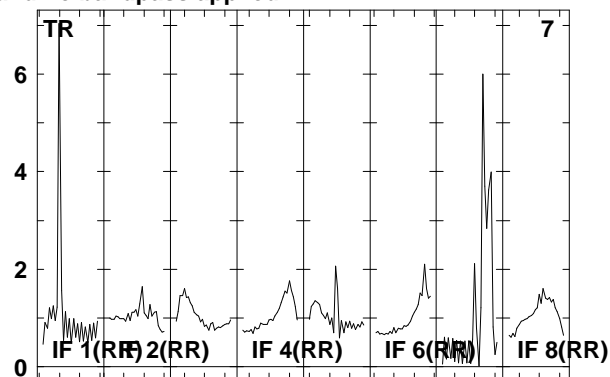
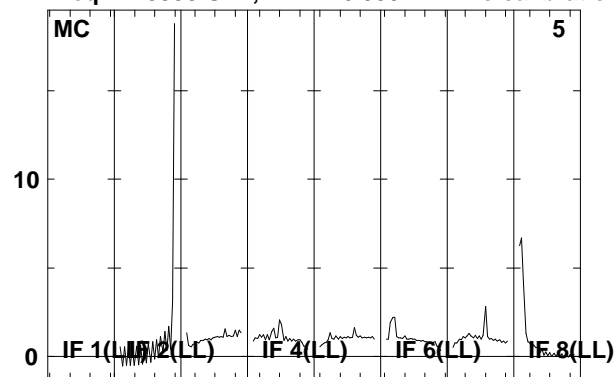

Lower frame: Real Jy  
Total-power spectrum Antenna: \*  
Timerange: 00/08:28:33 to 00/08:33:09

Plot file version 231 created 08-AUG-2008 17:00:19

J0209+13 E0006B.UVDATA.1

Freq = 1.5950 GHz, Bw = 16.000 MH No calibration applied and no bandpass applied

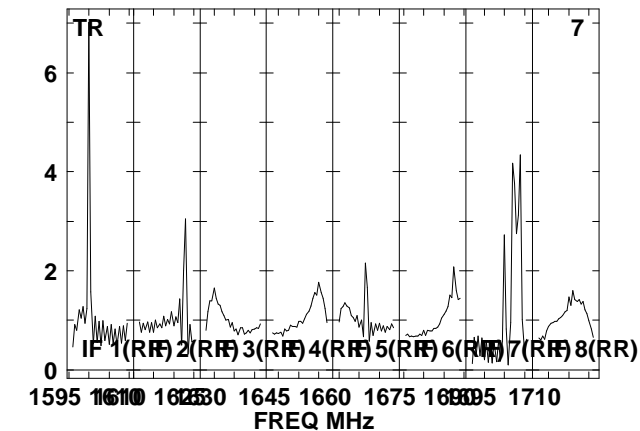
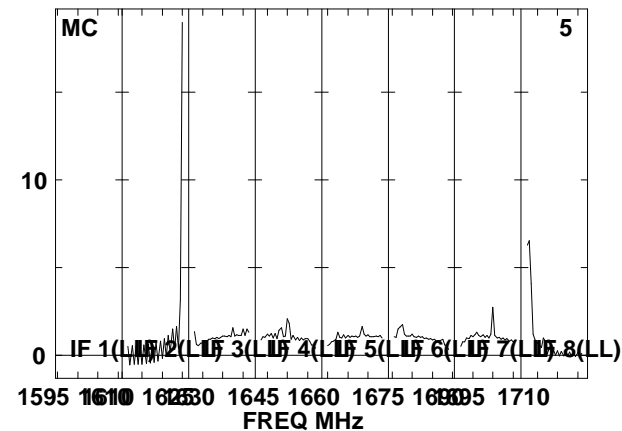
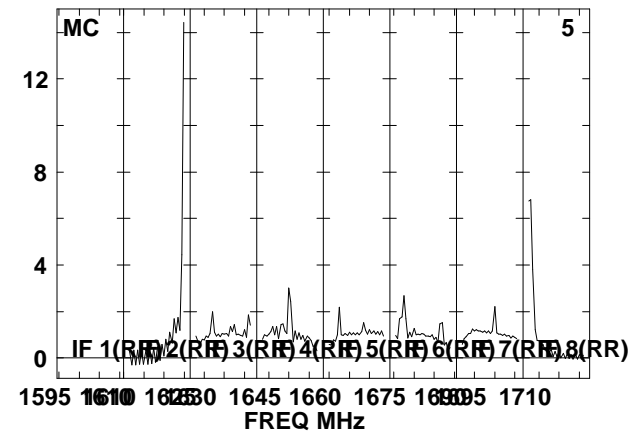
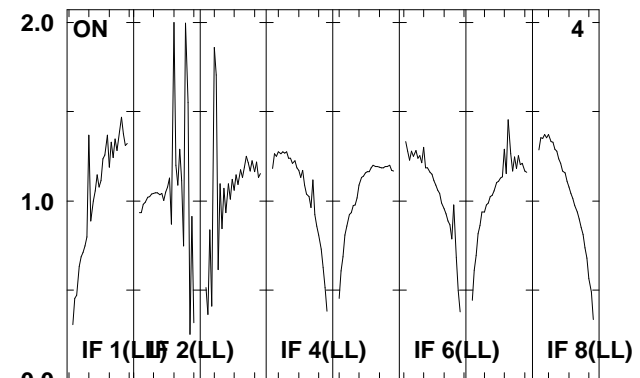
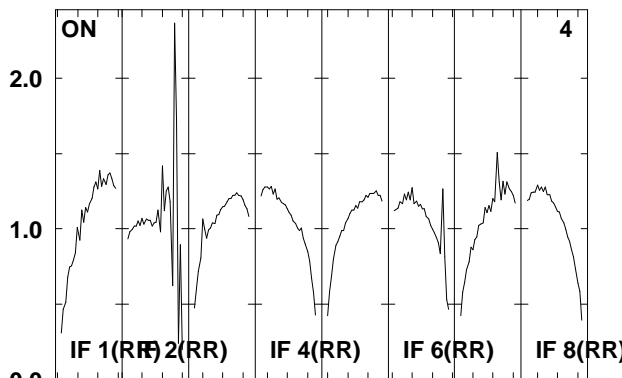
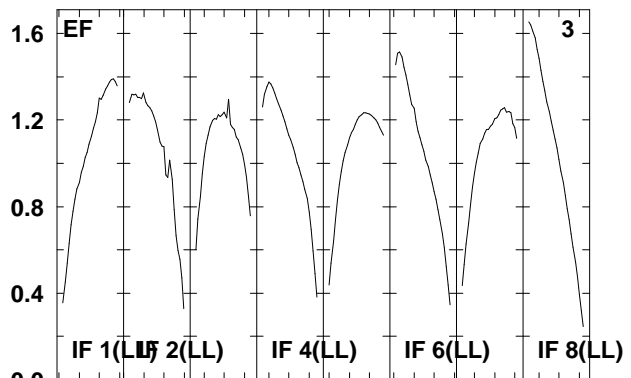
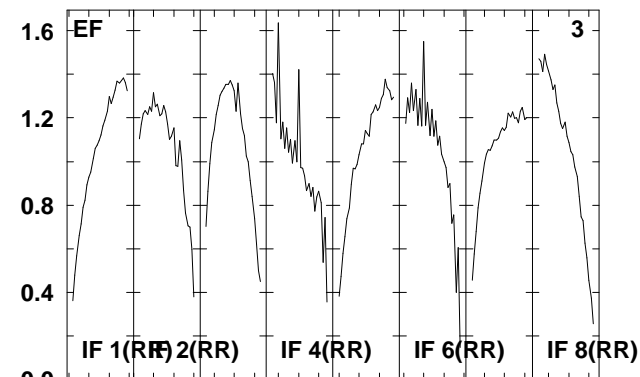
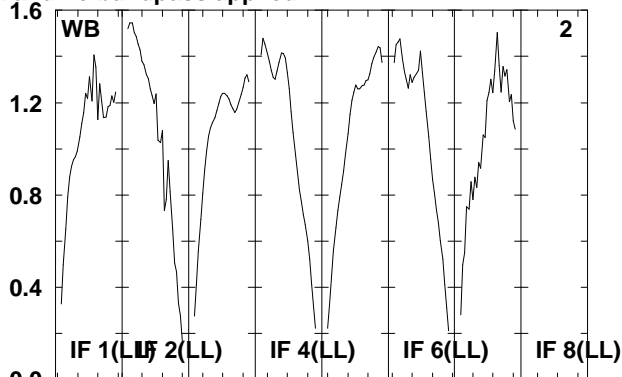
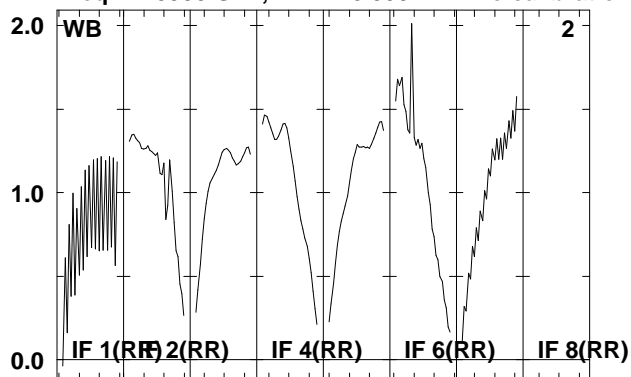

Lower frame: Real Jy  
Total-power spectrum Antenna: \*  
Timerange: 00/08:33:41 to 00/08:35:17

Plot file version 232 created 08-AUG-2008 17:00:19

J0209+13 EO006B.UVDATA.1

Freq = 1.5950 GHz, Bw = 16.000 MH No calibration applied and no bandpass applied

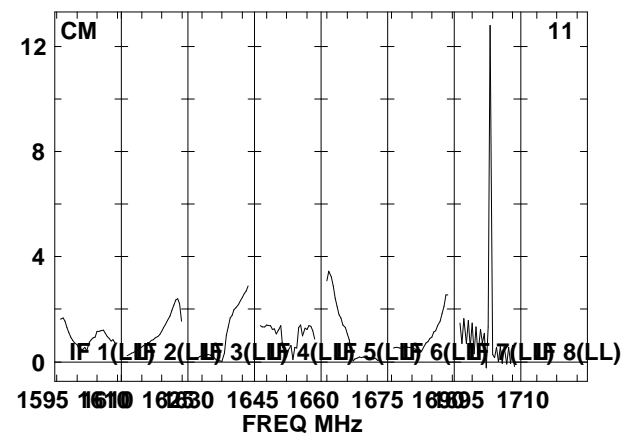
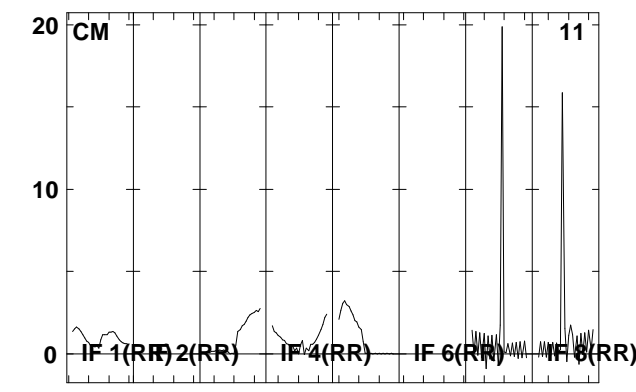
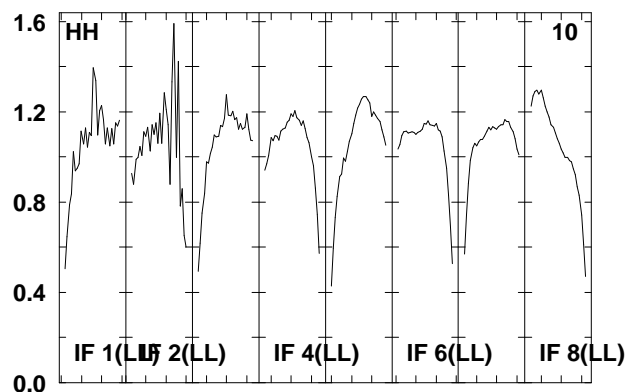
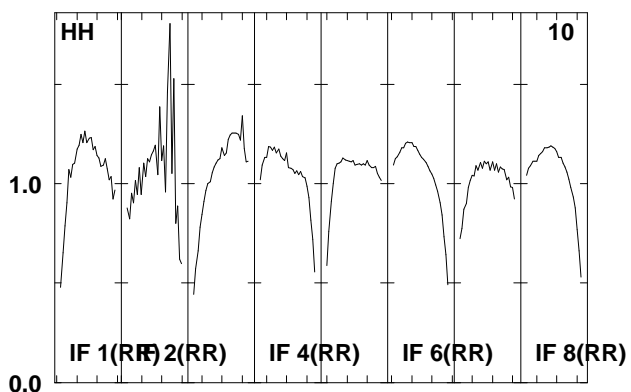
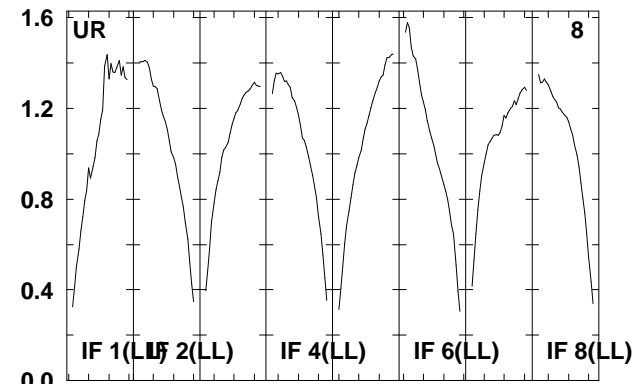
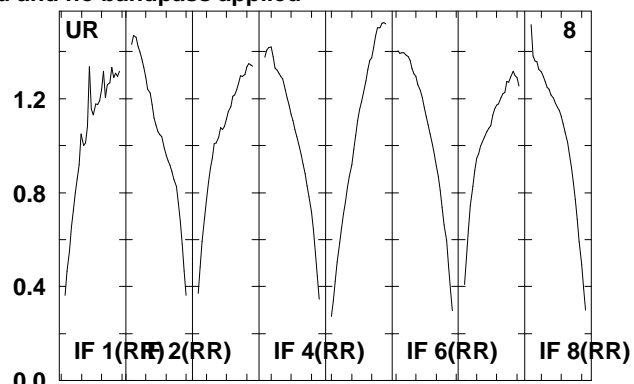
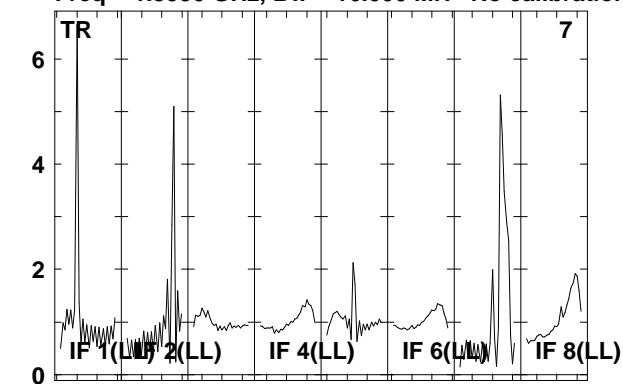

Lower frame: Real Jy

Total-power spectrum Antenna: \*

Timerange: 00/08:33:41 to 00/08:35:17

Plot file version 233 created 08-AUG-2008 17:00:20

J021348 EO06B.UVDATA.1

Freq = 1.5950 GHz, Bw = 16.000 MH No calibration applied and no bandpass applied

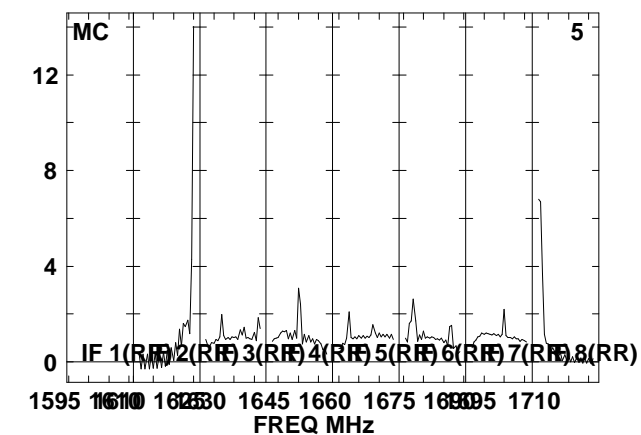
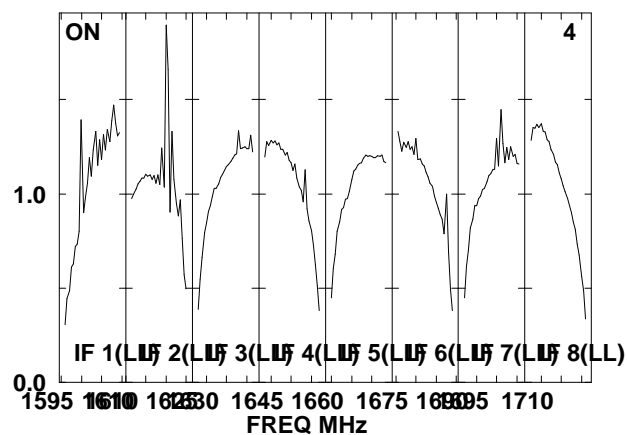
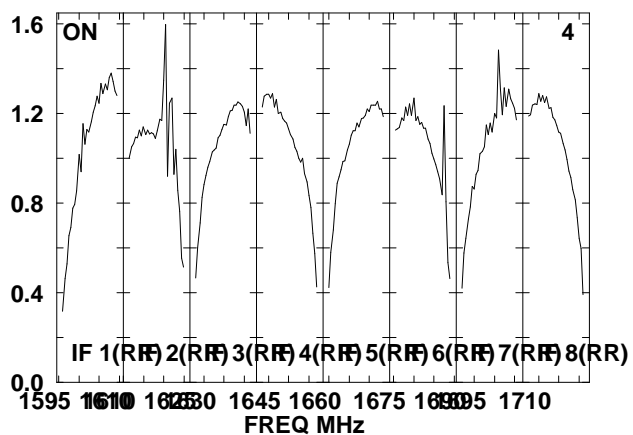
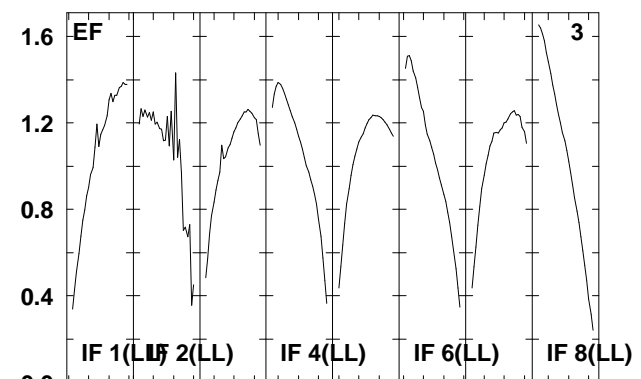
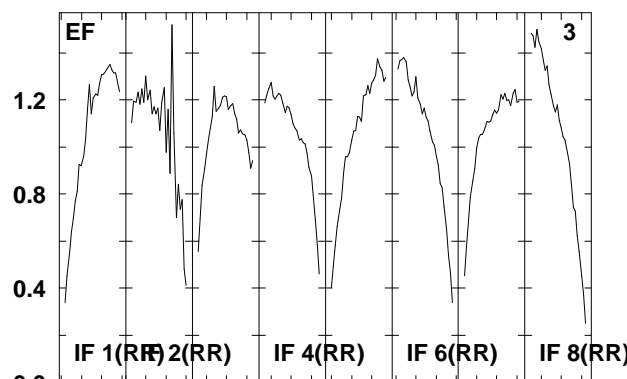
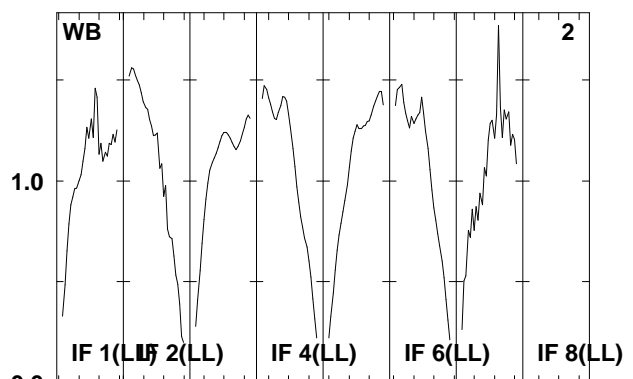
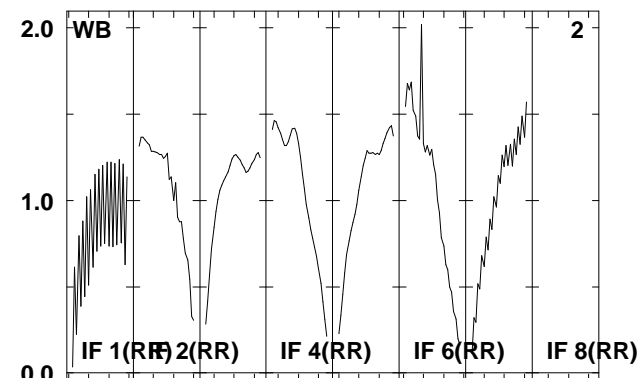
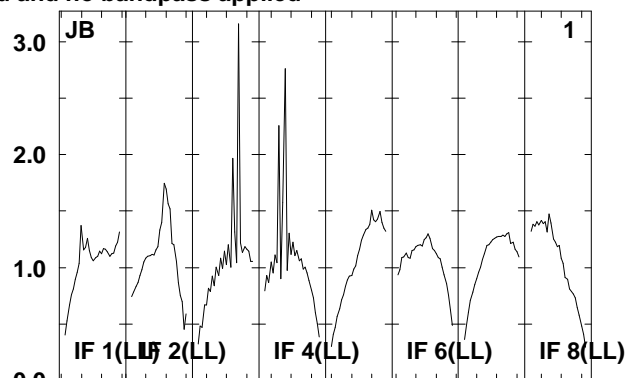
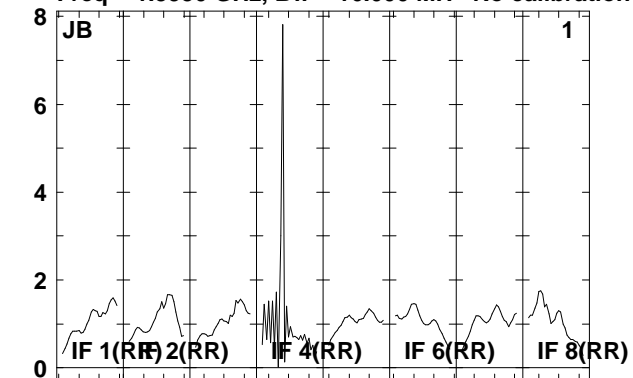

Lower frame: Real Jy  
Total-power spectrum Antenna: \*  
Timerange: 00/08:35:53 to 00/08:40:29

Plot file version 234 created 08-AUG-2008 17:00:20

J021348 EO006B.UVDATA.1

Freq = 1.5950 GHz, Bw = 16.000 MH No calibration applied and no bandpass applied

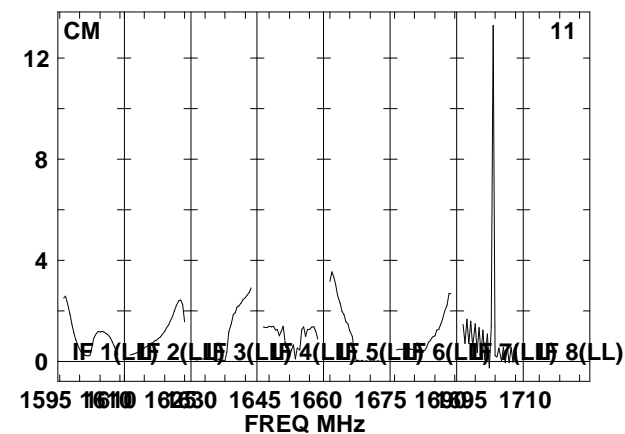
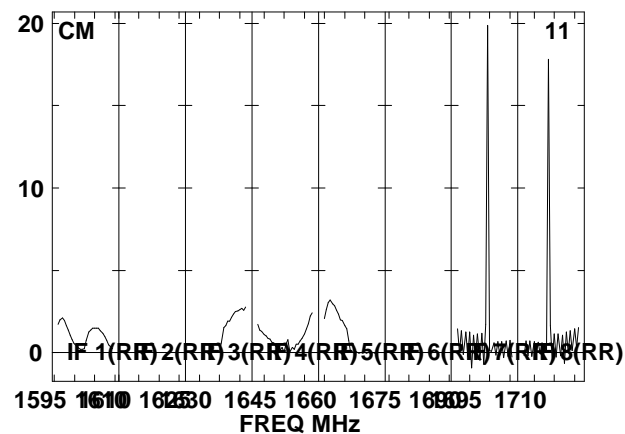
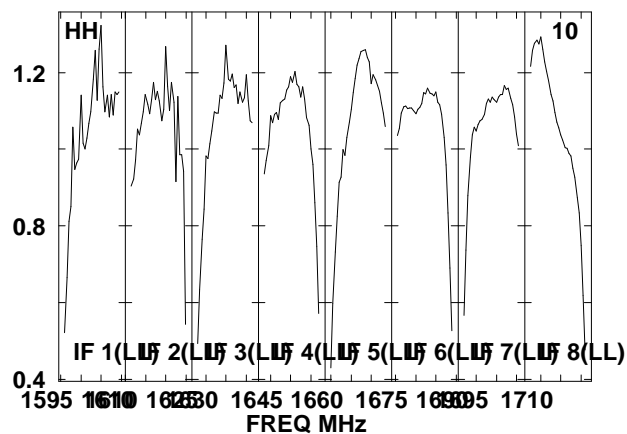
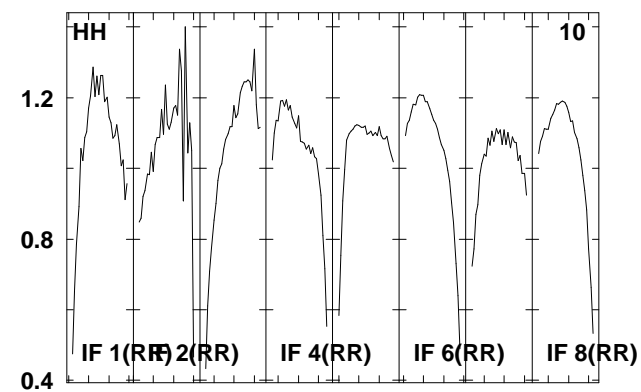
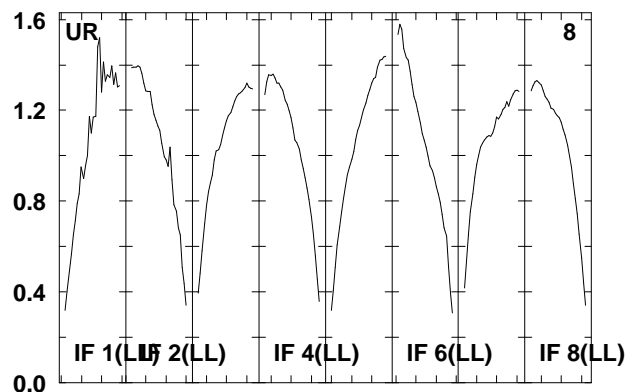
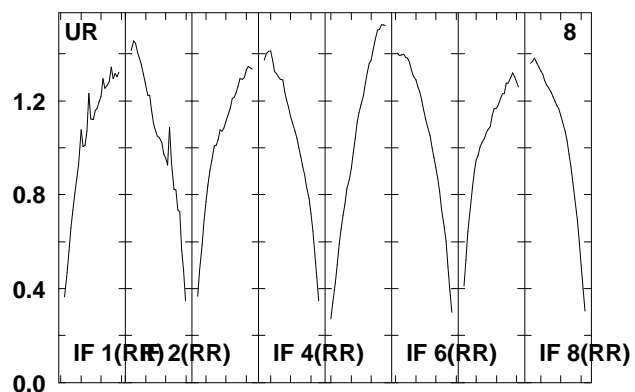
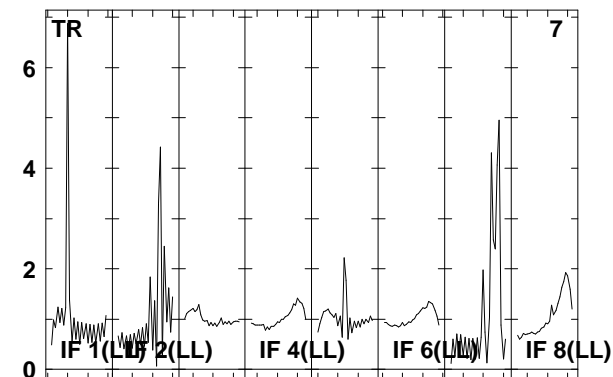
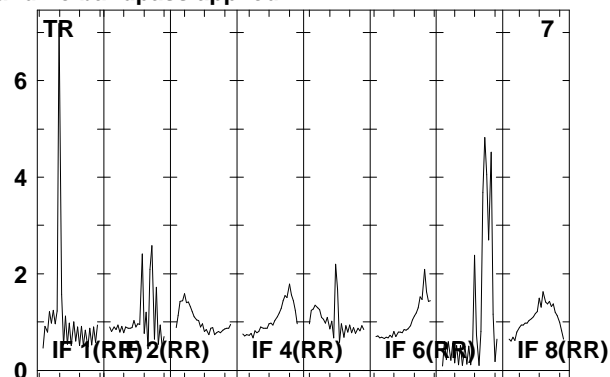
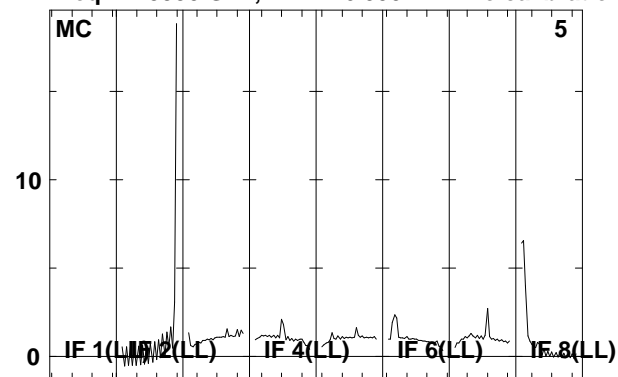

Lower frame: Real Jy  
Total-power spectrum Antenna: \*  
Timerange: 00/08:35:53 to 00/08:40:29

Plot file version 235 created 08-AUG-2008 17:00:21

J0209+13 EO006B.UVDATA.1

Freq = 1.5950 GHz, Bw = 16.000 MH No calibration applied and no bandpass applied

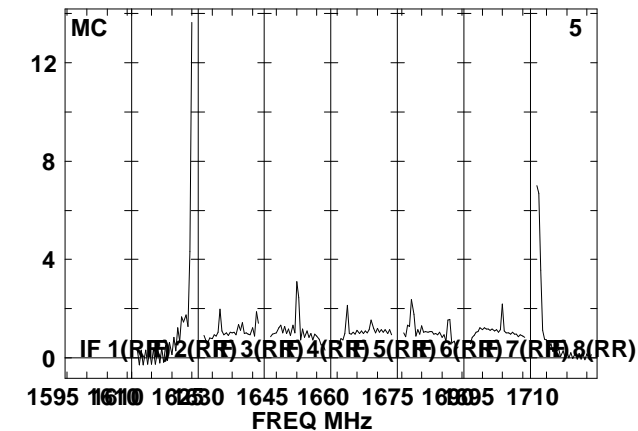
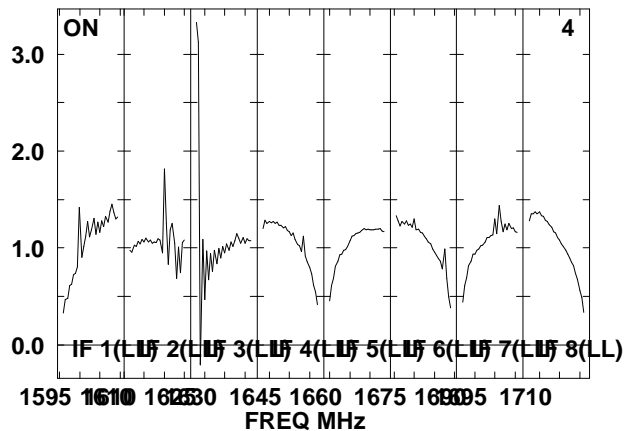
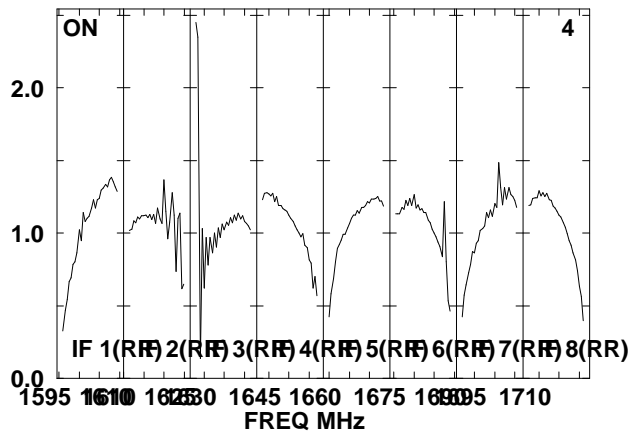
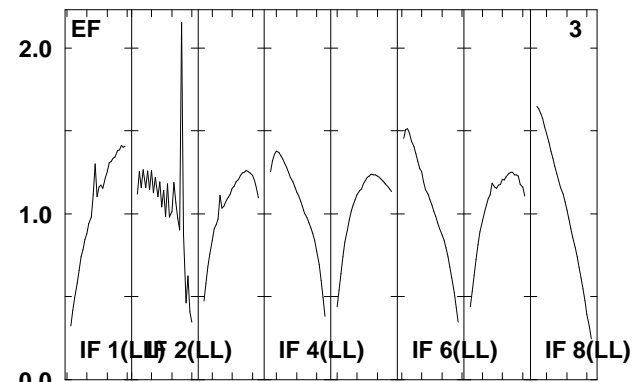
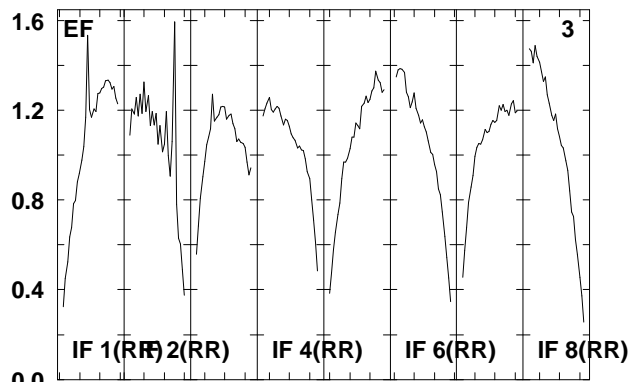
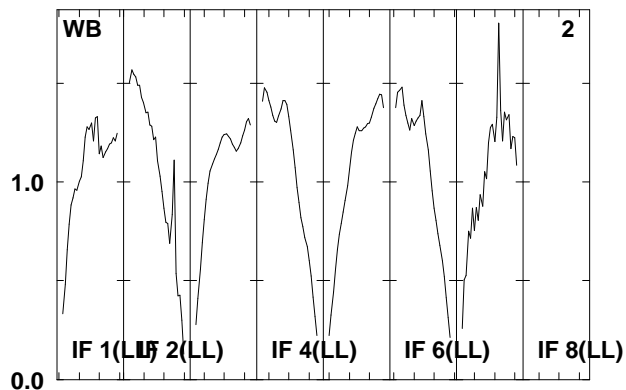
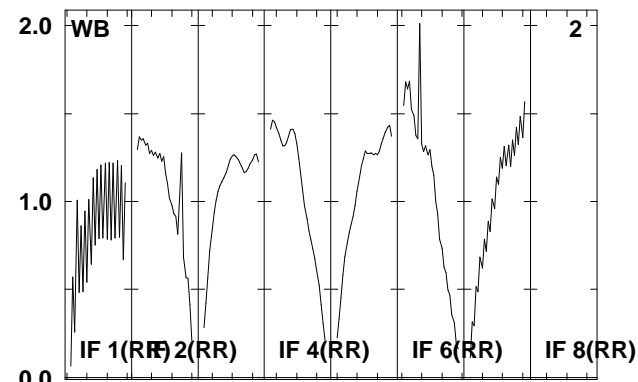
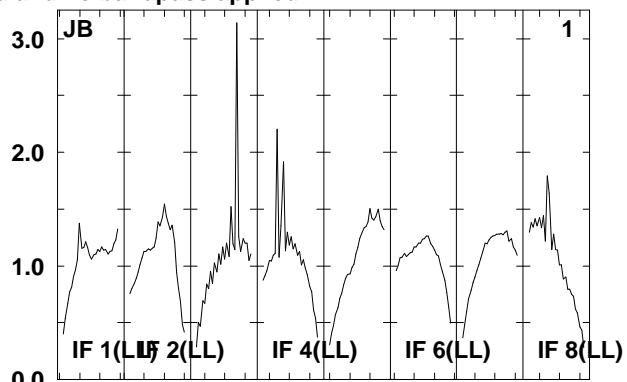
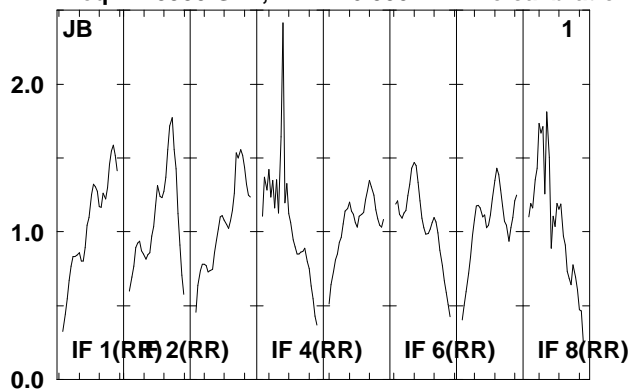

Lower frame: Real Jy  
Total-power spectrum Antenna: \*  
Timerange: 00/08:41:01 to 00/08:42:37

Plot file version 236 created 08-AUG-2008 17:00:21

J0209+13 EO006B.UVDATA.1

Freq = 1.5950 GHz, Bw = 16.000 MH No calibration applied and no bandpass applied

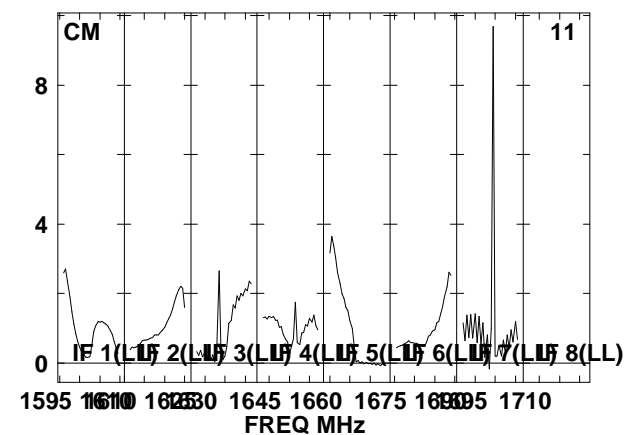
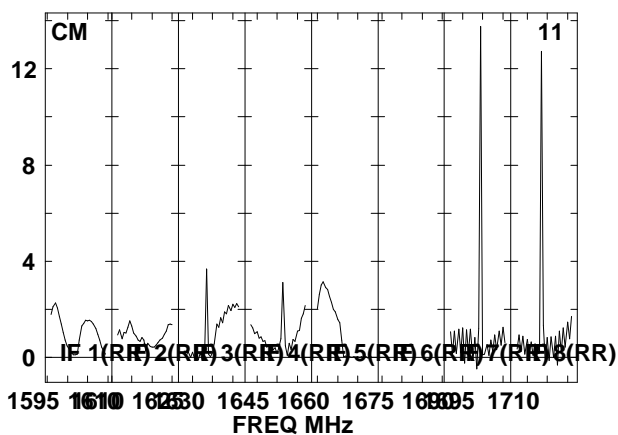
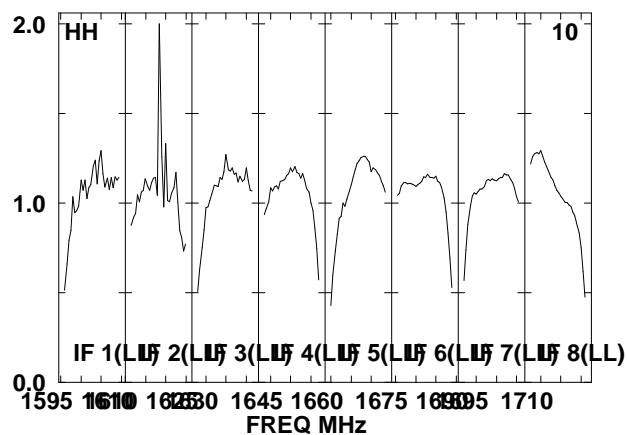
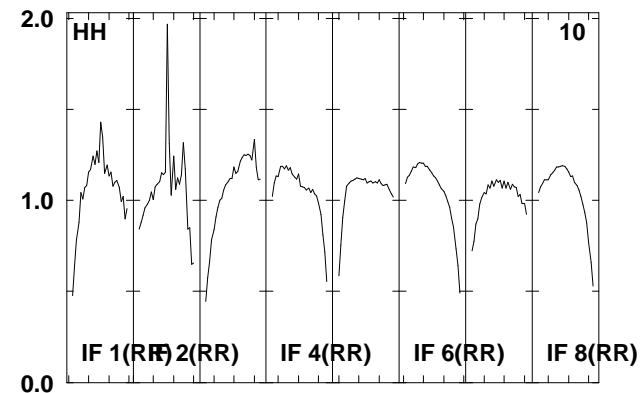
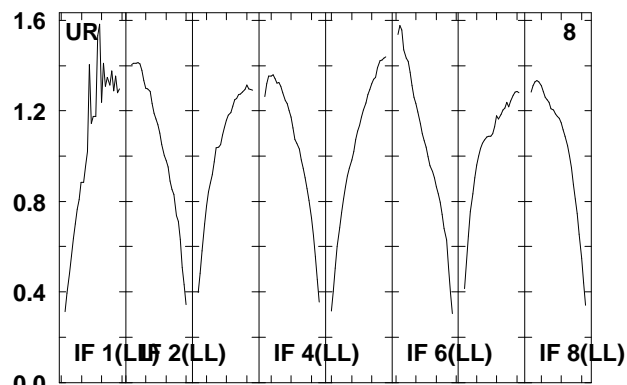
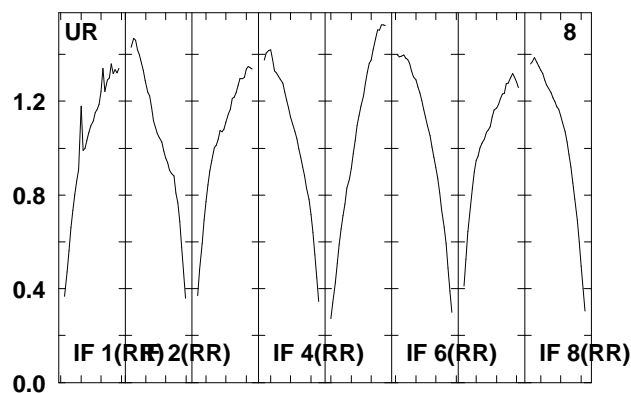
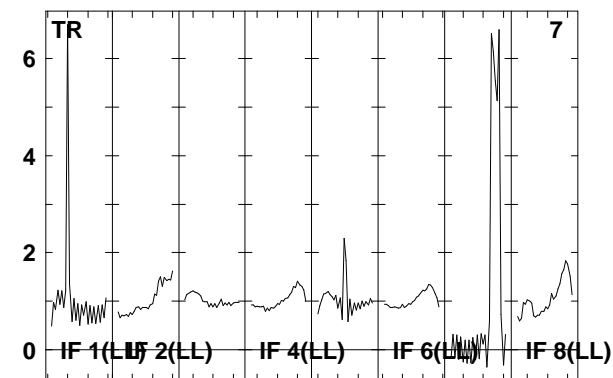
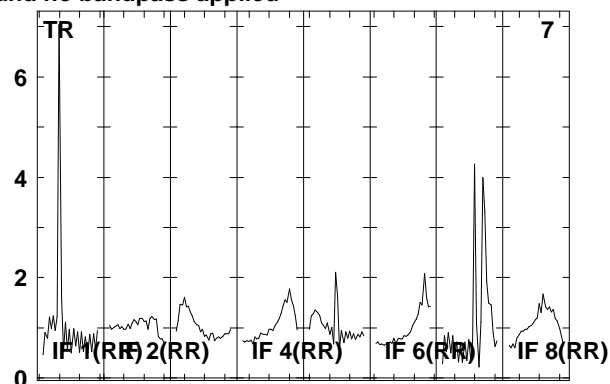
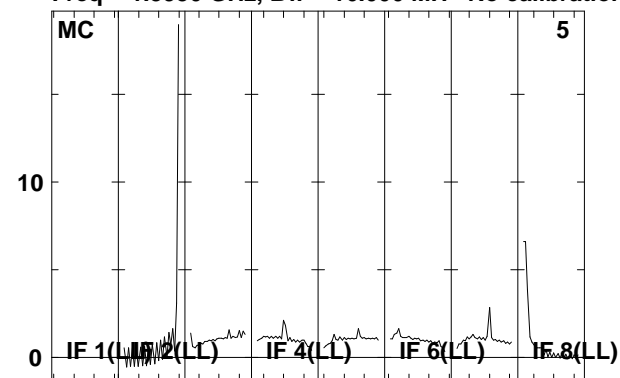

Lower frame: Real Jy

Total-power spectrum Antenna: \*

Timerange: 00/08:41:01 to 00/08:42:37



Plot file version 237 created 08-AUG-2008 17:00:22

J021348 EO006B.UVDATA.1

Freq = 1.5950 GHz, Bw = 16.000 MH No calibration applied and no bandpass applied

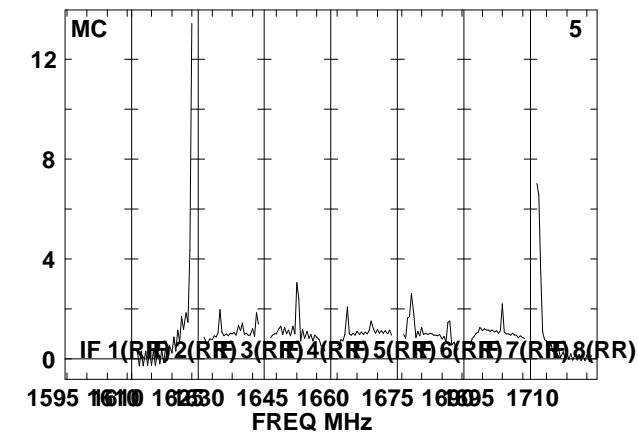
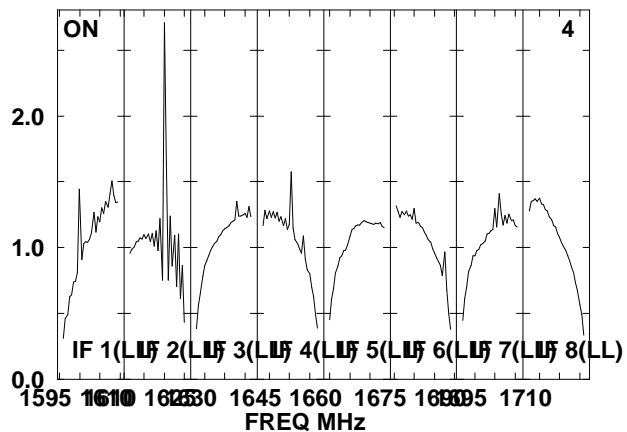
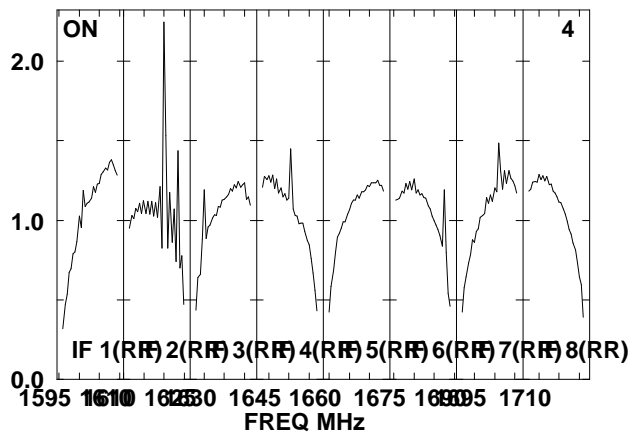
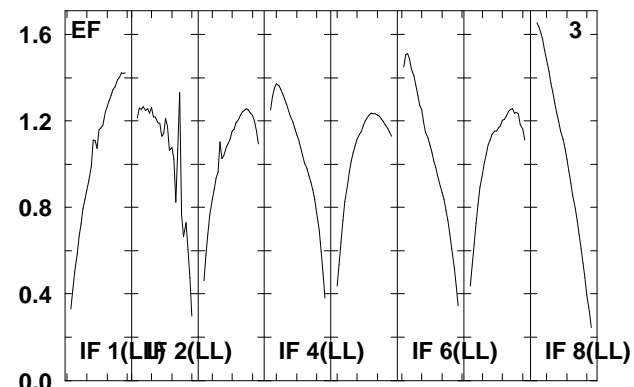
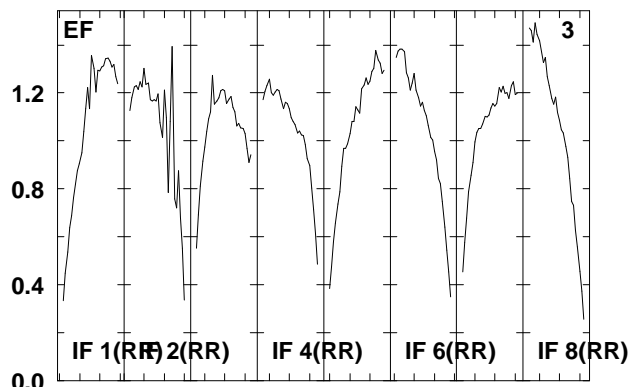
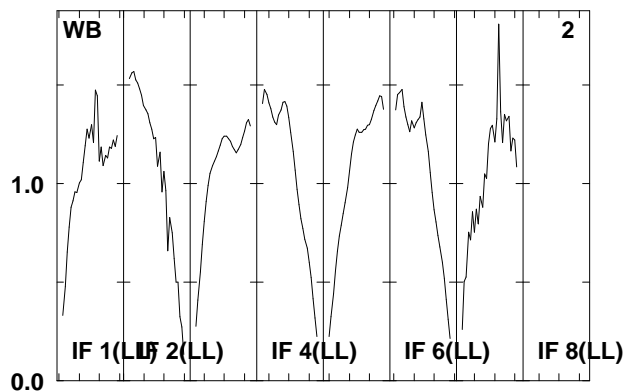
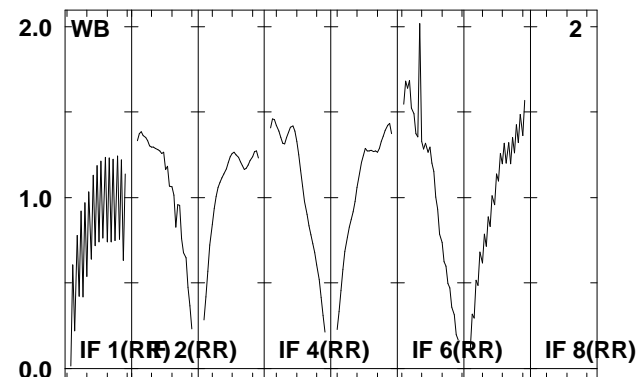
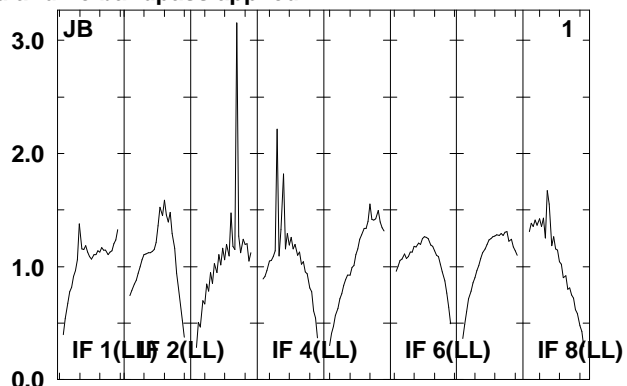
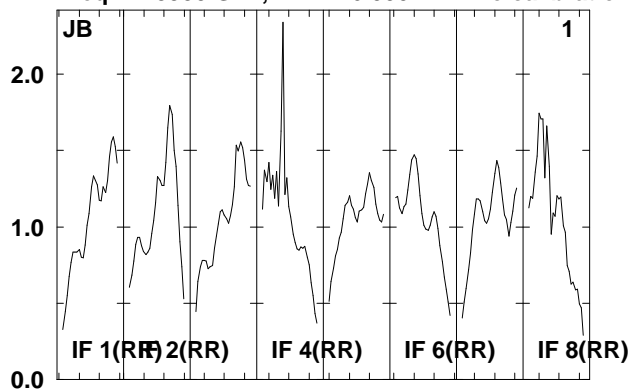

Lower frame: Real Jy  
Total-power spectrum Antenna: \*  
Timerange: 00/08:43:13 to 00/08:47:41

Plot file version 238 created 08-AUG-2008 17:00:23

J021348 EO006B.UVDATA.1

Freq = 1.5950 GHz, Bw = 16.000 MH No calibration applied and no bandpass applied

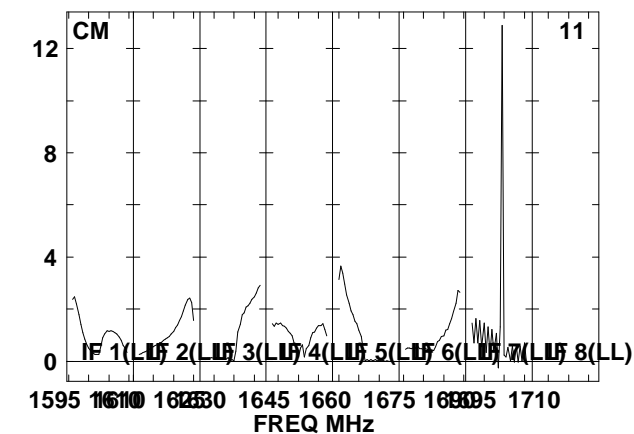
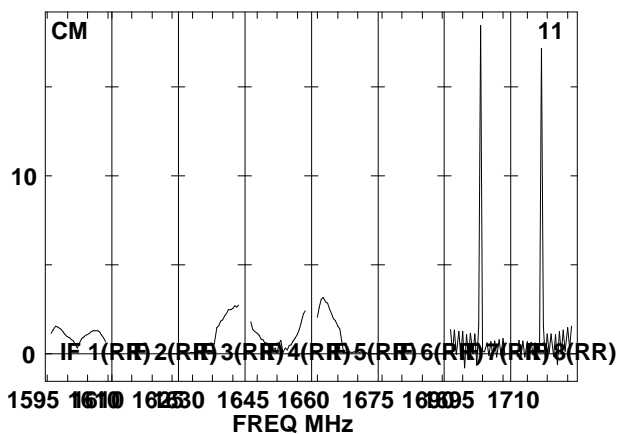
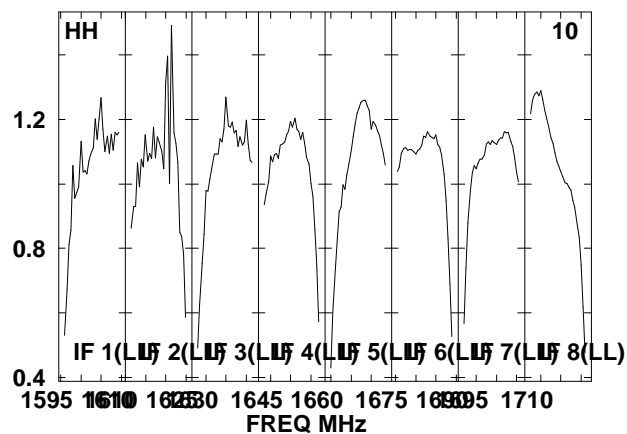
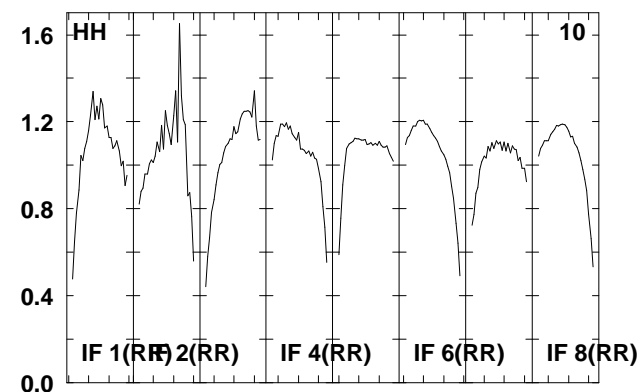
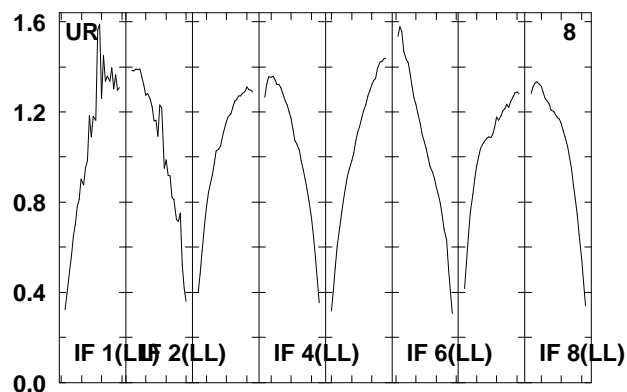
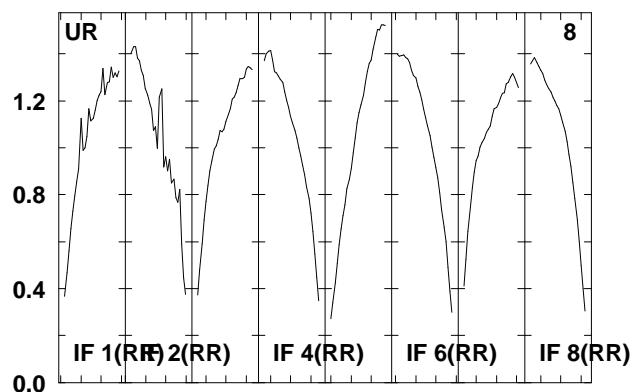
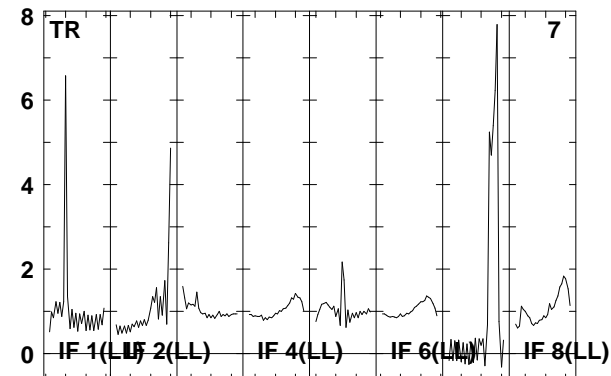
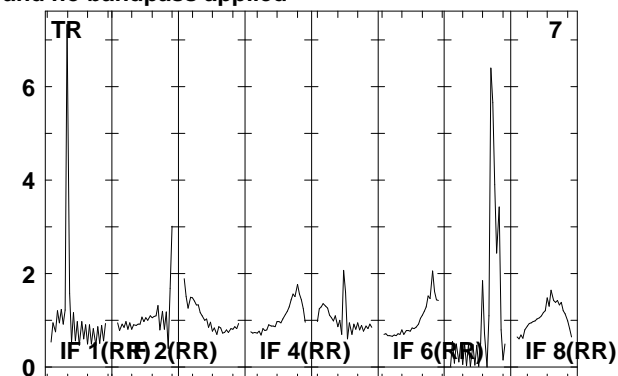
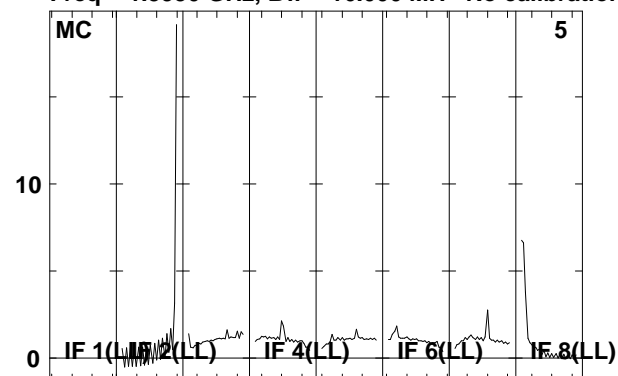

Lower frame: Real Jy

Total-power spectrum Antenna: \*

Timerange: 00/08:43:13 to 00/08:47:41

Plot file version 239 created 08-AUG-2008 17:00:24

J0209+13 E0006B.UVDATA.1

Freq = 1.5950 GHz, Bw = 16.000 MH No calibration applied and no bandpass applied

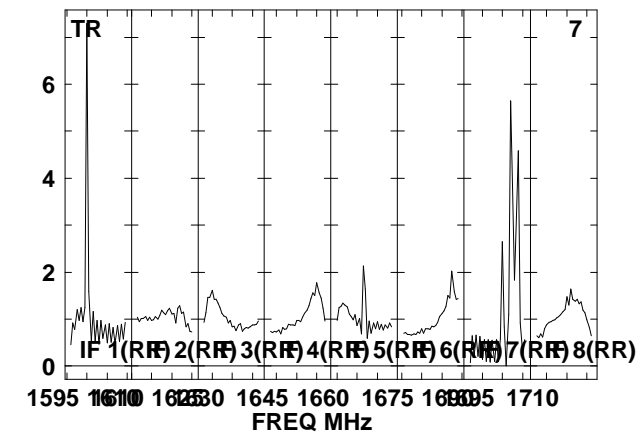
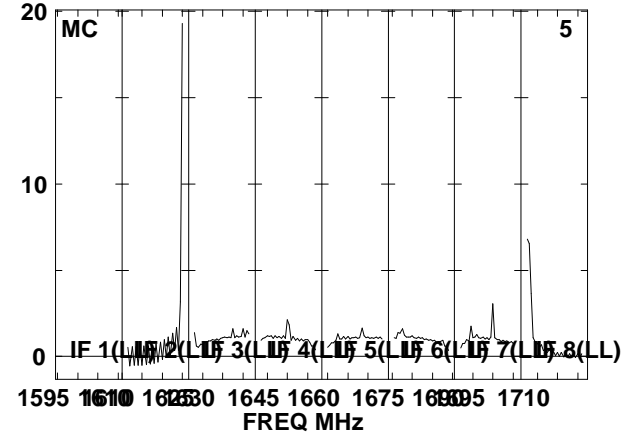
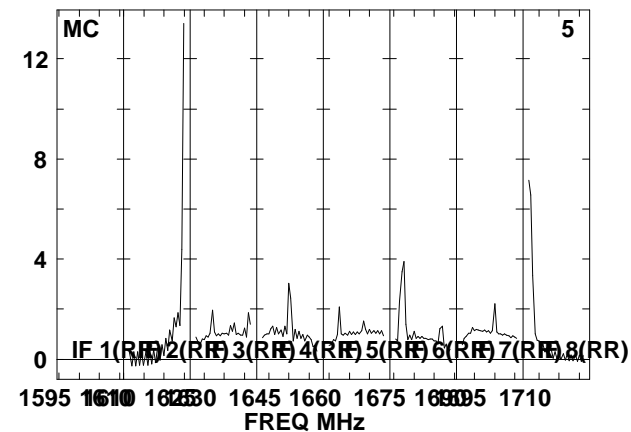
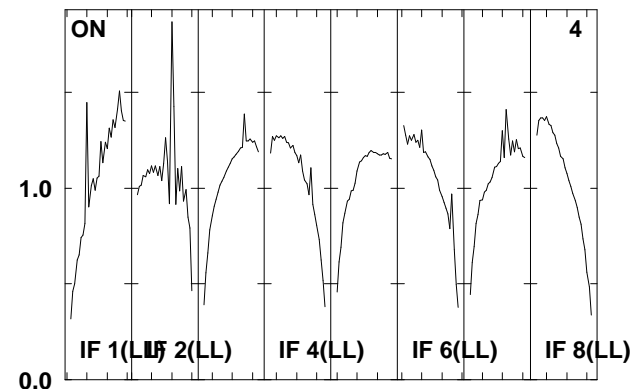
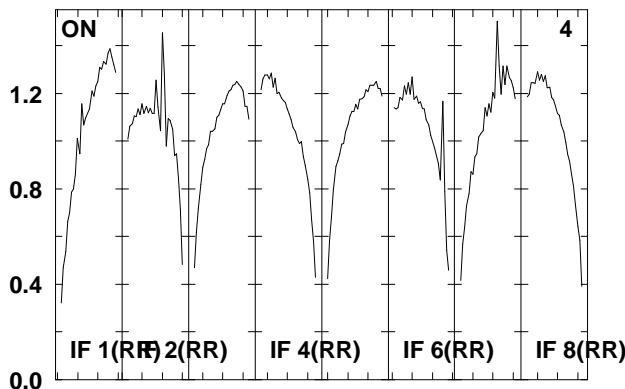
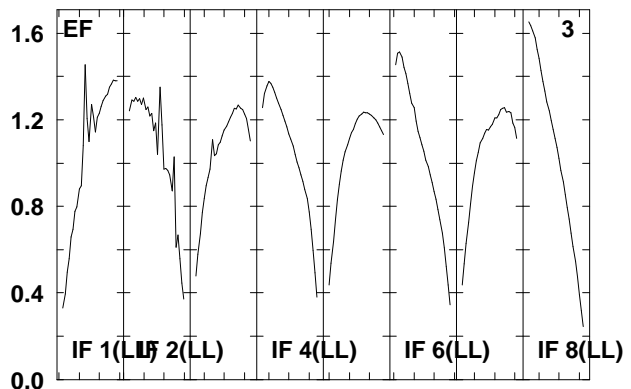
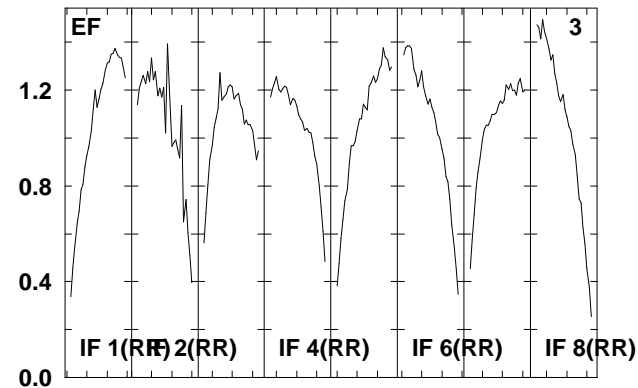
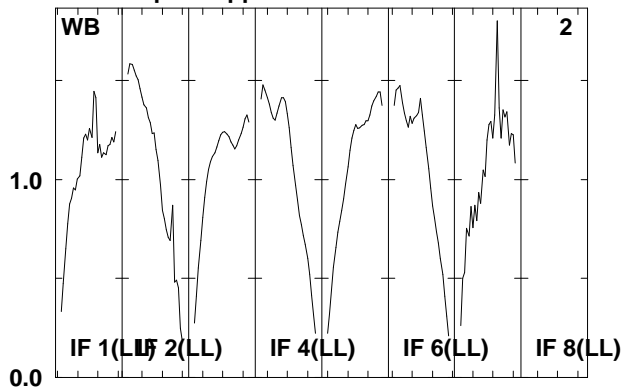
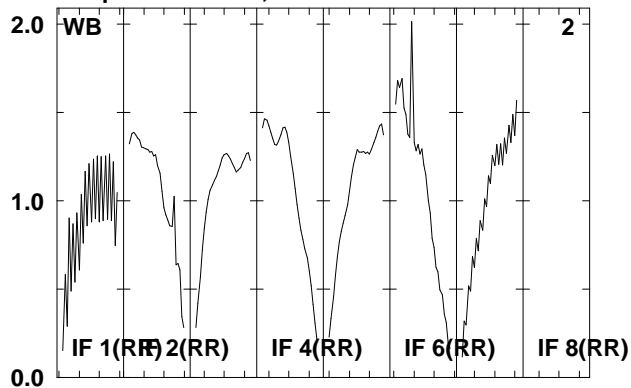

Lower frame: Real Jy  
Total-power spectrum Antenna: \*  
Timerange: 00/08:48:27 to 00/08:49:51

Plot file version 240 created 08-AUG-2008 17:00:24

J0209+13 EO006B.UVDATA.1

Freq = 1.5950 GHz, Bw = 16.000 MH No calibration applied and no bandpass applied

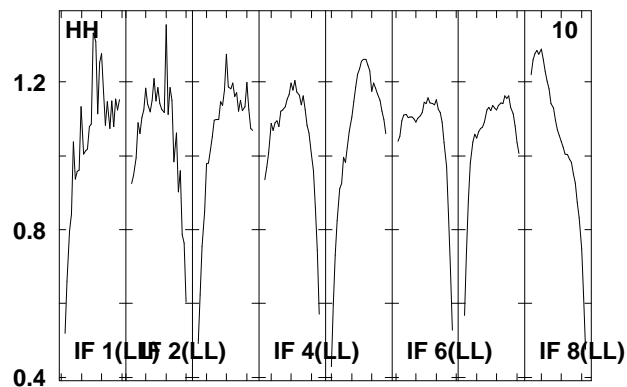
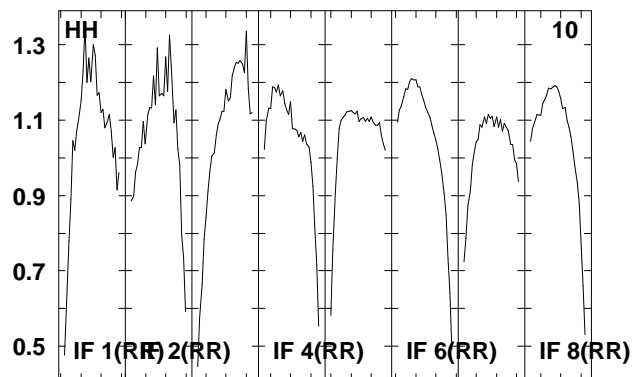
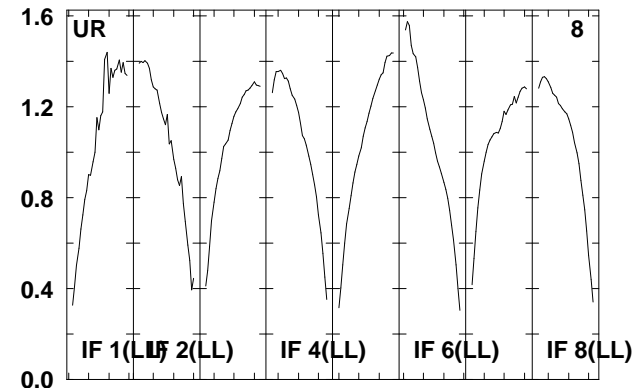
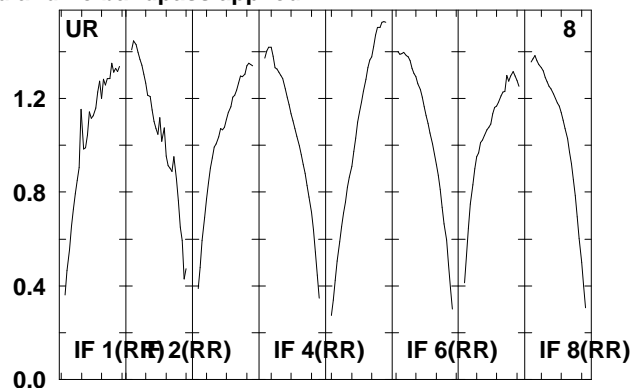
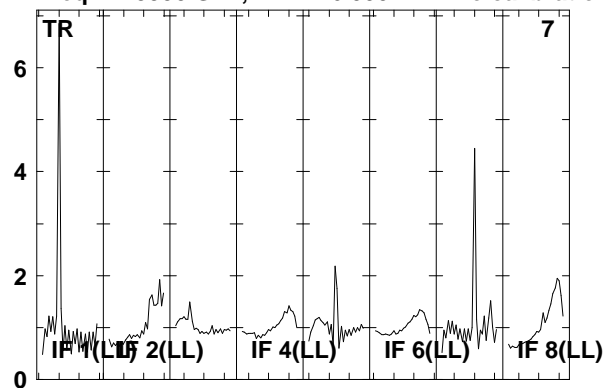

Lower frame: Real Jy  
Total-power spectrum Antenna: \*  
Timerange: 00/08:48:27 to 00/08:49:51

Plot file version 241 created 08-AUG-2008 17:00:24

J021348 EO006B.UVDATA.1

Freq = 1.5950 GHz, Bw = 16.000 MH No calibration applied and no bandpass applied

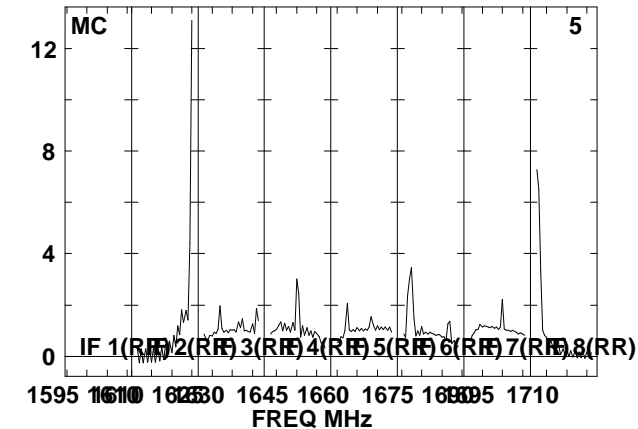
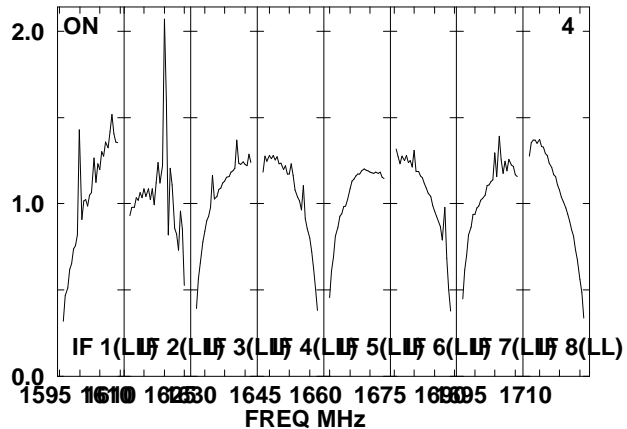
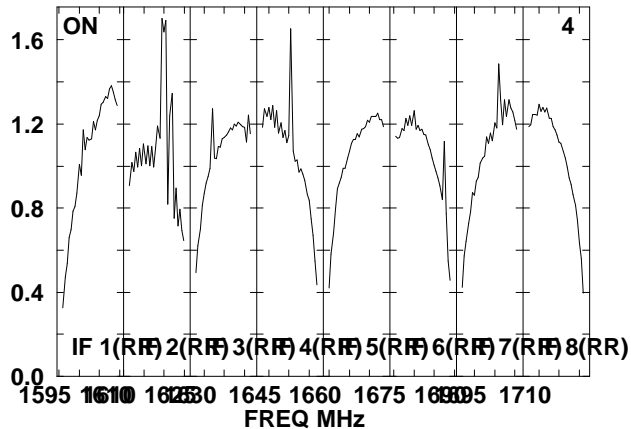
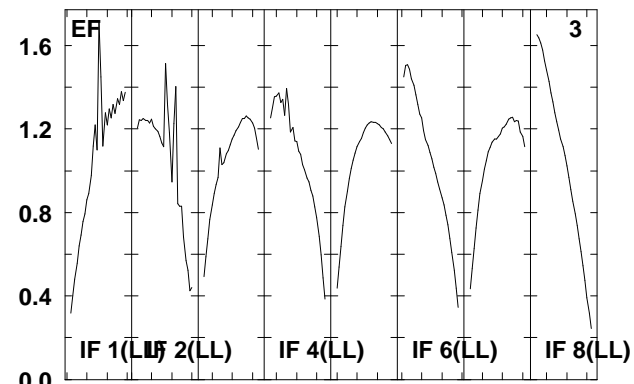
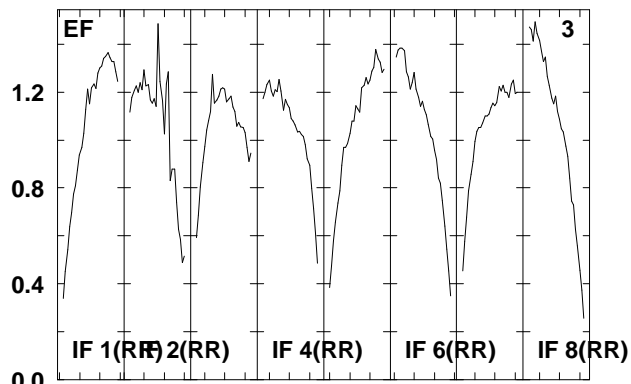
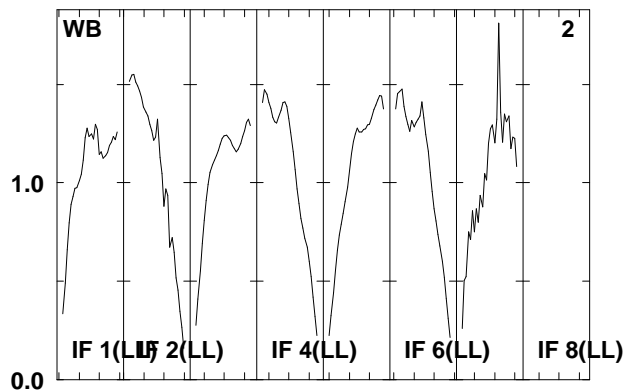
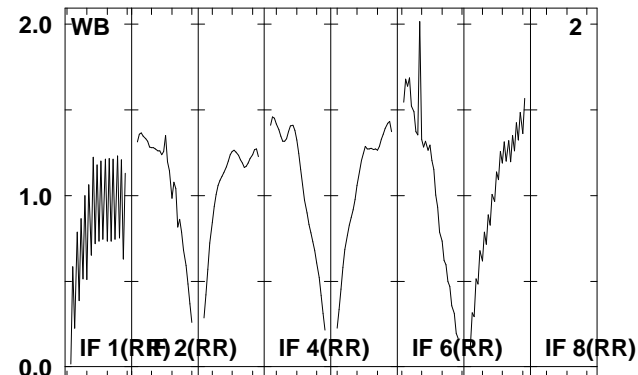
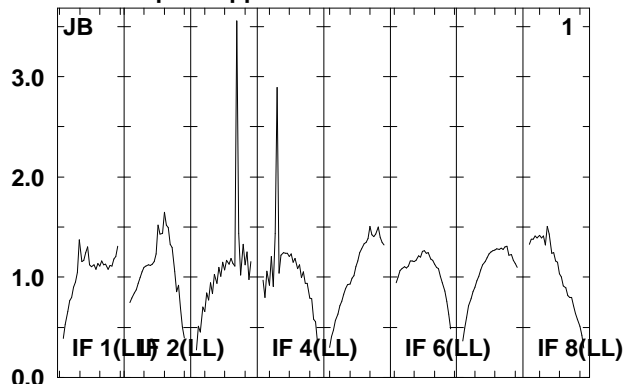
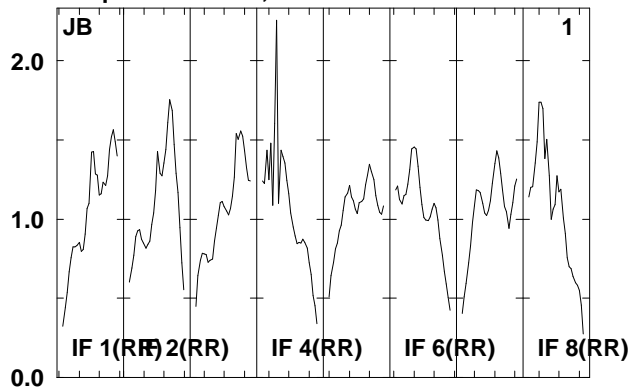

Lower frame: Real Jy  
Total-power spectrum Antenna: \*  
Timerange: 00/08:50:31 to 00/08:55:07

Plot file version 242 created 08-AUG-2008 17:00:25

J021348 EO006B.UVDATA.1

Freq = 1.5950 GHz, Bw = 16.000 MH No calibration applied and no bandpass applied

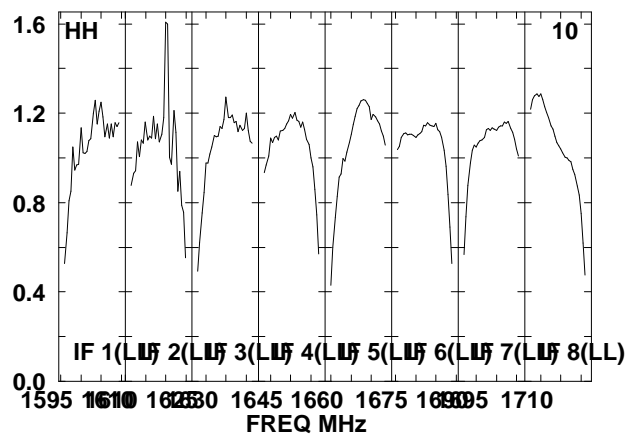
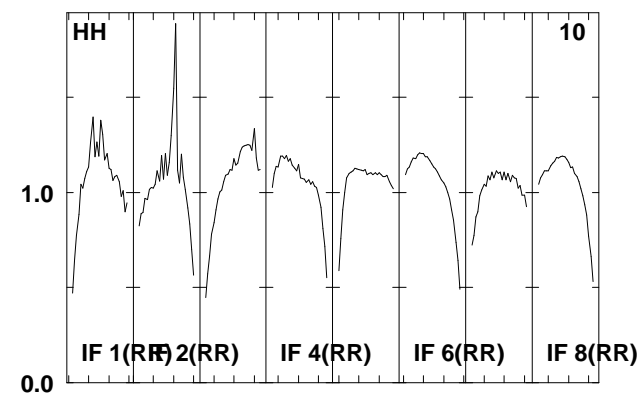
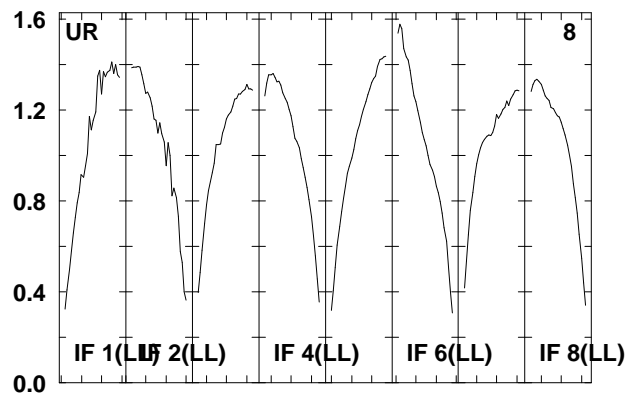
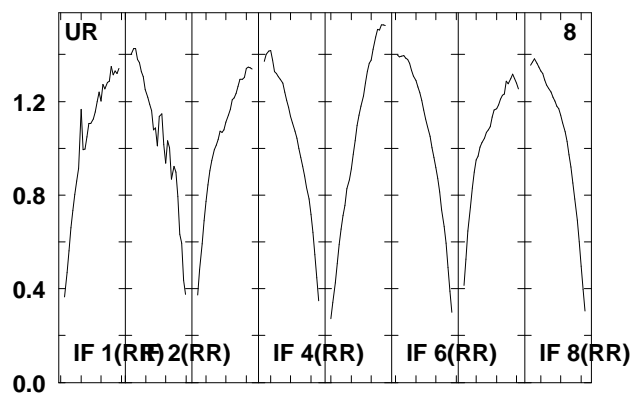
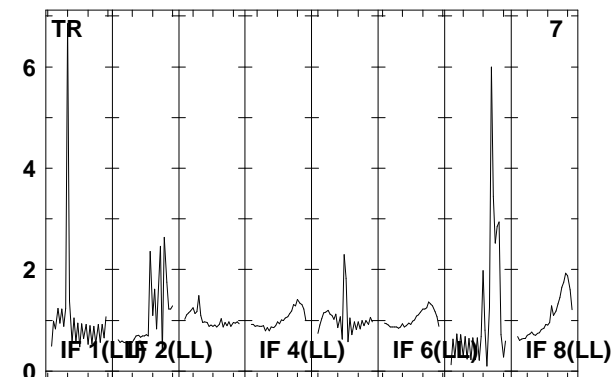
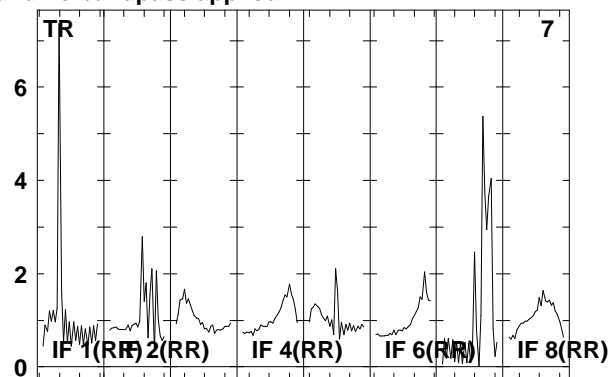
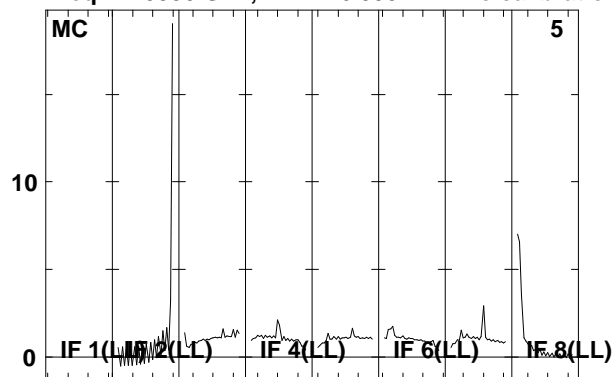

Lower frame: Real Jy

Total-power spectrum Antenna: \*

Timerange: 00/08:50:31 to 00/08:55:07

Plot file version 243 created 08-AUG-2008 17:00:26

J0209+13 EO006B.UVDATA.1

Freq = 1.5950 GHz, Bw = 16.000 MH No calibration applied and no bandpass applied

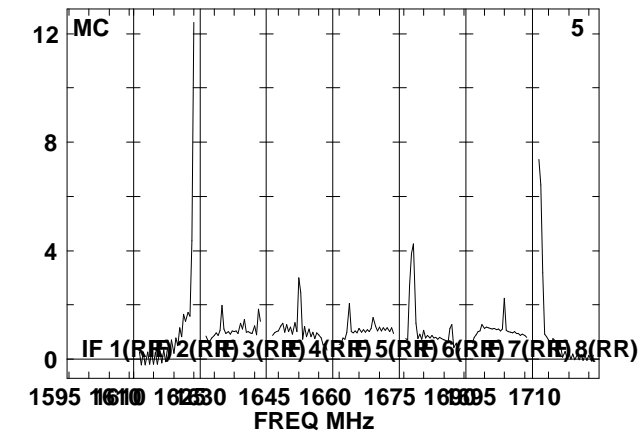
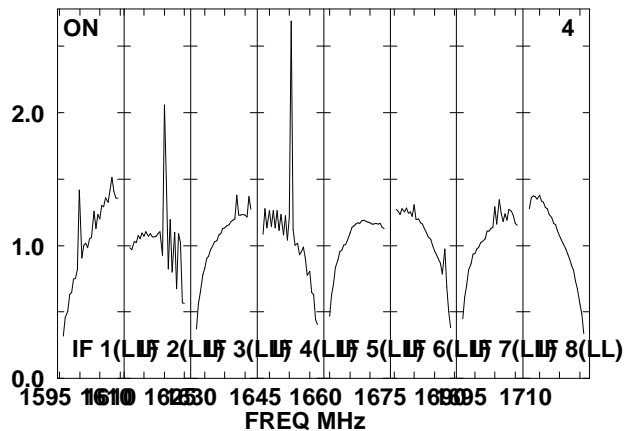
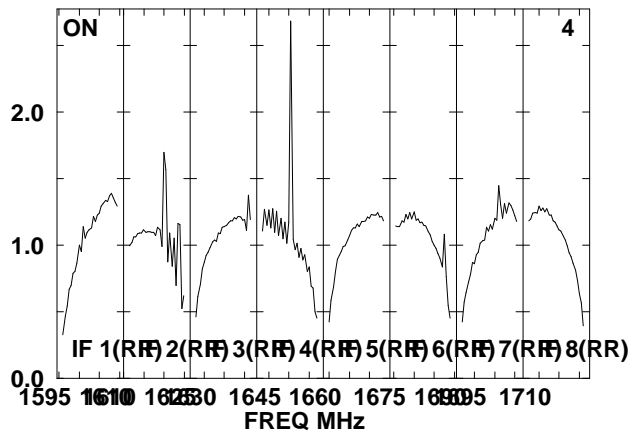
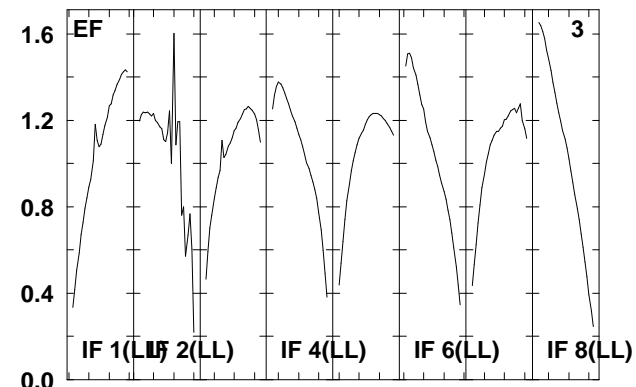
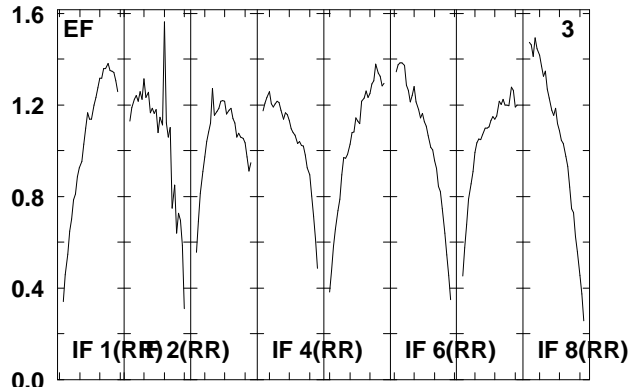
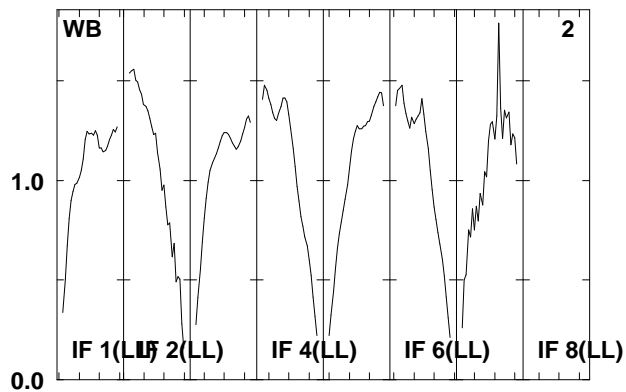
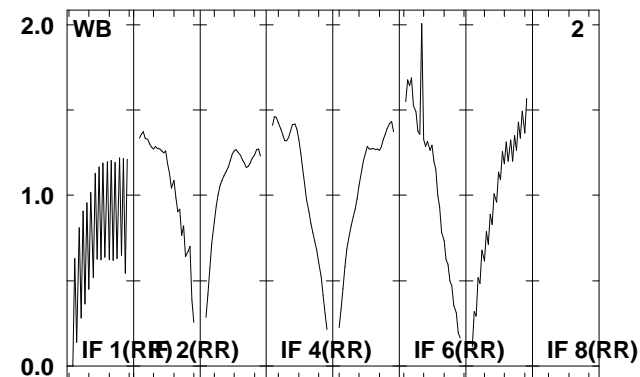
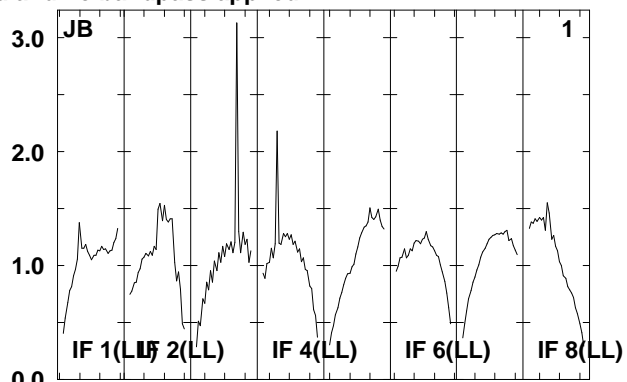
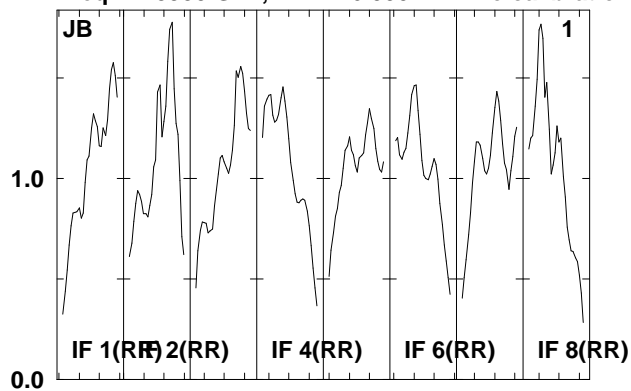

Lower frame: Real Jy  
Total-power spectrum Antenna: \*  
Timerange: 00/08:55:43 to 00/08:57:19

Plot file version 244 created 08-AUG-2008 17:00:26

J0209+13 EO006B.UVDATA.1

Freq = 1.5950 GHz, Bw = 16.000 MH No calibration applied and no bandpass applied

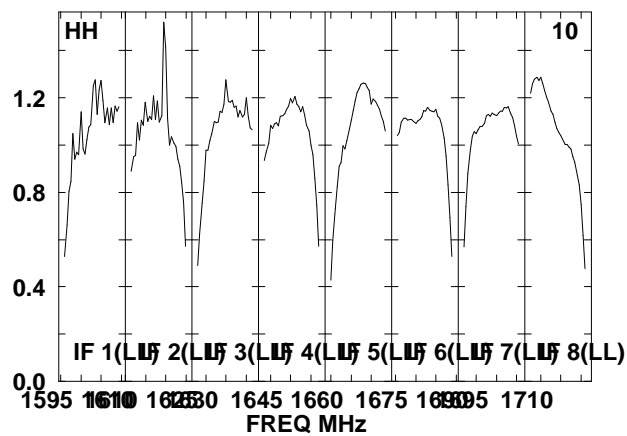
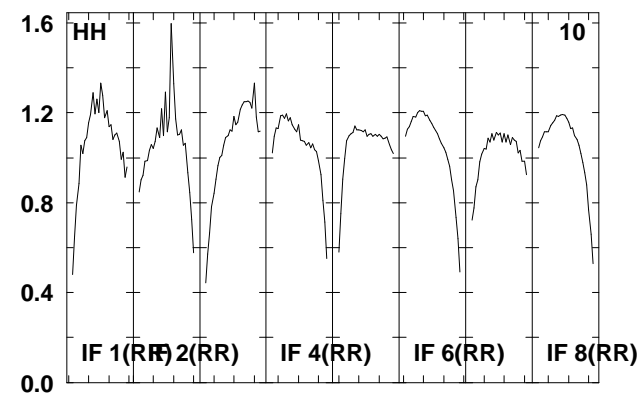
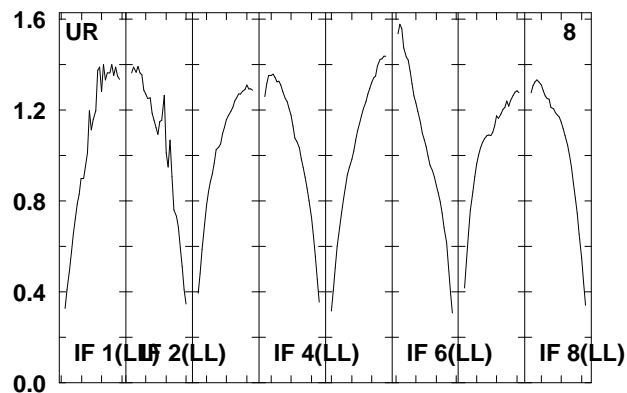
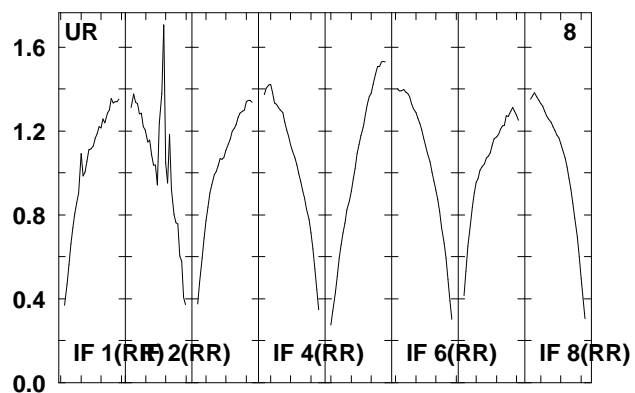
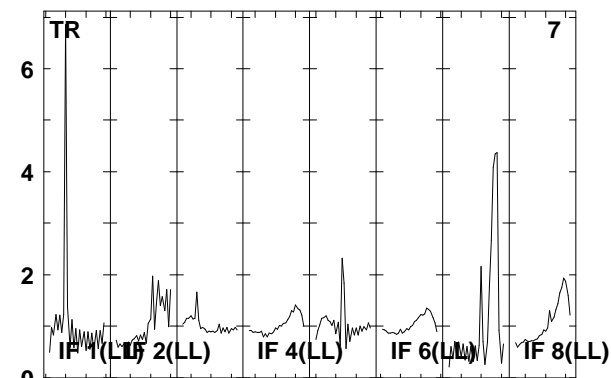
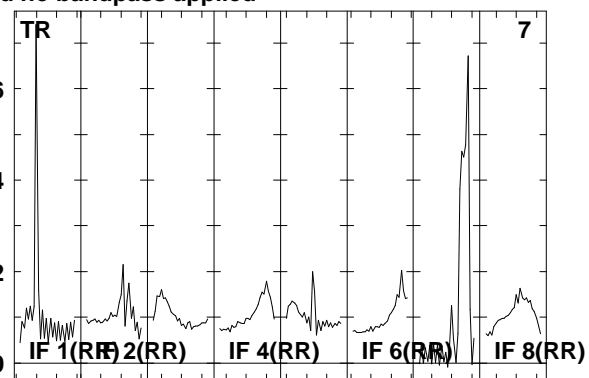
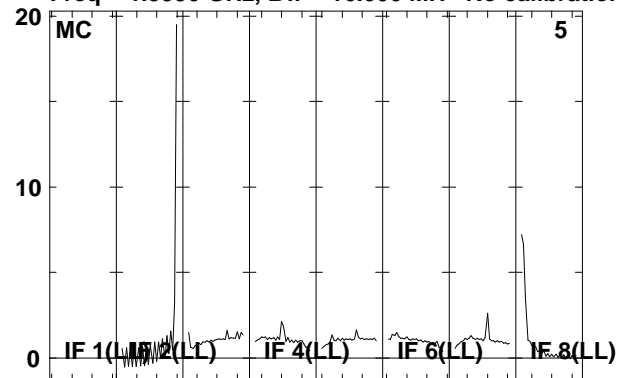

Lower frame: Real Jy

Total-power spectrum Antenna: \*

Timerange: 00/08:55:43 to 00/08:57:19



Plot file version 245 created 08-AUG-2008 17:00:27

J021348 EO006B.UVDATA.1

Freq = 1.5950 GHz, Bw = 16.000 MH No calibration applied and no bandpass applied

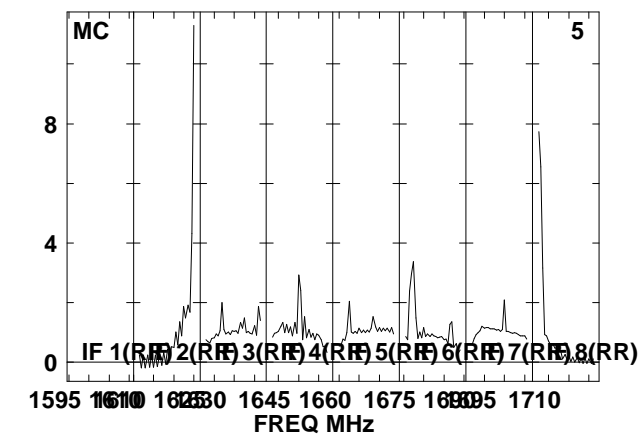
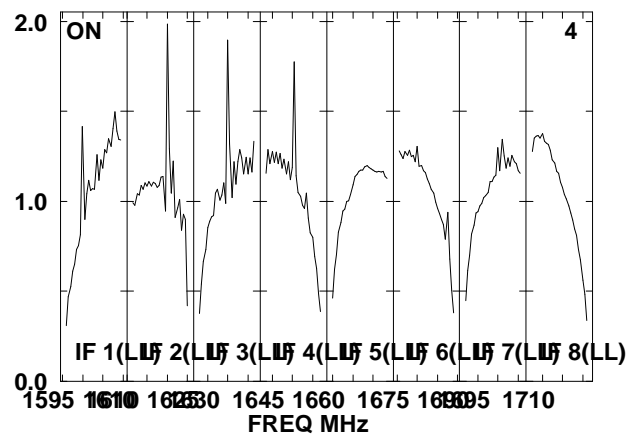
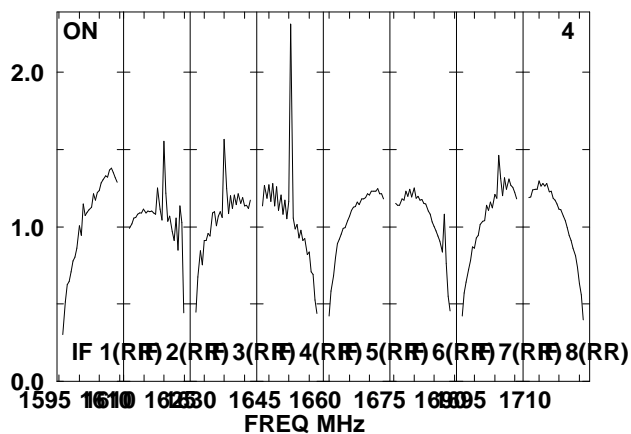
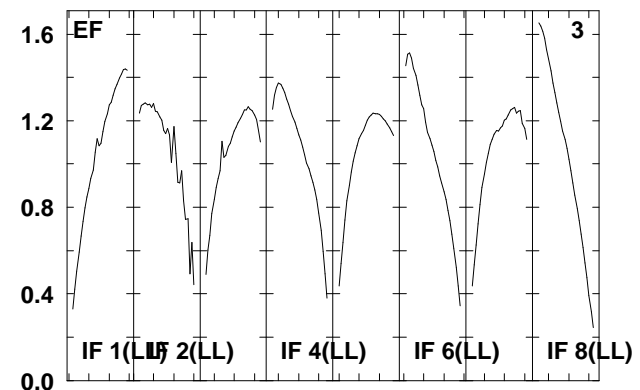
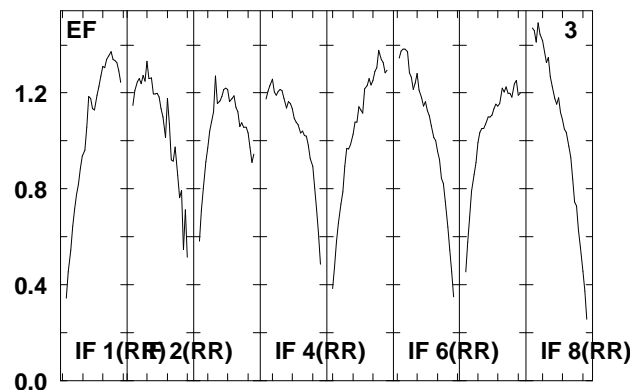
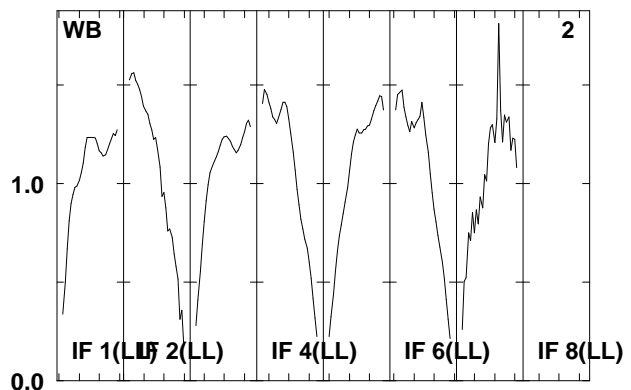
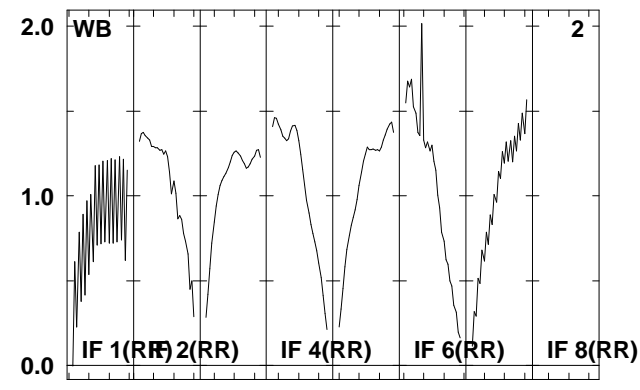
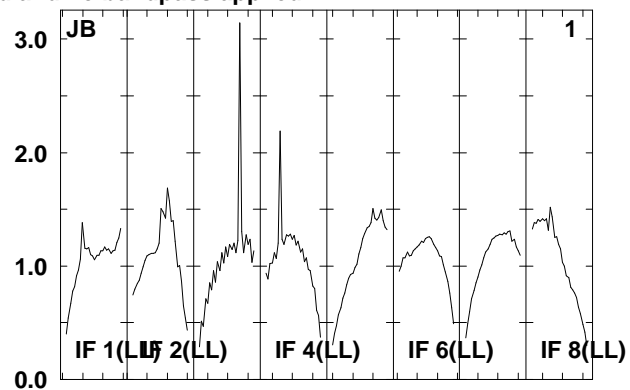
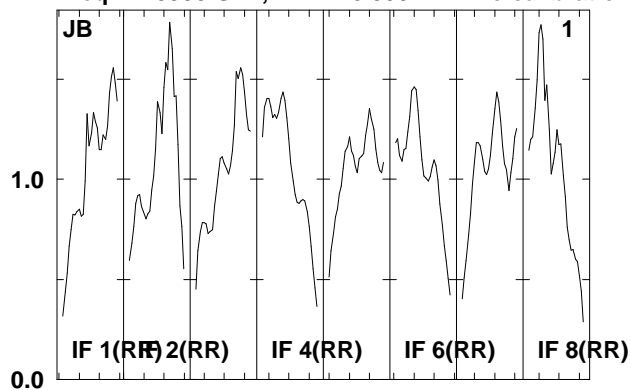

Lower frame: Real Jy  
Total-power spectrum Antenna: \*  
Timerange: 00/08:57:51 to 00/09:02:27

Plot file version 246 created 08-AUG-2008 17:00:28

J021348 EO006B.UVDATA.1

Freq = 1.5950 GHz, Bw = 16.000 MH No calibration applied and no bandpass applied

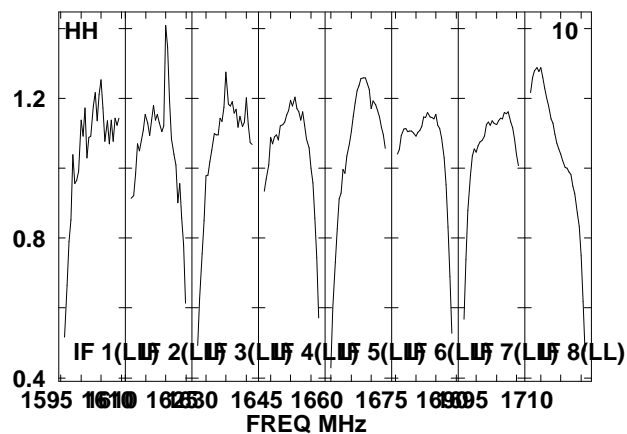
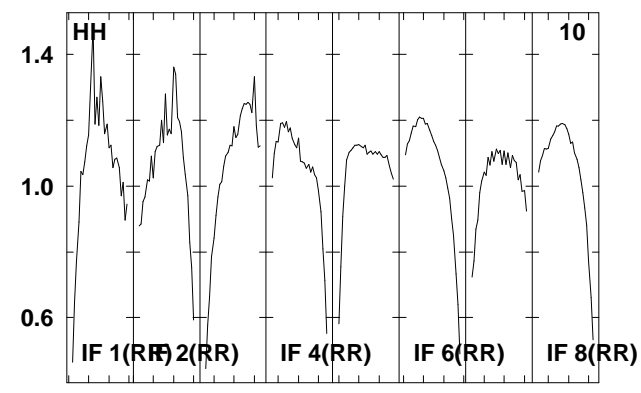
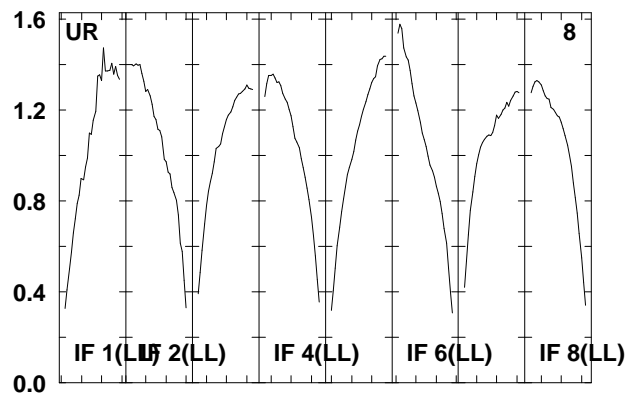
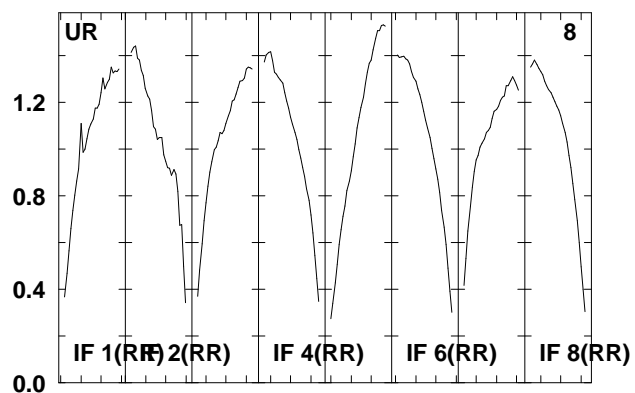
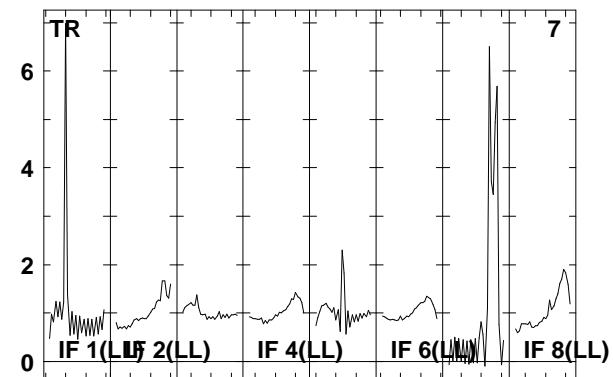
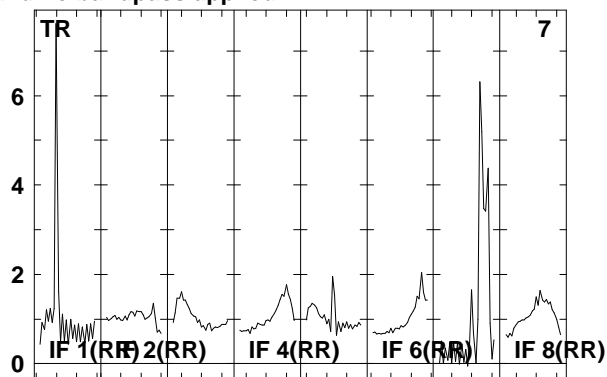
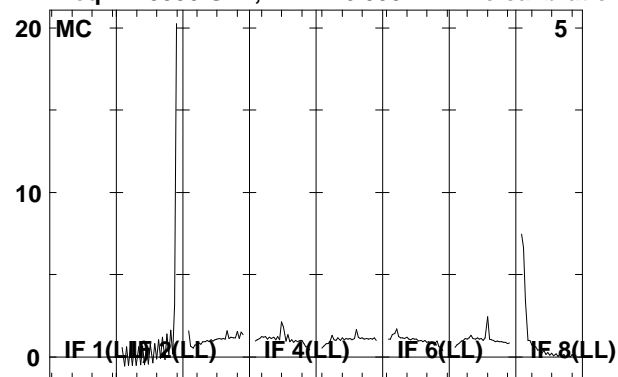

Lower frame: Real Jy

Total-power spectrum Antenna: \*

Timerange: 00/08:57:51 to 00/09:02:27

Plot file version 247 created 08-AUG-2008 17:00:29

J0209+13 EO006B.UVDATA.1

Freq = 1.5950 GHz, Bw = 16.000 MH No calibration applied and no bandpass applied

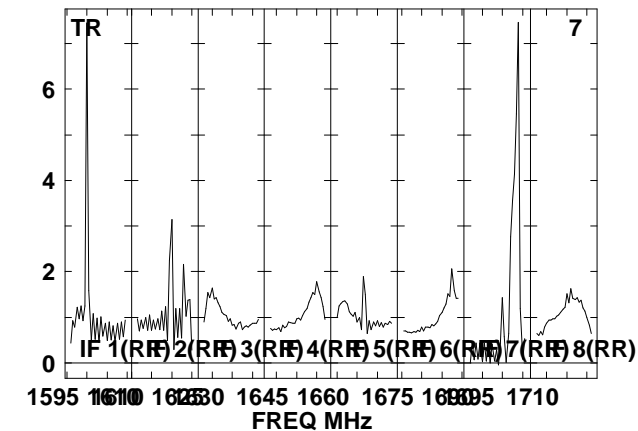
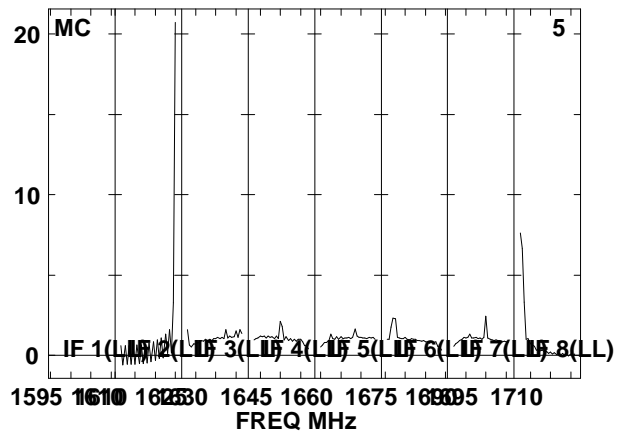
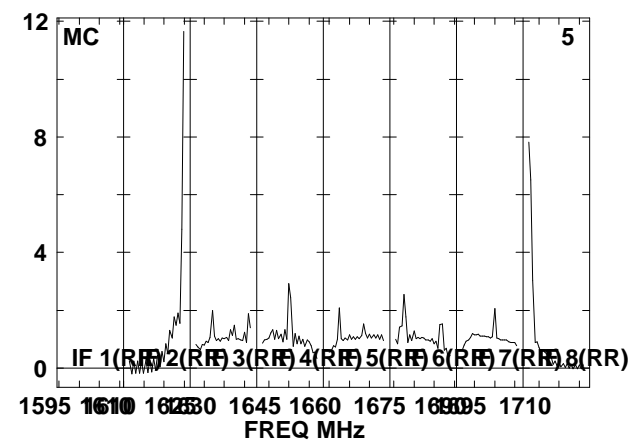
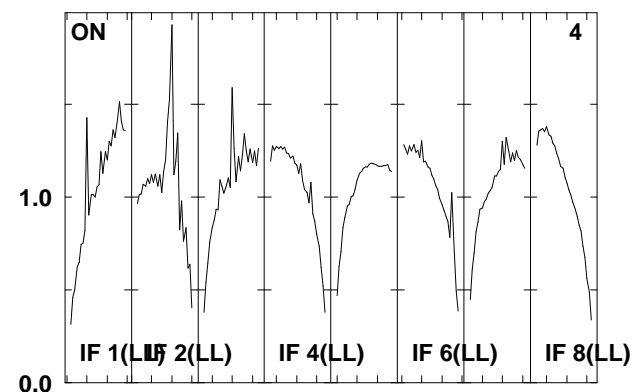
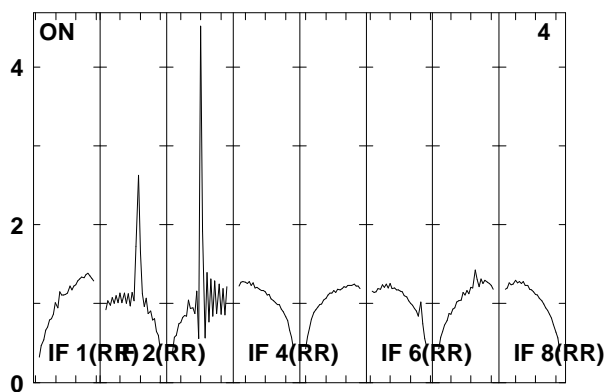
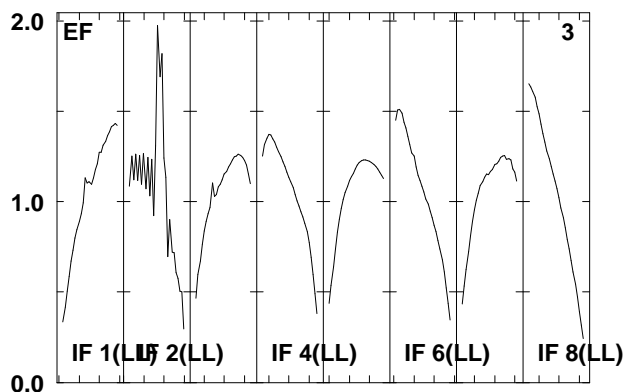
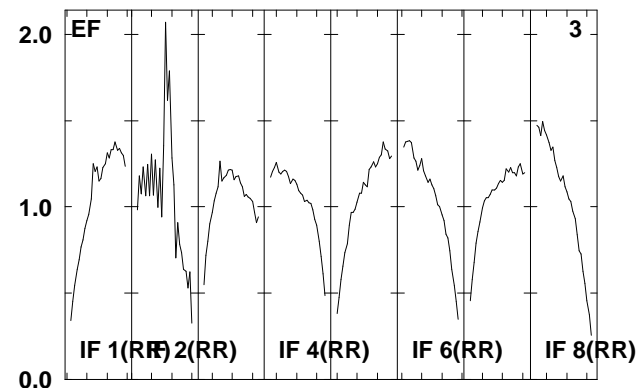
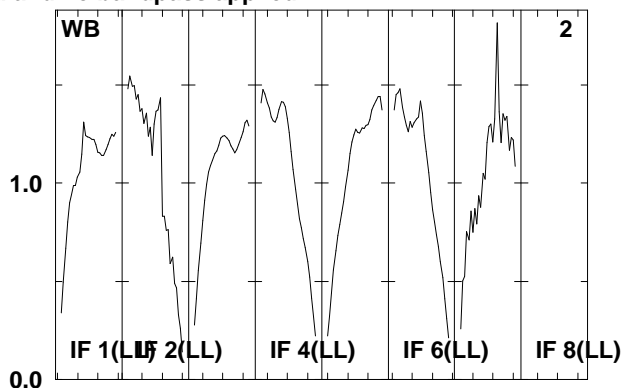
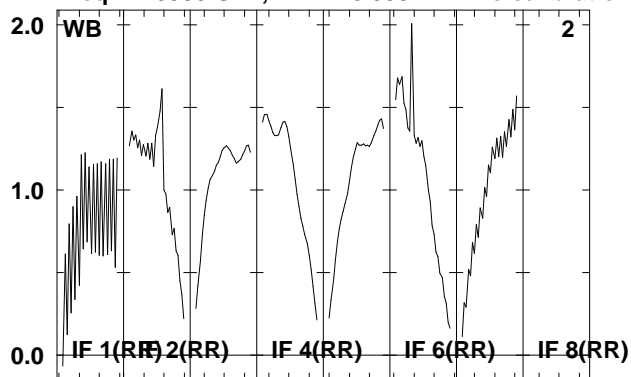

Lower frame: Real Jy  
Total-power spectrum Antenna: \*  
Timerange: 00/09:03:03 to 00/09:04:39

Plot file version 248 created 08-AUG-2008 17:00:29

J0209+13 EO006B.UVDATA.1

Freq = 1.5950 GHz, Bw = 16.000 MH No calibration applied and no bandpass applied

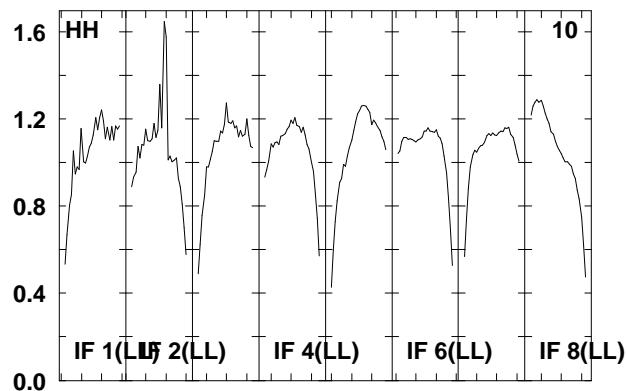
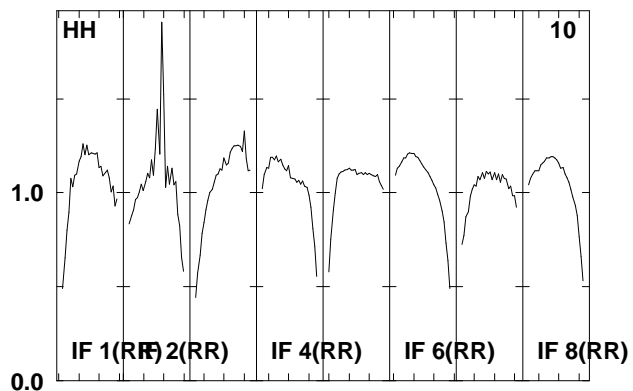
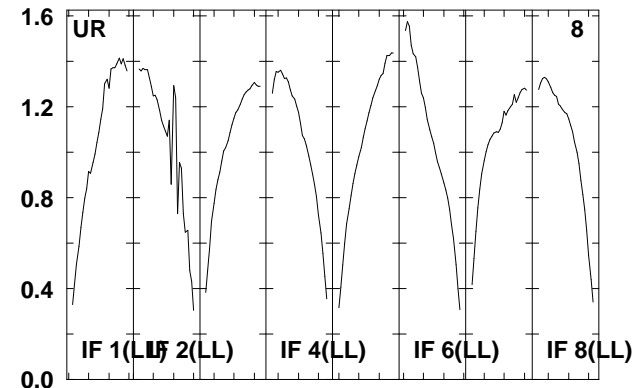
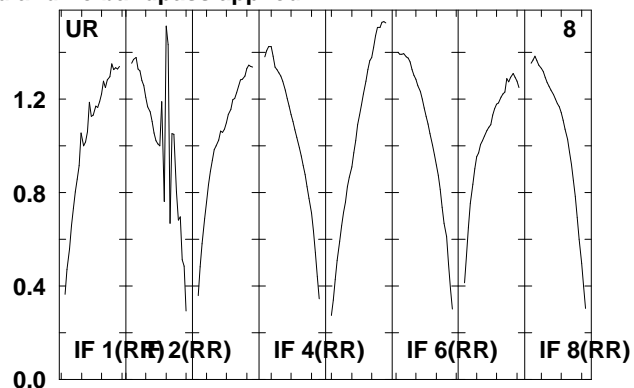
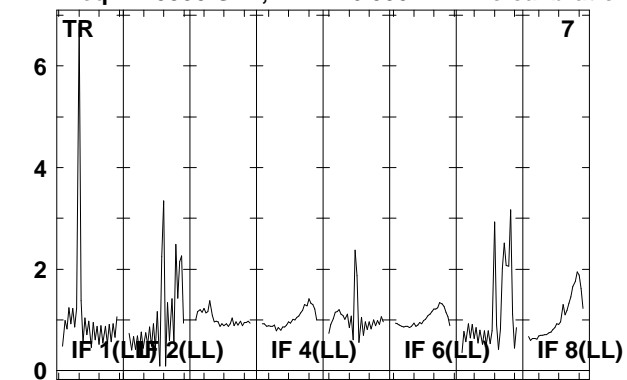

Lower frame: Real Jy  
Total-power spectrum Antenna: \*  
Timerange: 00/09:03:03 to 00/09:04:39

Plot file version 249 created 08-AUG-2008 17:00:29

J021348 EO006B.UVDATA.1

Freq = 1.5950 GHz, Bw = 16.000 MH No calibration applied and no bandpass applied

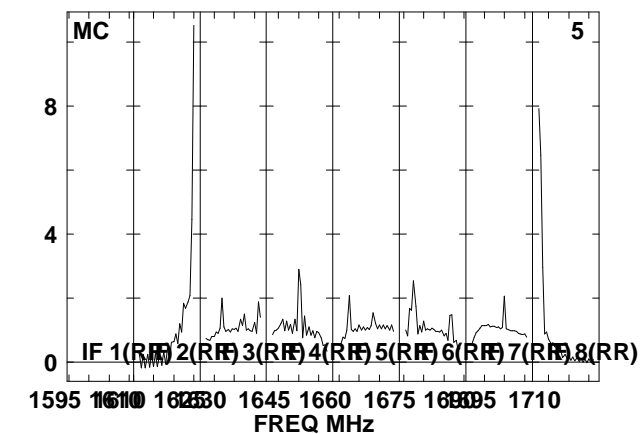
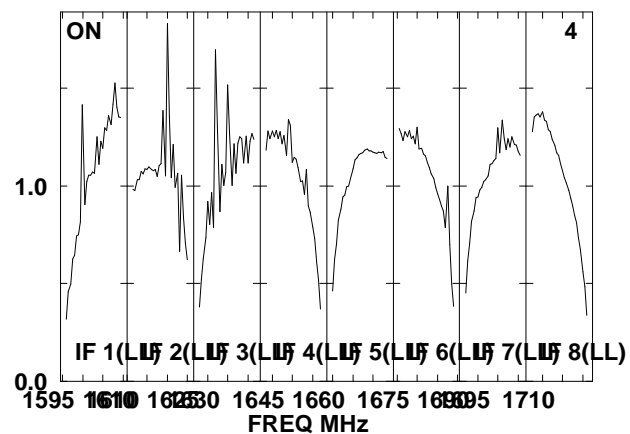
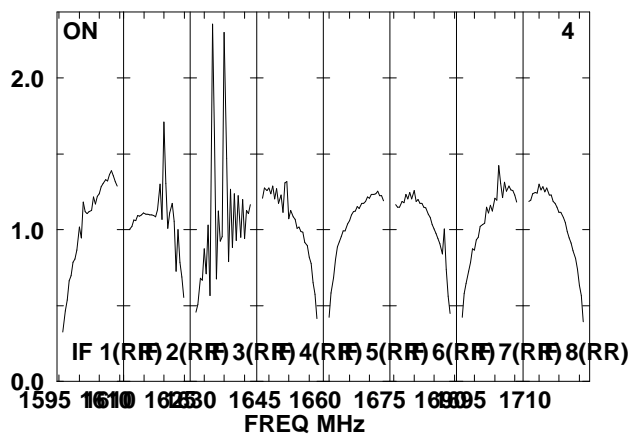
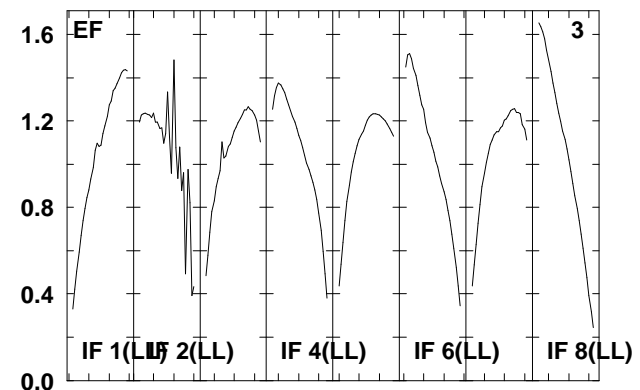
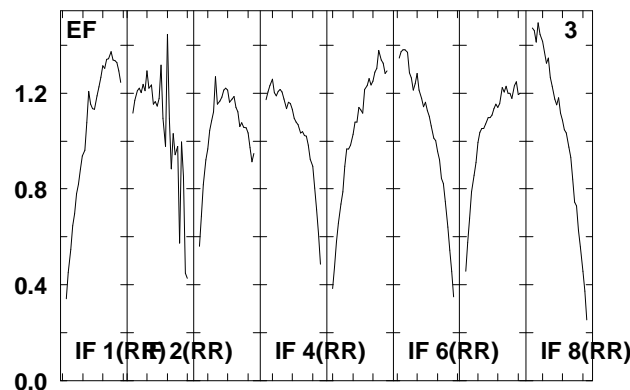
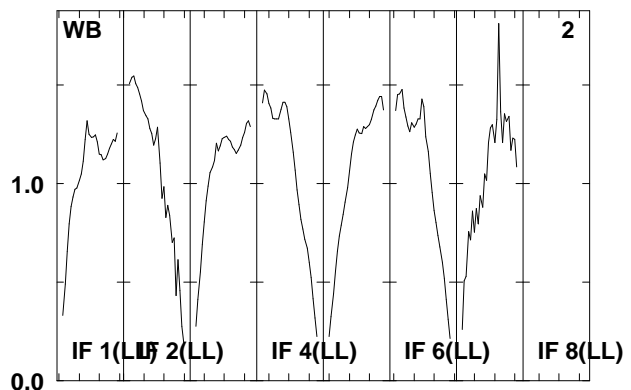
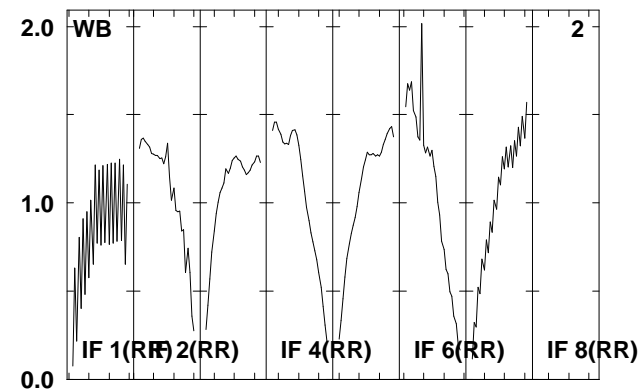
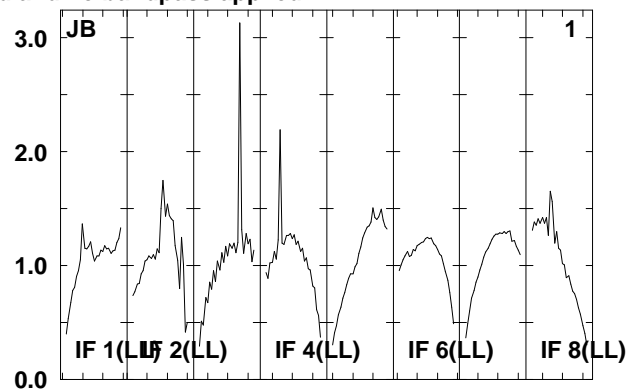
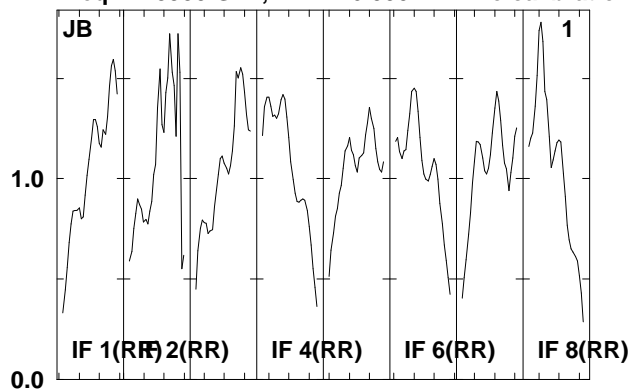

Lower frame: Real Jy  
Total-power spectrum Antenna: \*  
Timerange: 00/09:05:11 to 00/09:09:47

Plot file version 250 created 08-AUG-2008 17:00:30

J021348 EO006B.UVDATA.1

Freq = 1.5950 GHz, Bw = 16.000 MH No calibration applied and no bandpass applied

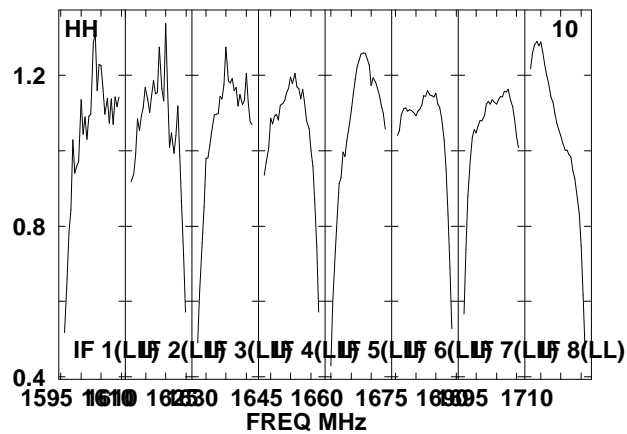
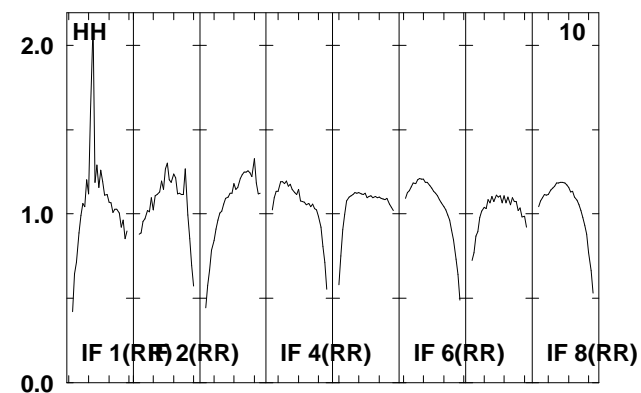
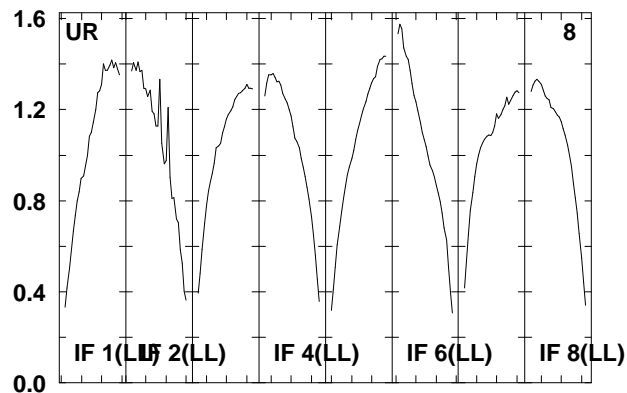
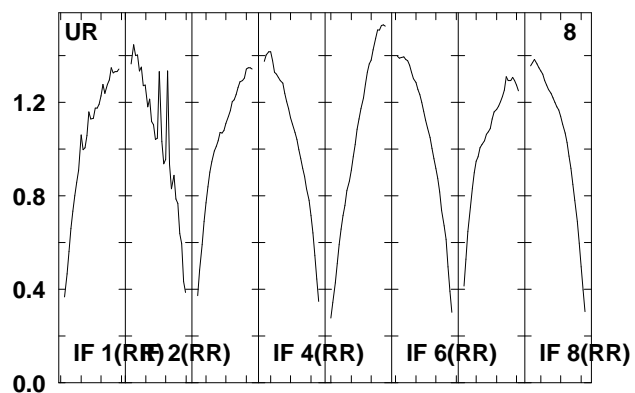
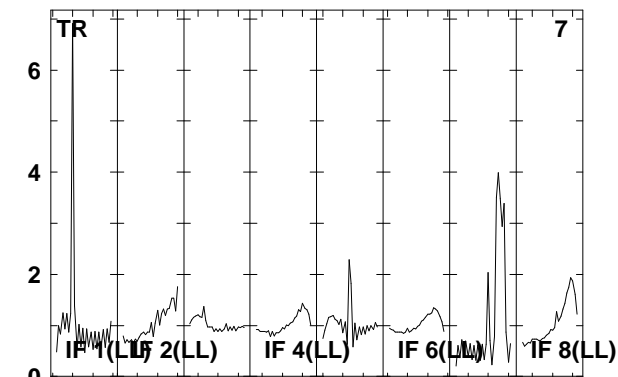
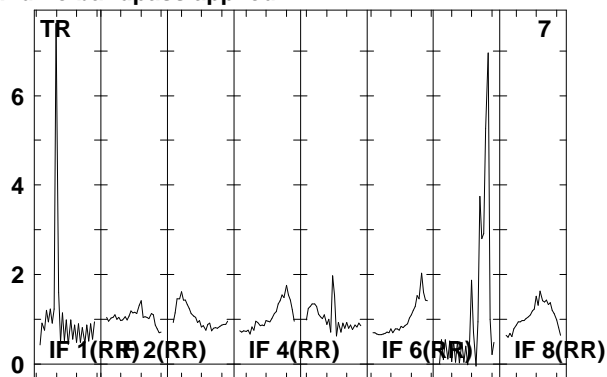
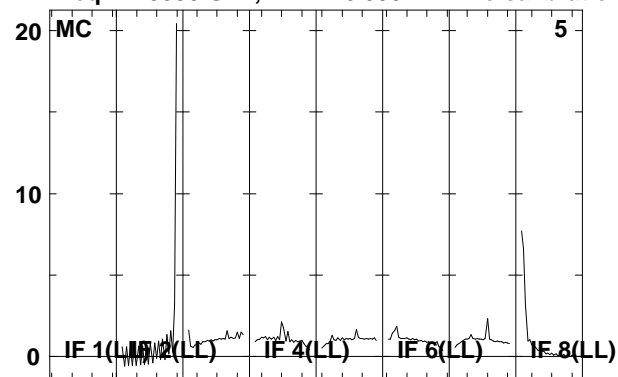

Lower frame: Real Jy

Total-power spectrum Antenna: \*

Timerange: 00/09:05:11 to 00/09:09:47

Plot file version 251 created 08-AUG-2008 17:00:31

J0209+13 EO006B.UVDATA.1

Freq = 1.5950 GHz, Bw = 16.000 MH No calibration applied and no bandpass applied

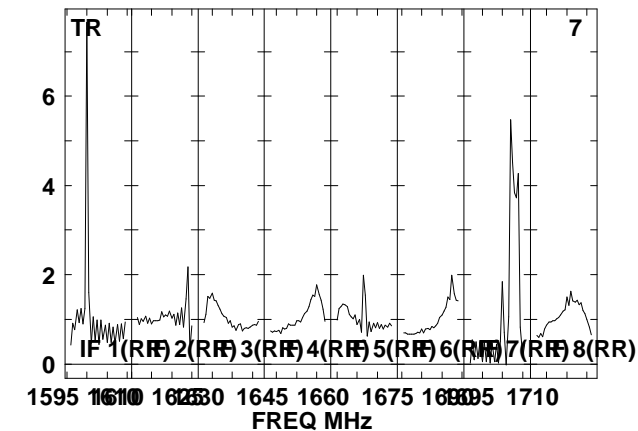
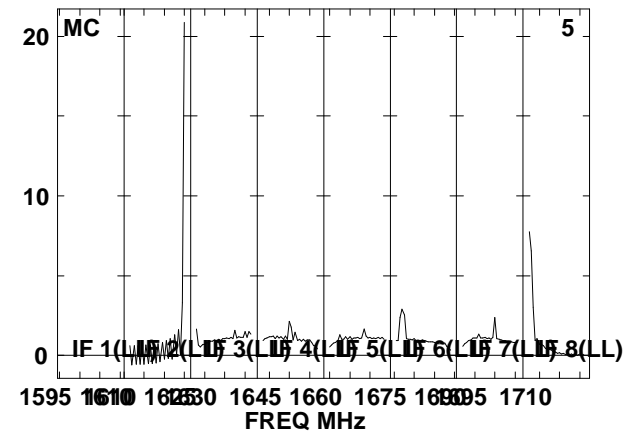
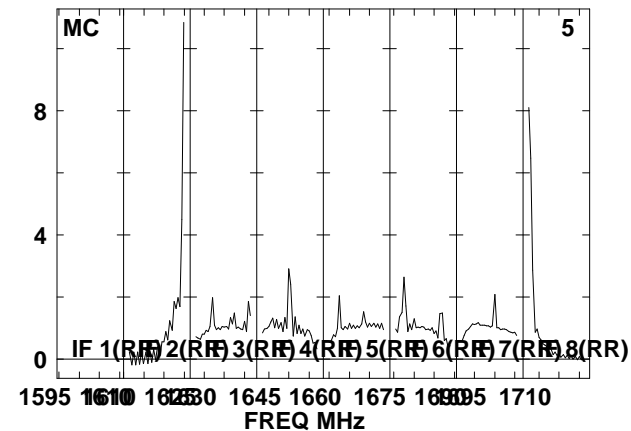
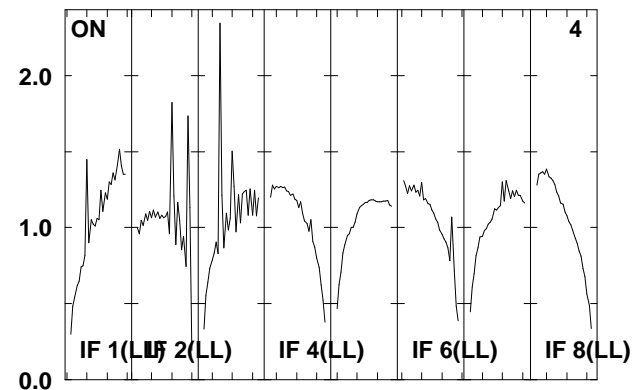
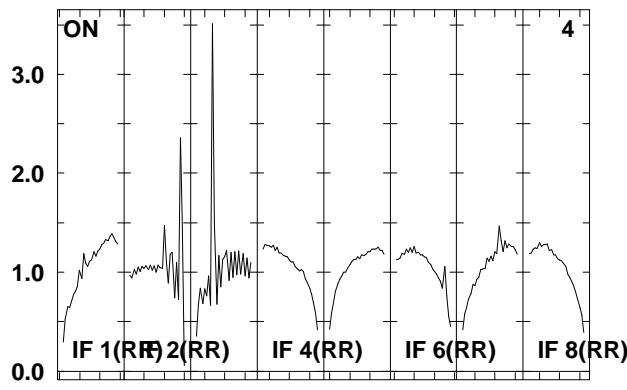
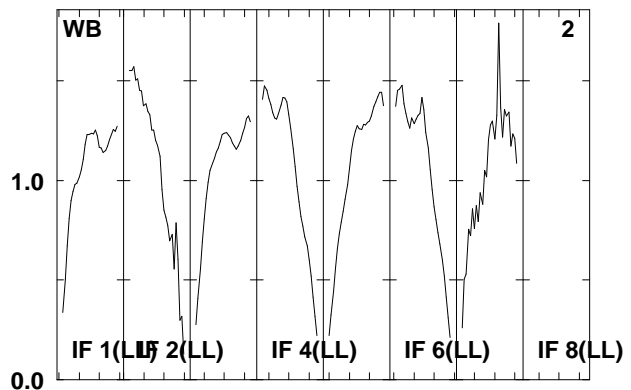
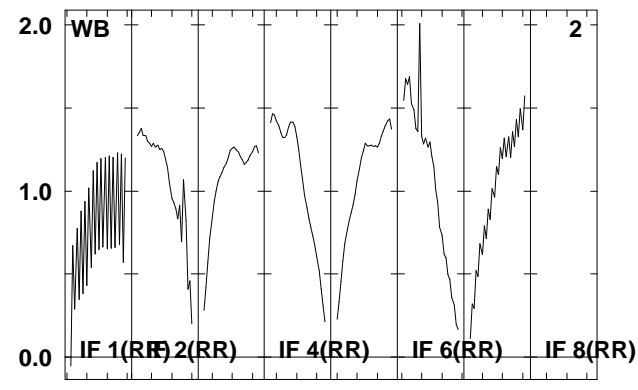
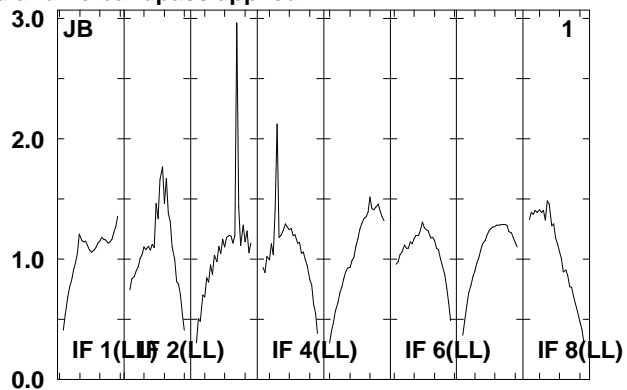
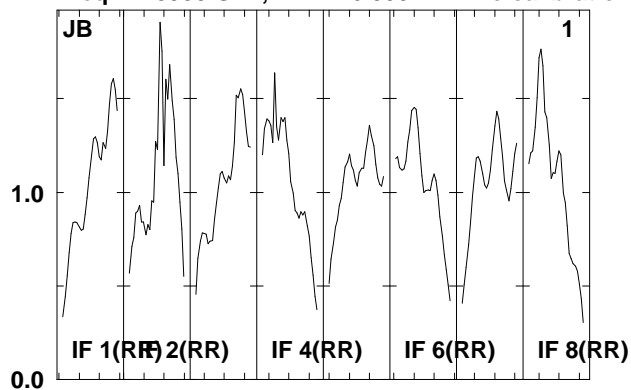

Lower frame: Real Jy  
Total-power spectrum Antenna: \*  
Timerange: 00/09:10:27 to 00/09:11:51

Plot file version 252 created 08-AUG-2008 17:00:32

J0209+13 EO006B.UVDATA.1

Freq = 1.5950 GHz, Bw = 16.000 MH No calibration applied and no bandpass applied

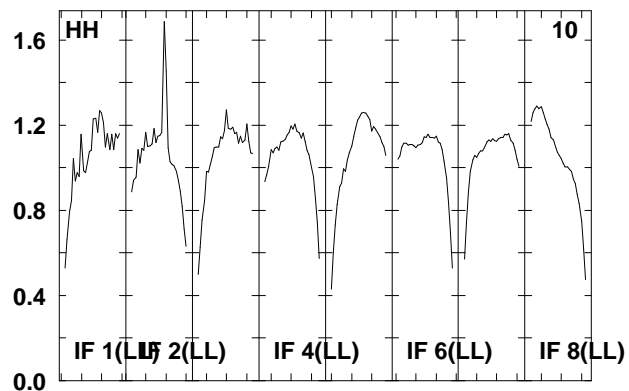
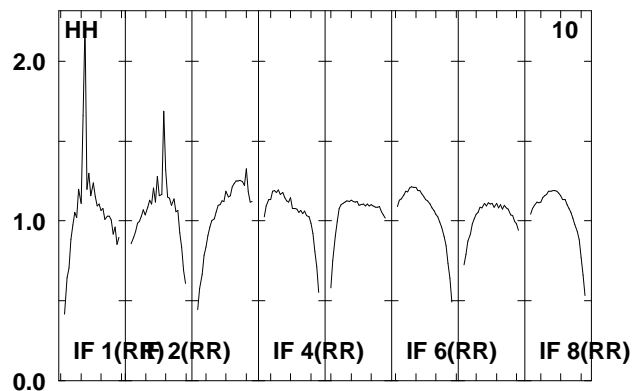
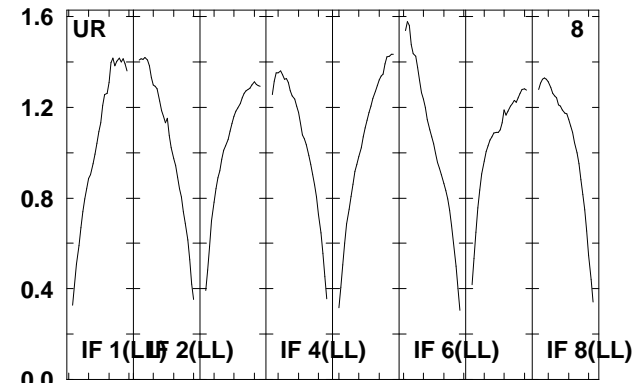
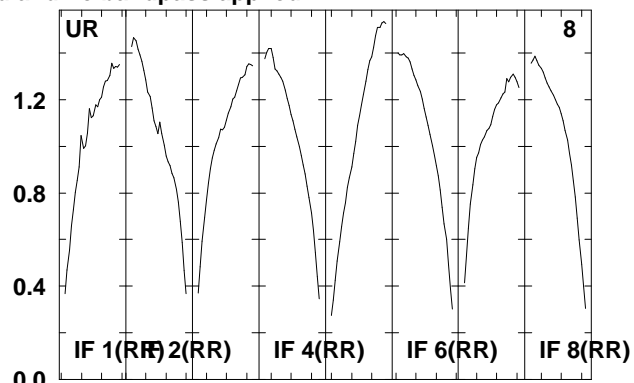
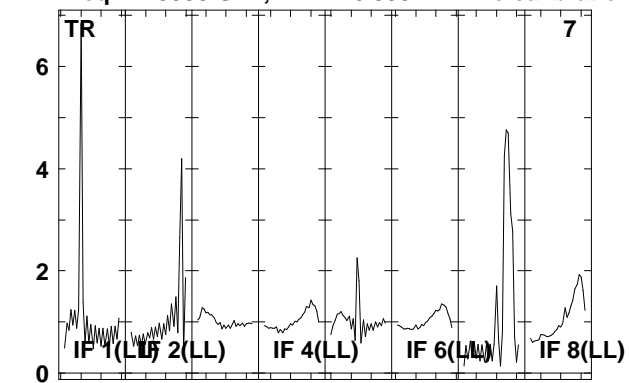

Lower frame: Real Jy  
Total-power spectrum Antenna: \*  
Timerange: 00/09:10:27 to 00/09:11:51



Plot file version 253 created 08-AUG-2008 17:00:32

J021348 EO006B.UVDATA.1

Freq = 1.5950 GHz, Bw = 16.000 MH No calibration applied and no bandpass applied

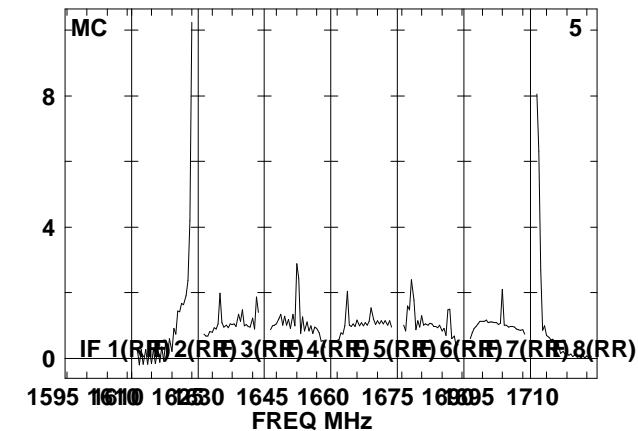
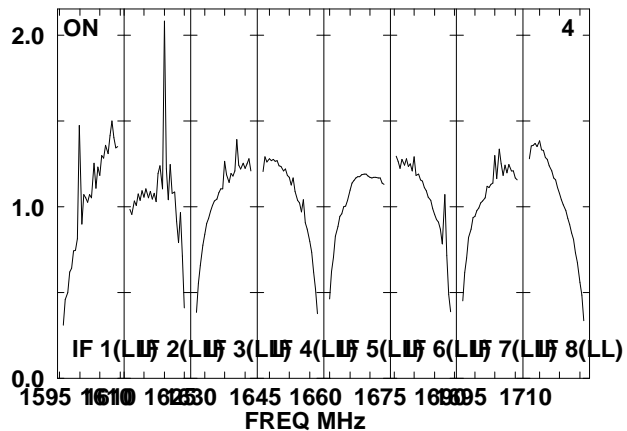
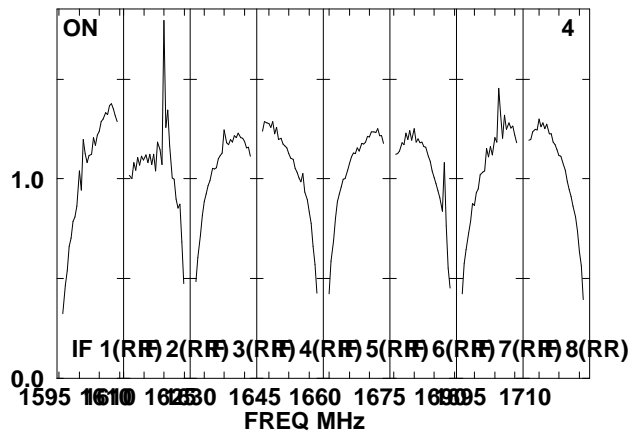
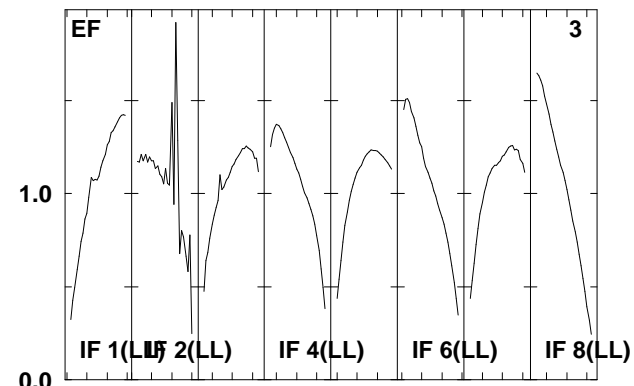
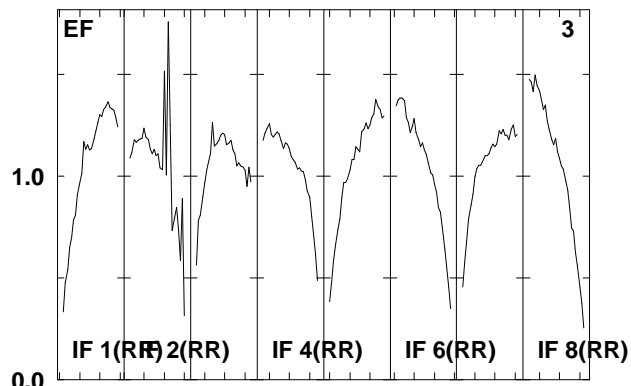
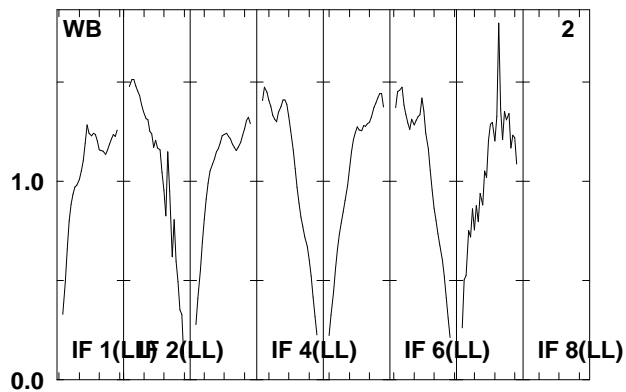
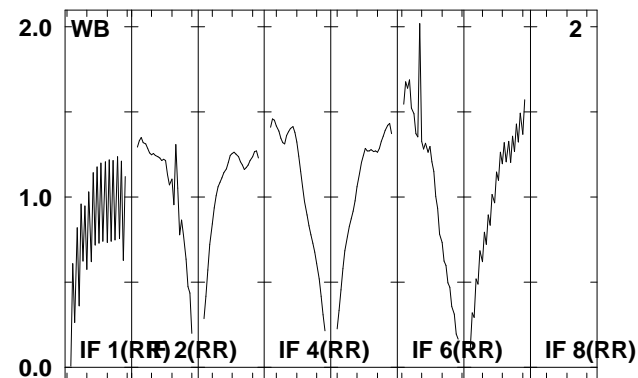
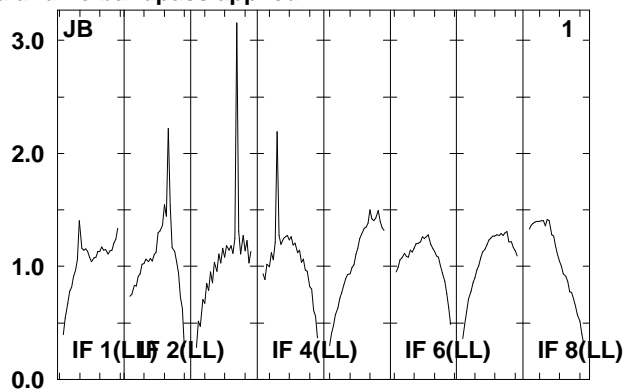
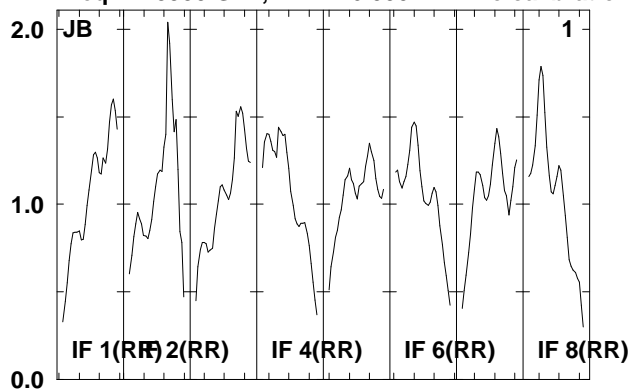

Lower frame: Real Jy

Total-power spectrum Antenna: \*

Timerange: 00/09:12:33 to 00/09:17:01

Plot file version 254 created 08-AUG-2008 17:00:32

J021348 EO006B.UVDATA.1

Freq = 1.5950 GHz, Bw = 16.000 MH No calibration applied and no bandpass applied

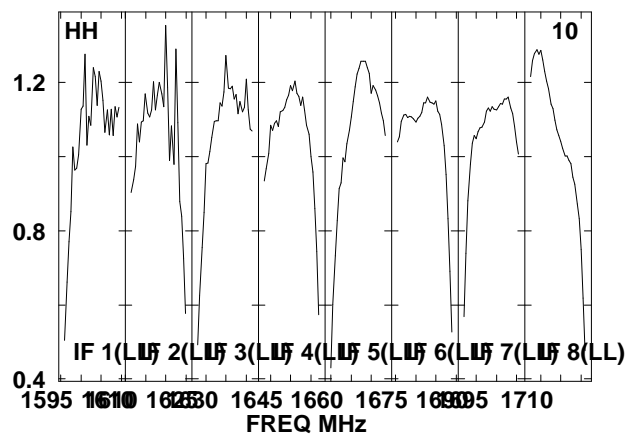
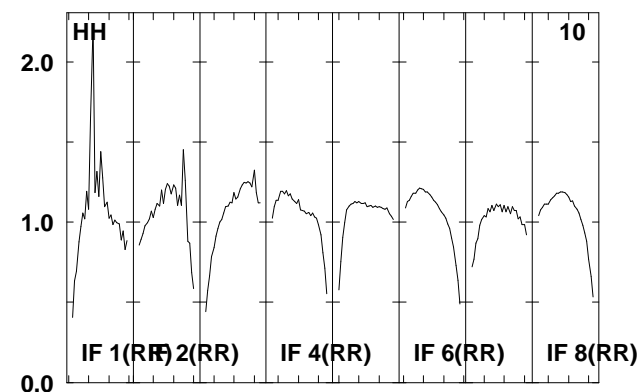
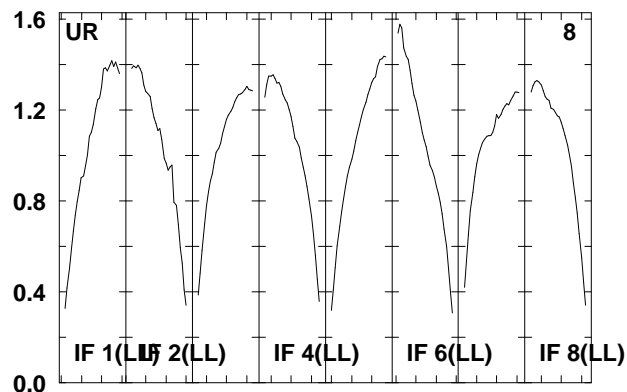
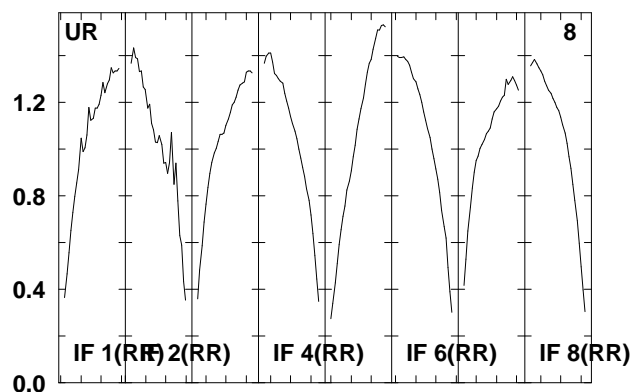
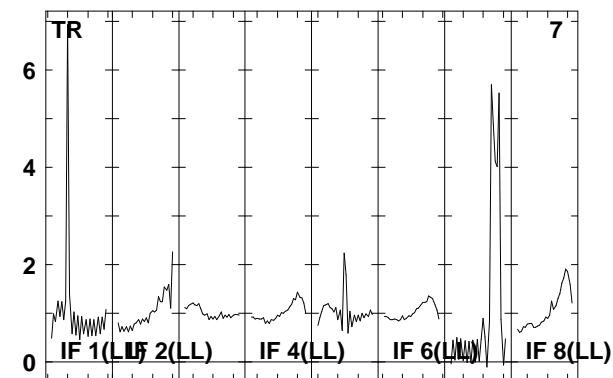
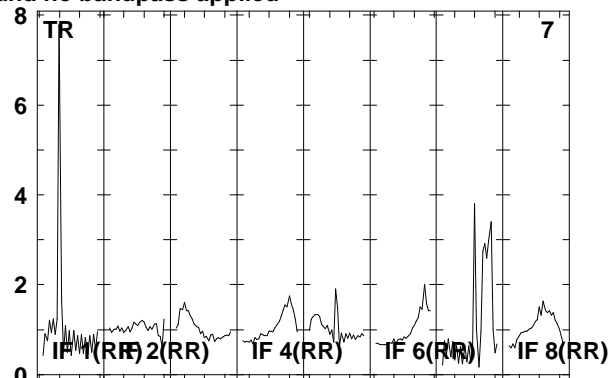
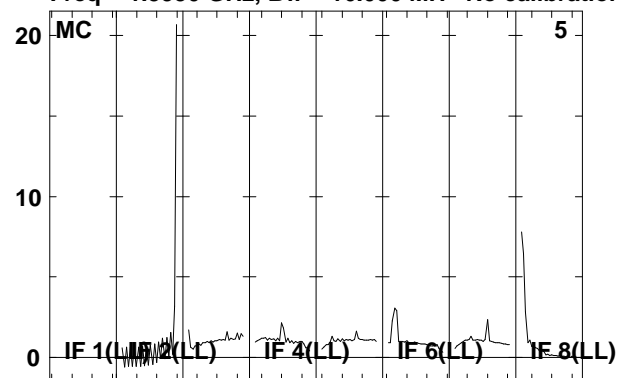

Lower frame: Real Jy

Total-power spectrum Antenna: \*

Timerange: 00/09:12:33 to 00/09:17:01

Plot file version 255 created 08-AUG-2008 17:00:34

J0209+13 EO006B.UVDATA.1

Freq = 1.5950 GHz, Bw = 16.000 MH No calibration applied and no bandpass applied

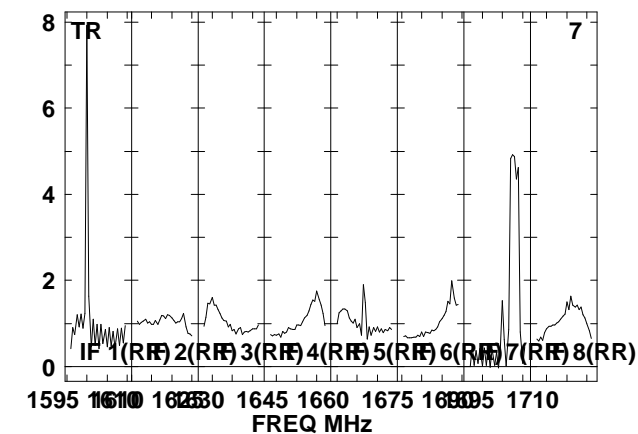
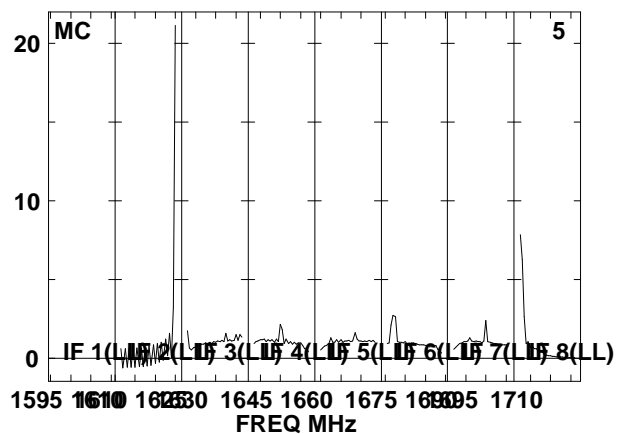
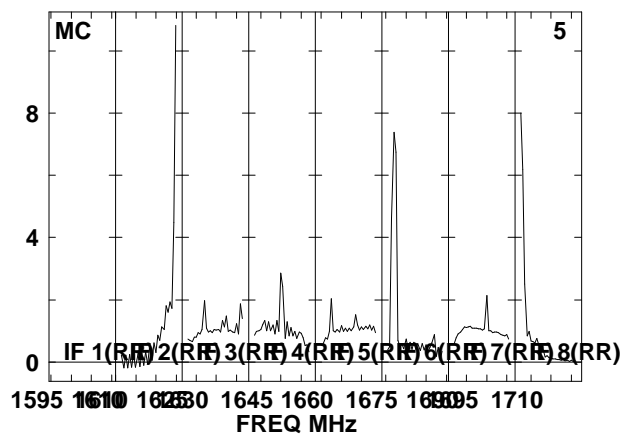
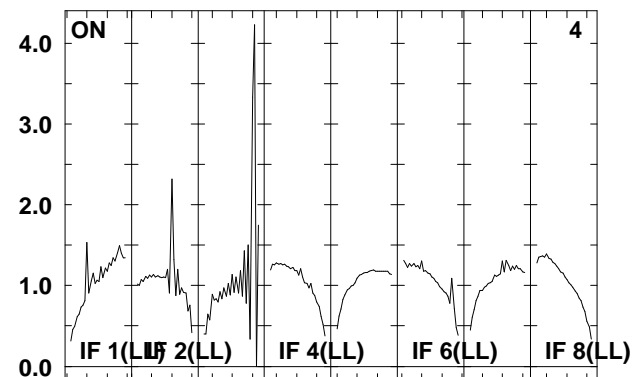
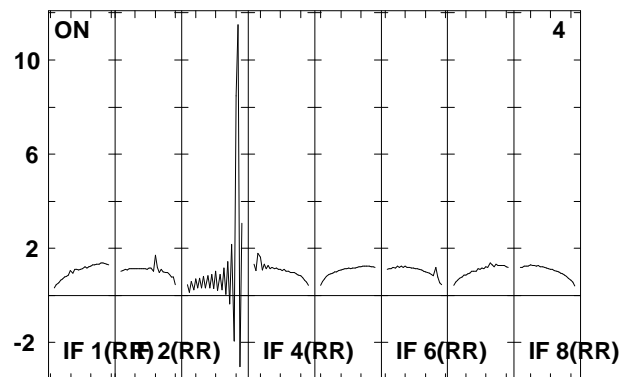
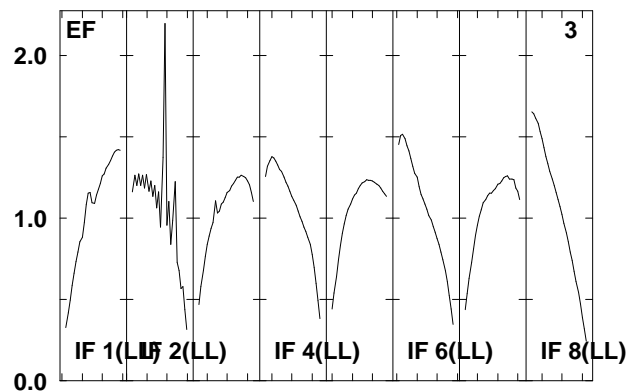
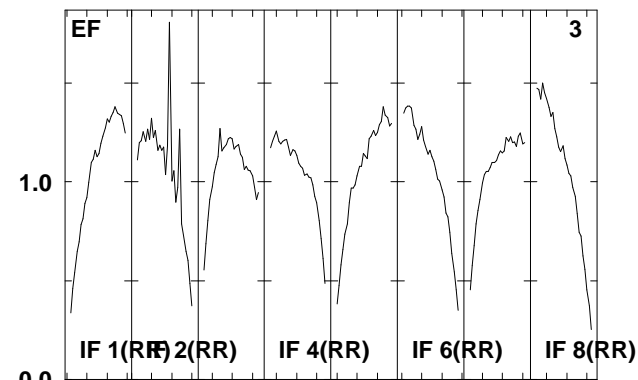
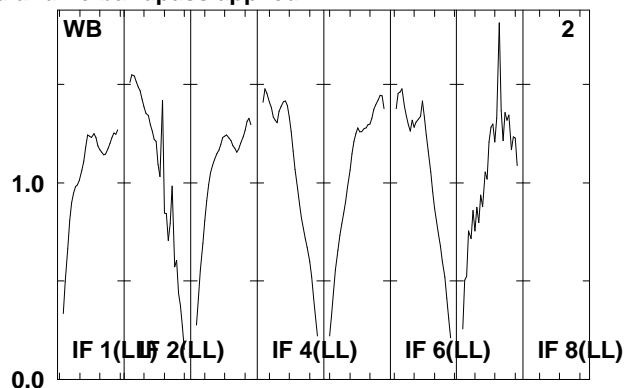
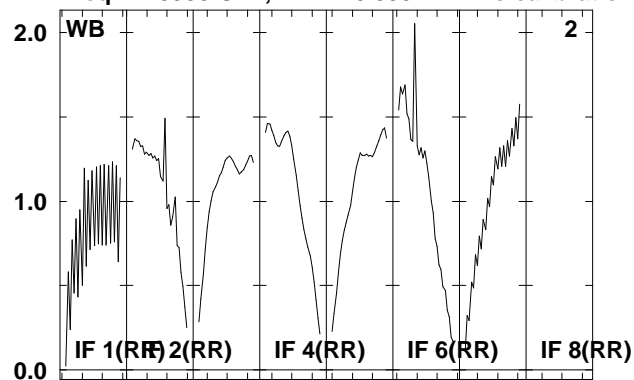

Lower frame: Real Jy  
Total-power spectrum Antenna: \*  
Timerange: 00/09:17:47 to 00/09:19:11

Plot file version 256 created 08-AUG-2008 17:00:34

J0209+13 EO006B.UVDATA.1

Freq = 1.5950 GHz, Bw = 16.000 MH No calibration applied and no bandpass applied

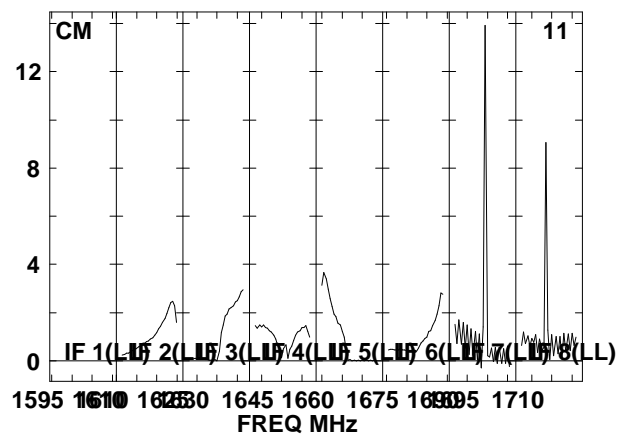
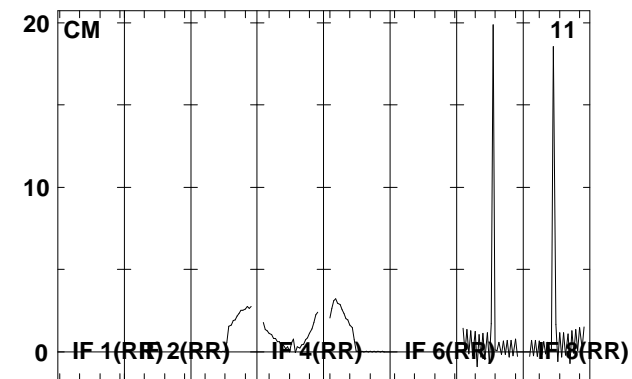
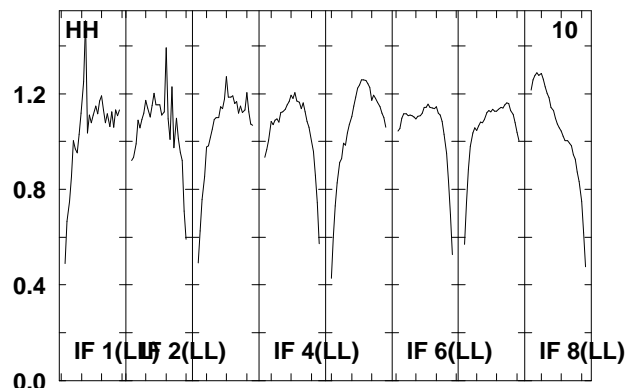
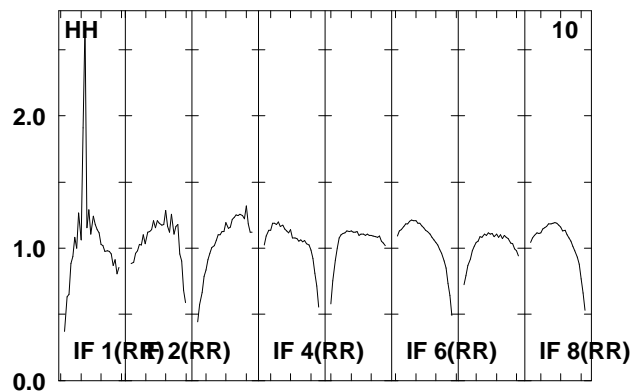
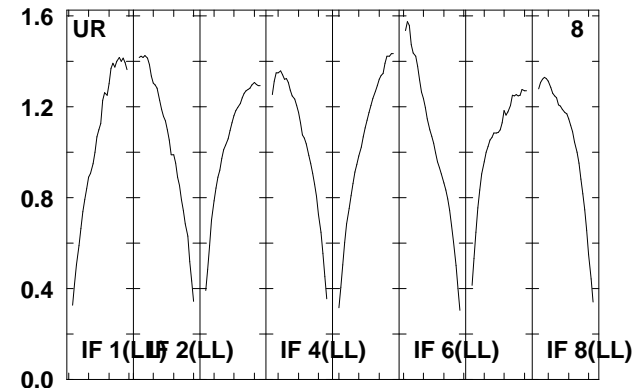
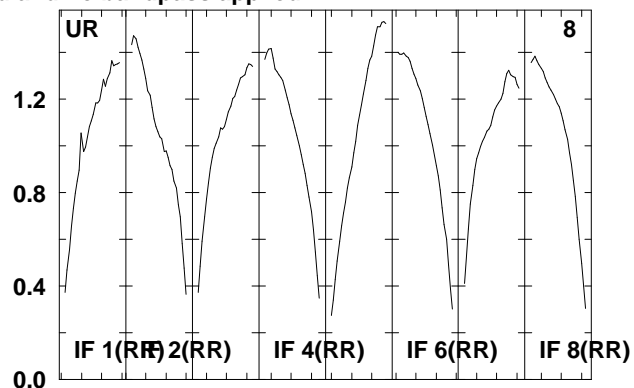
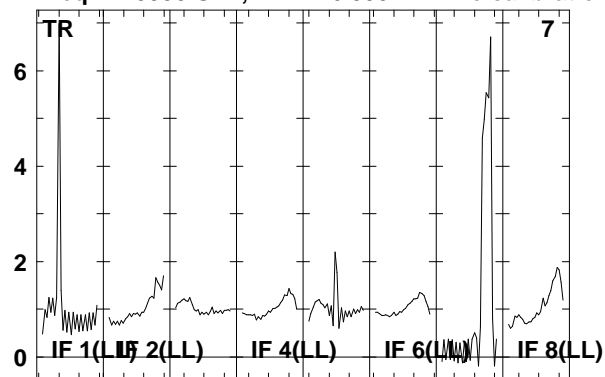

Lower frame: Real Jy

Total-power spectrum Antenna: \*

Timerange: 00/09:17:47 to 00/09:19:11

Plot file version 257 created 08-AUG-2008 17:00:35

J021348 EO006B.UVDATA.1

Freq = 1.5950 GHz, Bw = 16.000 MH No calibration applied and no bandpass applied

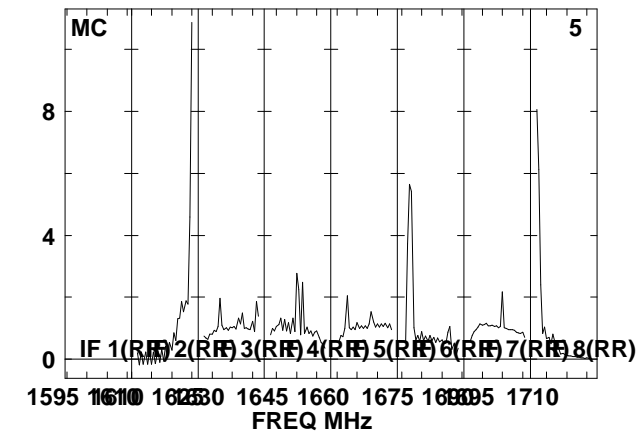
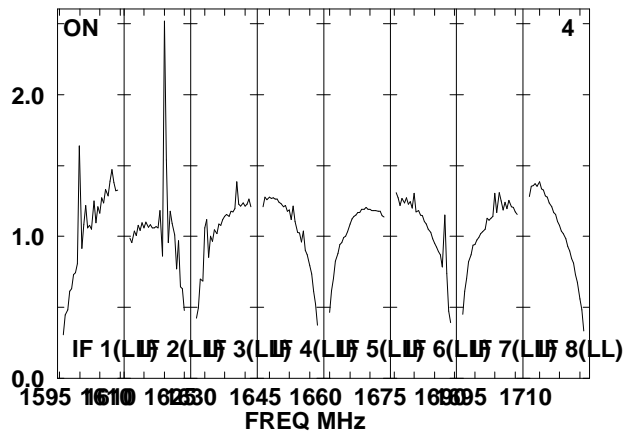
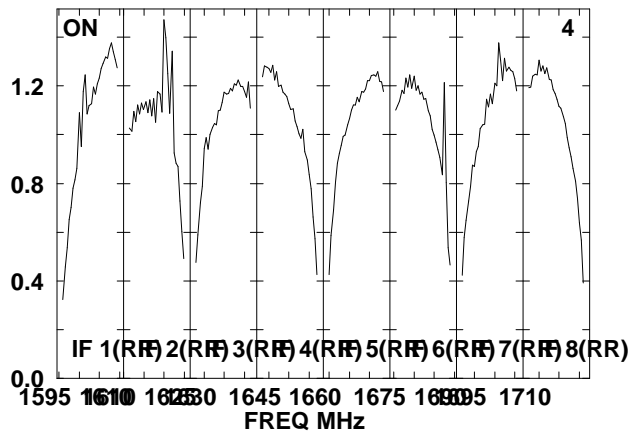
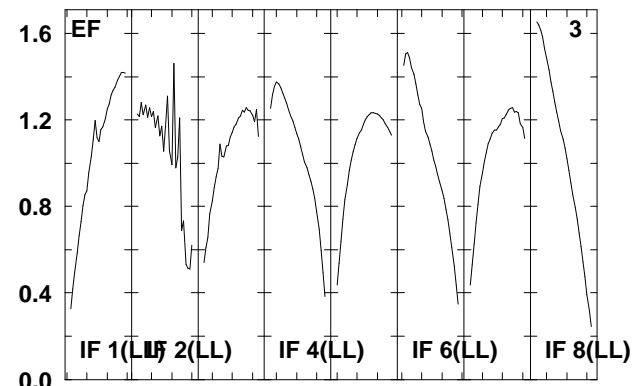
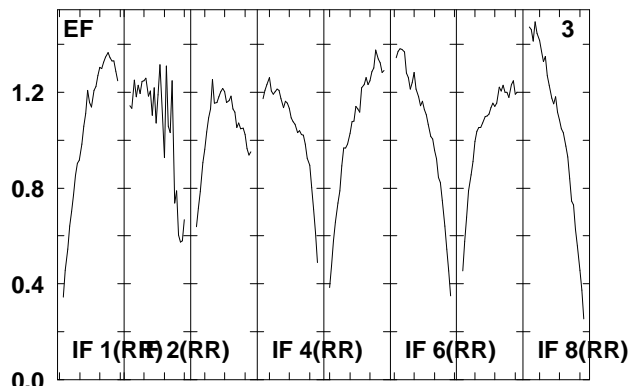
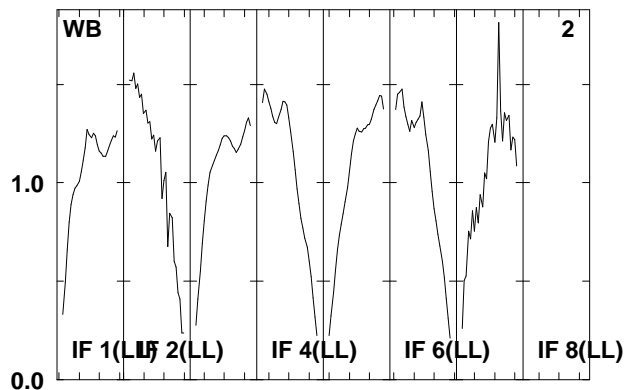
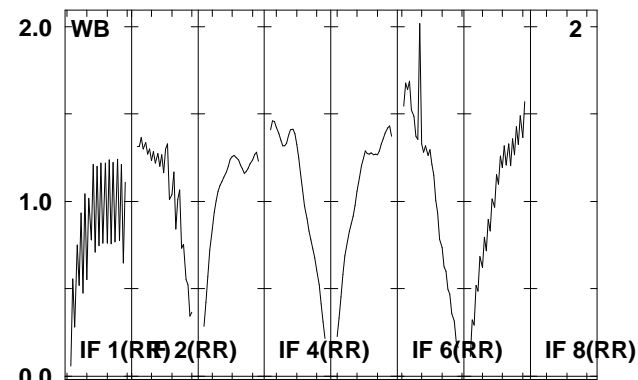
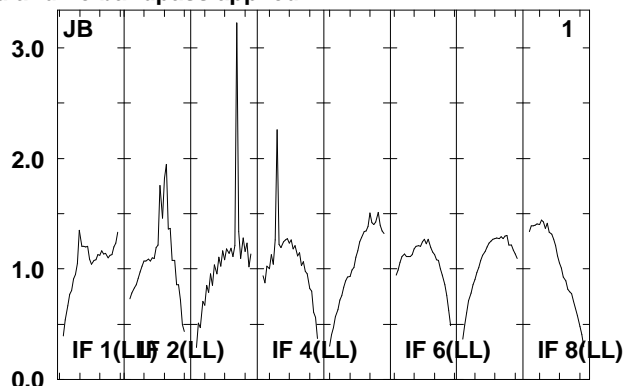
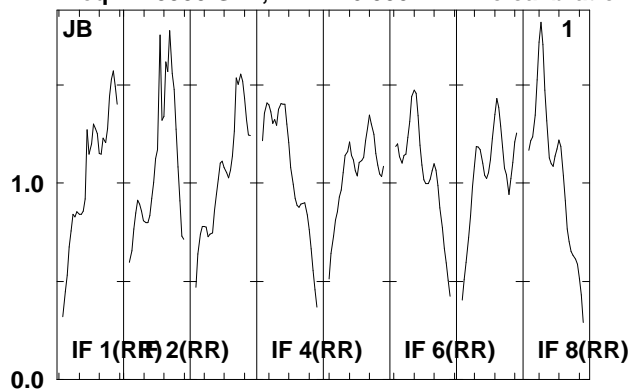

Lower frame: Real Jy

Total-power spectrum Antenna: \*

Timerange: 00/09:19:53 to 00/09:24:21

Plot file version 258 created 08-AUG-2008 17:00:35

J021348 EO006B.UVDATA.1

Freq = 1.5950 GHz, Bw = 16.000 MH No calibration applied and no bandpass applied

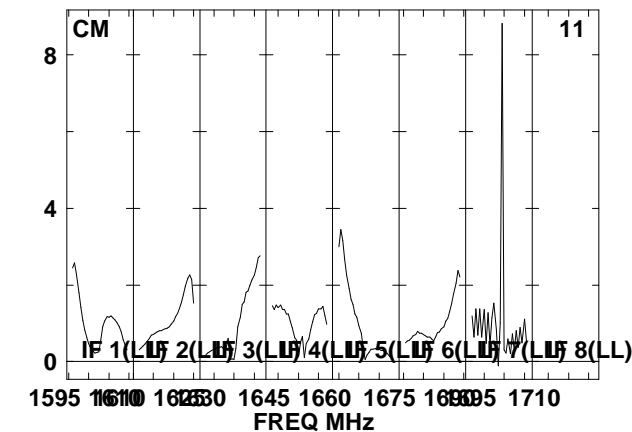
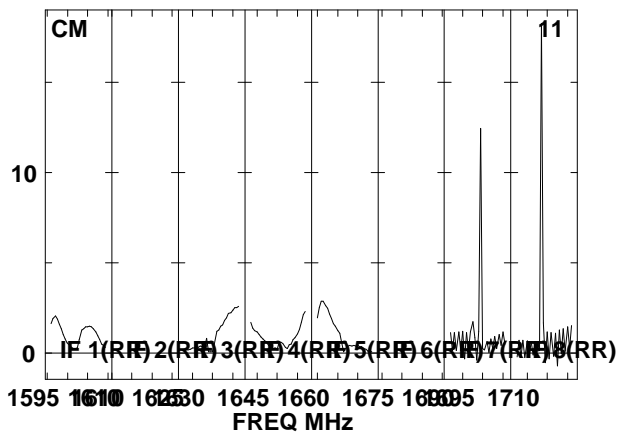
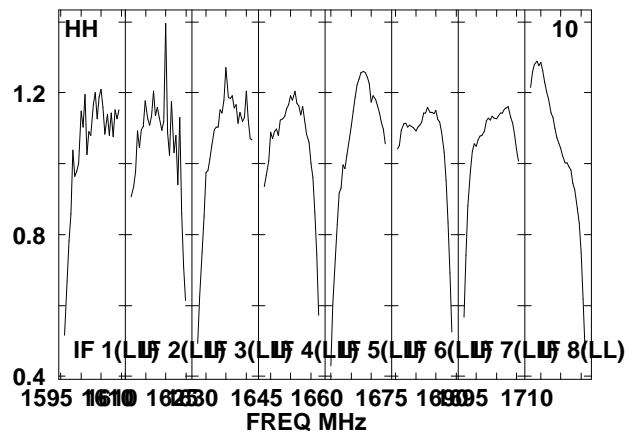
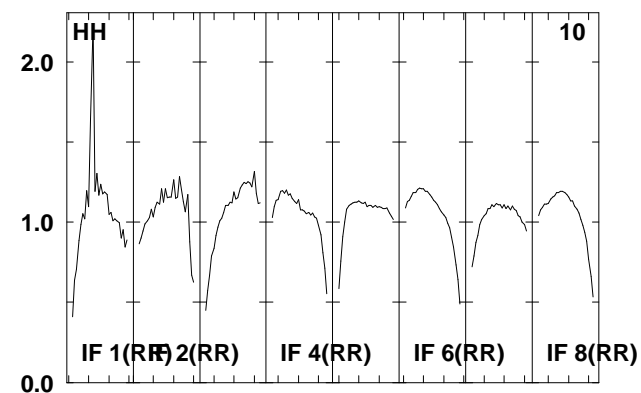
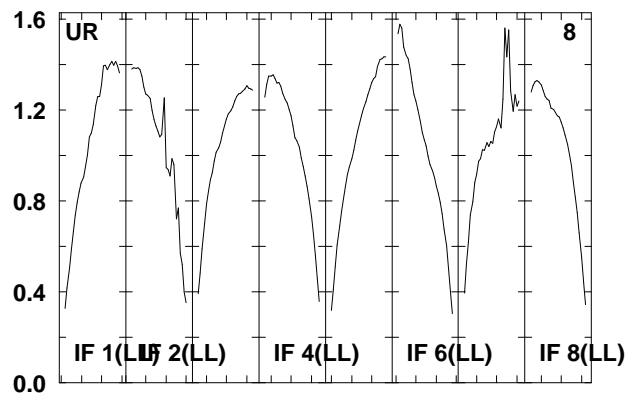
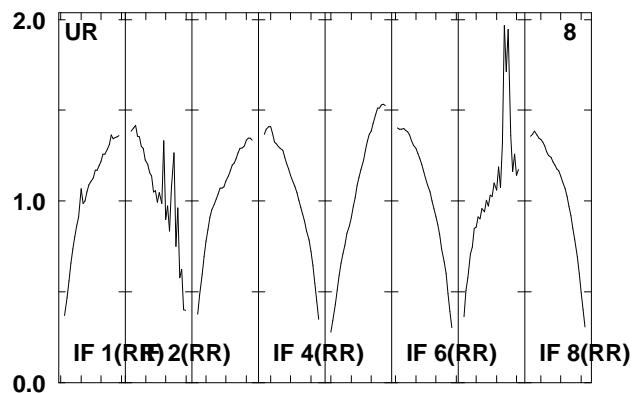
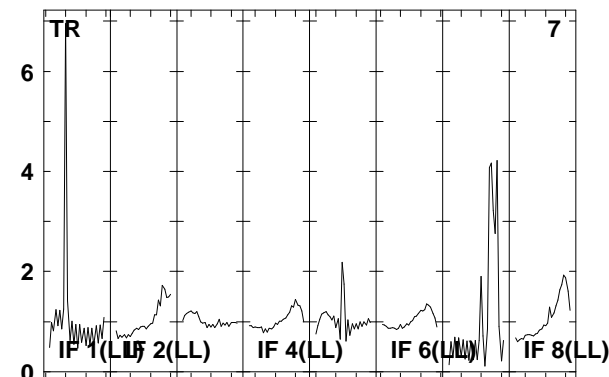
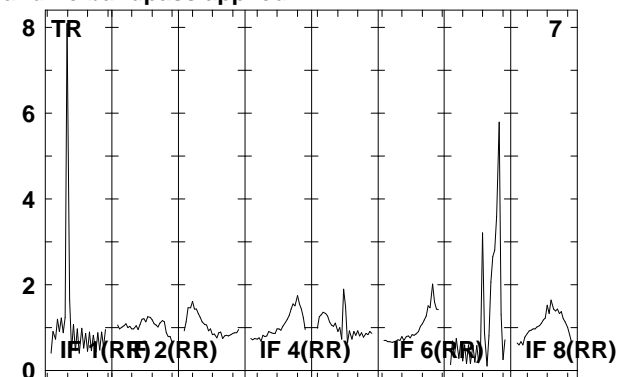
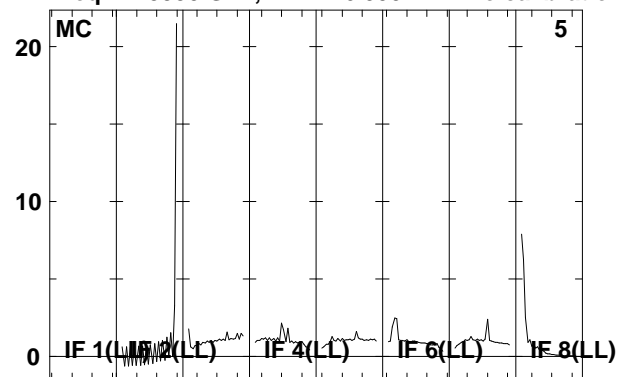

Lower frame: Real Jy

Total-power spectrum Antenna: \*

Timerange: 00/09:19:53 to 00/09:24:21

Plot file version 259 created 08-AUG-2008 17:00:36

J0209+13 EO006B.UVDATA.1

Freq = 1.5950 GHz, Bw = 16.000 MH No calibration applied and no bandpass applied

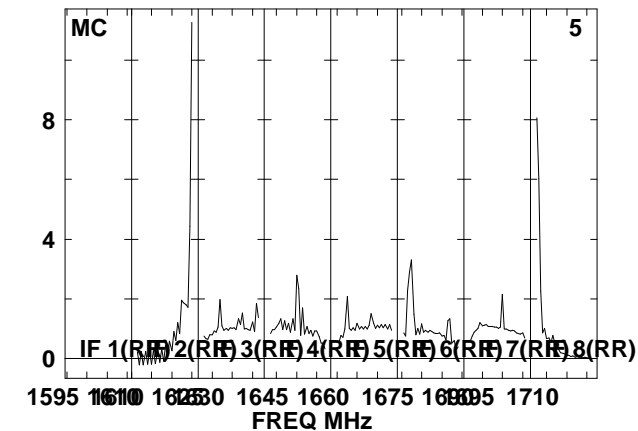
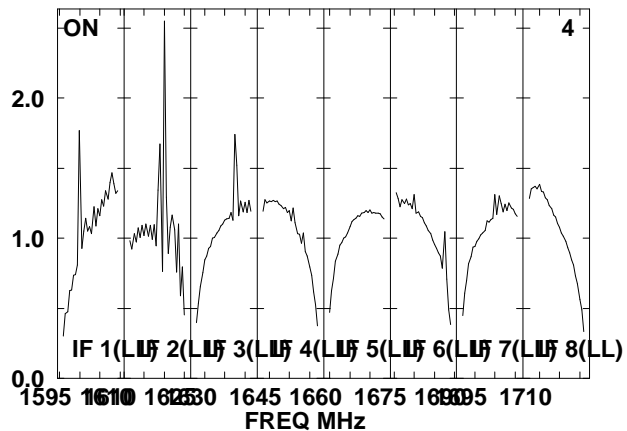
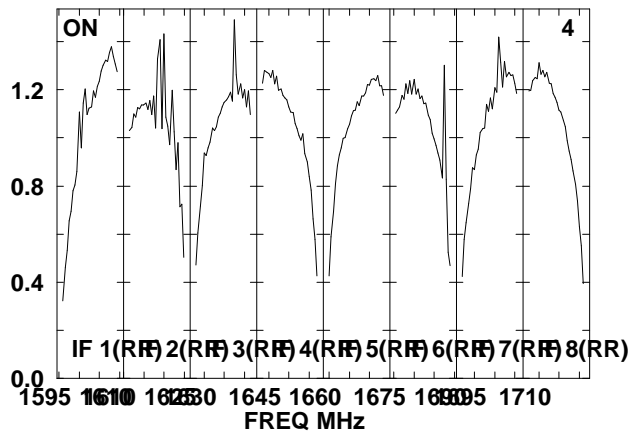
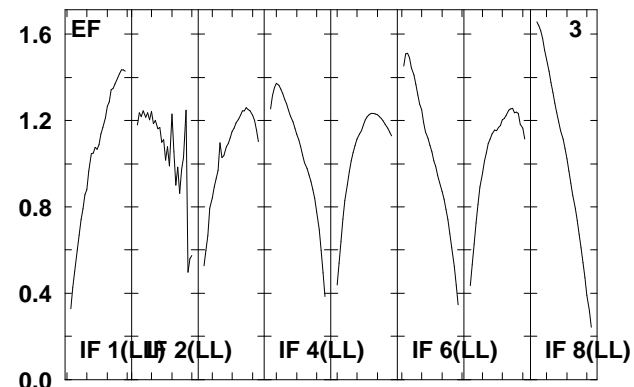
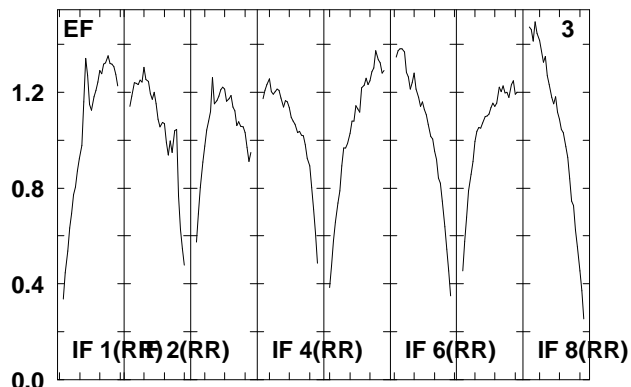
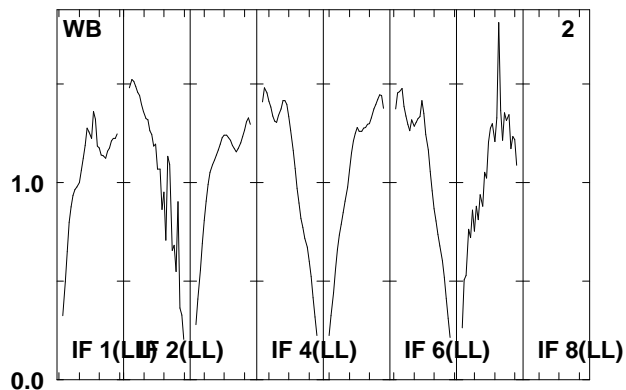
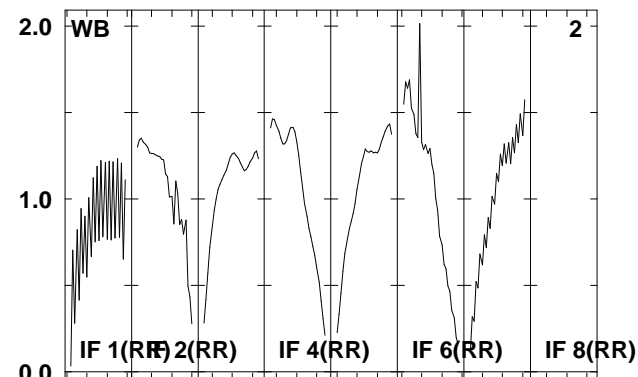
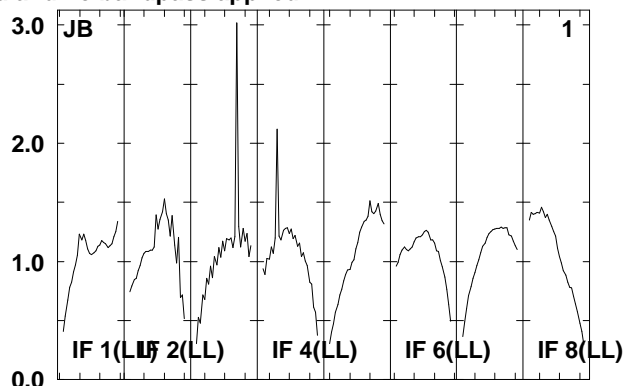
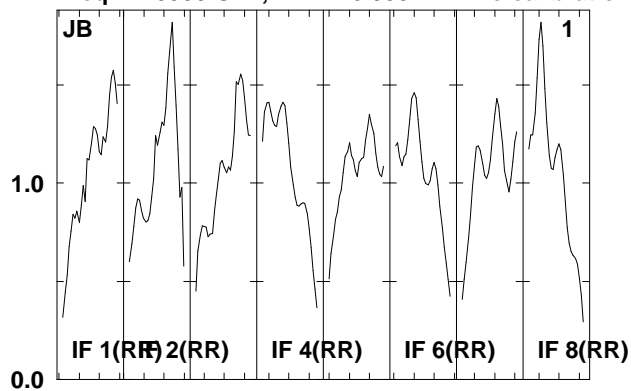

Lower frame: Real Jy

Total-power spectrum Antenna: \*

Timerange: 00/09:25:03 to 00/09:26:31

Plot file version 260 created 08-AUG-2008 17:00:36

J0209+13 EO006B.UVDATA.1

Freq = 1.5950 GHz, Bw = 16.000 MH No calibration applied and no bandpass applied

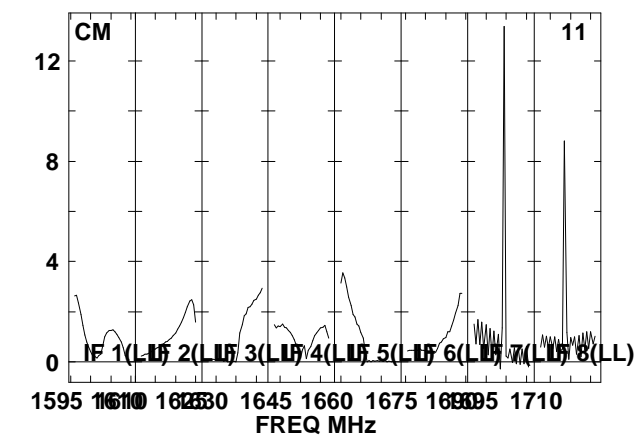
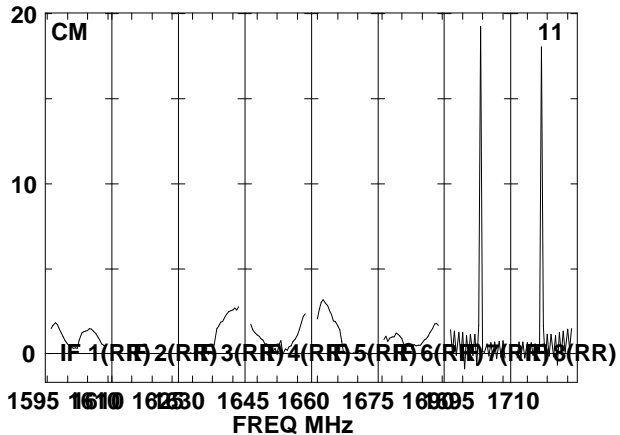
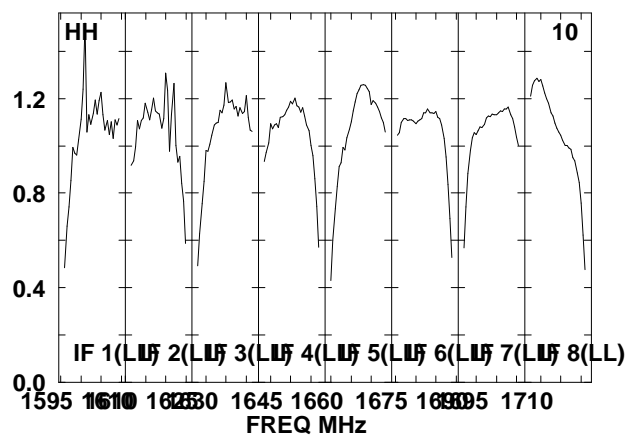
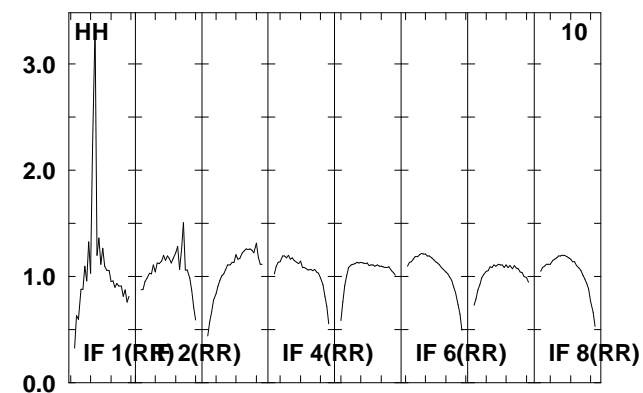
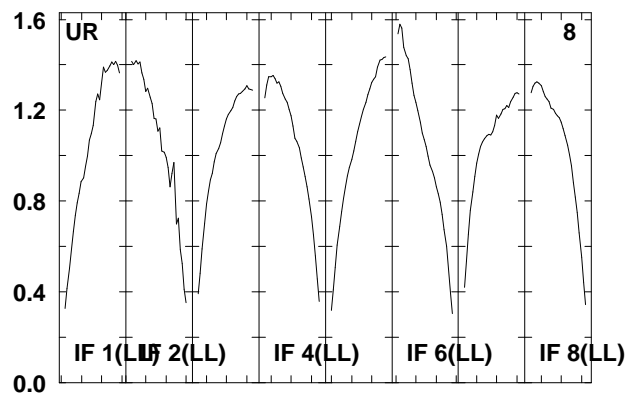
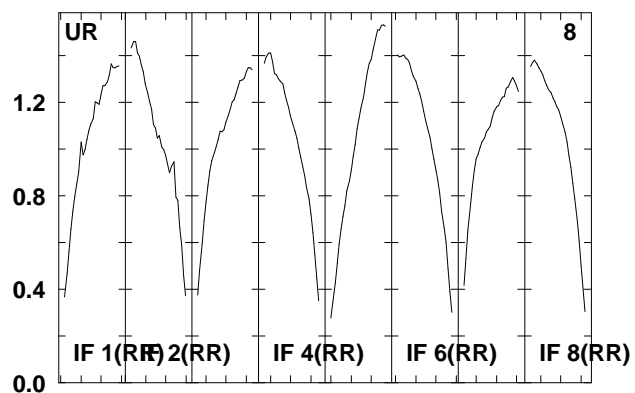
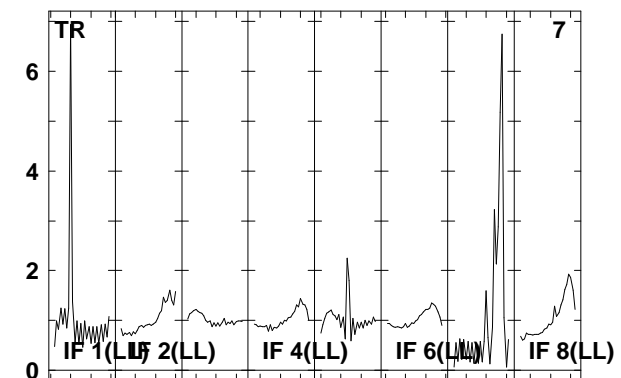
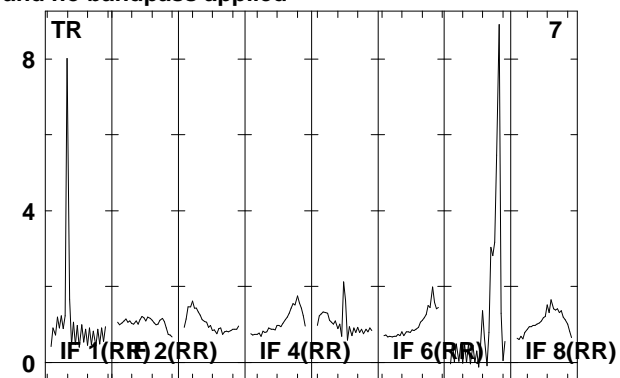
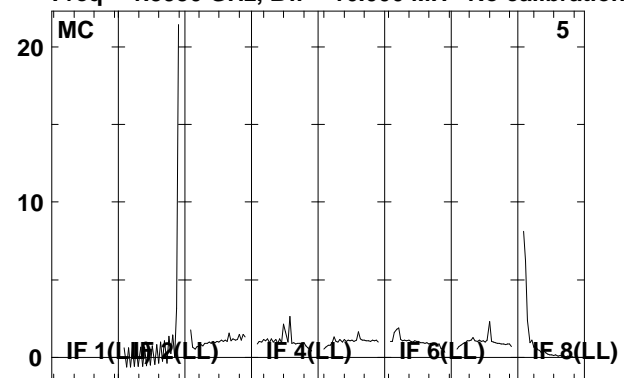

Lower frame: Real Jy

Total-power spectrum Antenna: \*

Timerange: 00/09:25:03 to 00/09:26:31



Plot file version 261 created 08-AUG-2008 17:00:37

J0920+44 EO006B.UVDATA.1

Freq = 1.5950 GHz, Bw = 16.000 MH No calibration applied and no bandpass applied

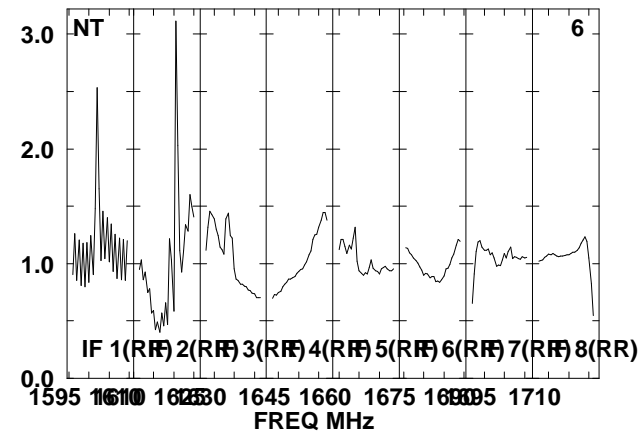
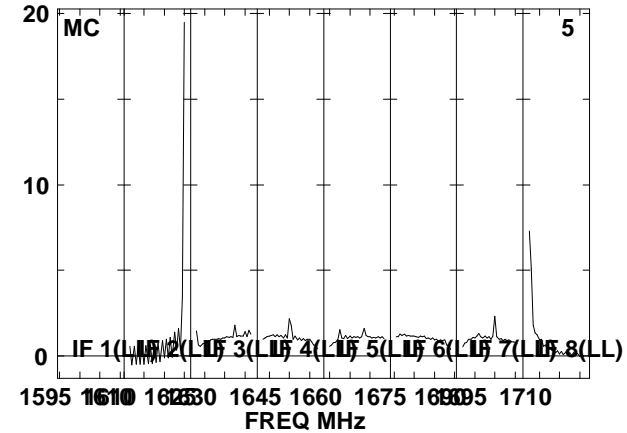
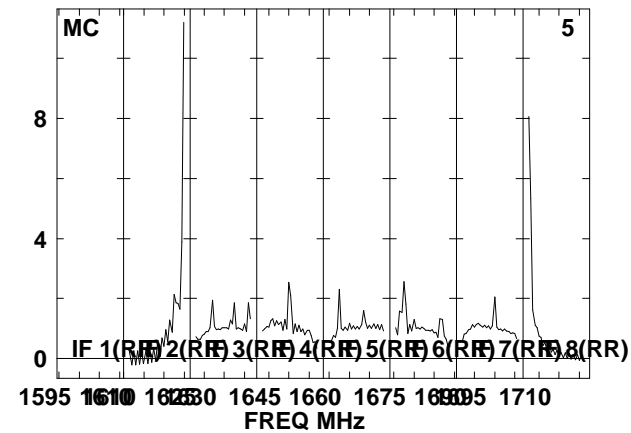
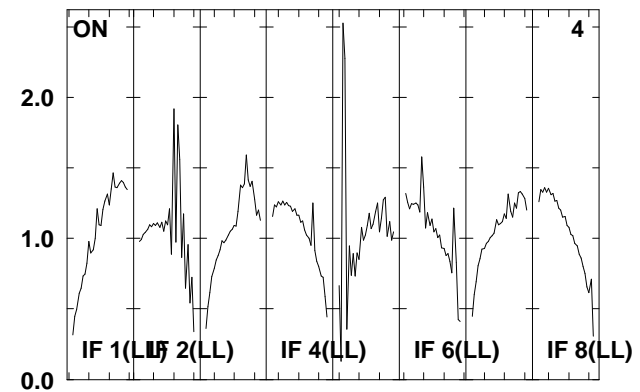
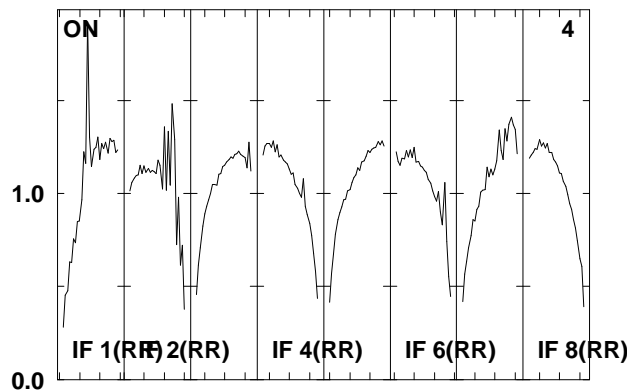
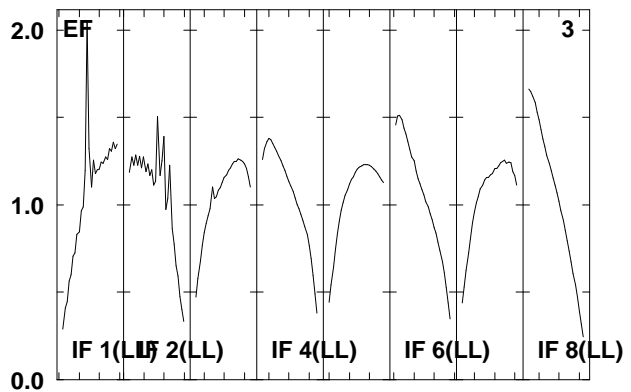
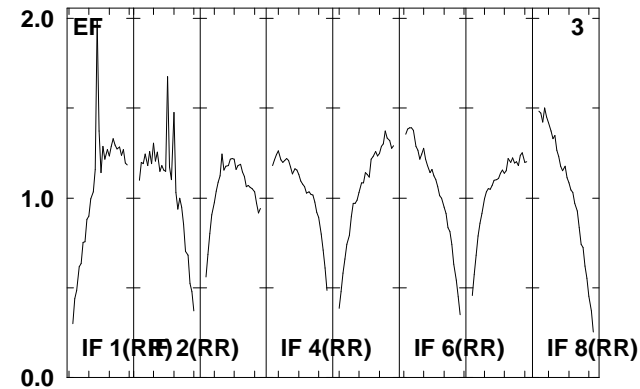
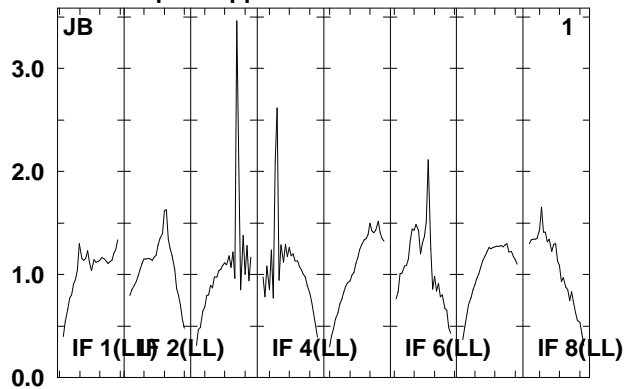
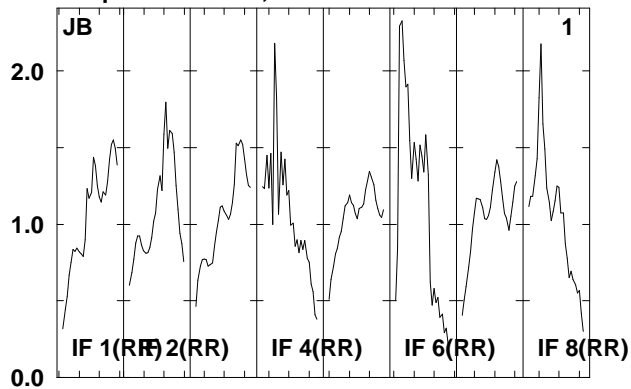

Lower frame: Real Jy  
Total-power spectrum Antenna: \*  
Timerange: 00/09:35:43 to 00/09:37:19

Plot file version 262 created 08-AUG-2008 17:00:38  
 J0920+44 EO006B.UVDATA.1  
 Freq = 1.5950 GHz, Bw = 16.000 MH No calibration applied and no bandpass applied

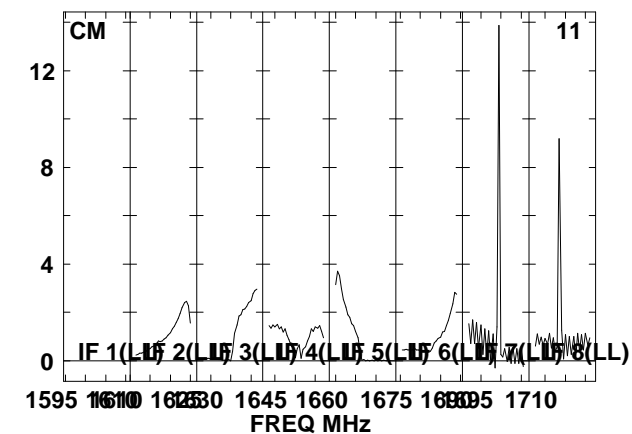
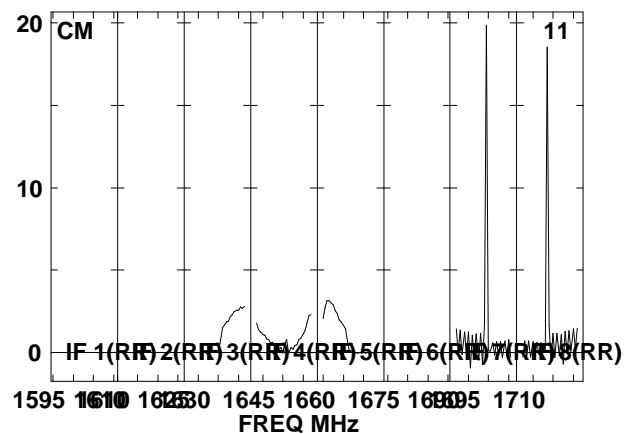
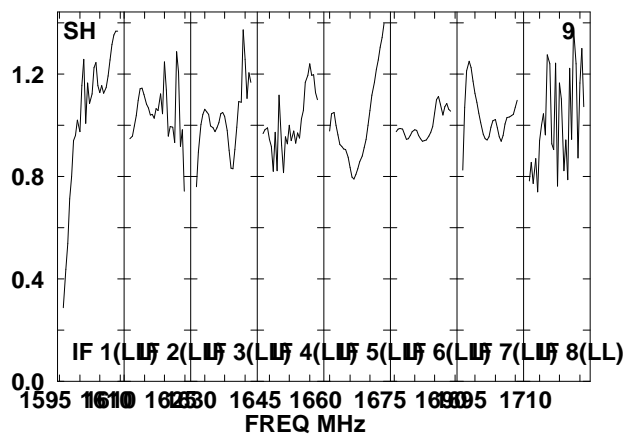
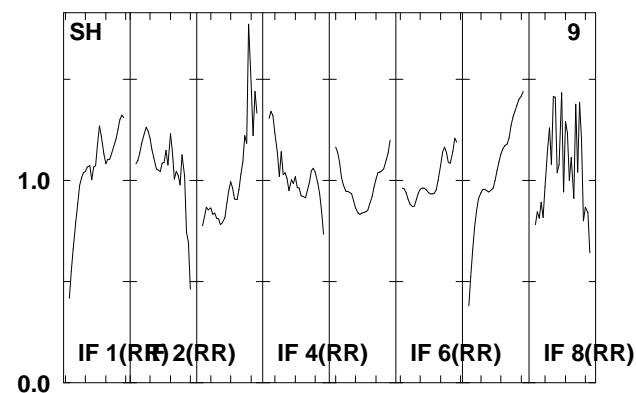
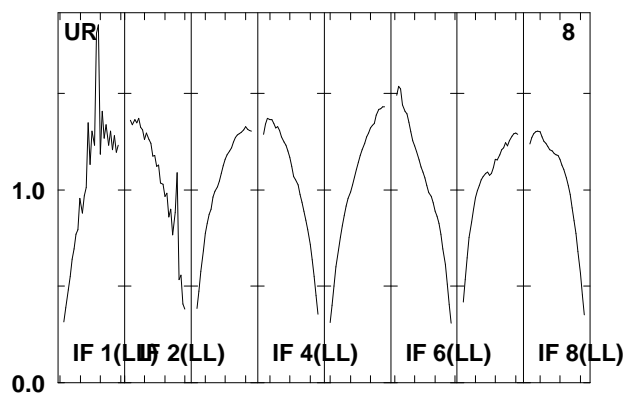
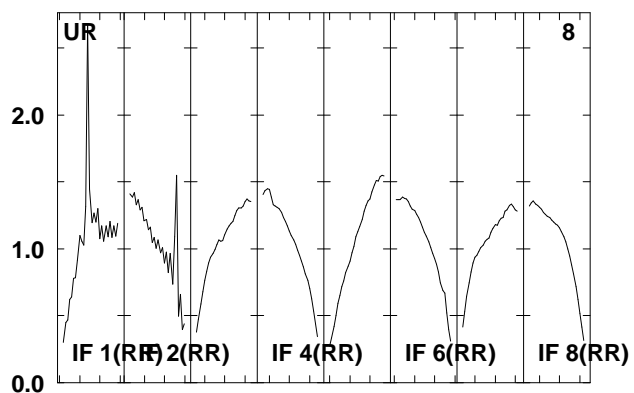
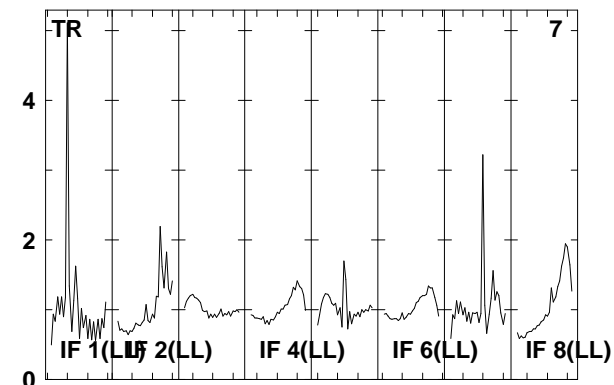
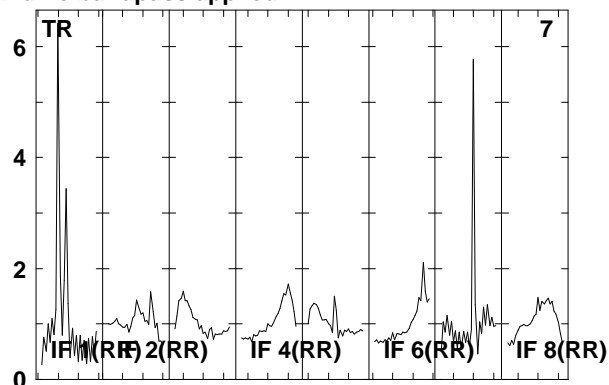
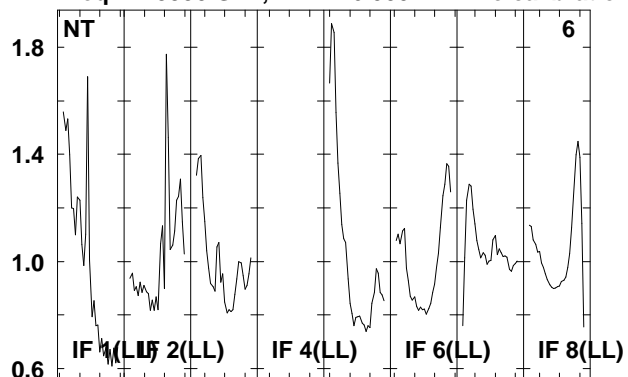

Lower frame: Real Jy  
 Total-power spectrum Antenna: \*  
 Timerange: 00/09:35:43 to 00/09:37:19

Plot file version 263 created 08-AUG-2008 17:00:38

J092159 EO006B.UVDATA.1

Freq = 1.5950 GHz, Bw = 16.000 MH No calibration applied and no bandpass applied

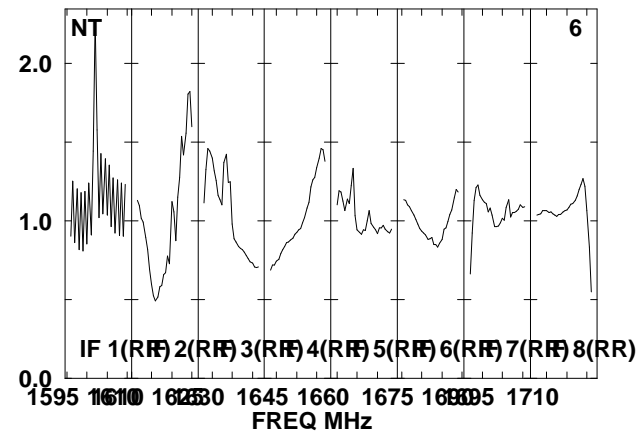
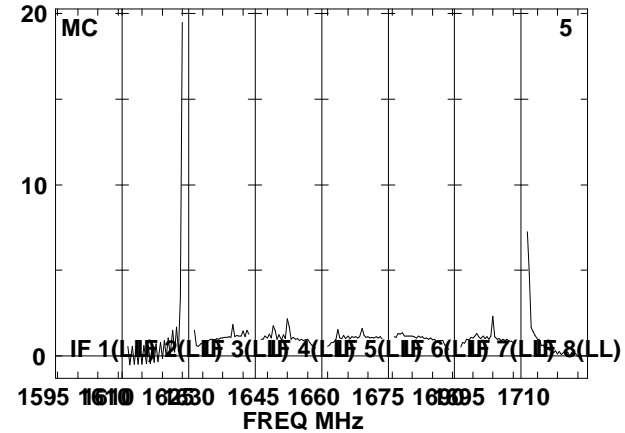
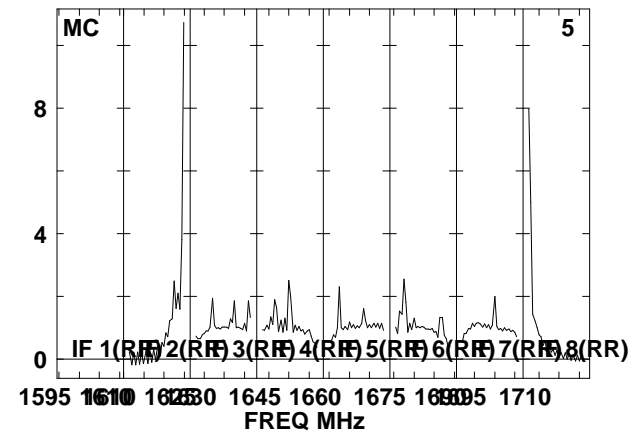
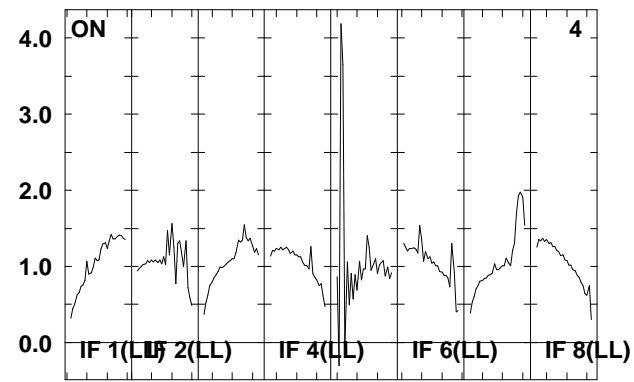
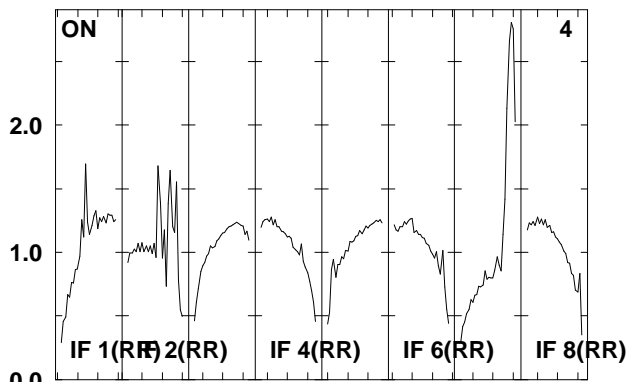
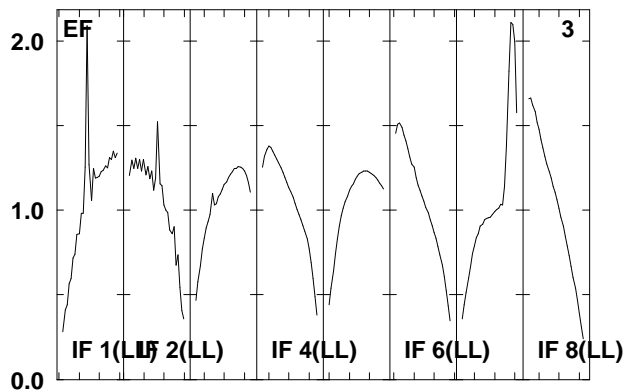
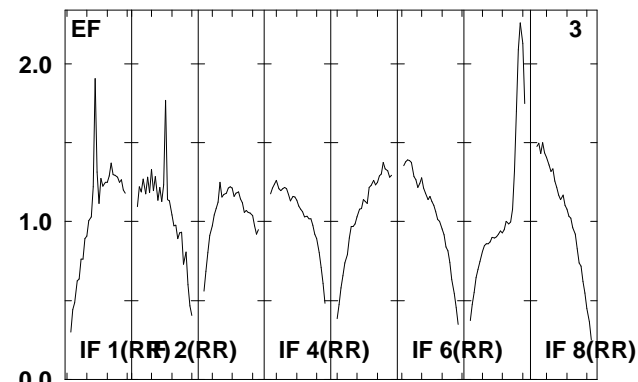
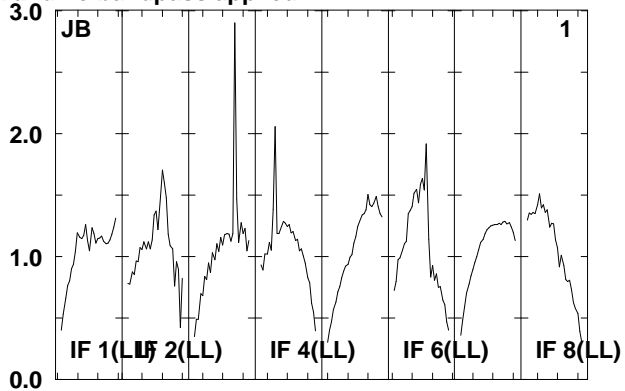
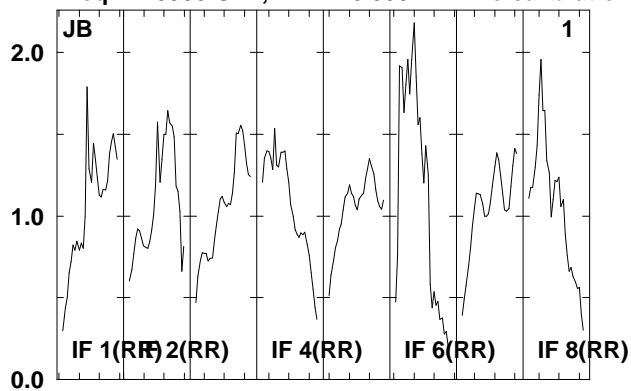

Lower frame: Real Jy  
Total-power spectrum Antenna: \*  
Timerange: 00/09:37:55 to 00/09:42:23

Plot file version 264 created 08-AUG-2008 17:00:39

J092159 EO006B.UVDATA.1

Freq = 1.5950 GHz, Bw = 16.000 MH No calibration applied and no bandpass applied

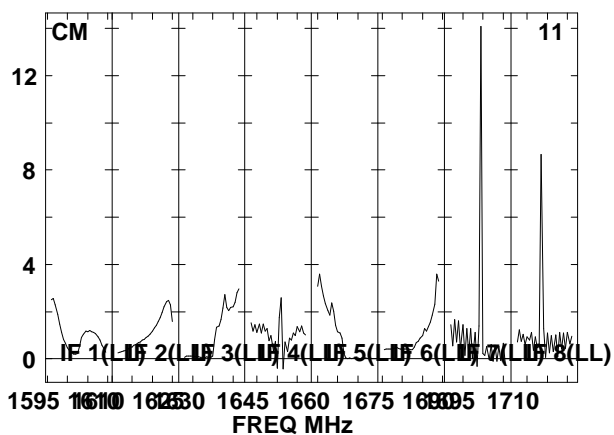
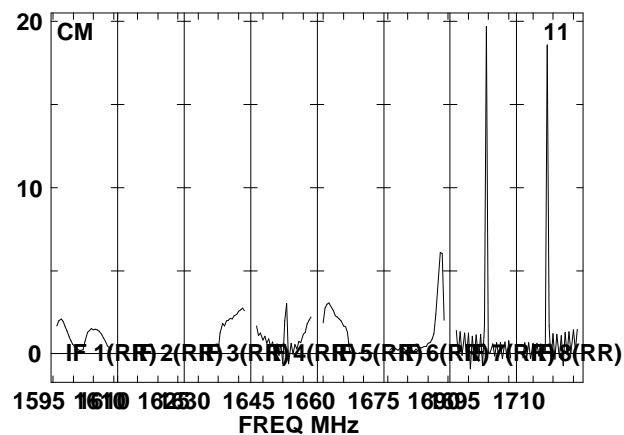
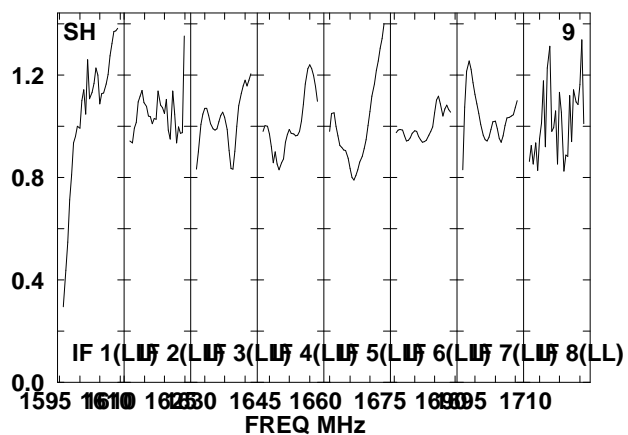
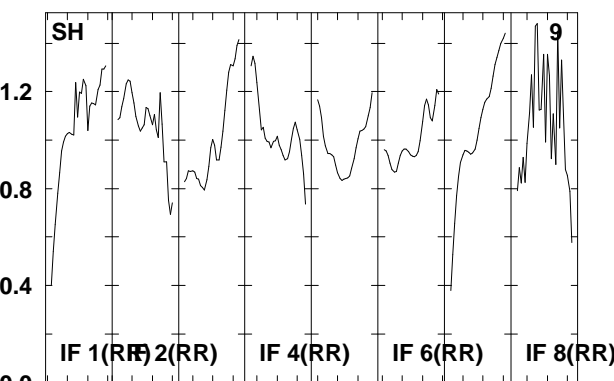
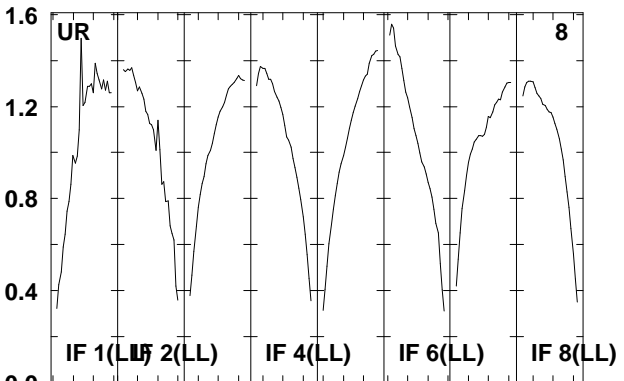
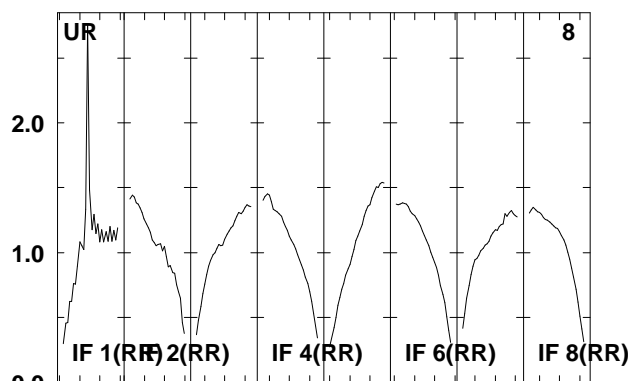
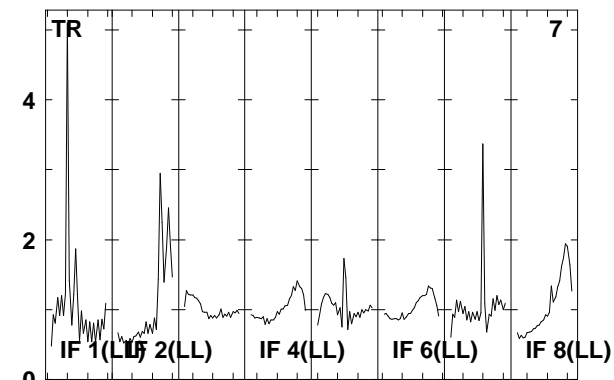
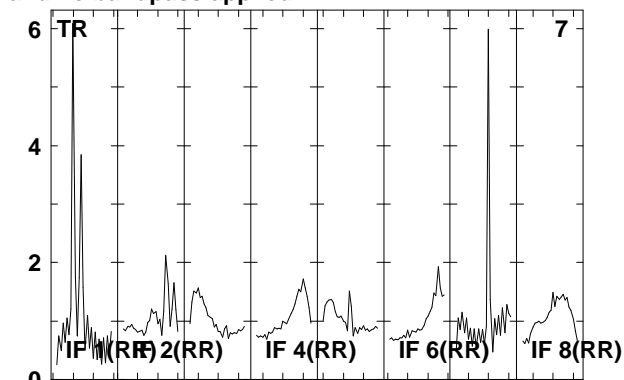
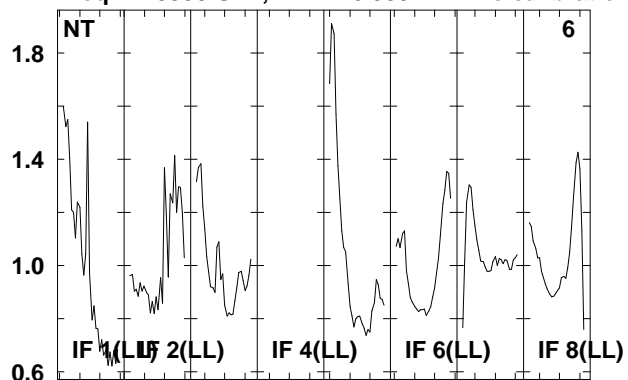

Lower frame: Real Jy  
Total-power spectrum Antenna: \*  
Timerange: 00/09:37:55 to 00/09:42:23

Plot file version 265 created 08-AUG-2008 17:00:40

J0920+44 EO006B.UVDATA.1

Freq = 1.5950 GHz, Bw = 16.000 MH No calibration applied and no bandpass applied

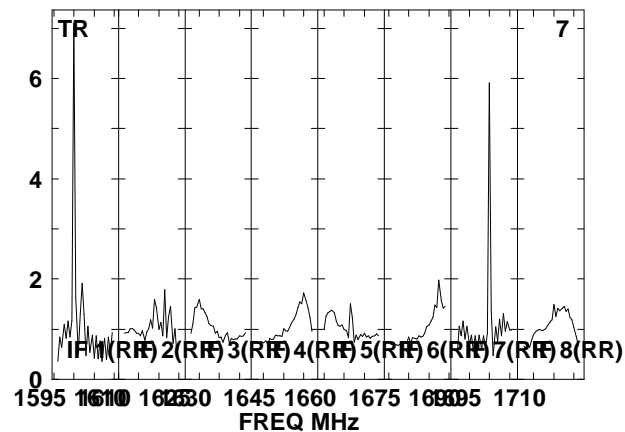
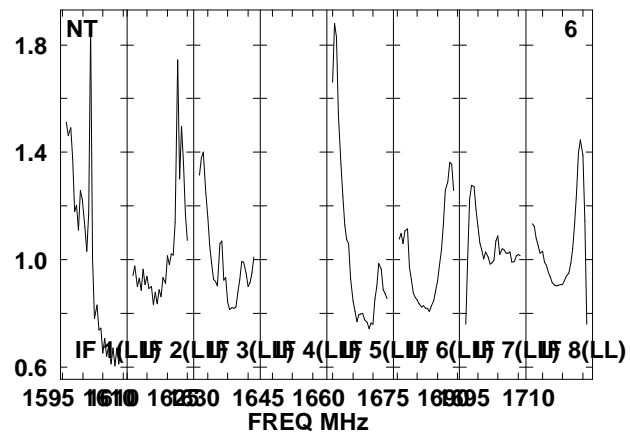
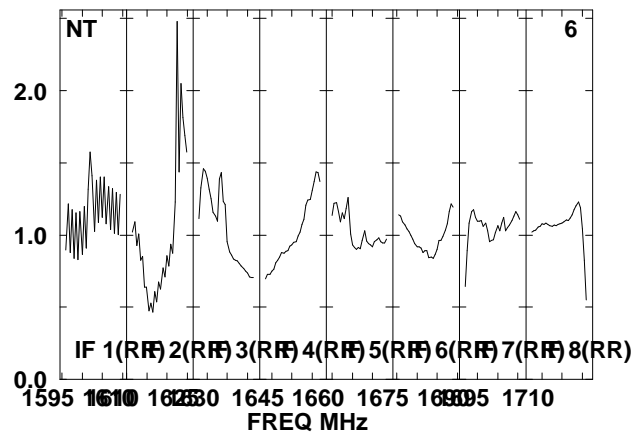
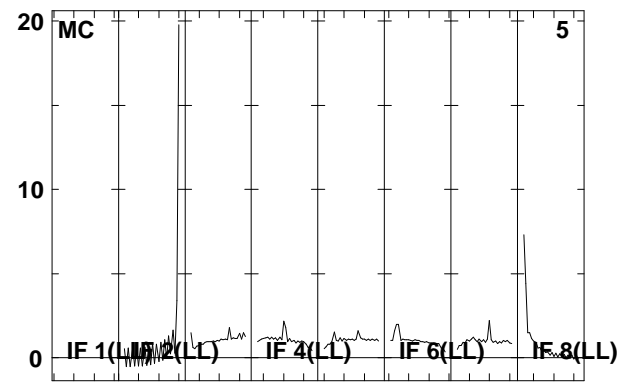
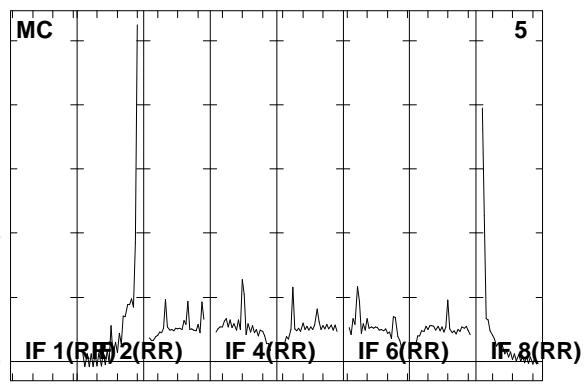
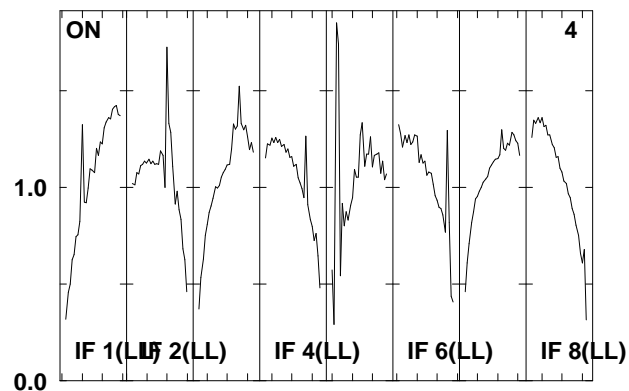
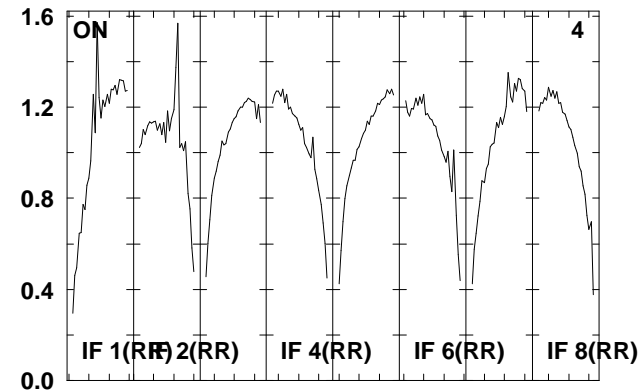
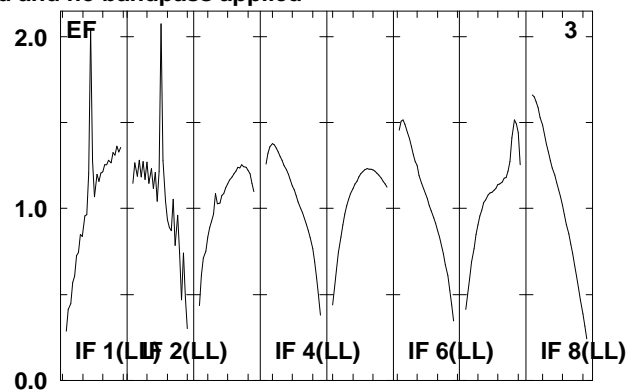
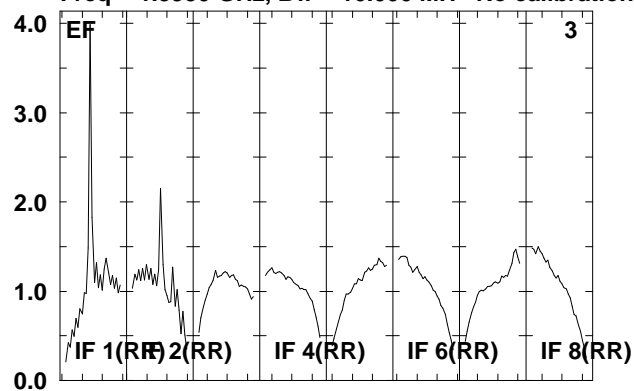

Lower frame: Real Jy  
Total-power spectrum Antenna: \*  
Timerange: 00/09:43:03 to 00/09:44:31

Plot file version 266 created 08-AUG-2008 17:00:40

J0920+44 EO006B.UVDATA.1

Freq = 1.5950 GHz, Bw = 16.000 MH No calibration applied and no bandpass applied

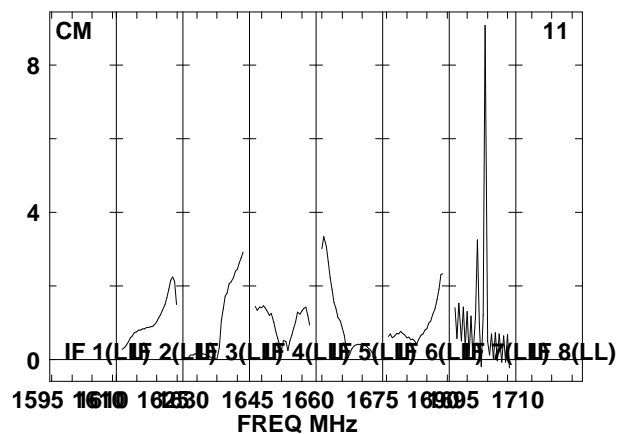
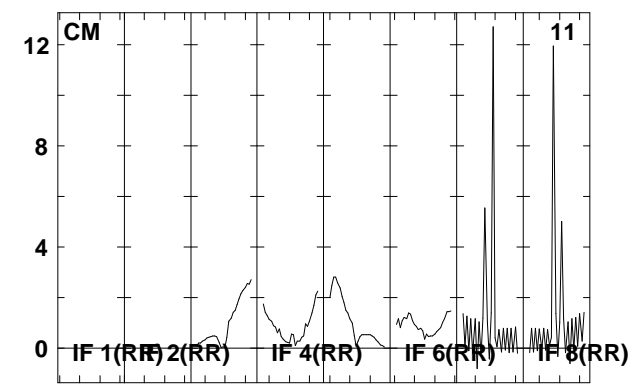
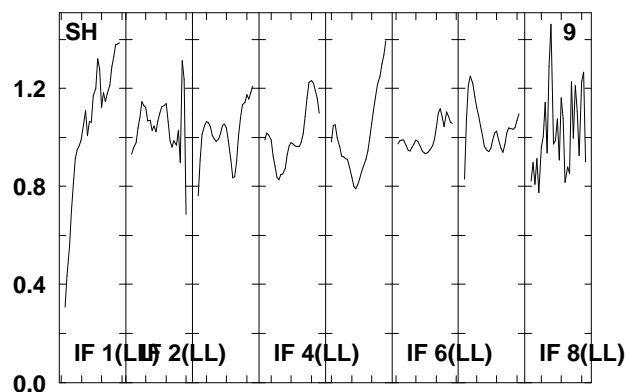
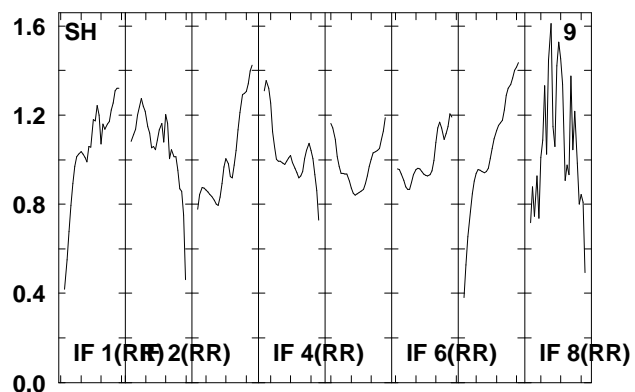
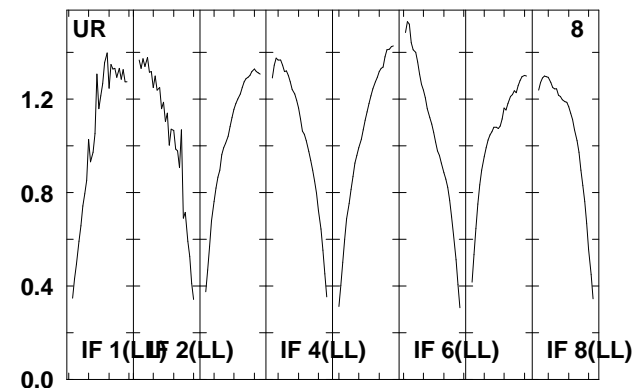
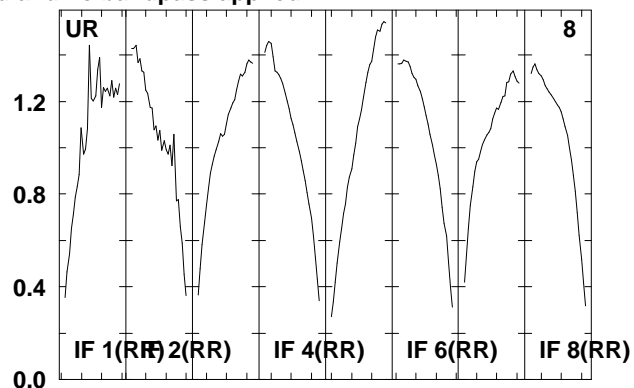
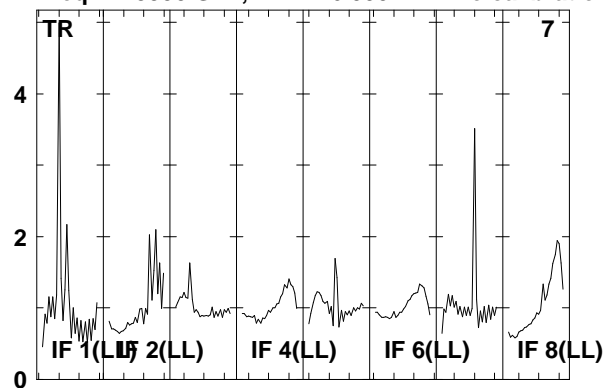

Lower frame: Real Jy

Total-power spectrum Antenna: \*

Timerange: 00/09:43:03 to 00/09:44:31

Plot file version 267 created 08-AUG-2008 17:00:41

J092159 EO006B.UVDATA.1

Freq = 1.5950 GHz, Bw = 16.000 MH No calibration applied and no bandpass applied

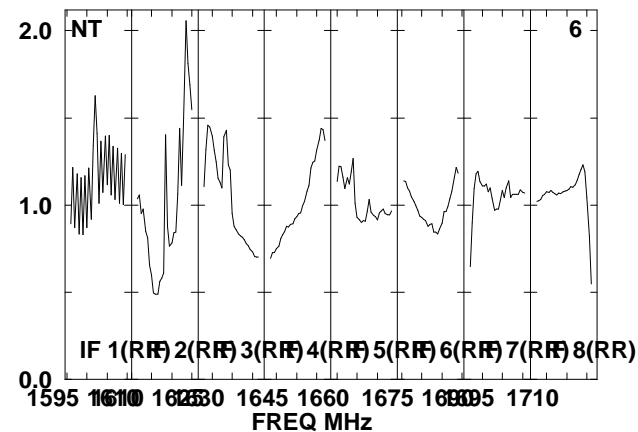
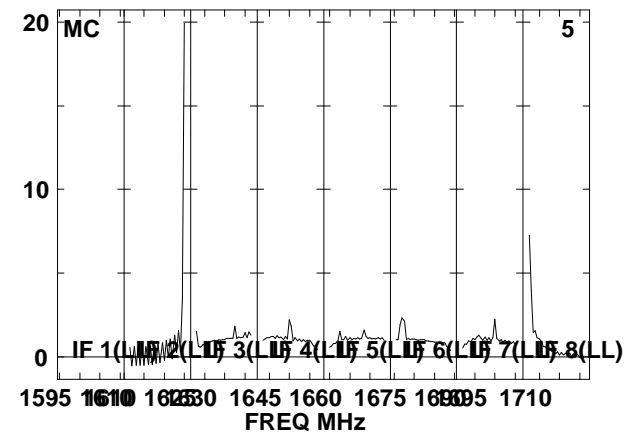
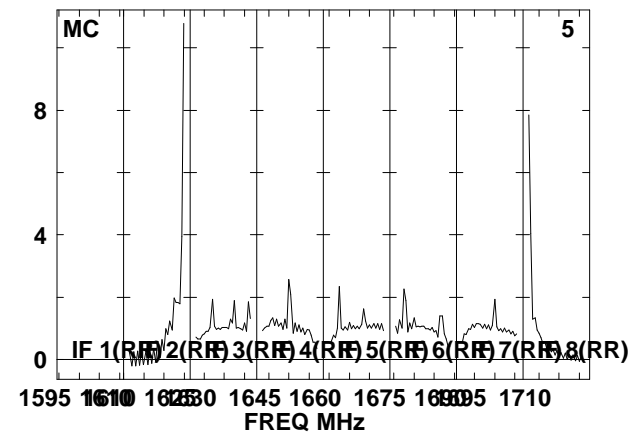
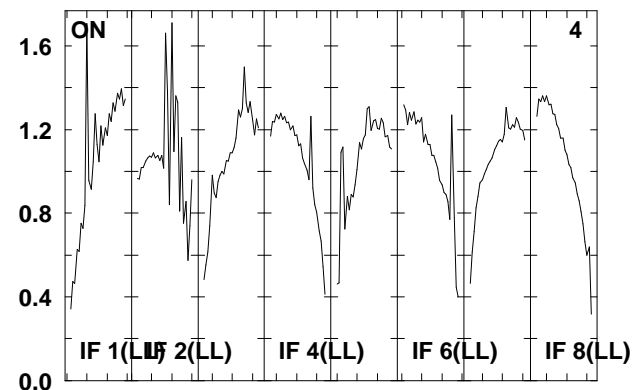
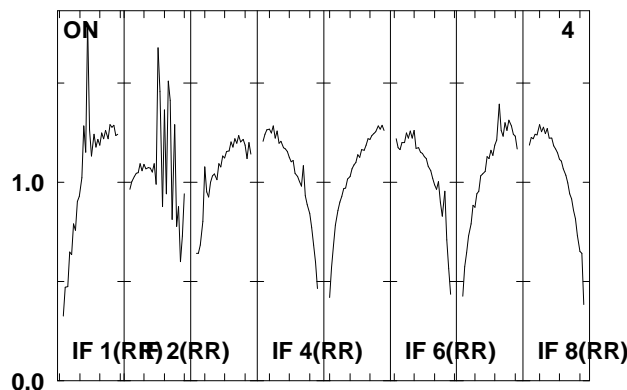
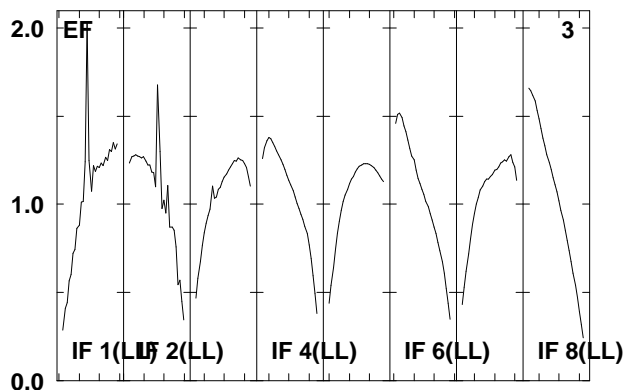
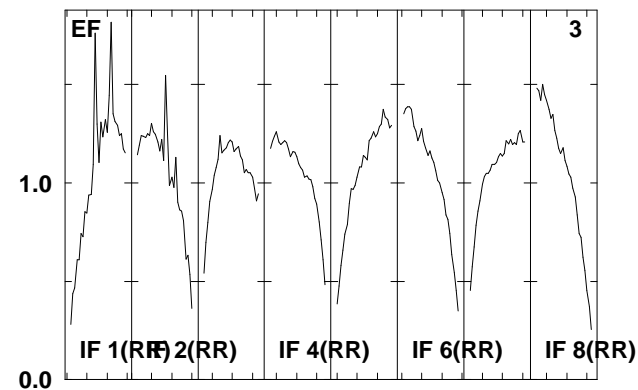
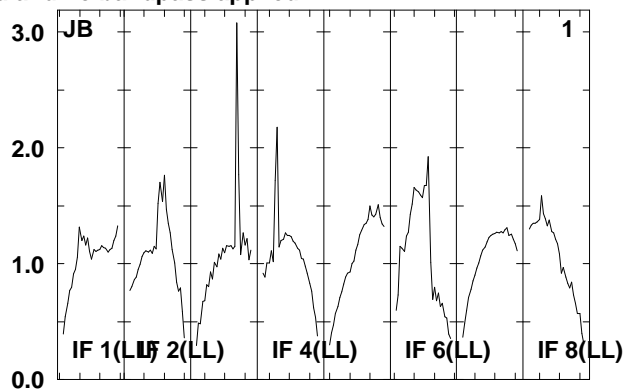
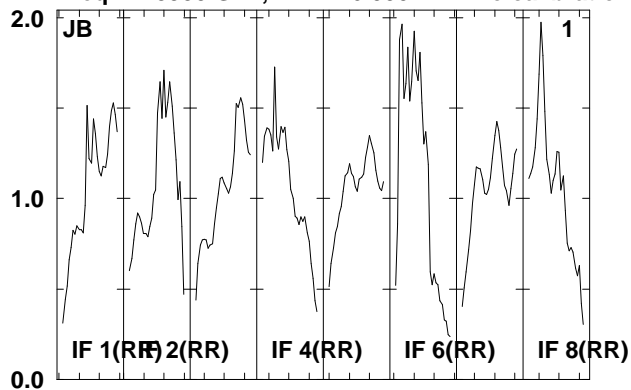

Lower frame: Real Jy  
Total-power spectrum Antenna: \*  
Timerange: 00/09:45:13 to 00/09:49:49

Plot file version 268 created 08-AUG-2008 17:00:42

J092159 EO006B.UVDATA.1

Freq = 1.5950 GHz, Bw = 16.000 MH No calibration applied and no bandpass applied

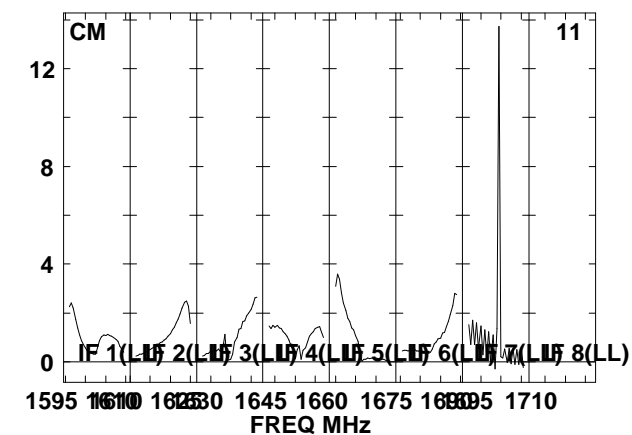
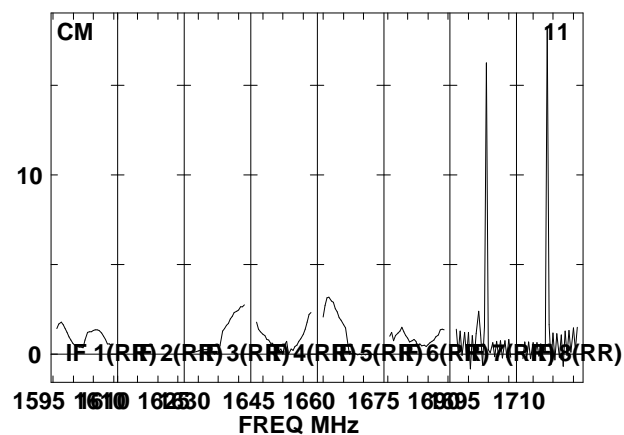
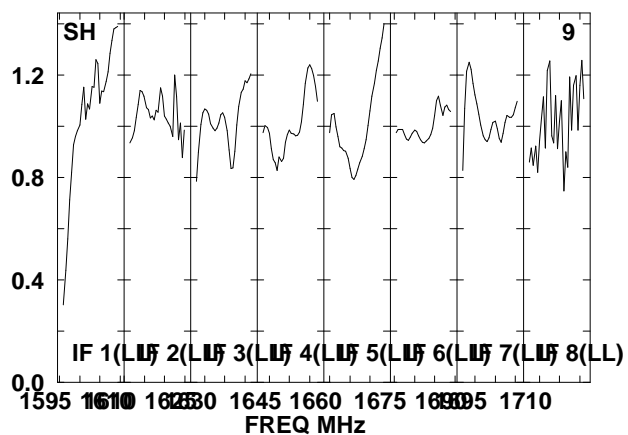
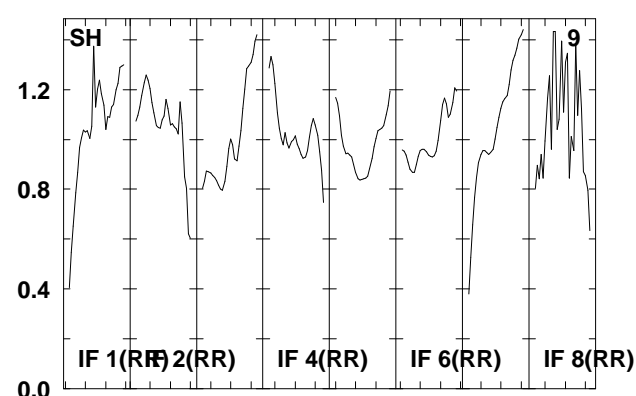
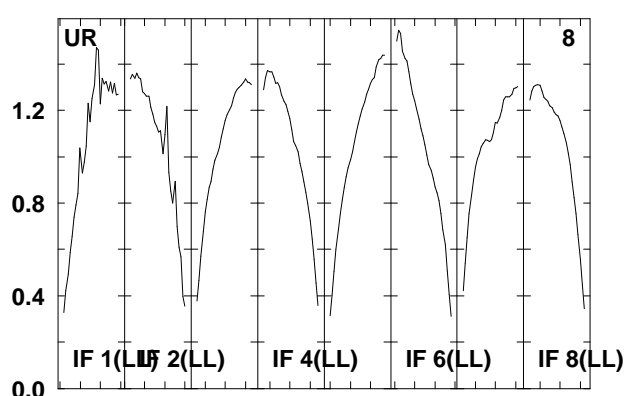
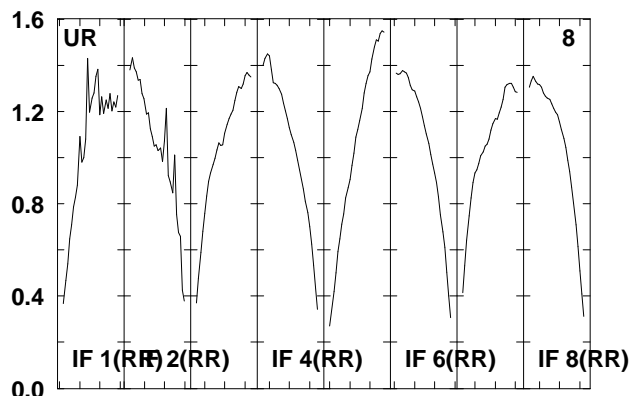
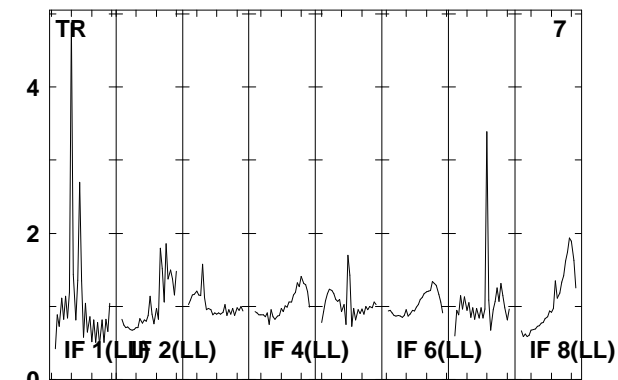
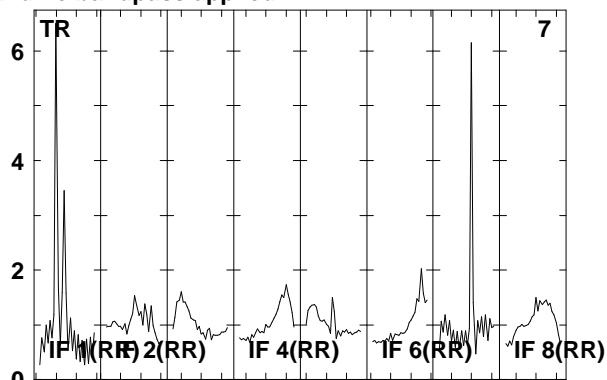
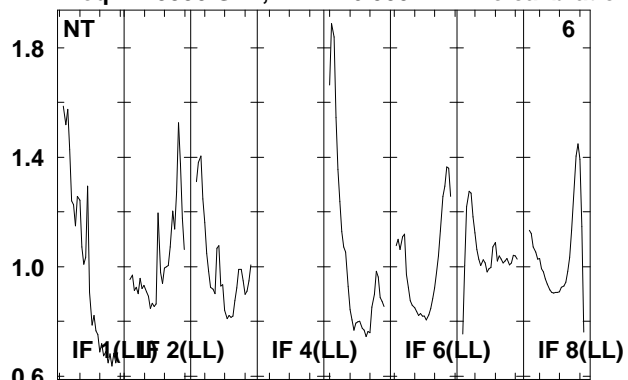

Lower frame: Real Jy

Total-power spectrum Antenna: \*

Timerange: 00/09:45:13 to 00/09:49:49



Plot file version 269 created 08-AUG-2008 17:00:43

J0920+44 EO006B.UVDATA.1

Freq = 1.5950 GHz, Bw = 16.000 MH No calibration applied and no bandpass applied

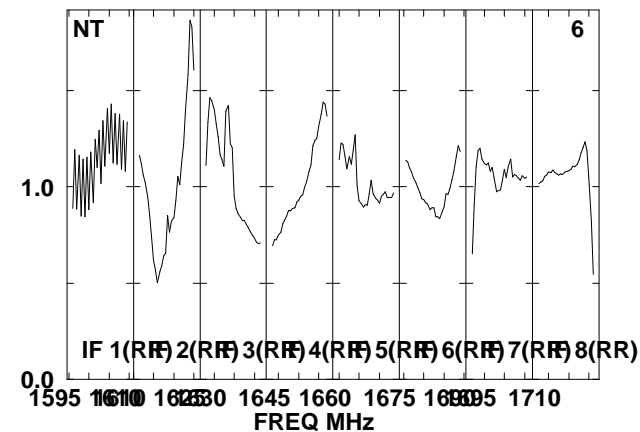
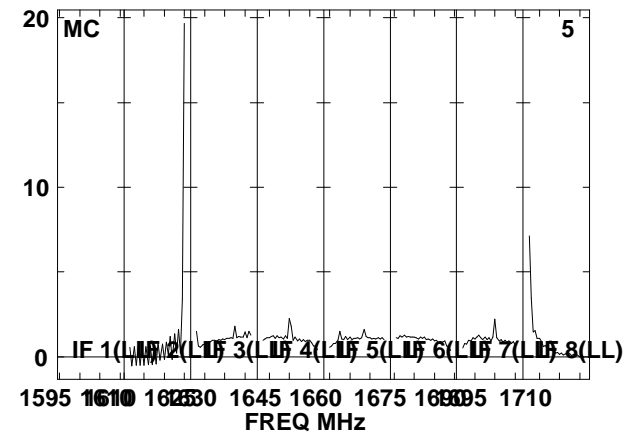
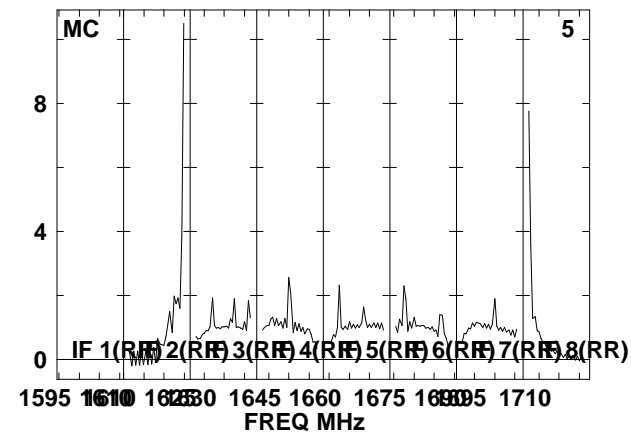
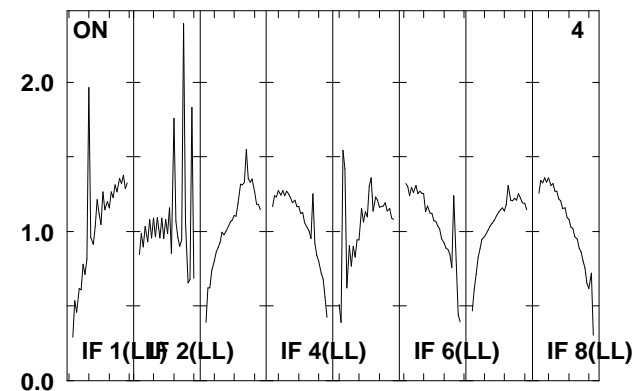
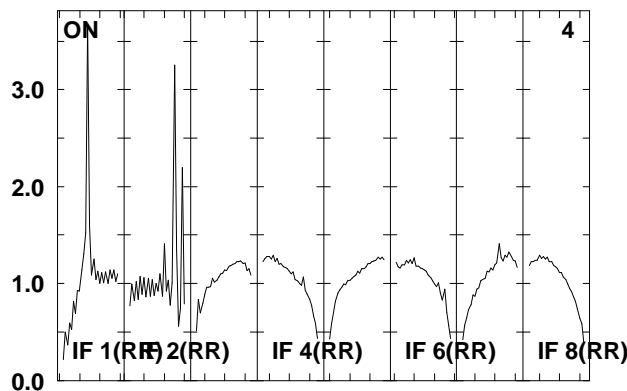
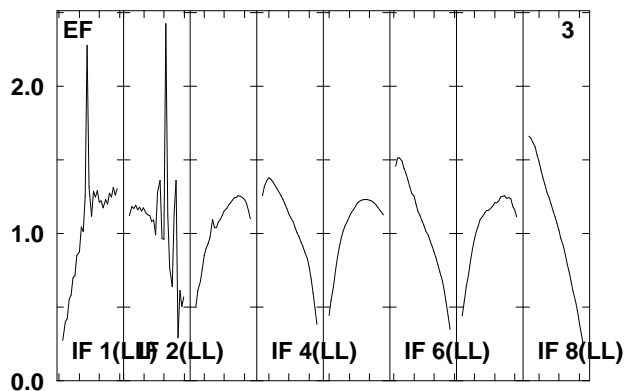
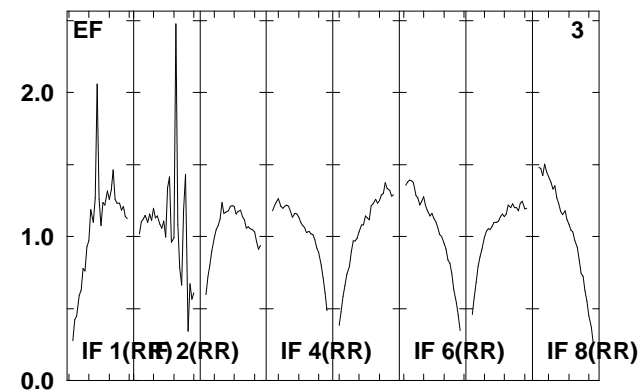
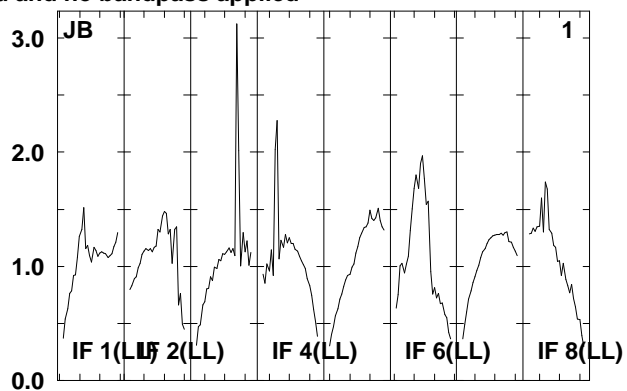
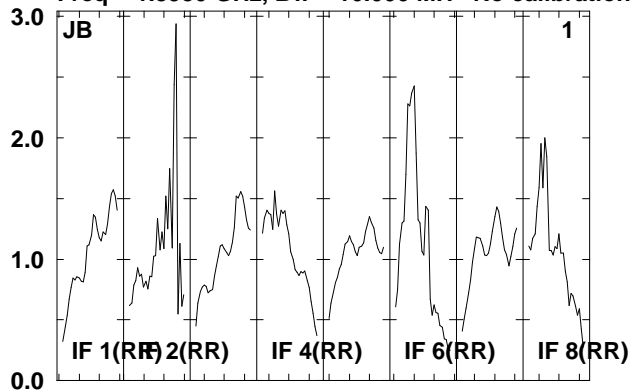

Lower frame: Real Jy  
Total-power spectrum Antenna: \*  
Timerange: 00/09:50:21 to 00/09:51:57

Plot file version 270 created 08-AUG-2008 17:00:43

J0920+44 EO006B.UVDATA.1

Freq = 1.5950 GHz, Bw = 16.000 MH No calibration applied and no bandpass applied

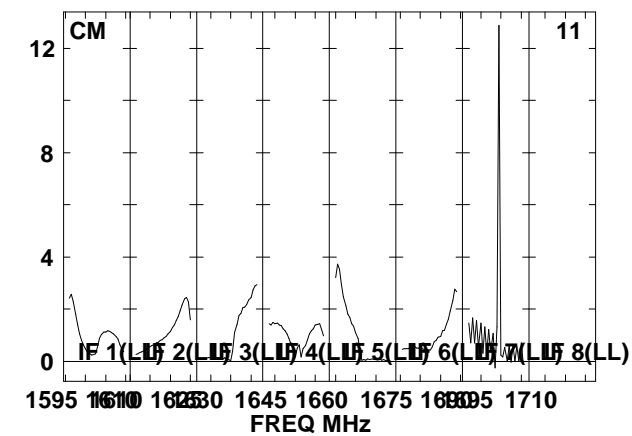
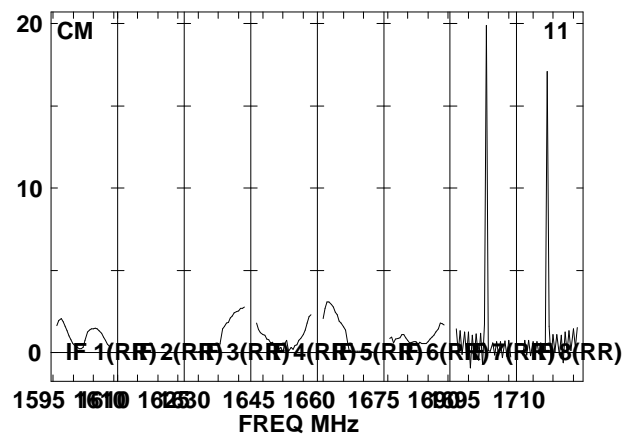
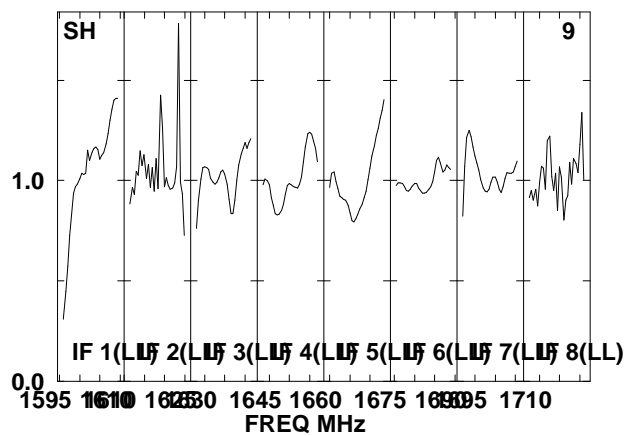
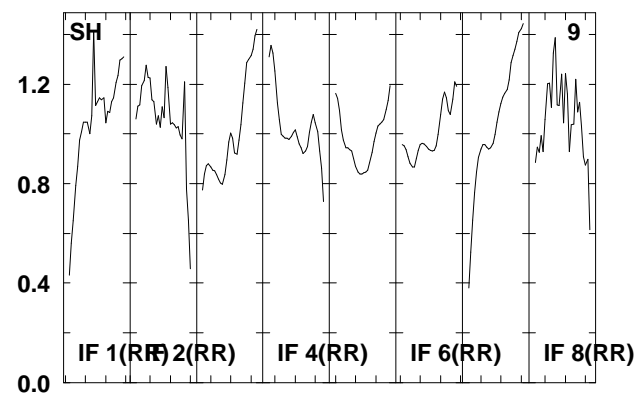
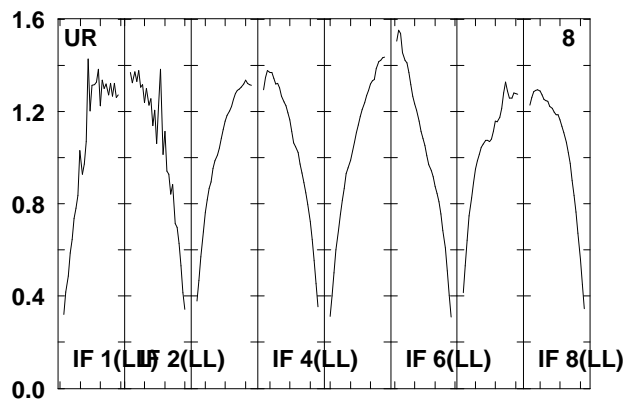
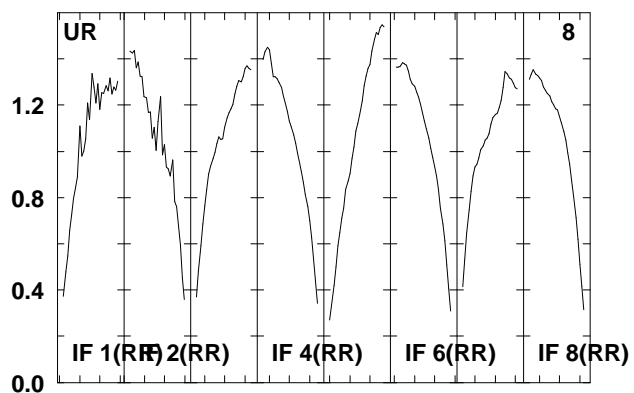
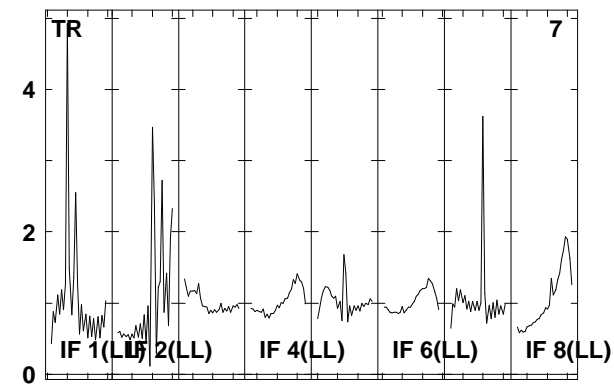
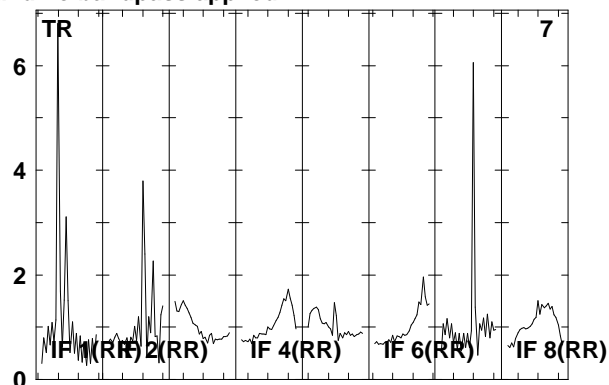
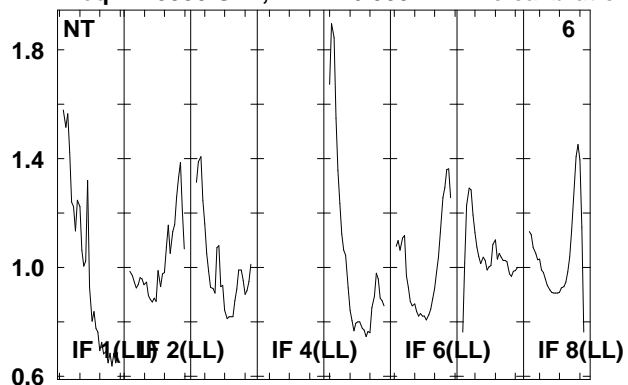

Lower frame: Real Jy

Total-power spectrum Antenna: \*

Timerange: 00/09:50:21 to 00/09:51:57

Plot file version 271 created 08-AUG-2008 17:00:44

J092159 EO006B.UVDATA.1

Freq = 1.5950 GHz, Bw = 16.000 MH No calibration applied and no bandpass applied

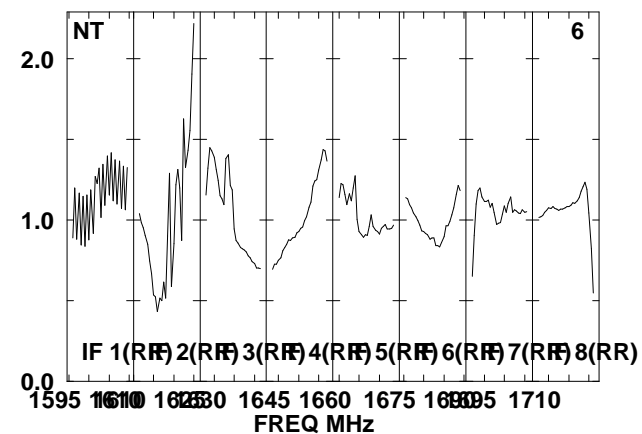
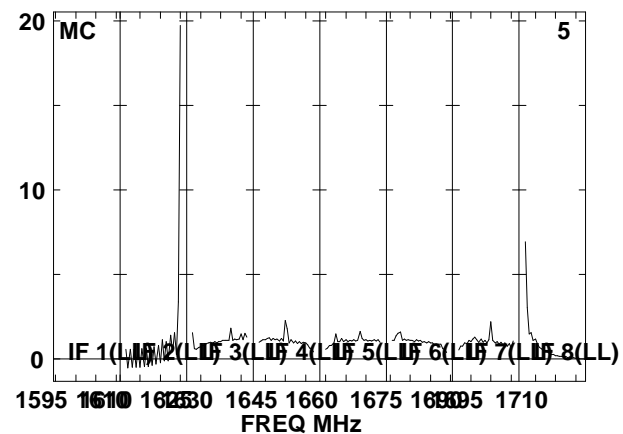
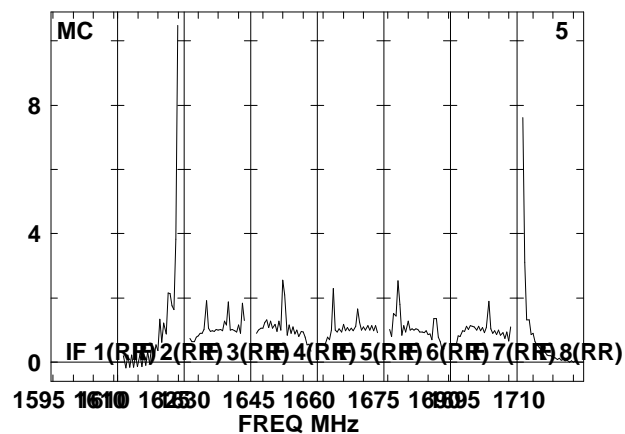
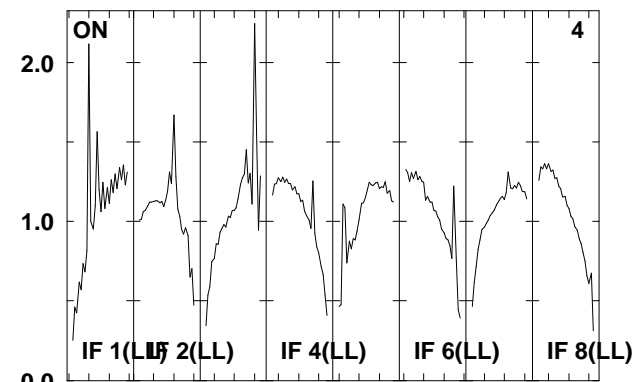
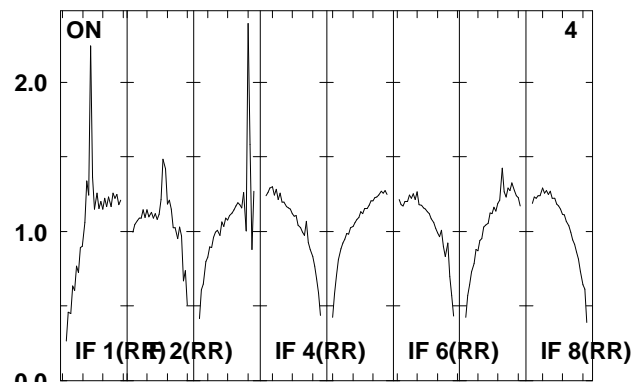
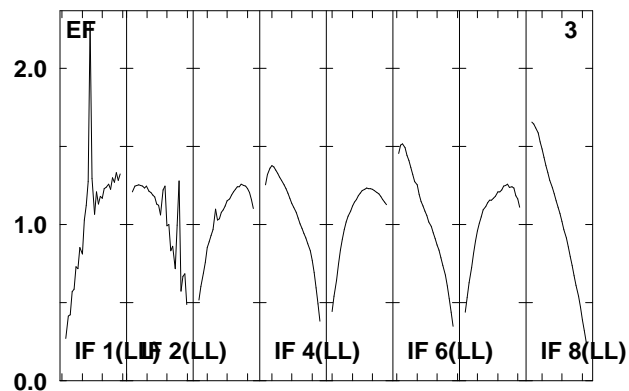
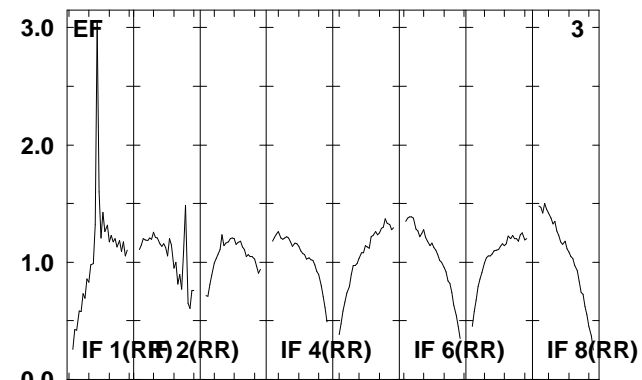
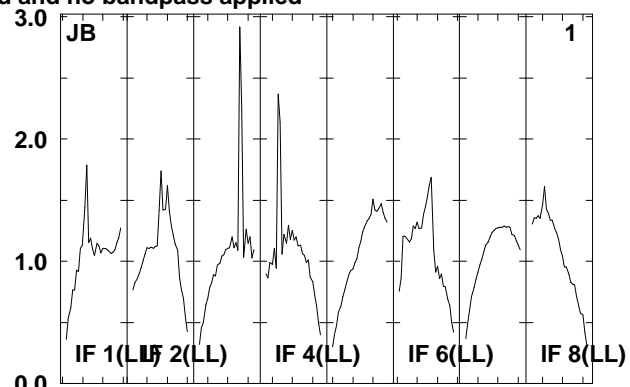
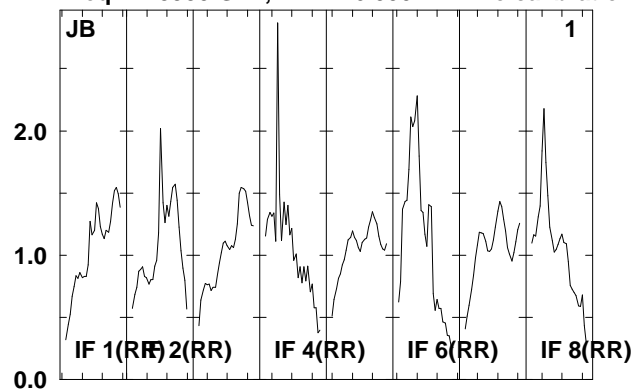

Lower frame: Real Jy  
Total-power spectrum Antenna: \*  
Timerange: 00/09:52:33 to 00/09:57:09

Plot file version 272 created 08-AUG-2008 17:00:44

J092159 EO006B.UVDATA.1

Freq = 1.5950 GHz, Bw = 16.000 MH No calibration applied and no bandpass applied

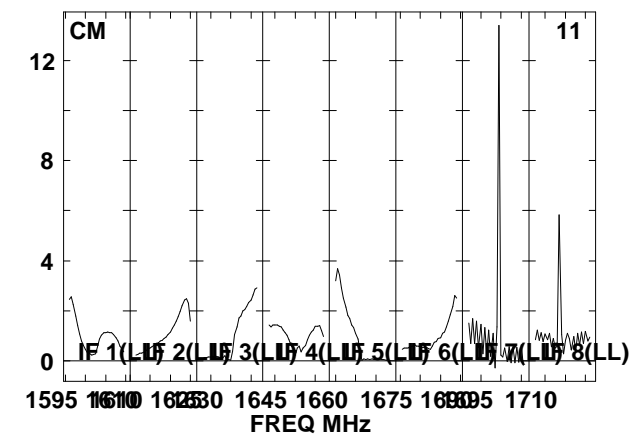
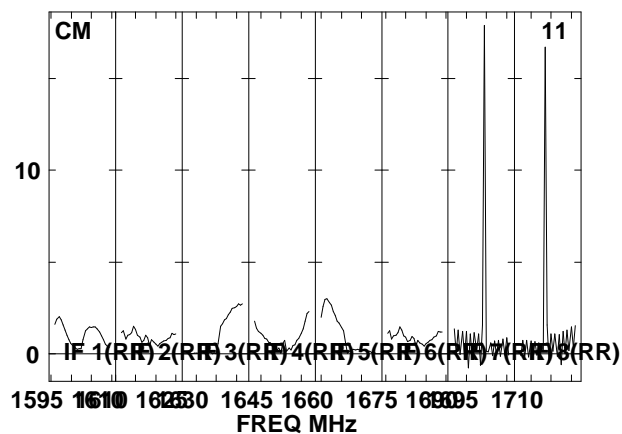
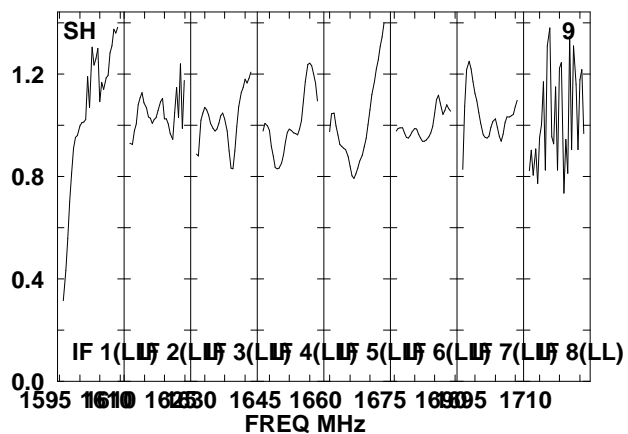
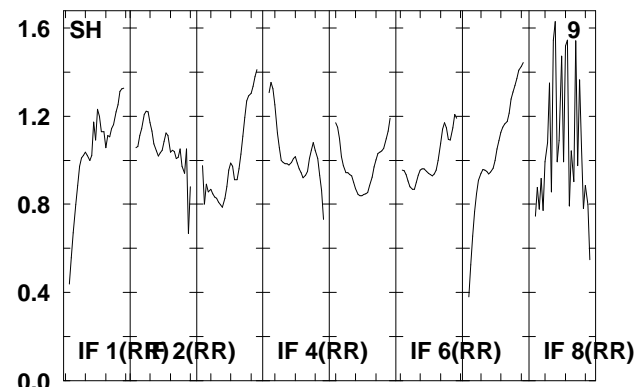
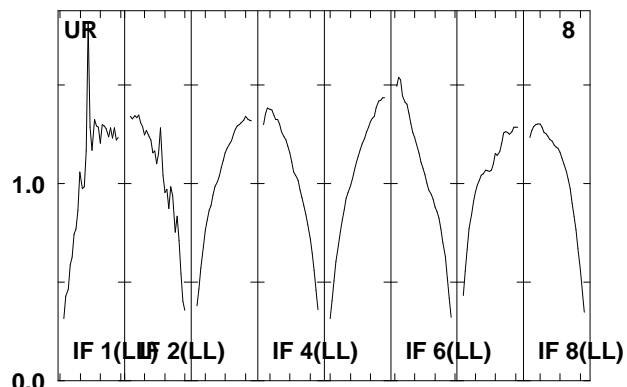
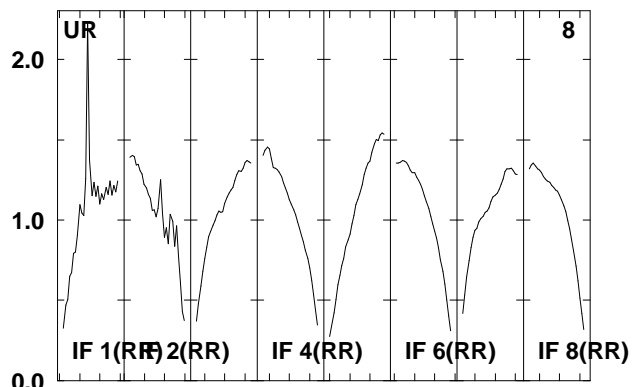
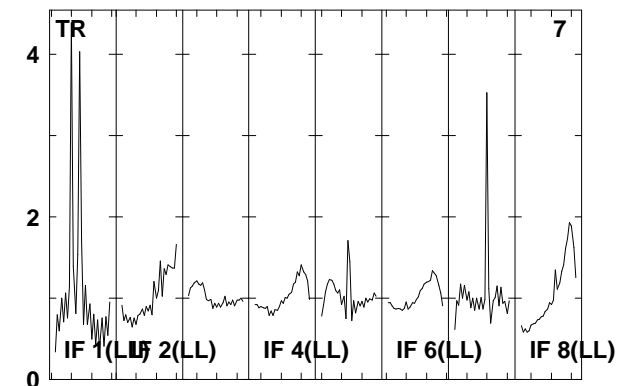
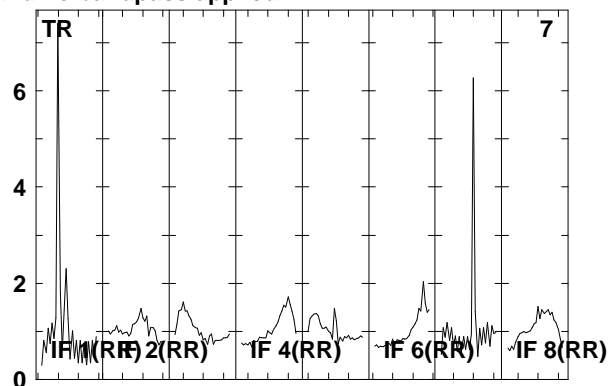
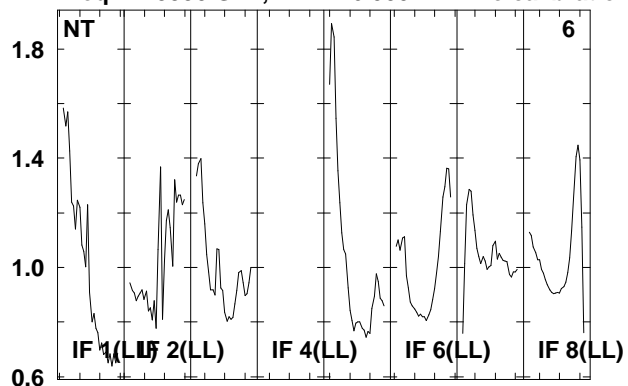

Lower frame: Real Jy  
Total-power spectrum Antenna: \*  
Timerange: 00/09:52:33 to 00/09:57:09

Plot file version 273 created 08-AUG-2008 17:00:45

J0920+44 EO006B.UVDATA.1

Freq = 1.5950 GHz, Bw = 16.000 MH No calibration applied and no bandpass applied

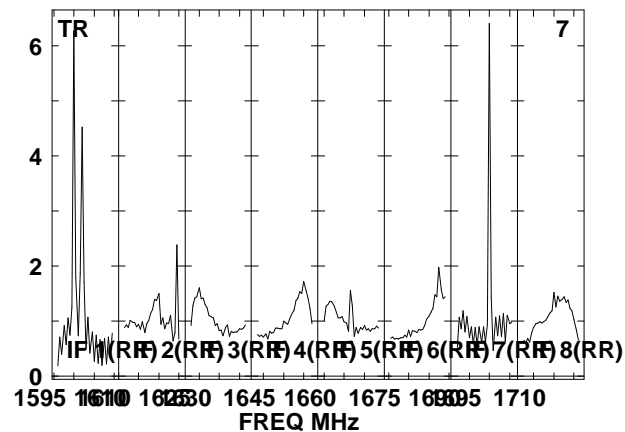
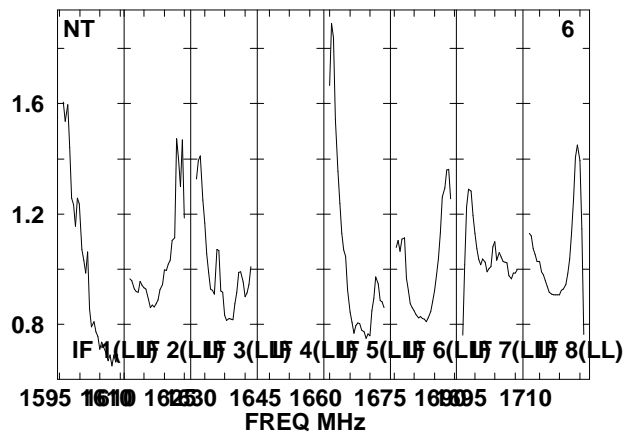
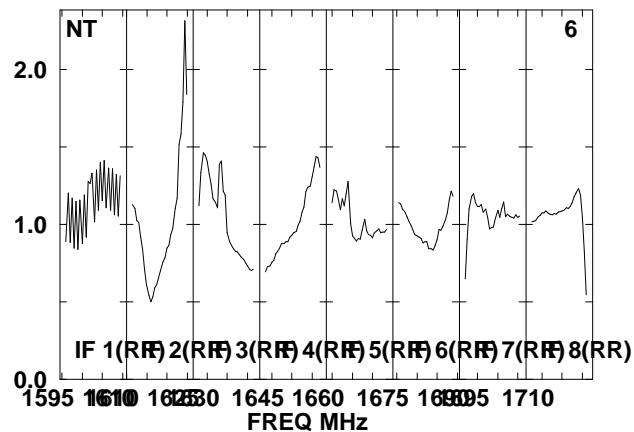
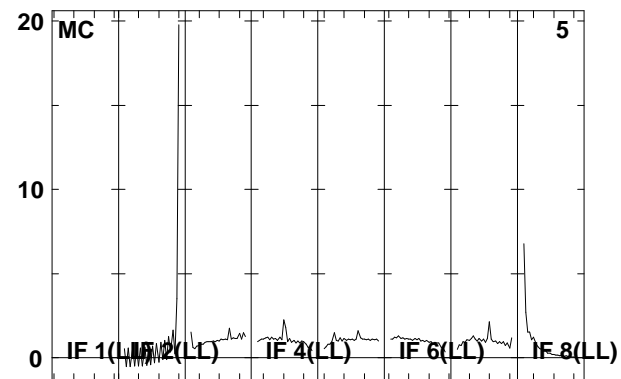
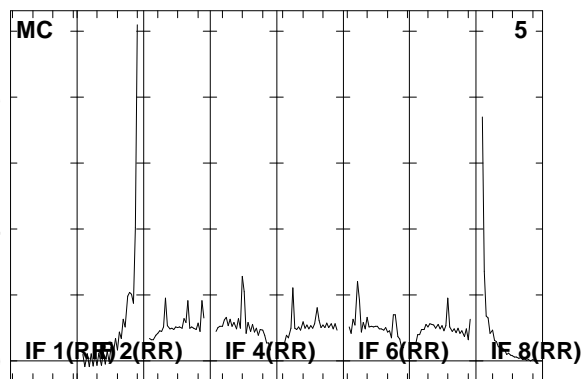
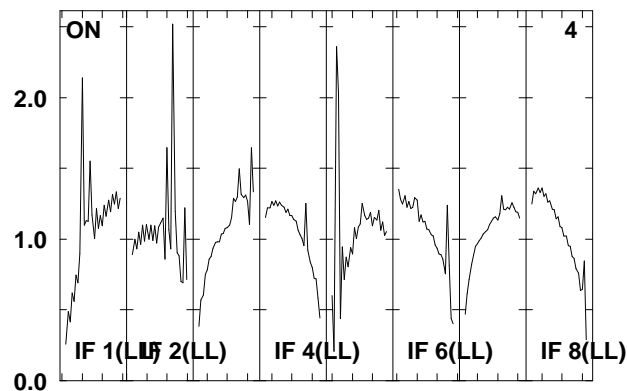
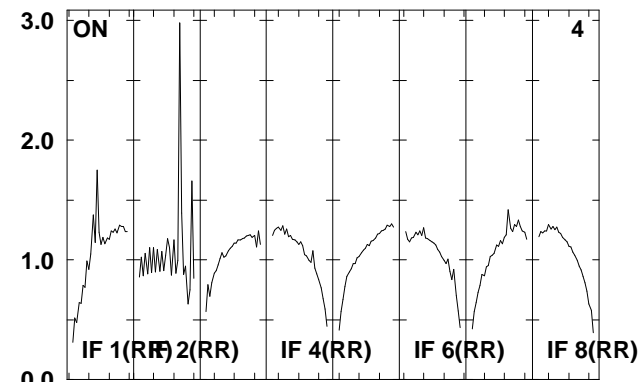
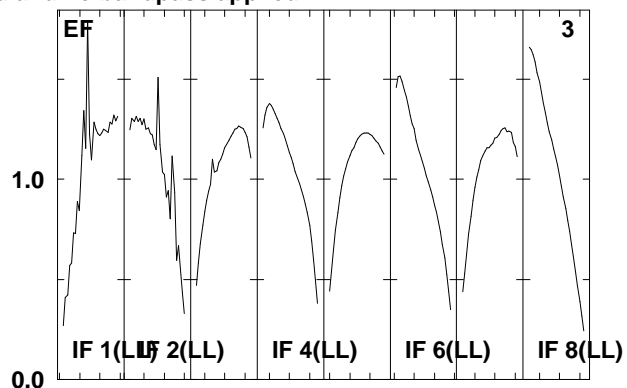
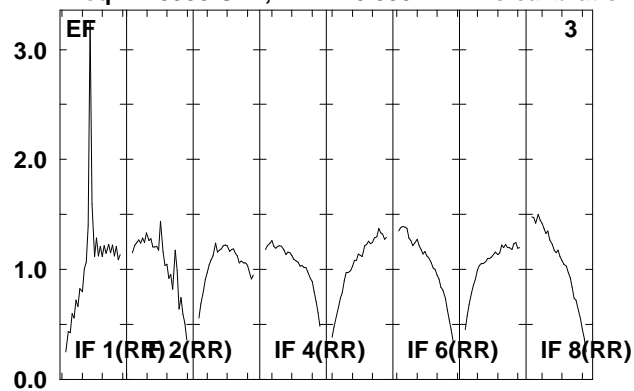

Lower frame: Real Jy  
Total-power spectrum Antenna: \*  
Timerange: 00/09:57:45 to 00/09:59:17

Plot file version 274 created 08-AUG-2008 17:00:46

J0920+44 EO006B.UVDATA.1

Freq = 1.5950 GHz, Bw = 16.000 MH No calibration applied and no bandpass applied

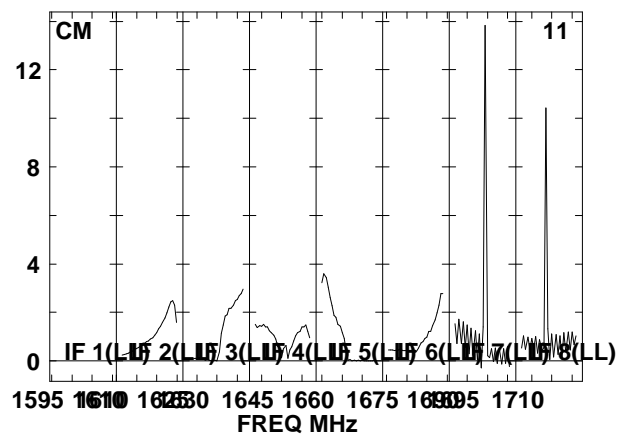
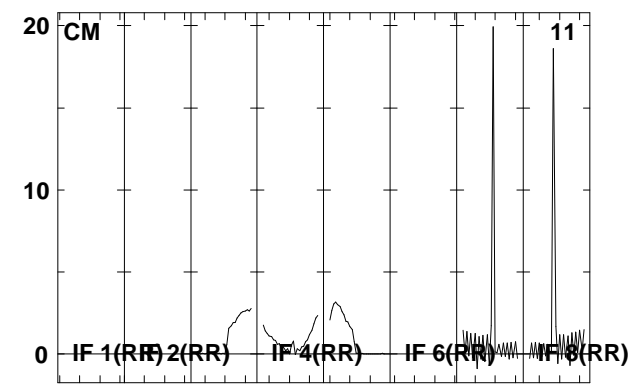
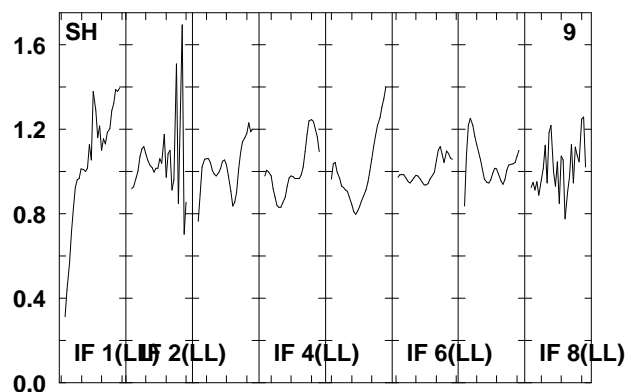
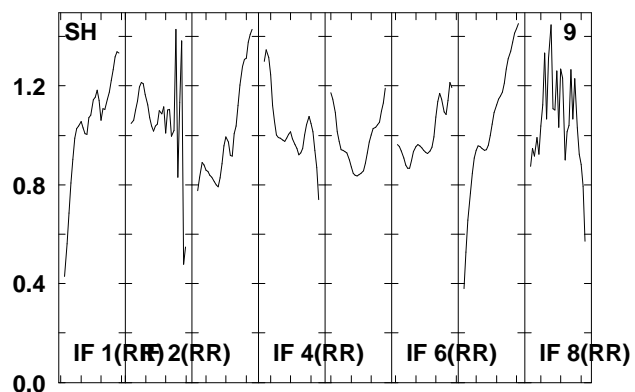
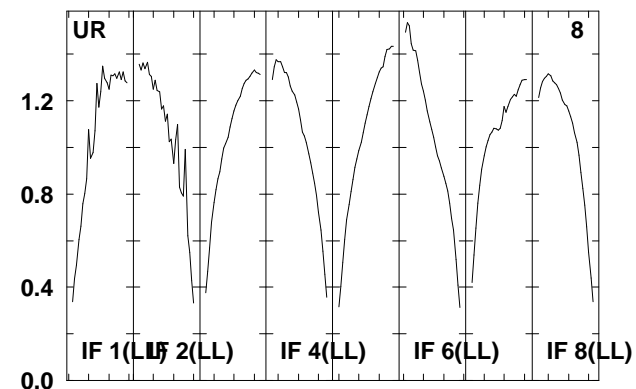
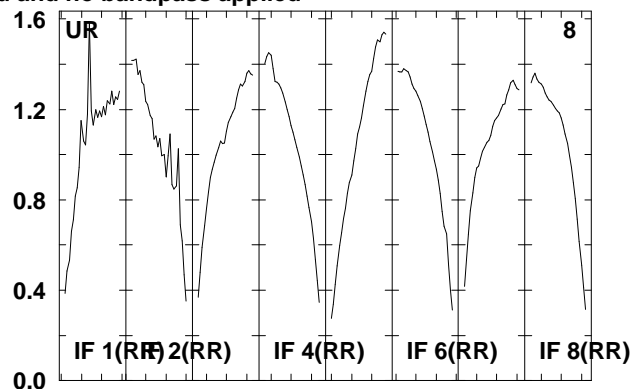
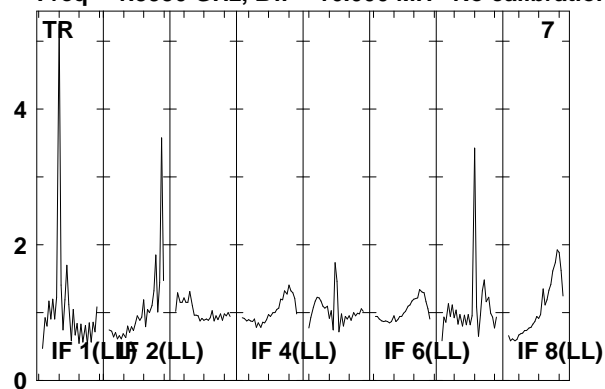

Lower frame: Real Jy

Total-power spectrum Antenna: \*

Timerange: 00/09:57:45 to 00/09:59:17

Plot file version 275 created 08-AUG-2008 17:00:46

J092159 EO006B.UVDATA.1

Freq = 1.5950 GHz, Bw = 16.000 MH No calibration applied and no bandpass applied

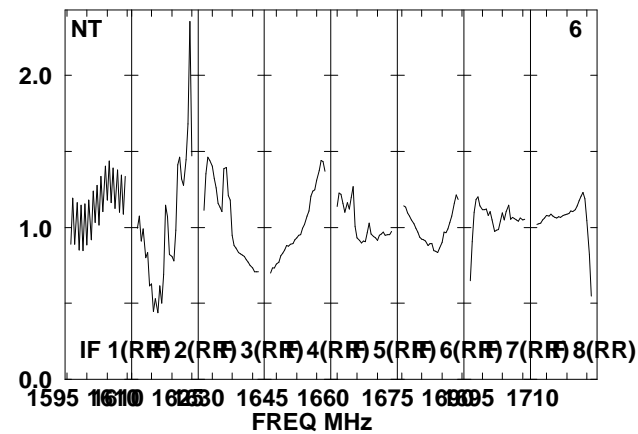
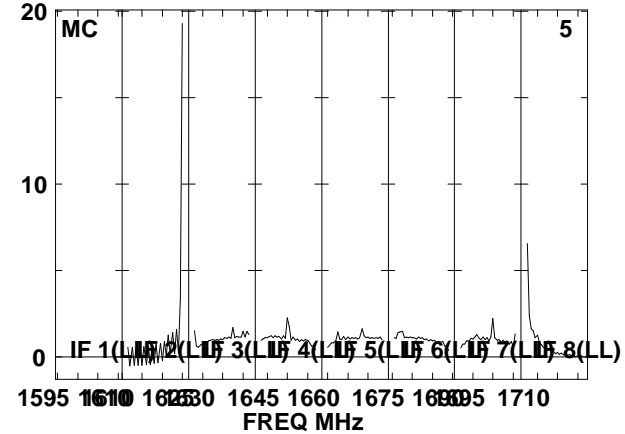
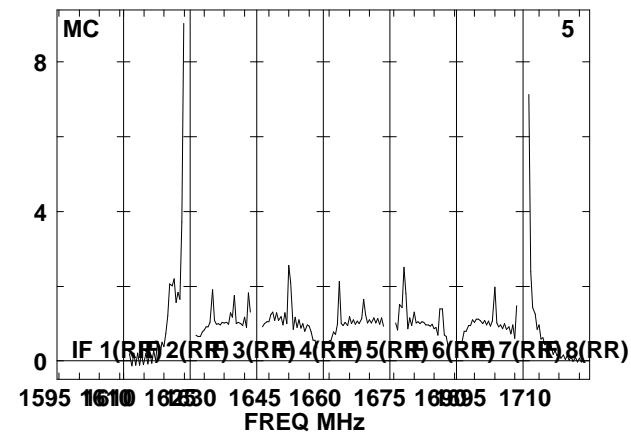
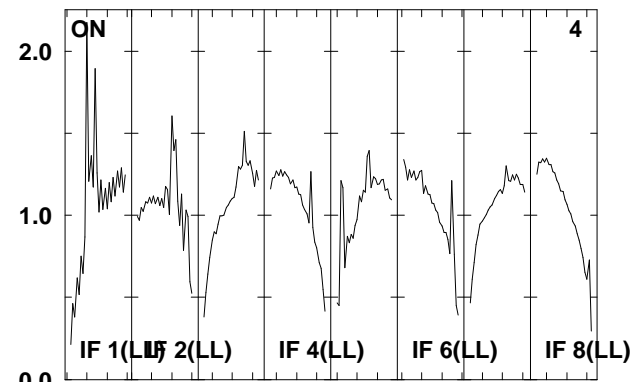
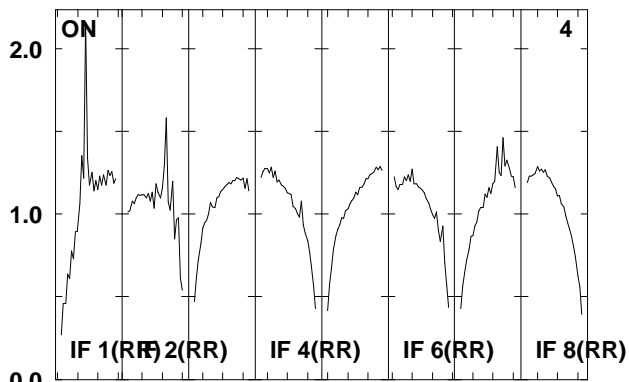
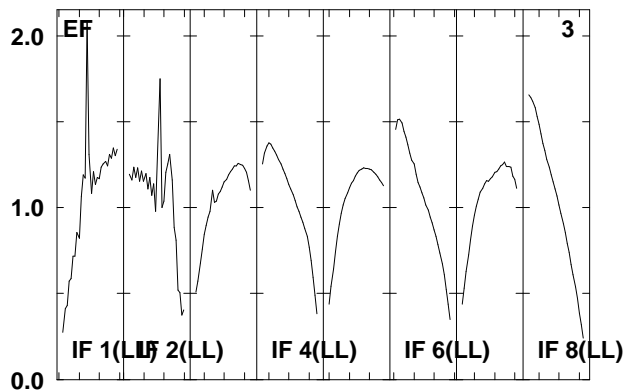
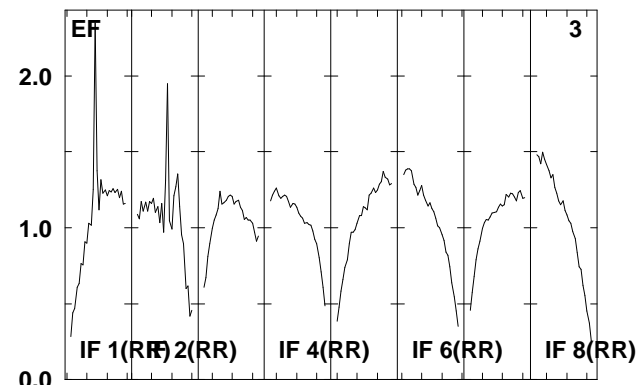
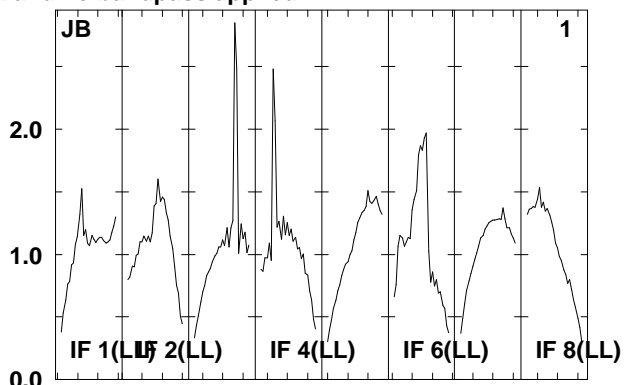
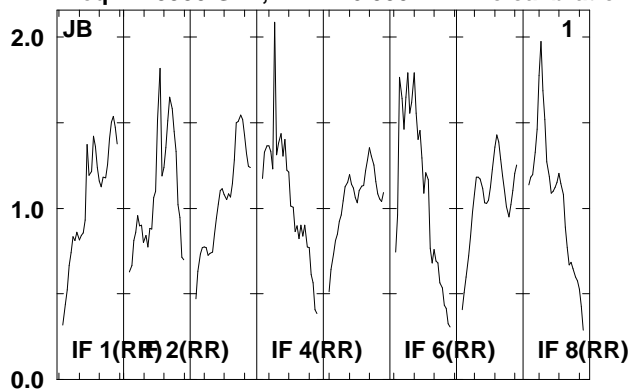

Lower frame: Real Jy  
Total-power spectrum Antenna: \*  
Timerange: 00/09:59:57 to 00/10:04:21

Plot file version 276 created 08-AUG-2008 17:00:47

J092159 EO006B.UVDATA.1

Freq = 1.5950 GHz, Bw = 16.000 MH No calibration applied and no bandpass applied

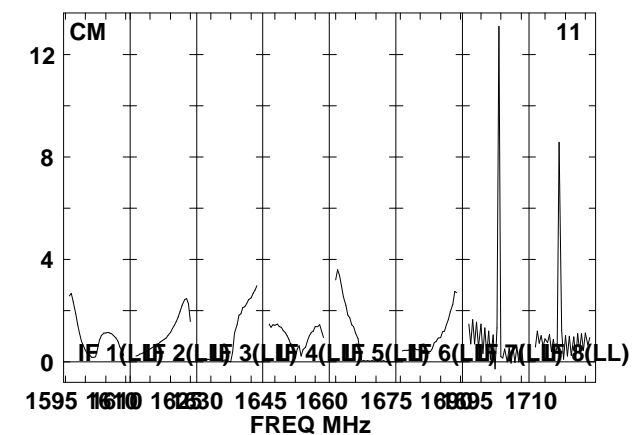
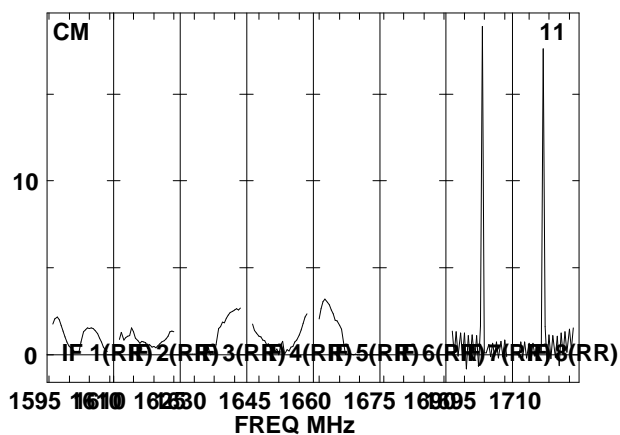
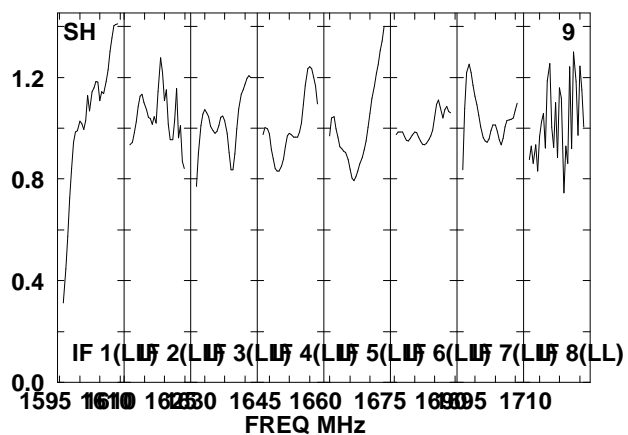
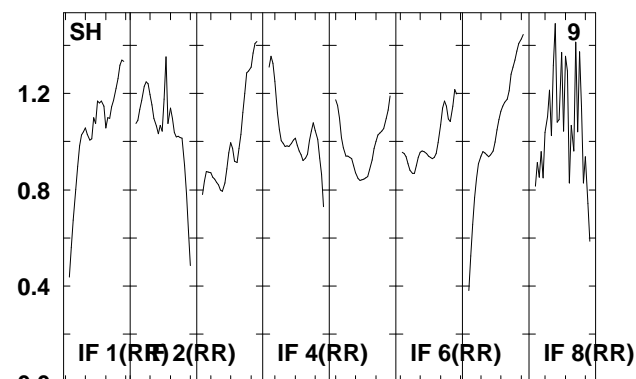
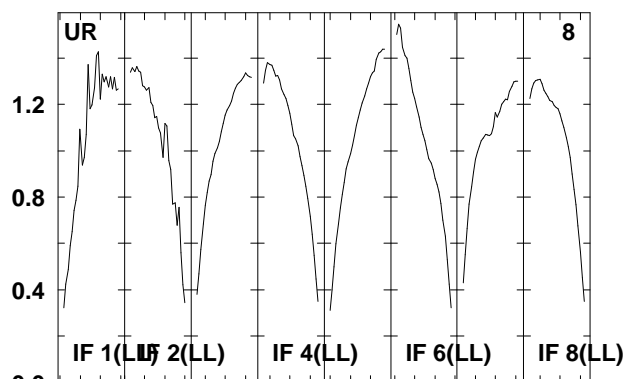
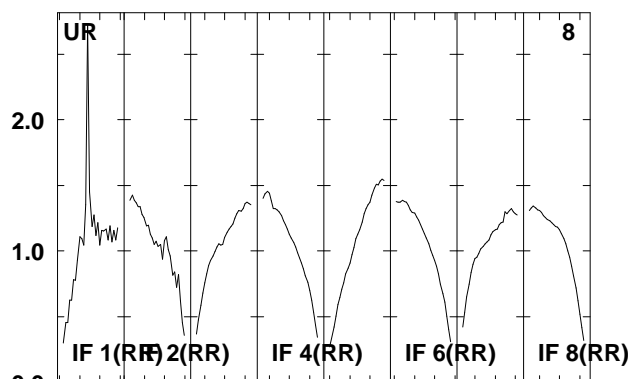
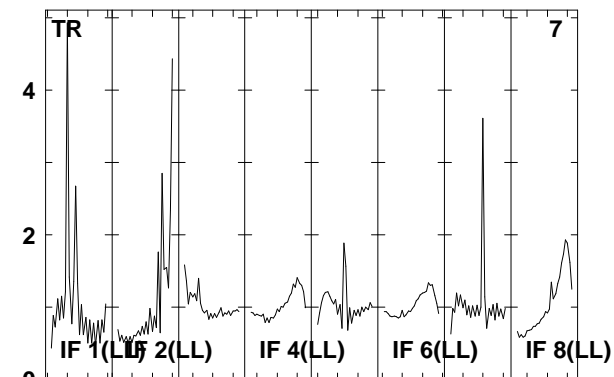
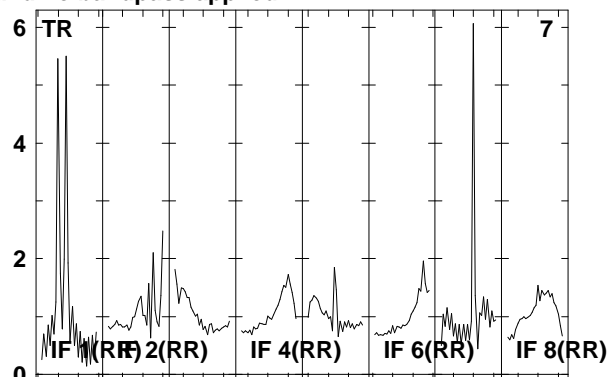
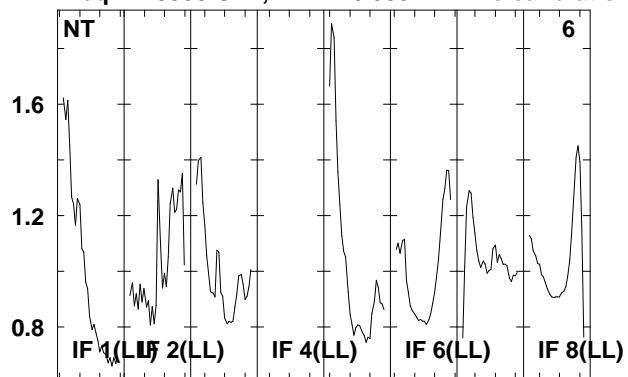

Lower frame: Real Jy  
Total-power spectrum Antenna: \*  
Timerange: 00/09:59:57 to 00/10:04:21



Plot file version 277 created 08-AUG-2008 17:00:48

J0920+44 EO006B.UVDATA.1

Freq = 1.5950 GHz, Bw = 16.000 MH No calibration applied and no bandpass applied

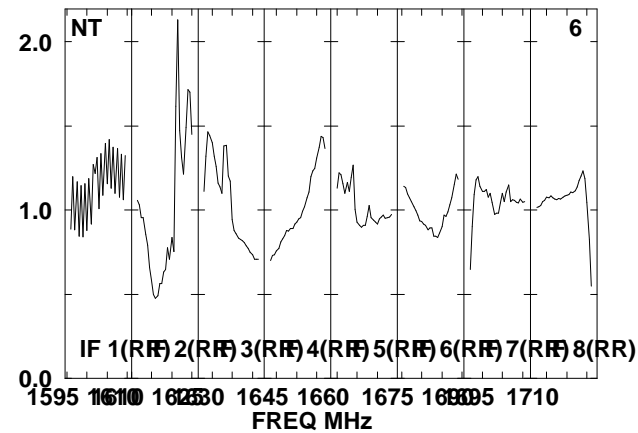
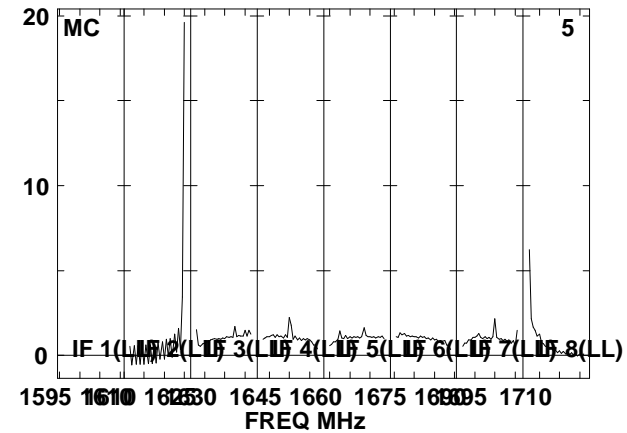
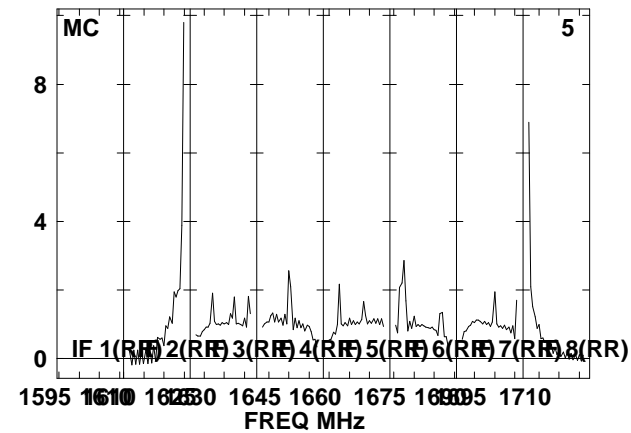
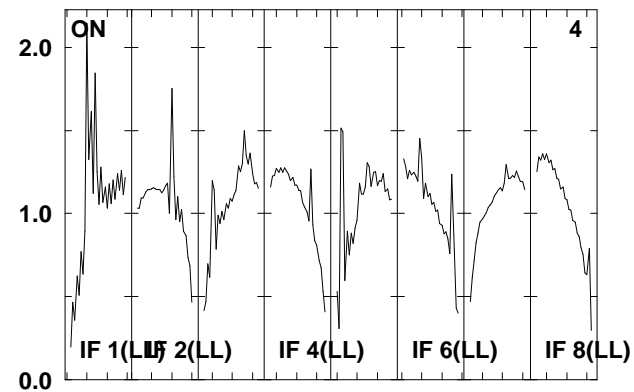
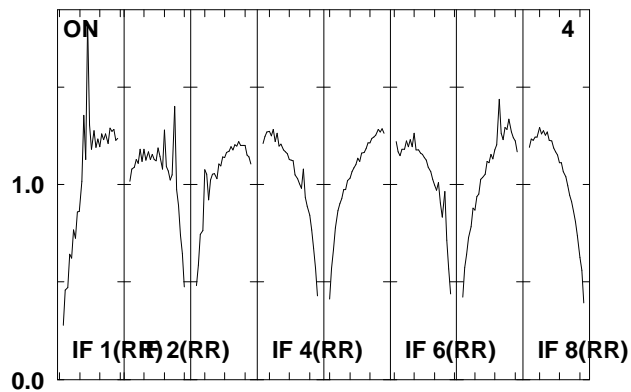
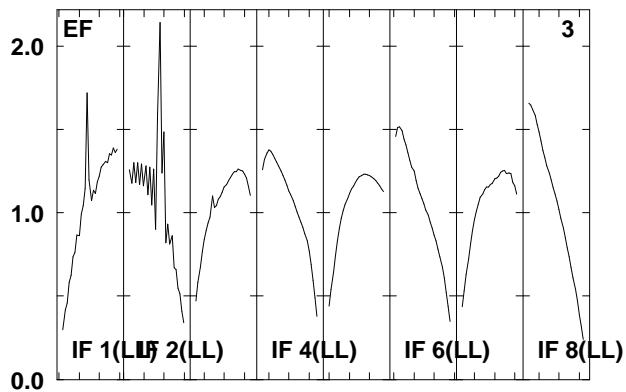
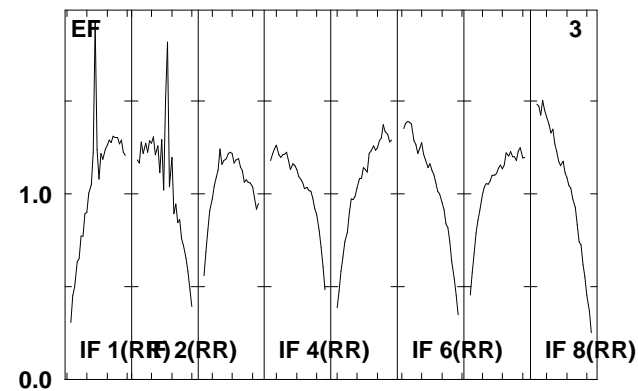
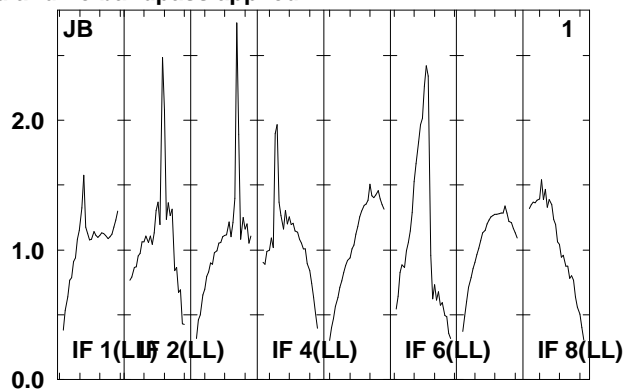
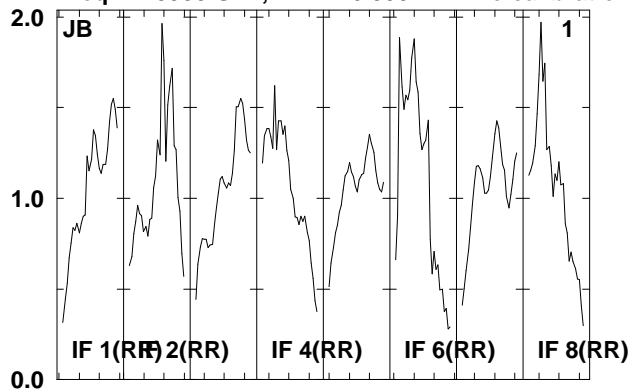

Lower frame: Real Jy  
Total-power spectrum Antenna: \*  
Timerange: 00/10:05:05 to 00/10:06:33

Plot file version 278 created 08-AUG-2008 17:00:48

J0920+44 EO06B.UVDATA.1

Freq = 1.5950 GHz, Bw = 16.000 MH No calibration applied and no bandpass applied

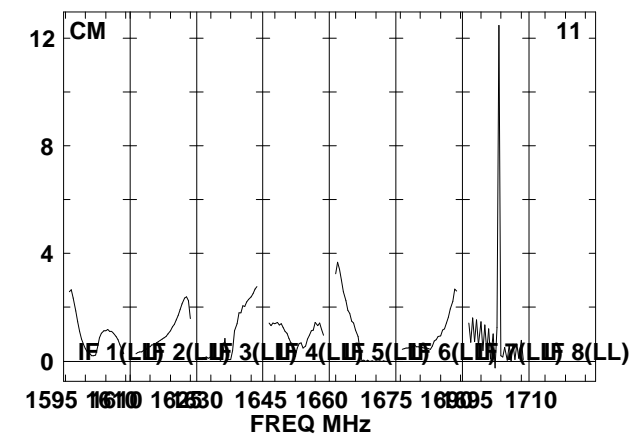
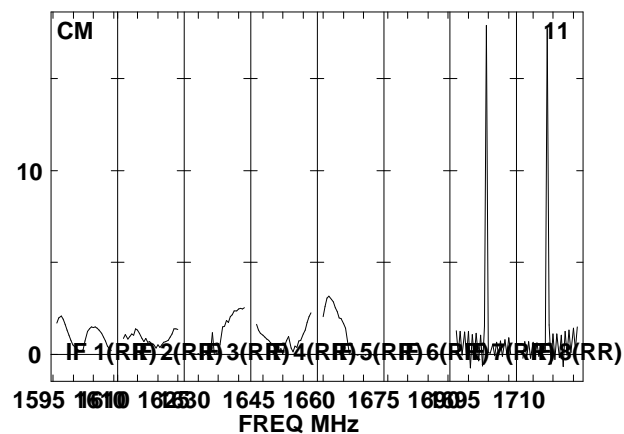
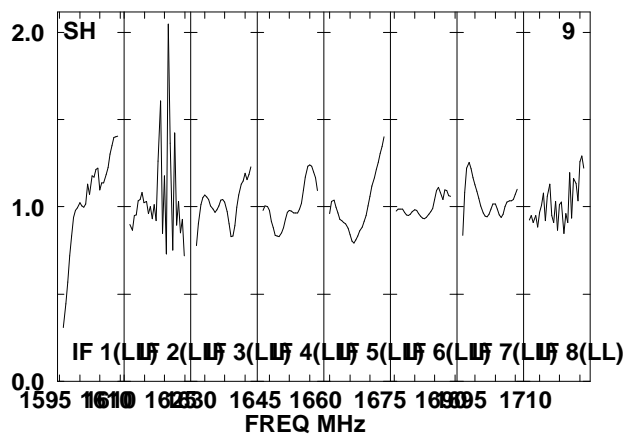
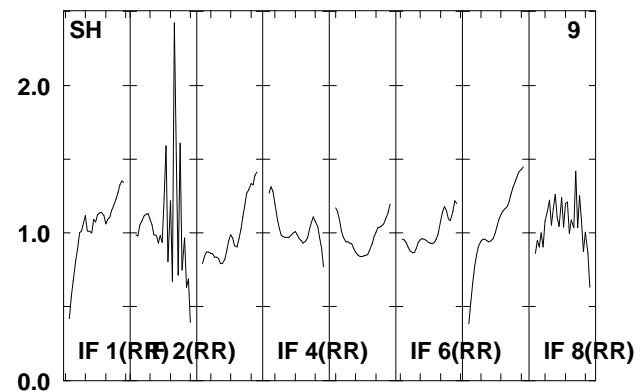
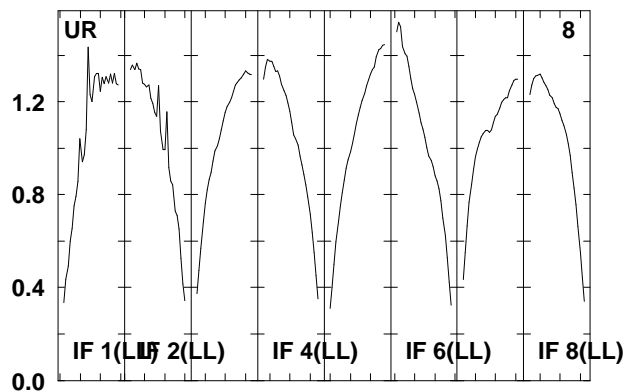
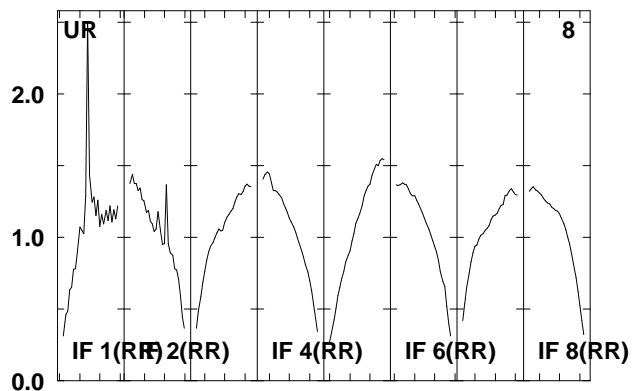
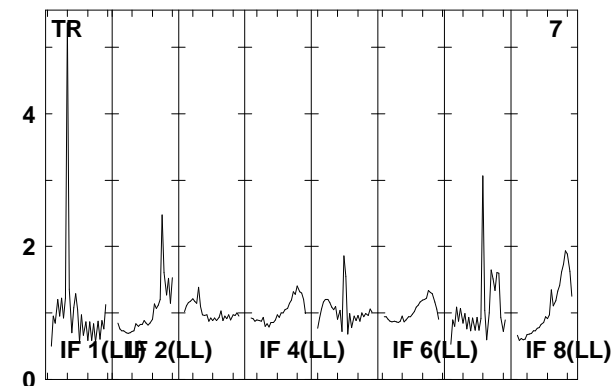
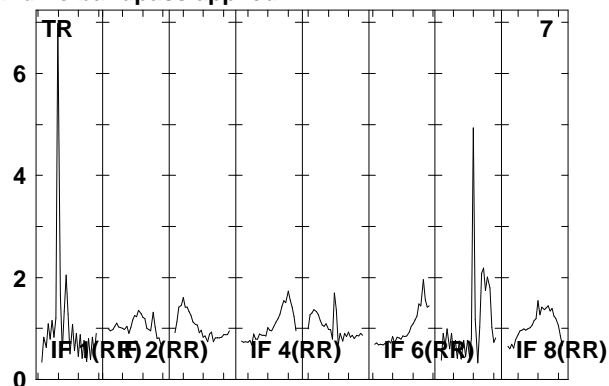
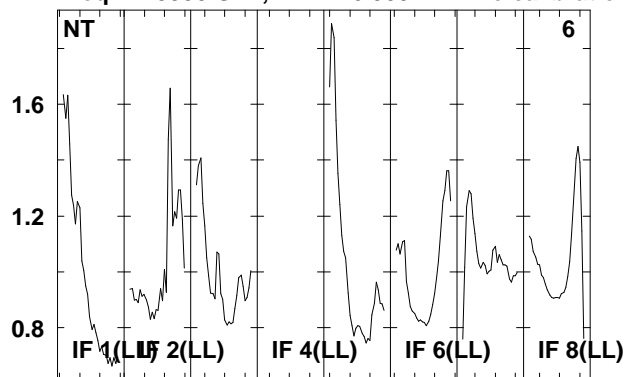

Lower frame: Real Jy  
Total-power spectrum Antenna: \*  
Timerange: 00/10:05:05 to 00/10:06:33

Plot file version 279 created 08-AUG-2008 17:00:49

J092159 EO006B.UVDATA.1

Freq = 1.5950 GHz, Bw = 16.000 MH No calibration applied and no bandpass applied

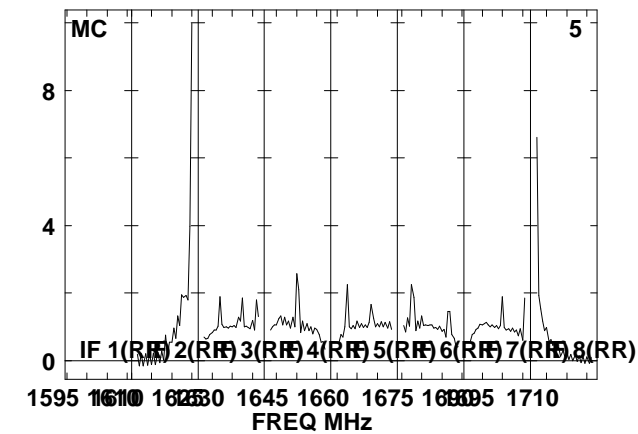
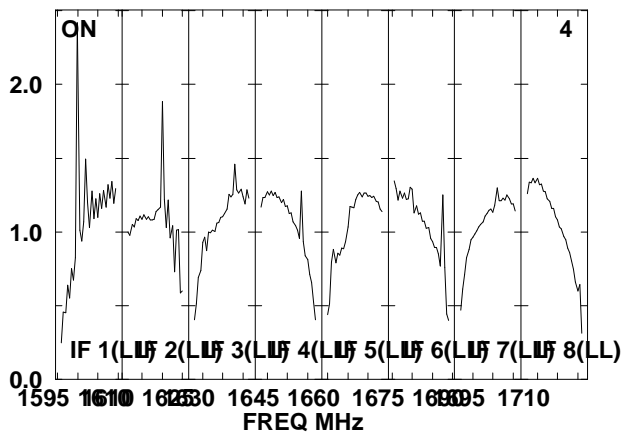
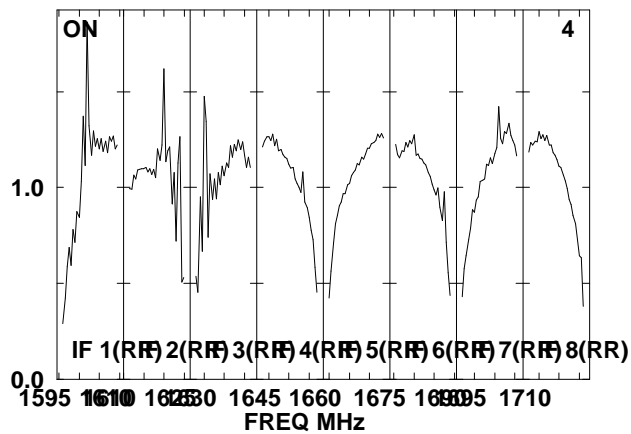
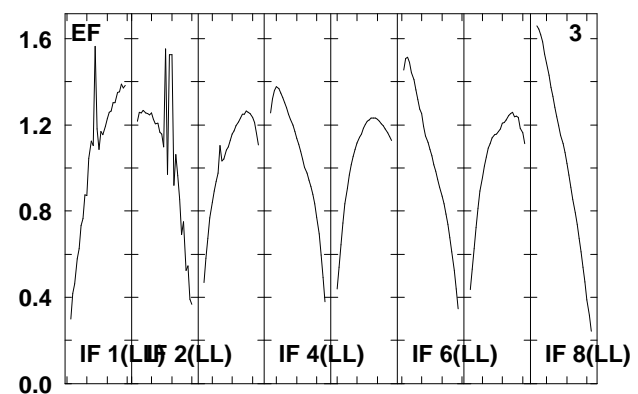
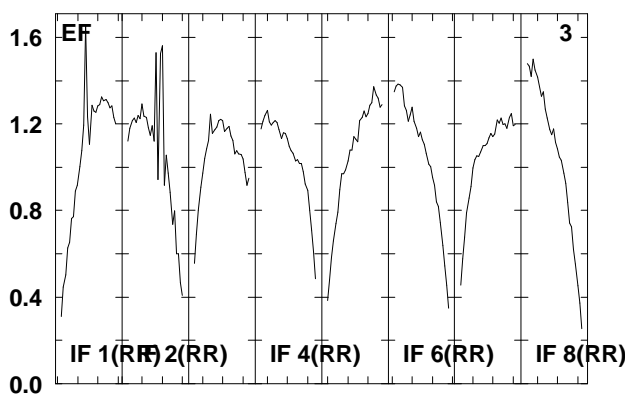
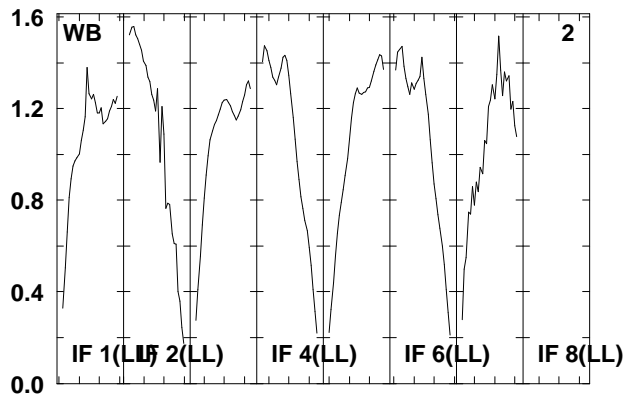
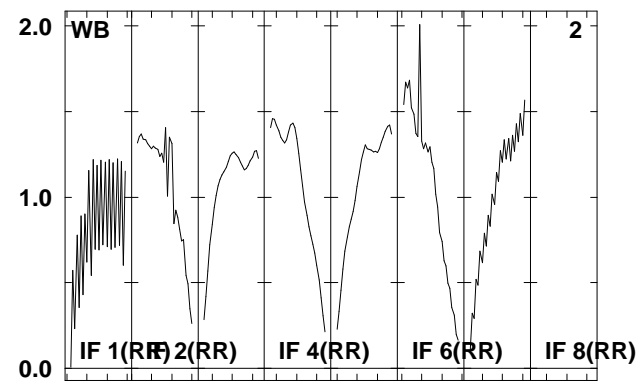
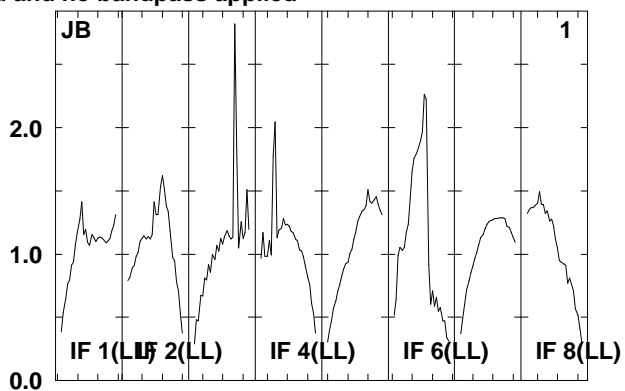
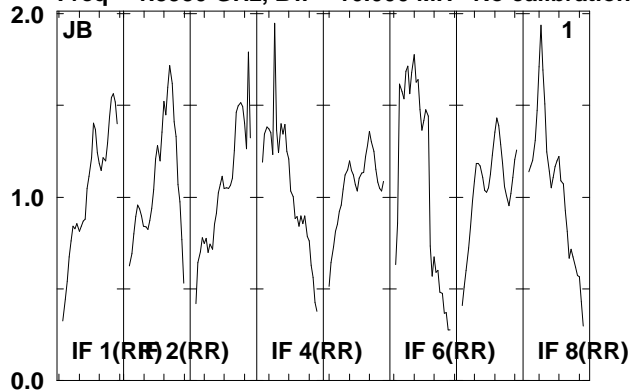

Lower frame: Real Jy  
Total-power spectrum Antenna: \*  
Timerange: 00/10/07:13 to 00/10/11:41

Plot file version 280 created 08-AUG-2008 17:00:49

J092159 EO006B.UVDATA.1

Freq = 1.5950 GHz, Bw = 16.000 MH No calibration applied and no bandpass applied

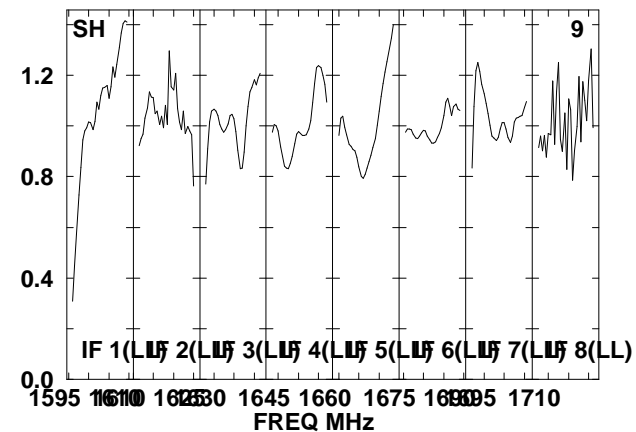
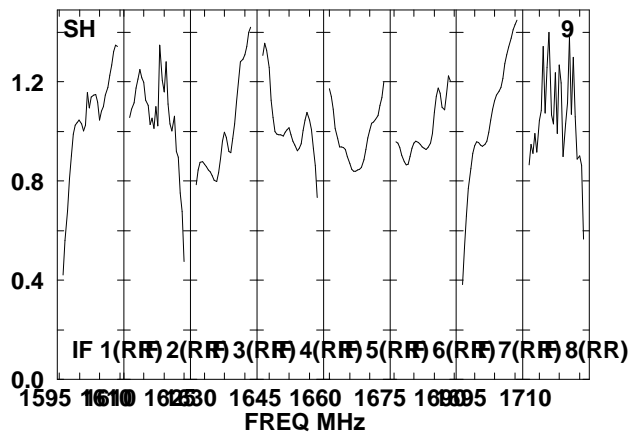
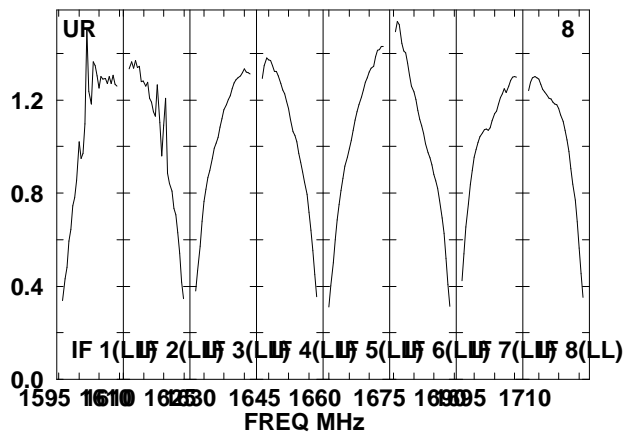
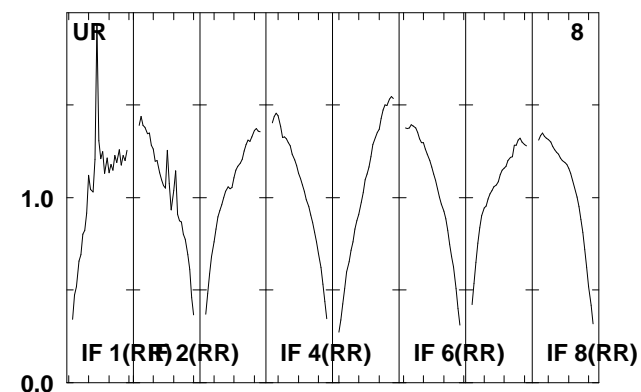
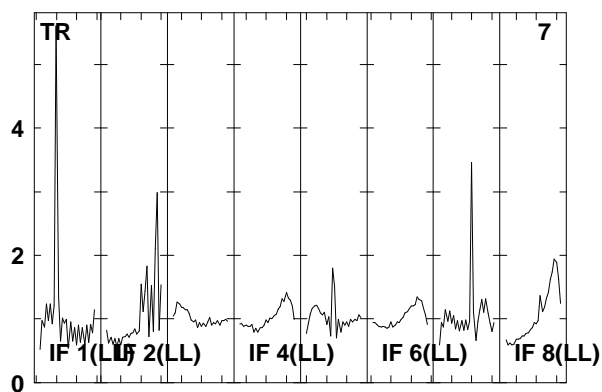
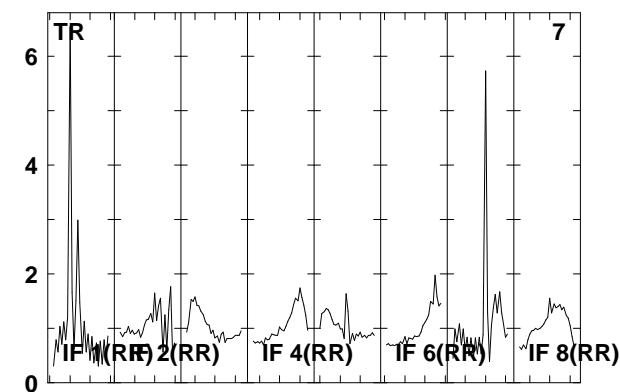
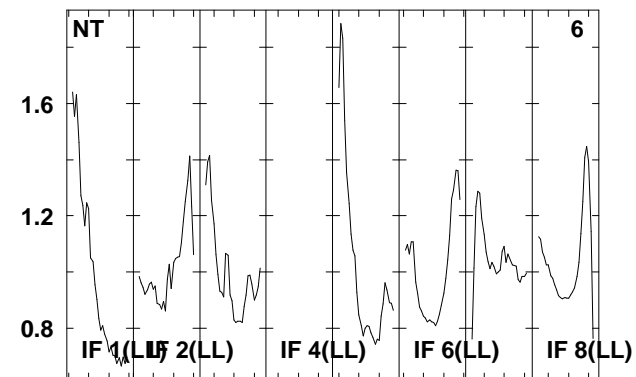
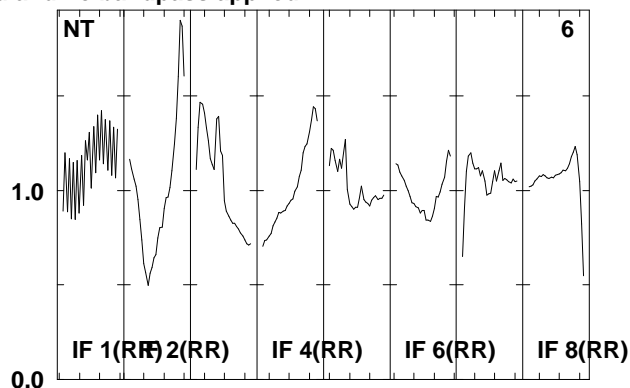
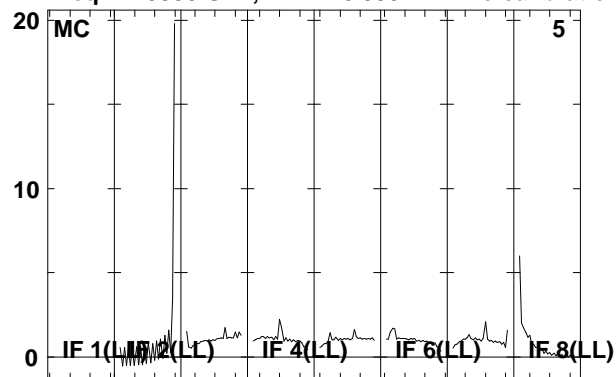

Lower frame: Real Jy

Total-power spectrum Antenna: \*

Timerange: 00/10:07:13 to 00/10:11:41

Plot file version 281 created 08-AUG-2008 17:00:50

J092159 EO006B.UVDATA.1

Freq = 1.5950 GHz, Bw = 16.000 MH No calibration applied and no bandpass applied

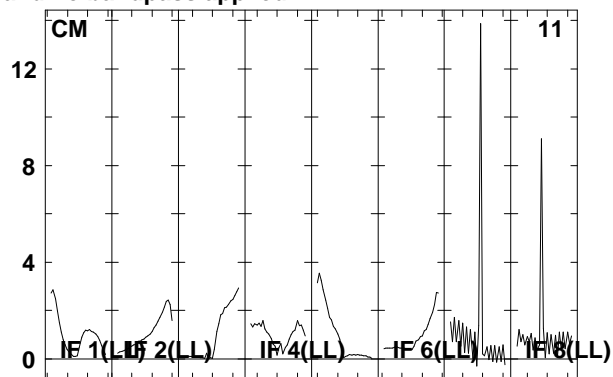
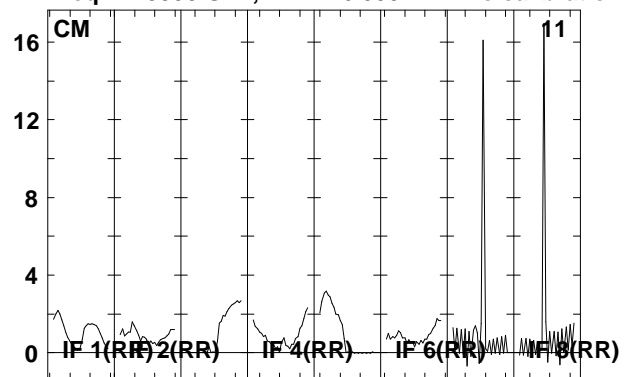

Lower frame: Real Jy  
Total-power spectrum Antenna: \*  
Timerange: 00/10:07:13 to 00/10:11:41

Plot file version 282 created 08-AUG-2008 17:00:51

J0920+44 EO006B.UVDATA.1

Freq = 1.5950 GHz, Bw = 16.000 MH No calibration applied and no bandpass applied

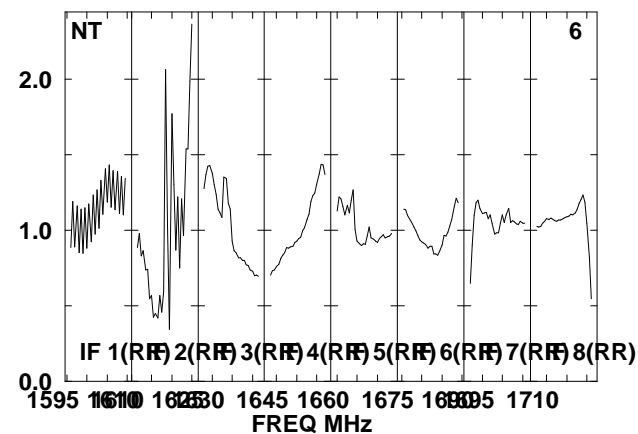
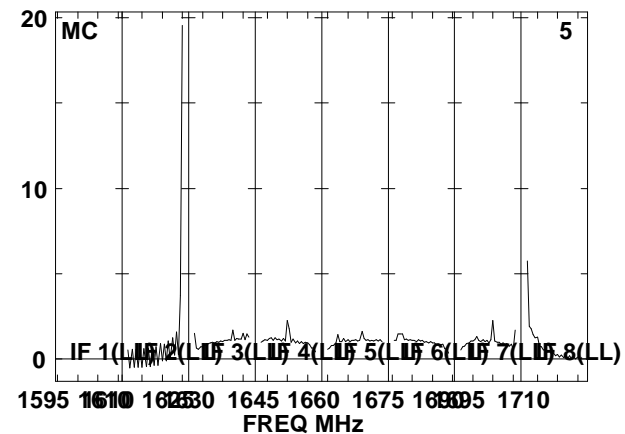
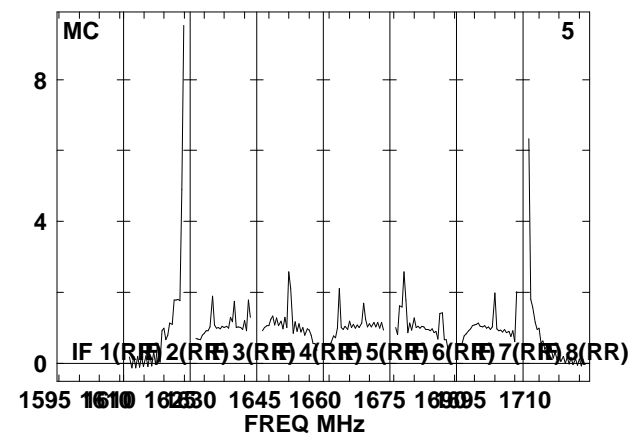
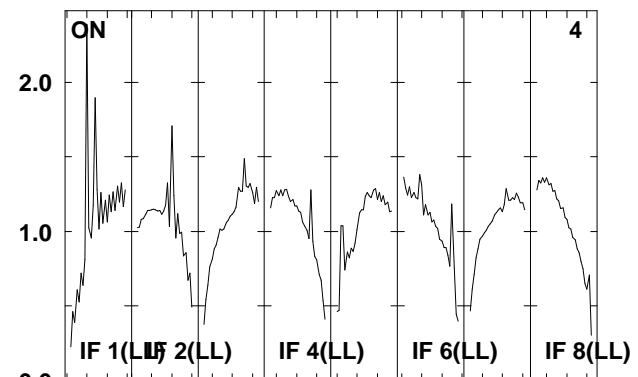
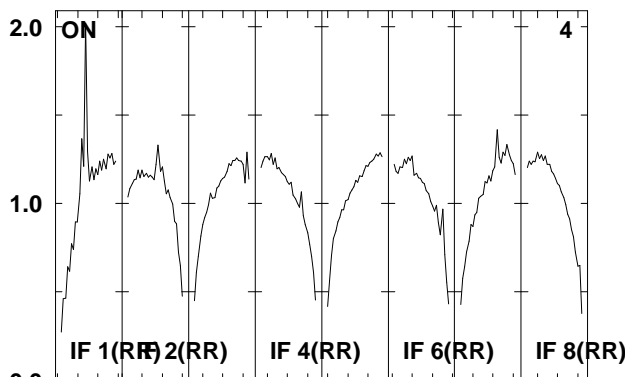
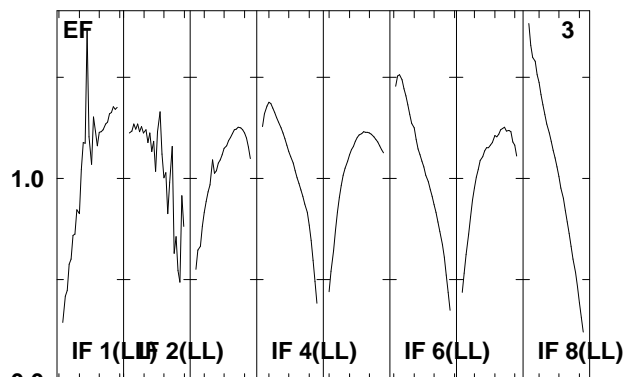
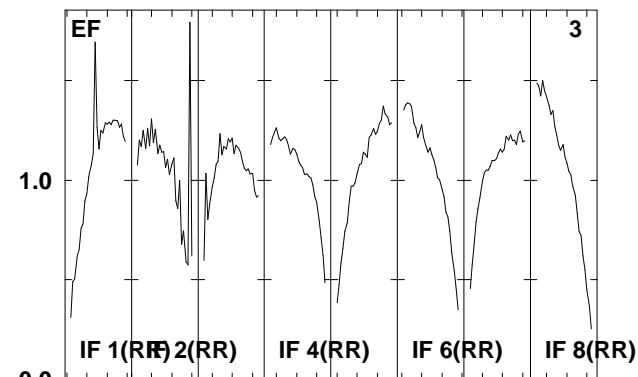
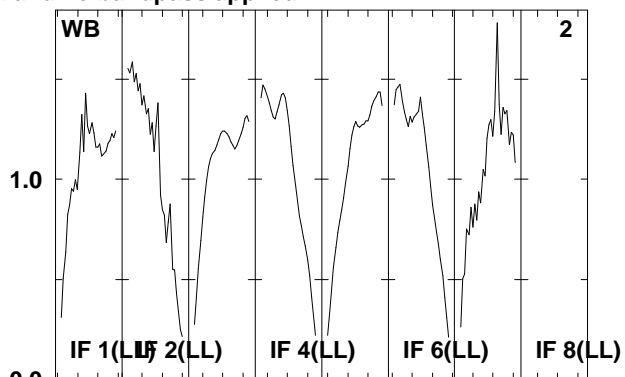
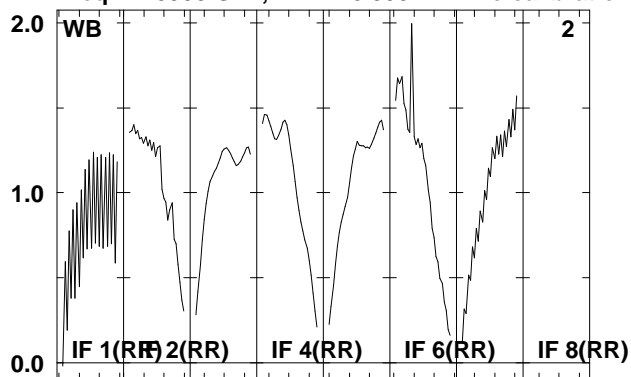

Lower frame: Real Jy  
Total-power spectrum Antenna: \*  
Timerange: 00/10:12:27 to 00/10:13:51

Plot file version 283 created 08-AUG-2008 17:00:51

J0920+44 EO006B.UVDATA.1

Freq = 1.5950 GHz, Bw = 16.000 MH No calibration applied and no bandpass applied

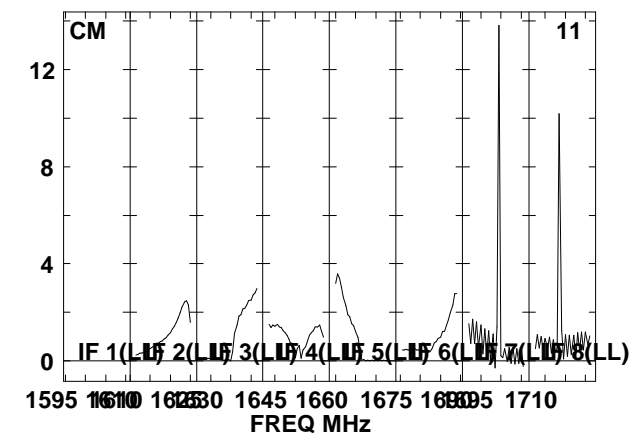
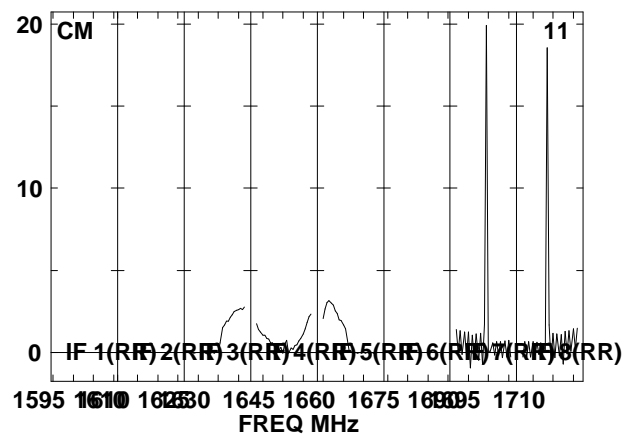
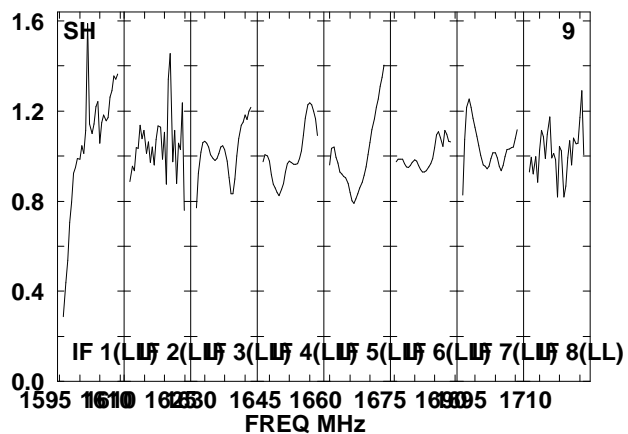
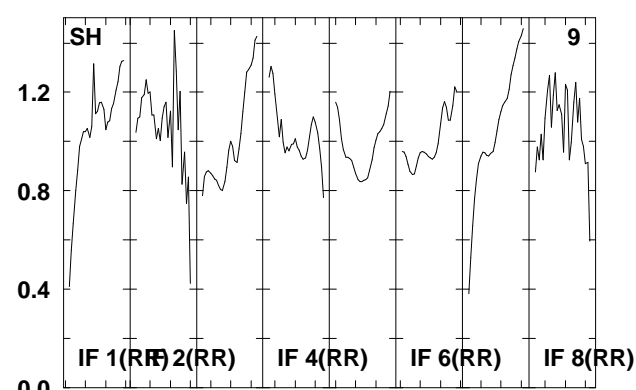
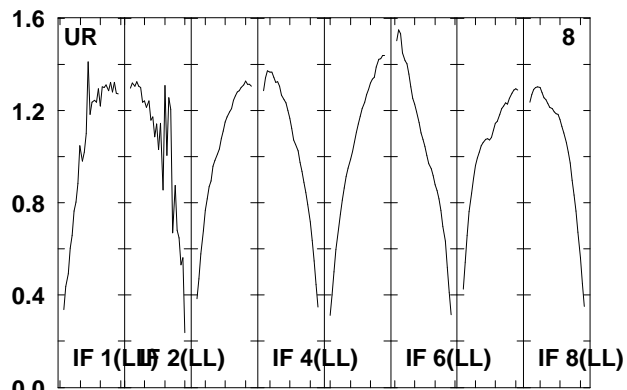
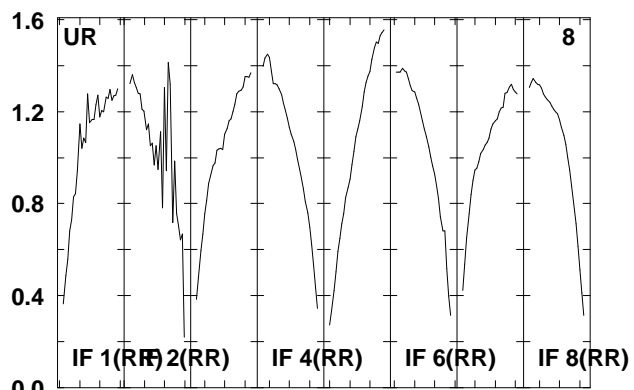
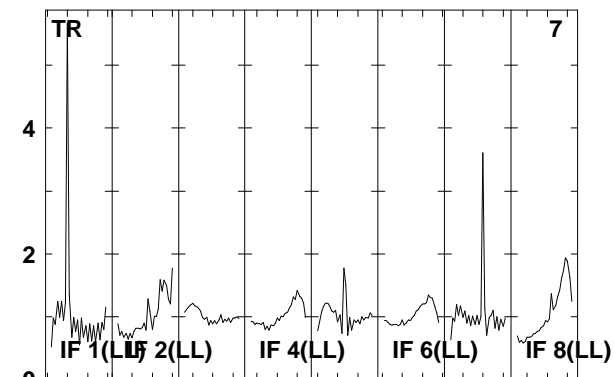
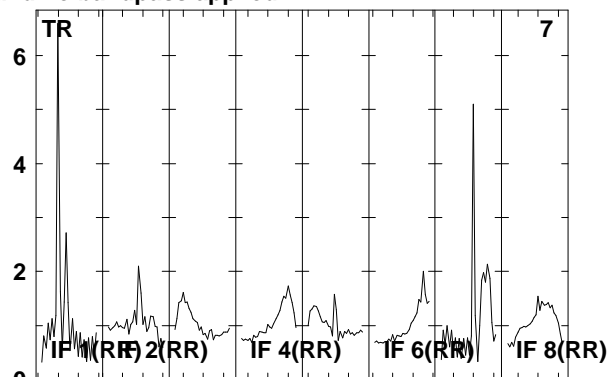
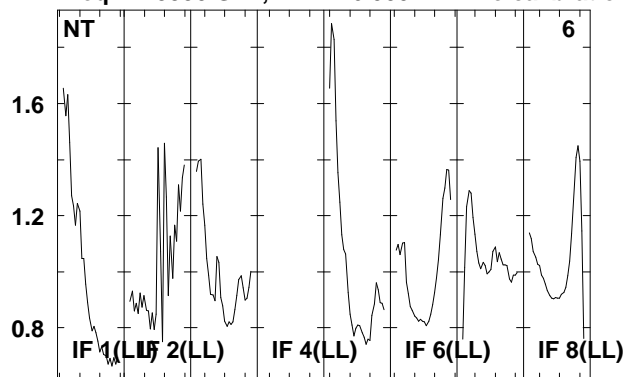

Lower frame: Real Jy  
Total-power spectrum Antenna: \*  
Timerange: 00/10/12:27 to 00/10/13:51

Plot file version 284 created 08-AUG-2008 17:00:52

J092159 EO006B.UVDATA.1

Freq = 1.5950 GHz, Bw = 16.000 MH No calibration applied and no bandpass applied

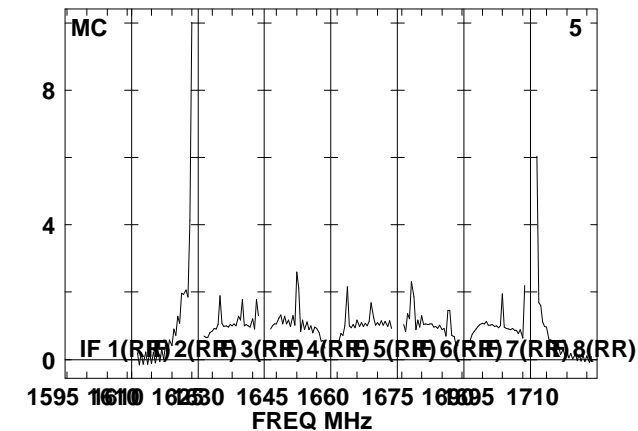
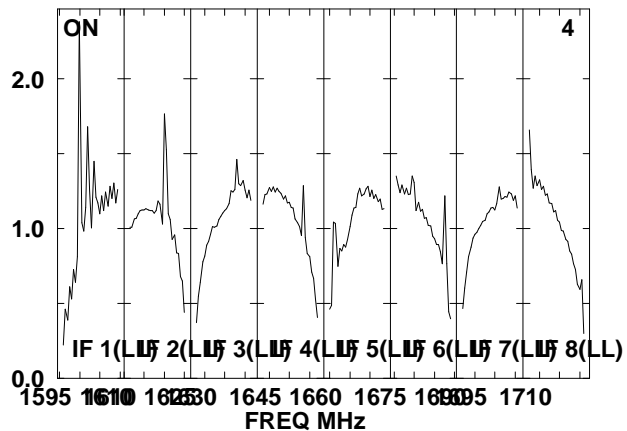
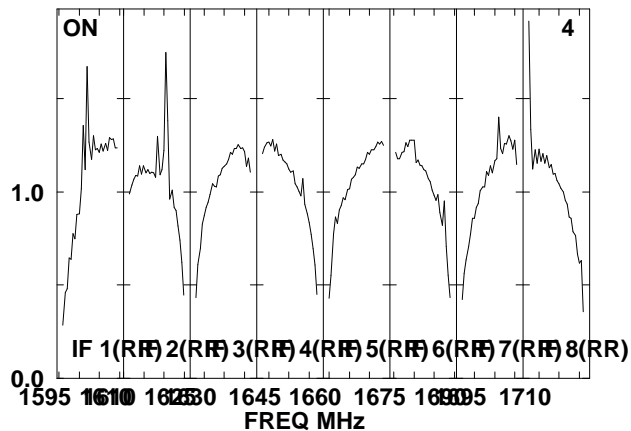
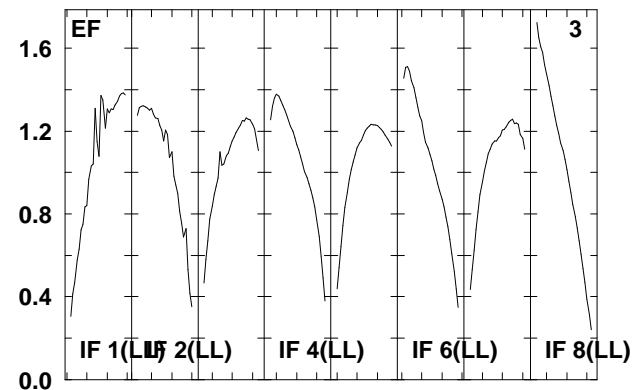
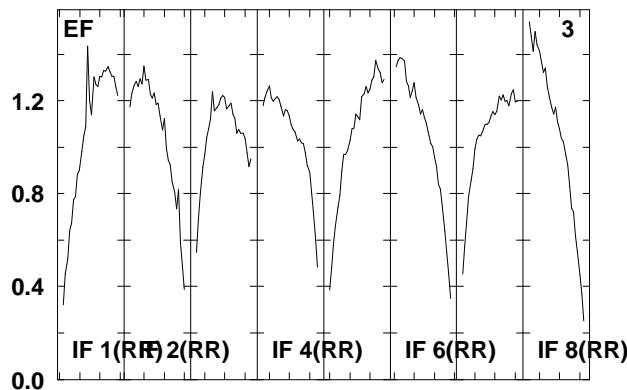
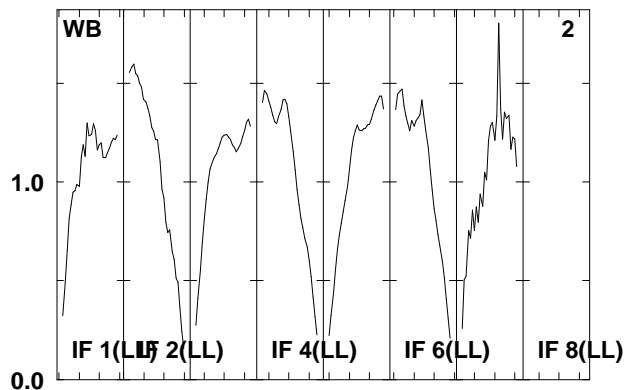
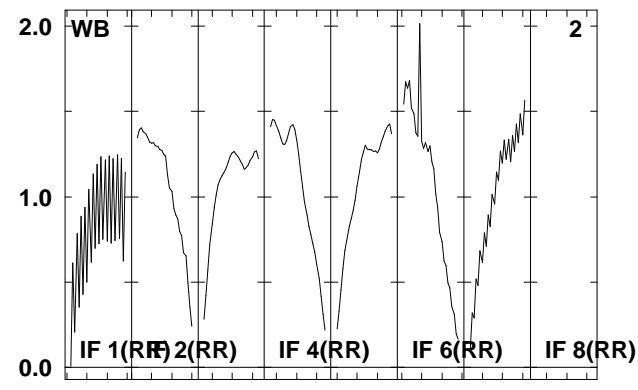
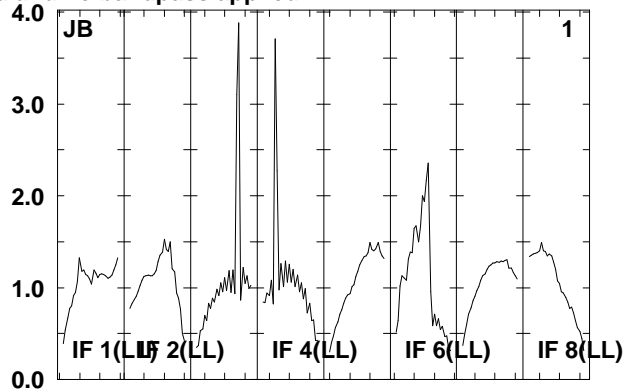
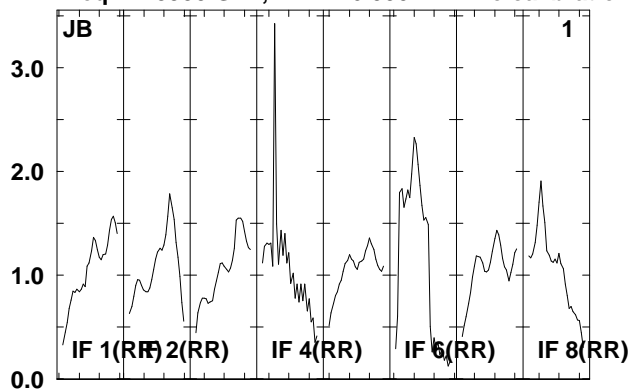

Lower frame: Real Jy  
Total-power spectrum Antenna: \*  
Timerange: 00/10:14:33 to 00/10:19:09



Plot file version 285 created 08-AUG-2008 17:00:52

J092159 EO006B.UVDATA.1

Freq = 1.5950 GHz, Bw = 16.000 MH No calibration applied and no bandpass applied

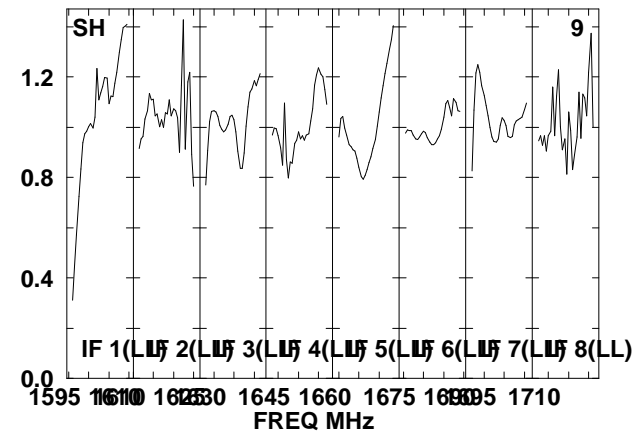
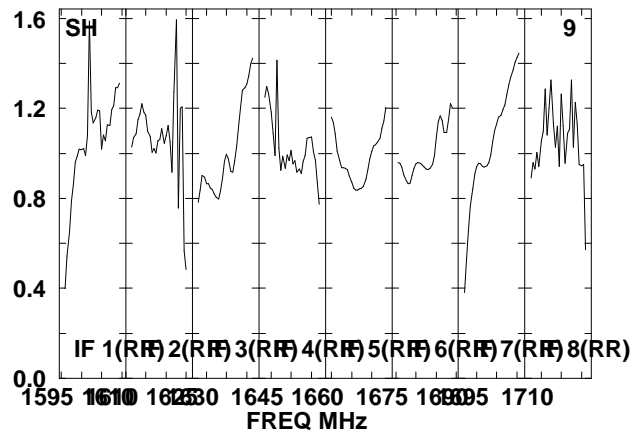
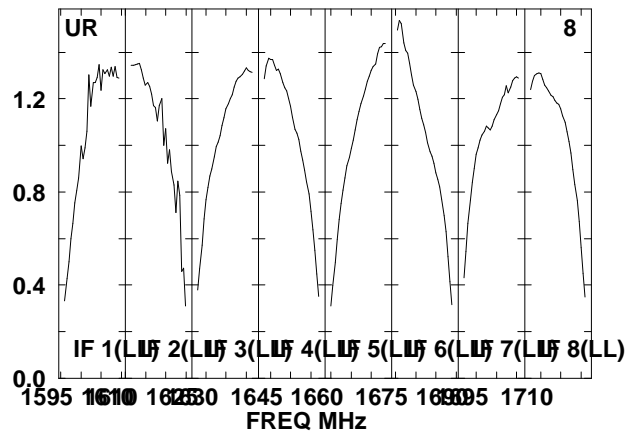
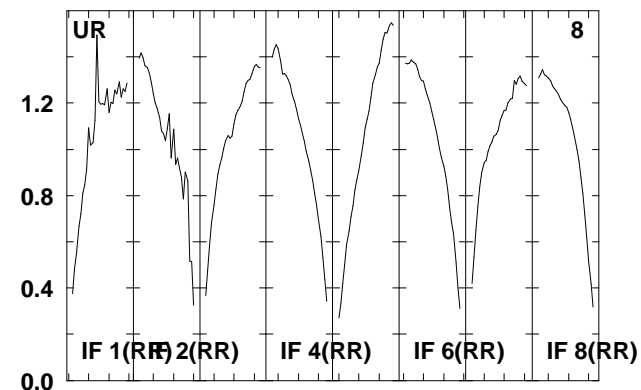
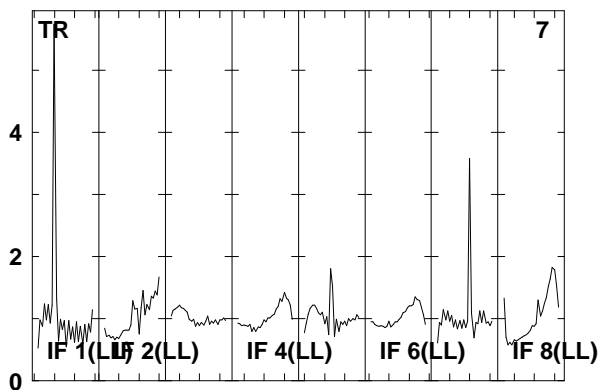
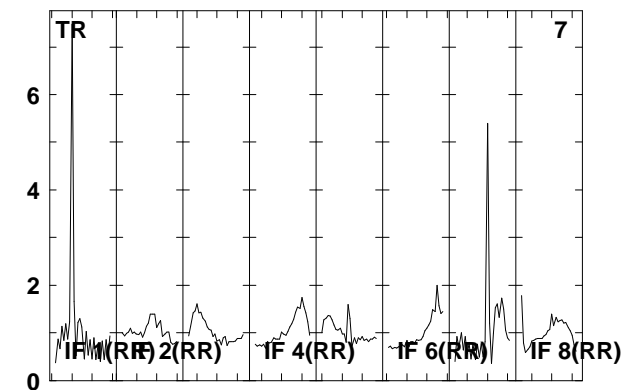
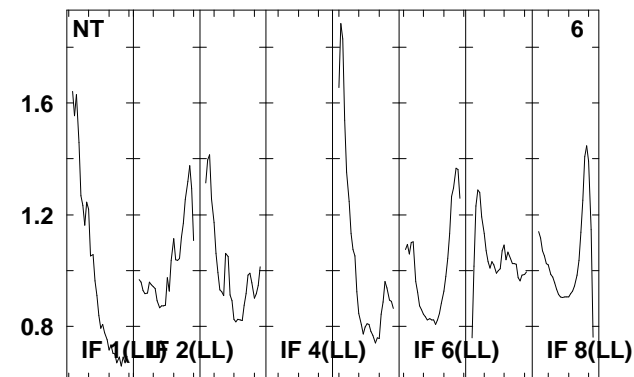
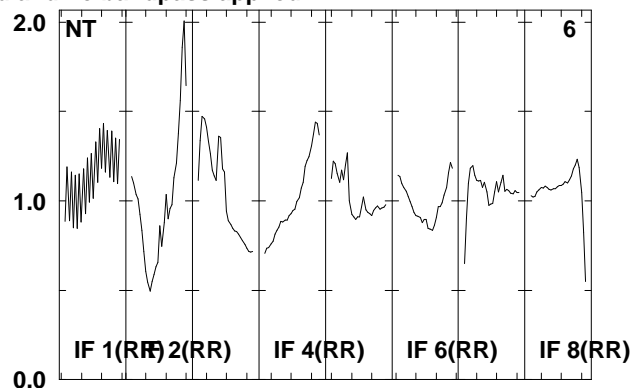
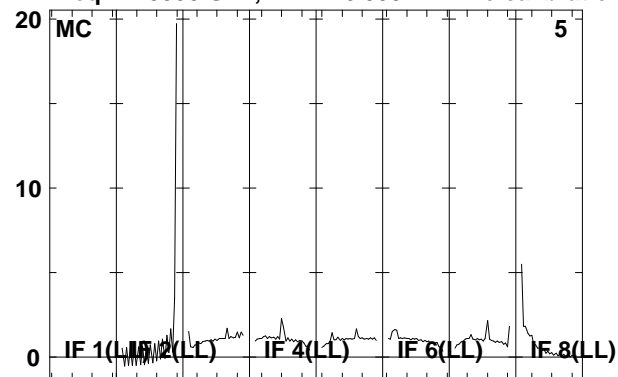

Lower frame: Real Jy  
Total-power spectrum Antenna: \*  
Timerange: 00/10:14:33 to 00/10:19:09

Plot file version 286 created 08-AUG-2008 17:00:53

J092159 EO006B.UVDATA.1

Freq = 1.5950 GHz, Bw = 16.000 MH No calibration applied and no bandpass applied

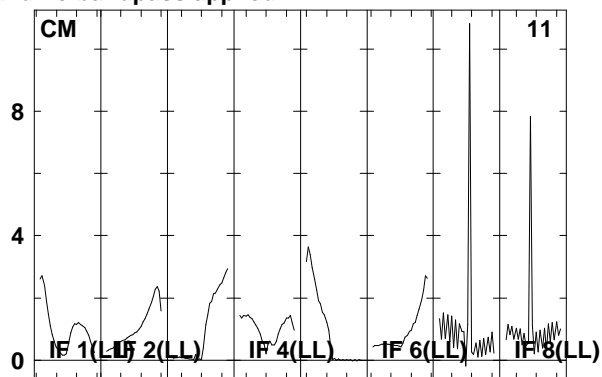
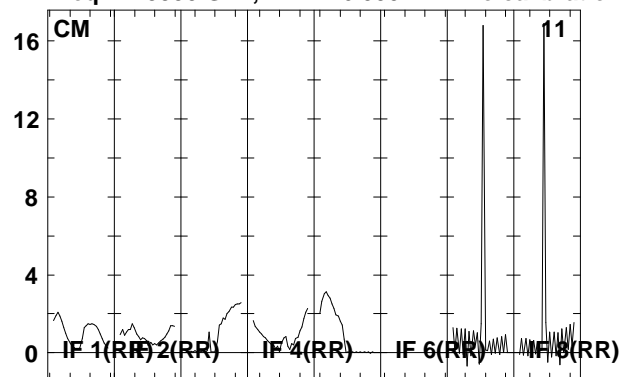

Lower frame: Real Jy  
Total-power spectrum Antenna: \*  
Timerange: 00/10:14:33 to 00/10:19:09

Plot file version 287 created 08-AUG-2008 17:00:53

J0920+44 EO006B.UVDATA.1

Freq = 1.5950 GHz, Bw = 16.000 MH No calibration applied and no bandpass applied

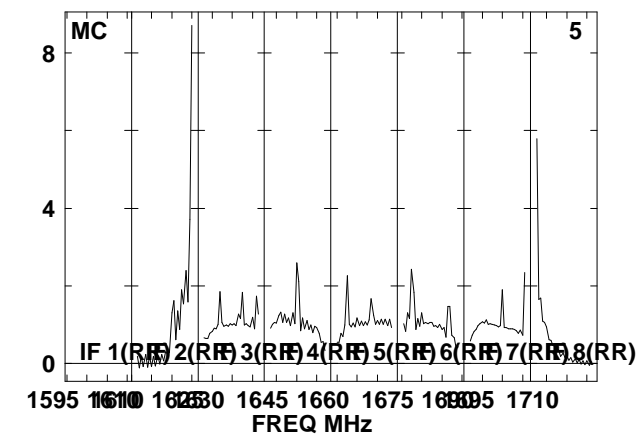
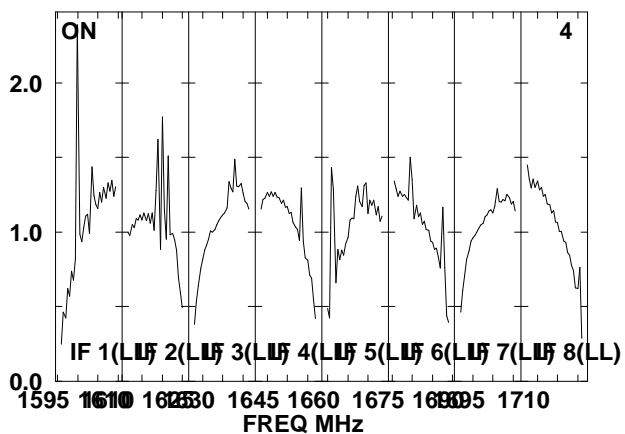
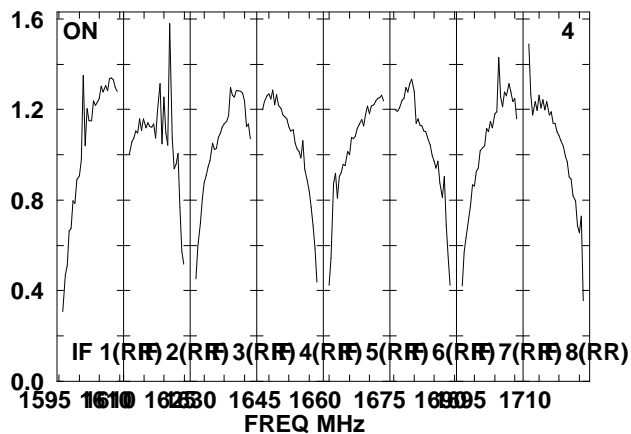
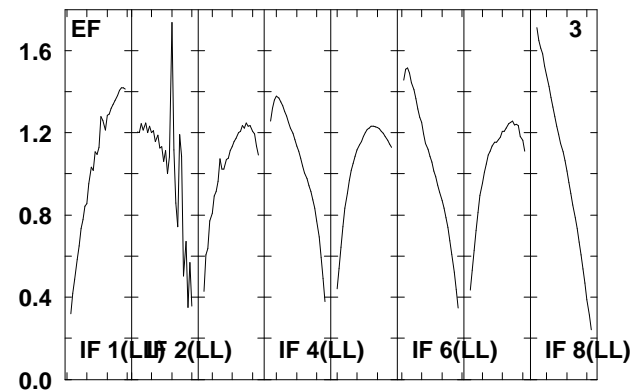
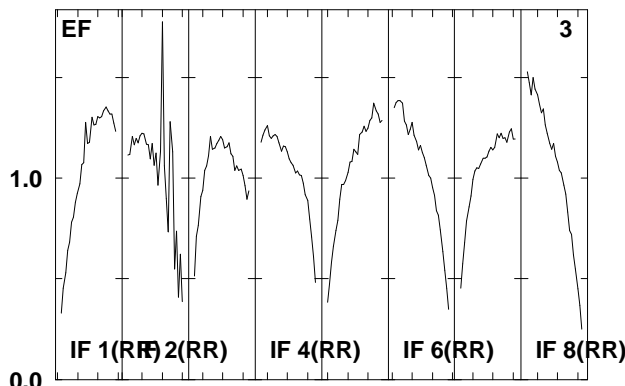
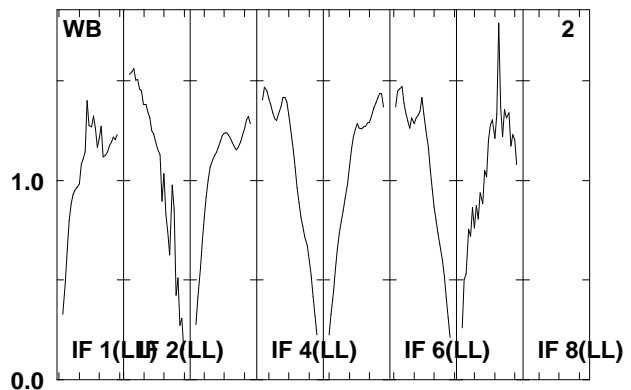
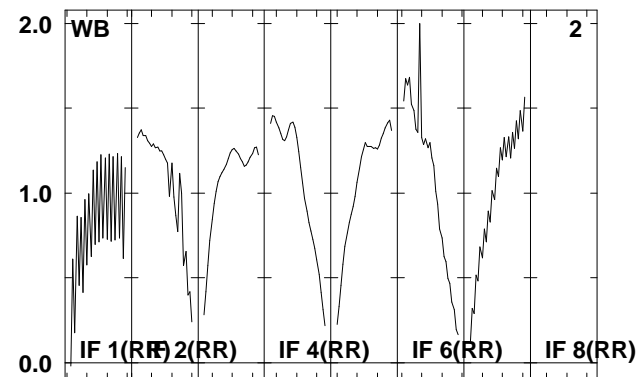
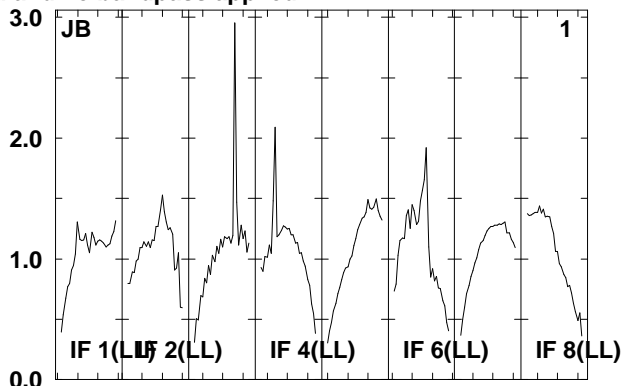
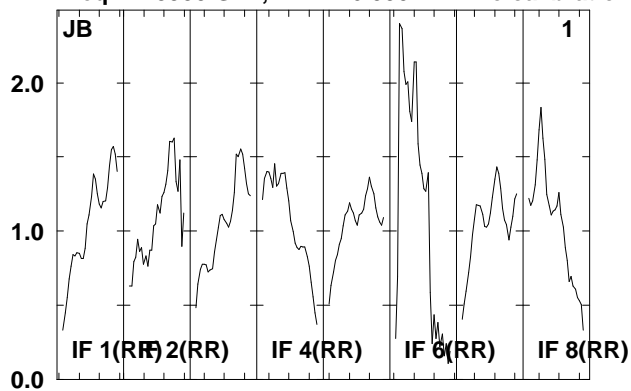

Lower frame: Real Jy  
Total-power spectrum Antenna: \*  
Timerange: 00/10:19:41 to 00/10:21:13

Plot file version 288 created 08-AUG-2008 17:00:54

J0920+44 EO006B.UVDATA.1

Freq = 1.5950 GHz, Bw = 16.000 MH No calibration applied and no bandpass applied

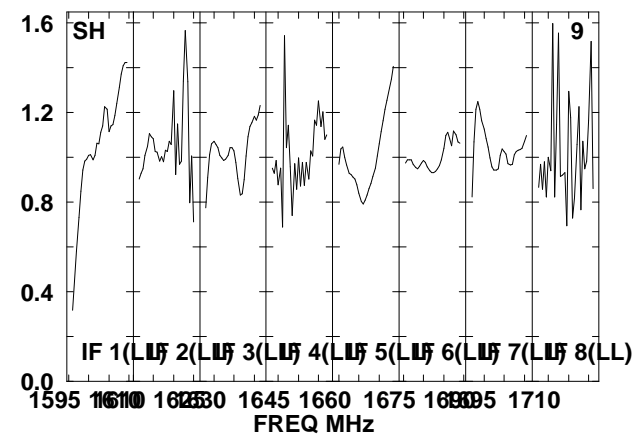
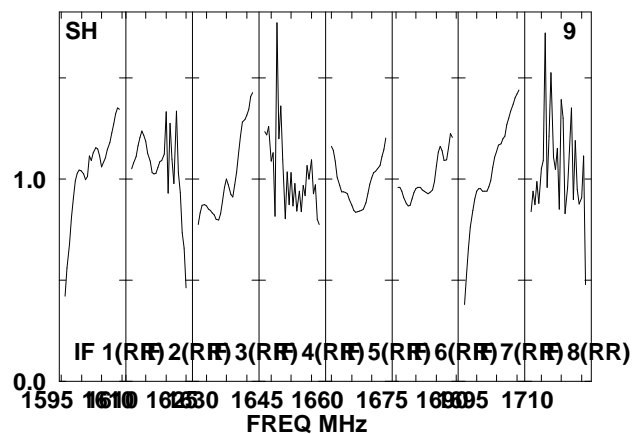
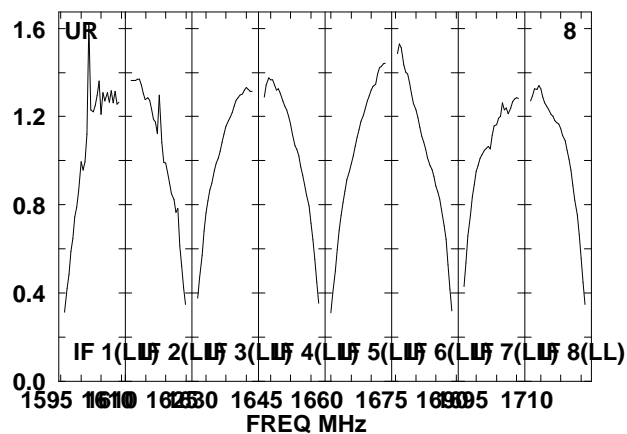
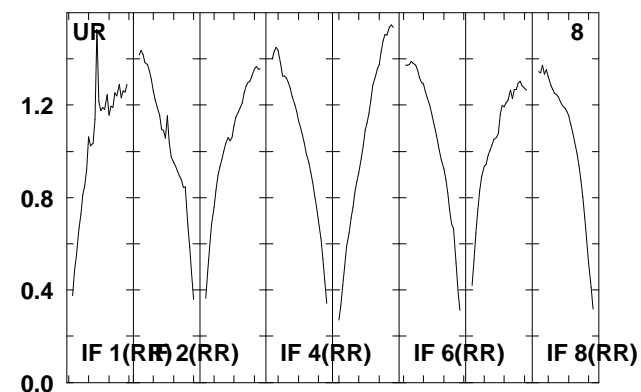
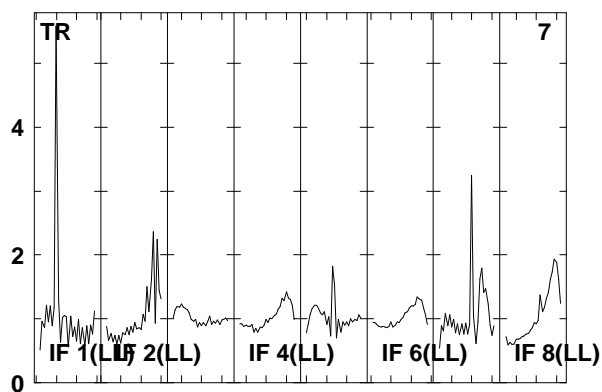
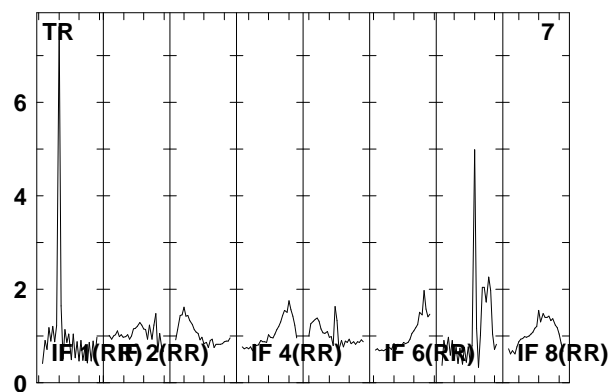
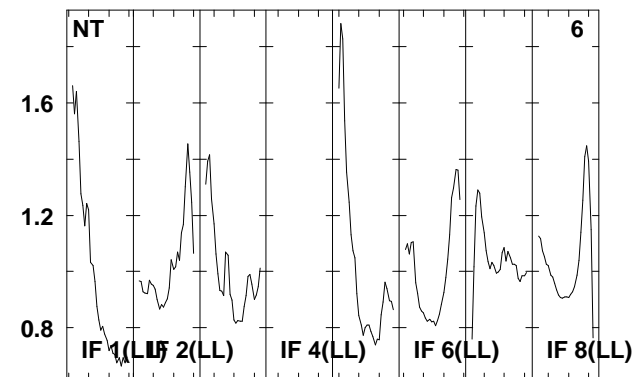
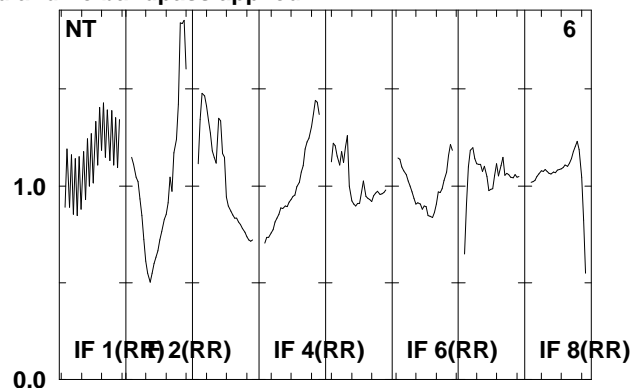
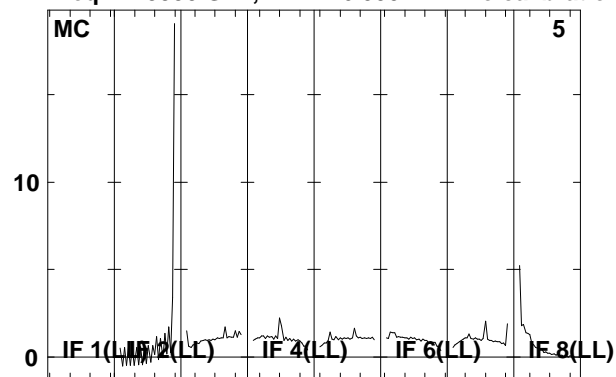

Lower frame: Real Jy

Total-power spectrum Antenna: \*

Timerange: 00/10:19:41 to 00/10:21:13

Plot file version 289 created 08-AUG-2008 17:00:54

J0920+44 EO006B.UVDATA.1

Freq = 1.5950 GHz, Bw = 16.000 MH No calibration applied and no bandpass applied

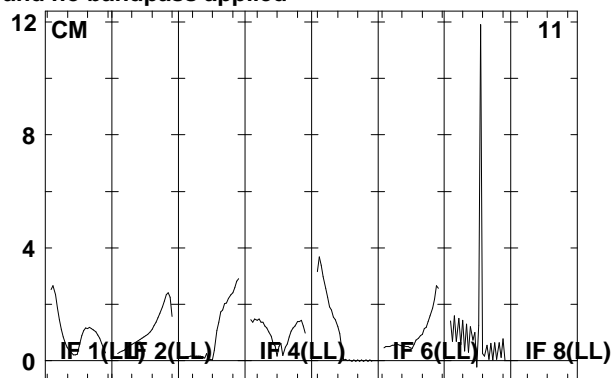
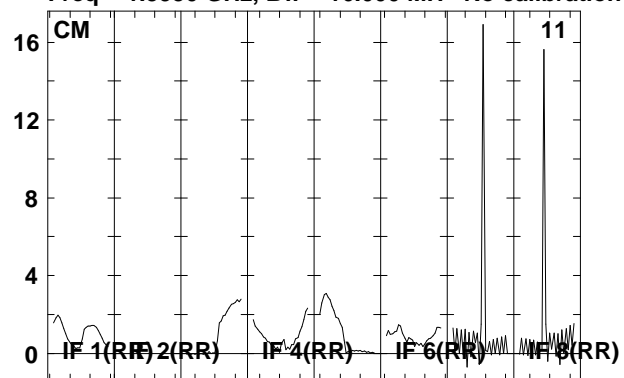

Lower frame: Real Jy  
Total-power spectrum Antenna: \*  
Timerange: 00/10:19:41 to 00/10:21:13

Plot file version 290 created 08-AUG-2008 17:00:54

J092159 EO06B.UVDATA.1

Freq = 1.5950 GHz, Bw = 16.000 MH No calibration applied and no bandpass applied

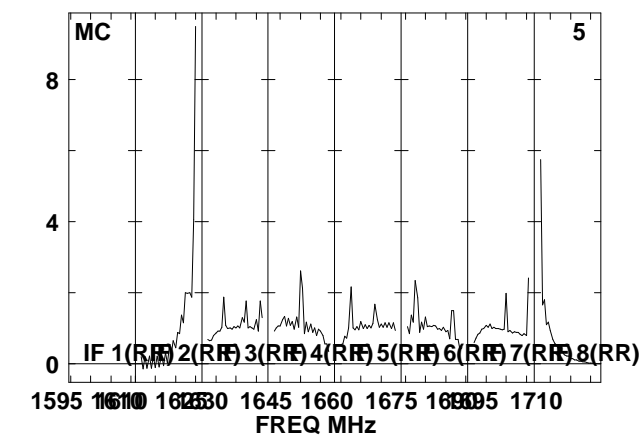
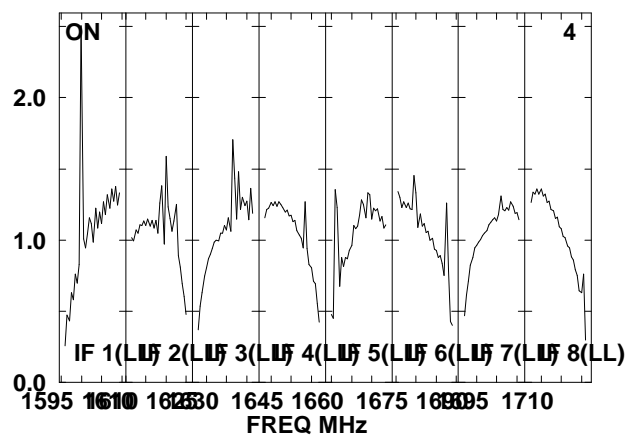
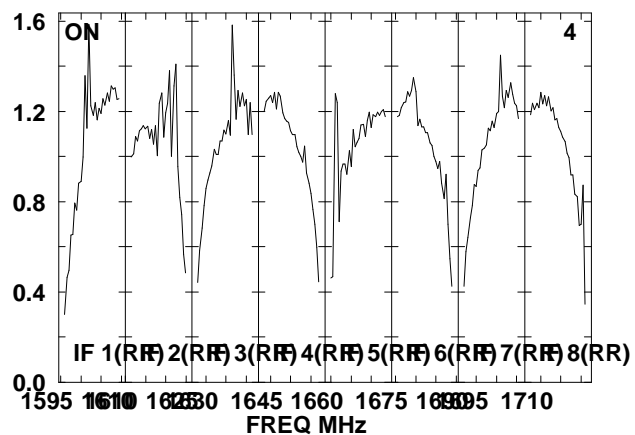
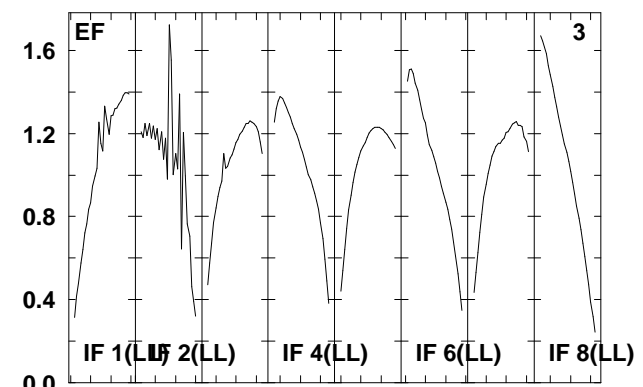
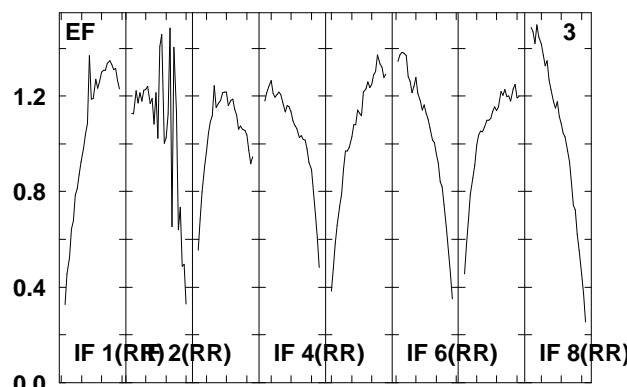
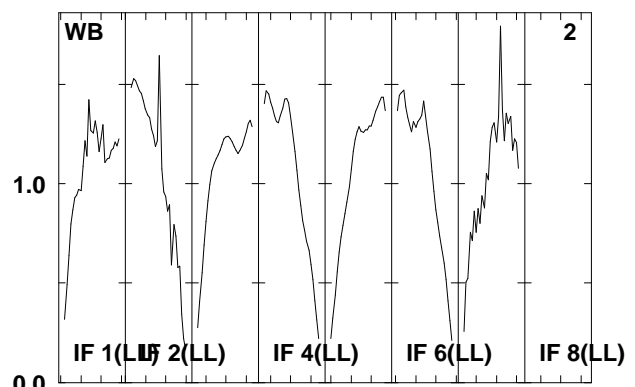
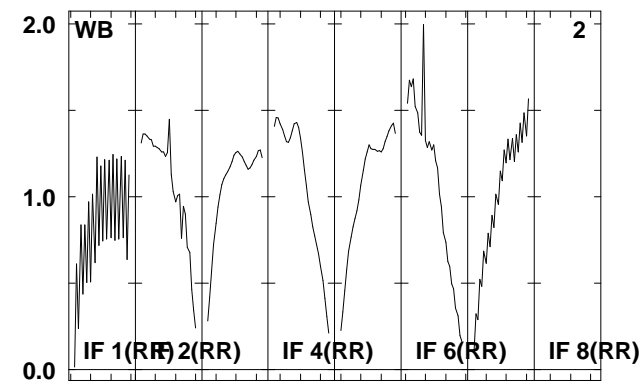
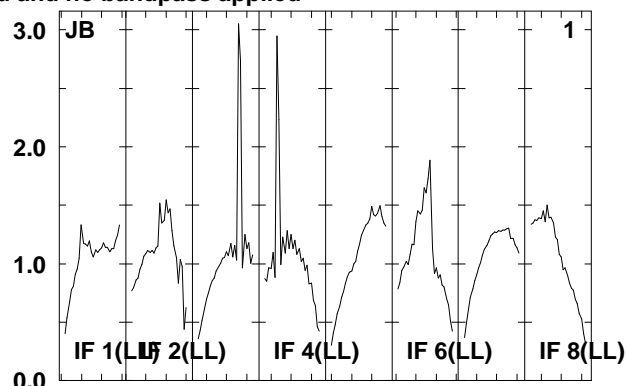
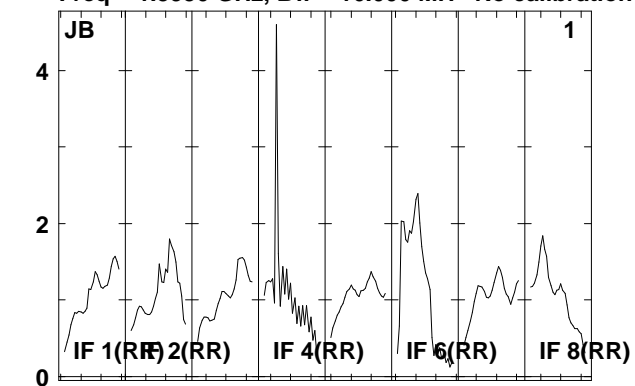

Lower frame: Real Jy  
Total-power spectrum Antenna: \*  
Timerange: 00/10/22:01 to 00/10/26:21

Plot file version 291 created 08-AUG-2008 17:00:55

J092159 EO06B.UVDATA.1

Freq = 1.5950 GHz, Bw = 16.000 MH No calibration applied and no bandpass applied

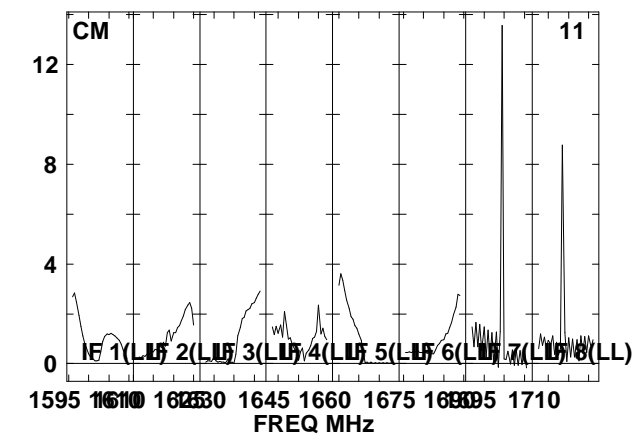
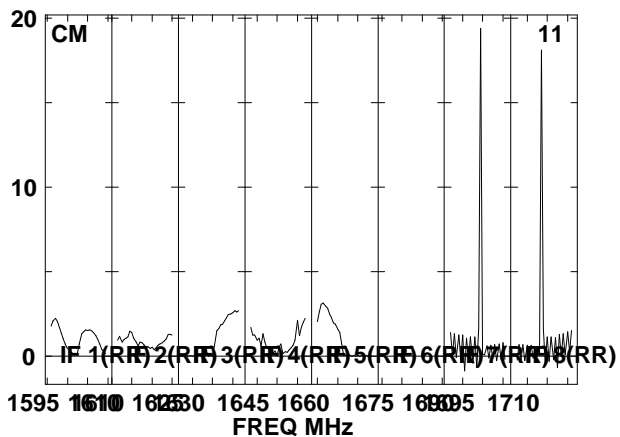
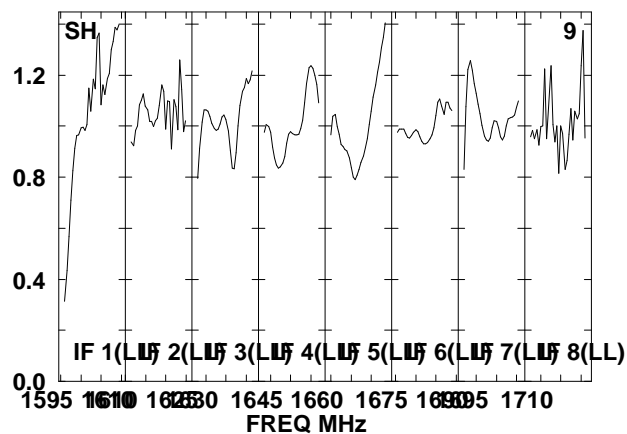
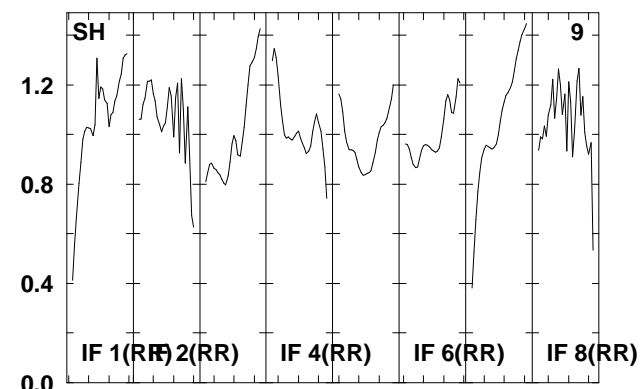
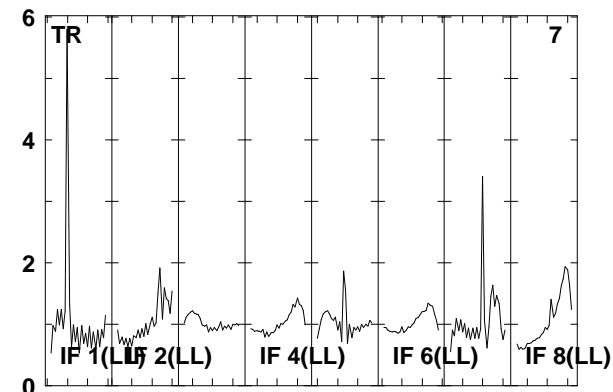
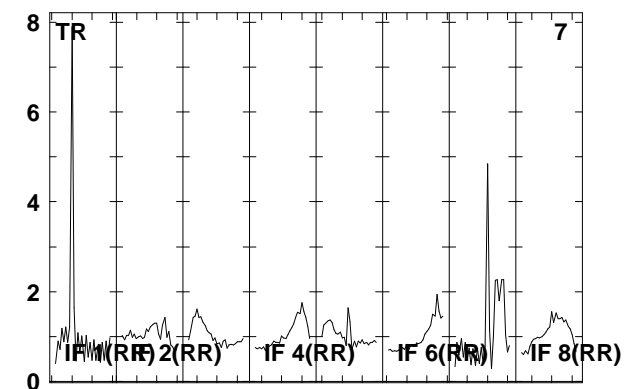
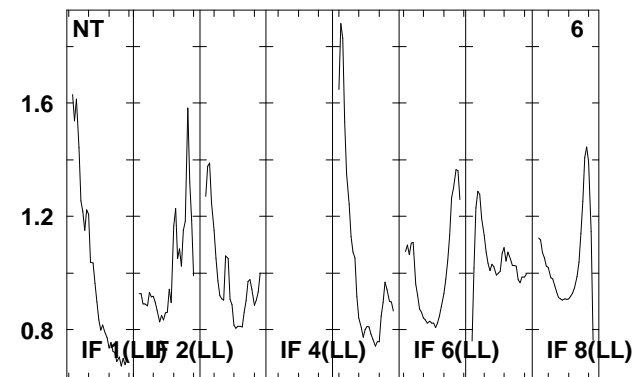
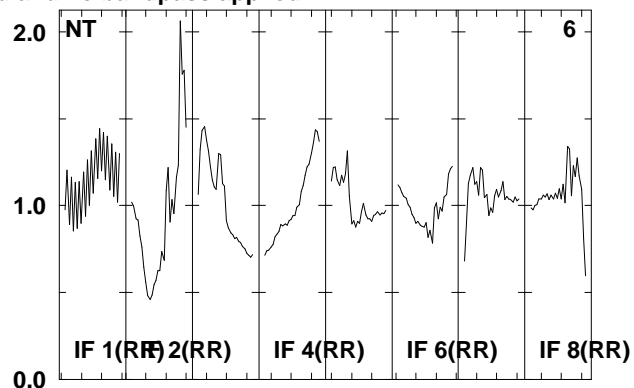
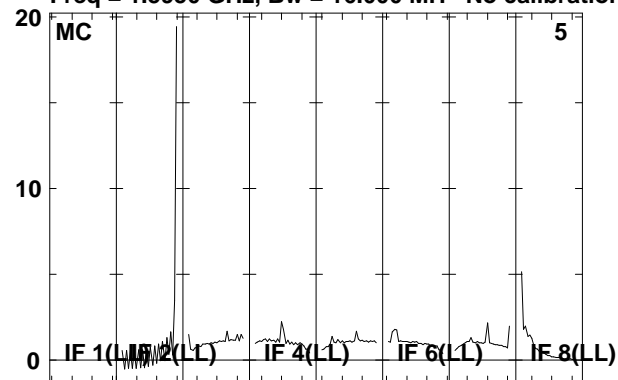

Lower frame: Real Jy  
Total-power spectrum Antenna: \*  
Timerange: 00/10:22:01 to 00/10:26:21

Plot file version 292 created 08-AUG-2008 17:00:56

J0920+44 EO006B.UVDATA.1

Freq = 1.5950 GHz, Bw = 16.000 MH No calibration applied and no bandpass applied

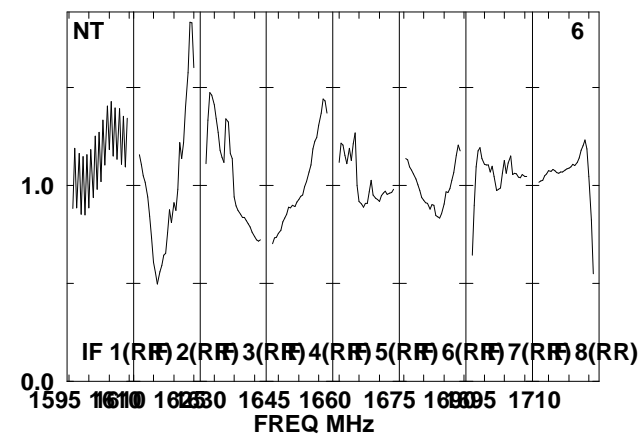
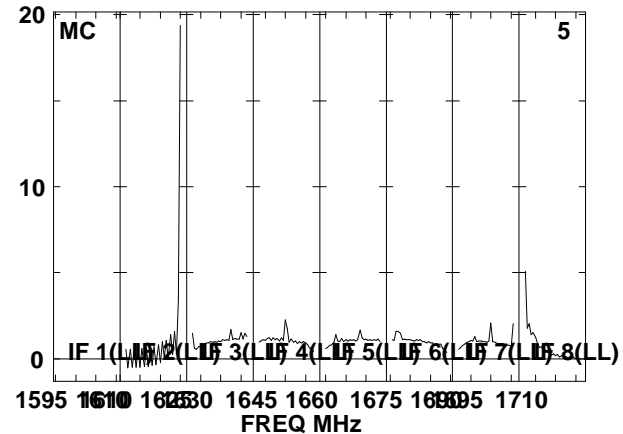
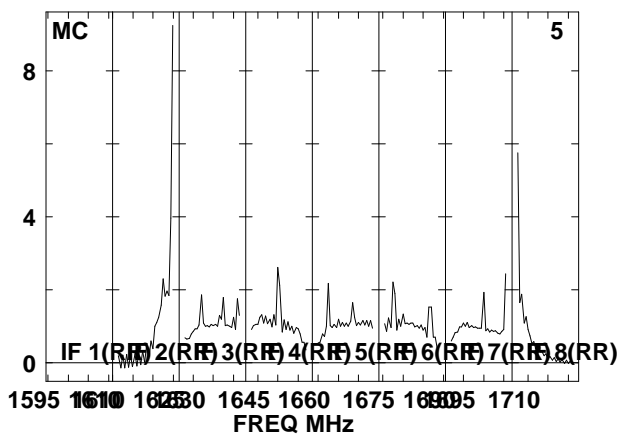
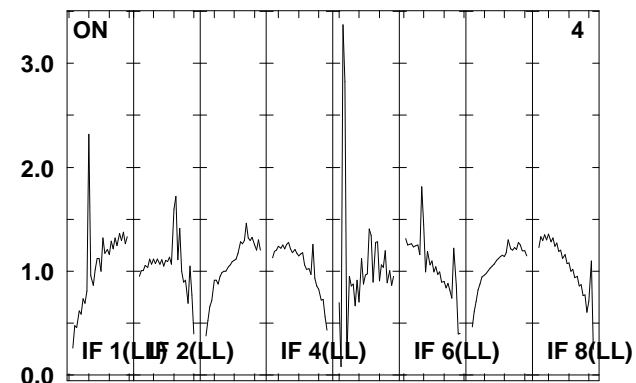
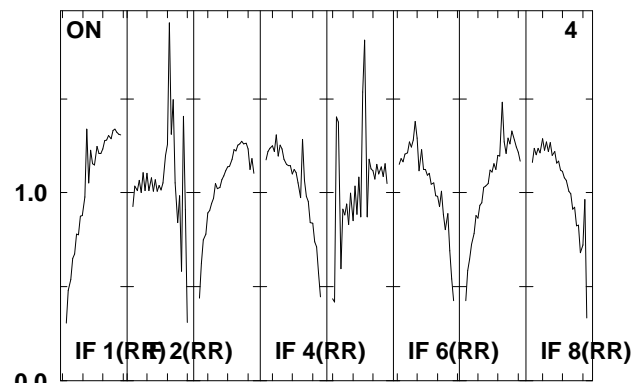
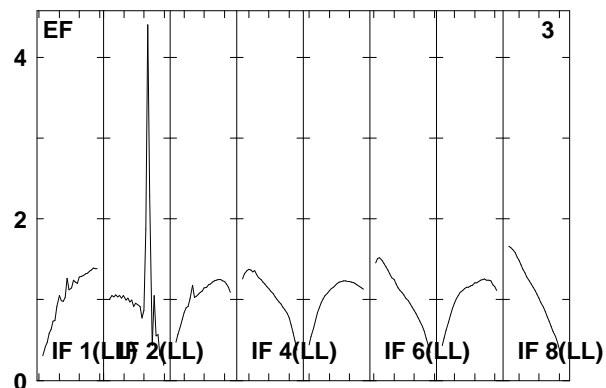
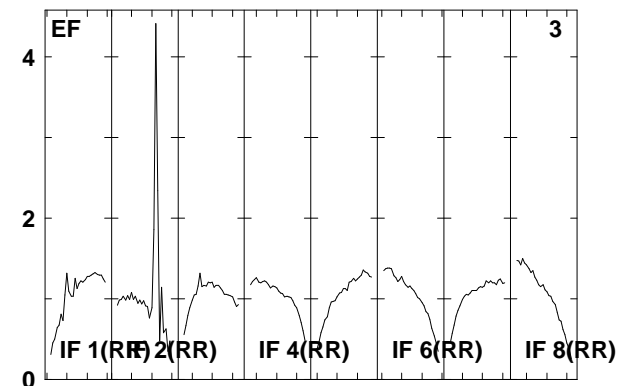
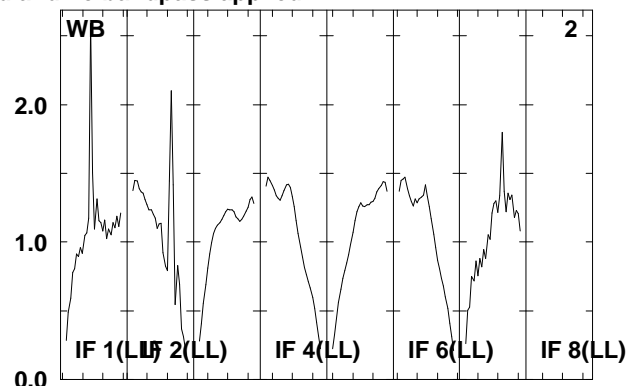
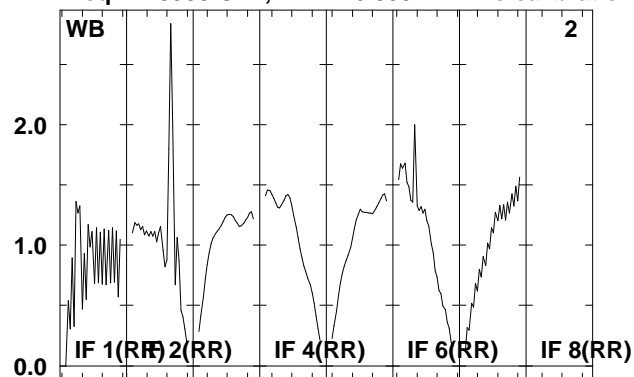

Lower frame: Real Jy  
Total-power spectrum Antenna: \*  
Timerange: 00/10:27:03 to 00/10:28:31



Plot file version 293 created 08-AUG-2008 17:00:56

J0920+44 EO006B.UVDATA.1

Freq = 1.5950 GHz, Bw = 16.000 MH No calibration applied and no bandpass applied

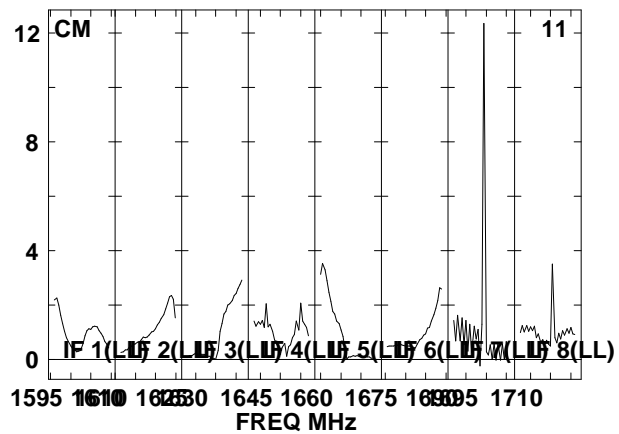
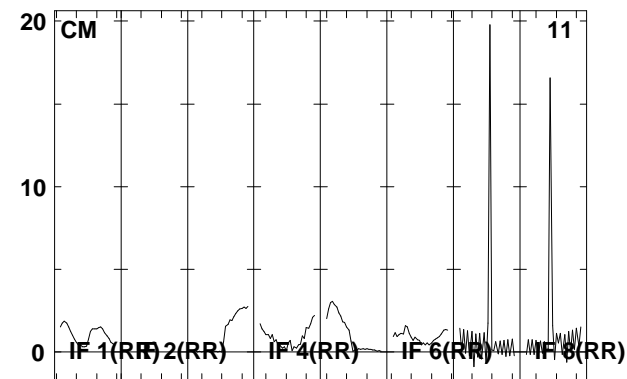
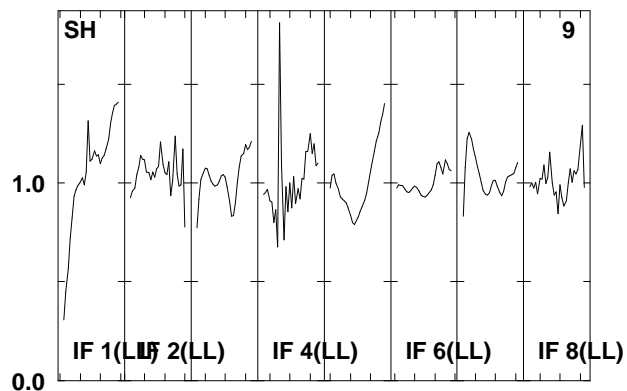
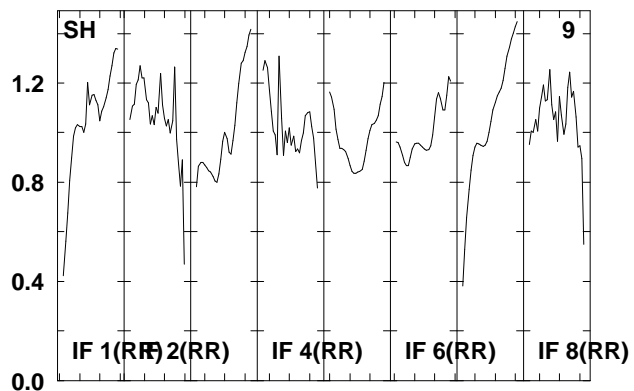
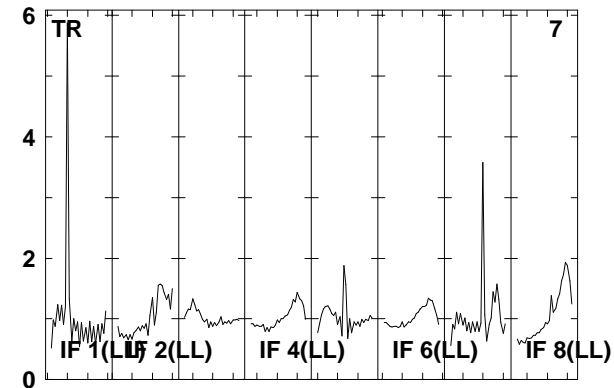
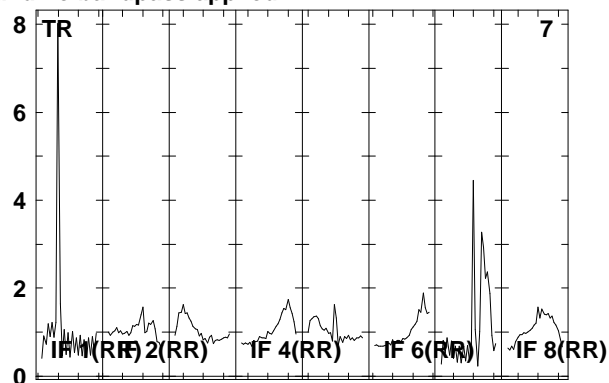
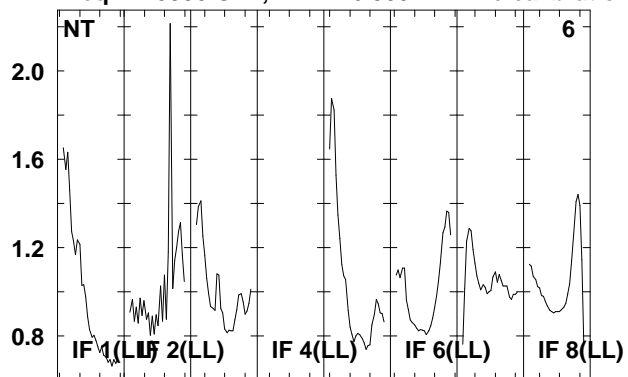

Lower frame: Real Jy

Total-power spectrum Antenna: \*

Timerange: 00/10/27:03 to 00/10/28:31

Plot file version 294 created 08-AUG-2008 17:00:57

J092159 EO006B.UVDATA.1

Freq = 1.5950 GHz, Bw = 16.000 MH No calibration applied and no bandpass applied

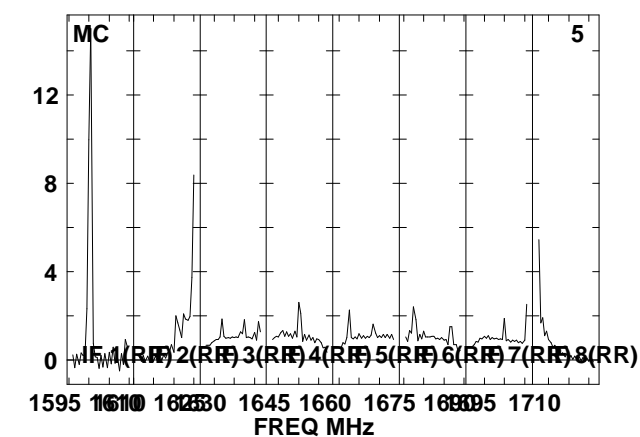
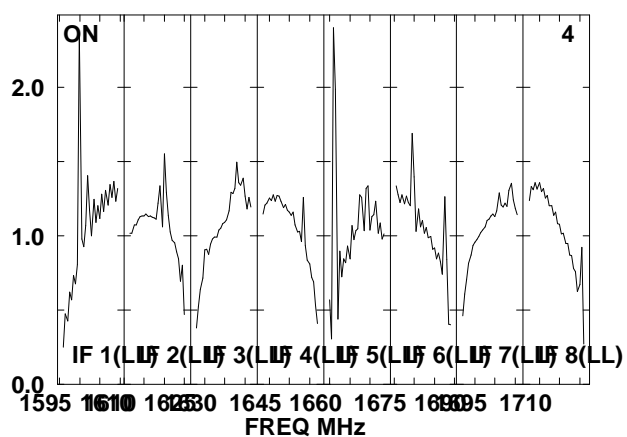
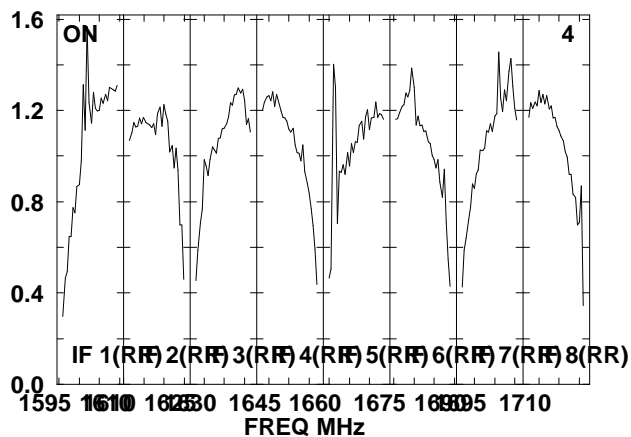
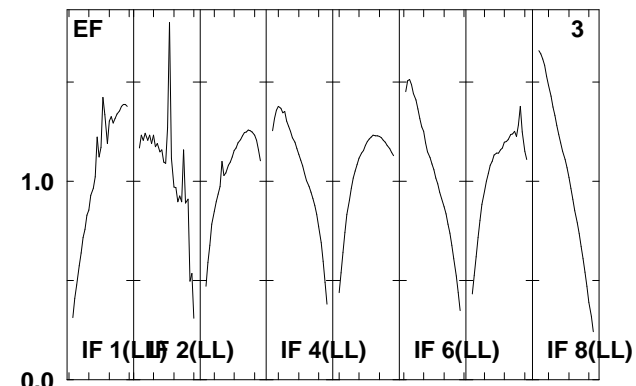
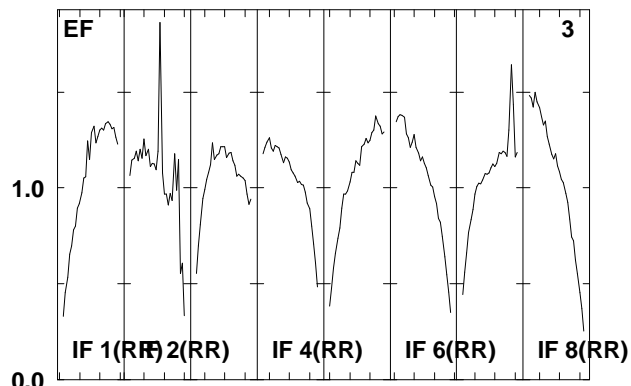
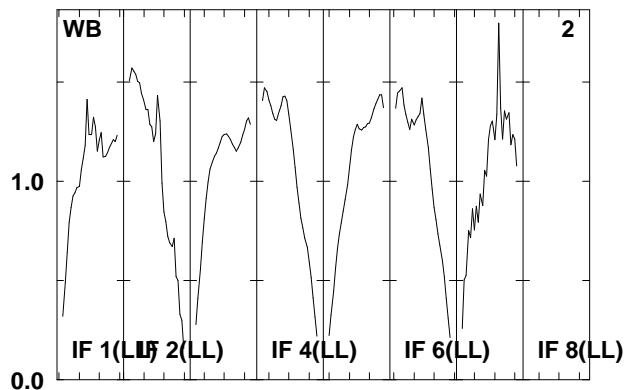
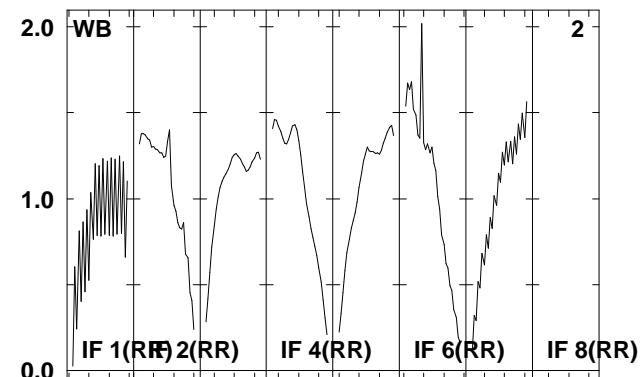
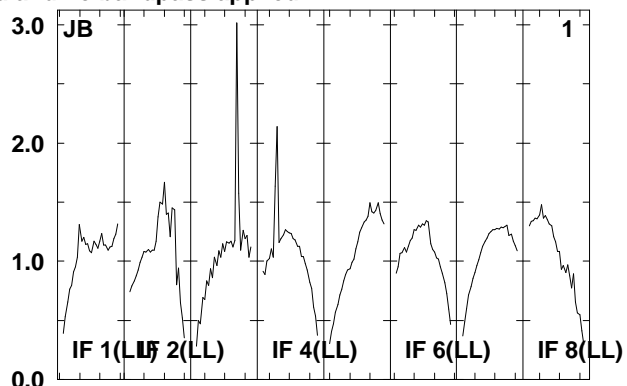
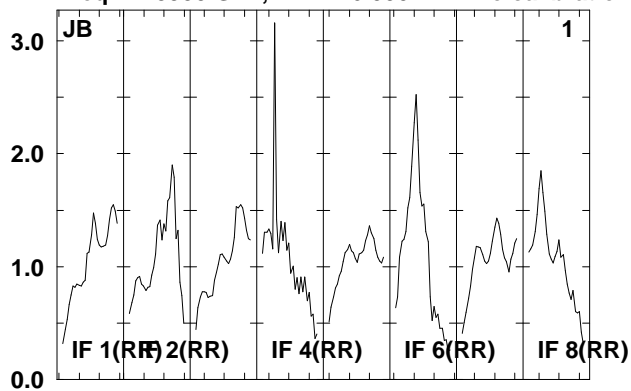

Lower frame: Real Jy  
Total-power spectrum Antenna: \*  
Timerange: 00/10:29:17 to 00/10:33:49

Plot file version 295 created 08-AUG-2008 17:00:57

J092159 EO006B.UVDATA.1

Freq = 1.5950 GHz, Bw = 16.000 MH No calibration applied and no bandpass applied

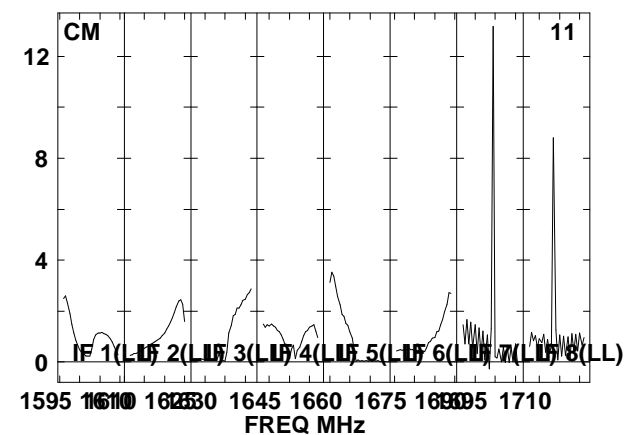
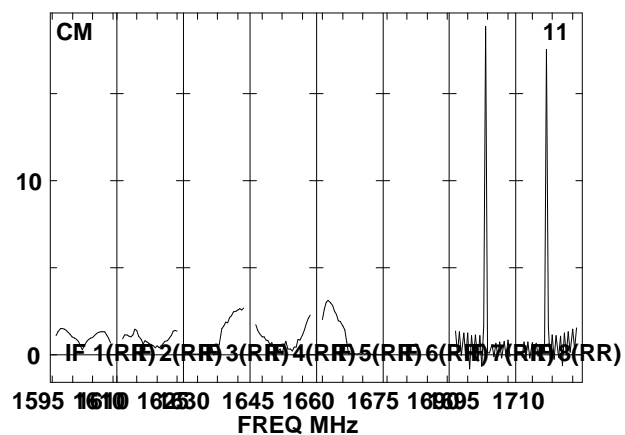
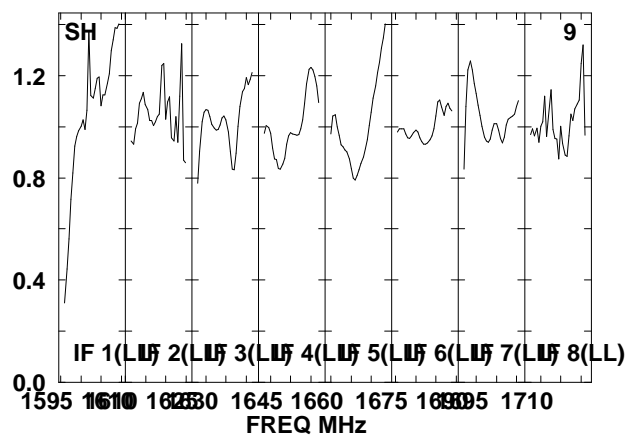
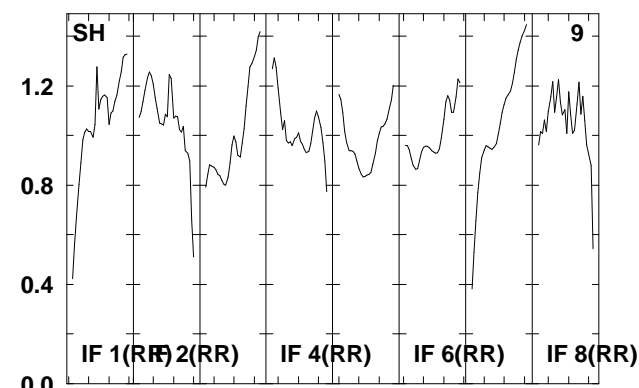
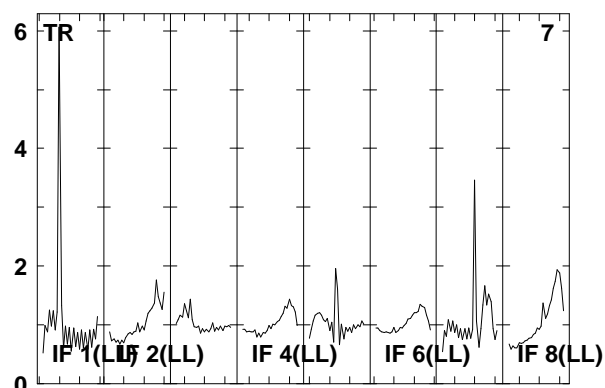
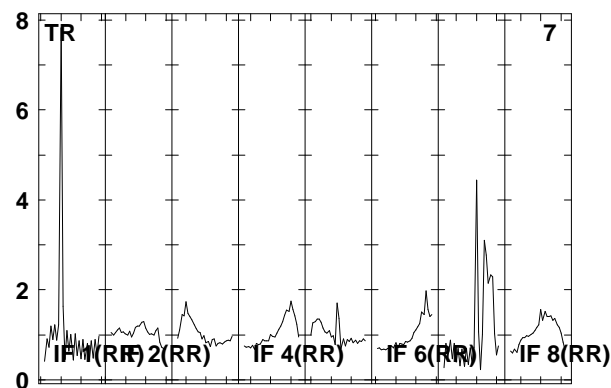
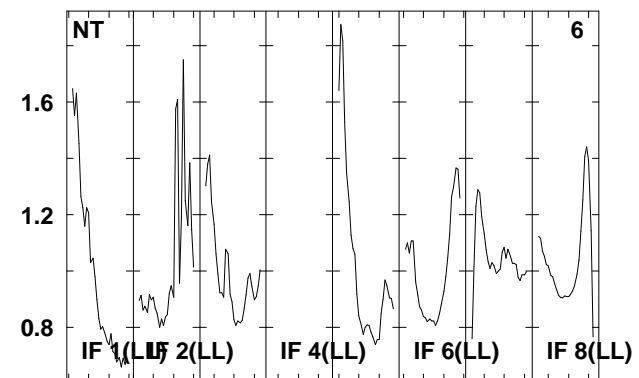
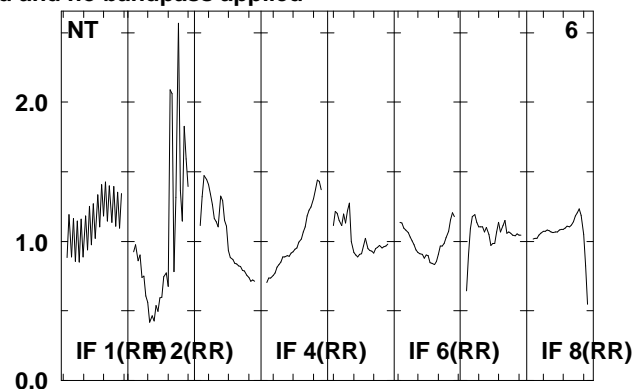
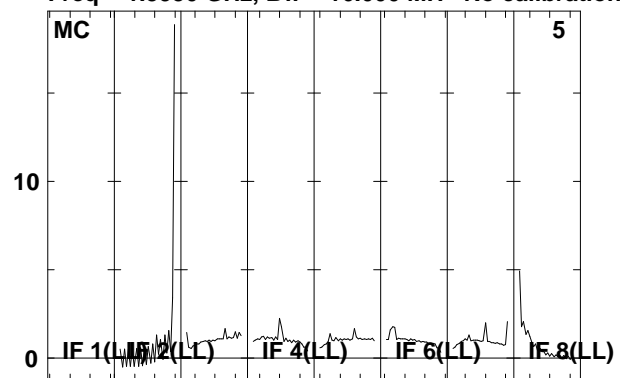

Lower frame: Real Jy  
Total-power spectrum Antenna: \*  
Timerange: 00/10:29:17 to 00/10:33:49

Plot file version 296 created 08-AUG-2008 17:00:59

J0920+44 EO006B.UVDATA.1

Freq = 1.5950 GHz, Bw = 16.000 MH No calibration applied and no bandpass applied

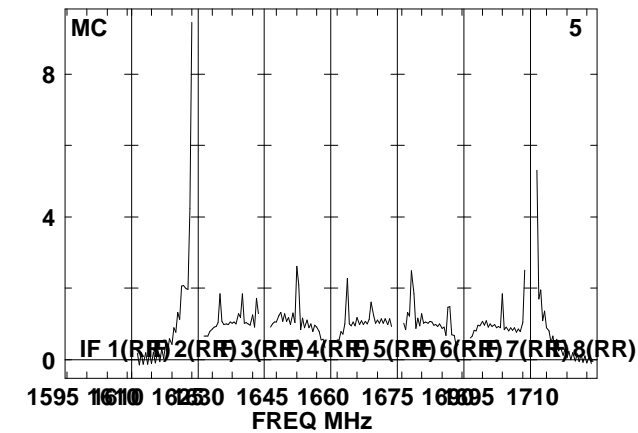
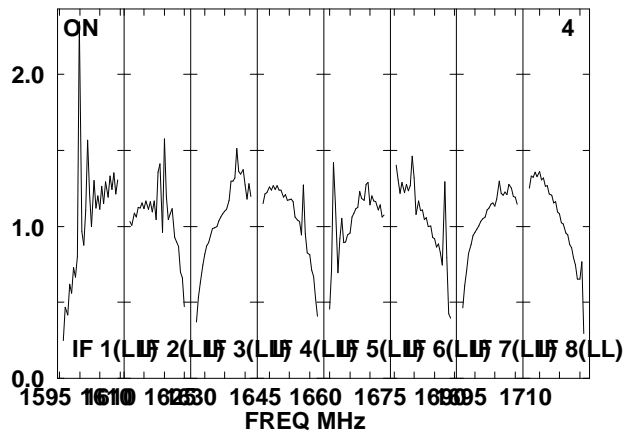
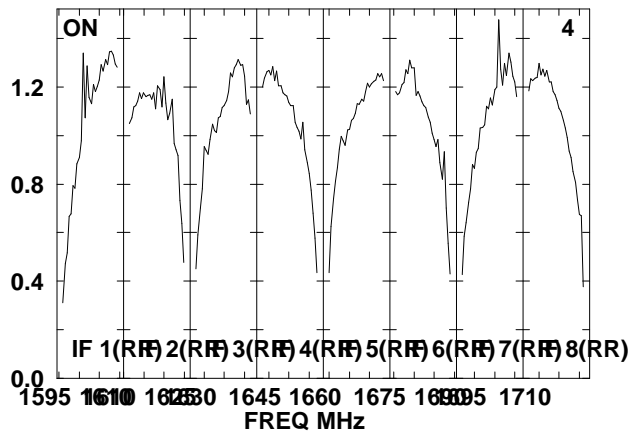
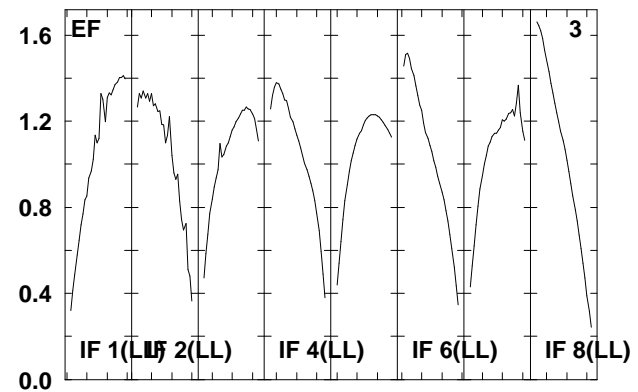
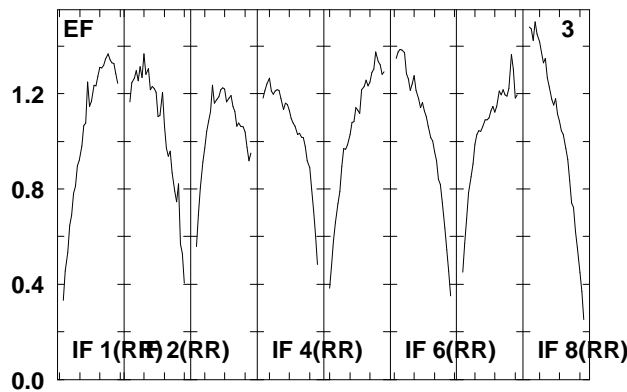
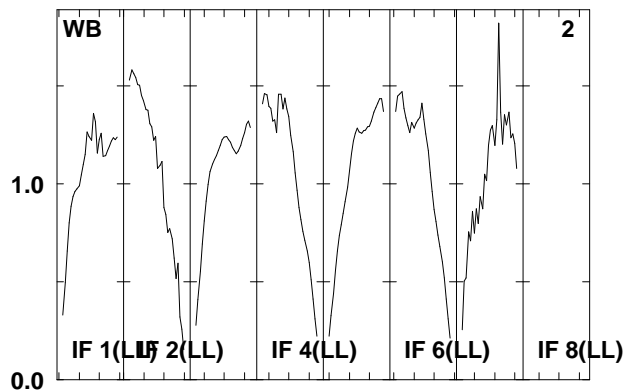
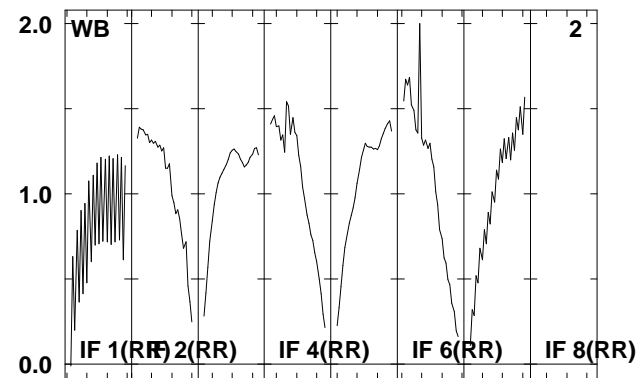
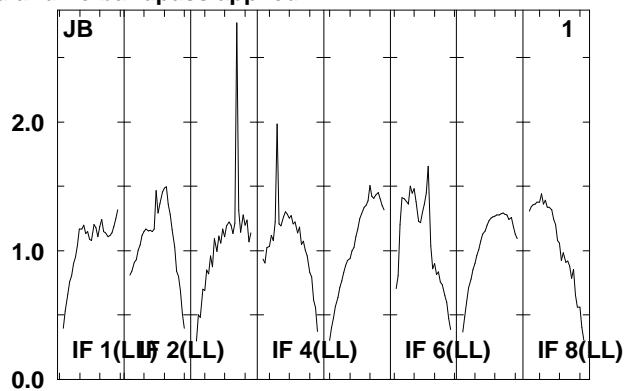
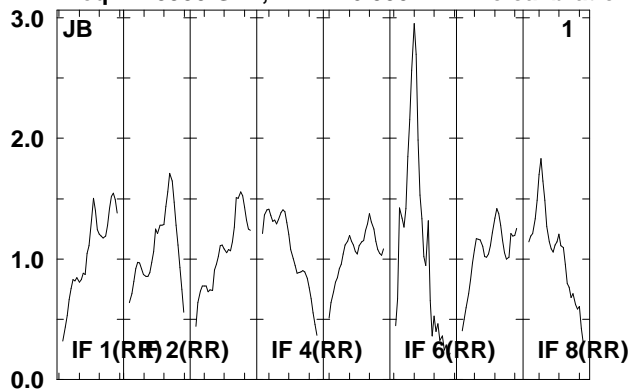

Lower frame: Real Jy  
Total-power spectrum Antenna: \*  
Timerange: 00/10:34:21 to 00/10:35:57

Plot file version 297 created 08-AUG-2008 17:00:59

J0920+44 EO006B.UVDATA.1

Freq = 1.5950 GHz, Bw = 16.000 MH No calibration applied and no bandpass applied

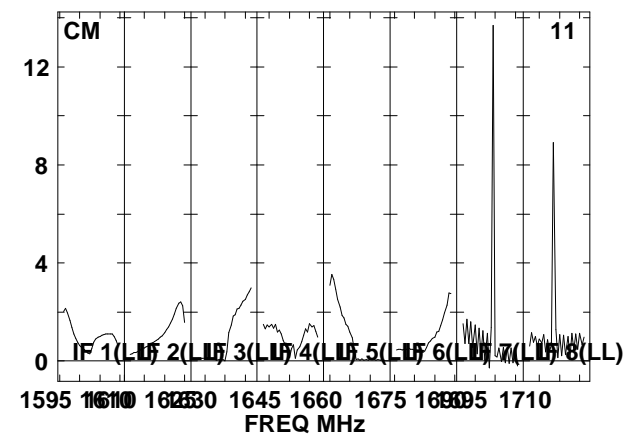
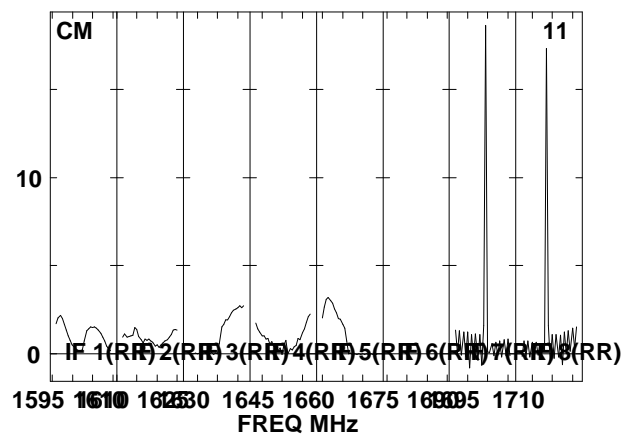
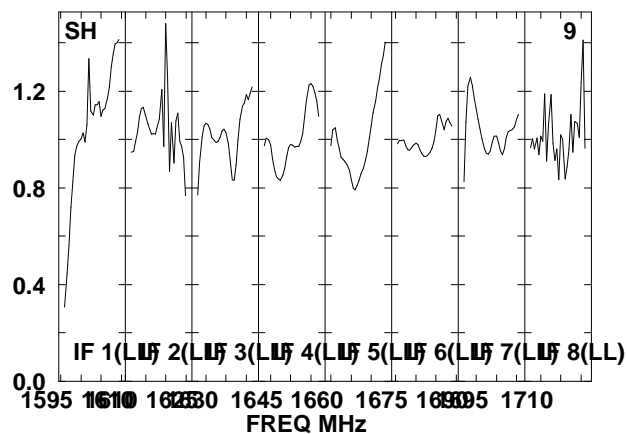
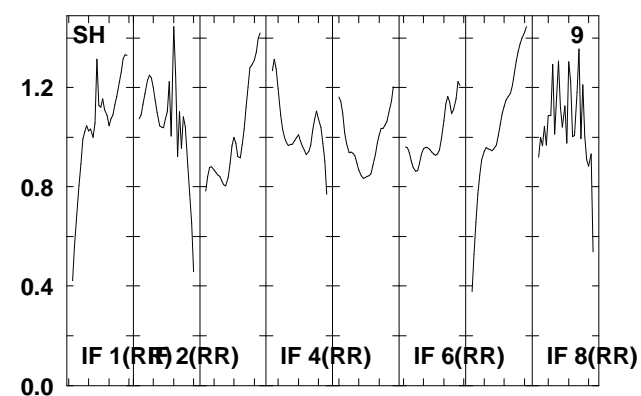
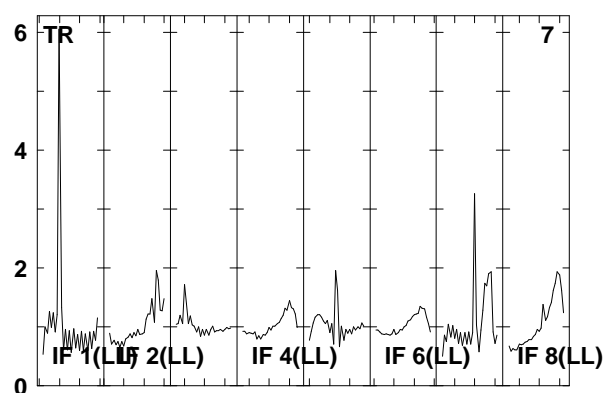
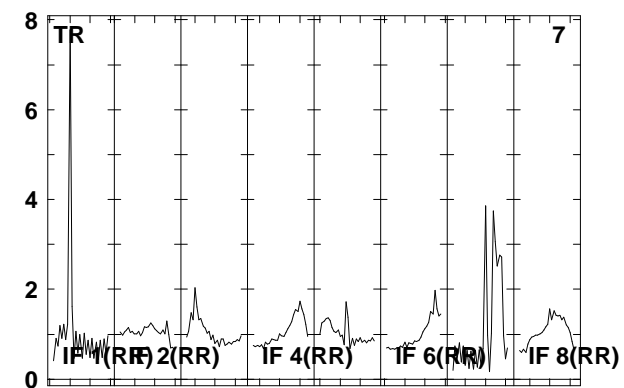
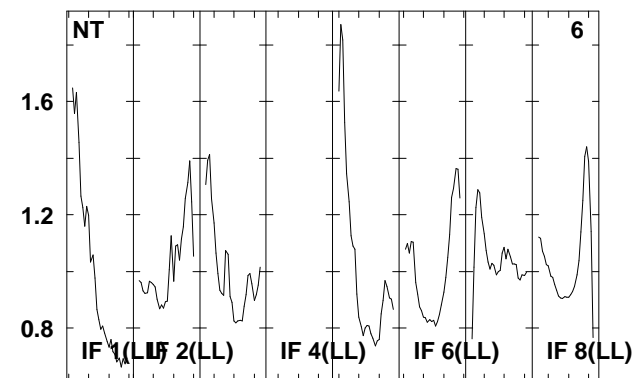
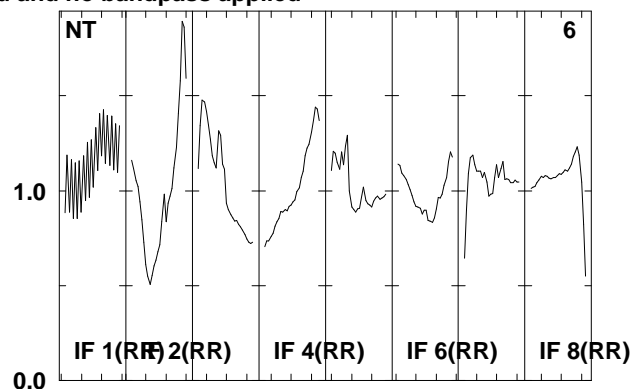
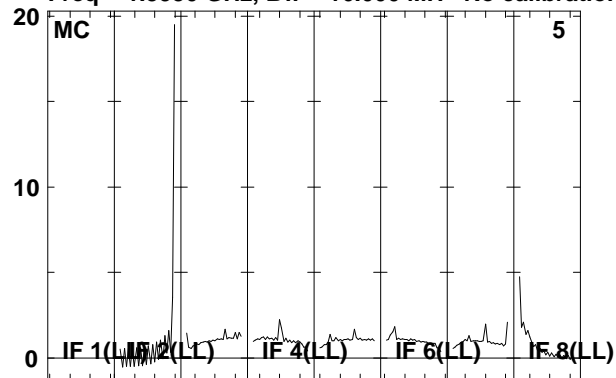

Lower frame: Real Jy

Total-power spectrum Antenna: \*

Timerange: 00/10:34:21 to 00/10:35:57

Plot file version 298 created 08-AUG-2008 17:01:00

J092159 EO006B.UVDATA.1

Freq = 1.5950 GHz, Bw = 16.000 MH No calibration applied and no bandpass applied

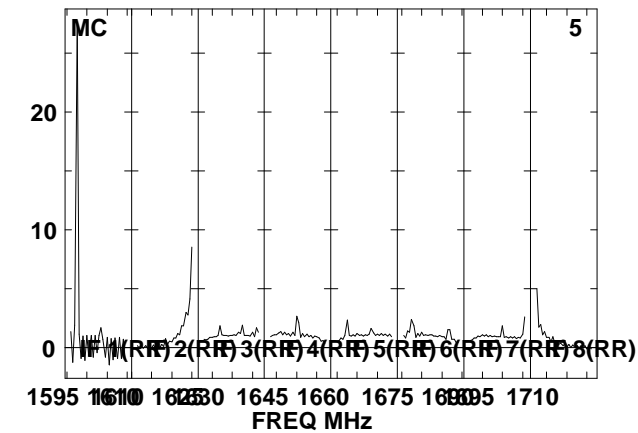
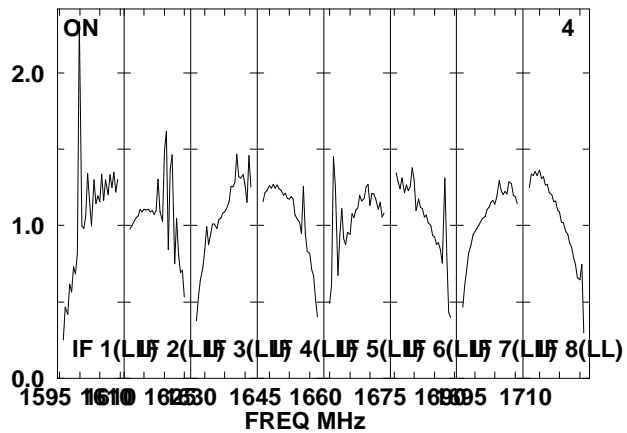
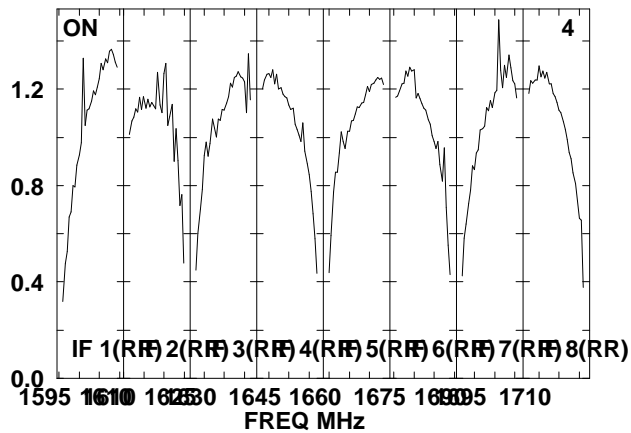
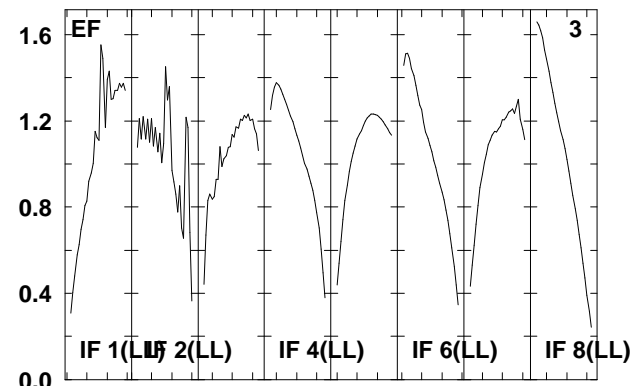
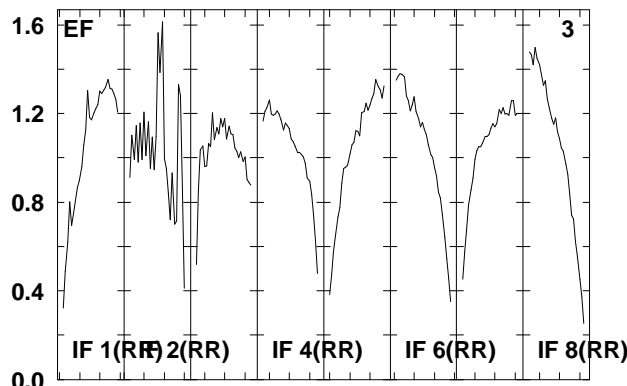
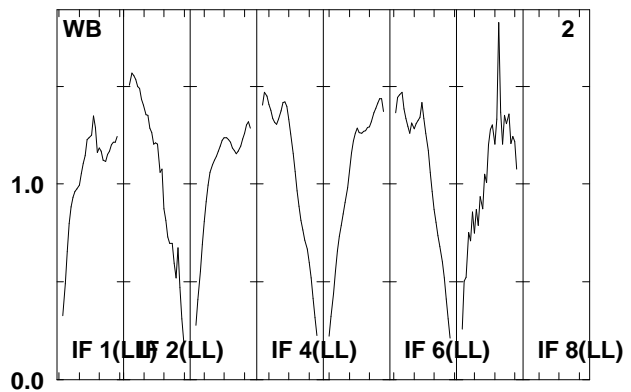
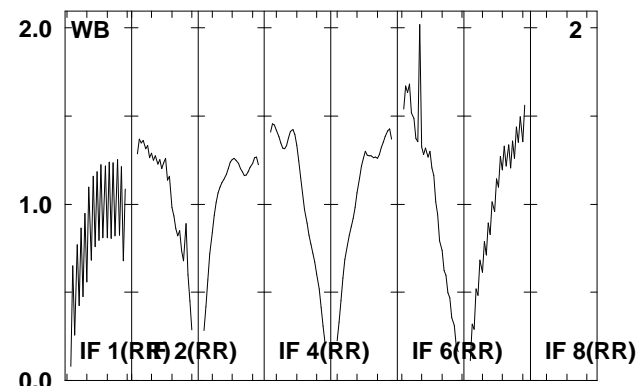
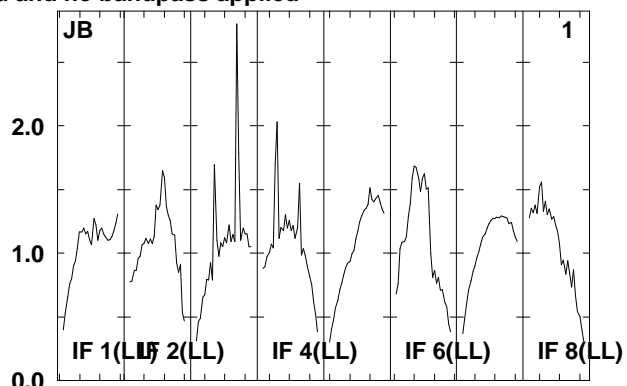
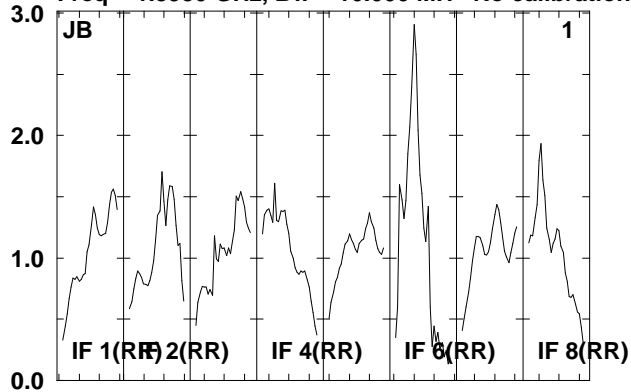

Lower frame: Real Jy  
Total-power spectrum Antenna: \*  
Timerange: 00/10:36:33 to 00/10:41:09

Plot file version 299 created 08-AUG-2008 17:01:00

J092159 EO006B.UVDATA.1

Freq = 1.5950 GHz, Bw = 16.000 MH No calibration applied and no bandpass applied

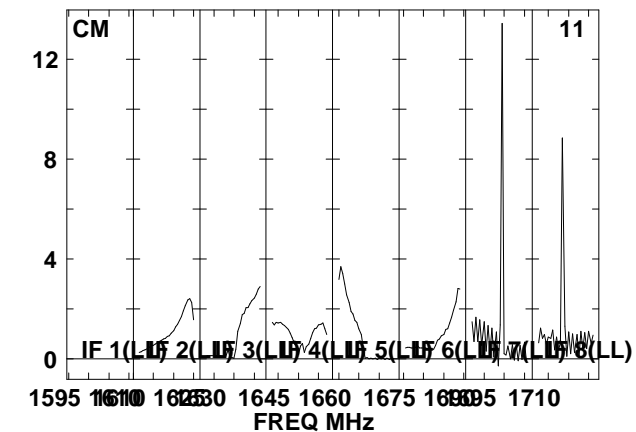
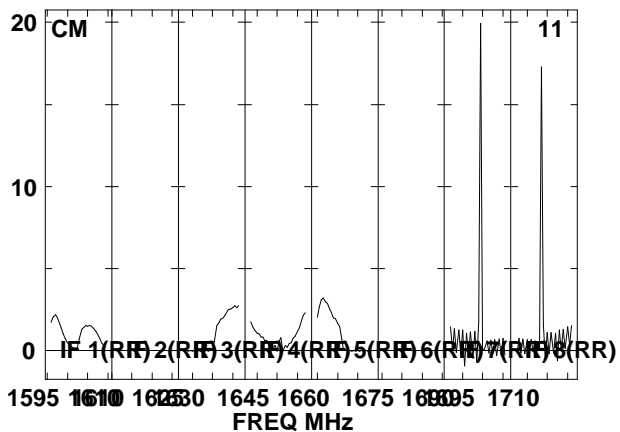
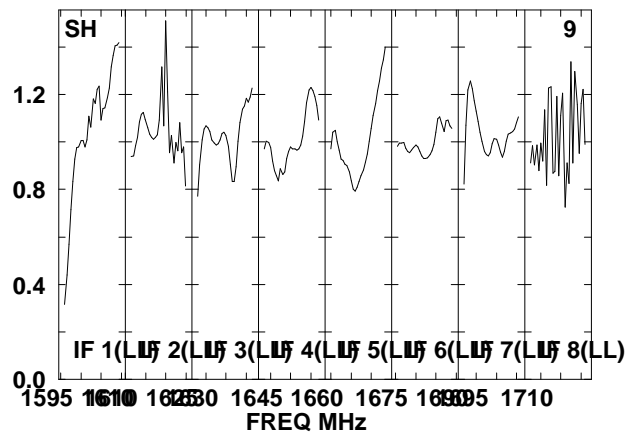
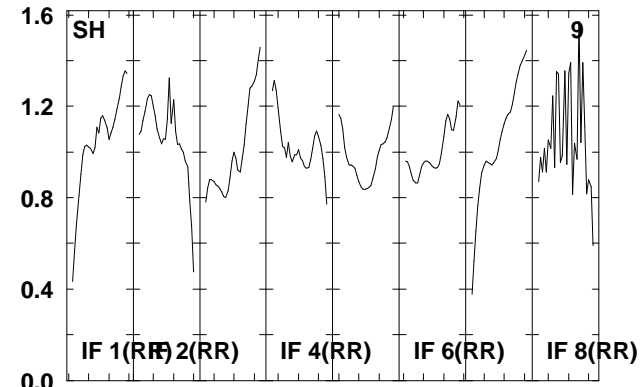
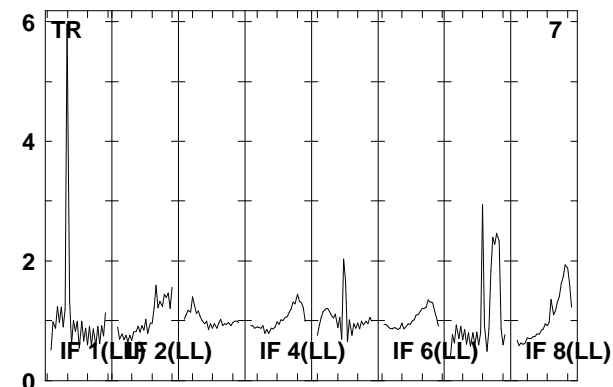
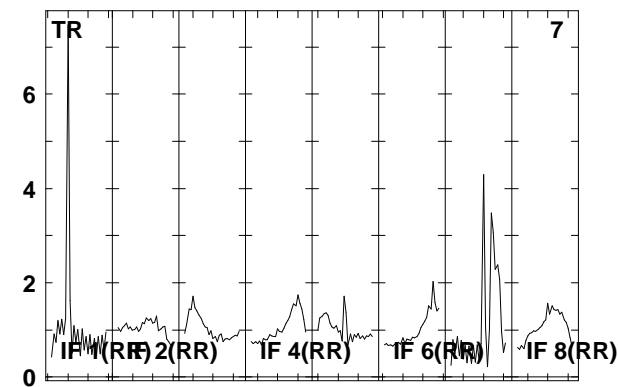
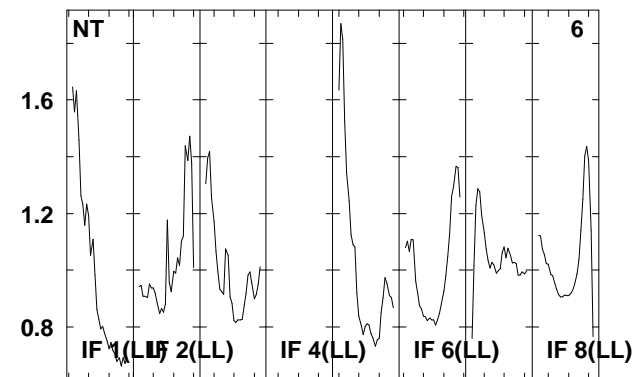
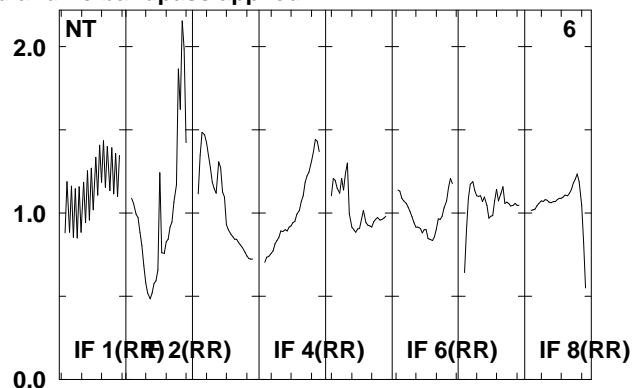
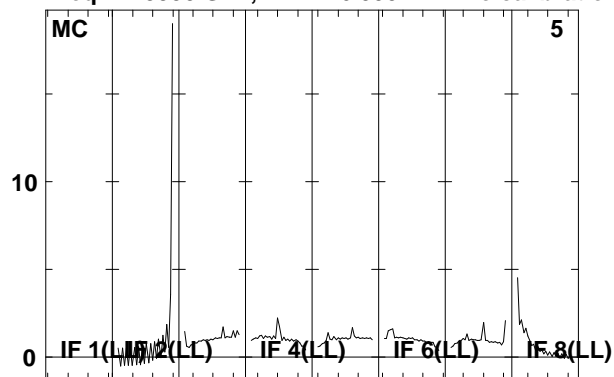

Lower frame: Real Jy

Total-power spectrum Antenna: \*

Timerange: 00/10:36:33 to 00/10:41:09

Plot file version 300 created 08-AUG-2008 17:01:01

J0920+44 EO006B.UVDATA.1

Freq = 1.5950 GHz, Bw = 16.000 MH No calibration applied and no bandpass applied

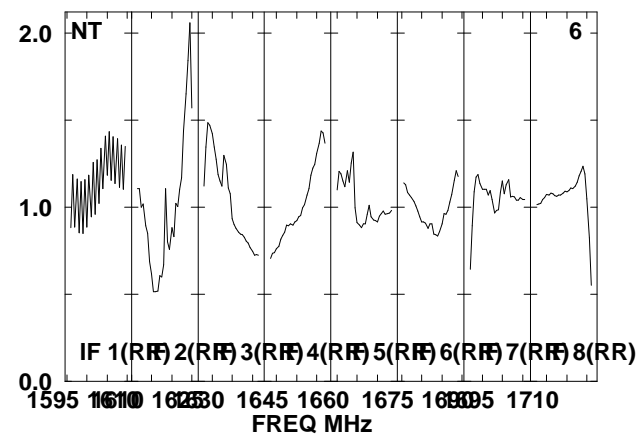
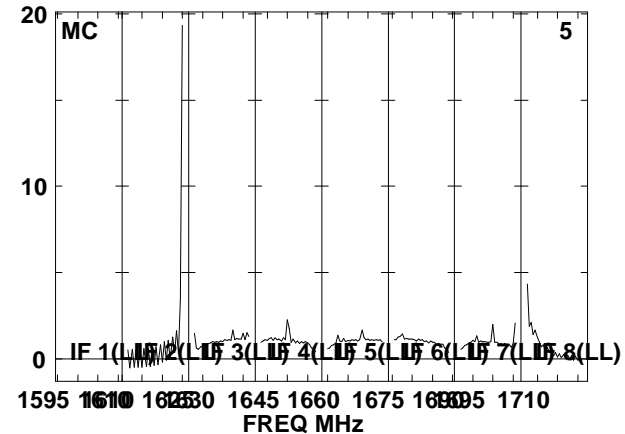
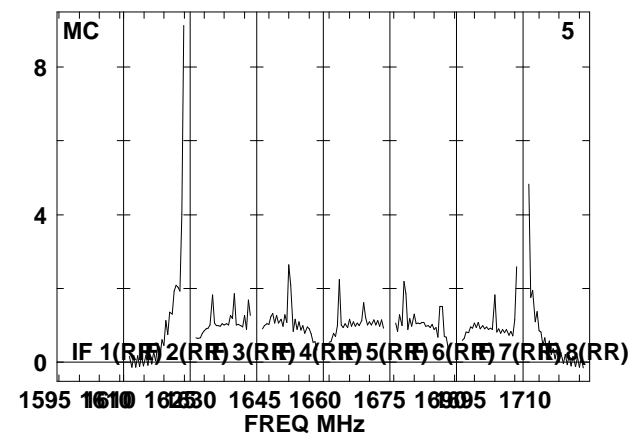
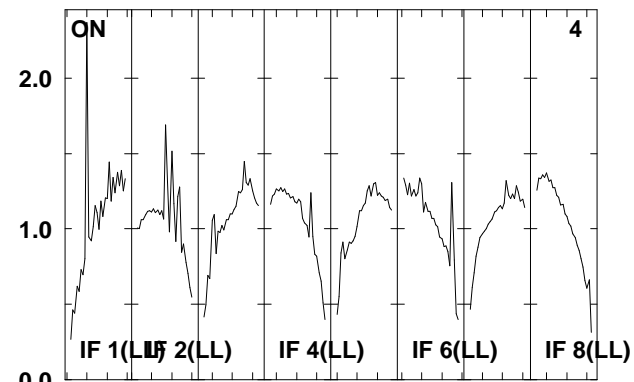
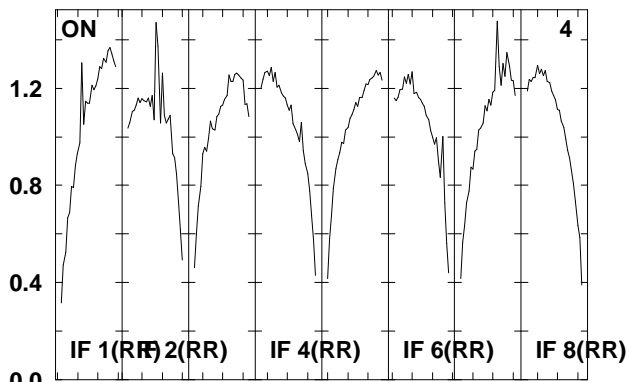
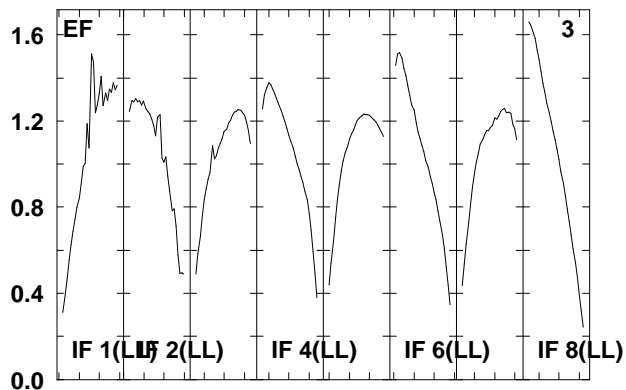
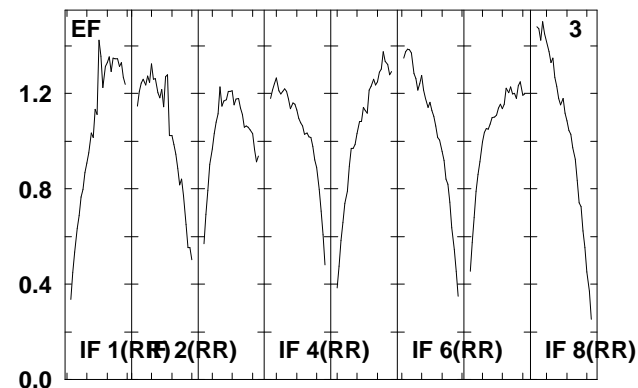
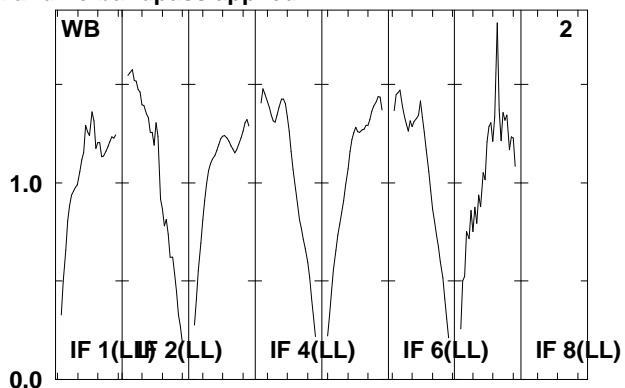
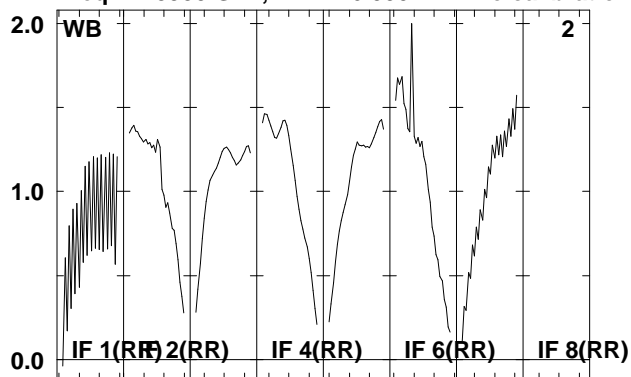

Lower frame: Real Jy  
Total-power spectrum Antenna: \*  
Timerange: 00/10:41:47 to 00/10:43:11



Plot file version 301 created 08-AUG-2008 17:01:02  
 J0920+44 EO006B.UVDATA.1  
 Freq = 1.5950 GHz, Bw = 16.000 MH No calibration applied and no bandpass applied

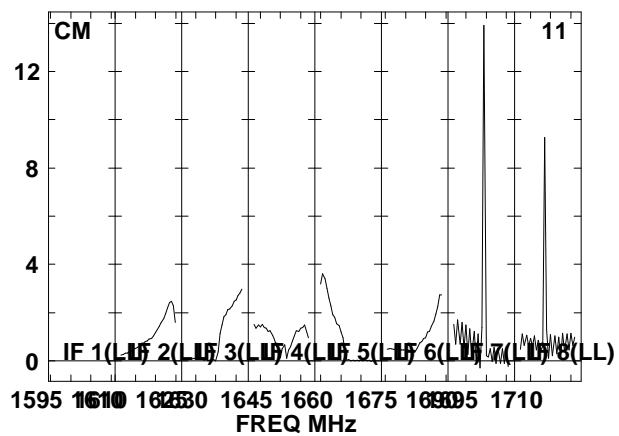
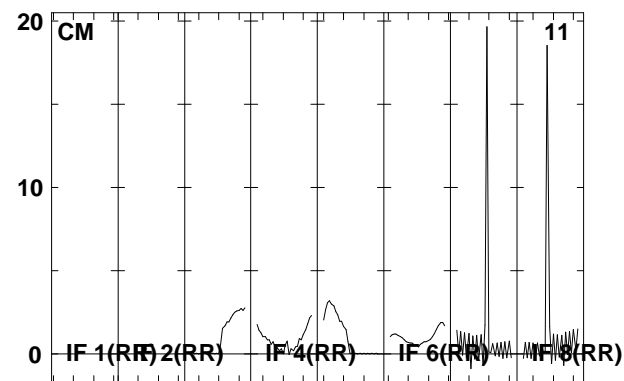
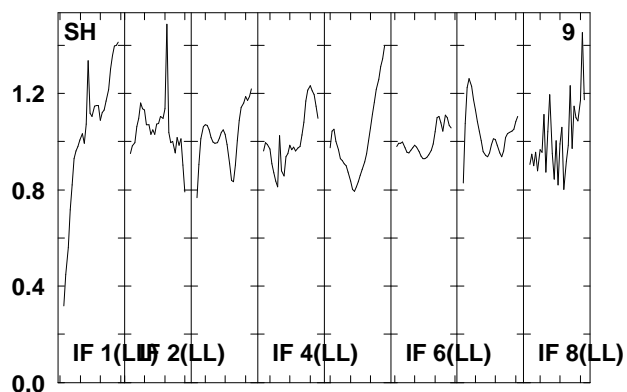
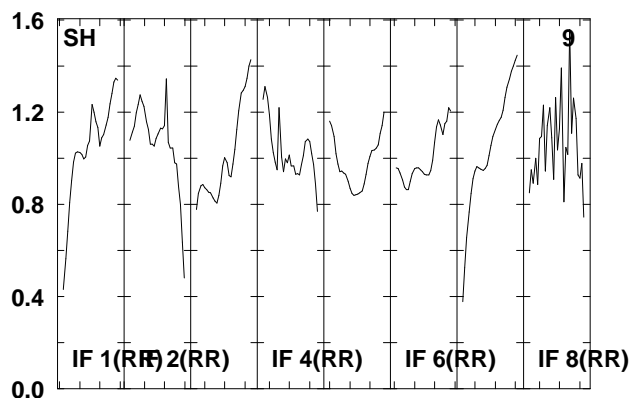
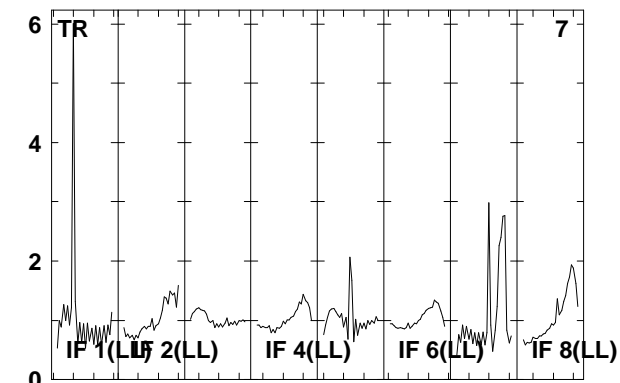
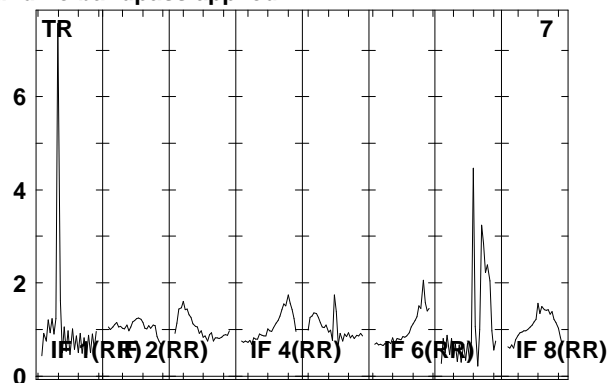
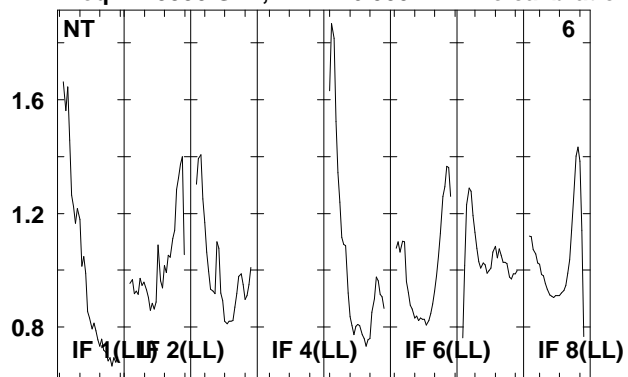

Lower frame: Real Jy  
 Total-power spectrum Antenna: \*  
 Timerange: 00/10:41:47 to 00/10:43:11

Plot file version 302 created 08-AUG-2008 17:01:02

J092159 EO006B.UVDATA.1

Freq = 1.5950 GHz, Bw = 16.000 MH No calibration applied and no bandpass applied

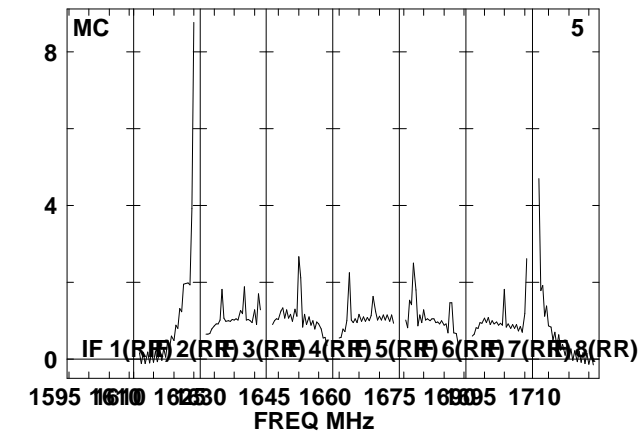
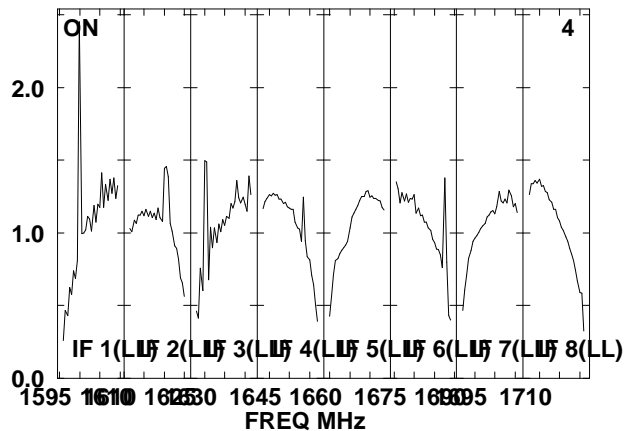
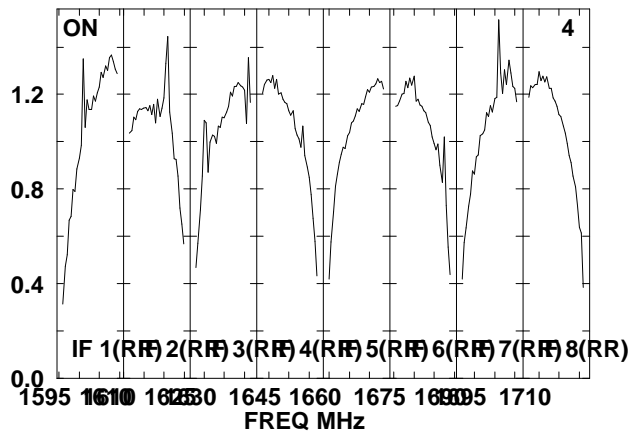
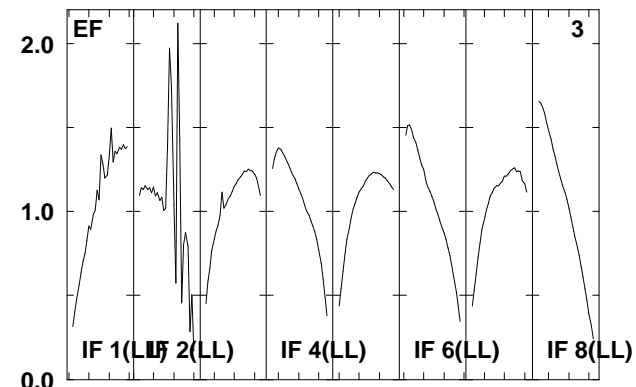
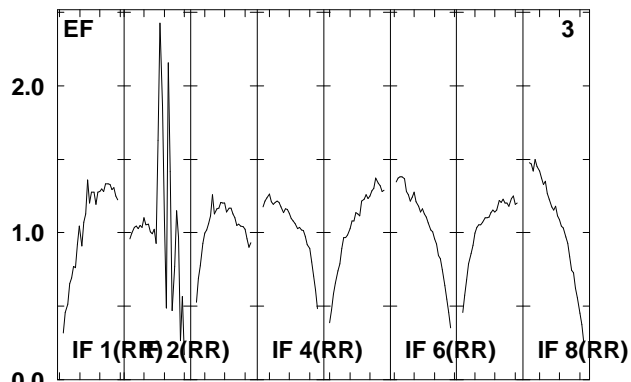
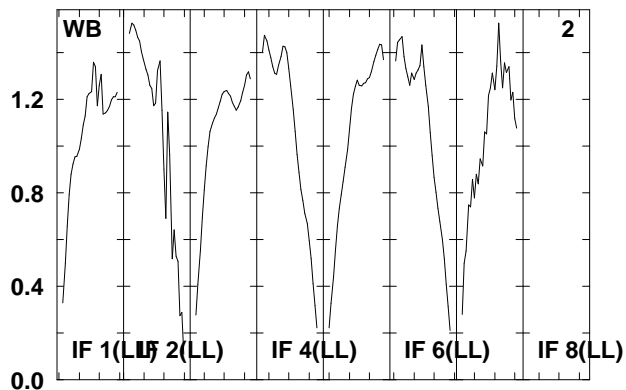
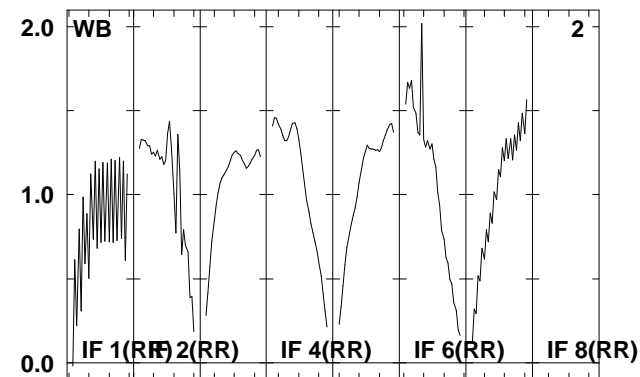
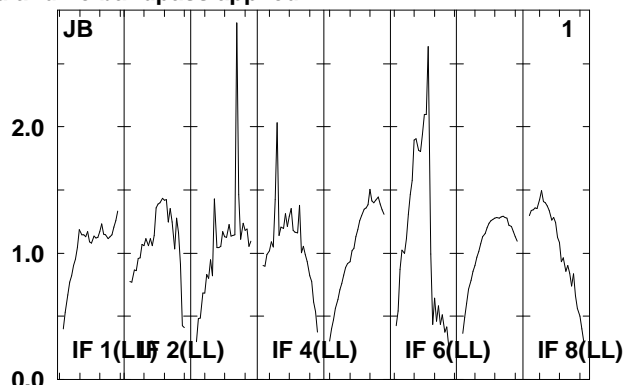
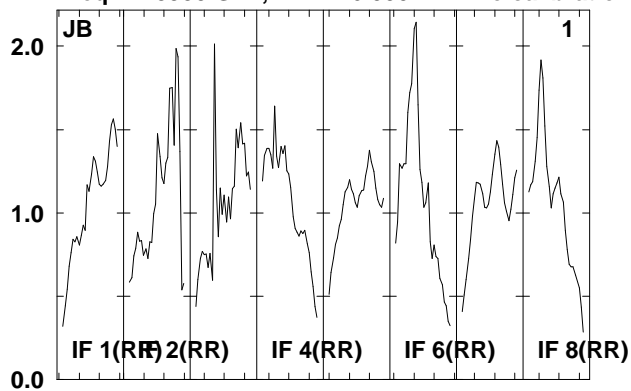

Lower frame: Real Jy

Total-power spectrum Antenna: \*

Timerange: 00/10:43:53 to 00/10:48:21

Plot file version 303 created 08-AUG-2008 17:01:03

J092159 EO006B.UVDATA.1

Freq = 1.5950 GHz, Bw = 16.000 MHz No calibration applied and no bandpass applied

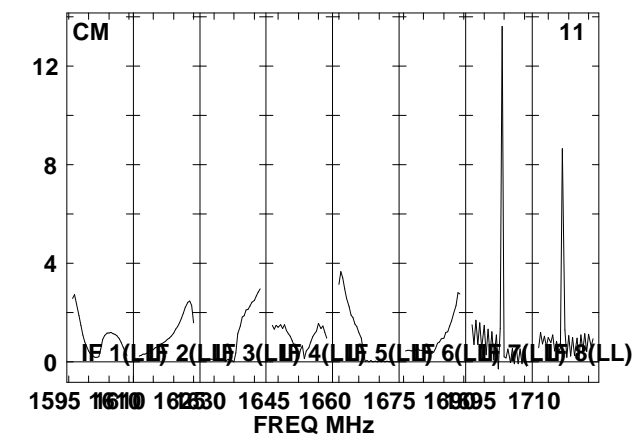
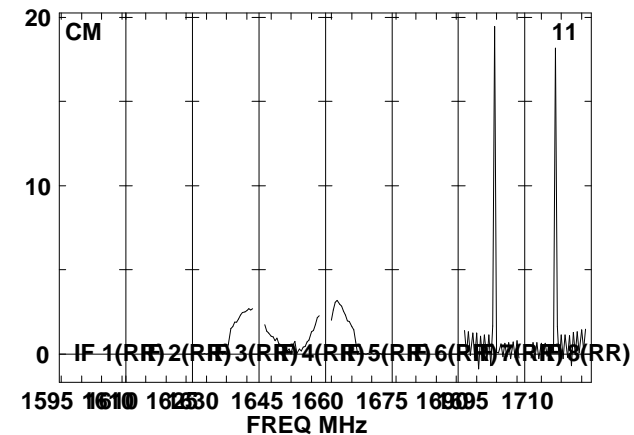
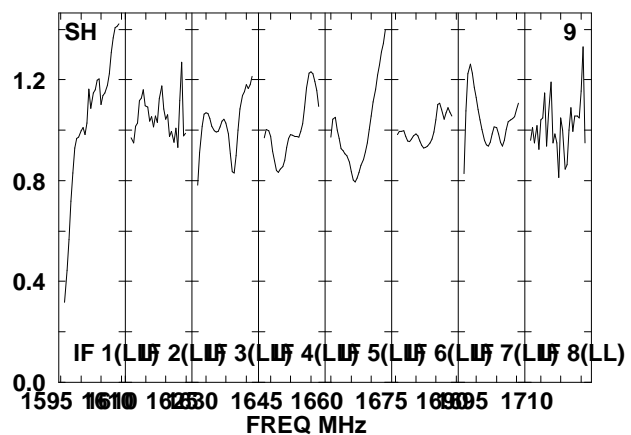
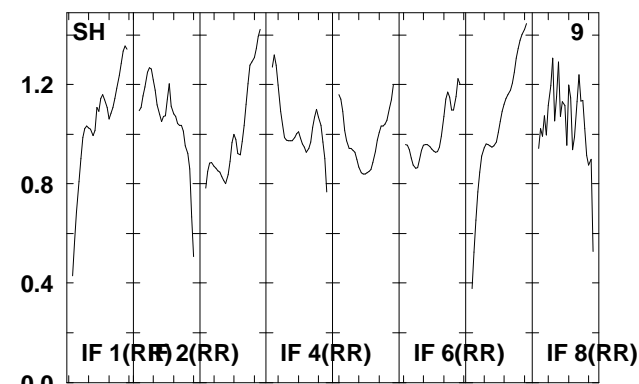
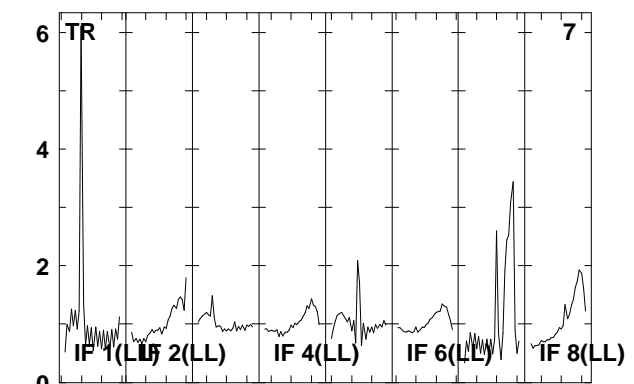
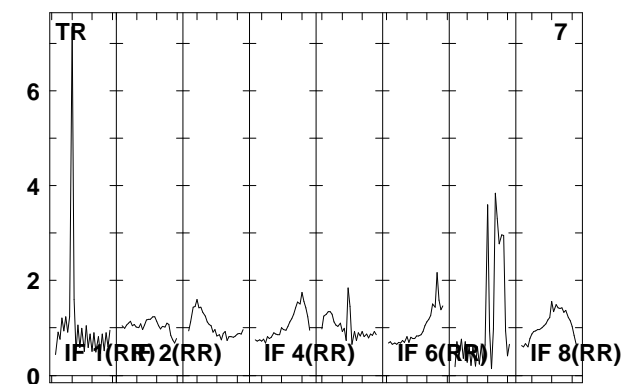
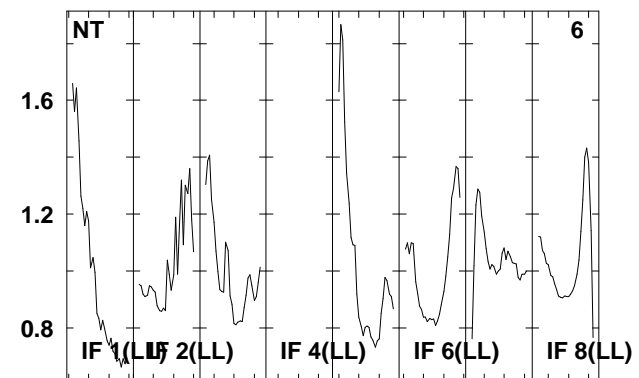
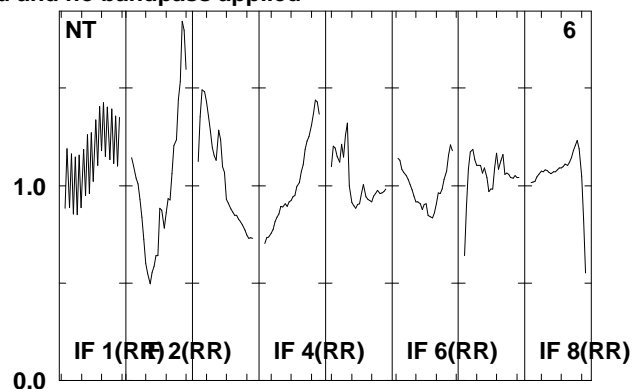
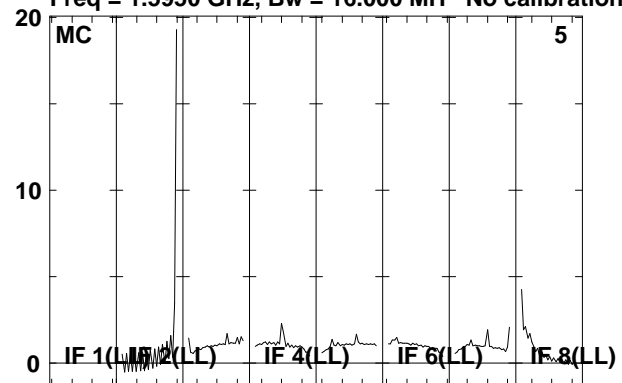

Lower frame: Real Jy

Total-power spectrum Antenna: \*

Timerange: 00/10:43:53 to 00/10:48:21

Plot file version 304 created 08-AUG-2008 17:01:04

J0920+44 EO006B.UVDATA.1

Freq = 1.5950 GHz, Bw = 16.000 MH No calibration applied and no bandpass applied

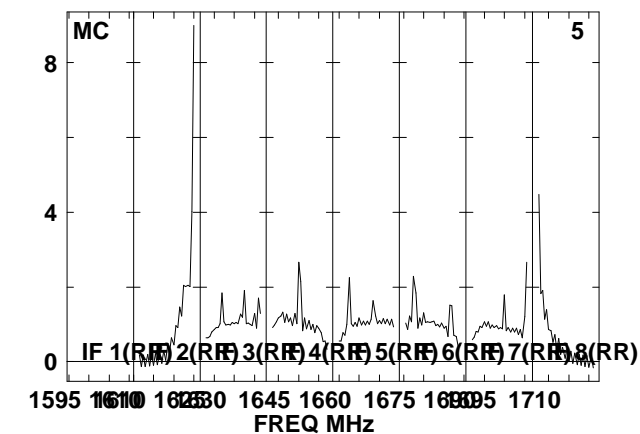
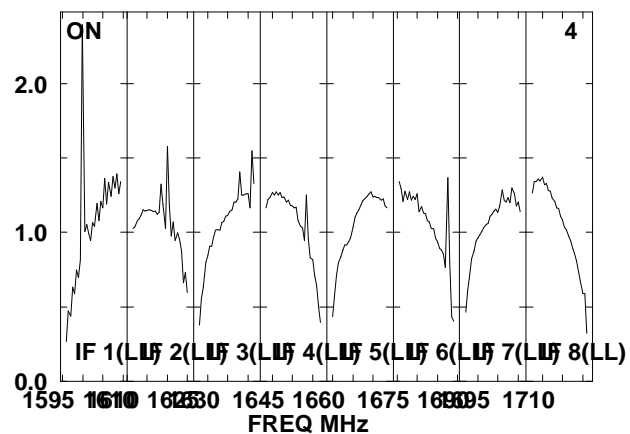
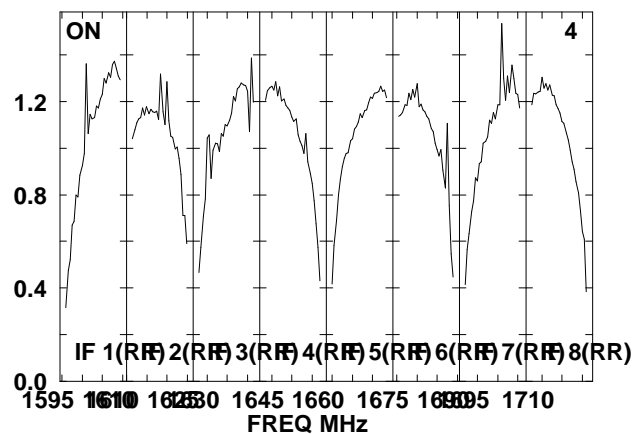
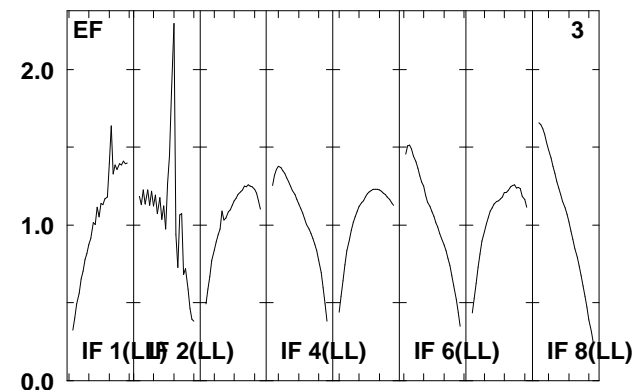
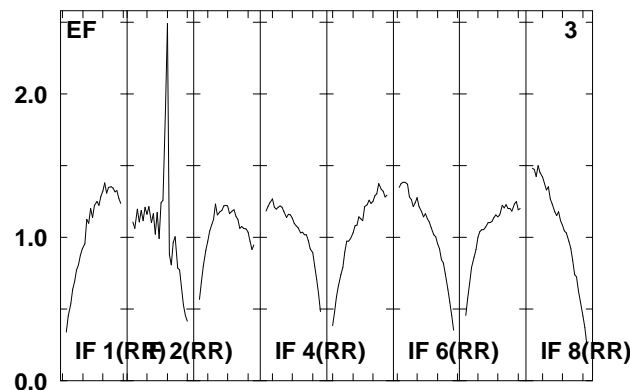
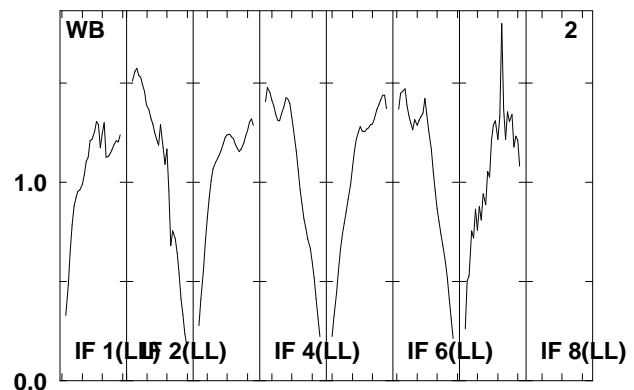
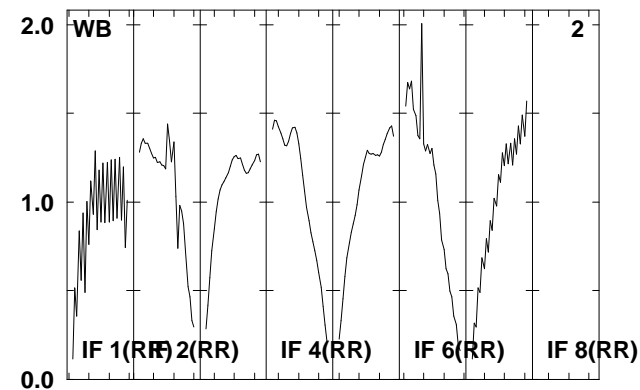
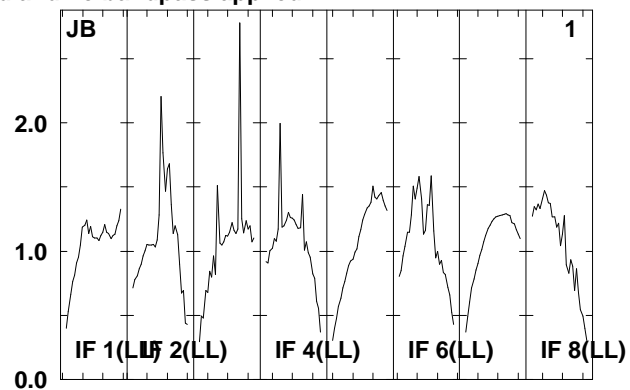
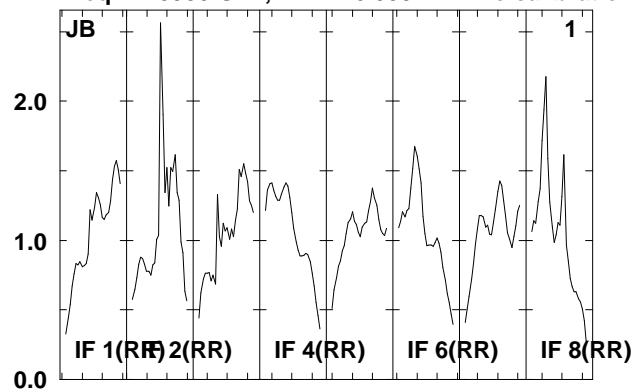

Lower frame: Real Jy  
Total-power spectrum Antenna: \*  
Timerange: 00/10:49:07 to 00/10:50:31

Plot file version 305 created 08-AUG-2008 17:01:04

J0920+44 EO006B.UVDATA.1

Freq = 1.5950 GHz, Bw = 16.000 MH No calibration applied and no bandpass applied

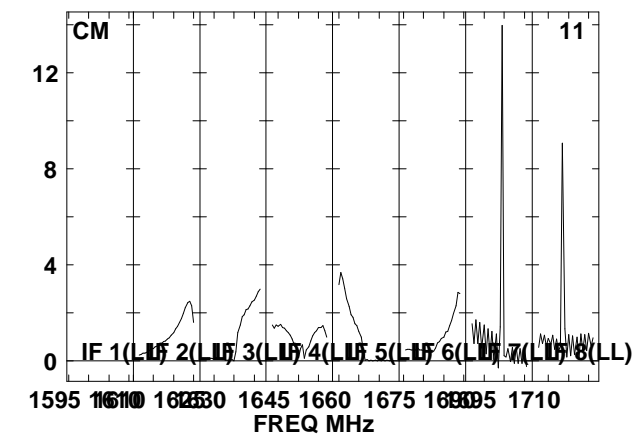
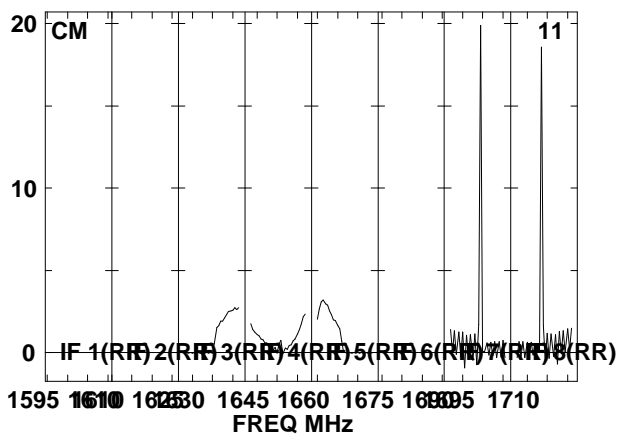
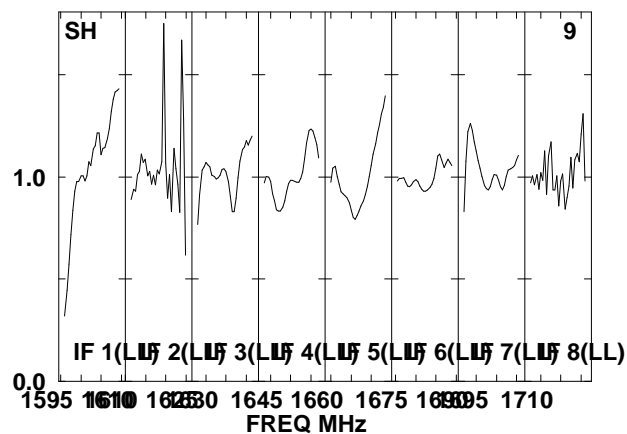
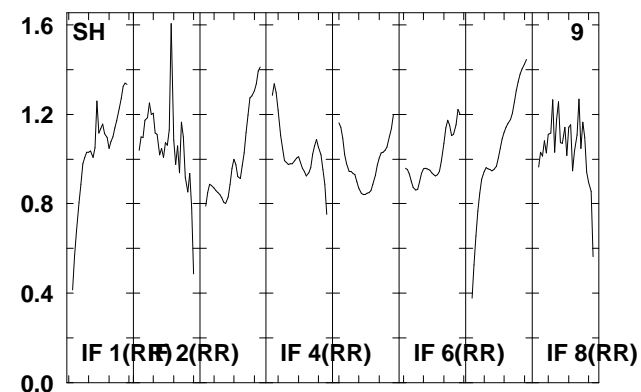
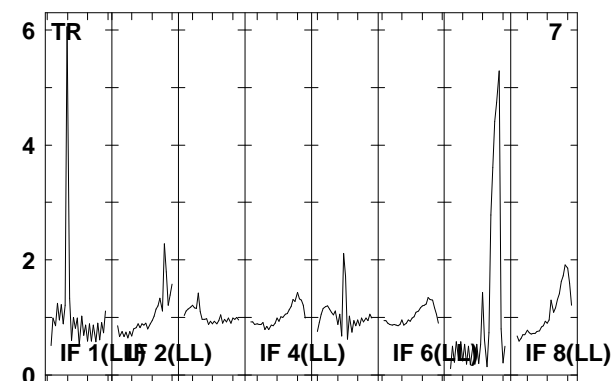
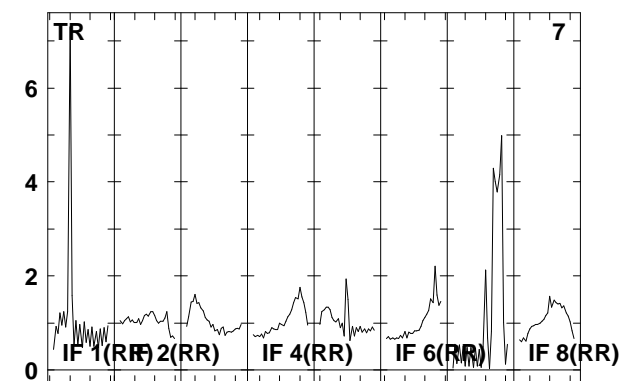
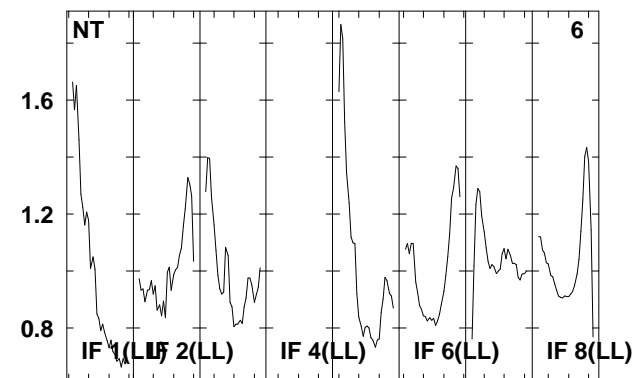
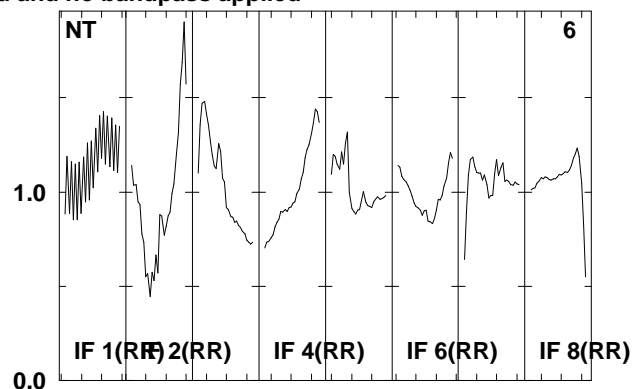
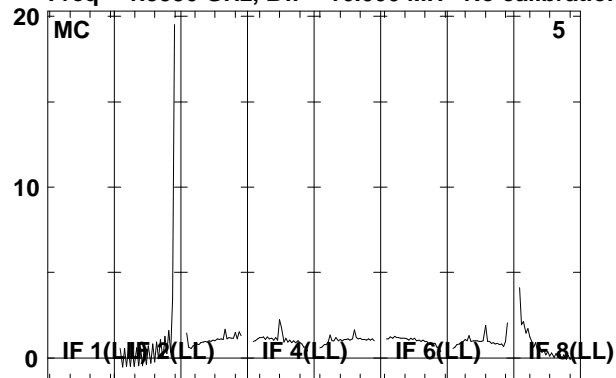

Lower frame: Real Jy

Total-power spectrum Antenna: \*

Timerange: 00/10:49:07 to 00/10:50:31

Plot file version 306 created 08-AUG-2008 17:01:05

J092159 EO006B.UVDATA.1

Freq = 1.5950 GHz, Bw = 16.000 MH No calibration applied and no bandpass applied

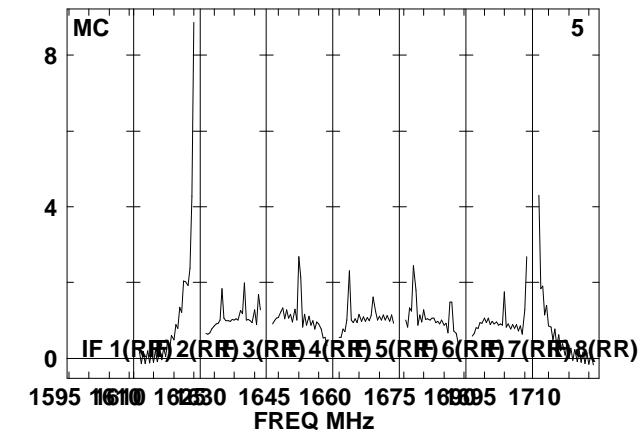
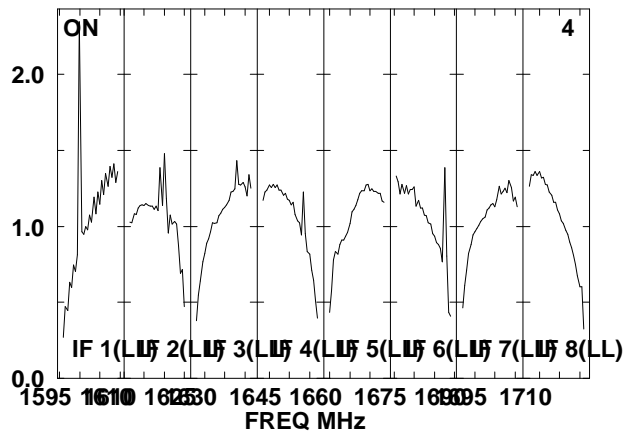
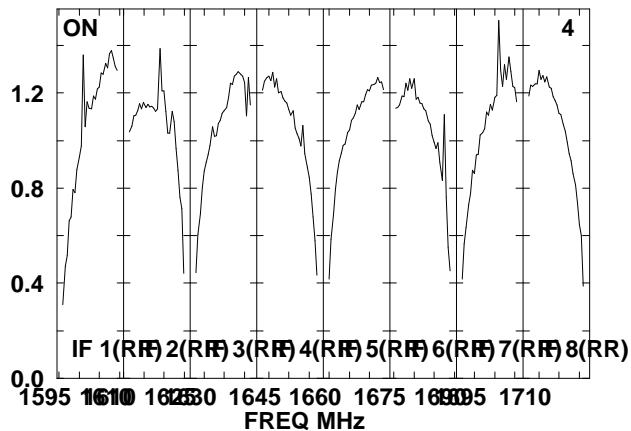
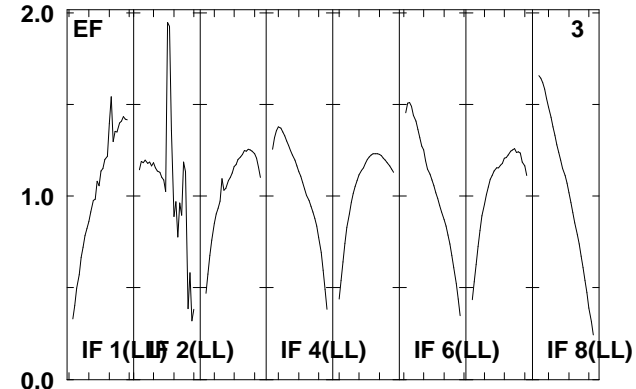
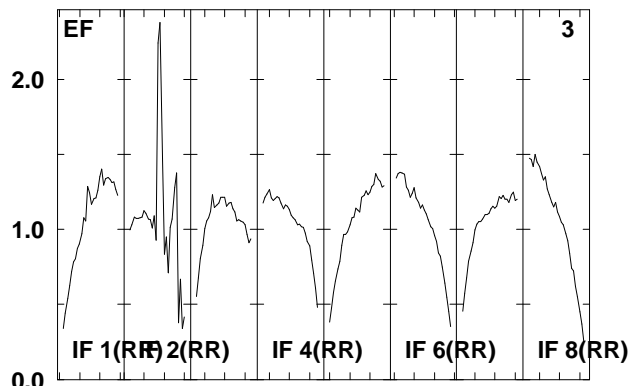
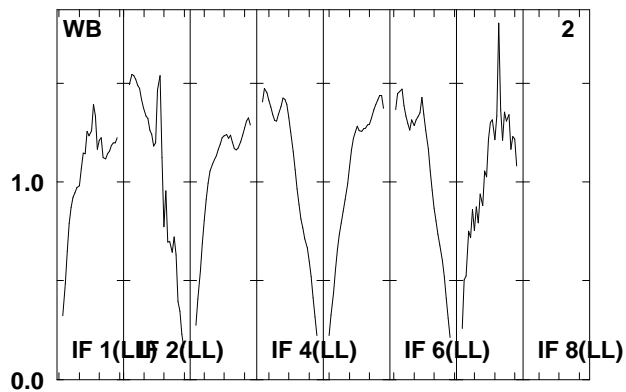
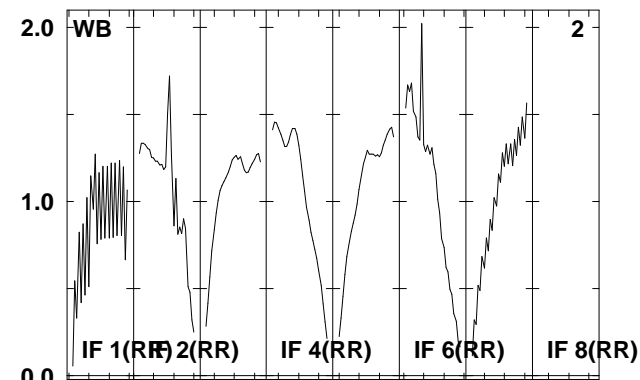
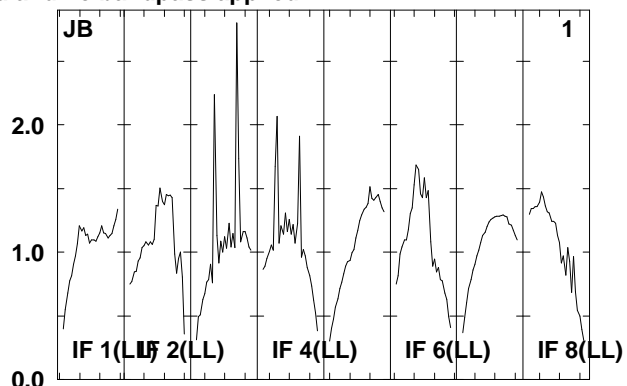
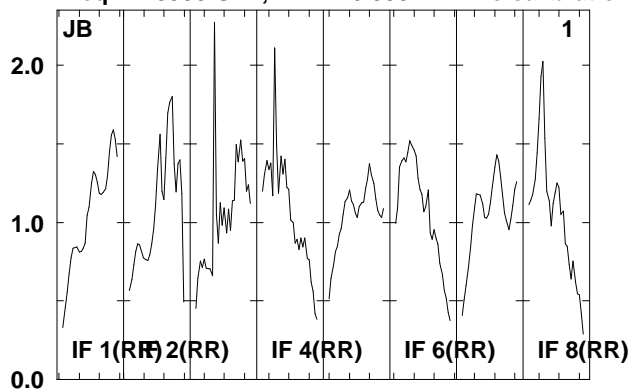

Lower frame: Real Jy  
Total-power spectrum Antenna: \*  
Timerange: 00/10:51:13 to 00/10:55:49

Plot file version 307 created 08-AUG-2008 17:01:06

J092159 EO06B.UVDATA.1

Freq = 1.5950 GHz, Bw = 16.000 MH No calibration applied and no bandpass applied

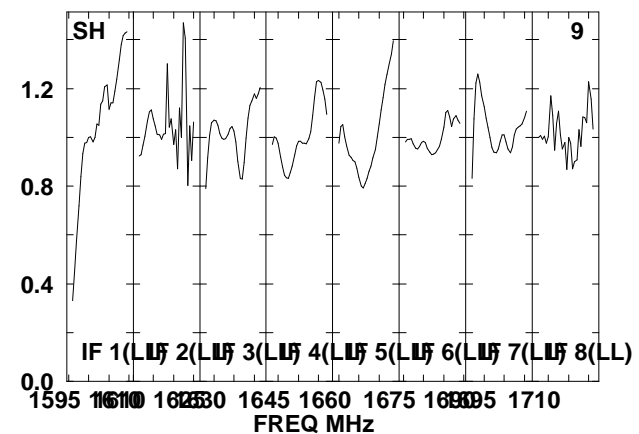
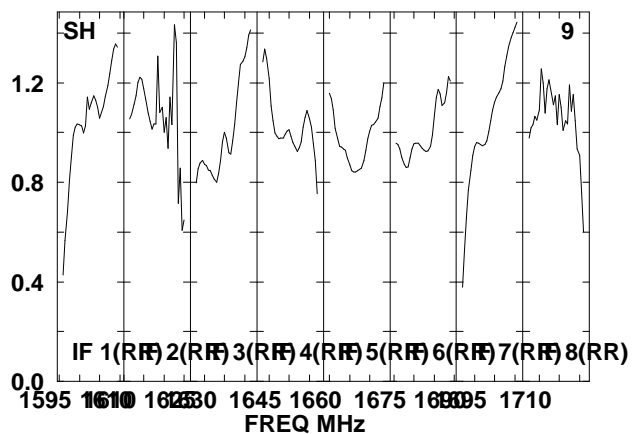
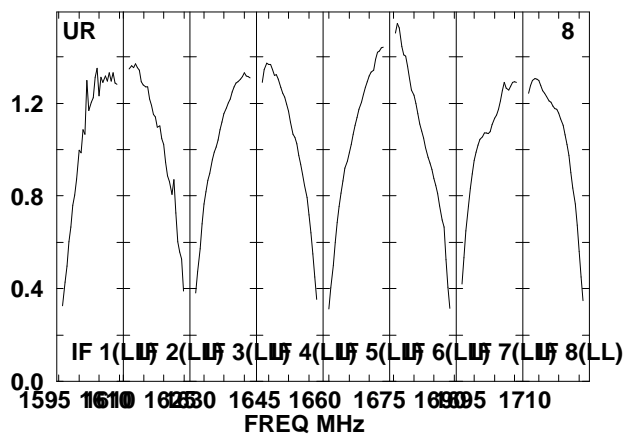
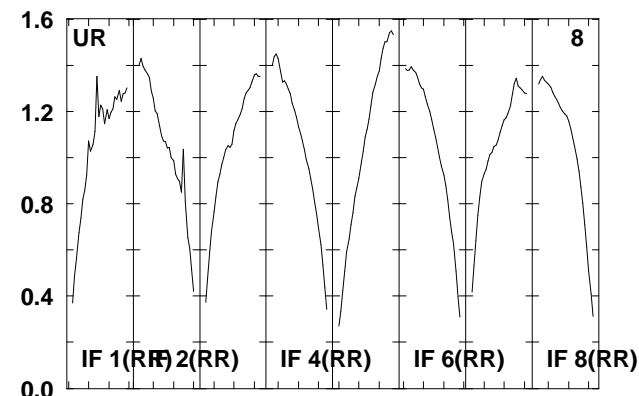
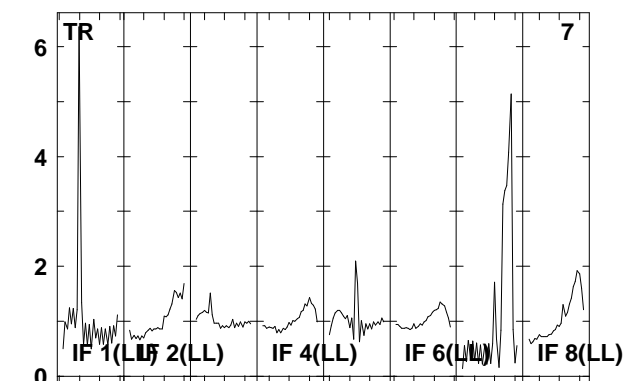
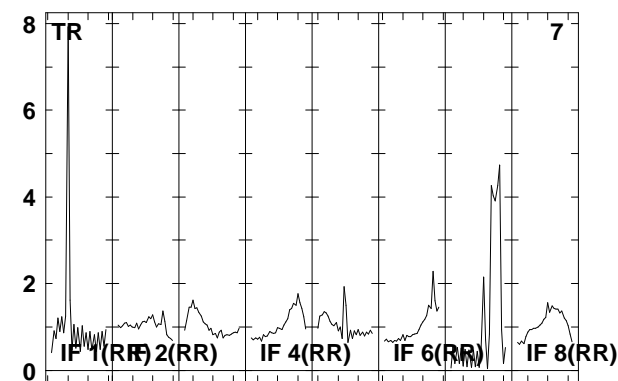
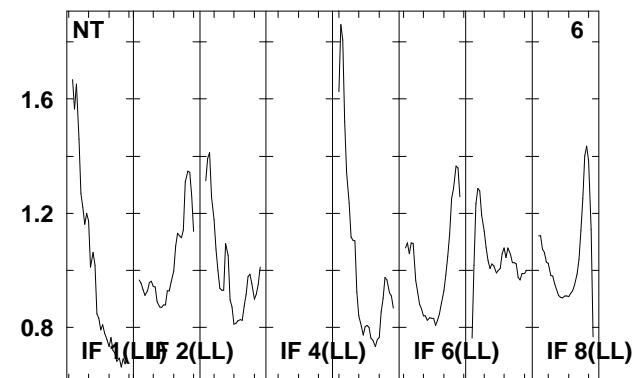
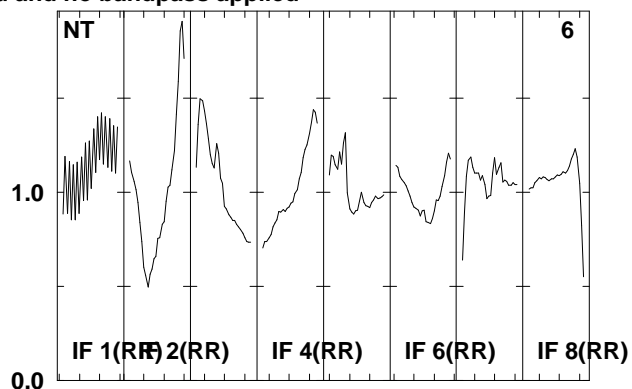
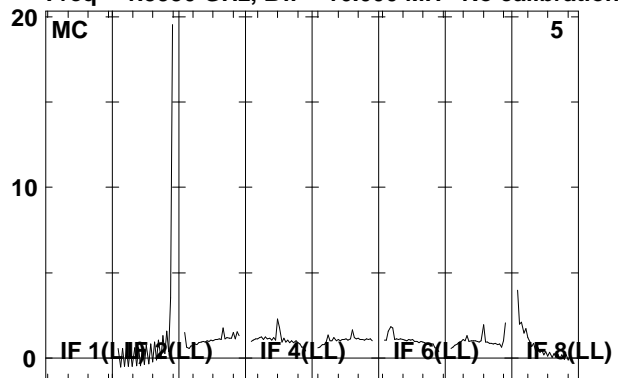

Lower frame: Real Jy

Total-power spectrum Antenna: \*

Timerange: 00/10:51:13 to 00/10:55:49

Plot file version 308 created 08-AUG-2008 17:01:06

J092159 EO006B.UVDATA.1

Freq = 1.5950 GHz, Bw = 16.000 MH No calibration applied and no bandpass applied

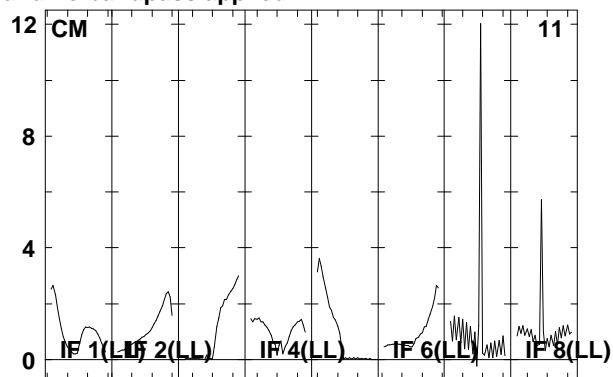
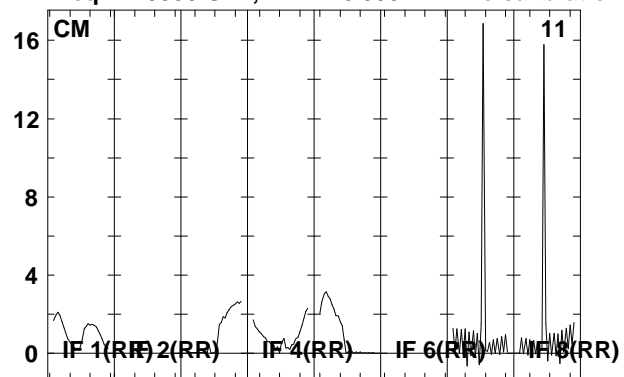

Lower frame: Real Jy  
Total-power spectrum Antenna: \*  
Timerange: 00/10:51:13 to 00/10:55:49



Plot file version 309 created 08-AUG-2008 17:01:07

J0920+44 EO006B.UVDATA.1

Freq = 1.5950 GHz, Bw = 16.000 MH No calibration applied and no bandpass applied

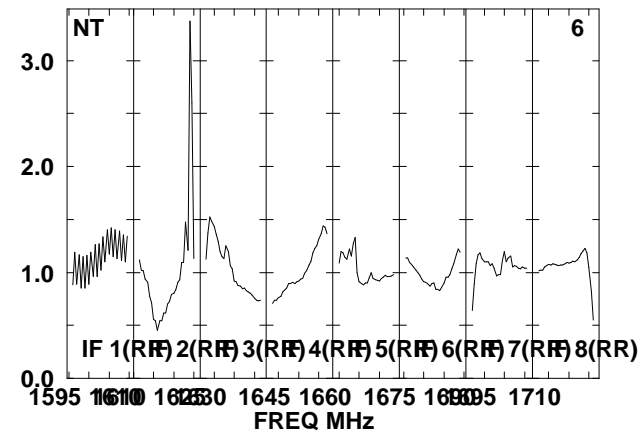
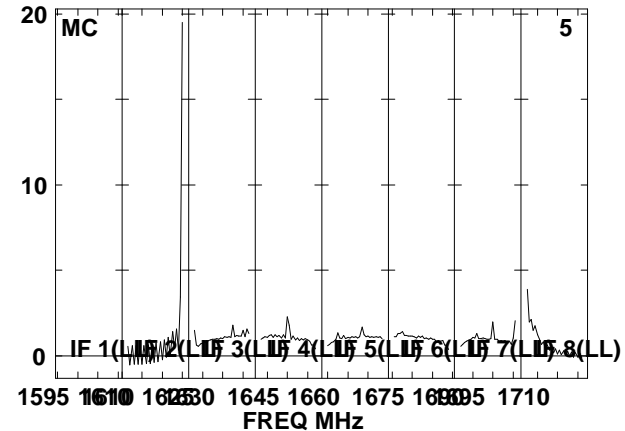
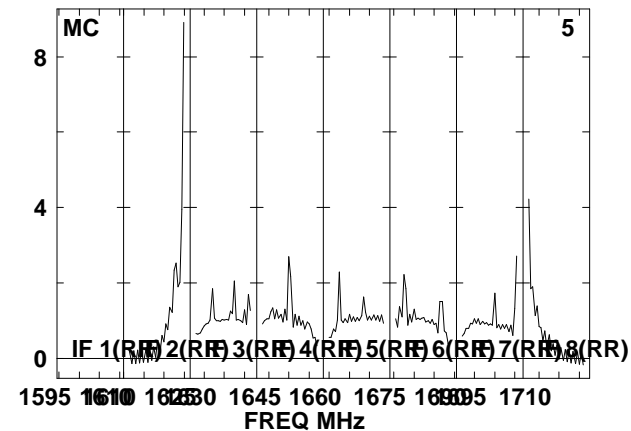
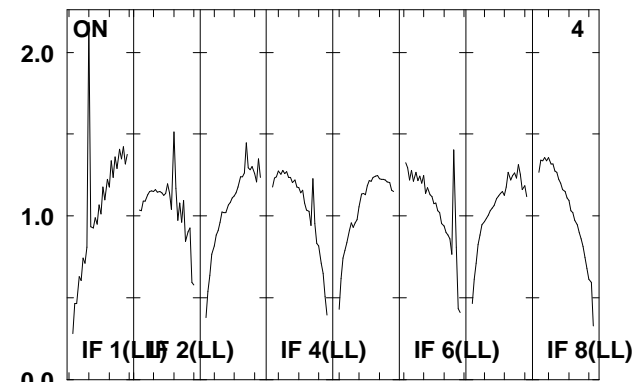
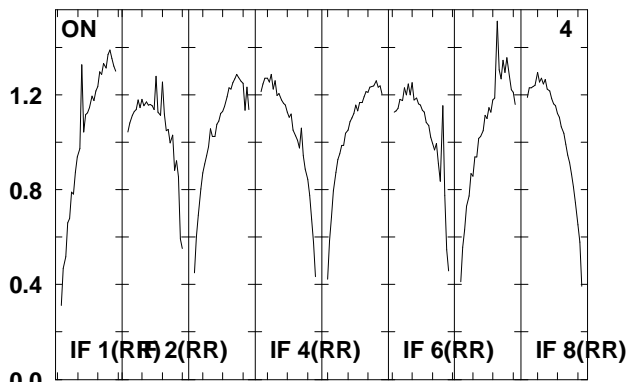
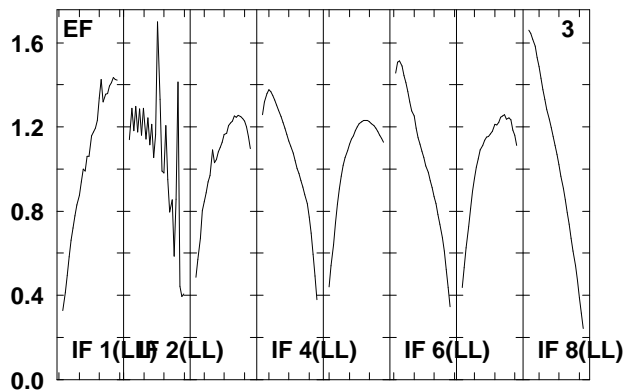
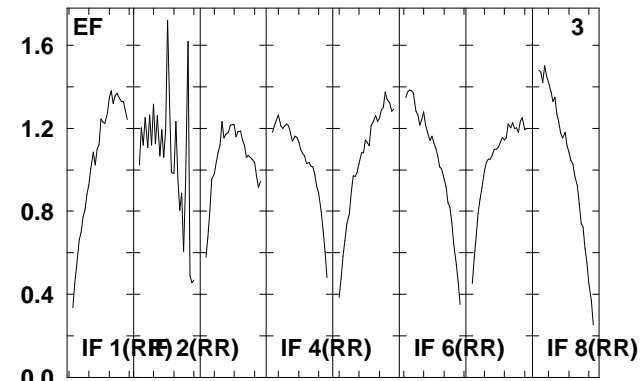
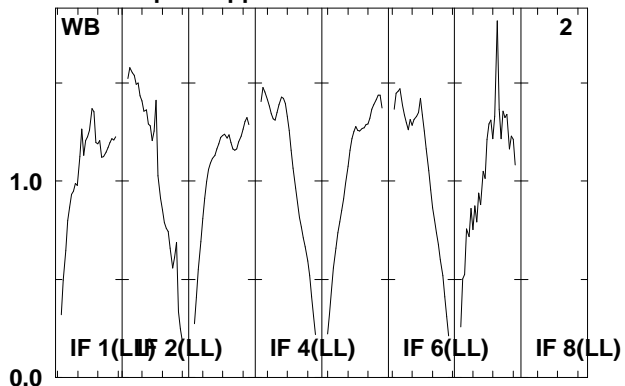
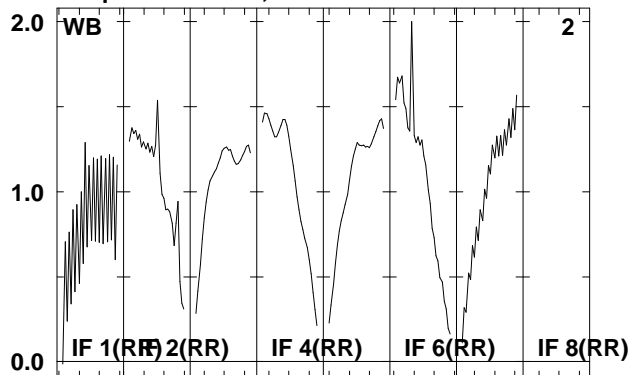

Lower frame: Real Jy  
Total-power spectrum Antenna: \*  
Timerange: 00/10:56:21 to 00/10:57:57

Plot file version 310 created 08-AUG-2008 17:01:07

J0920+44 EO006B.UVDATA.1

Freq = 1.5950 GHz, Bw = 16.000 MH No calibration applied and no bandpass applied

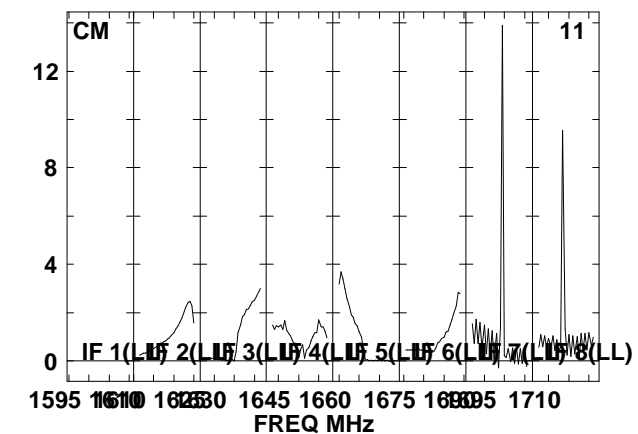
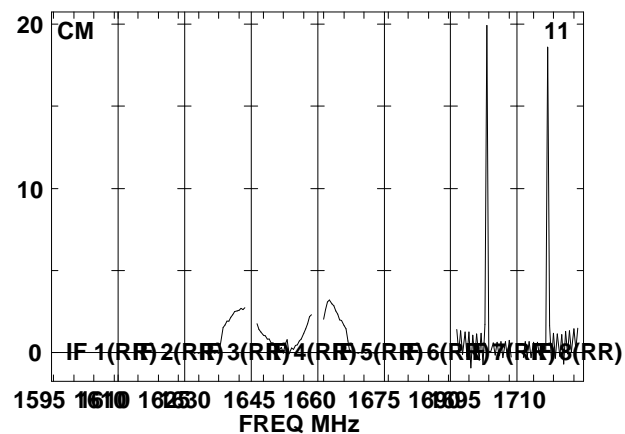
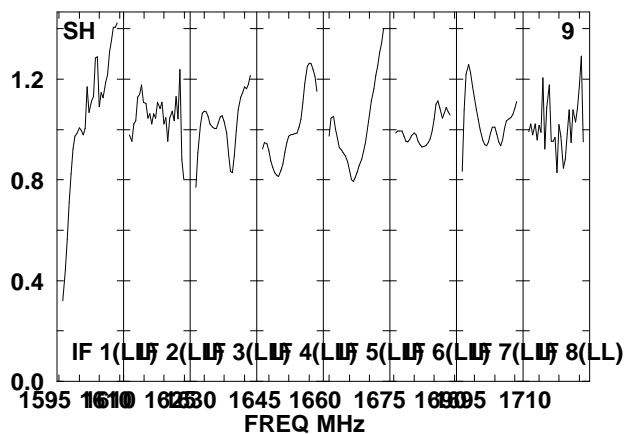
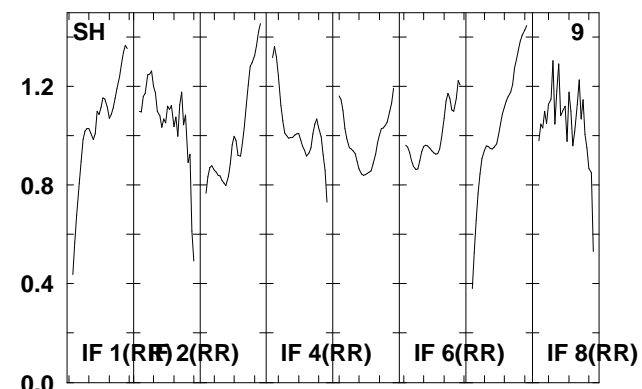
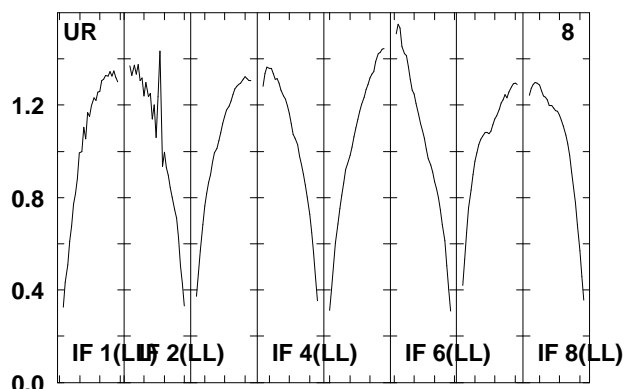
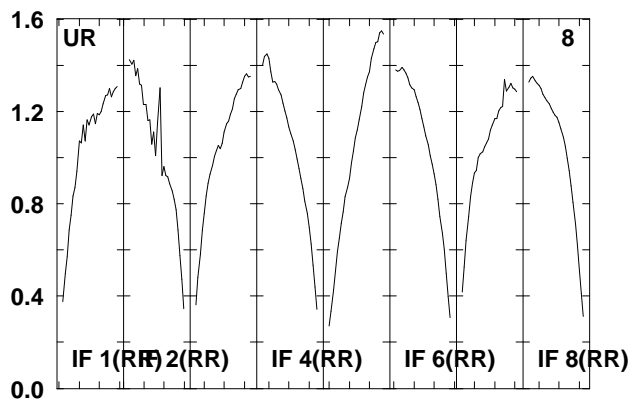
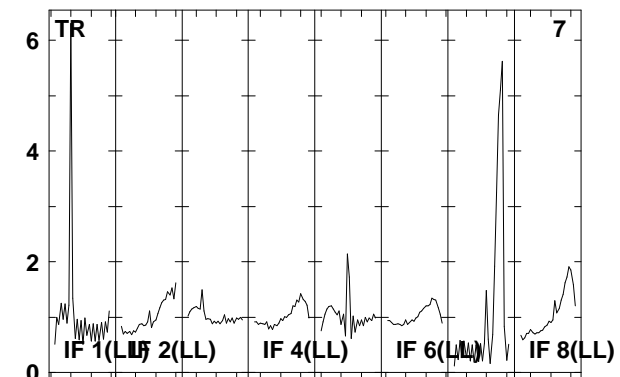
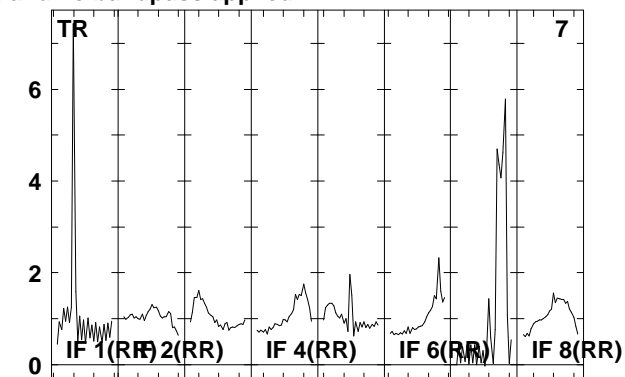
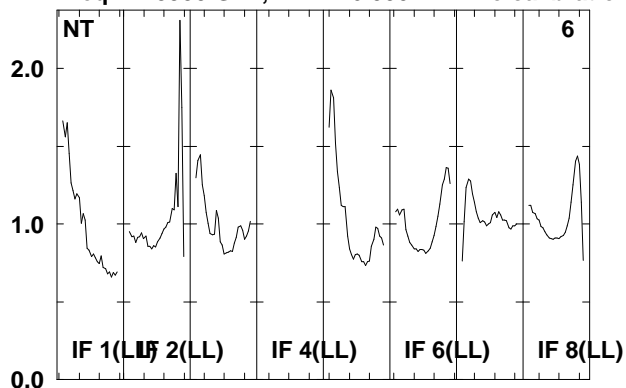

Lower frame: Real Jy  
Total-power spectrum Antenna: \*  
Timerange: 00/10:56:21 to 00/10:57:57

Plot file version 311 created 08-AUG-2008 17:01:08

J092159 EO006B.UVDATA.1

Freq = 1.5950 GHz, Bw = 16.000 MH No calibration applied and no bandpass applied

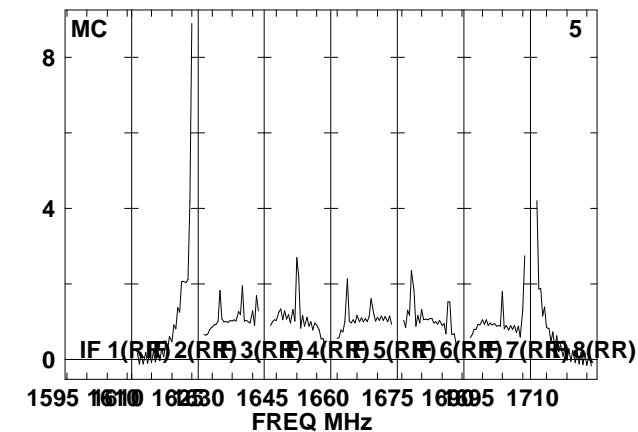
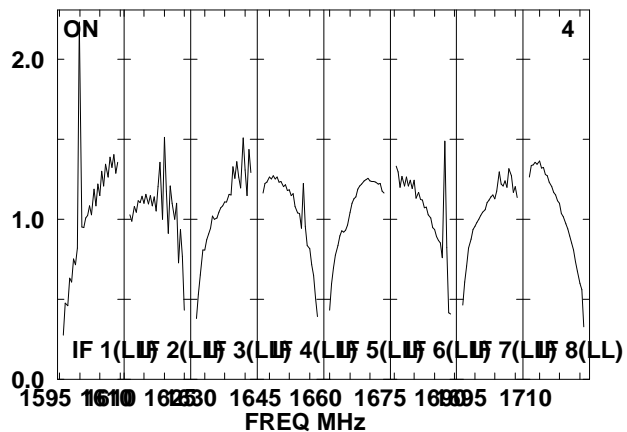
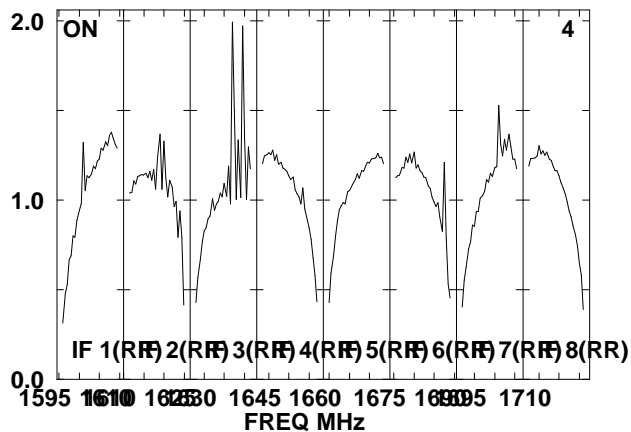
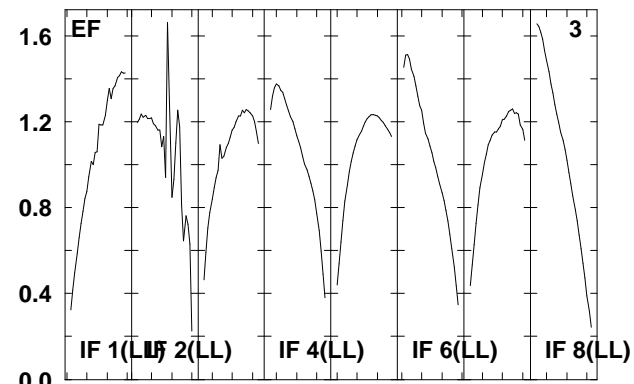
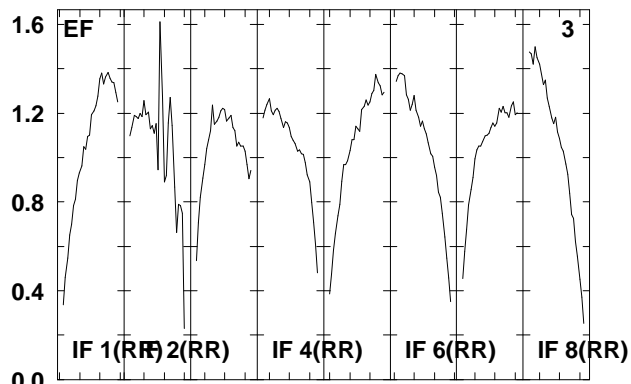
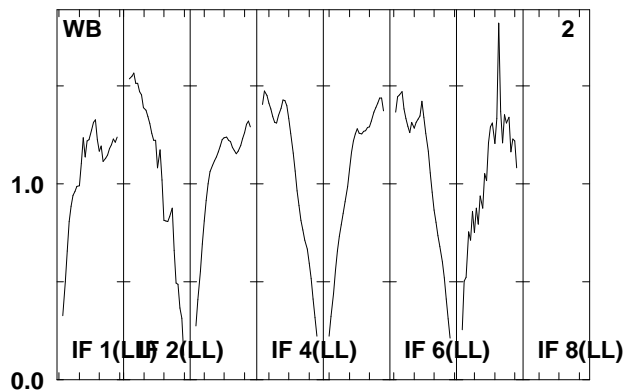
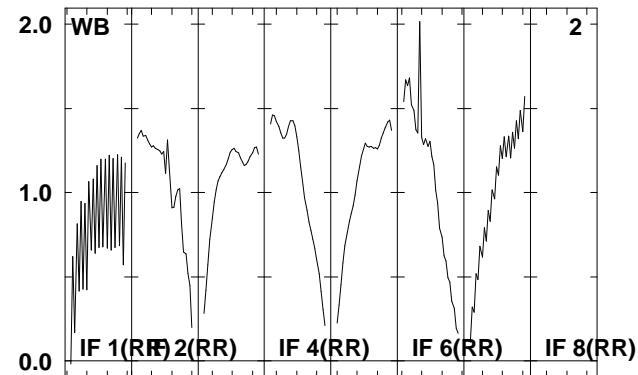
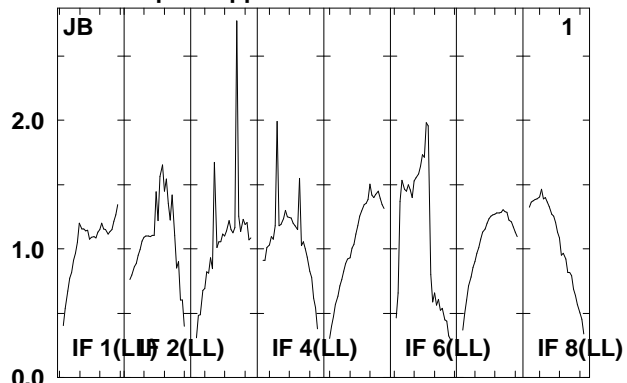
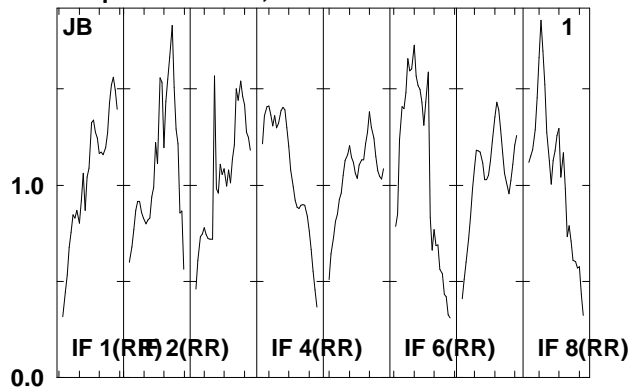

Lower frame: Real Jy  
Total-power spectrum Antenna: \*  
Timerange: 00/10:58:33 to 00/11:03:09

Plot file version 312 created 08-AUG-2008 17:01:08

J092159 EO006B.UVDATA.1

Freq = 1.5950 GHz, Bw = 16.000 MH No calibration applied and no bandpass applied

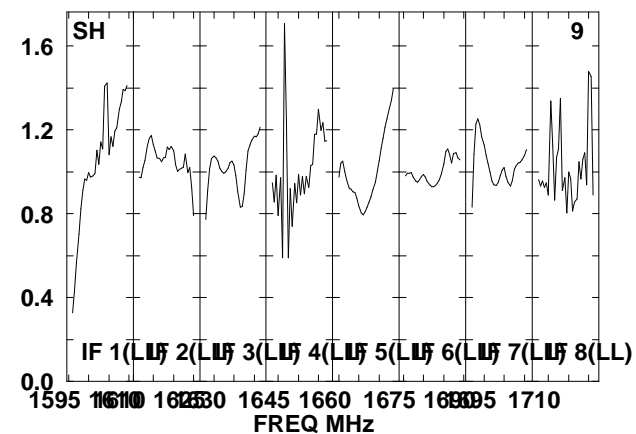
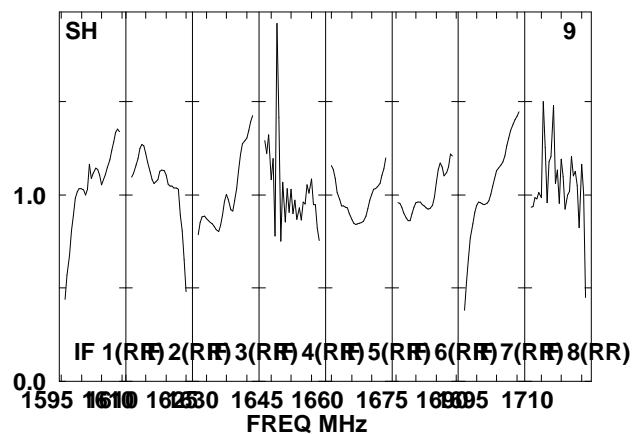
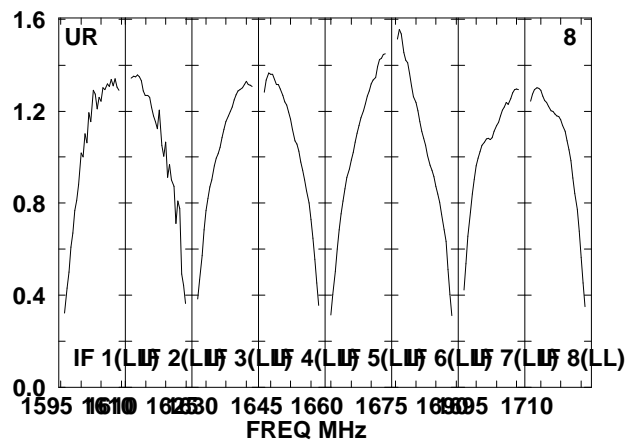
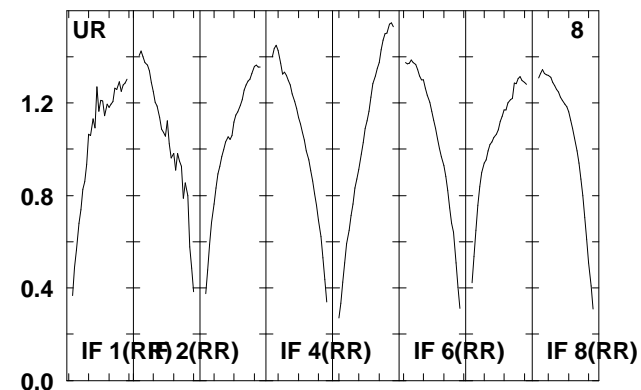
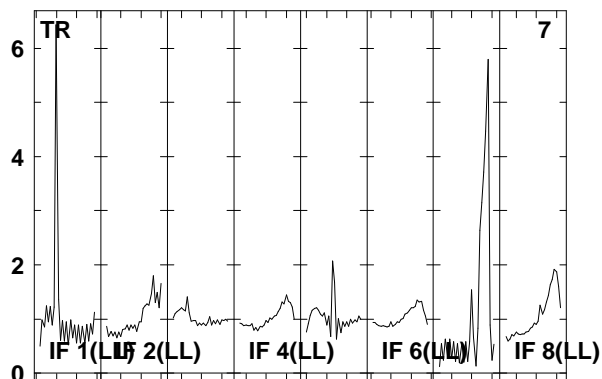
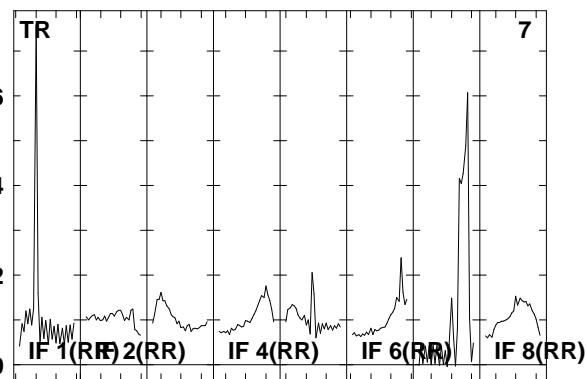
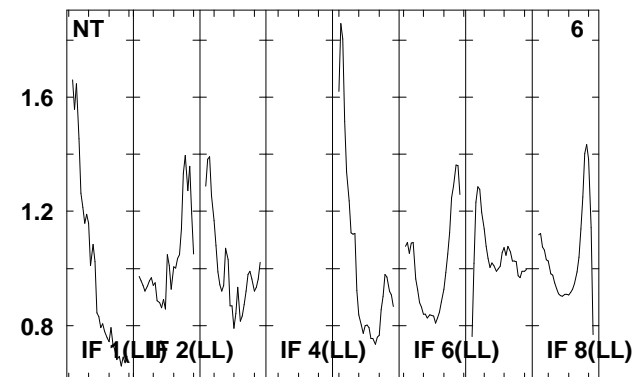
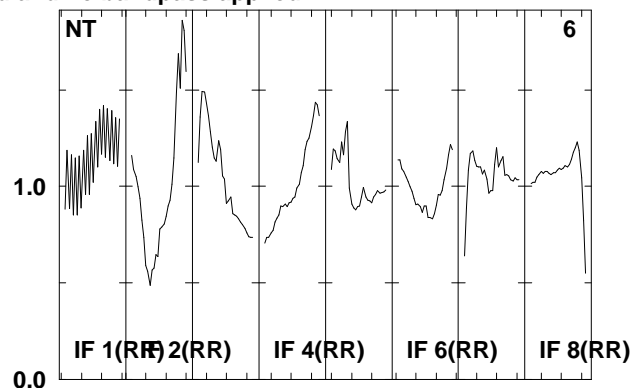
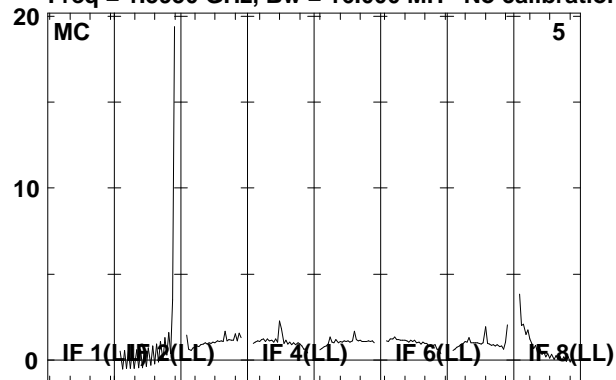

Lower frame: Real Jy

Total-power spectrum Antenna: \*

Timerange: 00/10:58:33 to 00/11:03:09

Plot file version 313 created 08-AUG-2008 17:01:09

J092159 EO006B.UVDATA.1

Freq = 1.5950 GHz, Bw = 16.000 MH No calibration applied and no bandpass applied

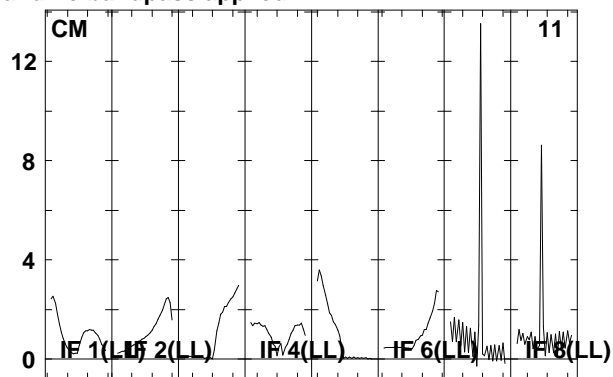
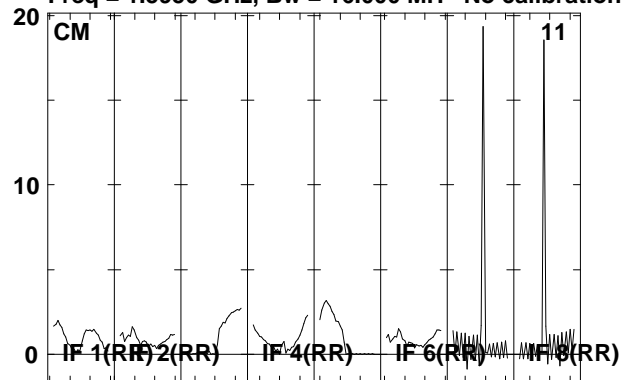

Lower frame: Real Jy  
Total-power spectrum Antenna: \*  
Timerange: 00/10:58:33 to 00/11:03:09

Plot file version 314 created 08-AUG-2008 17:01:10

J0920+44 EO006B.UVDATA.1

Freq = 1.5950 GHz, Bw = 16.000 MH No calibration applied and no bandpass applied

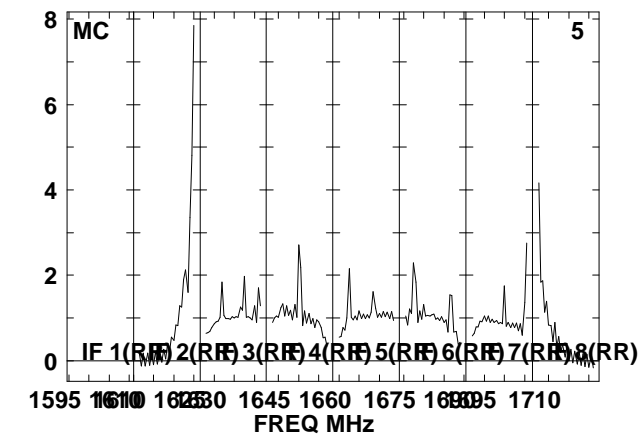
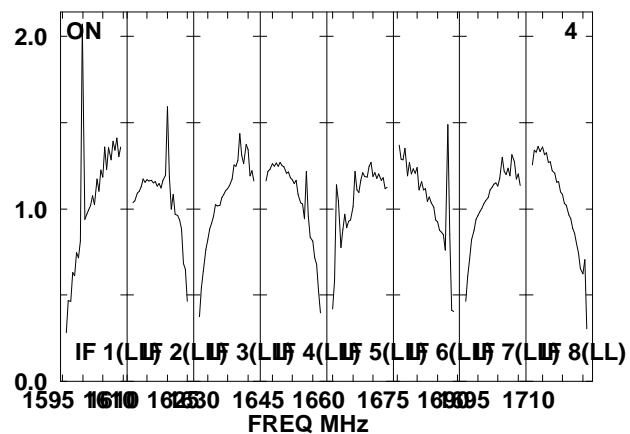
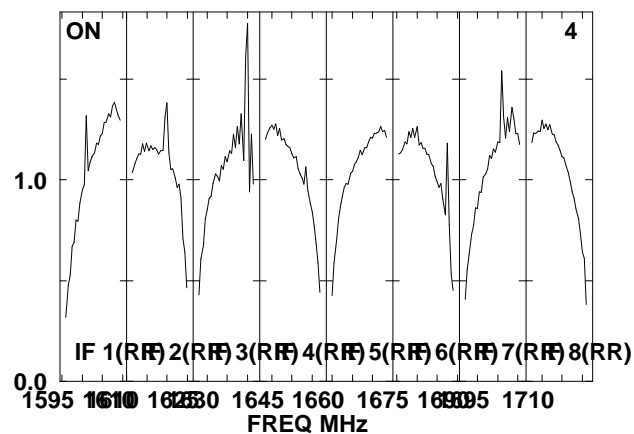
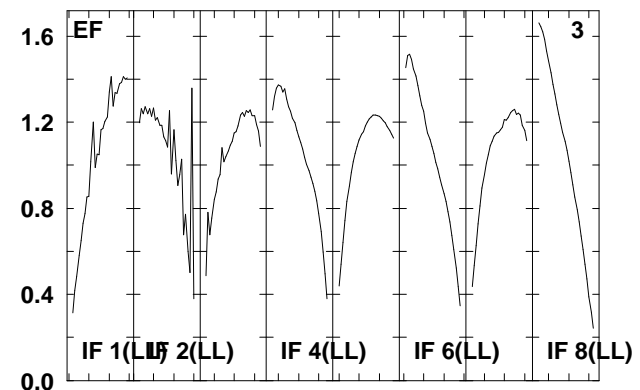
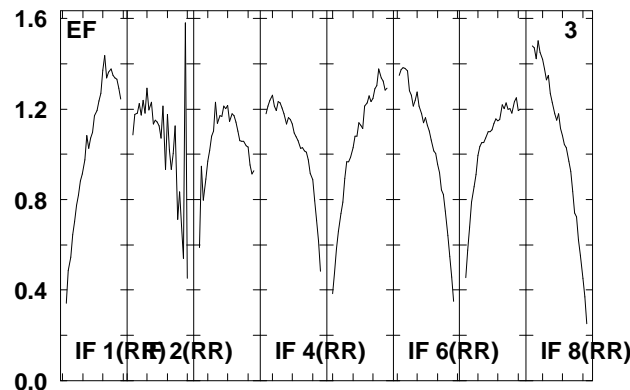
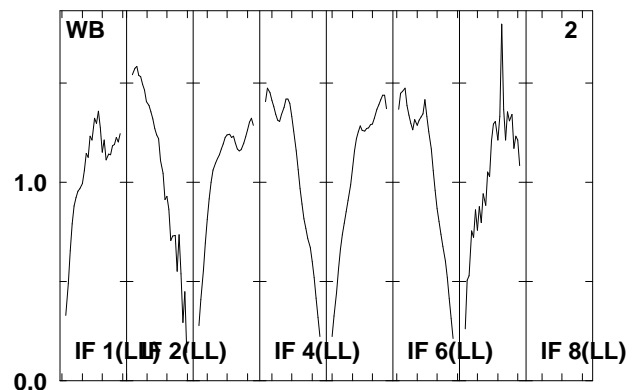
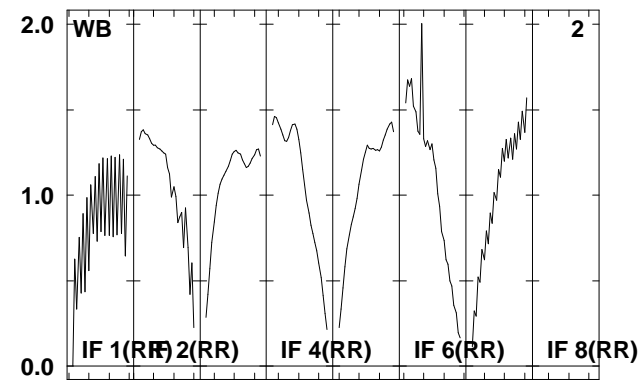
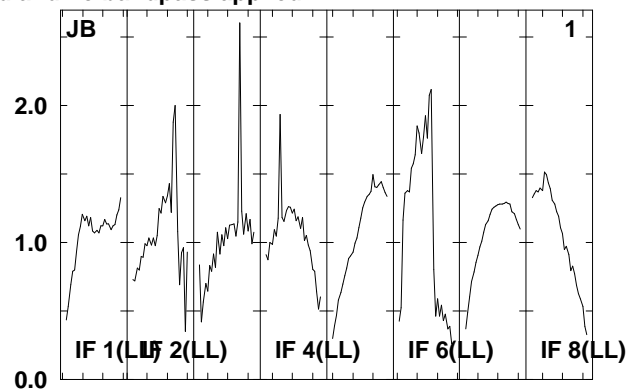
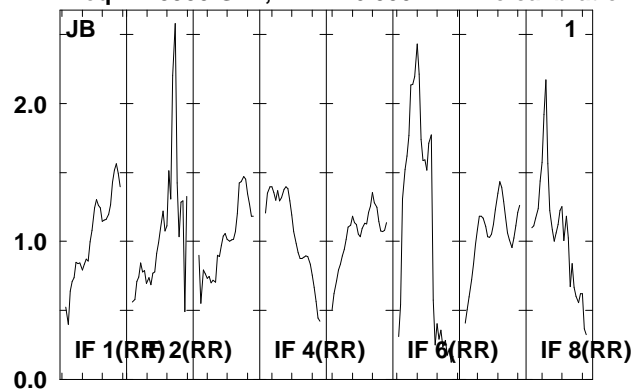

Lower frame: Real Jy  
Total-power spectrum Antenna: \*  
Timerange: 00/11:03:41 to 00/11:05:17

Plot file version 315 created 08-AUG-2008 17:01:10

J0920+44 EO006B.UVDATA.1

Freq = 1.5950 GHz, Bw = 16.000 MH No calibration applied and no bandpass applied

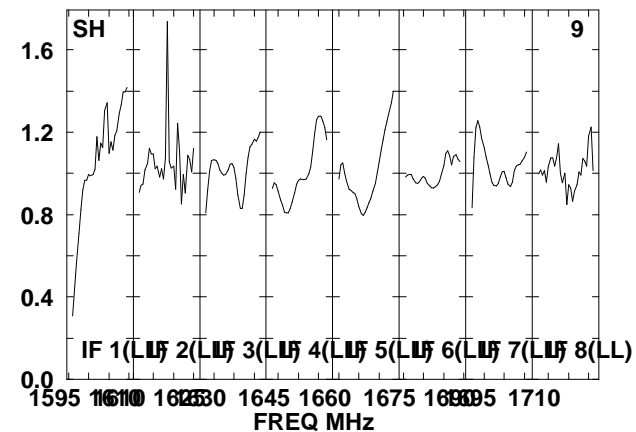
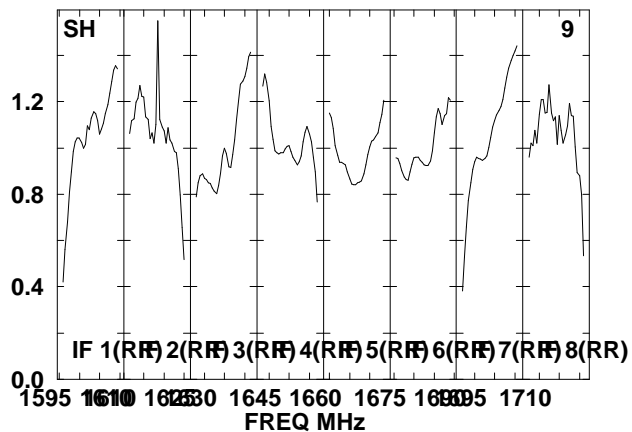
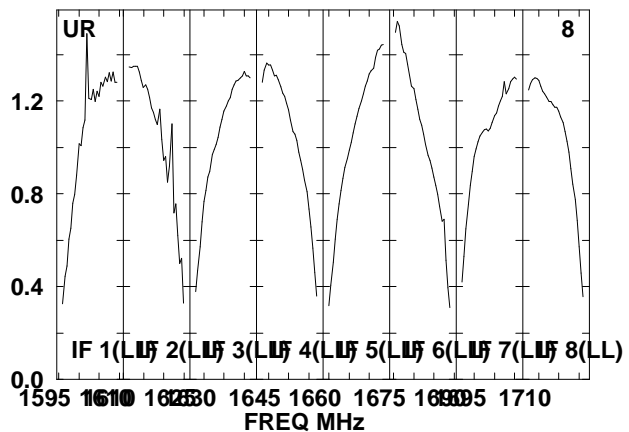
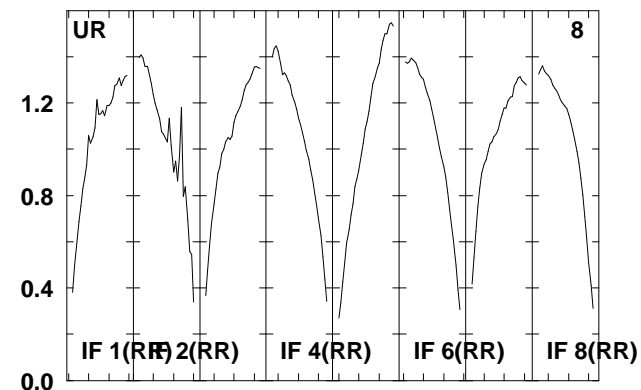
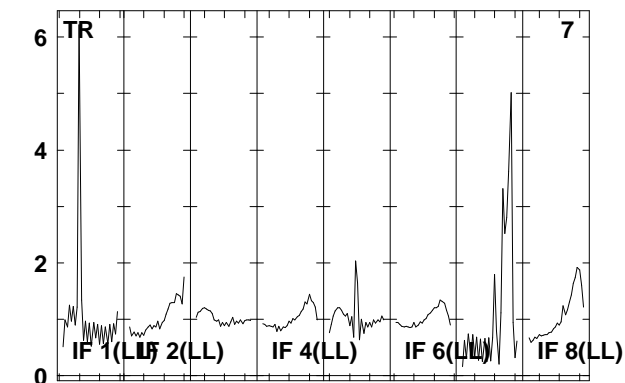
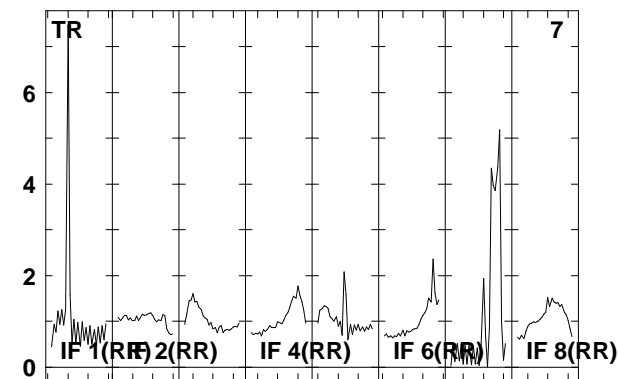
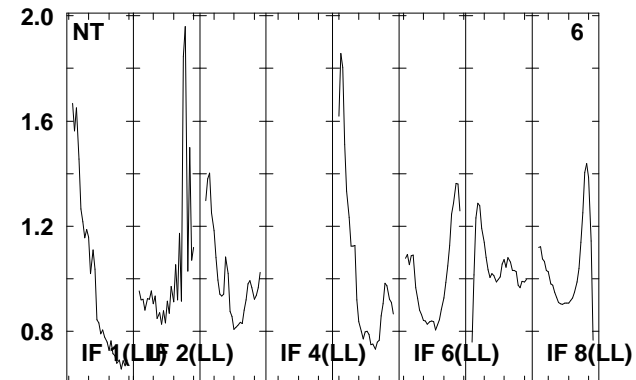
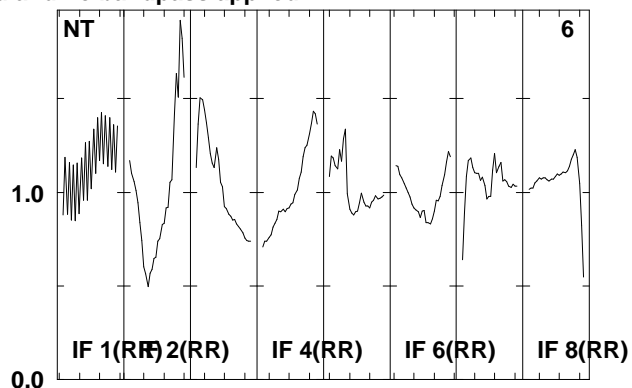
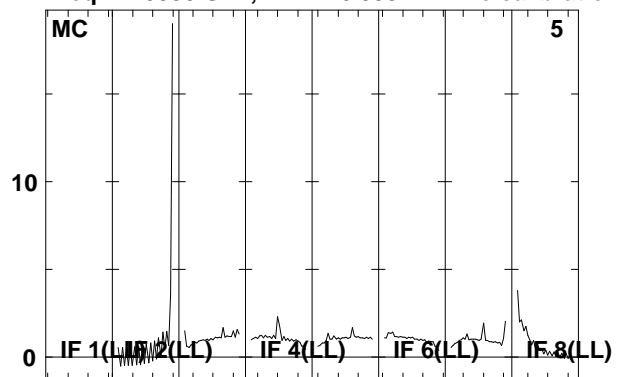

Lower frame: Real Jy

Total-power spectrum Antenna: \*

Timerange: 00/11:03:41 to 00/11:05:17

Plot file version 316 created 08-AUG-2008 17:01:11

J0920+44 EO006B.UVDATA.1

Freq = 1.5950 GHz, Bw = 16.000 MH No calibration applied and no bandpass applied

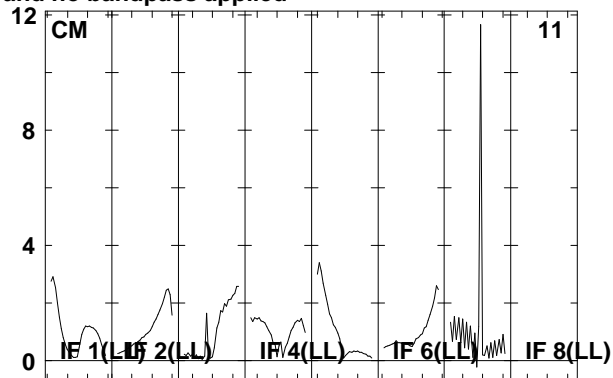
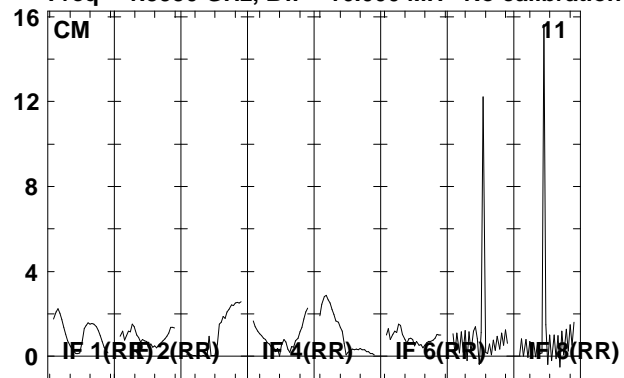

Lower frame: Real Jy  
Total-power spectrum Antenna: \*  
Timerange: 00/11:03:41 to 00/11:05:17



Plot file version 317 created 08-AUG-2008 17:01:11

J092159 EO006B.UVDATA.1

Freq = 1.5950 GHz, Bw = 16.000 MH No calibration applied and no bandpass applied

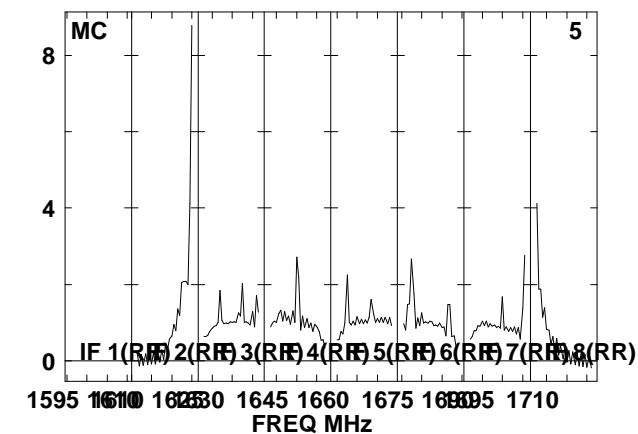
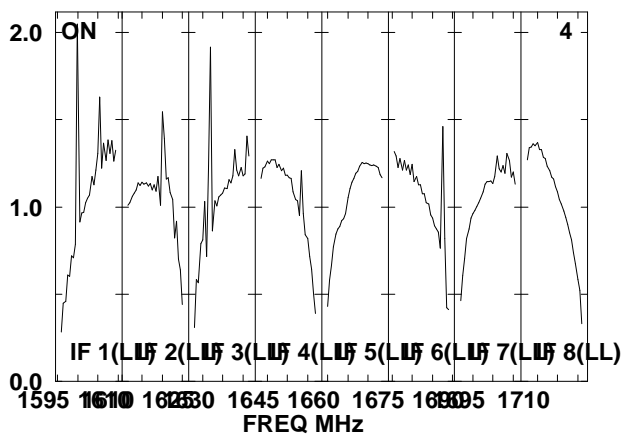
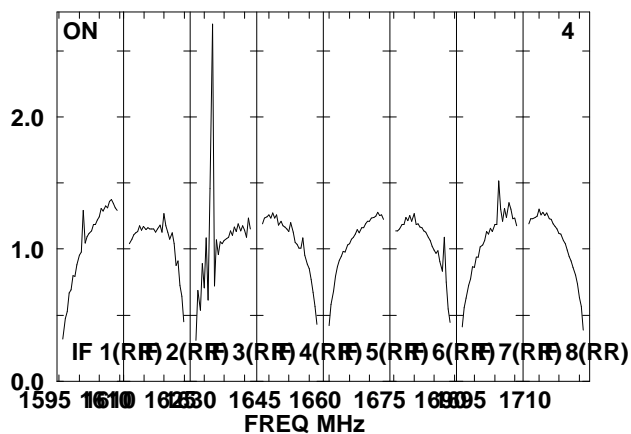
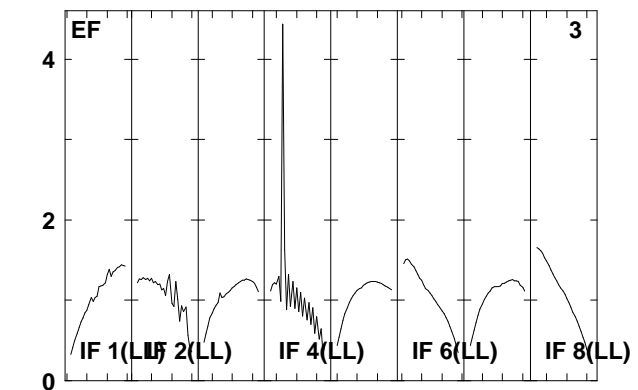
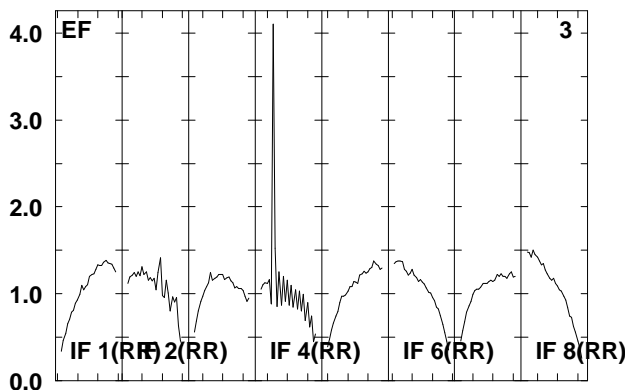
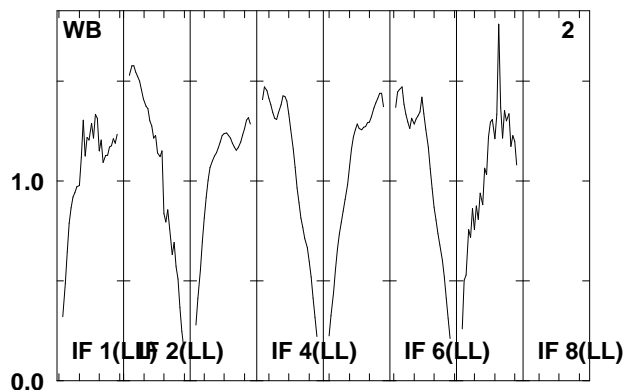
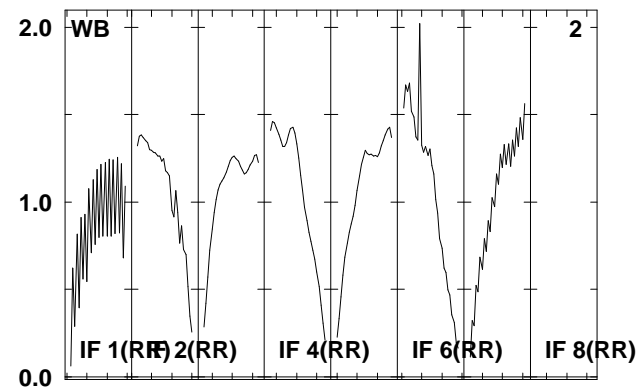
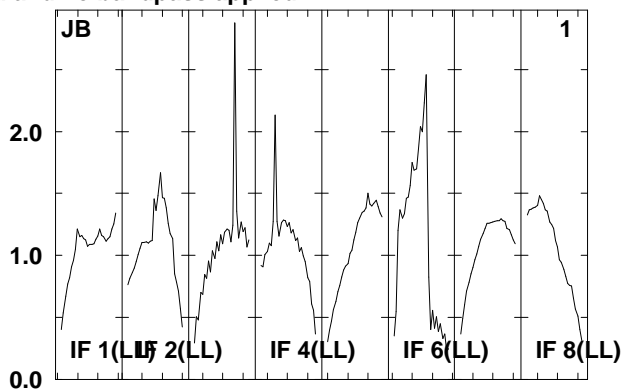
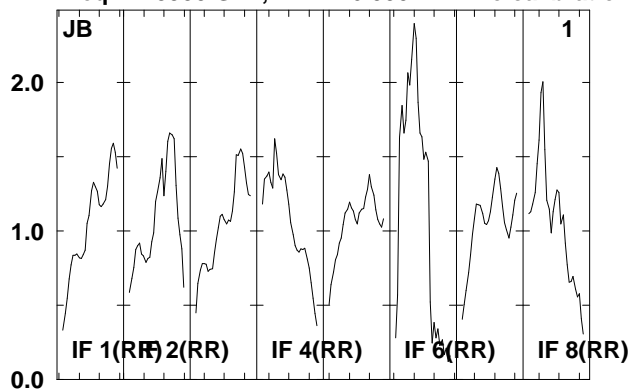

Lower frame: Real Jy  
Total-power spectrum Antenna: \*  
Timerange: 00/11:05:53 to 00/11:10:29

Plot file version 318 created 08-AUG-2008 17:01:12

J092159 EO006B.UVDATA.1

Freq = 1.5950 GHz, Bw = 16.000 MH No calibration applied and no bandpass applied

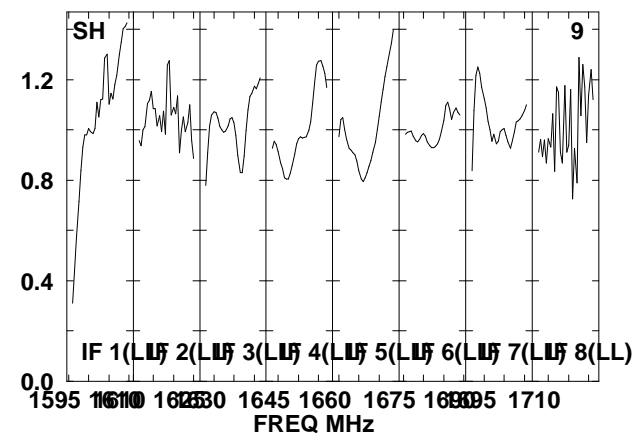
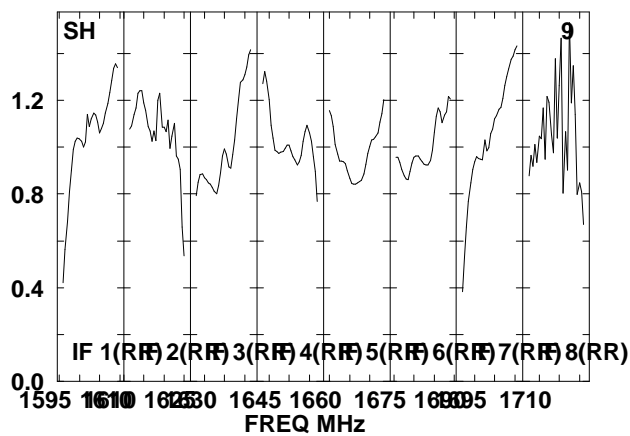
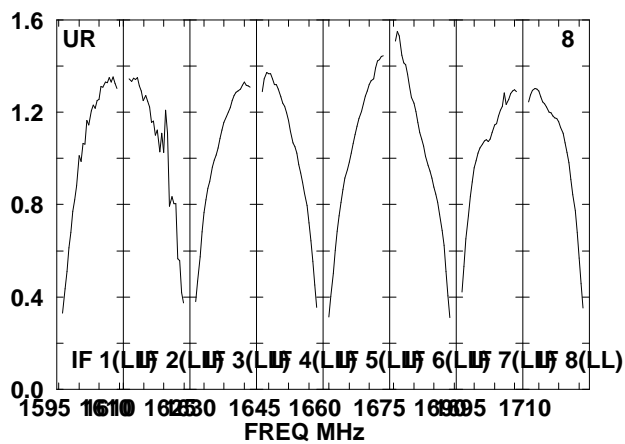
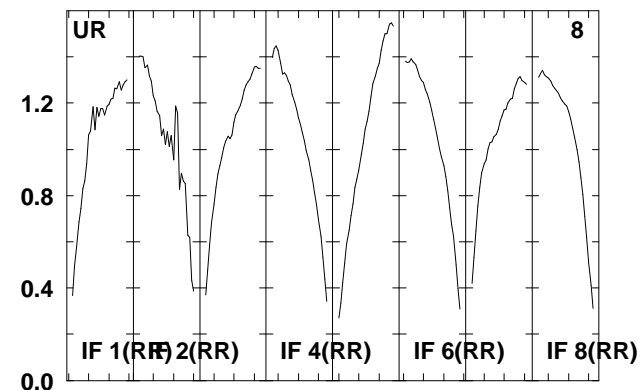
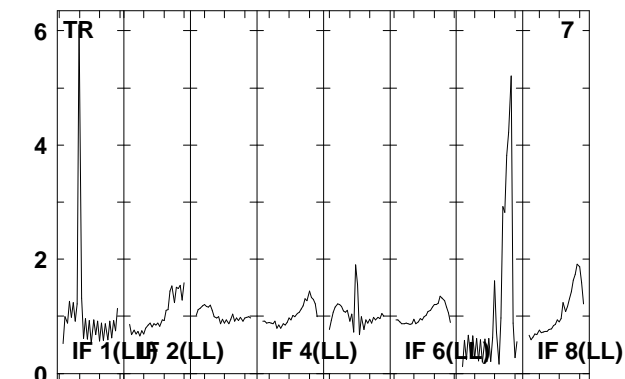
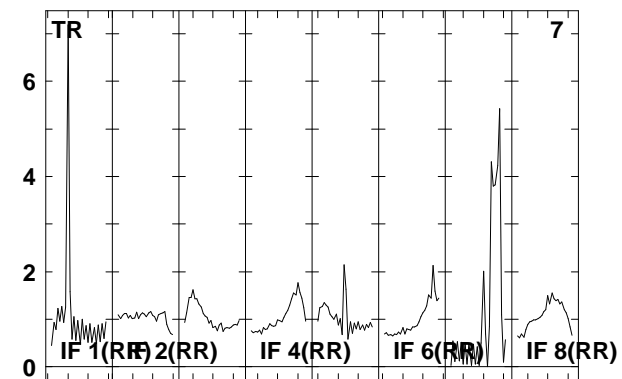
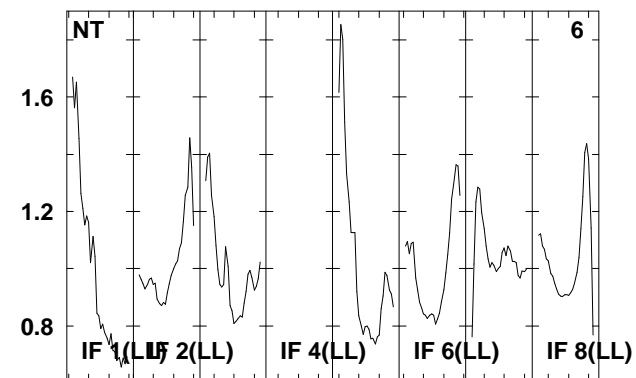
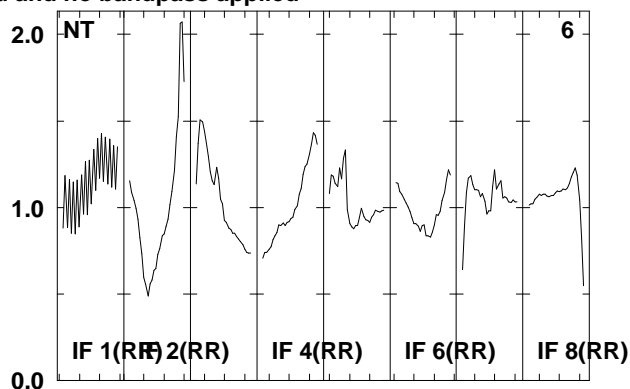
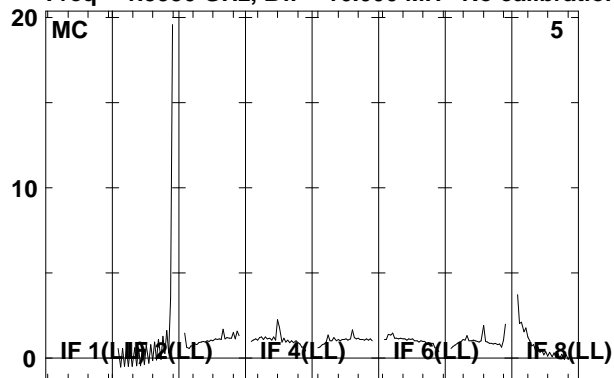

Lower frame: Real Jy  
Total-power spectrum Antenna: \*  
Timerange: 00/11:05:53 to 00/11:10:29

Plot file version 319 created 08-AUG-2008 17:01:13

J092159 EO006B.UVDATA.1

Freq = 1.5950 GHz, Bw = 16.000 MH No calibration applied and no bandpass applied

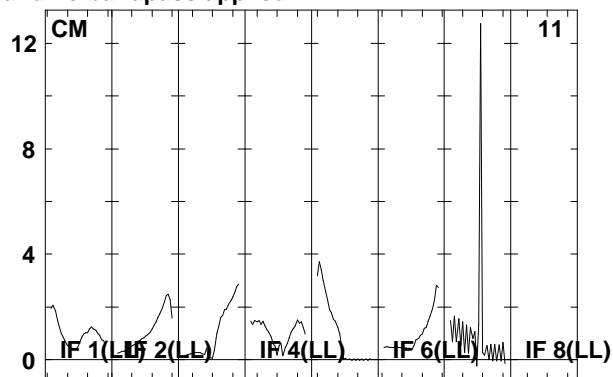
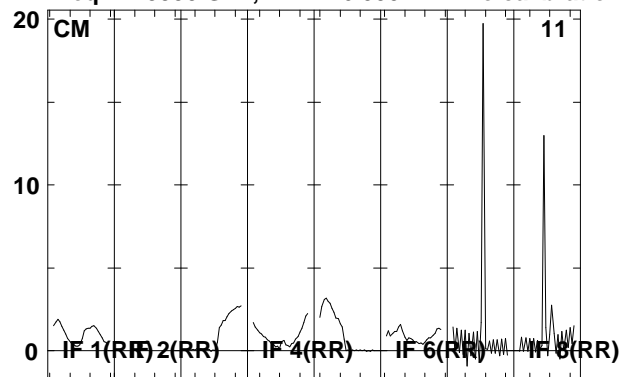

Lower frame: Real Jy  
Total-power spectrum Antenna: \*  
Timerange: 00/11:05:53 to 00/11:10:29

Plot file version 320 created 08-AUG-2008 17:01:13

J0920+44 EO006B.UVDATA.1

Freq = 1.5950 GHz, Bw = 16.000 MH No calibration applied and no bandpass applied

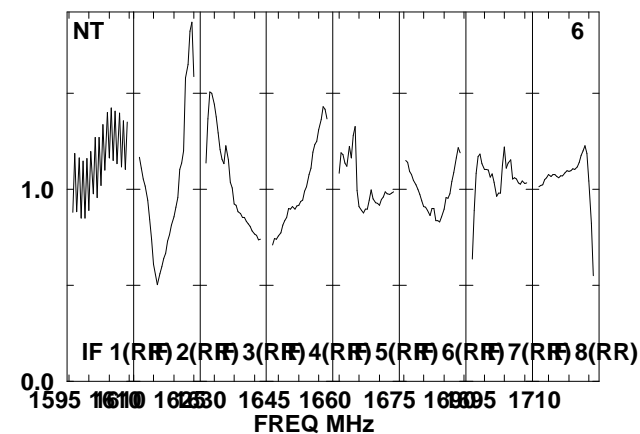
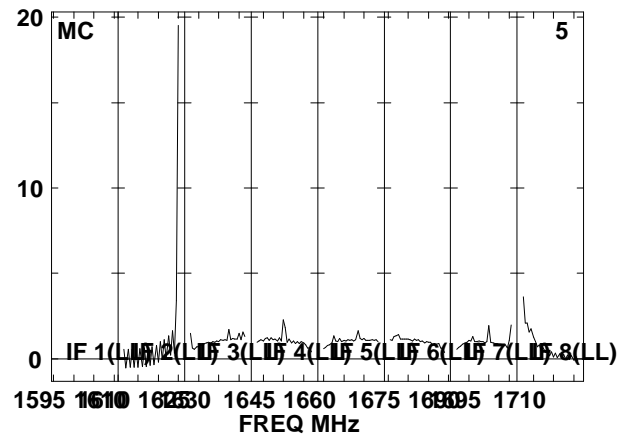
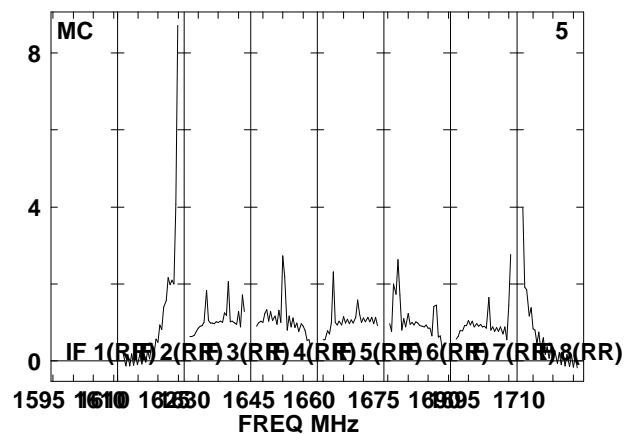
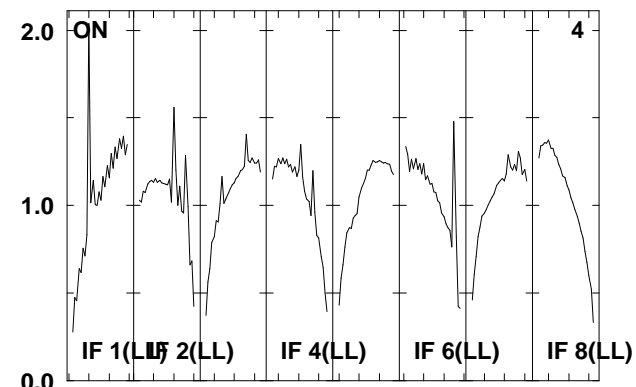
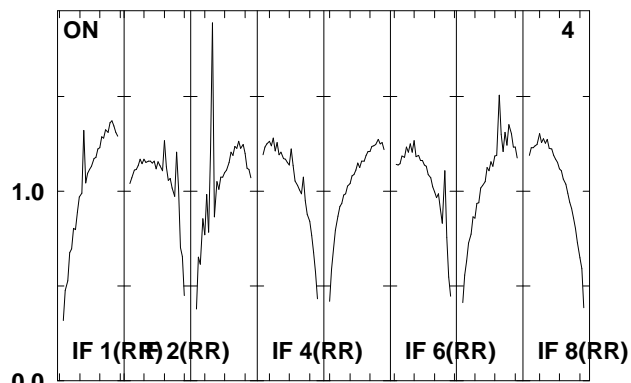
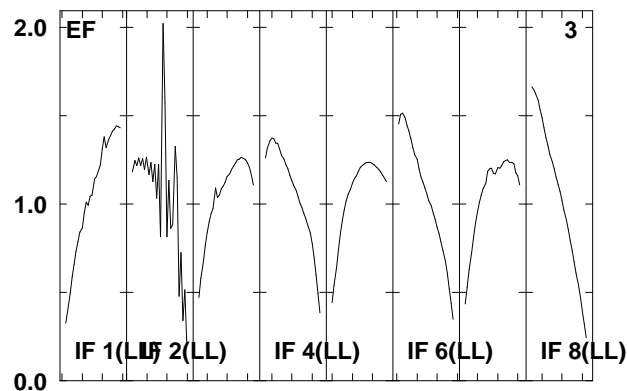
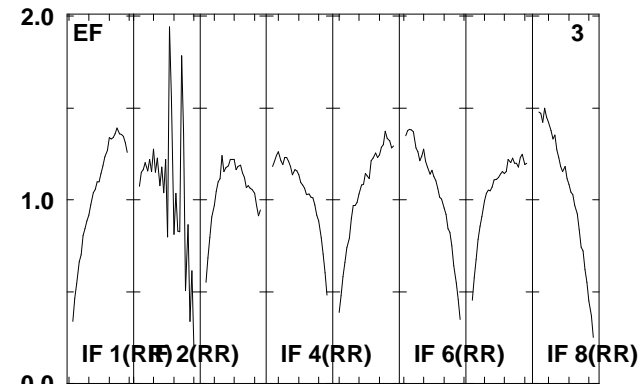
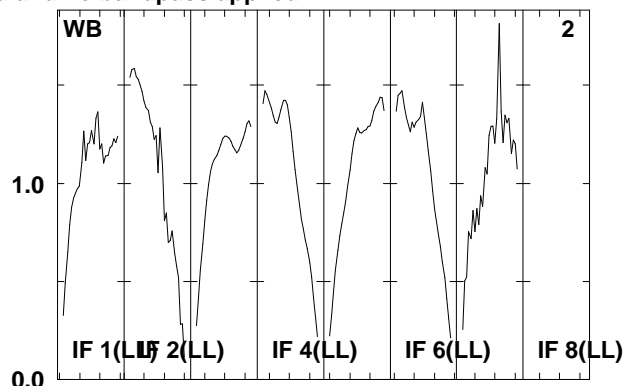
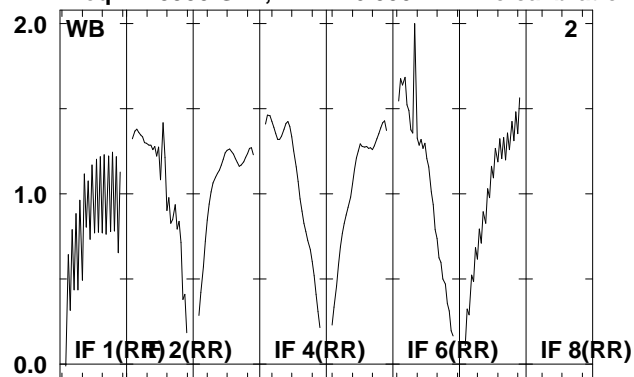

Lower frame: Real Jy  
Total-power spectrum Antenna: \*  
Timerange: 00/11:11:01 to 00/11:12:37

Plot file version 321 created 08-AUG-2008 17:01:13

J0920+44 EO006B.UVDATA.1

Freq = 1.5950 GHz, Bw = 16.000 MH No calibration applied and no bandpass applied

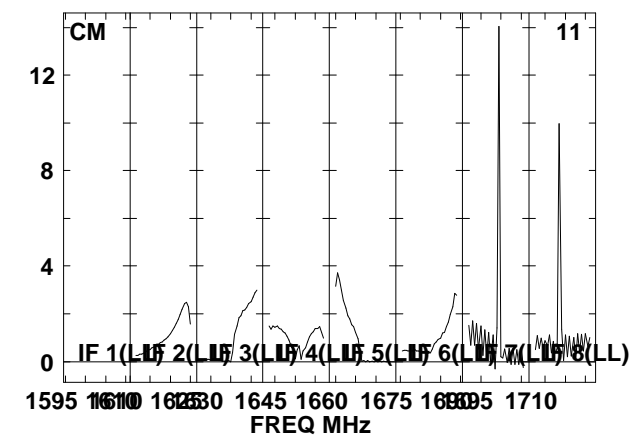
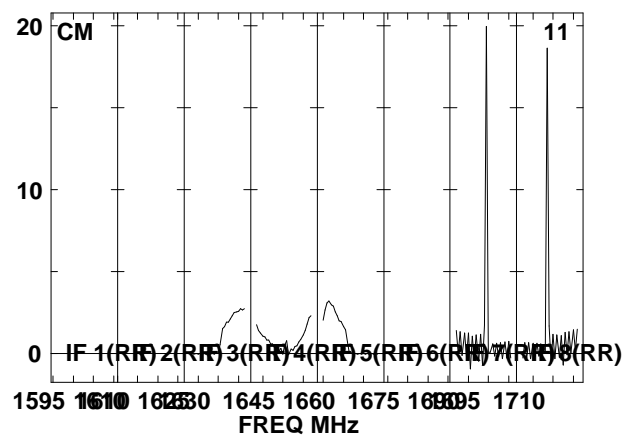
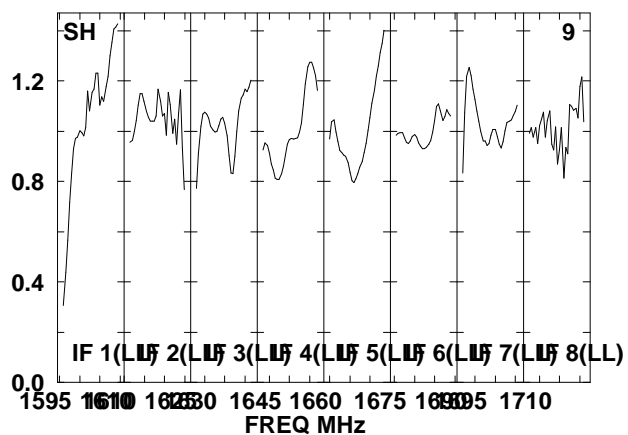
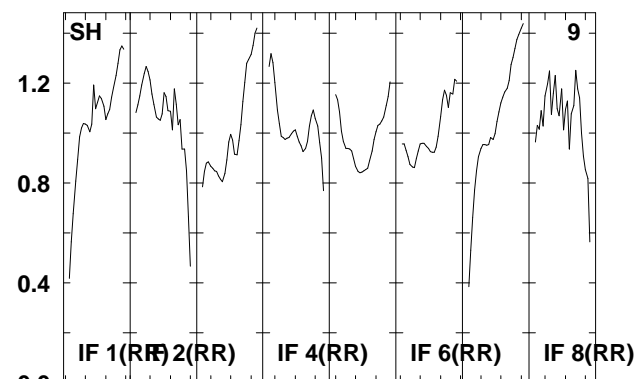
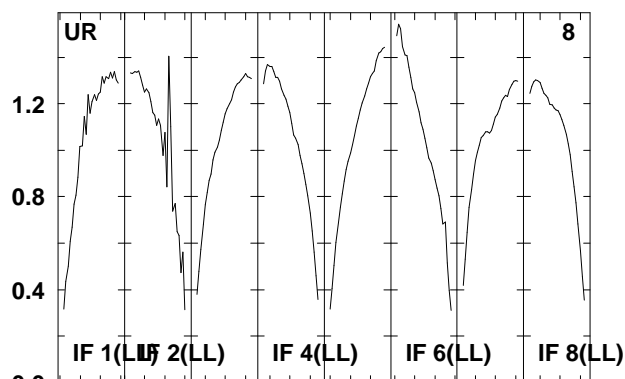
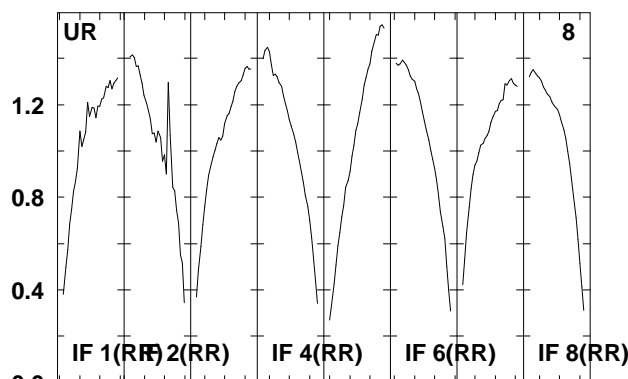
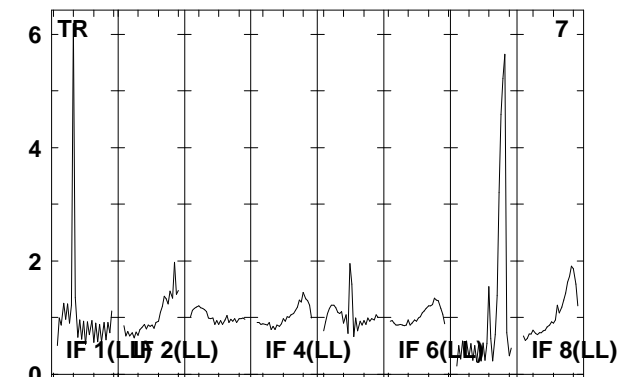
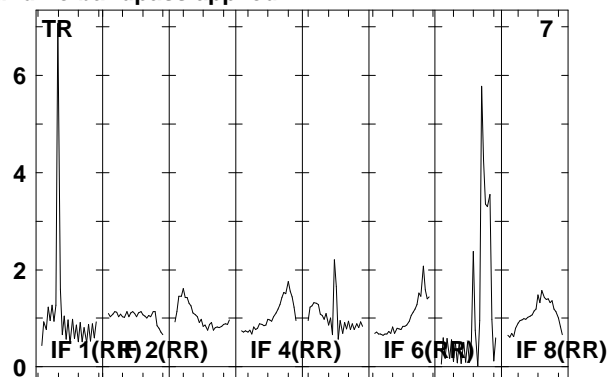
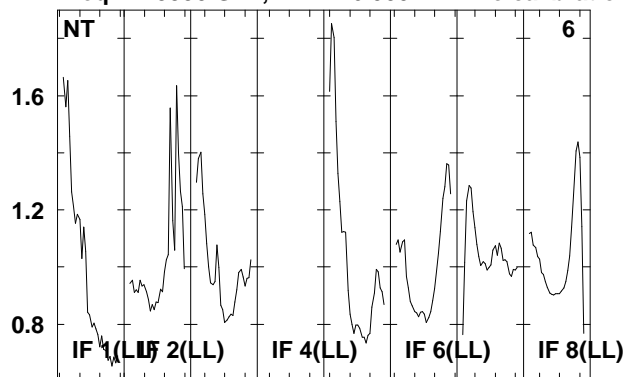

Lower frame: Real Jy  
Total-power spectrum Antenna: \*  
Timerange: 00/11:11:01 to 00/11:12:37

Plot file version 322 created 08-AUG-2008 17:01:14

J092159 EO006B.UVDATA.1

Freq = 1.5950 GHz, Bw = 16.000 MH No calibration applied and no bandpass applied

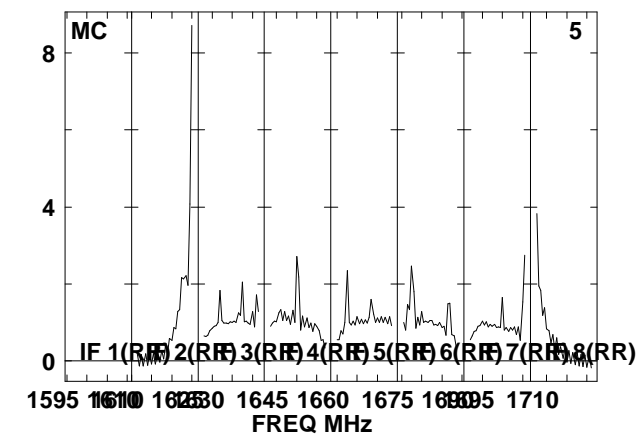
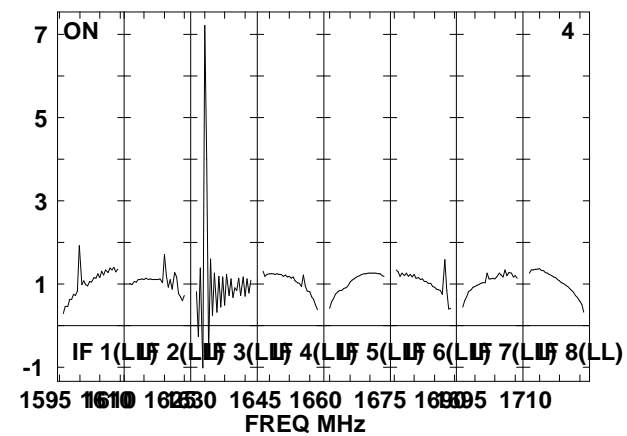
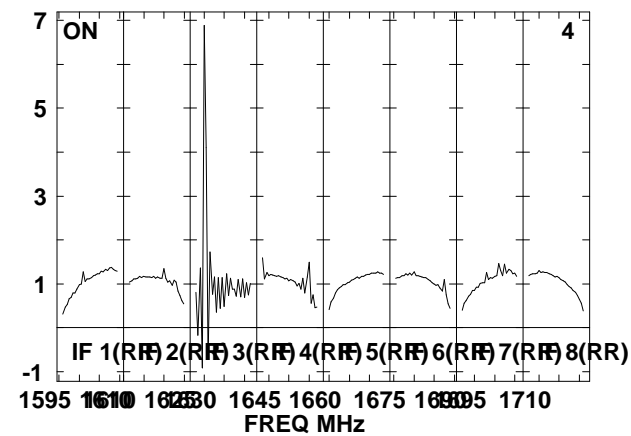
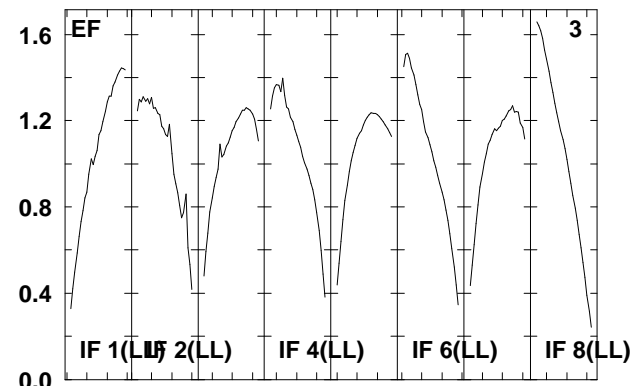
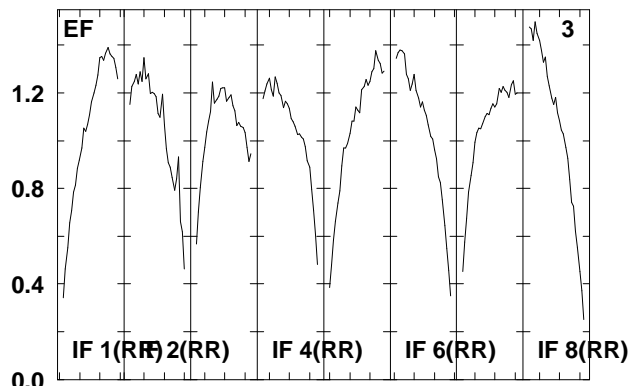
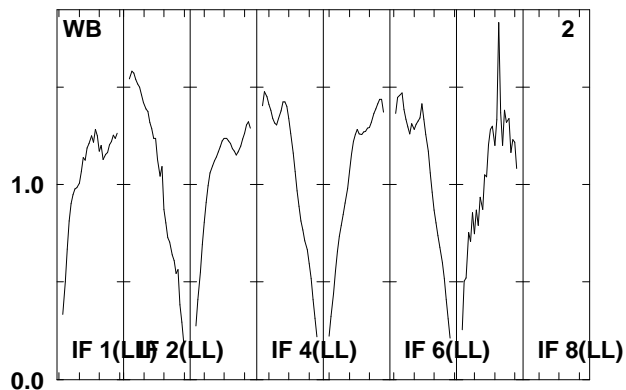
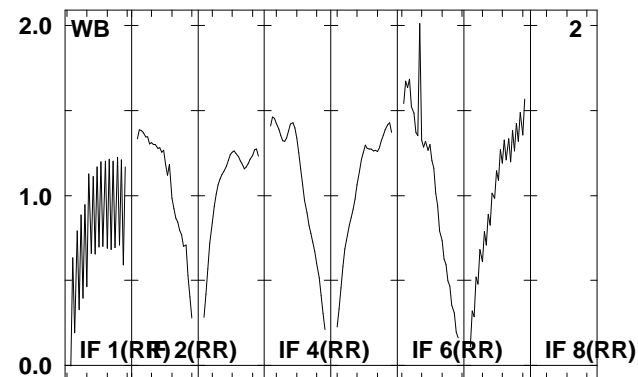
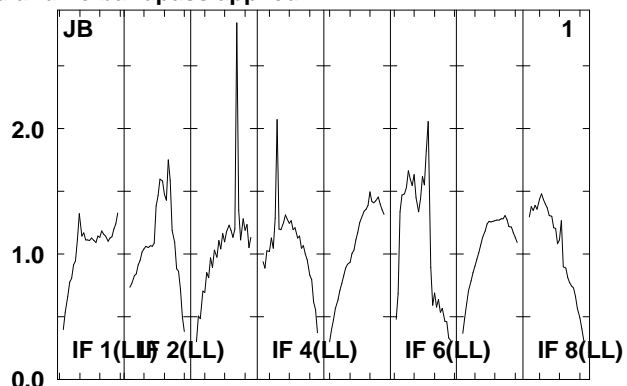
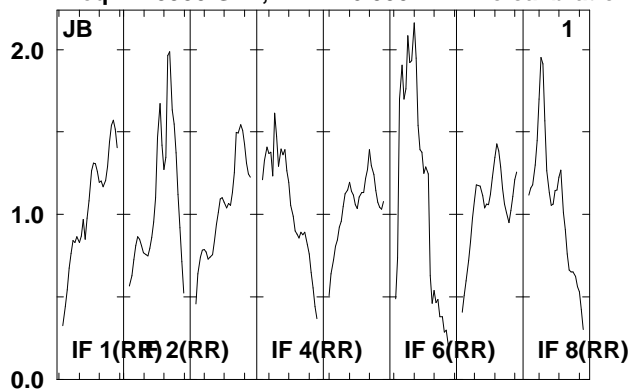

Lower frame: Real Jy  
Total-power spectrum Antenna: \*  
Timerange: 00/11:13:13 to 00/11:17:49

Plot file version 323 created 08-AUG-2008 17:01:14

J092159 EO006B.UVDATA.1

Freq = 1.5950 GHz, Bw = 16.000 MH No calibration applied and no bandpass applied

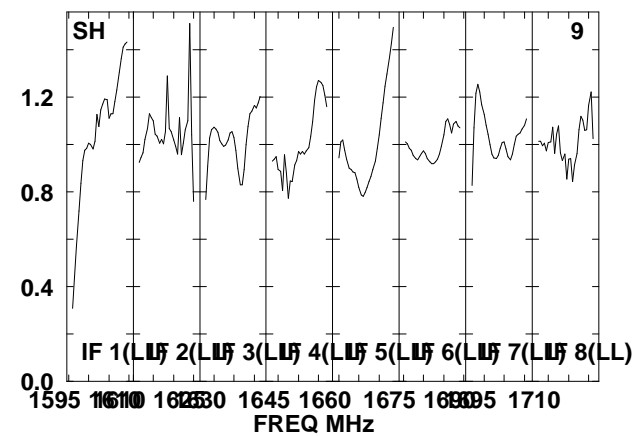
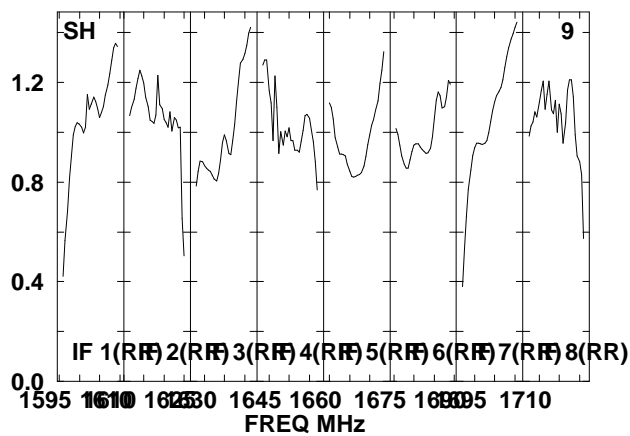
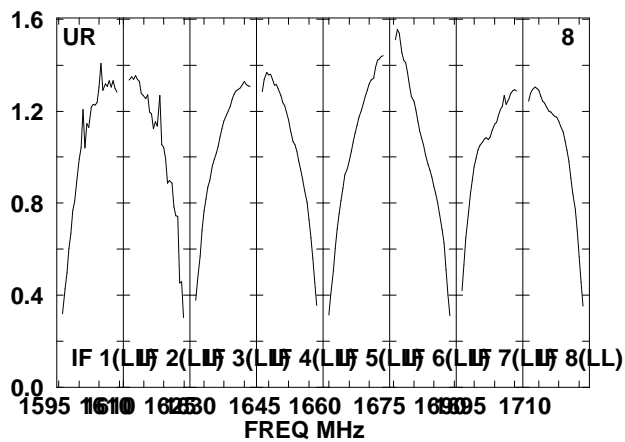
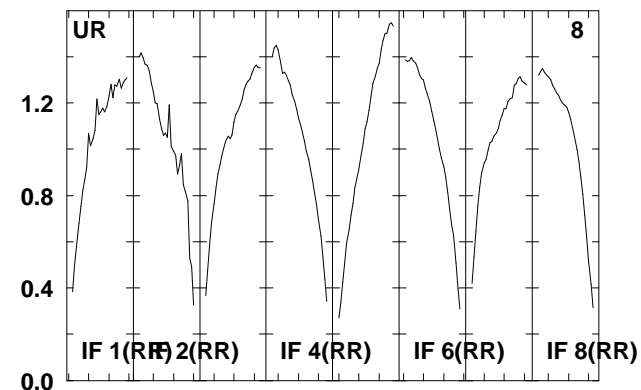
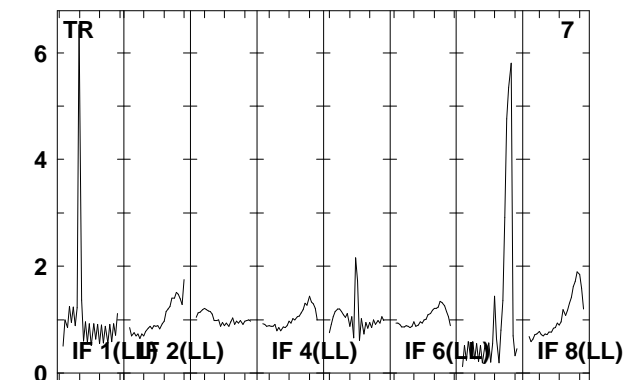
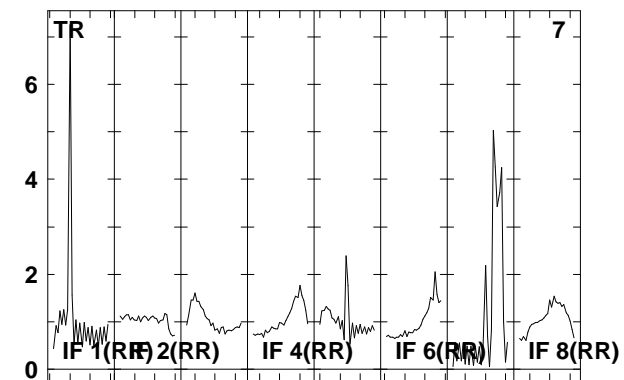
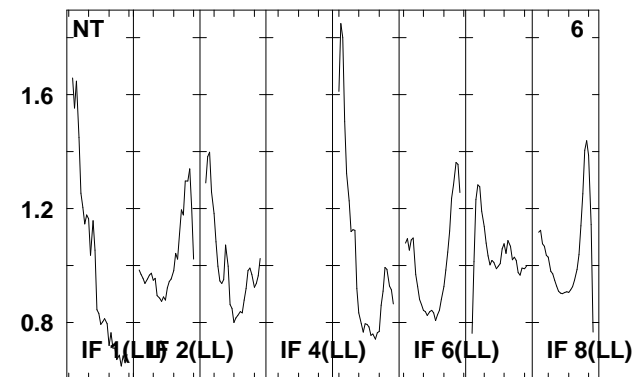
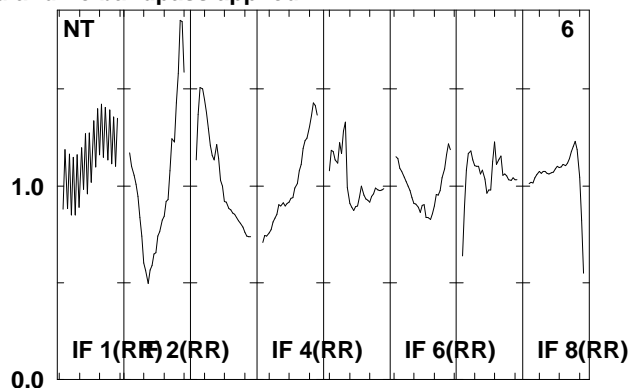
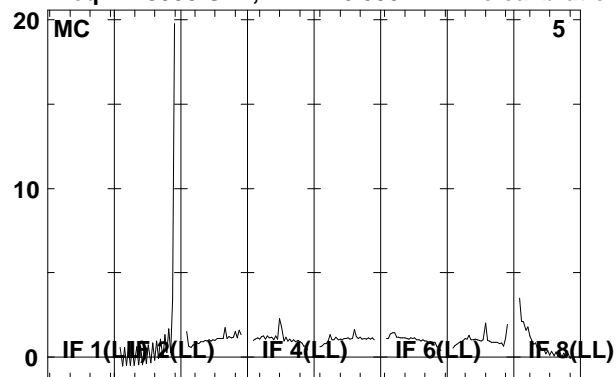

Lower frame: Real Jy

Total-power spectrum Antenna: \*

Timerange: 00/11:13:13 to 00/11:17:49

Plot file version 324 created 08-AUG-2008 17:01:15

J092159 EO006B.UVDATA.1

Freq = 1.5950 GHz, Bw = 16.000 MH No calibration applied and no bandpass applied

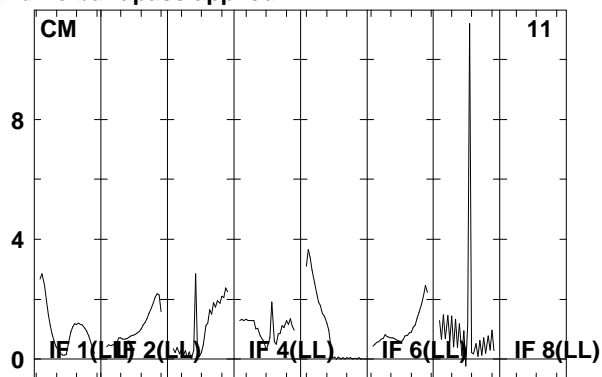
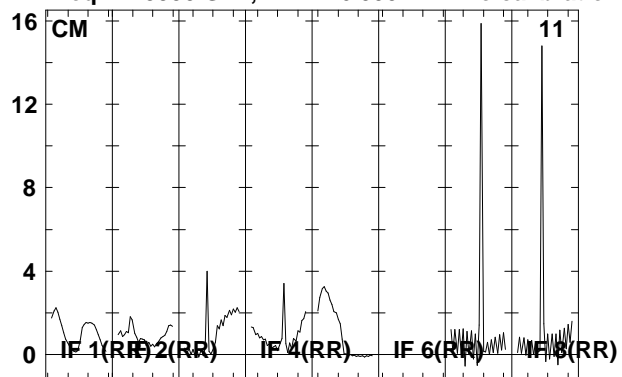

Lower frame: Real Jy  
Total-power spectrum Antenna: \*  
Timerange: 00/11:13:13 to 00/11:17:49



Plot file version 325 created 08-AUG-2008 17:01:16

J0920+44 EO006B.UVDATA.1

Freq = 1.5950 GHz, Bw = 16.000 MH No calibration applied and no bandpass applied

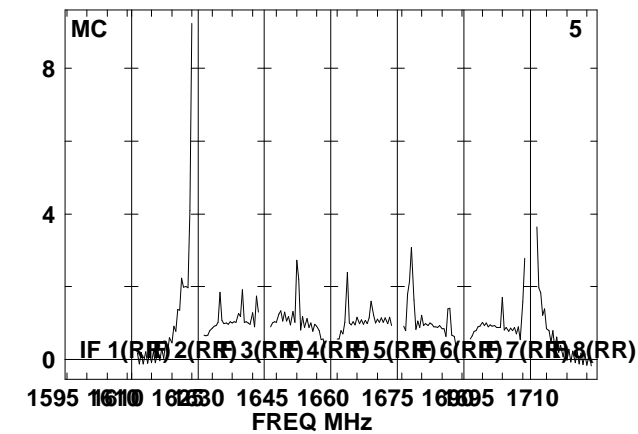
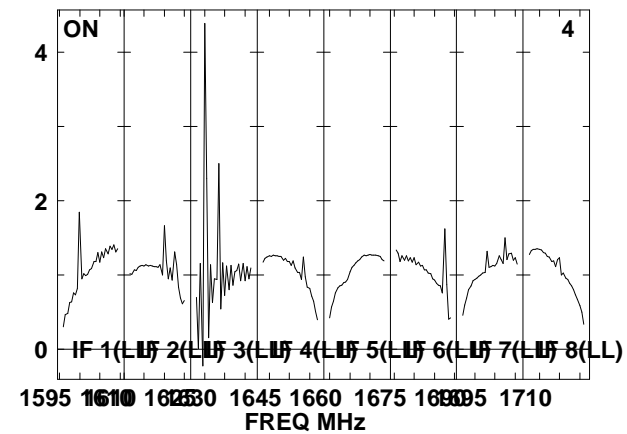
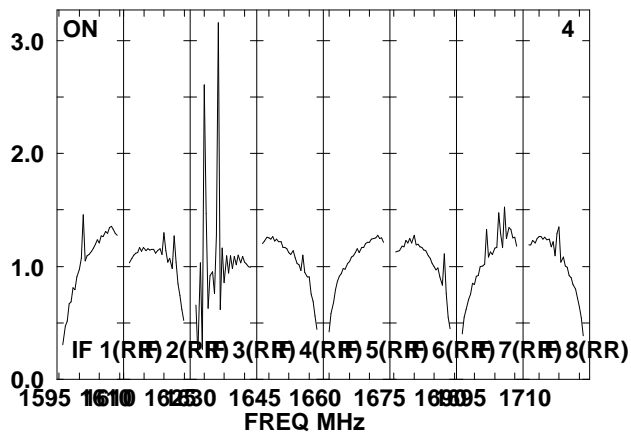
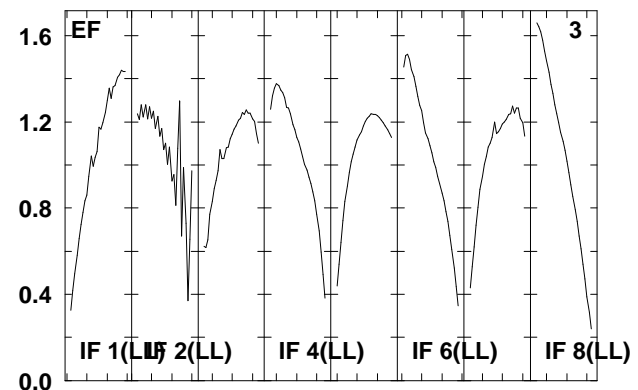
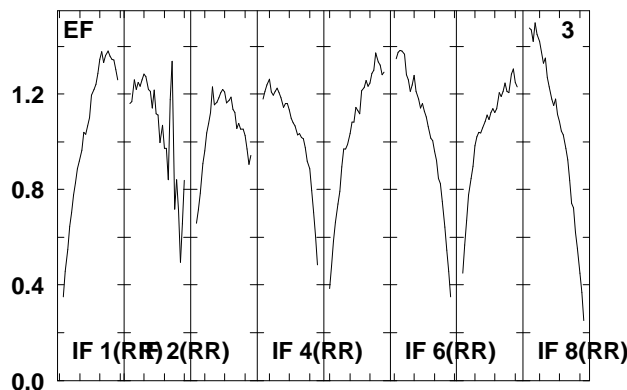
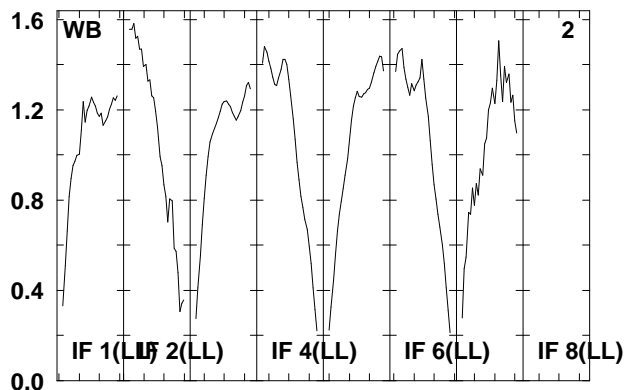
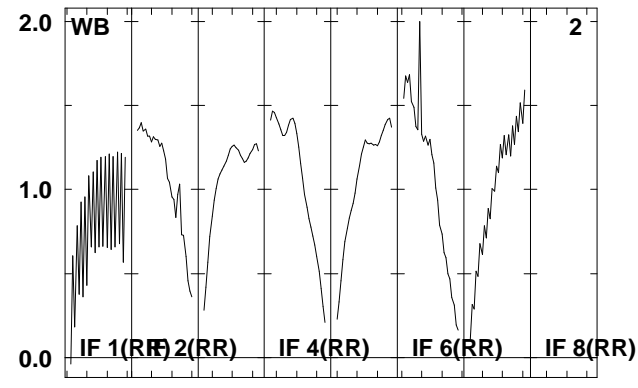
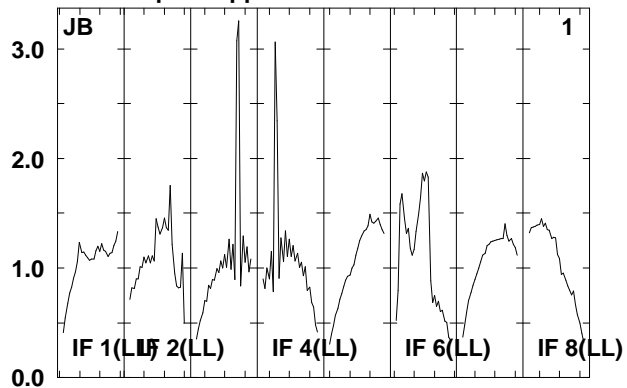
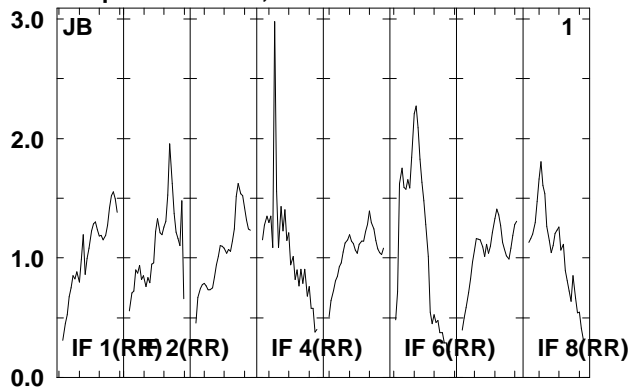

Lower frame: Real Jy  
Total-power spectrum Antenna: \*  
Timerange: 00/11:18:21 to 00/11:19:57

Plot file version 326 created 08-AUG-2008 17:01:16

J0920+44 EO006B.UVDATA.1

Freq = 1.5950 GHz, Bw = 16.000 MH No calibration applied and no bandpass applied

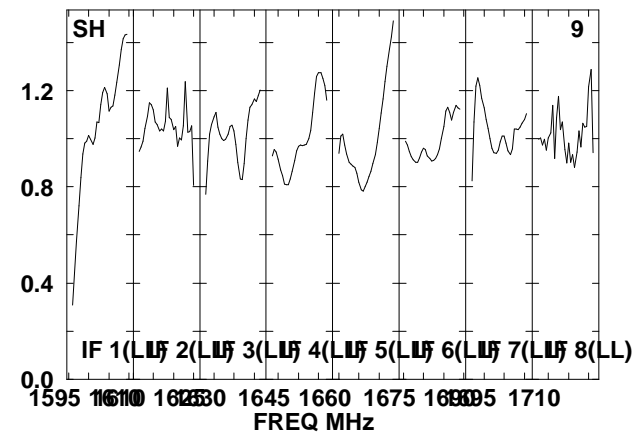
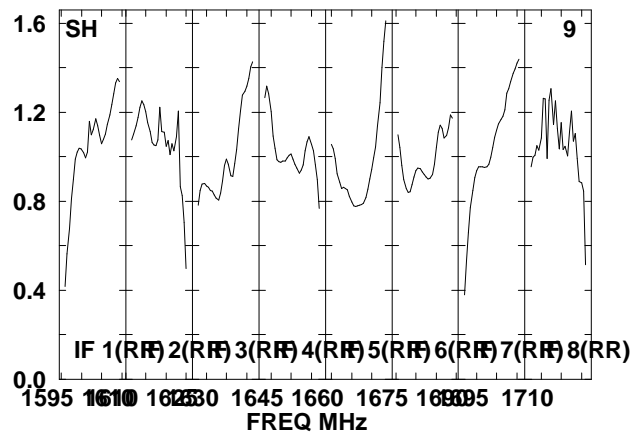
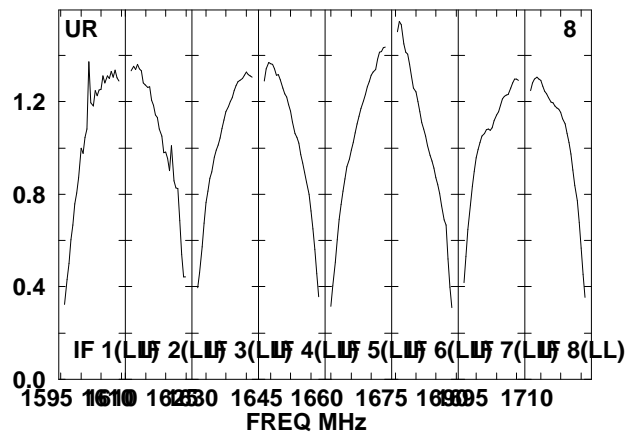
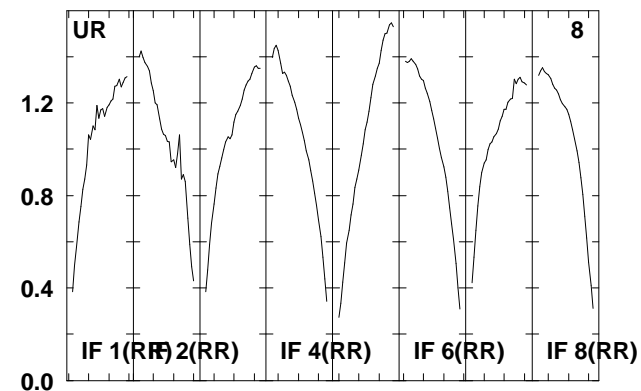
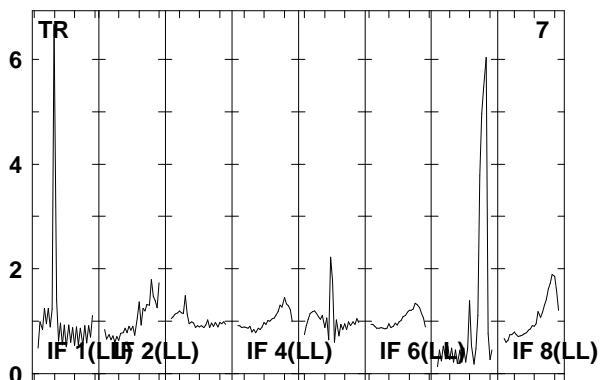
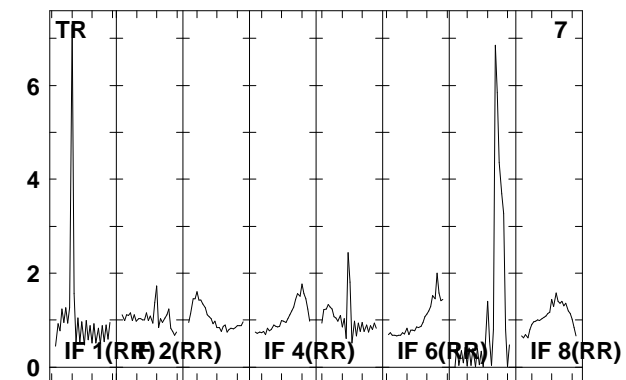
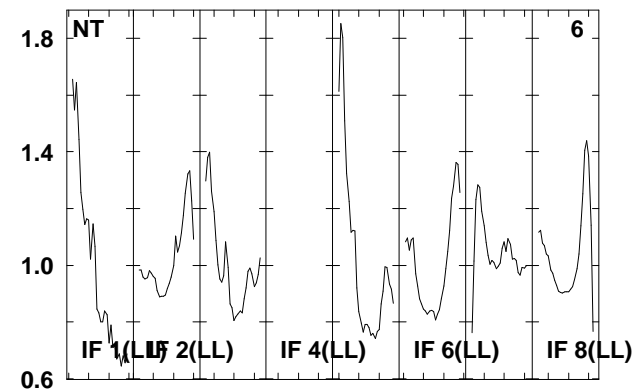
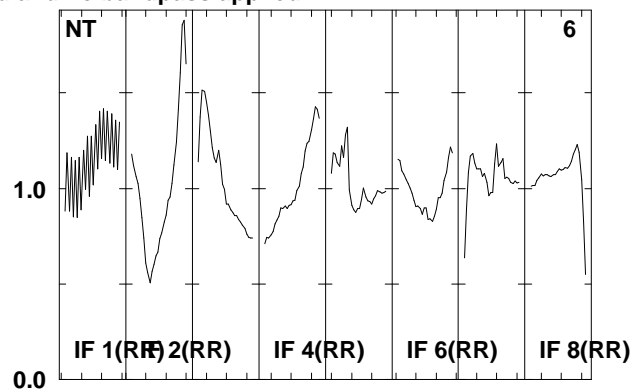
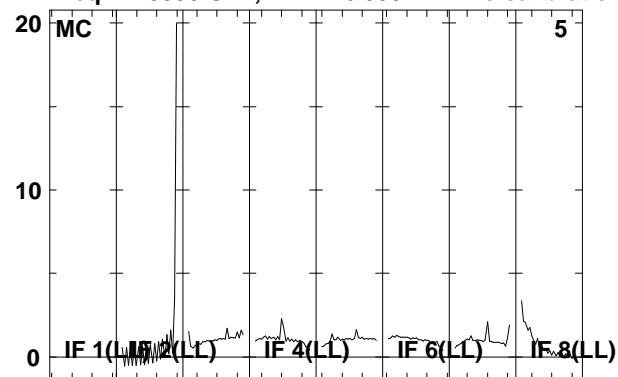

Lower frame: Real Jy

Total-power spectrum Antenna: \*

Timerange: 00/11:18:21 to 00/11:19:57

Plot file version 327 created 08-AUG-2008 17:01:17

J0920+44 EO006B.UVDATA.1

Freq = 1.5950 GHz, Bw = 16.000 MH No calibration applied and no bandpass applied

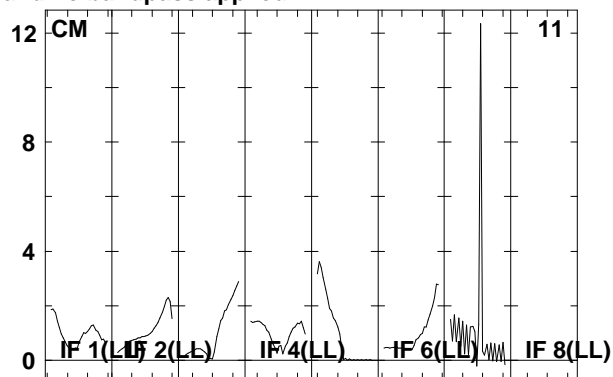
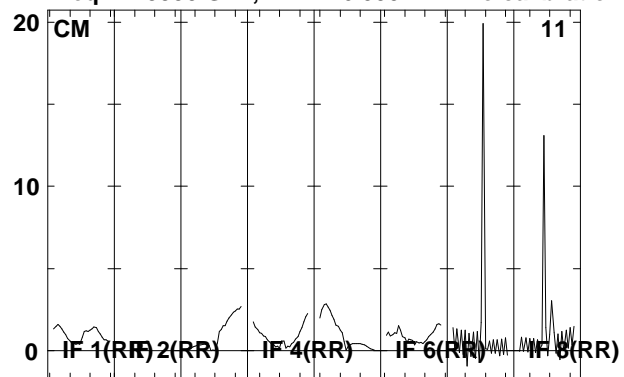

Lower frame: Real Jy  
Total-power spectrum Antenna: \*  
Timerange: 00/11:18:21 to 00/11:19:57

Plot file version 328 created 08-AUG-2008 17:01:17

J092159 EO006B.UVDATA.1

Freq = 1.5950 GHz, Bw = 16.000 MH No calibration applied and no bandpass applied

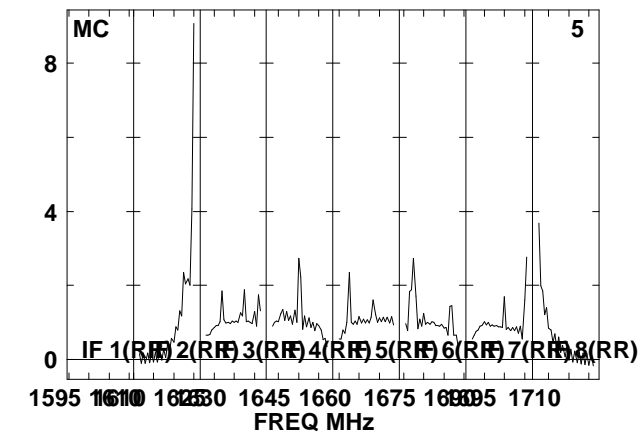
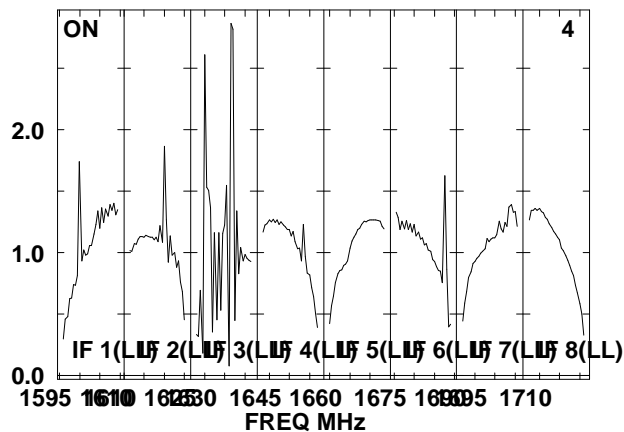
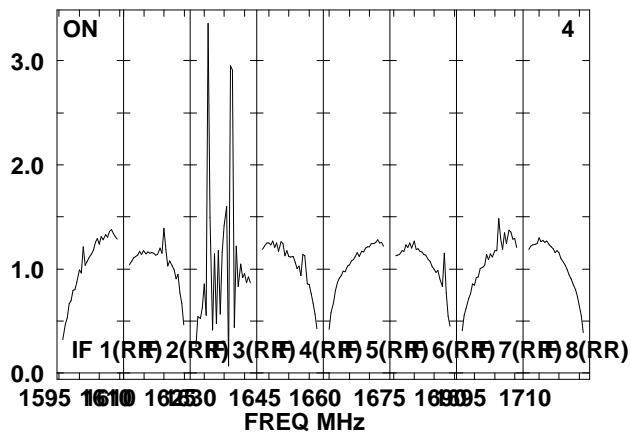
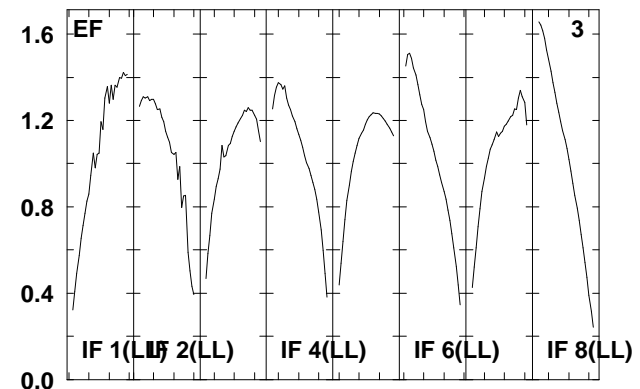
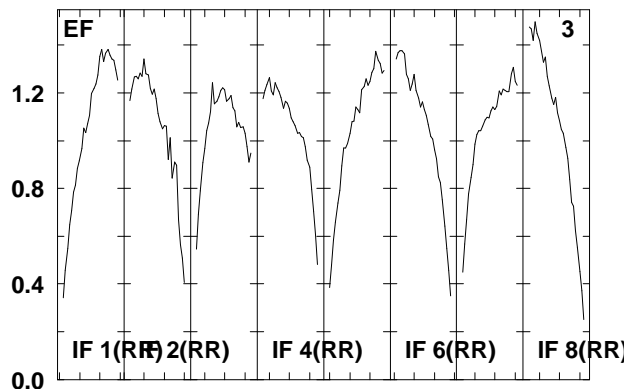
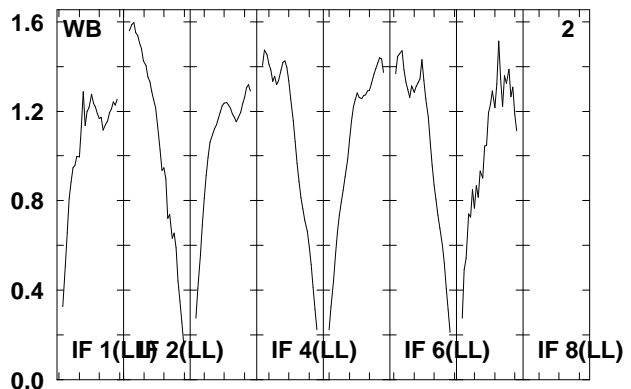
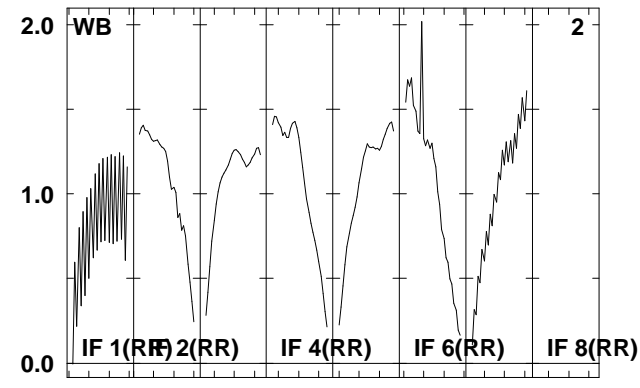
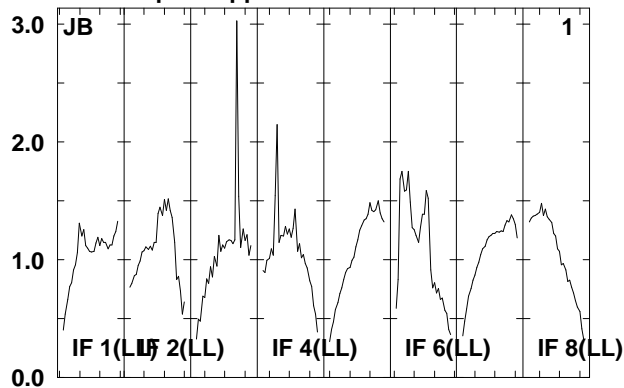
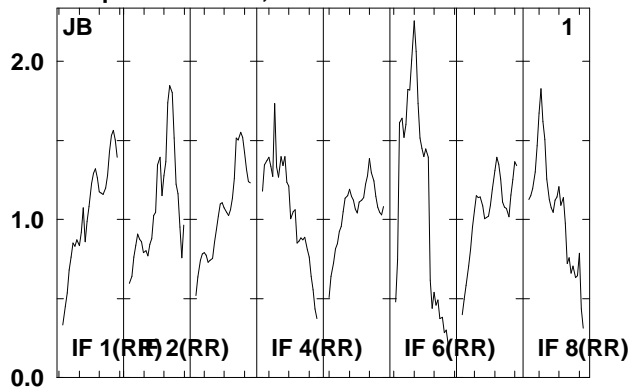

Lower frame: Real Jy  
Total-power spectrum Antenna: \*  
Timerange: 00/11:20:33 to 00/11:25:01

Plot file version 329 created 08-AUG-2008 17:01:17

J092159 EO006B.UVDATA.1

Freq = 1.5950 GHz, Bw = 16.000 MH No calibration applied and no bandpass applied

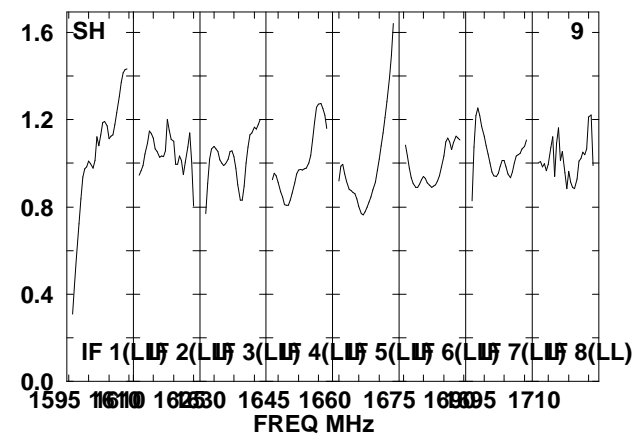
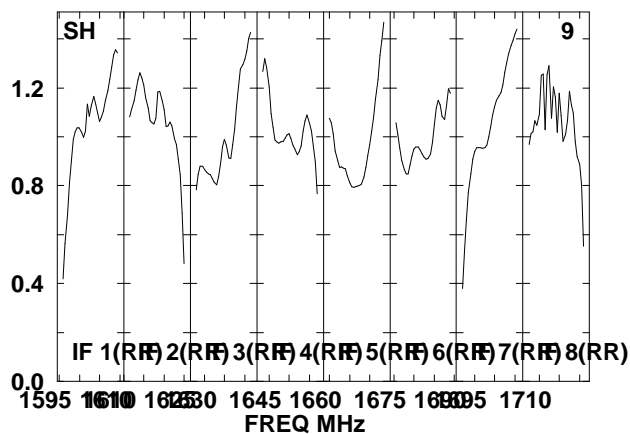
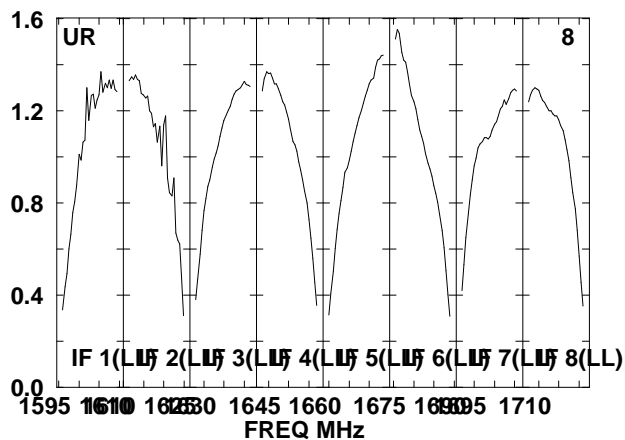
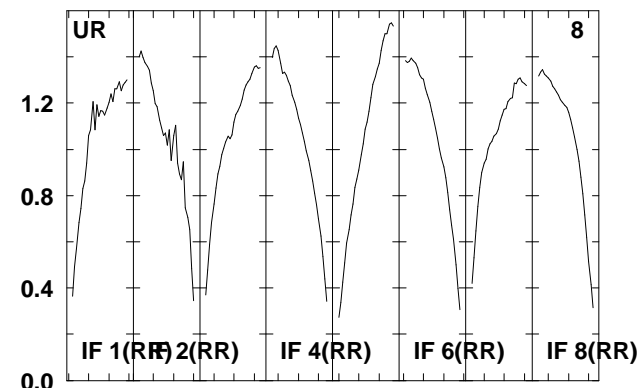
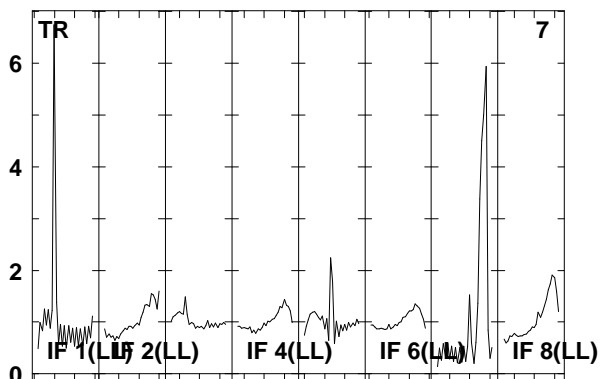
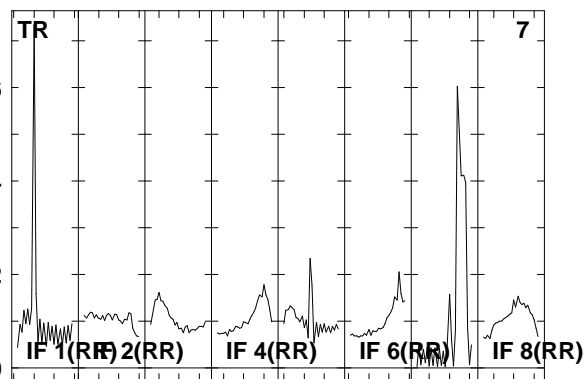
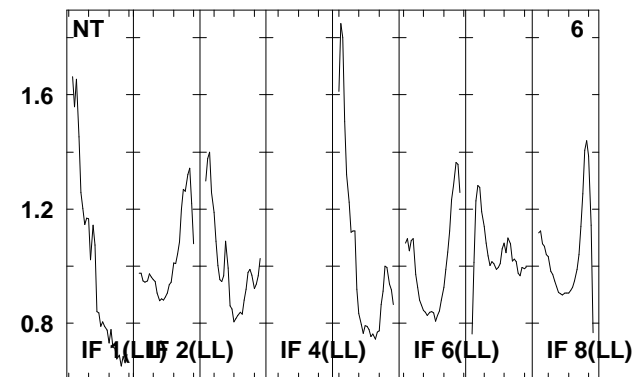
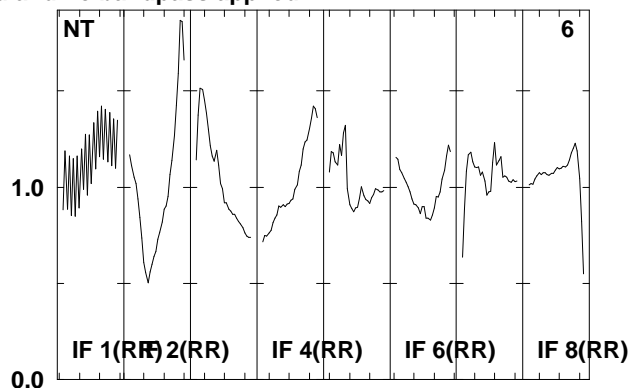
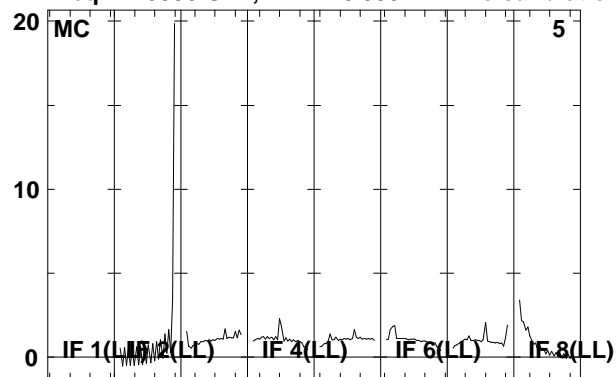

Lower frame: Real Jy

Total-power spectrum Antenna: \*

Timerange: 00/11:20:33 to 00/11:25:01

Plot file version 330 created 08-AUG-2008 17:01:18

J092159 EO006B.UVDATA.1

Freq = 1.5950 GHz, Bw = 16.000 MH No calibration applied and no bandpass applied

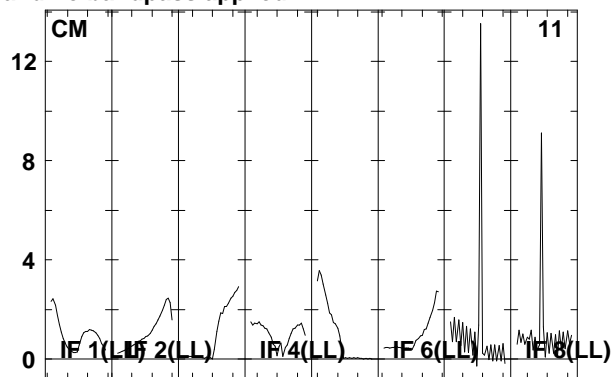
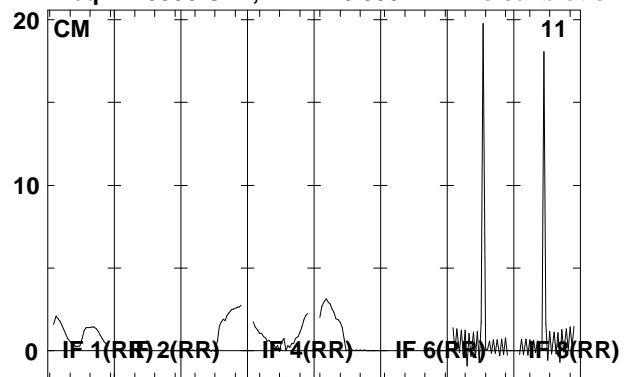

Lower frame: Real Jy  
Total-power spectrum Antenna: \*  
Timerange: 00/11:20:33 to 00/11:25:01

Plot file version 331 created 08-AUG-2008 17:01:18

J0920+44 EO006B.UVDATA.1

Freq = 1.5950 GHz, Bw = 16.000 MH No calibration applied and no bandpass applied

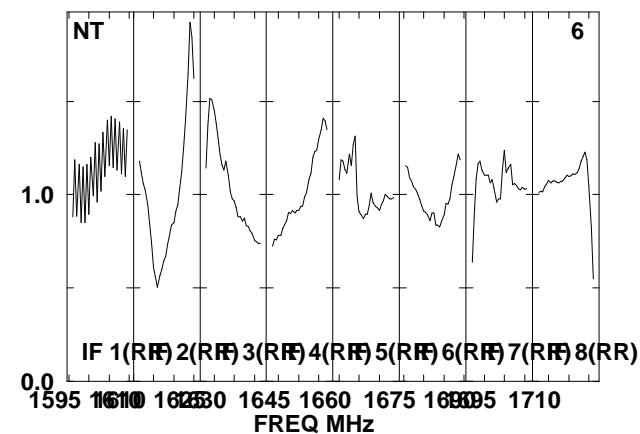
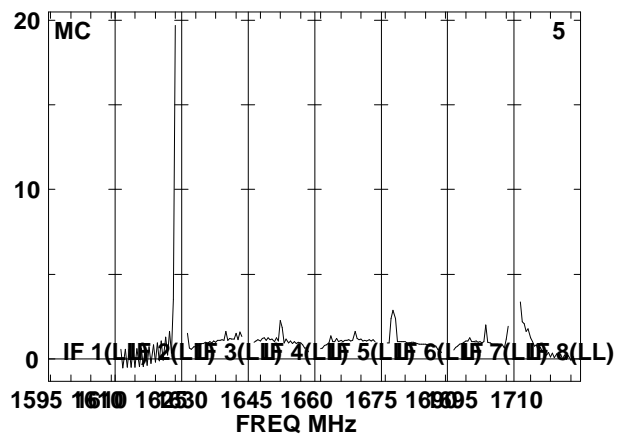
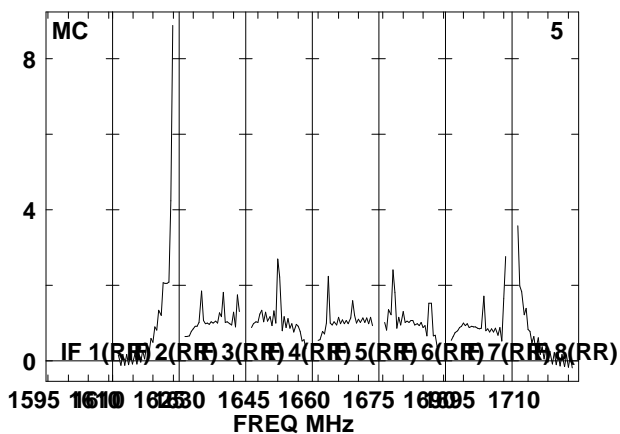
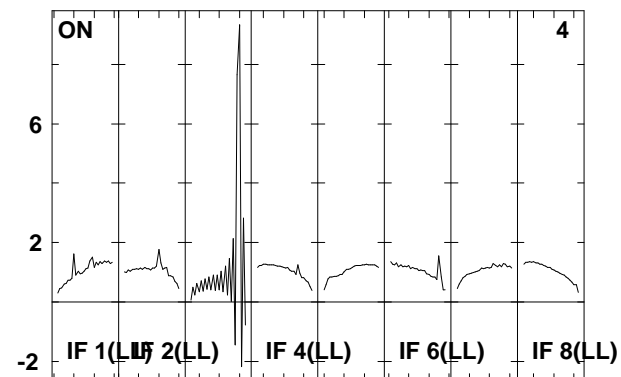
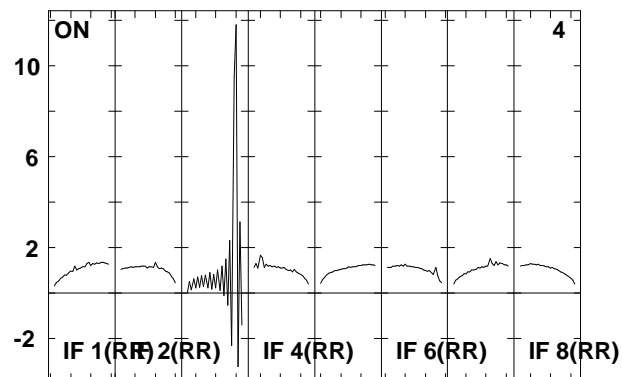
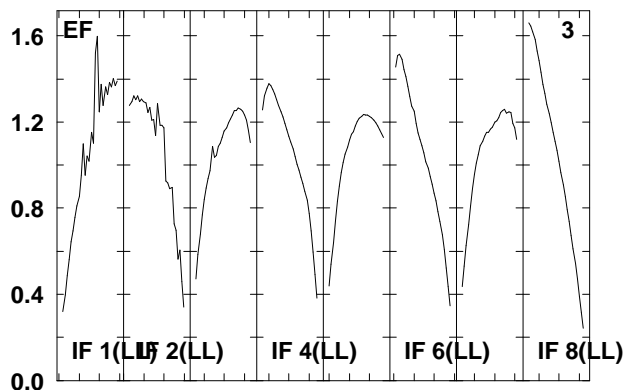
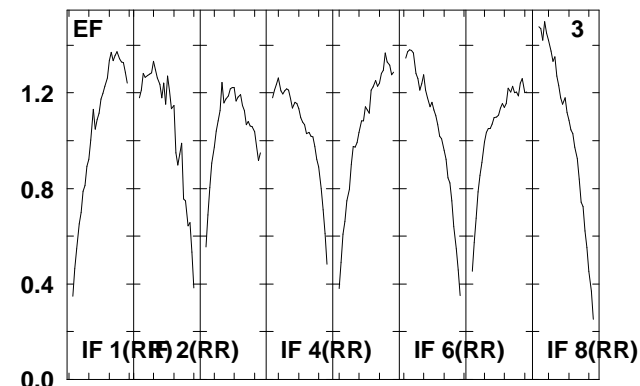
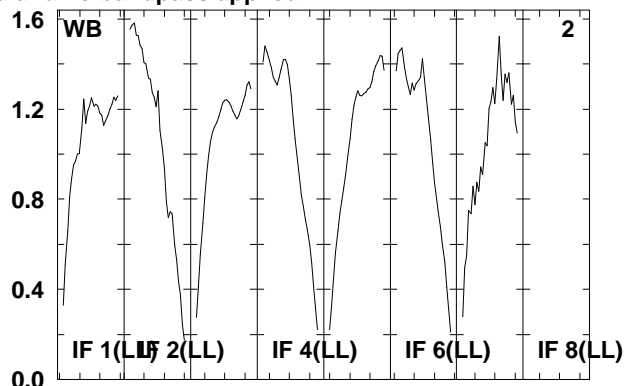
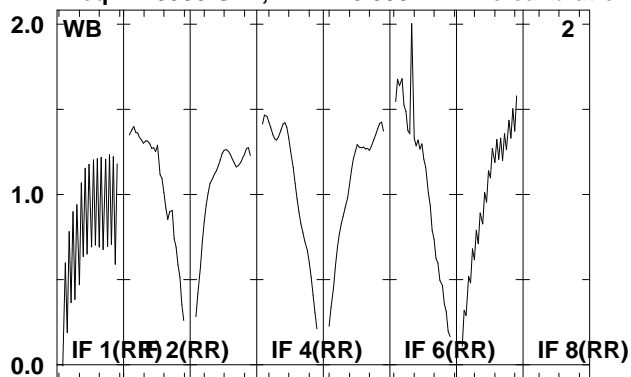

Lower frame: Real Jy

Total-power spectrum Antenna: \*

Timerange: 00/11:25:41 to 00/11:27:17

Plot file version 332 created 08-AUG-2008 17:01:19

J0920+44 EO006B.UVDATA.1

Freq = 1.5950 GHz, Bw = 16.000 MH No calibration applied and no bandpass applied

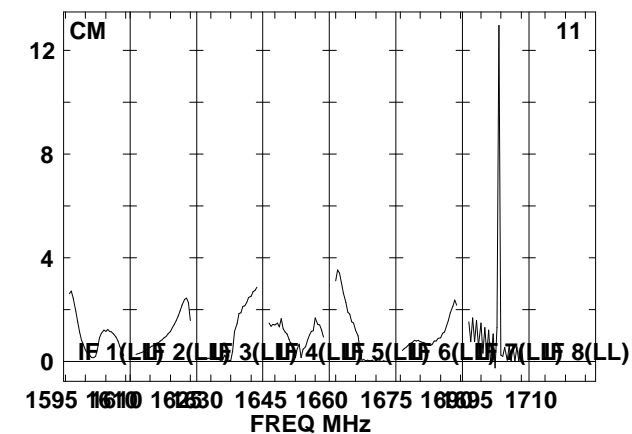
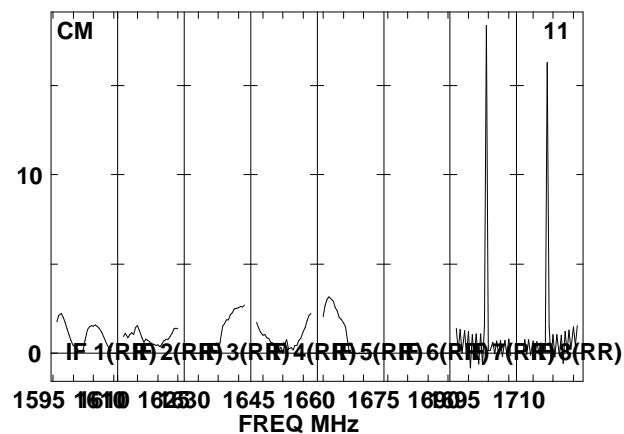
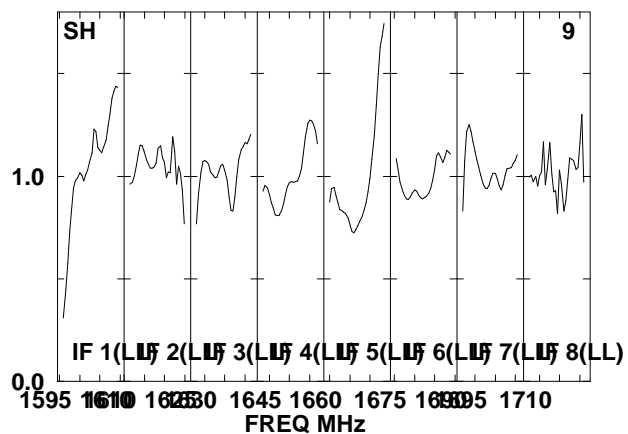
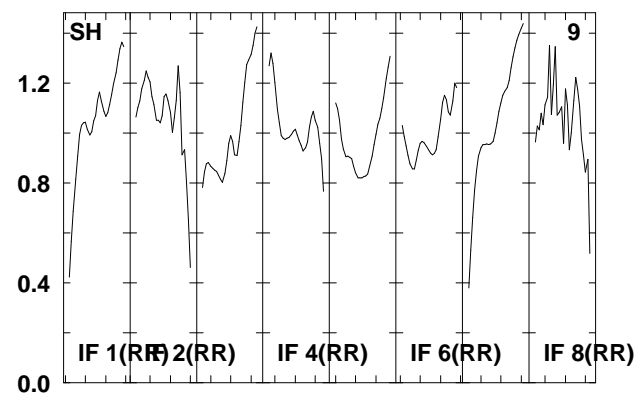
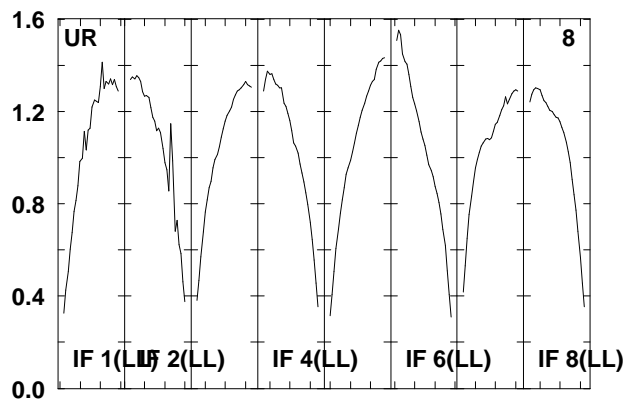
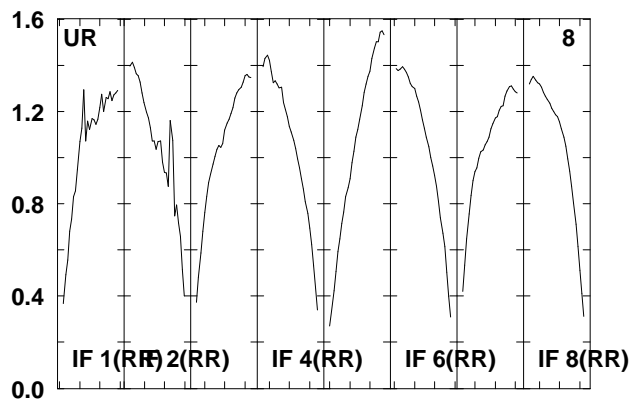
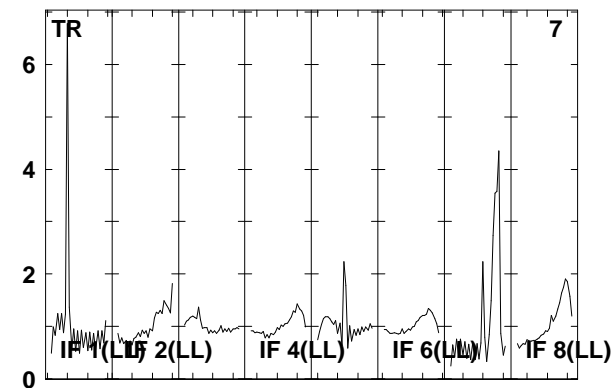
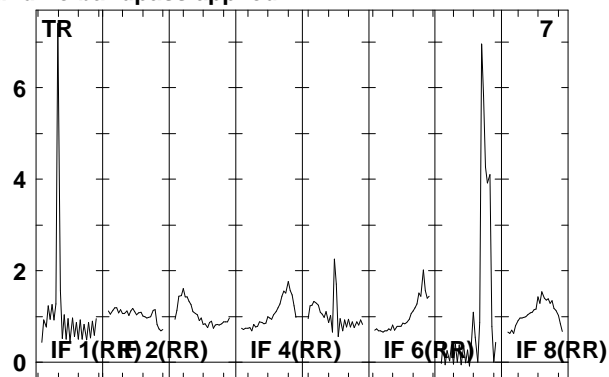
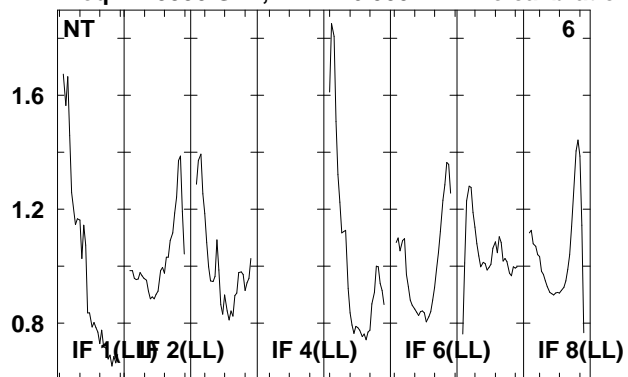

Lower frame: Real Jy

Total-power spectrum Antenna: \*

Timerange: 00/11:25:41 to 00/11:27:17



Plot file version 333 created 08-AUG-2008 17:01:19

J092159 EO006B.UVDATA.1

Freq = 1.5950 GHz, Bw = 16.000 MH No calibration applied and no bandpass applied

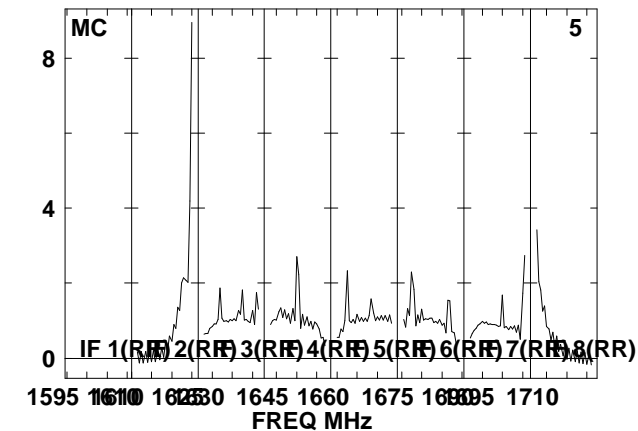
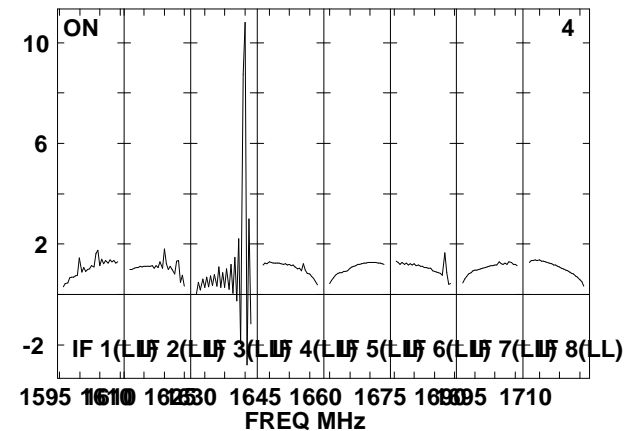
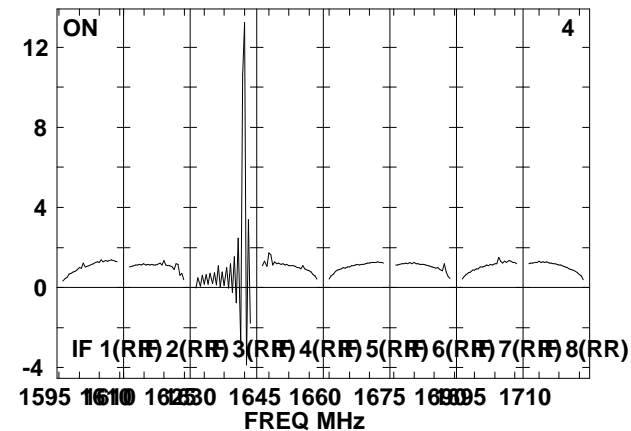
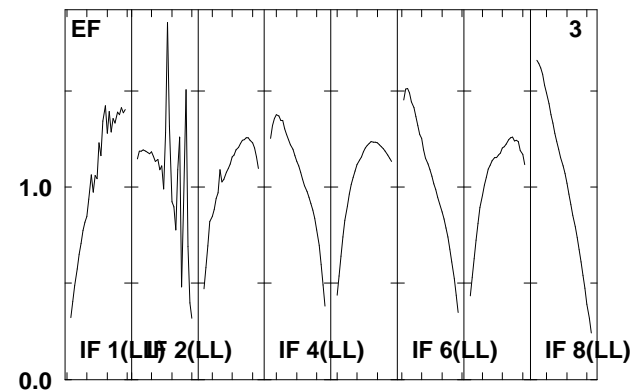
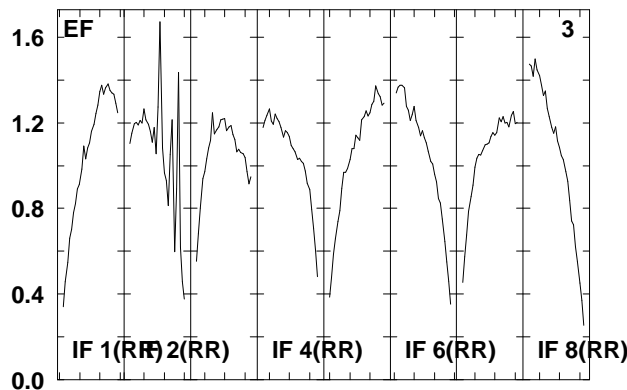
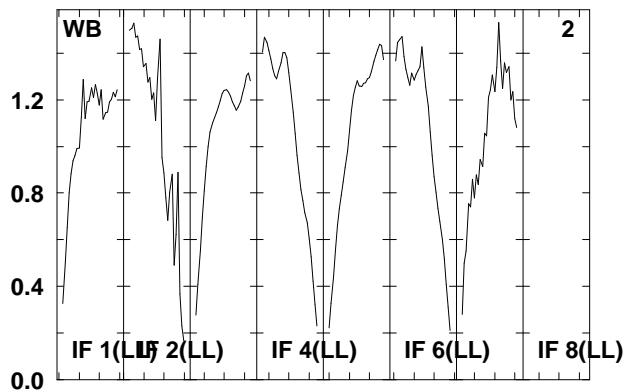
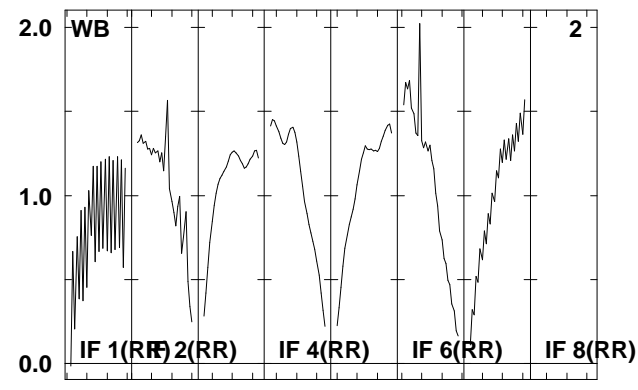
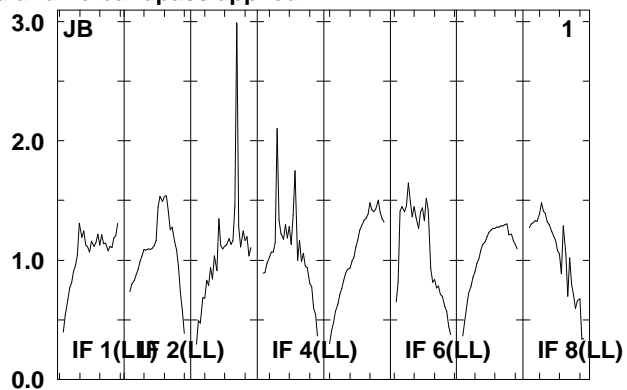
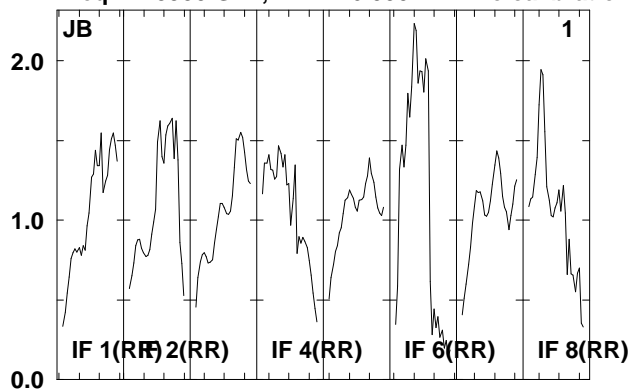

Lower frame: Real Jy  
Total-power spectrum Antenna: \*  
Timerange: 00/11:27:53 to 00/11:32:29

Plot file version 334 created 08-AUG-2008 17:01:20

J092159 EO06B.UVDATA.1

Freq = 1.5950 GHz, Bw = 16.000 MH No calibration applied and no bandpass applied

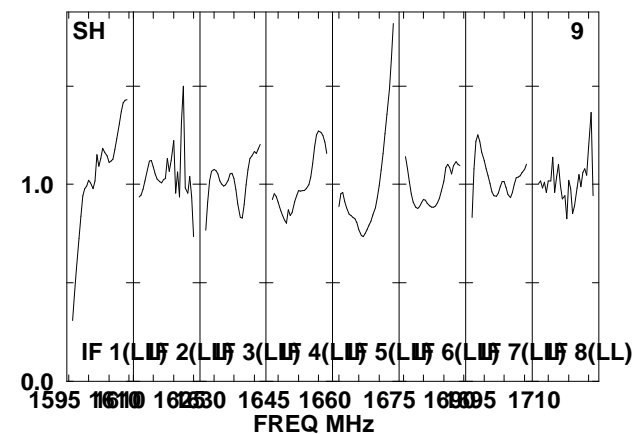
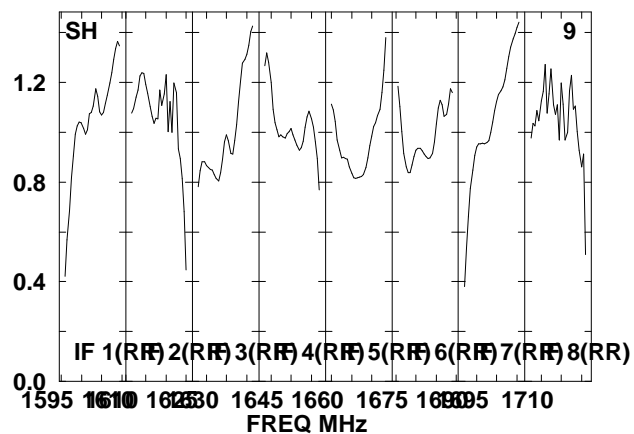
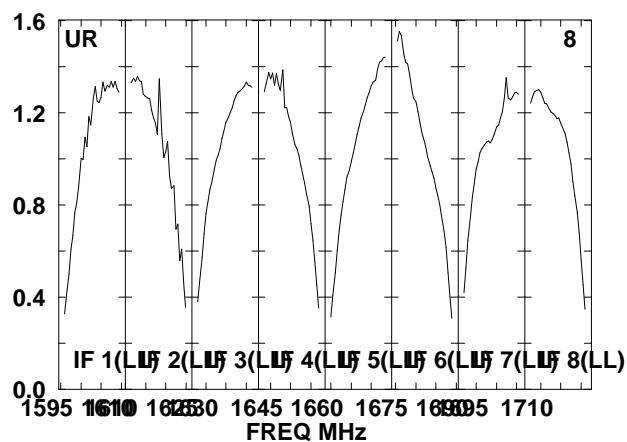
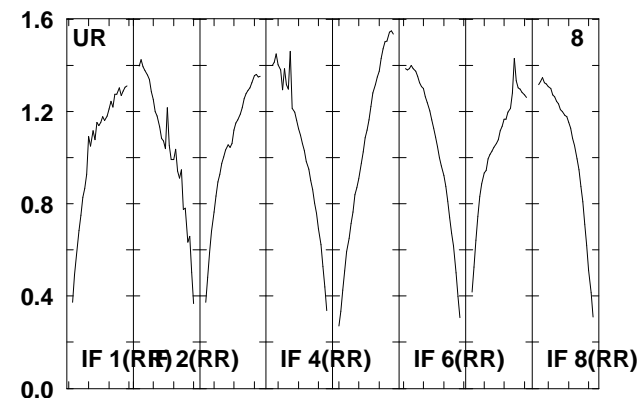
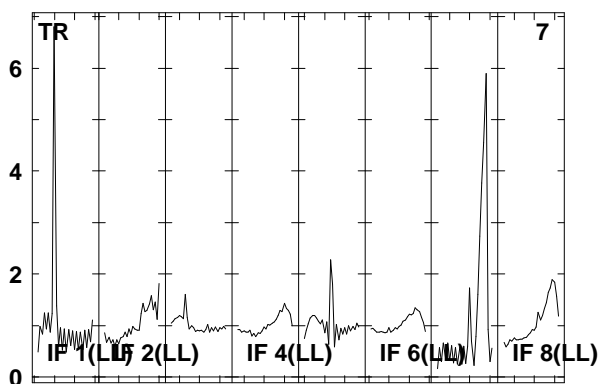
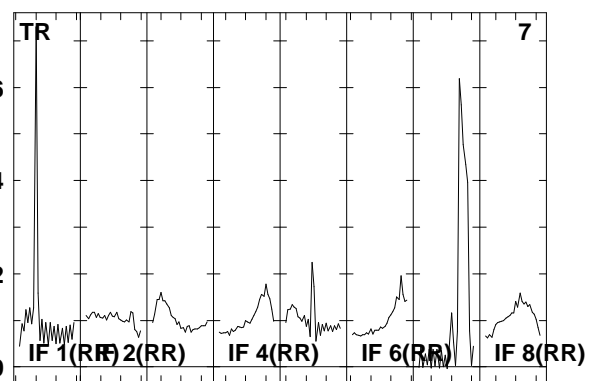
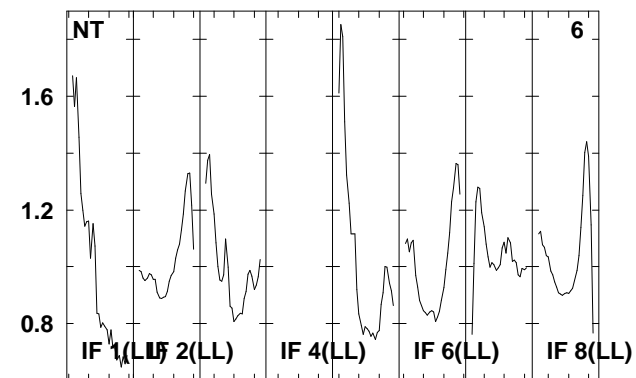
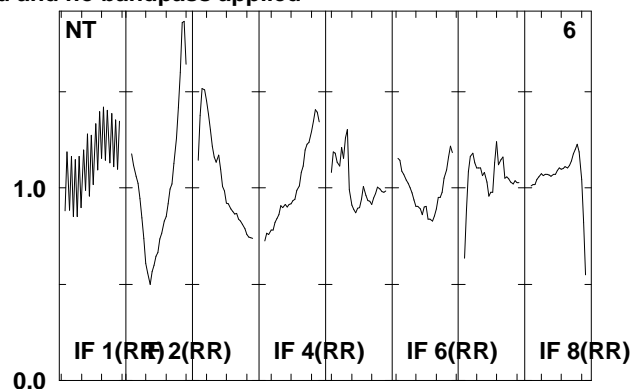
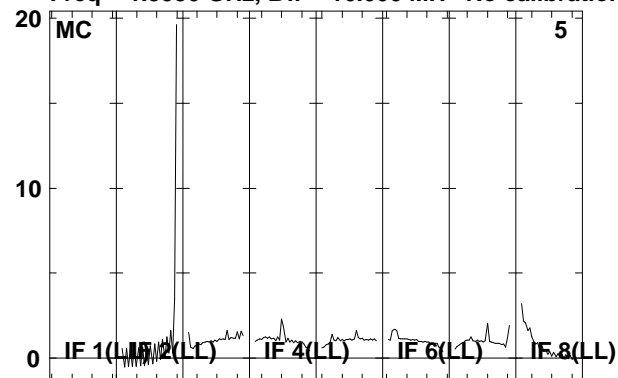

Lower frame: Real Jy

Total-power spectrum Antenna: \*

Timerange: 00/11:27:53 to 00/11:32:29

Plot file version 335 created 08-AUG-2008 17:01:21

J092159 EO006B.UVDATA.1

Freq = 1.5950 GHz, Bw = 16.000 MH No calibration applied and no bandpass applied

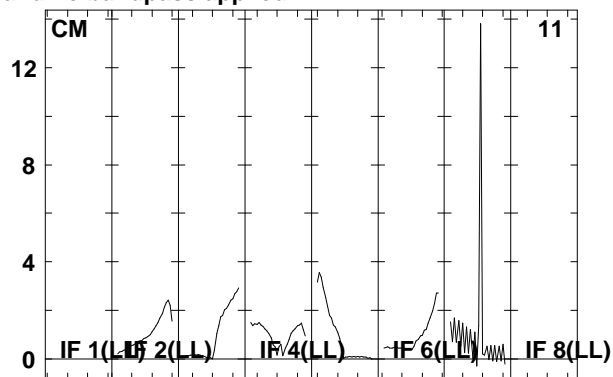
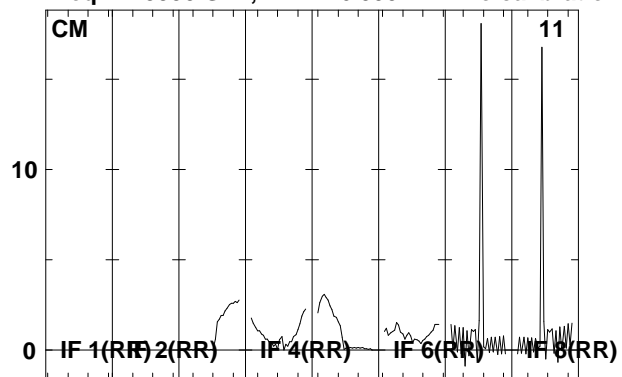

Lower frame: Real Jy  
Total-power spectrum Antenna: \*  
Timerange: 00/11:27:53 to 00/11:32:29

Plot file version 336 created 08-AUG-2008 17:01:21

J0920+44 EO006B.UVDATA.1

Freq = 1.5950 GHz, Bw = 16.000 MH No calibration applied and no bandpass applied

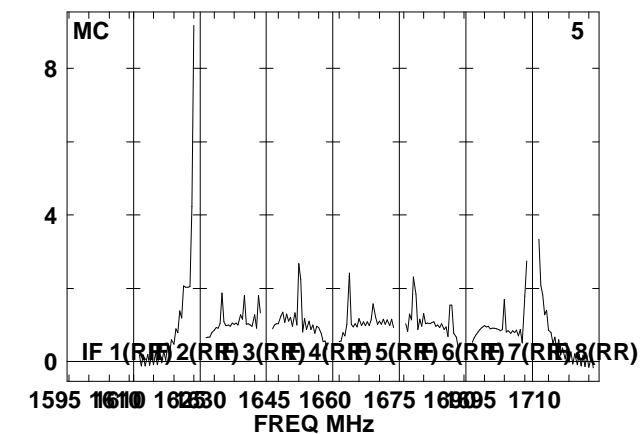
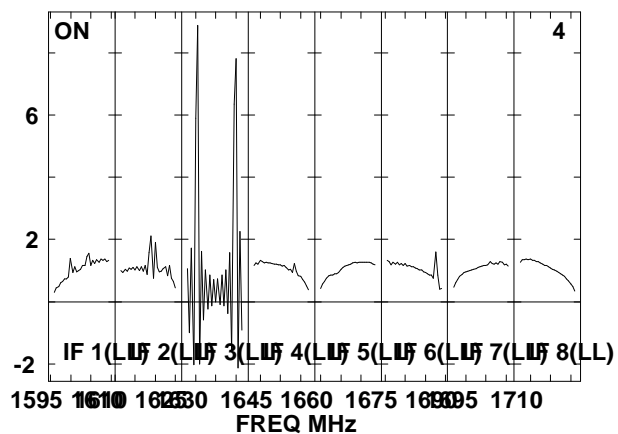
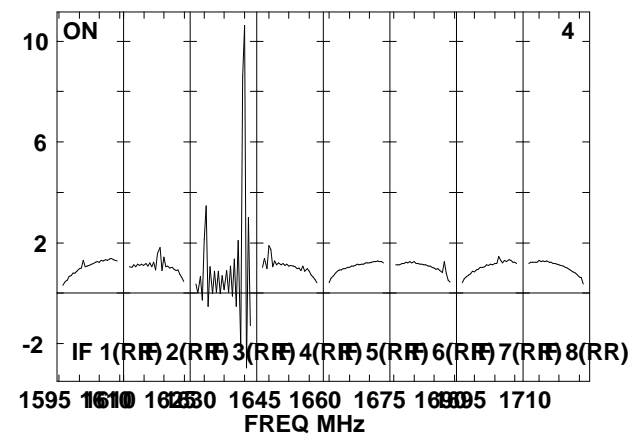
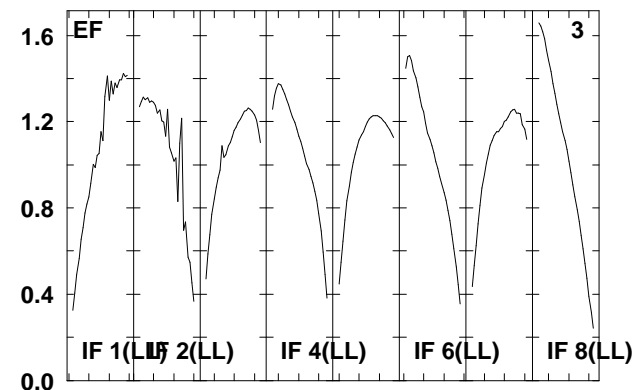
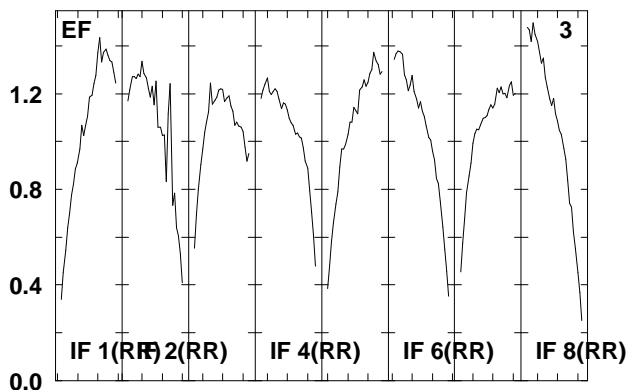
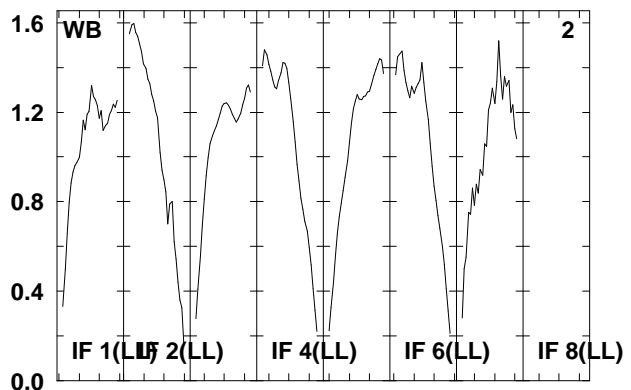
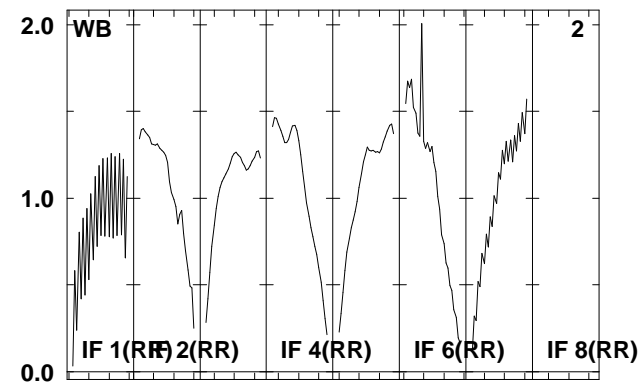
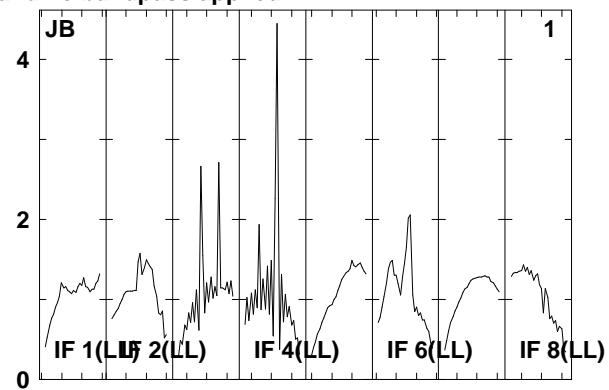
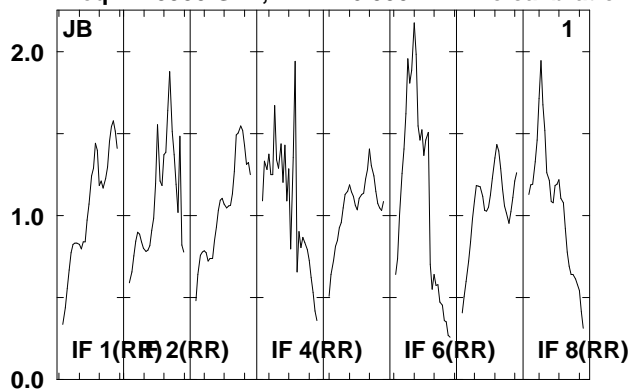

Lower frame: Real Jy  
Total-power spectrum Antenna: \*  
Timerange: 00/11:33:01 to 00/11:34:33

Plot file version 337 created 08-AUG-2008 17:01:22

J0920+44 EO006B.UVDATA.1

Freq = 1.5950 GHz, Bw = 16.000 MH No calibration applied and no bandpass applied

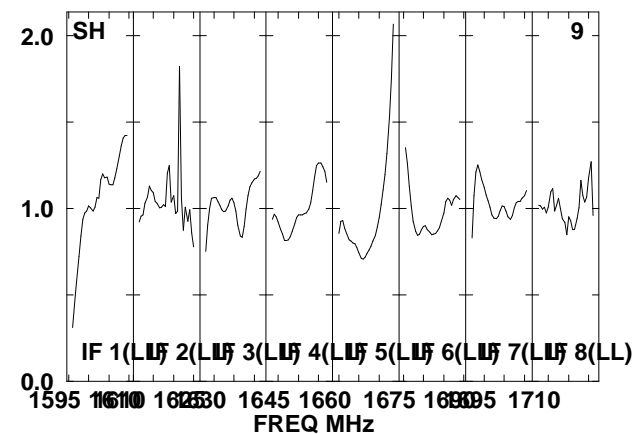
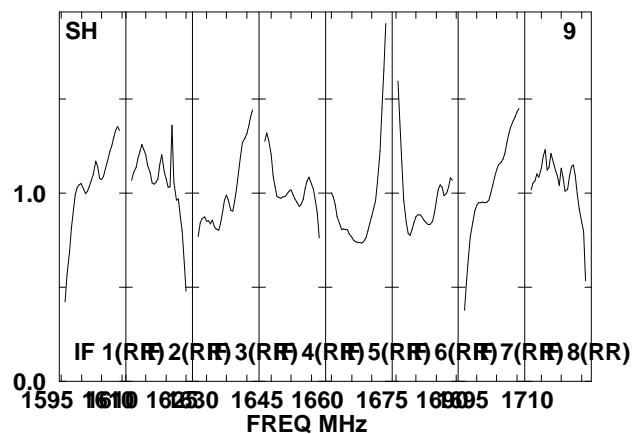
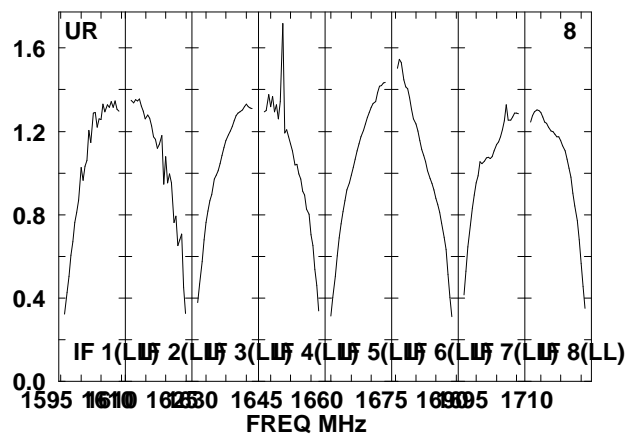
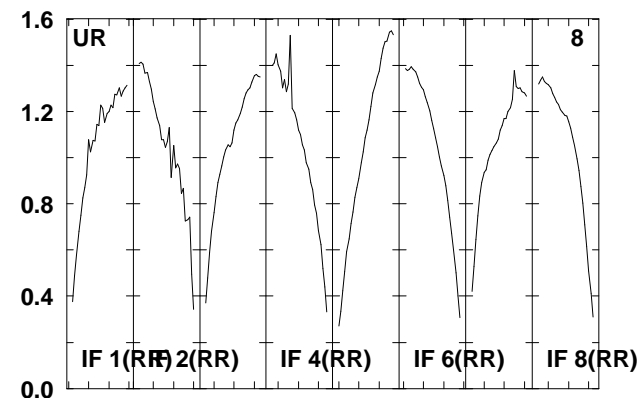
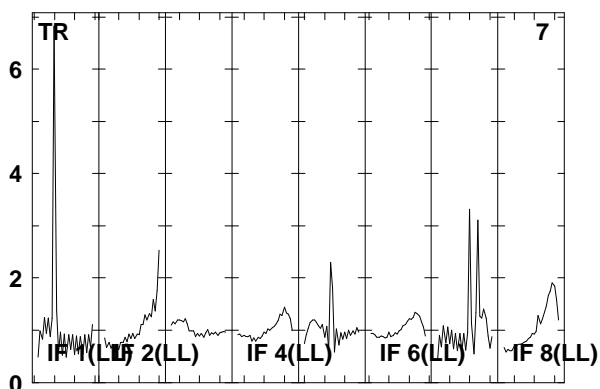
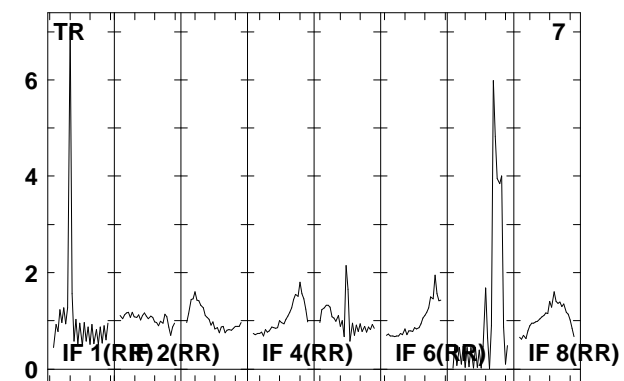
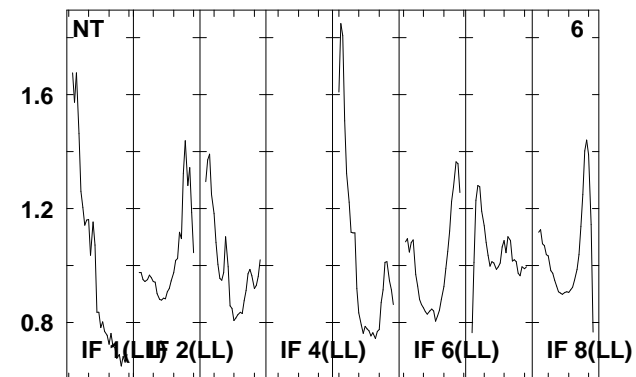
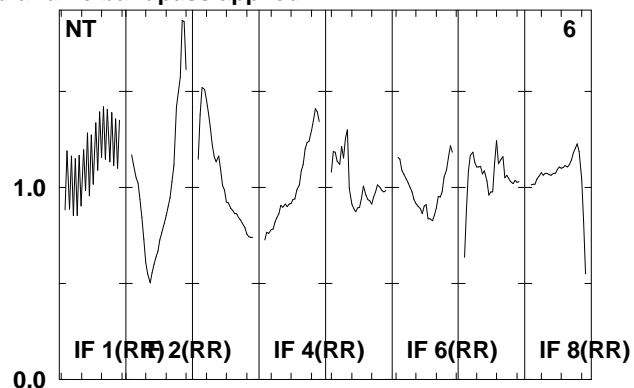
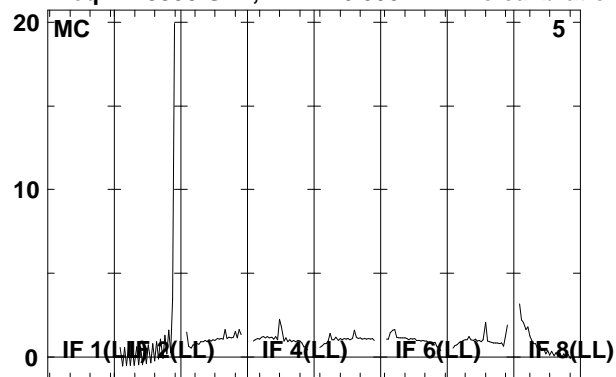

Lower frame: Real Jy

Total-power spectrum Antenna: \*

Timerange: 00/11:33:01 to 00/11:34:33

Plot file version 338 created 08-AUG-2008 17:01:22

J0920+44 EO006B.UVDATA.1

Freq = 1.5950 GHz, Bw = 16.000 MH No calibration applied and no bandpass applied

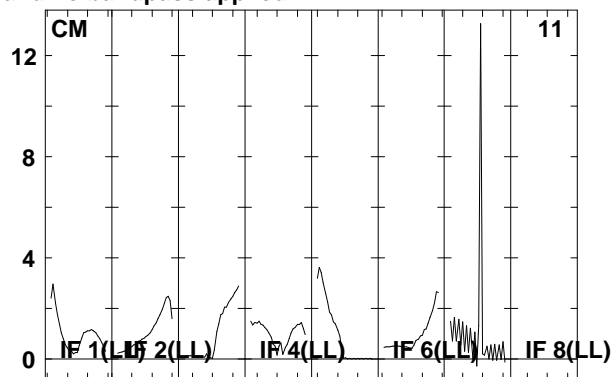
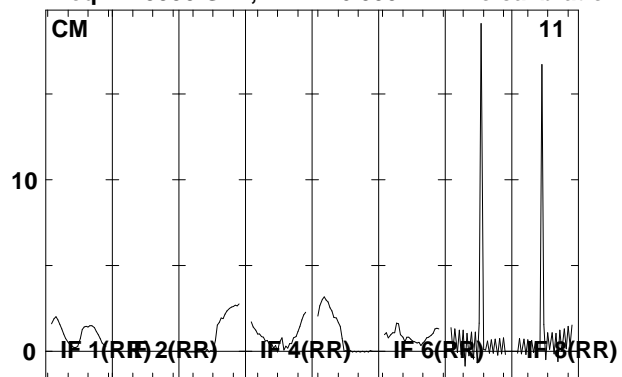

Lower frame: Real Jy  
Total-power spectrum Antenna: \*  
Timerange: 00/11:33:01 to 00/11:34:33

Plot file version 339 created 08-AUG-2008 17:01:22

J092159 EO006B.UVDATA.1

Freq = 1.5950 GHz, Bw = 16.000 MH No calibration applied and no bandpass applied

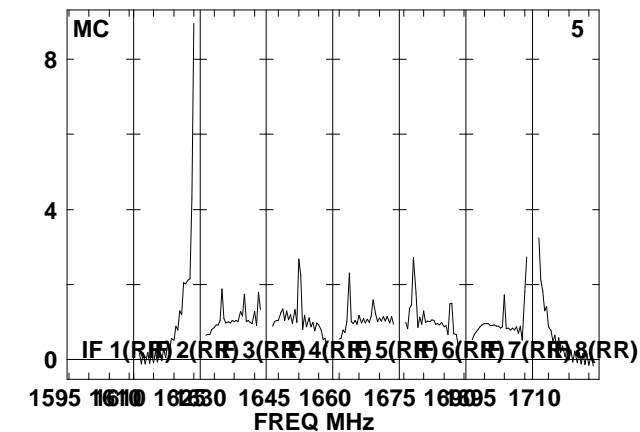
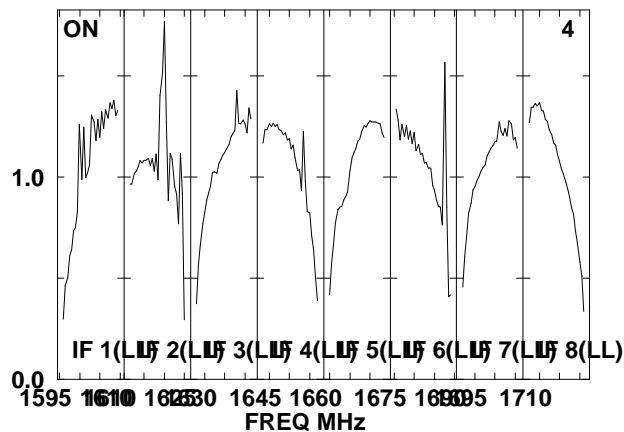
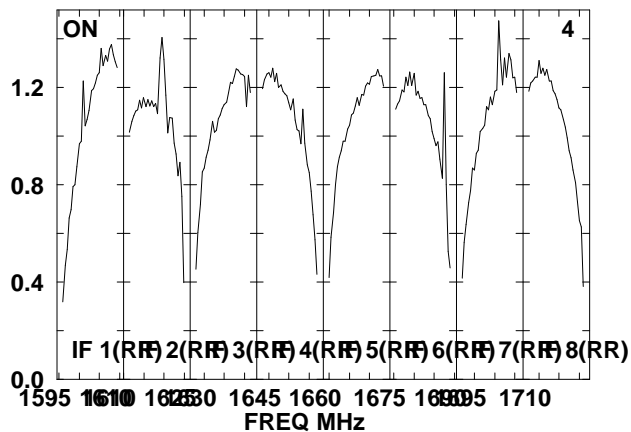
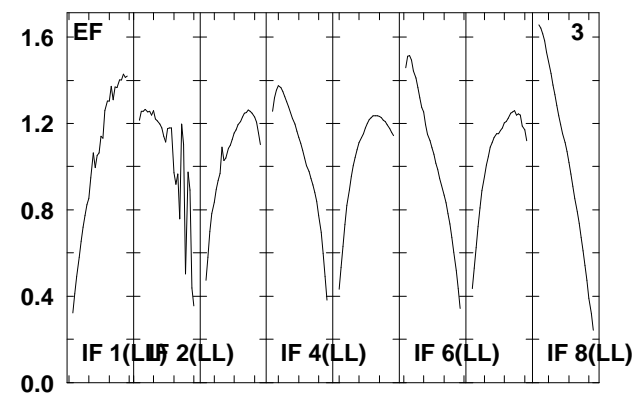
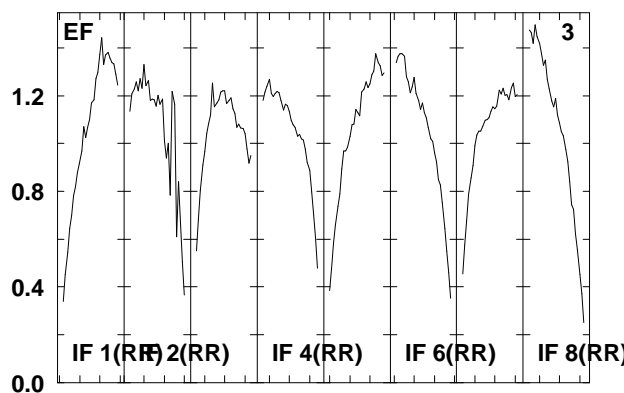
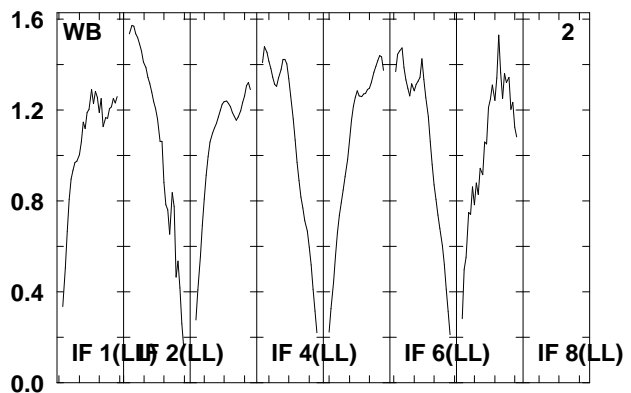
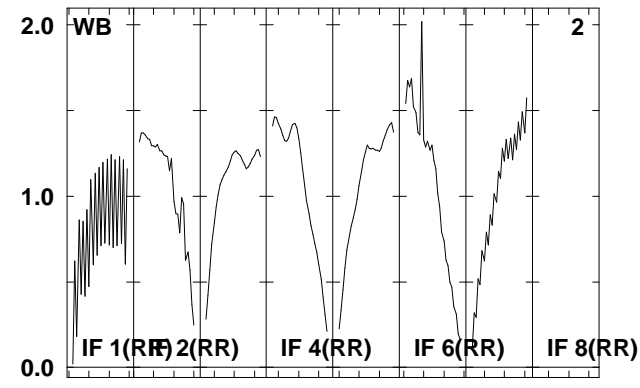
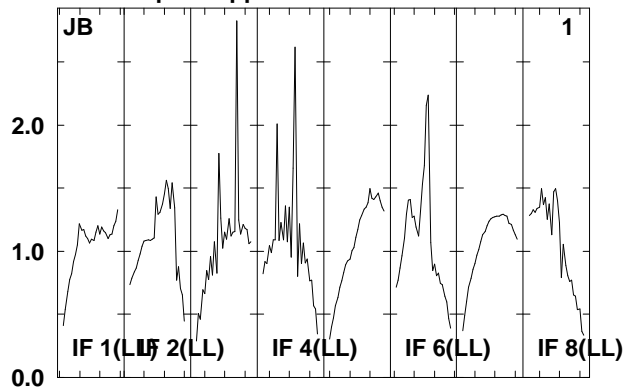
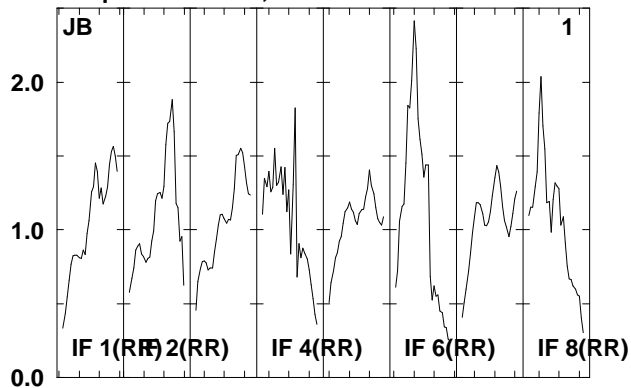

Lower frame: Real Jy  
Total-power spectrum Antenna: \*  
Timerange: 00/11:35:17 to 00/11:39:49

Plot file version 340 created 08-AUG-2008 17:01:23

J092159 EO006B.UVDATA.1

Freq = 1.5950 GHz, Bw = 16.000 MH No calibration applied and no bandpass applied

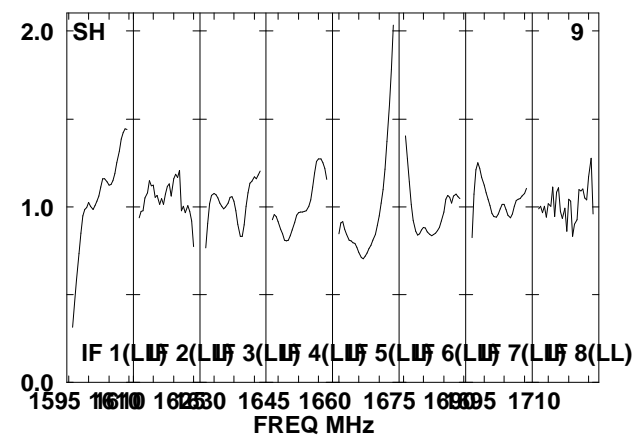
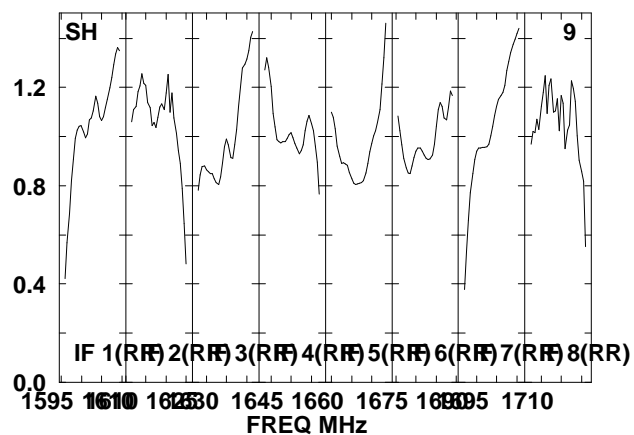
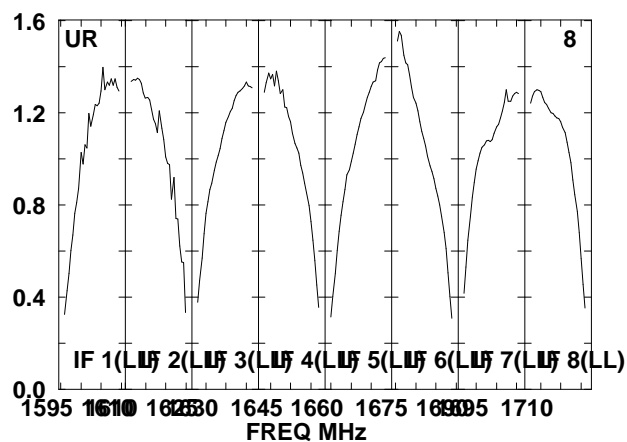
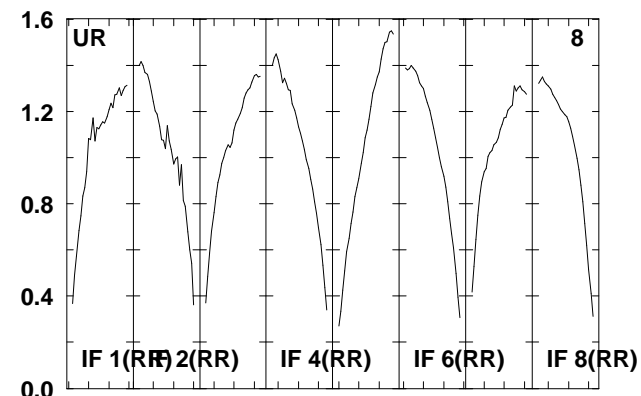
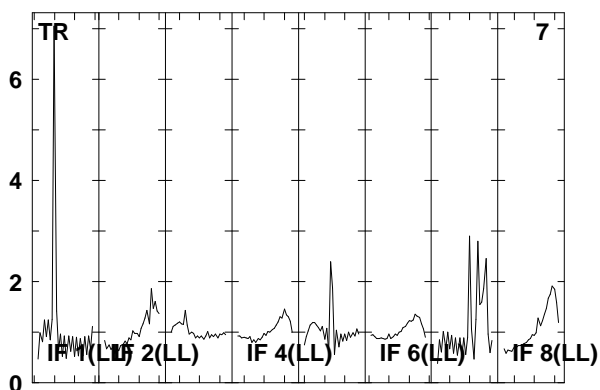
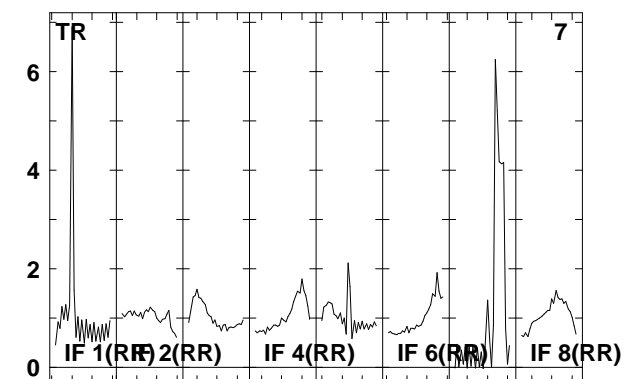
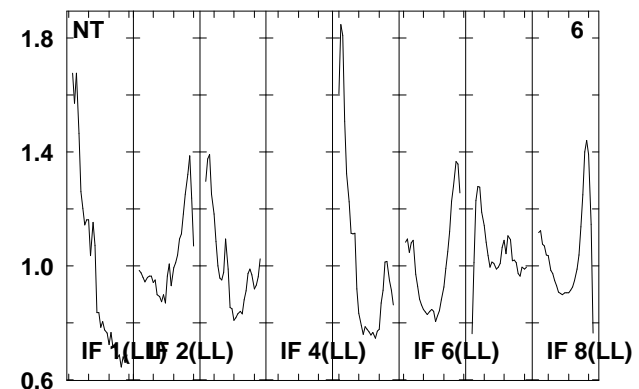
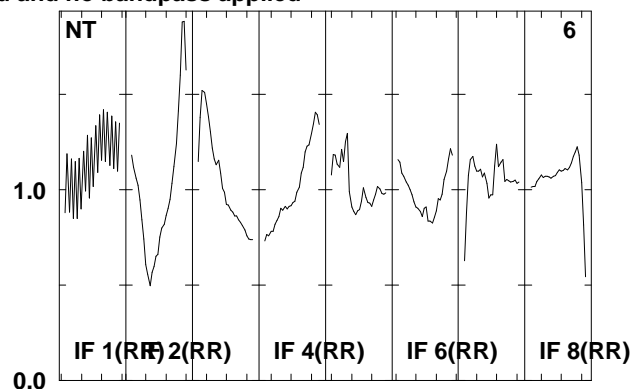
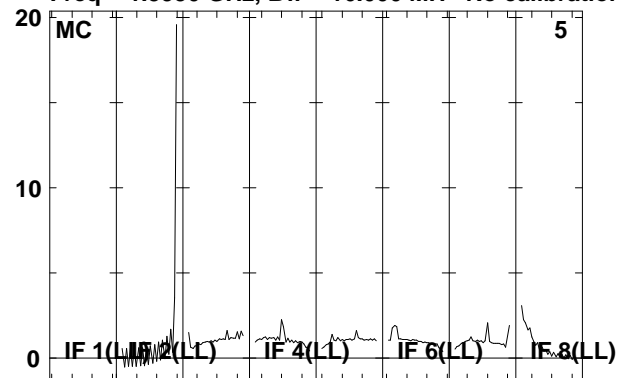

Lower frame: Real Jy

Total-power spectrum Antenna: \*

Timerange: 00/11:35:17 to 00/11:39:49



Plot file version 341 created 08-AUG-2008 17:01:24

J092159 EO006B.UVDATA.1

Freq = 1.5950 GHz, Bw = 16.000 MH No calibration applied and no bandpass applied

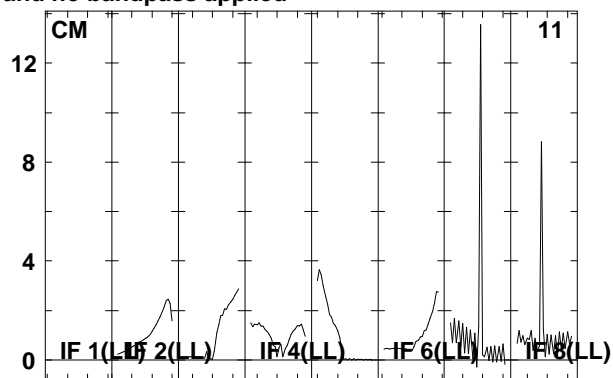
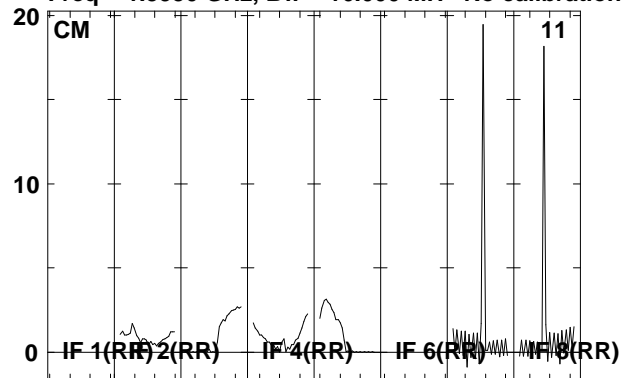

Lower frame: Real Jy  
Total-power spectrum Antenna: \*  
Timerange: 00/11:35:17 to 00/11:39:49

Plot file version 342 created 08-AUG-2008 17:01:24

J0920+44 EO006B.UVDATA.1

Freq = 1.5950 GHz, Bw = 16.000 MH No calibration applied and no bandpass applied

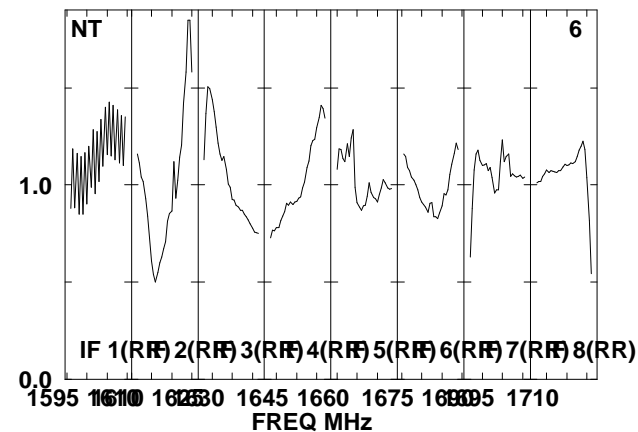
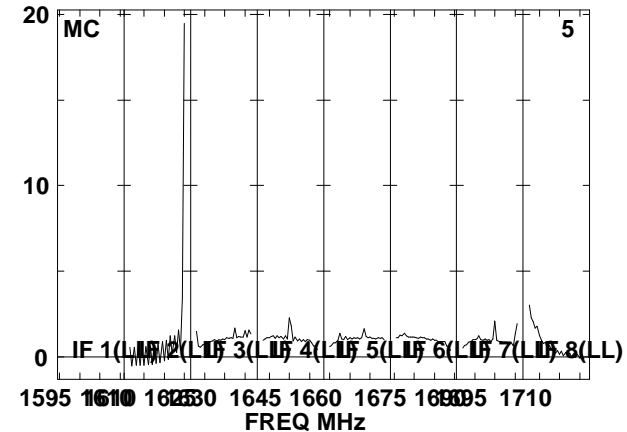
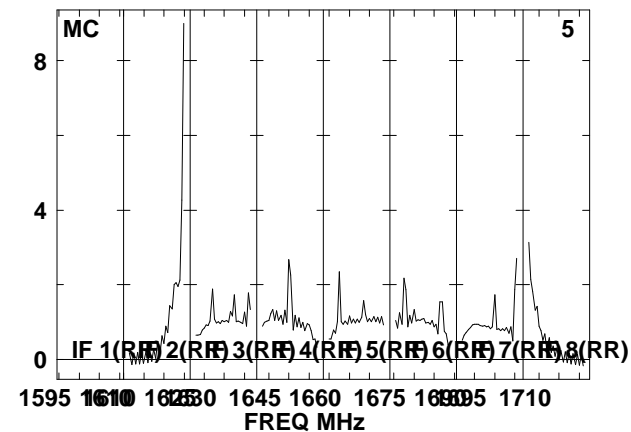
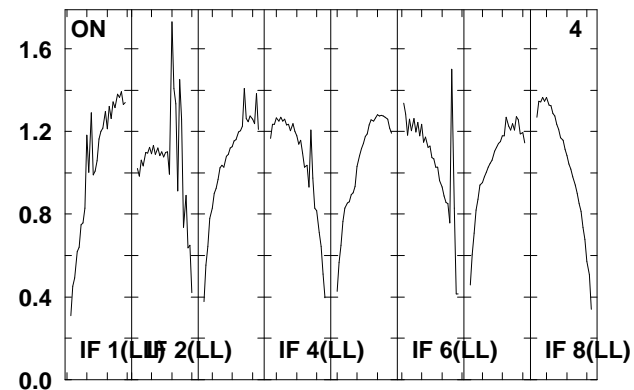
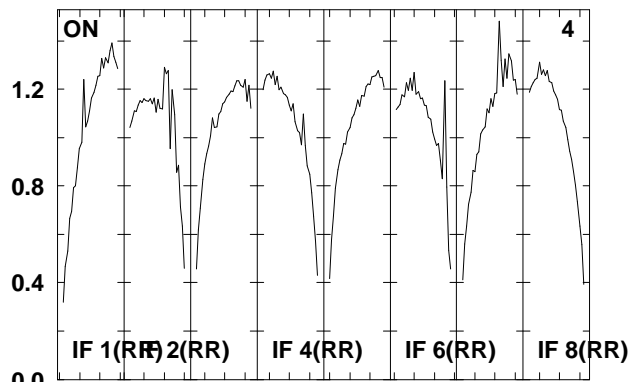
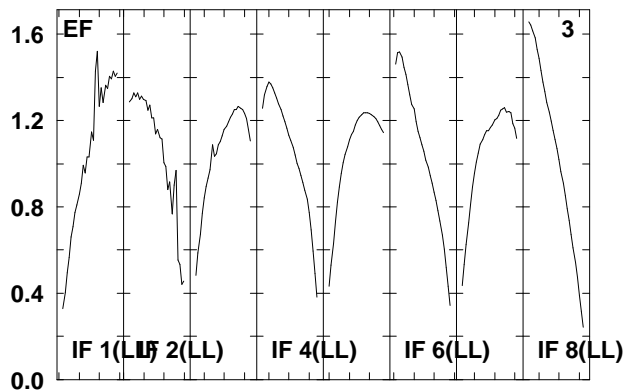
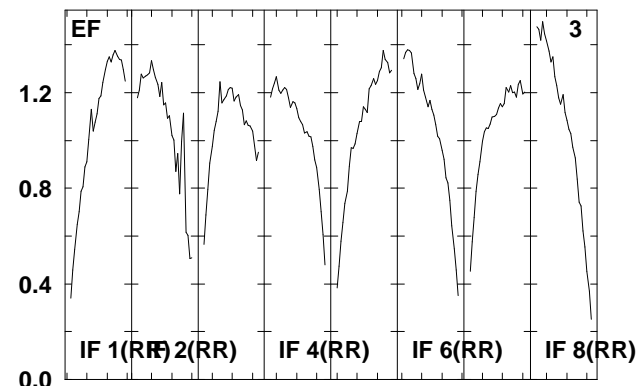
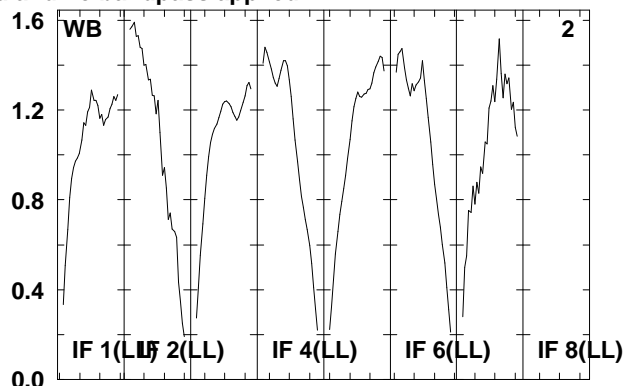
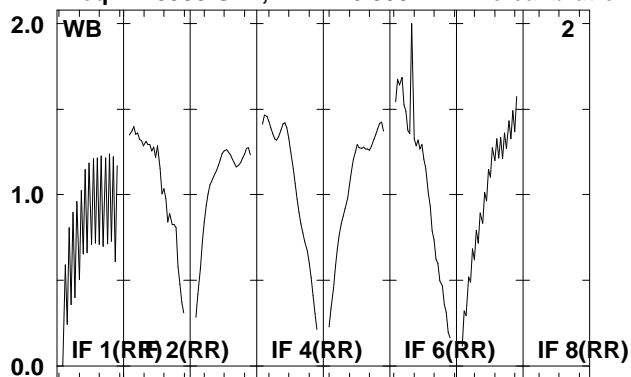

Lower frame: Real Jy  
Total-power spectrum Antenna: \*  
Timerange: 00/11:40:25 to 00/11:41:57

Plot file version 343 created 08-AUG-2008 17:01:25

J0920+44 EO06B.UVDATA.1

Freq = 1.5950 GHz, Bw = 16.000 MH No calibration applied and no bandpass applied

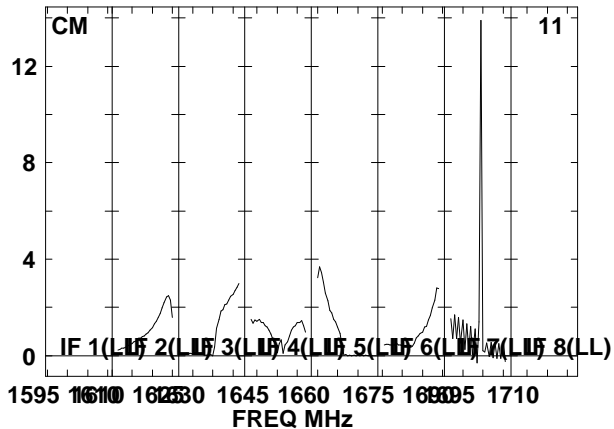
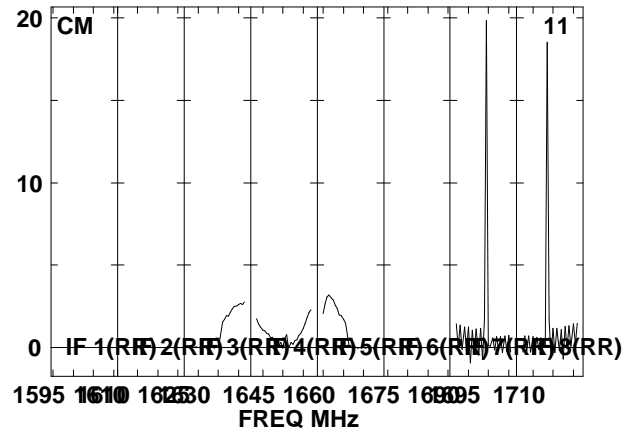
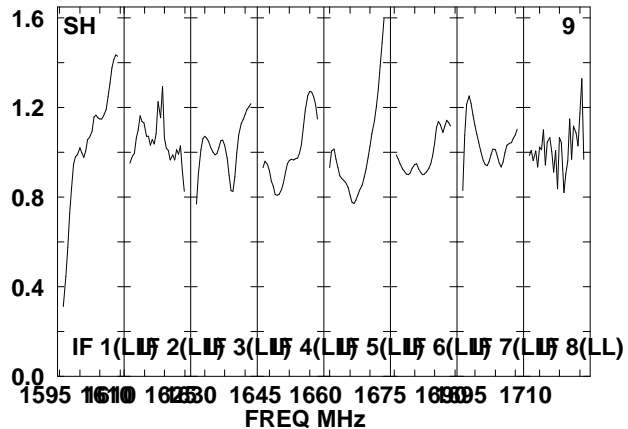
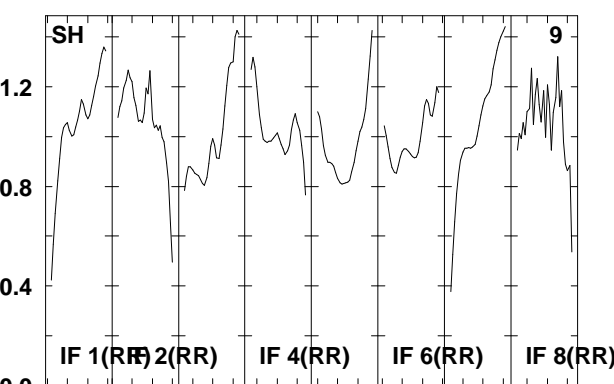
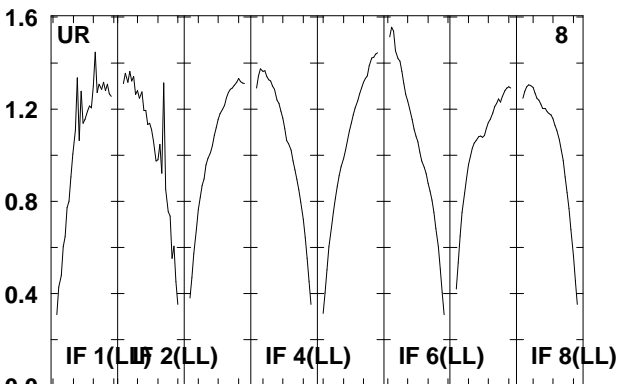
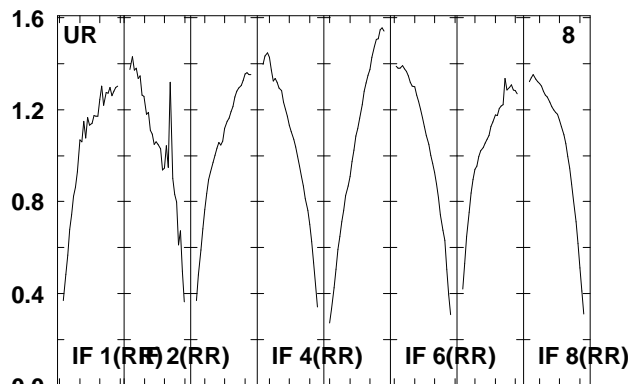
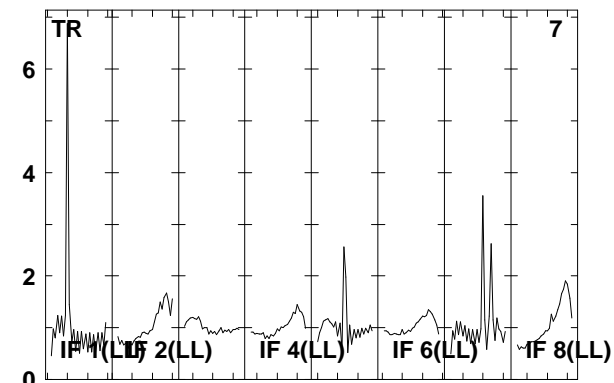
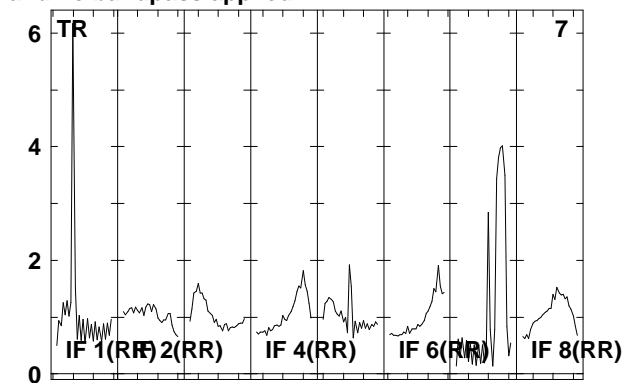
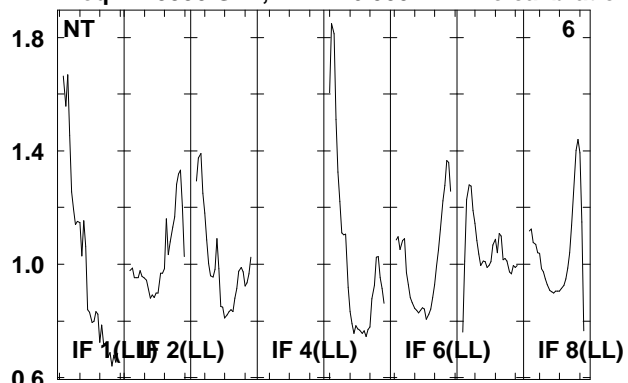

Lower frame: Real Jy  
Total-power spectrum Antenna: \*  
Timerange: 00/11:40:25 to 00/11:41:57

Plot file version 344 created 08-AUG-2008 17:01:25

J092159 EO006B.UVDATA.1

Freq = 1.5950 GHz, Bw = 16.000 MH No calibration applied and no bandpass applied

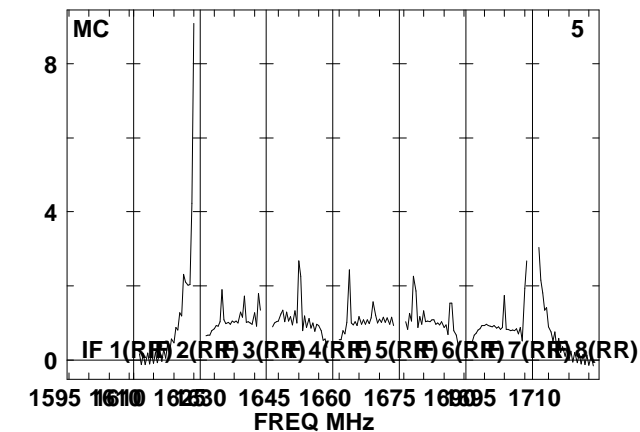
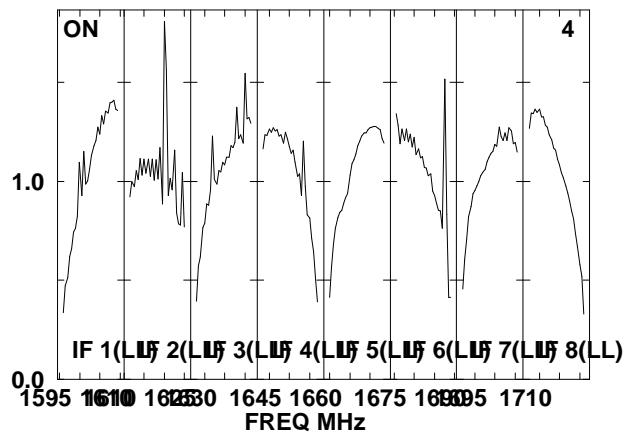
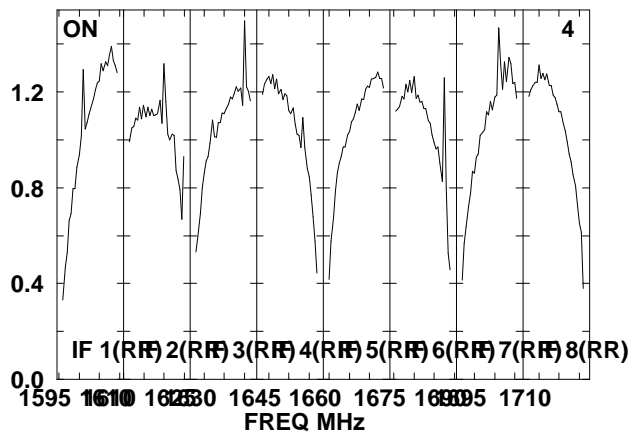
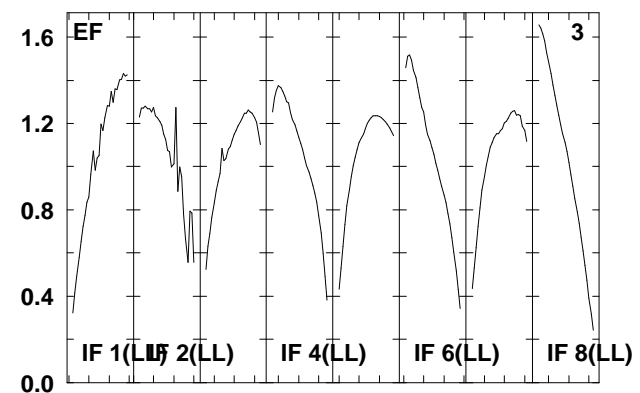
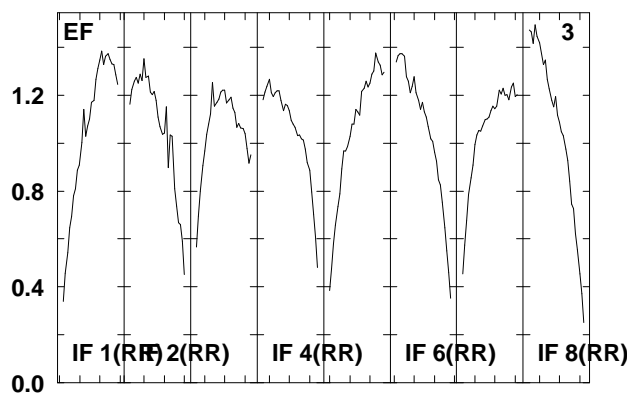
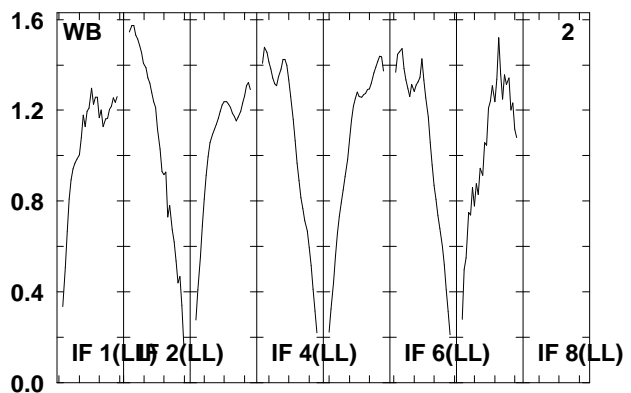
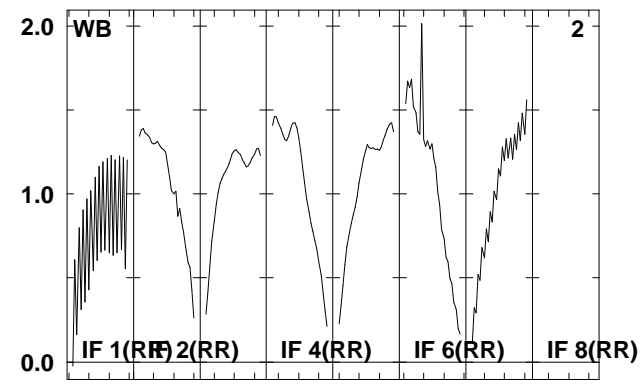
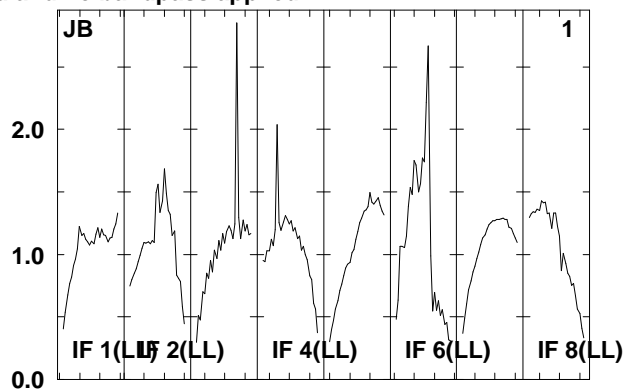
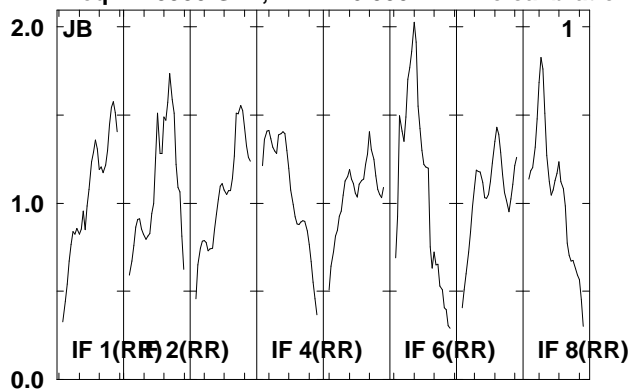

Lower frame: Real Jy  
Total-power spectrum Antenna: \*  
Timerange: 00/11:42:33 to 00/11:47:01

Plot file version 345 created 08-AUG-2008 17:01:26

J092159 EO06B.UVDATA.1

Freq = 1.5950 GHz, Bw = 16.000 MH No calibration applied and no bandpass applied

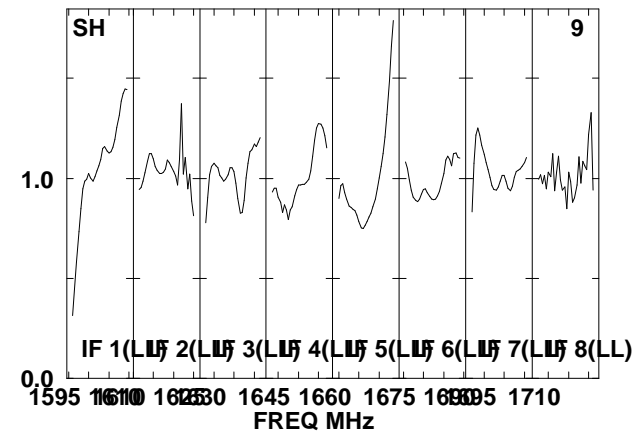
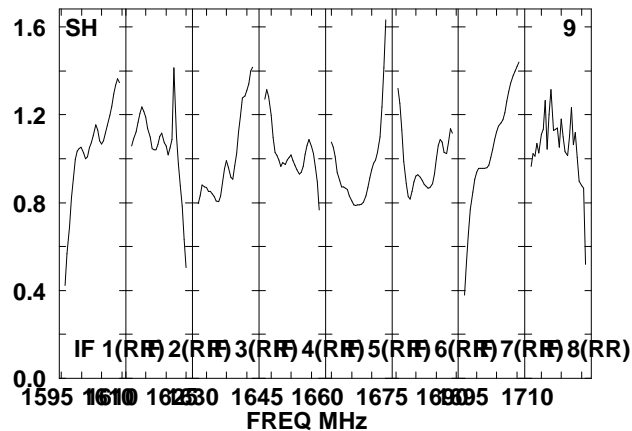
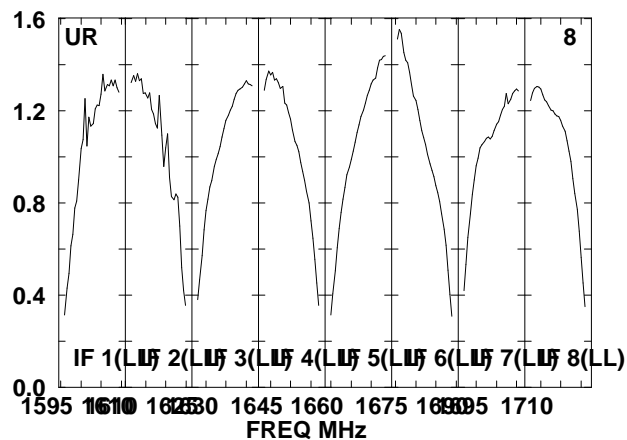
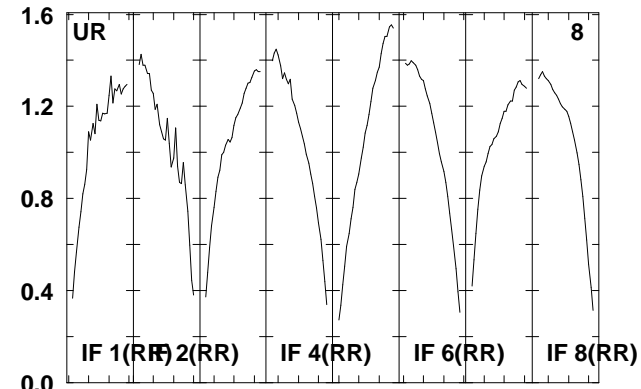
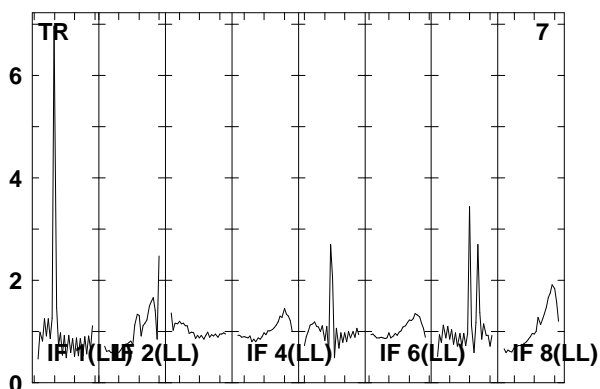
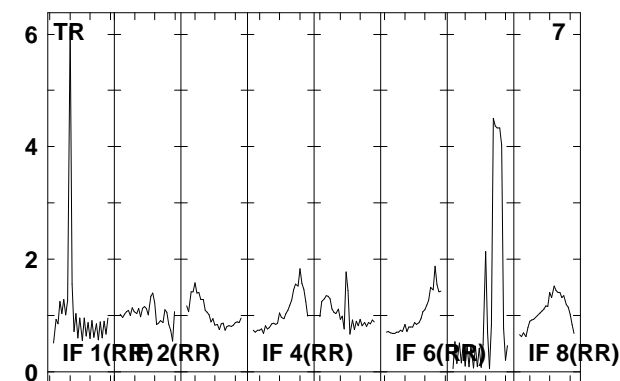
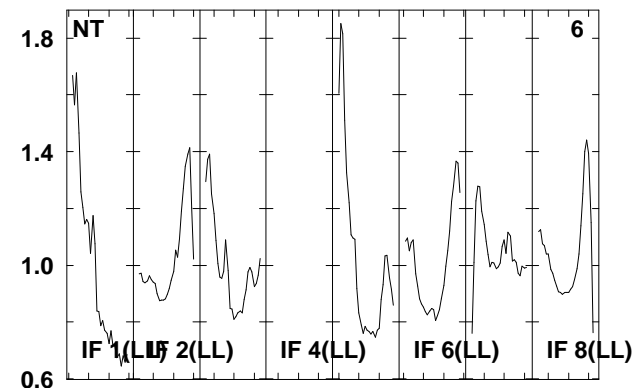
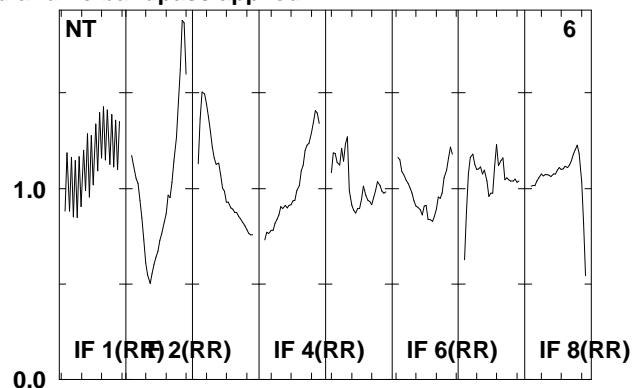
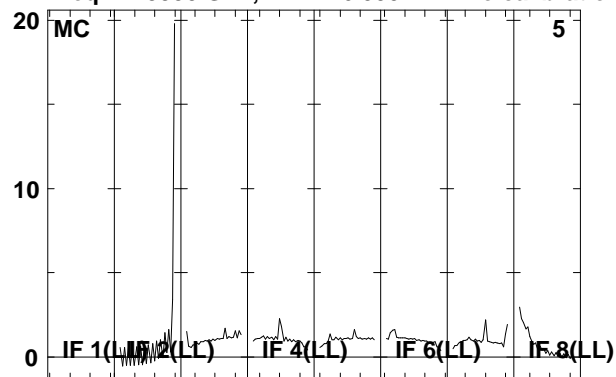

Lower frame: Real Jy

Total-power spectrum Antenna: \*

Timerange: 00/11:42:33 to 00/11:47:01

Plot file version 346 created 08-AUG-2008 17:01:27

J092159 EO006B.UVDATA.1

Freq = 1.5950 GHz, Bw = 16.000 MH No calibration applied and no bandpass applied

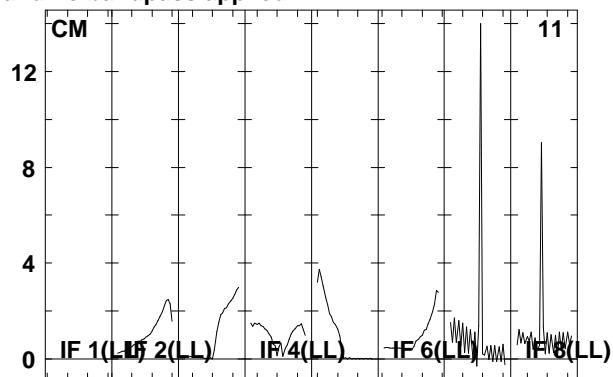
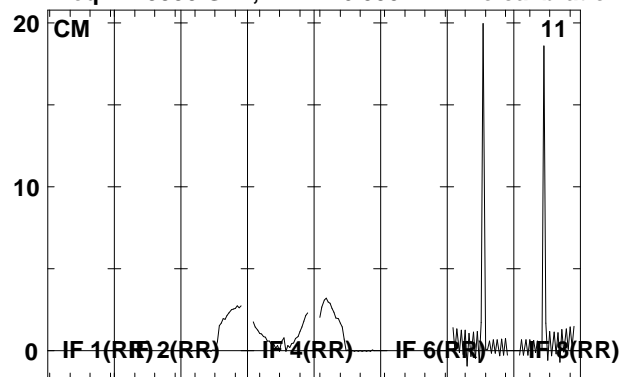

Lower frame: Real Jy  
Total-power spectrum Antenna: \*  
Timerange: 00/11:42:33 to 00/11:47:01

Plot file version 347 created 08-AUG-2008 17:01:27

J0920+44 EO006B.UVDATA.1

Freq = 1.5950 GHz, Bw = 16.000 MH No calibration applied and no bandpass applied

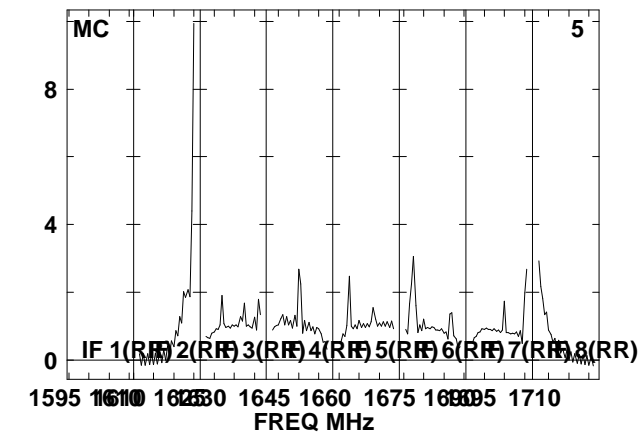
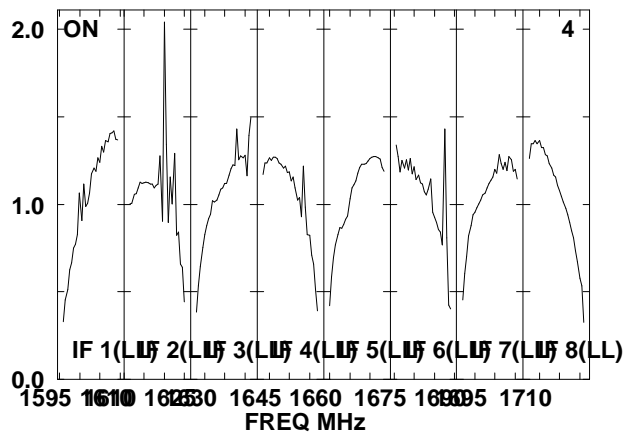
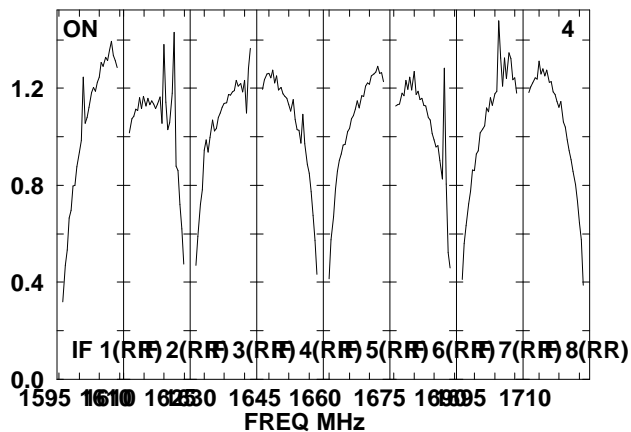
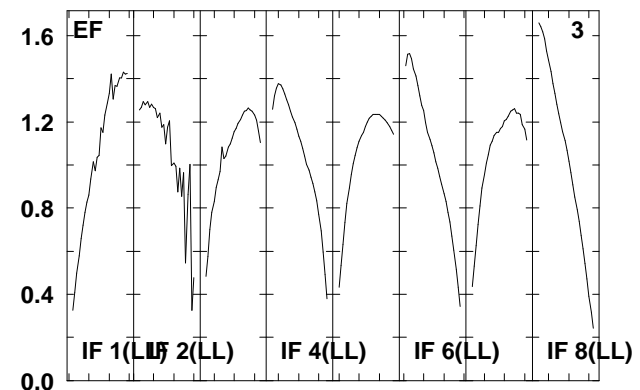
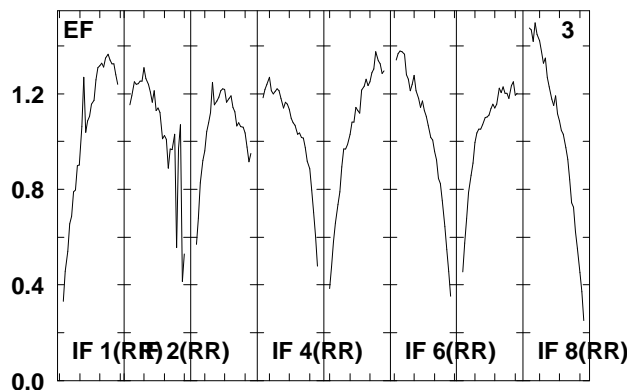
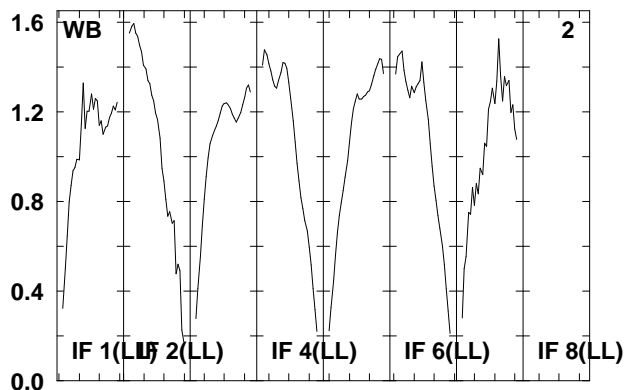
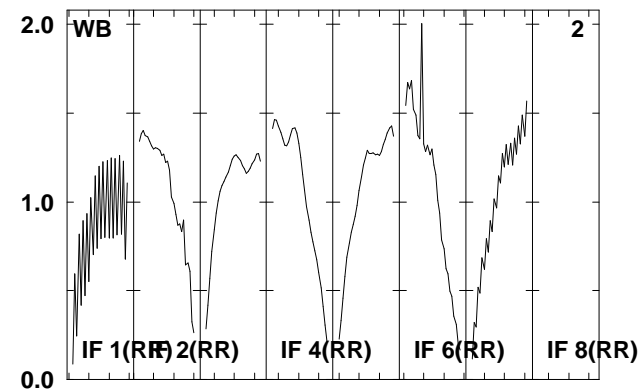
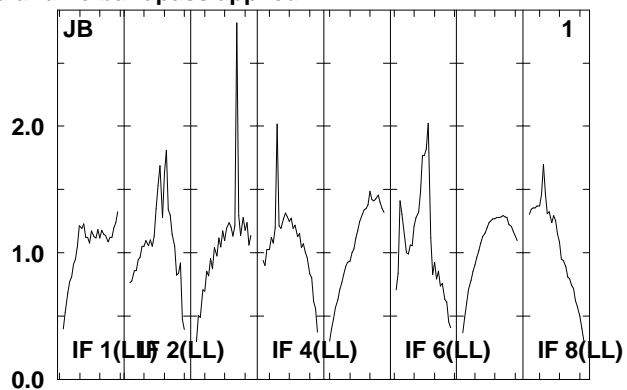
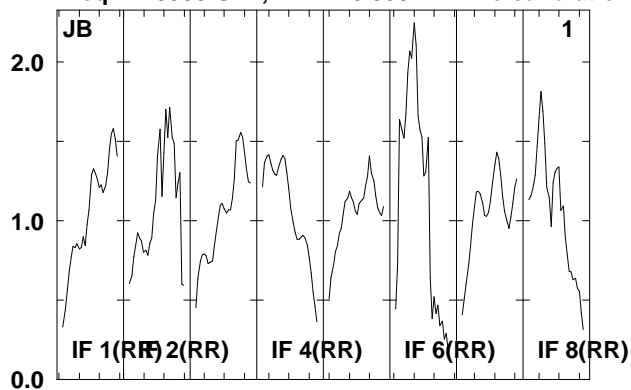

Lower frame: Real Jy  
Total-power spectrum Antenna: \*  
Timerange: 00/11:47:41 to 00/11:49:17

Plot file version 348 created 08-AUG-2008 17:01:28

J0920+44 EO006B.UVDATA.1

Freq = 1.5950 GHz, Bw = 16.000 MH No calibration applied and no bandpass applied

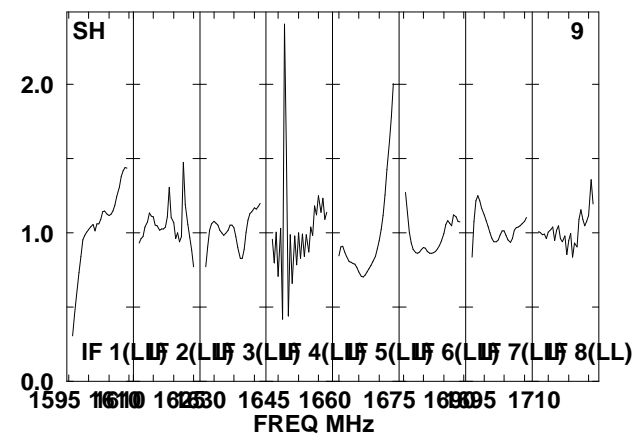
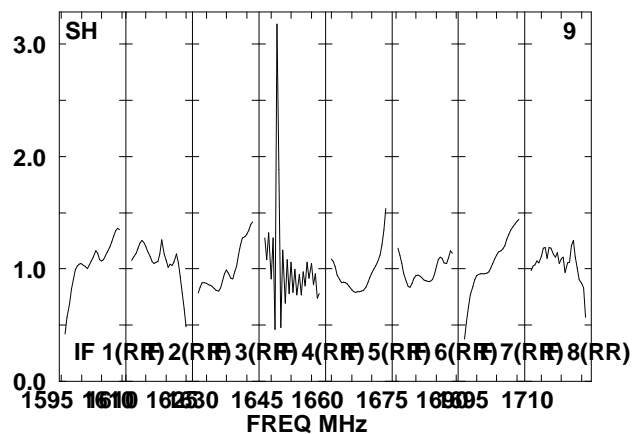
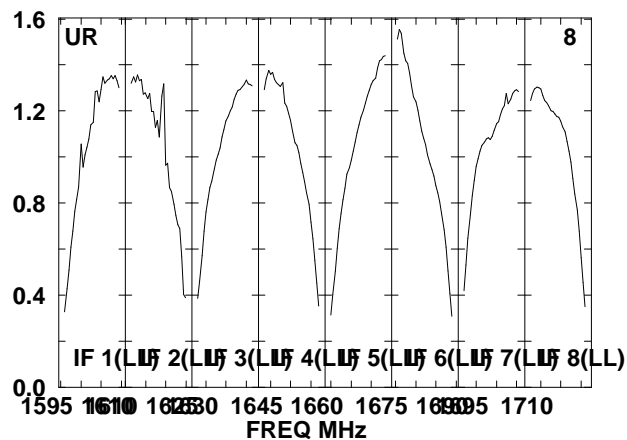
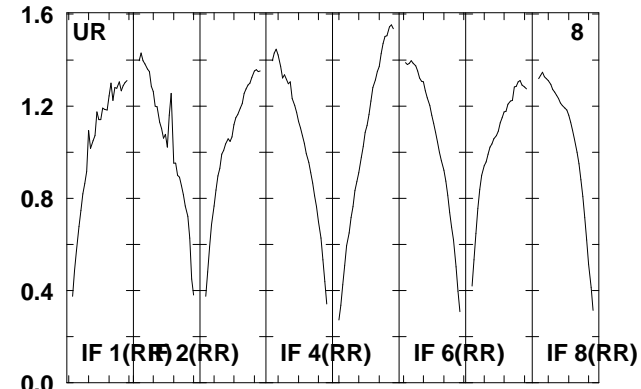
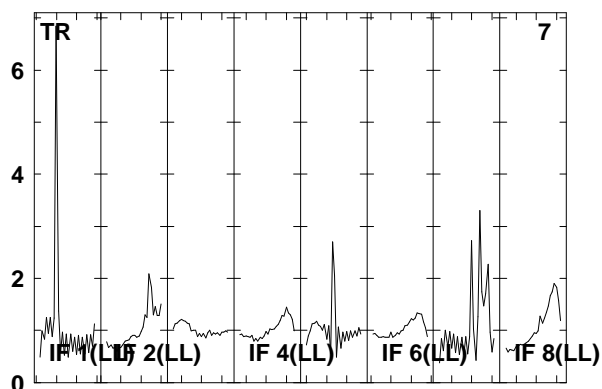
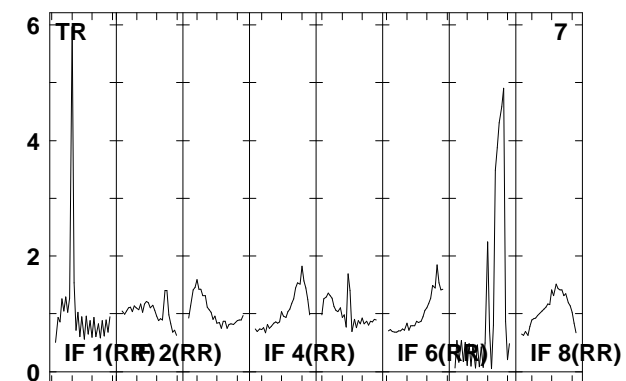
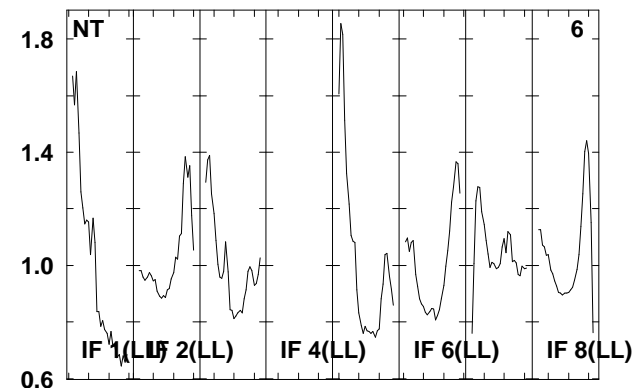
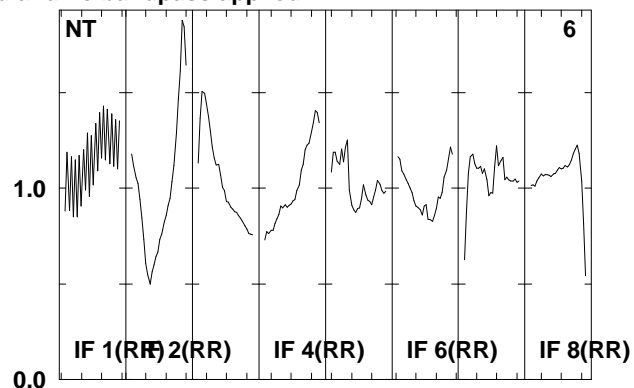
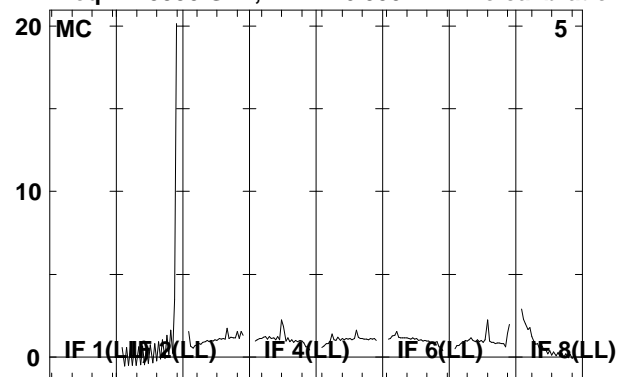

Lower frame: Real Jy

Total-power spectrum Antenna: \*

Timerange: 00/11:47:41 to 00/11:49:17



Plot file version 349 created 08-AUG-2008 17:01:28

J0920+44 EO006B.UVDATA.1

Freq = 1.5950 GHz, Bw = 16.000 MH No calibration applied and no bandpass applied

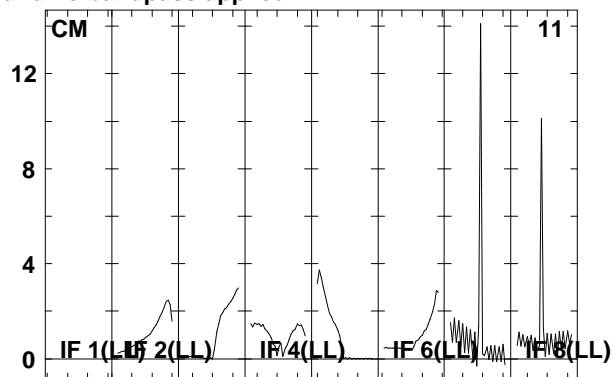
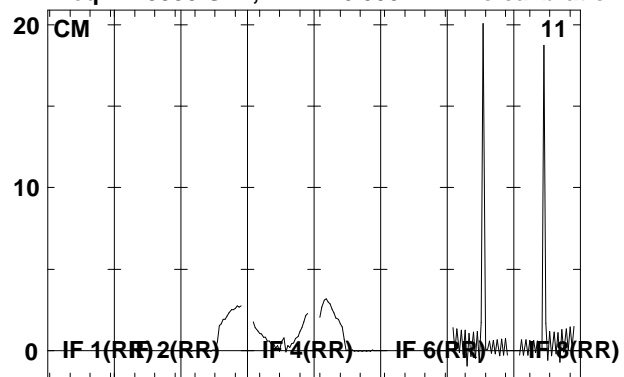

Lower frame: Real Jy  
Total-power spectrum Antenna: \*  
Timerange: 00/11:47:41 to 00/11:49:17

Plot file version 350 created 08-AUG-2008 17:01:28

J092159 EO006B.UVDATA.1

Freq = 1.5950 GHz, Bw = 16.000 MH No calibration applied and no bandpass applied

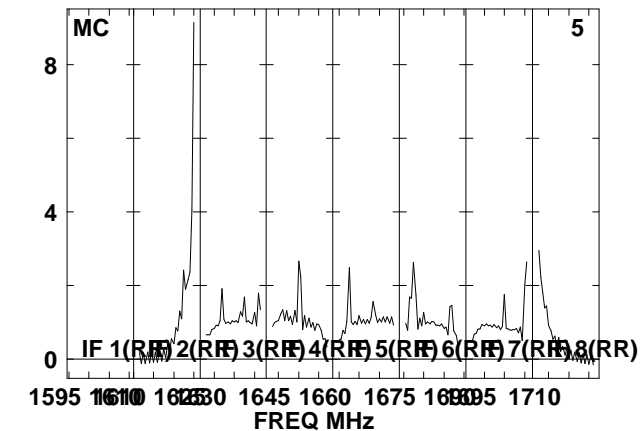
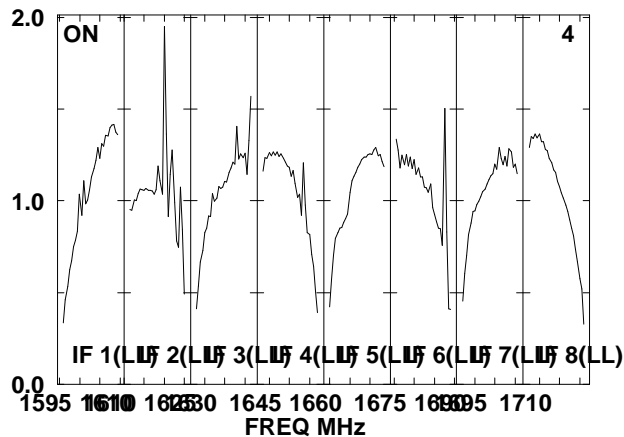
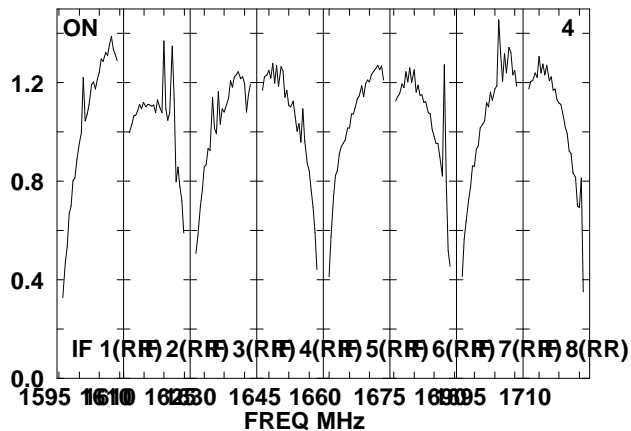
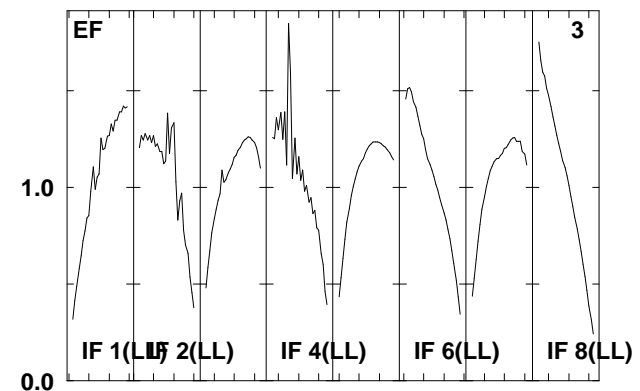
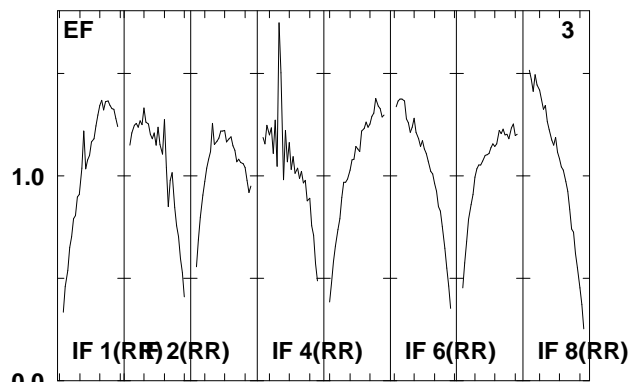
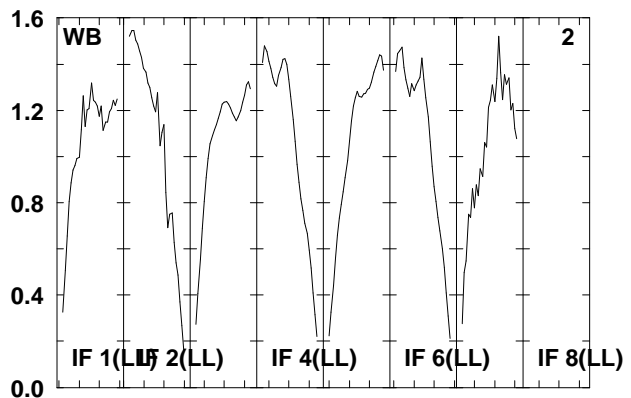
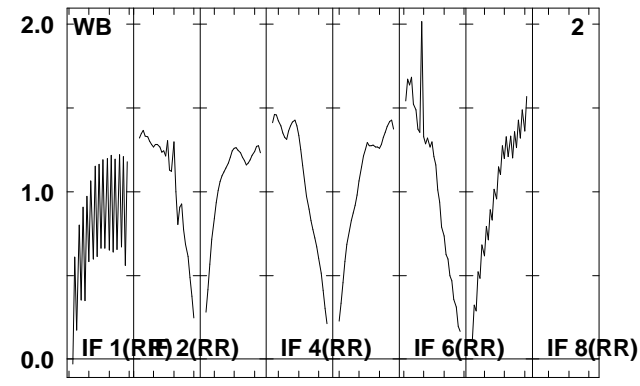
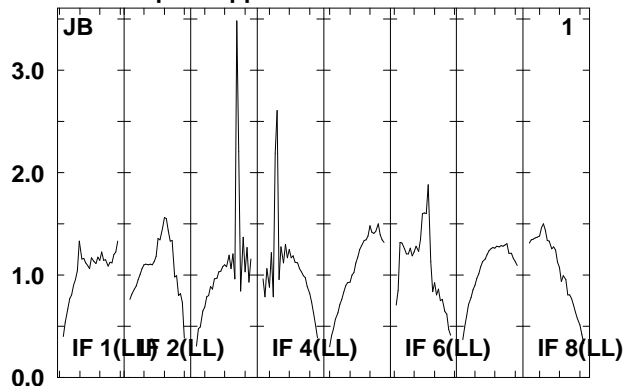
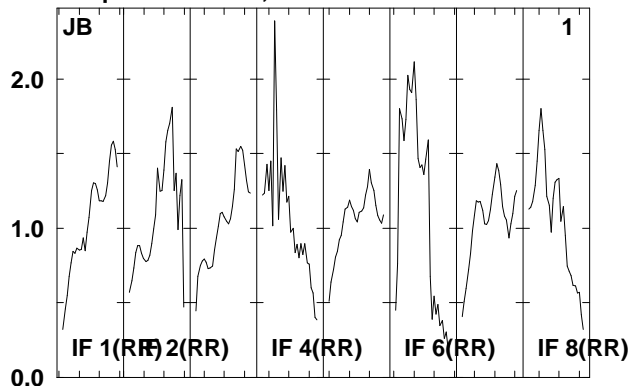

Lower frame: Real Jy  
Total-power spectrum Antenna: \*  
Timerange: 00/11:49:53 to 00/11:54:29

Plot file version 351 created 08-AUG-2008 17:01:29

J092159 EO006B.UVDATA.1

Freq = 1.5950 GHz, Bw = 16.000 MH No calibration applied and no bandpass applied

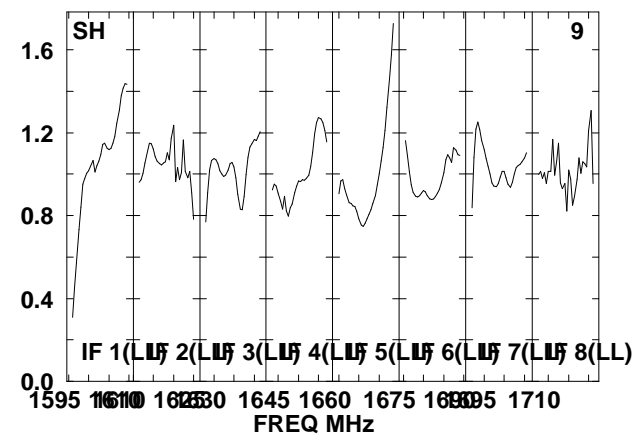
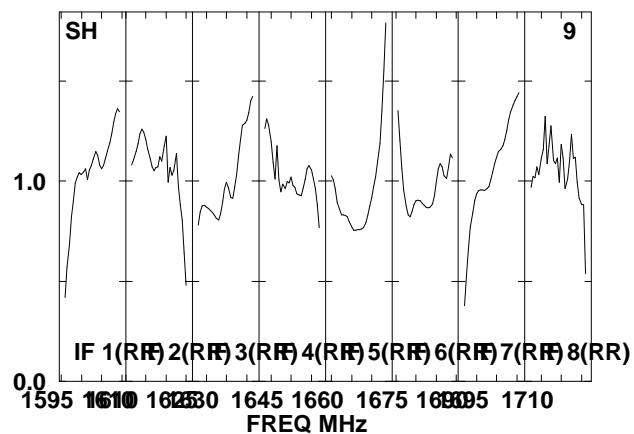
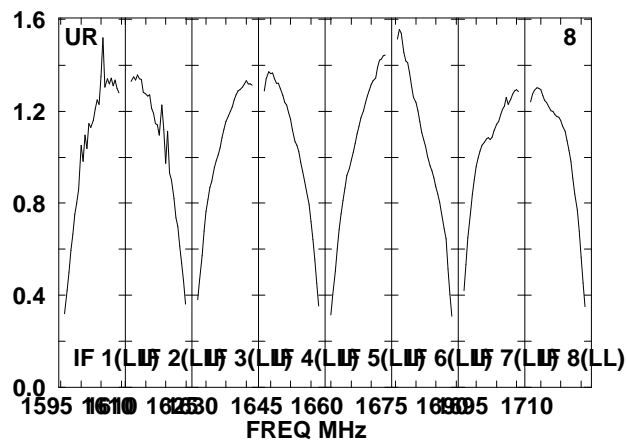
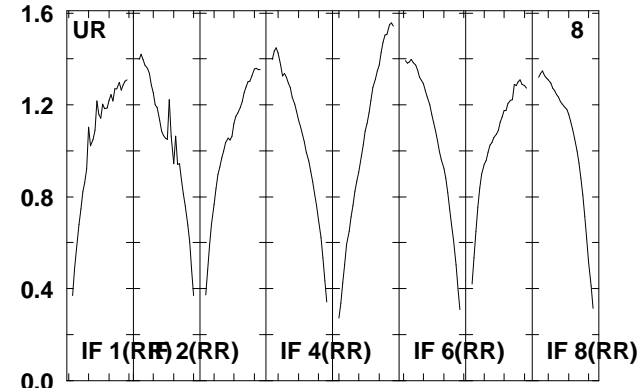
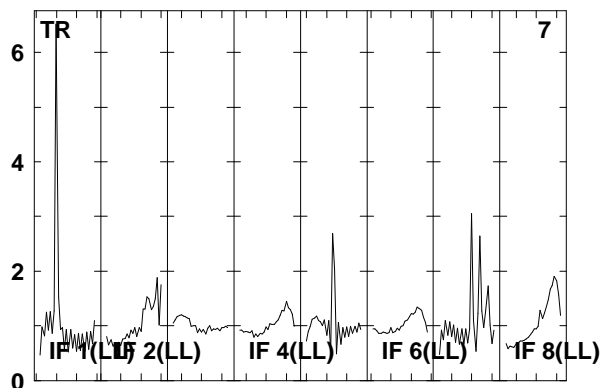
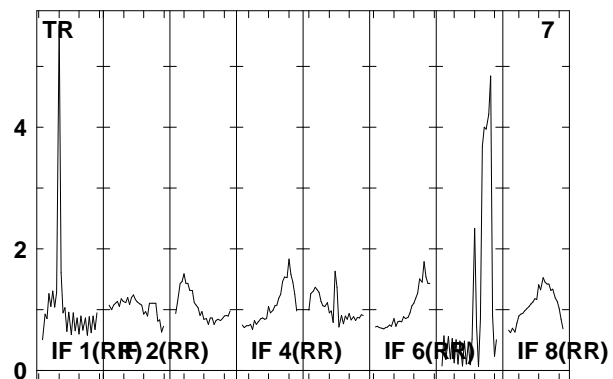
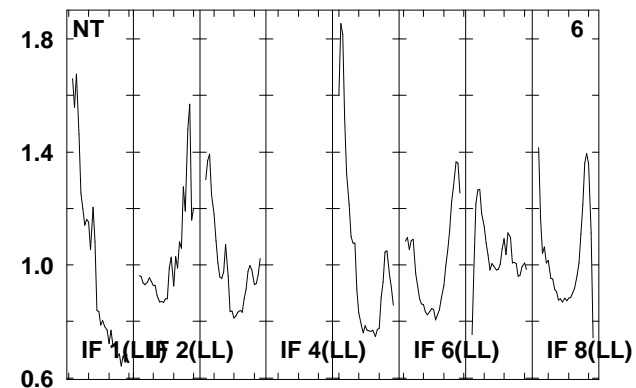
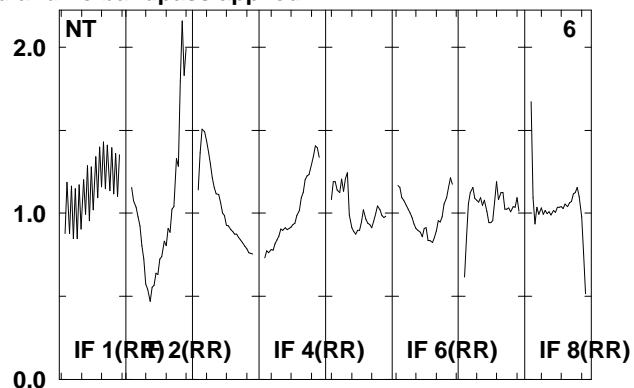
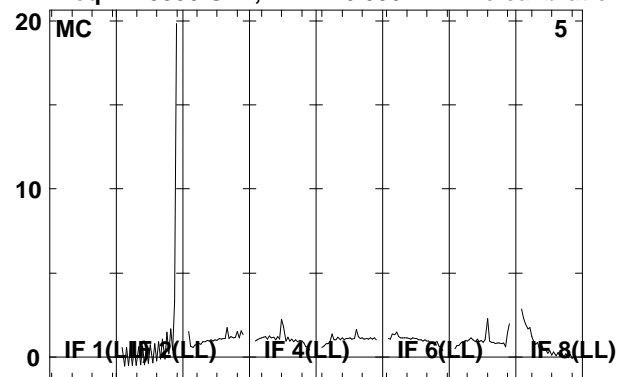

Lower frame: Real Jy

Total-power spectrum Antenna: \*

Timerange: 00/11:49:53 to 00/11:54:29

Plot file version 352 created 08-AUG-2008 17:01:29

J092159 EO006B.UVDATA.1

Freq = 1.5950 GHz, Bw = 16.000 MH No calibration applied and no bandpass applied

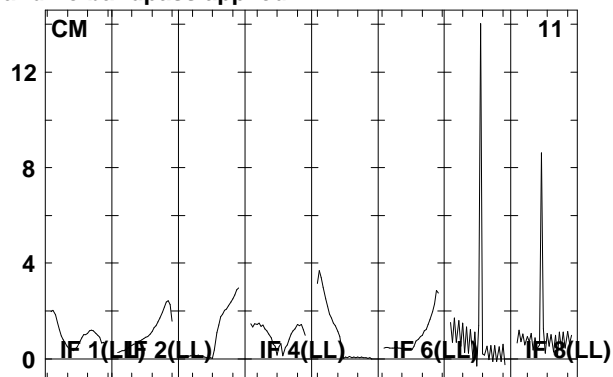
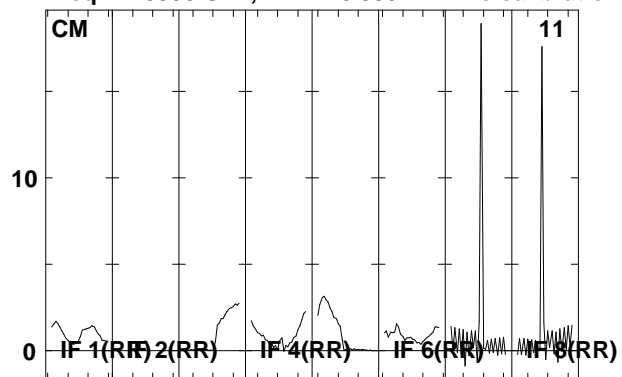

Lower frame: Real Jy  
Total-power spectrum Antenna: \*  
Timerange: 00/11:49:53 to 00/11:54:29

Plot file version 353 created 08-AUG-2008 17:01:31

J0920+44 EO006B.UVDATA.1

Freq = 1.5950 GHz, Bw = 16.000 MH No calibration applied and no bandpass applied

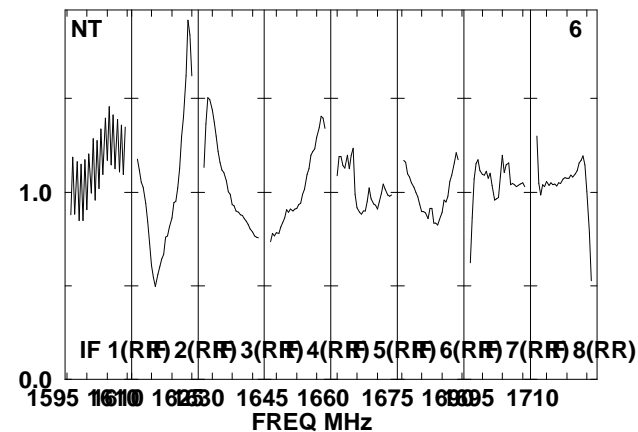
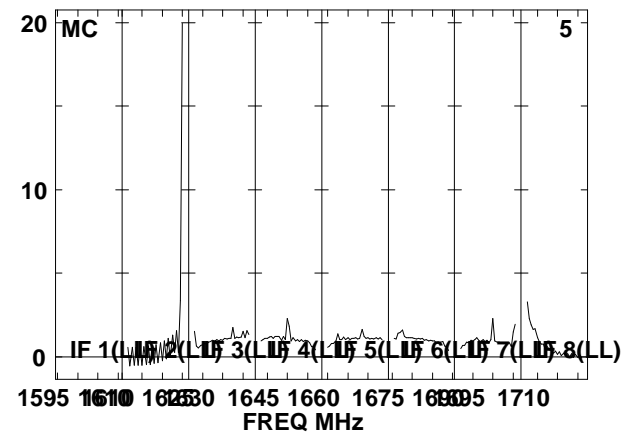
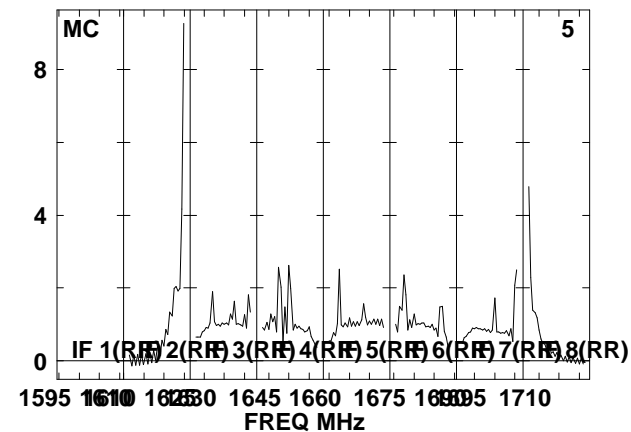
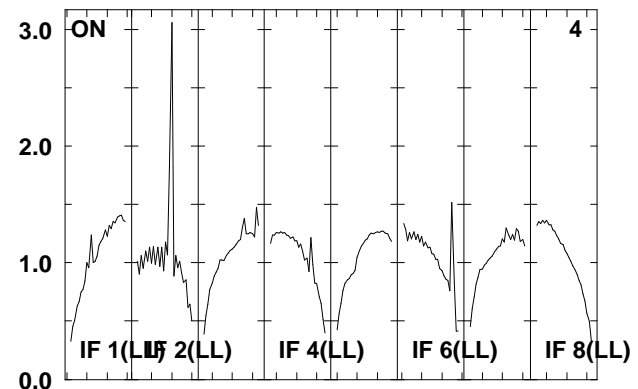
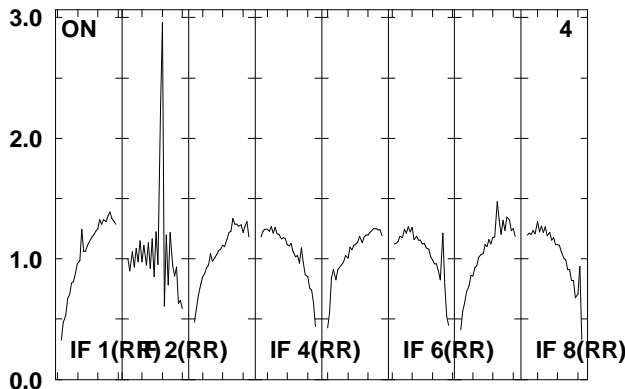
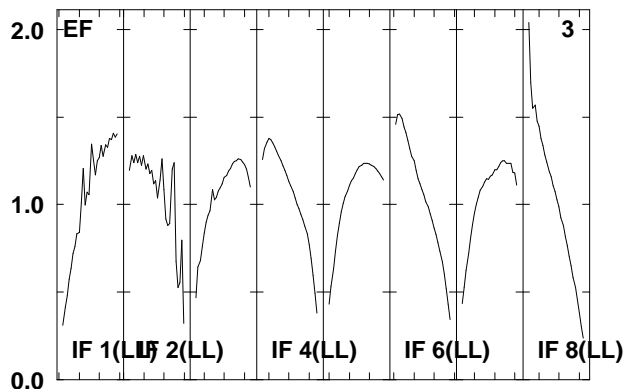
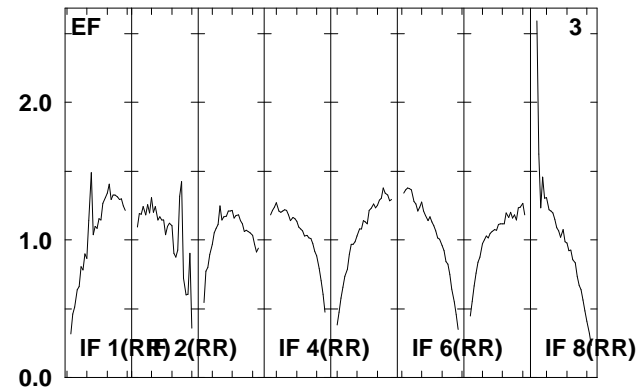
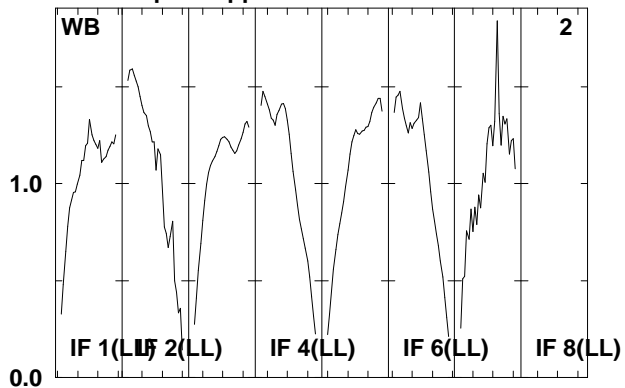
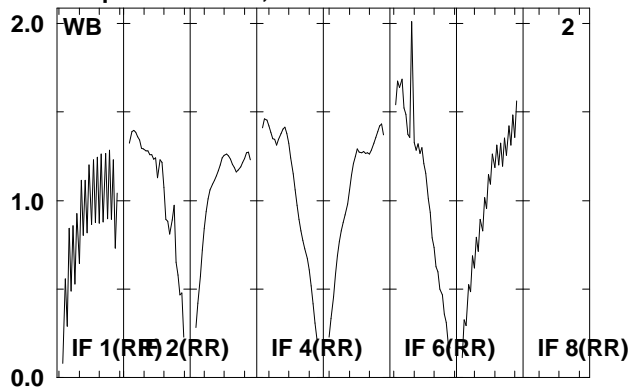

Lower frame: Real Jy  
Total-power spectrum Antenna: \*  
Timerange: 00/11:55:01 to 00/11:56:37

Plot file version 354 created 08-AUG-2008 17:01:31  
 J0920+44 EO006B.UVDATA.1  
 Freq = 1.5950 GHz, Bw = 16.000 MH No calibration applied and no bandpass applied

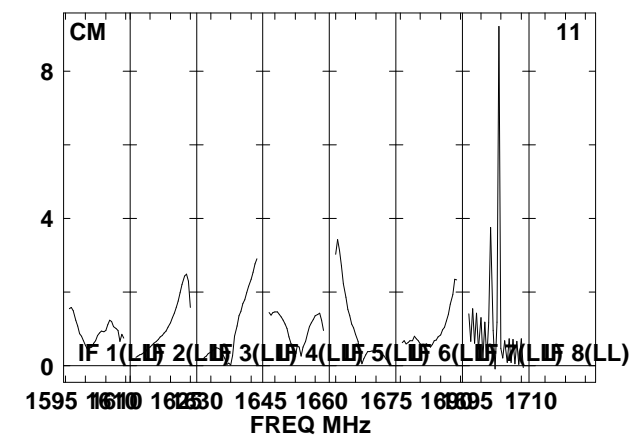
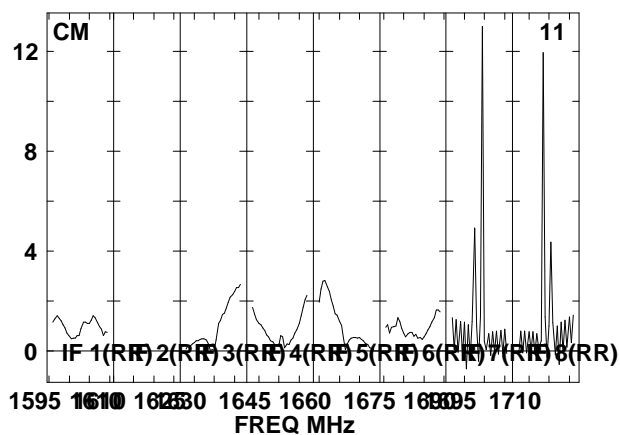
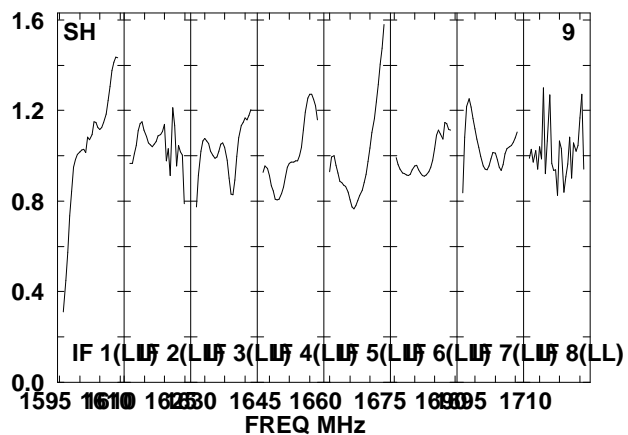
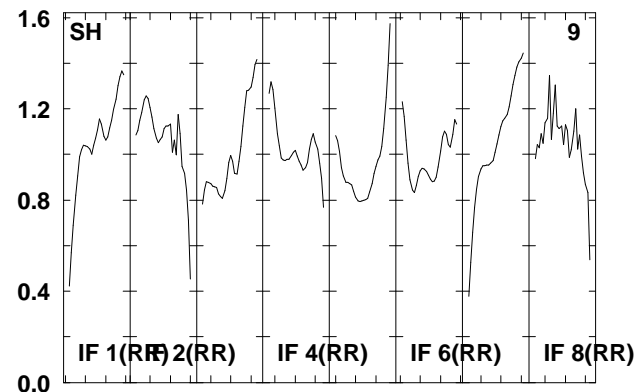
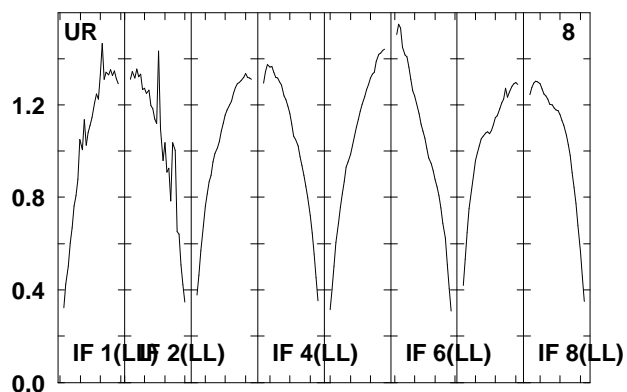
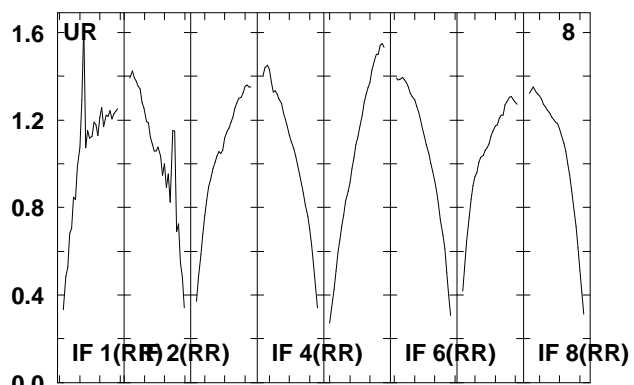
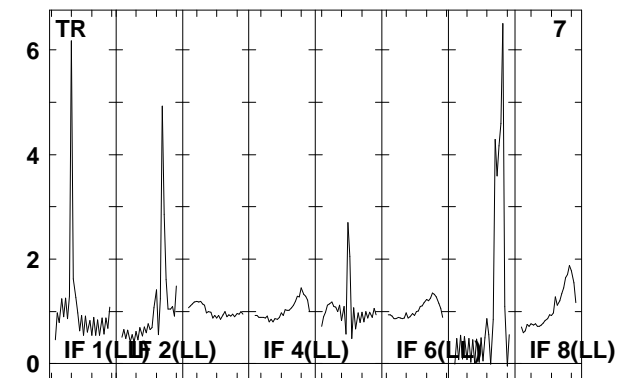
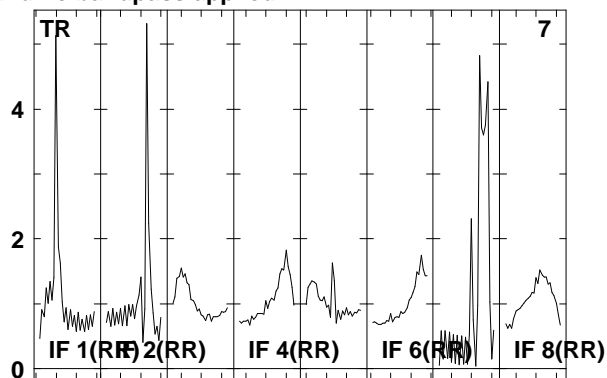
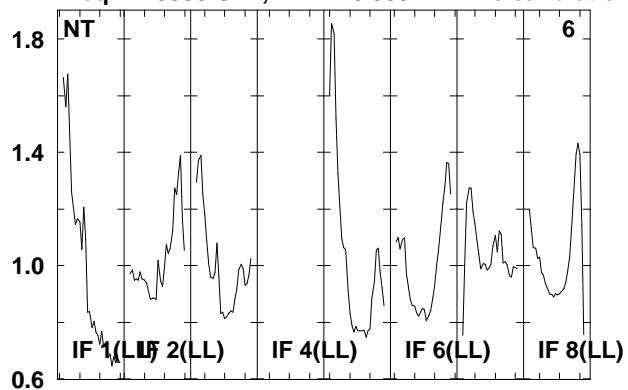

Lower frame: Real Jy  
 Total-power spectrum Antenna: \*  
 Timerange: 00/11:55:01 to 00/11:56:37

Plot file version 355 created 08-AUG-2008 17:01:32

J092159 EO006B.UVDATA.1

Freq = 1.5950 GHz, Bw = 16.000 MH No calibration applied and no bandpass applied

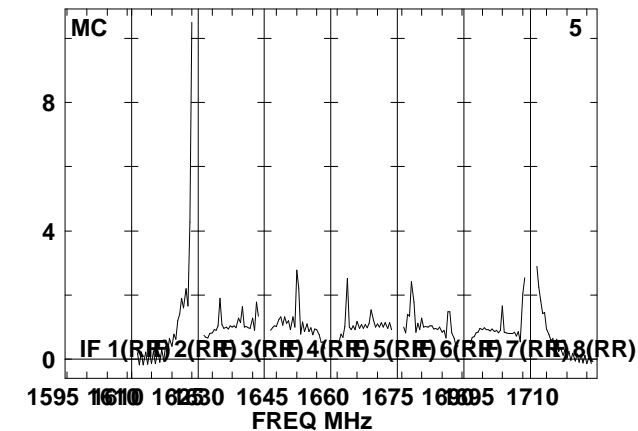
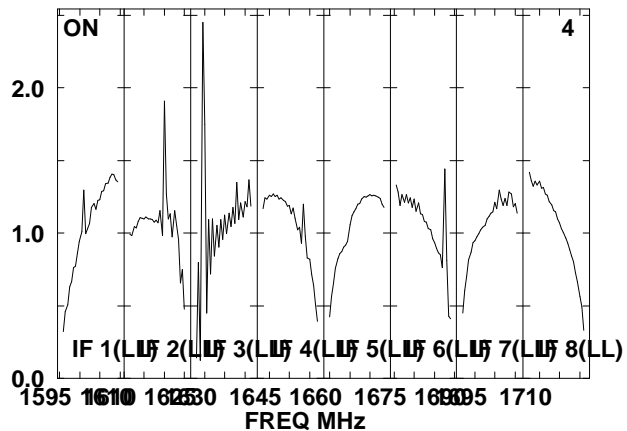
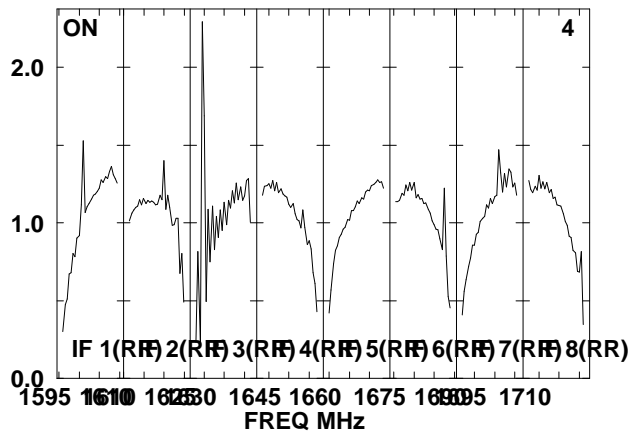
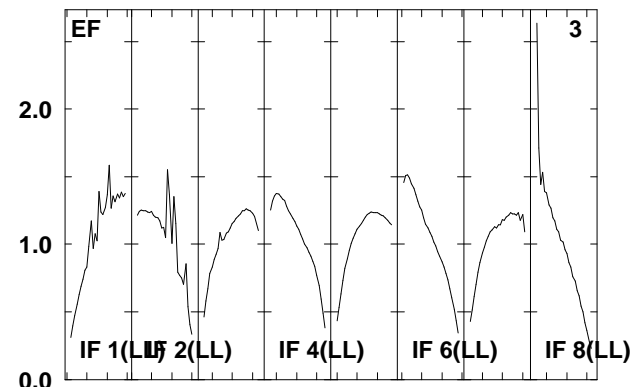
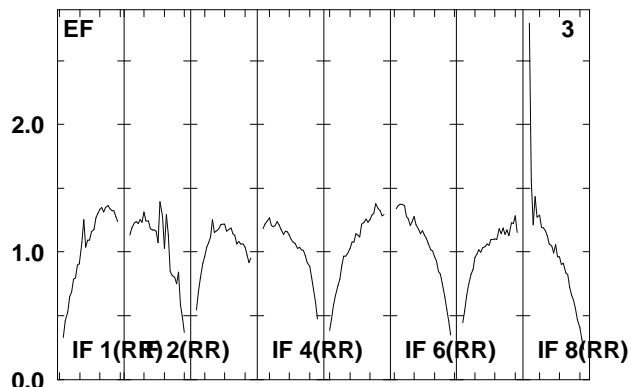
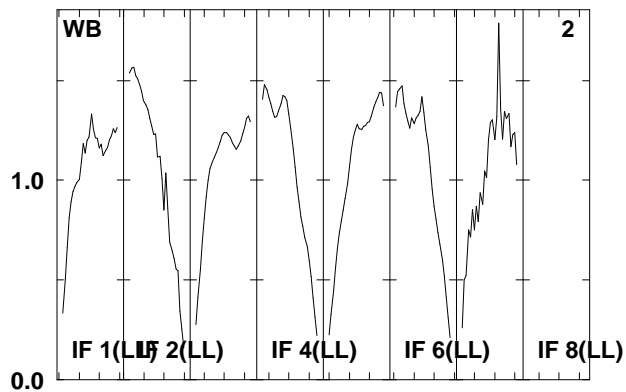
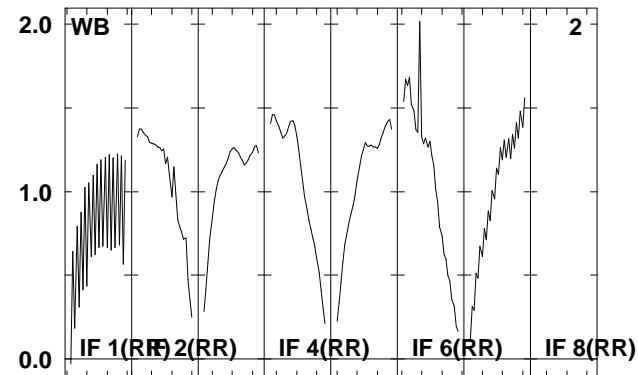
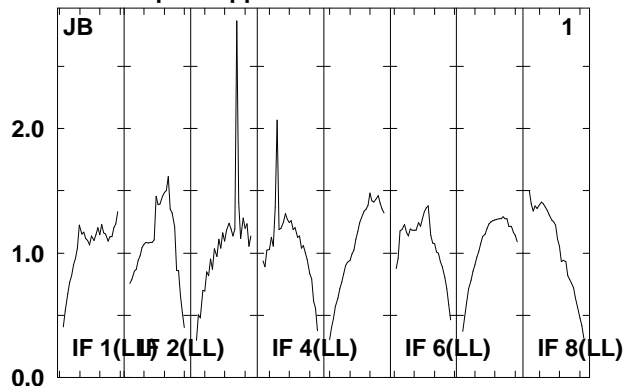
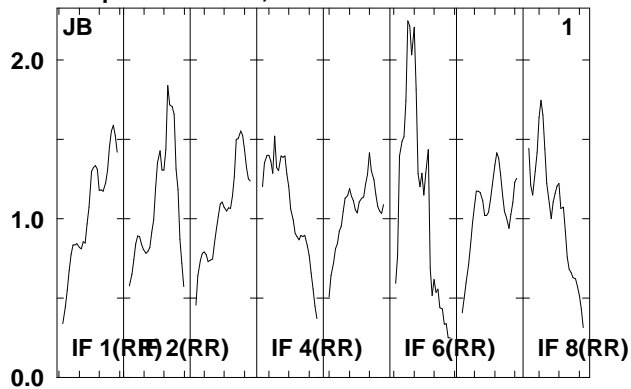

Lower frame: Real Jy  
Total-power spectrum Antenna: \*  
Timerange: 00/11:57:13 to 00/12:01:49

Plot file version 356 created 08-AUG-2008 17:01:32

J092159 EO06B.UVDATA.1

Freq = 1.5950 GHz, Bw = 16.000 MH No calibration applied and no bandpass applied

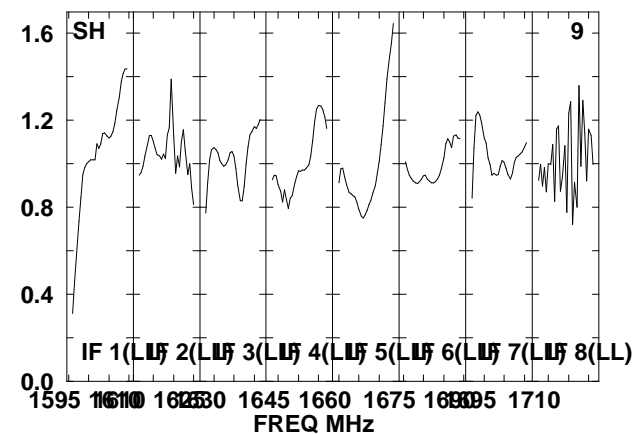
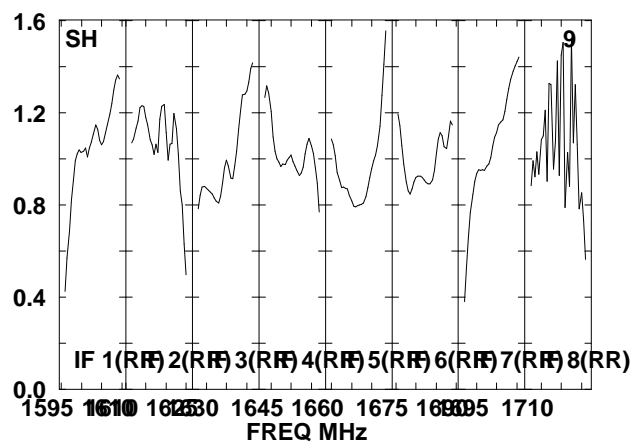
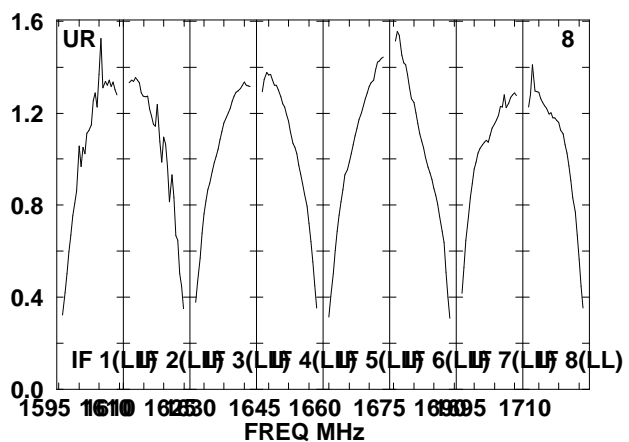
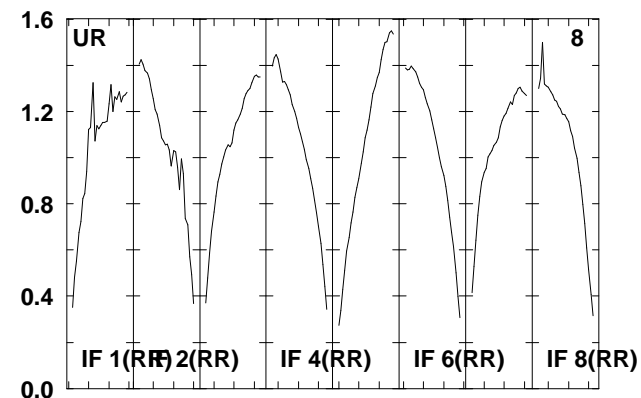
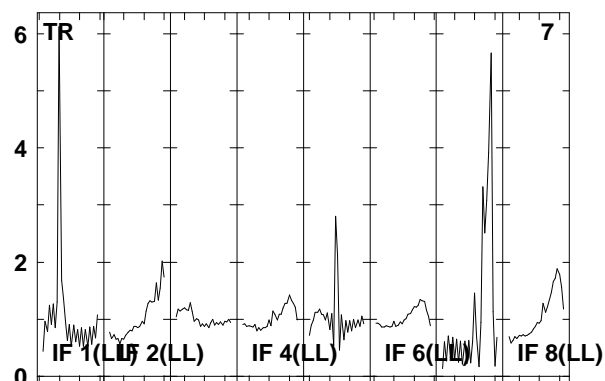
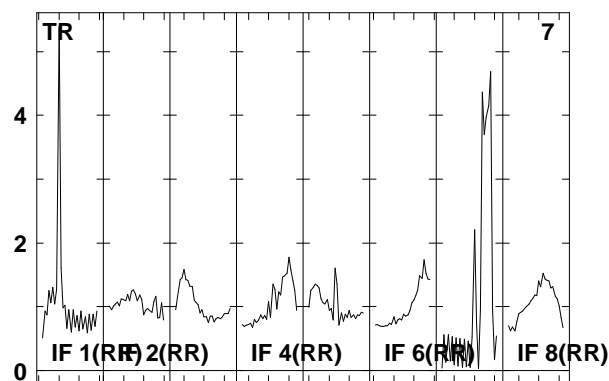
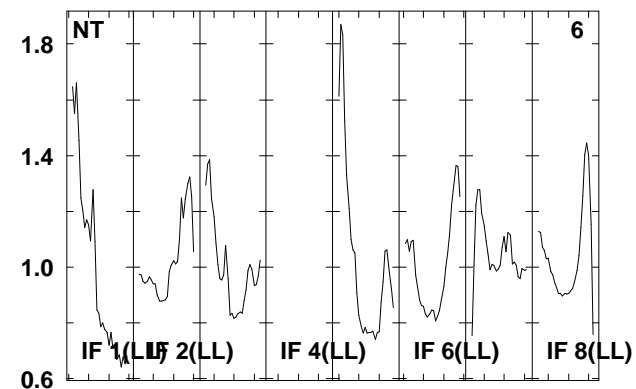
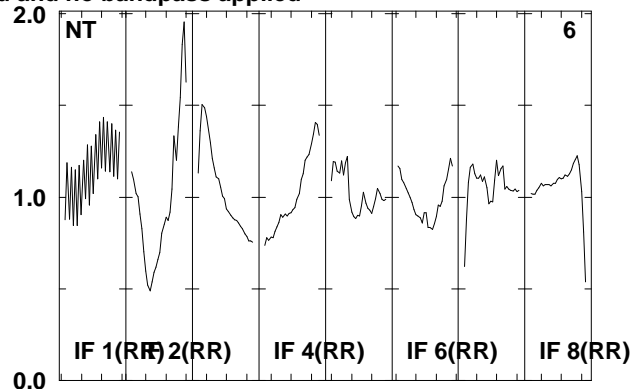
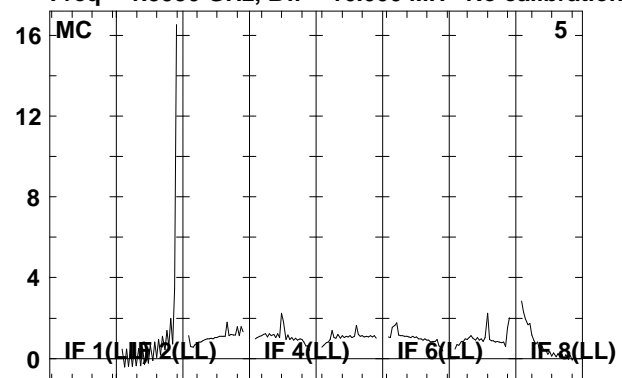

Lower frame: Real Jy

Total-power spectrum Antenna: \*

Timerange: 00/11:57:13 to 00/12:01:49



Plot file version 357 created 08-AUG-2008 17:01:33

J092159 EO006B.UVDATA.1

Freq = 1.5950 GHz, Bw = 16.000 MH No calibration applied and no bandpass applied

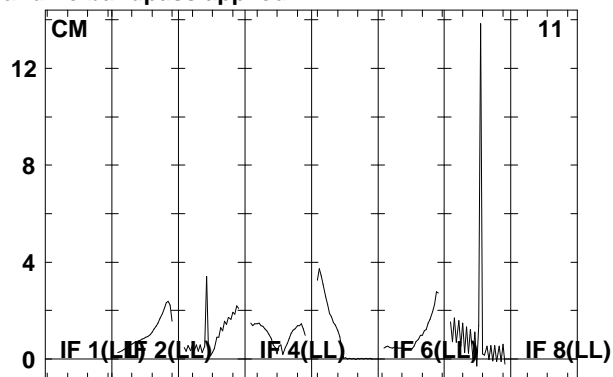
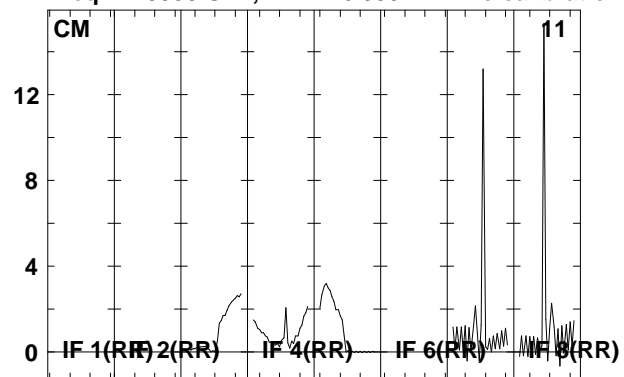

Lower frame: Real Jy  
Total-power spectrum Antenna: \*  
Timerange: 00/11:57:13 to 00/12:01:49

Plot file version 358 created 08-AUG-2008 17:01:34

J0920+44 EO006B.UVDATA.1

Freq = 1.5950 GHz, Bw = 16.000 MH No calibration applied and no bandpass applied

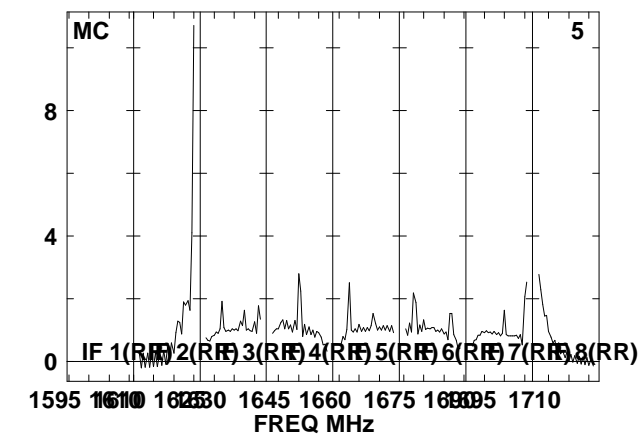
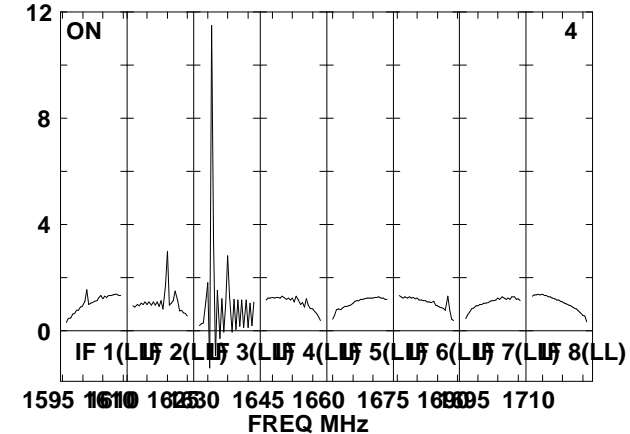
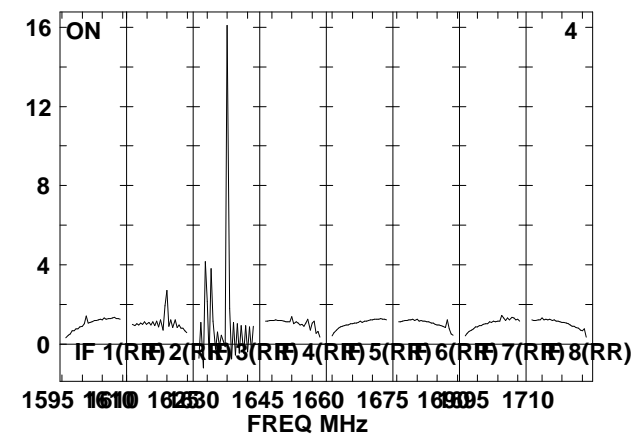
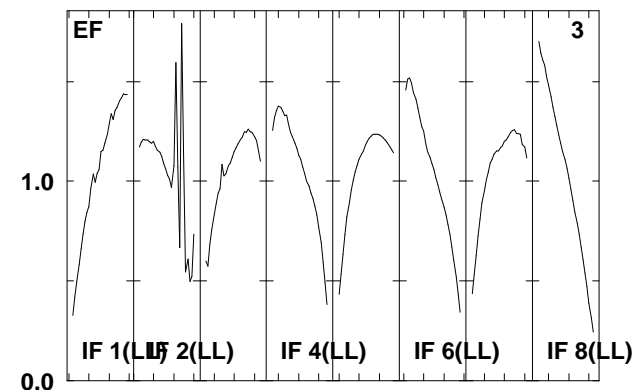
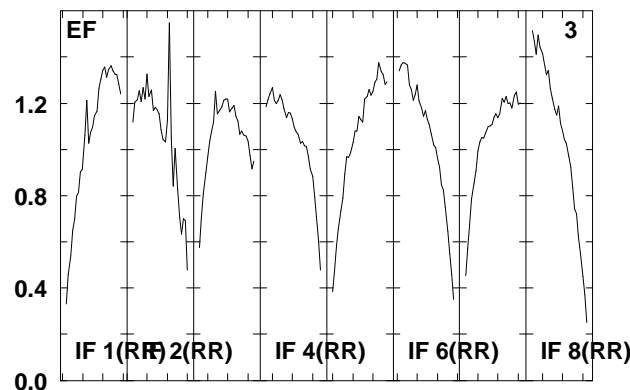
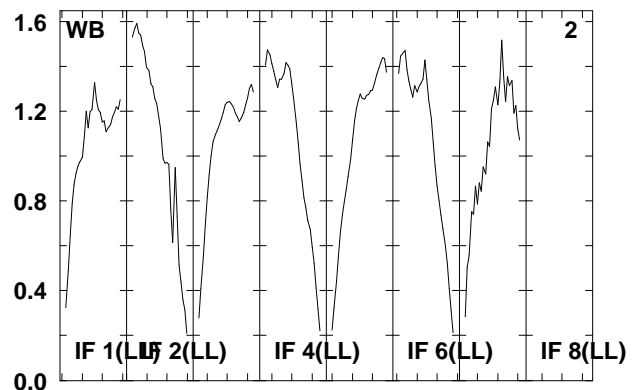
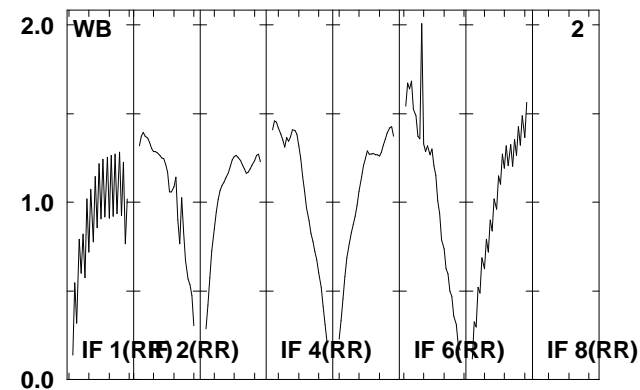
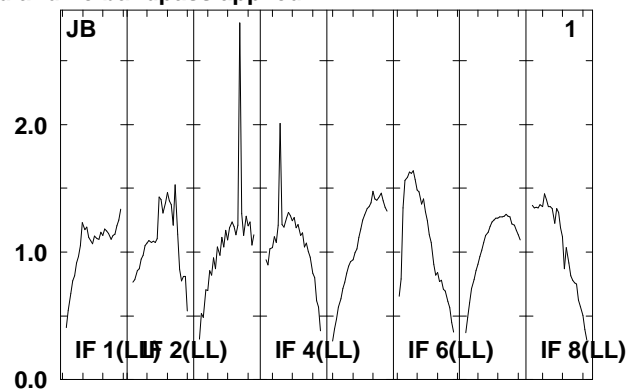
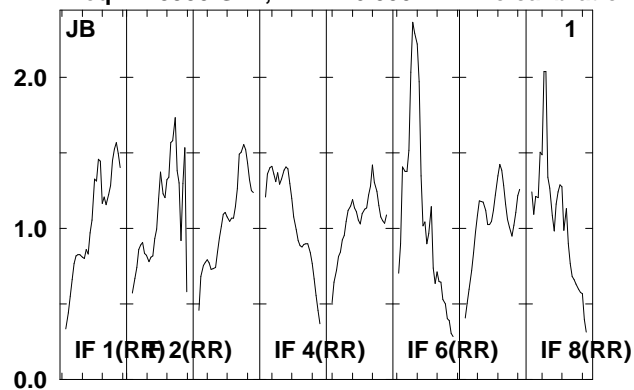

Lower frame: Real Jy  
Total-power spectrum Antenna: \*  
Timerange: 00/12:02:25 to 00/12:03:57

Plot file version 359 created 08-AUG-2008 17:01:34  
 J0920+44 EO006B.UVDATA.1  
 Freq = 1.5950 GHz, Bw = 16.000 MH No calibration applied and no bandpass applied

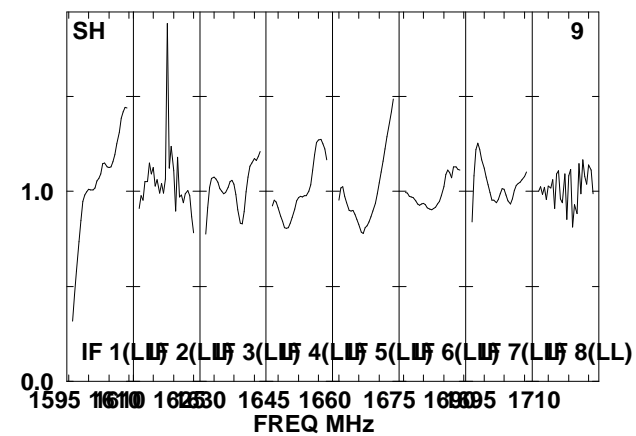
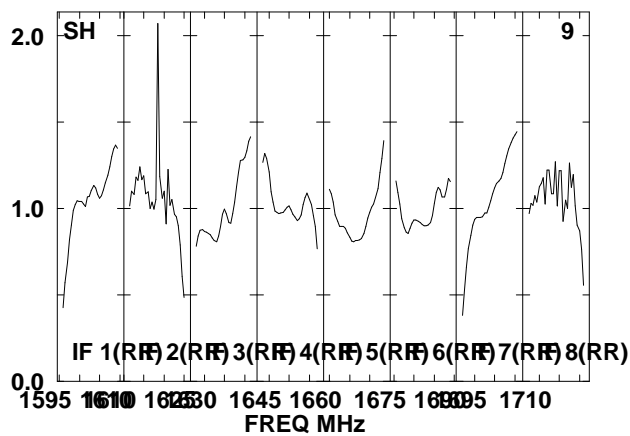
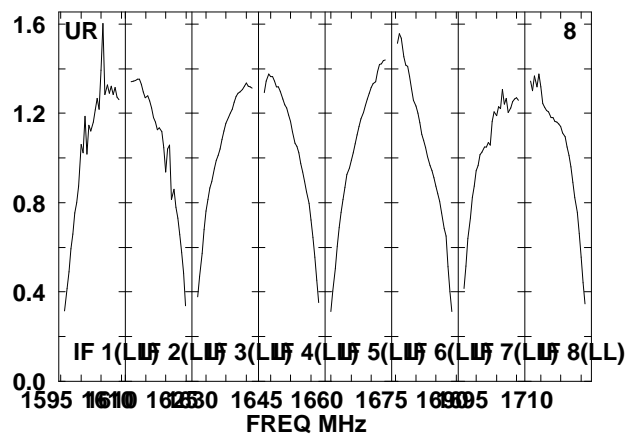
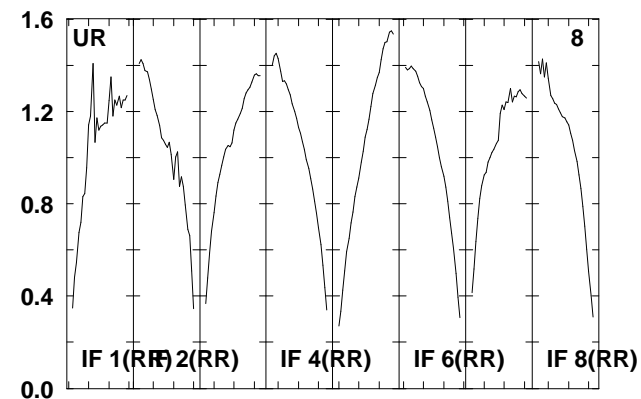
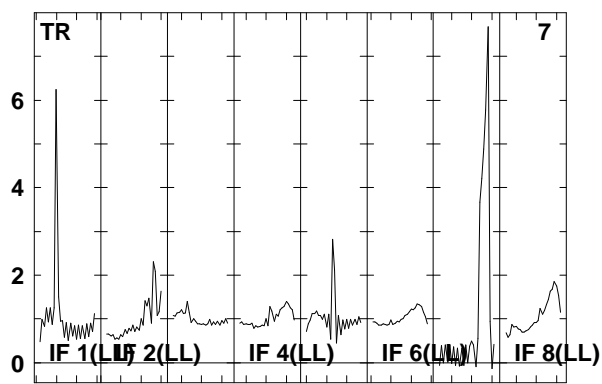
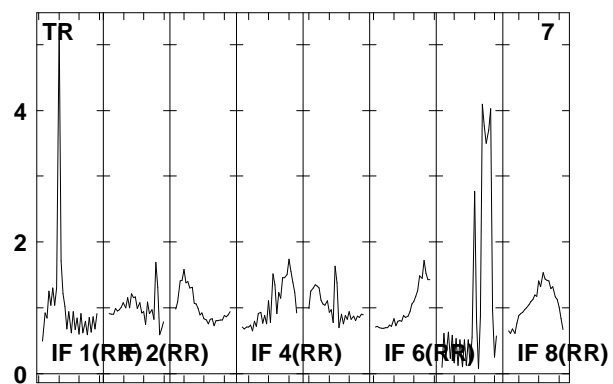
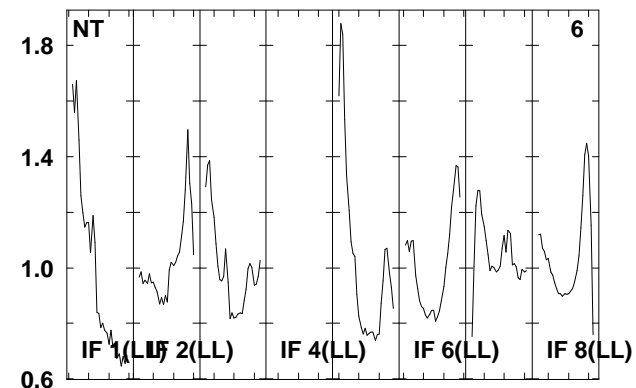
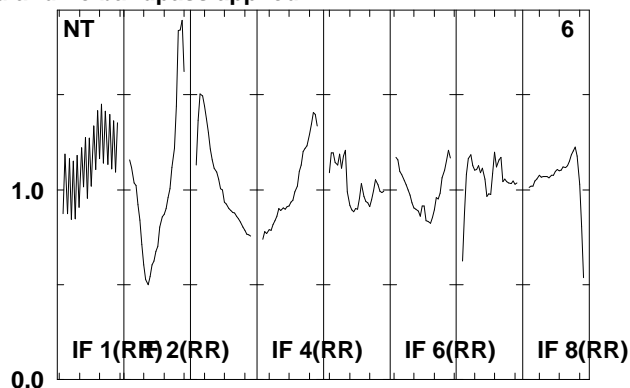
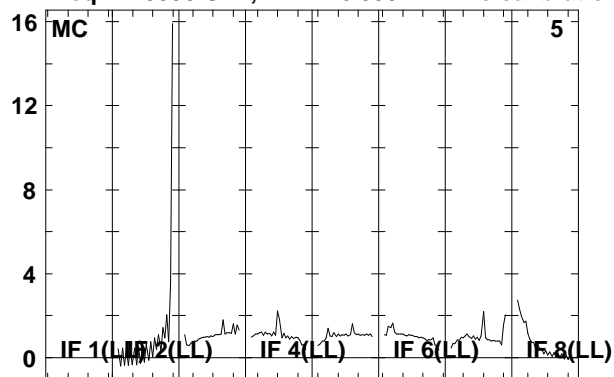

Lower frame: Real Jy  
 Total-power spectrum Antenna: \*  
 Timerange: 00/12:02:25 to 00/12:03:57

Plot file version 360 created 08-AUG-2008 17:01:35

J0920+44 EO006B.UVDATA.1

Freq = 1.5950 GHz, Bw = 16.000 MH No calibration applied and no bandpass applied

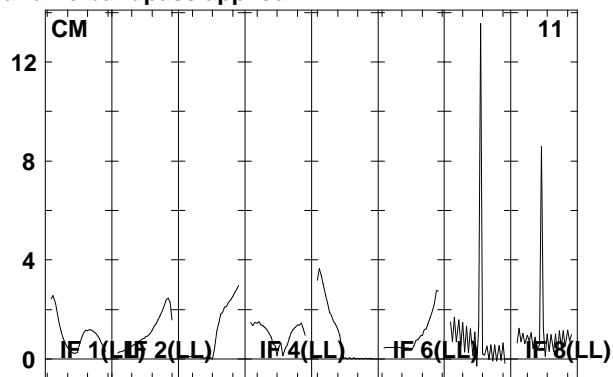
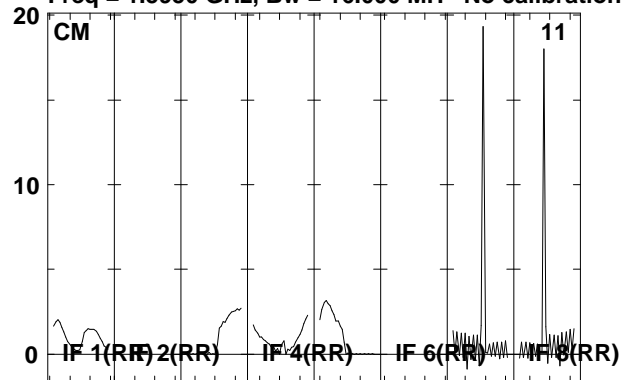

Lower frame: Real Jy  
Total-power spectrum Antenna: \*  
Timerange: 00/12:02:25 to 00/12:03:57

Plot file version 361 created 08-AUG-2008 17:01:35

J092159 EO006B.UVDATA.1

Freq = 1.5950 GHz, Bw = 16.000 MH No calibration applied and no bandpass applied

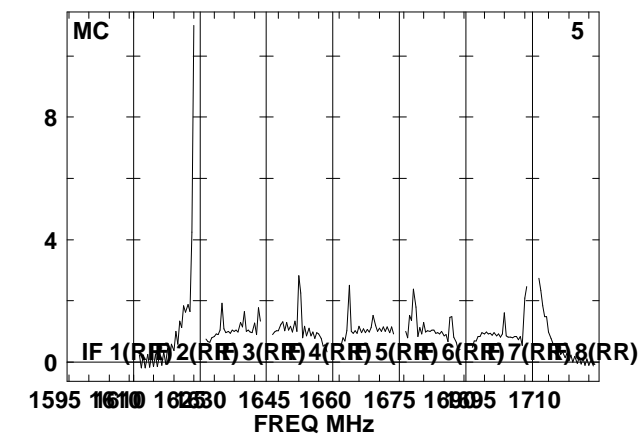
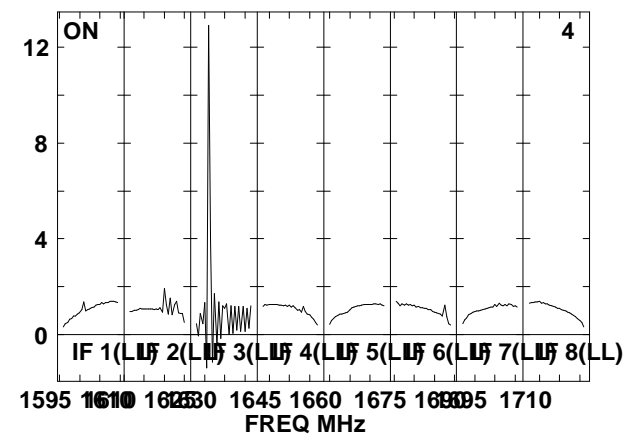
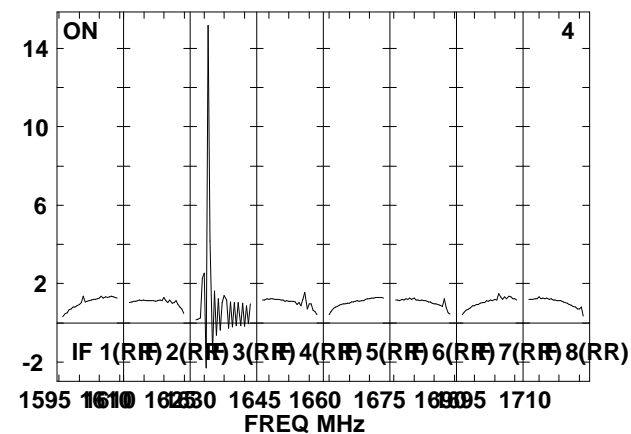
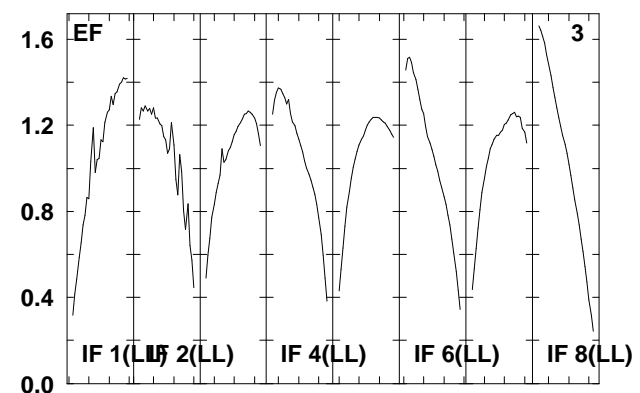
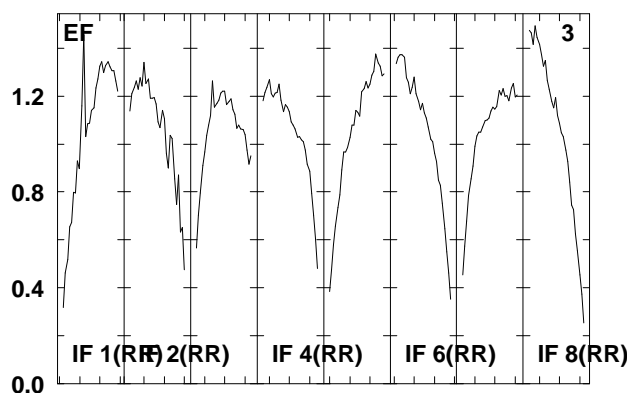
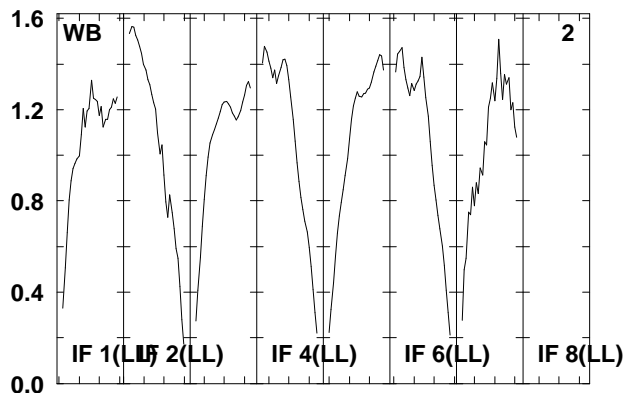
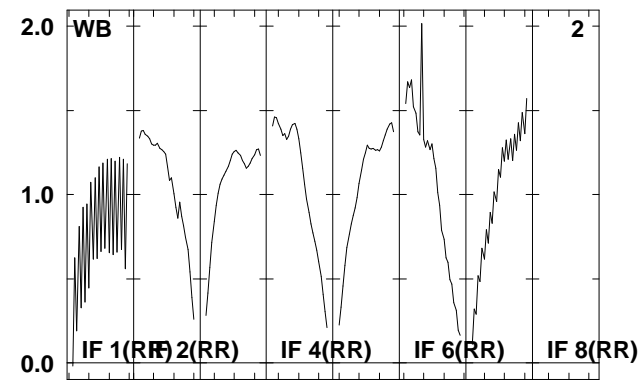
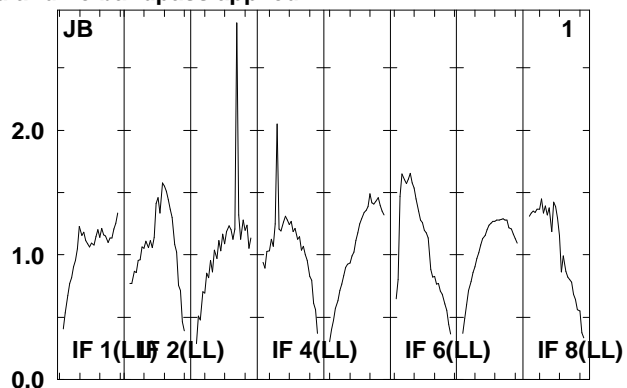
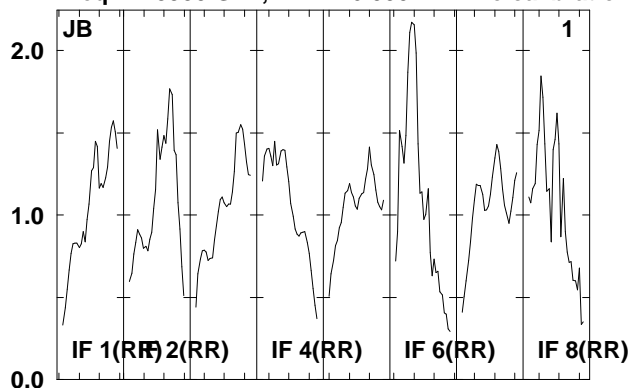

Lower frame: Real Jy  
Total-power spectrum Antenna: \*  
Timerange: 00/12:04:33 to 00/12:09:09

Plot file version 362 created 08-AUG-2008 17:01:36

J092159 EO06B.UVDATA.1

Freq = 1.5950 GHz, Bw = 16.000 MH No calibration applied and no bandpass applied

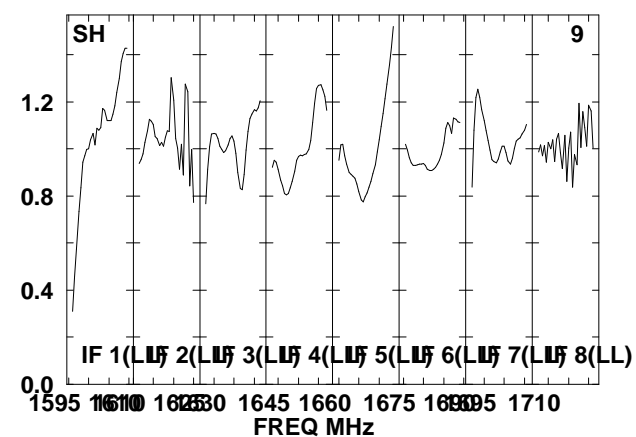
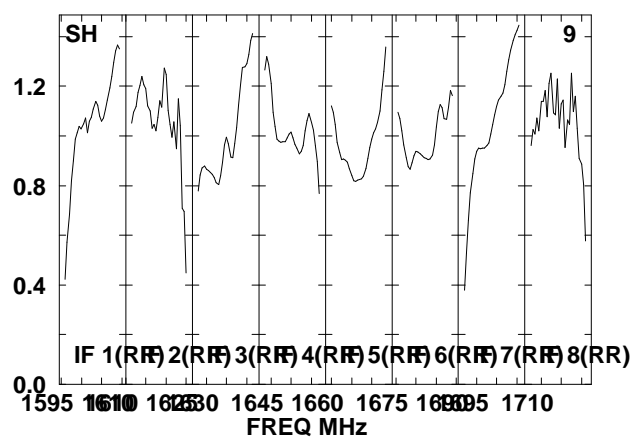
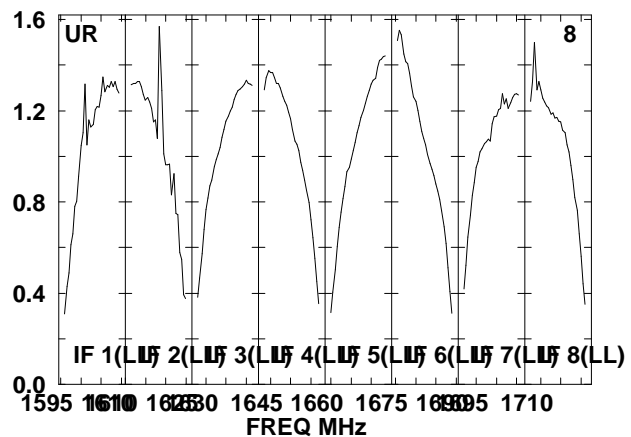
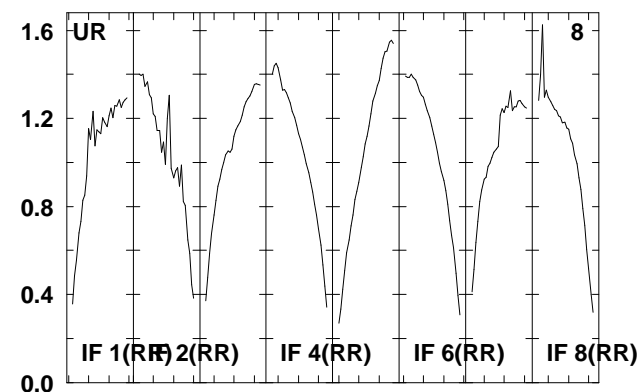
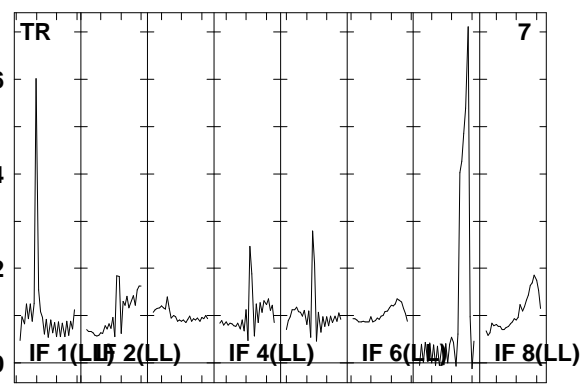
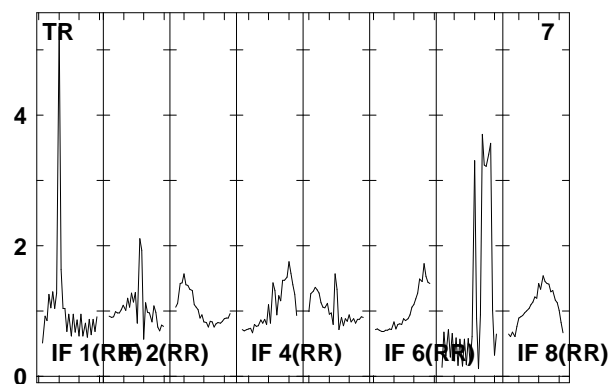
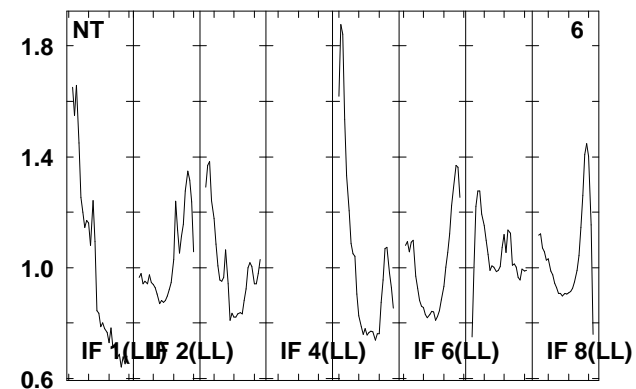
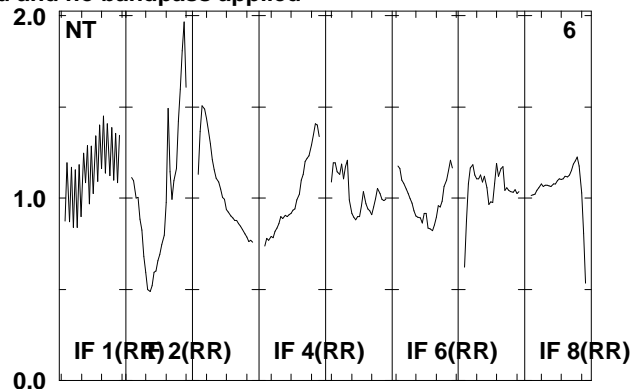
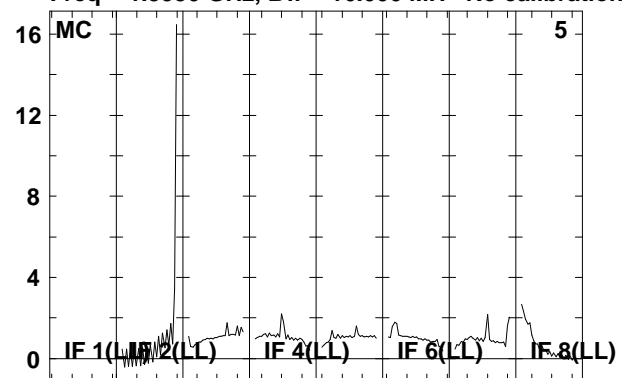

Lower frame: Real Jy

Total-power spectrum Antenna: \*

Timerange: 00/12:04:33 to 00/12:09:09

Plot file version 363 created 08-AUG-2008 17:01:36

J092159 EO06B.UVDATA.1

Freq = 1.5950 GHz, Bw = 16.000 MH No calibration applied and no bandpass applied

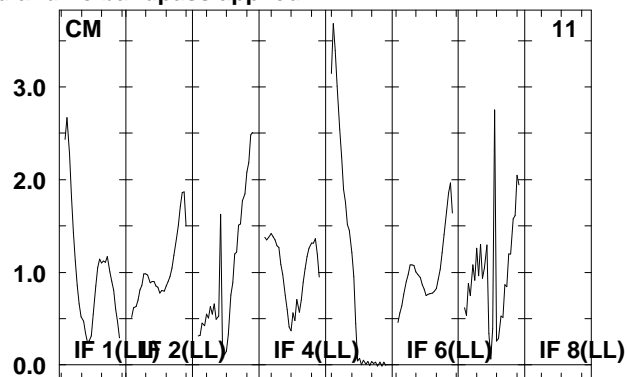
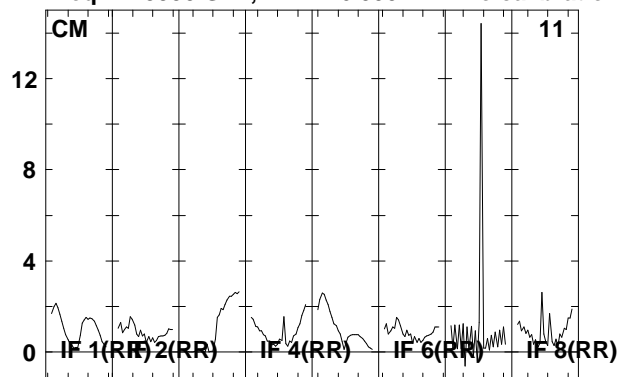

Lower frame: Real Jy  
Total-power spectrum Antenna: \*  
Timerange: 00/12:04:33 to 00/12:09:09

Plot file version 364 created 08-AUG-2008 17:01:37

J0920+44 EO006B.UVDATA.1

Freq = 1.5950 GHz, Bw = 16.000 MH No calibration applied and no bandpass applied

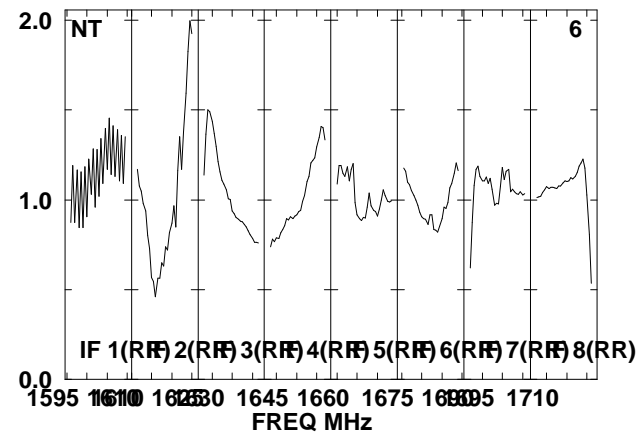
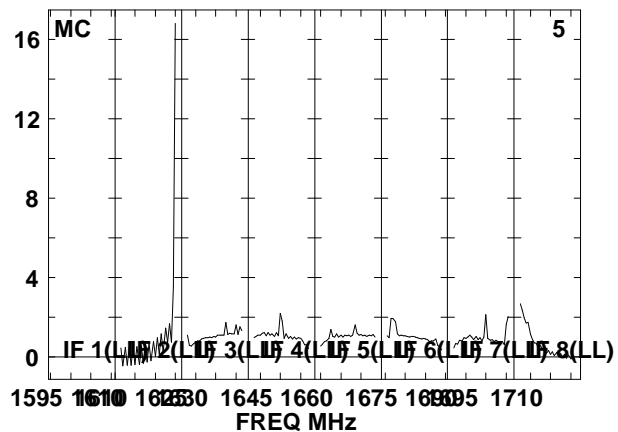
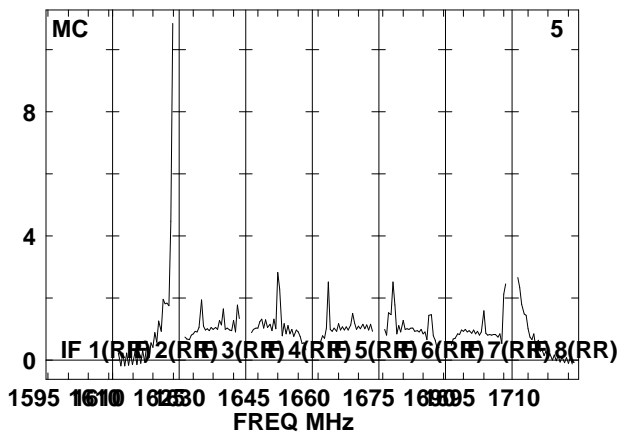
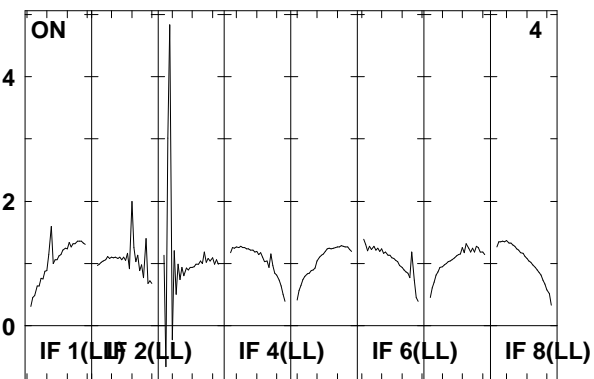
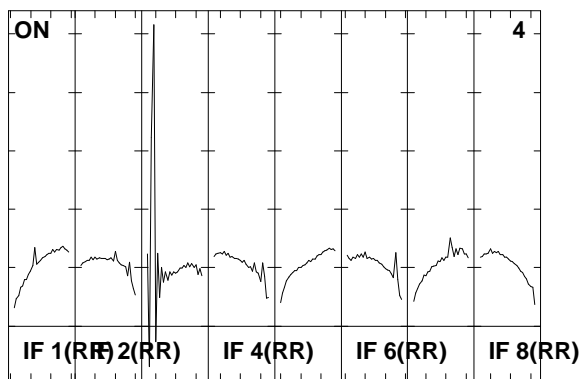
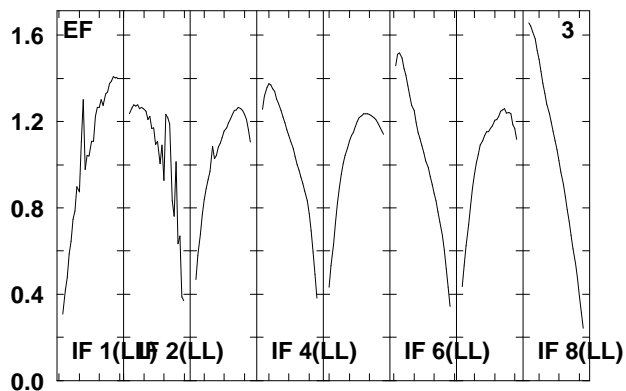
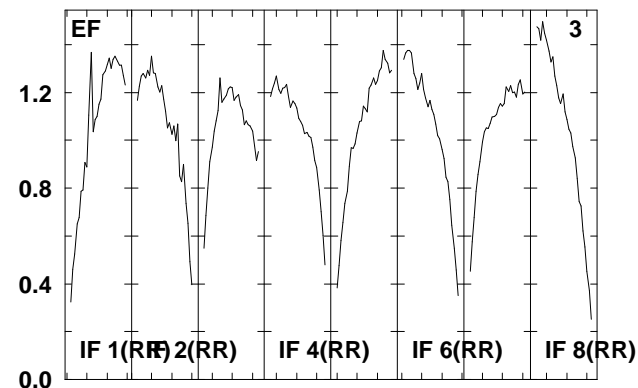
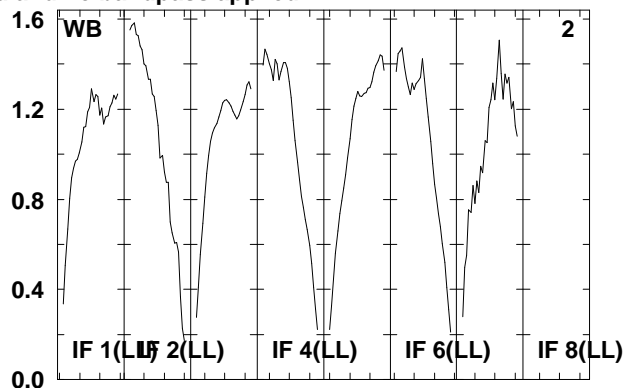
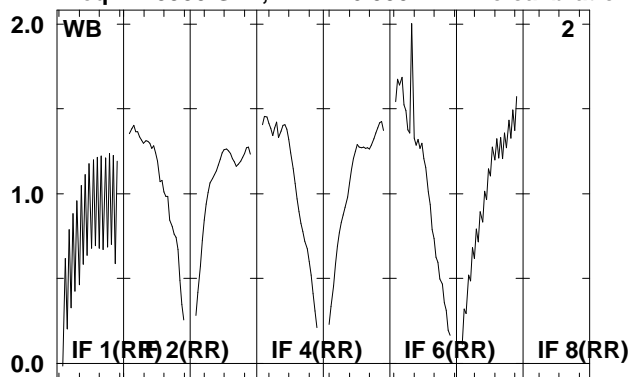

Lower frame: Real Jy  
Total-power spectrum Antenna: \*  
Timerange: 00/12:09:47 to 00/12:11:11



Plot file version 365 created 08-AUG-2008 17:01:37

J0920+44 EO06B.UVDATA.1

Freq = 1.5950 GHz, Bw = 16.000 MH No calibration applied and no bandpass applied

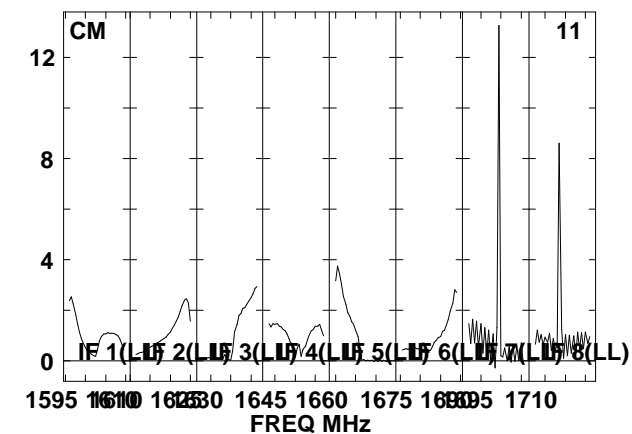
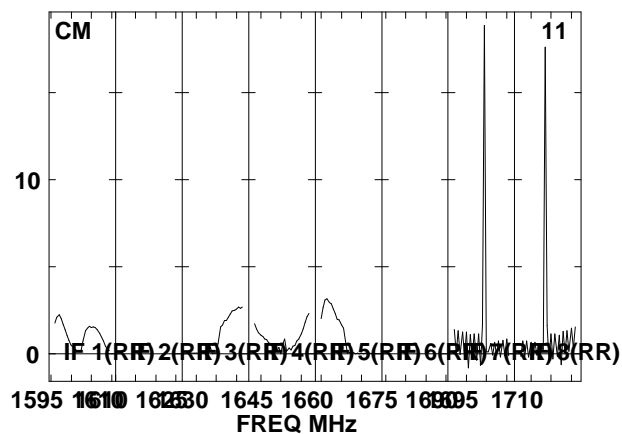
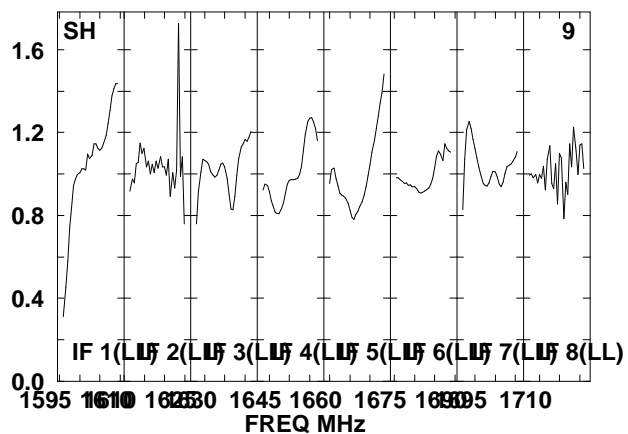
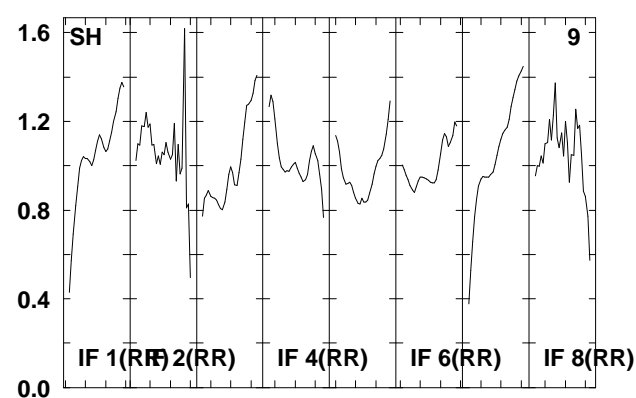
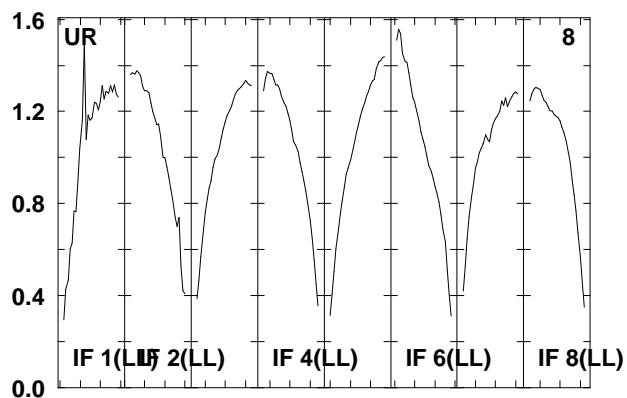
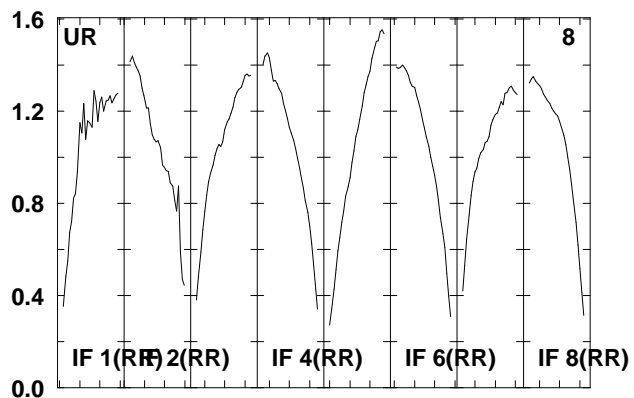
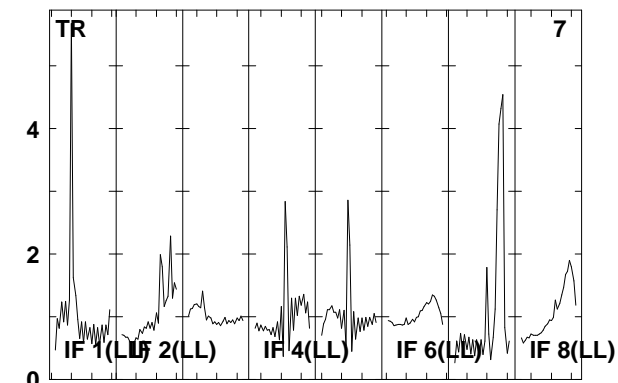
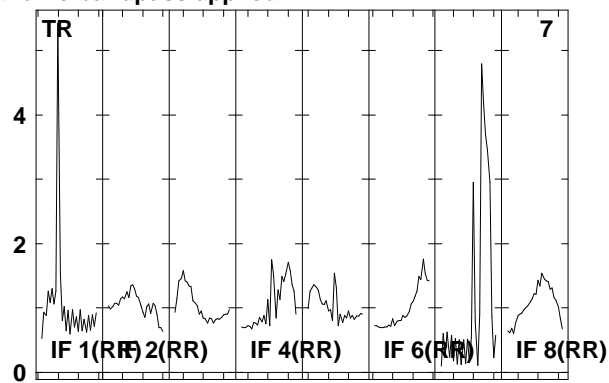
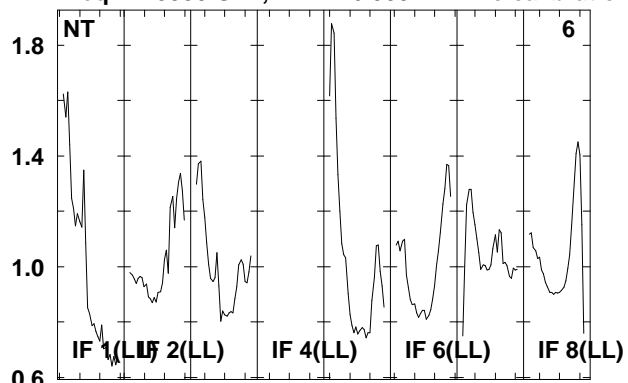

Lower frame: Real Jy  
Total-power spectrum Antenna: \*  
Timerange: 00/12:09:47 to 00/12:11:11

Plot file version 366 created 08-AUG-2008 17:01:38

J092159 EO006B.UVDATA.1

Freq = 1.5950 GHz, Bw = 16.000 MH No calibration applied and no bandpass applied

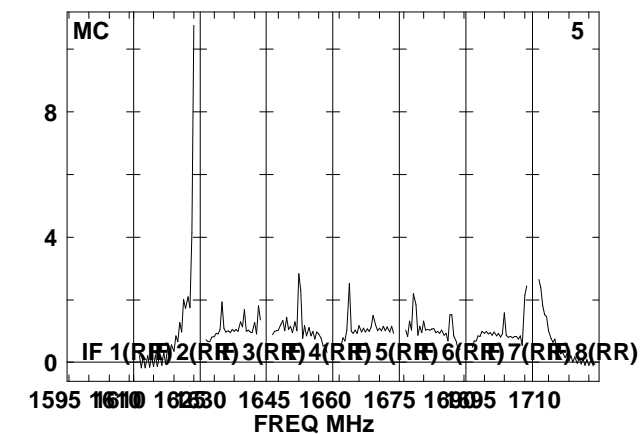
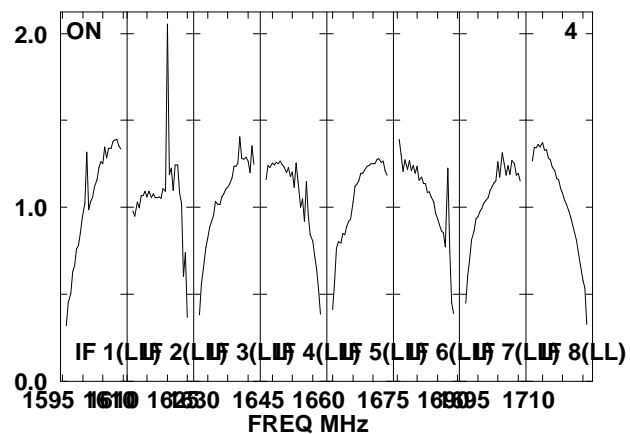
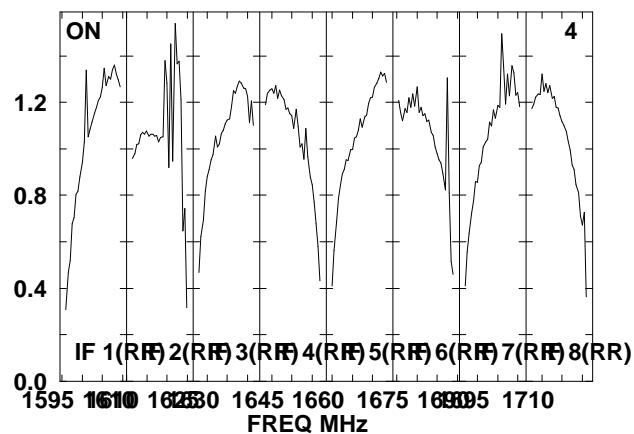
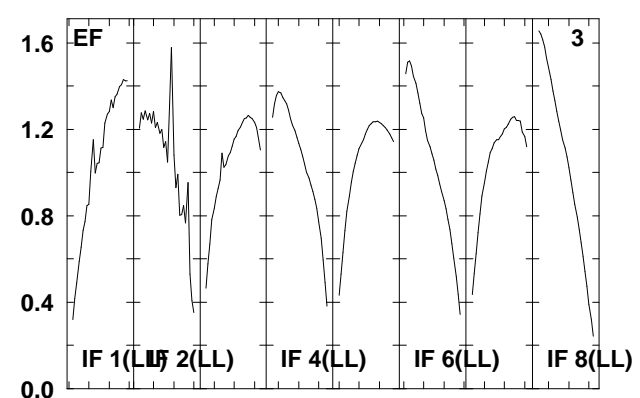
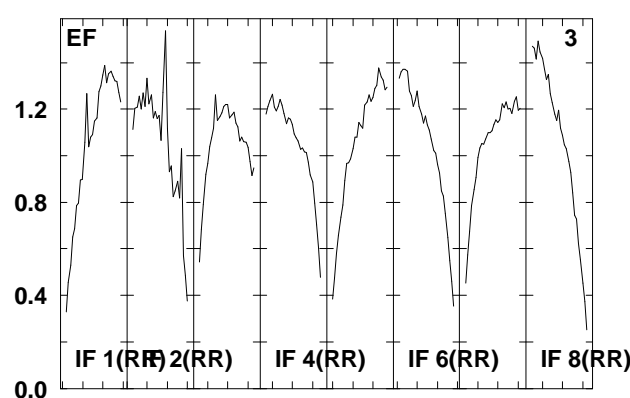
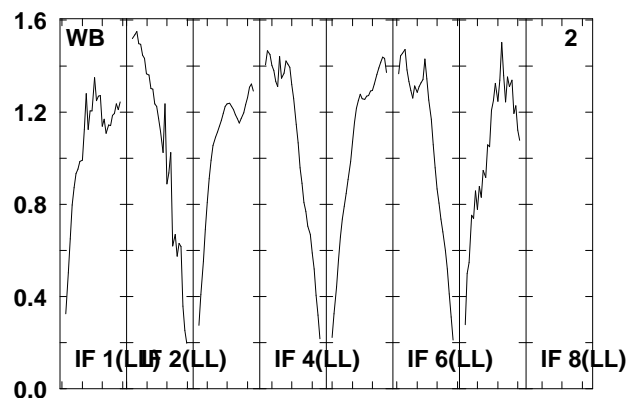
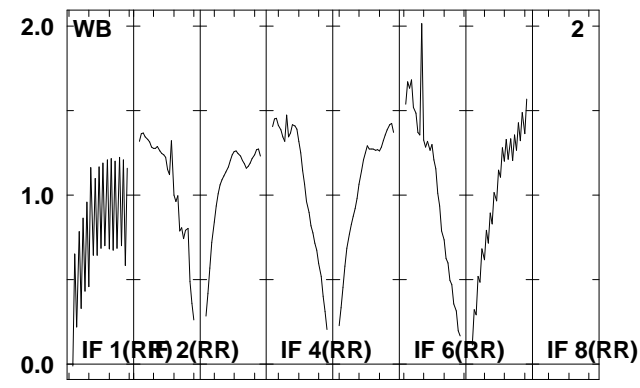
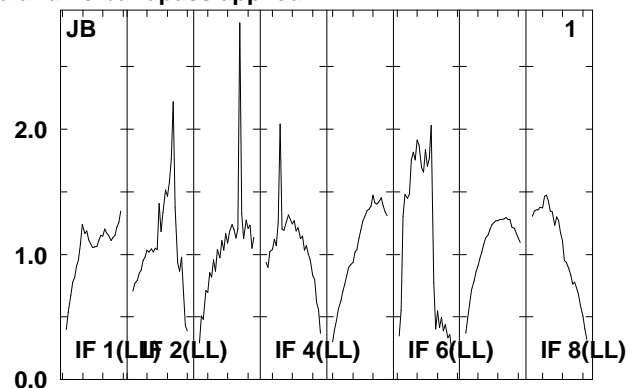
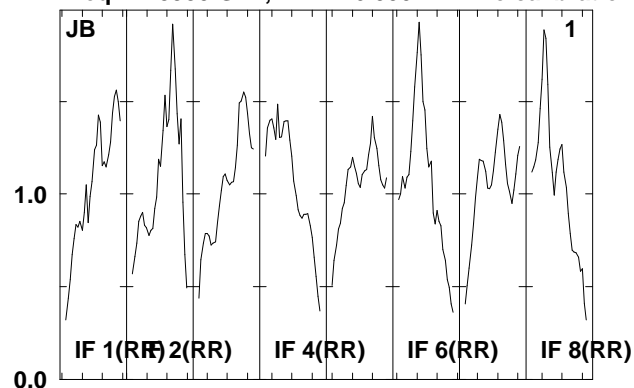

Lower frame: Real Jy  
Total-power spectrum Antenna: \*  
Timerange: 00/12:11:53 to 00/12:16:29

Plot file version 367 created 08-AUG-2008 17:01:39

J092159 EO06B.UVDATA.1

Freq = 1.5950 GHz, Bw = 16.000 MHz No calibration applied and no bandpass applied

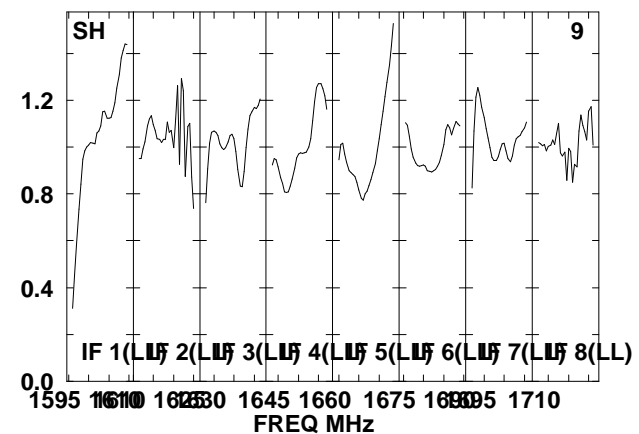
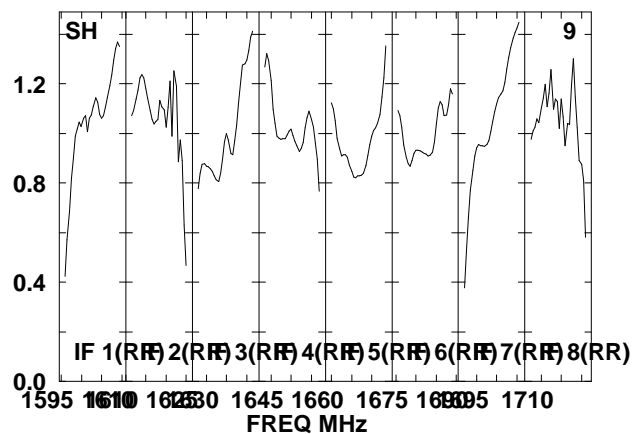
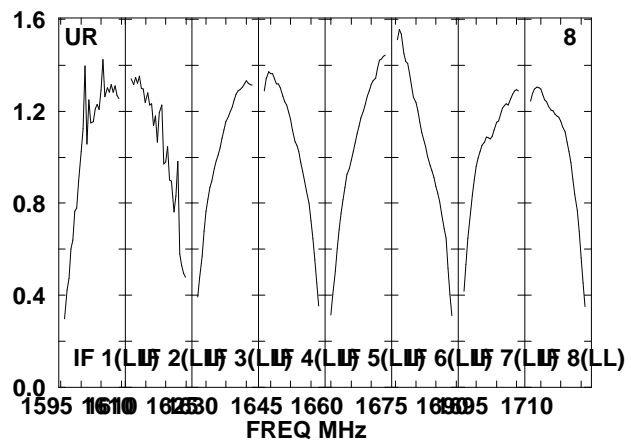
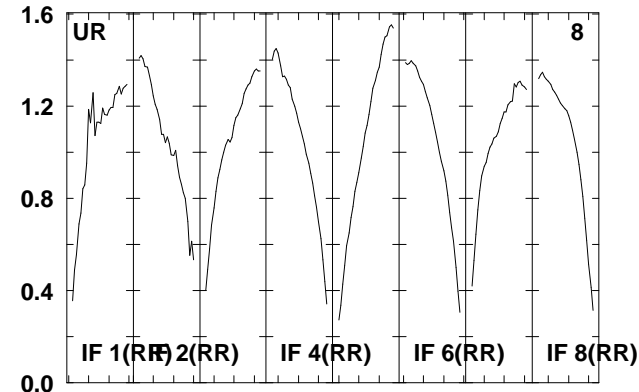
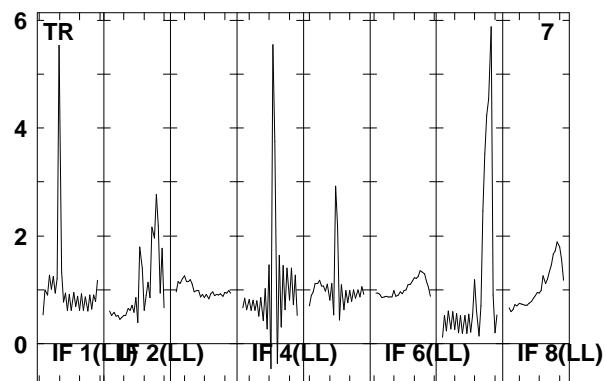
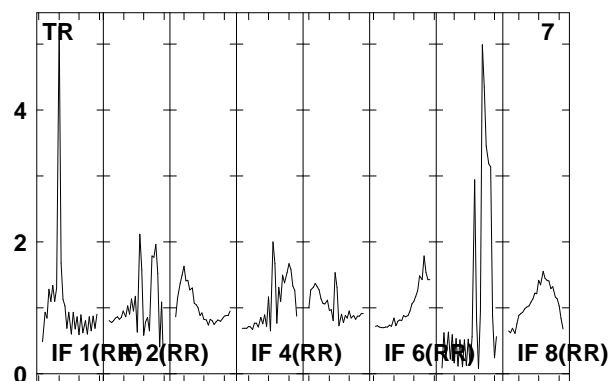
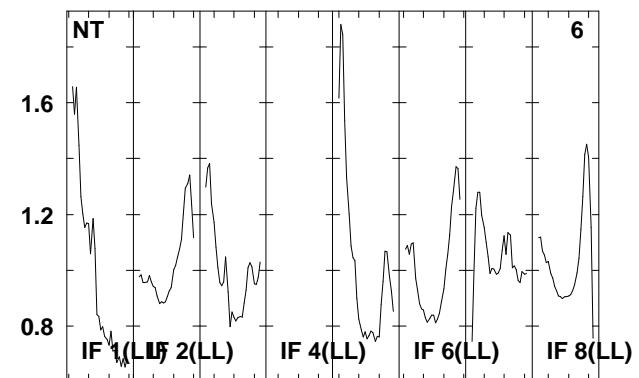
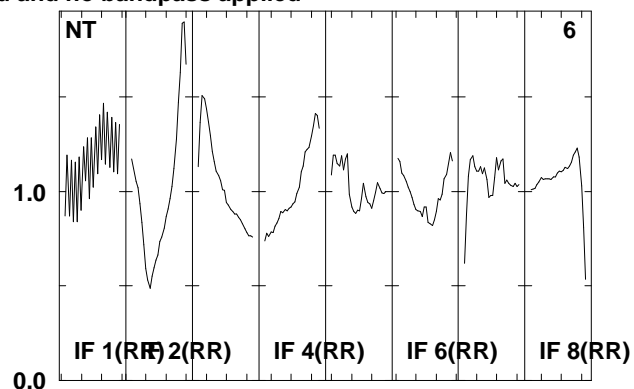
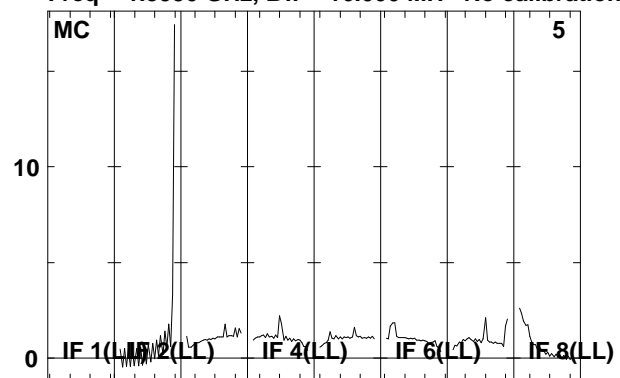

Lower frame: Real Jy

Total-power spectrum Antenna: \*

Timerange: 00/12:11:53 to 00/12:16:29

Plot file version 368 created 08-AUG-2008 17:01:40

J092159 EO006B.UVDATA.1

Freq = 1.5950 GHz, Bw = 16.000 MH No calibration applied and no bandpass applied

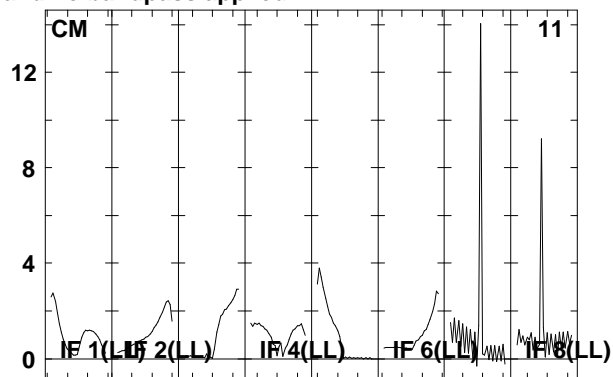
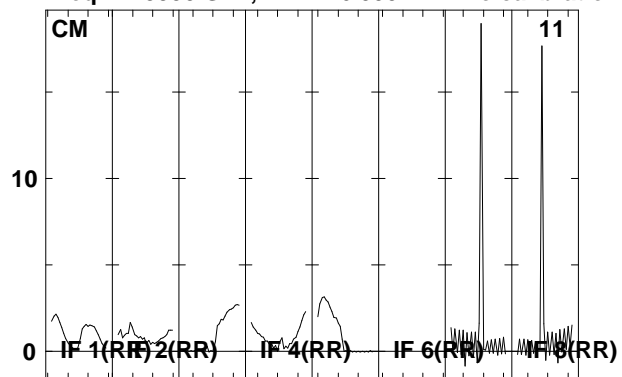

Lower frame: Real Jy  
Total-power spectrum Antenna: \*  
Timerange: 00/12:11:53 to 00/12:16:29

Plot file version 369 created 08-AUG-2008 17:01:40

J0920+44 EO006B.UVDATA.1

Freq = 1.5950 GHz, Bw = 16.000 MH No calibration applied and no bandpass applied

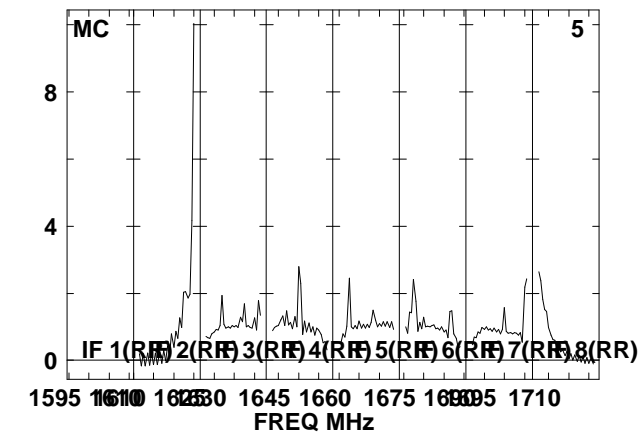
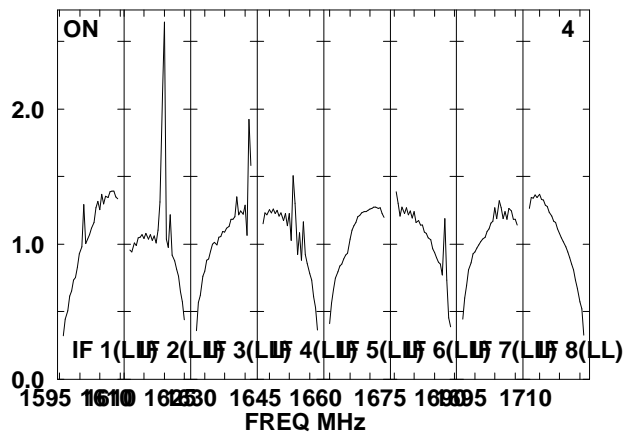
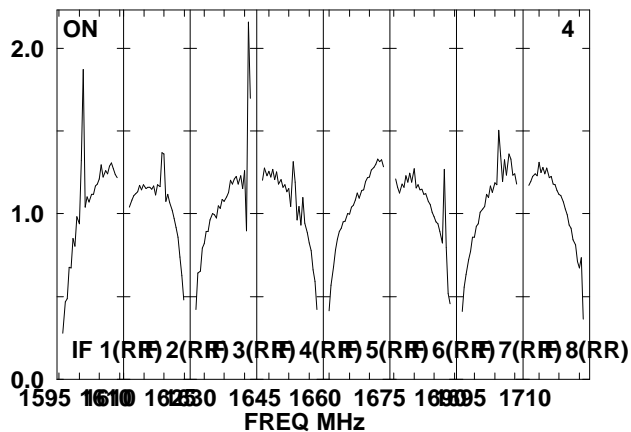
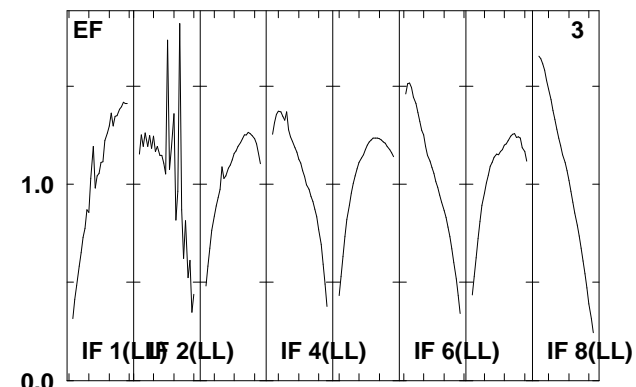
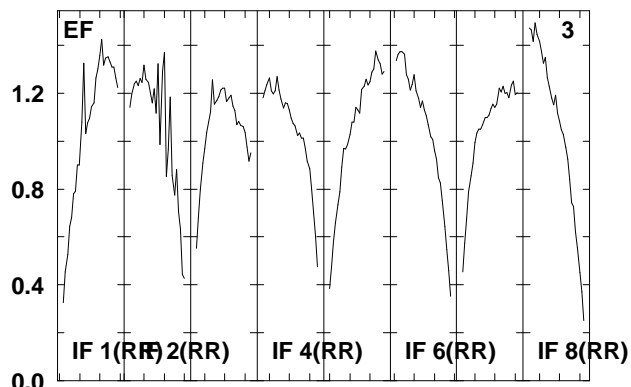
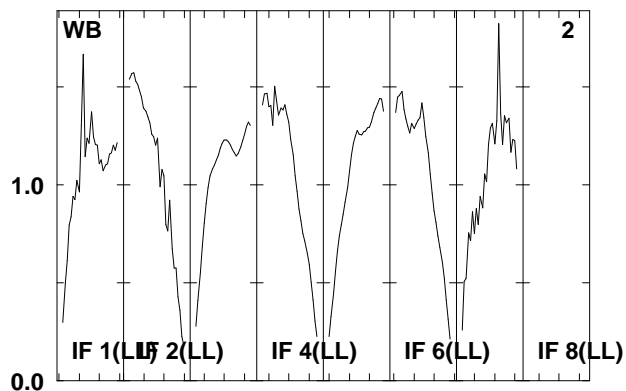
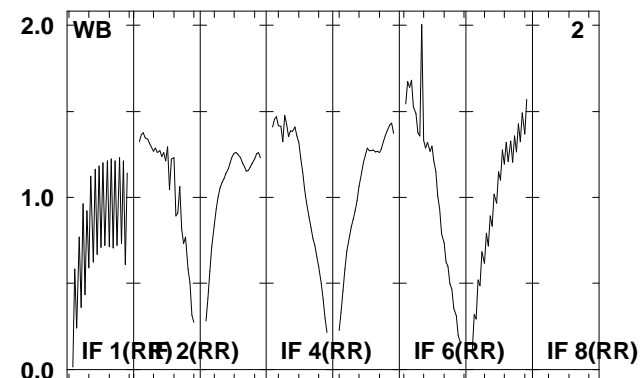
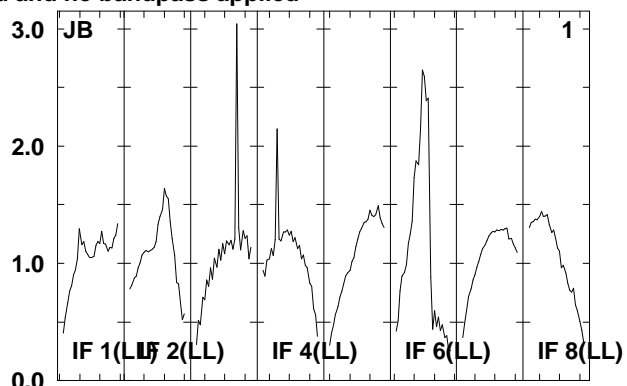
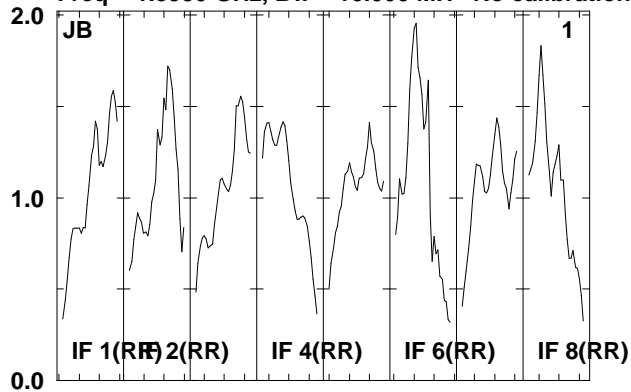

Lower frame: Real Jy  
Total-power spectrum Antenna: \*  
Timerange: 00/12:17:05 to 00/12:18:37

Plot file version 370 created 08-AUG-2008 17:01:40

J0920+44 EO006B.UVDATA.1

Freq = 1.5950 GHz, Bw = 16.000 MH No calibration applied and no bandpass applied

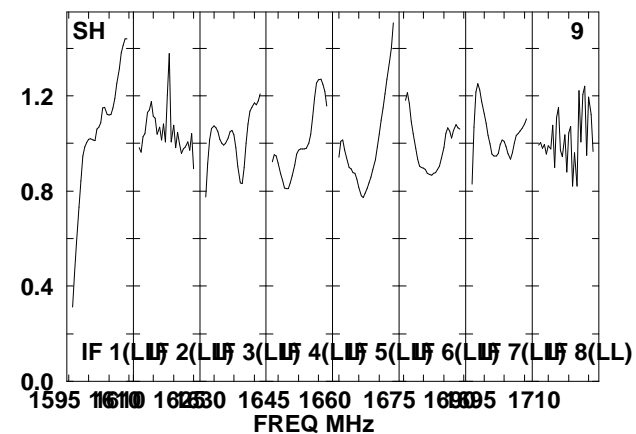
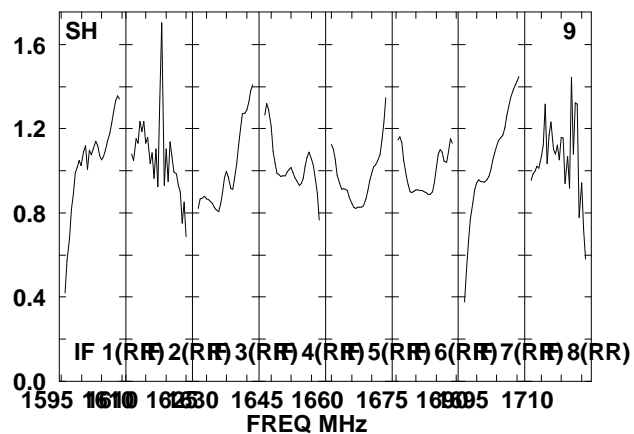
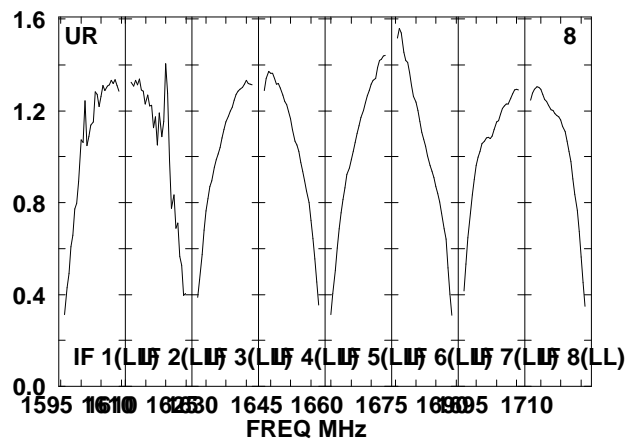
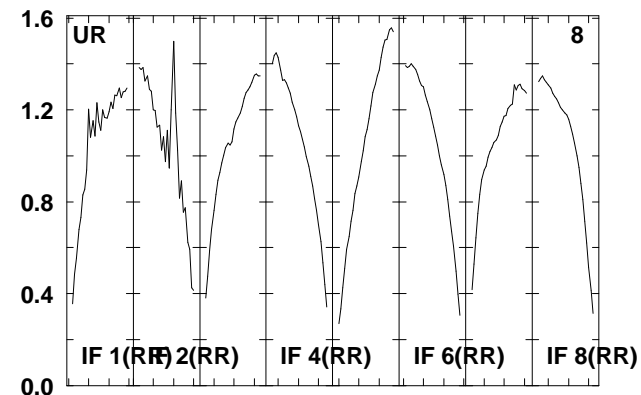
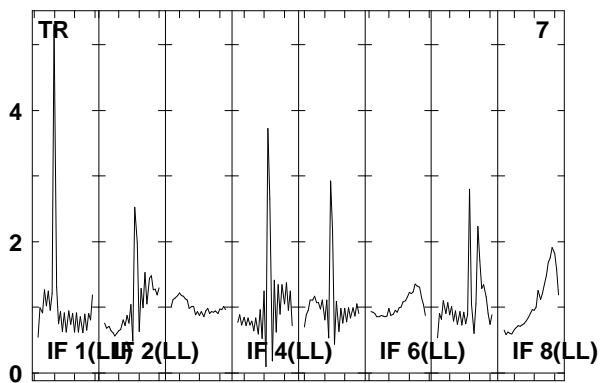
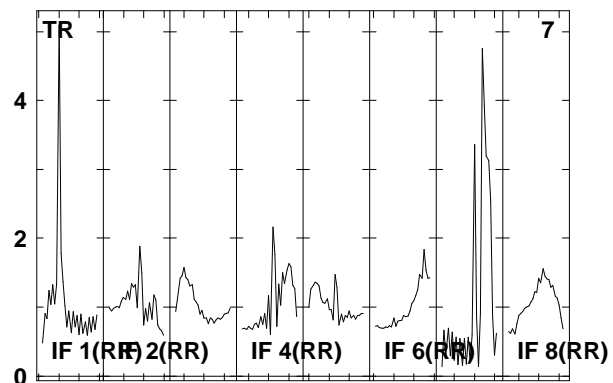
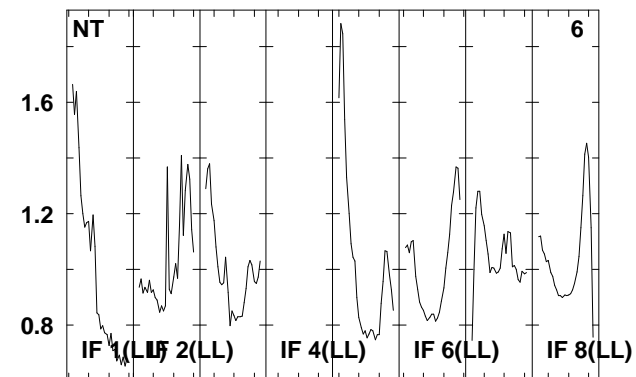
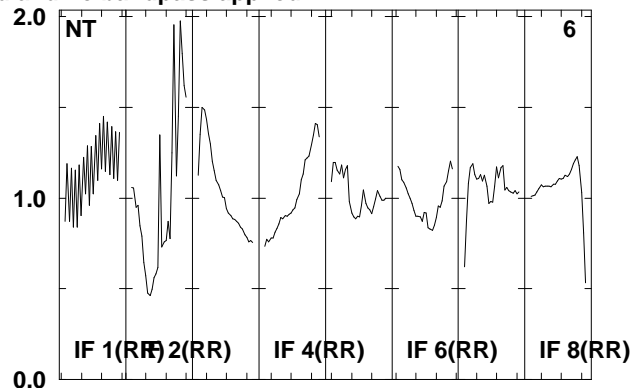
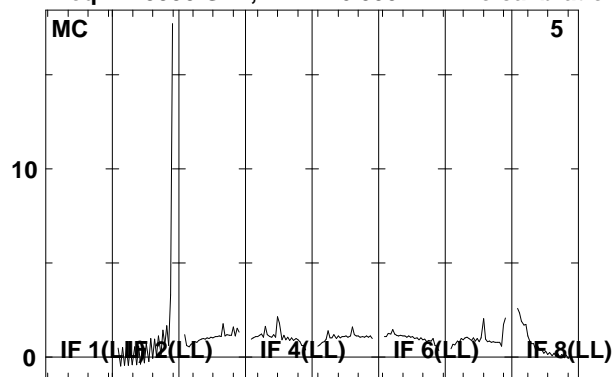

Lower frame: Real Jy

Total-power spectrum Antenna: \*

Timerange: 00/12:17:05 to 00/12:18:37

Plot file version 371 created 08-AUG-2008 17:01:41

J0920+44 EO006B.UVDATA.1

Freq = 1.5950 GHz, Bw = 16.000 MH No calibration applied and no bandpass applied

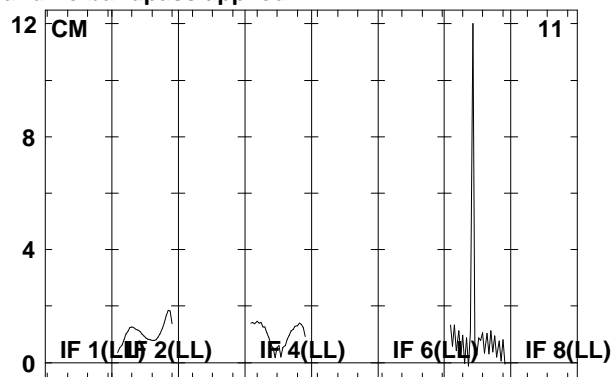
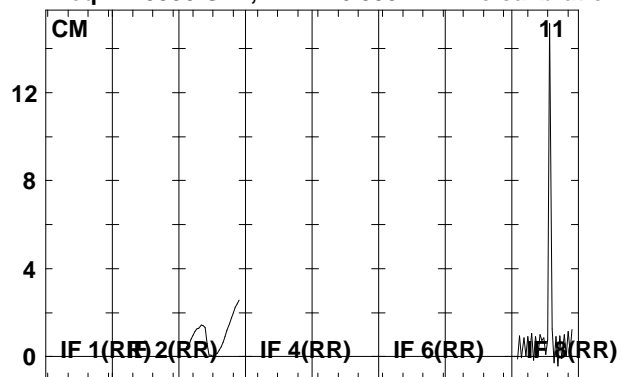

Lower frame: Real Jy  
Total-power spectrum Antenna: \*  
Timerange: 00/12:17:05 to 00/12:18:37

Plot file version 372 created 08-AUG-2008 17:01:41

J092159 EO006B.UVDATA.1

Freq = 1.5950 GHz, Bw = 16.000 MH No calibration applied and no bandpass applied

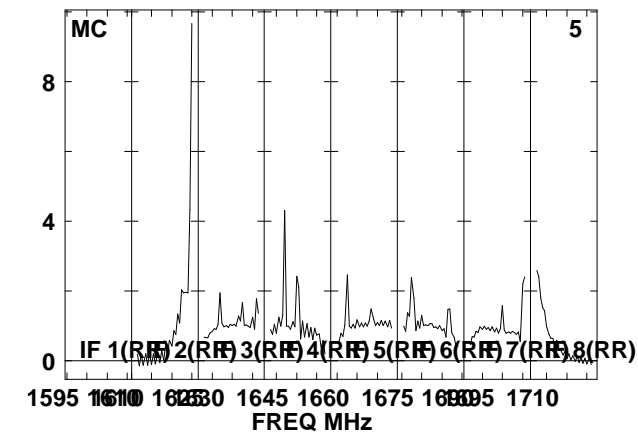
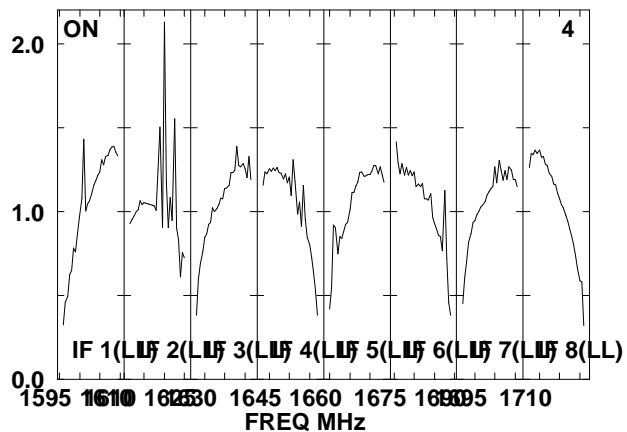
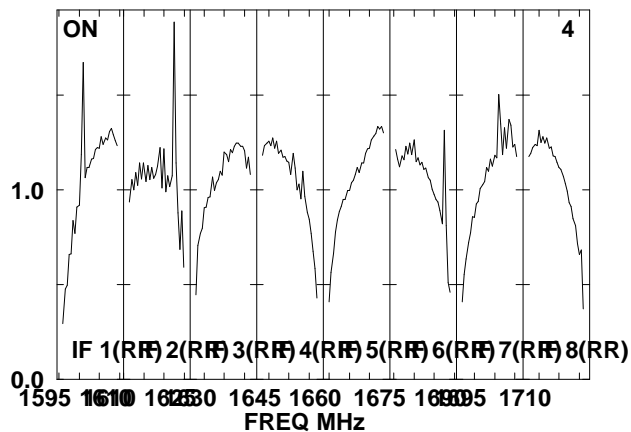
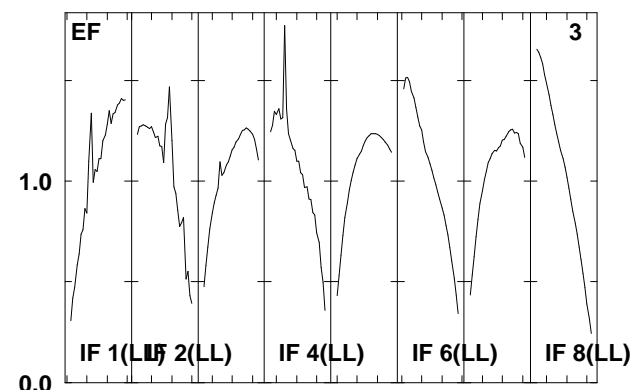
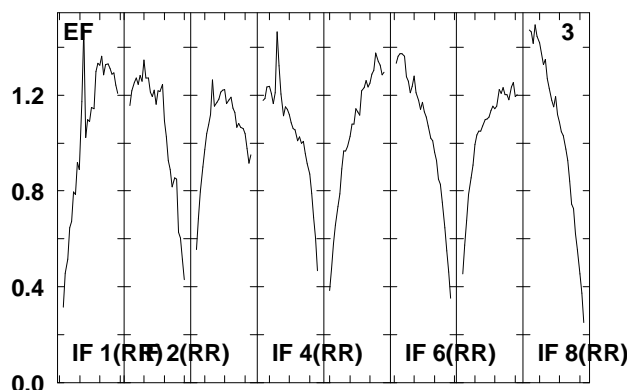
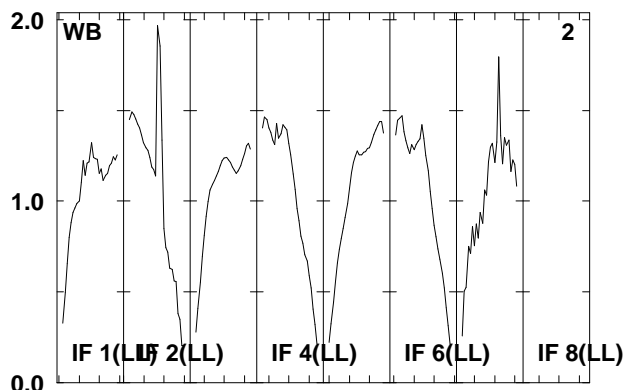
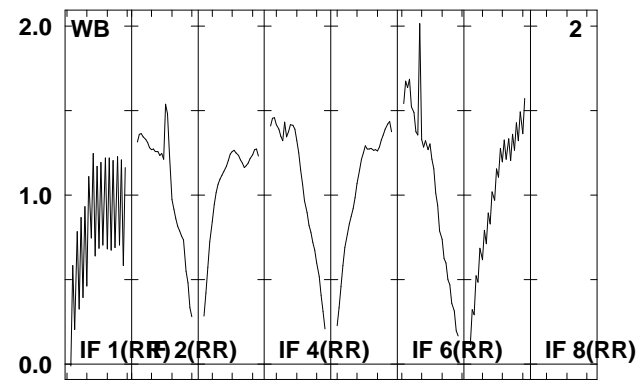
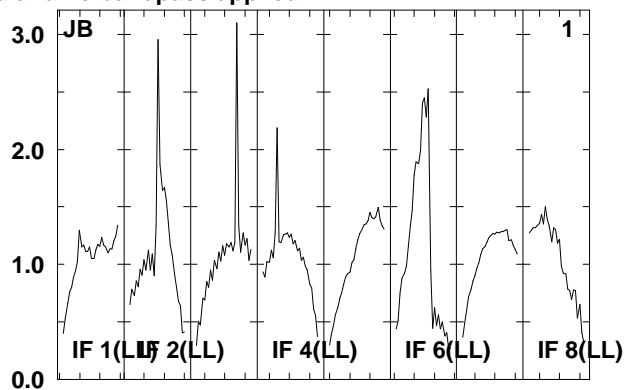
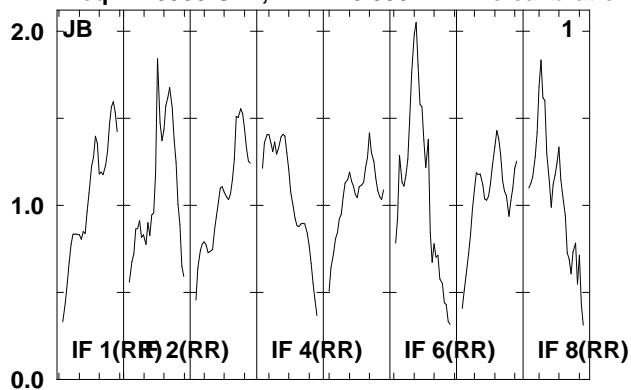

Lower frame: Real Jy  
Total-power spectrum Antenna: \*  
Timerange: 00/12:19:13 to 00/12:23:49



Plot file version 373 created 08-AUG-2008 17:01:42

J092159 EO006B.UVDATA.1

Freq = 1.5950 GHz, Bw = 16.000 MH No calibration applied and no bandpass applied

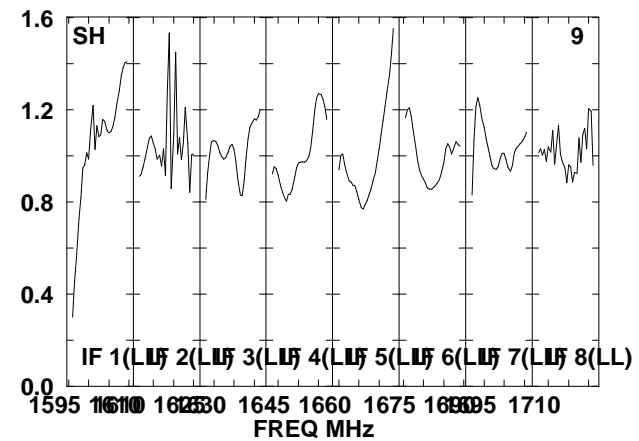
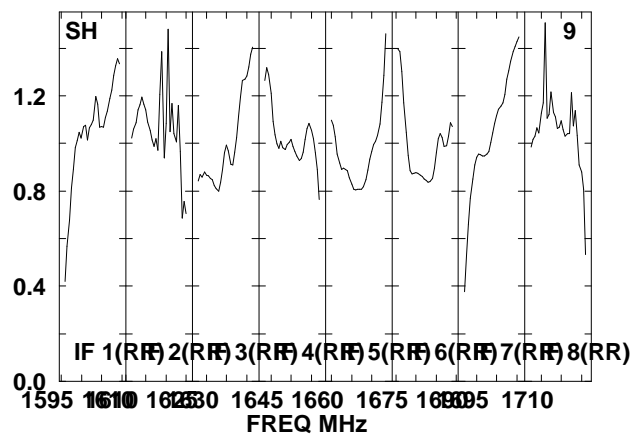
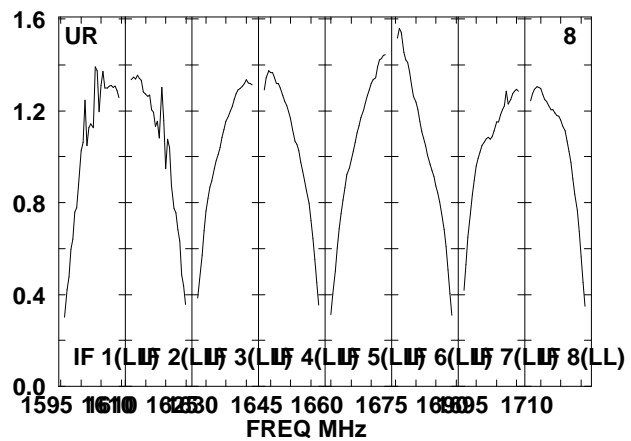
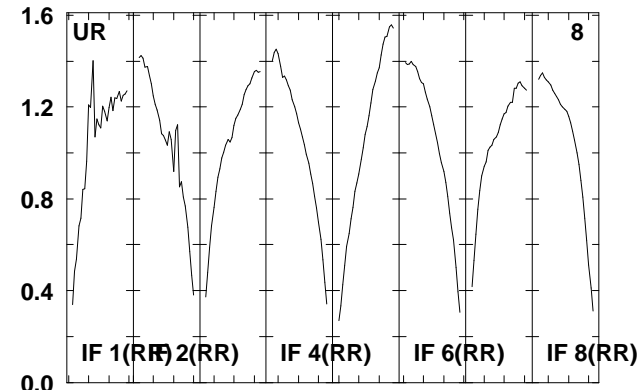
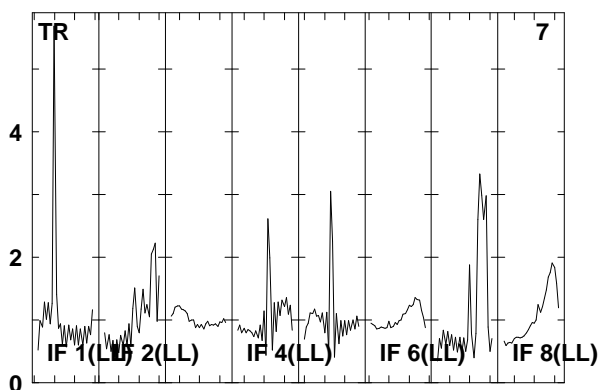
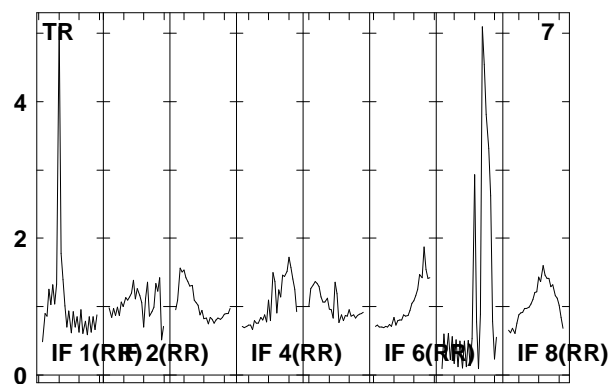
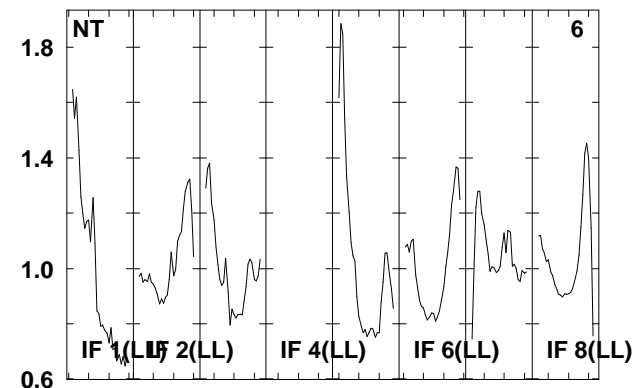
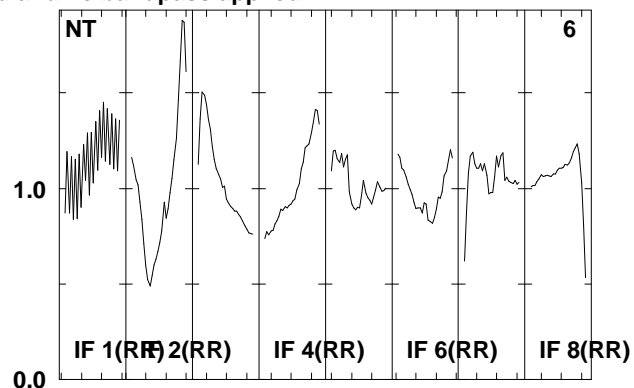
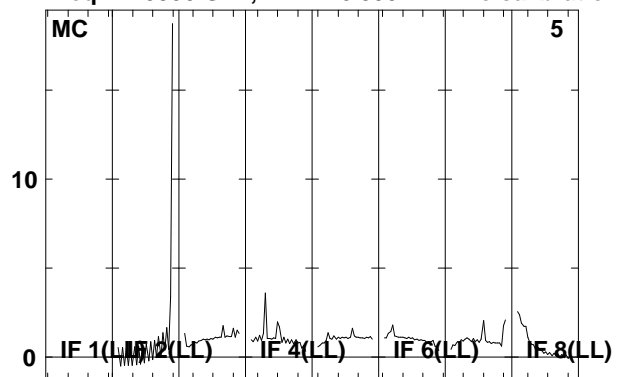

Lower frame: Real Jy

Total-power spectrum Antenna: \*

Timerange: 00/12:19:13 to 00/12:23:49

Plot file version 374 created 08-AUG-2008 17:01:43

J092159 EO006B.UVDATA.1

Freq = 1.5950 GHz, Bw = 16.000 MH No calibration applied and no bandpass applied

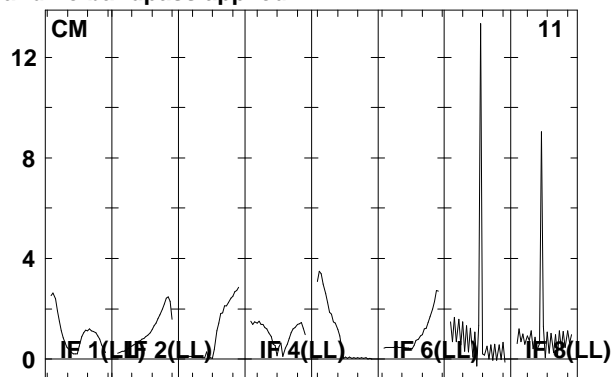
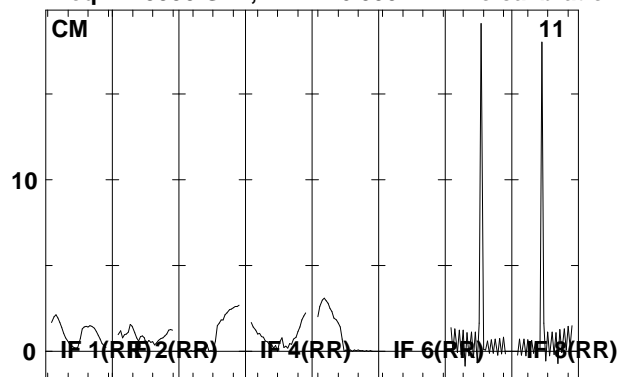

Lower frame: Real Jy  
Total-power spectrum Antenna: \*  
Timerange: 00/12:19:13 to 00/12:23:49

Plot file version 375 created 08-AUG-2008 17:01:43

J0920+44 EO006B.UVDATA.1

Freq = 1.5950 GHz, Bw = 16.000 MH No calibration applied and no bandpass applied

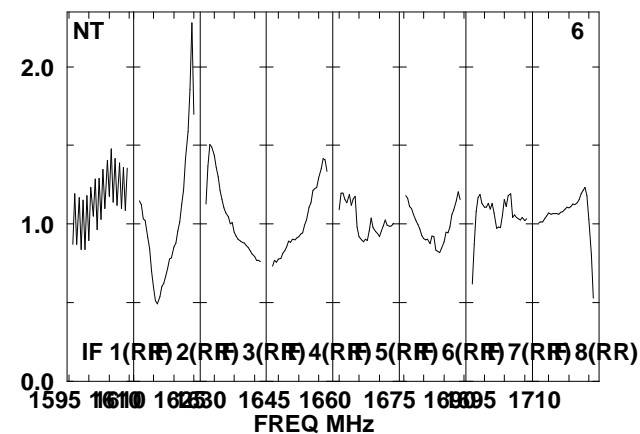
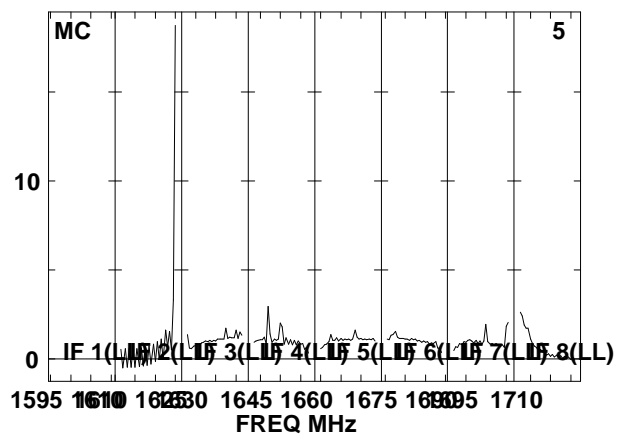
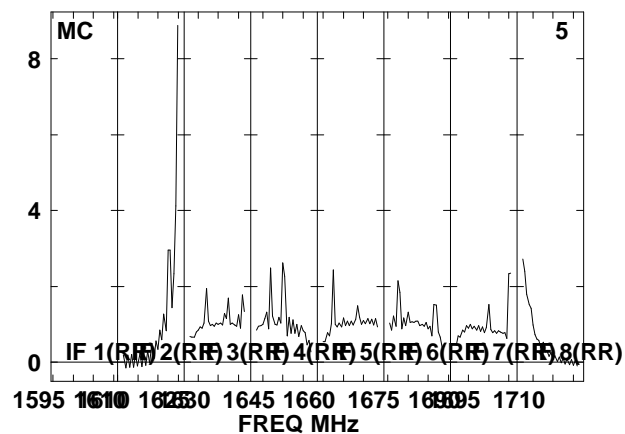
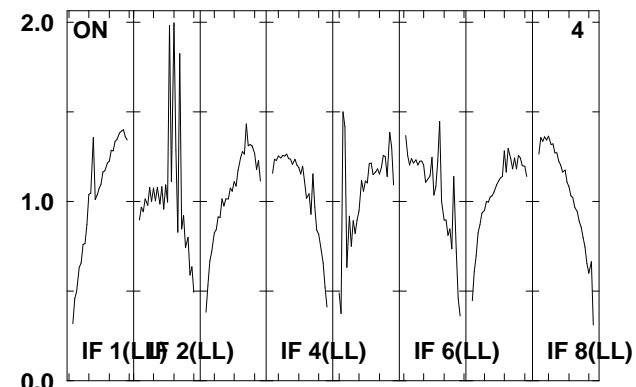
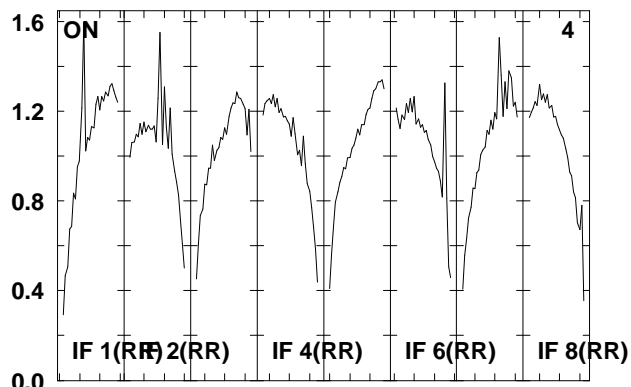
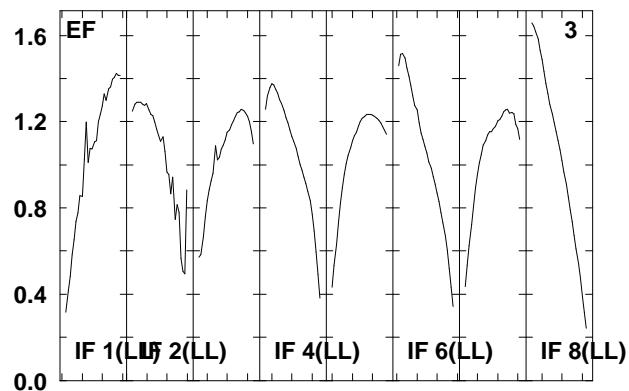
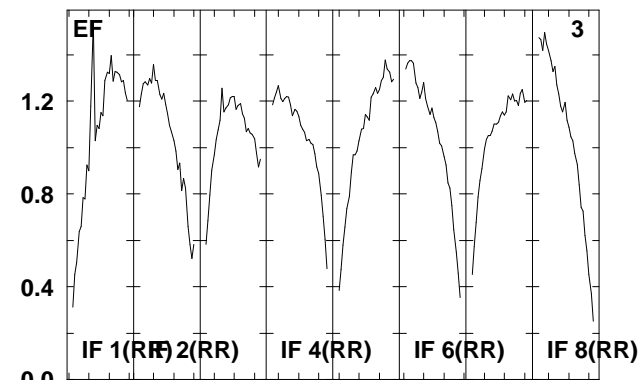
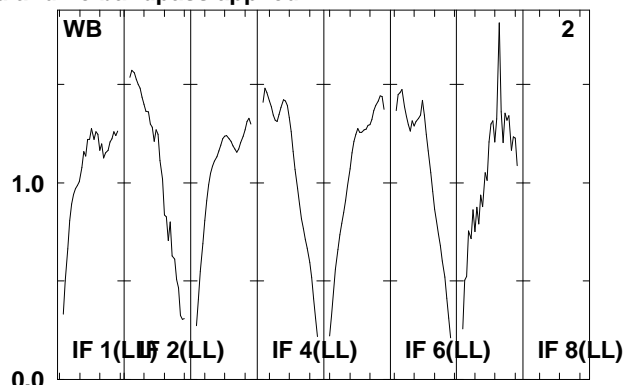
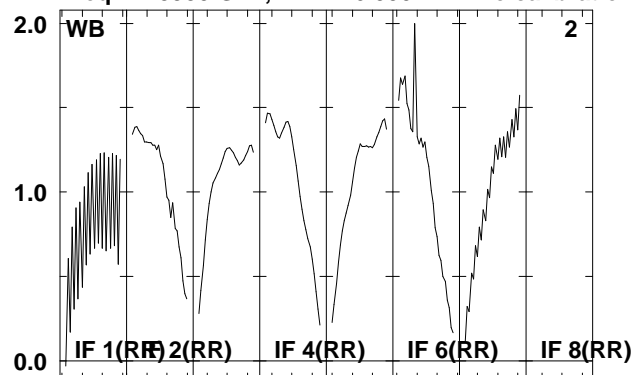

Lower frame: Real Jy

Total-power spectrum Antenna: \*

Timerange: 00/12:24:21 to 00/12:25:57

Plot file version 376 created 08-AUG-2008 17:01:43

J0920+44 EO006B.UVDATA.1

Freq = 1.5950 GHz, Bw = 16.000 MH No calibration applied and no bandpass applied

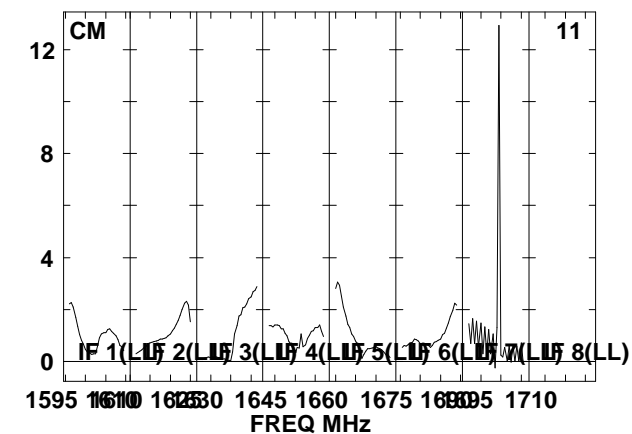
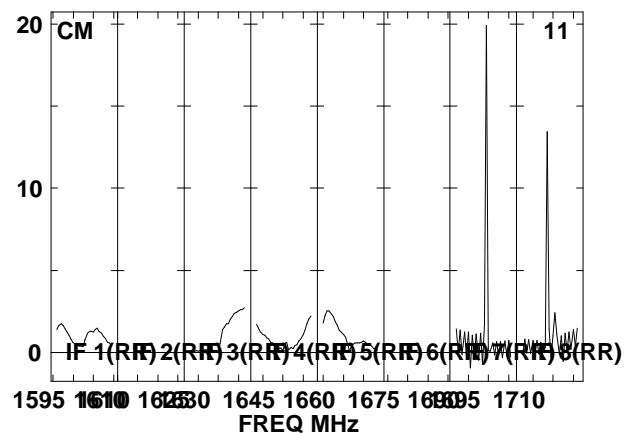
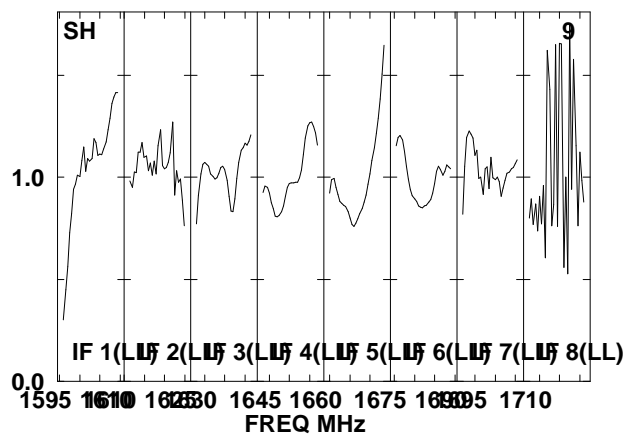
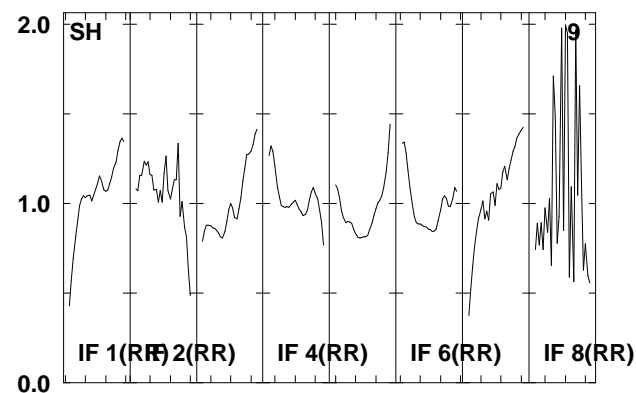
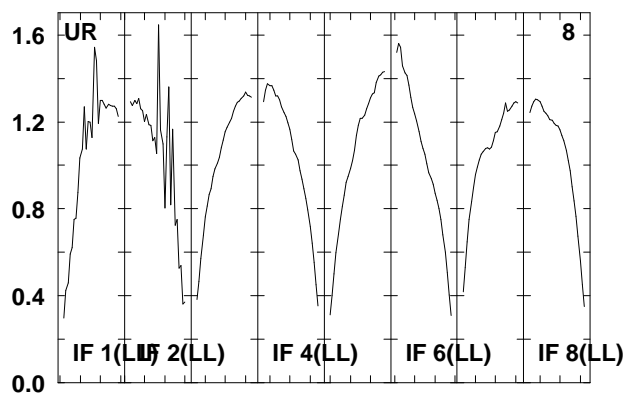
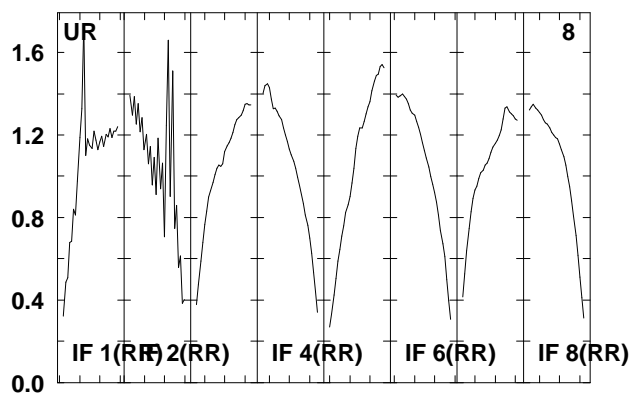
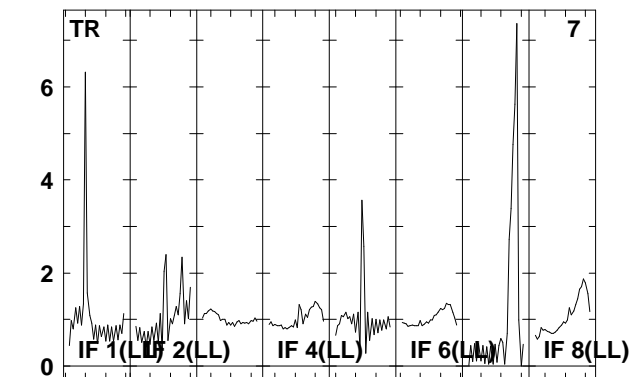
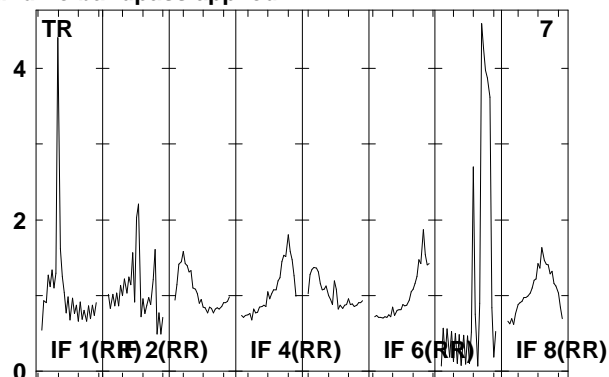
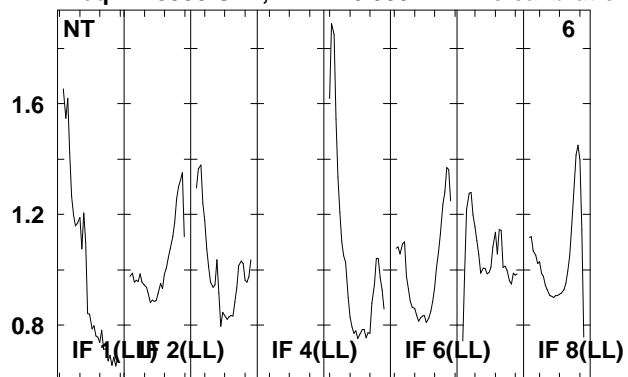

Lower frame: Real Jy  
Total-power spectrum Antenna: \*  
Timerange: 00/12:24:21 to 00/12:25:57

Plot file version 377 created 08-AUG-2008 17:01:44

J092159 EO006B.UVDATA.1

Freq = 1.5950 GHz, Bw = 16.000 MH No calibration applied and no bandpass applied

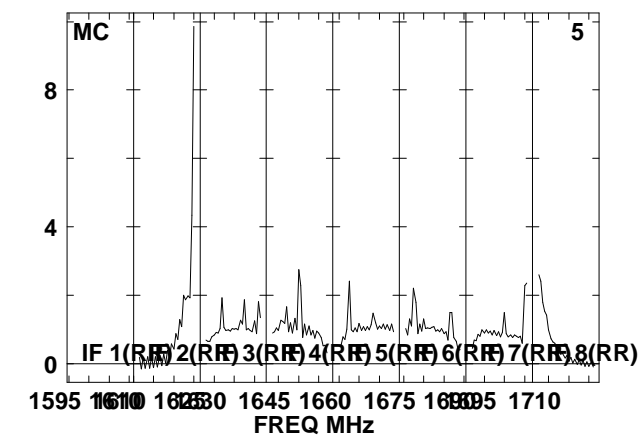
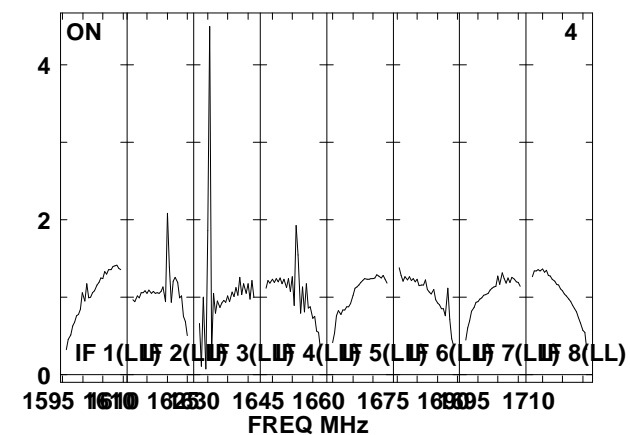
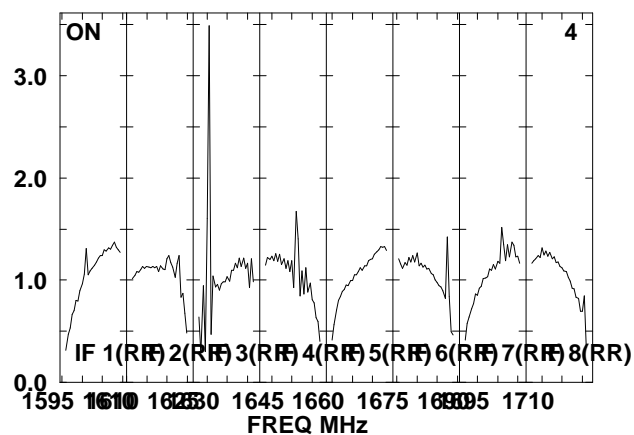
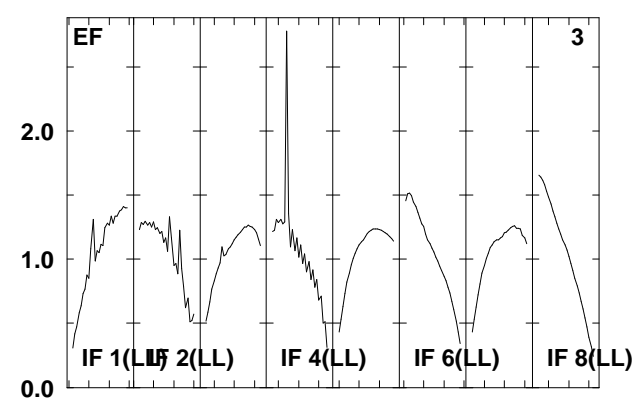
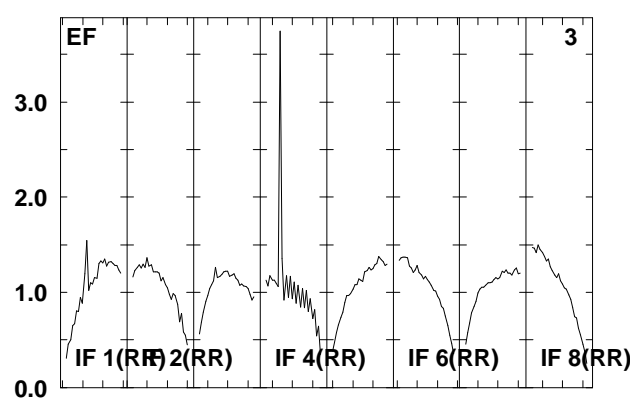
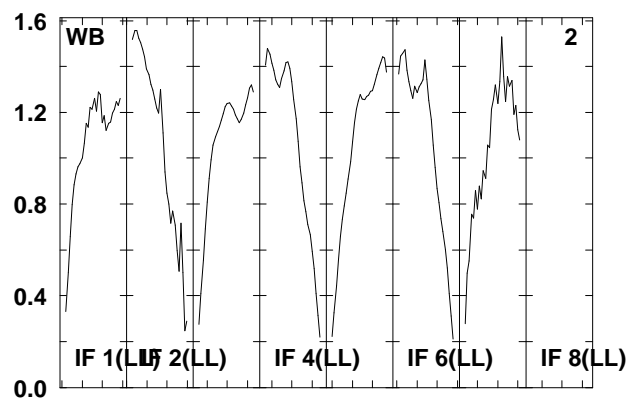
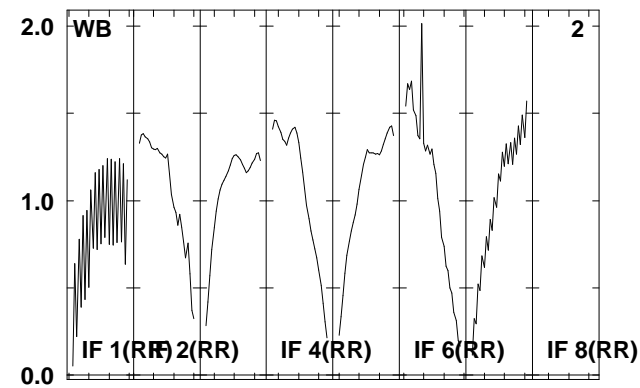
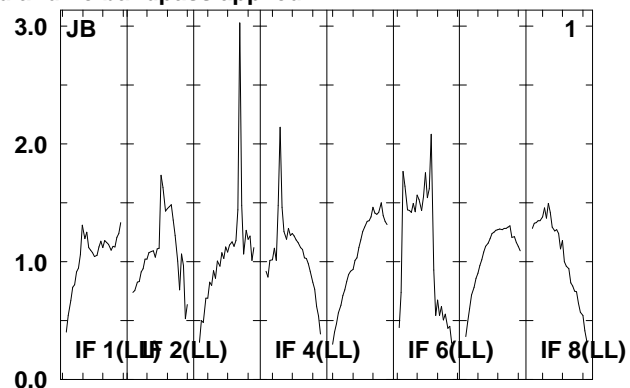
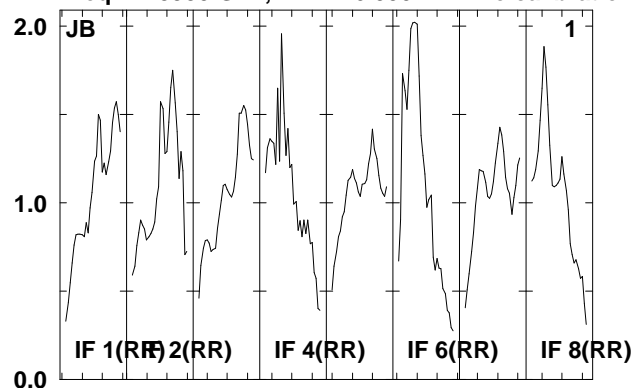

Lower frame: Real Jy  
Total-power spectrum Antenna: \*  
Timerange: 00/12:26:33 to 00/12:31:09

Plot file version 378 created 08-AUG-2008 17:01:44

J092159 EO06B.UVDATA.1

Freq = 1.5950 GHz, Bw = 16.000 MH No calibration applied and no bandpass applied

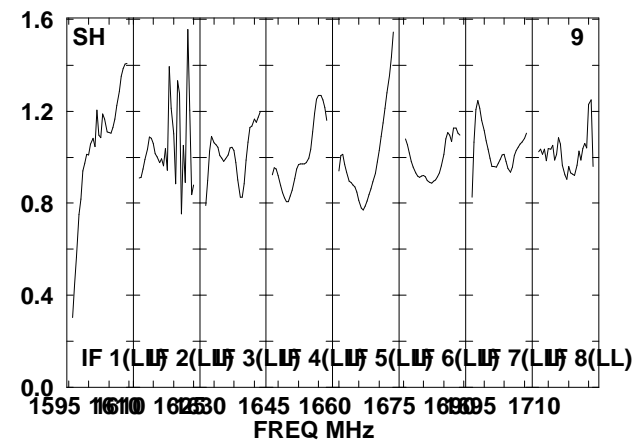
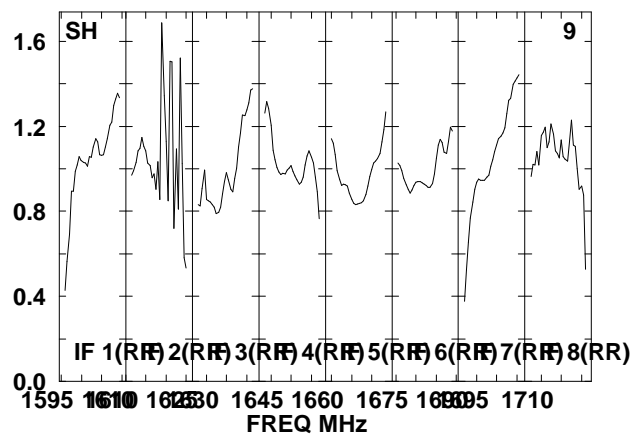
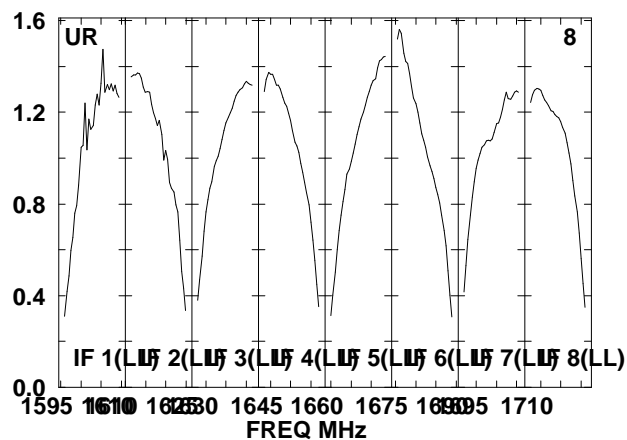
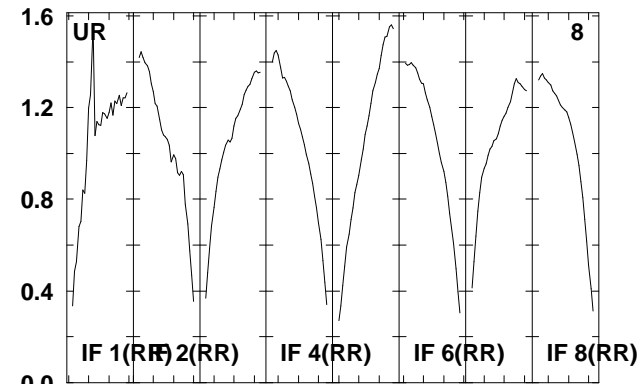
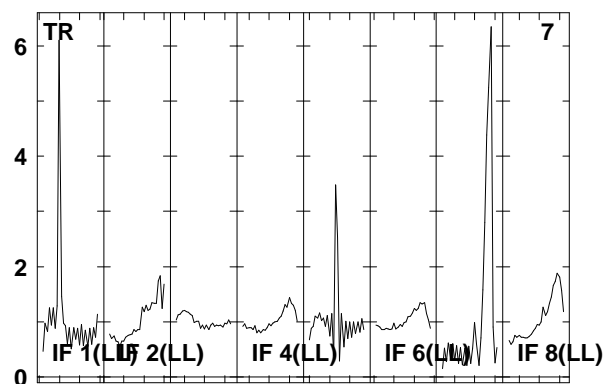
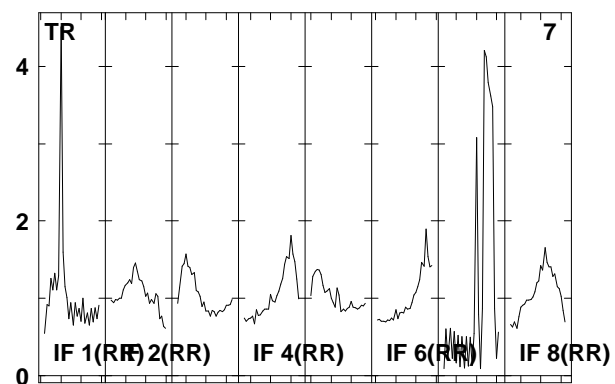
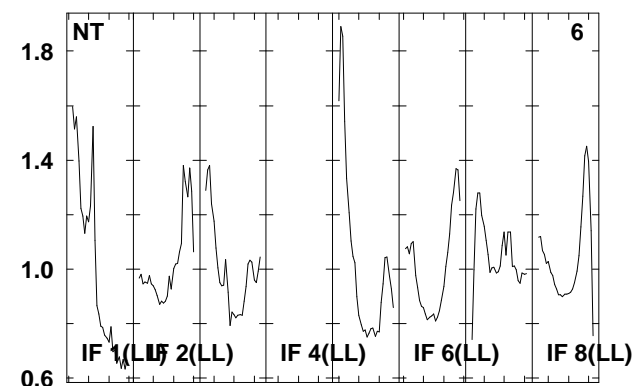
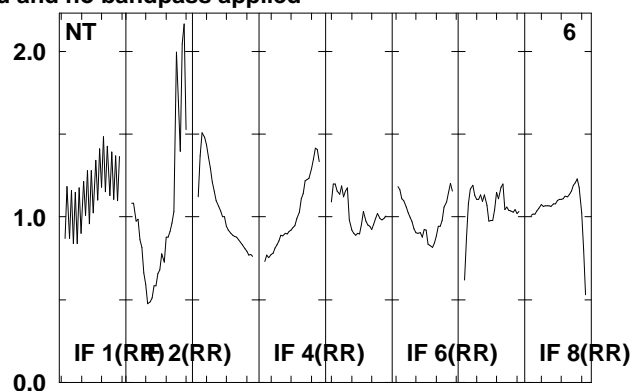
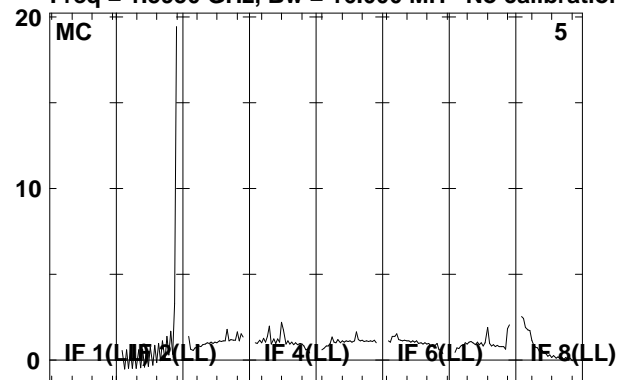

Lower frame: Real Jy  
Total-power spectrum Antenna: \*  
Timerange: 00/12:26:33 to 00/12:31:09

Plot file version 379 created 08-AUG-2008 17:01:45

J092159 EO006B.UVDATA.1

Freq = 1.5950 GHz, Bw = 16.000 MH No calibration applied and no bandpass applied

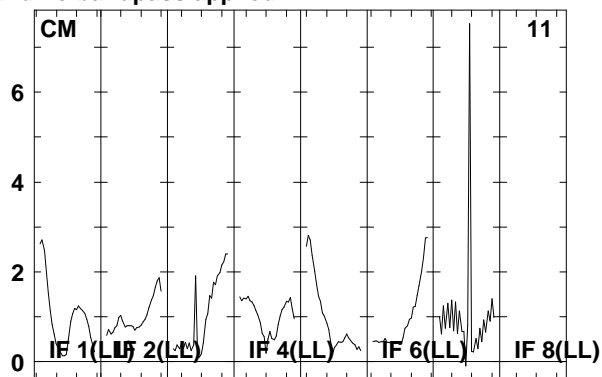
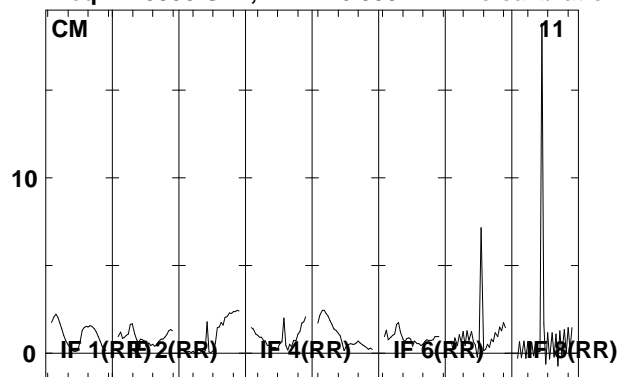

Lower frame: Real Jy  
Total-power spectrum Antenna: \*  
Timerange: 00/12:26:33 to 00/12:31:09

Plot file version 380 created 08-AUG-2008 17:01:46

J0920+44 EO006B.UVDATA.1

Freq = 1.5950 GHz, Bw = 16.000 MH No calibration applied and no bandpass applied

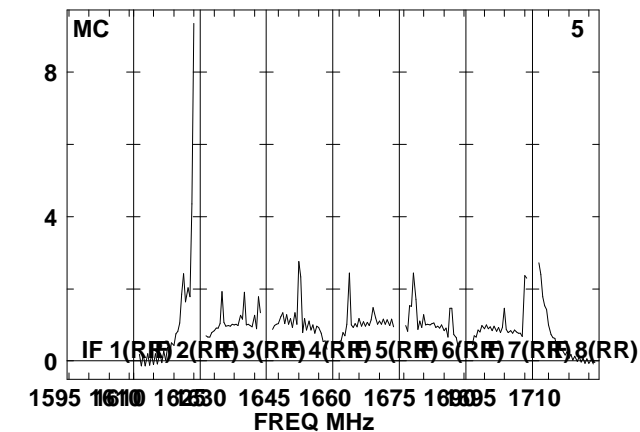
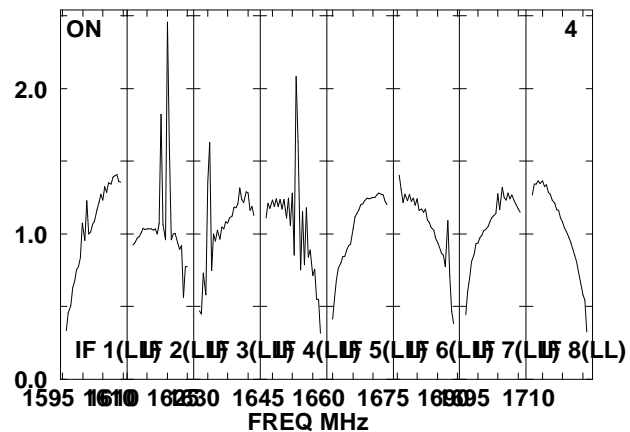
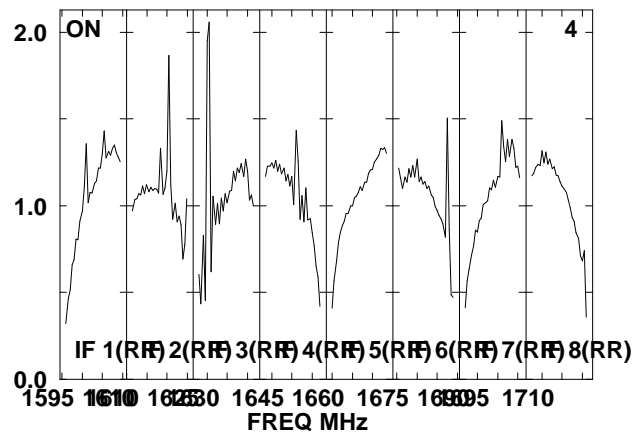
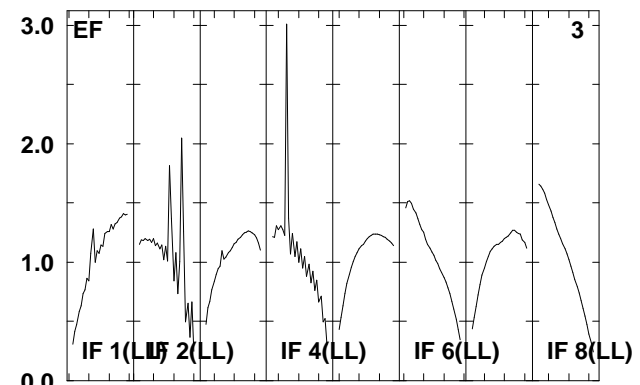
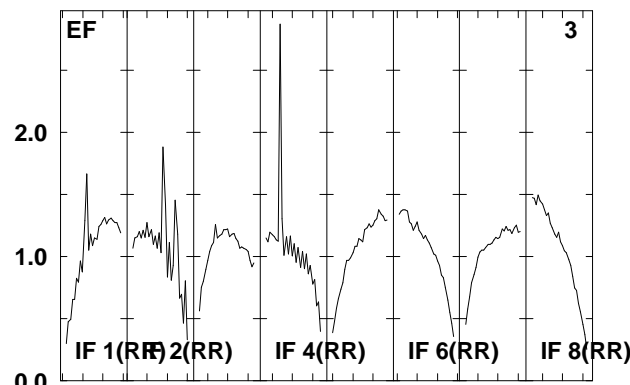
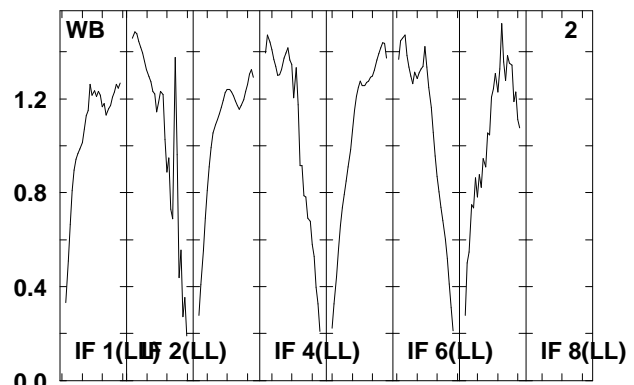
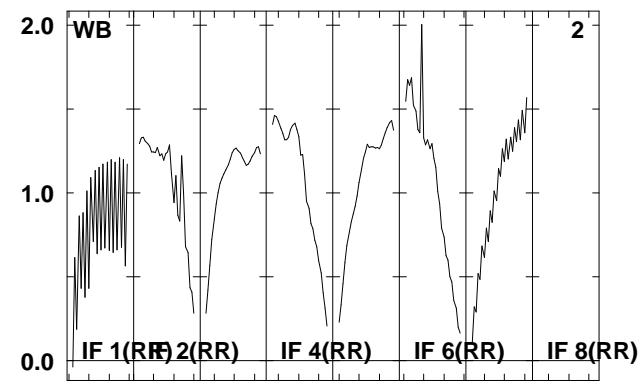
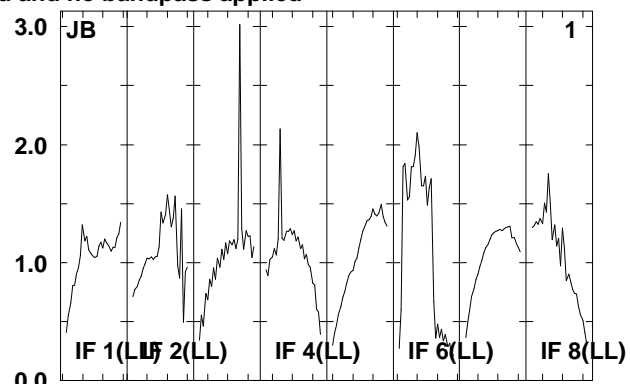
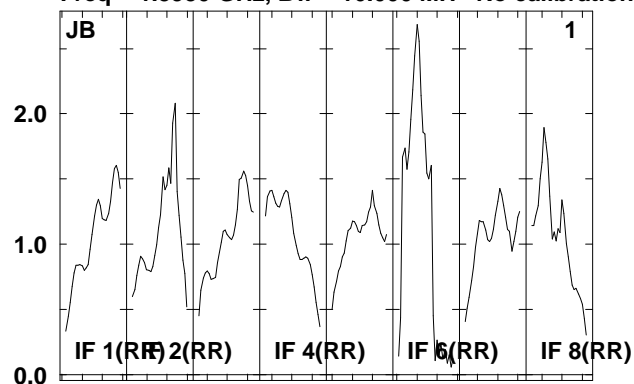

Lower frame: Real Jy  
Total-power spectrum Antenna: \*  
Timerange: 00/12:31:41 to 00/12:33:17



Plot file version 381 created 08-AUG-2008 17:01:46

J0920+44 EO006B.UVDATA.1

Freq = 1.5950 GHz, Bw = 16.000 MH No calibration applied and no bandpass applied

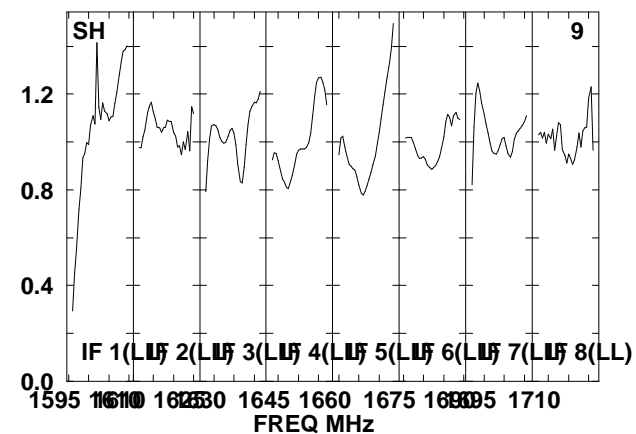
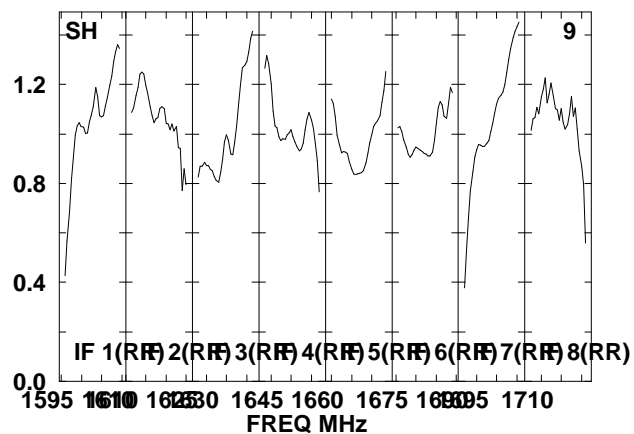
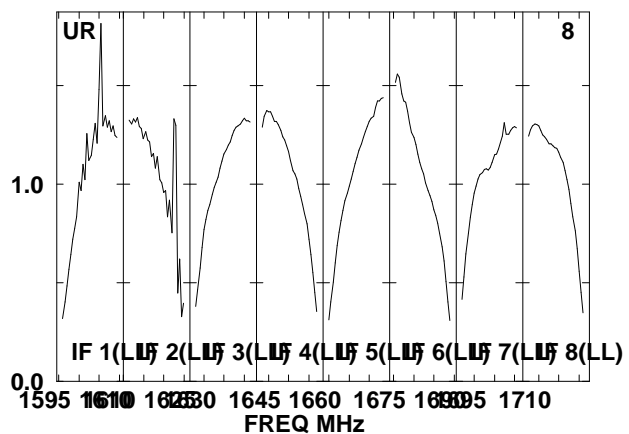
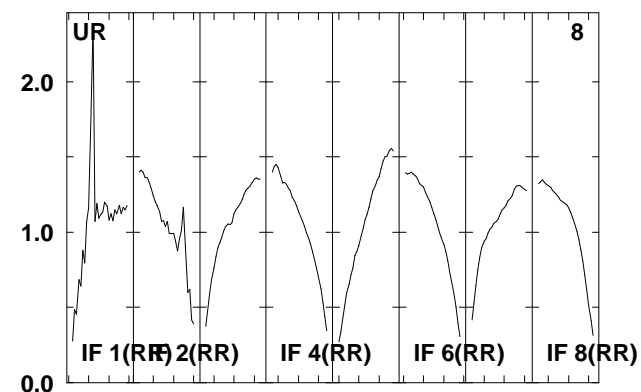
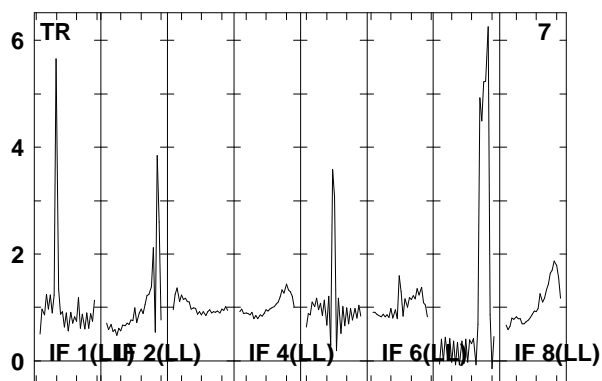
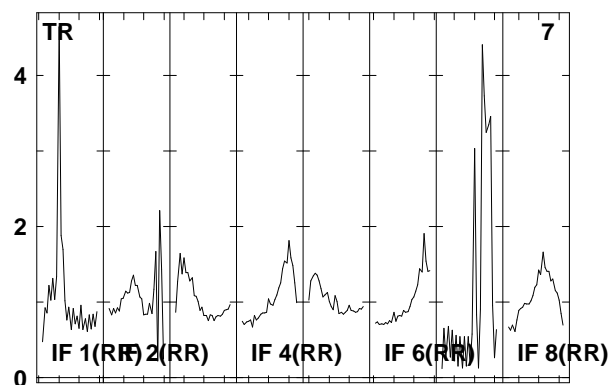
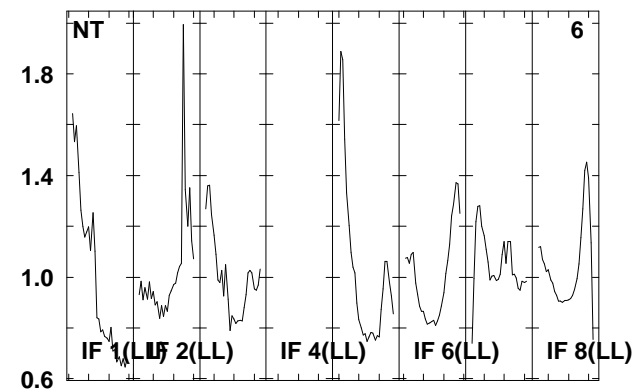
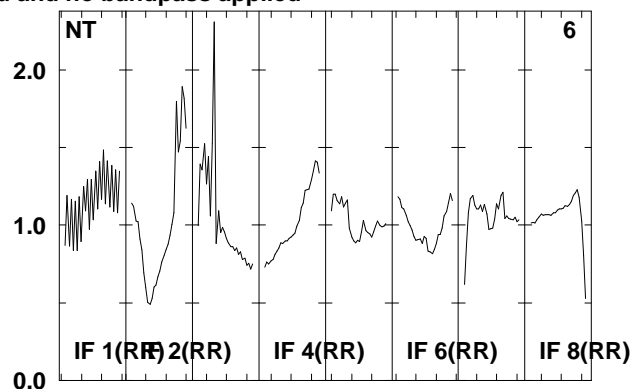
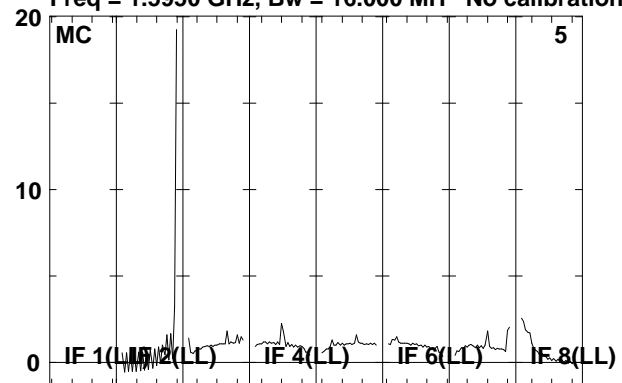

Lower frame: Real Jy

Total-power spectrum Antenna: \*

Timerange: 00/12:31:41 to 00/12:33:17

Plot file version 382 created 08-AUG-2008 17:01:47

J0920+44 EO006B.UVDATA.1

Freq = 1.5950 GHz, Bw = 16.000 MH No calibration applied and no bandpass applied

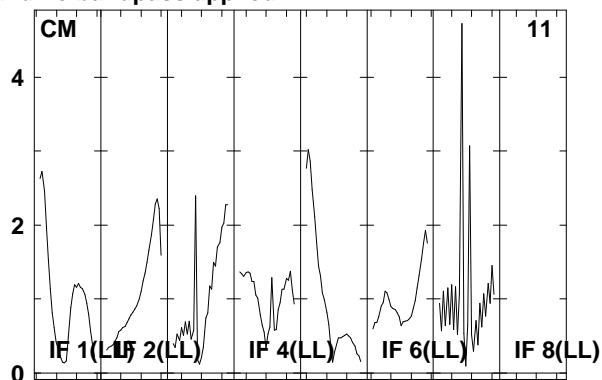
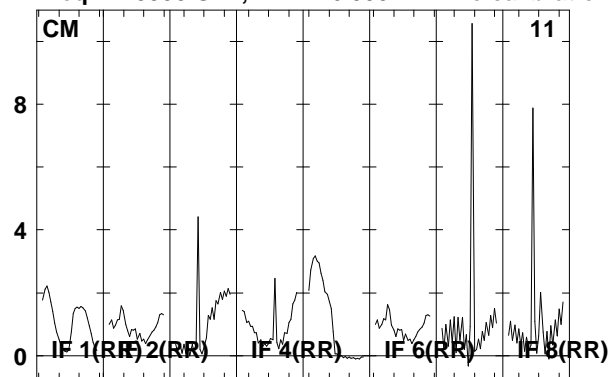

Lower frame: Real Jy  
Total-power spectrum Antenna: \*  
Timerange: 00/12:31:41 to 00/12:33:17

Plot file version 383 created 08-AUG-2008 17:01:47

J0927+39 EO006B.UVDATA.1

Freq = 1.5950 GHz, Bw = 16.000 MH No calibration applied and no bandpass applied

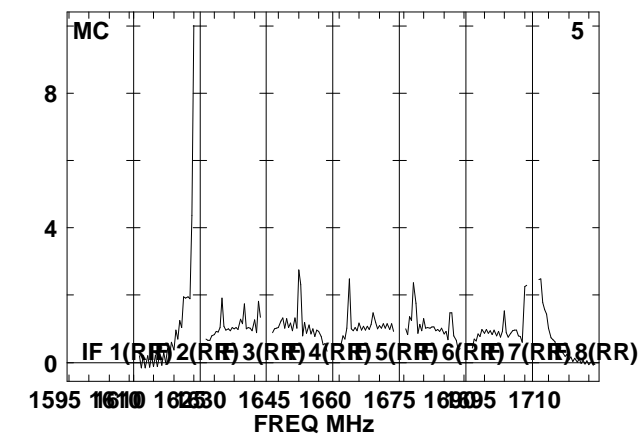
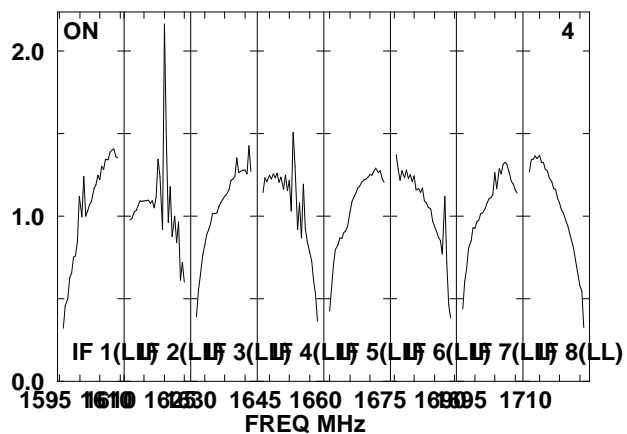
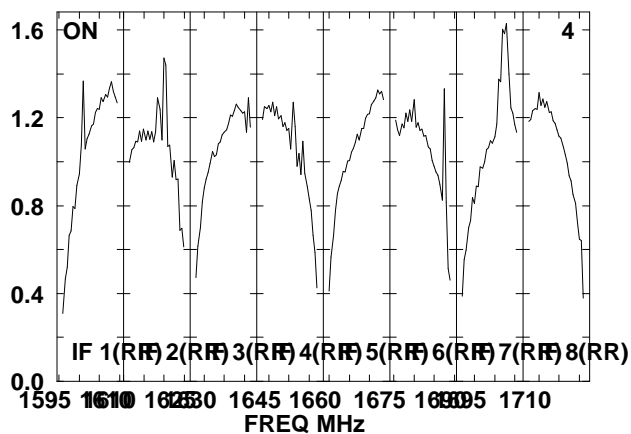
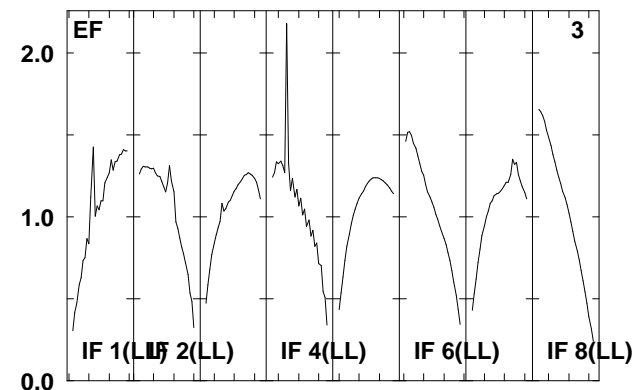
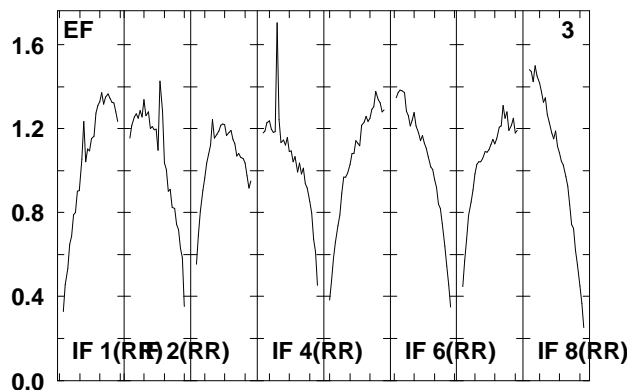
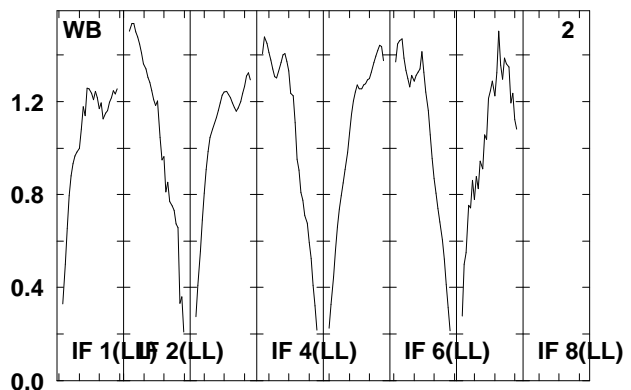
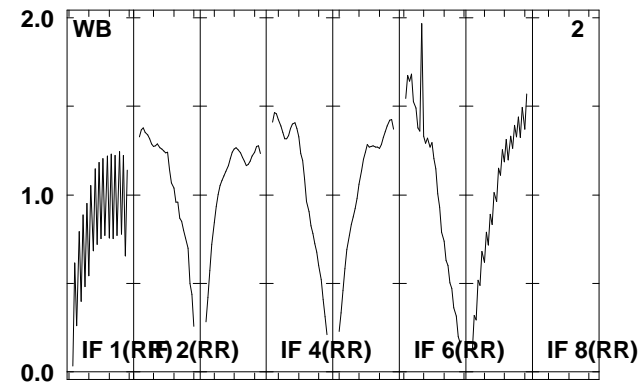
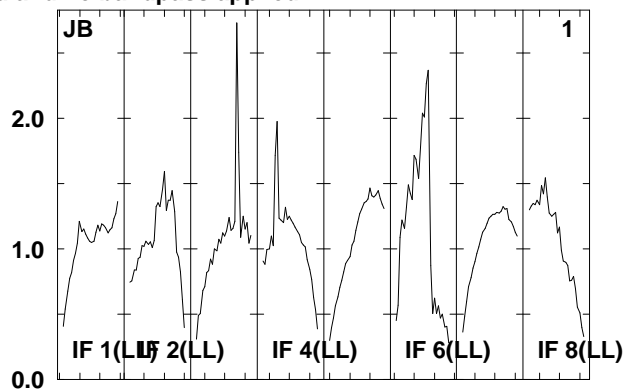
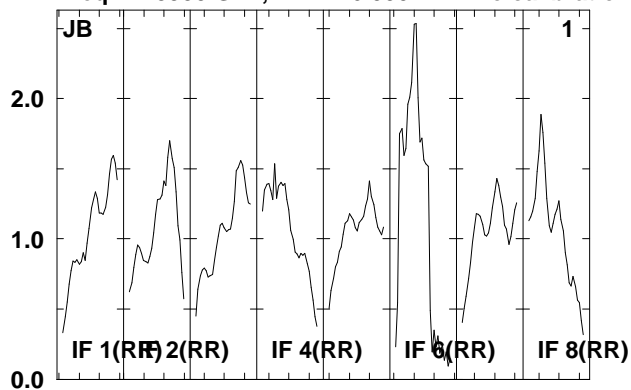

Lower frame: Real Jy  
Total-power spectrum Antenna: \*  
Timerange: 00/12:34:23 to 00/12:41:19

Plot file version 384 created 08-AUG-2008 17:01:48

J0927+39 EO006B.UVDATA.1

Freq = 1.5950 GHz, Bw = 16.000 MH No calibration applied and no bandpass applied

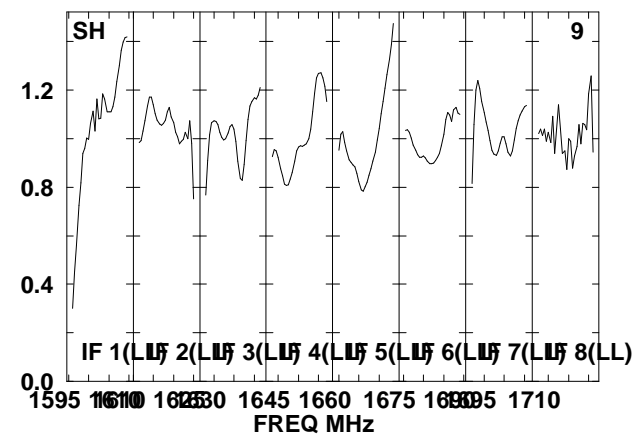
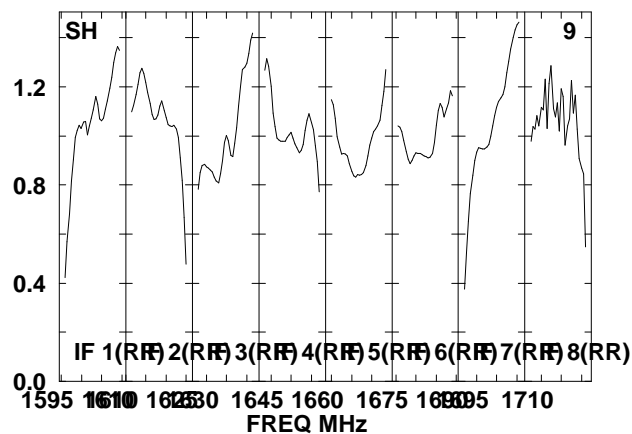
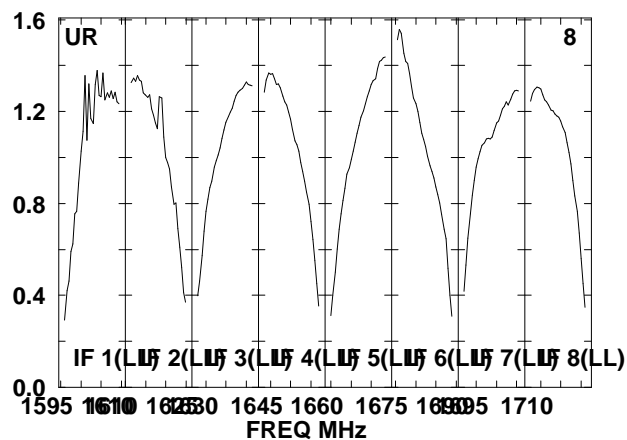
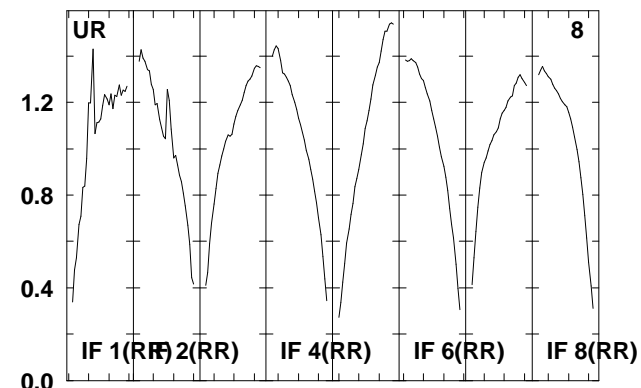
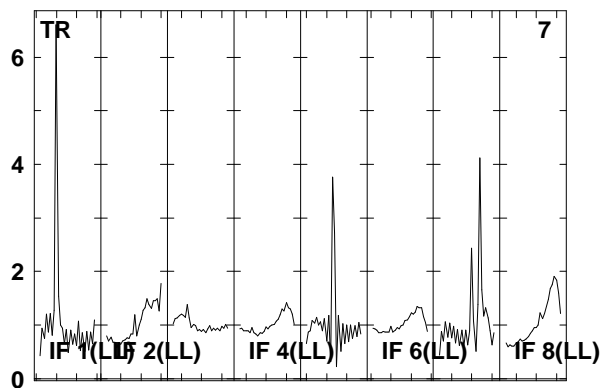
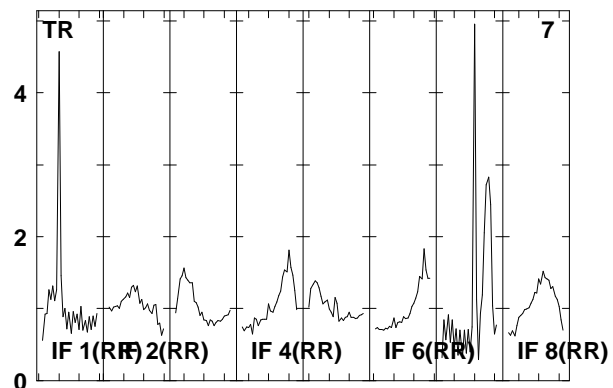
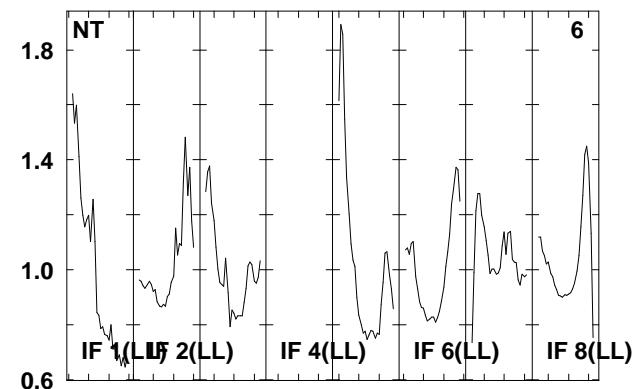
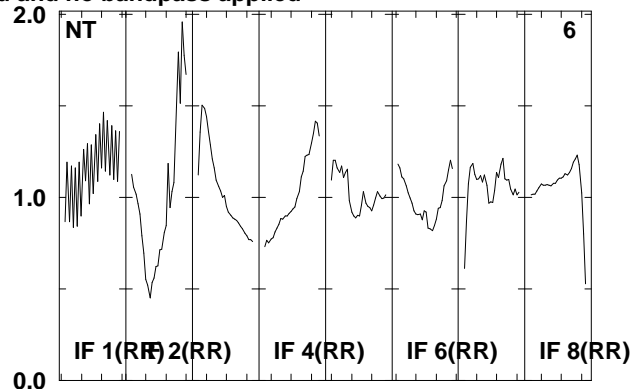
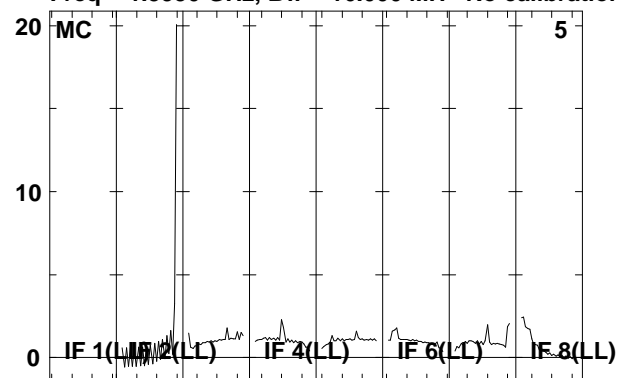

Lower frame: Real Jy

Total-power spectrum Antenna: \*

Timerange: 00/12:34:23 to 00/12:41:19

Plot file version 385 created 08-AUG-2008 17:01:49

J0927+39 EO006B.UVDATA.1

Freq = 1.5950 GHz, Bw = 16.000 MH No calibration applied and no bandpass applied

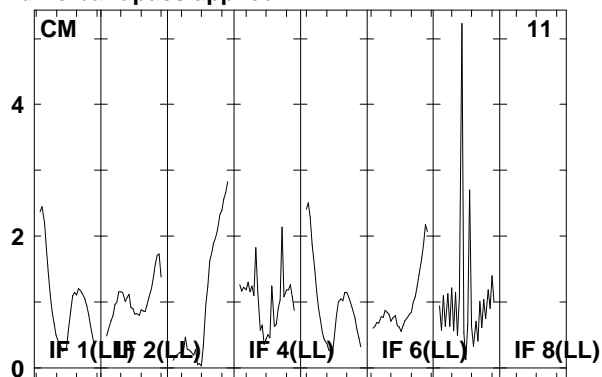
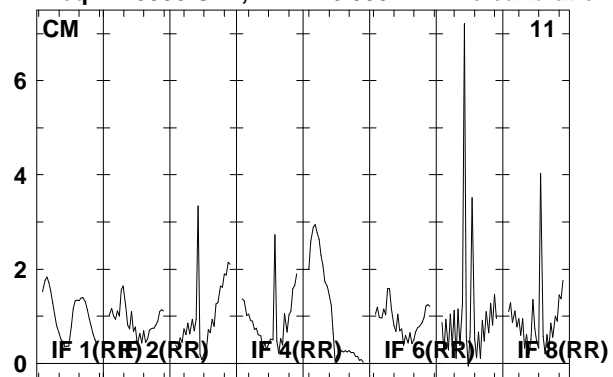

Lower frame: Real Jy  
Total-power spectrum Antenna: \*  
Timerange: 00/12:34:23 to 00/12:41:19

Plot file version 386 created 08-AUG-2008 17:01:50

J0920+44 EO006B.UVDATA.1

Freq = 1.5950 GHz, Bw = 16.000 MH No calibration applied and no bandpass applied

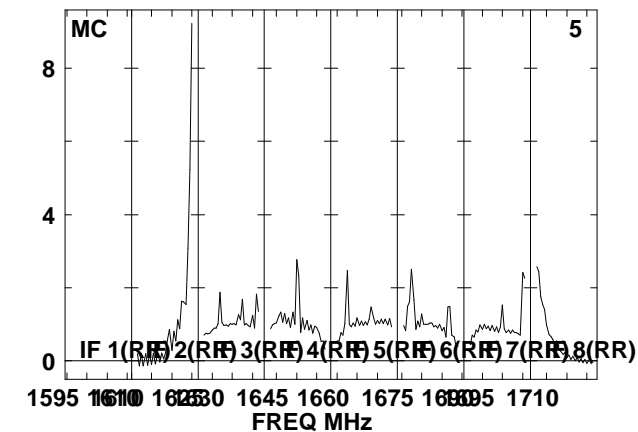
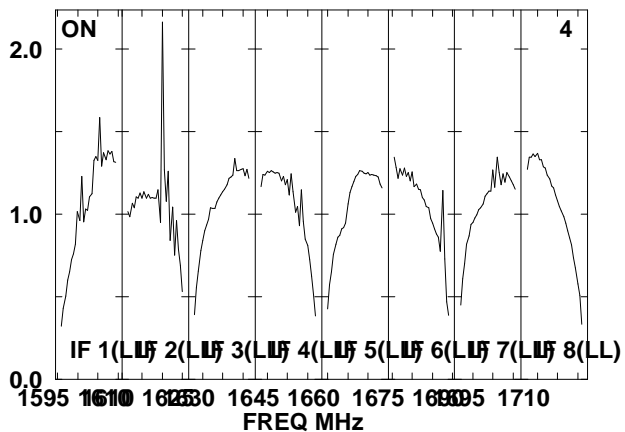
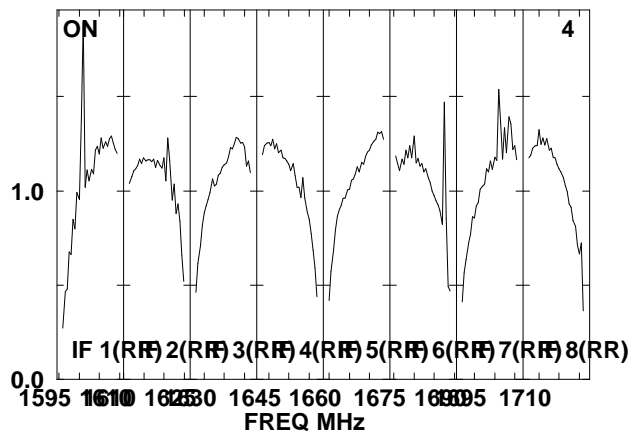
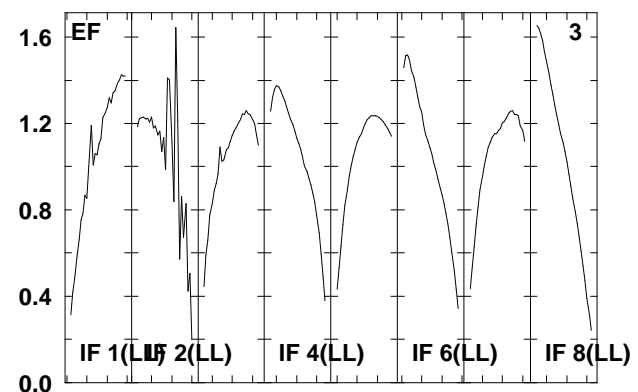
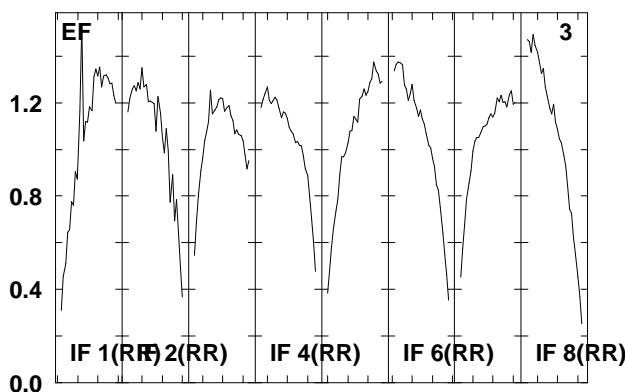
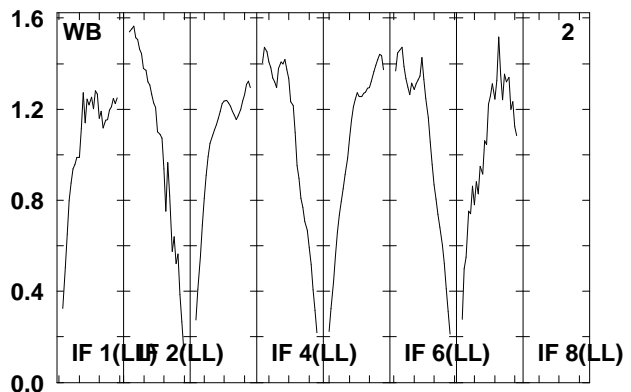
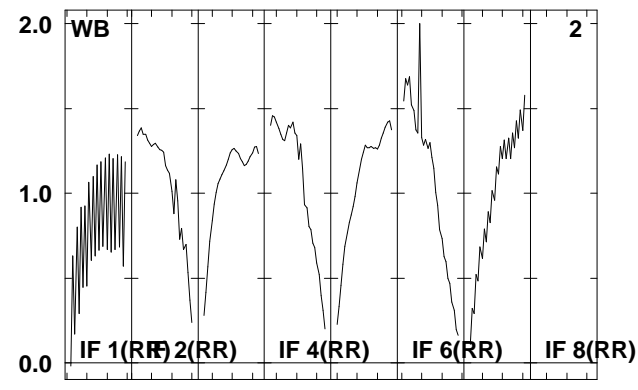
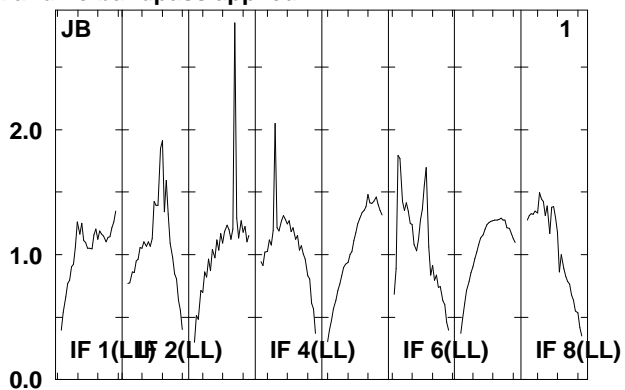
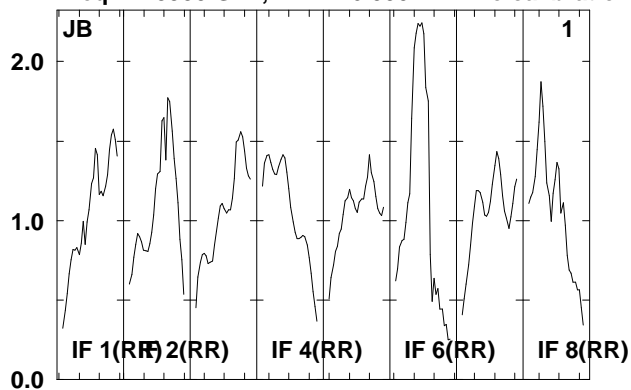

Lower frame: Real Jy  
Total-power spectrum Antenna: \*  
Timerange: 00/12:43:03 to 00/12:44:31

Plot file version 387 created 08-AUG-2008 17:01:50

J0920+44 EO006B.UVDATA.1

Freq = 1.5950 GHz, Bw = 16.000 MH No calibration applied and no bandpass applied

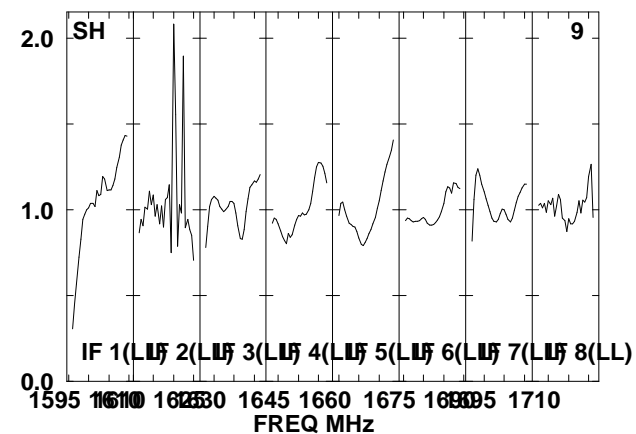
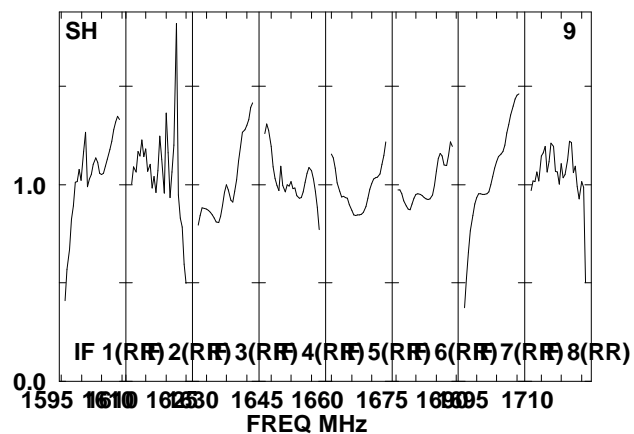
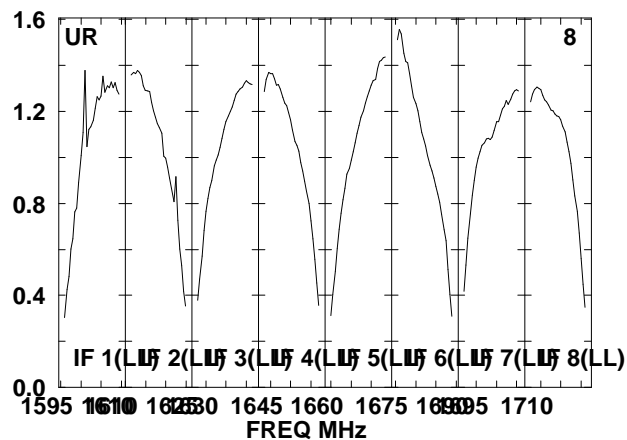
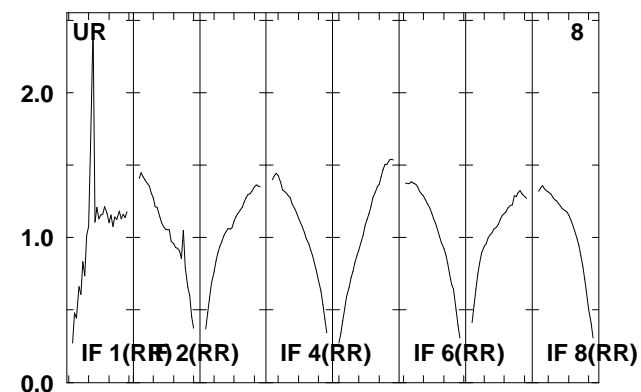
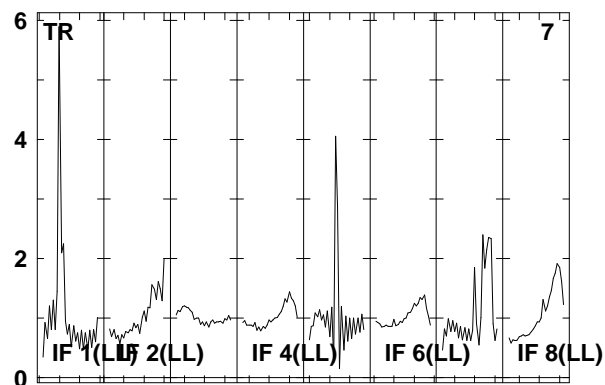
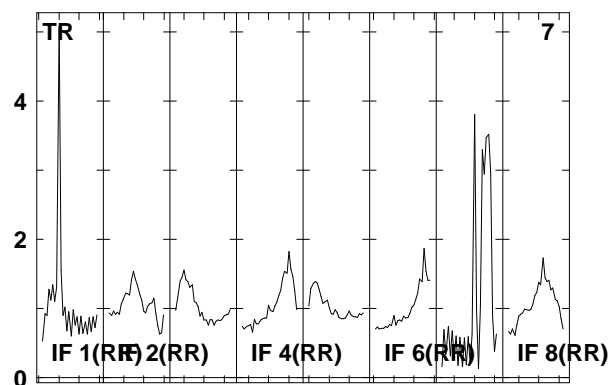
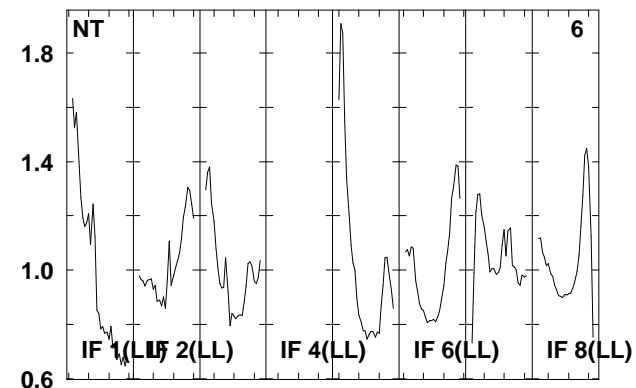
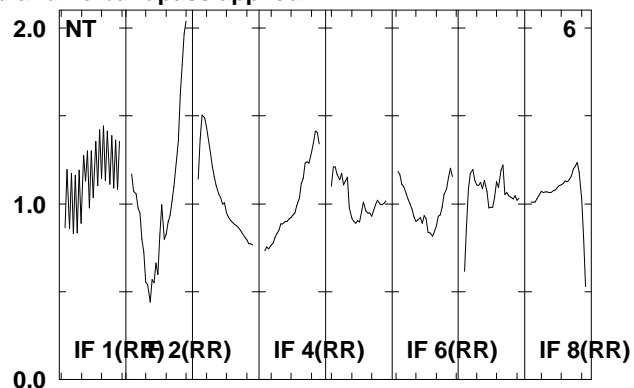
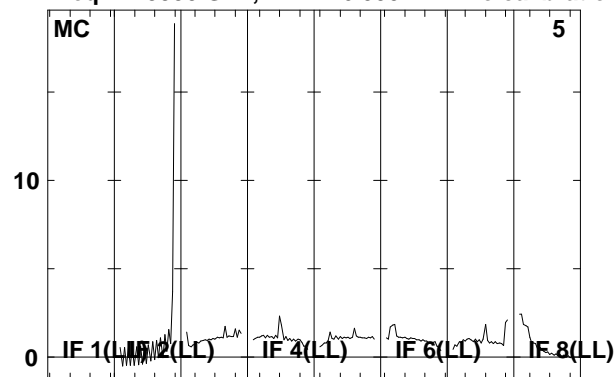

Lower frame: Real Jy

Total-power spectrum Antenna: \*

Timerange: 00/12:43:03 to 00/12:44:31

Plot file version 388 created 08-AUG-2008 17:01:51

J0920+44 EO006B.UVDATA.1

Freq = 1.5950 GHz, Bw = 16.000 MH No calibration applied and no bandpass applied

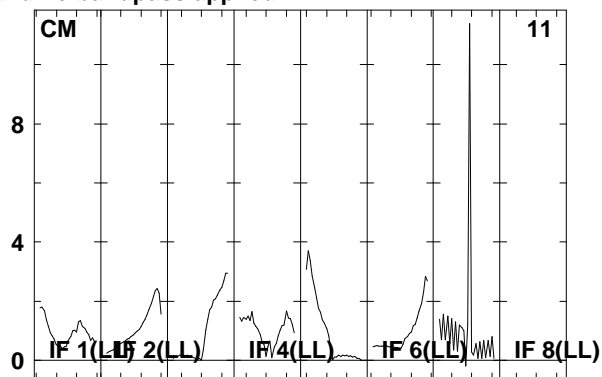
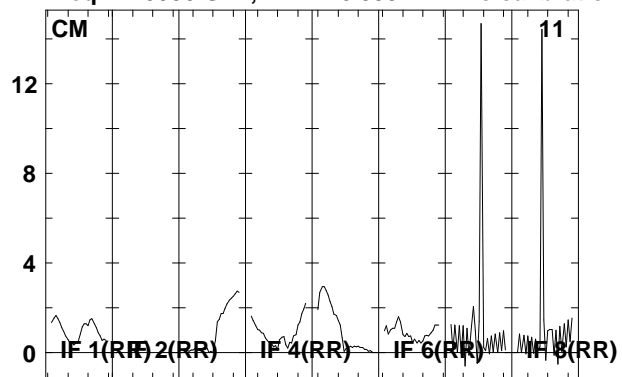

Lower frame: Real Jy  
Total-power spectrum Antenna: \*  
Timerange: 00/12:43:03 to 00/12:44:31



Plot file version 389 created 08-AUG-2008 17:01:51

J092159 EO006B.UVDATA.1

Freq = 1.5950 GHz, Bw = 16.000 MH No calibration applied and no bandpass applied

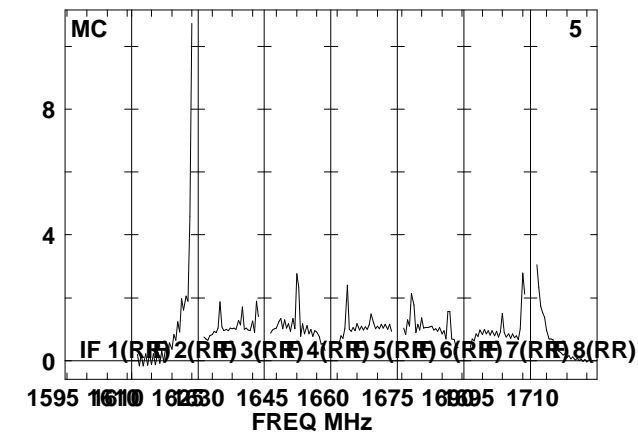
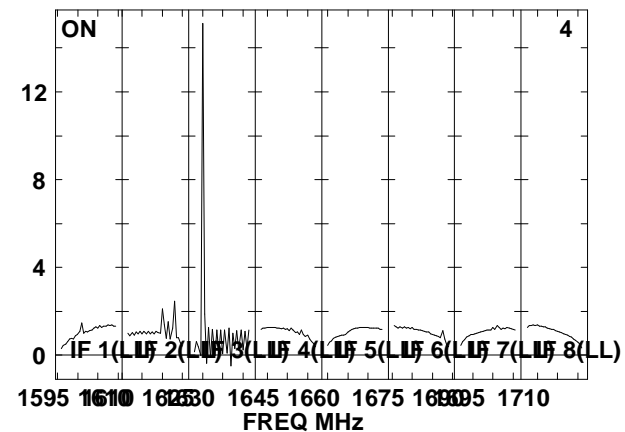
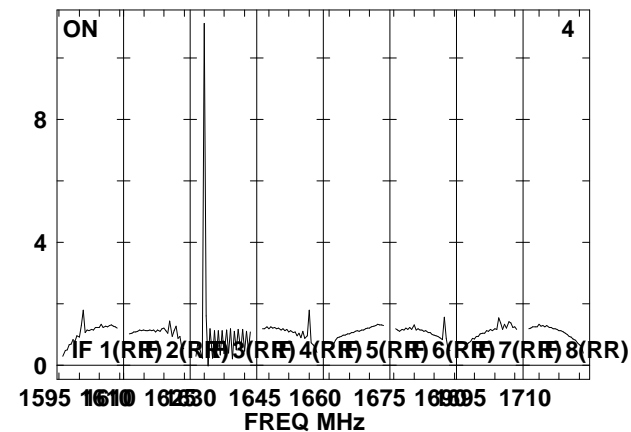
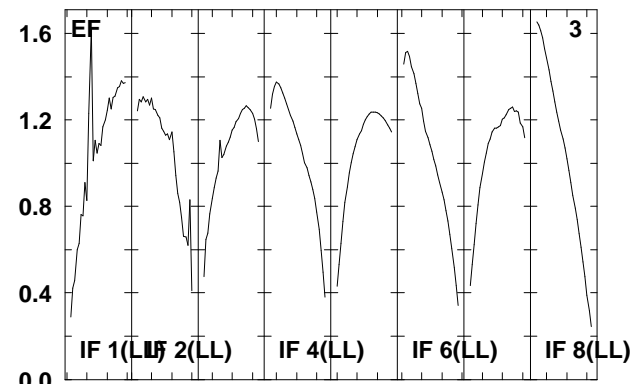
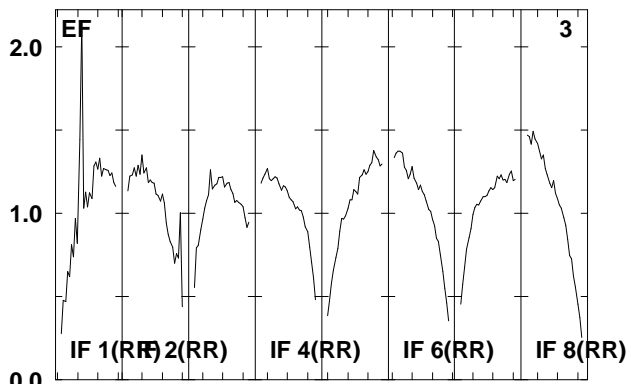
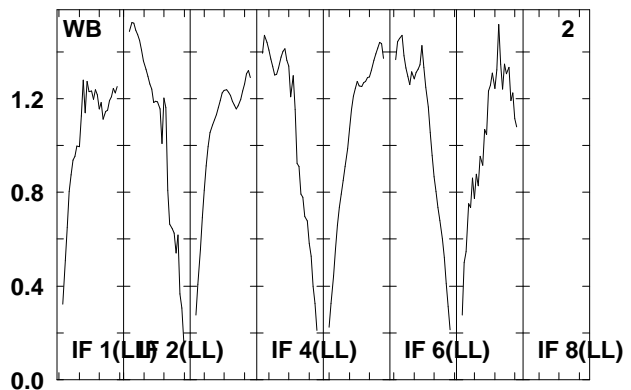
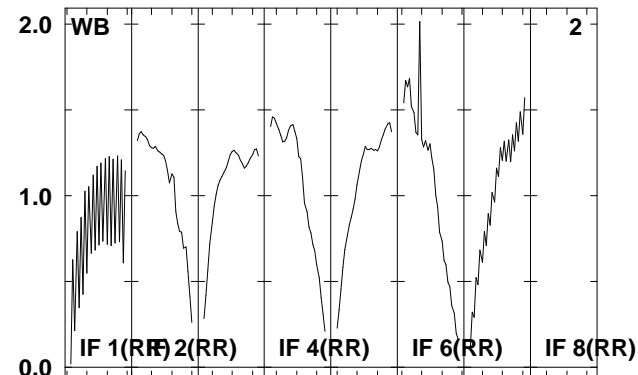
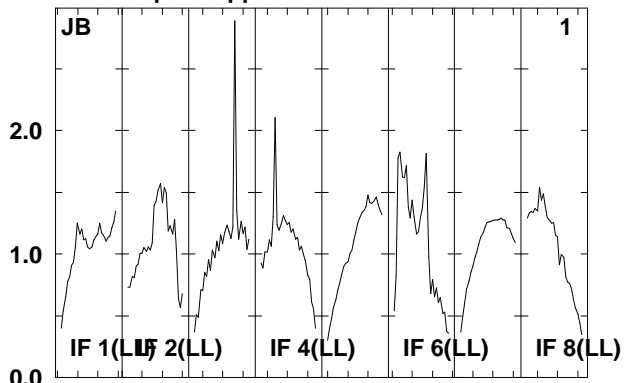
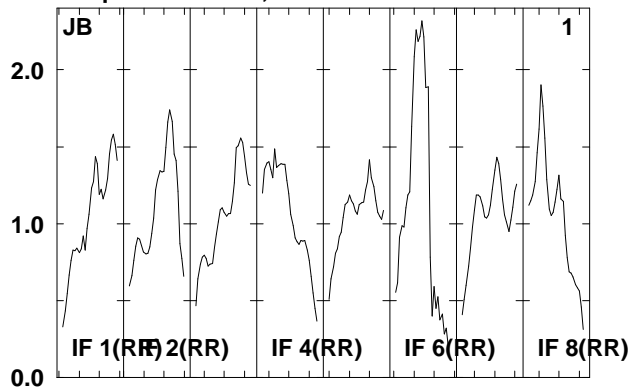

Lower frame: Real Jy  
Total-power spectrum Antenna: \*  
Timerange: 00/12:45:13 to 00/12:49:41

Plot file version 390 created 08-AUG-2008 17:01:52

J092159 EO06B.UVDATA.1

Freq = 1.5950 GHz, Bw = 16.000 MH No calibration applied and no bandpass applied

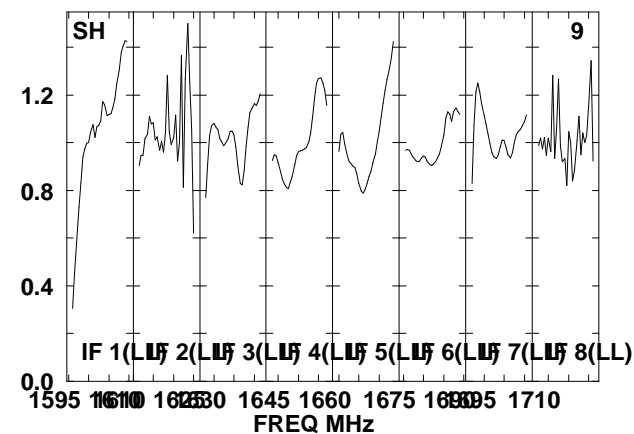
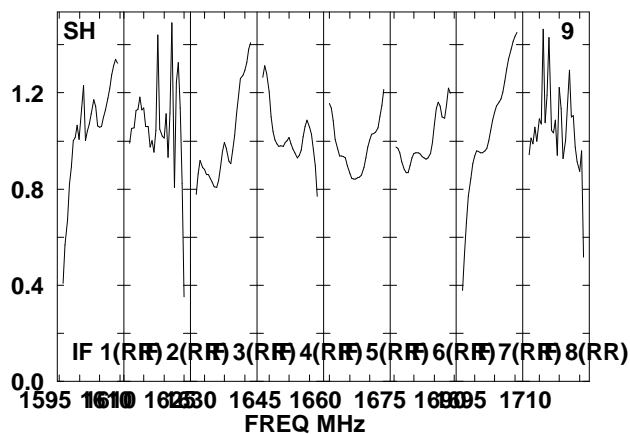
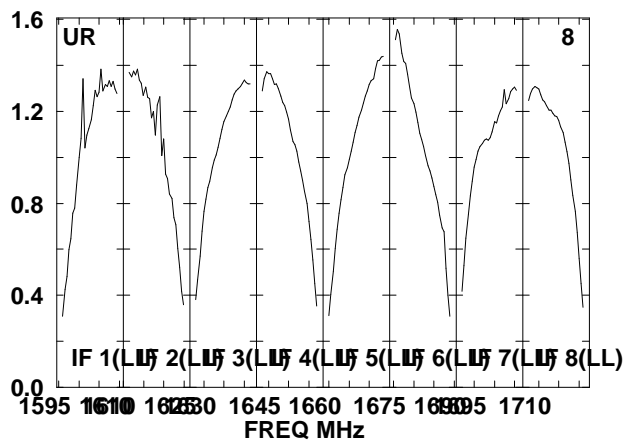
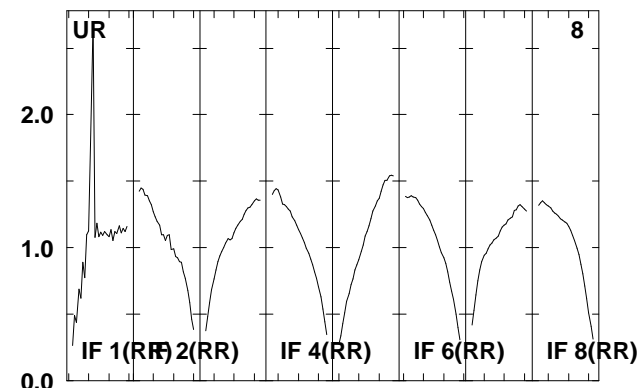
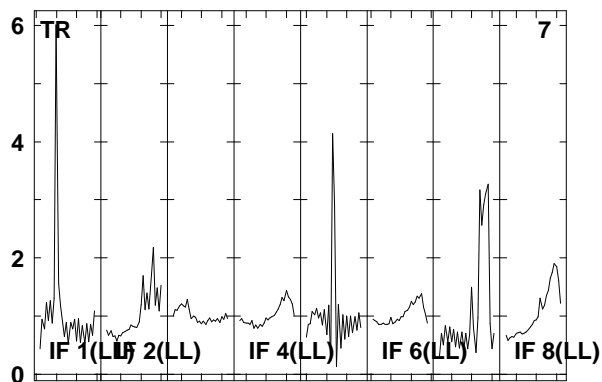
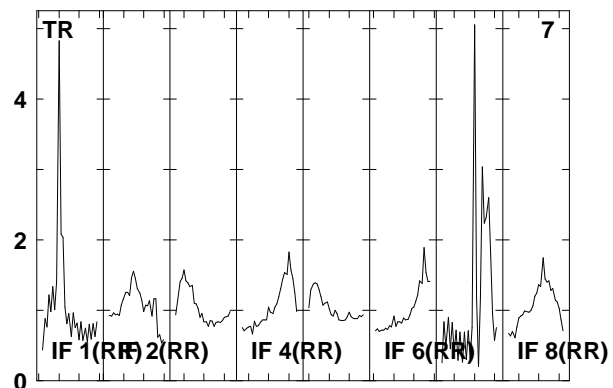
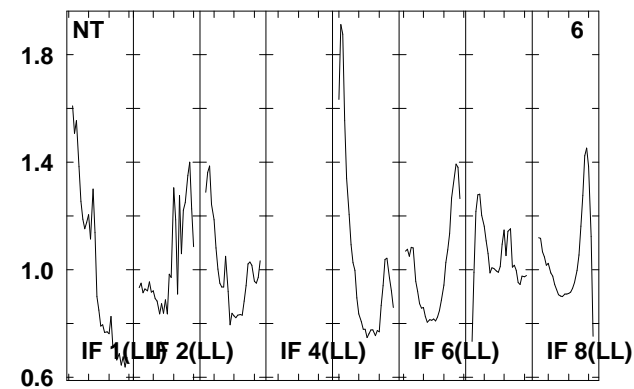
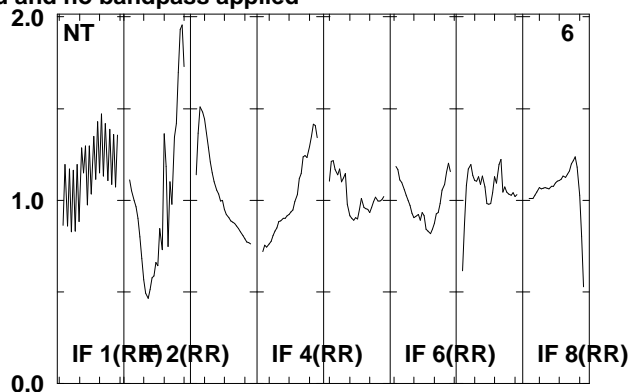
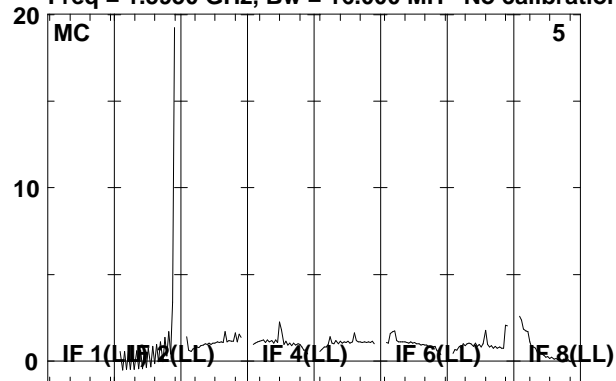

Lower frame: Real Jy

Total-power spectrum Antenna: \*

Timerange: 00/12:45:13 to 00/12:49:41

Plot file version 391 created 08-AUG-2008 17:01:53

J092159 EO006B.UVDATA.1

Freq = 1.5950 GHz, Bw = 16.000 MH No calibration applied and no bandpass applied

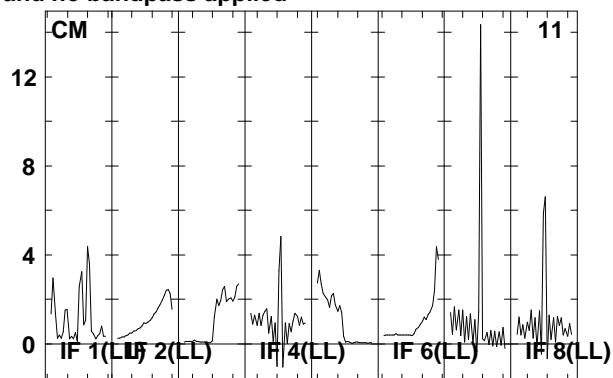
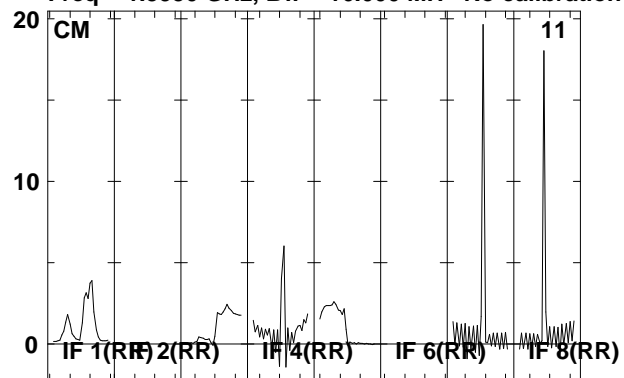

Lower frame: Real Jy  
Total-power spectrum Antenna: \*  
Timerange: 00/12:45:13 to 00/12:49:41

Plot file version 392 created 08-AUG-2008 17:01:53

J0920+44 EO006B.UVDATA.1

Freq = 1.5950 GHz, Bw = 16.000 MH No calibration applied and no bandpass applied

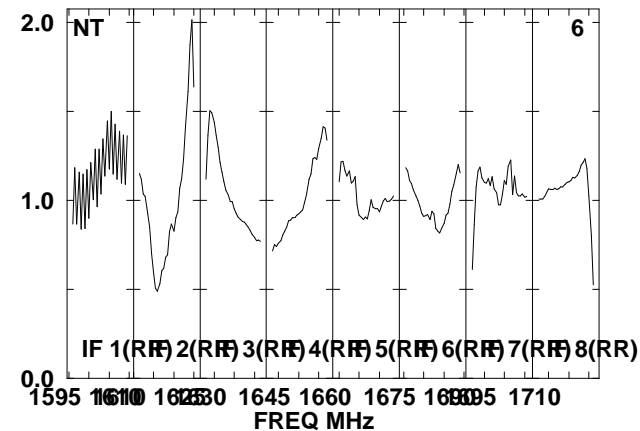
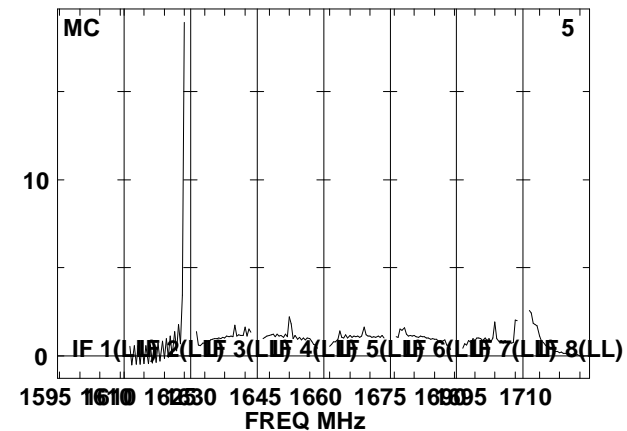
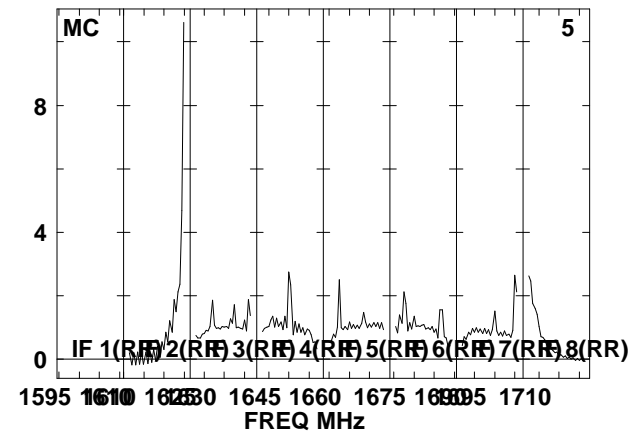
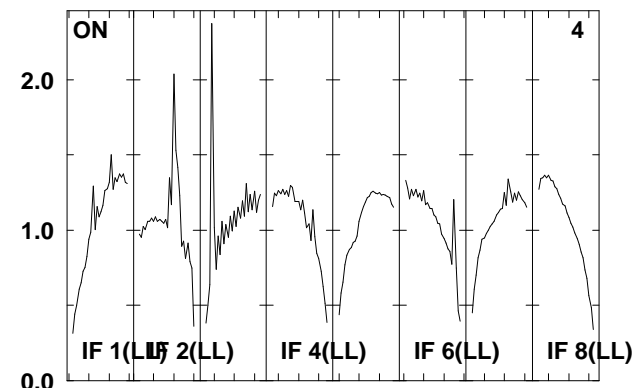
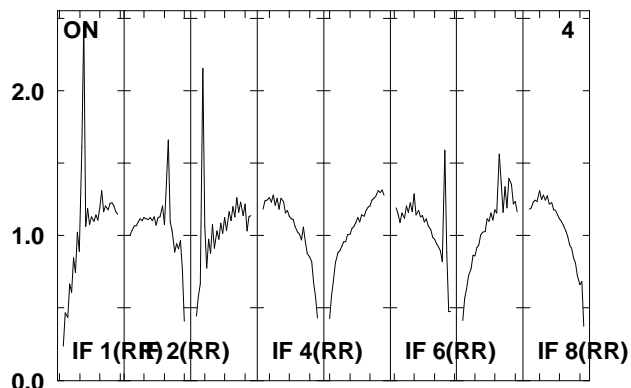
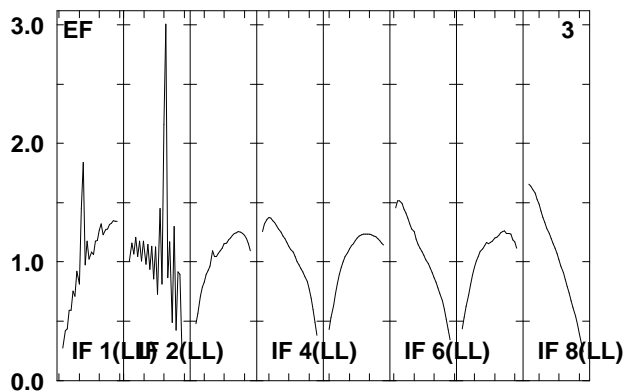
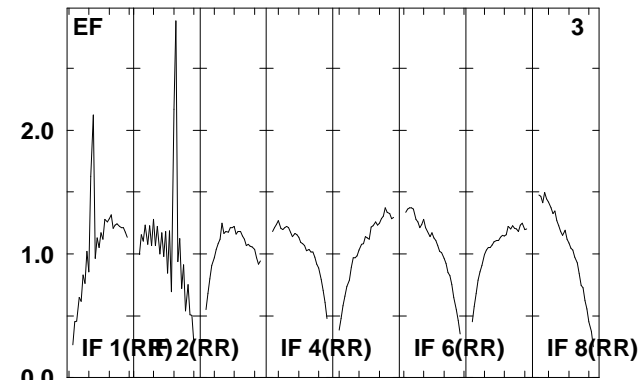
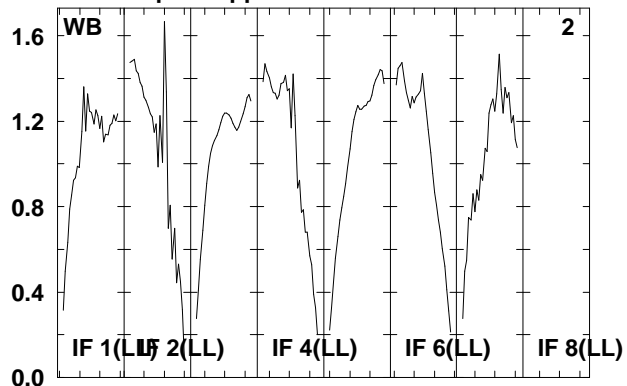
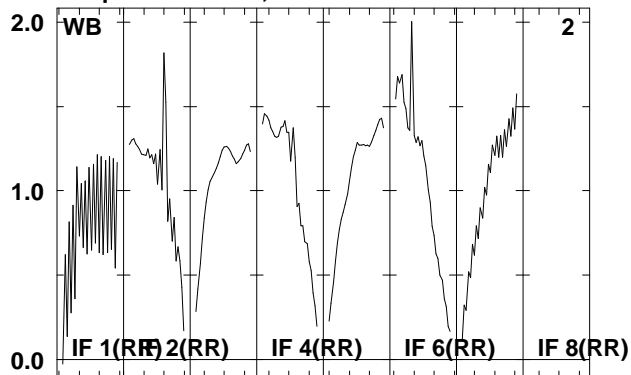

Lower frame: Real Jy  
Total-power spectrum Antenna: \*  
Timerange: 00/12:50:23 to 00/12:51:51

Plot file version 393 created 08-AUG-2008 17:01:53  
 J0920+44 EO006B.UVDATA.1  
 Freq = 1.5950 GHz, Bw = 16.000 MH No calibration applied and no bandpass applied

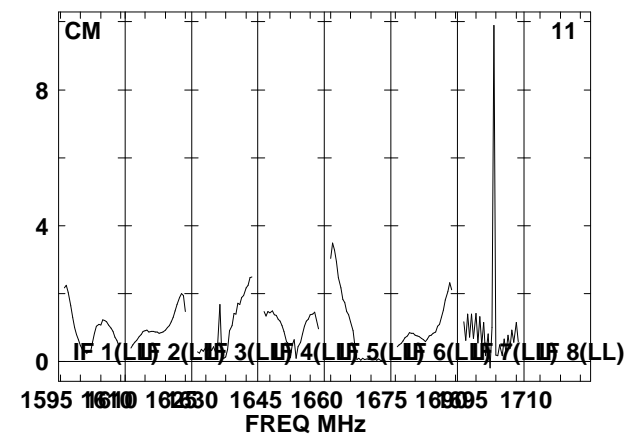
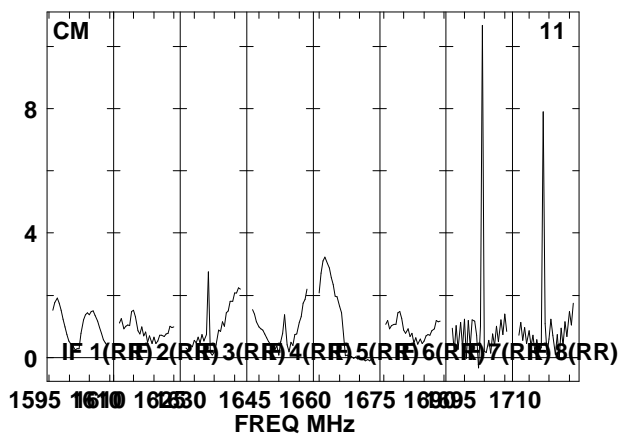
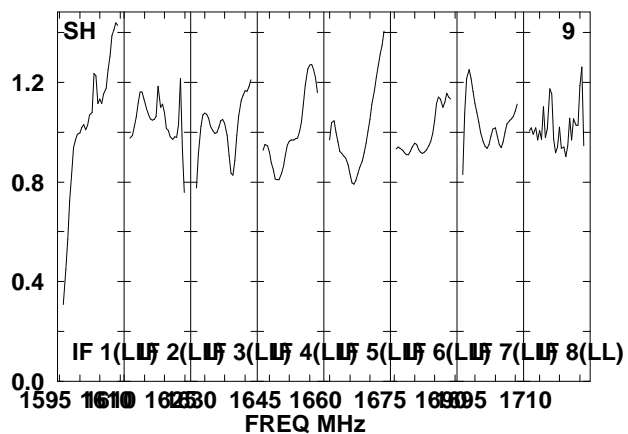
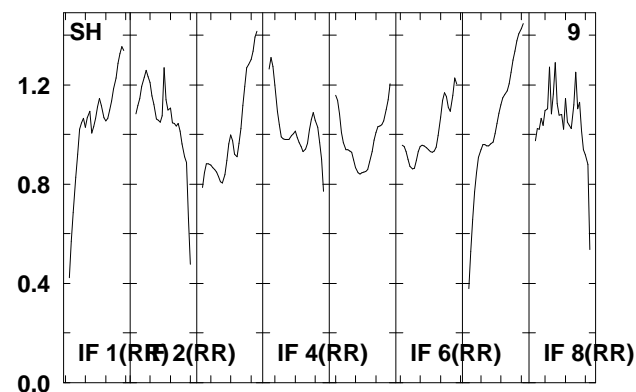
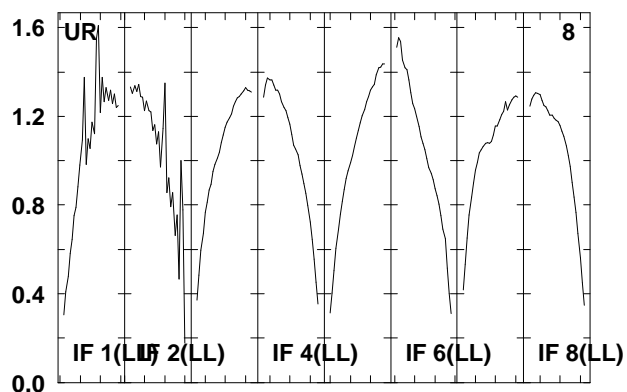
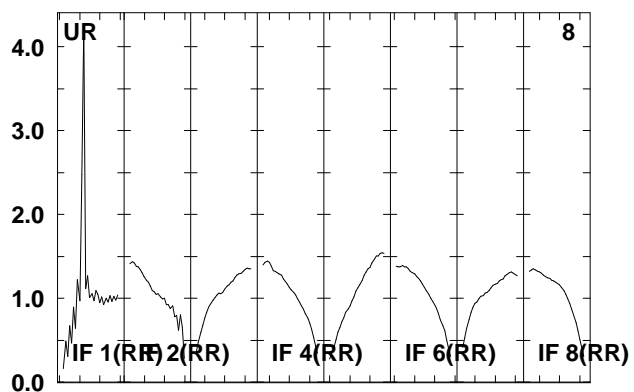
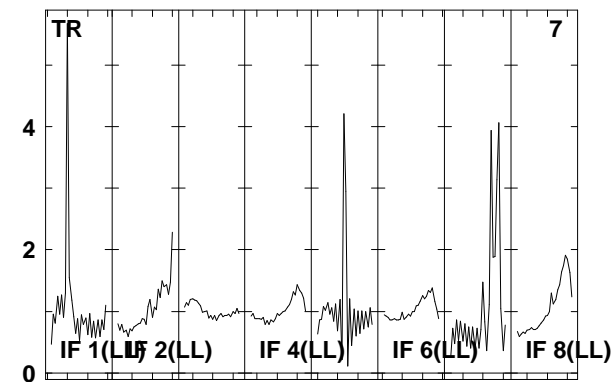
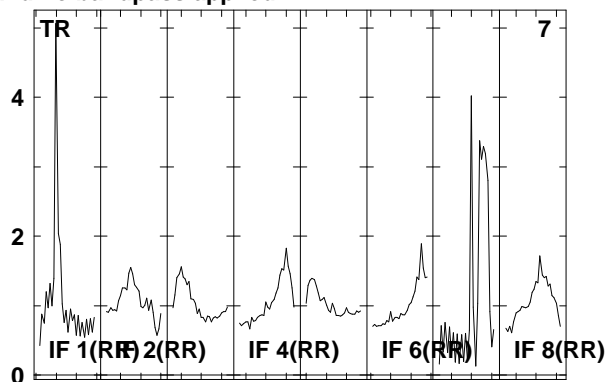
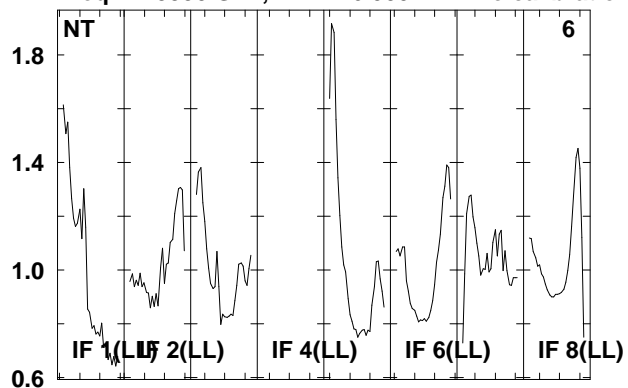

Lower frame: Real Jy  
 Total-power spectrum Antenna: \*  
 Timerange: 00/12:50:23 to 00/12:51:51

Plot file version 394 created 08-AUG-2008 17:01:54

J092159 EO006B.UVDATA.1

Freq = 1.5950 GHz, Bw = 16.000 MH No calibration applied and no bandpass applied

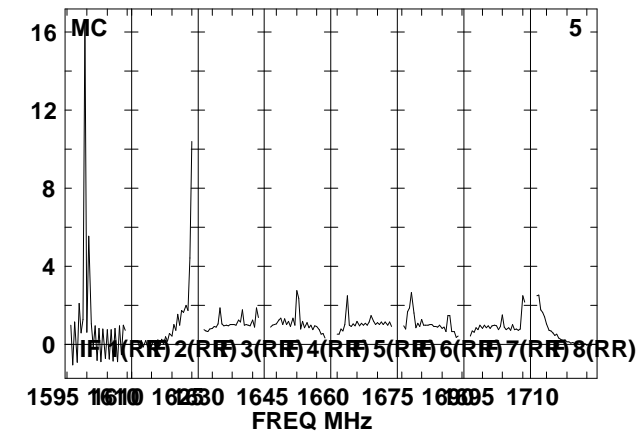
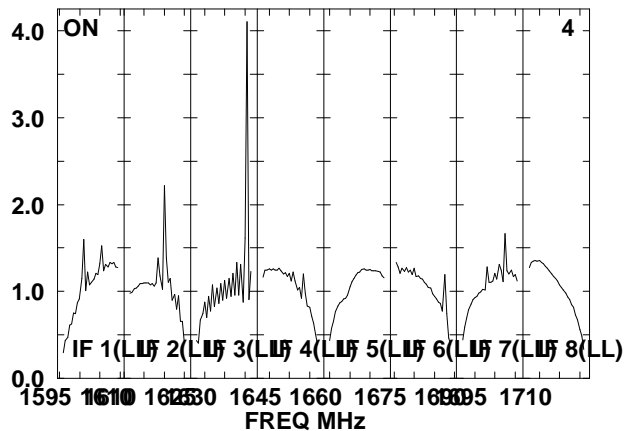
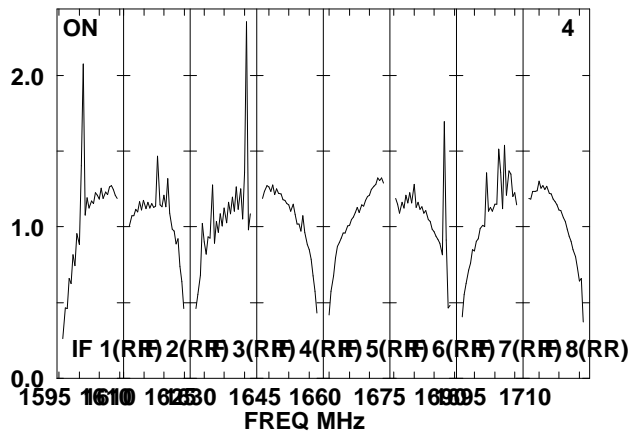
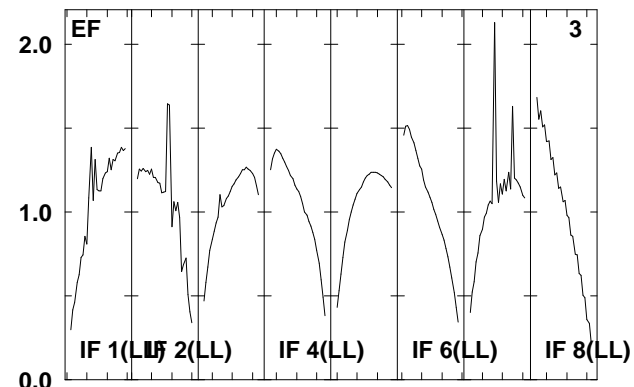
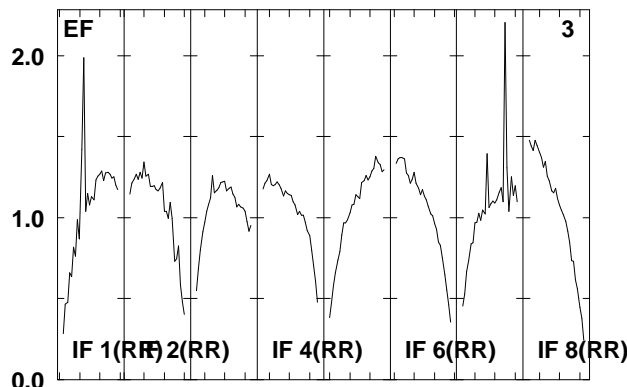
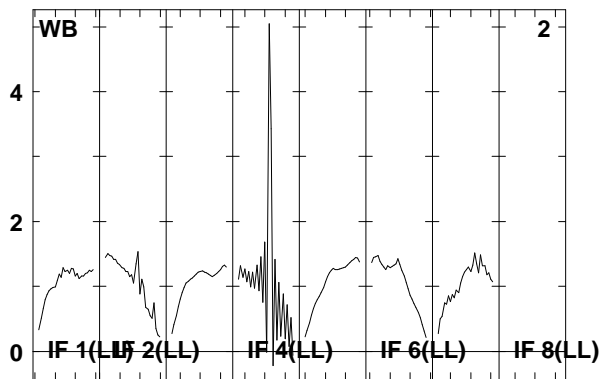
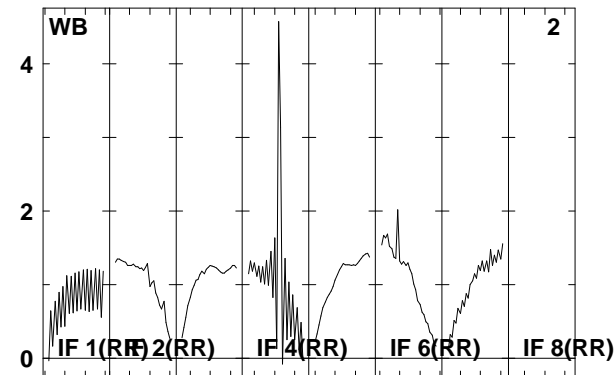
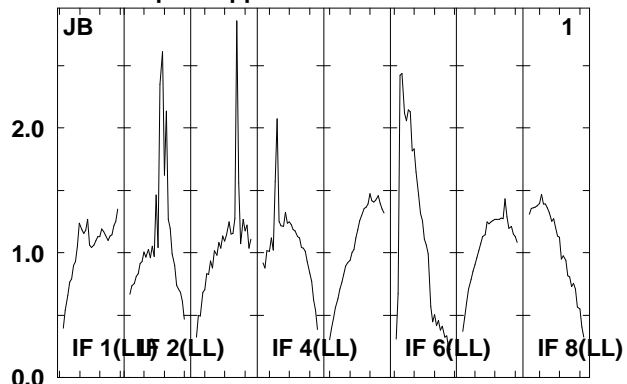
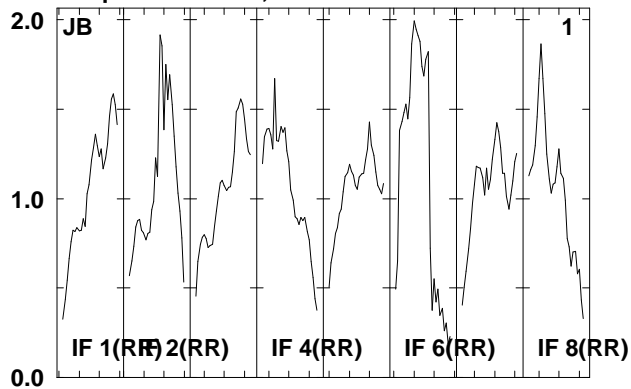

Lower frame: Real Jy  
Total-power spectrum Antenna: \*  
Timerange: 00/12:52:33 to 00/12:57:09

Plot file version 395 created 08-AUG-2008 17:01:54

J092159 EO006B.UVDATA.1

Freq = 1.5950 GHz, Bw = 16.000 MH No calibration applied and no bandpass applied

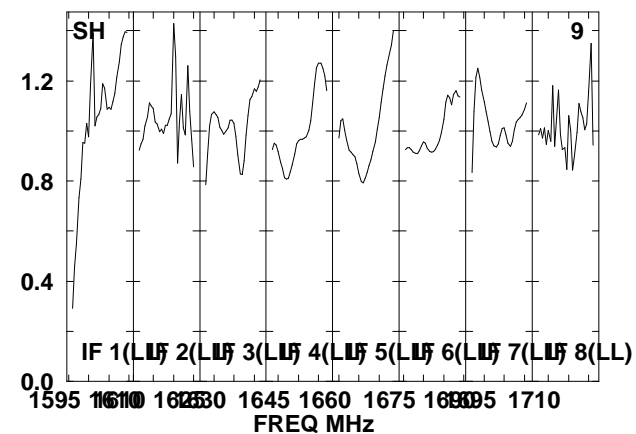
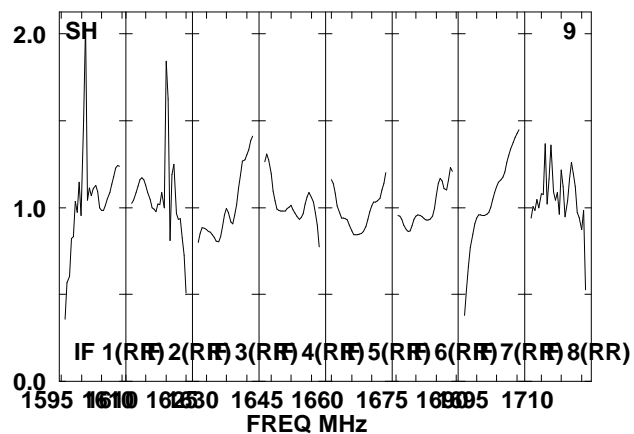
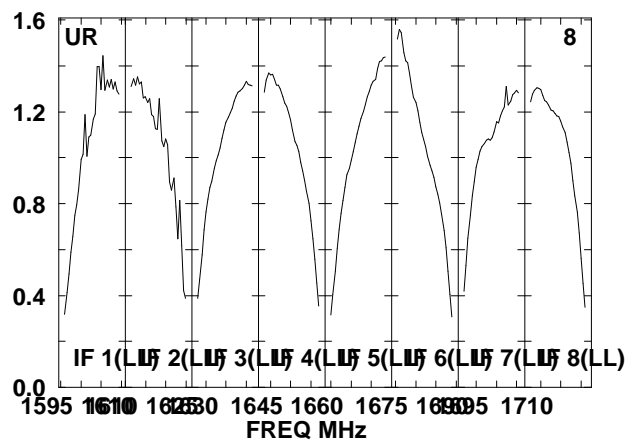
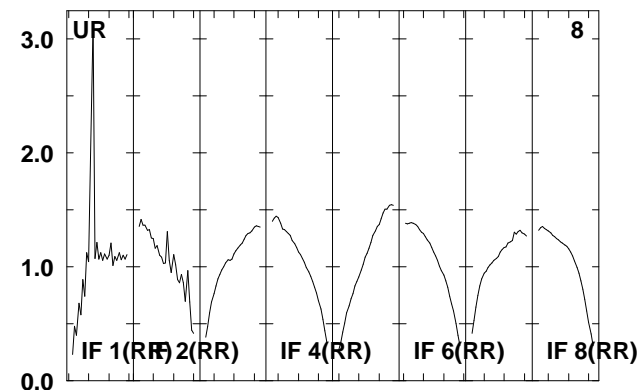
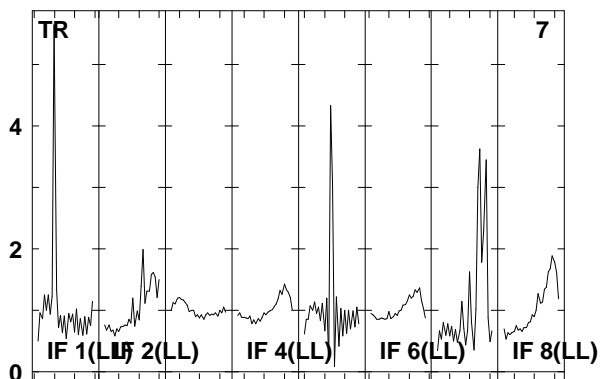
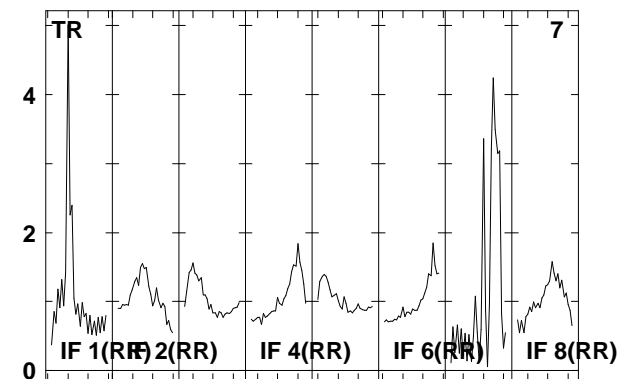
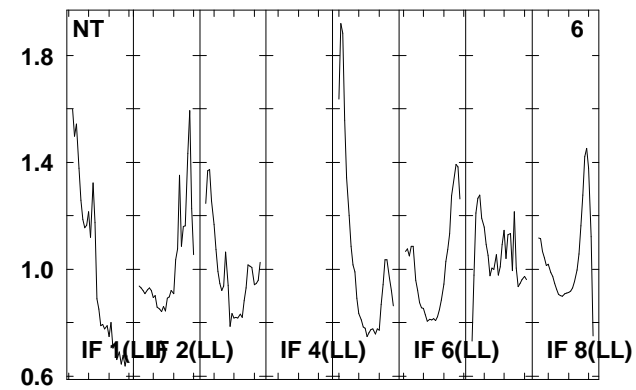
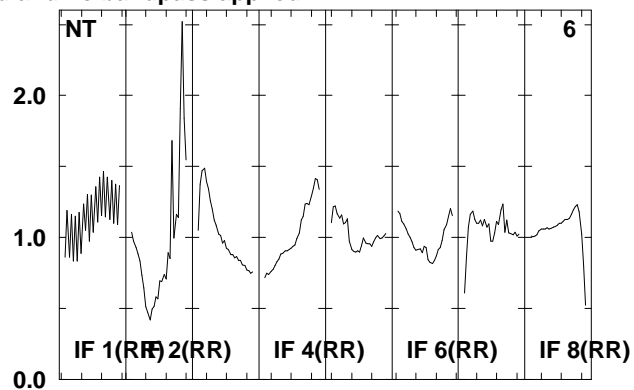
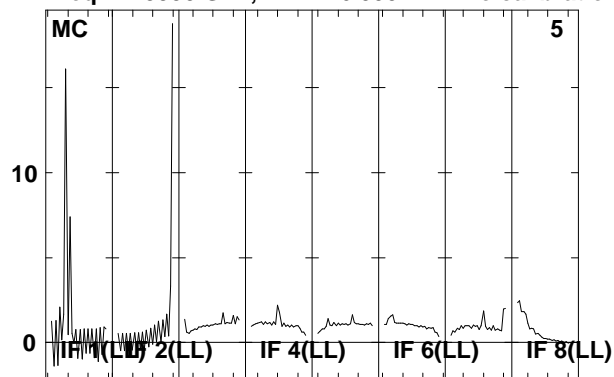

Lower frame: Real Jy

Total-power spectrum Antenna: \*

Timerange: 00/12:52:33 to 00/12:57:09

Plot file version 396 created 08-AUG-2008 17:01:55

J092159 EO006B.UVDATA.1

Freq = 1.5950 GHz, Bw = 16.000 MH No calibration applied and no bandpass applied

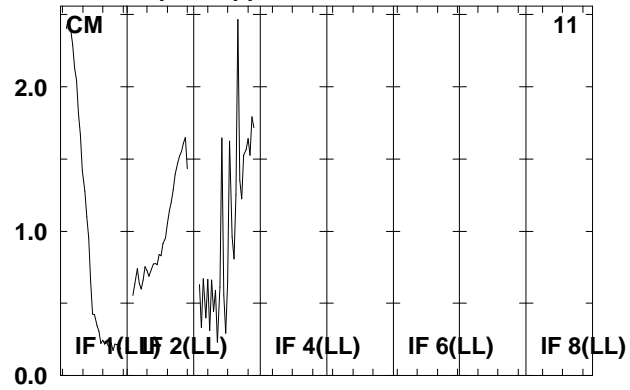
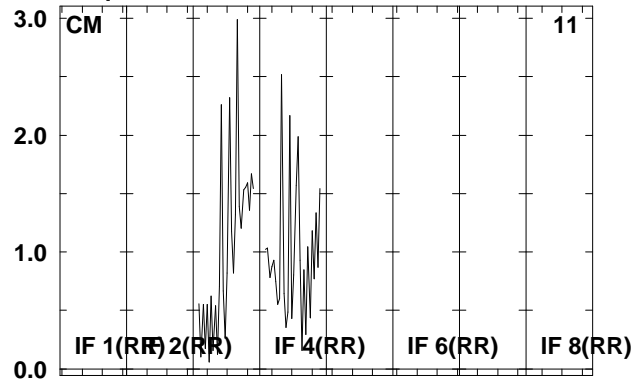

Lower frame: Real Jy  
Total-power spectrum Antenna: \*  
Timerange: 00/12:52:33 to 00/12:57:09



Plot file version 397 created 08-AUG-2008 17:01:55

J0920+44 EO006B.UVDATA.1

Freq = 1.5950 GHz, Bw = 16.000 MH No calibration applied and no bandpass applied

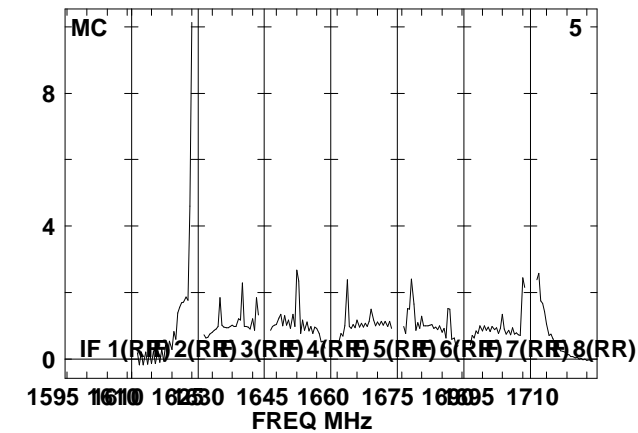
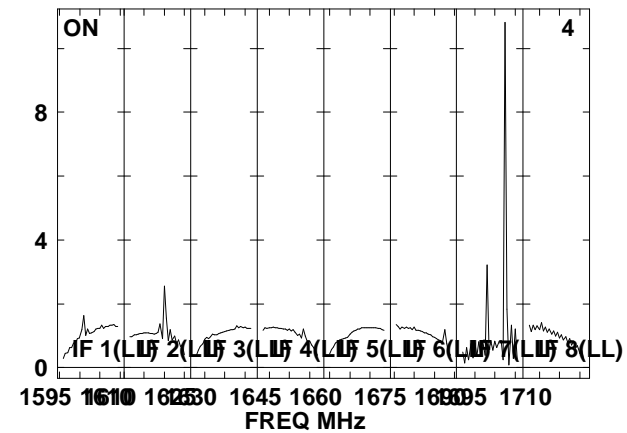
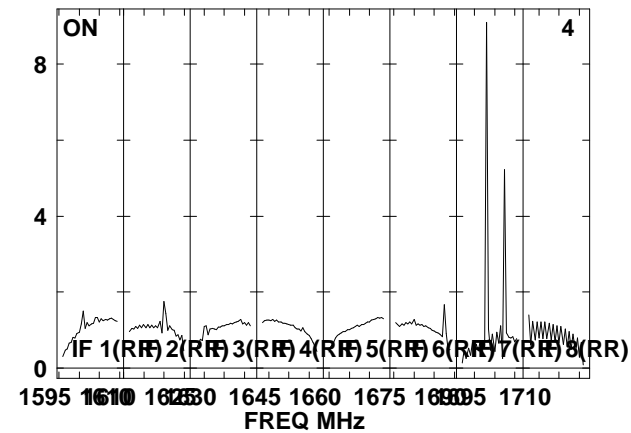
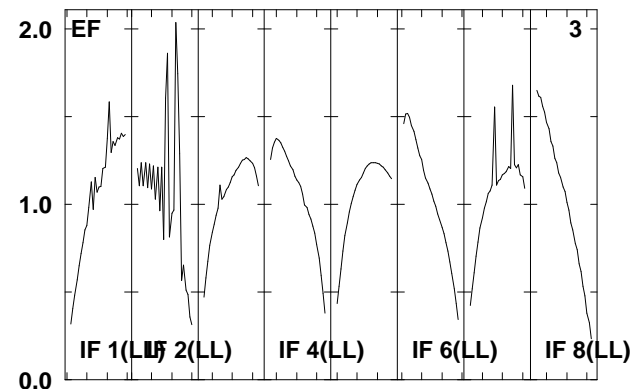
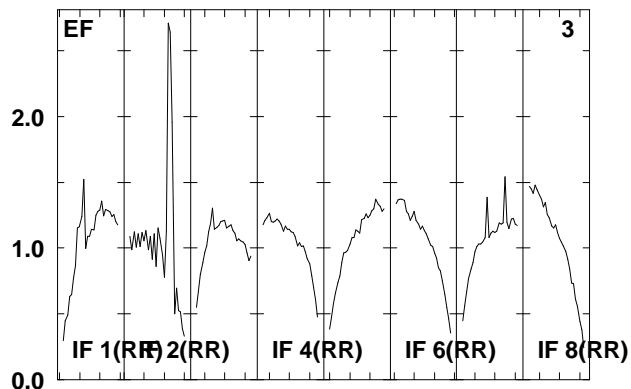
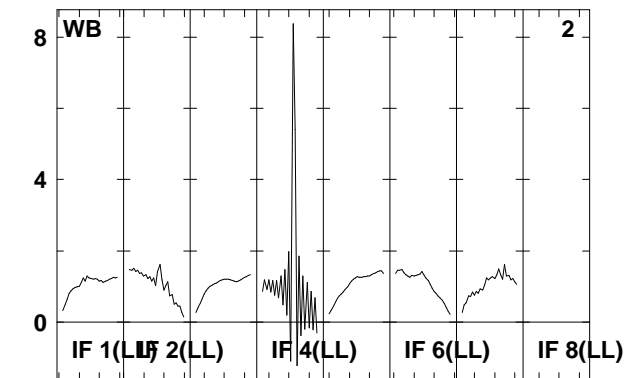
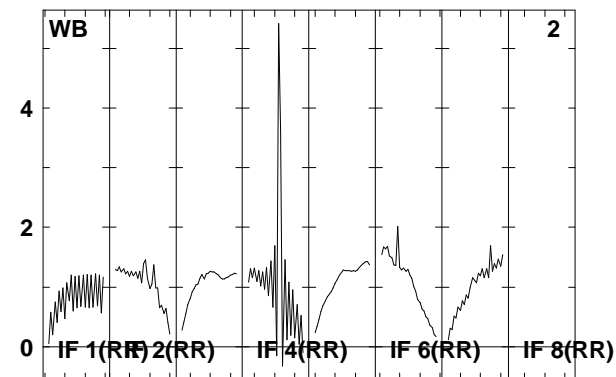
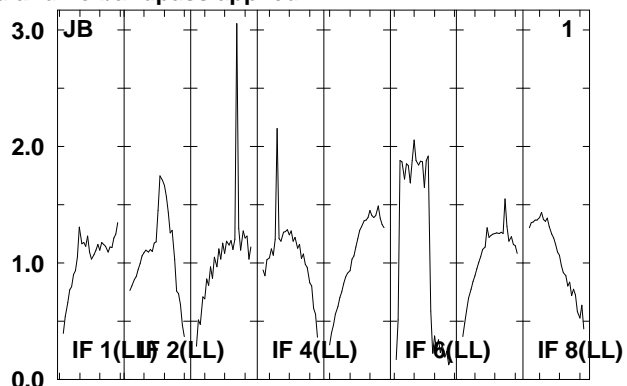
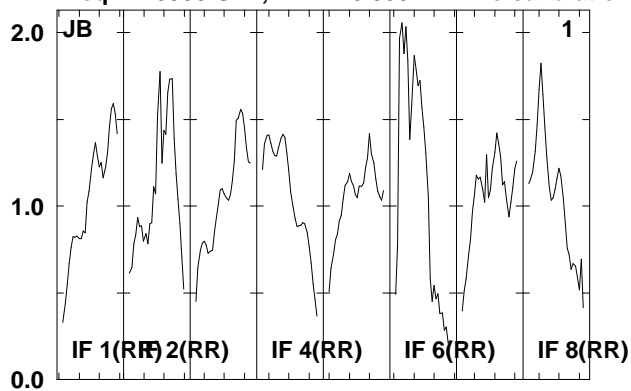

Lower frame: Real Jy  
Total-power spectrum Antenna: \*  
Timerange: 00/12:57:41 to 00/12:59:17

Plot file version 398 created 08-AUG-2008 17:01:56

J0920+44 EO006B.UVDATA.1

Freq = 1.5950 GHz, Bw = 16.000 MH No calibration applied and no bandpass applied

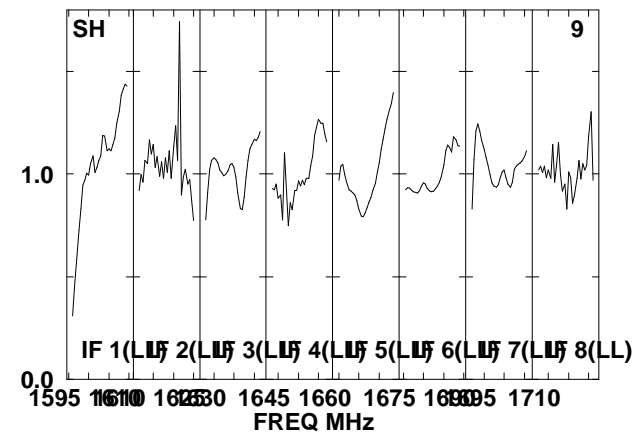
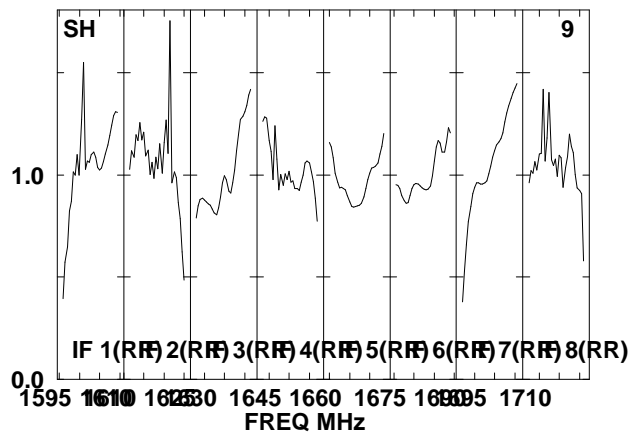
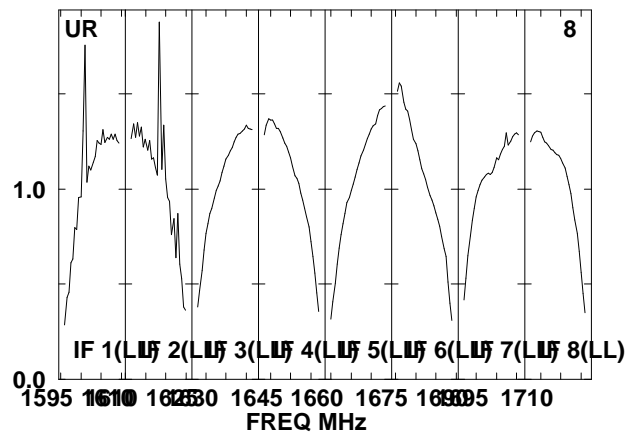
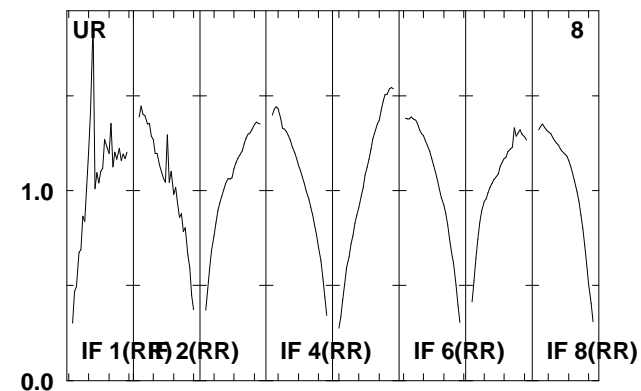
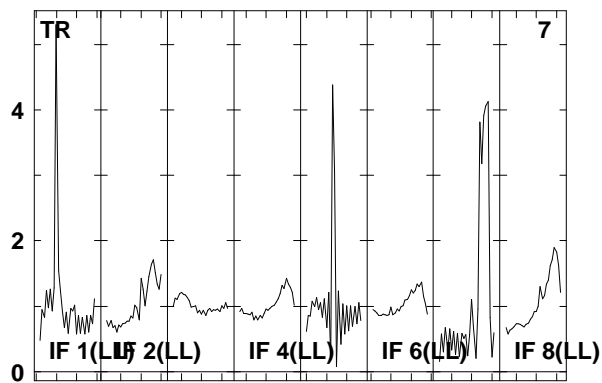
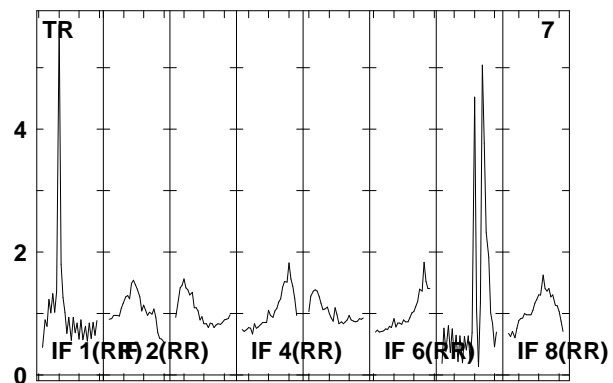
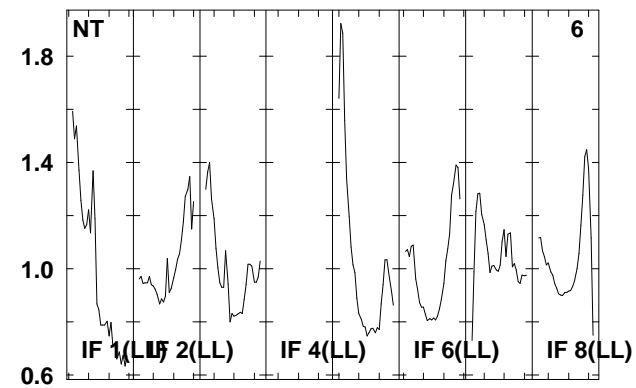
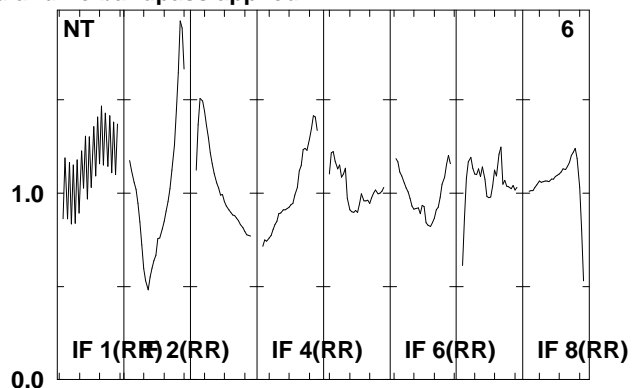
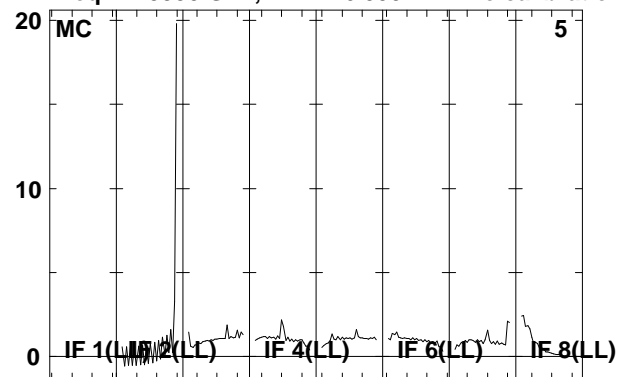

Lower frame: Real Jy

Total-power spectrum Antenna: \*

Timerange: 00/12:57:41 to 00/12:59:17

Plot file version 399 created 08-AUG-2008 17:01:56

J0920+44 EO006B.UVDATA.1

Freq = 1.5950 GHz, Bw = 16.000 MH No calibration applied and no bandpass applied

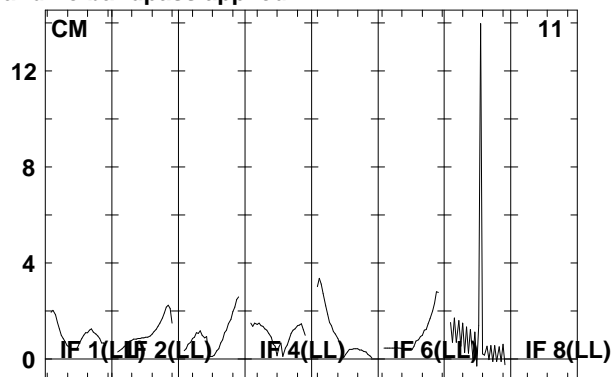
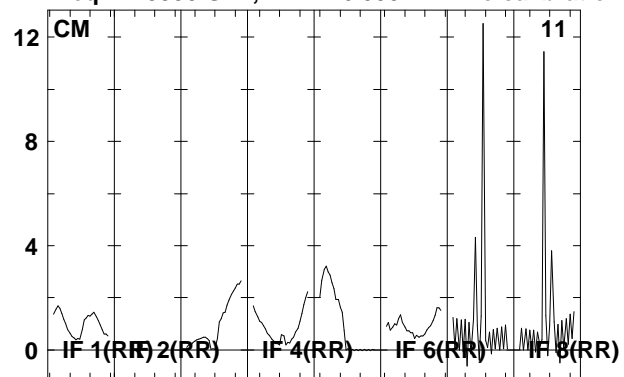

Lower frame: Real Jy  
Total-power spectrum Antenna: \*  
Timerange: 00/12:57:41 to 00/12:59:17

Plot file version 400 created 08-AUG-2008 17:01:57

J092159 EO006B.UVDATA.1

Freq = 1.5950 GHz, Bw = 16.000 MH No calibration applied and no bandpass applied

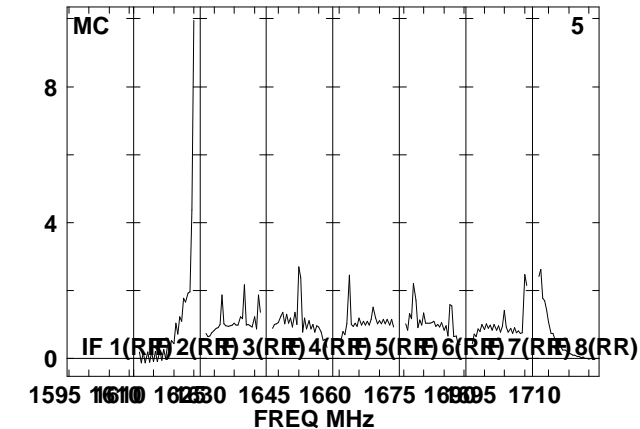
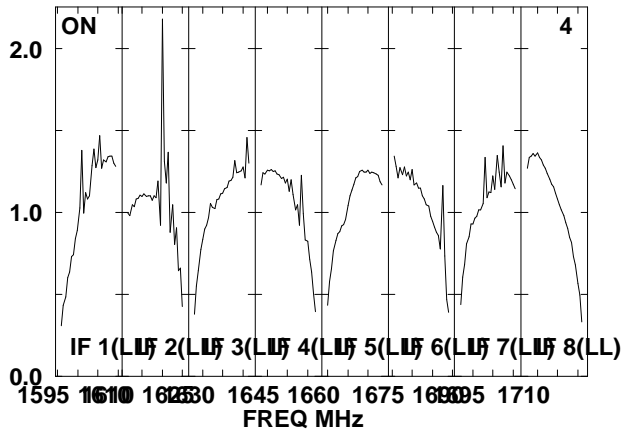
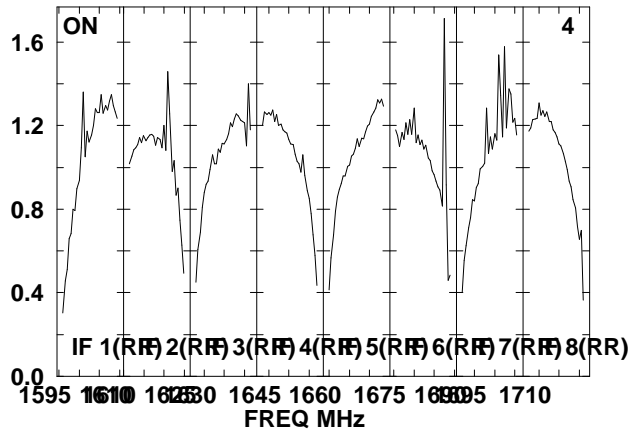
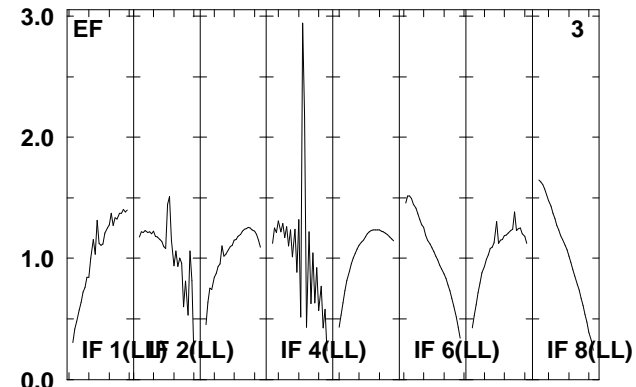
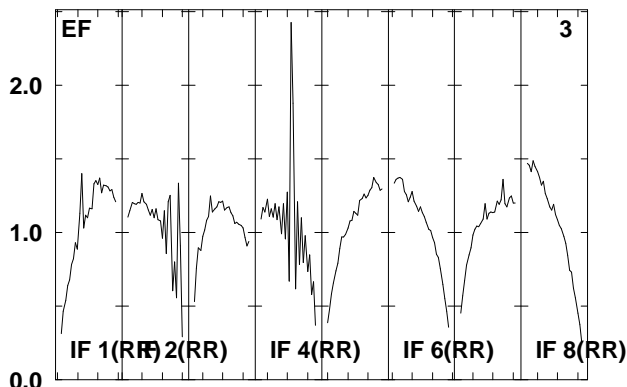
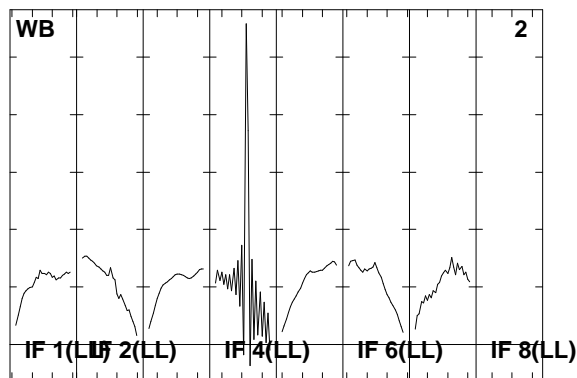
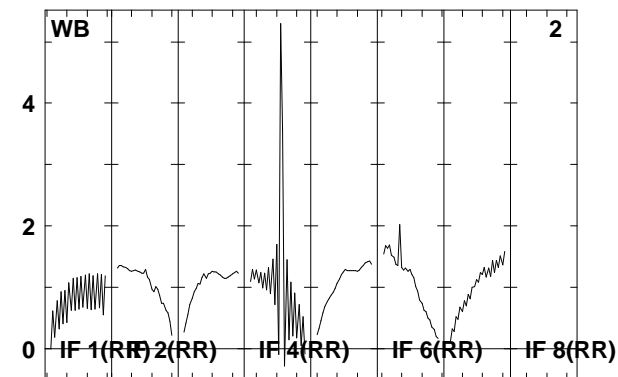
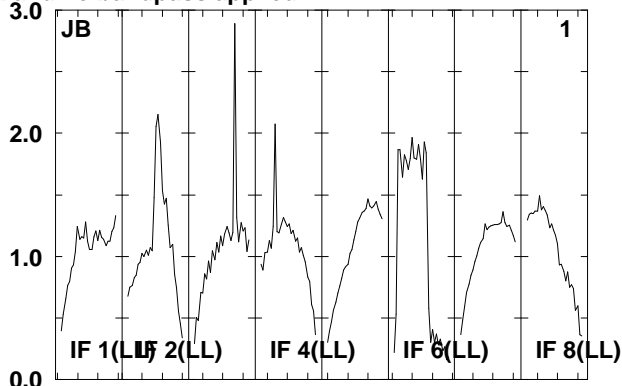
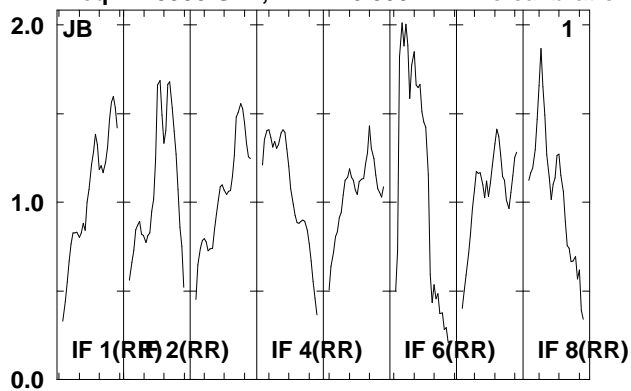

Lower frame: Real Jy  
Total-power spectrum Antenna: \*  
Timerange: 00/12:59:53 to 00/13:04:29

Plot file version 401 created 08-AUG-2008 17:01:58

J092159 EO06B.UVDATA.1

Freq = 1.5950 GHz, Bw = 16.000 MH No calibration applied and no bandpass applied

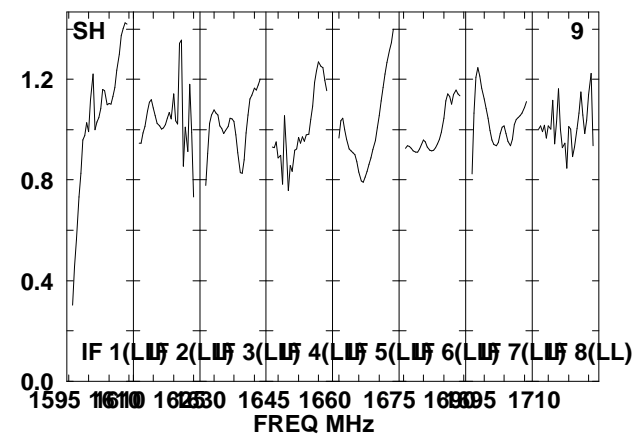
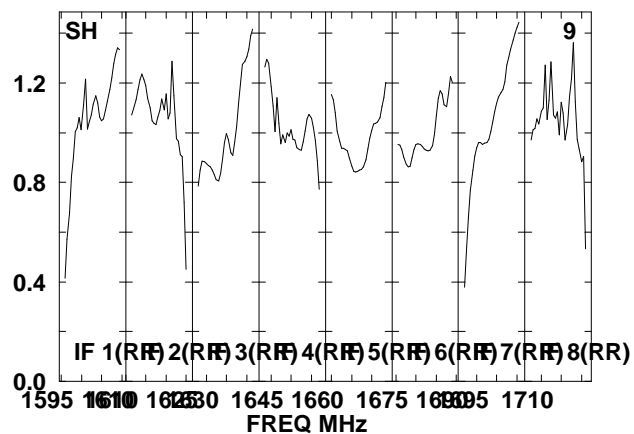
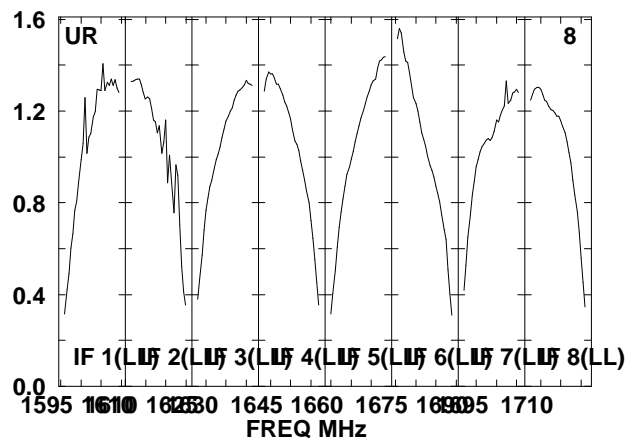
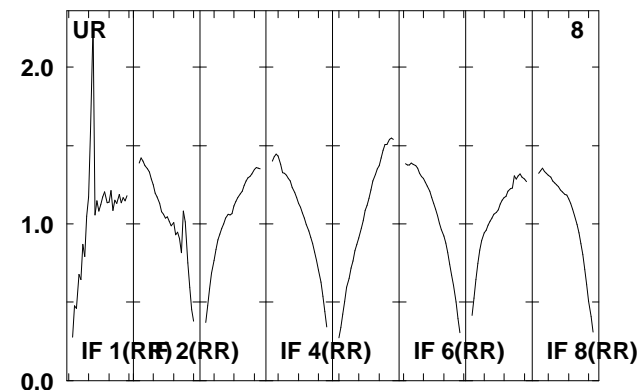
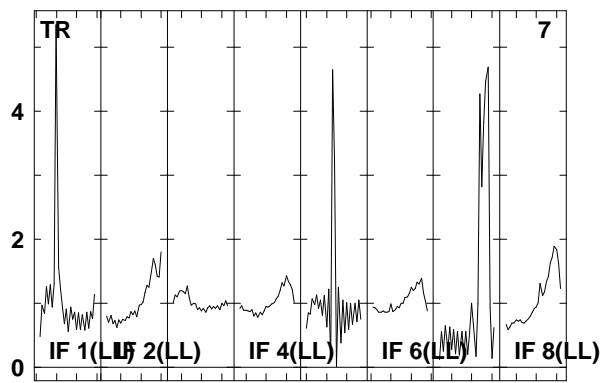
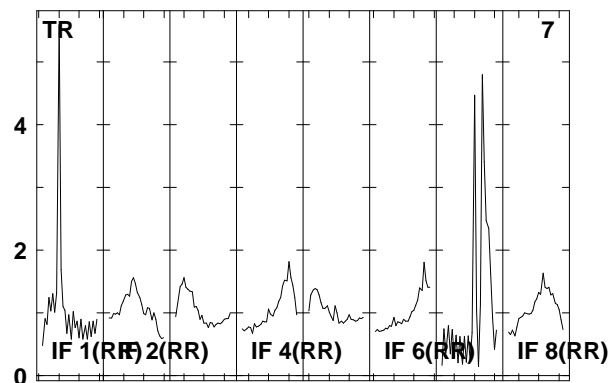
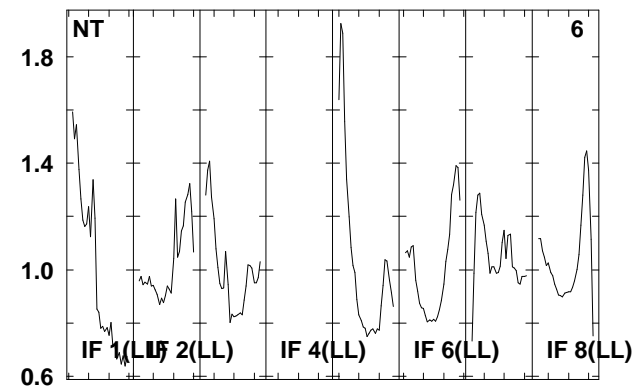
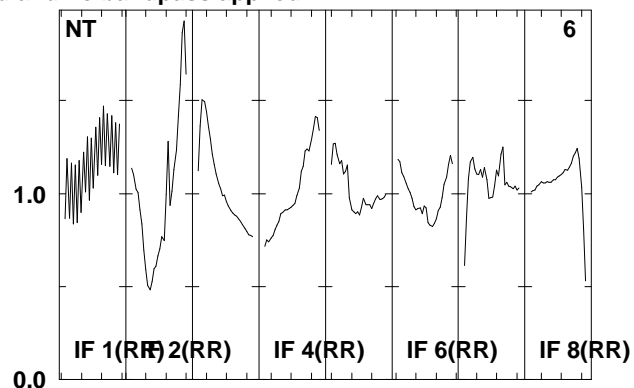
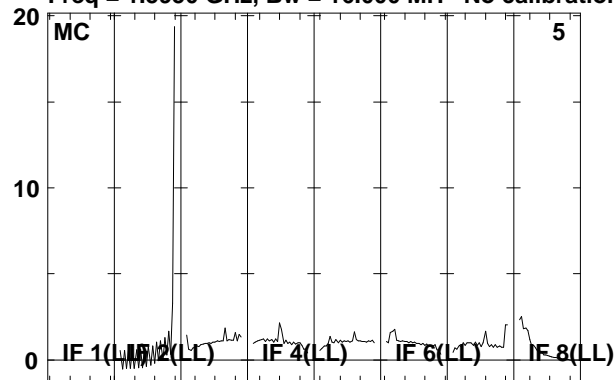

Lower frame: Real Jy

Total-power spectrum Antenna: \*

Timerange: 00/12:59:53 to 00/13:04:29

Plot file version 402 created 08-AUG-2008 17:01:59

J092159 EO006B.UVDATA.1

Freq = 1.5950 GHz, Bw = 16.000 MH No calibration applied and no bandpass applied

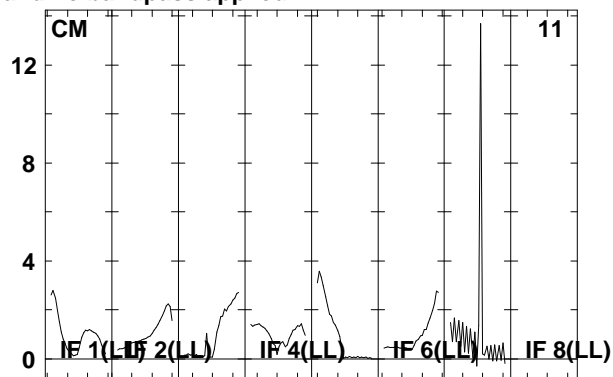
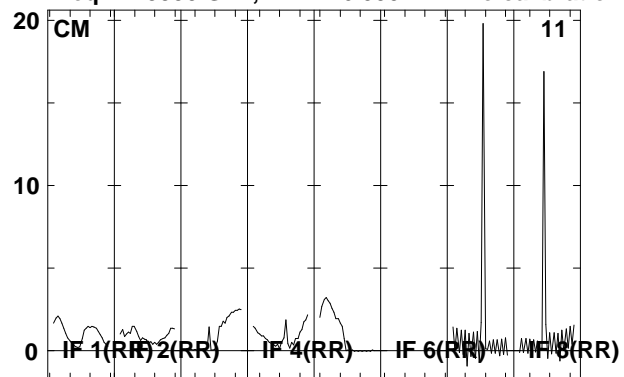

Lower frame: Real Jy  
Total-power spectrum Antenna: \*  
Timerange: 00/12:59:53 to 00/13:04:29

Plot file version 403 created 08-AUG-2008 17:02:00

J0920+44 EO006B.UVDATA.1

Freq = 1.5950 GHz, Bw = 16.000 MH No calibration applied and no bandpass applied

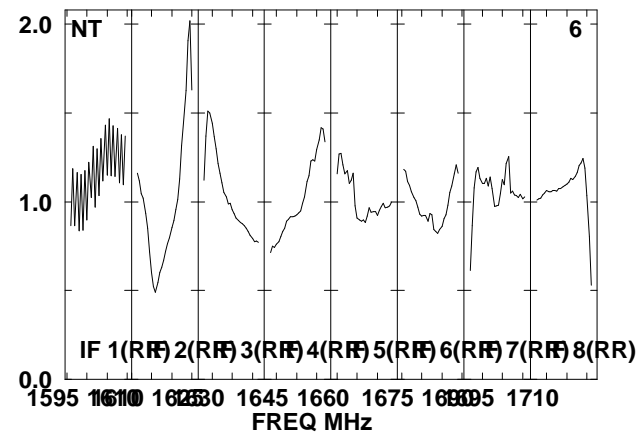
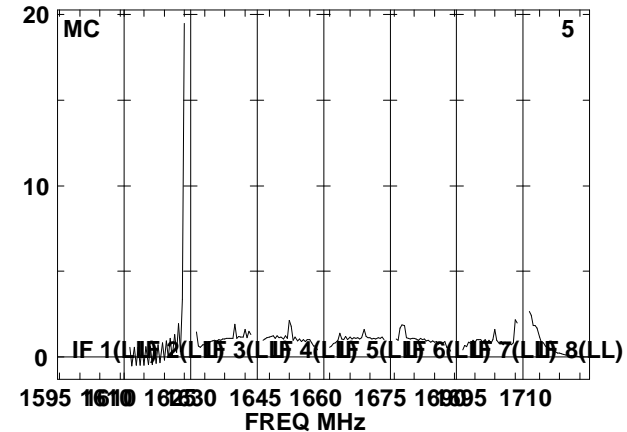
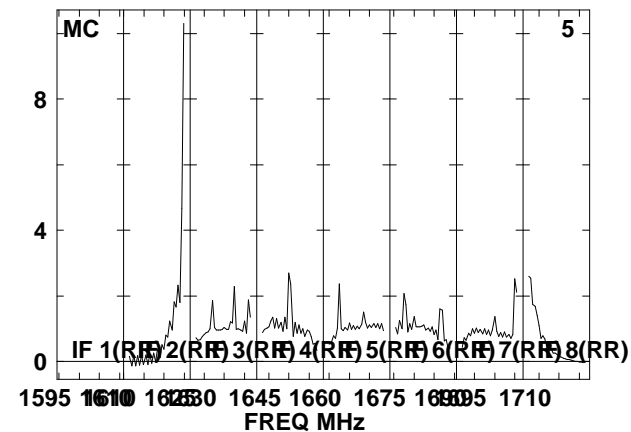
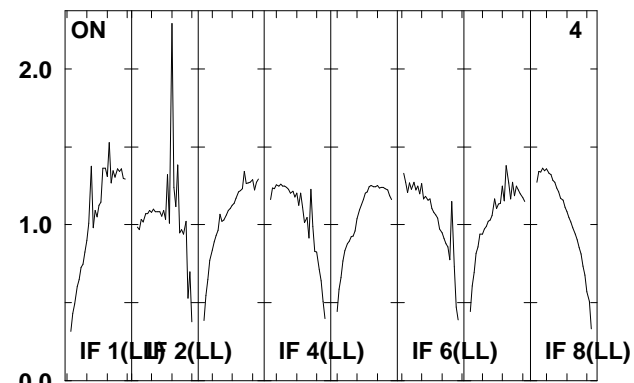
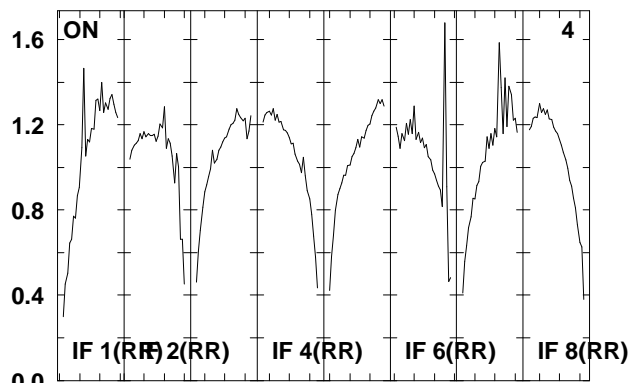
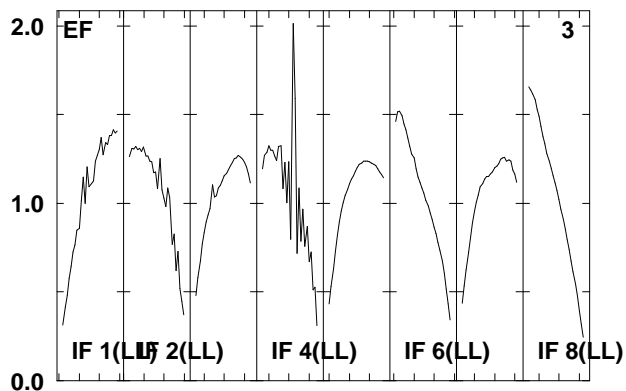
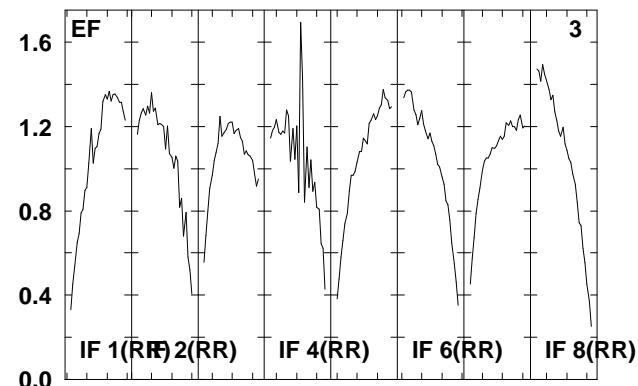
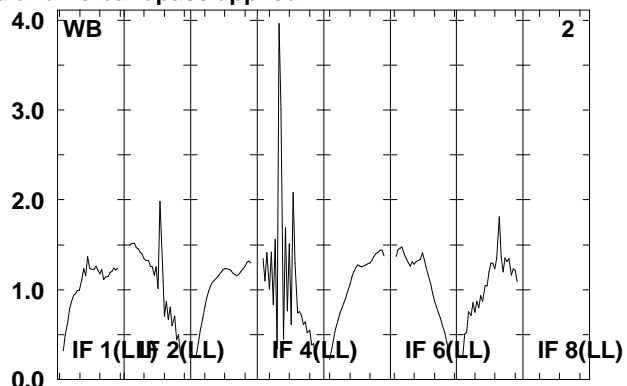
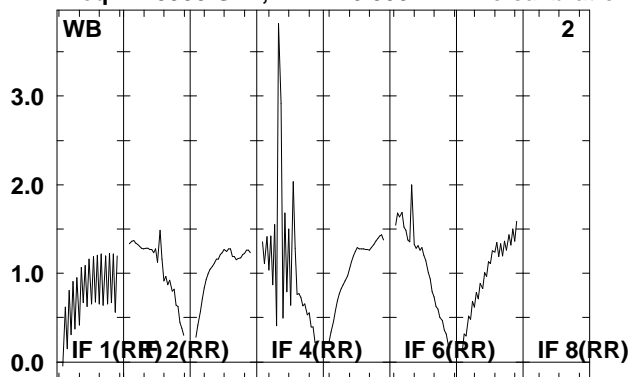

Lower frame: Real Jy  
Total-power spectrum Antenna: \*  
Timerange: 00/13:05:01 to 00/13:06:37

Plot file version 404 created 08-AUG-2008 17:02:00

J0920+44 EO06B.UVDATA.1

Freq = 1.5950 GHz, Bw = 16.000 MH No calibration applied and no bandpass applied

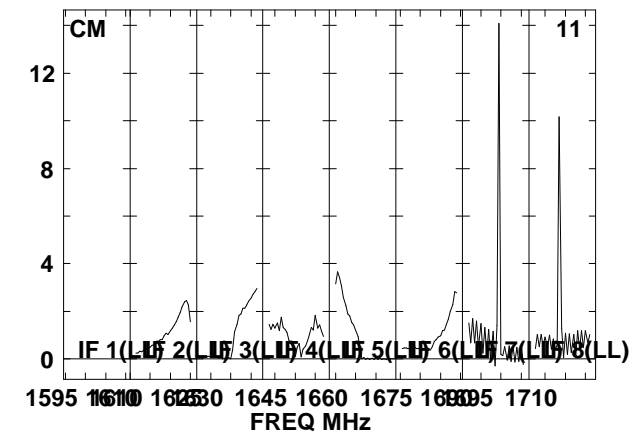
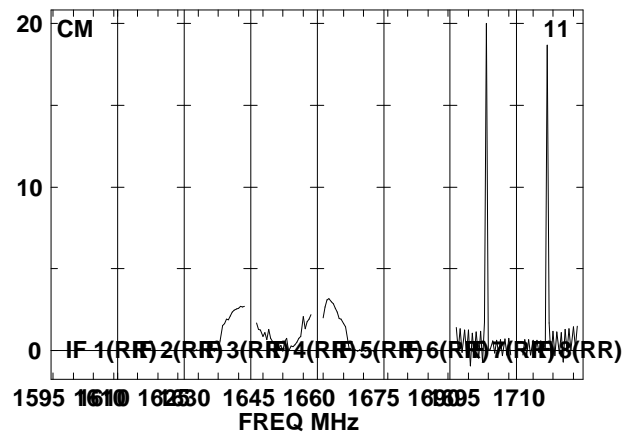
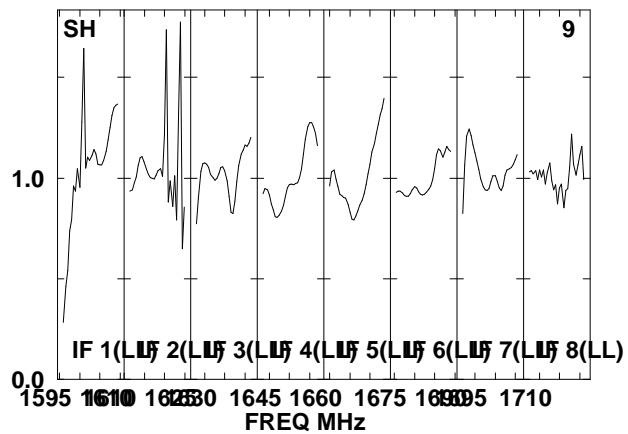
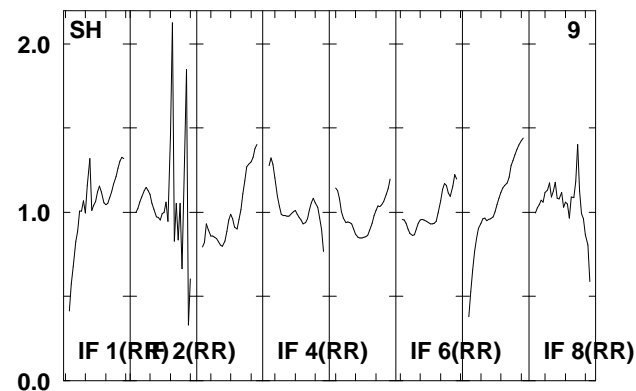
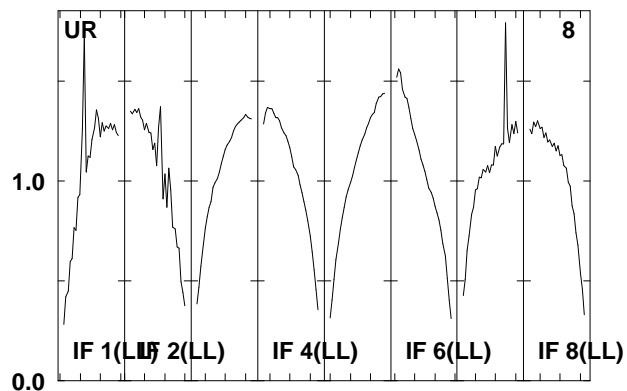
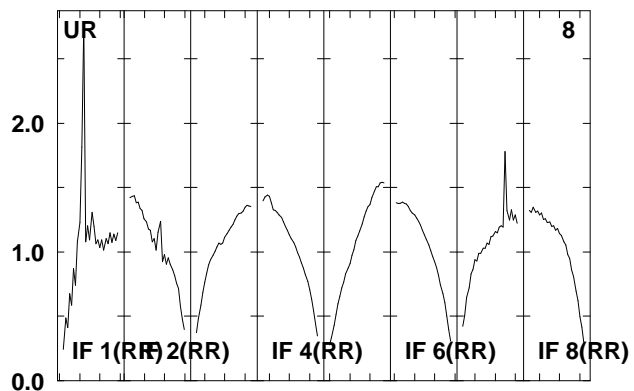
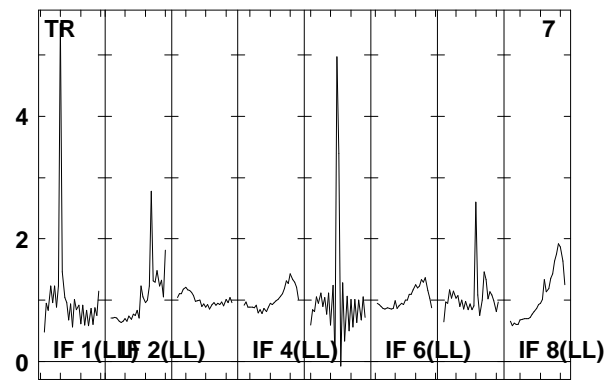
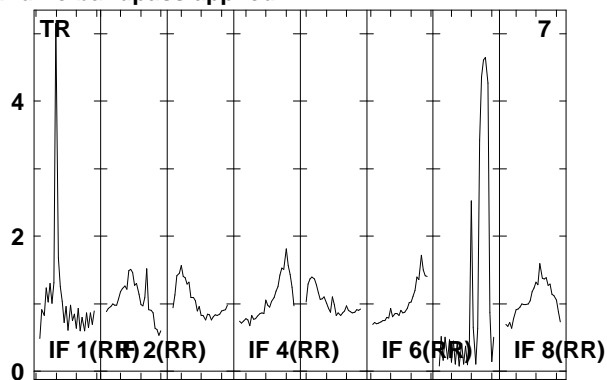
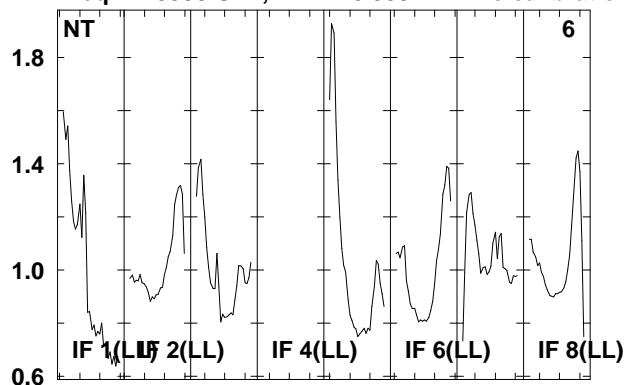

Lower frame: Real Jy  
Total-power spectrum Antenna: \*  
Timerange: 00/13:05:01 to 00/13:06:37



Plot file version 405 created 08-AUG-2008 17:02:01

J092159 EO006B.UVDATA.1

Freq = 1.5950 GHz, Bw = 16.000 MH No calibration applied and no bandpass applied

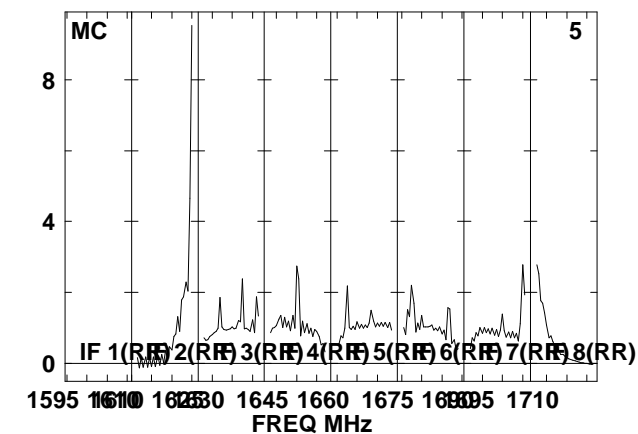
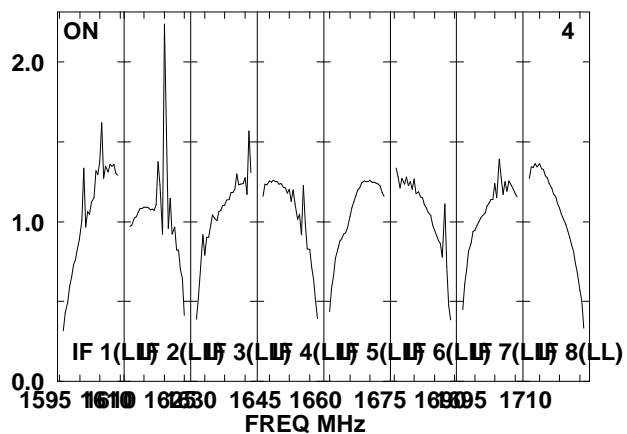
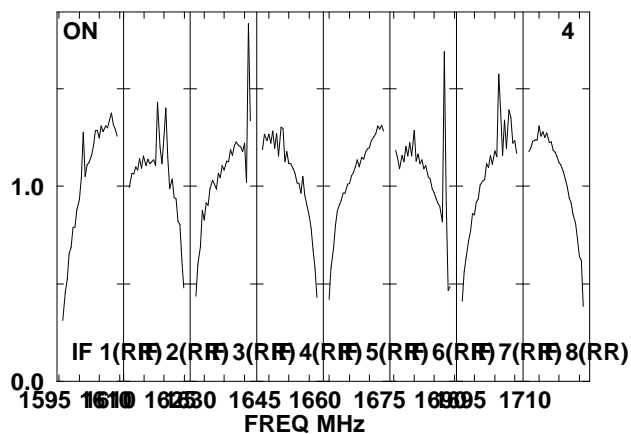
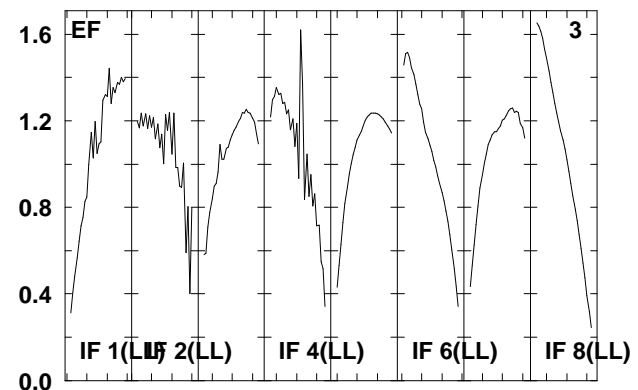
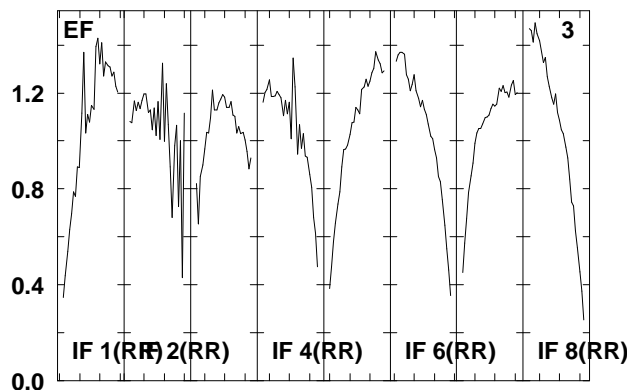
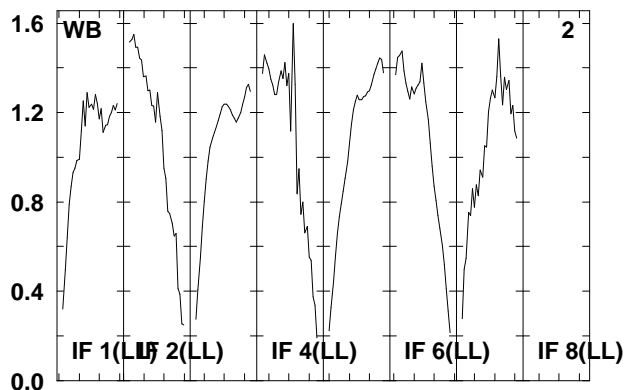
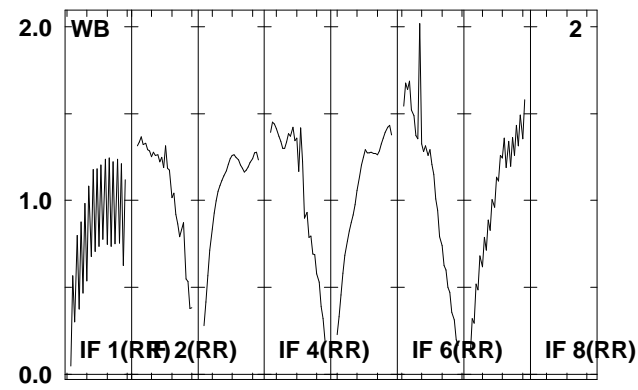
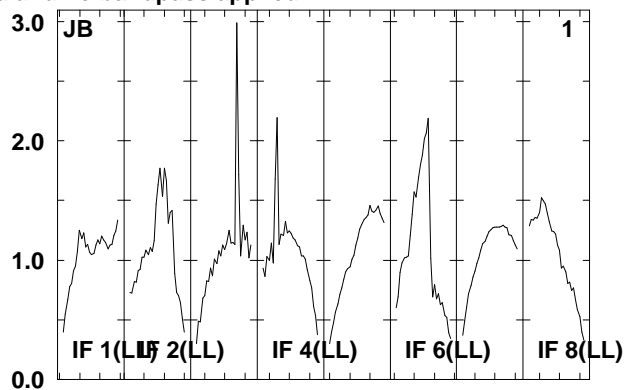
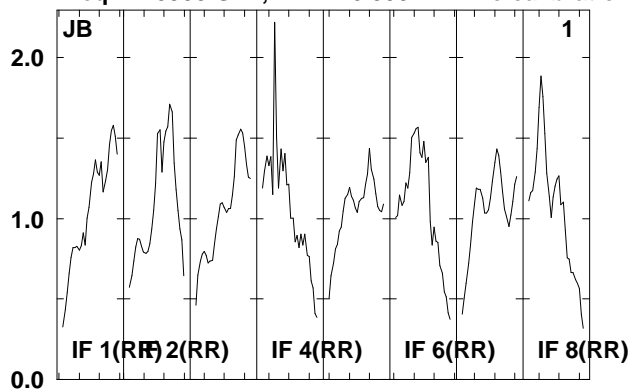

Lower frame: Real Jy  
Total-power spectrum Antenna: \*  
Timerange: 00/13:07:13 to 00/13:11:41

Plot file version 406 created 08-AUG-2008 17:02:01

J092159 EO06B.UVDATA.1

Freq = 1.5950 GHz, Bw = 16.000 MH No calibration applied and no bandpass applied

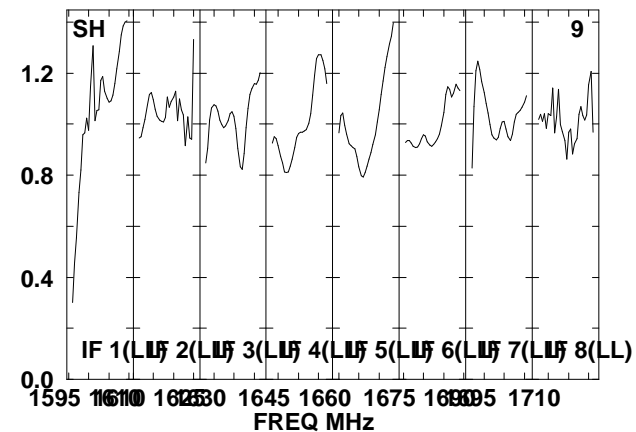
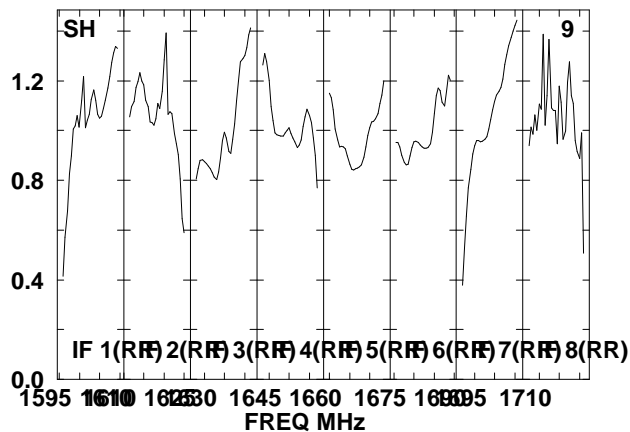
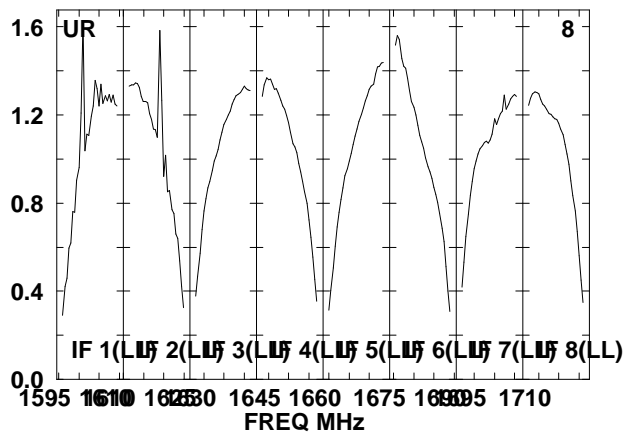
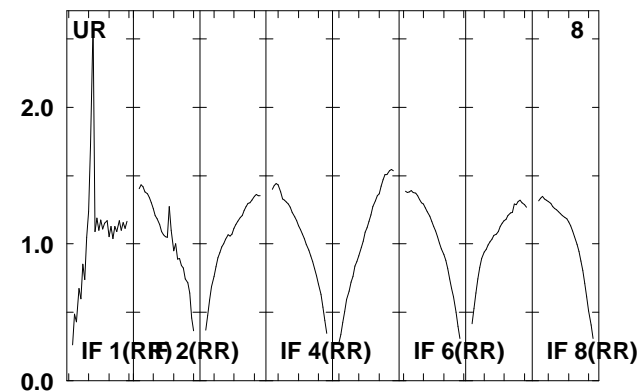
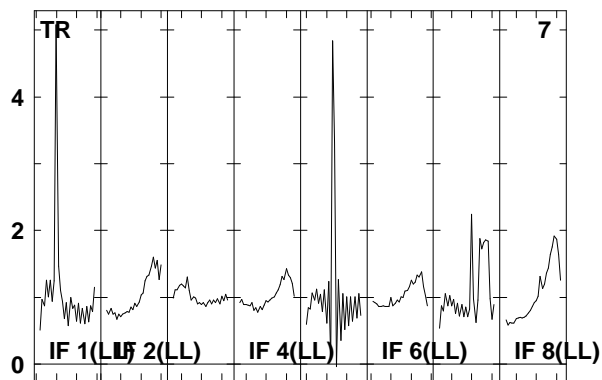
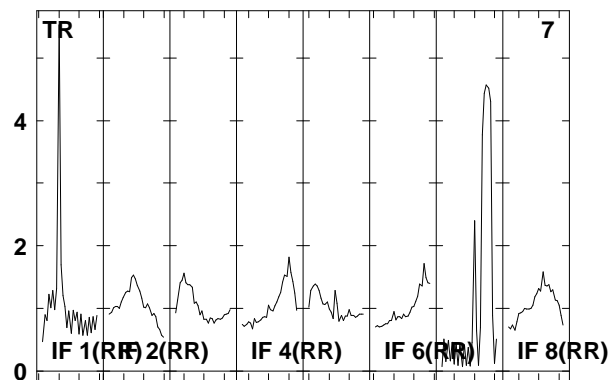
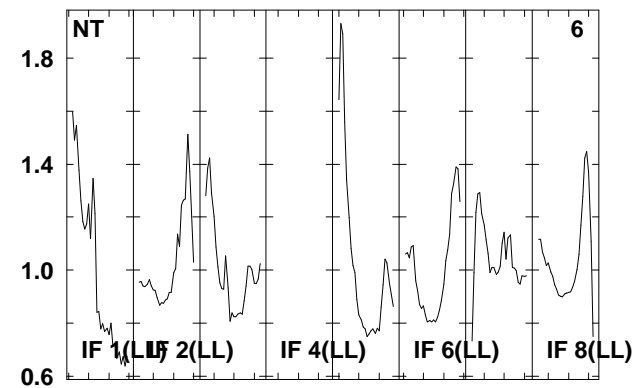
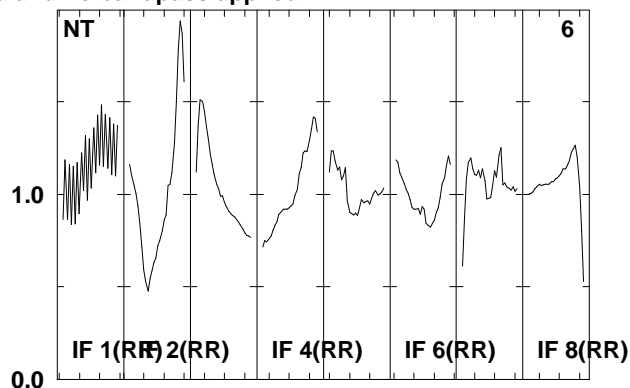
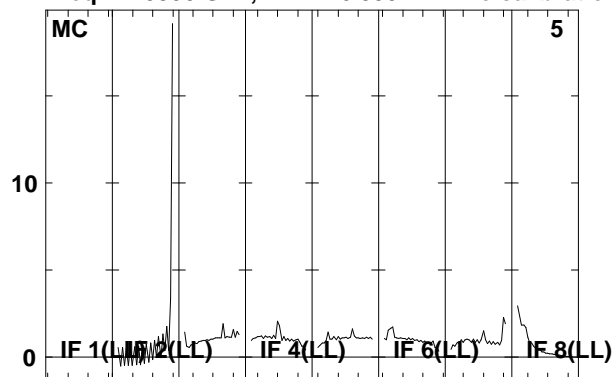

Lower frame: Real Jy

Total-power spectrum Antenna: \*

Timerange: 00/13:07:13 to 00/13:11:41

Plot file version 407 created 08-AUG-2008 17:02:02

J092159 EO006B.UVDATA.1

Freq = 1.5950 GHz, Bw = 16.000 MH No calibration applied and no bandpass applied

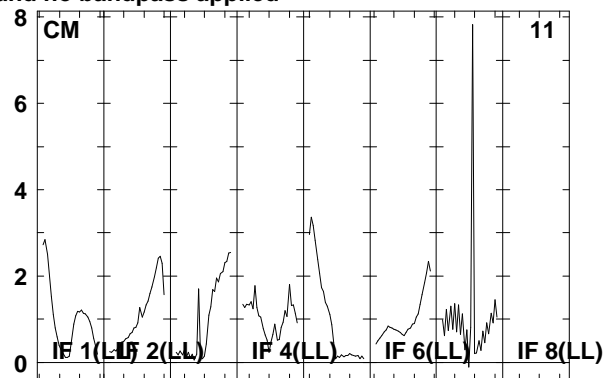
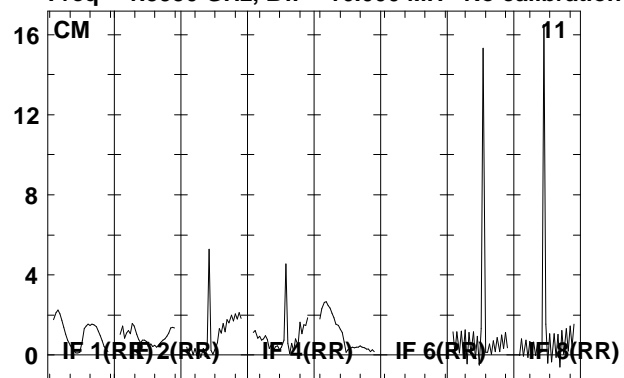

Lower frame: Real Jy  
Total-power spectrum Antenna: \*  
Timerange: 00/13:07:13 to 00/13:11:41

Plot file version 408 created 08-AUG-2008 17:02:03

J0920+44 EO006B.UVDATA.1

Freq = 1.5950 GHz, Bw = 16.000 MH No calibration applied and no bandpass applied

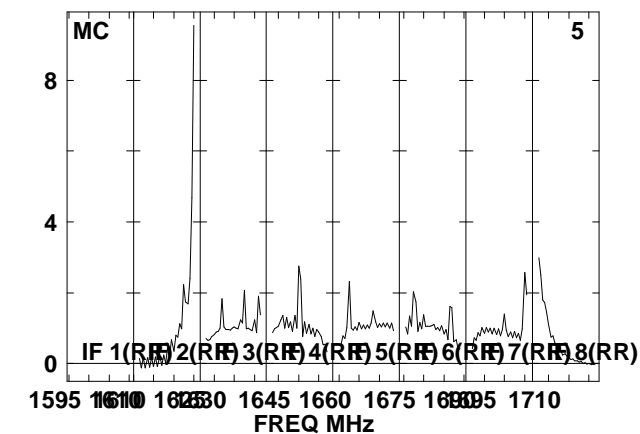
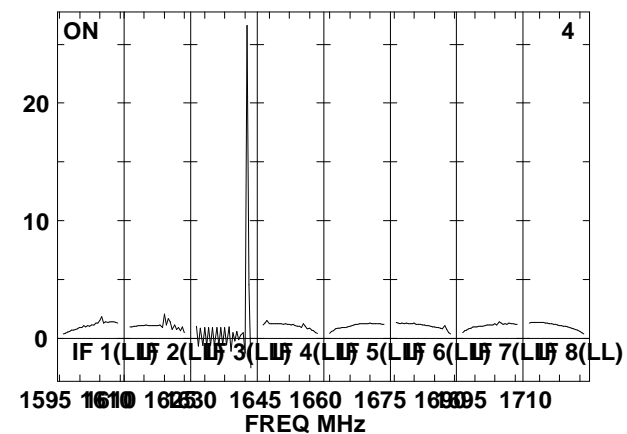
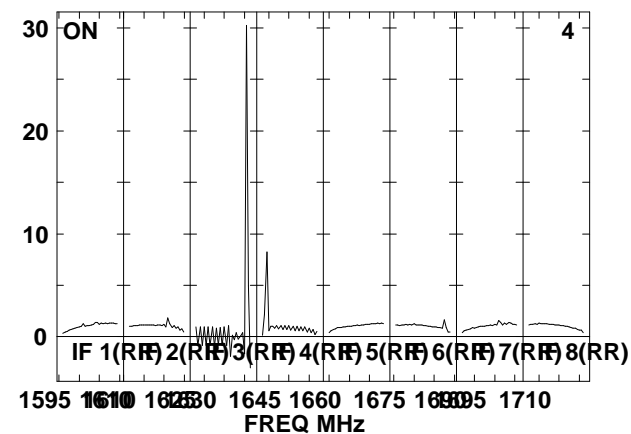
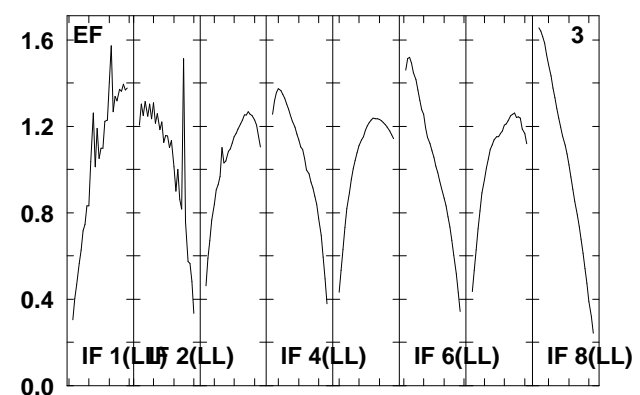
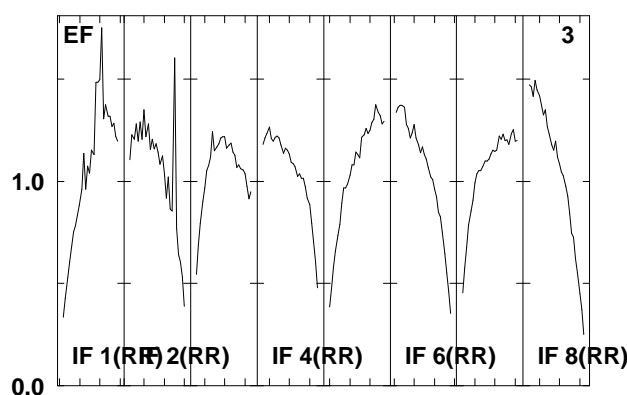
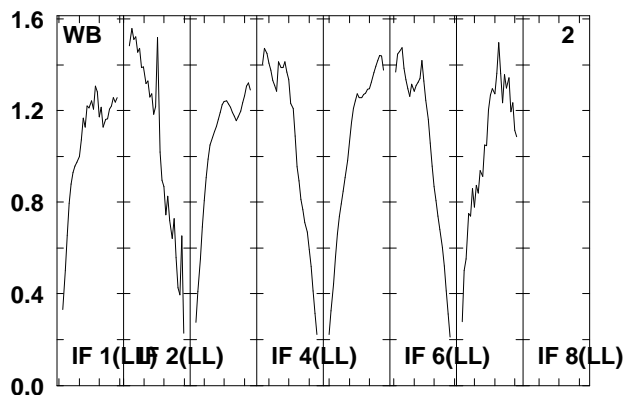
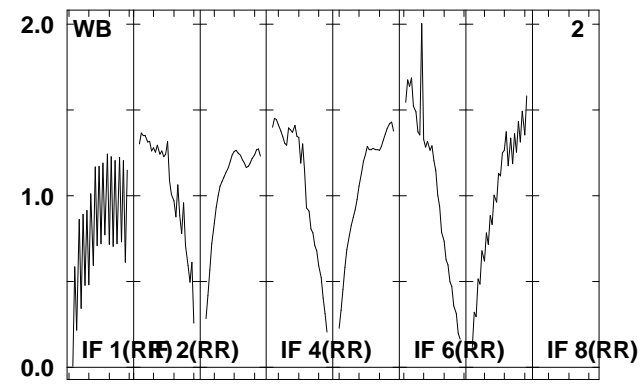
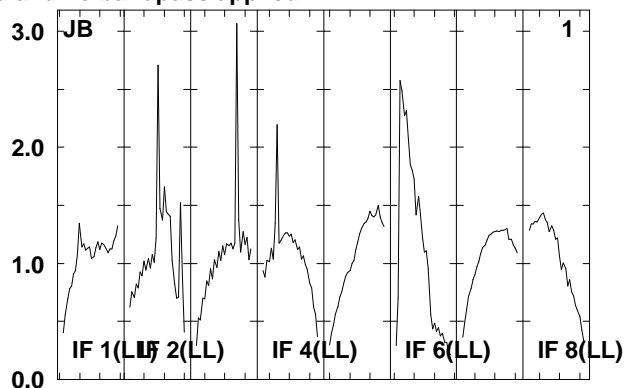
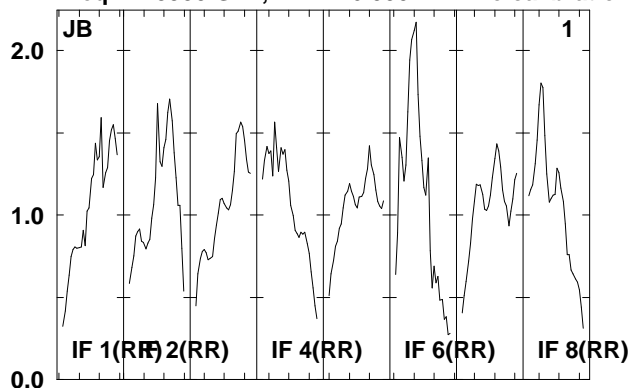

Lower frame: Real Jy  
Total-power spectrum Antenna: \*  
Timerange: 00/13:12:35 to 00/13:13:51

Plot file version 409 created 08-AUG-2008 17:02:04

J0920+44 EO006B.UVDATA.1

Freq = 1.5950 GHz, Bw = 16.000 MH No calibration applied and no bandpass applied

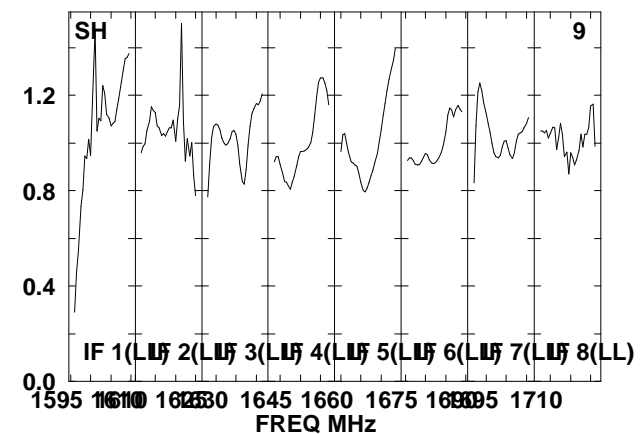
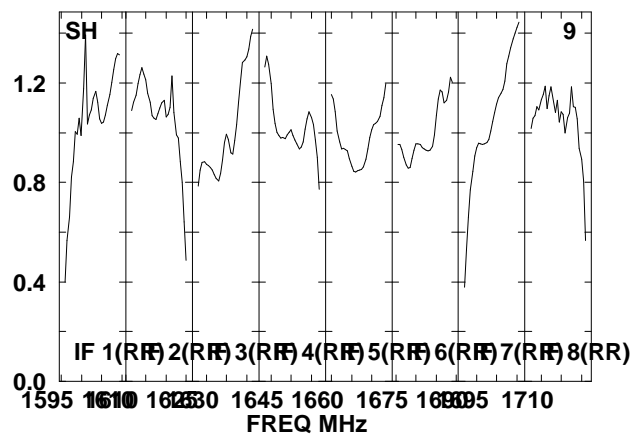
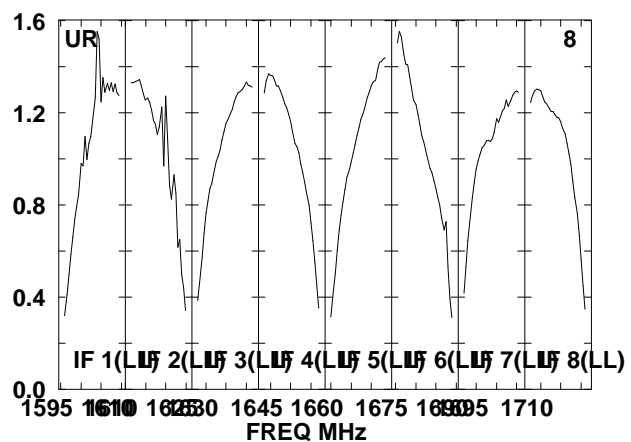
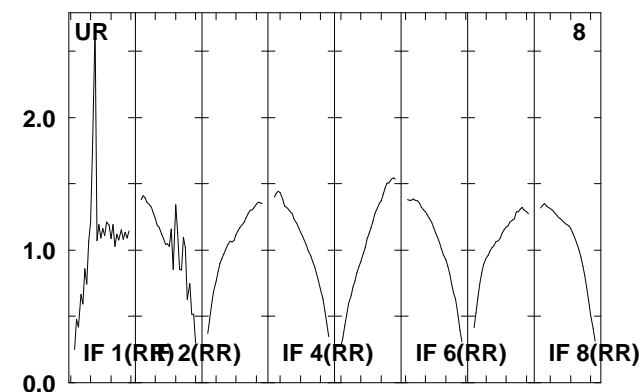
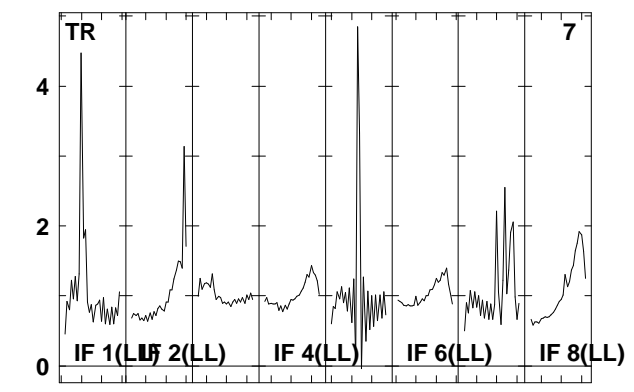
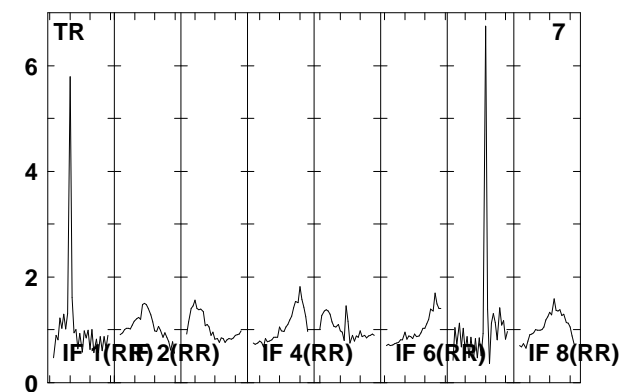
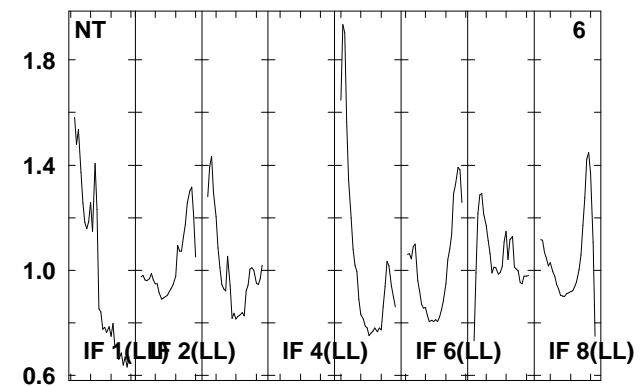
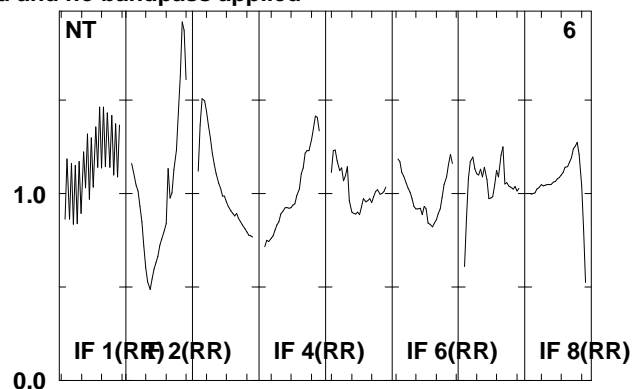
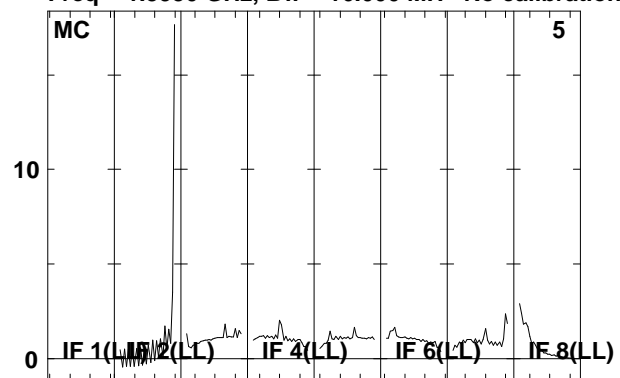

Lower frame: Real Jy

Total-power spectrum Antenna: \*

Timerange: 00/13:12:35 to 00/13:13:51

Plot file version 410 created 08-AUG-2008 17:02:04

J0920+44 EO006B.UVDATA.1

Freq = 1.5950 GHz, Bw = 16.000 MH No calibration applied and no bandpass applied

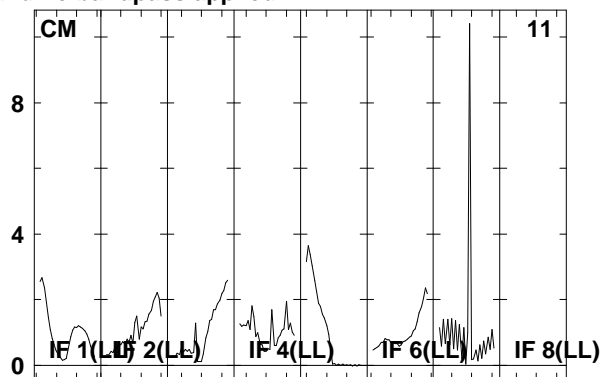
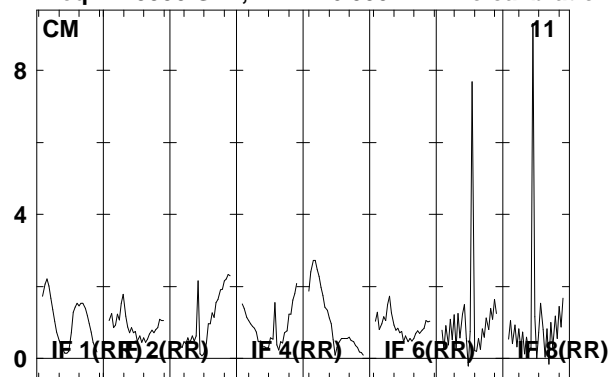

Lower frame: Real Jy  
Total-power spectrum Antenna: \*  
Timerange: 00/13:12:35 to 00/13:13:51

Plot file version 411 created 08-AUG-2008 17:02:04

J092159 EO006B.UVDATA.1

Freq = 1.5950 GHz, Bw = 16.000 MH No calibration applied and no bandpass applied

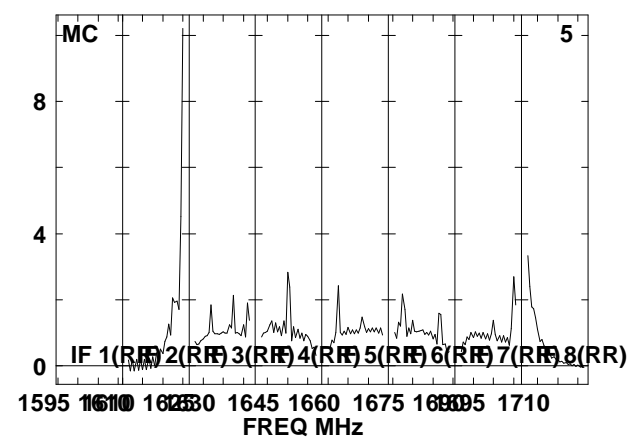
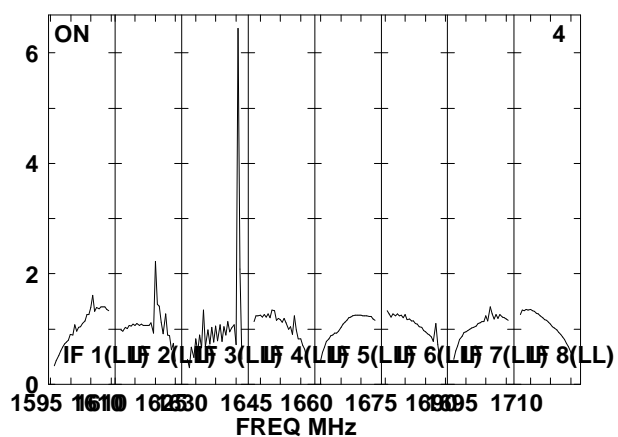
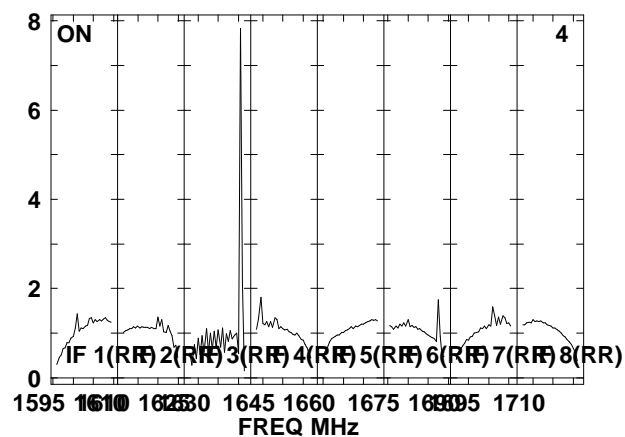
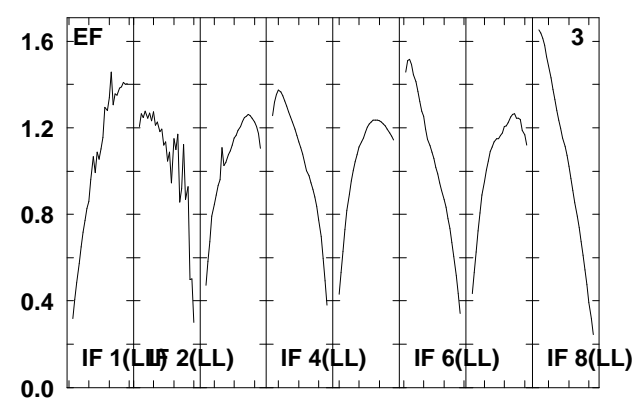
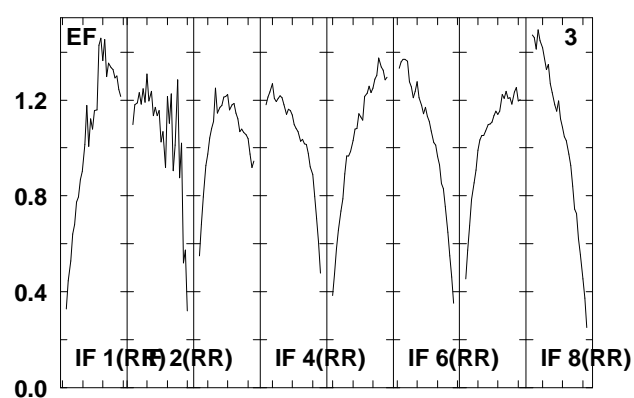
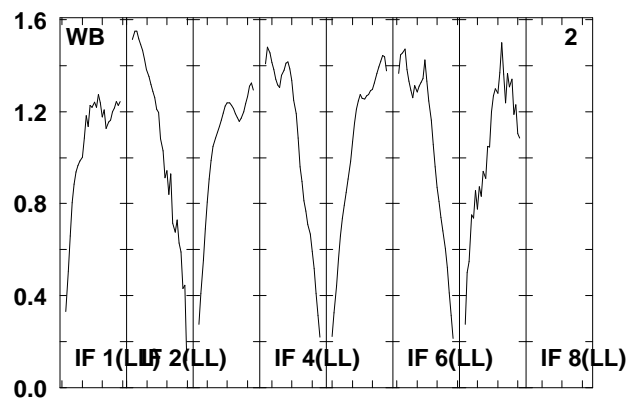
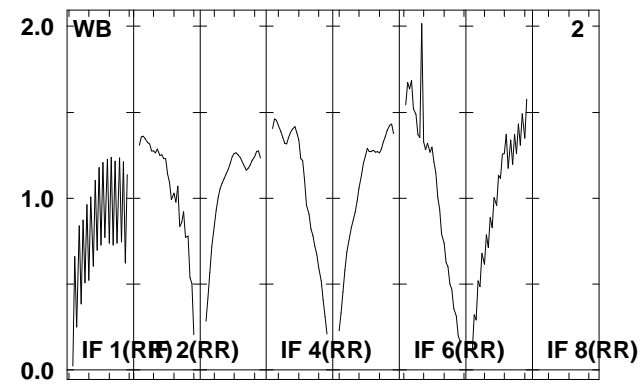
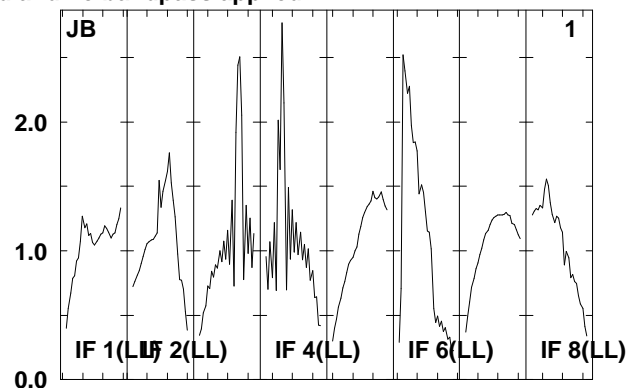
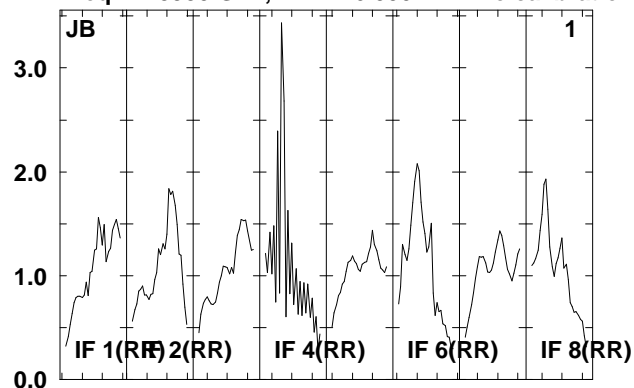

Lower frame: Real Jy  
Total-power spectrum Antenna: \*  
Timerange: 00/13:14:37 to 00/13:19:01

Plot file version 412 created 08-AUG-2008 17:02:05

J092159 EO06B.UVDATA.1

Freq = 1.5950 GHz, Bw = 16.000 MH No calibration applied and no bandpass applied

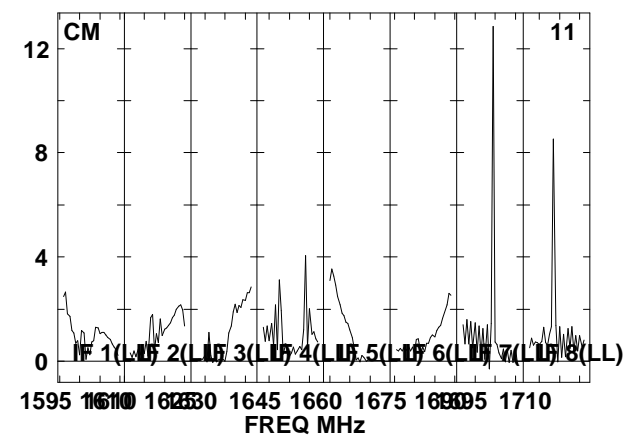
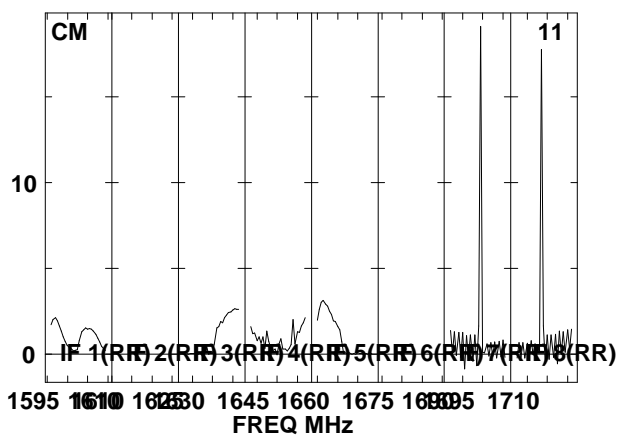
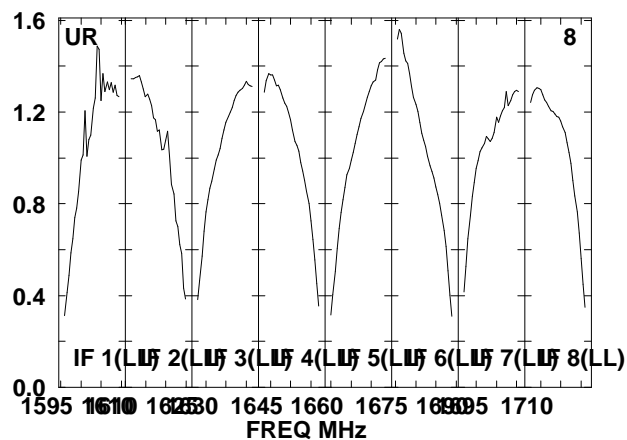
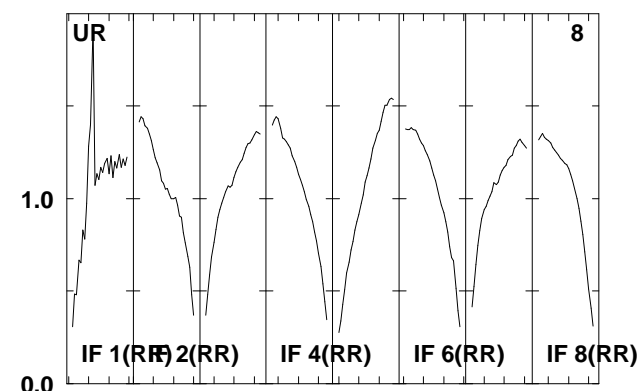
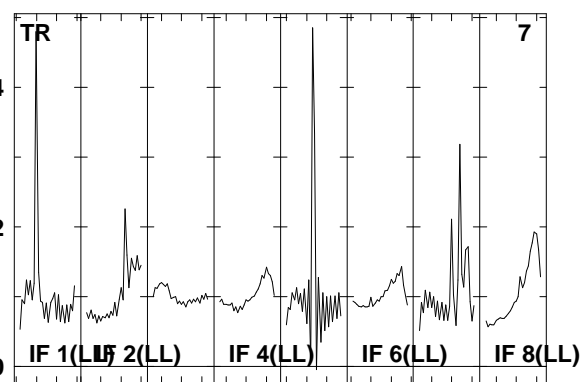
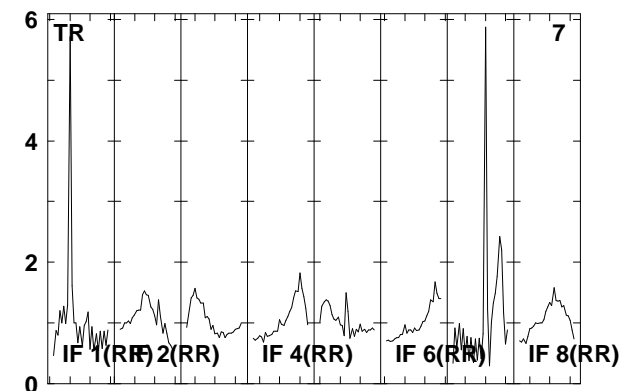
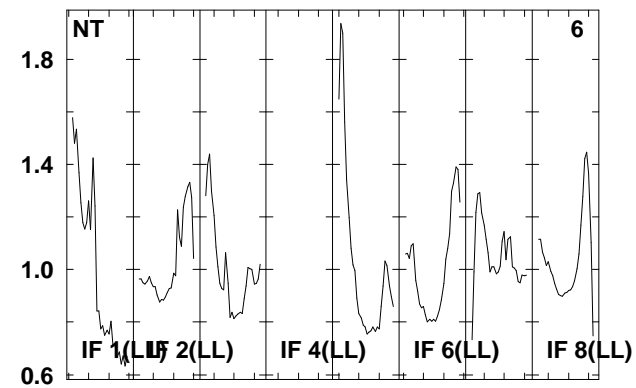
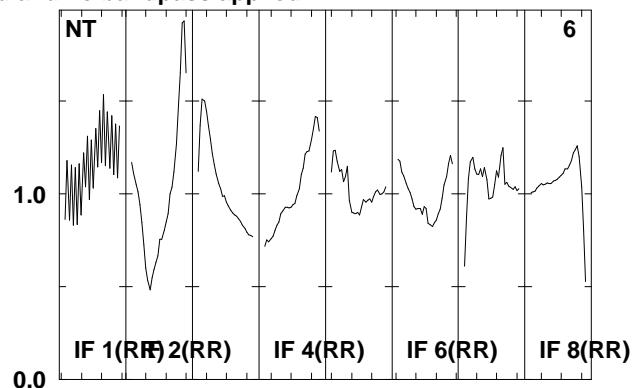
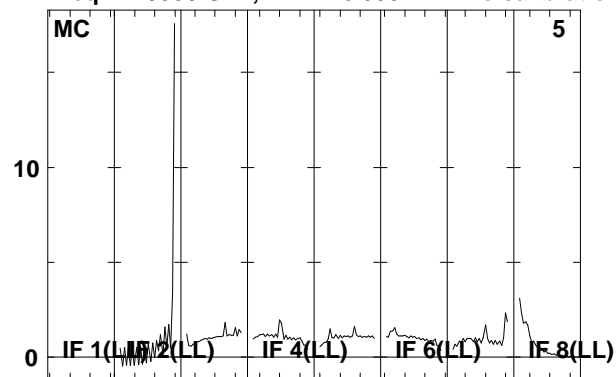

Lower frame: Real Jy

Total-power spectrum Antenna: \*

Timerange: 00/13:14:37 to 00/13:19:01



Plot file version 413 created 08-AUG-2008 17:02:06

J0920+44 EO006B.UVDATA.1

Freq = 1.5950 GHz, Bw = 16.000 MH No calibration applied and no bandpass applied

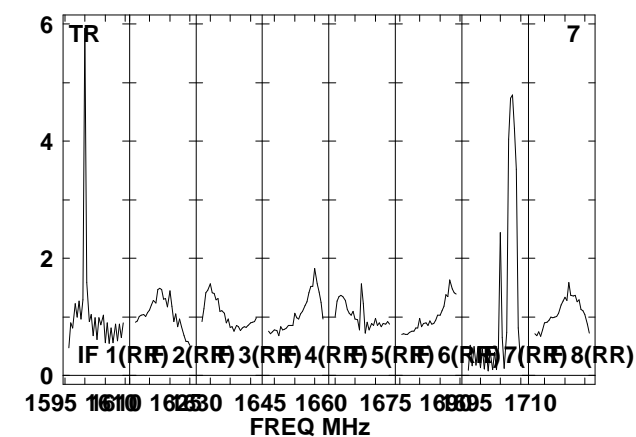
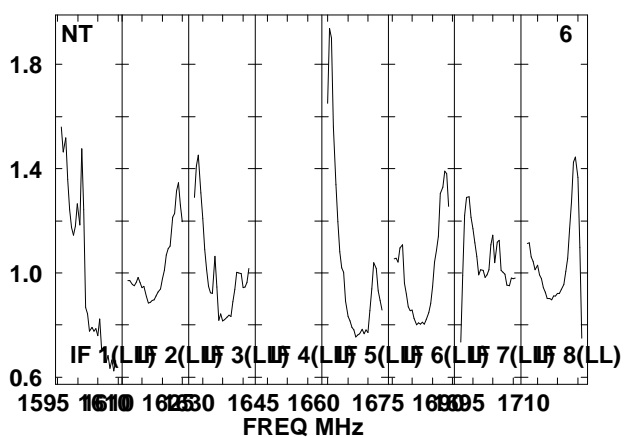
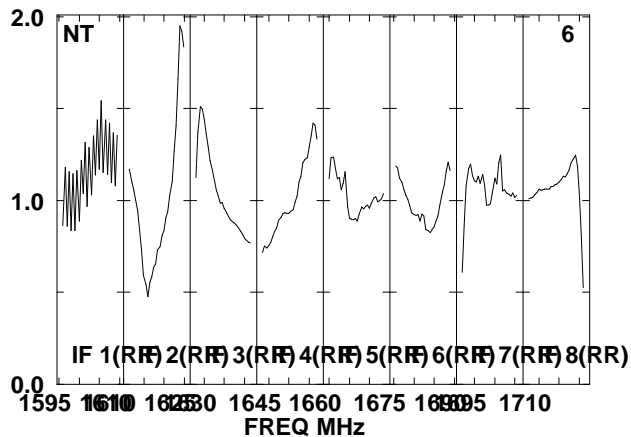
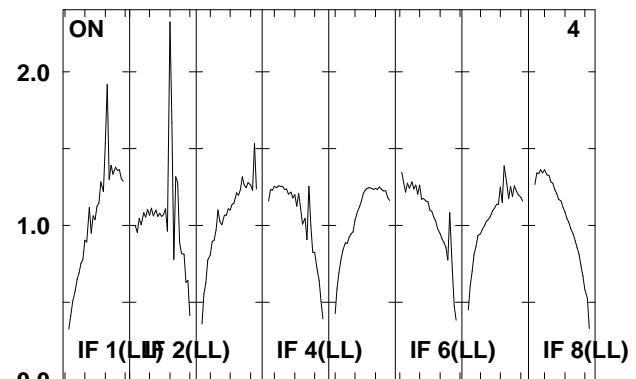
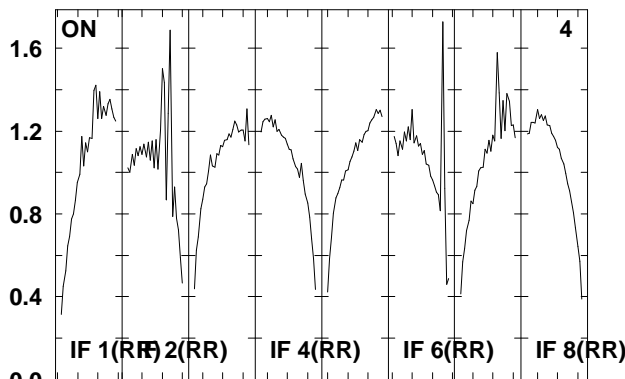
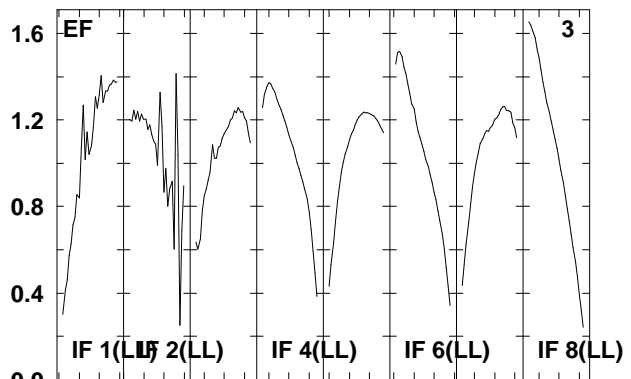
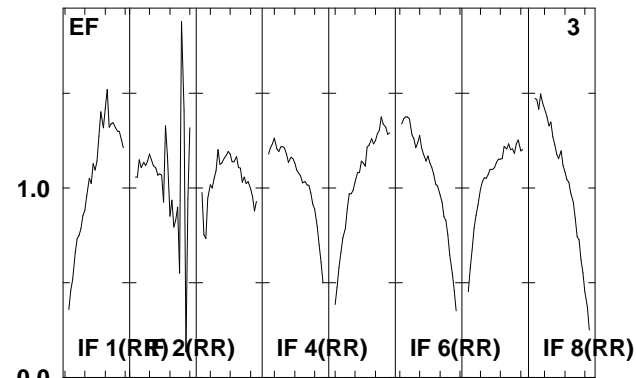
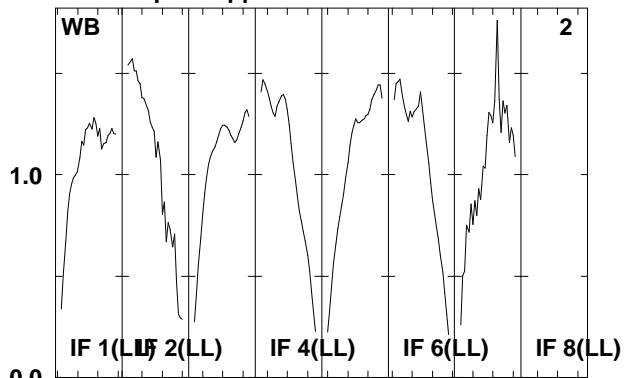
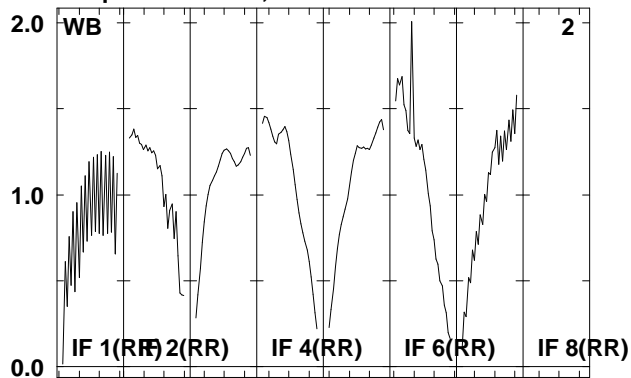

Lower frame: Real Jy  
Total-power spectrum Antenna: \*  
Timerange: 00/13:19:43 to 00/13:21:11

Plot file version 414 created 08-AUG-2008 17:02:06

J0920+44 EO006B.UVDATA.1

Freq = 1.5950 GHz, Bw = 16.000 MH No calibration applied and no bandpass applied

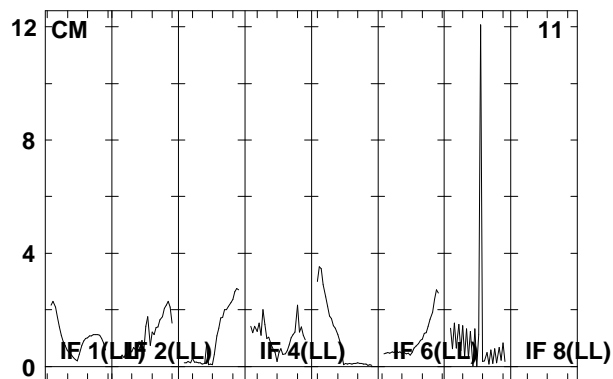
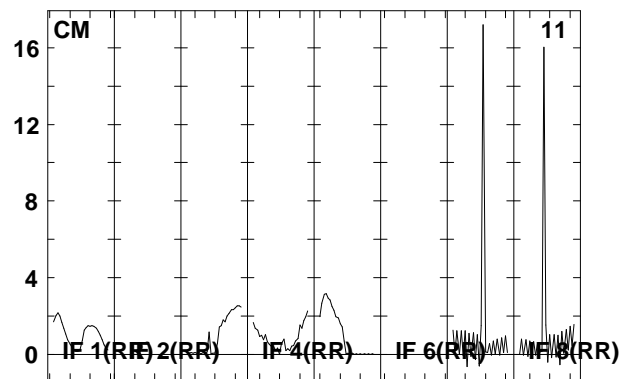
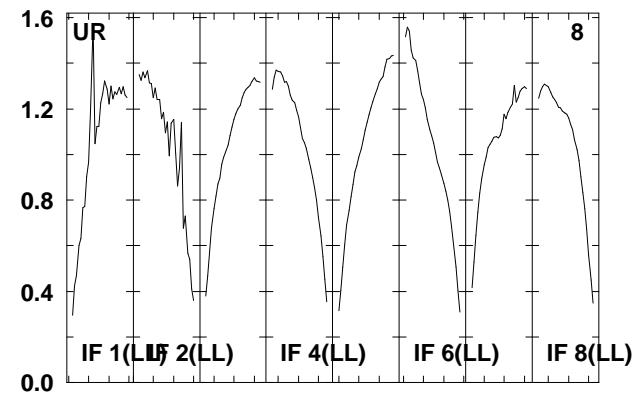
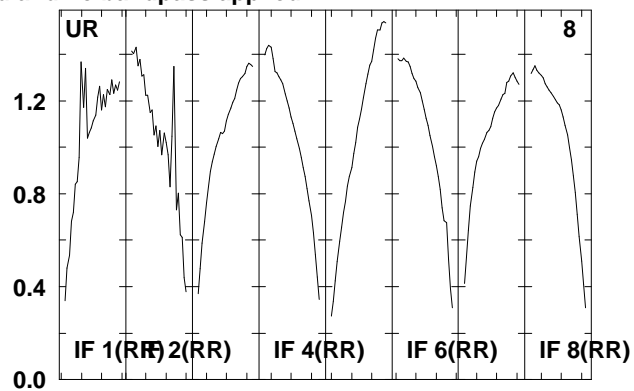
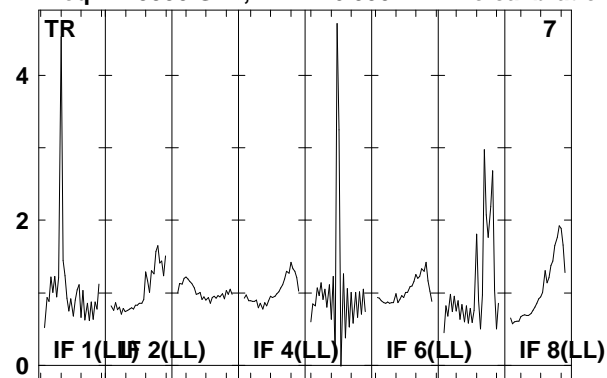

Lower frame: Real Jy  
Total-power spectrum Antenna: \*  
Timerange: 00/13:19:43 to 00/13:21:11

Plot file version 415 created 08-AUG-2008 17:02:07

J092159 EO006B.UVDATA.1

Freq = 1.5950 GHz, Bw = 16.000 MH No calibration applied and no bandpass applied

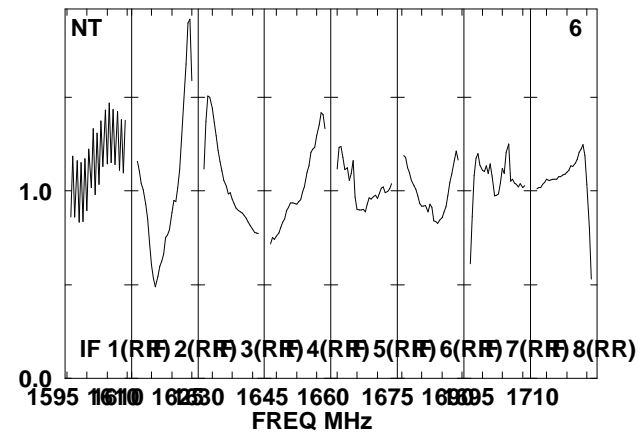
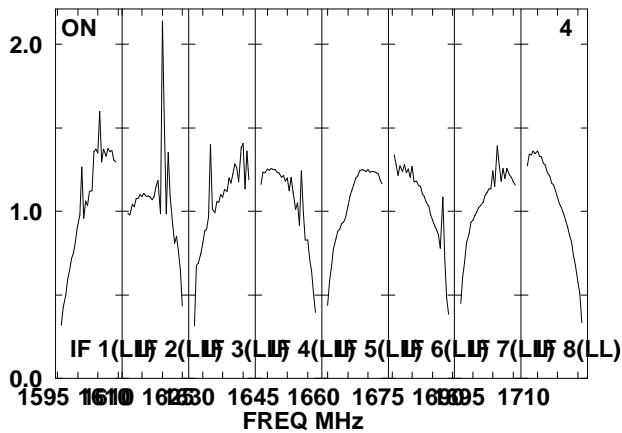
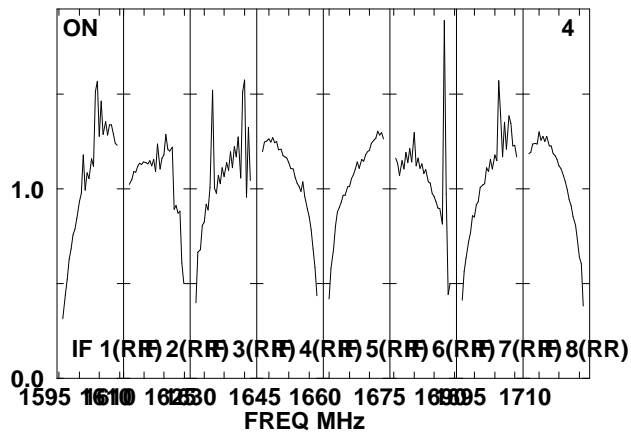
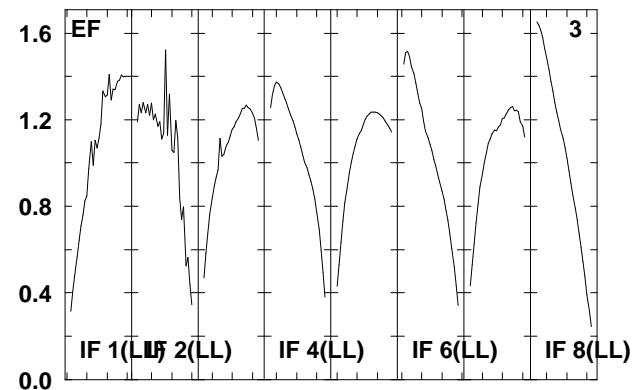
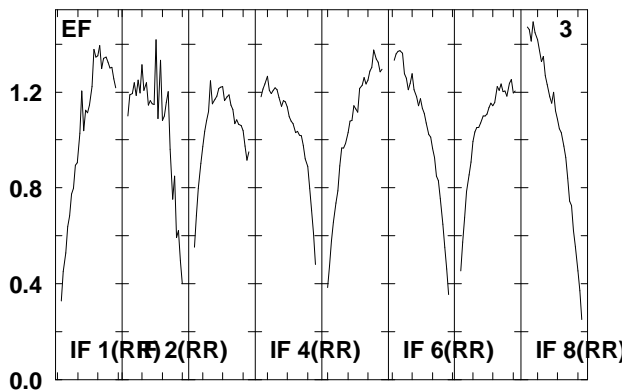
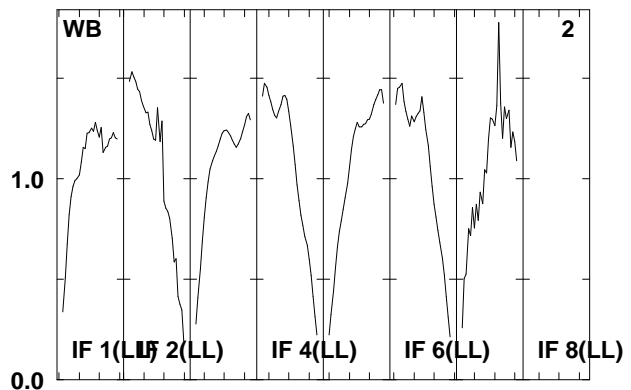
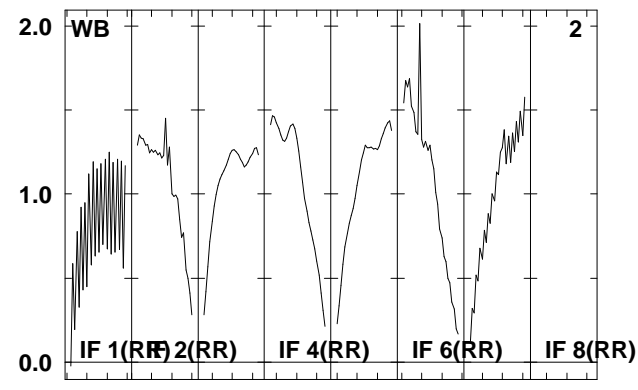
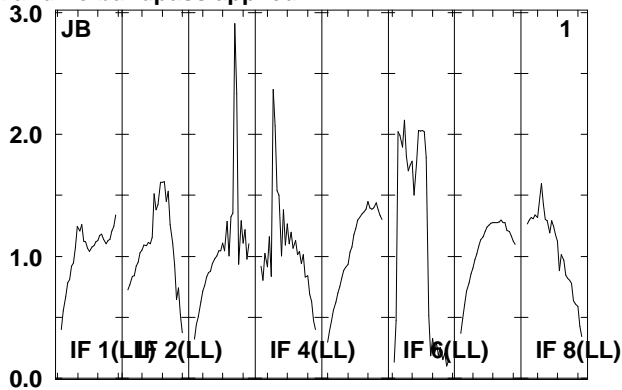
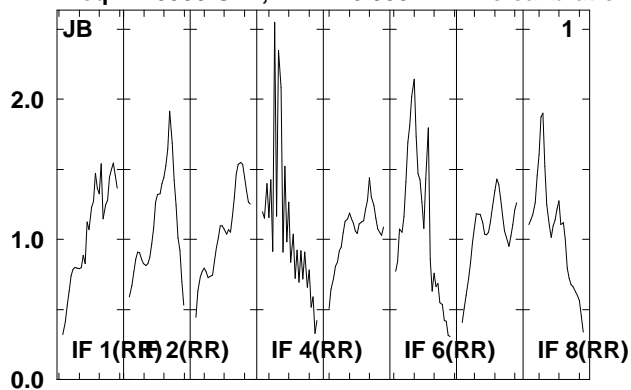

Lower frame: Real Jy  
Total-power spectrum Antenna: \*  
Timerange: 00/13:21:53 to 00/13:26:29

Plot file version 416 created 08-AUG-2008 17:02:07

J092159 EO006B.UVDATA.1

Freq = 1.5950 GHz, Bw = 16.000 MH No calibration applied and no bandpass applied

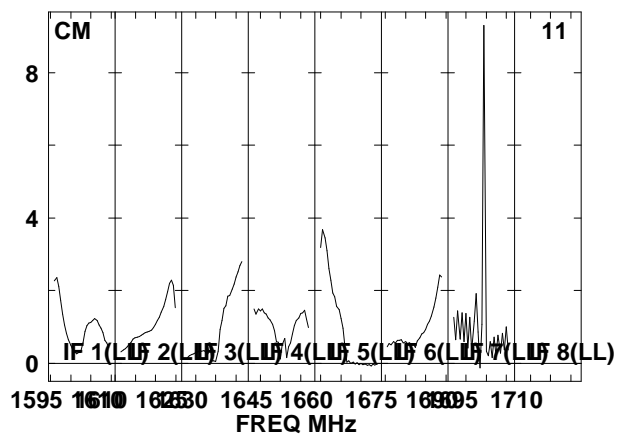
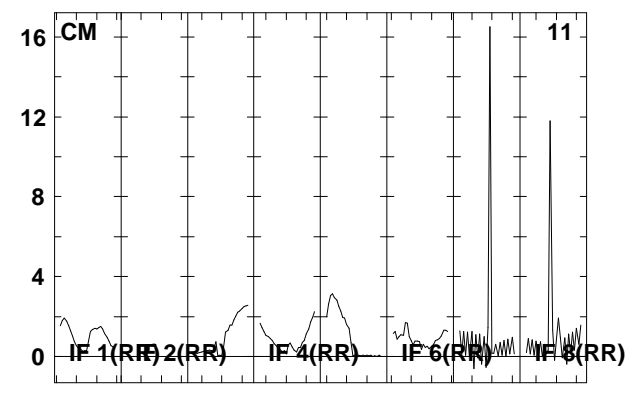
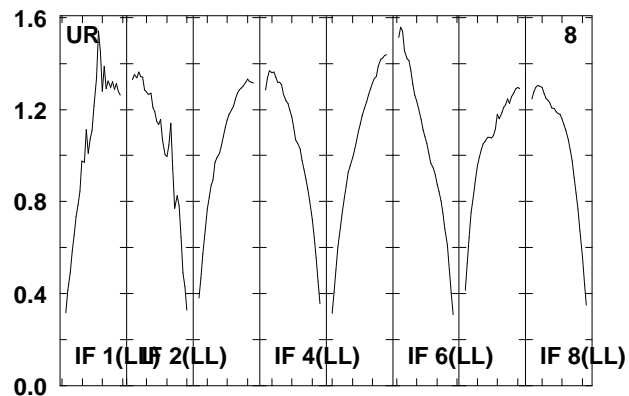
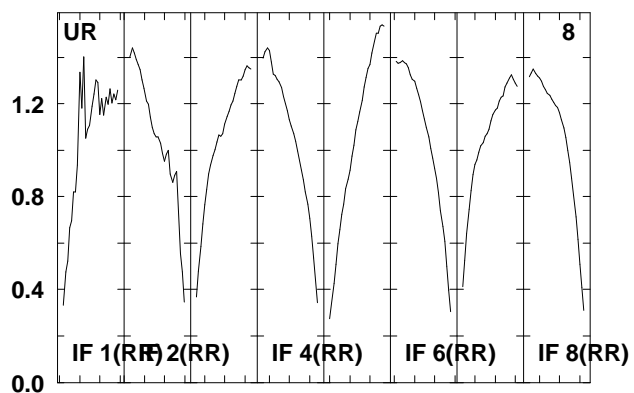
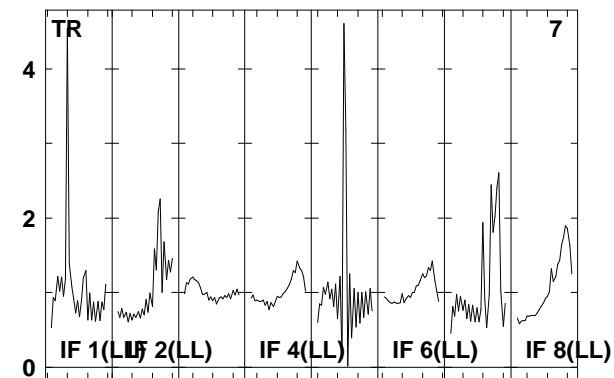
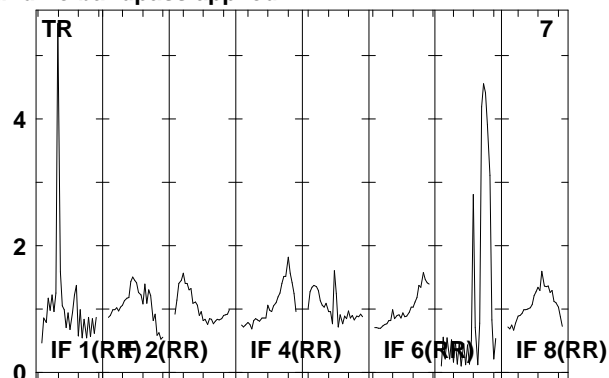
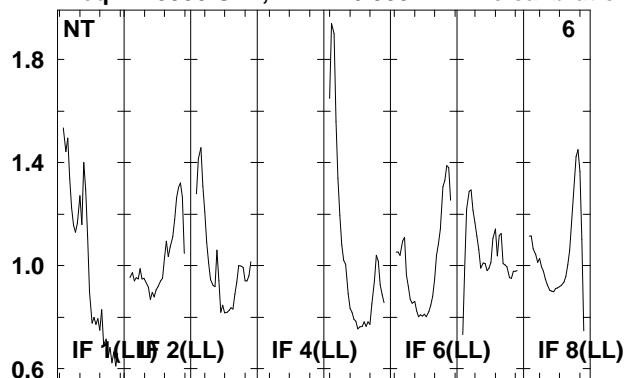

Lower frame: Real Jy

Total-power spectrum Antenna: \*

Timerange: 00/13:21:53 to 00/13:26:29

Plot file version 417 created 08-AUG-2008 17:02:08

J0920+44 EO006B.UVDATA.1

Freq = 1.5950 GHz, Bw = 16.000 MH No calibration applied and no bandpass applied

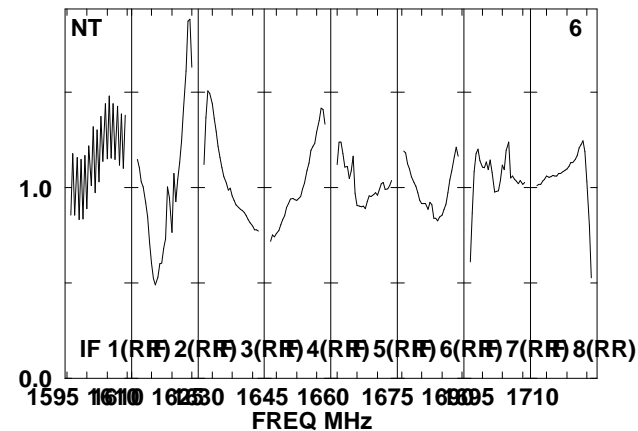
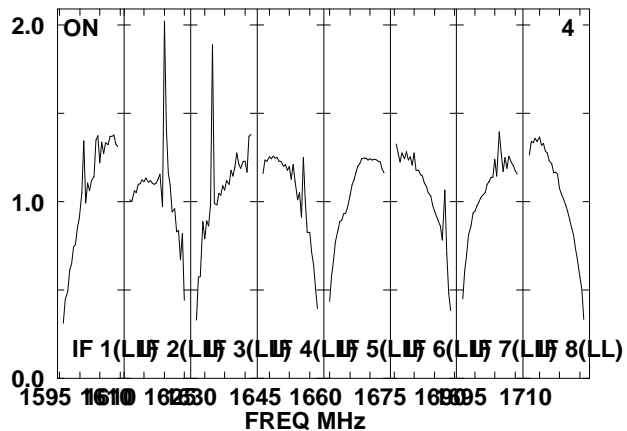
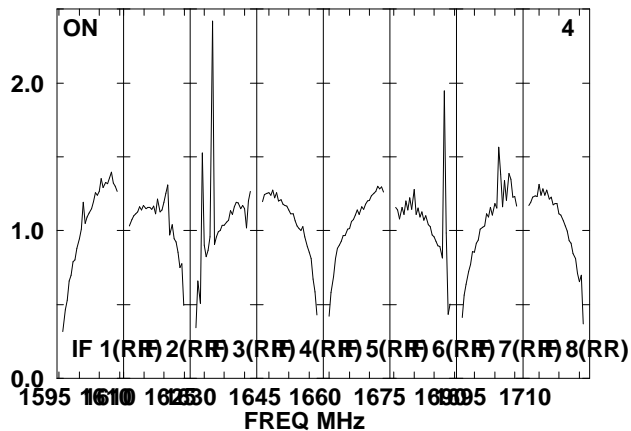
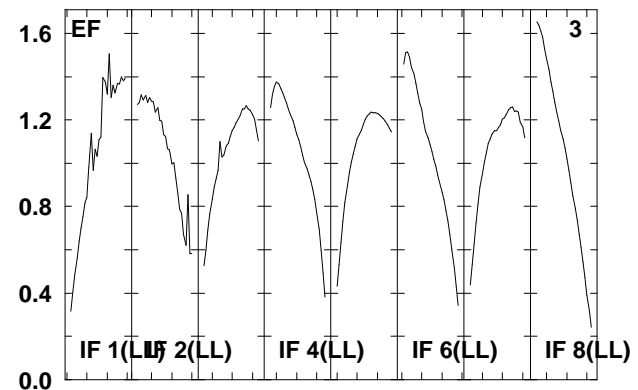
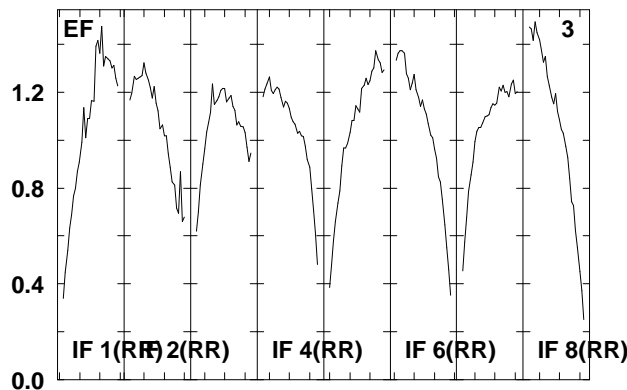
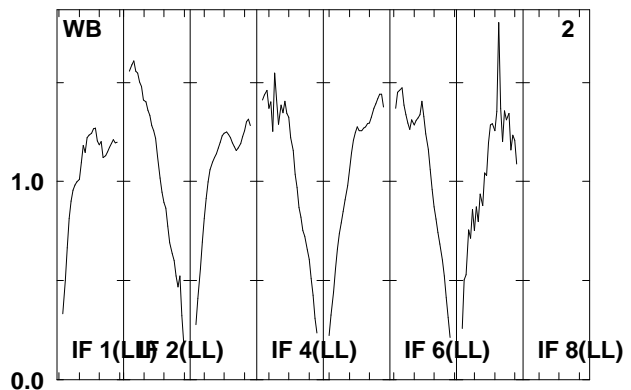
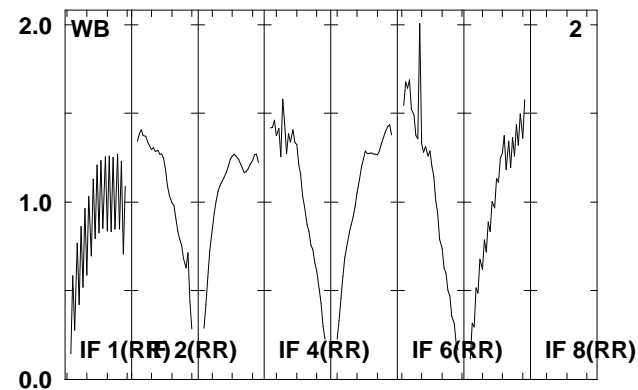
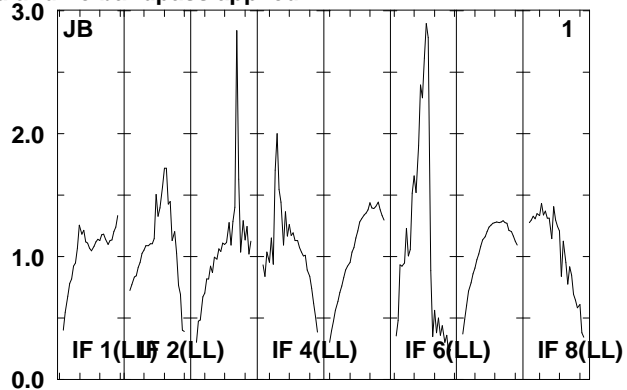
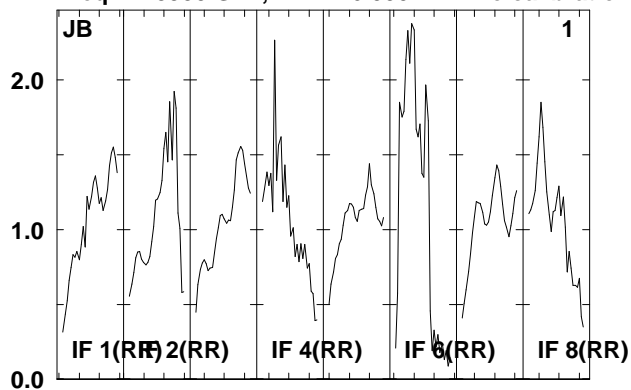

Lower frame: Real Jy  
Total-power spectrum Antenna: \*  
Timerange: 00/13:27:01 to 00/13:28:37

Plot file version 418 created 08-AUG-2008 17:02:08

J0920+44 EO06B.UVDATA.1

Freq = 1.5950 GHz, Bw = 16.000 MH No calibration applied and no bandpass applied

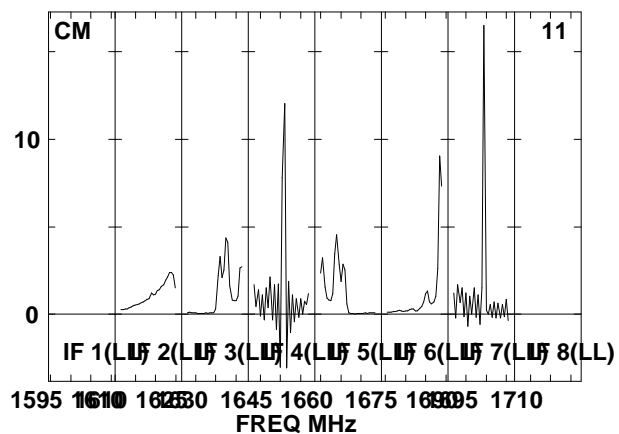
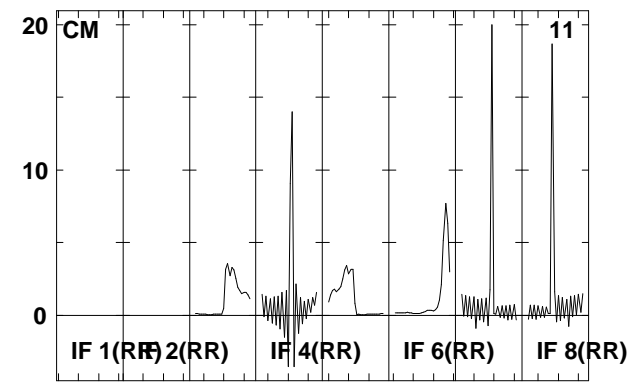
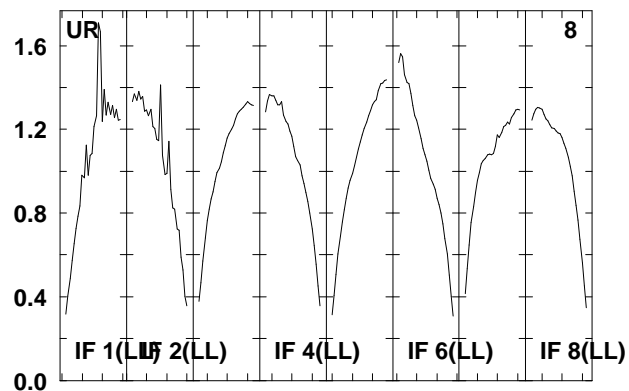
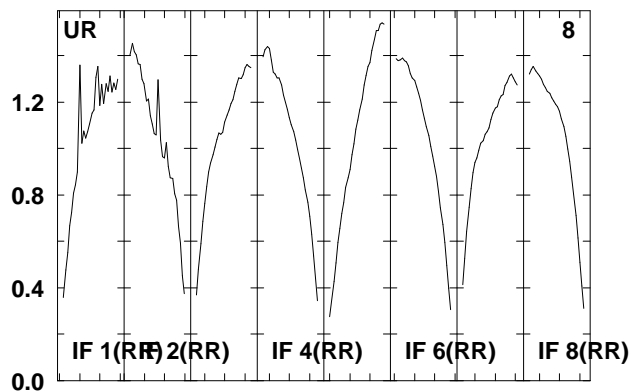
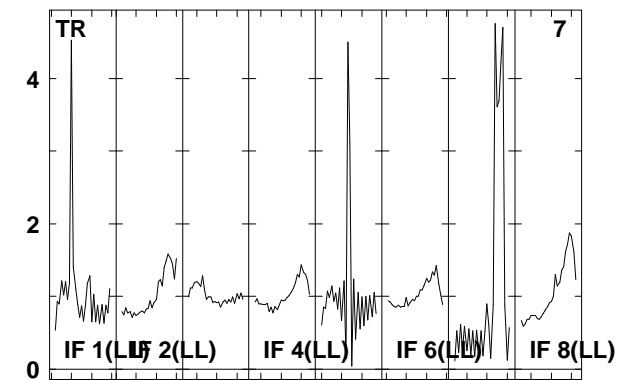
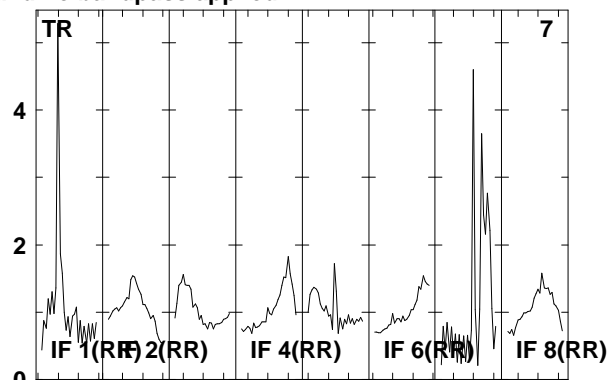
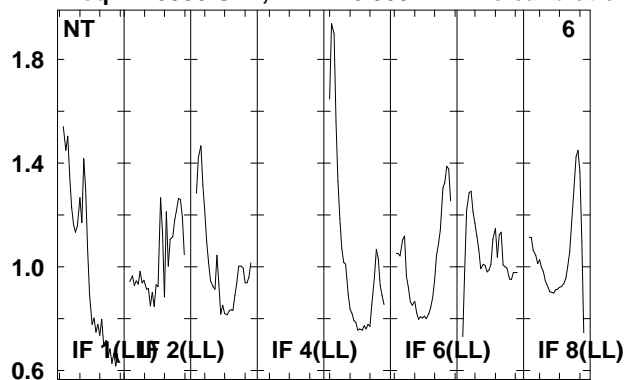

Lower frame: Real Jy

Total-power spectrum Antenna: \*

Timerange: 00/13:27:01 to 00/13:28:37

Plot file version 419 created 08-AUG-2008 17:02:08

J092159 EO006B.UVDATA.1

Freq = 1.5950 GHz, Bw = 16.000 MH No calibration applied and no bandpass applied

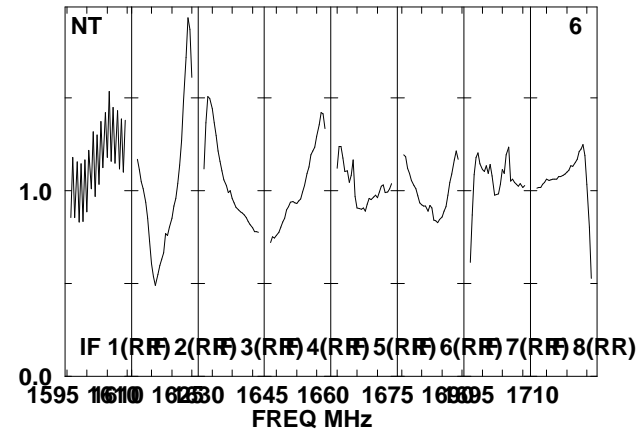
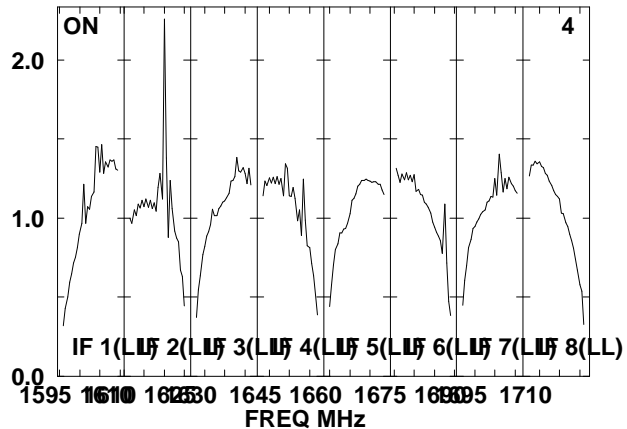
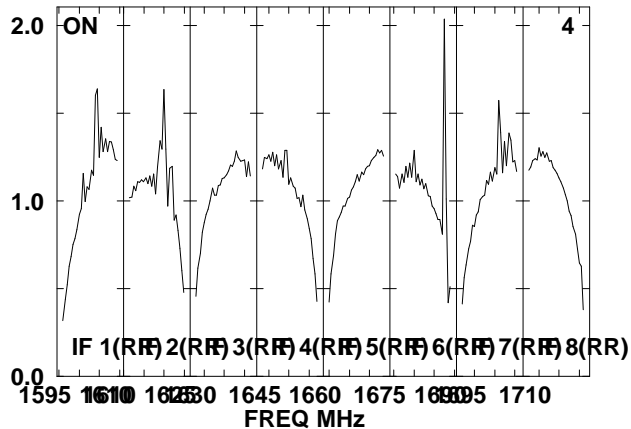
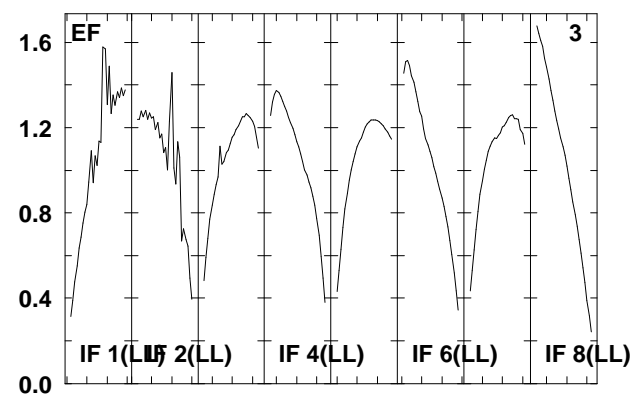
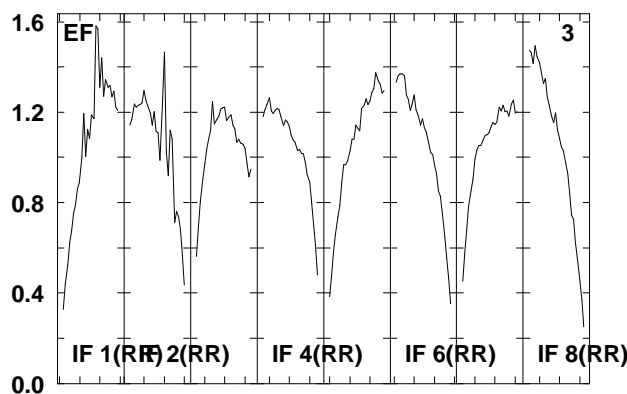
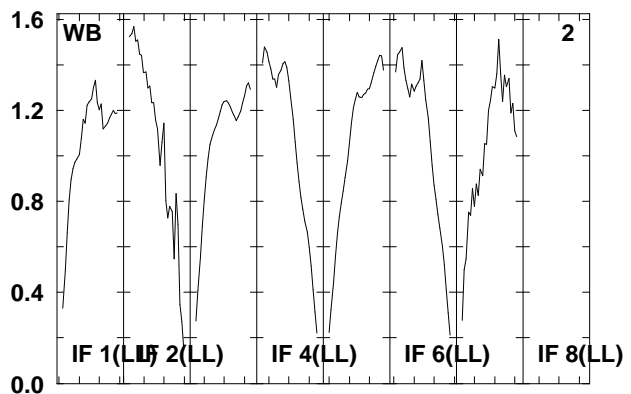
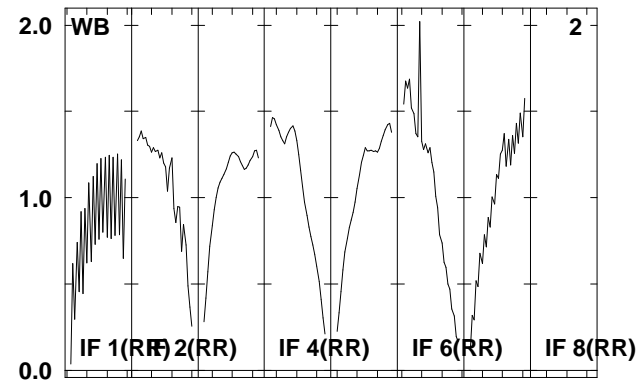
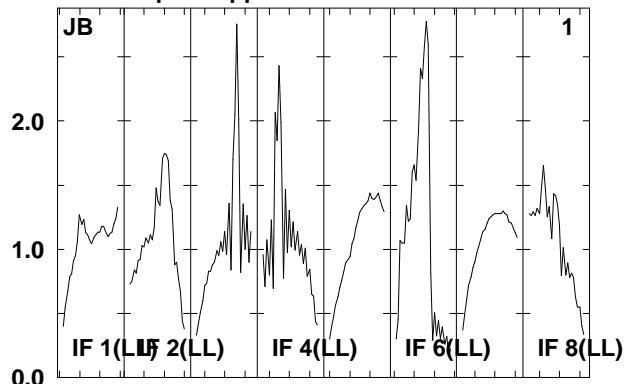
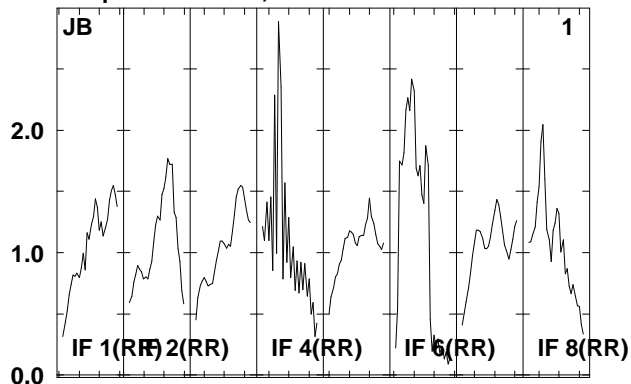

Lower frame: Real Jy  
Total-power spectrum Antenna: \*  
Timerange: 00/13:29:13 to 00/13:33:41

Plot file version 420 created 08-AUG-2008 17:02:09

J092159 EO006B.UVDATA.1

Freq = 1.5950 GHz, Bw = 16.000 MH No calibration applied and no bandpass applied

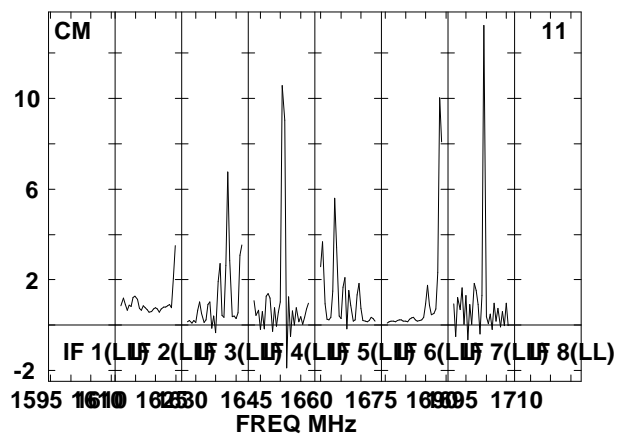
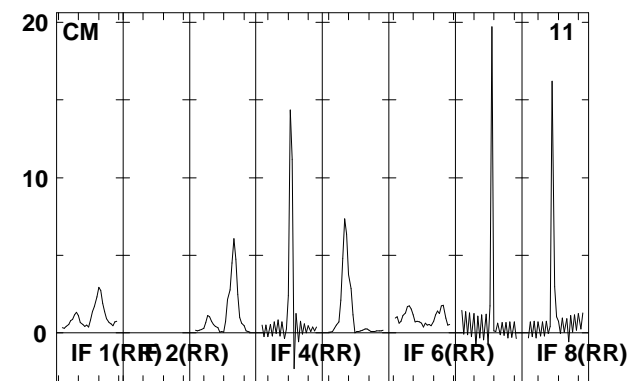
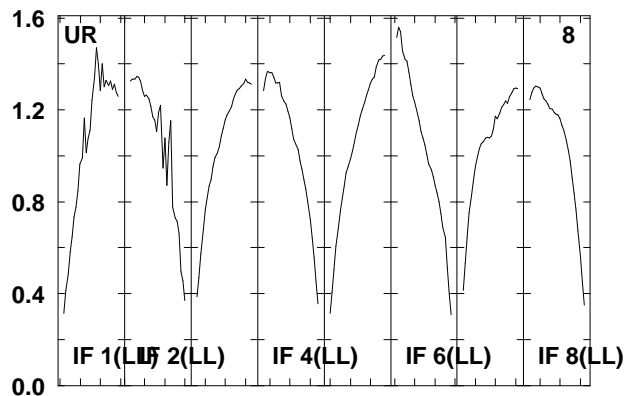
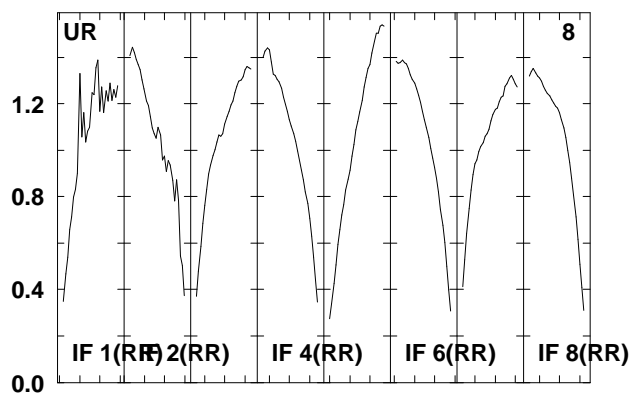
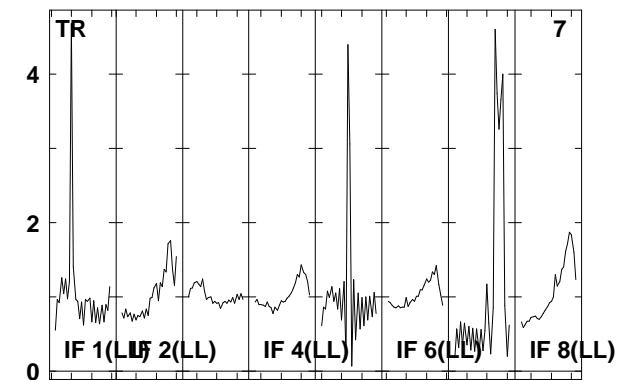
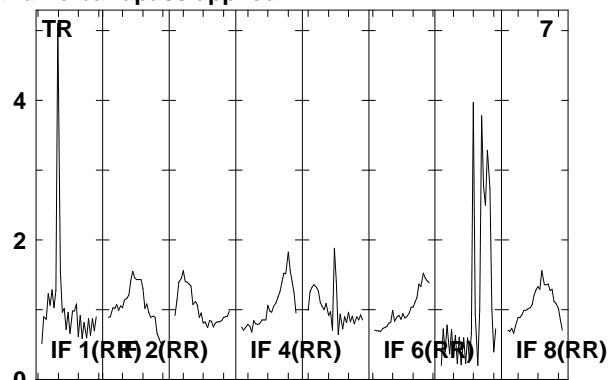
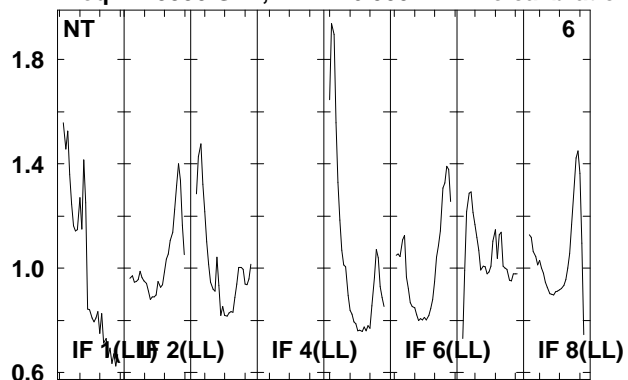

Lower frame: Real Jy

Total-power spectrum Antenna: \*

Timerange: 00/13:29:13 to 00/13:33:41



Plot file version 421 created 08-AUG-2008 17:02:10

J0920+44 EO006B.UVDATA.1

Freq = 1.5950 GHz, Bw = 16.000 MH No calibration applied and no bandpass applied

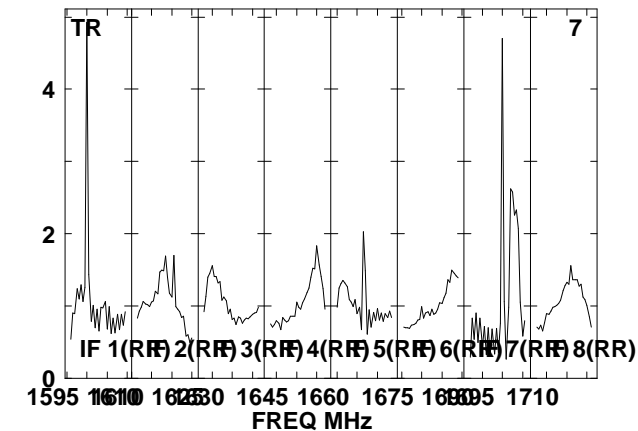
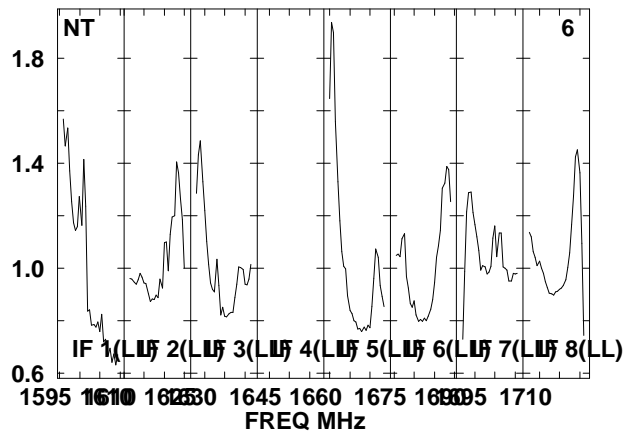
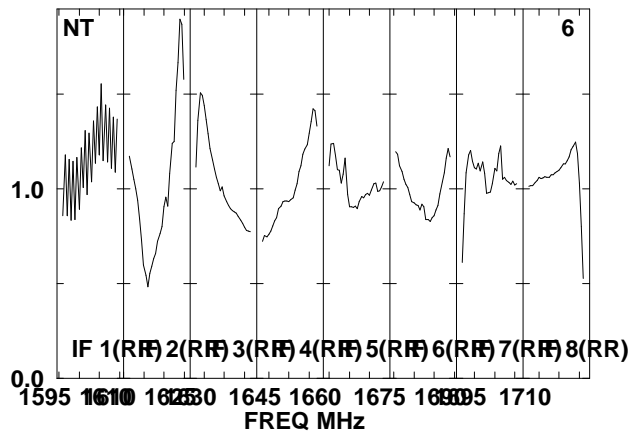
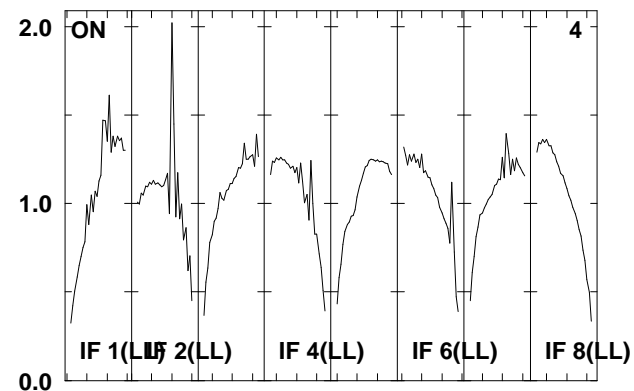
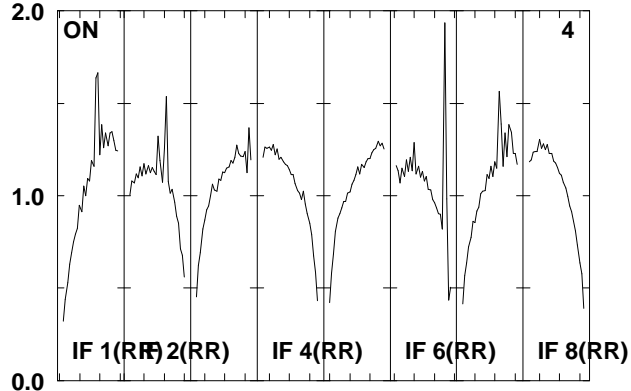
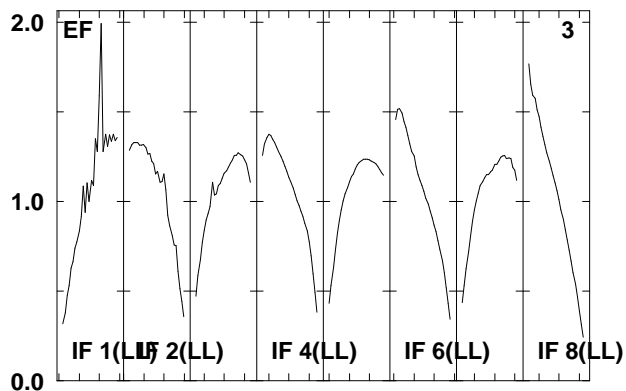
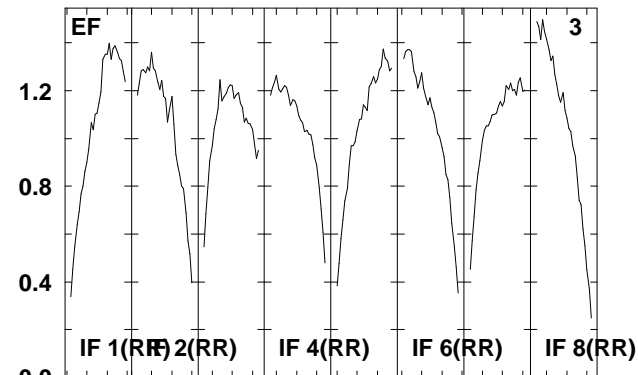
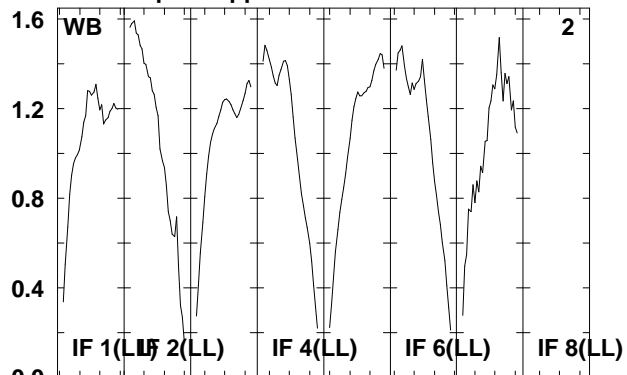
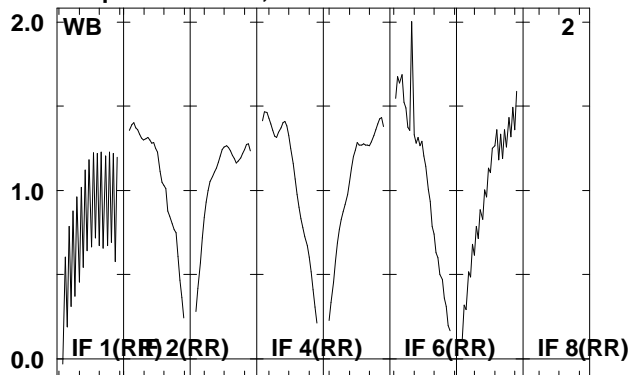

Lower frame: Real Jy  
Total-power spectrum Antenna: \*  
Timerange: 00/13:34:23 to 00/13:35:51

Plot file version 422 created 08-AUG-2008 17:02:10

J0920+44 EO006B.UVDATA.1

Freq = 1.5950 GHz, Bw = 16.000 MH No calibration applied and no bandpass applied

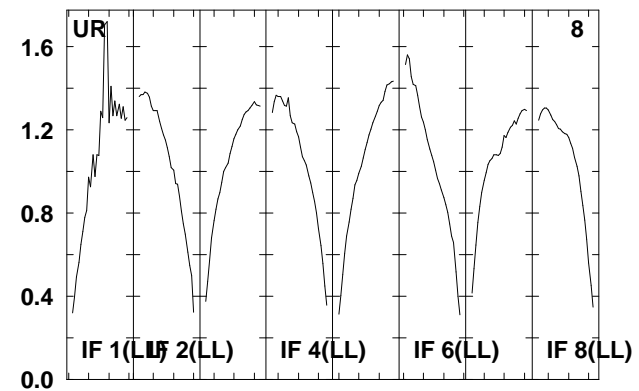
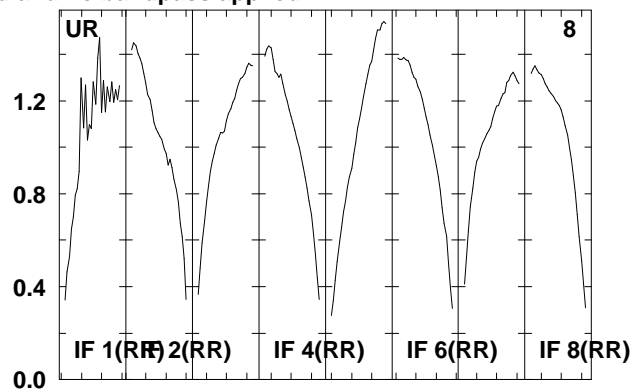
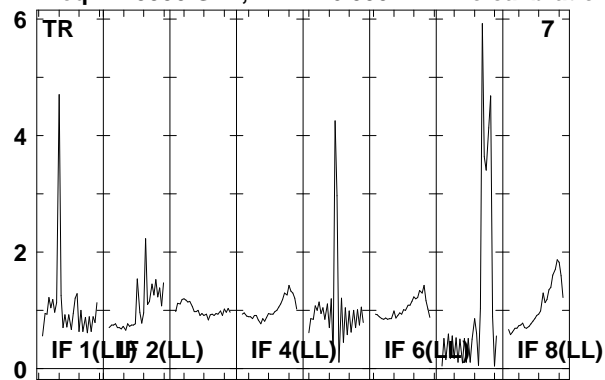

Lower frame: Real Jy  
Total-power spectrum Antenna: \*  
Timerange: 00/13:34:23 to 00/13:35:51

Plot file version 423 created 08-AUG-2008 17:02:10

J092159 EO006B.UVDATA.1

Freq = 1.5950 GHz, Bw = 16.000 MH No calibration applied and no bandpass applied

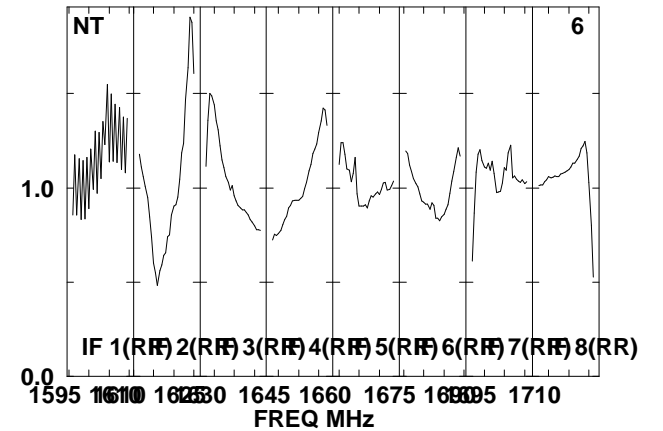
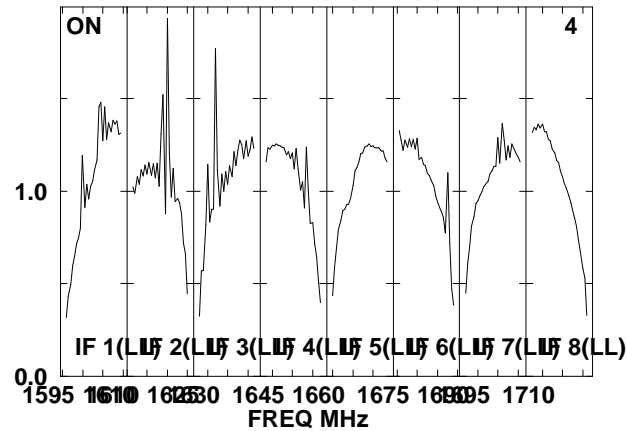
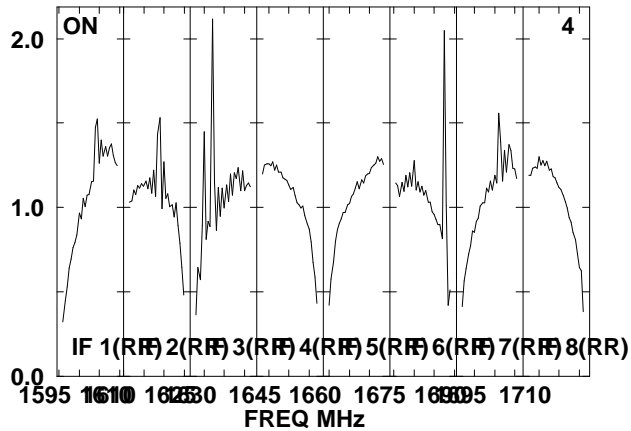
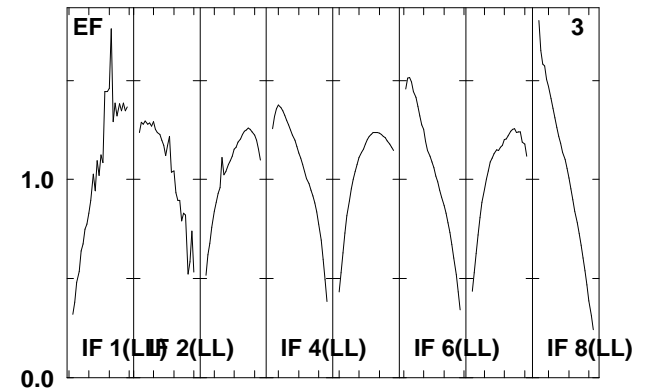
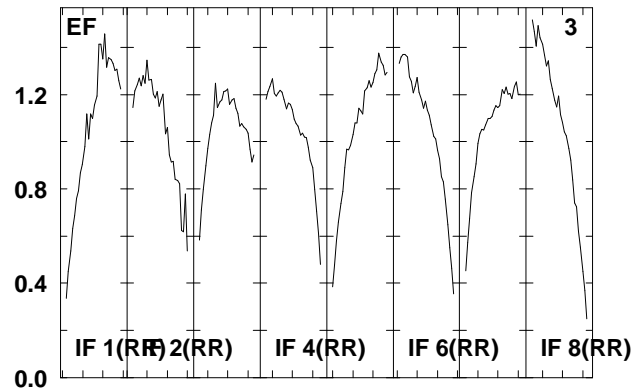
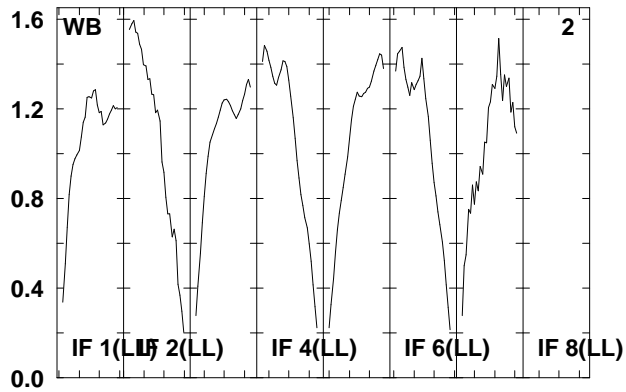
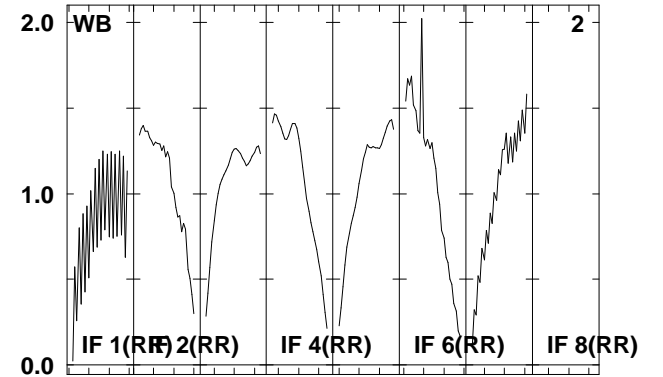
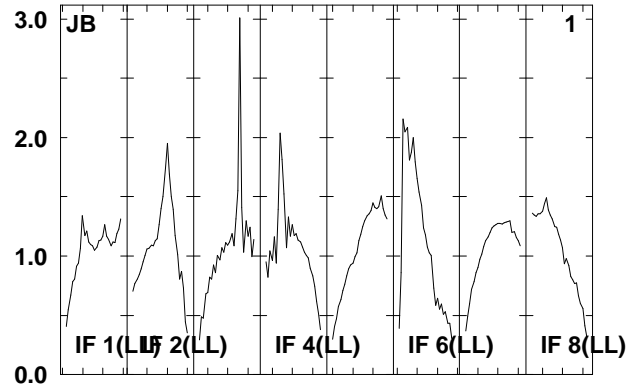
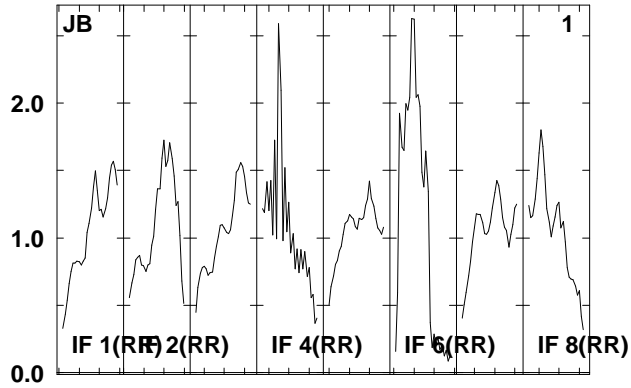

Lower frame: Real Jy  
Total-power spectrum Antenna: \*  
Timerange: 00/13:36:33 to 00/13:41:09

Plot file version 424 created 08-AUG-2008 17:02:11

J092159 EO006B.UVDATA.1

Freq = 1.5950 GHz, Bw = 16.000 MH No calibration applied and no bandpass applied

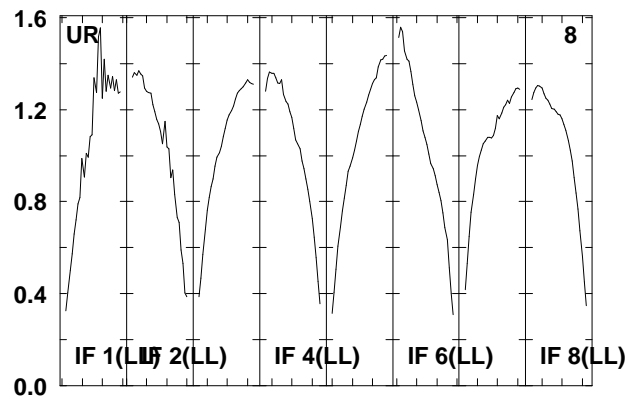
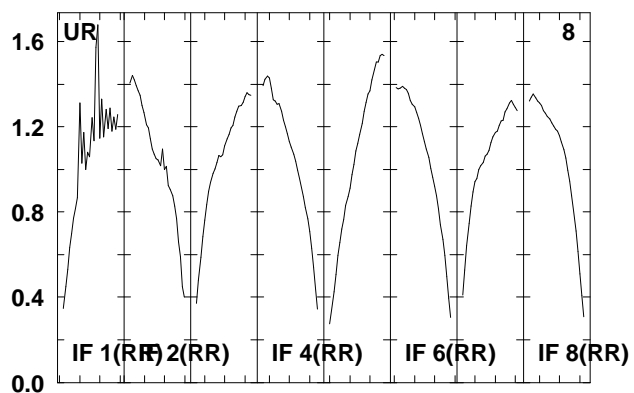
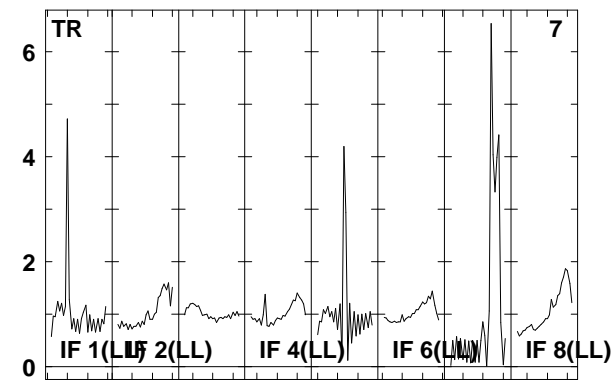
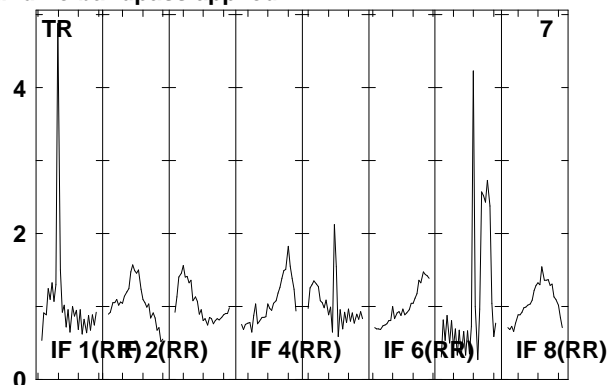
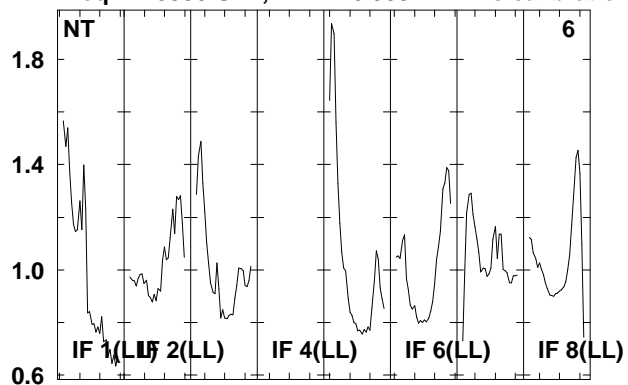

Lower frame: Real Jy  
Total-power spectrum Antenna: \*  
Timerange: 00/13:36:33 to 00/13:41:09

Plot file version 425 created 08-AUG-2008 17:02:12

J0920+44 EO006B.UVDATA.1

Freq = 1.5950 GHz, Bw = 16.000 MH No calibration applied and no bandpass applied

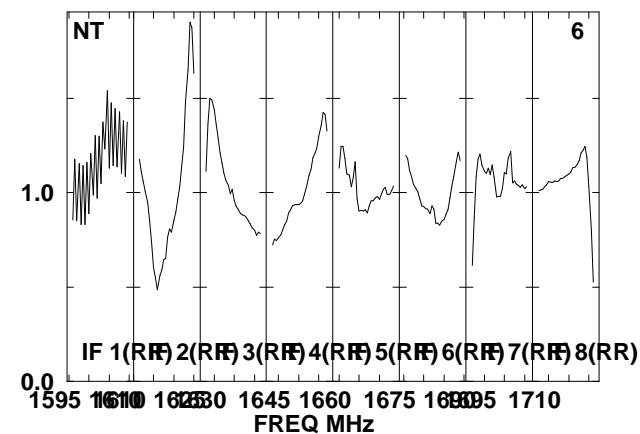
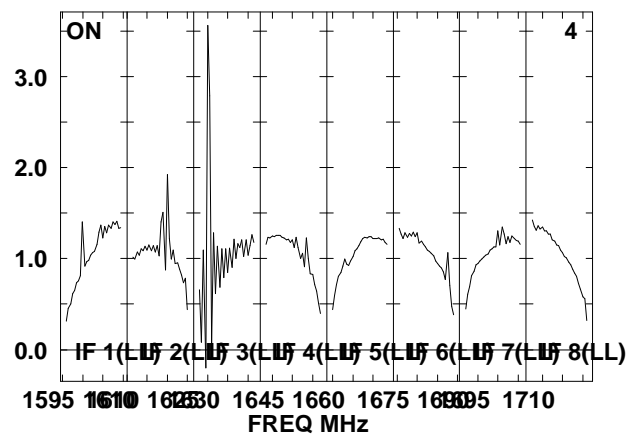
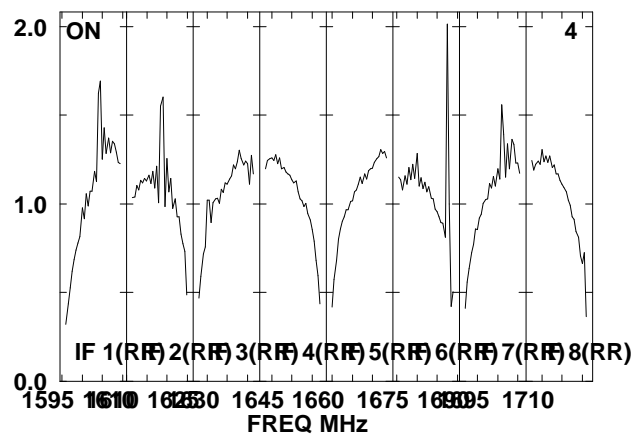
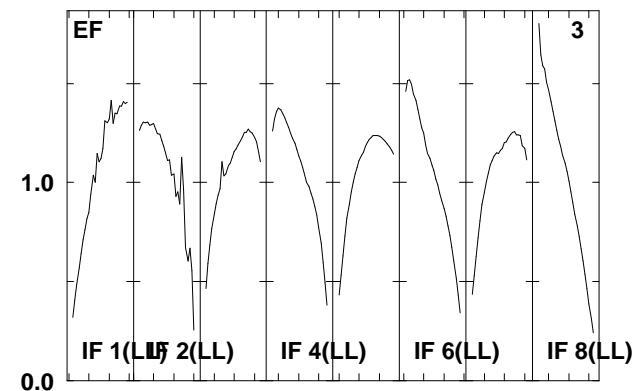
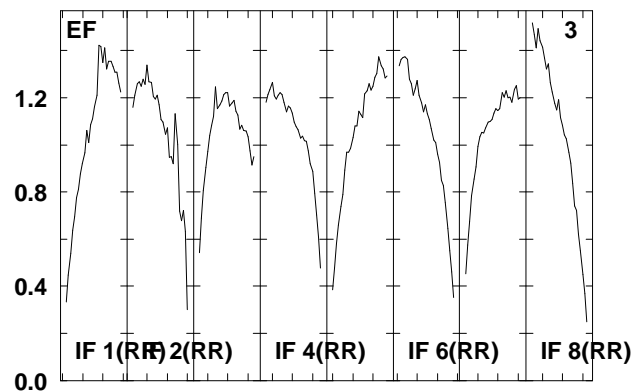
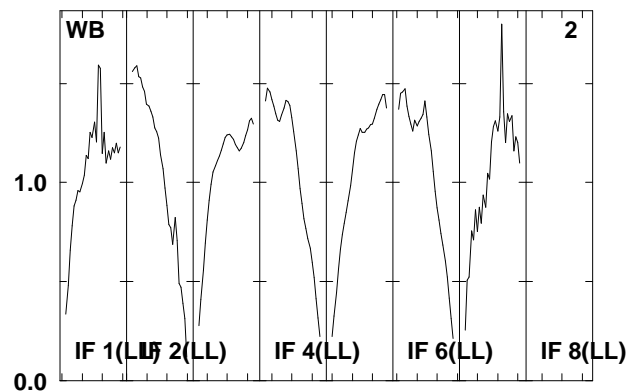
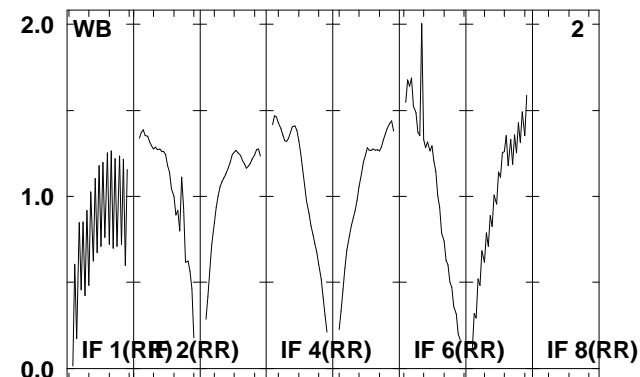
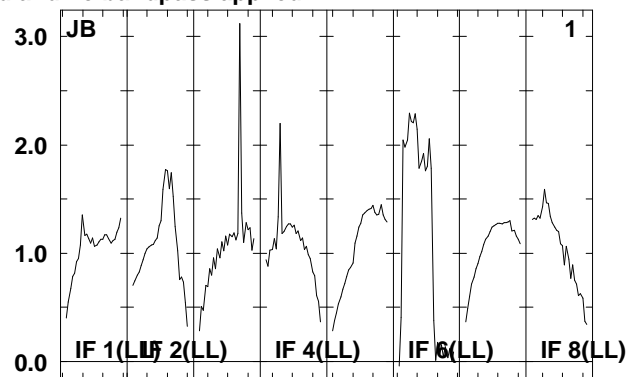
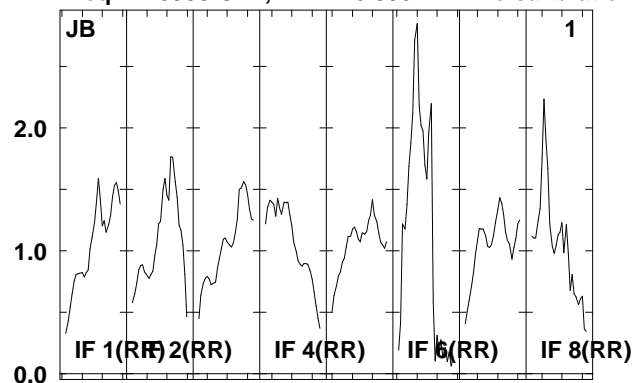

Lower frame: Real Jy  
Total-power spectrum Antenna: \*  
Timerange: 00/13:41:45 to 00/13:43:17

Plot file version 426 created 08-AUG-2008 17:02:12

J0920+44 EO006B.UVDATA.1

Freq = 1.5950 GHz, Bw = 16.000 MH No calibration applied and no bandpass applied

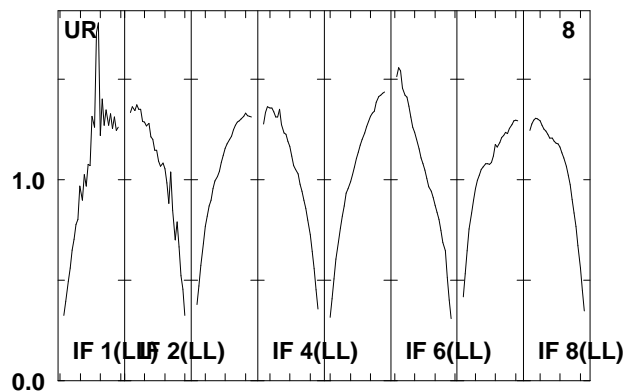
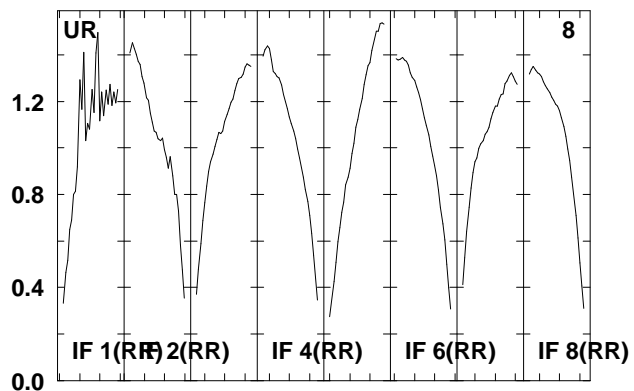
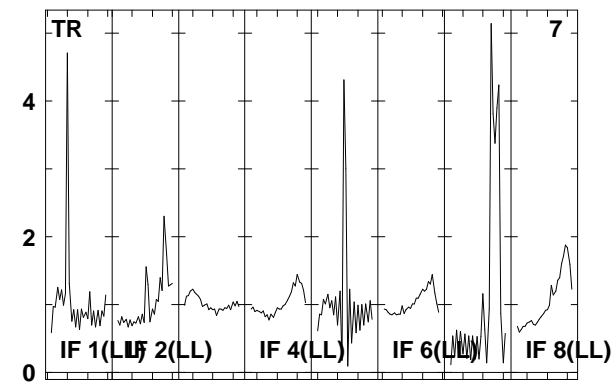
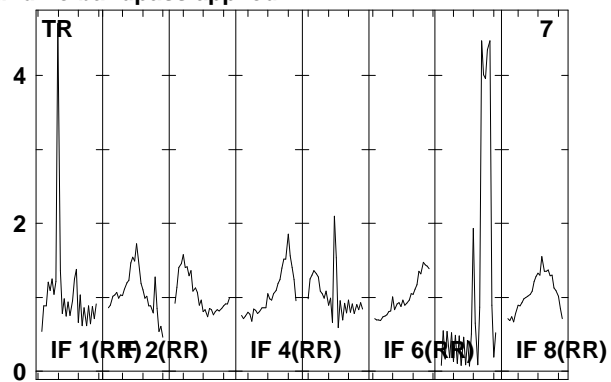
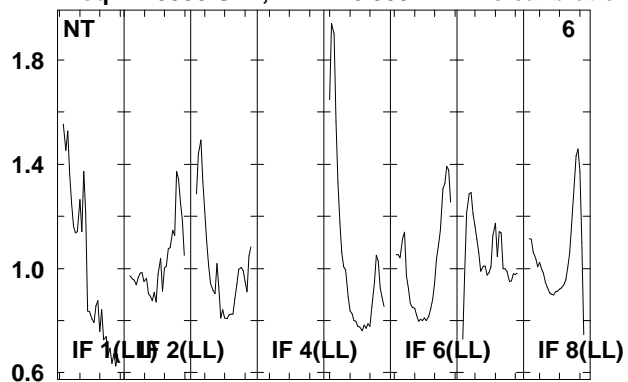

Lower frame: Real Jy  
Total-power spectrum Antenna: \*  
Timerange: 00/13:41:45 to 00/13:43:17

Plot file version 427 created 08-AUG-2008 17:02:12

J092159 EO006B.UVDATA.1

Freq = 1.5950 GHz, Bw = 16.000 MH No calibration applied and no bandpass applied

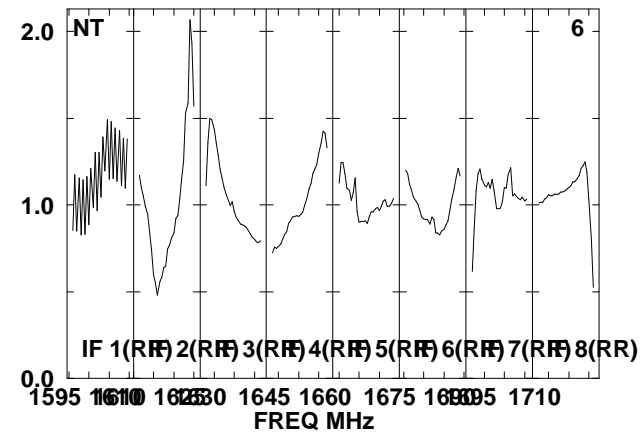
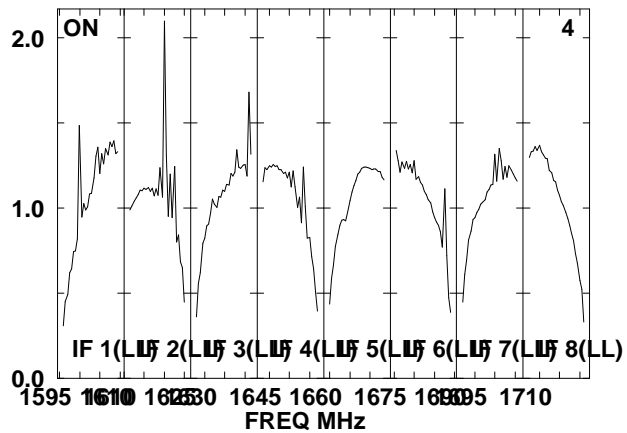
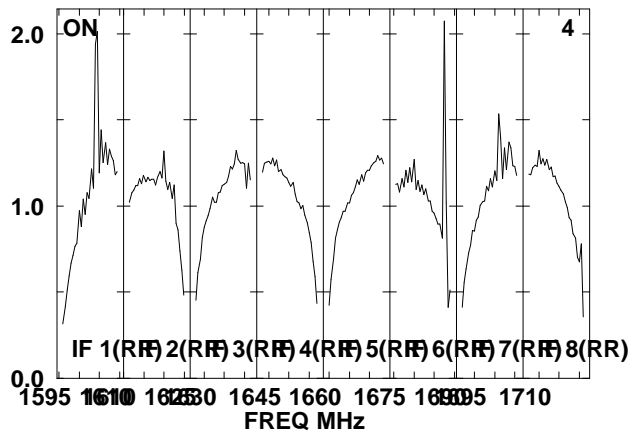
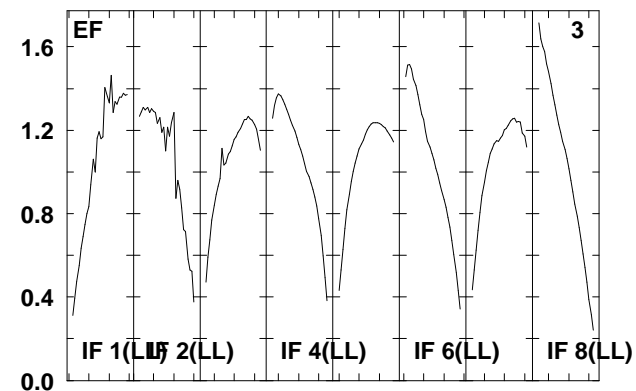
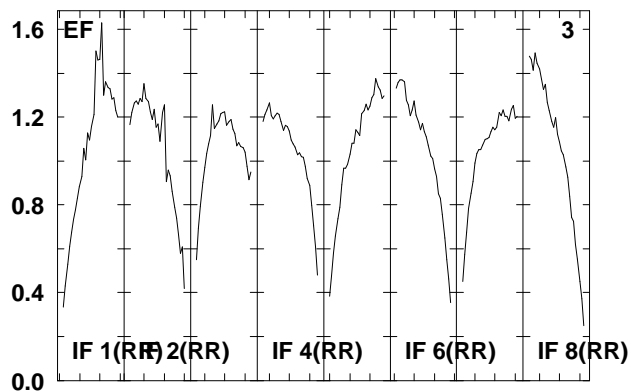
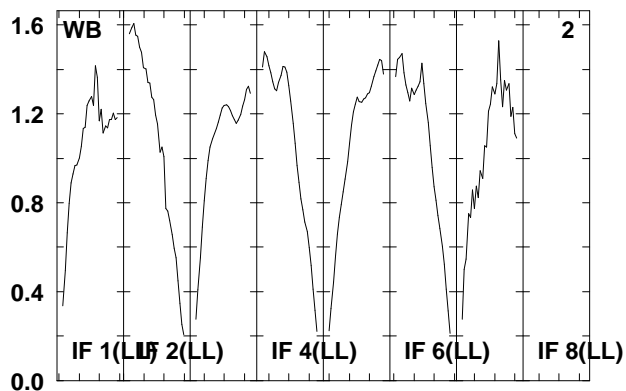
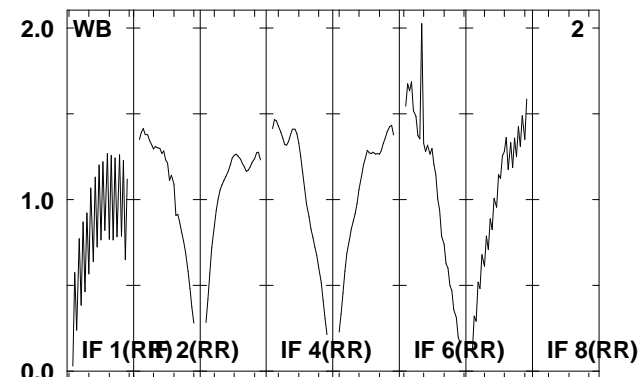
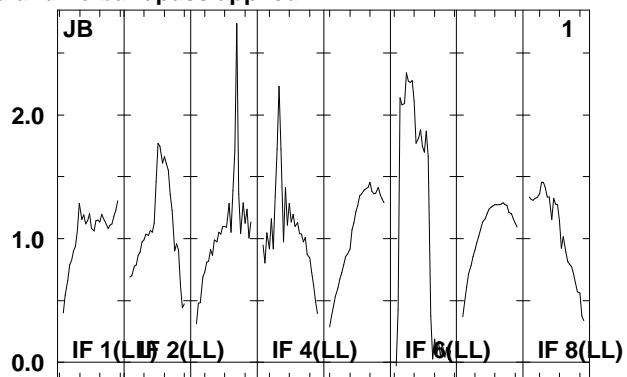
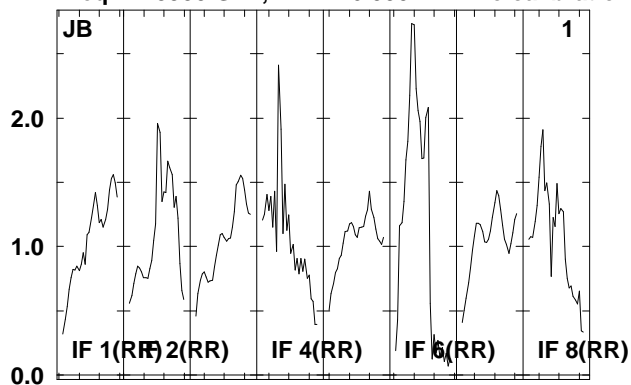

Lower frame: Real Jy  
Total-power spectrum Antenna: \*  
Timerange: 00/13:43:53 to 00/13:48:29

Plot file version 428 created 08-AUG-2008 17:02:13

J092159\_EO006B.UVDATA.1

Freq = 1.5950 GHz, Bw = 16.000 MH No calibration applied and no bandpass applied

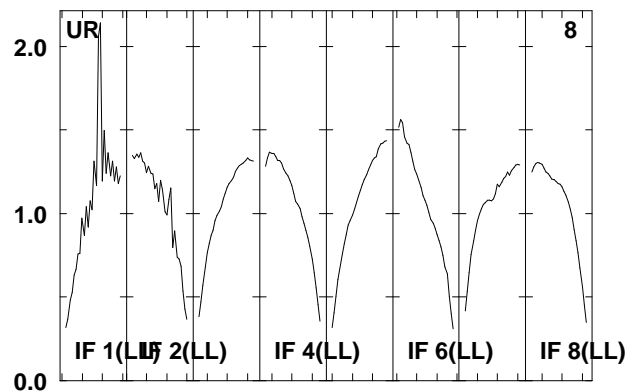
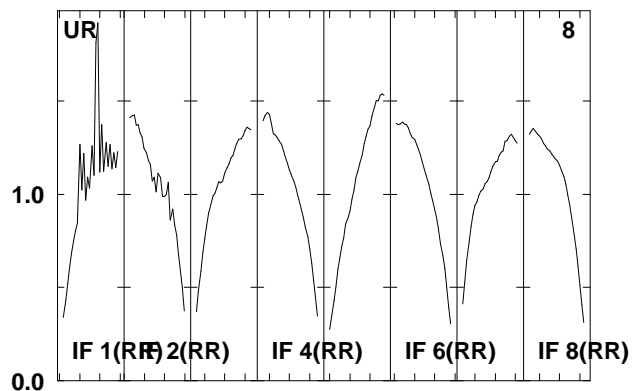
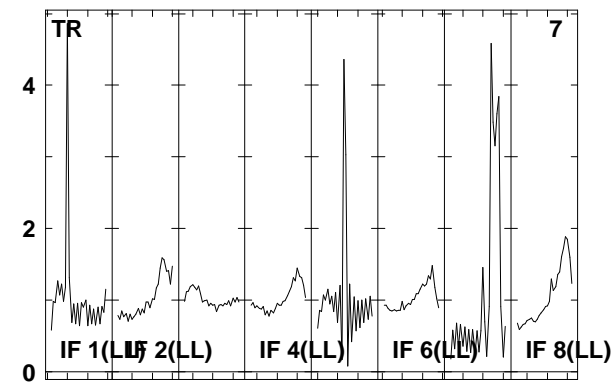
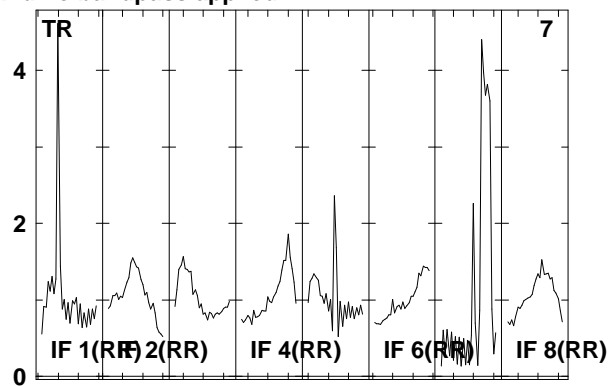
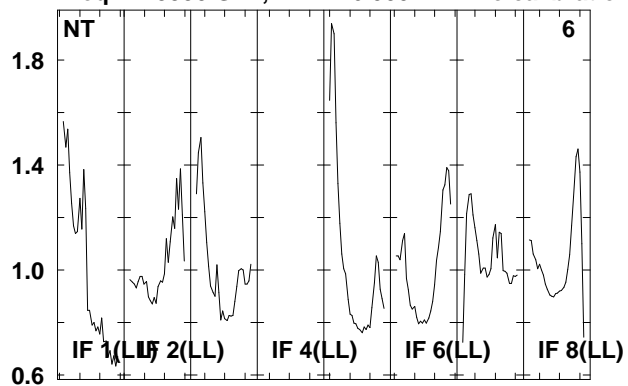

Lower frame: Real Jy  
Total-power spectrum Antenna: \*  
Timerange: 00/13:43:53 to 00/13:48:29



Plot file version 429 created 08-AUG-2008 17:02:14

J0920+44 EO006B.UVDATA.1

Freq = 1.5950 GHz, Bw = 16.000 MH No calibration applied and no bandpass applied

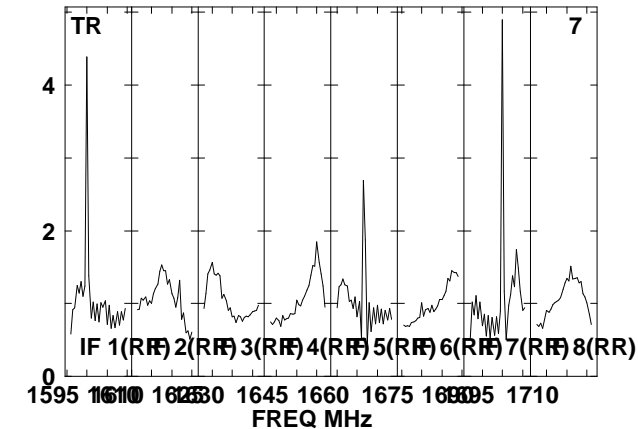
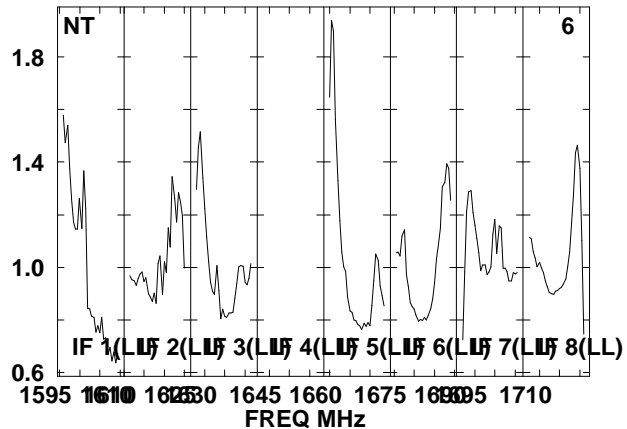
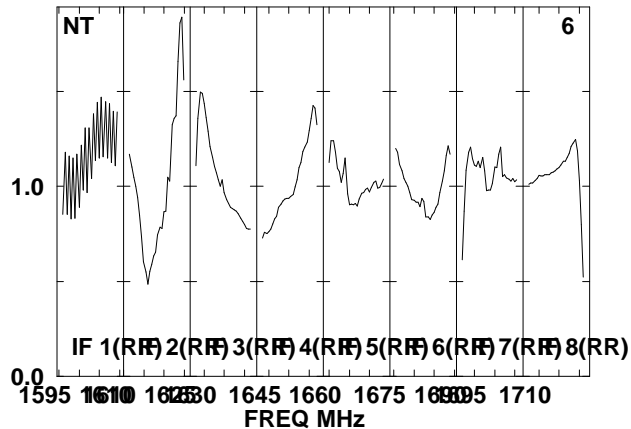
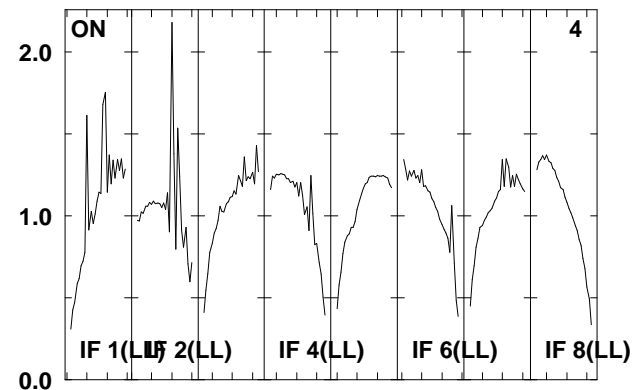
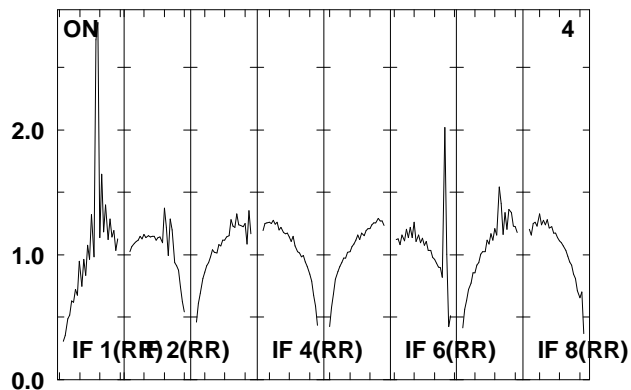
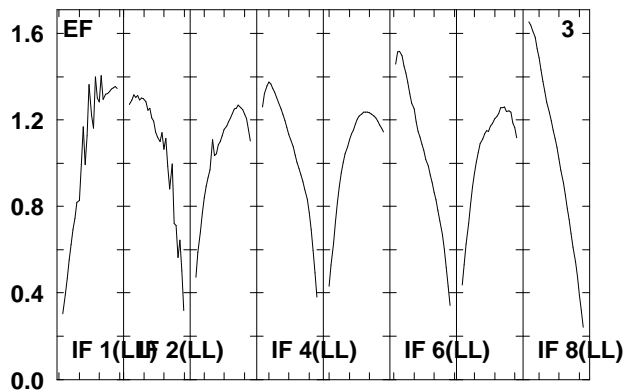
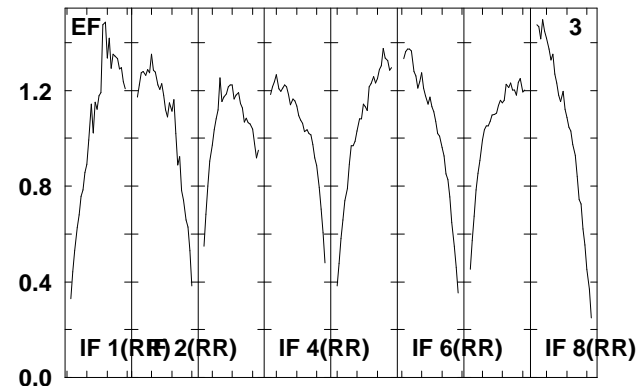
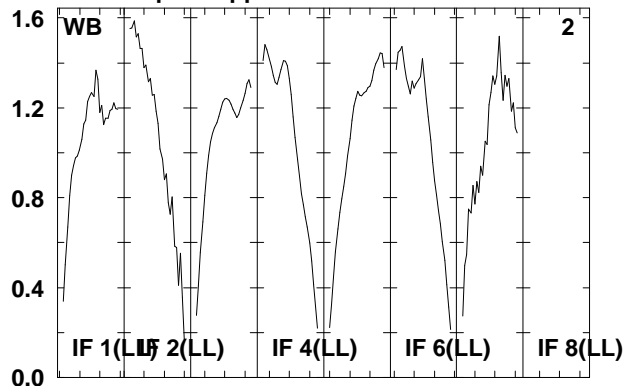
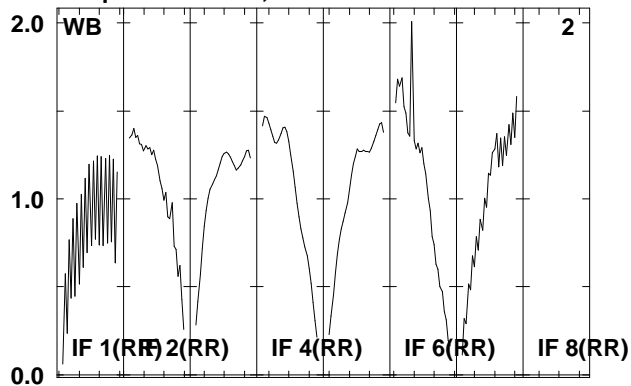

Lower frame: Real Jy

Total-power spectrum Antenna: \*

Timerange: 00/13:49:01 to 00/13:50:37

Plot file version 430 created 08-AUG-2008 17:02:14

J0920+44 EO006B.UVDATA.1

Freq = 1.5950 GHz, Bw = 16.000 MH No calibration applied and no bandpass applied

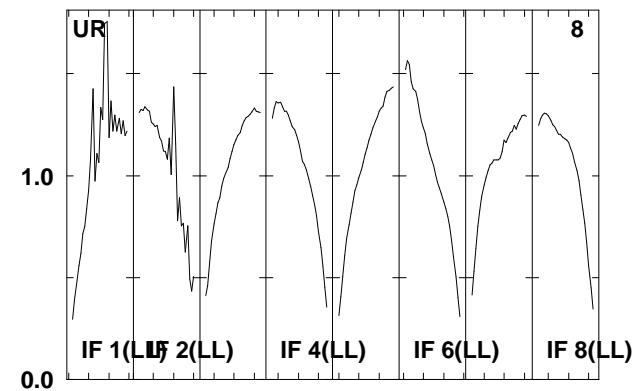
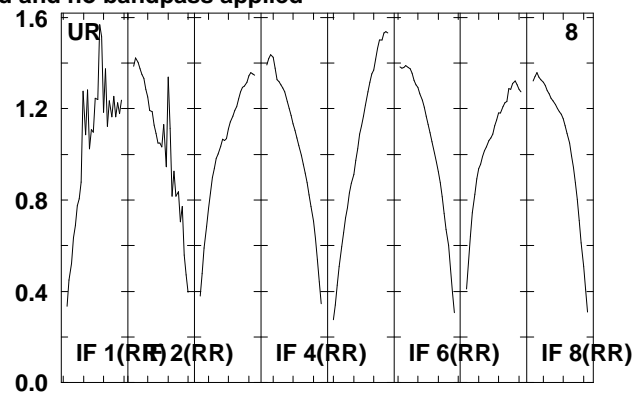
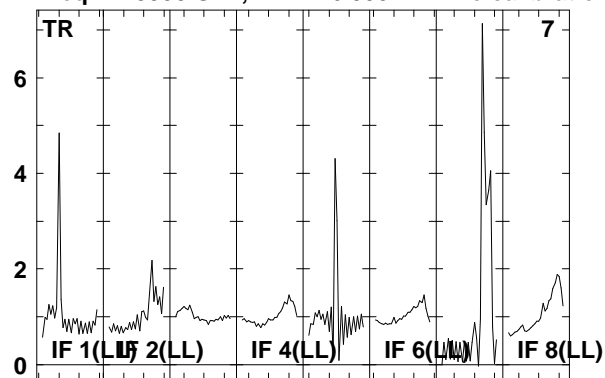

Lower frame: Real Jy  
Total-power spectrum Antenna: \*  
Timerange: 00/13:49:01 to 00/13:50:37

Plot file version 431 created 08-AUG-2008 17:02:14

J092159 EO006B.UVDATA.1

Freq = 1.5950 GHz, Bw = 16.000 MH No calibration applied and no bandpass applied

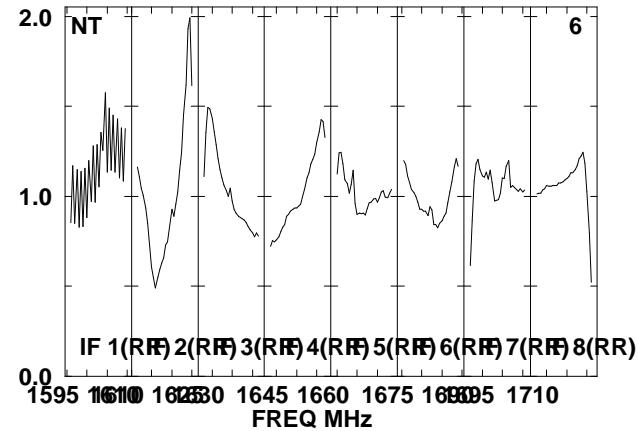
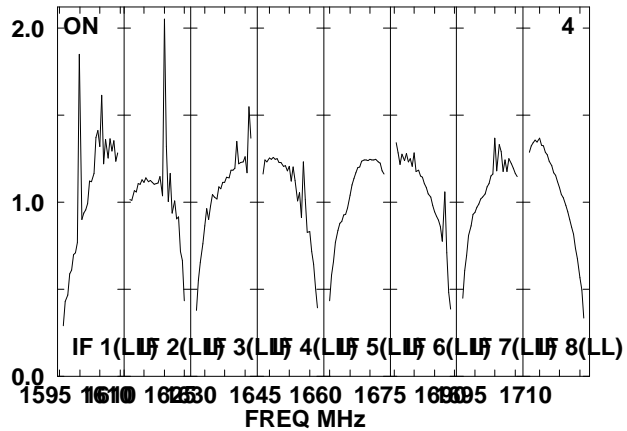
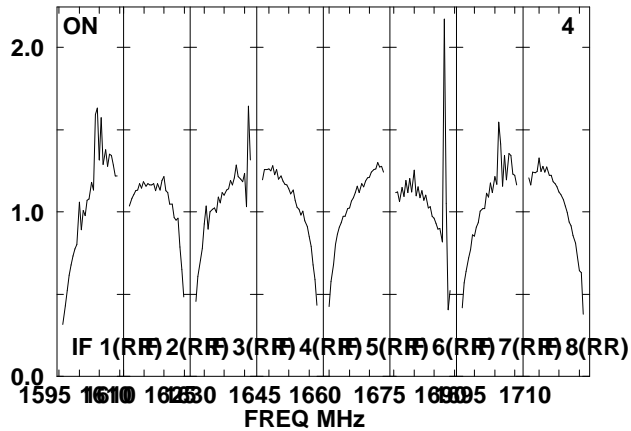
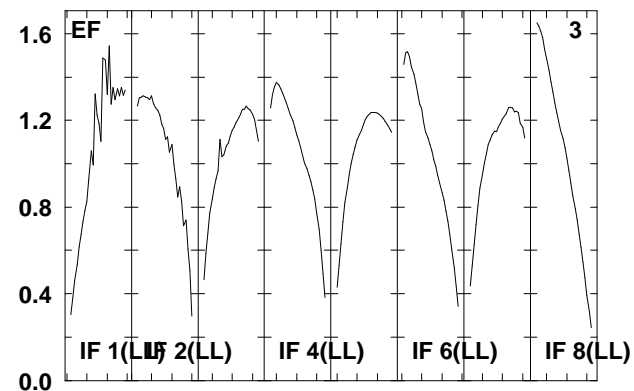
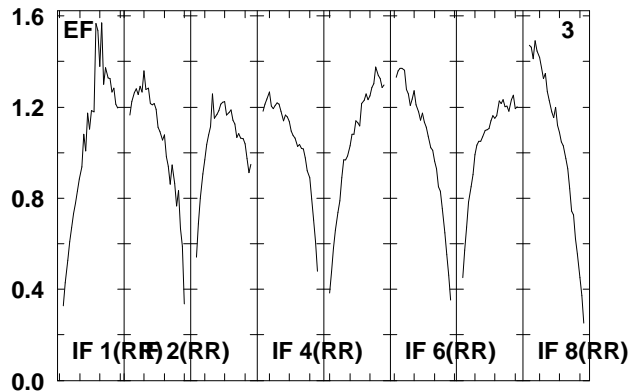
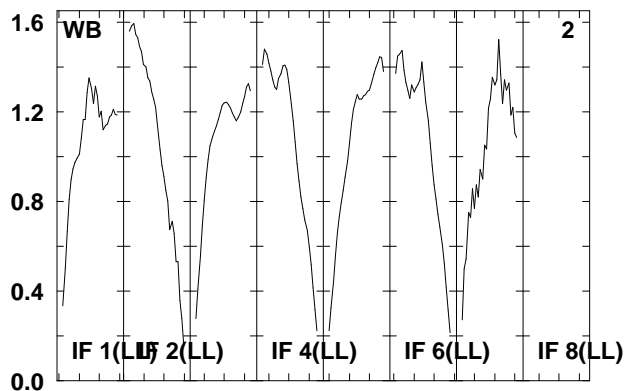
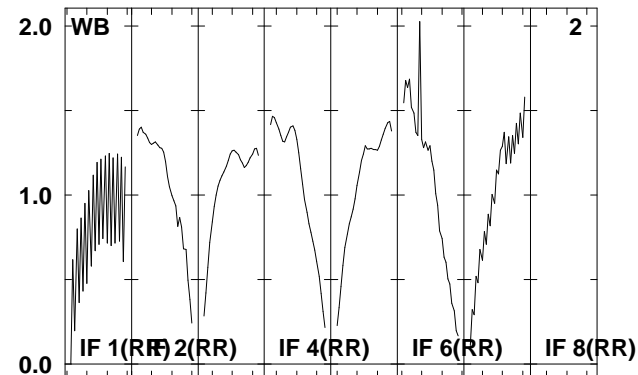
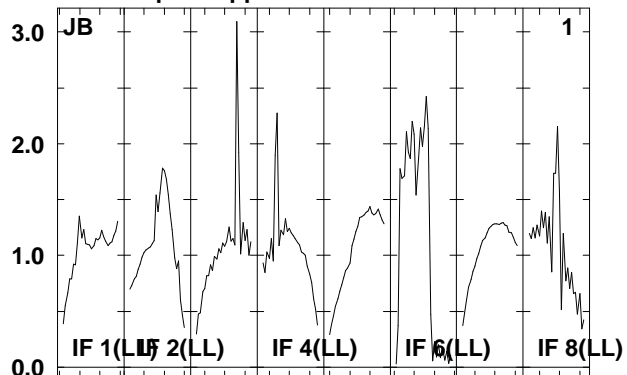
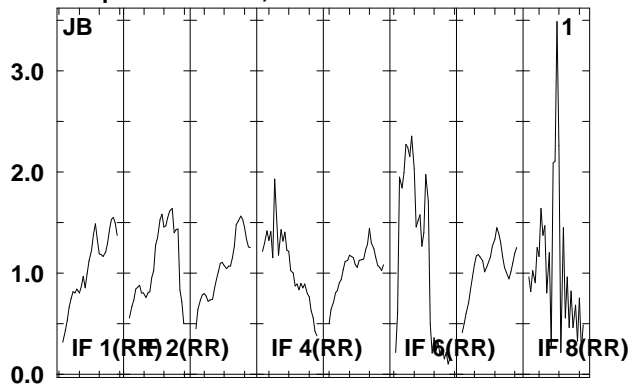

Lower frame: Real Jy  
Total-power spectrum Antenna: \*  
Timerange: 00/13:51:13 to 00/13:55:41

Plot file version 432 created 08-AUG-2008 17:02:15

J092159\_EO006B.UVDATA.1

Freq = 1.5950 GHz, Bw = 16.000 MH No calibration applied and no bandpass applied

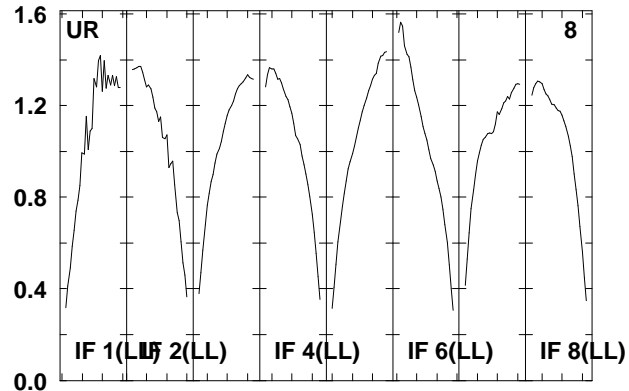
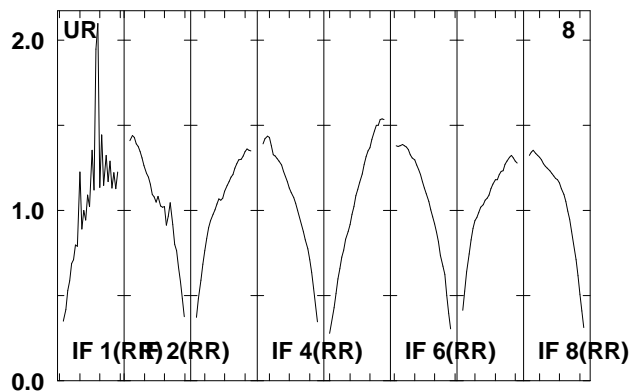
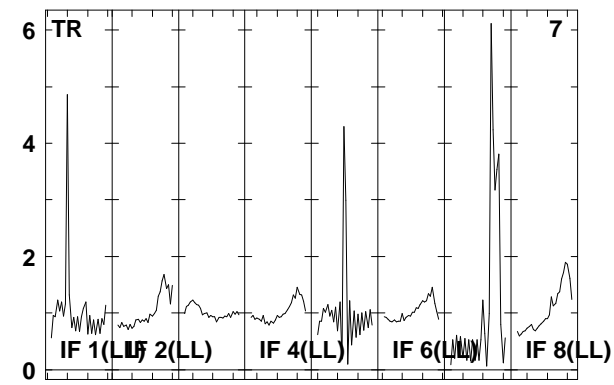
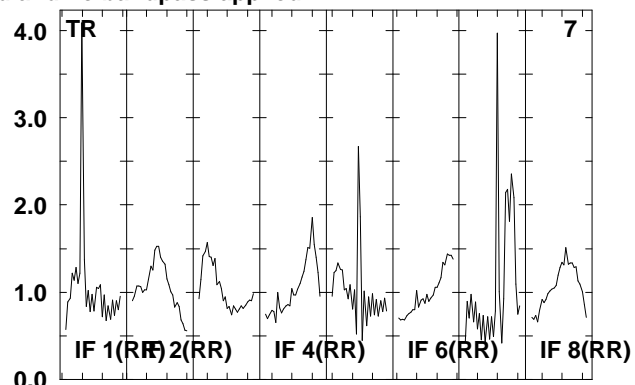
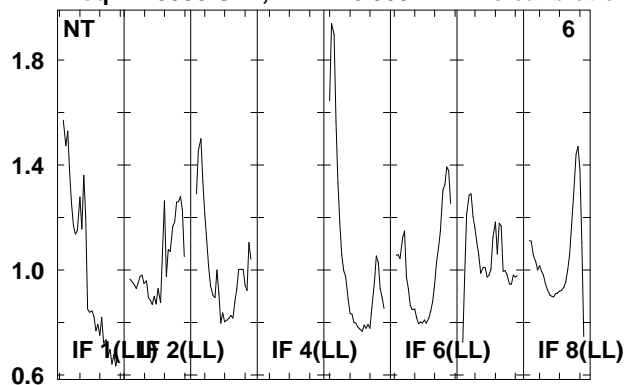

Lower frame: Real Jy  
Total-power spectrum Antenna: \*  
Timerange: 00/13:51:13 to 00/13:55:41

Plot file version 433 created 08-AUG-2008 17:02:16

J0920+44 EO006B.UVDATA.1

Freq = 1.5950 GHz, Bw = 16.000 MH No calibration applied and no bandpass applied

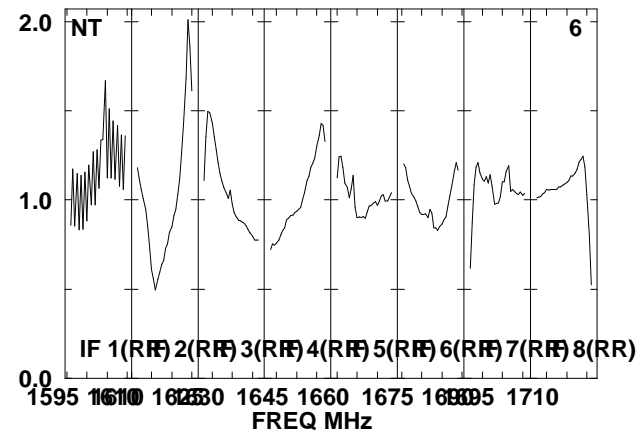
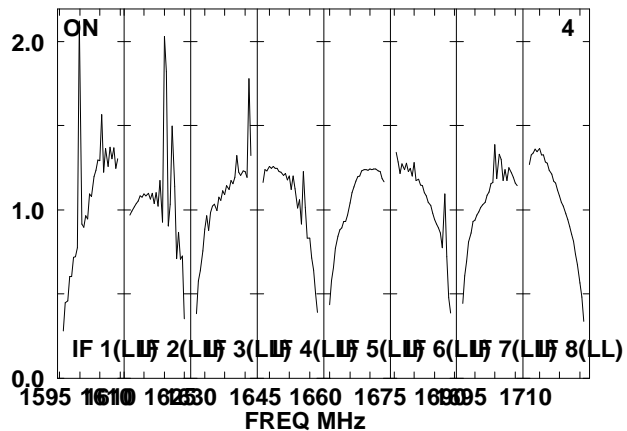
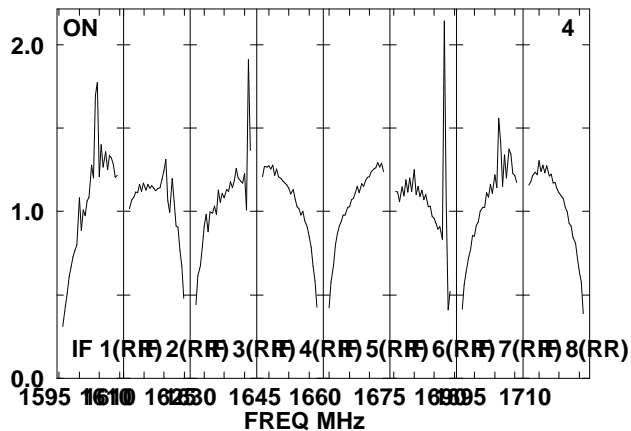
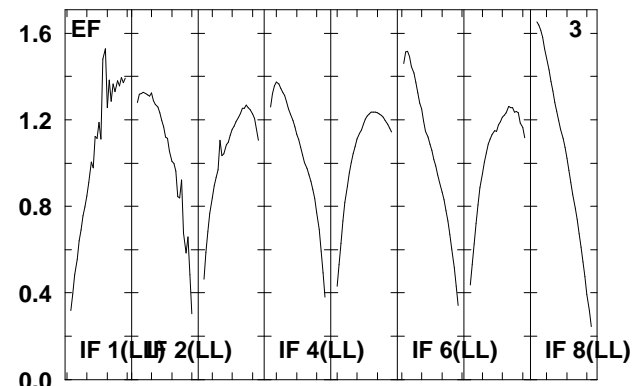
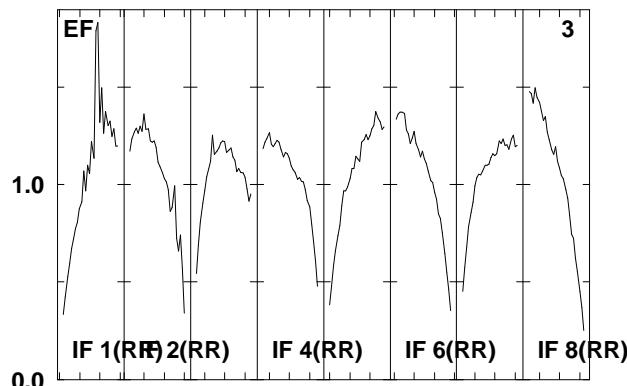
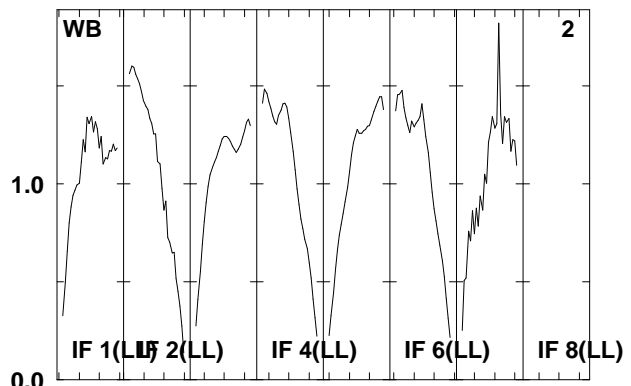
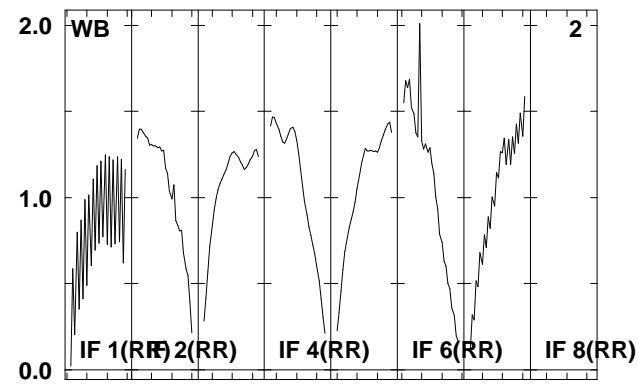
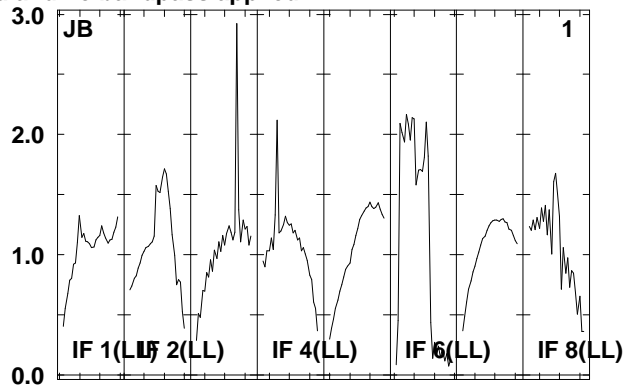
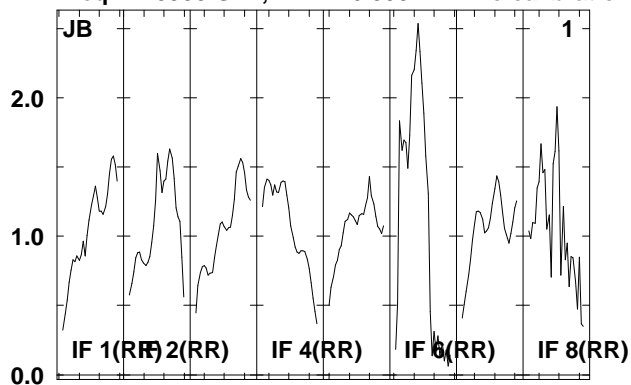

Lower frame: Real Jy  
Total-power spectrum Antenna: \*  
Timerange: 00/13:56:21 to 00/13:57:57

Plot file version 434 created 08-AUG-2008 17:02:16

J0920+44 EO06B.UVDATA.1

Freq = 1.5950 GHz, Bw = 16.000 MH No calibration applied and no bandpass applied

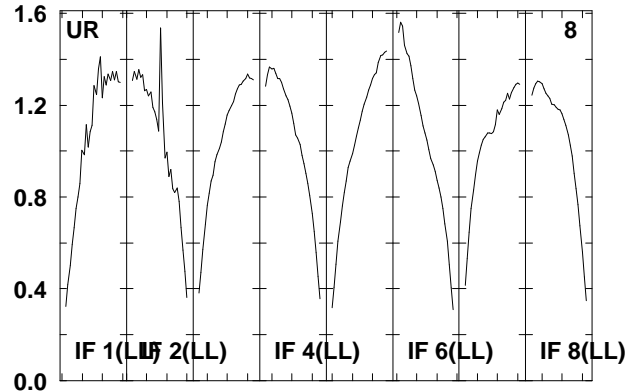
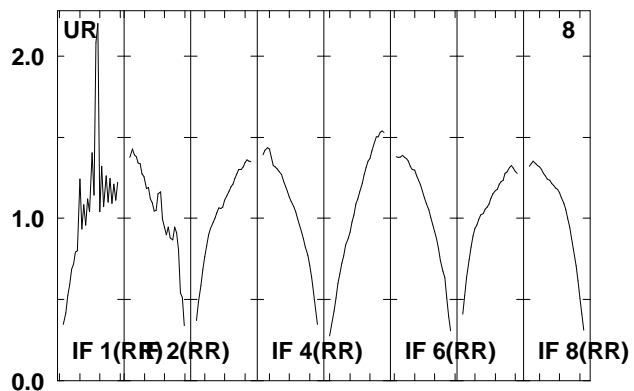
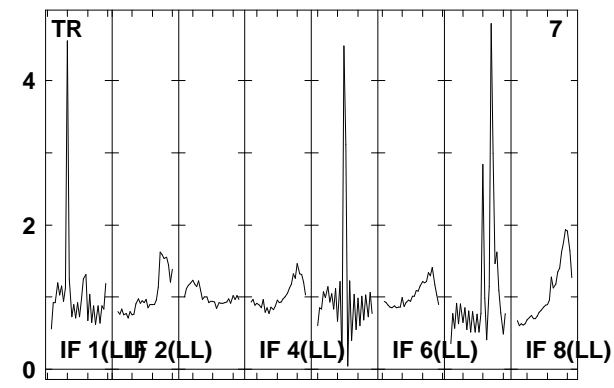
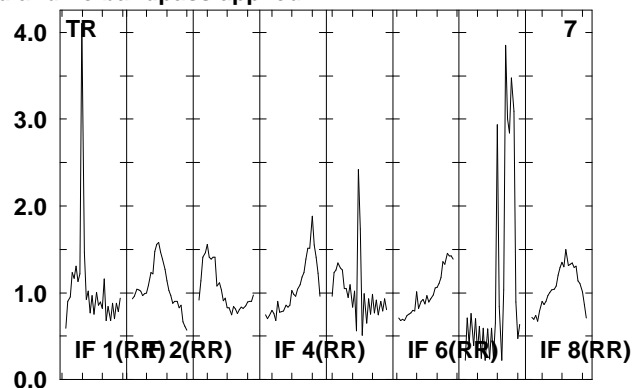
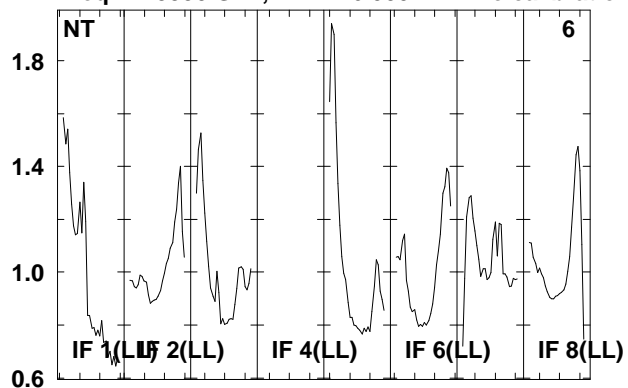

Lower frame: Real Jy  
Total-power spectrum Antenna: \*  
Timerange: 00/13:56:21 to 00/13:57:57

Plot file version 435 created 08-AUG-2008 17:02:16

J092159 EO006B.UVDATA.1

Freq = 1.5950 GHz, Bw = 16.000 MH No calibration applied and no bandpass applied

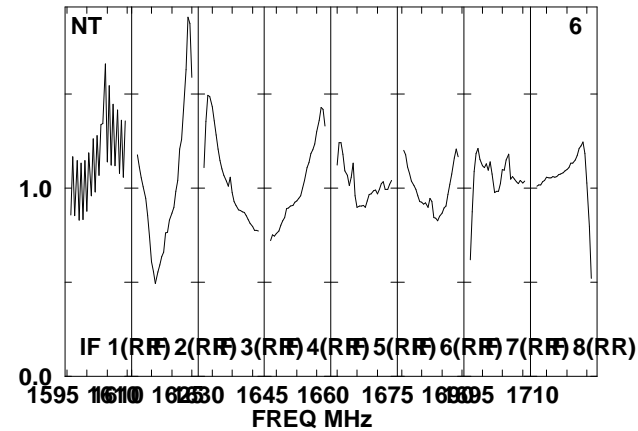
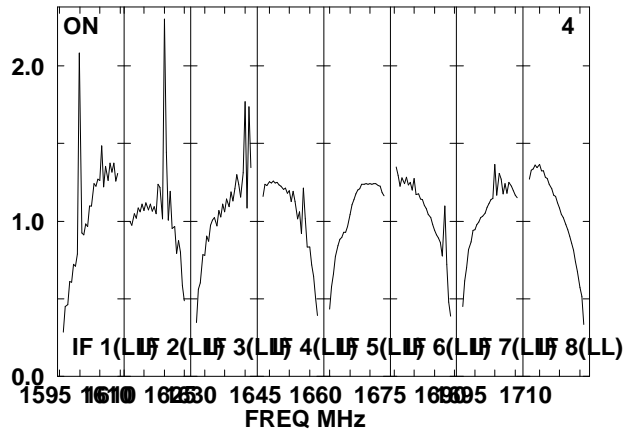
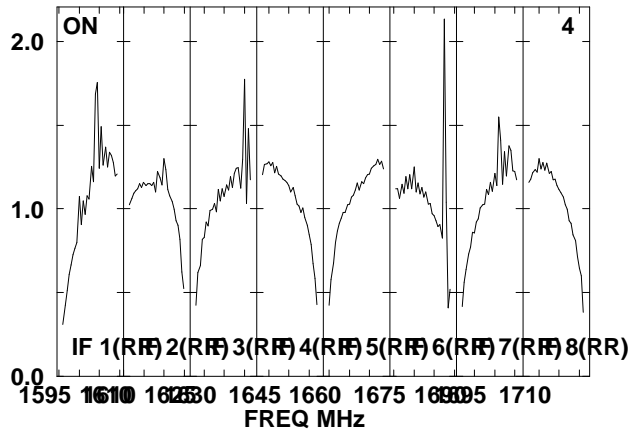
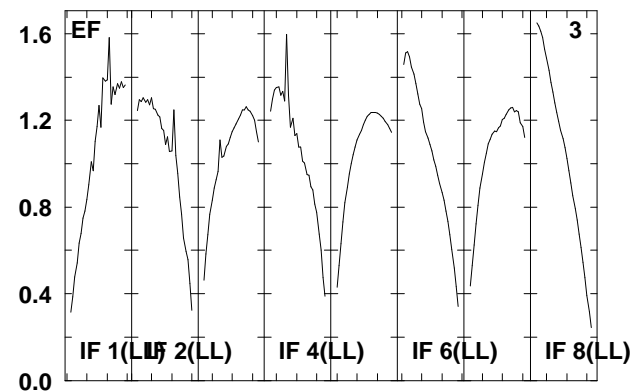
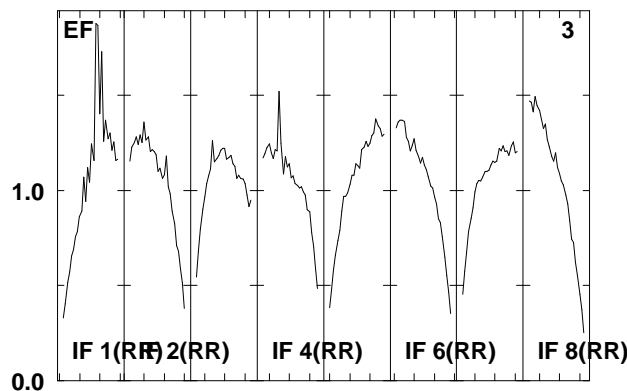
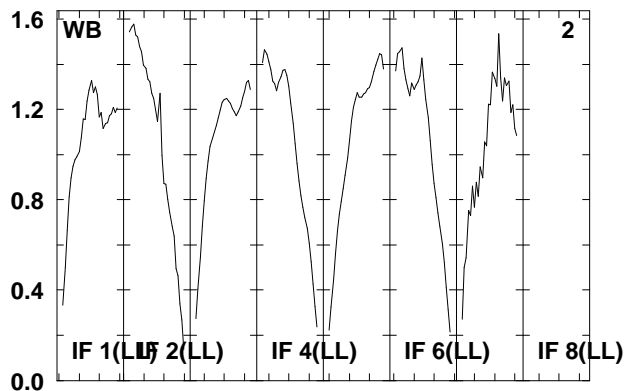
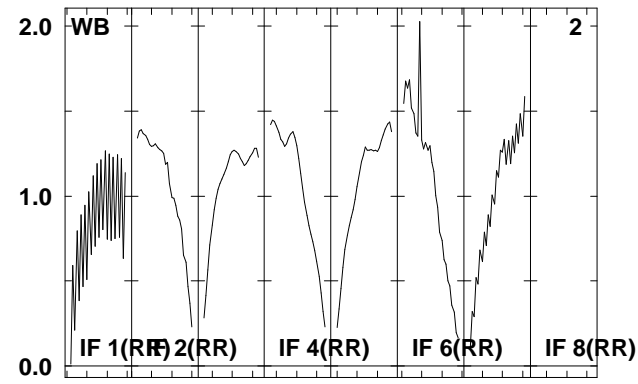
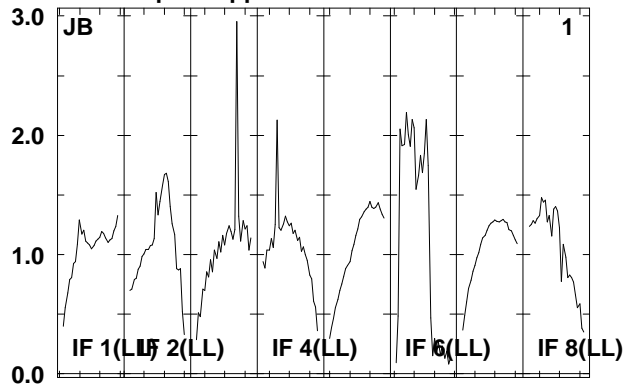
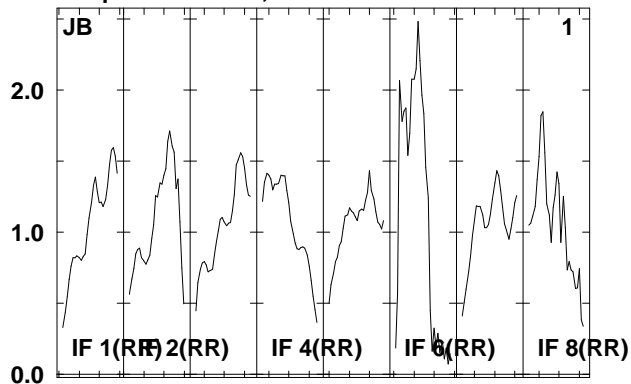

Lower frame: Real Jy  
Total-power spectrum Antenna: \*  
Timerange: 00/13:58:33 to 00/14:03:01

Plot file version 436 created 08-AUG-2008 17:02:17

J092159 EO006B.UVDATA.1

Freq = 1.5950 GHz, Bw = 16.000 MH No calibration applied and no bandpass applied

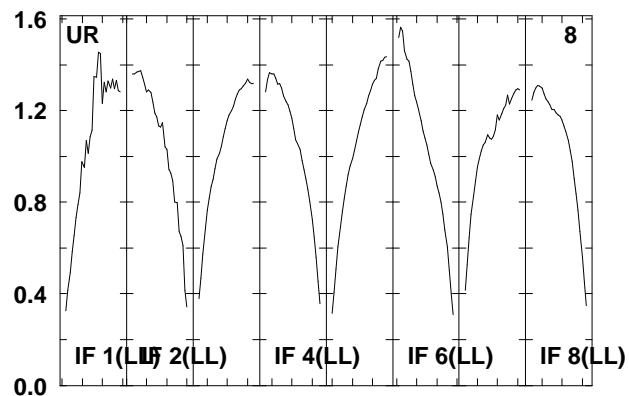
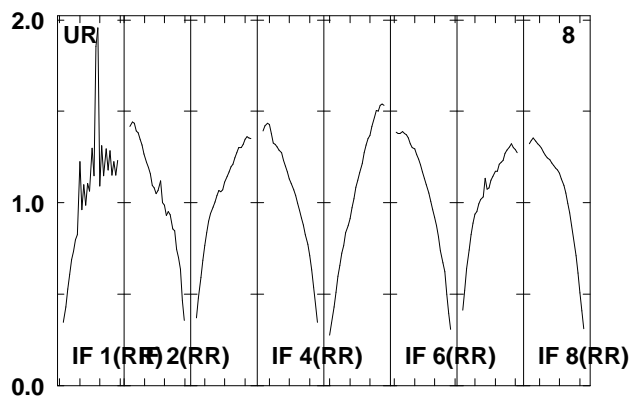
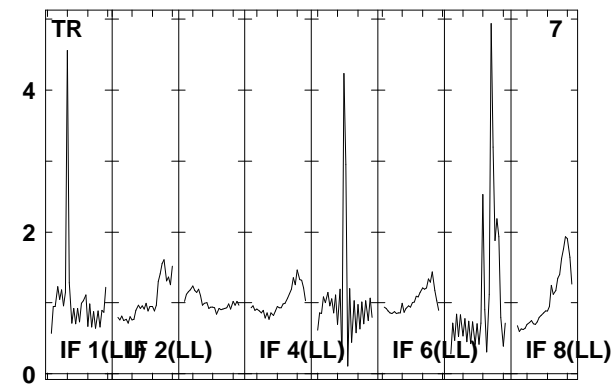
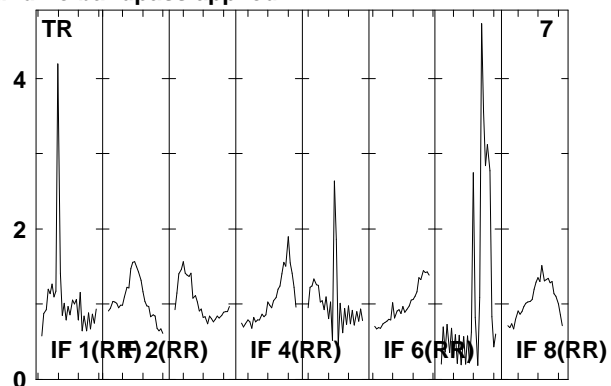
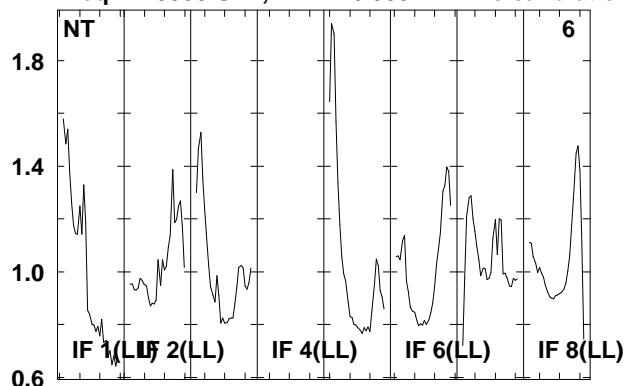

Lower frame: Real Jy  
Total-power spectrum Antenna: \*  
Timerange: 00/13:58:33 to 00/14:03:01



Plot file version 437 created 08-AUG-2008 17:02:18

J0920+44 EO006B.UVDATA.1

Freq = 1.5950 GHz, Bw = 16.000 MH No calibration applied and no bandpass applied

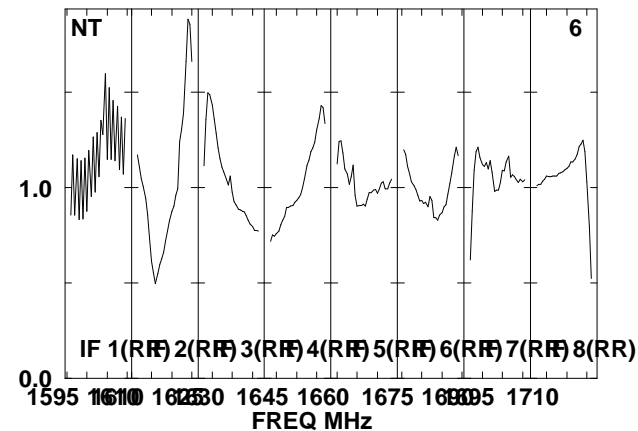
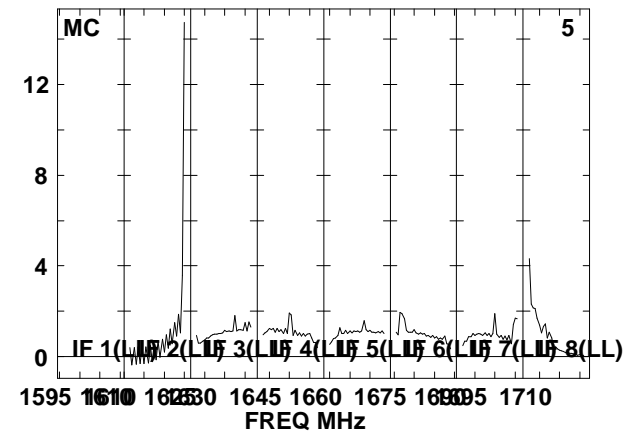
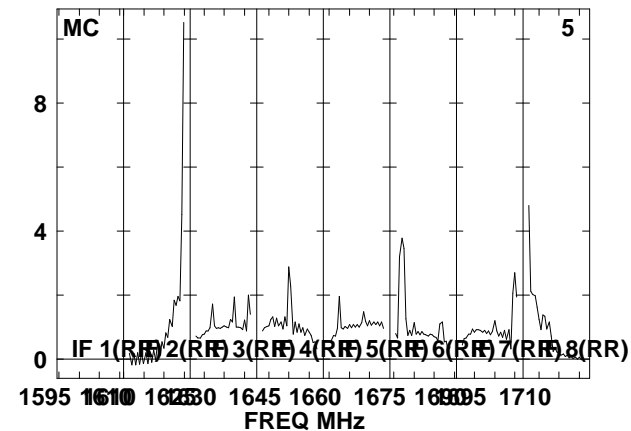
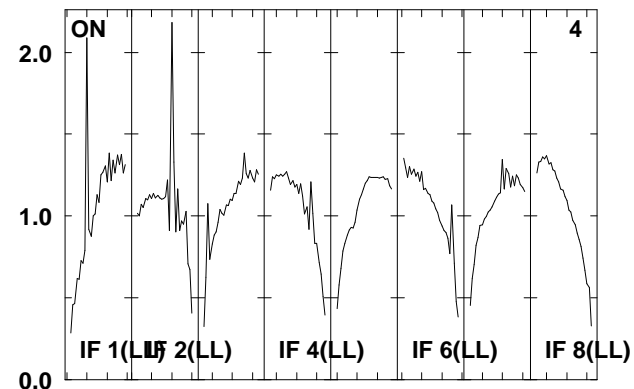
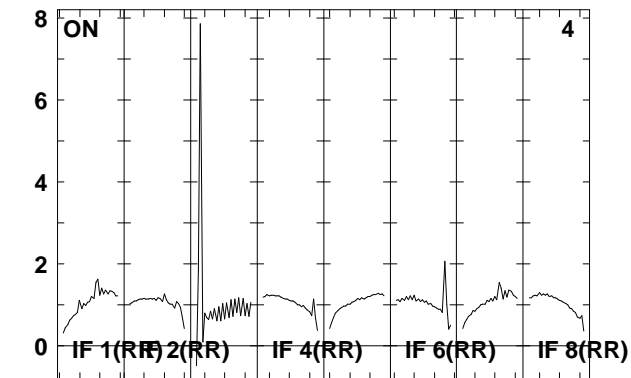
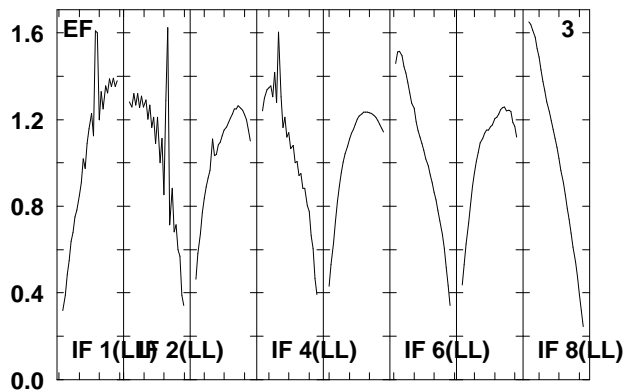
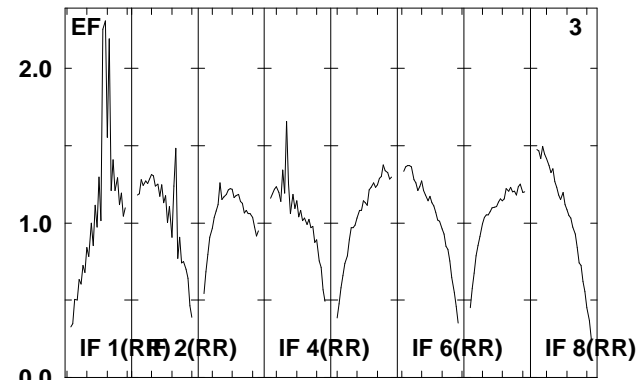
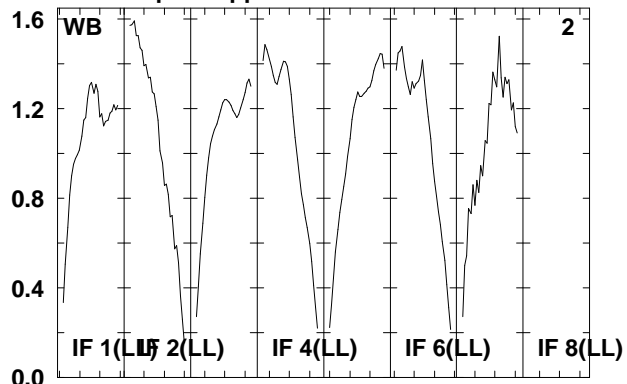
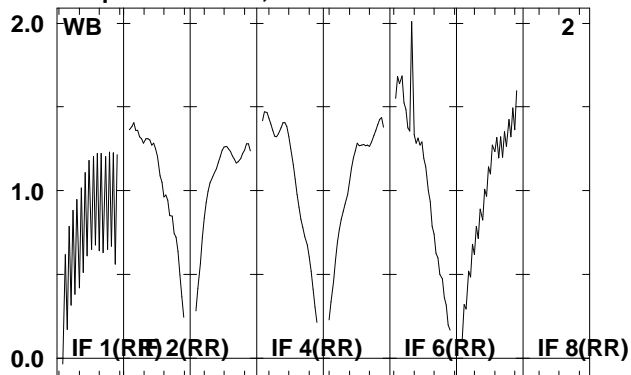

Lower frame: Real Jy  
Total-power spectrum Antenna: \*  
Timerange: 00/14:03:43 to 00/14:05:11

Plot file version 438 created 08-AUG-2008 17:02:18

J0920+44 EO006B.UVDATA.1

Freq = 1.5950 GHz, Bw = 16.000 MH No calibration applied and no bandpass applied

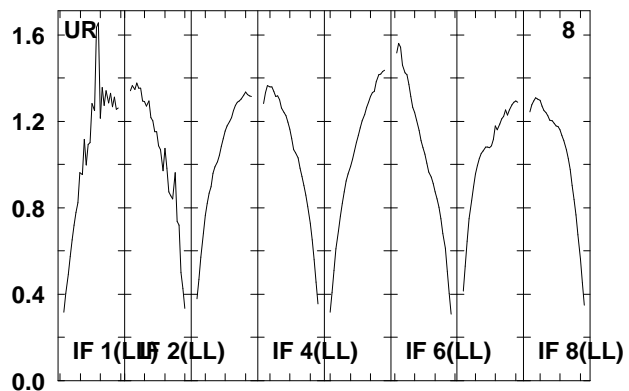
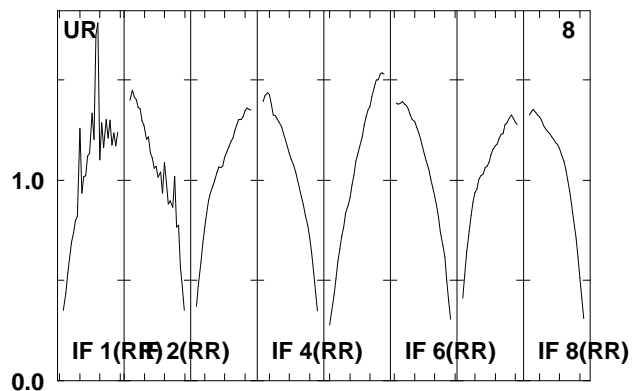
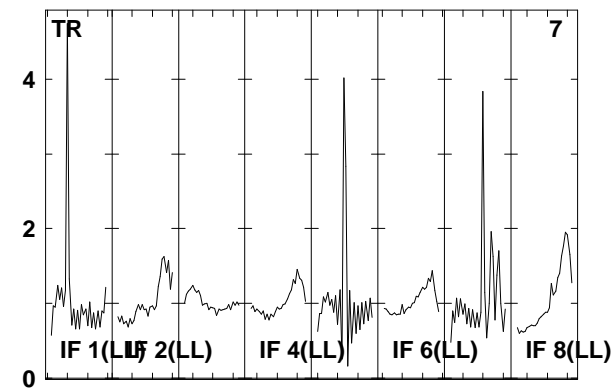
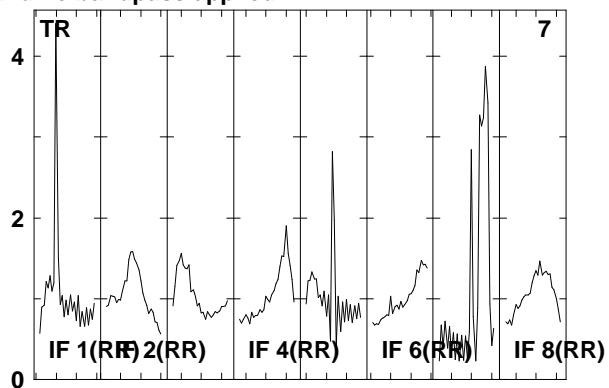
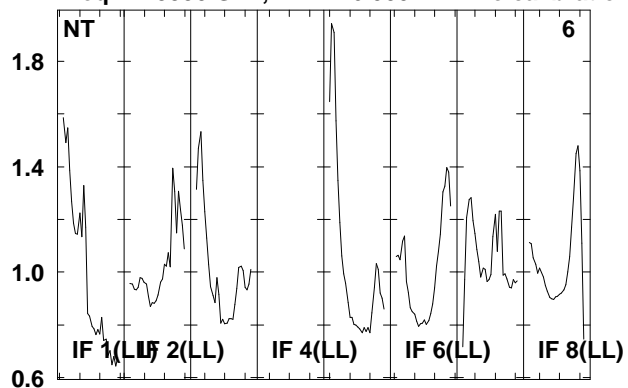

Lower frame: Real Jy  
Total-power spectrum Antenna: \*  
Timerange: 00/14:03:43 to 00/14:05:11

Plot file version 439 created 08-AUG-2008 17:02:18

J092159 EO006B.UVDATA.1

Freq = 1.5950 GHz, Bw = 16.000 MH No calibration applied and no bandpass applied

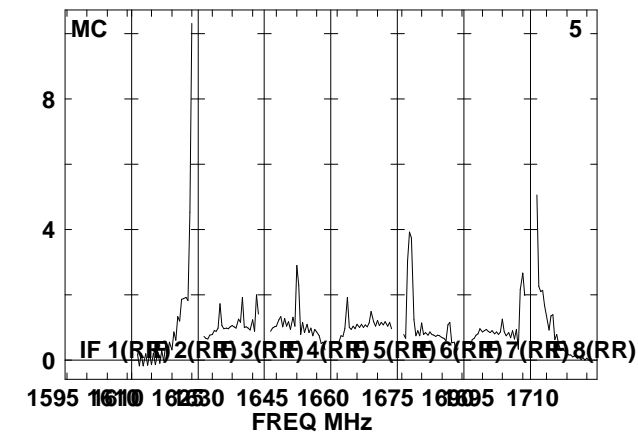
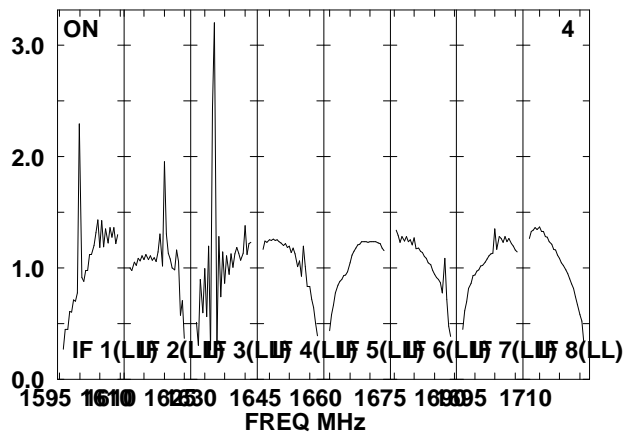
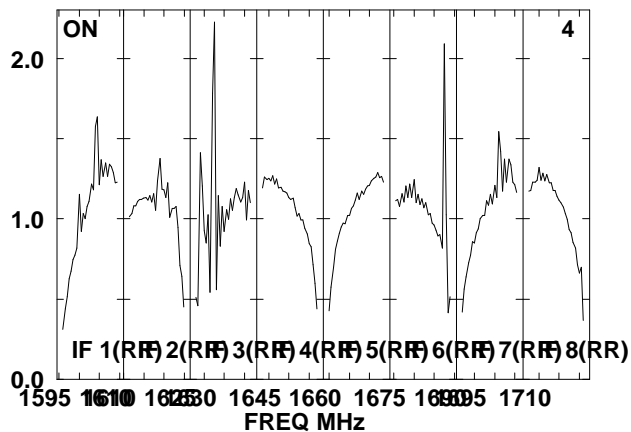
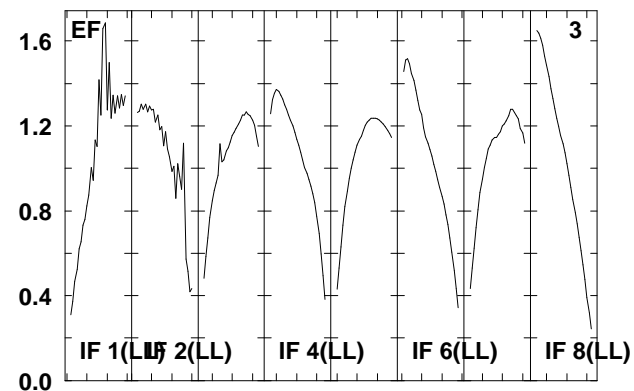
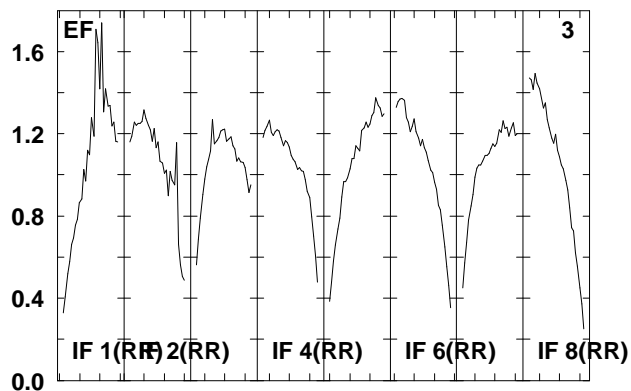
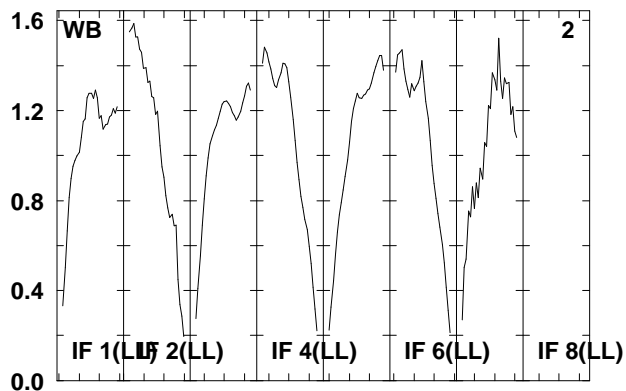
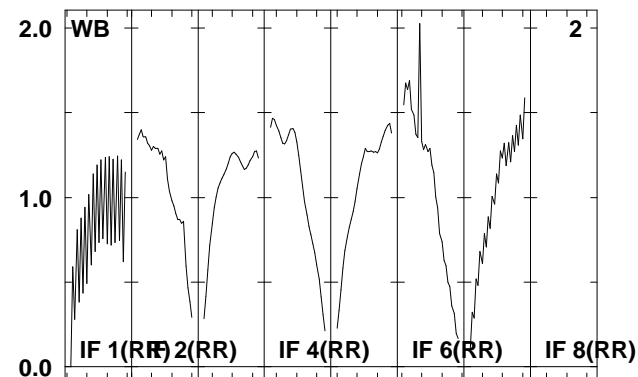
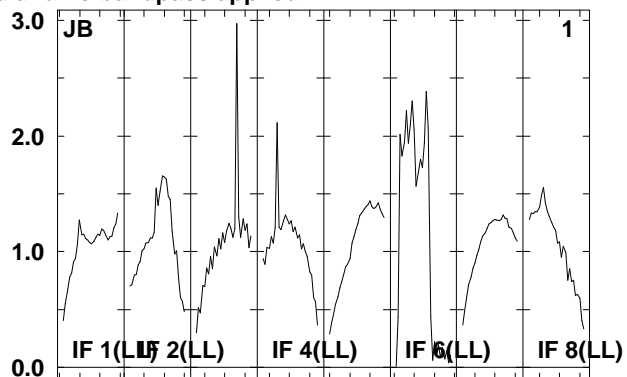
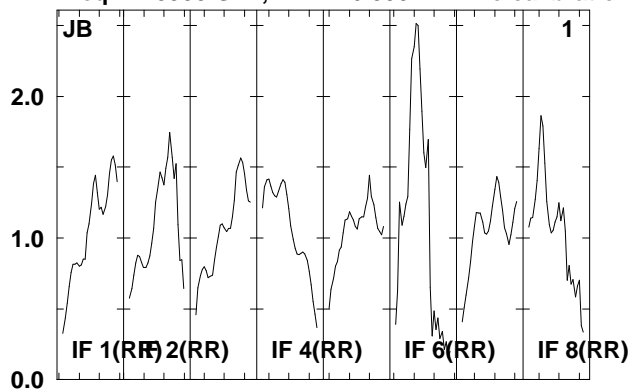

Lower frame: Real Jy  
Total-power spectrum Antenna: \*  
Timerange: 00/14:05:53 to 00/14:10:29

Plot file version 440 created 08-AUG-2008 17:02:19

J092159 EO006B.UVDATA.1

Freq = 1.5950 GHz, Bw = 16.000 MH No calibration applied and no bandpass applied

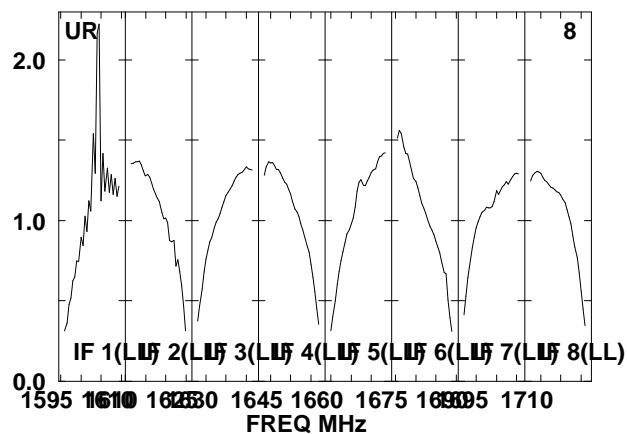
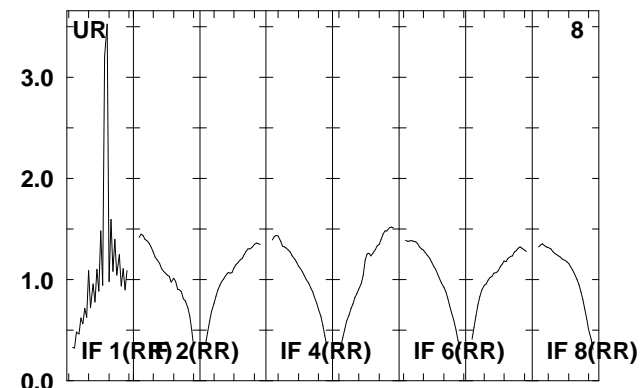
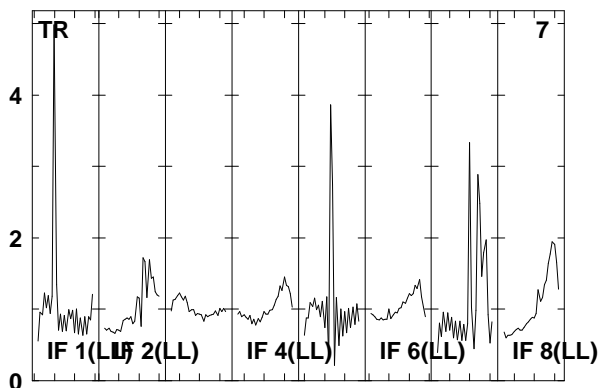
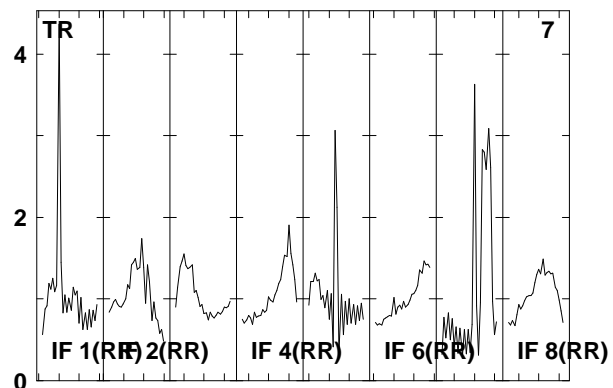
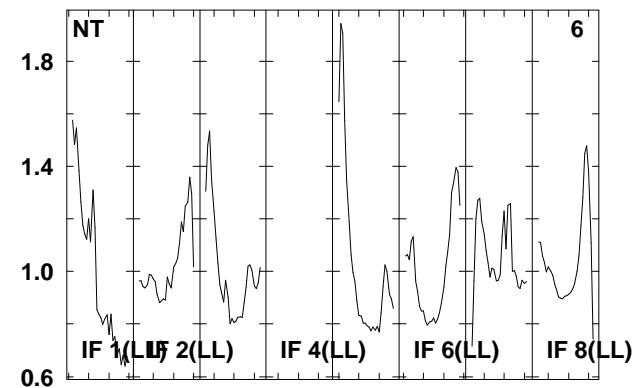
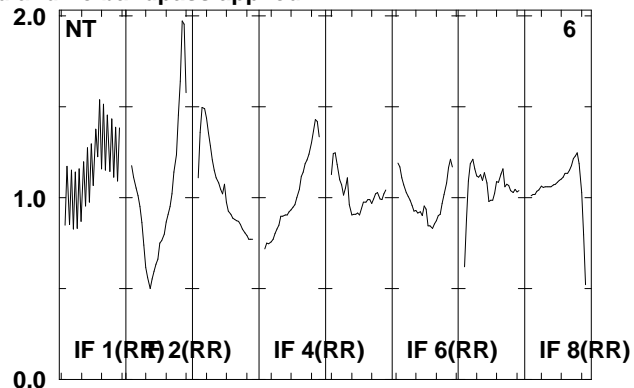
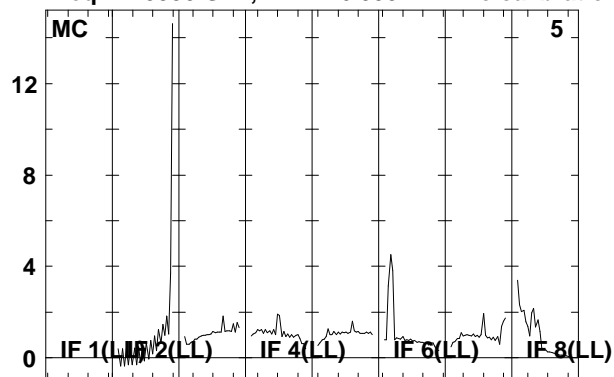

Lower frame: Real Jy

Total-power spectrum Antenna: \*

Timerange: 00/14:05:53 to 00/14:10:29

Plot file version 441 created 08-AUG-2008 17:02:20

J0920+44 EO006B.UVDATA.1

Freq = 1.5950 GHz, Bw = 16.000 MH No calibration applied and no bandpass applied

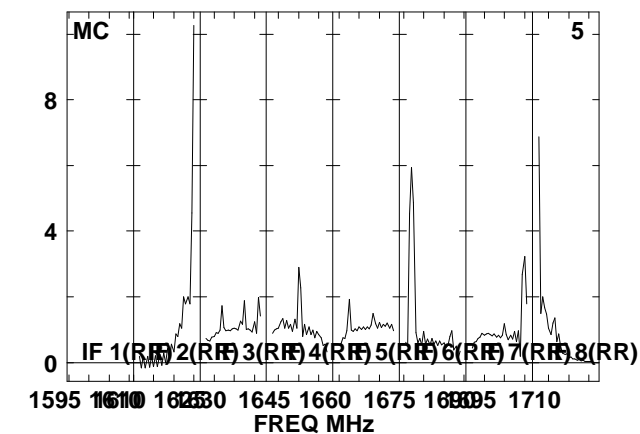
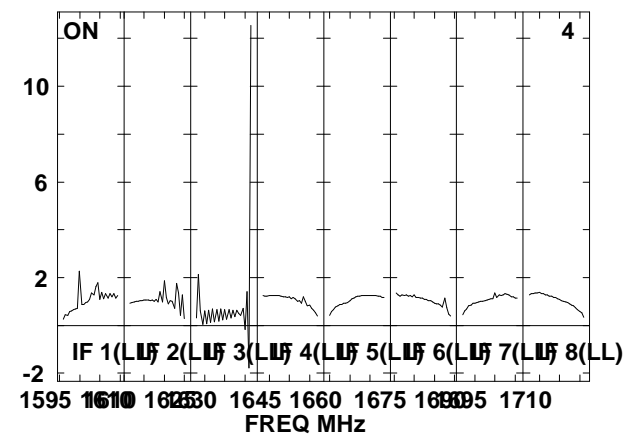
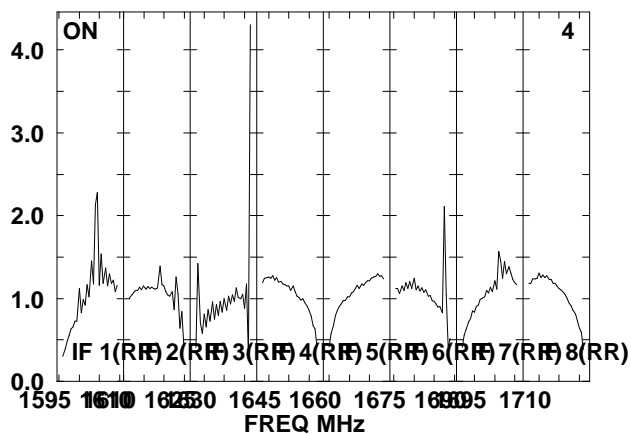
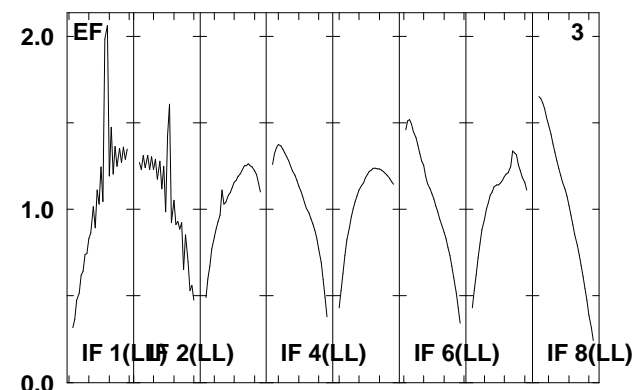
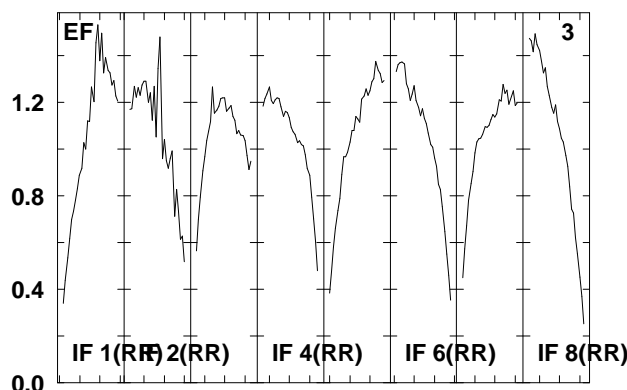
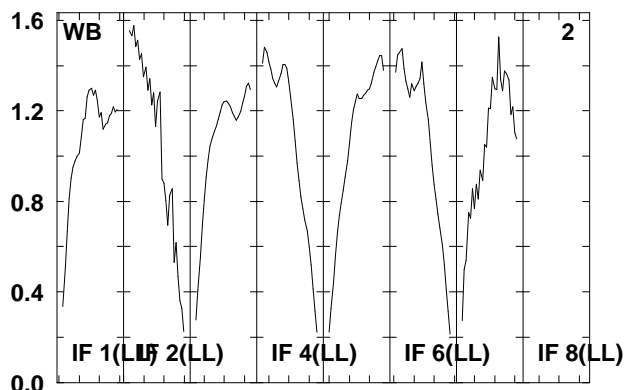
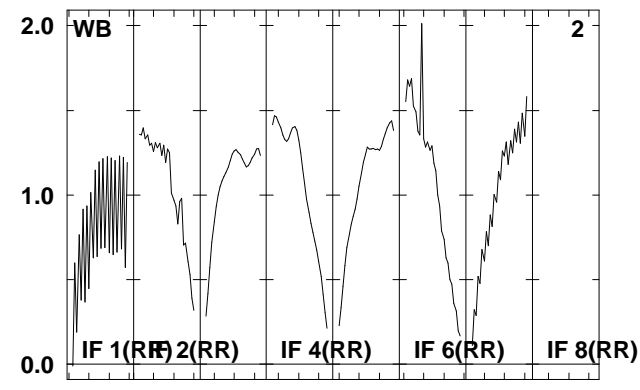
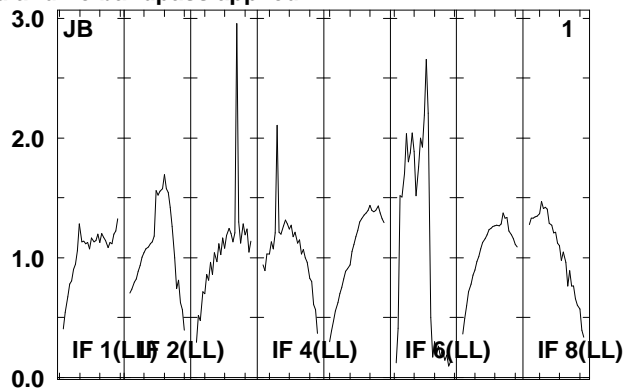
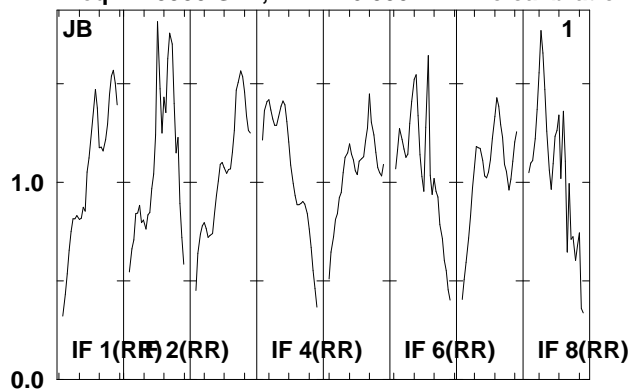

Lower frame: Real Jy  
Total-power spectrum Antenna: \*  
Timerange: 00/14:11:01 to 00/14:12:37

Plot file version 442 created 08-AUG-2008 17:02:21

J0920+44 EO006B.UVDATA.1

Freq = 1.5950 GHz, Bw = 16.000 MH No calibration applied and no bandpass applied

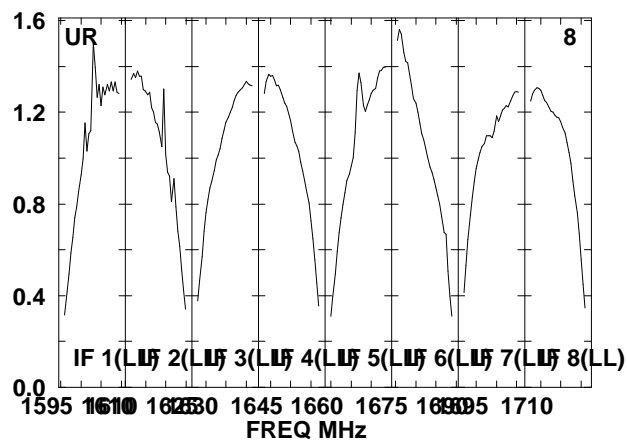
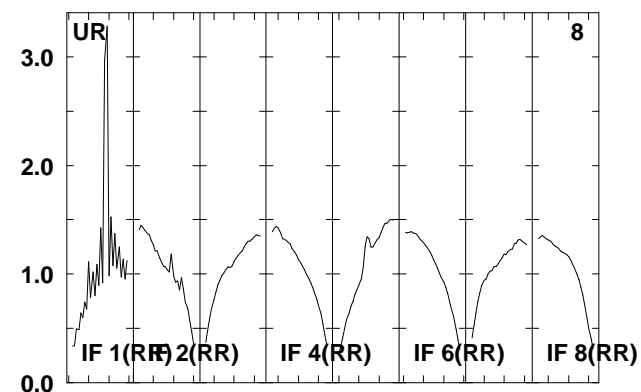
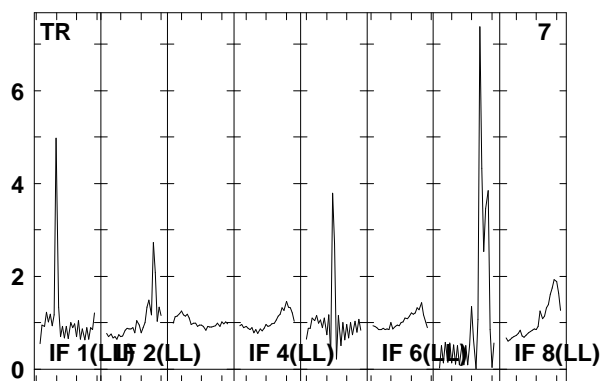
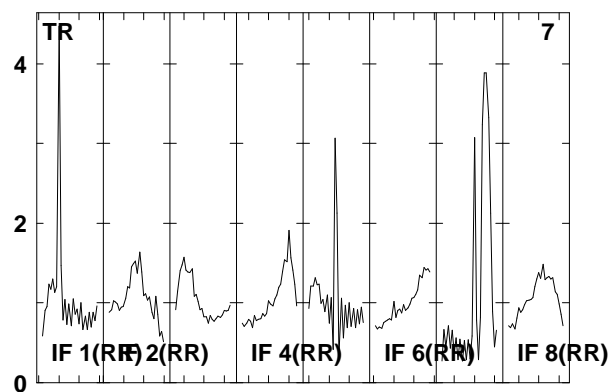
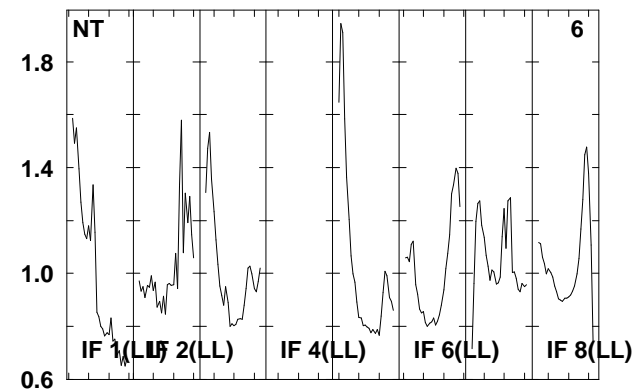
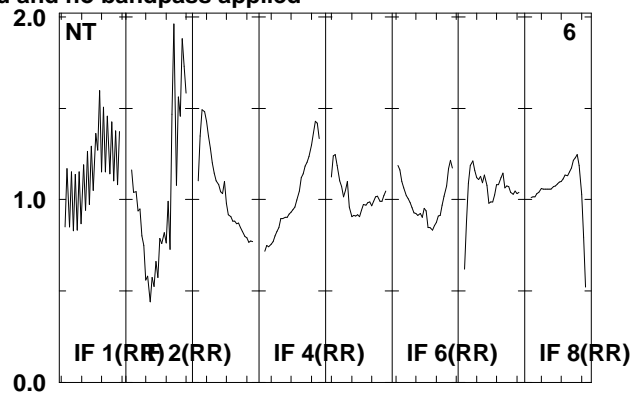
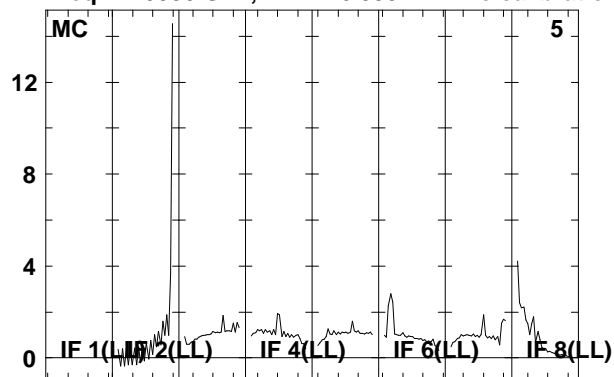

Lower frame: Real Jy

Total-power spectrum Antenna: \*

Timerange: 00/14:11:01 to 00/14:12:37

Plot file version 443 created 08-AUG-2008 17:02:21

J092159 EO006B.UVDATA.1

Freq = 1.5950 GHz, Bw = 16.000 MH No calibration applied and no bandpass applied

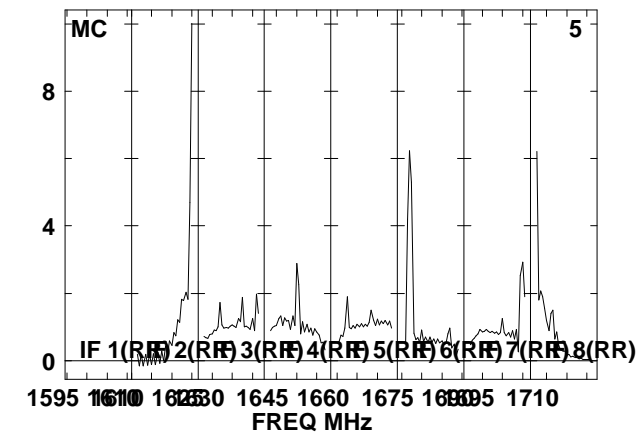
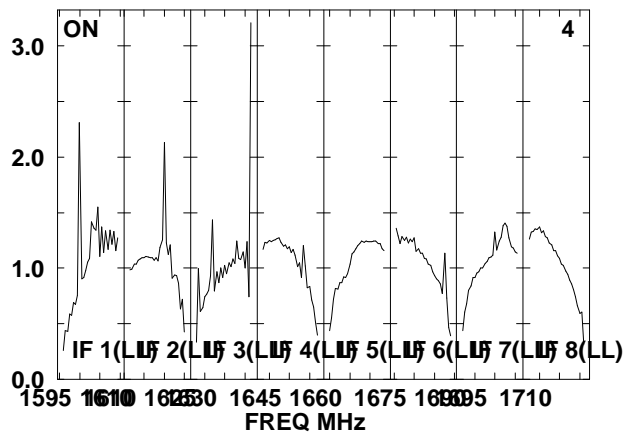
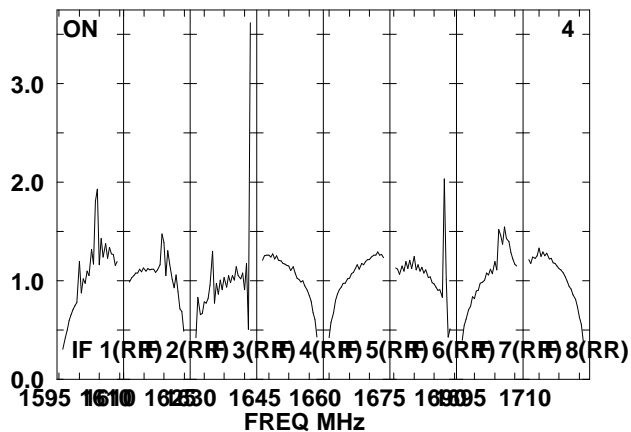
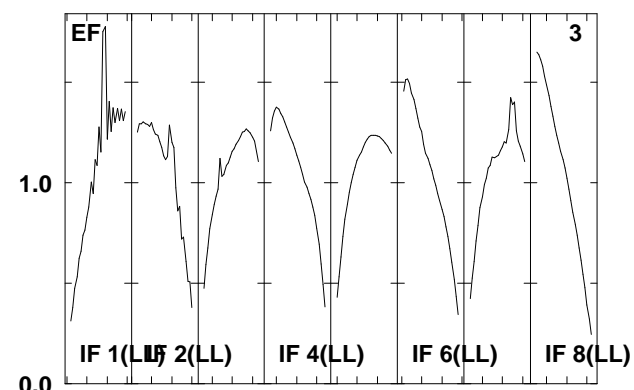
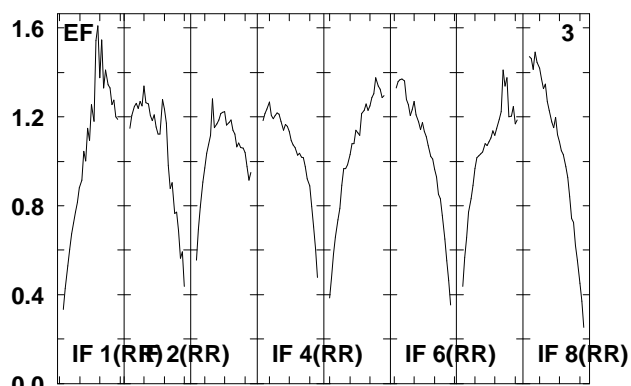
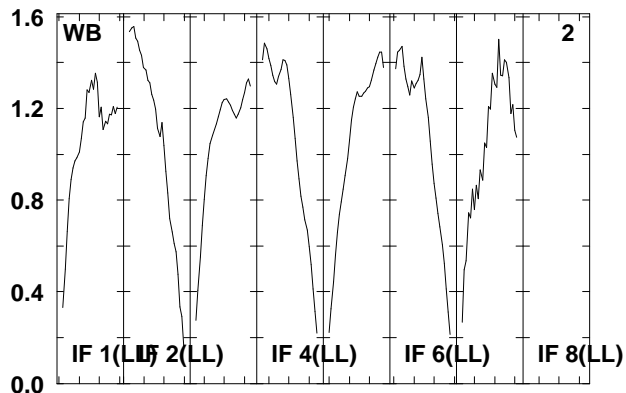
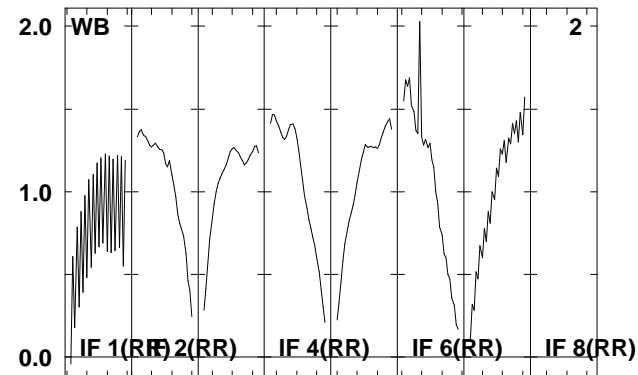
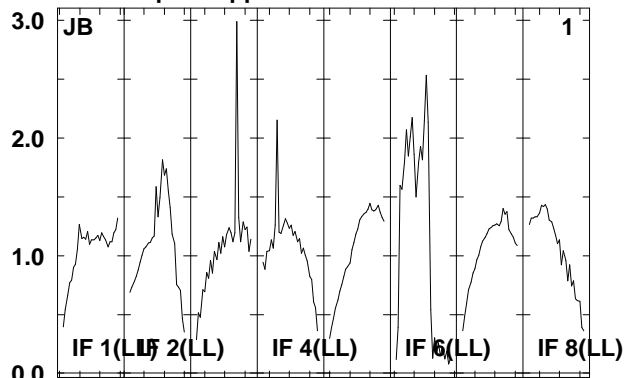
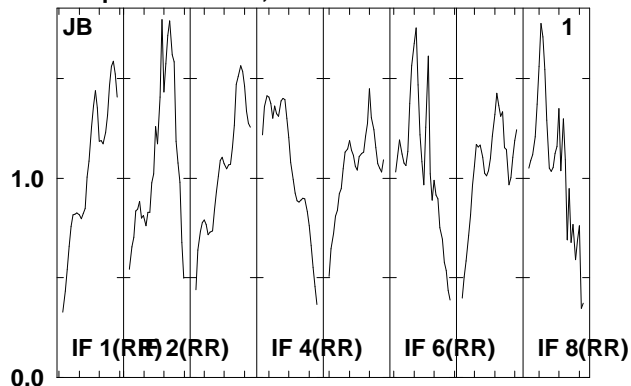

Lower frame: Real Jy  
Total-power spectrum Antenna: \*  
Timerange: 00/14:13:13 to 00/14:17:49

Plot file version 444 created 08-AUG-2008 17:02:22

J092159 EO06B.UVDATA.1

Freq = 1.5950 GHz, Bw = 16.000 MH No calibration applied and no bandpass applied

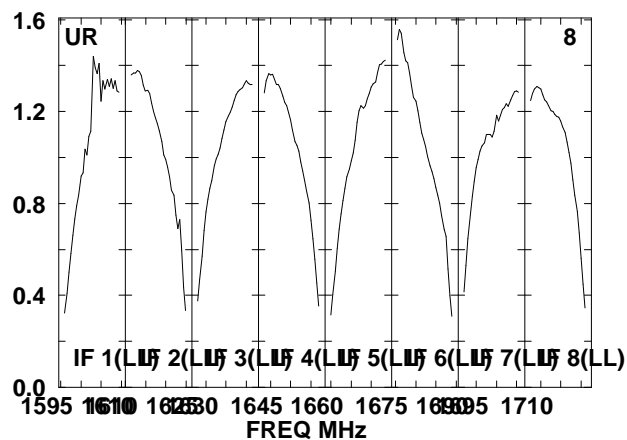
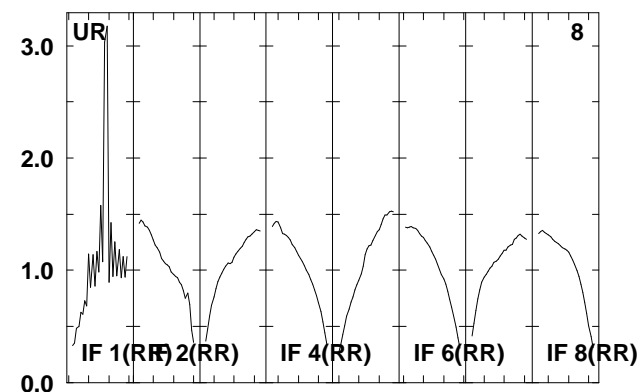
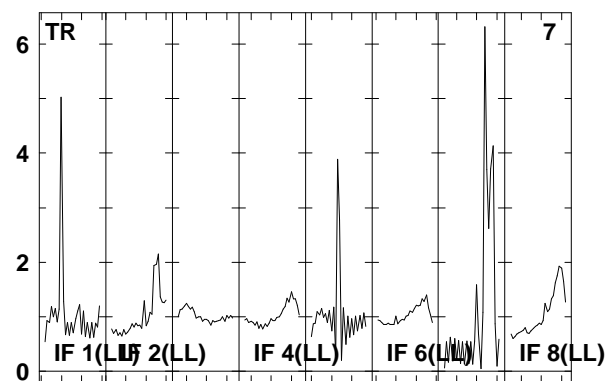
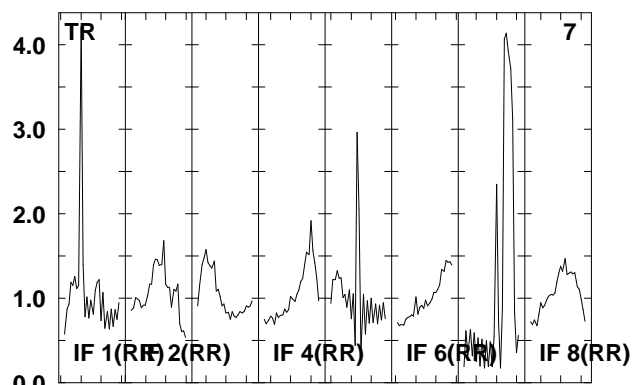
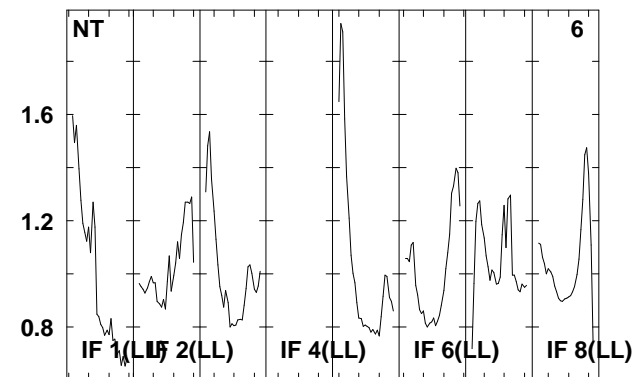
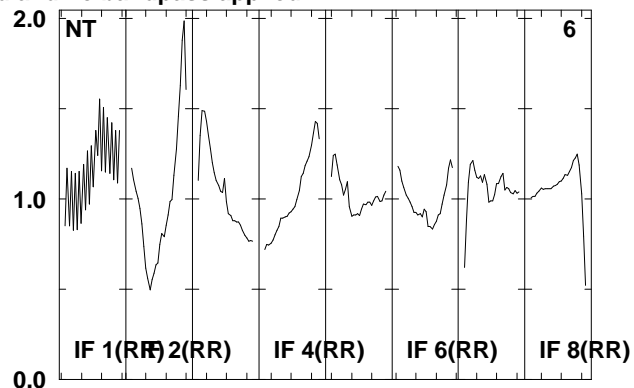
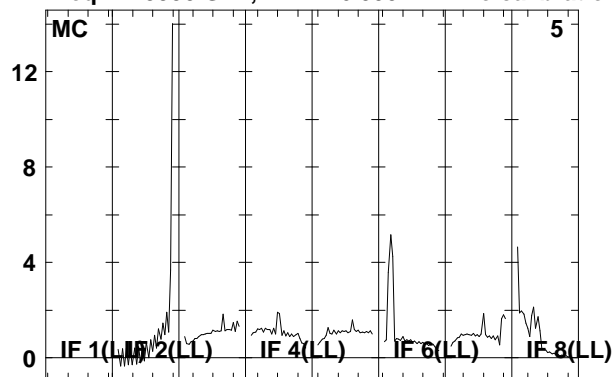

Lower frame: Real Jy

Total-power spectrum Antenna: \*

Timerange: 00/14:13:13 to 00/14:17:49



Plot file version 445 created 08-AUG-2008 17:02:23

J0920+44 EO006B.UVDATA.1

Freq = 1.5950 GHz, Bw = 16.000 MH No calibration applied and no bandpass applied

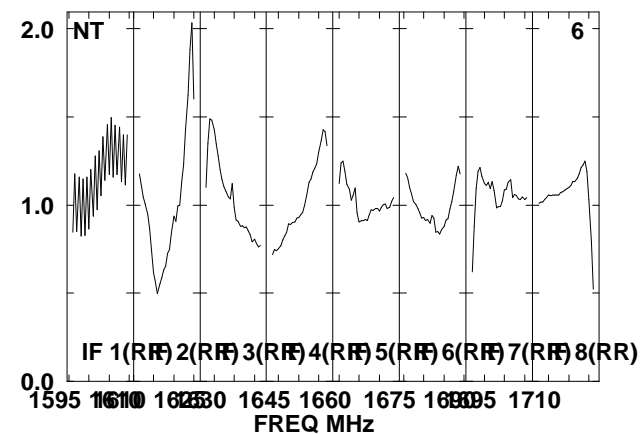
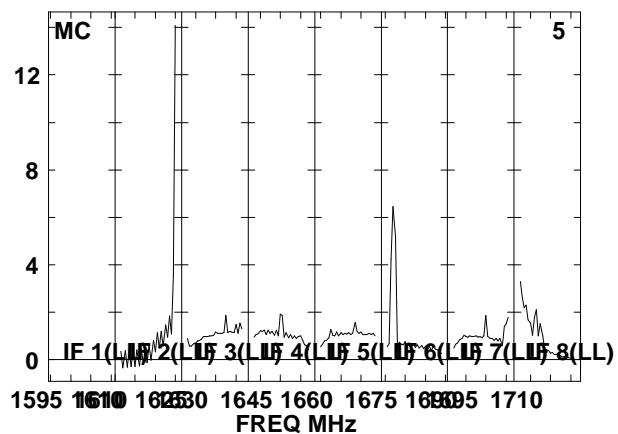
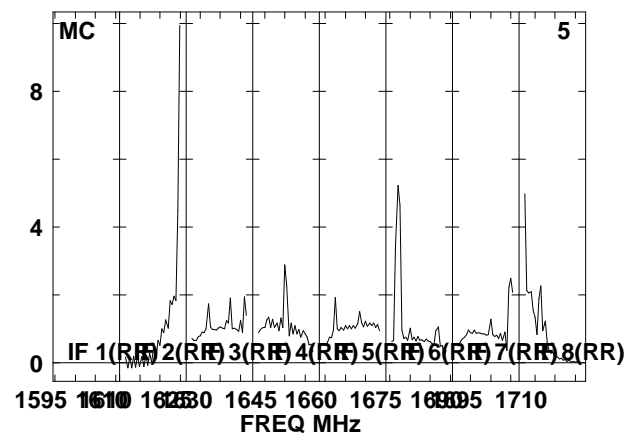
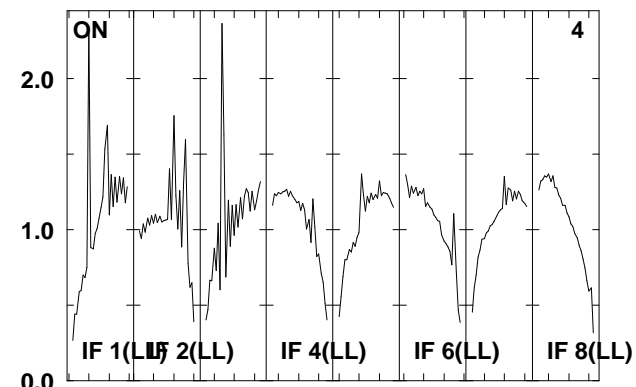
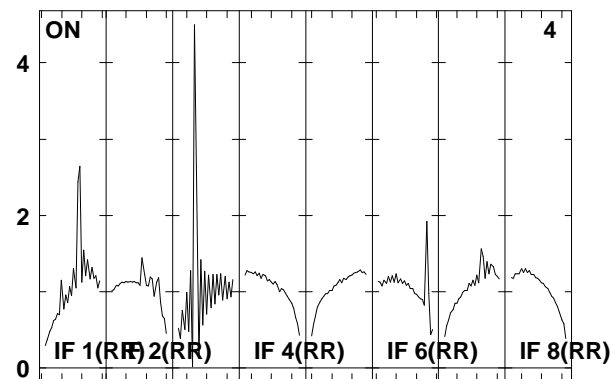
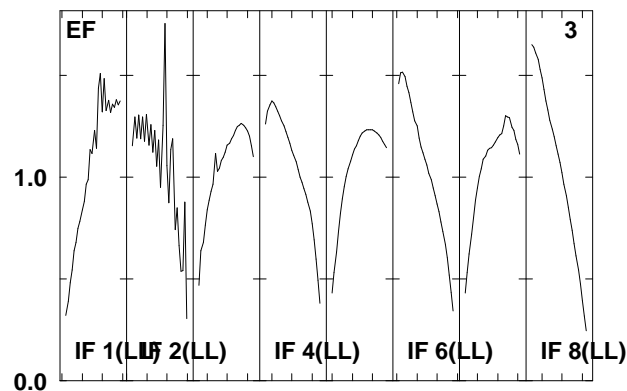
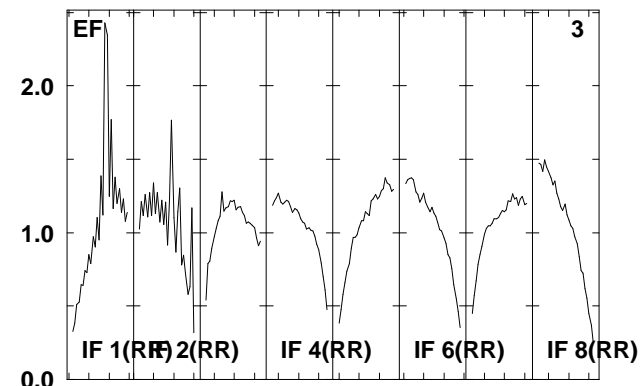
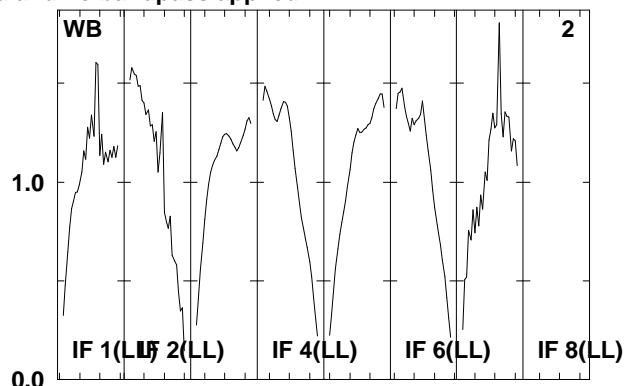
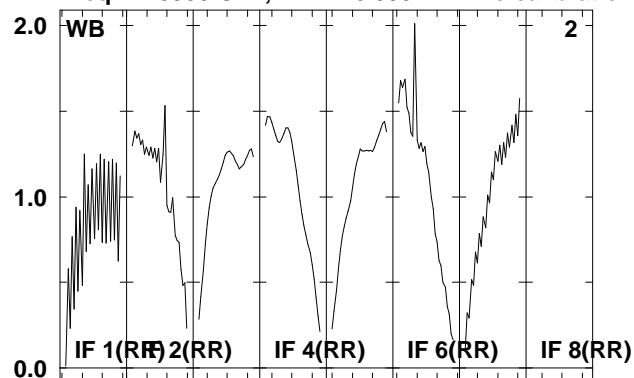

Lower frame: Real Jy  
Total-power spectrum Antenna: \*  
Timerange: 00/14:18:21 to 00/14:19:57

Plot file version 446 created 08-AUG-2008 17:02:23

J0920+44 EO006B.UVDATA.1

Freq = 1.5950 GHz, Bw = 16.000 MH No calibration applied and no bandpass applied

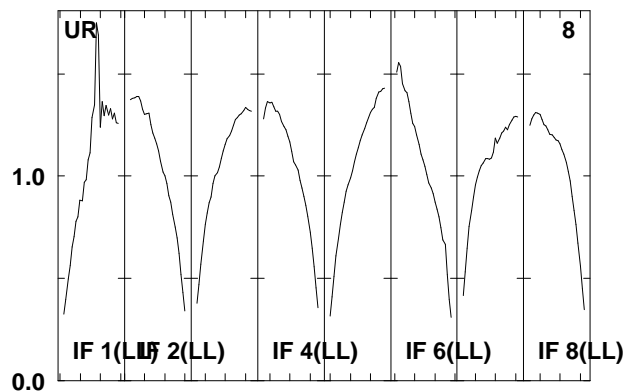
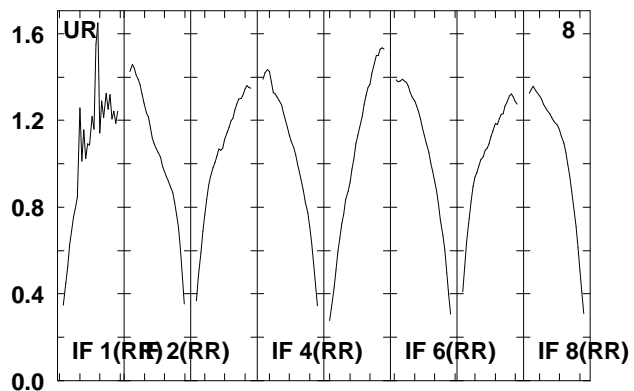
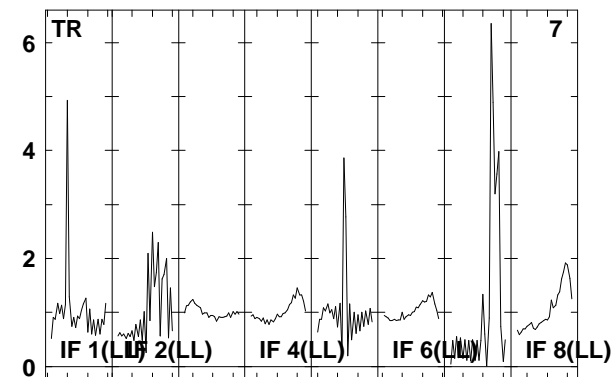
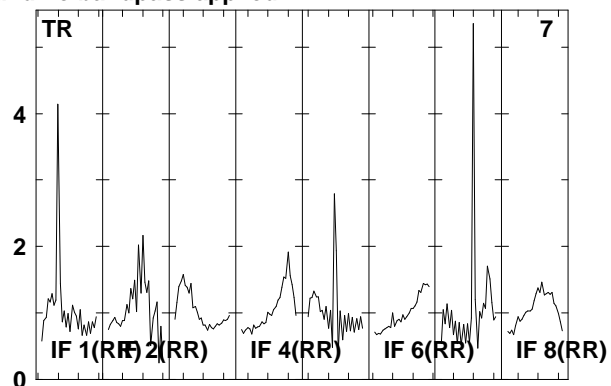
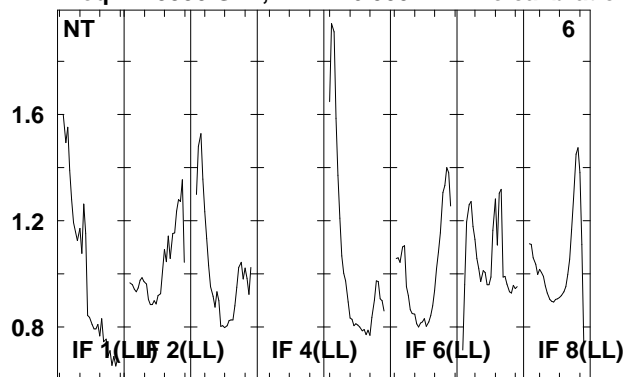

Lower frame: Real Jy  
Total-power spectrum Antenna: \*  
Timerange: 00/14:18:21 to 00/14:19:57

Plot file version 447 created 08-AUG-2008 17:02:23

J092159 EO006B.UVDATA.1

Freq = 1.5950 GHz, Bw = 16.000 MH No calibration applied and no bandpass applied

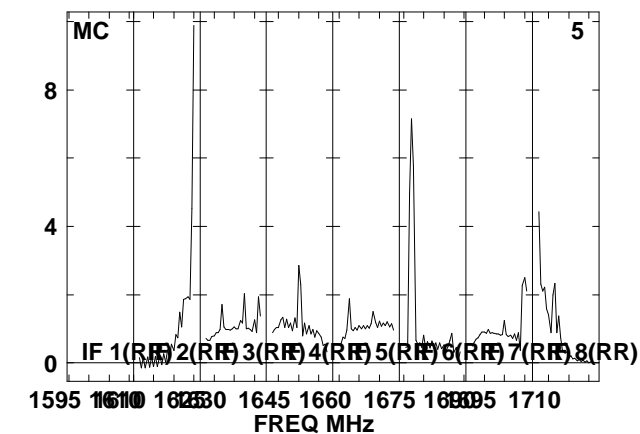
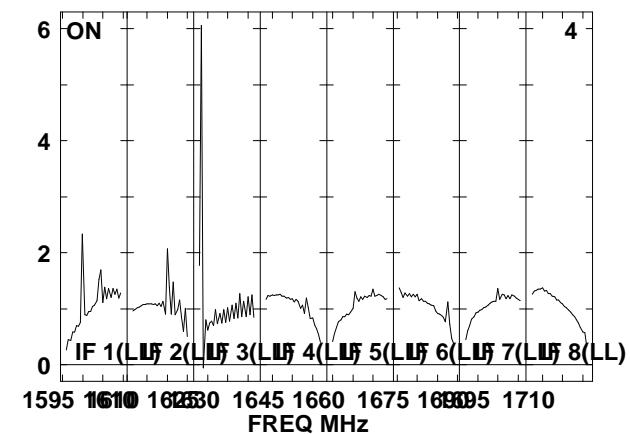
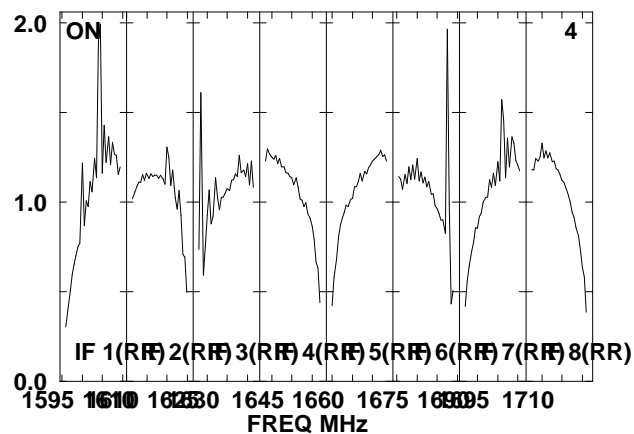
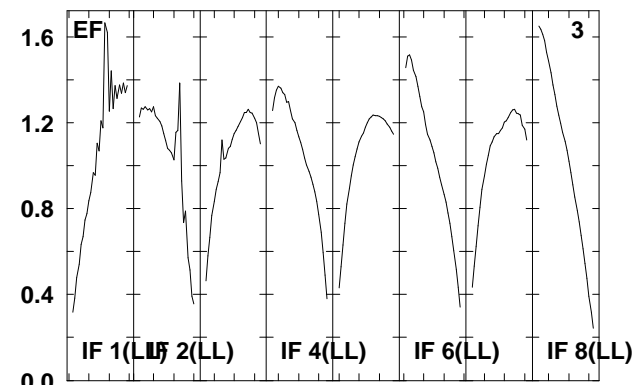
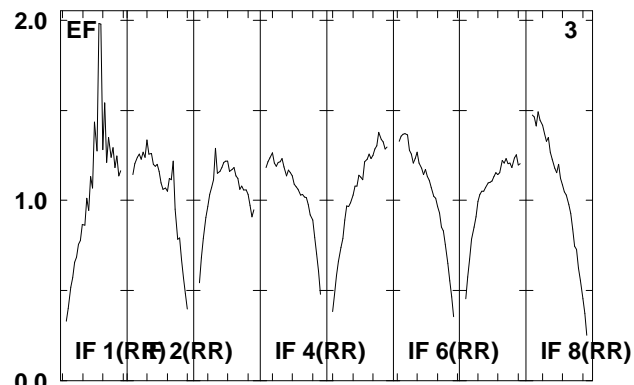
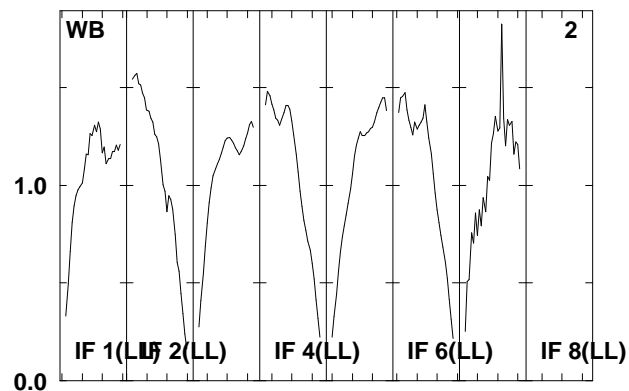
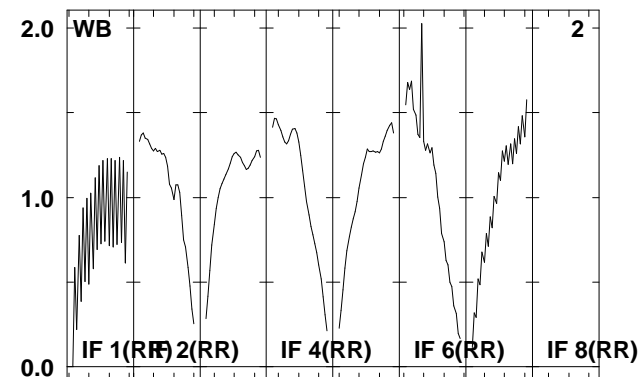
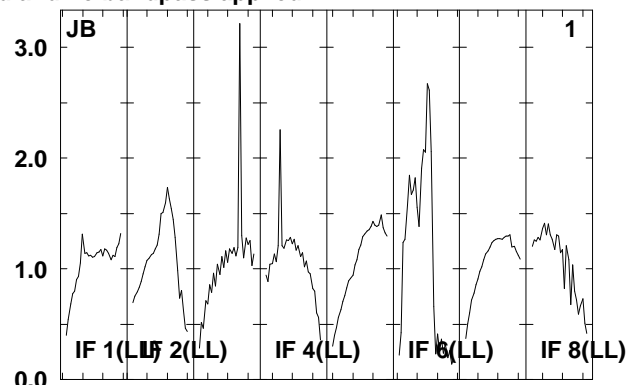
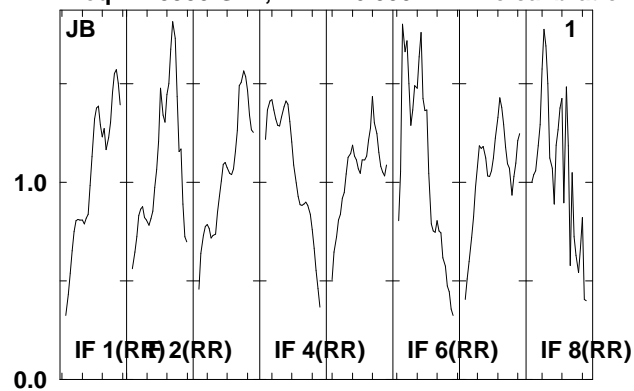

Lower frame: Real Jy  
Total-power spectrum Antenna: \*  
Timerange: 00/14:20:33 to 00/14:25:09

Plot file version 448 created 08-AUG-2008 17:02:24

J092159 EO006B.UVDATA.1

Freq = 1.5950 GHz, Bw = 16.000 MH No calibration applied and no bandpass applied

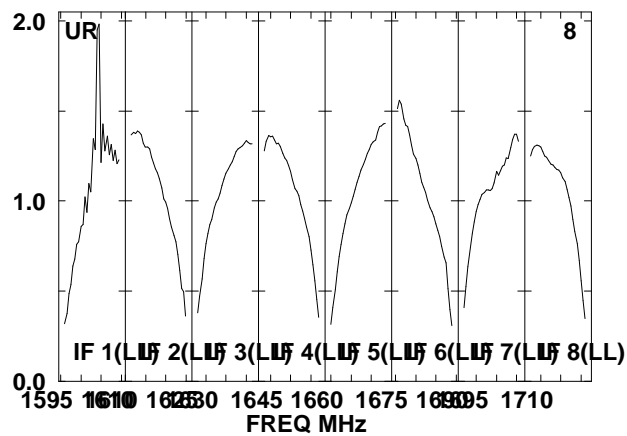
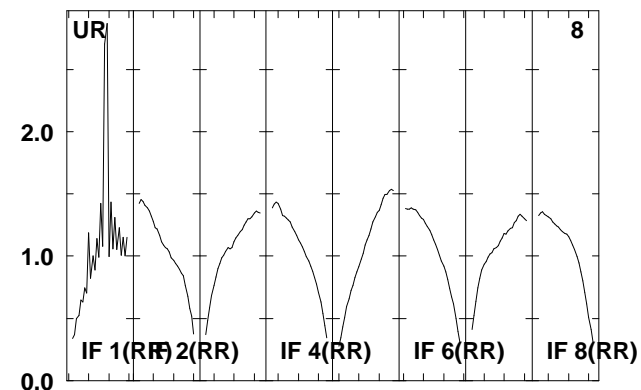
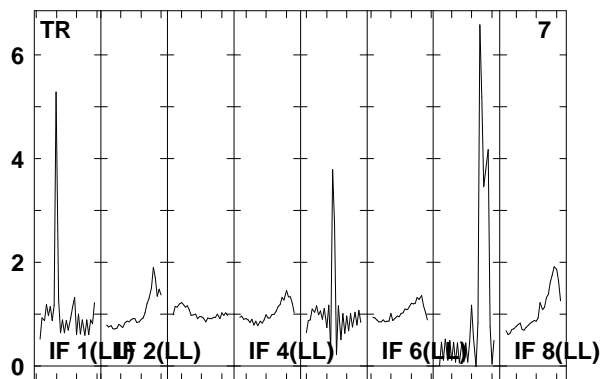
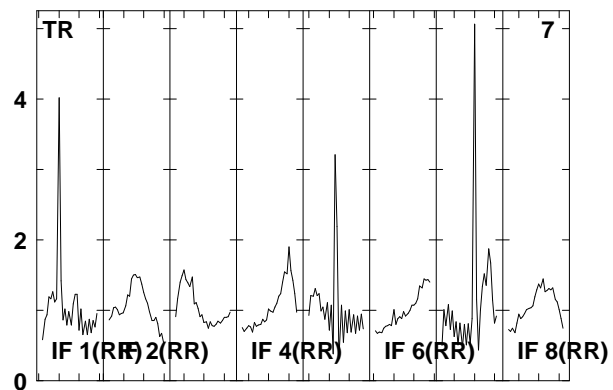
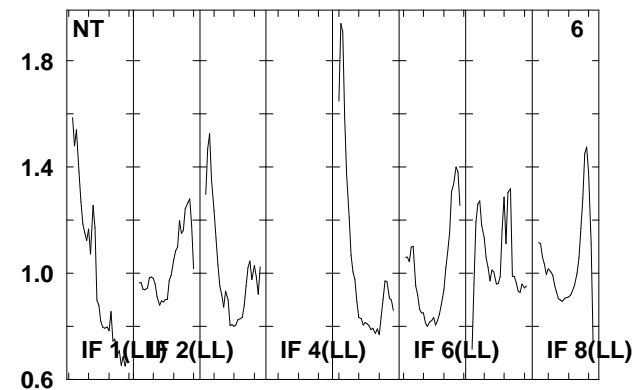
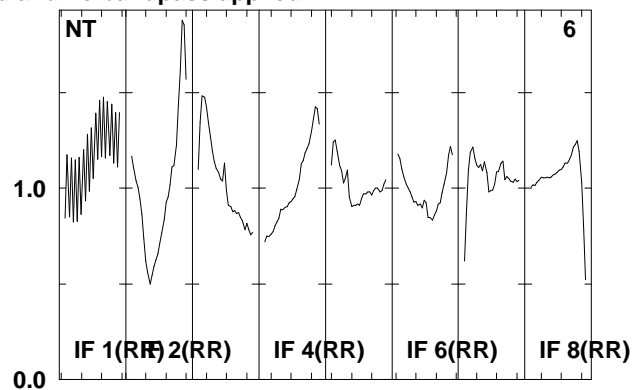
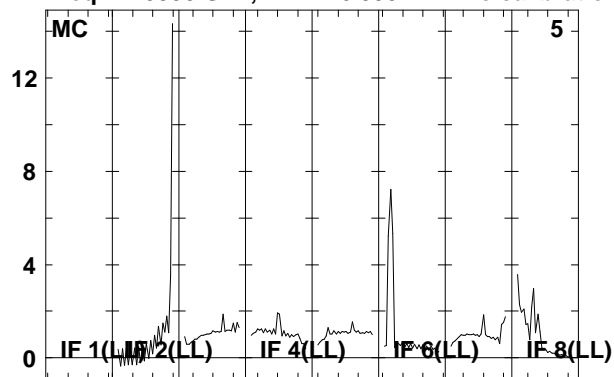

Lower frame: Real Jy

Total-power spectrum Antenna: \*

Timerange: 00/14:20:33 to 00/14:25:09

Plot file version 449 created 08-AUG-2008 17:02:25

J0920+44 EO006B.UVDATA.1

Freq = 1.5950 GHz, Bw = 16.000 MH No calibration applied and no bandpass applied

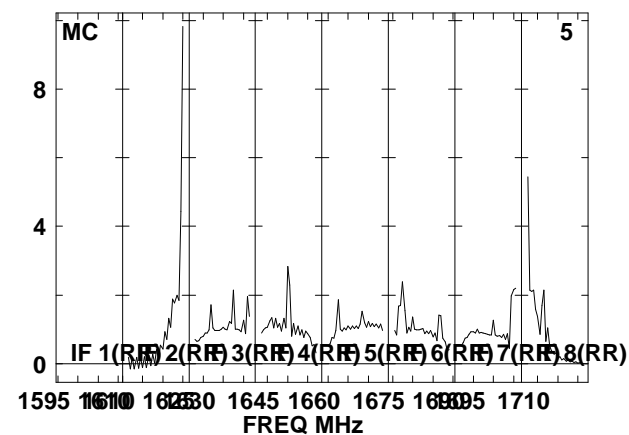
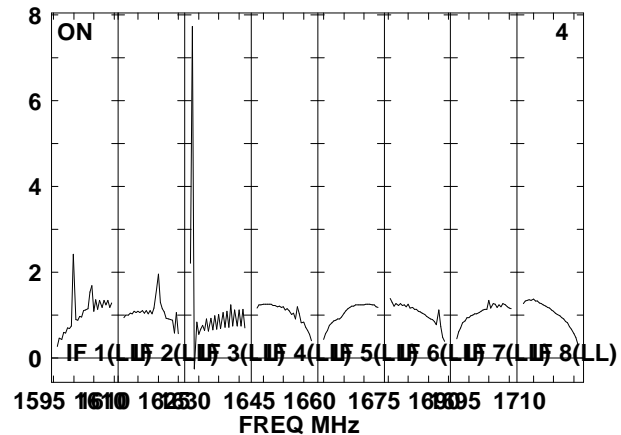
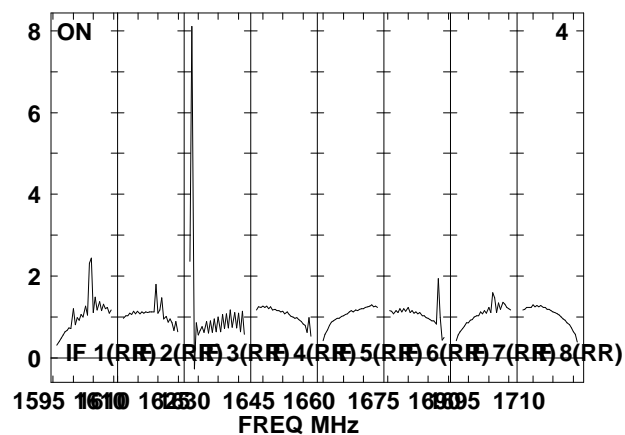
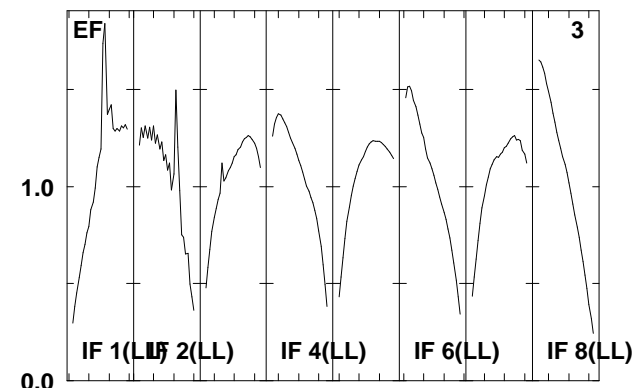
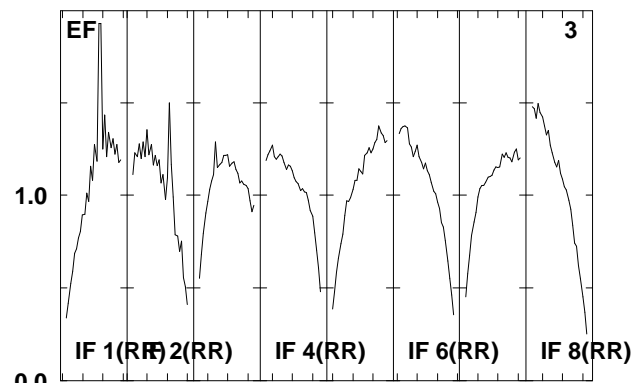
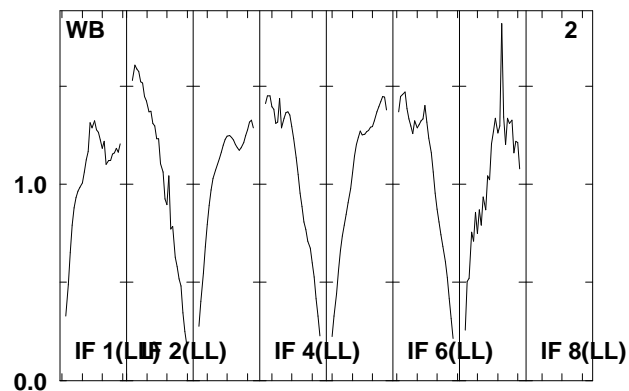
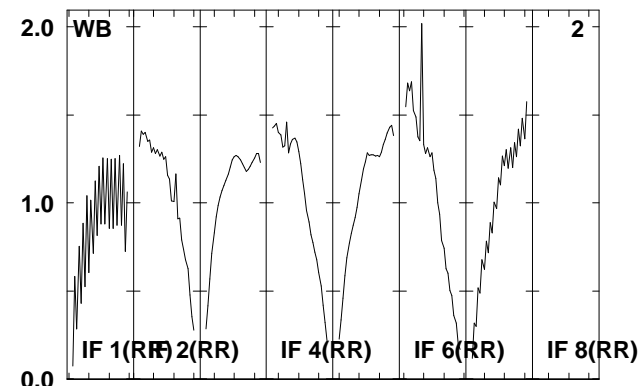
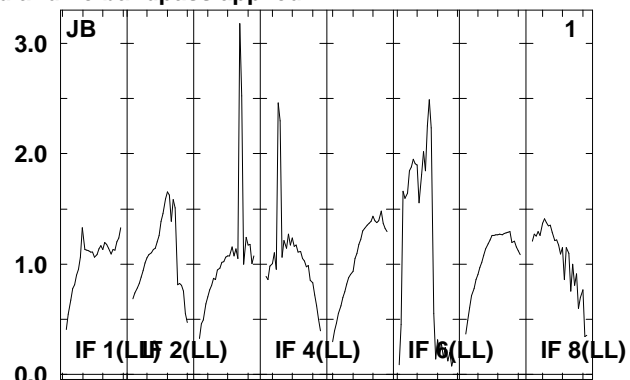
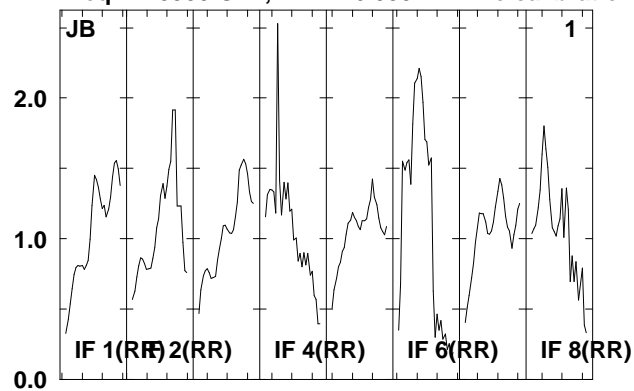

Lower frame: Real Jy  
Total-power spectrum Antenna: \*  
Timerange: 00/14:25:41 to 00/14:27:17

Plot file version 450 created 08-AUG-2008 17:02:25

J0920+44 EO006B.UVDATA.1

Freq = 1.5950 GHz, Bw = 16.000 MH No calibration applied and no bandpass applied

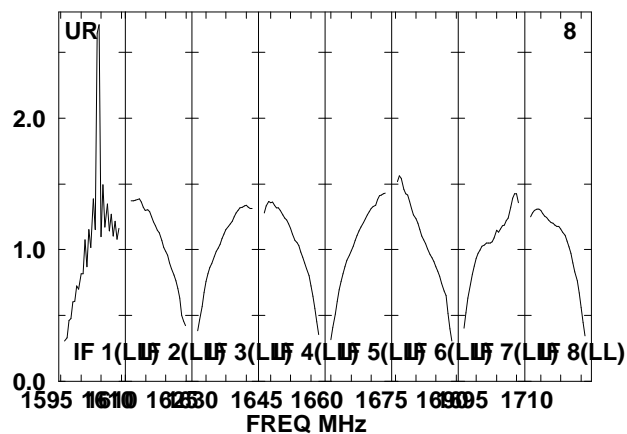
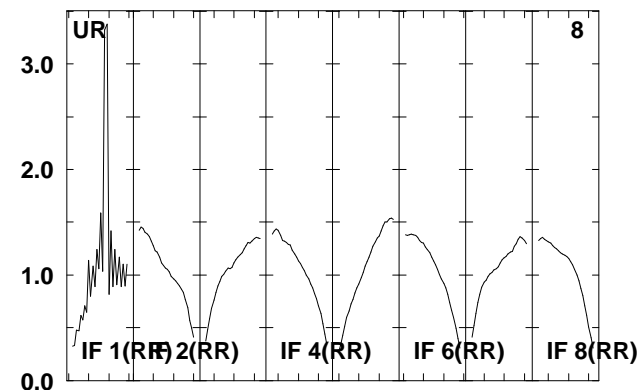
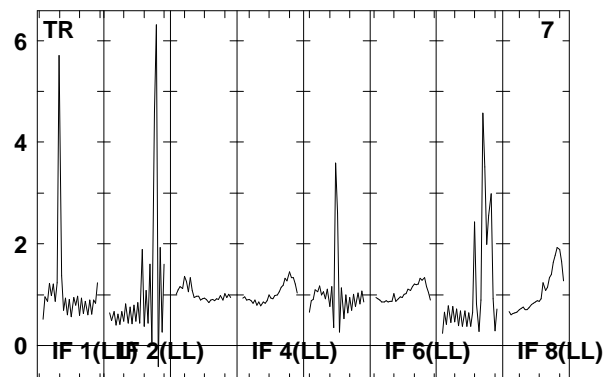
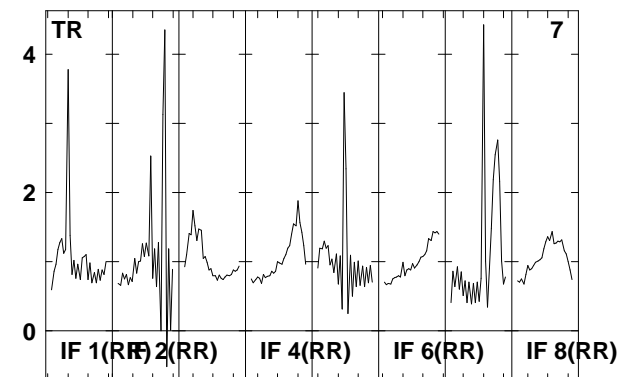
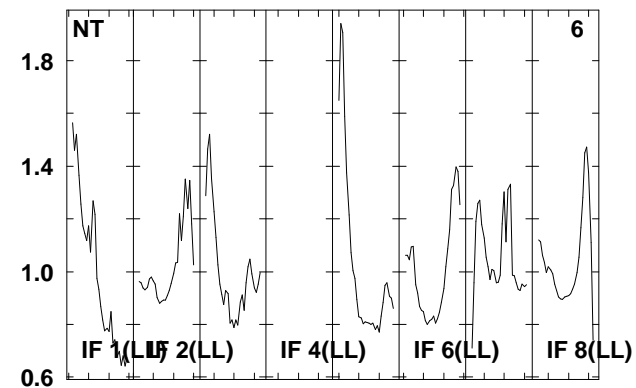
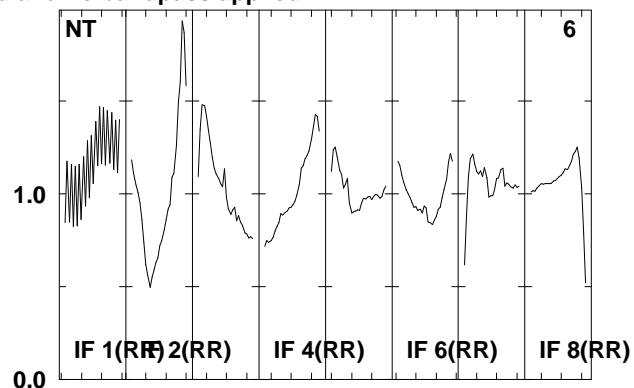
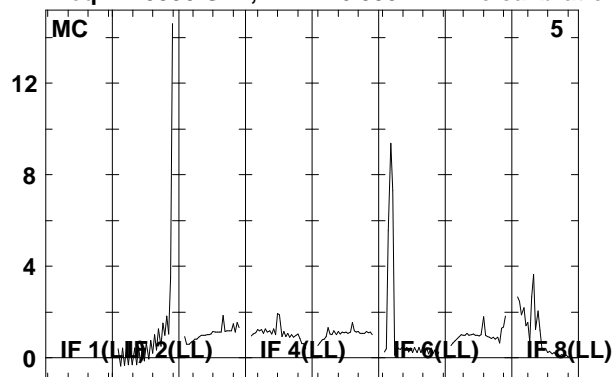

Lower frame: Real Jy

Total-power spectrum Antenna: \*

Timerange: 00/14:25:41 to 00/14:27:17

Plot file version 451 created 08-AUG-2008 17:02:26

J092159 EO006B.UVDATA.1

Freq = 1.5950 GHz, Bw = 16.000 MH No calibration applied and no bandpass applied

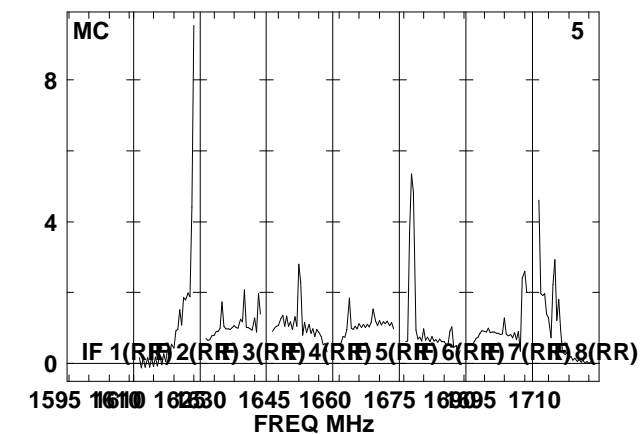
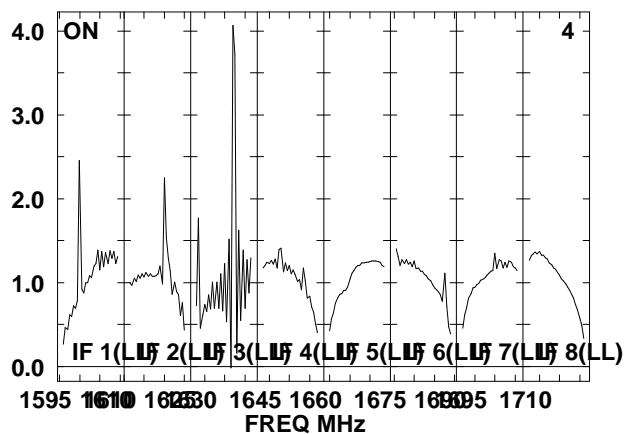
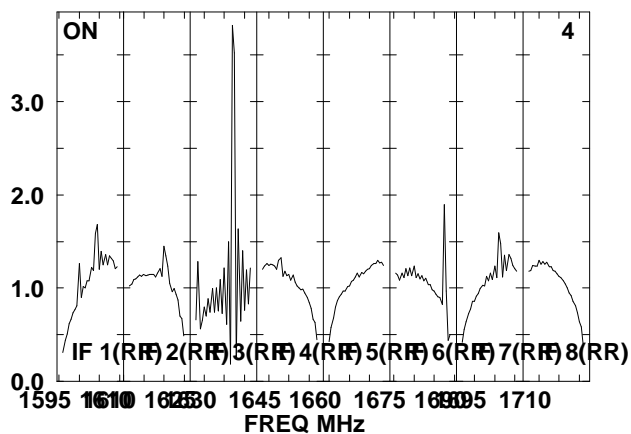
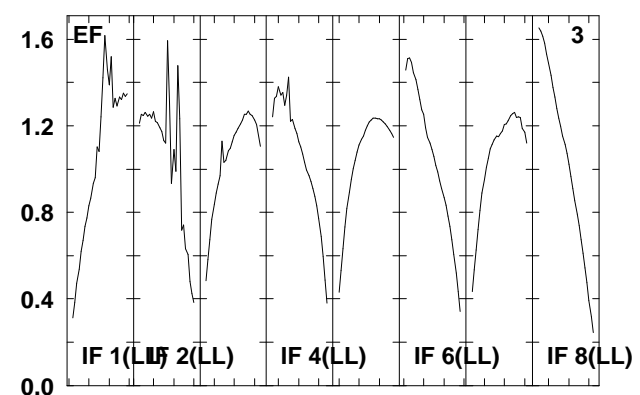
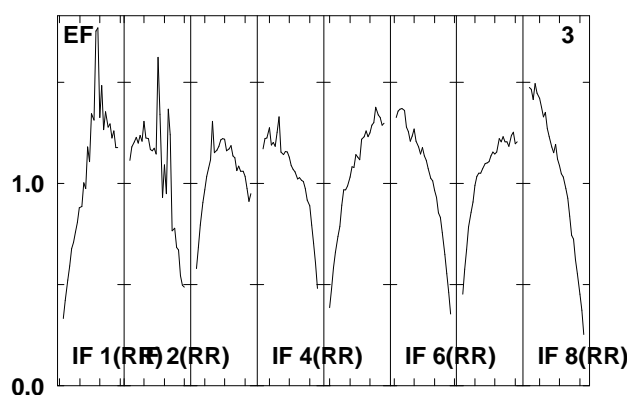
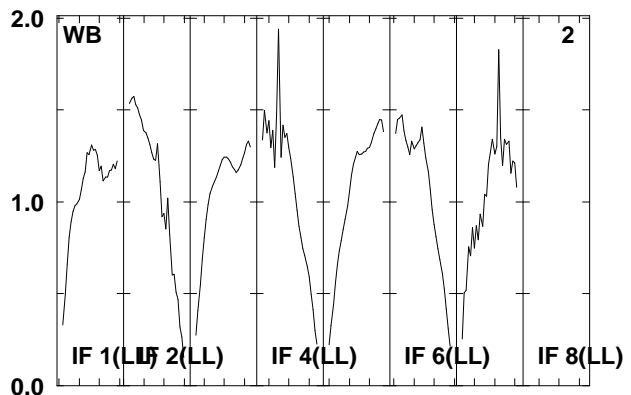
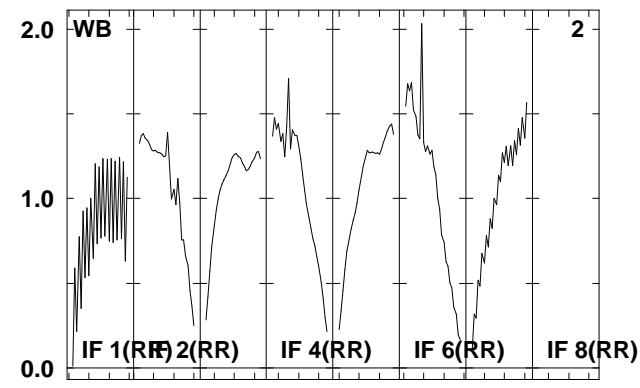
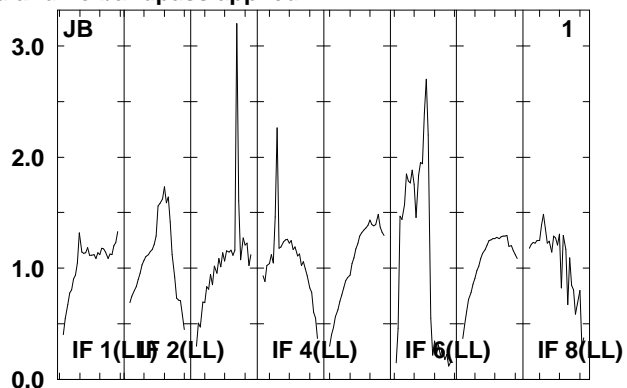
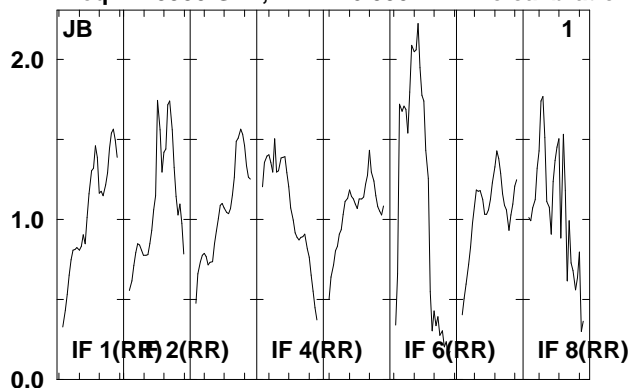

Lower frame: Real Jy  
Total-power spectrum Antenna: \*  
Timerange: 00/14:27:53 to 00/14:32:21

Plot file version 452 created 08-AUG-2008 17:02:26

J092159 EO06B.UVDATA.1

Freq = 1.5950 GHz, Bw = 16.000 MH No calibration applied and no bandpass applied

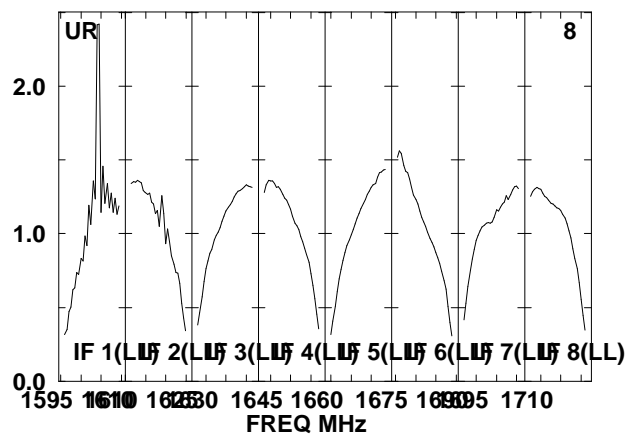
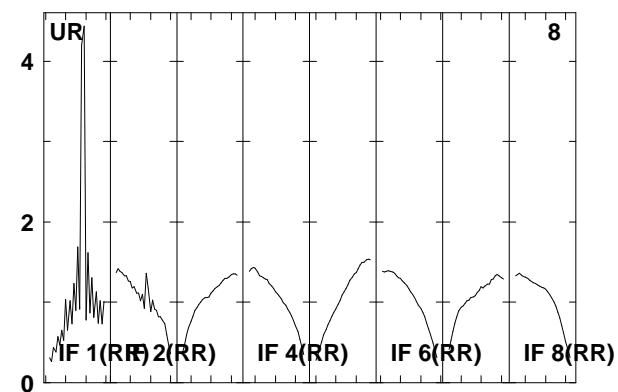
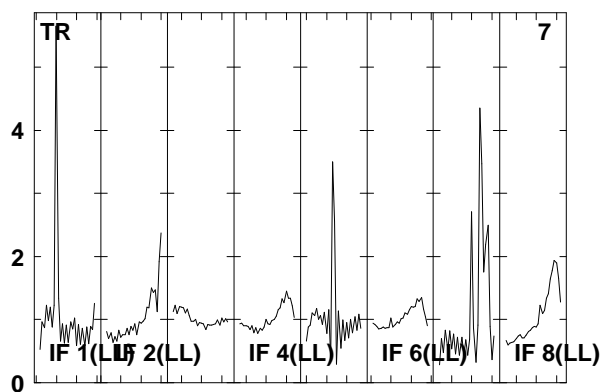
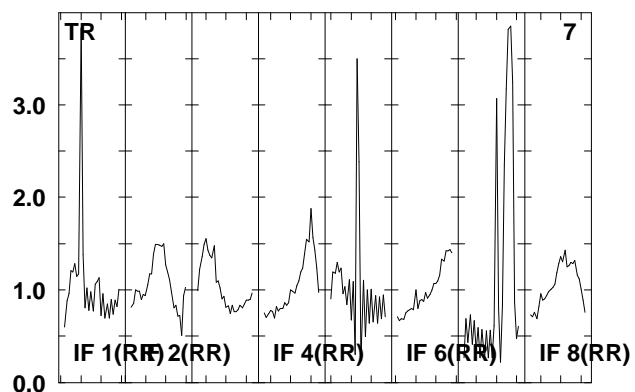
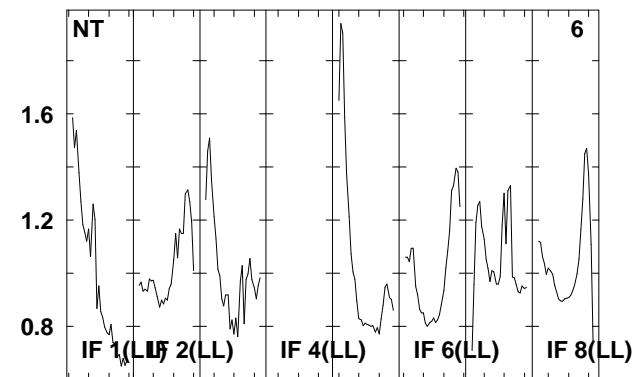
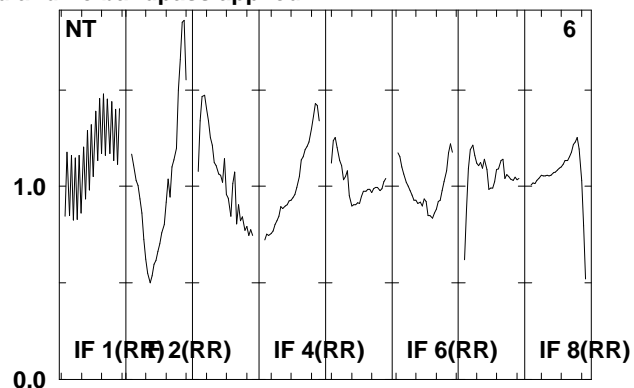
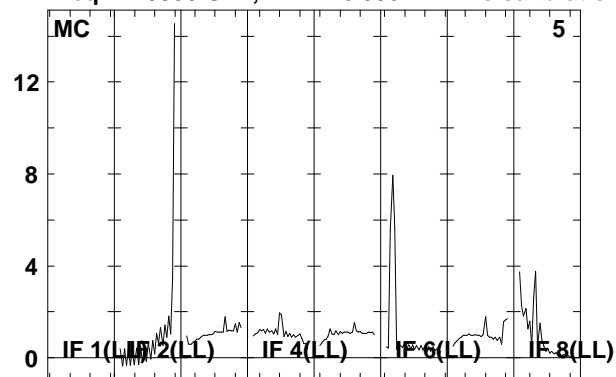

Lower frame: Real Jy

Total-power spectrum Antenna: \*

Timerange: 00/14:27:53 to 00/14:32:21



Plot file version 453 created 08-AUG-2008 17:02:27

J0920+44 EO006B.UVDATA.1

Freq = 1.5950 GHz, Bw = 16.000 MH No calibration applied and no bandpass applied

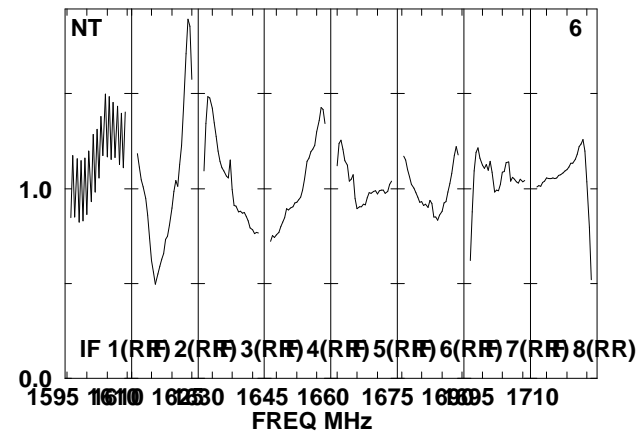
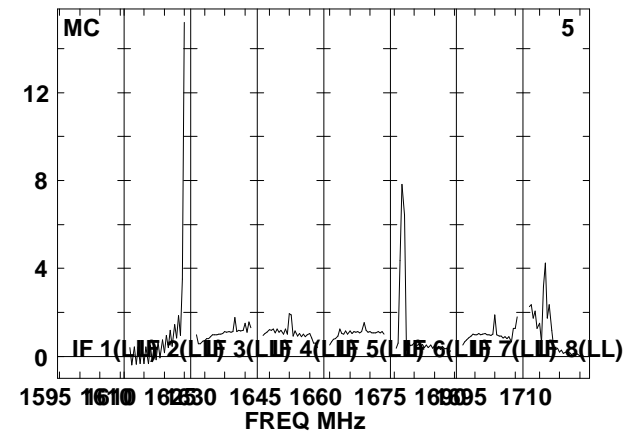
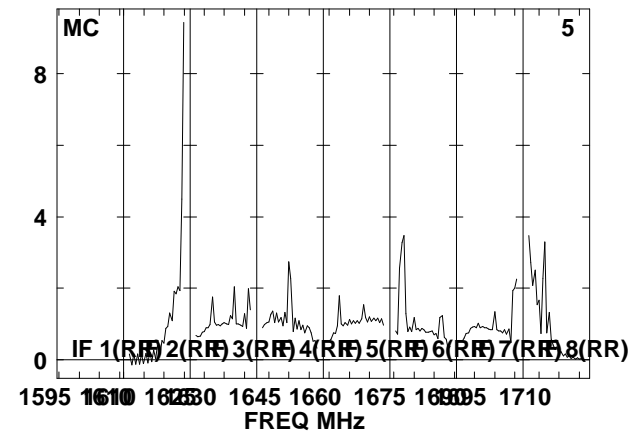
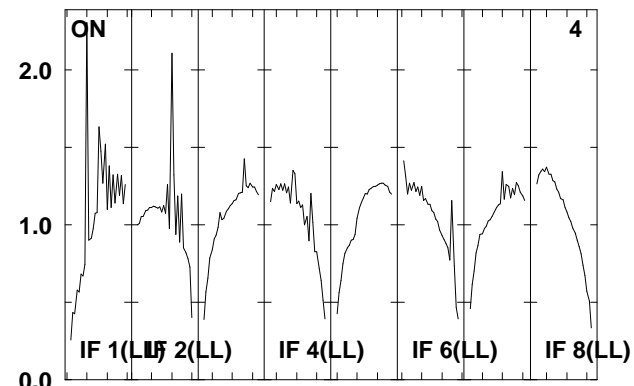
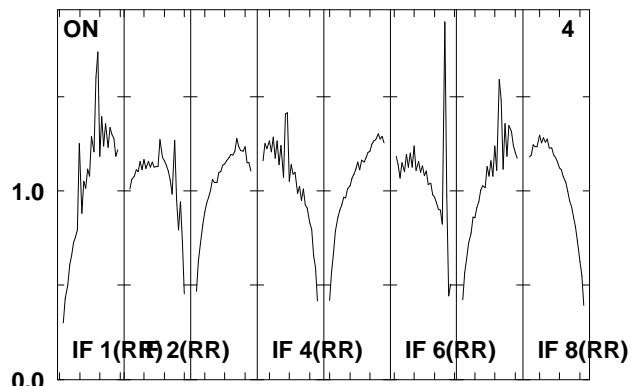
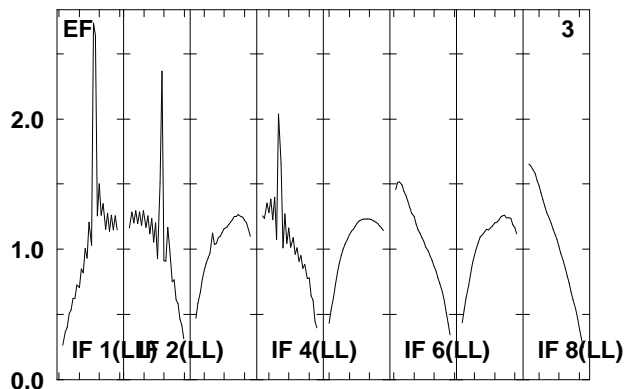
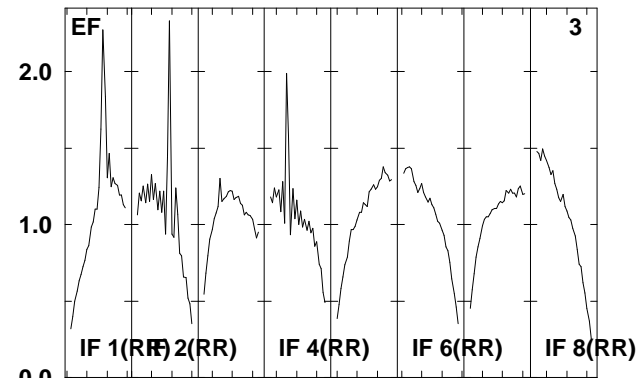
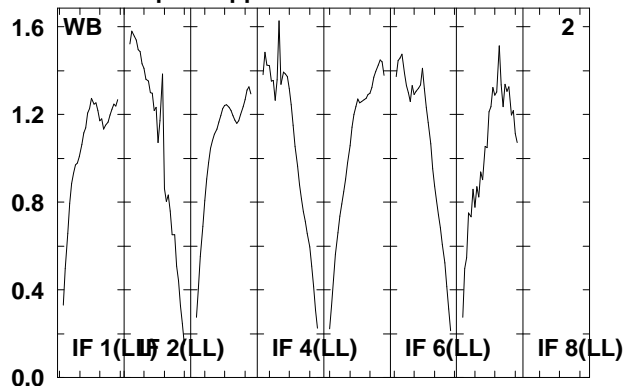
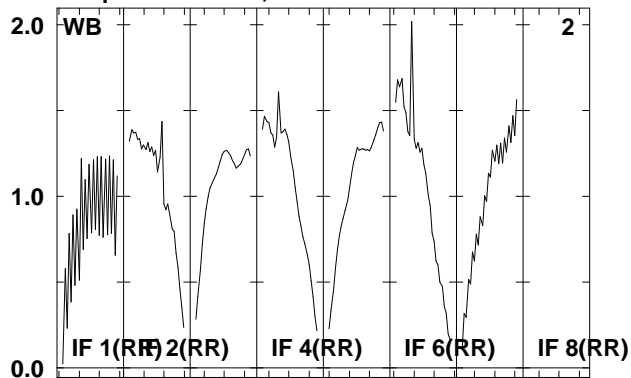

Lower frame: Real Jy  
Total-power spectrum Antenna: \*  
Timerange: 00/14:33:03 to 00/14:34:31

Plot file version 454 created 08-AUG-2008 17:02:28

J0920+44 EO006B.UVDATA.1

Freq = 1.5950 GHz, Bw = 16.000 MH No calibration applied and no bandpass applied

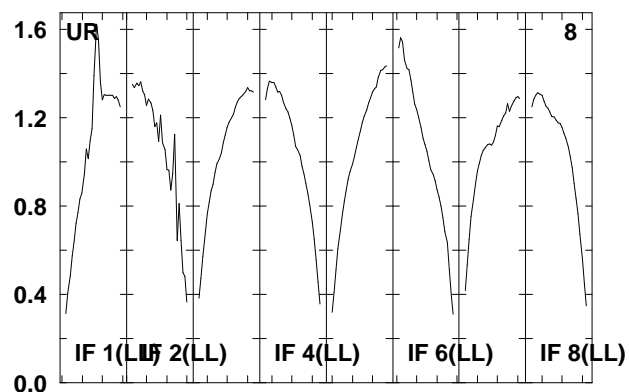
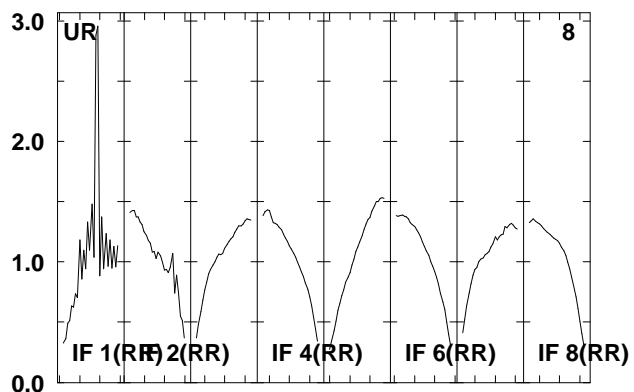
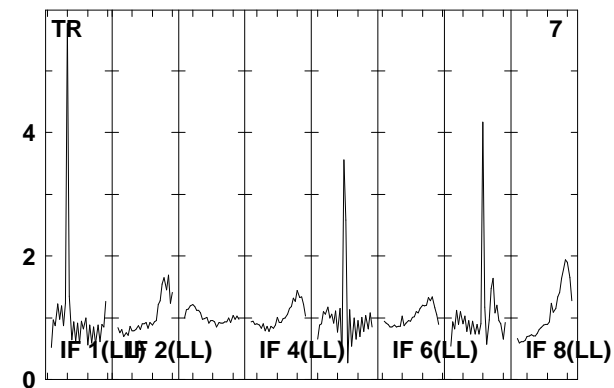
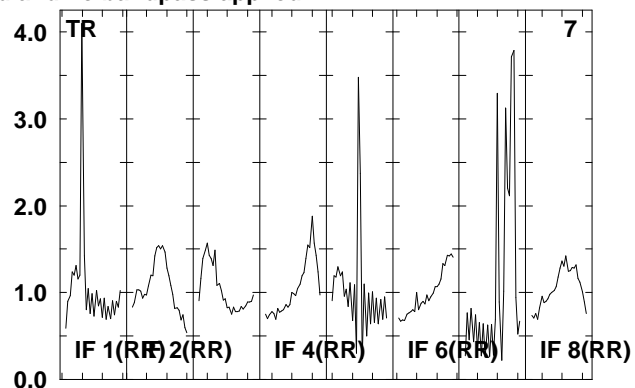
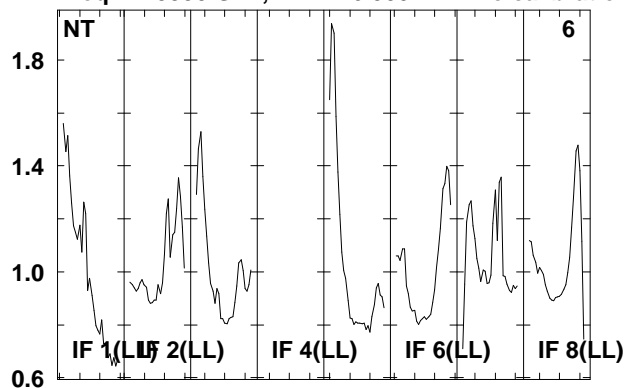

Lower frame: Real Jy  
Total-power spectrum Antenna: \*  
Timerange: 00/14:33:03 to 00/14:34:31

Plot file version 455 created 08-AUG-2008 17:02:28

J092159 EO006B.UVDATA.1

Freq = 1.5950 GHz, Bw = 16.000 MH No calibration applied and no bandpass applied

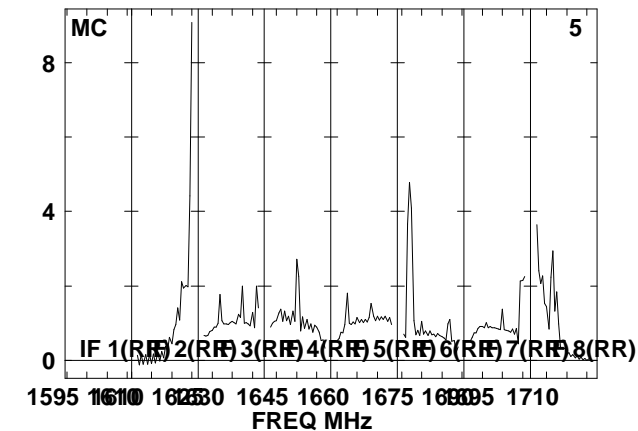
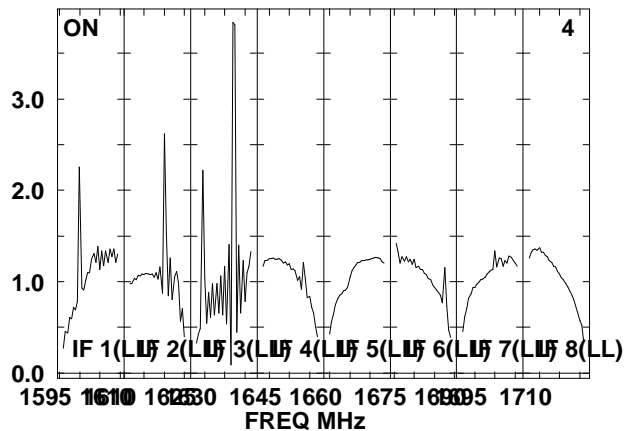
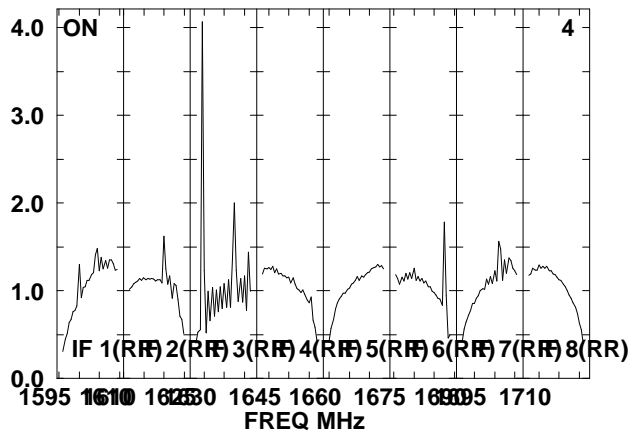
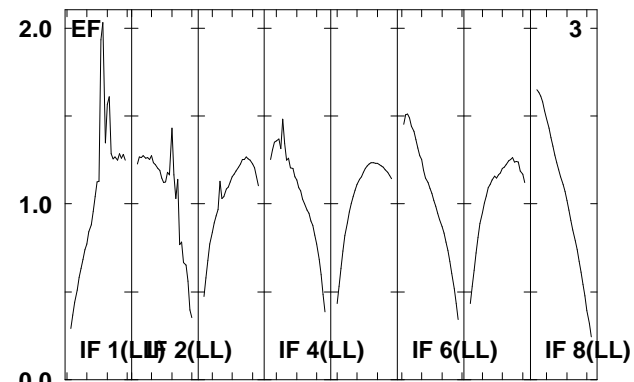
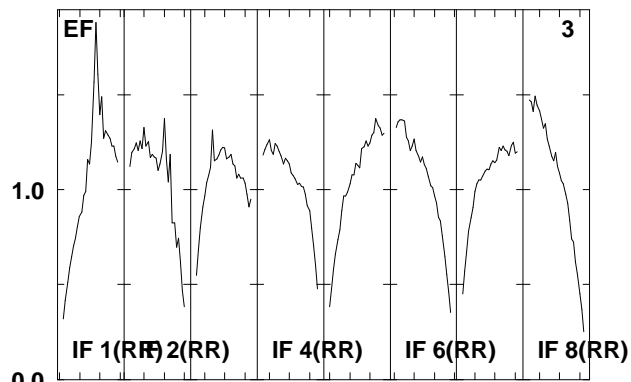
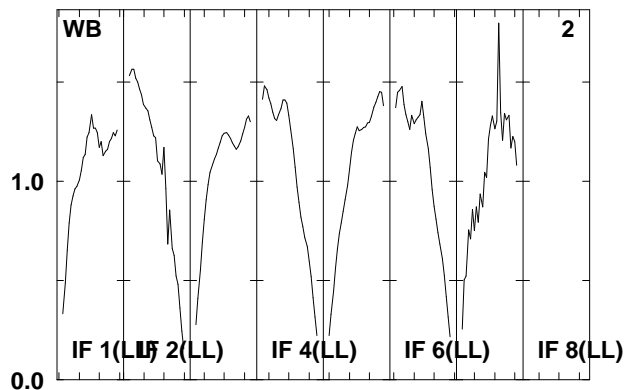
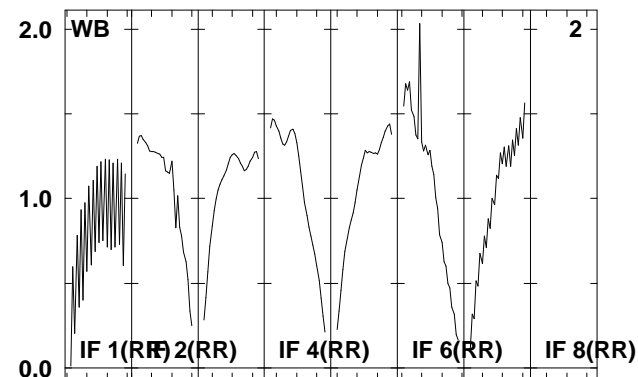
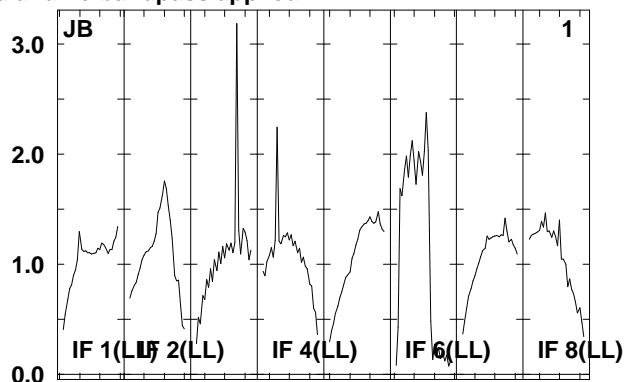
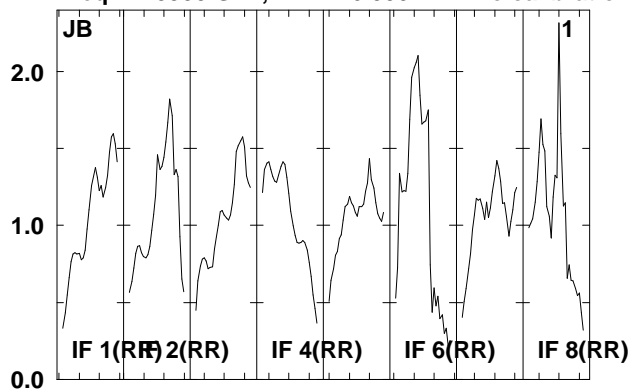

Lower frame: Real Jy  
Total-power spectrum Antenna: \*  
Timerange: 00/14:35:13 to 00/14:39:41

Plot file version 456 created 08-AUG-2008 17:02:29

J092159 EO006B.UVDATA.1

Freq = 1.5950 GHz, Bw = 16.000 MH No calibration applied and no bandpass applied

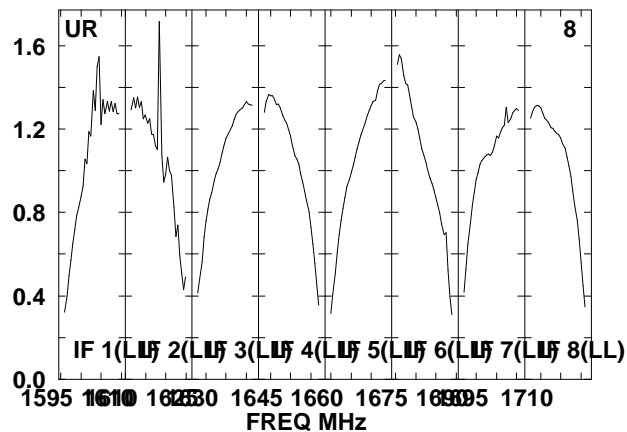
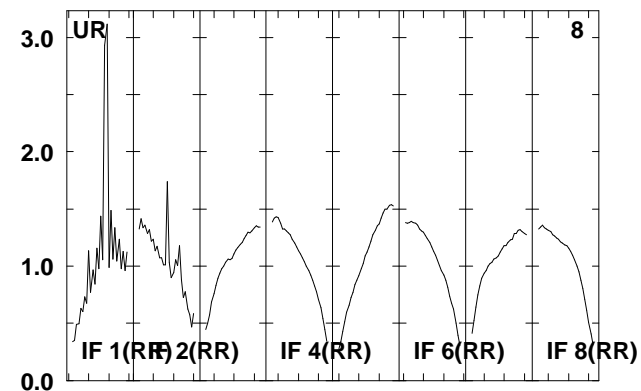
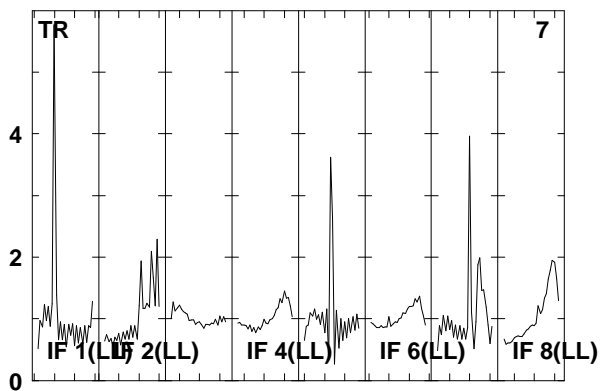
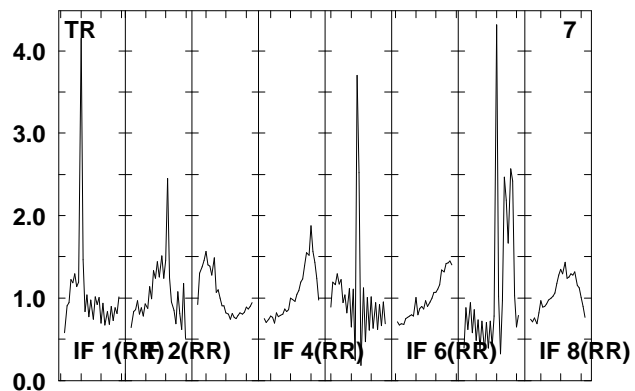
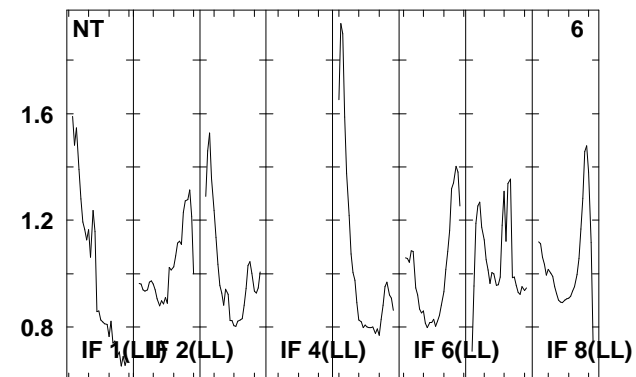
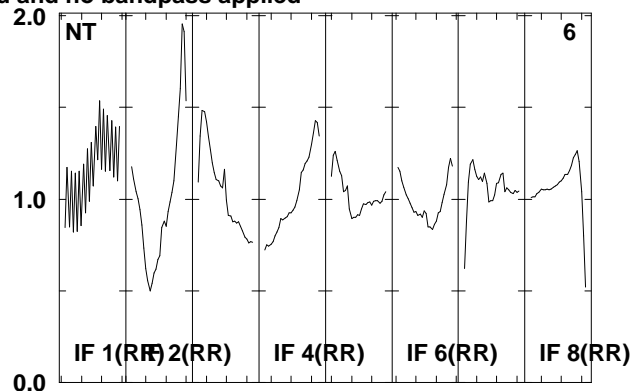
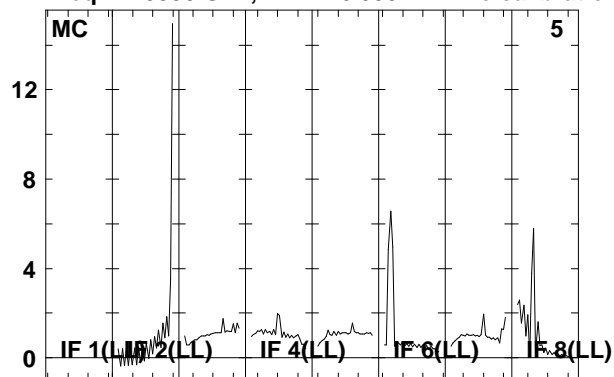

Lower frame: Real Jy

Total-power spectrum Antenna: \*

Timerange: 00/14:35:13 to 00/14:39:41

Plot file version 457 created 08-AUG-2008 17:02:30

J0920+44 EO006B.UVDATA.1

Freq = 1.5950 GHz, Bw = 16.000 MH No calibration applied and no bandpass applied

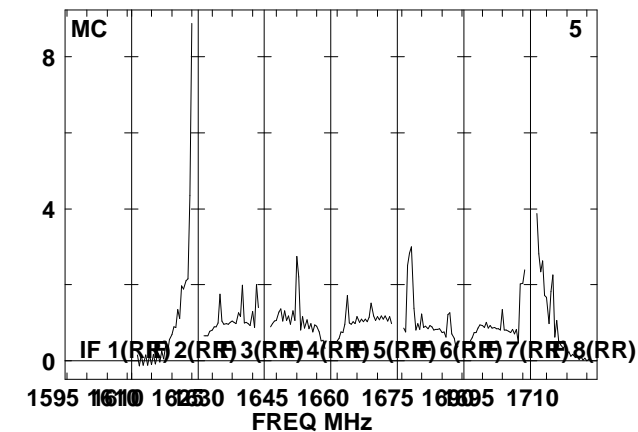
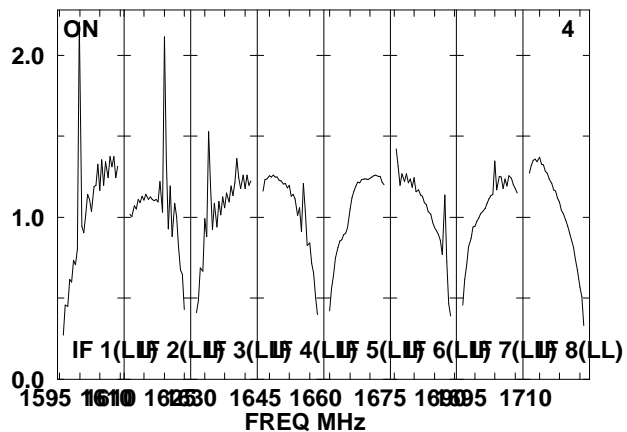
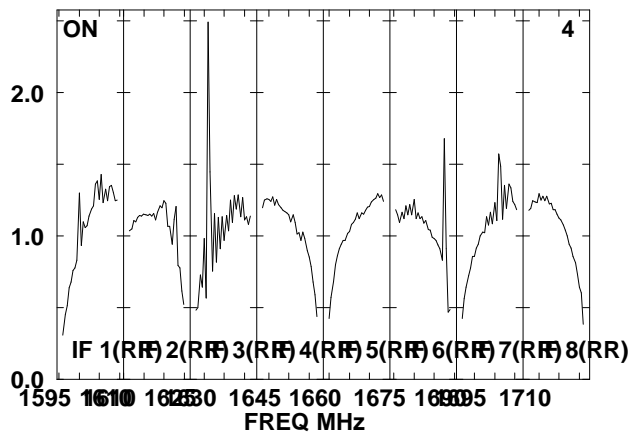
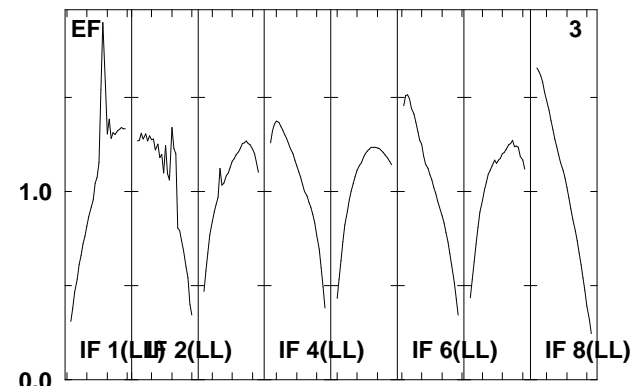
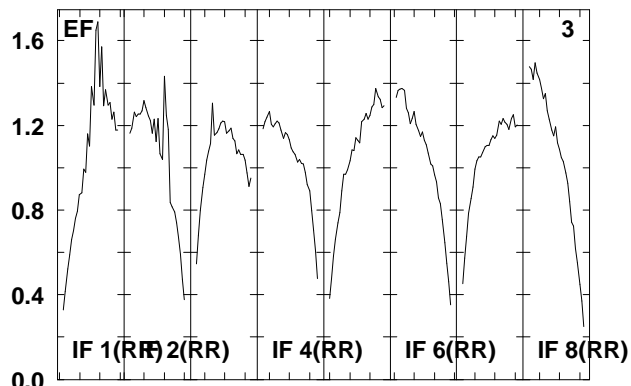
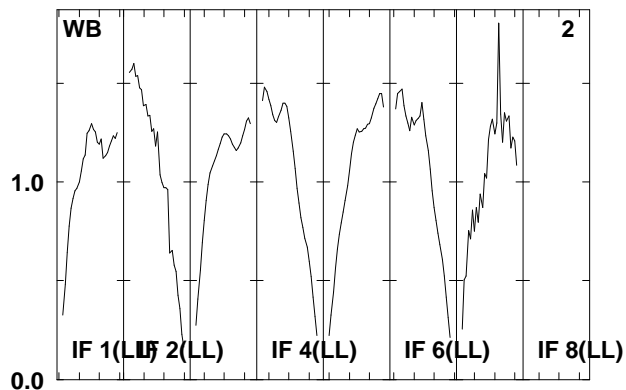
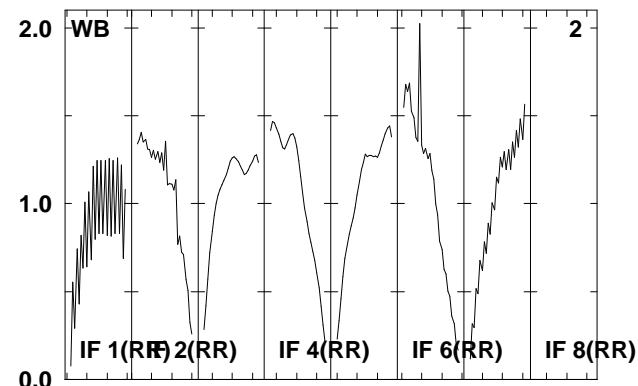
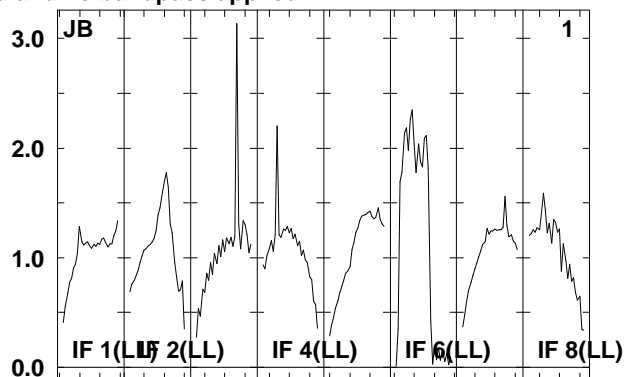
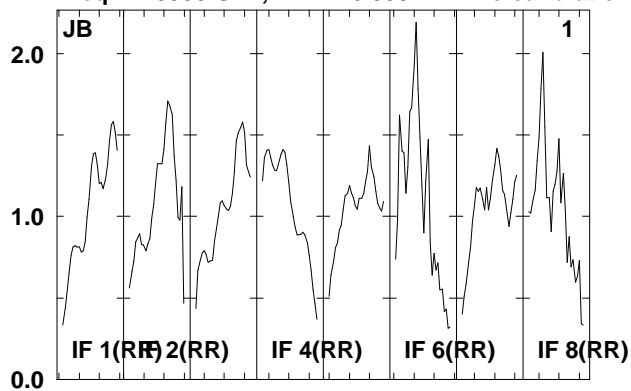

Lower frame: Real Jy  
Total-power spectrum Antenna: \*  
Timerange: 00/14:40:21 to 00/14:41:57

Plot file version 458 created 08-AUG-2008 17:02:30

J0920+44 EO006B.UVDATA.1

Freq = 1.5950 GHz, Bw = 16.000 MH No calibration applied and no bandpass applied

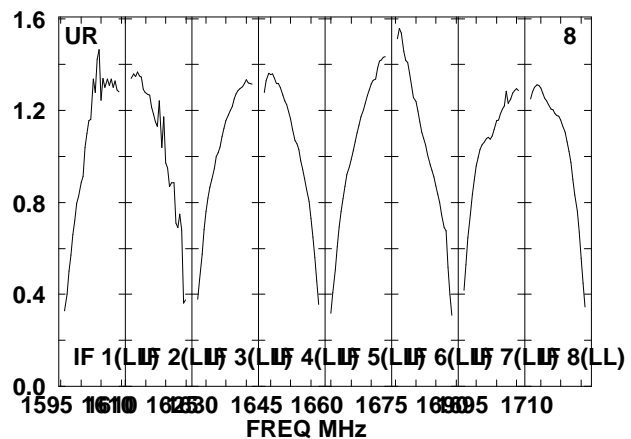
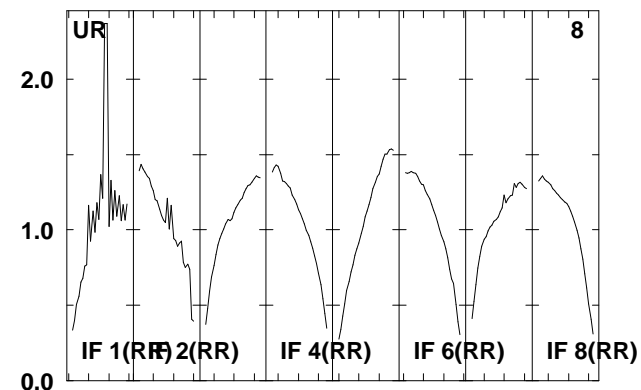
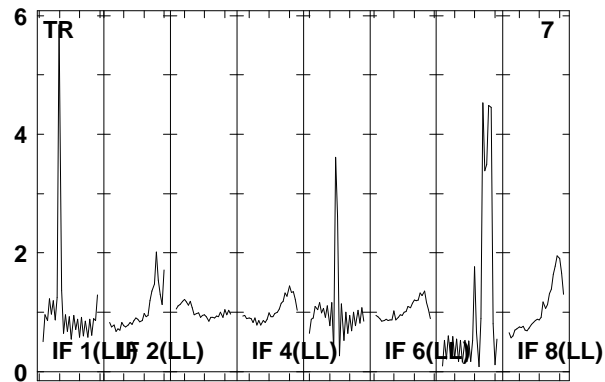
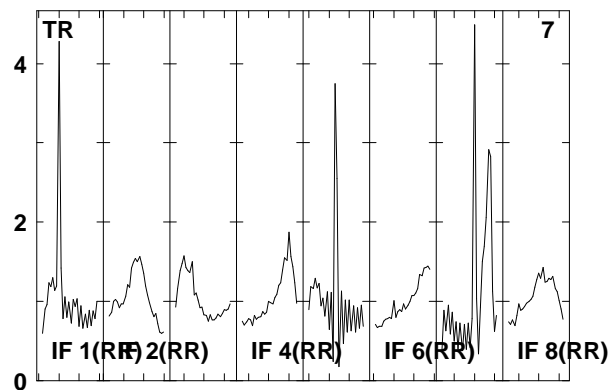
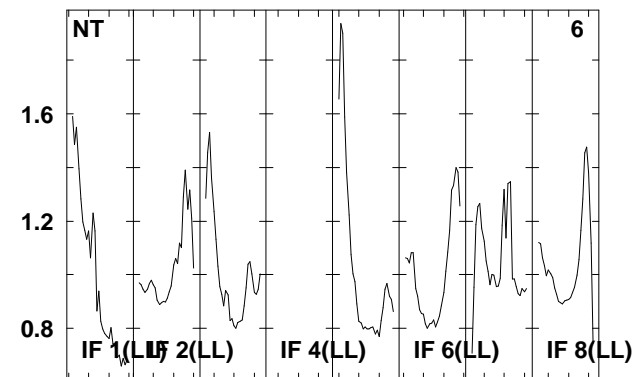
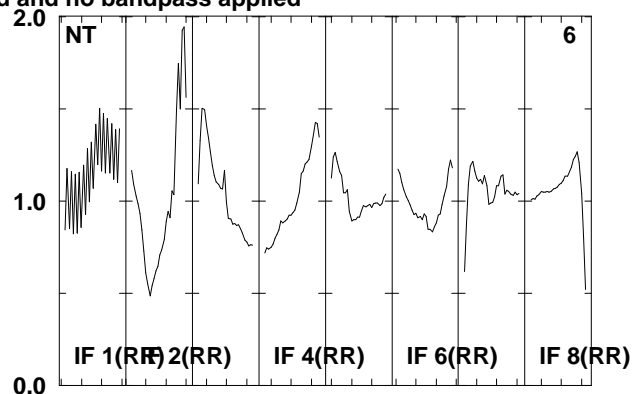
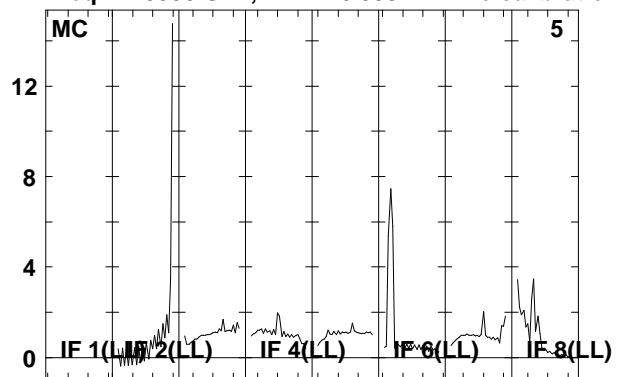

Lower frame: Real Jy

Total-power spectrum Antenna: \*

Timerange: 00/14:40:21 to 00/14:41:57

Plot file version 459 created 08-AUG-2008 17:02:30

J092159 EO006B.UVDATA.1

Freq = 1.5950 GHz, Bw = 16.000 MH No calibration applied and no bandpass applied

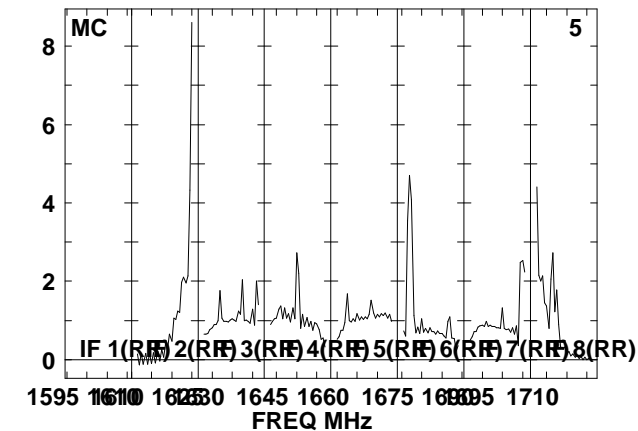
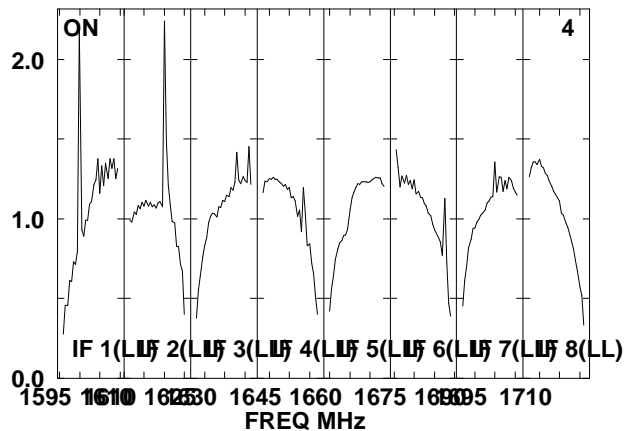
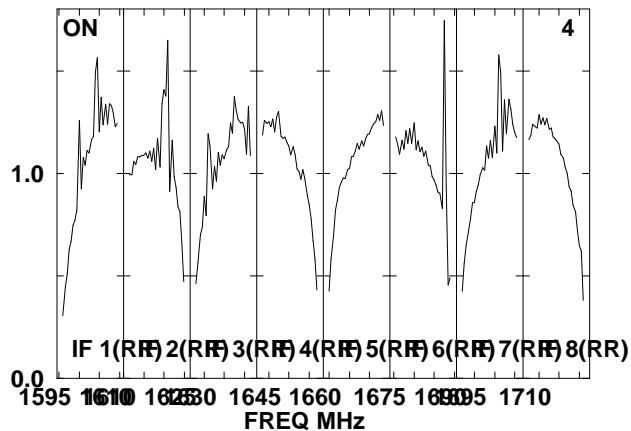
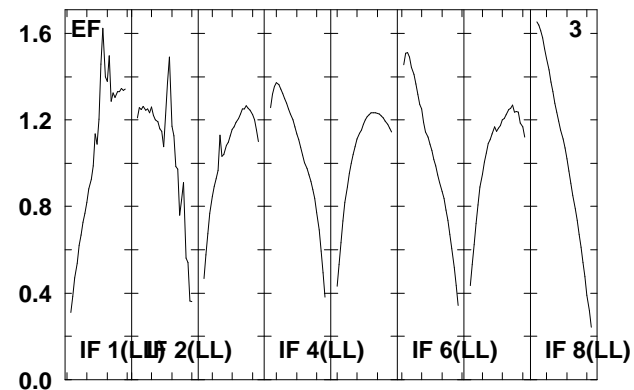
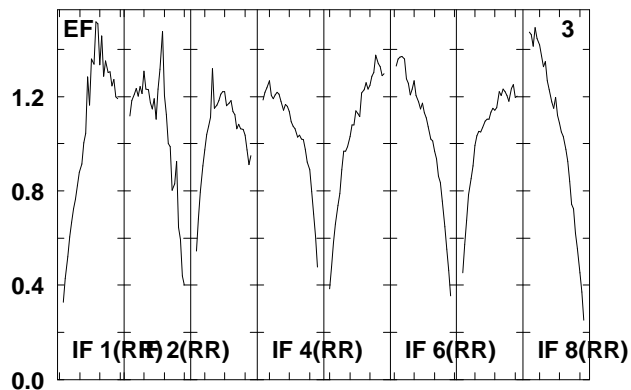
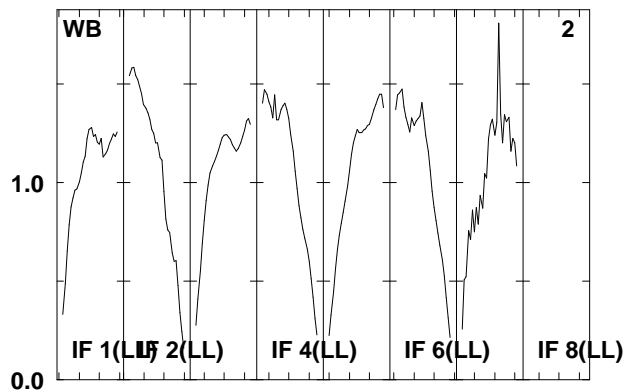
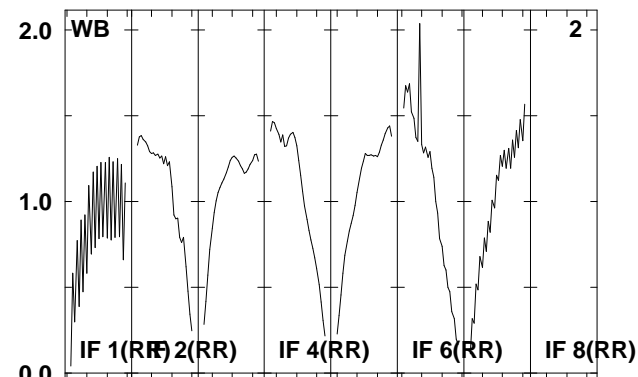
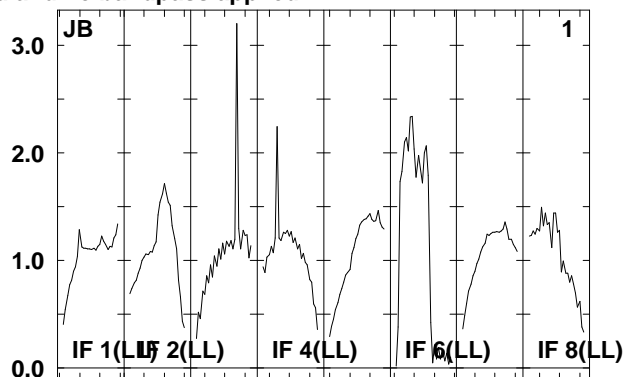
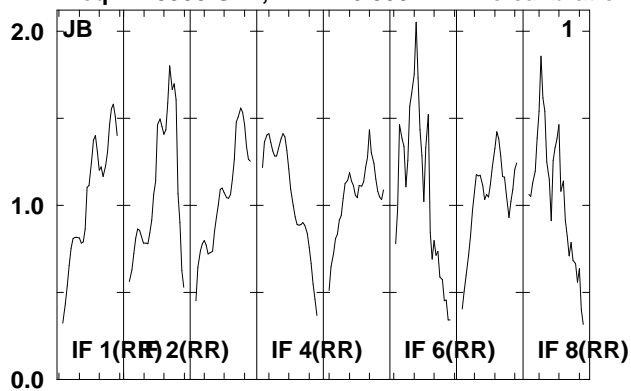

Lower frame: Real Jy  
Total-power spectrum Antenna: \*  
Timerange: 00/14:42:37 to 00/14:47:01

Plot file version 460 created 08-AUG-2008 17:02:31

J092159 EO006B.UVDATA.1

Freq = 1.5950 GHz, Bw = 16.000 MH No calibration applied and no bandpass applied

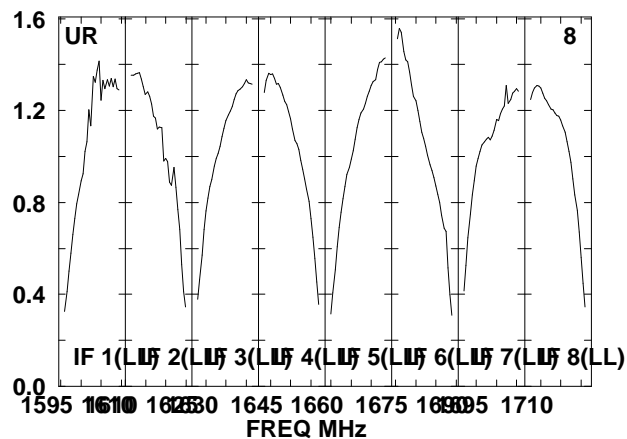
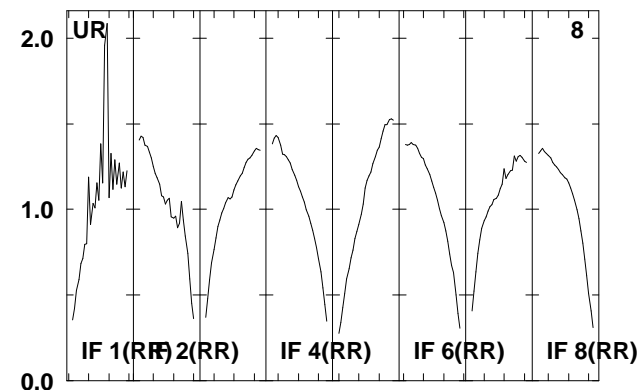
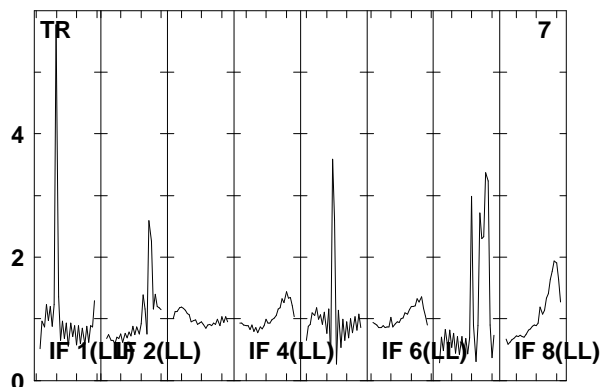
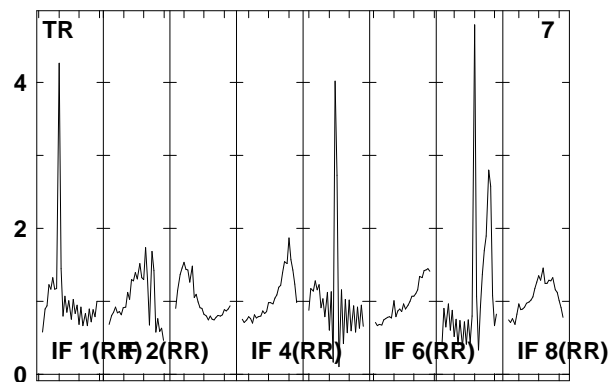
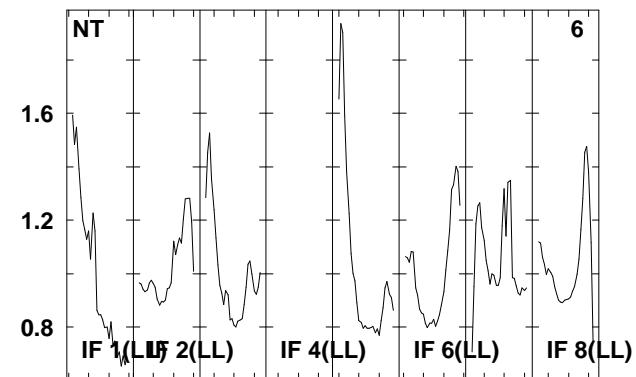
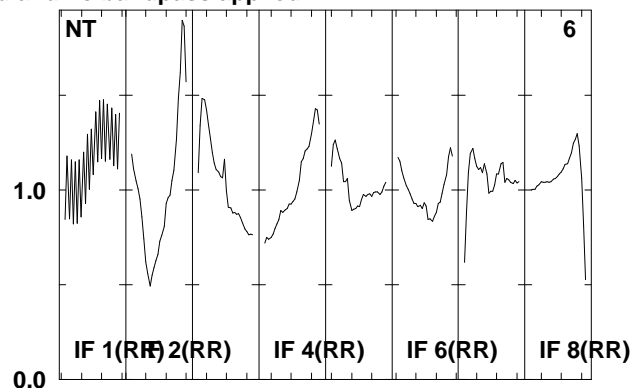
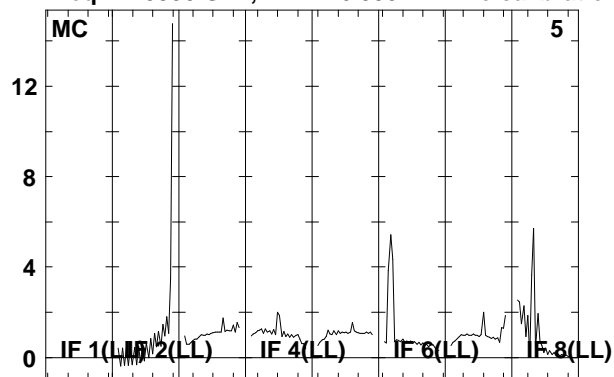

Lower frame: Real Jy

Total-power spectrum Antenna: \*

Timerange: 00/14:42:37 to 00/14:47:01



Plot file version 461 created 08-AUG-2008 17:02:32

J0920+44 EO006B.UVDATA.1

Freq = 1.5950 GHz, Bw = 16.000 MH No calibration applied and no bandpass applied

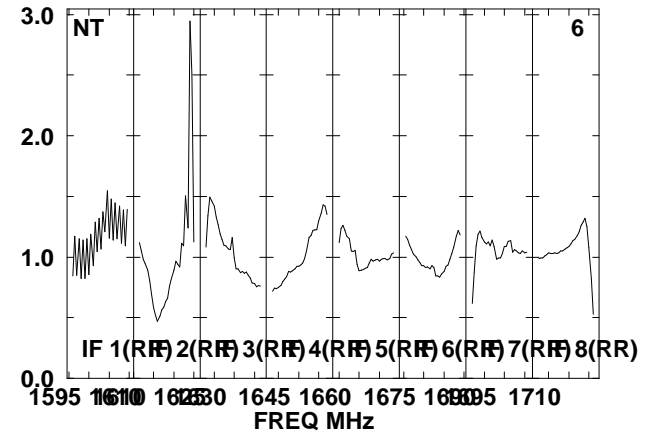
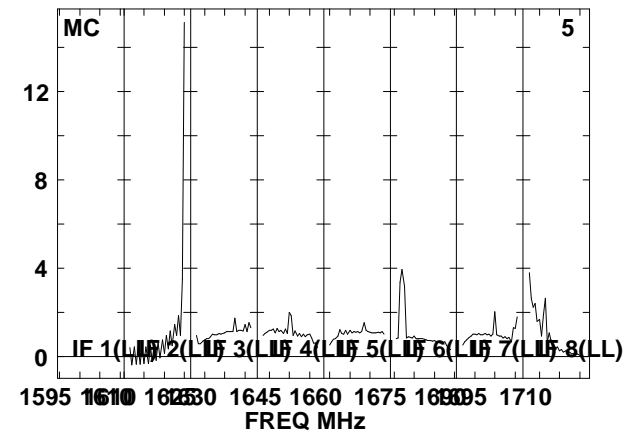
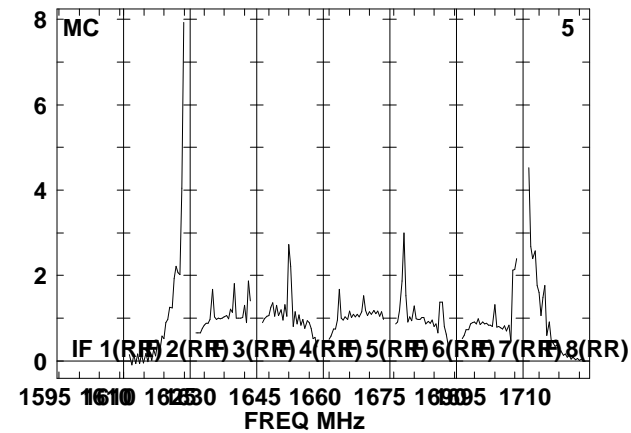
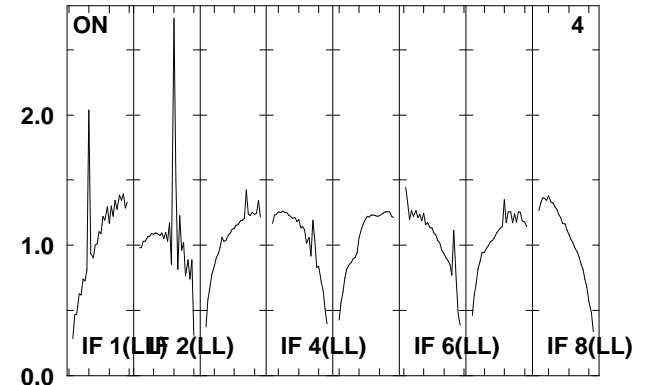
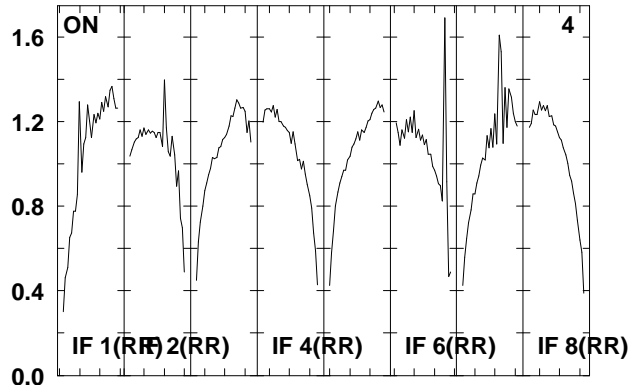
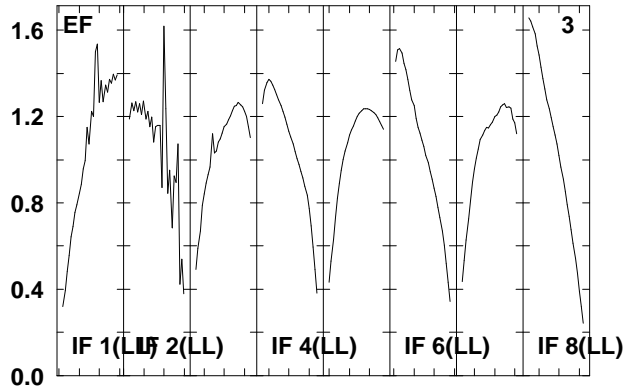
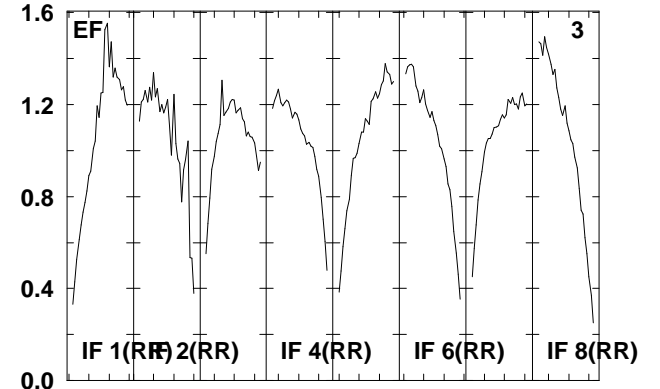
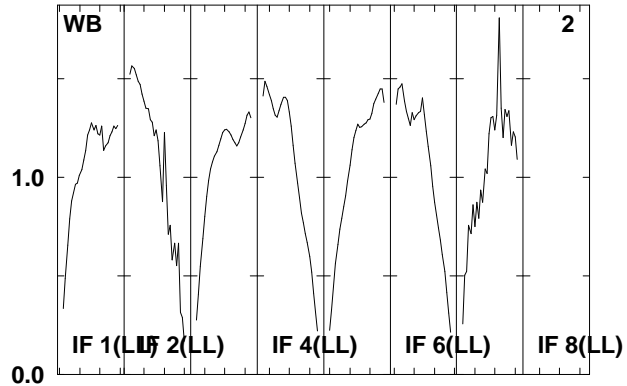
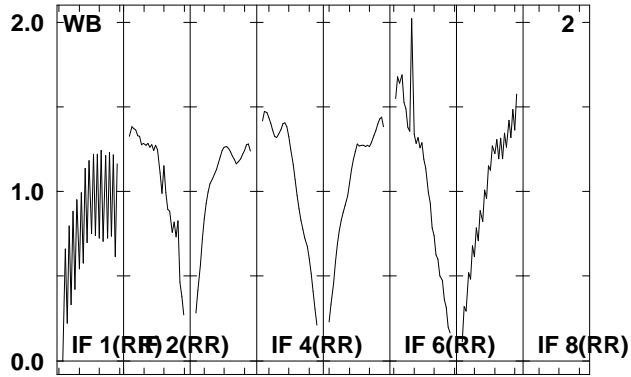

Lower frame: Real Jy  
Total-power spectrum Antenna: \*  
Timerange: 00/14:47:43 to 00/14:49:11

Plot file version 462 created 08-AUG-2008 17:02:33

J0920+44 EO006B.UVDATA.1

Freq = 1.5950 GHz, Bw = 16.000 MH No calibration applied and no bandpass applied

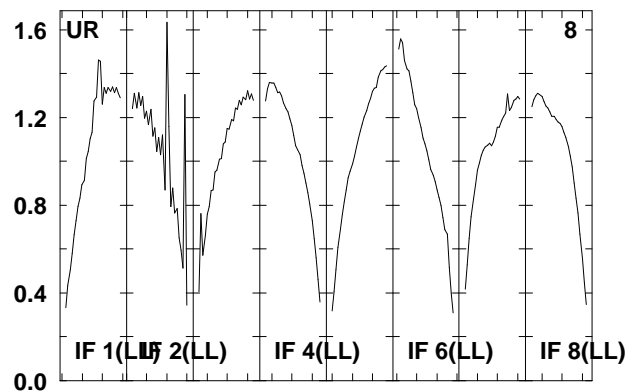
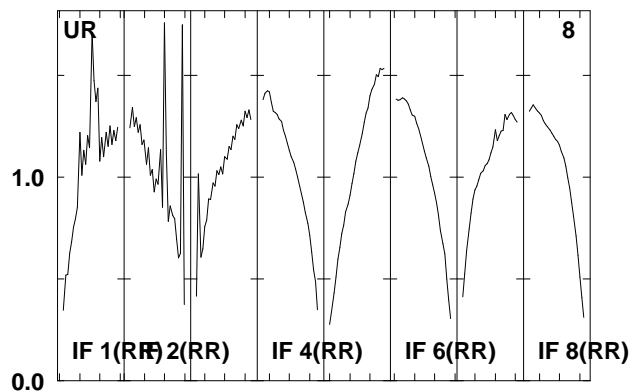
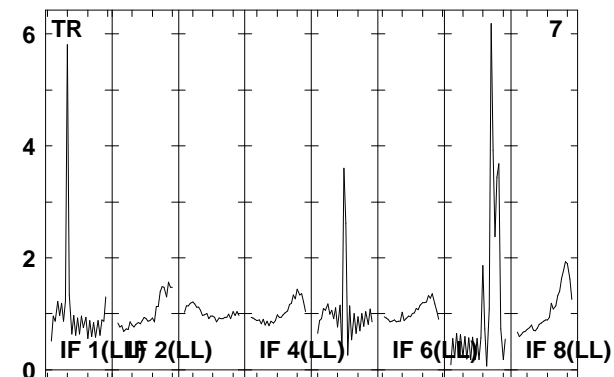
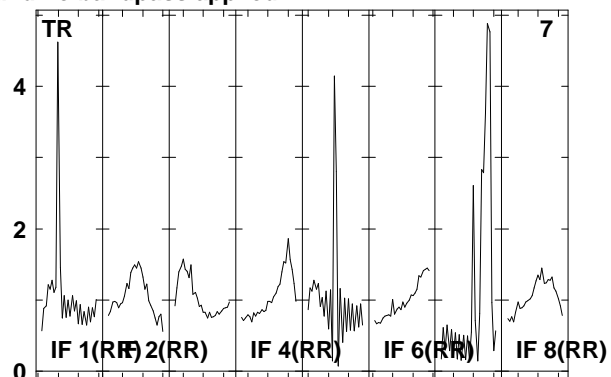
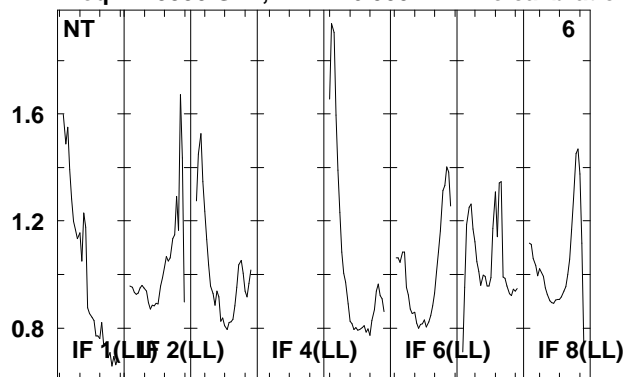

Lower frame: Real Jy  
Total-power spectrum Antenna: \*  
Timerange: 00/14:47:43 to 00/14:49:11

Plot file version 463 created 08-AUG-2008 17:02:33

J092159 EO006B.UVDATA.1

Freq = 1.5950 GHz, Bw = 16.000 MH No calibration applied and no bandpass applied

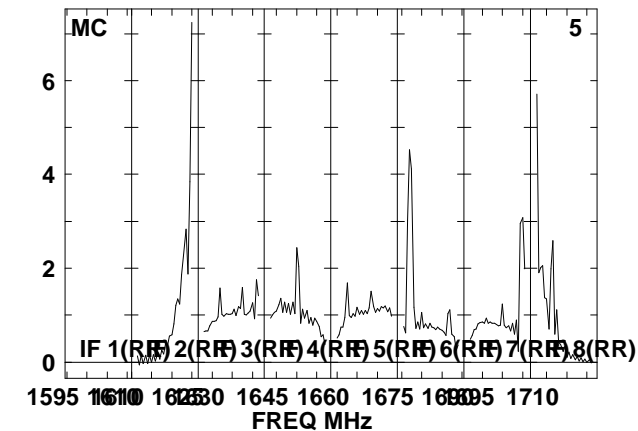
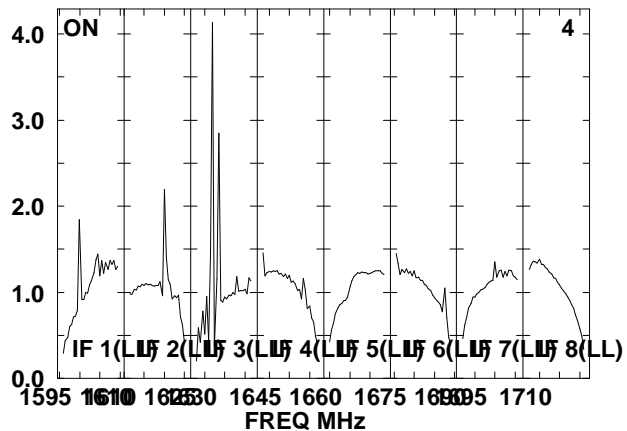
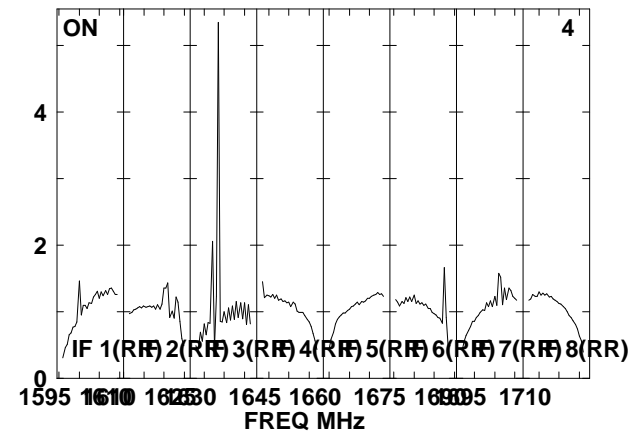
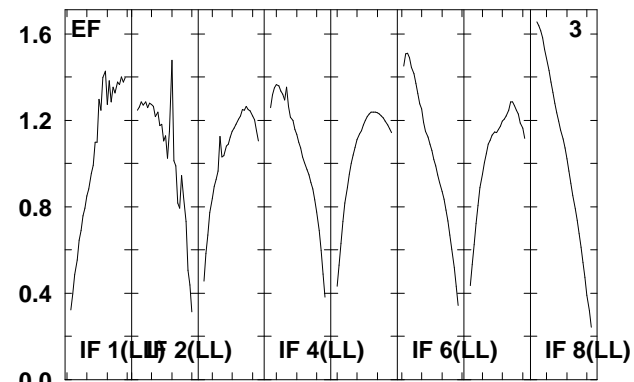
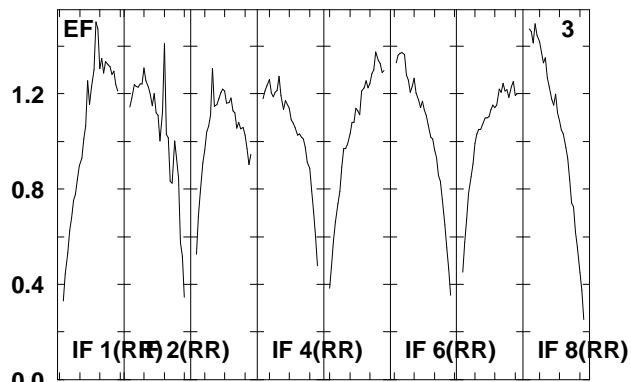
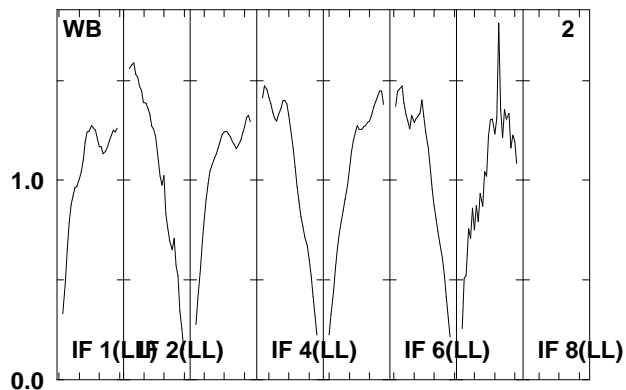
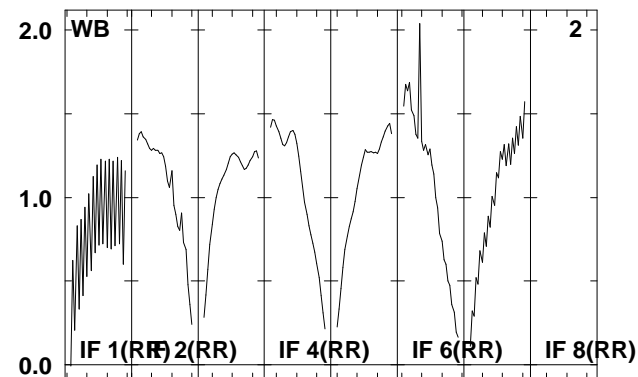
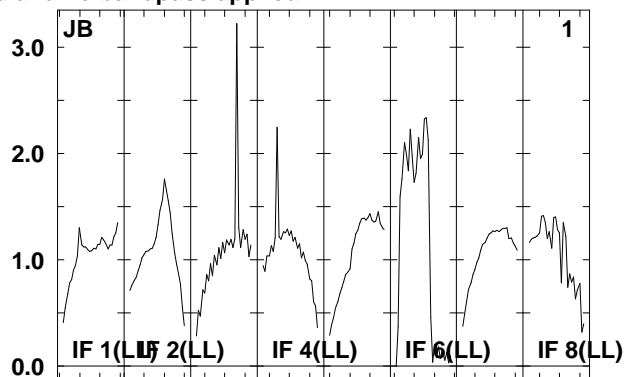
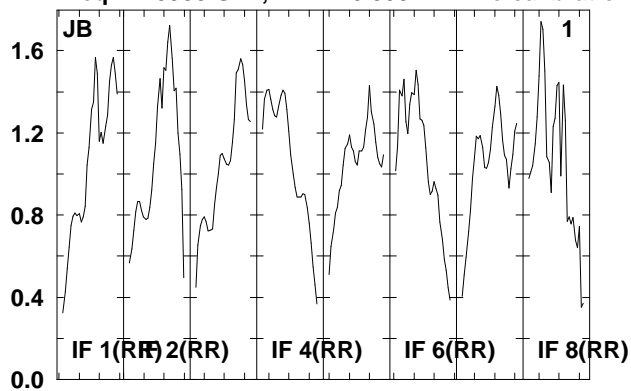

Lower frame: Real Jy  
Total-power spectrum Antenna: \*  
Timerange: 00/14:49:53 to 00/14:54:29

Plot file version 464 created 08-AUG-2008 17:02:33

J092159 EO006B.UVDATA.1

Freq = 1.5950 GHz, Bw = 16.000 MH No calibration applied and no bandpass applied

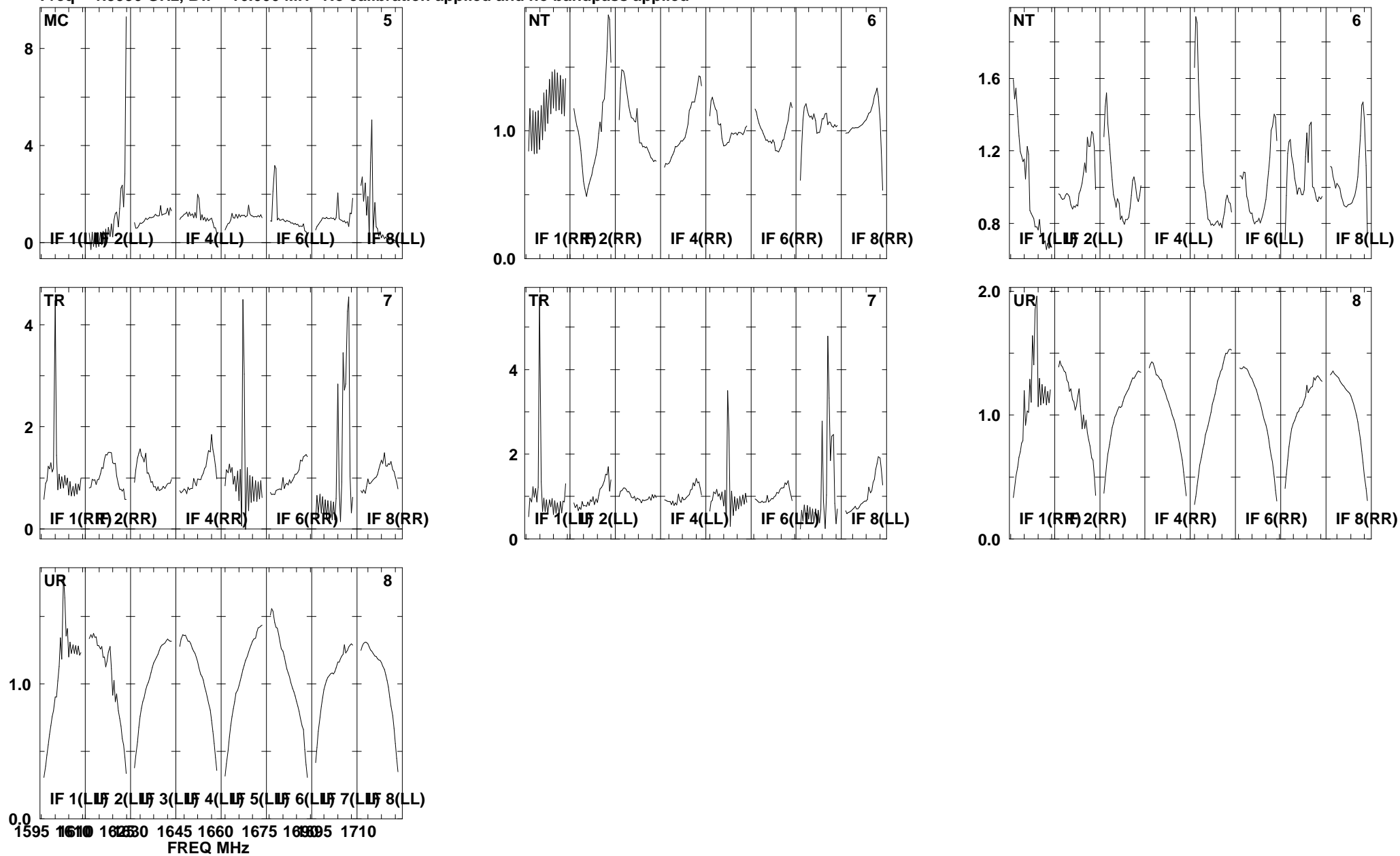

Lower frame: Real Jy  
Total-power spectrum Antenna: \*  
Timerange: 00/14:49:53 to 00/14:54:29

Plot file version 465 created 08-AUG-2008 17:02:34

J0920+44 EO006B.UVDATA.1

Freq = 1.5950 GHz, Bw = 16.000 MH No calibration applied and no bandpass applied

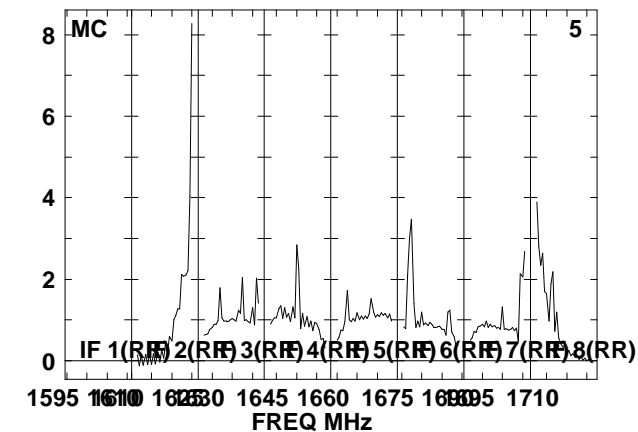
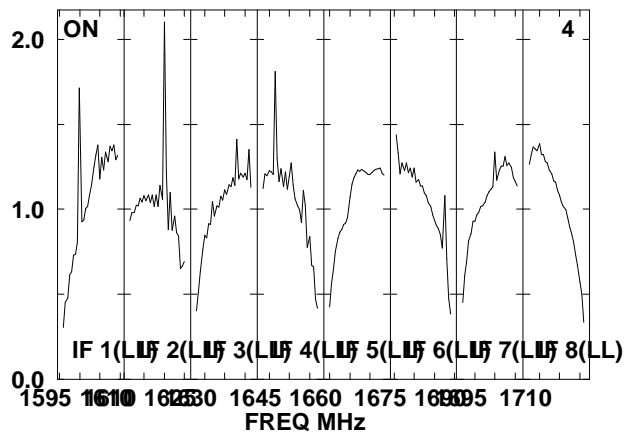
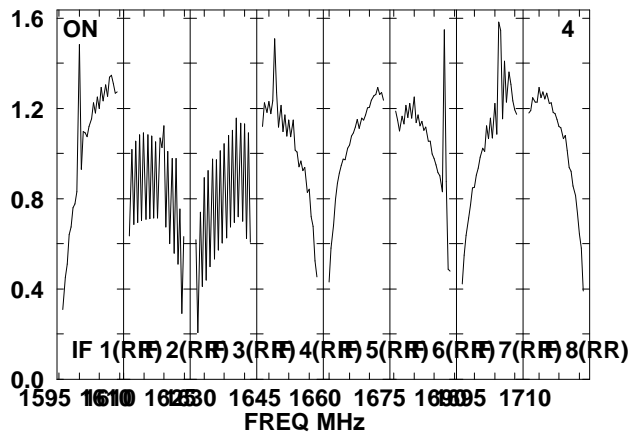
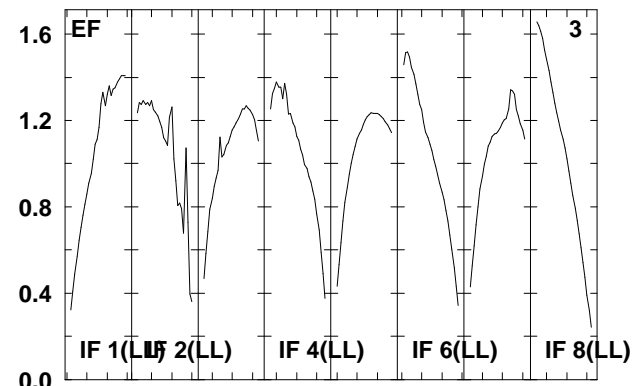
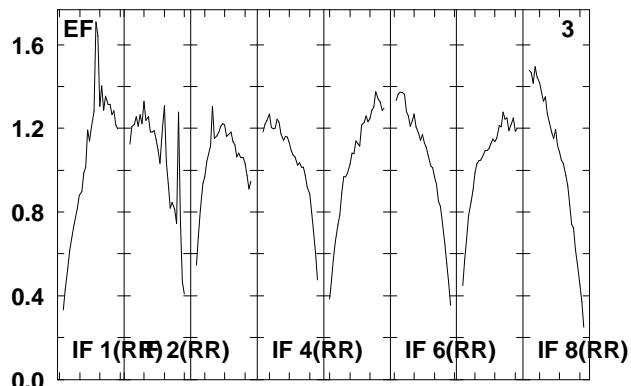
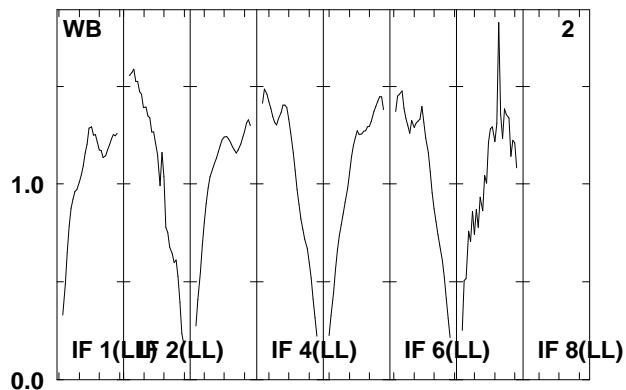
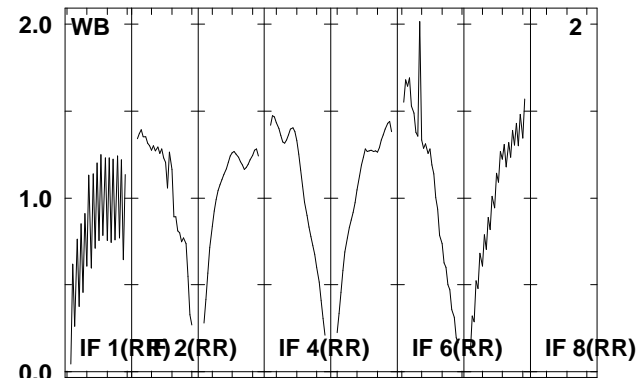
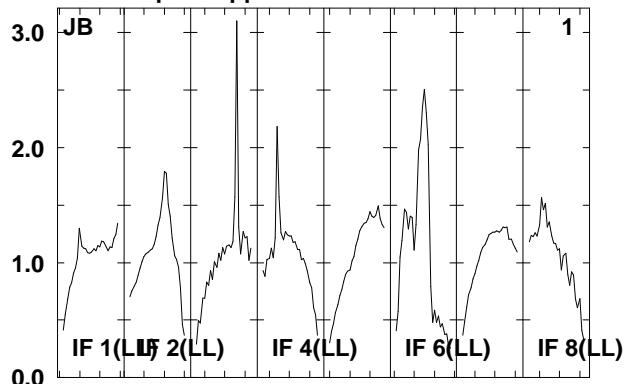
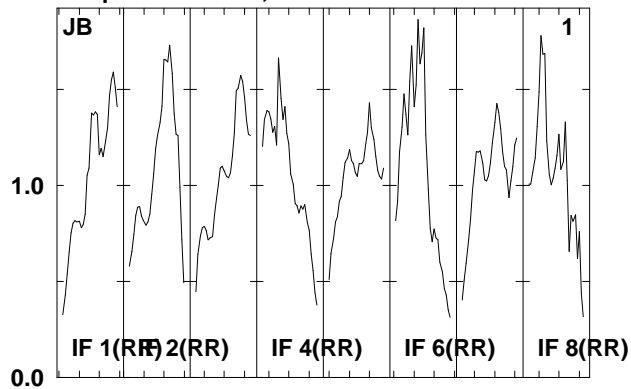

Lower frame: Real Jy  
Total-power spectrum Antenna: \*  
Timerange: 00/14:55:01 to 00/14:56:37

Plot file version 466 created 08-AUG-2008 17:02:35

J0920+44 EO006B.UVDATA.1

Freq = 1.5950 GHz, Bw = 16.000 MH No calibration applied and no bandpass applied

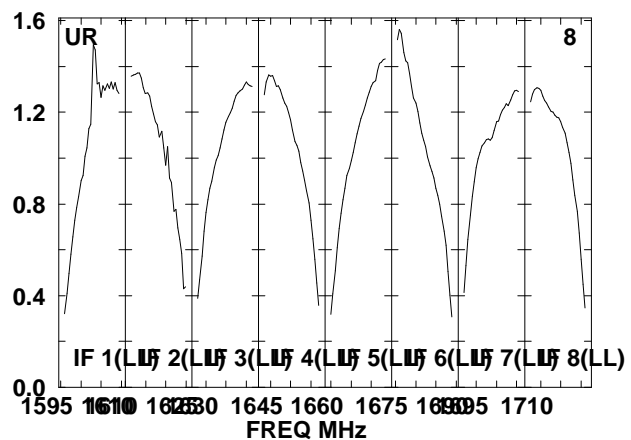
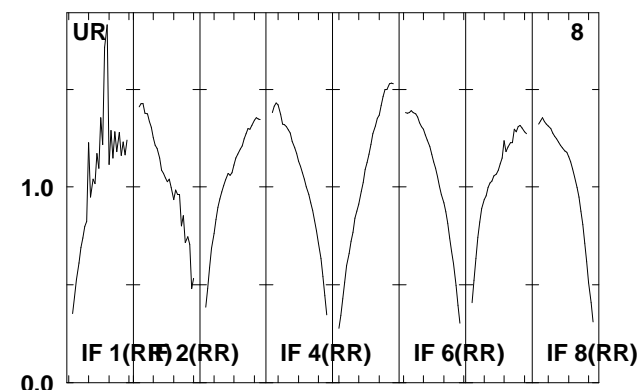
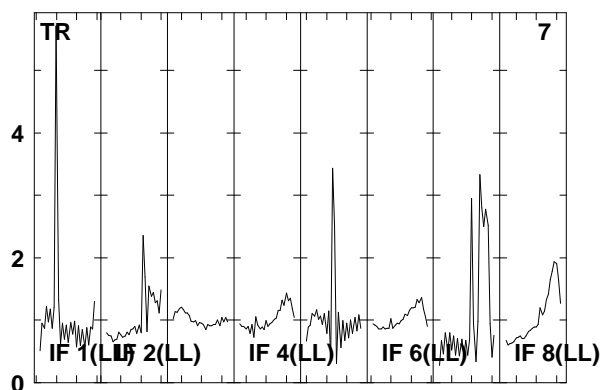
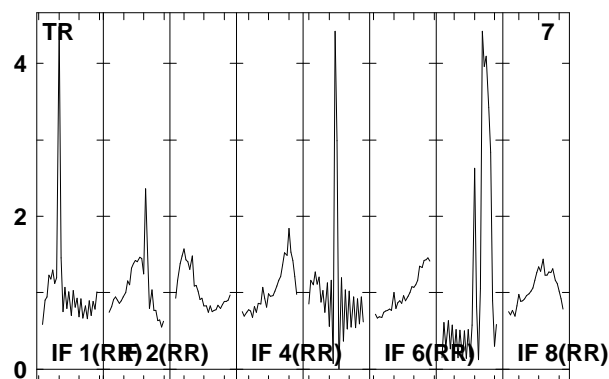
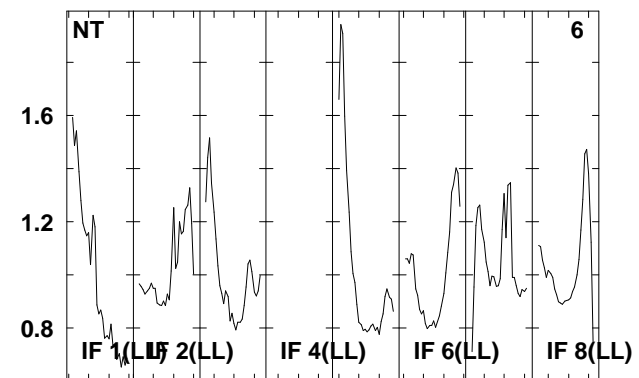
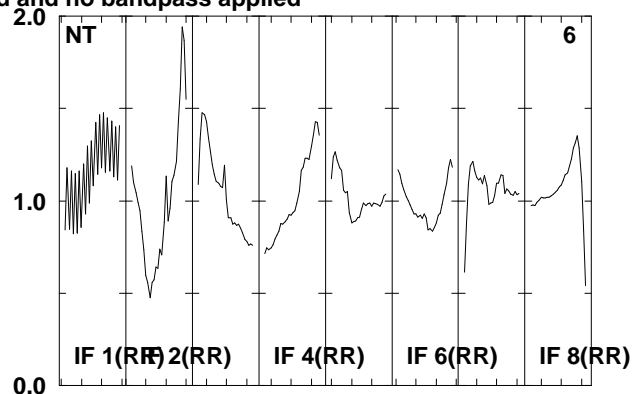
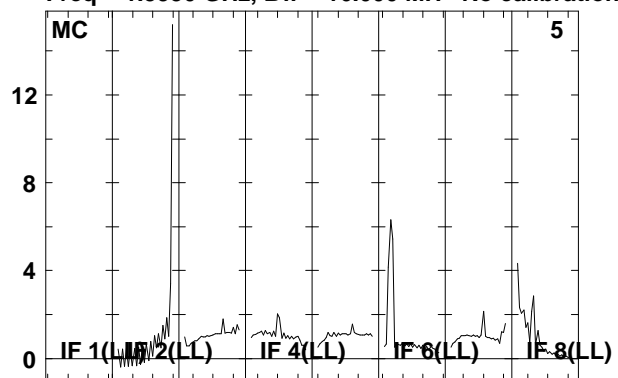

Lower frame: Real Jy

Total-power spectrum Antenna: \*

Timerange: 00/14:55:01 to 00/14:56:37

Plot file version 467 created 08-AUG-2008 17:02:35

J092159 EO006B.UVDATA.1

Freq = 1.5950 GHz, Bw = 16.000 MH No calibration applied and no bandpass applied

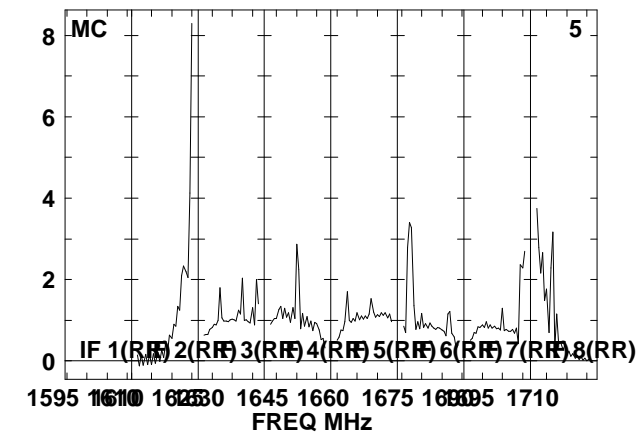
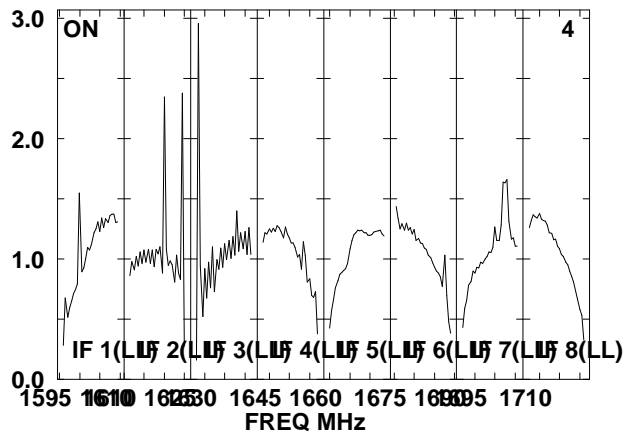
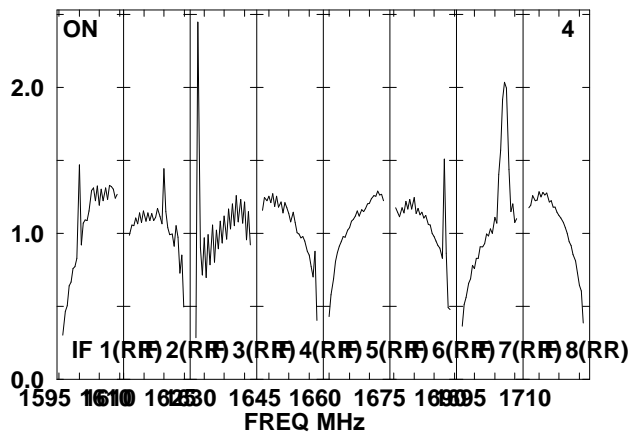
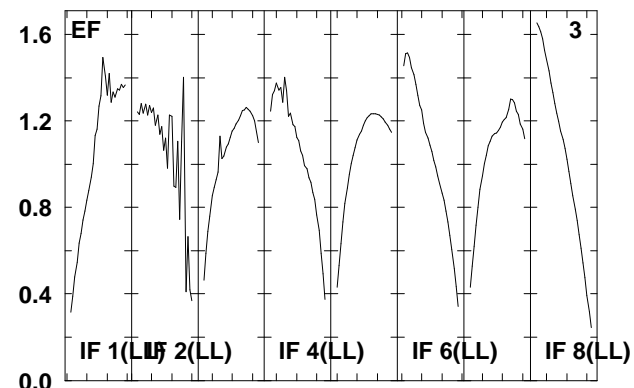
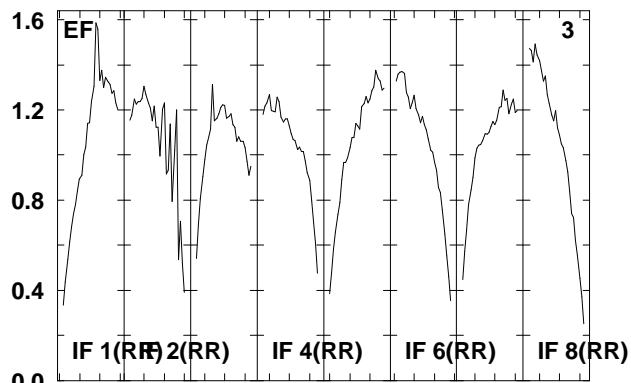
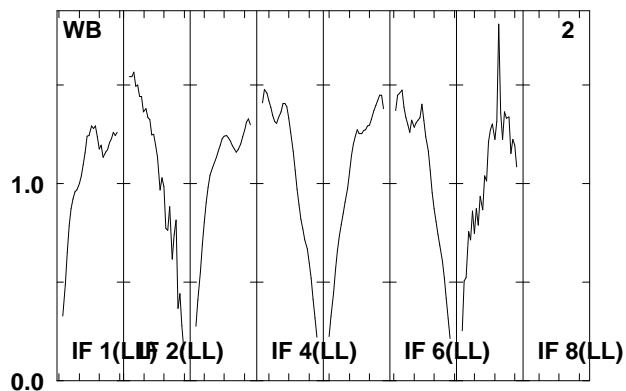
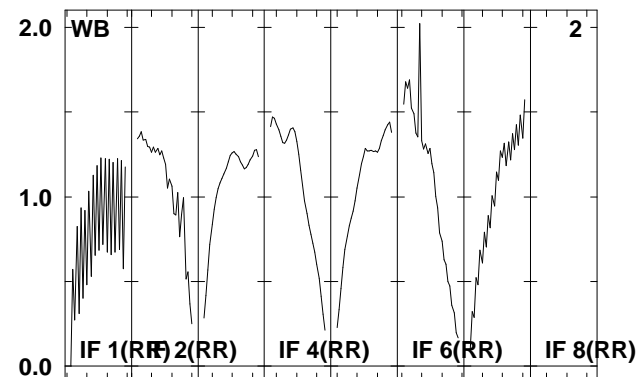
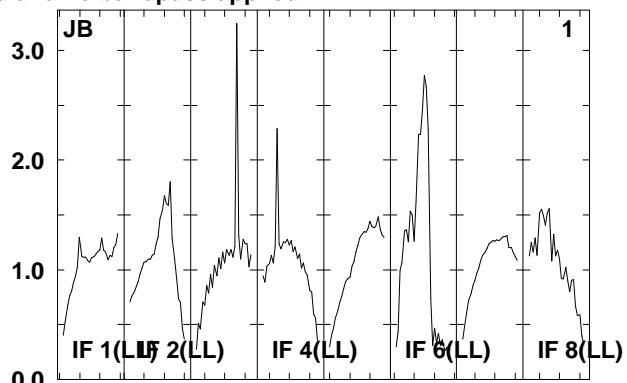
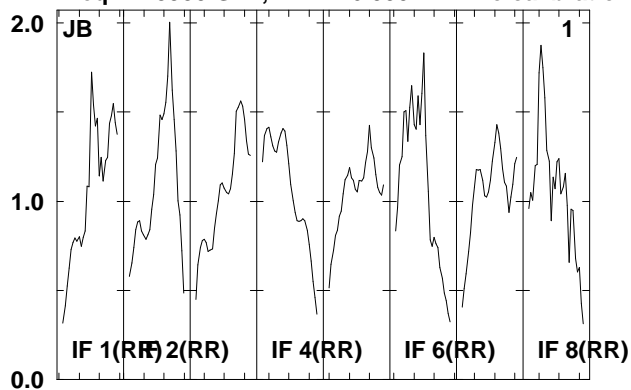

Lower frame: Real Jy  
Total-power spectrum Antenna: \*  
Timerange: 00/14:57:13 to 00/15:01:49

Plot file version 468 created 08-AUG-2008 17:02:36

J092159 EO006B.UVDATA.1

Freq = 1.5950 GHz, Bw = 16.000 MH No calibration applied and no bandpass applied

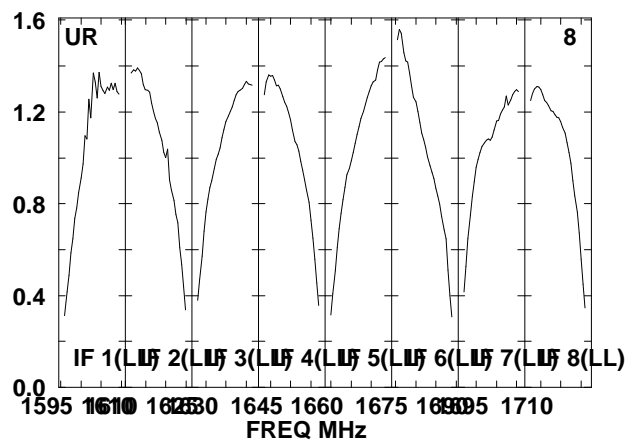
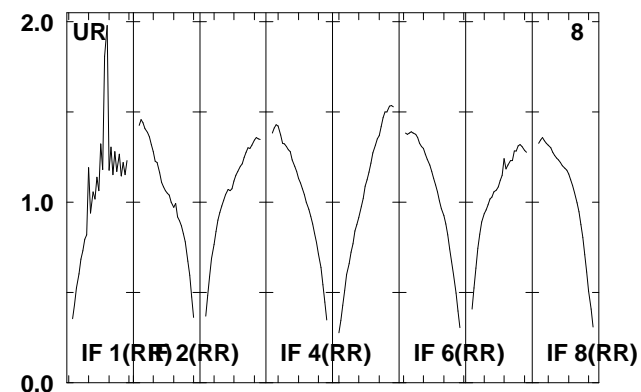
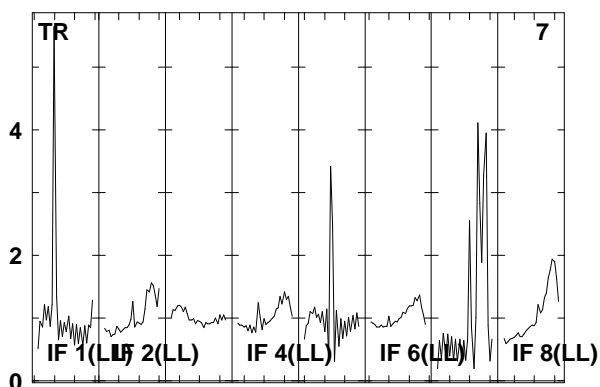
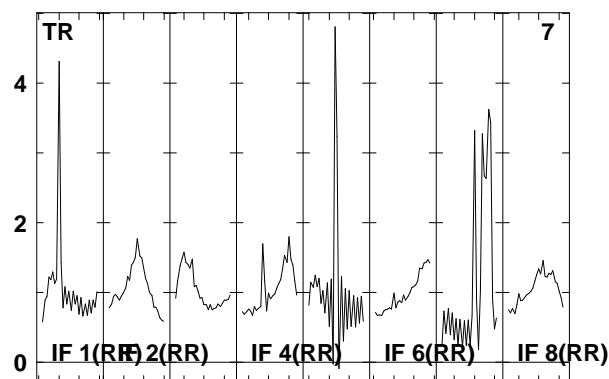
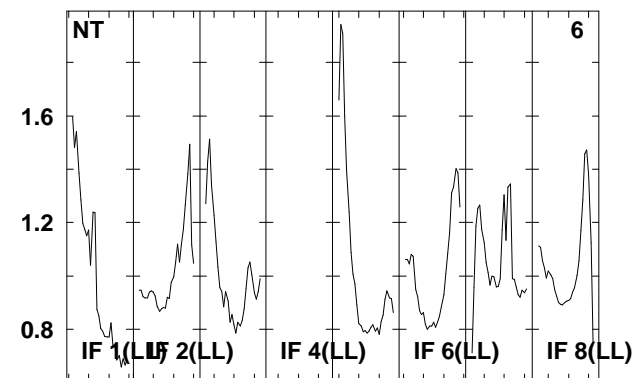
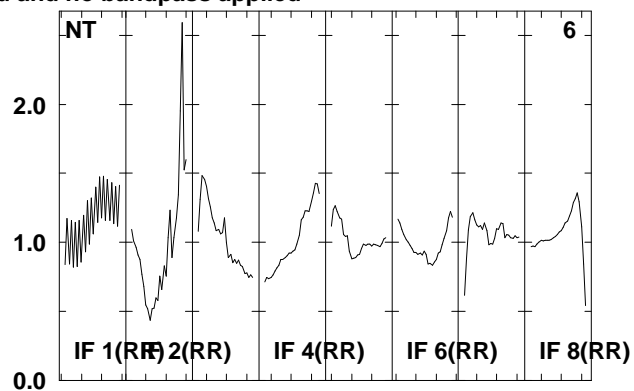
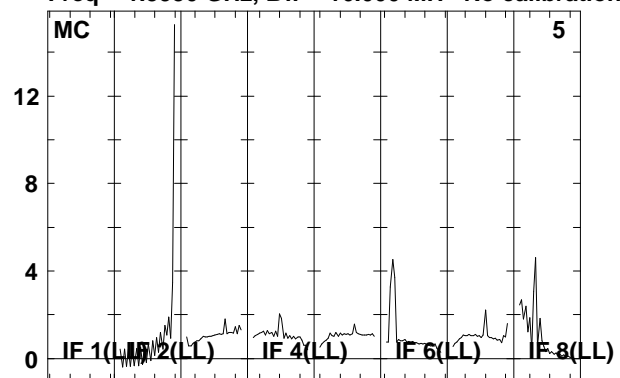

Lower frame: Real Jy

Total-power spectrum Antenna: \*

Timerange: 00/14:57:13 to 00/15:01:49



Plot file version 469 created 08-AUG-2008 17:02:37

J0920+44 EO006B.UVDATA.1

Freq = 1.5950 GHz, Bw = 16.000 MH No calibration applied and no bandpass applied

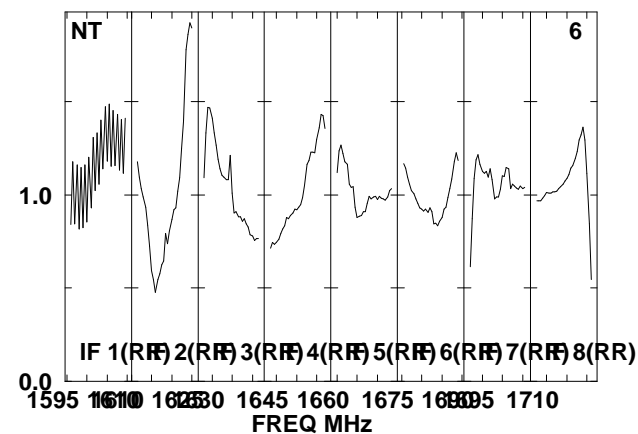
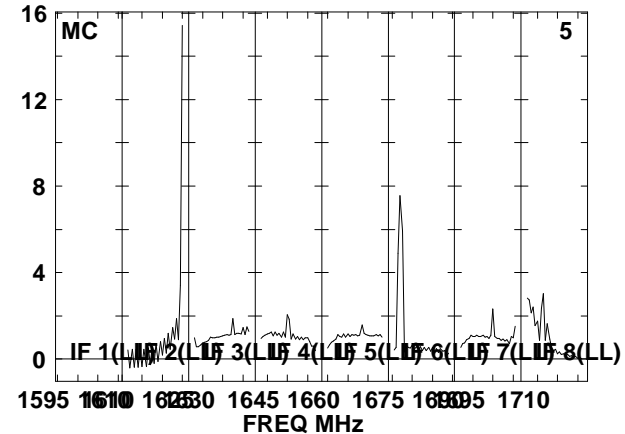
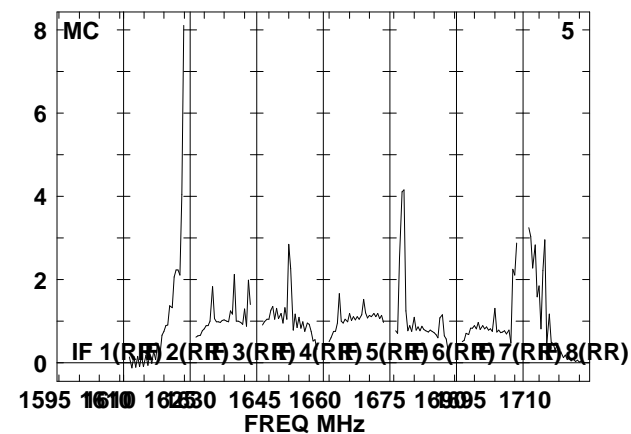
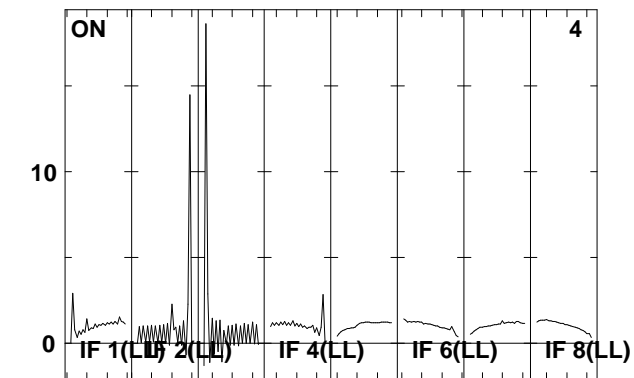
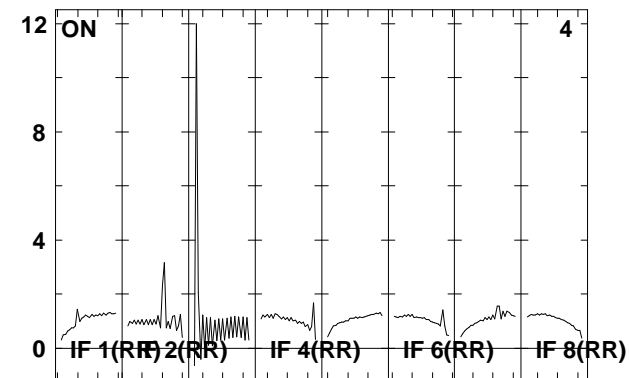
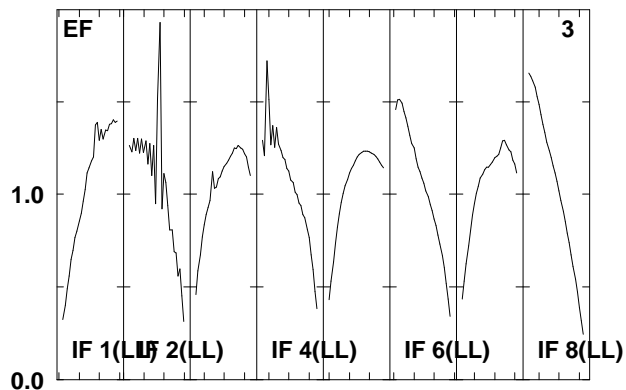
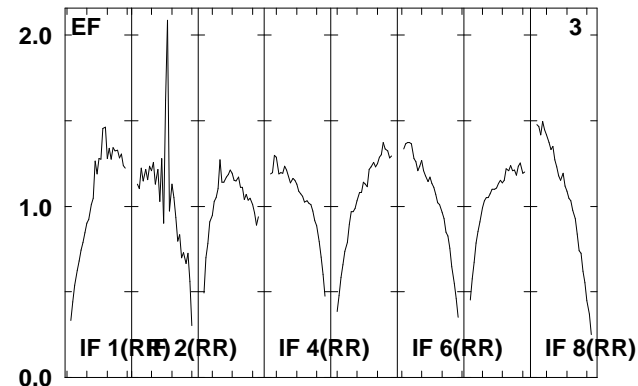
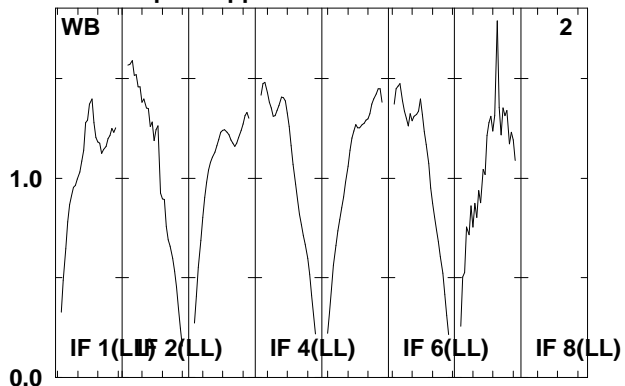
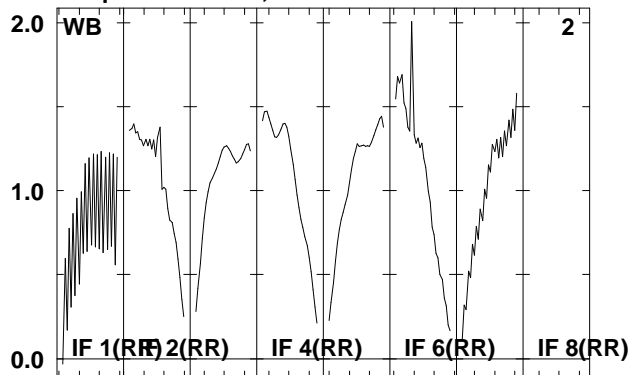

Lower frame: Real Jy  
Total-power spectrum Antenna: \*  
Timerange: 00/15:02:21 to 00/15:03:57

Plot file version 470 created 08-AUG-2008 17:02:37

J0920+44 EO006B.UVDATA.1

Freq = 1.5950 GHz, Bw = 16.000 MH No calibration applied and no bandpass applied

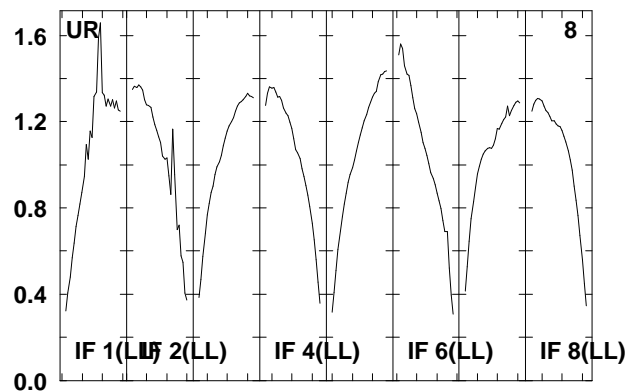
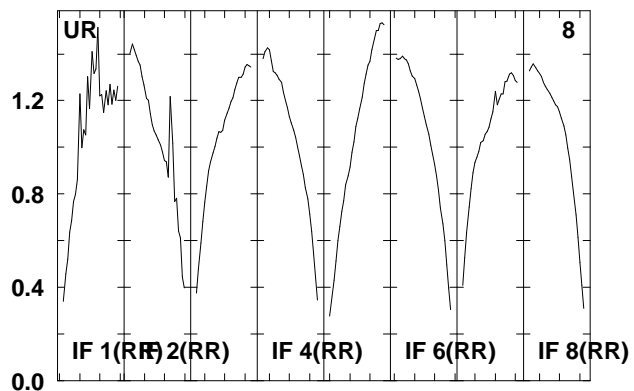
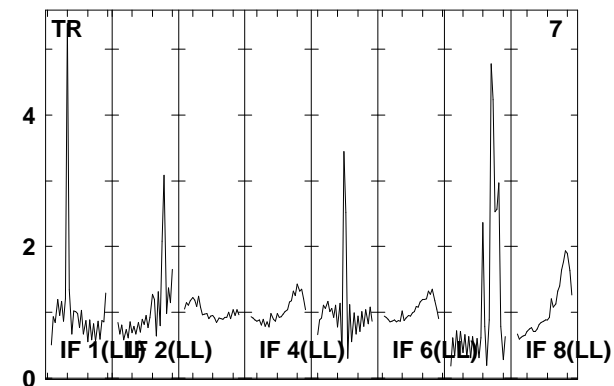
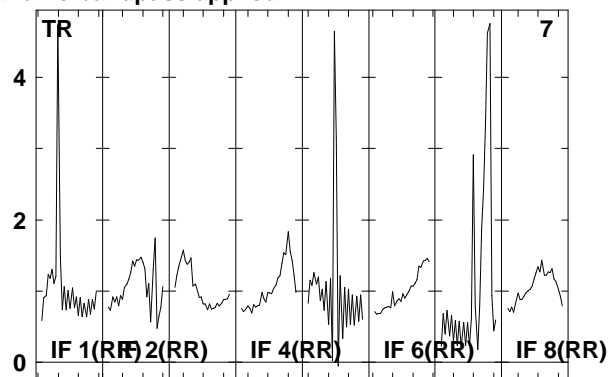
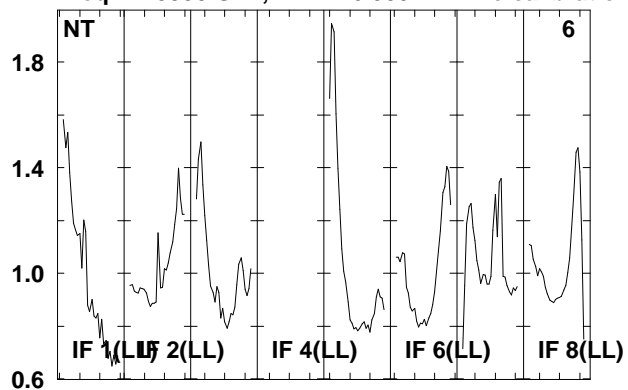

Lower frame: Real Jy  
Total-power spectrum Antenna: \*  
Timerange: 00/15:02:21 to 00/15:03:57

Plot file version 471 created 08-AUG-2008 17:02:38

J092159 EO006B.UVDATA.1

Freq = 1.5950 GHz, Bw = 16.000 MH No calibration applied and no bandpass applied

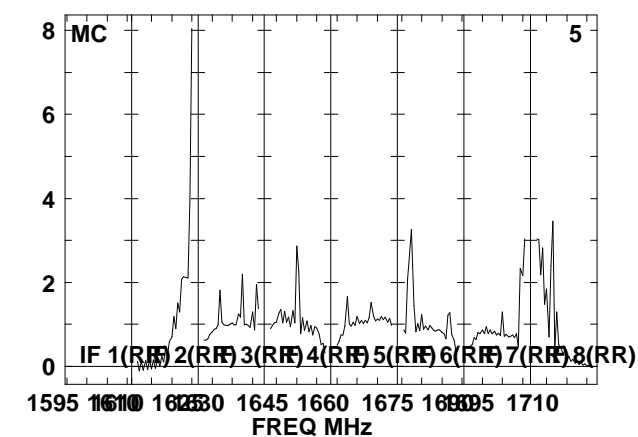
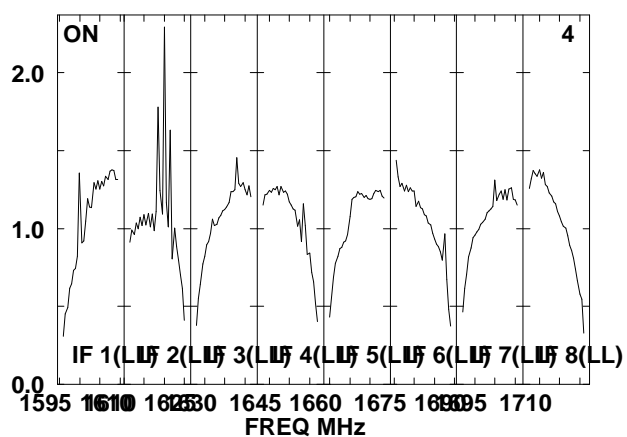
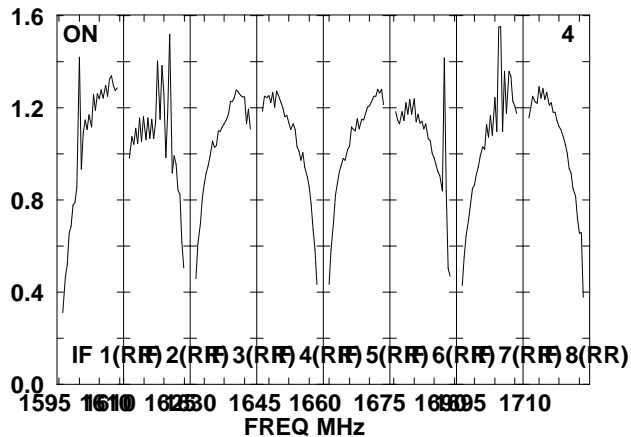
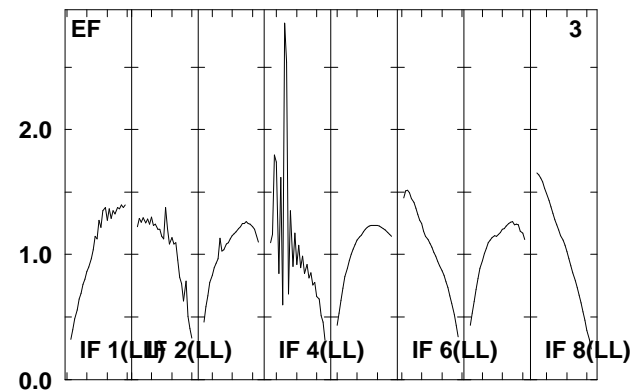
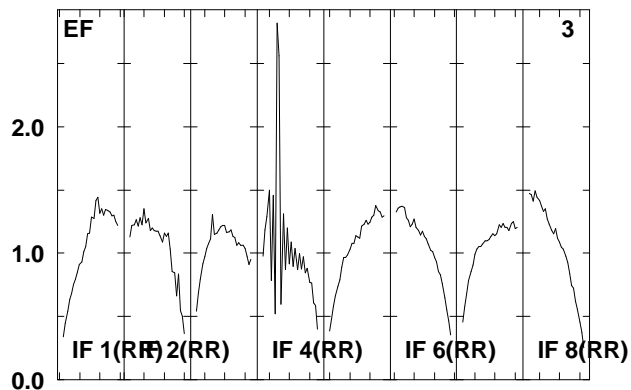
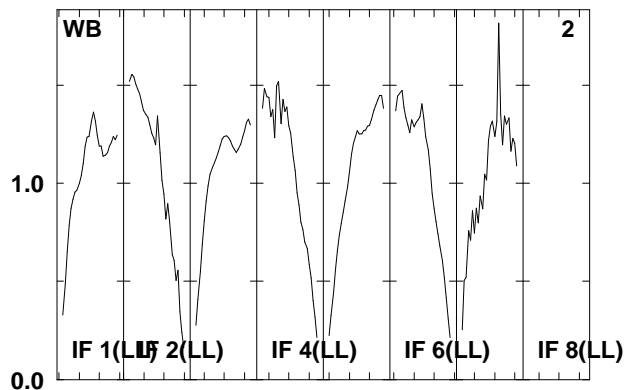
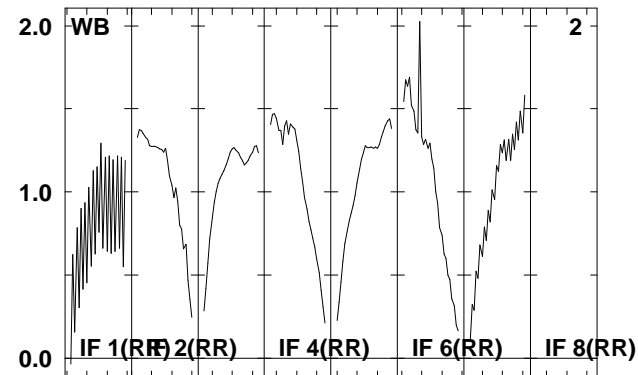
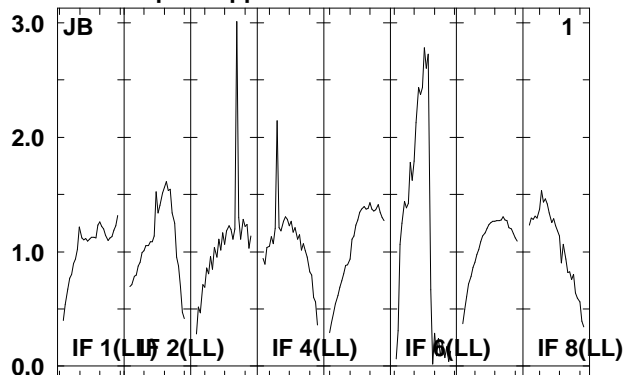
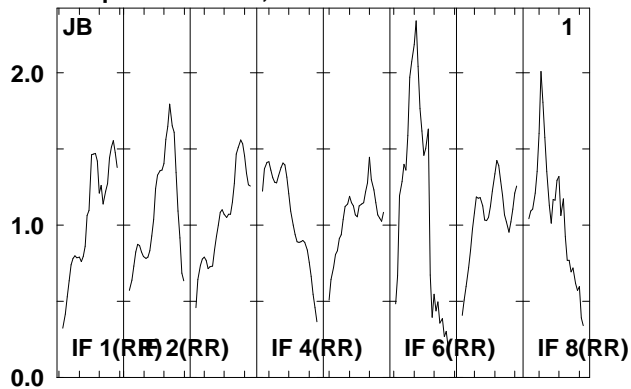

Lower frame: Real Jy  
Total-power spectrum Antenna: \*  
Timerange: 00/15:04:33 to 00/15:09:09

Plot file version 472 created 08-AUG-2008 17:02:38

J092159 EO006B.UVDATA.1

Freq = 1.5950 GHz, Bw = 16.000 MH No calibration applied and no bandpass applied

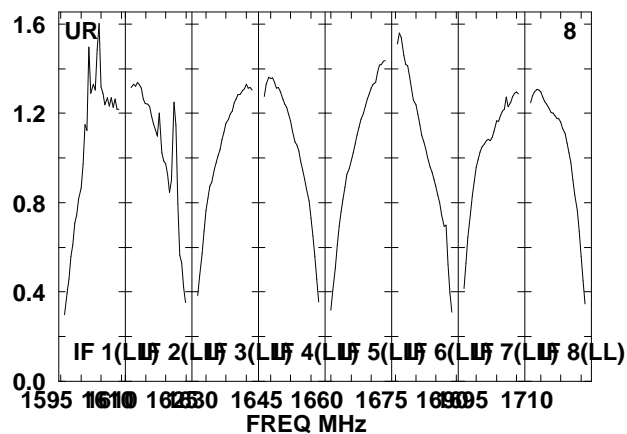
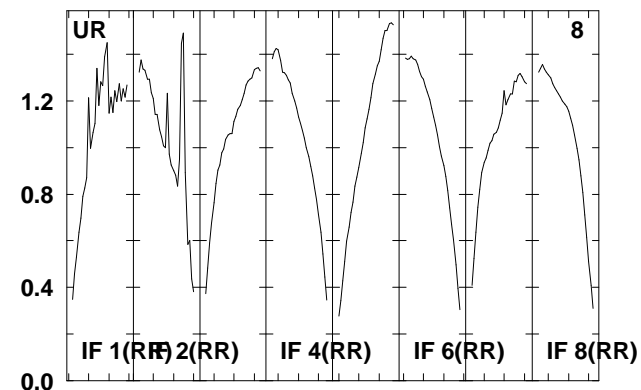
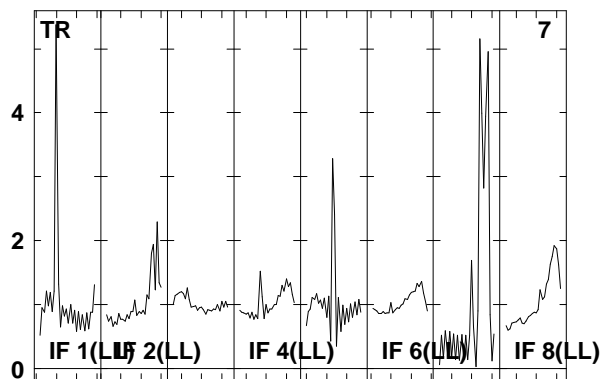
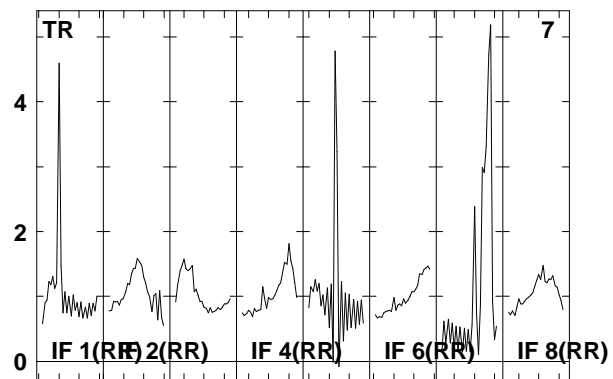
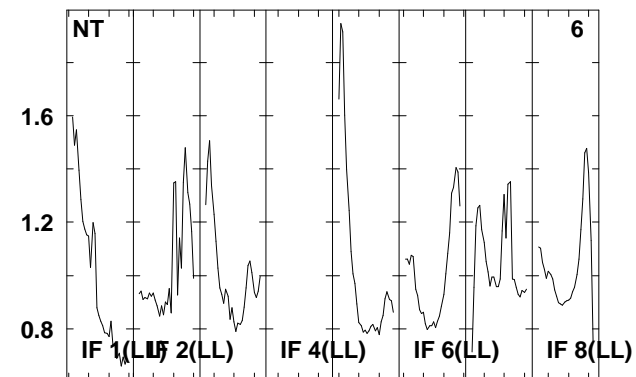
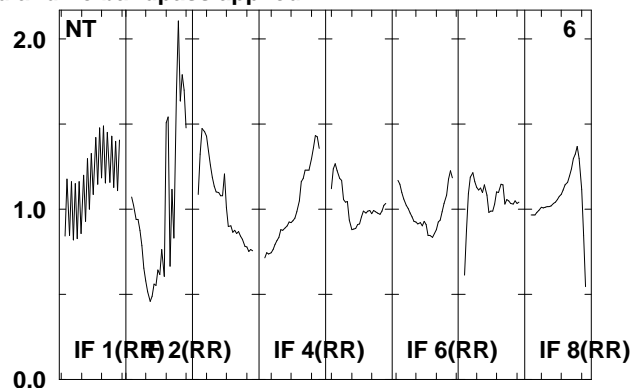
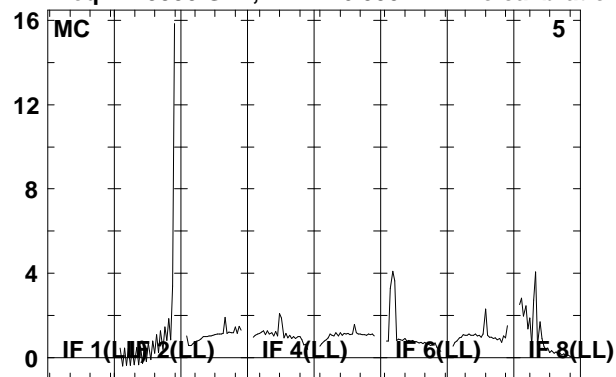

Lower frame: Real Jy

Total-power spectrum Antenna: \*

Timerange: 00/15:04:33 to 00/15:09:09

Plot file version 473 created 08-AUG-2008 17:02:39

J0920+44 EO006B.UVDATA.1

Freq = 1.5950 GHz, Bw = 16.000 MH No calibration applied and no bandpass applied

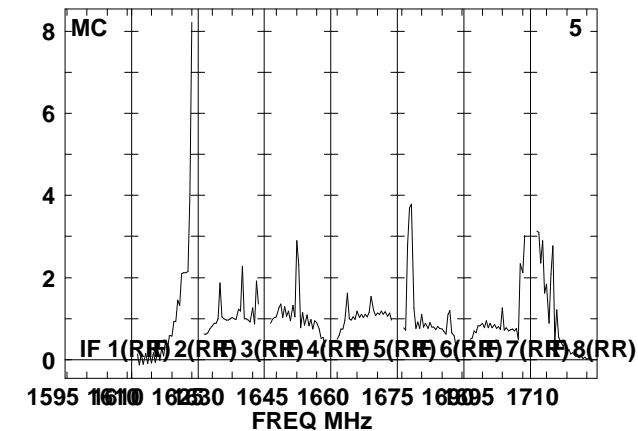
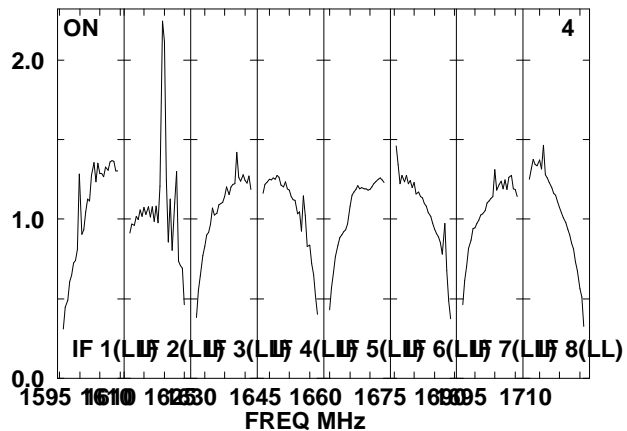
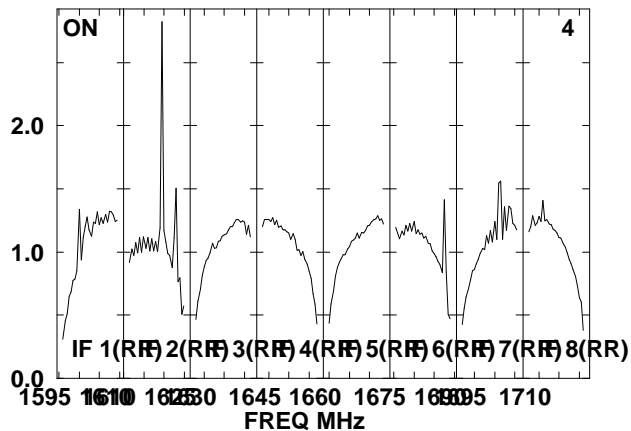
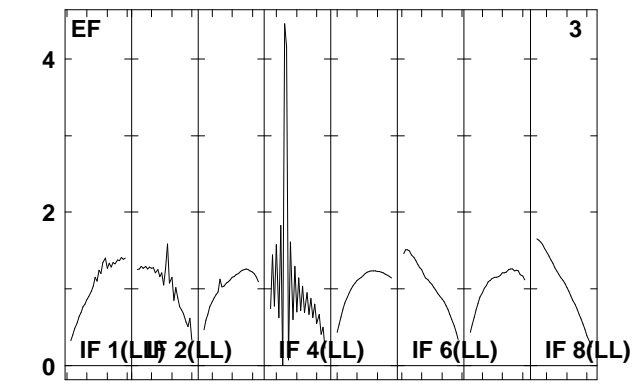
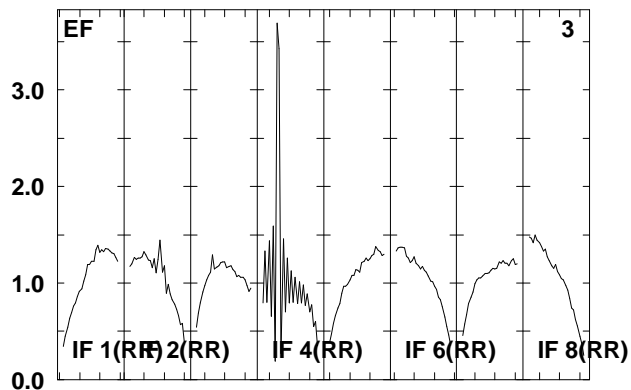
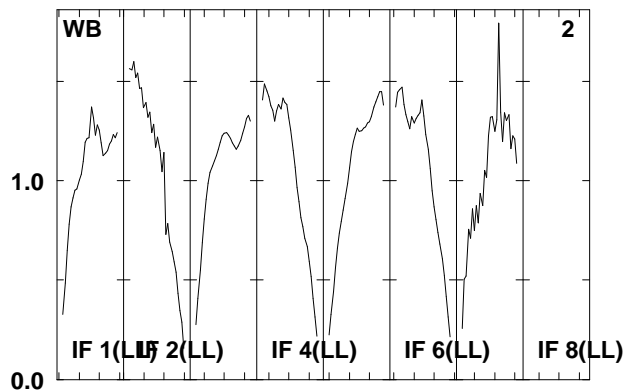
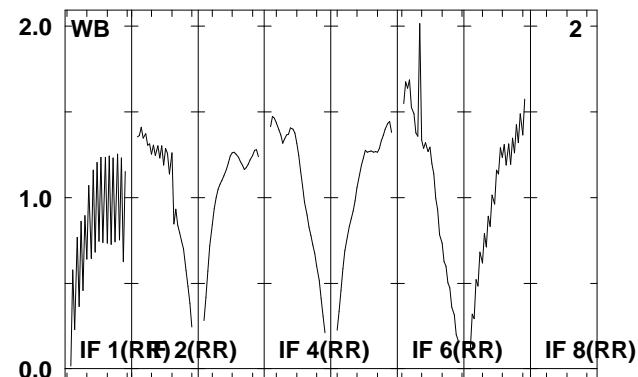
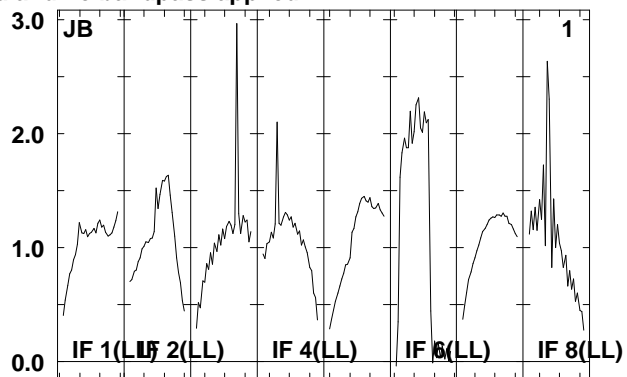
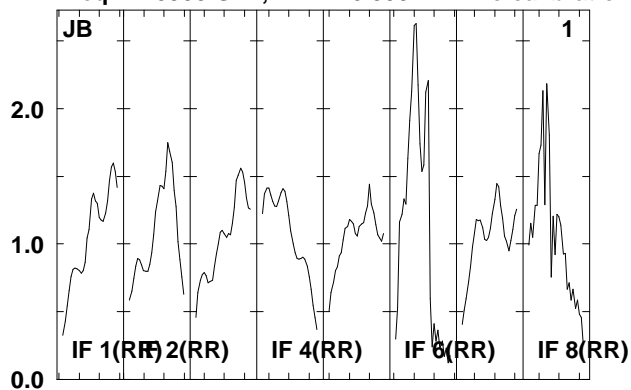

Lower frame: Real Jy  
Total-power spectrum Antenna: \*  
Timerange: 00/15:09:41 to 00/15:11:17

Plot file version 474 created 08-AUG-2008 17:02:39

J0920+44 EO006B.UVDATA.1

Freq = 1.5950 GHz, Bw = 16.000 MH No calibration applied and no bandpass applied

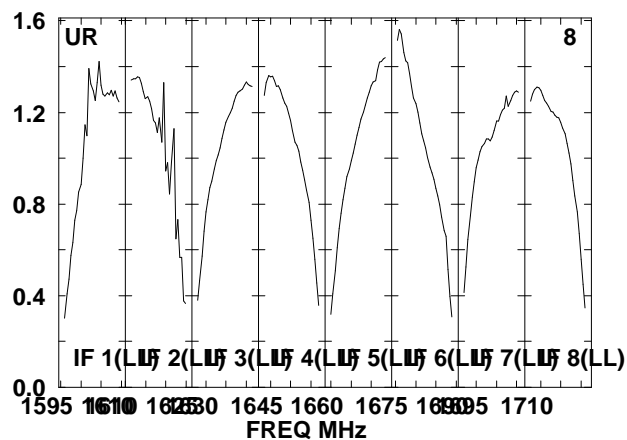
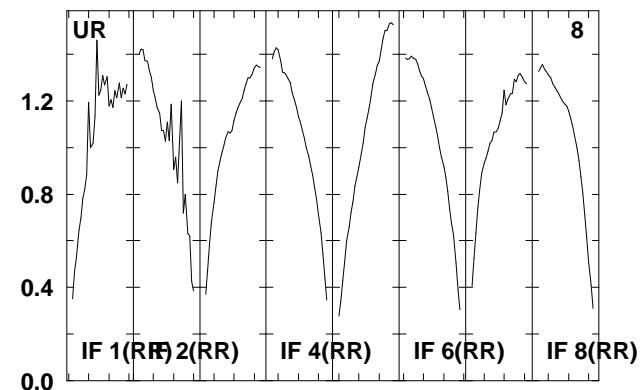
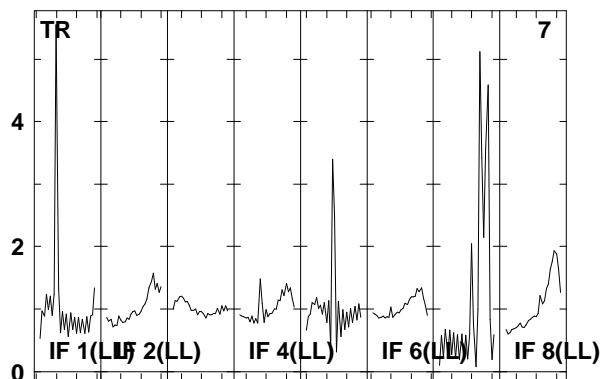
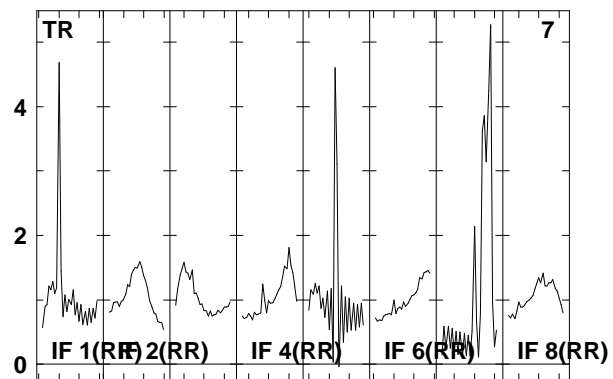
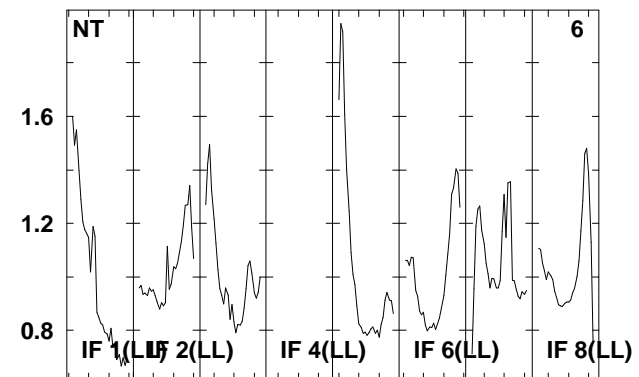
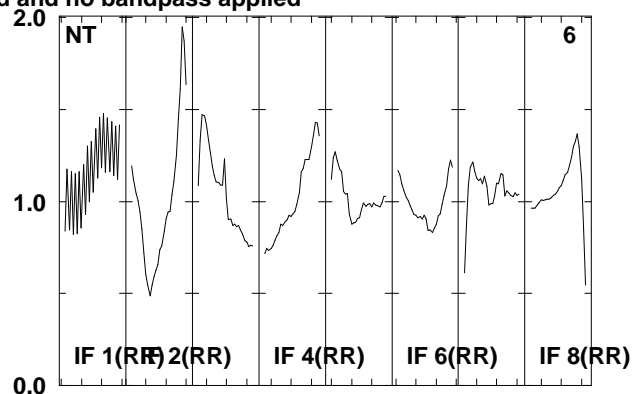
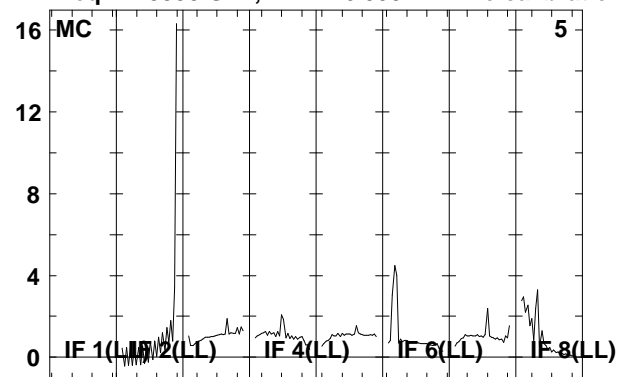

Lower frame: Real Jy

Total-power spectrum Antenna: \*

Timerange: 00/15:09:41 to 00/15:11:17

Plot file version 475 created 08-AUG-2008 17:02:39

J092159 EO006B.UVDATA.1

Freq = 1.5950 GHz, Bw = 16.000 MH No calibration applied and no bandpass applied

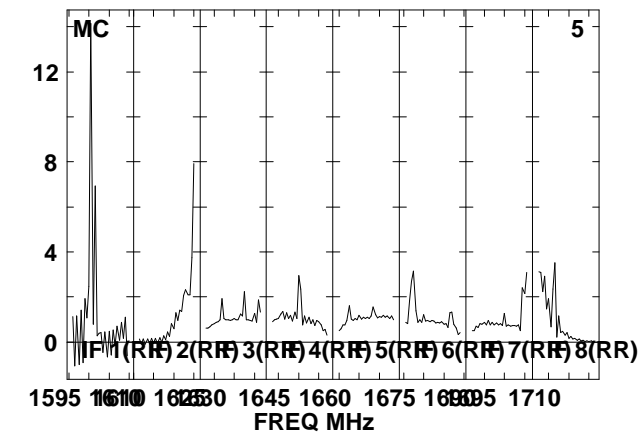
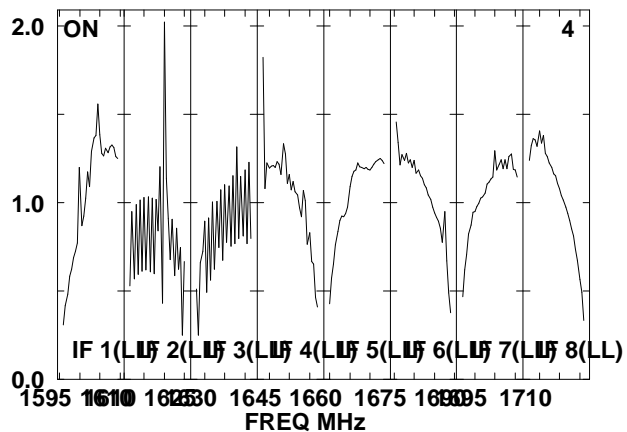
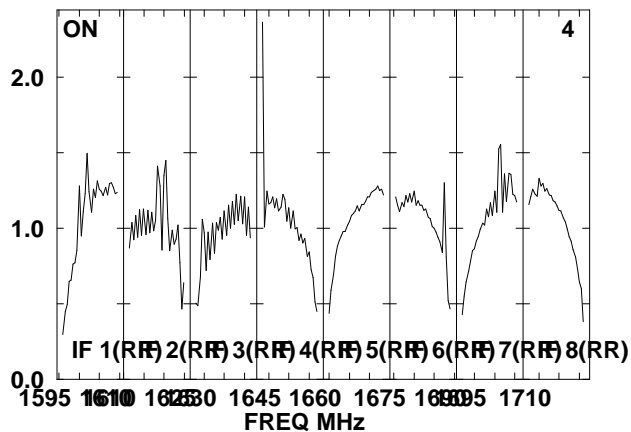
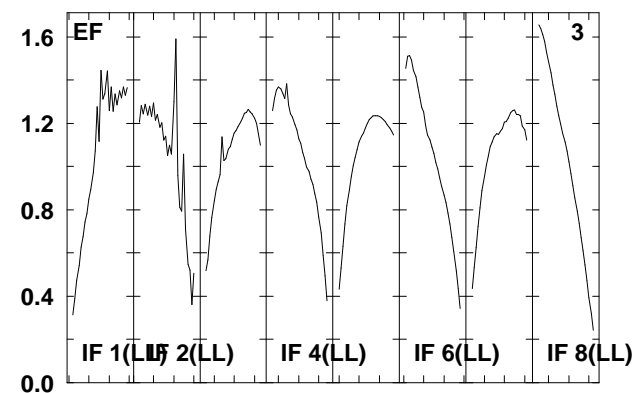
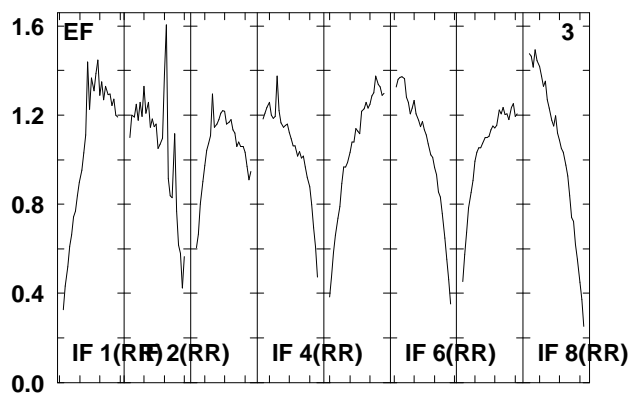
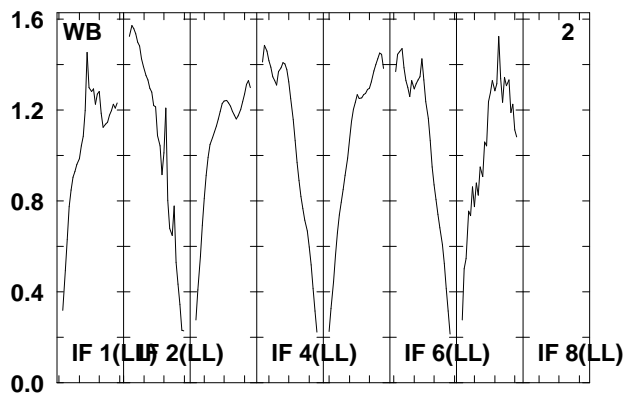
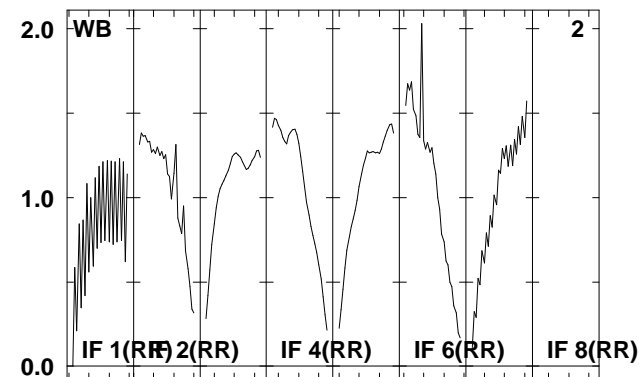
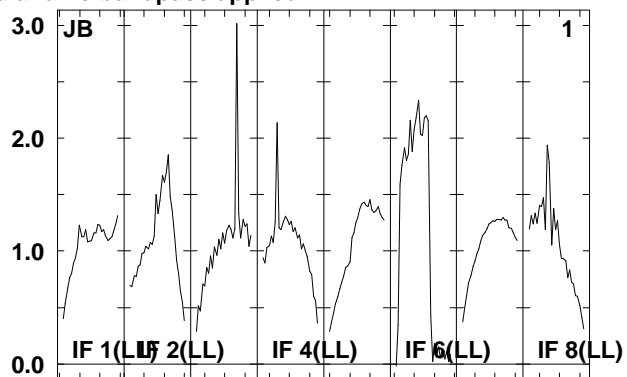
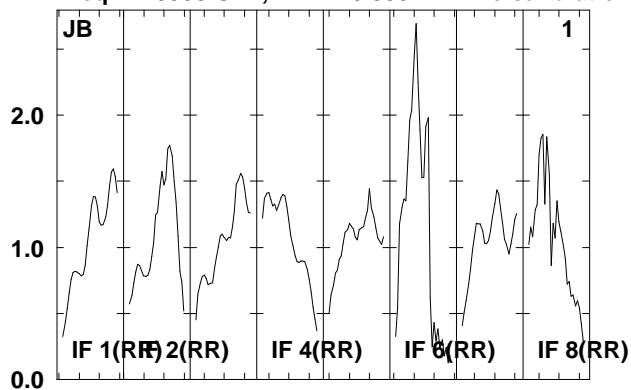

Lower frame: Real Jy  
Total-power spectrum Antenna: \*  
Timerange: 00/15:11:53 to 00/15:16:29

Plot file version 476 created 08-AUG-2008 17:02:40

J092159 EO006B.UVDATA.1

Freq = 1.5950 GHz, Bw = 16.000 MH No calibration applied and no bandpass applied

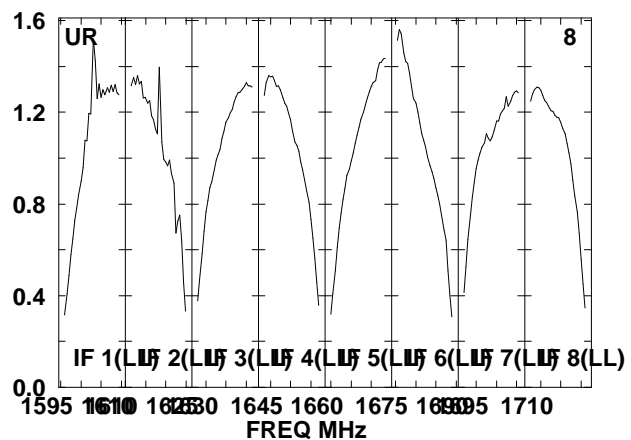
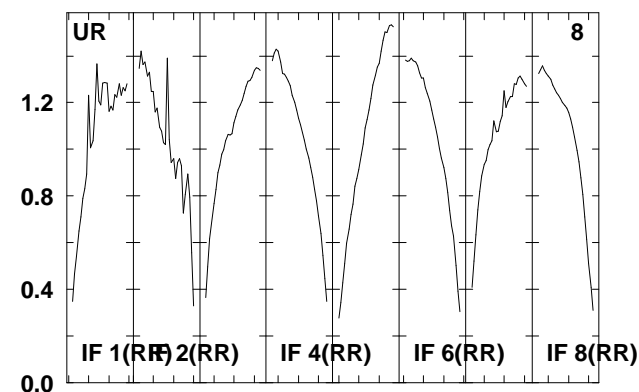
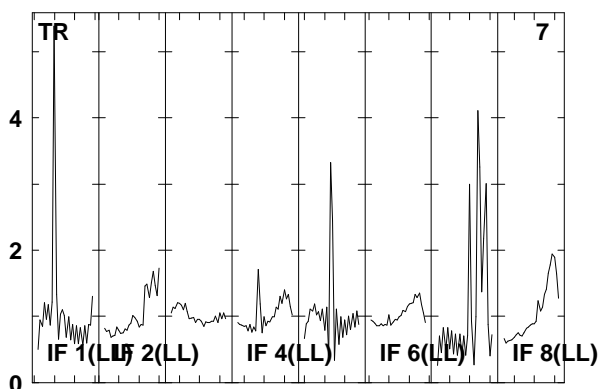
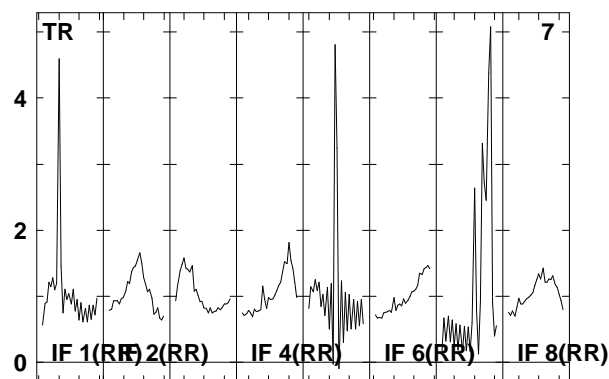
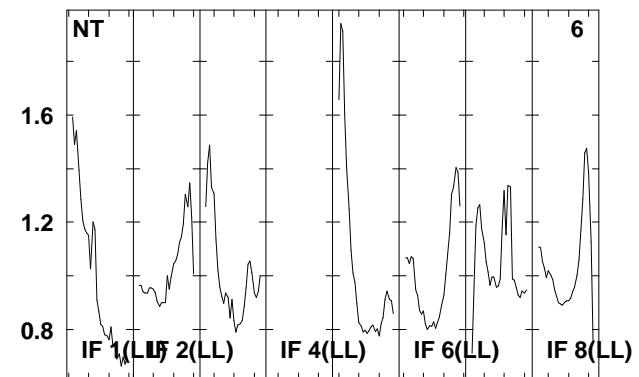
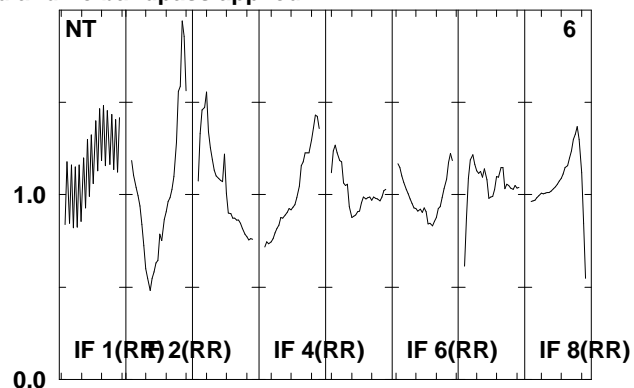
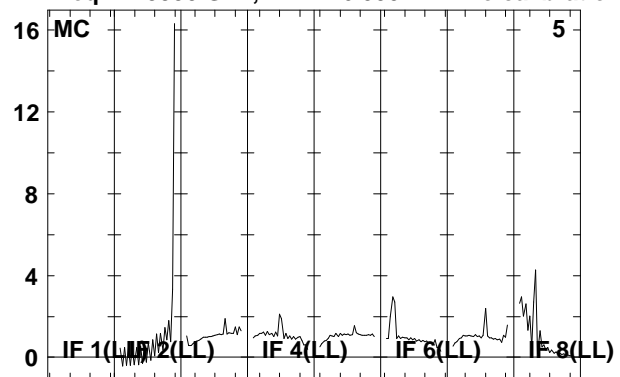

Lower frame: Real Jy

Total-power spectrum Antenna: \*

Timerange: 00/15:11:53 to 00/15:16:29



Plot file version 477 created 08-AUG-2008 17:02:41

J0920+44 EO006B.UVDATA.1

Freq = 1.5950 GHz, Bw = 16.000 MH No calibration applied and no bandpass applied

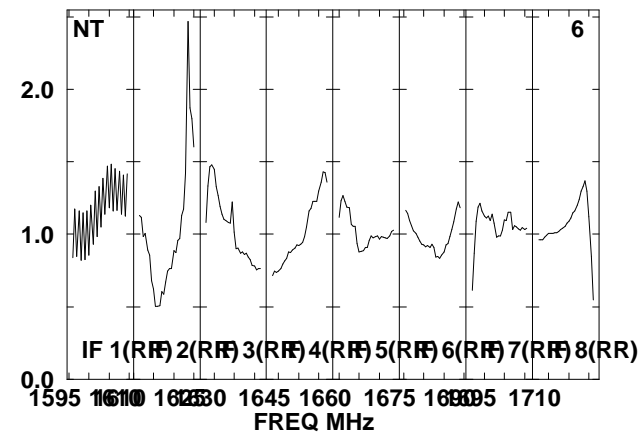
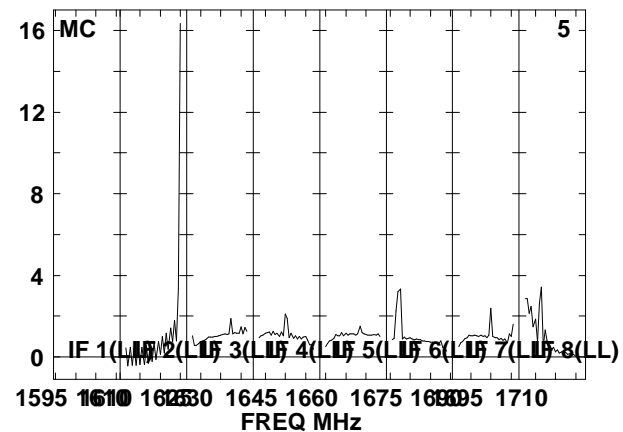
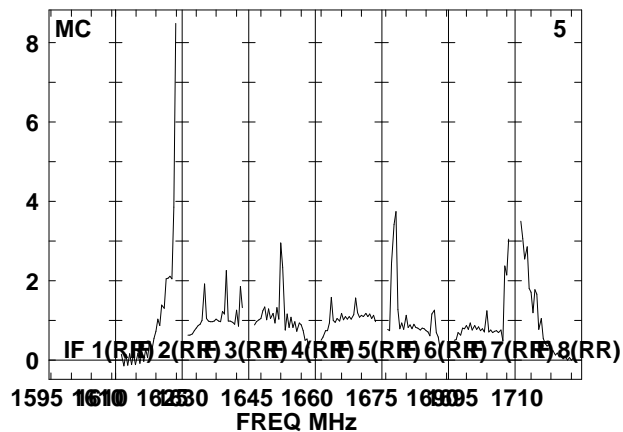
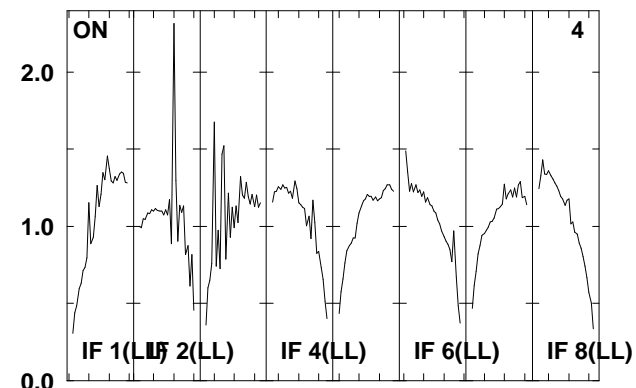
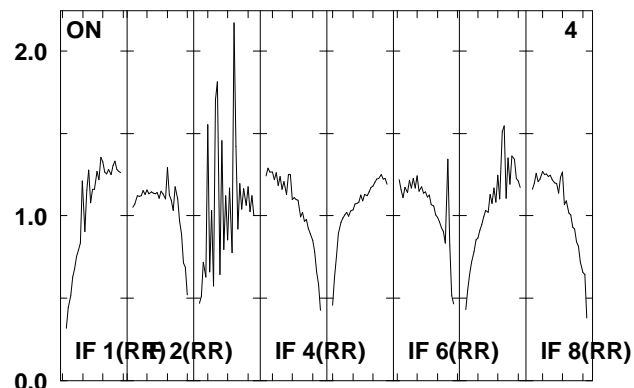
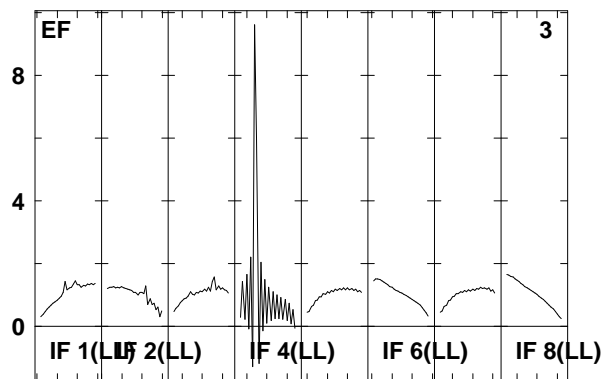
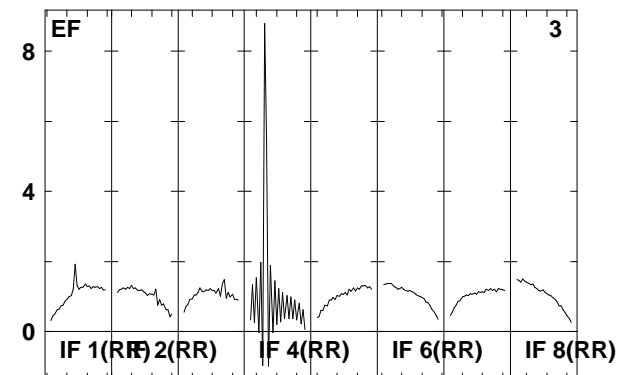
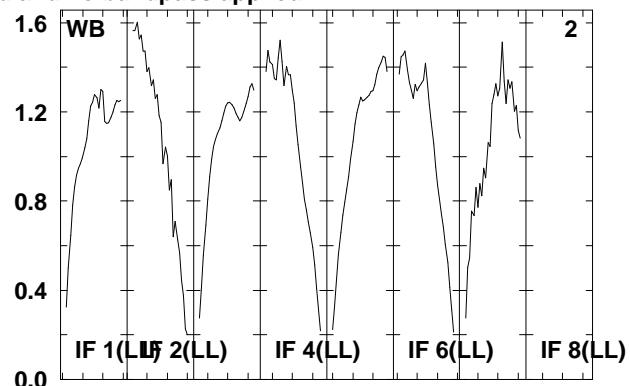
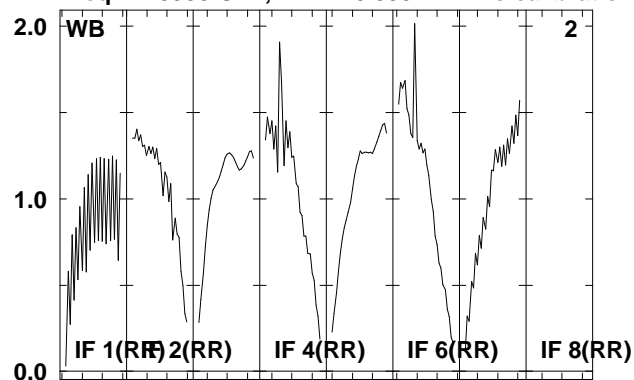

Lower frame: Real Jy  
Total-power spectrum Antenna: \*  
Timerange: 00/15:17:01 to 00/15:18:37

Plot file version 478 created 08-AUG-2008 17:02:41

J0920+44 EO006B.UVDATA.1

Freq = 1.5950 GHz, Bw = 16.000 MH No calibration applied and no bandpass applied

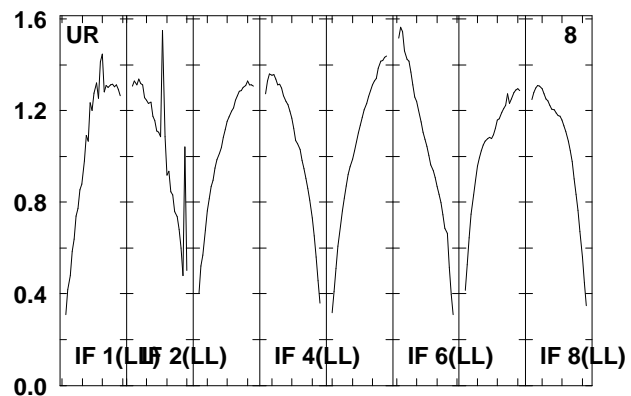
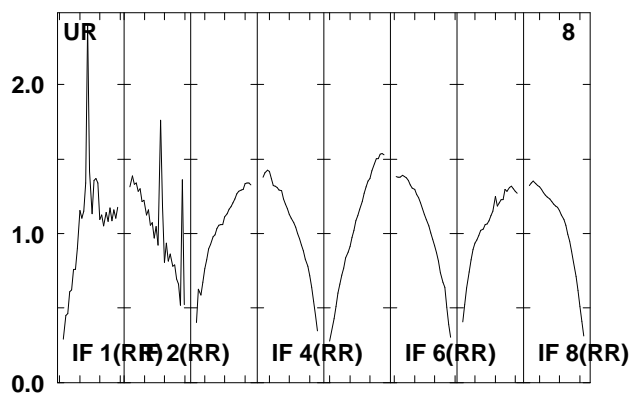
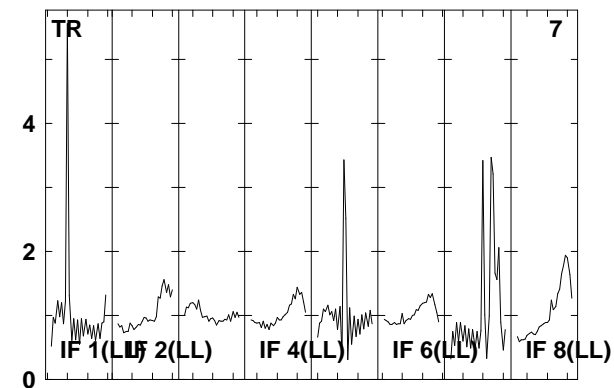
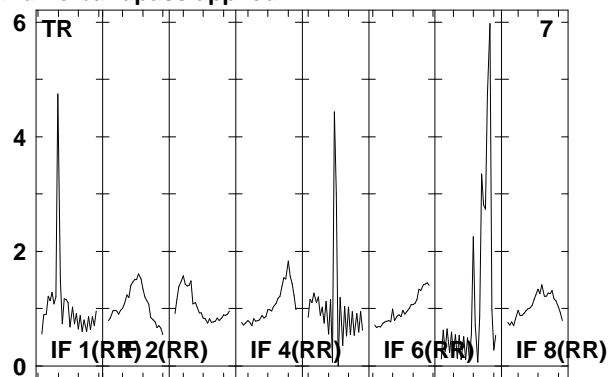
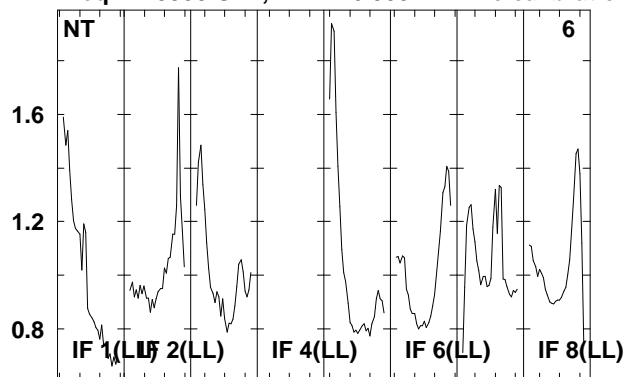

Lower frame: Real Jy  
Total-power spectrum Antenna: \*  
Timerange: 00/15:17:01 to 00/15:18:37

Plot file version 479 created 08-AUG-2008 17:02:42

J092159 EO006B.UVDATA.1

Freq = 1.5950 GHz, Bw = 16.000 MH No calibration applied and no bandpass applied

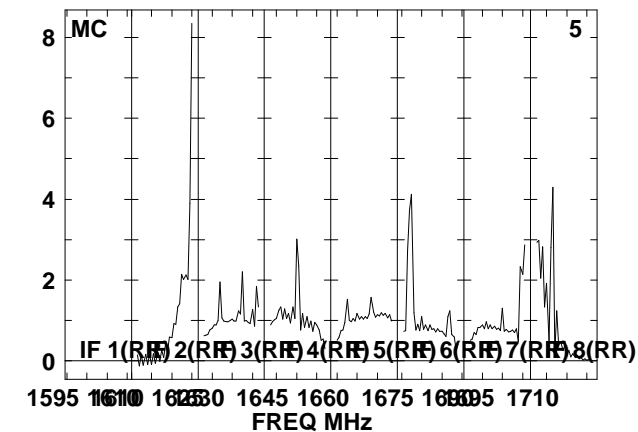
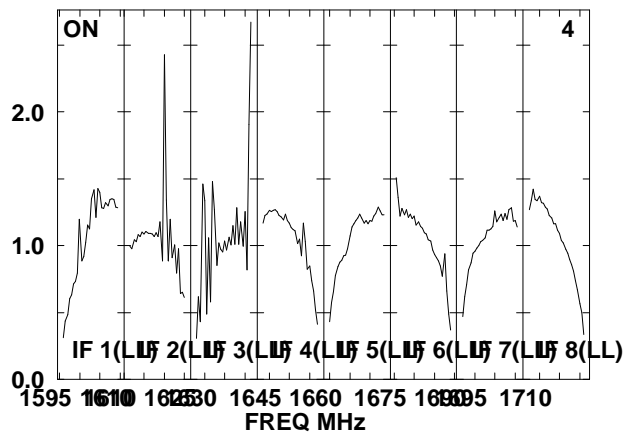
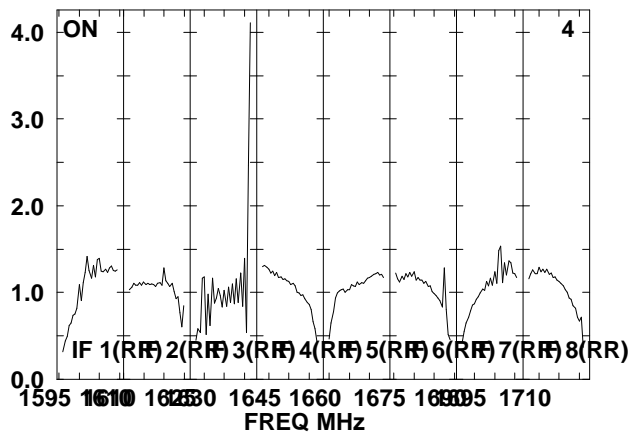
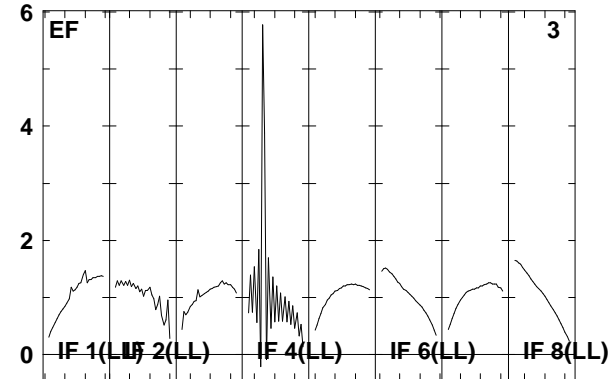
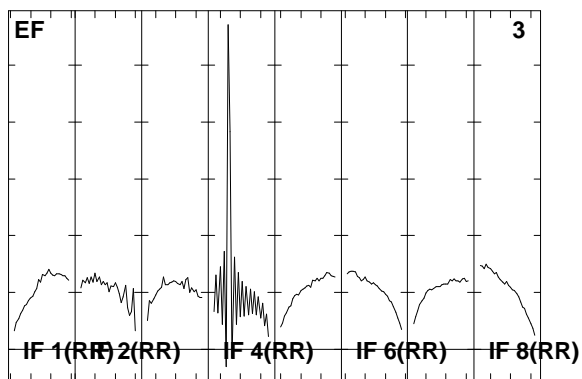
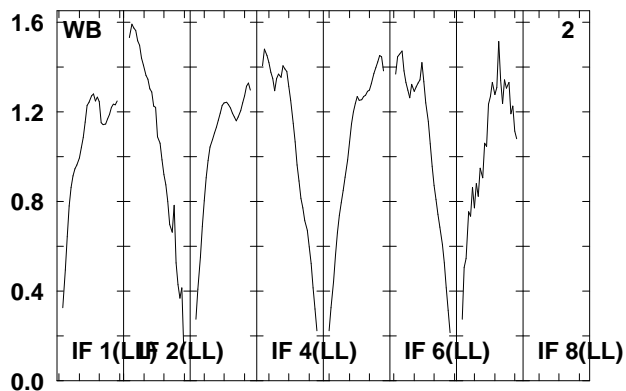
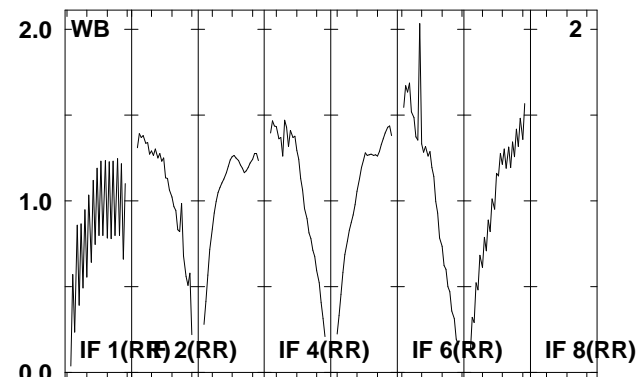
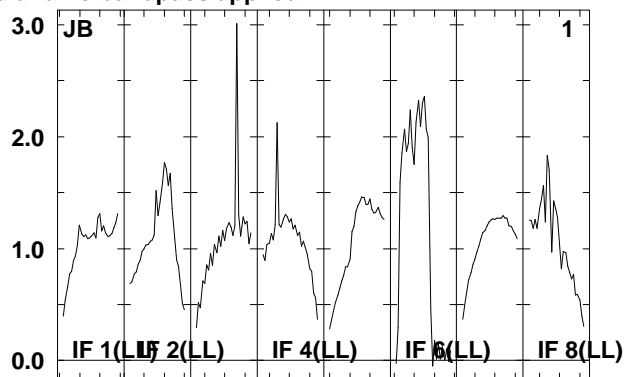
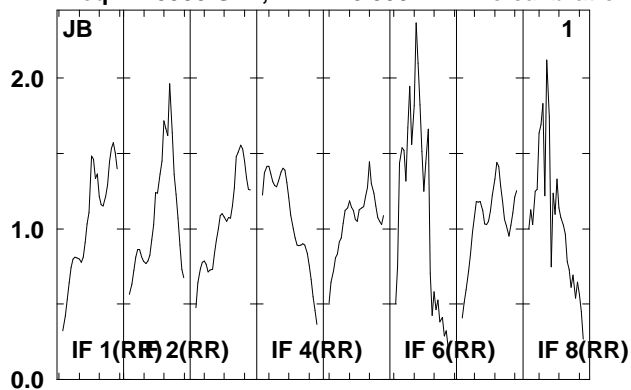

Lower frame: Real Jy  
Total-power spectrum Antenna: \*  
Timerange: 00/15:19:13 to 00/15:23:49

Plot file version 480 created 08-AUG-2008 17:02:42

J092159 EO006B.UVDATA.1

Freq = 1.5950 GHz, Bw = 16.000 MH No calibration applied and no bandpass applied

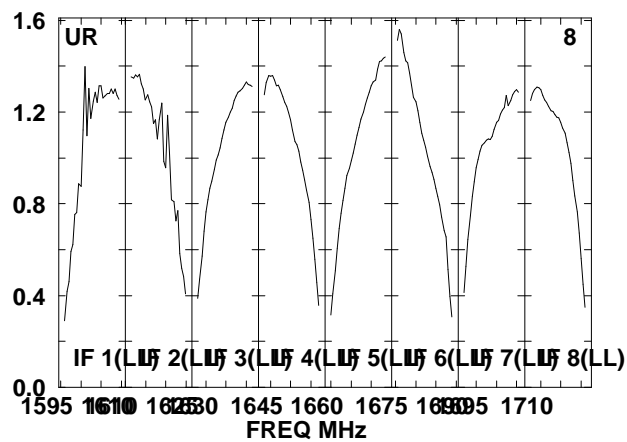
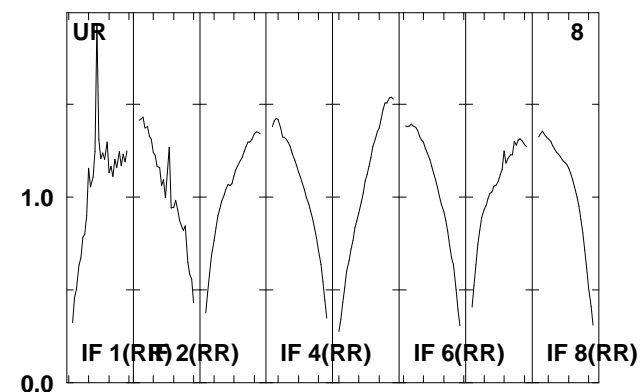
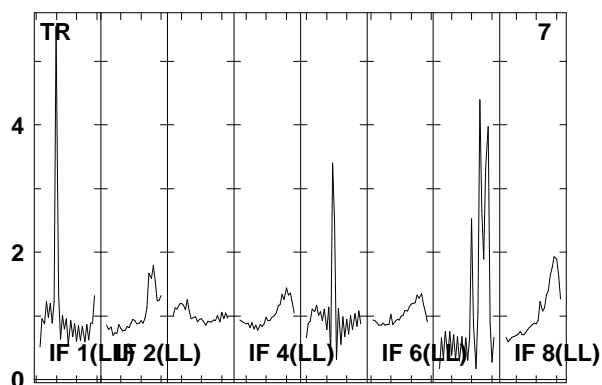
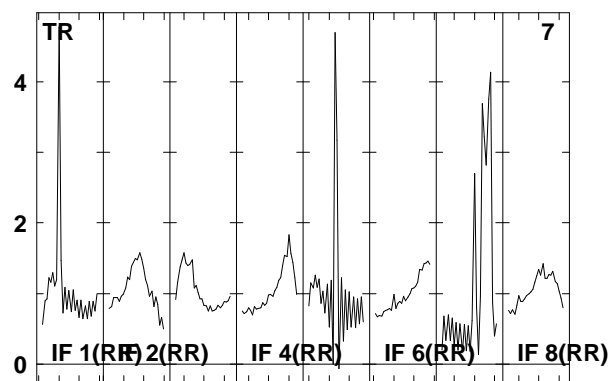
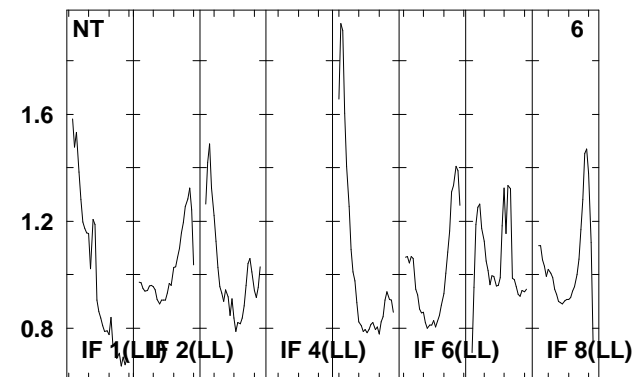
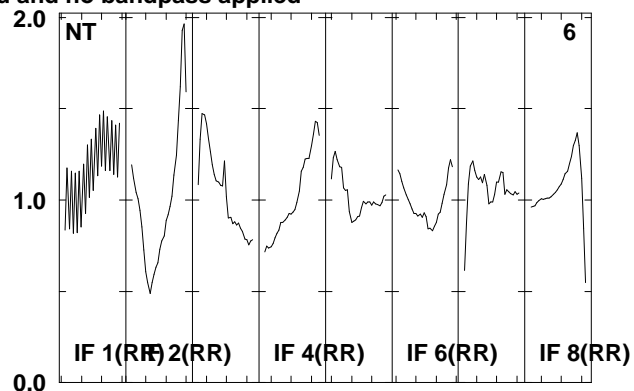
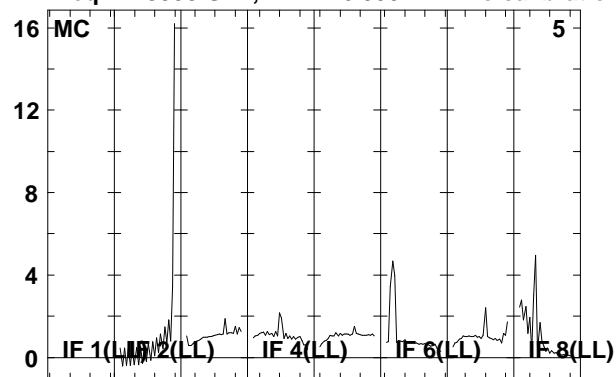

Lower frame: Real Jy

Total-power spectrum Antenna: \*

Timerange: 00/15:19:13 to 00/15:23:49

Plot file version 481 created 08-AUG-2008 17:02:43

J0920+44 EO006B.UVDATA.1

Freq = 1.5950 GHz, Bw = 16.000 MH No calibration applied and no bandpass applied

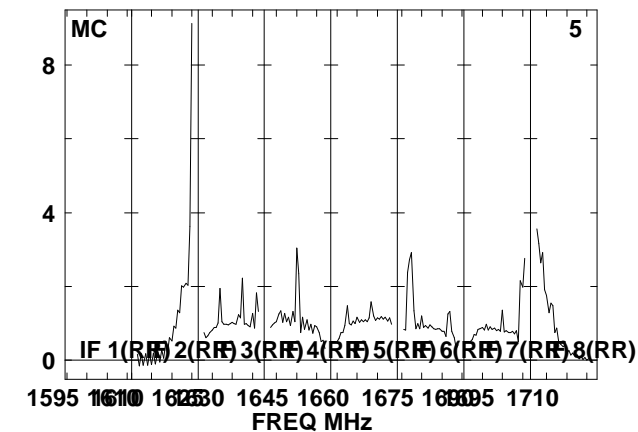
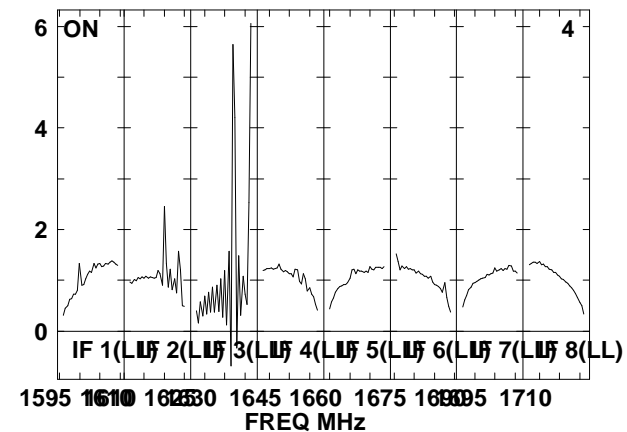
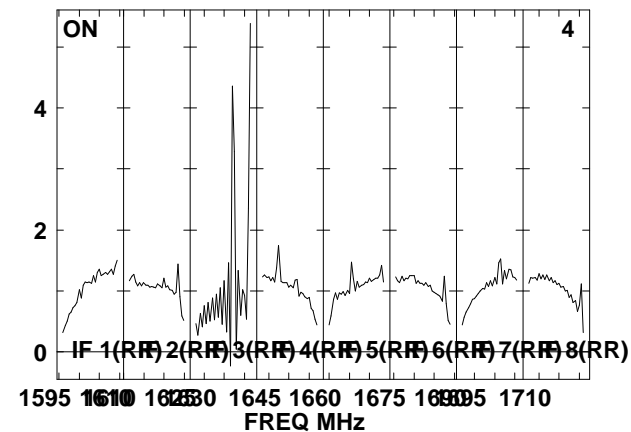
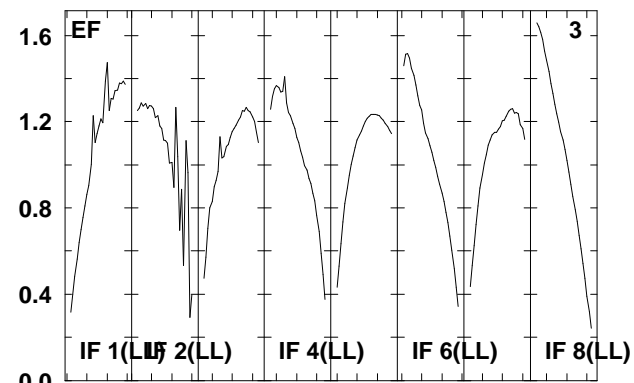
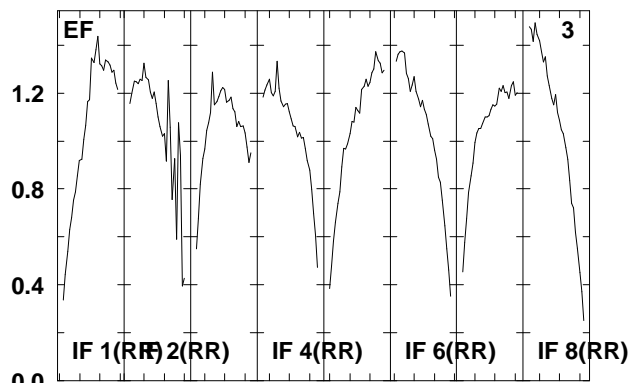
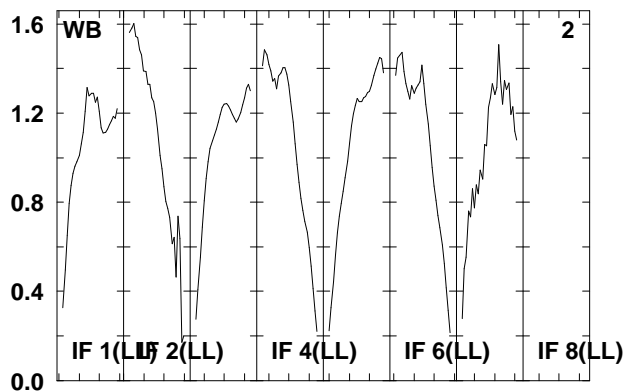
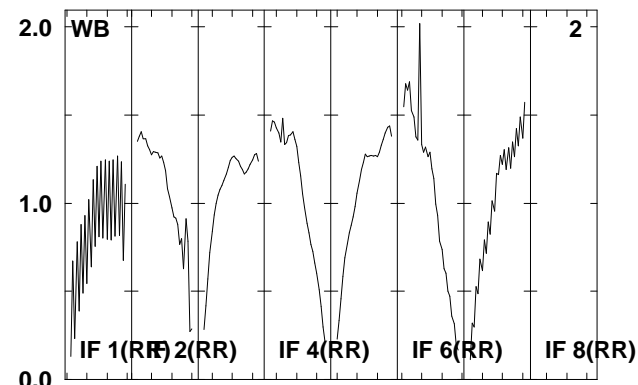
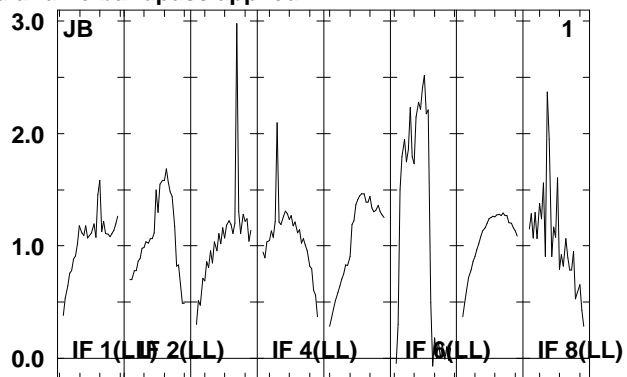
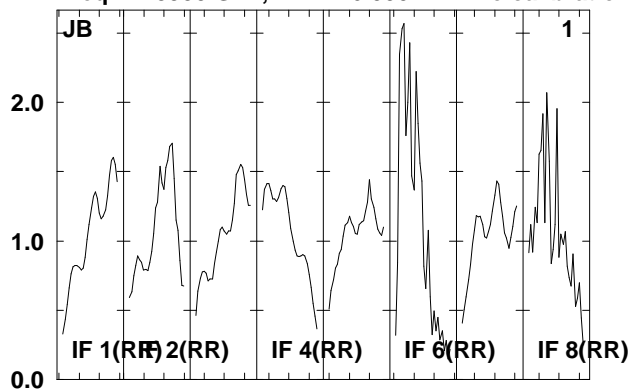

Lower frame: Real Jy  
Total-power spectrum Antenna: \*  
Timerange: 00/15:24:21 to 00/15:25:49

Plot file version 482 created 08-AUG-2008 17:02:44

J0920+44 EO006B.UVDATA.1

Freq = 1.5950 GHz, Bw = 16.000 MH No calibration applied and no bandpass applied

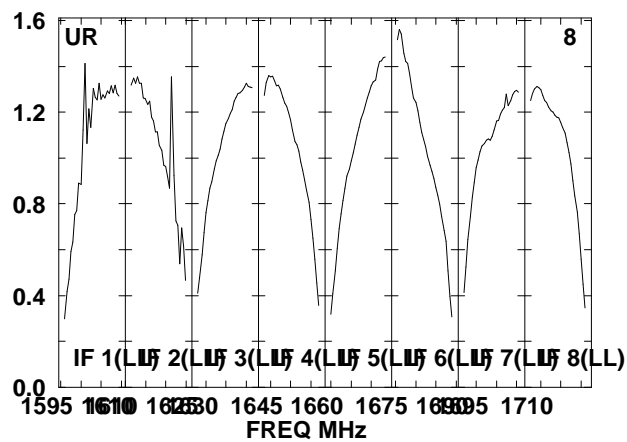
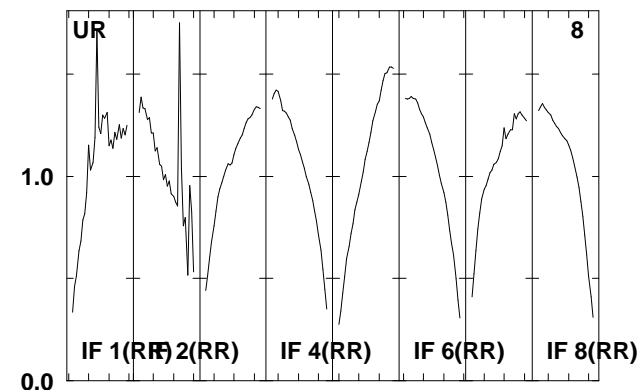
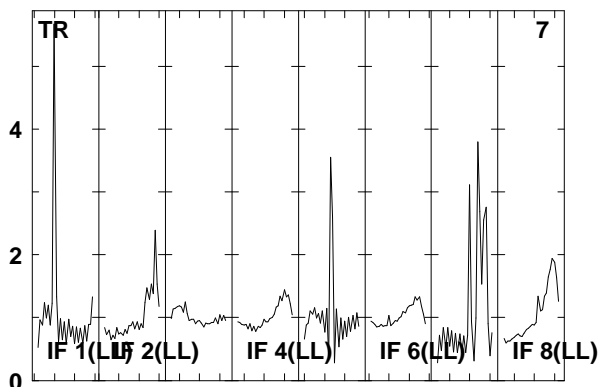
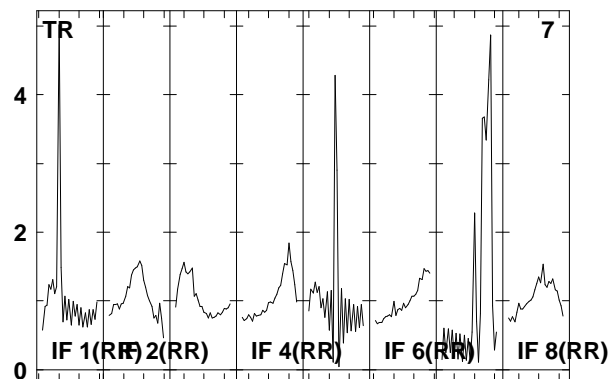
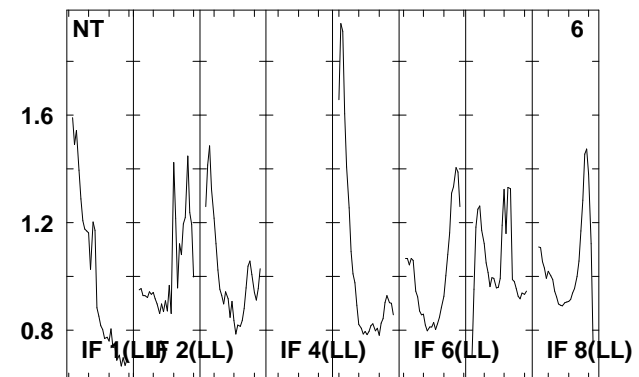
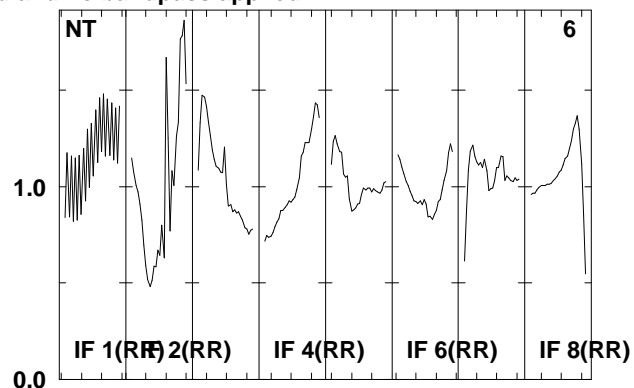
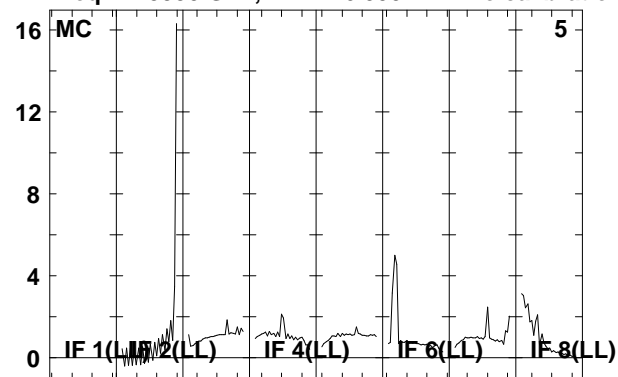

Lower frame: Real Jy

Total-power spectrum Antenna: \*

Timerange: 00/15:24:21 to 00/15:25:49