

Plot file version 1 created 14-MAY-2010 15:16:52
 J1344+66 EO007.UVDATA.1
 Freq = 4.9270 GHz, Bw = 16.000 MH No calibration applied and no bandpass applied

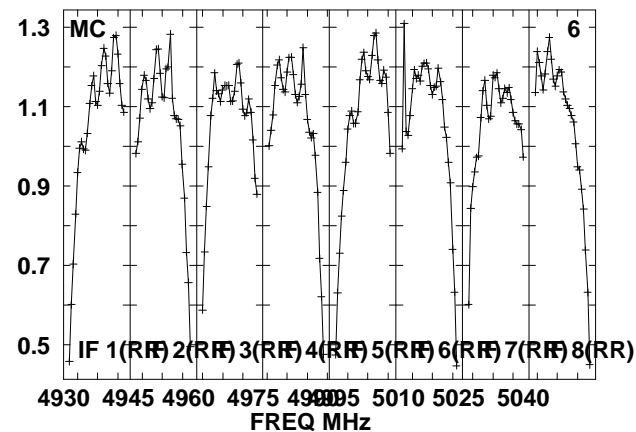
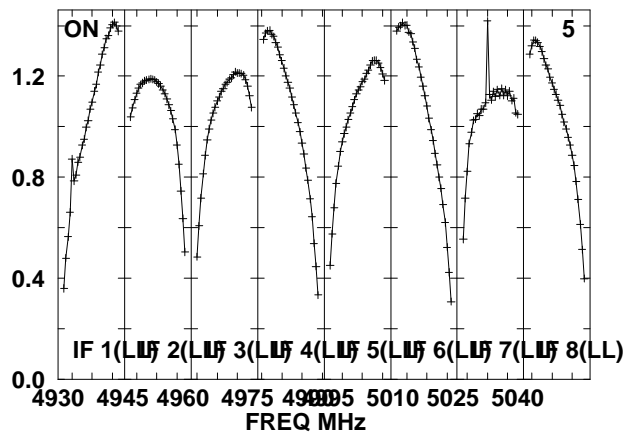
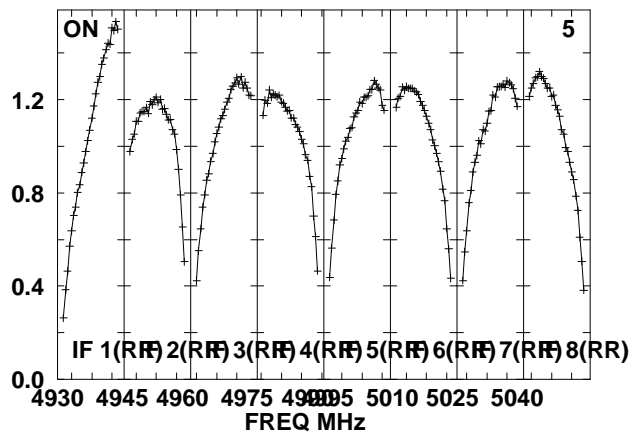
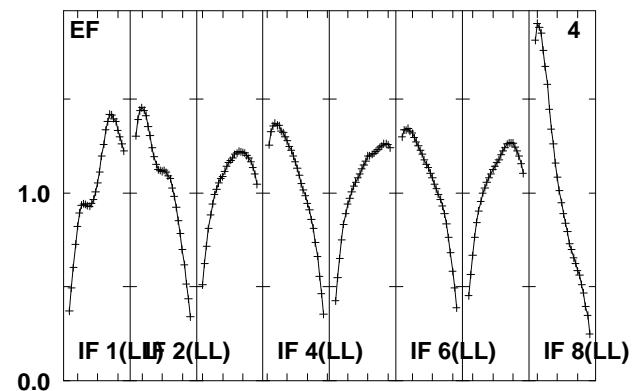
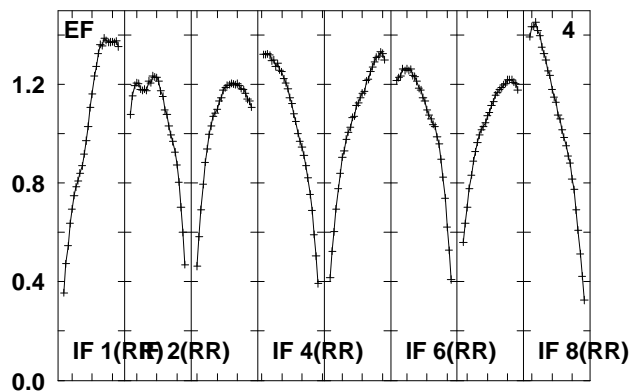
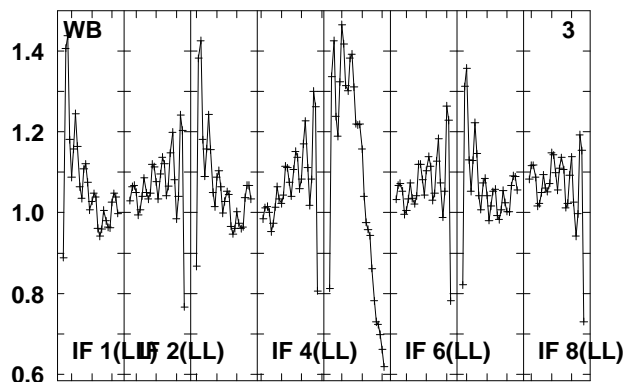
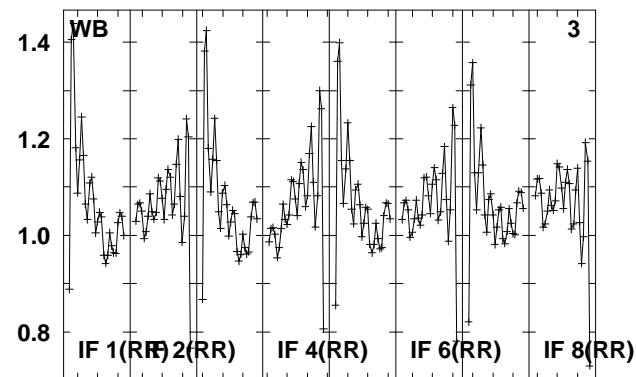
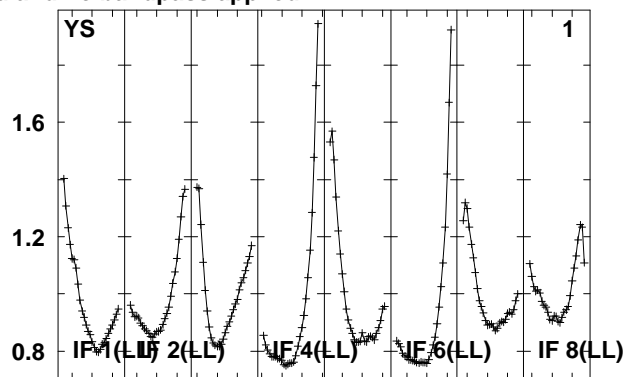
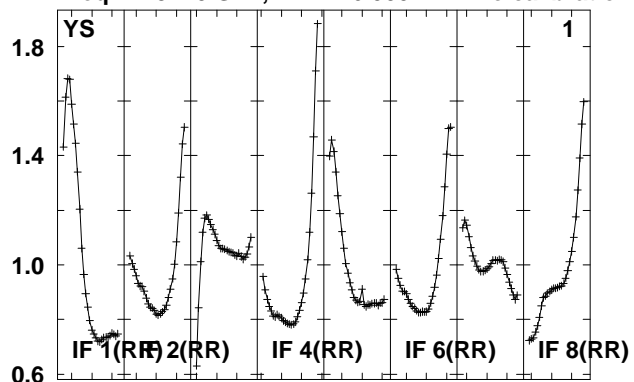

Lower frame: Real Jy
 Total-power spectrum Antenna: *
 Timerange: 00/02:00:01 to 00/02:01:29

Plot file version 2 created 14-MAY-2010 15:16:52

J1344+66 EO007.UVDATA.1

Freq = 4.9270 GHz, Bw = 16.000 MH No calibration applied and no bandpass applied

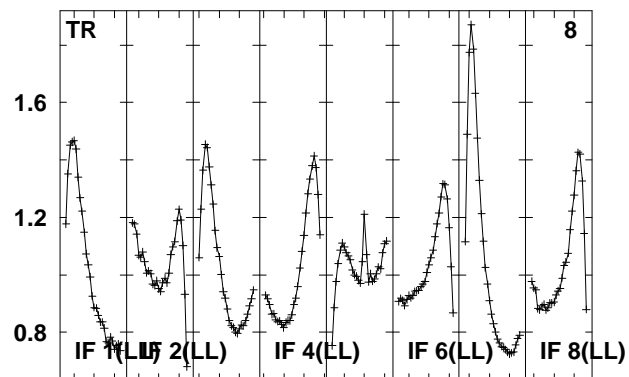
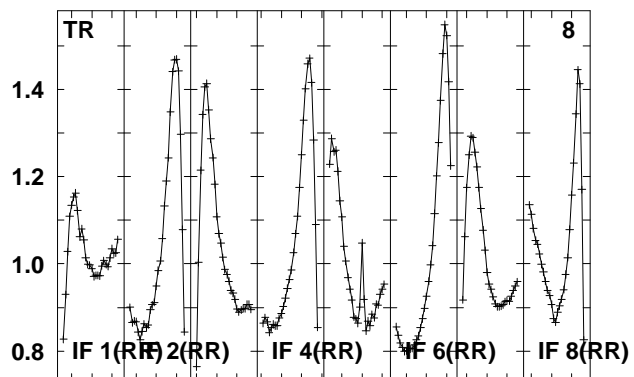
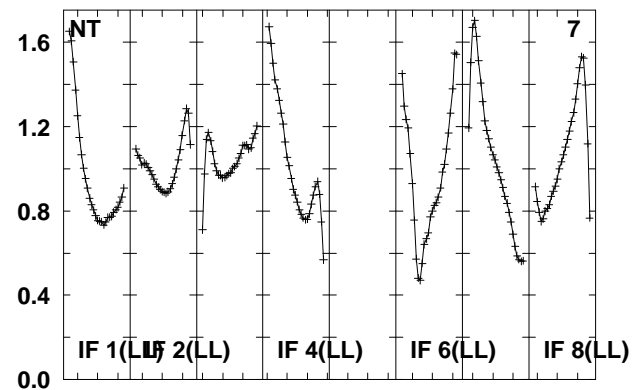
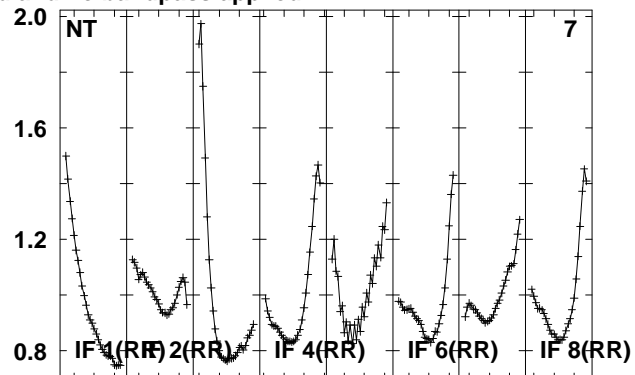
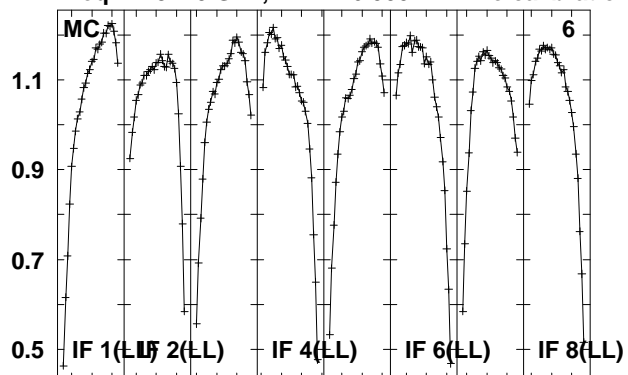

Lower frame: Real Jy
Total-power spectrum Antenna: *
Timerange: 00/02:00:01 to 00/02:01:29

Plot file version 3 created 14-MAY-2010 15:16:53
 J135355 EO007.UVDATA.1
 Freq = 4.9270 GHz, Bw = 16.000 MH No calibration applied and no bandpass applied

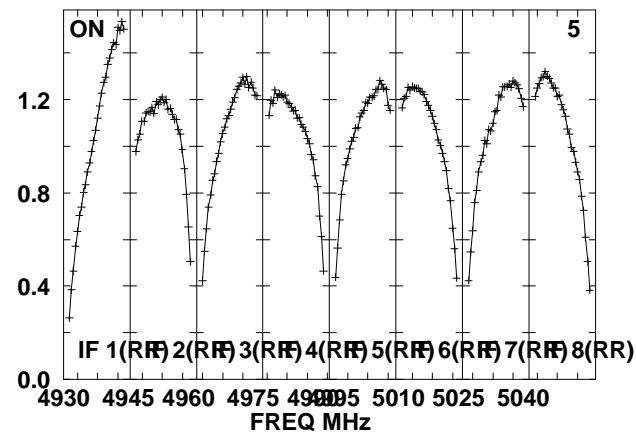
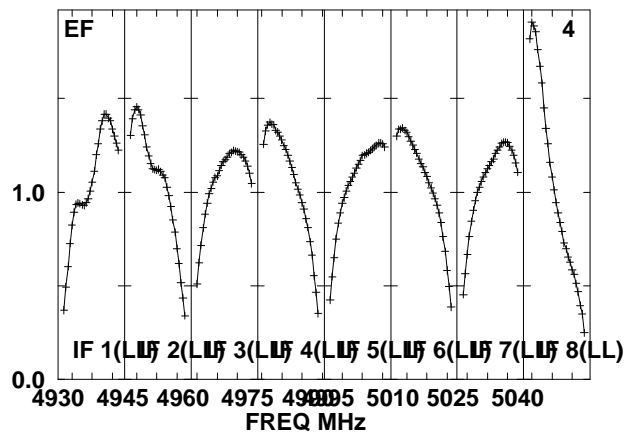
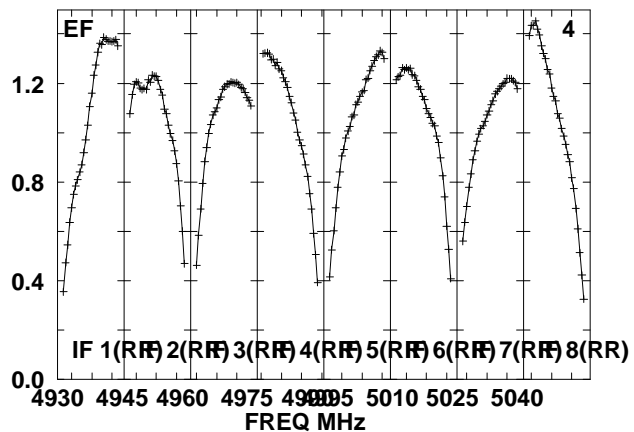
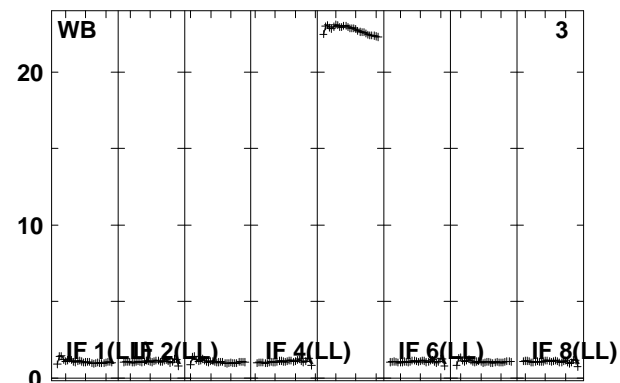
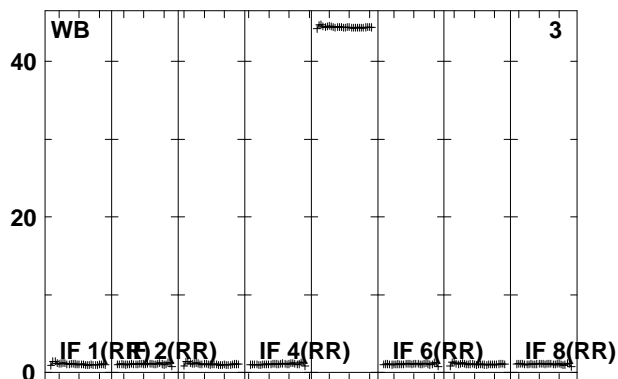
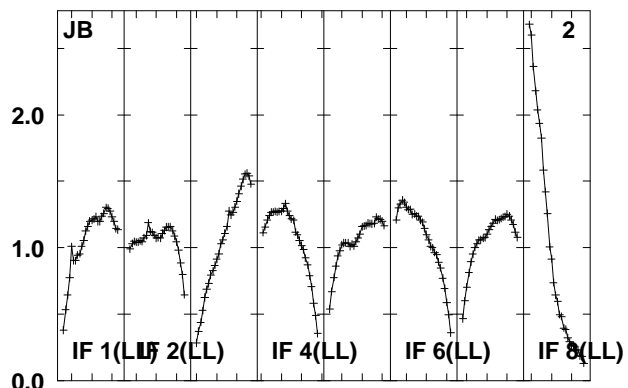
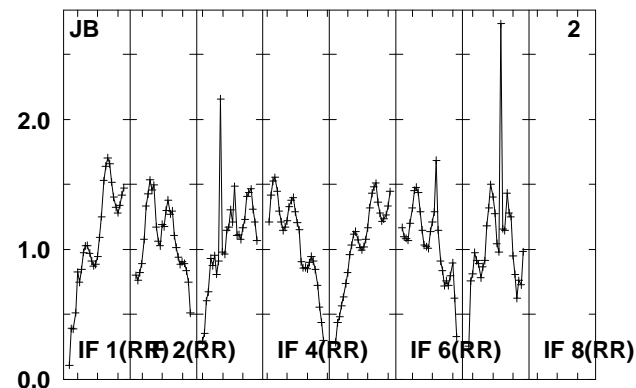
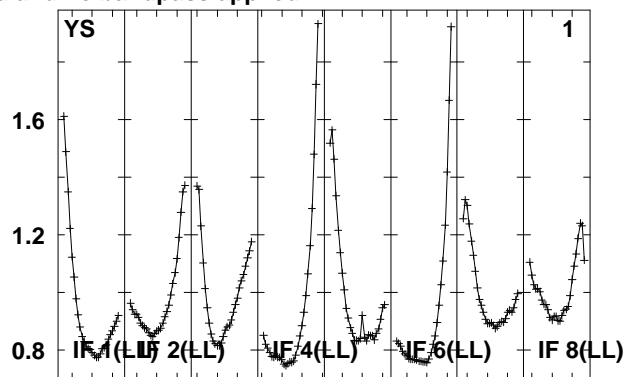
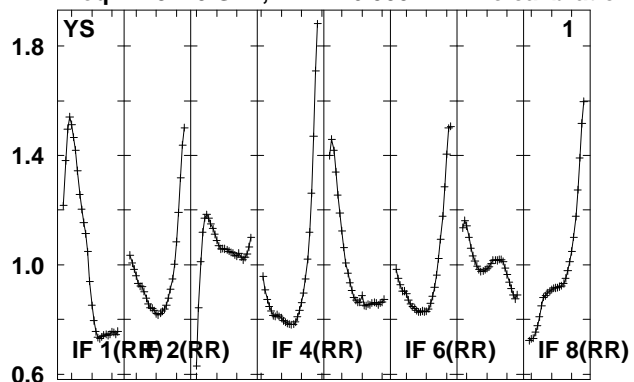

Lower frame: Real Jy
 Total-power spectrum Antenna: *
 Timerange: 00/02:02:07 to 00/02:07:05

Plot file version 4 created 14-MAY-2010 15:16:53

J135355 EO007.UVDATA.1

Freq = 4.9270 GHz, Bw = 16.000 MH No calibration applied and no bandpass applied

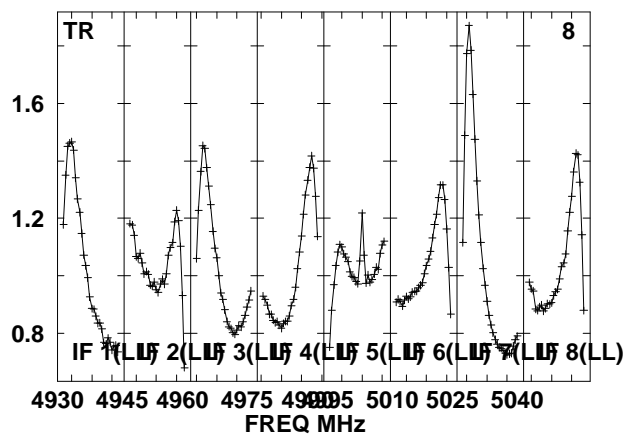
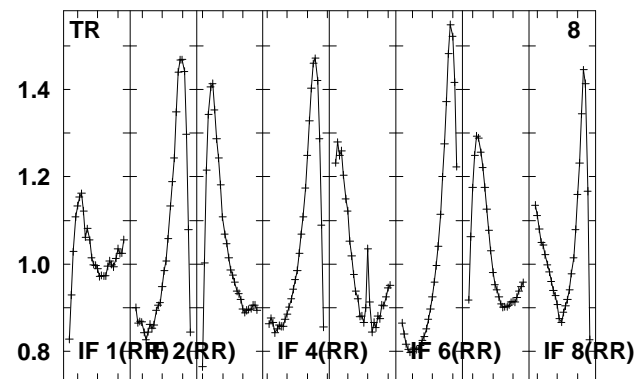
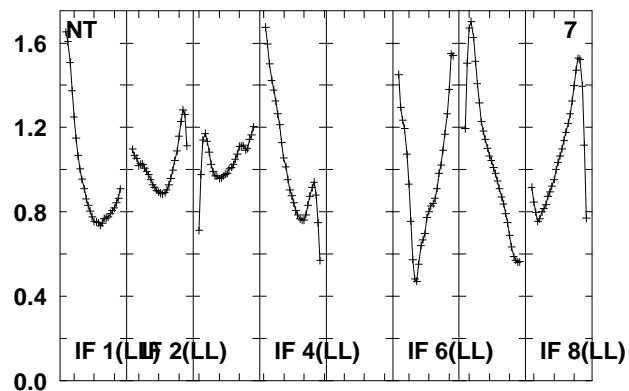
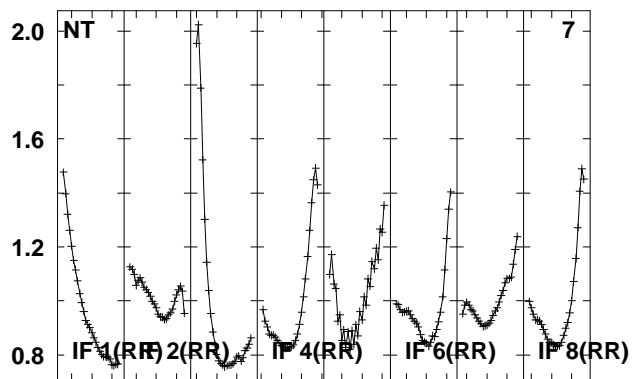
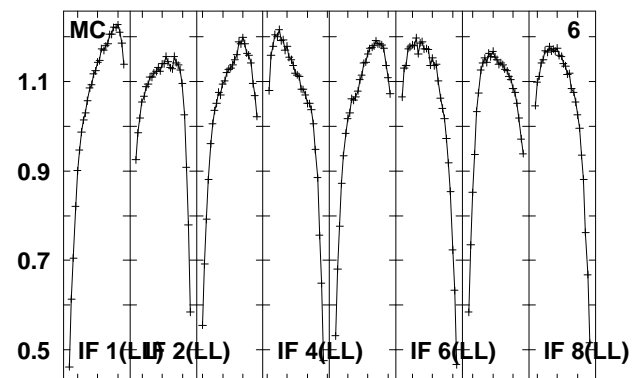
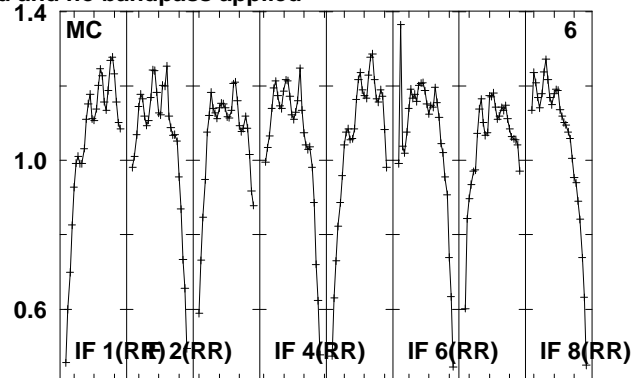
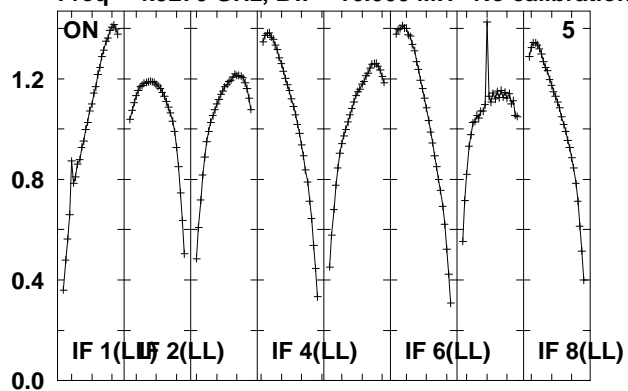

Lower frame: Real Jy

Total-power spectrum Antenna: *

Timerange: 00/02:02:07 to 00/02:07:05

Plot file version 5 created 14-MAY-2010 15:16:54

J1344+66 EO007.UVDATA.1

Freq = 4.9270 GHz, Bw = 16.000 MH No calibration applied and no bandpass applied

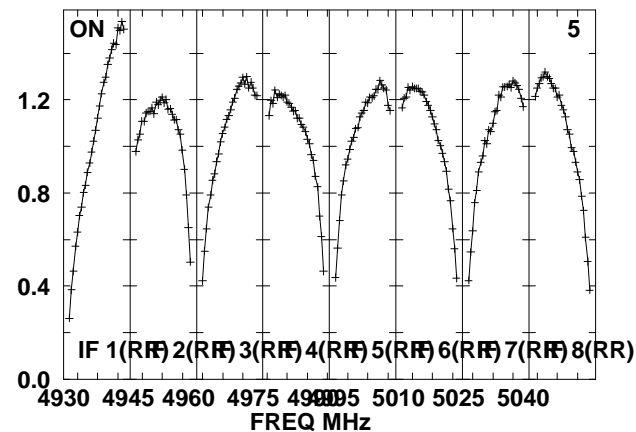
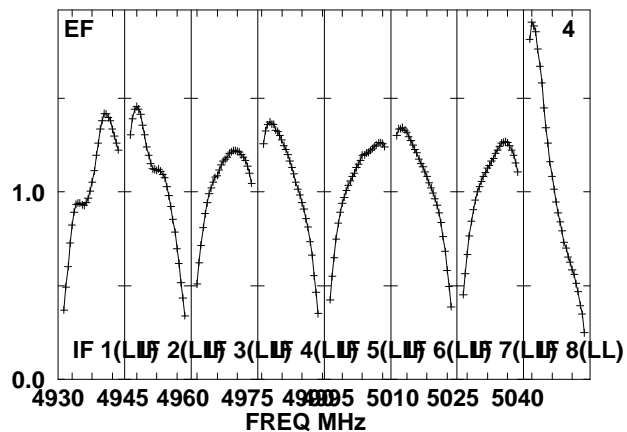
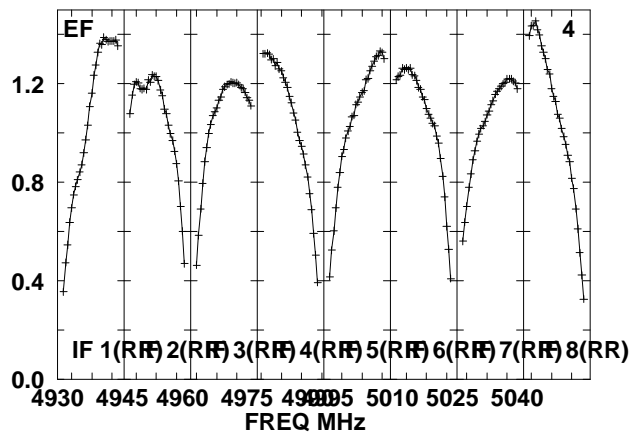
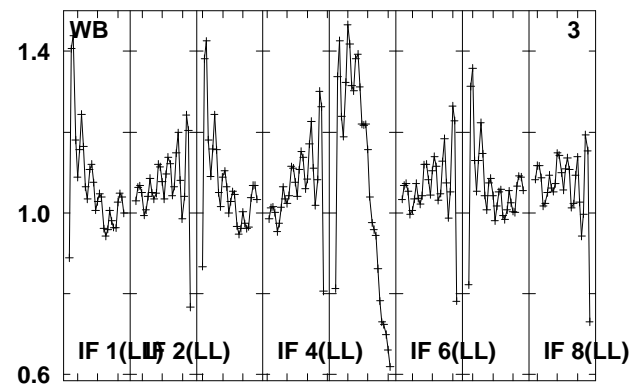
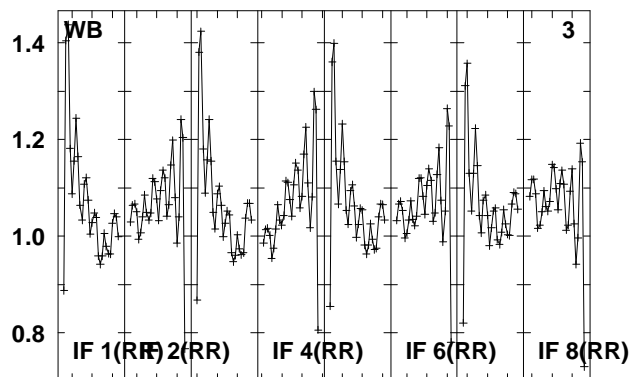
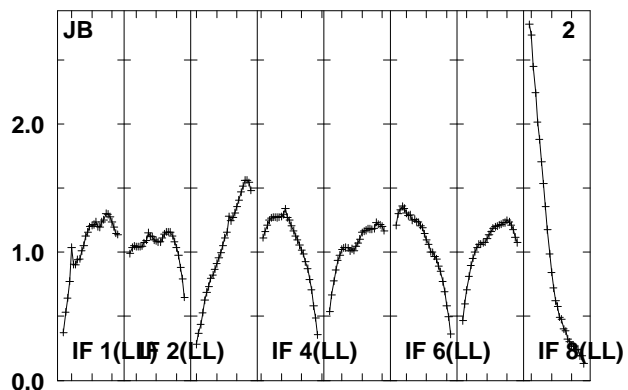
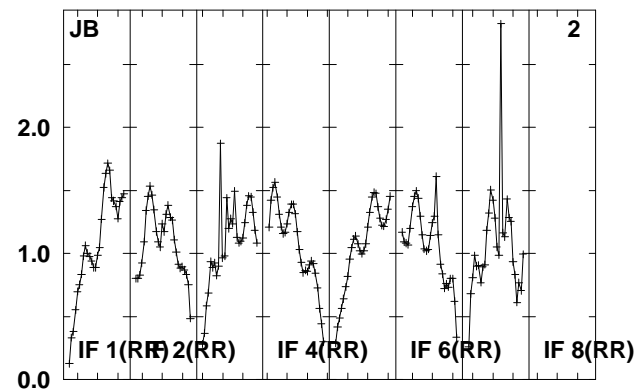
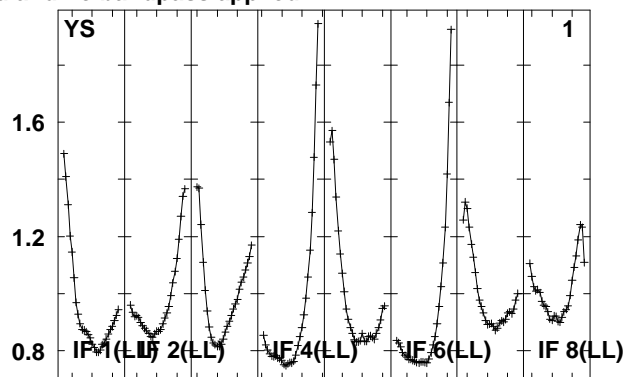
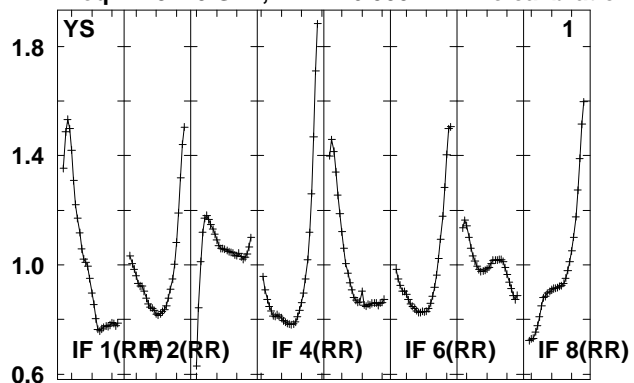

Lower frame: Real Jy
Total-power spectrum Antenna: *
Timerange: 00/02:07:47 to 00/02:09:13

Plot file version 6 created 14-MAY-2010 15:16:54

J1344+66 EO007.UVDATA.1

Freq = 4.9270 GHz, Bw = 16.000 MH No calibration applied and no bandpass applied

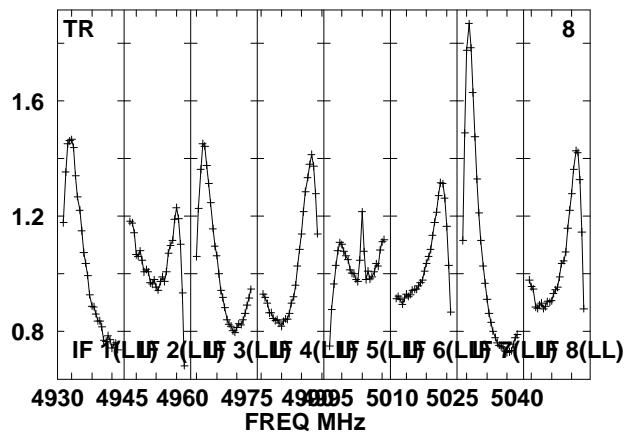
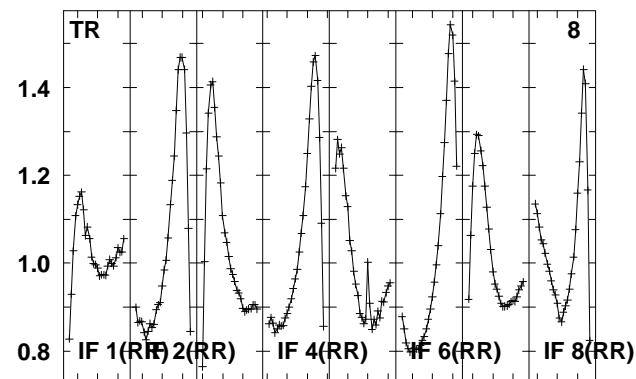
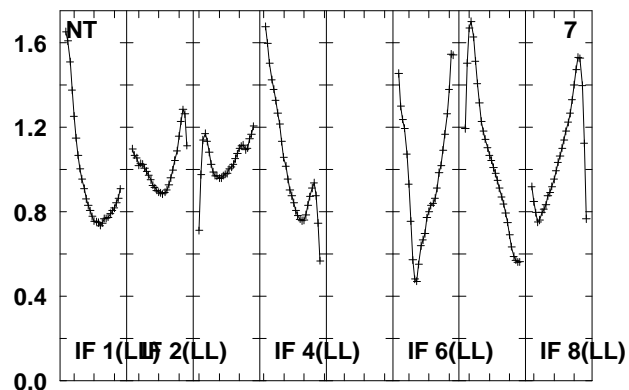
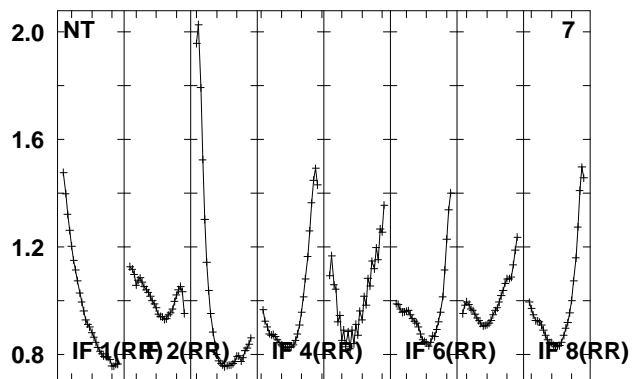
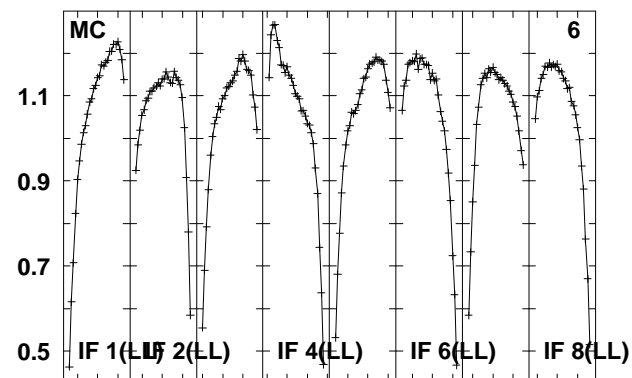
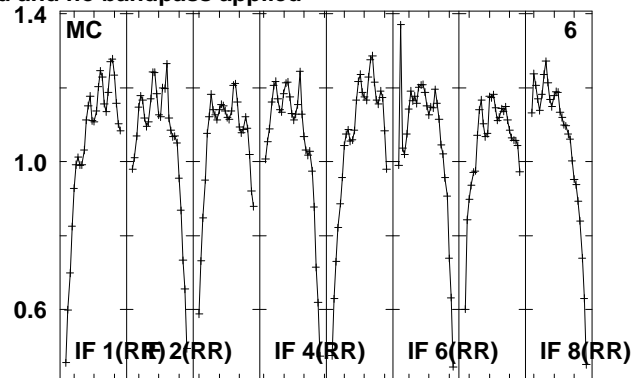
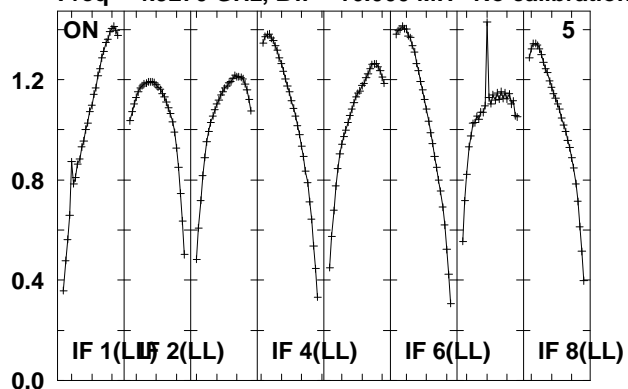

Lower frame: Real Jy

Total-power spectrum Antenna: *

Timerange: 00/02:07:47 to 00/02:09:13

Plot file version 7 created 14-MAY-2010 15:16:54
 J135355 EO007.UVDATA.1
 Freq = 4.9270 GHz, Bw = 16.000 MH No calibration applied and no bandpass applied

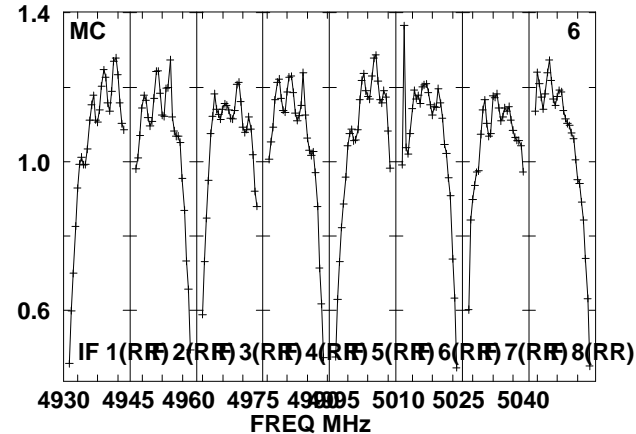
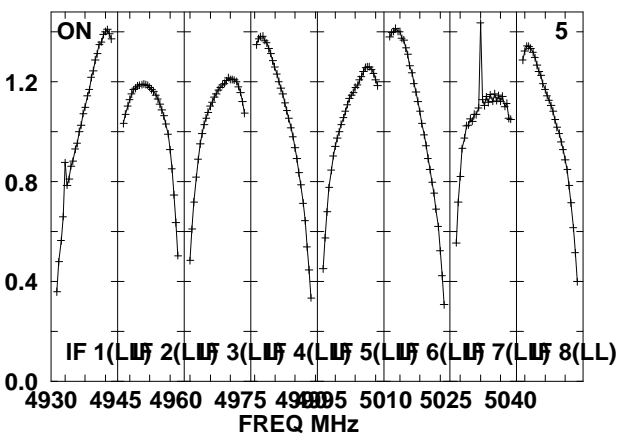
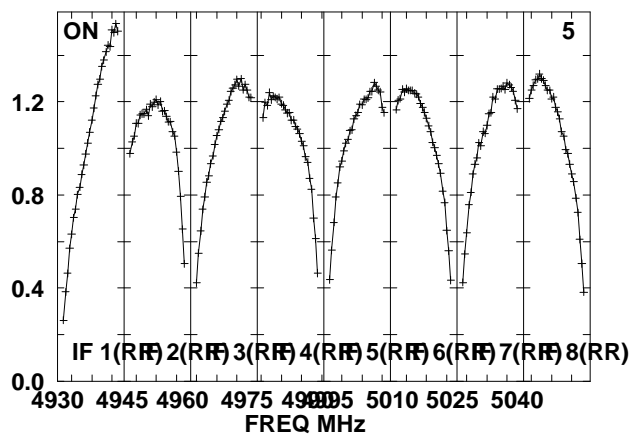
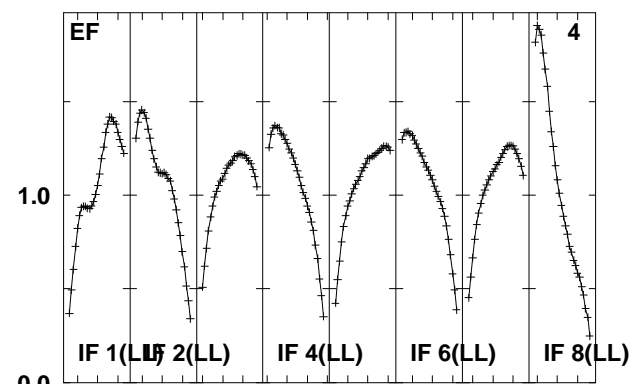
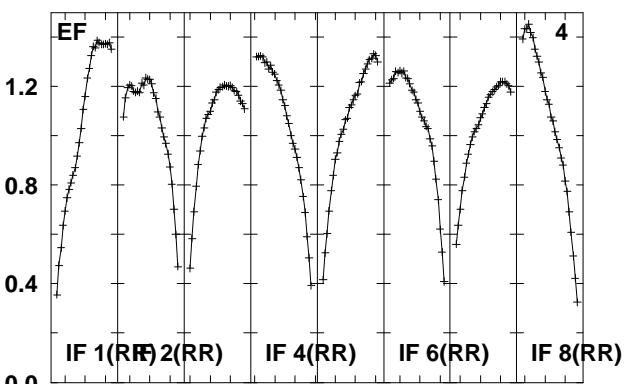
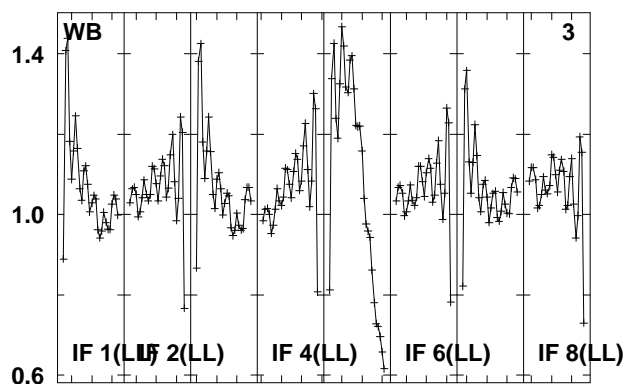
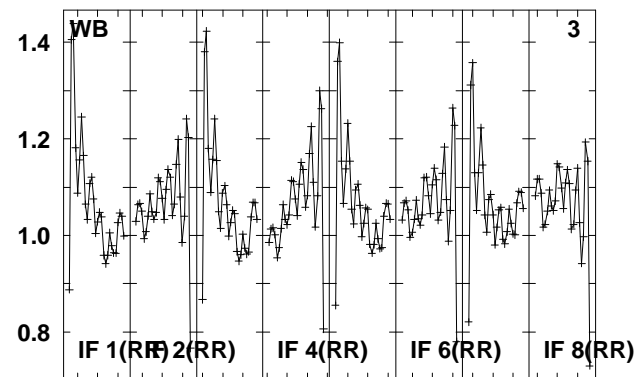
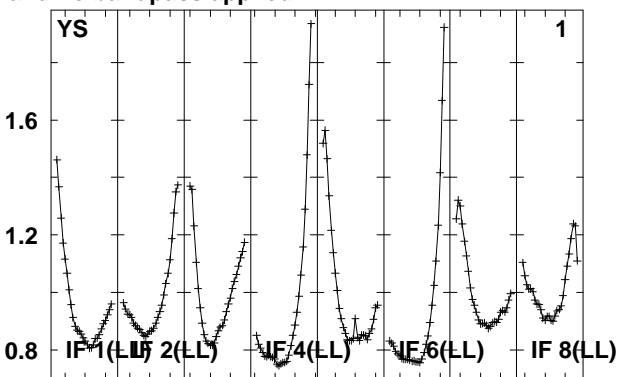
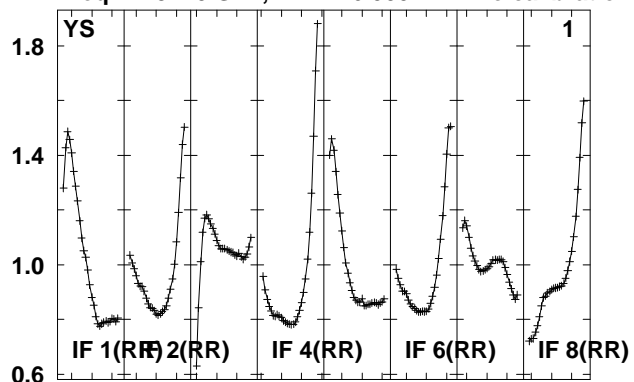

Lower frame: Real Jy
 Total-power spectrum Antenna: *
 Timerange: 00/02:09:53 to 00/02:14:51

Plot file version 8 created 14-MAY-2010 15:16:55

J135355 EO007.UVDATA.1

Freq = 4.9270 GHz, Bw = 16.000 MH No calibration applied and no bandpass applied

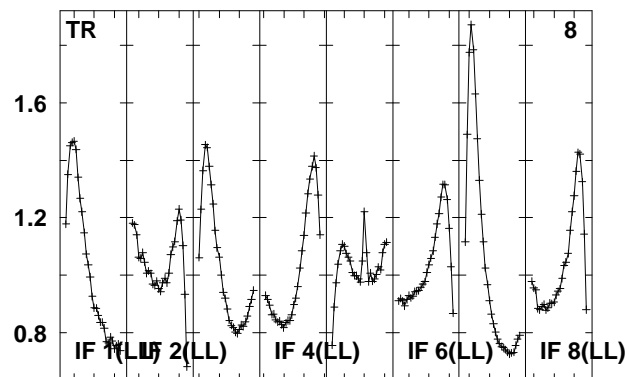
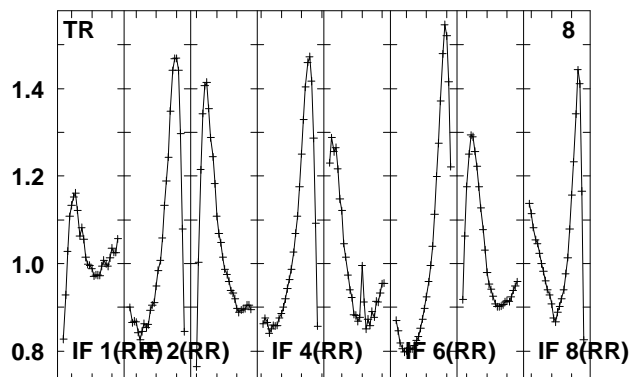
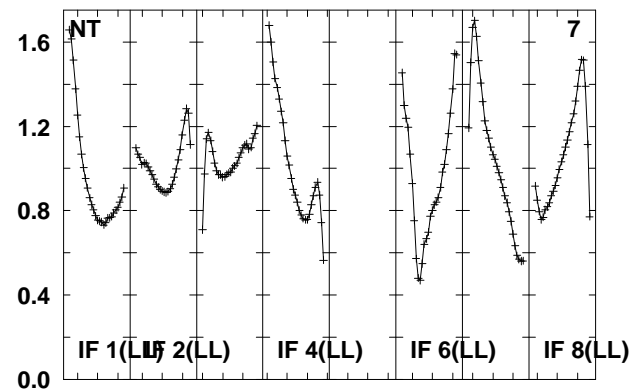
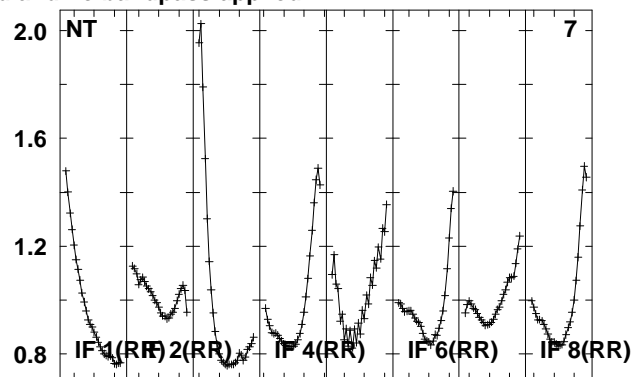
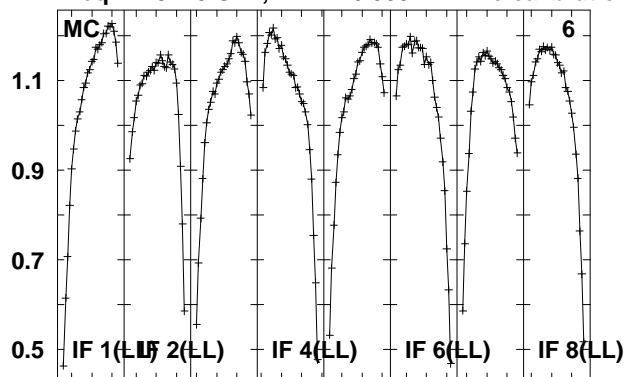

Lower frame: Real Jy
Total-power spectrum Antenna: *
Timerange: 00/02:09:53 to 00/02:14:51

Plot file version 9 created 14-MAY-2010 15:16:55
 J1344+66 EO007.UVDATA.1
 Freq = 4.9270 GHz, Bw = 16.000 MH No calibration applied and no bandpass applied

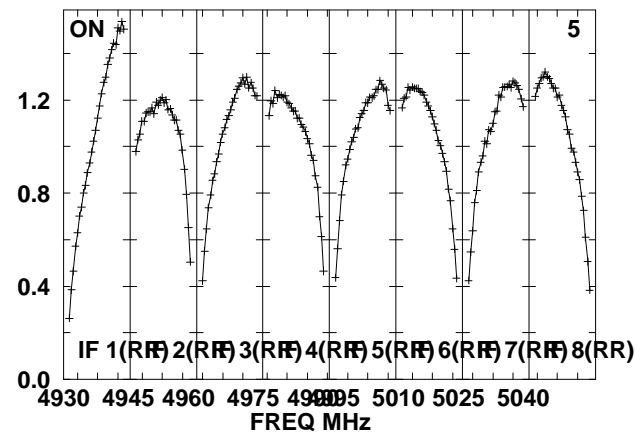
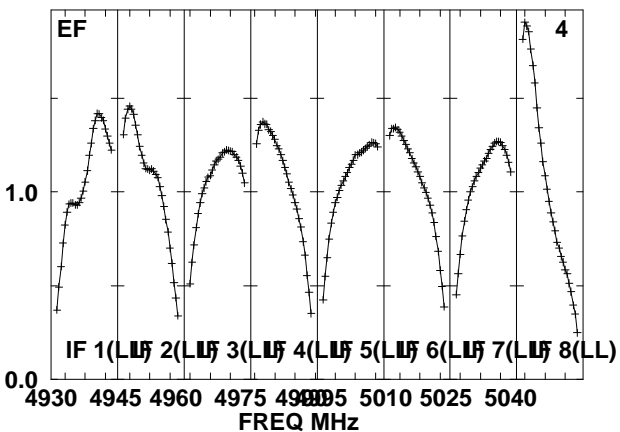
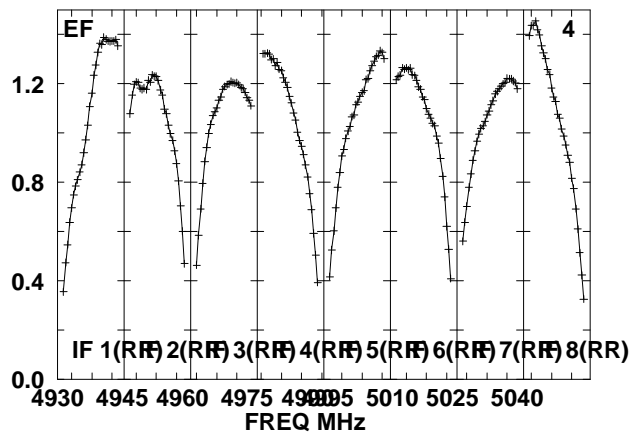
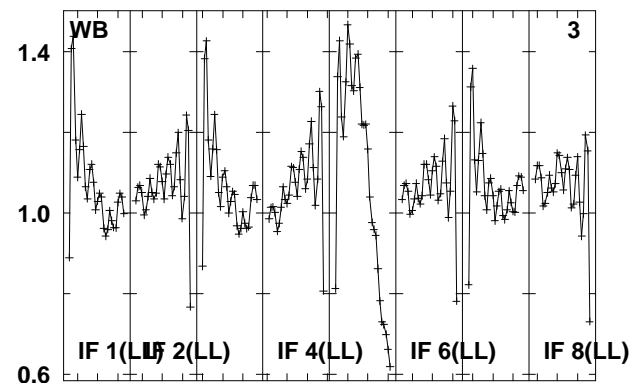
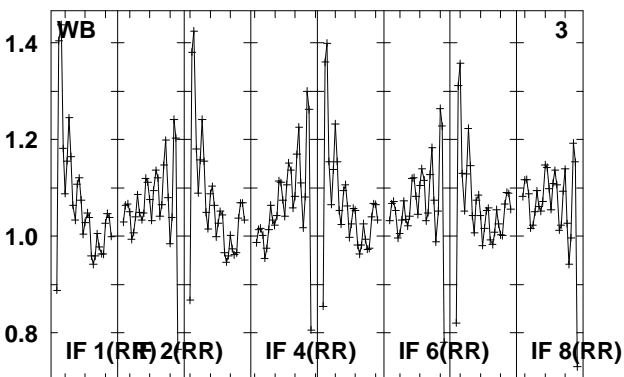
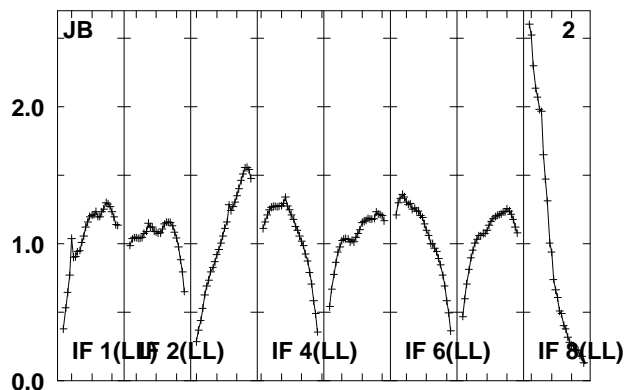
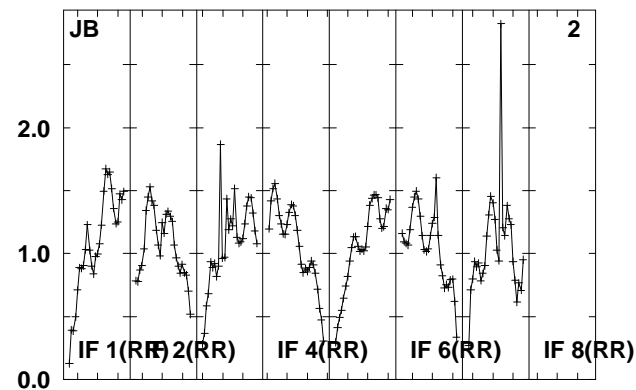
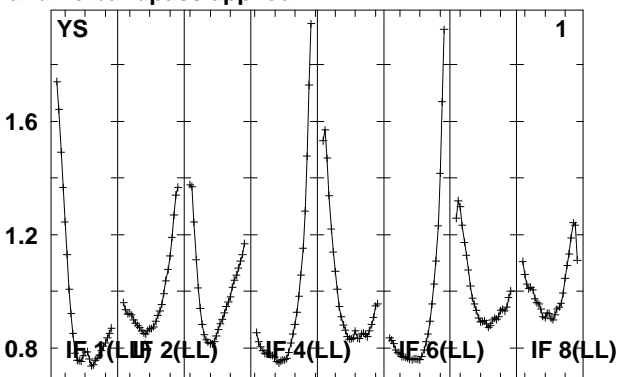
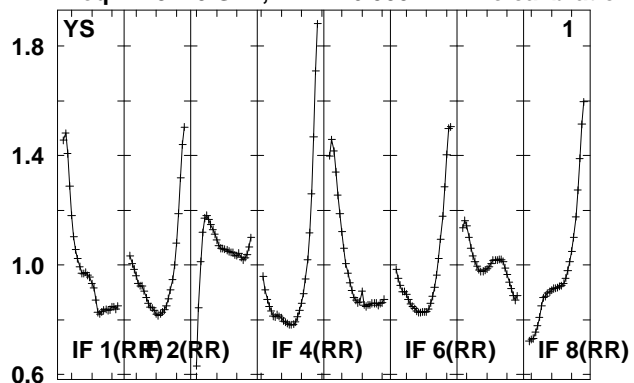

Lower frame: Real Jy
 Total-power spectrum Antenna: *
 Timerange: 00/02:15:31 to 00/02:16:59

Plot file version 10 created 14-MAY-2010 15:16:55

J1344+66 EO007.UVDATA.1

Freq = 4.9270 GHz, Bw = 16.000 MH No calibration applied and no bandpass applied

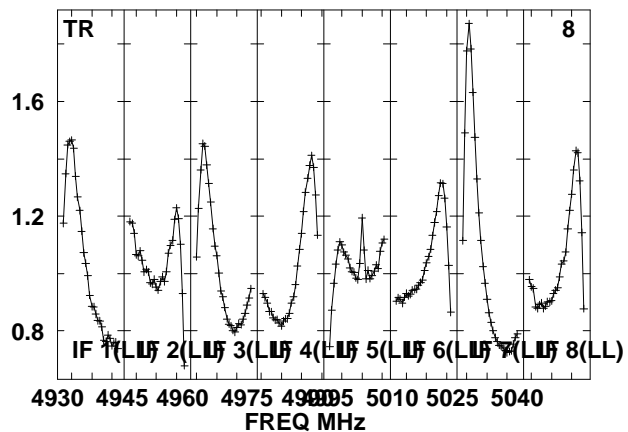
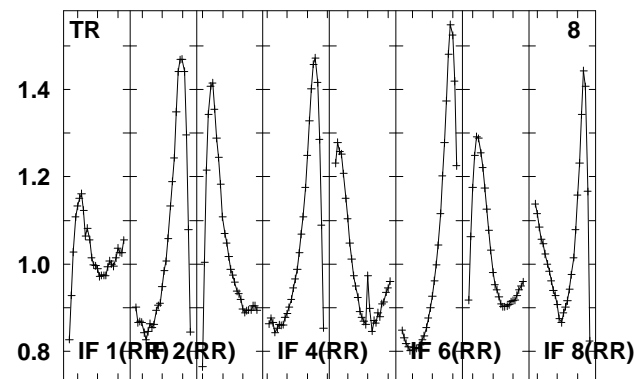
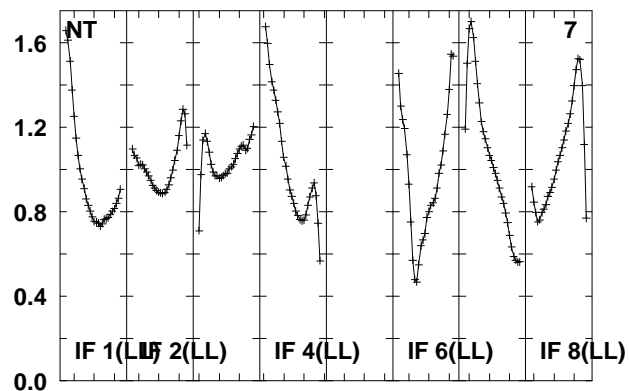
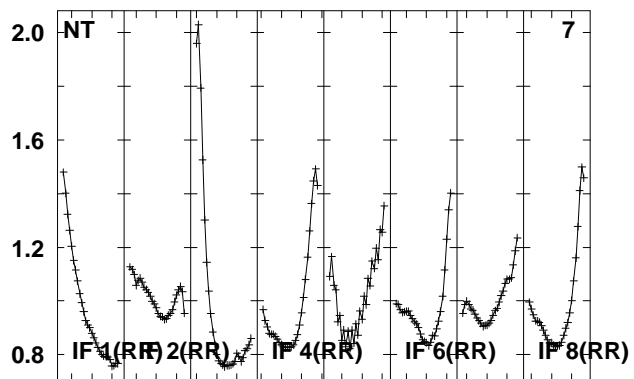
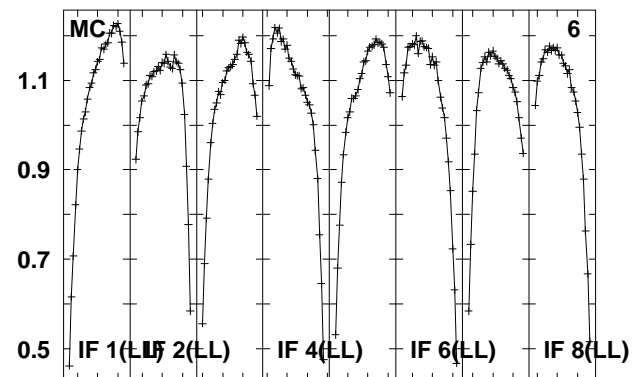
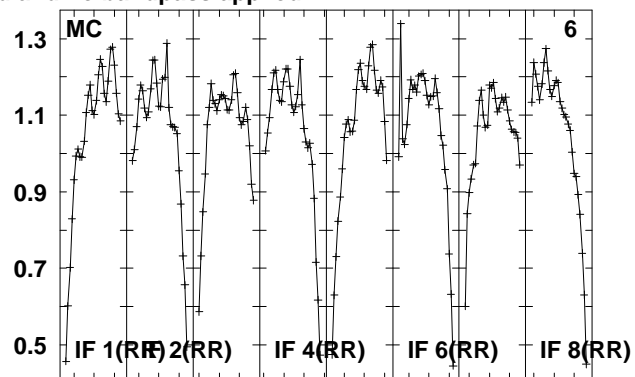
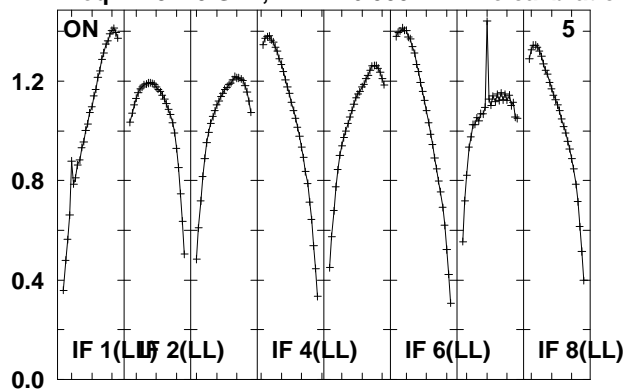

Lower frame: Real Jy

Total-power spectrum Antenna: *

Timerange: 00/02:15:31 to 00/02:16:59

Plot file version 11 created 14-MAY-2010 15:16:56
 J135355 EO007.UVDATA.1
 Freq = 4.9270 GHz, Bw = 16.000 MH No calibration applied and no bandpass applied

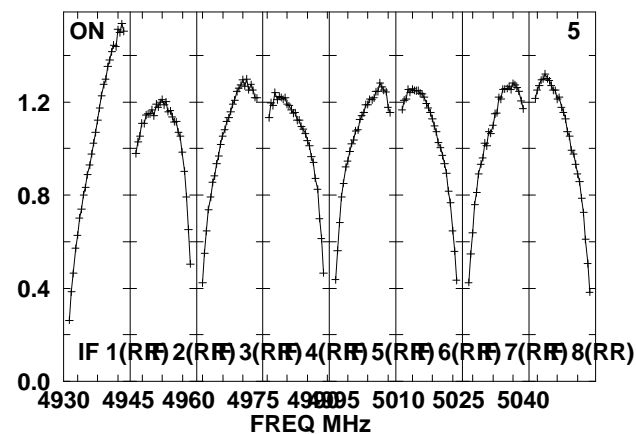
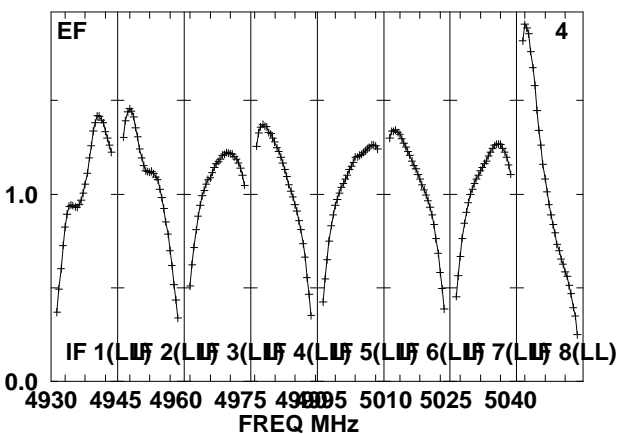
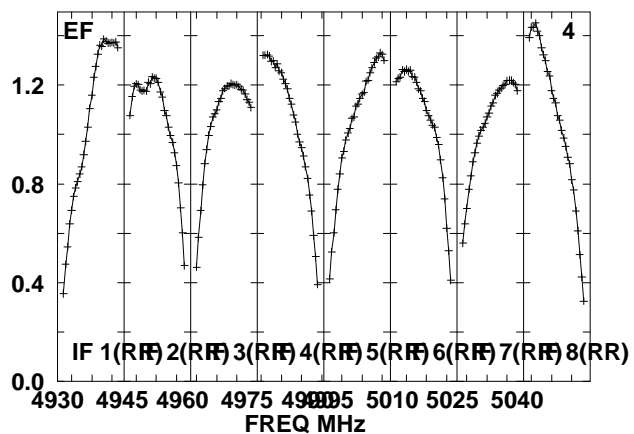
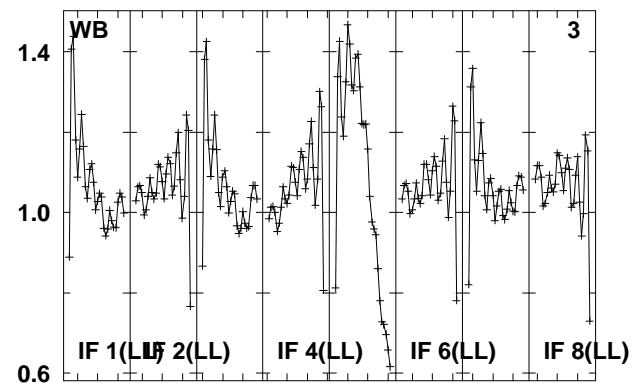
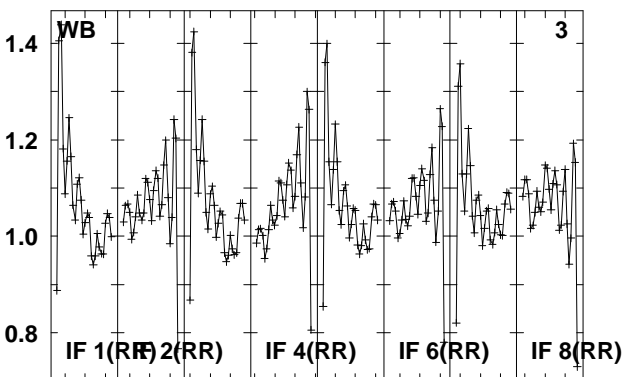
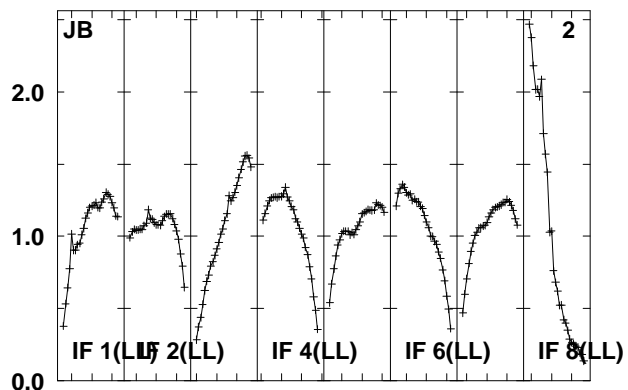
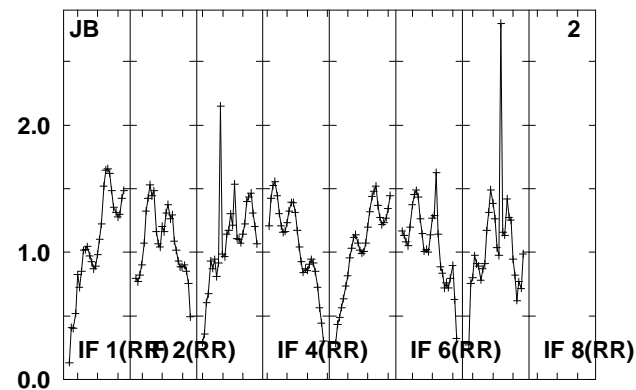
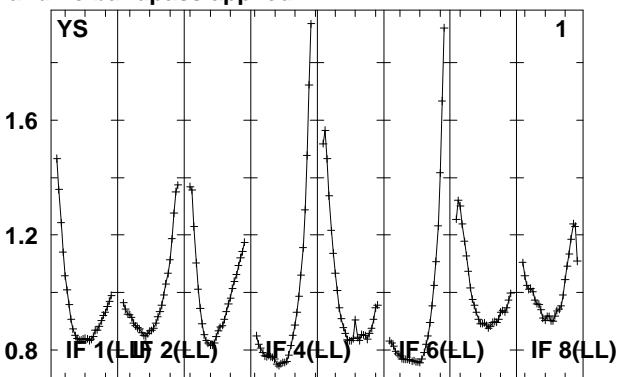
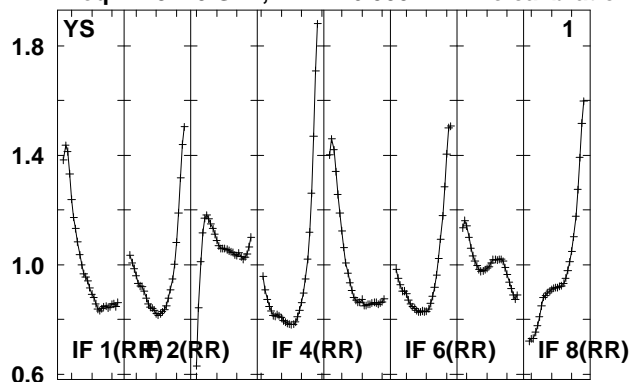

Lower frame: Real Jy
 Total-power spectrum Antenna: *
 Timerange: 00/02:17:39 to 00/02:22:35

Plot file version 12 created 14-MAY-2010 15:16:56

J135355 EO007.UVDATA.1

Freq = 4.9270 GHz, Bw = 16.000 MH No calibration applied and no bandpass applied

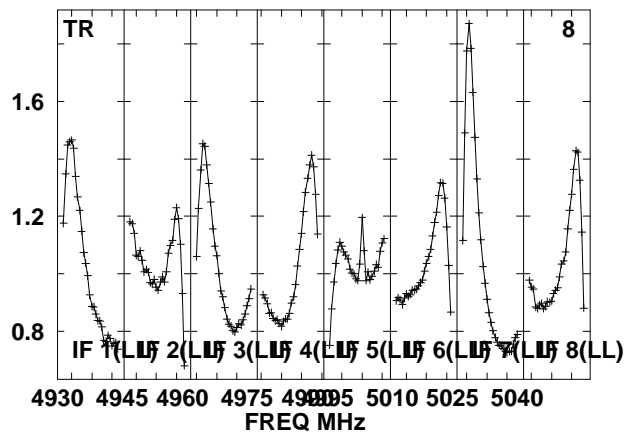
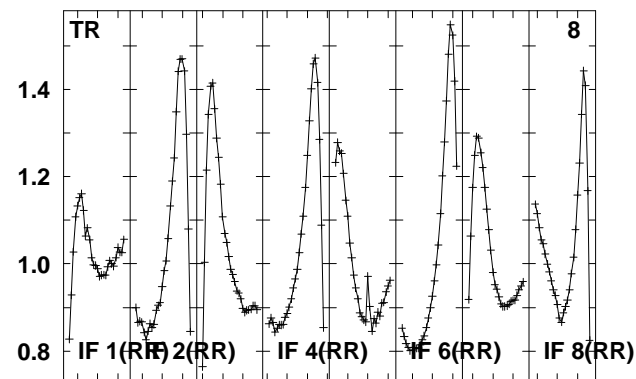
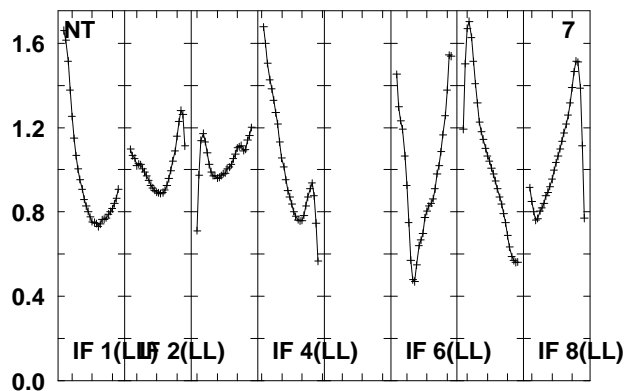
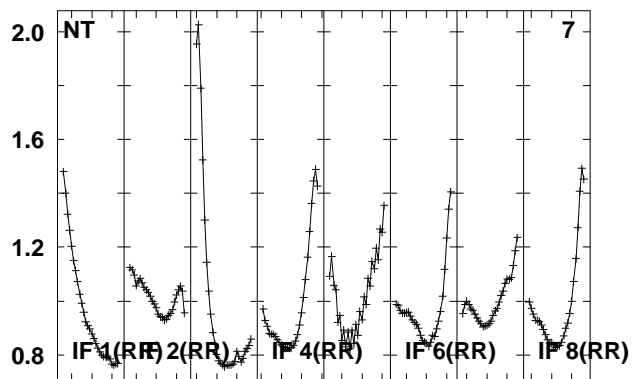
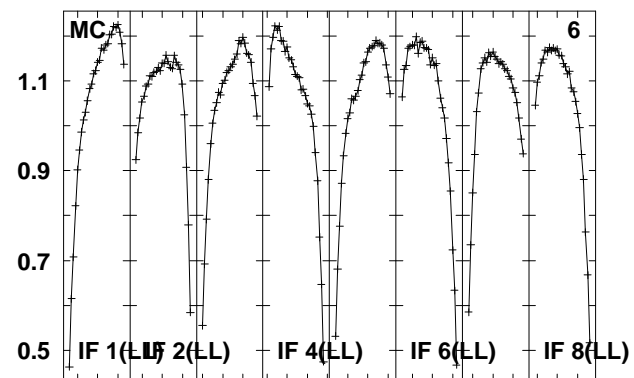
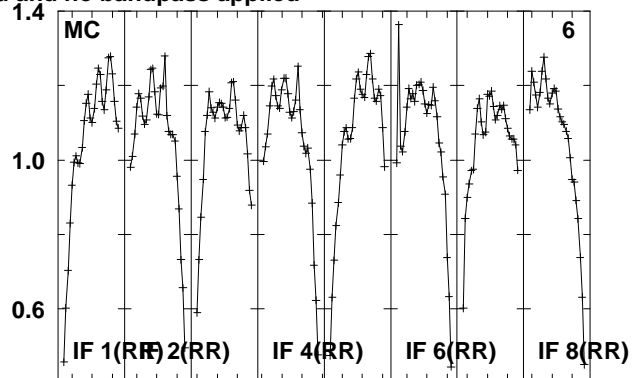
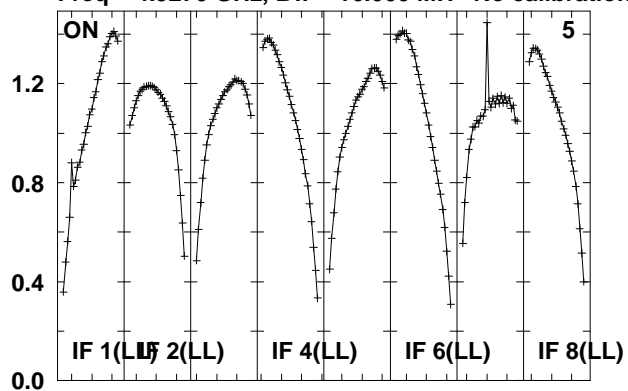

Lower frame: Real Jy

Total-power spectrum Antenna: *

Timerange: 00/02:17:39 to 00/02:22:35

Plot file version 13 created 14-MAY-2010 15:16:57

J1344+66 EO007.UVDATA.1

Freq = 4.9270 GHz, Bw = 16.000 MH No calibration applied and no bandpass applied

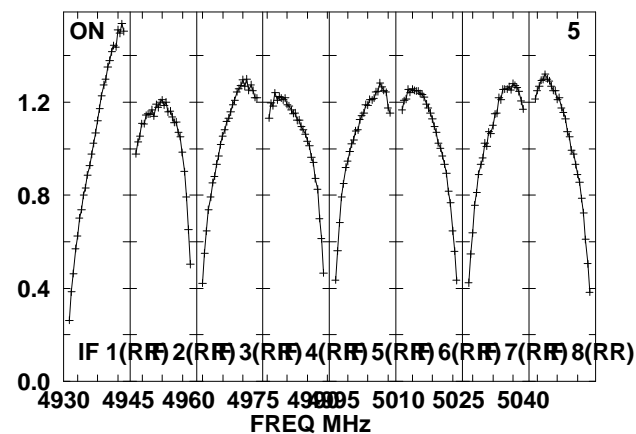
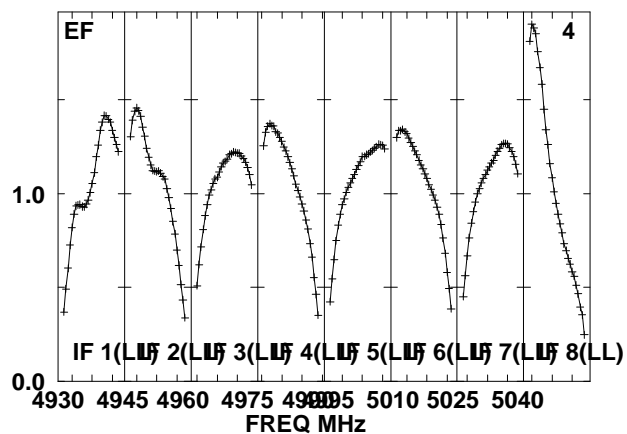
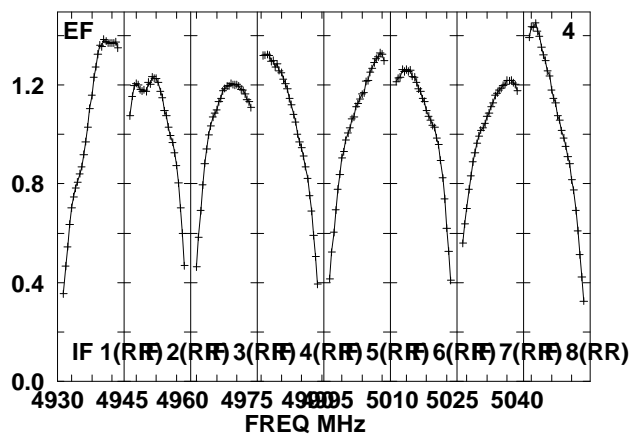
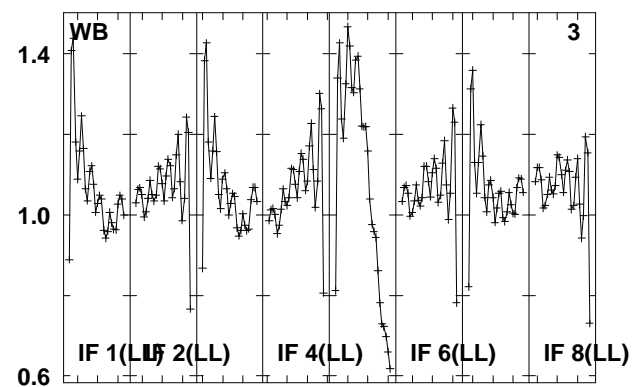
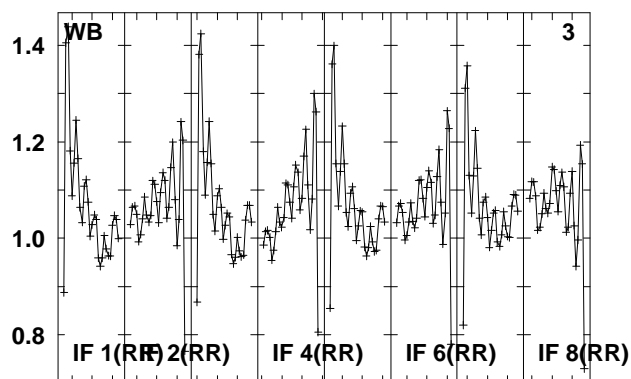
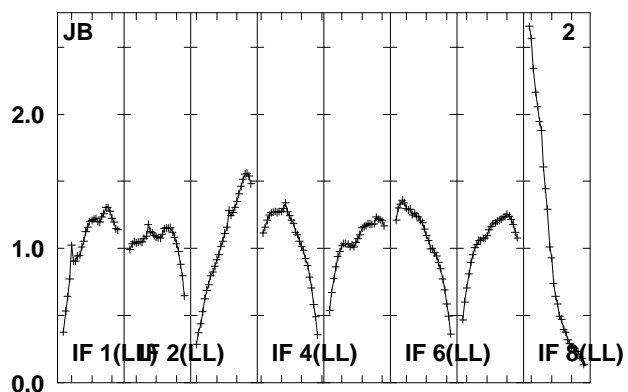
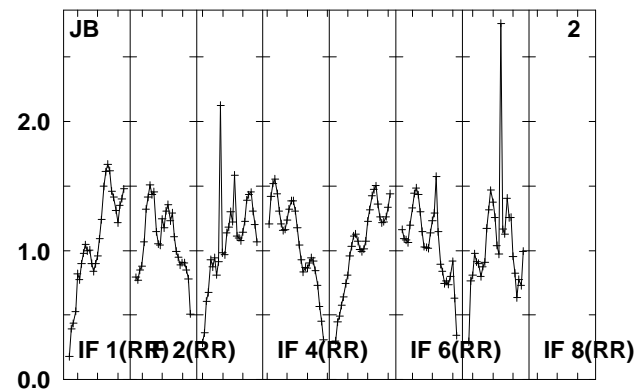
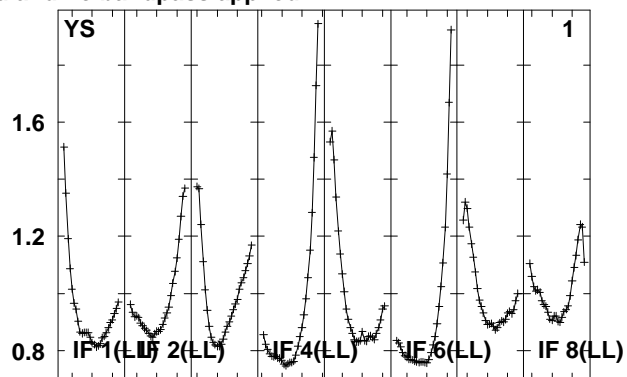
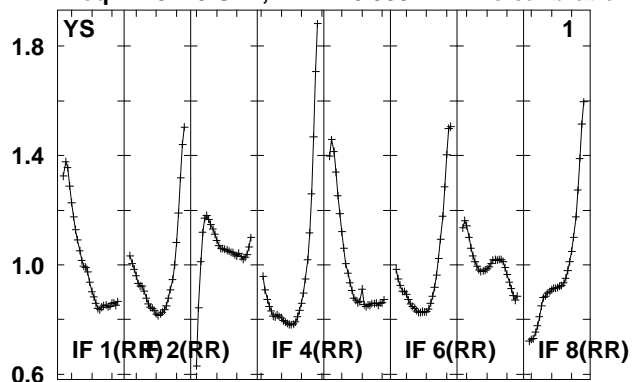

Lower frame: Real Jy
Total-power spectrum Antenna: *
Timerange: 00/02:23:17 to 00/02:24:45

Plot file version 14 created 14-MAY-2010 15:16:57

J1344+66 EO007.UVDATA.1

Freq = 4.9270 GHz, Bw = 16.000 MH No calibration applied and no bandpass applied

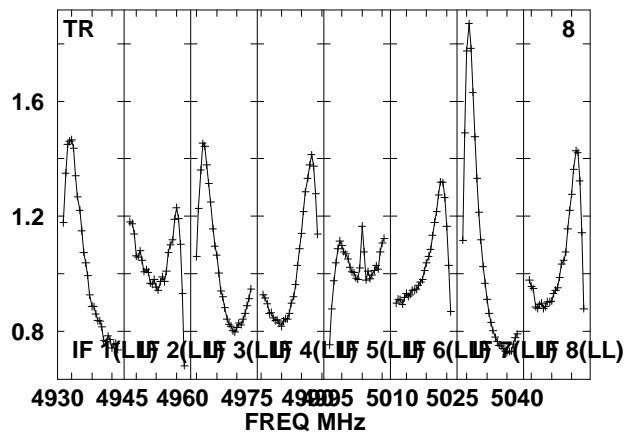
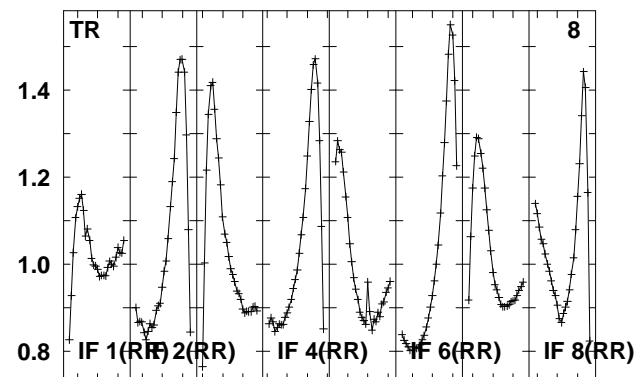
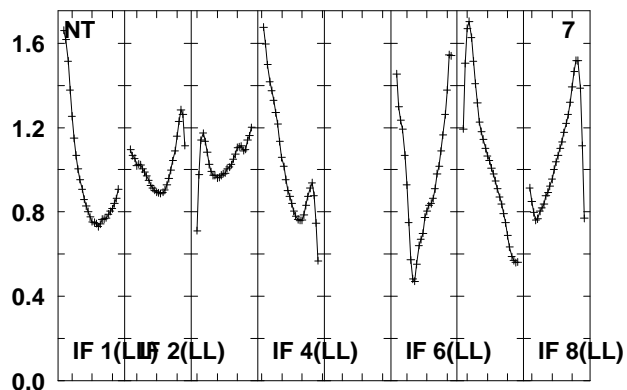
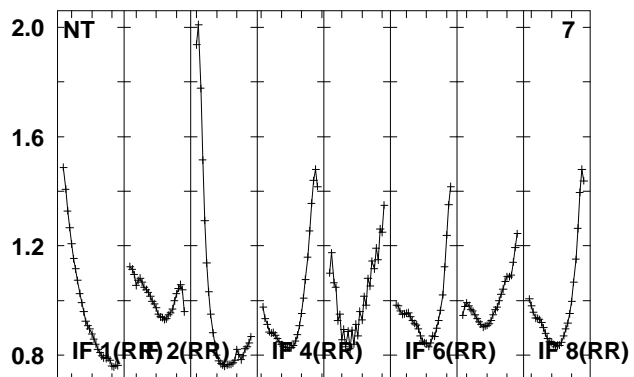
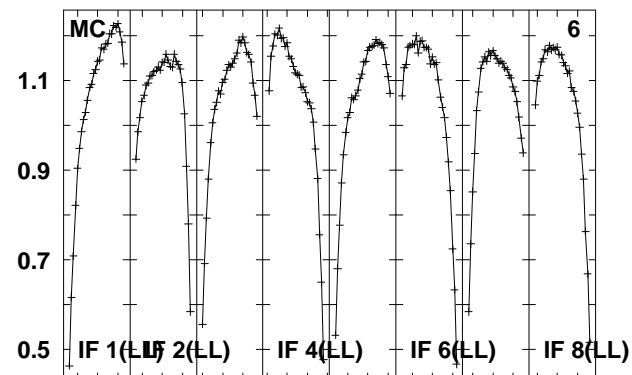
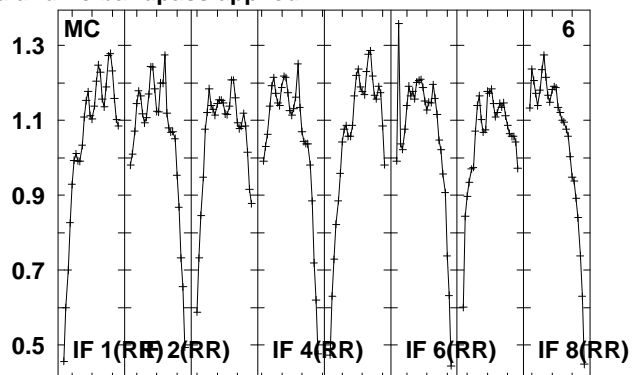
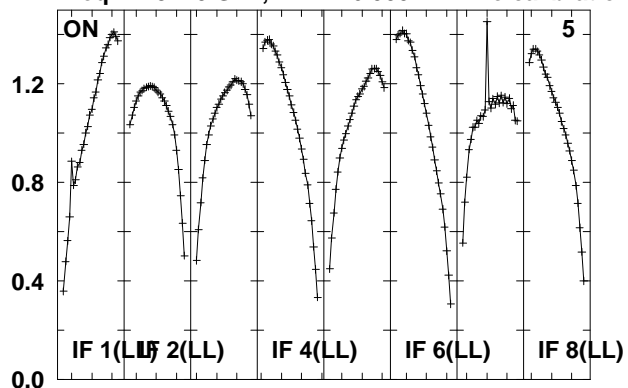

Lower frame: Real Jy

Total-power spectrum Antenna: *

Timerange: 00/02:23:17 to 00/02:24:45

Plot file version 15 created 14-MAY-2010 15:16:57
 J135355 EO007.UVDATA.1
 Freq = 4.9270 GHz, Bw = 16.000 MH No calibration applied and no bandpass applied

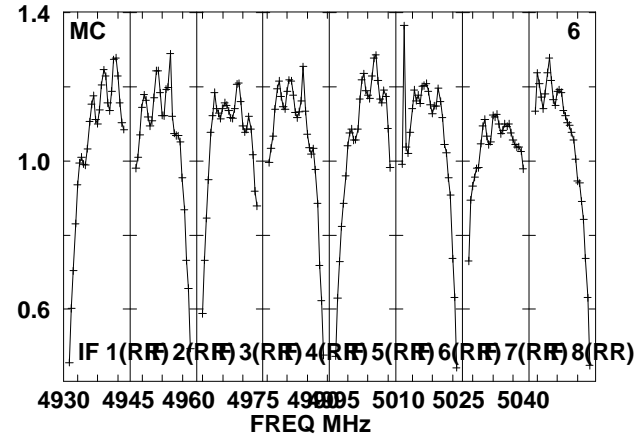
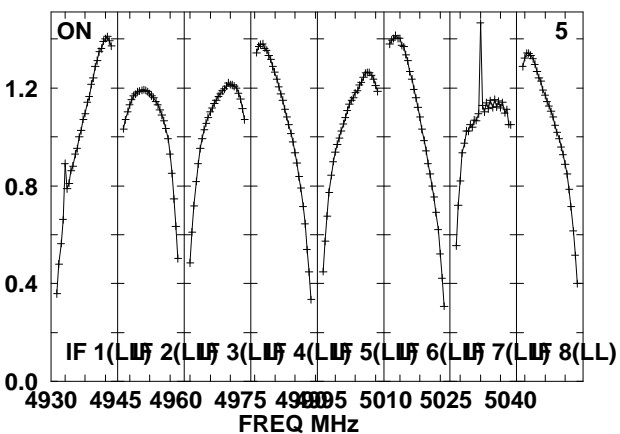
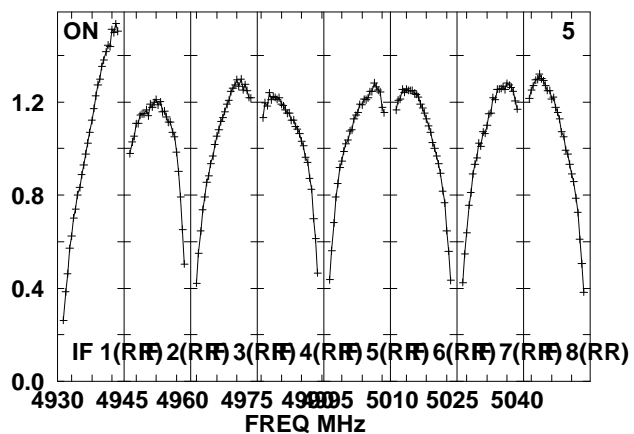
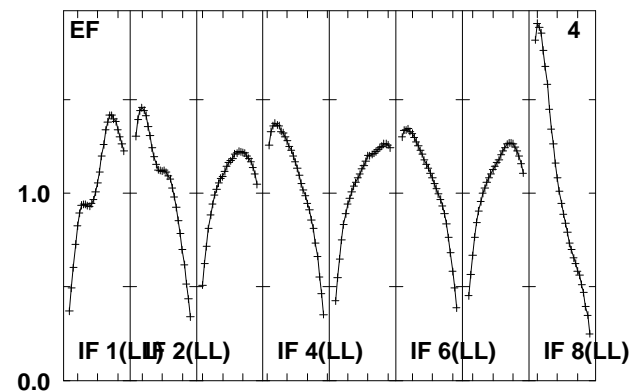
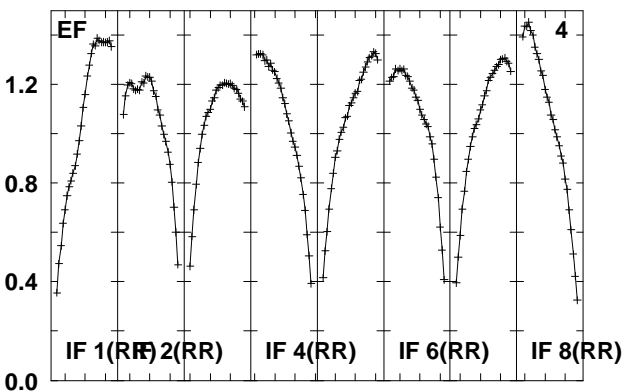
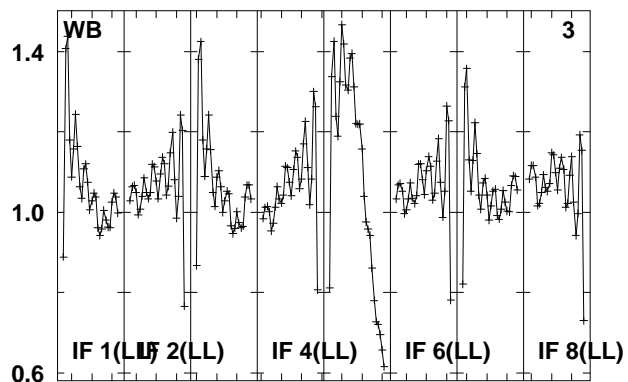
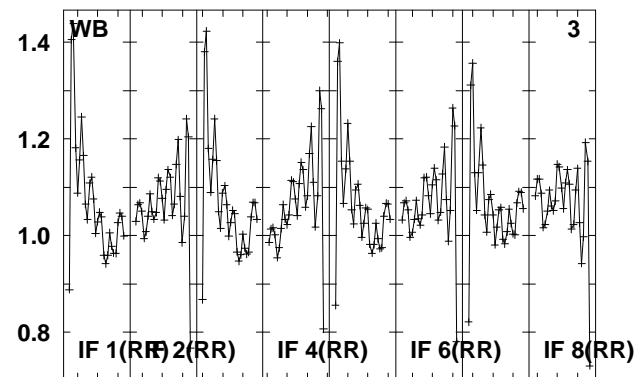
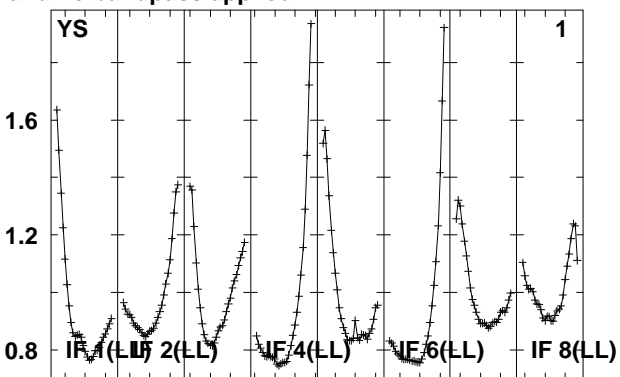
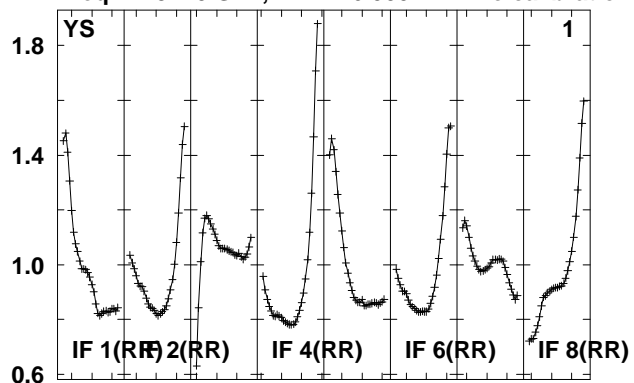

Lower frame: Real Jy
 Total-power spectrum Antenna: *
 Timerange: 00/02:25:24 to 00/02:30:20

Plot file version 16 created 14-MAY-2010 15:16:58

J135355 EO007.UVDATA.1

Freq = 4.9270 GHz, Bw = 16.000 MH No calibration applied and no bandpass applied

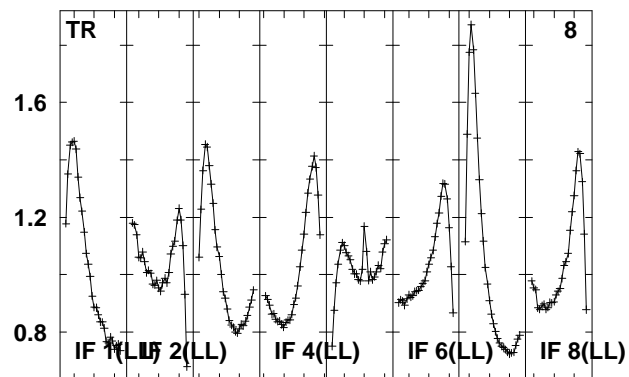
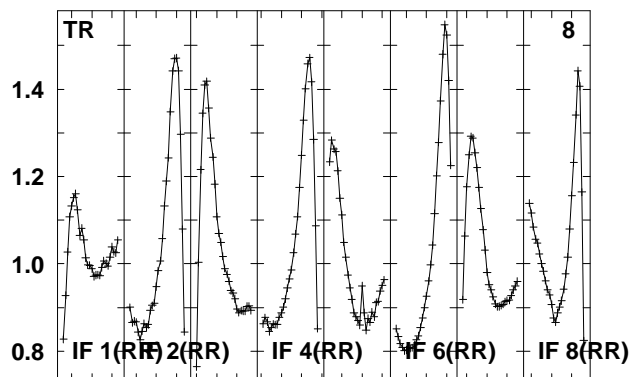
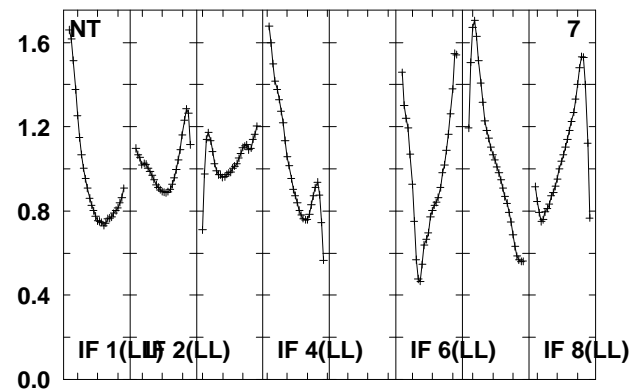
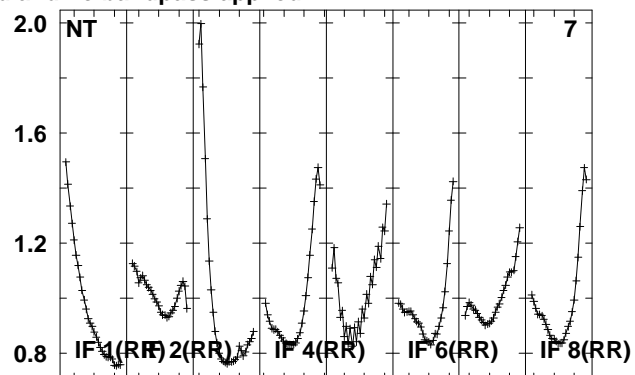
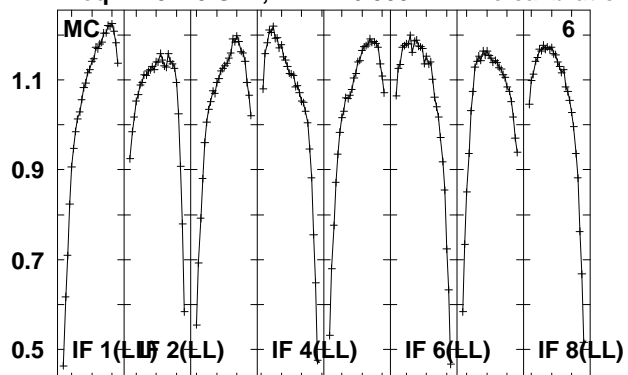

Lower frame: Real Jy
Total-power spectrum Antenna: *
Timerange: 00/02:25:24 to 00/02:30:20

Plot file version 17 created 14-MAY-2010 15:16:58
 J1344+66 EO007.UVDATA.1
 Freq = 4.9270 GHz, Bw = 16.000 MH No calibration applied and no bandpass applied

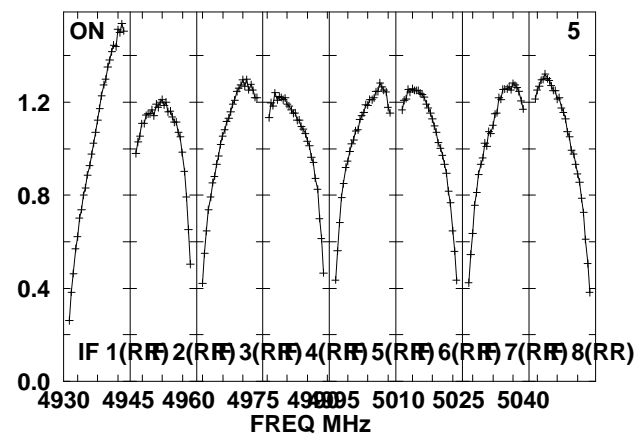
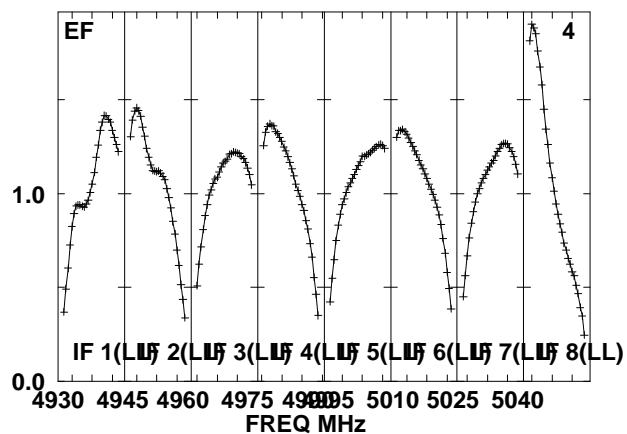
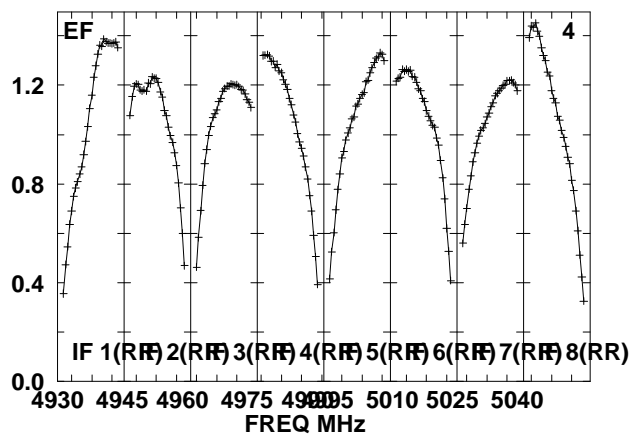
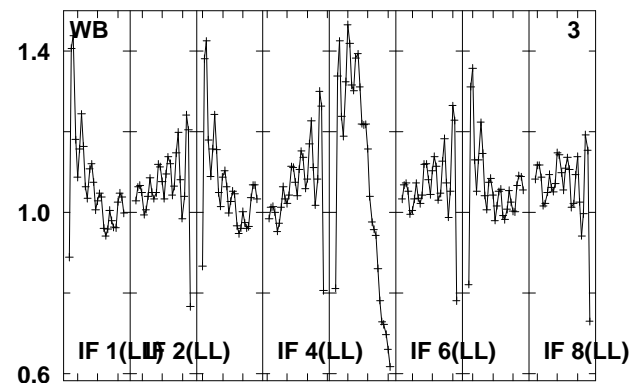
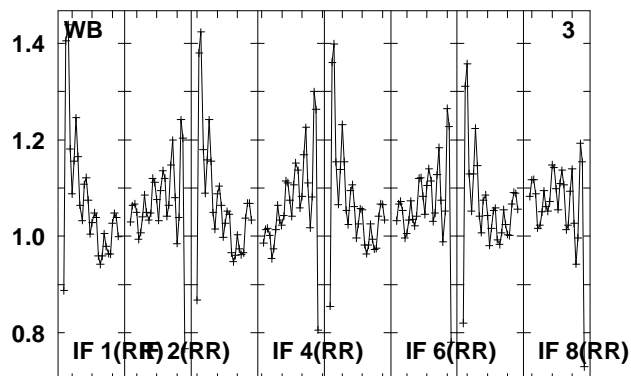
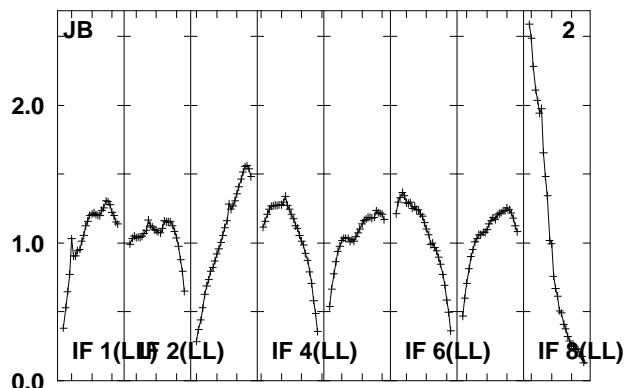
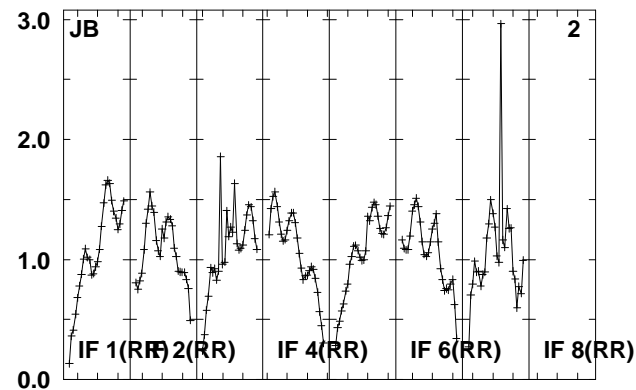
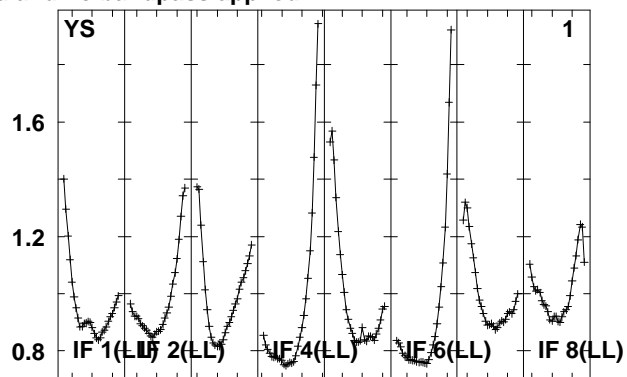
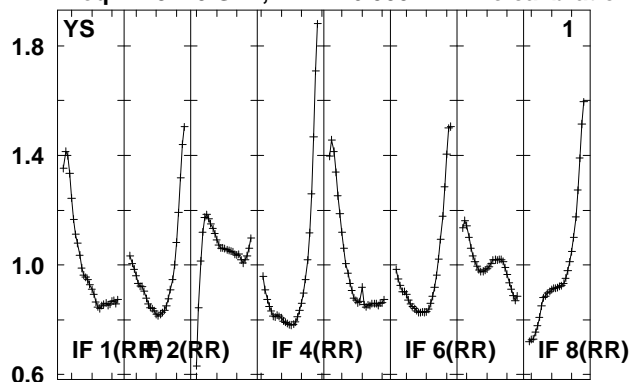

Lower frame: Real Jy
 Total-power spectrum Antenna: *
 Timerange: 00/02:31:03 to 00/02:32:29

Plot file version 18 created 14-MAY-2010 15:16:58

J1344+66 EO007.UVDATA.1

Freq = 4.9270 GHz, Bw = 16.000 MH No calibration applied and no bandpass applied

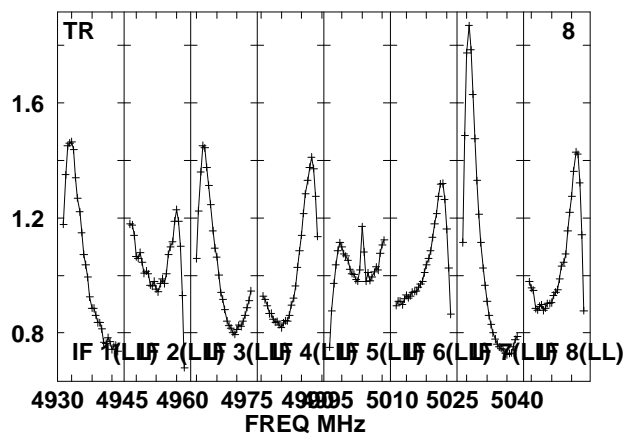
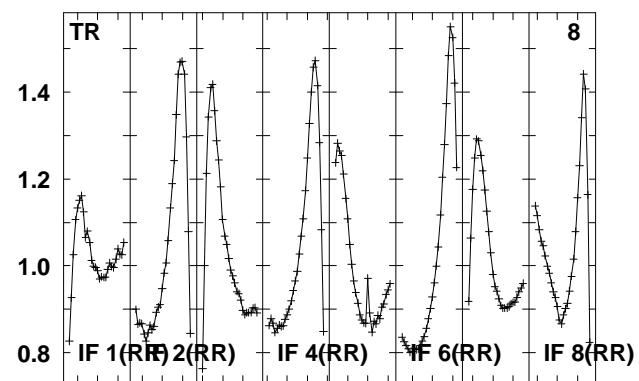
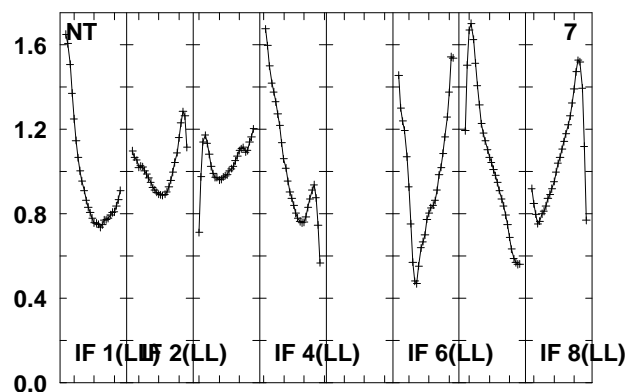
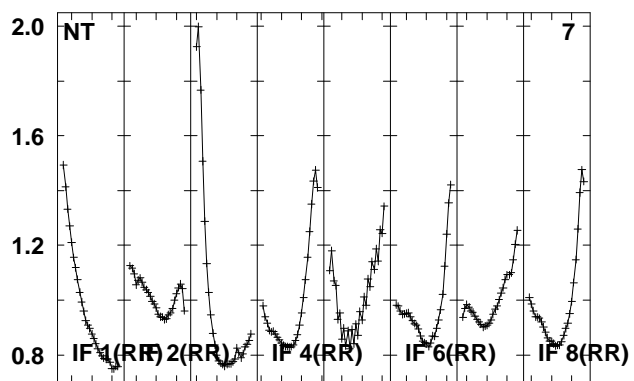
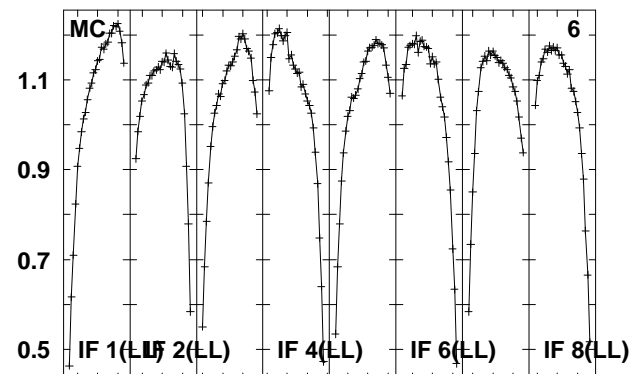
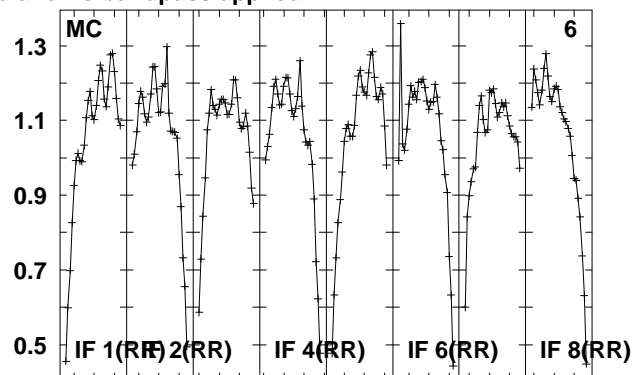
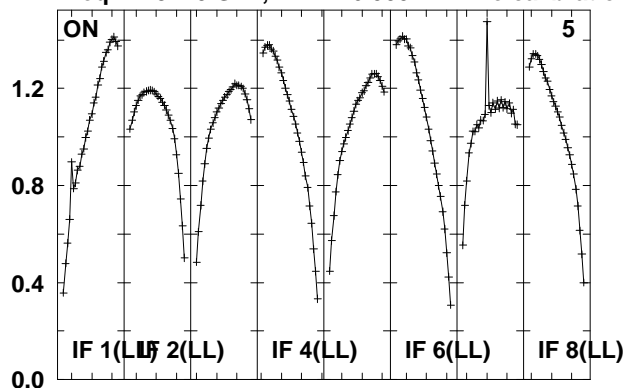

Lower frame: Real Jy

Total-power spectrum Antenna: *

Timerange: 00/02:31:03 to 00/02:32:29

Plot file version 19 created 14-MAY-2010 15:16:59
 J135355 EO007.UVDATA.1
 Freq = 4.9270 GHz, Bw = 16.000 MH No calibration applied and no bandpass applied

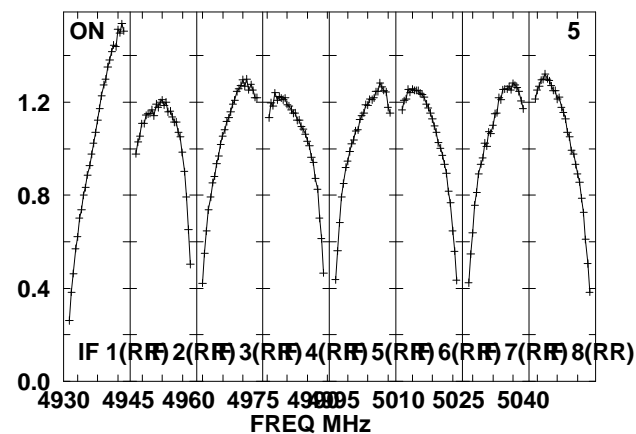
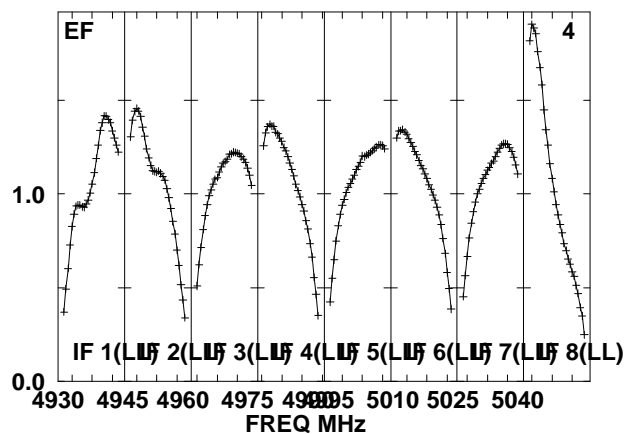
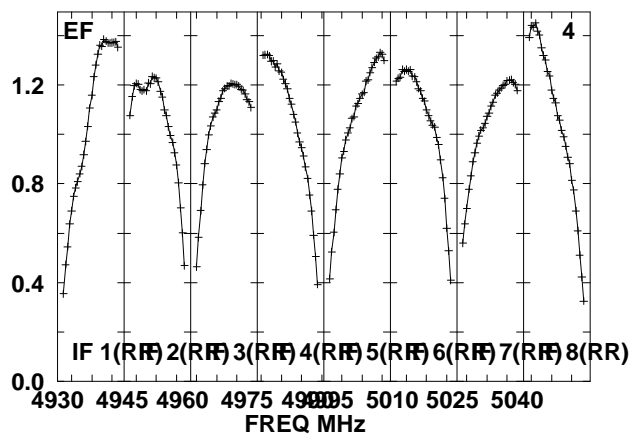
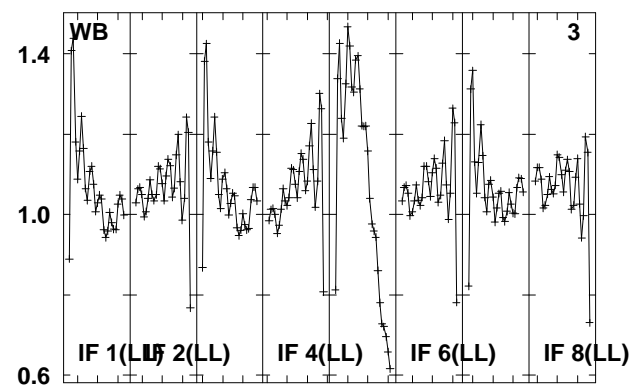
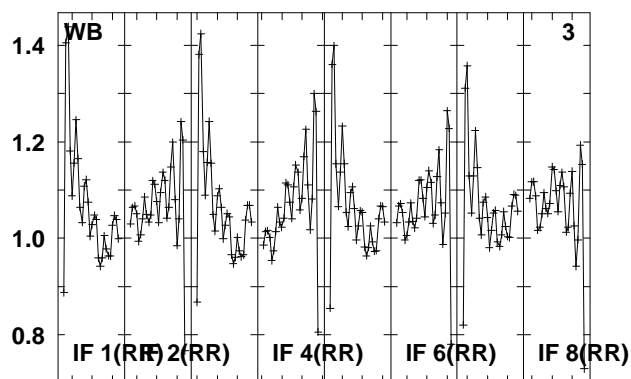
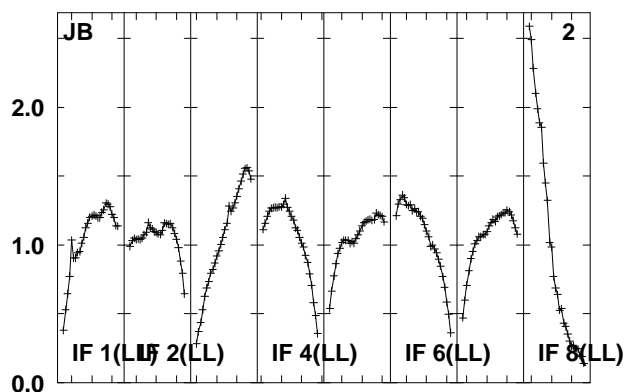
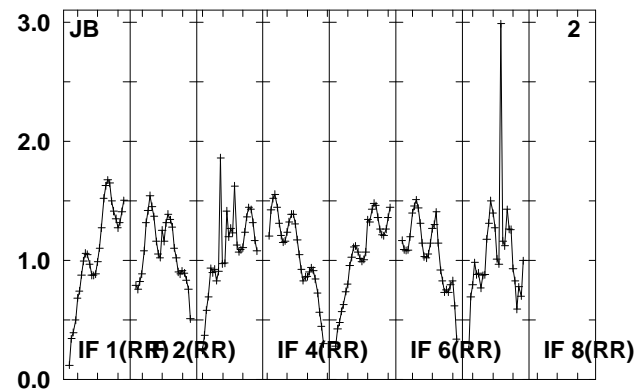
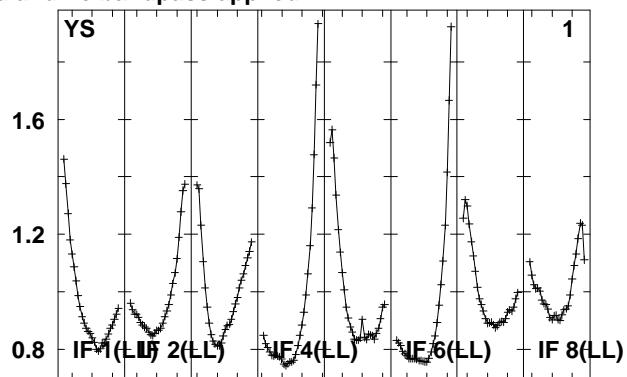
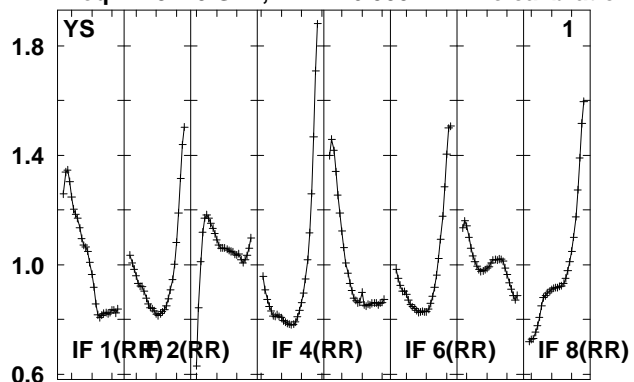

Lower frame: Real Jy
 Total-power spectrum Antenna: *
 Timerange: 00/02:33:09 to 00/02:38:07

Plot file version 20 created 14-MAY-2010 15:16:59

J135355 EO007.UVDATA.1

Freq = 4.9270 GHz, Bw = 16.000 MH No calibration applied and no bandpass applied

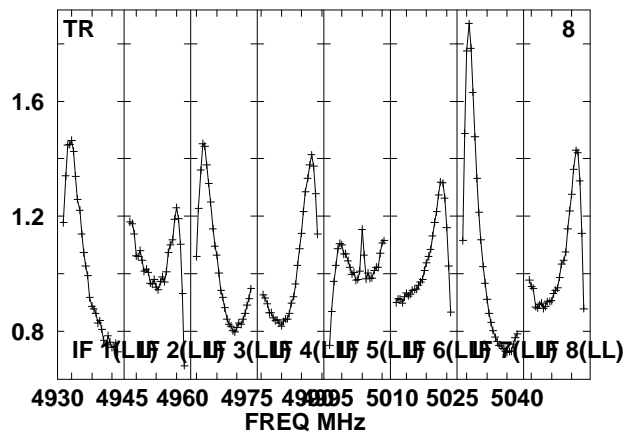
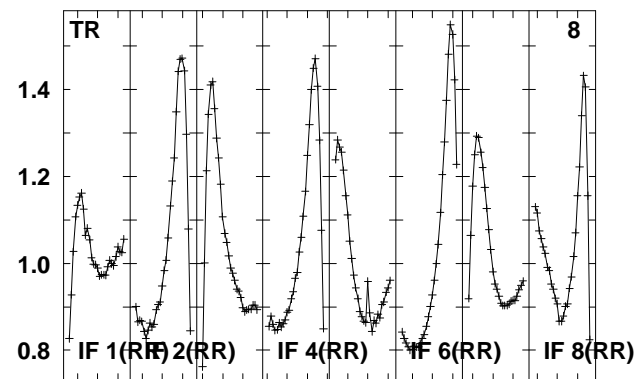
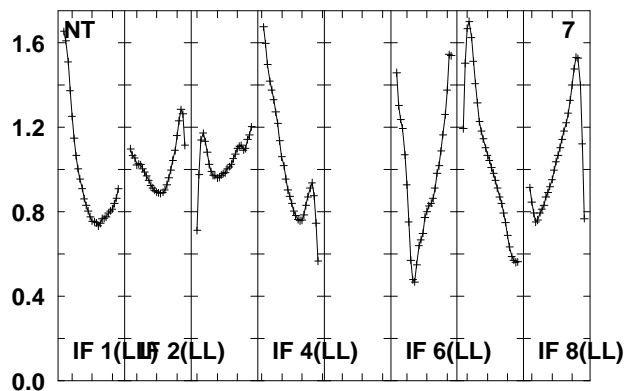
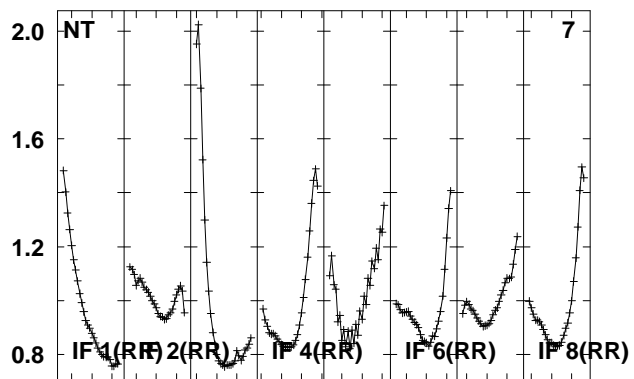
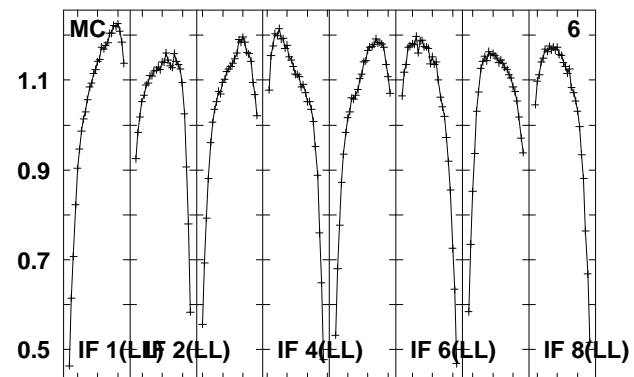
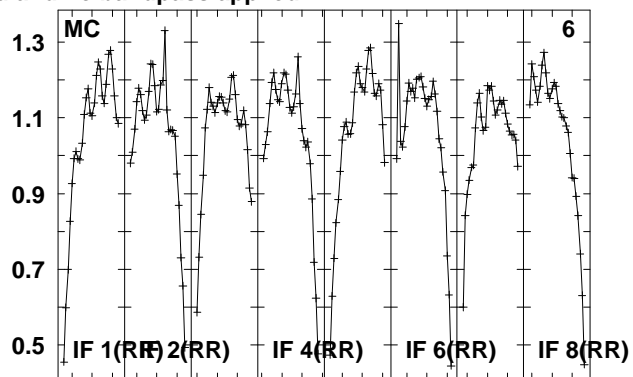
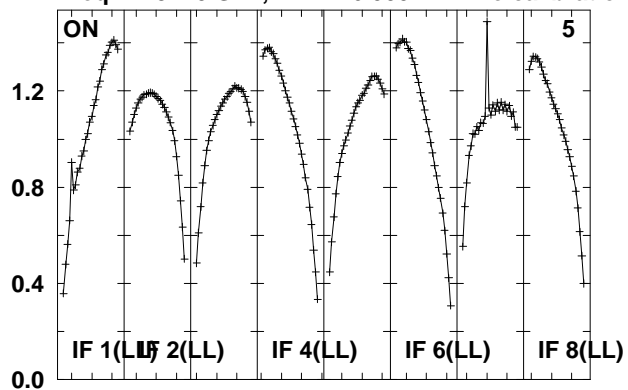

Lower frame: Real Jy

Total-power spectrum Antenna: *

Timerange: 00/02:33:09 to 00/02:38:07

Plot file version 21 created 14-MAY-2010 15:17:00
 J1344+66 EO007.UVDATA.1
 Freq = 4.9270 GHz, Bw = 16.000 MH No calibration applied and no bandpass applied

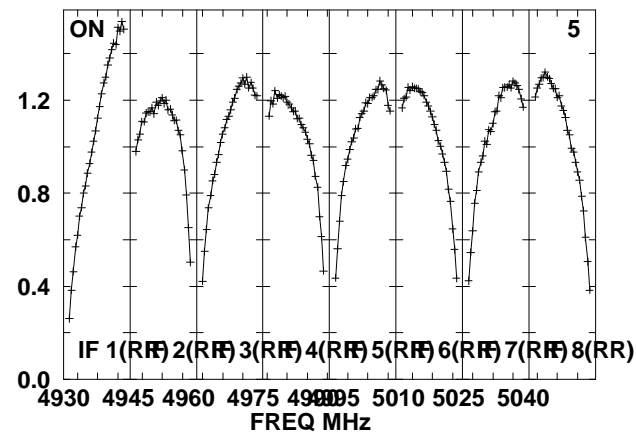
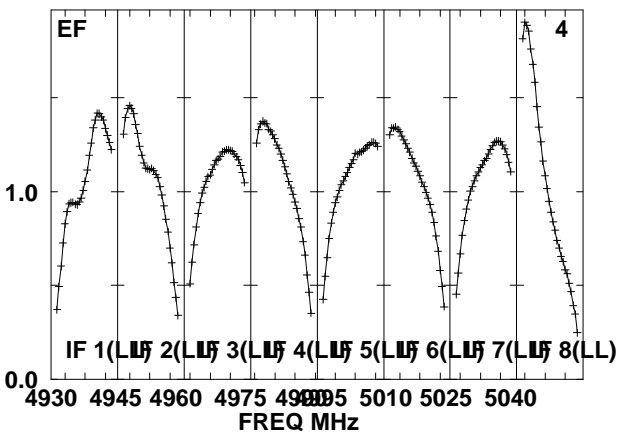
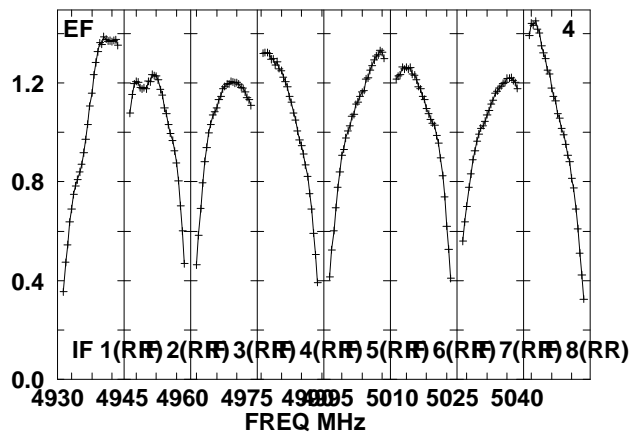
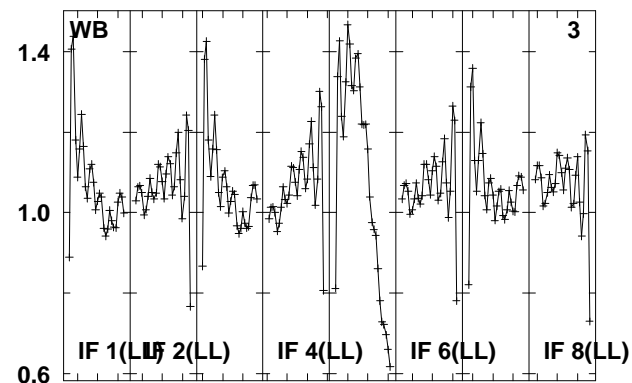
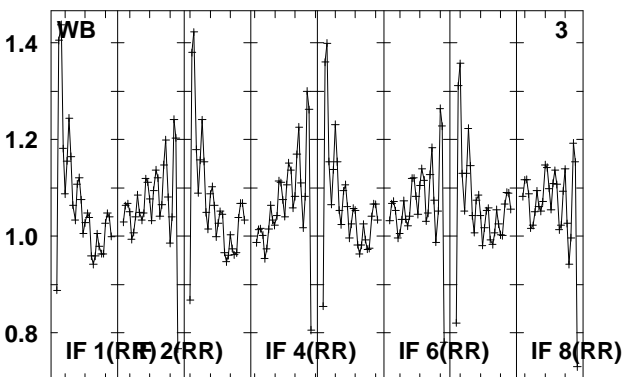
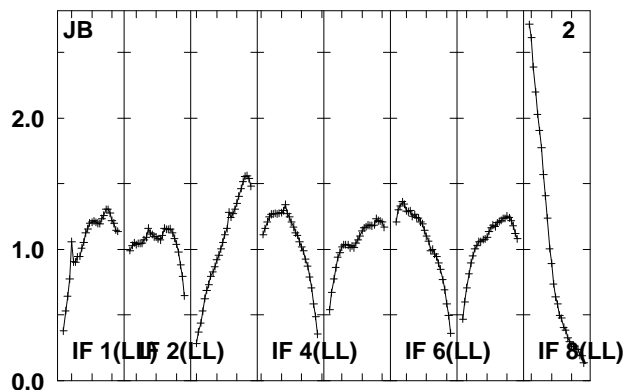
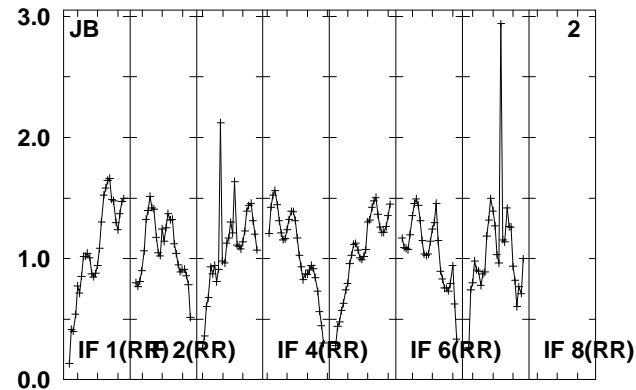
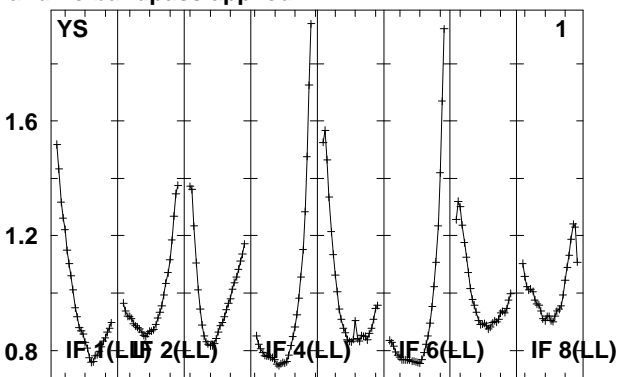
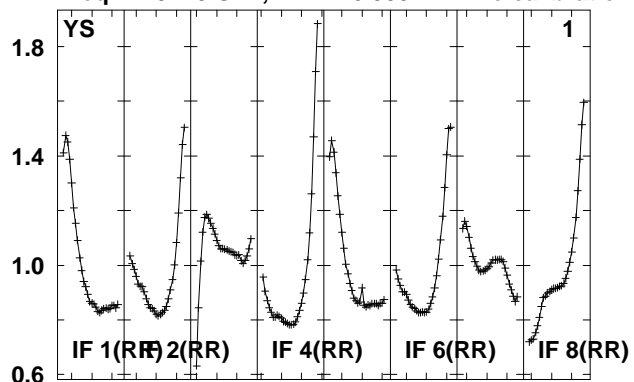

Lower frame: Real Jy
 Total-power spectrum Antenna: *
 Timerange: 00/02:38:49 to 00/02:40:17

Plot file version 22 created 14-MAY-2010 15:17:00

J1344+66 EO007.UVDATA.1

Freq = 4.9270 GHz, Bw = 16.000 MH No calibration applied and no bandpass applied

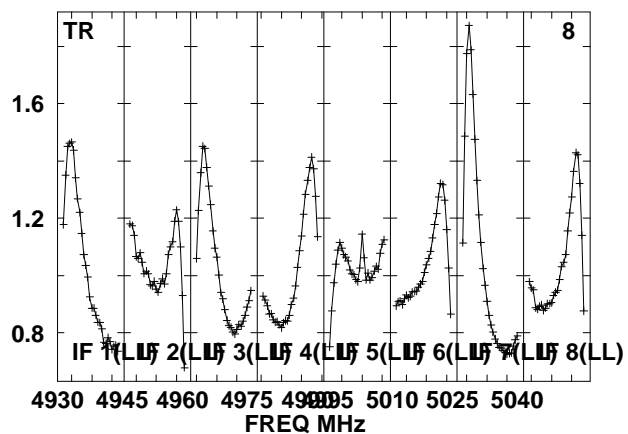
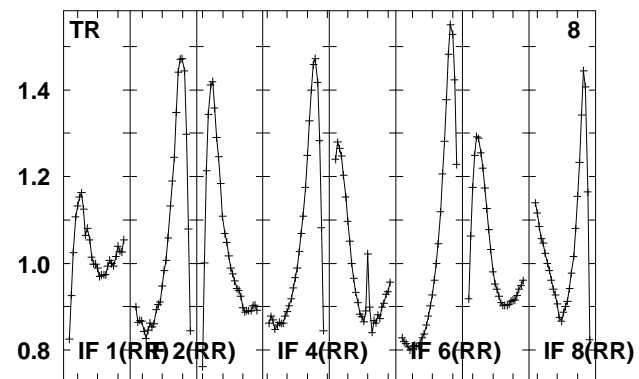
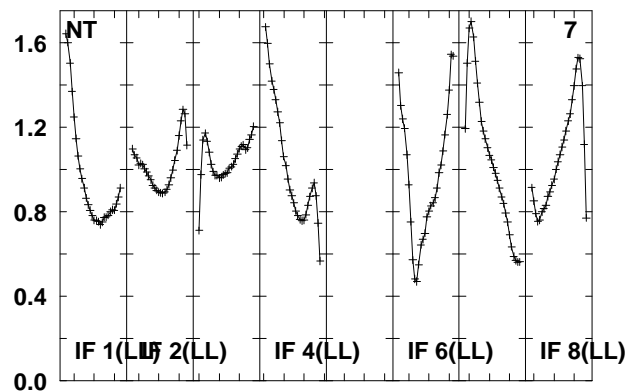
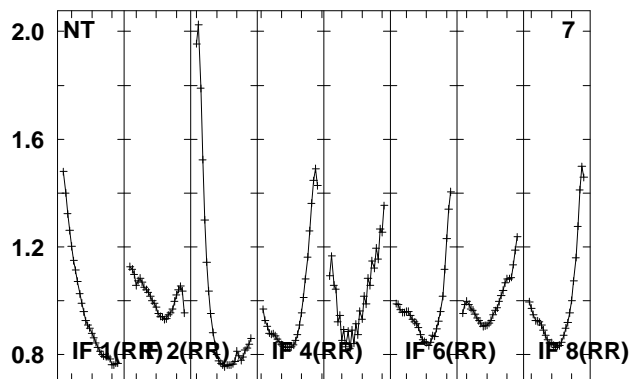
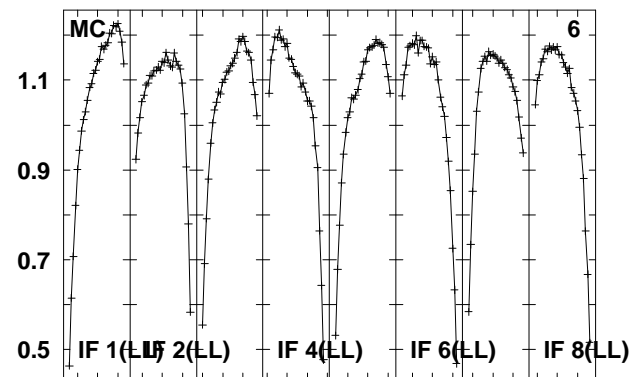
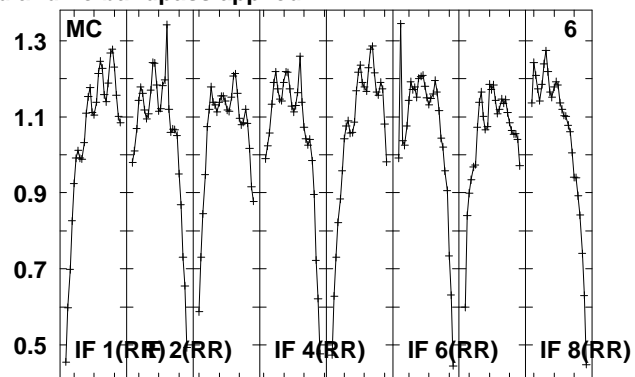
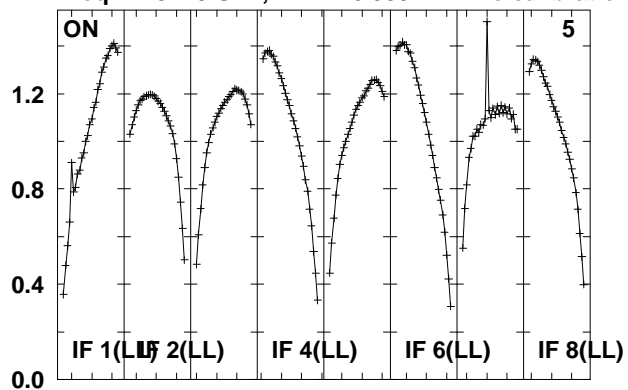

Lower frame: Real Jy

Total-power spectrum Antenna: *

Timerange: 00/02:38:49 to 00/02:40:17

Plot file version 23 created 14-MAY-2010 15:17:00
 J135355 EO007.UVDATA.1
 Freq = 4.9270 GHz, Bw = 16.000 MH No calibration applied and no bandpass applied

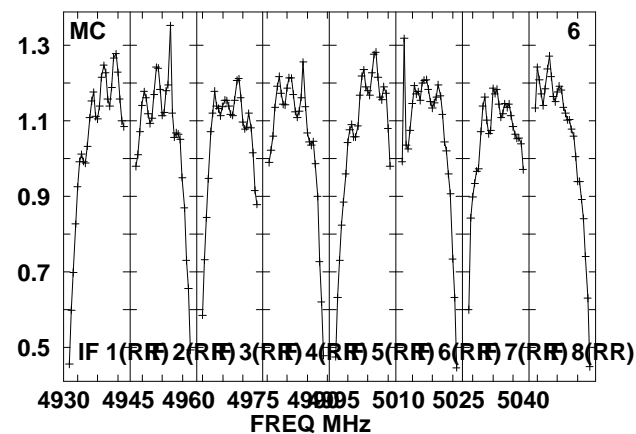
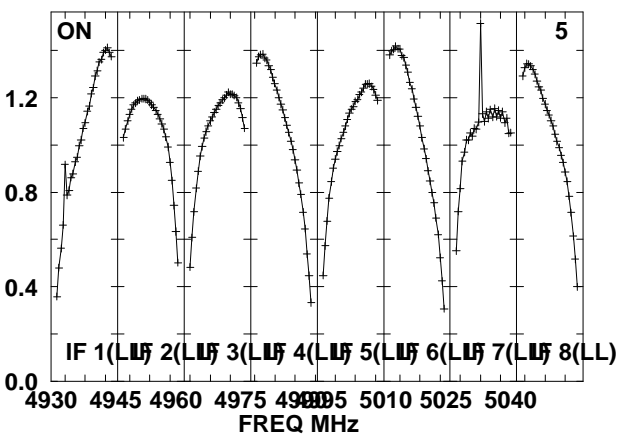
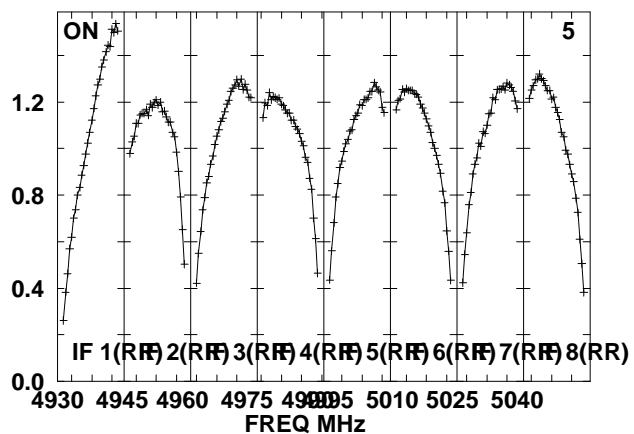
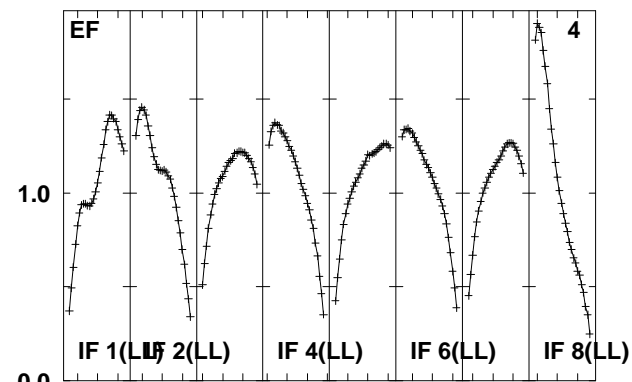
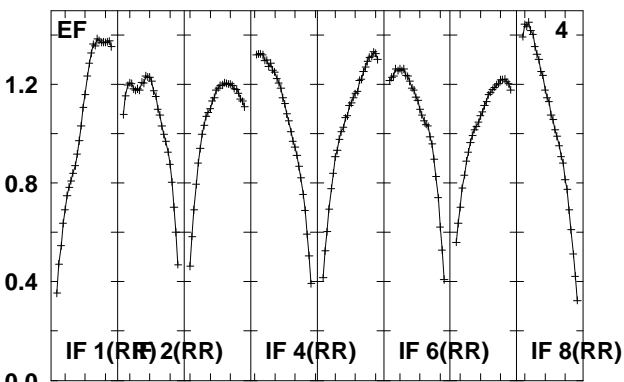
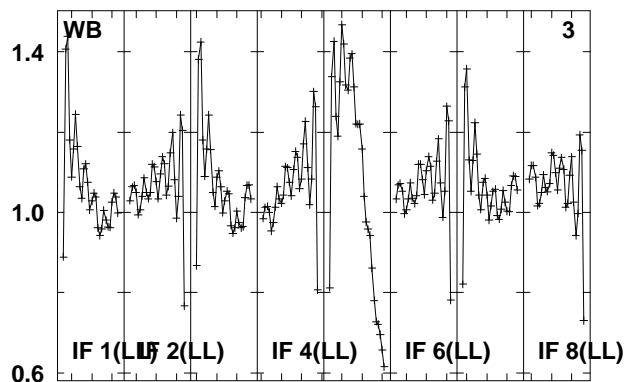
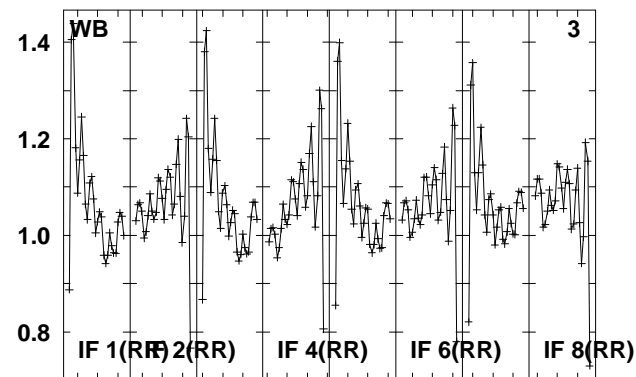
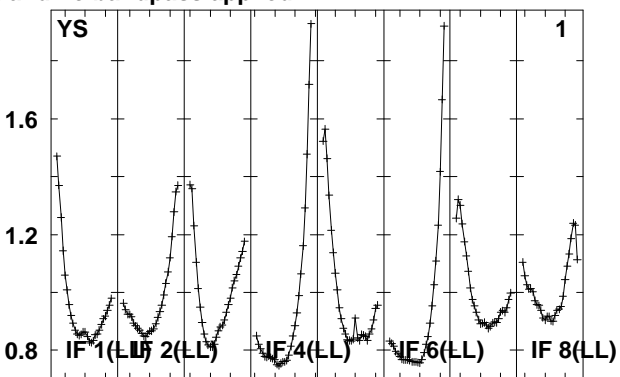
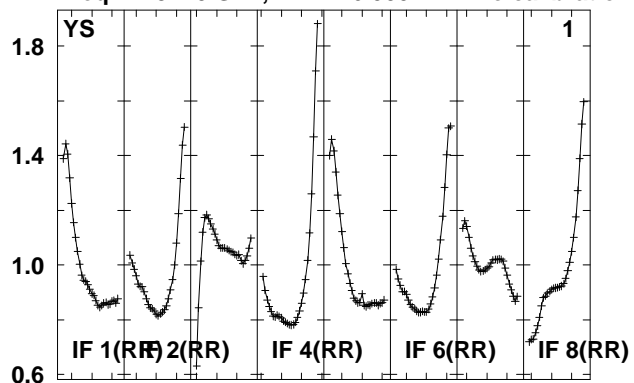

Lower frame: Real Jy
 Total-power spectrum Antenna: *
 Timerange: 00/02:40:57 to 00/02:45:55

Plot file version 24 created 14-MAY-2010 15:17:01

J135355 EO007.UVDATA.1

Freq = 4.9270 GHz, Bw = 16.000 MH No calibration applied and no bandpass applied

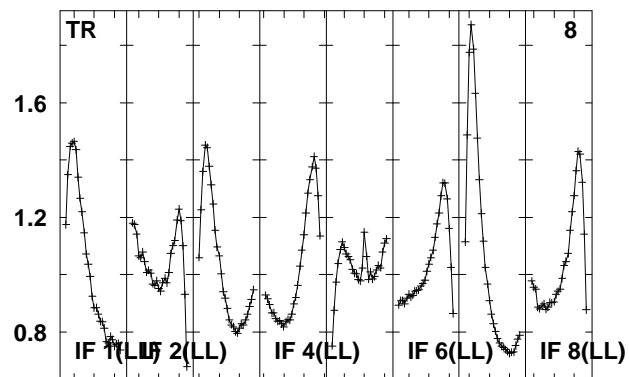
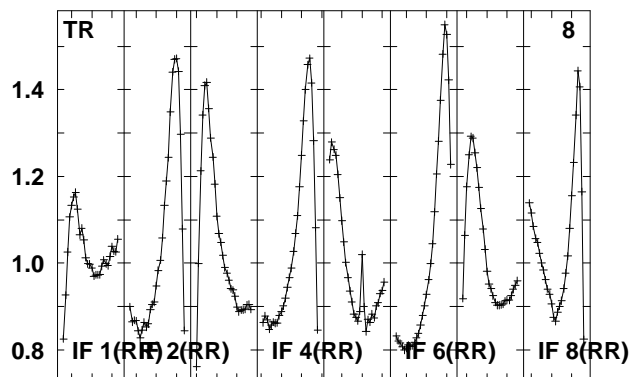
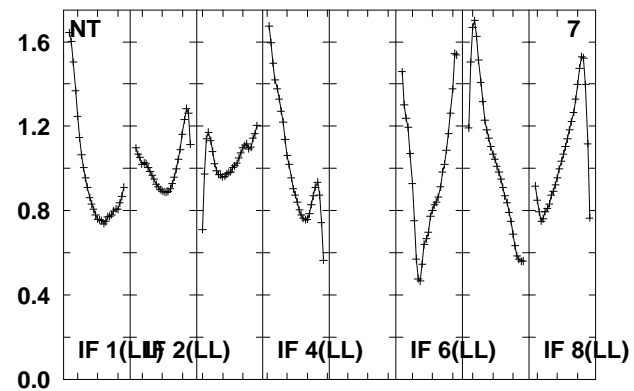
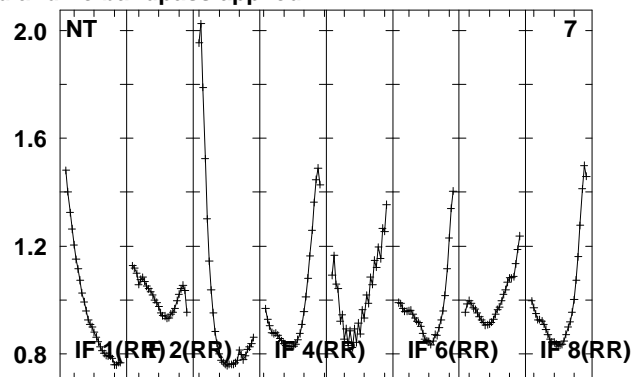
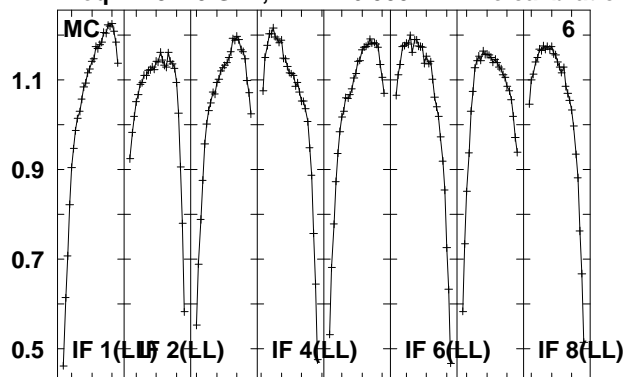

Lower frame: Real Jy
Total-power spectrum Antenna: *
Timerange: 00/02:40:57 to 00/02:45:55

Plot file version 25 created 14-MAY-2010 15:17:01

J1344+66 EO007.UVDATA.1

Freq = 4.9270 GHz, Bw = 16.000 MH No calibration applied and no bandpass applied

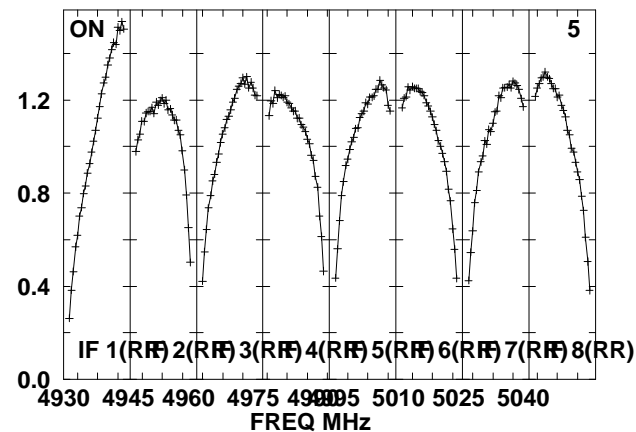
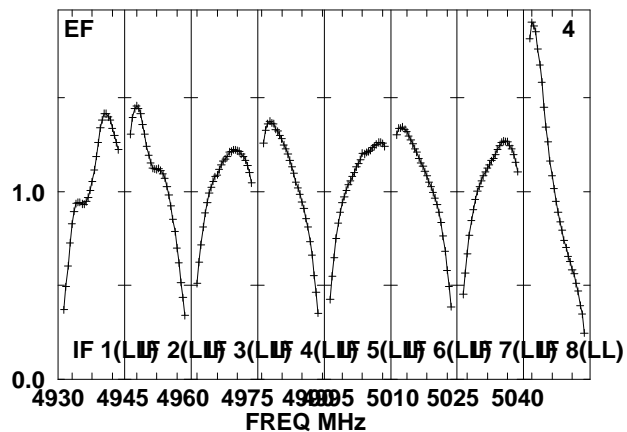
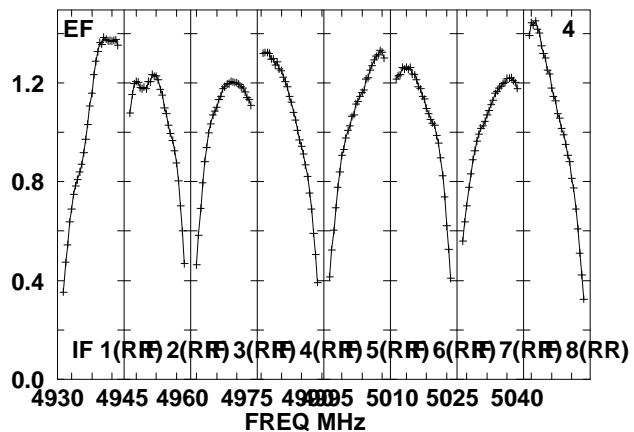
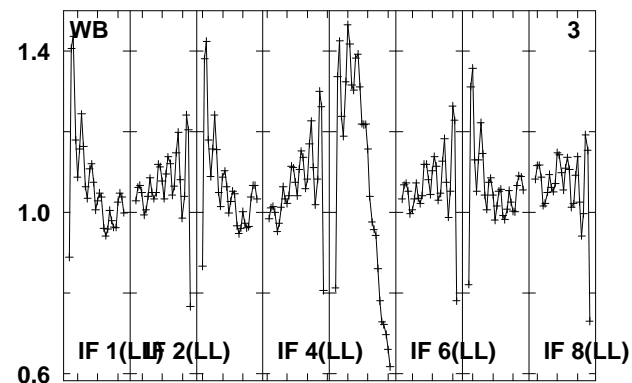
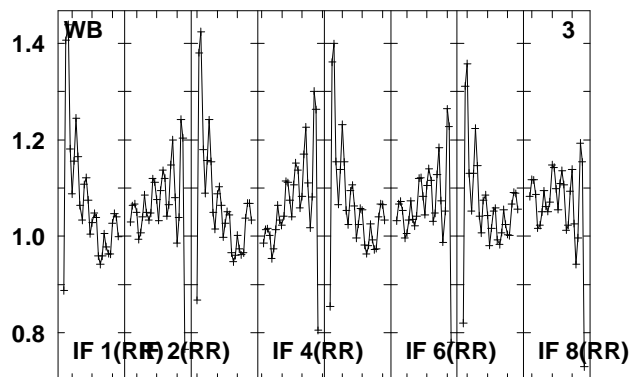
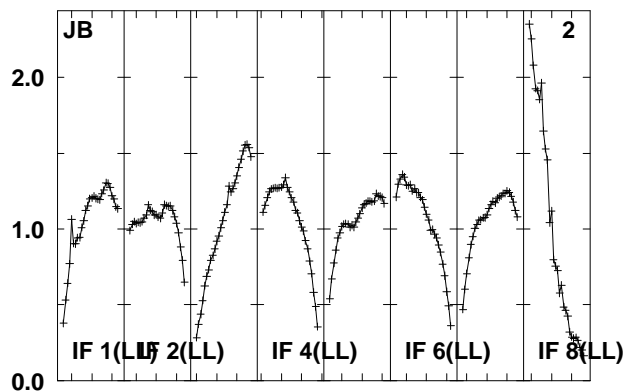
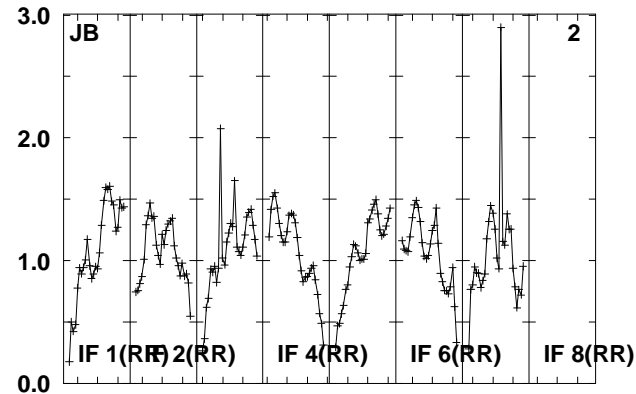
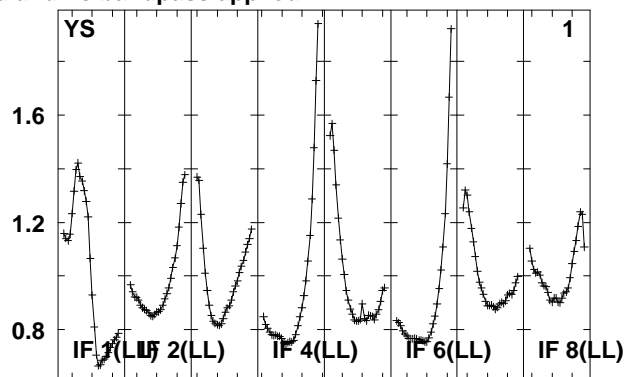
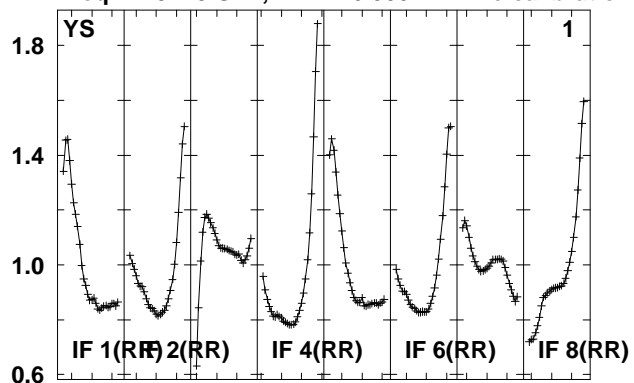

Lower frame: Real Jy
Total-power spectrum Antenna: *
Timerange: 00/02:46:33 to 00/02:48:01

Plot file version 26 created 14-MAY-2010 15:17:01

J1344+66 EO007.UVDATA.1

Freq = 4.9270 GHz, Bw = 16.000 MH No calibration applied and no bandpass applied

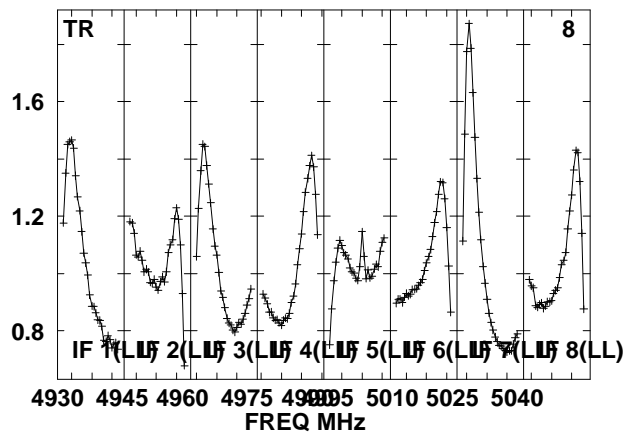
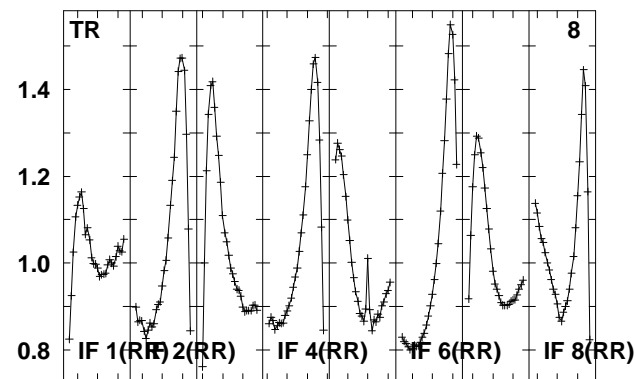
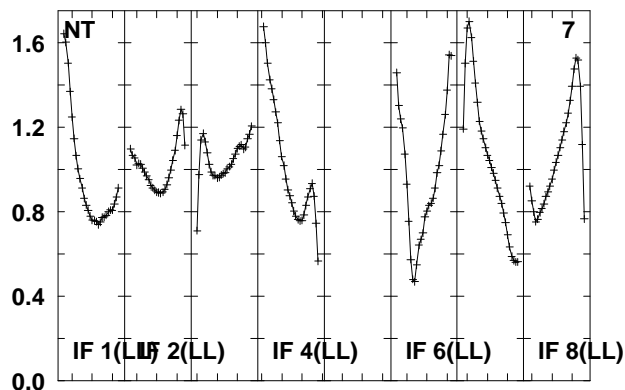
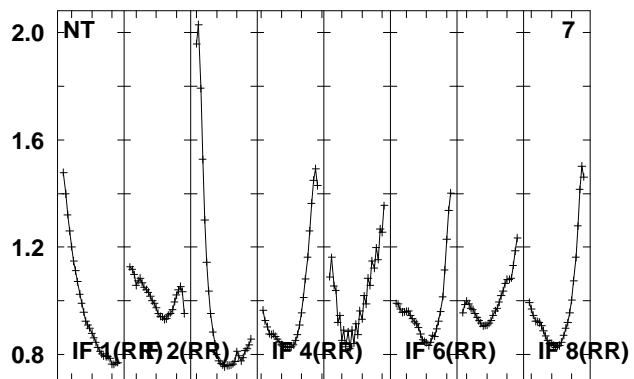
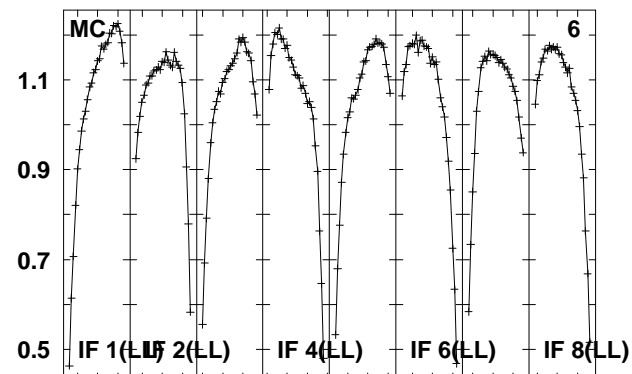
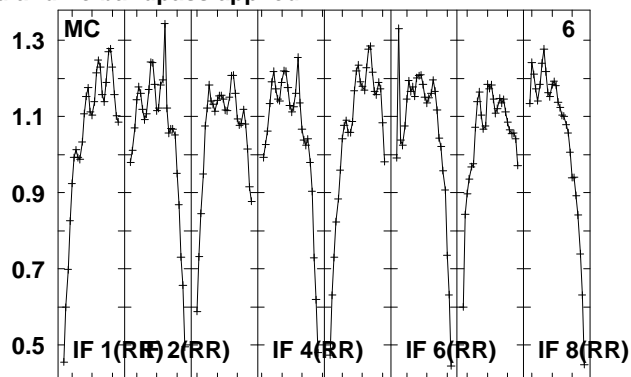
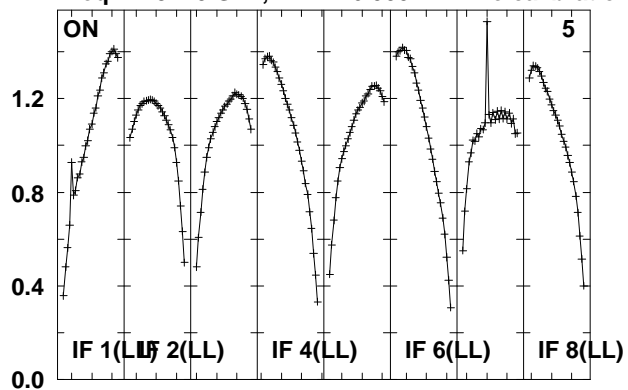

Lower frame: Real Jy

Total-power spectrum Antenna: *

Timerange: 00/02:46:33 to 00/02:48:01

Plot file version 27 created 14-MAY-2010 15:17:02
 J135355 EO007.UVDATA.1
 Freq = 4.9270 GHz, Bw = 16.000 MH No calibration applied and no bandpass applied

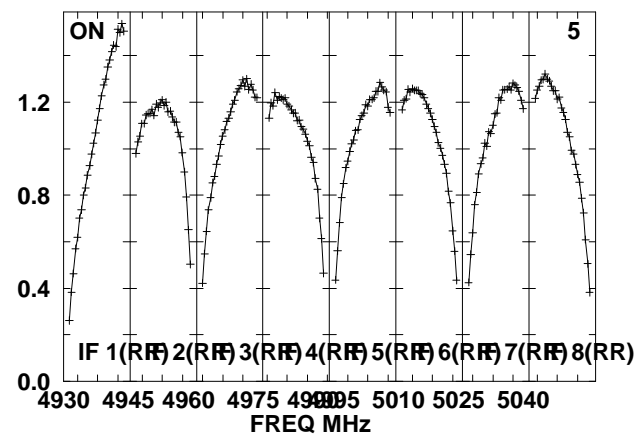
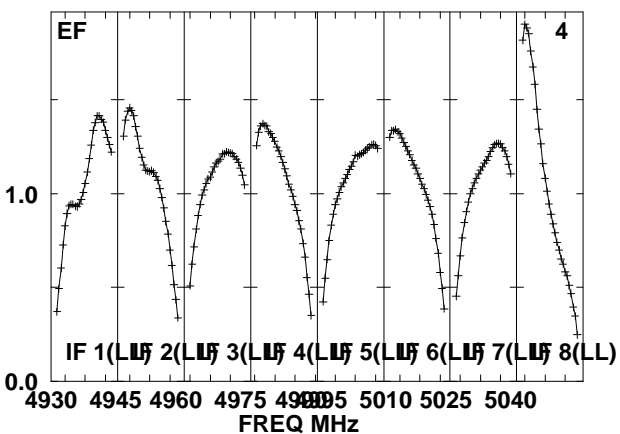
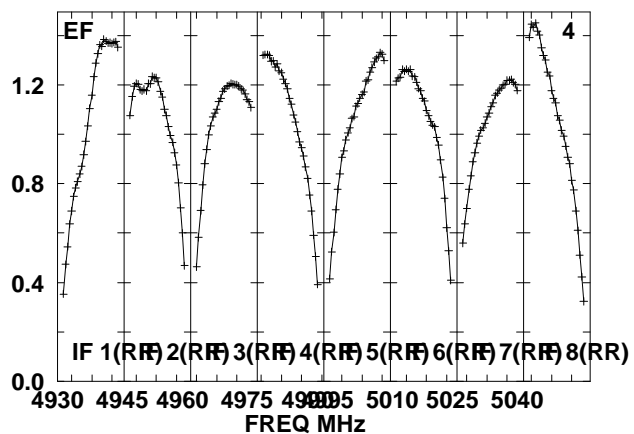
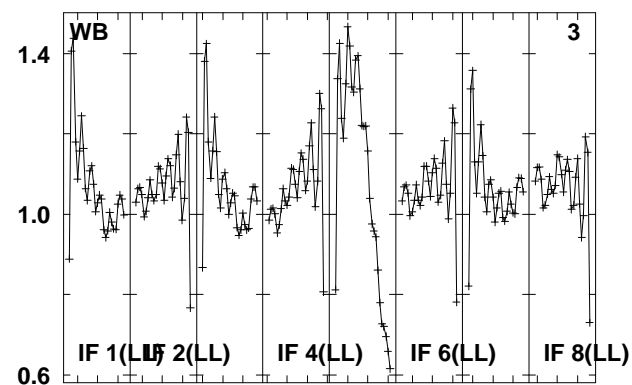
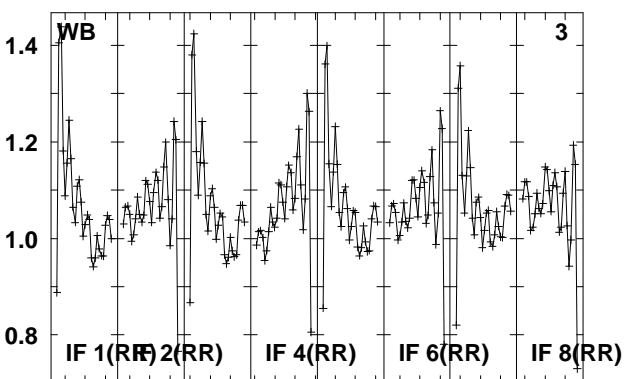
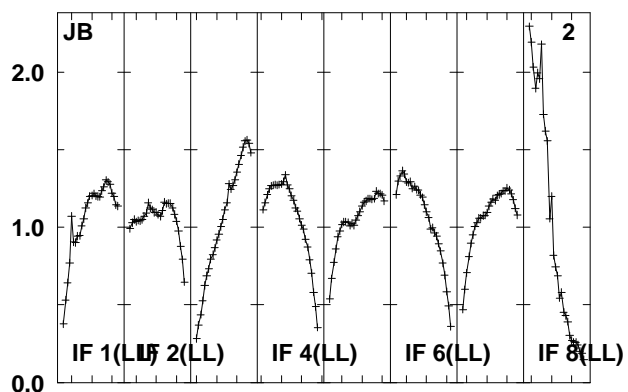
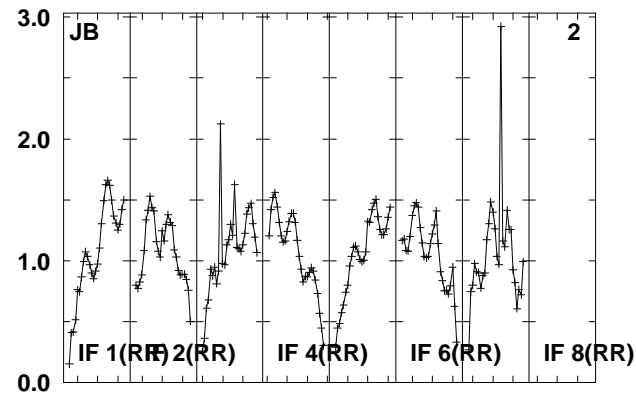
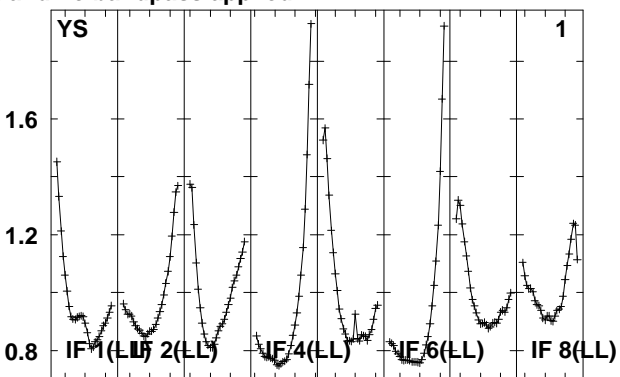
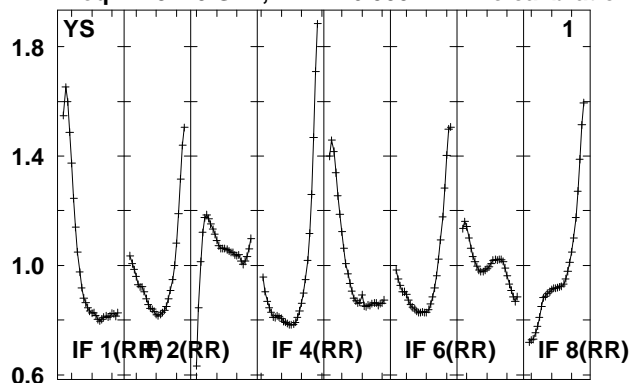

Lower frame: Real Jy
 Total-power spectrum Antenna: *
 Timerange: 00/02:48:41 to 00/02:53:39

Plot file version 28 created 14-MAY-2010 15:17:02

J135355 EO007.UVDATA.1

Freq = 4.9270 GHz, Bw = 16.000 MH No calibration applied and no bandpass applied

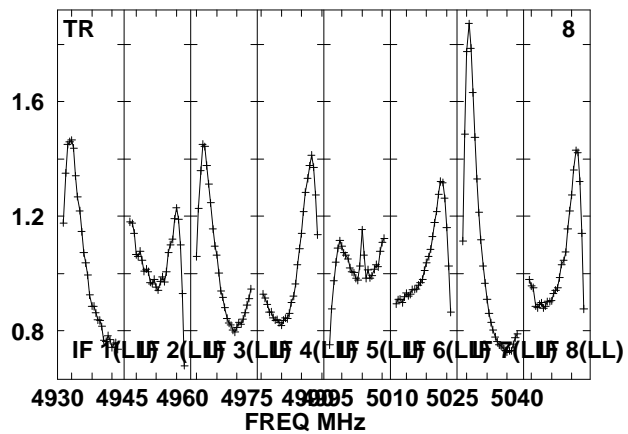
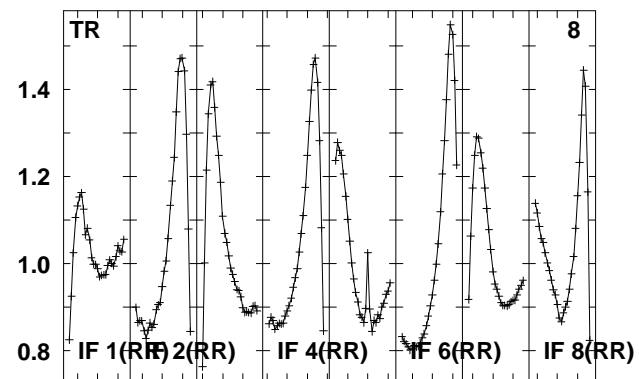
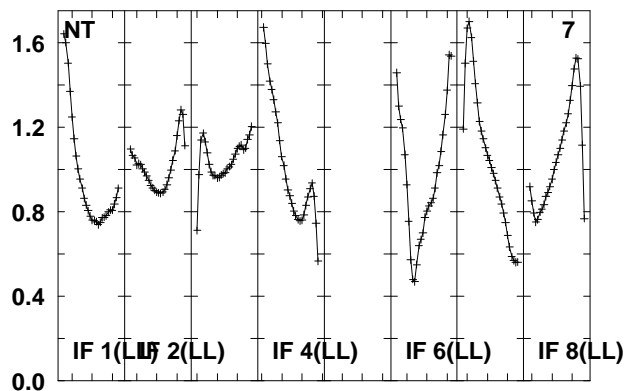
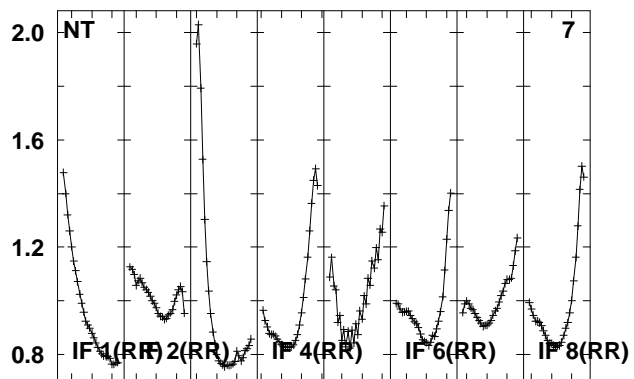
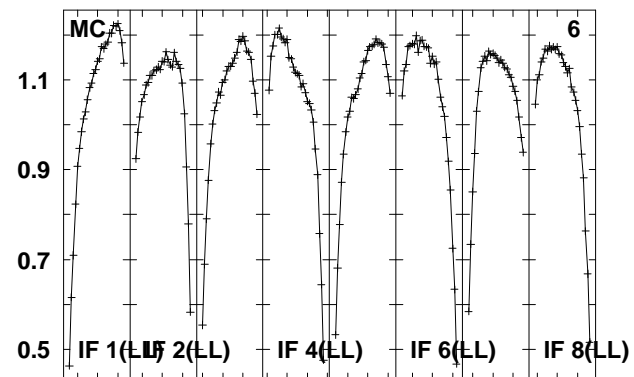
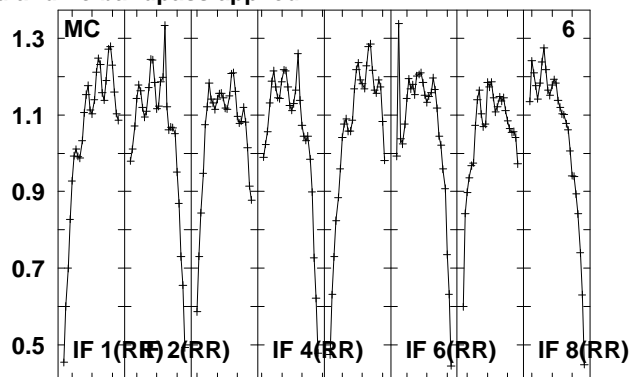
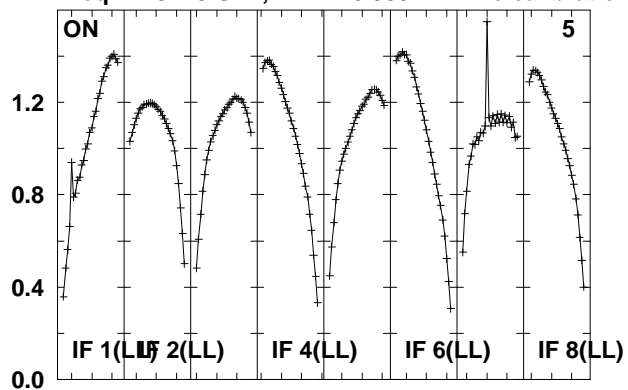

Lower frame: Real Jy

Total-power spectrum Antenna: *

Timerange: 00/02:48:41 to 00/02:53:39

Plot file version 29 created 14-MAY-2010 15:17:03
 J1344+66 EO007.UVDATA.1
 Freq = 4.9270 GHz, Bw = 16.000 MH No calibration applied and no bandpass applied

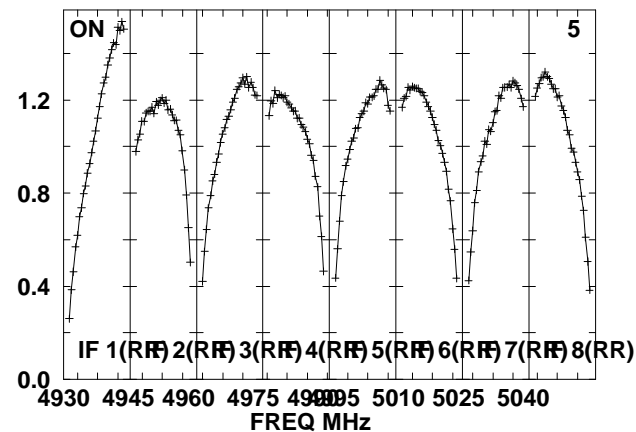
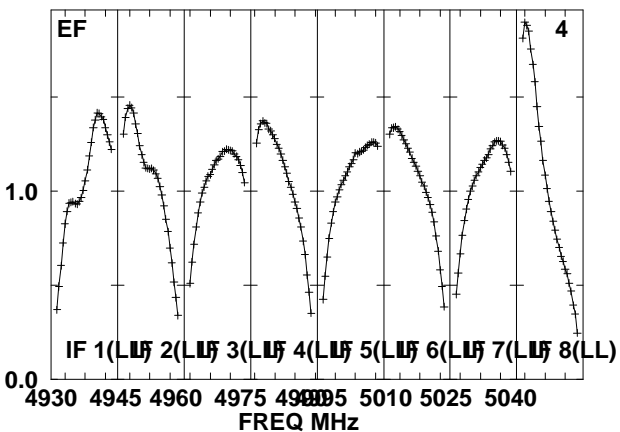
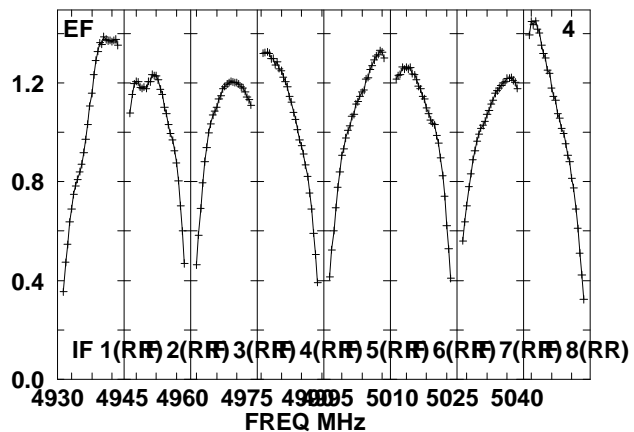
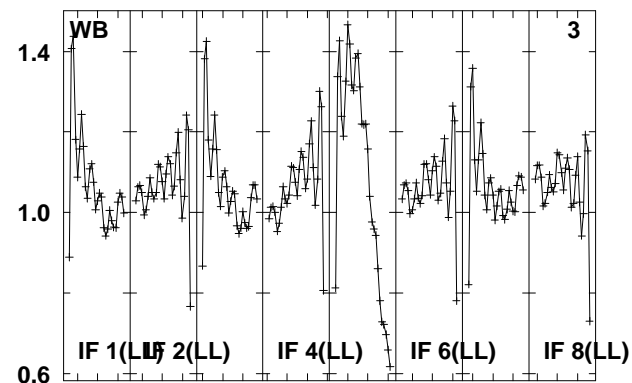
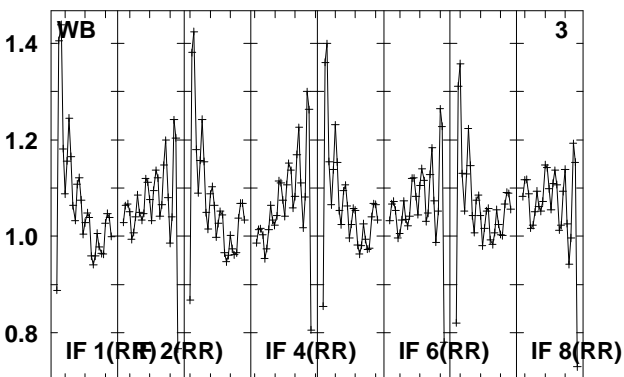
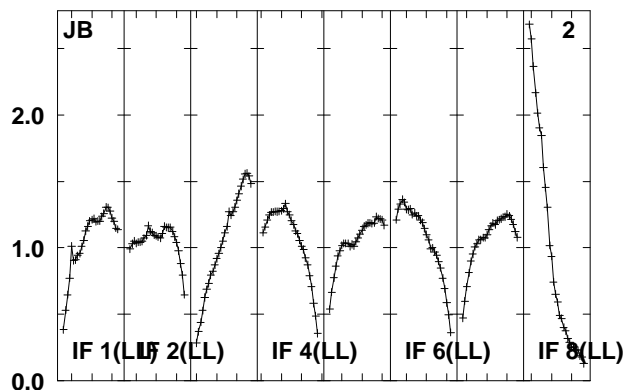
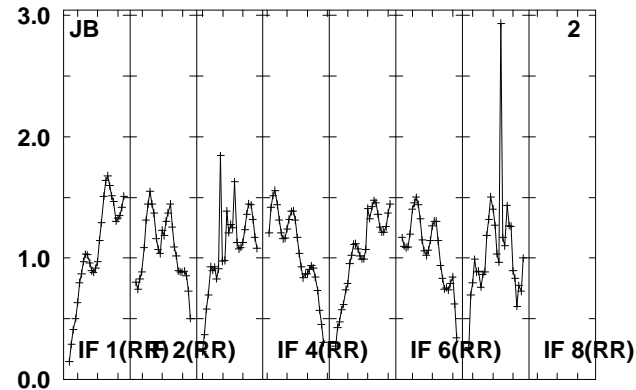
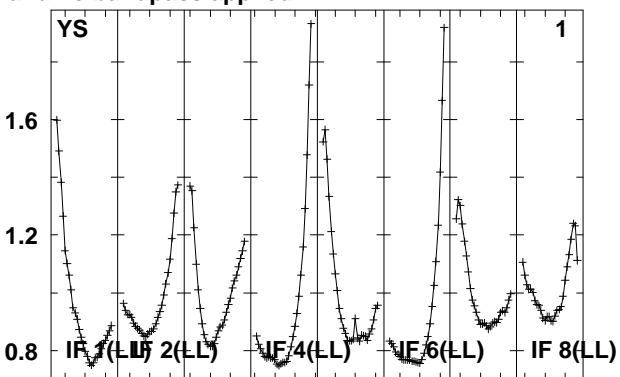
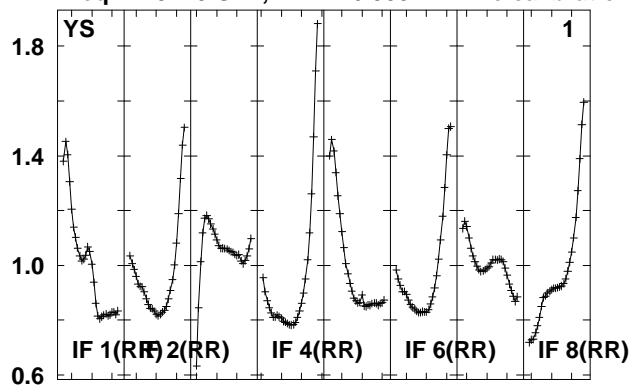

Lower frame: Real Jy
 Total-power spectrum Antenna: *
 Timerange: 00/02:54:21 to 00/02:55:49

Plot file version 30 created 14-MAY-2010 15:17:03

J1344+66 EO007.UVDATA.1

Freq = 4.9270 GHz, Bw = 16.000 MH No calibration applied and no bandpass applied

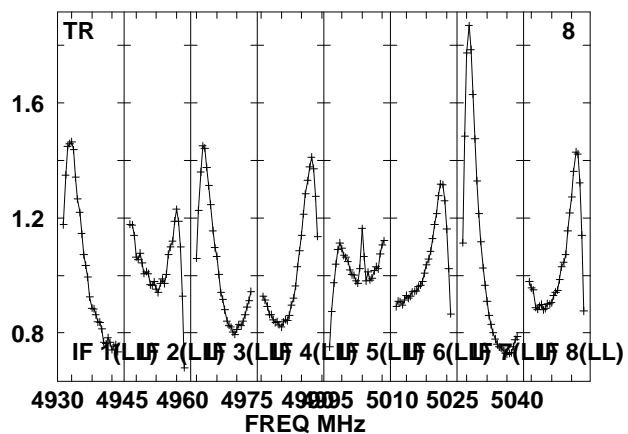
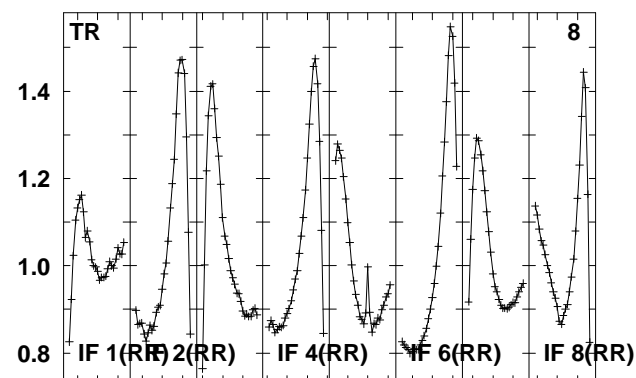
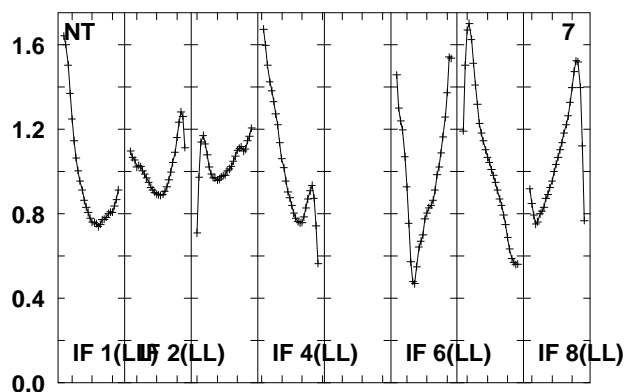
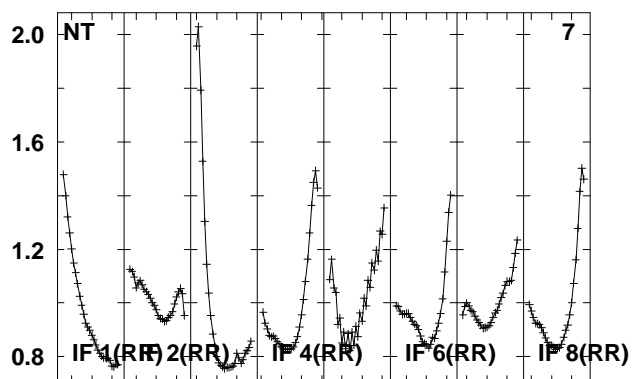
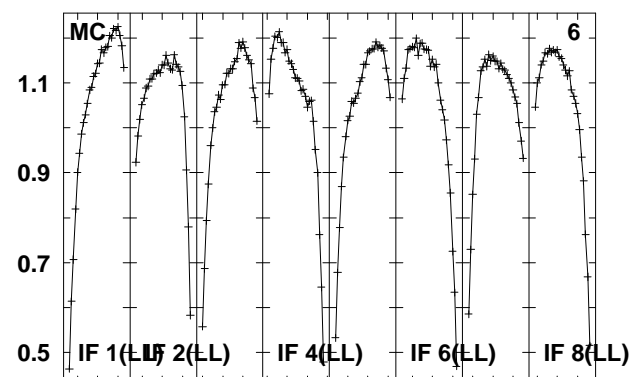
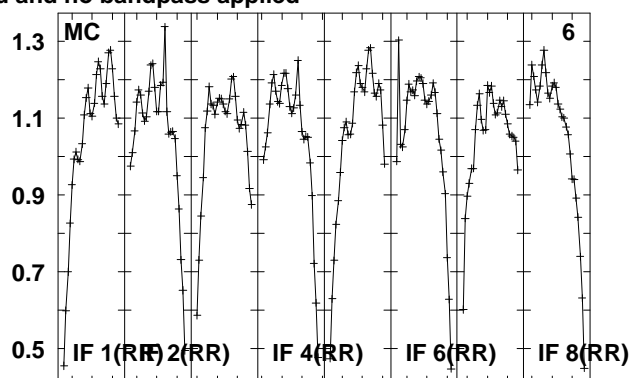
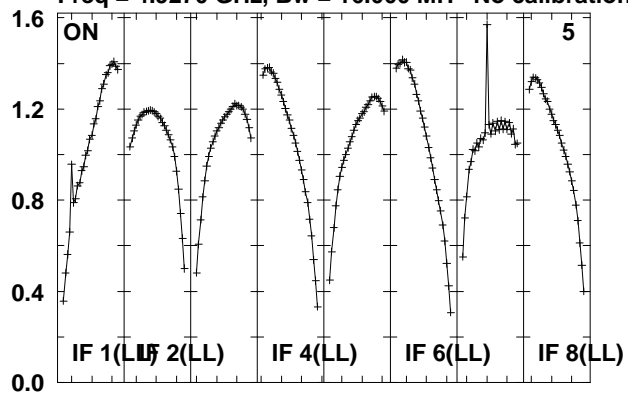

Lower frame: Real Jy

Total-power spectrum Antenna: *

Timerange: 00/02:54:21 to 00/02:55:49

Plot file version 31 created 14-MAY-2010 15:17:03
 J135355 EO007.UVDATA.1
 Freq = 4.9270 GHz, Bw = 16.000 MH No calibration applied and no bandpass applied

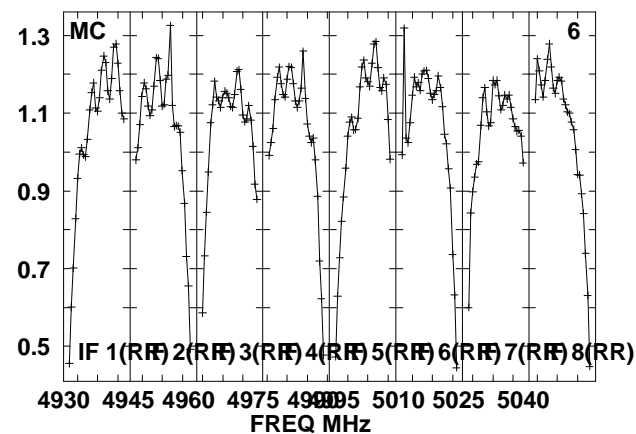
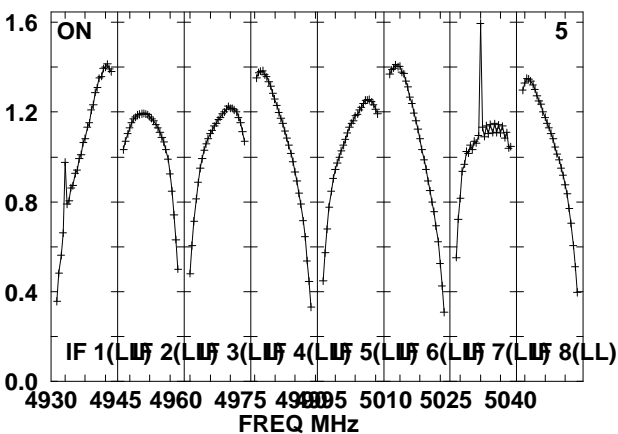
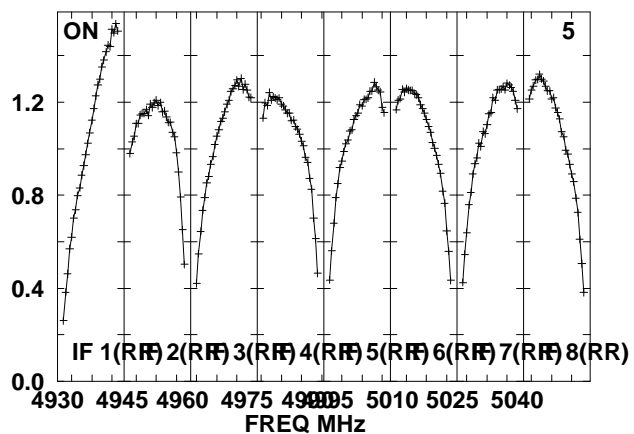
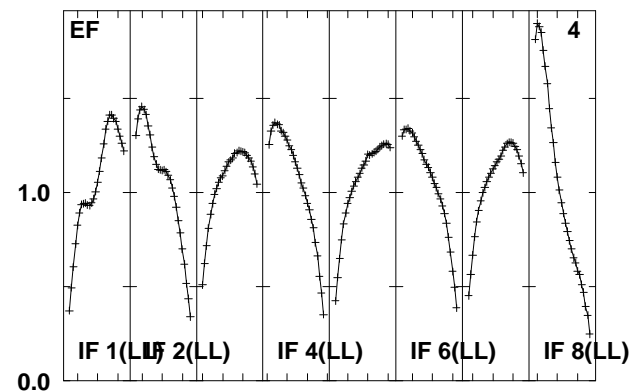
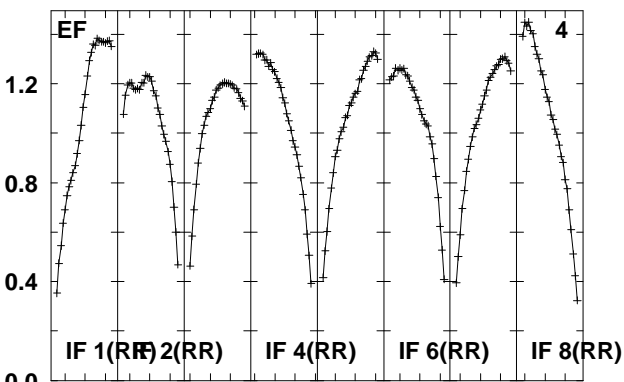
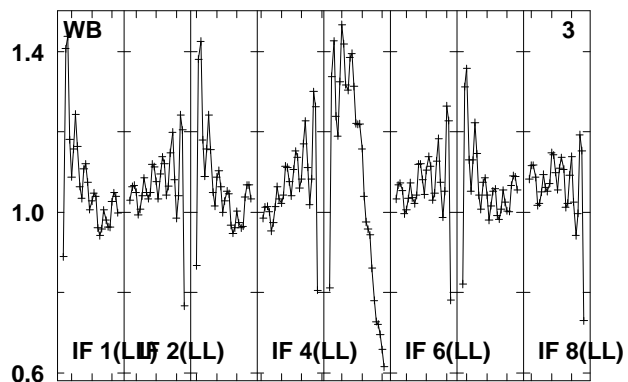
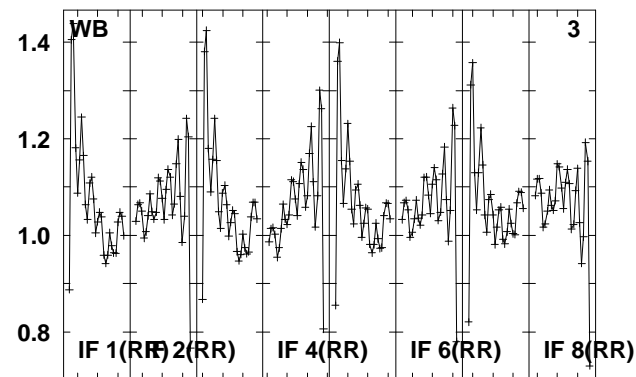
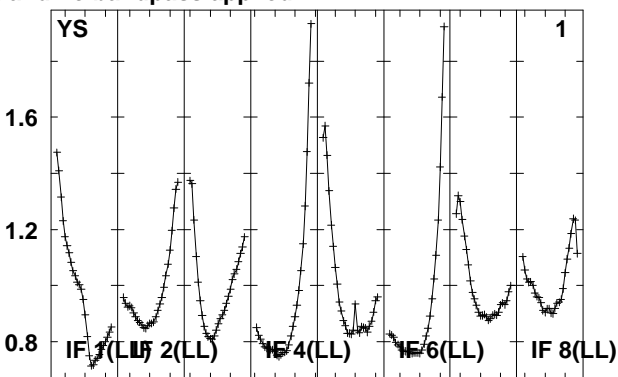
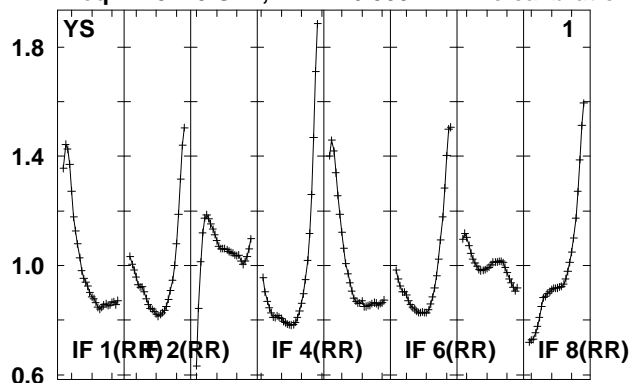

Lower frame: Real Jy
 Total-power spectrum Antenna: *
 Timerange: 00/02:56:27 to 00/03:01:23

Plot file version 32 created 14-MAY-2010 15:17:04

J135355 EO007.UVDATA.1

Freq = 4.9270 GHz, Bw = 16.000 MH No calibration applied and no bandpass applied

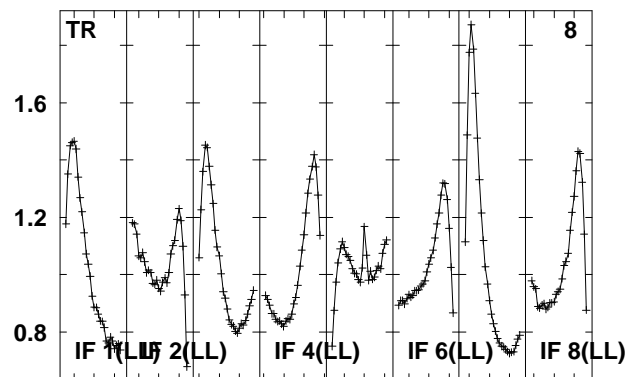
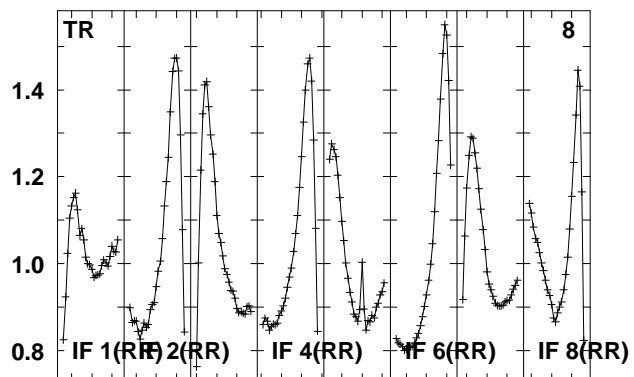
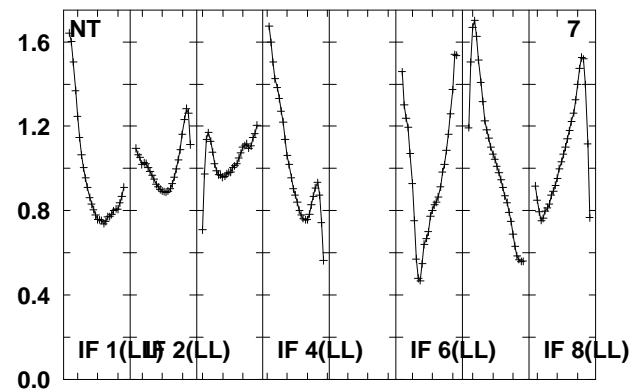
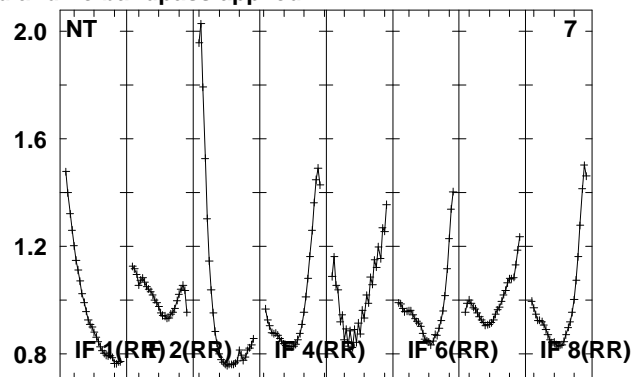
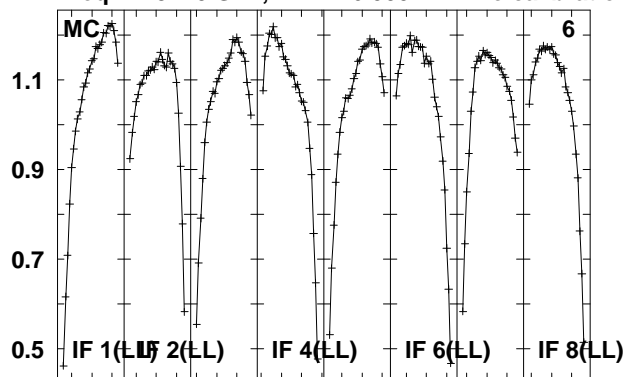

Lower frame: Real Jy
Total-power spectrum Antenna: *
Timerange: 00/02:56:27 to 00/03:01:23

Plot file version 33 created 14-MAY-2010 15:17:04

J1344+66 EO007.UVDATA.1

Freq = 4.9270 GHz, Bw = 16.000 MH No calibration applied and no bandpass applied

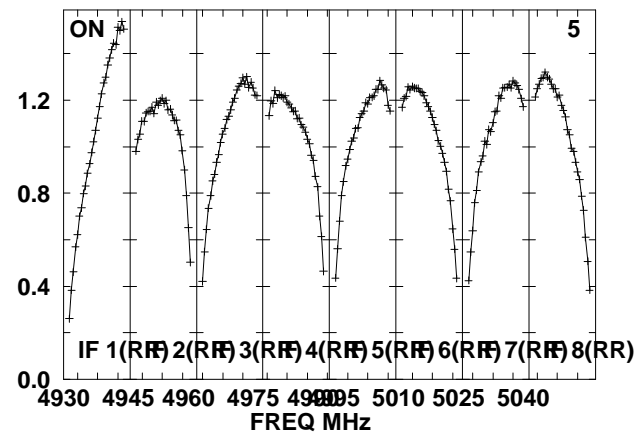
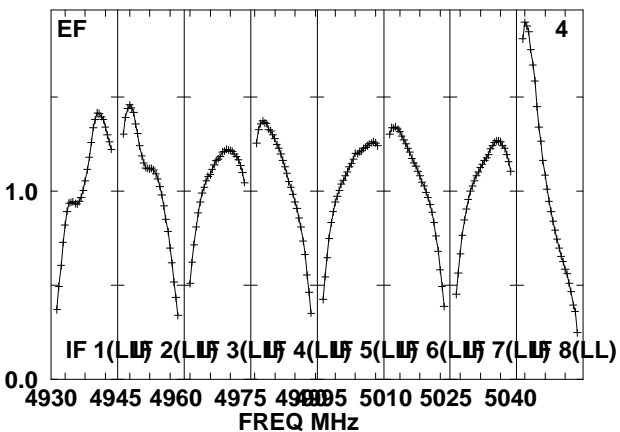
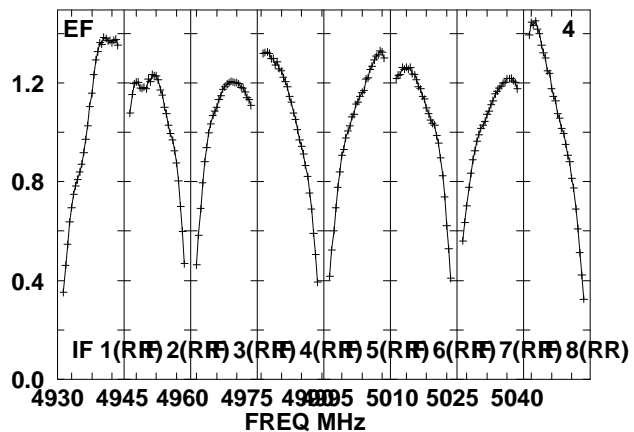
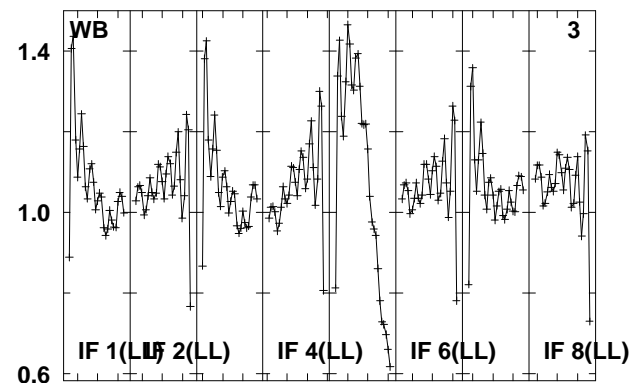
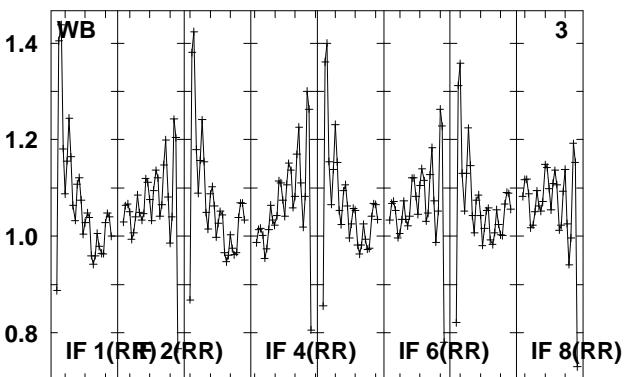
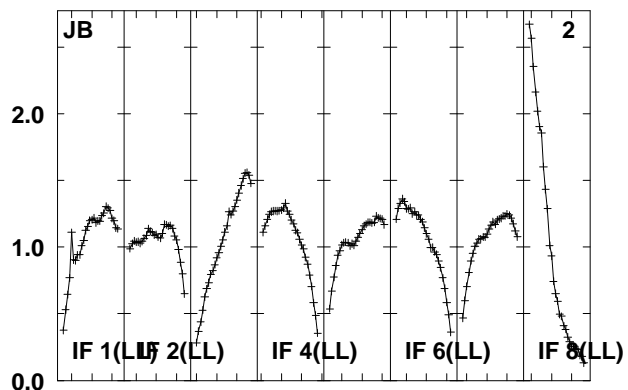
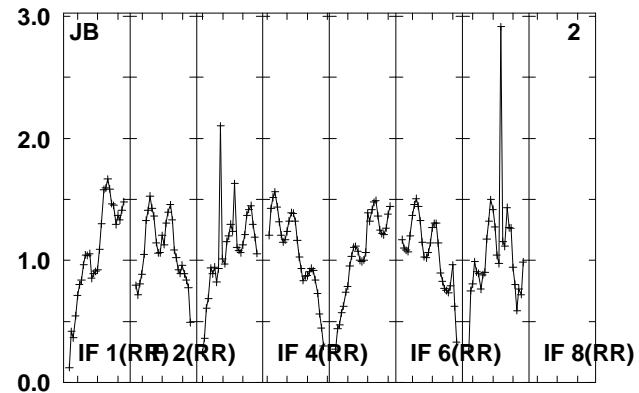
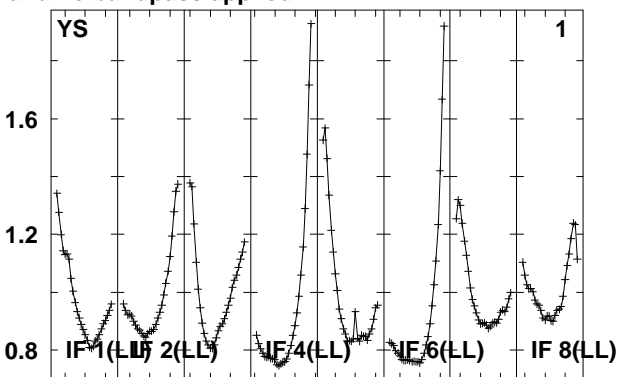
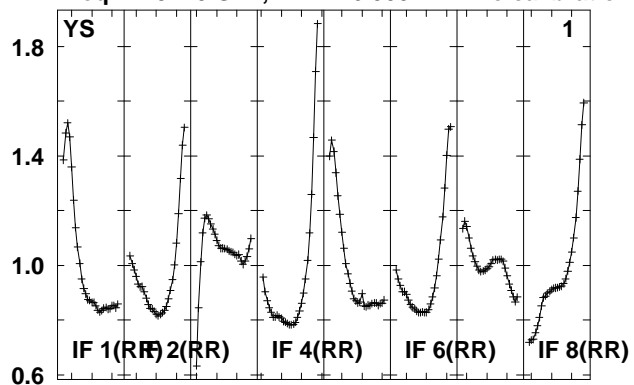

Lower frame: Real Jy
Total-power spectrum Antenna: *
Timerange: 00/03:02:03 to 00/03:03:31

Plot file version 34 created 14-MAY-2010 15:17:04

J1344+66 EO007.UVDATA.1

Freq = 4.9270 GHz, Bw = 16.000 MH No calibration applied and no bandpass applied

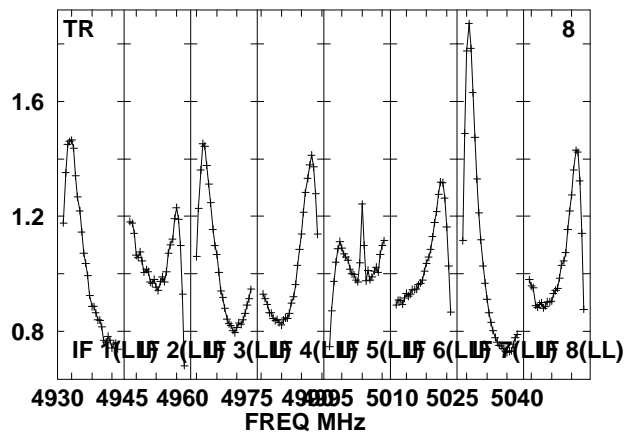
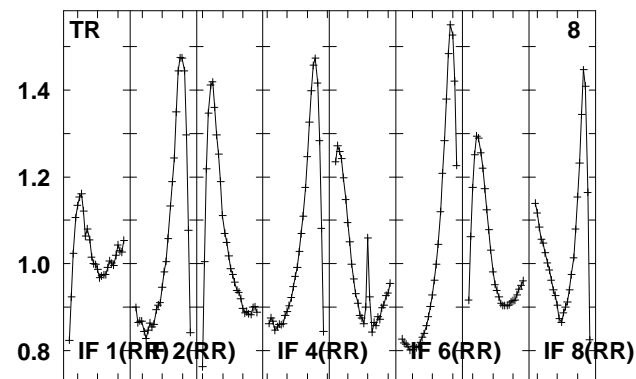
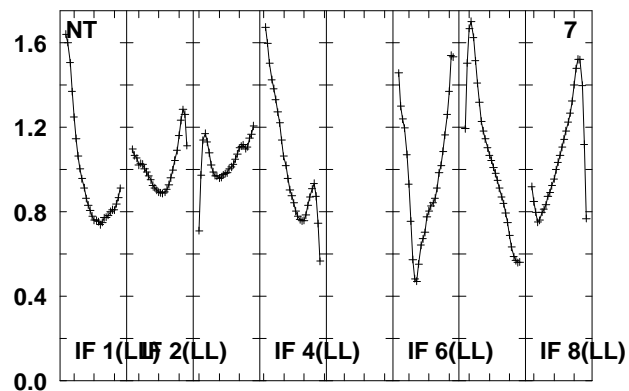
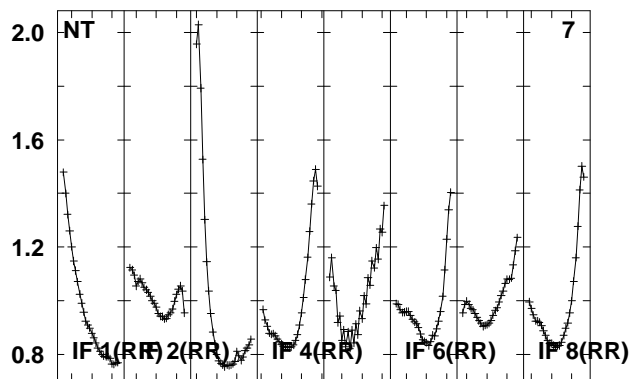
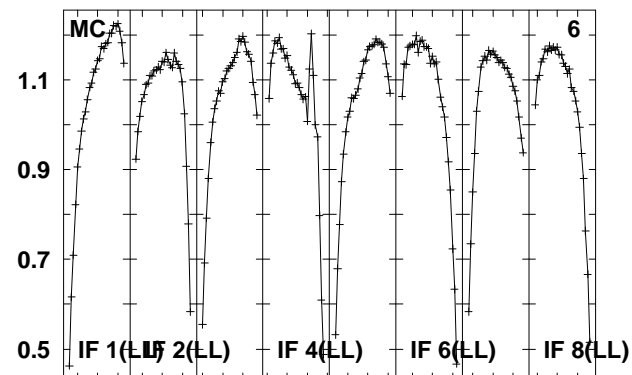
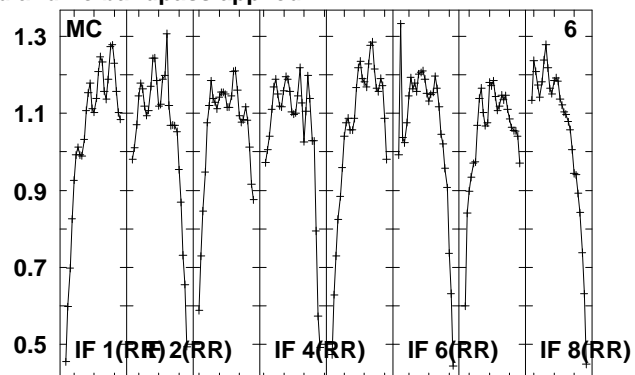
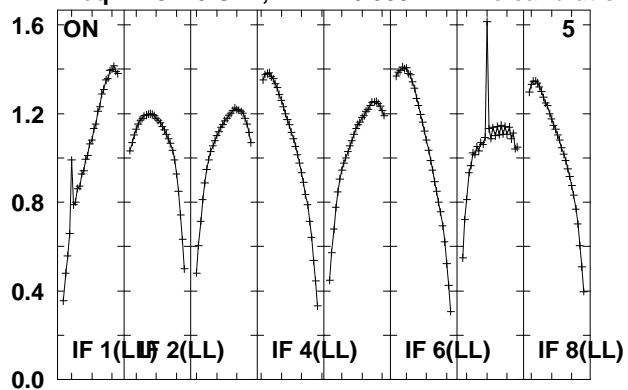

Lower frame: Real Jy

Total-power spectrum Antenna: *

Timerange: 00/03:02:03 to 00/03:03:31

Plot file version 35 created 14-MAY-2010 15:17:05
 J135355 EO007.UVDATA.1
 Freq = 4.9270 GHz, Bw = 16.000 MH No calibration applied and no bandpass applied

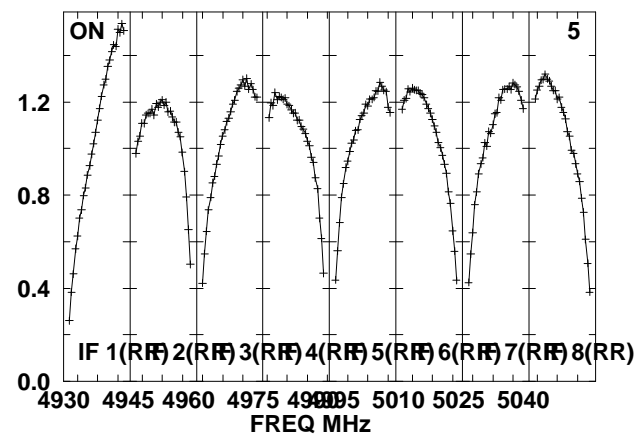
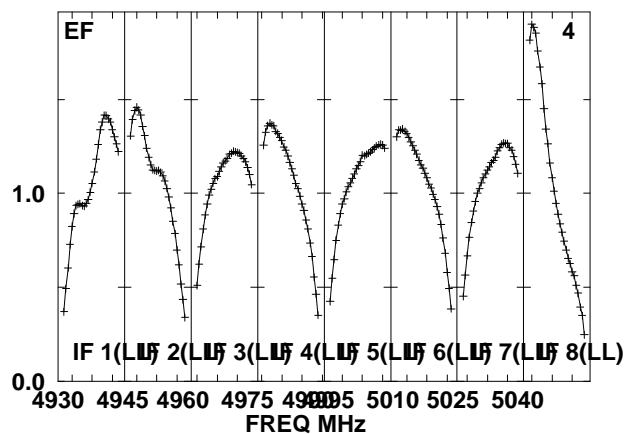
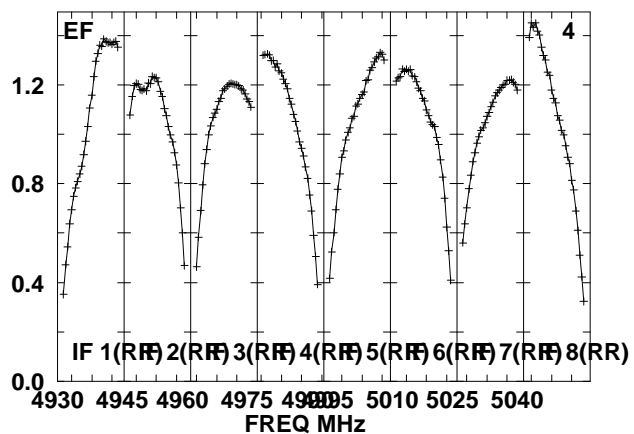
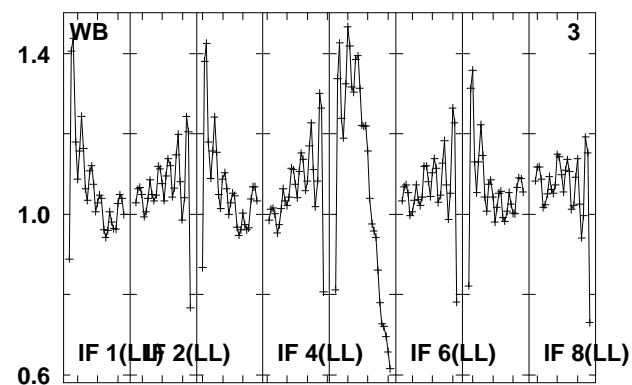
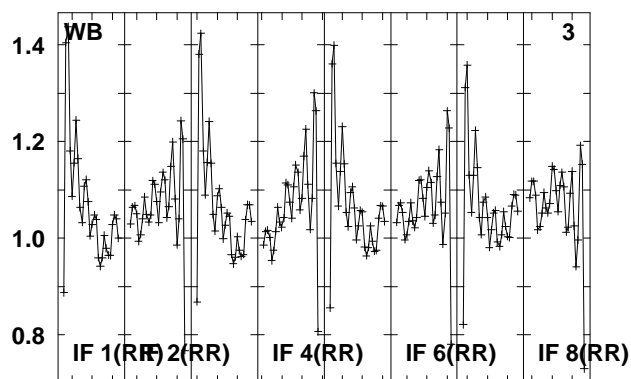
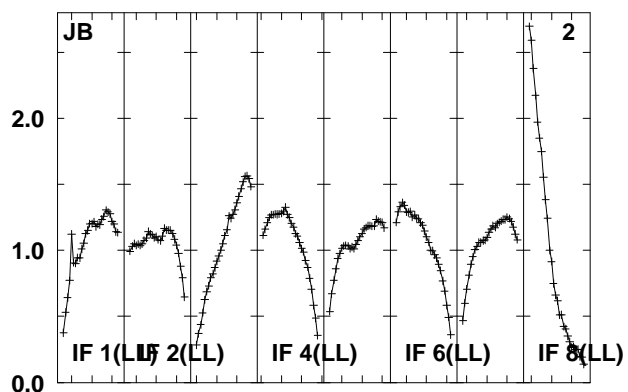
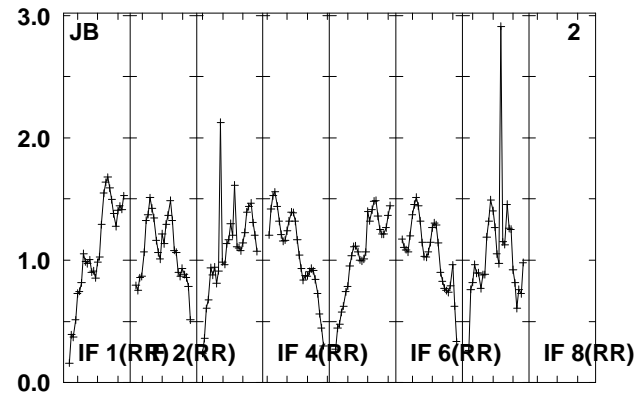
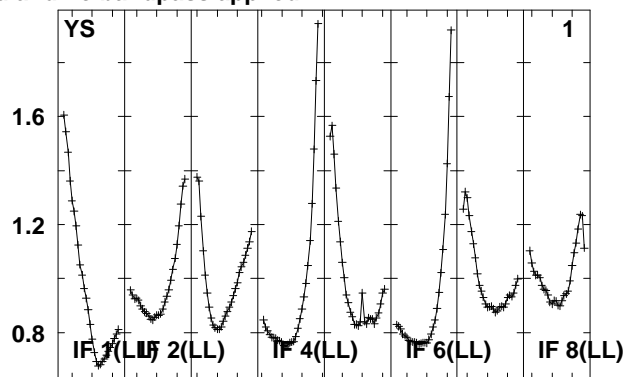
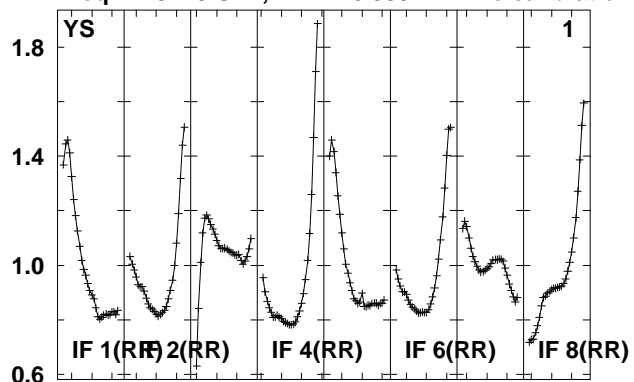

Lower frame: Real Jy
 Total-power spectrum Antenna: *
 Timerange: 00/03:04:11 to 00/03:09:07

Plot file version 36 created 14-MAY-2010 15:17:05

J135355 EO007.UVDATA.1

Freq = 4.9270 GHz, Bw = 16.000 MH No calibration applied and no bandpass applied

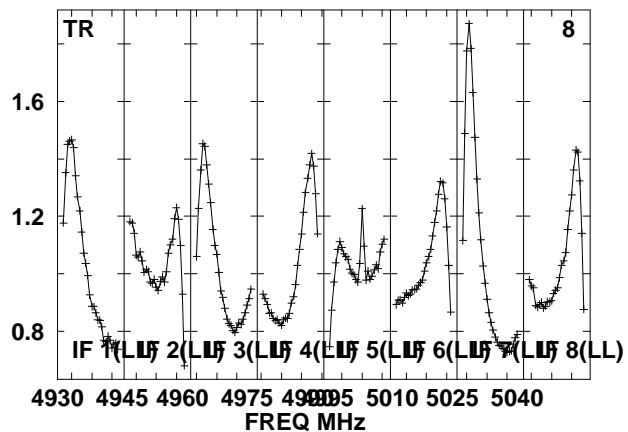
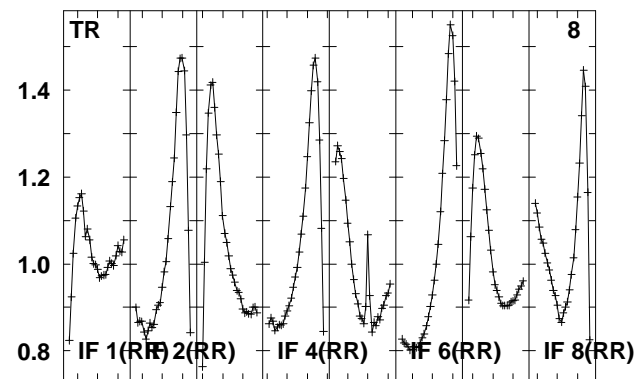
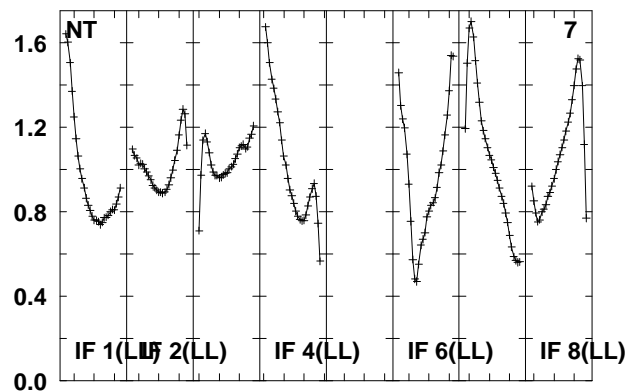
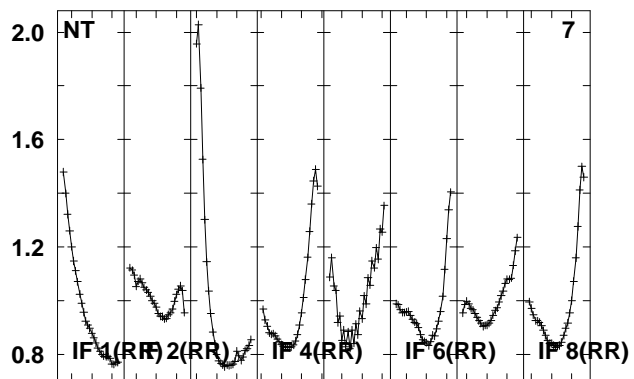
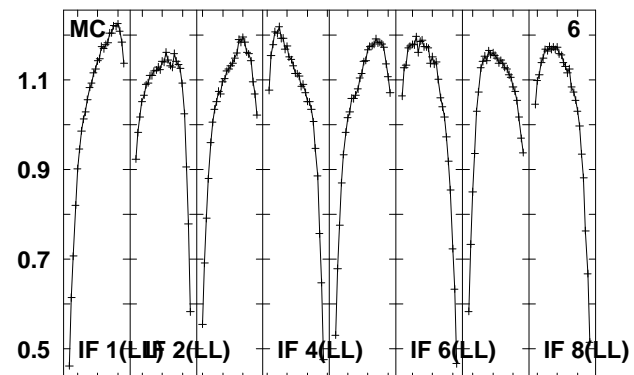
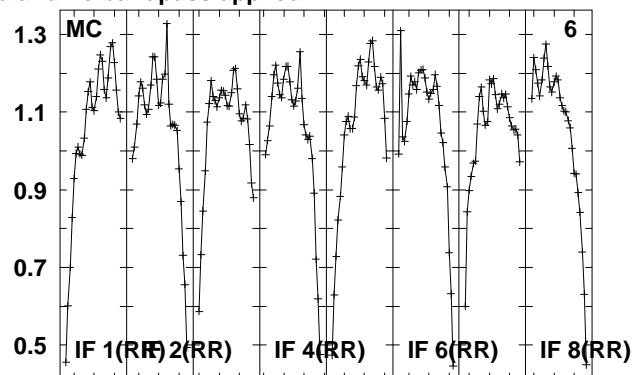
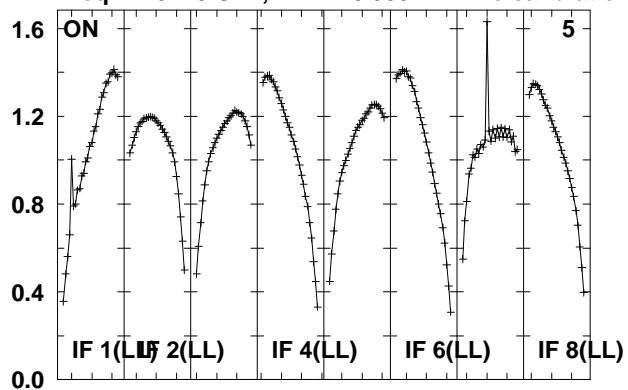

Lower frame: Real Jy

Total-power spectrum Antenna: *

Timerange: 00/03:04:11 to 00/03:09:07

Plot file version 37 created 14-MAY-2010 15:17:06
 J1344+66 EO007.UVDATA.1
 Freq = 4.9270 GHz, Bw = 16.000 MH No calibration applied and no bandpass applied

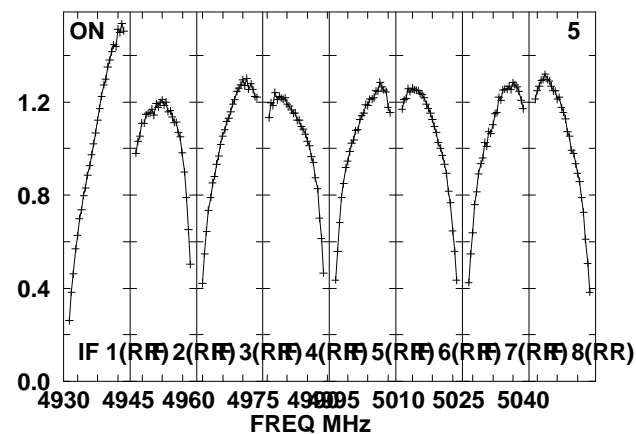
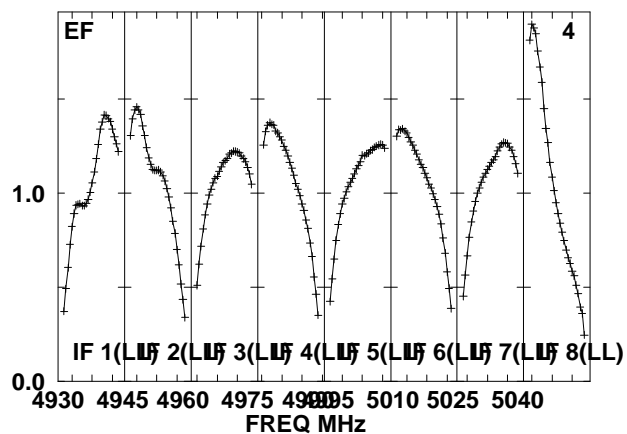
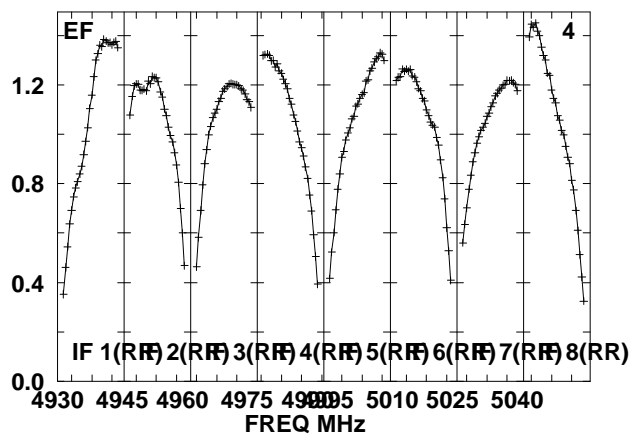
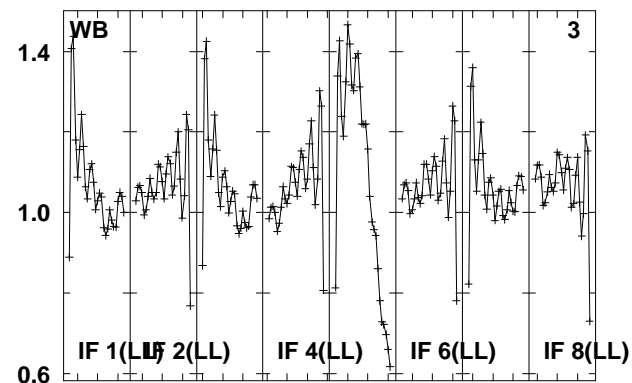
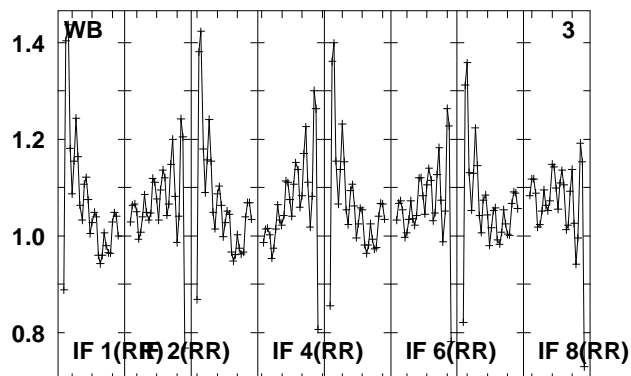
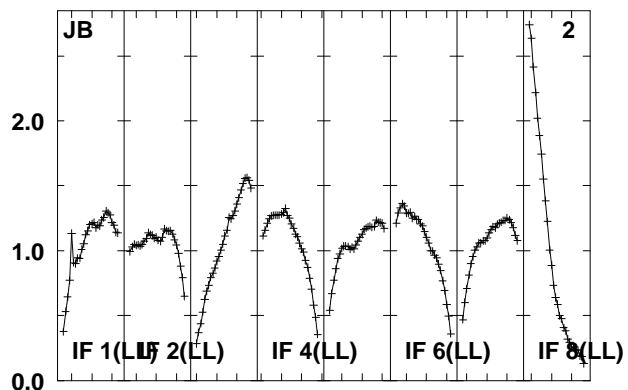
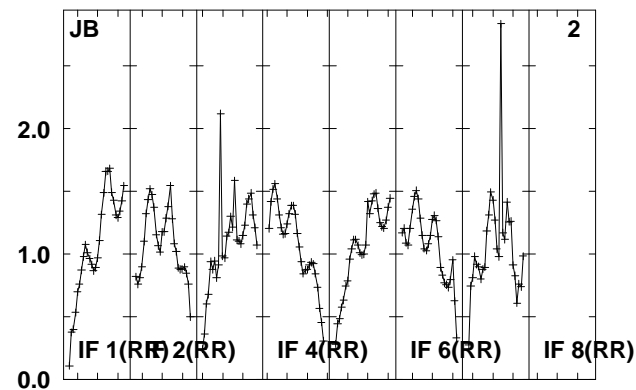
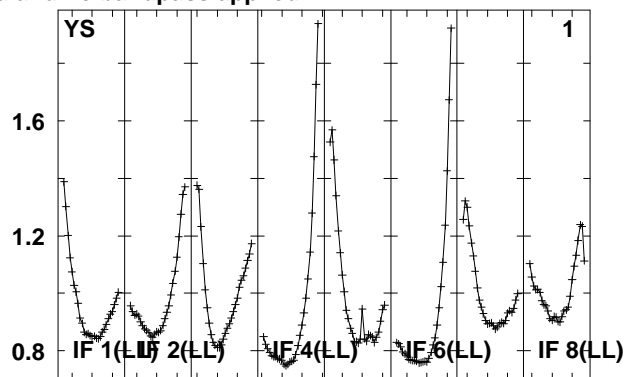
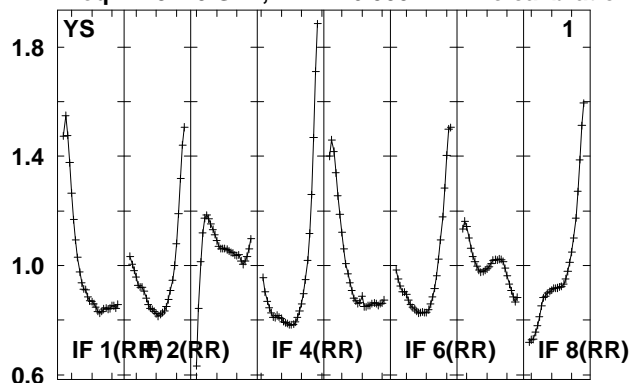

Lower frame: Real Jy
 Total-power spectrum Antenna: *
 Timerange: 00/03:09:50 to 00/03:11:16

Plot file version 38 created 14-MAY-2010 15:17:06

J1344+66 EO007.UVDATA.1

Freq = 4.9270 GHz, Bw = 16.000 MH No calibration applied and no bandpass applied

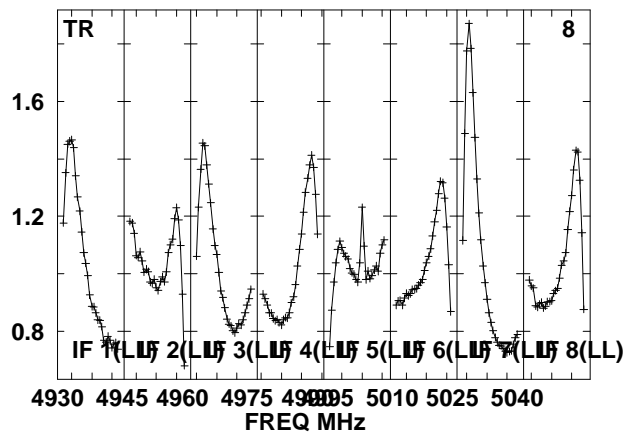
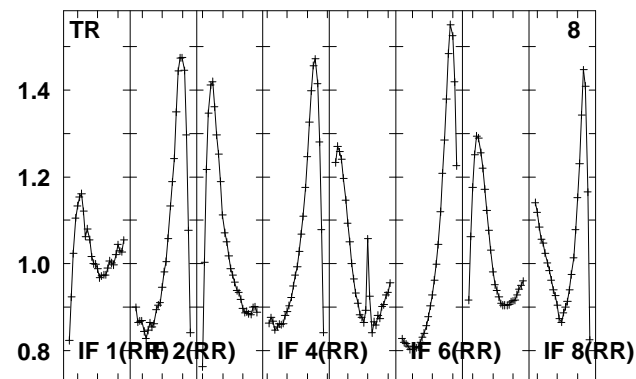
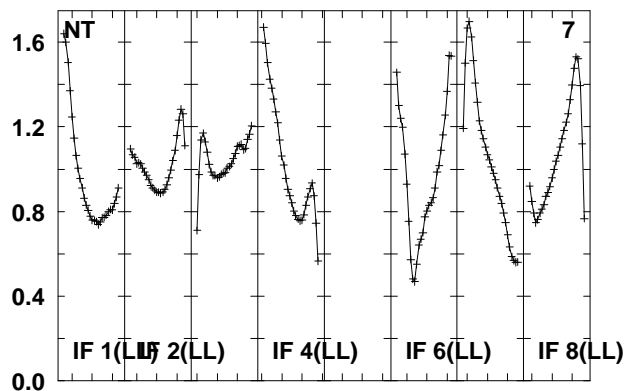
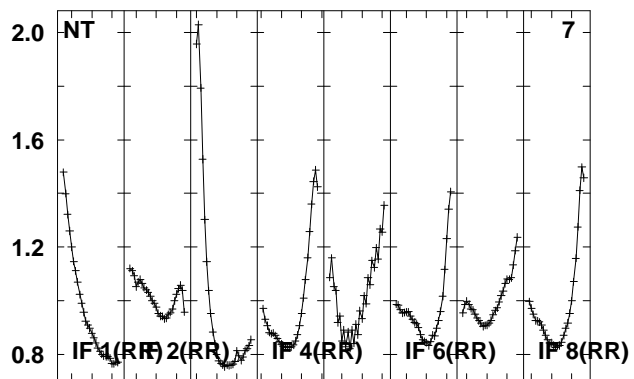
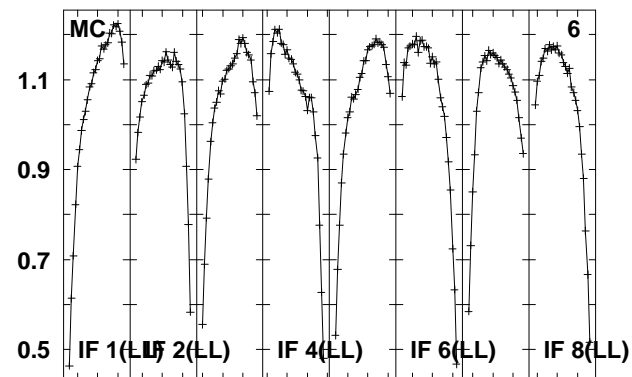
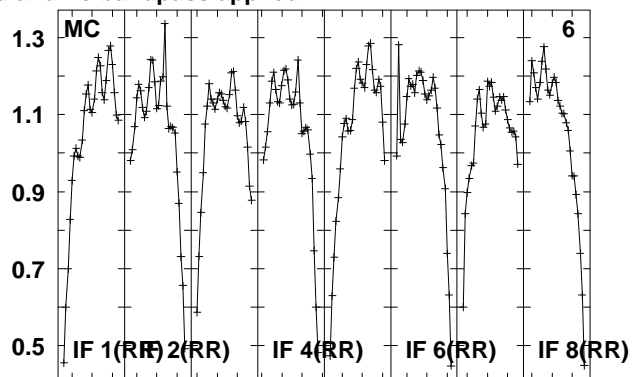
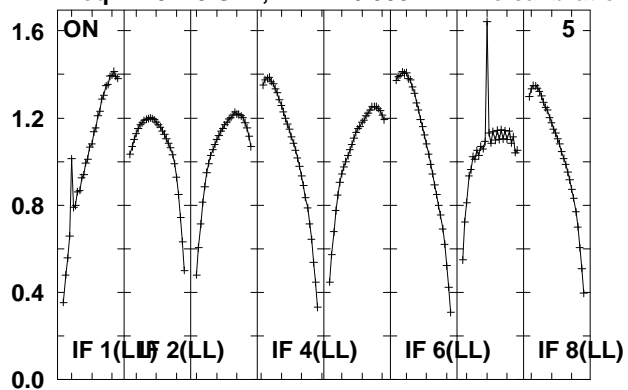

Lower frame: Real Jy

Total-power spectrum Antenna: *

Timerange: 00/03:09:50 to 00/03:11:16

Plot file version 39 created 14-MAY-2010 15:17:06
 J135355 EO007.UVDATA.1
 Freq = 4.9270 GHz, Bw = 16.000 MH No calibration applied and no bandpass applied

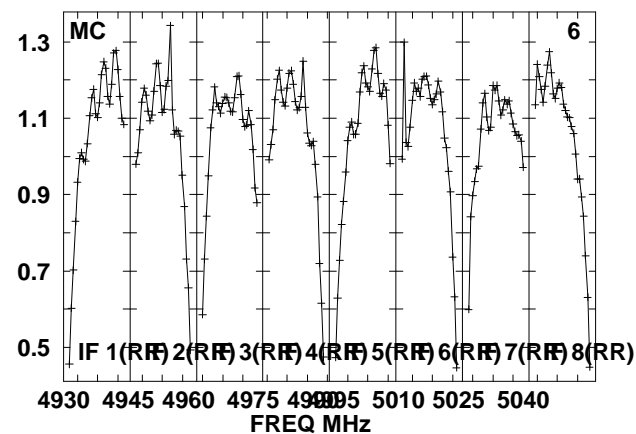
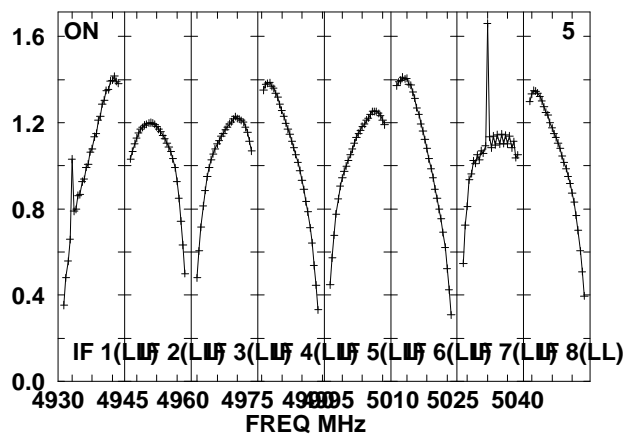
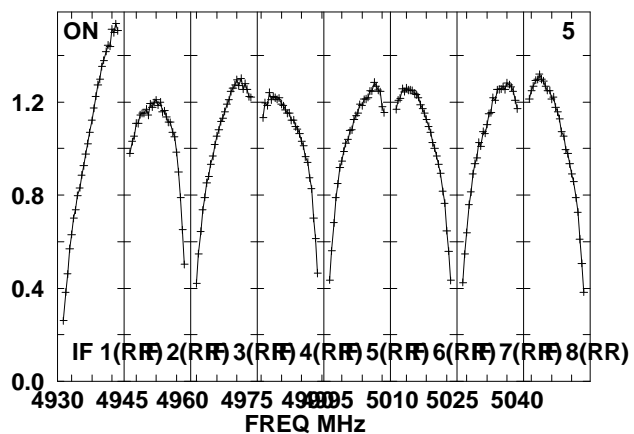
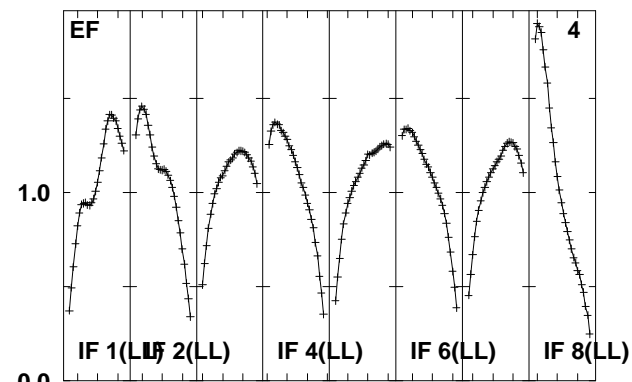
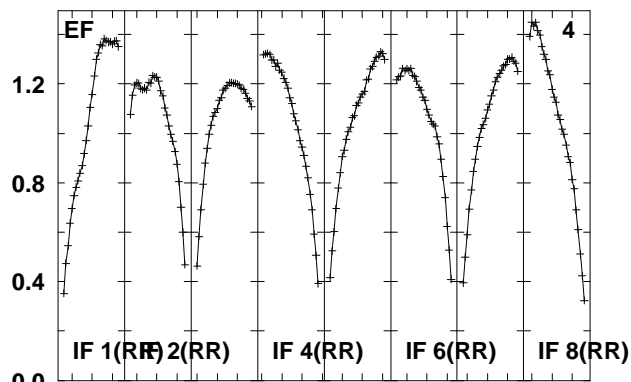
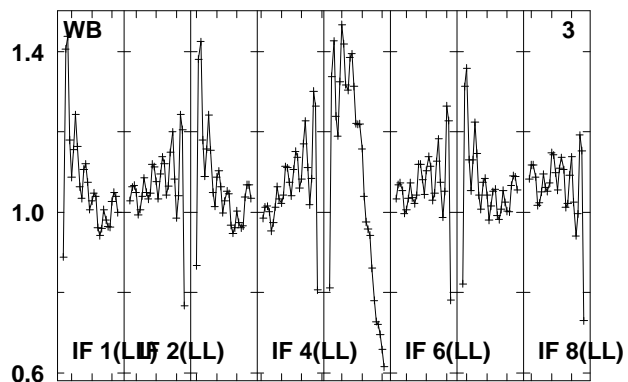
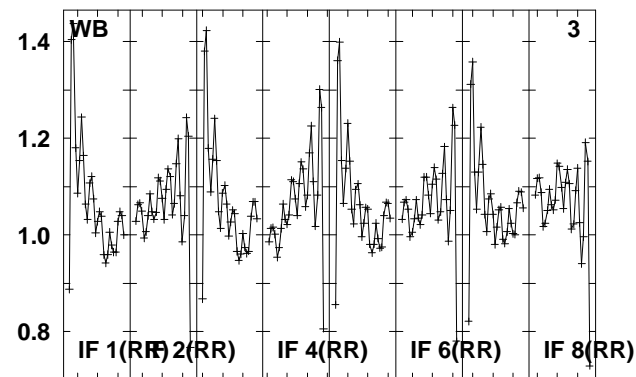
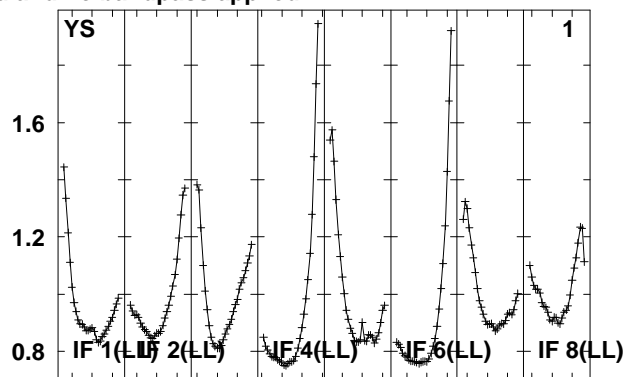
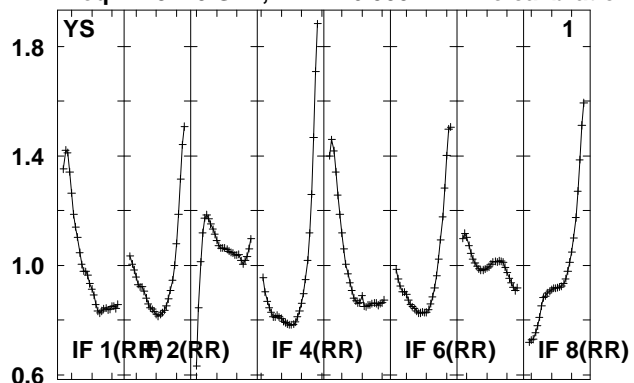

Lower frame: Real Jy
 Total-power spectrum Antenna: *
 Timerange: 00/03:11:55 to 00/03:16:51

Plot file version 40 created 14-MAY-2010 15:17:07

J135355 EO007.UVDATA.1

Freq = 4.9270 GHz, Bw = 16.000 MH No calibration applied and no bandpass applied

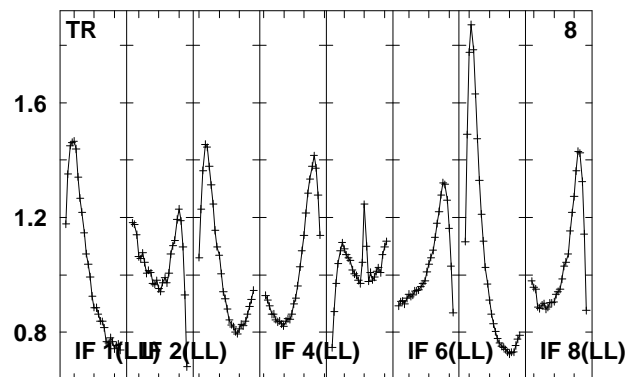
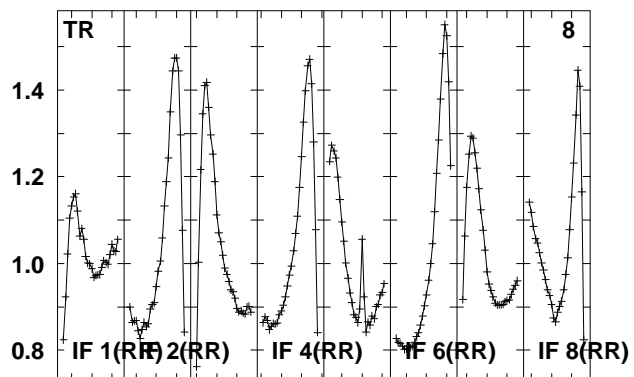
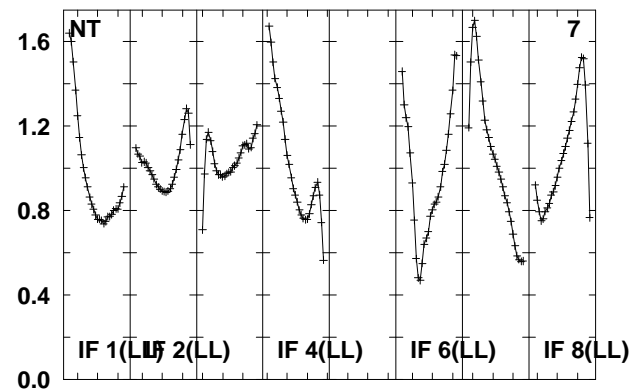
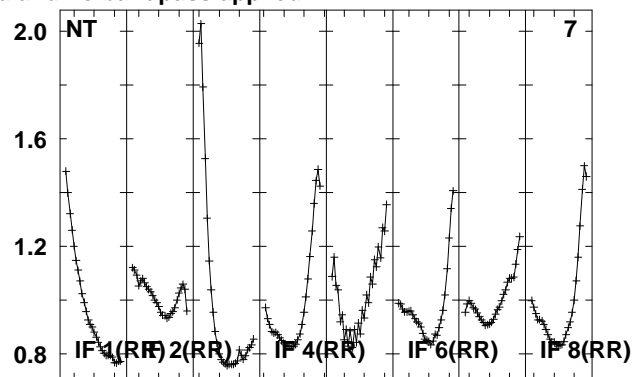
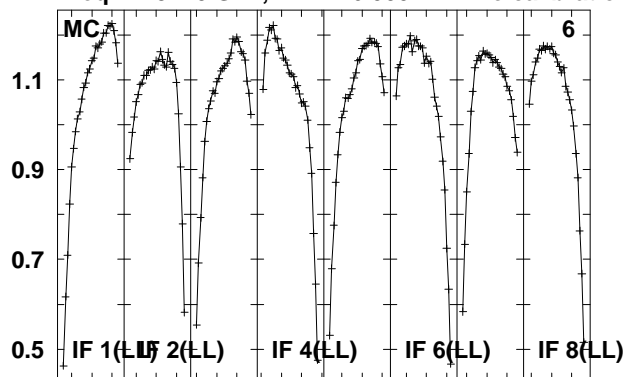

Lower frame: Real Jy
Total-power spectrum Antenna: *
Timerange: 00/03:11:55 to 00/03:16:51

Plot file version 41 created 14-MAY-2010 15:17:07

J1344+66 EO007.UVDATA.1

Freq = 4.9270 GHz, Bw = 16.000 MH No calibration applied and no bandpass applied

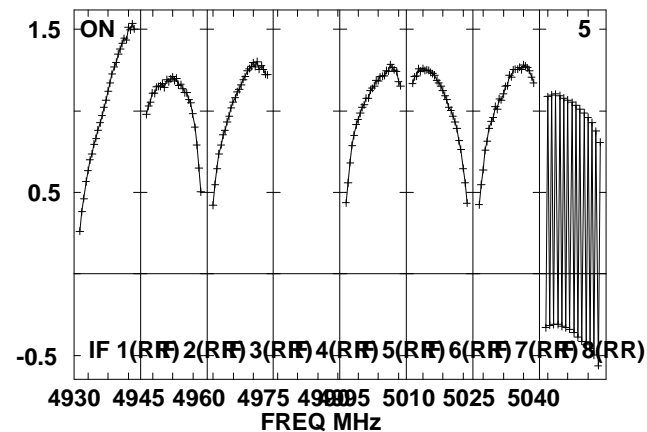
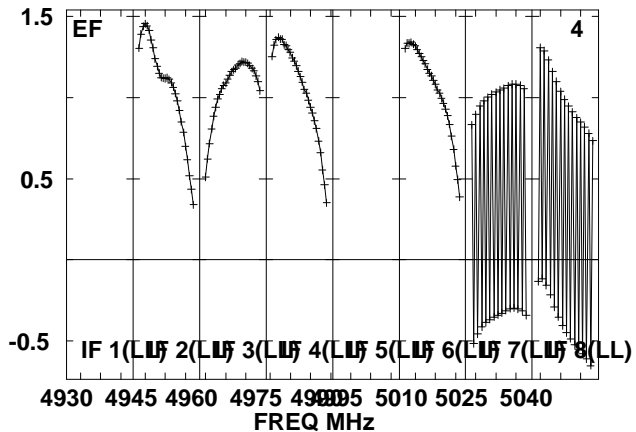
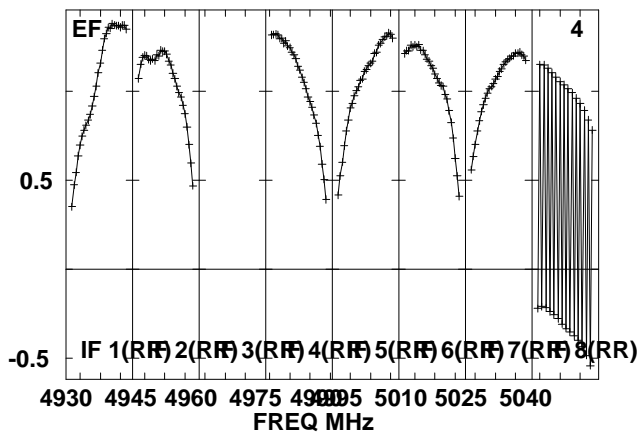
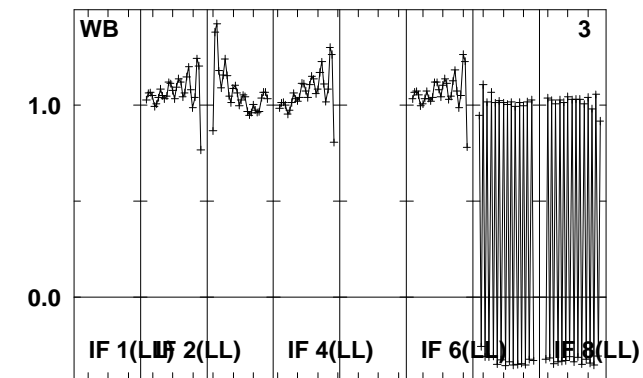
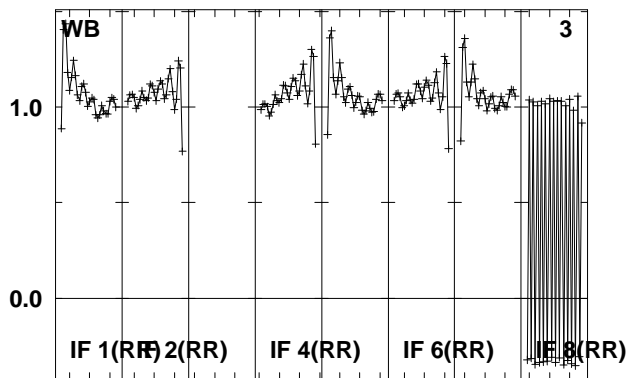
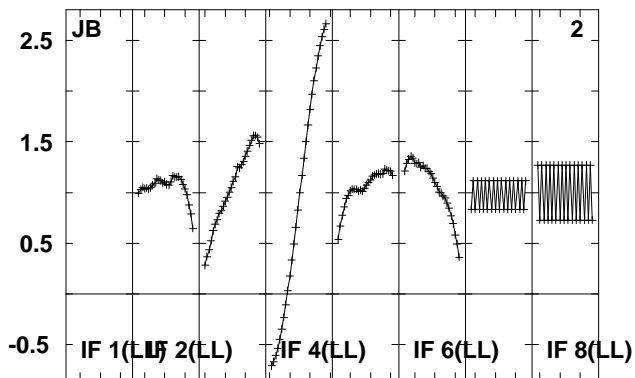
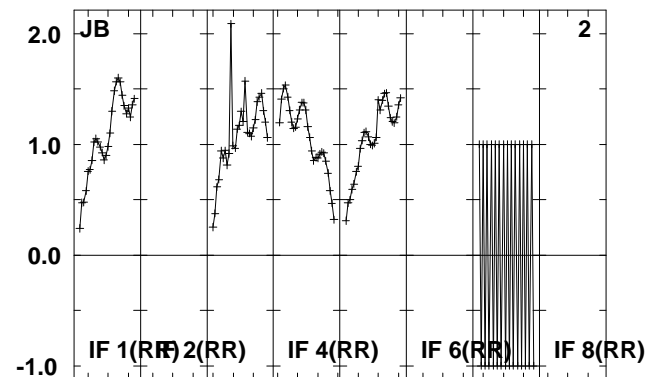
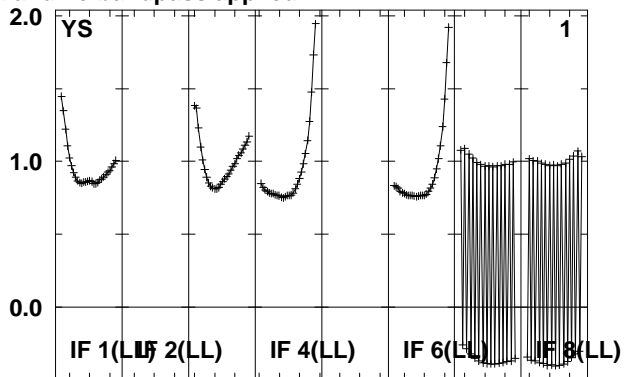
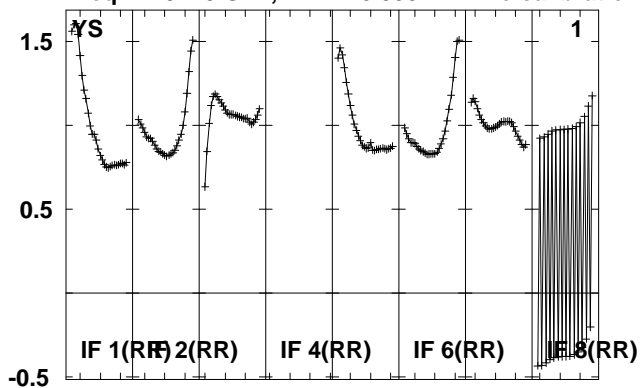

Lower frame: Real Jy

Total-power spectrum Antenna: *

Timerange: 00/03:17:30 to 00/03:18:56

Plot file version 42 created 14-MAY-2010 15:17:08

J1344+66 EO007.UVDATA.1

Freq = 4.9270 GHz, Bw = 16.000 MH No calibration applied and no bandpass applied

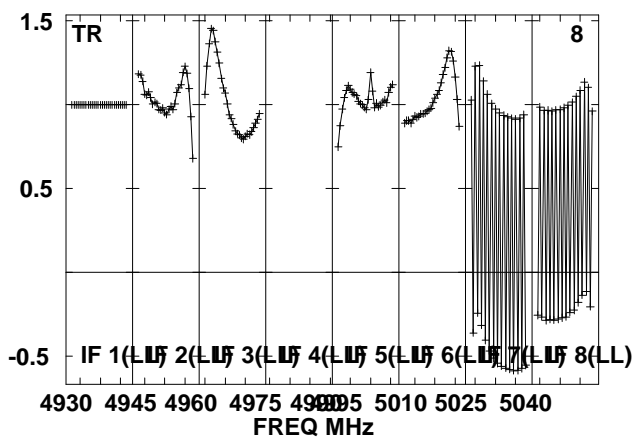
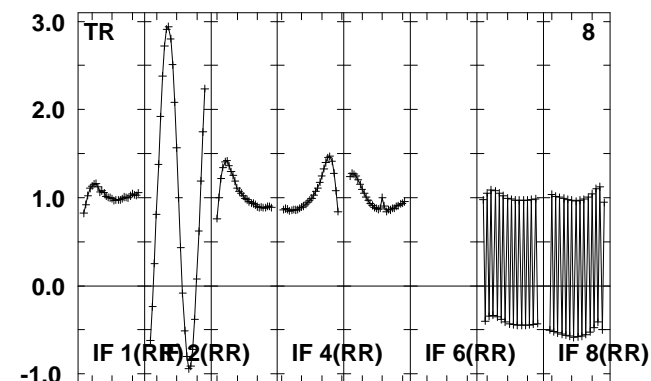
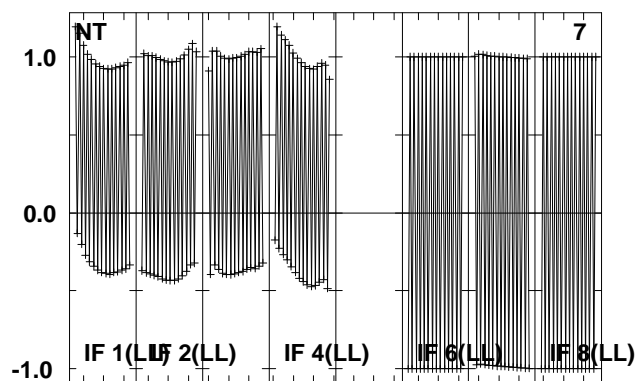
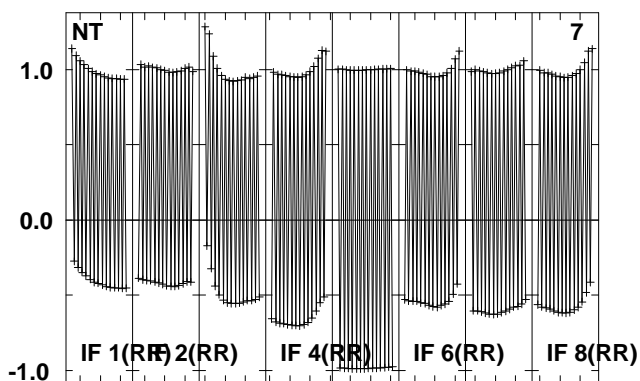
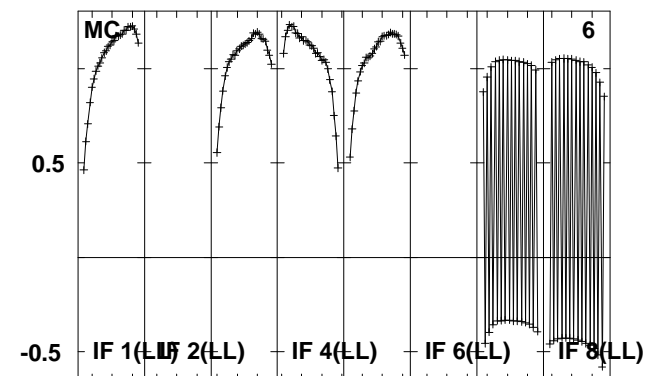
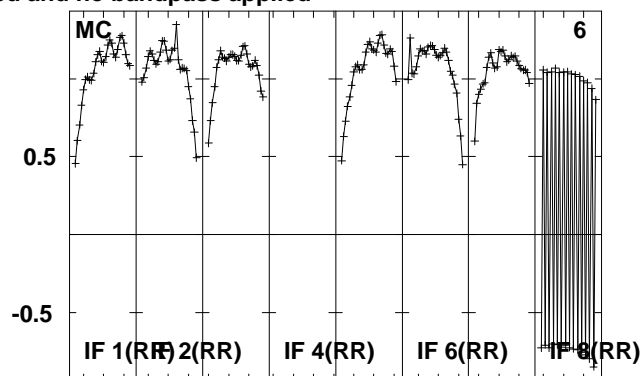
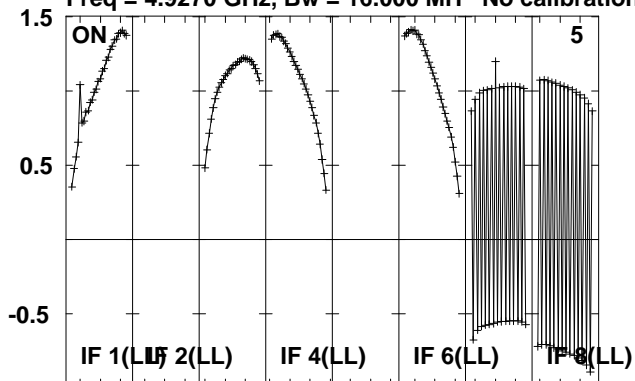

Lower frame: Real Jy

Total-power spectrum Antenna: *

Timerange: 00/03:17:30 to 00/03:18:56

Plot file version 43 created 14-MAY-2010 15:17:08
 J135355 EO007.UVDATA.1
 Freq = 4.9270 GHz, Bw = 16.000 MH No calibration applied and no bandpass applied

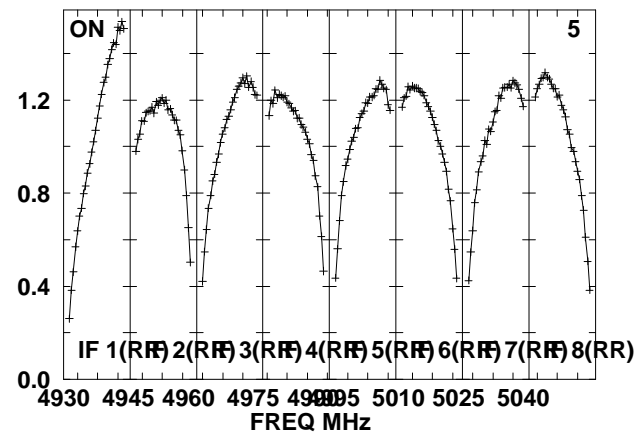
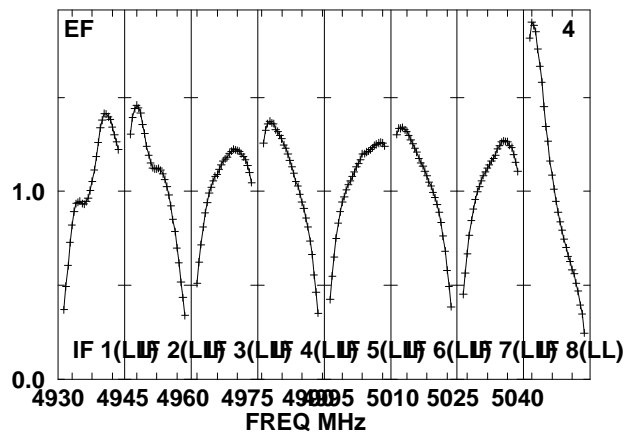
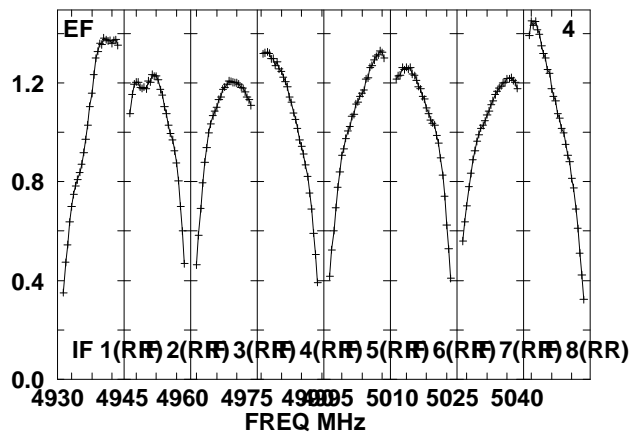
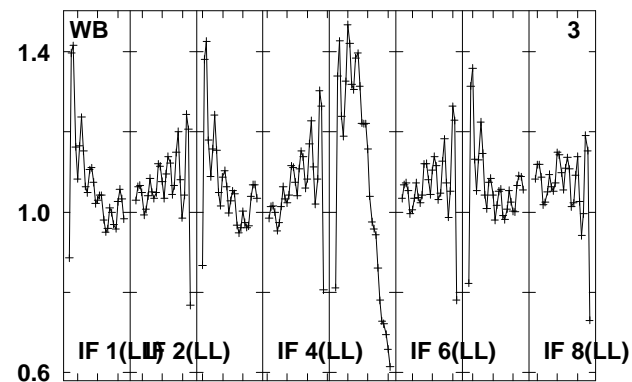
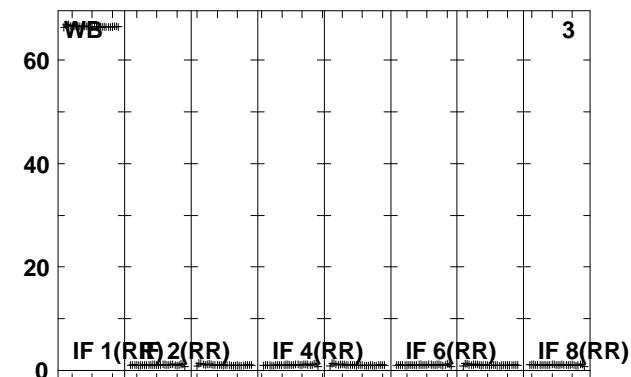
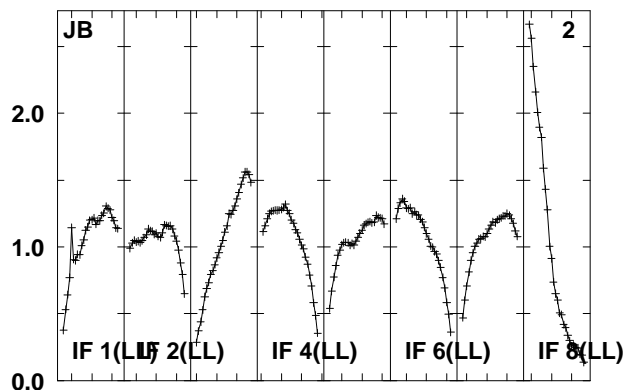
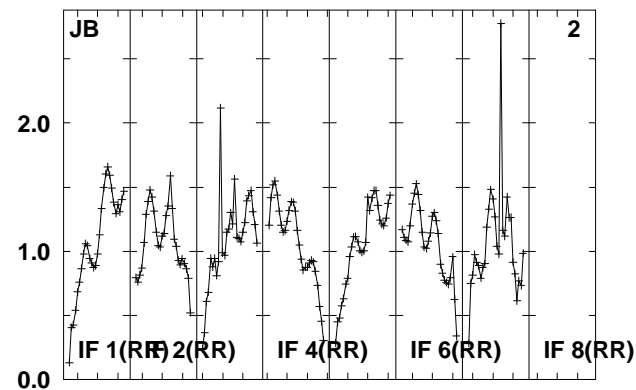
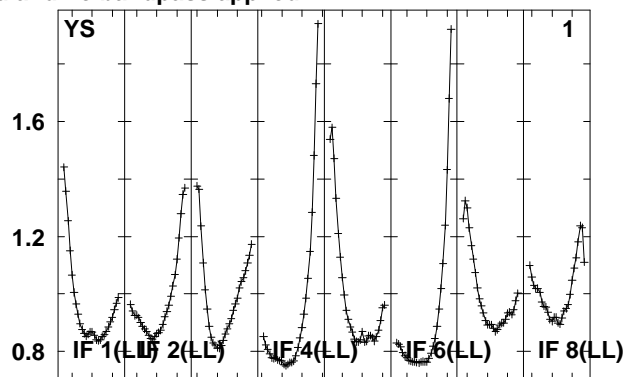
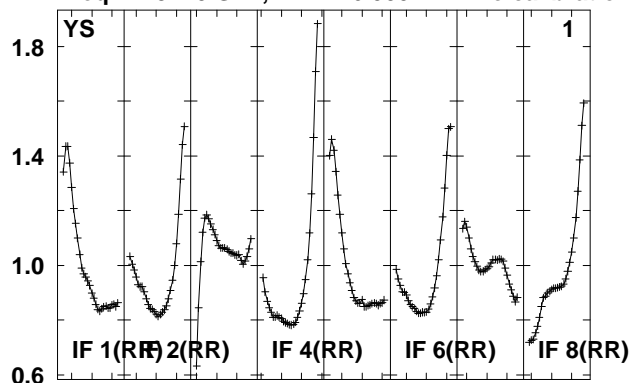

Lower frame: Real Jy
 Total-power spectrum Antenna: *
 Timerange: 00/03:19:36 to 00/03:24:34

Plot file version 44 created 14-MAY-2010 15:17:09

J135355 EO007.UVDATA.1

Freq = 4.9270 GHz, Bw = 16.000 MH No calibration applied and no bandpass applied

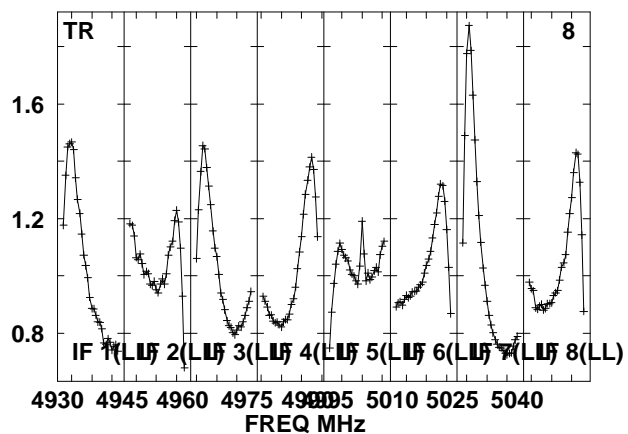
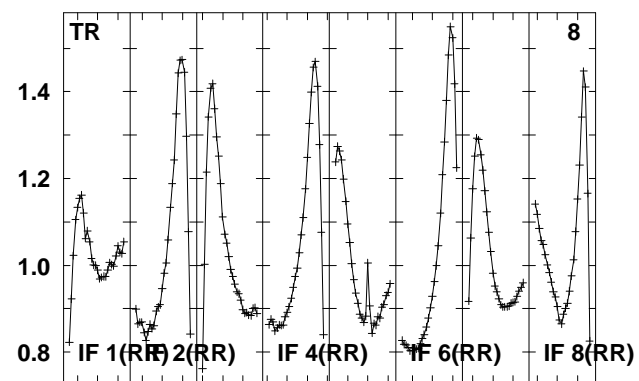
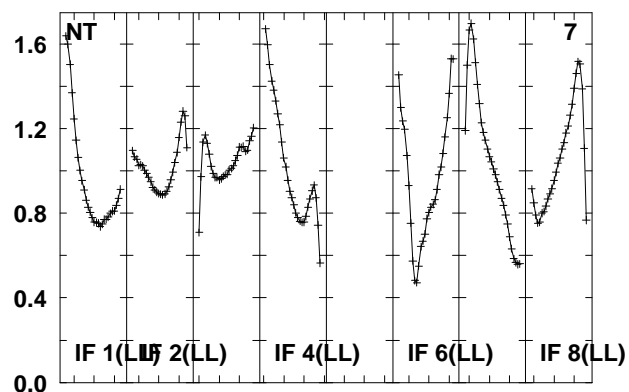
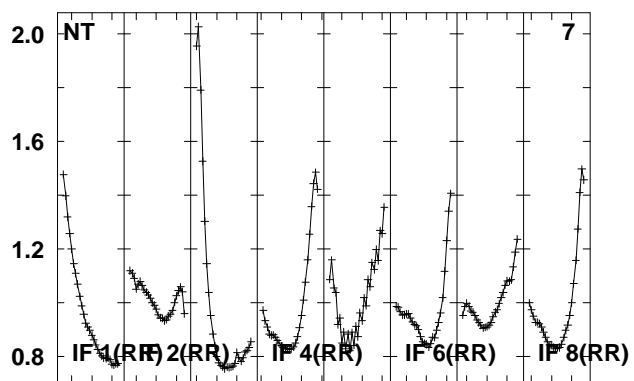
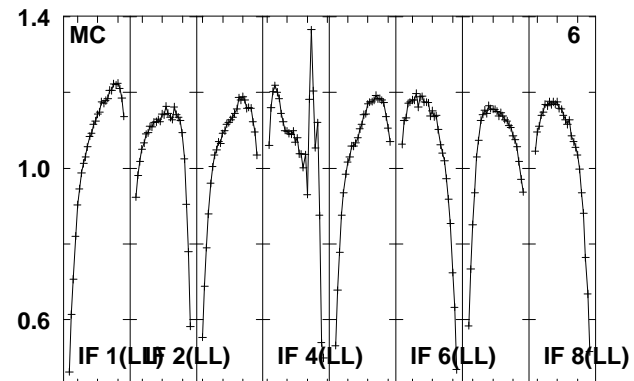
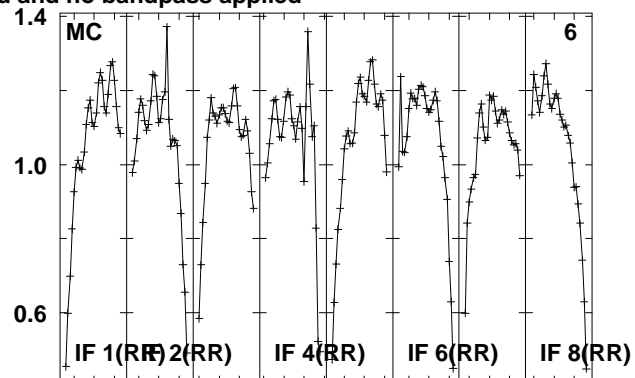
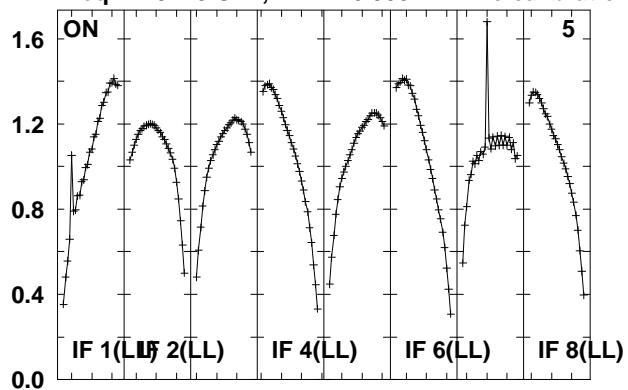

Lower frame: Real Jy

Total-power spectrum Antenna: *

Timerange: 00/03:19:36 to 00/03:24:34

Plot file version 45 created 14-MAY-2010 15:17:09
 J1344+66 EO007.UVDATA.1
 Freq = 4.9270 GHz, Bw = 16.000 MH No calibration applied and no bandpass applied

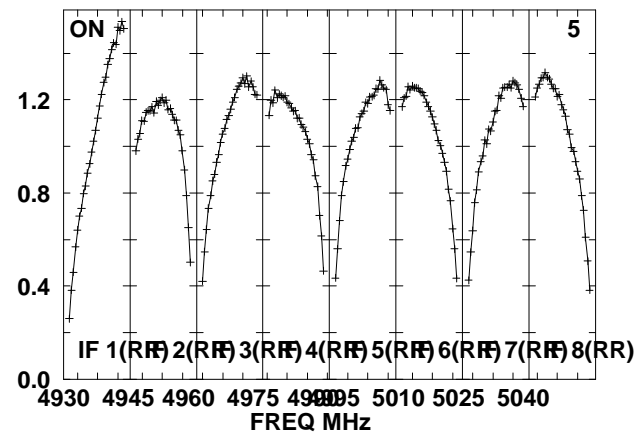
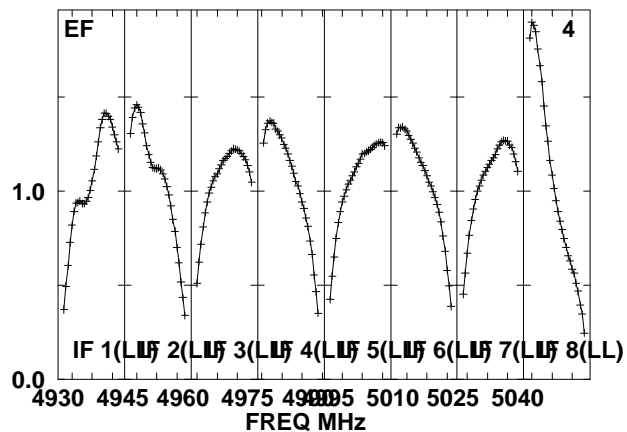
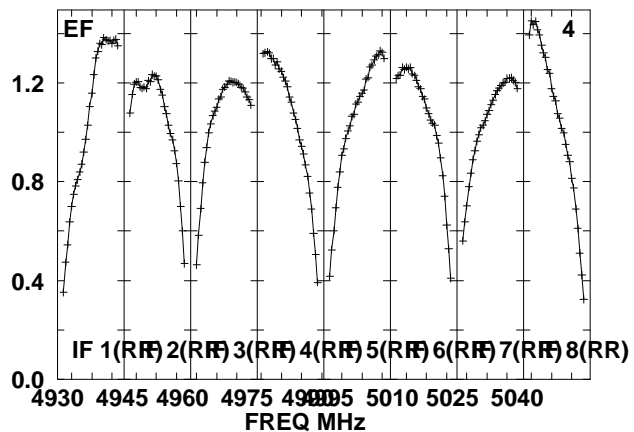
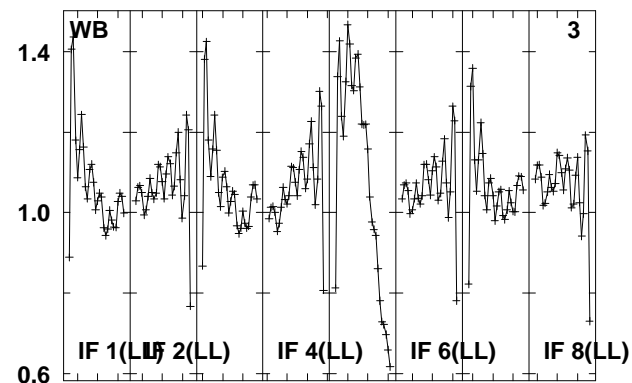
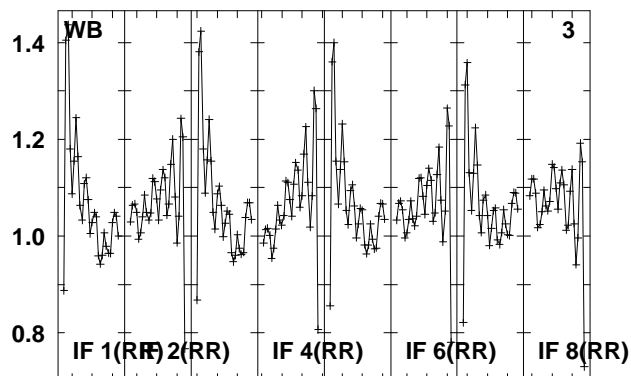
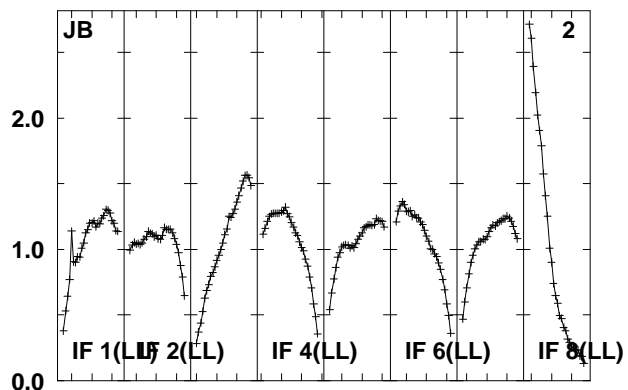
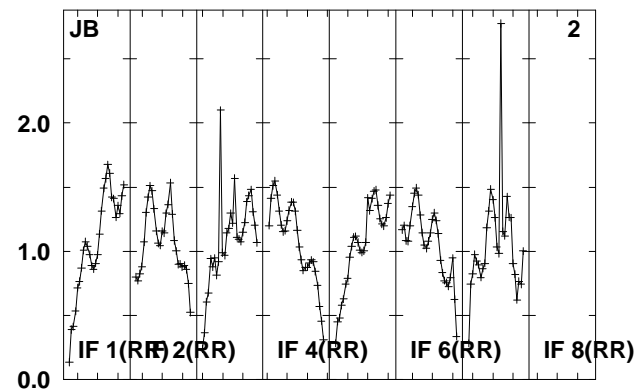
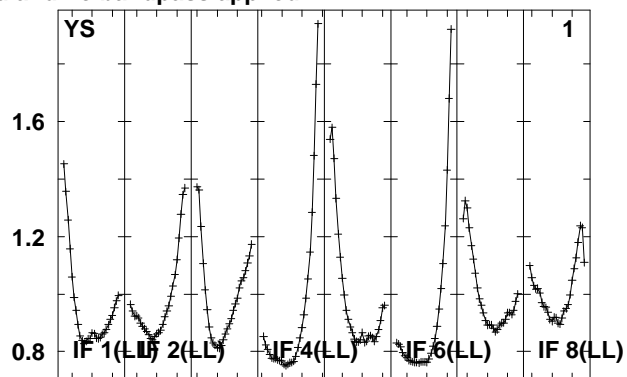
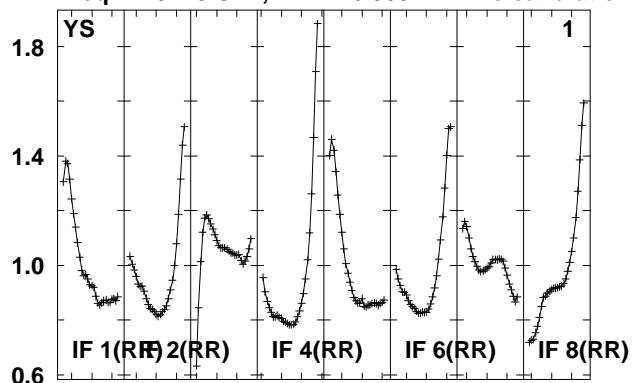

Lower frame: Real Jy
 Total-power spectrum Antenna: *
 Timerange: 00/03:25:14 to 00/03:26:42

Plot file version 46 created 14-MAY-2010 15:17:09

J1344+66 EO007.UVDATA.1

Freq = 4.9270 GHz, Bw = 16.000 MH No calibration applied and no bandpass applied

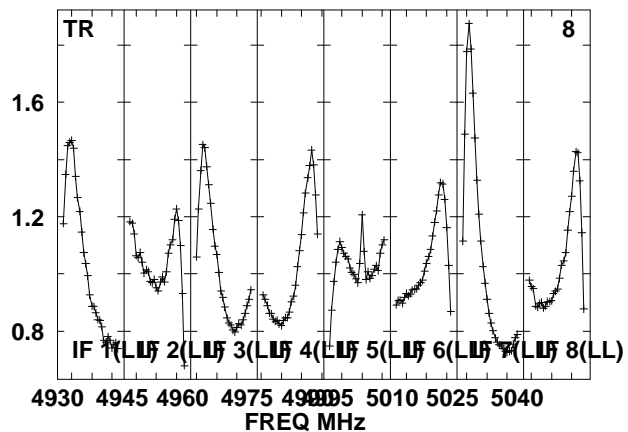
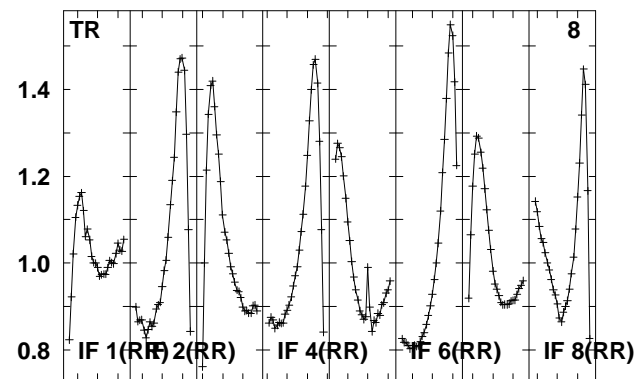
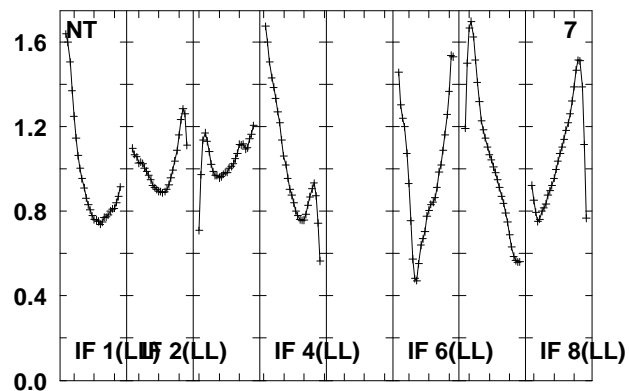
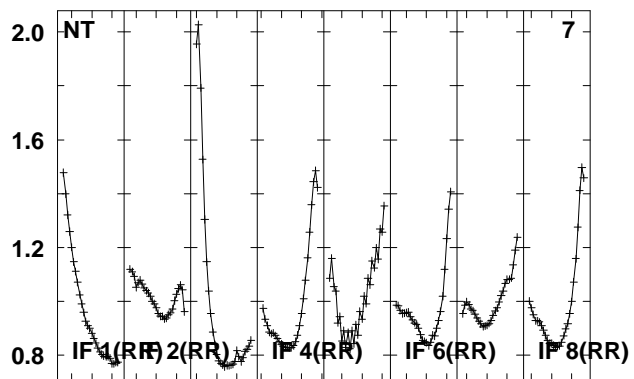
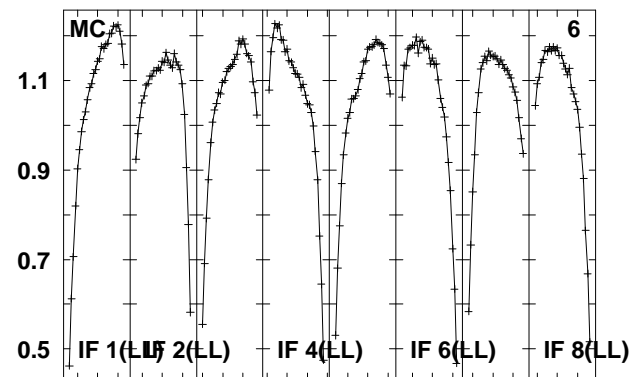
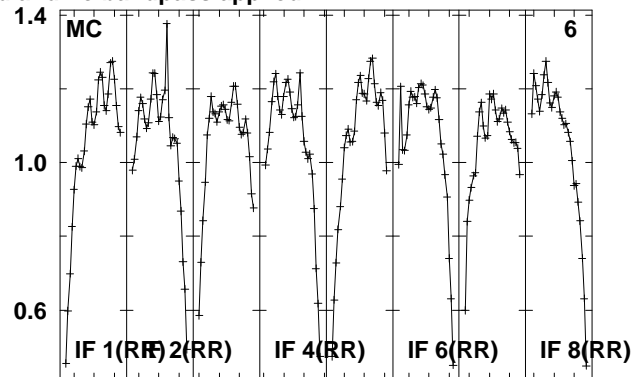
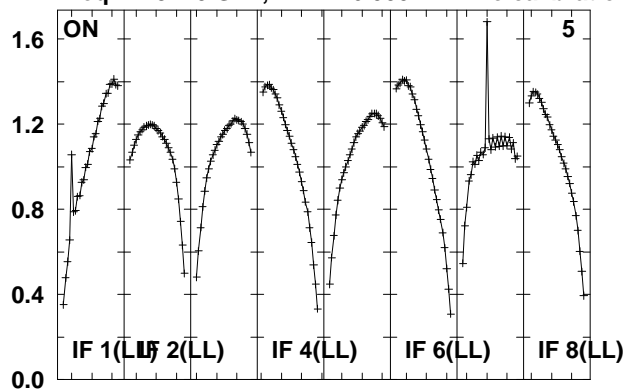

Lower frame: Real Jy

Total-power spectrum Antenna: *

Timerange: 00/03:25:14 to 00/03:26:42

Plot file version 47 created 14-MAY-2010 15:17:09
 J135355 EO007.UVDATA.1
 Freq = 4.9270 GHz, Bw = 16.000 MH No calibration applied and no bandpass applied

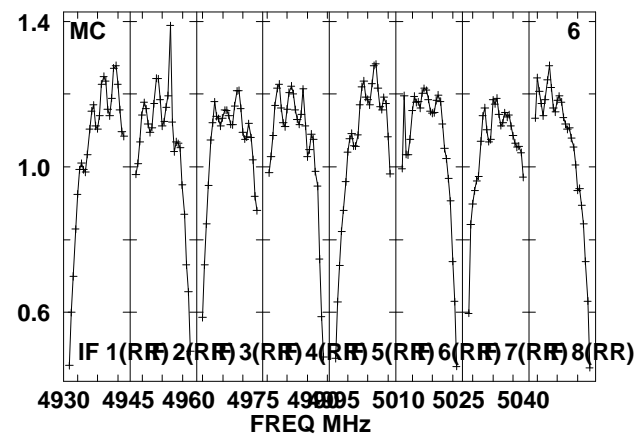
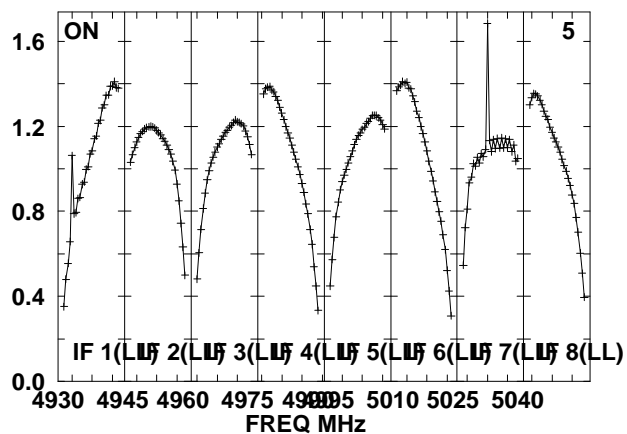
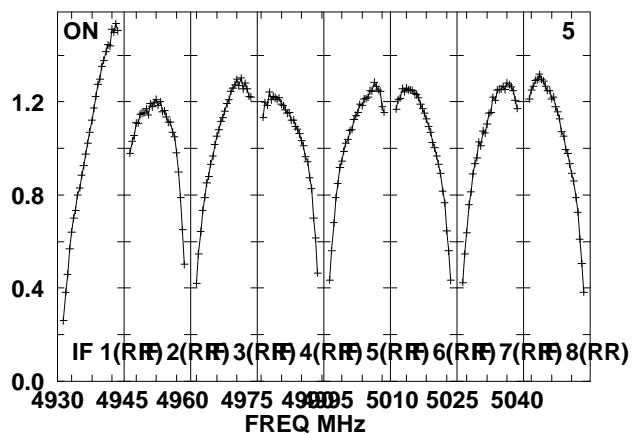
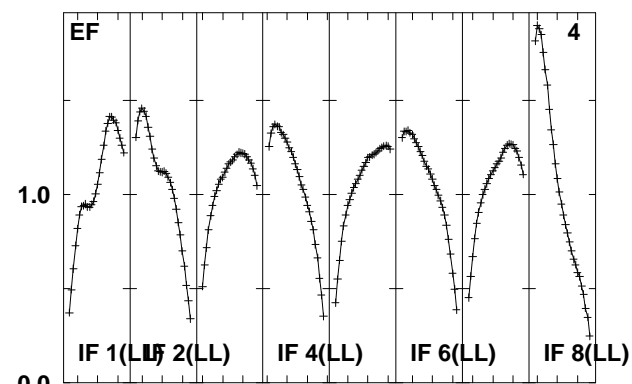
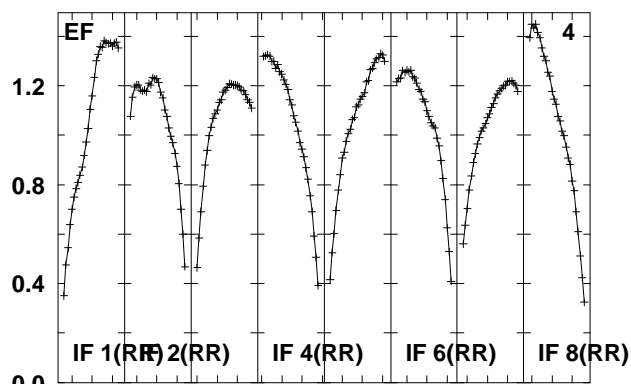
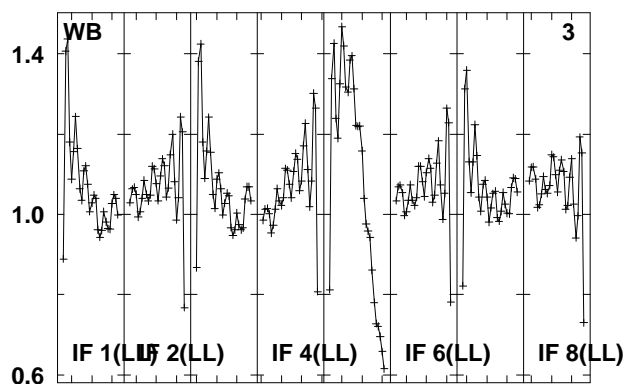
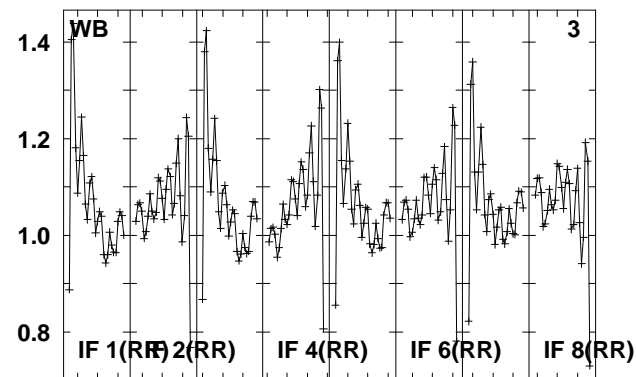
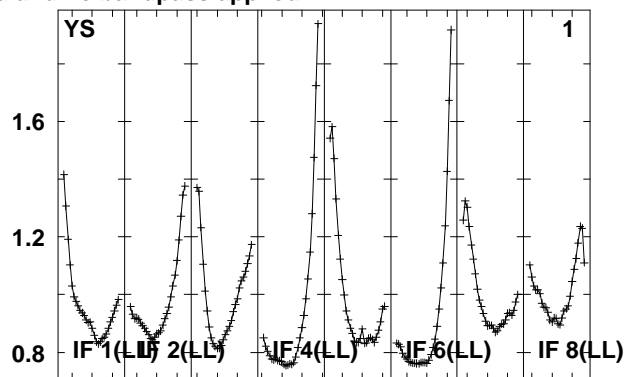
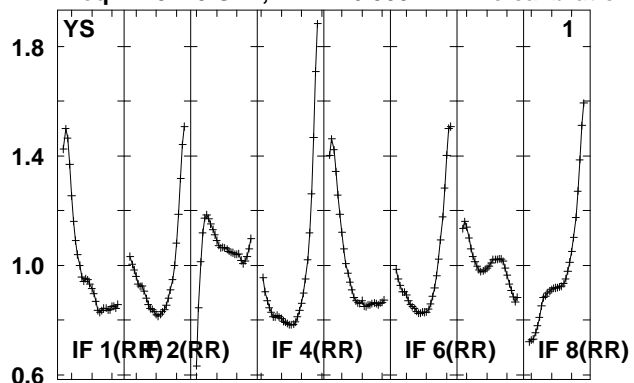

Lower frame: Real Jy
 Total-power spectrum Antenna: *
 Timerange: 00/03:27:18 to 00/03:32:16

Plot file version 48 created 14-MAY-2010 15:17:10

J135355 EO007.UVDATA.1

Freq = 4.9270 GHz, Bw = 16.000 MH No calibration applied and no bandpass applied

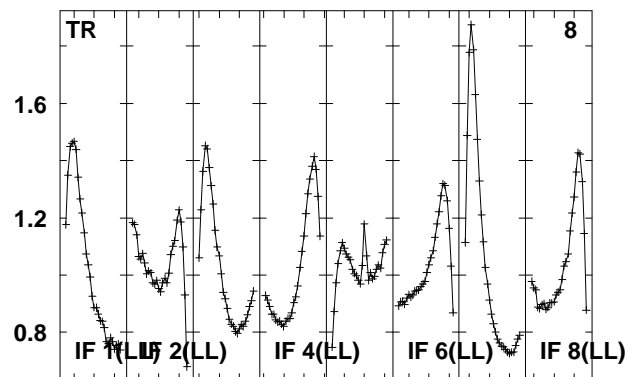
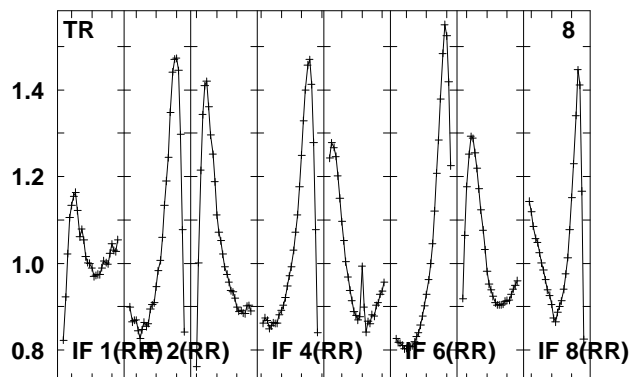
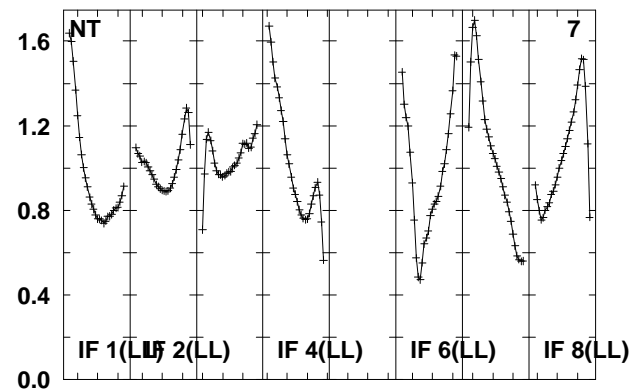
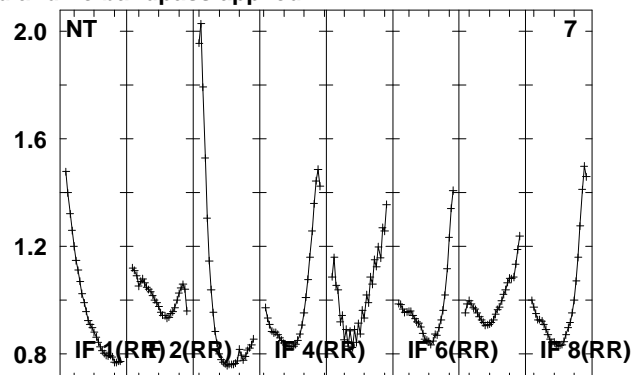
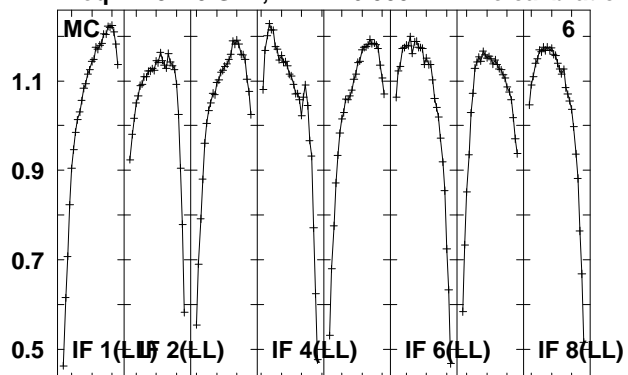

Lower frame: Real Jy
Total-power spectrum Antenna: *
Timerange: 00/03:27:18 to 00/03:32:16

Plot file version 49 created 14-MAY-2010 15:17:10
 J1344+66 EO007.UVDATA.1
 Freq = 4.9270 GHz, Bw = 16.000 MH No calibration applied and no bandpass applied

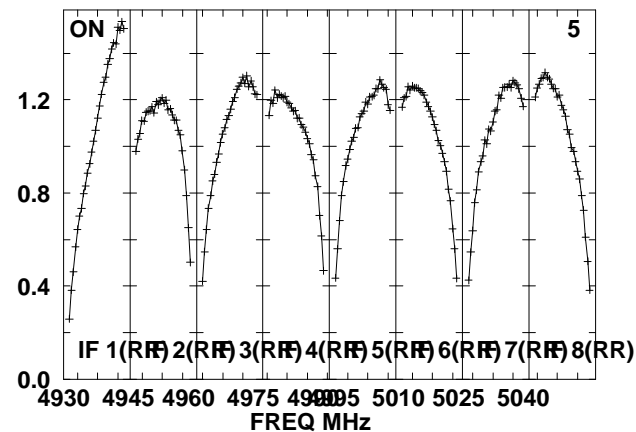
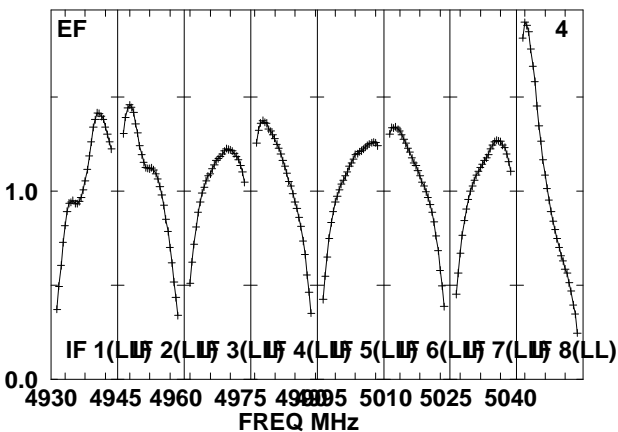
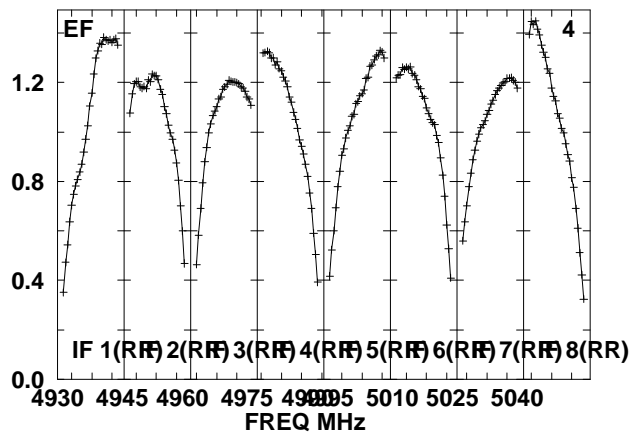
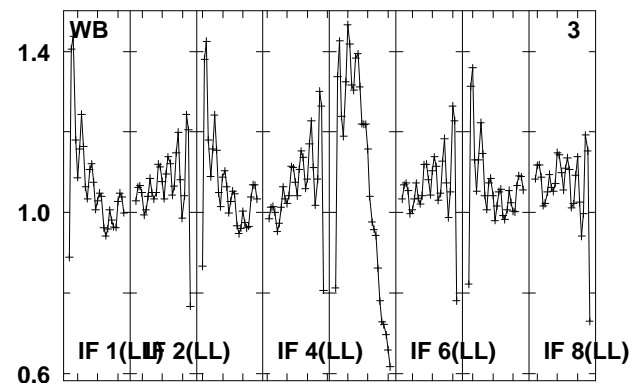
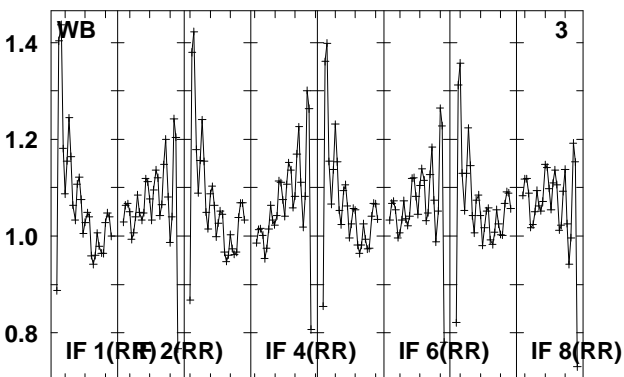
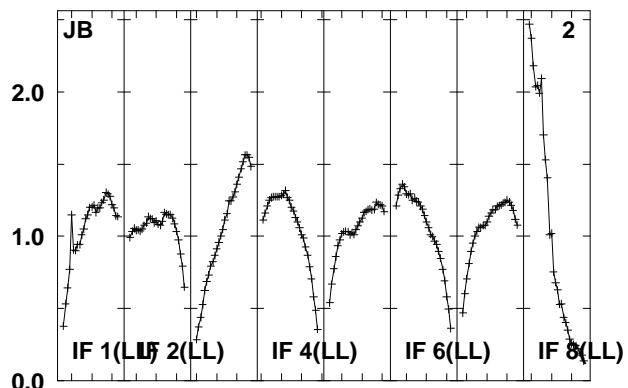
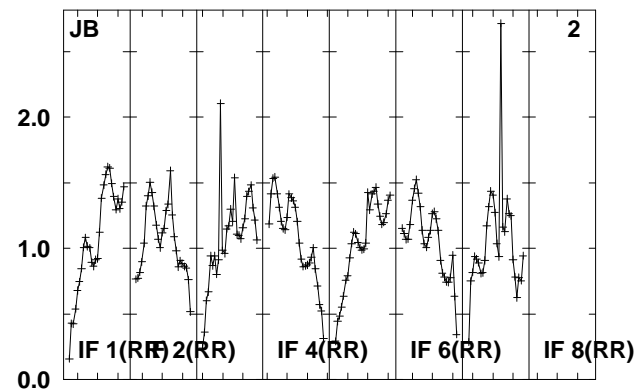
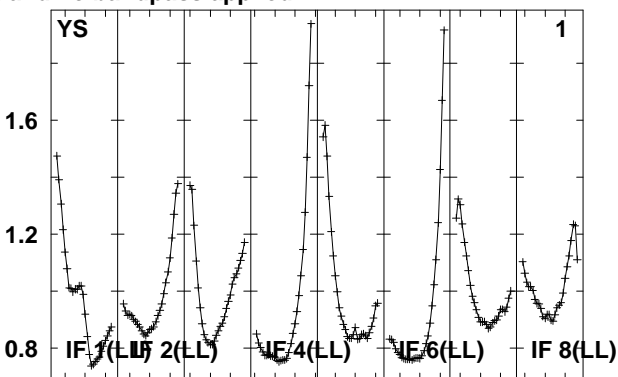
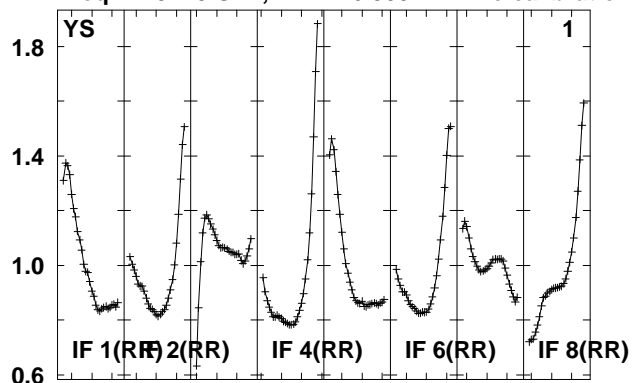

Lower frame: Real Jy
 Total-power spectrum Antenna: *
 Timerange: 00/03:32:52 to 00/03:34:20

Plot file version 50 created 14-MAY-2010 15:17:11

J1344+66 EO007.UVDATA.1

Freq = 4.9270 GHz, Bw = 16.000 MH No calibration applied and no bandpass applied

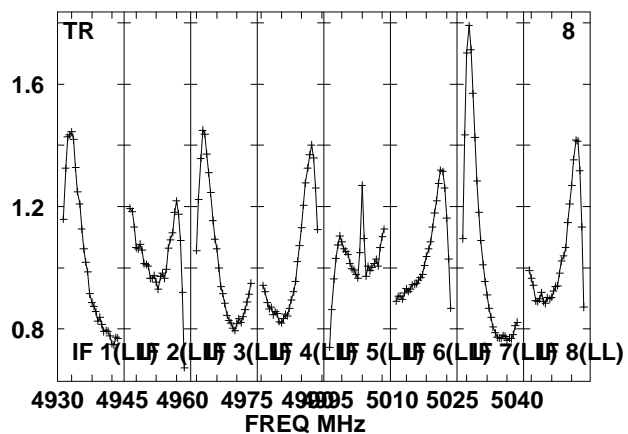
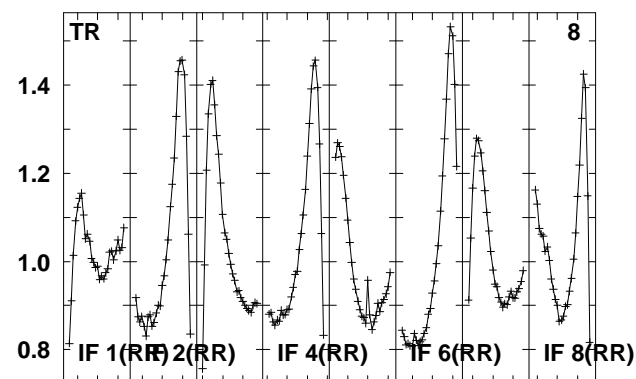
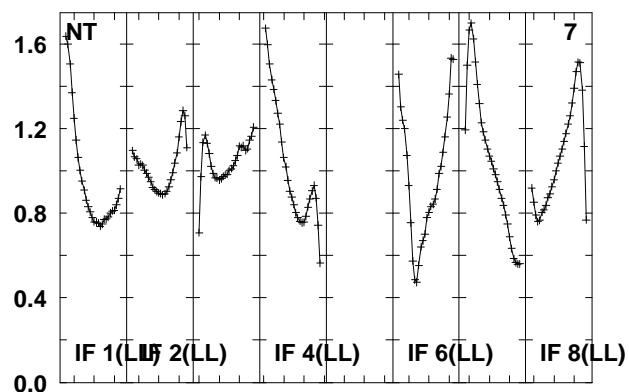
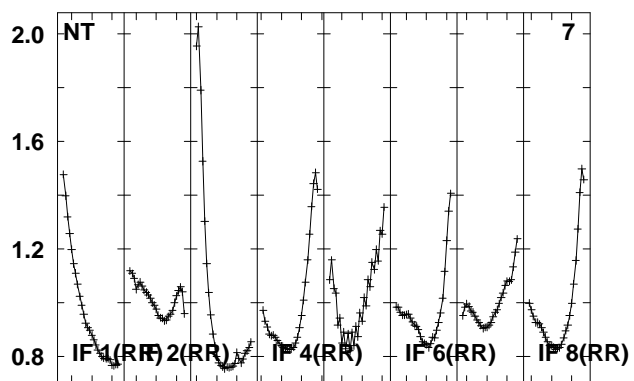
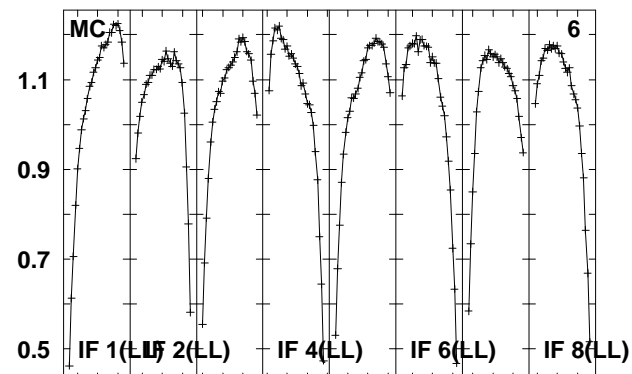
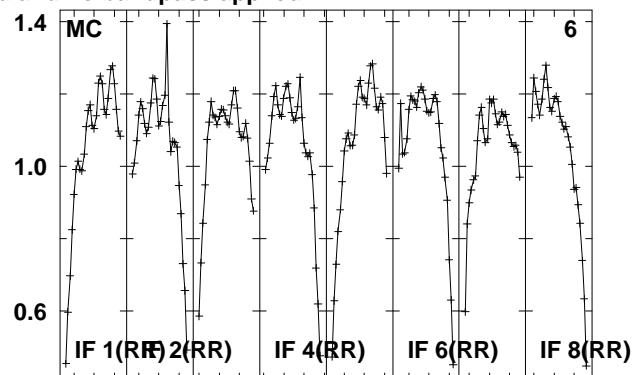
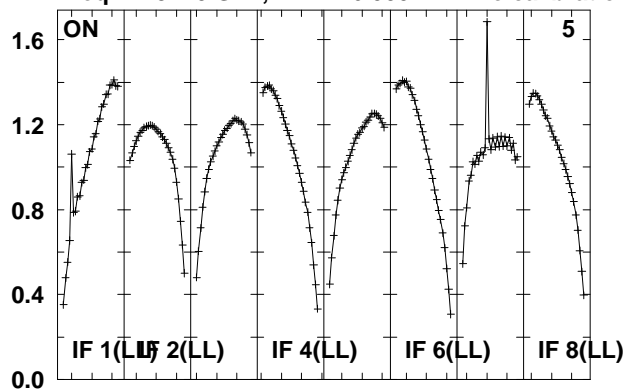

Lower frame: Real Jy

Total-power spectrum Antenna: *

Timerange: 00/03:32:52 to 00/03:34:20

Plot file version 51 created 14-MAY-2010 15:17:11
 J135355 EO007.UVDATA.1
 Freq = 4.9270 GHz, Bw = 16.000 MH No calibration applied and no bandpass applied

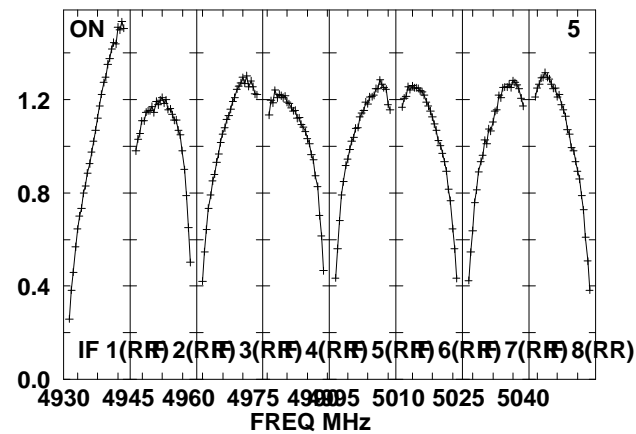
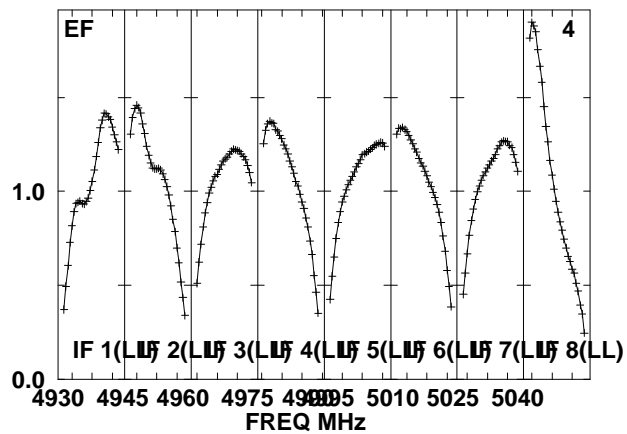
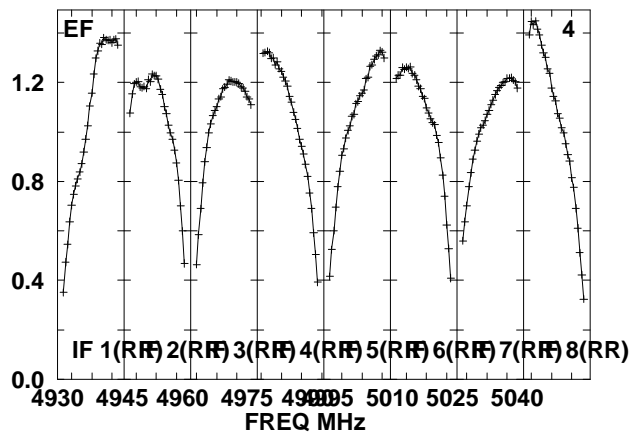
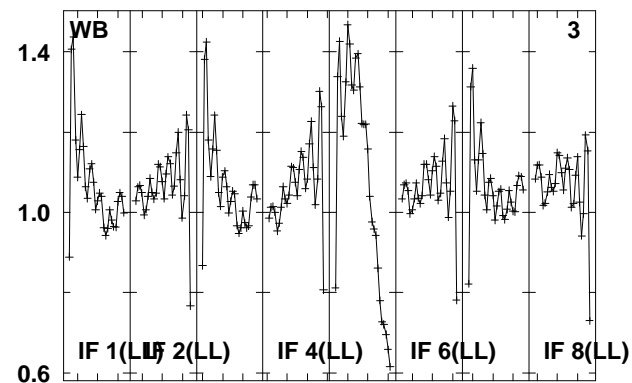
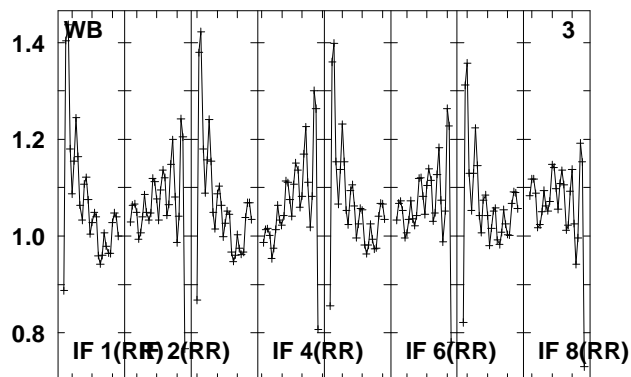
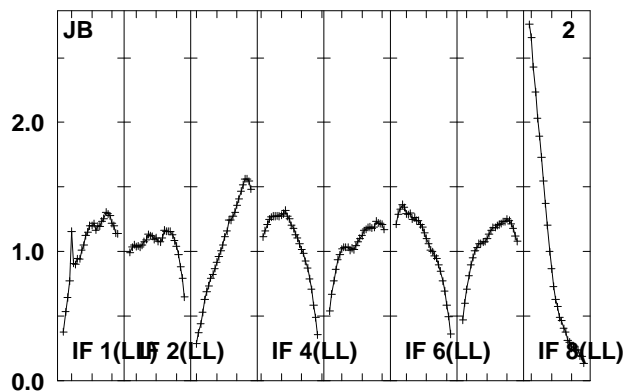
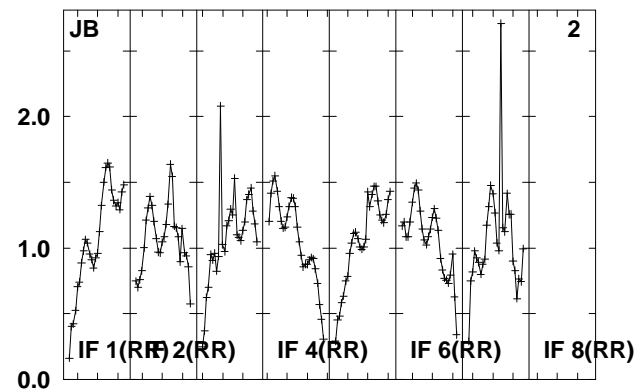
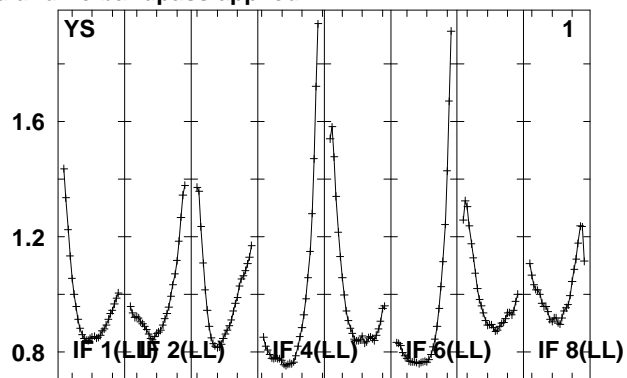
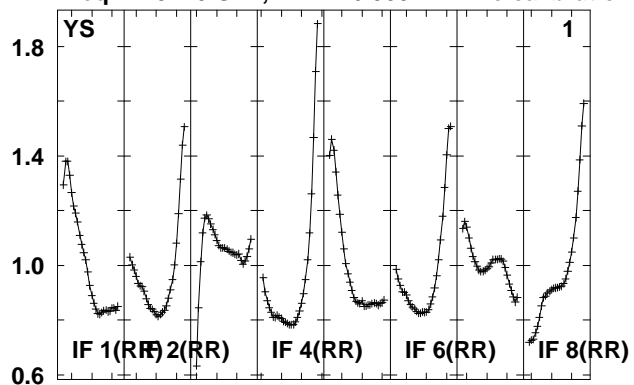

Lower frame: Real Jy
 Total-power spectrum Antenna: *
 Timerange: 00/03:34:58 to 00/03:39:54

Plot file version 52 created 14-MAY-2010 15:17:11

J135355 EO007.UVDATA.1

Freq = 4.9270 GHz, Bw = 16.000 MH No calibration applied and no bandpass applied

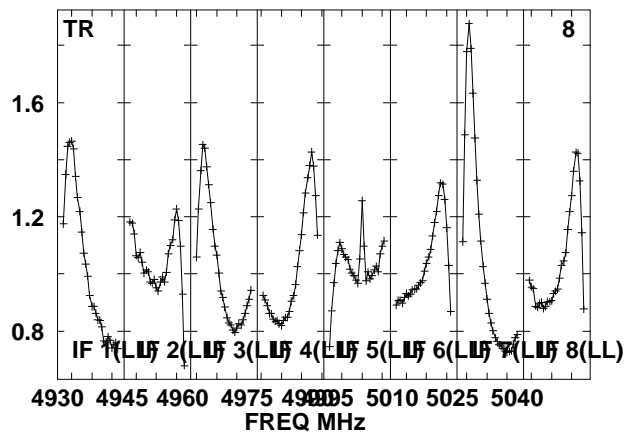
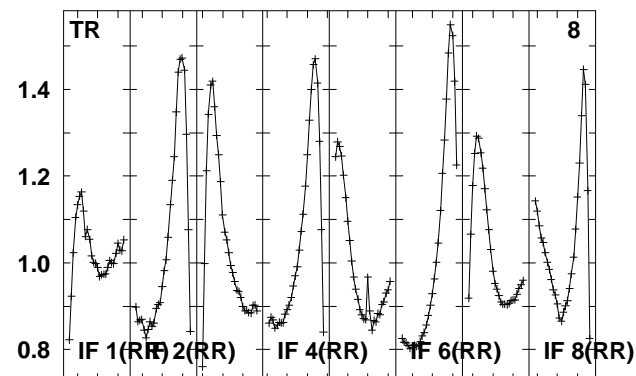
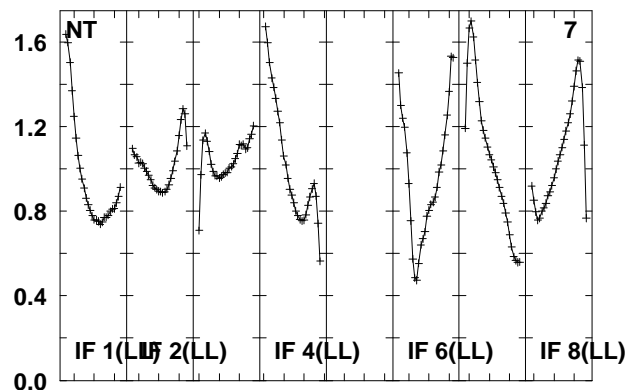
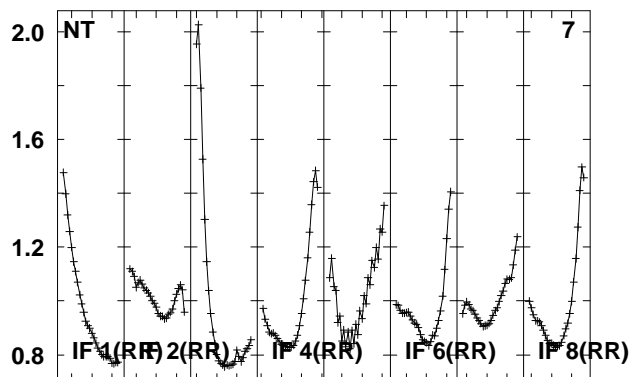
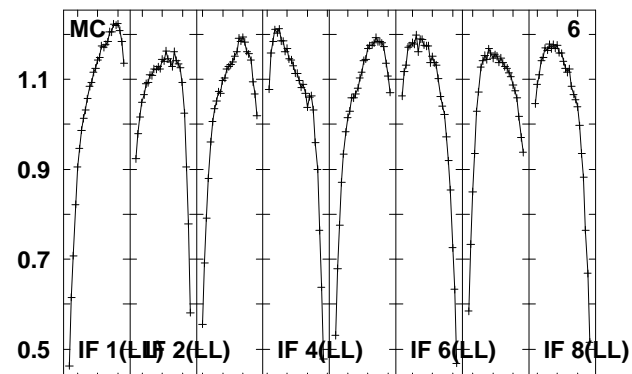
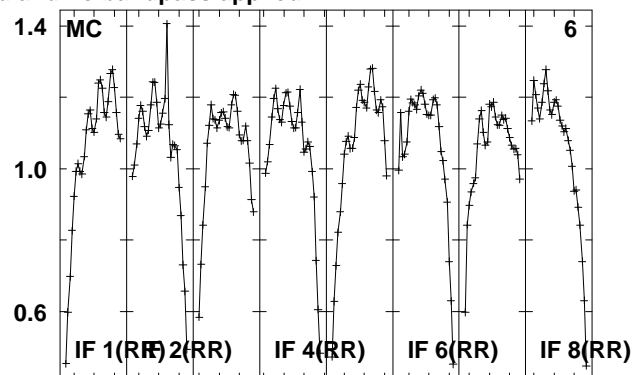
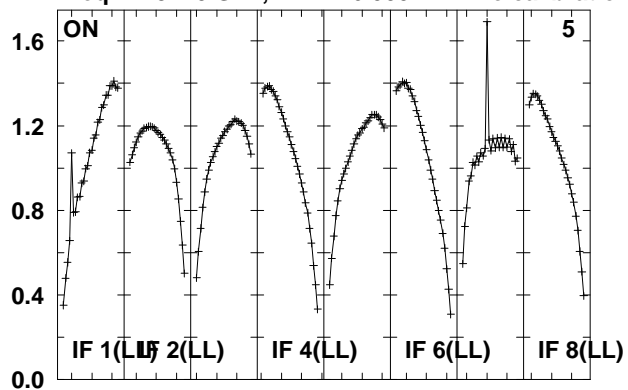

Lower frame: Real Jy

Total-power spectrum Antenna: *

Timerange: 00/03:34:58 to 00/03:39:54

Plot file version 53 created 14-MAY-2010 15:17:12

J1344+66 EO007.UVDATA.1

Freq = 4.9270 GHz, Bw = 16.000 MH No calibration applied and no bandpass applied

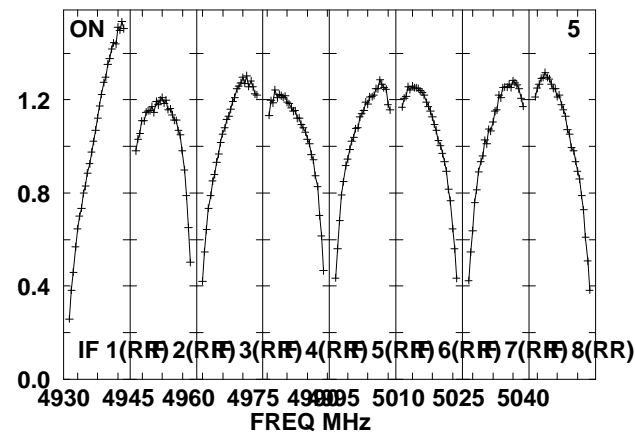
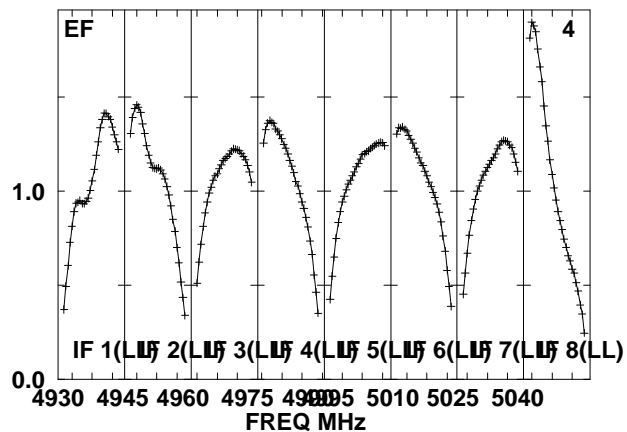
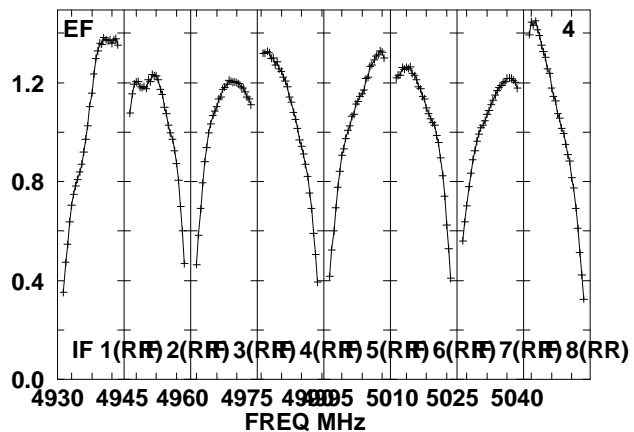
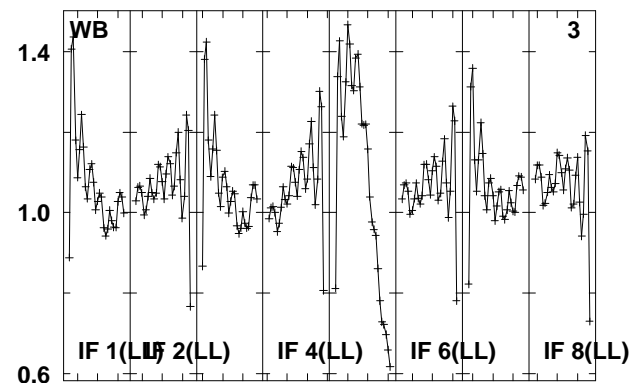
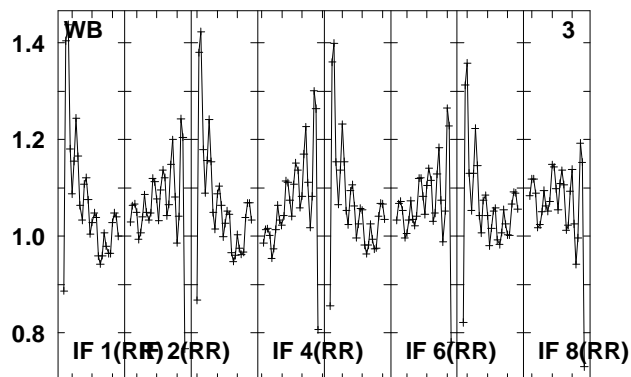
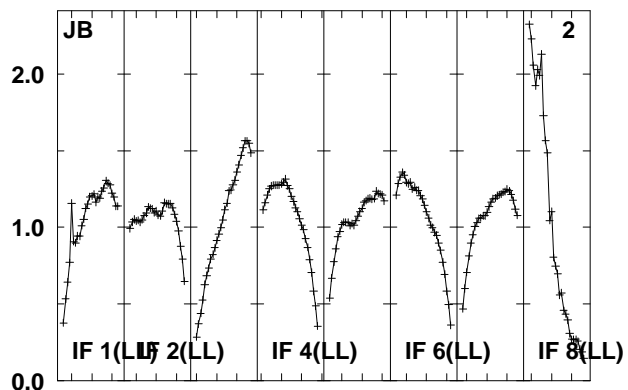
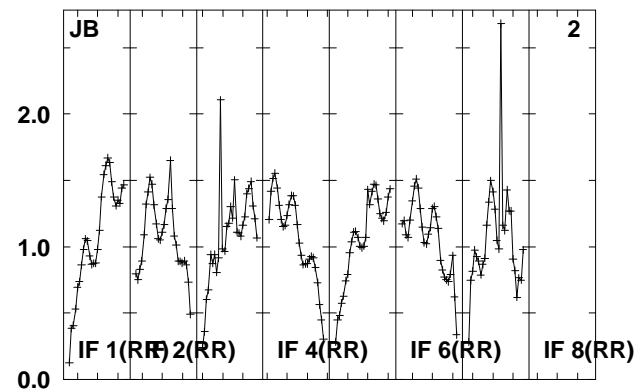
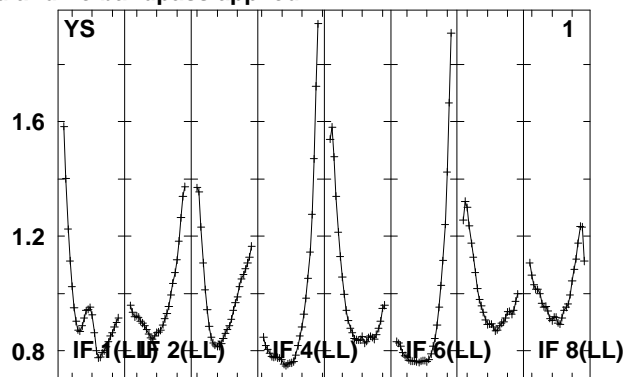
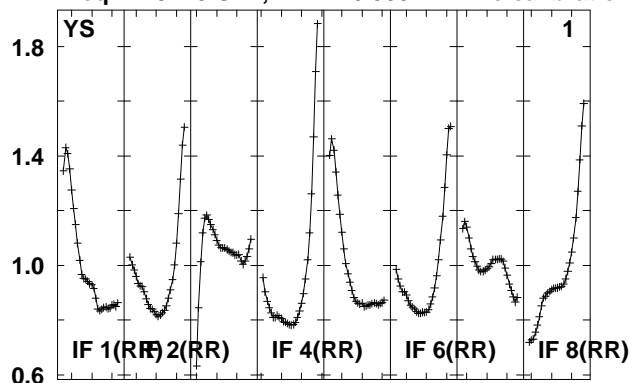

Lower frame: Real Jy

Total-power spectrum Antenna: *

Timerange: 00/03:40:34 to 00/03:42:00

Plot file version 54 created 14-MAY-2010 15:17:12

J1344+66 EO007.UVDATA.1

Freq = 4.9270 GHz, Bw = 16.000 MH No calibration applied and no bandpass applied

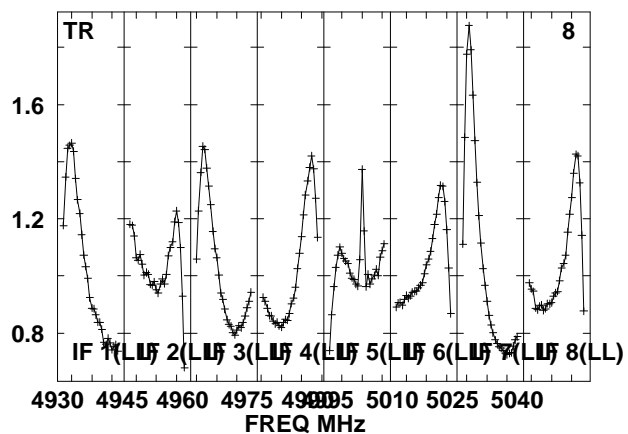
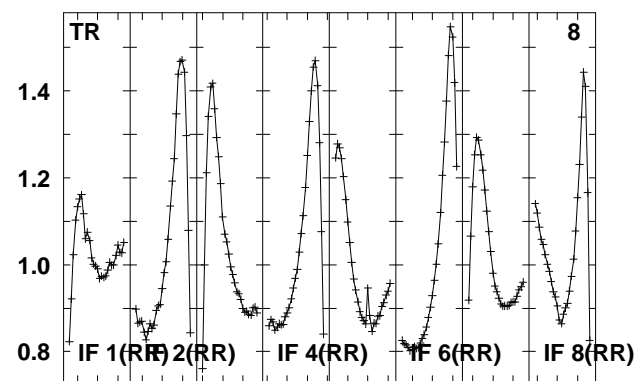
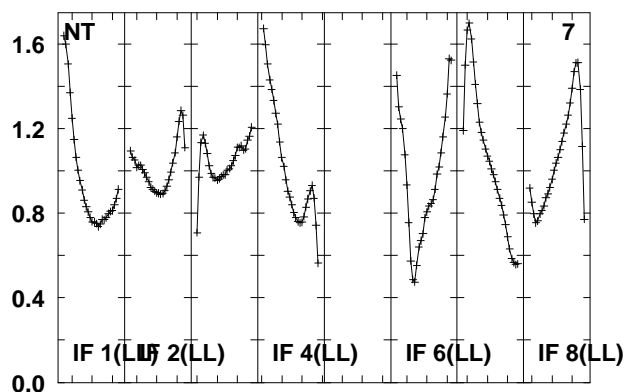
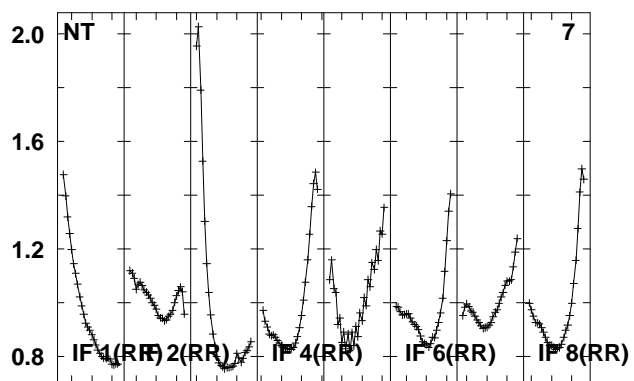
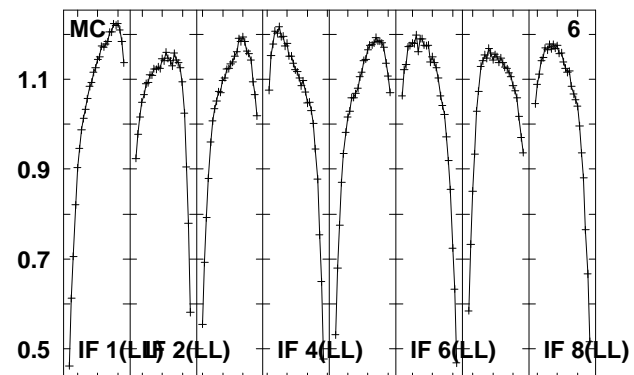
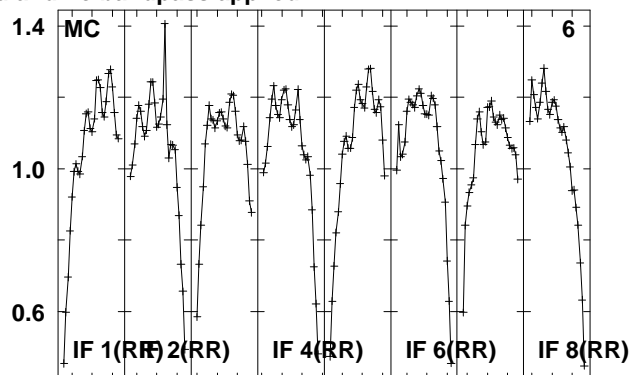
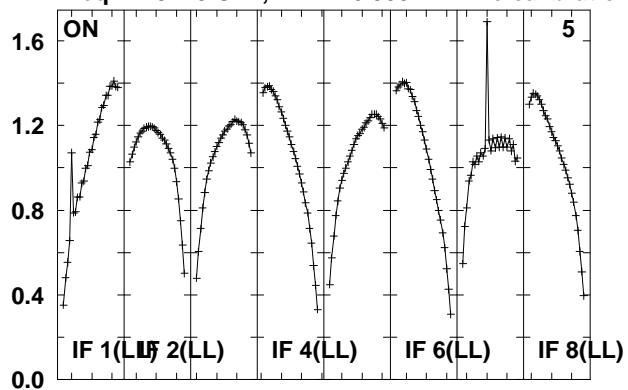

Lower frame: Real Jy

Total-power spectrum Antenna: *

Timerange: 00/03:40:34 to 00/03:42:00

Plot file version 55 created 14-MAY-2010 15:17:12
 J135355 EO007.UVDATA.1
 Freq = 4.9270 GHz, Bw = 16.000 MH No calibration applied and no bandpass applied

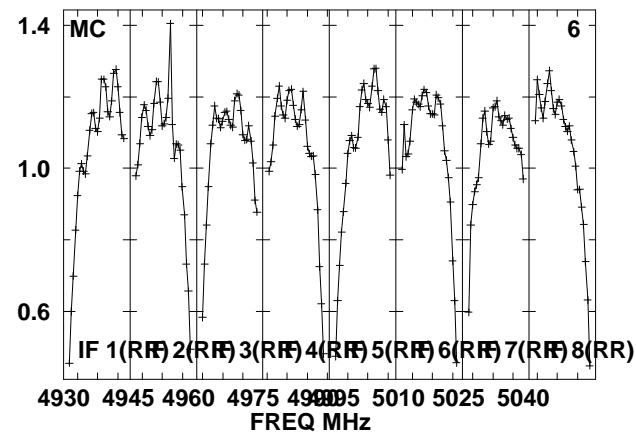
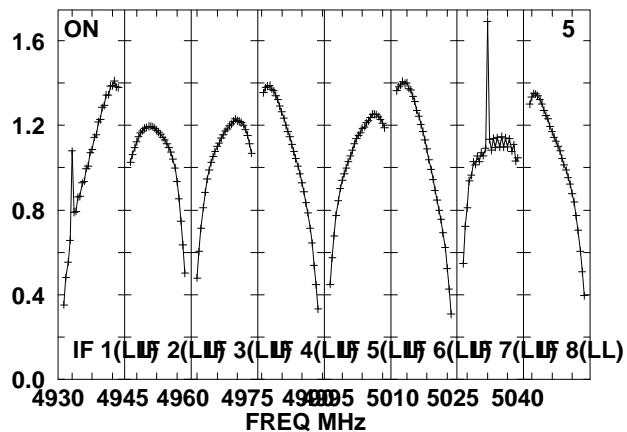
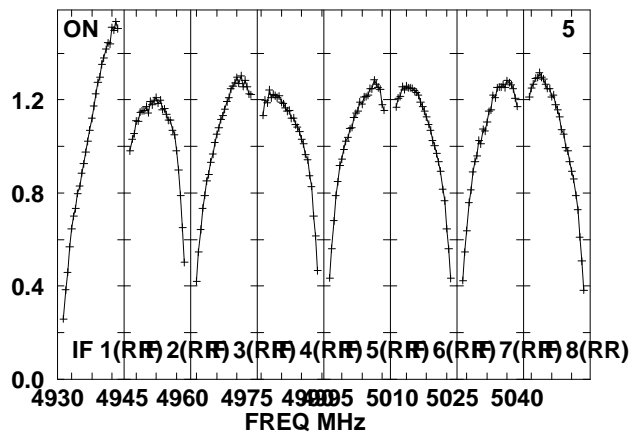
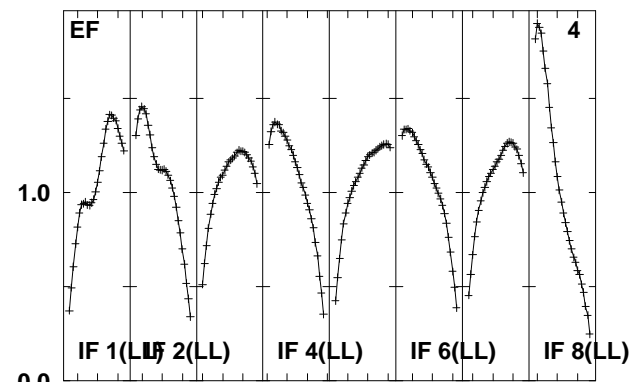
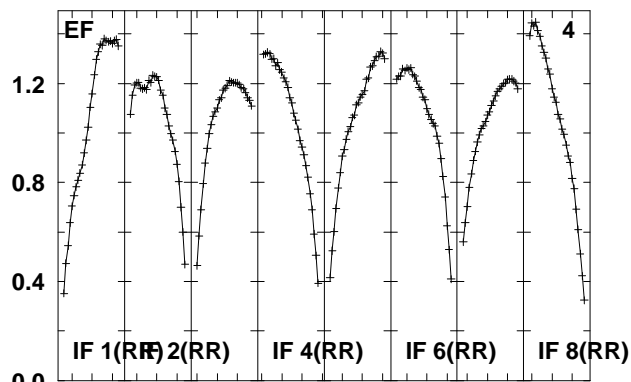
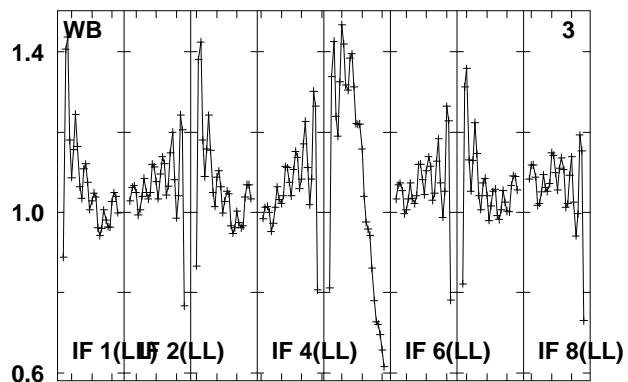
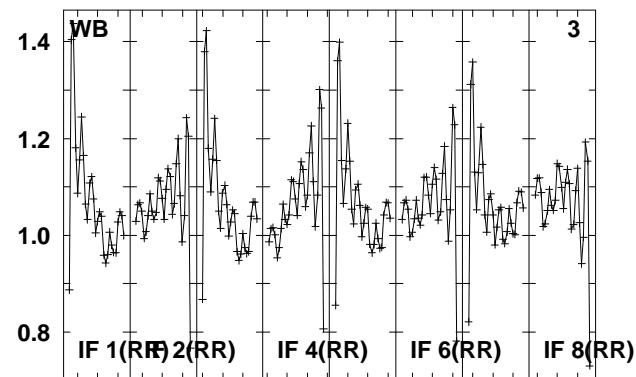
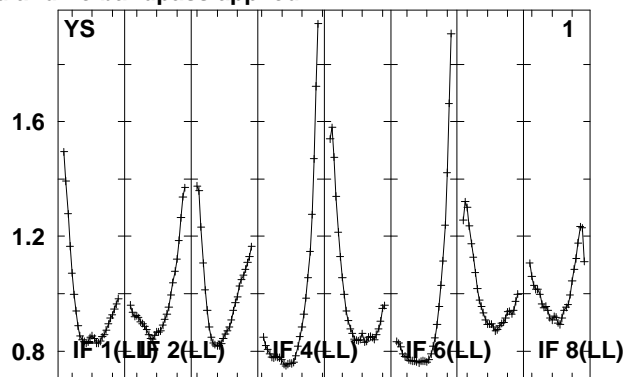
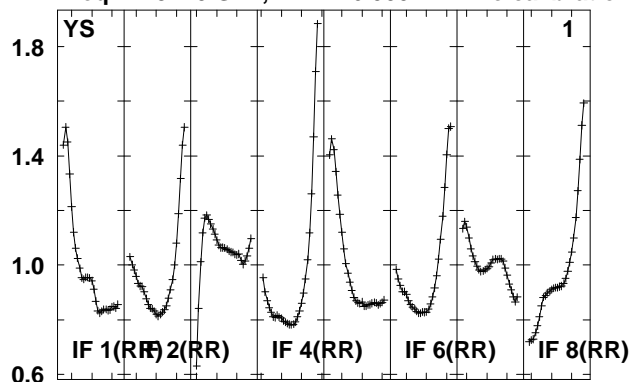

Lower frame: Real Jy
 Total-power spectrum Antenna: *
 Timerange: 00/03:42:36 to 00/03:47:34

Plot file version 56 created 14-MAY-2010 15:17:13

J135355 EO007.UVDATA.1

Freq = 4.9270 GHz, Bw = 16.000 MH No calibration applied and no bandpass applied

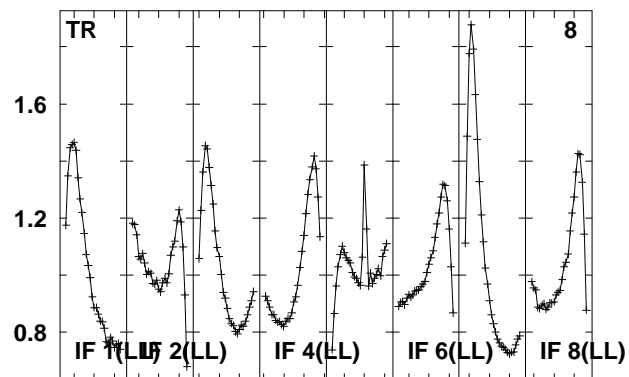
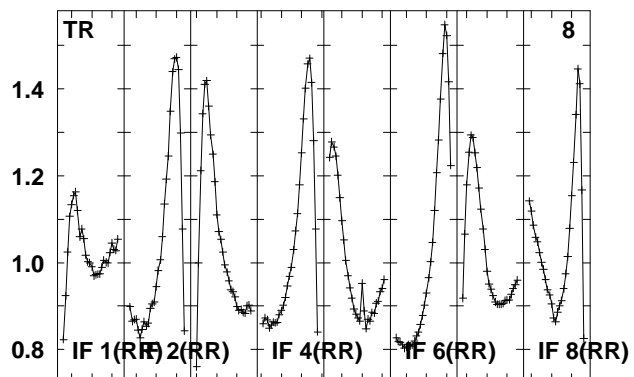
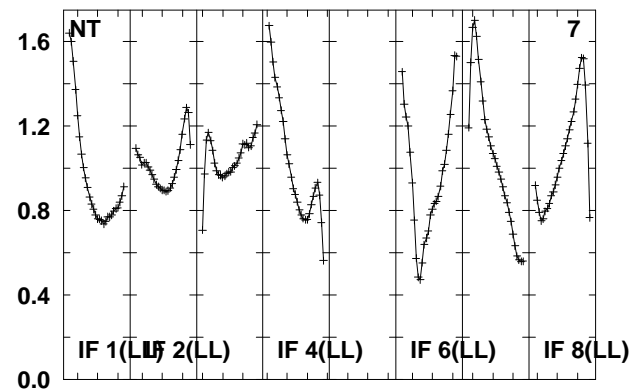
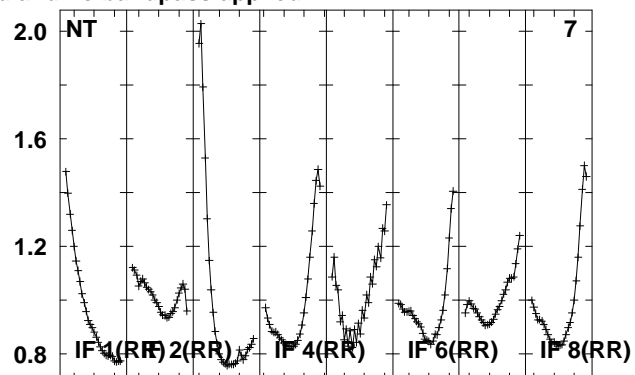
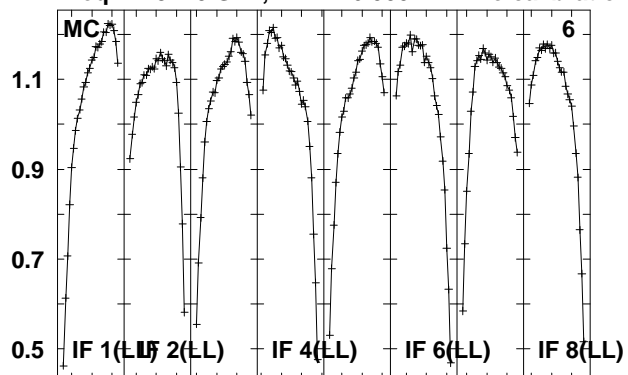

Lower frame: Real Jy
Total-power spectrum Antenna: *
Timerange: 00/03:42:36 to 00/03:47:34

Plot file version 57 created 14-MAY-2010 15:17:13

J1344+66 EO007.UVDATA.1

Freq = 4.9270 GHz, Bw = 16.000 MH No calibration applied and no bandpass applied

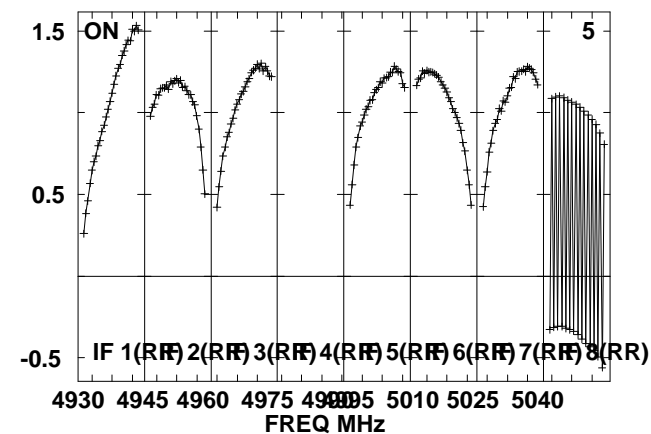
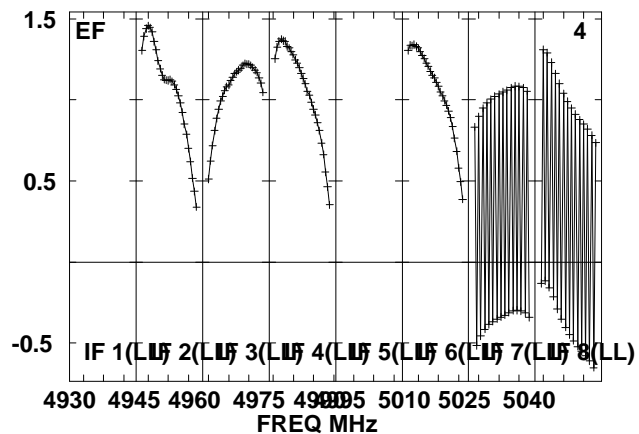
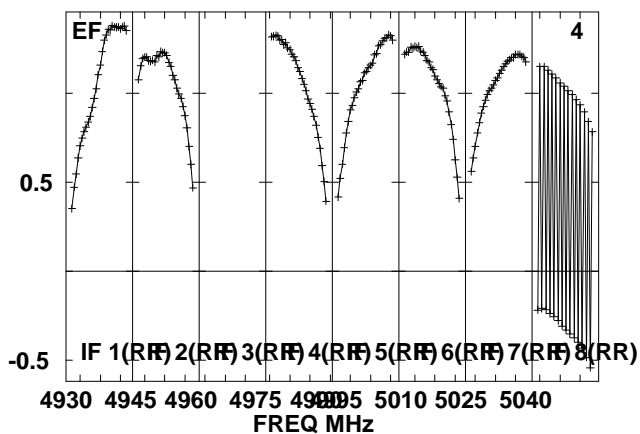
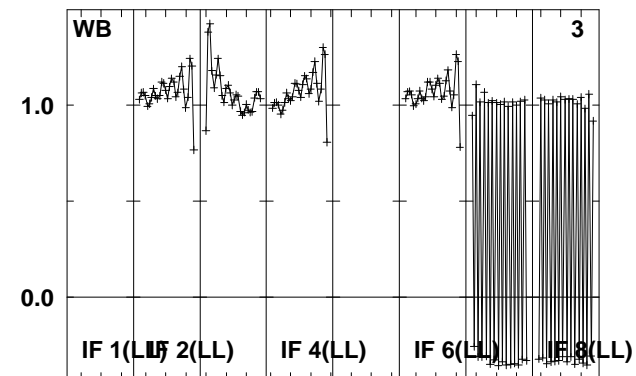
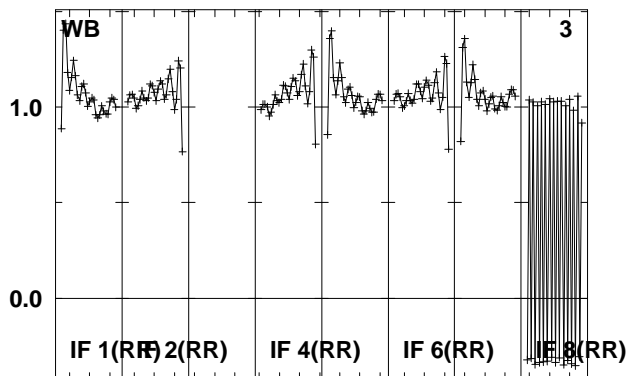
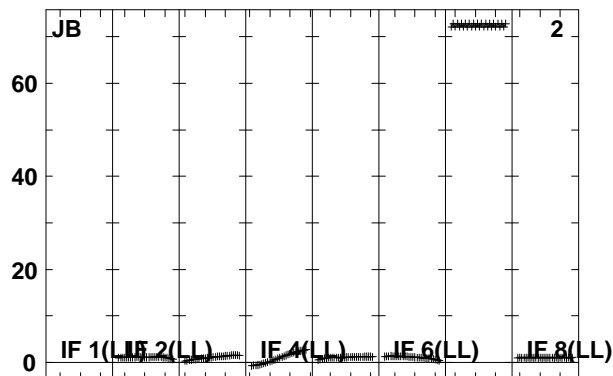
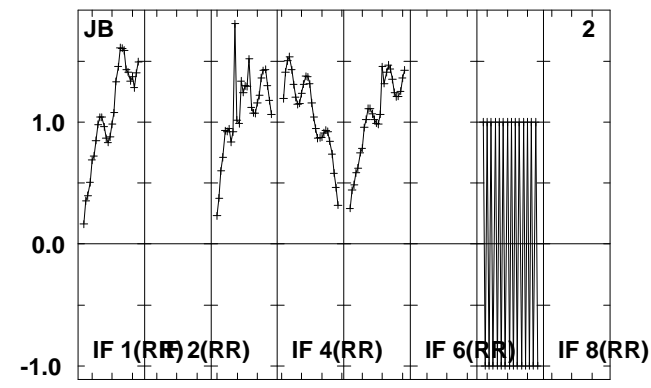
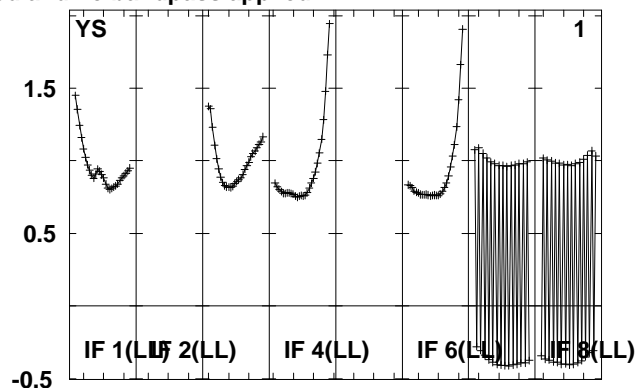
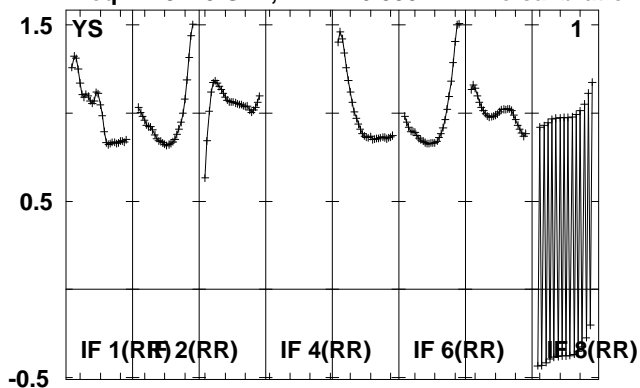

Lower frame: Real Jy
Total-power spectrum Antenna: *
Timerange: 00/03:48:08 to 00/03:49:36

Plot file version 58 created 14-MAY-2010 15:17:14

J1344+66 EO007.UVDATA.1

Freq = 4.9270 GHz, Bw = 16.000 MH No calibration applied and no bandpass applied

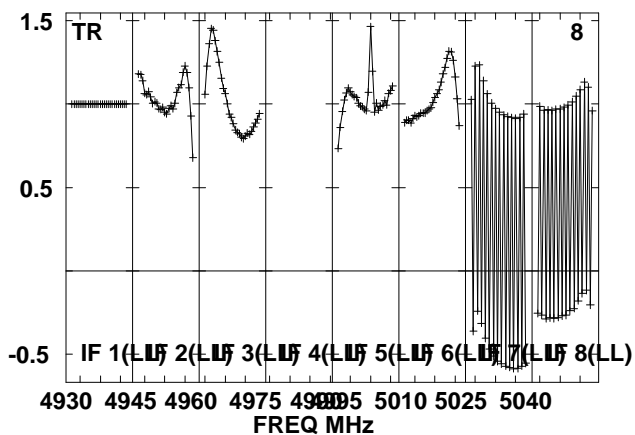
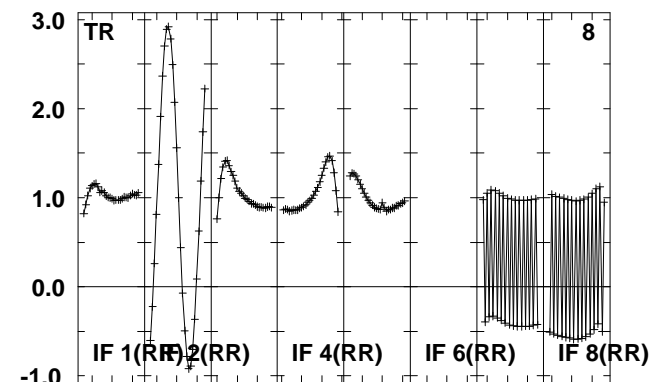
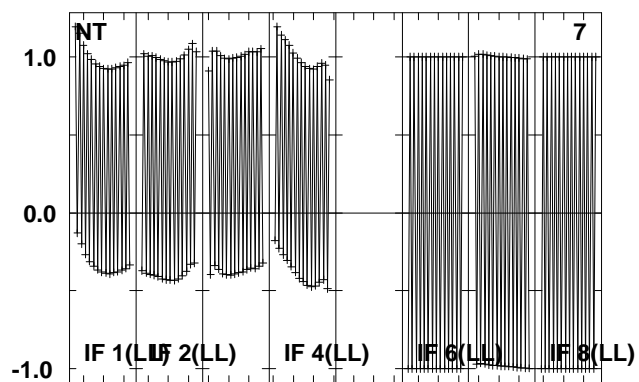
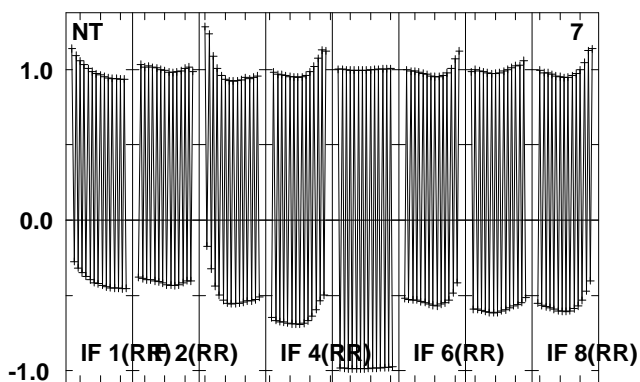
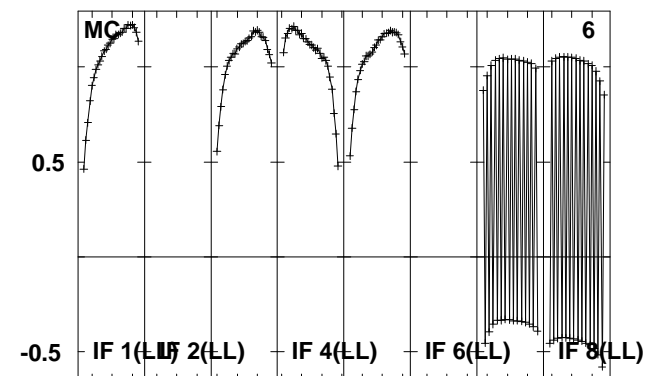
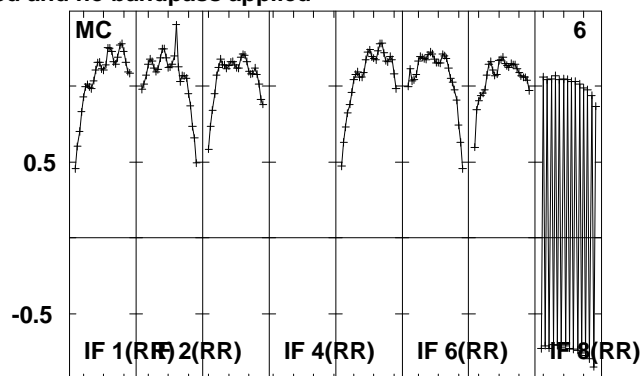
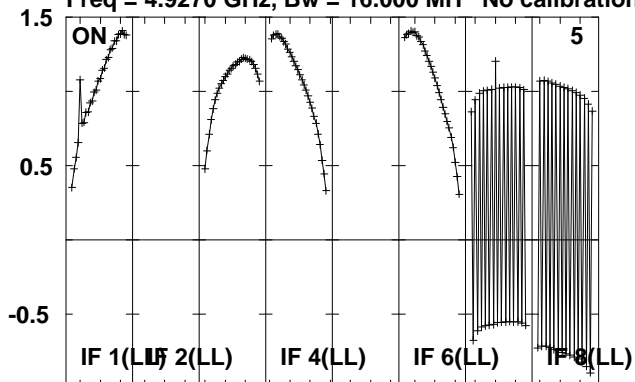

Lower frame: Real Jy

Total-power spectrum Antenna: *

Timerange: 00/03:48:08 to 00/03:49:36

Plot file version 59 created 14-MAY-2010 15:17:14

J135355 EO007.UVDATA.1

Freq = 4.9270 GHz, Bw = 16.000 MH No calibration applied and no bandpass applied

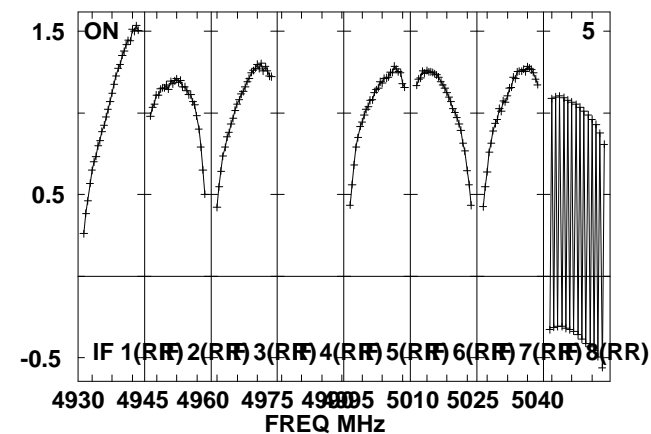
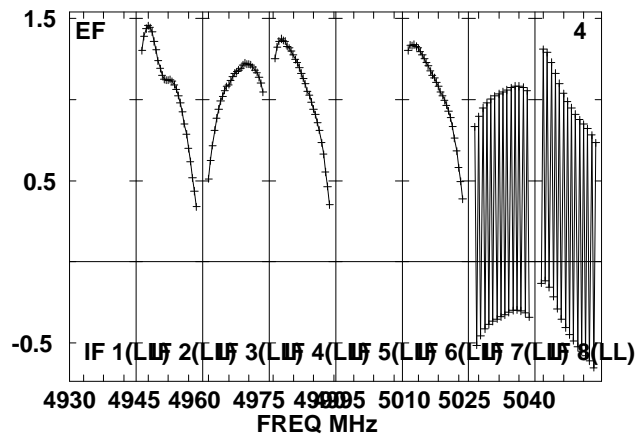
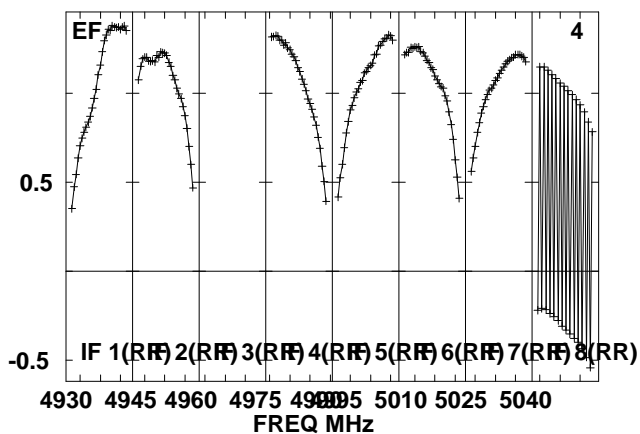
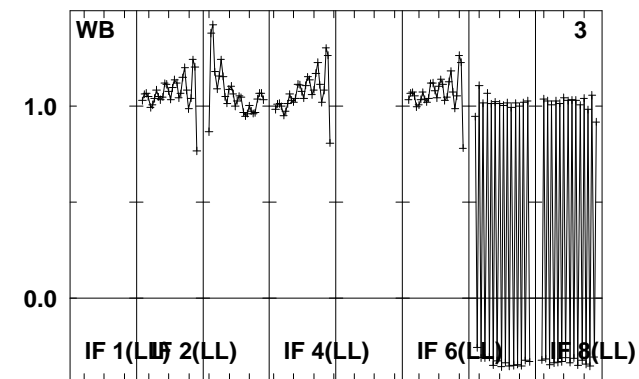
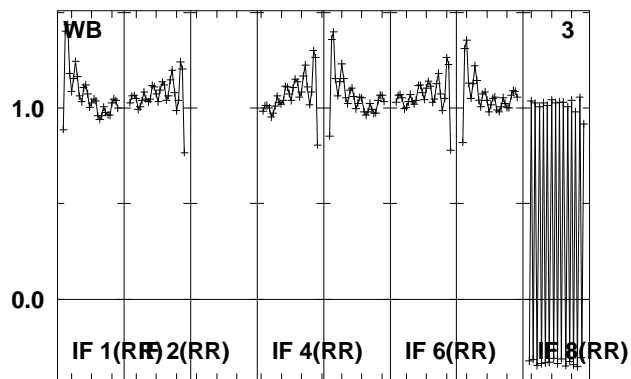
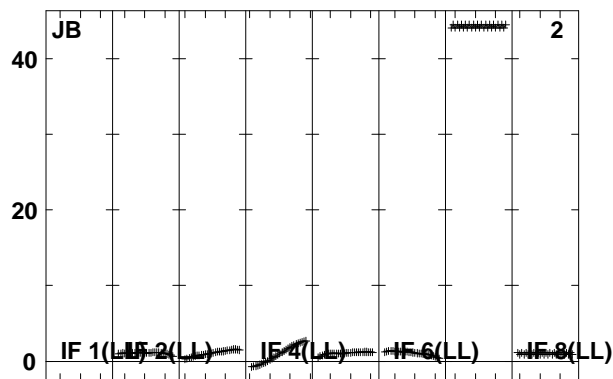
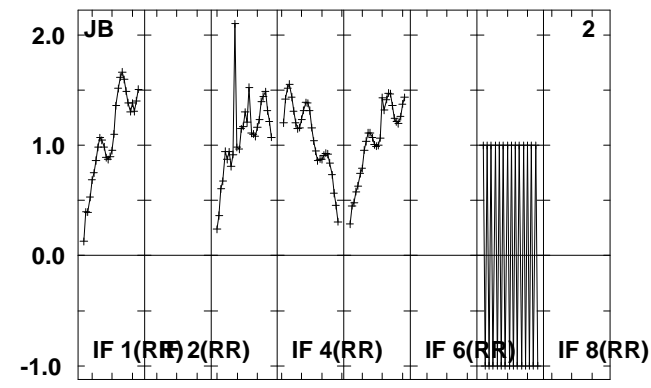
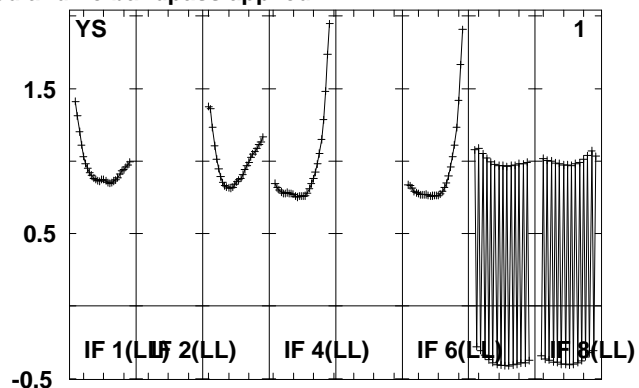
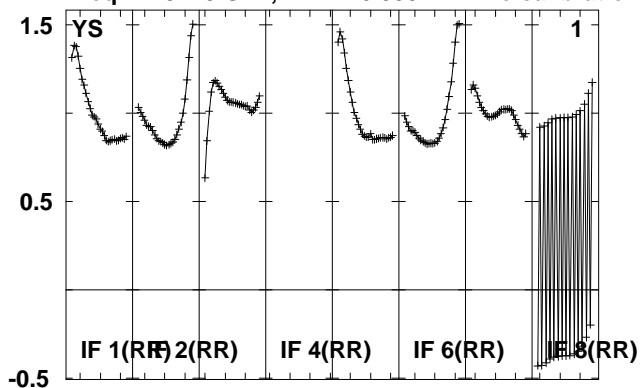

Lower frame: Real Jy
Total-power spectrum Antenna: *
Timerange: 00/03:50:12 to 00/03:55:08

Plot file version 60 created 14-MAY-2010 15:17:15

J135355 EO007.UVDATA.1

Freq = 4.9270 GHz, Bw = 16.000 MH No calibration applied and no bandpass applied

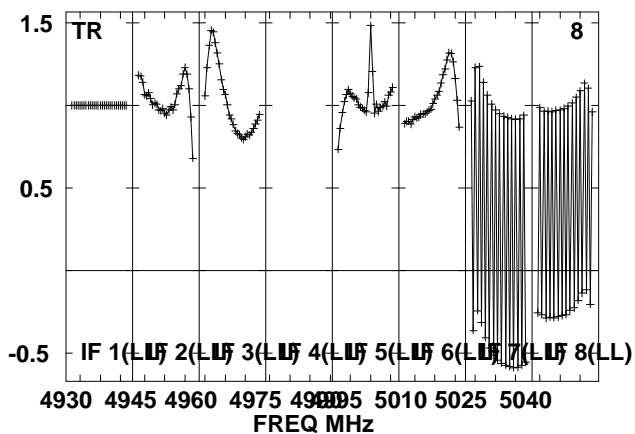
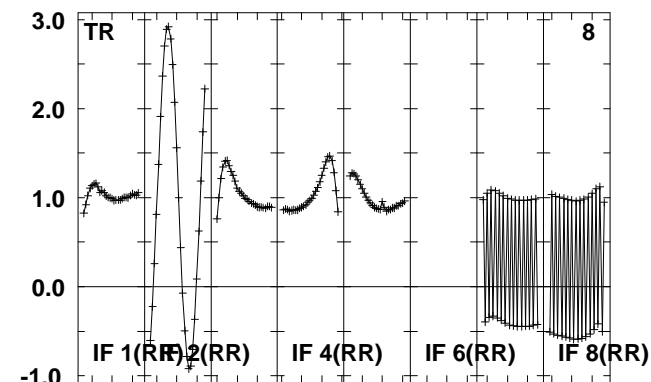
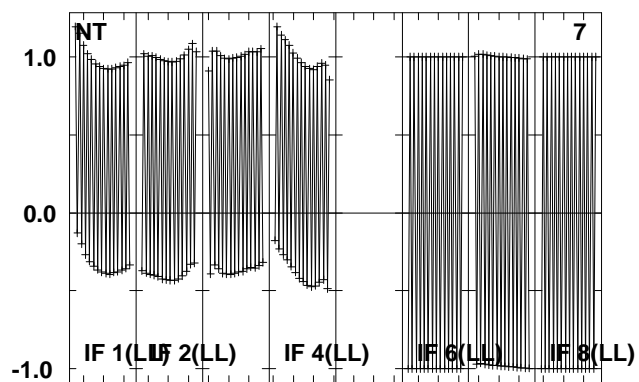
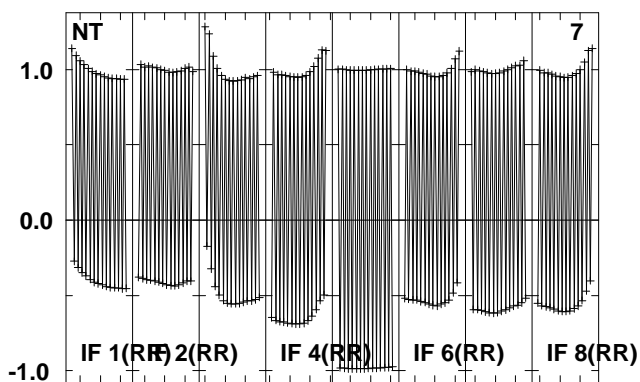
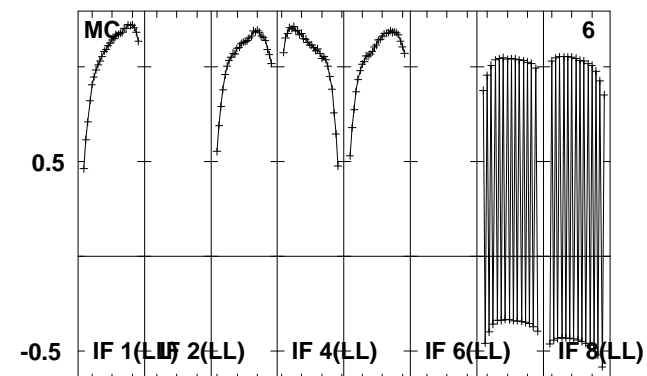
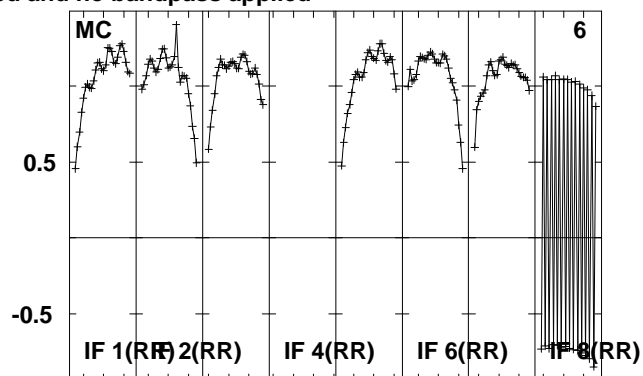
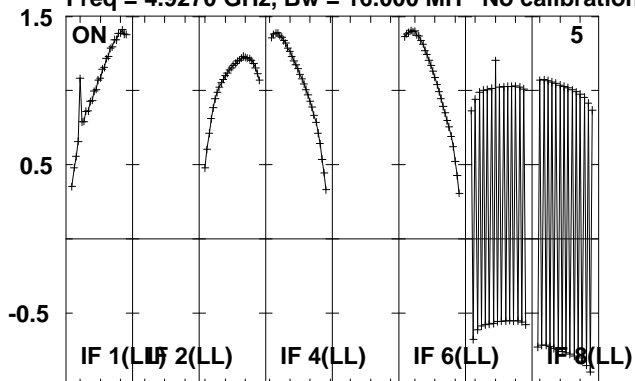

4930 4945 4960 4975 4990 5005 5010 5025 5040
FREQ MHz

Lower frame: Real Jy

Total-power spectrum Antenna: *

Timerange: 00/03:50:12 to 00/03:55:08

Plot file version 61 created 14-MAY-2010 15:17:15

J1344+66 EO007.UVDATA.1

Freq = 4.9270 GHz, Bw = 16.000 MH No calibration applied and no bandpass applied

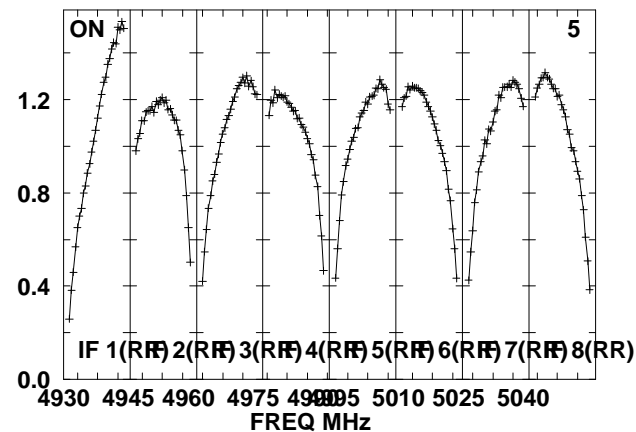
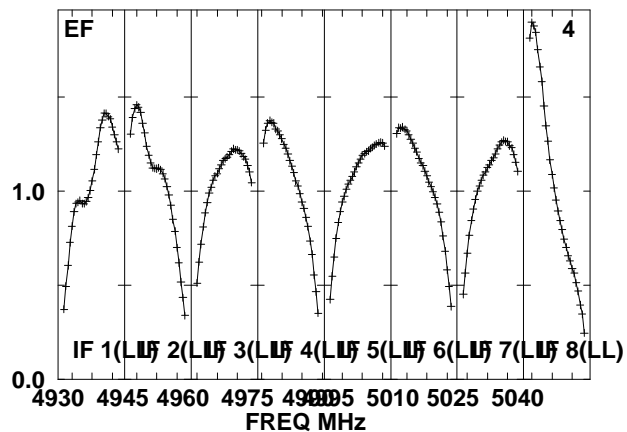
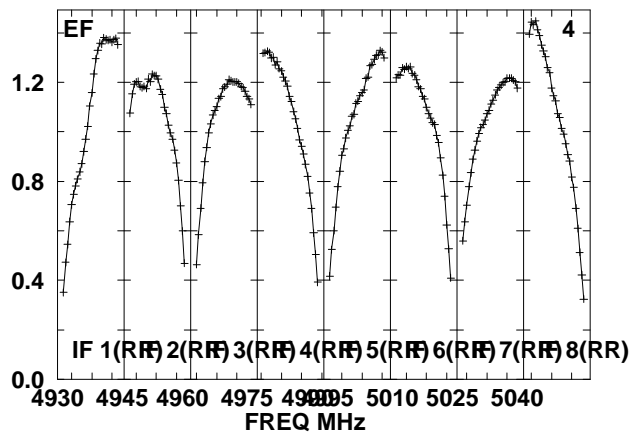
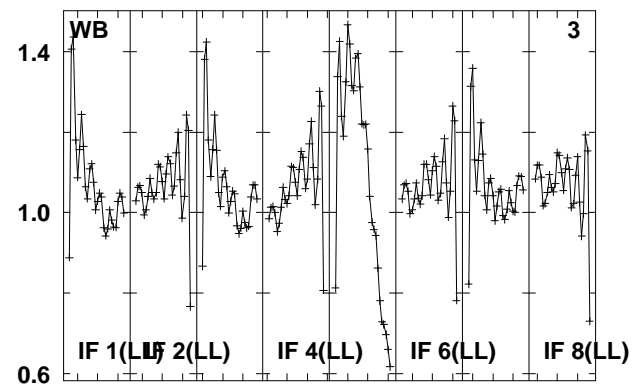
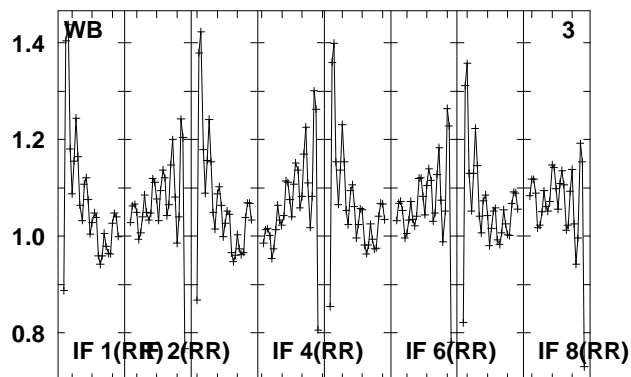
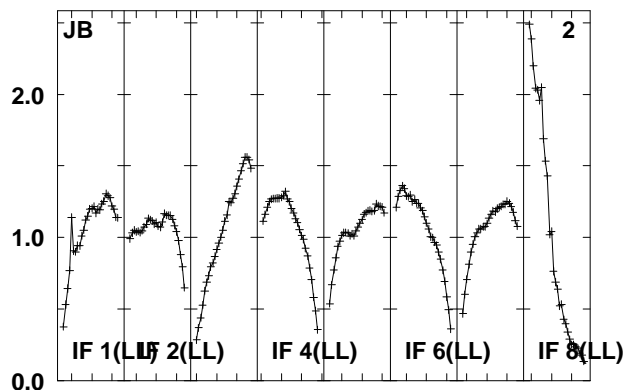
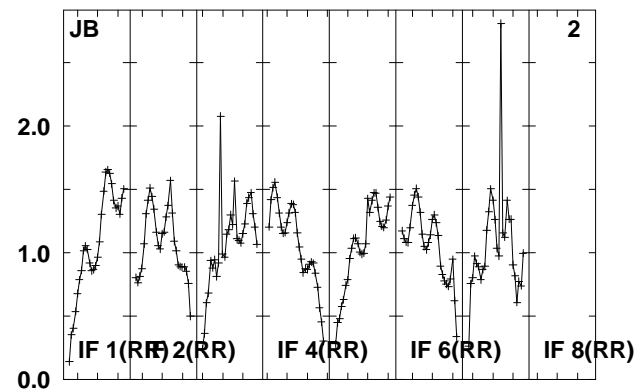
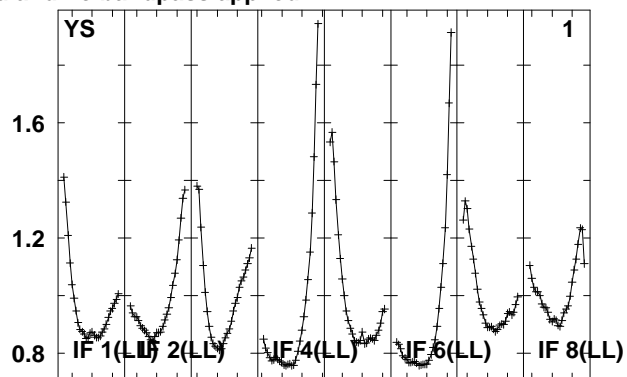
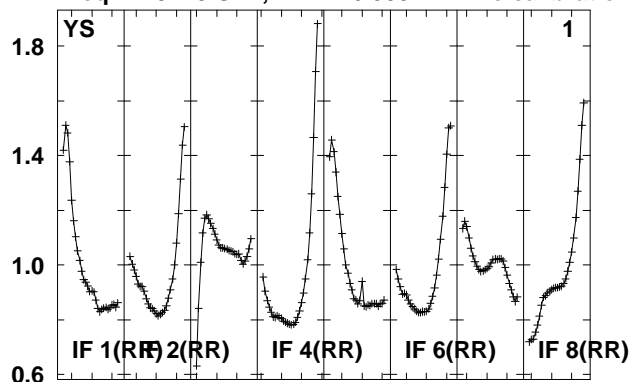

Lower frame: Real Jy

Total-power spectrum Antenna: *

Timerange: 00/03:55:47 to 00/03:57:13

Plot file version 62 created 14-MAY-2010 15:17:15

J1344+66 EO007.UVDATA.1

Freq = 4.9270 GHz, Bw = 16.000 MH No calibration applied and no bandpass applied

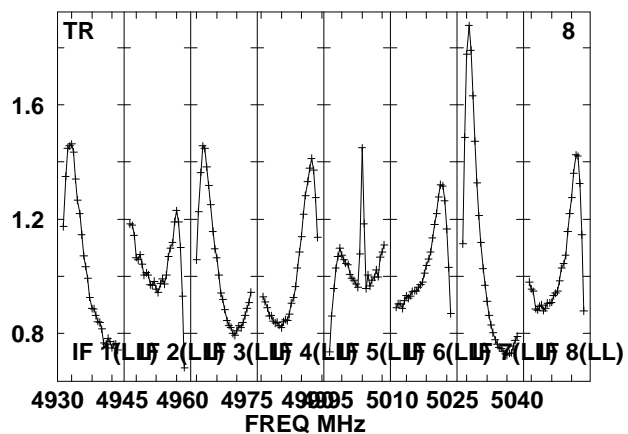
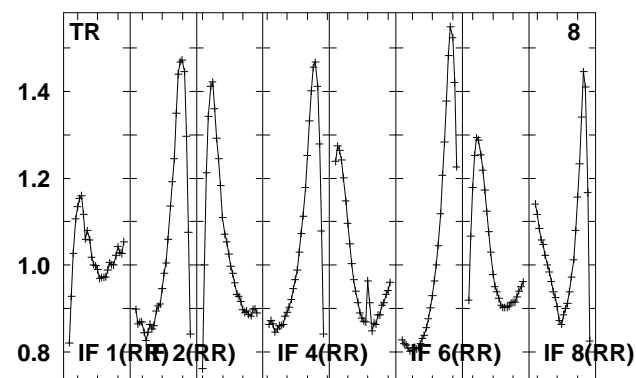
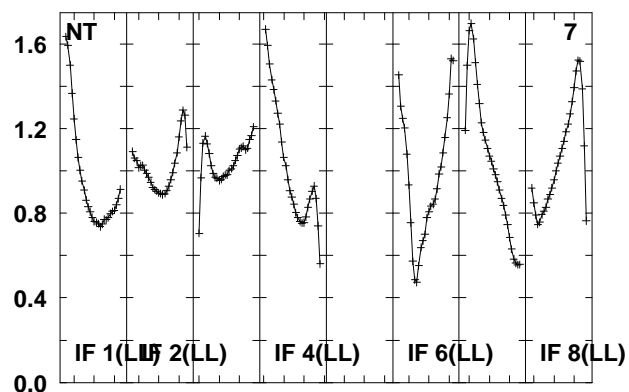
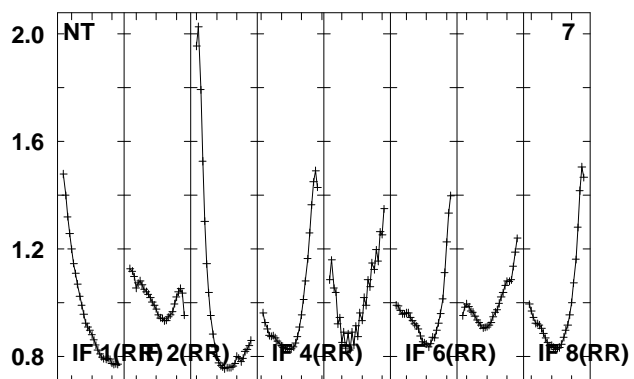
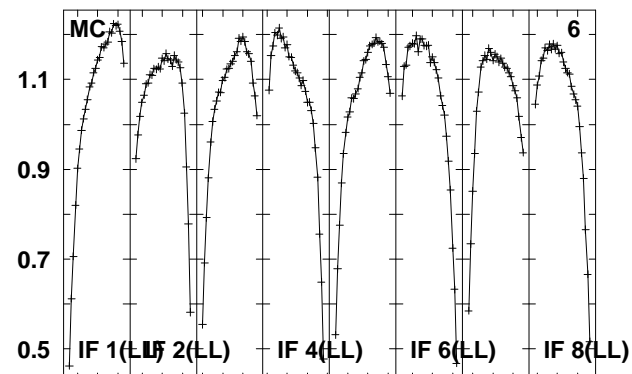
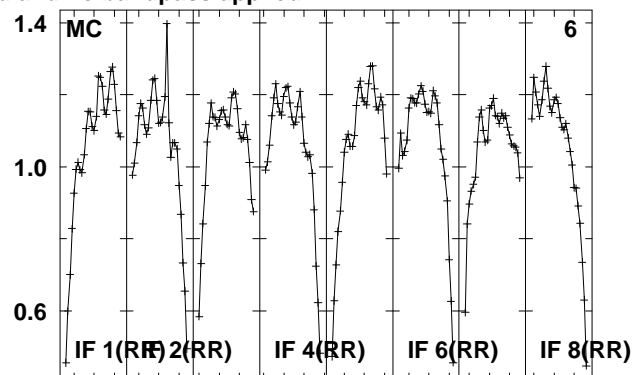
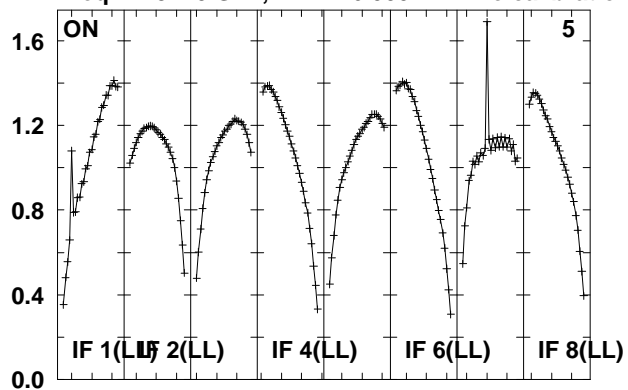

Lower frame: Real Jy

Total-power spectrum Antenna: *

Timerange: 00/03:55:47 to 00/03:57:13

Plot file version 63 created 14-MAY-2010 15:17:16
 J135355 EO007.UVDATA.1
 Freq = 4.9270 GHz, Bw = 16.000 MH No calibration applied and no bandpass applied

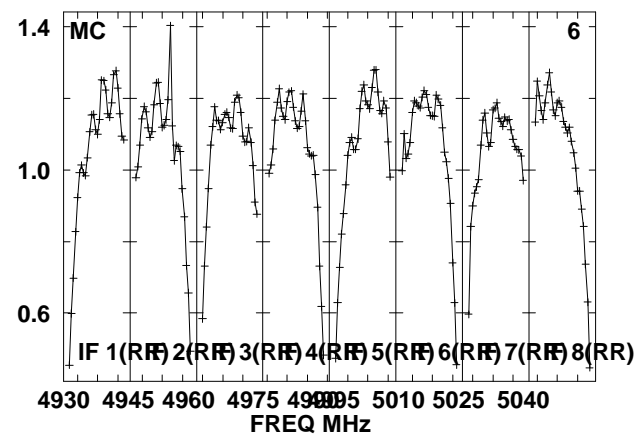
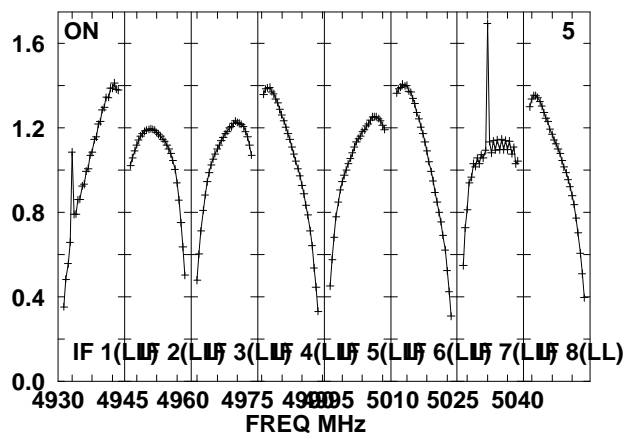
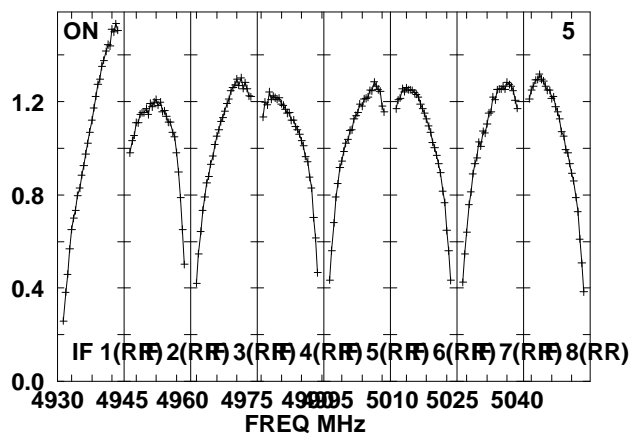
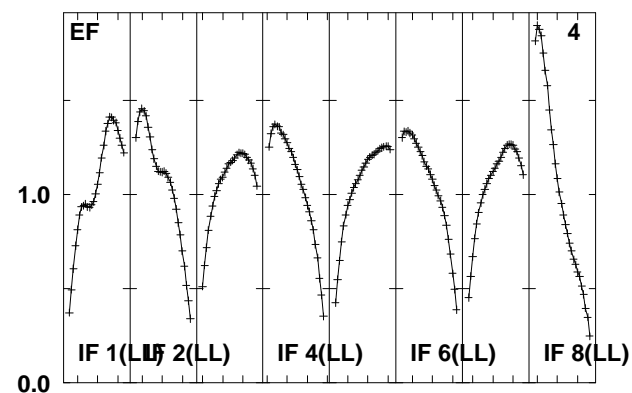
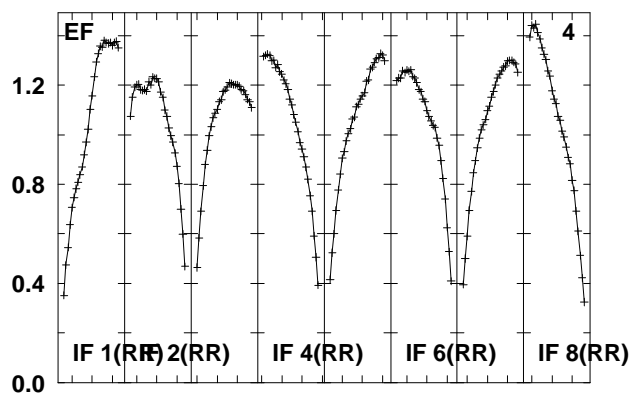
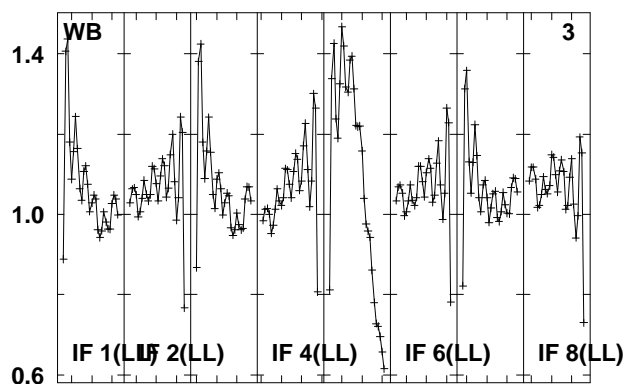
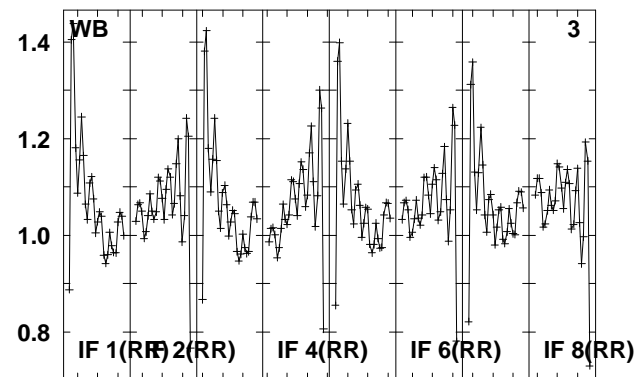
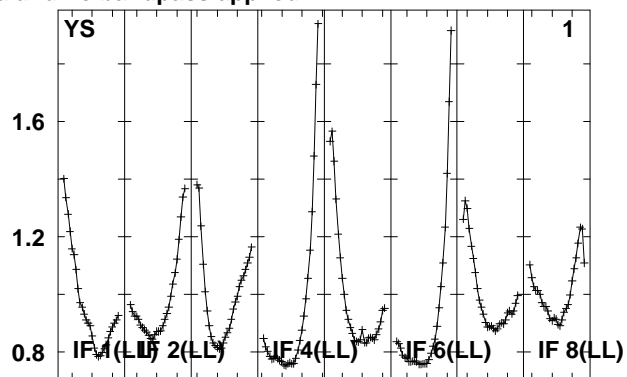
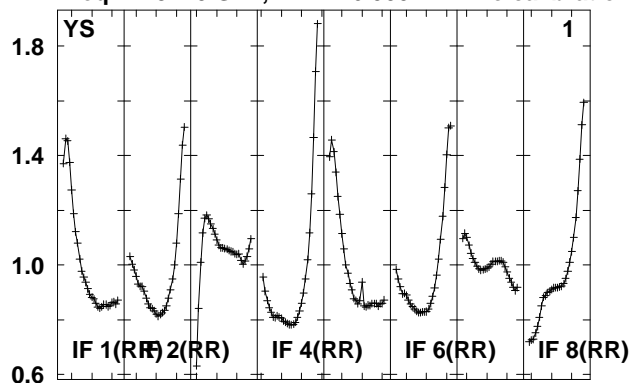

Lower frame: Real Jy
 Total-power spectrum Antenna: *
 Timerange: 00/03:57:48 to 00/04:02:44

Plot file version 64 created 14-MAY-2010 15:17:16

J135355 EO007.UVDATA.1

Freq = 4.9270 GHz, Bw = 16.000 MH No calibration applied and no bandpass applied

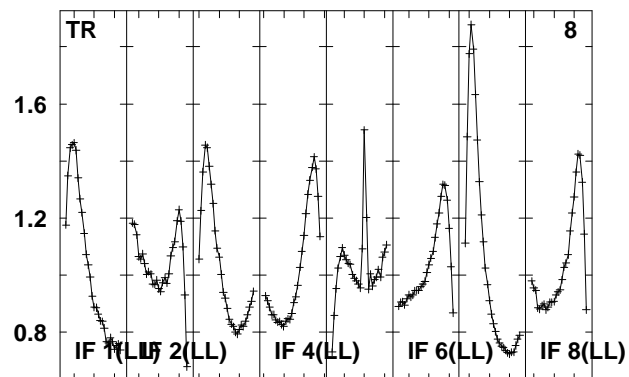
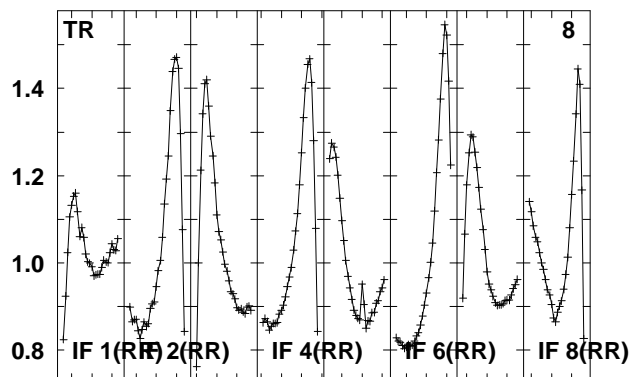
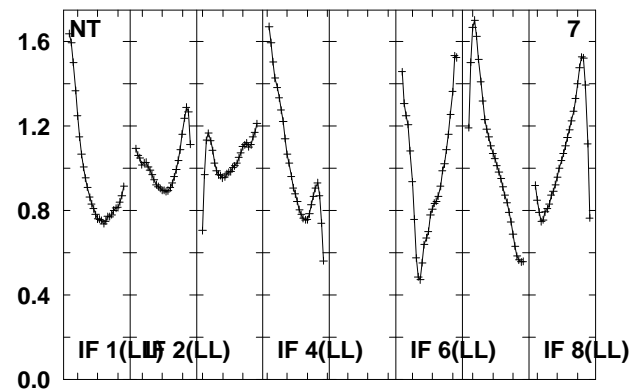
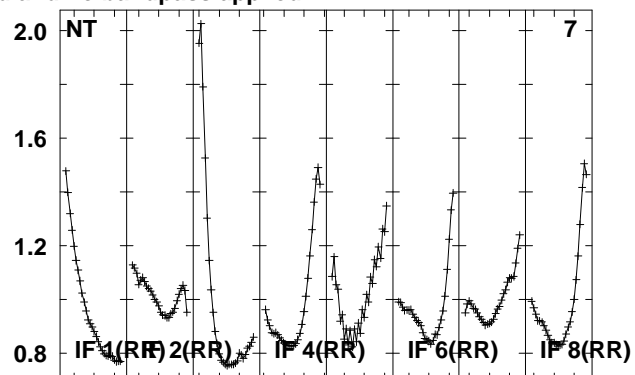
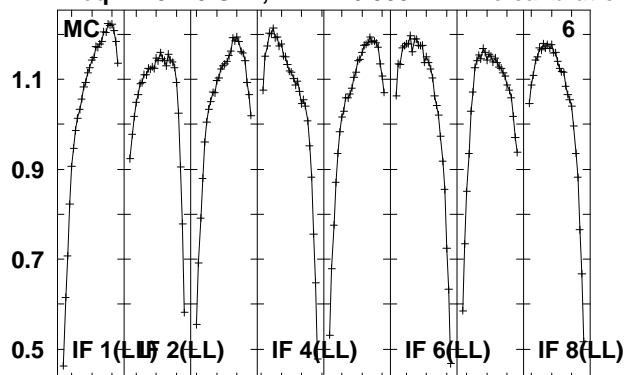

Lower frame: Real Jy
Total-power spectrum Antenna: *
Timerange: 00/03:57:48 to 00/04:02:44

Plot file version 65 created 14-MAY-2010 15:17:16

J1344+66 EO007.UVDATA.1

Freq = 4.9270 GHz, Bw = 16.000 MH No calibration applied and no bandpass applied

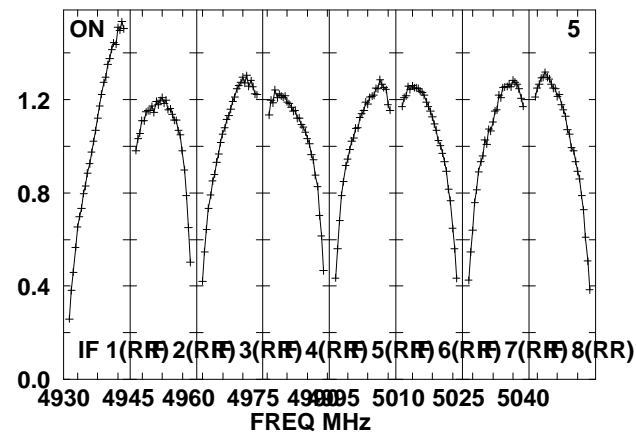
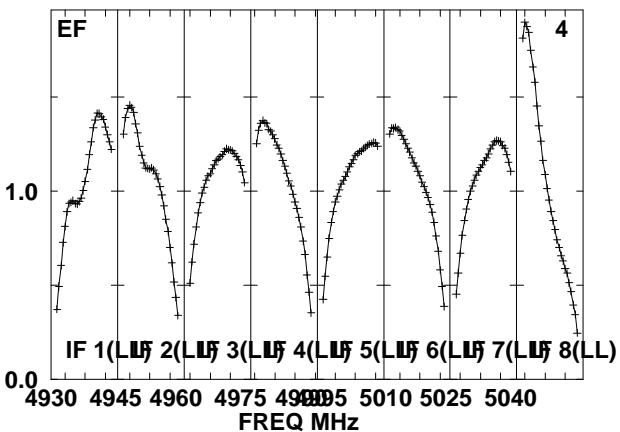
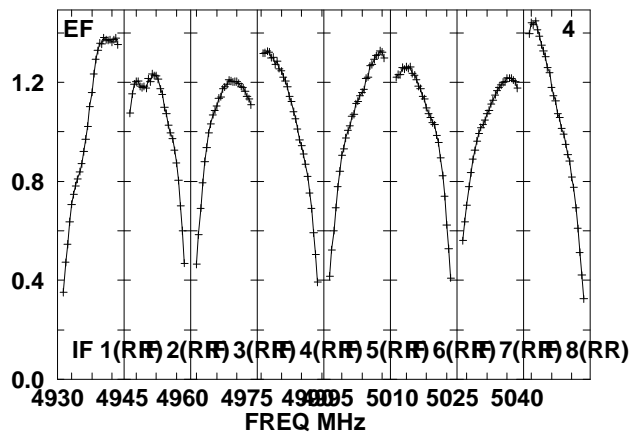
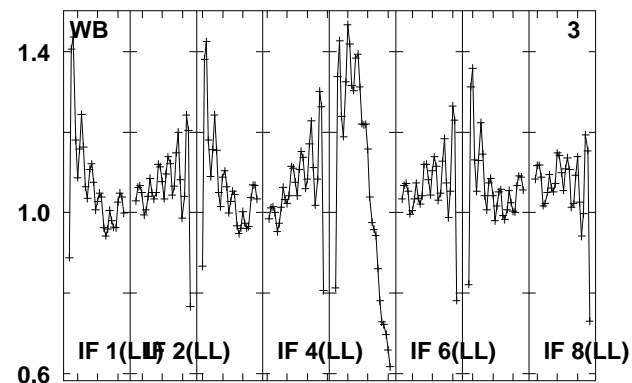
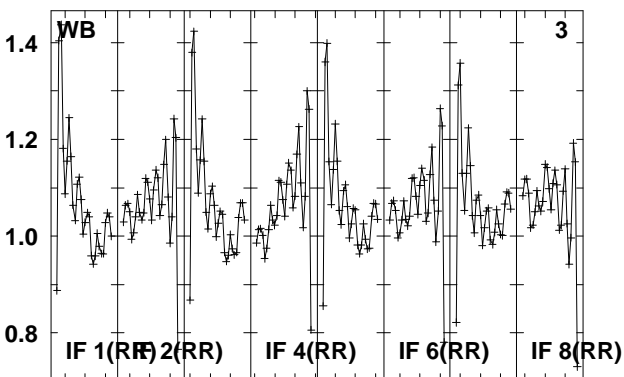
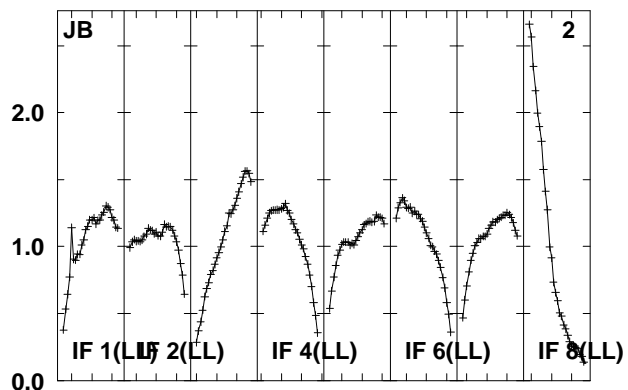
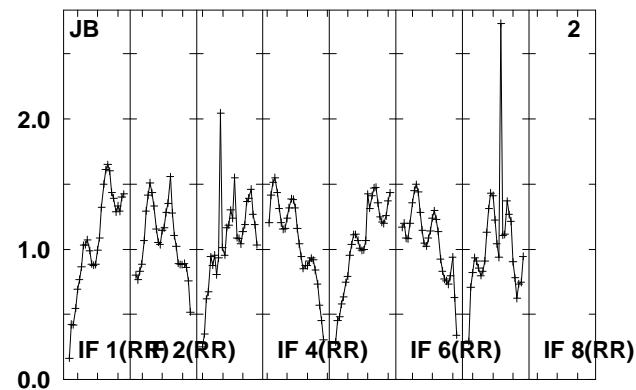
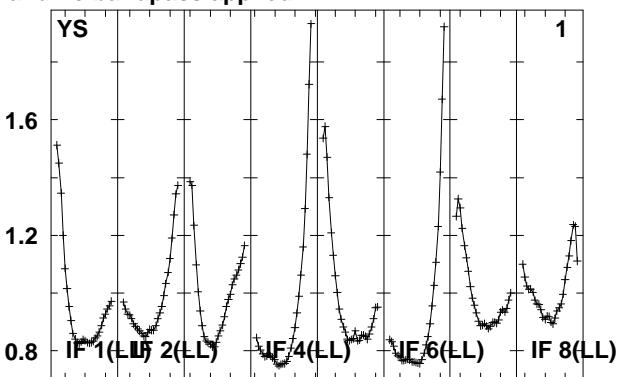
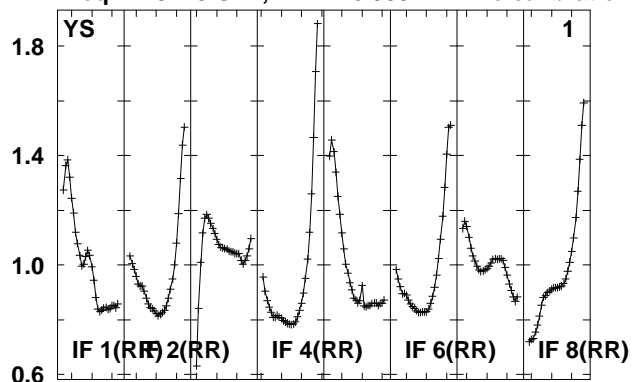

Lower frame: Real Jy

Total-power spectrum Antenna: *

Timerange: 00/04:03:20 to 00/04:04:46

Plot file version 66 created 14-MAY-2010 15:17:17

J1344+66 EO007.UVDATA.1

Freq = 4.9270 GHz, Bw = 16.000 MH No calibration applied and no bandpass applied

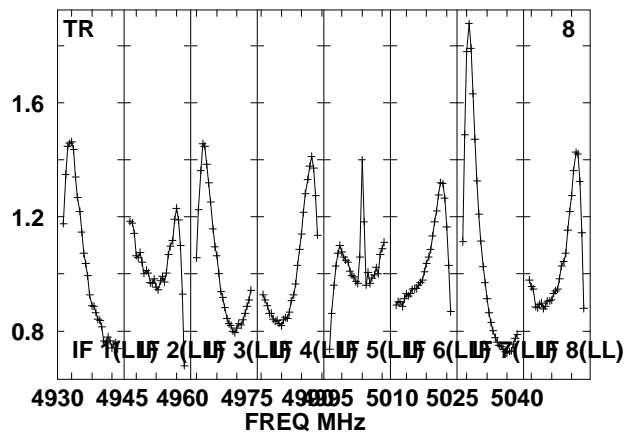
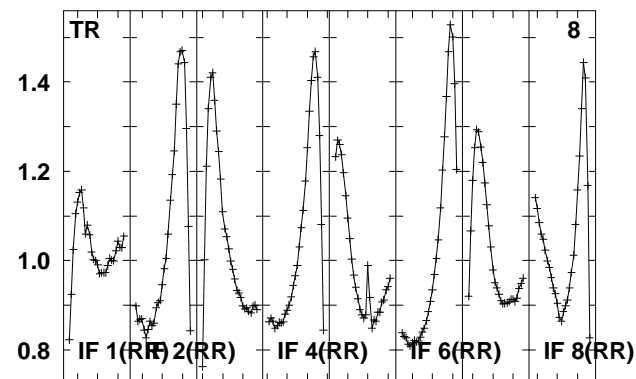
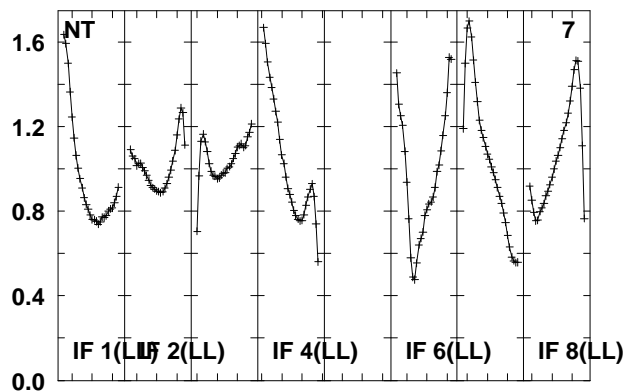
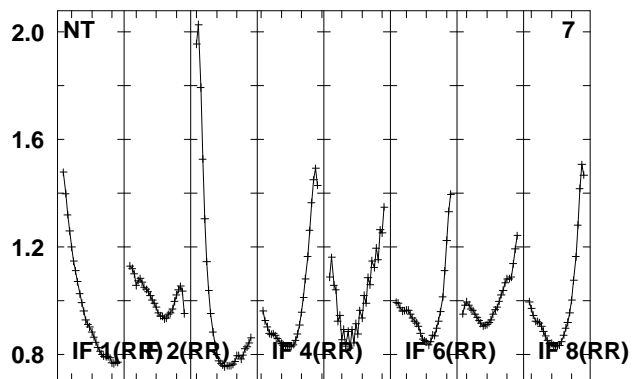
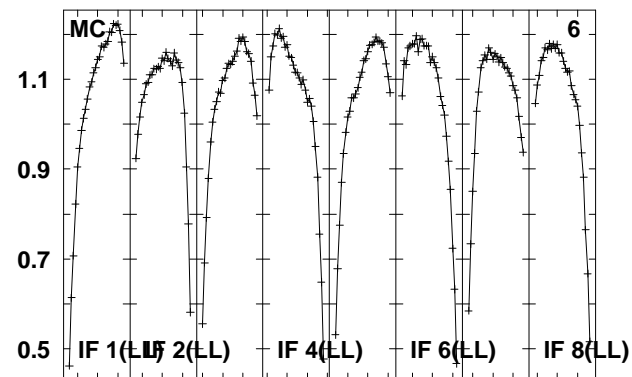
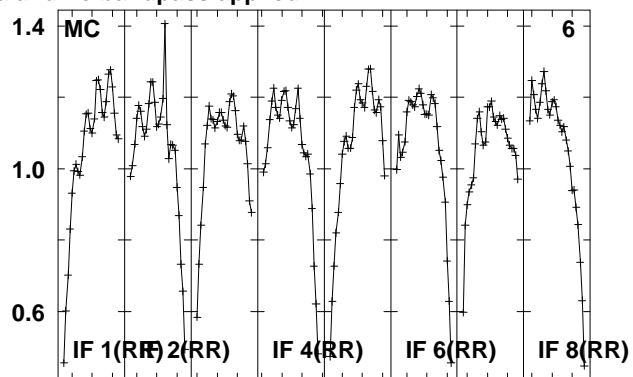
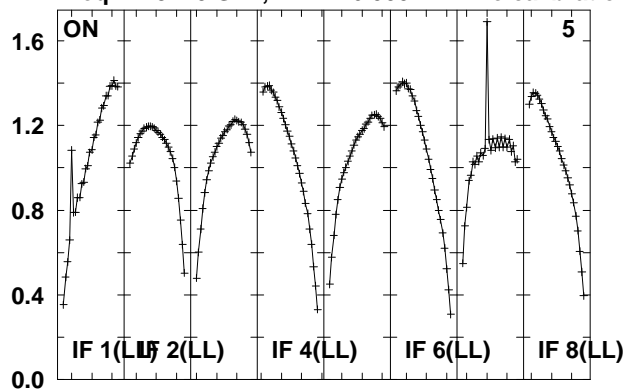

Lower frame: Real Jy

Total-power spectrum Antenna: *

Timerange: 00/04:03:20 to 00/04:04:46

Plot file version 67 created 14-MAY-2010 15:17:17
 J135355 EO007.UVDATA.1
 Freq = 4.9270 GHz, Bw = 16.000 MH No calibration applied and no bandpass applied

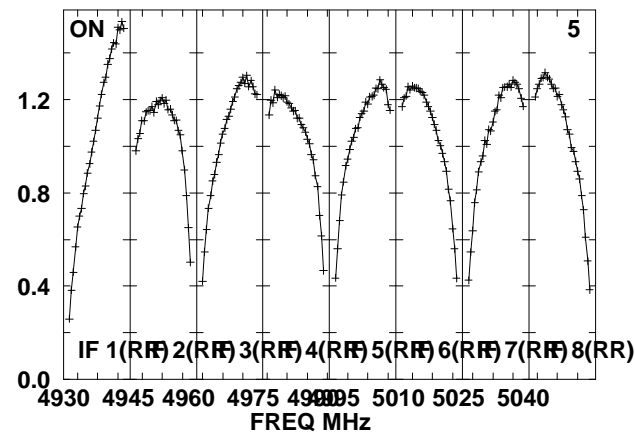
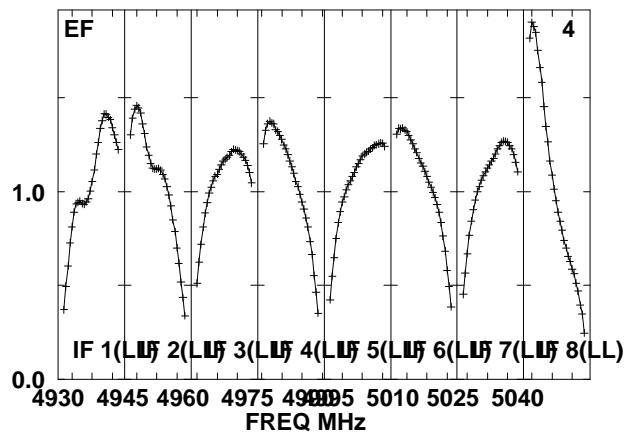
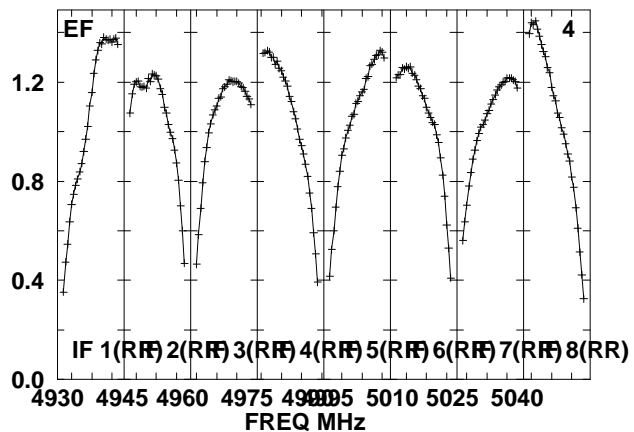
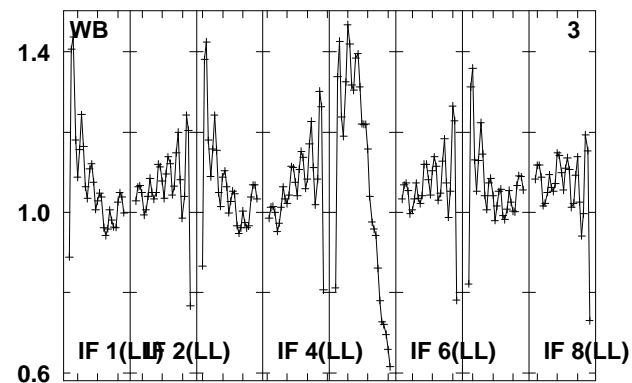
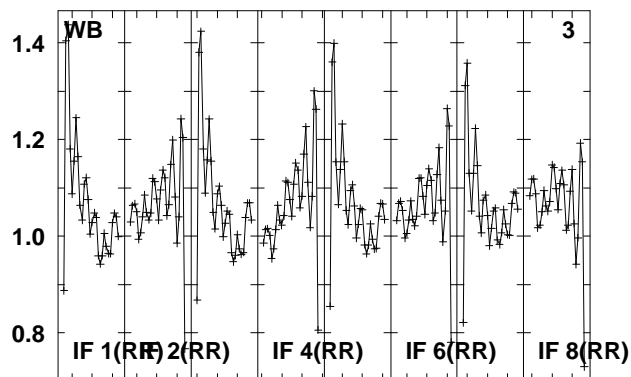
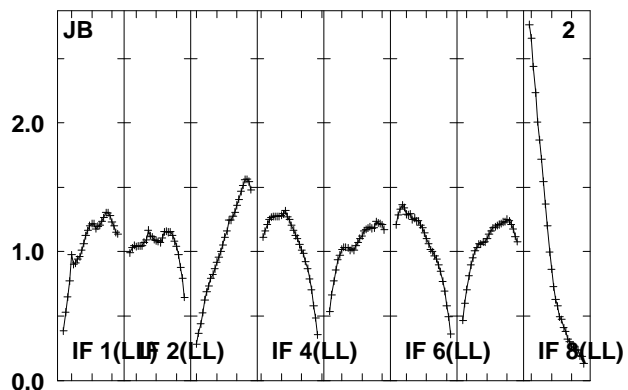
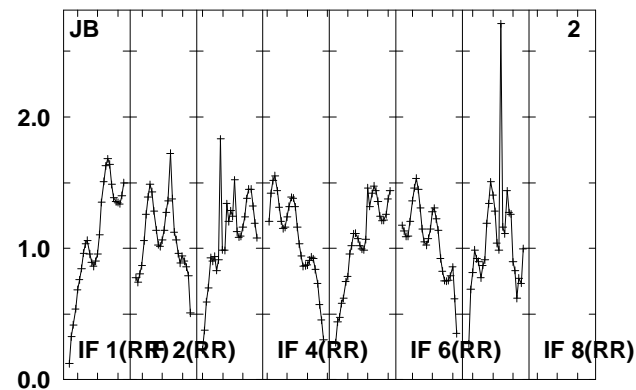
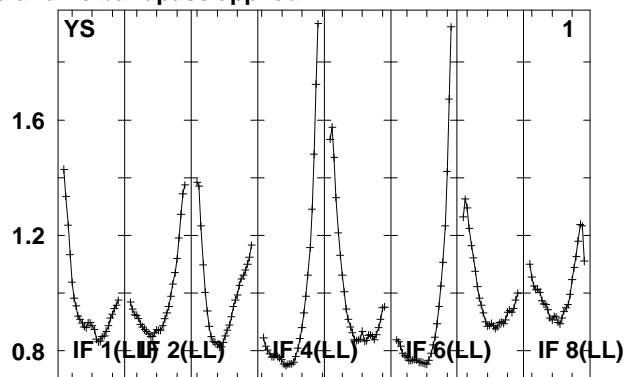
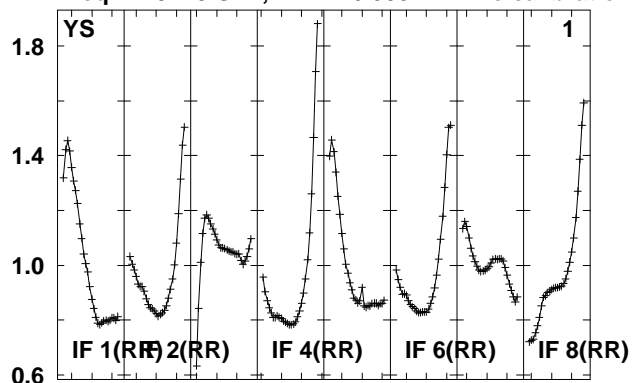

Lower frame: Real Jy
 Total-power spectrum Antenna: *
 Timerange: 00/04:05:22 to 00/04:10:20

Plot file version 68 created 14-MAY-2010 15:17:18

J135355 EO007.UVDATA.1

Freq = 4.9270 GHz, Bw = 16.000 MH No calibration applied and no bandpass applied

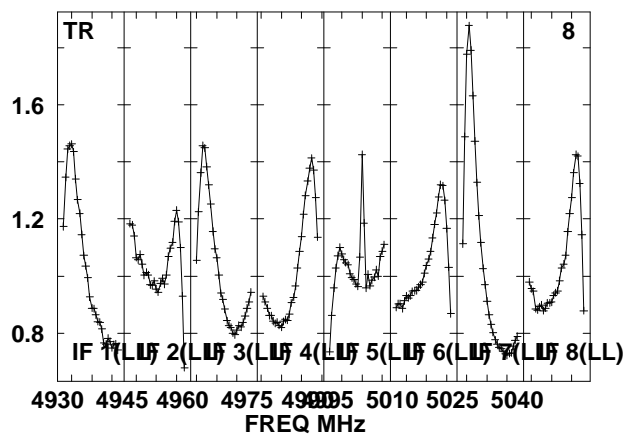
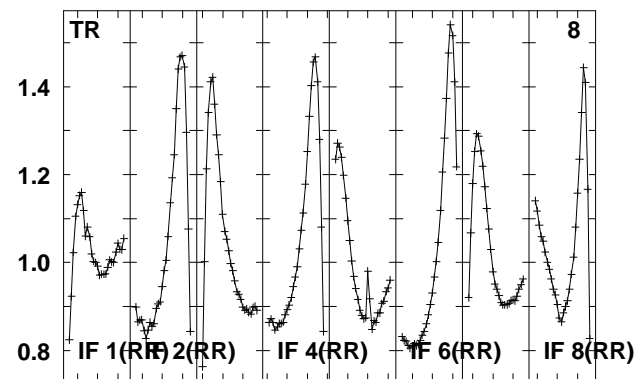
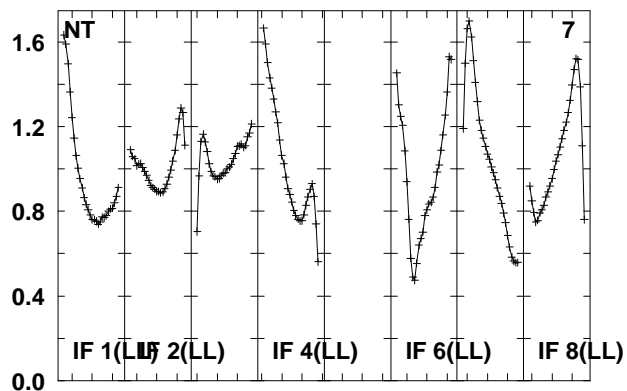
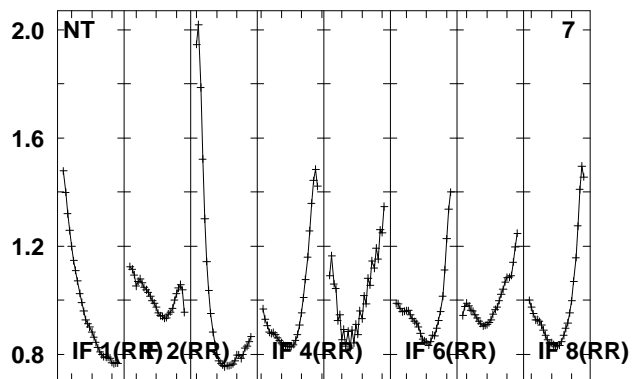
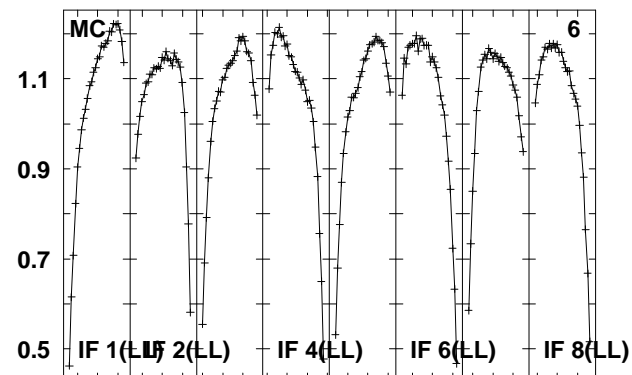
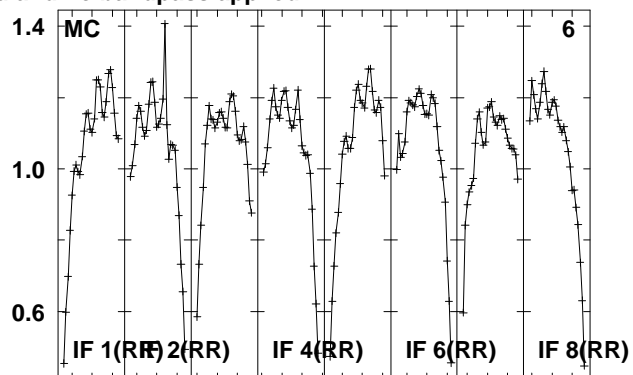
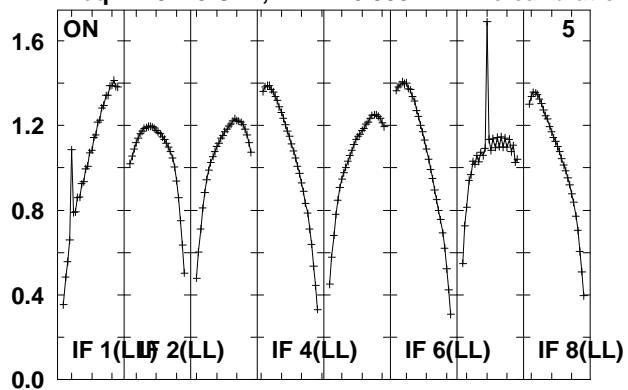

Lower frame: Real Jy

Total-power spectrum Antenna: *

Timerange: 00/04:05:22 to 00/04:10:20

Plot file version 69 created 14-MAY-2010 15:17:18

J1344+66 EO007.UVDATA.1

Freq = 4.9270 GHz, Bw = 16.000 MH No calibration applied and no bandpass applied

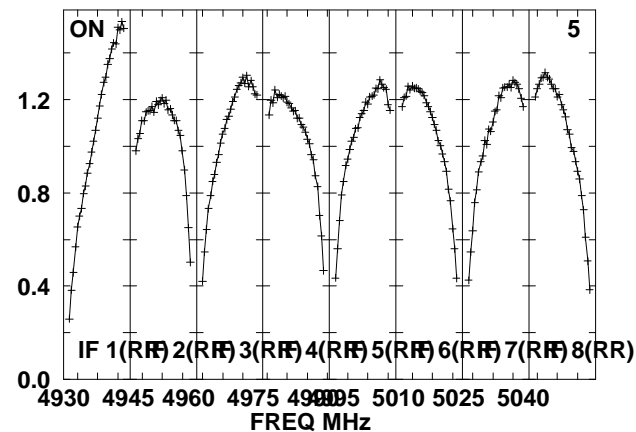
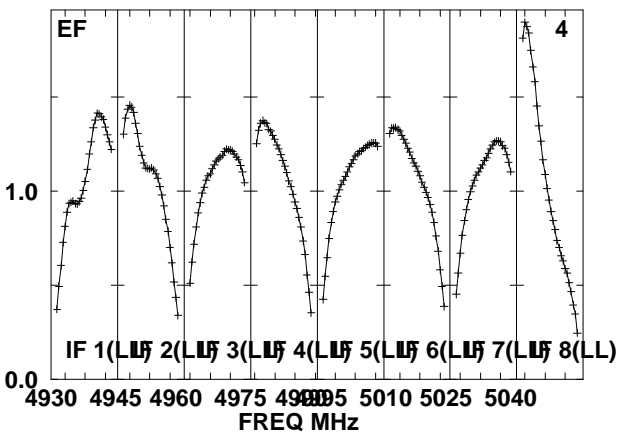
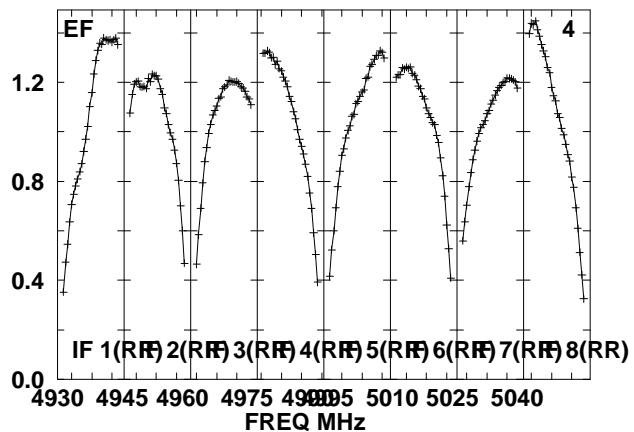
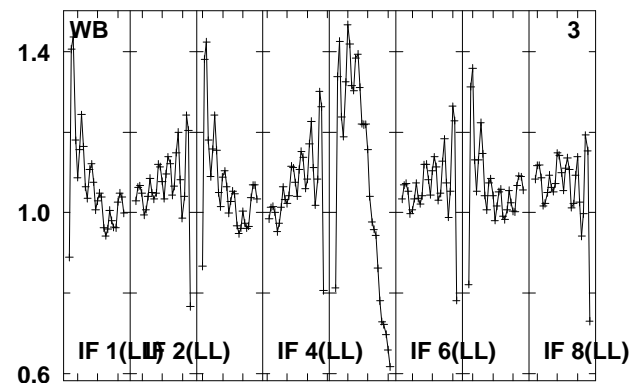
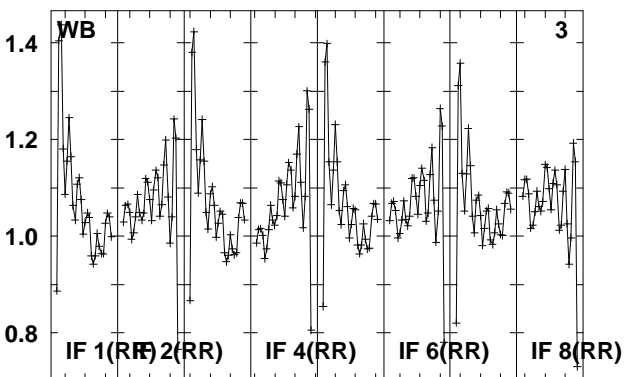
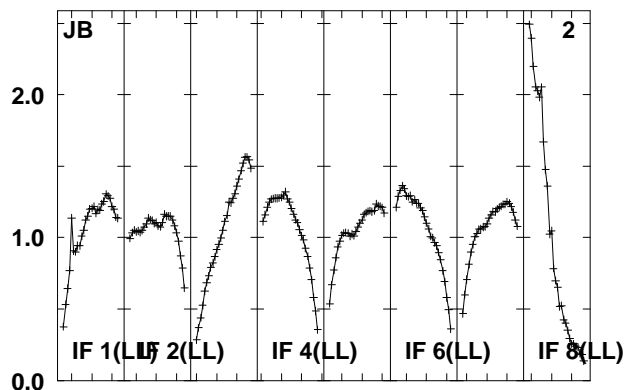
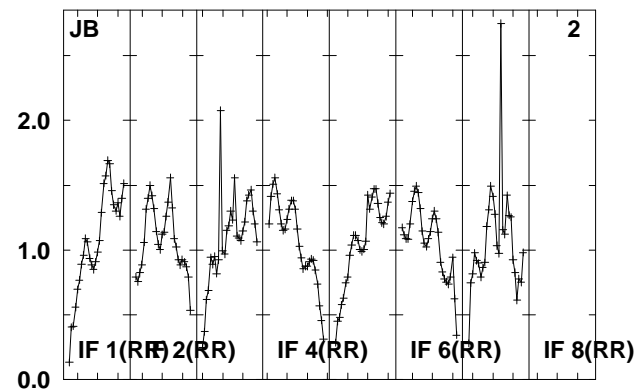
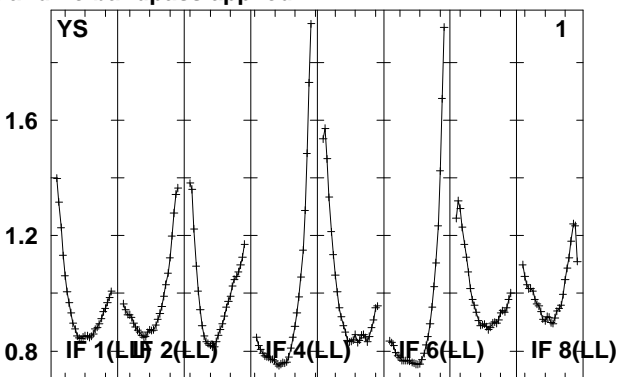
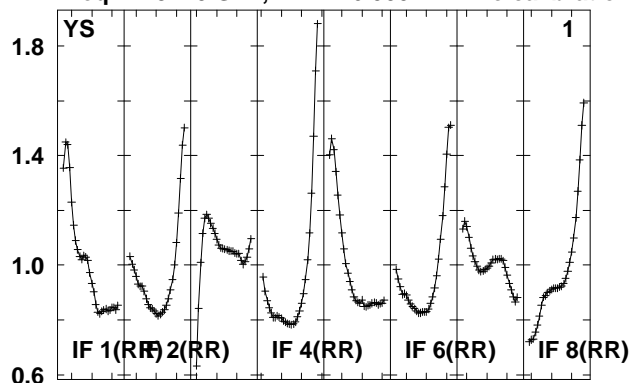

Lower frame: Real Jy

Total-power spectrum Antenna: *

Timerange: 00/04:10:54 to 00/04:12:20

Plot file version 70 created 14-MAY-2010 15:17:18

J1344+66 EO007.UVDATA.1

Freq = 4.9270 GHz, Bw = 16.000 MH No calibration applied and no bandpass applied

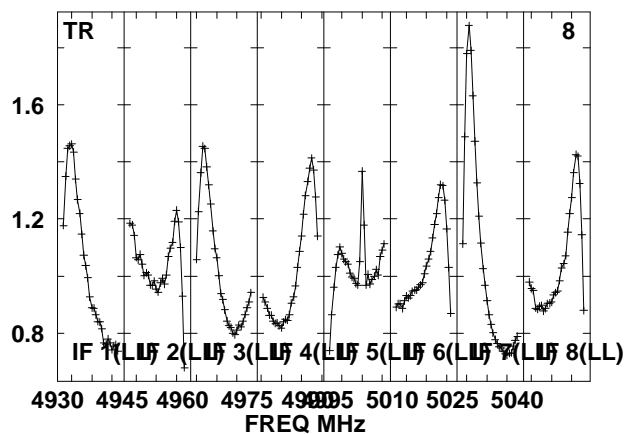
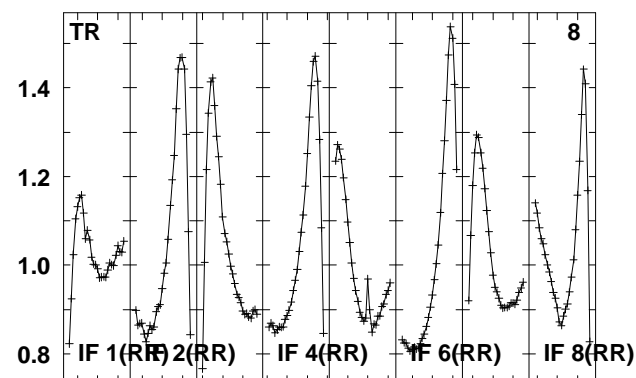
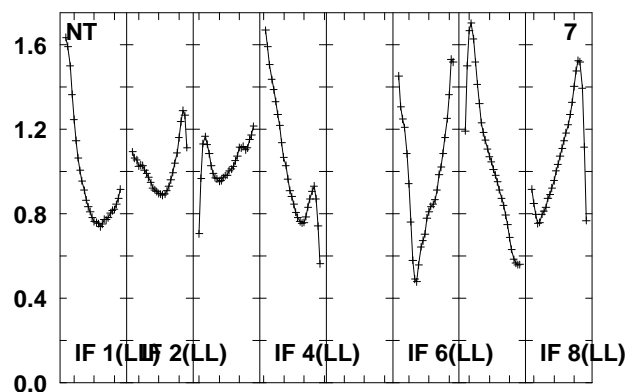
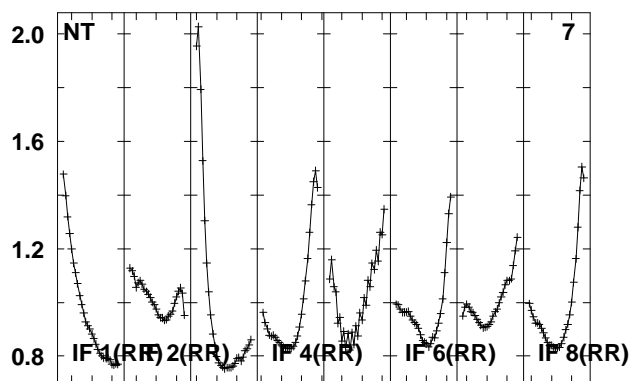
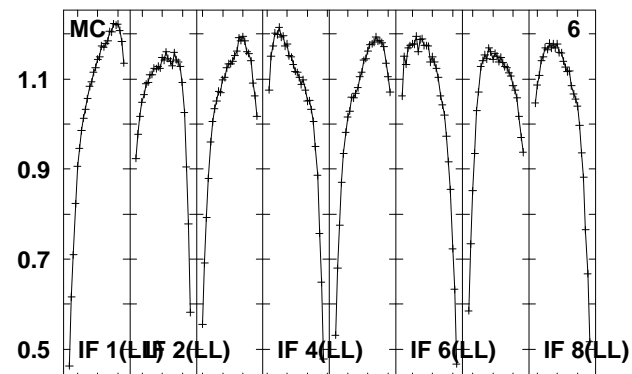
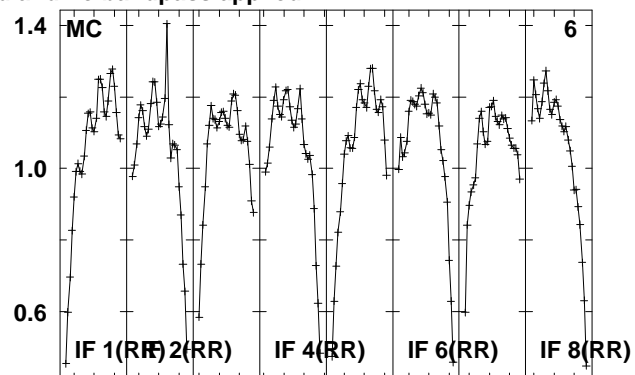
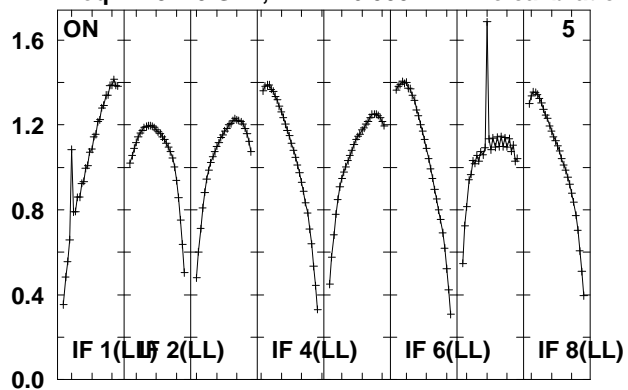

Lower frame: Real Jy

Total-power spectrum Antenna: *

Timerange: 00/04:10:54 to 00/04:12:20

Plot file version 71 created 14-MAY-2010 15:17:19
 J135355 EO007.UVDATA.1
 Freq = 4.9270 GHz, Bw = 16.000 MH No calibration applied and no bandpass applied

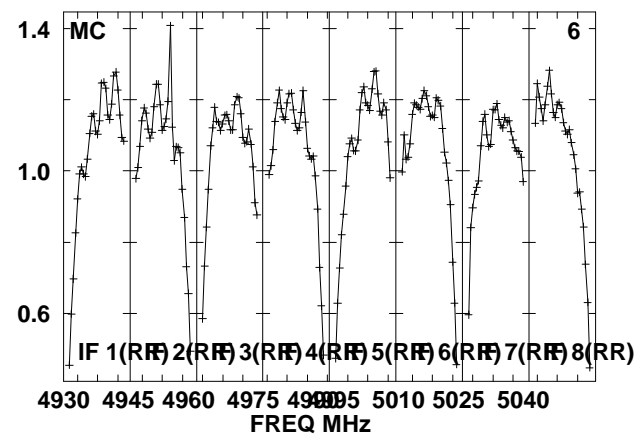
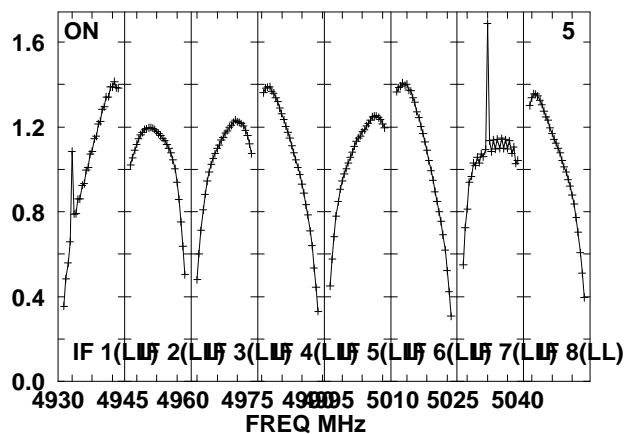
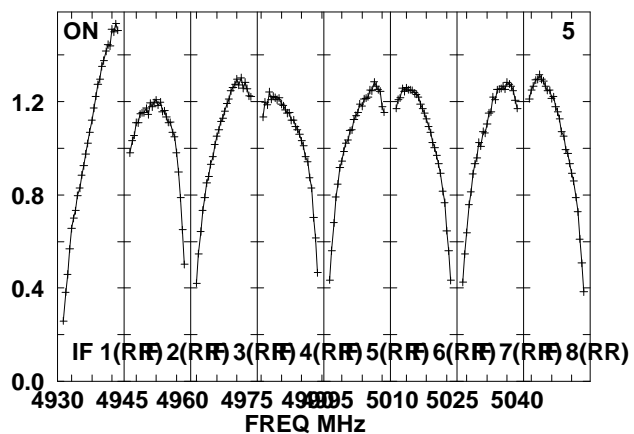
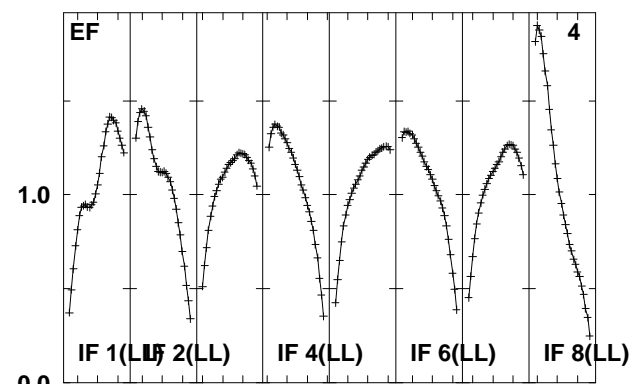
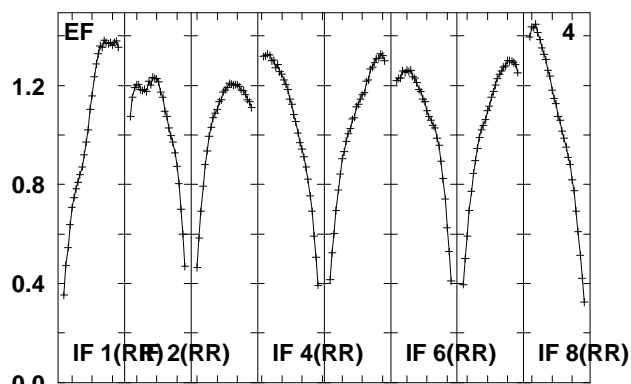
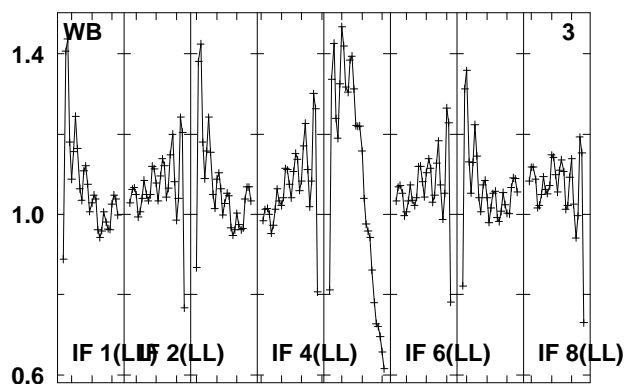
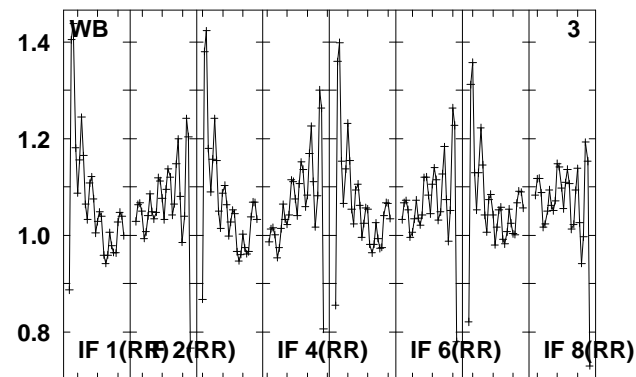
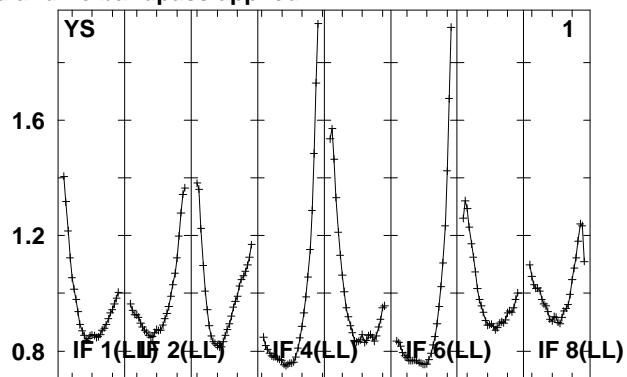
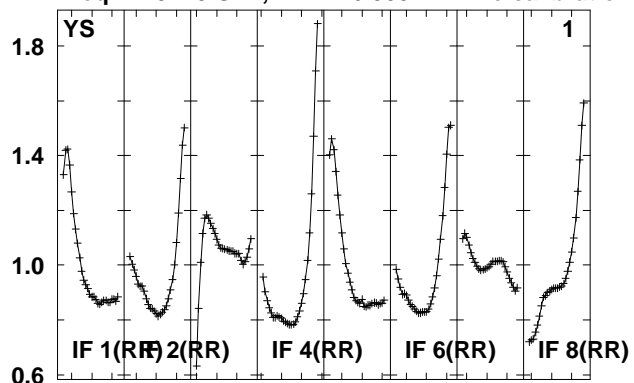

Lower frame: Real Jy
 Total-power spectrum Antenna: *
 Timerange: 00/04:12:55 to 00/04:17:51

Plot file version 72 created 14-MAY-2010 15:17:19

J135355 EO007.UVDATA.1

Freq = 4.9270 GHz, Bw = 16.000 MH No calibration applied and no bandpass applied

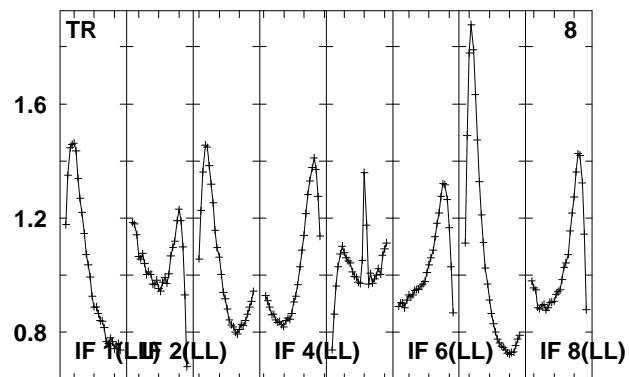
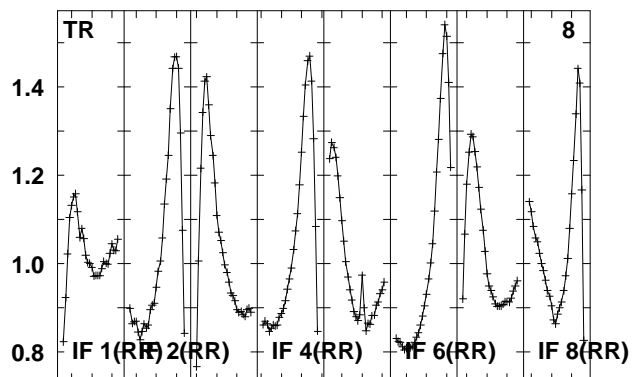
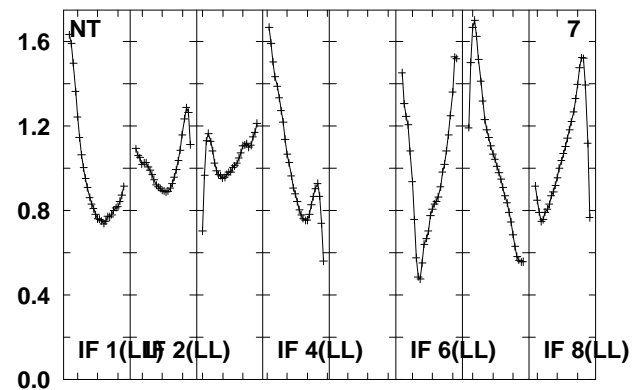
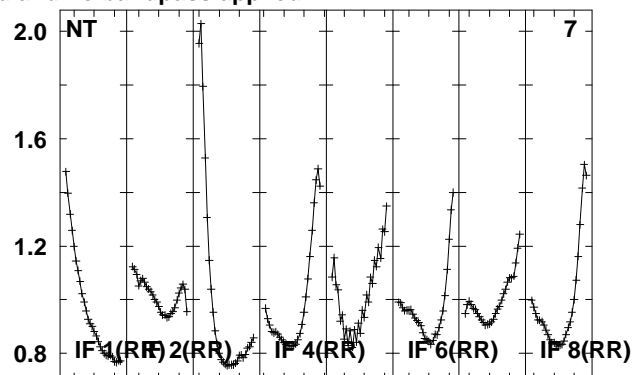
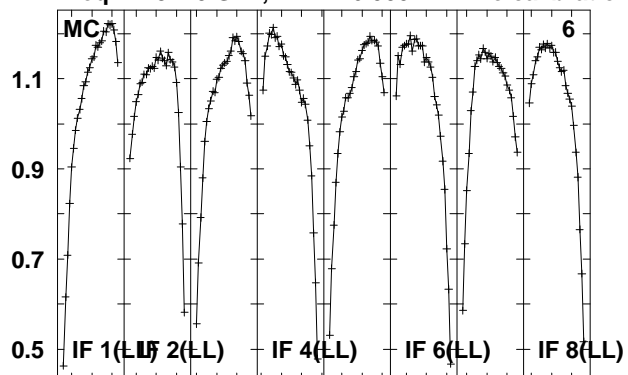

Lower frame: Real Jy
Total-power spectrum Antenna: *
Timerange: 00/04:12:55 to 00/04:17:51

Plot file version 73 created 14-MAY-2010 15:17:20

J1344+66 EO007.UVDATA.1

Freq = 4.9270 GHz, Bw = 16.000 MH No calibration applied and no bandpass applied

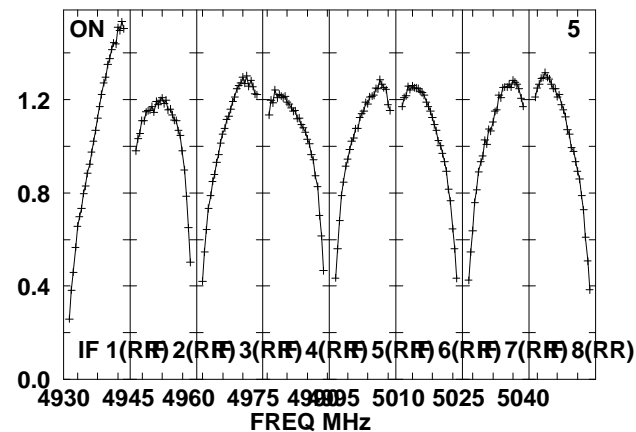
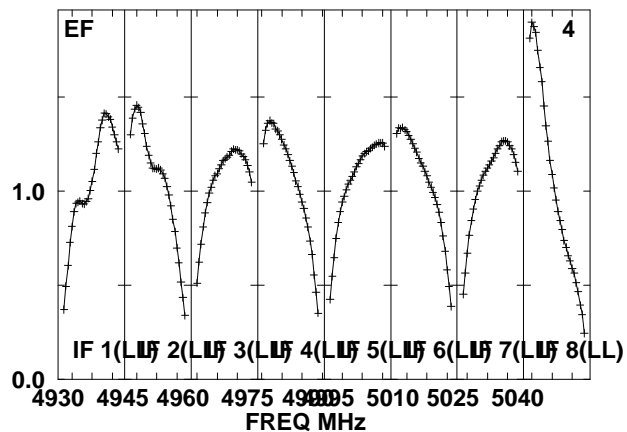
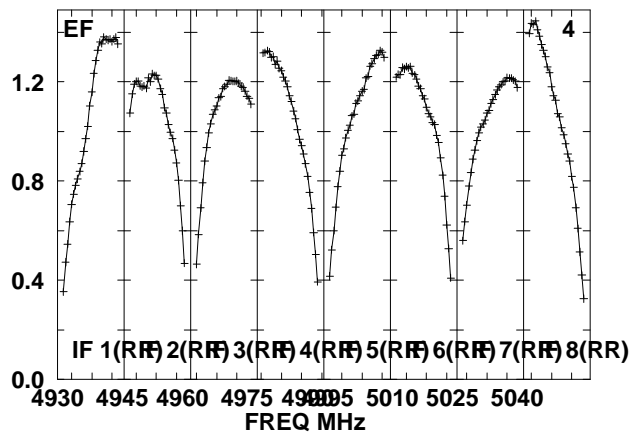
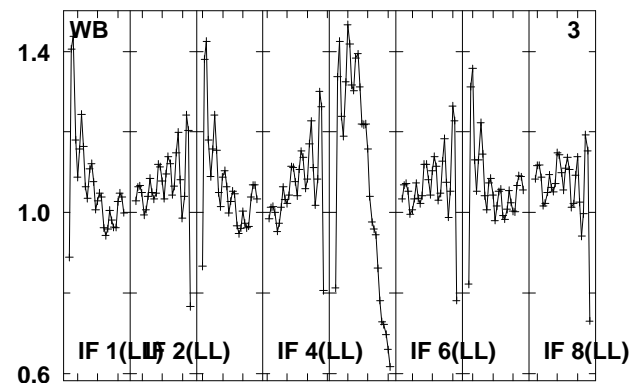
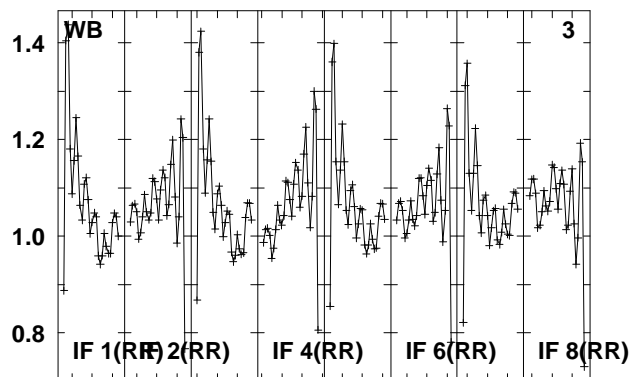
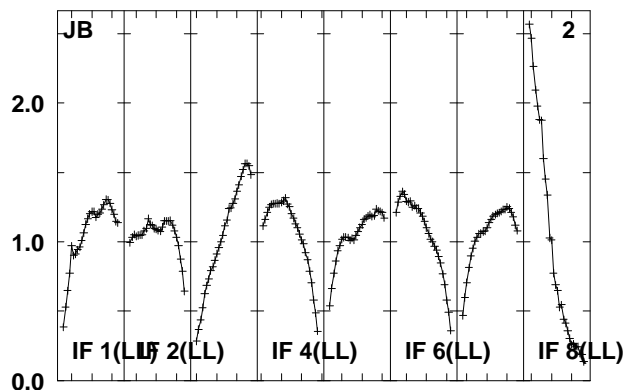
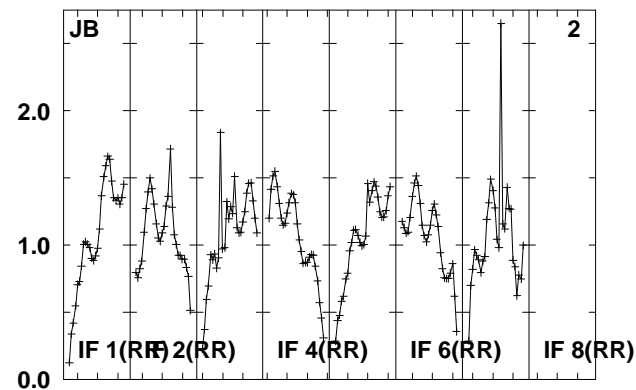
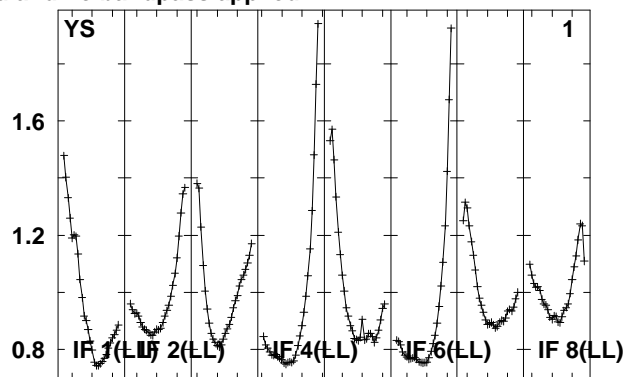
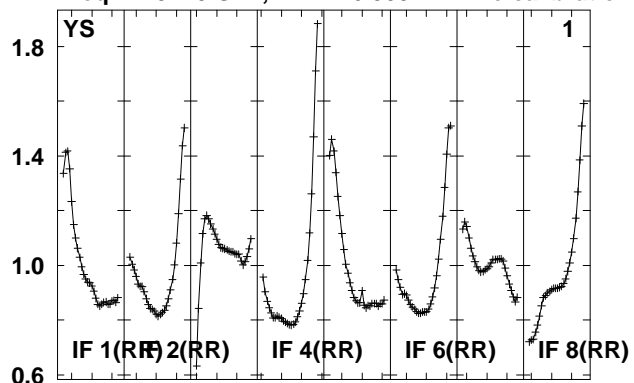

Lower frame: Real Jy

Total-power spectrum Antenna: *

Timerange: 00/04:18:25 to 00/04:19:53

Plot file version 74 created 14-MAY-2010 15:17:20

J1344+66 EO007.UVDATA.1

Freq = 4.9270 GHz, Bw = 16.000 MH No calibration applied and no bandpass applied

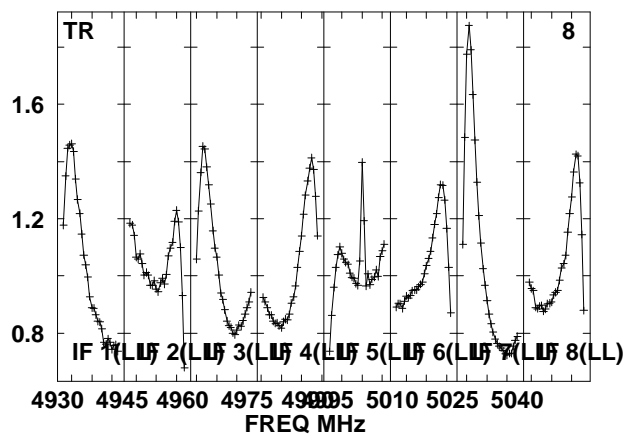
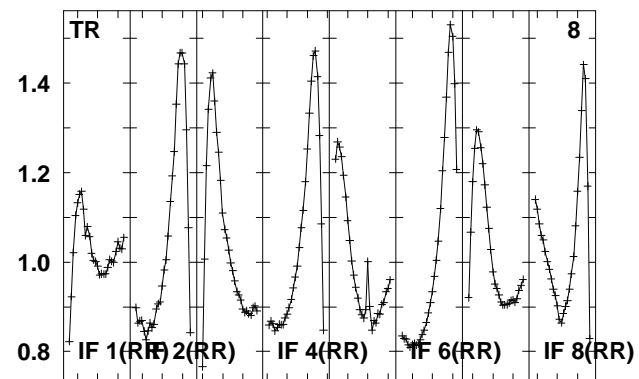
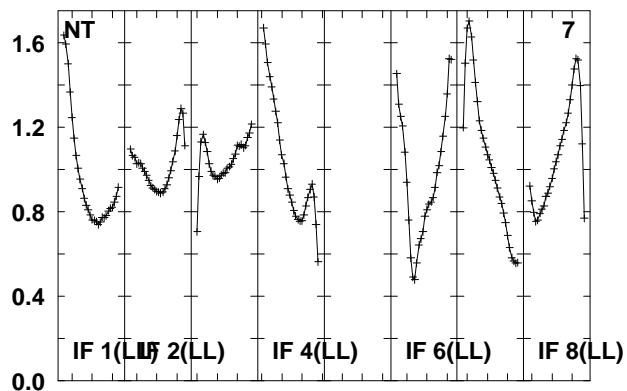
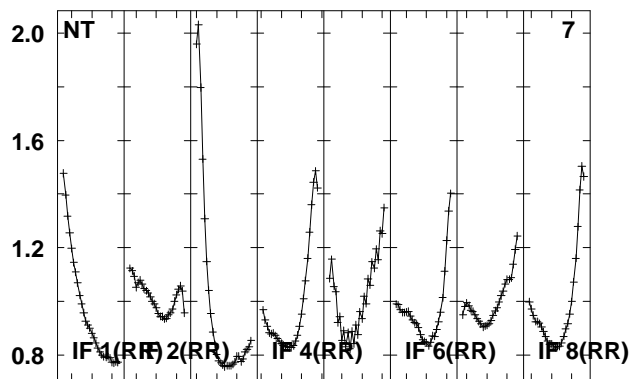
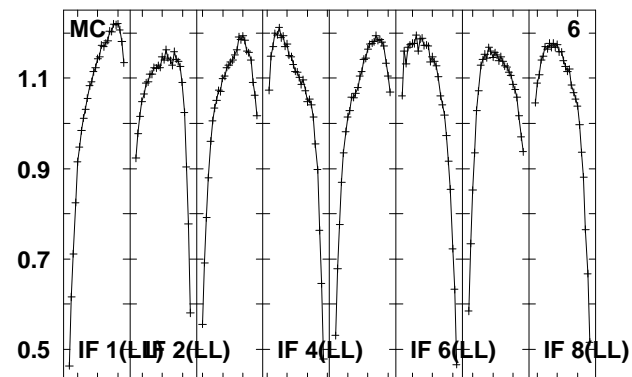
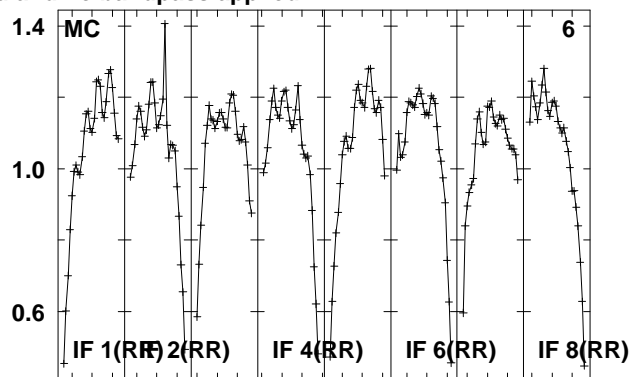
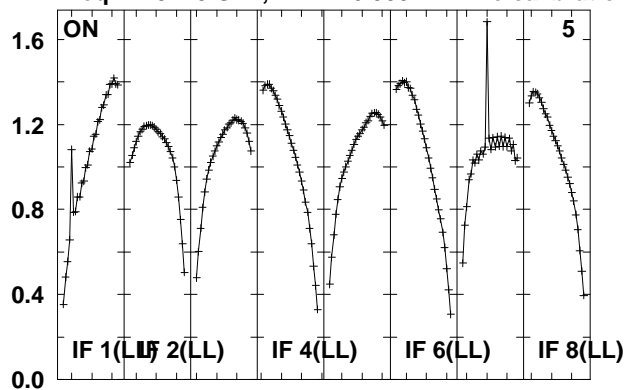

Lower frame: Real Jy

Total-power spectrum Antenna: *

Timerange: 00/04:18:25 to 00/04:19:53

Plot file version 75 created 14-MAY-2010 15:17:20
 J135355 EO007.UVDATA.1
 Freq = 4.9270 GHz, Bw = 16.000 MH No calibration applied and no bandpass applied

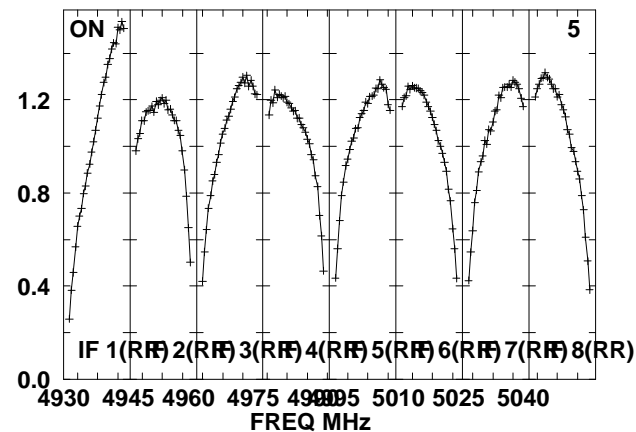
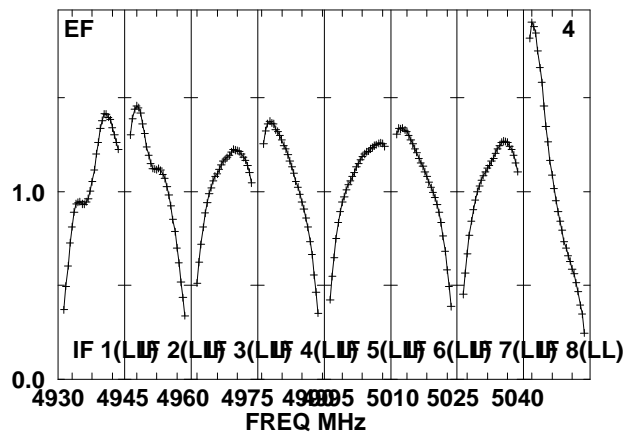
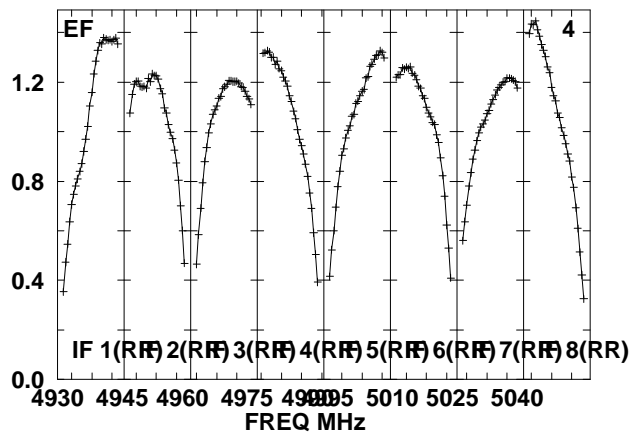
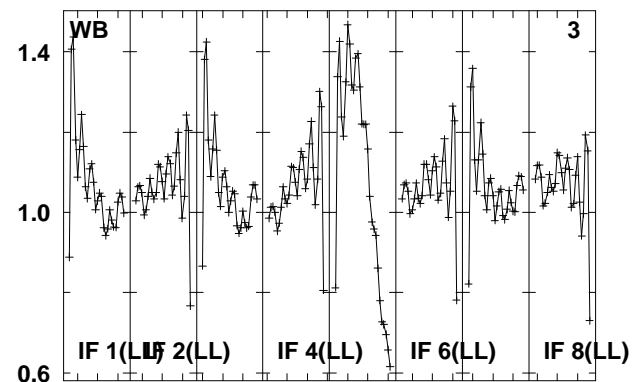
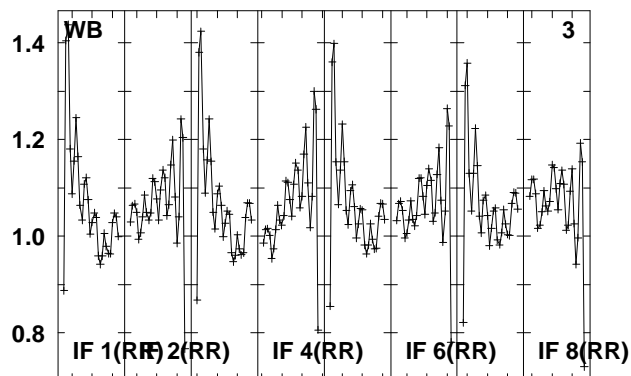
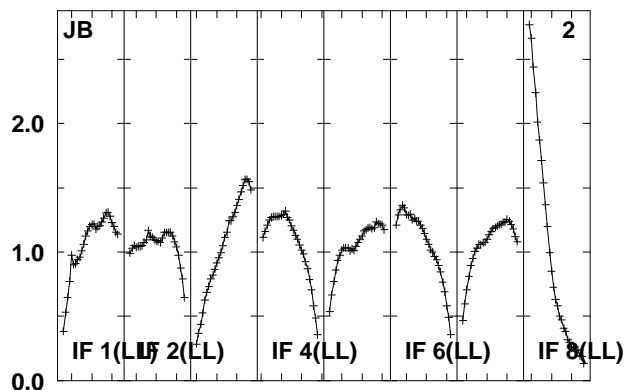
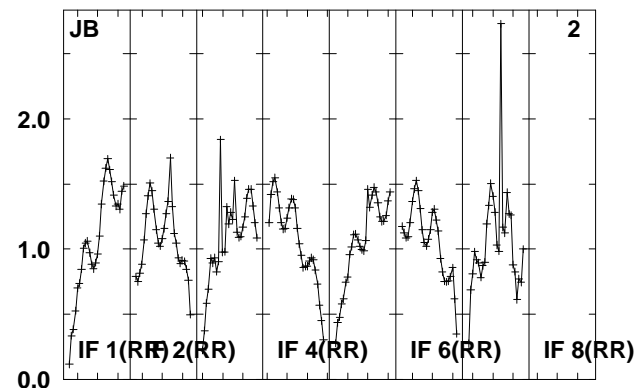
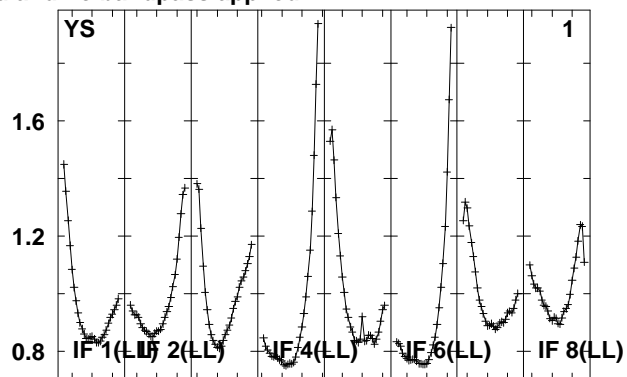
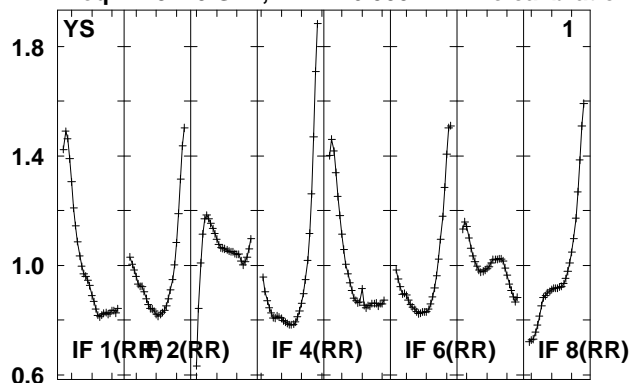

Lower frame: Real Jy
 Total-power spectrum Antenna: *
 Timerange: 00/04:20 to 00/04:25:25

Plot file version 76 created 14-MAY-2010 15:17:21

J135355 EO007.UVDATA.1

Freq = 4.9270 GHz, Bw = 16.000 MH No calibration applied and no bandpass applied

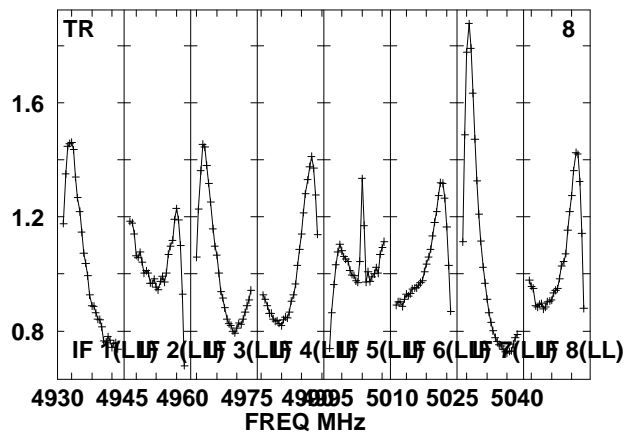
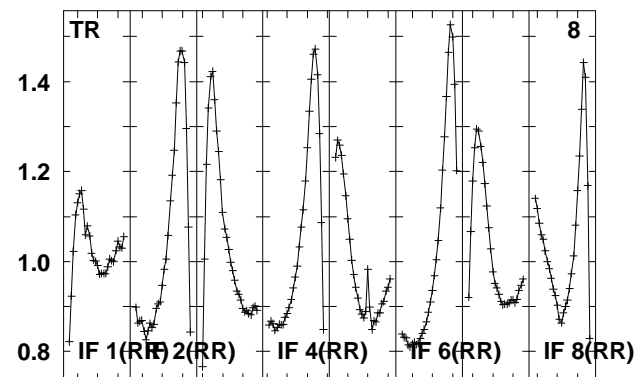
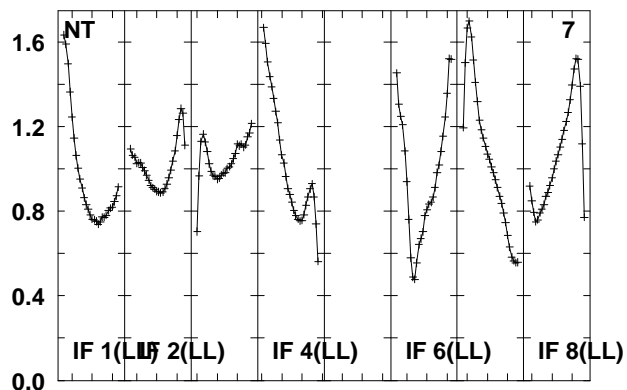
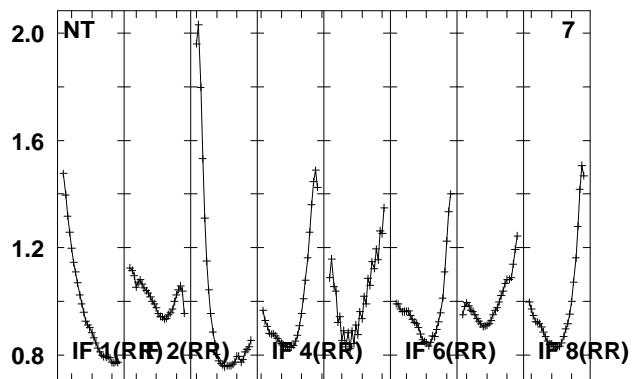
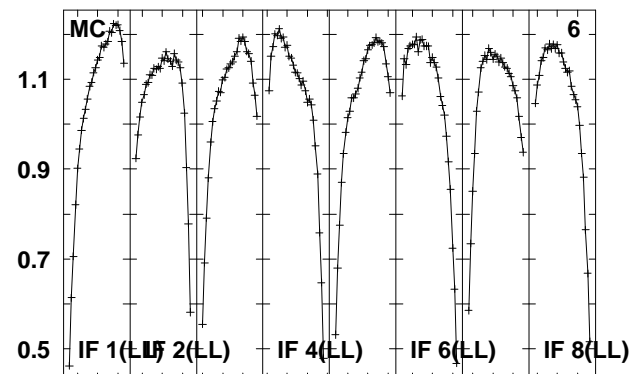
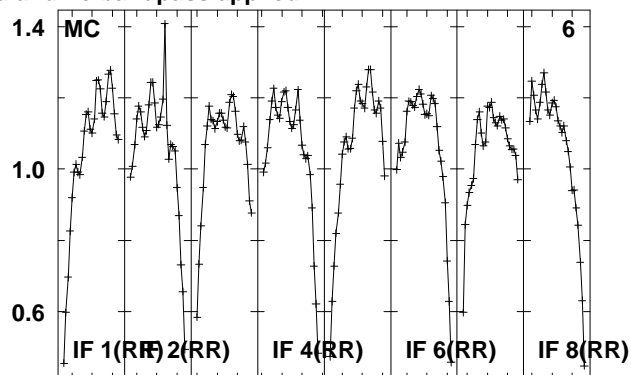
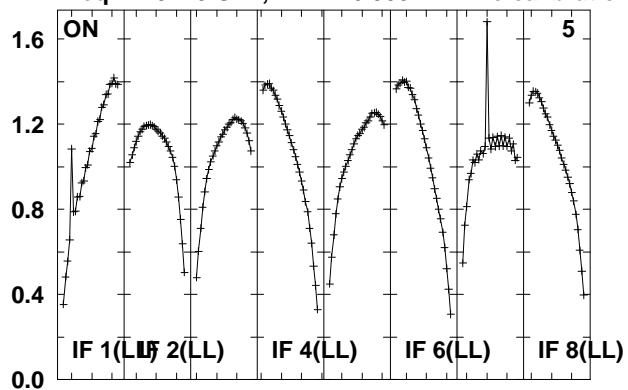

Lower frame: Real Jy

Total-power spectrum Antenna: *

Timerange: 00/04:20:27 to 00/04:25:25

Plot file version 77 created 14-MAY-2010 15:17:21

J1344+66 EO007.UVDATA.1

Freq = 4.9270 GHz, Bw = 16.000 MH No calibration applied and no bandpass applied

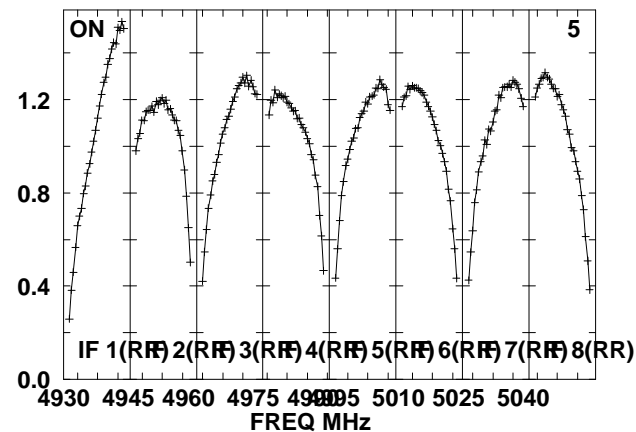
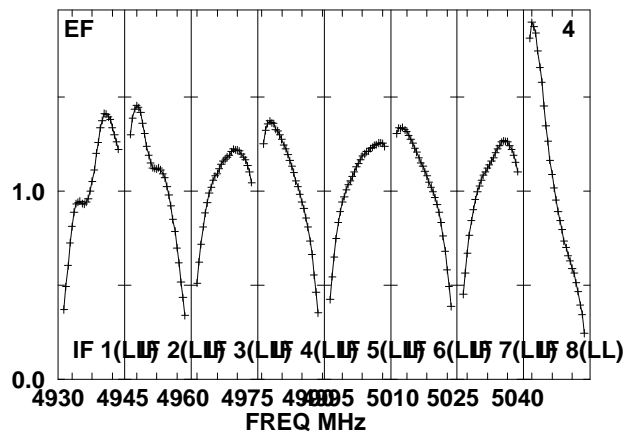
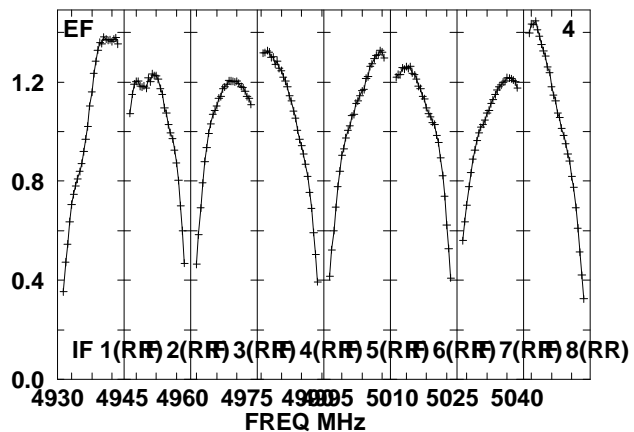
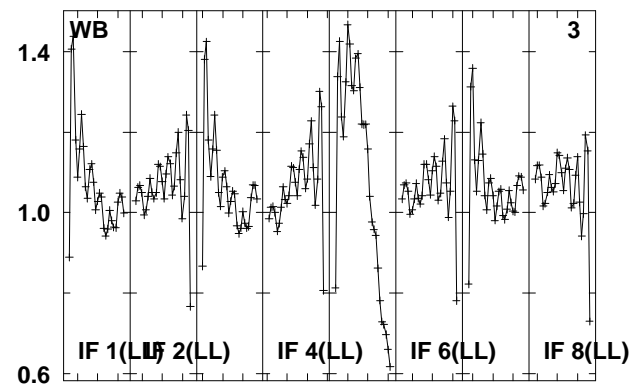
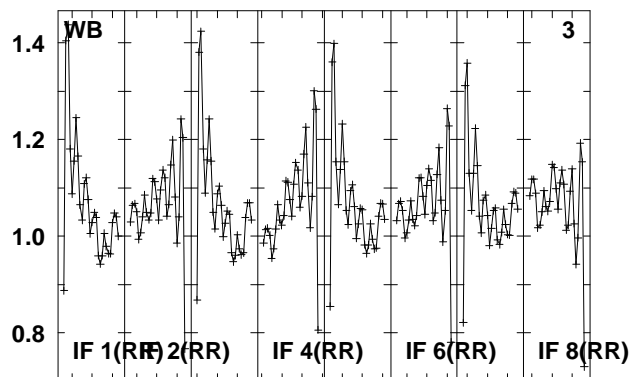
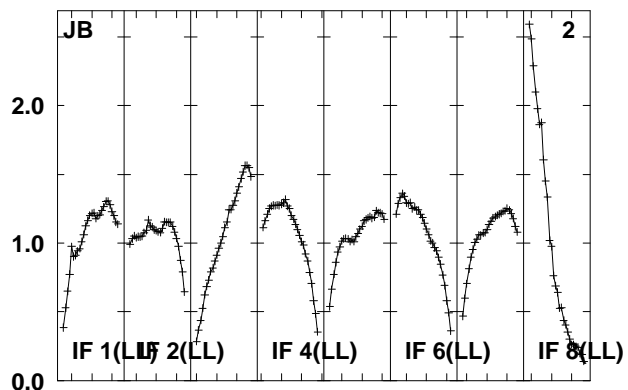
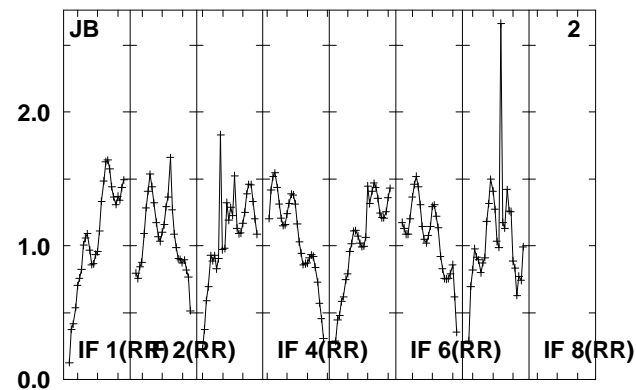
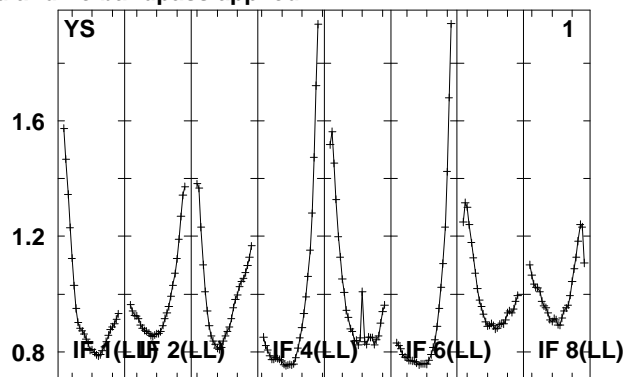
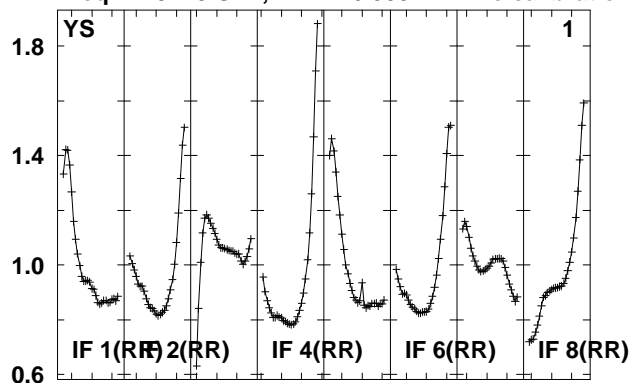

Lower frame: Real Jy
Total-power spectrum Antenna: *
Timerange: 00/04:25:58 to 00/04:27:24

Plot file version 78 created 14-MAY-2010 15:17:21

J1344+66 EO007.UVDATA.1

Freq = 4.9270 GHz, Bw = 16.000 MH No calibration applied and no bandpass applied

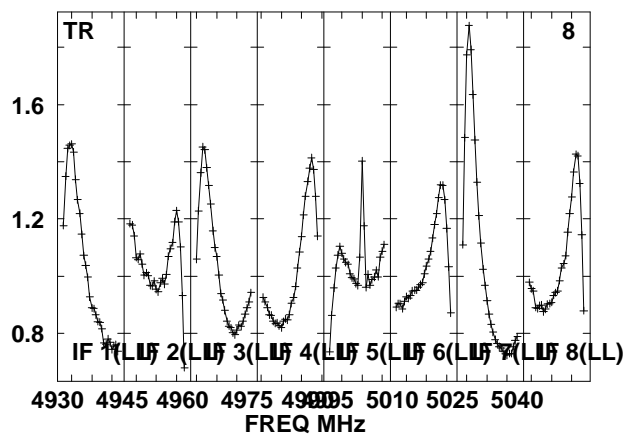
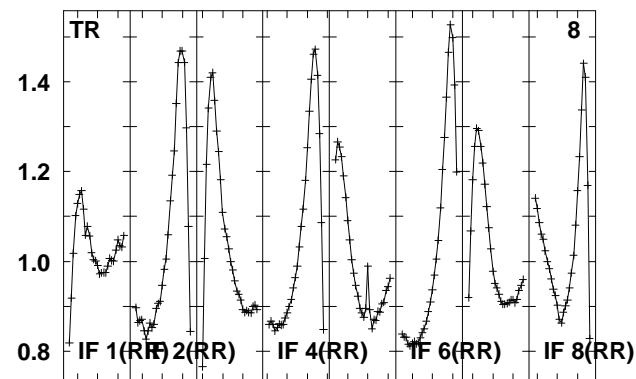
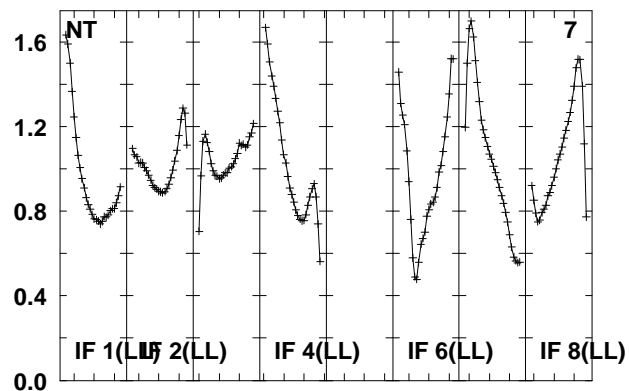
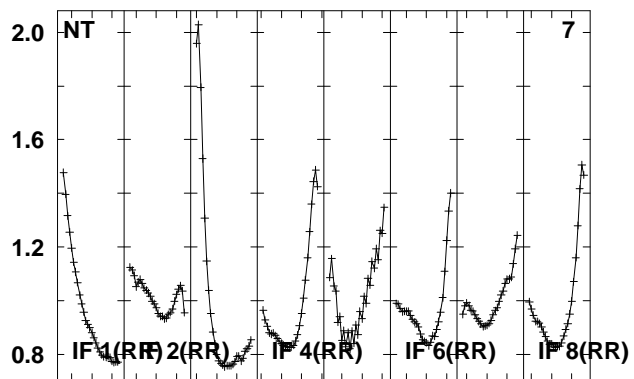
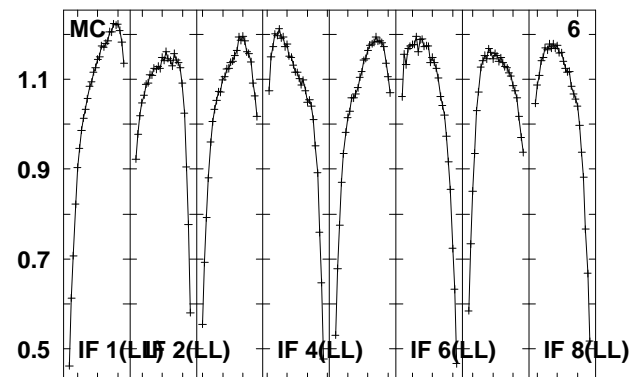
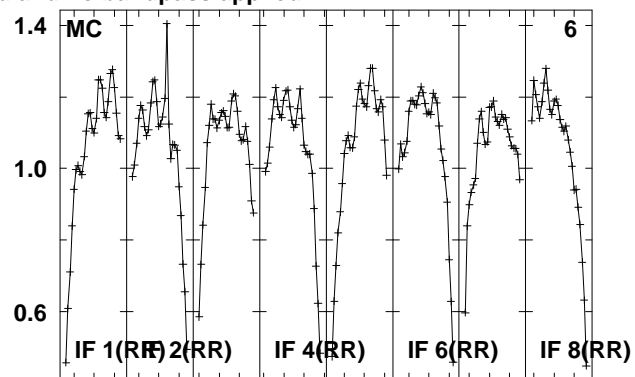
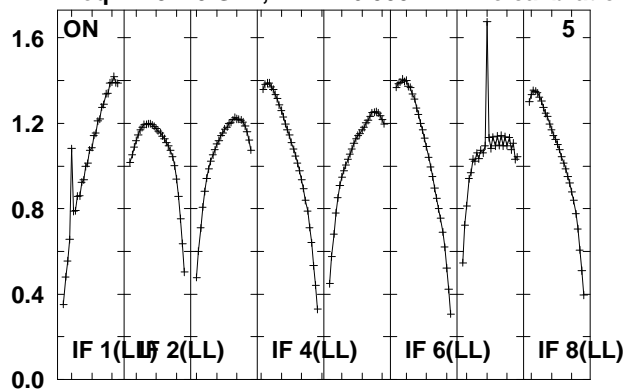

Lower frame: Real Jy

Total-power spectrum Antenna: *

Timerange: 00/04:25:58 to 00/04:27:24

Plot file version 79 created 14-MAY-2010 15:17:22
 J135355 EO007.UVDATA.1
 Freq = 4.9270 GHz, Bw = 16.000 MH No calibration applied and no bandpass applied

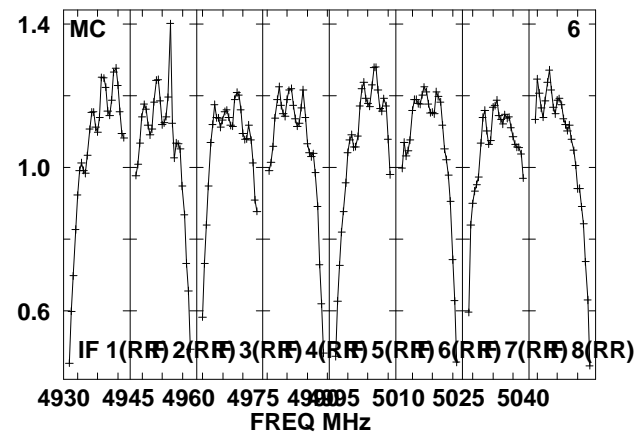
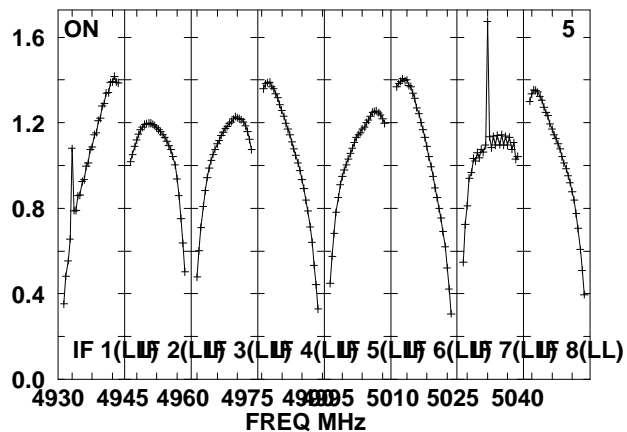
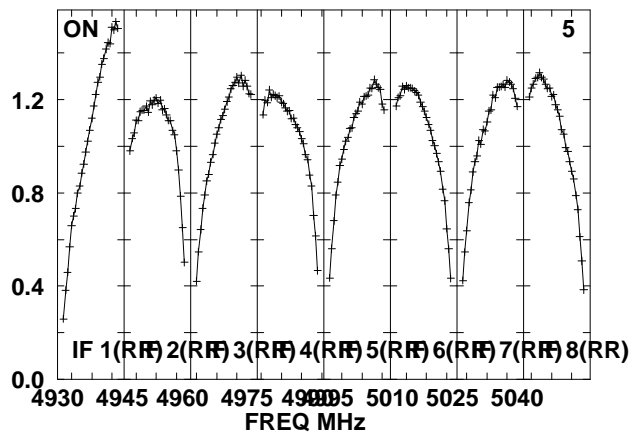
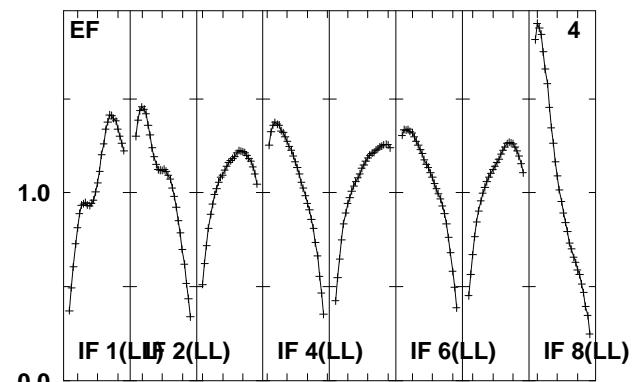
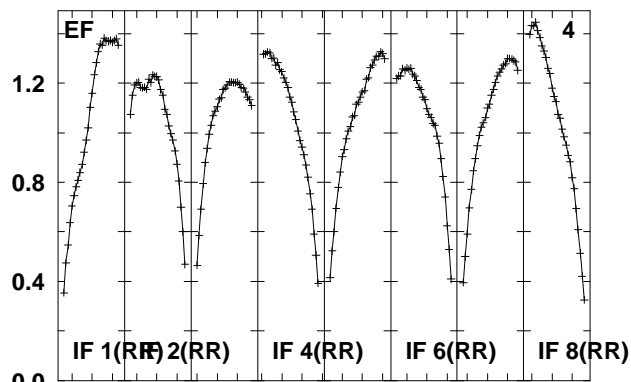
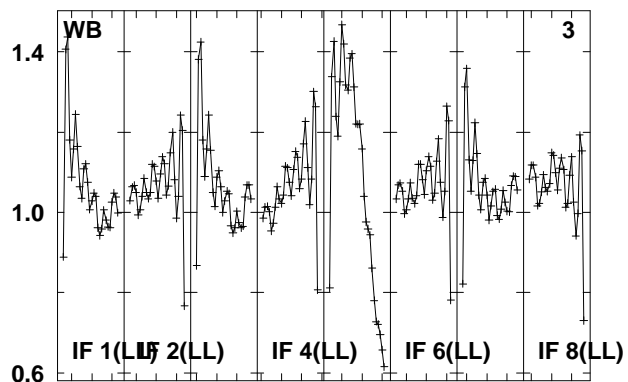
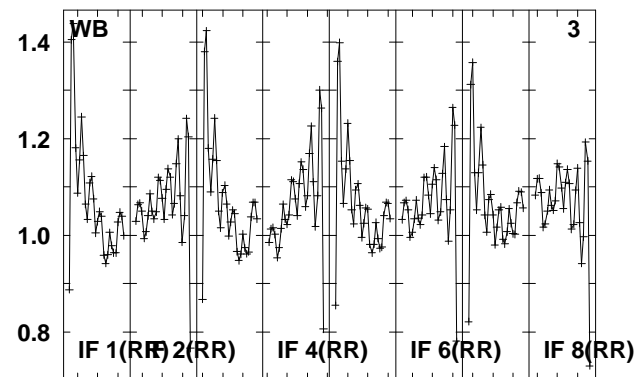
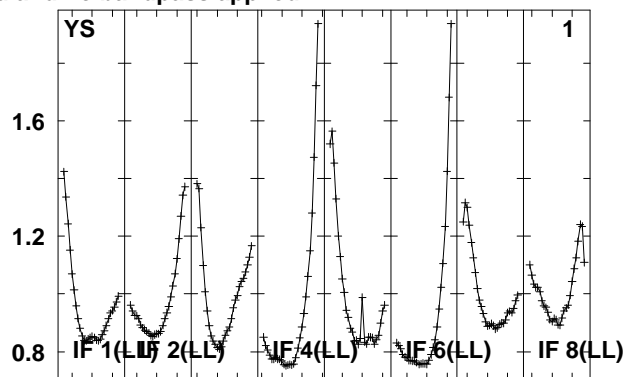
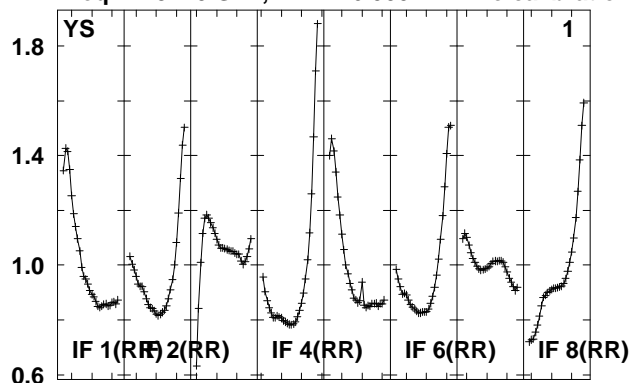

Lower frame: Real Jy
 Total-power spectrum Antenna: *
 Timerange: 00/04:27:57 to 00/04:32:53

Plot file version 80 created 14-MAY-2010 15:17:22

J135355 EO007.UVDATA.1

Freq = 4.9270 GHz, Bw = 16.000 MH No calibration applied and no bandpass applied

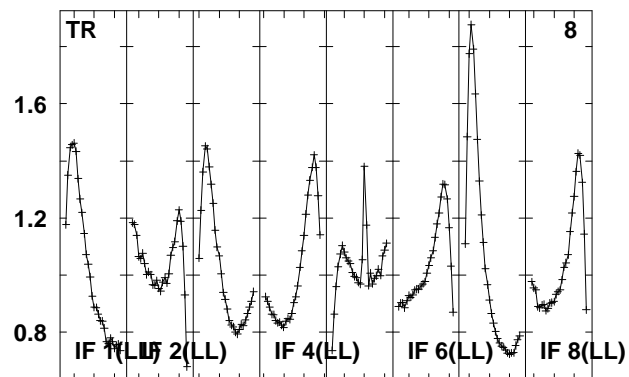
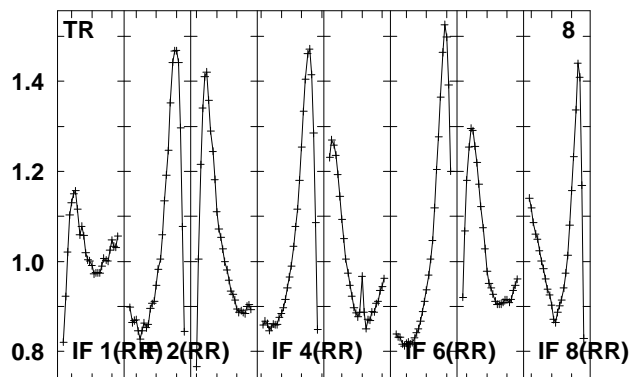
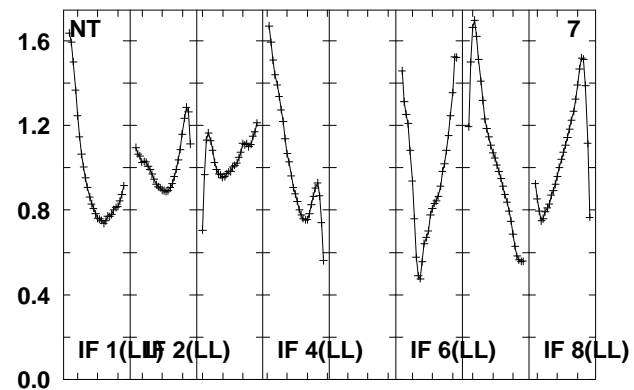
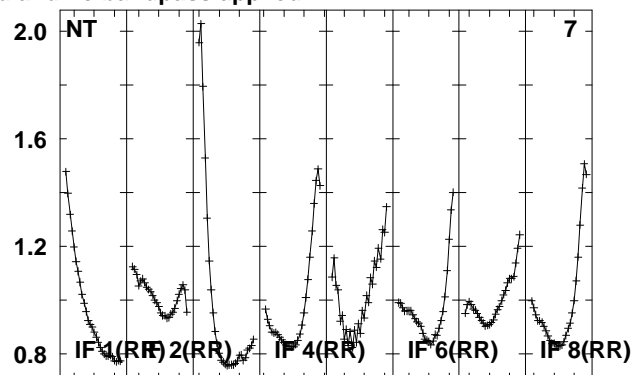
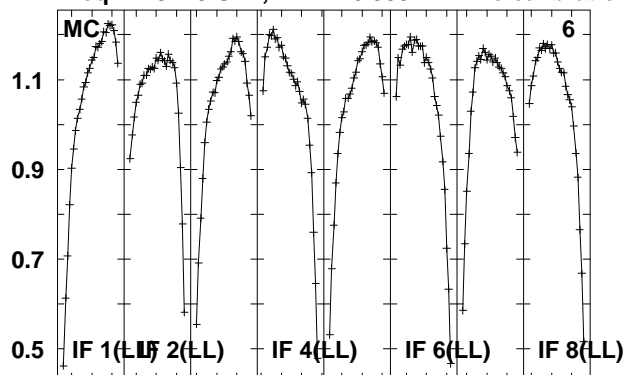

Lower frame: Real Jy
Total-power spectrum Antenna: *
Timerange: 00/04:27:57 to 00/04:32:53

Plot file version 81 created 14-MAY-2010 15:17:23

J1344+66 EO007.UVDATA.1

Freq = 4.9270 GHz, Bw = 16.000 MH No calibration applied and no bandpass applied

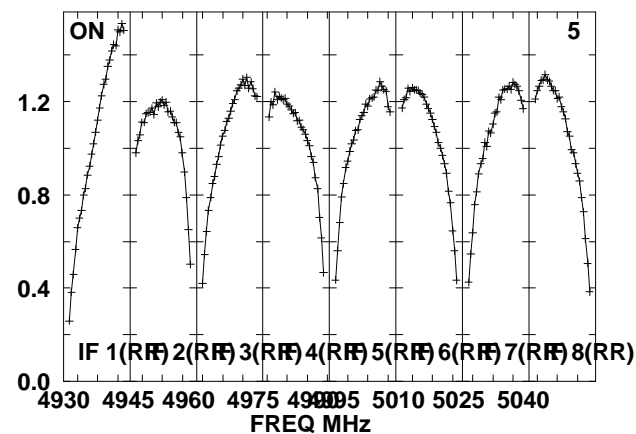
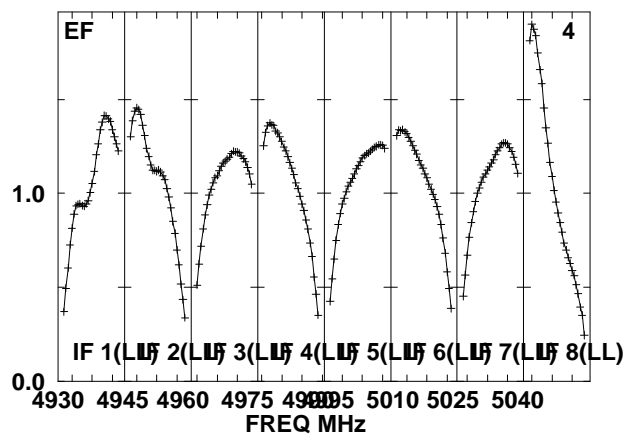
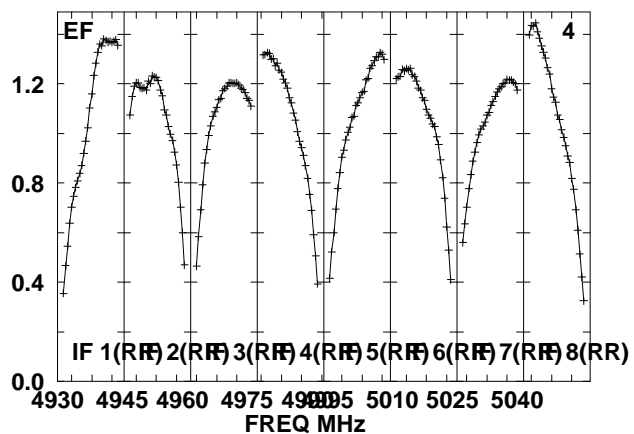
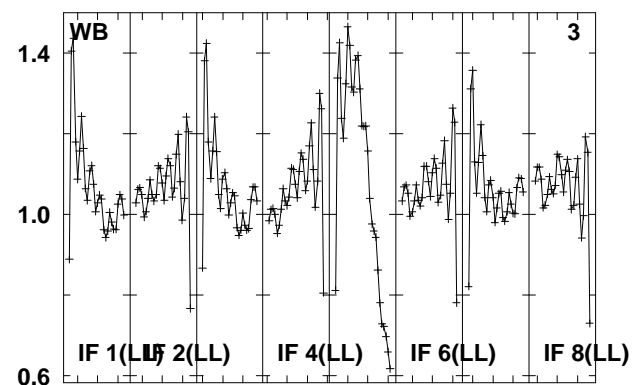
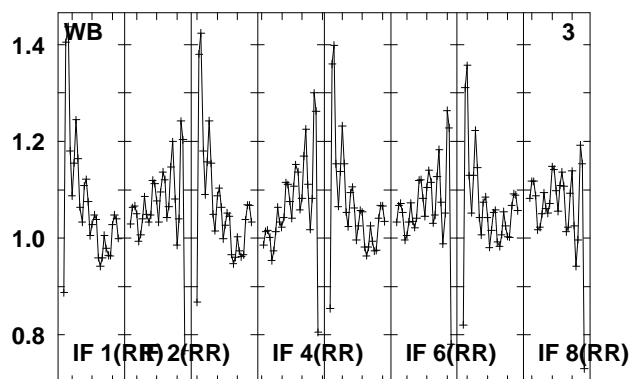
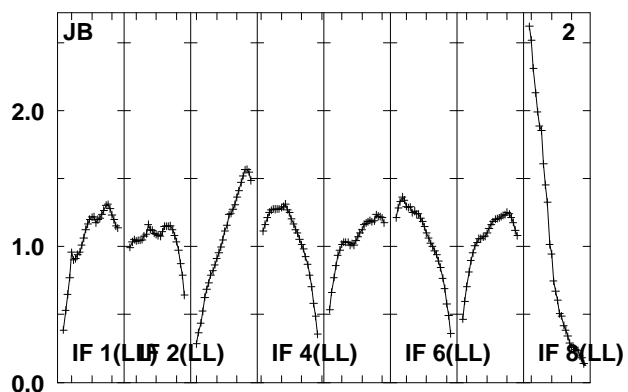
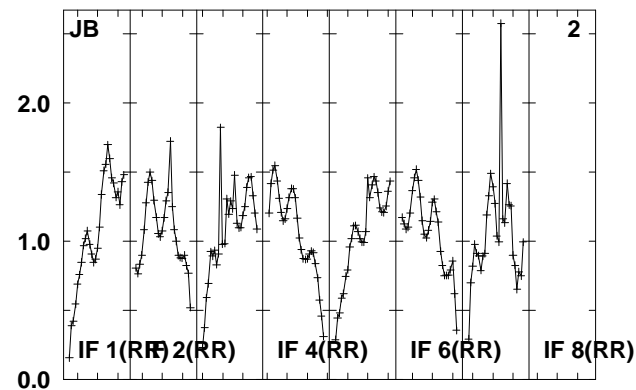
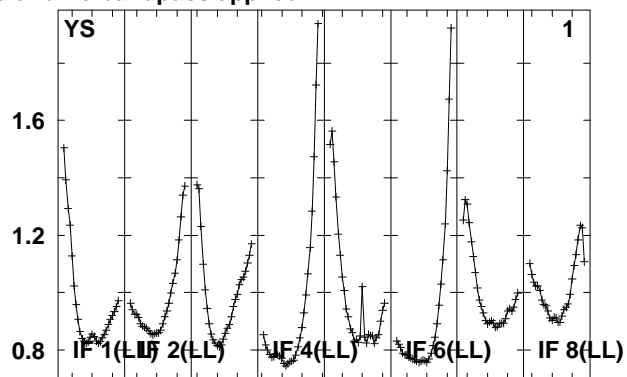
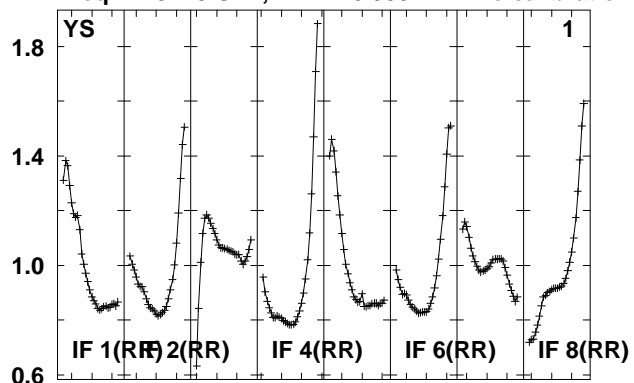

Lower frame: Real Jy

Total-power spectrum Antenna: *

Timerange: 00/04:33:26 to 00/04:34:54

Plot file version 82 created 14-MAY-2010 15:17:23

J1344+66 EO007.UVDATA.1

Freq = 4.9270 GHz, Bw = 16.000 MH No calibration applied and no bandpass applied

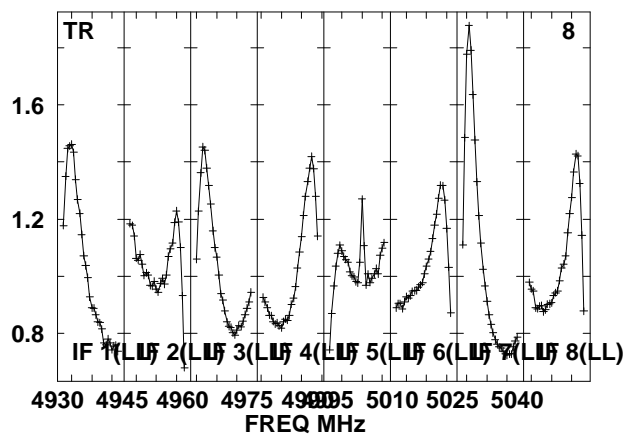
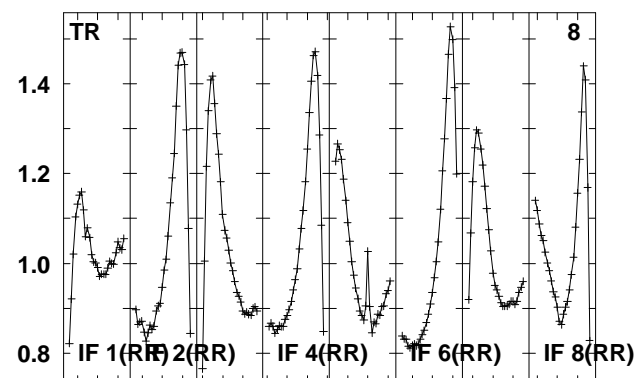
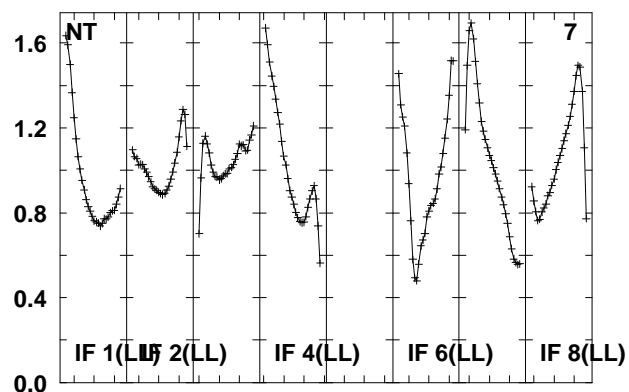
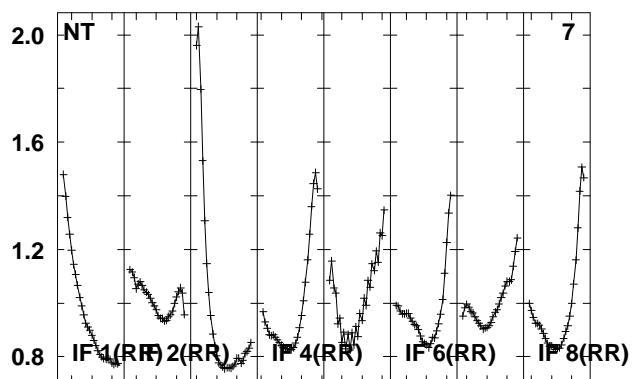
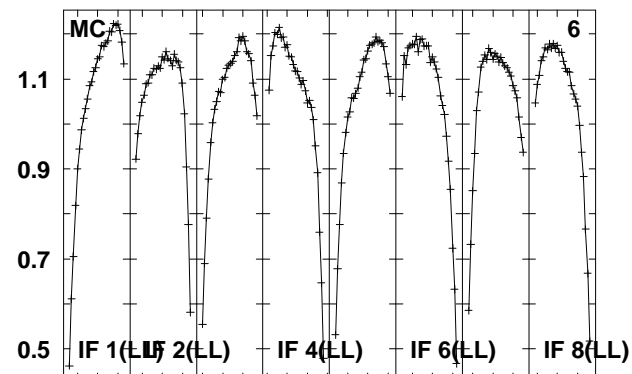
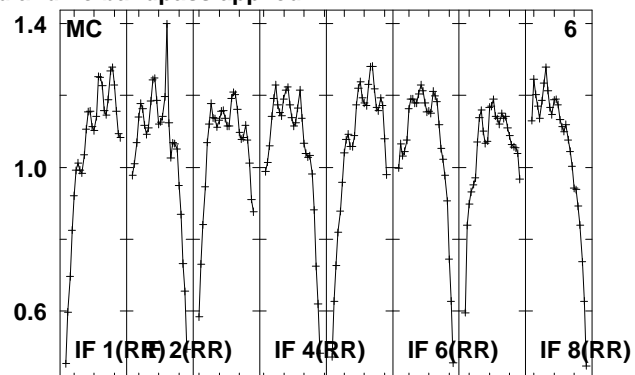
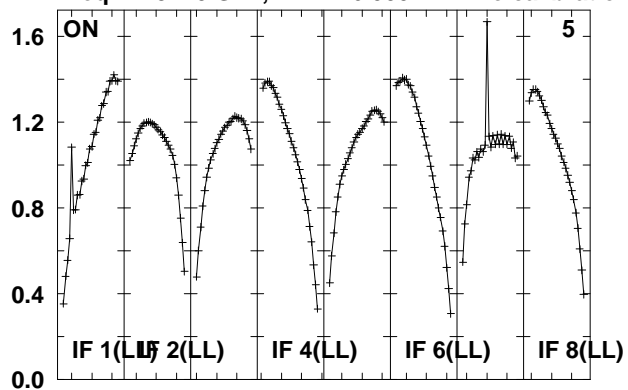

Lower frame: Real Jy

Total-power spectrum Antenna: *

Timerange: 00/04:33:26 to 00/04:34:54

Plot file version 83 created 14-MAY-2010 15:17:23
 J135355 EO007.UVDATA.1
 Freq = 4.9270 GHz, Bw = 16.000 MH No calibration applied and no bandpass applied

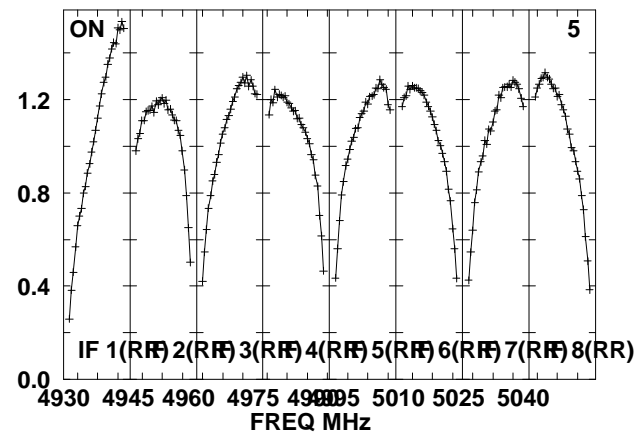
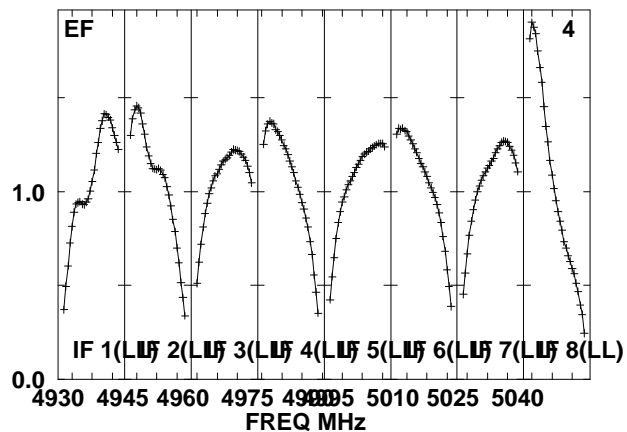
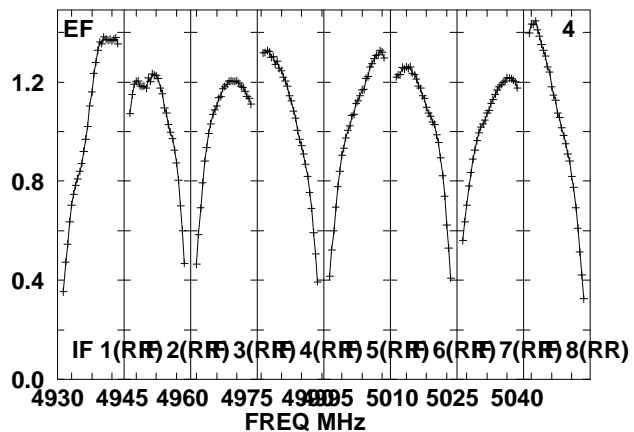
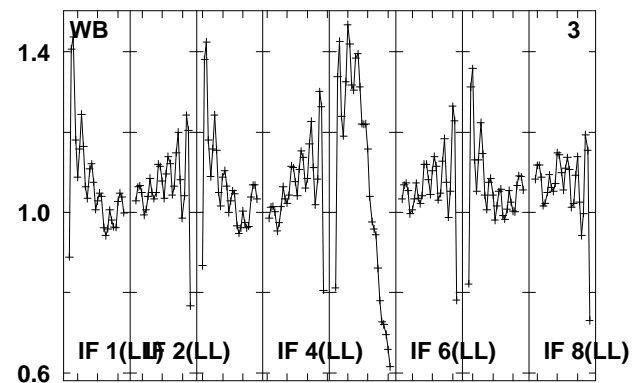
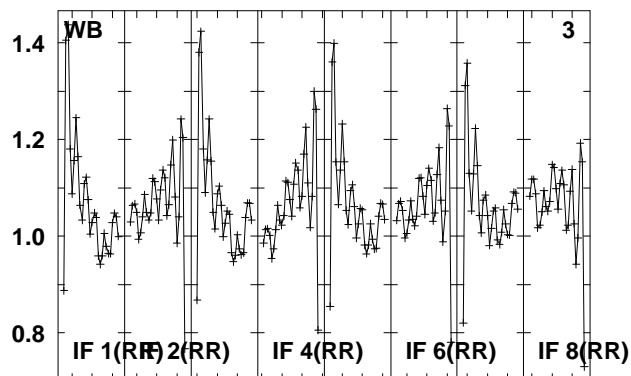
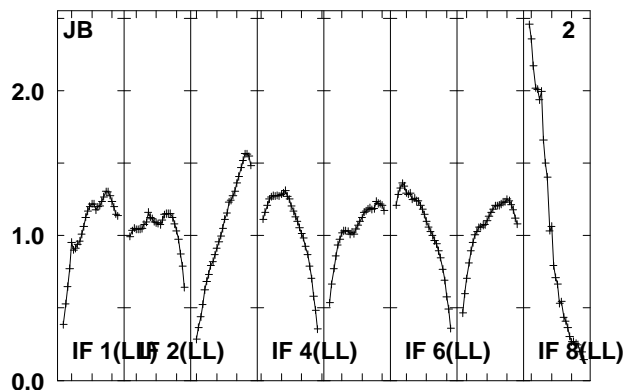
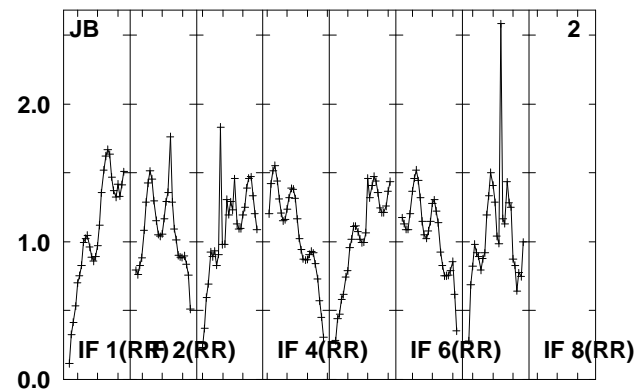
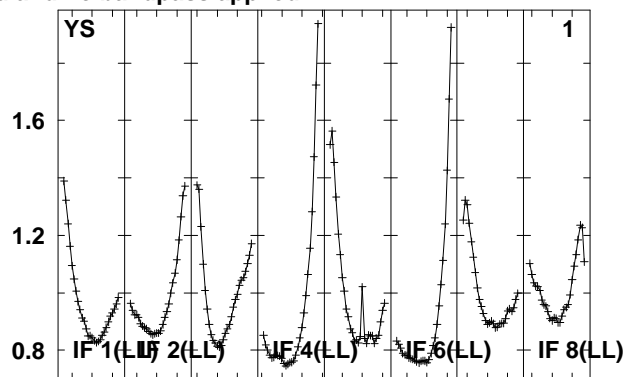
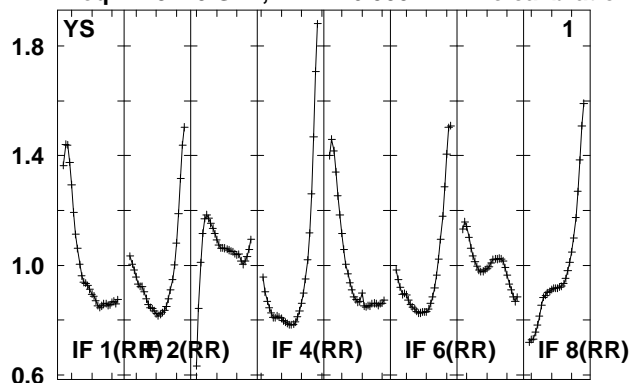

Lower frame: Real Jy
 Total-power spectrum Antenna: *
 Timerange: 00/04:35:26 to 00/04:40:22

Plot file version 84 created 14-MAY-2010 15:17:24

J135355 EO007.UVDATA.1

Freq = 4.9270 GHz, Bw = 16.000 MH No calibration applied and no bandpass applied

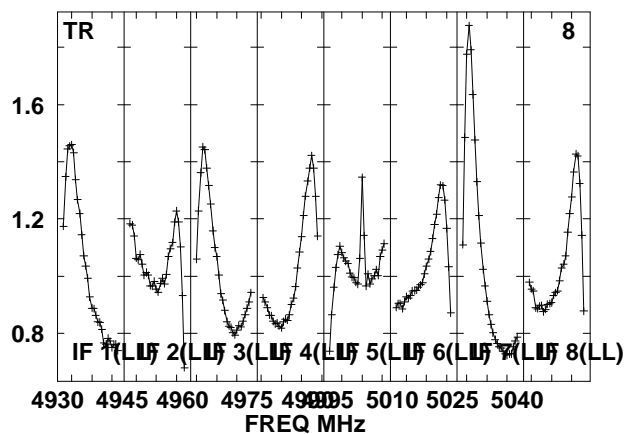
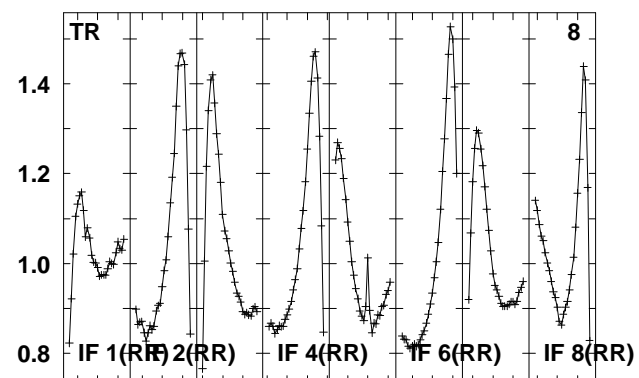
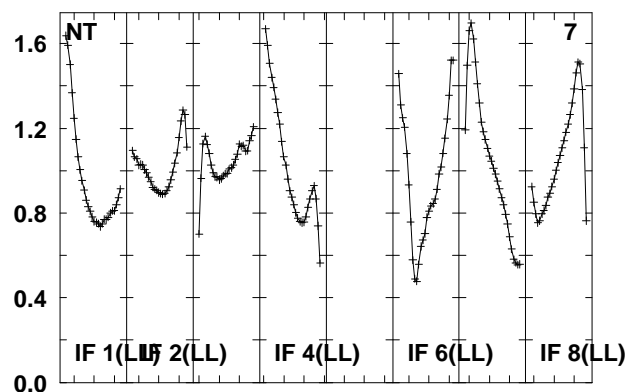
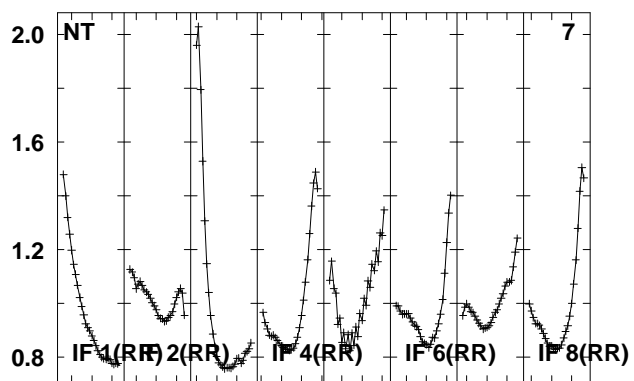
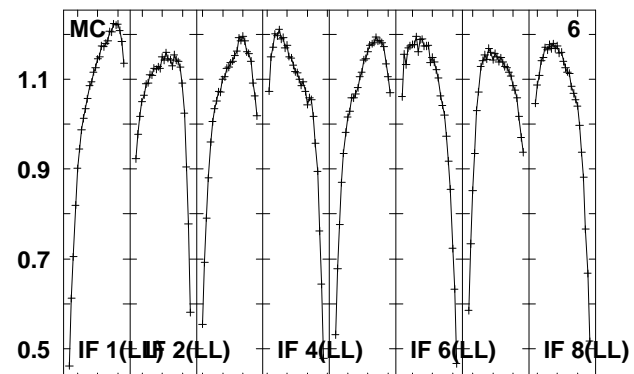
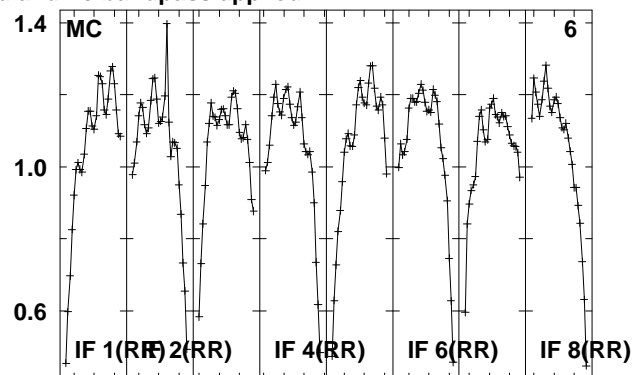
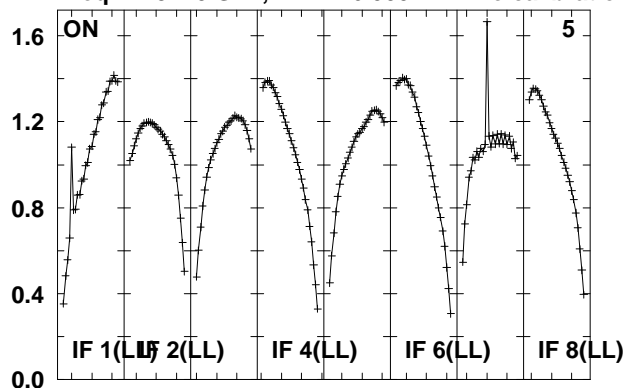

Lower frame: Real Jy

Total-power spectrum Antenna: *

Timerange: 00/04:35:26 to 00/04:40:22

Plot file version 85 created 14-MAY-2010 15:17:24

J1344+66 EO007.UVDATA.1

Freq = 4.9270 GHz, Bw = 16.000 MH No calibration applied and no bandpass applied

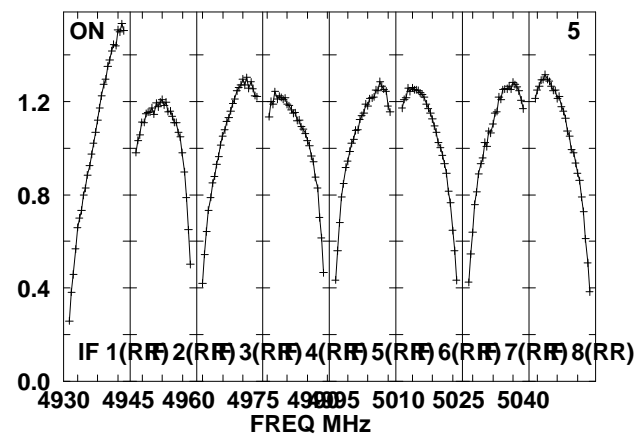
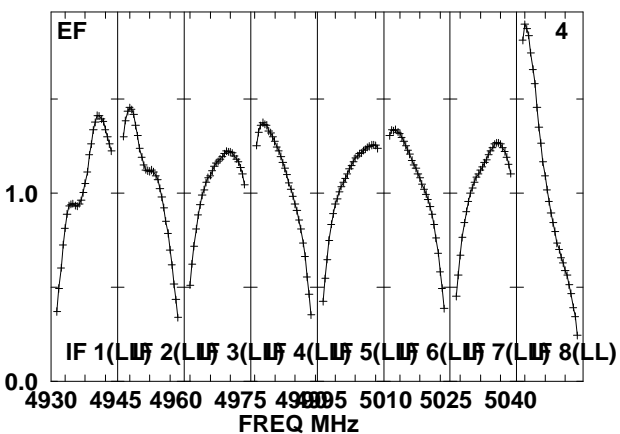
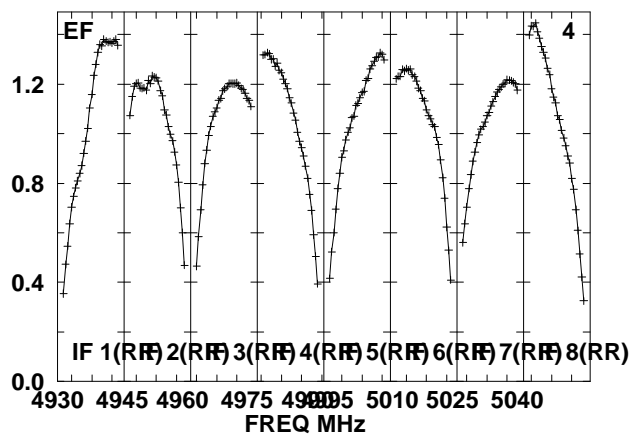
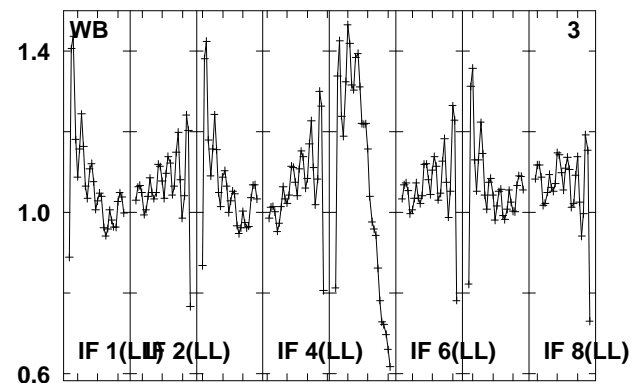
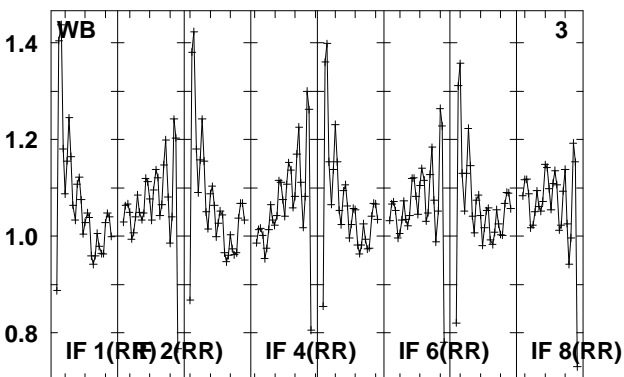
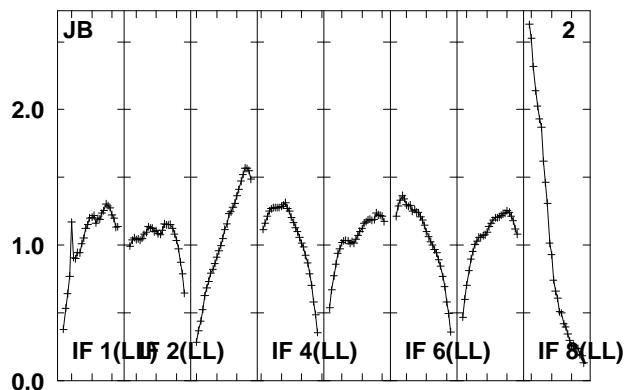
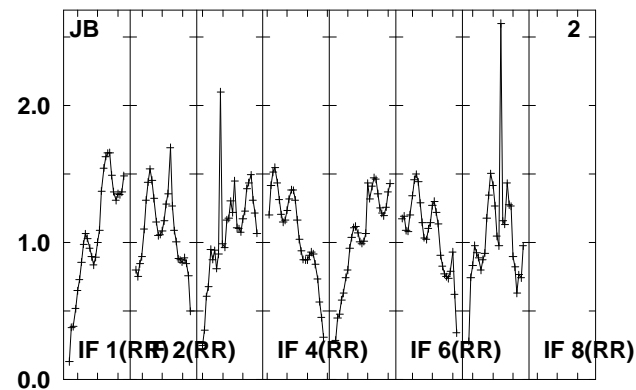
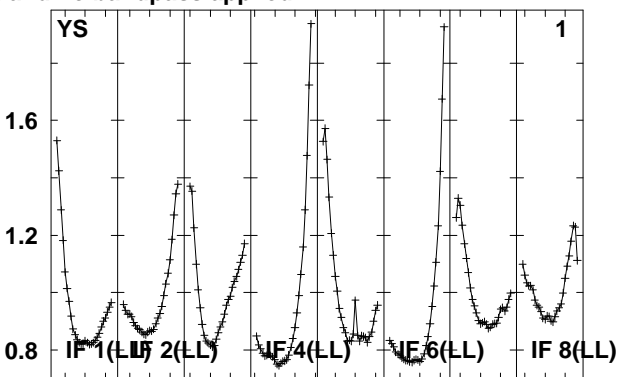
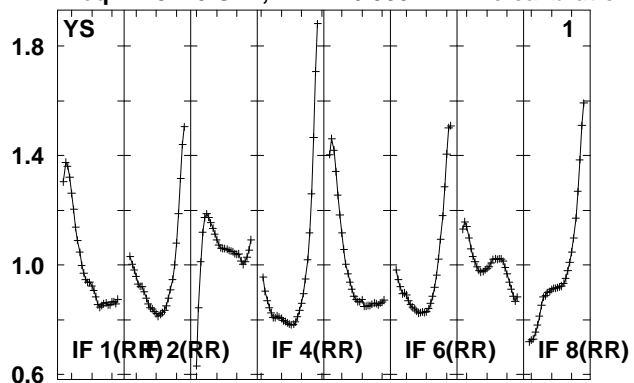

Lower frame: Real Jy

Total-power spectrum Antenna: *

Timerange: 00/04:40:56 to 00/04:42:24

Plot file version 86 created 14-MAY-2010 15:17:24

J1344+66 EO007.UVDATA.1

Freq = 4.9270 GHz, Bw = 16.000 MH No calibration applied and no bandpass applied

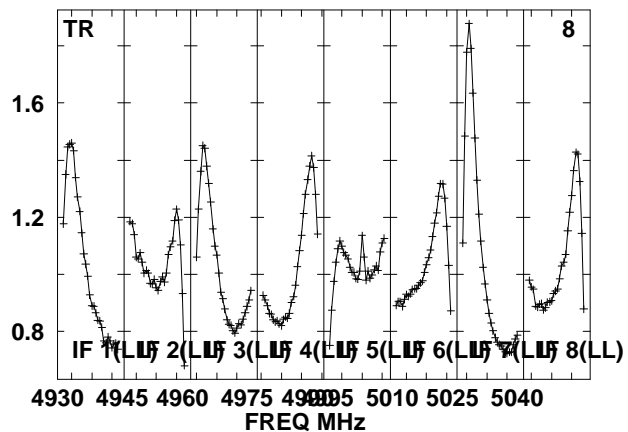
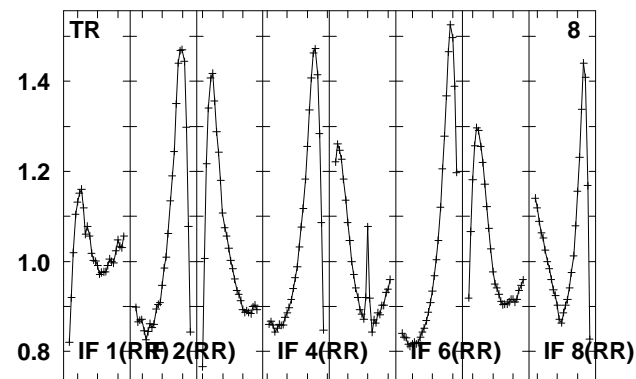
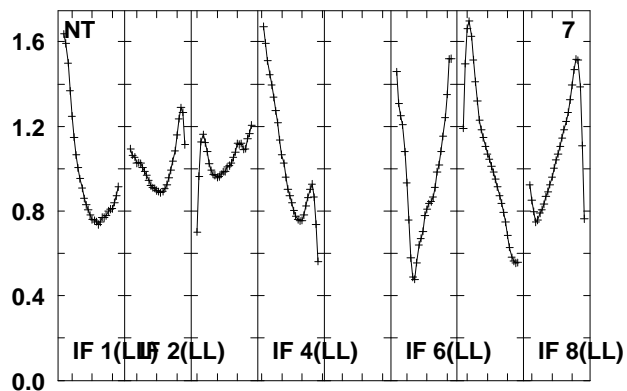
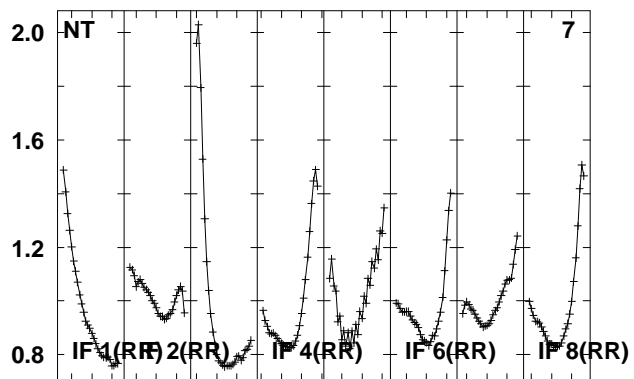
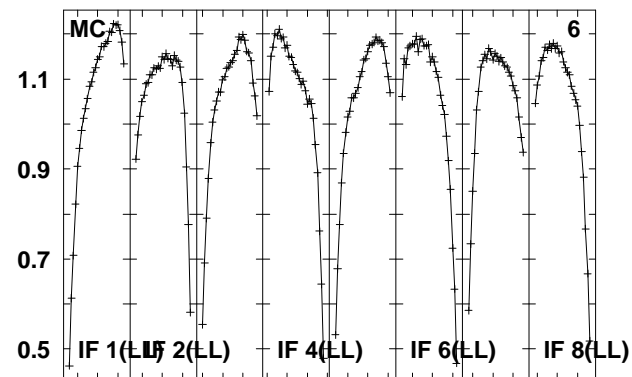
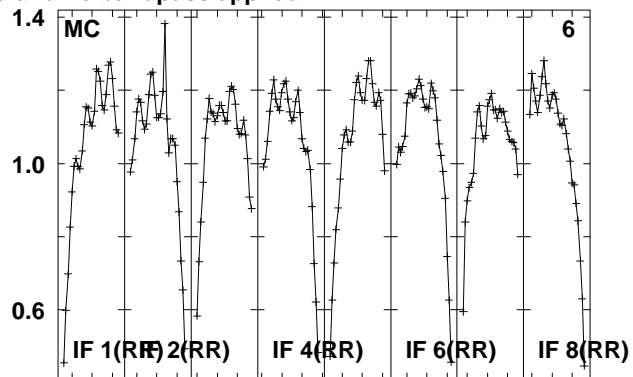
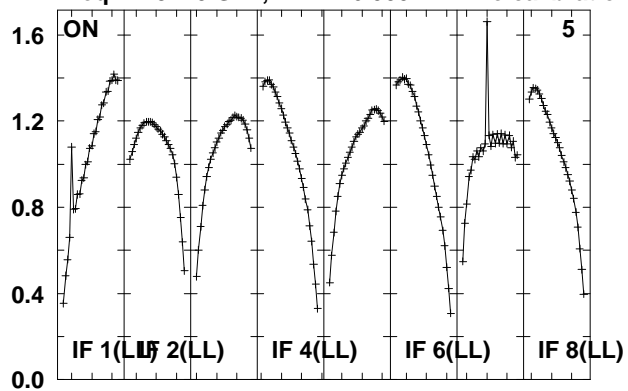

Lower frame: Real Jy

Total-power spectrum Antenna: *

Timerange: 00/04:40:56 to 00/04:42:24

Plot file version 87 created 14-MAY-2010 15:17:25

1842+681 EO007.UVDATA.1

Freq = 4.9270 GHz, Bw = 16.000 MH No calibration applied and no bandpass applied

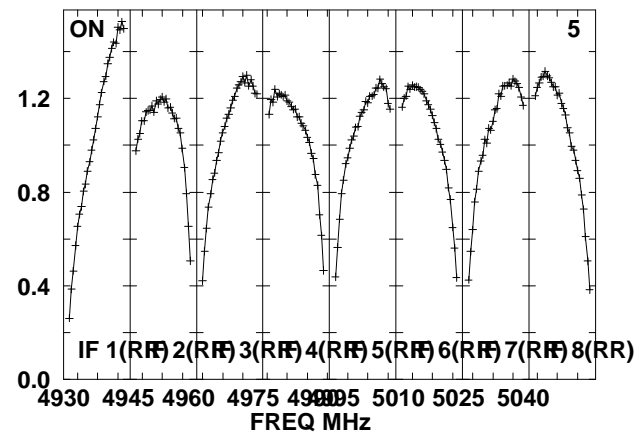
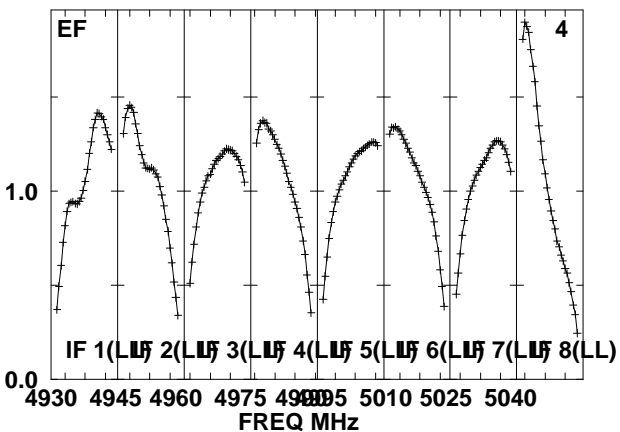
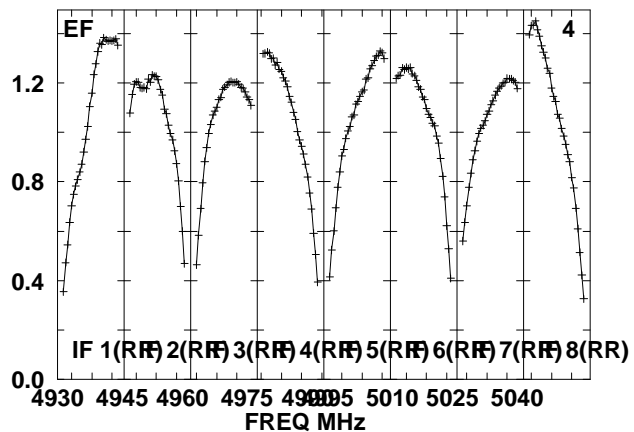
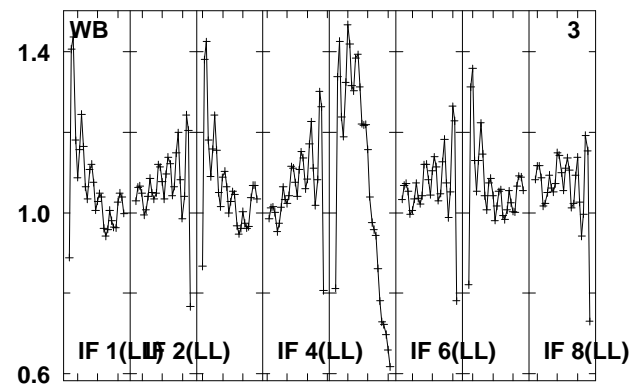
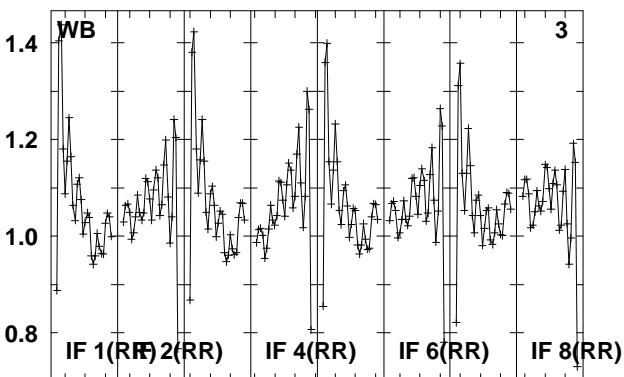
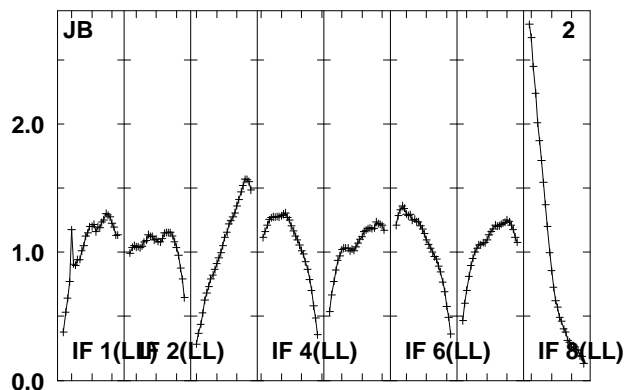
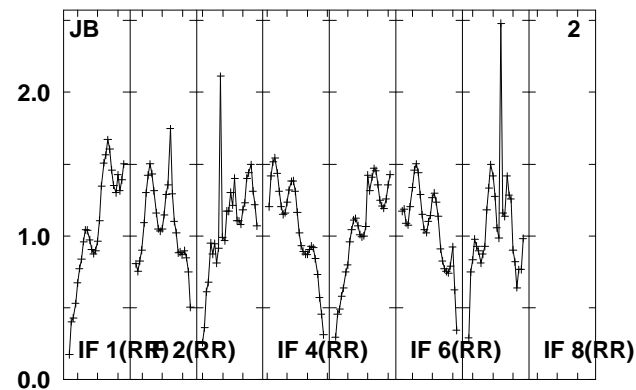
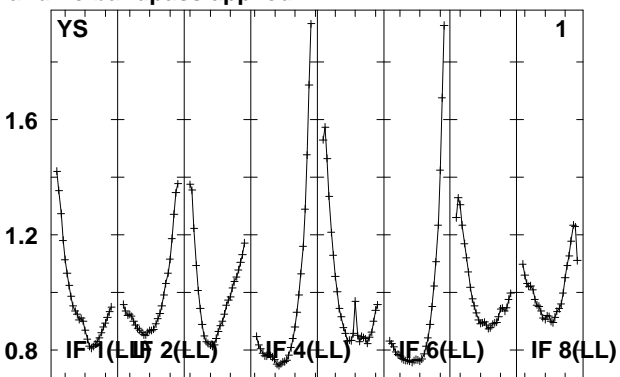
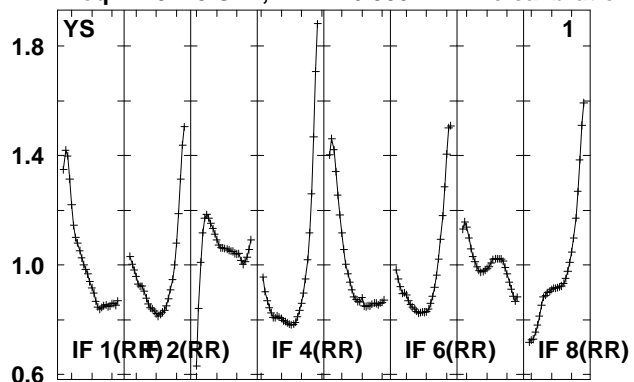

Lower frame: Real Jy

Total-power spectrum Antenna: *

Timerange: 00/04:47:46 to 00/04:52:42

Plot file version 88 created 14-MAY-2010 15:17:25

1842+681 EO007.UVDATA.1

Freq = 4.9270 GHz, Bw = 16.000 MH No calibration applied and no bandpass applied

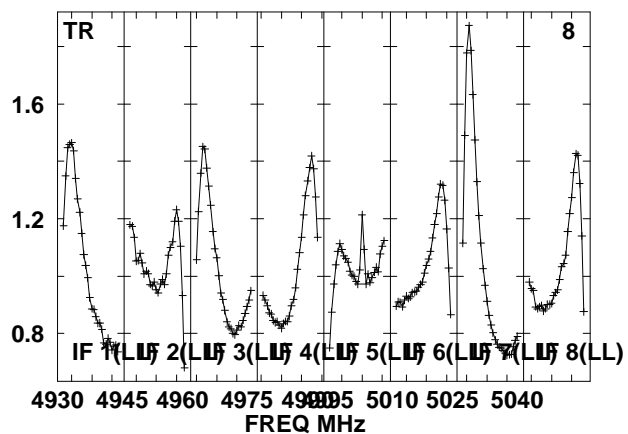
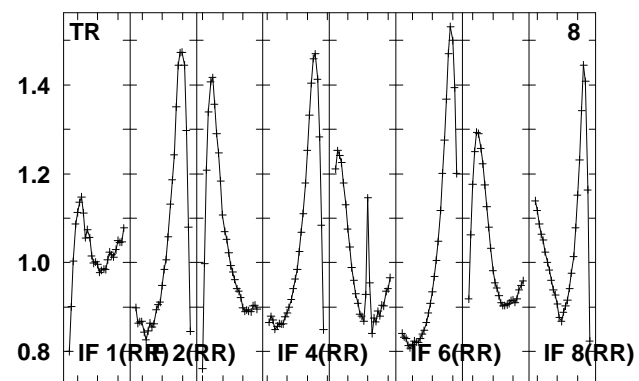
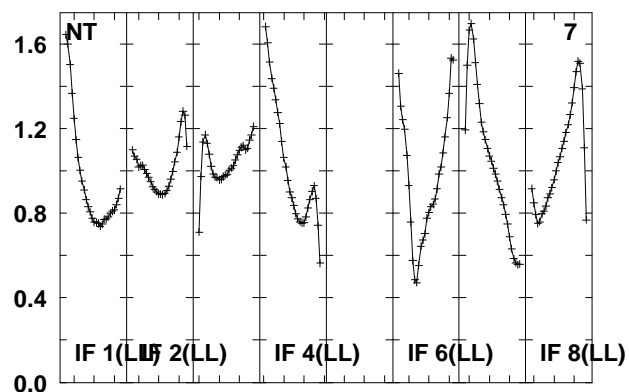
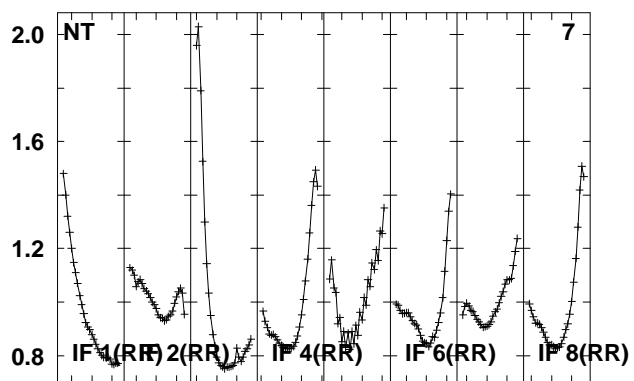
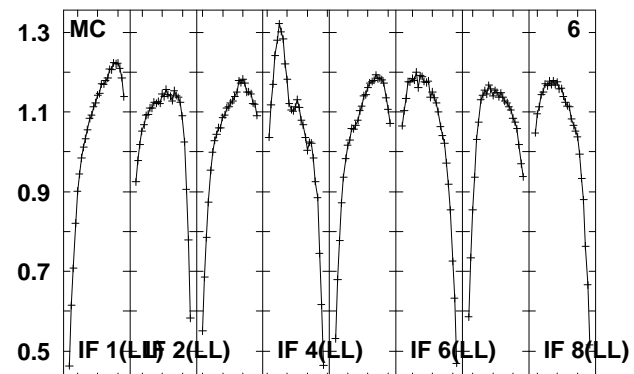
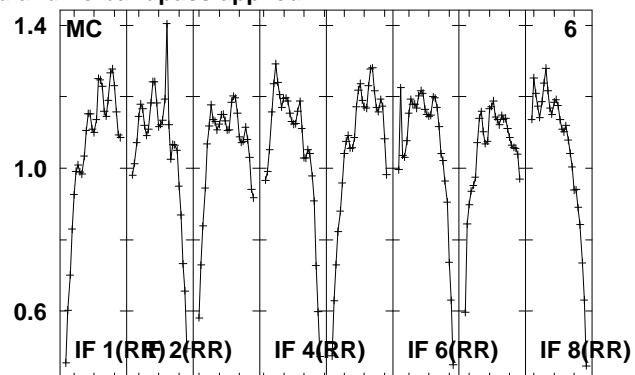
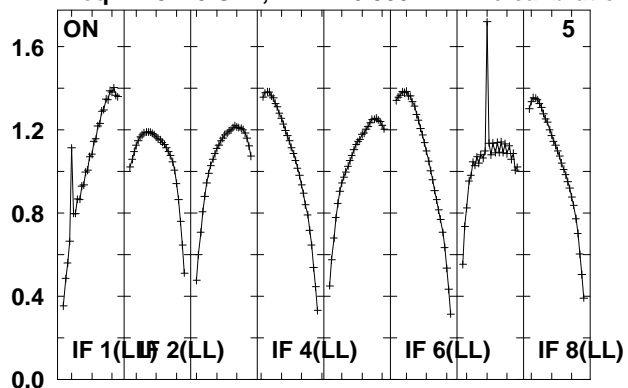

Lower frame: Real Jy

Total-power spectrum Antenna: *

Timerange: 00/04:47:46 to 00/04:52:42

Plot file version 89 created 14-MAY-2010 15:17:26

J2110-10 EO007.UVDATA.1

Freq = 4.9270 GHz, Bw = 16.000 MH No calibration applied and no bandpass applied

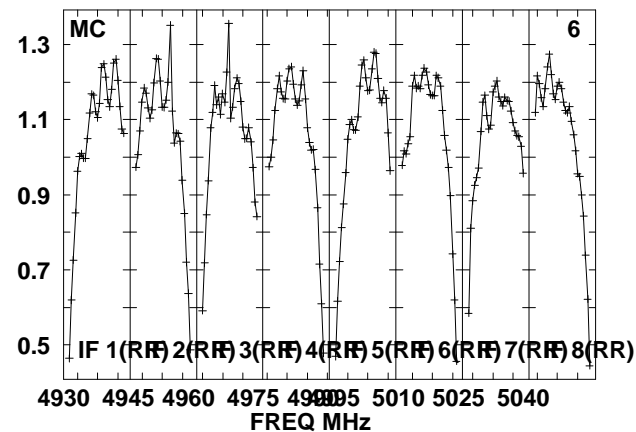
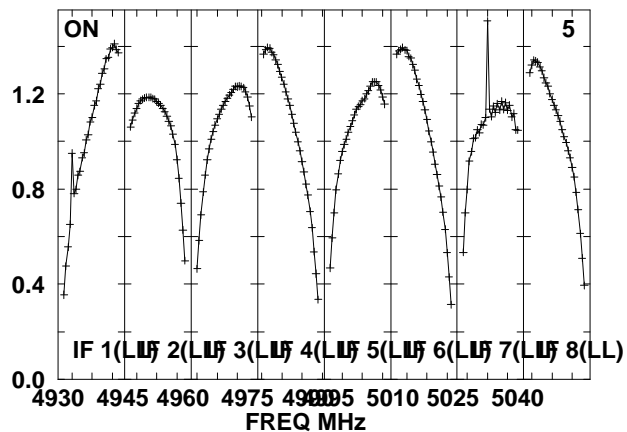
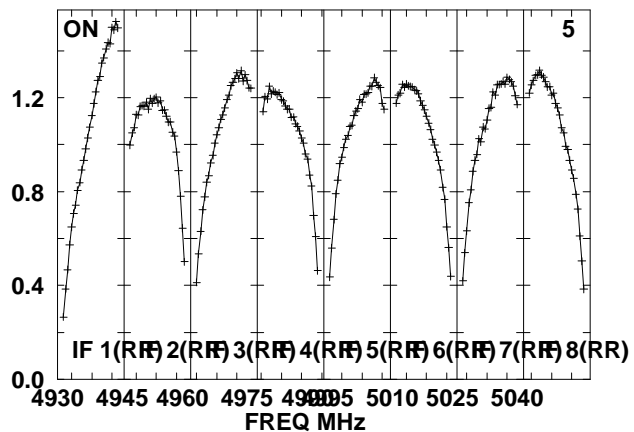
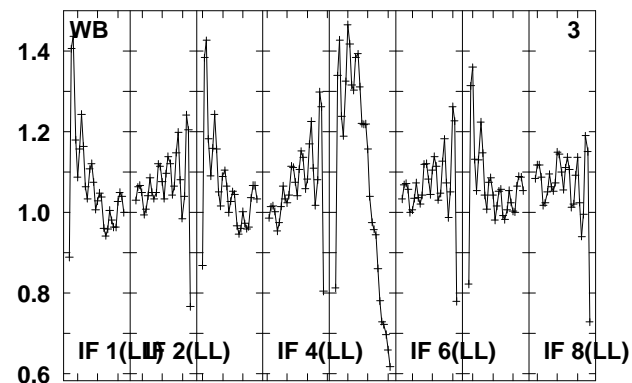
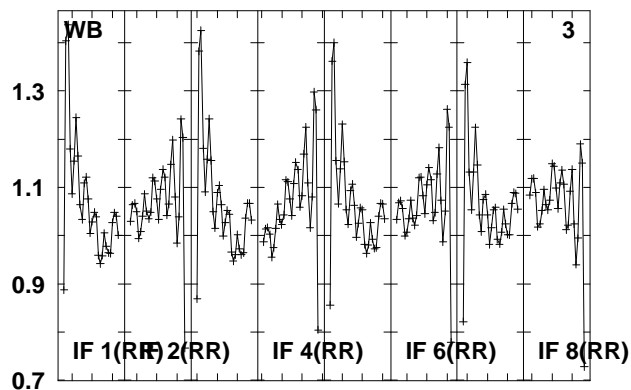
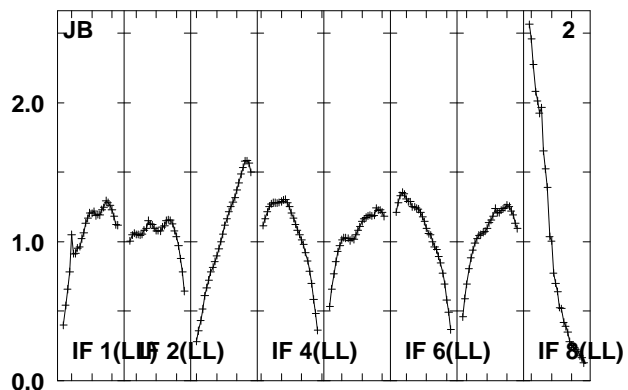
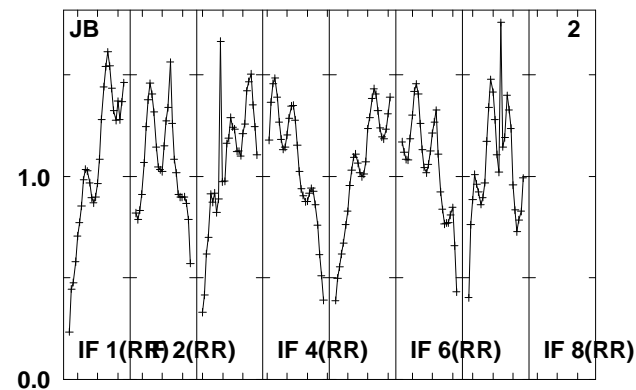
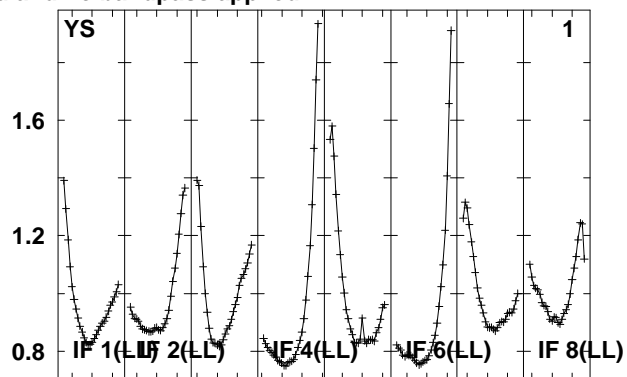
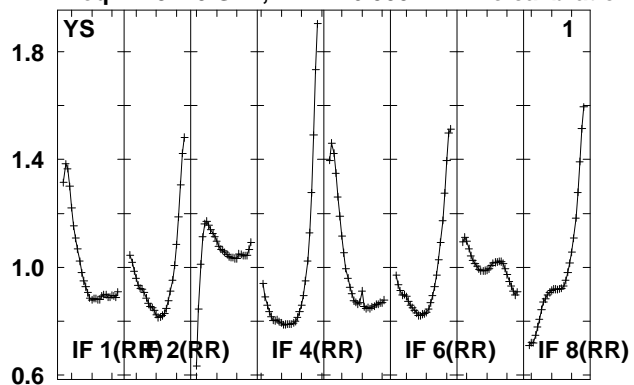

Lower frame: Real Jy
Total-power spectrum Antenna: *
Timerange: 00/04:59:29 to 00/05:00:55

Plot file version 90 created 14-MAY-2010 15:17:26

J2110-10 EO007.UVDATA.1

Freq = 4.9270 GHz, Bw = 16.000 MH No calibration applied and no bandpass applied

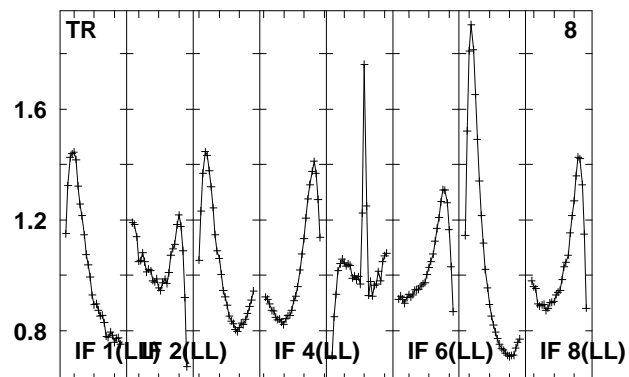
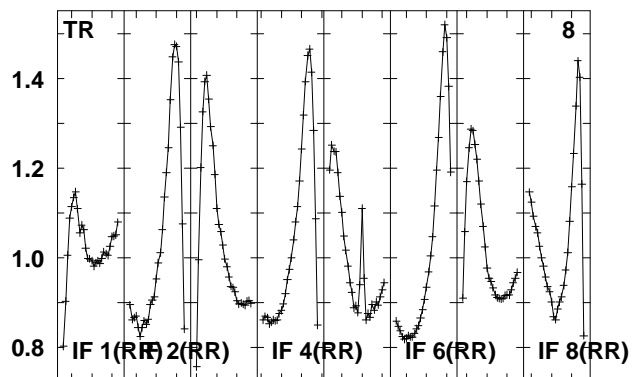
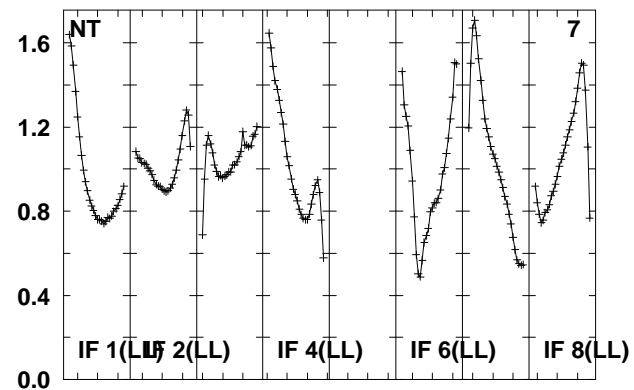
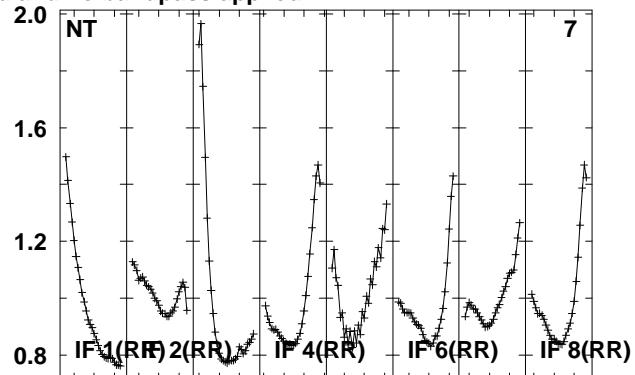
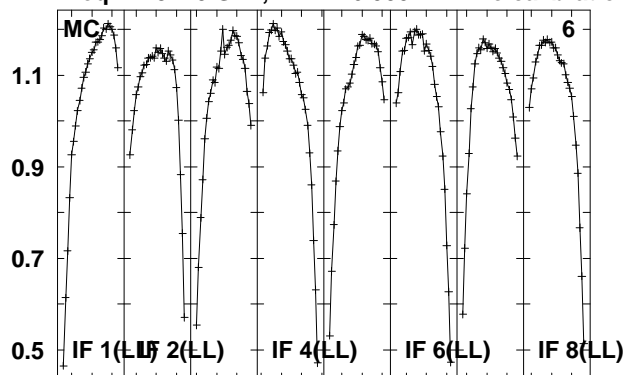

Lower frame: Real Jy
Total-power spectrum Antenna: *
Timerange: 00/04:59:29 to 00/05:00:55

Plot file version 91 created 14-MAY-2010 15:17:26
 J210358 EO007.UVDATA.1
 Freq = 4.9270 GHz, Bw = 16.000 MH No calibration applied and no bandpass applied

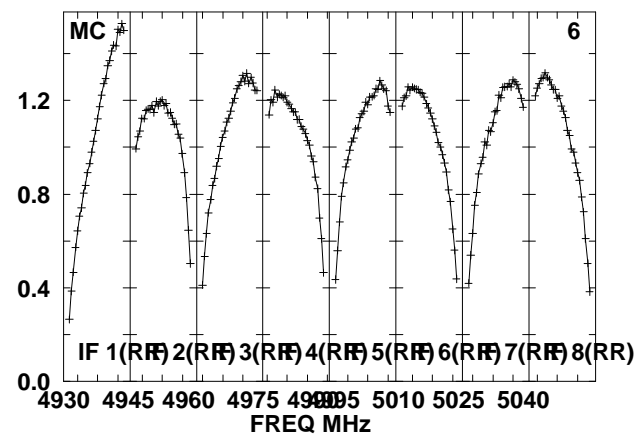
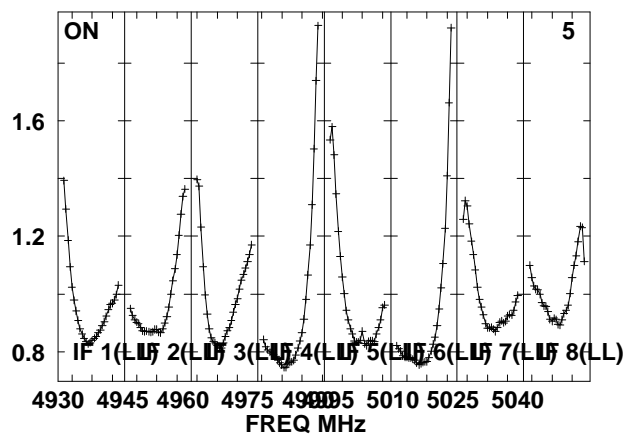
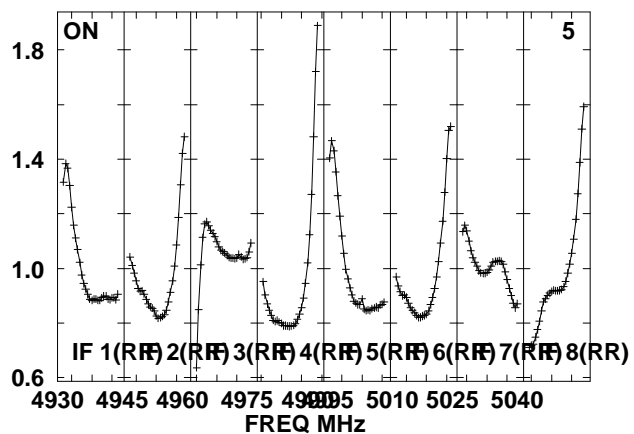
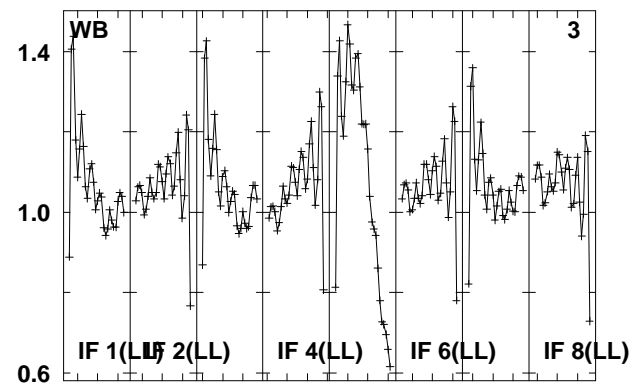
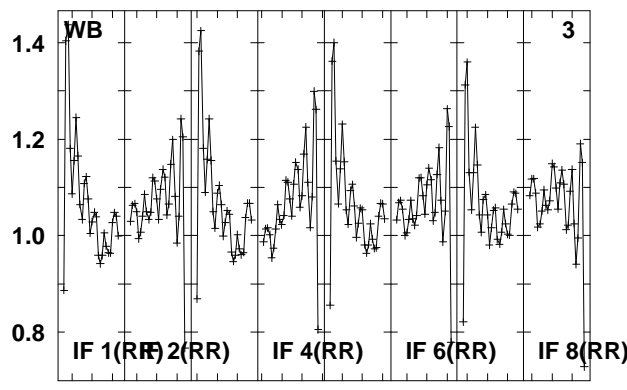
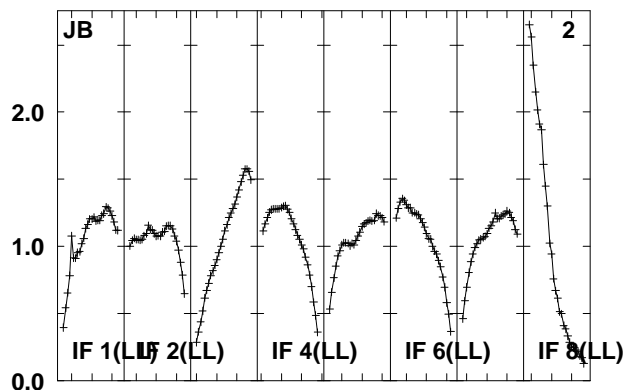
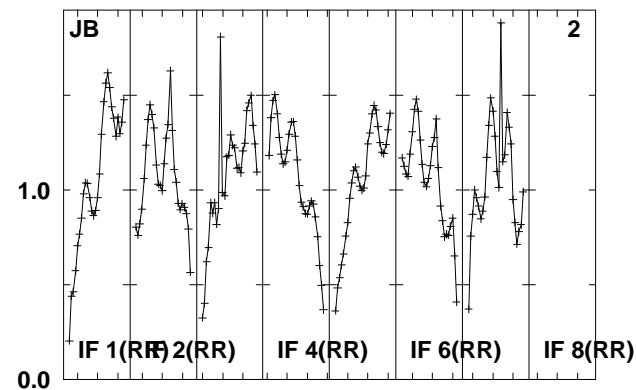
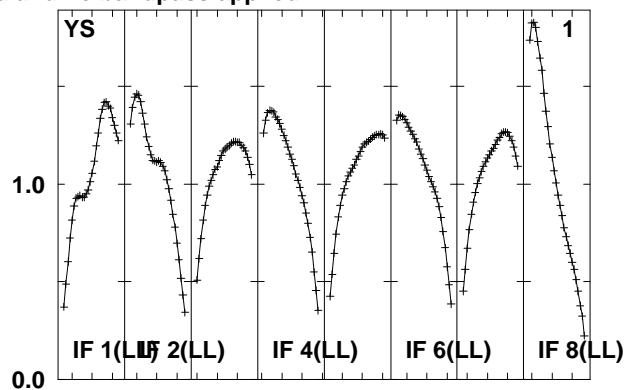
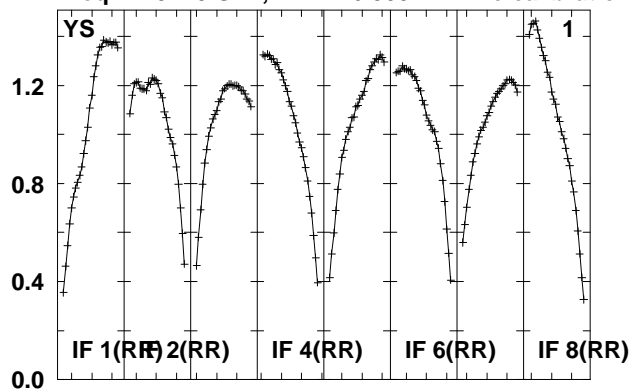

Lower frame: Real Jy
 Total-power spectrum Antenna: *
 Timerange: 00/05:01:36 to 00/05:06:34

Plot file version 92 created 14-MAY-2010 15:17:27

J210358 EO007.UVDATA.1

Freq = 4.9270 GHz, Bw = 16.000 MH No calibration applied and no bandpass applied

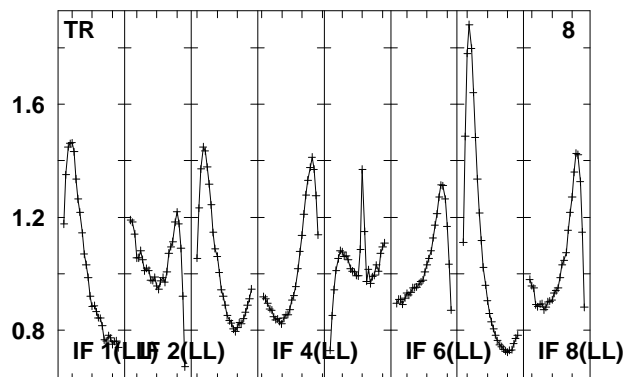
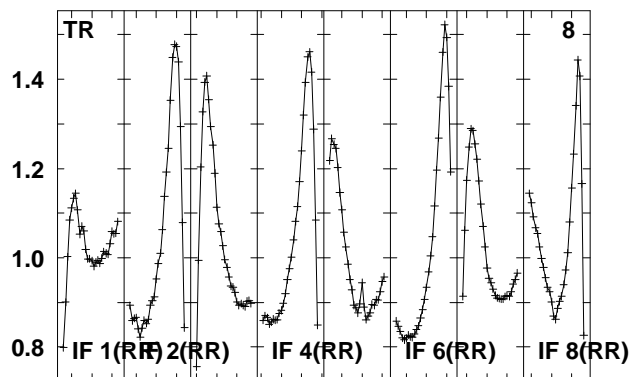
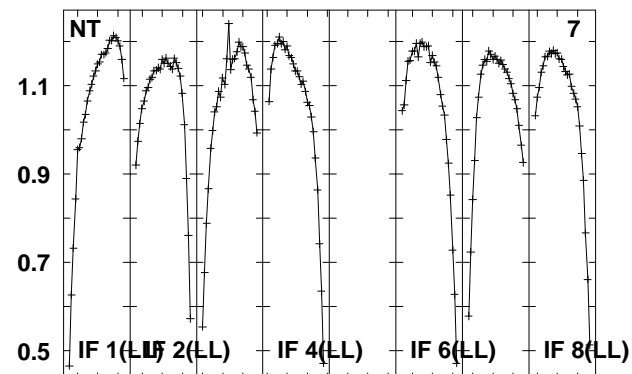
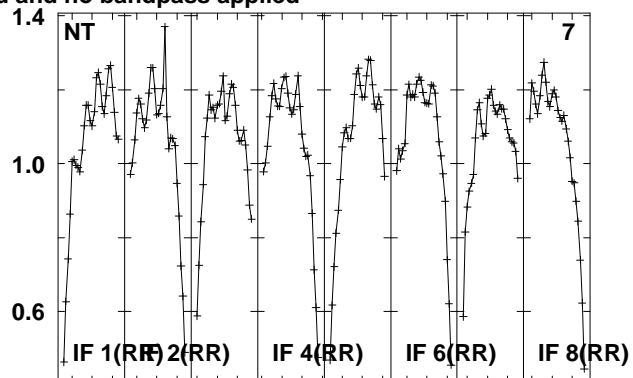
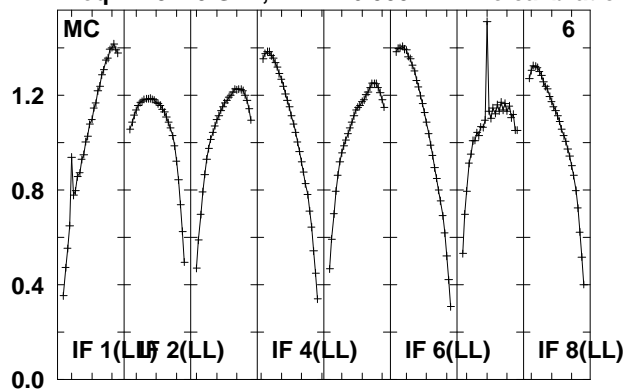

Lower frame: Real Jy
Total-power spectrum Antenna: *
Timerange: 00/05:01:36 to 00/05:06:34

Plot file version 93 created 14-MAY-2010 15:17:27

J2110-10 EO007.UVDATA.1

Freq = 4.9270 GHz, Bw = 16.000 MH No calibration applied and no bandpass applied

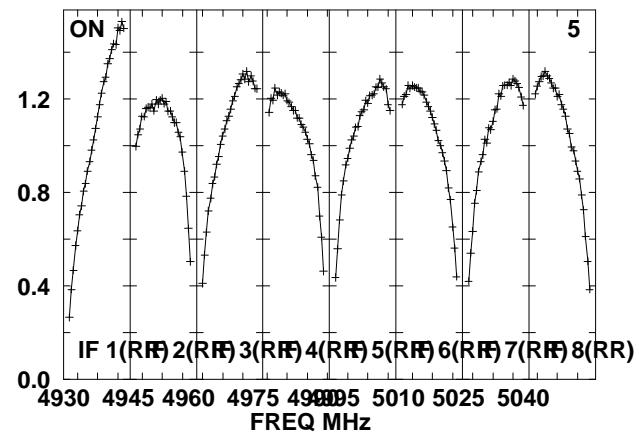
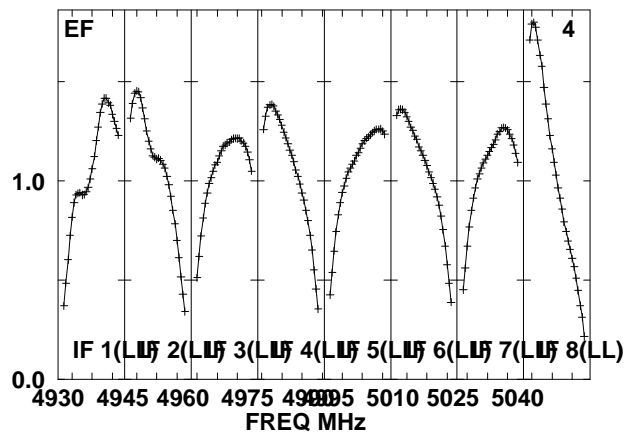
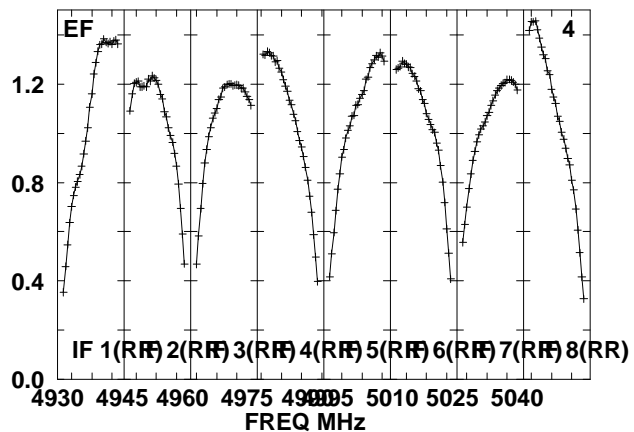
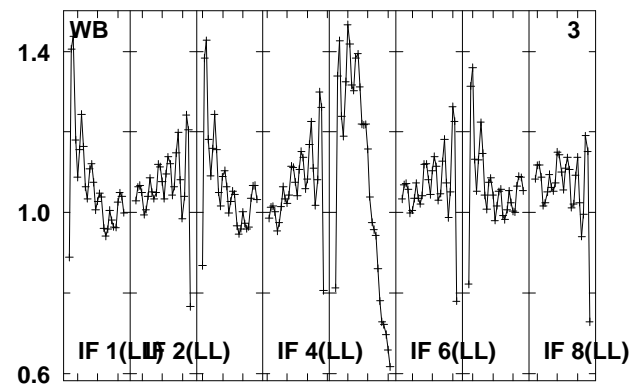
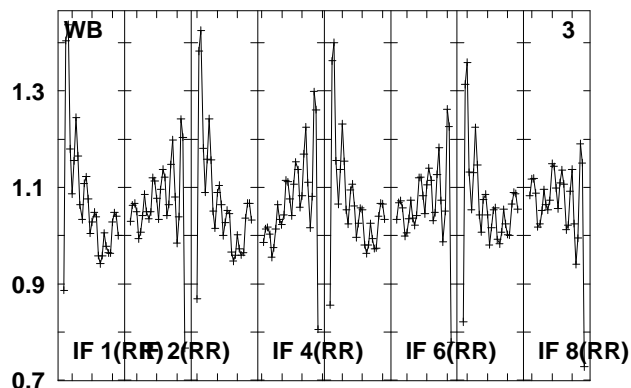
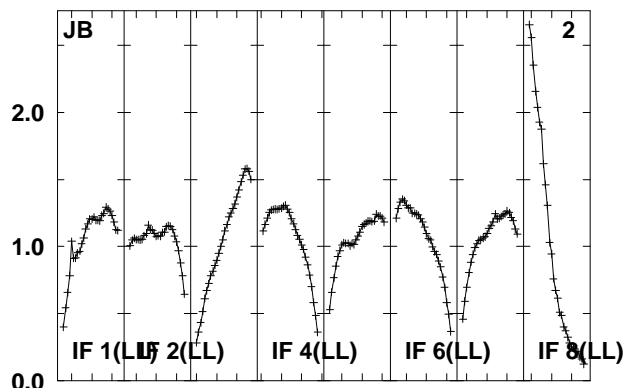
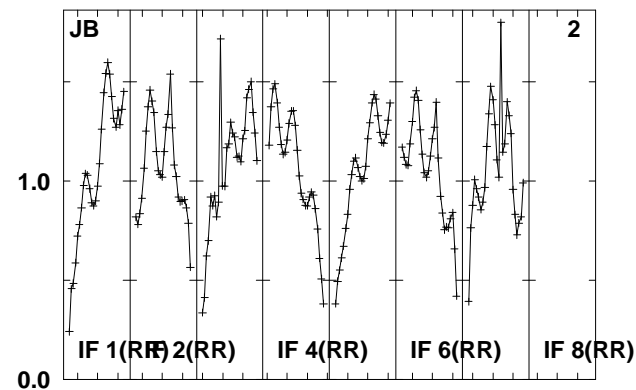
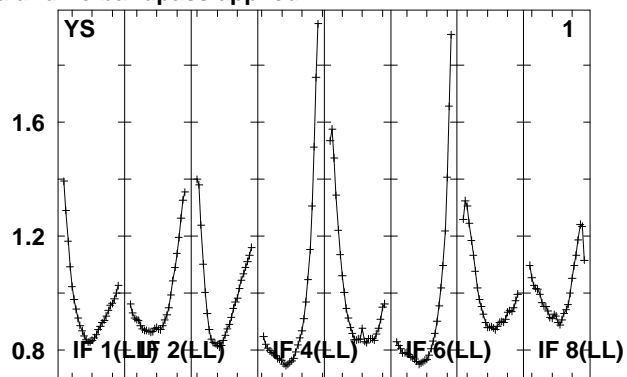
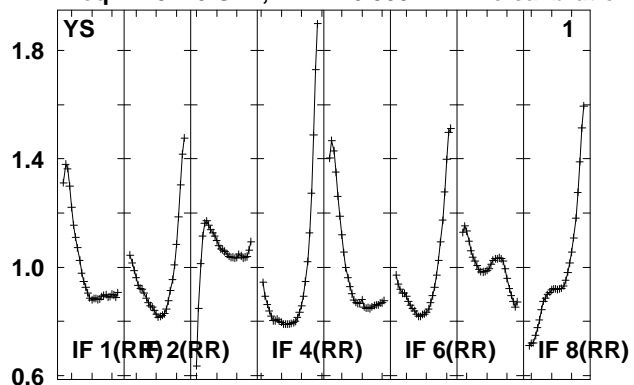

Lower frame: Real Jy
Total-power spectrum Antenna: *
Timerange: 00/05:07:13 to 00/05:08:37

Plot file version 94 created 14-MAY-2010 15:17:27

J2110-10 EO007.UVDATA.1

Freq = 4.9270 GHz, Bw = 16.000 MH No calibration applied and no bandpass applied

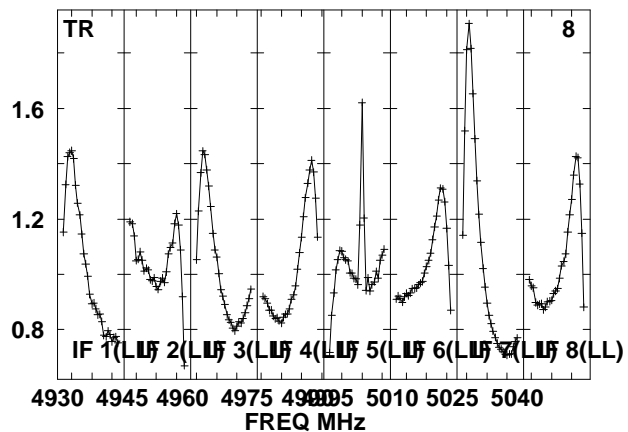
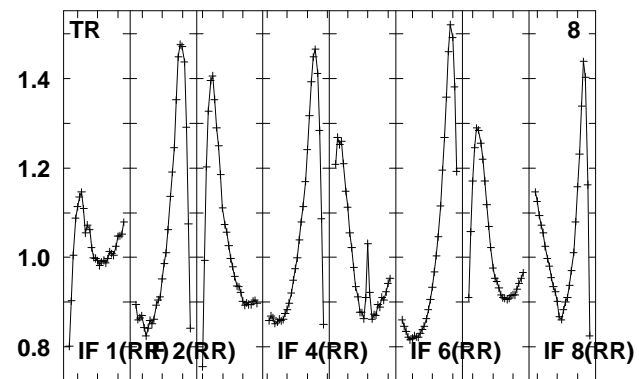
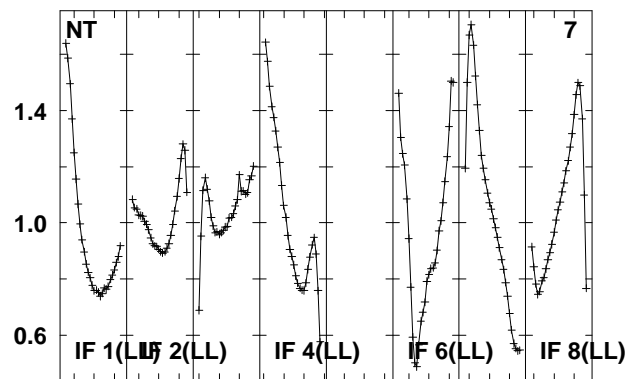
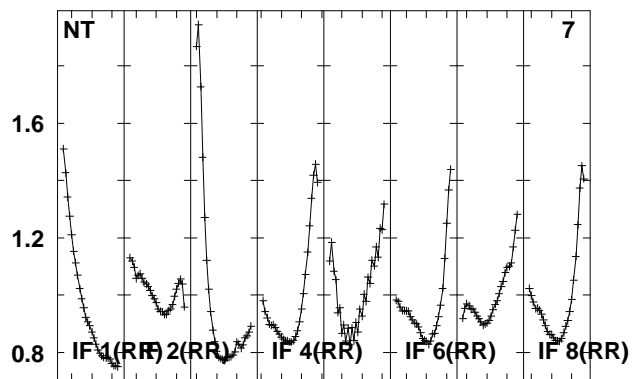
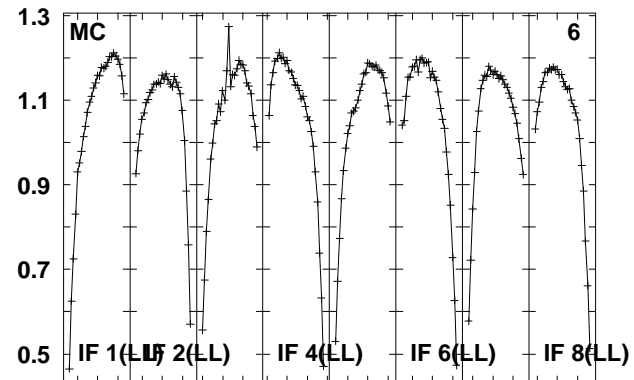
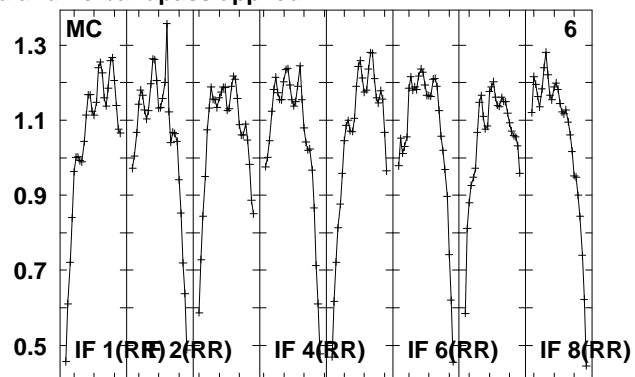
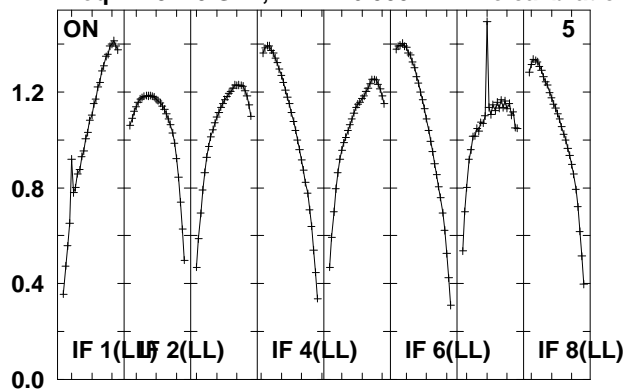

Lower frame: Real Jy

Total-power spectrum Antenna: *

Timerange: 00/05:07:13 to 00/05:08:37

Plot file version 95 created 14-MAY-2010 15:17:28
 J210358 EO007.UVDATA.1
 Freq = 4.9270 GHz, Bw = 16.000 MH No calibration applied and no bandpass applied

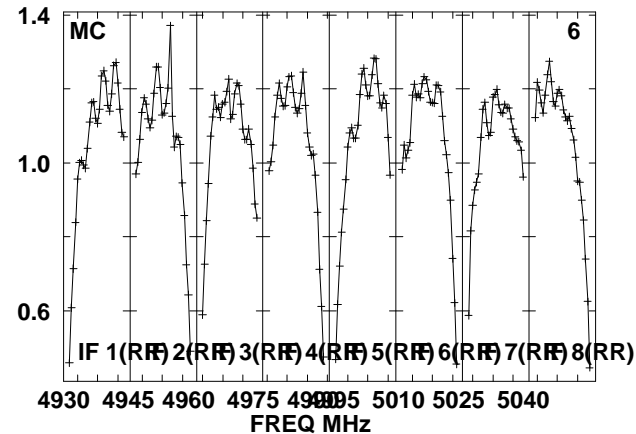
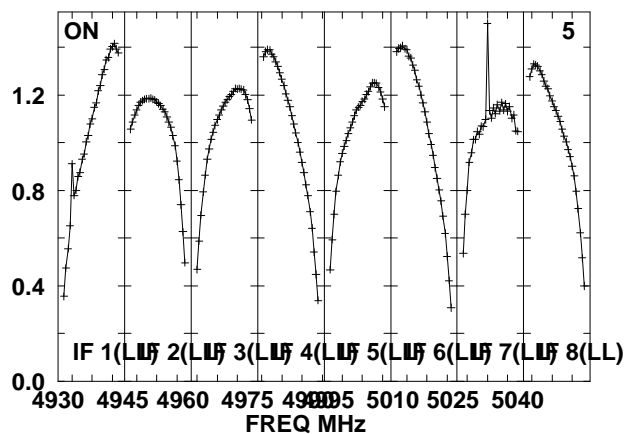
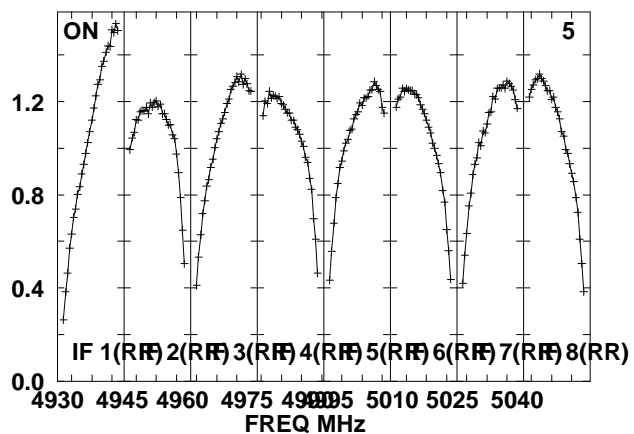
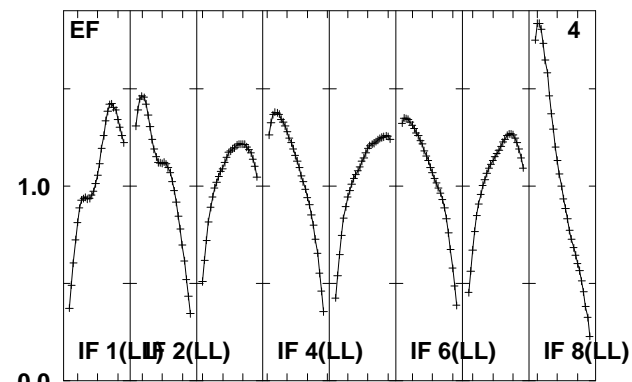
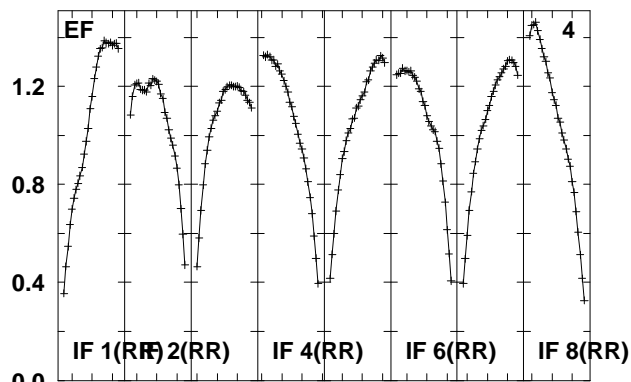
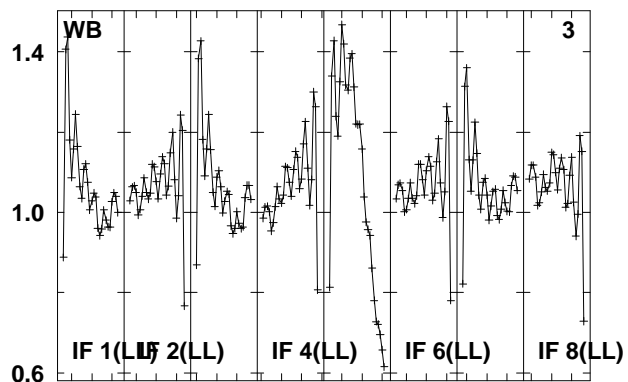
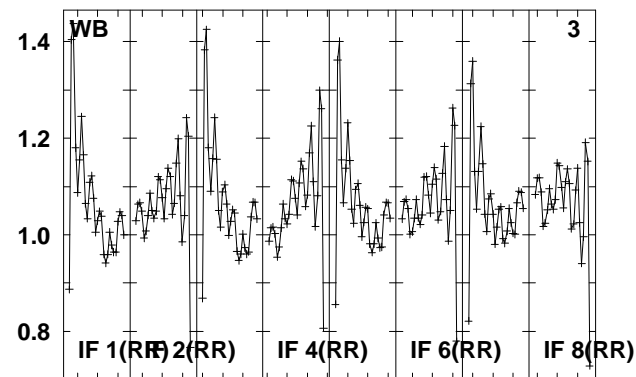
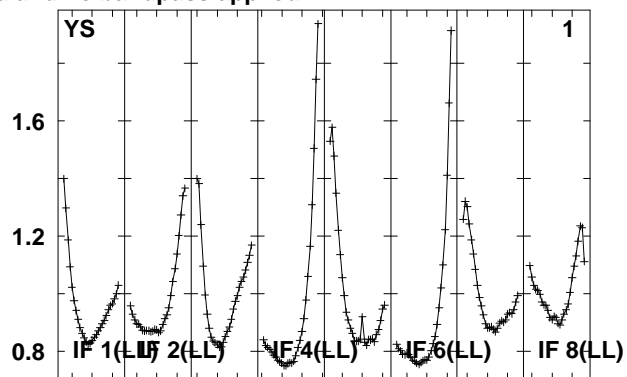
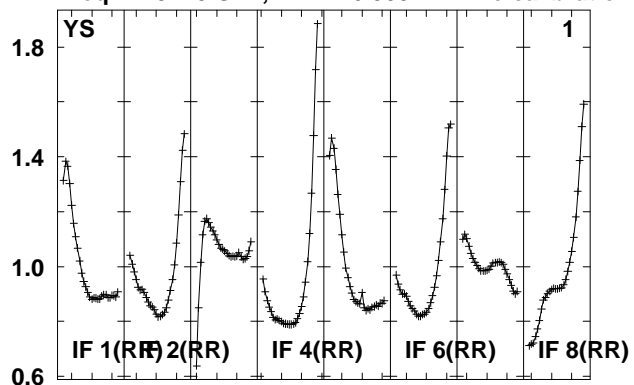

Lower frame: Real Jy
 Total-power spectrum Antenna: *
 Timerange: 00/05:09:17 to 00/05:14:13

Plot file version 96 created 14-MAY-2010 15:17:28

J210358 EO007.UVDATA.1

Freq = 4.9270 GHz, Bw = 16.000 MH No calibration applied and no bandpass applied

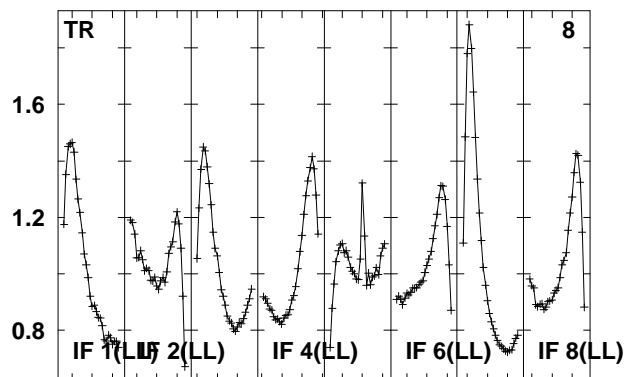
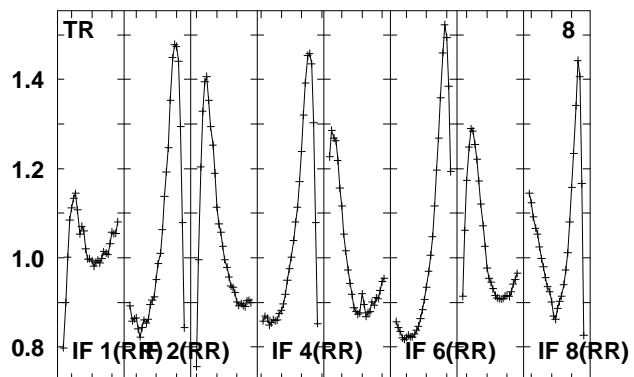
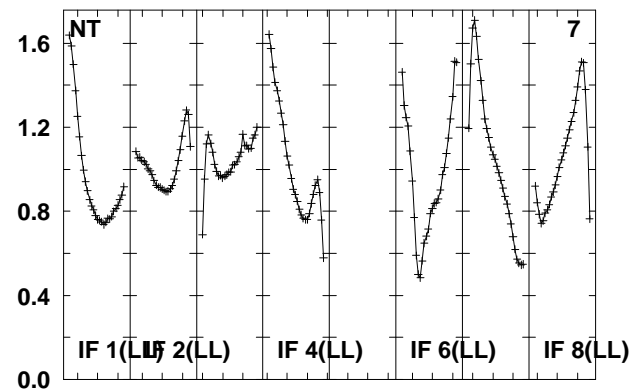
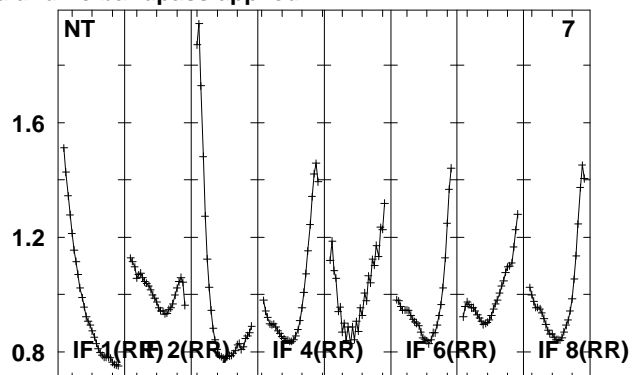
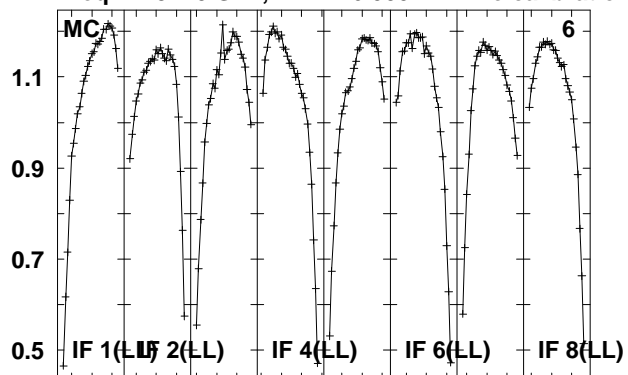

Lower frame: Real Jy
Total-power spectrum Antenna: *
Timerange: 00/05:09:17 to 00/05:14:13

Plot file version 97 created 14-MAY-2010 15:17:29

J2110-10 EO007.UVDATA.1

Freq = 4.9270 GHz, Bw = 16.000 MH No calibration applied and no bandpass applied

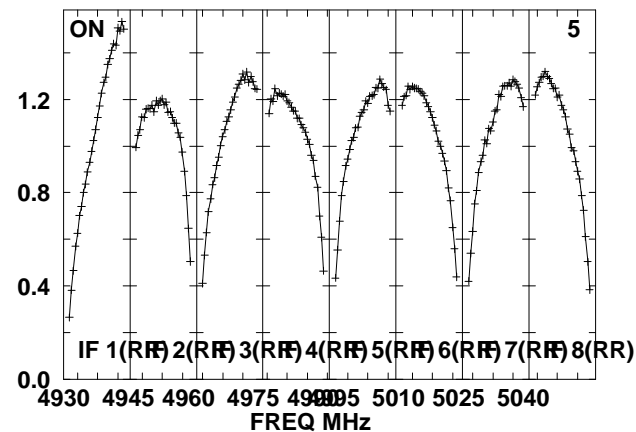
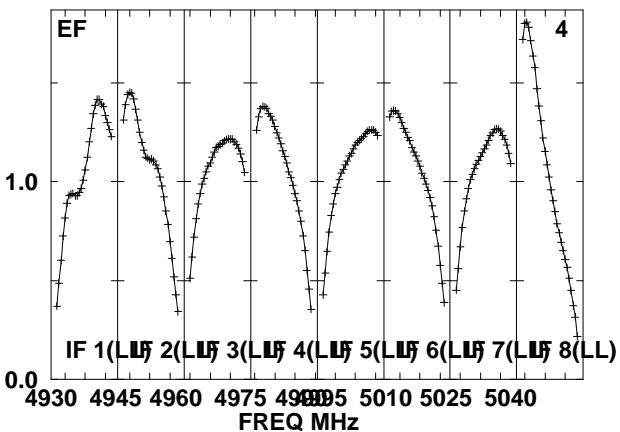
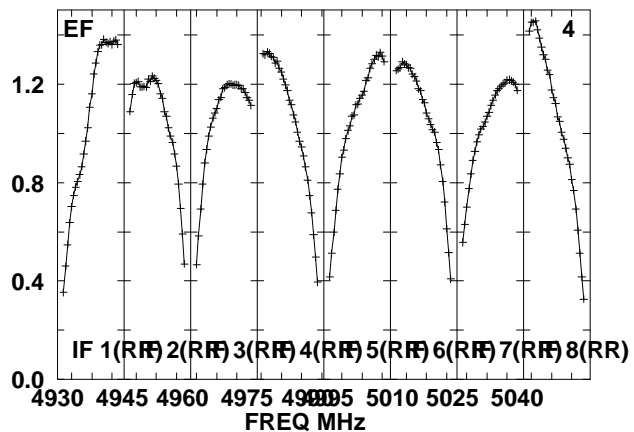
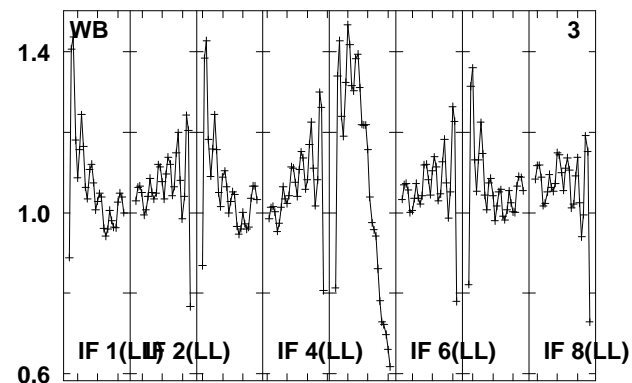
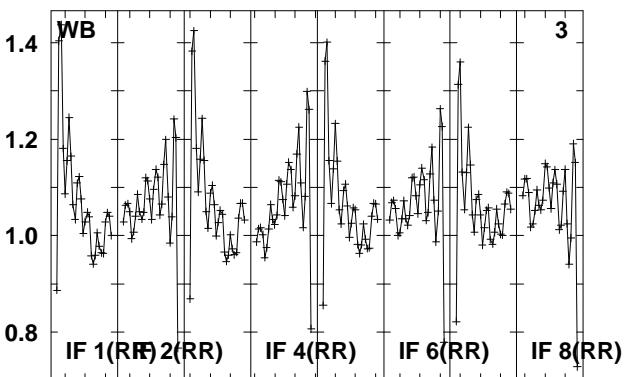
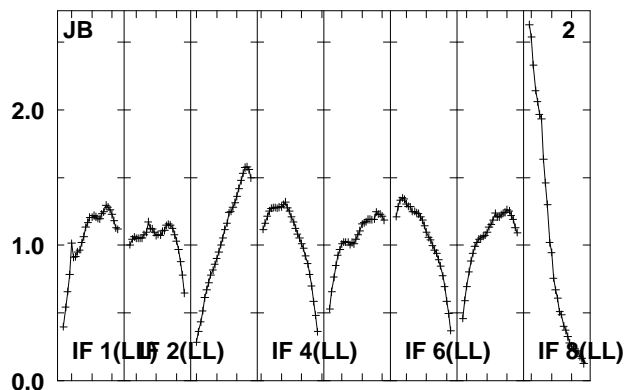
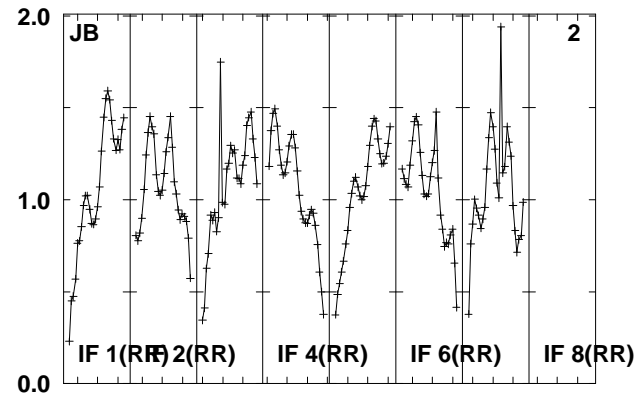
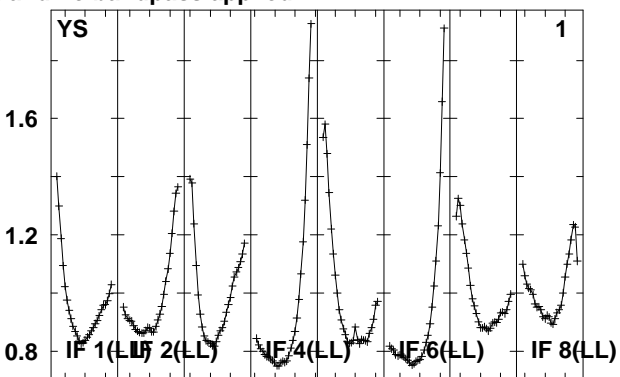
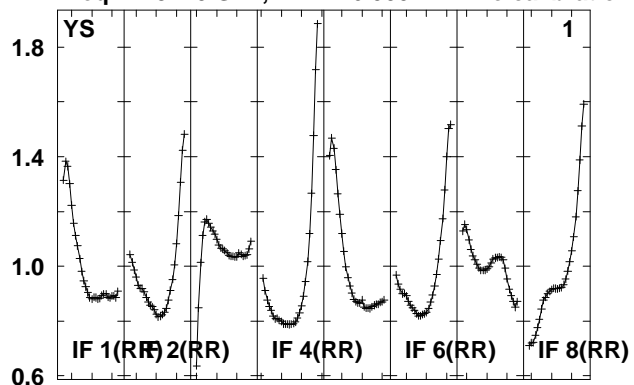

Lower frame: Real Jy

Total-power spectrum Antenna: *

Timerange: 00/05:14:51 to 00/05:16:19

Plot file version 98 created 14-MAY-2010 15:17:29

J2110-10 EO007.UVDATA.1

Freq = 4.9270 GHz, Bw = 16.000 MH No calibration applied and no bandpass applied

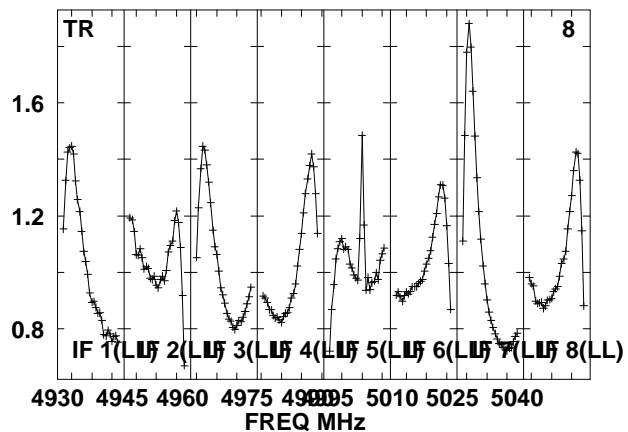
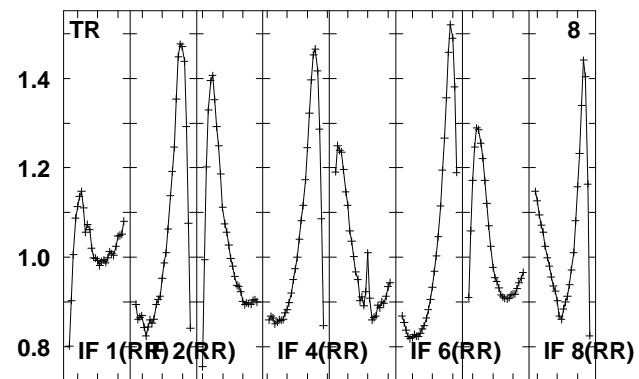
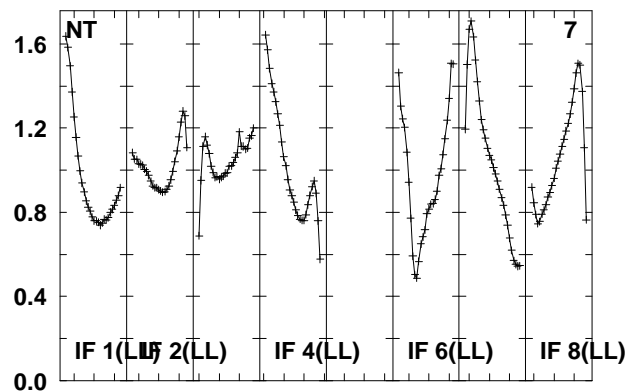
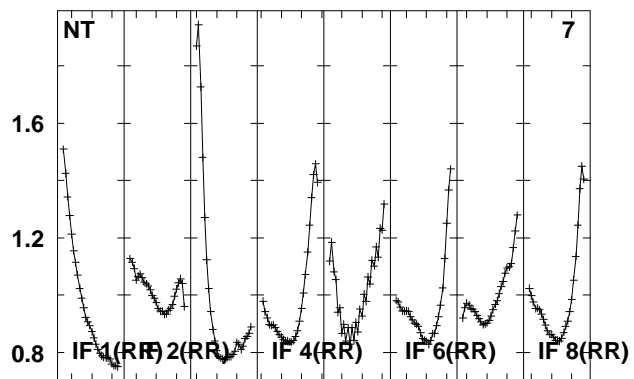
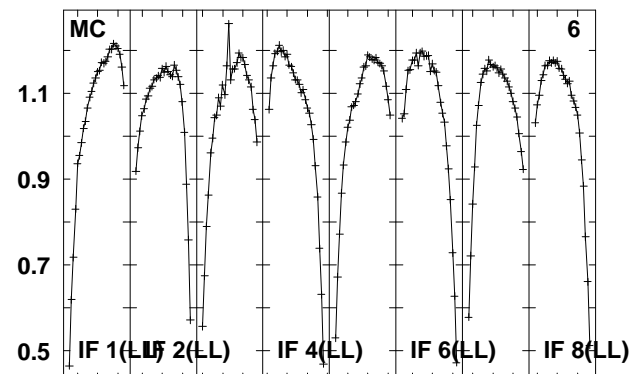
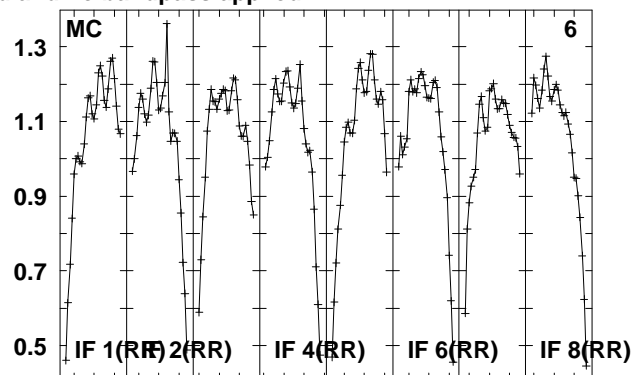
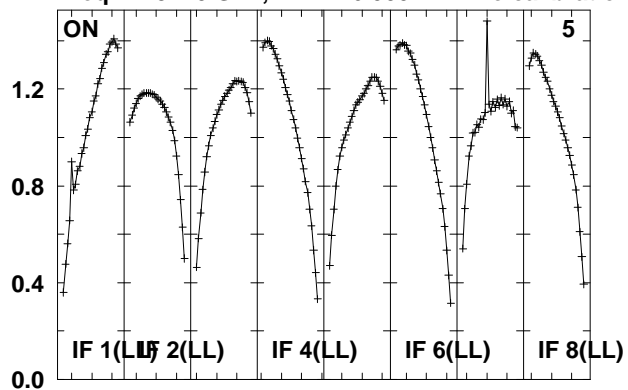

Lower frame: Real Jy

Total-power spectrum Antenna: *

Timerange: 00/05:14:51 to 00/05:16:19

Plot file version 99 created 14-MAY-2010 15:17:29
 J210358 EO007.UVDATA.1
 Freq = 4.9270 GHz, Bw = 16.000 MH No calibration applied and no bandpass applied

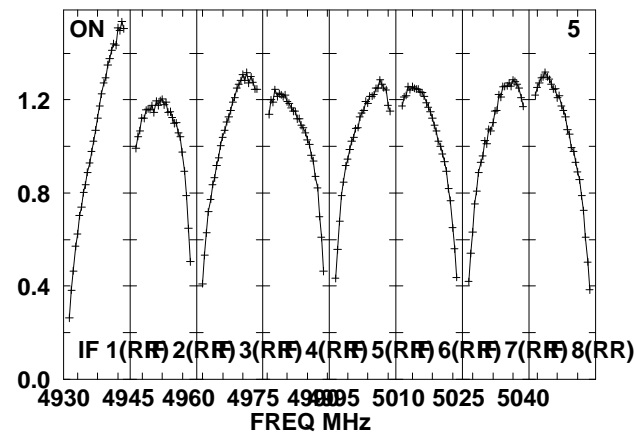
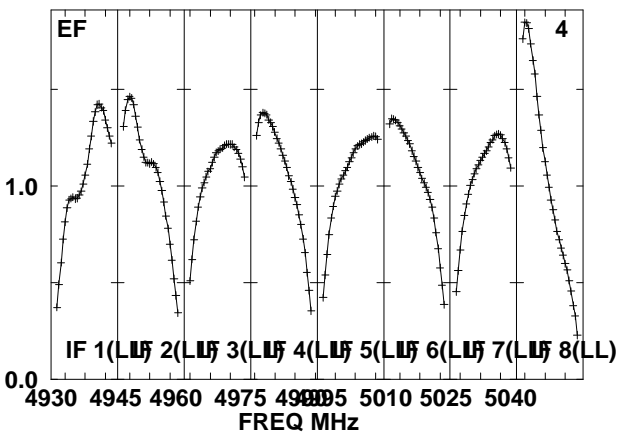
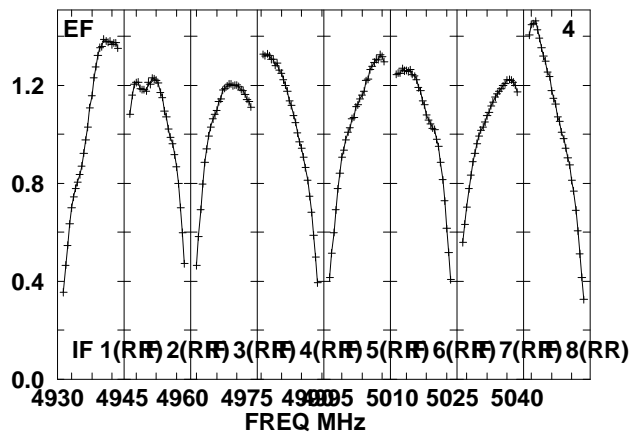
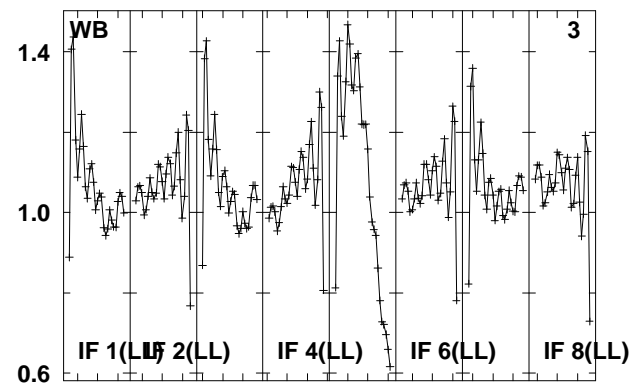
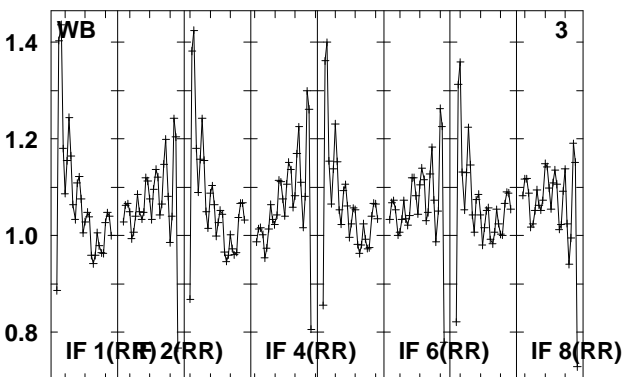
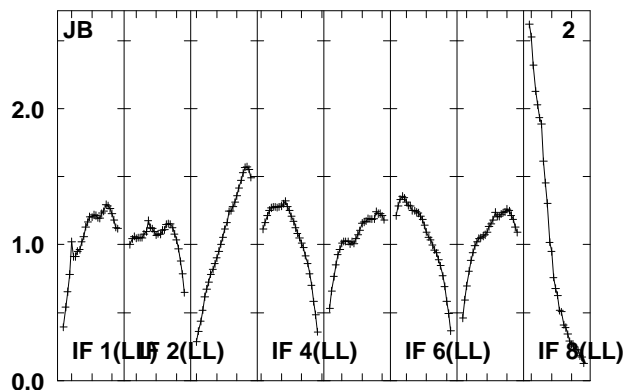
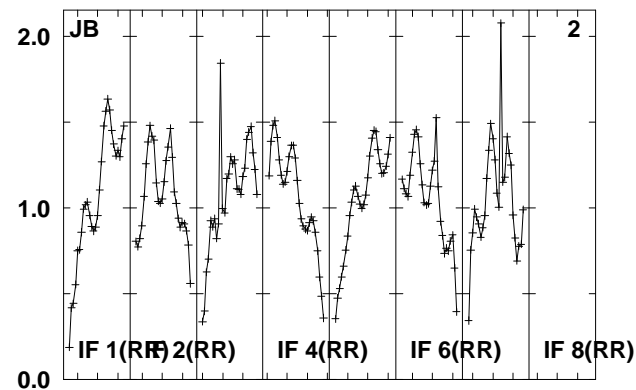
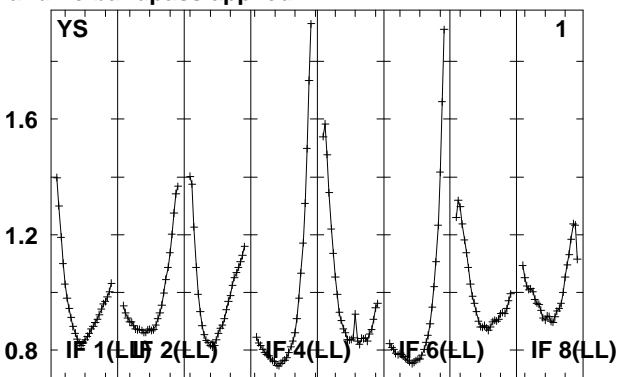
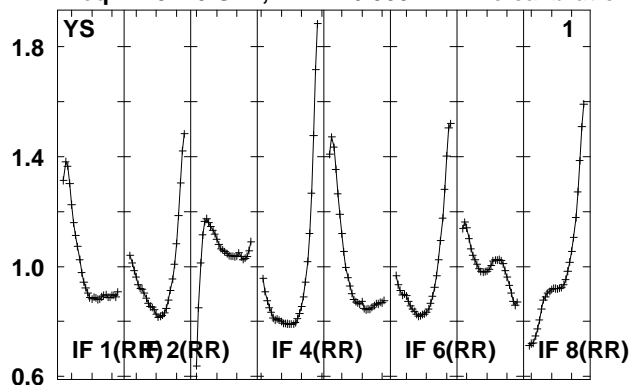

Lower frame: Real Jy
 Total-power spectrum Antenna: *
 Timerange: 00/05:16:58 to 00/05:21:54

Plot file version 100 created 14-MAY-2010 15:17:30

J210358 EO007.UVDATA.1

Freq = 4.9270 GHz, Bw = 16.000 MH No calibration applied and no bandpass applied

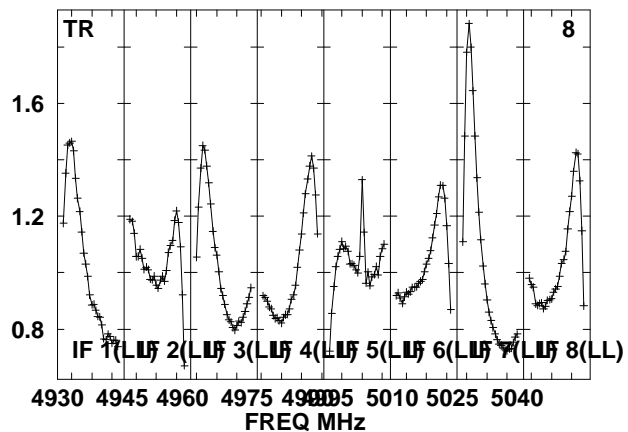
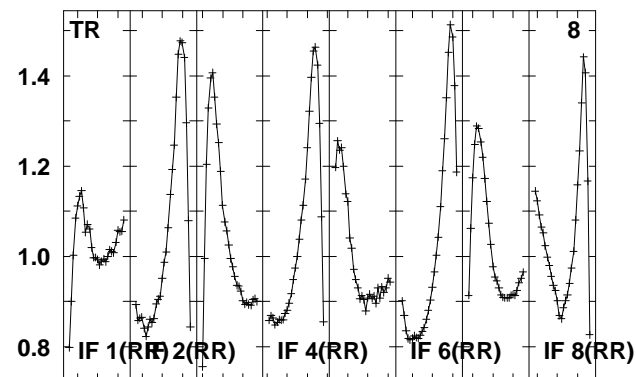
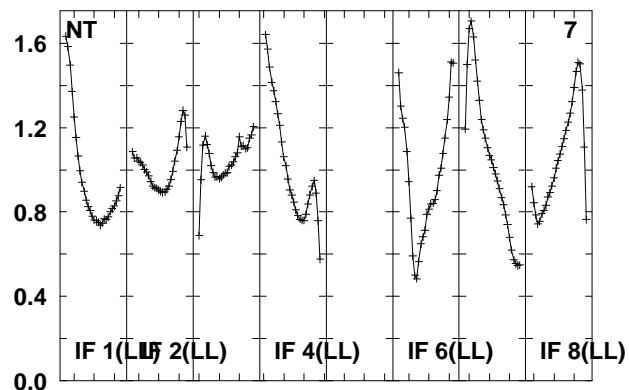
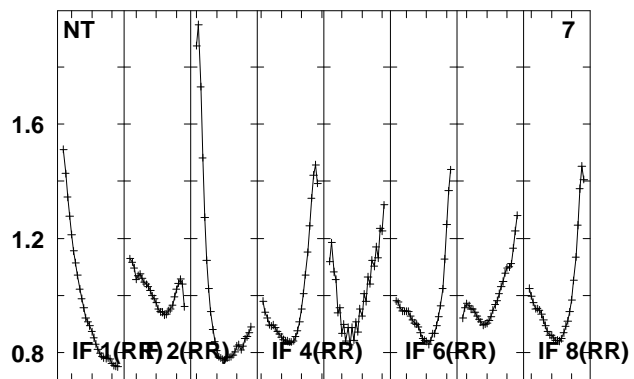
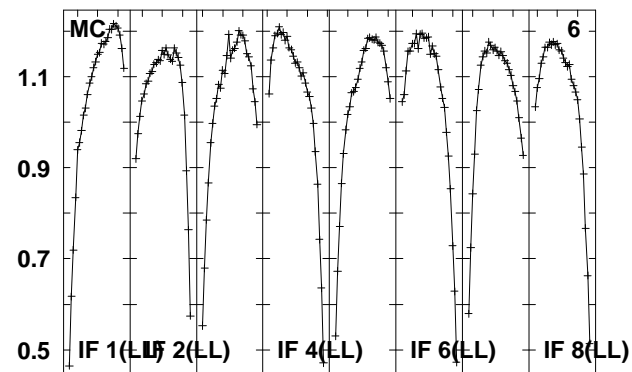
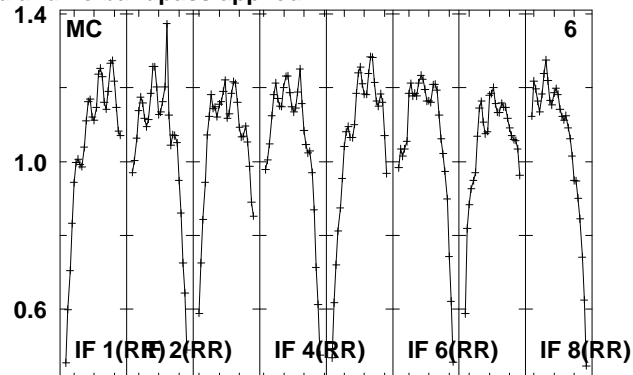
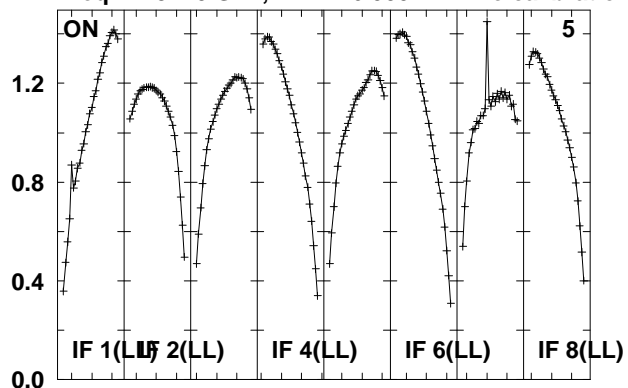

Lower frame: Real Jy

Total-power spectrum Antenna: *

Timerange: 00/05:16:58 to 00/05:21:54

Plot file version 101 created 14-MAY-2010 15:17:30

J2110-10 EO007.UVDATA.1

Freq = 4.9270 GHz, Bw = 16.000 MH No calibration applied and no bandpass applied

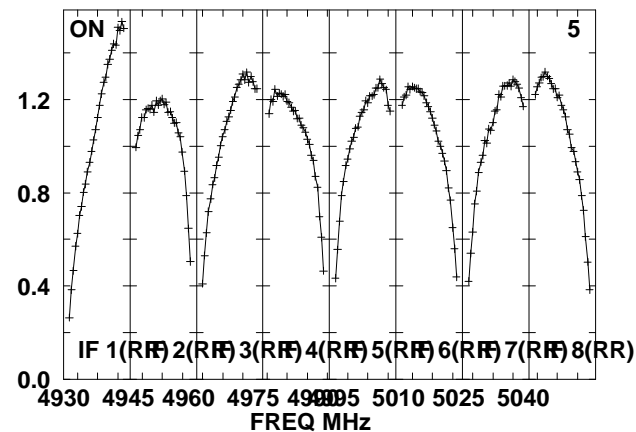
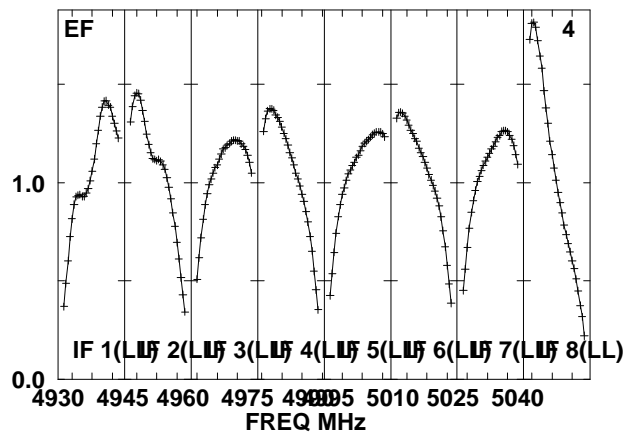
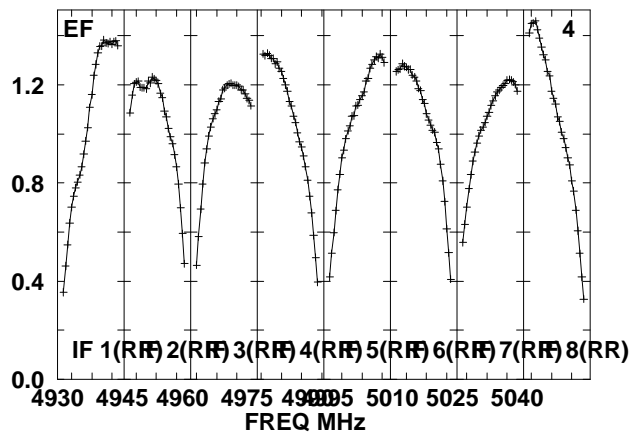
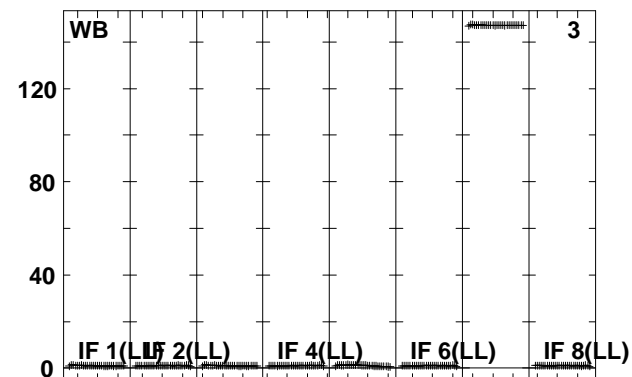
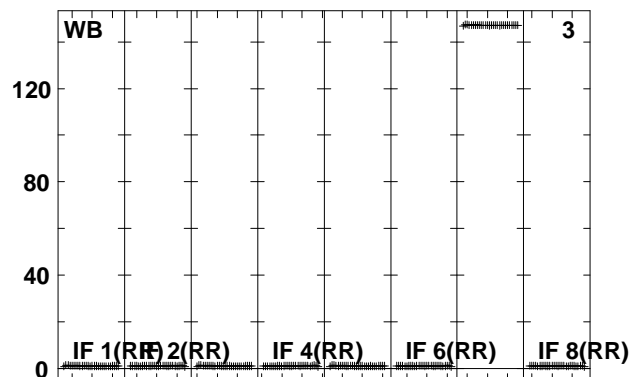
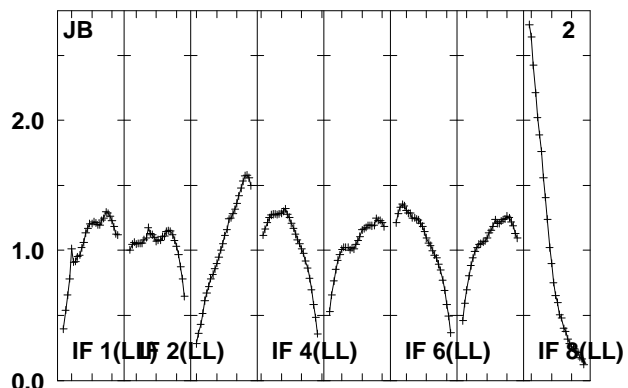
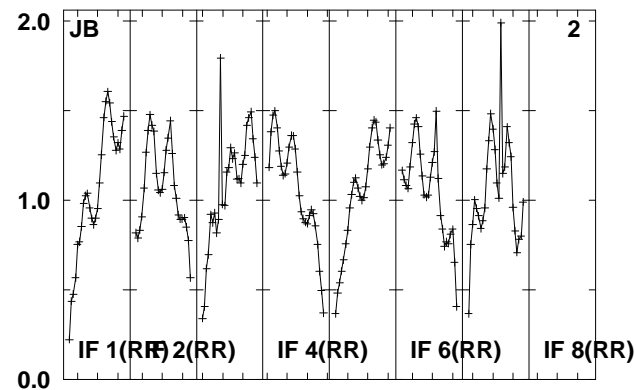
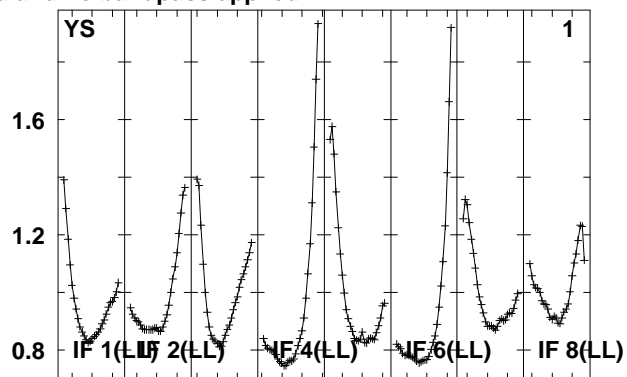
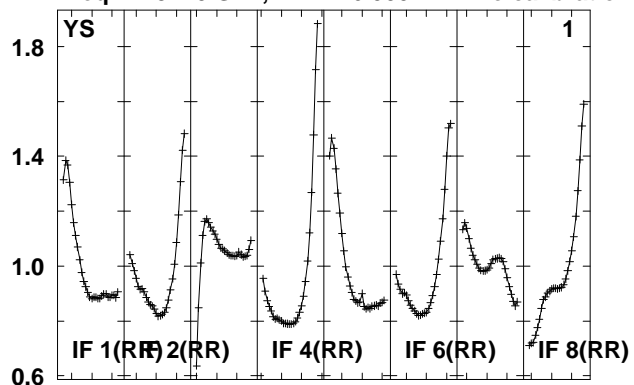

Lower frame: Real Jy

Total-power spectrum Antenna: *

Timerange: 00/05:22:34 to 00/05:24:02

Plot file version 102 created 14-MAY-2010 15:17:30

J2110-10 EO007.UVDATA.1

Freq = 4.9270 GHz, Bw = 16.000 MH No calibration applied and no bandpass applied

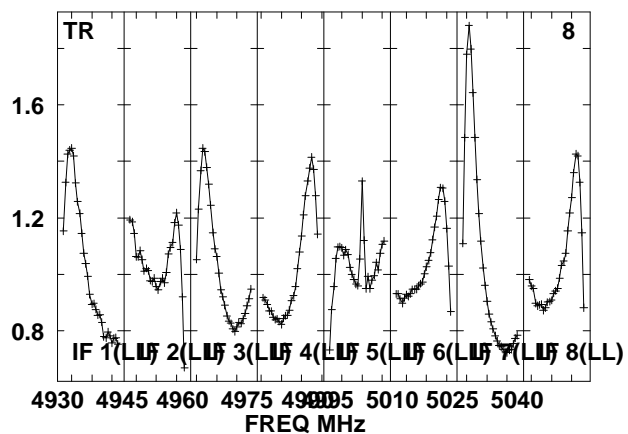
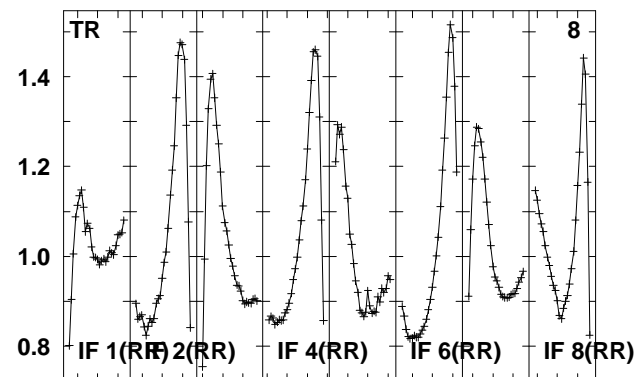
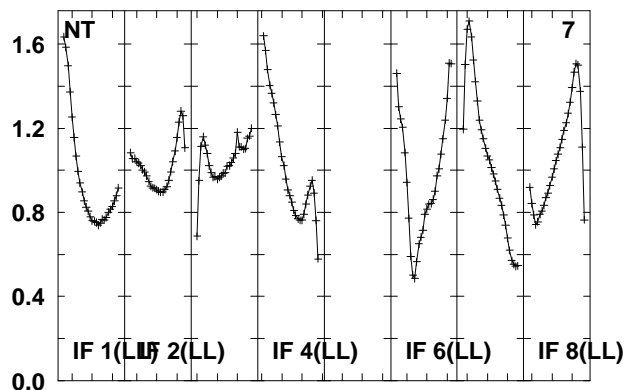
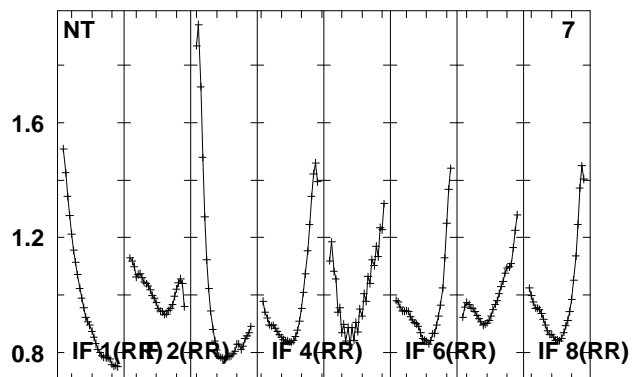
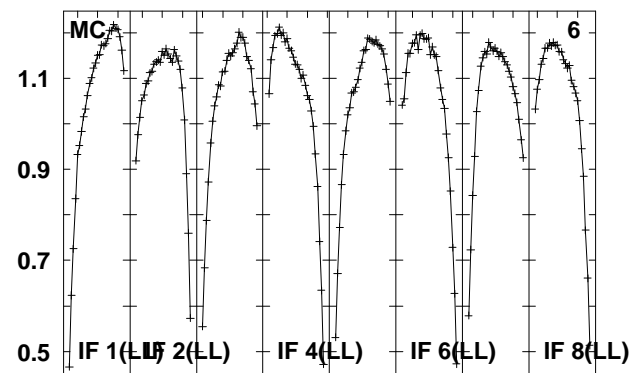
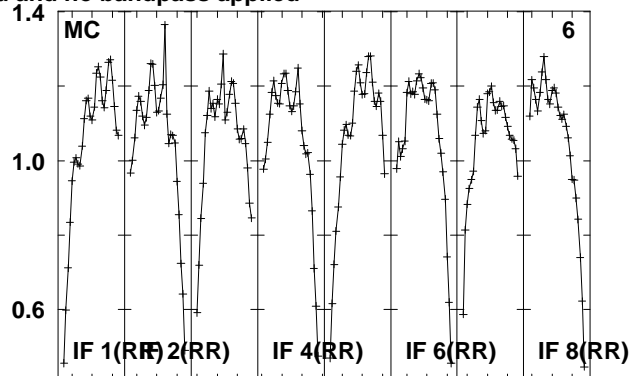
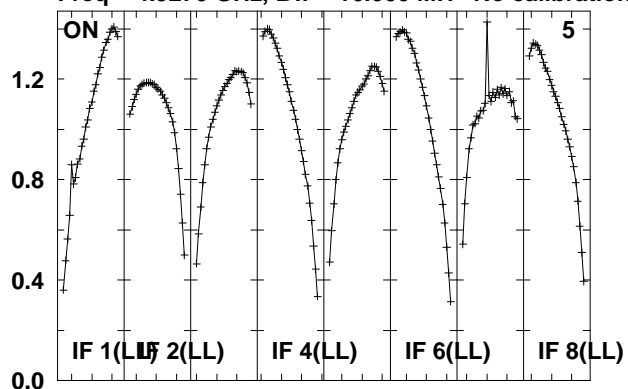

Lower frame: Real Jy

Total-power spectrum Antenna: *

Timerange: 00/05:22:34 to 00/05:24:02

Plot file version 103 created 14-MAY-2010 15:17:31
 J210358 EO007.UVDATA.1
 Freq = 4.9270 GHz, Bw = 16.000 MH No calibration applied and no bandpass applied

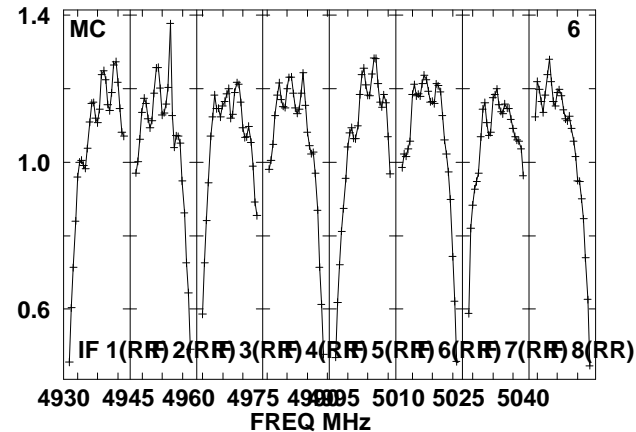
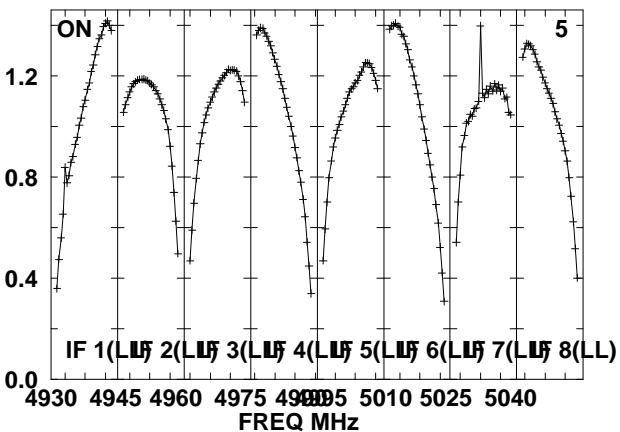
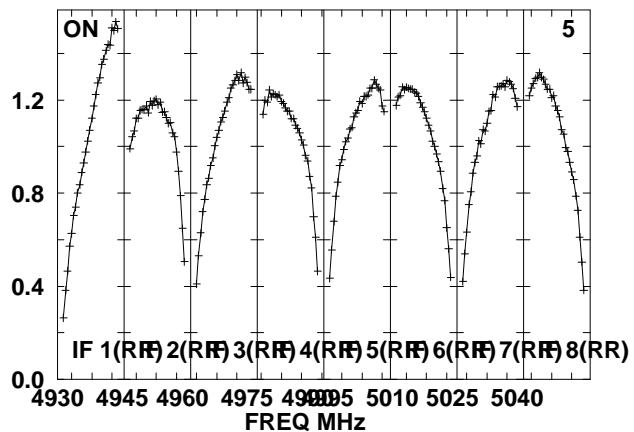
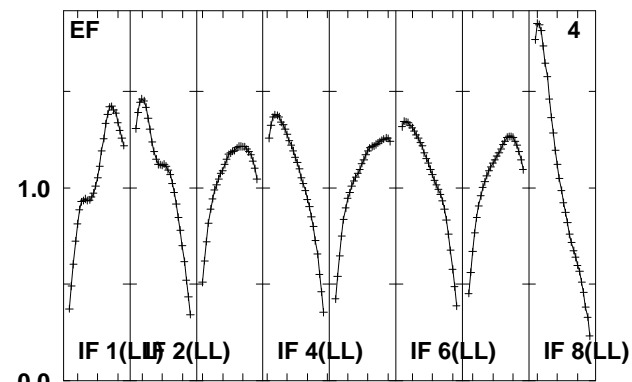
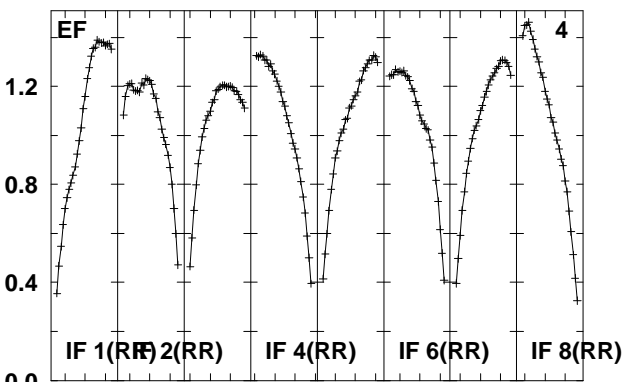
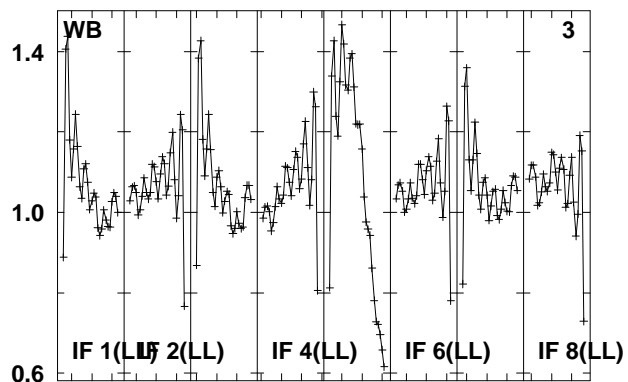
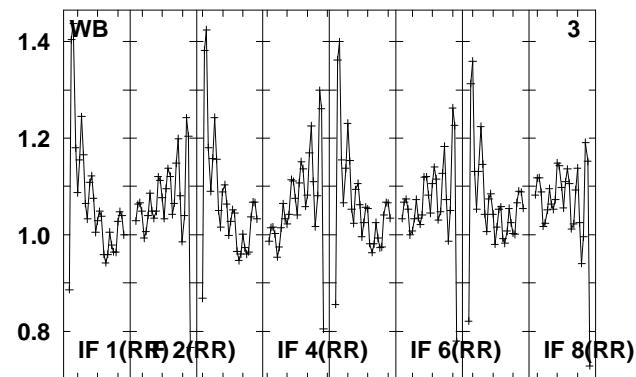
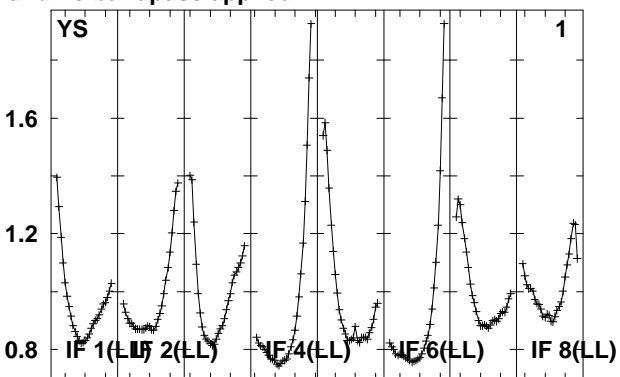
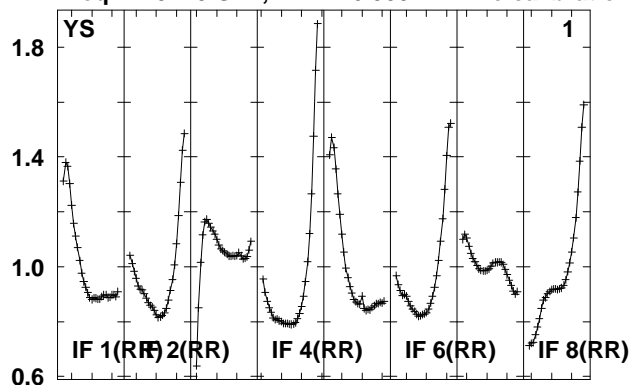

Lower frame: Real Jy
 Total-power spectrum Antenna: *
 Timerange: 00/05:24:39 to 00/05:29:35

Plot file version 104 created 14-MAY-2010 15:17:31

J210358 EO007.UVDATA.1

Freq = 4.9270 GHz, Bw = 16.000 MH No calibration applied and no bandpass applied

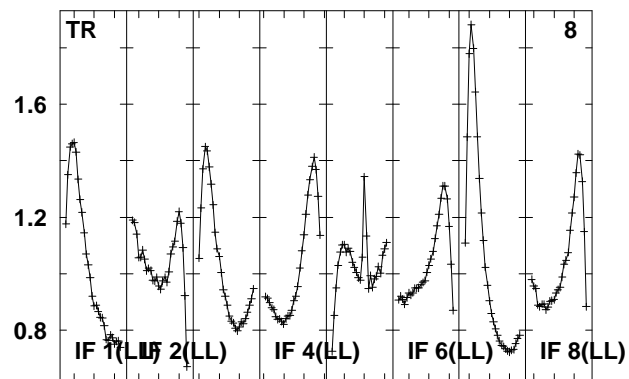
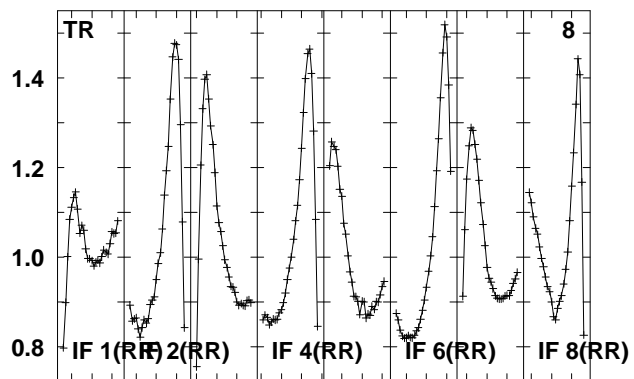
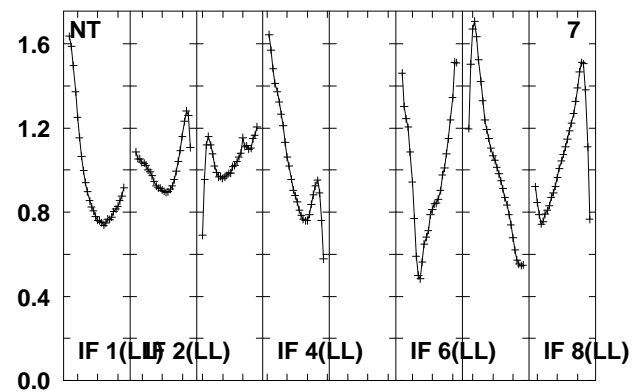
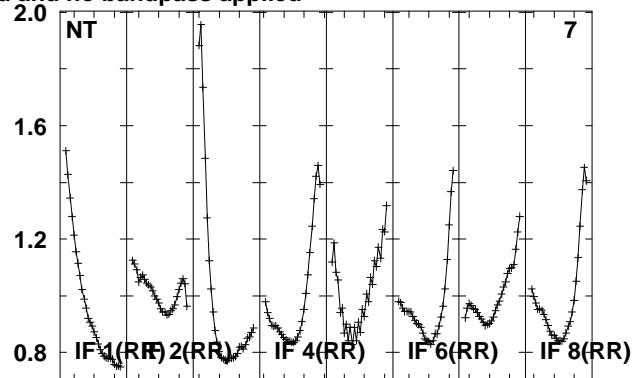
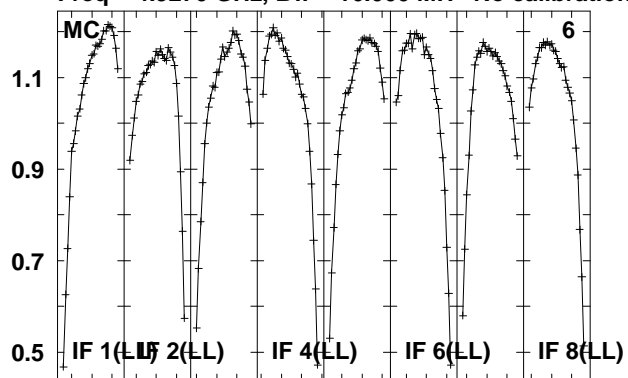

Lower frame: Real Jy
Total-power spectrum Antenna: *
Timerange: 00/05:24:39 to 00/05:29:35

Plot file version 105 created 14-MAY-2010 15:17:32

J2110-10 EO007.UVDATA.1

Freq = 4.9270 GHz, Bw = 16.000 MH No calibration applied and no bandpass applied

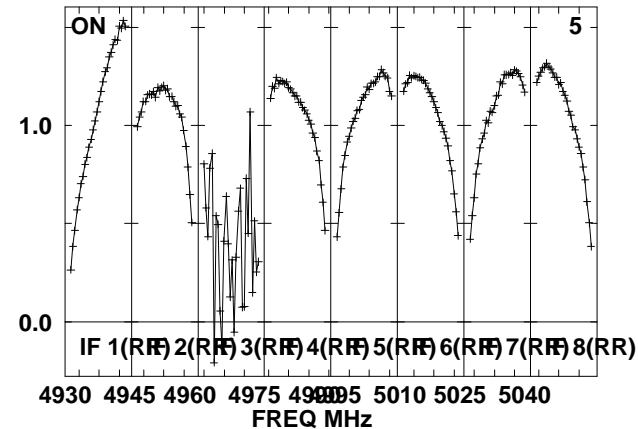
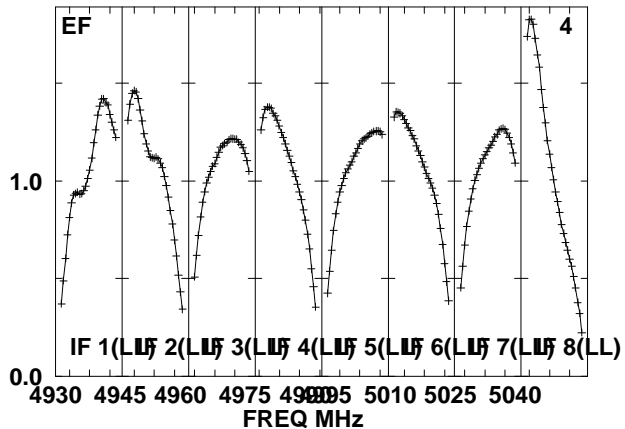
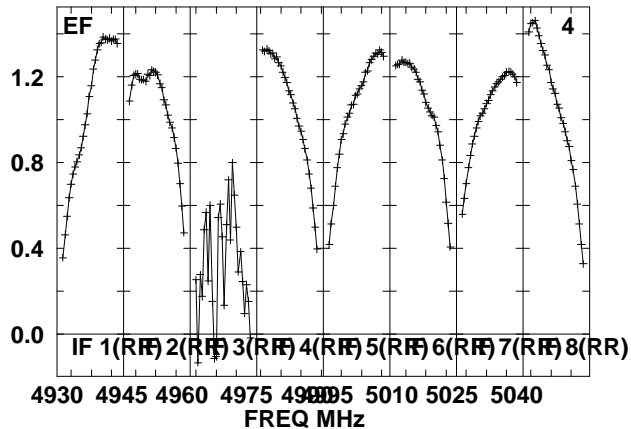
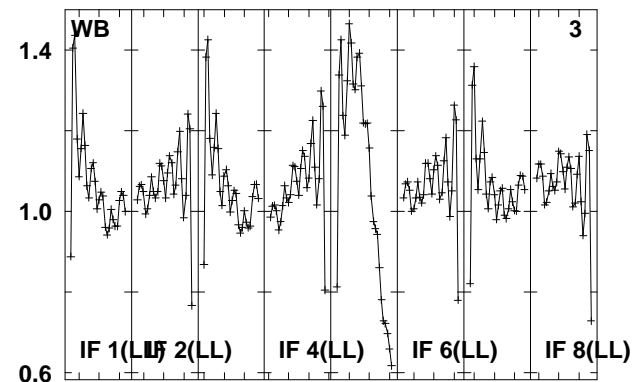
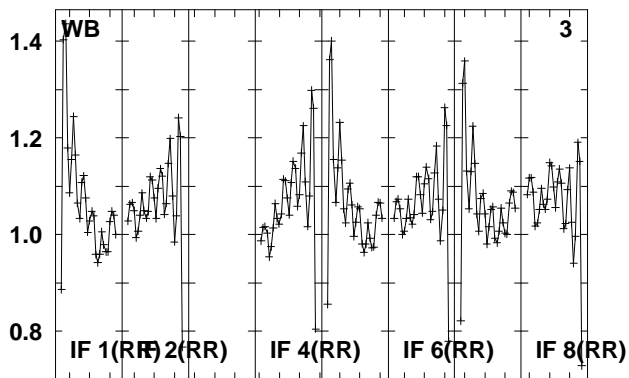
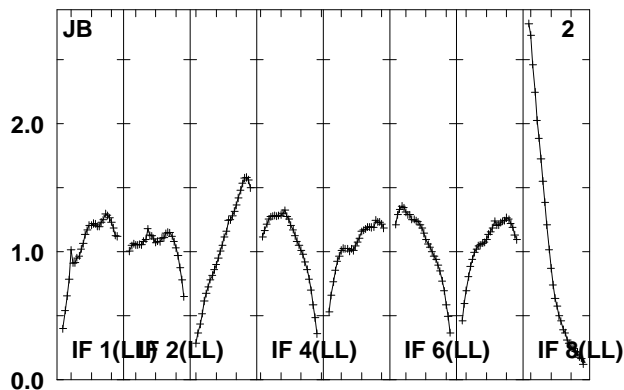
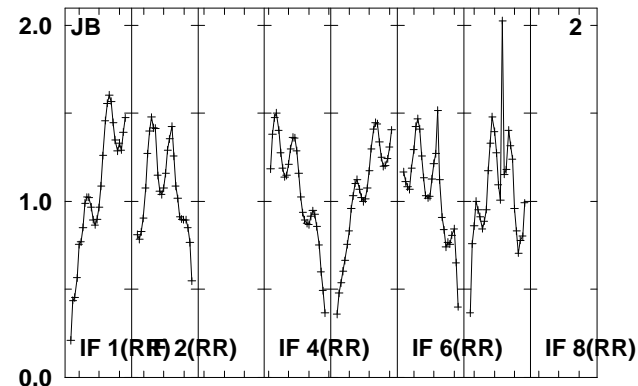
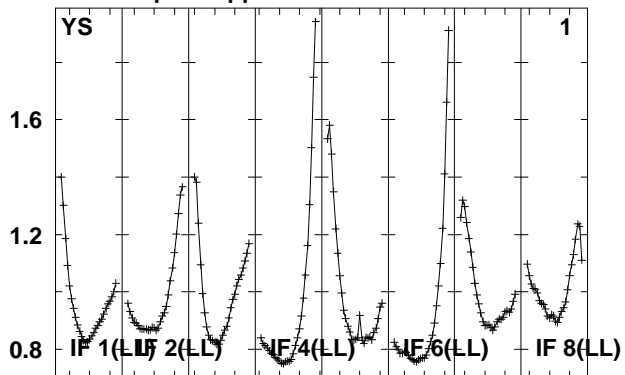
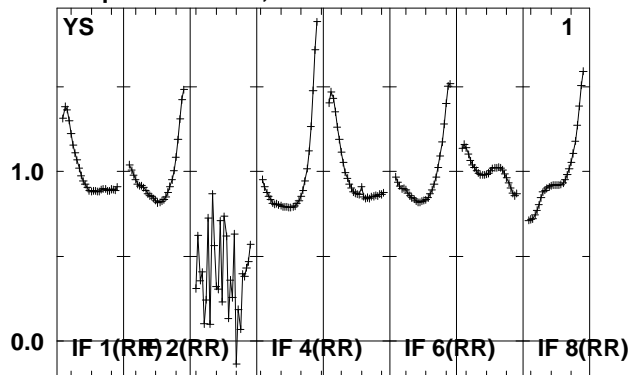

Lower frame: Real Jy
Total-power spectrum Antenna: *
Timerange: 00/05:30:13 to 00/05:31:41

Plot file version 106 created 14-MAY-2010 15:17:32

J2110-10 EO007.UVDATA.1

Freq = 4.9270 GHz, Bw = 16.000 MH No calibration applied and no bandpass applied

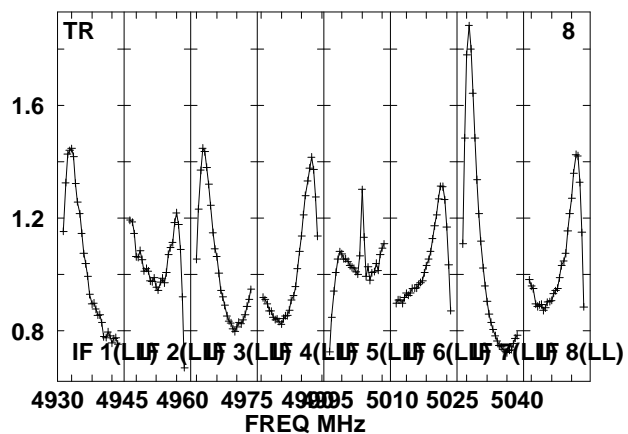
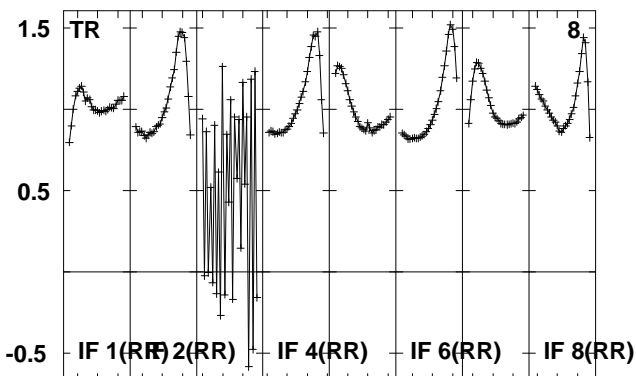
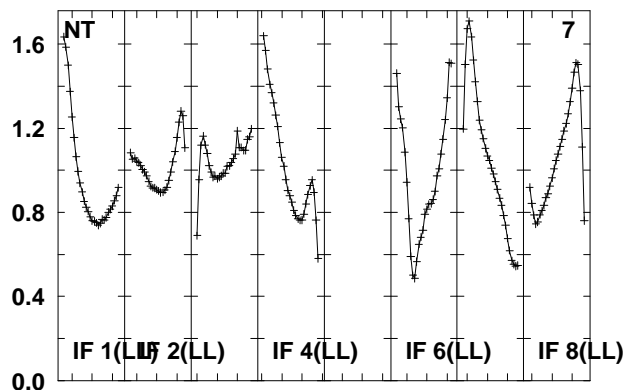
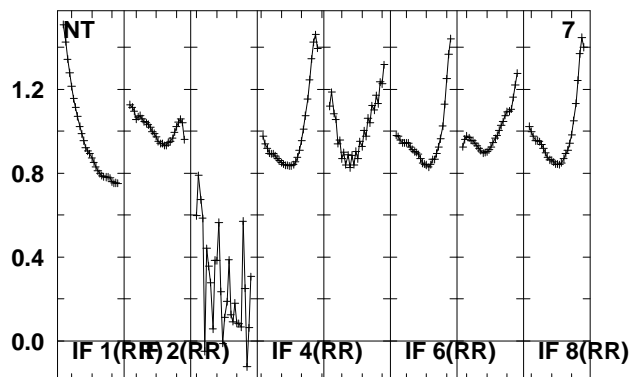
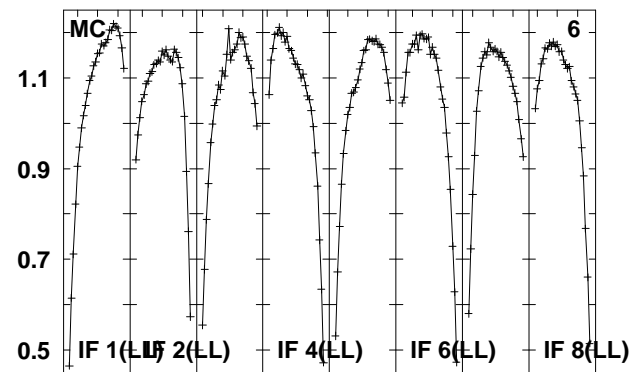
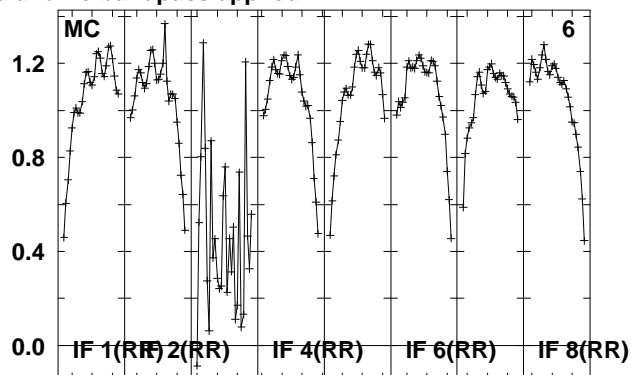
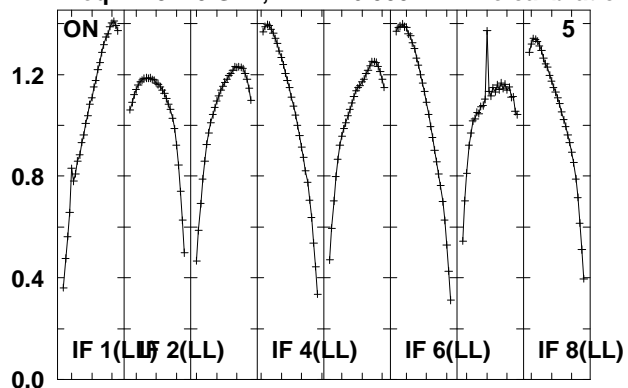

Lower frame: Real Jy

Total-power spectrum Antenna: *

Timerange: 00/05:30:13 to 00/05:31:41

Plot file version 107 created 14-MAY-2010 15:17:32

J210358 EO007.UVDATA.1

Freq = 4.9270 GHz, Bw = 16.000 MH No calibration applied and no bandpass applied

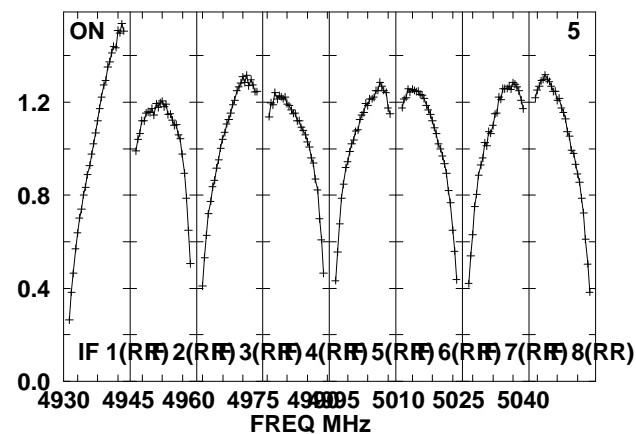
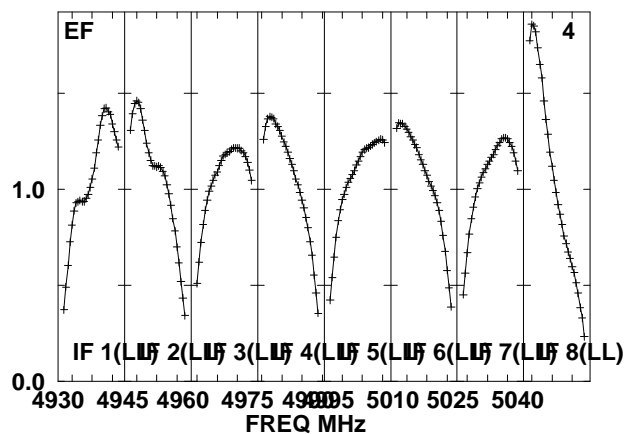
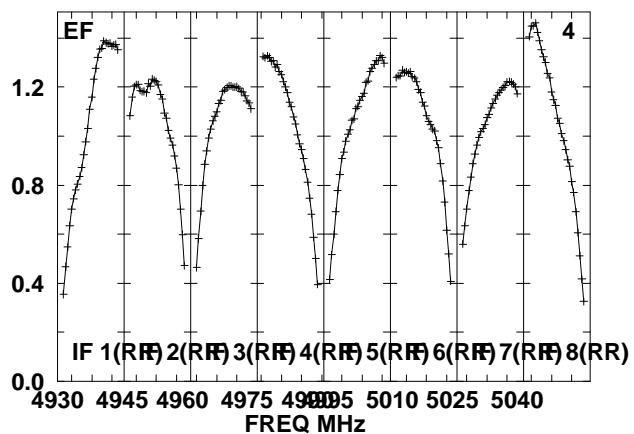
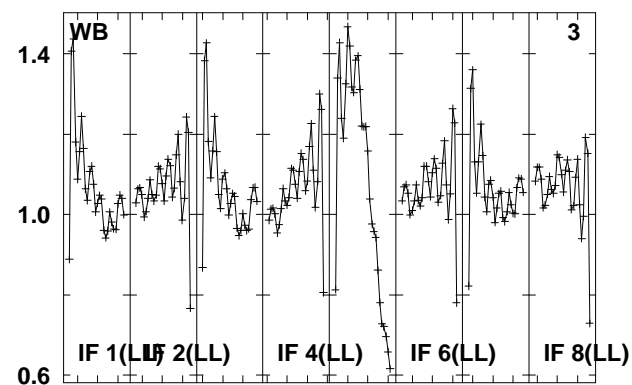
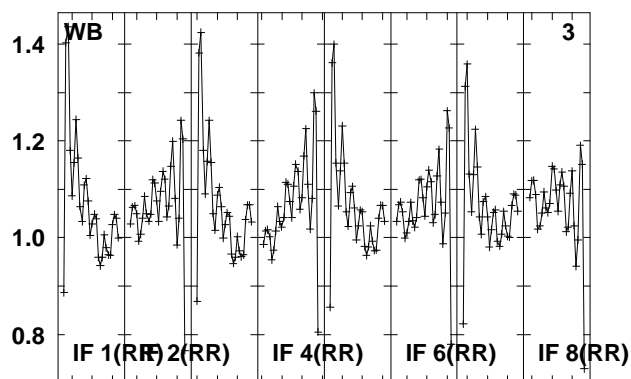
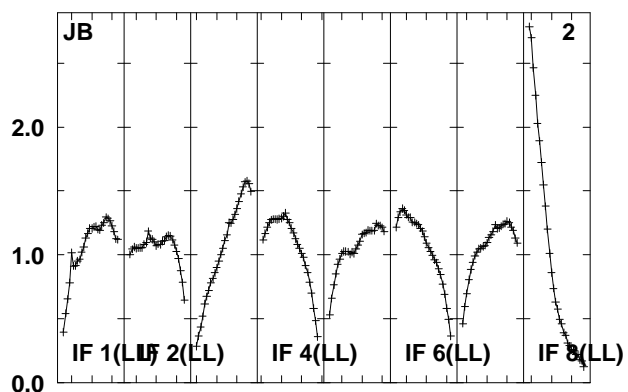
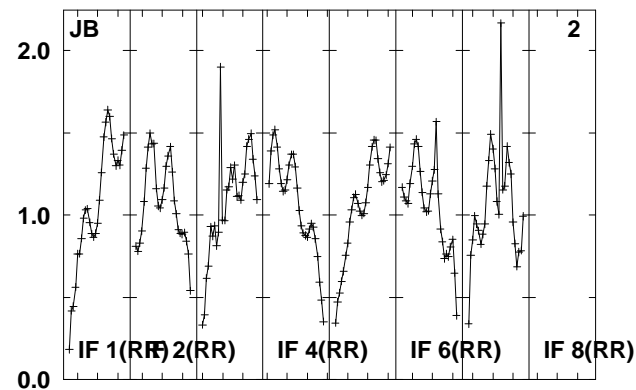
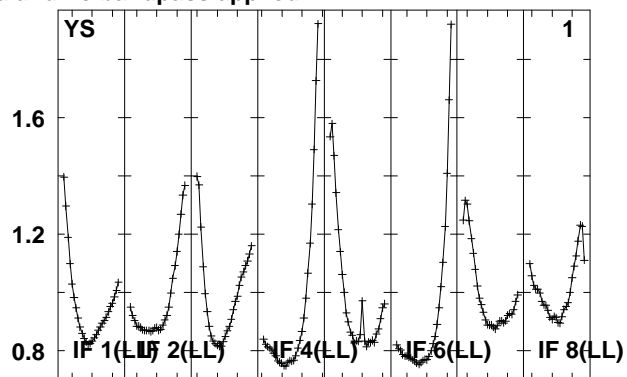
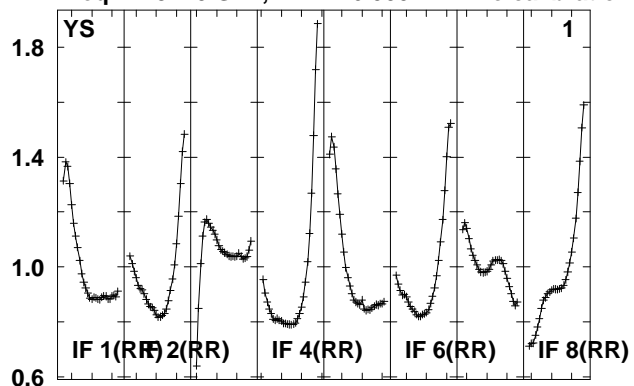

Lower frame: Real Jy

Total-power spectrum Antenna: *

Timerange: 00/05:32:20 to 00/05:37:16

Plot file version 108 created 14-MAY-2010 15:17:33

J210358 EO007.UVDATA.1

Freq = 4.9270 GHz, Bw = 16.000 MH No calibration applied and no bandpass applied

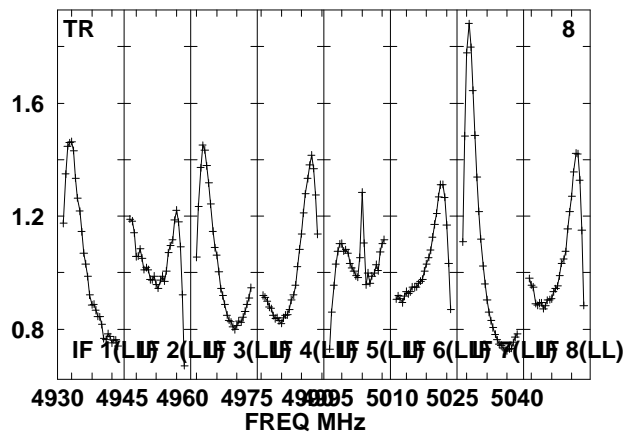
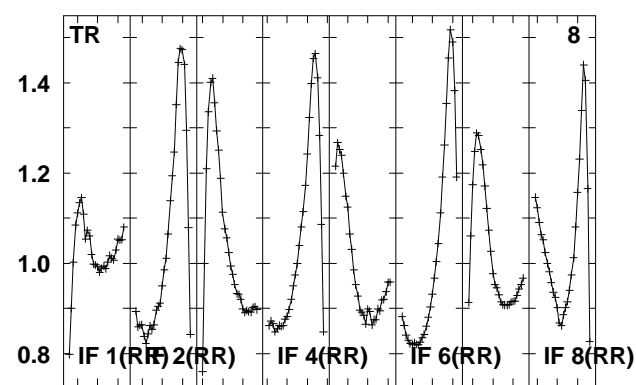
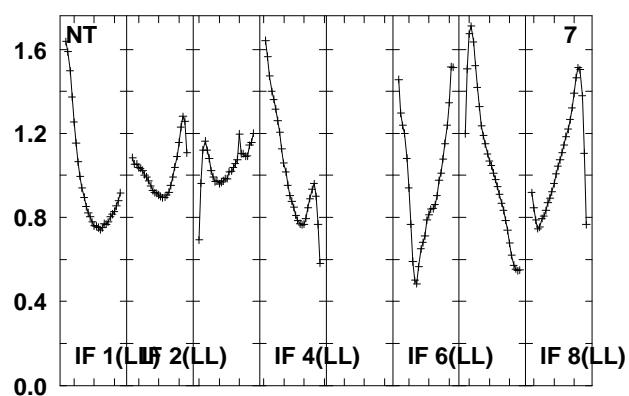
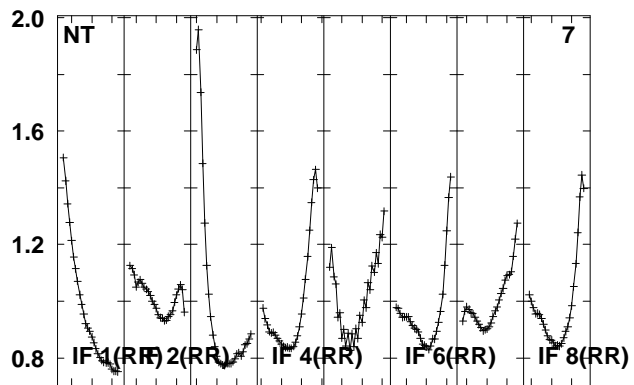
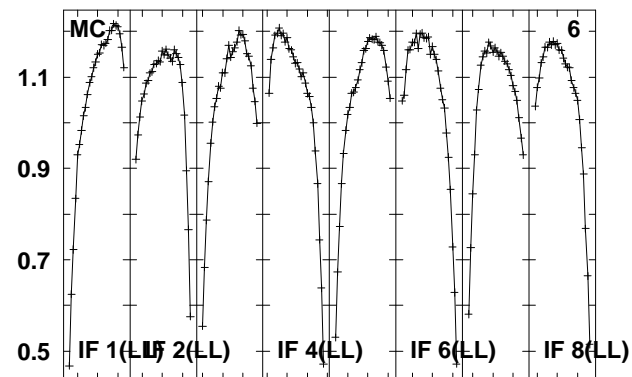
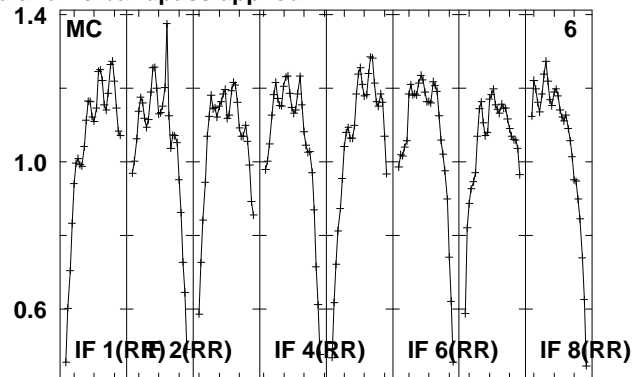
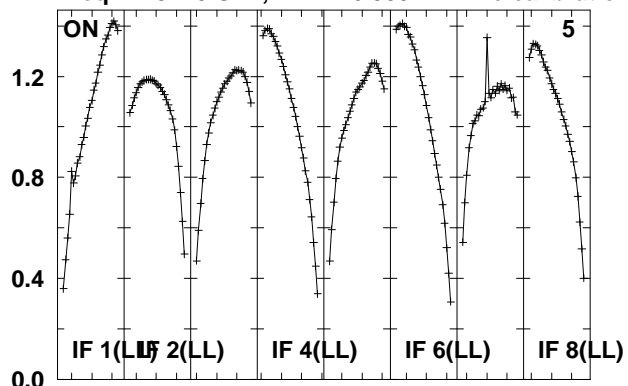

Lower frame: Real Jy

Total-power spectrum Antenna: *

Timerange: 00/05:32:20 to 00/05:37:16

Plot file version 109 created 14-MAY-2010 15:17:33

J2110-10 EO007.UVDATA.1

Freq = 4.9270 GHz, Bw = 16.000 MH No calibration applied and no bandpass applied

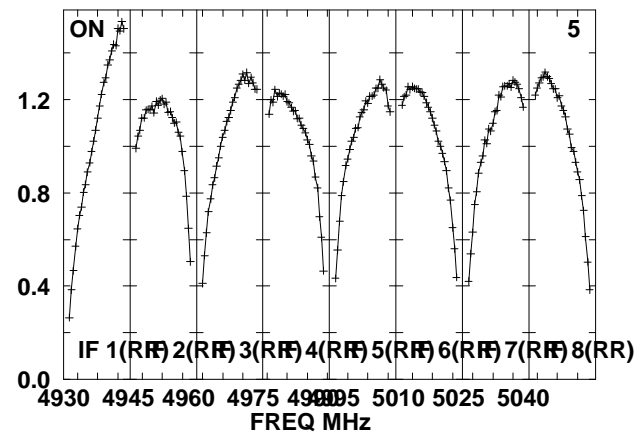
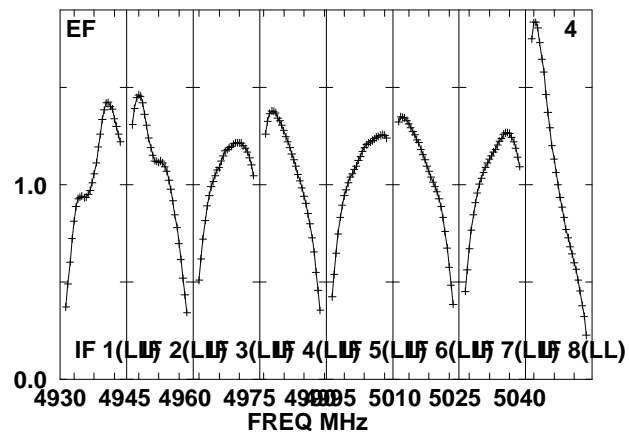
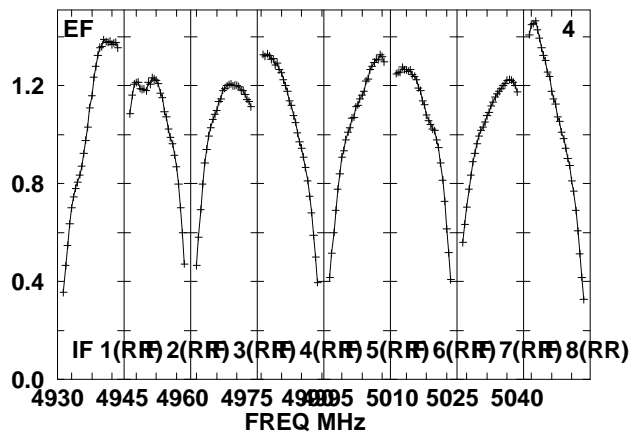
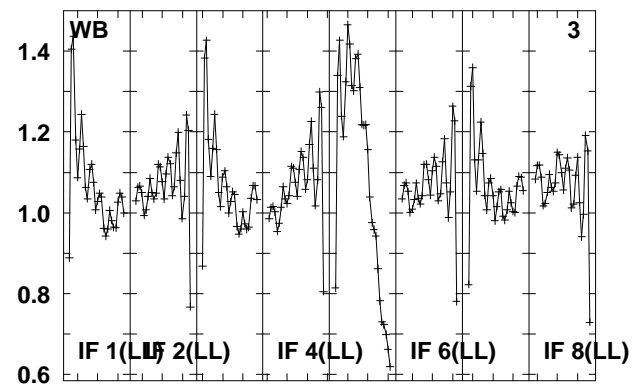
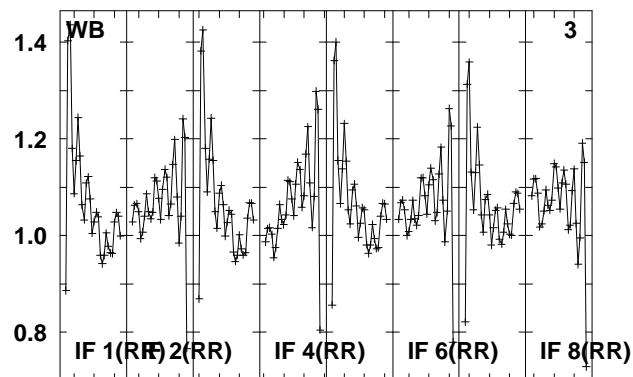
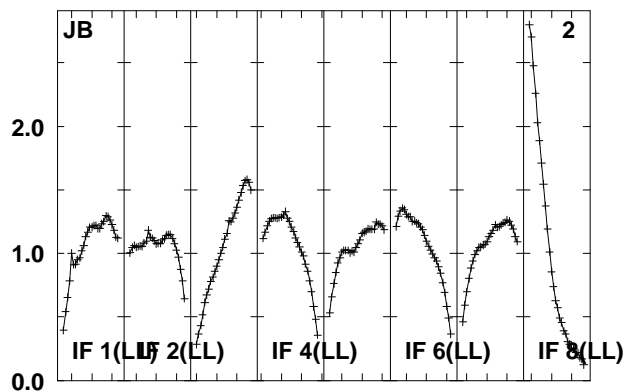
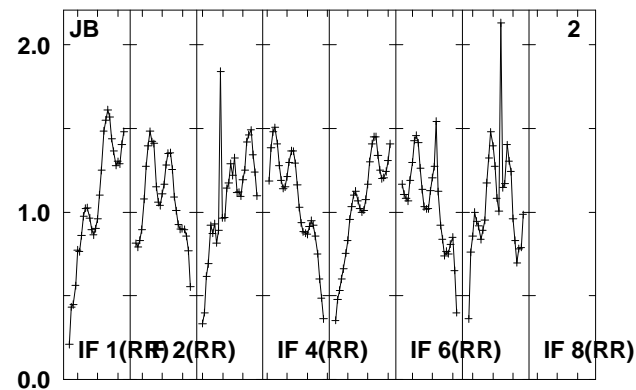
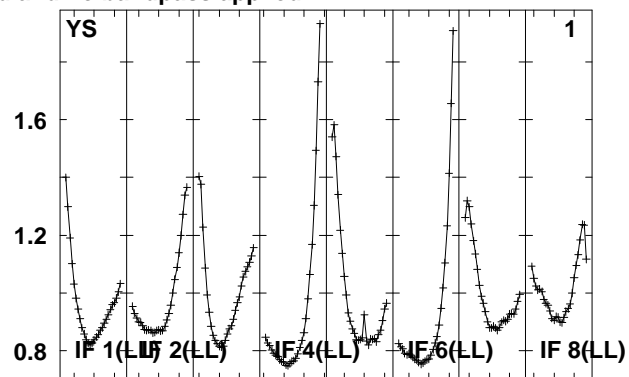
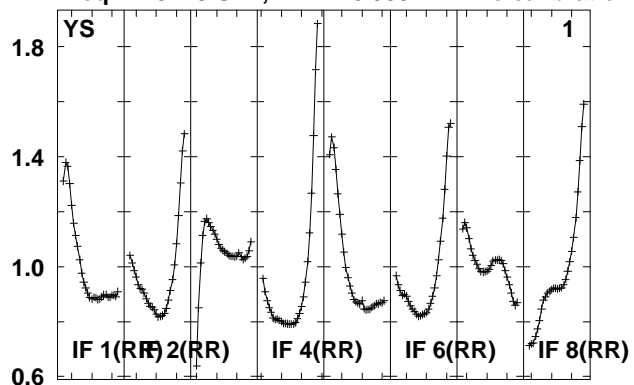

Lower frame: Real Jy

Total-power spectrum Antenna: *

Timerange: 00/05:37:56 to 00/05:39:22

Plot file version 110 created 14-MAY-2010 15:17:33

J2110-10 EO007.UVDATA.1

Freq = 4.9270 GHz, Bw = 16.000 MH No calibration applied and no bandpass applied

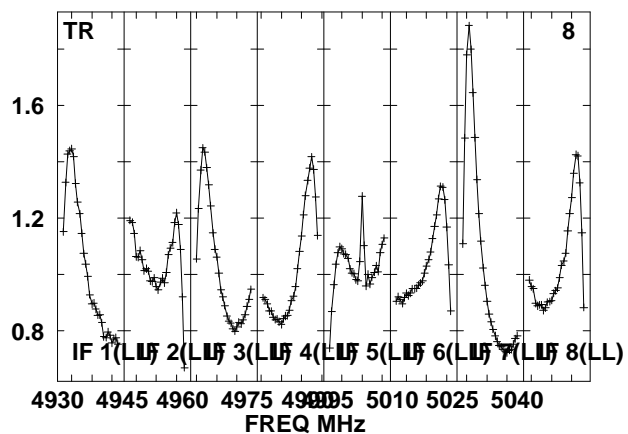
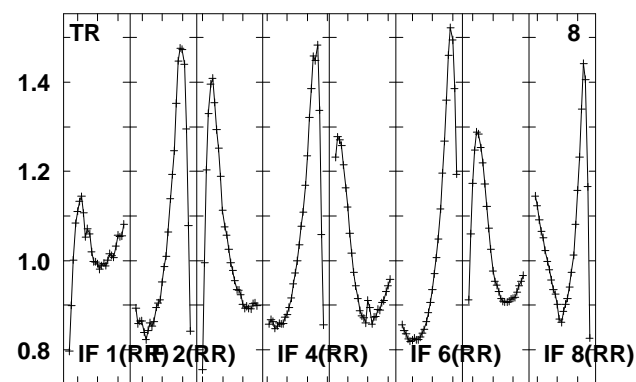
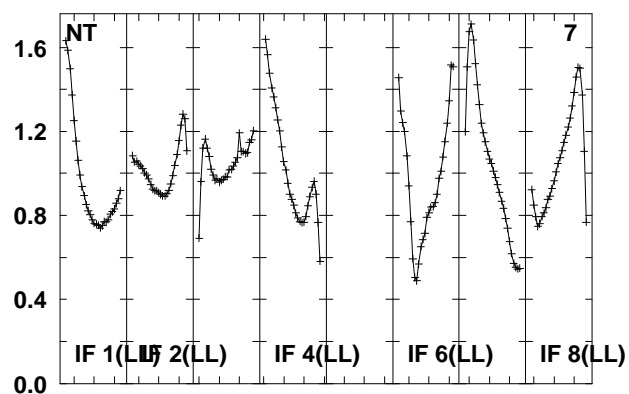
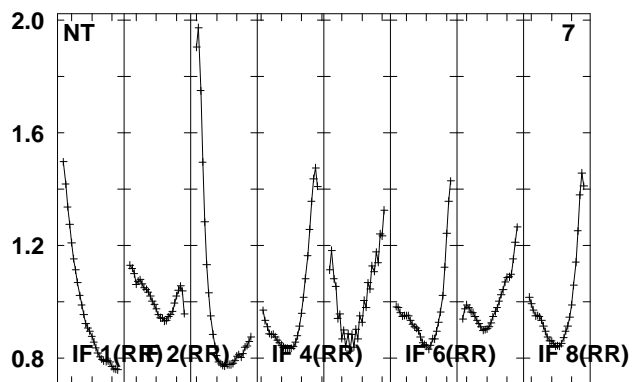
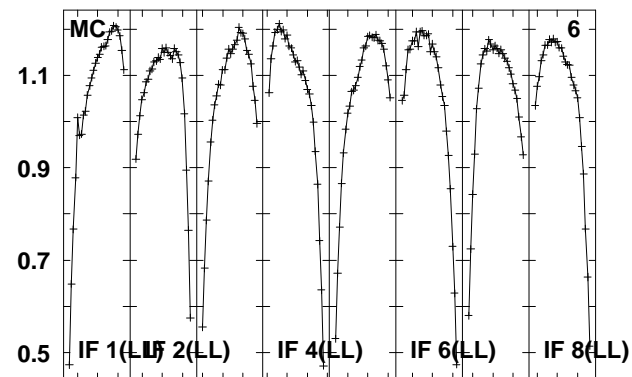
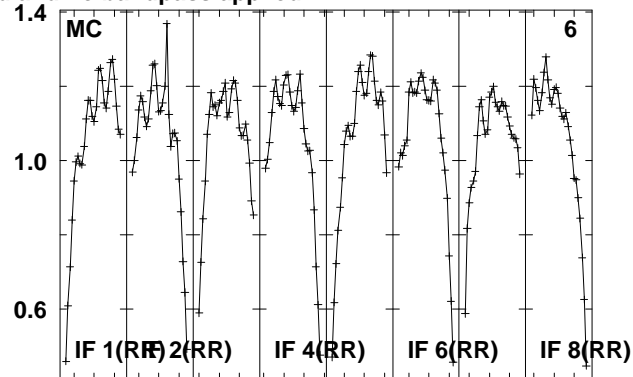
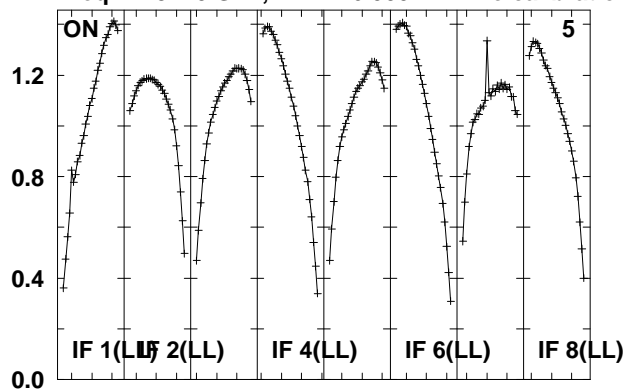

Lower frame: Real Jy

Total-power spectrum Antenna: *

Timerange: 00/05:37:56 to 00/05:39:22

Plot file version 111 created 14-MAY-2010 15:17:34

J210358 EO007.UVDATA.1

Freq = 4.9270 GHz, Bw = 16.000 MH No calibration applied and no bandpass applied

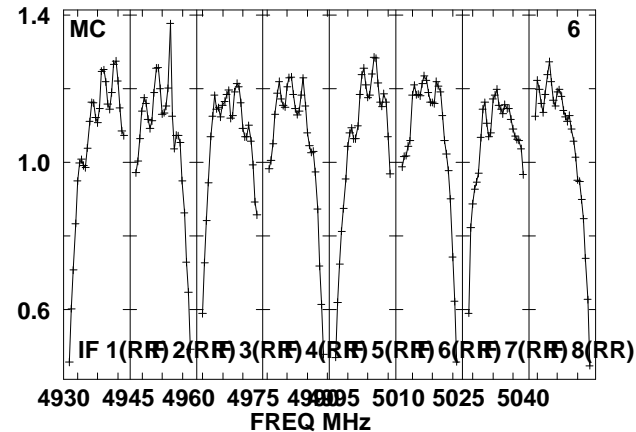
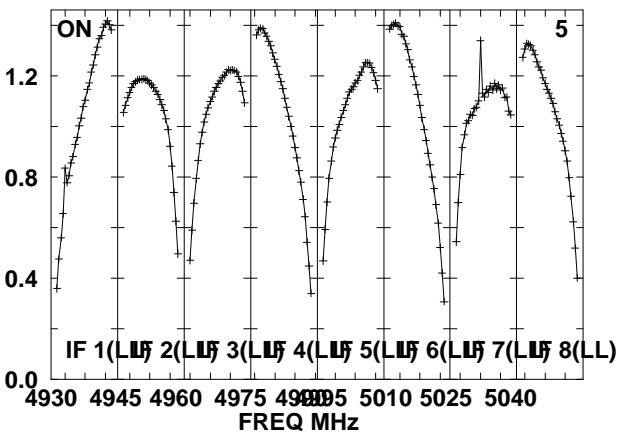
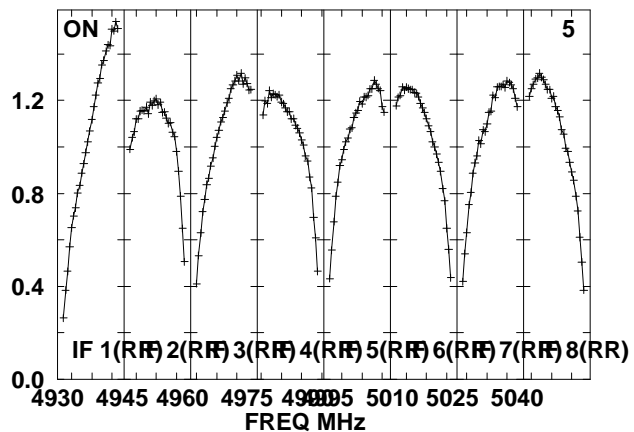
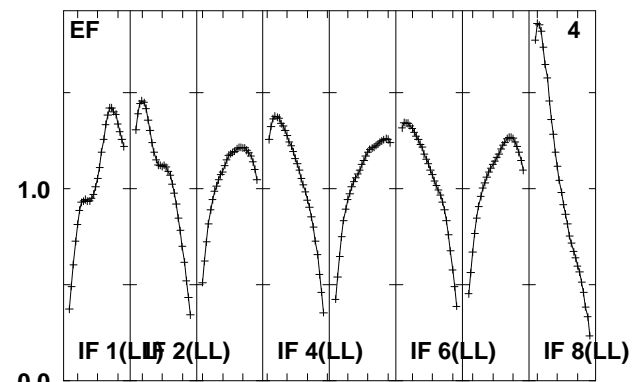
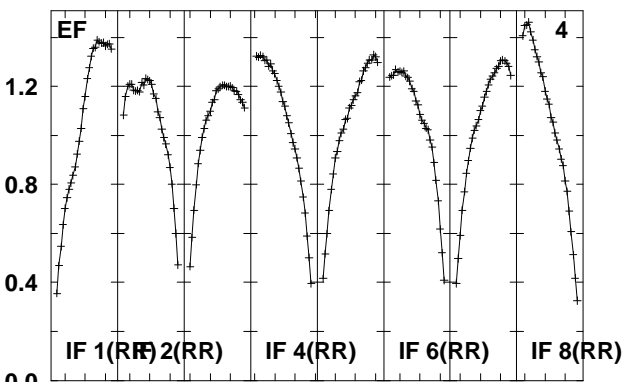
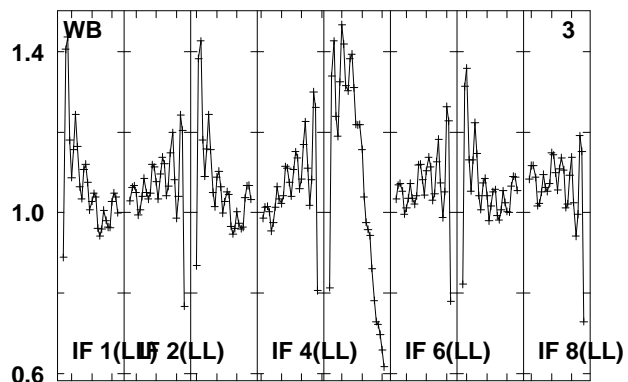
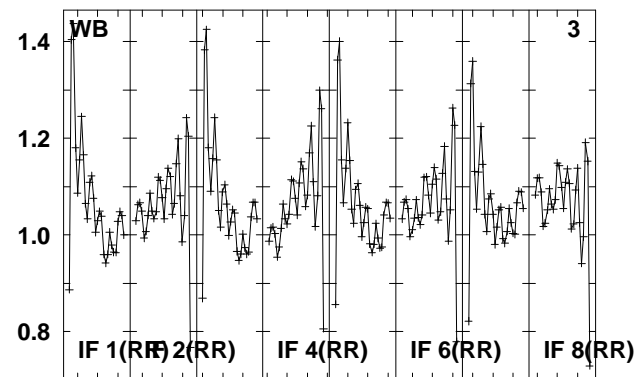
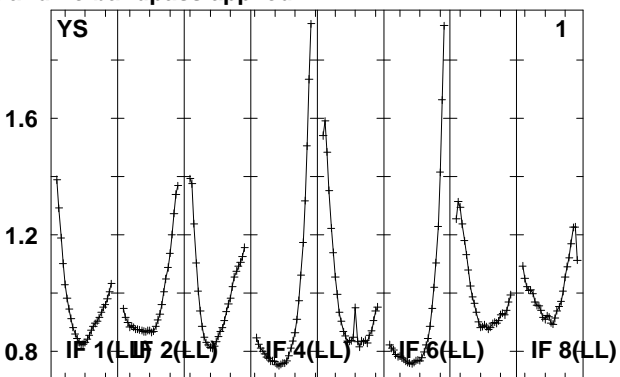
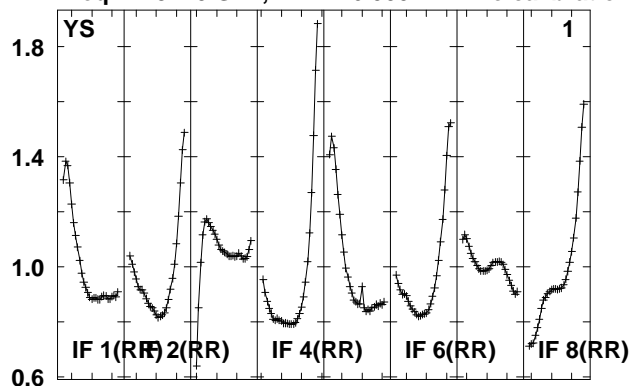

Lower frame: Real Jy
Total-power spectrum Antenna: *
Timerange: 00/05:40:01 to 00/05:44:57

Plot file version 112 created 14-MAY-2010 15:17:34

J210358 EO007.UVDATA.1

Freq = 4.9270 GHz, Bw = 16.000 MH No calibration applied and no bandpass applied

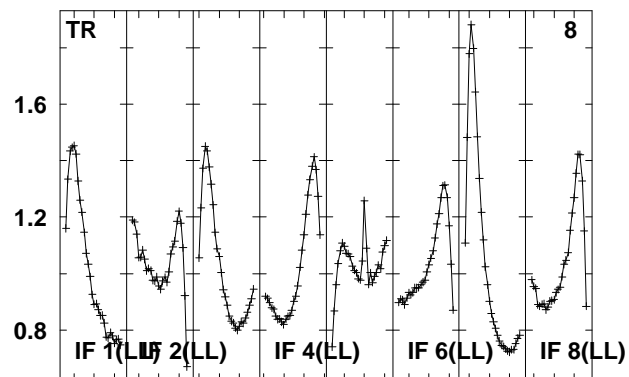
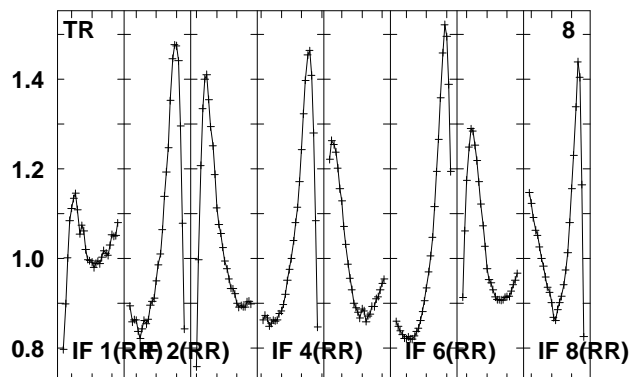
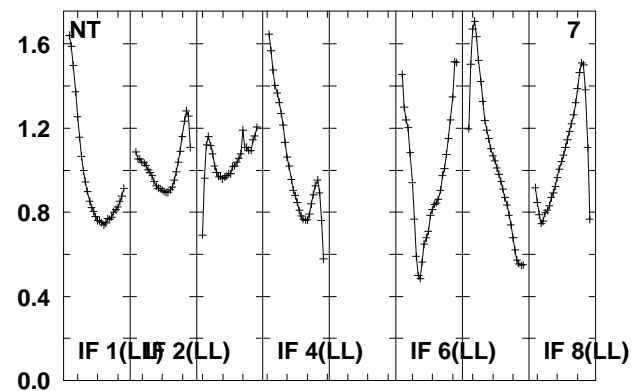
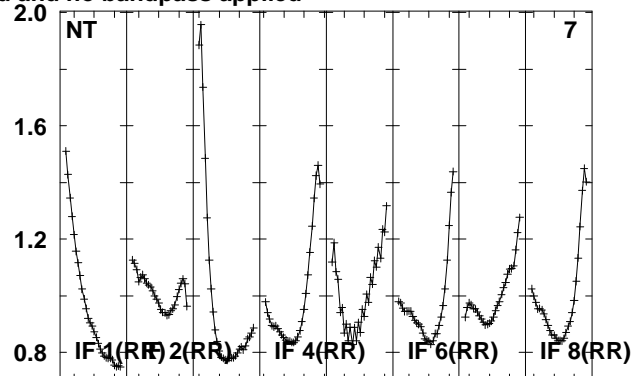
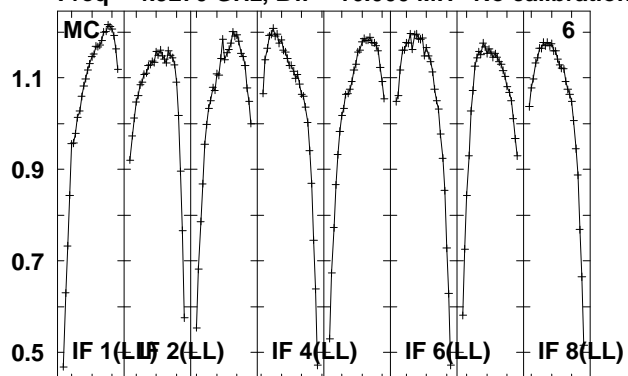

Lower frame: Real Jy
Total-power spectrum Antenna: *
Timerange: 00/05:40:01 to 00/05:44:57

Plot file version 113 created 14-MAY-2010 15:17:35

J2110-10 EO007.UVDATA.1

Freq = 4.9270 GHz, Bw = 16.000 MH No calibration applied and no bandpass applied

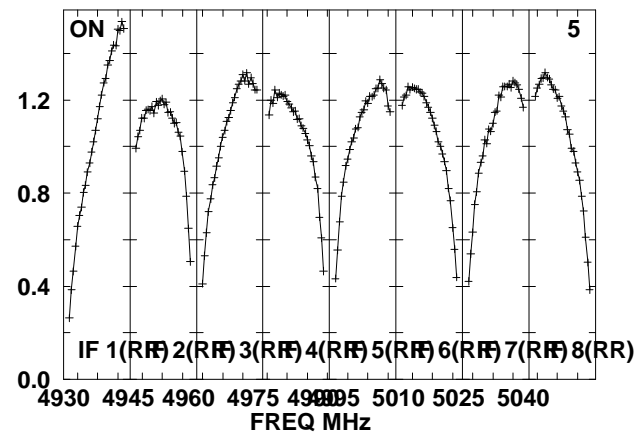
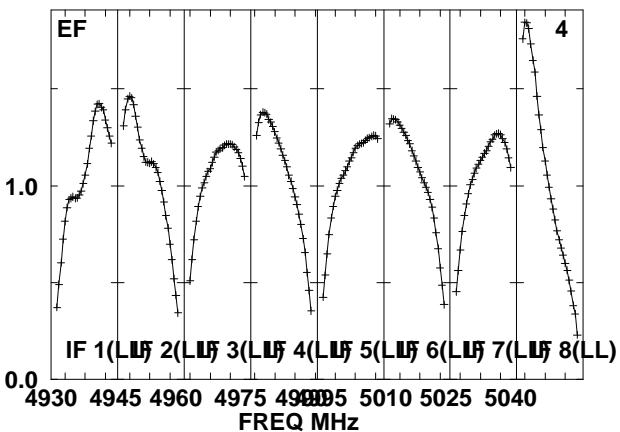
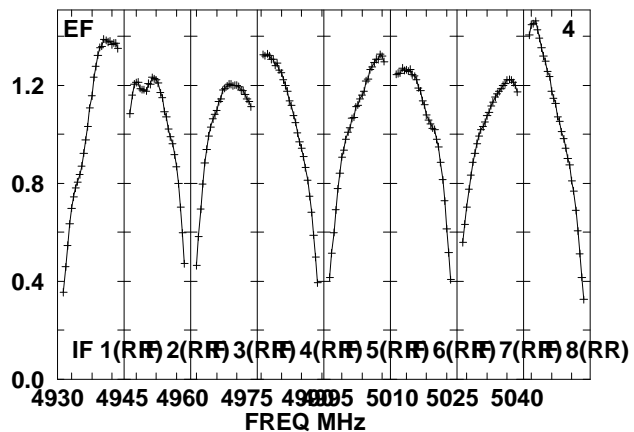
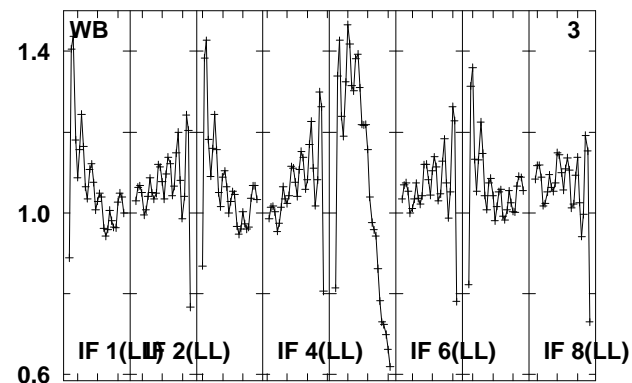
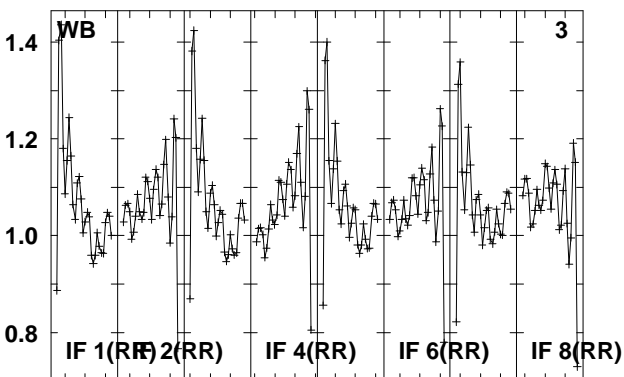
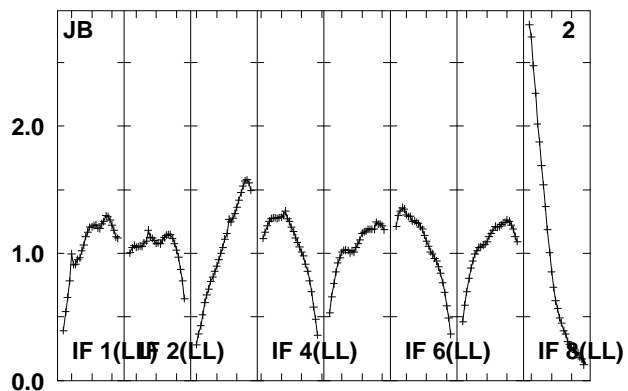
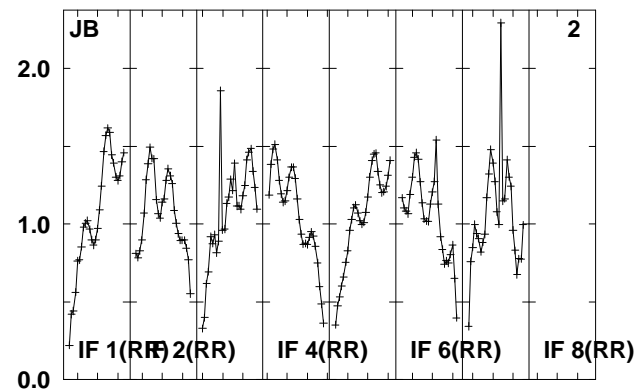
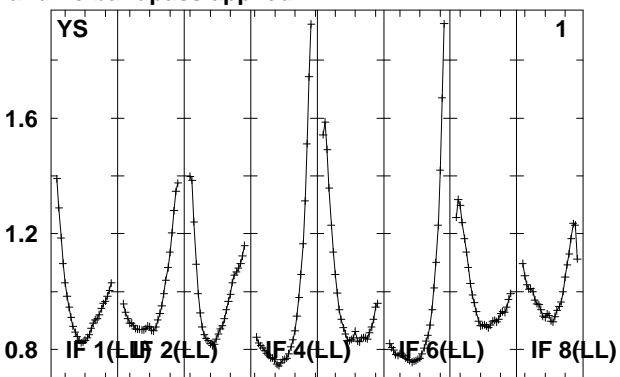
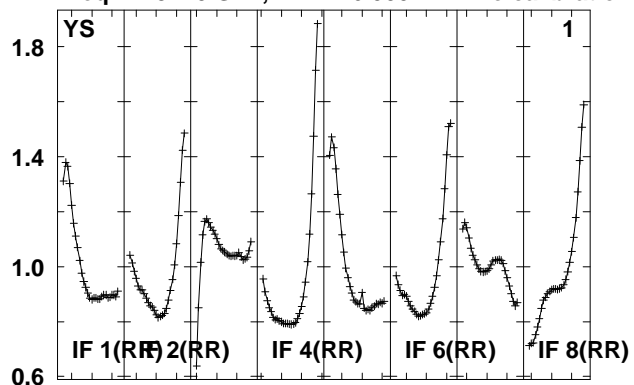

Lower frame: Real Jy

Total-power spectrum Antenna: *

Timerange: 00/05:45:35 to 00/05:47:03

Plot file version 114 created 14-MAY-2010 15:17:35

J2110-10 EO007.UVDATA.1

Freq = 4.9270 GHz, Bw = 16.000 MH No calibration applied and no bandpass applied

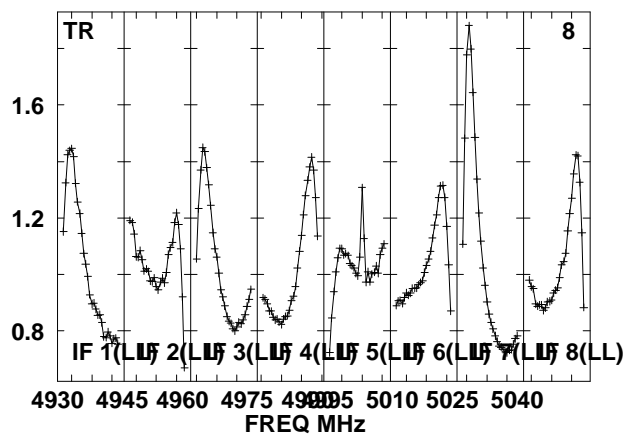
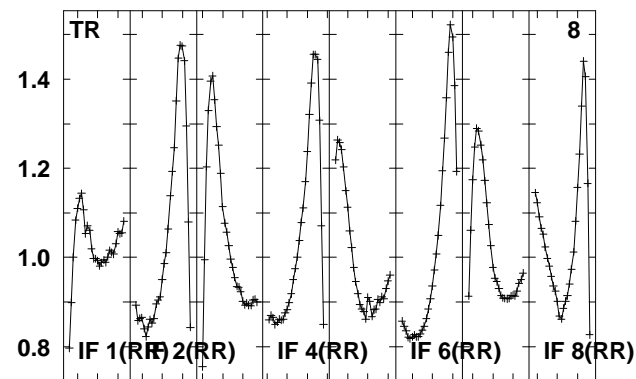
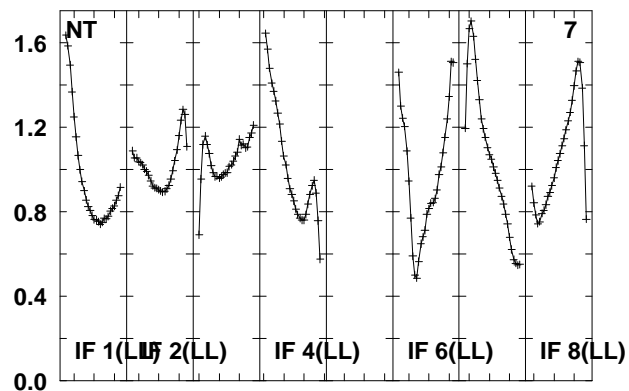
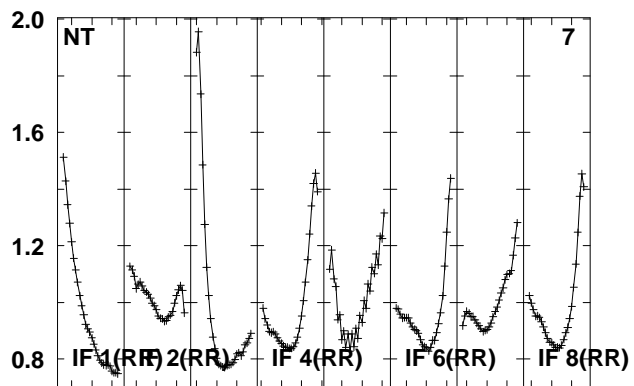
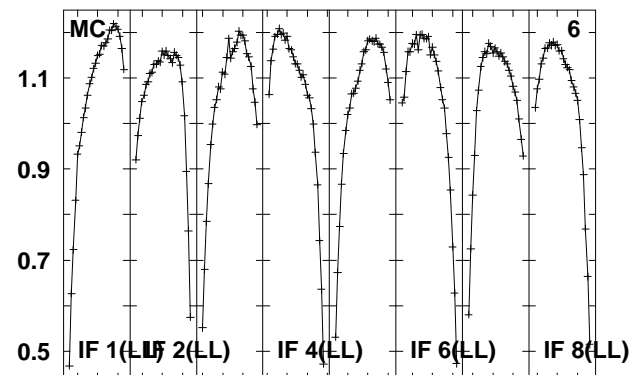
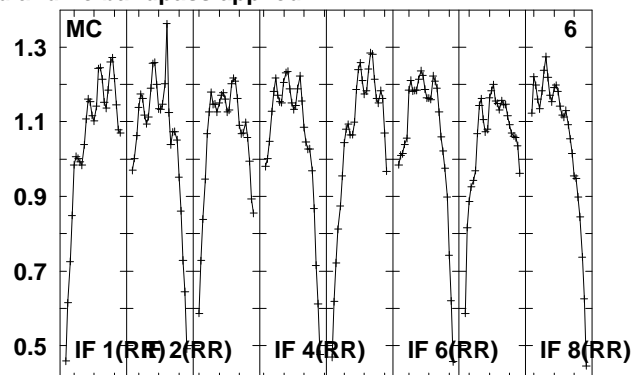
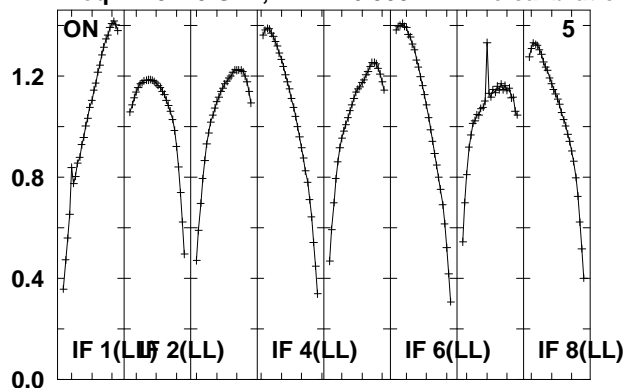

Lower frame: Real Jy

Total-power spectrum Antenna: *

Timerange: 00/05:45:35 to 00/05:47:03

Plot file version 115 created 14-MAY-2010 15:17:36

J210358 EO007.UVDATA.1

Freq = 4.9270 GHz, Bw = 16.000 MH No calibration applied and no bandpass applied

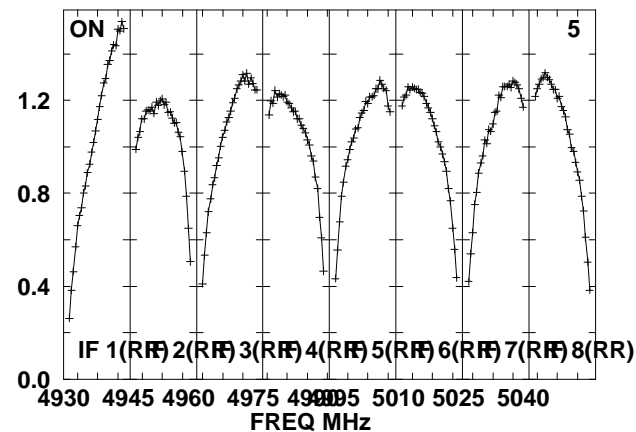
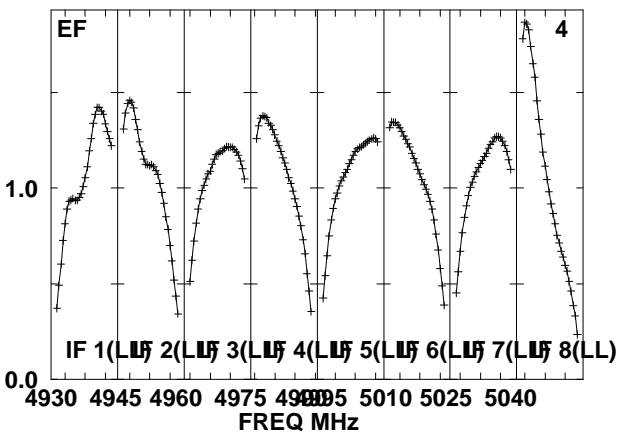
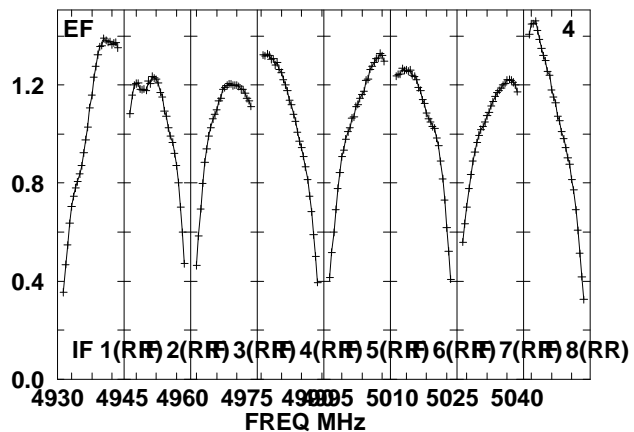
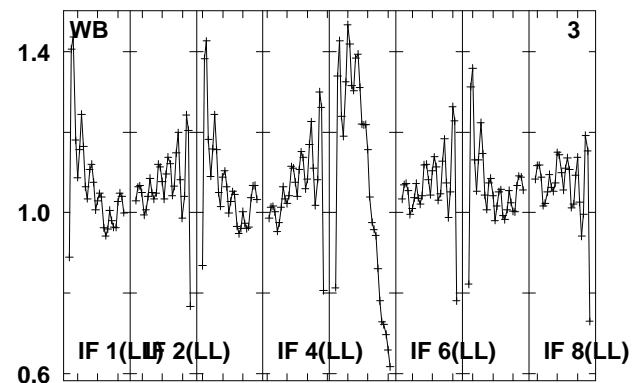
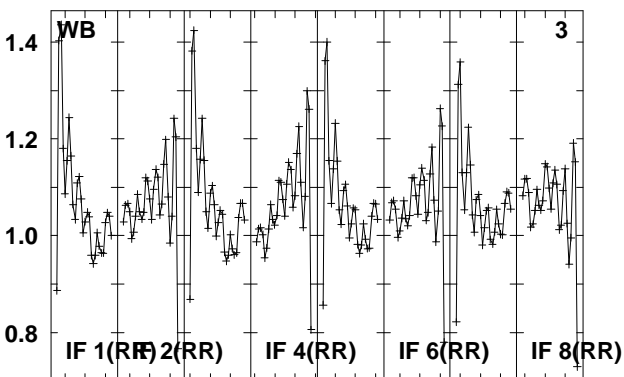
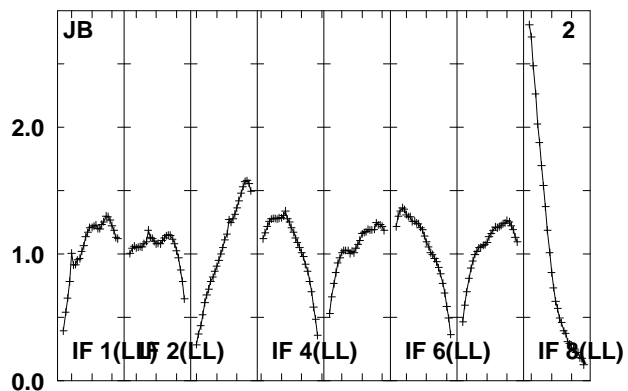
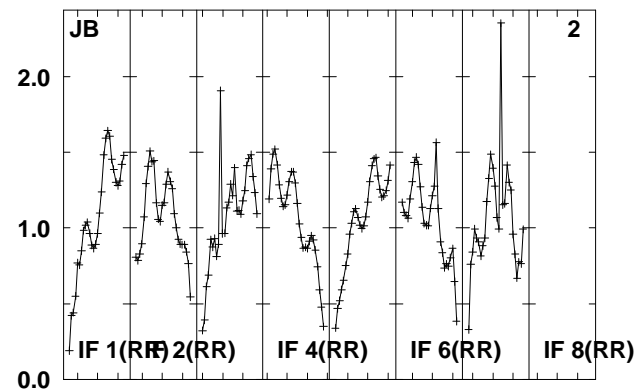
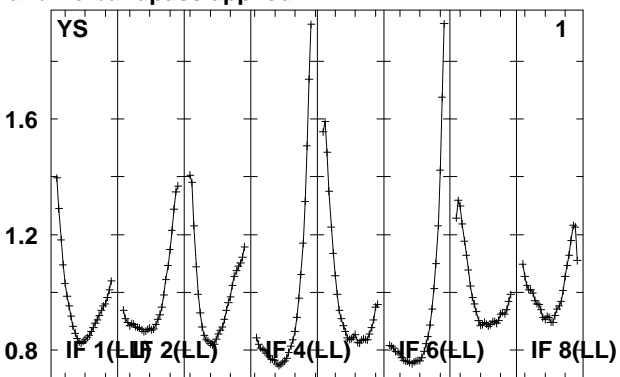
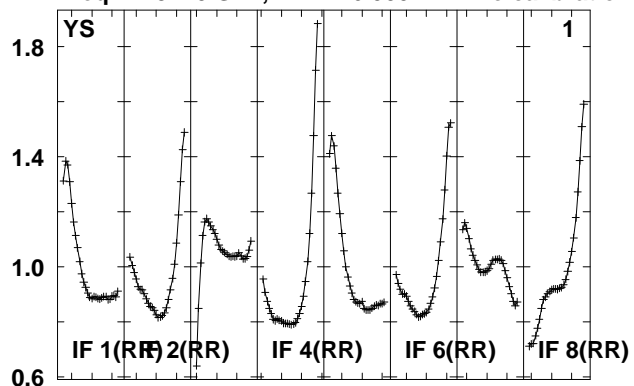

Lower frame: Real Jy
Total-power spectrum Antenna: *
Timerange: 00/05:47:43 to 00/05:52:37

Plot file version 116 created 14-MAY-2010 15:17:36

J210358 EO007.UVDATA.1

Freq = 4.9270 GHz, Bw = 16.000 MH No calibration applied and no bandpass applied

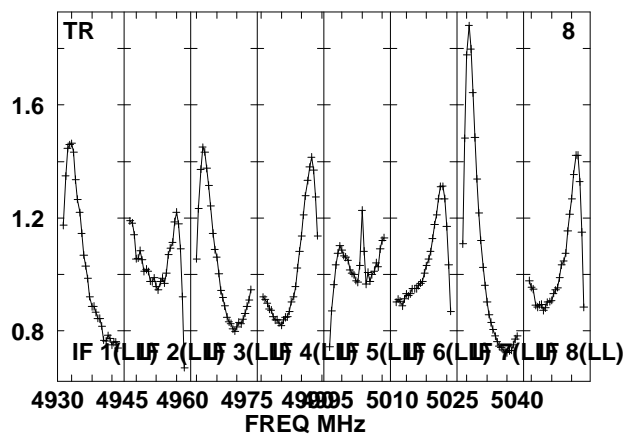
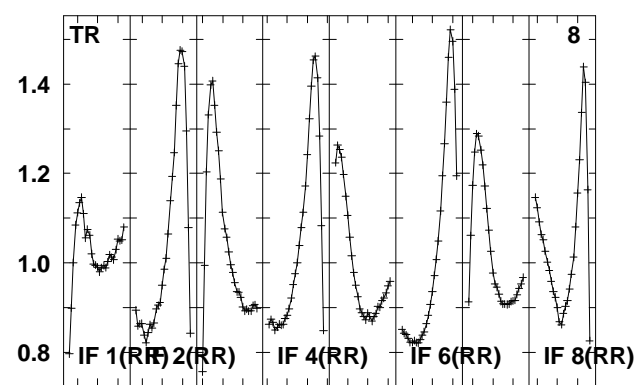
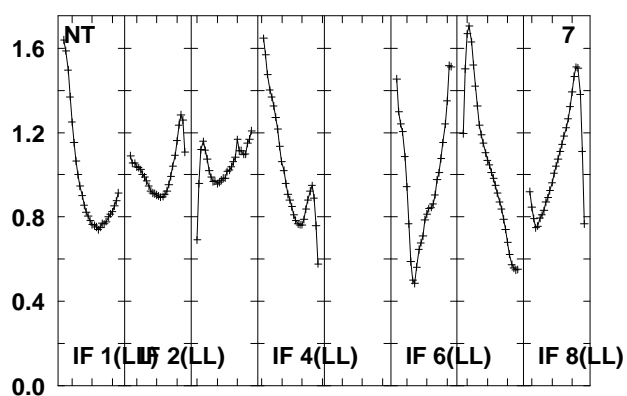
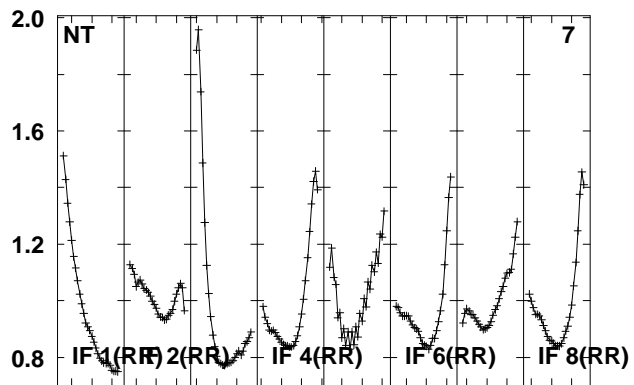
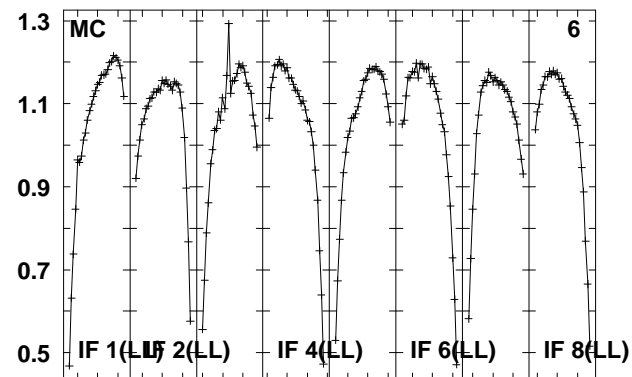
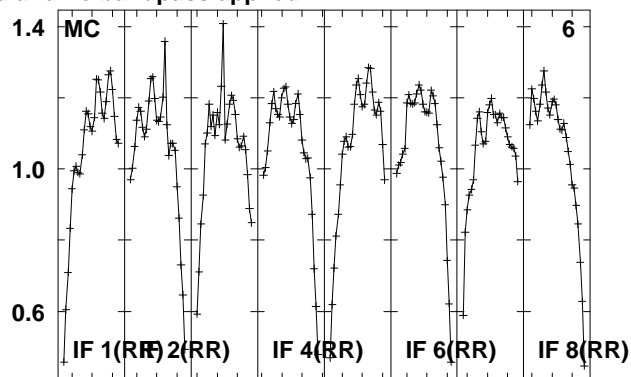
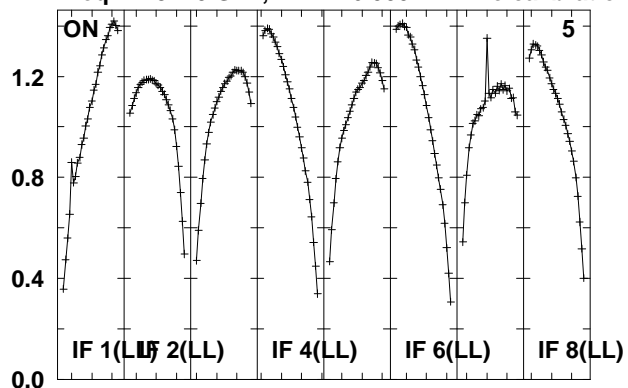

Lower frame: Real Jy

Total-power spectrum Antenna: *

Timerange: 00/05:47:43 to 00/05:52:37

Plot file version 117 created 14-MAY-2010 15:17:37

J2110-10 EO007.UVDATA.1

Freq = 4.9270 GHz, Bw = 16.000 MH No calibration applied and no bandpass applied

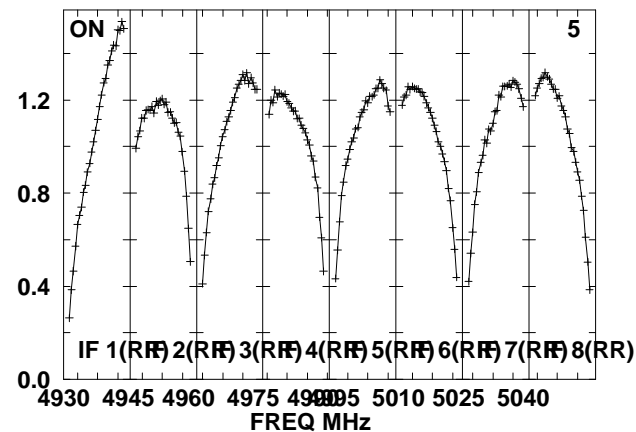
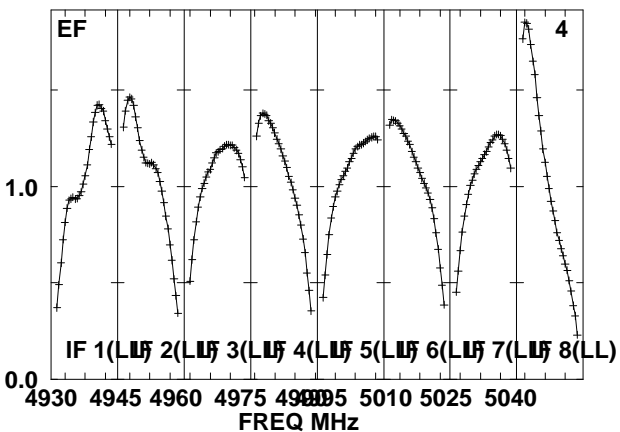
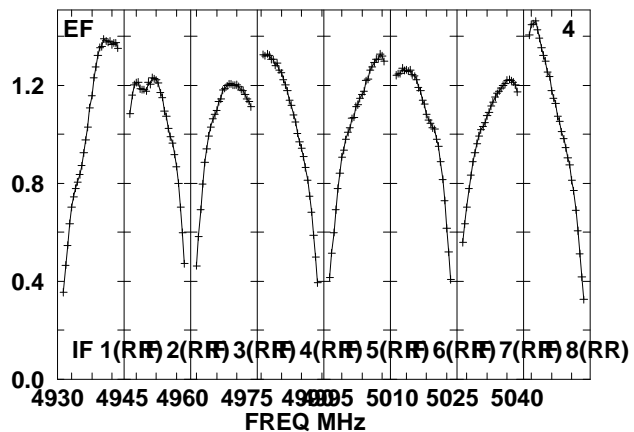
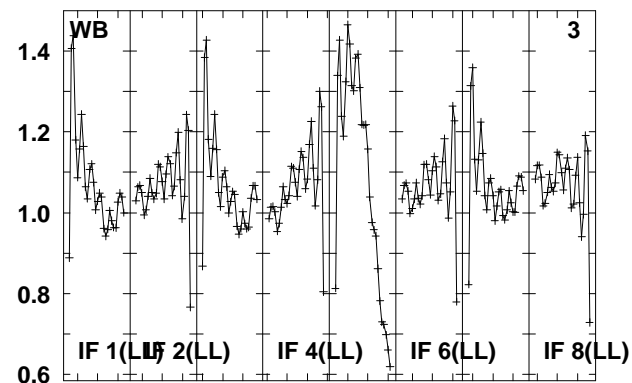
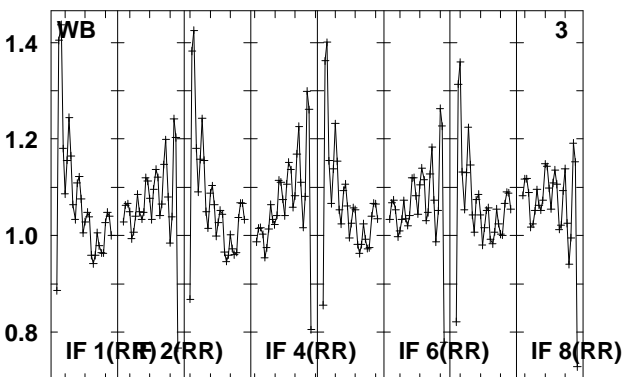
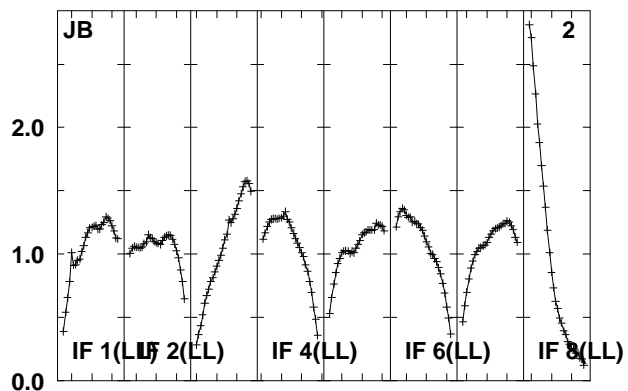
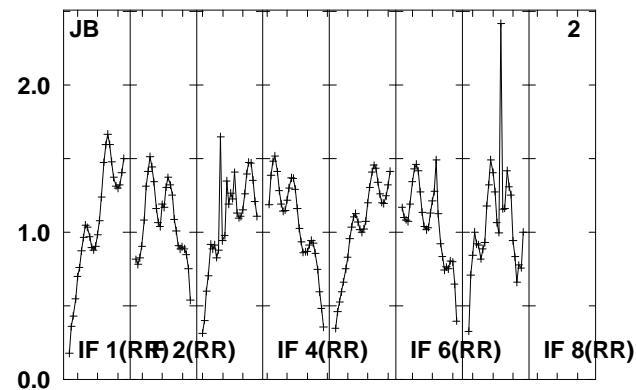
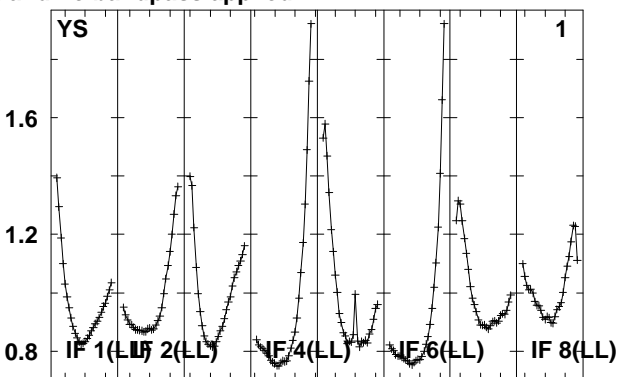
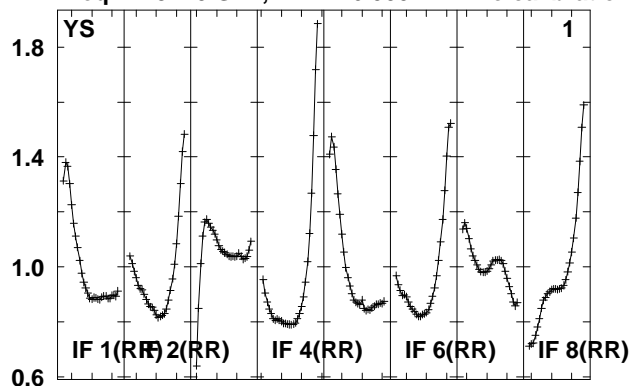

Lower frame: Real Jy

Total-power spectrum Antenna: *

Timerange: 00/05:53:19 to 00/05:54:45

Plot file version 118 created 14-MAY-2010 15:17:37

J2110-10 EO007.UVDATA.1

Freq = 4.9270 GHz, Bw = 16.000 MH No calibration applied and no bandpass applied

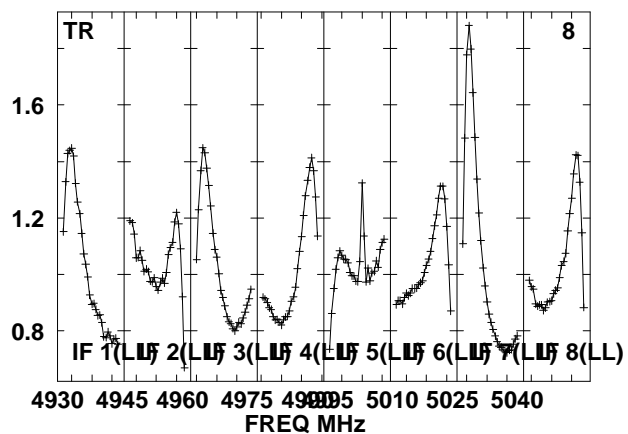
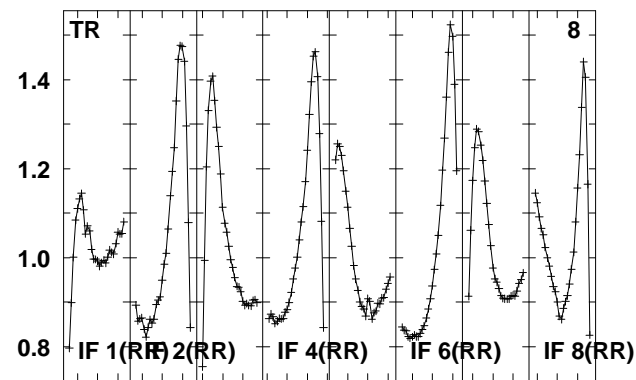
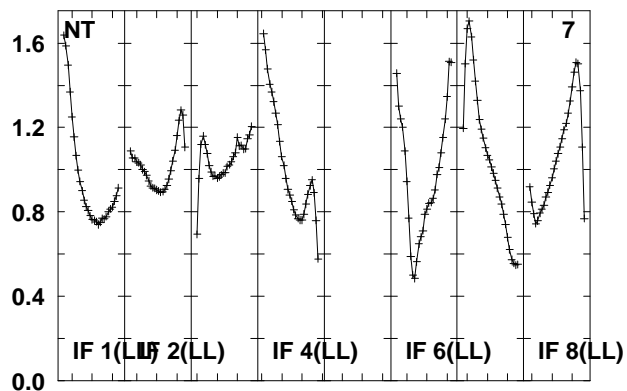
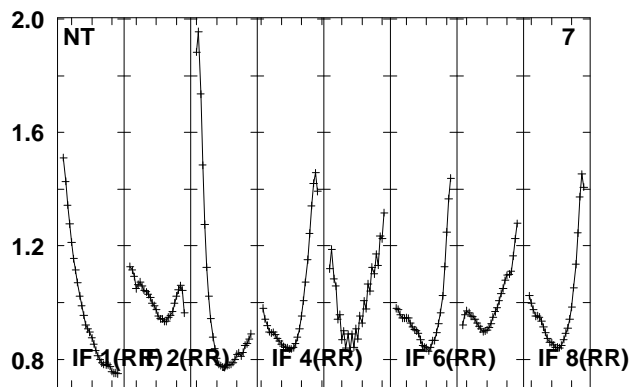
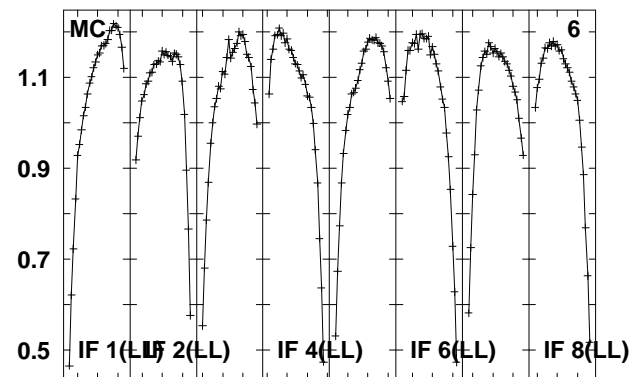
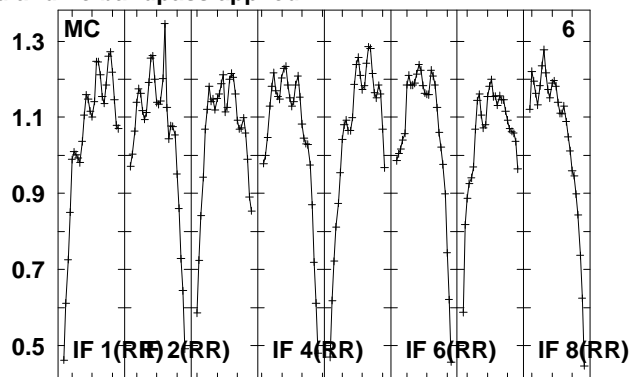
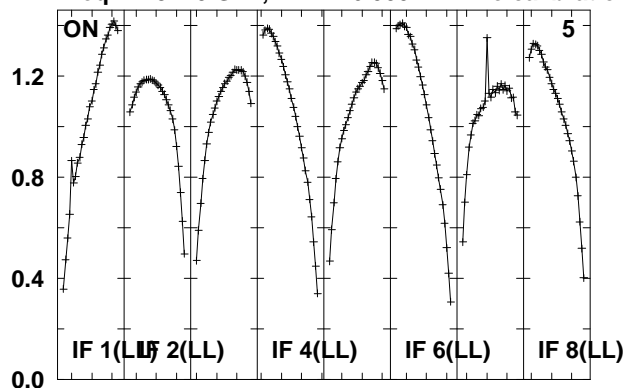

Lower frame: Real Jy

Total-power spectrum Antenna: *

Timerange: 00/05:53:19 to 00/05:54:45

Plot file version 119 created 14-MAY-2010 15:17:37

J210358 EO007.UVDATA.1

Freq = 4.9270 GHz, Bw = 16.000 MH No calibration applied and no bandpass applied

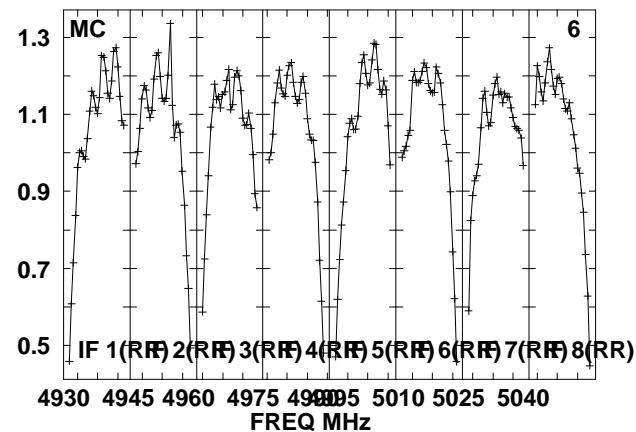
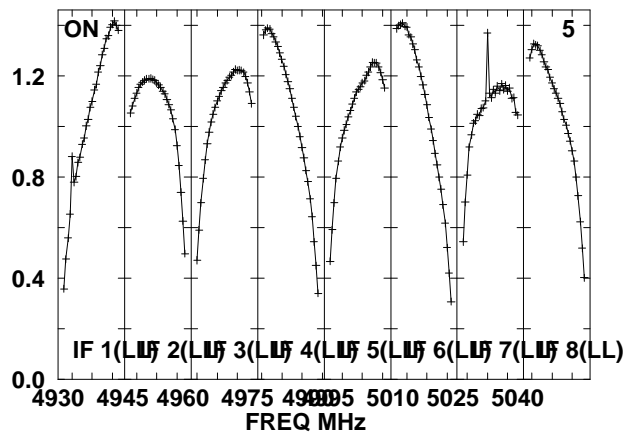
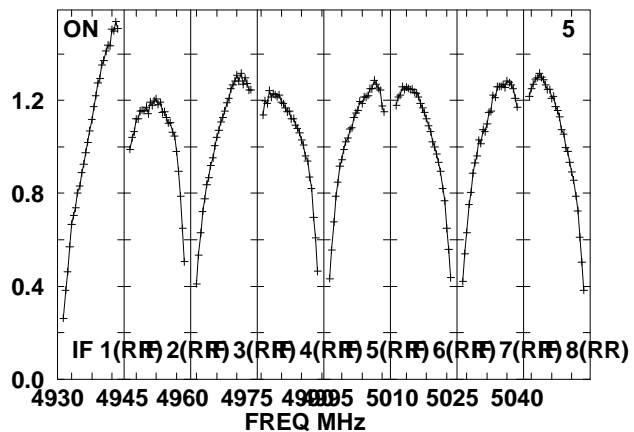
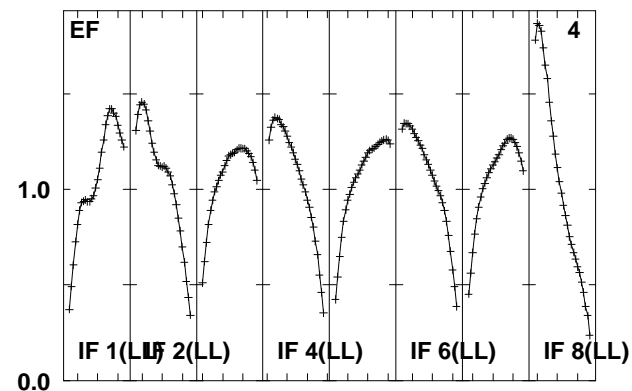
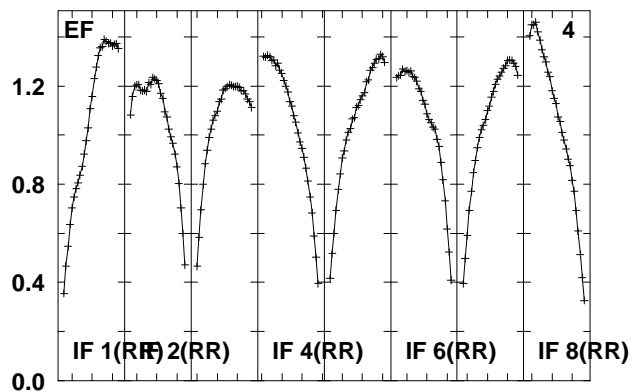
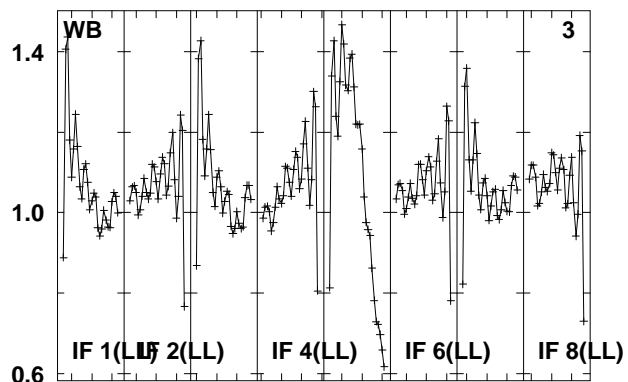
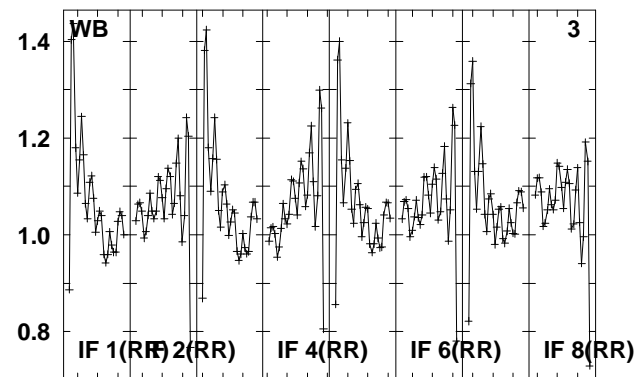
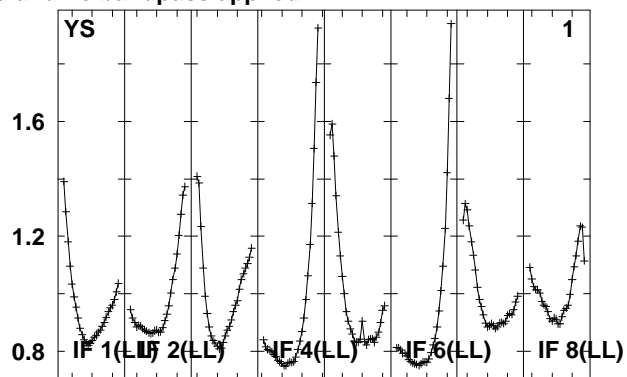
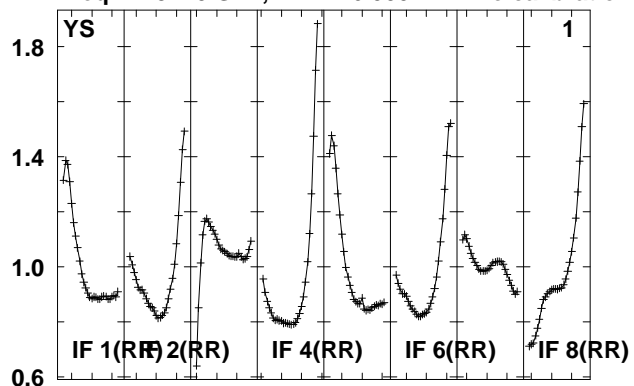

Lower frame: Real Jy
Total-power spectrum Antenna: *
Timerange: 00/05:55:23 to 00/06:00:19

Plot file version 120 created 14-MAY-2010 15:17:38

J210358 EO007.UVDATA.1

Freq = 4.9270 GHz, Bw = 16.000 MH No calibration applied and no bandpass applied

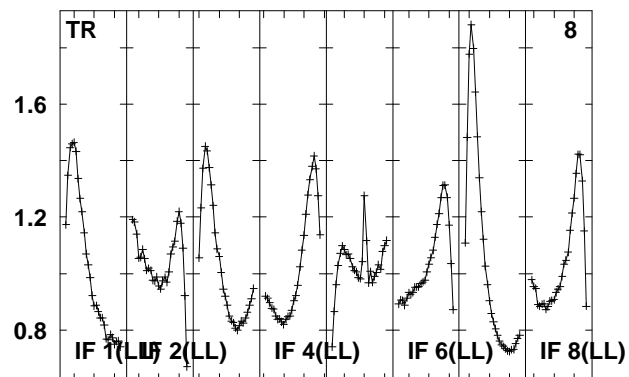
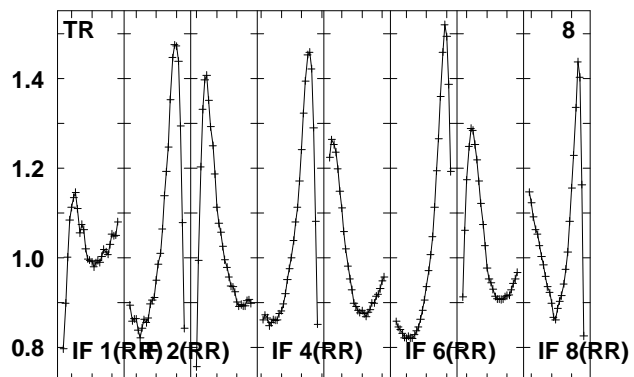
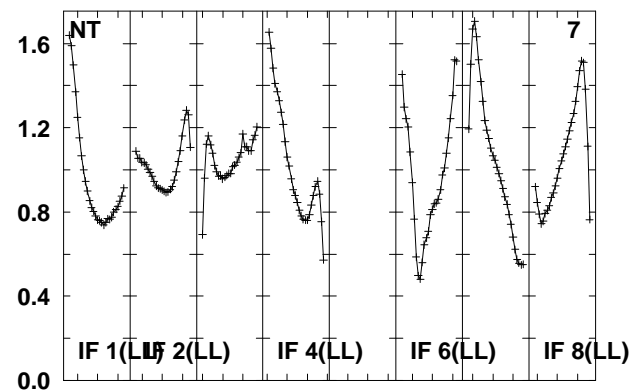
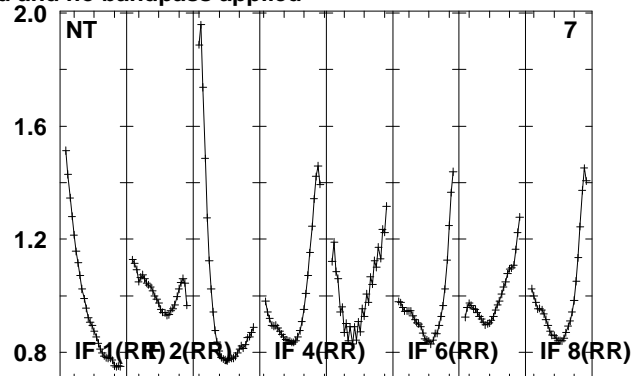
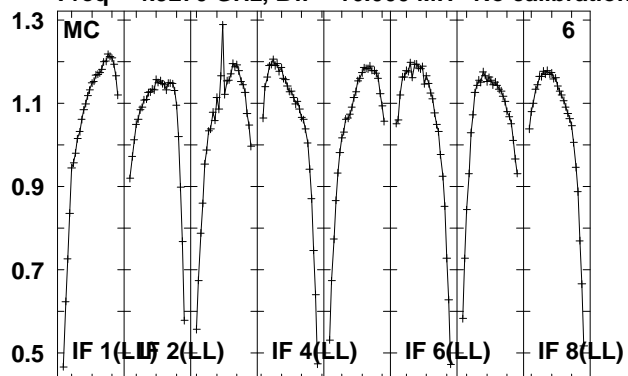

Lower frame: Real Jy
Total-power spectrum Antenna: *
Timerange: 00/05:55:23 to 00/06:00:19

Plot file version 121 created 14-MAY-2010 15:17:39

J2110-10 EO007.UVDATA.1

Freq = 4.9270 GHz, Bw = 16.000 MH No calibration applied and no bandpass applied

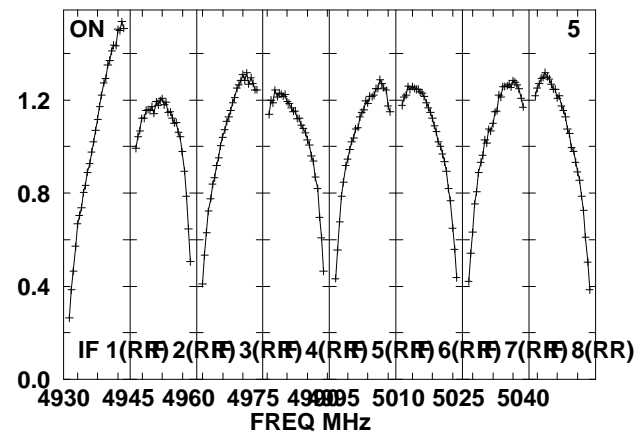
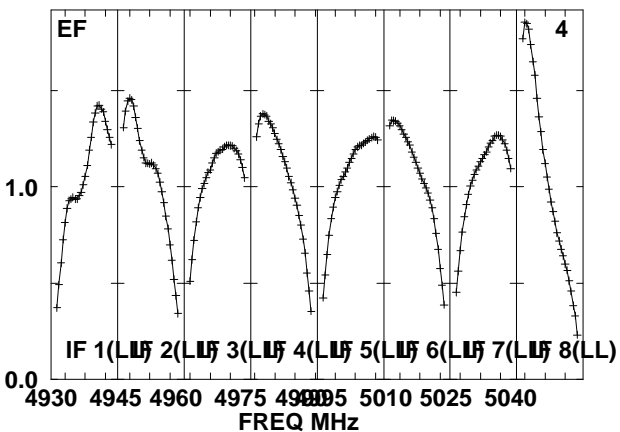
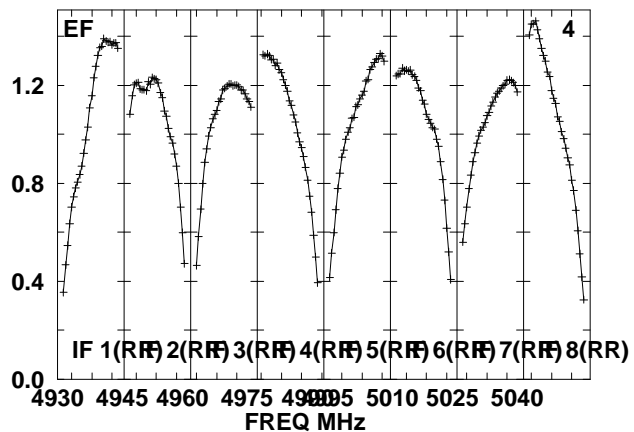
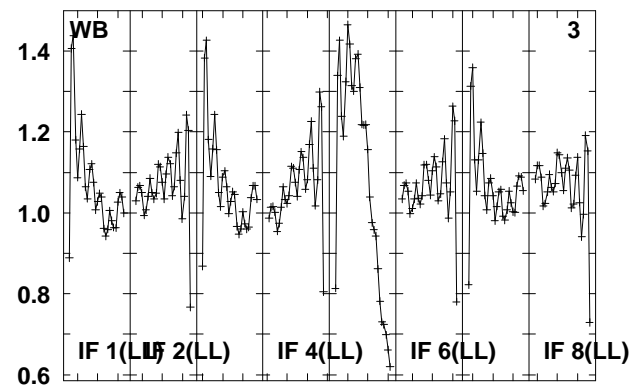
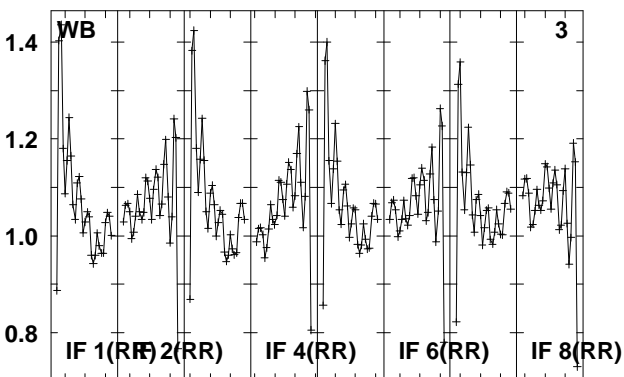
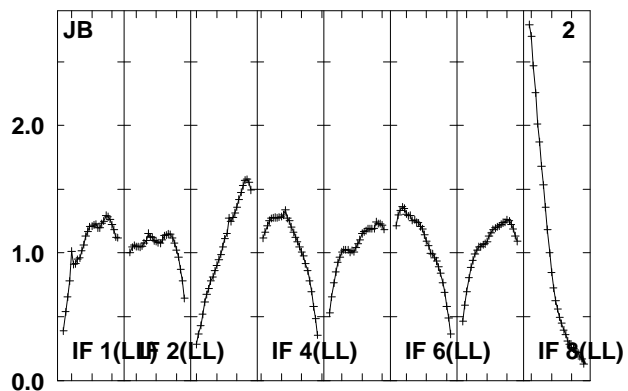
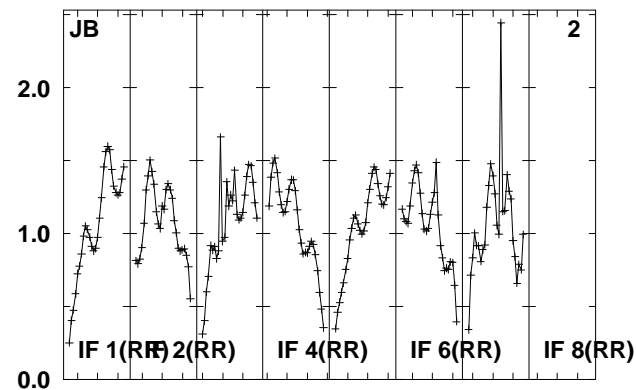
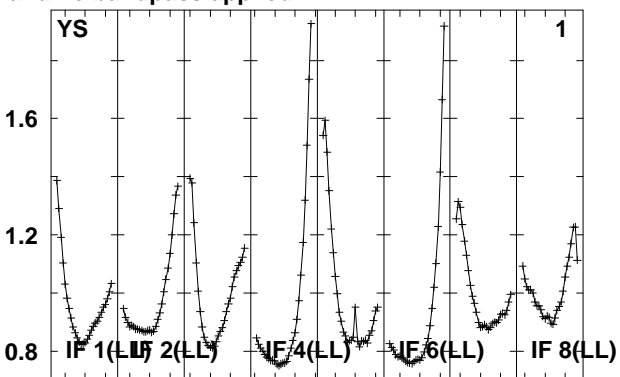
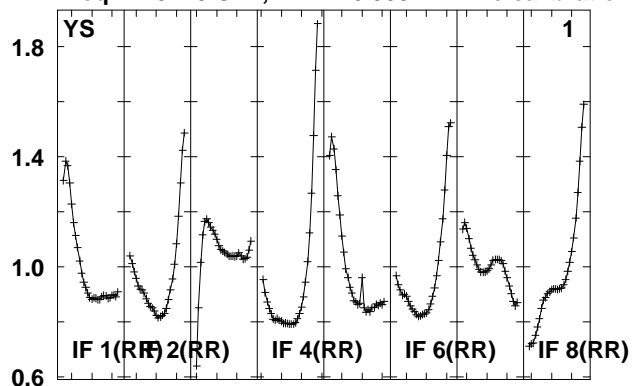

Lower frame: Real Jy

Total-power spectrum Antenna: *

Timerange: 00/06:00:58 to 00/06:02:26

Plot file version 122 created 14-MAY-2010 15:17:39

J2110-10 EO007.UVDATA.1

Freq = 4.9270 GHz, Bw = 16.000 MH No calibration applied and no bandpass applied

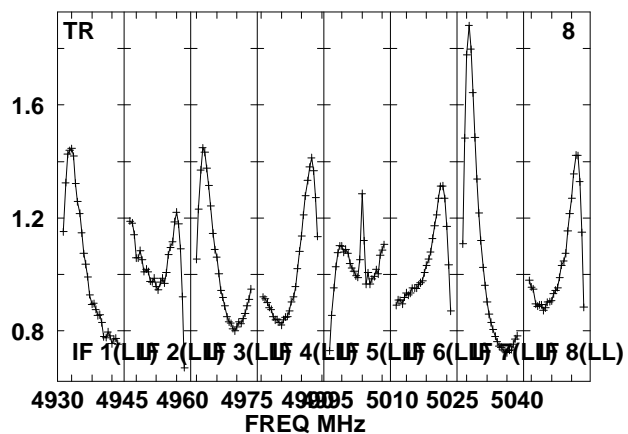
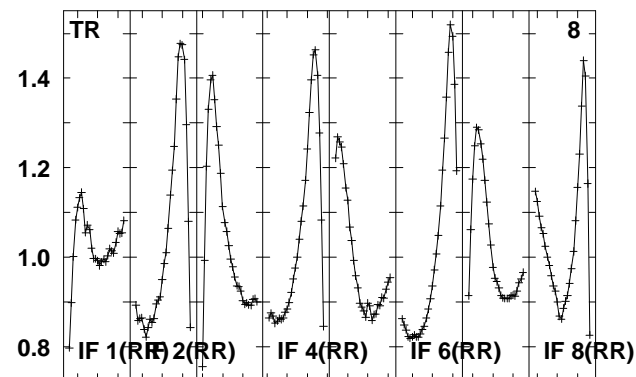
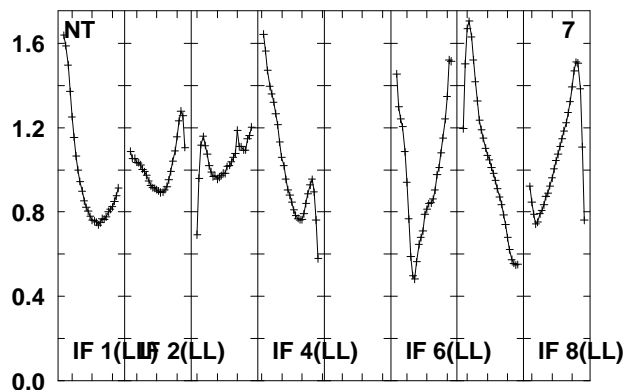
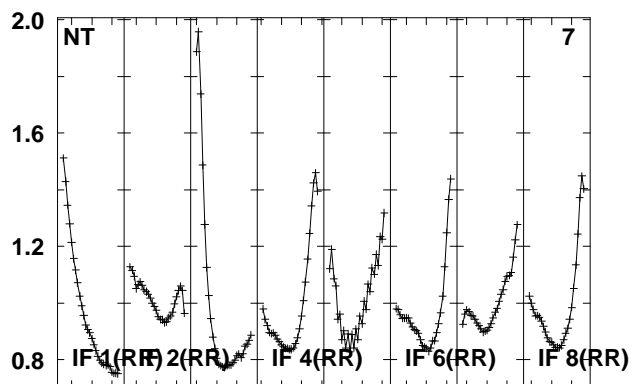
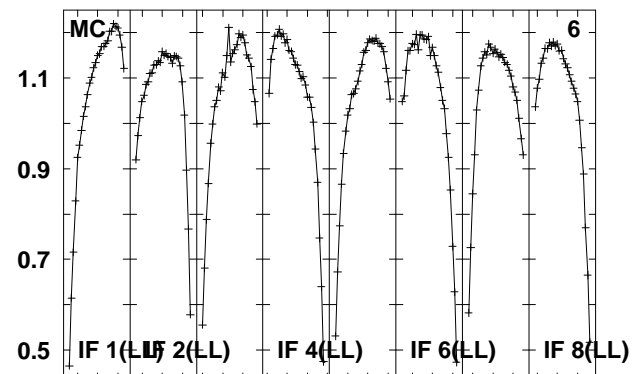
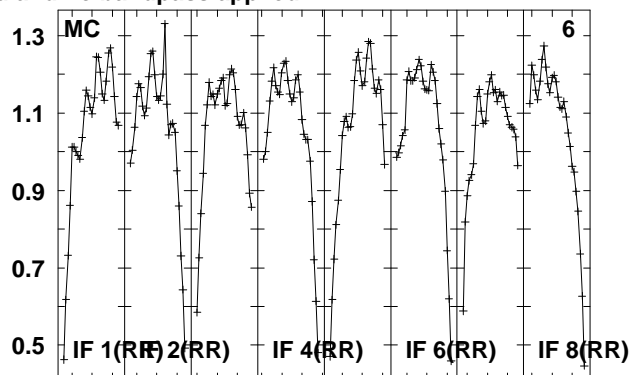
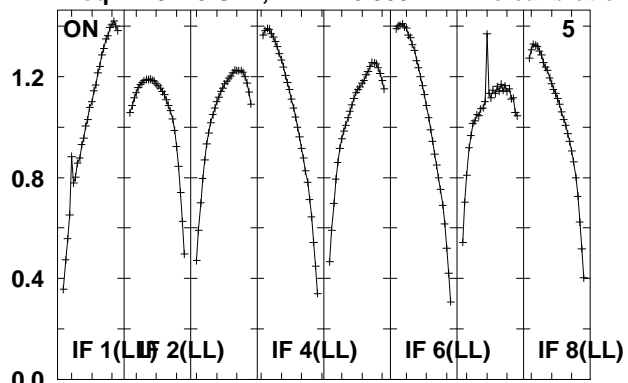

Lower frame: Real Jy

Total-power spectrum Antenna: *

Timerange: 00/06:00:58 to 00/06:02:26

Plot file version 123 created 14-MAY-2010 15:17:39

J210358 EO007.UVDATA.1

Freq = 4.9270 GHz, Bw = 16.000 MH No calibration applied and no bandpass applied

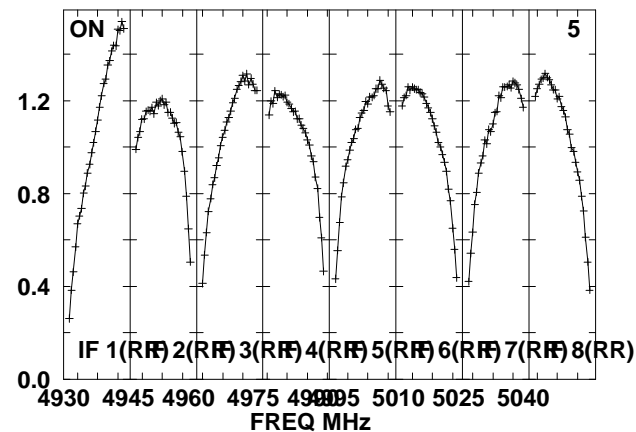
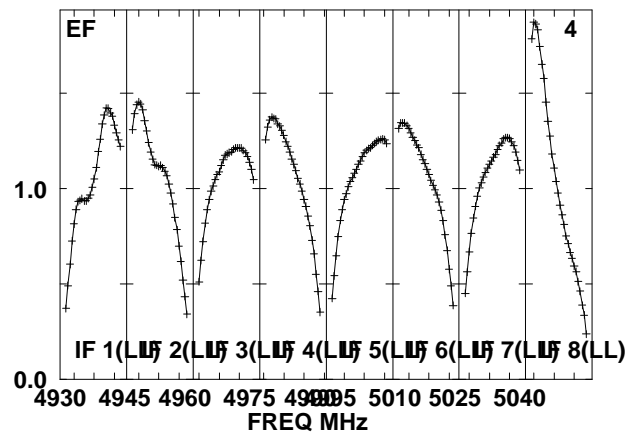
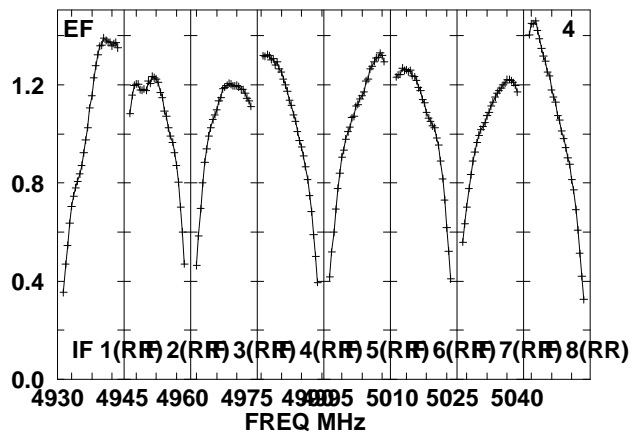
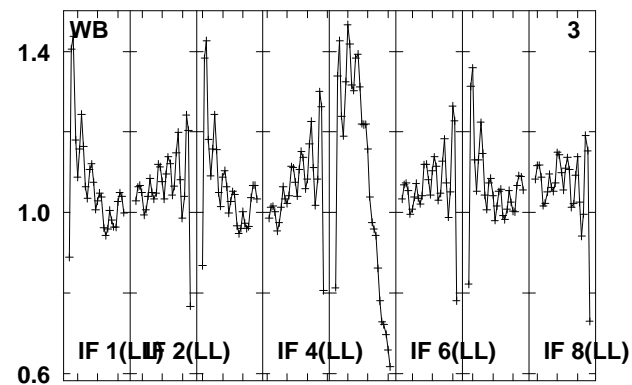
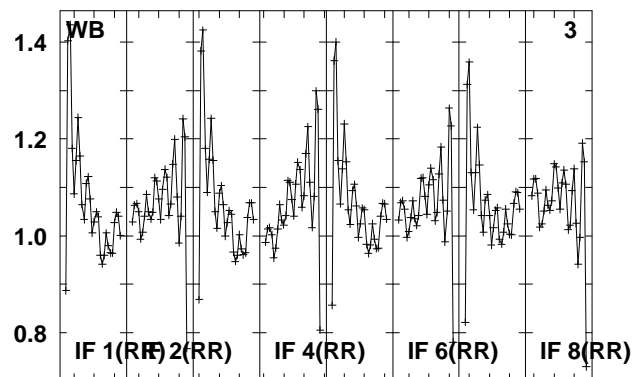
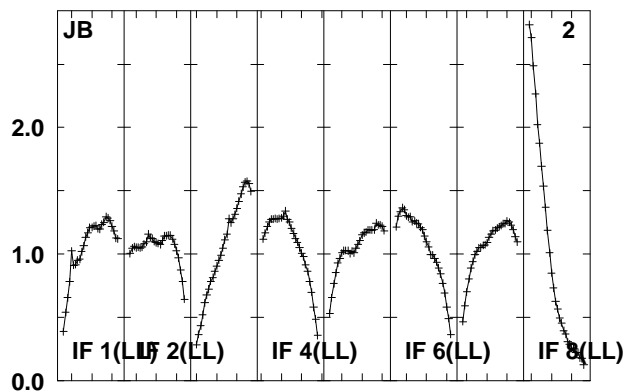
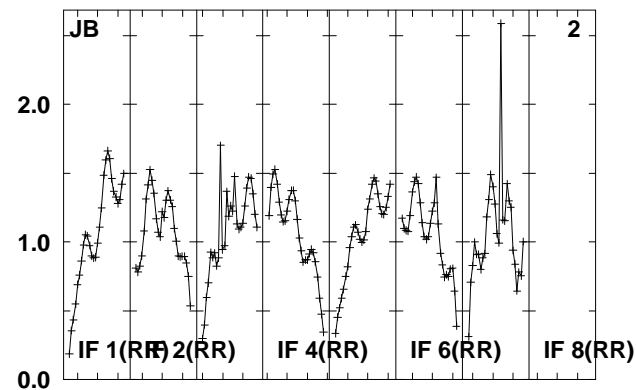
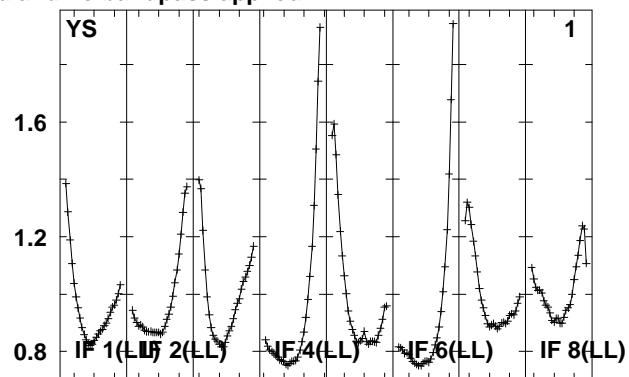
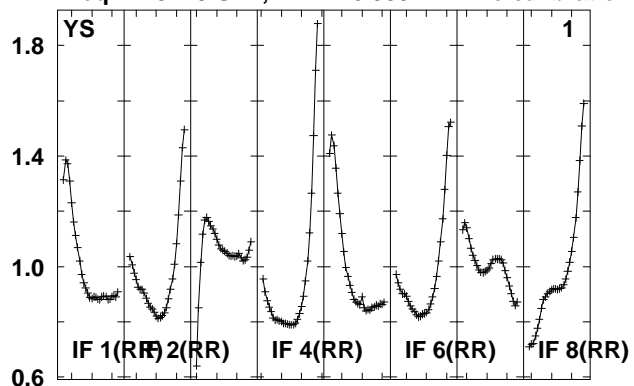

Lower frame: Real Jy

Total-power spectrum Antenna: *

Timerange: 00/06:03:06 to 00/06:08:00

Plot file version 124 created 14-MAY-2010 15:17:40

J210358 EO007.UVDATA.1

Freq = 4.9270 GHz, Bw = 16.000 MH No calibration applied and no bandpass applied

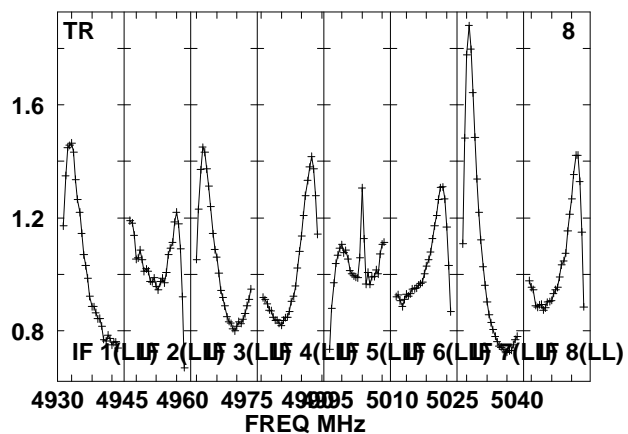
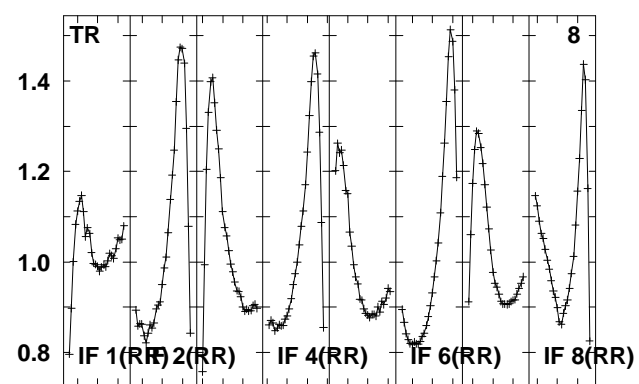
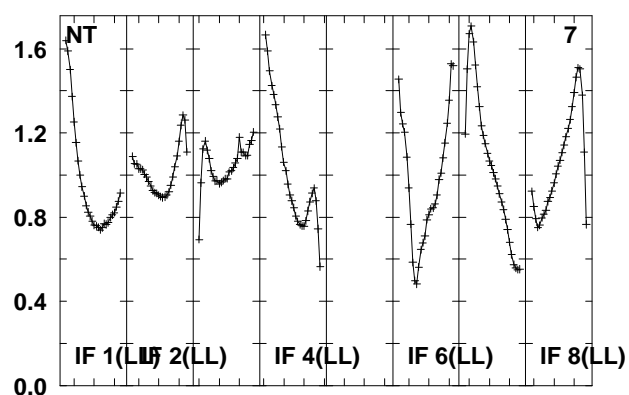
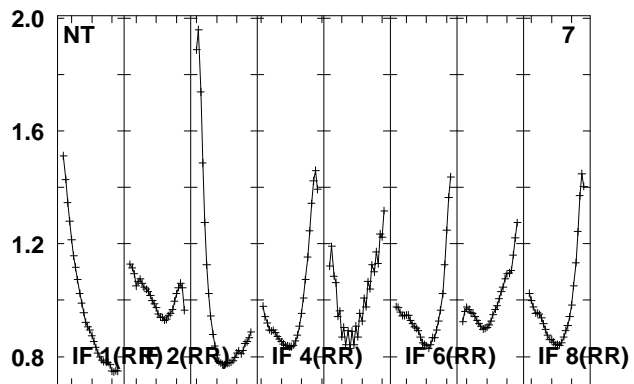
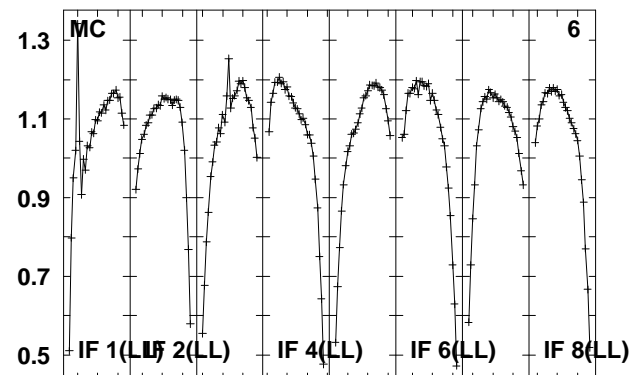
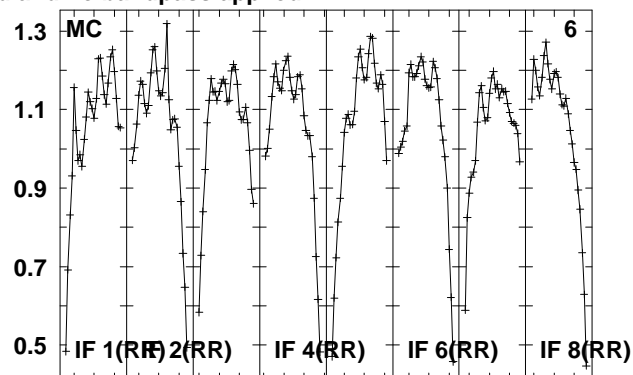
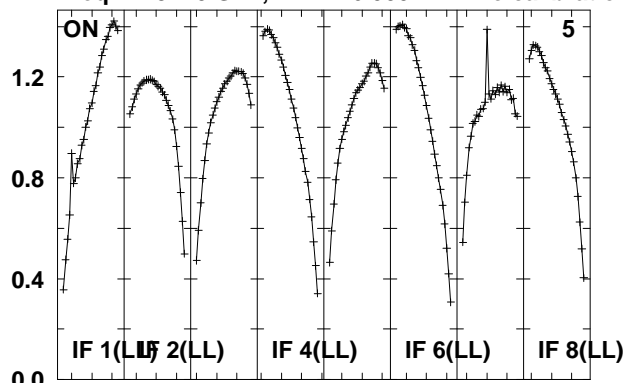

Lower frame: Real Jy

Total-power spectrum Antenna: *

Timerange: 00/06:03:06 to 00/06:08:00

Plot file version 125 created 14-MAY-2010 15:17:40

J2110-10 EO007.UVDATA.1

Freq = 4.9270 GHz, Bw = 16.000 MH No calibration applied and no bandpass applied

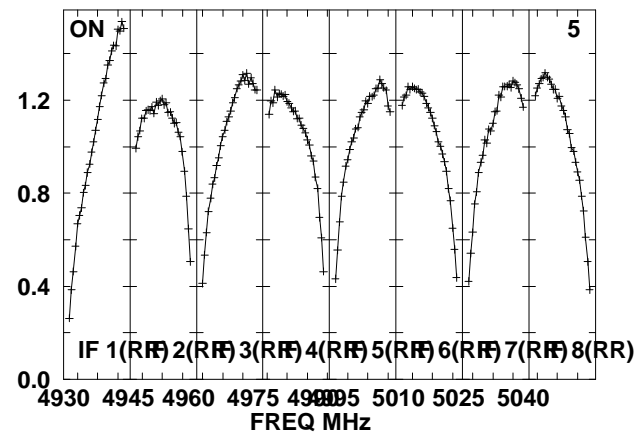
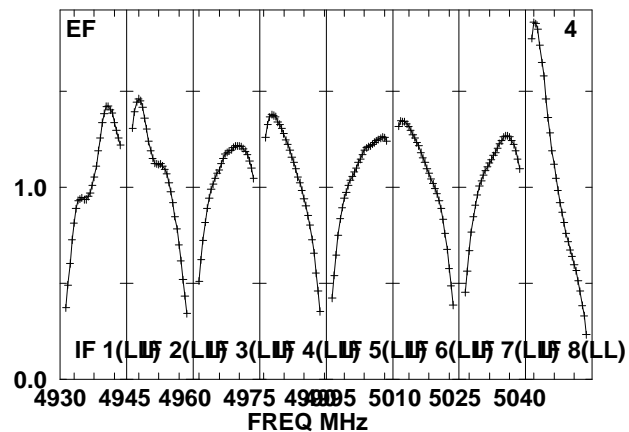
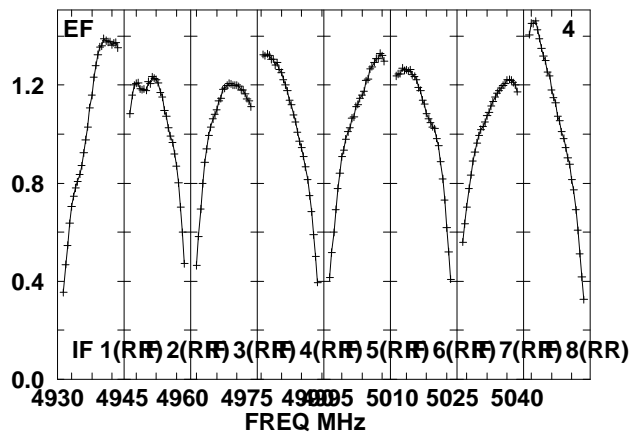
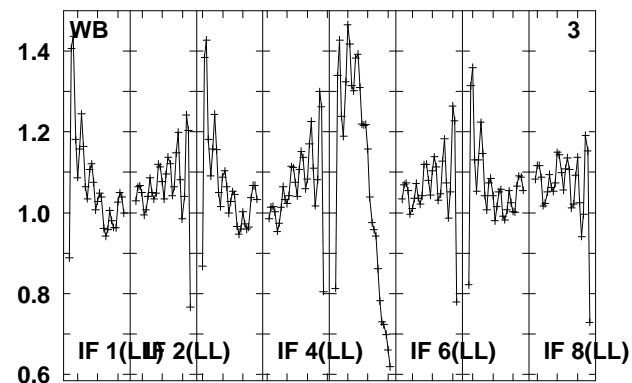
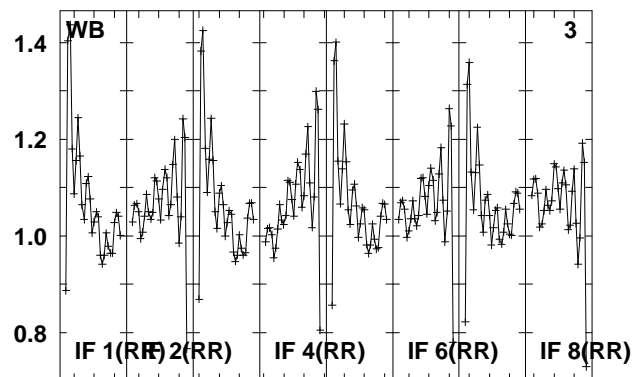
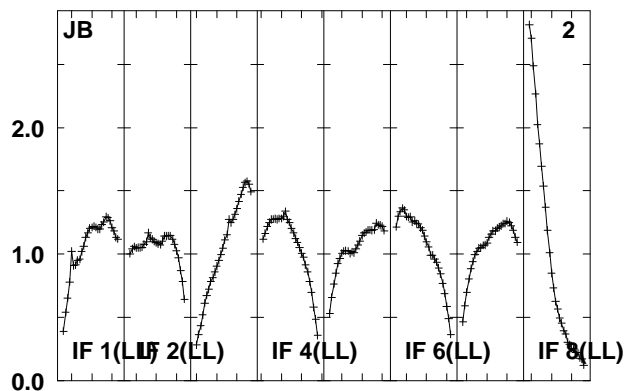
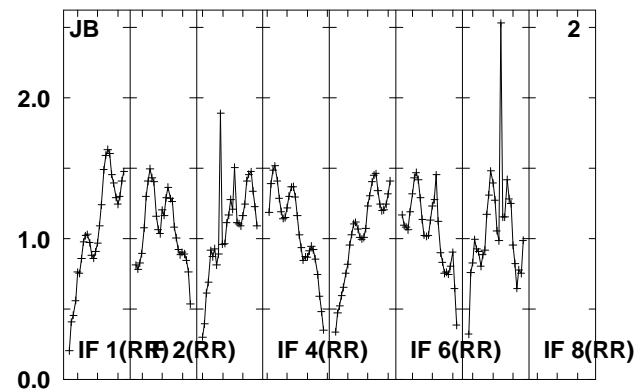
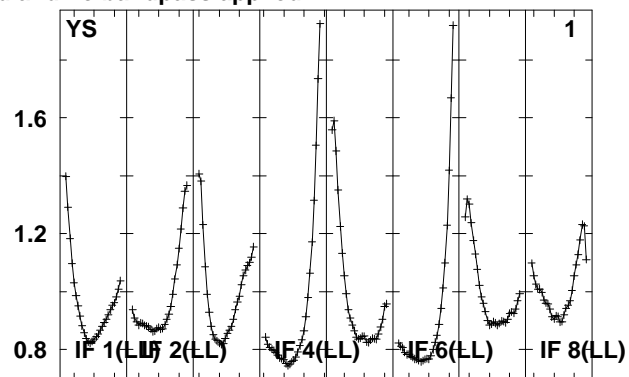
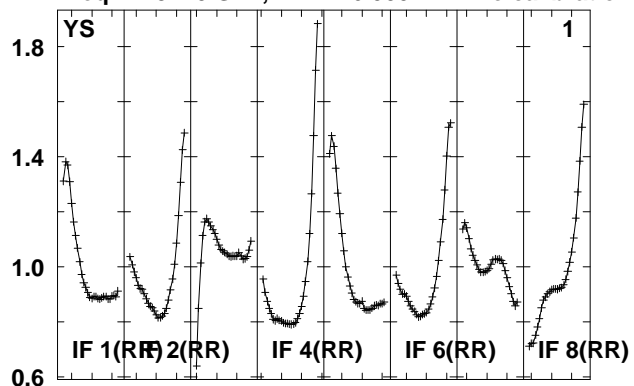

Lower frame: Real Jy

Total-power spectrum Antenna: *

Timerange: 00/06:08:41 to 00/06:10:09

Plot file version 126 created 14-MAY-2010 15:17:40

J2110-10 EO007.UVDATA.1

Freq = 4.9270 GHz, Bw = 16.000 MH No calibration applied and no bandpass applied

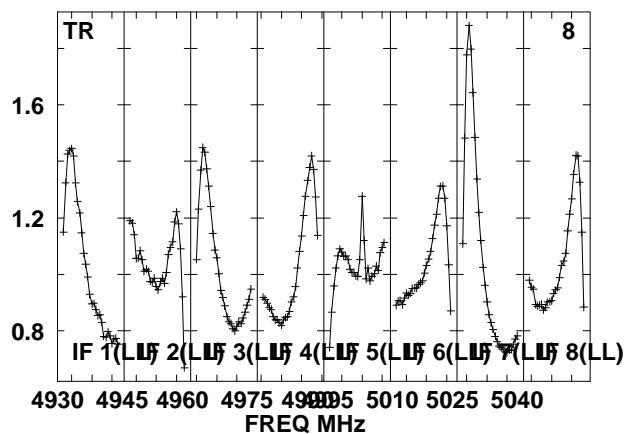
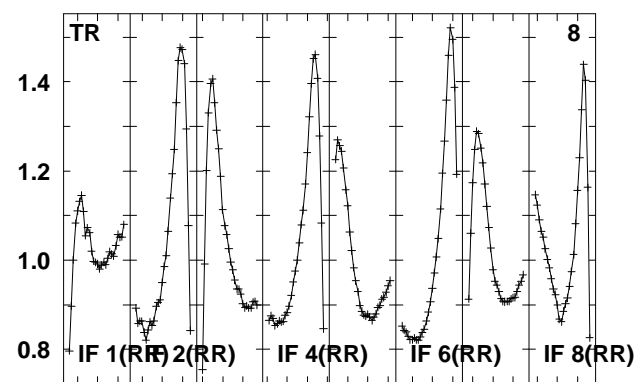
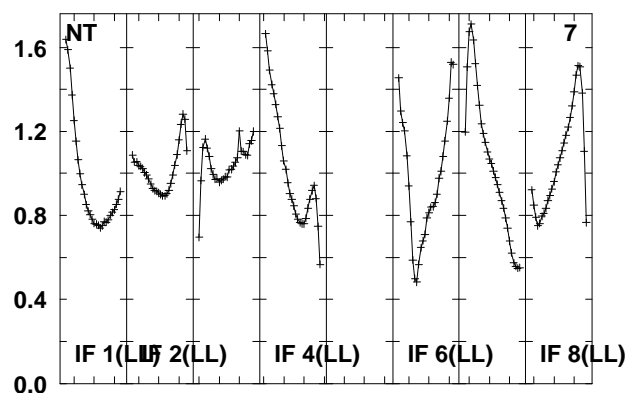
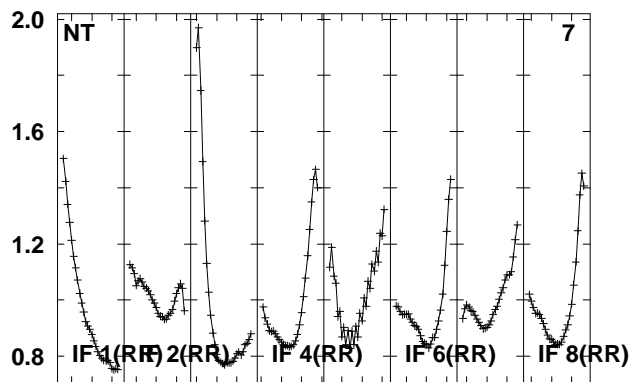
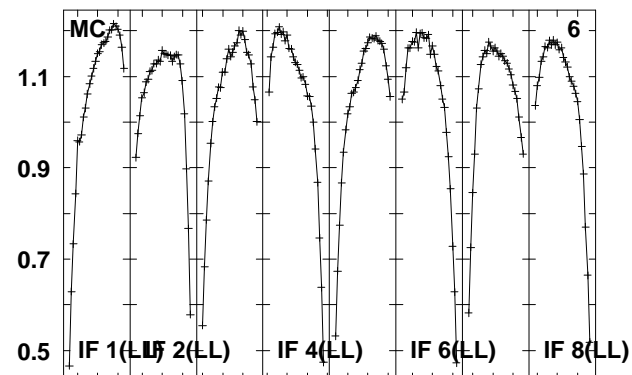
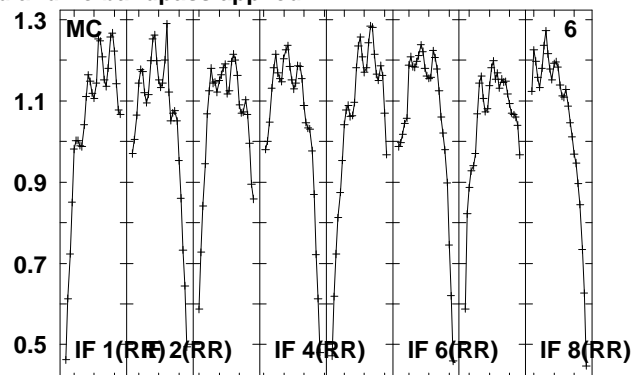
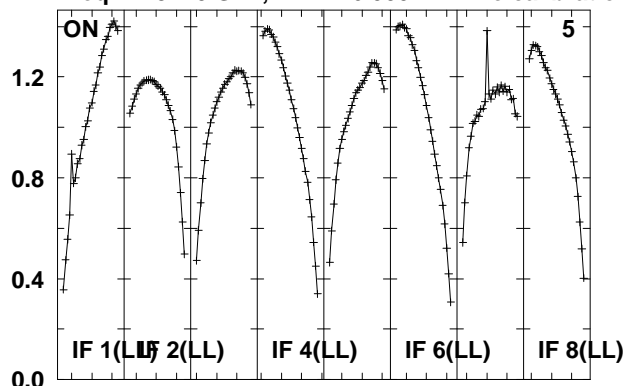

Lower frame: Real Jy

Total-power spectrum Antenna: *

Timerange: 00/06:08:41 to 00/06:10:09

Plot file version 127 created 14-MAY-2010 15:17:41
 J210358 EO007.UVDATA.1
 Freq = 4.9270 GHz, Bw = 16.000 MH No calibration applied and no bandpass applied

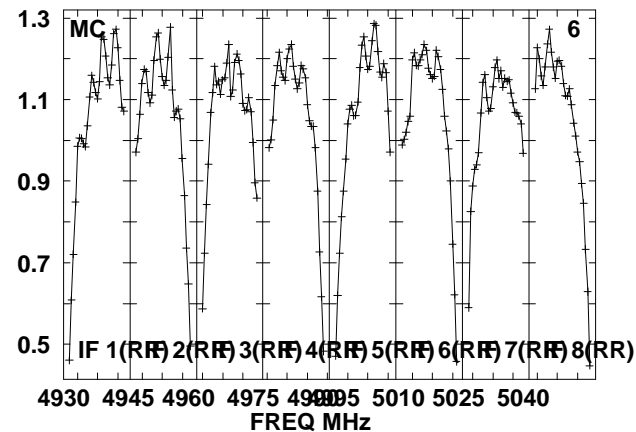
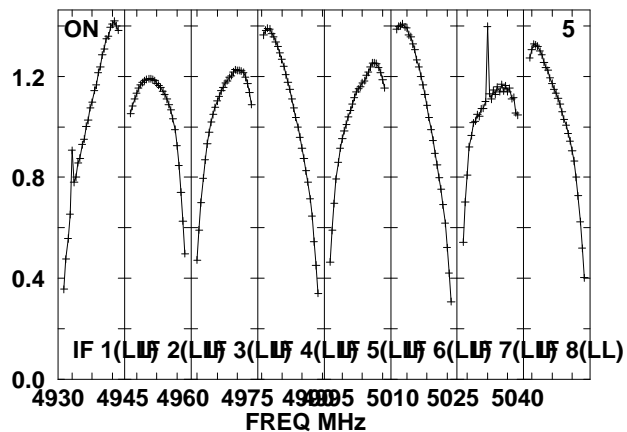
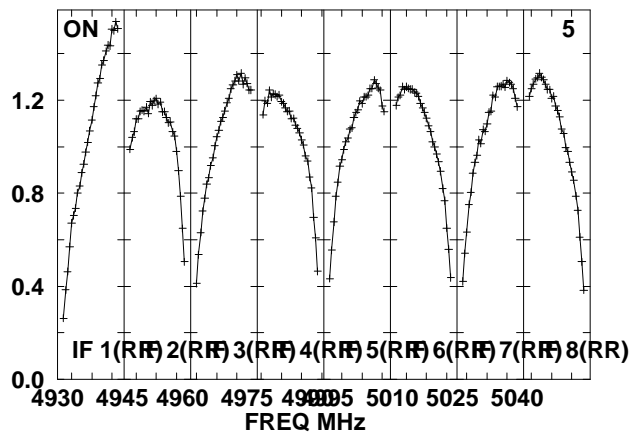
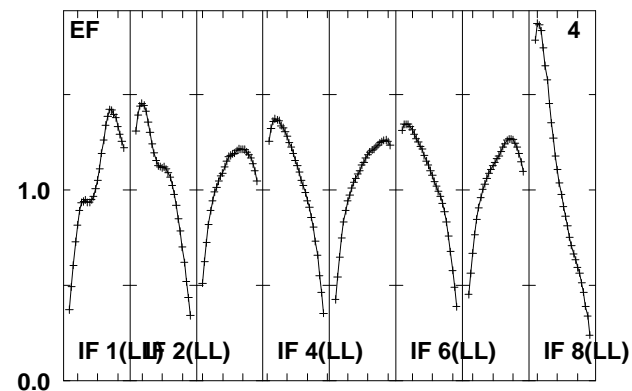
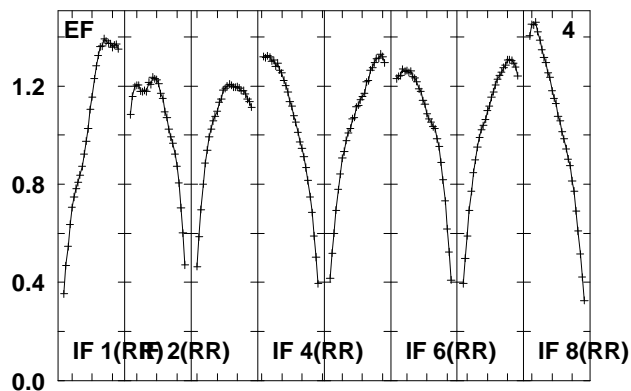
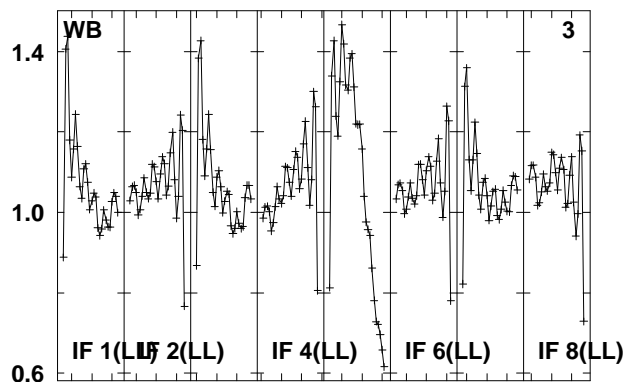
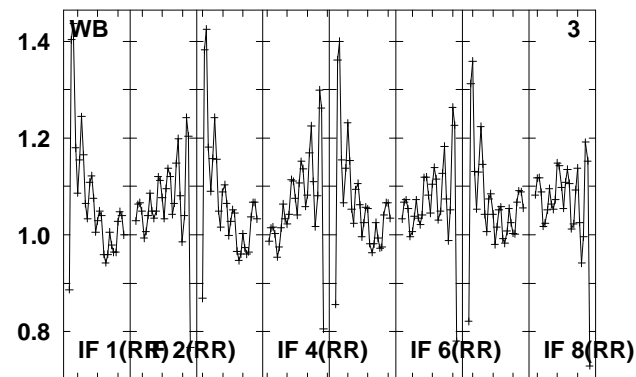
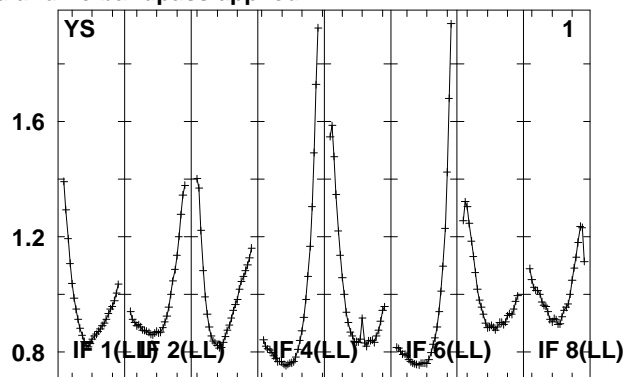
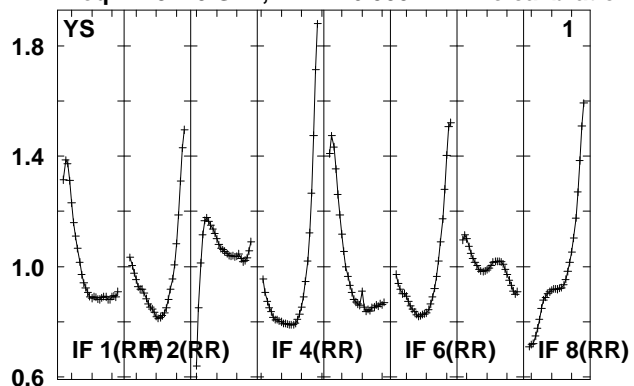

Lower frame: Real Jy
 Total-power spectrum Antenna: *
 Timerange: 00/06:10:46 to 00/06:15:42

Plot file version 128 created 14-MAY-2010 15:17:41

J210358 EO007.UVDATA.1

Freq = 4.9270 GHz, Bw = 16.000 MH No calibration applied and no bandpass applied

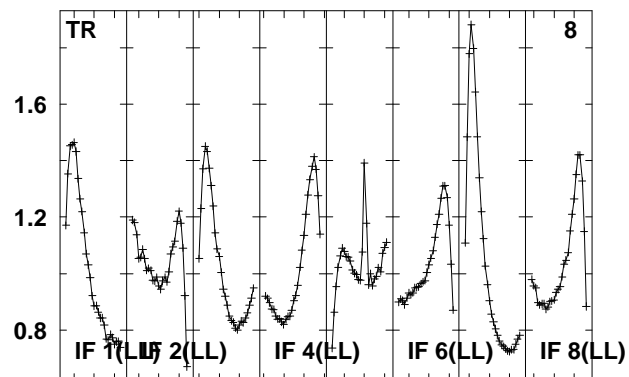
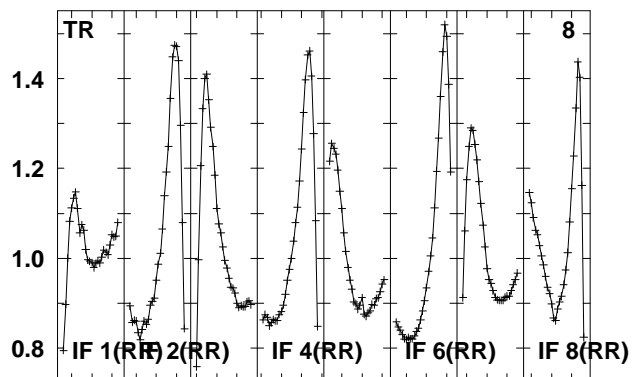
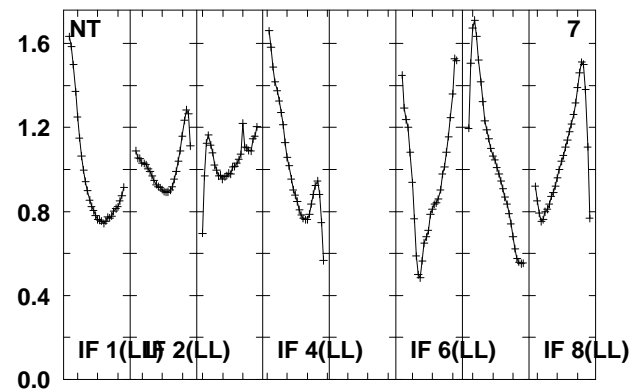
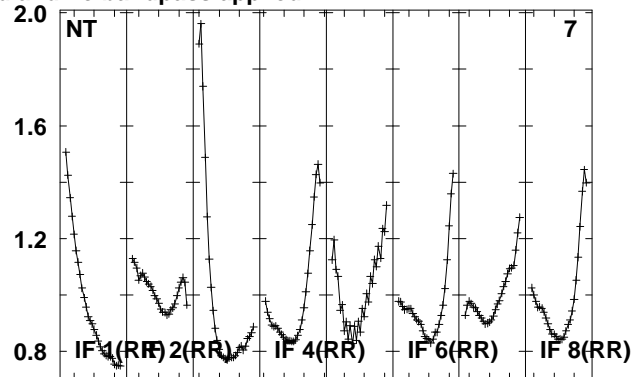
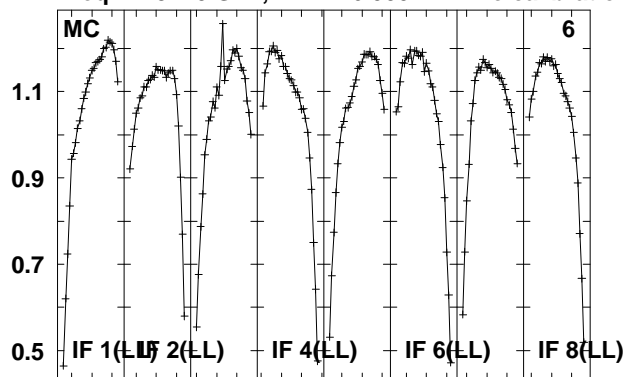

Lower frame: Real Jy
Total-power spectrum Antenna: *
Timerange: 00/06:10:46 to 00/06:15:42

Plot file version 129 created 14-MAY-2010 15:17:42

J2110-10 EO007.UVDATA.1

Freq = 4.9270 GHz, Bw = 16.000 MH No calibration applied and no bandpass applied

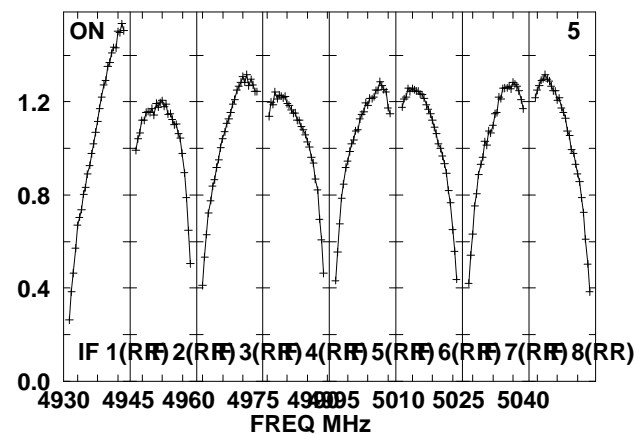
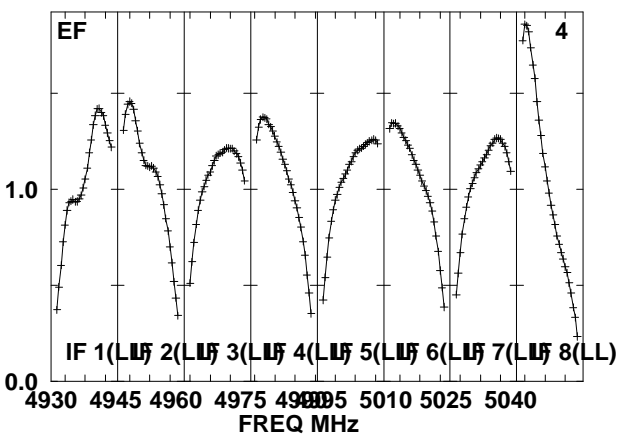
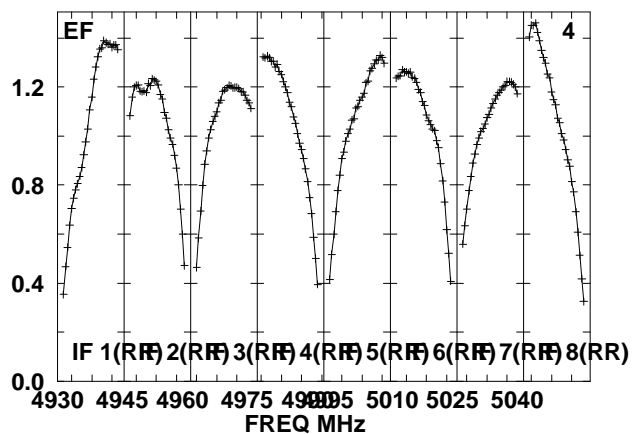
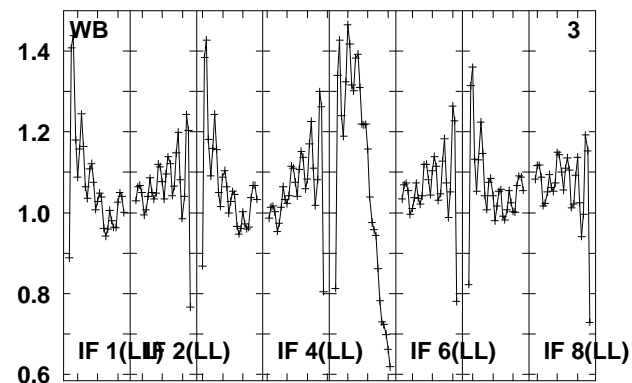
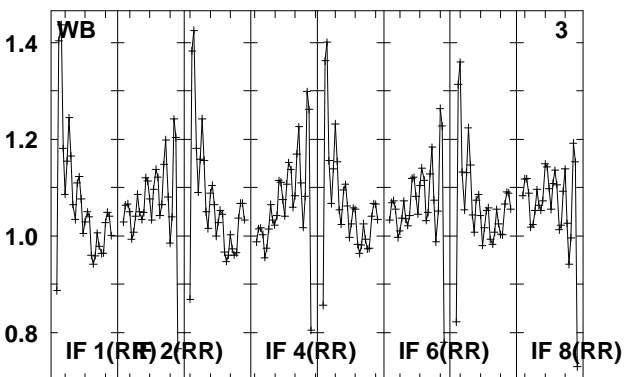
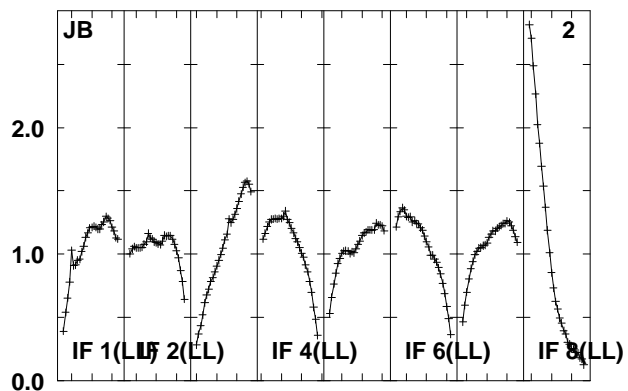
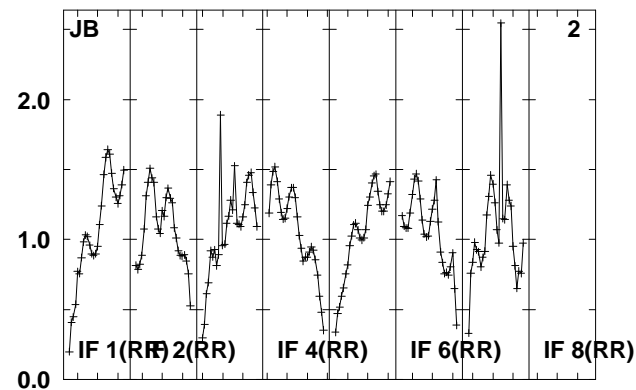
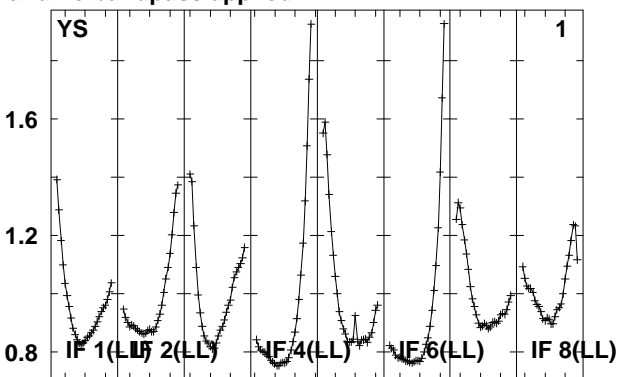
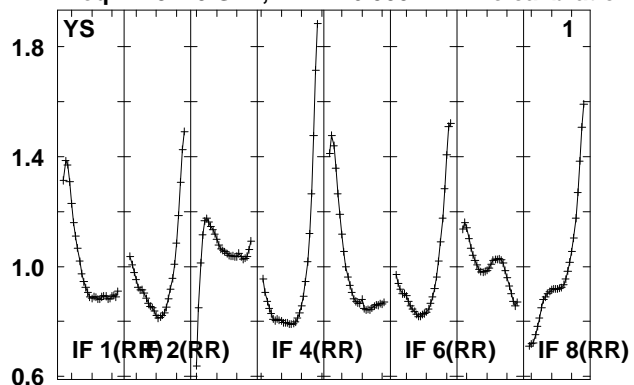

Lower frame: Real Jy
Total-power spectrum Antenna: *
Timerange: 00/06:16:20 to 00/06:17:48

Plot file version 130 created 14-MAY-2010 15:17:42

J2110-10 EO007.UVDATA.1

Freq = 4.9270 GHz, Bw = 16.000 MH No calibration applied and no bandpass applied

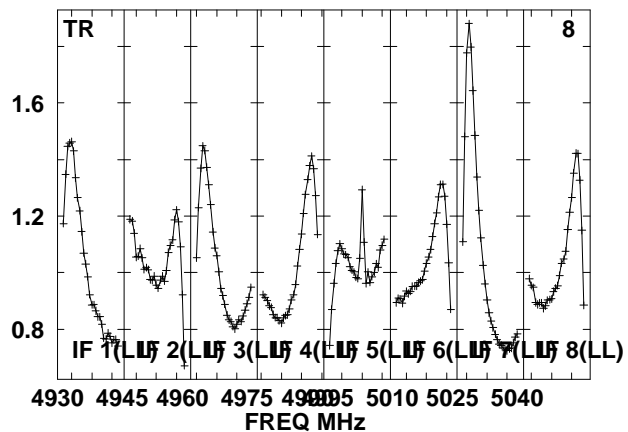
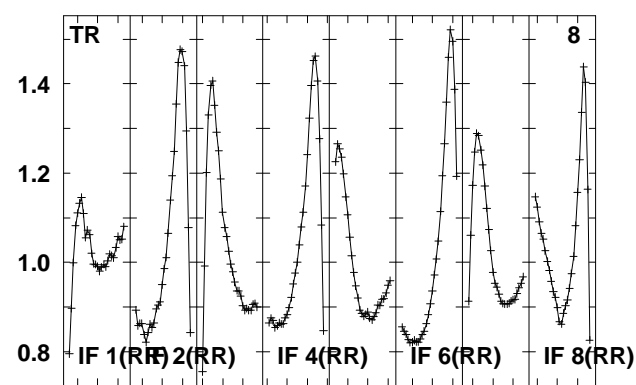
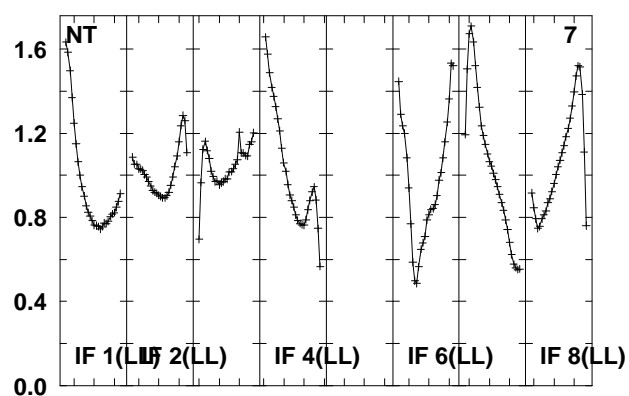
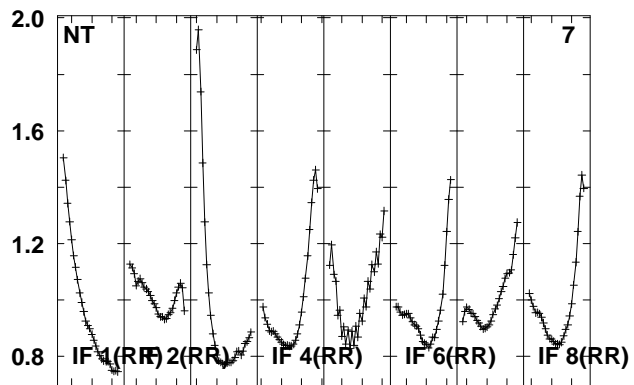
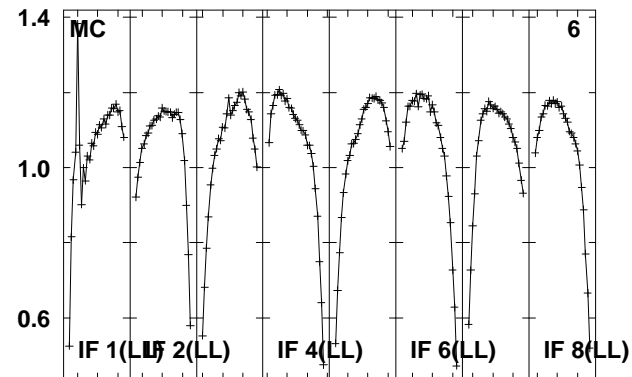
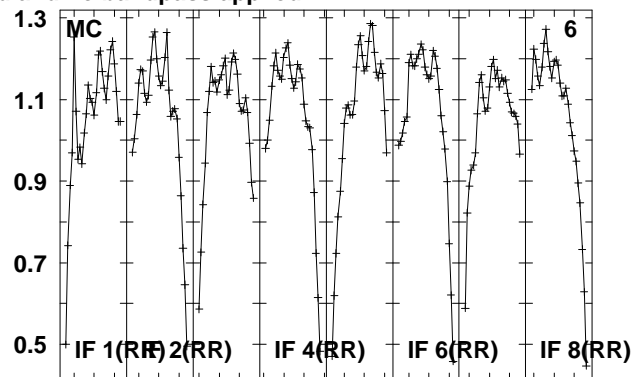
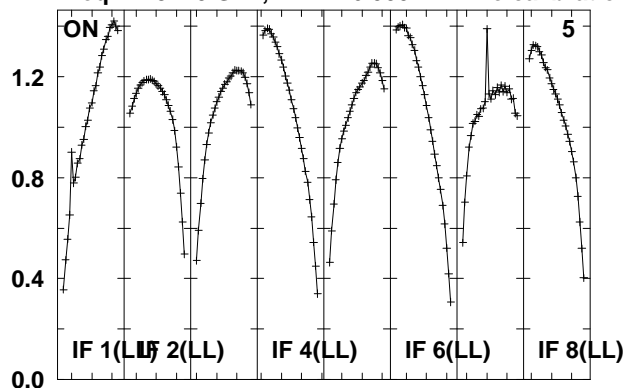

Lower frame: Real Jy

Total-power spectrum Antenna: *

Timerange: 00/06:16:20 to 00/06:17:48

Plot file version 131 created 14-MAY-2010 15:17:42
 J210358 EO007.UVDATA.1
 Freq = 4.9270 GHz, Bw = 16.000 MH No calibration applied and no bandpass applied

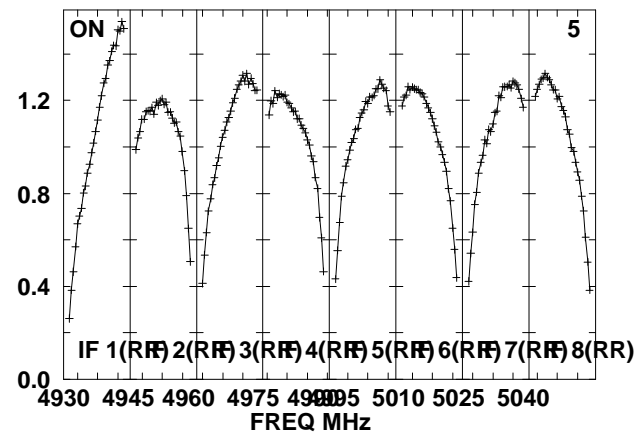
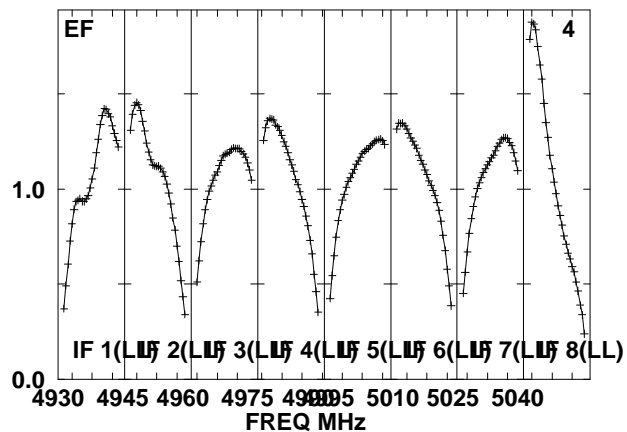
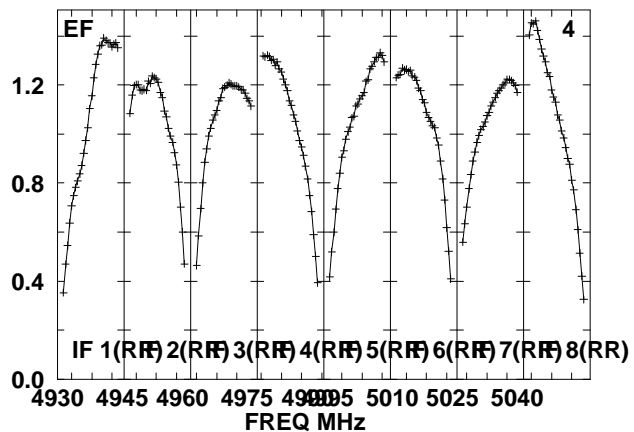
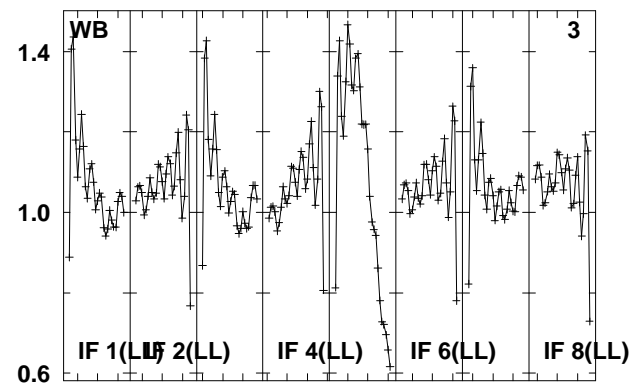
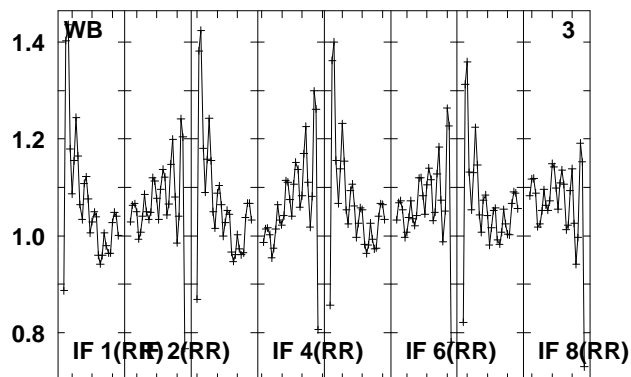
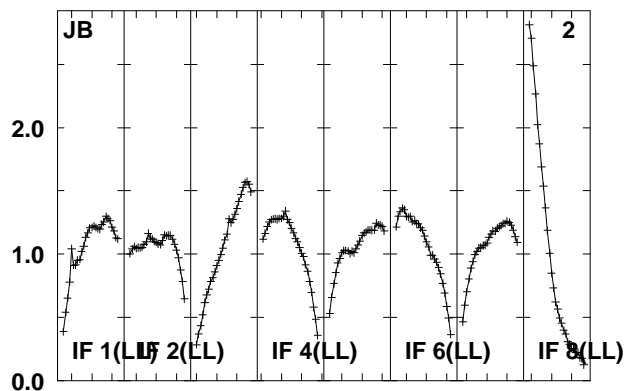
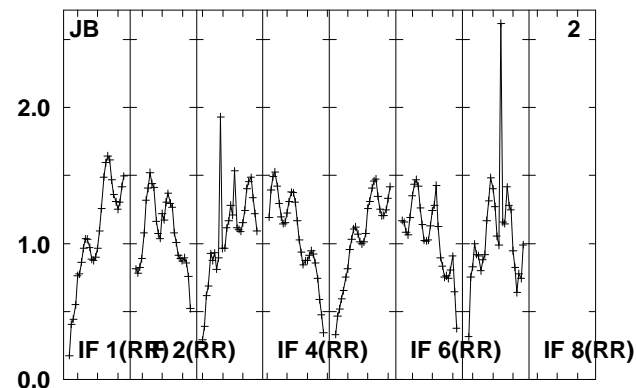
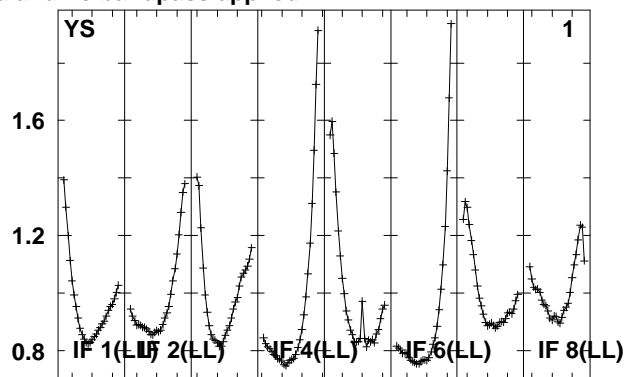
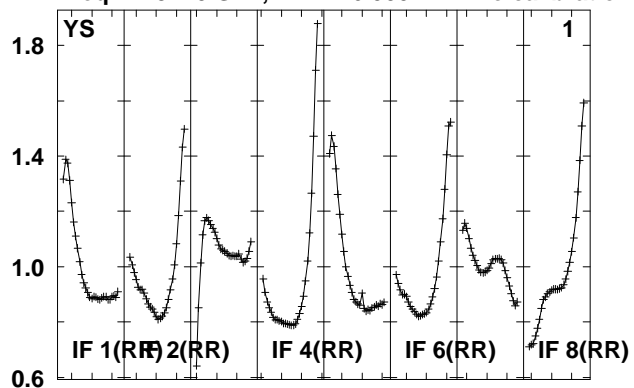

Lower frame: Real Jy
 Total-power spectrum Antenna: *
 Timerange: 00/06:18:28 to 00/06:23:22

Plot file version 132 created 14-MAY-2010 15:17:43

J210358 EO007.UVDATA.1

Freq = 4.9270 GHz, Bw = 16.000 MH No calibration applied and no bandpass applied

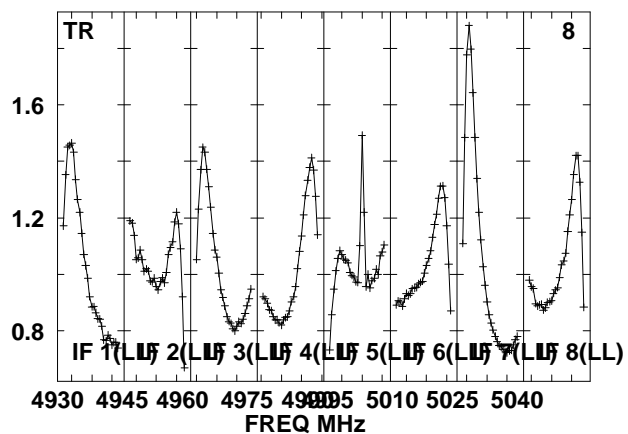
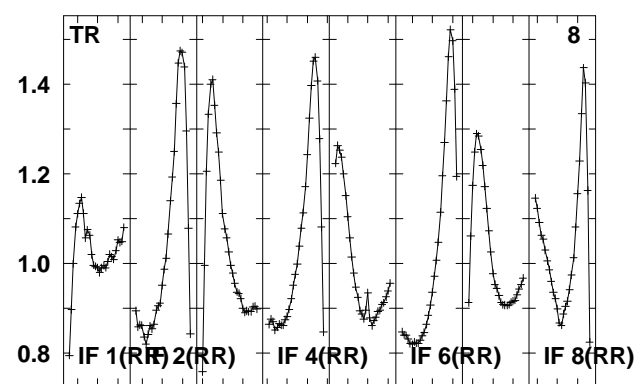
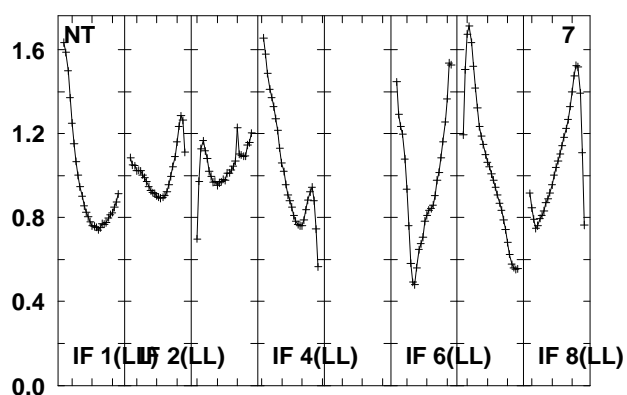
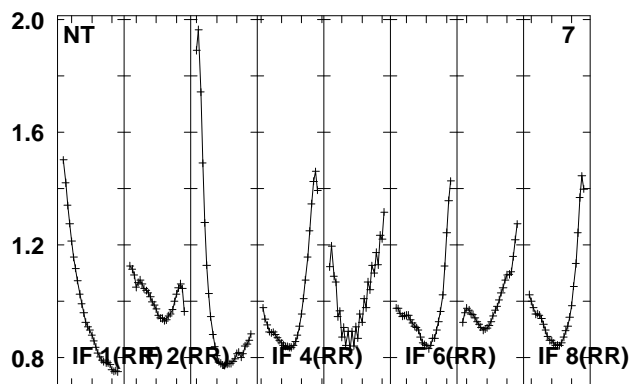
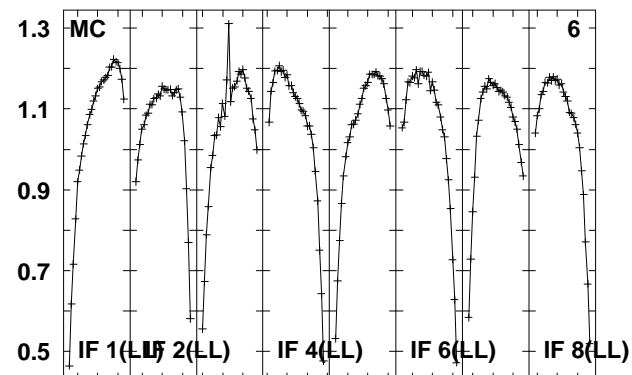
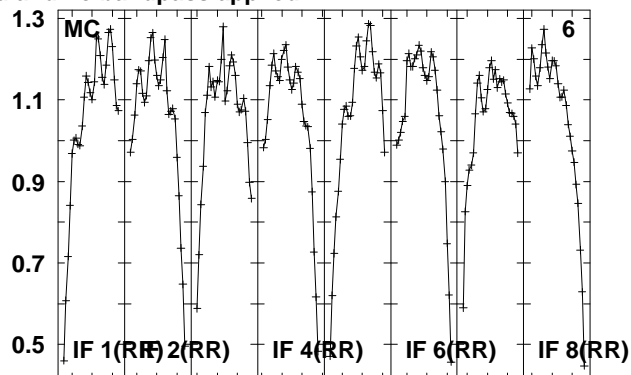
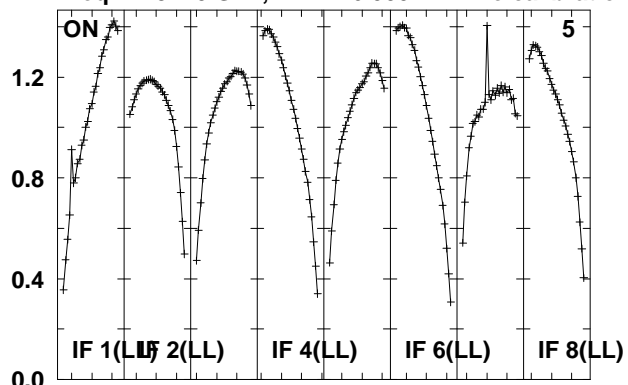

Lower frame: Real Jy

Total-power spectrum Antenna: *

Timerange: 00/06:18:28 to 00/06:23:22

Plot file version 133 created 14-MAY-2010 15:17:43

J2110-10 EO007.UVDATA.1

Freq = 4.9270 GHz, Bw = 16.000 MH No calibration applied and no bandpass applied

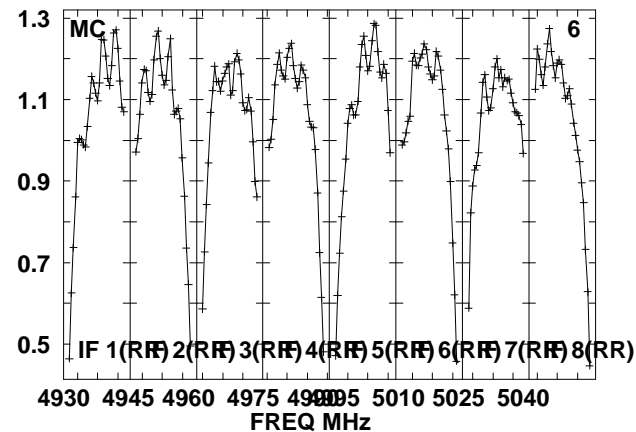
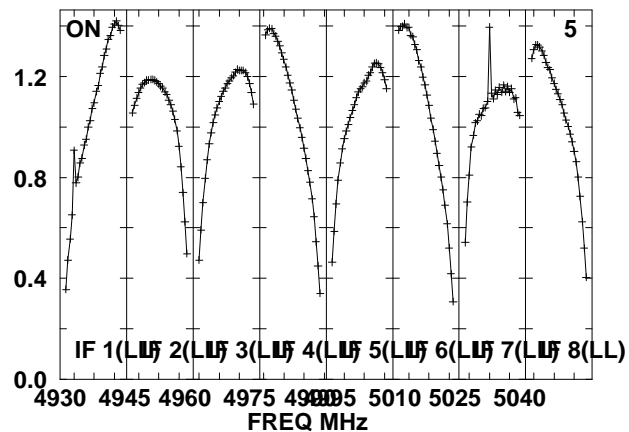
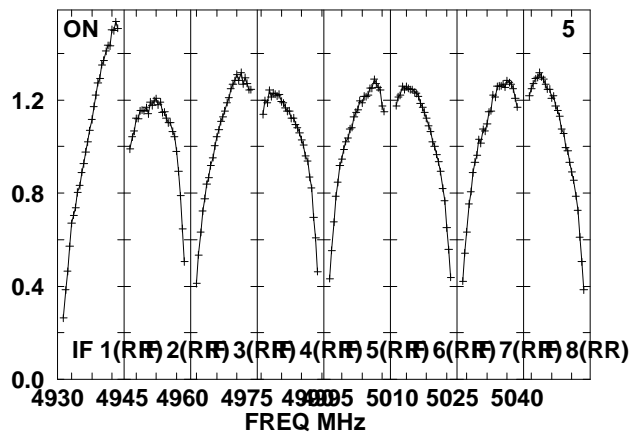
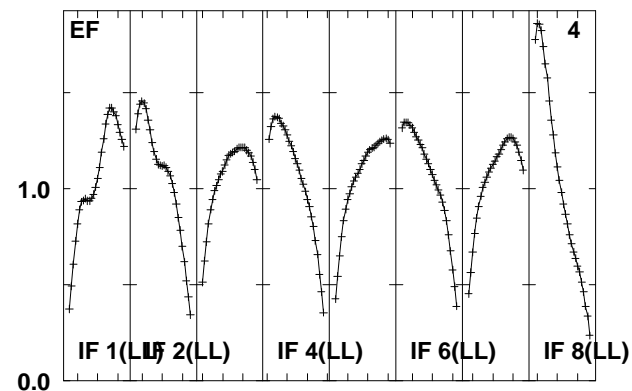
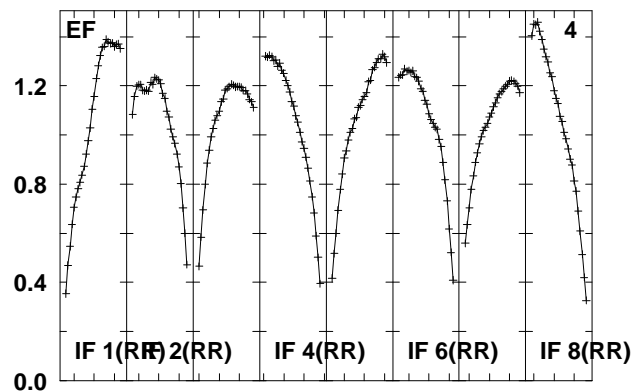
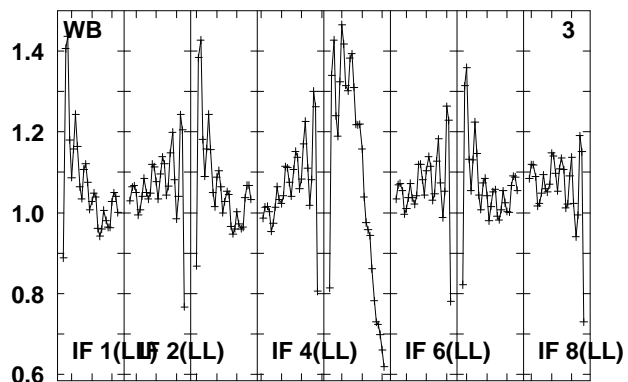
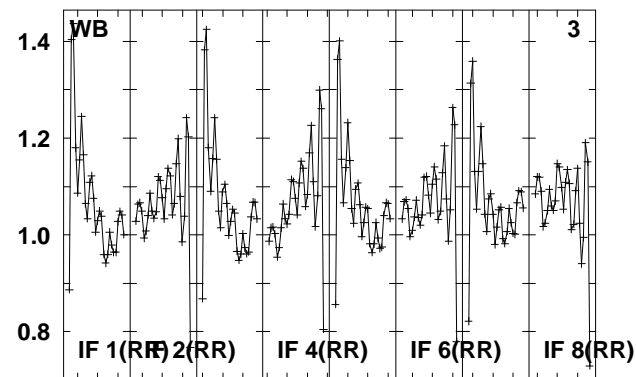
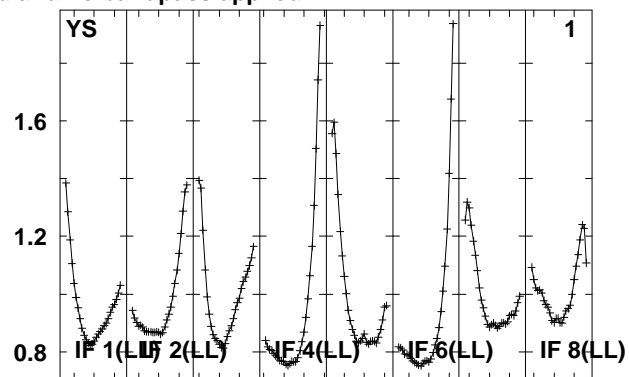
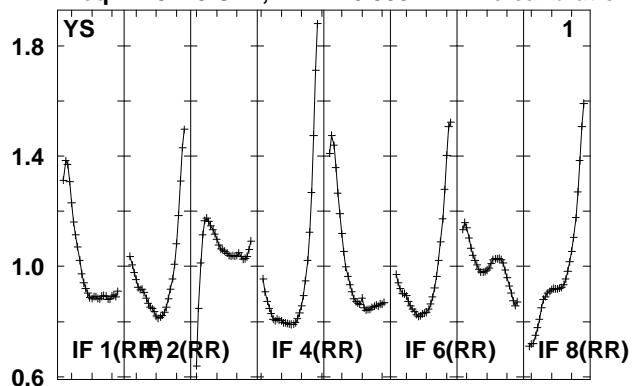

Lower frame: Real Jy

Total-power spectrum Antenna: *

Timerange: 00/06:24:03 to 00/06:25:29

Plot file version 134 created 14-MAY-2010 15:17:43

J2110-10 EO007.UVDATA.1

Freq = 4.9270 GHz, Bw = 16.000 MH No calibration applied and no bandpass applied

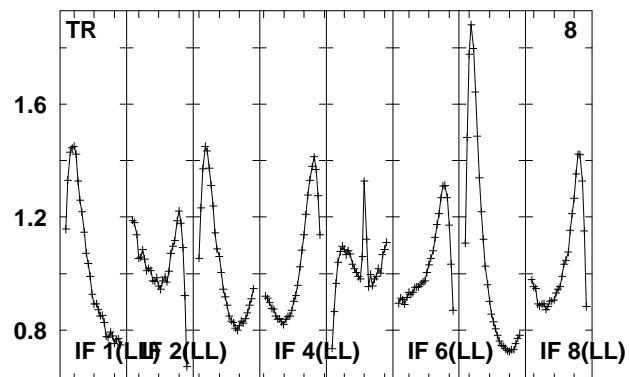
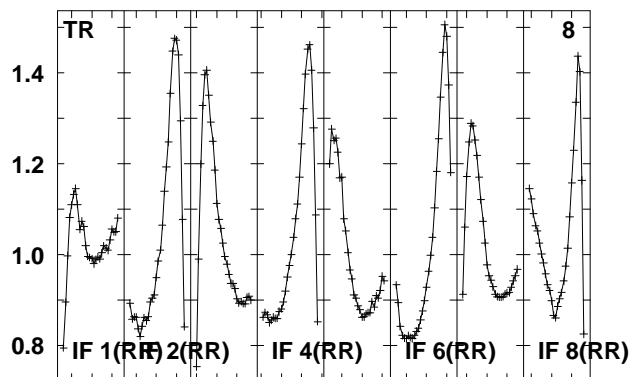
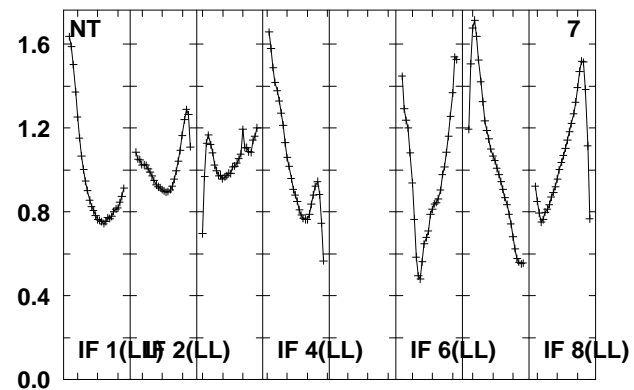
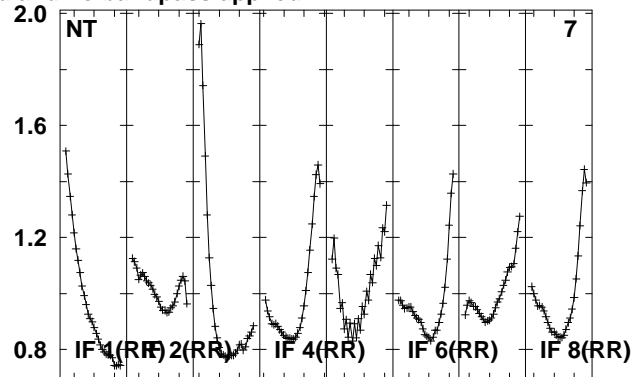
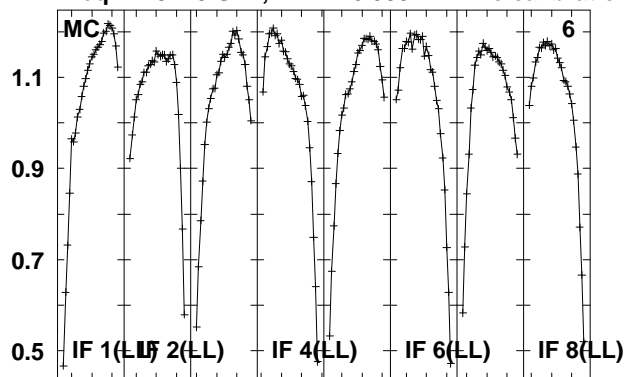

Lower frame: Real Jy
Total-power spectrum Antenna: *
Timerange: 00/06:24:03 to 00/06:25:29

Plot file version 135 created 14-MAY-2010 15:17:44
 J210358 EO007.UVDATA.1
 Freq = 4.9270 GHz, Bw = 16.000 MH No calibration applied and no bandpass applied

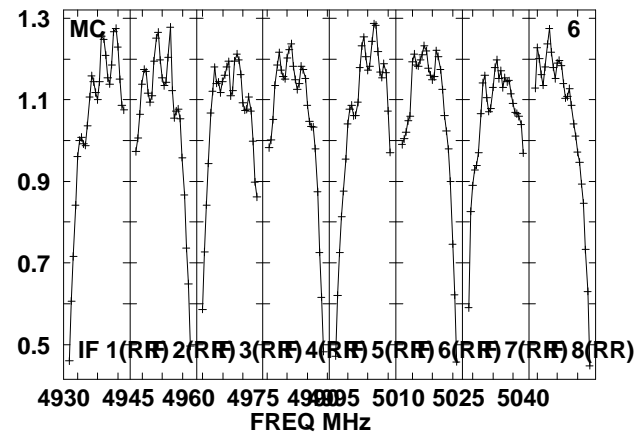
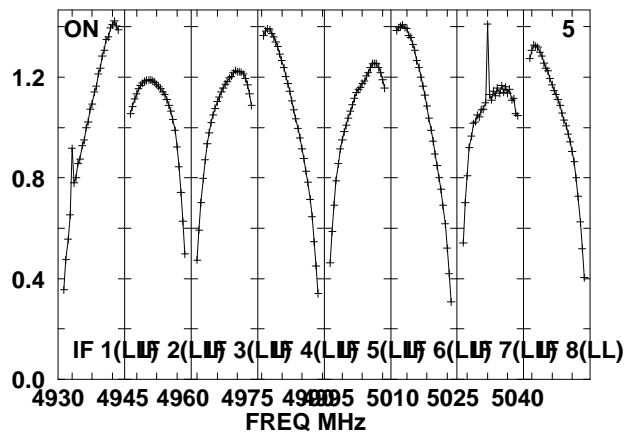
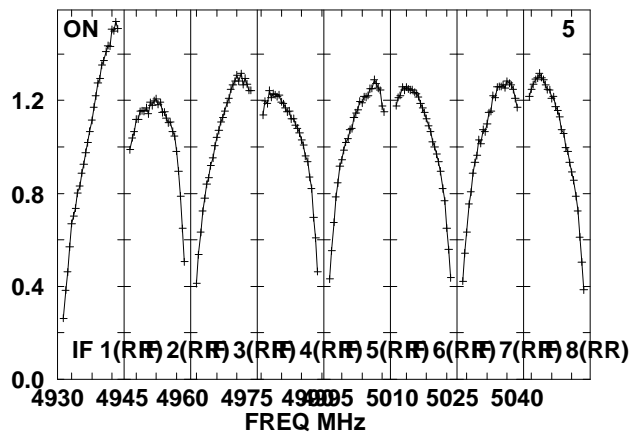
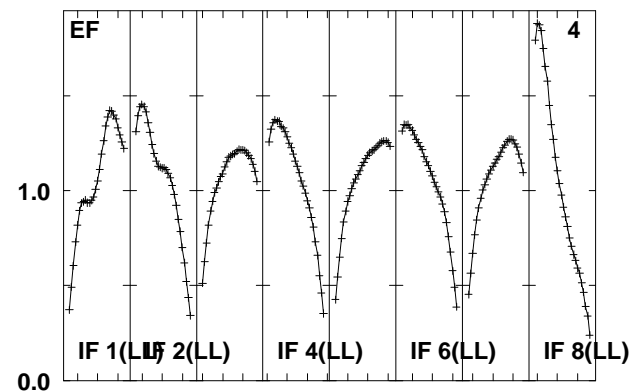
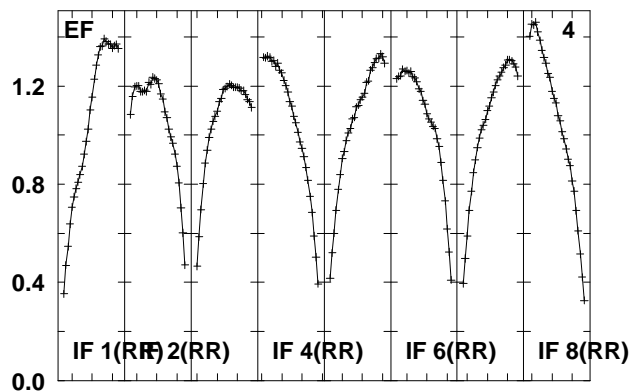
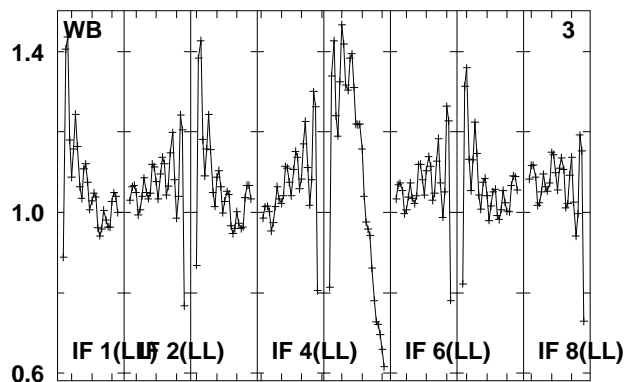
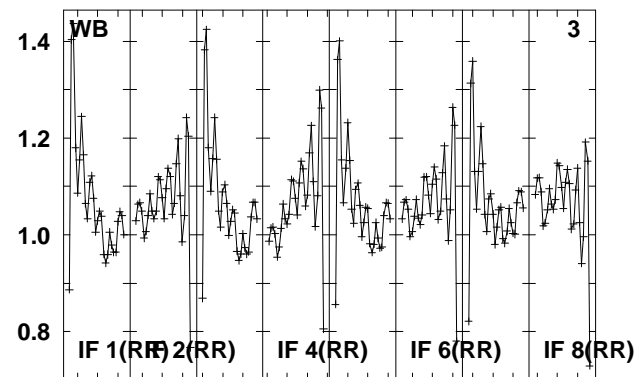
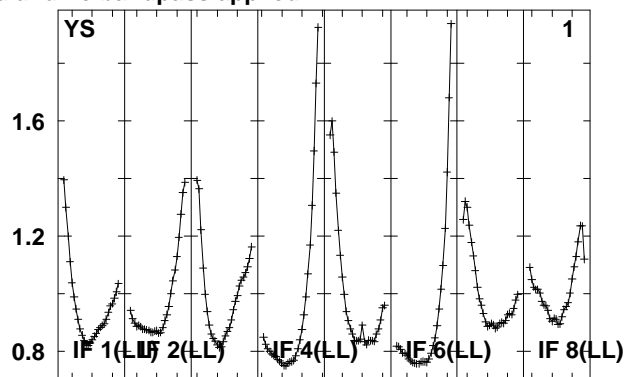
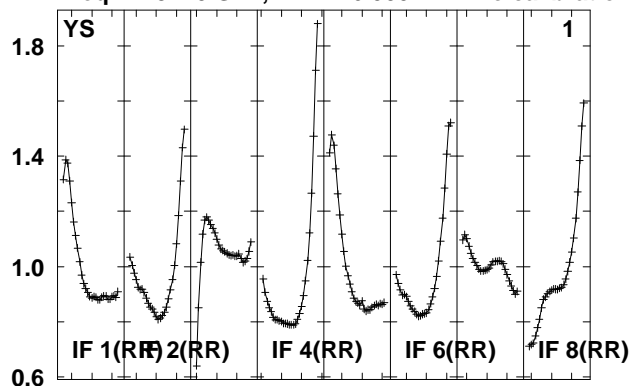

Lower frame: Real Jy
 Total-power spectrum Antenna: *
 Timerange: 00/06:26:08 to 00/06:31:04

Plot file version 136 created 14-MAY-2010 15:17:44

J210358 EO007.UVDATA.1

Freq = 4.9270 GHz, Bw = 16.000 MH No calibration applied and no bandpass applied

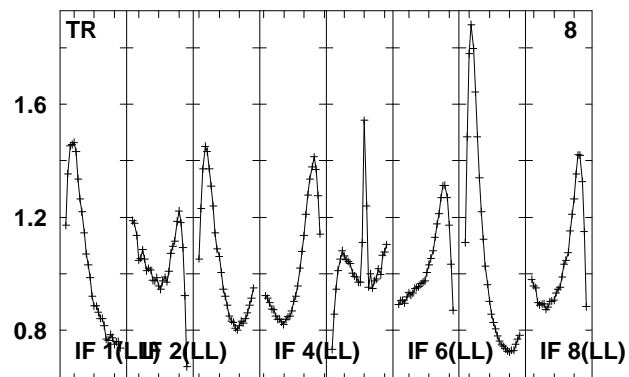
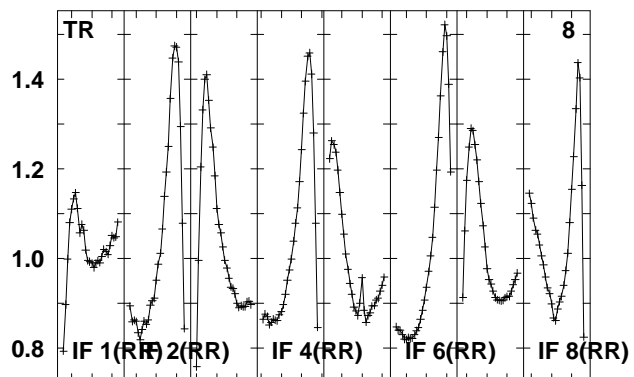
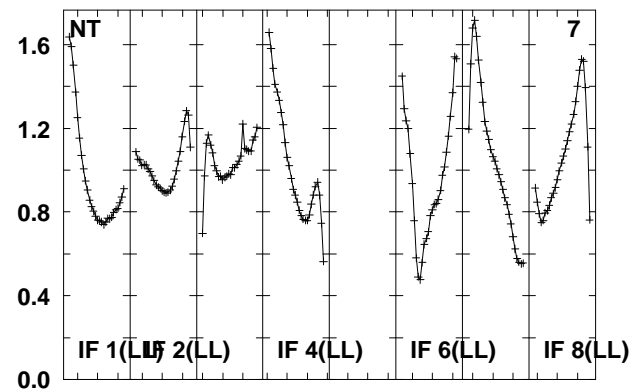
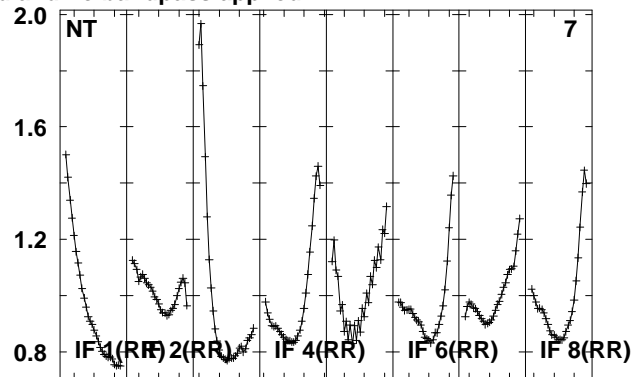
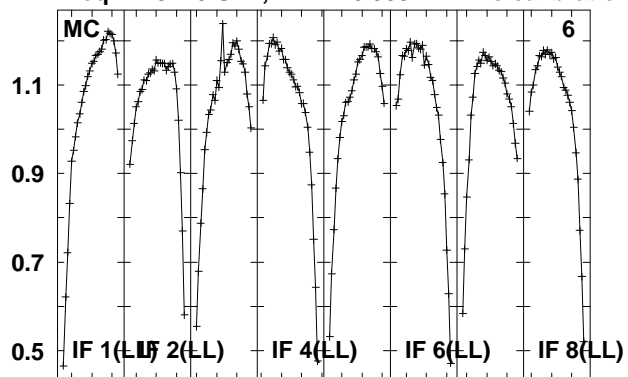

Lower frame: Real Jy
Total-power spectrum Antenna: *
Timerange: 00/06:26:08 to 00/06:31:04

Plot file version 137 created 14-MAY-2010 15:17:45

J2110-10 EO007.UVDATA.1

Freq = 4.9270 GHz, Bw = 16.000 MH No calibration applied and no bandpass applied

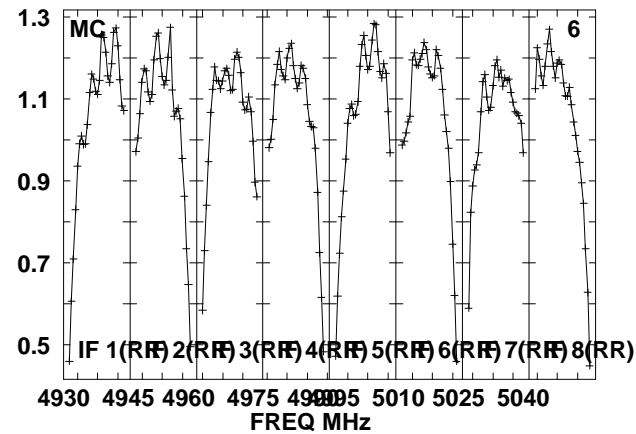
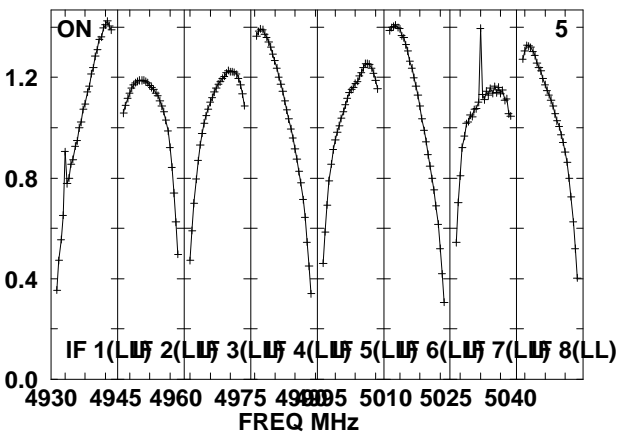
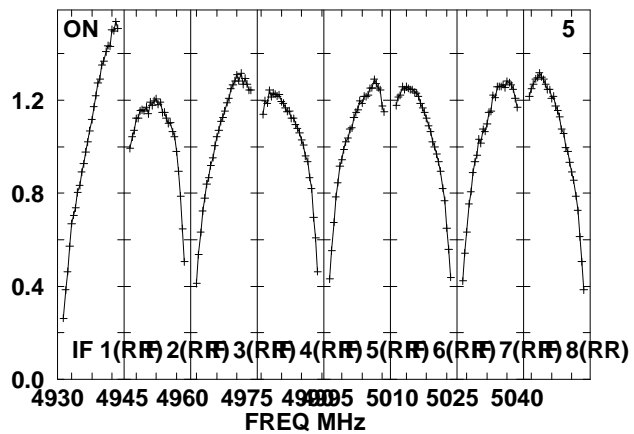
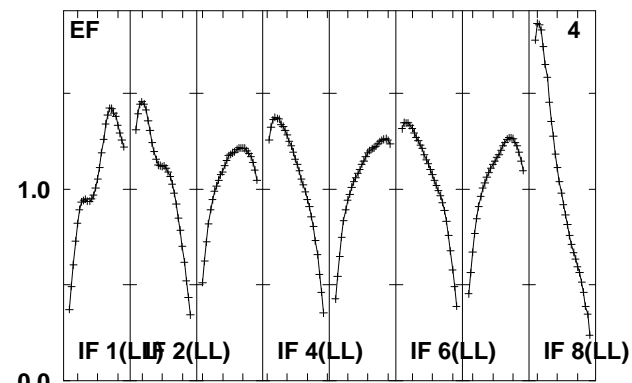
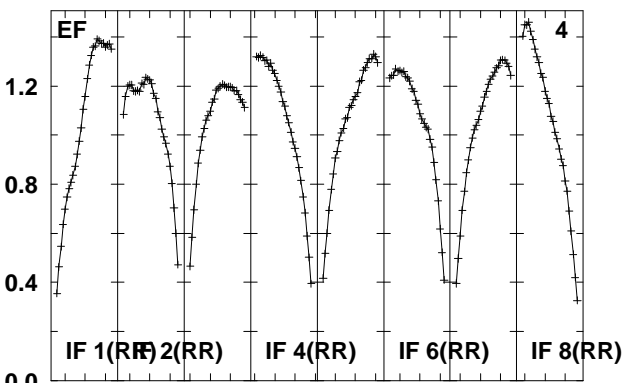
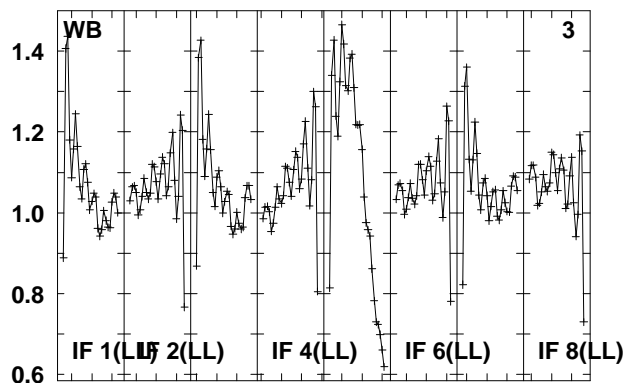
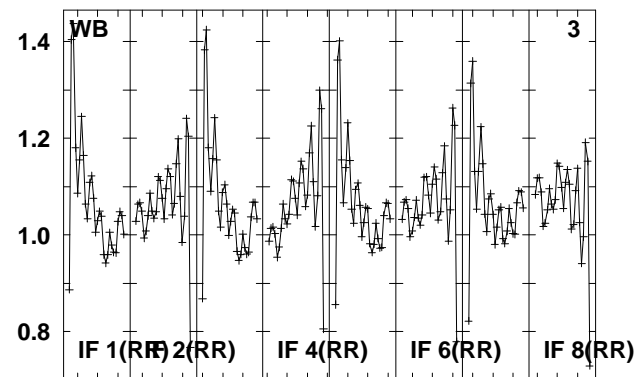
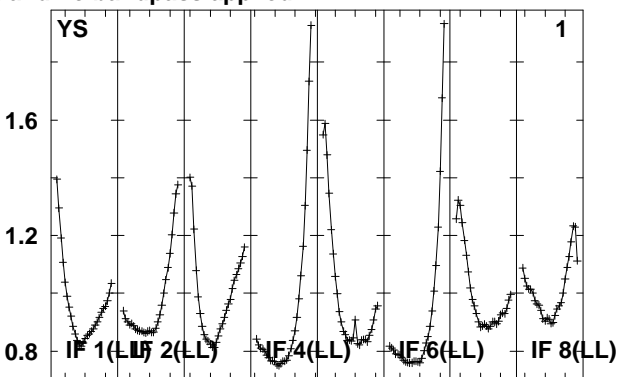
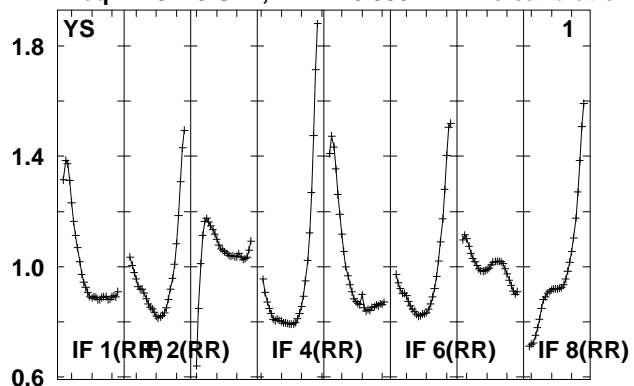

Lower frame: Real Jy
Total-power spectrum Antenna: *
Timerange: 00/06:31:42 to 00/06:33:10

Plot file version 138 created 14-MAY-2010 15:17:45

J2110-10 EO007.UVDATA.1

Freq = 4.9270 GHz, Bw = 16.000 MH No calibration applied and no bandpass applied

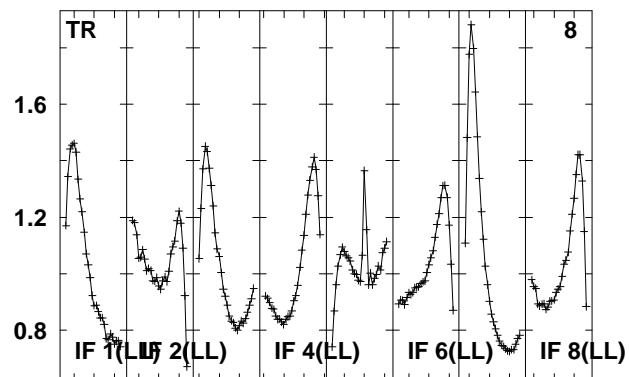
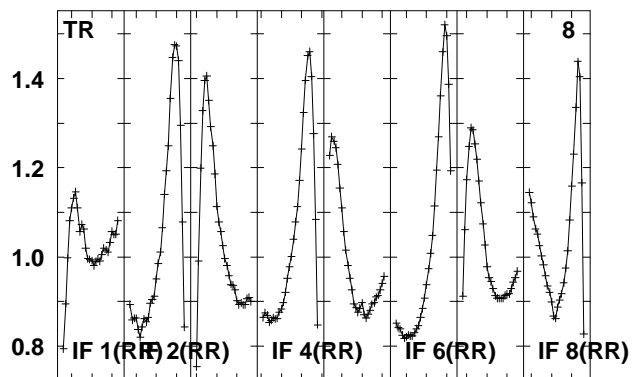
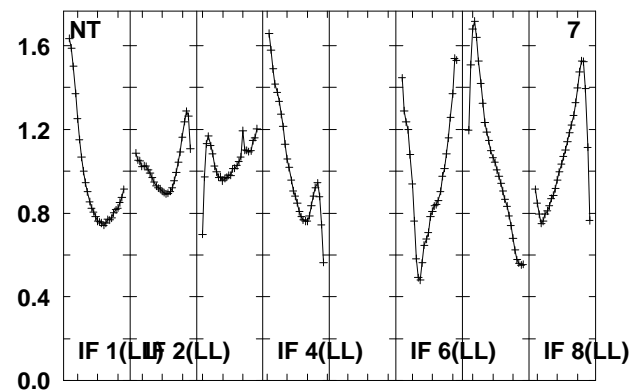
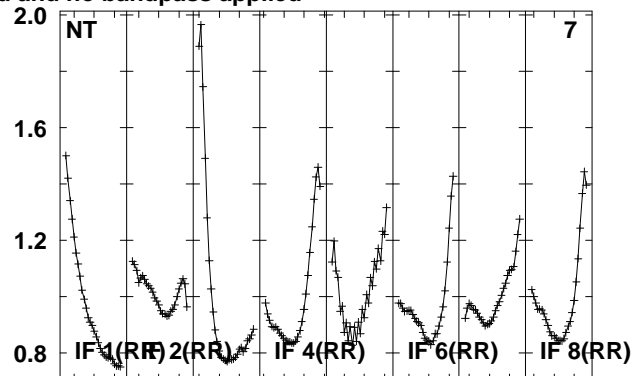
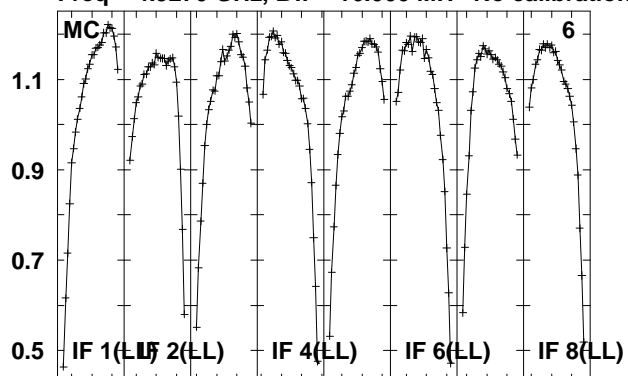

Lower frame: Real Jy
Total-power spectrum Antenna: *
Timerange: 00/06:31:42 to 00/06:33:10

Plot file version 139 created 14-MAY-2010 15:17:45

J210358 EO007.UVDATA.1

Freq = 4.9270 GHz, Bw = 16.000 MH No calibration applied and no bandpass applied

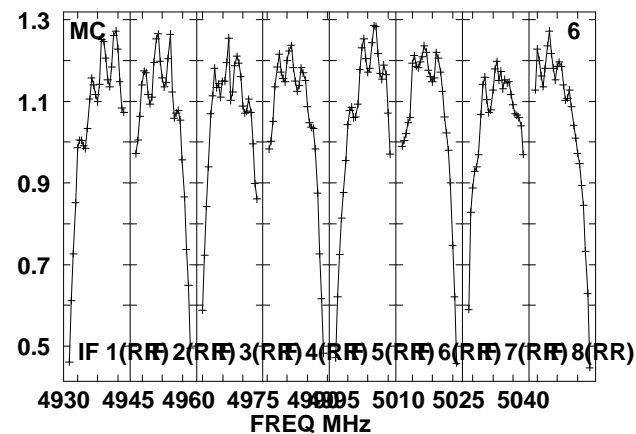
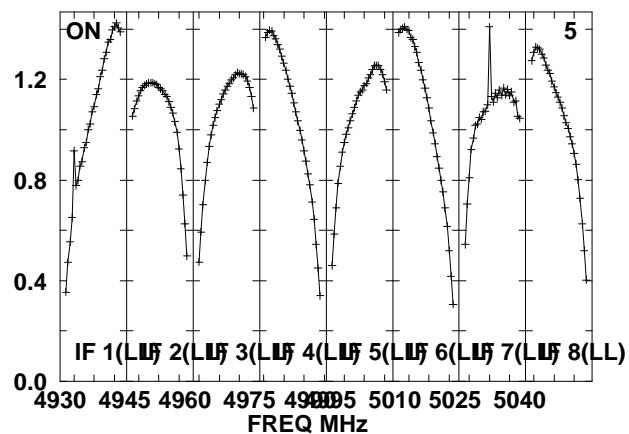
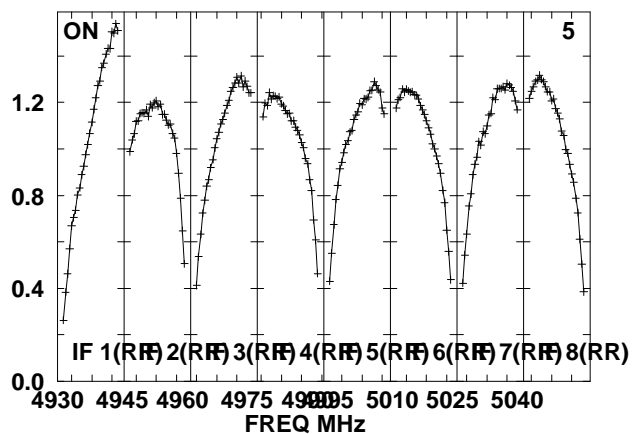
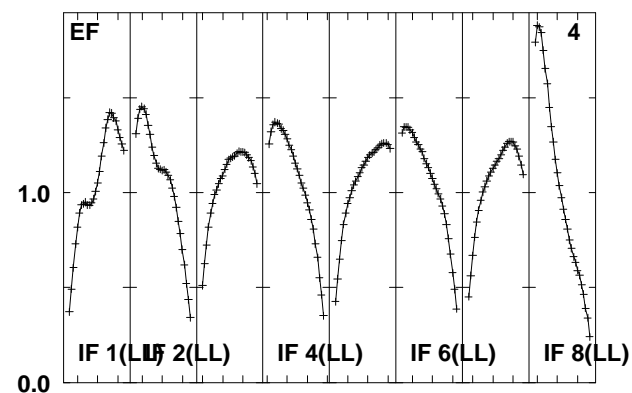
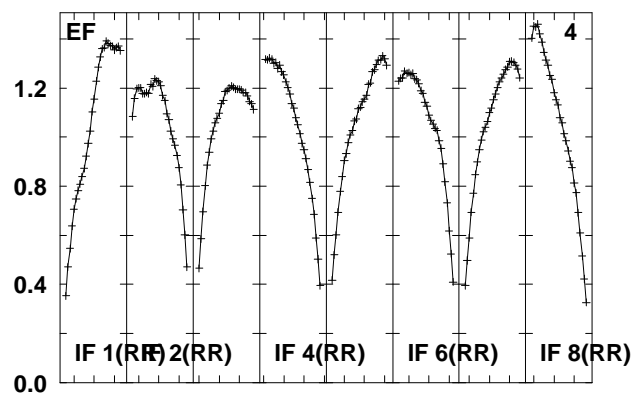
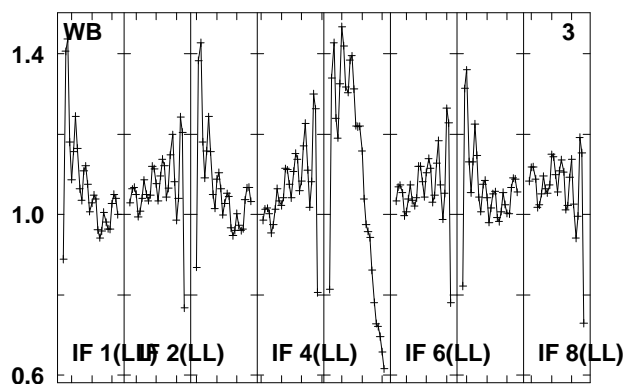
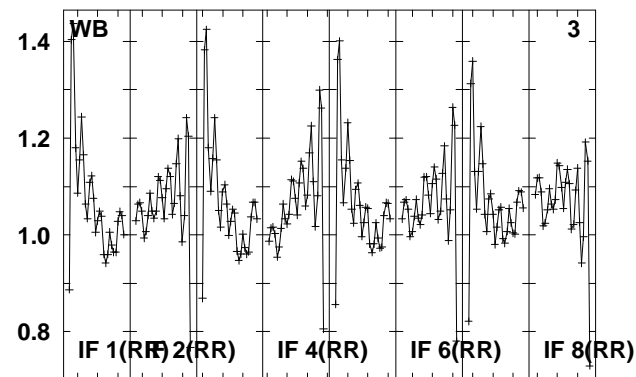
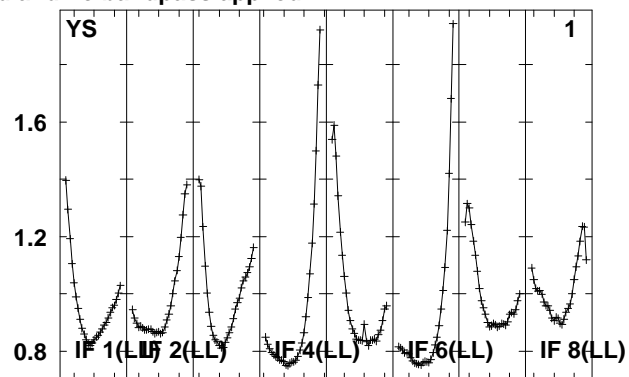
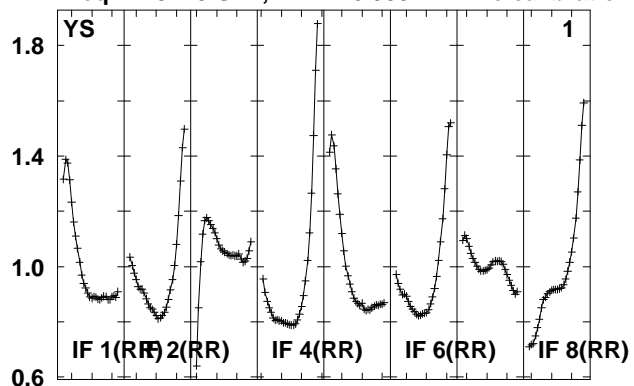

Lower frame: Real Jy

Total-power spectrum Antenna: *

Timerange: 00/06:33:50 to 00/06:38:48

Plot file version 140 created 14-MAY-2010 15:17:46

J210358 EO007.UVDATA.1

Freq = 4.9270 GHz, Bw = 16.000 MH No calibration applied and no bandpass applied

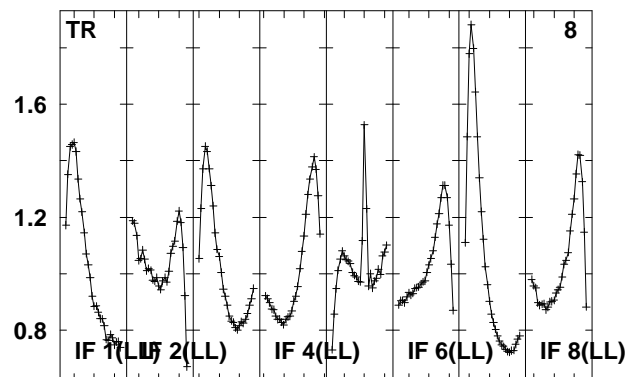
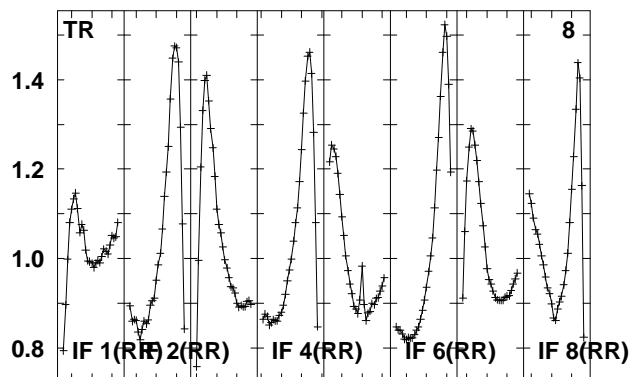
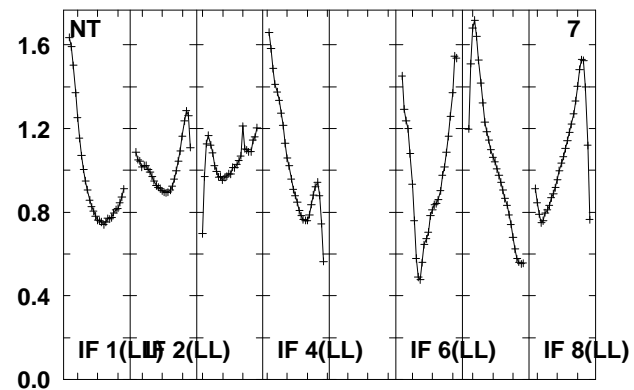
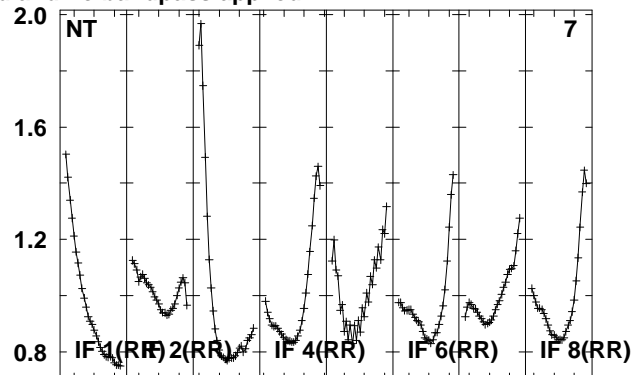
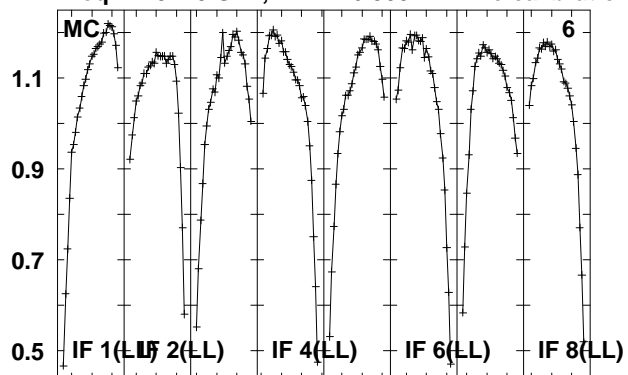

Lower frame: Real Jy
Total-power spectrum Antenna: *
Timerange: 00/06:33:50 to 00/06:38:48

Plot file version 141 created 14-MAY-2010 15:17:46

J2110-10 EO007.UVDATA.1

Freq = 4.9270 GHz, Bw = 16.000 MH No calibration applied and no bandpass applied

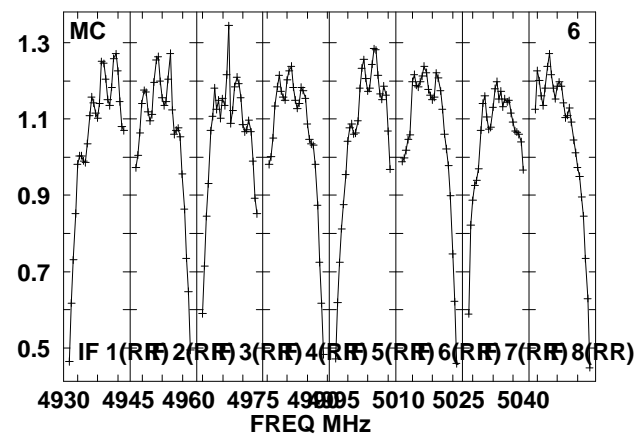
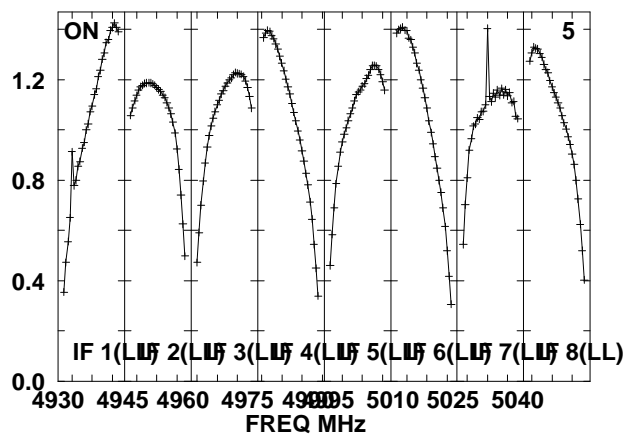
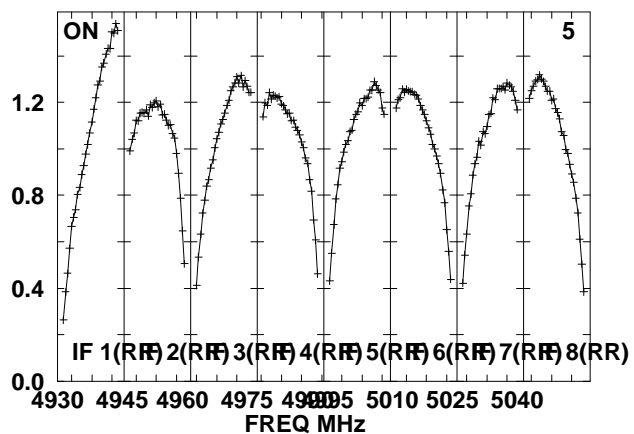
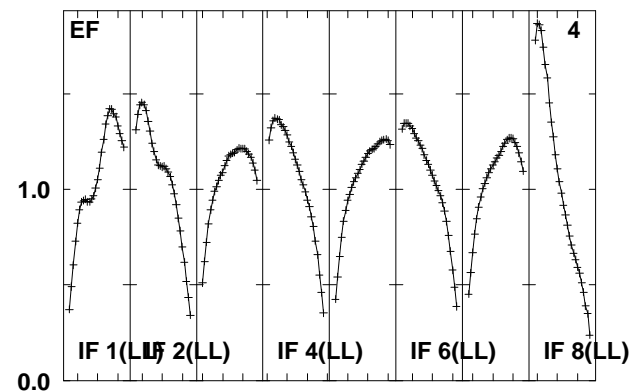
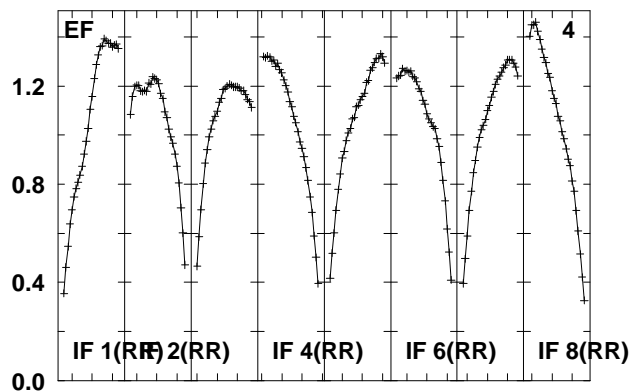
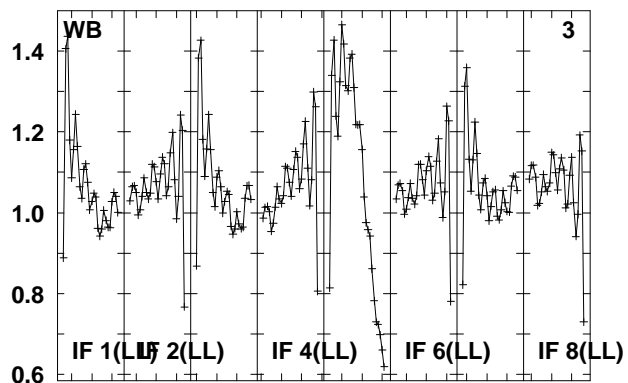
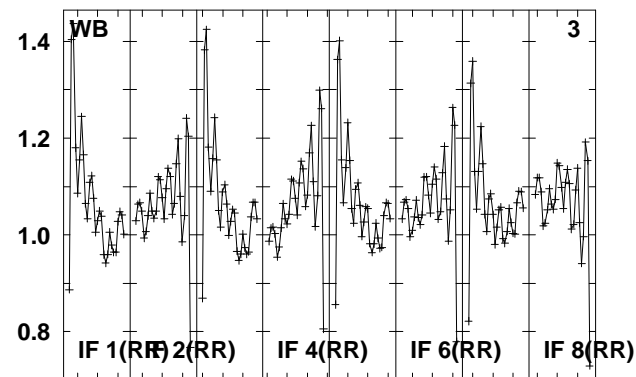
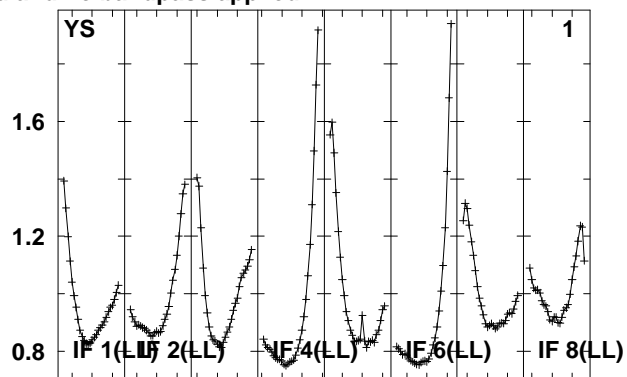
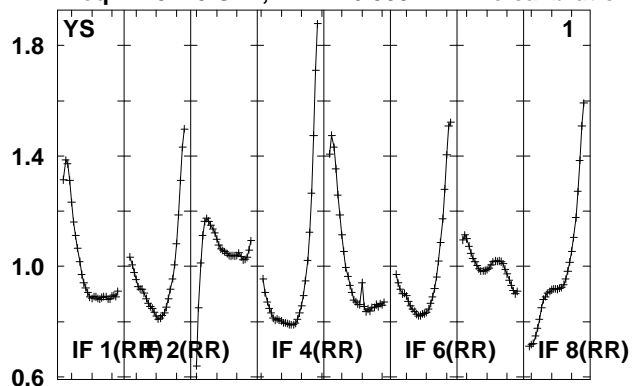

Lower frame: Real Jy

Total-power spectrum Antenna: *

Timerange: 00/06:39:26 to 00/06:40:52

Plot file version 142 created 14-MAY-2010 15:17:46

J2110-10 EO007.UVDATA.1

Freq = 4.9270 GHz, Bw = 16.000 MH No calibration applied and no bandpass applied

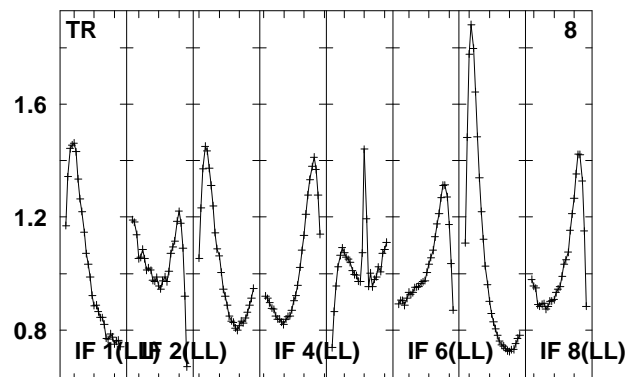
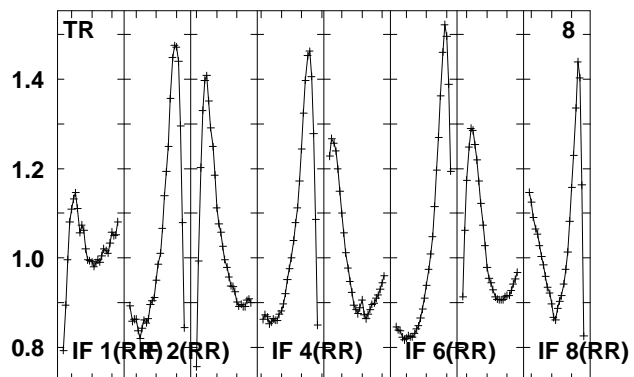
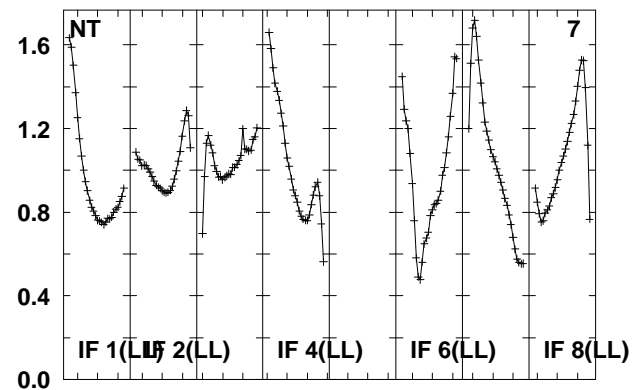
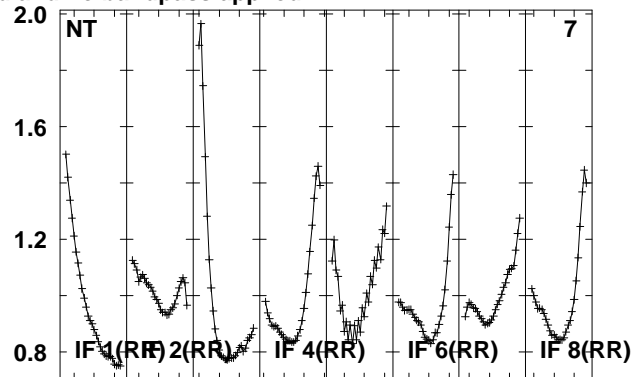
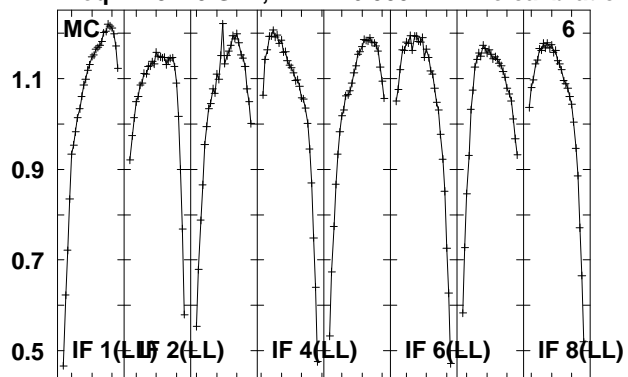

Lower frame: Real Jy
Total-power spectrum Antenna: *
Timerange: 00/06:39:26 to 00/06:40:52

Plot file version 143 created 14-MAY-2010 15:17:46

J210358 EO007.UVDATA.1

Freq = 4.9270 GHz, Bw = 16.000 MH No calibration applied and no bandpass applied

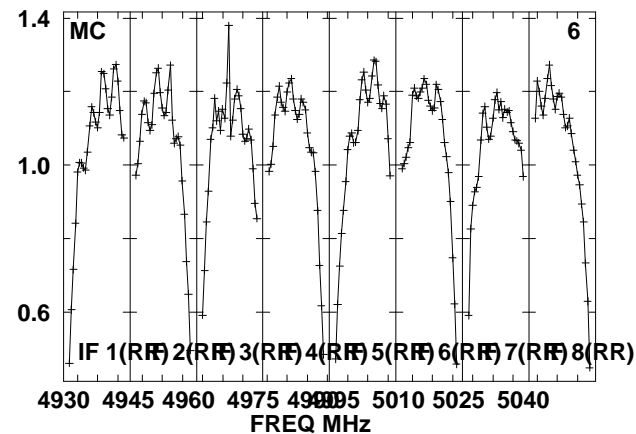
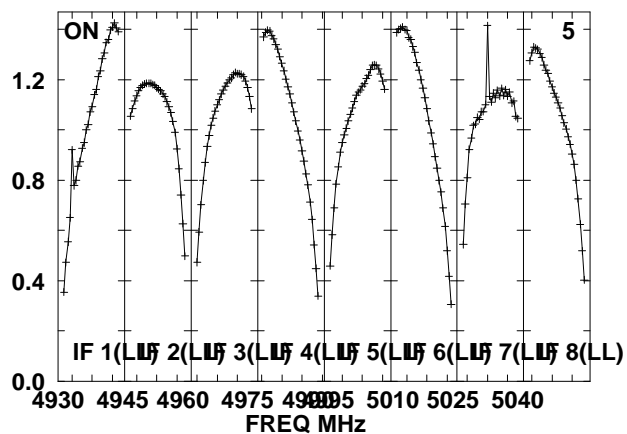
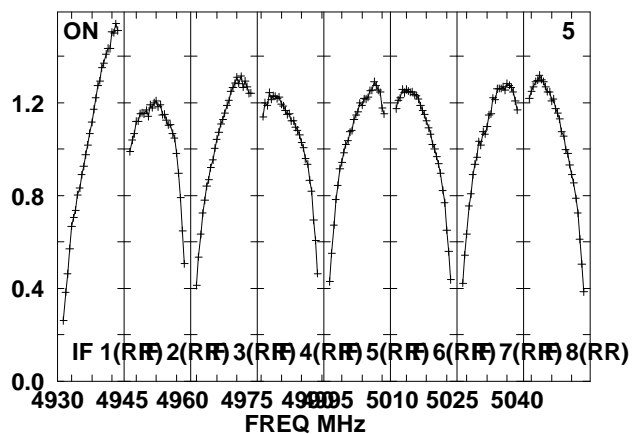
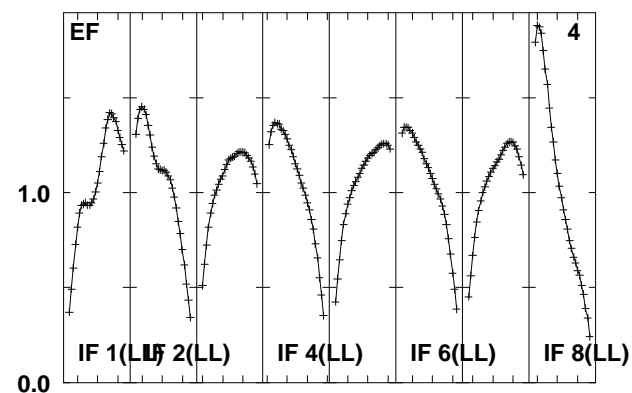
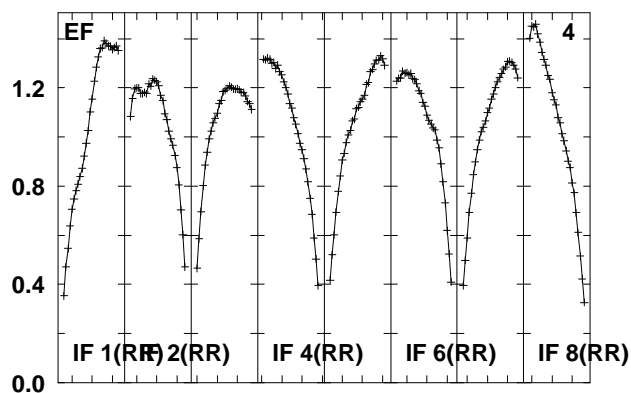
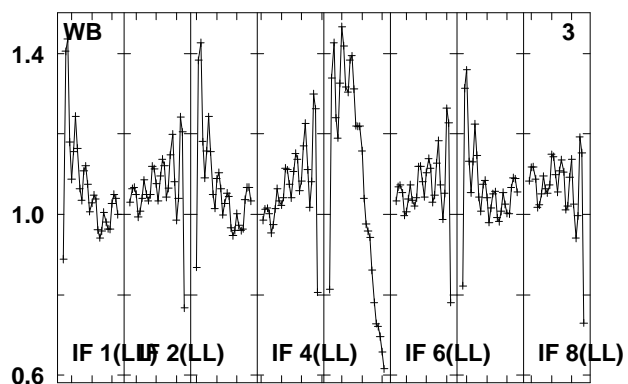
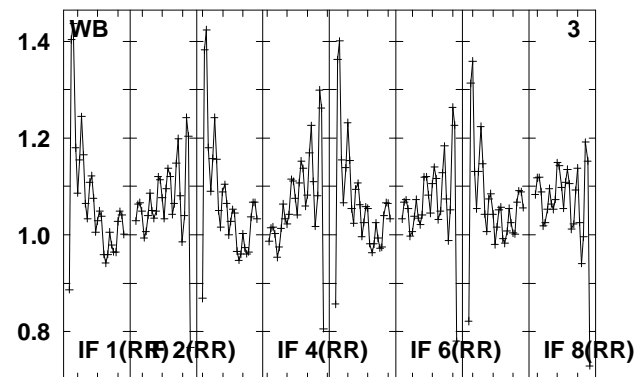
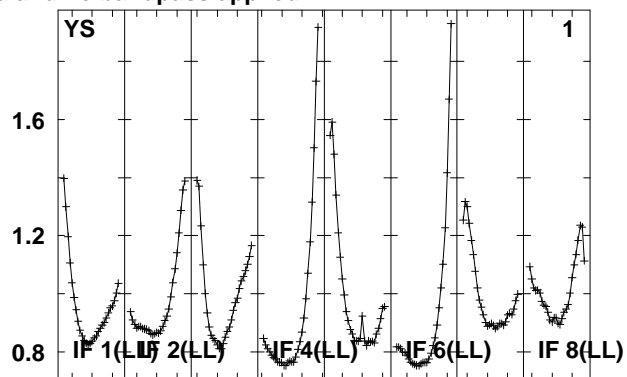
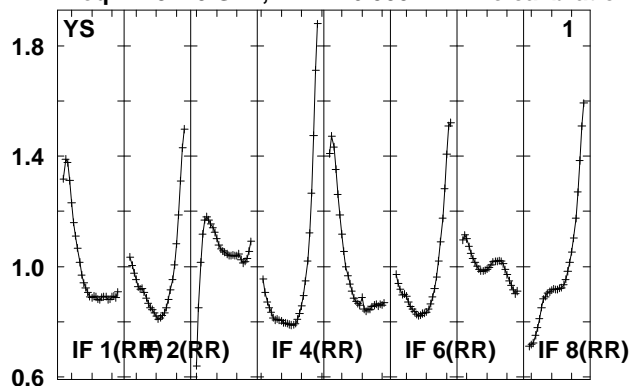

Lower frame: Real Jy

Total-power spectrum Antenna: *

Timerange: 00/06:41:30 to 00/06:46:28

Plot file version 144 created 14-MAY-2010 15:17:47

J210358 EO007.UVDATA.1

Freq = 4.9270 GHz, Bw = 16.000 MH No calibration applied and no bandpass applied

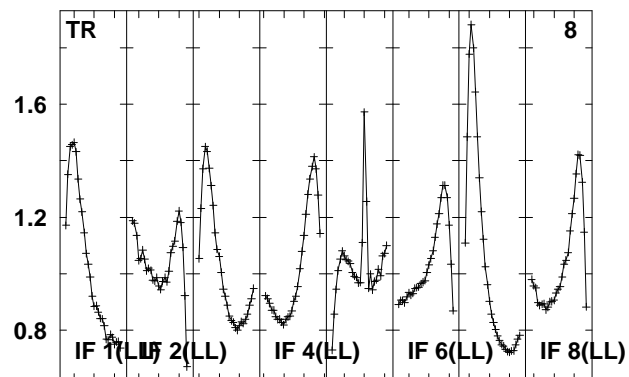
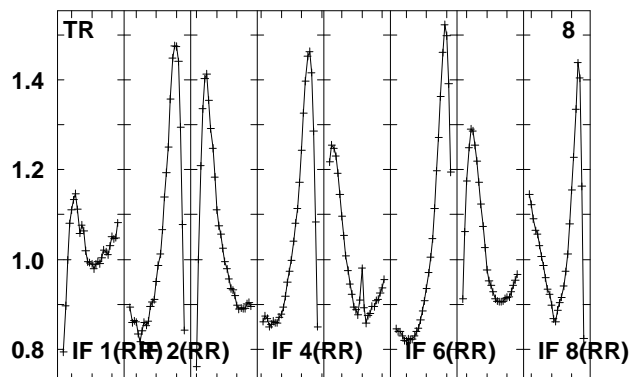
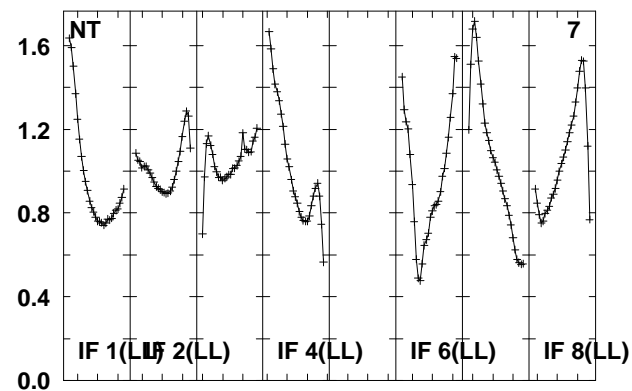
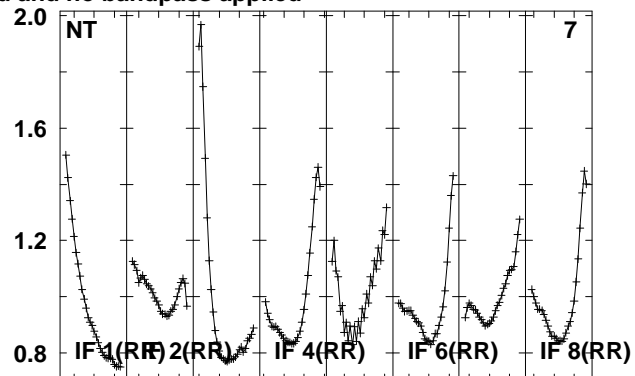
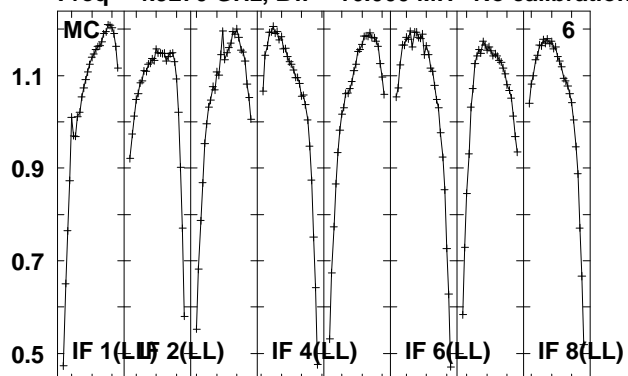

Lower frame: Real Jy
Total-power spectrum Antenna: *
Timerange: 00/06:41:30 to 00/06:46:28

Plot file version 145 created 14-MAY-2010 15:17:47

J2110-10 EO007.UVDATA.1

Freq = 4.9270 GHz, Bw = 16.000 MH No calibration applied and no bandpass applied

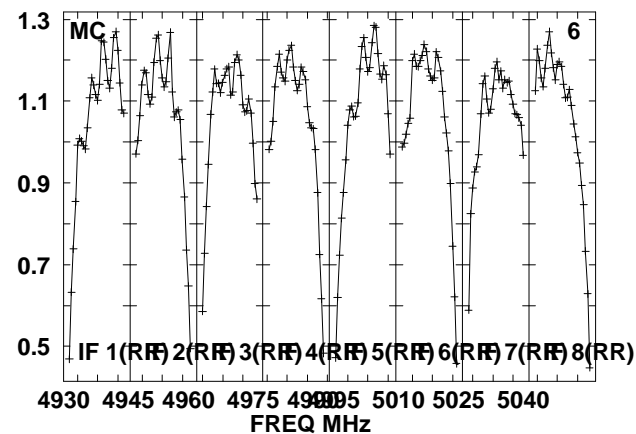
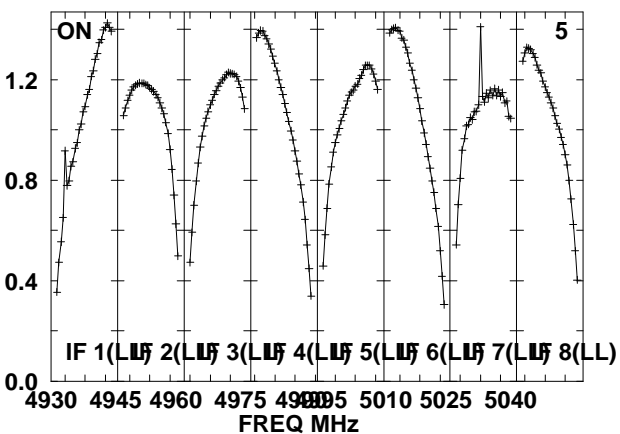
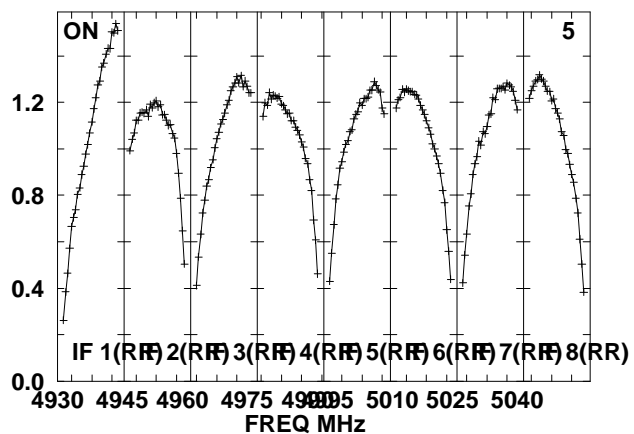
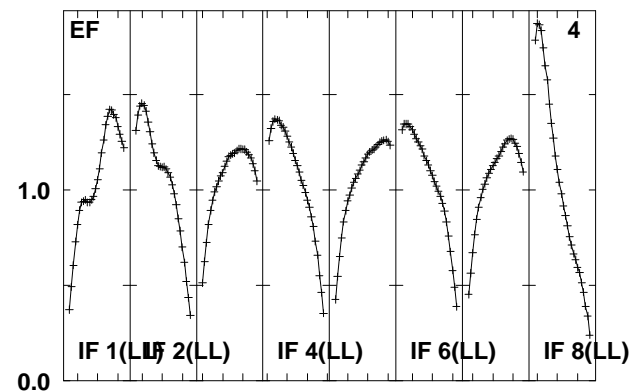
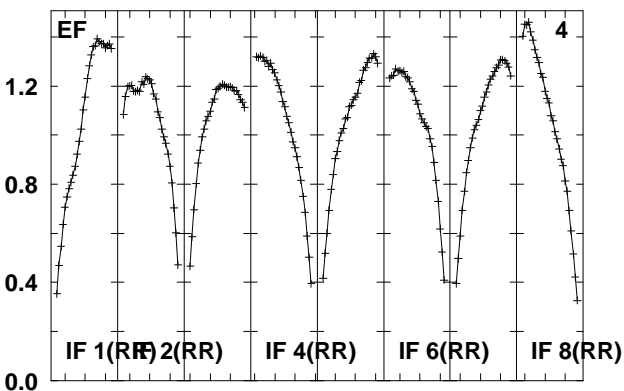
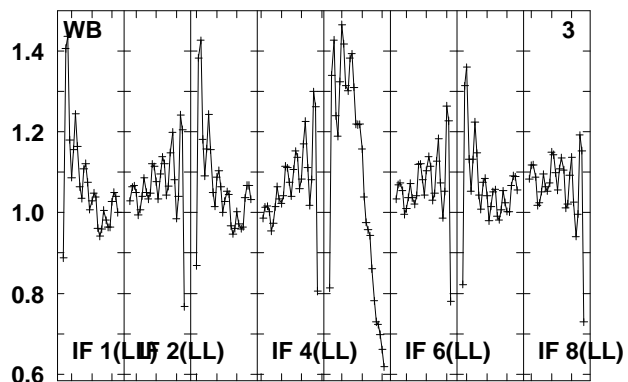
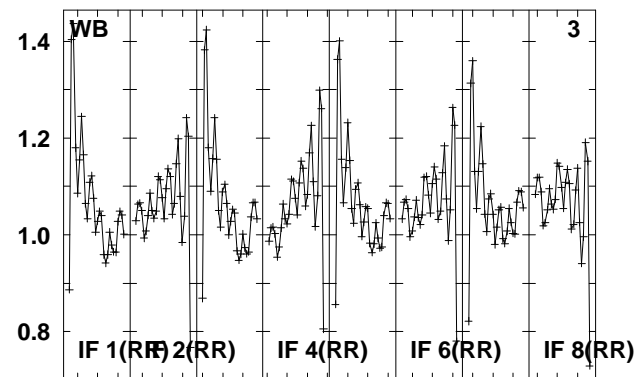
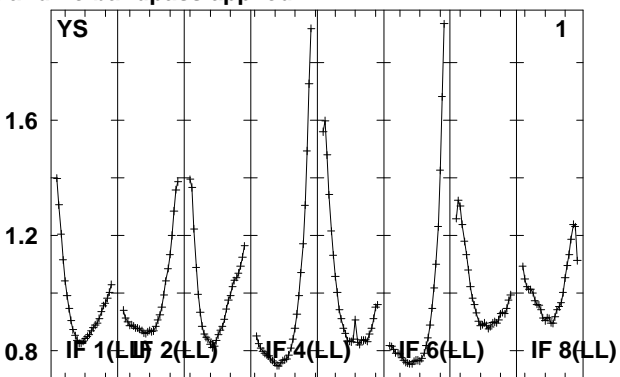
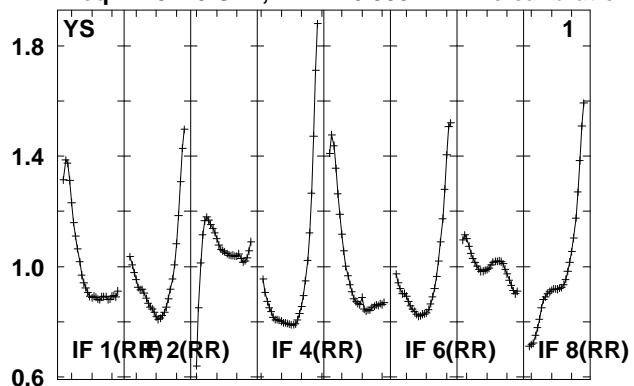

Lower frame: Real Jy
Total-power spectrum Antenna: *
Timerange: 00/06:47:05 to 00/06:48:31

Plot file version 146 created 14-MAY-2010 15:17:48

J2110-10 EO007.UVDATA.1

Freq = 4.9270 GHz, Bw = 16.000 MH No calibration applied and no bandpass applied

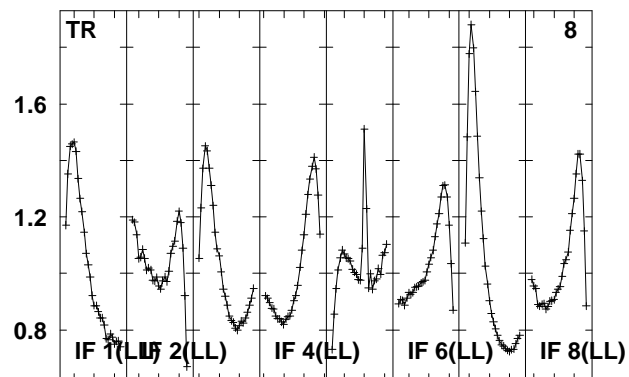
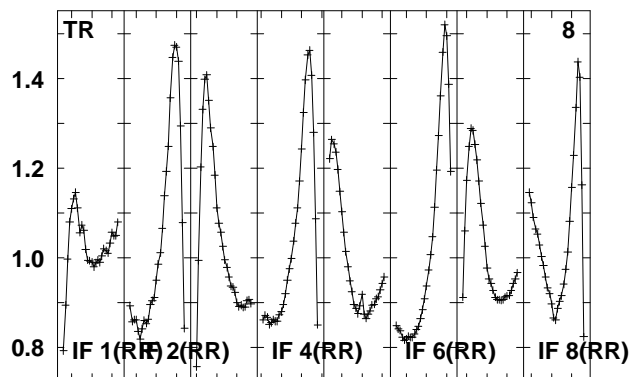
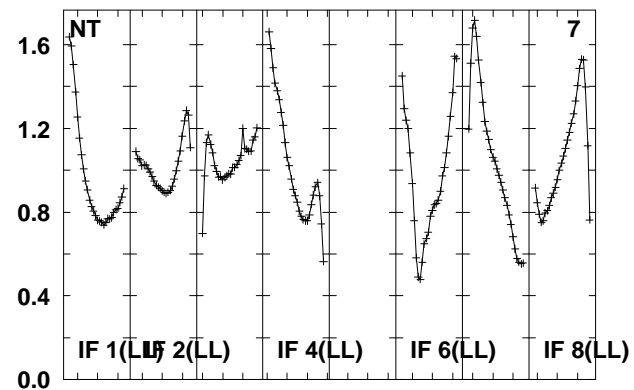
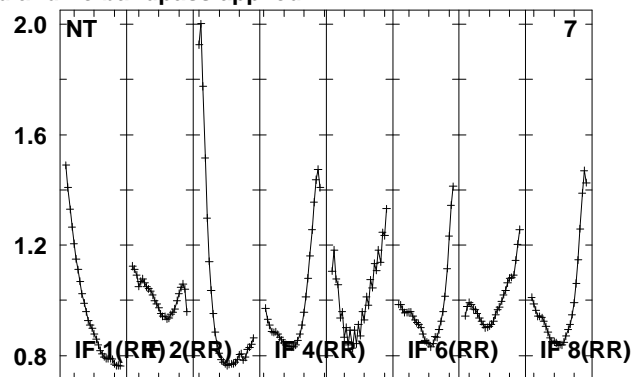
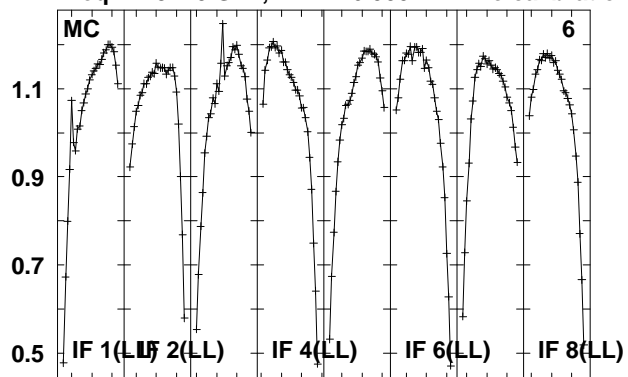

Lower frame: Real Jy
Total-power spectrum Antenna: *
Timerange: 00/06:47:05 to 00/06:48:31

Plot file version 147 created 14-MAY-2010 15:17:48
 J210358 EO007.UVDATA.1
 Freq = 4.9270 GHz, Bw = 16.000 MH No calibration applied and no bandpass applied

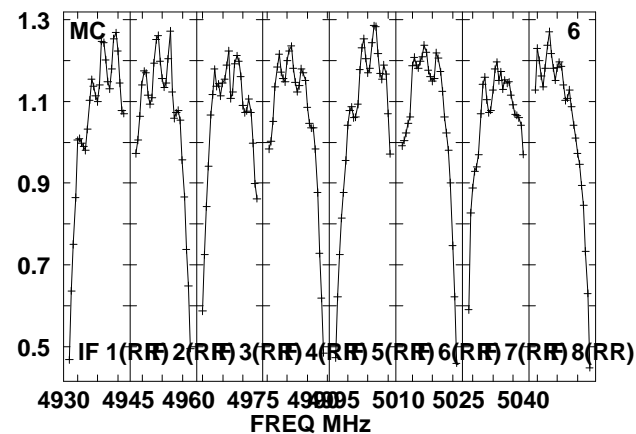
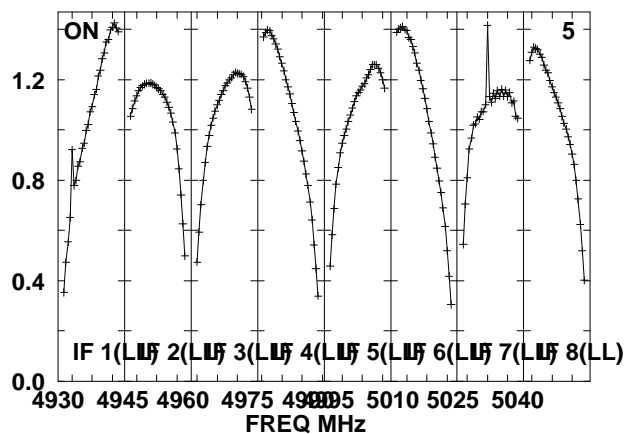
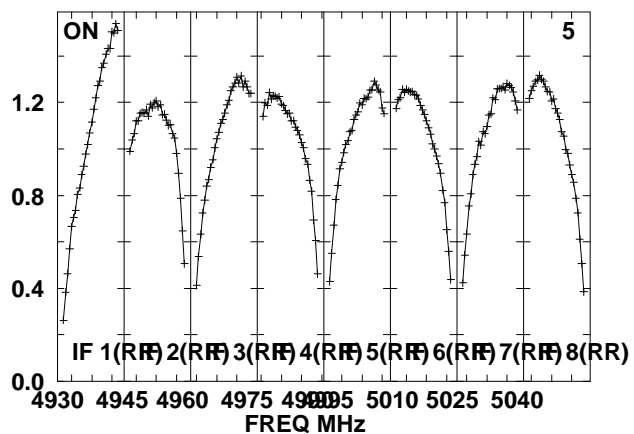
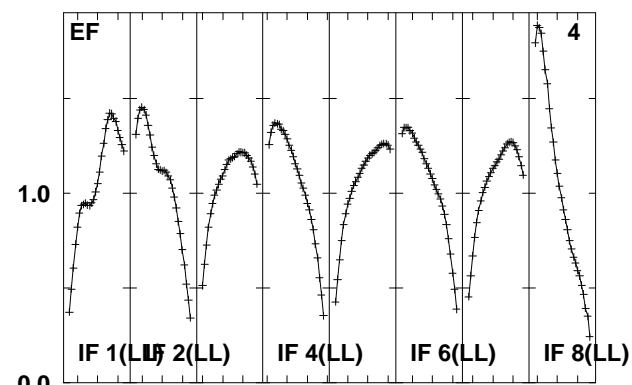
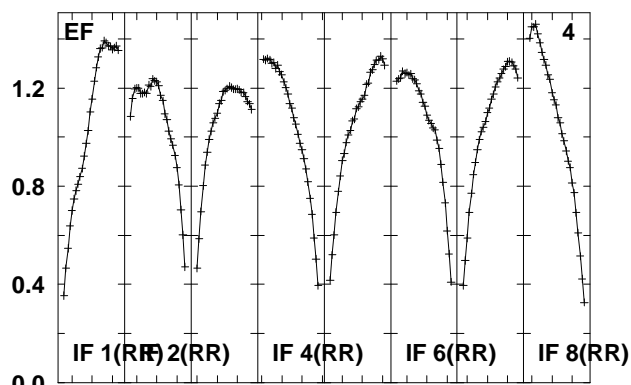
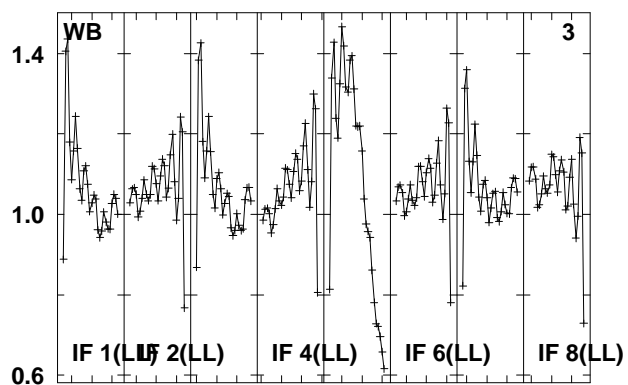
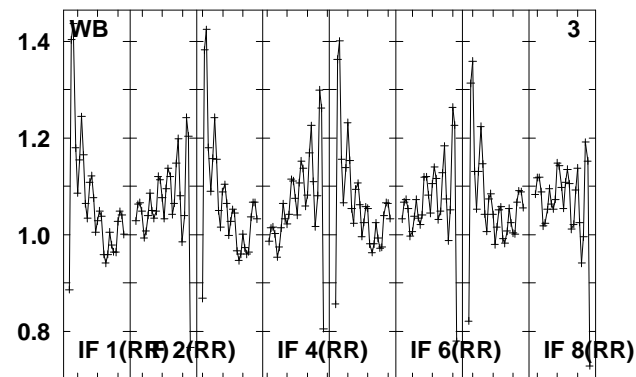
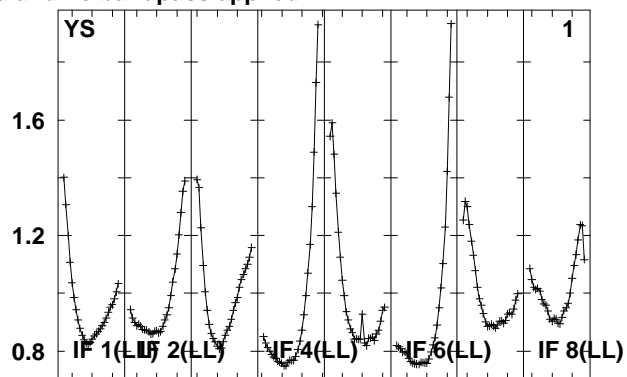
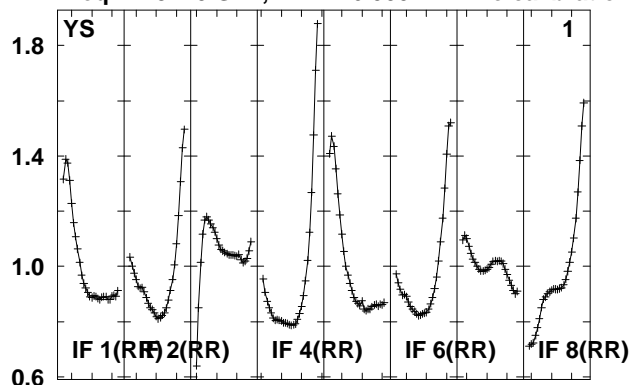

Lower frame: Real Jy
 Total-power spectrum Antenna: *
 Timerange: 00/06:49:12 to 00/06:54:10

Plot file version 148 created 14-MAY-2010 15:17:48

J210358 EO007.UVDATA.1

Freq = 4.9270 GHz, Bw = 16.000 MH No calibration applied and no bandpass applied

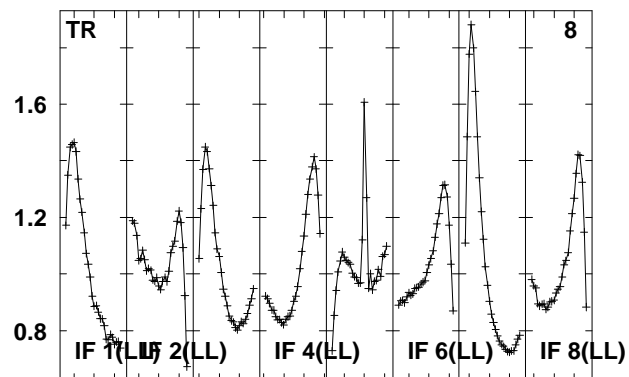
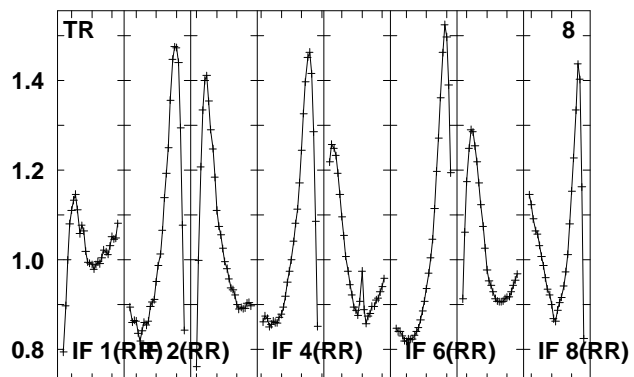
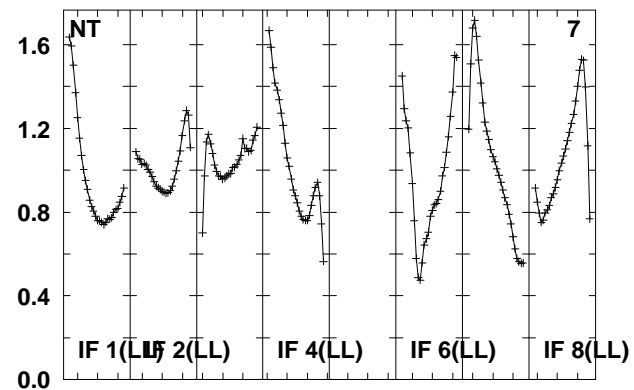
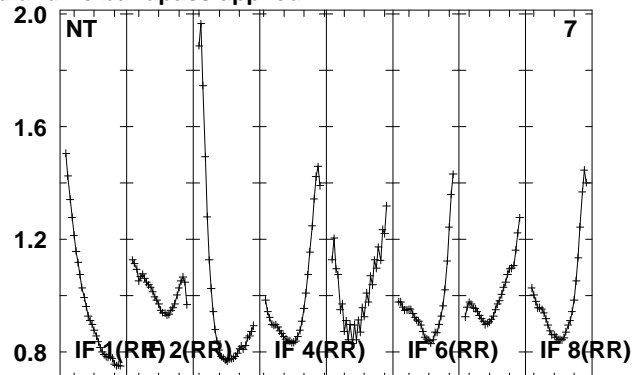
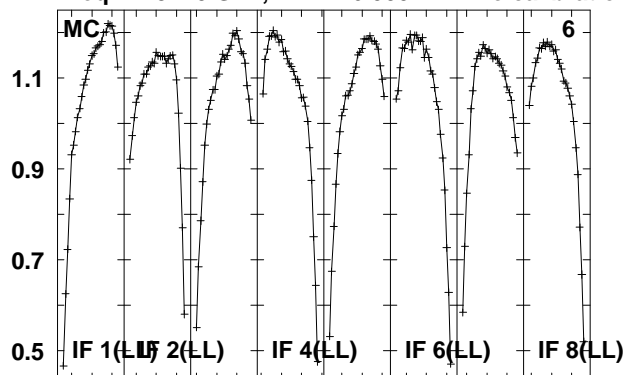

Lower frame: Real Jy
Total-power spectrum Antenna: *
Timerange: 00/06:49:12 to 00/06:54:10

Plot file version 149 created 14-MAY-2010 15:17:49

J2110-10 EO007.UVDATA.1

Freq = 4.9270 GHz, Bw = 16.000 MH No calibration applied and no bandpass applied

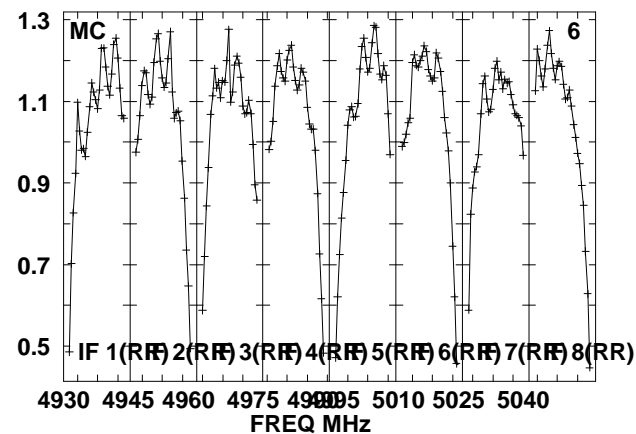
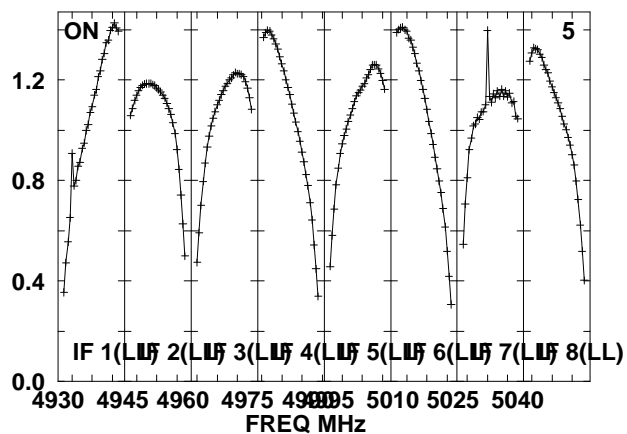
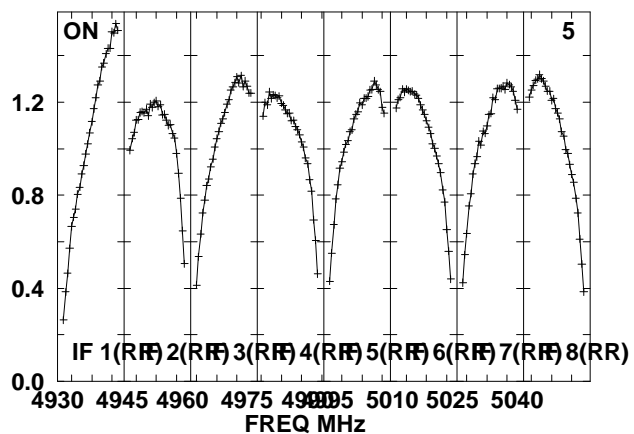
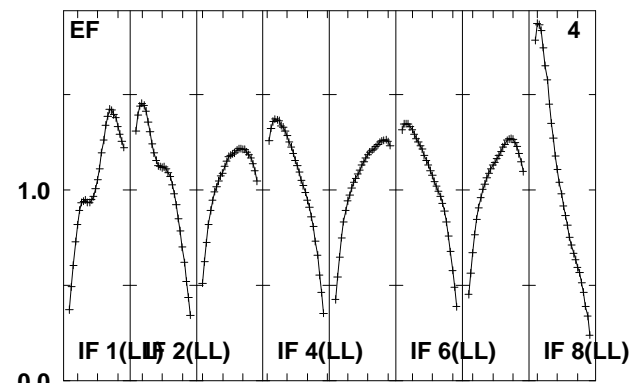
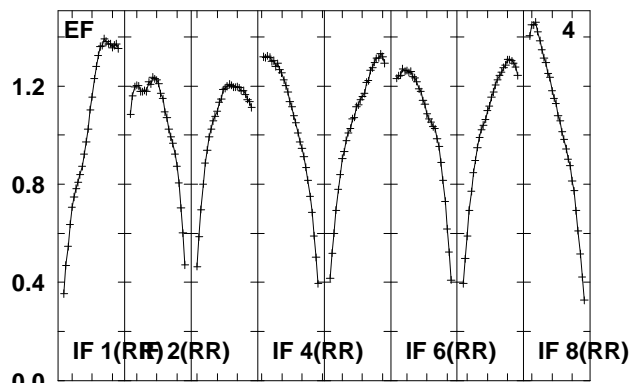
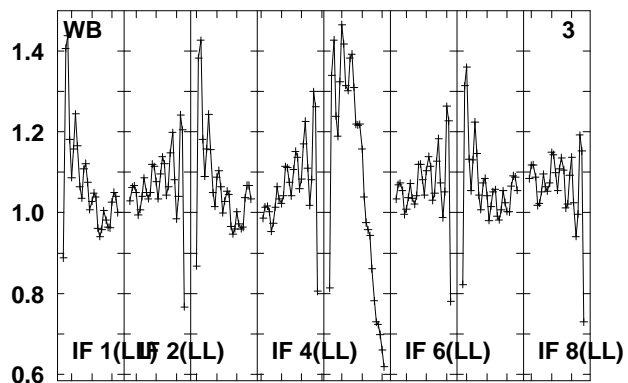
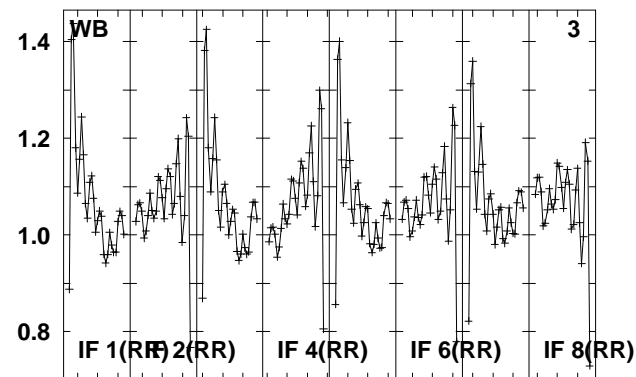
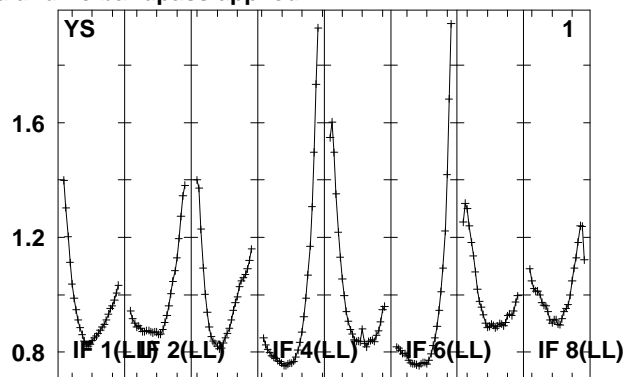
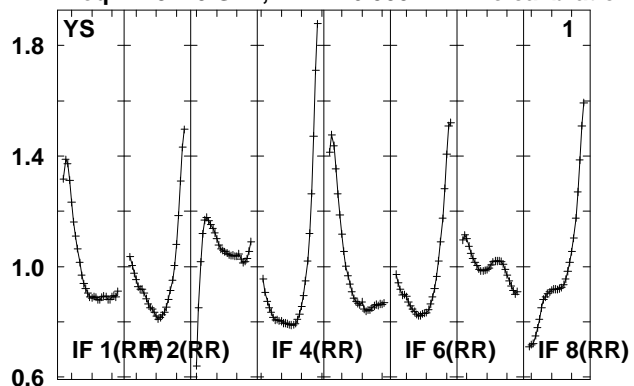

Lower frame: Real Jy
Total-power spectrum Antenna: *
Timerange: 00/06:54:48 to 00/06:56:16

Plot file version 150 created 14-MAY-2010 15:17:49

J2110-10 EO007.UVDATA.1

Freq = 4.9270 GHz, Bw = 16.000 MH No calibration applied and no bandpass applied

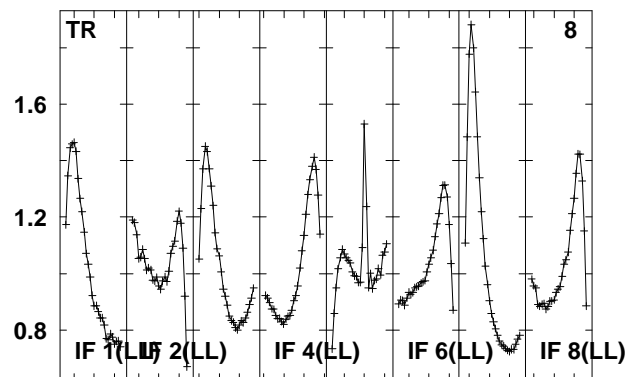
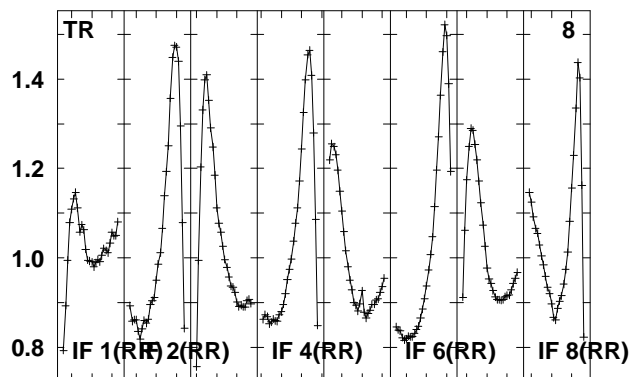
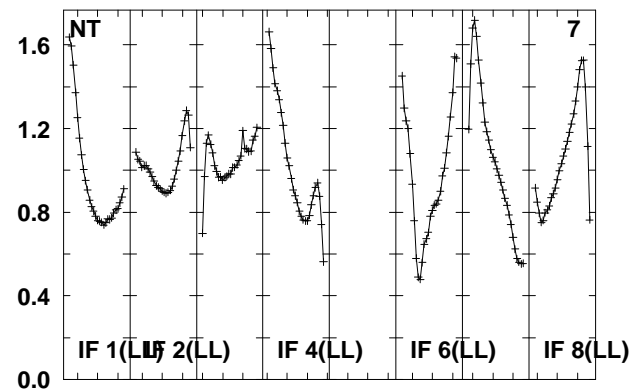
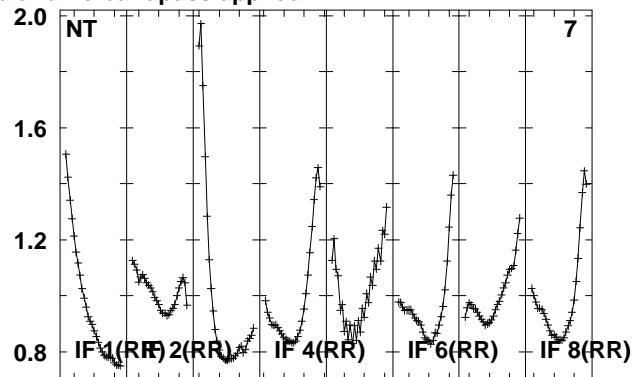
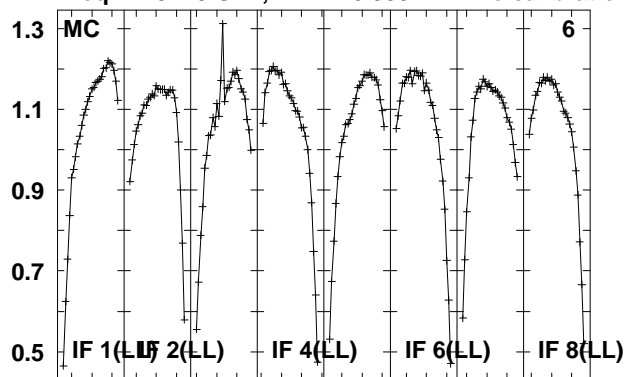

Lower frame: Real Jy
Total-power spectrum Antenna: *
Timerange: 00/06:54:48 to 00/06:56:16

Plot file version 151 created 14-MAY-2010 15:17:49

J210358 EO007.UVDATA.1

Freq = 4.9270 GHz, Bw = 16.000 MH No calibration applied and no bandpass applied

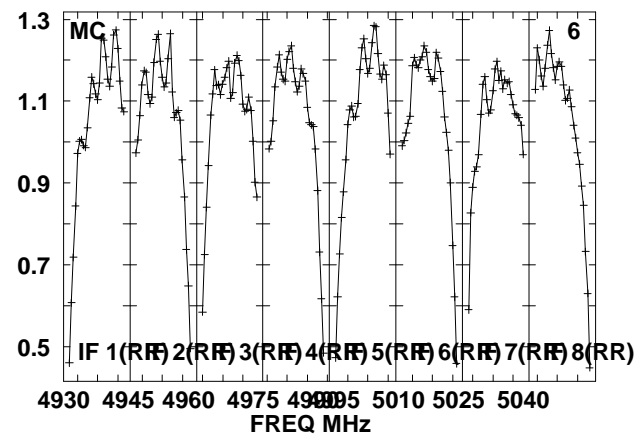
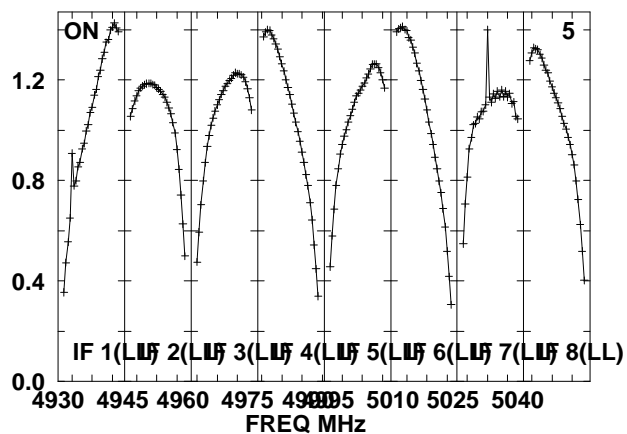
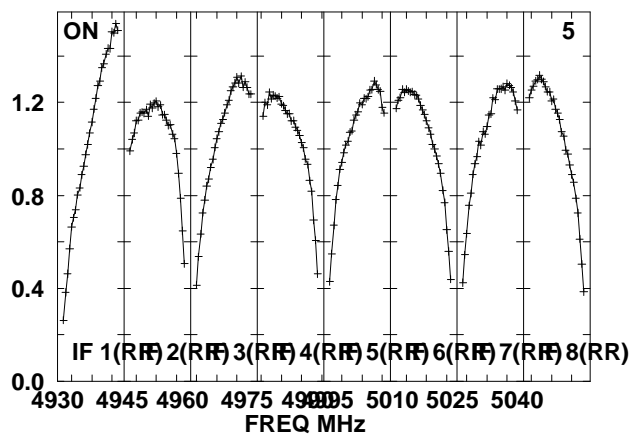
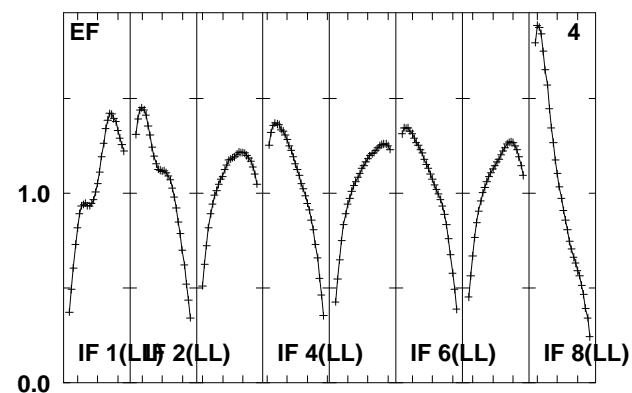
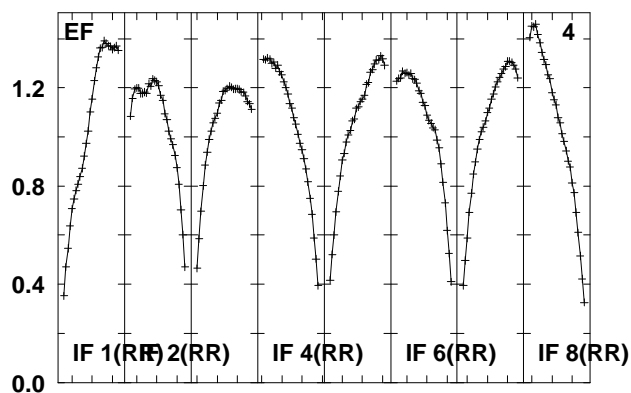
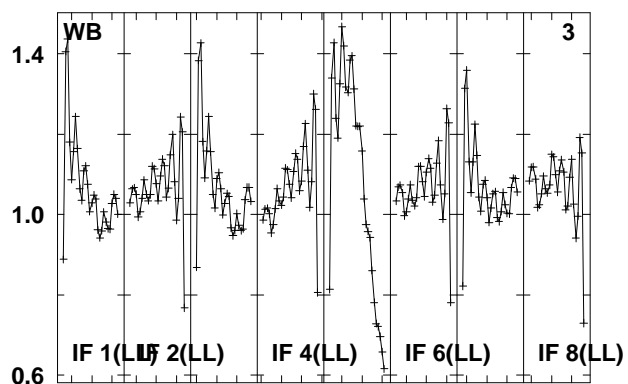
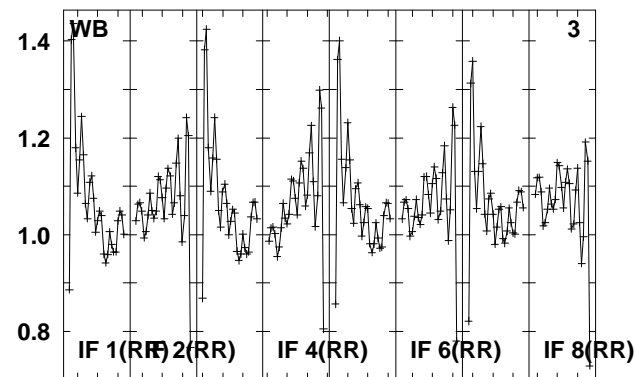
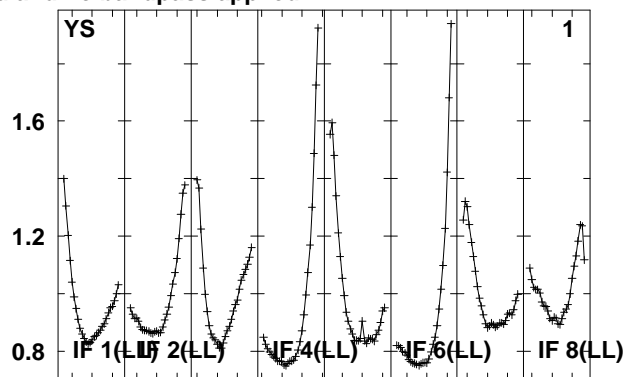
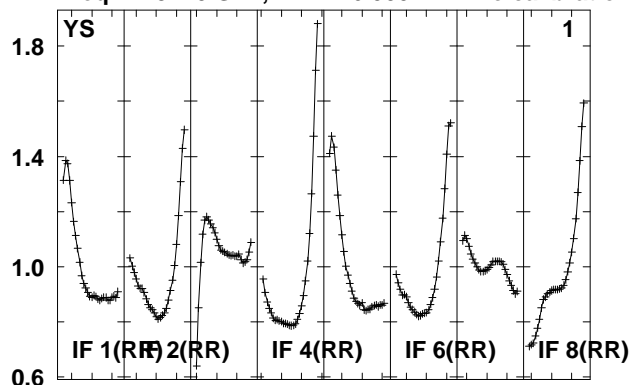

Lower frame: Real Jy
Total-power spectrum Antenna: *
Timerange: 00/06:56:53 to 00/07:01:49

Plot file version 152 created 14-MAY-2010 15:17:50

J210358 EO007.UVDATA.1

Freq = 4.9270 GHz, Bw = 16.000 MH No calibration applied and no bandpass applied

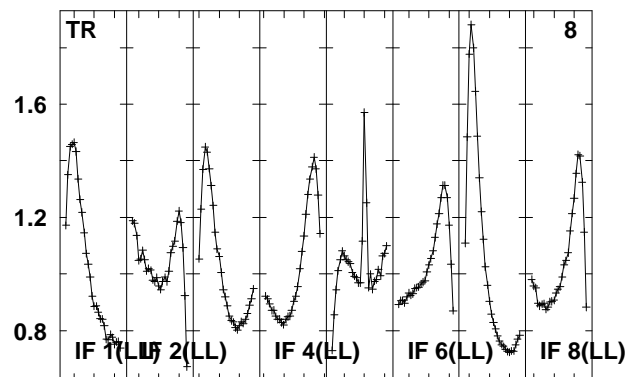
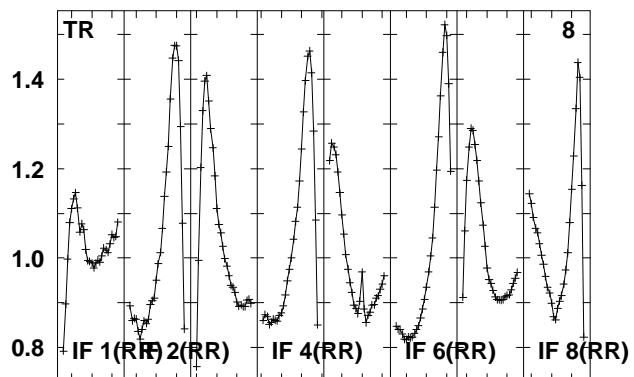
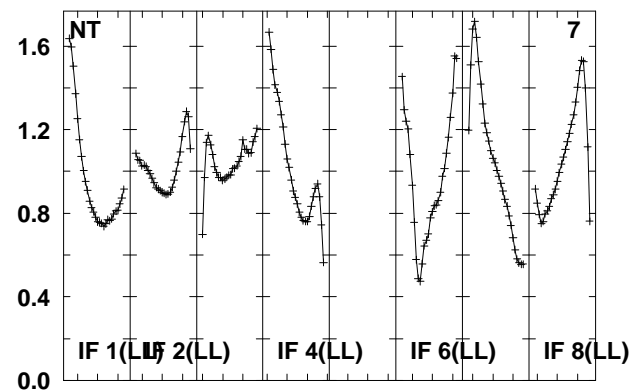
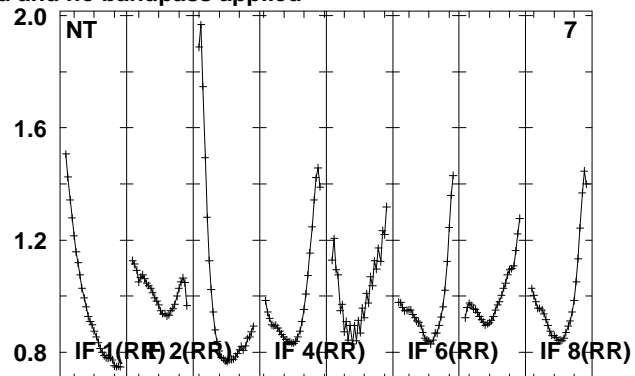
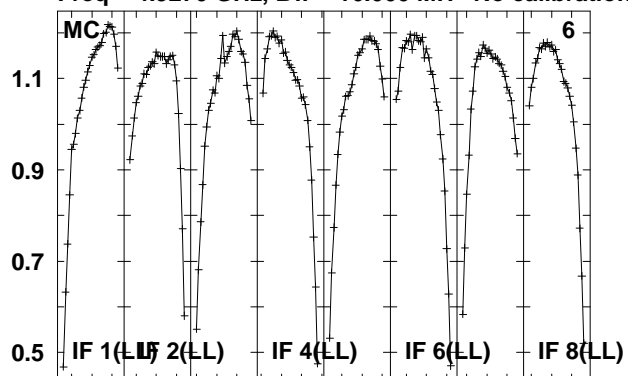

Lower frame: Real Jy
Total-power spectrum Antenna: *
Timerange: 00/06:56:53 to 00/07:01:49

Plot file version 153 created 14-MAY-2010 15:17:50

J2110-10 EO007.UVDATA.1

Freq = 4.9270 GHz, Bw = 16.000 MH No calibration applied and no bandpass applied

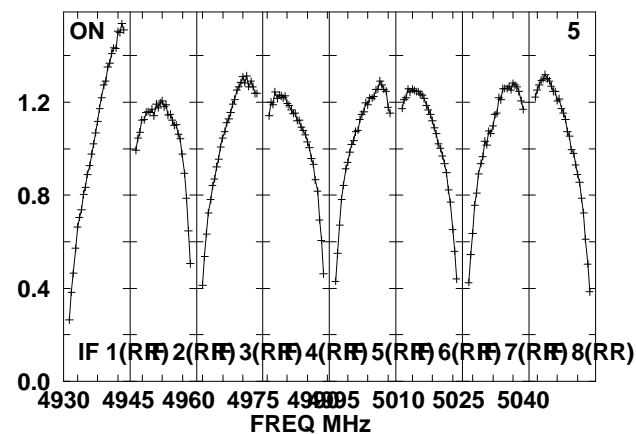
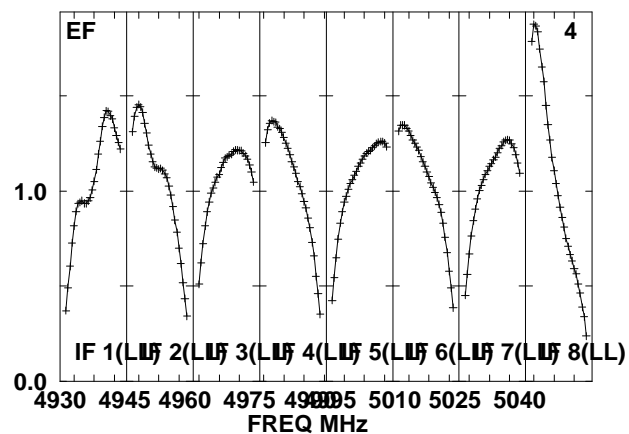
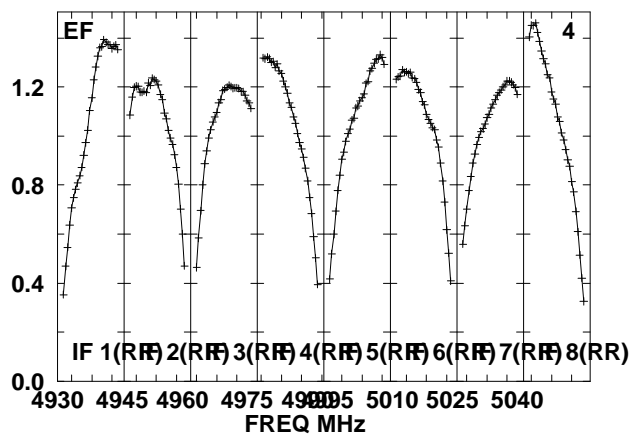
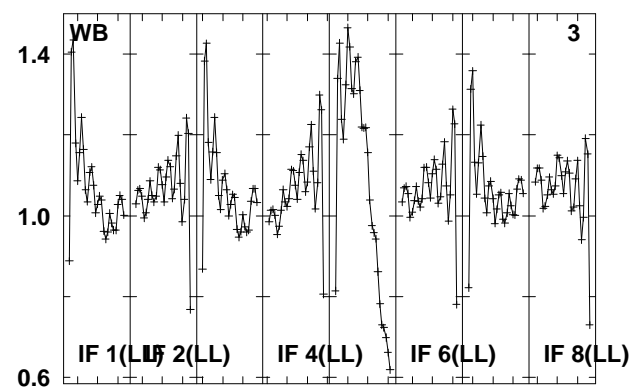
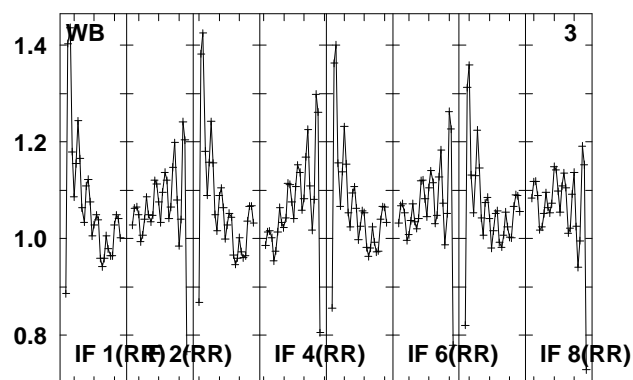
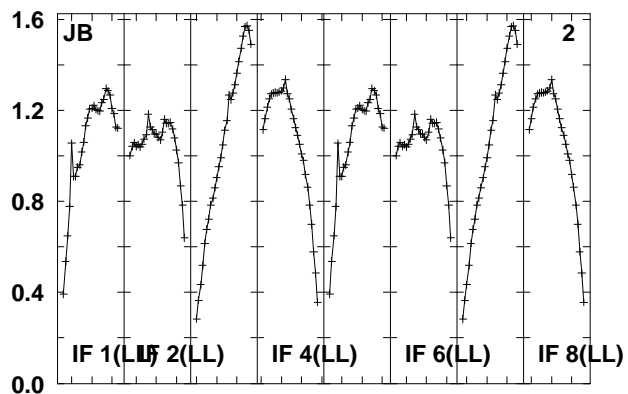
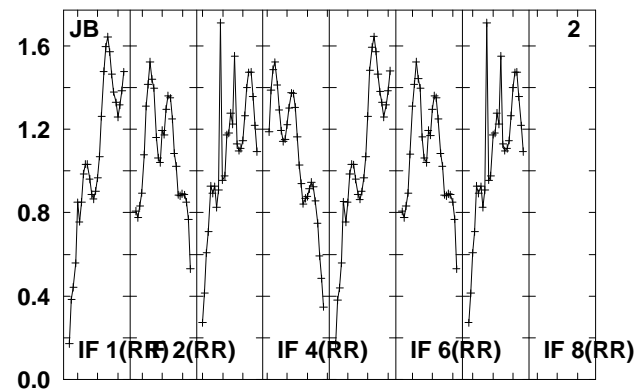
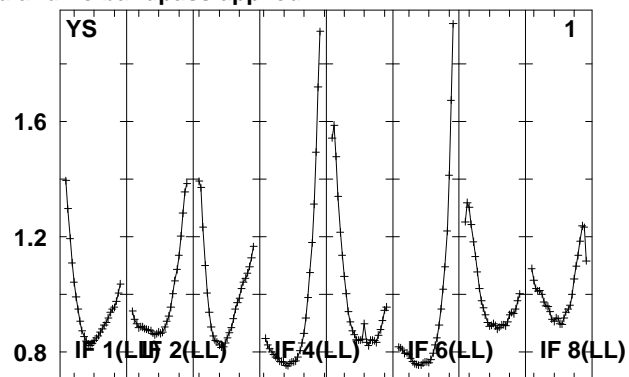
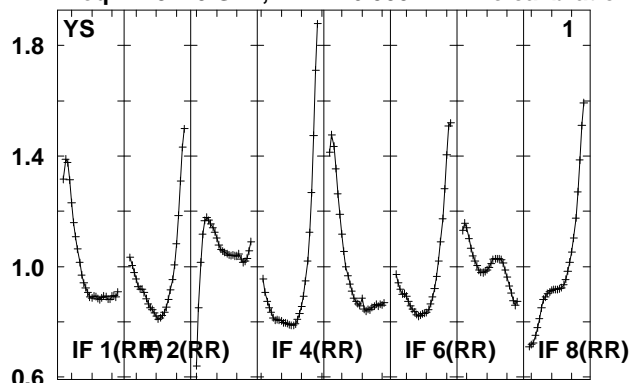

Lower frame: Real Jy
Total-power spectrum Antenna: *
Timerange: 00/07:02:27 to 00/07:03:55

Plot file version 154 created 14-MAY-2010 15:17:50

J2110-10 EO007.UVDATA.1

Freq = 4.9270 GHz, Bw = 16.000 MH No calibration applied and no bandpass applied

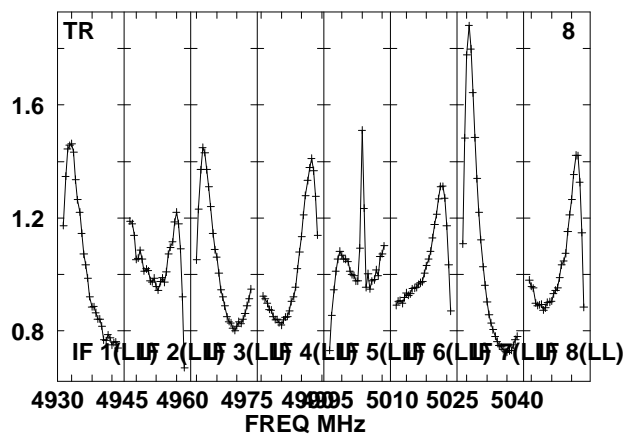
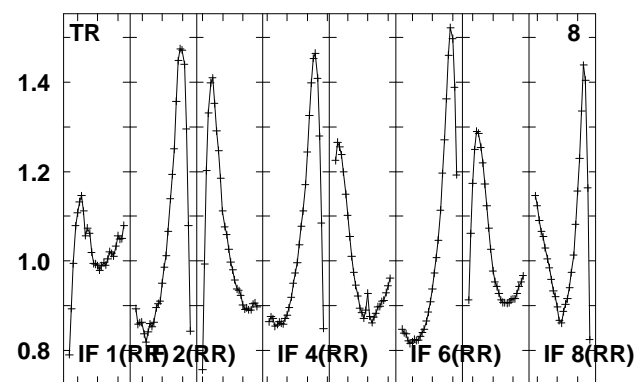
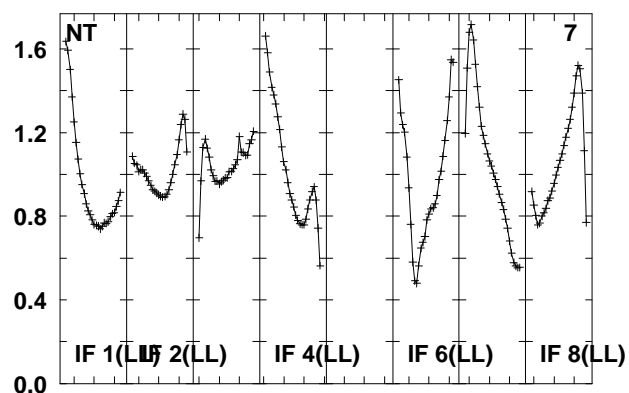
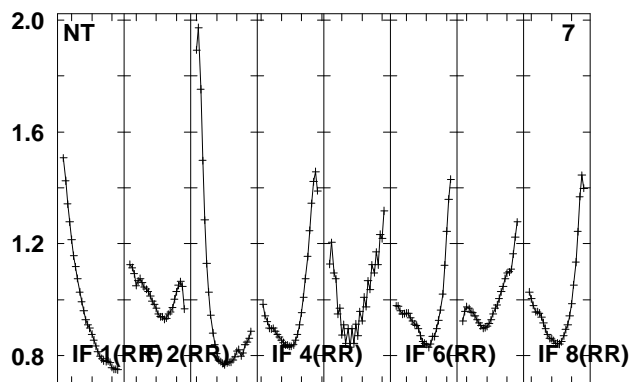
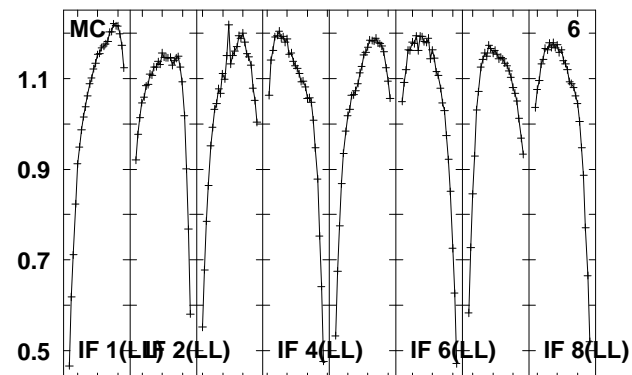
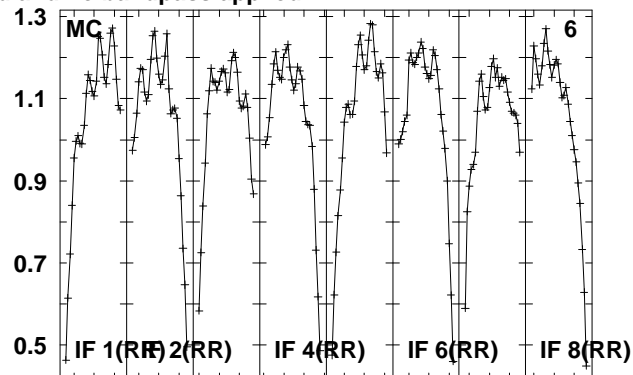
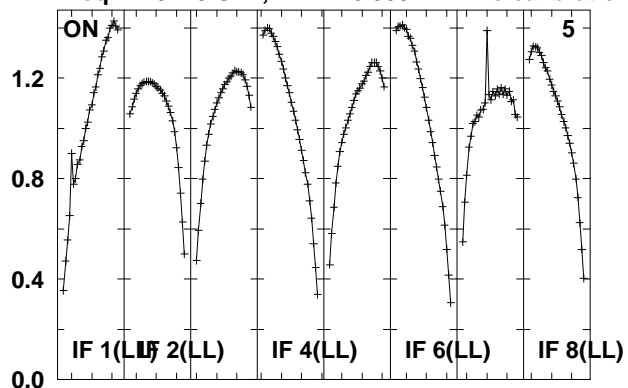

Lower frame: Real Jy

Total-power spectrum Antenna: *

Timerange: 00/07:02:27 to 00/07:03:55

Plot file version 155 created 14-MAY-2010 15:17:51
 J210358 EO007.UVDATA.1
 Freq = 4.9270 GHz, Bw = 16.000 MH No calibration applied and no bandpass applied

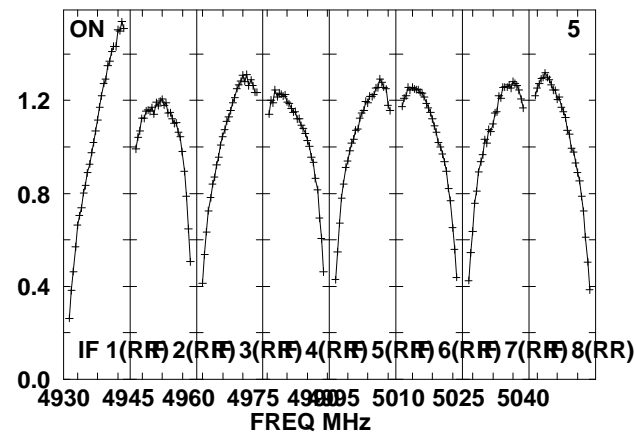
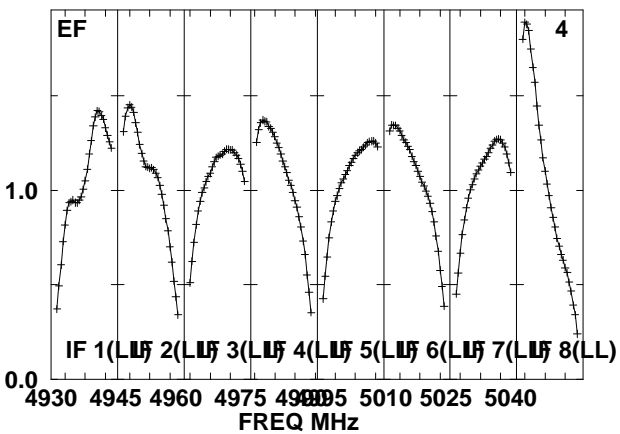
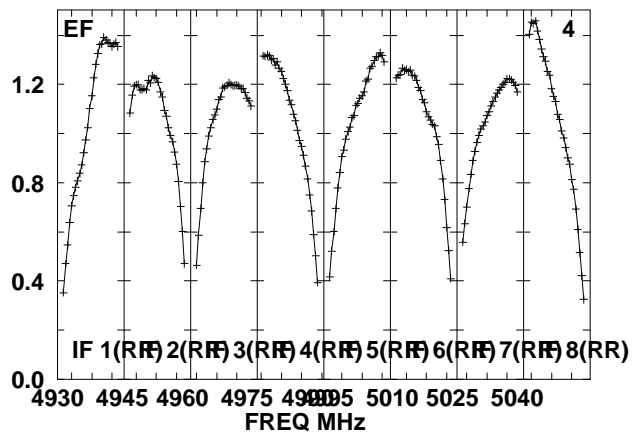
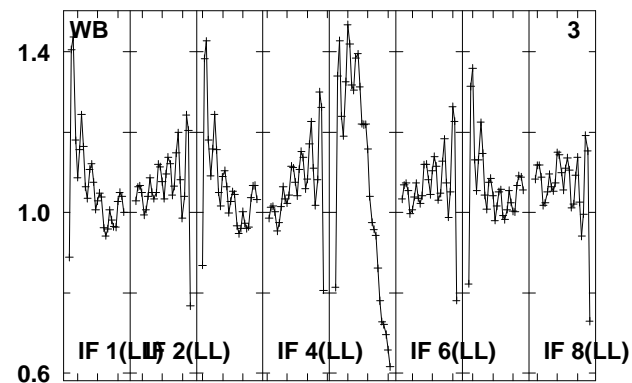
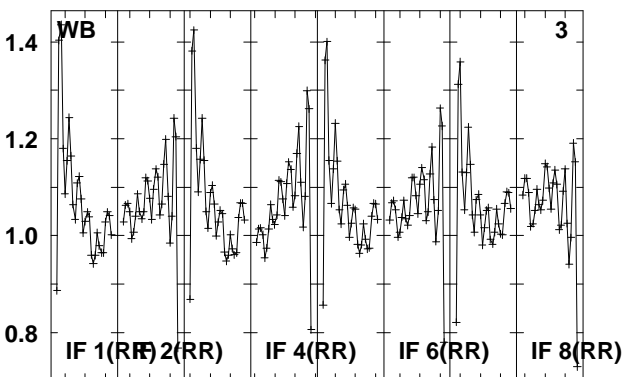
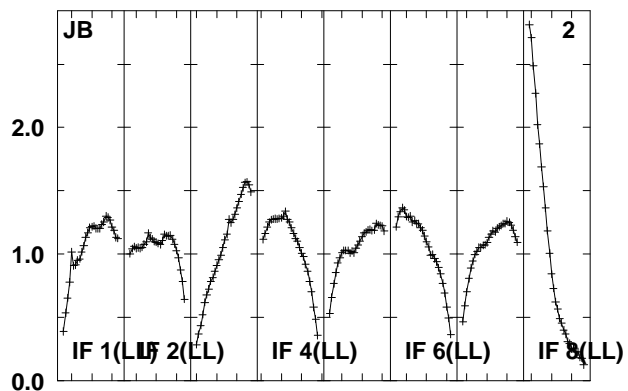
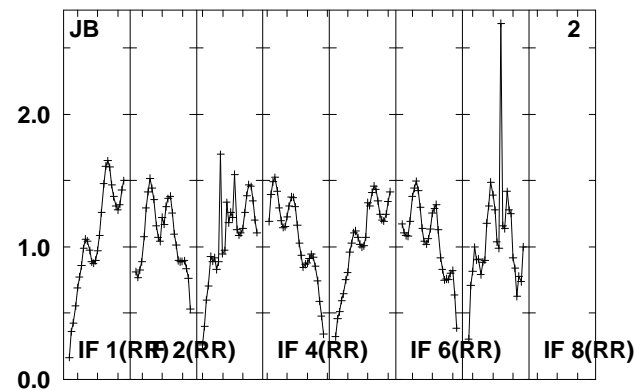
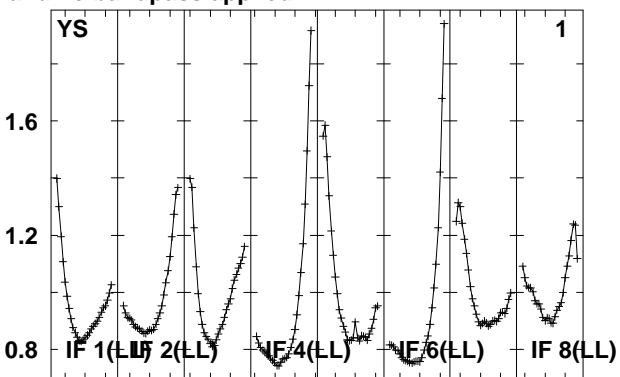
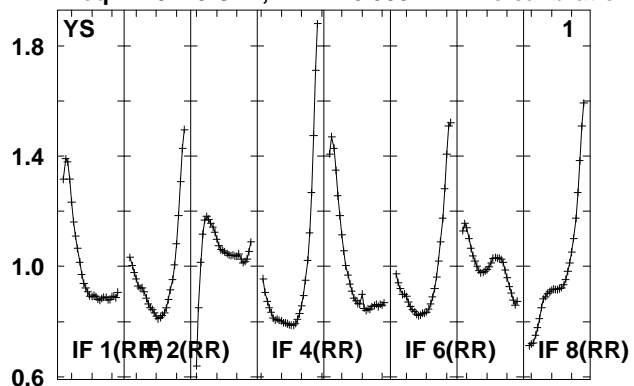

Lower frame: Real Jy
 Total-power spectrum Antenna: *
 Timerange: 00/07:04:34 to 00/07:09:30

Plot file version 156 created 14-MAY-2010 15:17:51

J210358 EO007.UVDATA.1

Freq = 4.9270 GHz, Bw = 16.000 MH No calibration applied and no bandpass applied

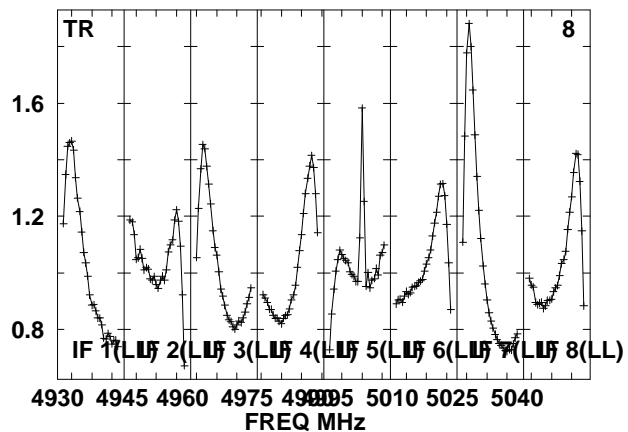
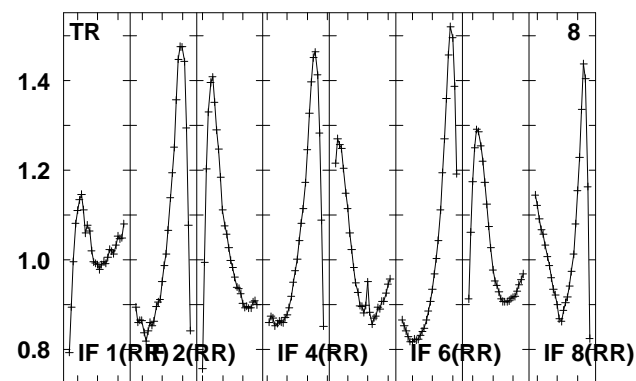
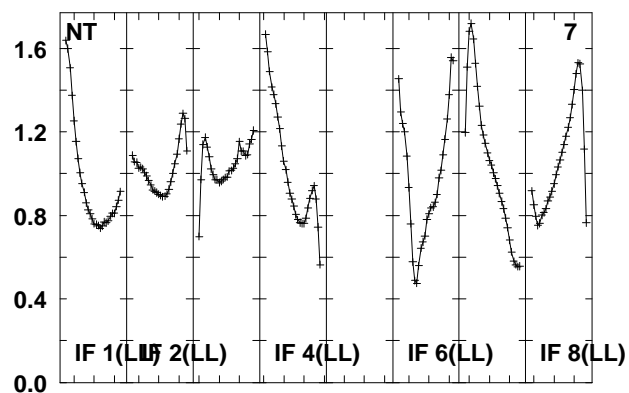
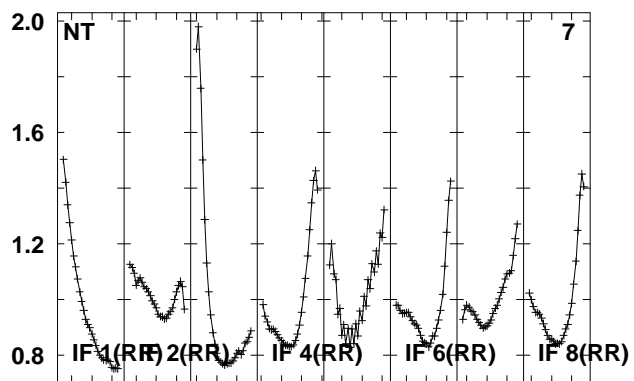
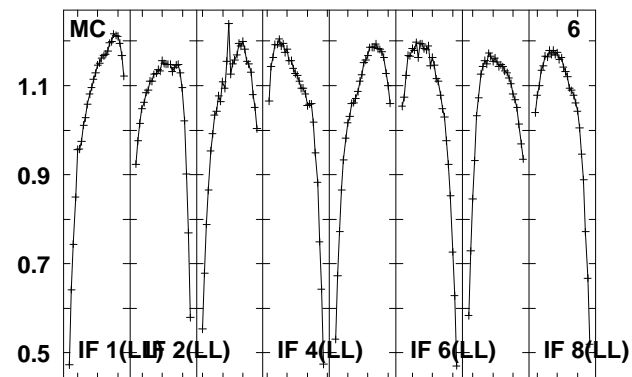
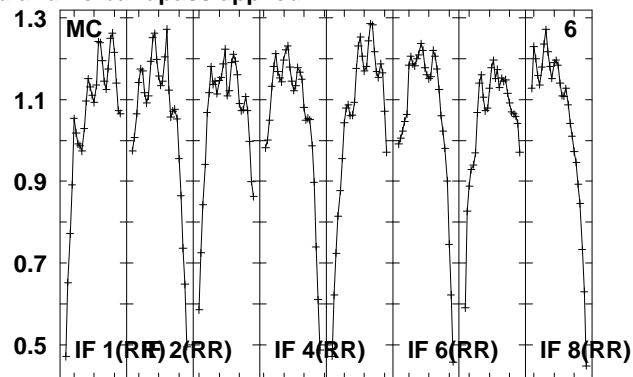
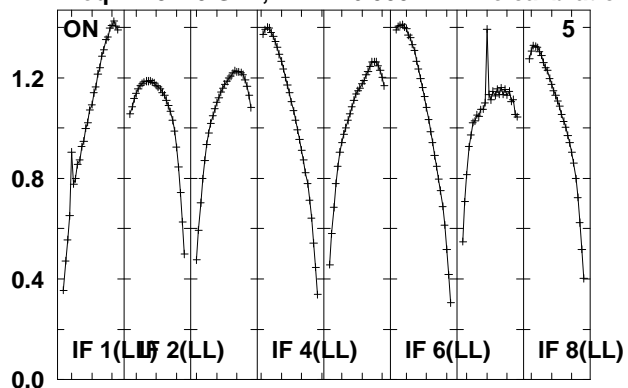

Lower frame: Real Jy

Total-power spectrum Antenna: *

Timerange: 00/07:04:34 to 00/07:09:30

Plot file version 157 created 14-MAY-2010 15:17:52

J2110-10 EO007.UVDATA.1

Freq = 4.9270 GHz, Bw = 16.000 MH No calibration applied and no bandpass applied

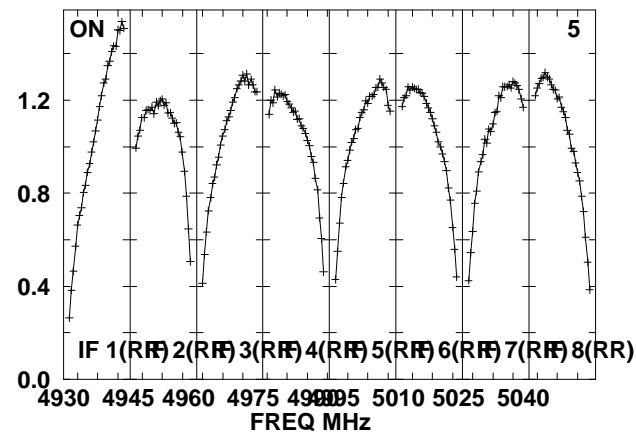
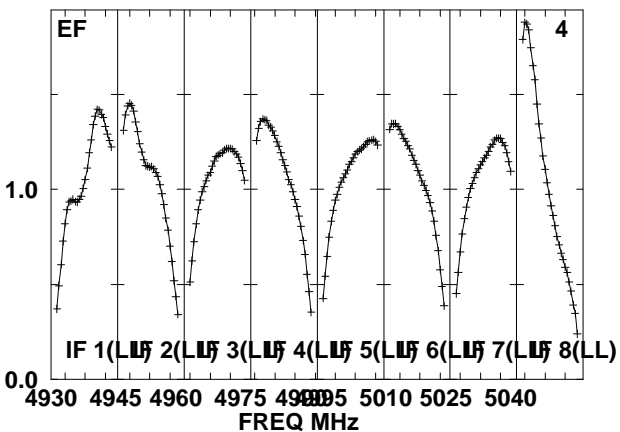
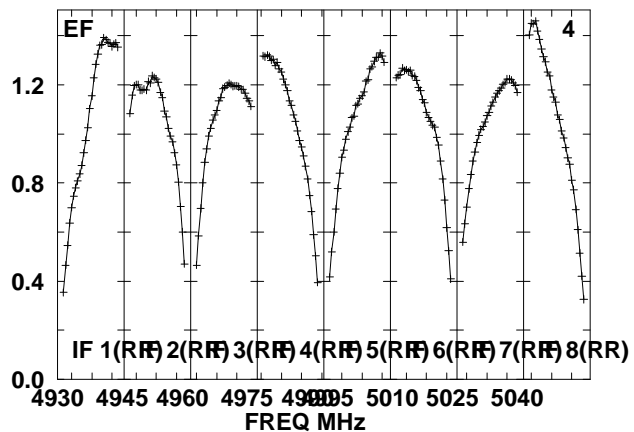
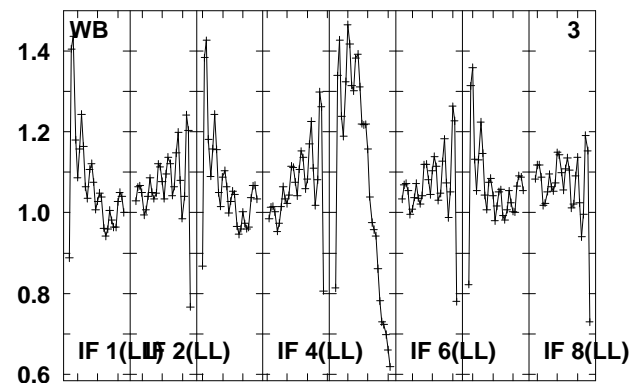
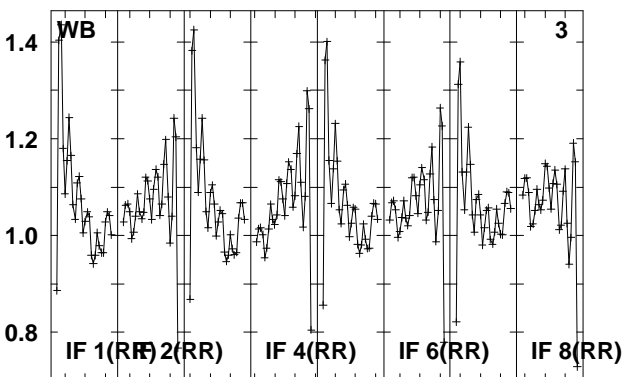
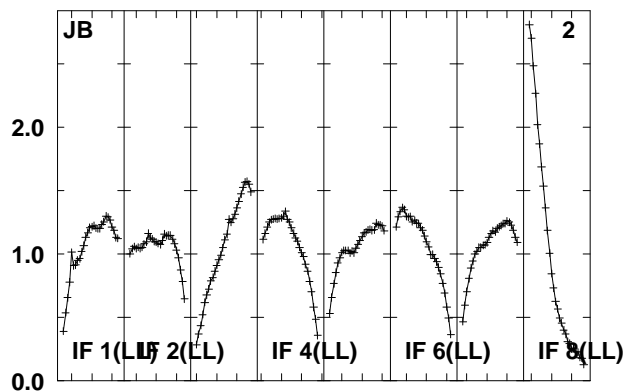
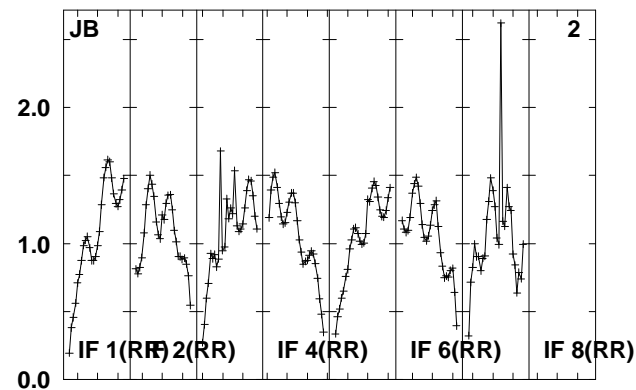
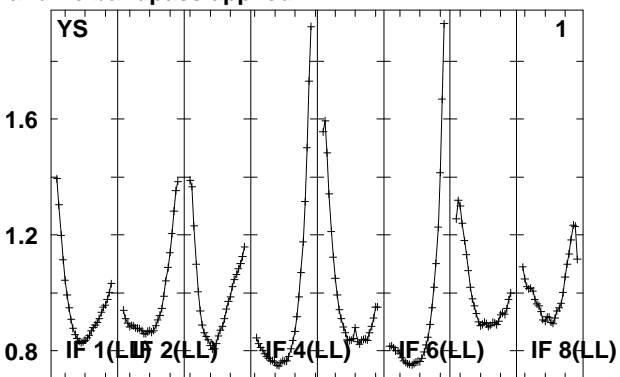
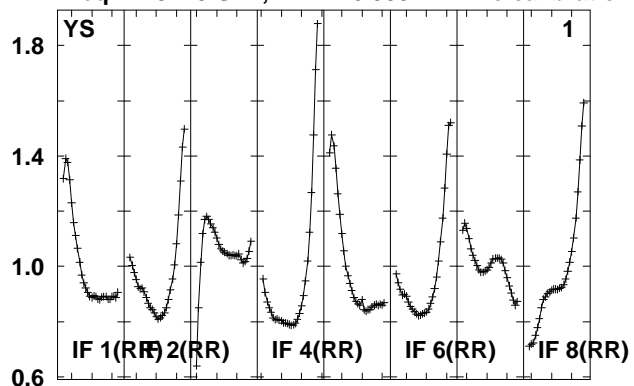

Lower frame: Real Jy
Total-power spectrum Antenna: *
Timerange: 00/07:10:10 to 00/07:11:38

Plot file version 158 created 14-MAY-2010 15:17:52

J2110-10 EO007.UVDATA.1

Freq = 4.9270 GHz, Bw = 16.000 MH No calibration applied and no bandpass applied

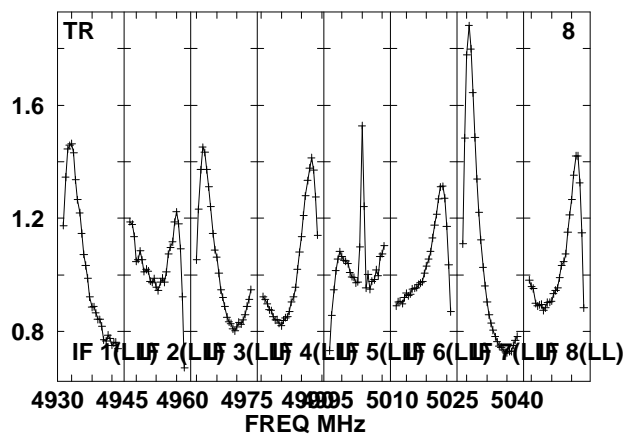
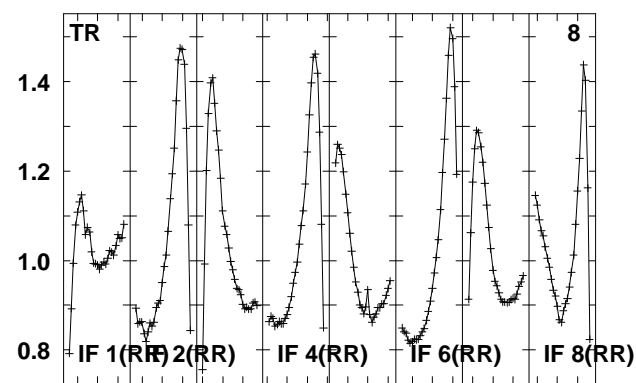
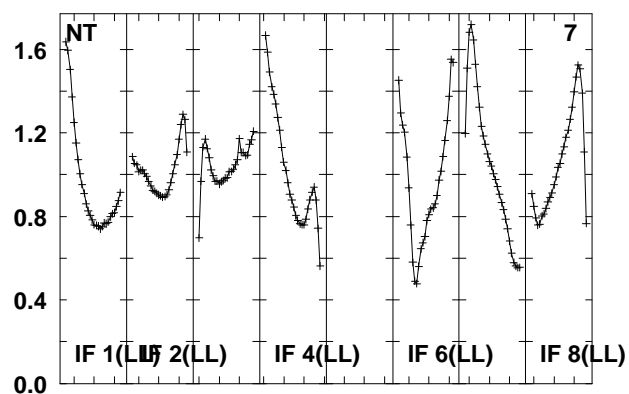
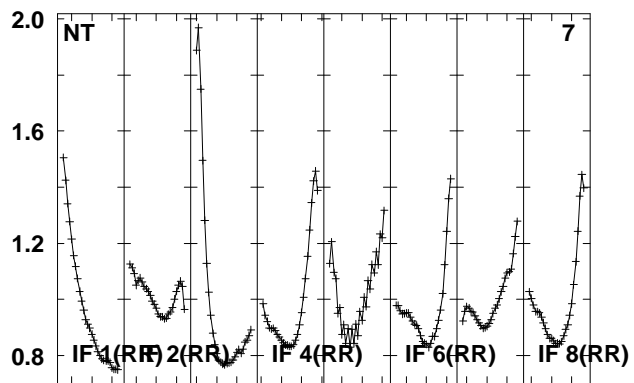
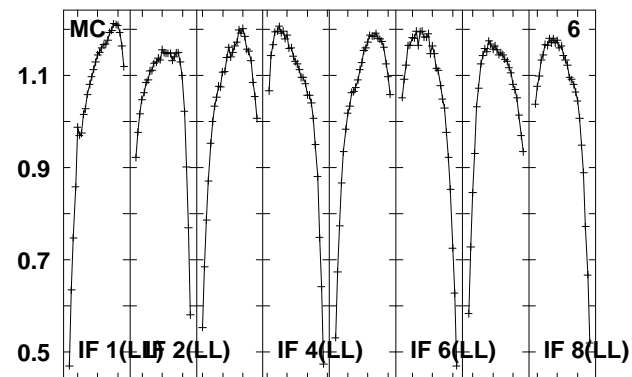
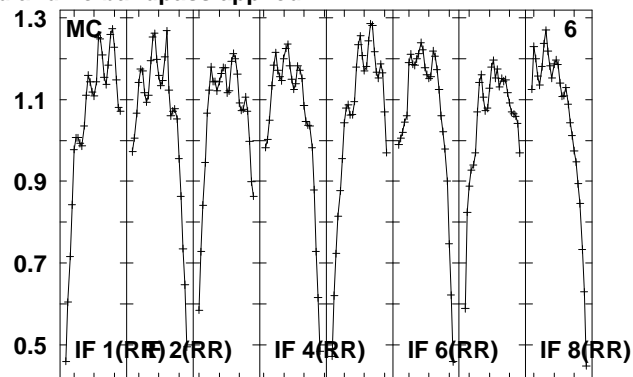
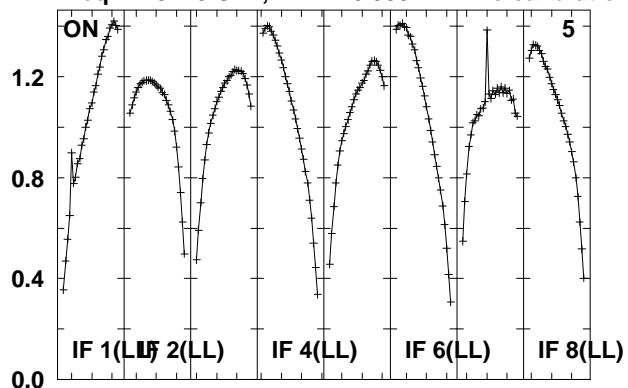

Lower frame: Real Jy

Total-power spectrum Antenna: *

Timerange: 00/07:10:10 to 00/07:11:38

Plot file version 159 created 14-MAY-2010 15:17:52

J210358 EO007.UVDATA.1

Freq = 4.9270 GHz, Bw = 16.000 MH No calibration applied and no bandpass applied

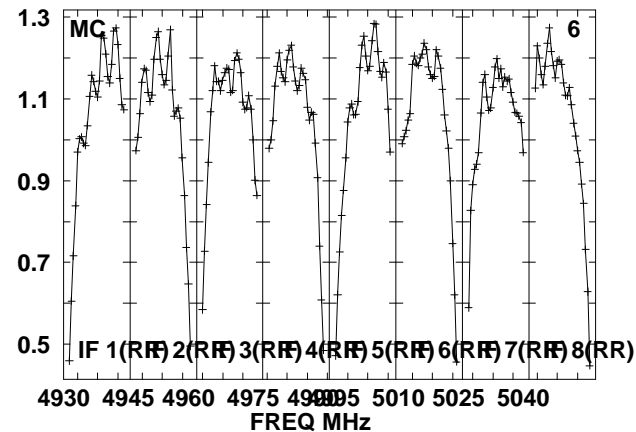
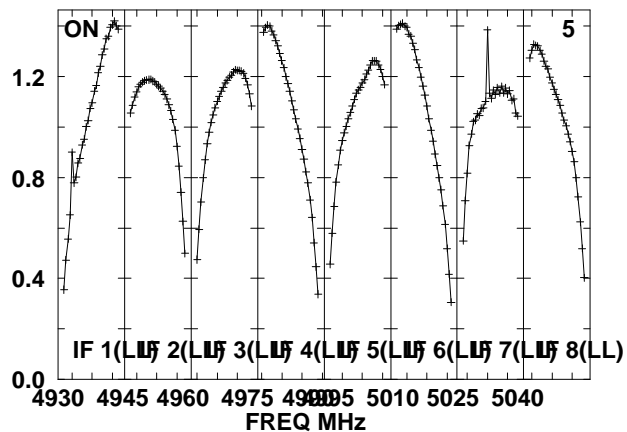
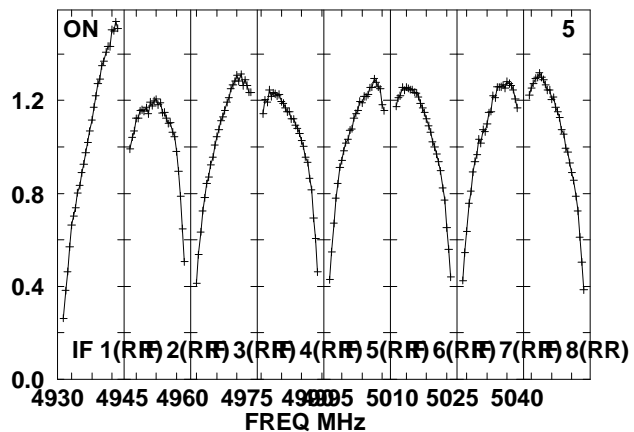
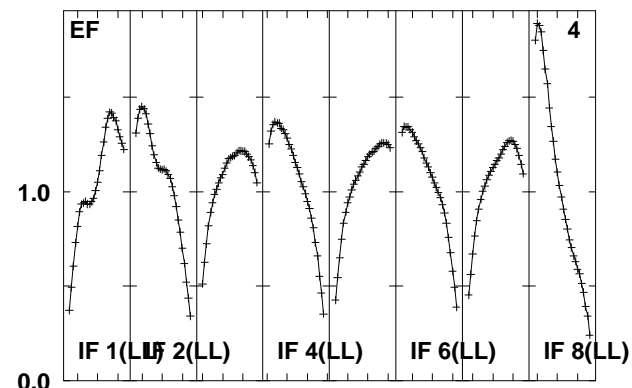
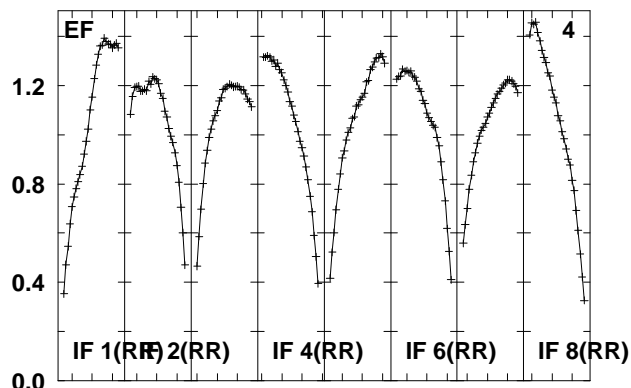
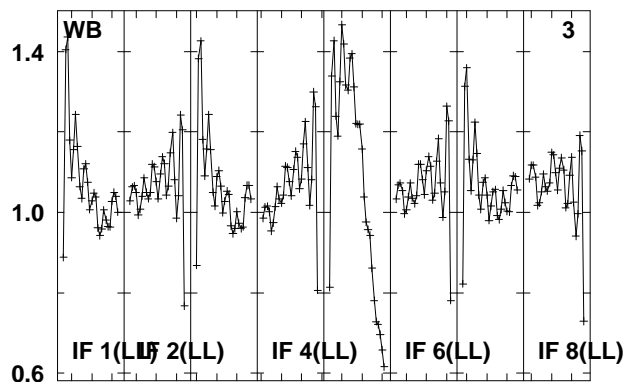
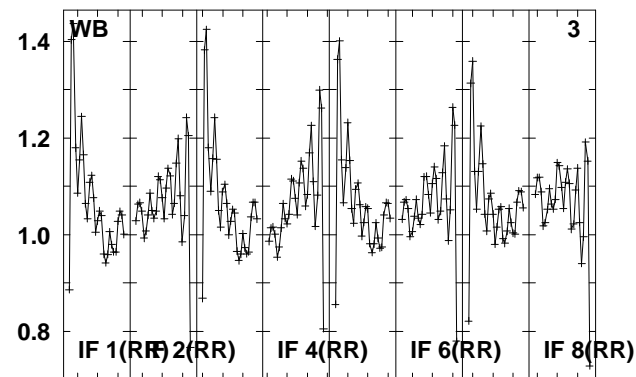
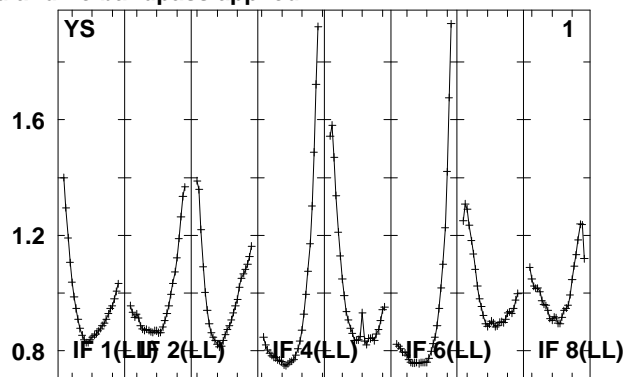
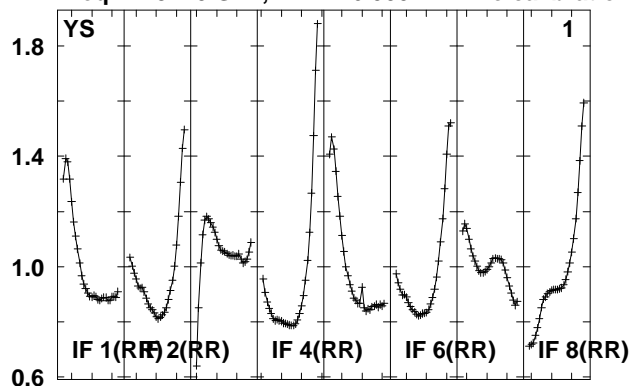

Lower frame: Real Jy

Total-power spectrum Antenna: *

Timerange: 00/07:12:14 to 00/07:17:12

Plot file version 160 created 14-MAY-2010 15:17:53

J210358 EO007.UVDATA.1

Freq = 4.9270 GHz, Bw = 16.000 MH No calibration applied and no bandpass applied

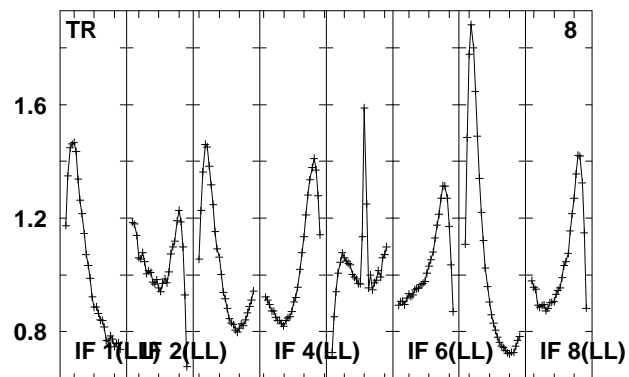
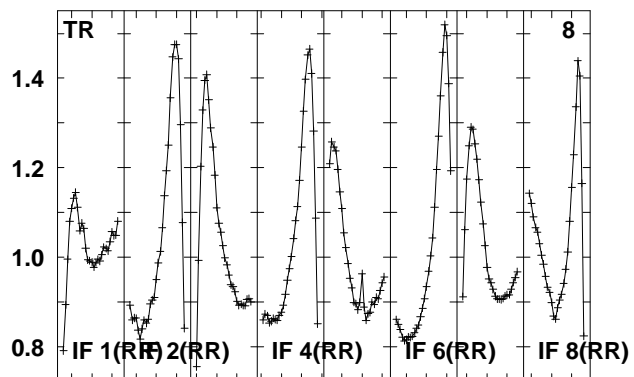
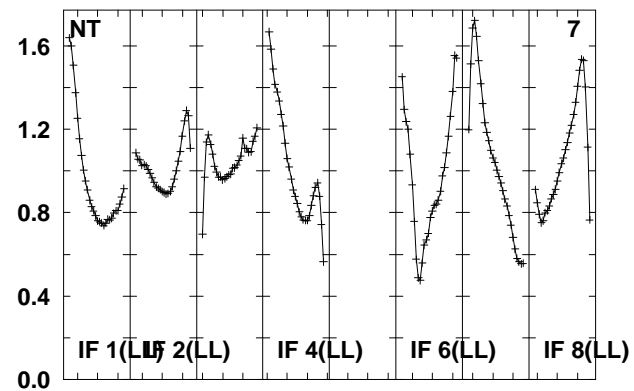
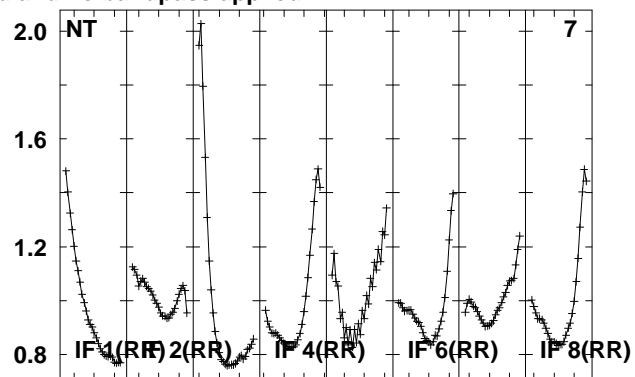
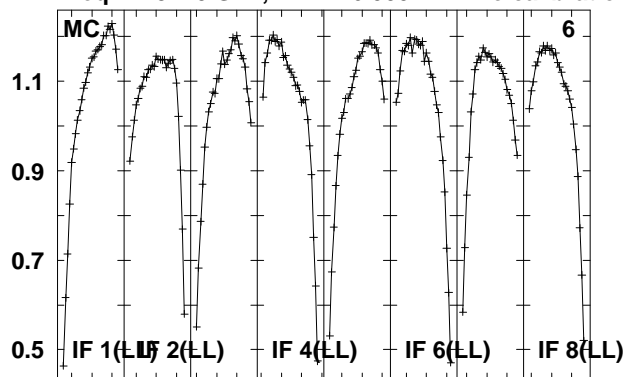

Lower frame: Real Jy
Total-power spectrum Antenna: *
Timerange: 00/07:12:14 to 00/07:17:12

Plot file version 161 created 14-MAY-2010 15:17:53

J2110-10 EO007.UVDATA.1

Freq = 4.9270 GHz, Bw = 16.000 MH No calibration applied and no bandpass applied

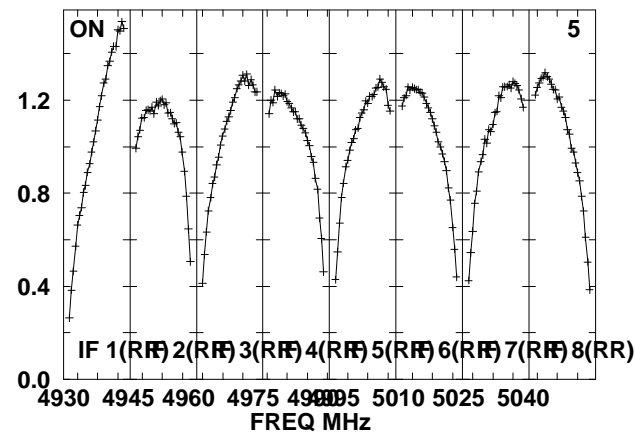
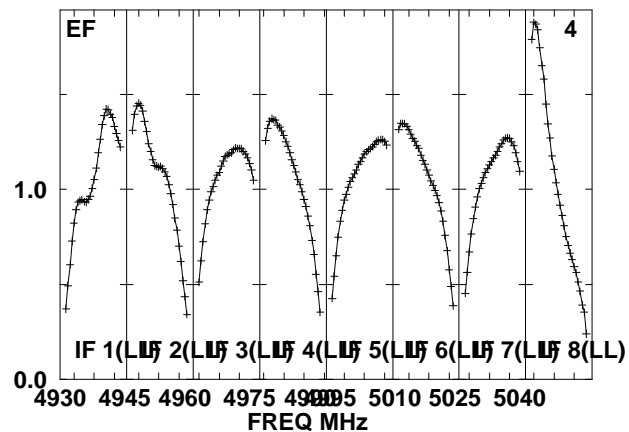
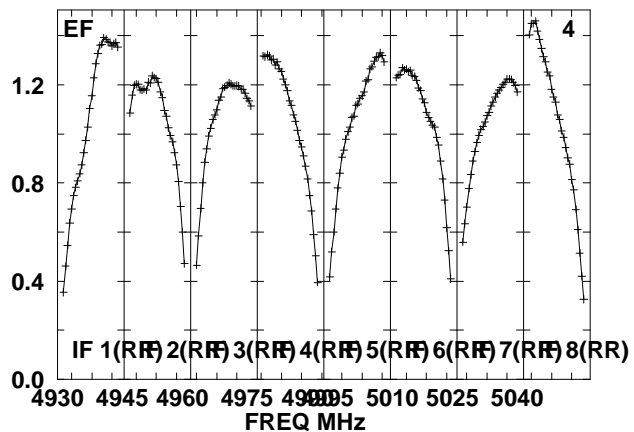
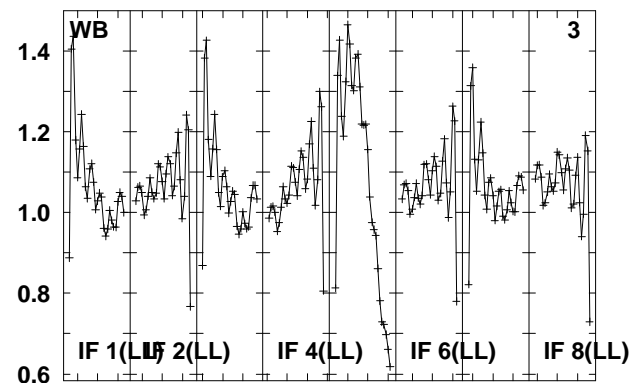
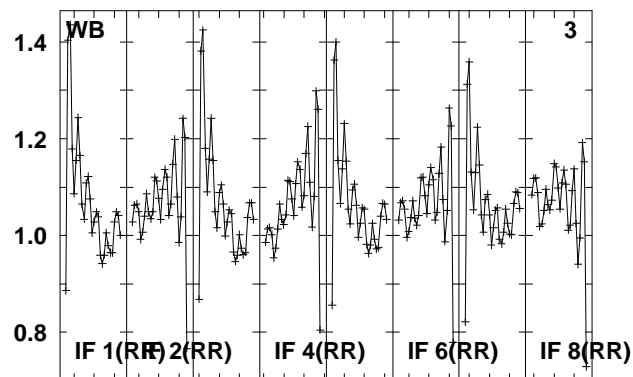
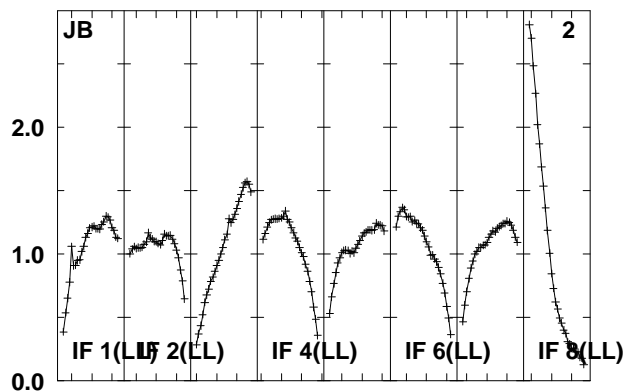
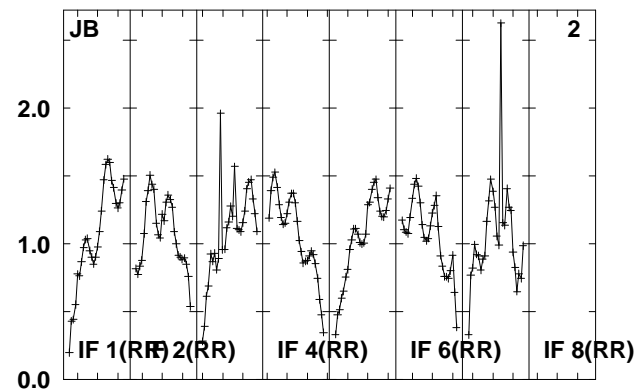
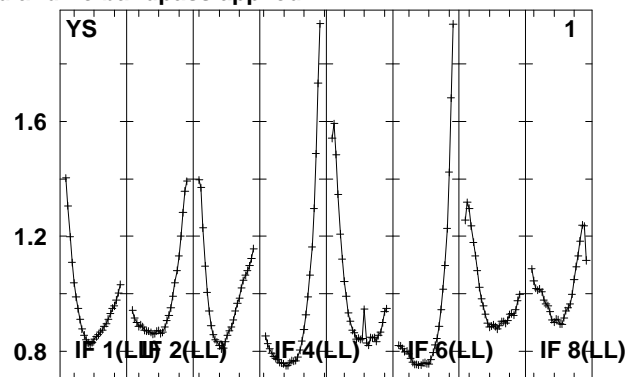
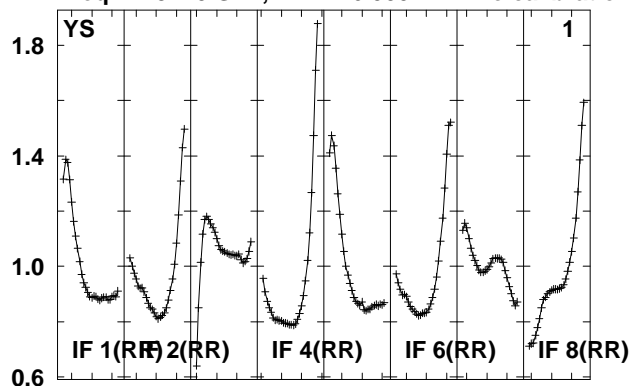

Lower frame: Real Jy

Total-power spectrum Antenna: *

Timerange: 00/07:17:50 to 00/07:19:16

Plot file version 162 created 14-MAY-2010 15:17:53

J2110-10 EO007.UVDATA.1

Freq = 4.9270 GHz, Bw = 16.000 MH No calibration applied and no bandpass applied

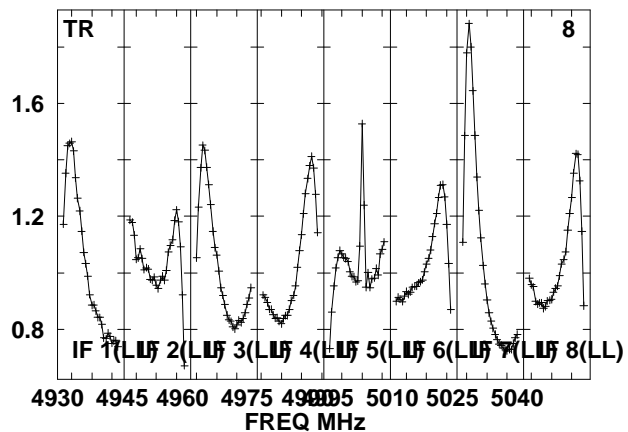
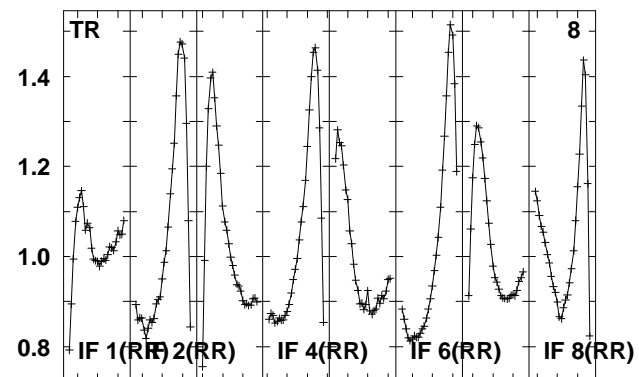
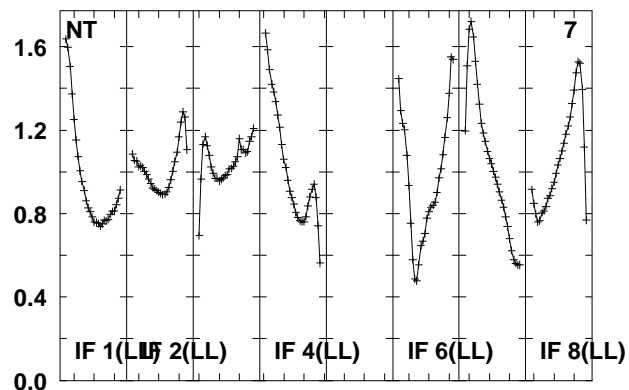
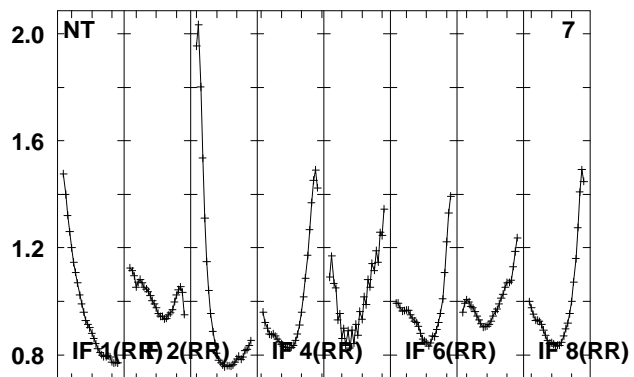
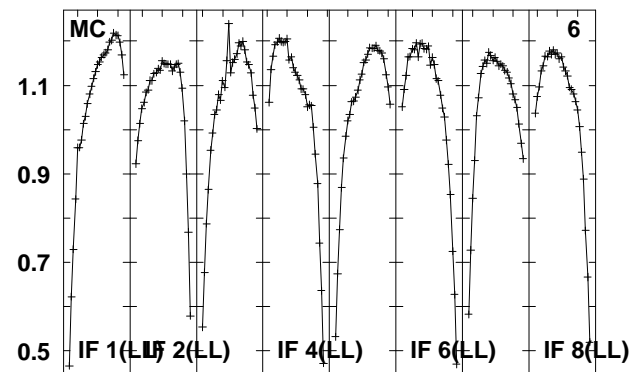
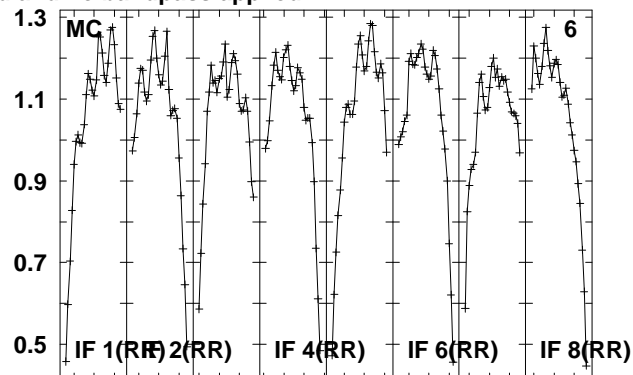
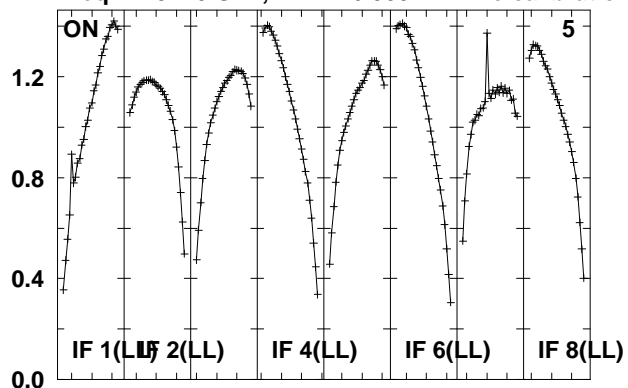

Lower frame: Real Jy

Total-power spectrum Antenna: *

Timerange: 00/07:17:50 to 00/07:19:16

Plot file version 163 created 14-MAY-2010 15:17:54

J210358 EO007.UVDATA.1

Freq = 4.9270 GHz, Bw = 16.000 MH No calibration applied and no bandpass applied

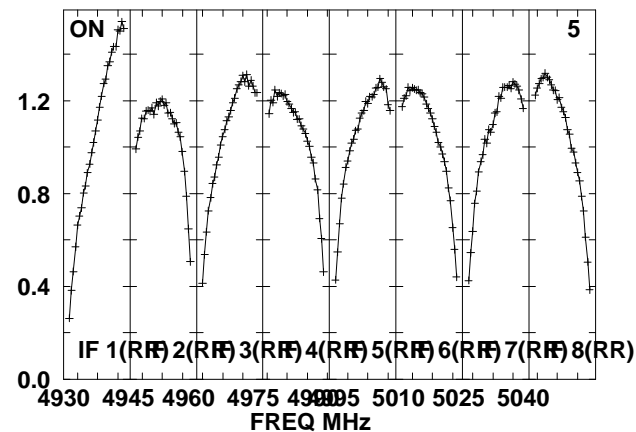
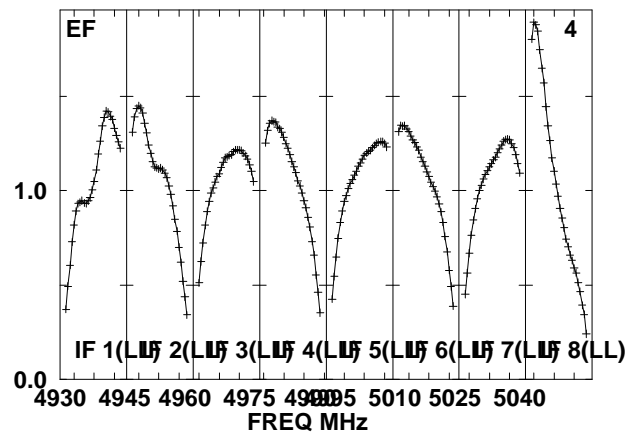
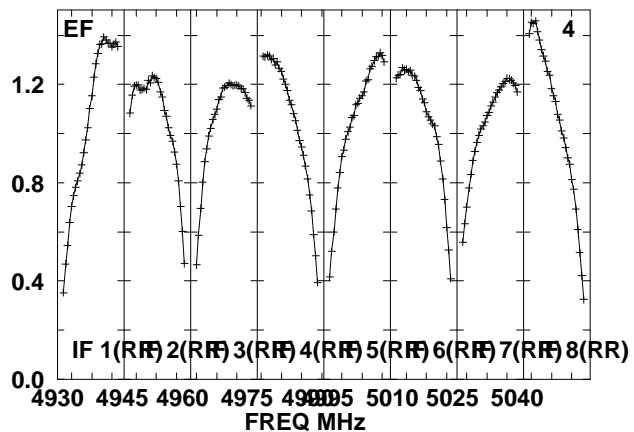
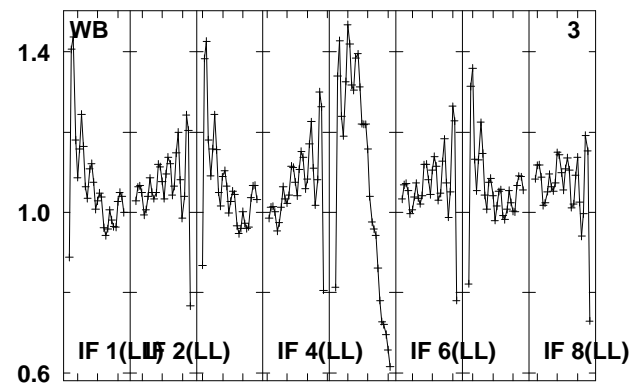
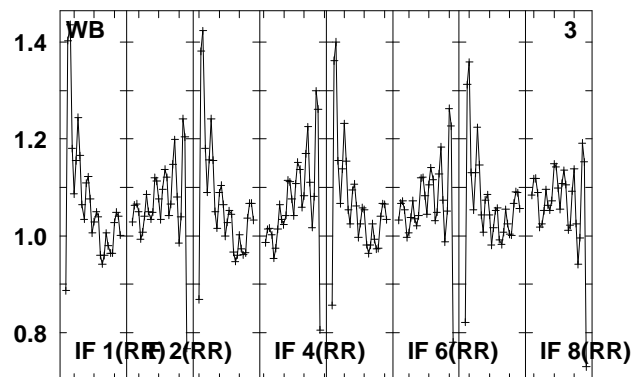
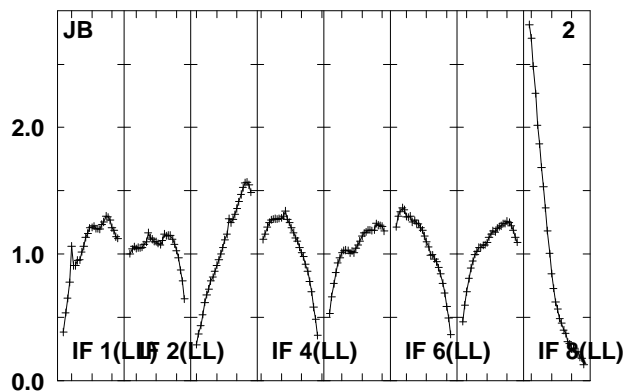
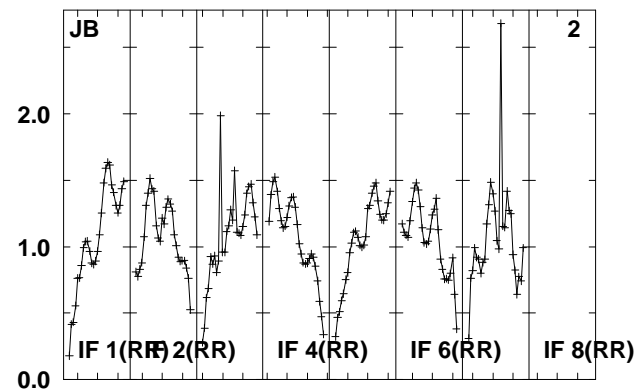
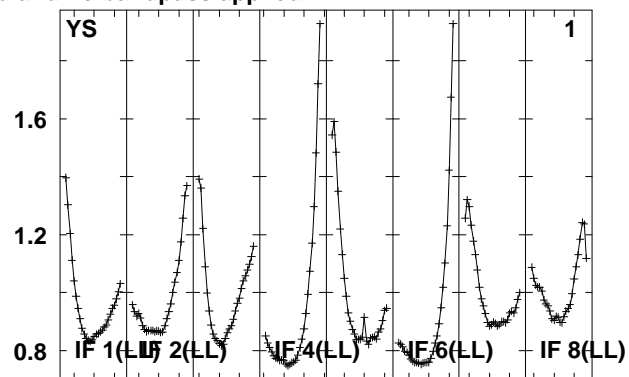
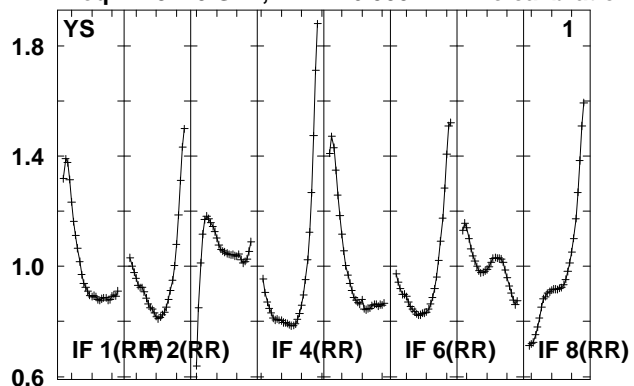

Lower frame: Real Jy
Total-power spectrum Antenna: *
Timerange: 00/07:19:54 to 00/07:24:50

Plot file version 164 created 14-MAY-2010 15:17:54

J210358 EO007.UVDATA.1

Freq = 4.9270 GHz, Bw = 16.000 MH No calibration applied and no bandpass applied

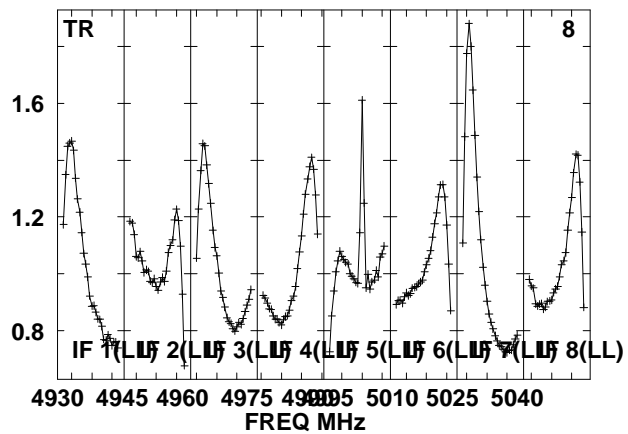
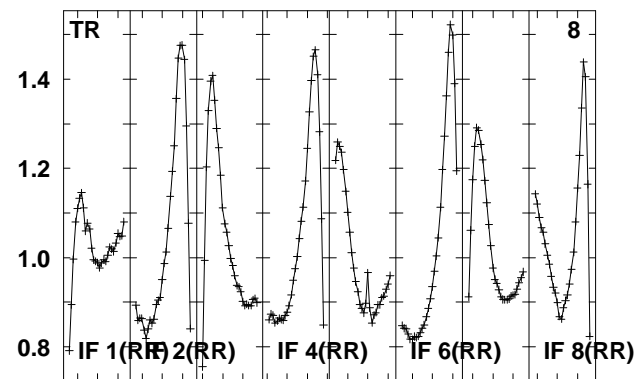
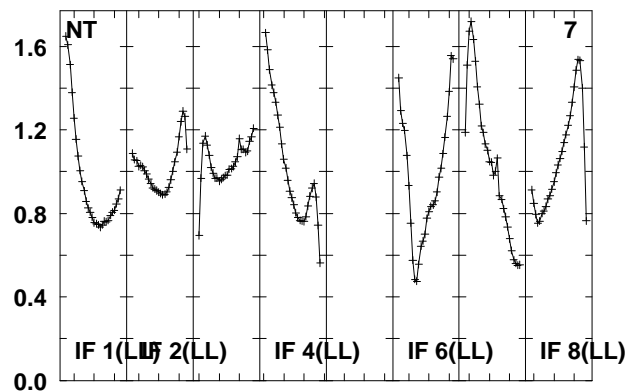
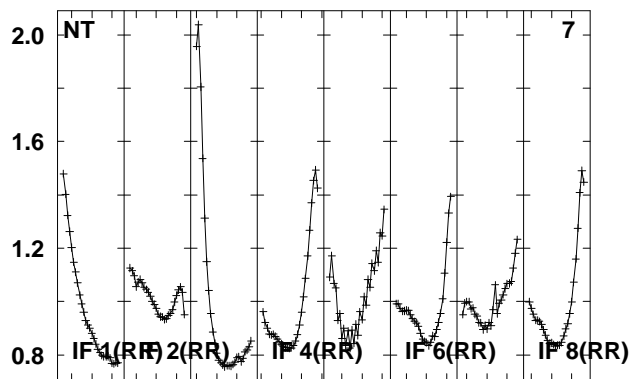
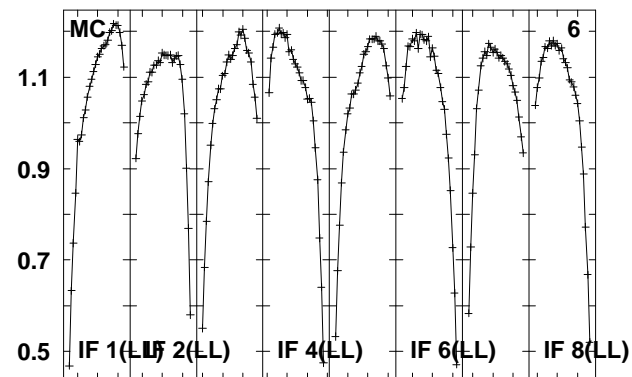
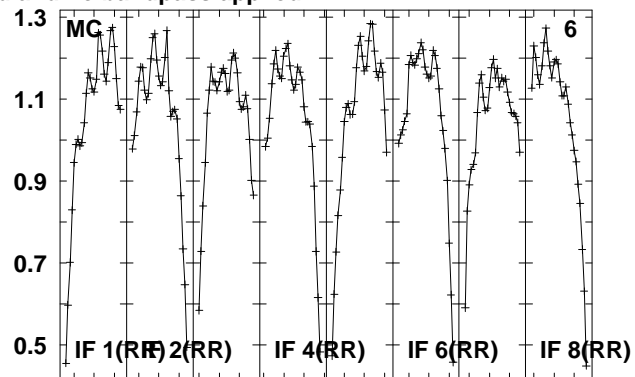
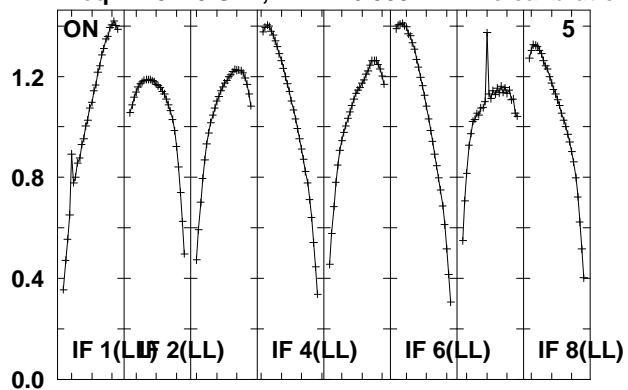

4930 4945 4960 4975 4990 5005 5010 5025 5040
FREQ MHz

Lower frame: Real Jy

Total-power spectrum Antenna: *

Timerange: 00/07:19:54 to 00/07:24:50

Plot file version 165 created 14-MAY-2010 15:17:55

J2110-10 EO007.UVDATA.1

Freq = 4.9270 GHz, Bw = 16.000 MH No calibration applied and no bandpass applied

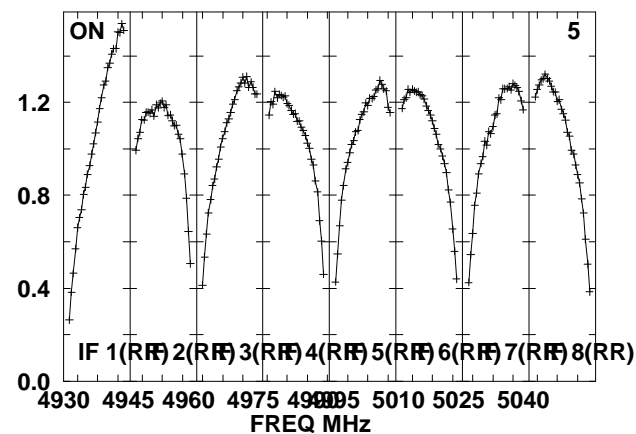
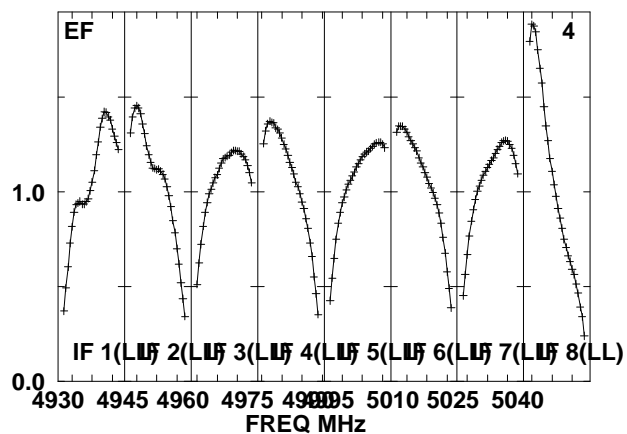
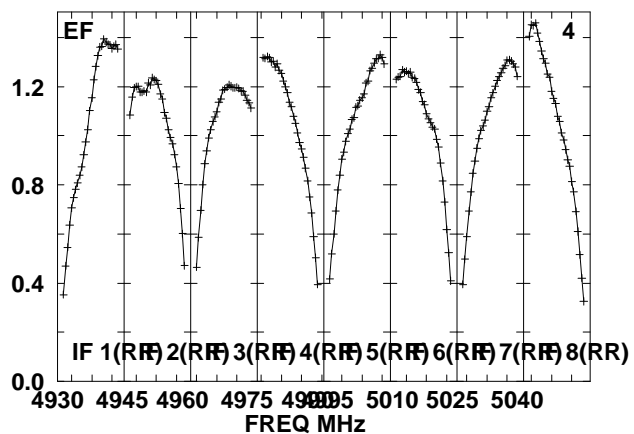
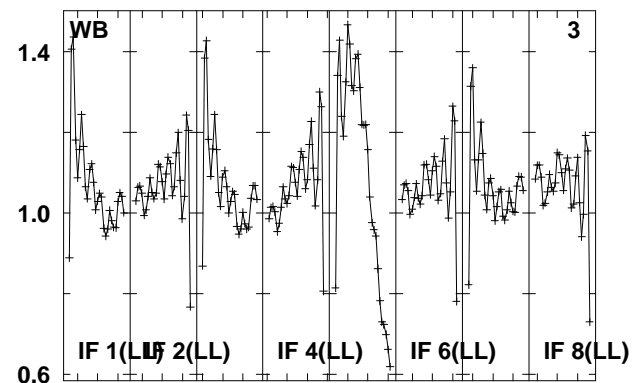
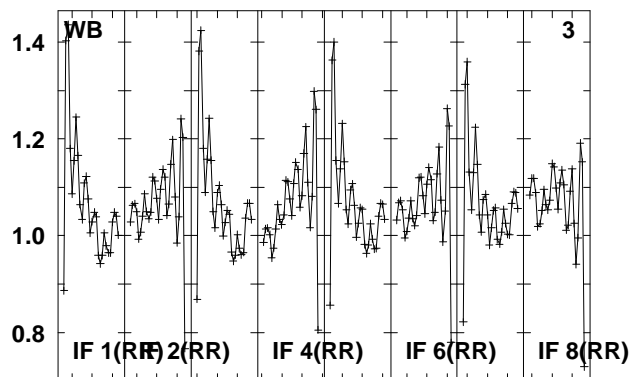
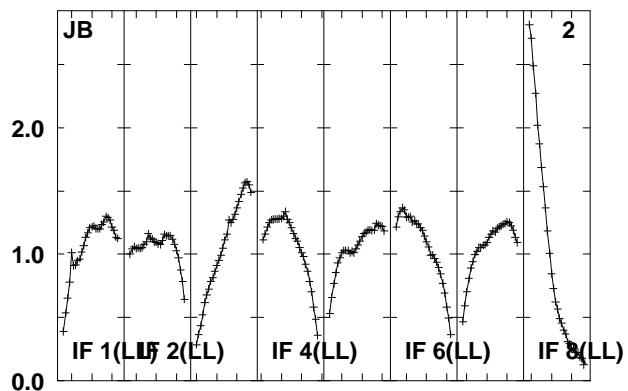
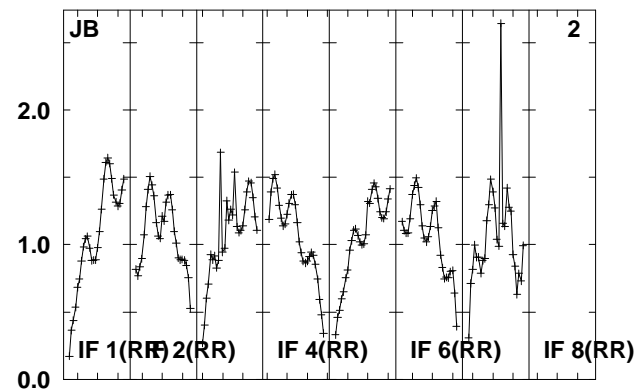
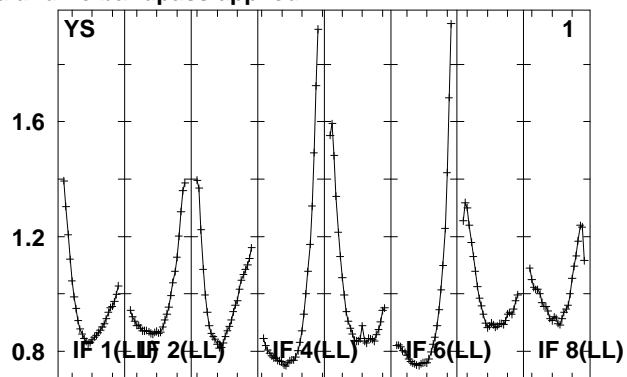
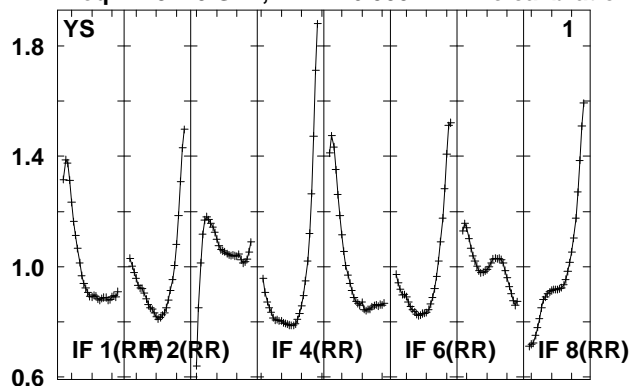

Lower frame: Real Jy

Total-power spectrum Antenna: *

Timerange: 00/07:25:32 to 00/07:27:00

Plot file version 166 created 14-MAY-2010 15:17:55

J2110-10 EO007.UVDATA.1

Freq = 4.9270 GHz, Bw = 16.000 MH No calibration applied and no bandpass applied

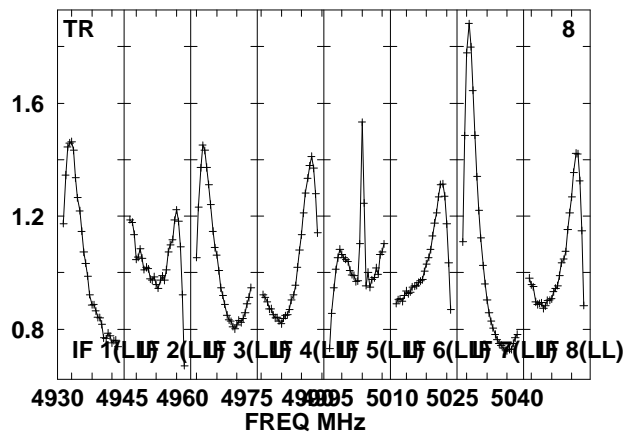
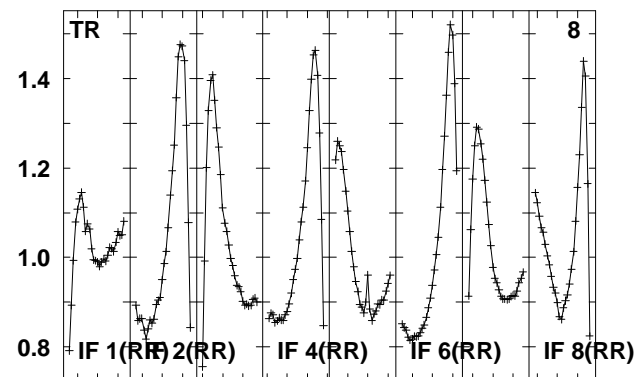
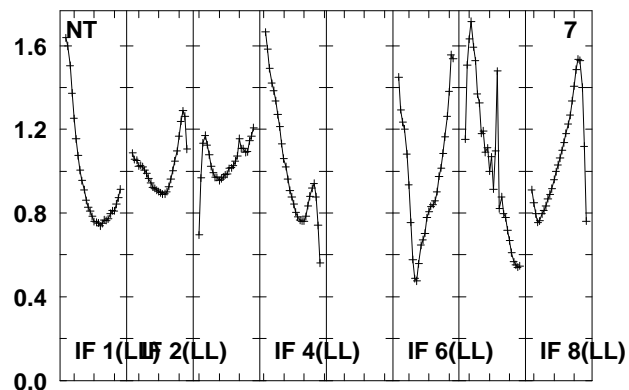
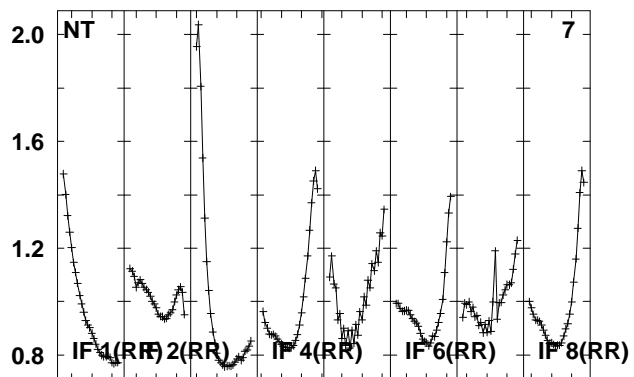
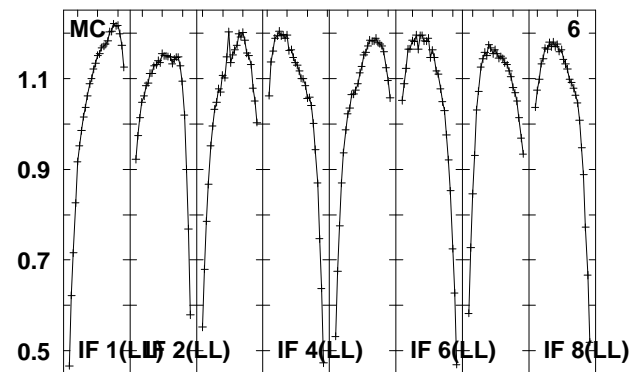
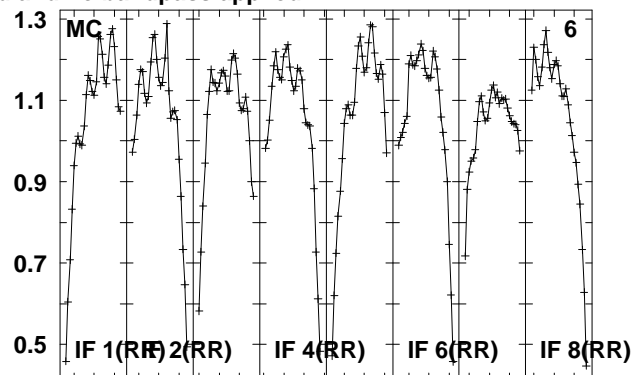
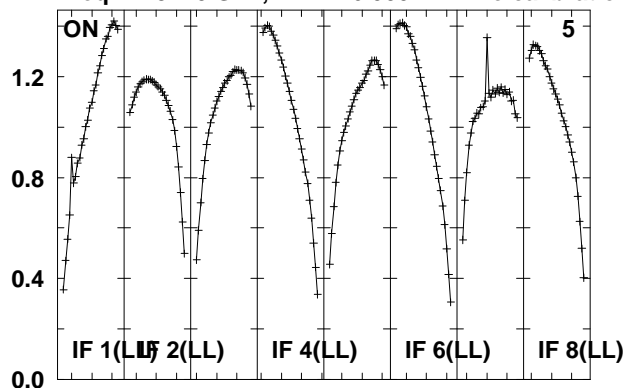

Lower frame: Real Jy

Total-power spectrum Antenna: *

Timerange: 00/07:25:32 to 00/07:27:00

Plot file version 167 created 14-MAY-2010 15:17:55

J210358 EO007.UVDATA.1

Freq = 4.9270 GHz, Bw = 16.000 MH No calibration applied and no bandpass applied

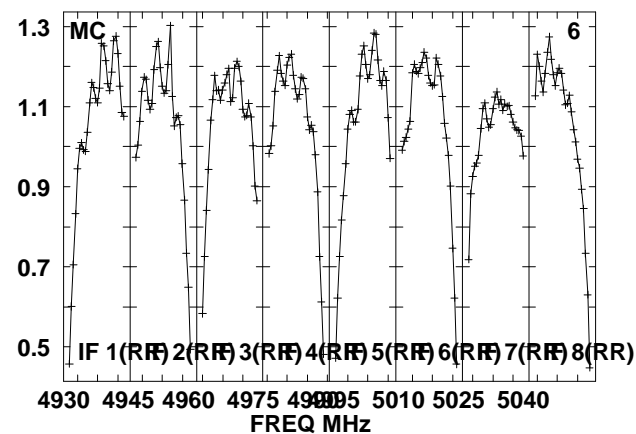
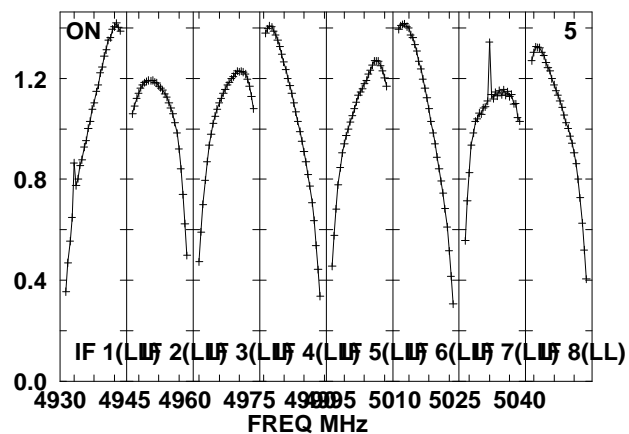
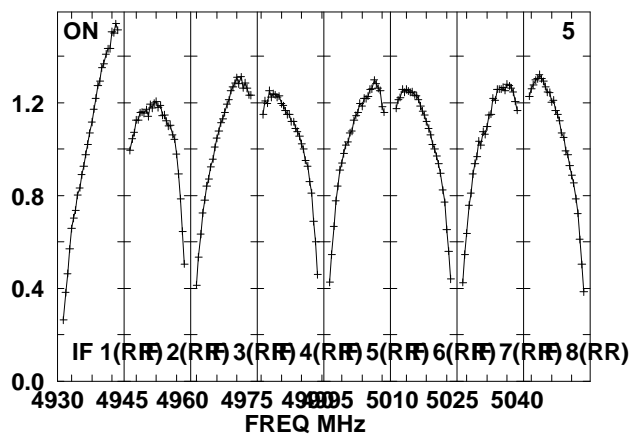
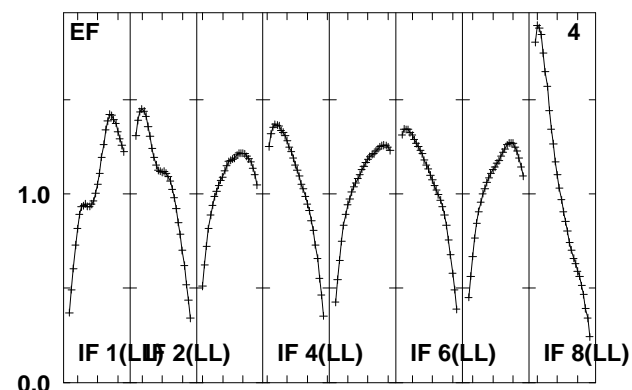
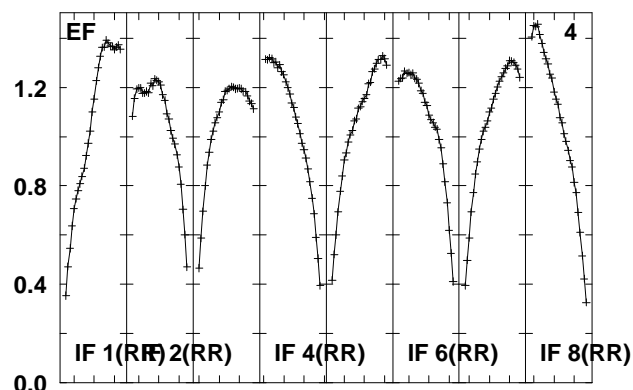
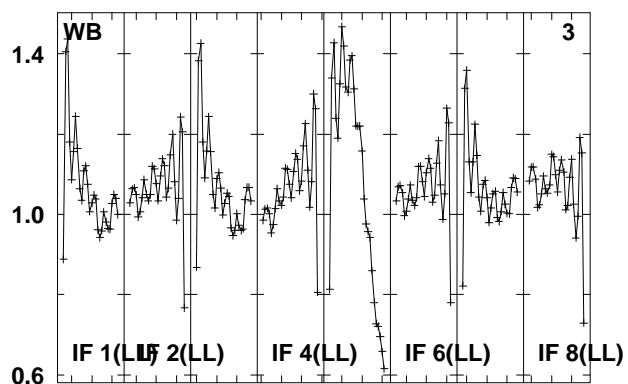
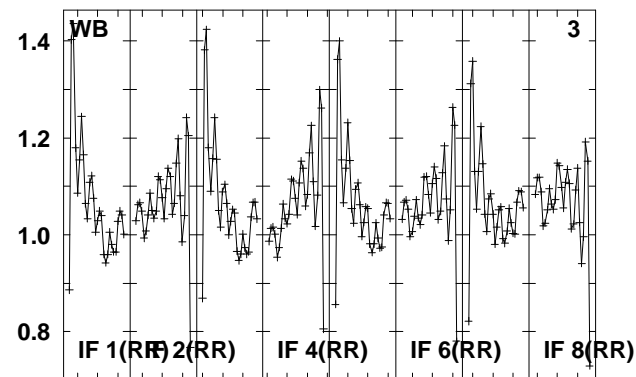
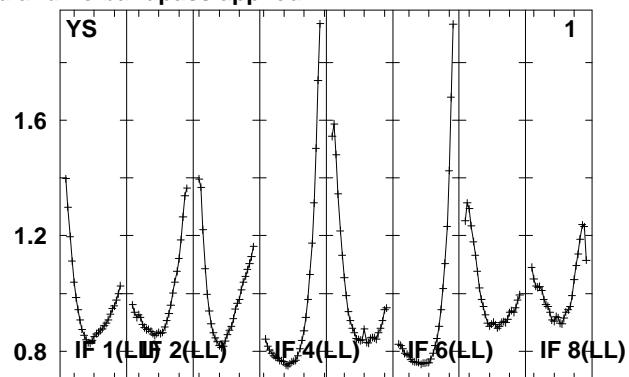
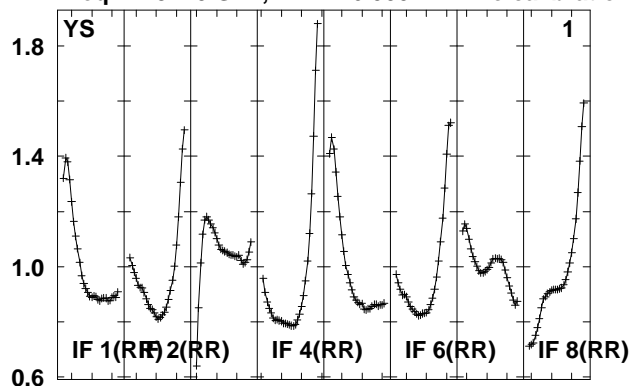

Lower frame: Real Jy
Total-power spectrum Antenna: *
Timerange: 00/07:27:36 to 00/07:32:34

Plot file version 168 created 14-MAY-2010 15:17:56

J210358 EO007.UVDATA.1

Freq = 4.9270 GHz, Bw = 16.000 MH No calibration applied and no bandpass applied

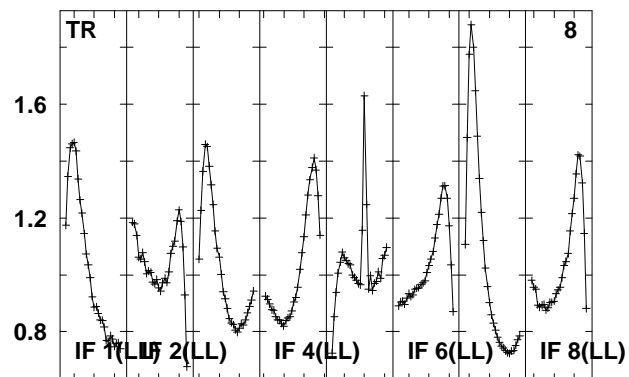
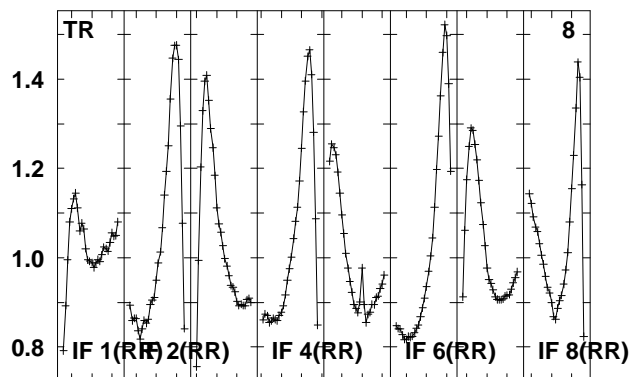
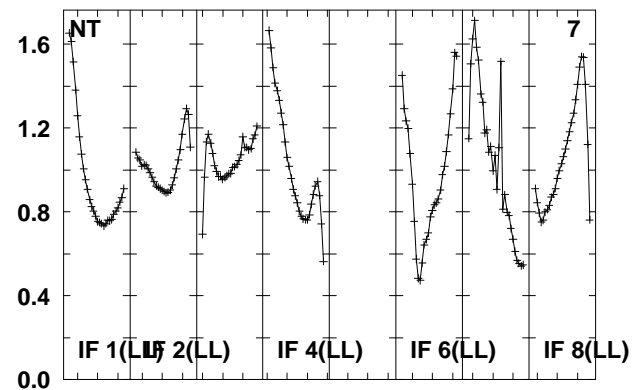
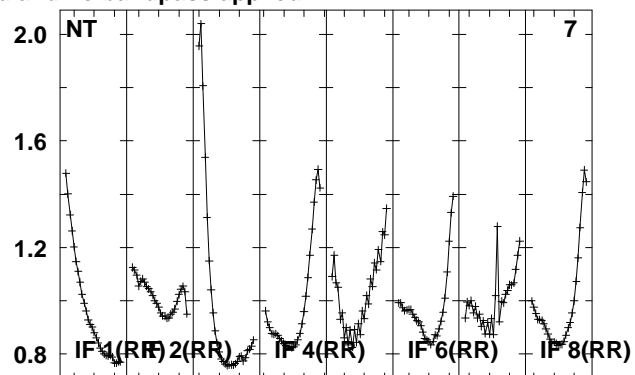
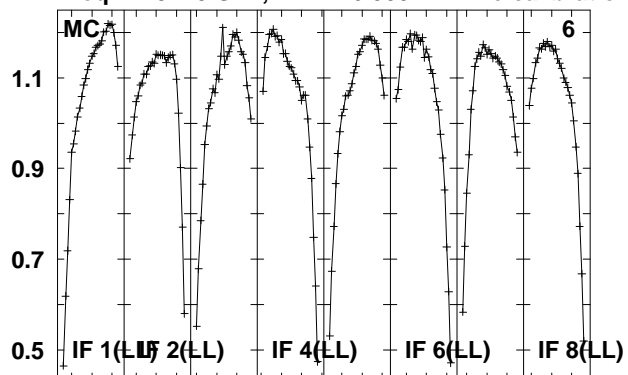

Lower frame: Real Jy
Total-power spectrum Antenna: *
Timerange: 00/07:27:36 to 00/07:32:34

Plot file version 169 created 14-MAY-2010 15:17:56

J2110-10 EO007.UVDATA.1

Freq = 4.9270 GHz, Bw = 16.000 MH No calibration applied and no bandpass applied

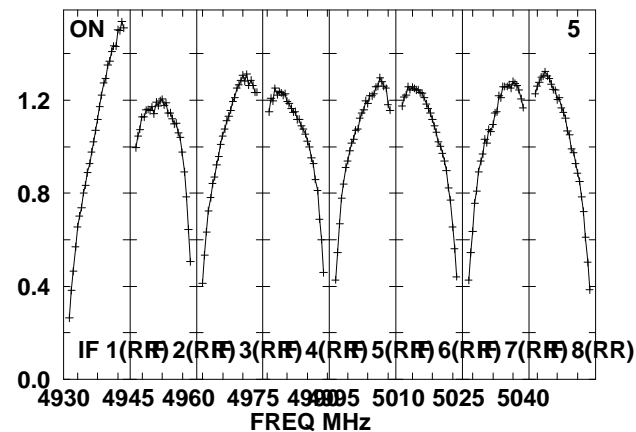
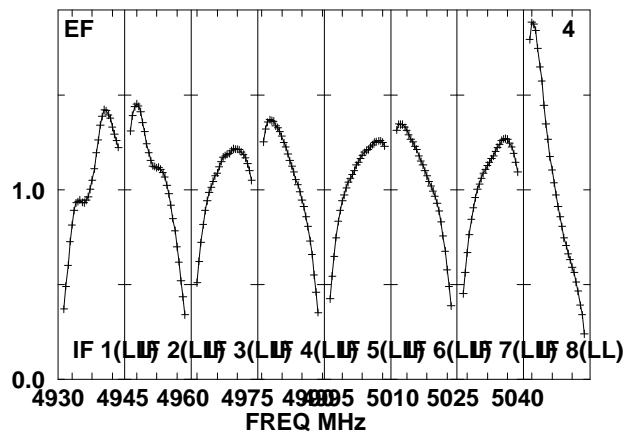
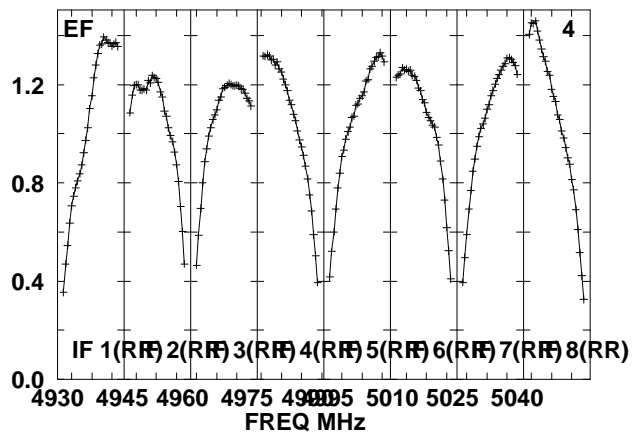
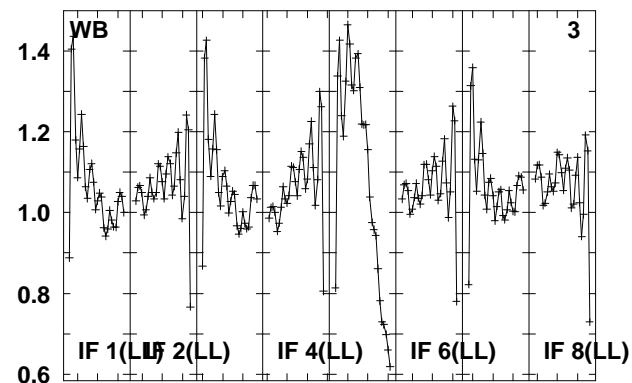
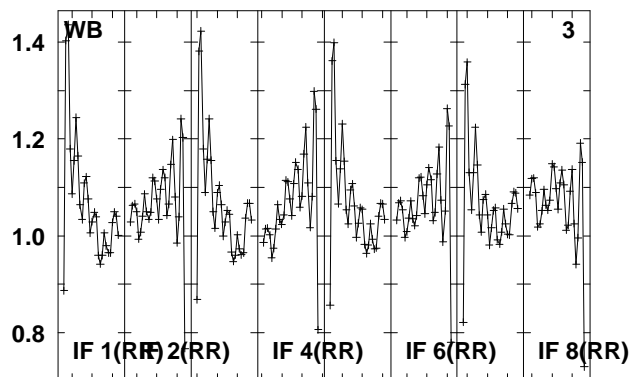
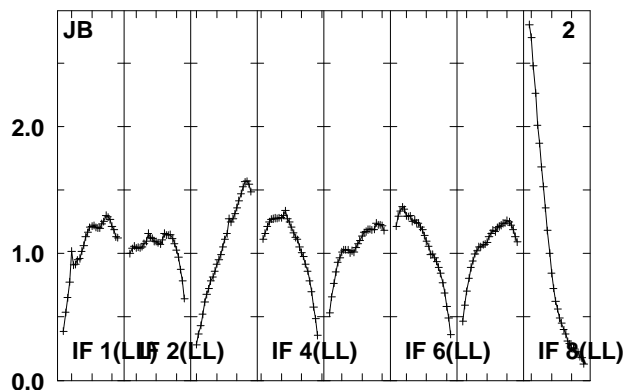
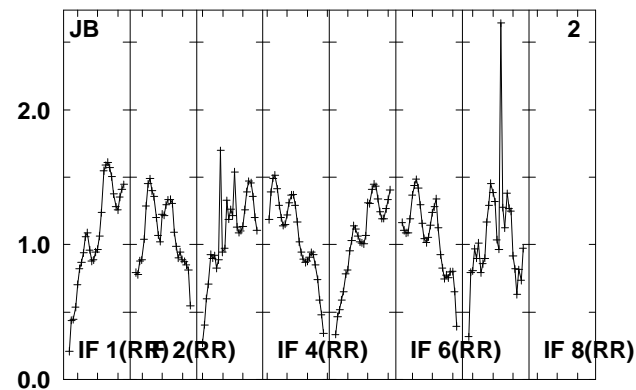
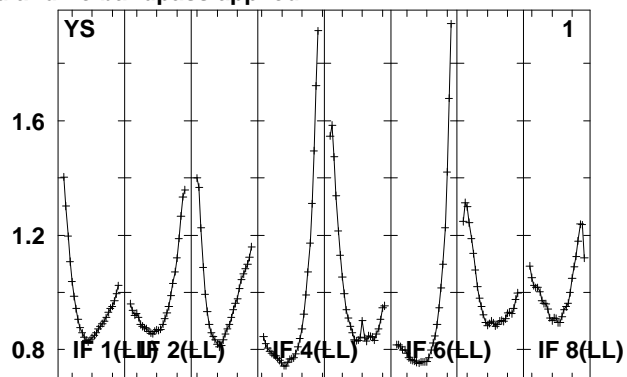
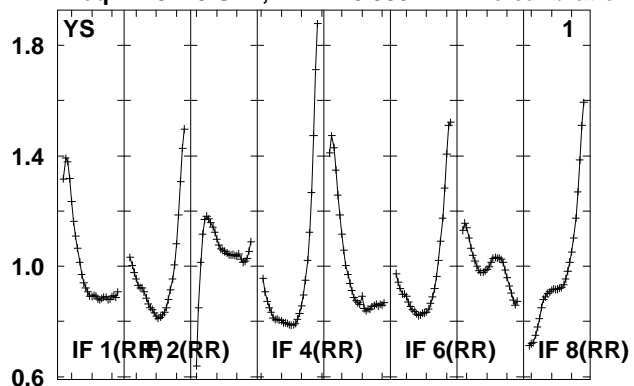

Lower frame: Real Jy
Total-power spectrum Antenna: *
Timerange: 00/07:33:10 to 00/07:34:38

Plot file version 170 created 14-MAY-2010 15:17:56

J2110-10 EO007.UVDATA.1

Freq = 4.9270 GHz, Bw = 16.000 MH No calibration applied and no bandpass applied

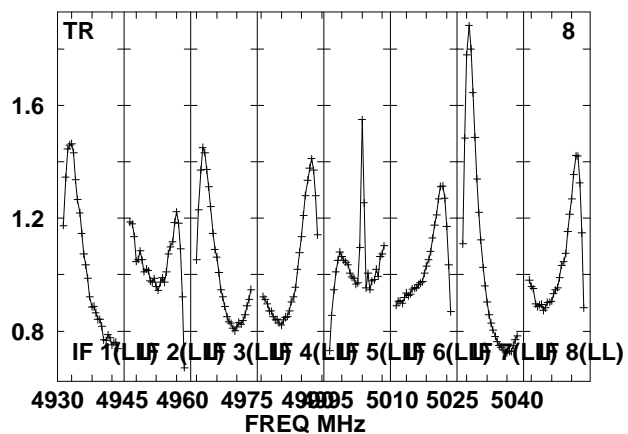
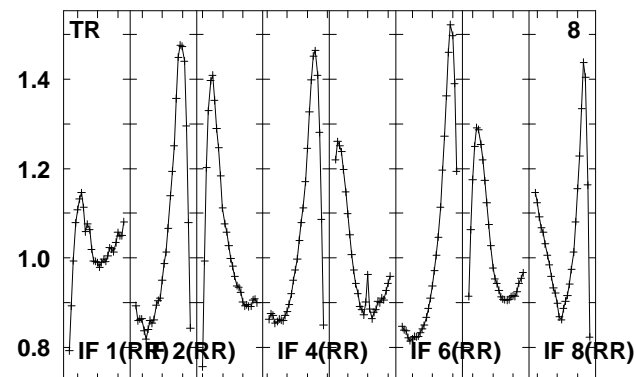
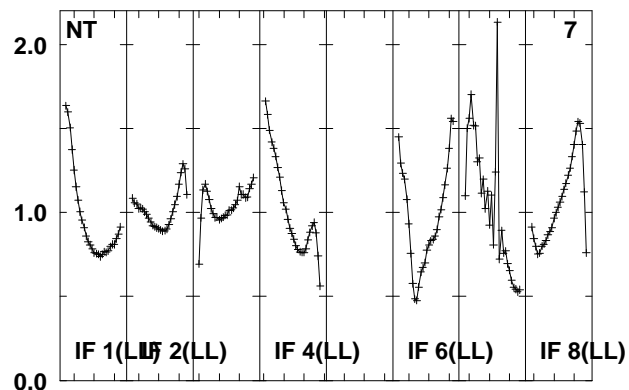
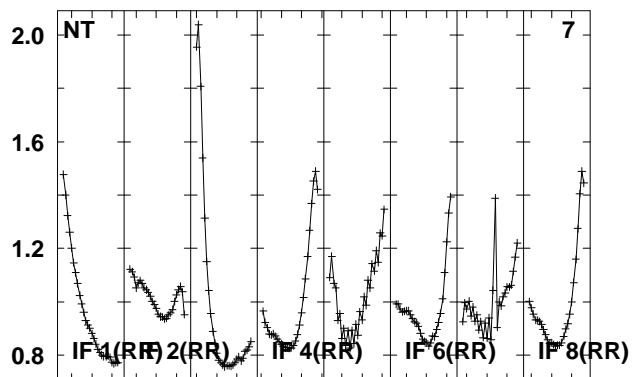
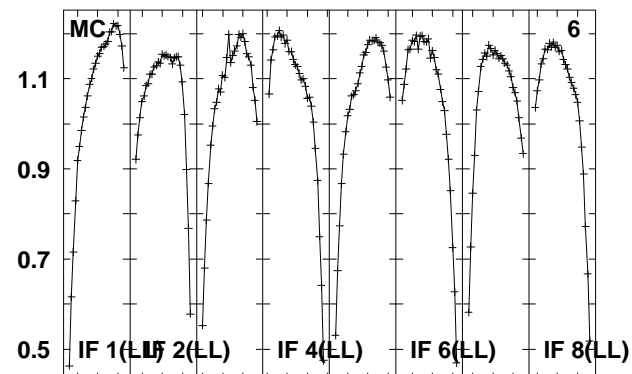
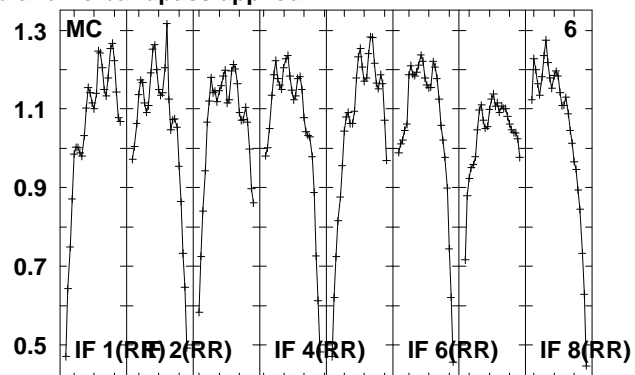
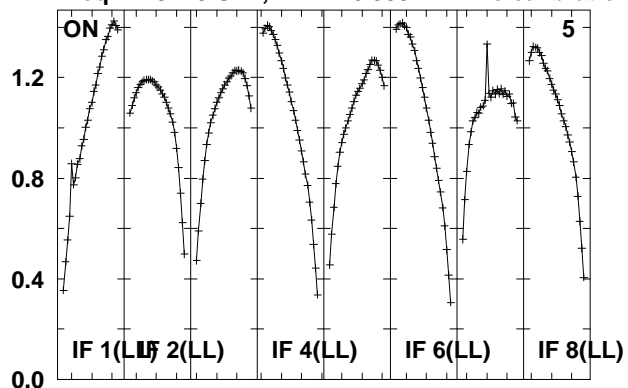

Lower frame: Real Jy

Total-power spectrum Antenna: *

Timerange: 00/07:33:10 to 00/07:34:38

Plot file version 171 created 14-MAY-2010 15:17:57

J210358 EO007.UVDATA.1

Freq = 4.9270 GHz, Bw = 16.000 MH No calibration applied and no bandpass applied

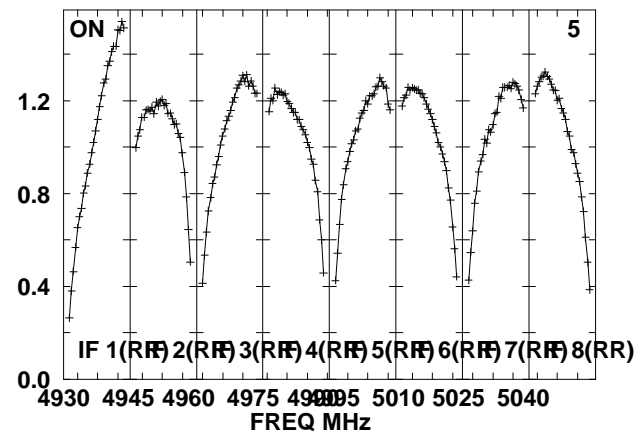
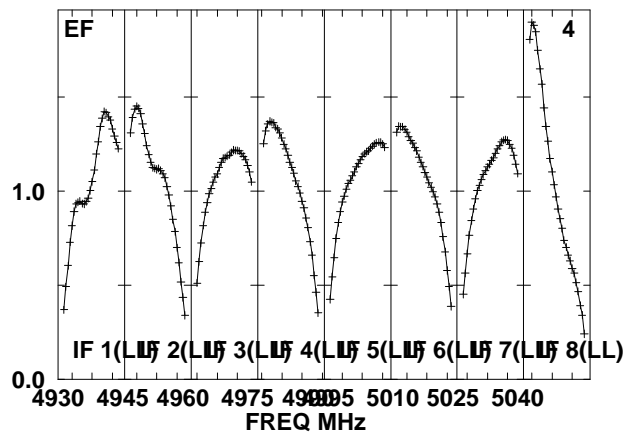
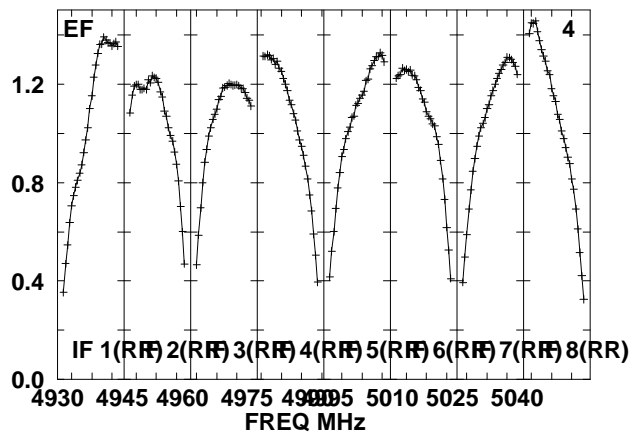
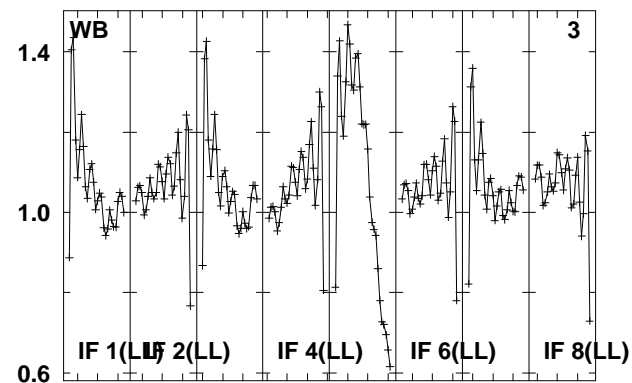
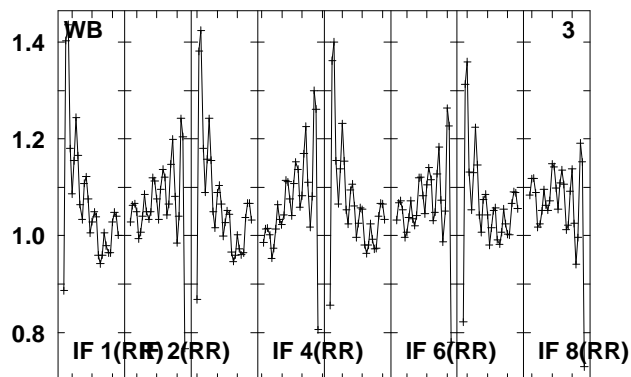
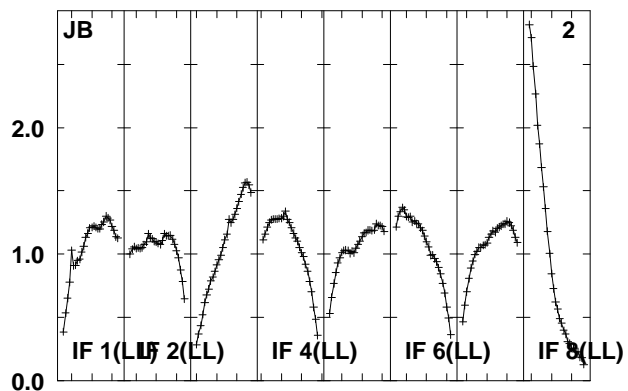
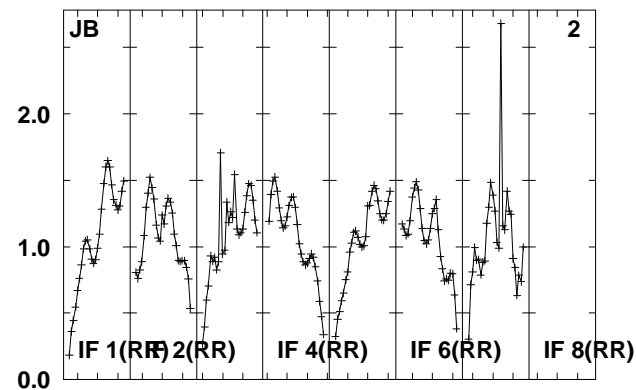
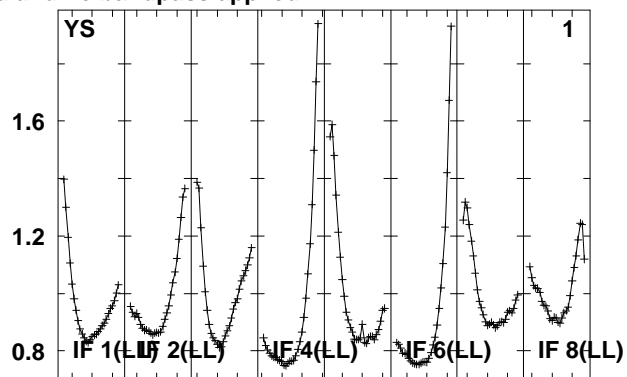
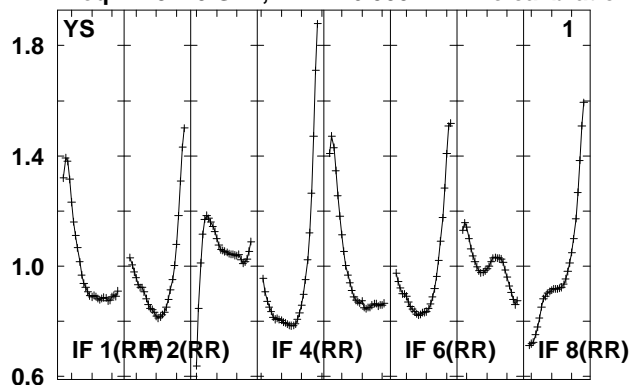

Lower frame: Real Jy
Total-power spectrum Antenna: *
Timerange: 00/07:35:18 to 00/07:40:12

Plot file version 172 created 14-MAY-2010 15:17:57

J210358 EO007.UVDATA.1

Freq = 4.9270 GHz, Bw = 16.000 MH No calibration applied and no bandpass applied

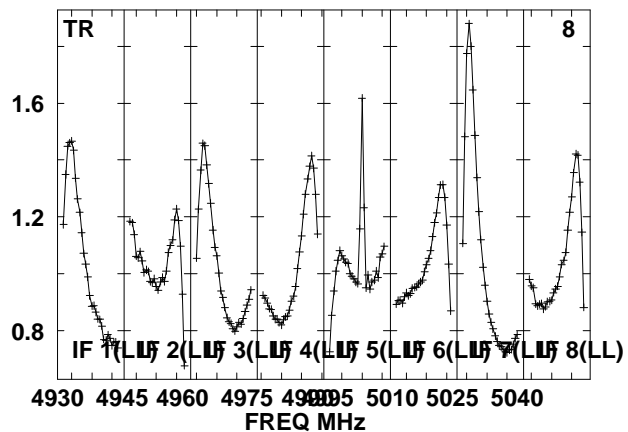
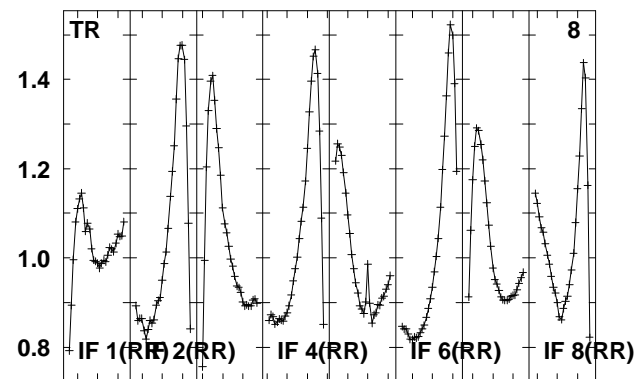
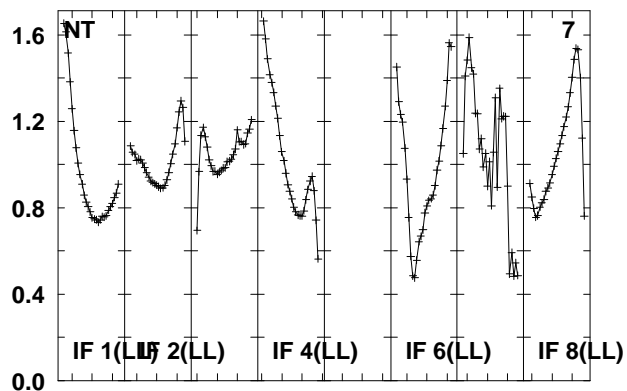
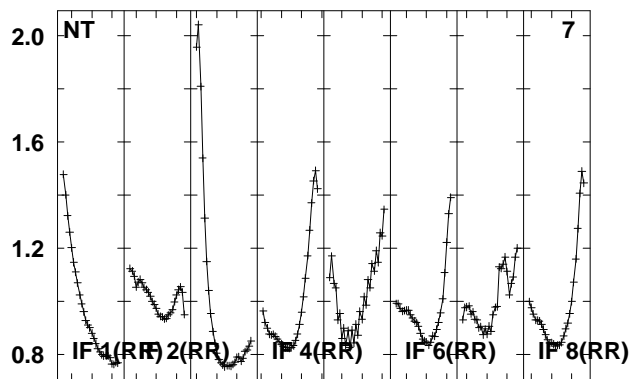
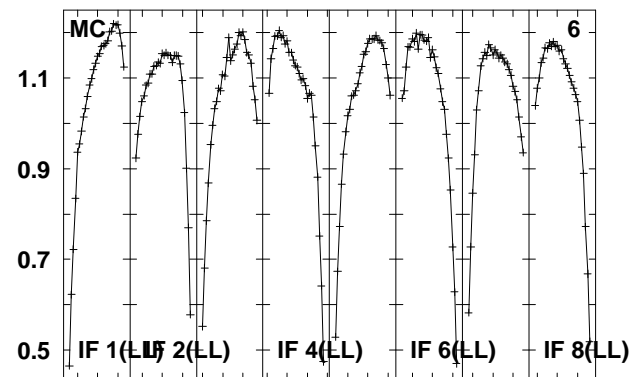
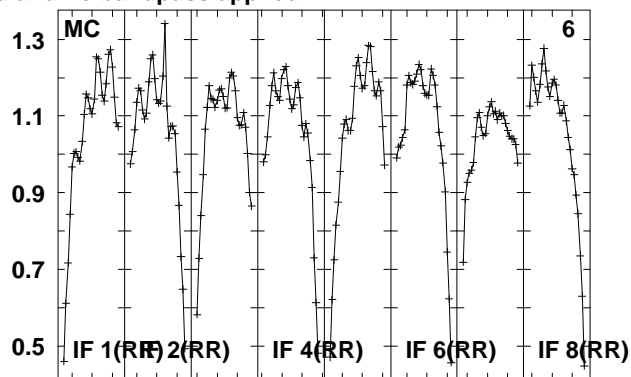
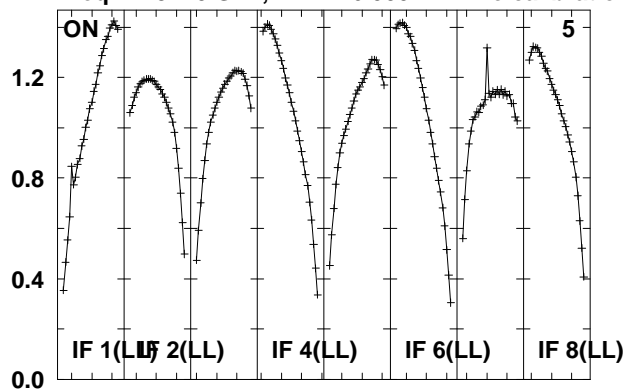

Lower frame: Real Jy

Total-power spectrum Antenna: *

Timerange: 00/07:35:18 to 00/07:40:12

Plot file version 173 created 14-MAY-2010 15:17:58

J2110-10 EO007.UVDATA.1

Freq = 4.9270 GHz, Bw = 16.000 MH No calibration applied and no bandpass applied

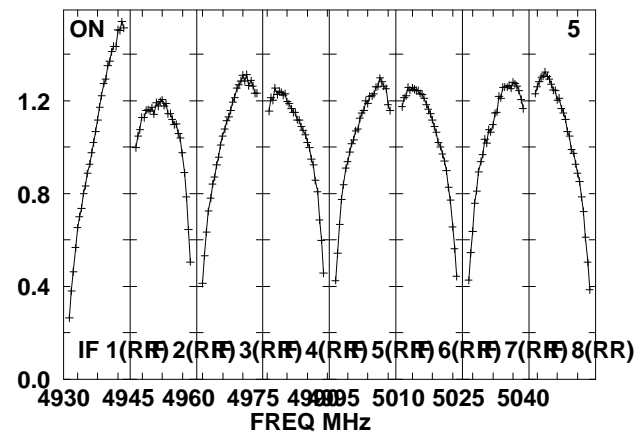
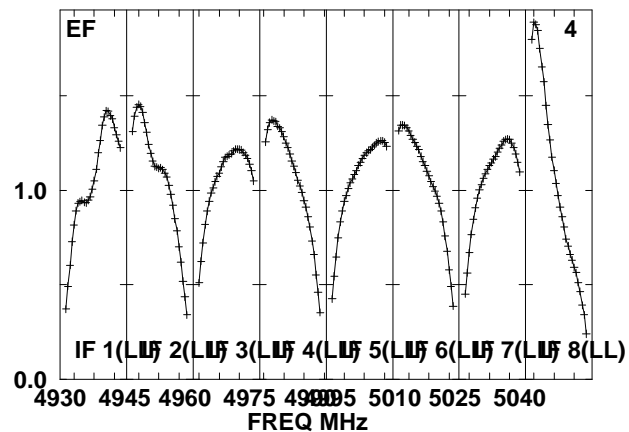
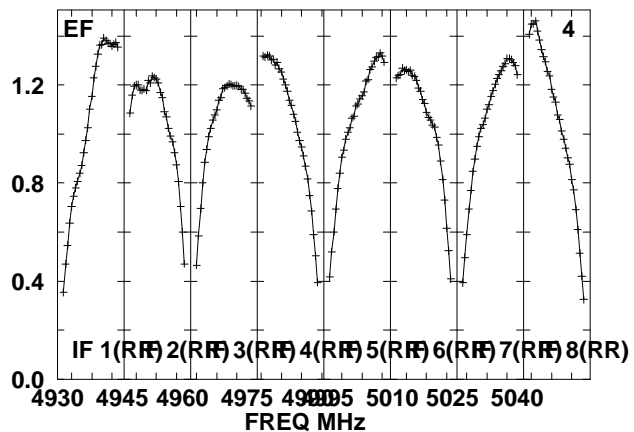
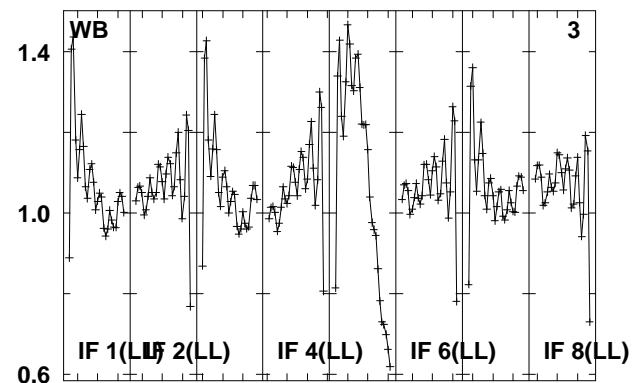
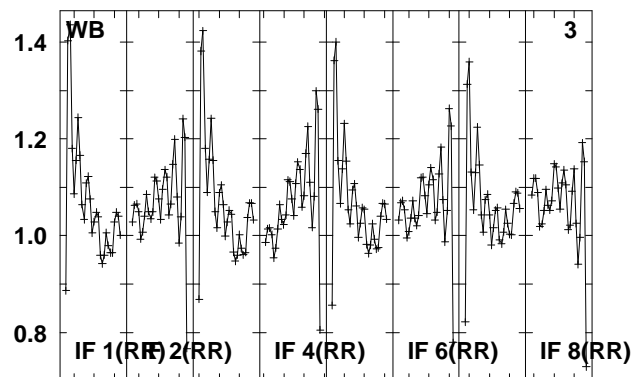
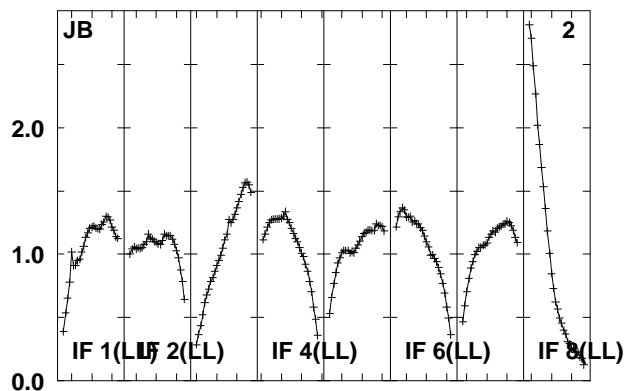
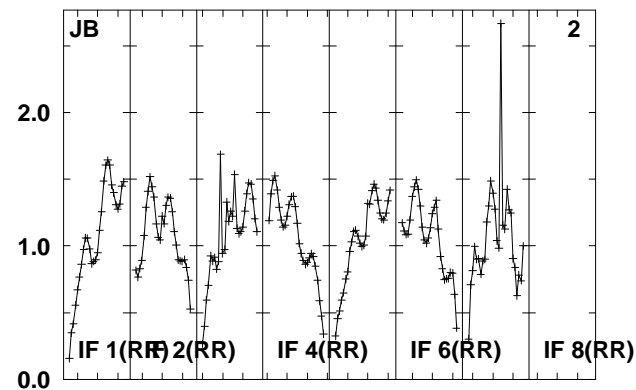
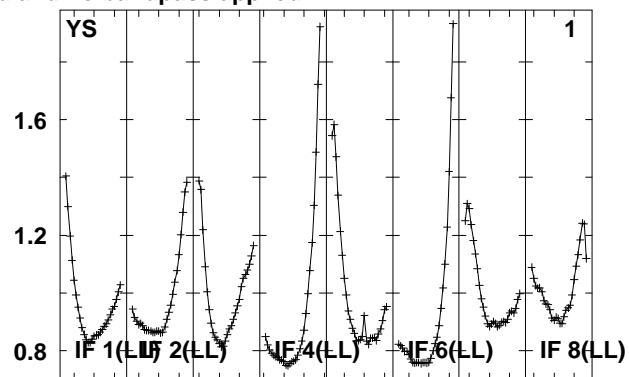
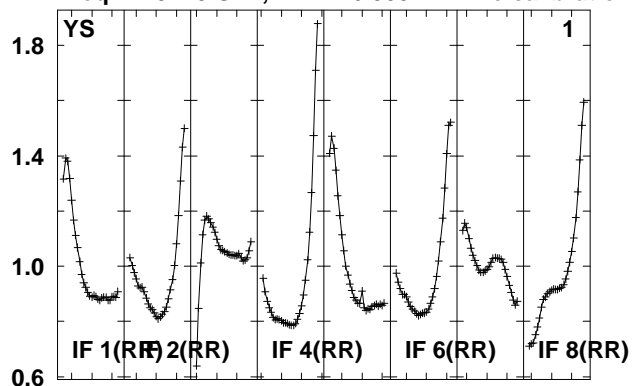

Lower frame: Real Jy

Total-power spectrum Antenna: *

Timerange: 00/07:40:53 to 00/07:42:21

Plot file version 174 created 14-MAY-2010 15:17:58

J2110-10 EO007.UVDATA.1

Freq = 4.9270 GHz, Bw = 16.000 MH No calibration applied and no bandpass applied

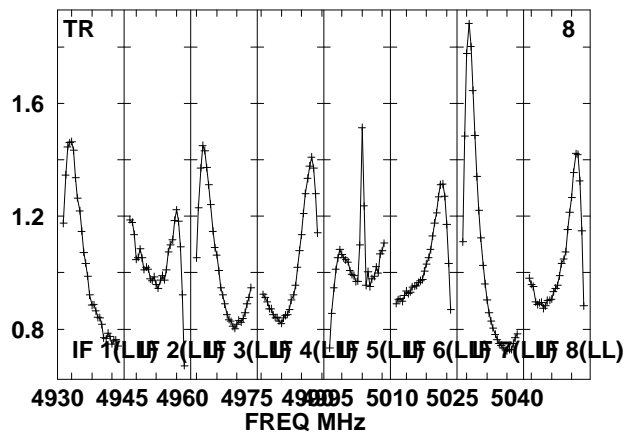
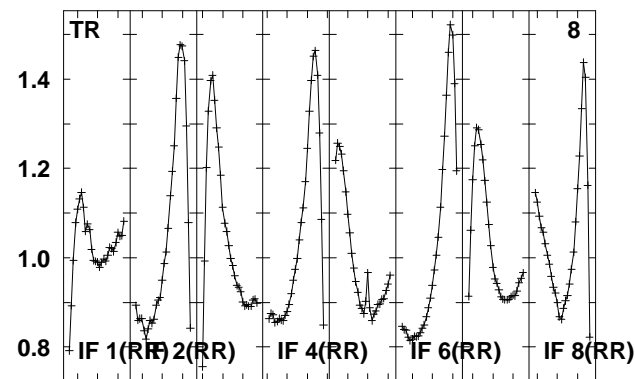
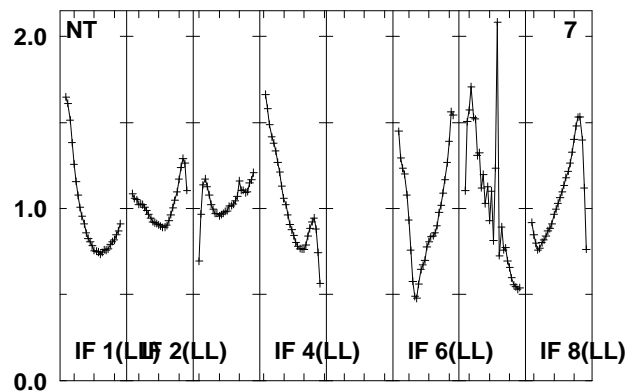
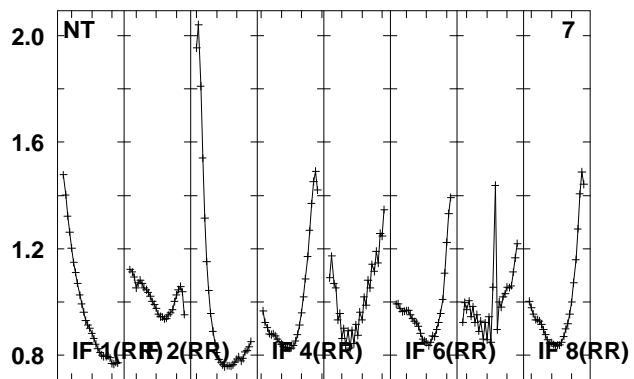
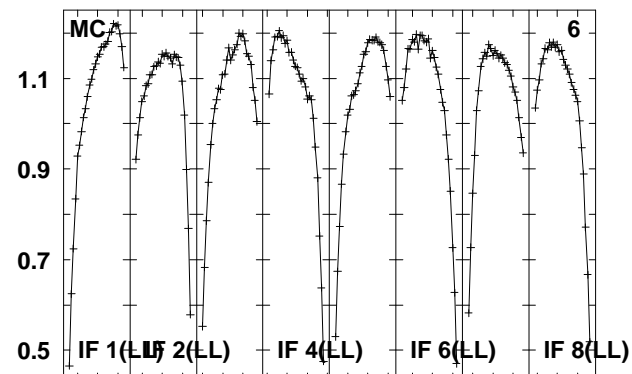
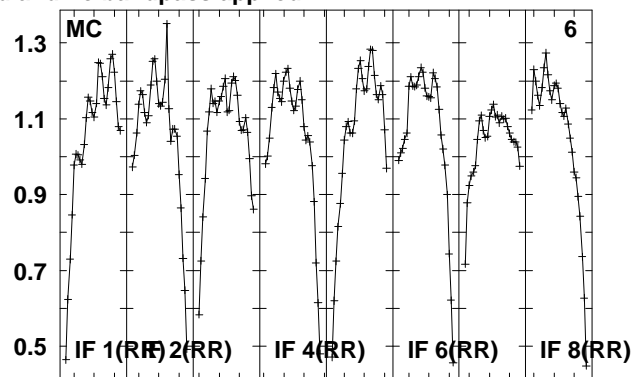
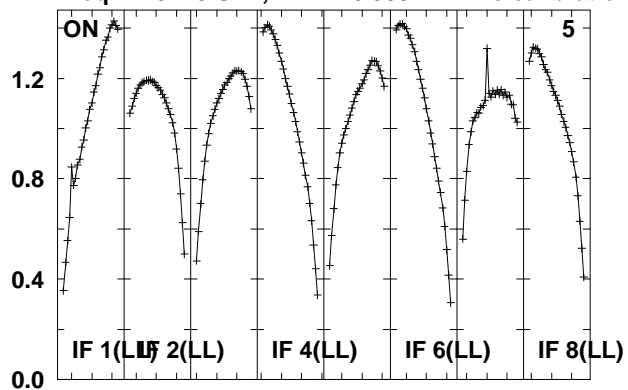

Lower frame: Real Jy

Total-power spectrum Antenna: *

Timerange: 00/07:40:53 to 00/07:42:21

Plot file version 175 created 14-MAY-2010 15:17:58
 J210358 EO007.UVDATA.1
 Freq = 4.9270 GHz, Bw = 16.000 MH No calibration applied and no bandpass applied

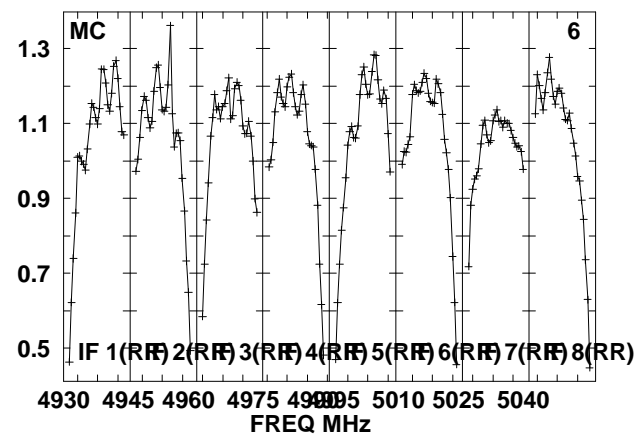
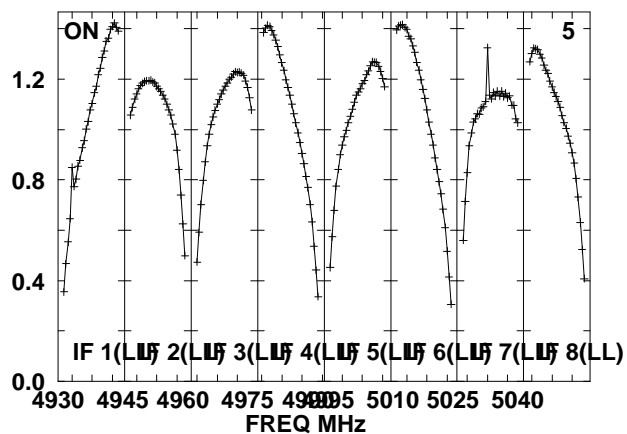
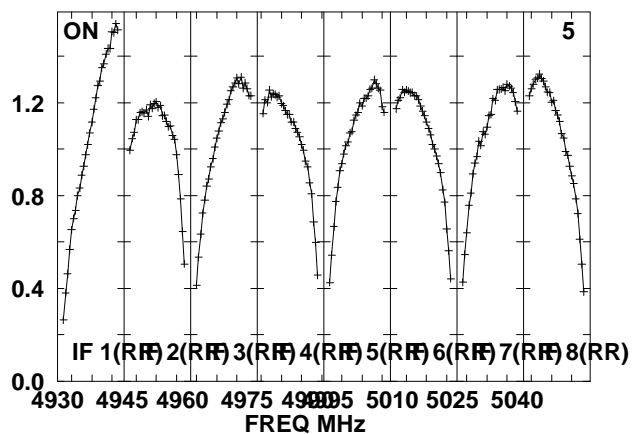
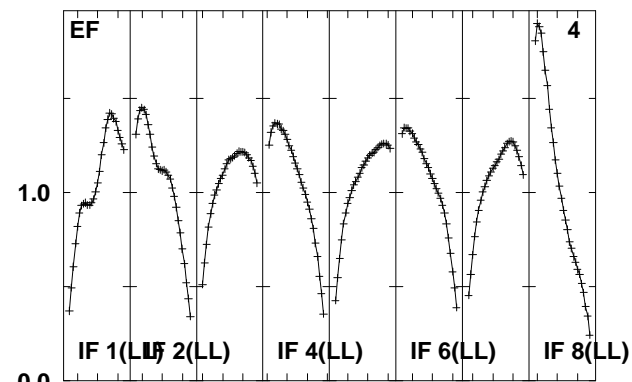
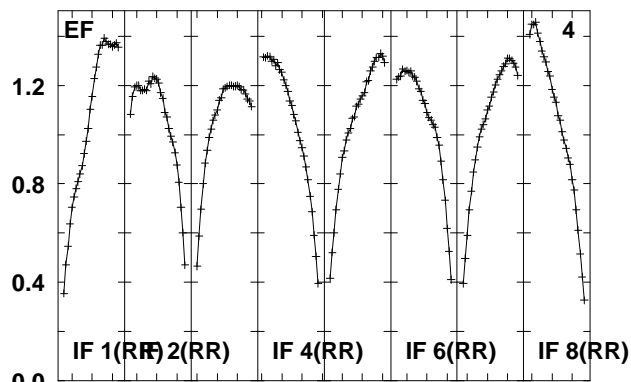
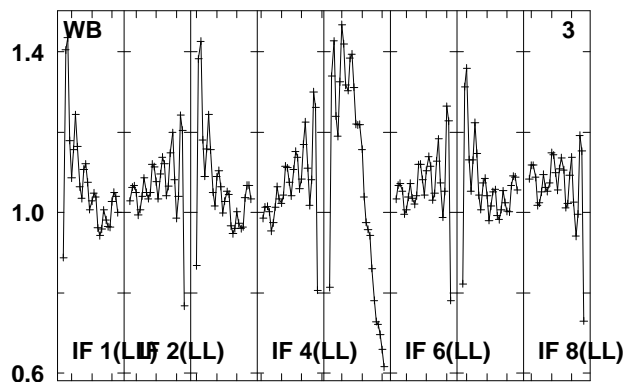
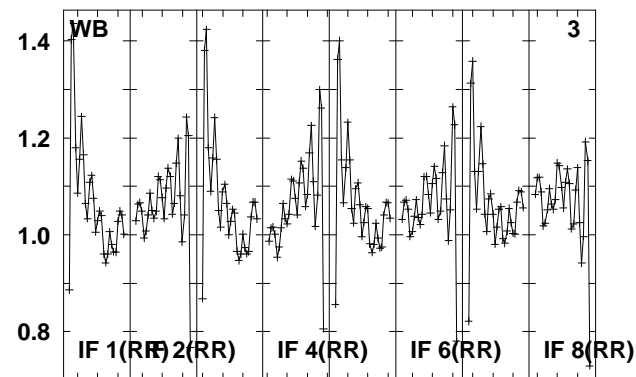
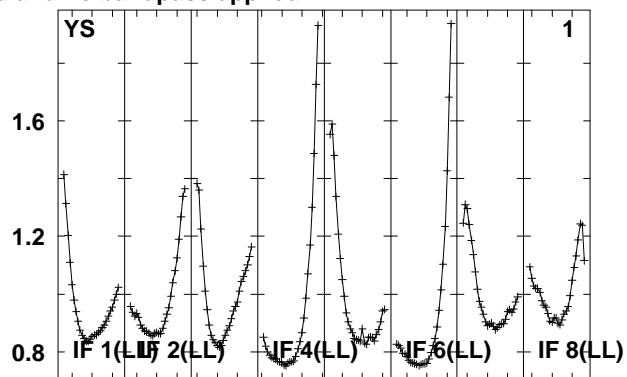
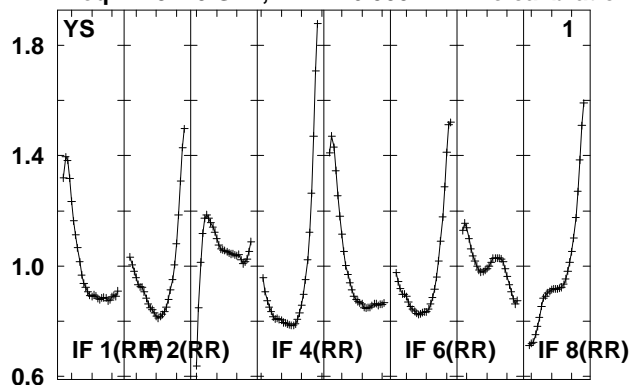

Lower frame: Real Jy
 Total-power spectrum Antenna: *
 Timerange: 00/07:42:57 to 00/07:47:55

Plot file version 176 created 14-MAY-2010 15:17:59

J210358 EO007.UVDATA.1

Freq = 4.9270 GHz, Bw = 16.000 MH No calibration applied and no bandpass applied

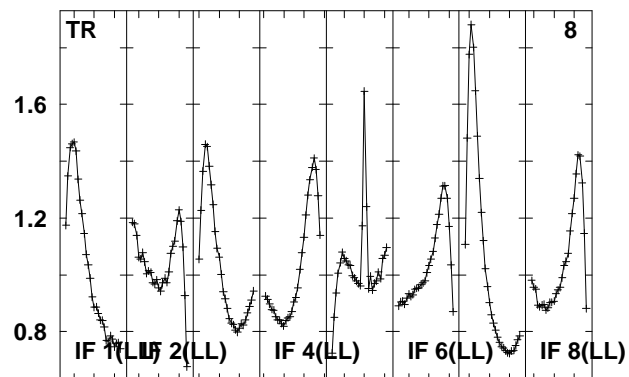
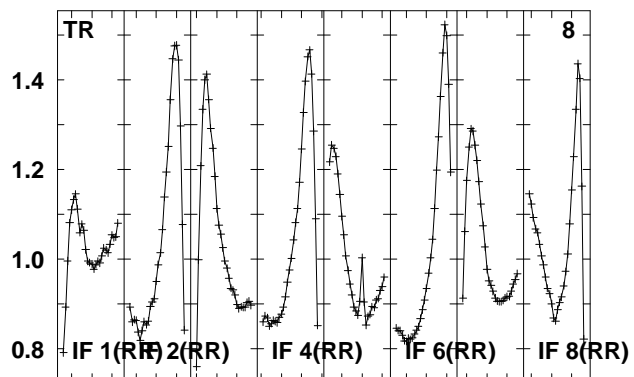
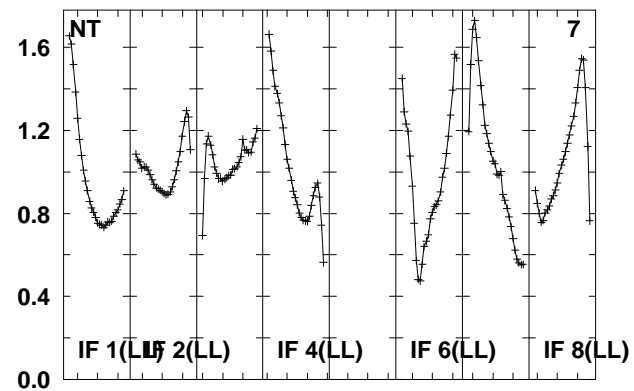
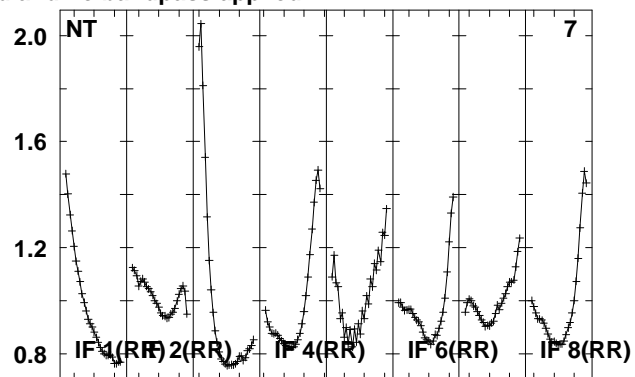
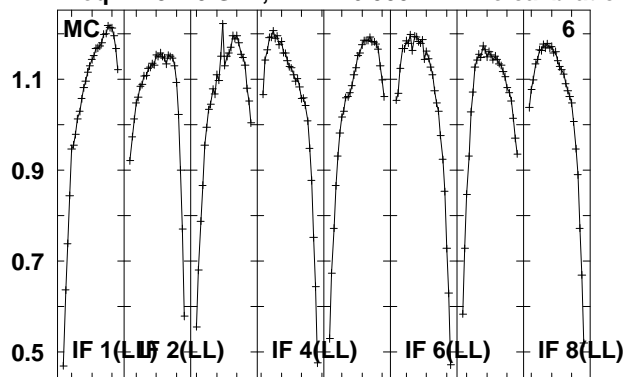

Lower frame: Real Jy
Total-power spectrum Antenna: *
Timerange: 00/07:42:57 to 00/07:47:55

Plot file version 177 created 14-MAY-2010 15:17:59

J2110-10 EO007.UVDATA.1

Freq = 4.9270 GHz, Bw = 16.000 MH No calibration applied and no bandpass applied

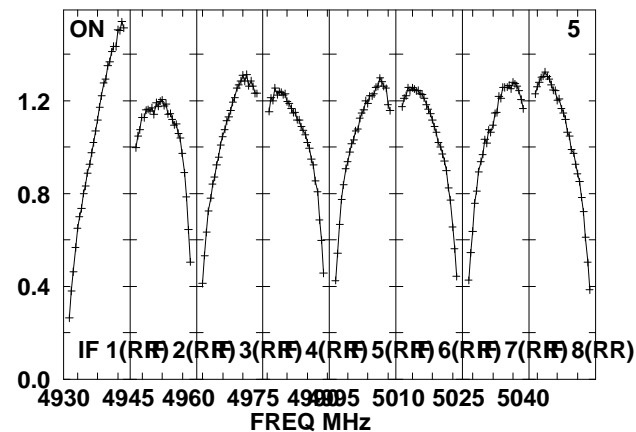
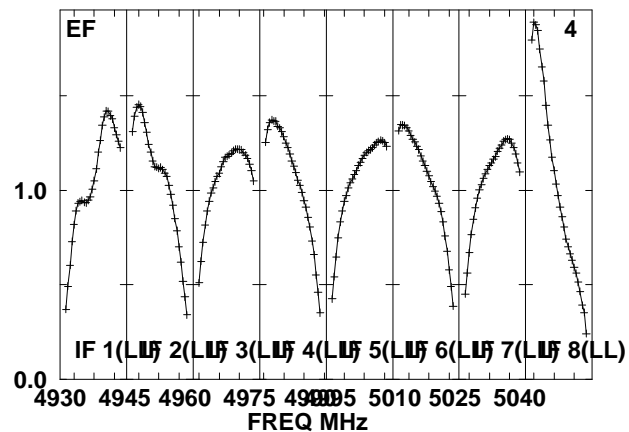
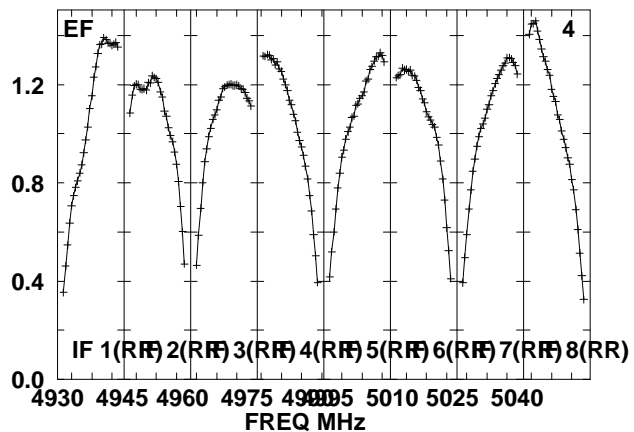
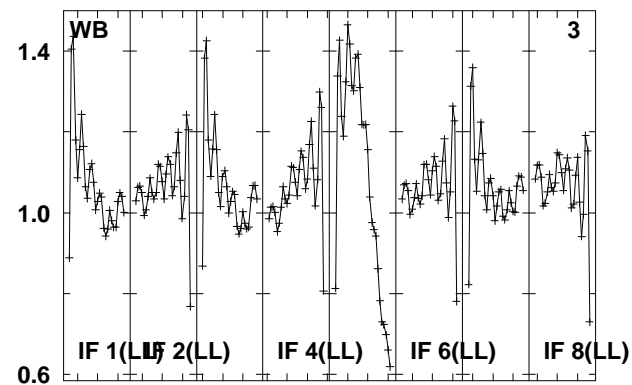
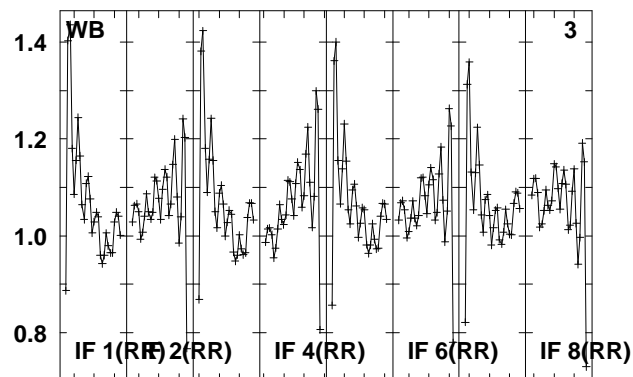
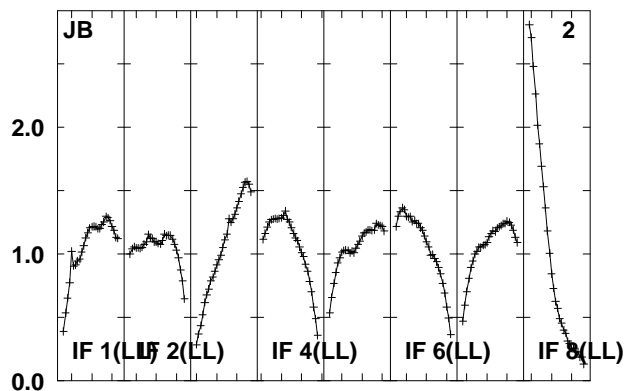
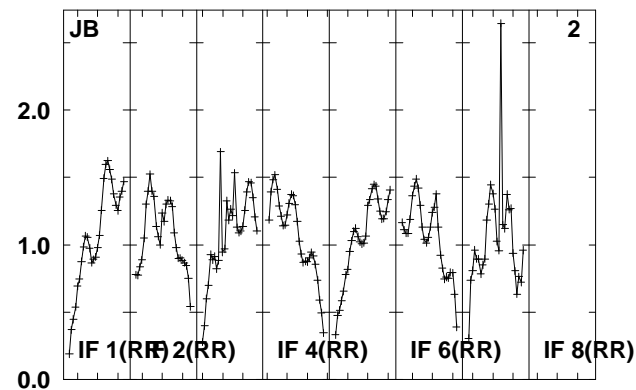
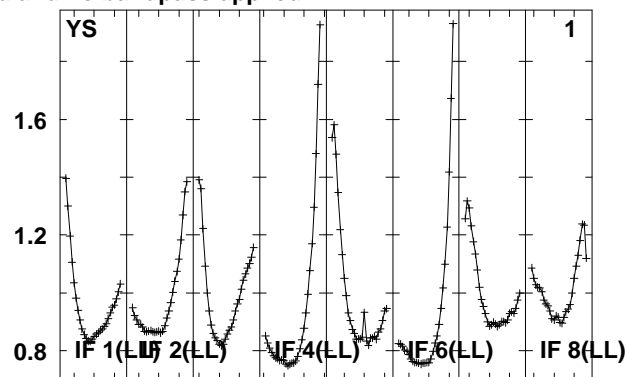
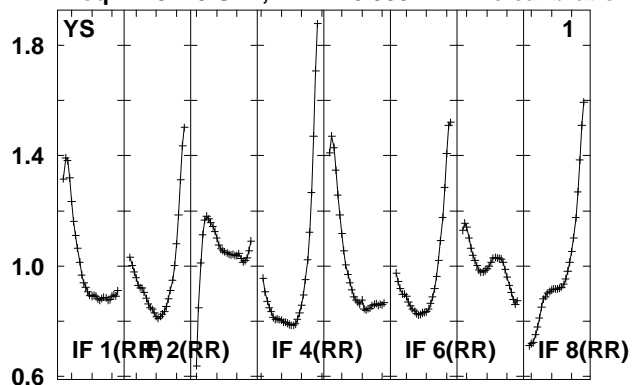

Lower frame: Real Jy
Total-power spectrum Antenna: *
Timerange: 00/07:48:31 to 00/07:49:59

Plot file version 178 created 14-MAY-2010 15:18:00

J2110-10 EO007.UVDATA.1

Freq = 4.9270 GHz, Bw = 16.000 MH No calibration applied and no bandpass applied

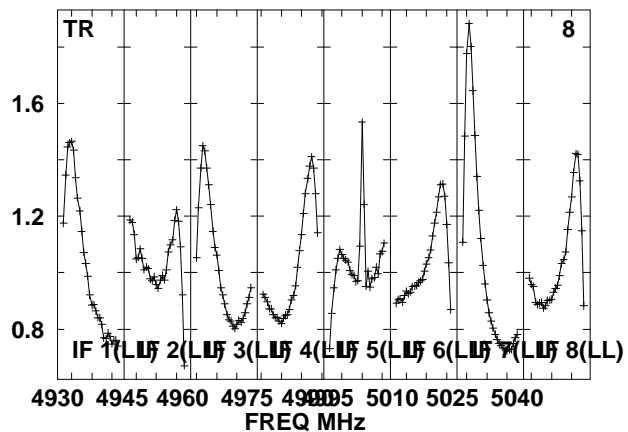
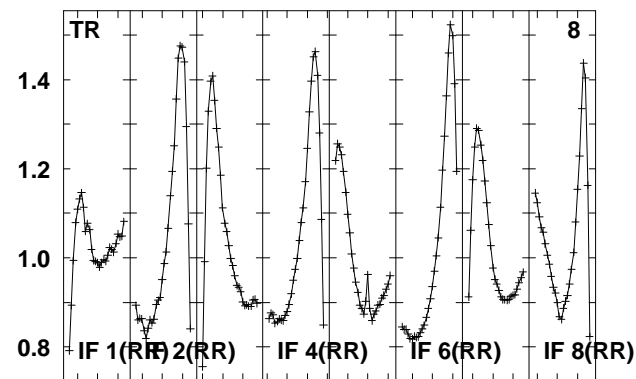
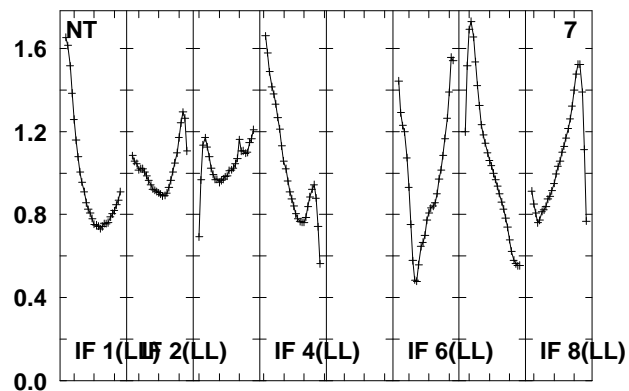
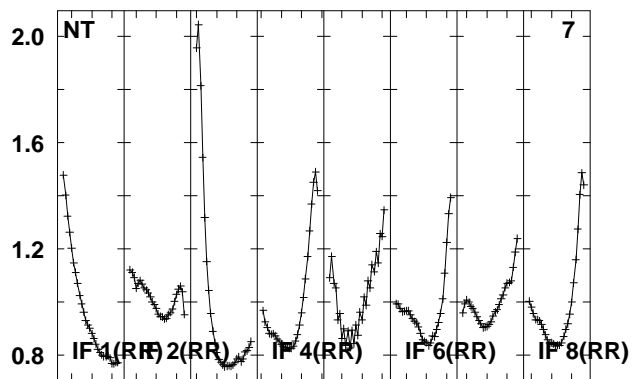
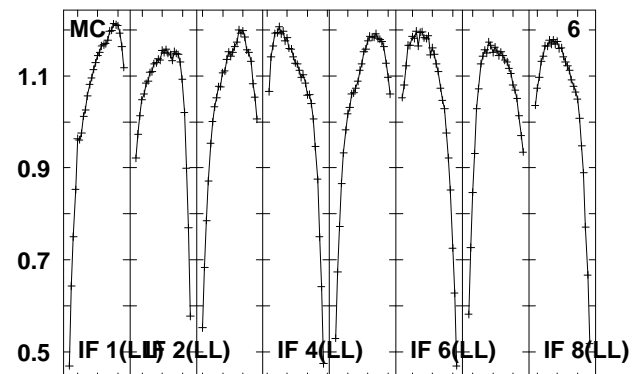
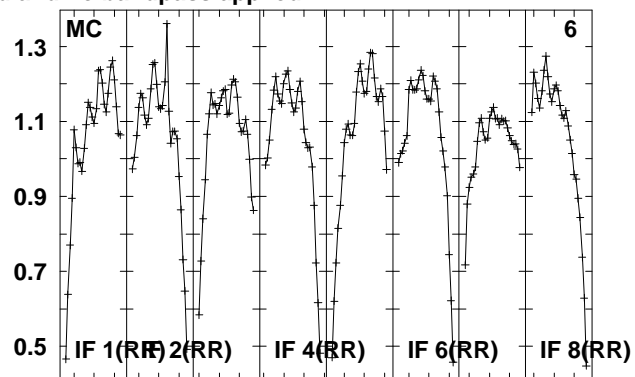
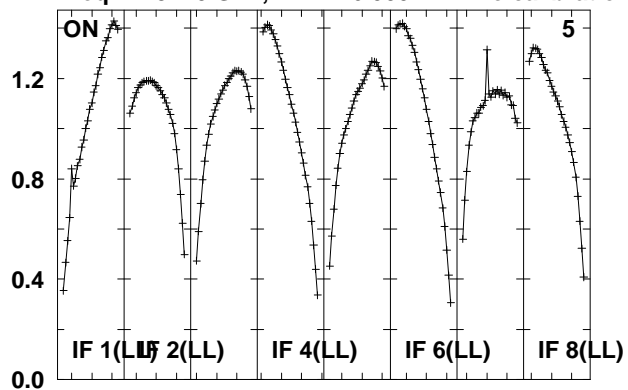

Lower frame: Real Jy

Total-power spectrum Antenna: *

Timerange: 00/07:48:31 to 00/07:49:59

Plot file version 179 created 14-MAY-2010 15:18:00
 J210358 EO007.UVDATA.1
 Freq = 4.9270 GHz, Bw = 16.000 MH No calibration applied and no bandpass applied

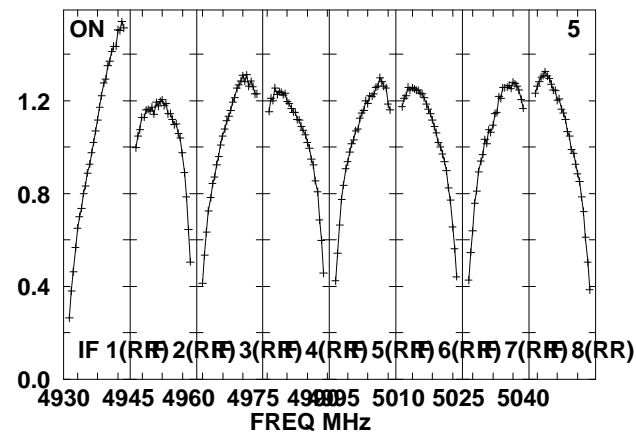
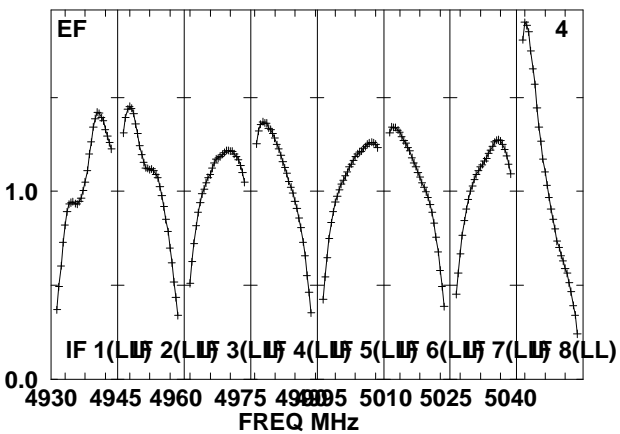
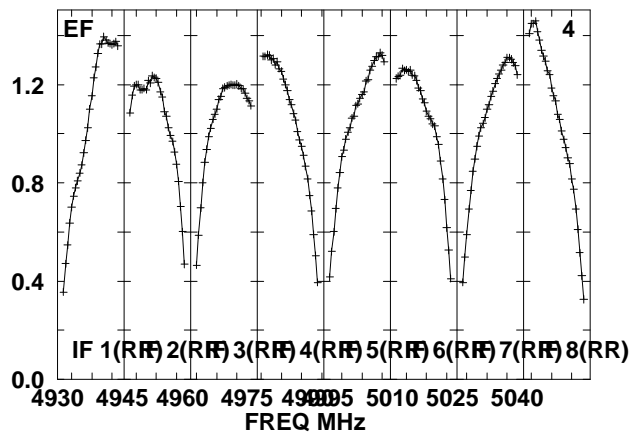
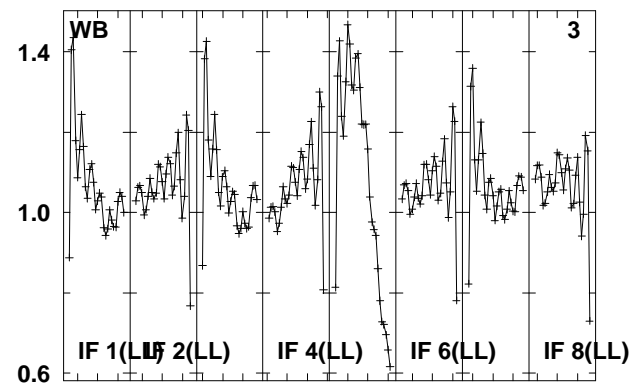
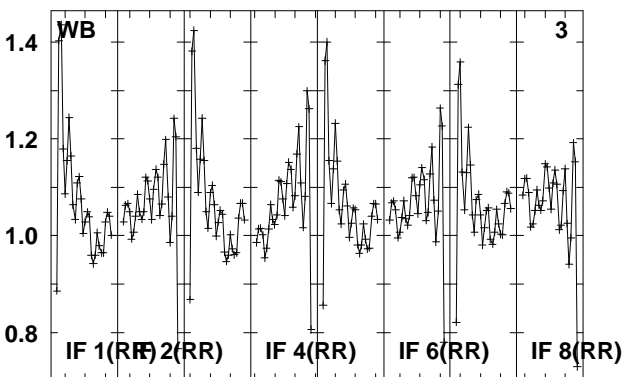
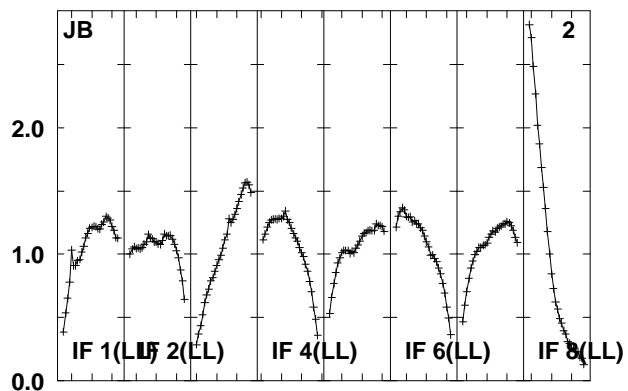
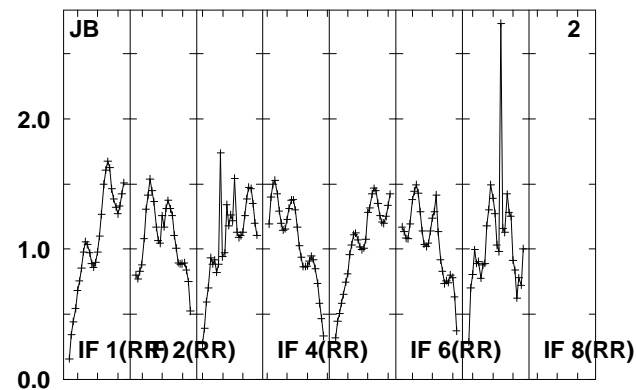
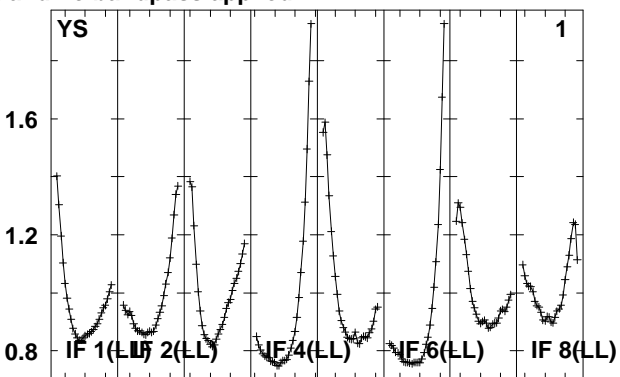
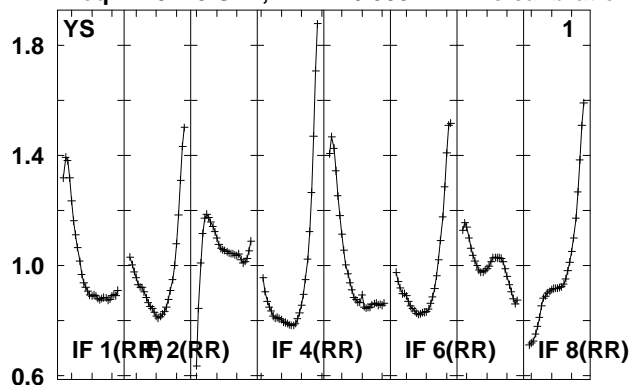

Lower frame: Real Jy
 Total-power spectrum Antenna: *
 Timerange: 00/07:50:39 to 00/07:55:33

Plot file version 180 created 14-MAY-2010 15:18:00

J210358 EO007.UVDATA.1

Freq = 4.9270 GHz, Bw = 16.000 MH No calibration applied and no bandpass applied

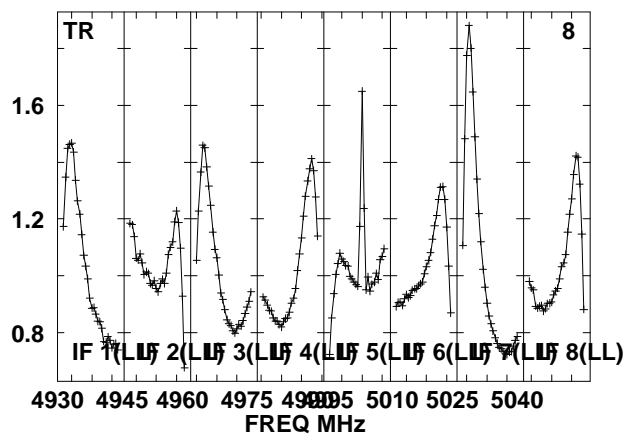
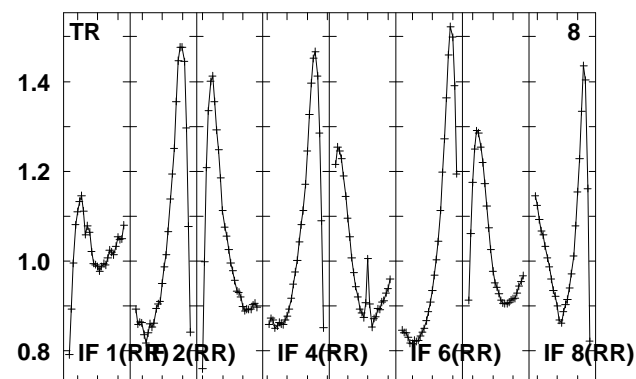
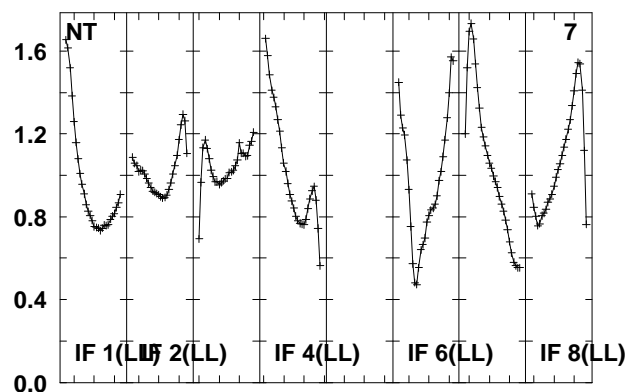
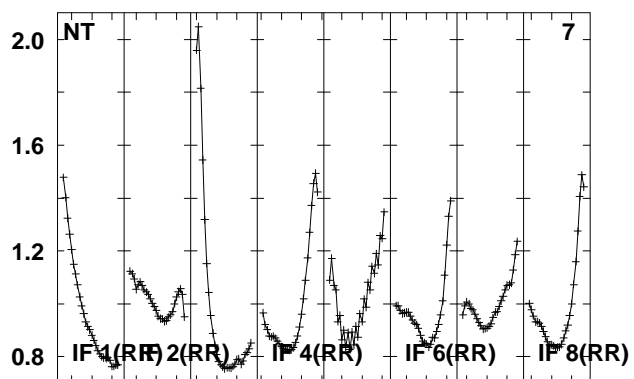
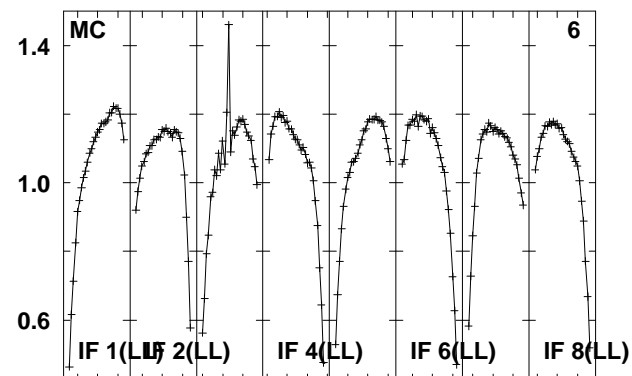
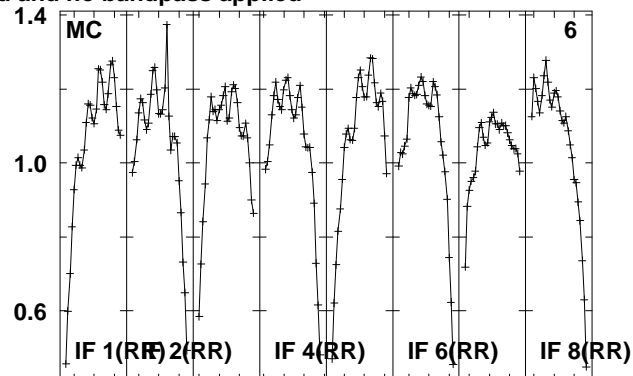
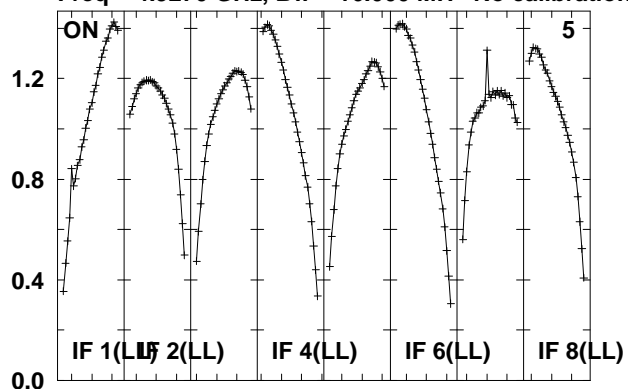

Lower frame: Real Jy

Total-power spectrum Antenna: *

Timerange: 00/07:50:39 to 00/07:55:33

Plot file version 181 created 14-MAY-2010 15:18:01

J2110-10 EO007.UVDATA.1

Freq = 4.9270 GHz, Bw = 16.000 MH No calibration applied and no bandpass applied

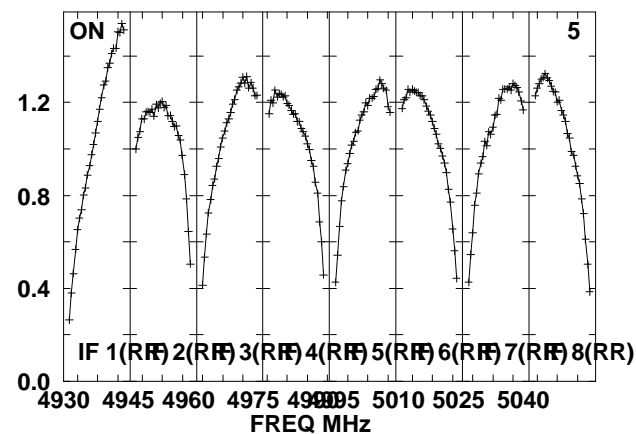
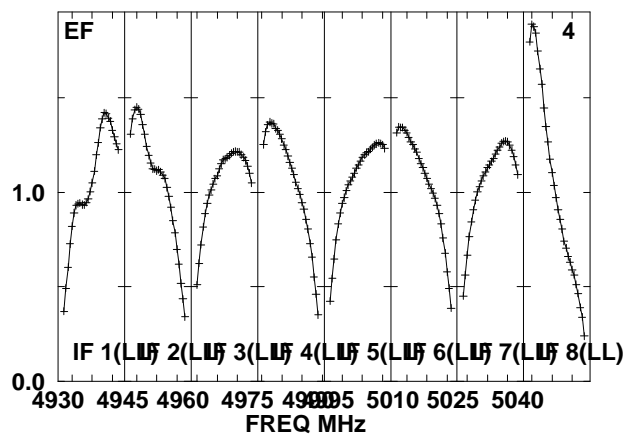
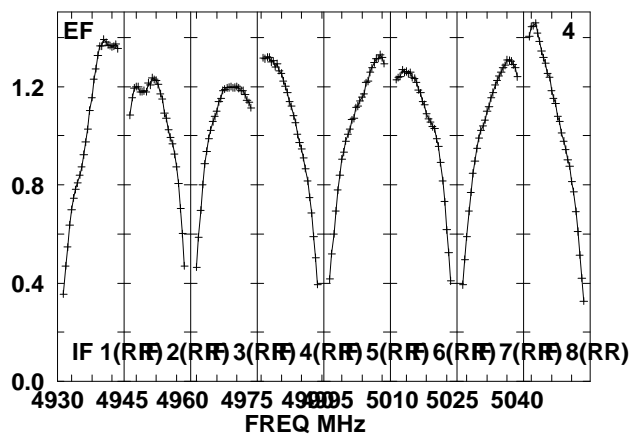
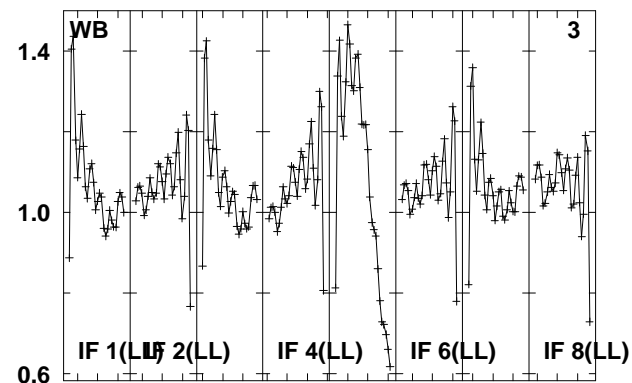
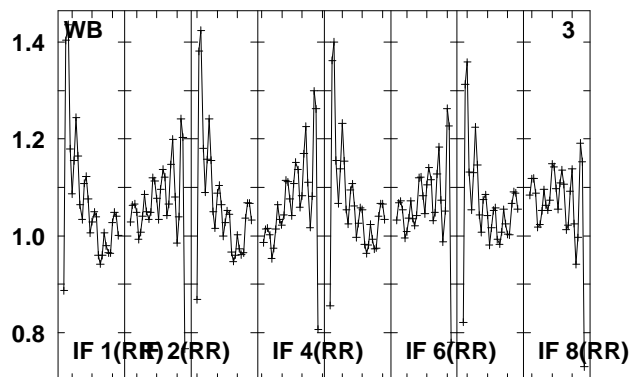
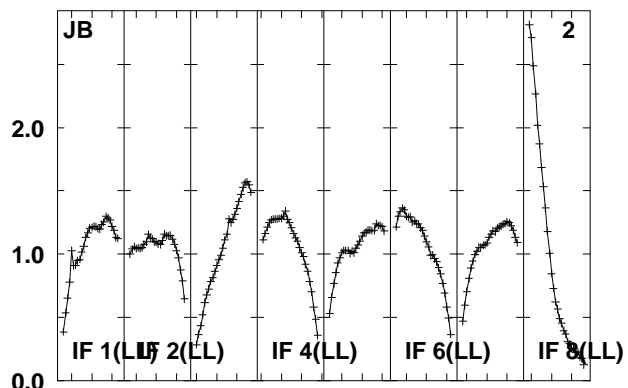
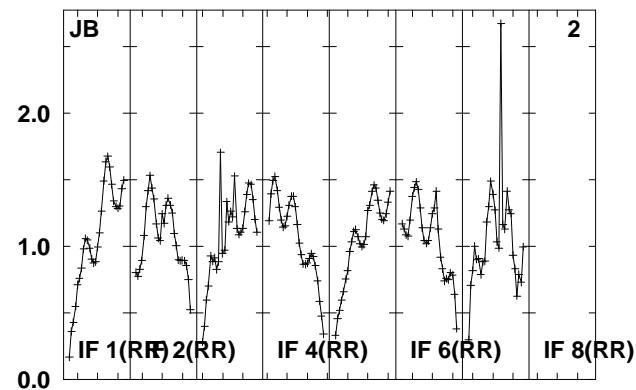
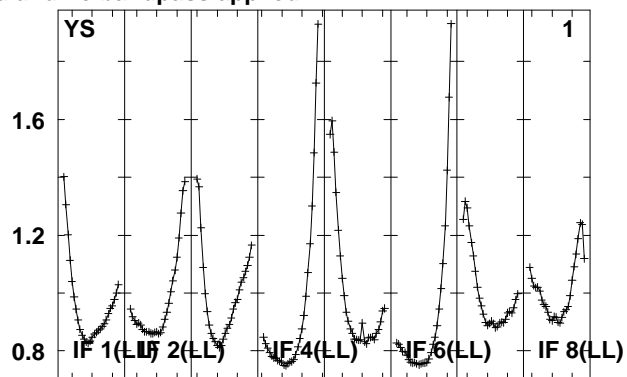
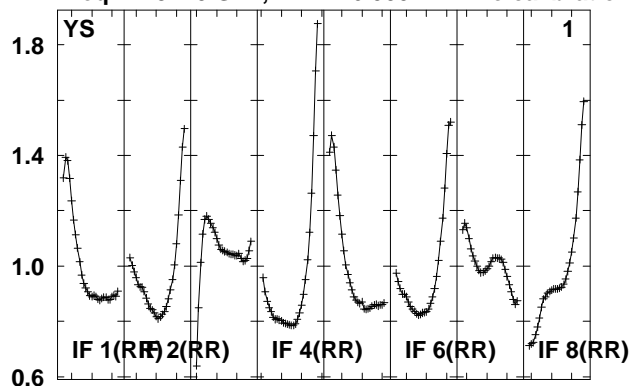

Lower frame: Real Jy

Total-power spectrum Antenna: *

Timerange: 00/07:56:14 to 00/07:57:40

Plot file version 182 created 14-MAY-2010 15:18:01

J2110-10 EO007.UVDATA.1

Freq = 4.9270 GHz, Bw = 16.000 MH No calibration applied and no bandpass applied

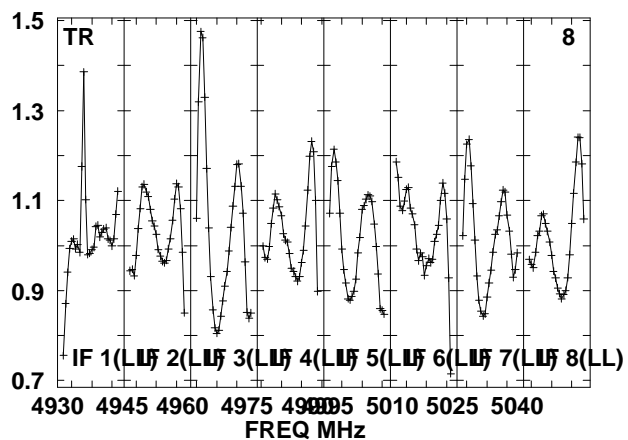
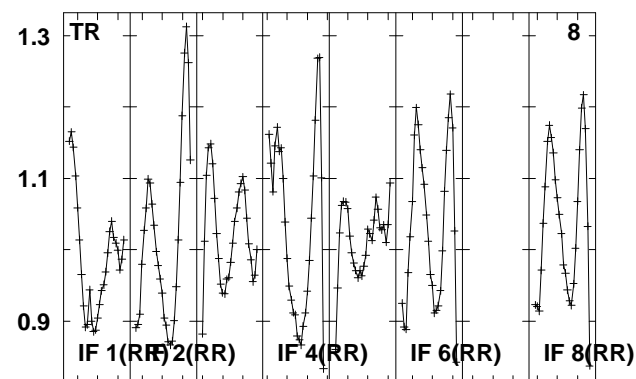
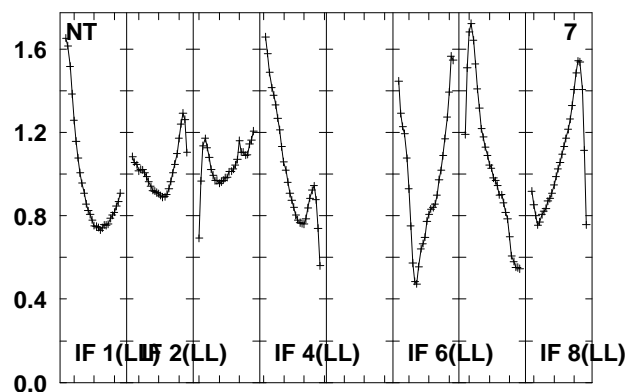
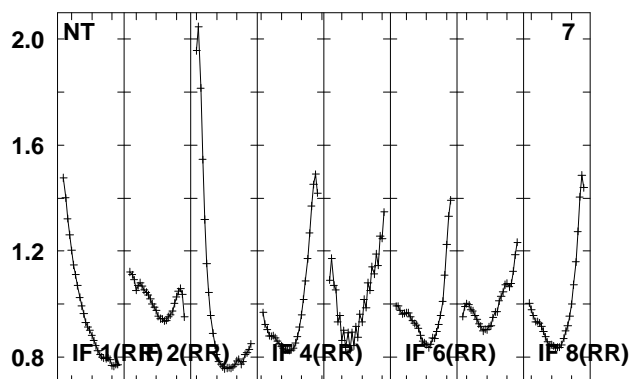
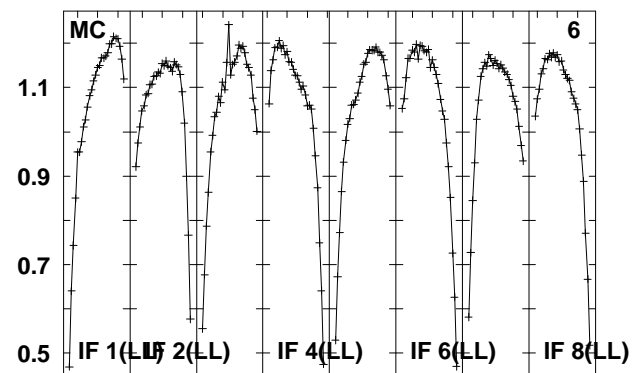
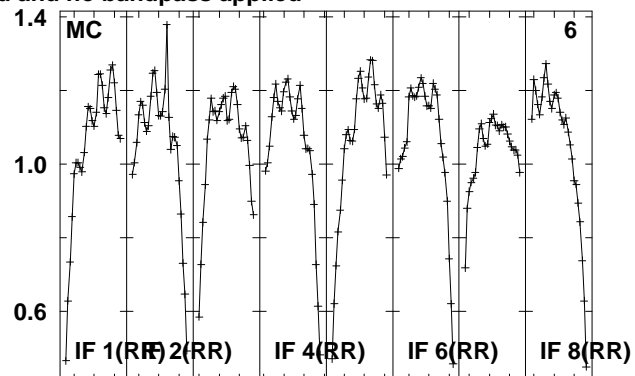
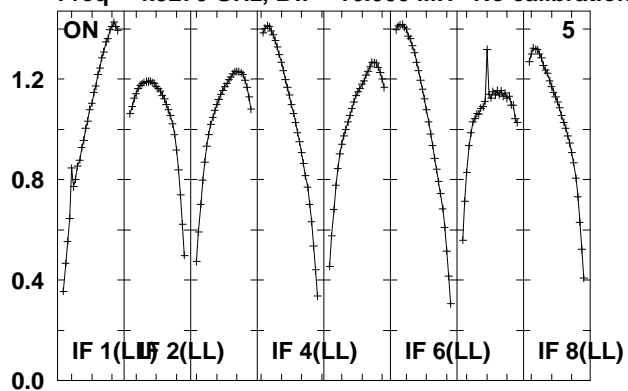

Lower frame: Real Jy

Total-power spectrum Antenna: *

Timerange: 00/07:56:14 to 00/07:57:40

Plot file version 183 created 14-MAY-2010 15:18:01
 J210358 EO007.UVDATA.1
 Freq = 4.9270 GHz, Bw = 16.000 MH No calibration applied and no bandpass applied

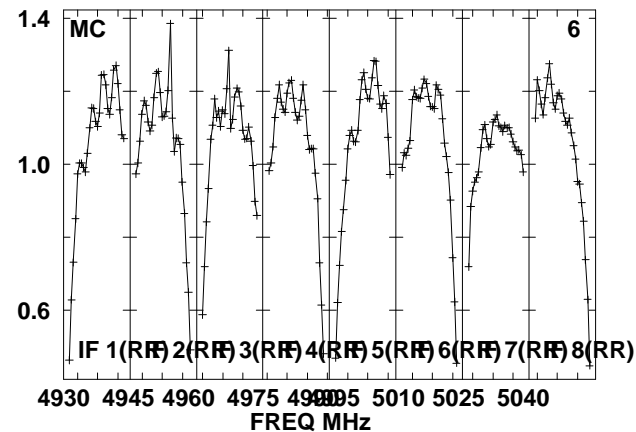
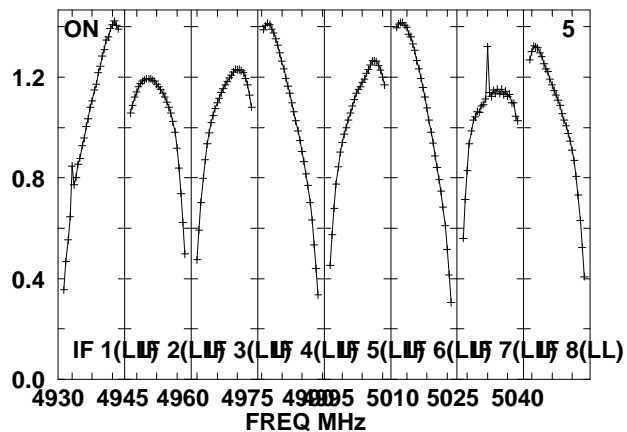
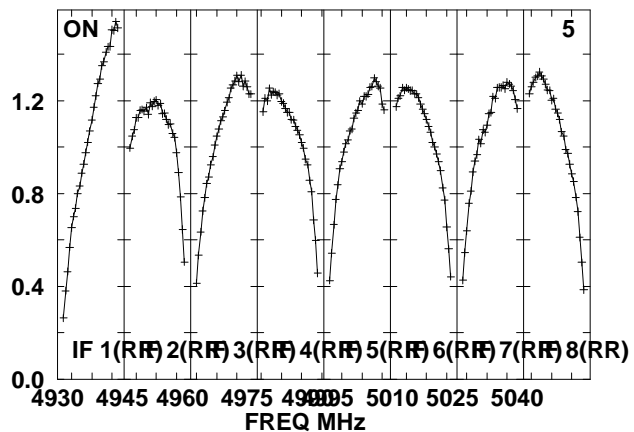
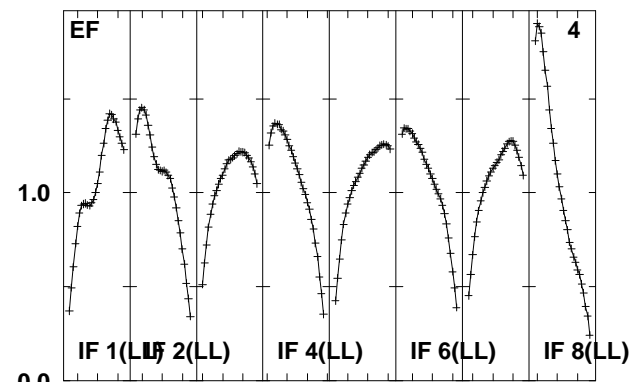
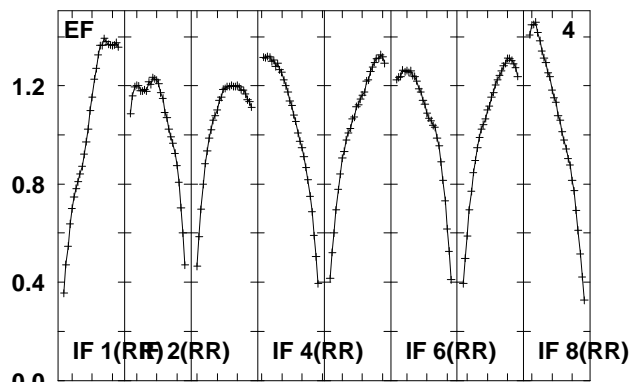
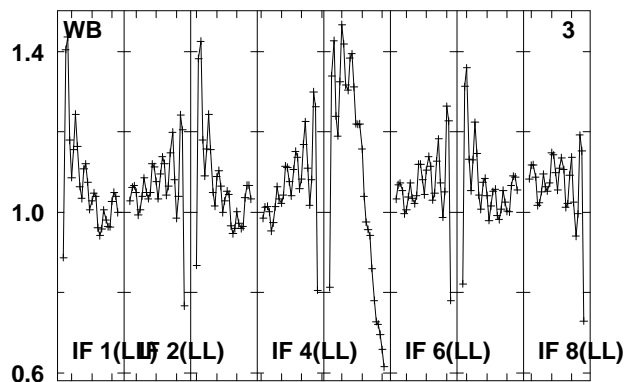
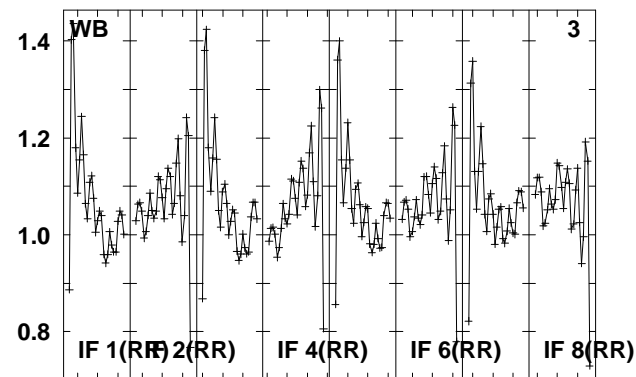
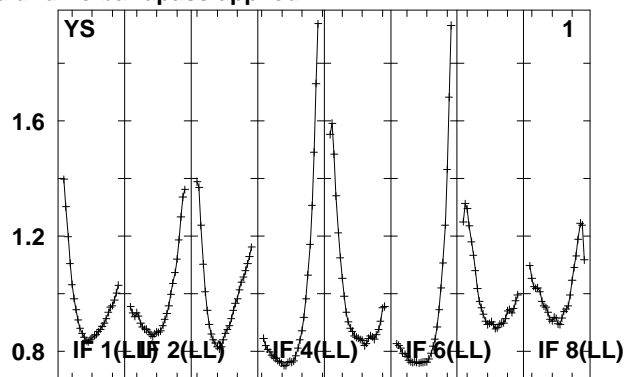
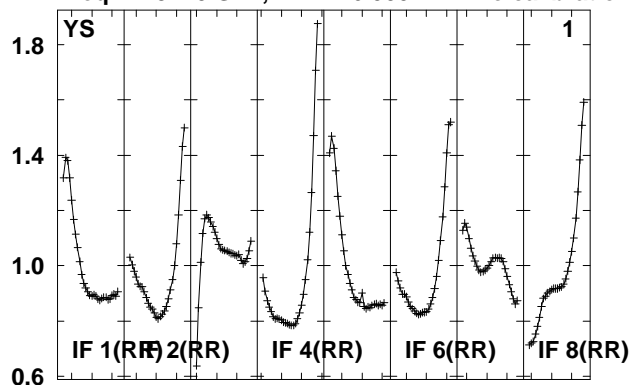

Lower frame: Real Jy
 Total-power spectrum Antenna: *
 Timerange: 00/07:58:18 to 00/08:03:16

Plot file version 184 created 14-MAY-2010 15:18:02

J210358 EO007.UVDATA.1

Freq = 4.9270 GHz, Bw = 16.000 MH No calibration applied and no bandpass applied

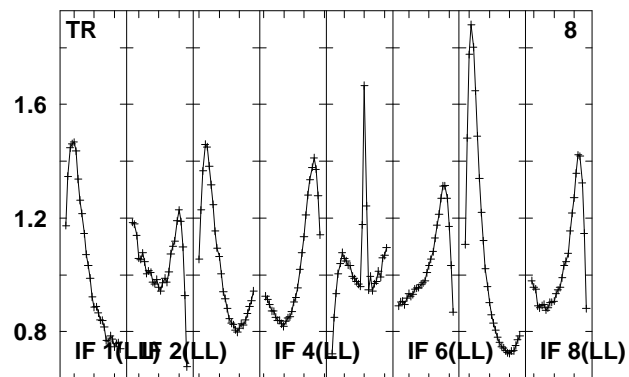
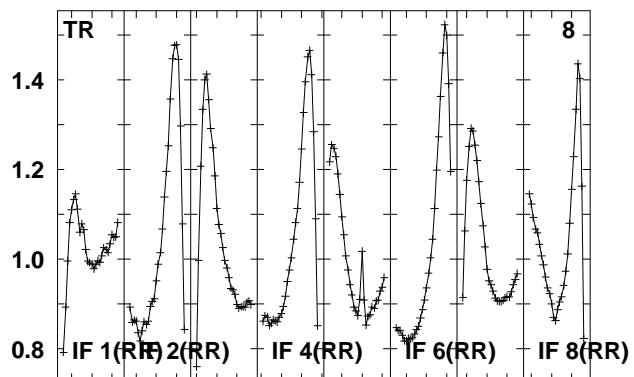
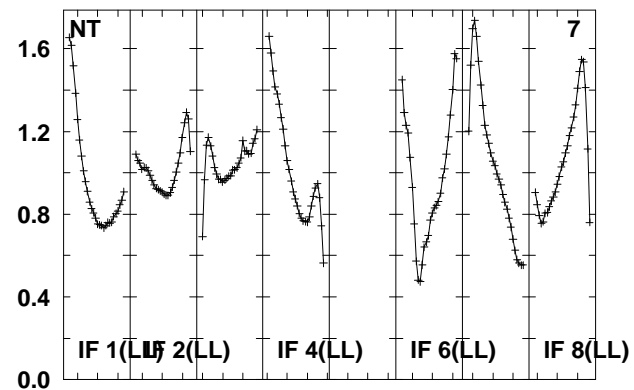
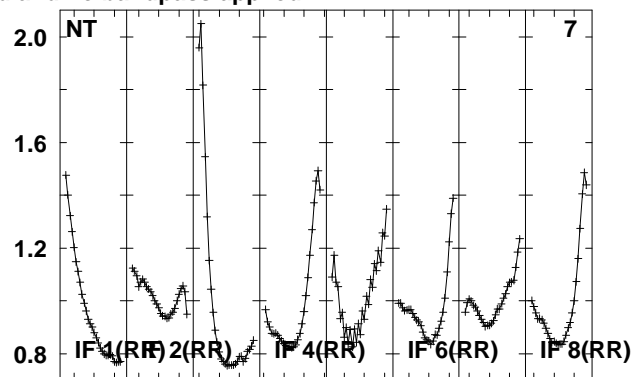
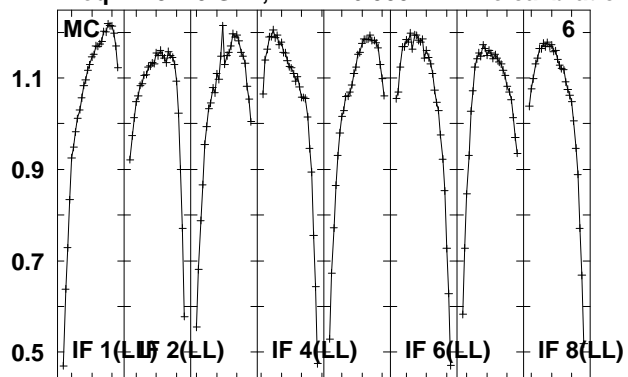

Lower frame: Real Jy
Total-power spectrum Antenna: *
Timerange: 00/07:58:18 to 00/08:03:16

Plot file version 185 created 14-MAY-2010 15:18:02

J2110-10 EO007.UVDATA.1

Freq = 4.9270 GHz, Bw = 16.000 MH No calibration applied and no bandpass applied

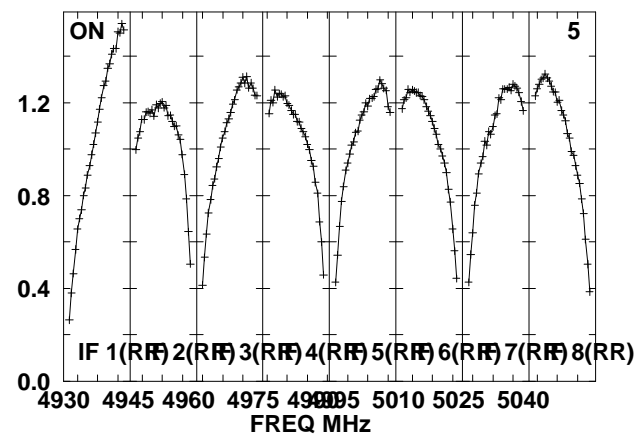
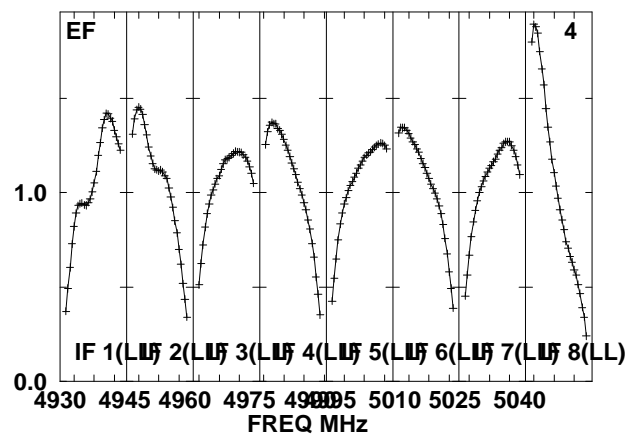
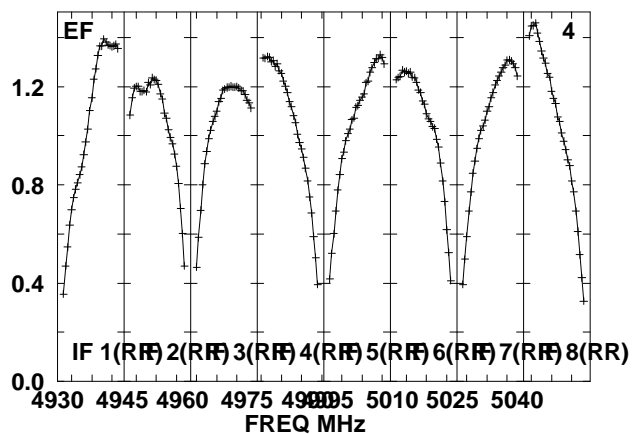
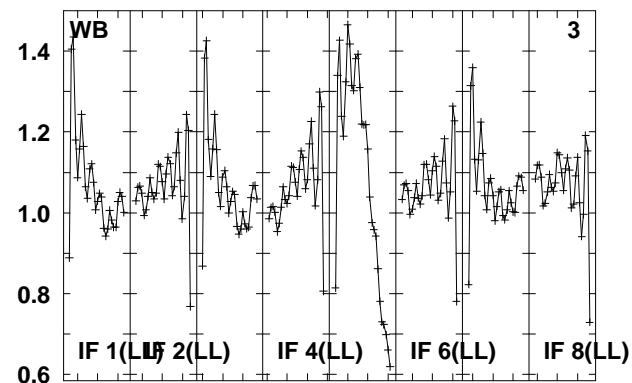
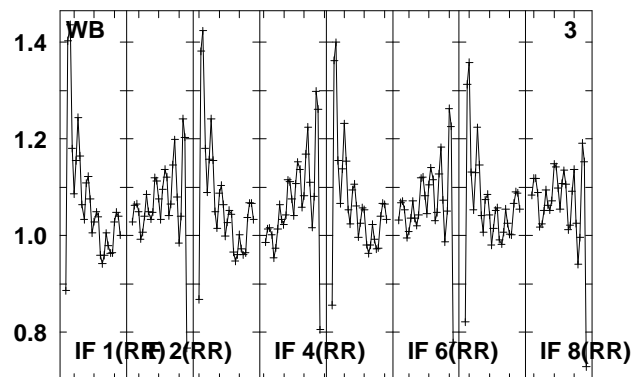
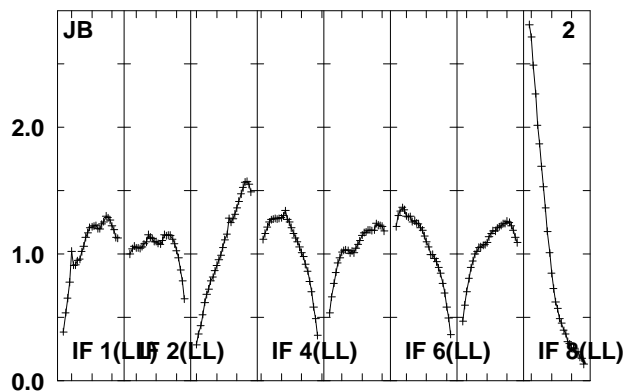
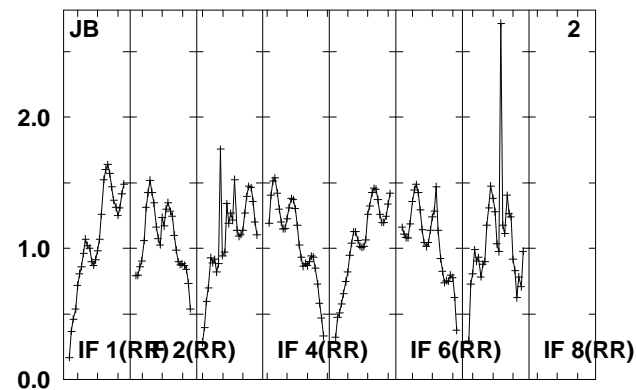
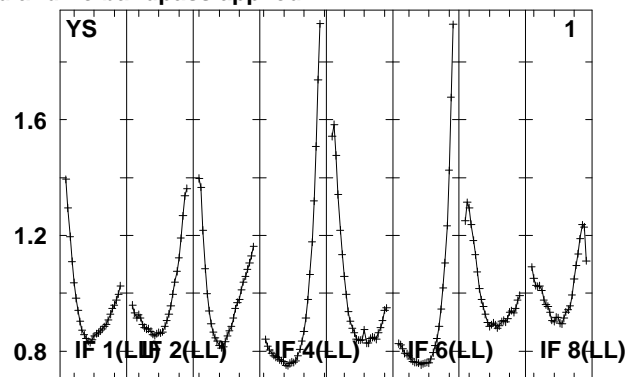
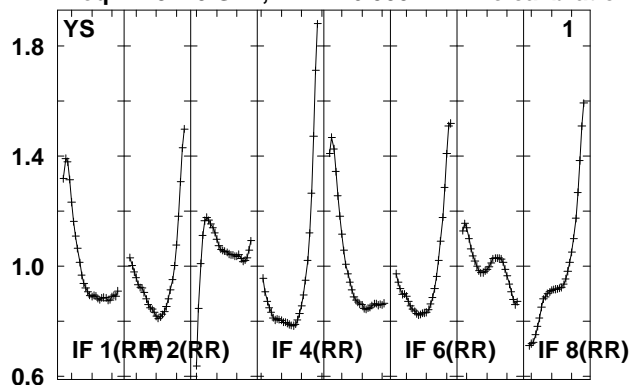

Lower frame: Real Jy

Total-power spectrum Antenna: *

Timerange: 00/08:03:50 to 00/08:05:18

Plot file version 186 created 14-MAY-2010 15:18:03

J2110-10 EO007.UVDATA.1

Freq = 4.9270 GHz, Bw = 16.000 MH No calibration applied and no bandpass applied

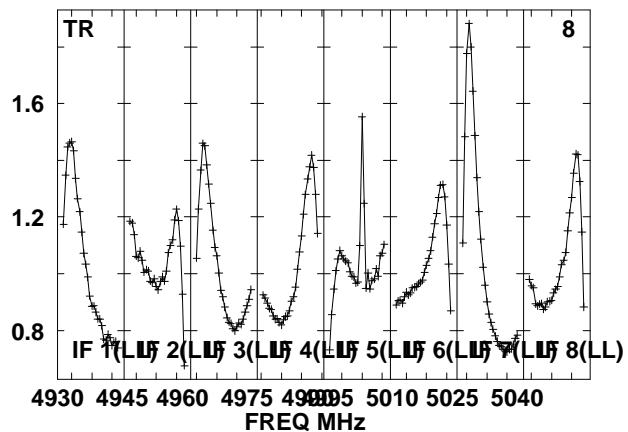
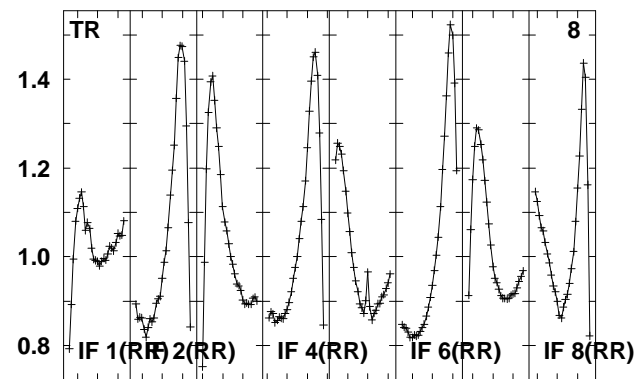
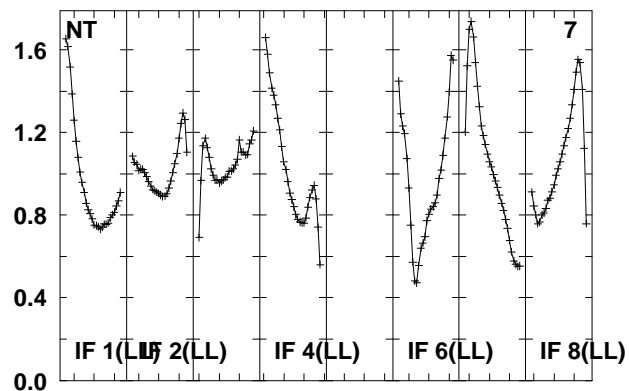
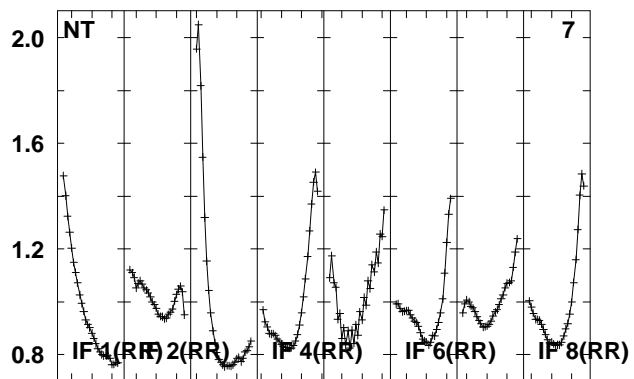
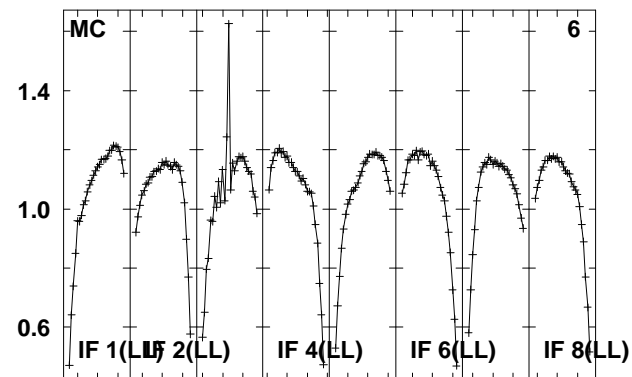
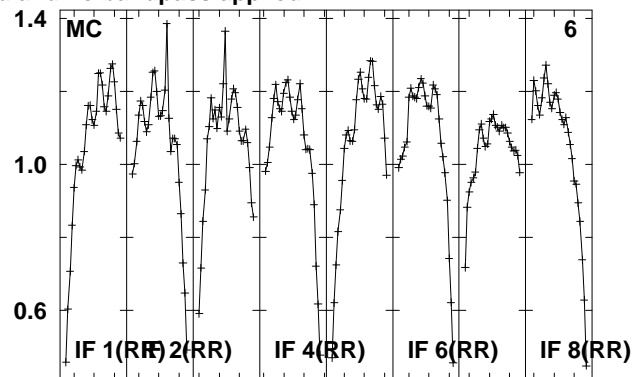
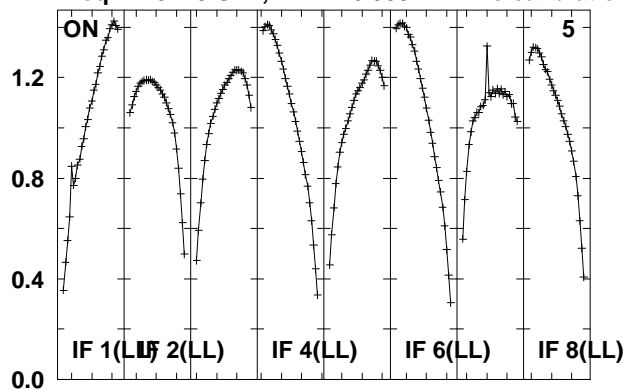

Lower frame: Real Jy

Total-power spectrum Antenna: *

Timerange: 00/08:03:50 to 00/08:05:18

Plot file version 187 created 14-MAY-2010 15:18:03
 J210358 EO007.UVDATA.1
 Freq = 4.9270 GHz, Bw = 16.000 MH No calibration applied and no bandpass applied

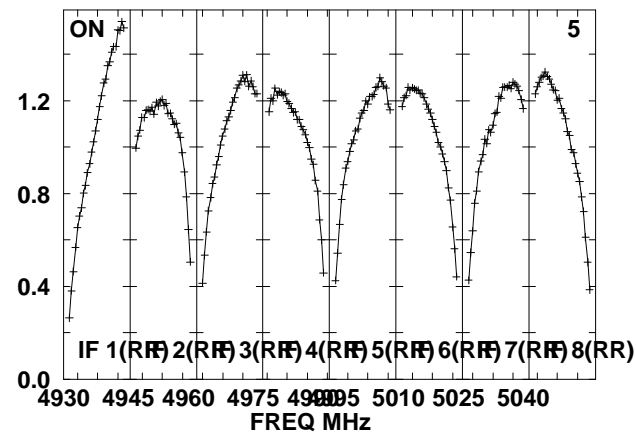
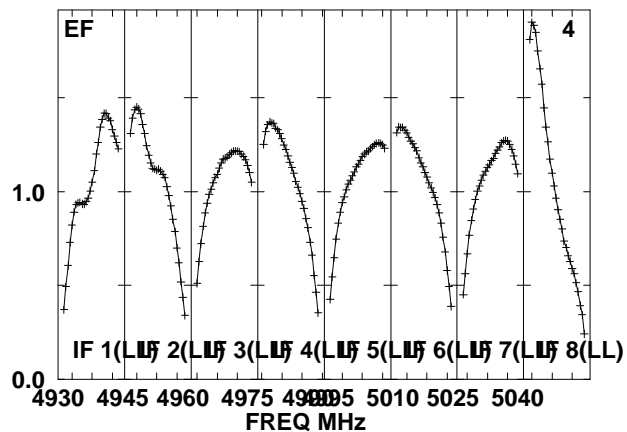
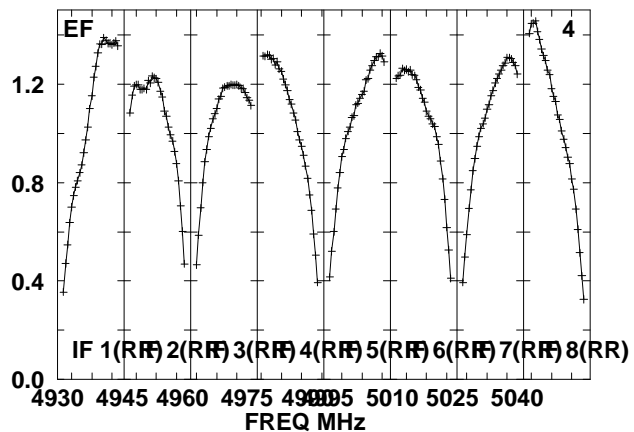
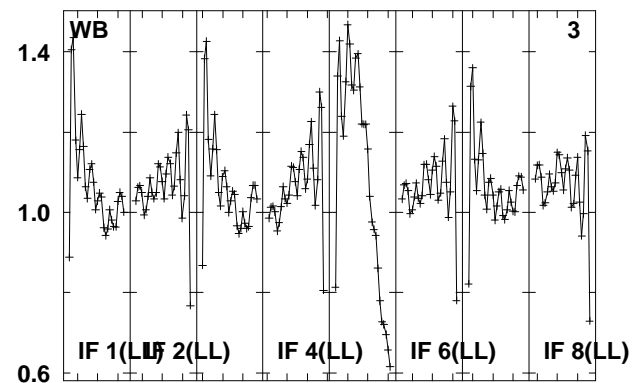
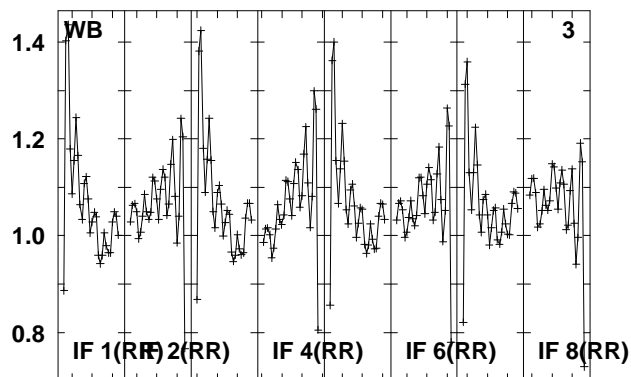
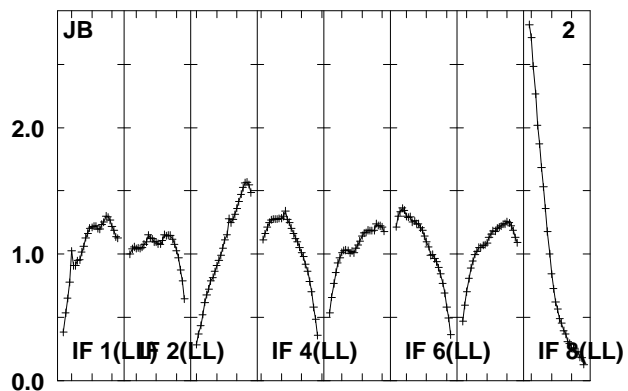
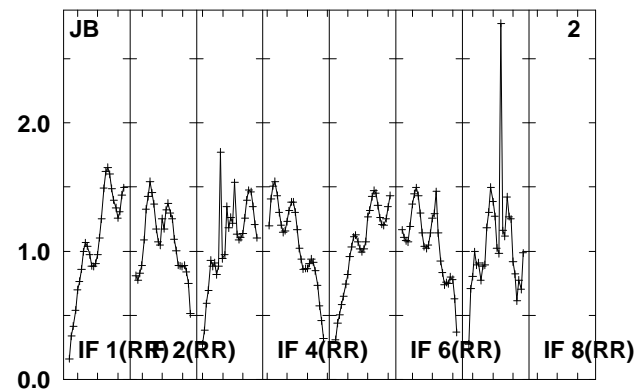
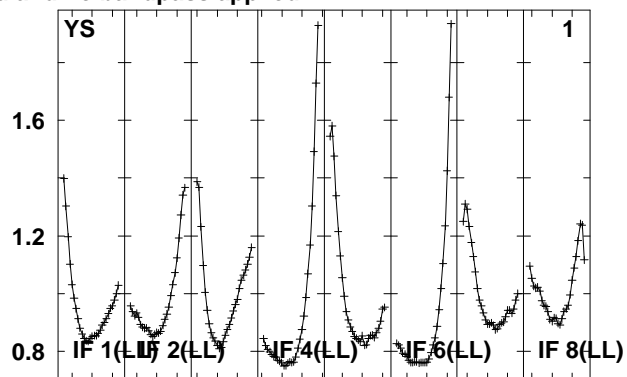
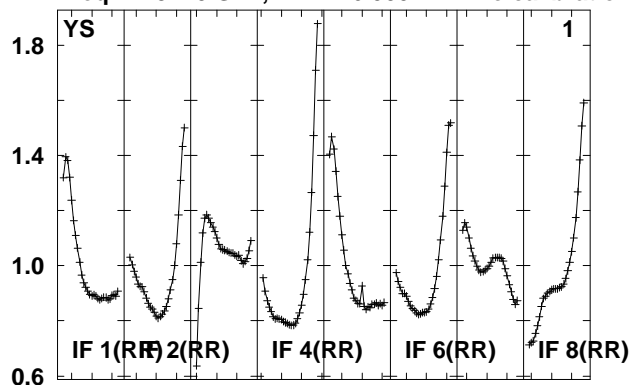

Lower frame: Real Jy
 Total-power spectrum Antenna: *
 Timerange: 00/08:05:58 to 00/08:10:54

Plot file version 188 created 14-MAY-2010 15:18:03

J210358 EO007.UVDATA.1

Freq = 4.9270 GHz, Bw = 16.000 MH No calibration applied and no bandpass applied

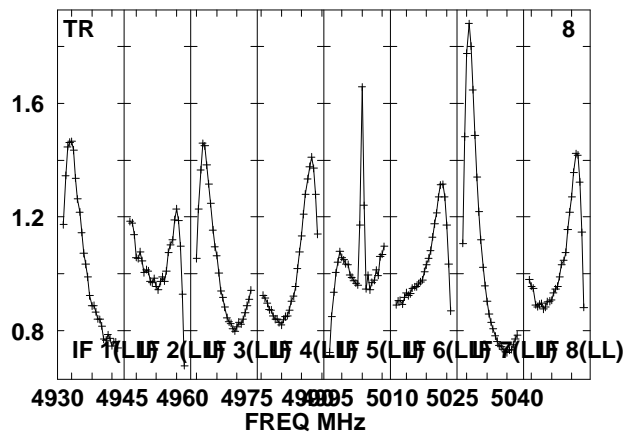
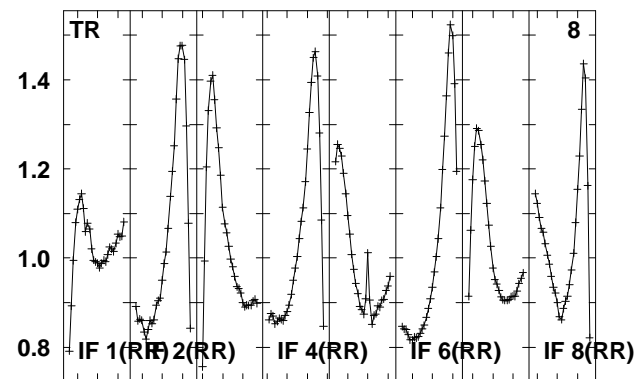
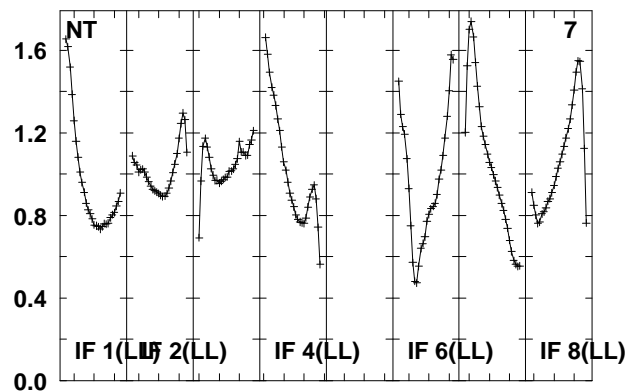
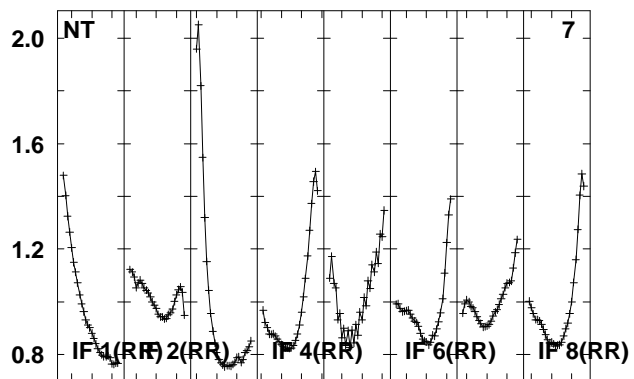
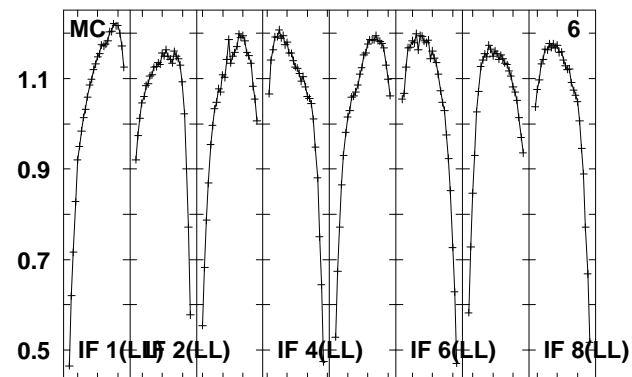
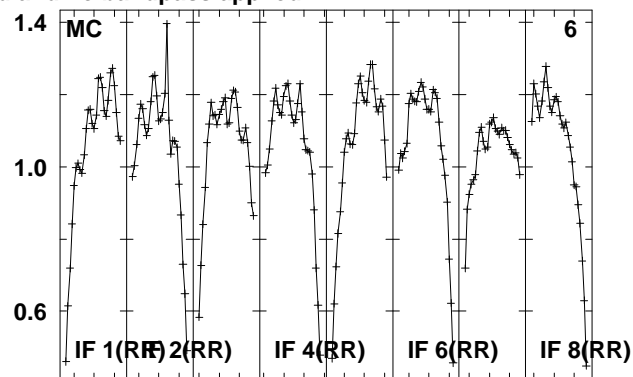
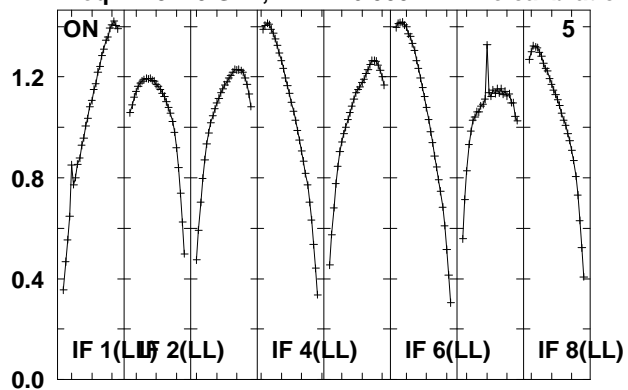

Lower frame: Real Jy

Total-power spectrum Antenna: *

Timerange: 00/08:05:58 to 00/08:10:54

Plot file version 189 created 14-MAY-2010 15:18:04

J2110-10 EO007.UVDATA.1

Freq = 4.9270 GHz, Bw = 16.000 MH No calibration applied and no bandpass applied

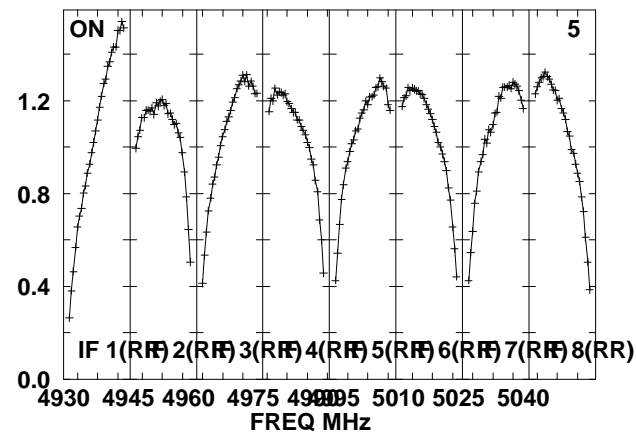
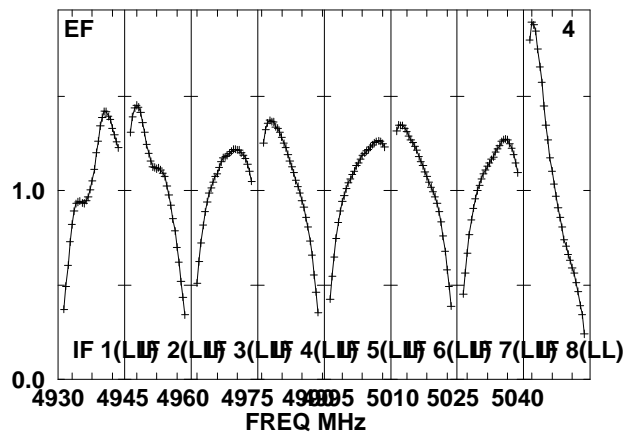
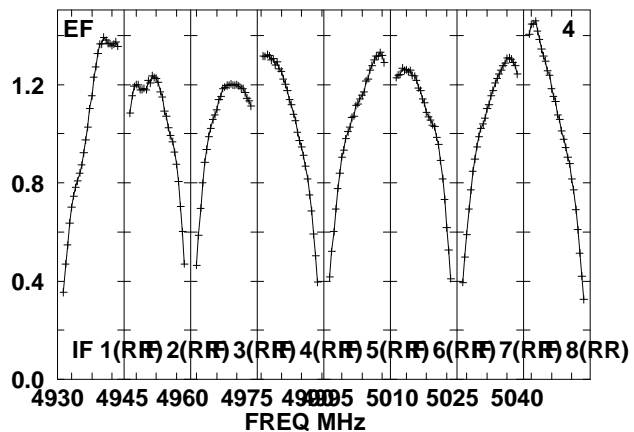
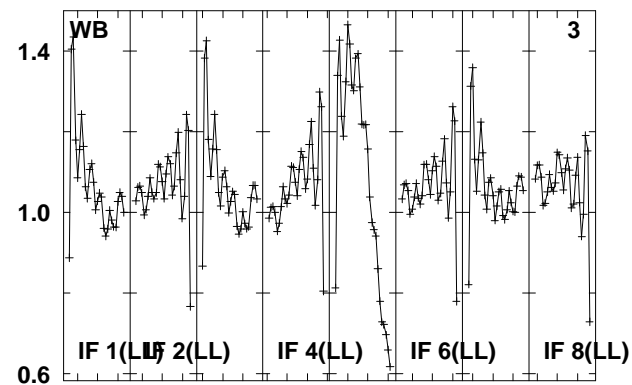
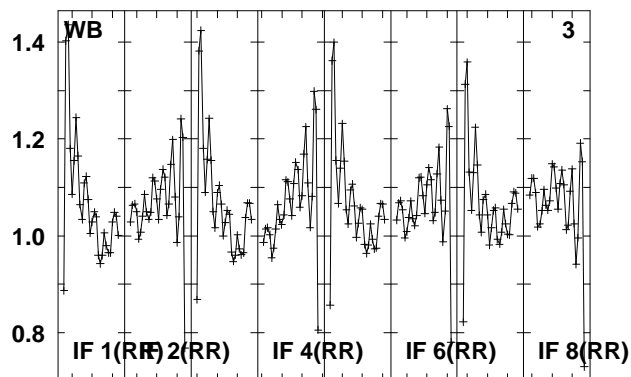
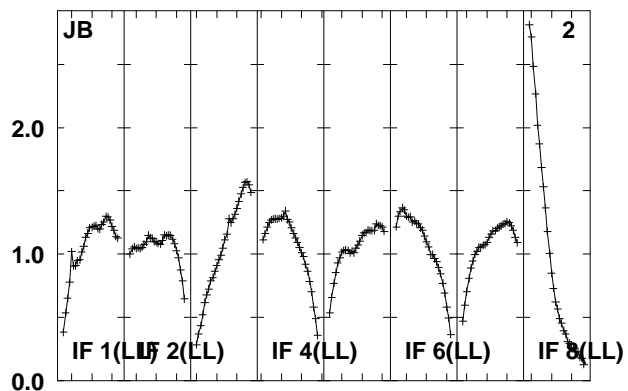
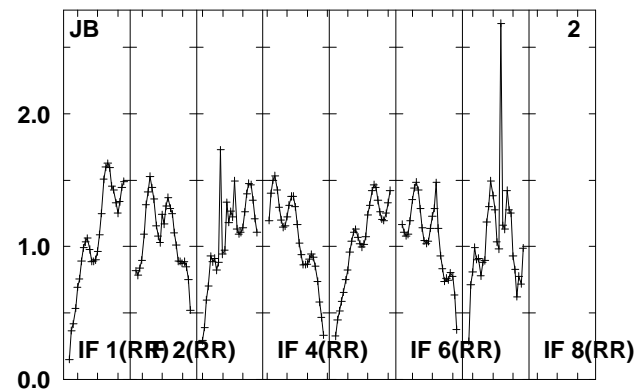
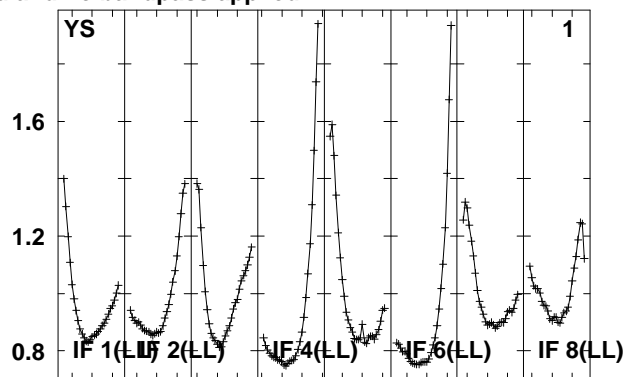
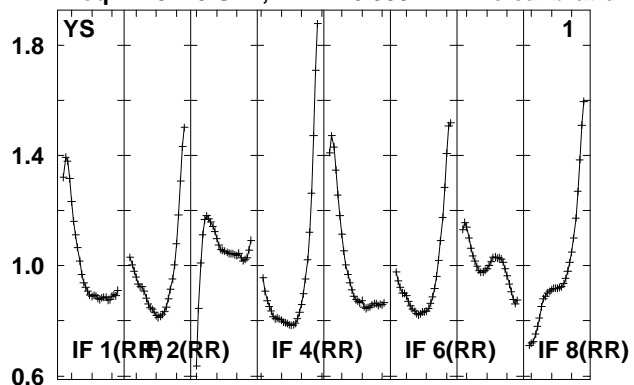

Lower frame: Real Jy

Total-power spectrum Antenna: *

Timerange: 00/08:11:34 to 00/08:13:02

Plot file version 190 created 14-MAY-2010 15:18:04

J2110-10 EO007.UVDATA.1

Freq = 4.9270 GHz, Bw = 16.000 MH No calibration applied and no bandpass applied

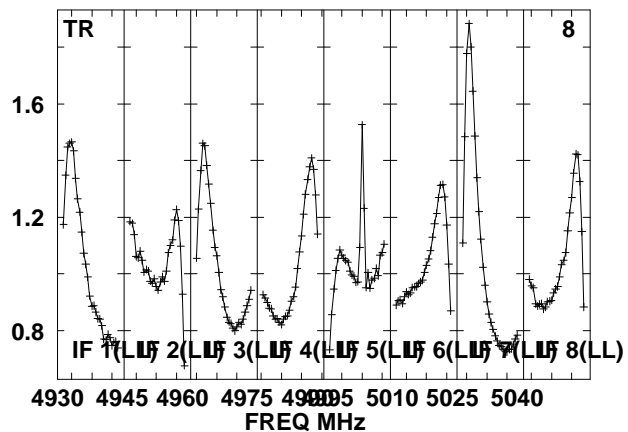
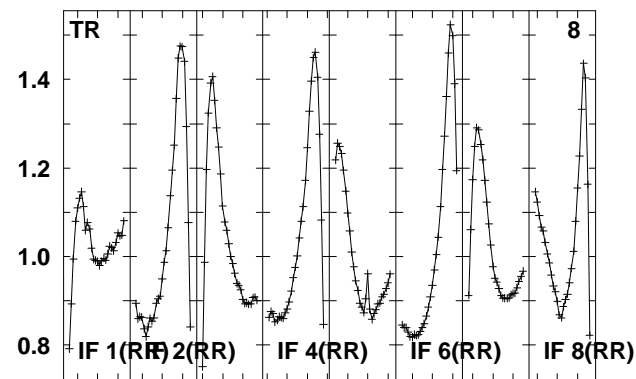
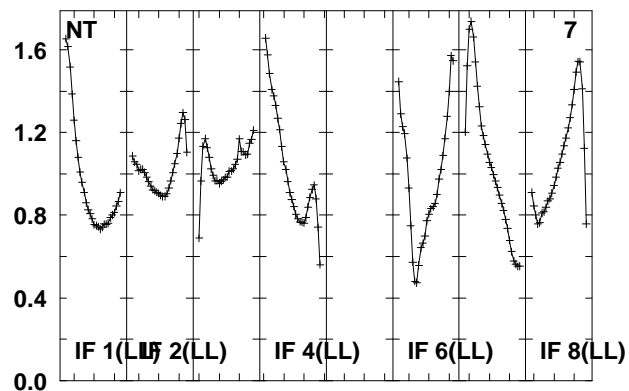
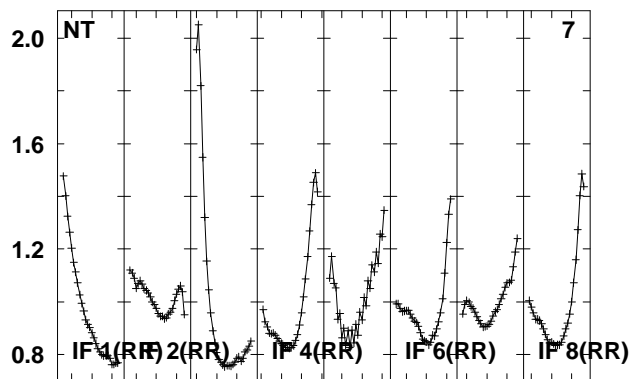
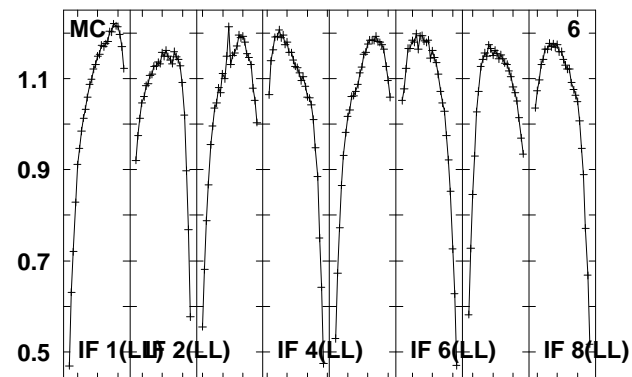
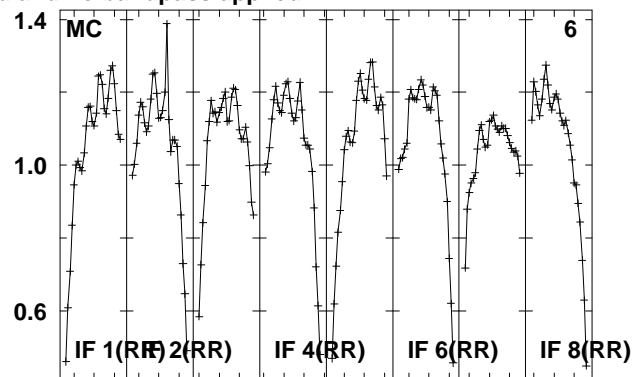
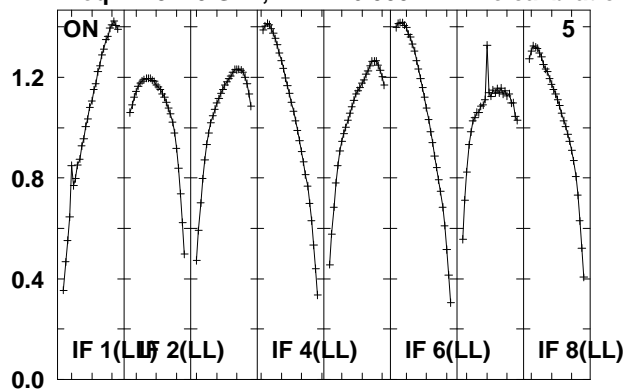

Lower frame: Real Jy

Total-power spectrum Antenna: *

Timerange: 00/08:11:34 to 00/08:13:02

Plot file version 191 created 14-MAY-2010 15:18:04

J0158+13 EO007.UVDATA.1

Freq = 4.9270 GHz, Bw = 16.000 MH No calibration applied and no bandpass applied

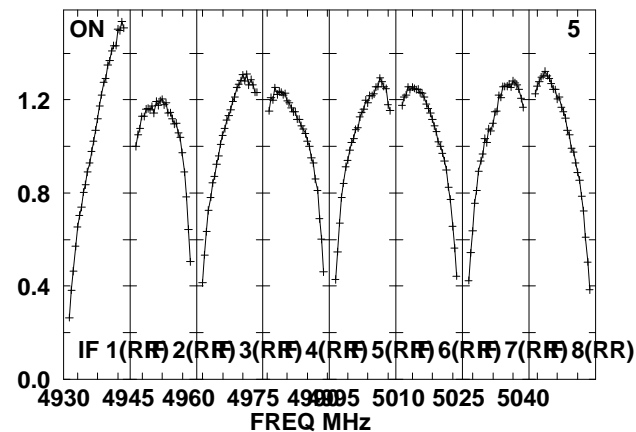
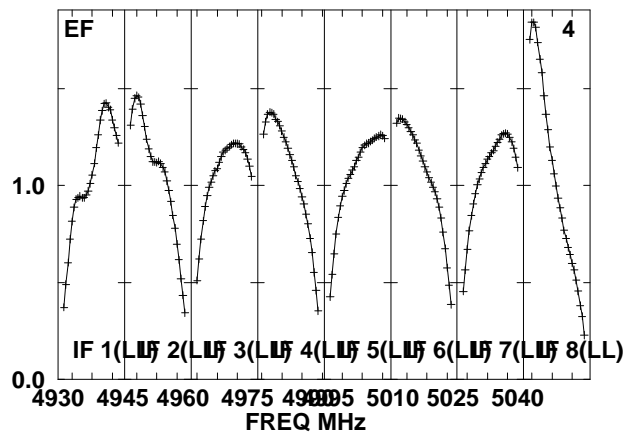
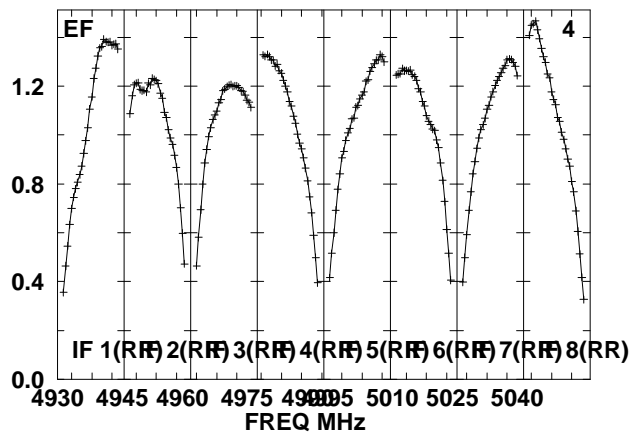
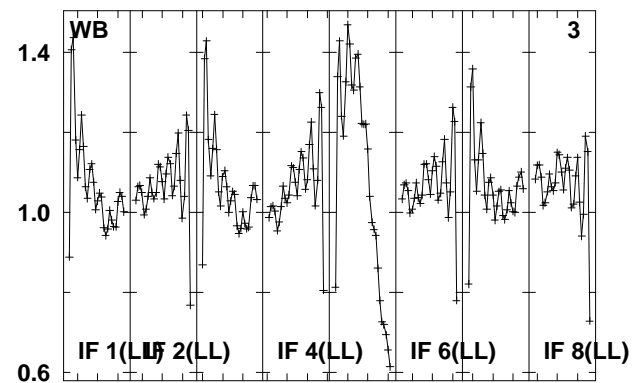
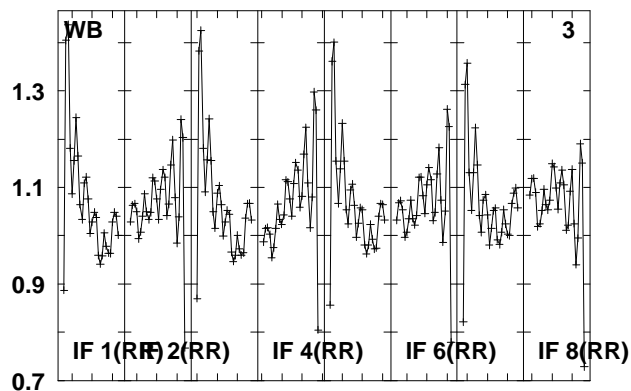
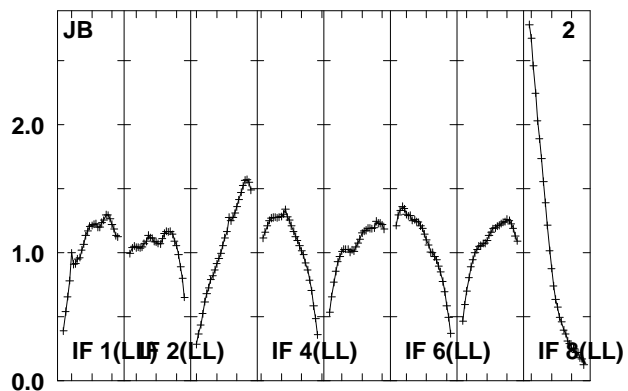
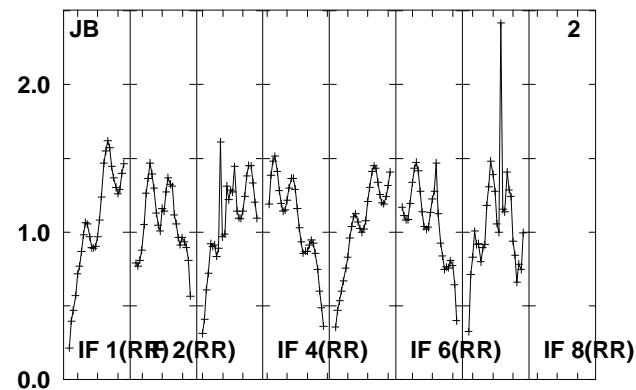
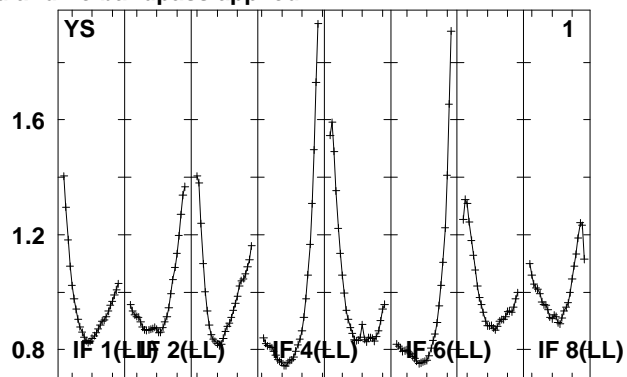
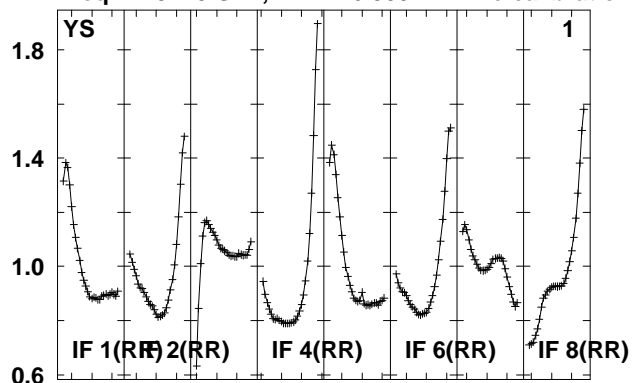

Lower frame: Real Jy
Total-power spectrum Antenna: *
Timerange: 00/08:18:32 to 00/08:19:58

Plot file version 192 created 14-MAY-2010 15:18:05

J0158+13 EO007.UVDATA.1

Freq = 4.9270 GHz, Bw = 16.000 MH No calibration applied and no bandpass applied

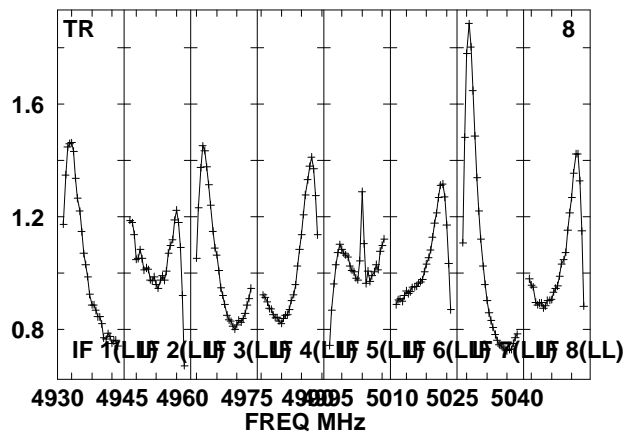
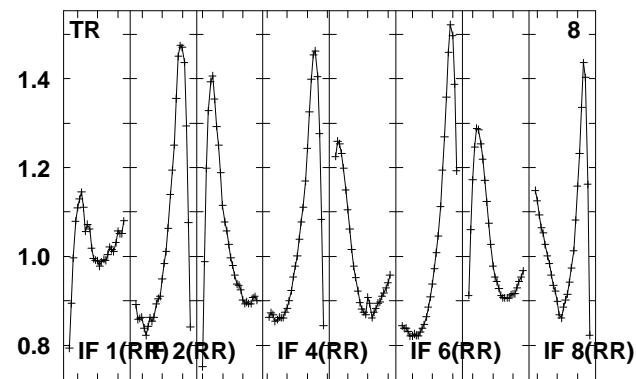
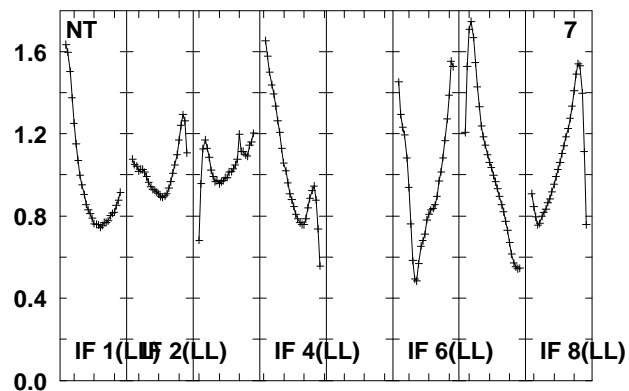
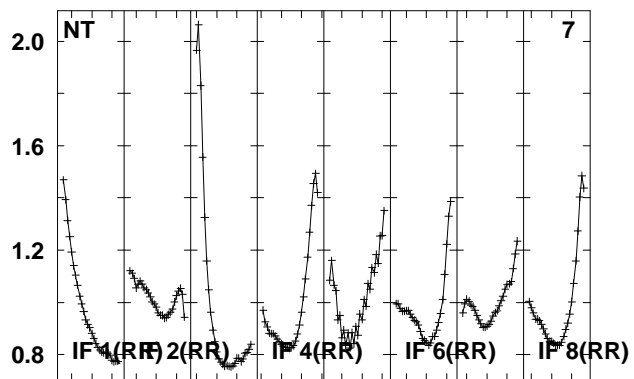
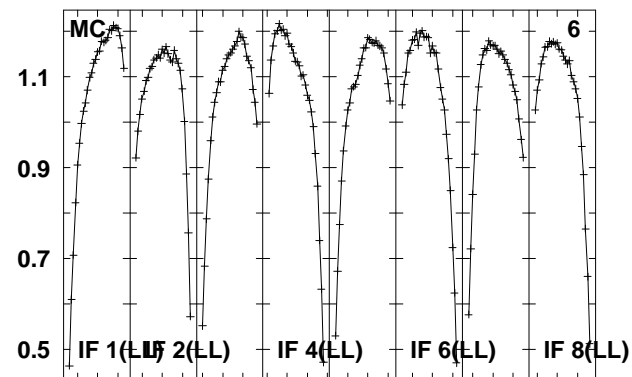
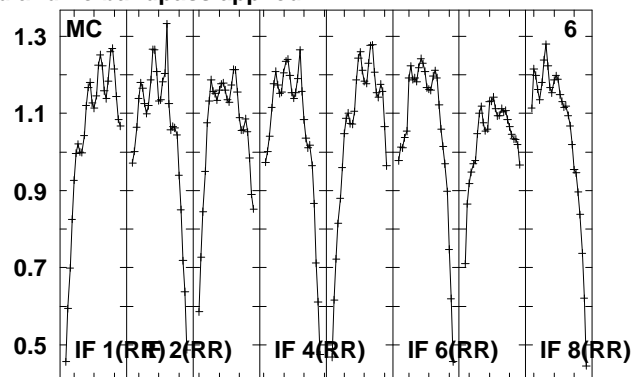
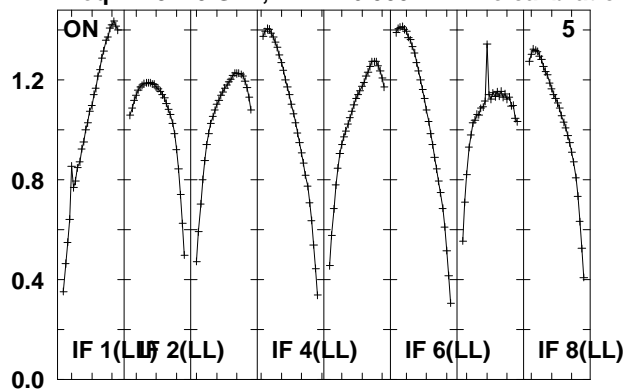

Lower frame: Real Jy

Total-power spectrum Antenna: *

Timerange: 00/08:18:32 to 00/08:19:58

Plot file version 193 created 14-MAY-2010 15:18:05
 J015028 EO007.UVDATA.1
 Freq = 4.9270 GHz, Bw = 16.000 MH No calibration applied and no bandpass applied

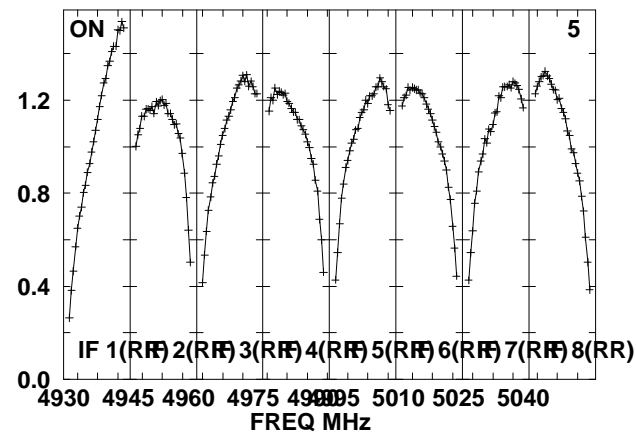
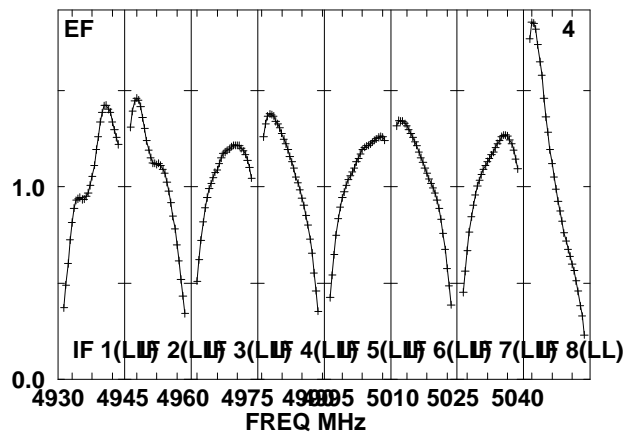
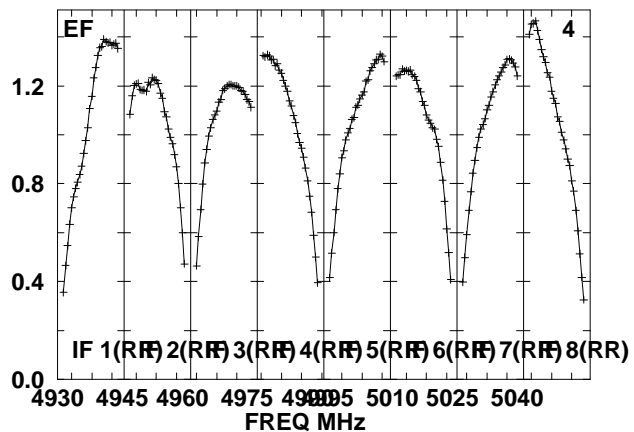
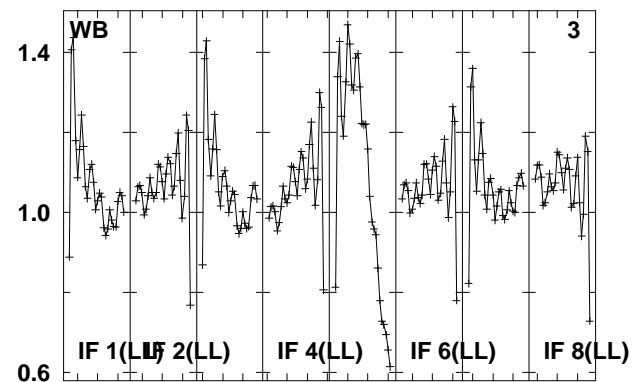
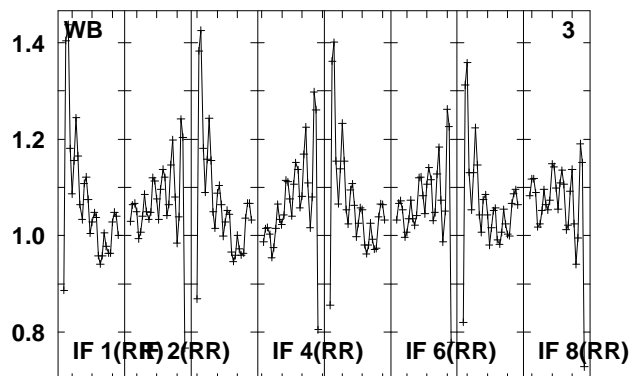
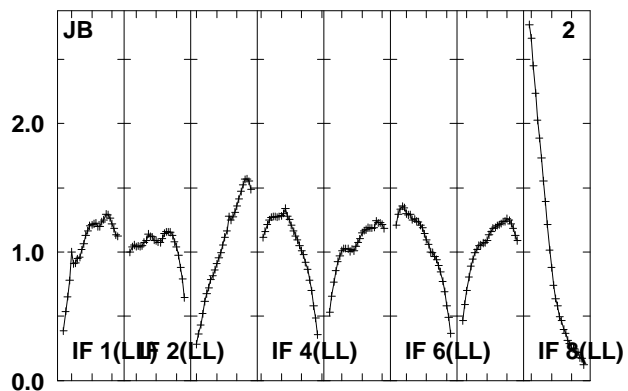
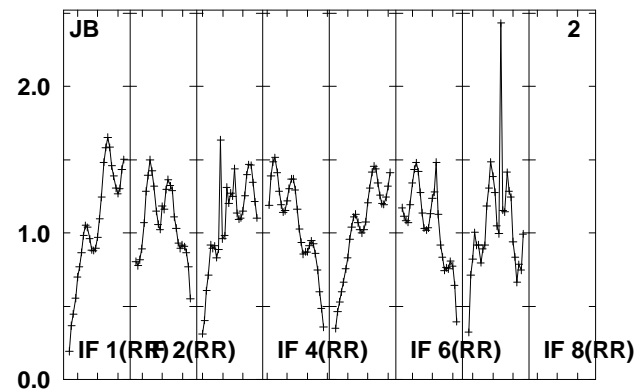
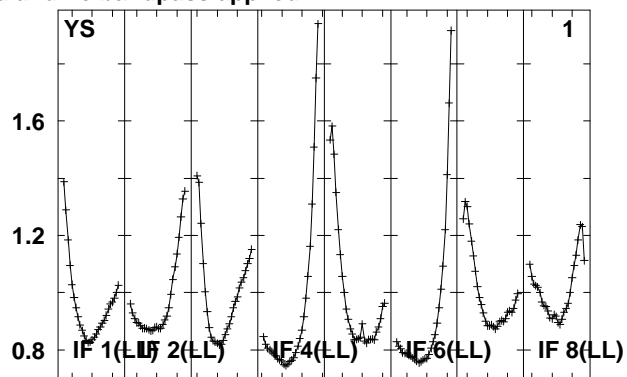
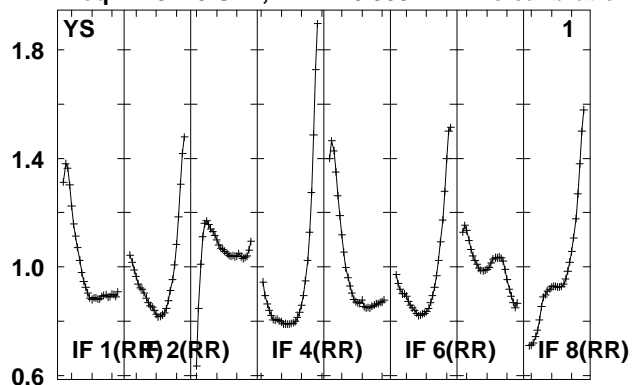

Lower frame: Real Jy
 Total-power spectrum Antenna: *
 Timerange: 00/08:20:29 to 00/08:25:27

Plot file version 194 created 14-MAY-2010 15:18:05

J015028 EO007.UVDATA.1

Freq = 4.9270 GHz, Bw = 16.000 MH No calibration applied and no bandpass applied

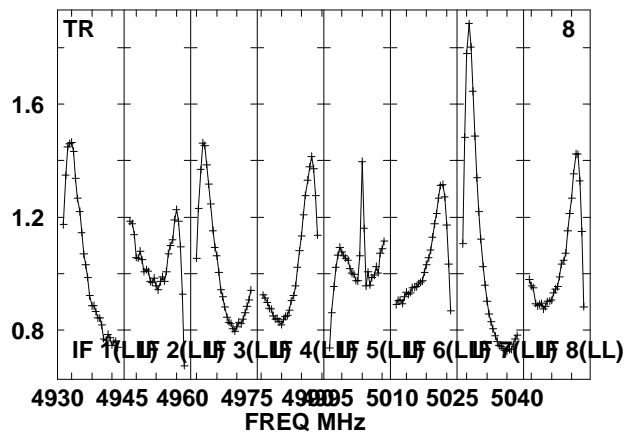
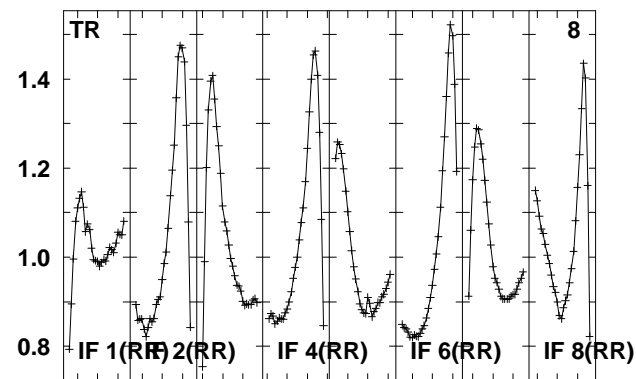
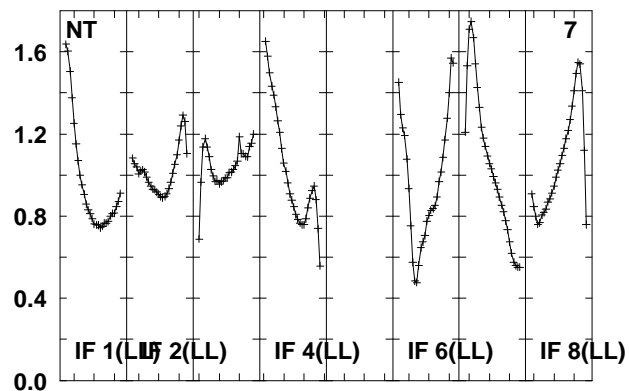
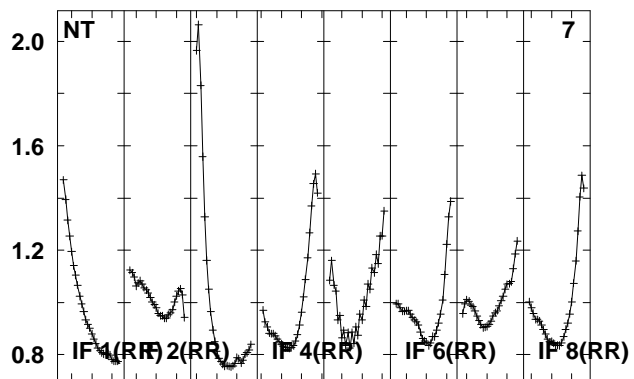
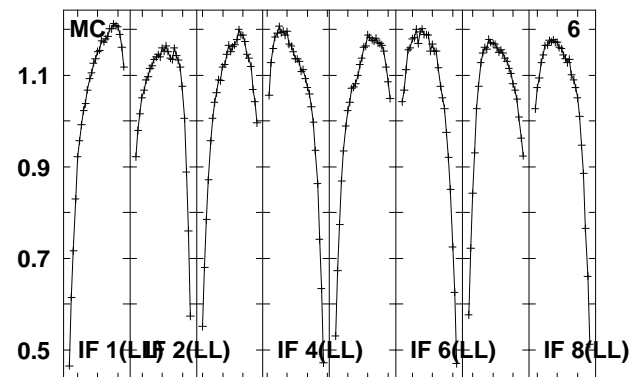
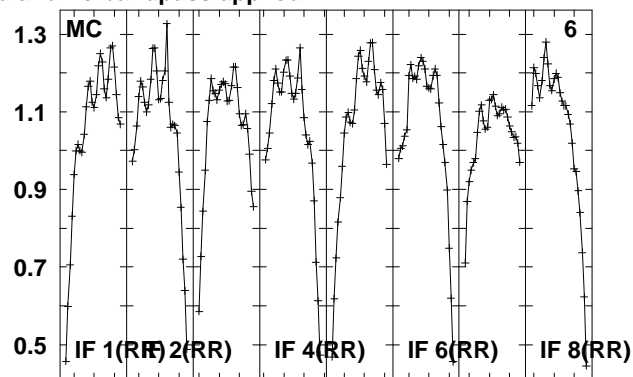
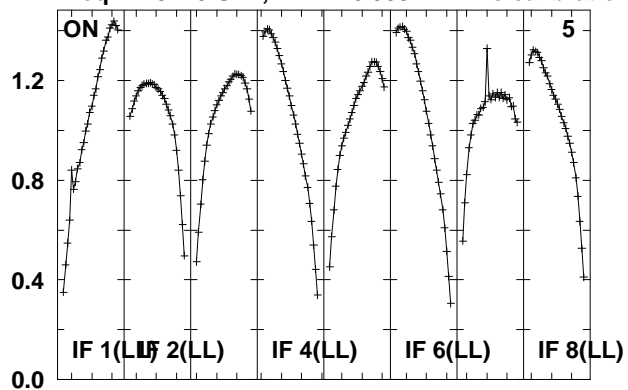

Lower frame: Real Jy

Total-power spectrum Antenna: *

Timerange: 00/08:20:29 to 00/08:25:27

Plot file version 195 created 14-MAY-2010 15:18:06

J0158+13 EO007.UVDATA.1

Freq = 4.9270 GHz, Bw = 16.000 MH No calibration applied and no bandpass applied

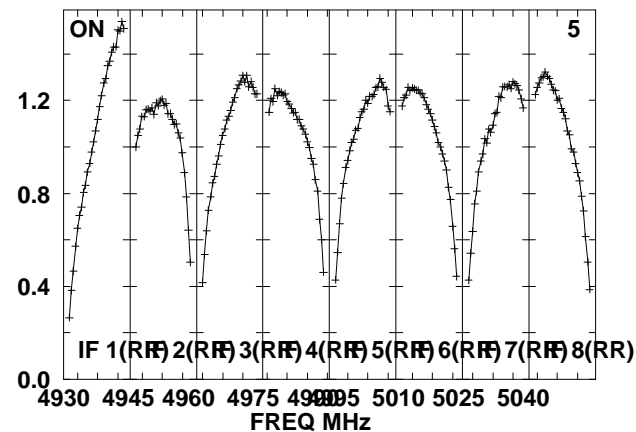
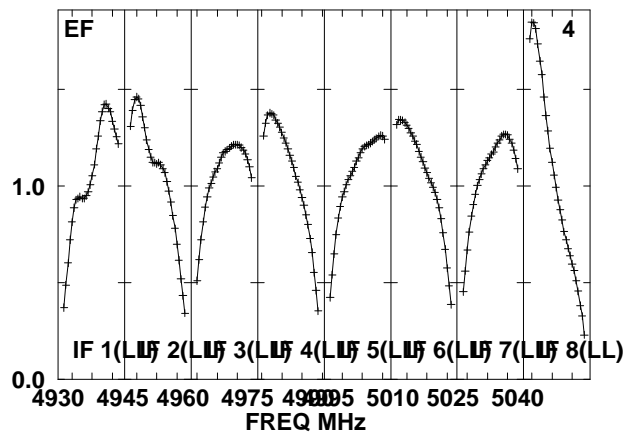
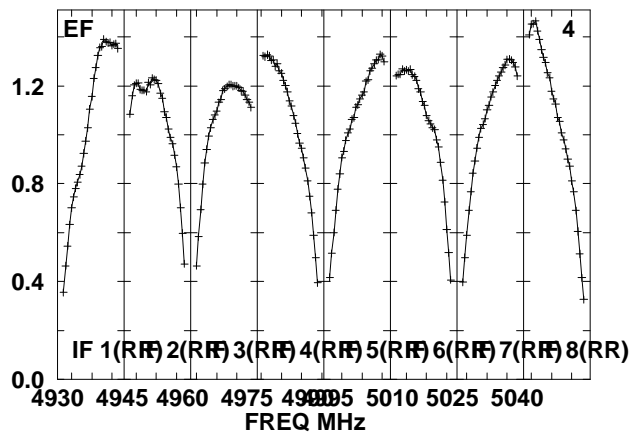
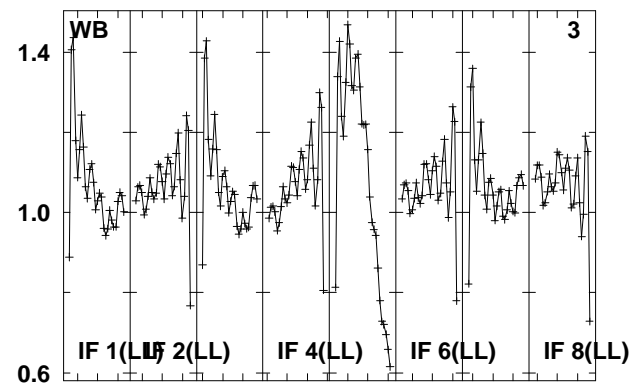
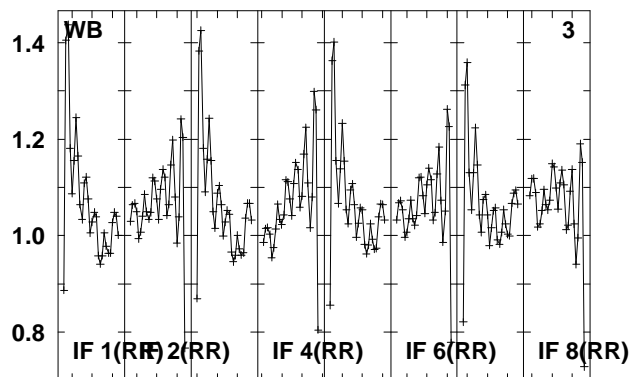
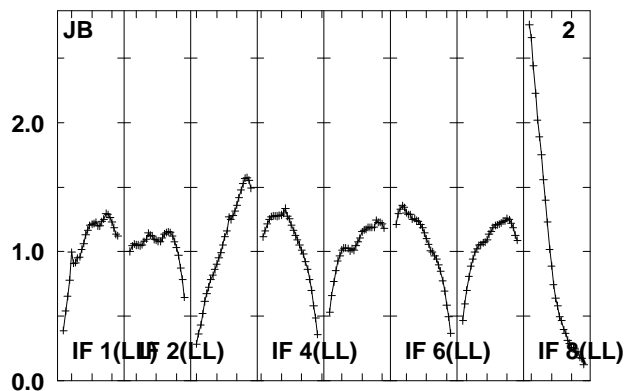
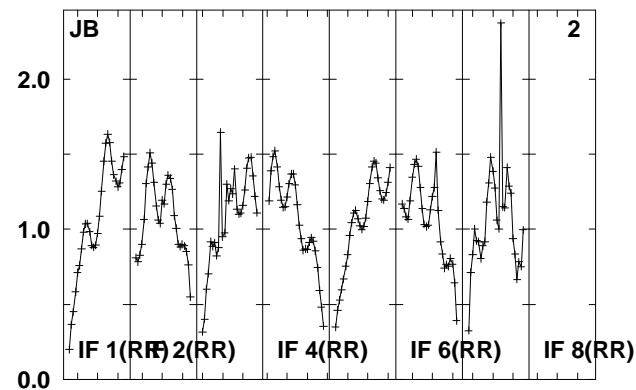
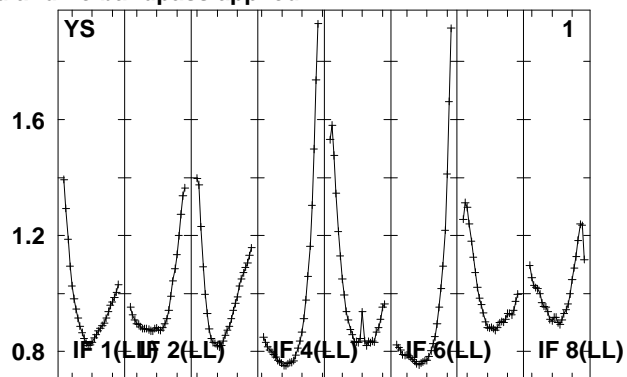
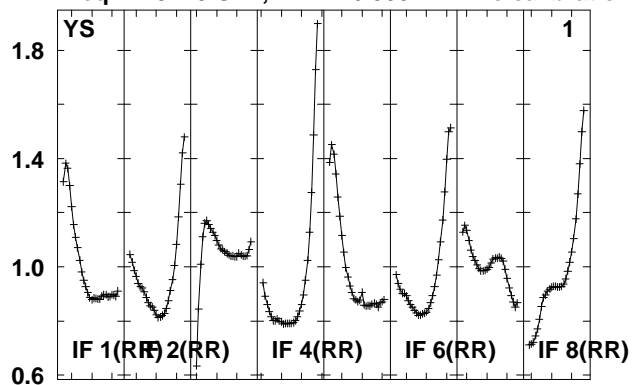

Lower frame: Real Jy
Total-power spectrum Antenna: *
Timerange: 00/08:25:55 to 00/08:27:21

Plot file version 196 created 14-MAY-2010 15:18:06

J0158+13 EO007.UVDATA.1

Freq = 4.9270 GHz, Bw = 16.000 MH No calibration applied and no bandpass applied

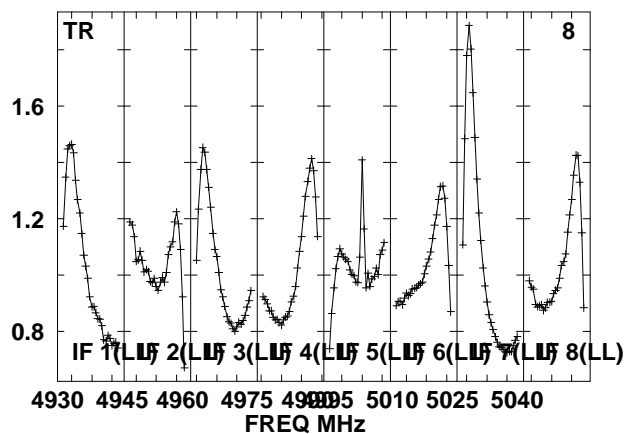
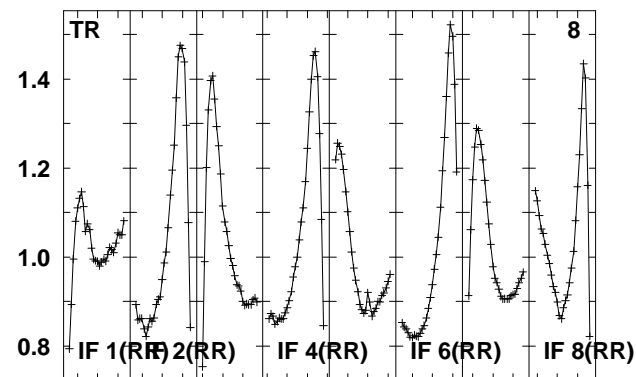
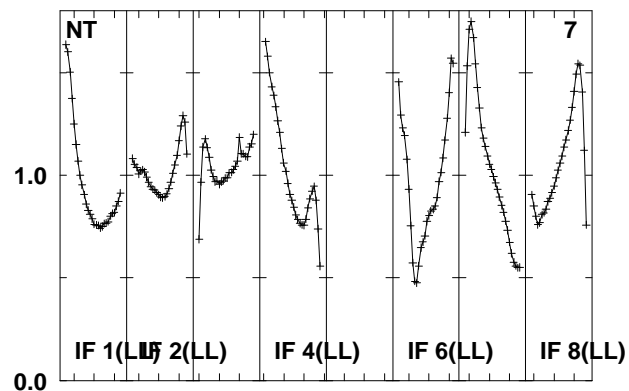
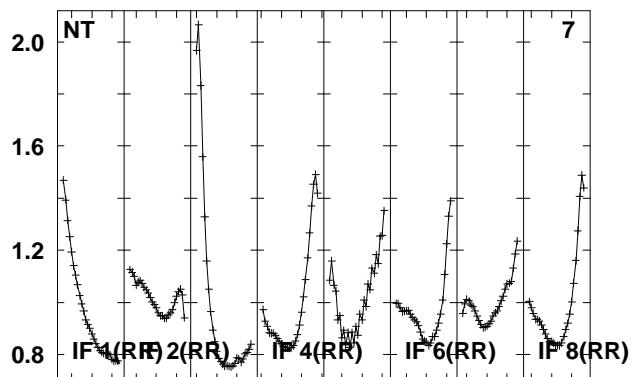
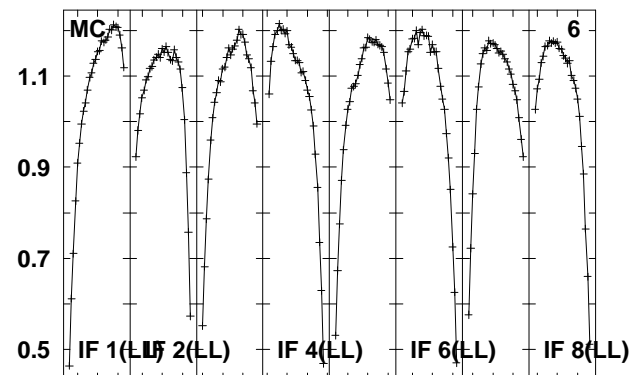
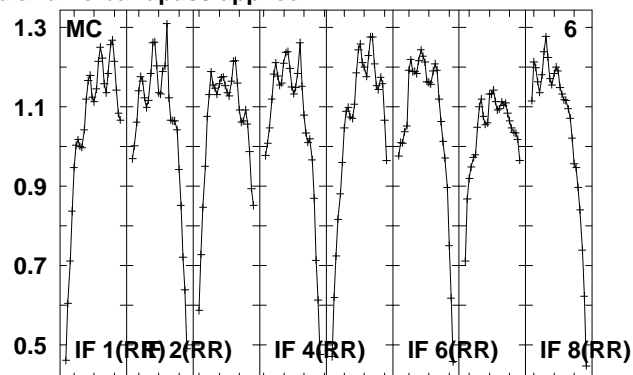
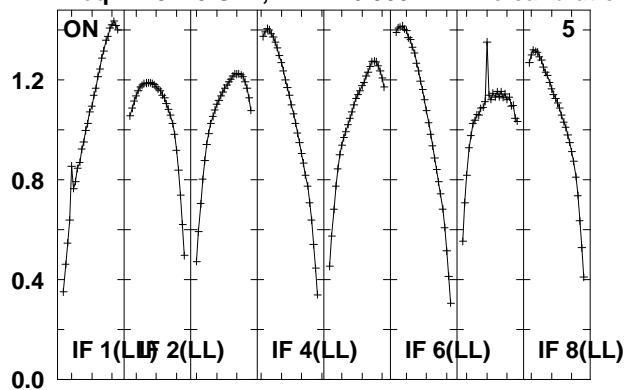

Lower frame: Real Jy

Total-power spectrum Antenna: *

Timerange: 00/08:25:55 to 00/08:27:21

Plot file version 197 created 14-MAY-2010 15:18:06
 J015028 EO007.UVDATA.1
 Freq = 4.9270 GHz, Bw = 16.000 MH No calibration applied and no bandpass applied

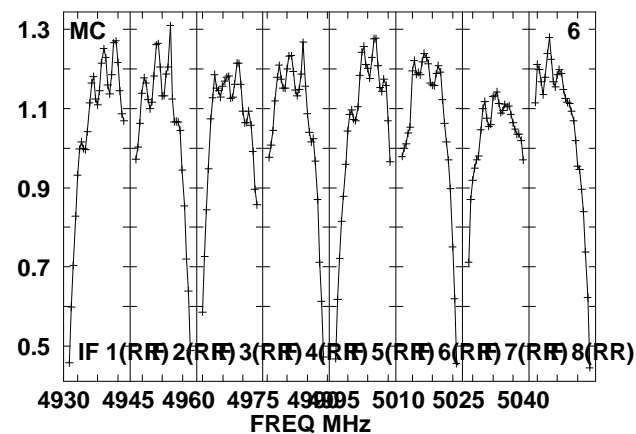
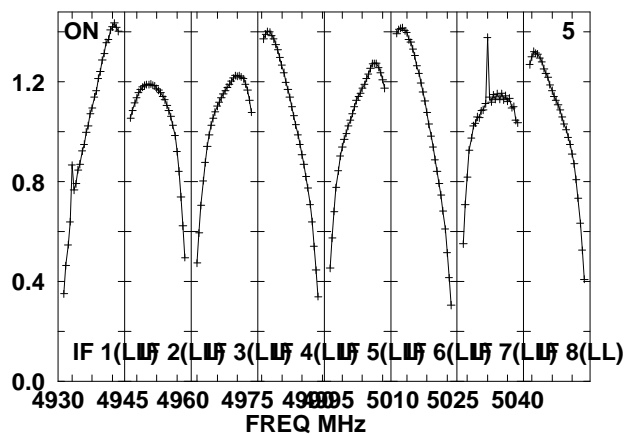
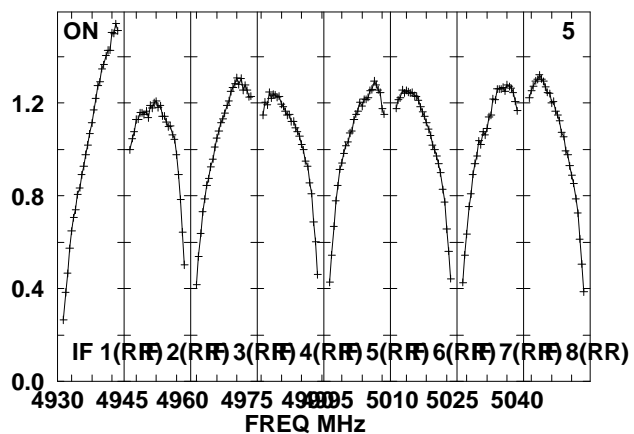
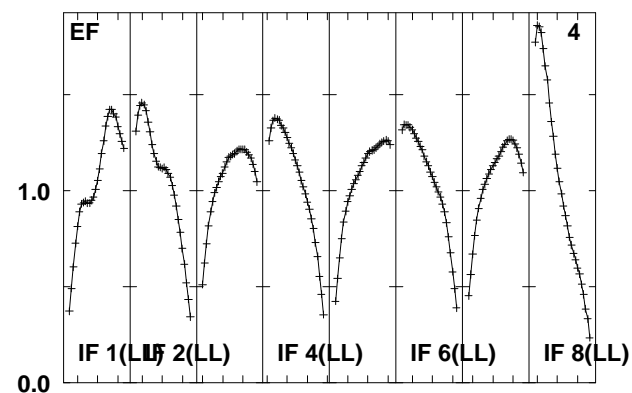
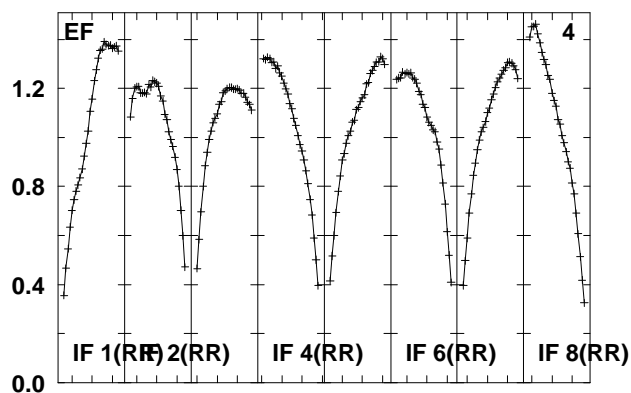
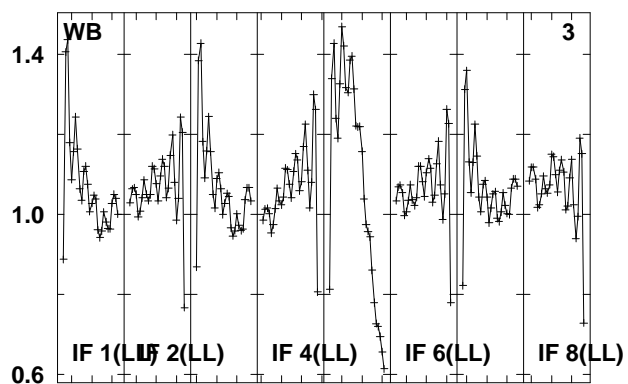
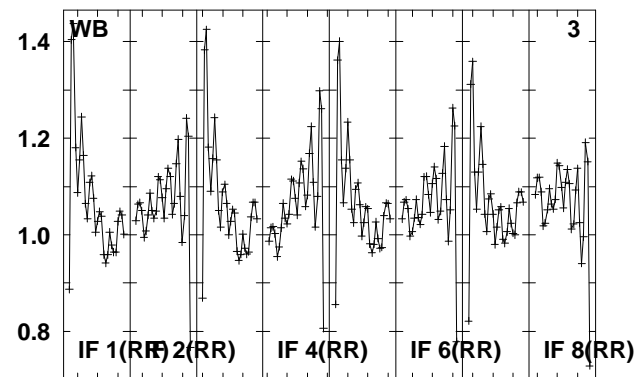
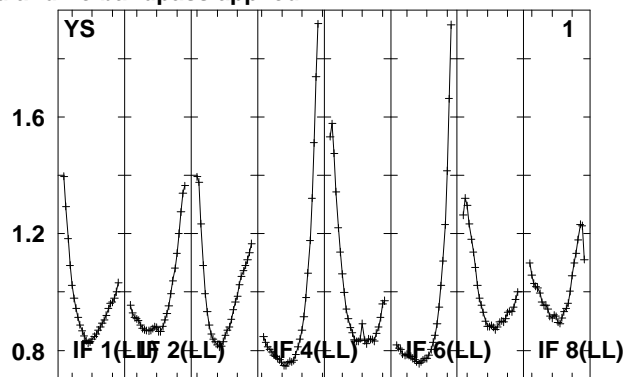
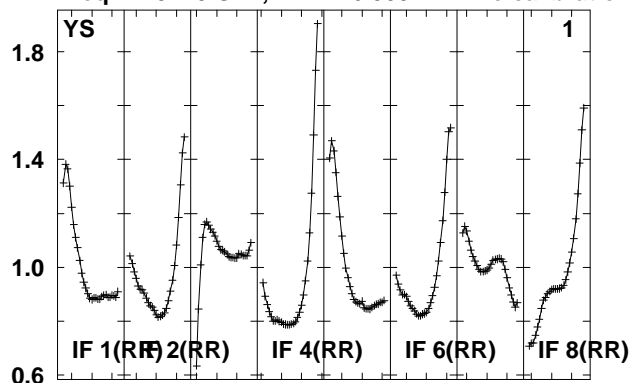

Lower frame: Real Jy
 Total-power spectrum Antenna: *
 Timerange: 00/08:27:54 to 00/08:32:52

Plot file version 198 created 14-MAY-2010 15:18:07

J015028 EO007.UVDATA.1

Freq = 4.9270 GHz, Bw = 16.000 MH No calibration applied and no bandpass applied

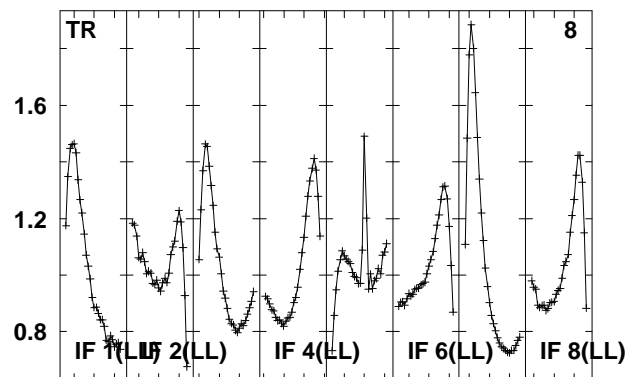
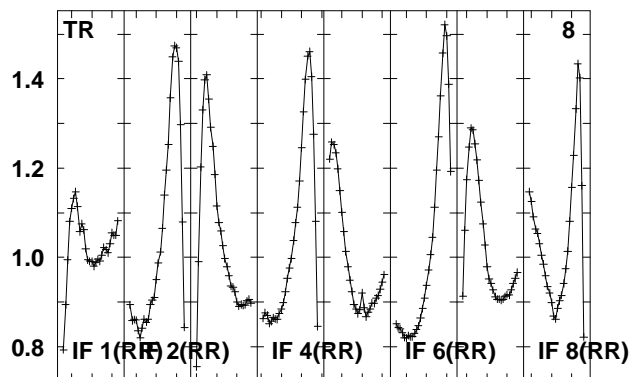
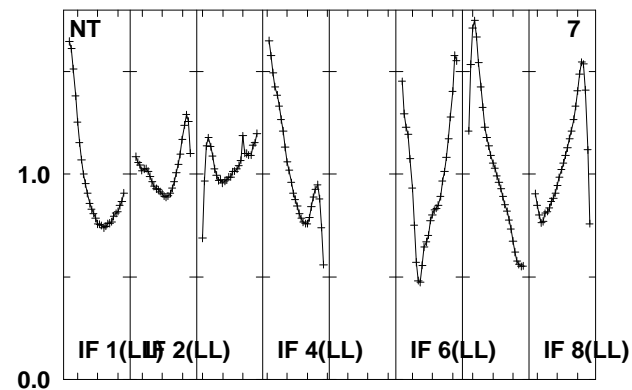
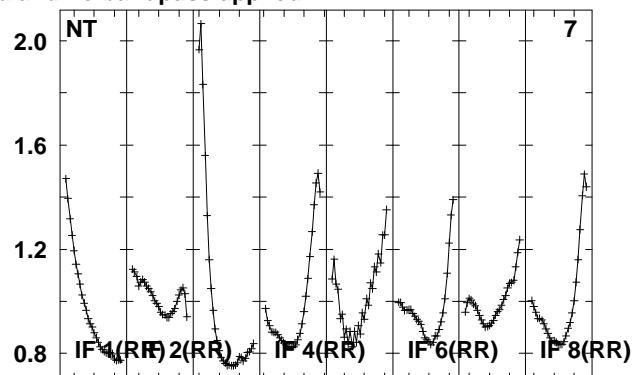
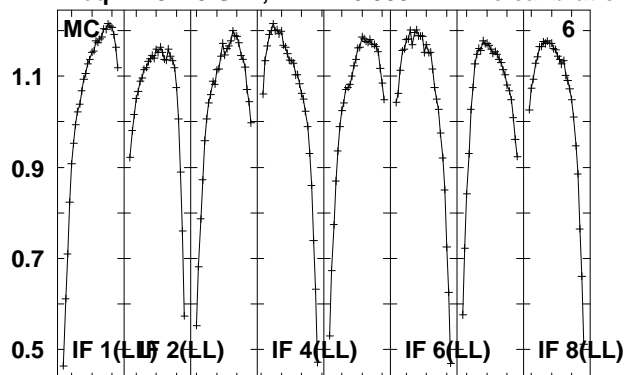

Lower frame: Real Jy
Total-power spectrum Antenna: *
Timerange: 00/08:27:54 to 00/08:32:52

Plot file version 199 created 14-MAY-2010 15:18:07

J0158+13 EO007.UVDATA.1

Freq = 4.9270 GHz, Bw = 16.000 MH No calibration applied and no bandpass applied

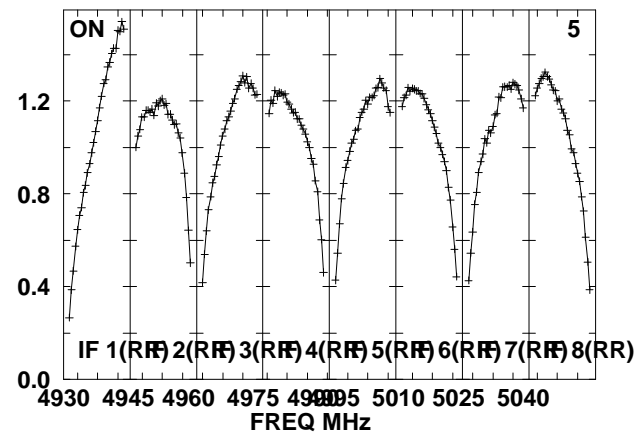
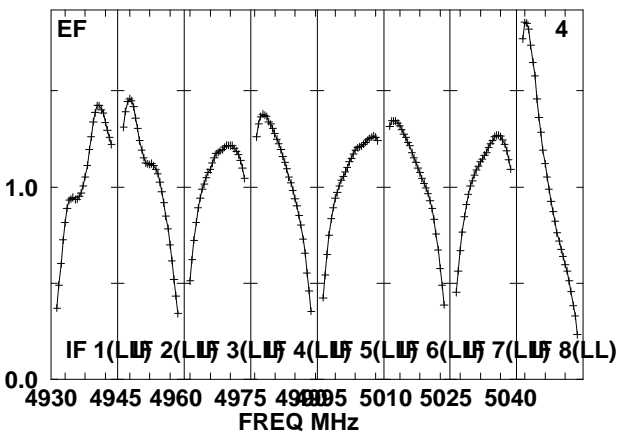
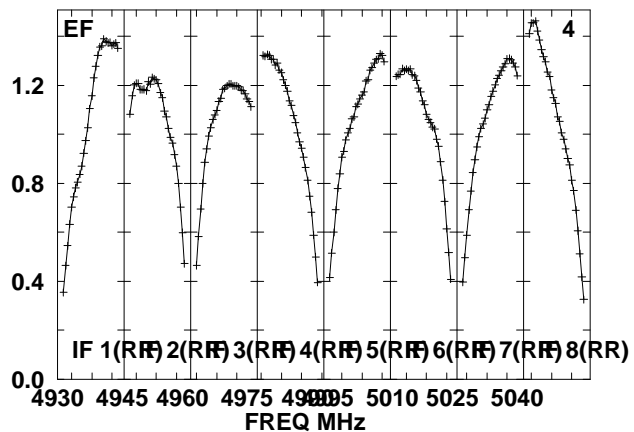
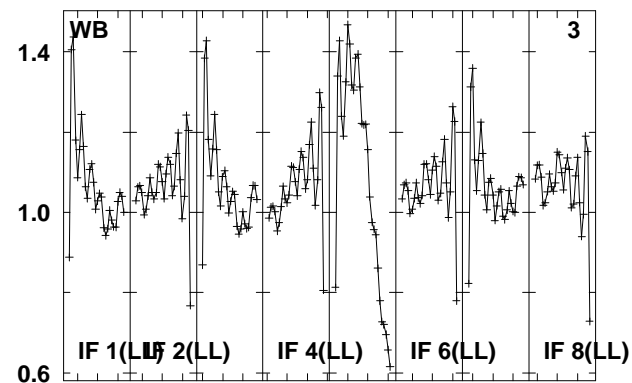
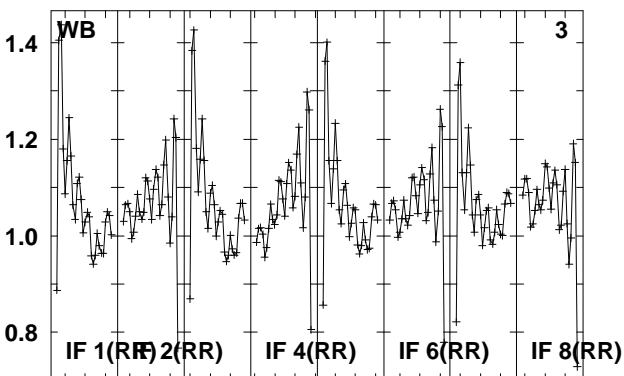
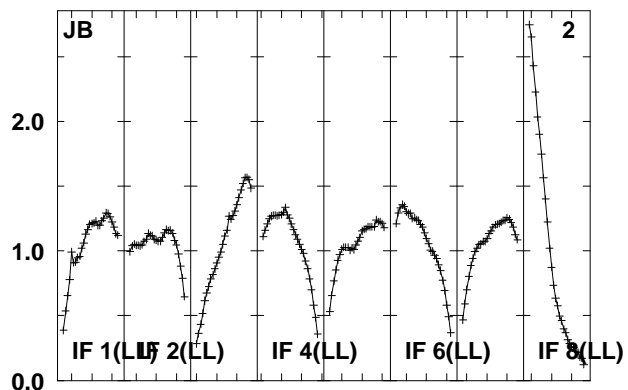
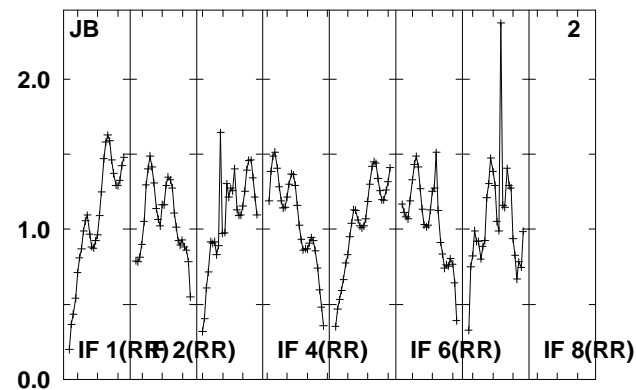
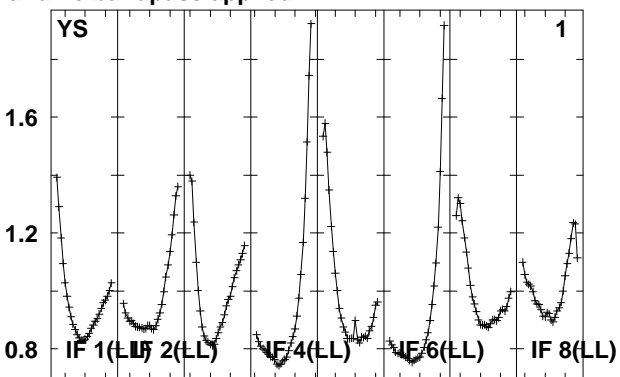
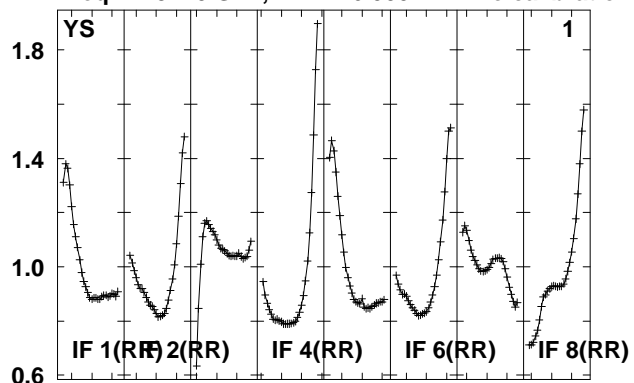

Lower frame: Real Jy

Total-power spectrum Antenna: *

Timerange: 00/08:33:18 to 00/08:34:46

Plot file version 200 created 14-MAY-2010 15:18:08

J0158+13 EO007.UVDATA.1

Freq = 4.9270 GHz, Bw = 16.000 MH No calibration applied and no bandpass applied

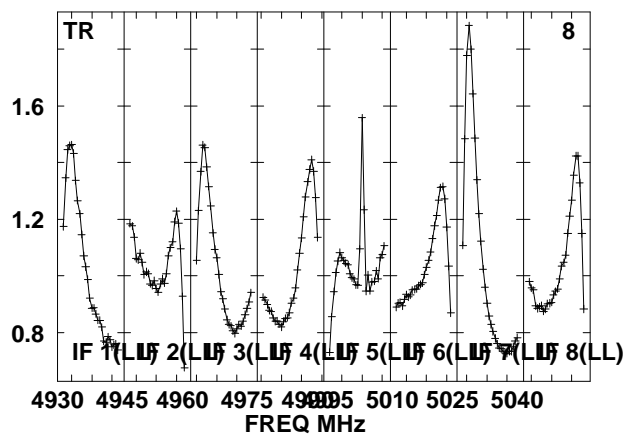
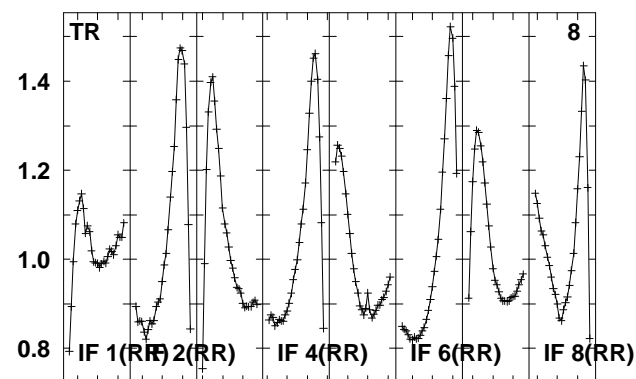
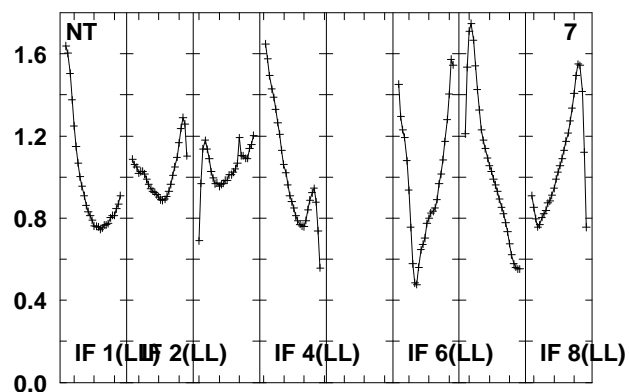
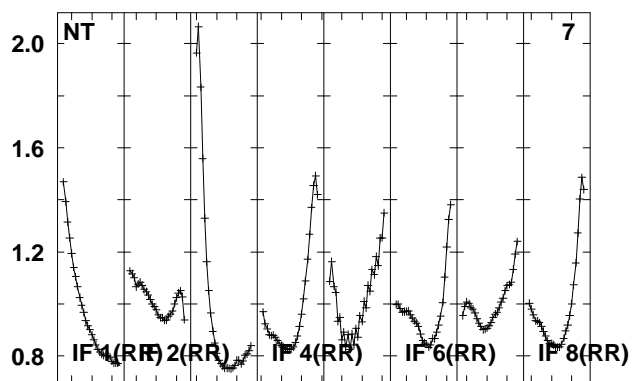
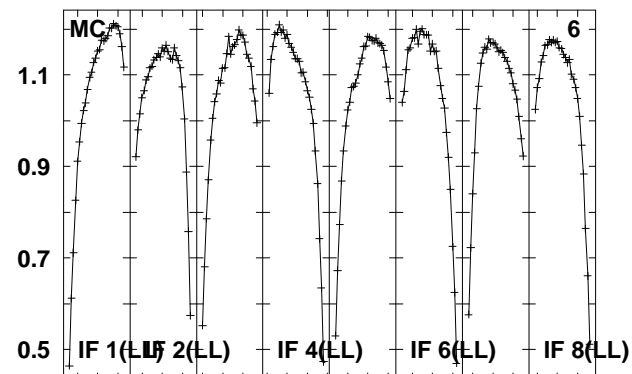
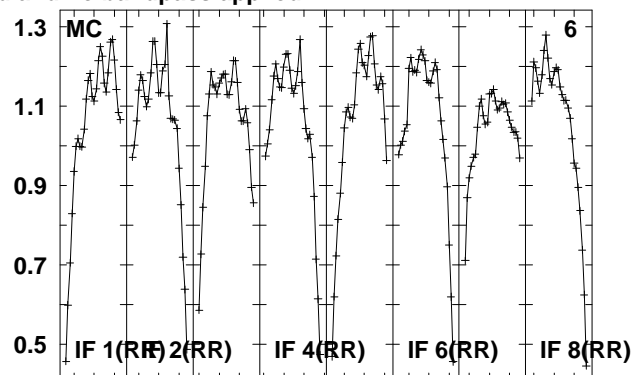
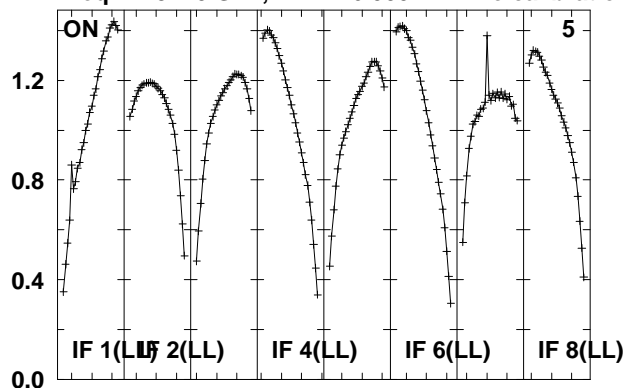

Lower frame: Real Jy

Total-power spectrum Antenna: *

Timerange: 00/08:33:18 to 00/08:34:46

Plot file version 201 created 14-MAY-2010 15:18:08
 J0209+13 EO007.UVDATA.1
 Freq = 4.9270 GHz, Bw = 16.000 MH No calibration applied and no bandpass applied

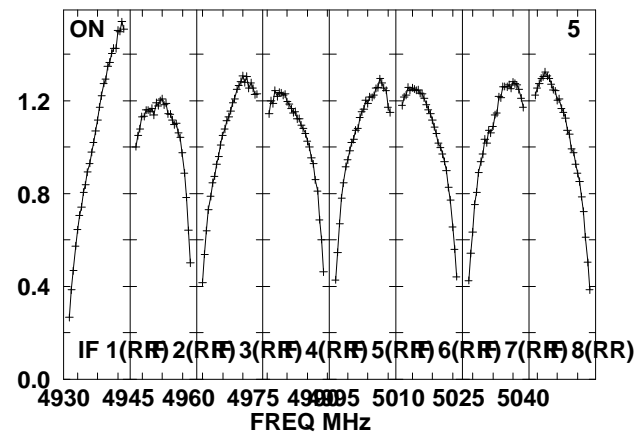
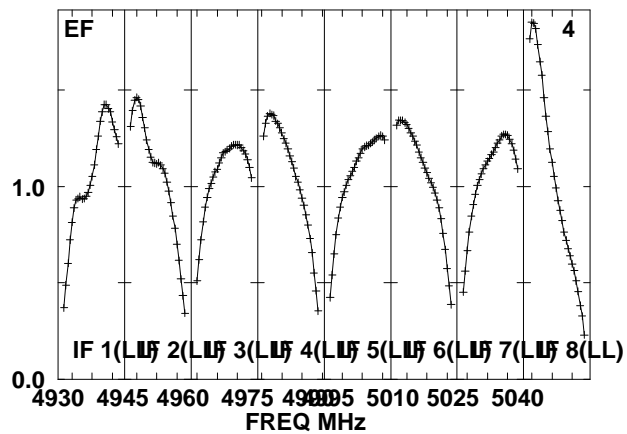
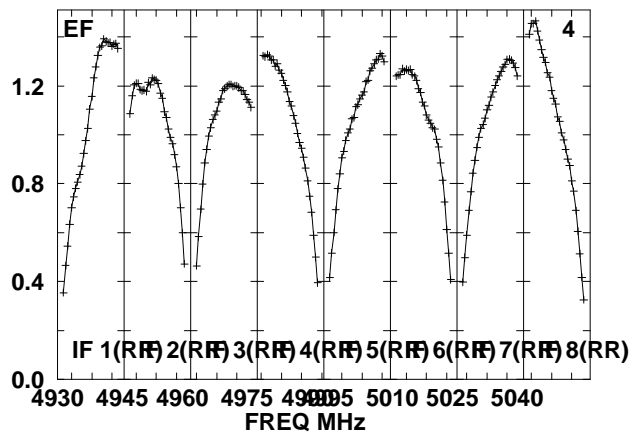
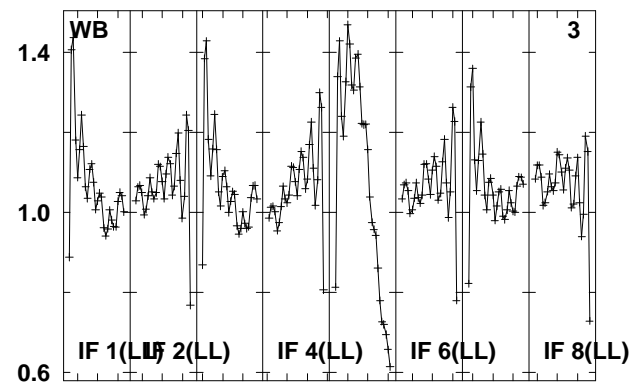
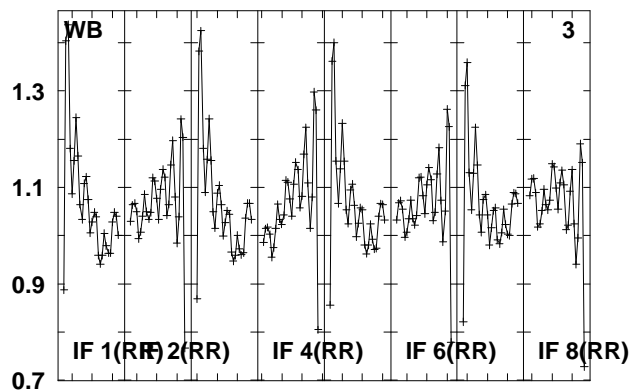
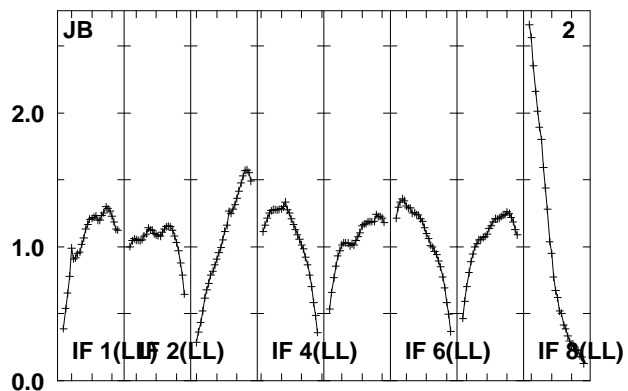
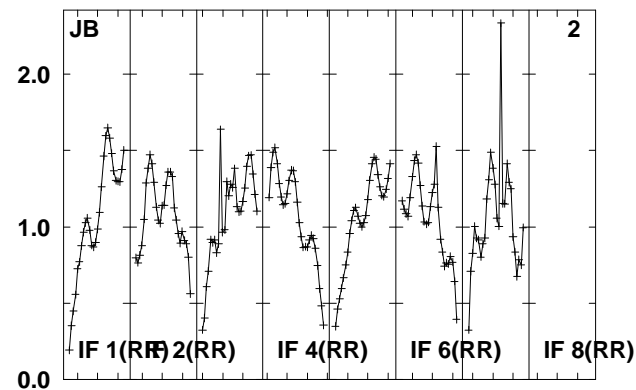
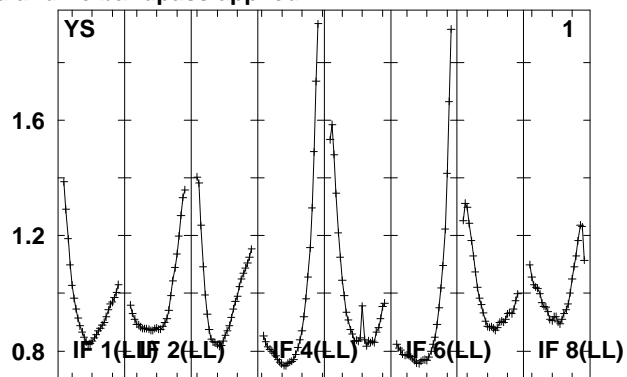
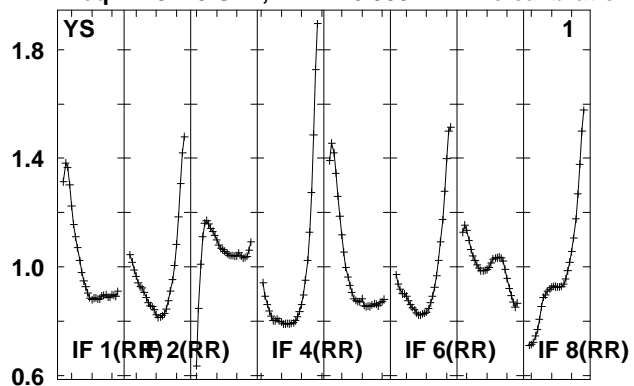

Lower frame: Real Jy
 Total-power spectrum Antenna: *
 Timerange: 00/08:35:20 to 00/08:36:46

Plot file version 202 created 14-MAY-2010 15:18:08

J0209+13 EO007.UVDATA.1

Freq = 4.9270 GHz, Bw = 16.000 MH No calibration applied and no bandpass applied

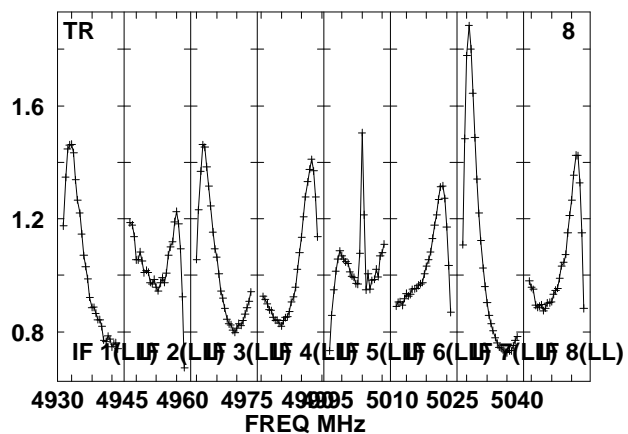
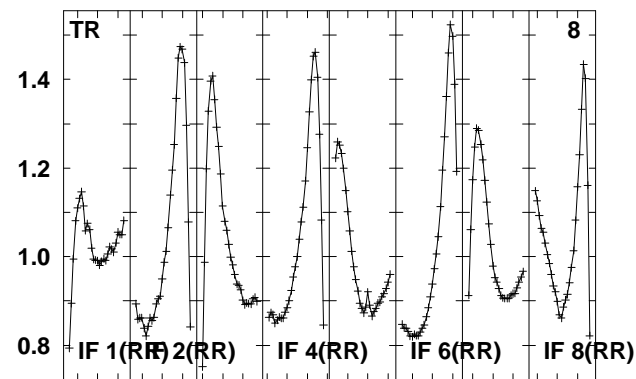
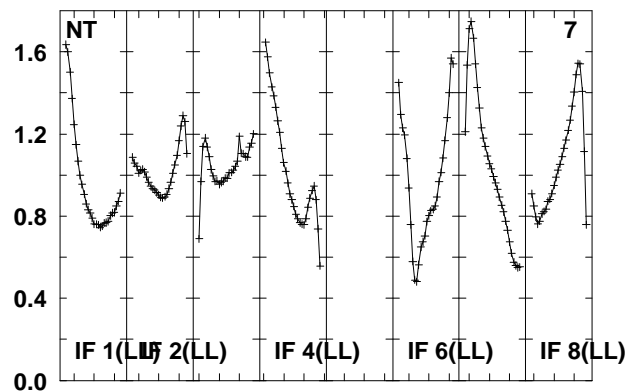
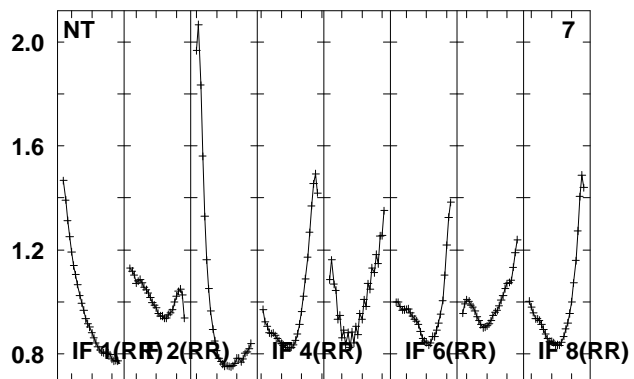
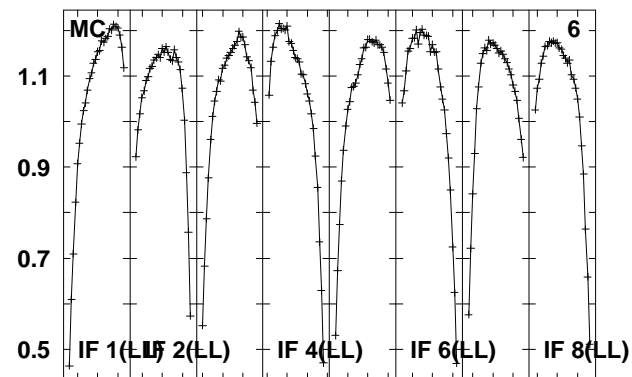
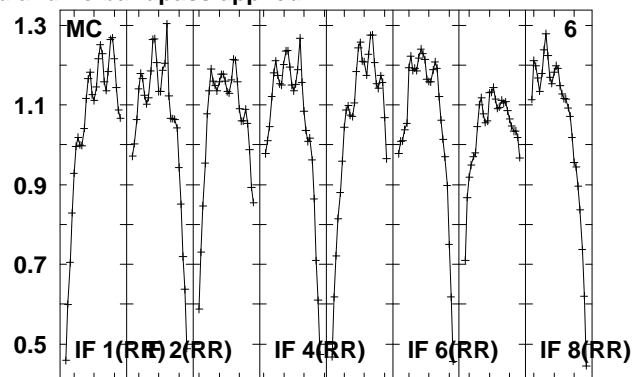
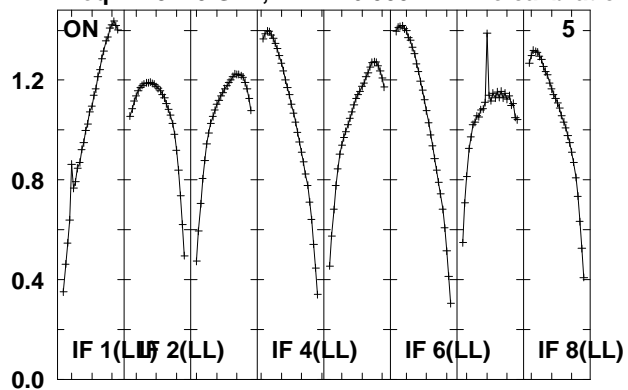

Lower frame: Real Jy

Total-power spectrum Antenna: *

Timerange: 00/08:35:20 to 00/08:36:46

Plot file version 203 created 14-MAY-2010 15:18:08
 J021348 EO007.UVDATA.1
 Freq = 4.9270 GHz, Bw = 16.000 MH No calibration applied and no bandpass applied

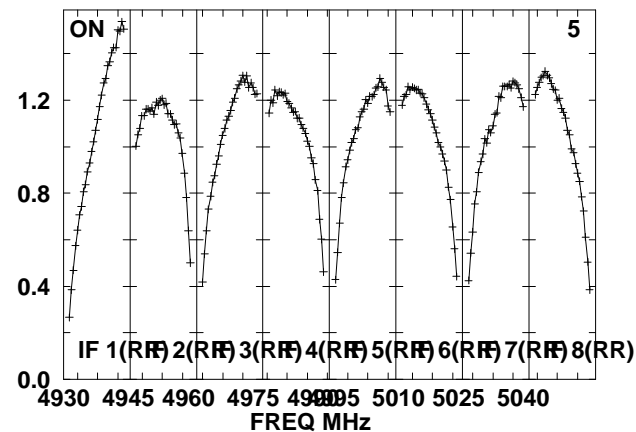
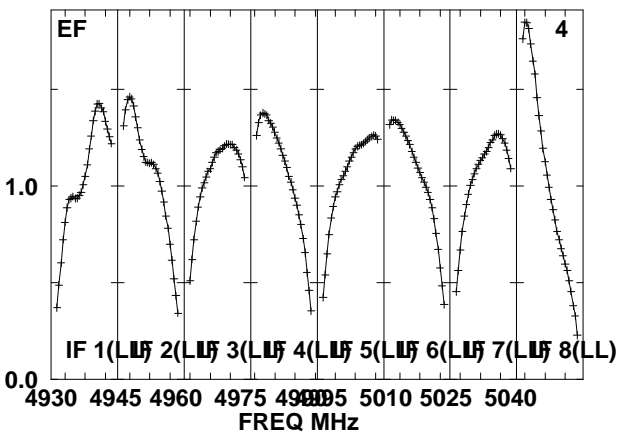
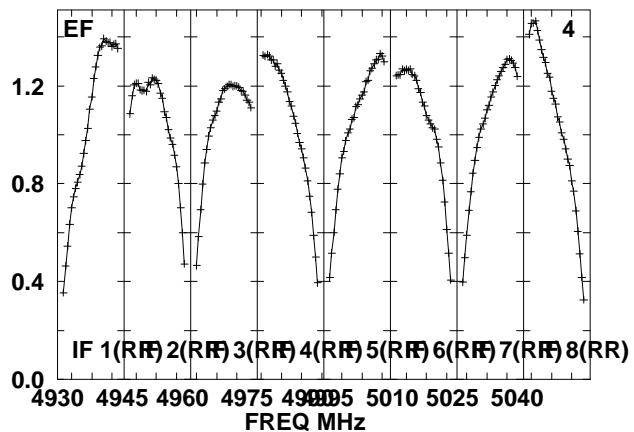
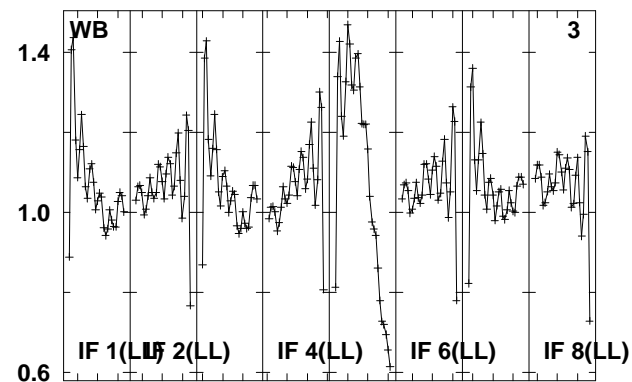
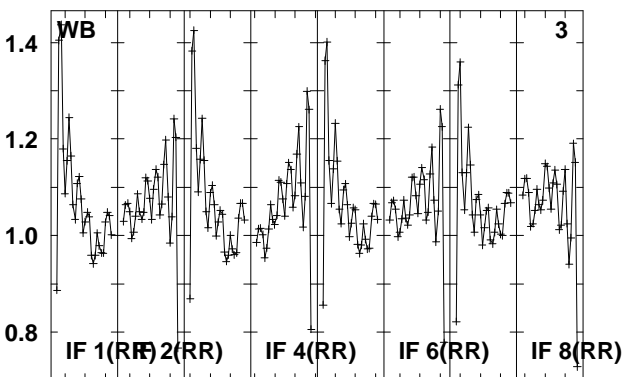
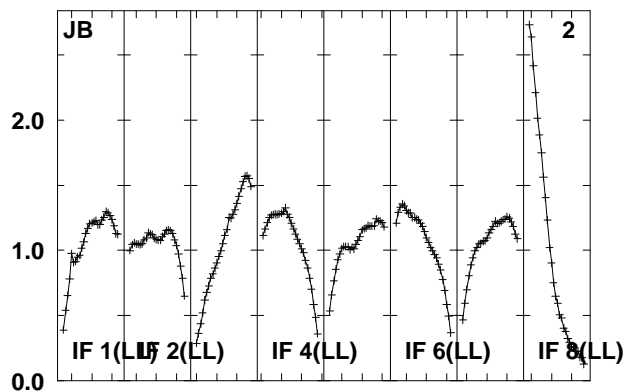
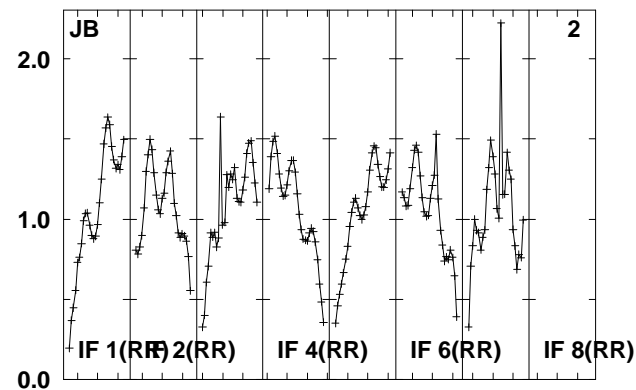
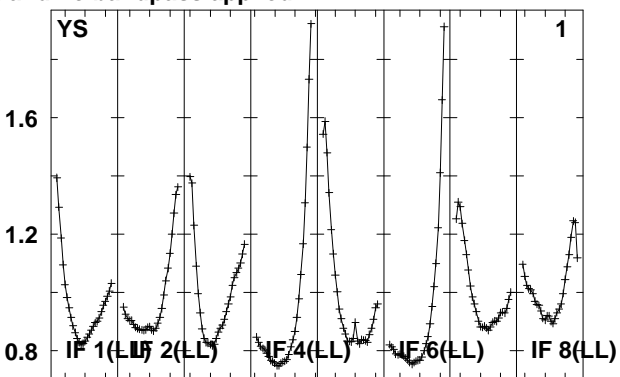
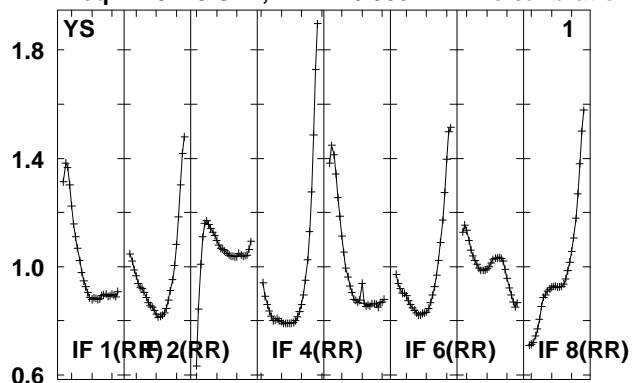

Lower frame: Real Jy
 Total-power spectrum Antenna: *
 Timerange: 00/08:37:14 to 00/08:42:14

Plot file version 204 created 14-MAY-2010 15:18:09

J021348 EO007.UVDATA.1

Freq = 4.9270 GHz, Bw = 16.000 MH No calibration applied and no bandpass applied

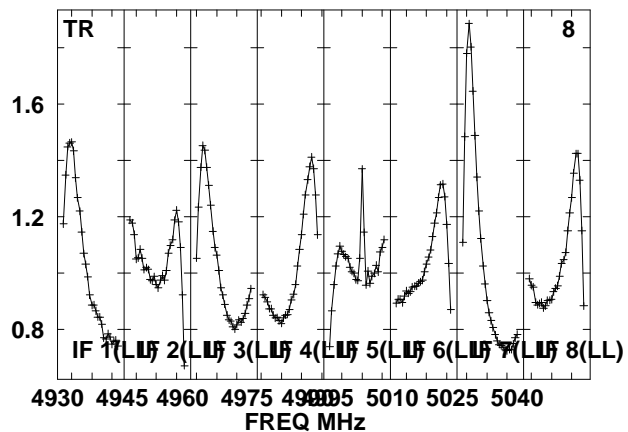
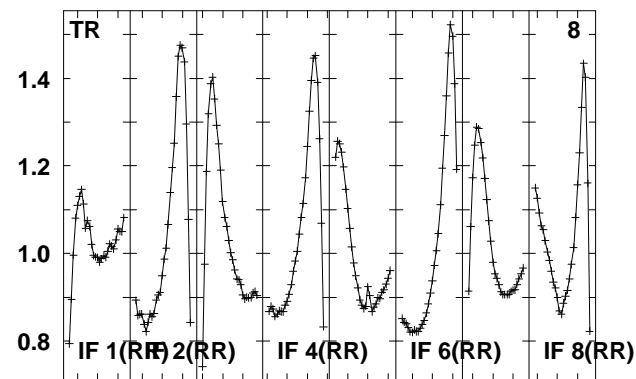
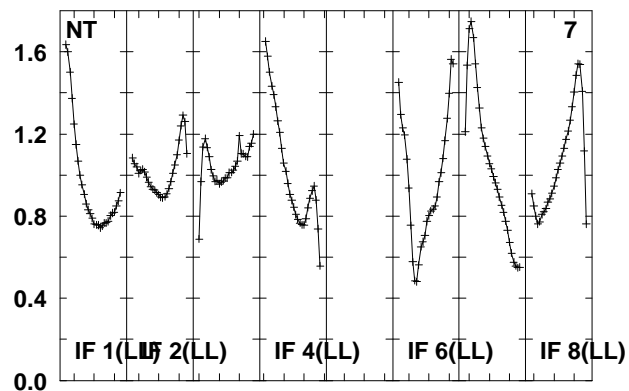
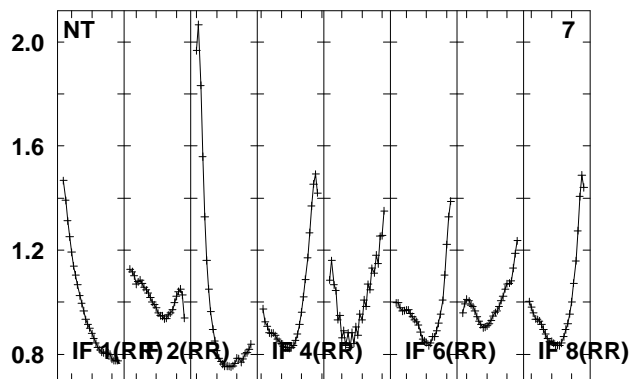
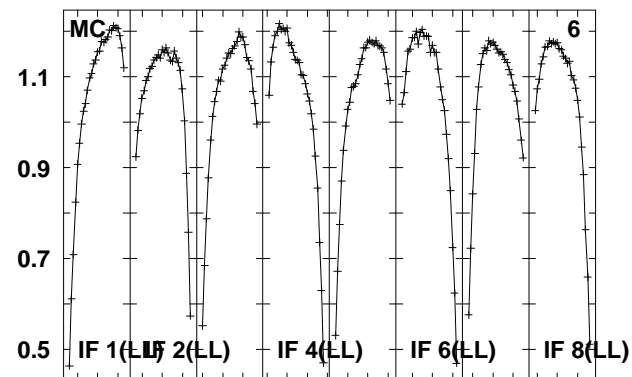
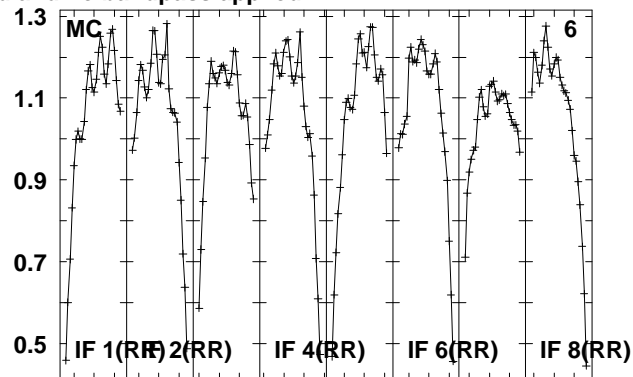
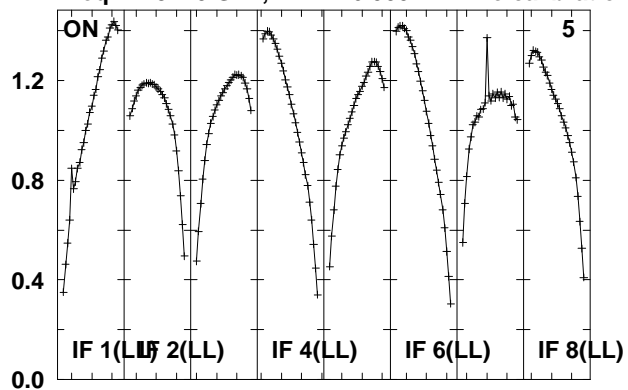

Lower frame: Real Jy

Total-power spectrum Antenna: *

Timerange: 00/08:37:14 to 00/08:42:14

Plot file version 205 created 14-MAY-2010 15:18:10

J0209+13 EO007.UVDATA.1

Freq = 4.9270 GHz, Bw = 16.000 MH No calibration applied and no bandpass applied

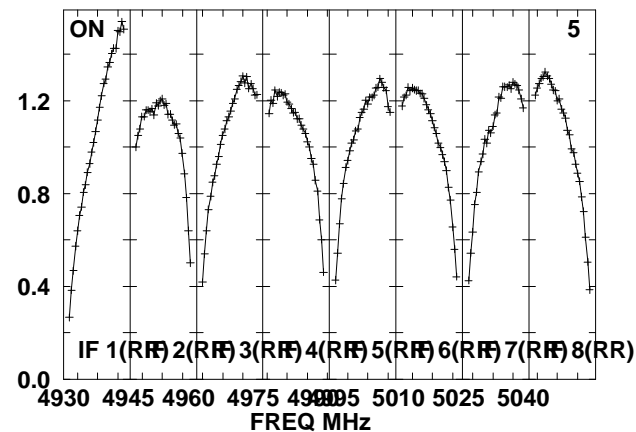
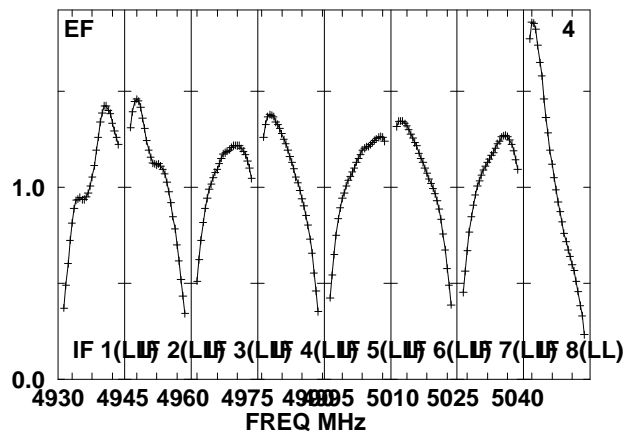
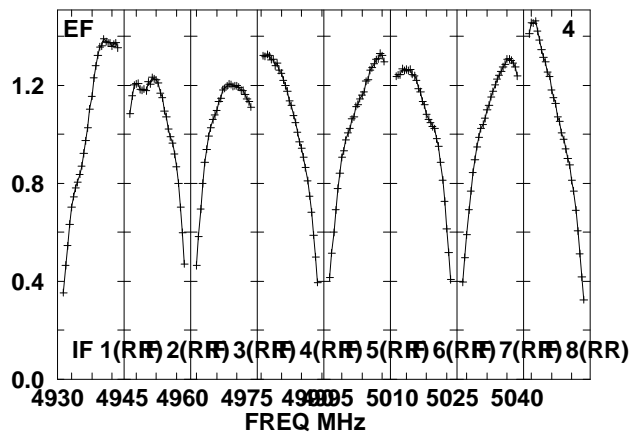
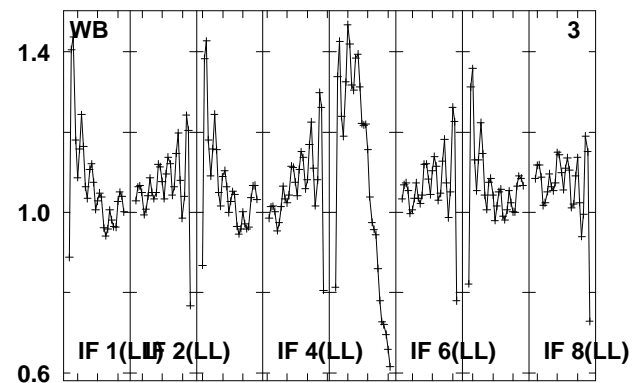
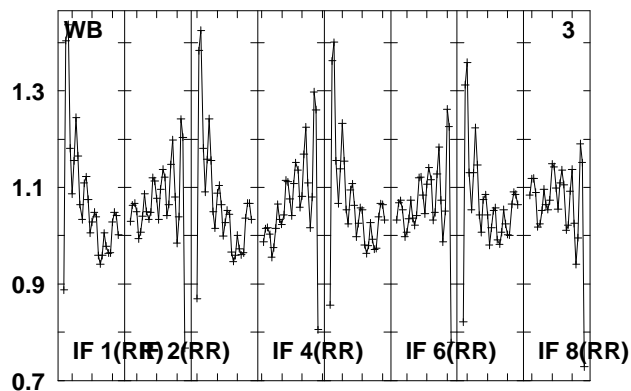
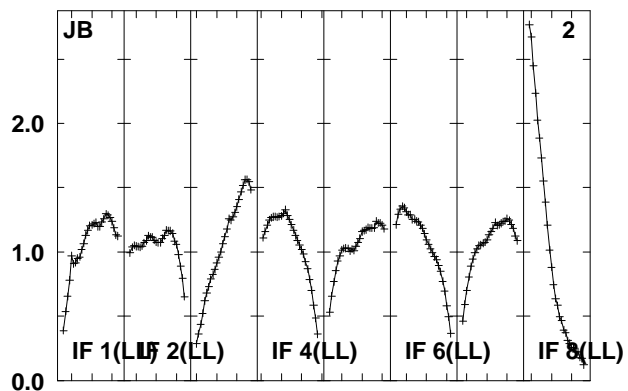
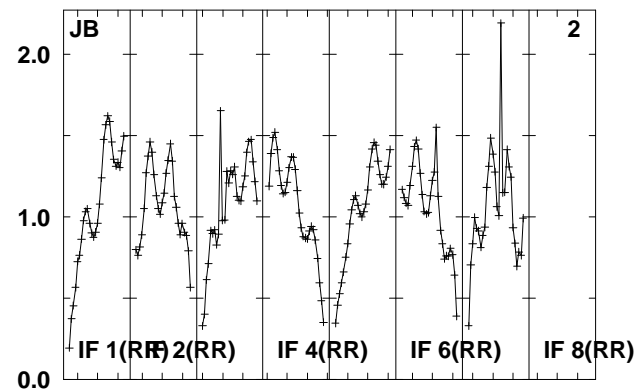
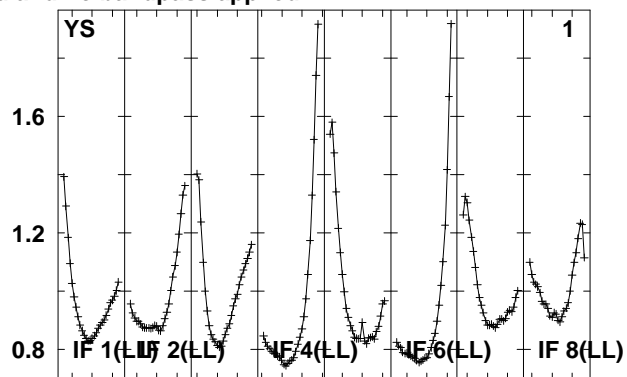
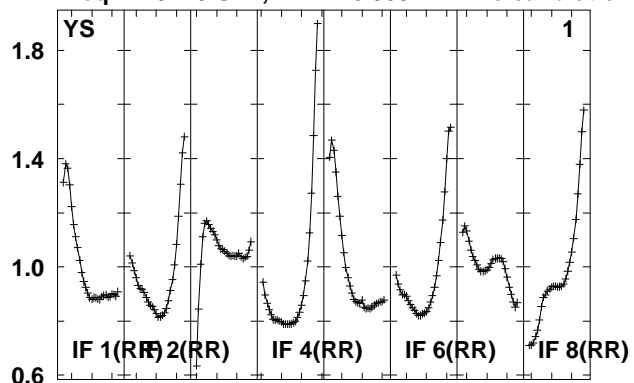

Lower frame: Real Jy
Total-power spectrum Antenna: *
Timerange: 00/08:42:40 to 00/08:44:10

Plot file version 206 created 14-MAY-2010 15:18:10

J0209+13 EO007.UVDATA.1

Freq = 4.9270 GHz, Bw = 16.000 MH No calibration applied and no bandpass applied

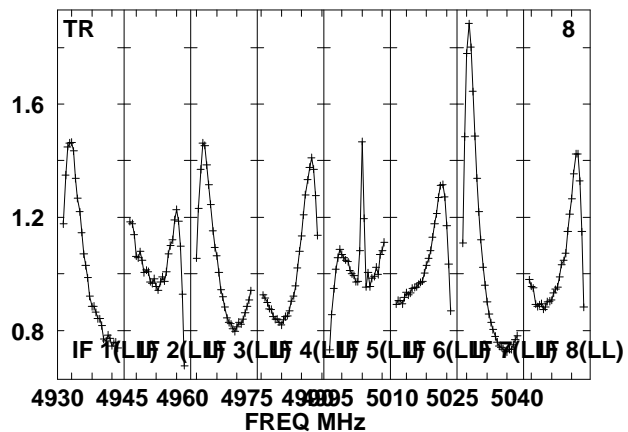
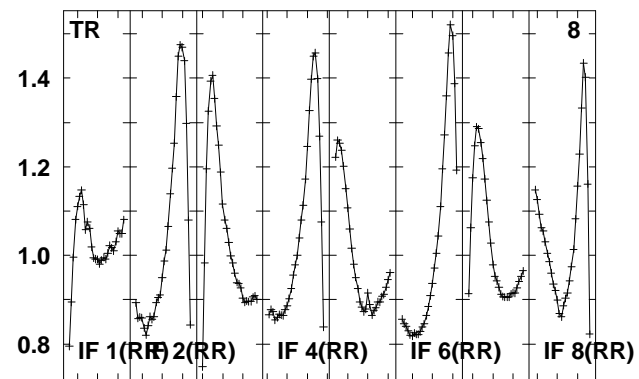
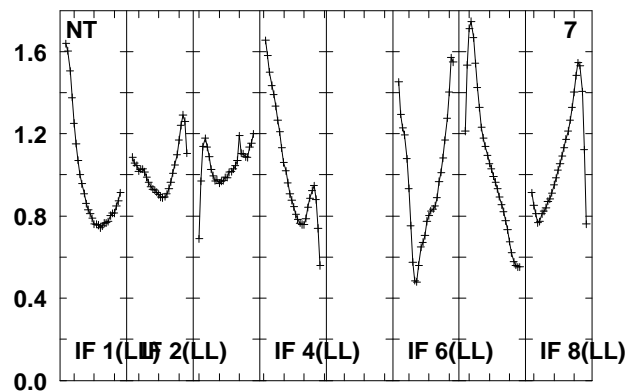
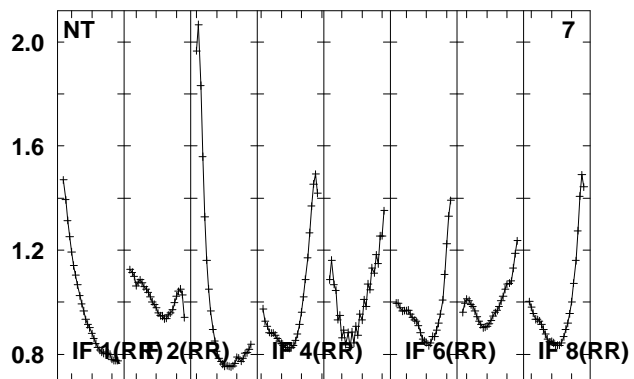
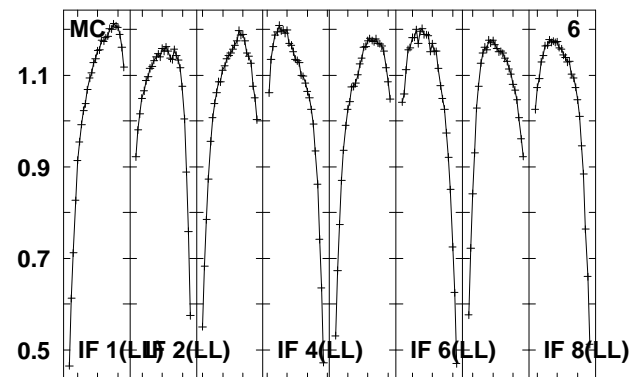
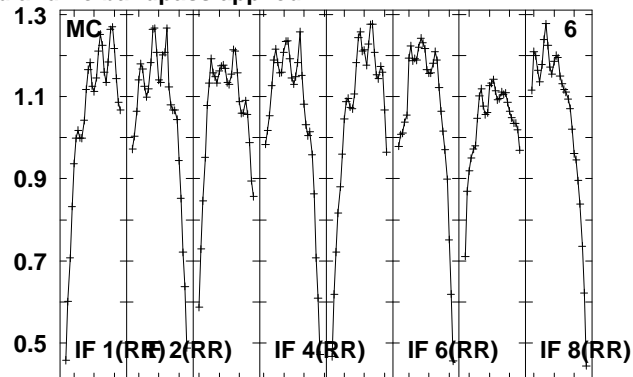
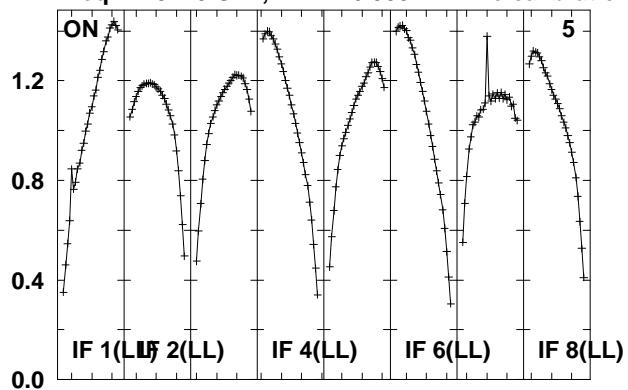

Lower frame: Real Jy

Total-power spectrum Antenna: *

Timerange: 00/08:42:40 to 00/08:44:10

Plot file version 207 created 14-MAY-2010 15:18:10

J021348 EO007.UVDATA.1

Freq = 4.9270 GHz, Bw = 16.000 MH No calibration applied and no bandpass applied

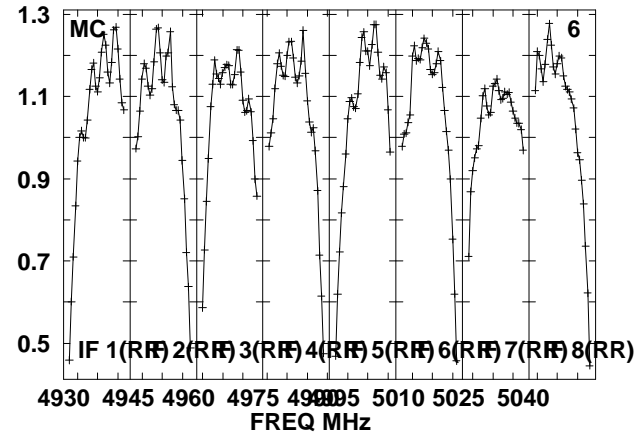
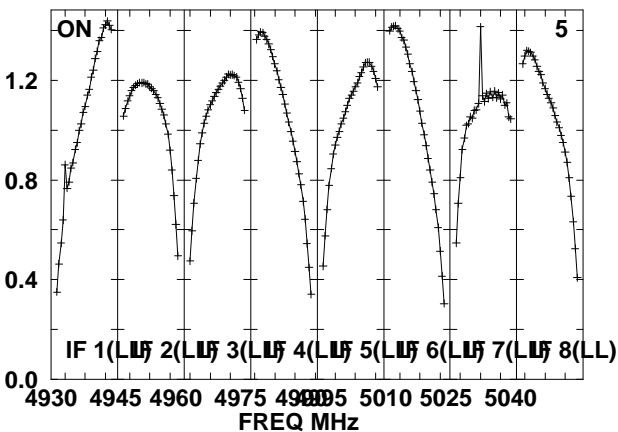
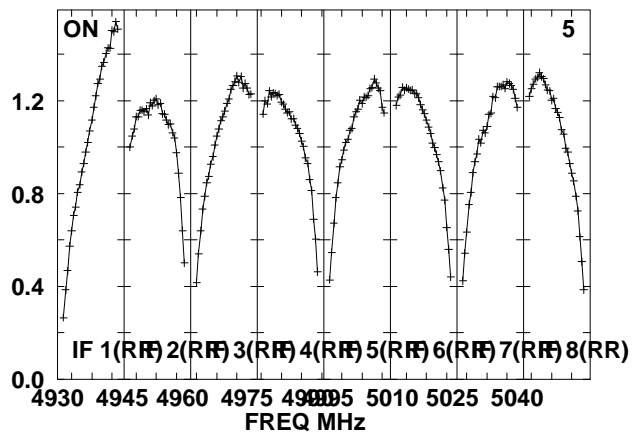
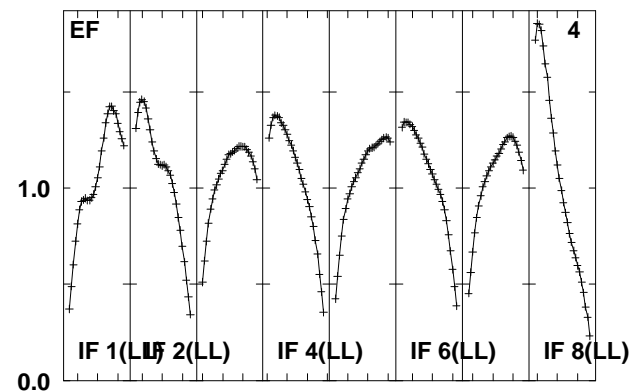
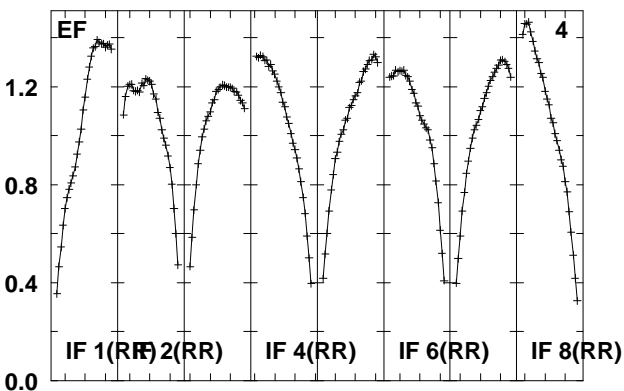
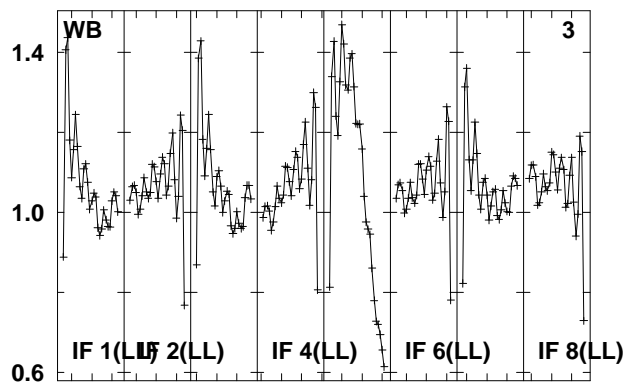
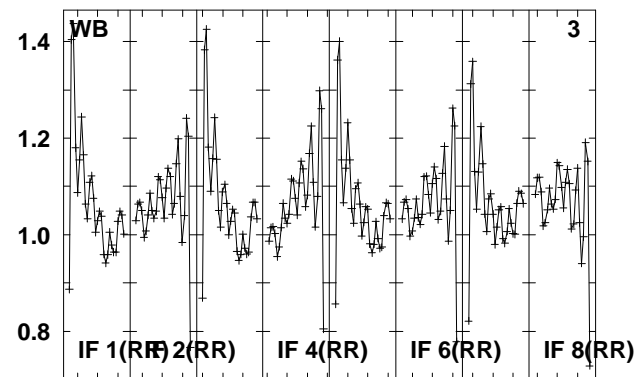
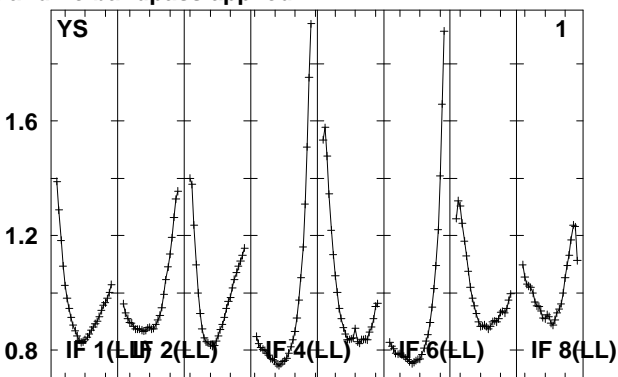
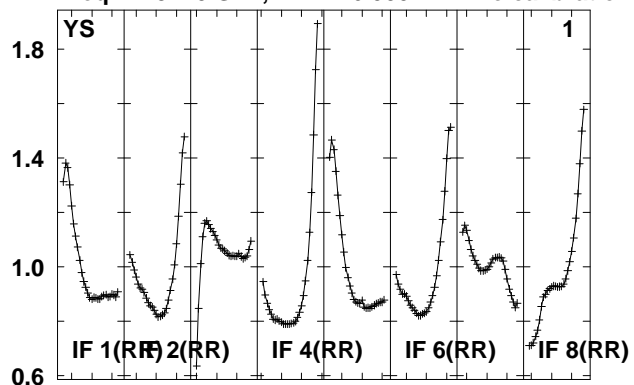

Lower frame: Real Jy
Total-power spectrum Antenna: *
Timerange: 00/08:44:36 to 00/08:49:34

Plot file version 208 created 14-MAY-2010 15:18:11

J021348 EO007.UVDATA.1

Freq = 4.9270 GHz, Bw = 16.000 MH No calibration applied and no bandpass applied

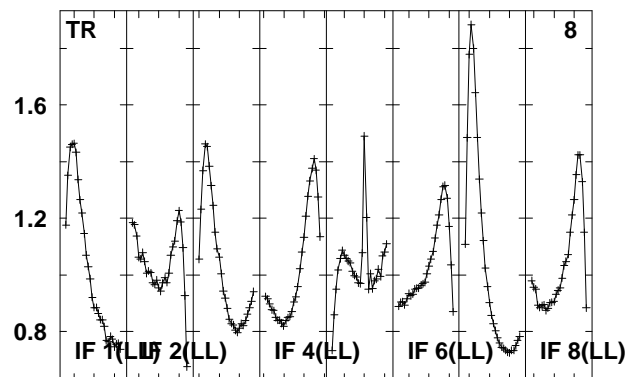
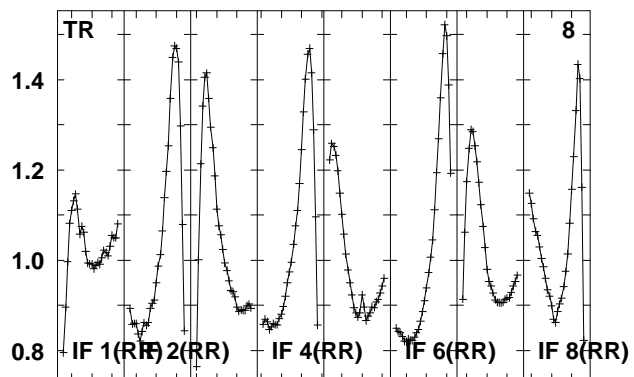
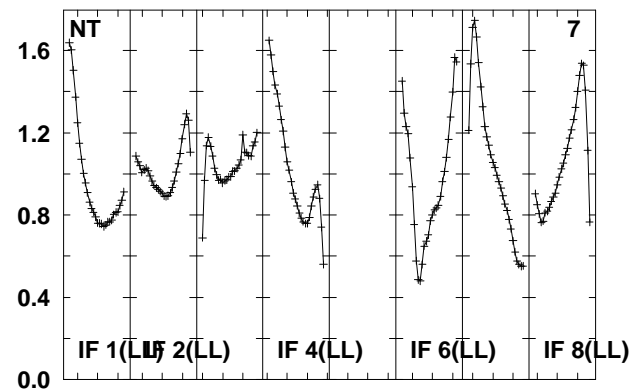
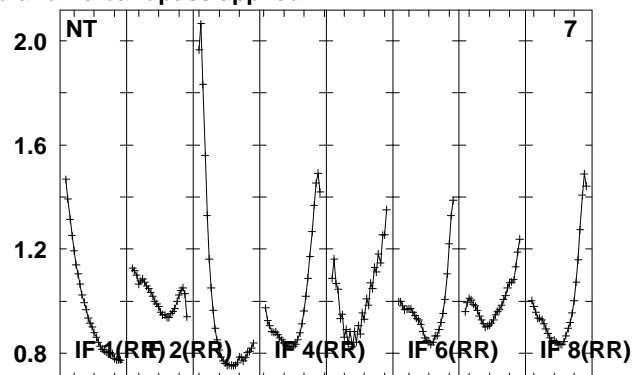
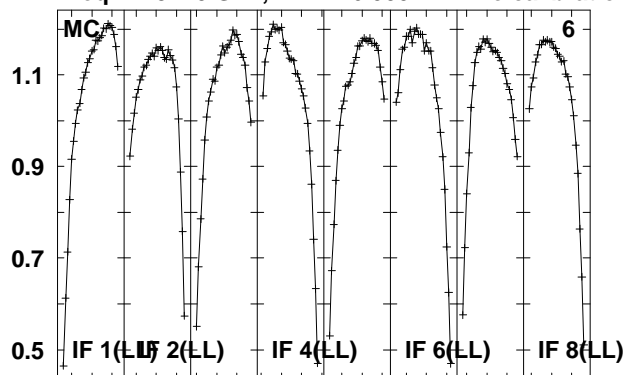

Lower frame: Real Jy
Total-power spectrum Antenna: *
Timerange: 00/08:44:36 to 00/08:49:34

Plot file version 209 created 14-MAY-2010 15:18:11
 J0209+13 EO007.UVDATA.1
 Freq = 4.9270 GHz, Bw = 16.000 MH No calibration applied and no bandpass applied

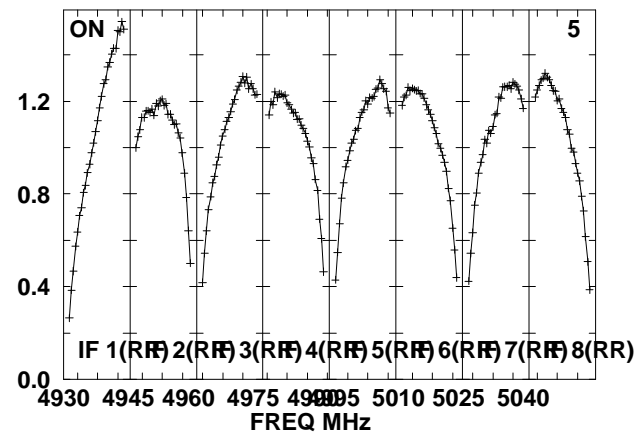
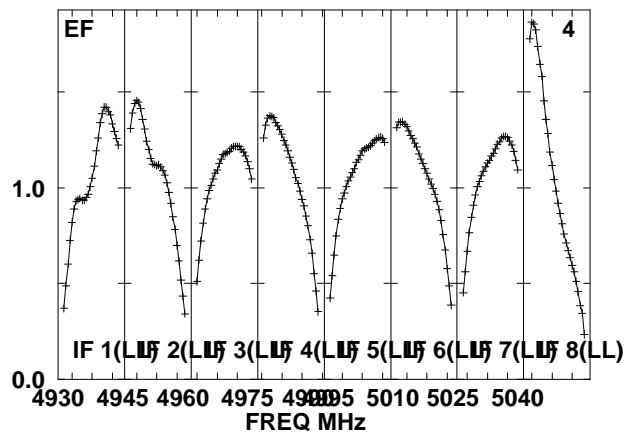
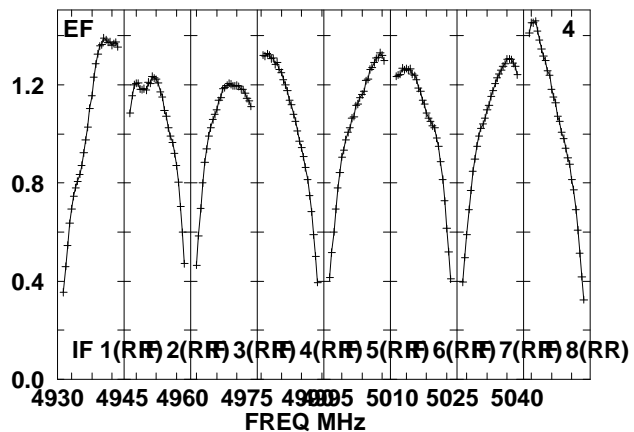
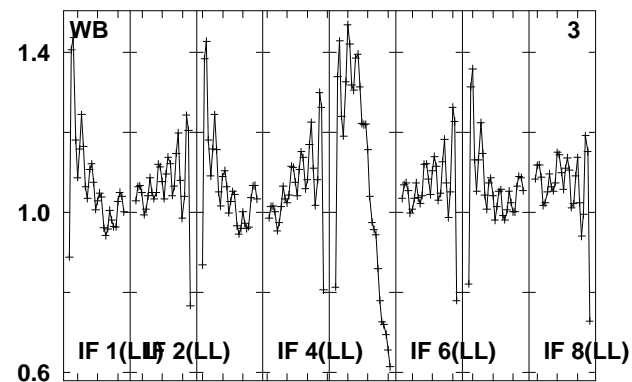
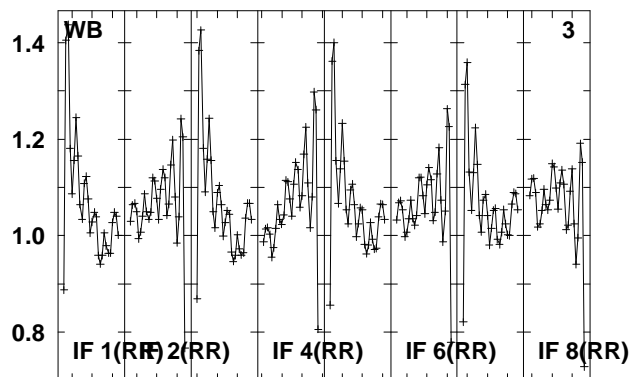
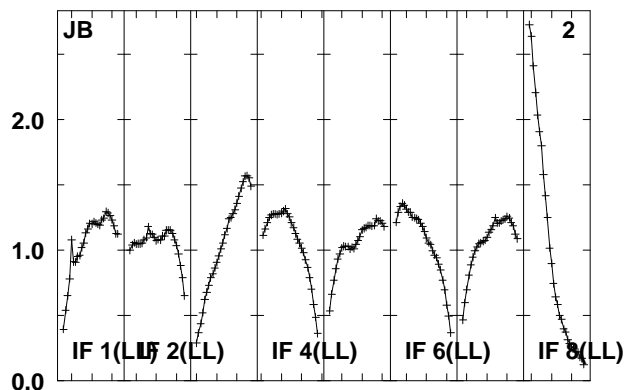
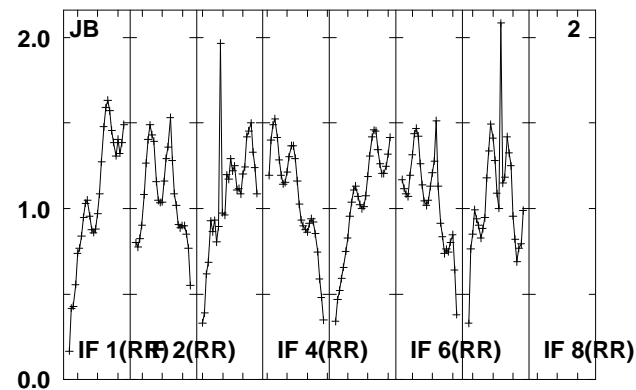
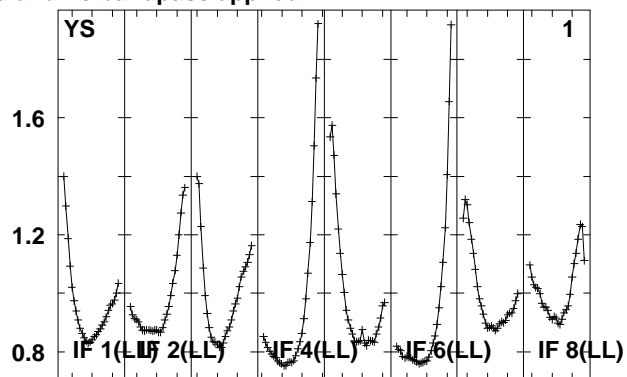
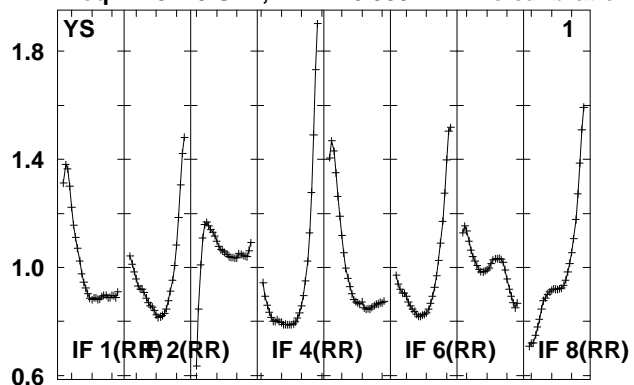

Lower frame: Real Jy
 Total-power spectrum Antenna: *
 Timerange: 00/08:50:02 to 00/08:51:28

Plot file version 210 created 14-MAY-2010 15:18:12

J0209+13 EO007.UVDATA.1

Freq = 4.9270 GHz, Bw = 16.000 MH No calibration applied and no bandpass applied

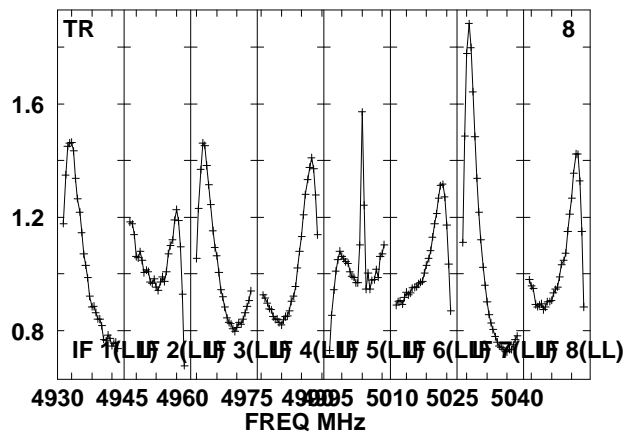
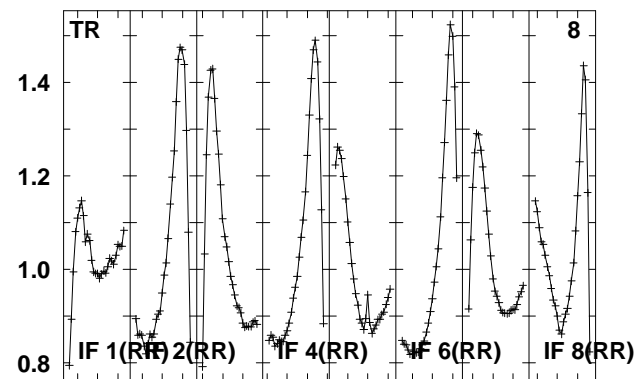
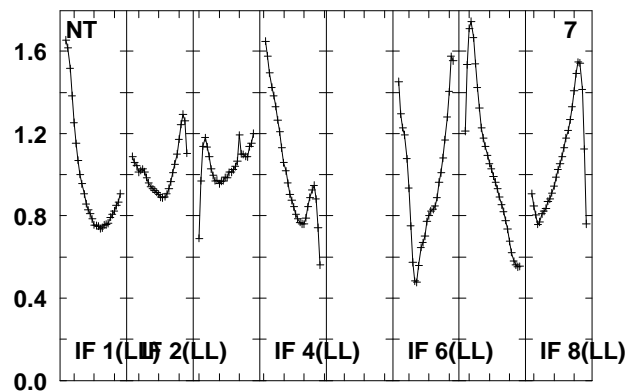
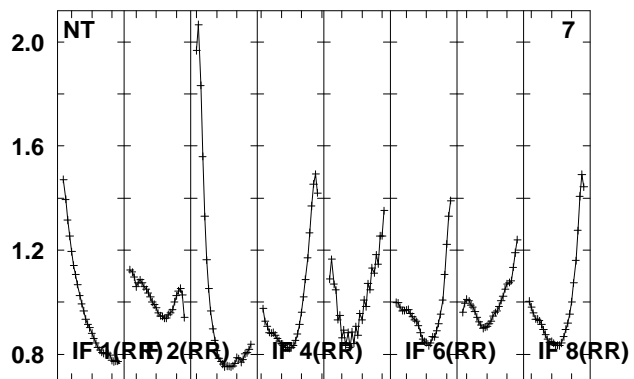
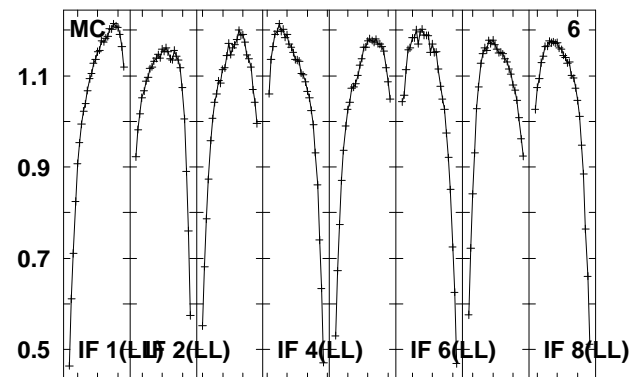
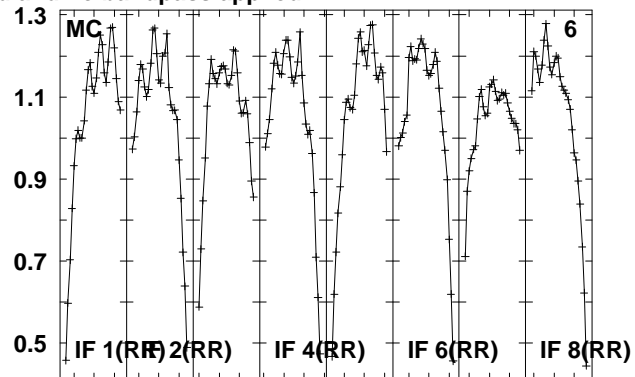
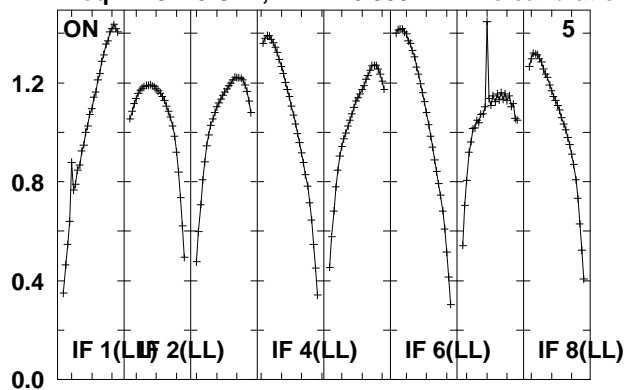

Lower frame: Real Jy

Total-power spectrum Antenna: *

Timerange: 00/08:50:02 to 00/08:51:28

Plot file version 211 created 14-MAY-2010 15:18:12
 J0158+13 EO007.UVDATA.1
 Freq = 4.9270 GHz, Bw = 16.000 MH No calibration applied and no bandpass applied

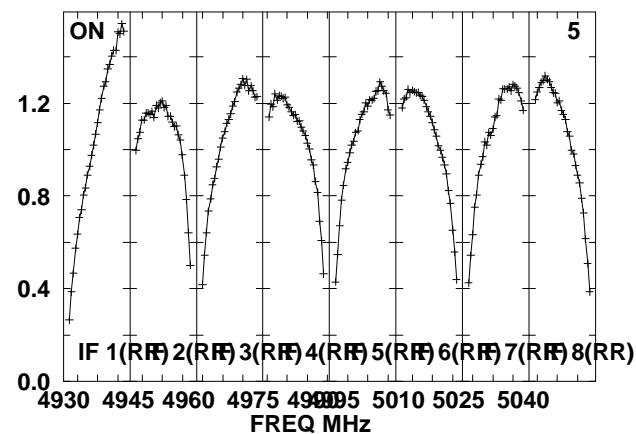
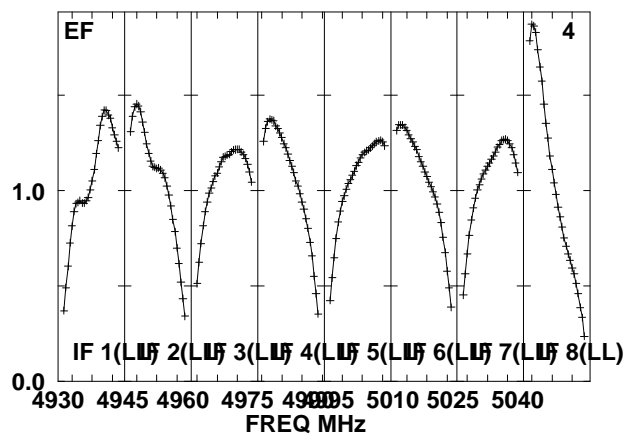
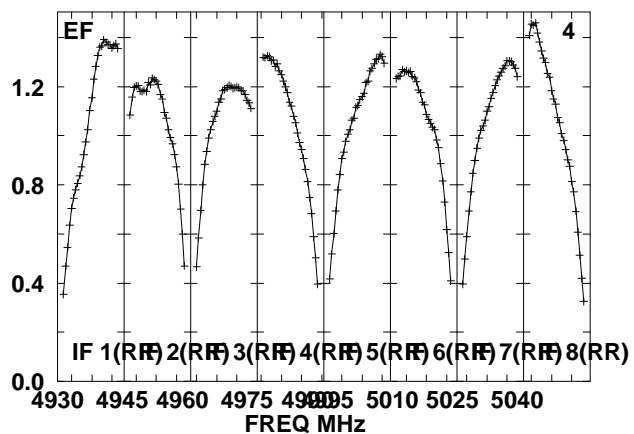
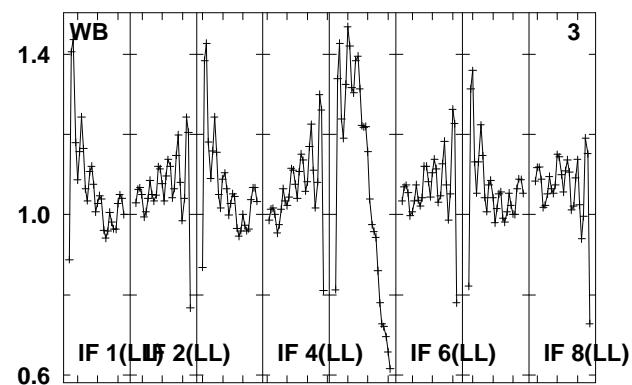
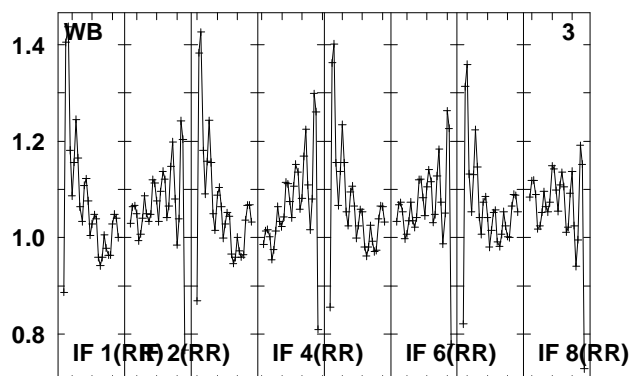
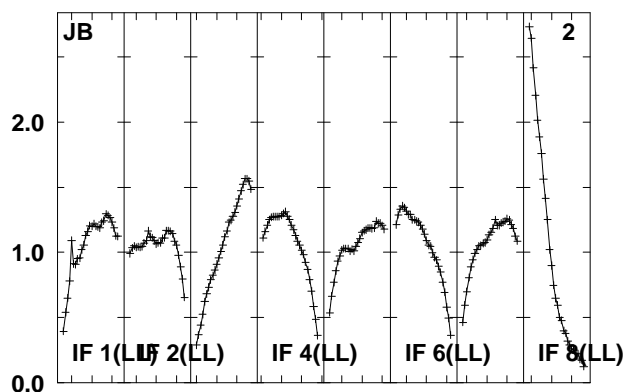
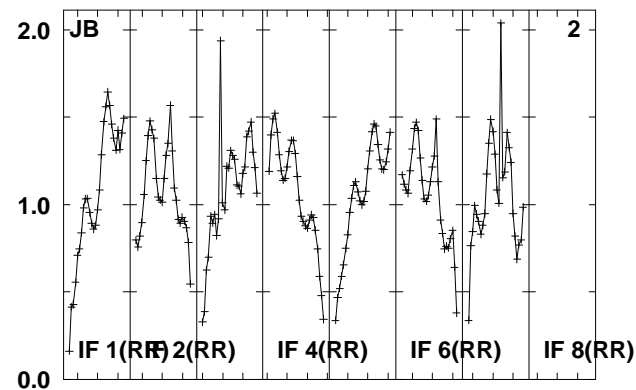
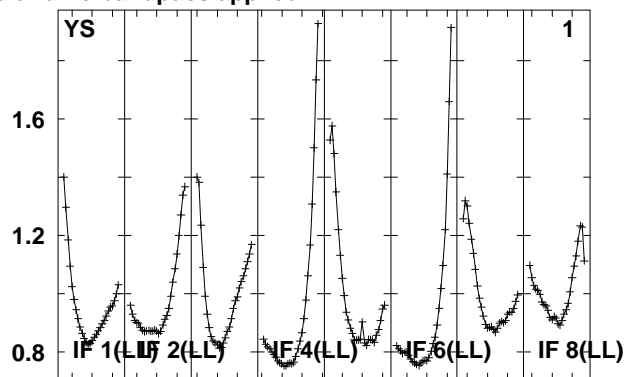
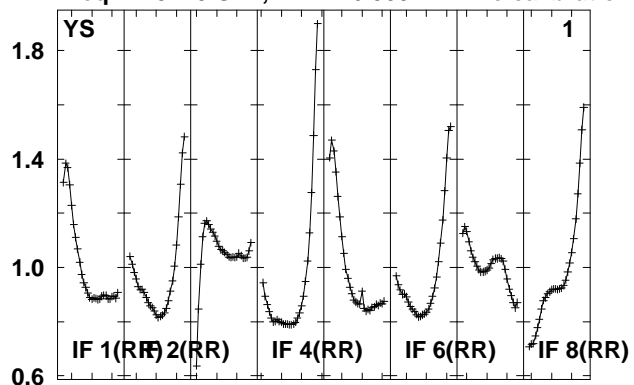

Lower frame: Real Jy
 Total-power spectrum Antenna: *
 Timerange: 00/08:52:04 to 00/08:53:32

Plot file version 212 created 14-MAY-2010 15:18:12

J0158+13 EO007.UVDATA.1

Freq = 4.9270 GHz, Bw = 16.000 MH No calibration applied and no bandpass applied

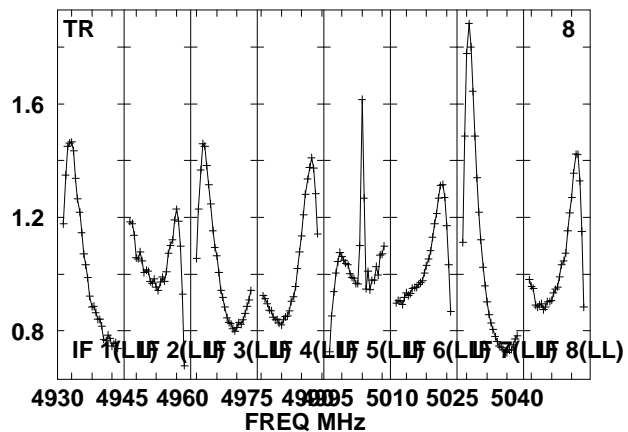
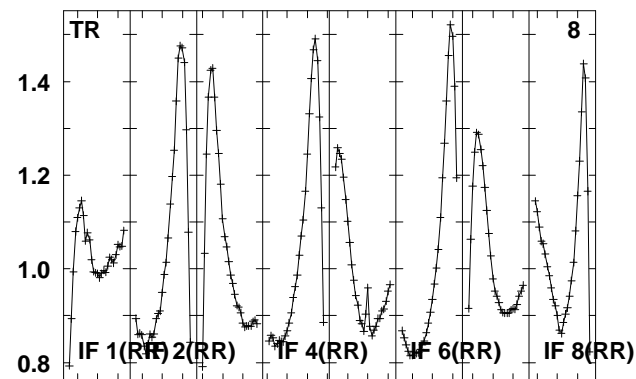
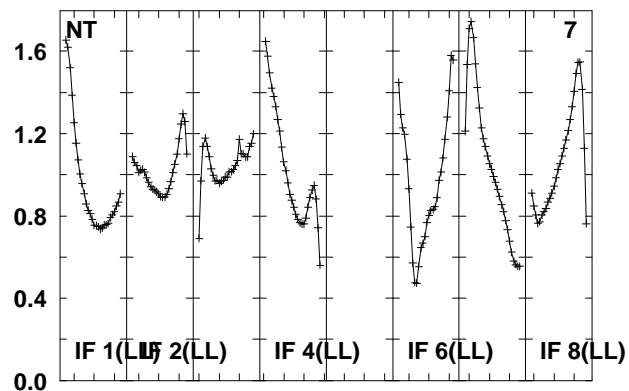
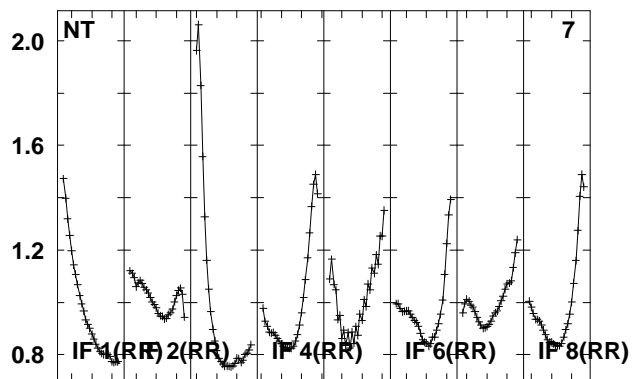
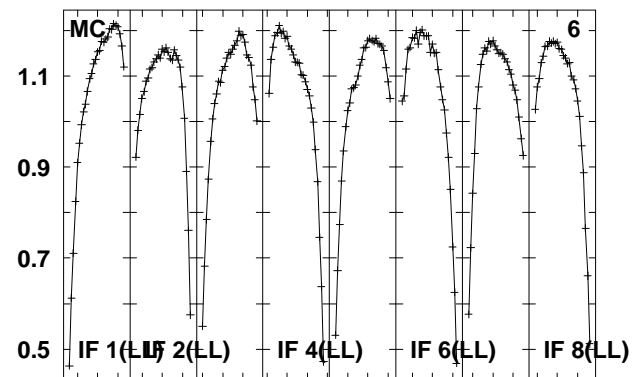
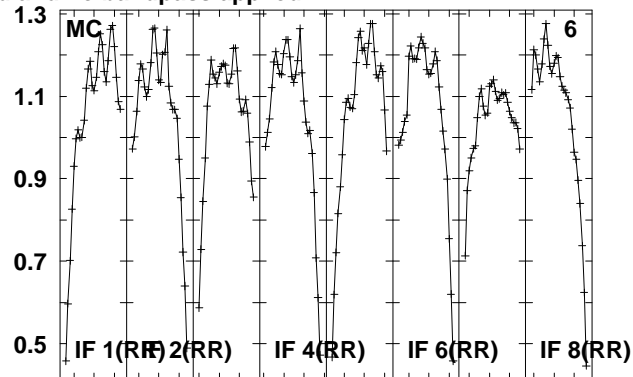
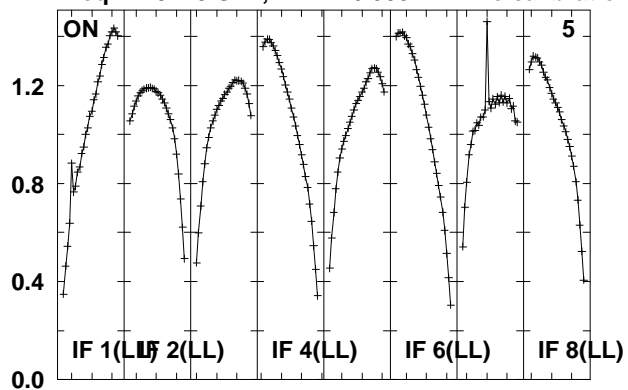

Lower frame: Real Jy

Total-power spectrum Antenna: *

Timerange: 00/08:52:04 to 00/08:53:32

Plot file version 213 created 14-MAY-2010 15:18:12
 J015028 EO007.UVDATA.1
 Freq = 4.9270 GHz, Bw = 16.000 MH No calibration applied and no bandpass applied

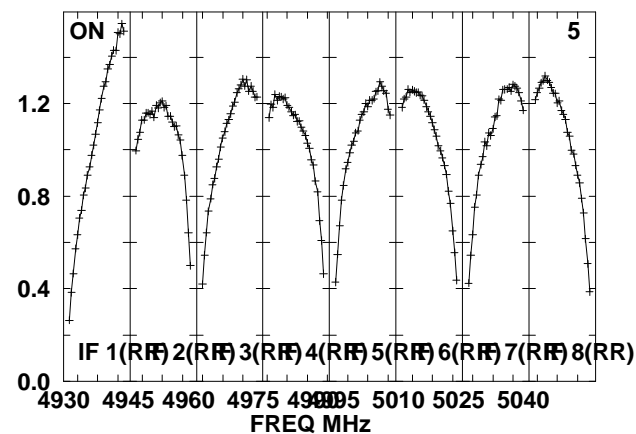
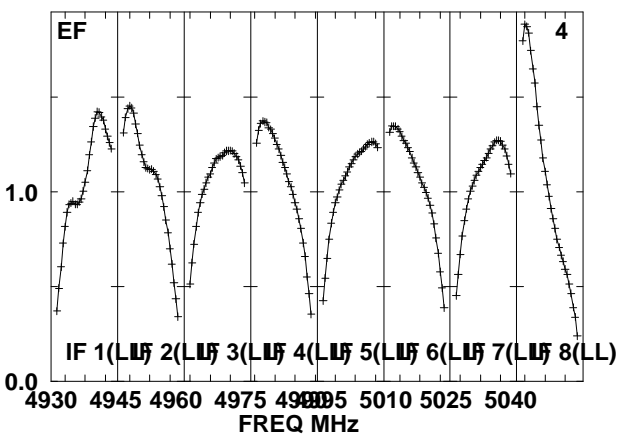
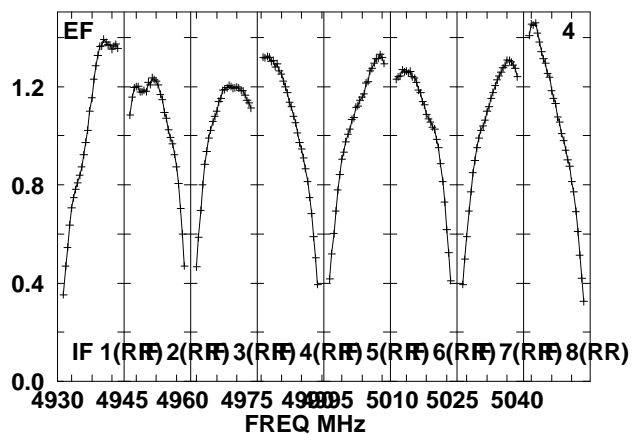
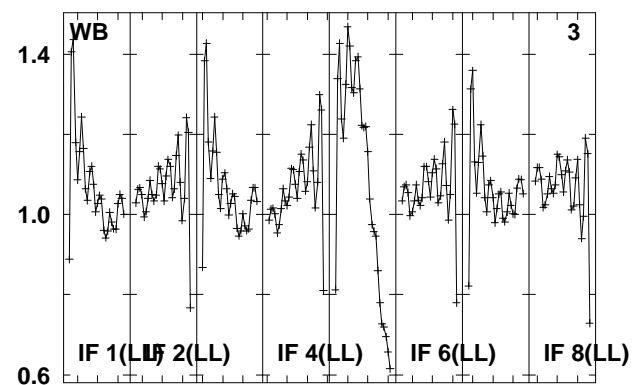
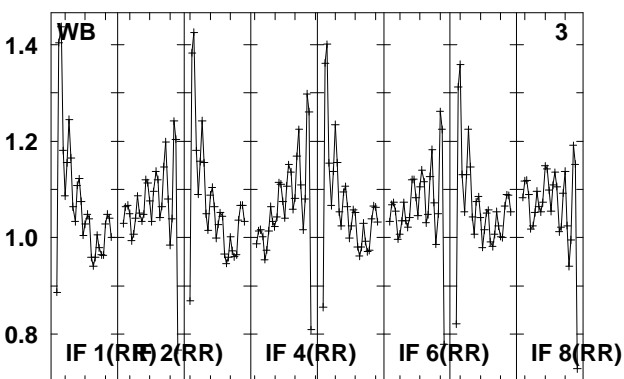
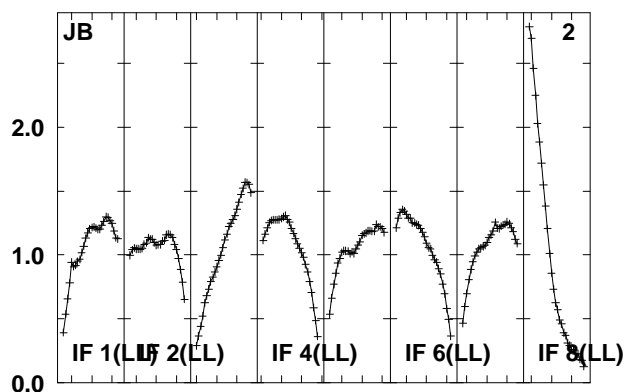
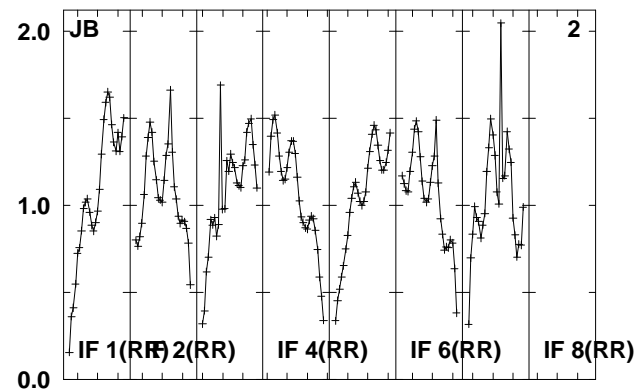
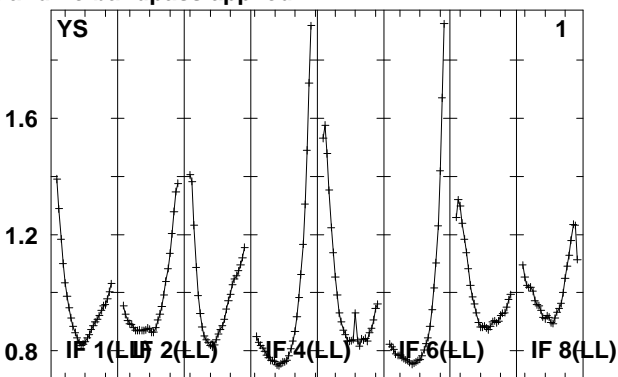
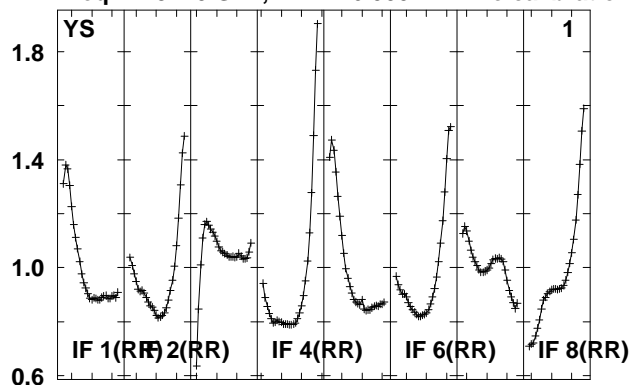

Lower frame: Real Jy
 Total-power spectrum Antenna: *
 Timerange: 00/08:54:00 to 00/08:59:00

Plot file version 214 created 14-MAY-2010 15:18:13

J015028 EO007.UVDATA.1

Freq = 4.9270 GHz, Bw = 16.000 MH No calibration applied and no bandpass applied

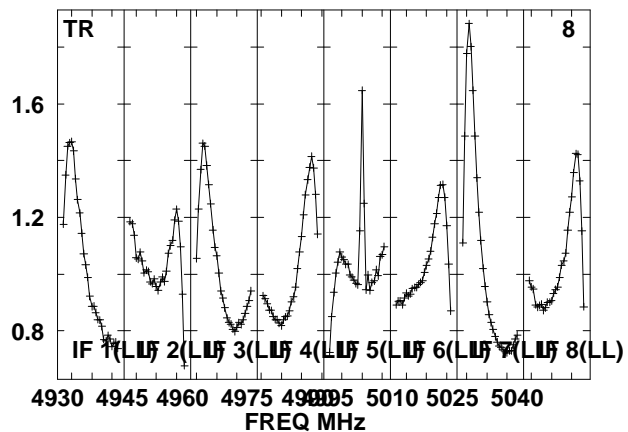
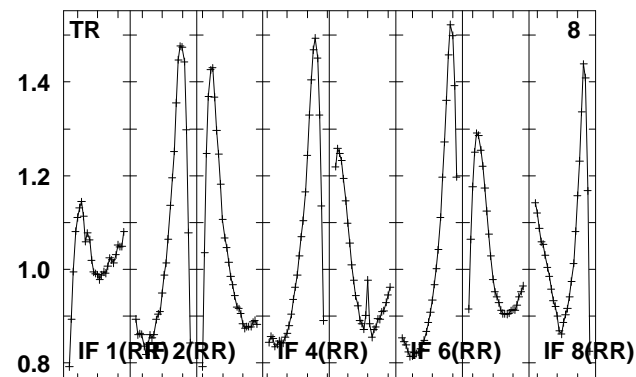
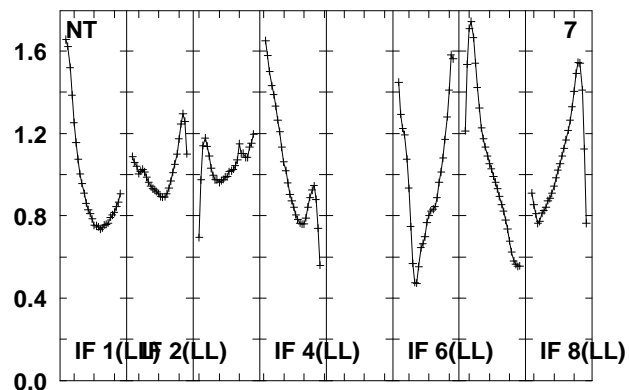
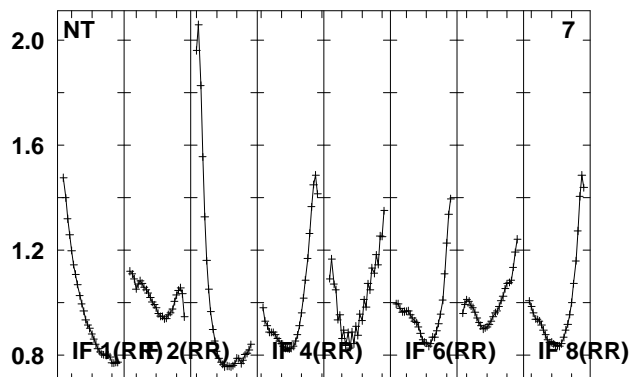
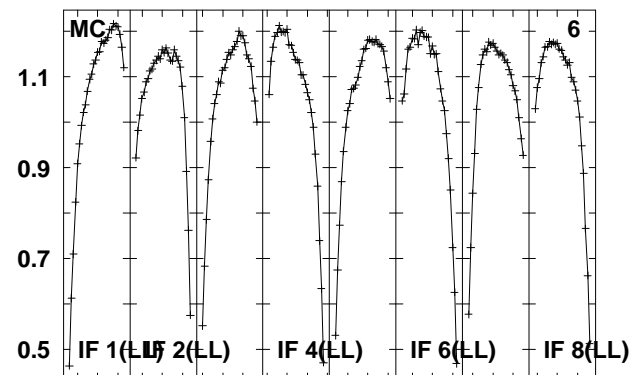
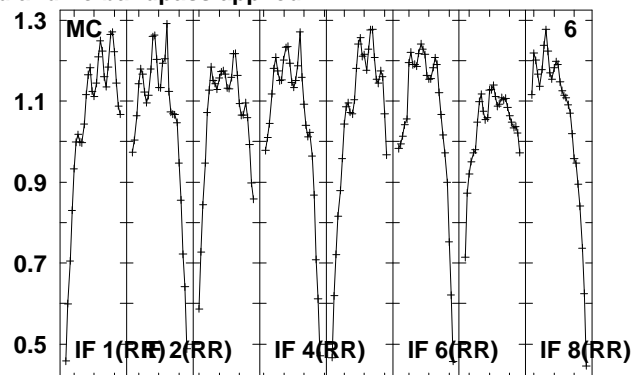
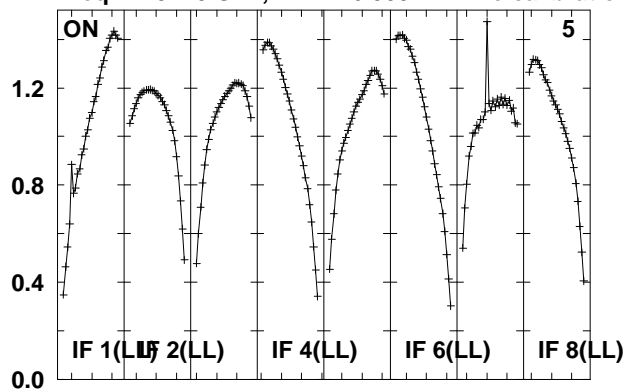

Lower frame: Real Jy

Total-power spectrum Antenna: *

Timerange: 00/08:54:00 to 00/08:59:00

Plot file version 215 created 14-MAY-2010 15:18:14
 J0158+13 EO007.UVDATA.1
 Freq = 4.9270 GHz, Bw = 16.000 MH No calibration applied and no bandpass applied

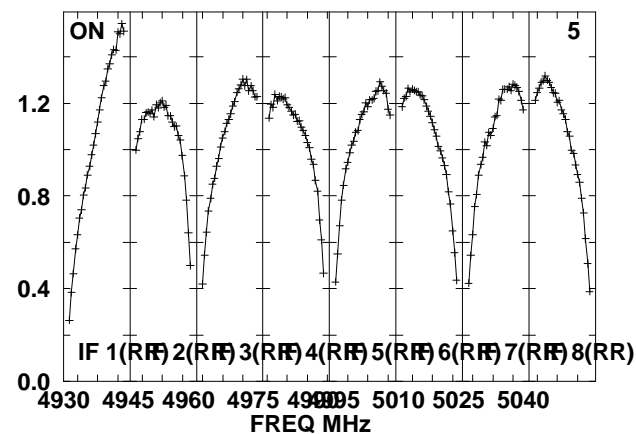
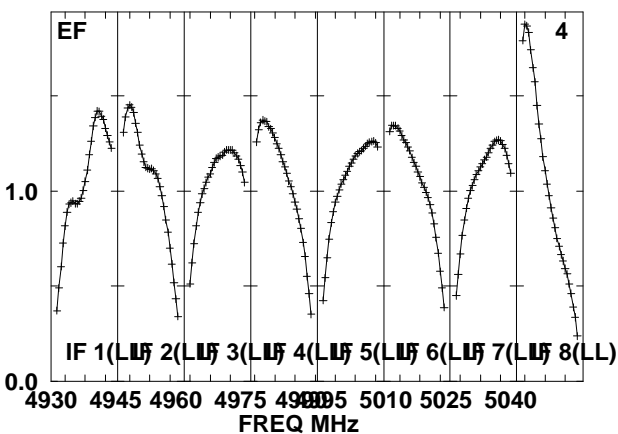
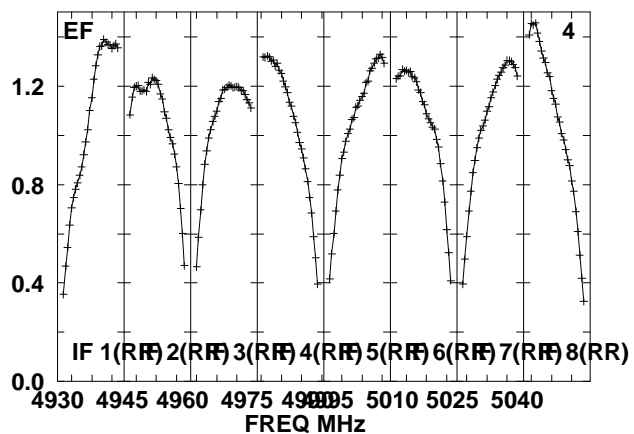
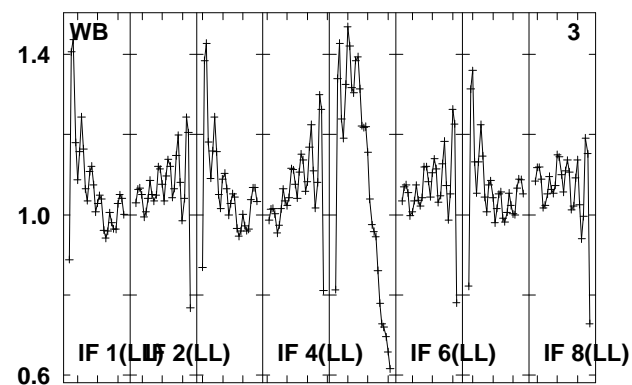
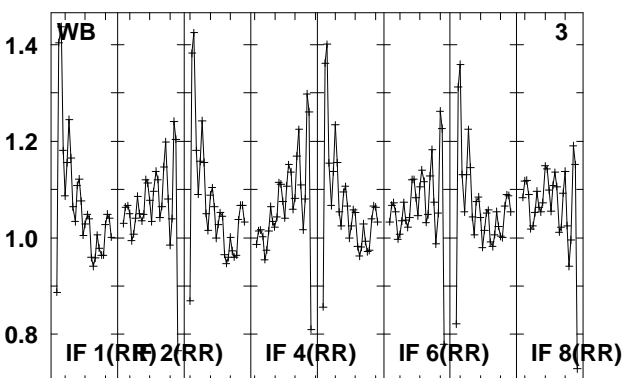
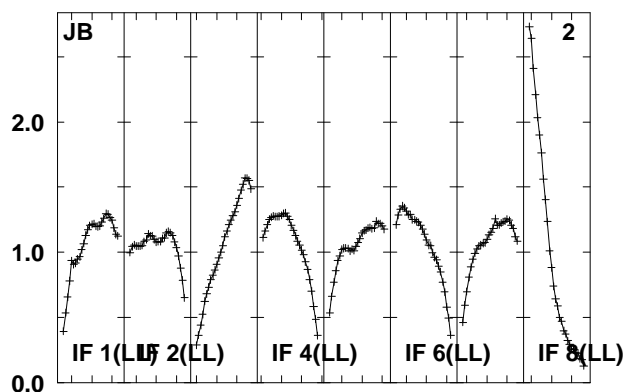
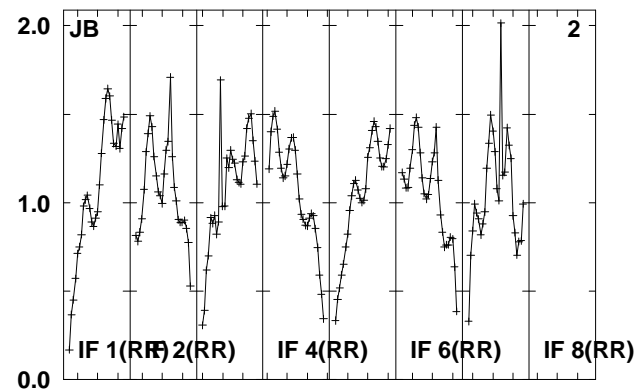
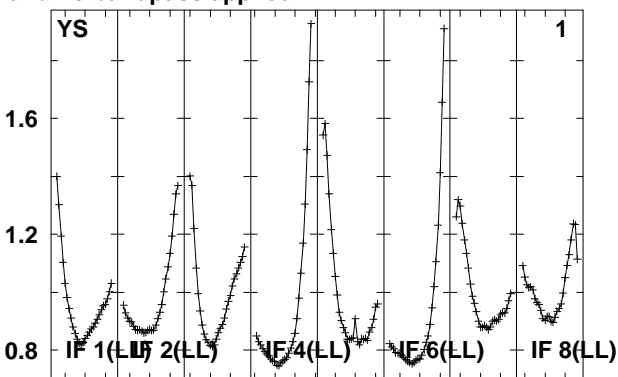
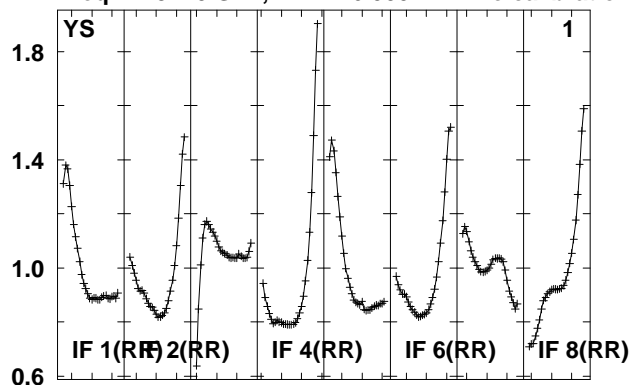

Lower frame: Real Jy
 Total-power spectrum Antenna: *
 Timerange: 00/08:59:28 to 00/09:00:56

Plot file version 216 created 14-MAY-2010 15:18:14

J0158+13 EO007.UVDATA.1

Freq = 4.9270 GHz, Bw = 16.000 MH No calibration applied and no bandpass applied

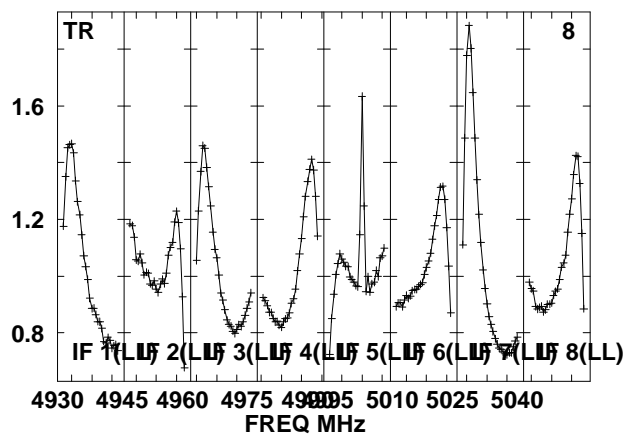
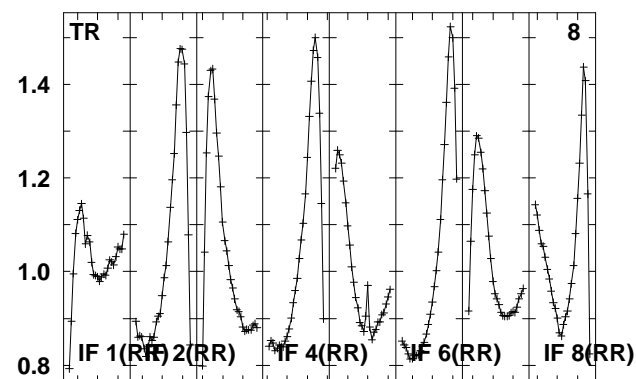
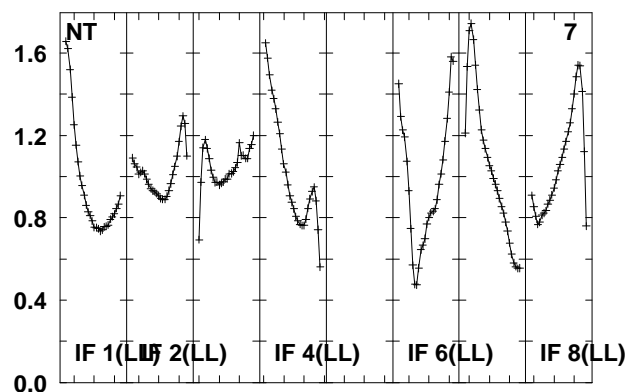
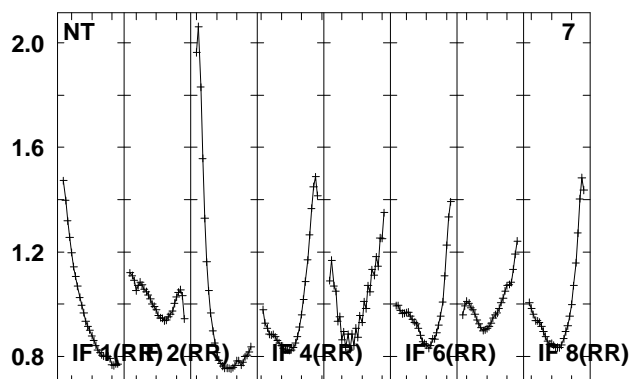
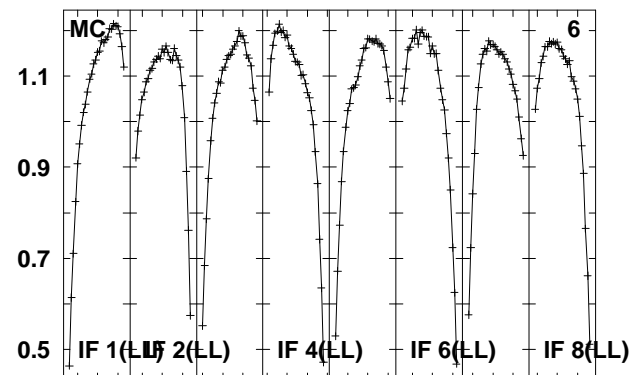
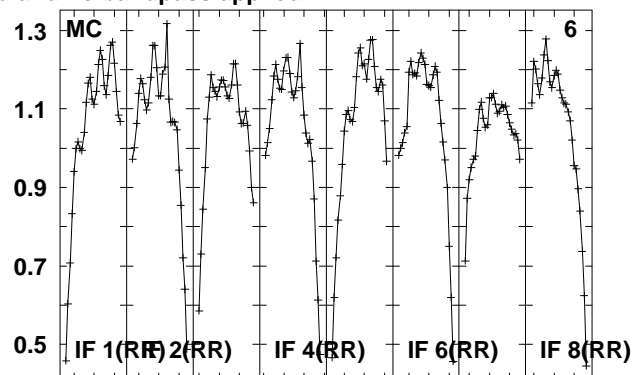
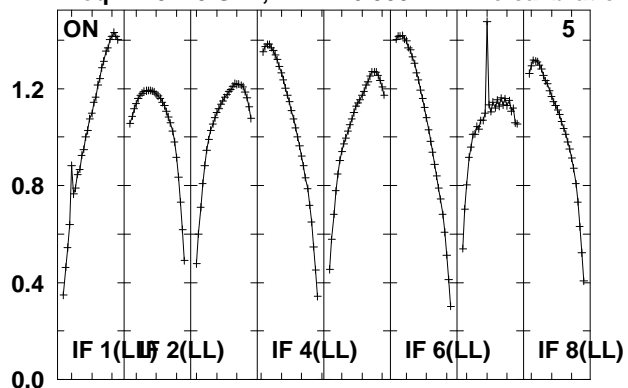

Lower frame: Real Jy

Total-power spectrum Antenna: *

Timerange: 00/08:59:28 to 00/09:00:56

Plot file version 217 created 14-MAY-2010 15:18:15
 J015028 EO007.UVDATA.1
 Freq = 4.9270 GHz, Bw = 16.000 MH No calibration applied and no bandpass applied

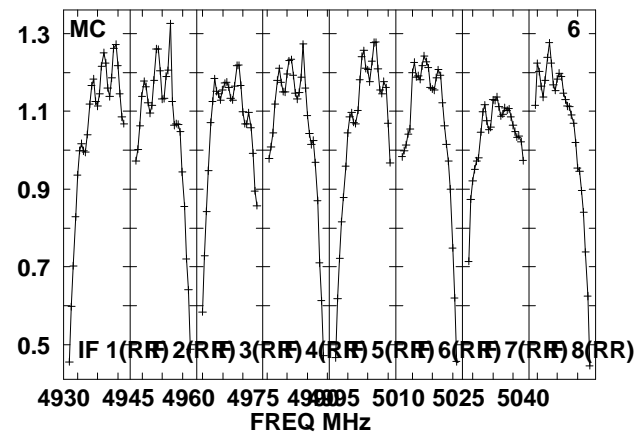
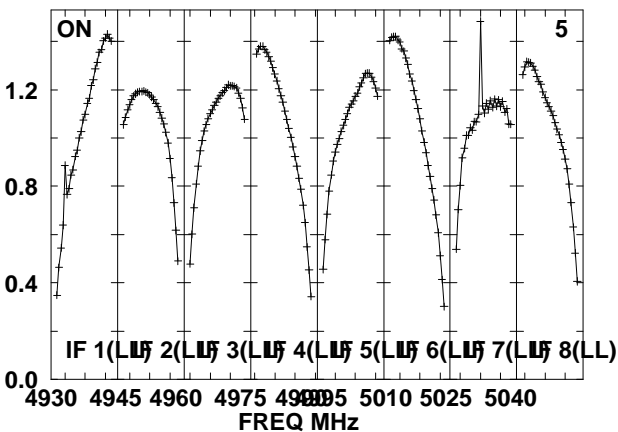
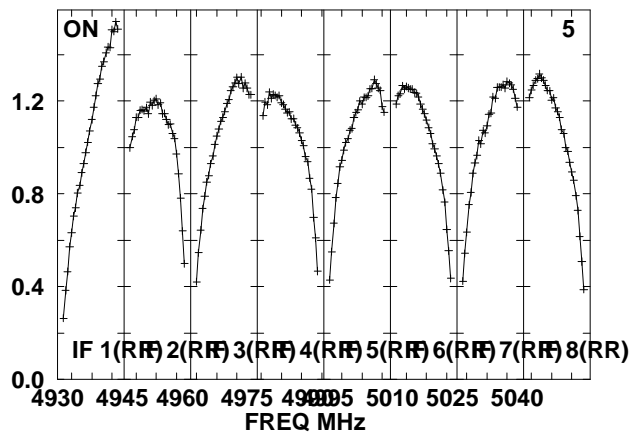
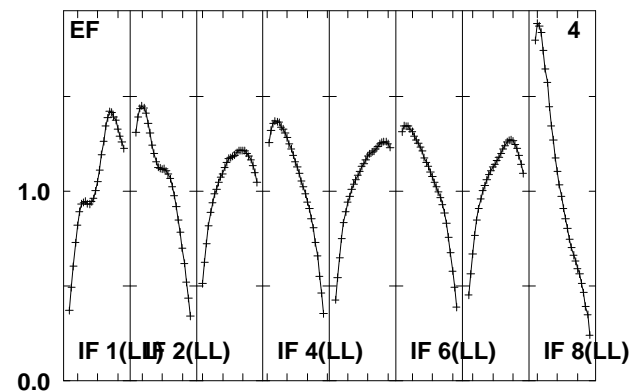
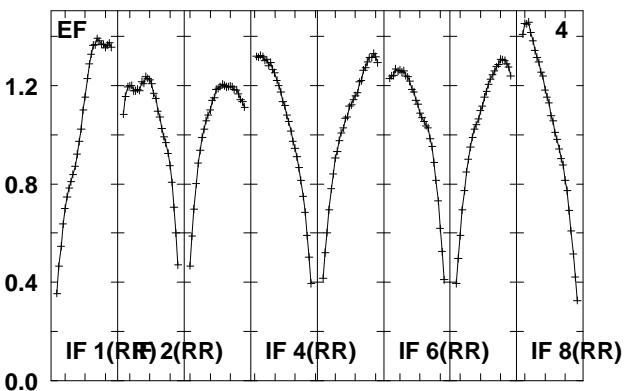
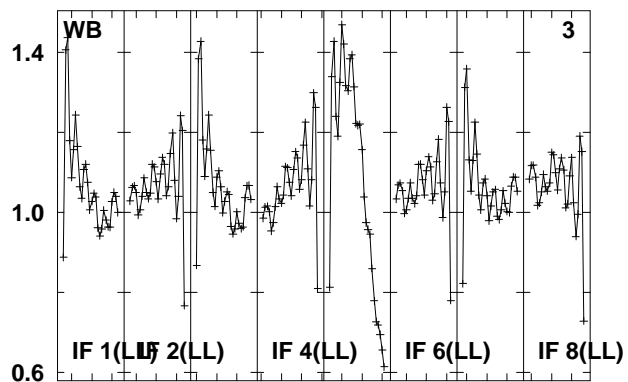
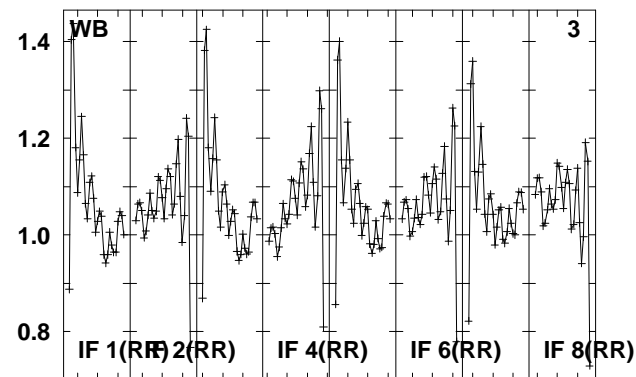
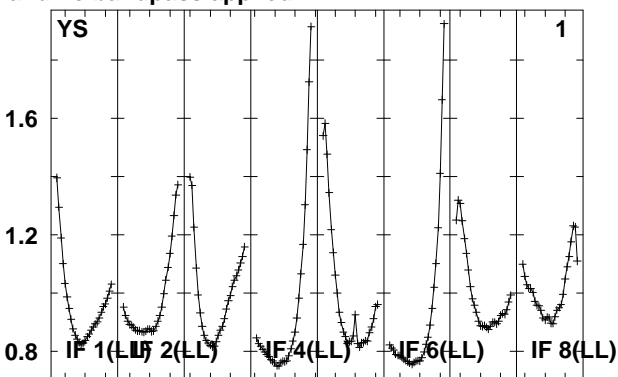
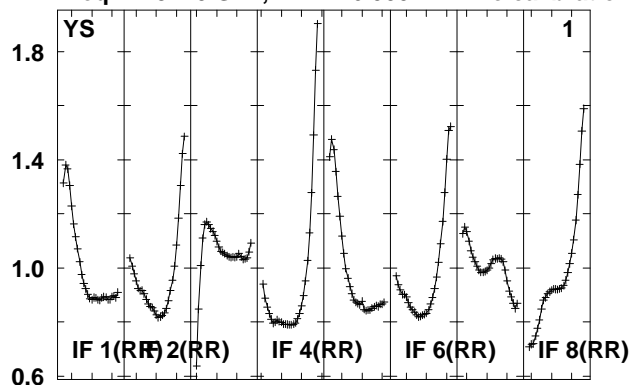

Lower frame: Real Jy
 Total-power spectrum Antenna: *
 Timerange: 00/09:01:26 to 00/09:06:24

Plot file version 218 created 14-MAY-2010 15:18:15

J015028 EO007.UVDATA.1

Freq = 4.9270 GHz, Bw = 16.000 MH No calibration applied and no bandpass applied

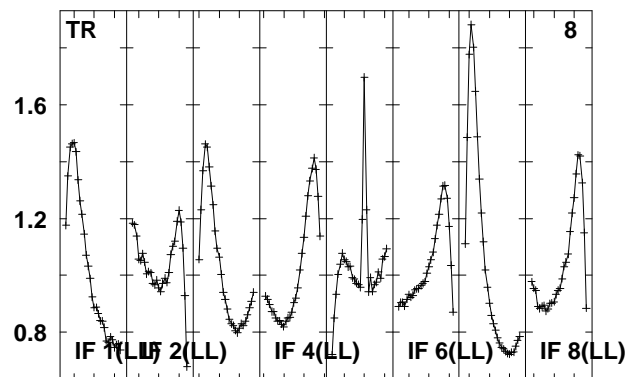
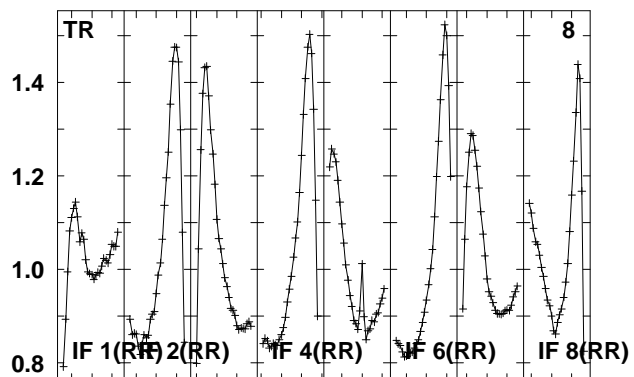
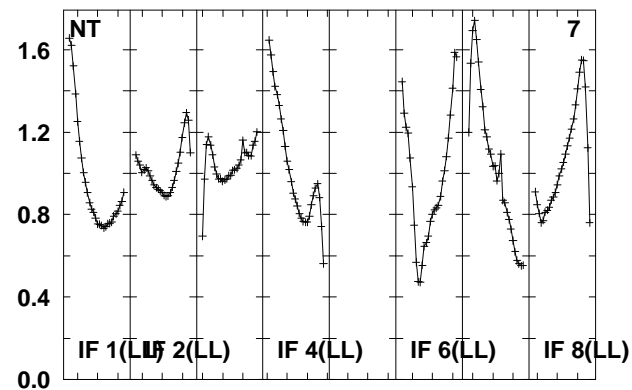
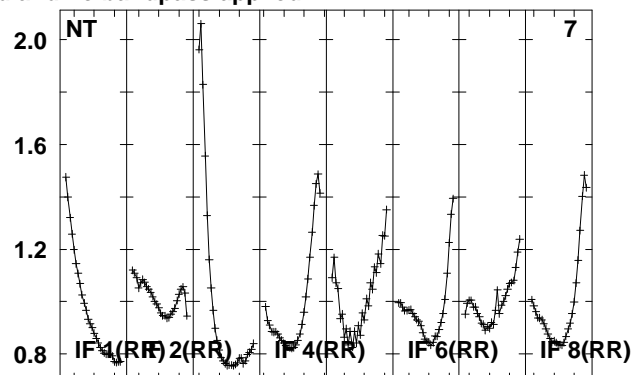
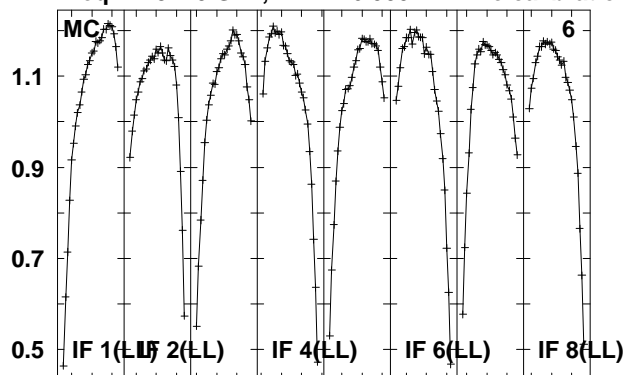

Lower frame: Real Jy
Total-power spectrum Antenna: *
Timerange: 00/09:01:26 to 00/09:06:24

Plot file version 219 created 14-MAY-2010 15:18:15
 J0158+13 EO007.UVDATA.1
 Freq = 4.9270 GHz, Bw = 16.000 MH No calibration applied and no bandpass applied

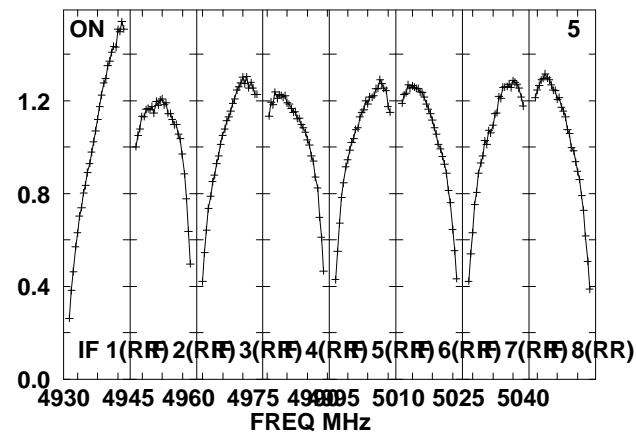
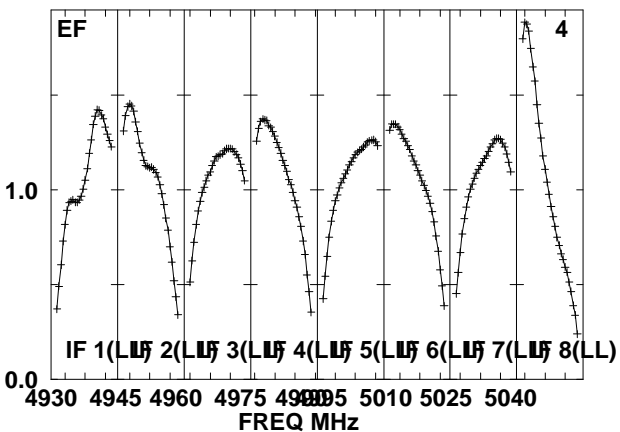
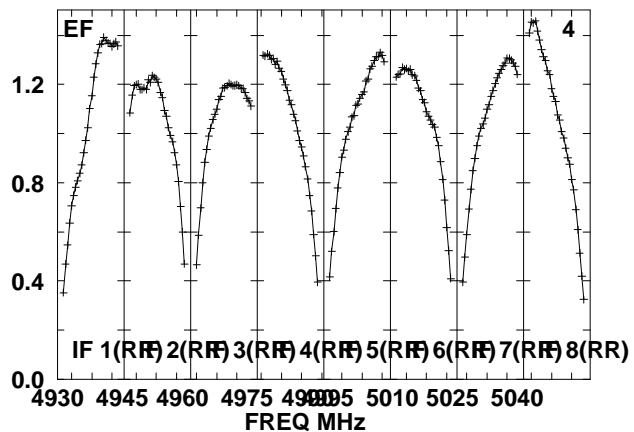
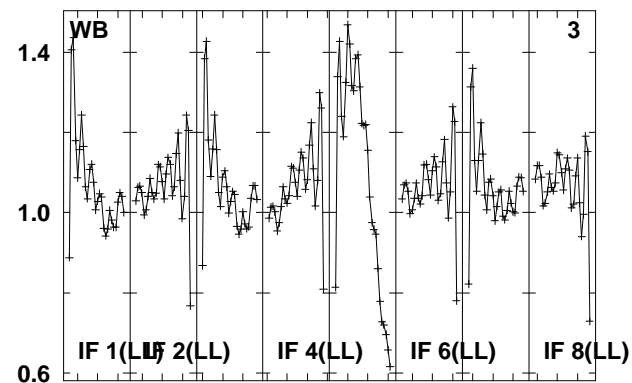
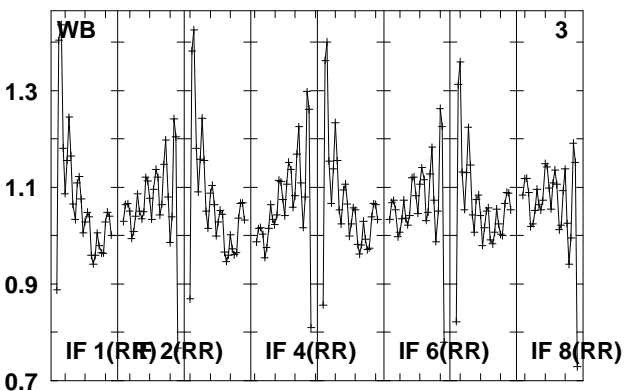
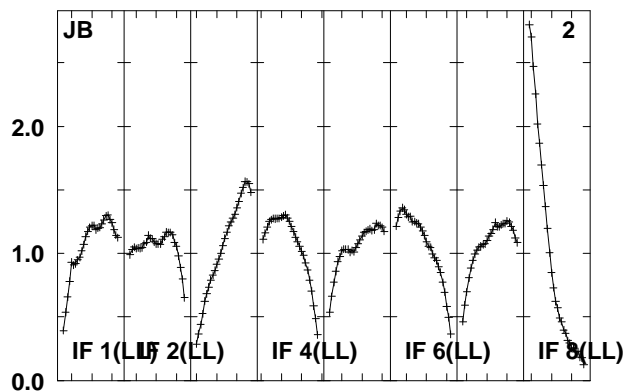
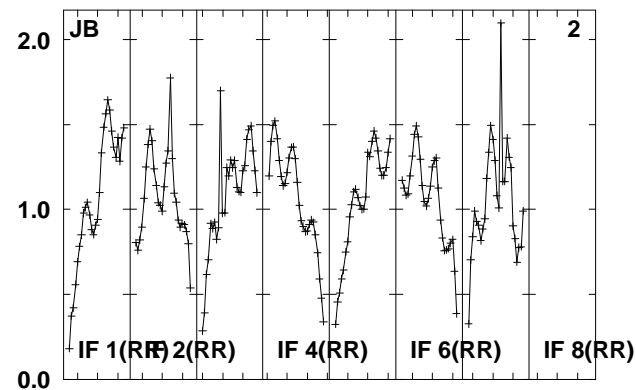
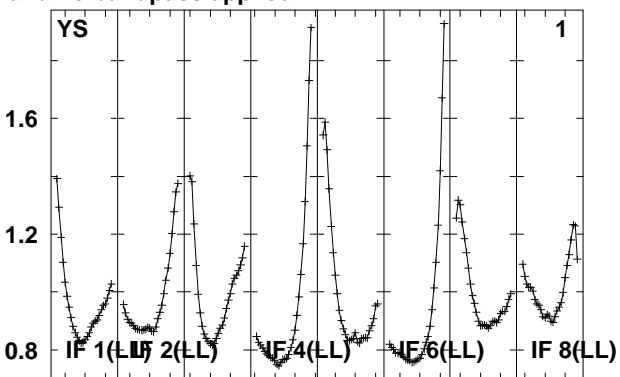
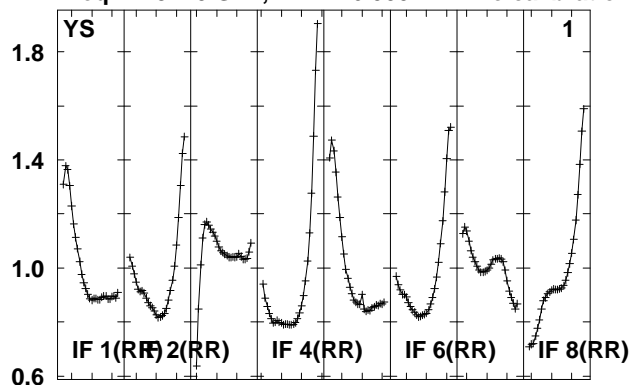

Lower frame: Real Jy
 Total-power spectrum Antenna: *
 Timerange: 00/09:06:54 to 00/09:08:22

Plot file version 220 created 14-MAY-2010 15:18:16

J0158+13 EO007.UVDATA.1

Freq = 4.9270 GHz, Bw = 16.000 MH No calibration applied and no bandpass applied

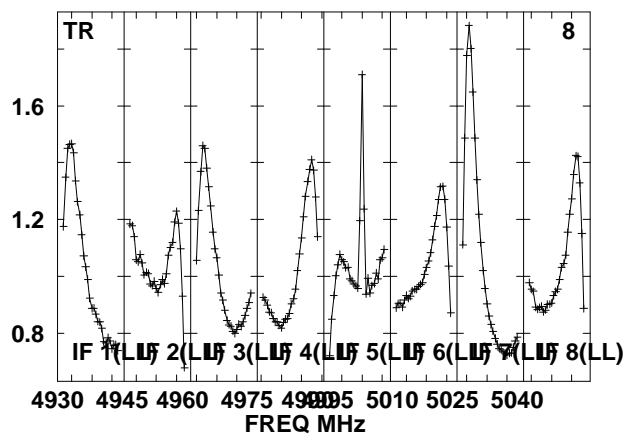
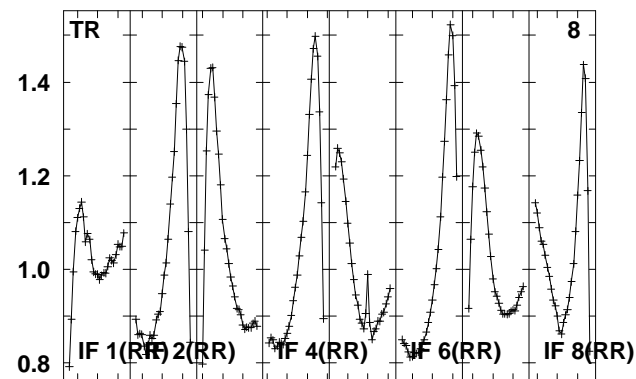
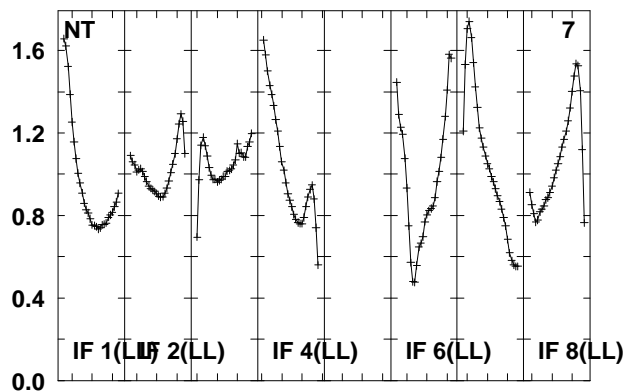
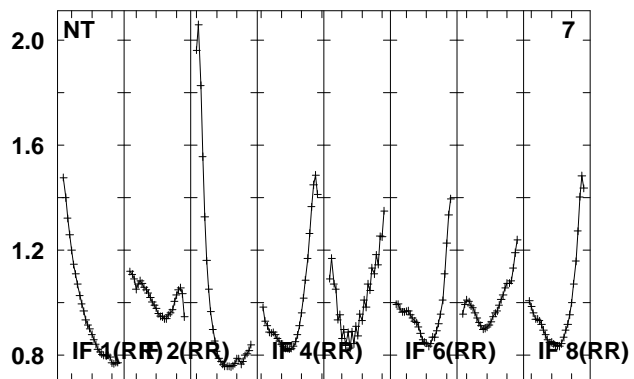
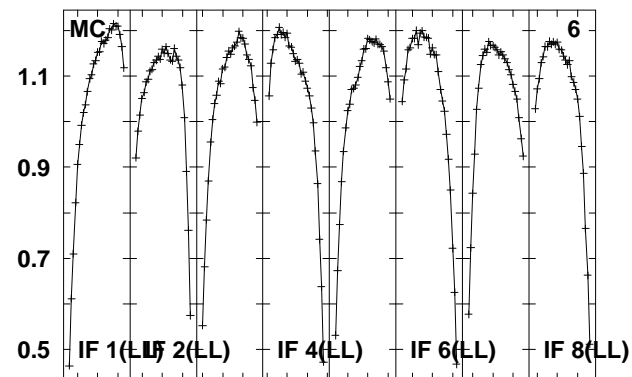
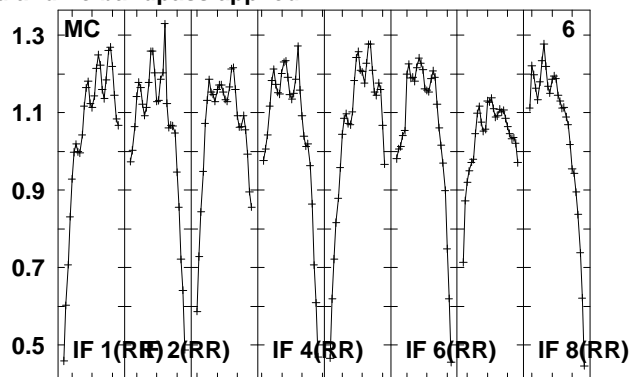
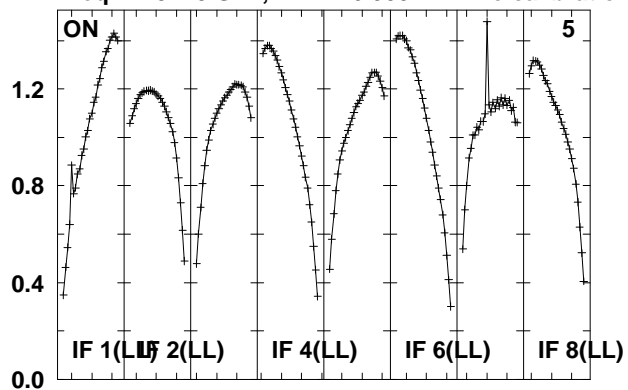

Lower frame: Real Jy

Total-power spectrum Antenna: *

Timerange: 00/09:06:54 to 00/09:08:22

Plot file version 221 created 14-MAY-2010 15:18:16

J0209+13 EO007.UVDATA.1

Freq = 4.9270 GHz, Bw = 16.000 MH No calibration applied and no bandpass applied

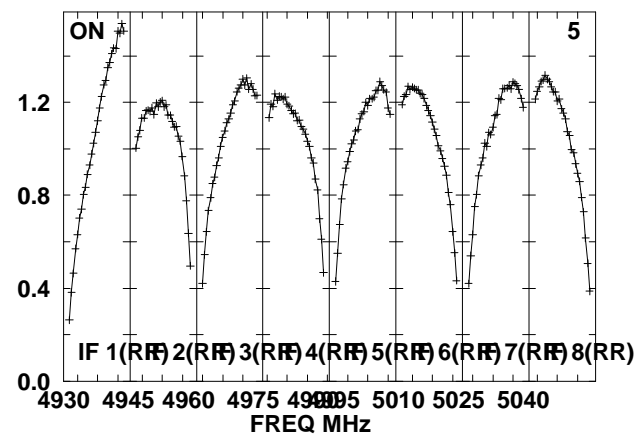
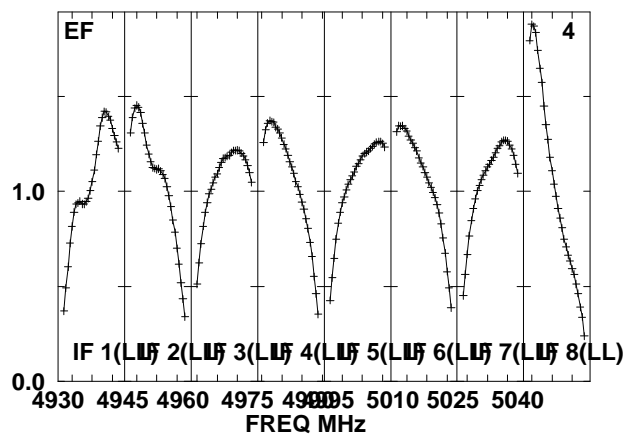
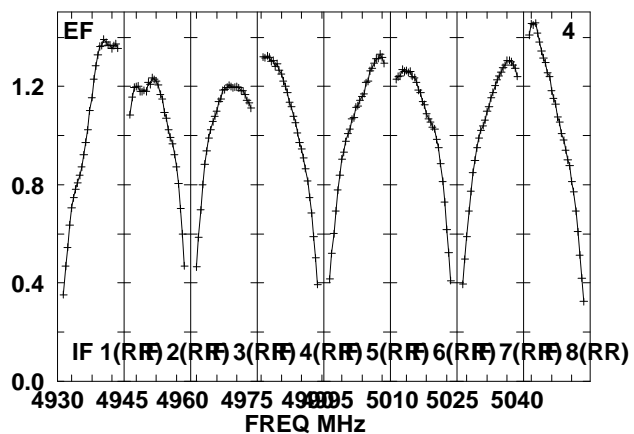
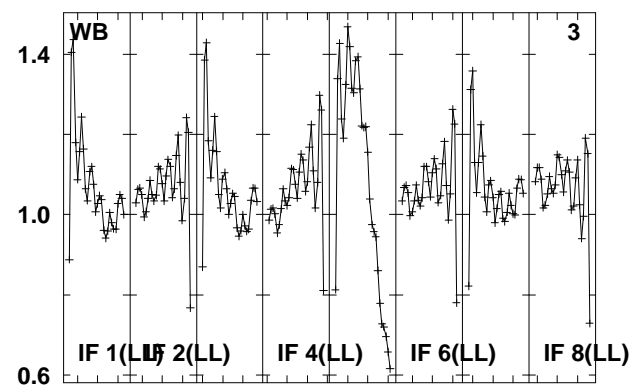
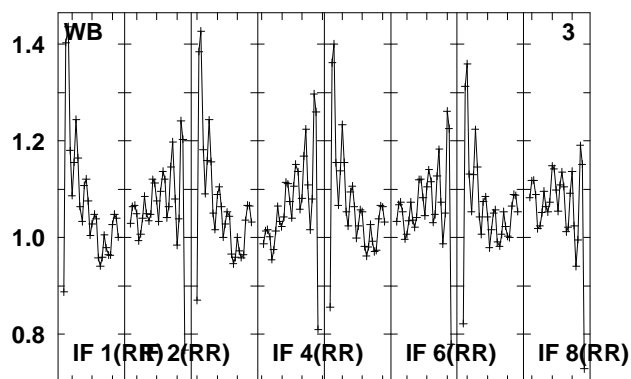
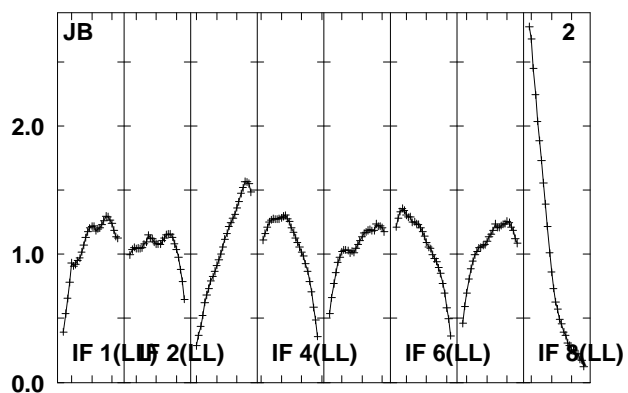
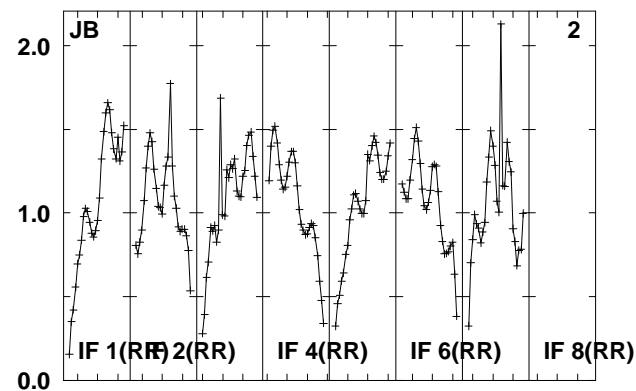
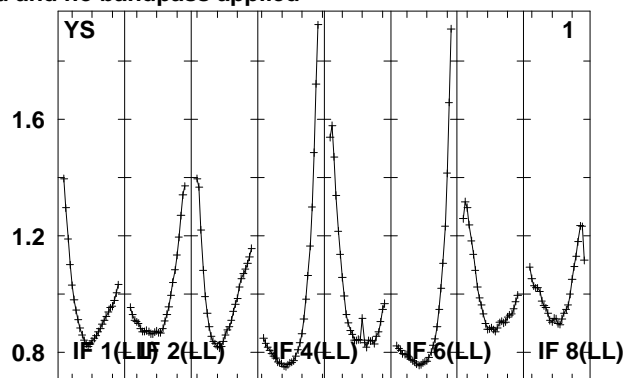
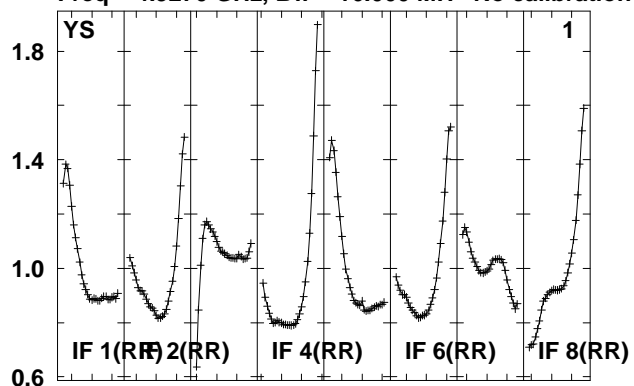

Lower frame: Real Jy

Total-power spectrum Antenna: *

Timerange: 00/09:08:56 to 00/09:10:22

Plot file version 222 created 14-MAY-2010 15:18:16

J0209+13 EO007.UVDATA.1

Freq = 4.9270 GHz, Bw = 16.000 MH No calibration applied and no bandpass applied

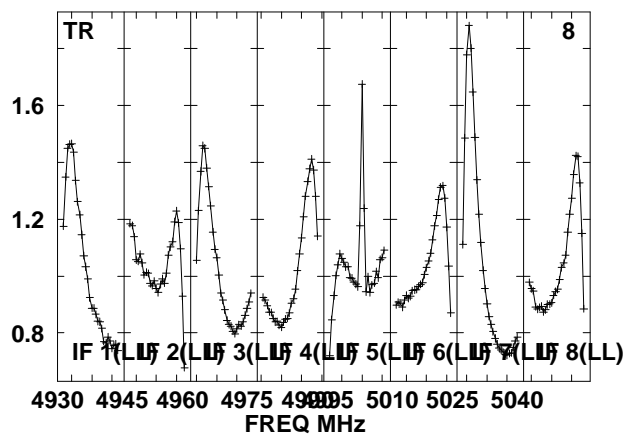
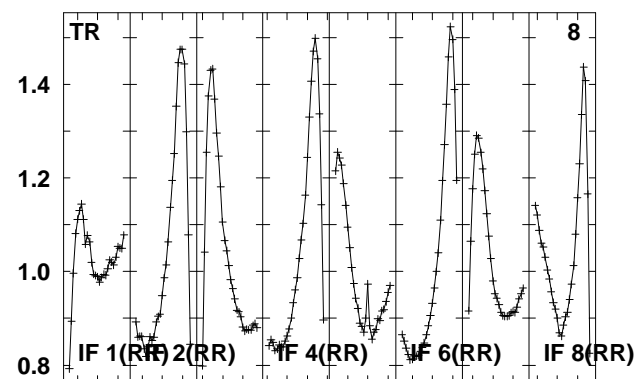
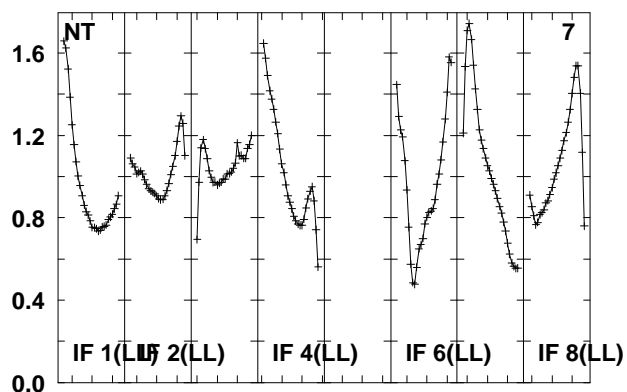
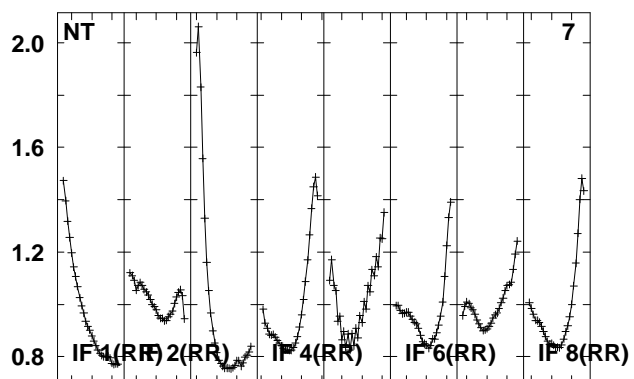
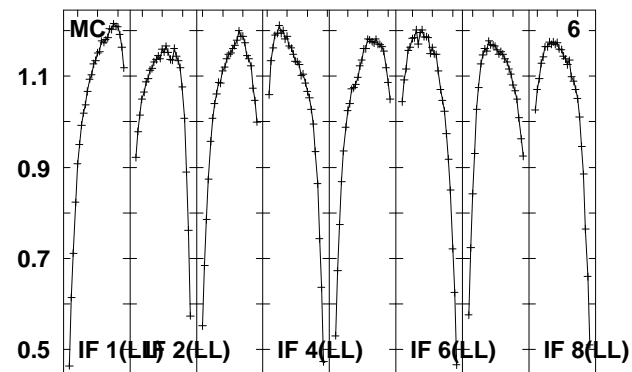
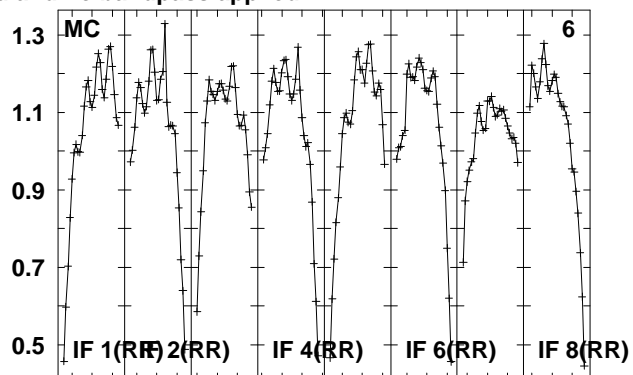
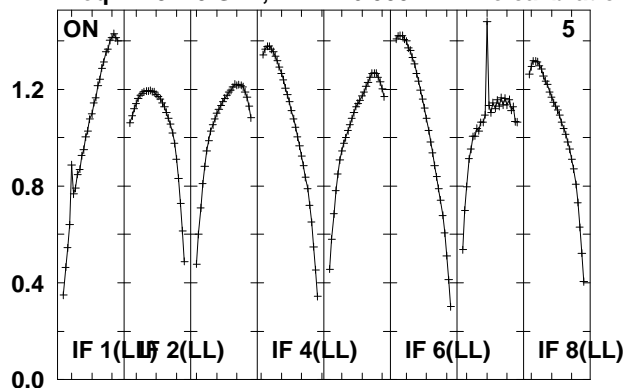

Lower frame: Real Jy

Total-power spectrum Antenna: *

Timerange: 00/09:08:56 to 00/09:10:22

Plot file version 223 created 14-MAY-2010 15:18:16
 J021348 EO007.UVDATA.1
 Freq = 4.9270 GHz, Bw = 16.000 MH No calibration applied and no bandpass applied

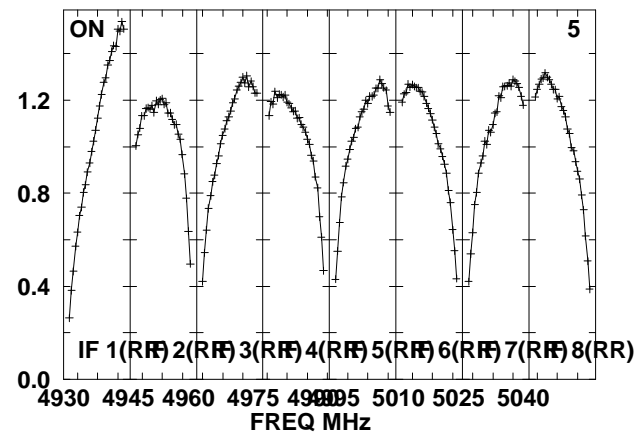
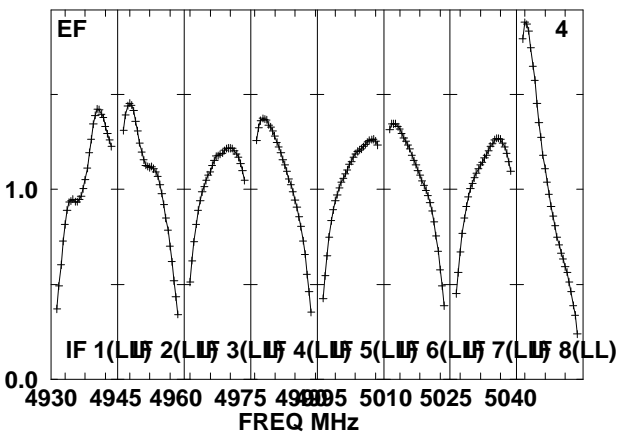
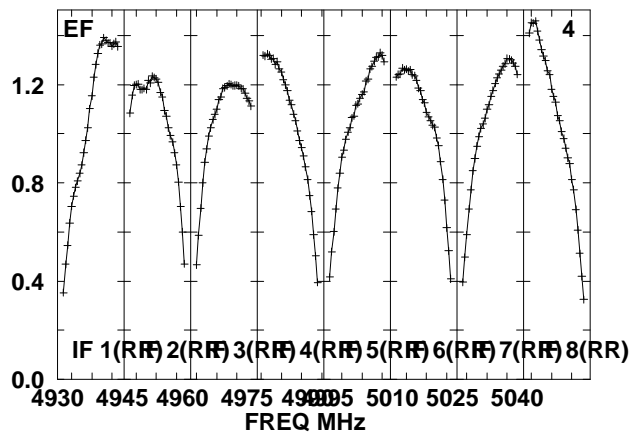
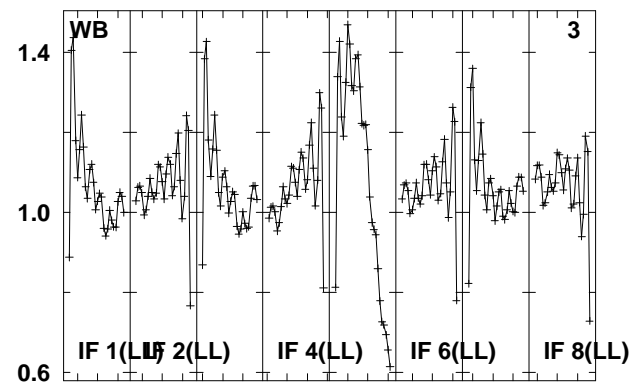
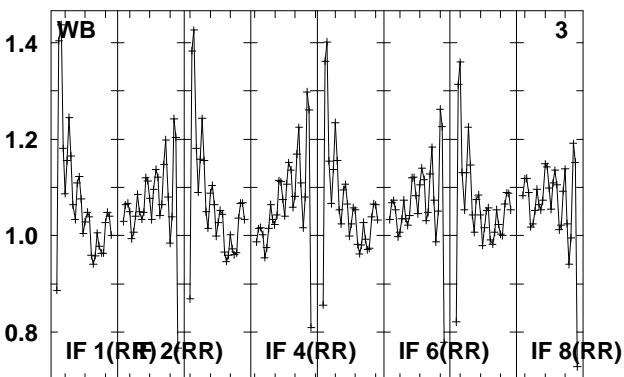
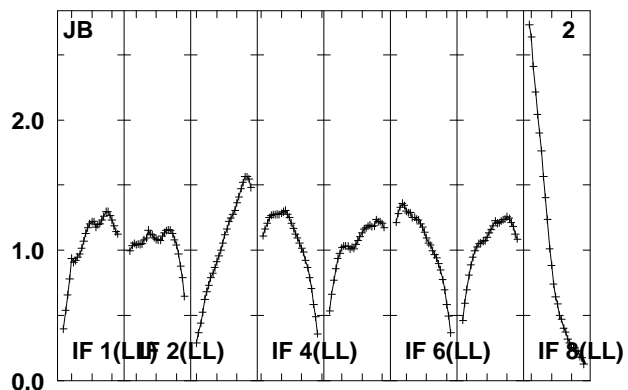
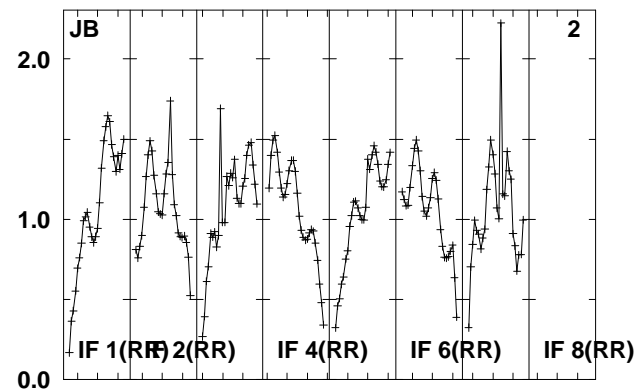
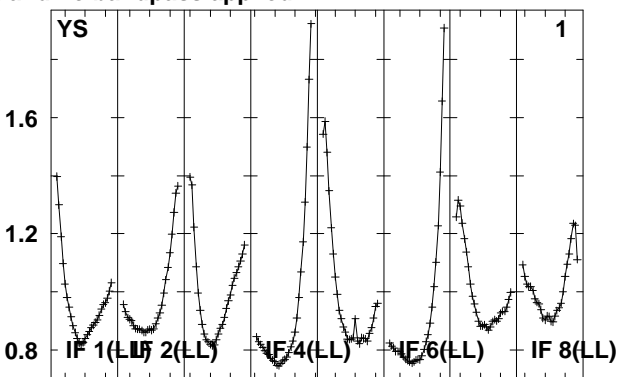
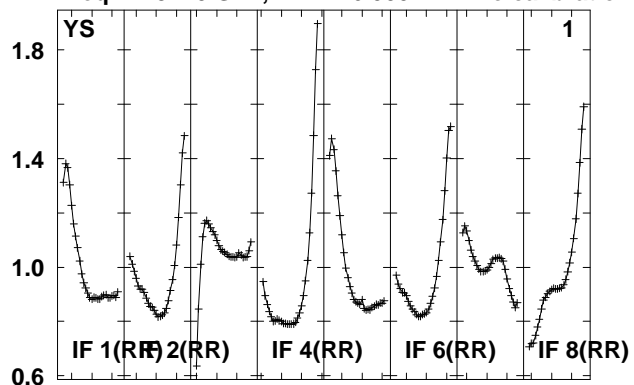

Lower frame: Real Jy
 Total-power spectrum Antenna: *
 Timerange: 00/09:10:50 to 00/09:15:46

Plot file version 224 created 14-MAY-2010 15:18:17

J021348 EO007.UVDATA.1

Freq = 4.9270 GHz, Bw = 16.000 MH No calibration applied and no bandpass applied

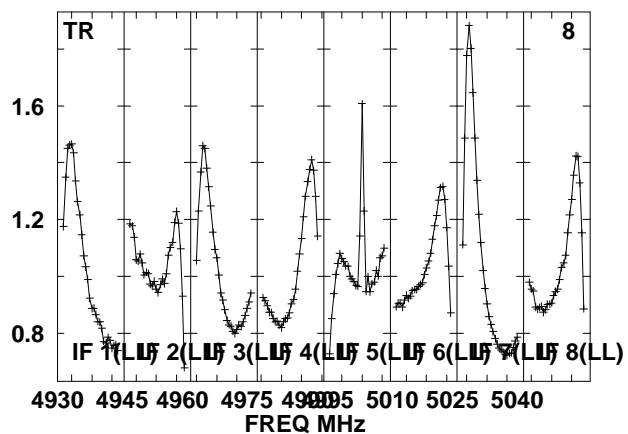
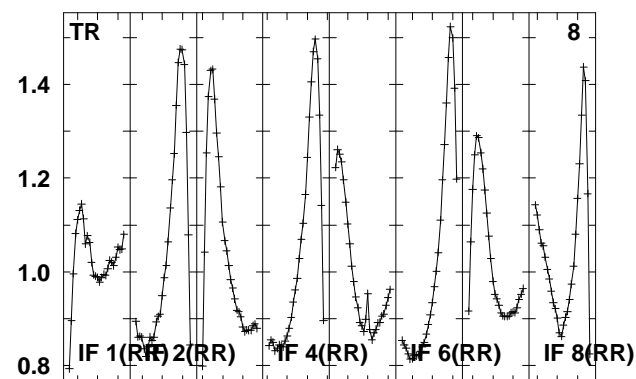
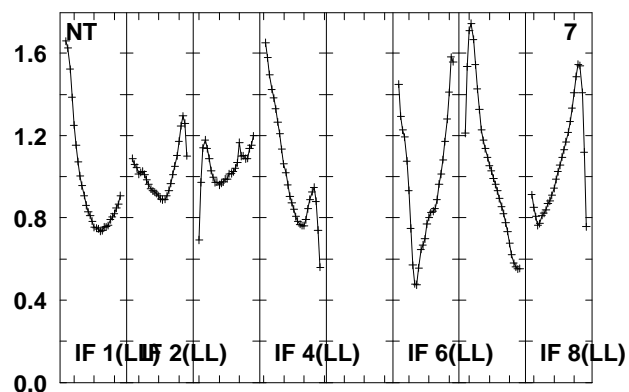
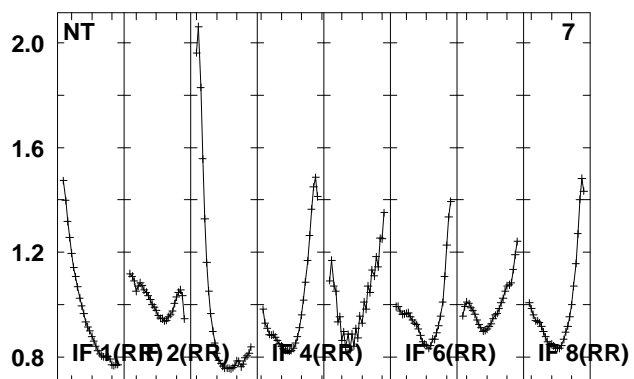
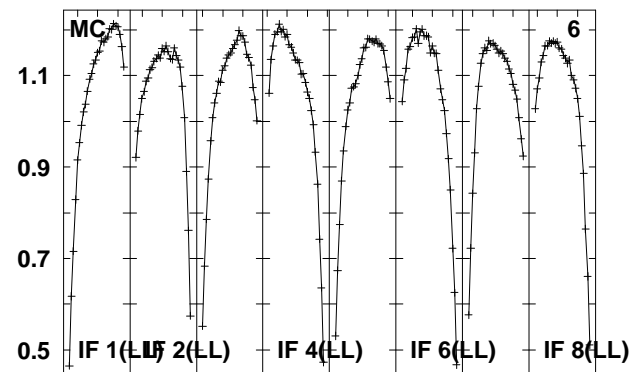
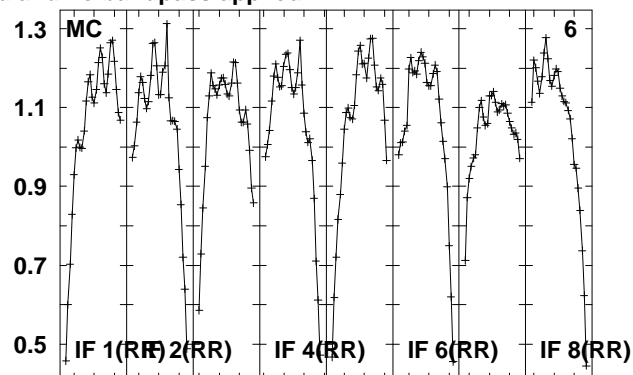
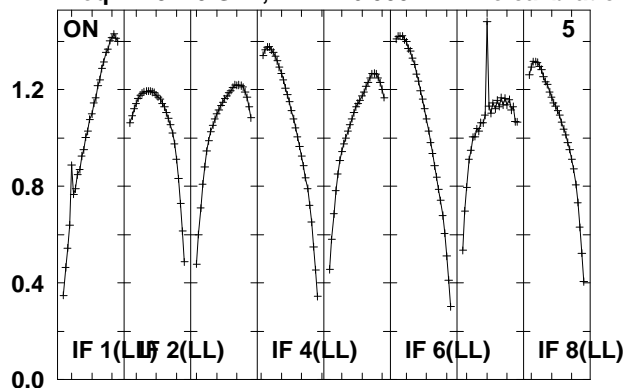

Lower frame: Real Jy

Total-power spectrum Antenna: *

Timerange: 00/09:10:50 to 00/09:15:46

Plot file version 225 created 14-MAY-2010 15:18:17

J0209+13 EO007.UVDATA.1

Freq = 4.9270 GHz, Bw = 16.000 MH No calibration applied and no bandpass applied

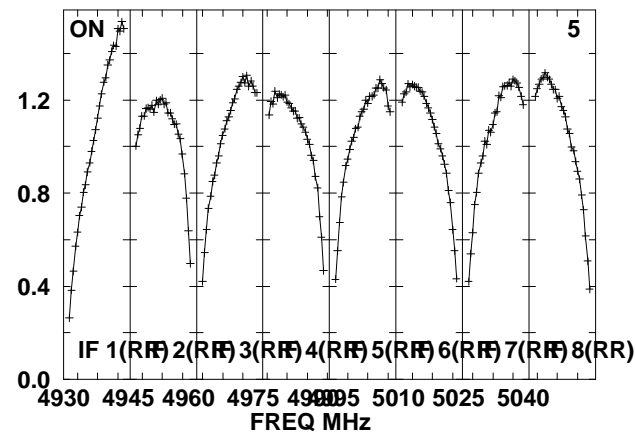
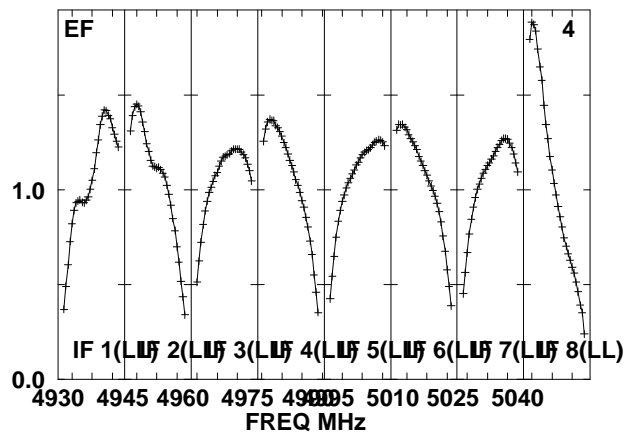
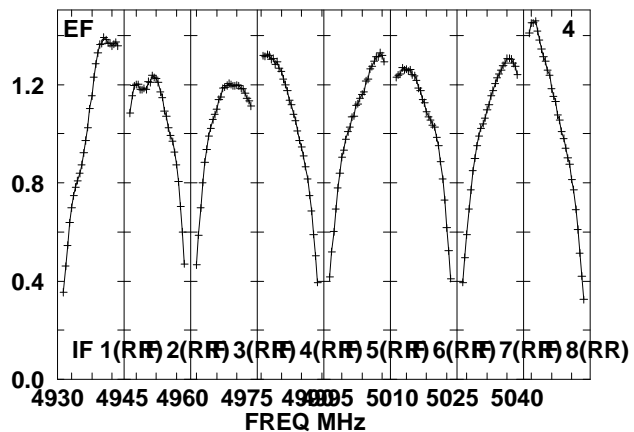
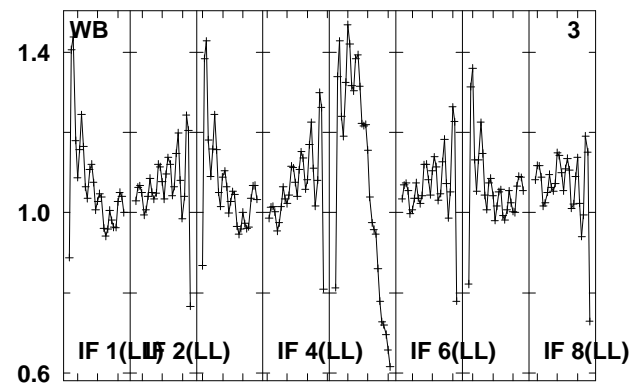
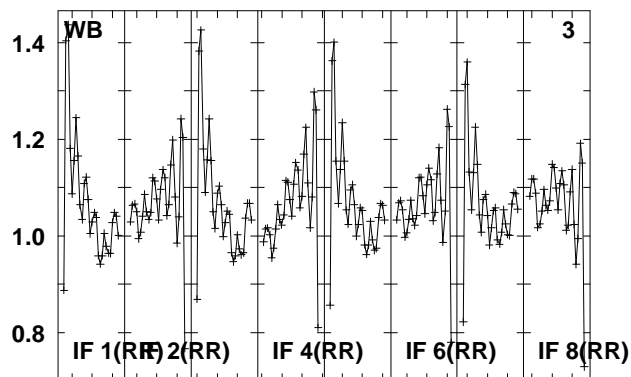
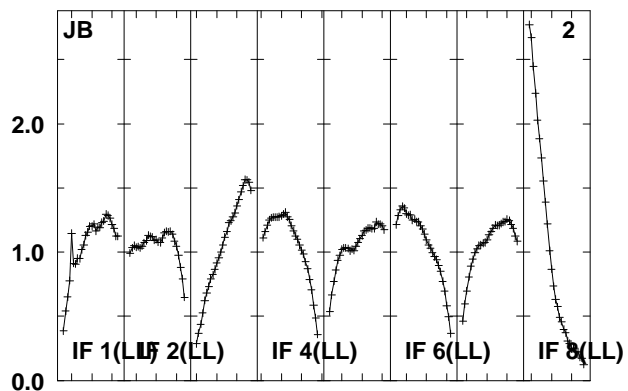
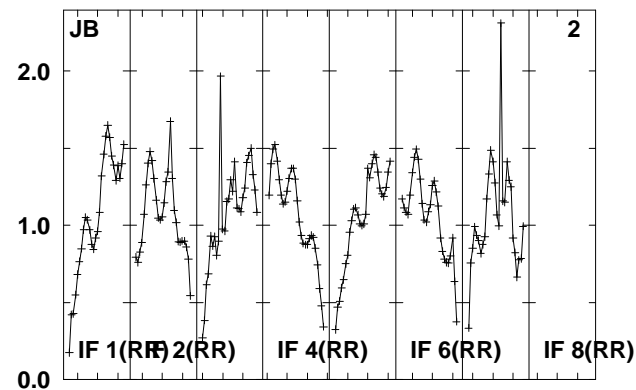
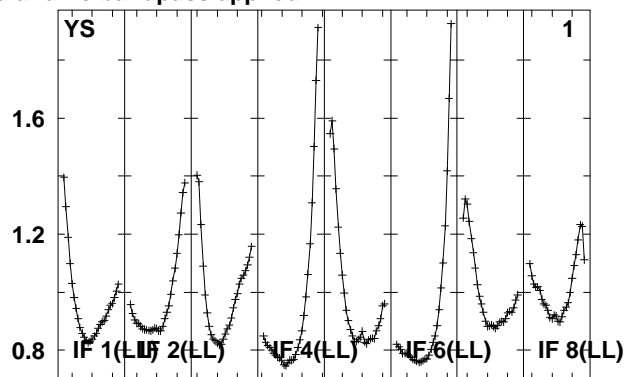
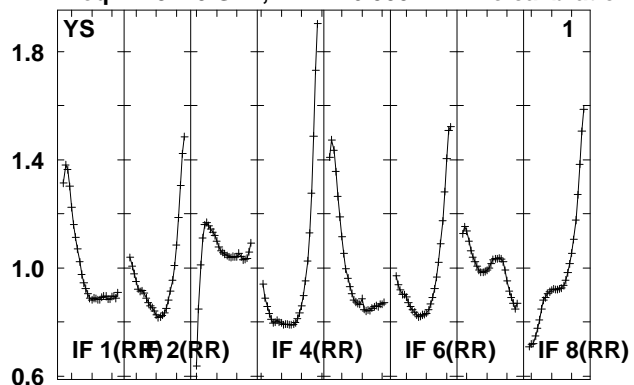

Lower frame: Real Jy
Total-power spectrum Antenna: *
Timerange: 00/09:16:16 to 00/09:17:42

Plot file version 226 created 14-MAY-2010 15:18:18

J0209+13 EO007.UVDATA.1

Freq = 4.9270 GHz, Bw = 16.000 MH No calibration applied and no bandpass applied

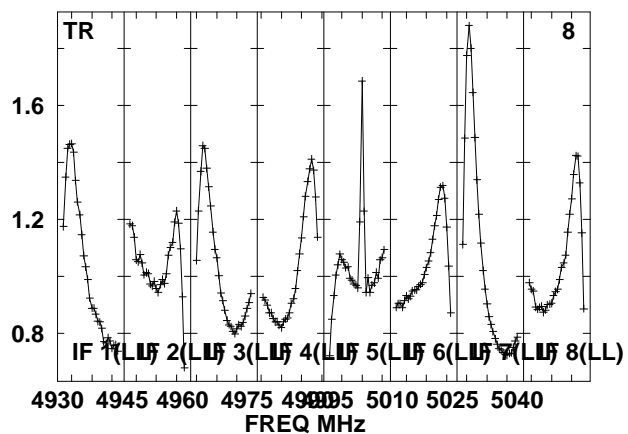
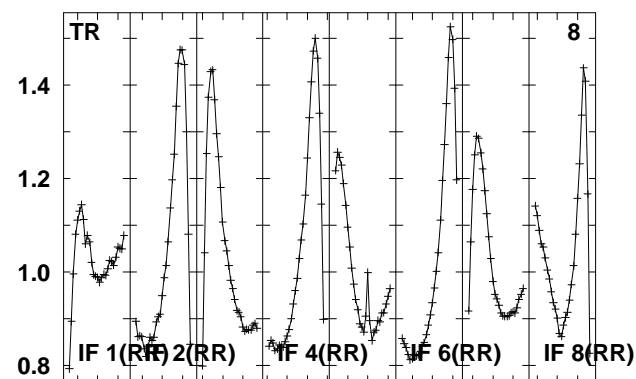
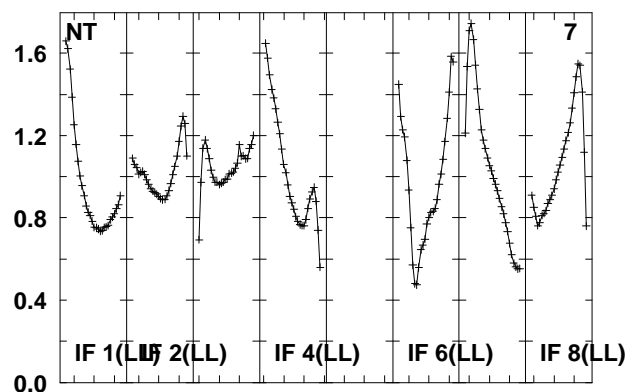
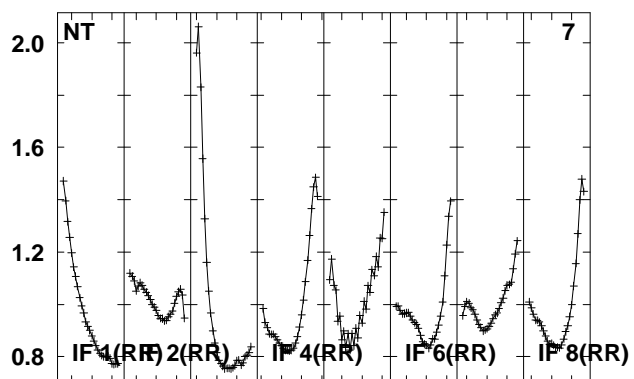
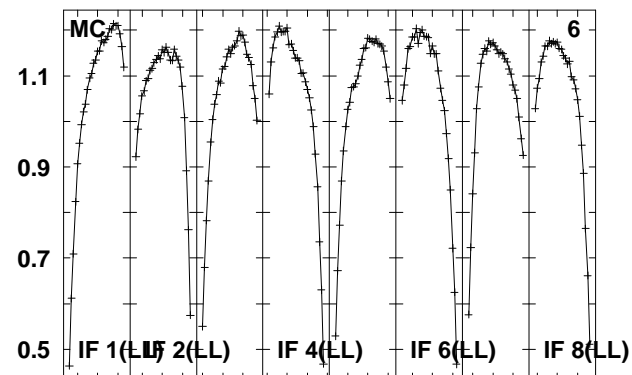
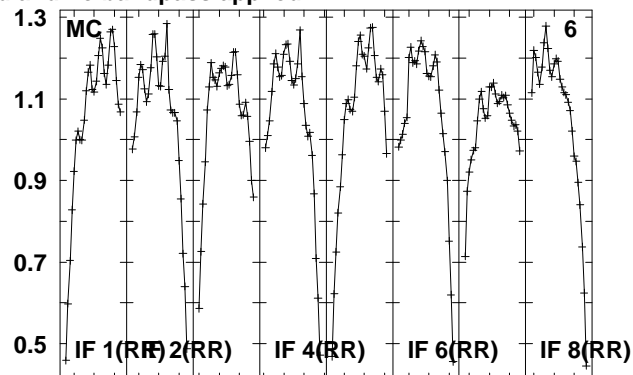
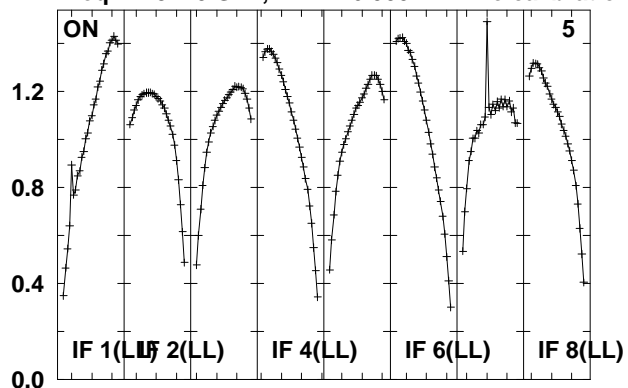

Lower frame: Real Jy

Total-power spectrum Antenna: *

Timerange: 00/09:16:16 to 00/09:17:42

Plot file version 227 created 14-MAY-2010 15:18:18
 J021348 EO007.UVDATA.1
 Freq = 4.9270 GHz, Bw = 16.000 MH No calibration applied and no bandpass applied

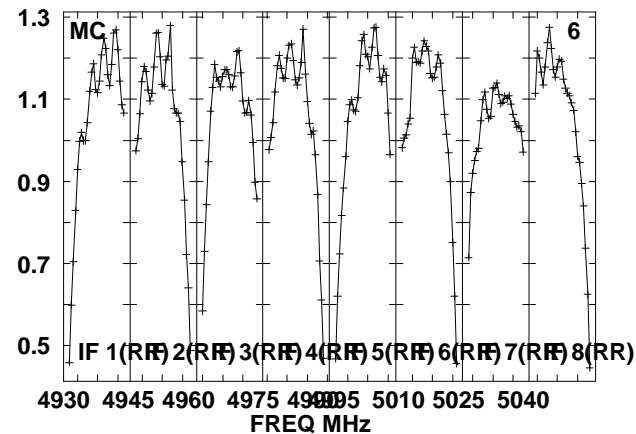
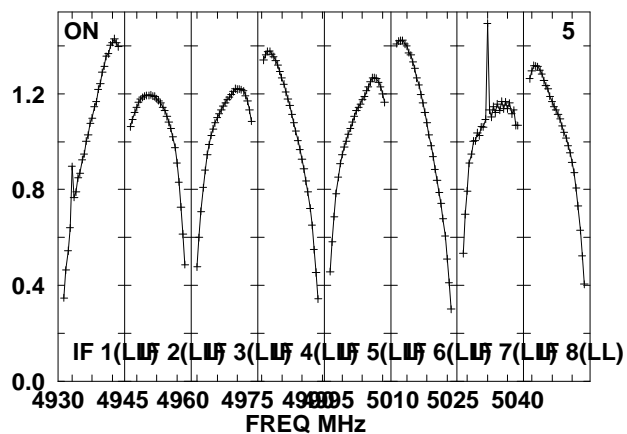
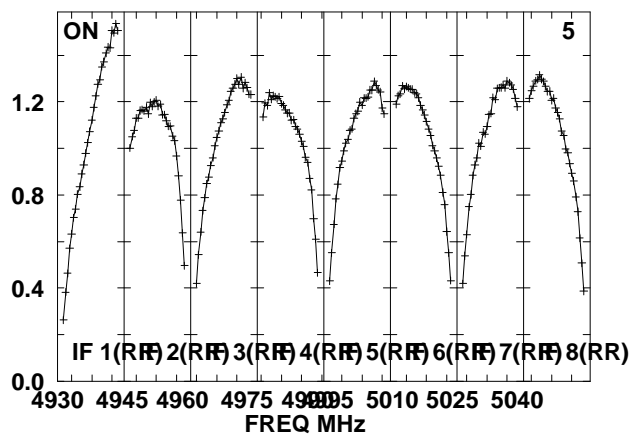
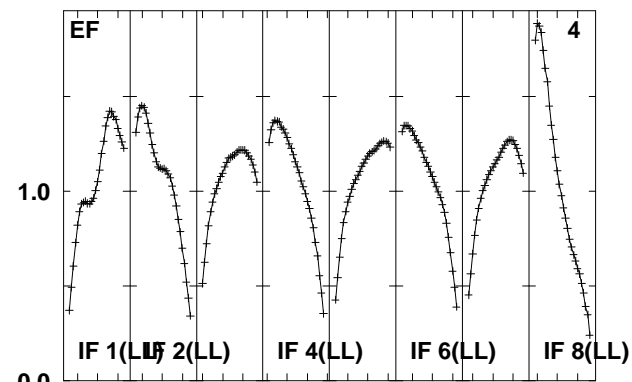
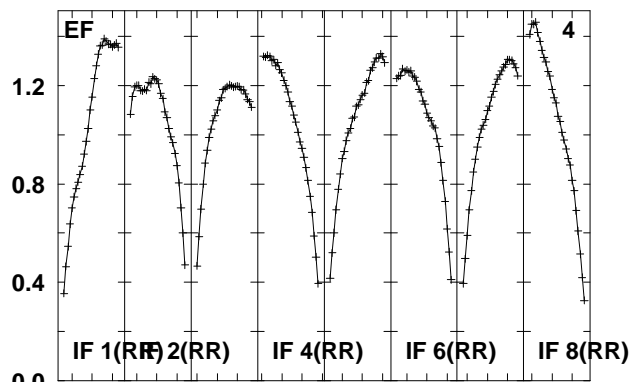
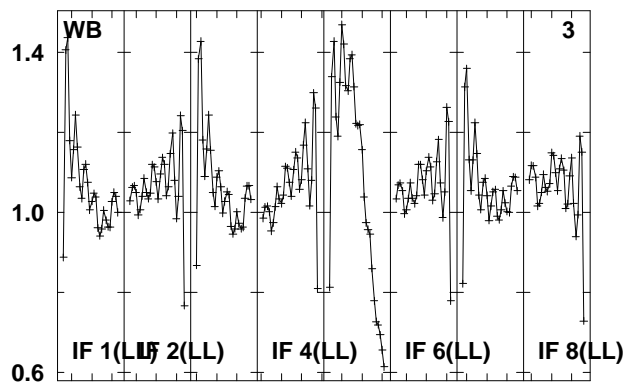
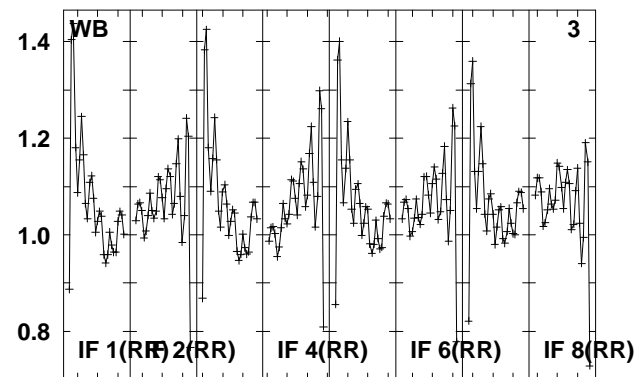
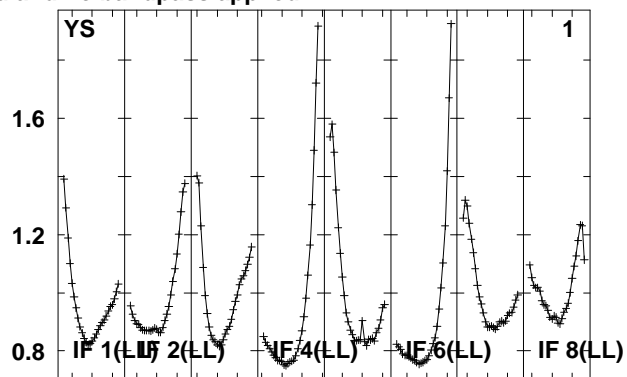
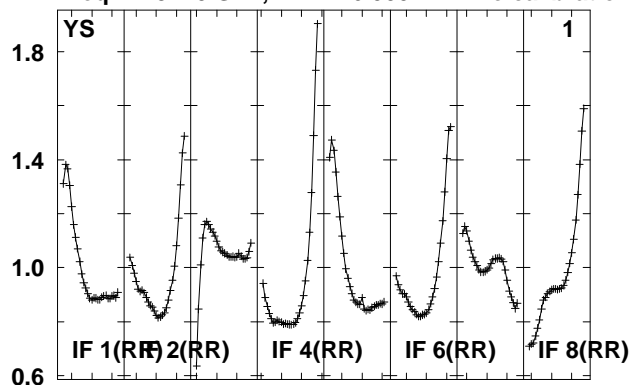

Lower frame: Real Jy
 Total-power spectrum Antenna: *
 Timerange: 00/09:18:10 to 00/09:23:08

Plot file version 228 created 14-MAY-2010 15:18:19

J021348 EO007.UVDATA.1

Freq = 4.9270 GHz, Bw = 16.000 MH No calibration applied and no bandpass applied

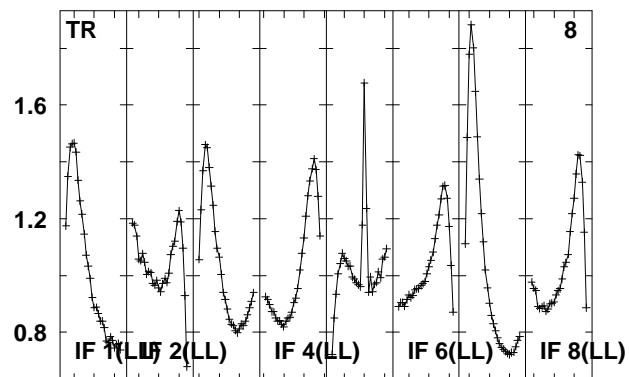
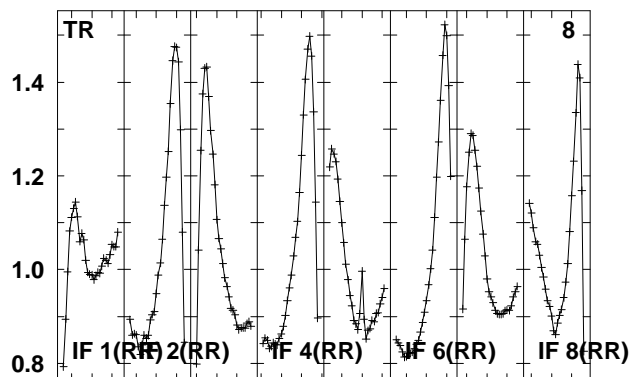
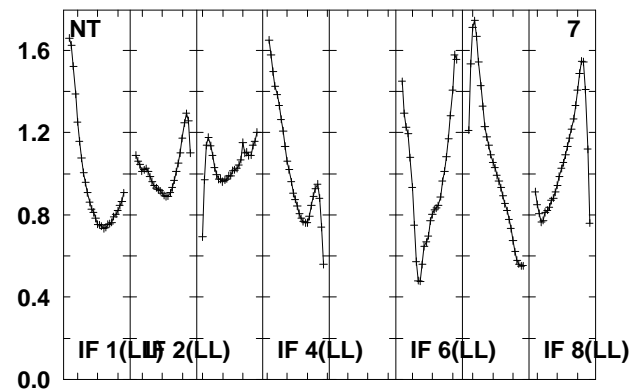
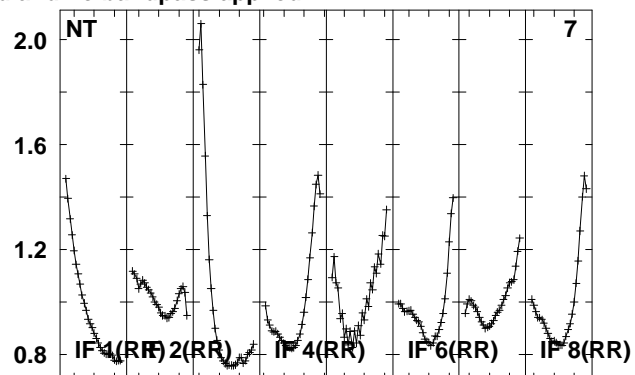
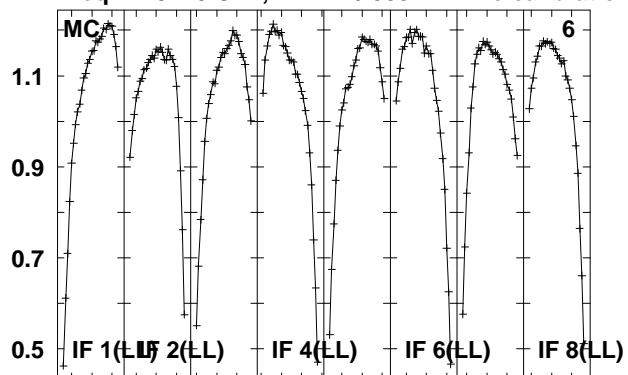

Lower frame: Real Jy
Total-power spectrum Antenna: *
Timerange: 00/09:18:10 to 00/09:23:08

Plot file version 229 created 14-MAY-2010 15:18:19

J0209+13 EO007.UVDATA.1

Freq = 4.9270 GHz, Bw = 16.000 MH No calibration applied and no bandpass applied

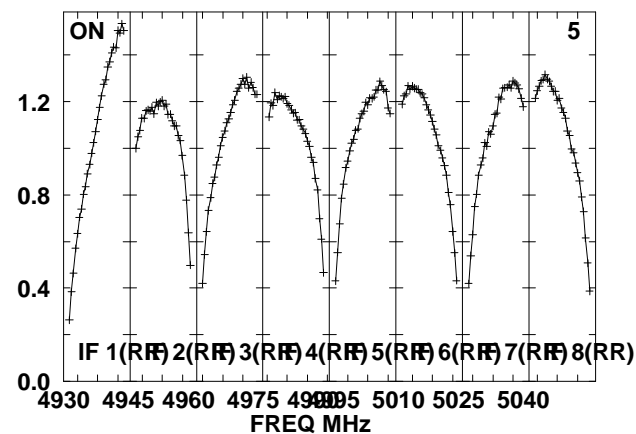
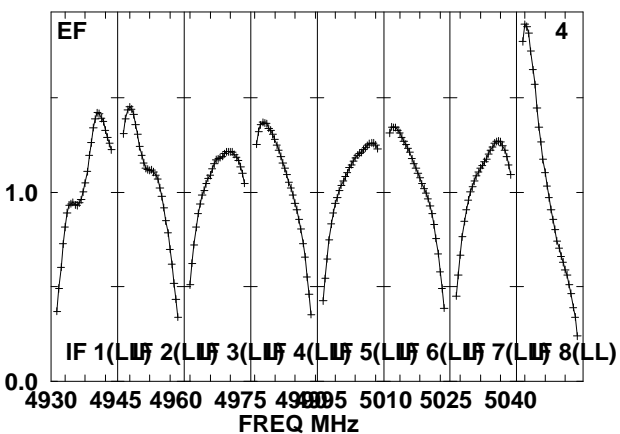
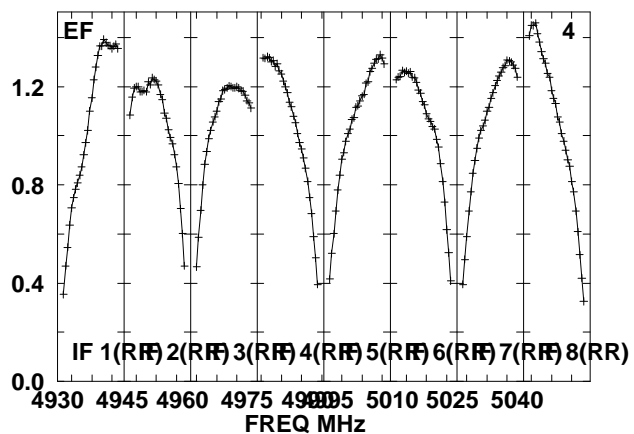
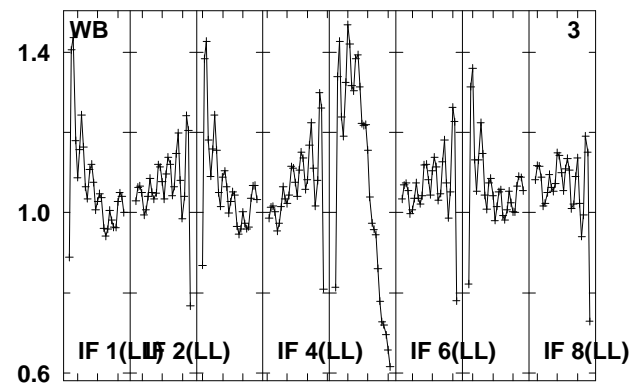
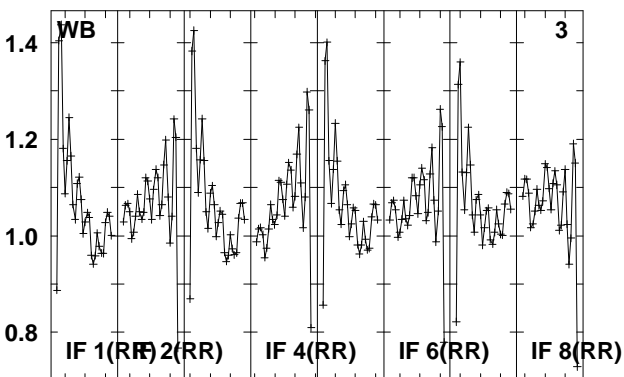
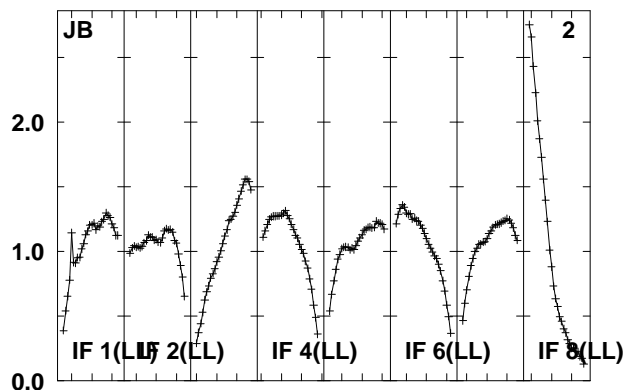
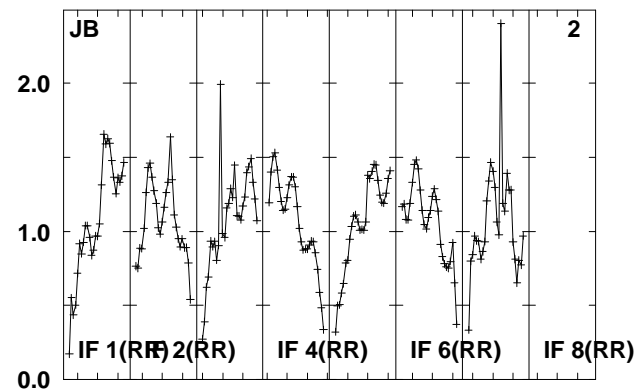
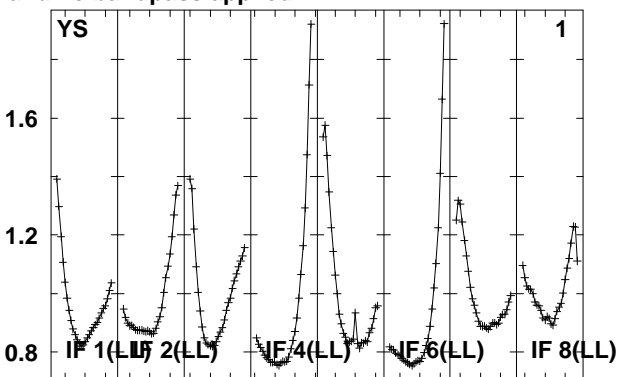
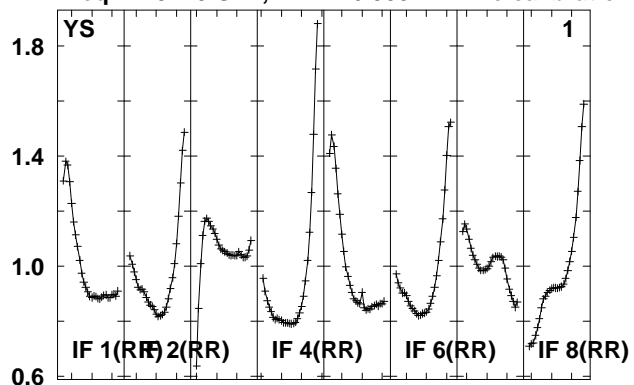

Lower frame: Real Jy
Total-power spectrum Antenna: *
Timerange: 00/09:23:36 to 00/09:25:04

Plot file version 230 created 14-MAY-2010 15:18:19

J0209+13 EO007.UVDATA.1

Freq = 4.9270 GHz, Bw = 16.000 MH No calibration applied and no bandpass applied

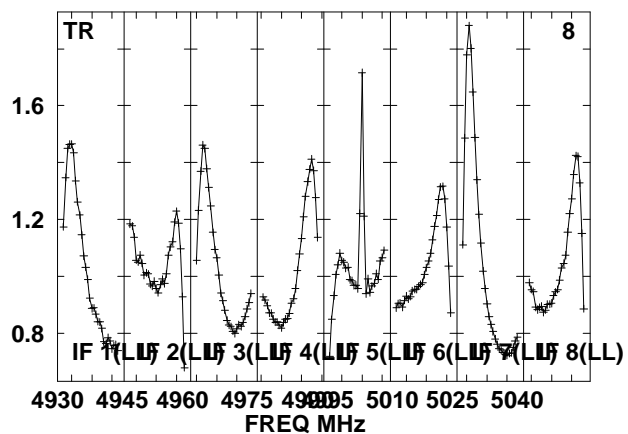
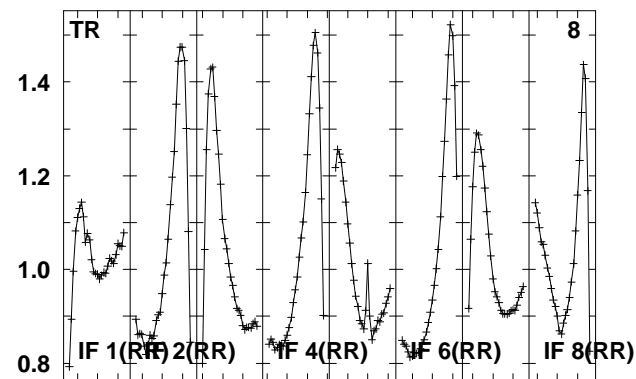
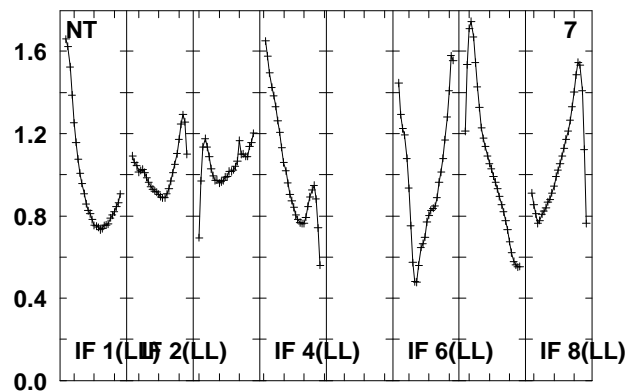
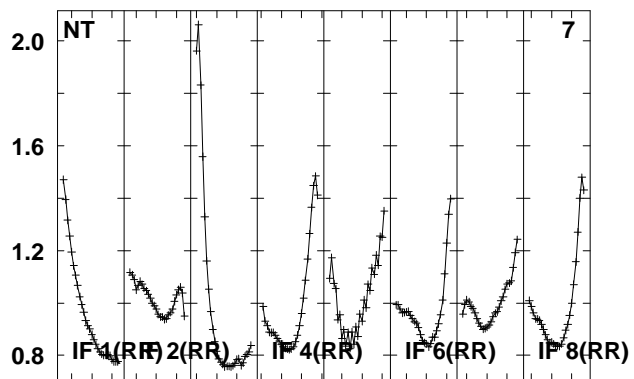
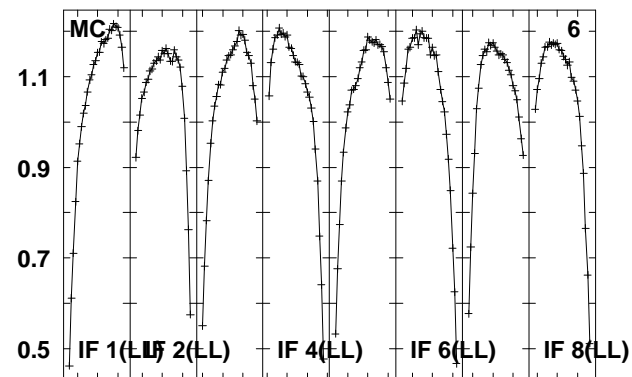
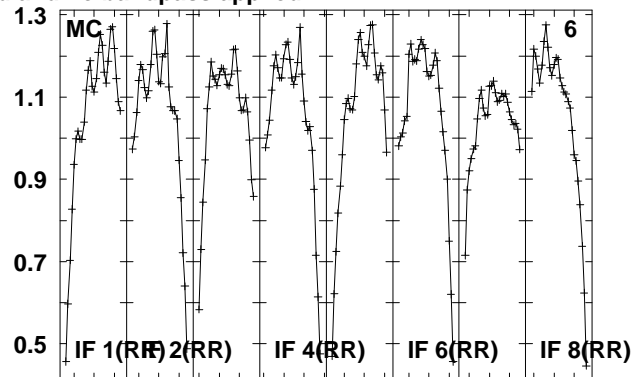
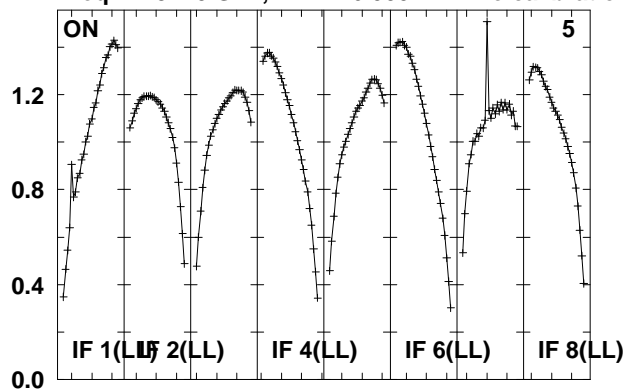

Lower frame: Real Jy

Total-power spectrum Antenna: *

Timerange: 00/09:23:36 to 00/09:25:04

Plot file version 231 created 14-MAY-2010 15:18:19

J0158+13 EO007.UVDATA.1

Freq = 4.9270 GHz, Bw = 16.000 MH No calibration applied and no bandpass applied

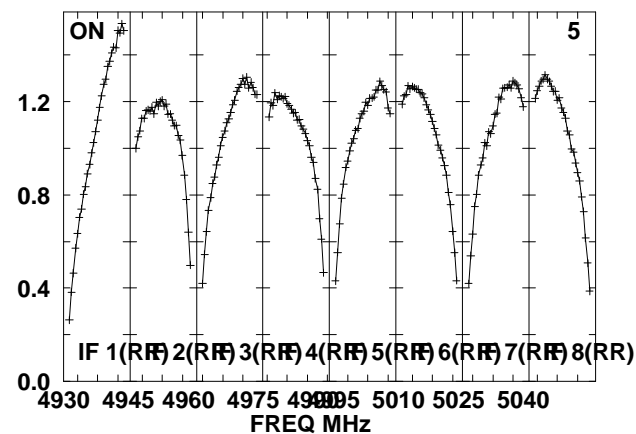
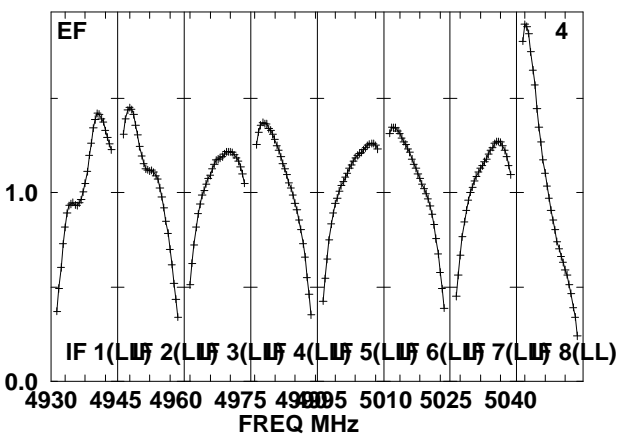
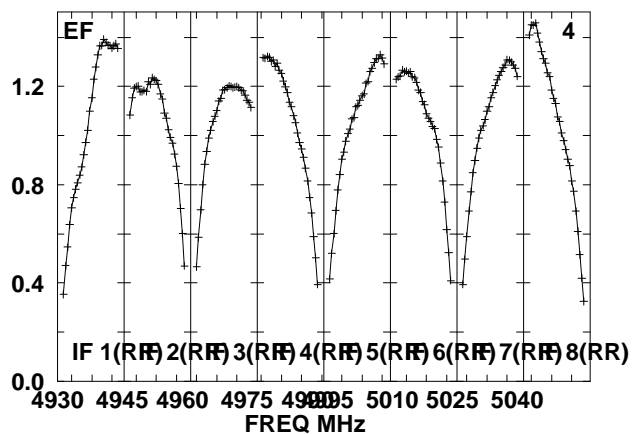
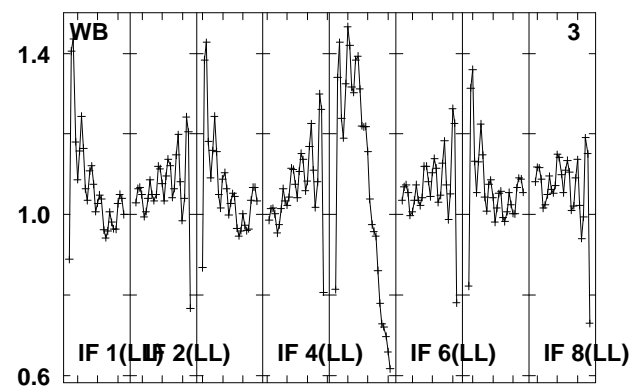
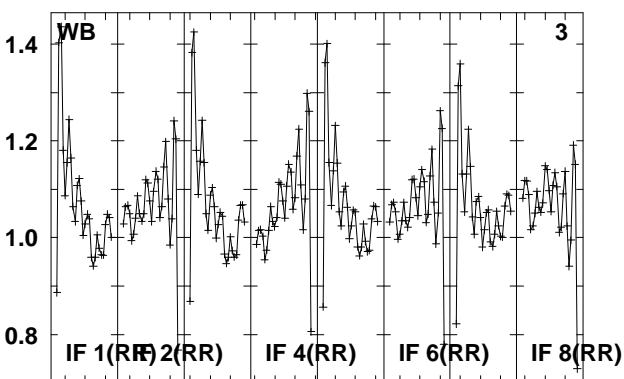
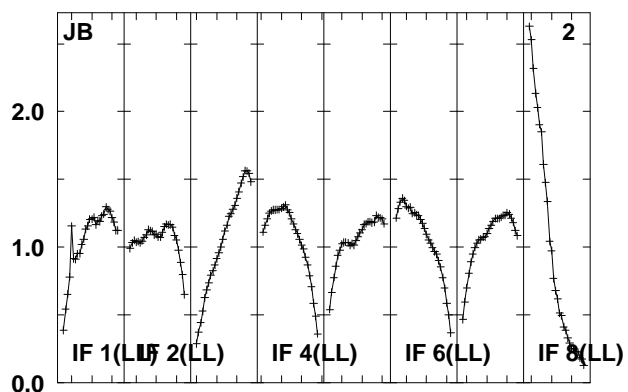
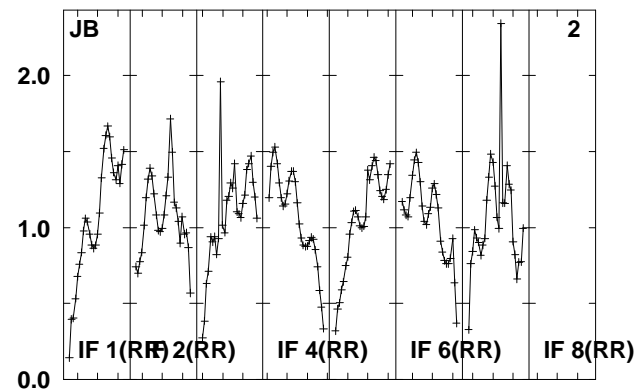
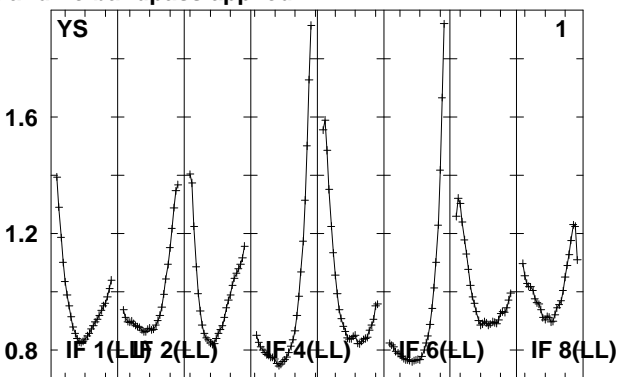
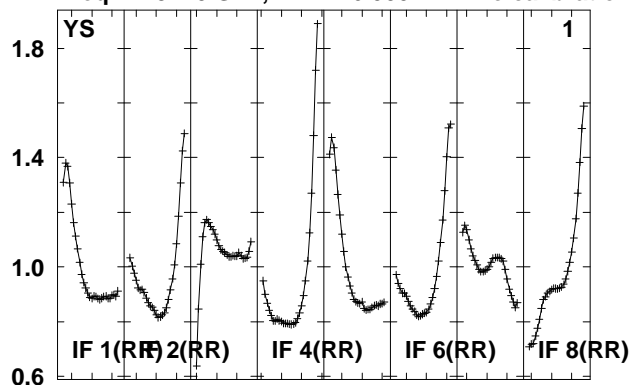

Lower frame: Real Jy

Total-power spectrum Antenna: *

Timerange: 00/09:25:40 to 00/09:27:06

Plot file version 232 created 14-MAY-2010 15:18:20

J0158+13 EO007.UVDATA.1

Freq = 4.9270 GHz, Bw = 16.000 MH No calibration applied and no bandpass applied

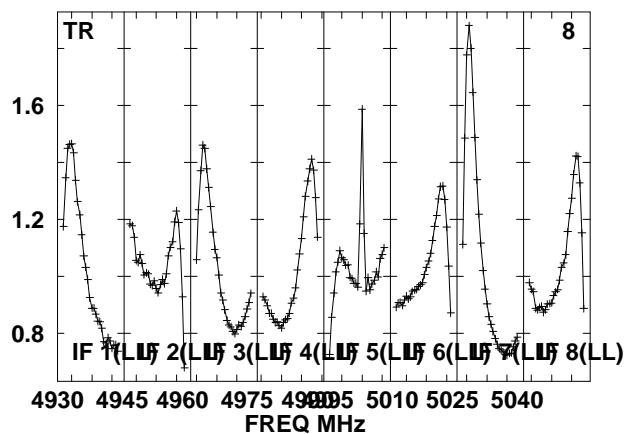
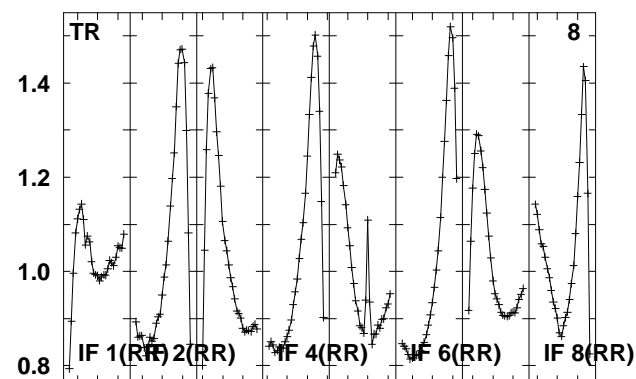
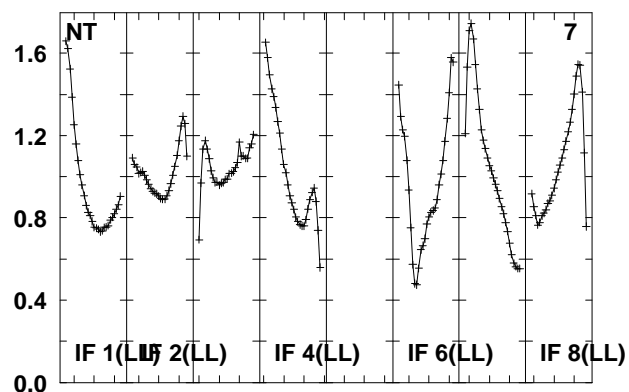
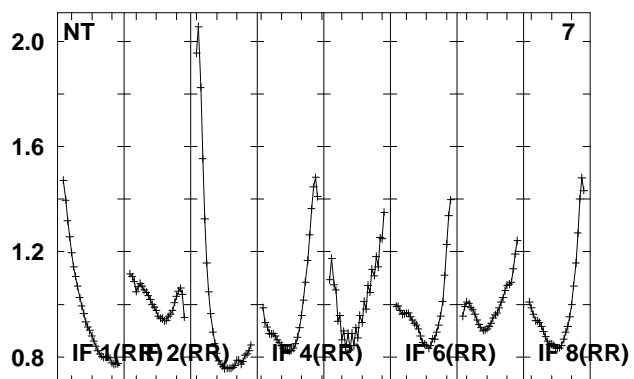
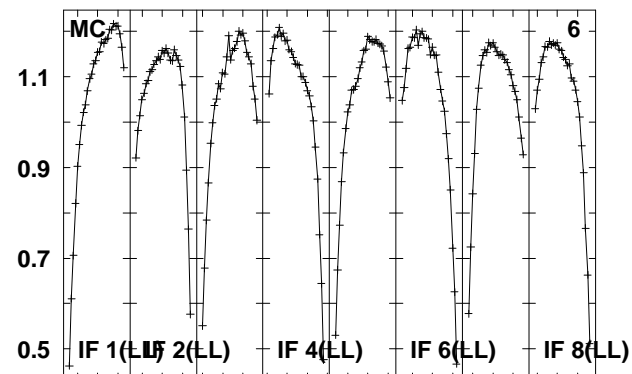
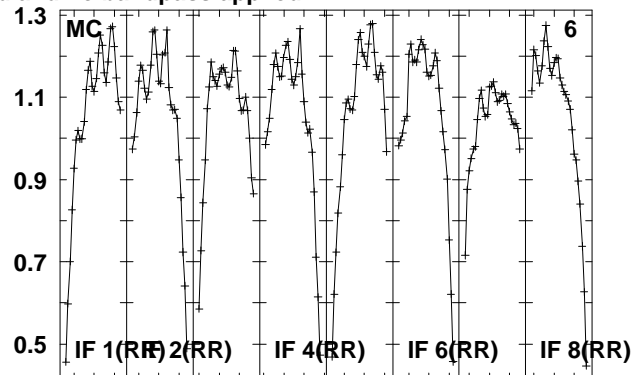
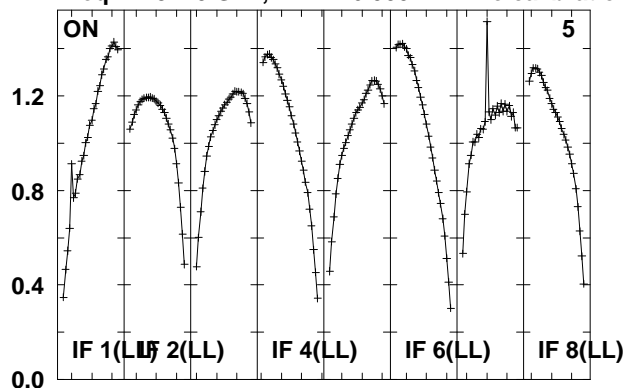

Lower frame: Real Jy

Total-power spectrum Antenna: *

Timerange: 00/09:25:40 to 00/09:27:06

Plot file version 233 created 14-MAY-2010 15:18:20
 J015028 EO007.UVDATA.1
 Freq = 4.9270 GHz, Bw = 16.000 MH No calibration applied and no bandpass applied

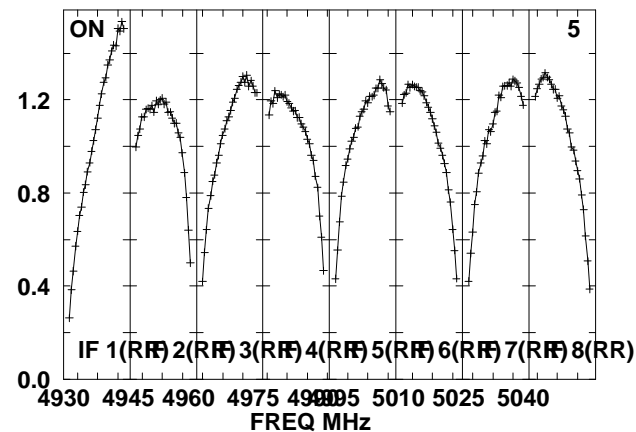
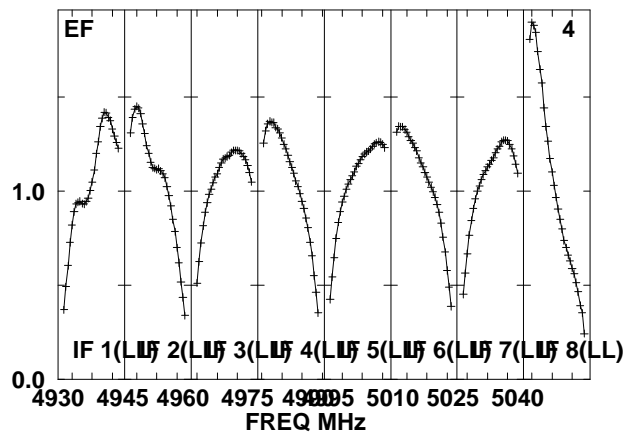
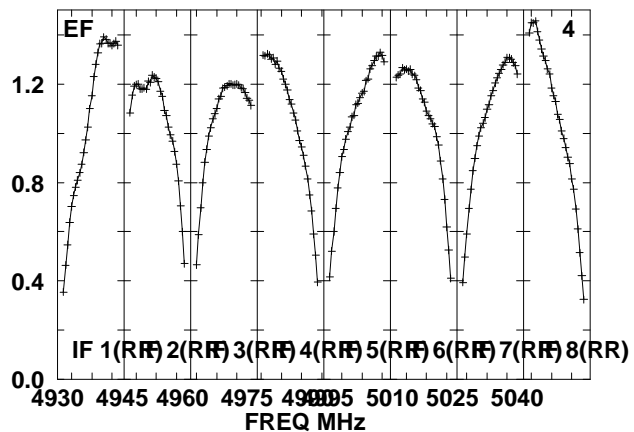
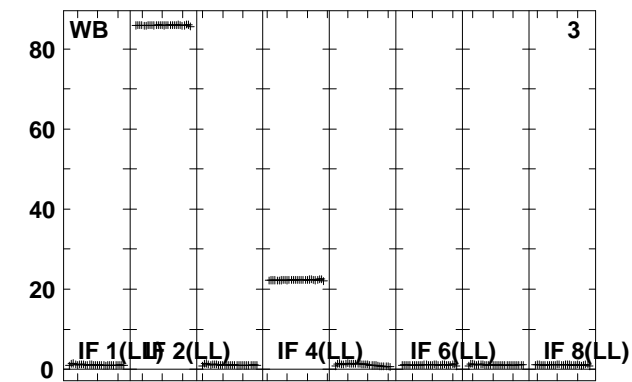
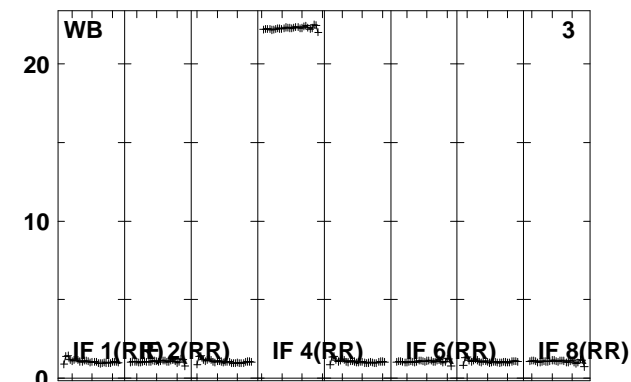
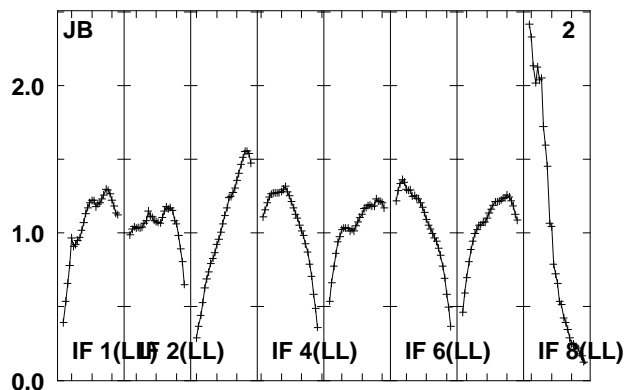
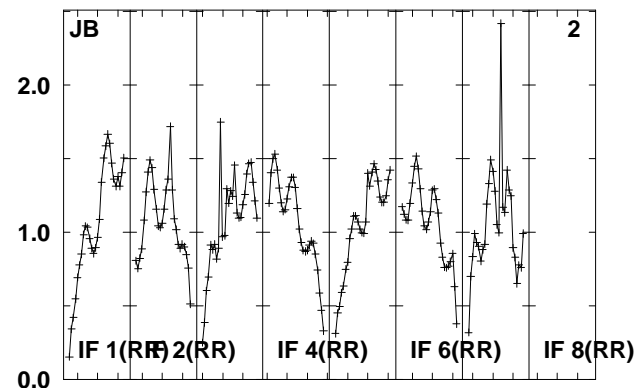
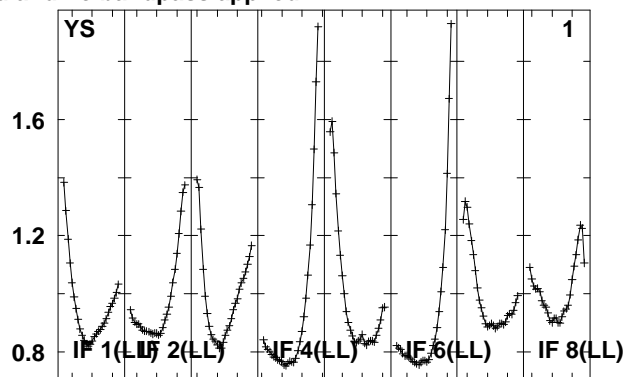
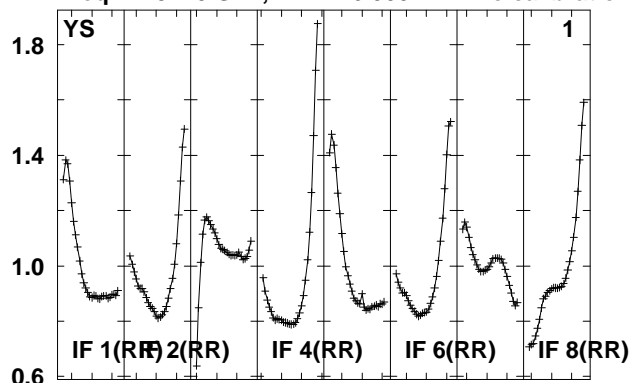

Lower frame: Real Jy
 Total-power spectrum Antenna: *
 Timerange: 00/09:27:38 to 00/09:32:34

Plot file version 234 created 14-MAY-2010 15:18:20

J015028 EO007.UVDATA.1

Freq = 4.9270 GHz, Bw = 16.000 MH No calibration applied and no bandpass applied

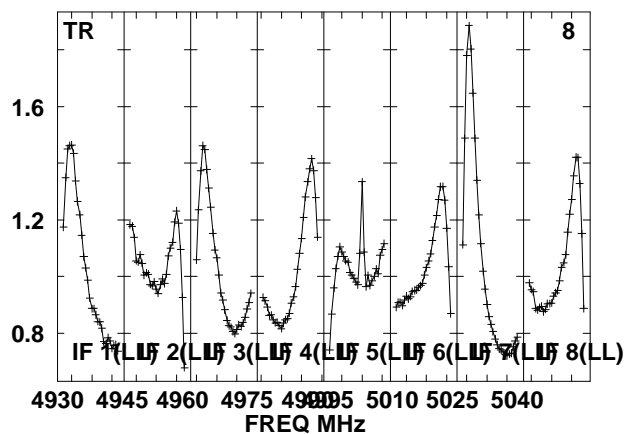
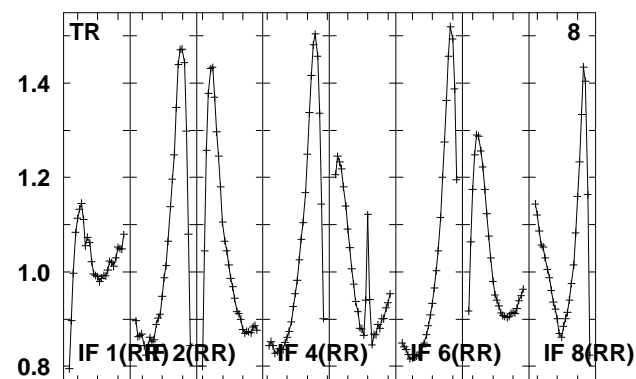
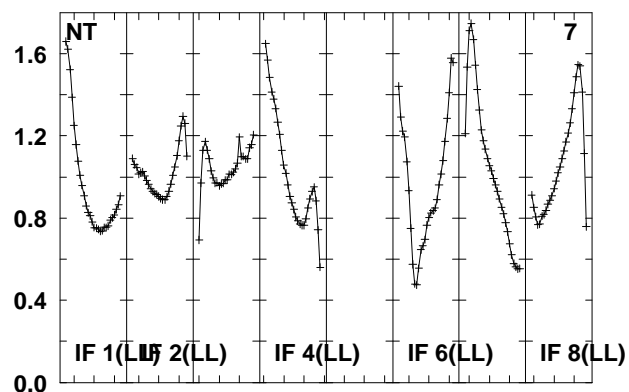
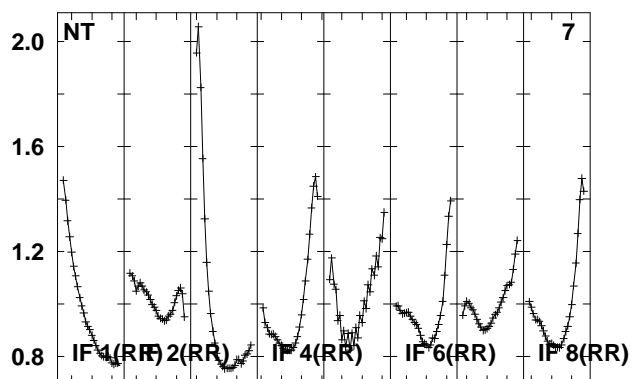
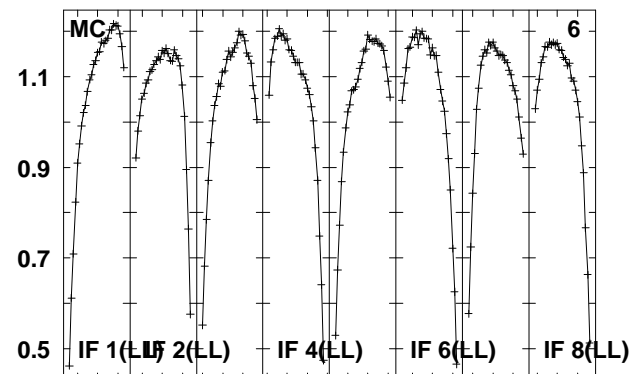
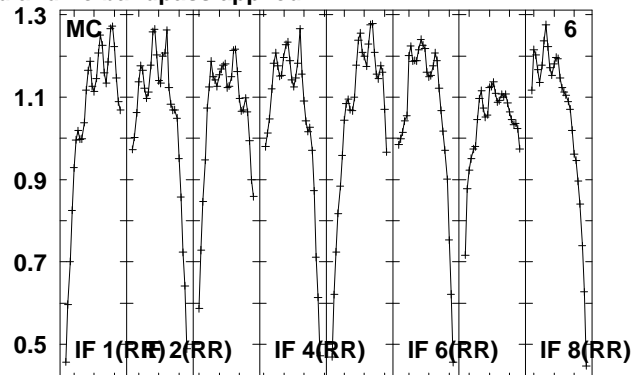
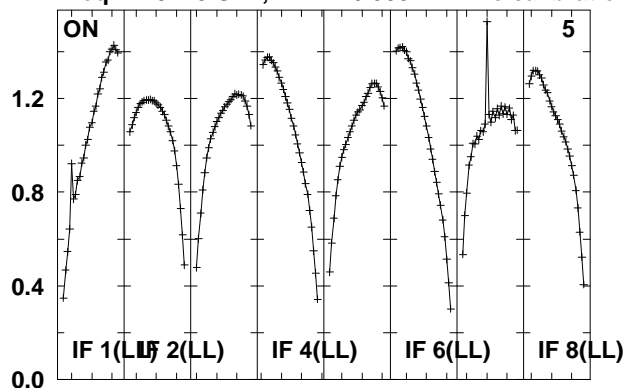

Lower frame: Real Jy

Total-power spectrum Antenna: *

Timerange: 00/09:27:38 to 00/09:32:34

Plot file version 235 created 14-MAY-2010 15:18:21

J0158+13 EO007.UVDATA.1

Freq = 4.9270 GHz, Bw = 16.000 MH No calibration applied and no bandpass applied

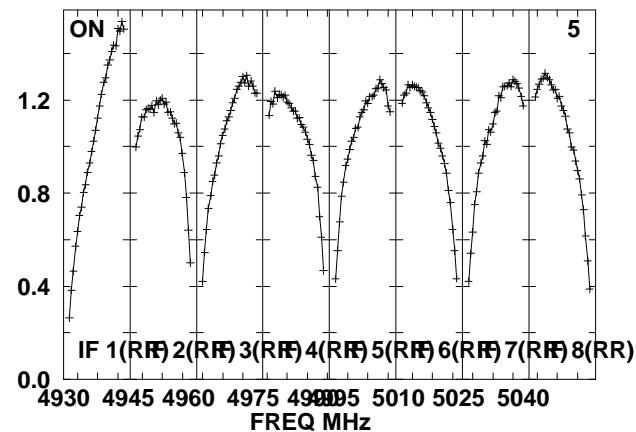
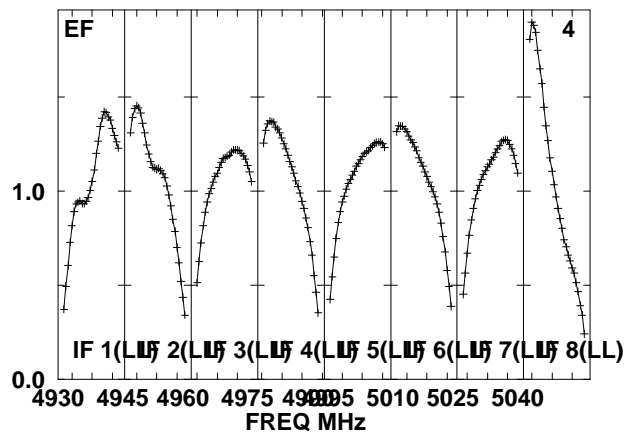
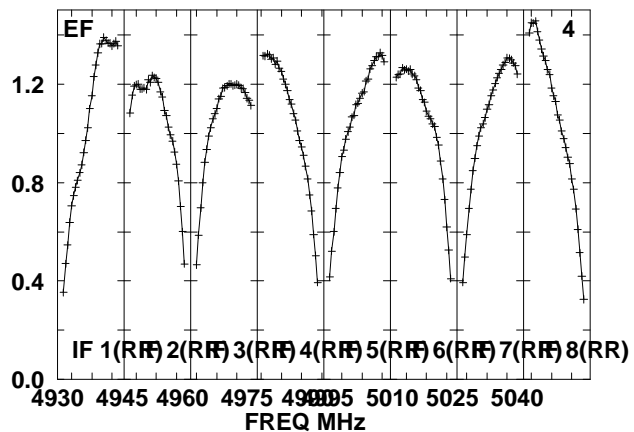
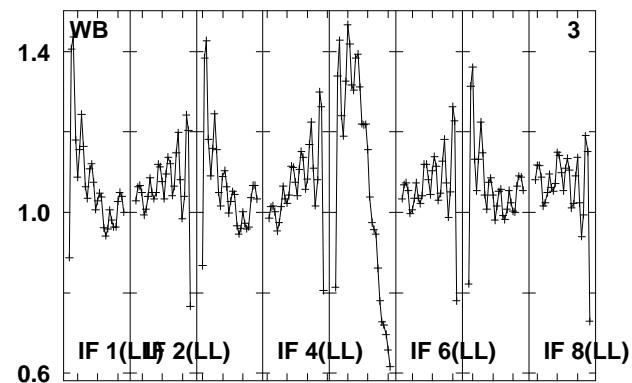
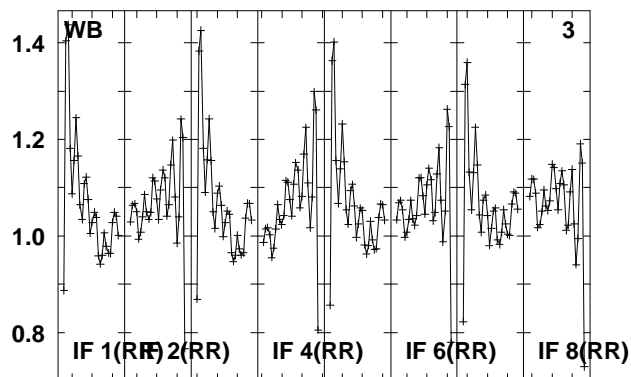
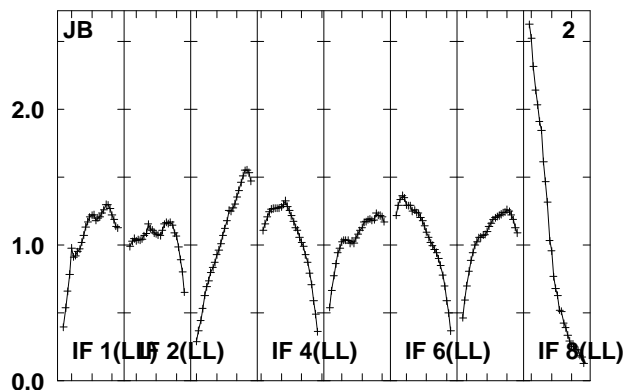
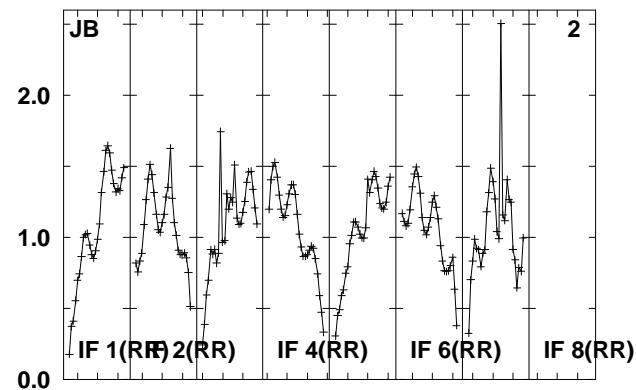
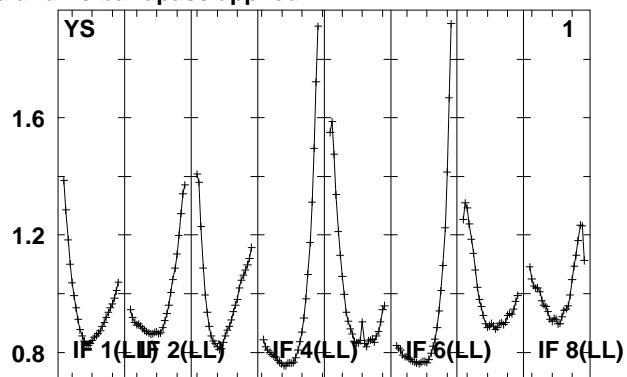
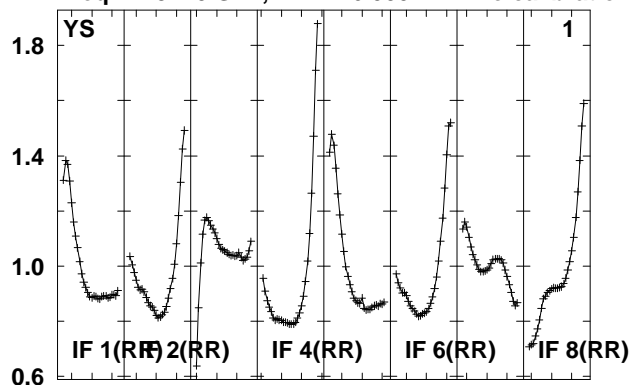

Lower frame: Real Jy

Total-power spectrum Antenna: *

Timerange: 00/09:33:04 to 00/09:34:32

Plot file version 236 created 14-MAY-2010 15:18:21

J0158+13 EO007.UVDATA.1

Freq = 4.9270 GHz, Bw = 16.000 MH No calibration applied and no bandpass applied

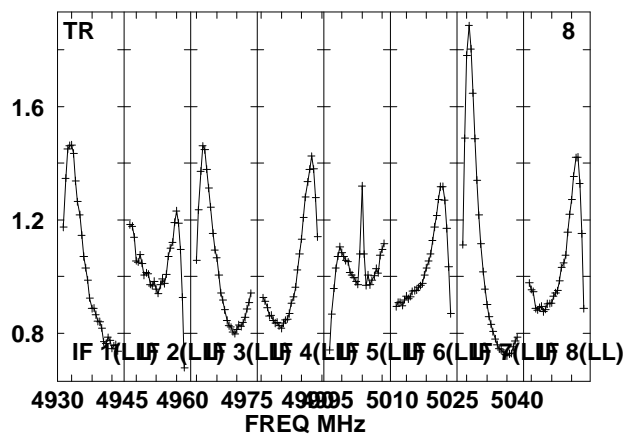
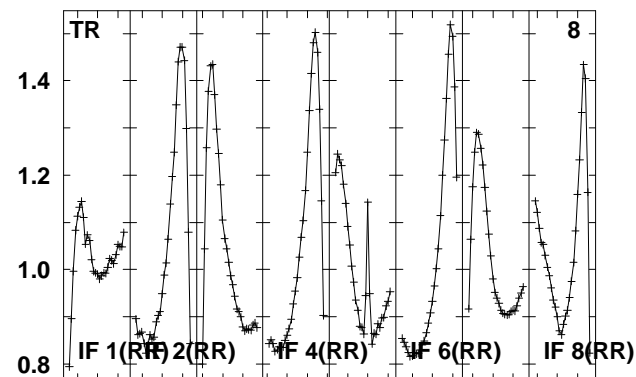
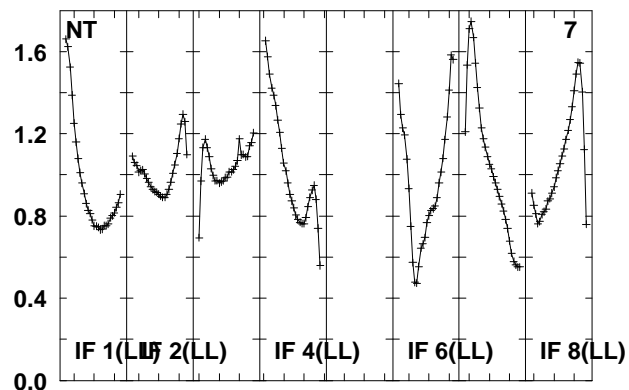
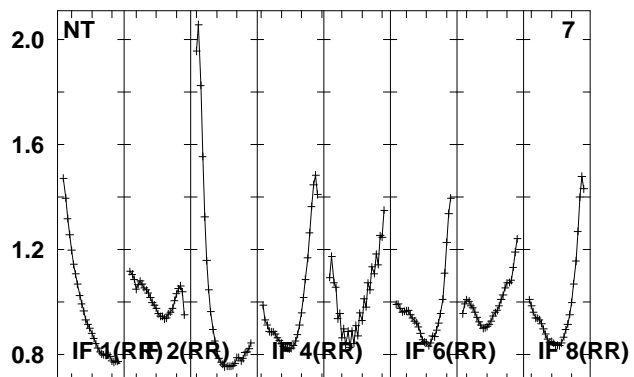
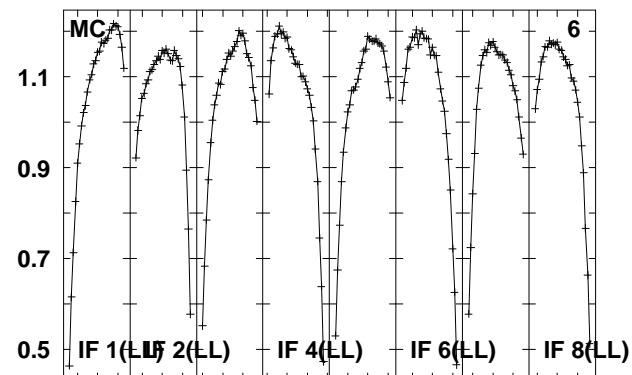
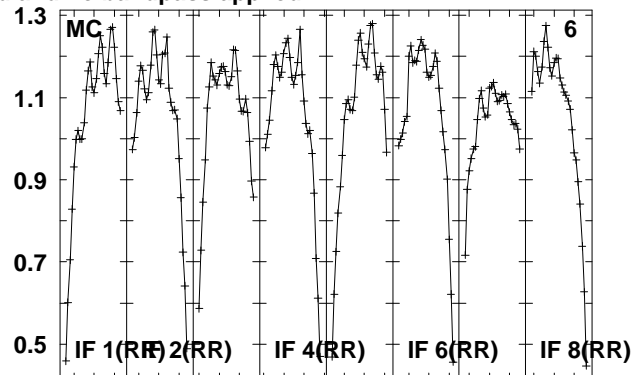
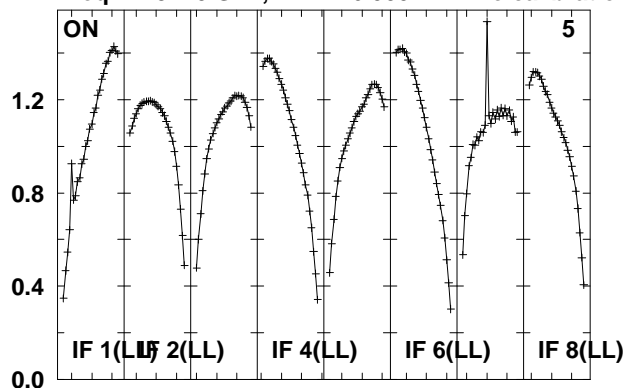

Lower frame: Real Jy

Total-power spectrum Antenna: *

Timerange: 00/09:33:04 to 00/09:34:32

Plot file version 237 created 14-MAY-2010 15:18:21
 J015028 EO007.UVDATA.1
 Freq = 4.9270 GHz, Bw = 16.000 MH No calibration applied and no bandpass applied

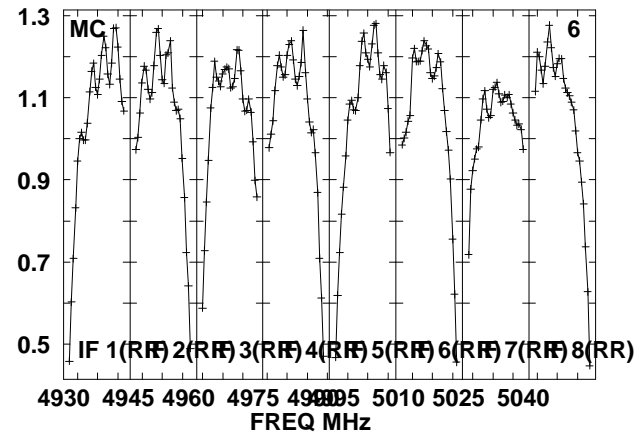
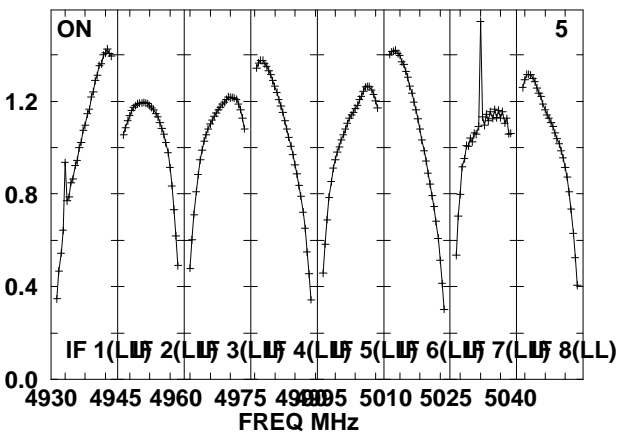
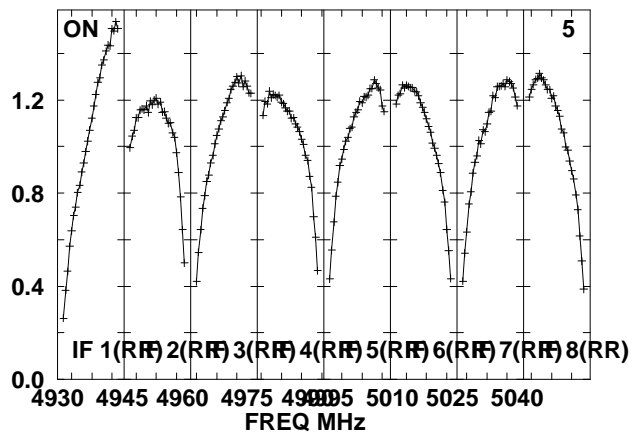
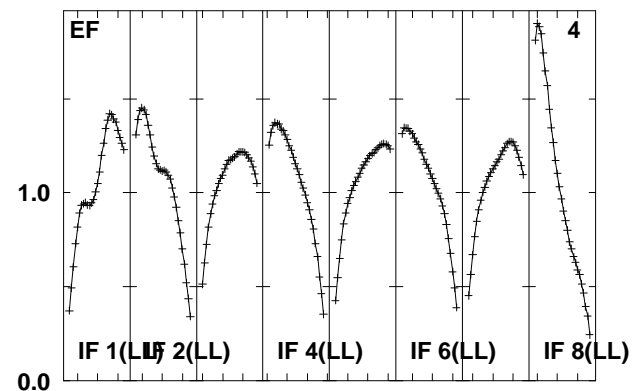
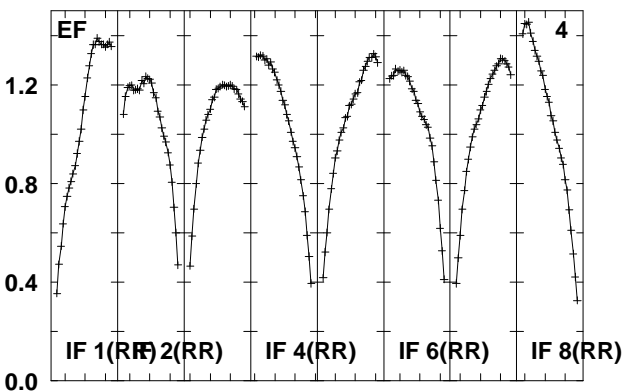
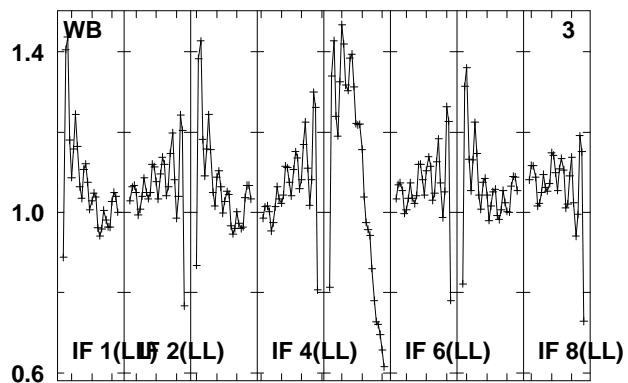
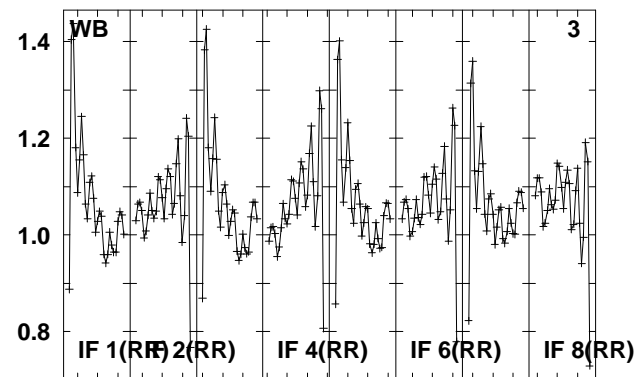
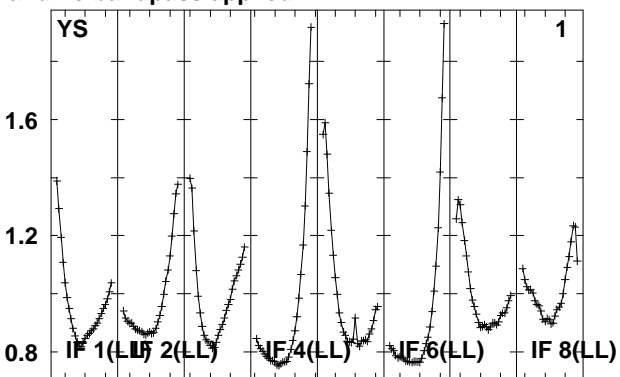
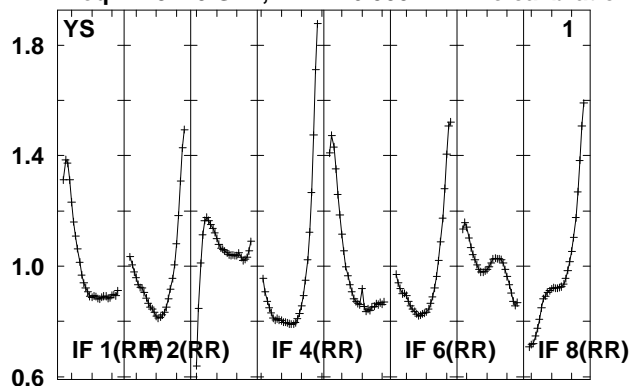

Lower frame: Real Jy
 Total-power spectrum Antenna: *
 Timerange: 00/09:35:02 to 00/09:40:00

Plot file version 238 created 14-MAY-2010 15:18:22

J015028 EO007.UVDATA.1

Freq = 4.9270 GHz, Bw = 16.000 MH No calibration applied and no bandpass applied

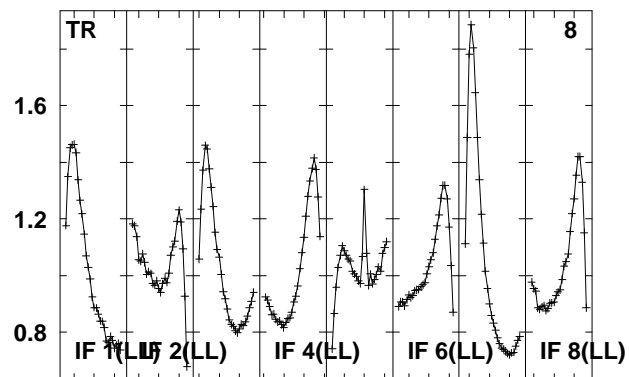
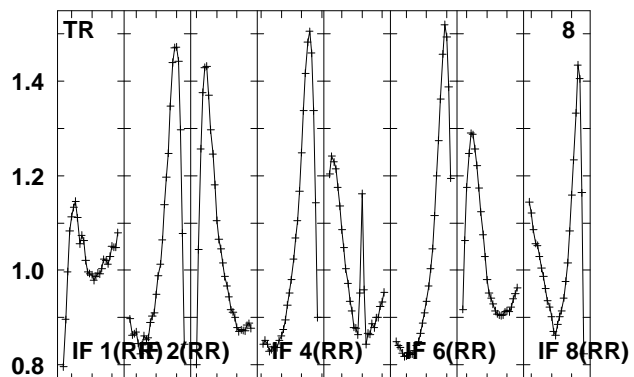
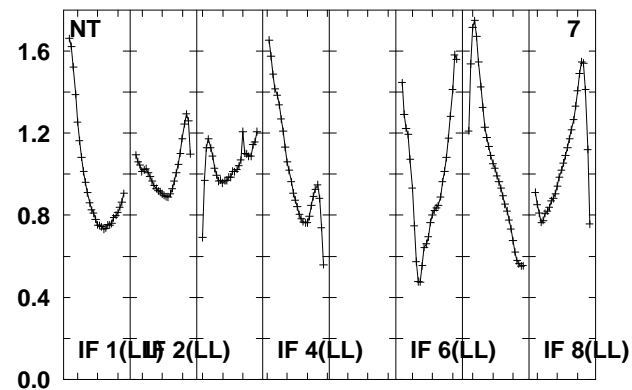
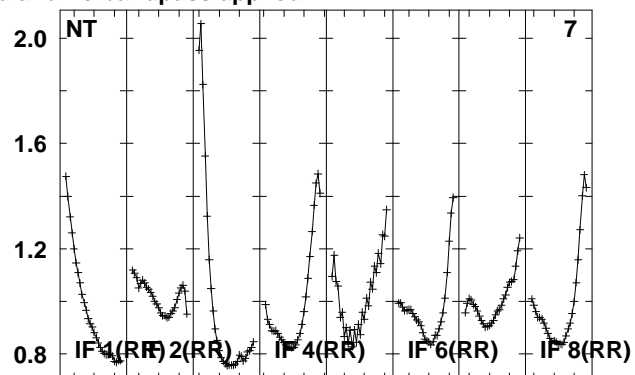
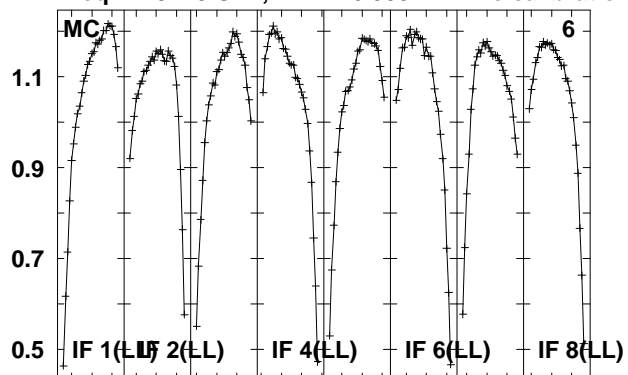

Lower frame: Real Jy
Total-power spectrum Antenna: *
Timerange: 00/09:35:02 to 00/09:40:00

Plot file version 239 created 14-MAY-2010 15:18:22
 J0158+13 EO007.UVDATA.1
 Freq = 4.9270 GHz, Bw = 16.000 MH No calibration applied and no bandpass applied

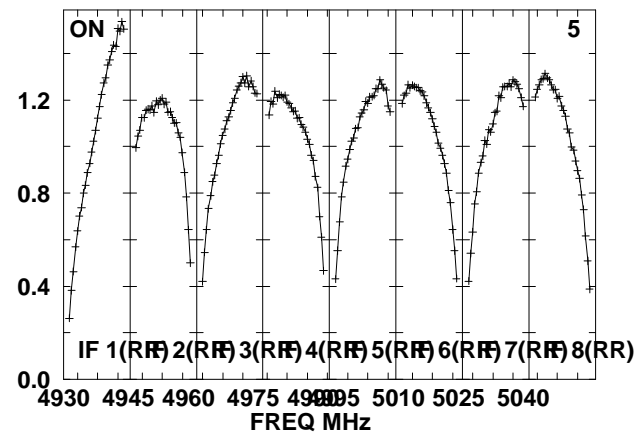
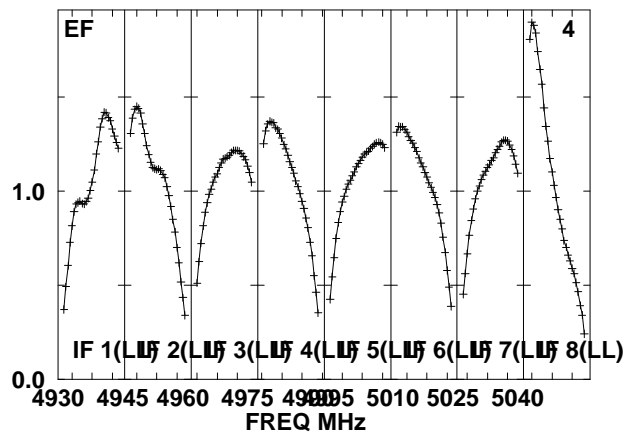
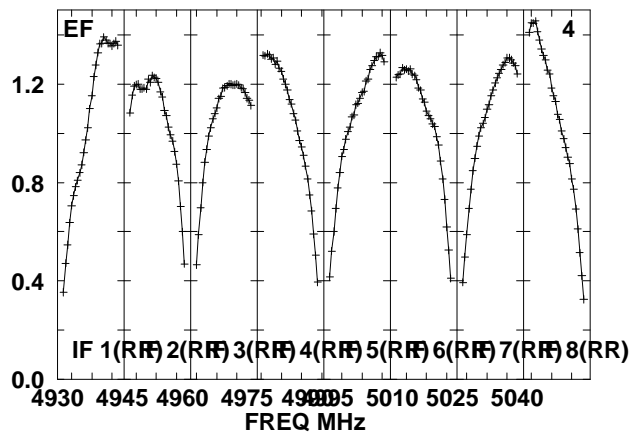
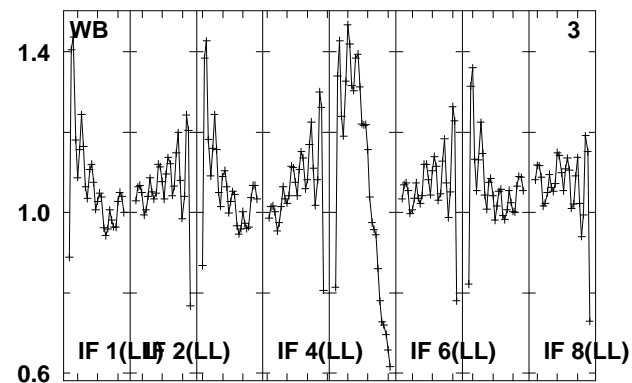
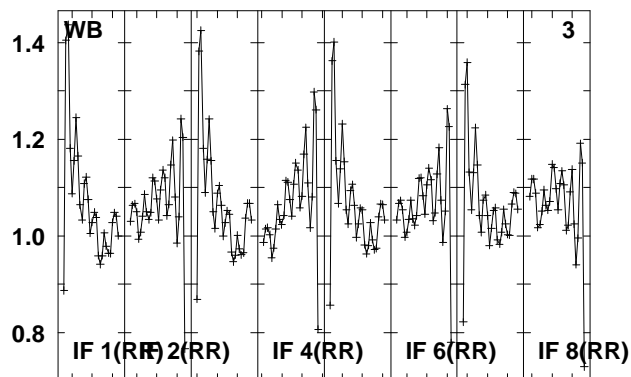
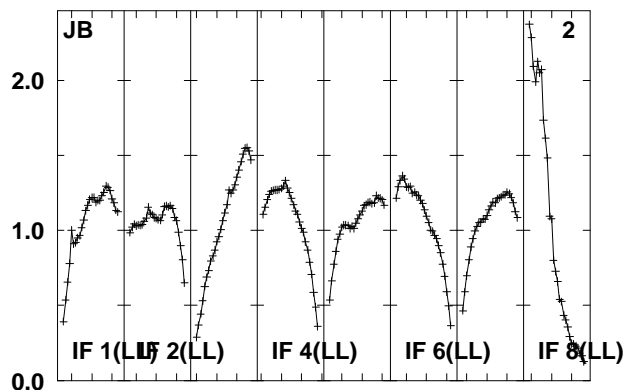
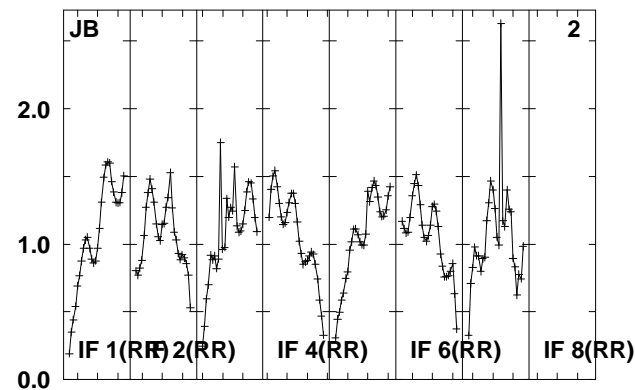
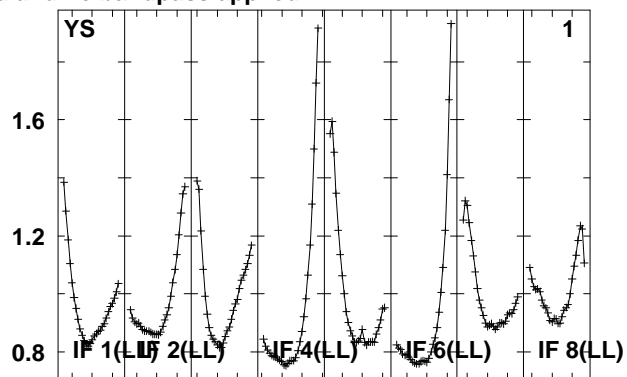
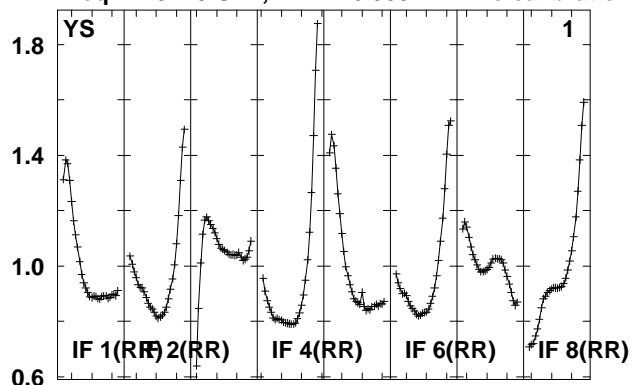

Lower frame: Real Jy
 Total-power spectrum Antenna: *
 Timerange: 00/09:40:30 to 00/09:41:58

Plot file version 240 created 14-MAY-2010 15:18:23

J0158+13 EO007.UVDATA.1

Freq = 4.9270 GHz, Bw = 16.000 MH No calibration applied and no bandpass applied

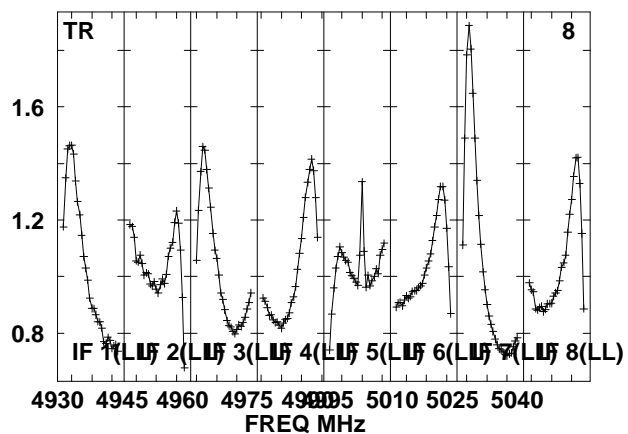
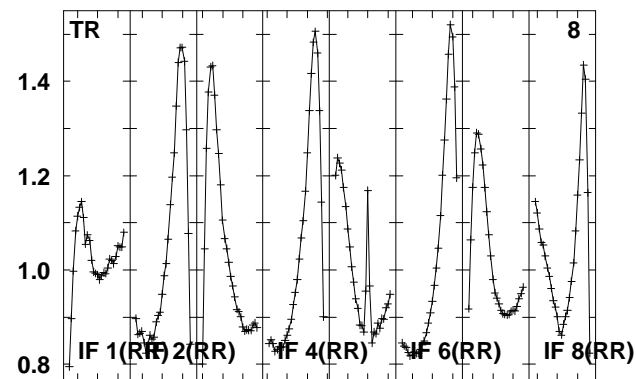
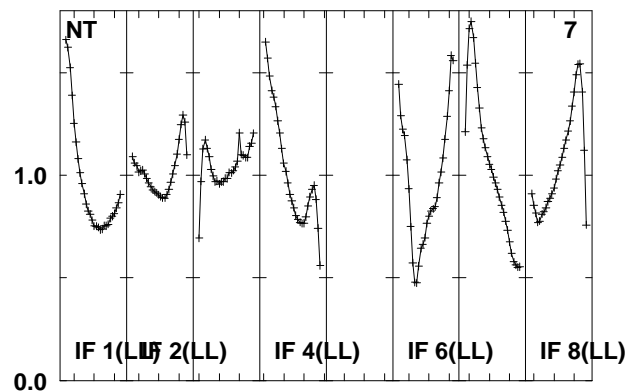
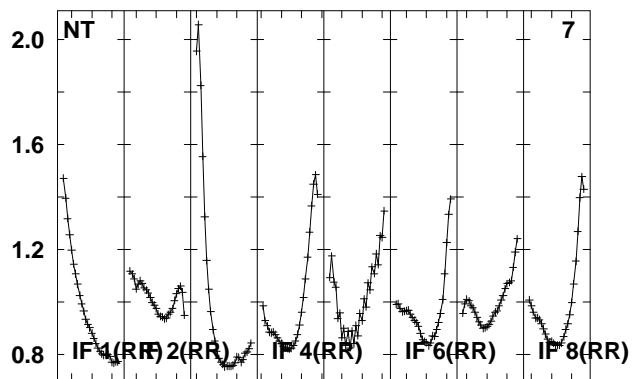
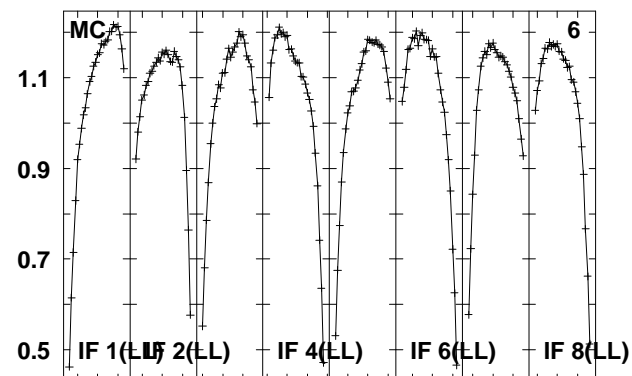
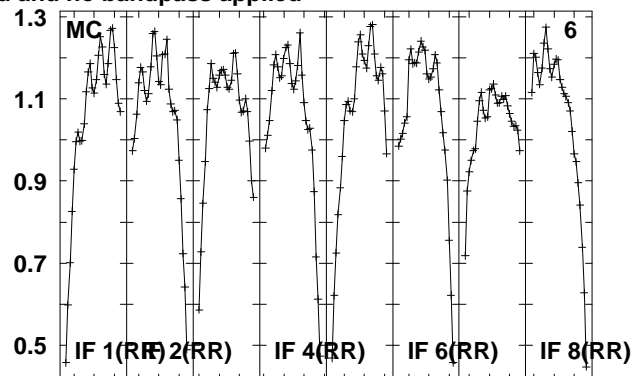
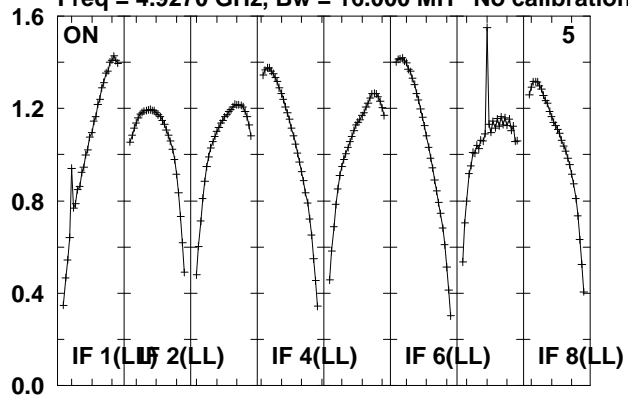

Lower frame: Real Jy

Total-power spectrum Antenna: *

Timerange: 00/09:40:30 to 00/09:41:58

Plot file version 241 created 14-MAY-2010 15:18:23

J0209+13 EO007.UVDATA.1

Freq = 4.9270 GHz, Bw = 16.000 MH No calibration applied and no bandpass applied

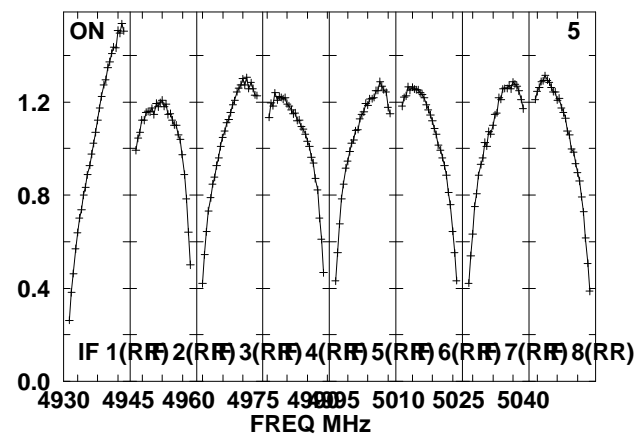
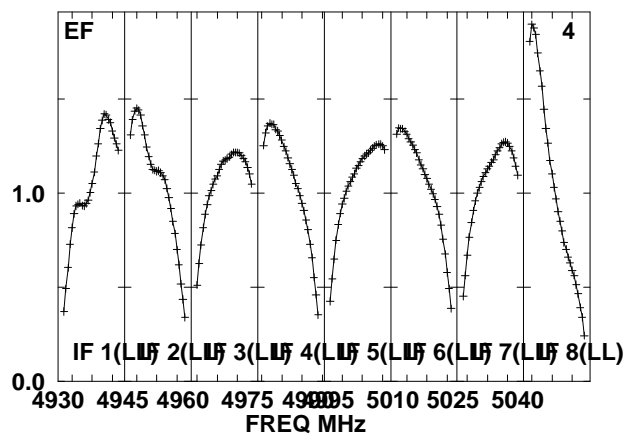
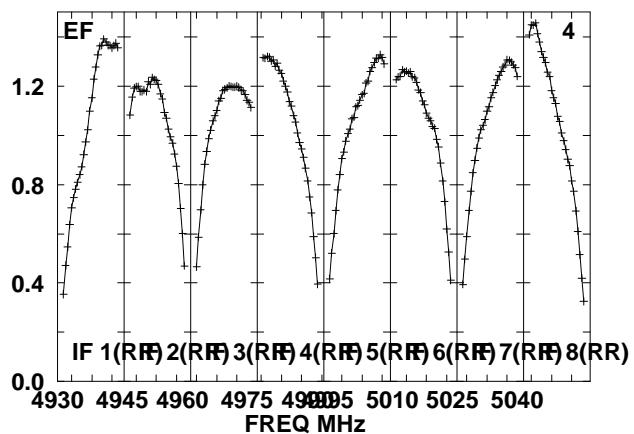
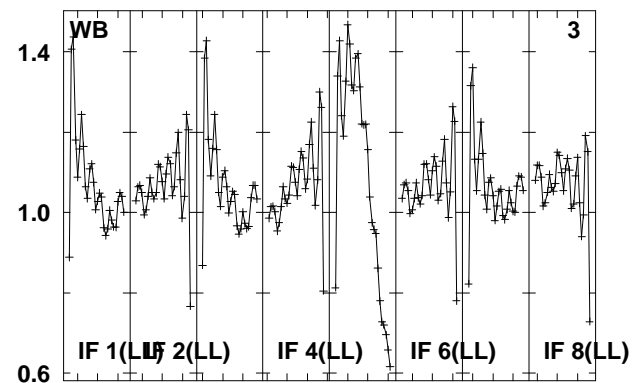
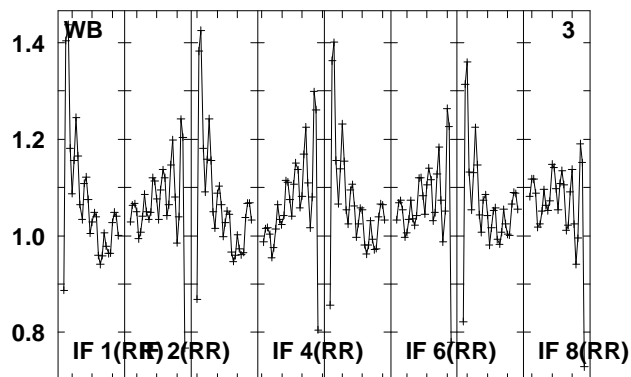
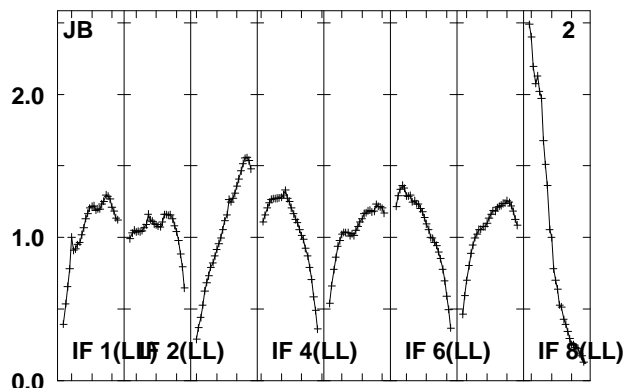
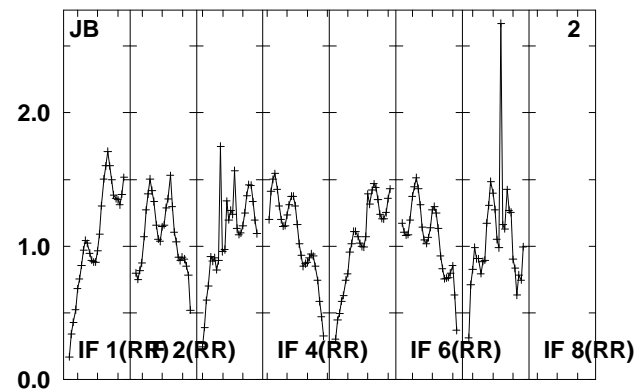
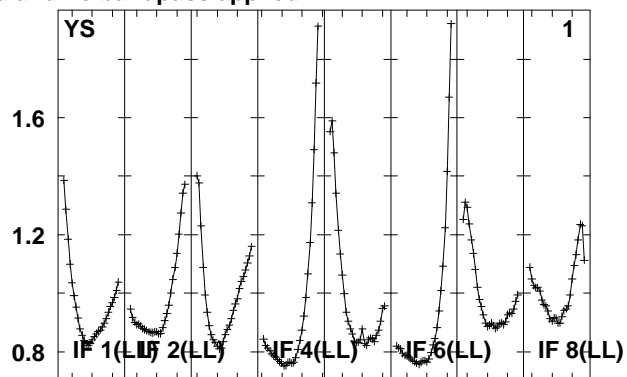
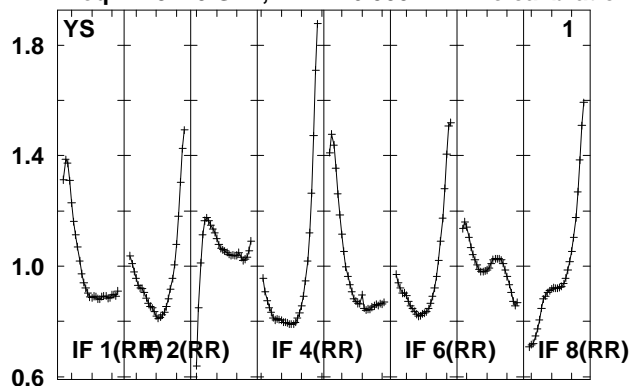

Lower frame: Real Jy
Total-power spectrum Antenna: *
Timerange: 00/09:42:32 to 00/09:44:00

Plot file version 242 created 14-MAY-2010 15:18:23

J0209+13 EO007.UVDATA.1

Freq = 4.9270 GHz, Bw = 16.000 MH No calibration applied and no bandpass applied

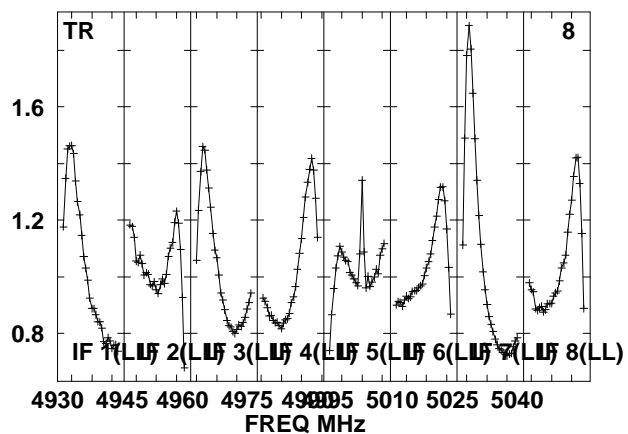
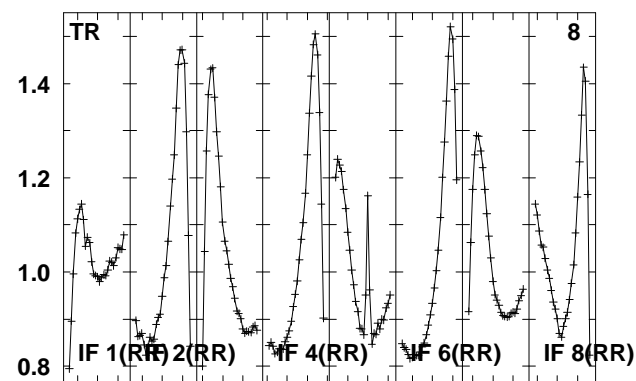
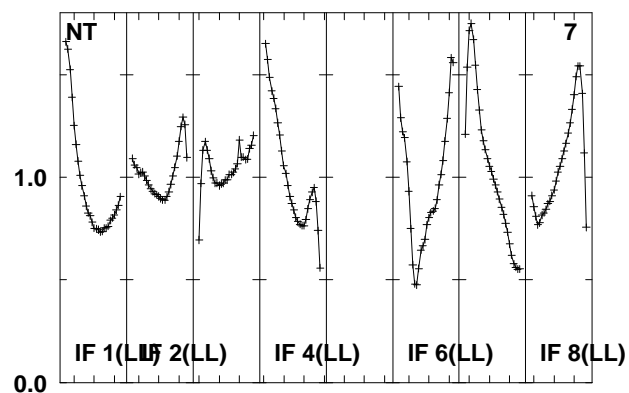
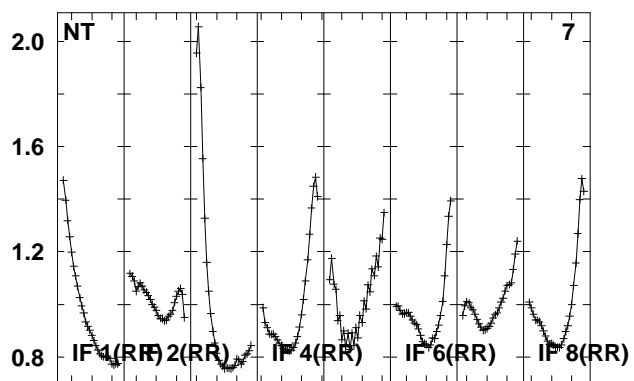
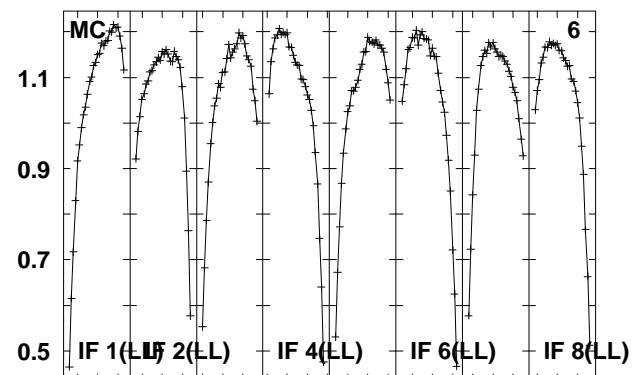
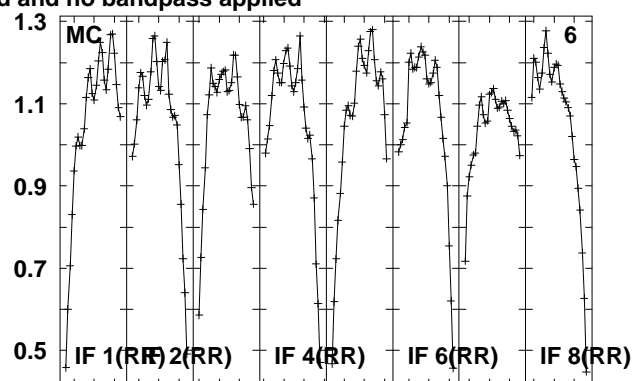
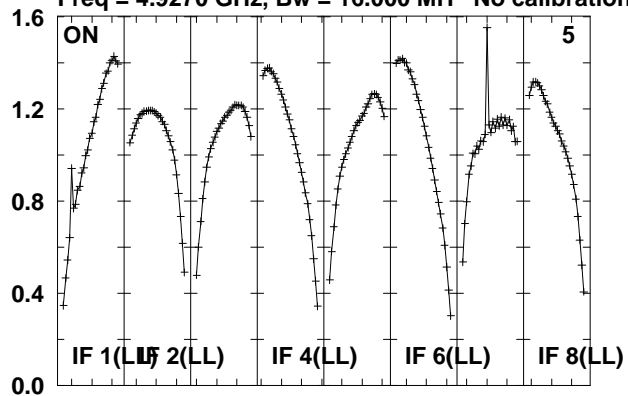

Lower frame: Real Jy

Total-power spectrum Antenna: *

Timerange: 00/09:42:32 to 00/09:44:00

Plot file version 243 created 14-MAY-2010 15:18:23

J021348 EO007.UVDATA.1

Freq = 4.9270 GHz, Bw = 16.000 MH No calibration applied and no bandpass applied

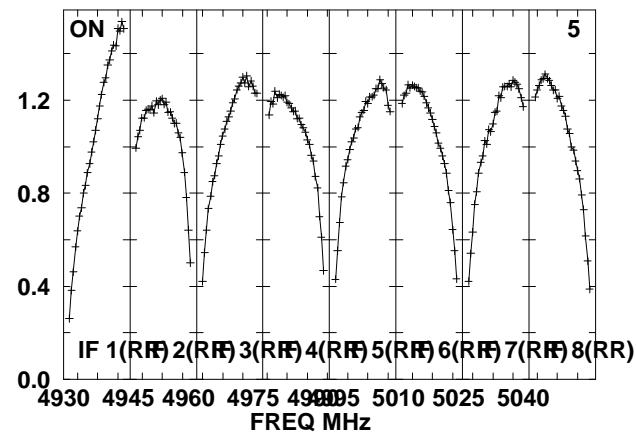
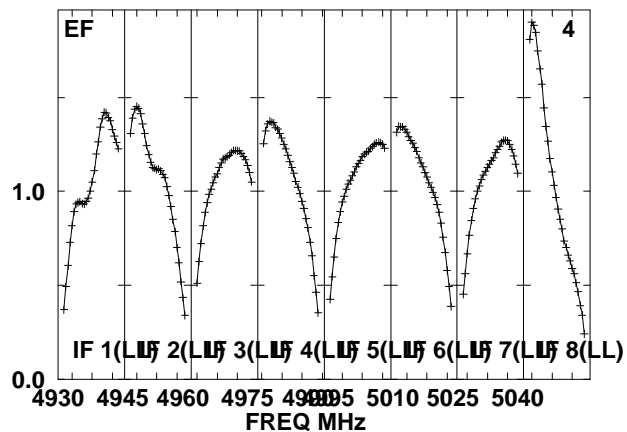
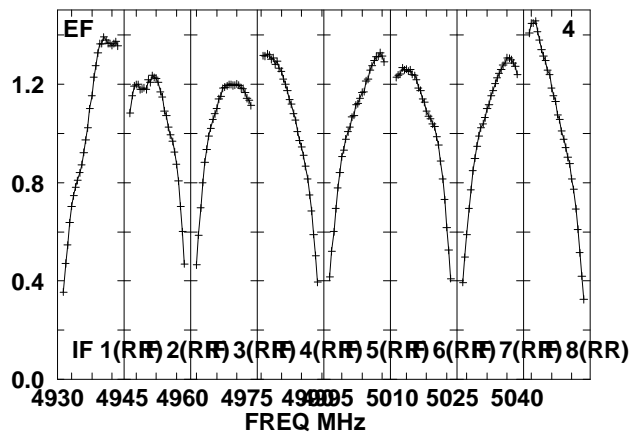
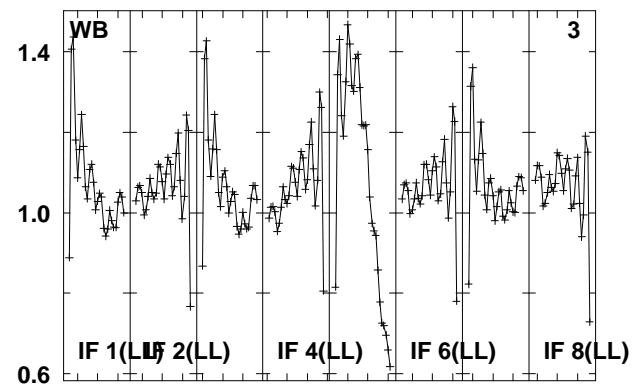
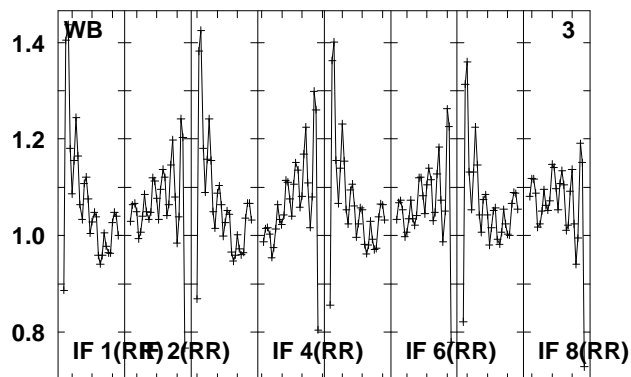
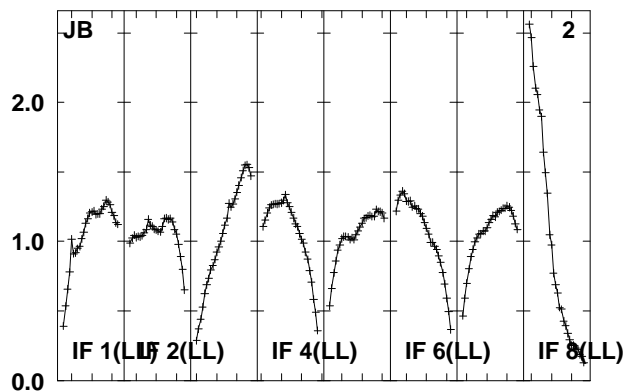
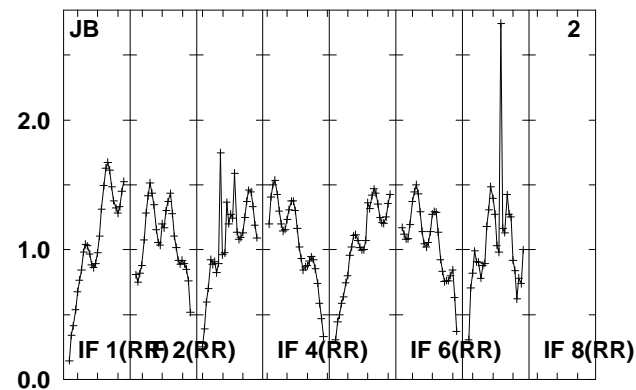
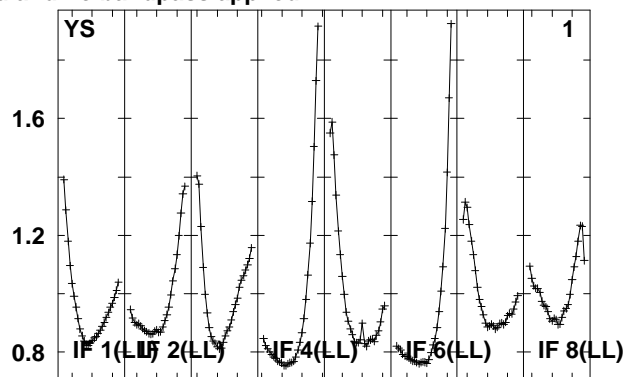
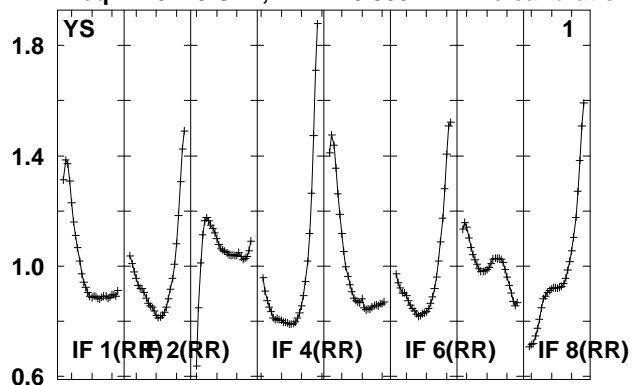

Lower frame: Real Jy

Total-power spectrum Antenna: *

Timerange: 00/09:44:26 to 00/09:49:22

Plot file version 244 created 14-MAY-2010 15:18:24

J021348 EO007.UVDATA.1

Freq = 4.9270 GHz, Bw = 16.000 MH No calibration applied and no bandpass applied

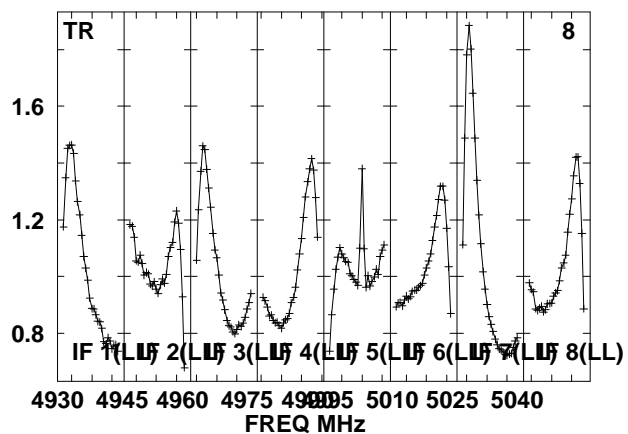
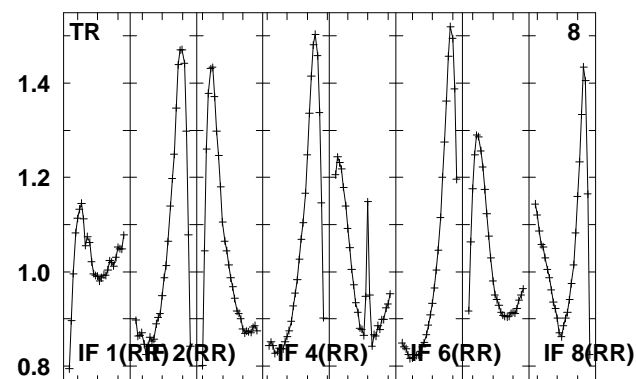
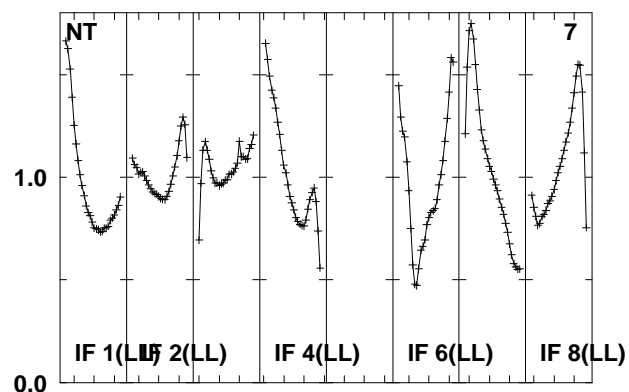
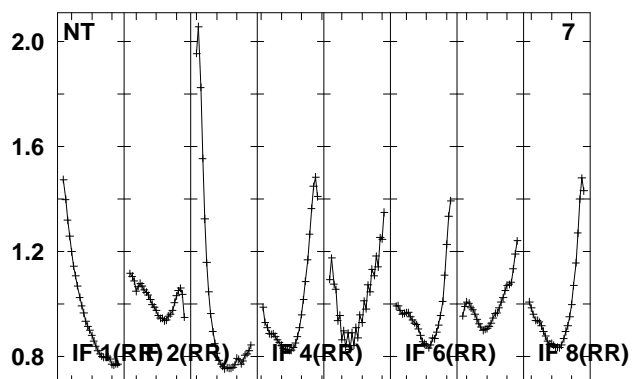
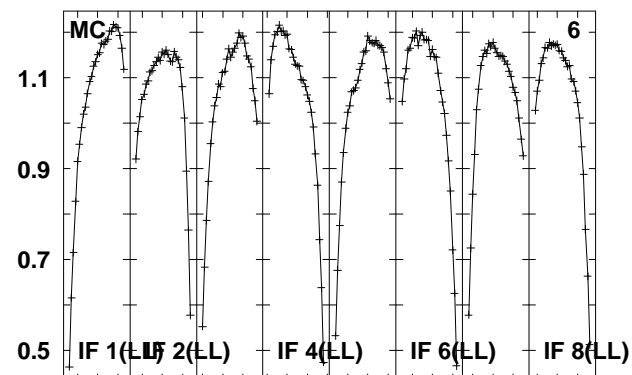
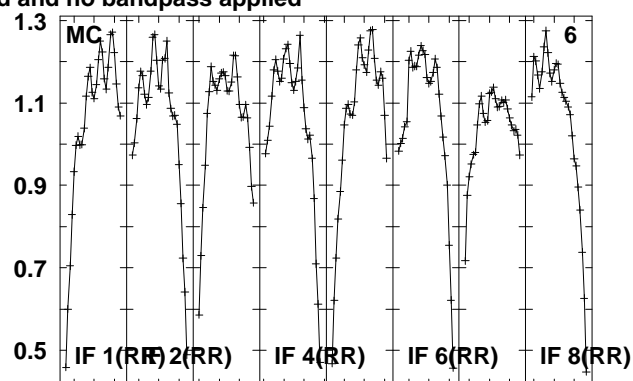
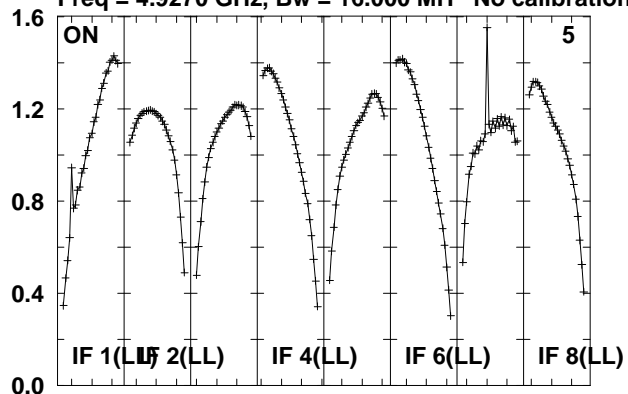

Lower frame: Real Jy

Total-power spectrum Antenna: *

Timerange: 00/09:44:26 to 00/09:49:22

Plot file version 245 created 14-MAY-2010 15:18:24

J0209+13 EO007.UVDATA.1

Freq = 4.9270 GHz, Bw = 16.000 MH No calibration applied and no bandpass applied

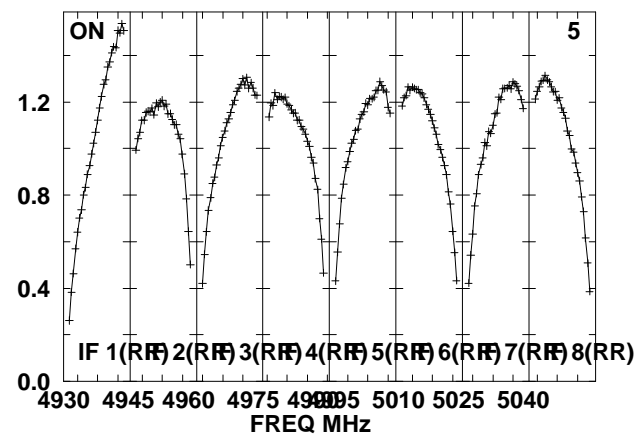
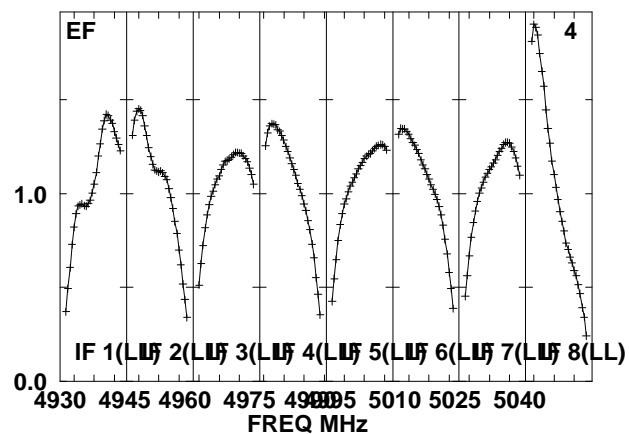
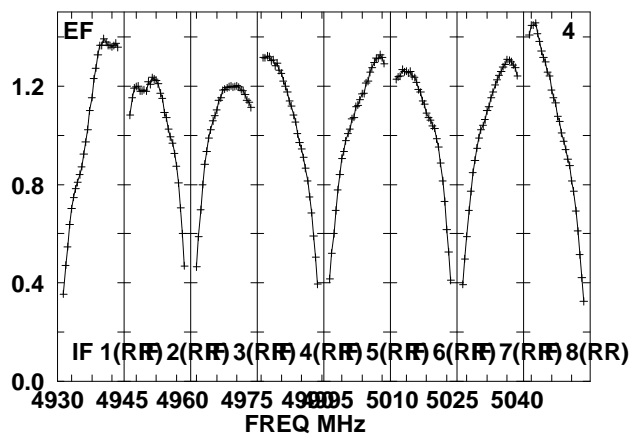
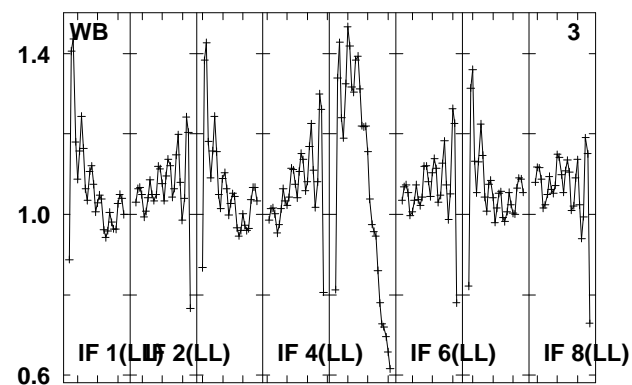
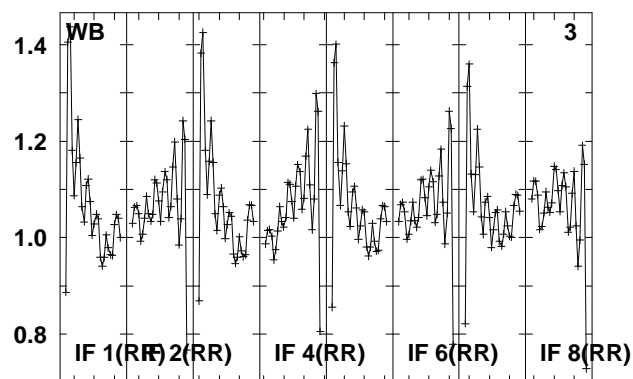
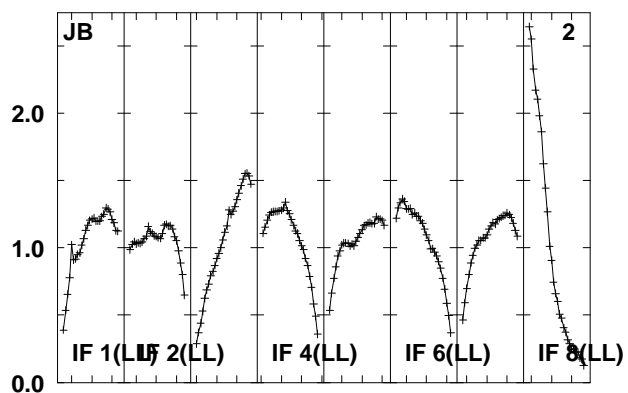
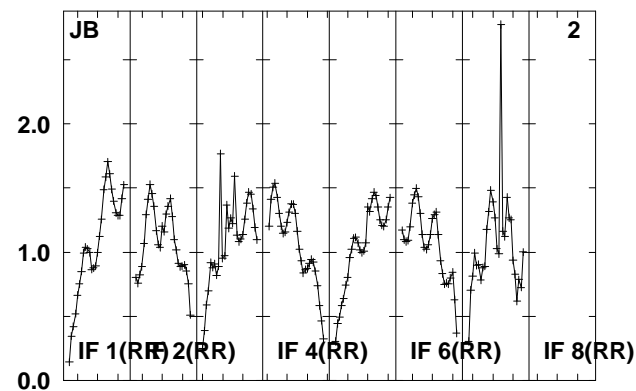
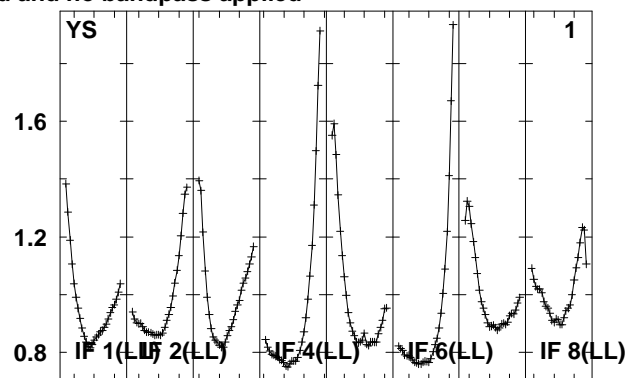
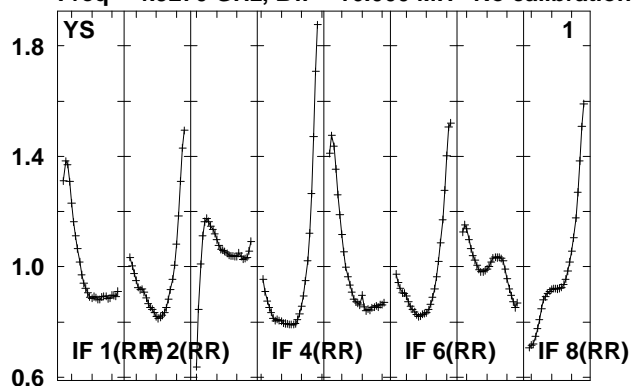

Lower frame: Real Jy

Total-power spectrum Antenna: *

Timerange: 00/09:49:54 to 00/09:51:20

Plot file version 246 created 14-MAY-2010 15:18:25

J0209+13 EO007.UVDATA.1

Freq = 4.9270 GHz, Bw = 16.000 MH No calibration applied and no bandpass applied

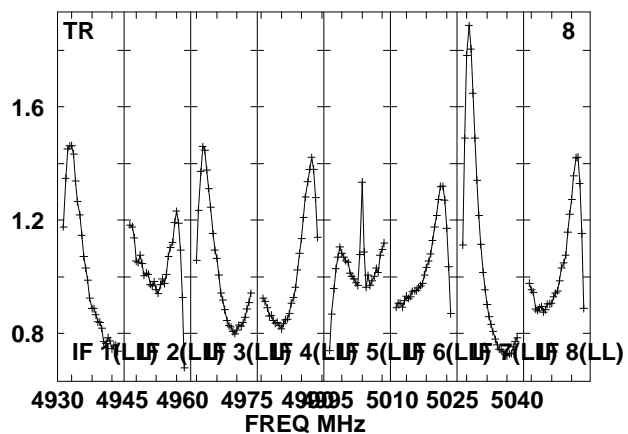
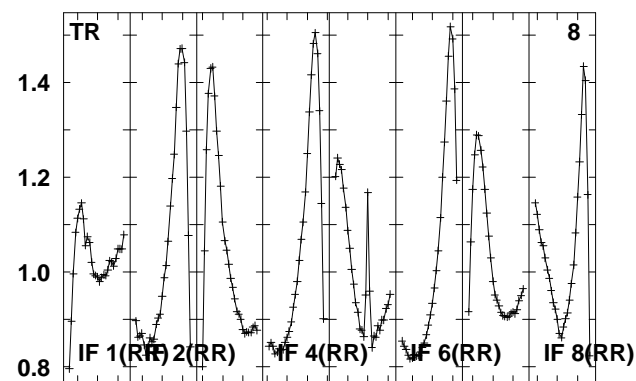
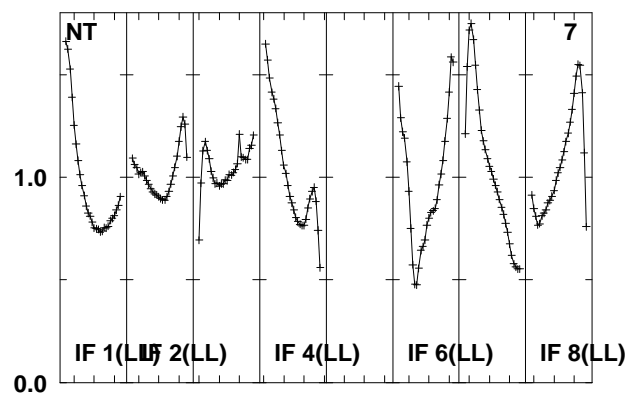
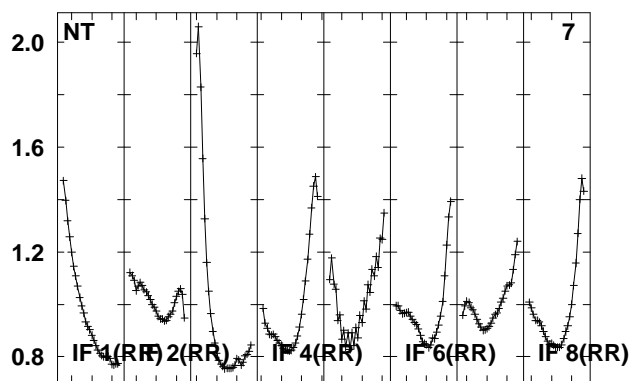
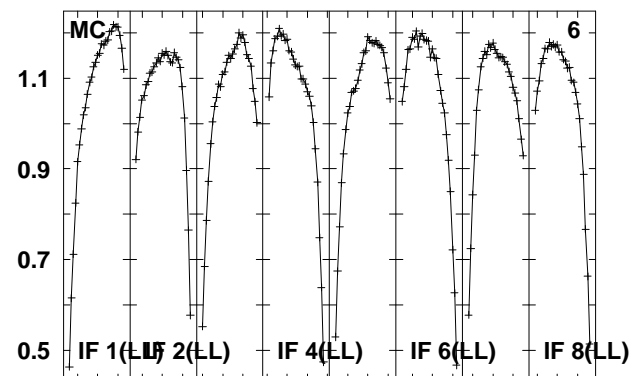
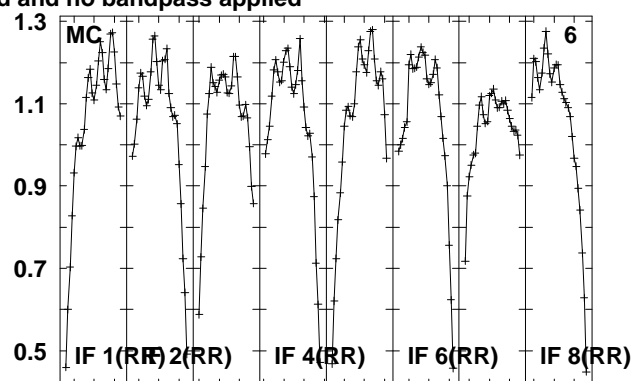
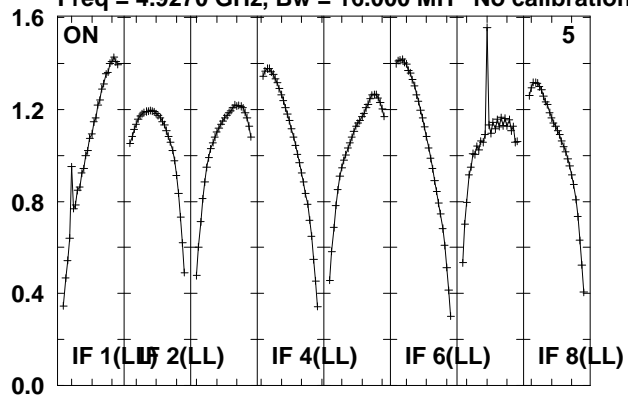

Lower frame: Real Jy

Total-power spectrum Antenna: *

Timerange: 00/09:49:54 to 00/09:51:20

Plot file version 247 created 14-MAY-2010 15:18:25
 J021348 EO007.UVDATA.1
 Freq = 4.9270 GHz, Bw = 16.000 MH No calibration applied and no bandpass applied

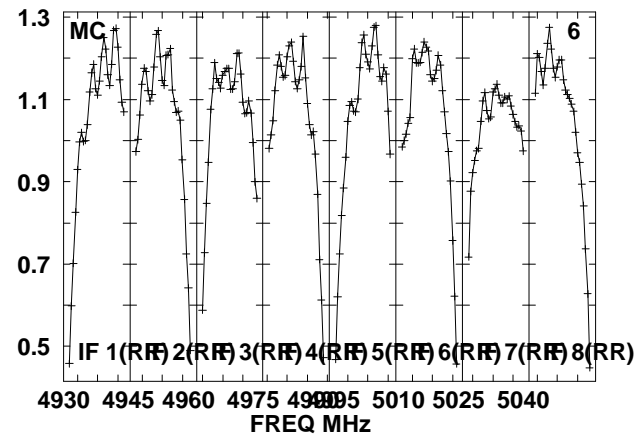
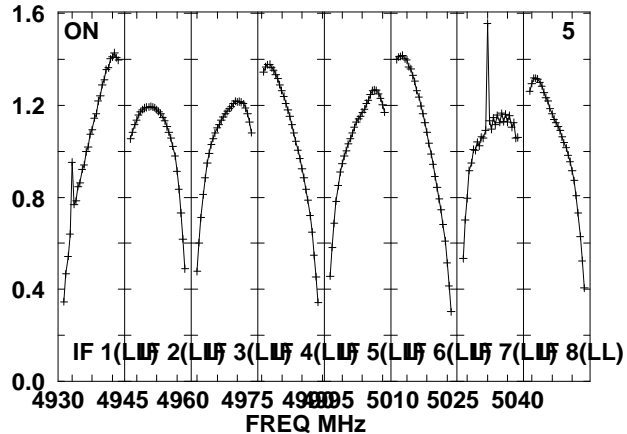
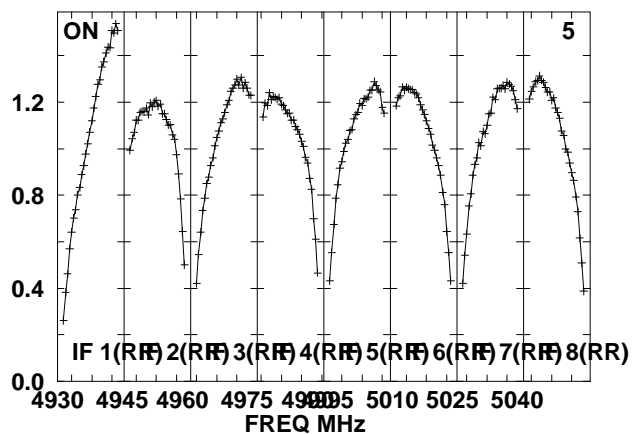
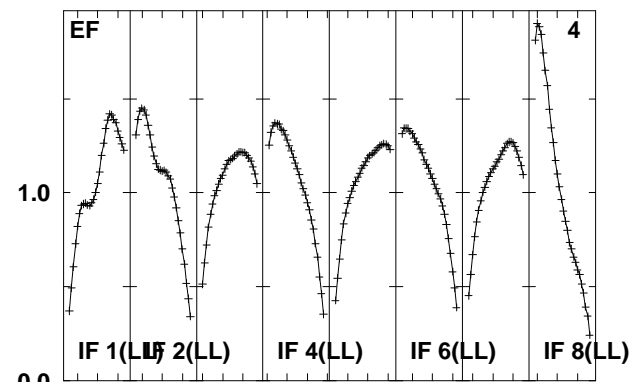
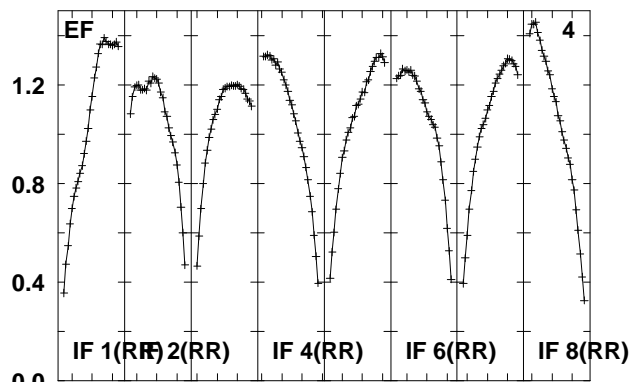
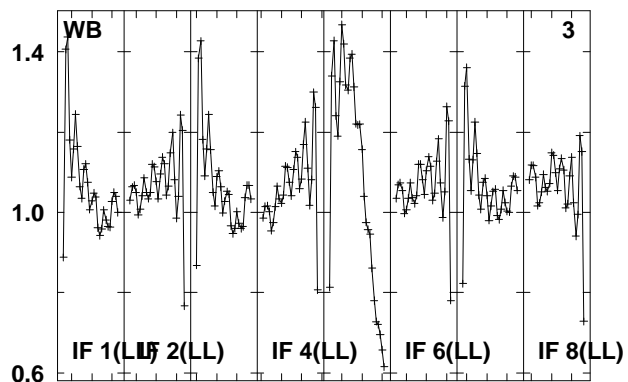
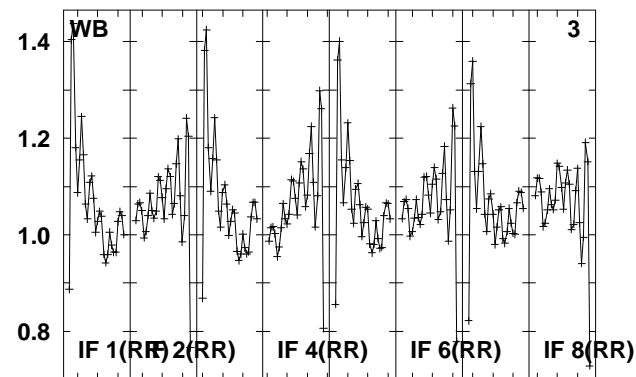
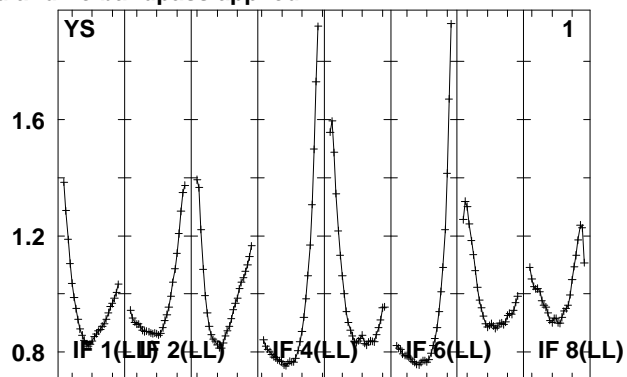
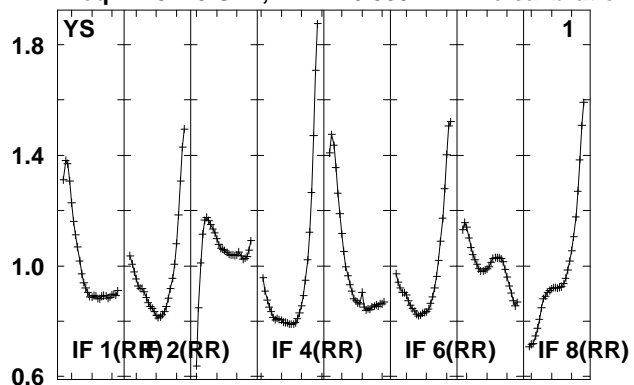

Lower frame: Real Jy
 Total-power spectrum Antenna: *
 Timerange: 00/09:51:48 to 00/09:56:46

Plot file version 248 created 14-MAY-2010 15:18:26

J021348 EO007.UVDATA.1

Freq = 4.9270 GHz, Bw = 16.000 MH No calibration applied and no bandpass applied

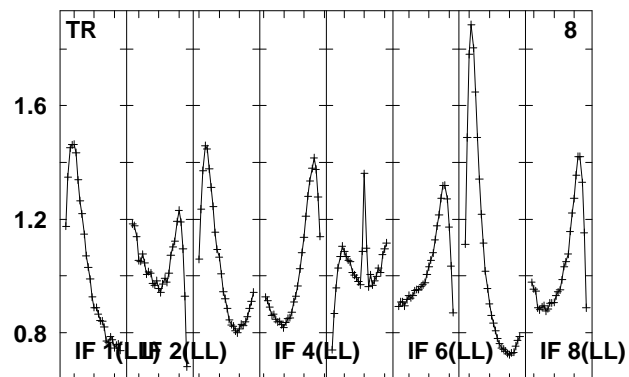
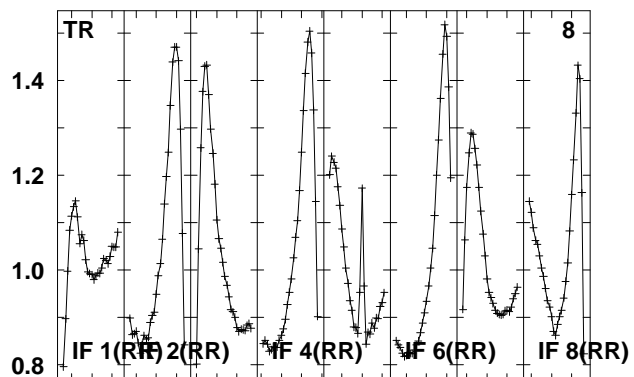
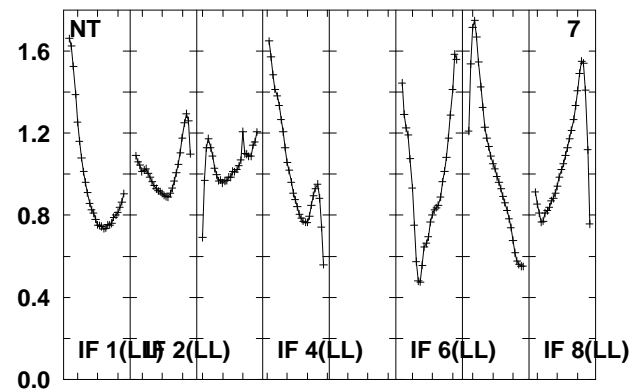
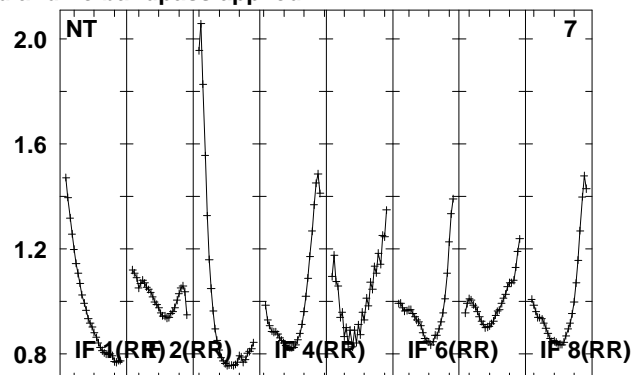
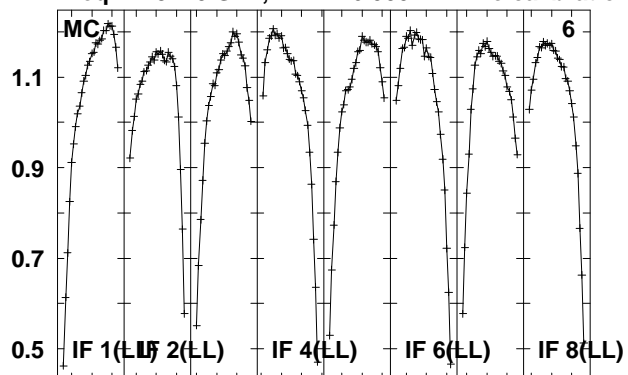

Lower frame: Real Jy
Total-power spectrum Antenna: *
Timerange: 00/09:51:48 to 00/09:56:46

Plot file version 249 created 14-MAY-2010 15:18:26

J0209+13 EO007.UVDATA.1

Freq = 4.9270 GHz, Bw = 16.000 MH No calibration applied and no bandpass applied

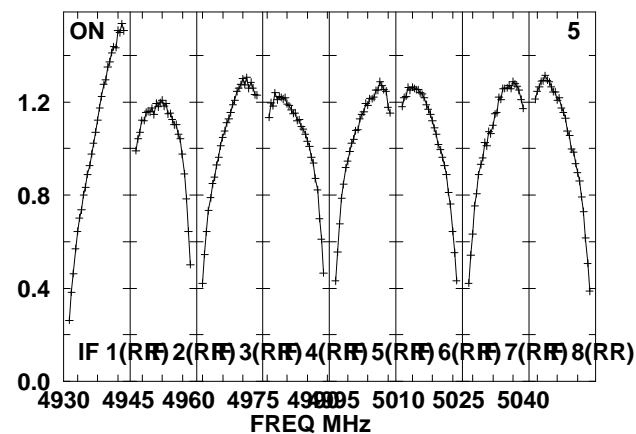
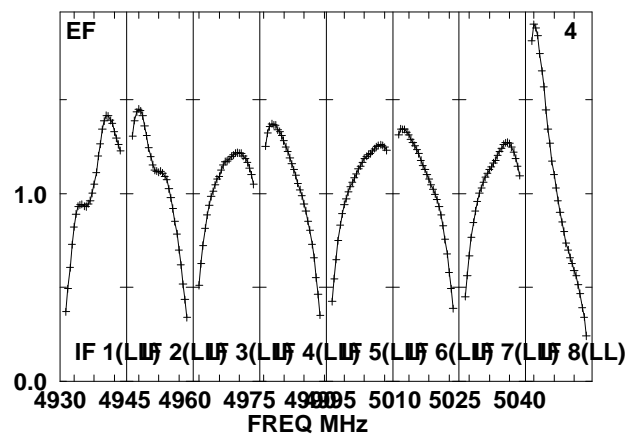
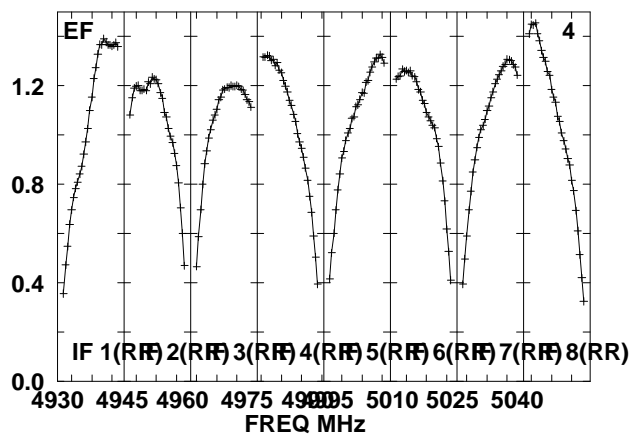
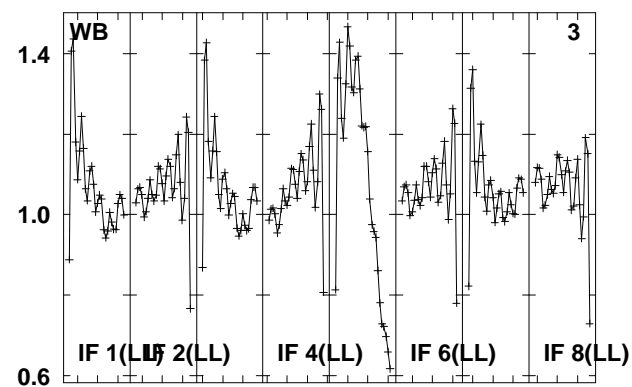
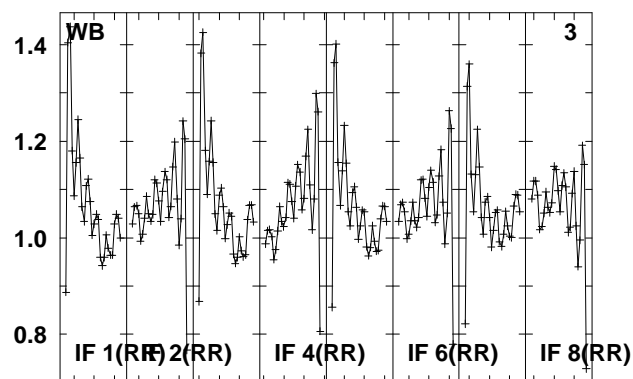
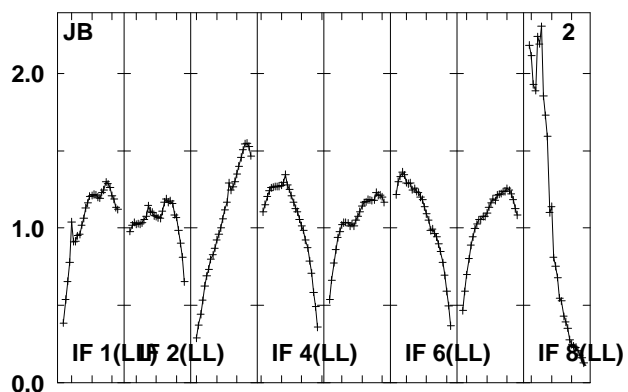
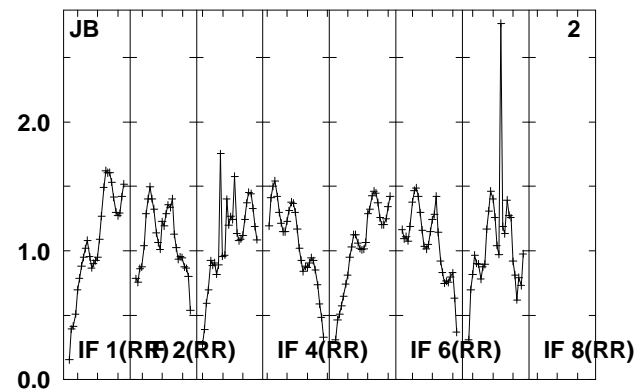
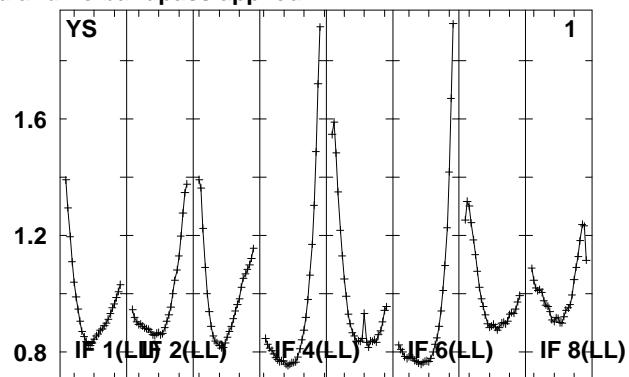
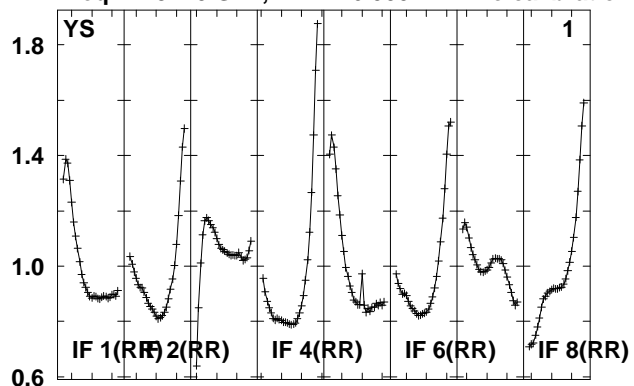

Lower frame: Real Jy

Total-power spectrum Antenna: *

Timerange: 00/09:57:12 to 00/09:58:42

Plot file version 250 created 14-MAY-2010 15:18:26

J0209+13 EO007.UVDATA.1

Freq = 4.9270 GHz, Bw = 16.000 MH No calibration applied and no bandpass applied

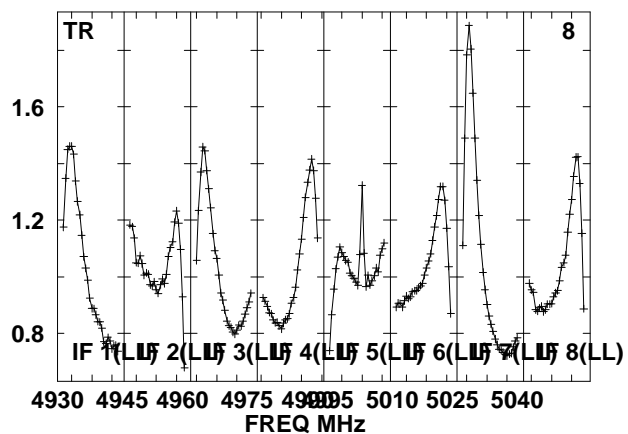
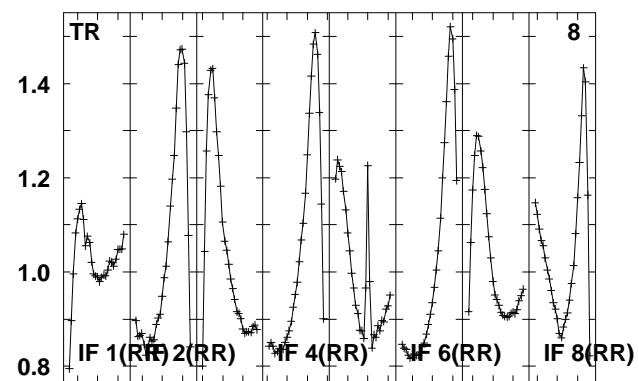
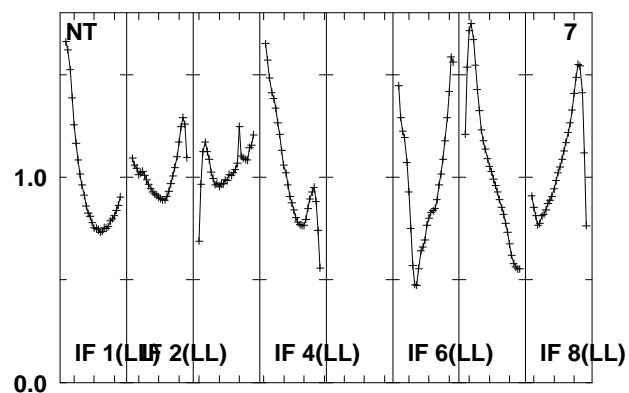
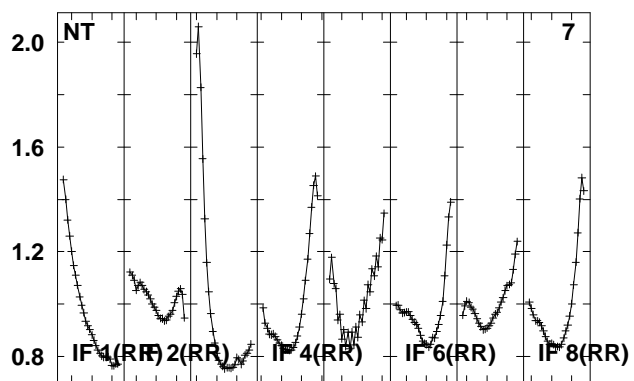
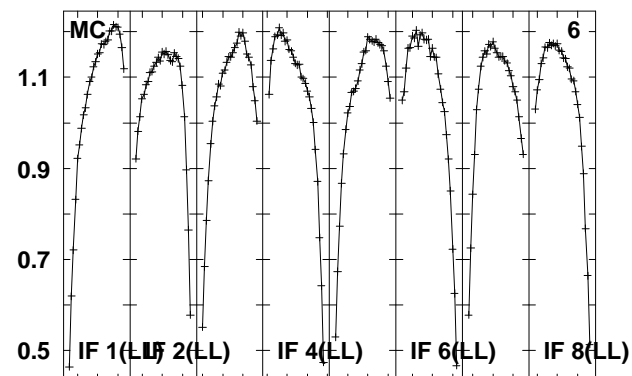
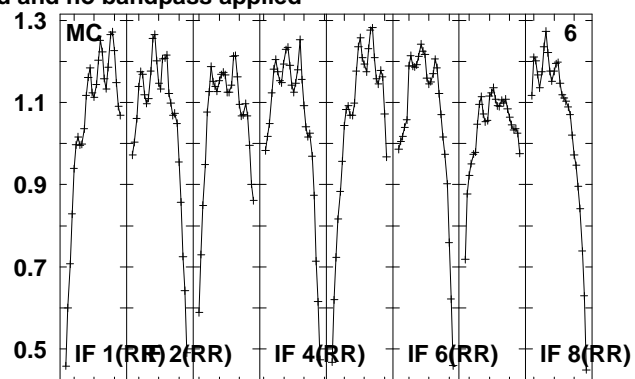
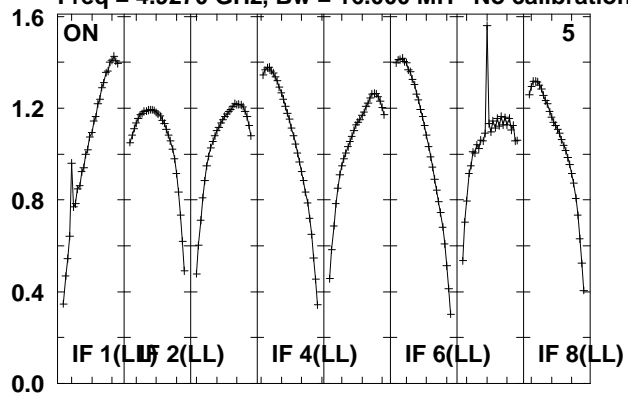

Lower frame: Real Jy

Total-power spectrum Antenna: *

Timerange: 00/09:57:12 to 00/09:58:42

Plot file version 251 created 14-MAY-2010 15:18:26

J0158+13 EO007.UVDATA.1

Freq = 4.9270 GHz, Bw = 16.000 MH No calibration applied and no bandpass applied

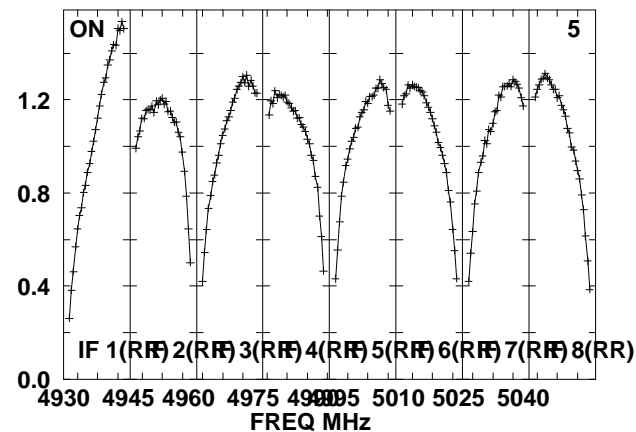
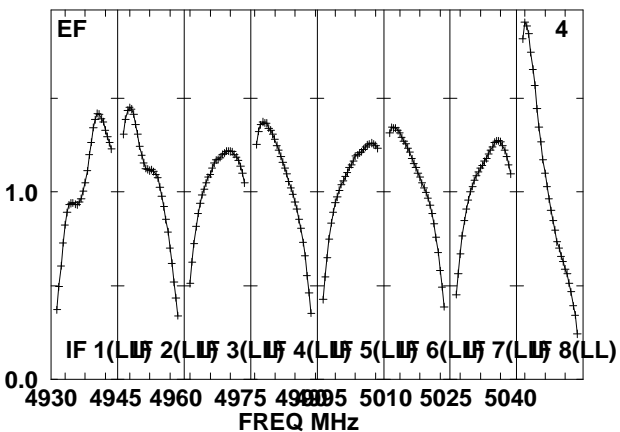
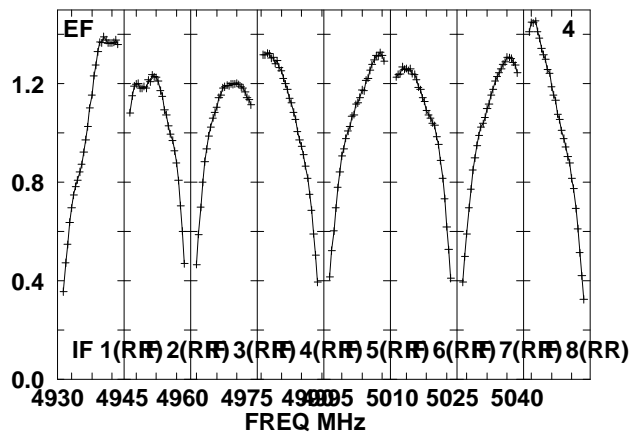
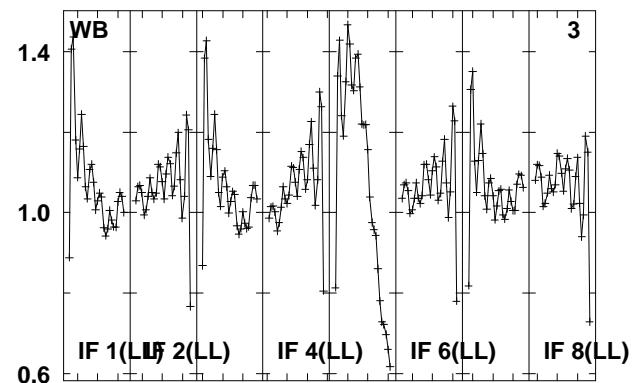
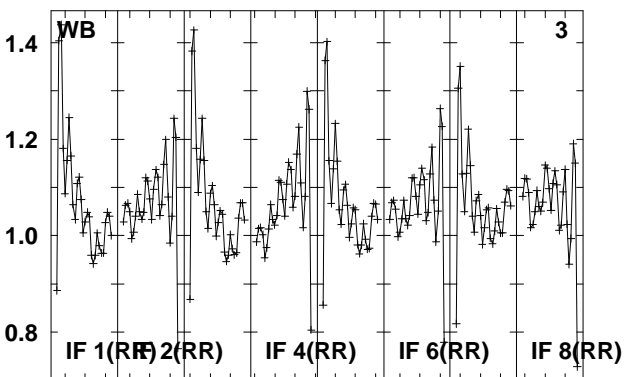
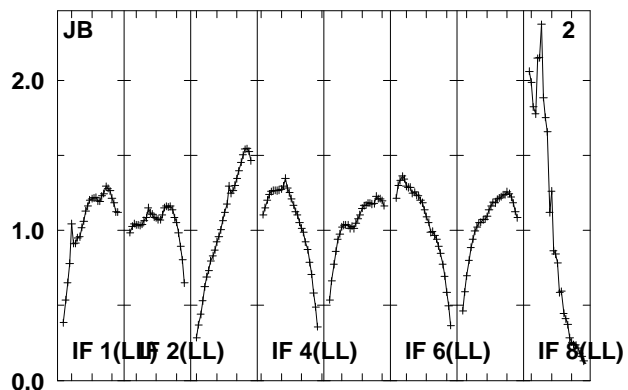
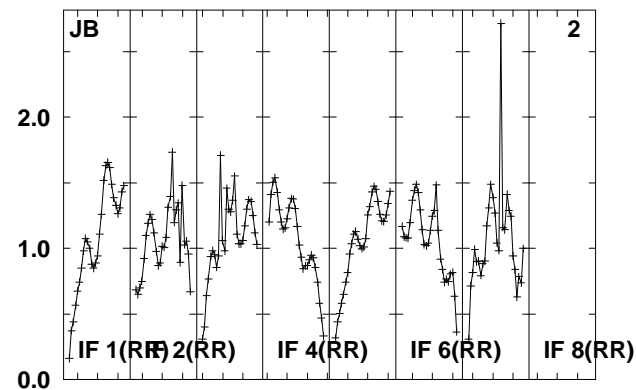
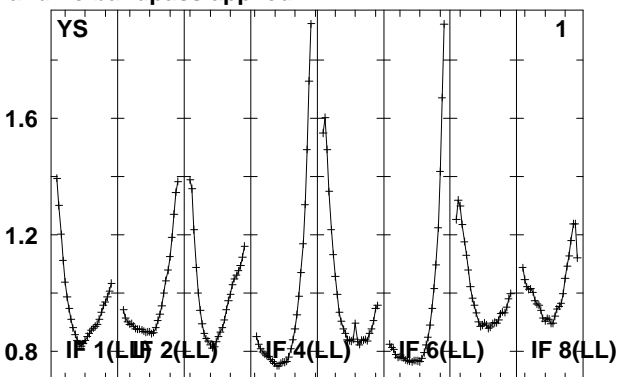
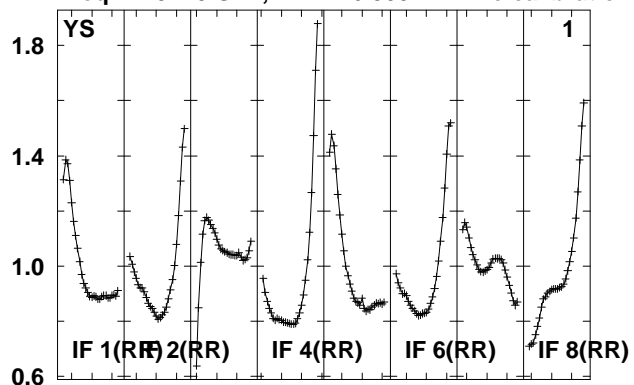

Lower frame: Real Jy
Total-power spectrum Antenna: *
Timerange: 00/09:59:18 to 00/10:00:44

Plot file version 252 created 14-MAY-2010 15:18:26

J0158+13 EO007.UVDATA.1

Freq = 4.9270 GHz, Bw = 16.000 MH No calibration applied and no bandpass applied

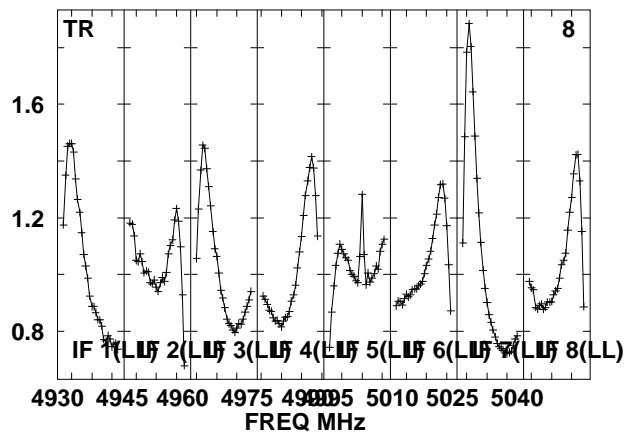
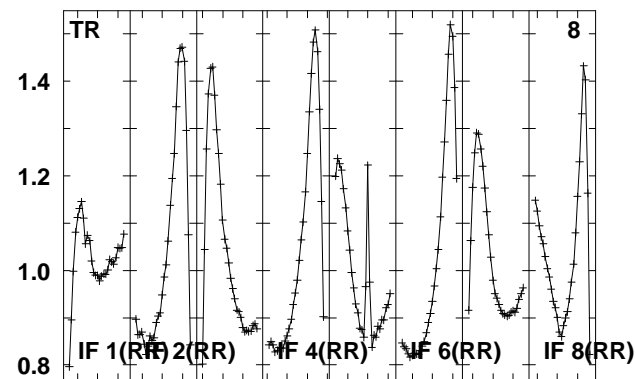
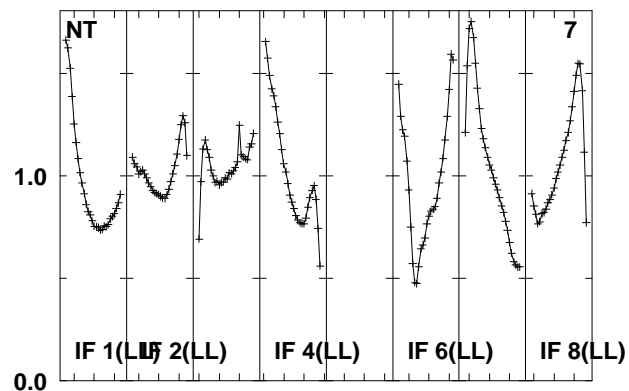
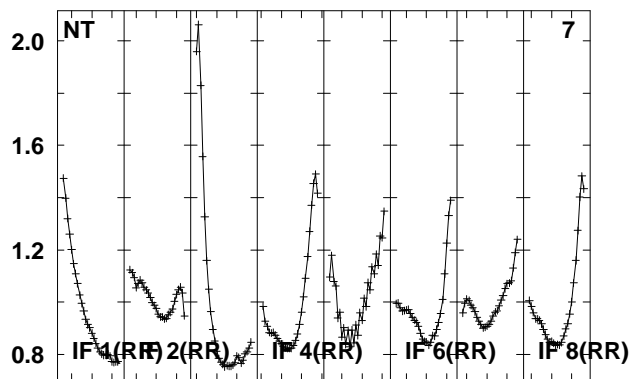
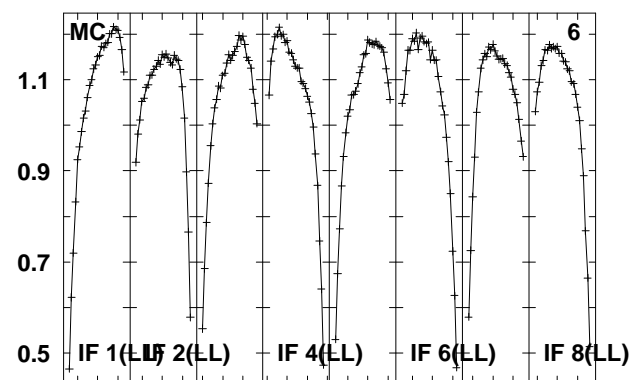
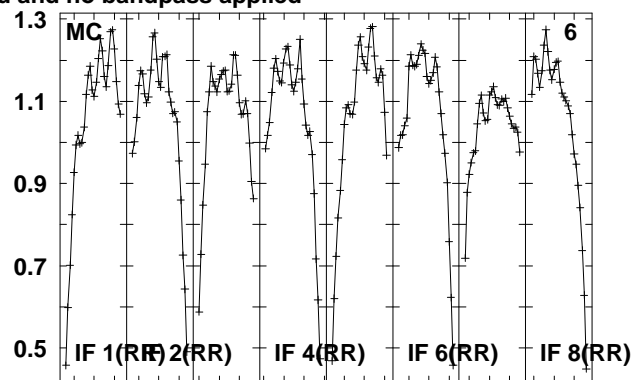
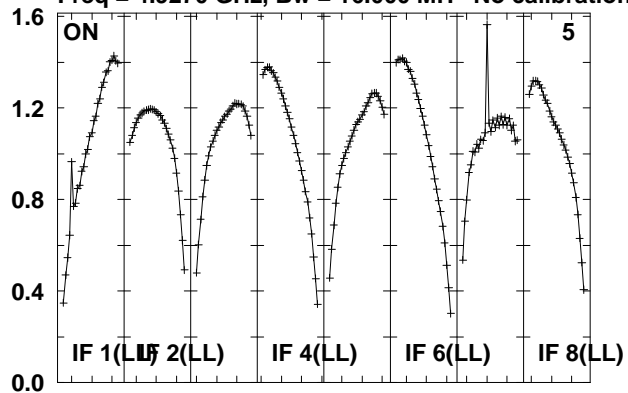

Lower frame: Real Jy

Total-power spectrum Antenna: *

Timerange: 00/09:59:18 to 00/10:00:44

Plot file version 253 created 14-MAY-2010 15:18:27
 J015028 EO007.UVDATA.1
 Freq = 4.9270 GHz, Bw = 16.000 MH No calibration applied and no bandpass applied

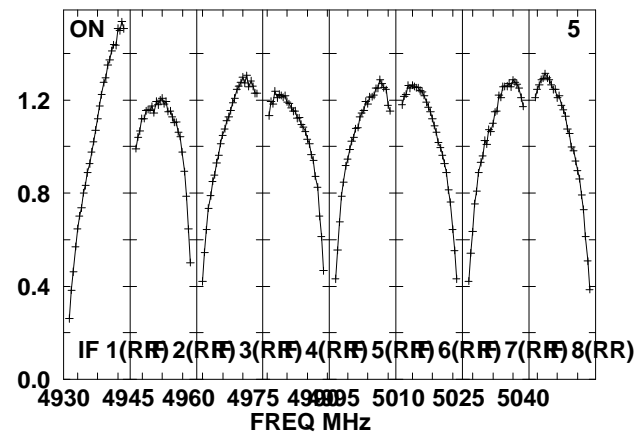
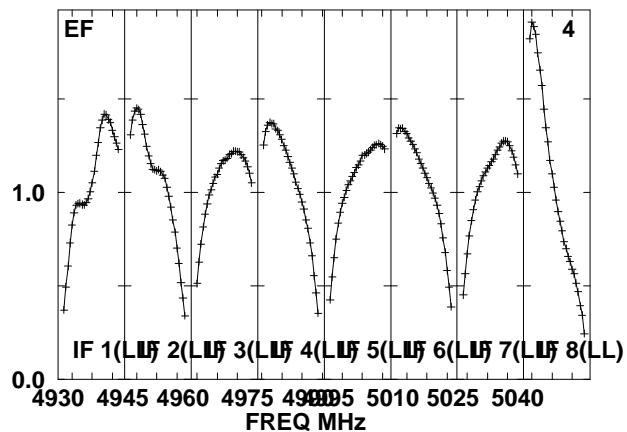
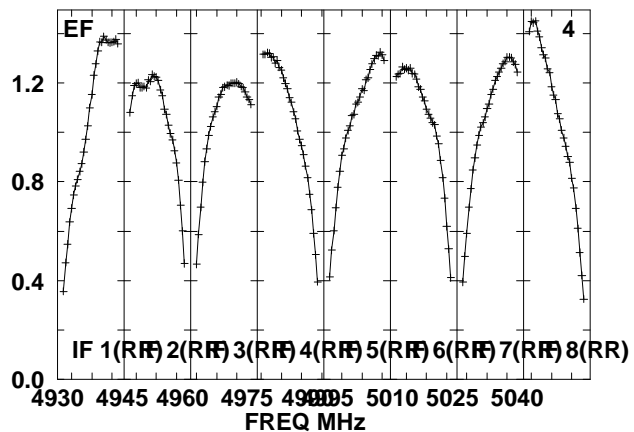
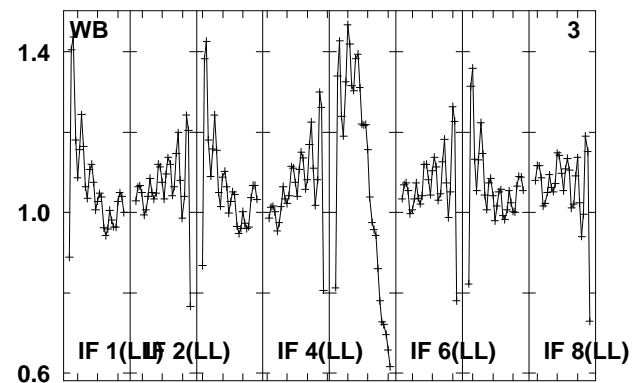
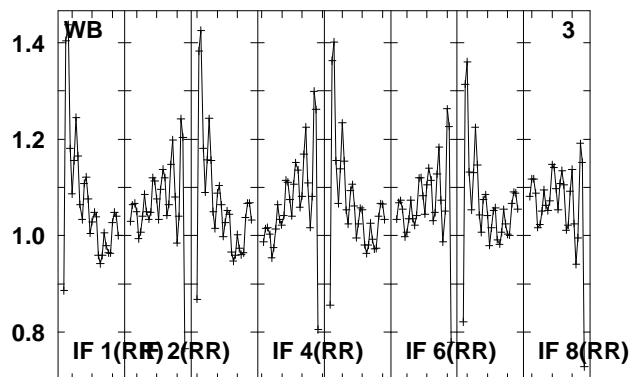
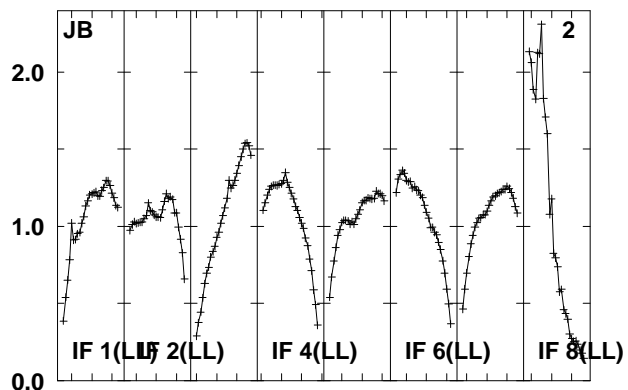
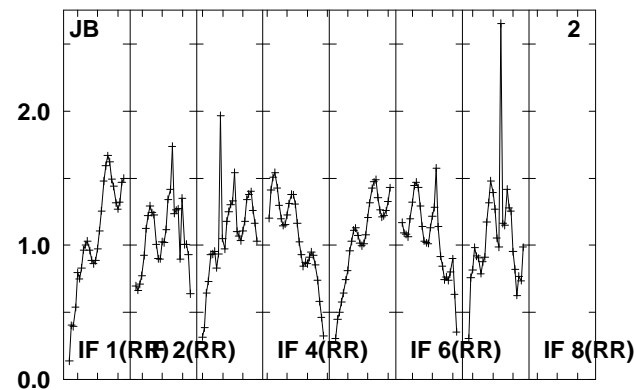
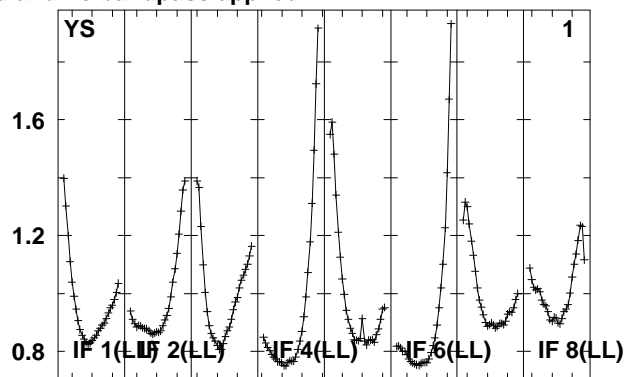
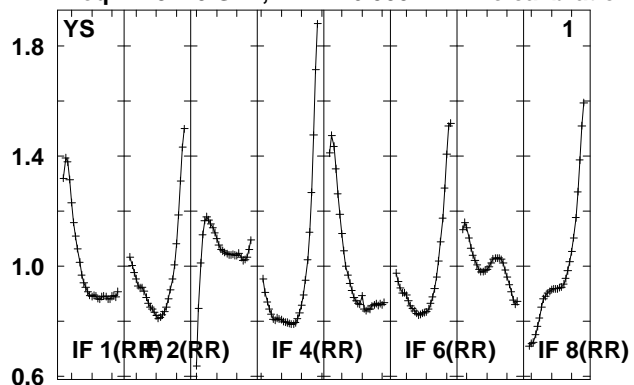

Lower frame: Real Jy
 Total-power spectrum Antenna: *
 Timerange: 00/10:01:16 to 00/10:06:14

Plot file version 254 created 14-MAY-2010 15:18:27

J015028 EO007.UVDATA.1

Freq = 4.9270 GHz, Bw = 16.000 MH No calibration applied and no bandpass applied

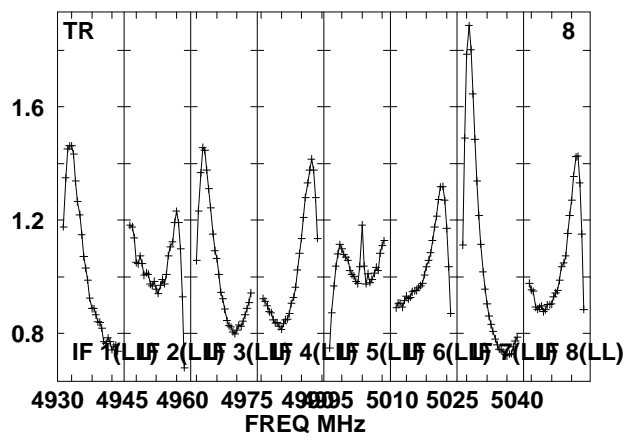
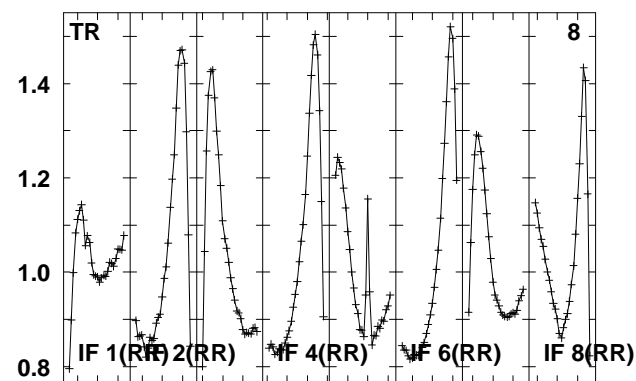
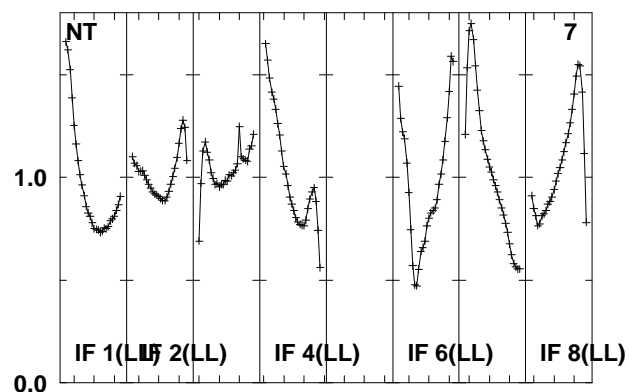
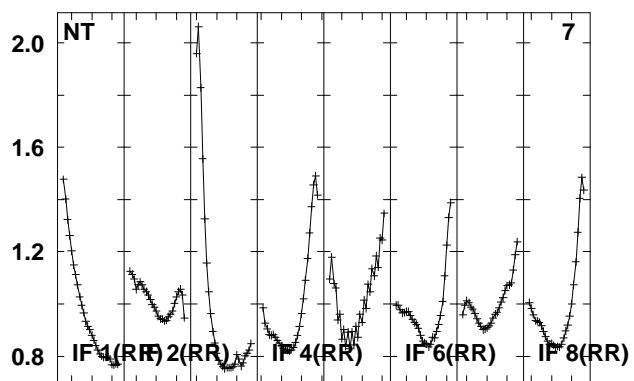
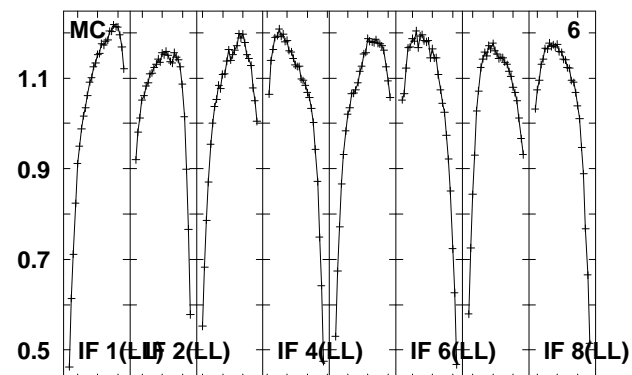
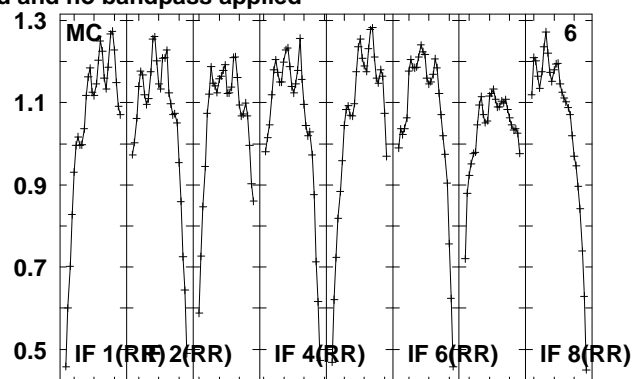
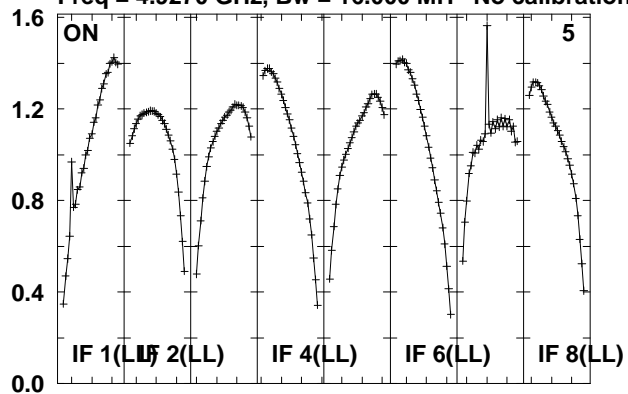

Lower frame: Real Jy

Total-power spectrum Antenna: *

Timerange: 00/10:01:16 to 00/10:06:14

Plot file version 255 created 14-MAY-2010 15:18:28

J0158+13 EO007.UVDATA.1

Freq = 4.9270 GHz, Bw = 16.000 MH No calibration applied and no bandpass applied

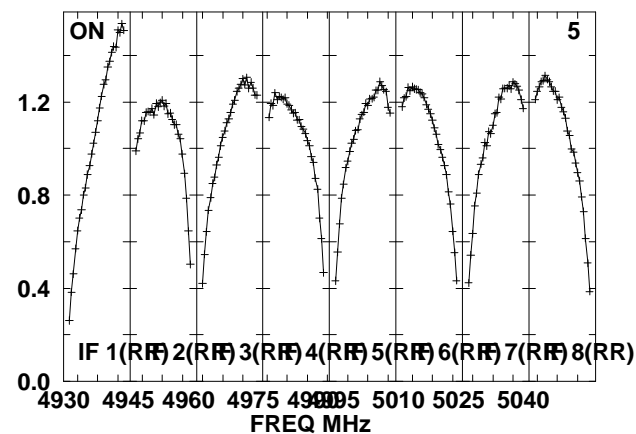
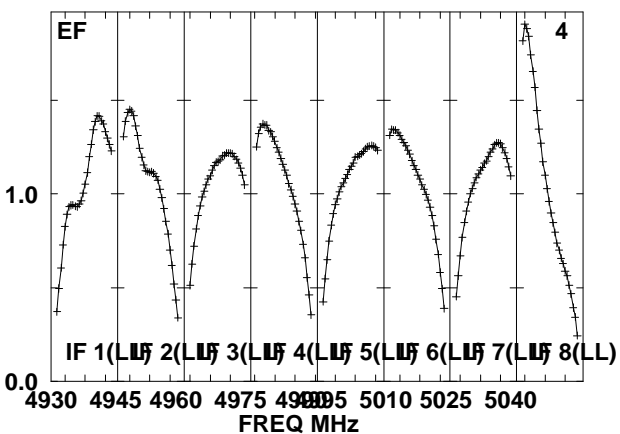
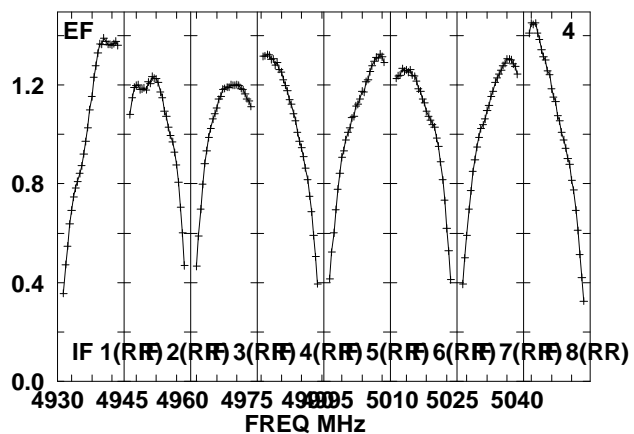
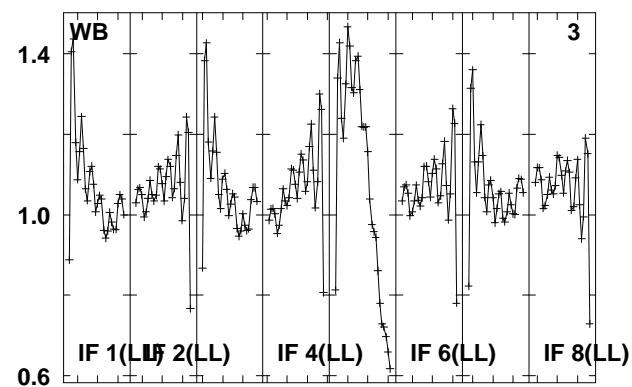
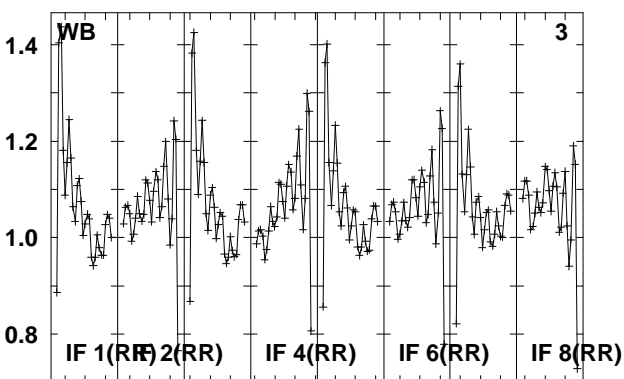
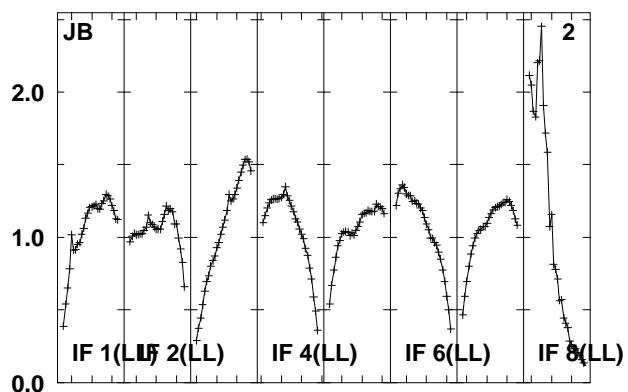
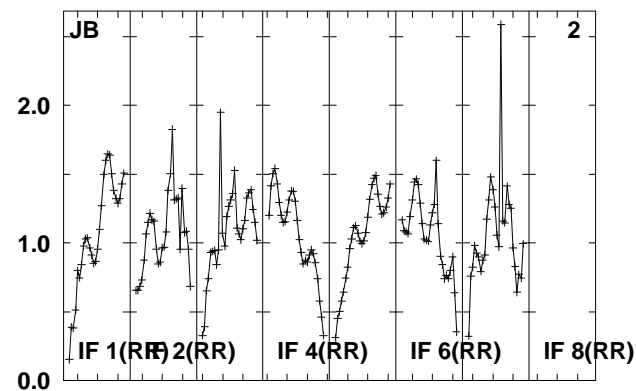
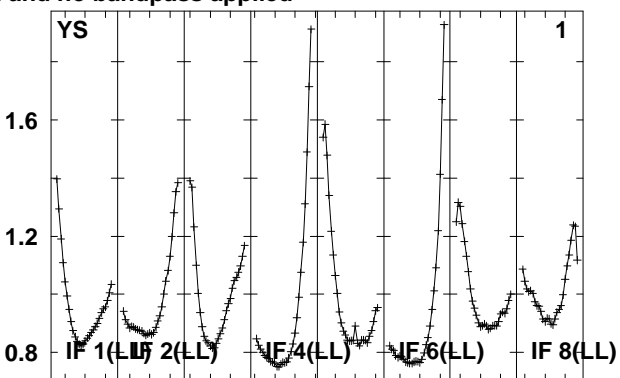
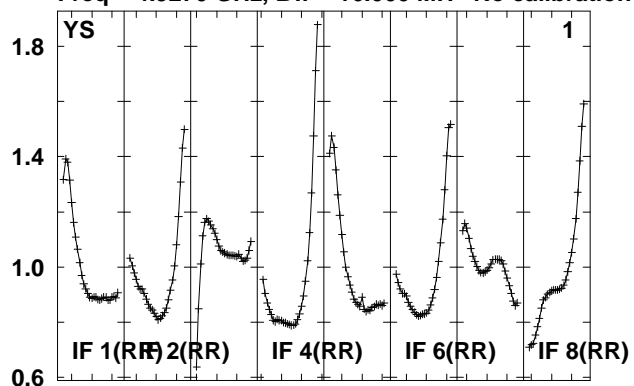

Lower frame: Real Jy

Total-power spectrum Antenna: *

Timerange: 00/10:06:44 to 00/10:08:10

Plot file version 256 created 14-MAY-2010 15:18:28

J0158+13 EO007.UVDATA.1

Freq = 4.9270 GHz, Bw = 16.000 MH No calibration applied and no bandpass applied

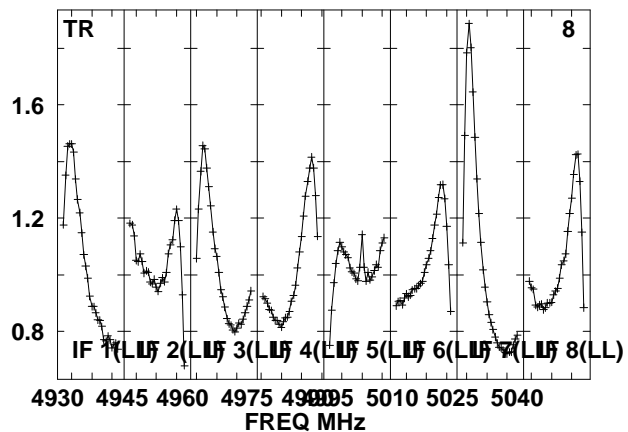
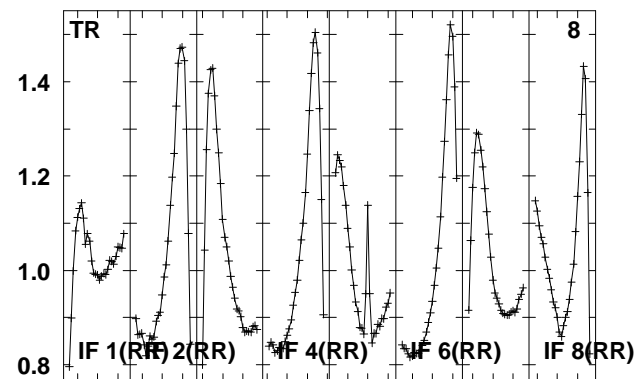
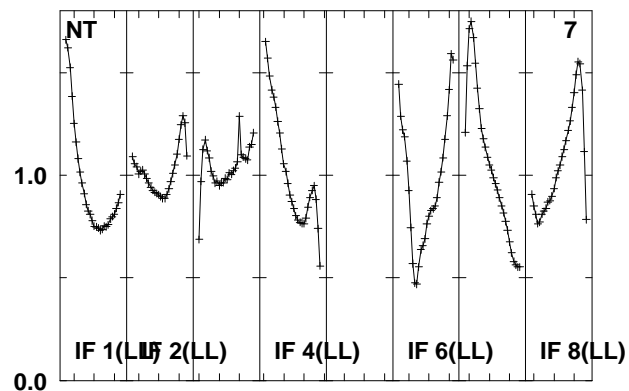
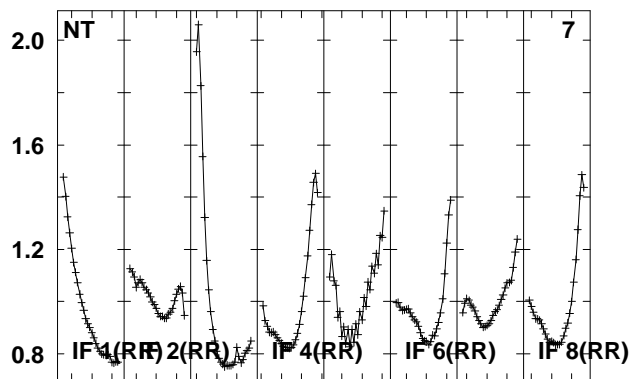
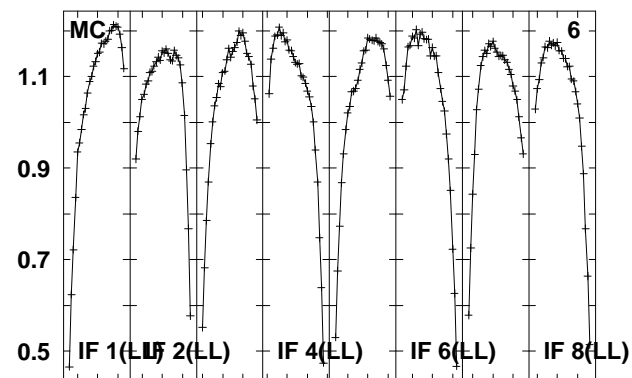
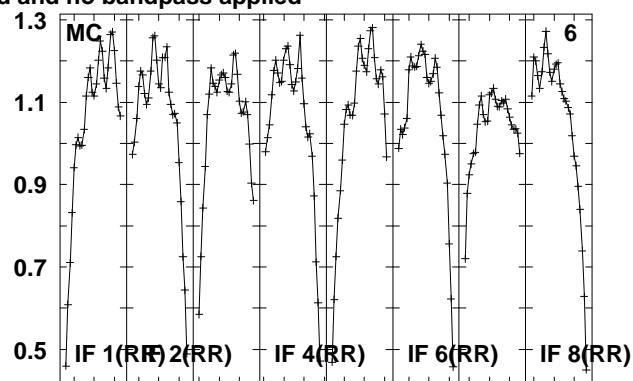
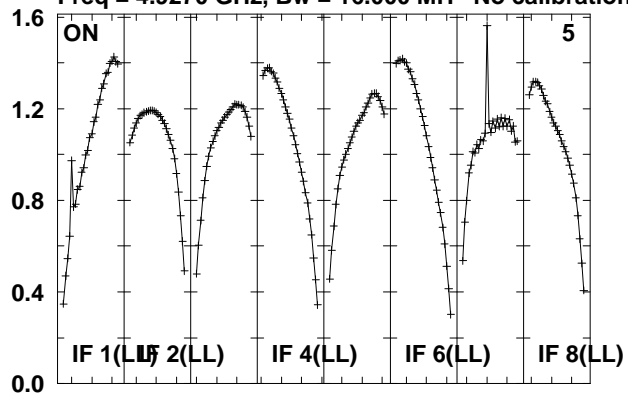

Lower frame: Real Jy

Total-power spectrum Antenna: *

Timerange: 00/10:06:44 to 00/10:08:10

Plot file version 257 created 14-MAY-2010 15:18:28
 J015028 EO007.UVDATA.1
 Freq = 4.9270 GHz, Bw = 16.000 MH No calibration applied and no bandpass applied

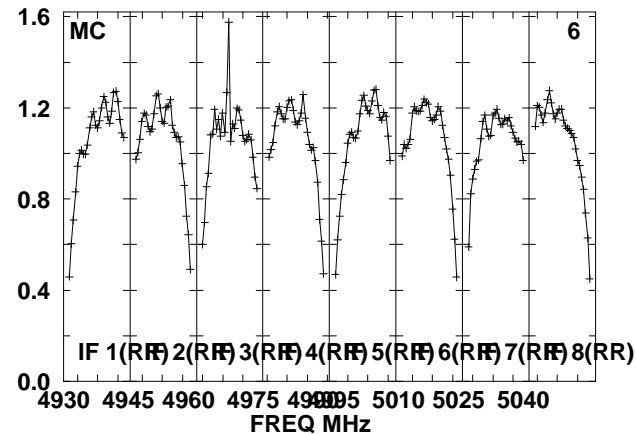
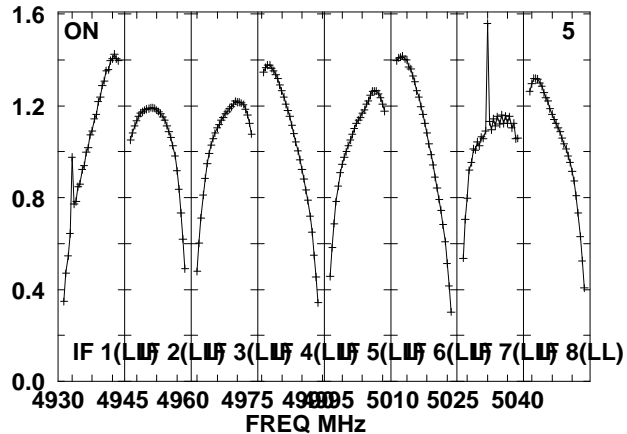
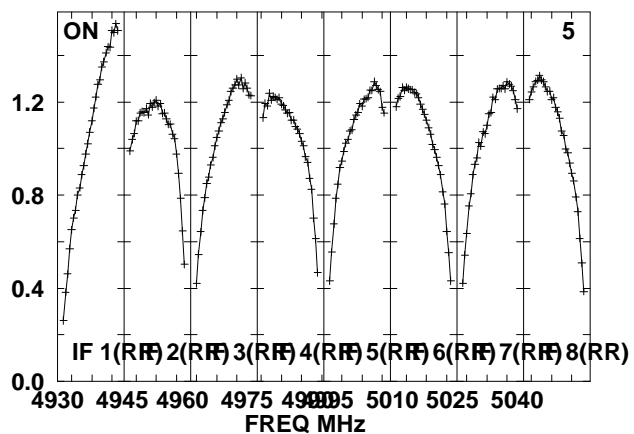
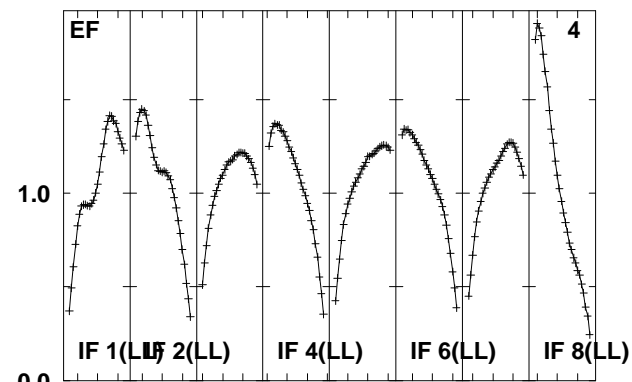
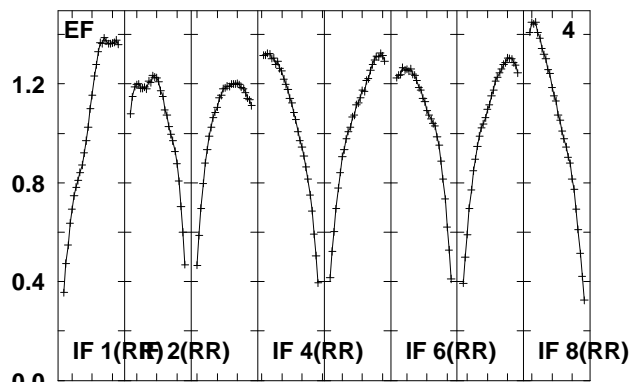
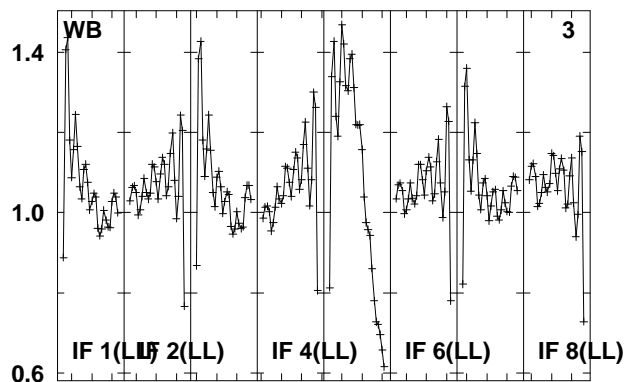
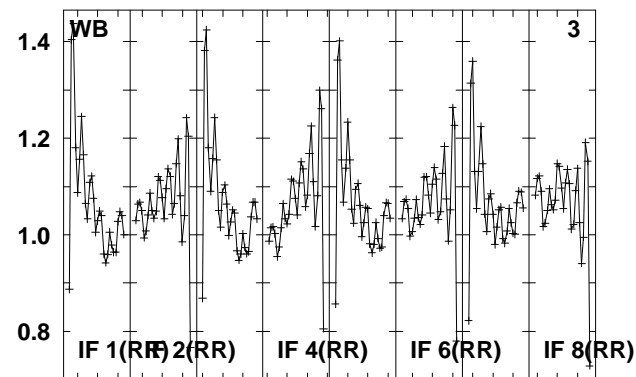
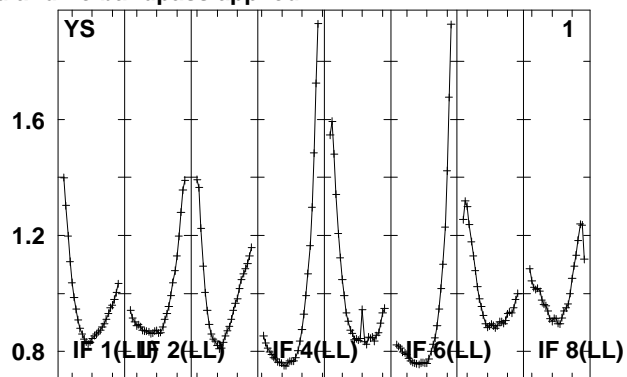
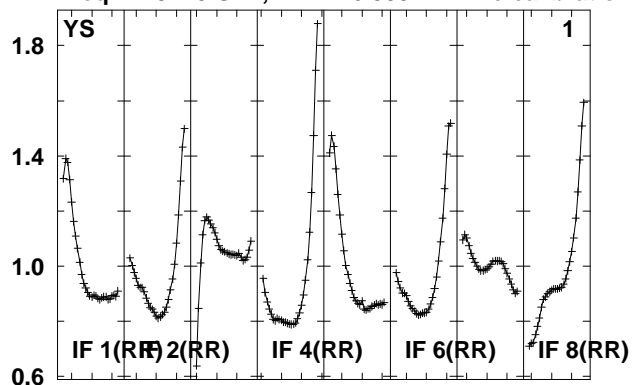

Lower frame: Real Jy
 Total-power spectrum Antenna: *
 Timerange: 00/10:08:43 to 00/10:13:39

Plot file version 258 created 14-MAY-2010 15:18:29

J015028 EO007.UVDATA.1

Freq = 4.9270 GHz, Bw = 16.000 MH No calibration applied and no bandpass applied

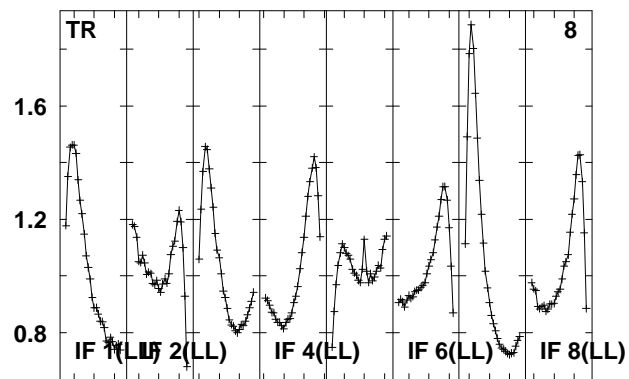
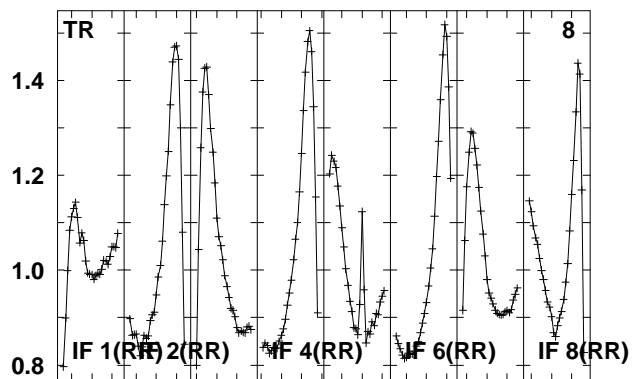
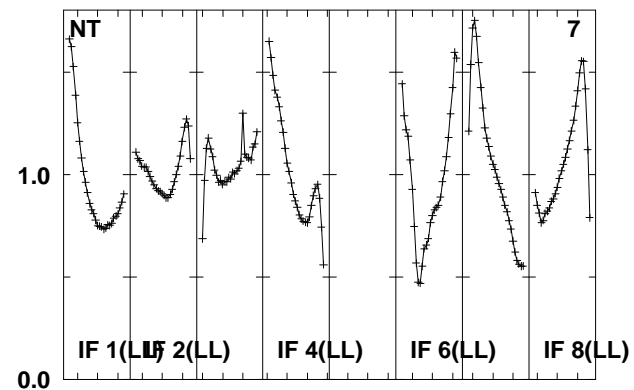
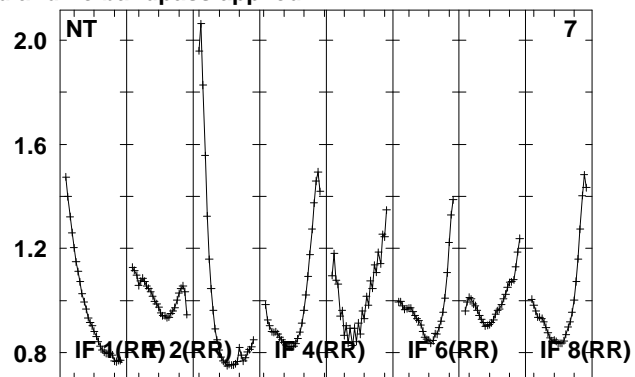
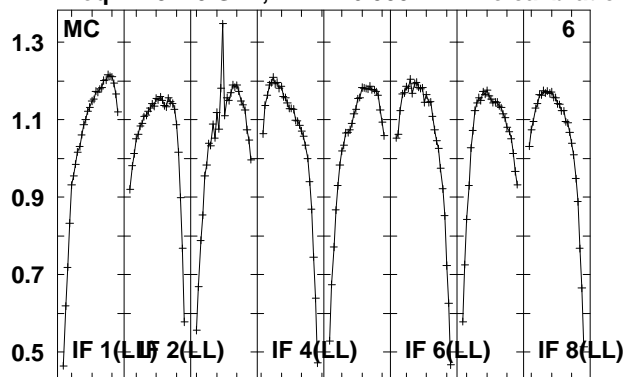

Lower frame: Real Jy
Total-power spectrum Antenna: *
Timerange: 00/10:08:43 to 00/10:13:39

Plot file version 259 created 14-MAY-2010 15:18:29

J0158+13 EO007.UVDATA.1

Freq = 4.9270 GHz, Bw = 16.000 MH No calibration applied and no bandpass applied

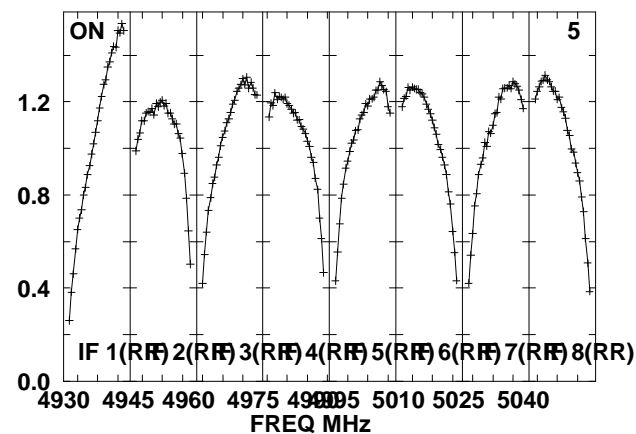
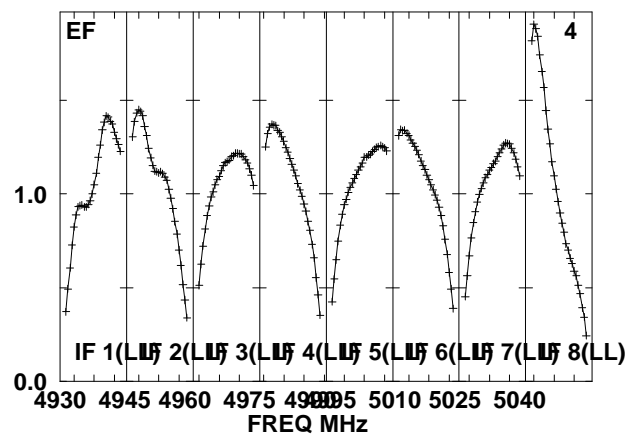
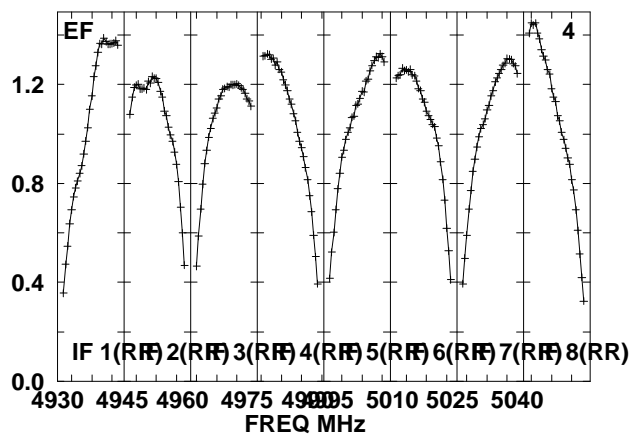
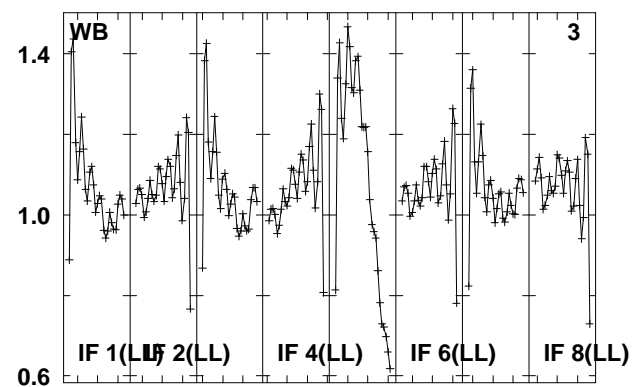
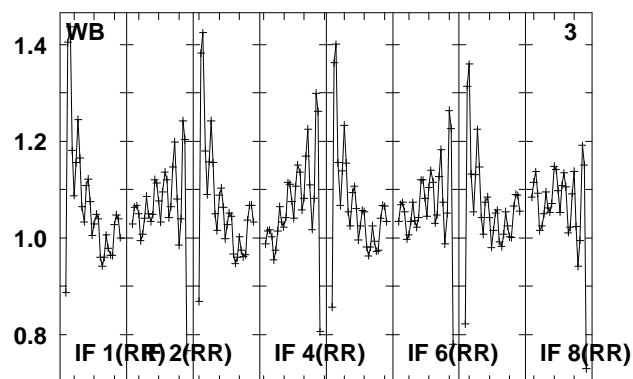
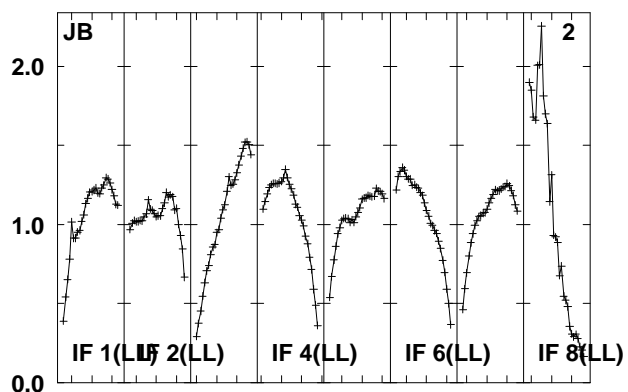
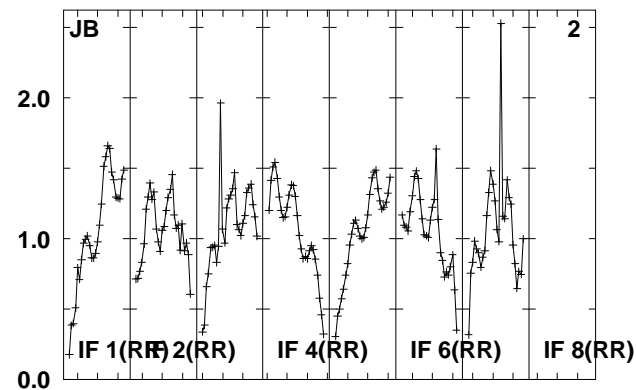
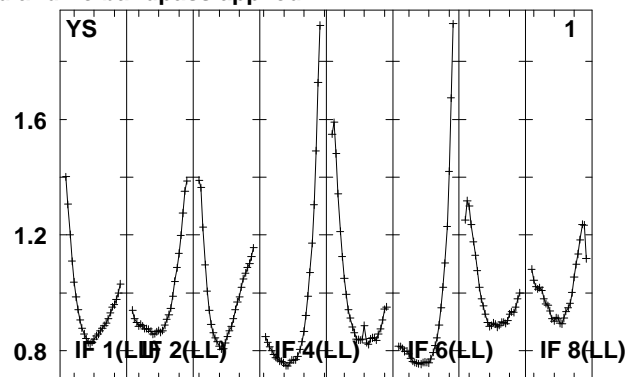
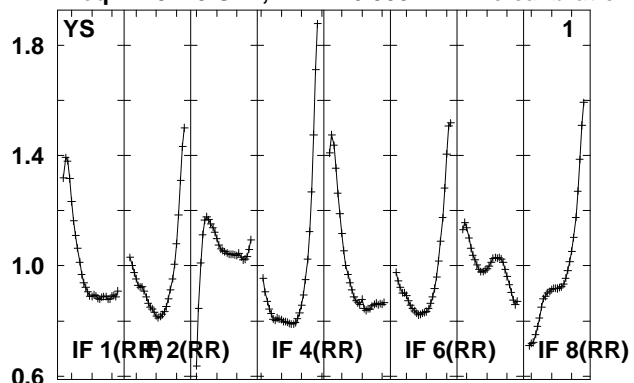

Lower frame: Real Jy

Total-power spectrum Antenna: *

Timerange: 00/10:14:11 to 00/10:15:39

Plot file version 260 created 14-MAY-2010 15:18:29

J0158+13 EO007.UVDATA.1

Freq = 4.9270 GHz, Bw = 16.000 MH No calibration applied and no bandpass applied

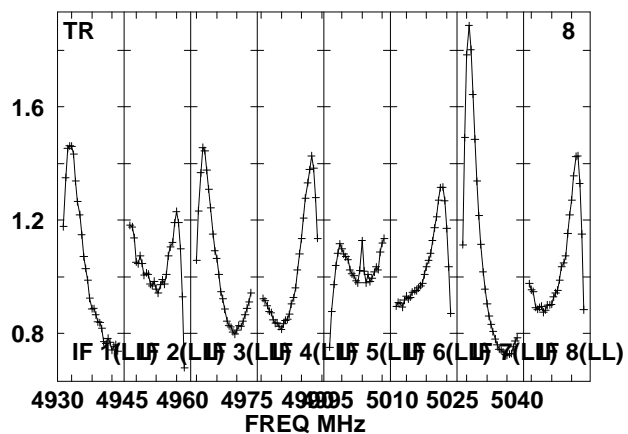
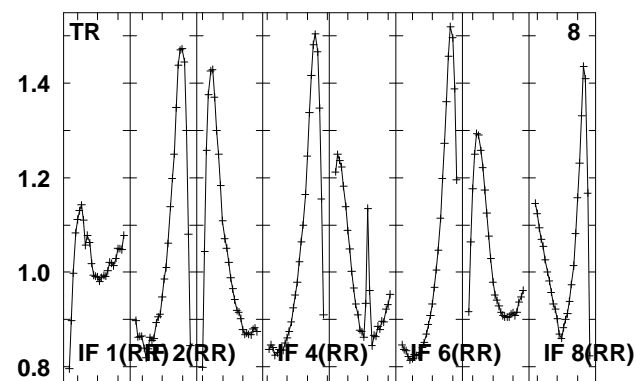
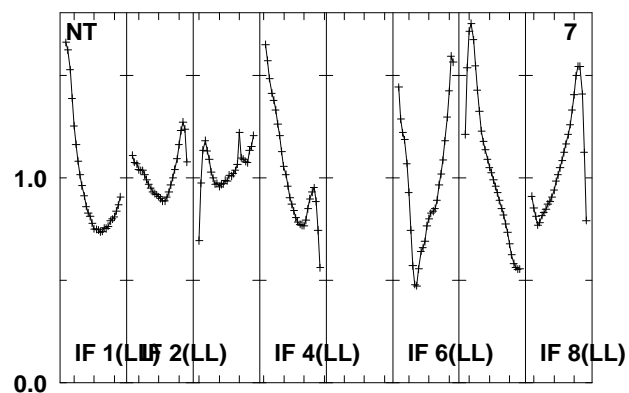
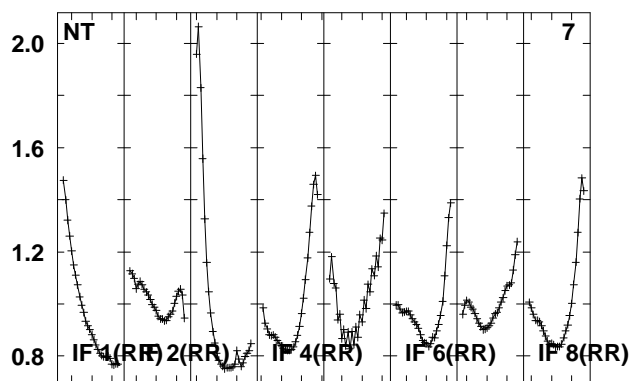
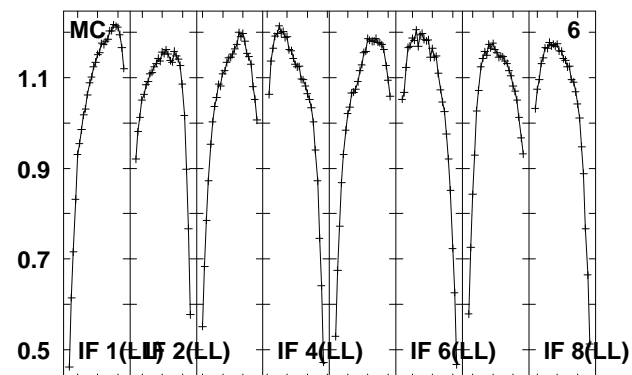
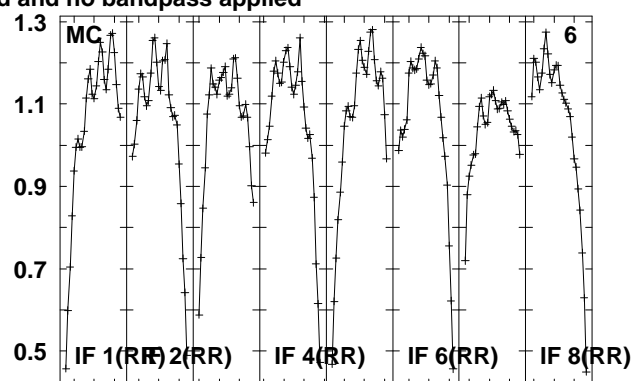
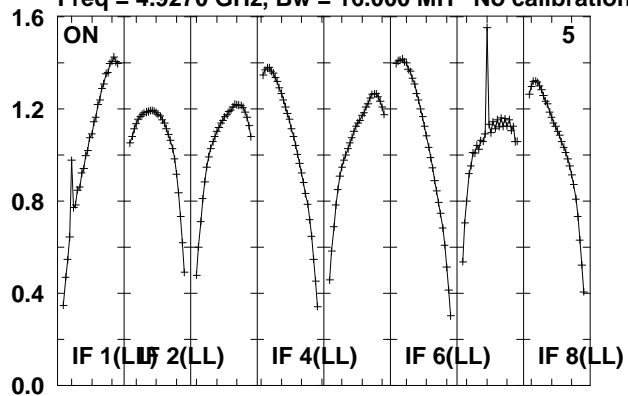

Lower frame: Real Jy

Total-power spectrum Antenna: *

Timerange: 00/10:14:11 to 00/10:15:39

Plot file version 261 created 14-MAY-2010 15:18:30

J0209+13 EO007.UVDATA.1

Freq = 4.9270 GHz, Bw = 16.000 MH No calibration applied and no bandpass applied

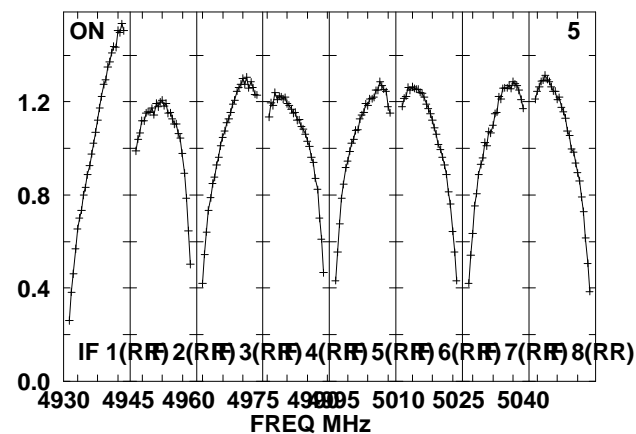
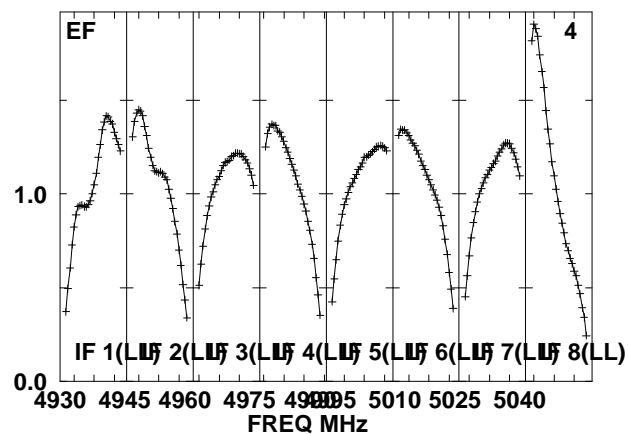
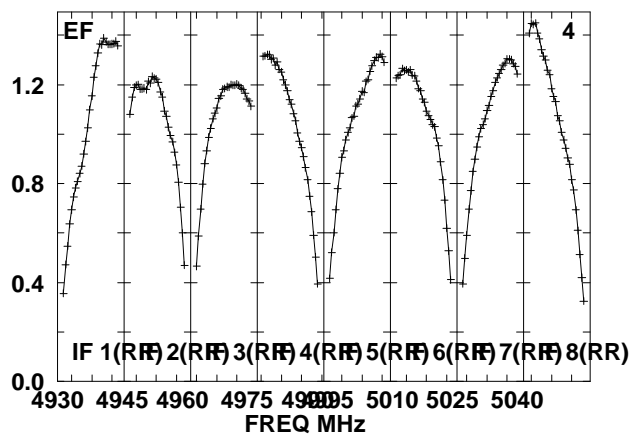
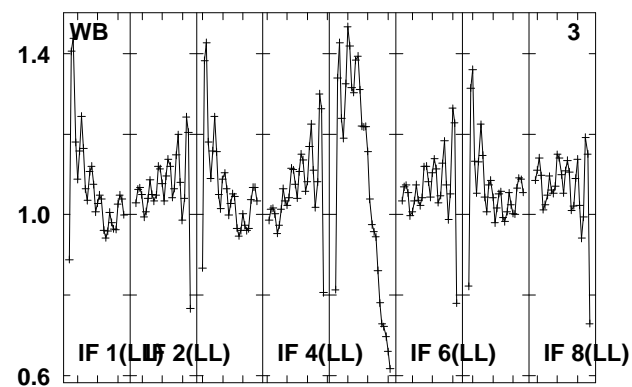
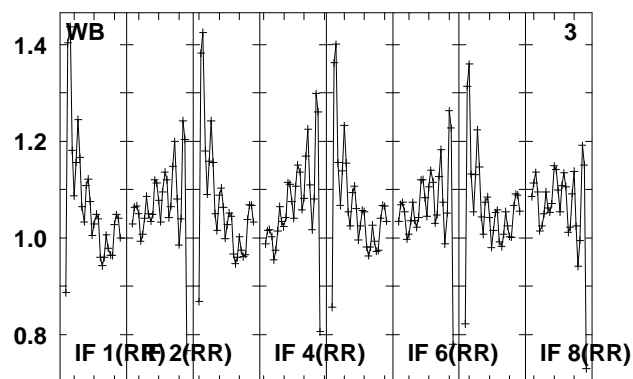
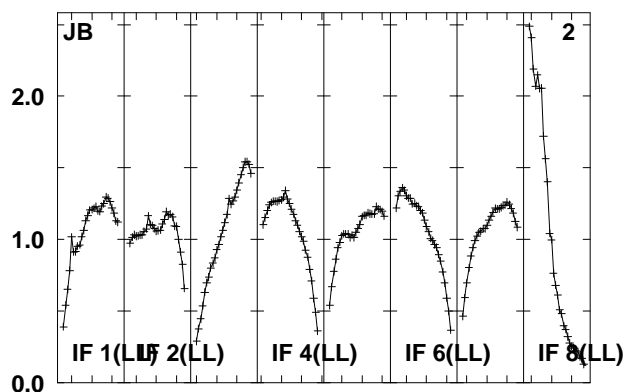
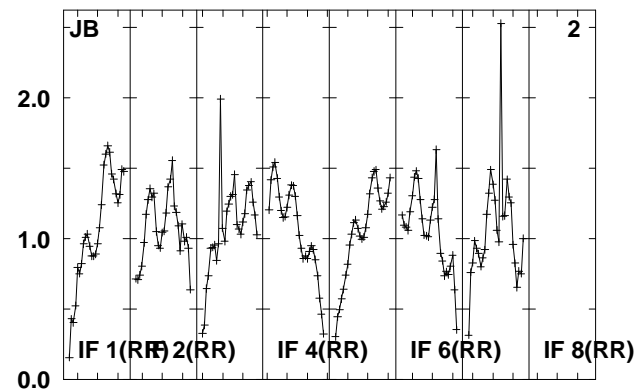
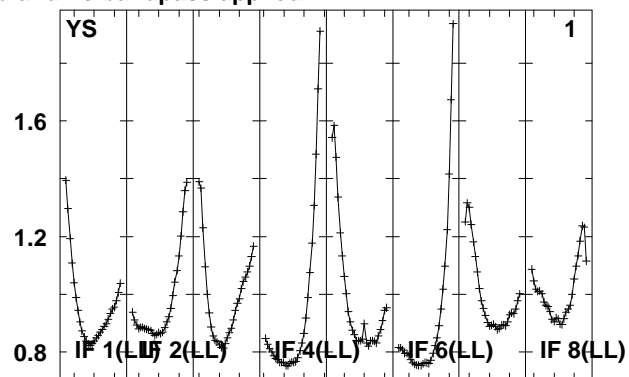
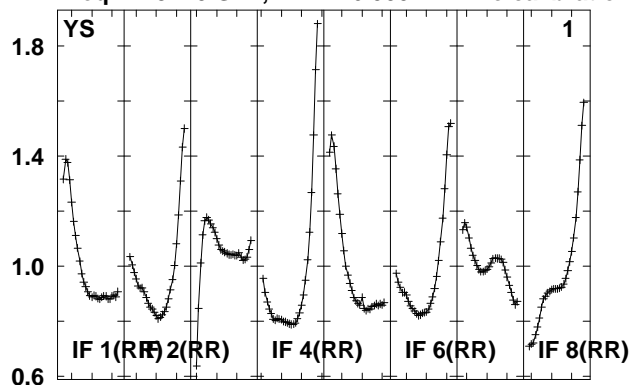

Lower frame: Real Jy

Total-power spectrum Antenna: *

Timerange: 00/10:16:14 to 00/10:17:40

Plot file version 262 created 14-MAY-2010 15:18:30

J0209+13 EO007.UVDATA.1

Freq = 4.9270 GHz, Bw = 16.000 MH No calibration applied and no bandpass applied

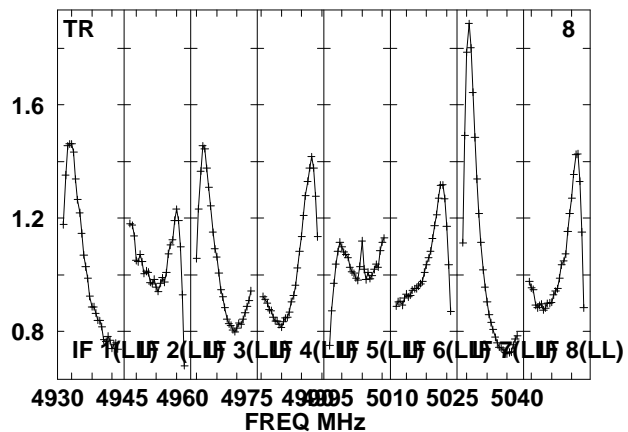
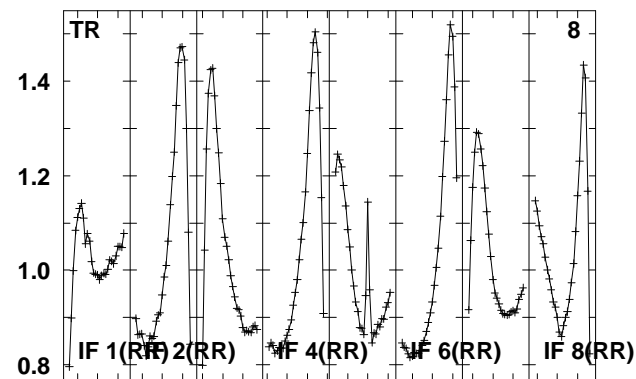
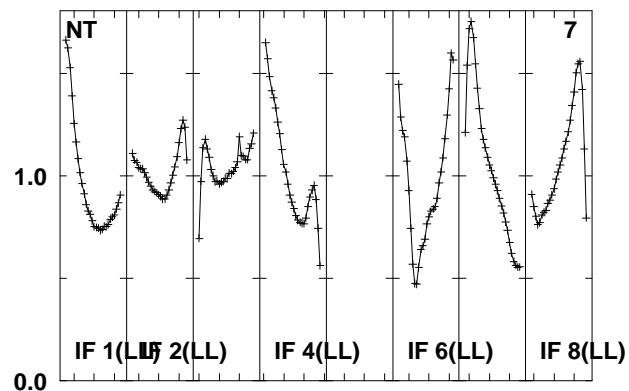
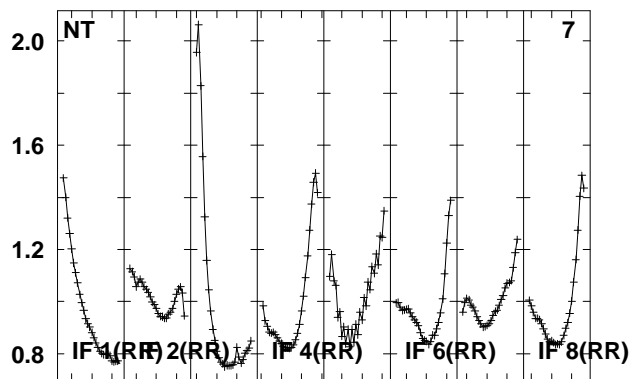
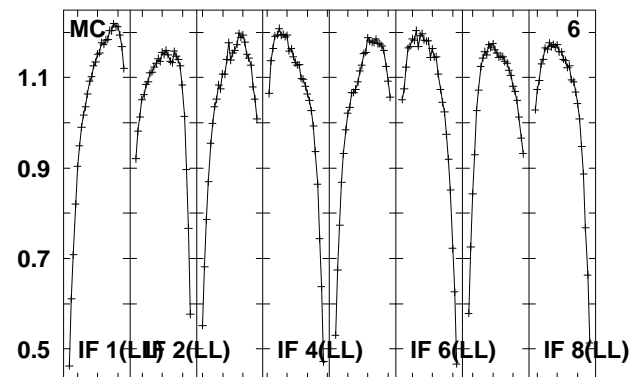
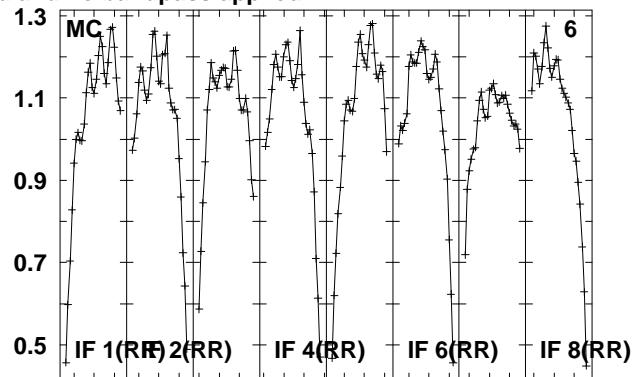
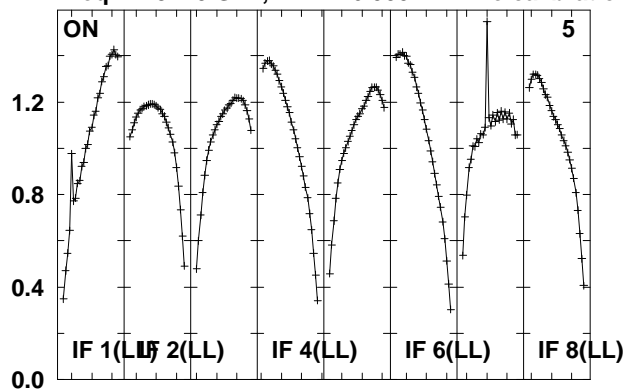

Lower frame: Real Jy

Total-power spectrum Antenna: *

Timerange: 00/10:16:14 to 00/10:17:40

Plot file version 263 created 14-MAY-2010 15:18:30
 J021348 EO007.UVDATA.1
 Freq = 4.9270 GHz, Bw = 16.000 MH No calibration applied and no bandpass applied

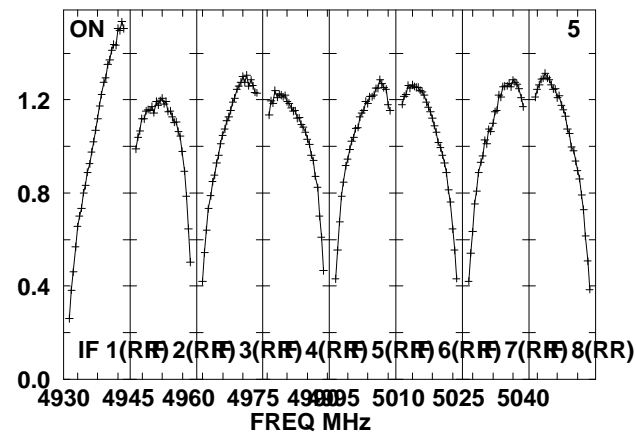
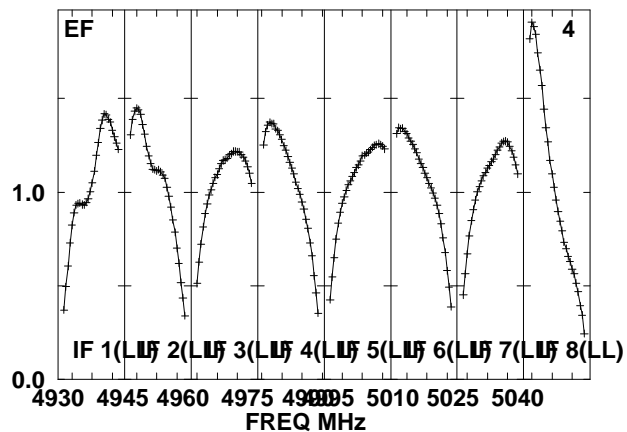
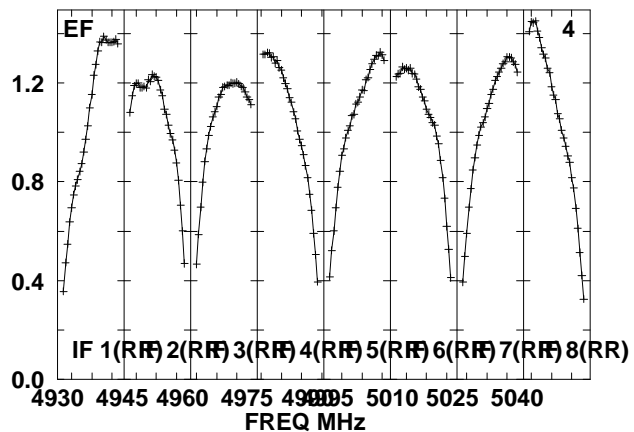
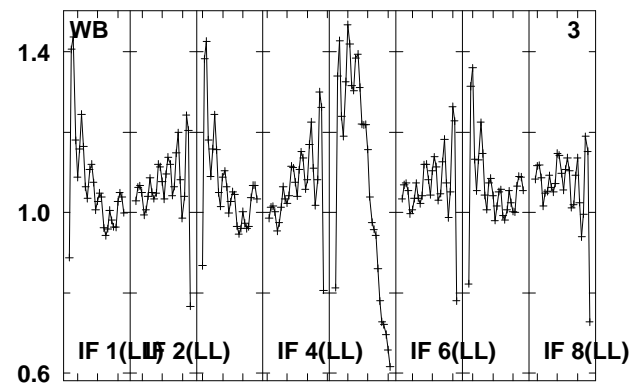
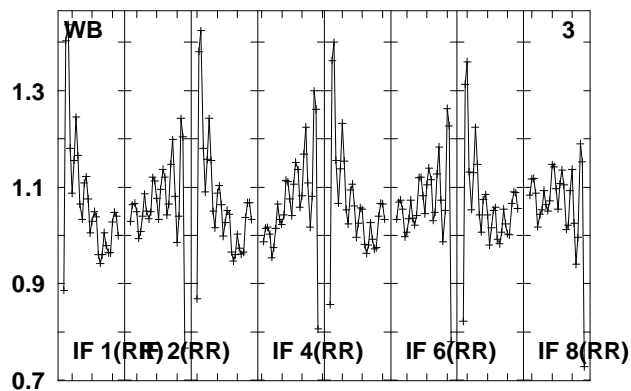
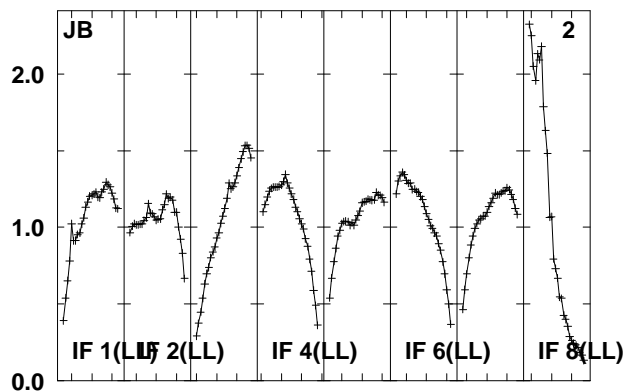
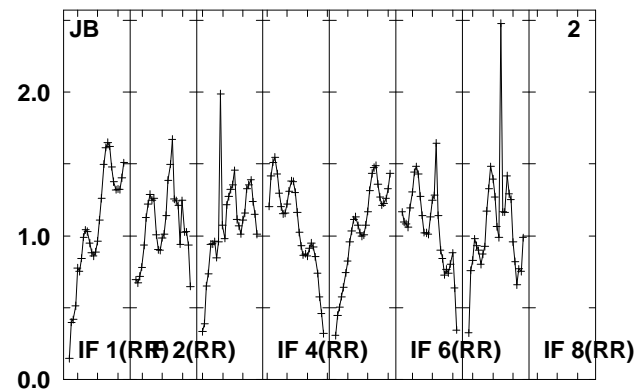
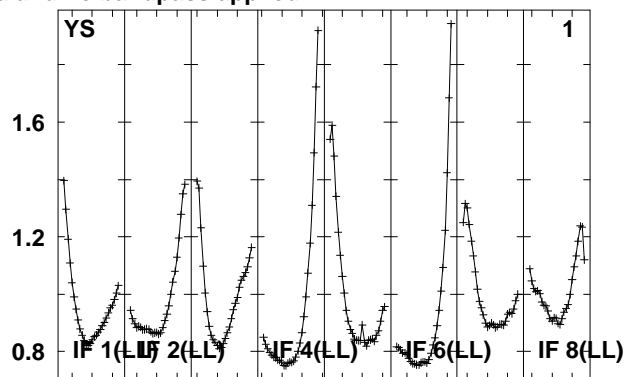
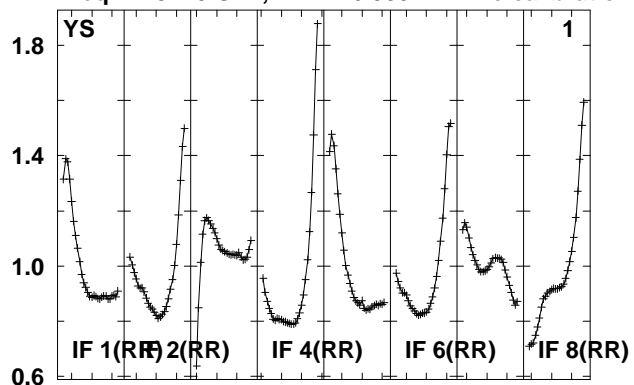

Lower frame: Real Jy
 Total-power spectrum Antenna: *
 Timerange: 00/10:18:09 to 00/10:23:07

Plot file version 264 created 14-MAY-2010 15:18:31

J021348 EO007.UVDATA.1

Freq = 4.9270 GHz, Bw = 16.000 MH No calibration applied and no bandpass applied

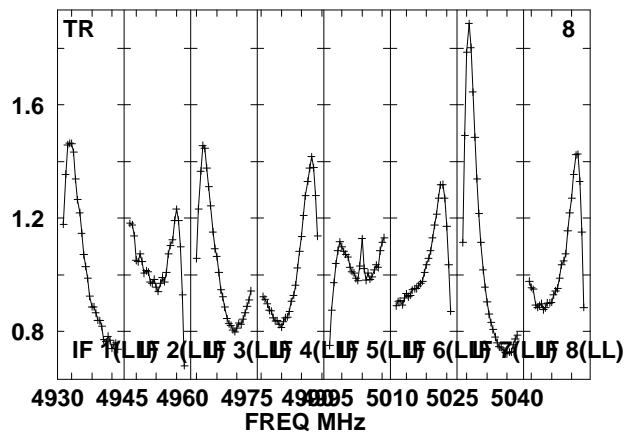
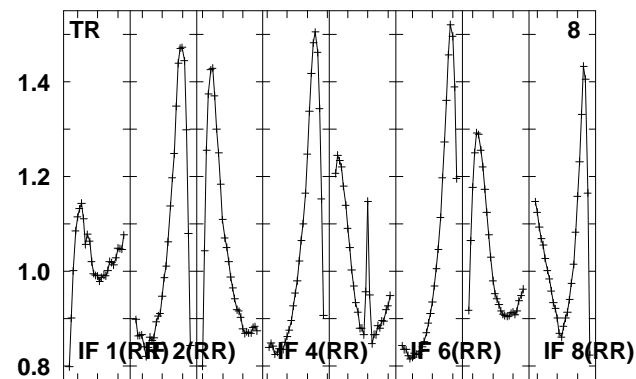
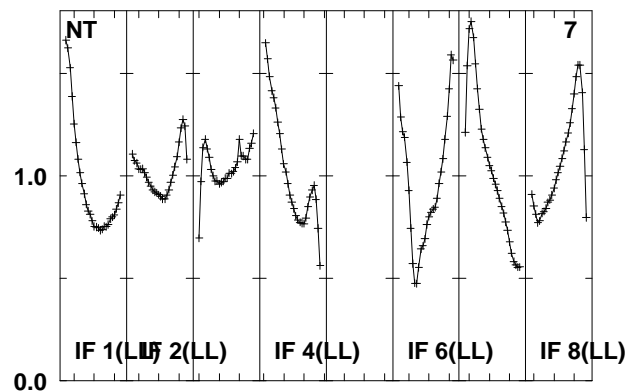
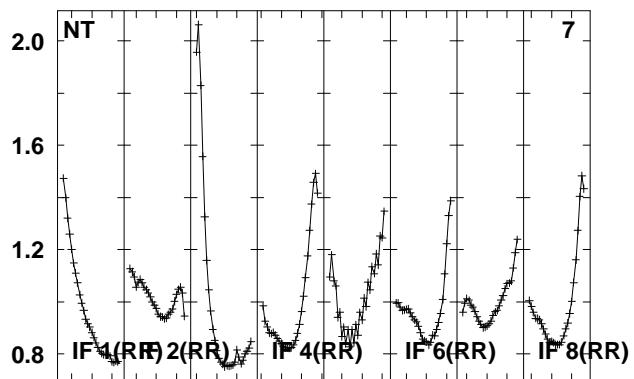
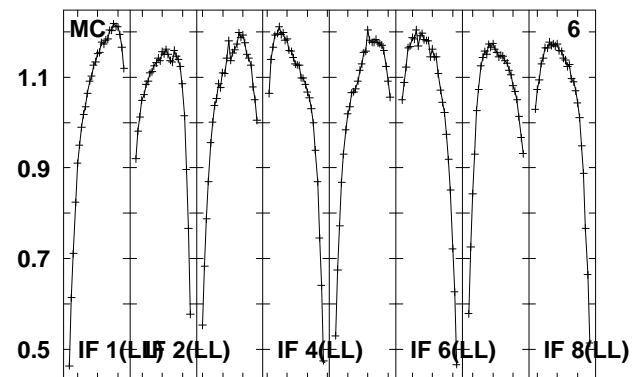
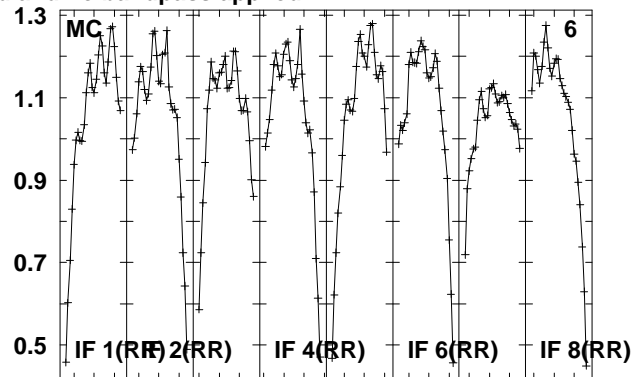
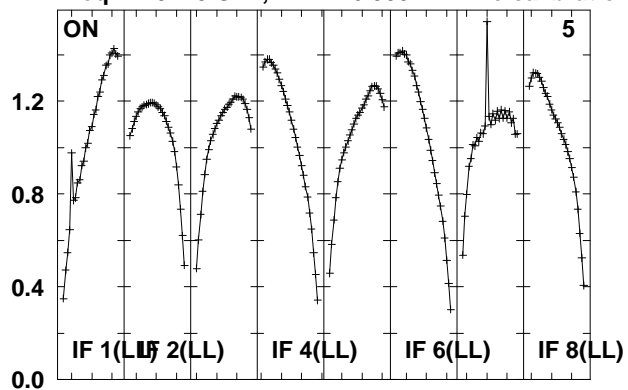

Lower frame: Real Jy

Total-power spectrum Antenna: *

Timerange: 00/10:18:09 to 00/10:23:07

Plot file version 265 created 14-MAY-2010 15:18:31
 J0209+13 EO007.UVDATA.1
 Freq = 4.9270 GHz, Bw = 16.000 MH No calibration applied and no bandpass applied

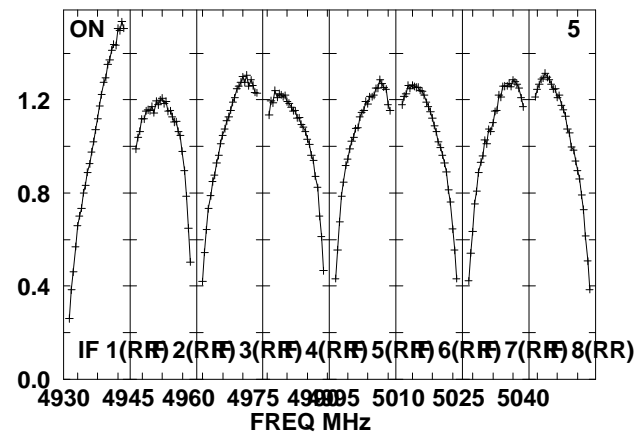
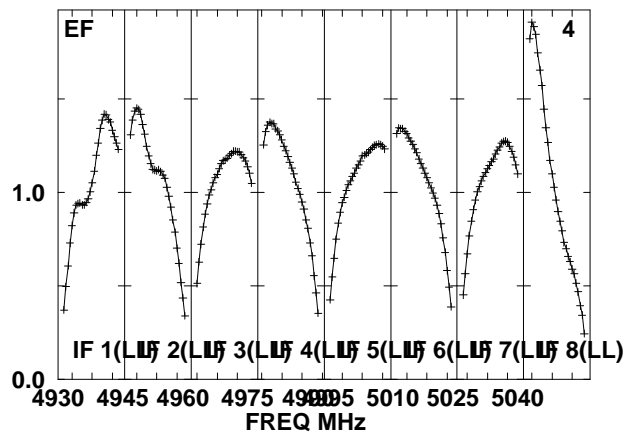
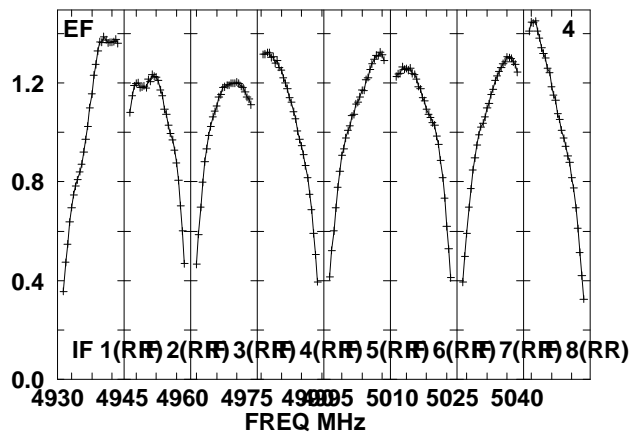
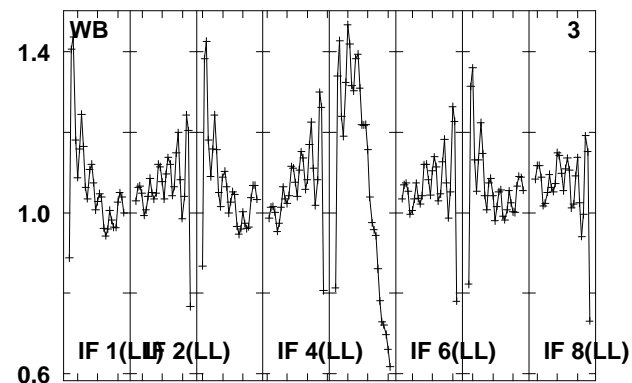
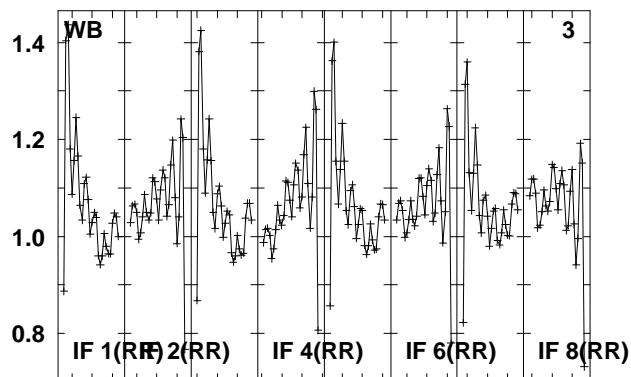
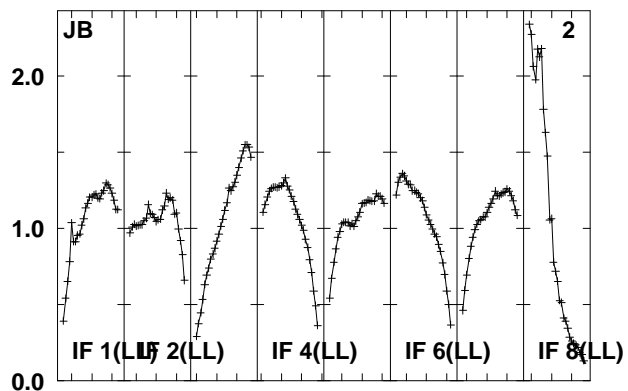
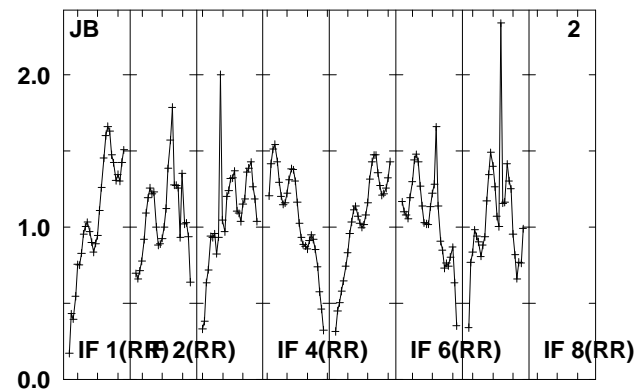
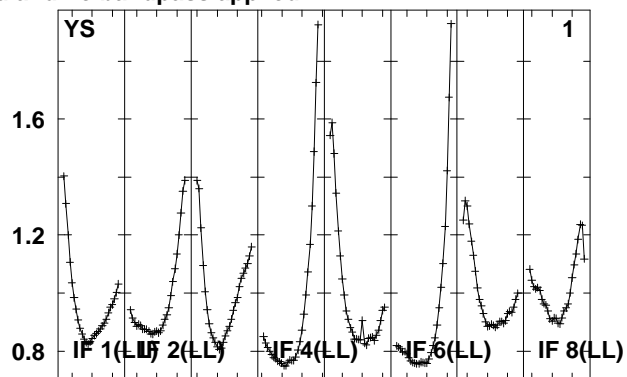
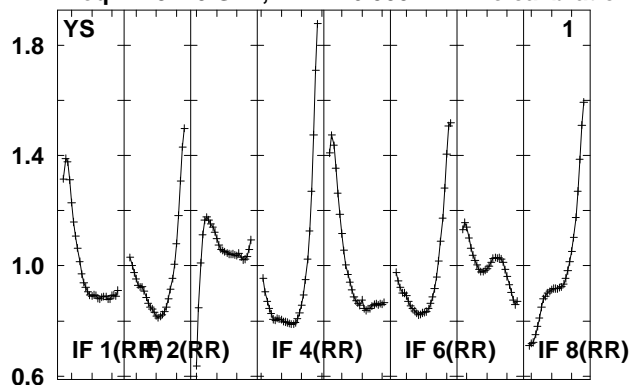

Lower frame: Real Jy
 Total-power spectrum Antenna: *
 Timerange: 00/10:23:35 to 00/10:25:03

Plot file version 266 created 14-MAY-2010 15:18:31

J0209+13 EO007.UVDATA.1

Freq = 4.9270 GHz, Bw = 16.000 MH No calibration applied and no bandpass applied

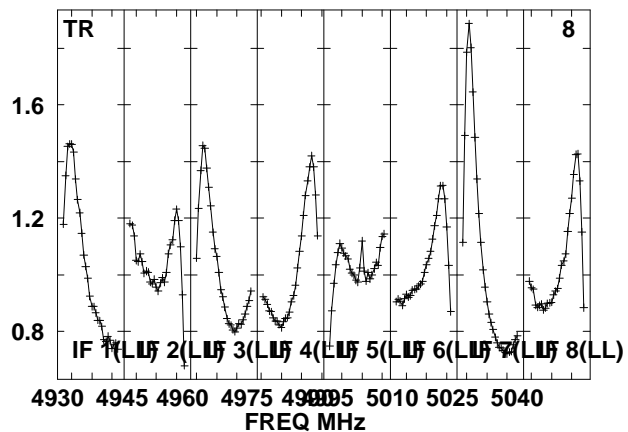
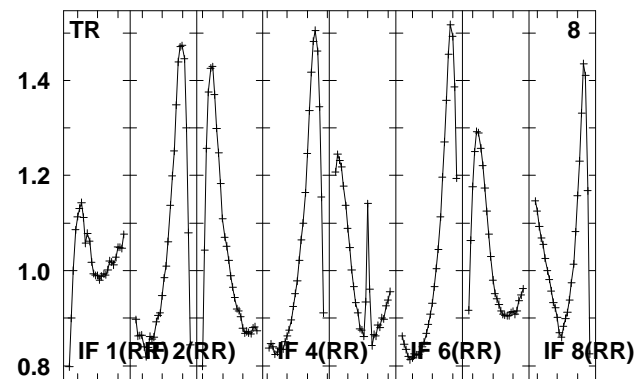
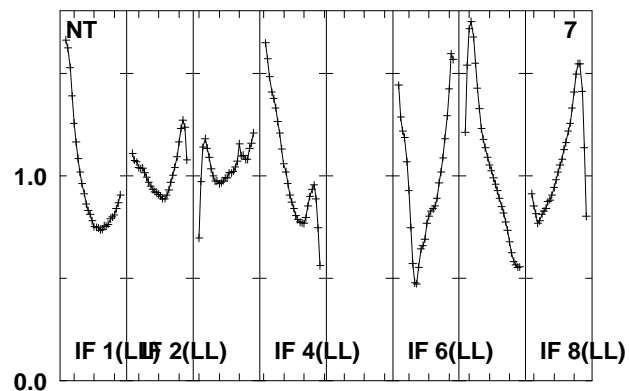
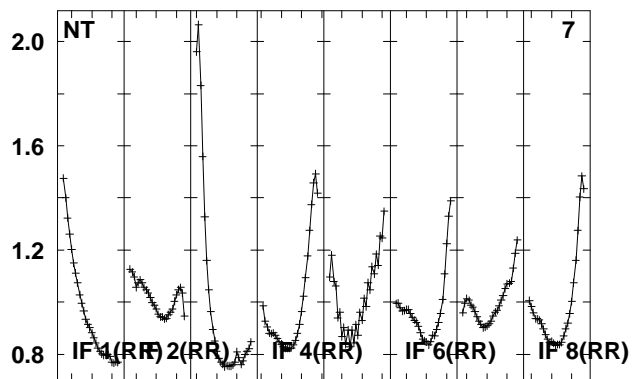
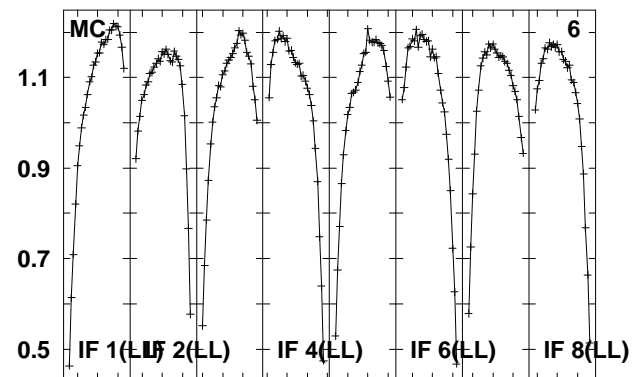
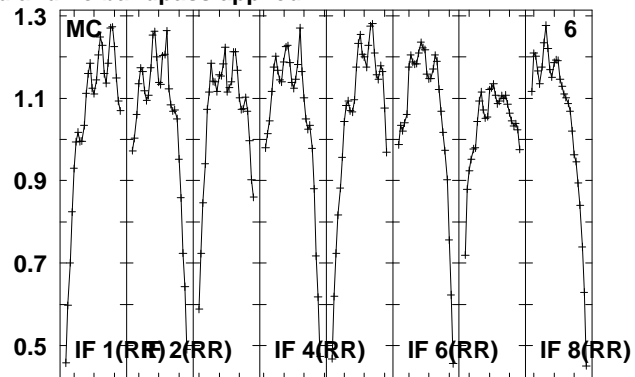
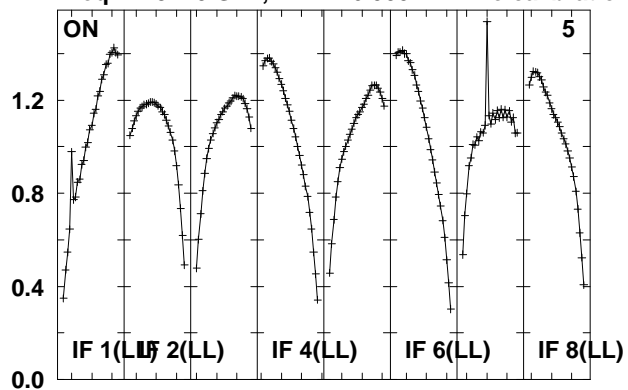

Lower frame: Real Jy

Total-power spectrum Antenna: *

Timerange: 00/10:23:35 to 00/10:25:03

Plot file version 267 created 14-MAY-2010 15:18:32
 J021348 EO007.UVDATA.1
 Freq = 4.9270 GHz, Bw = 16.000 MH No calibration applied and no bandpass applied

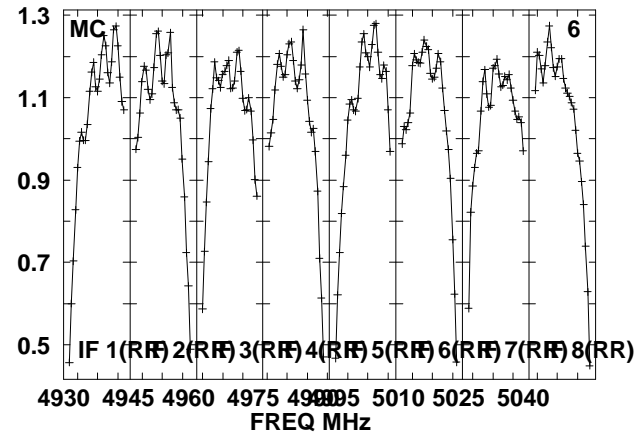
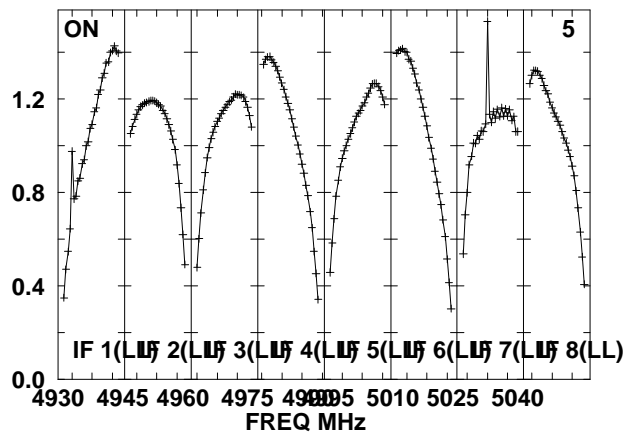
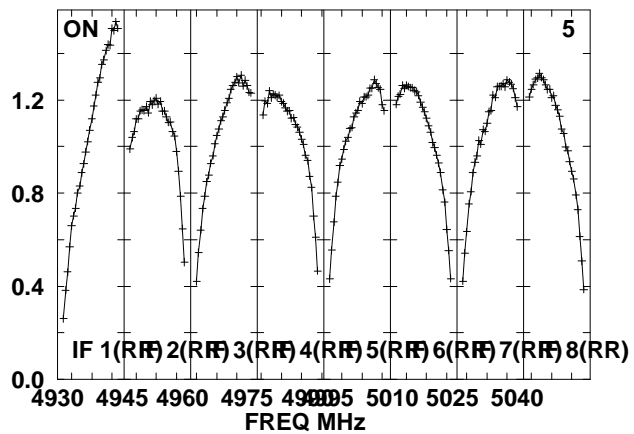
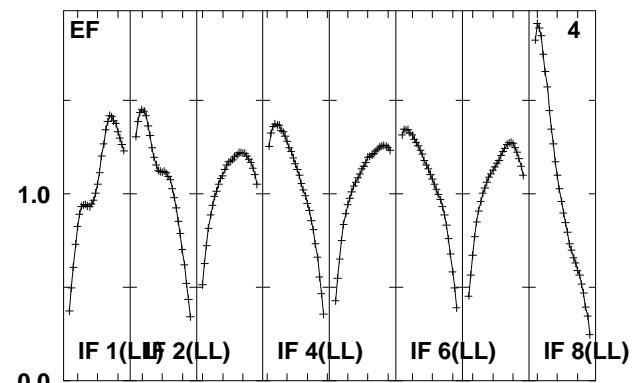
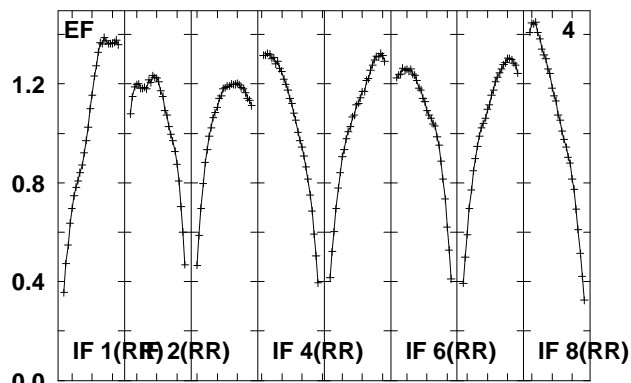
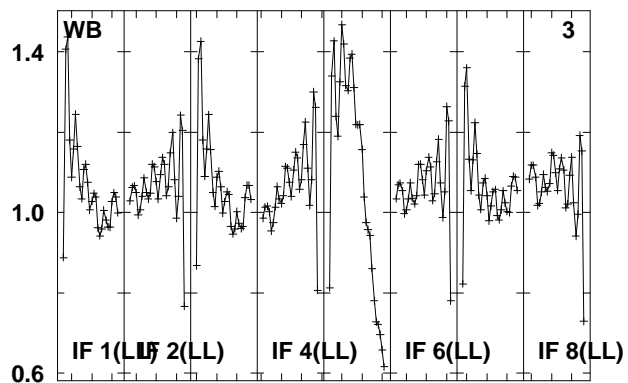
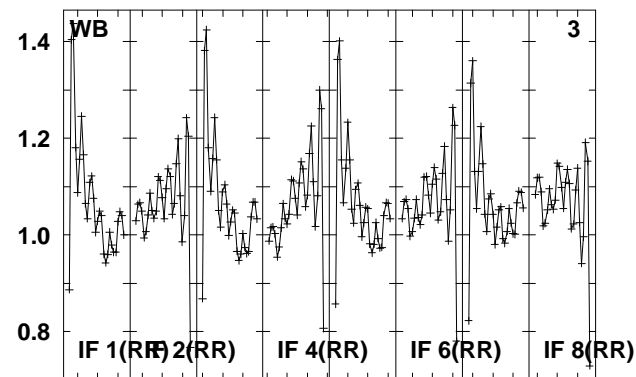
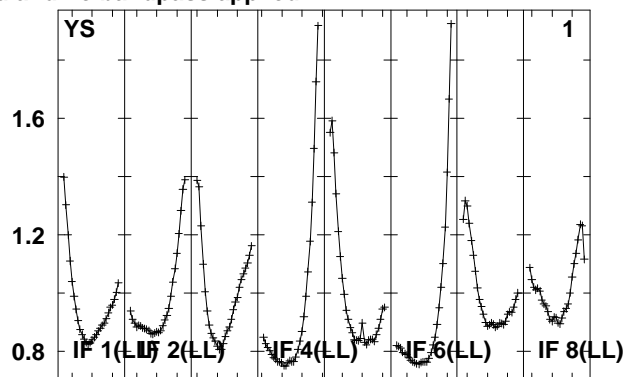
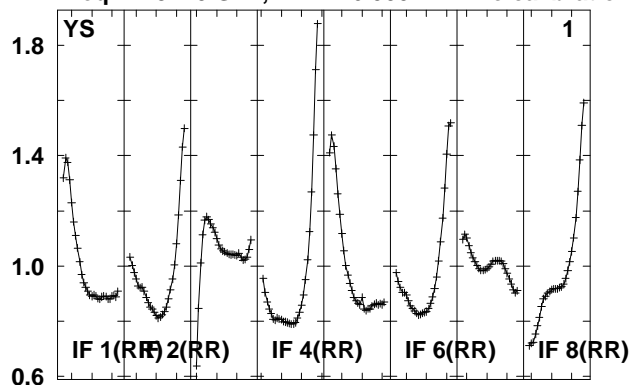

Lower frame: Real Jy
 Total-power spectrum Antenna: *
 Timerange: 00/10:25:30 to 00/10:30:26

Plot file version 268 created 14-MAY-2010 15:18:32

J021348 EO007.UVDATA.1

Freq = 4.9270 GHz, Bw = 16.000 MH No calibration applied and no bandpass applied

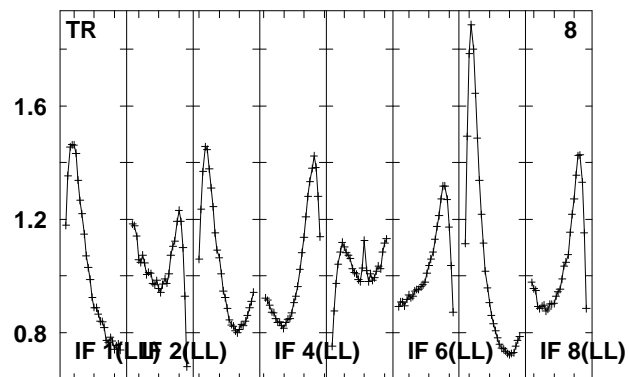
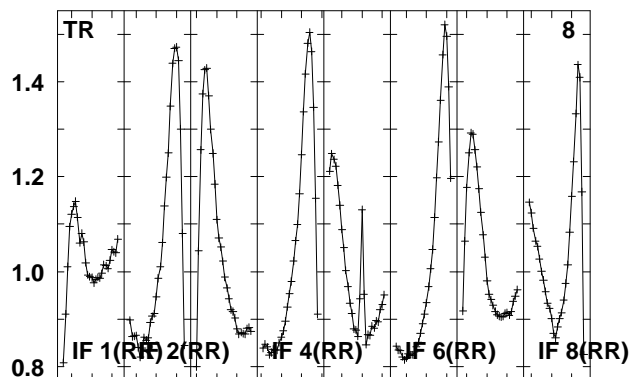
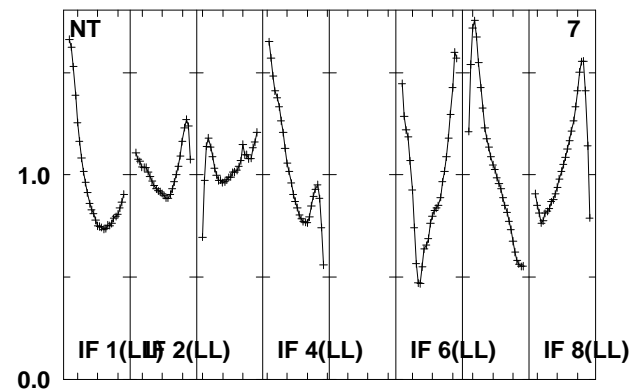
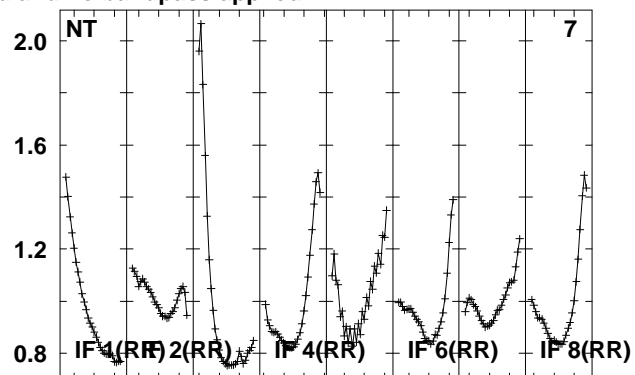
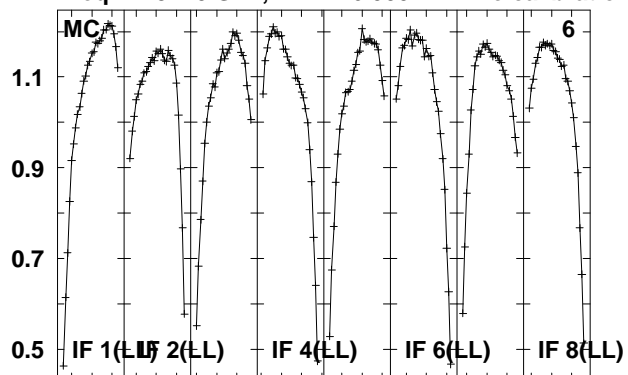

Lower frame: Real Jy
Total-power spectrum Antenna: *
Timerange: 00/10:25:30 to 00/10:30:26

Plot file version 269 created 14-MAY-2010 15:18:33

J0209+13 EO007.UVDATA.1

Freq = 4.9270 GHz, Bw = 16.000 MH No calibration applied and no bandpass applied

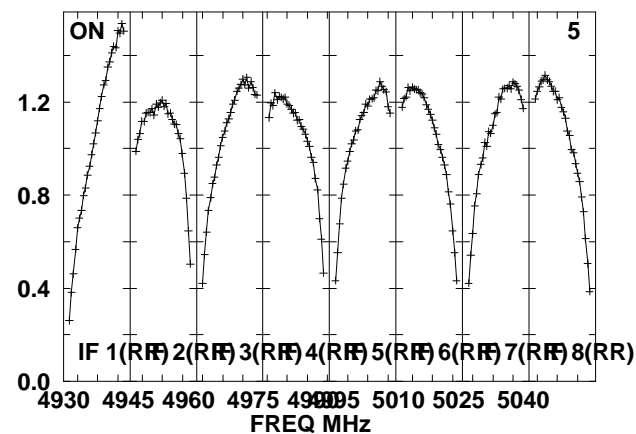
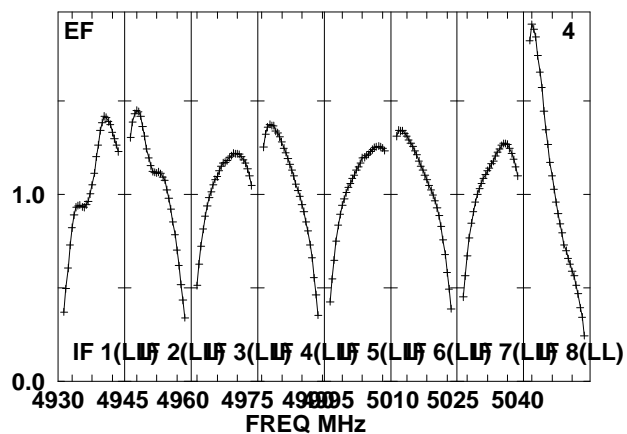
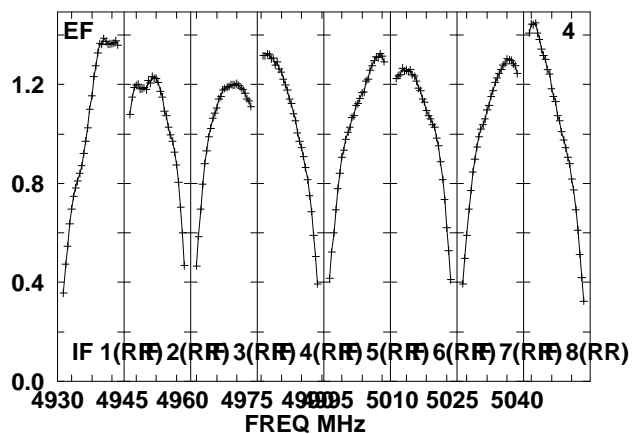
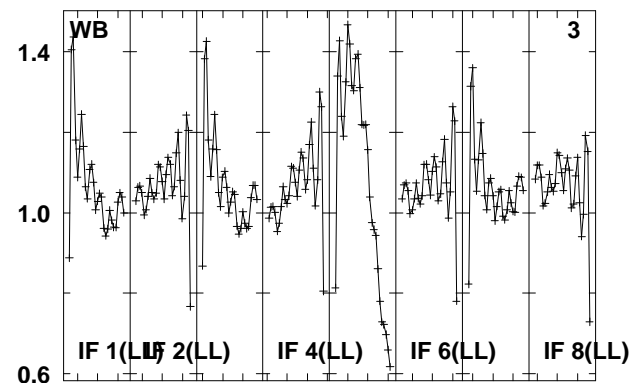
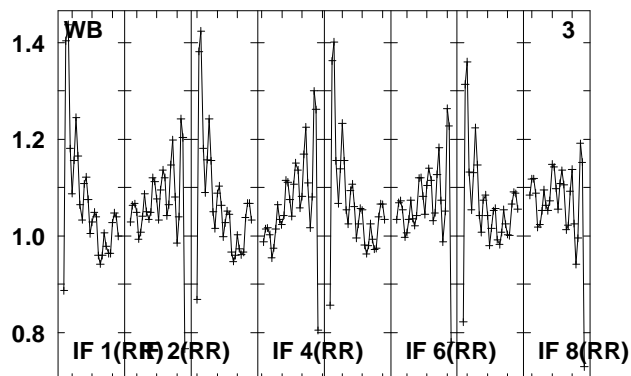
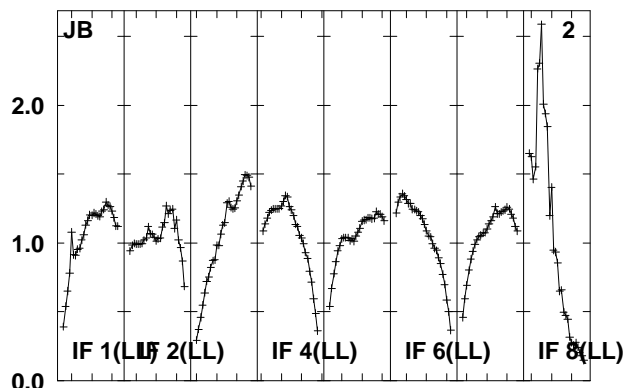
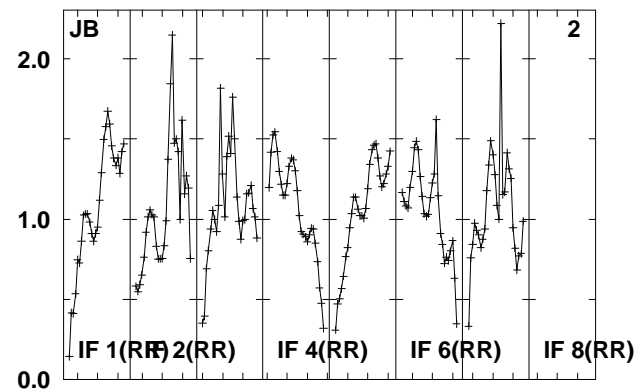
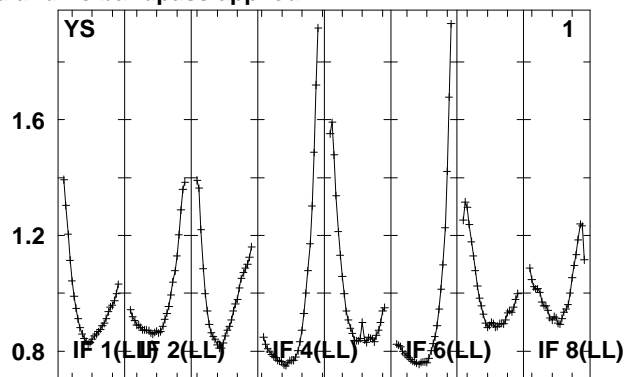
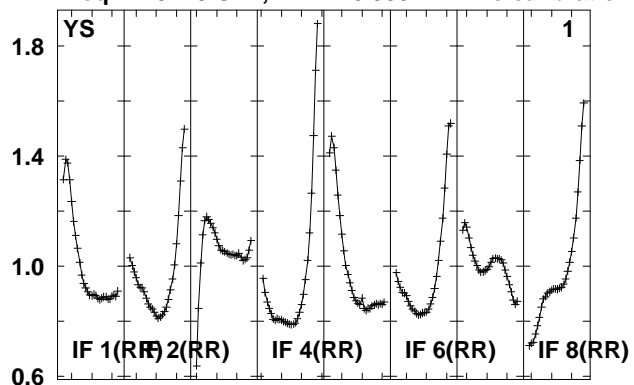

Lower frame: Real Jy

Total-power spectrum Antenna: *

Timerange: 00/10:30:55 to 00/10:32:23

Plot file version 270 created 14-MAY-2010 15:18:33

J0209+13 EO007.UVDATA.1

Freq = 4.9270 GHz, Bw = 16.000 MH No calibration applied and no bandpass applied

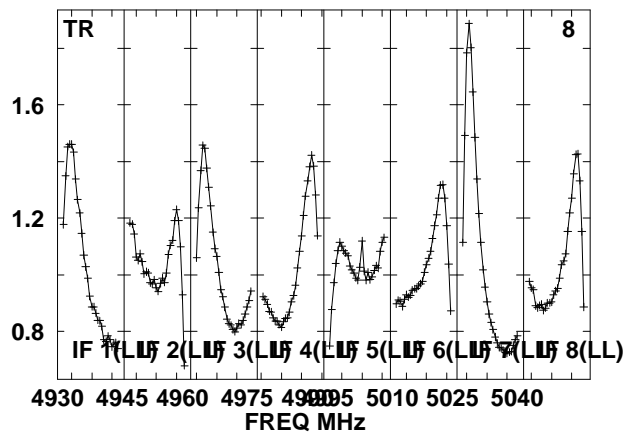
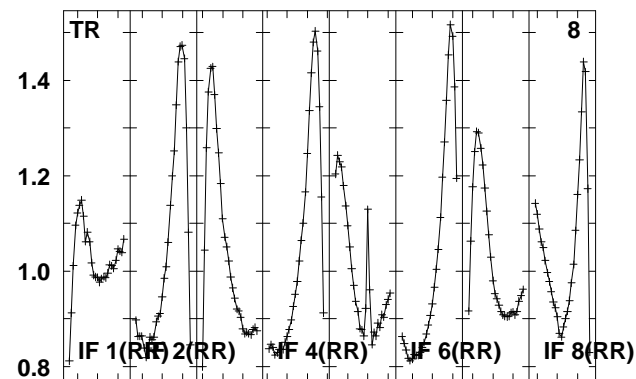
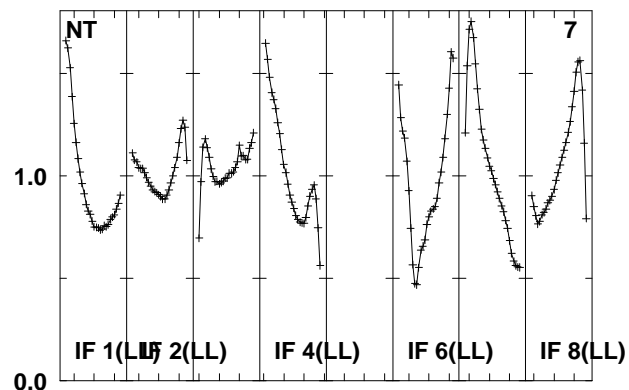
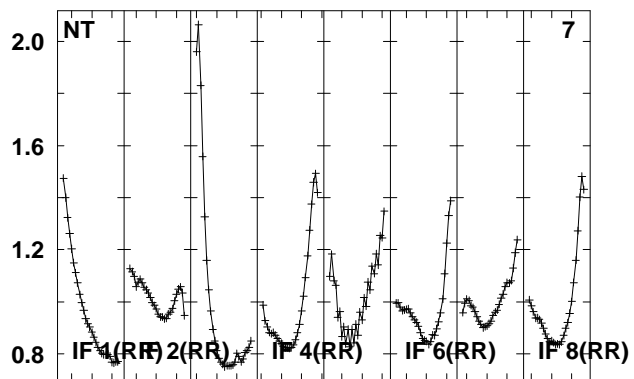
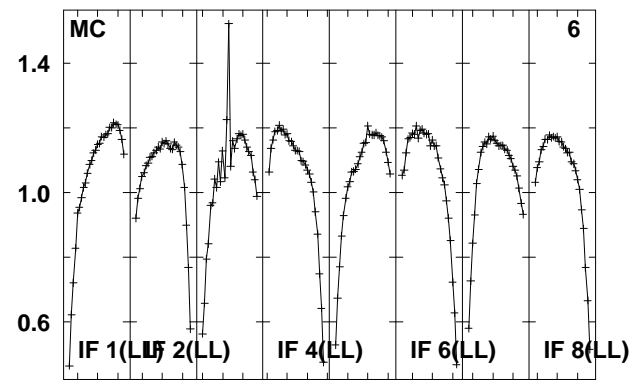
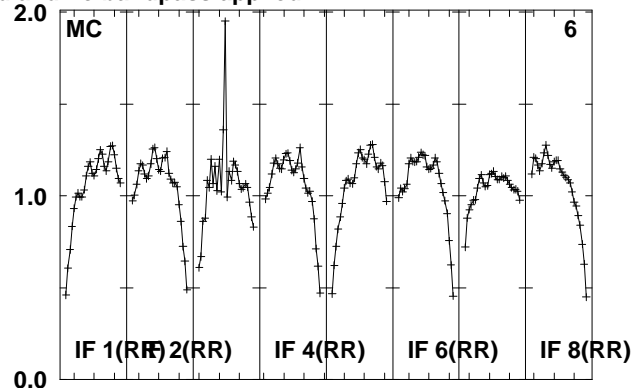
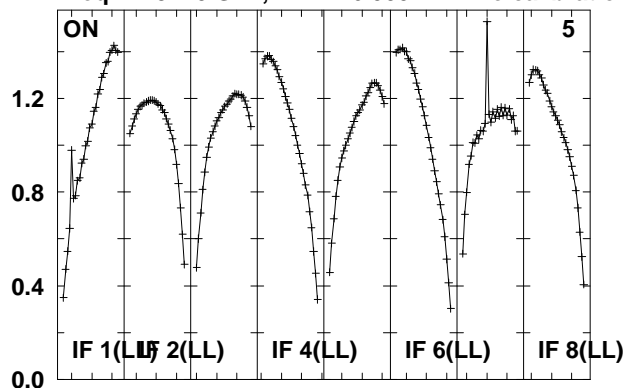

Lower frame: Real Jy

Total-power spectrum Antenna: *

Timerange: 00/10:30:55 to 00/10:32:23

Plot file version 271 created 14-MAY-2010 15:18:33

J0158+13 EO007.UVDATA.1

Freq = 4.9270 GHz, Bw = 16.000 MH No calibration applied and no bandpass applied

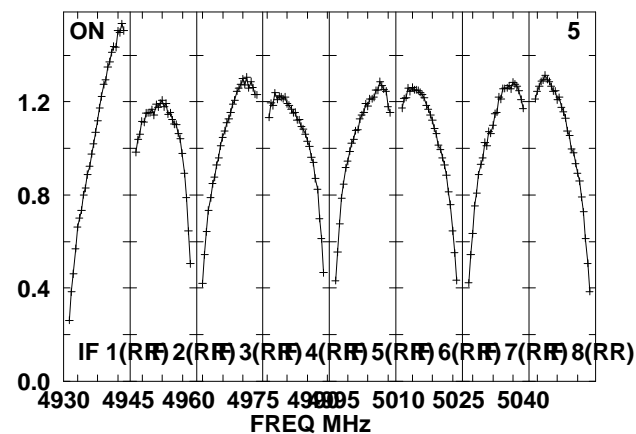
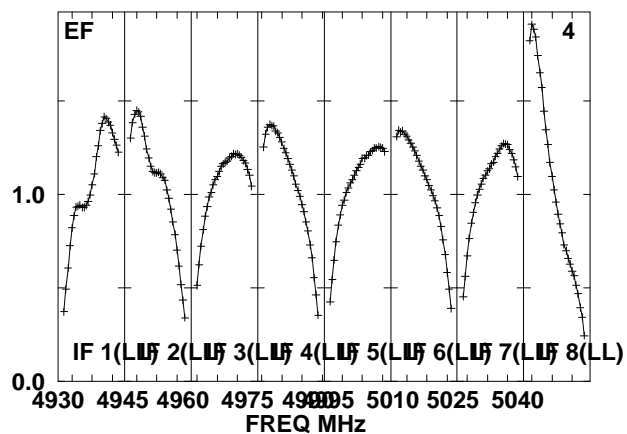
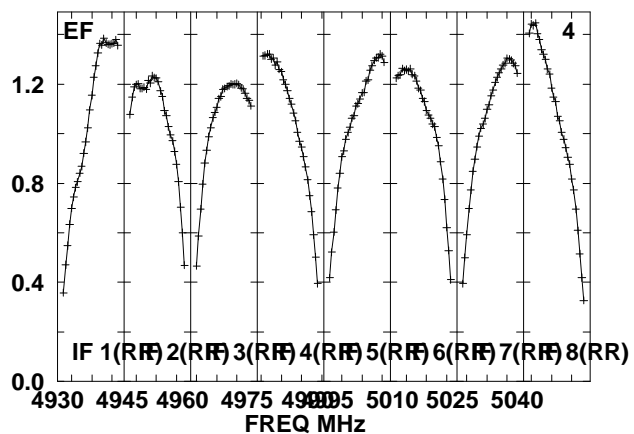
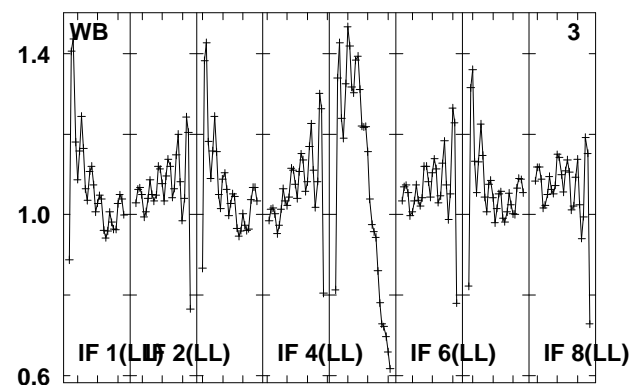
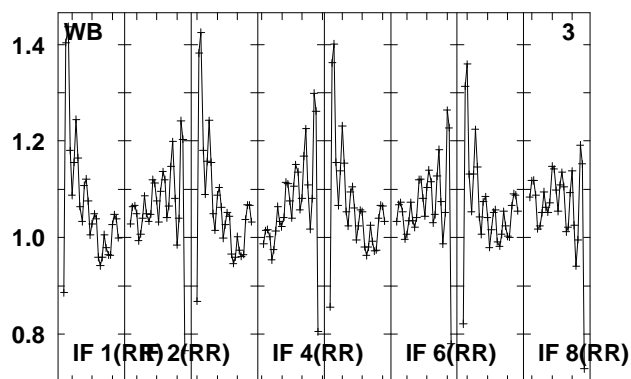
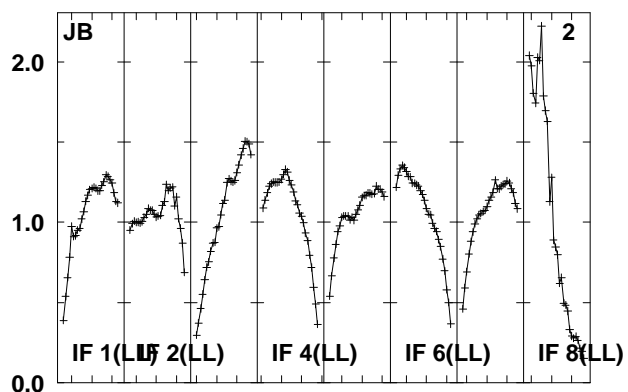
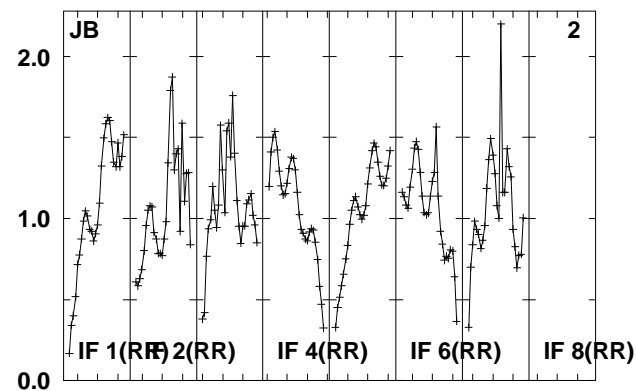
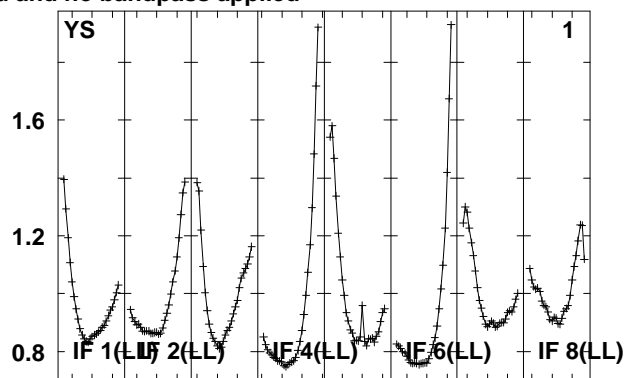
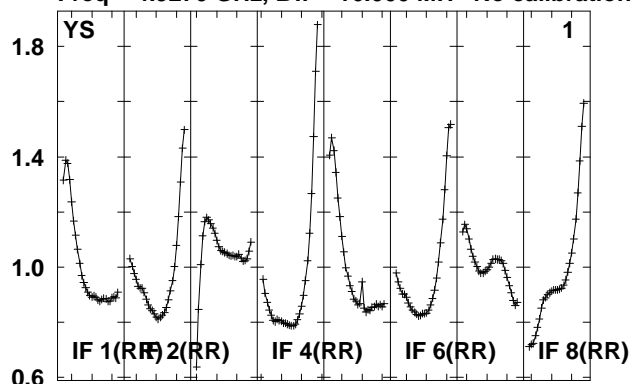

Lower frame: Real Jy
Total-power spectrum Antenna: *
Timerange: 00/10:33:00 to 00/10:34:28

Plot file version 272 created 14-MAY-2010 15:18:33

J0158+13 EO007.UVDATA.1

Freq = 4.9270 GHz, Bw = 16.000 MH No calibration applied and no bandpass applied

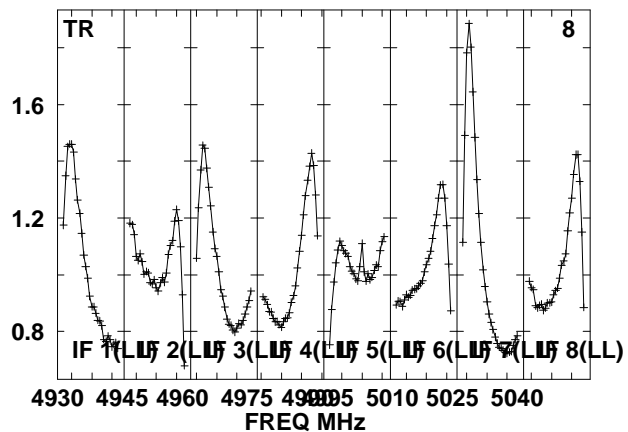
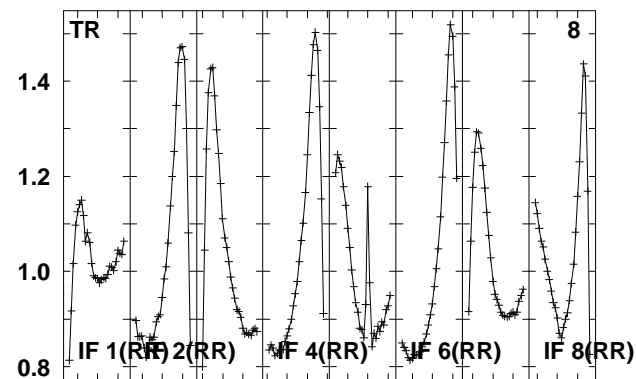
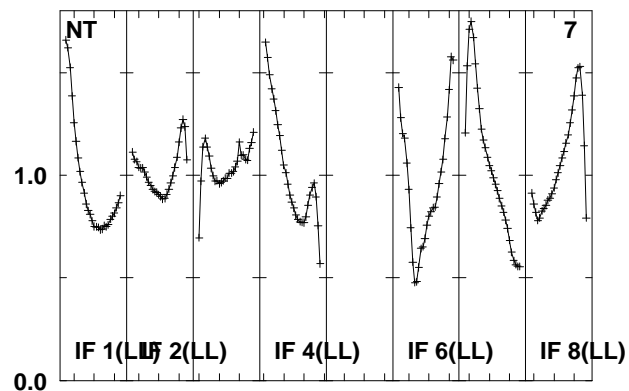
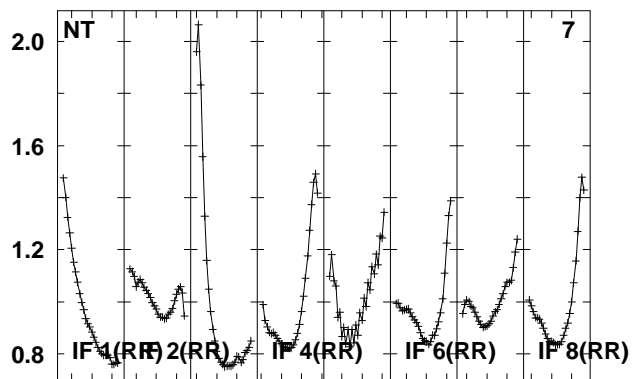
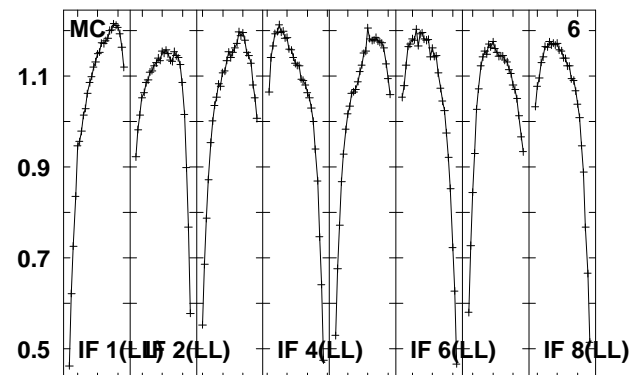
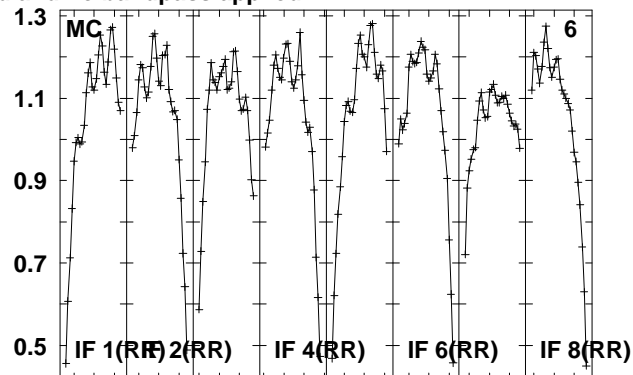
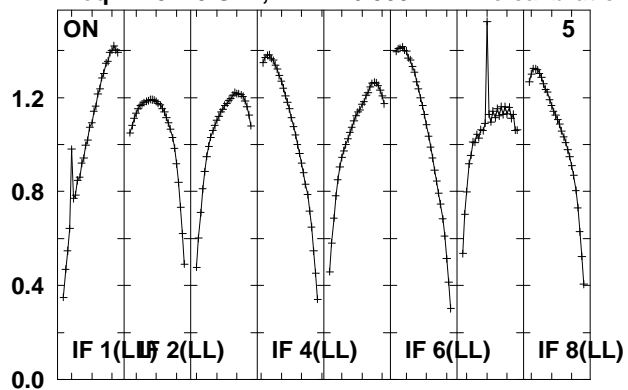

Lower frame: Real Jy

Total-power spectrum Antenna: *

Timerange: 00/10:33:00 to 00/10:34:28

Plot file version 273 created 14-MAY-2010 15:18:34

J015028 EO007.UVDATA.1

Freq = 4.9270 GHz, Bw = 16.000 MH No calibration applied and no bandpass applied

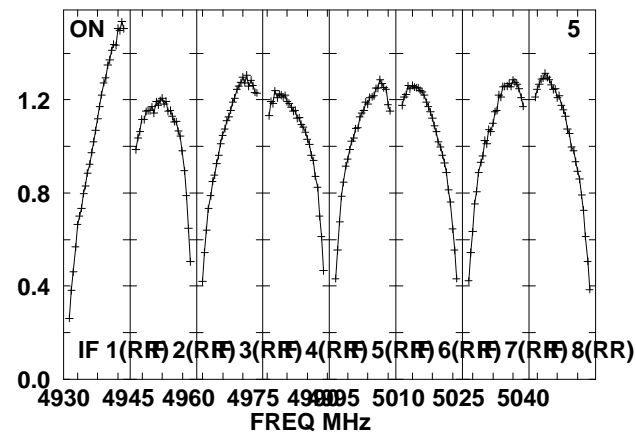
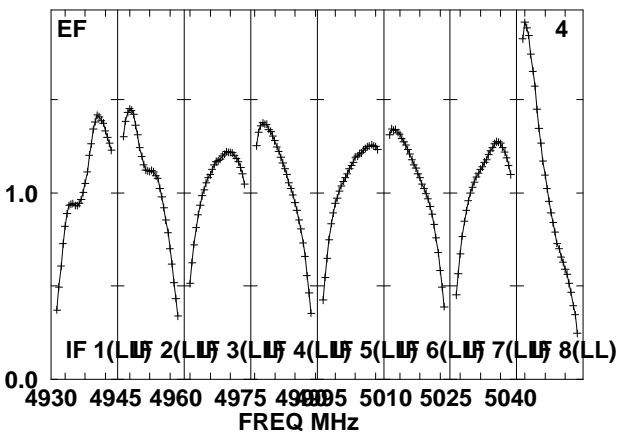
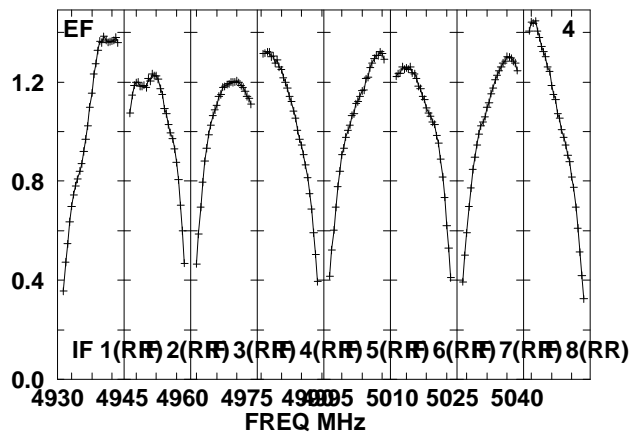
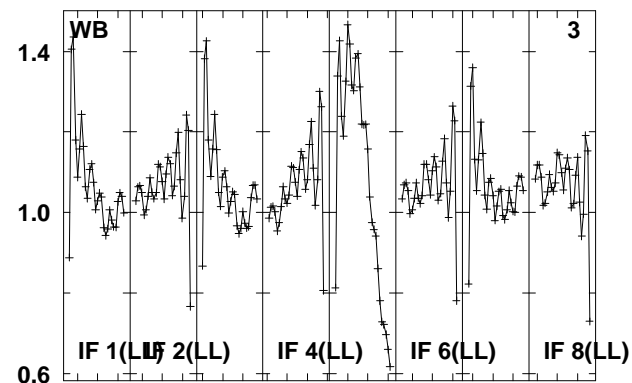
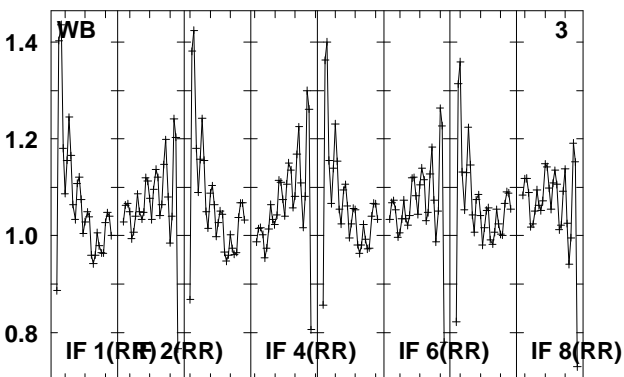
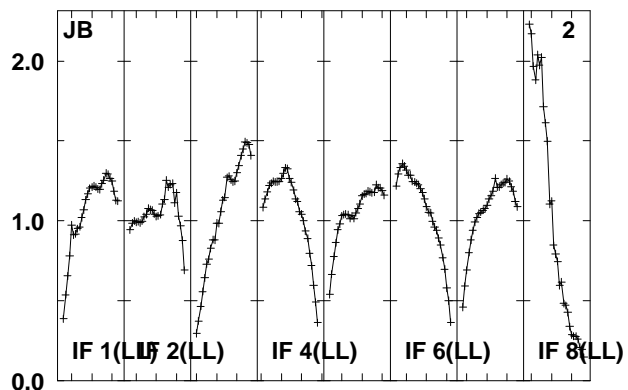
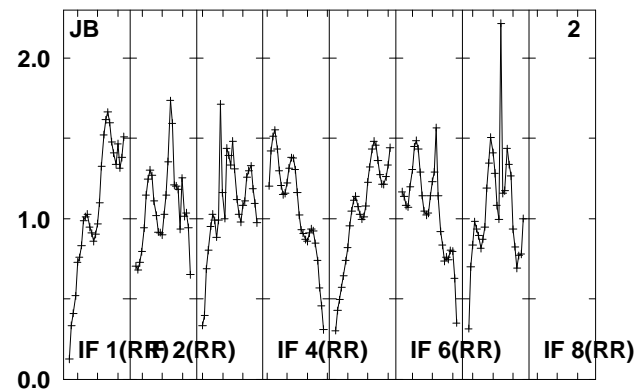
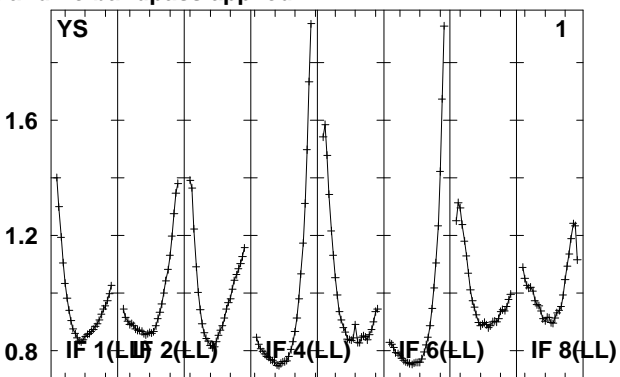
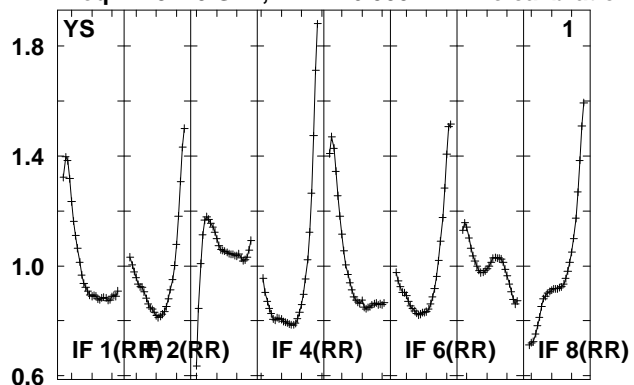

Lower frame: Real Jy

Total-power spectrum Antenna: *

Timerange: 00/10:35:00 to 00/10:39:58

Plot file version 274 created 14-MAY-2010 15:18:34

J015028 EO007.UVDATA.1

Freq = 4.9270 GHz, Bw = 16.000 MH No calibration applied and no bandpass applied

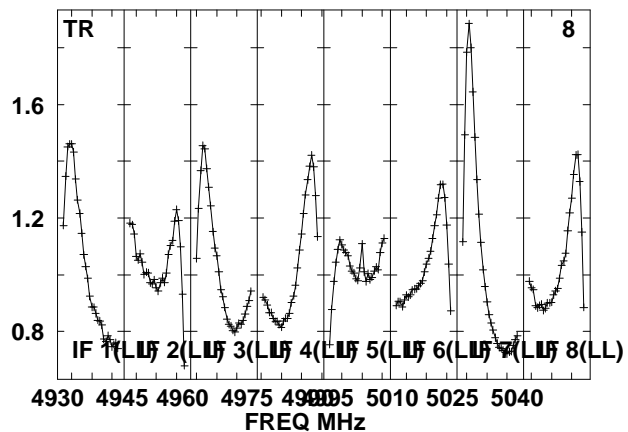
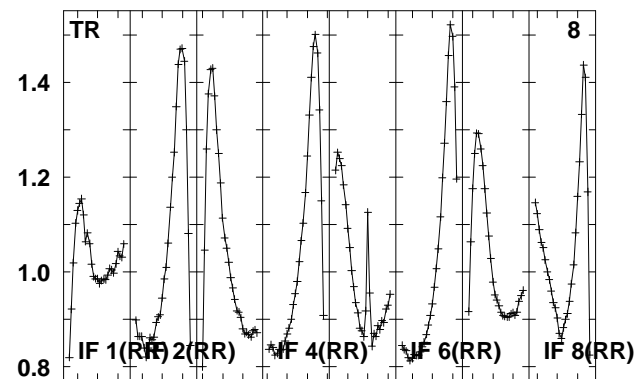
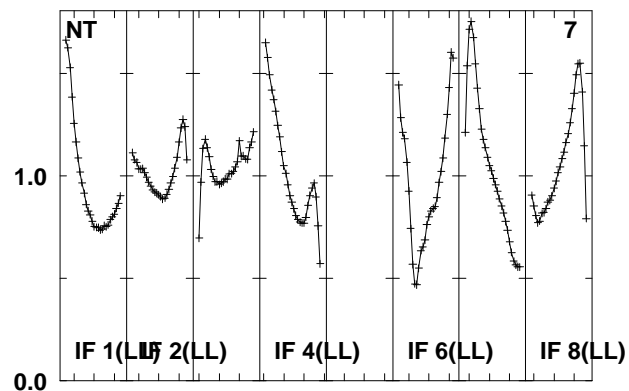
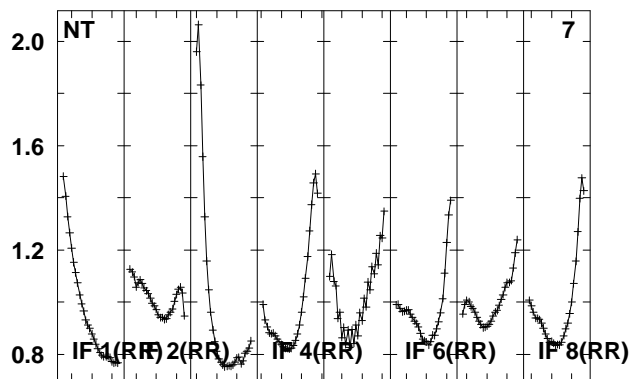
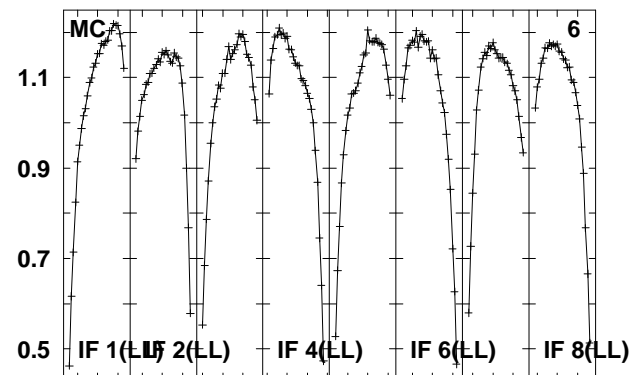
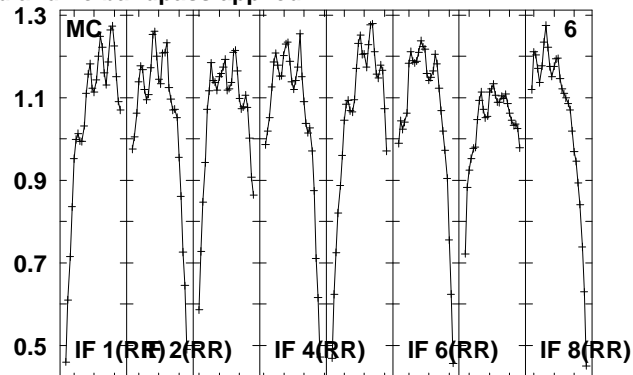
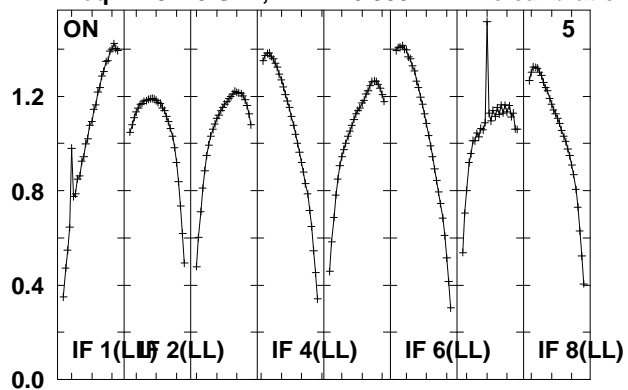

Lower frame: Real Jy

Total-power spectrum Antenna: *

Timerange: 00/10:35:00 to 00/10:39:58

Plot file version 275 created 14-MAY-2010 15:18:35

J0158+13 EO007.UVDATA.1

Freq = 4.9270 GHz, Bw = 16.000 MH No calibration applied and no bandpass applied

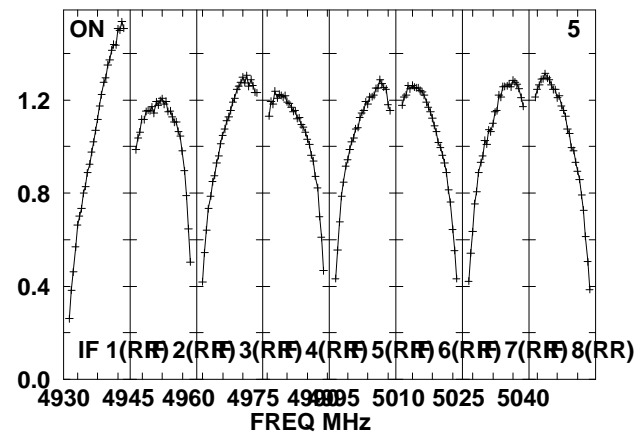
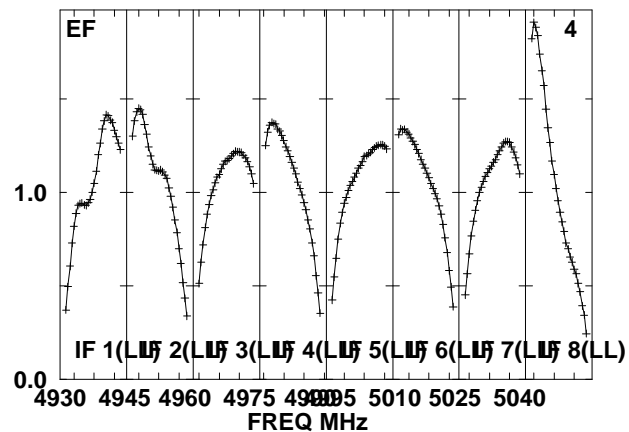
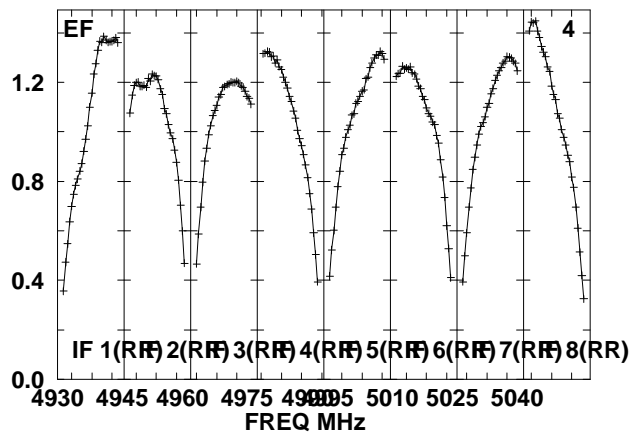
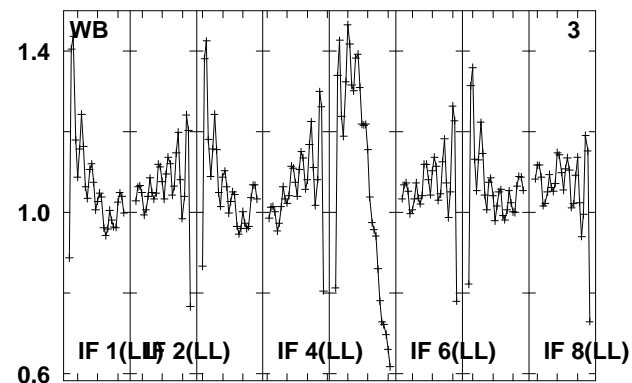
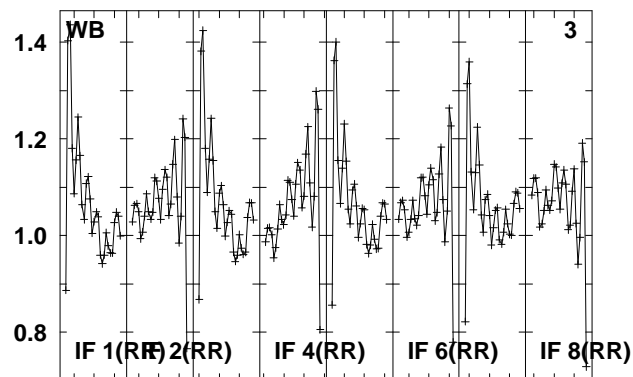
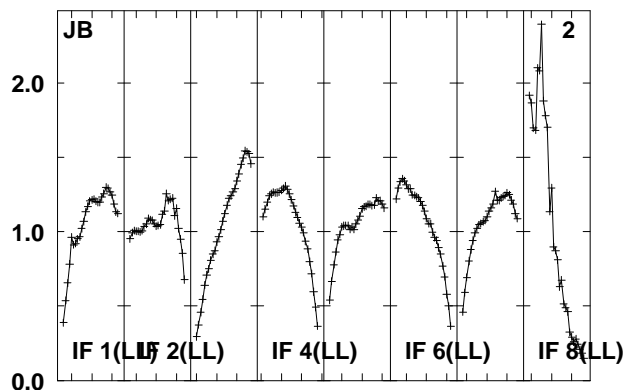
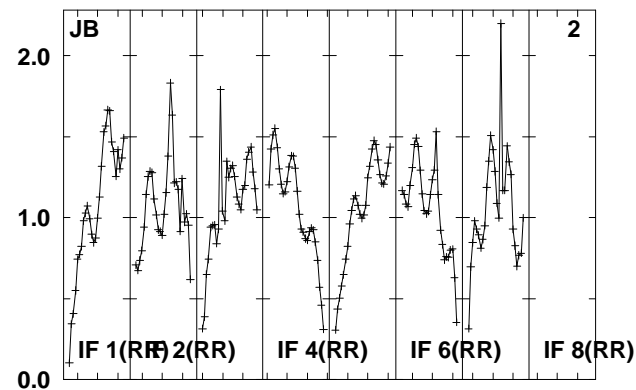
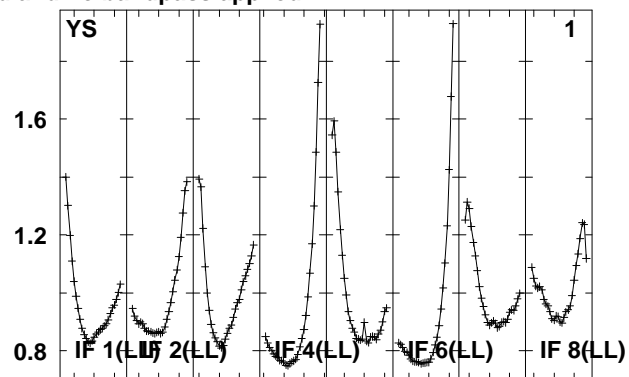
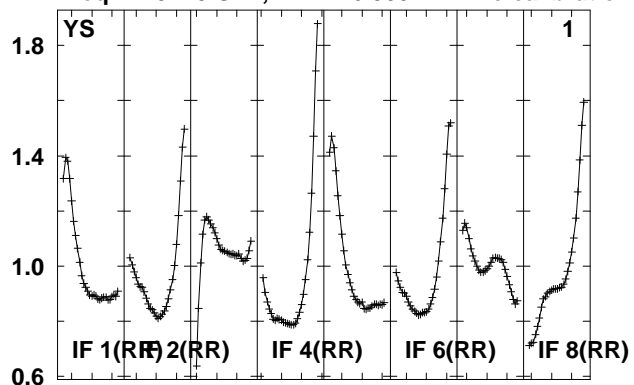

Lower frame: Real Jy

Total-power spectrum Antenna: *

Timerange: 00/10:40:29 to 00/10:41:55

Plot file version 276 created 14-MAY-2010 15:18:35

J0158+13 EO007.UVDATA.1

Freq = 4.9270 GHz, Bw = 16.000 MH No calibration applied and no bandpass applied

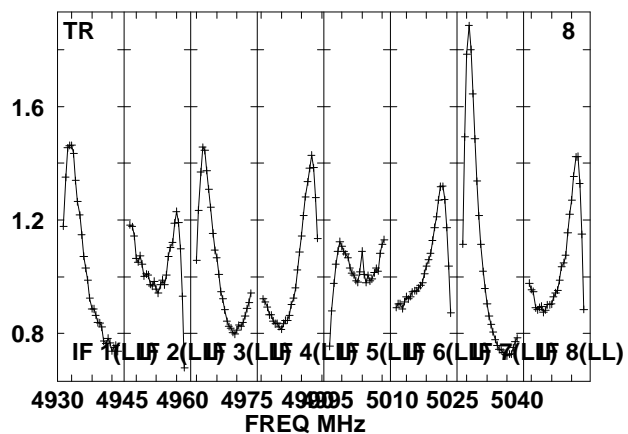
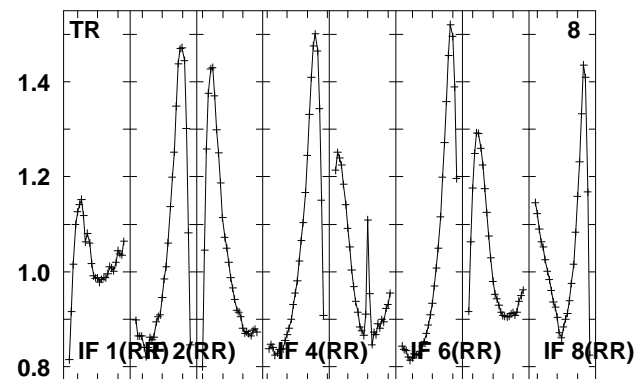
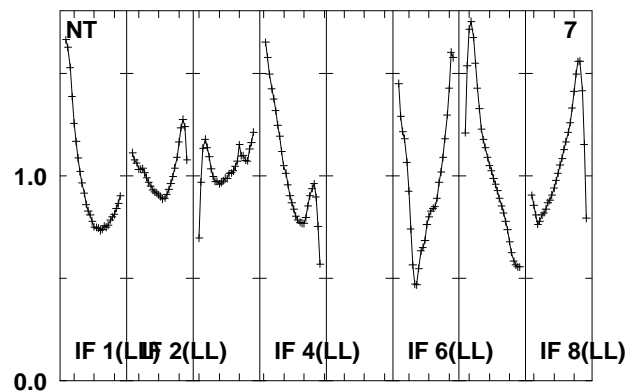
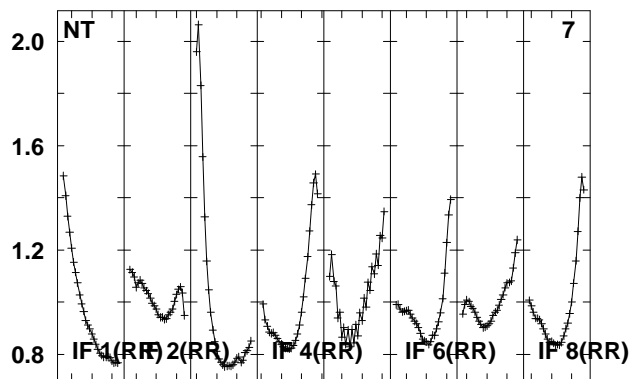
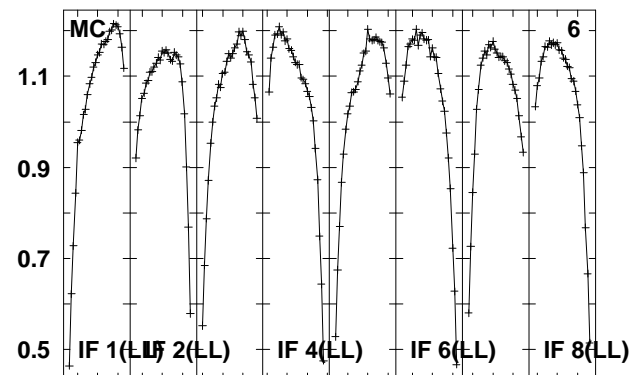
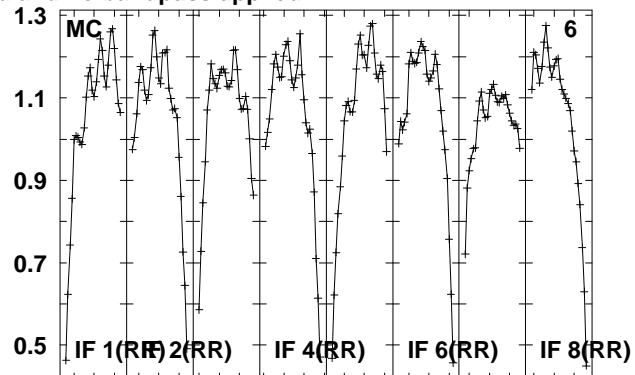
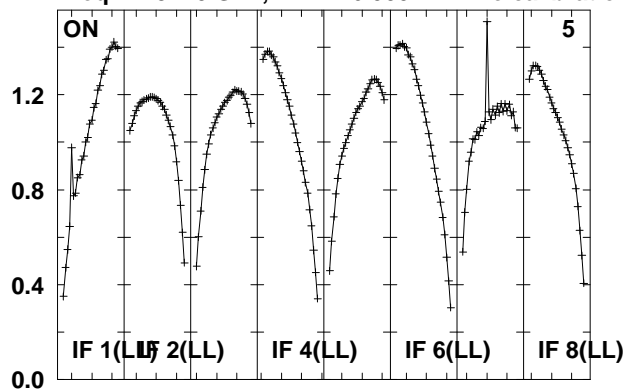

Lower frame: Real Jy

Total-power spectrum Antenna: *

Timerange: 00/10:40:29 to 00/10:41:55

Plot file version 277 created 14-MAY-2010 15:18:35
 J015028 EO007.UVDATA.1
 Freq = 4.9270 GHz, Bw = 16.000 MH No calibration applied and no bandpass applied

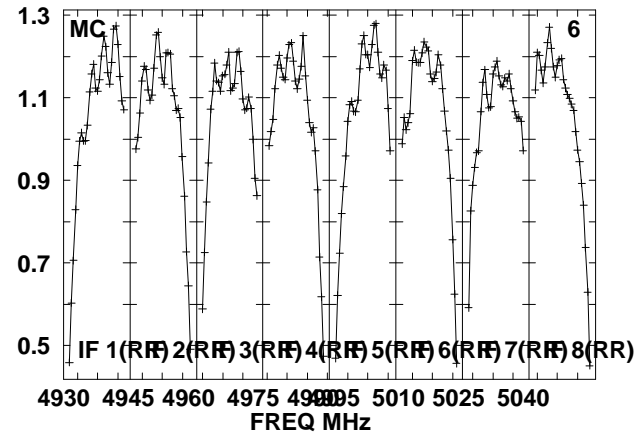
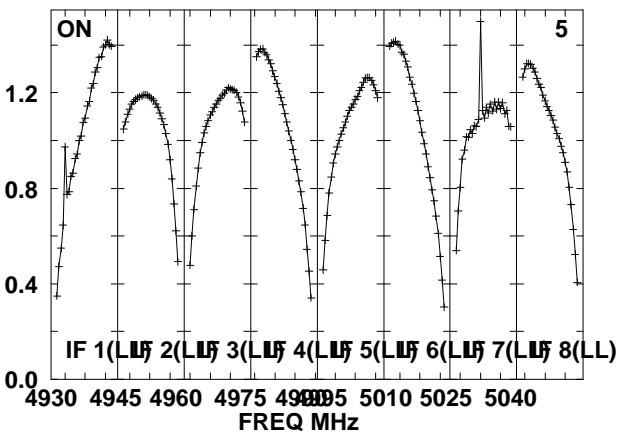
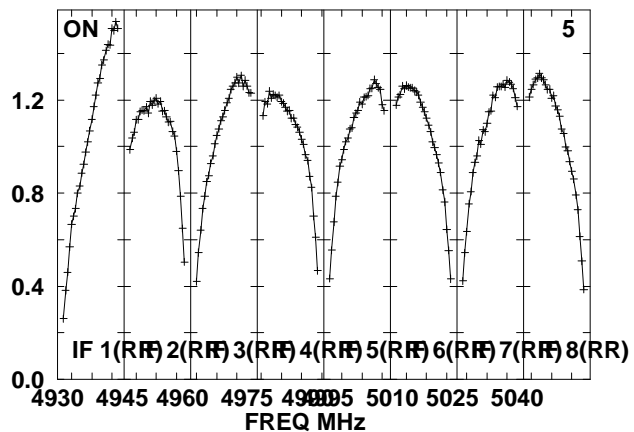
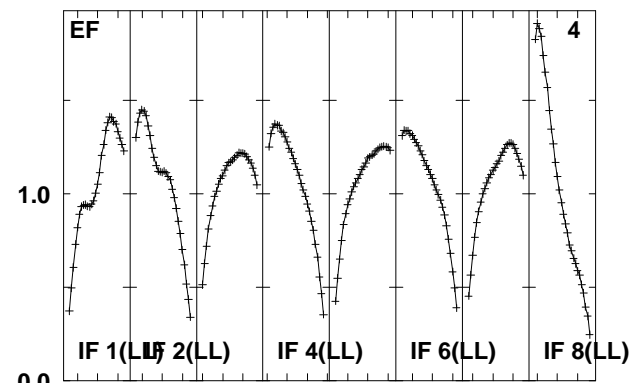
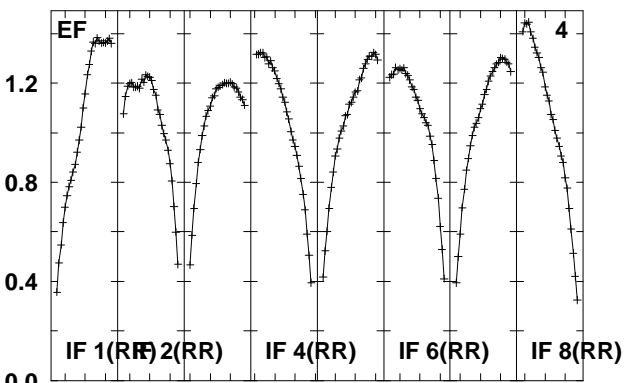
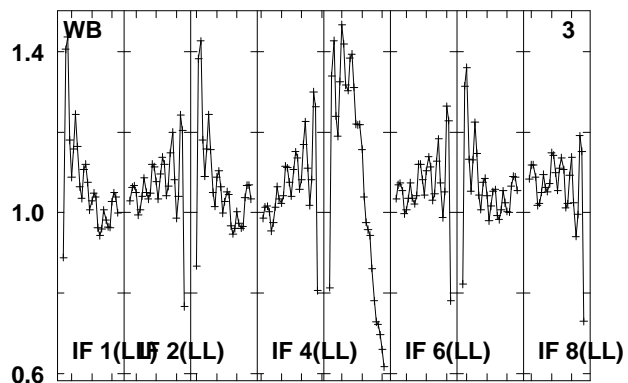
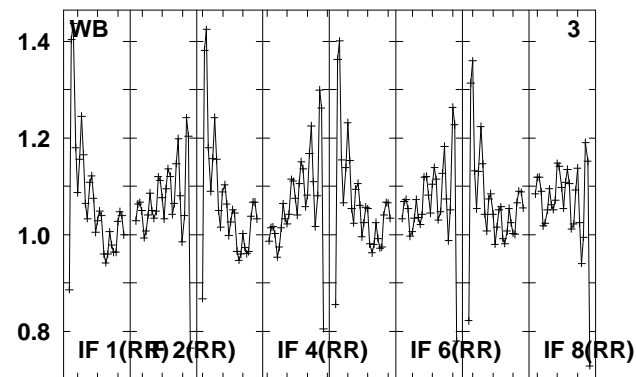
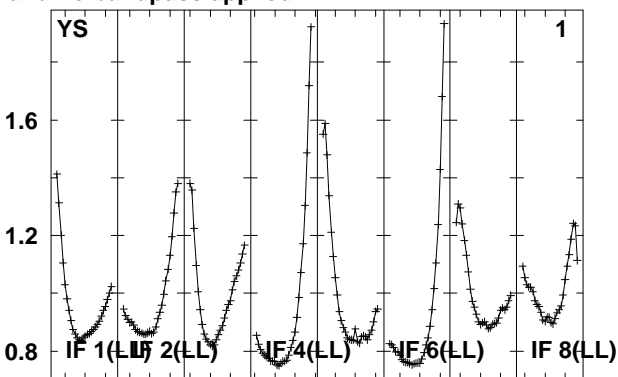
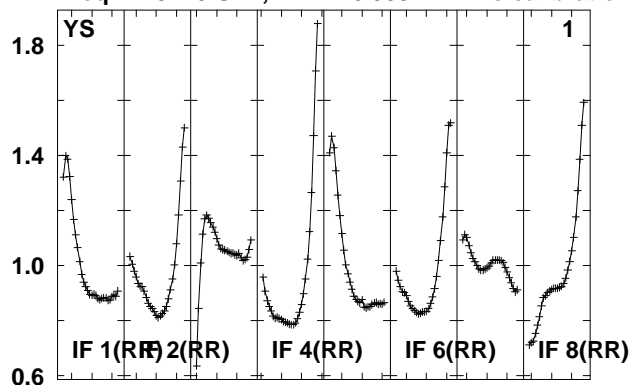

Lower frame: Real Jy
 Total-power spectrum Antenna: *
 Timerange: 00/10:42:29 to 00/10:47:25

Plot file version 278 created 14-MAY-2010 15:18:36

J015028 EO007.UVDATA.1

Freq = 4.9270 GHz, Bw = 16.000 MH No calibration applied and no bandpass applied

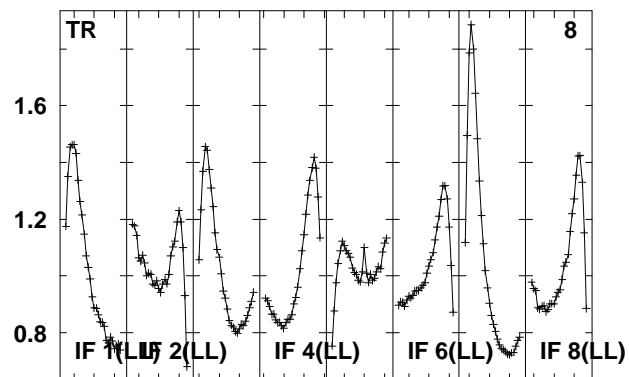
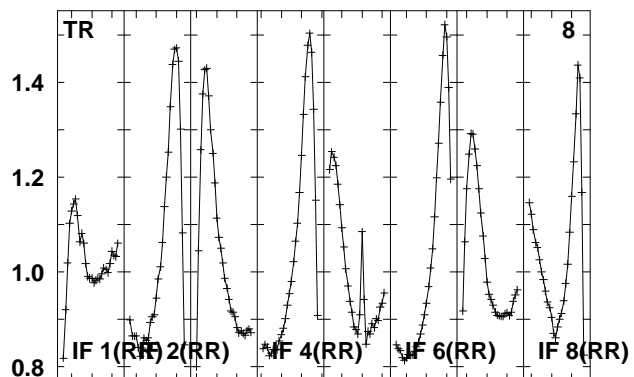
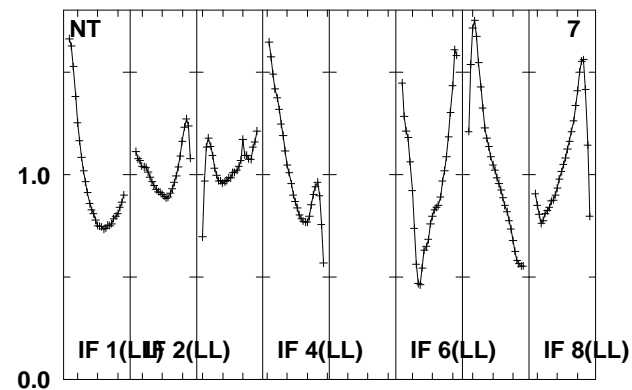
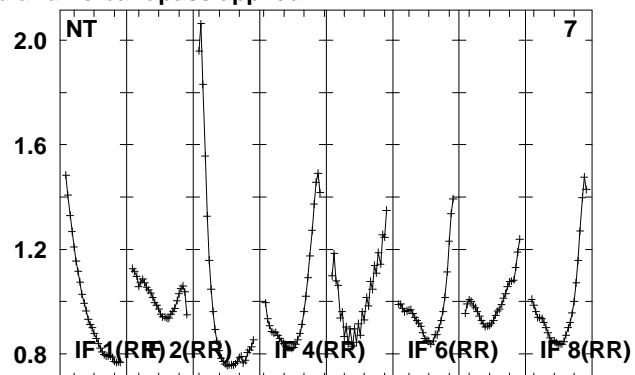
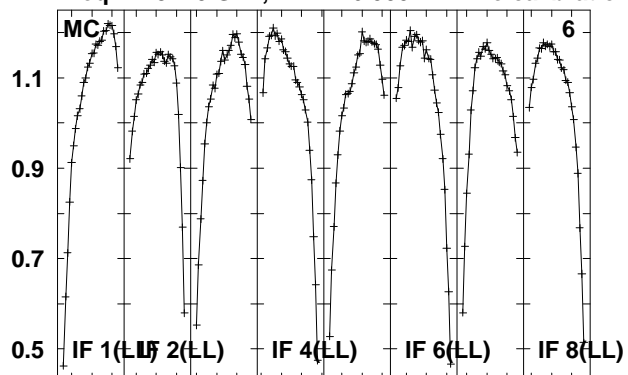

Lower frame: Real Jy
Total-power spectrum Antenna: *
Timerange: 00/10:42:29 to 00/10:47:25

Plot file version 279 created 14-MAY-2010 15:18:36

J0158+13 EO007.UVDATA.1

Freq = 4.9270 GHz, Bw = 16.000 MH No calibration applied and no bandpass applied

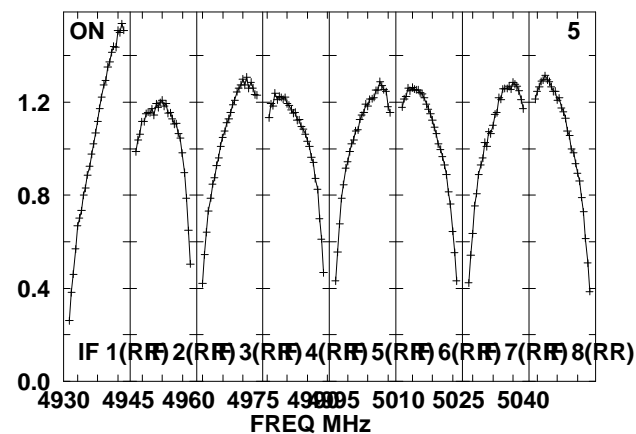
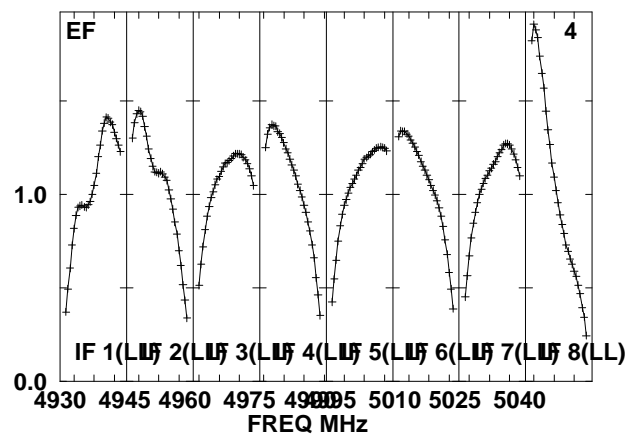
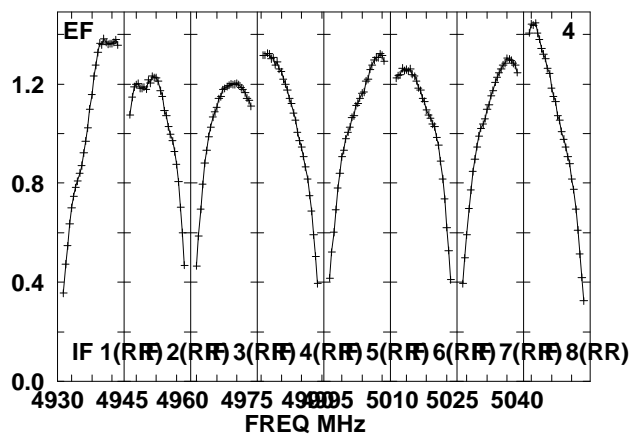
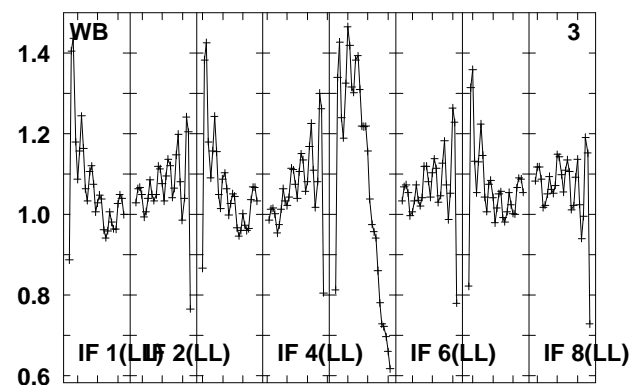
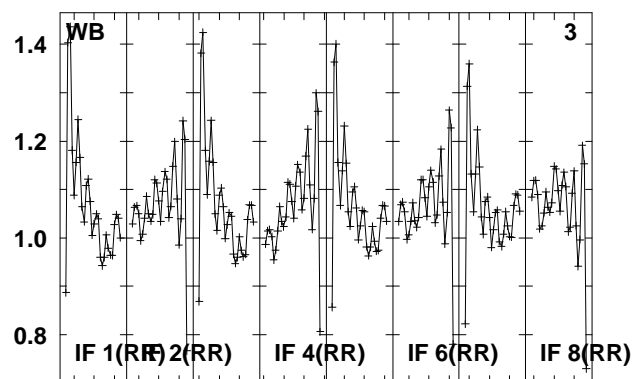
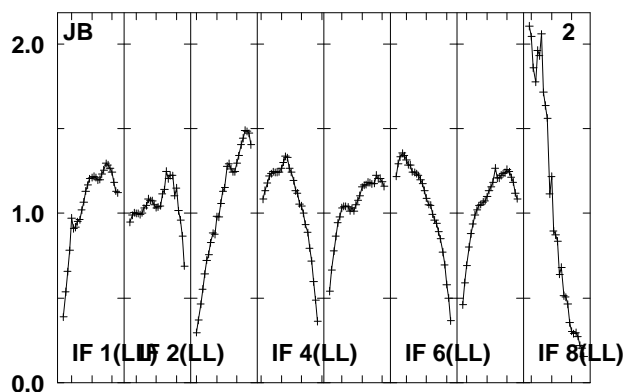
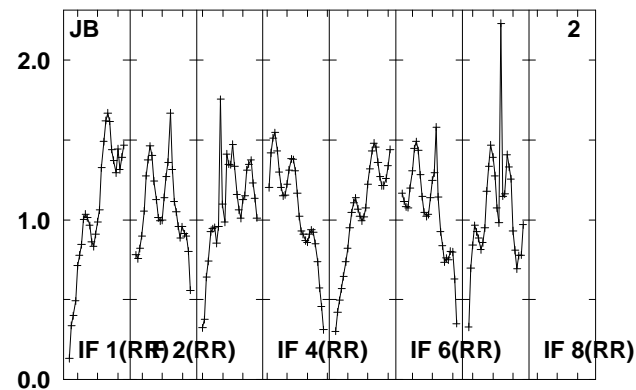
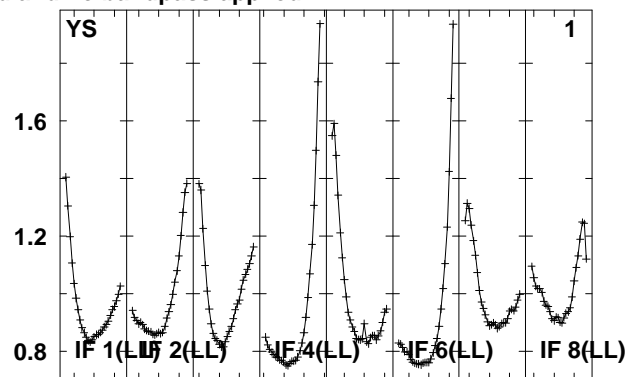
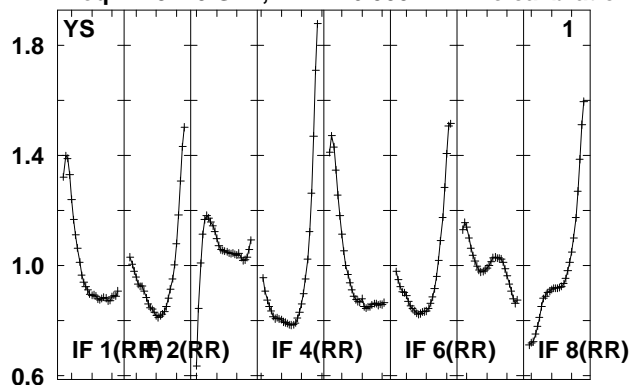

Lower frame: Real Jy

Total-power spectrum Antenna: *

Timerange: 00/10:47:58 to 00/10:49:26

Plot file version 280 created 14-MAY-2010 15:18:36

J0158+13 EO007.UVDATA.1

Freq = 4.9270 GHz, Bw = 16.000 MH No calibration applied and no bandpass applied

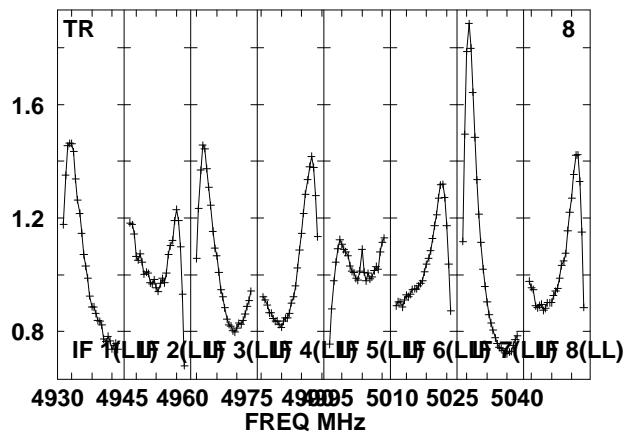
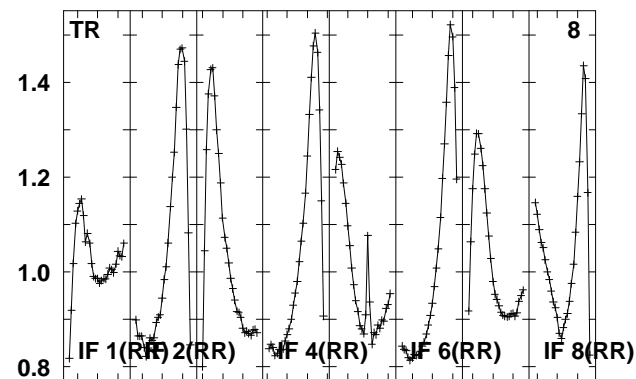
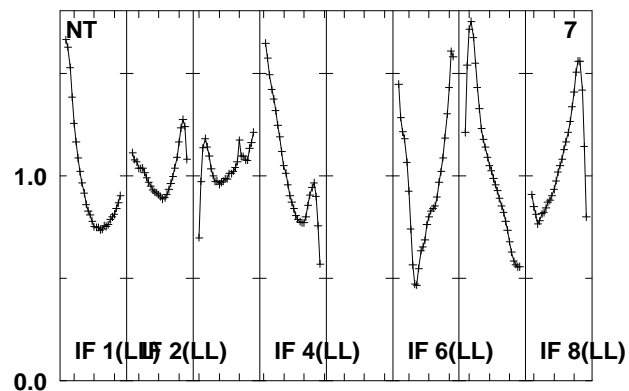
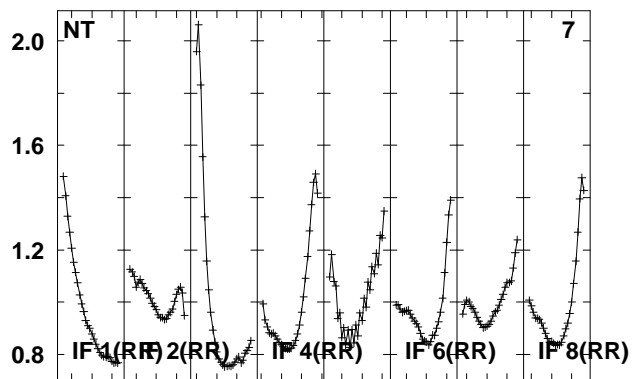
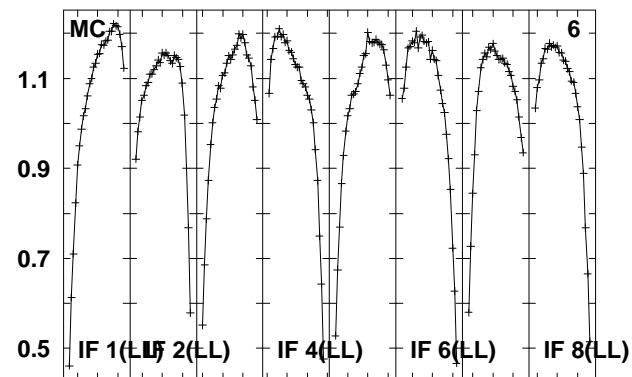
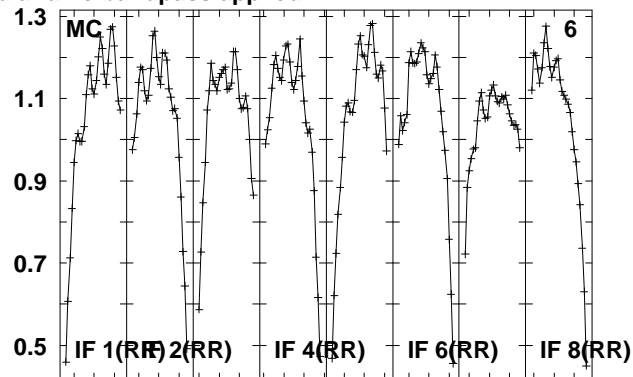
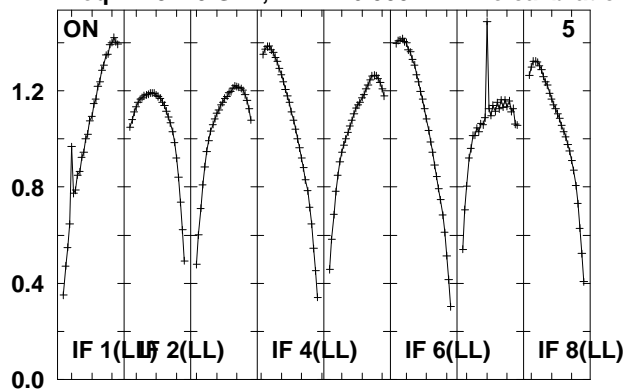

Lower frame: Real Jy

Total-power spectrum Antenna: *

Timerange: 00/10:47:58 to 00/10:49:26

Plot file version 281 created 14-MAY-2010 15:18:37

J0209+13 EO007.UVDATA.1

Freq = 4.9270 GHz, Bw = 16.000 MH No calibration applied and no bandpass applied

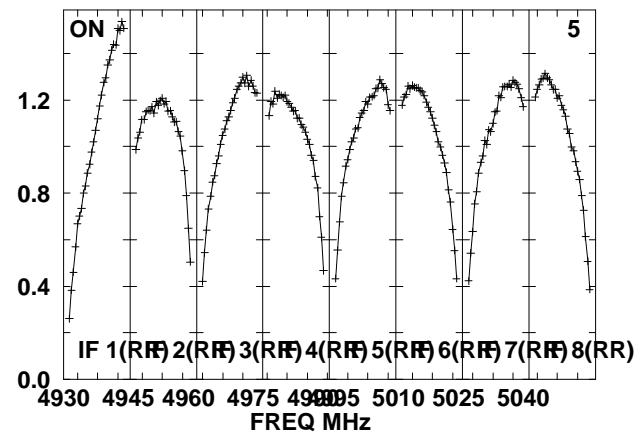
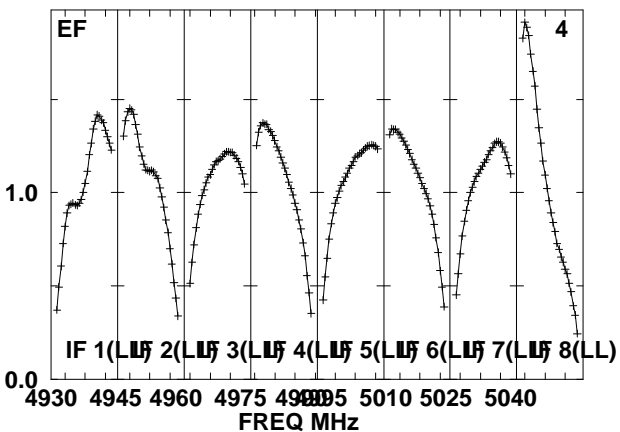
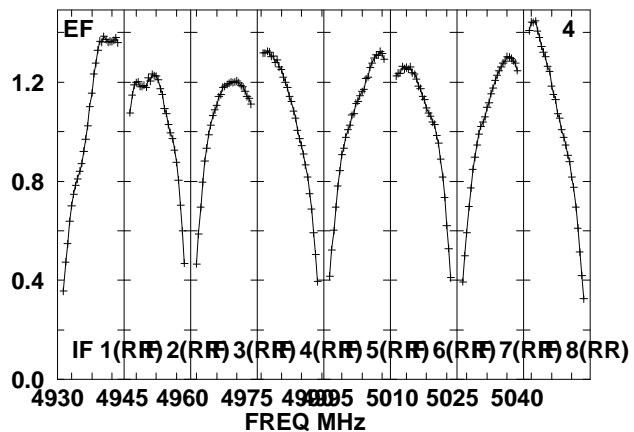
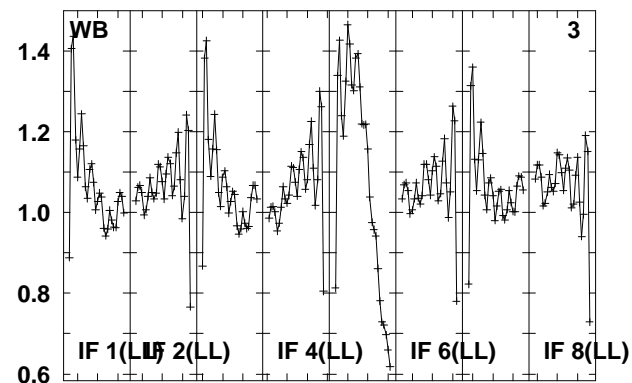
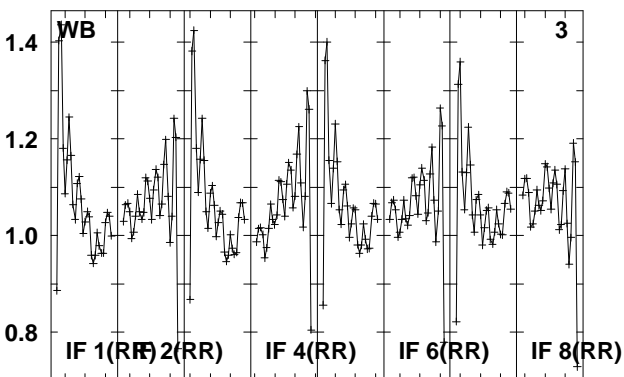
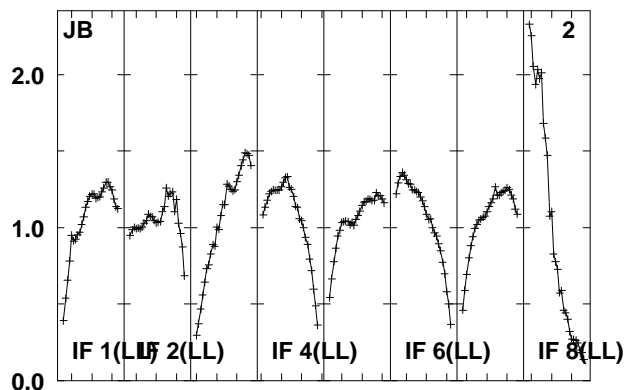
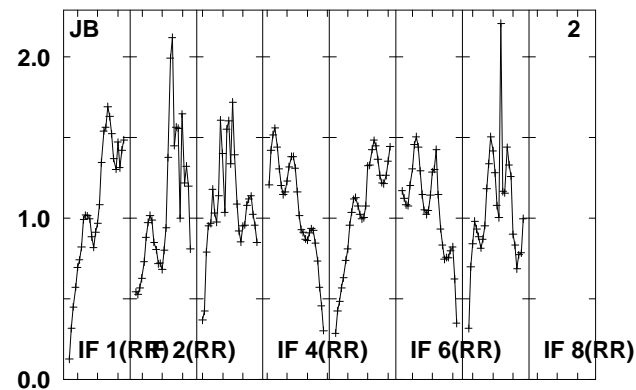
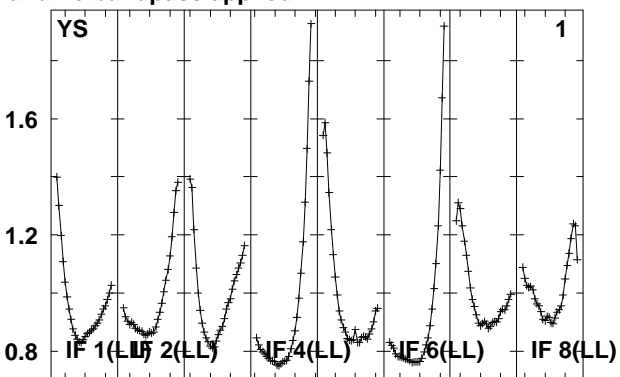
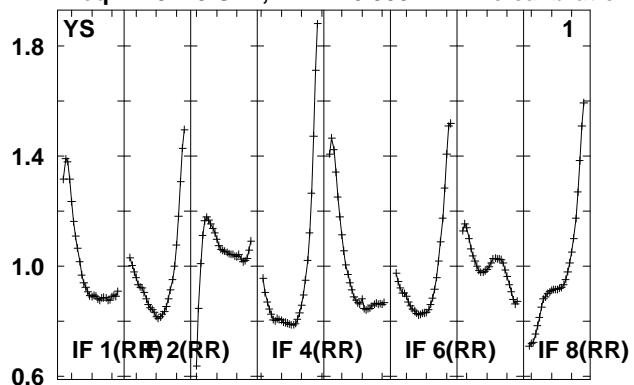

Lower frame: Real Jy

Total-power spectrum Antenna: *

Timerange: 00/10:50:02 to 00/10:51:30

Plot file version 282 created 14-MAY-2010 15:18:37

J0209+13 EO007.UVDATA.1

Freq = 4.9270 GHz, Bw = 16.000 MH No calibration applied and no bandpass applied

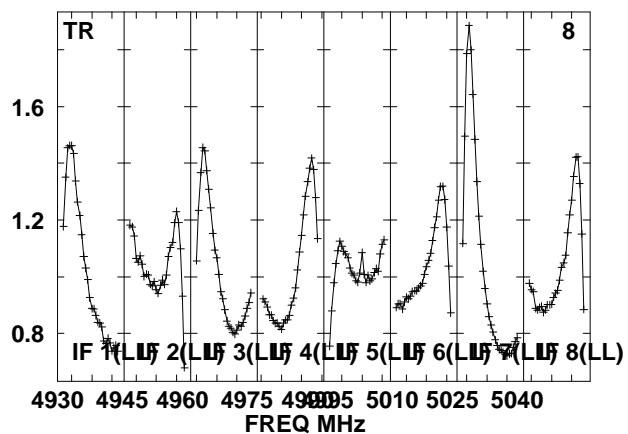
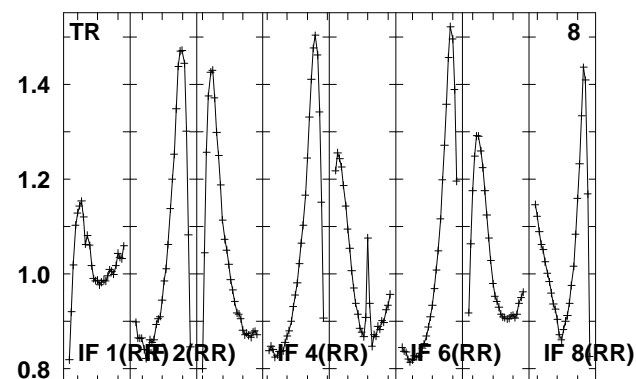
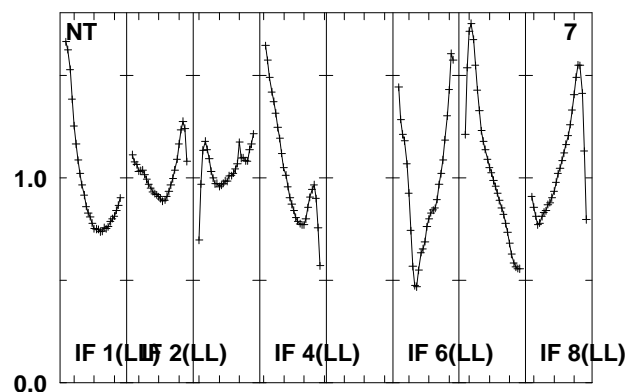
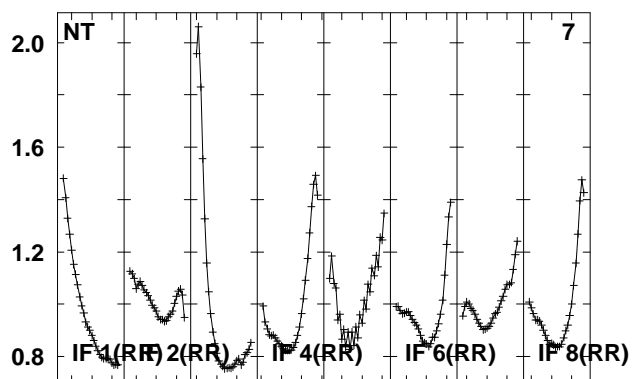
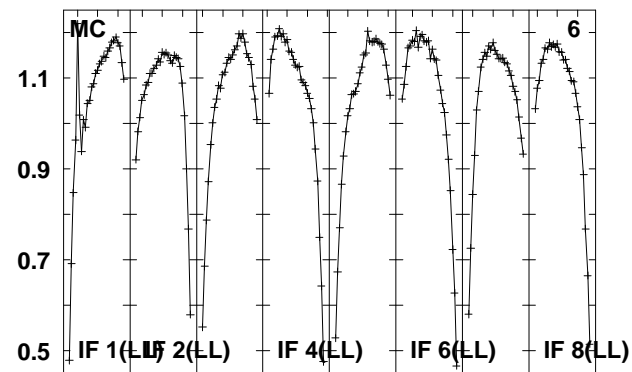
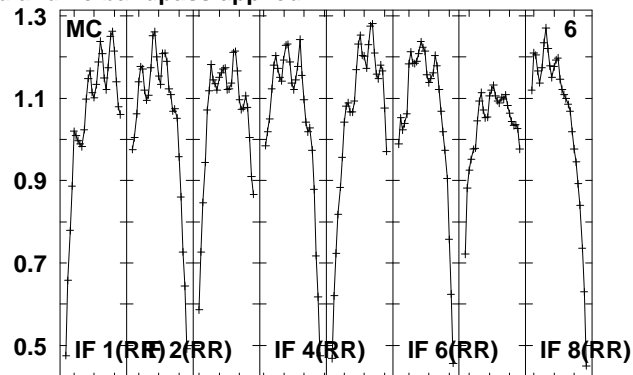
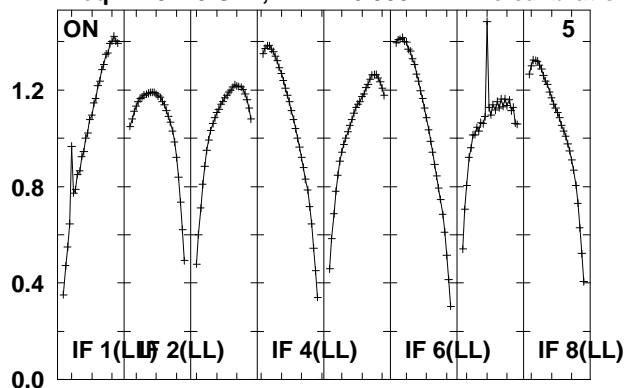

Lower frame: Real Jy

Total-power spectrum Antenna: *

Timerange: 00/10:50:02 to 00/10:51:30

Plot file version 283 created 14-MAY-2010 15:18:37

J021348 EO007.UVDATA.1

Freq = 4.9270 GHz, Bw = 16.000 MH No calibration applied and no bandpass applied

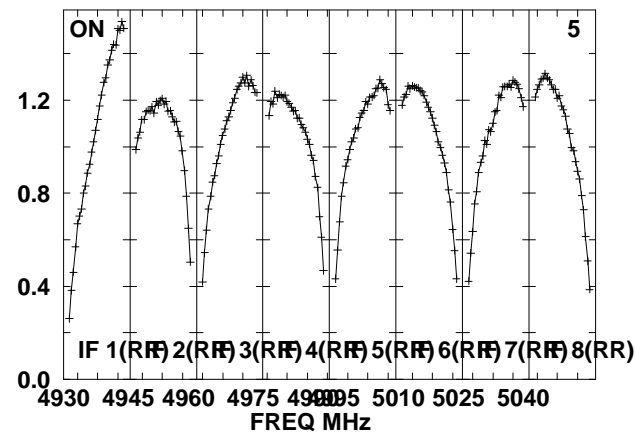
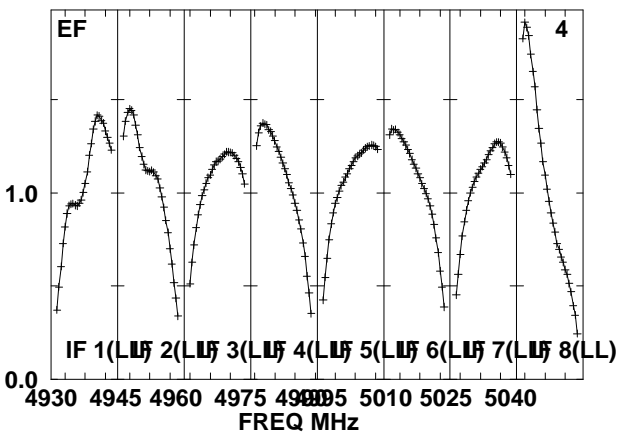
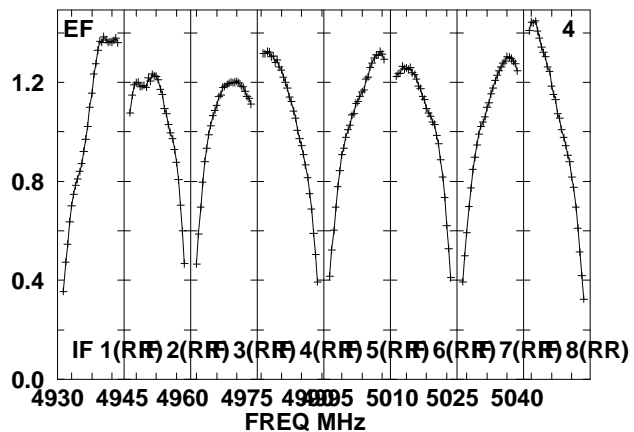
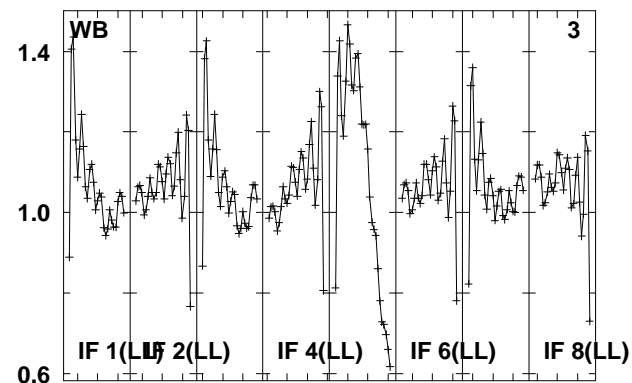
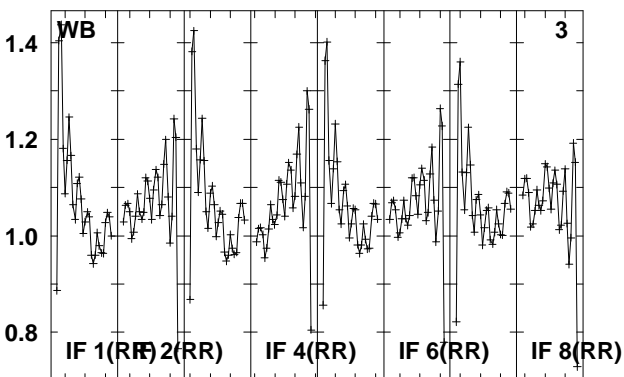
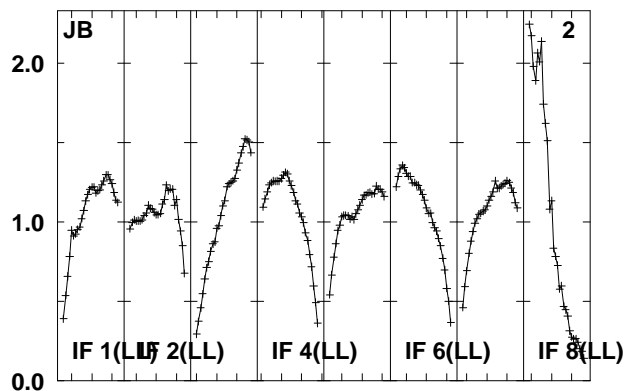
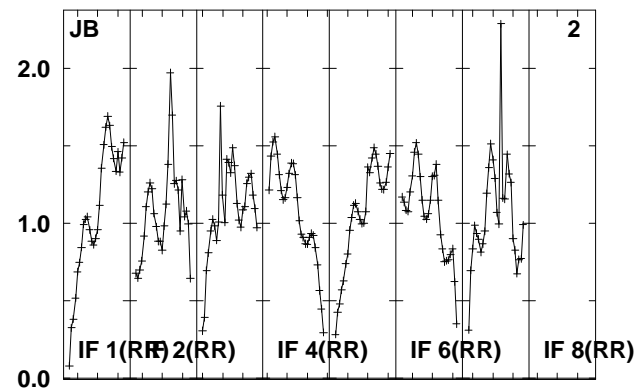
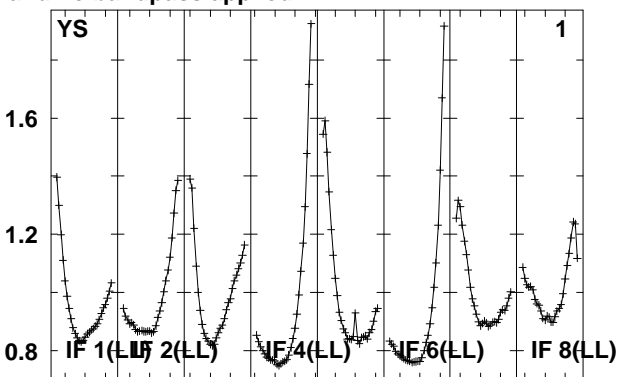
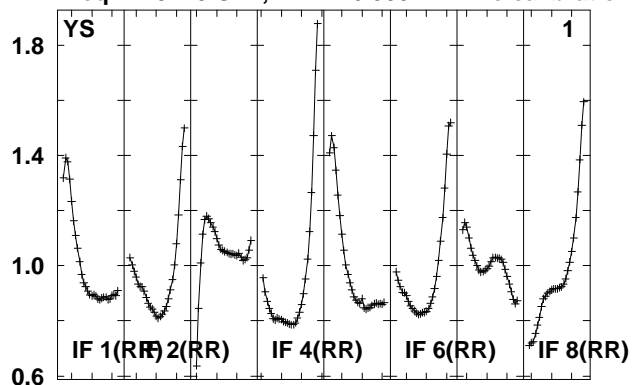

Lower frame: Real Jy
Total-power spectrum Antenna: *
Timerange: 00/10:51:56 to 00/10:56:54

Plot file version 284 created 14-MAY-2010 15:18:38

J021348 EO007.UVDATA.1

Freq = 4.9270 GHz, Bw = 16.000 MH No calibration applied and no bandpass applied

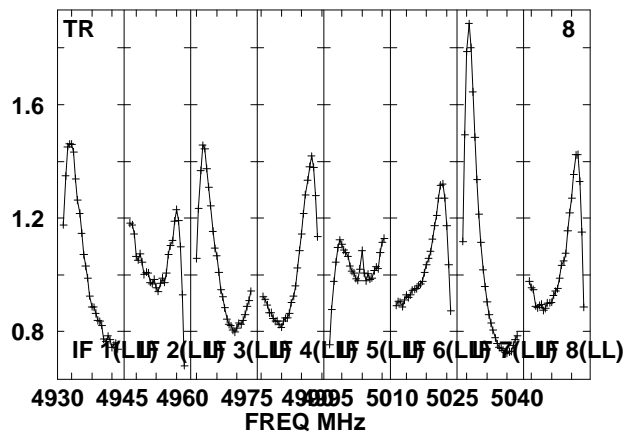
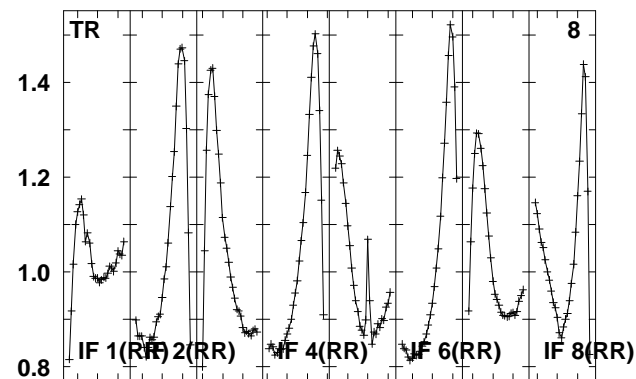
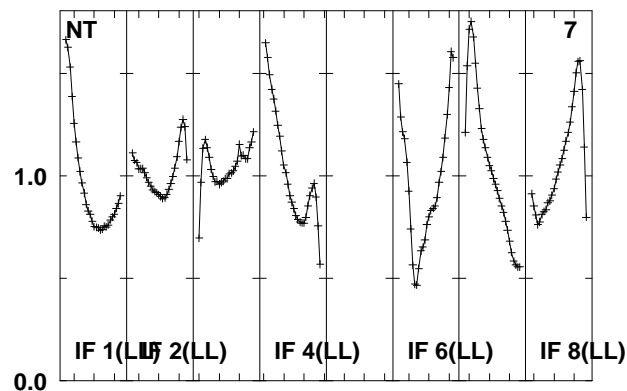
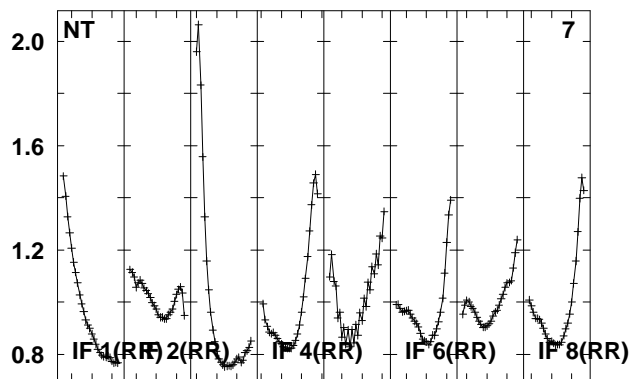
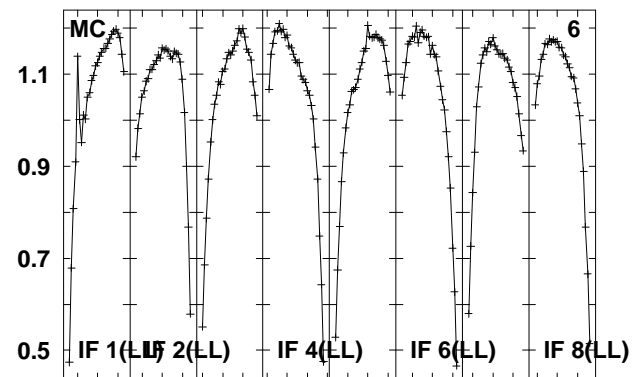
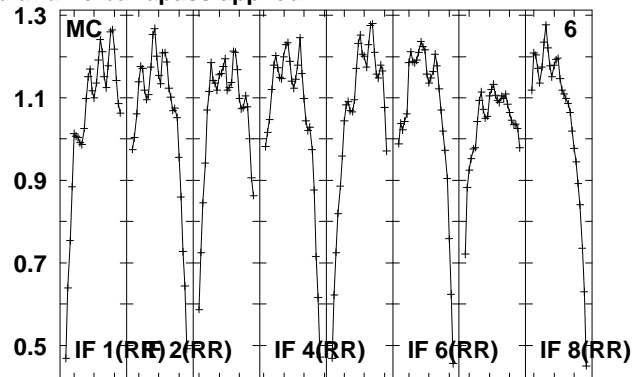
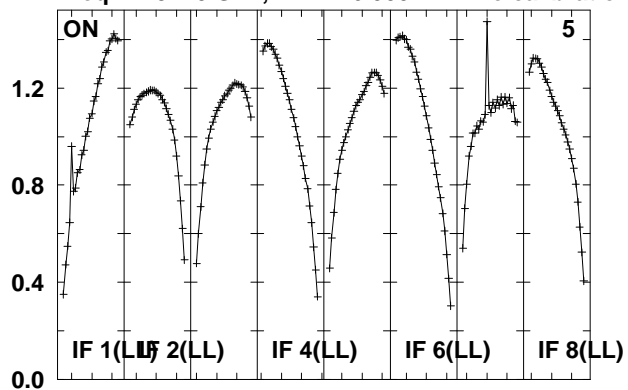

Lower frame: Real Jy

Total-power spectrum Antenna: *

Timerange: 00/10:51:56 to 00/10:56:54

Plot file version 285 created 14-MAY-2010 15:18:38

J0209+13 EO007.UVDATA.1

Freq = 4.9270 GHz, Bw = 16.000 MH No calibration applied and no bandpass applied

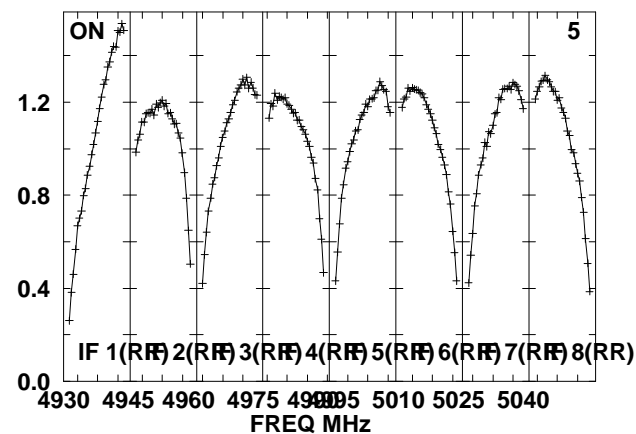
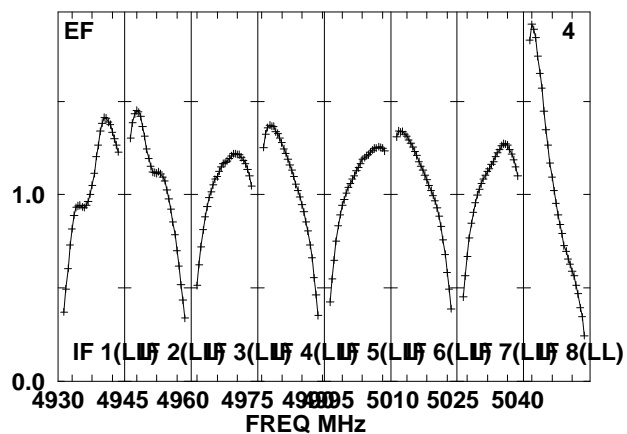
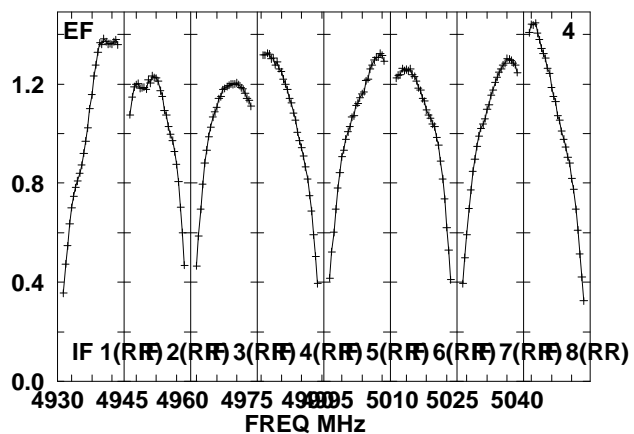
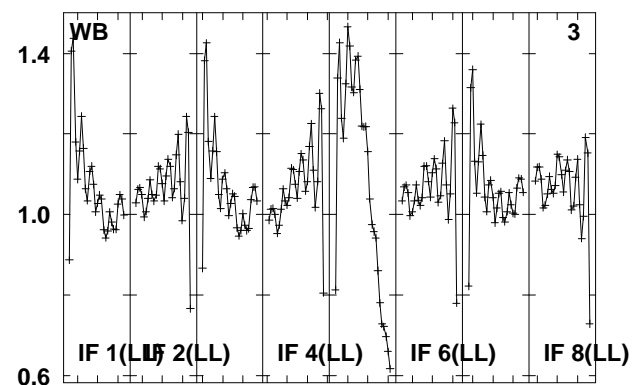
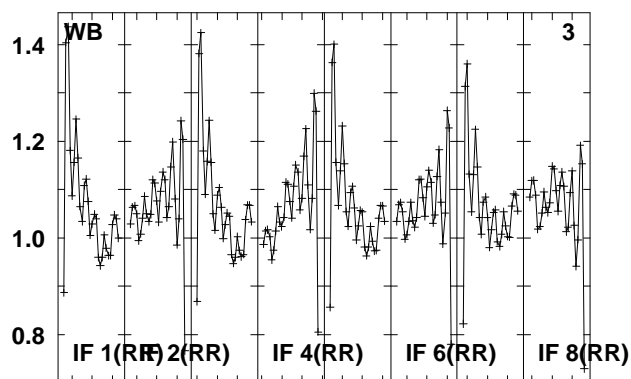
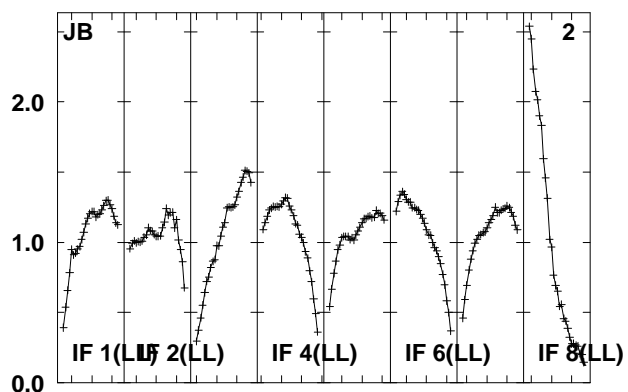
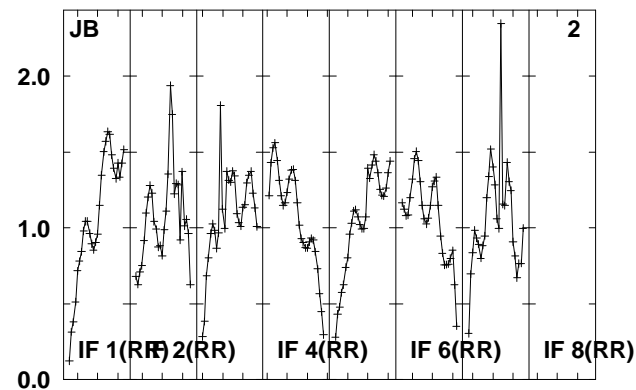
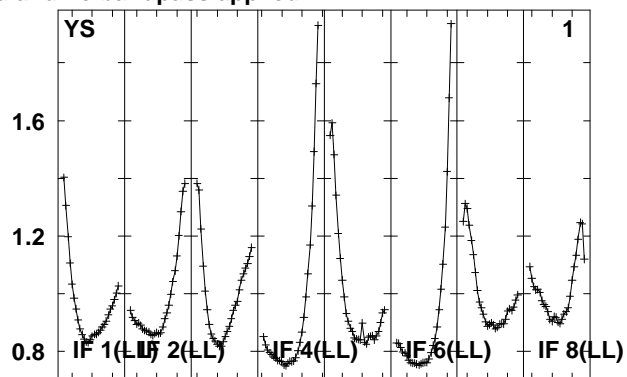
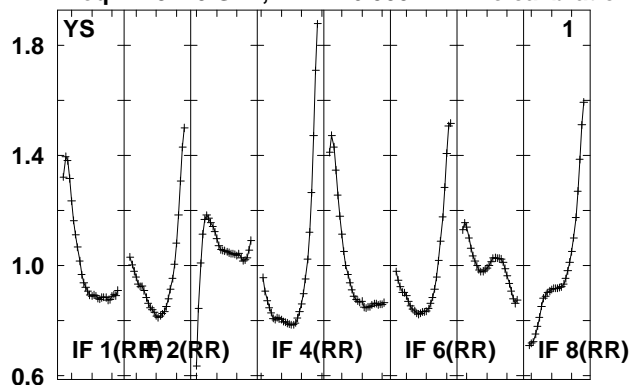

Lower frame: Real Jy
Total-power spectrum Antenna: *
Timerange: 00/10:57:22 to 00/10:58:50

Plot file version 286 created 14-MAY-2010 15:18:38

J0209+13 EO007.UVDATA.1

Freq = 4.9270 GHz, Bw = 16.000 MH No calibration applied and no bandpass applied

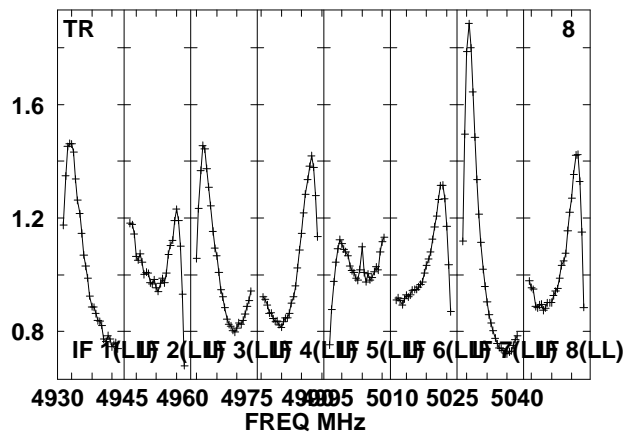
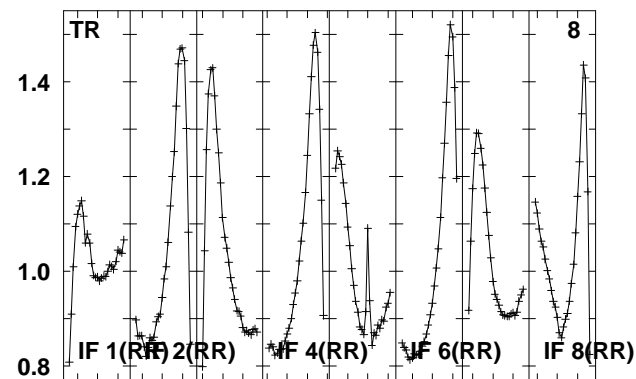
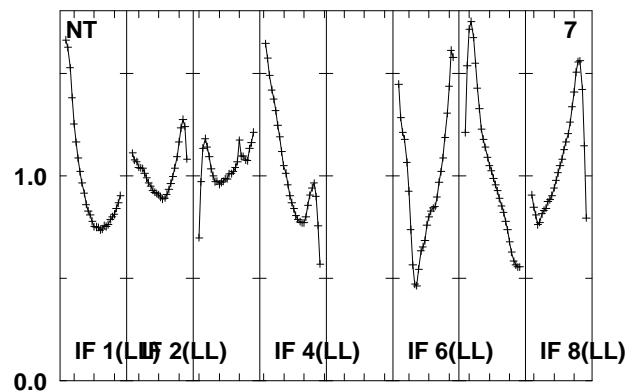
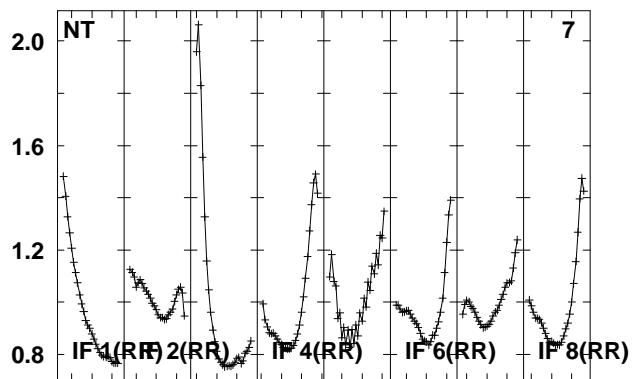
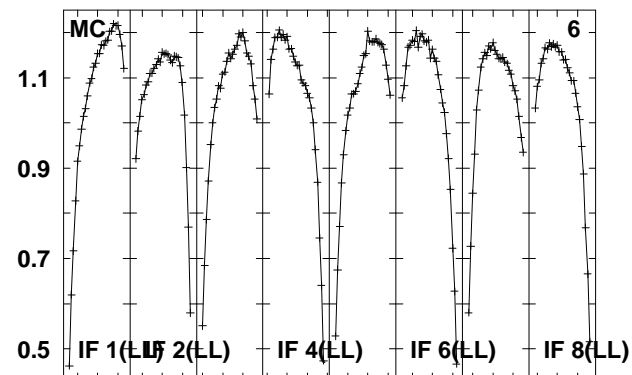
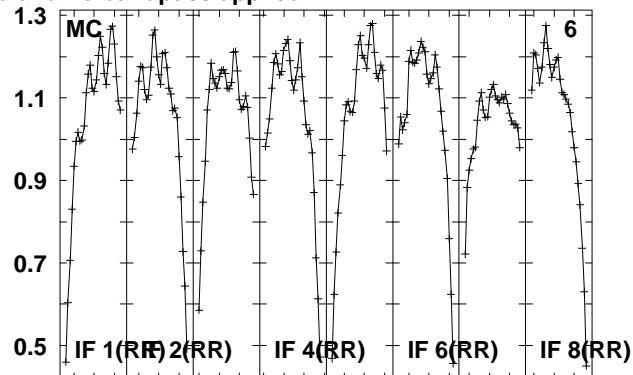
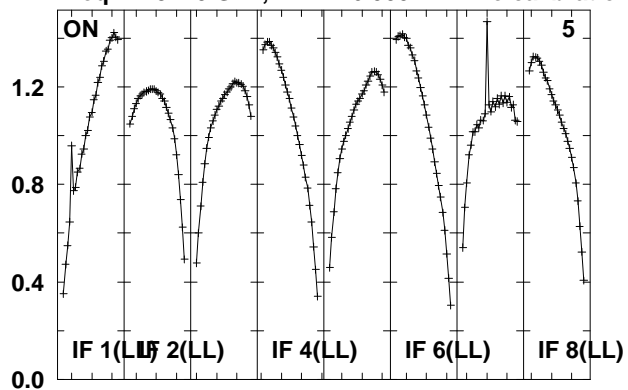

Lower frame: Real Jy

Total-power spectrum Antenna: *

Timerange: 00/10:57:22 to 00/10:58:50

Plot file version 287 created 14-MAY-2010 15:18:39

J021348 EO007.UVDATA.1

Freq = 4.9270 GHz, Bw = 16.000 MH No calibration applied and no bandpass applied

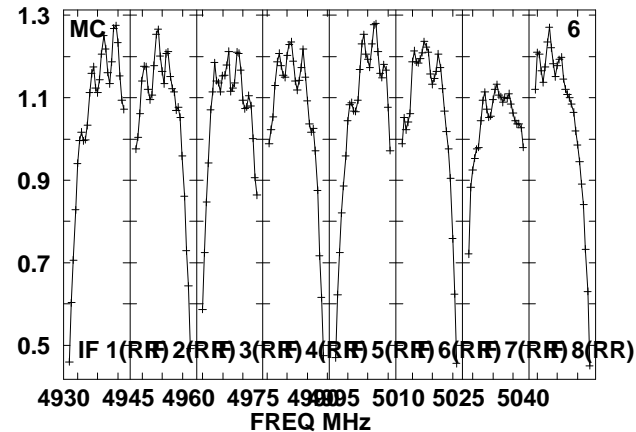
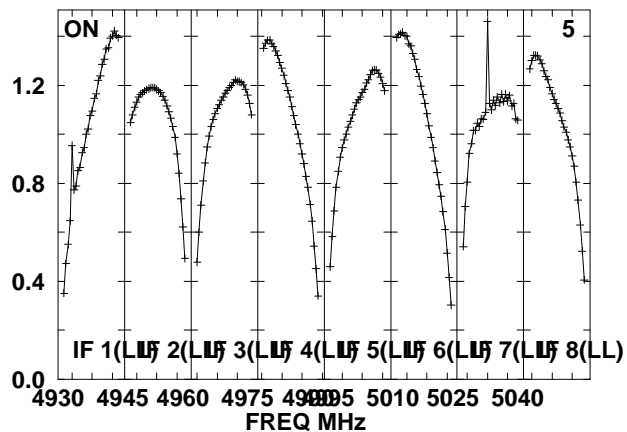
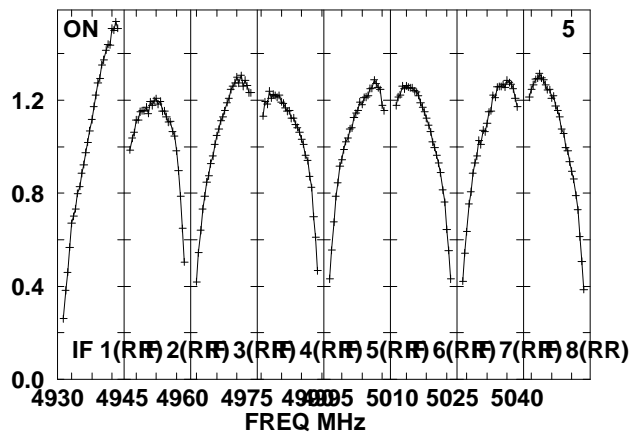
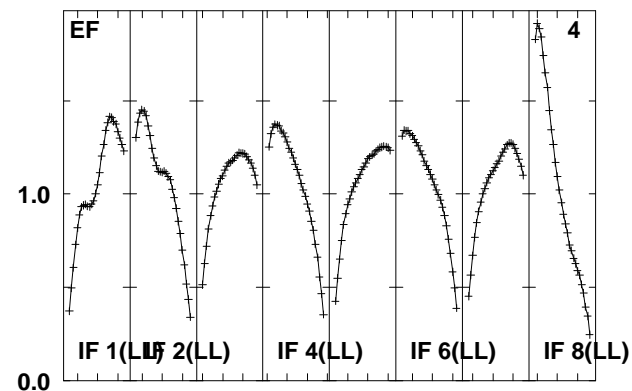
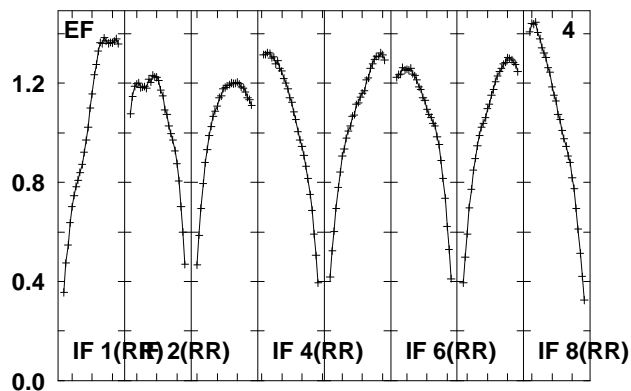
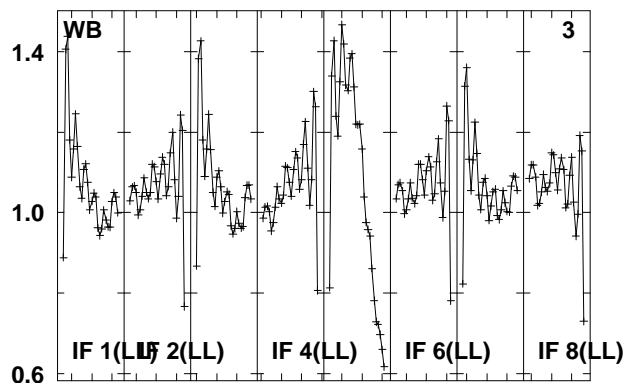
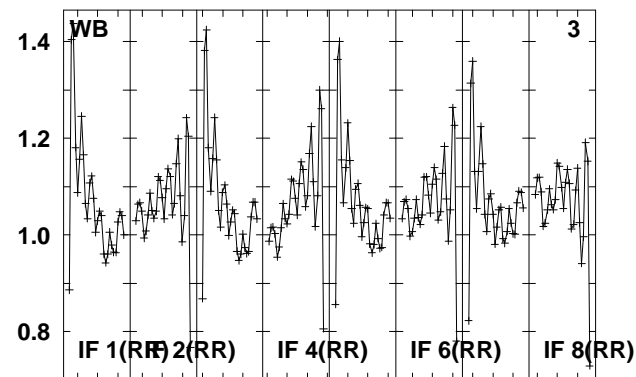
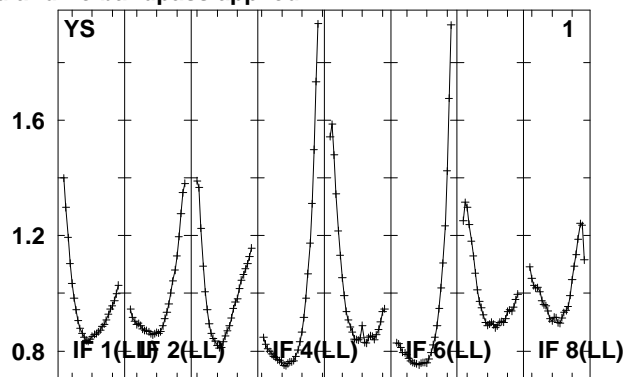
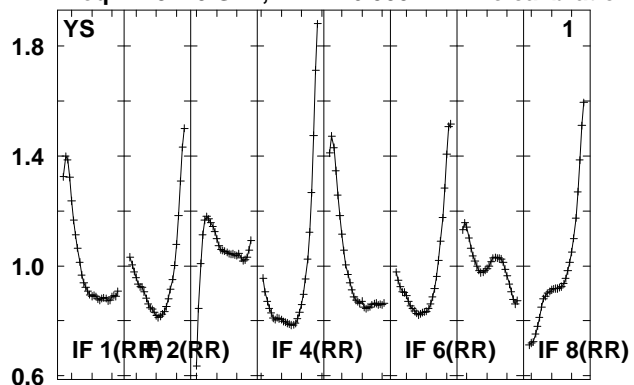

Lower frame: Real Jy
Total-power spectrum Antenna: *
Timerange: 00/10:59:16 to 00/11:04:16

Plot file version 288 created 14-MAY-2010 15:18:39

J021348 EO007.UVDATA.1

Freq = 4.9270 GHz, Bw = 16.000 MH No calibration applied and no bandpass applied

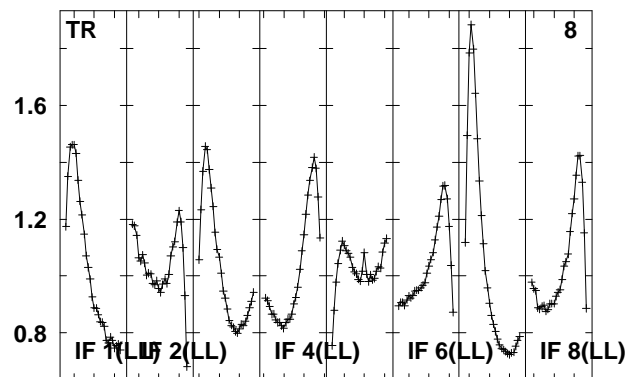
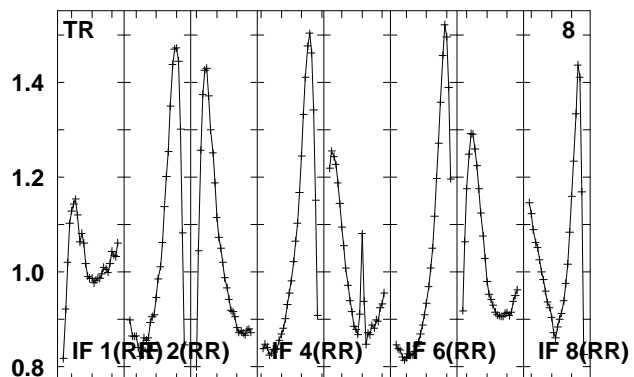
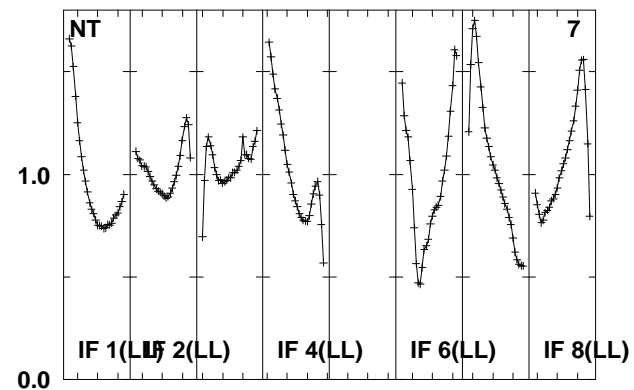
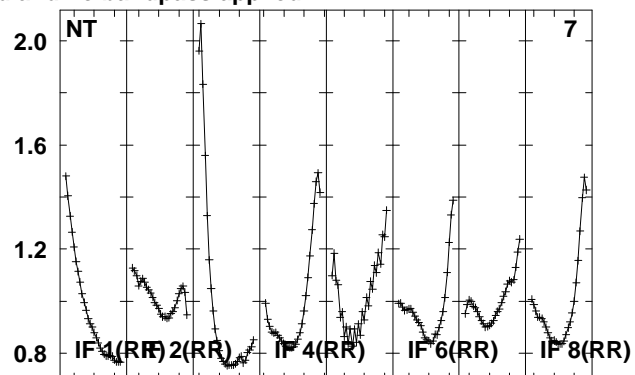
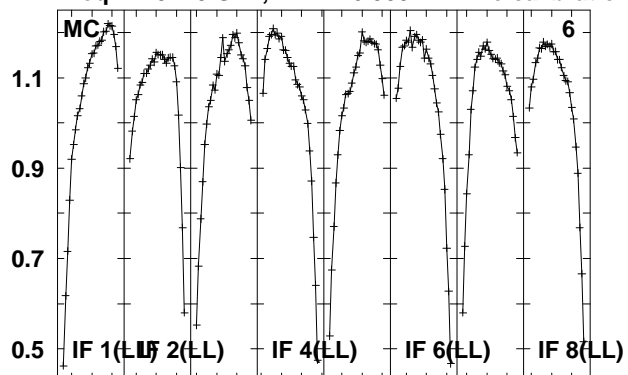

Lower frame: Real Jy
Total-power spectrum Antenna: *
Timerange: 00/10:59:16 to 00/11:04:16

Plot file version 289 created 14-MAY-2010 15:18:40

J0209+13 EO007.UVDATA.1

Freq = 4.9270 GHz, Bw = 16.000 MH No calibration applied and no bandpass applied

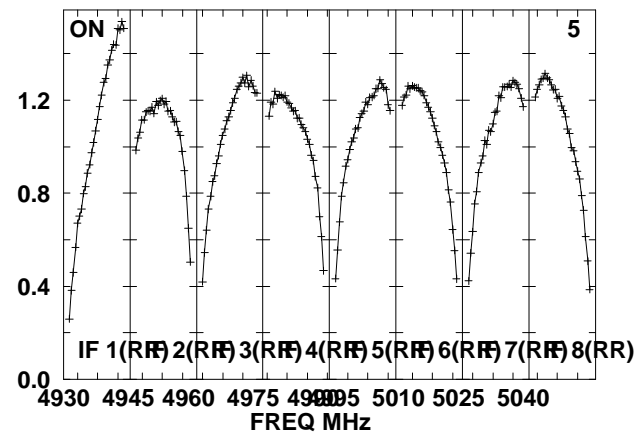
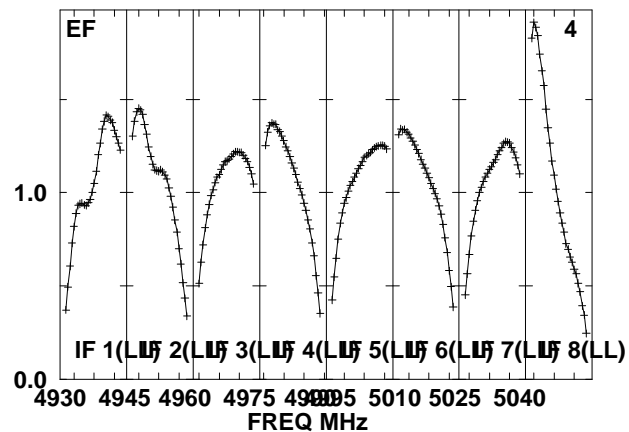
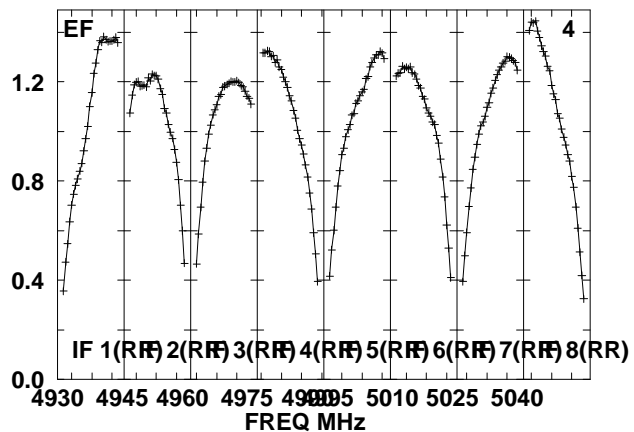
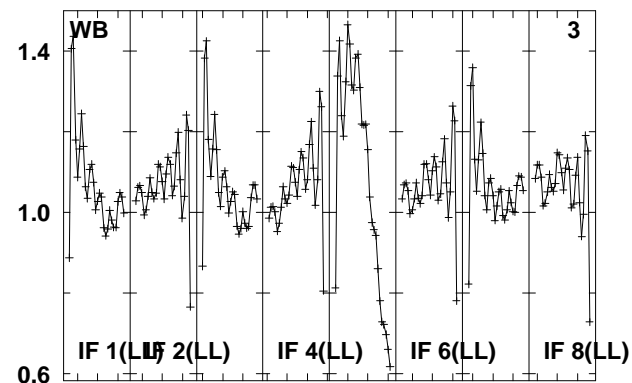
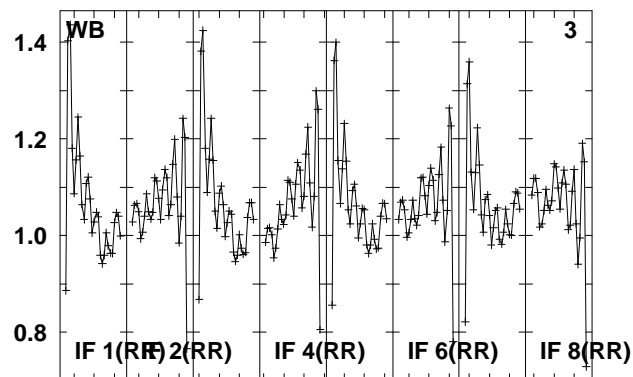
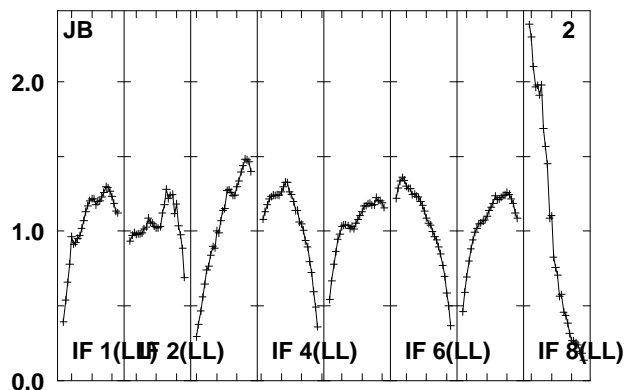
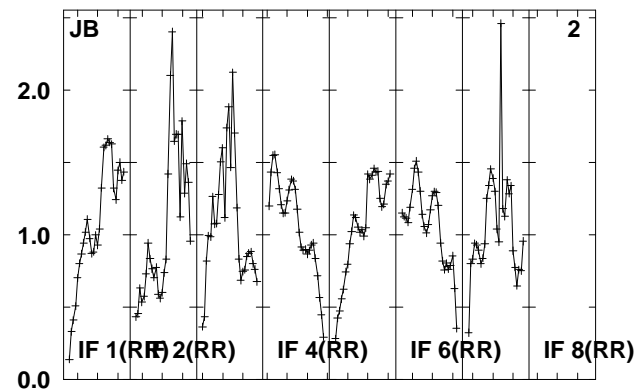
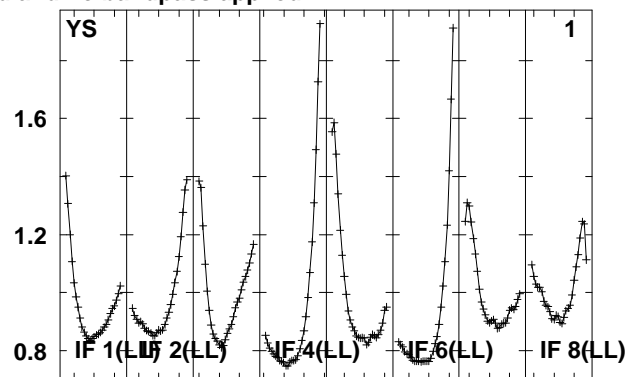
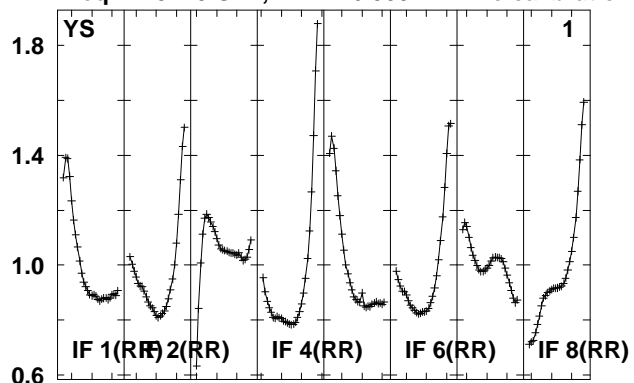

Lower frame: Real Jy

Total-power spectrum Antenna: *

Timerange: 00/11:04:42 to 00/11:06:10

Plot file version 290 created 14-MAY-2010 15:18:40

J0209+13 EO007.UVDATA.1

Freq = 4.9270 GHz, Bw = 16.000 MH No calibration applied and no bandpass applied

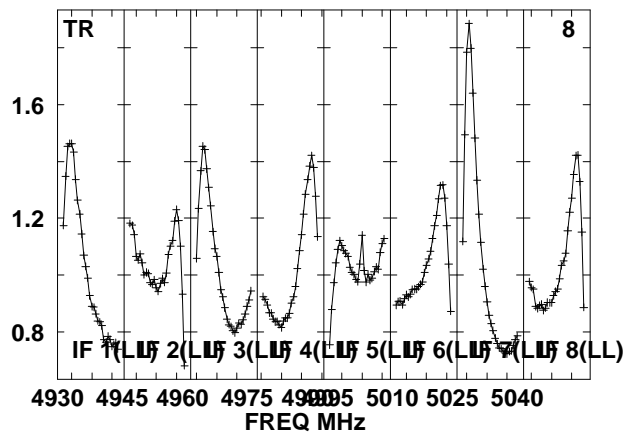
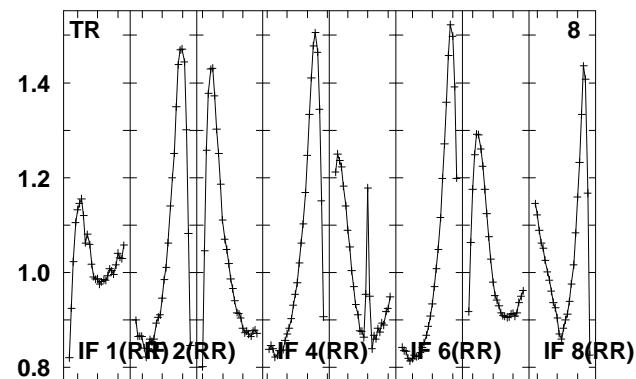
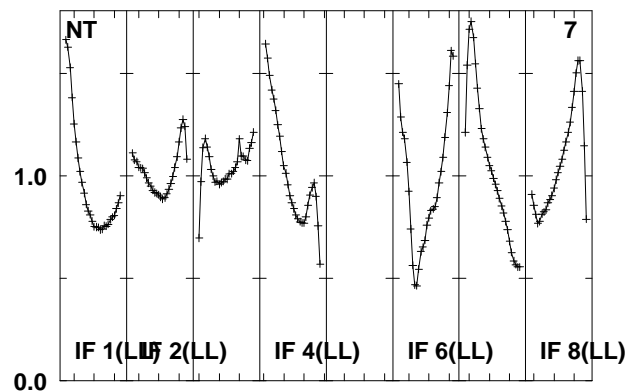
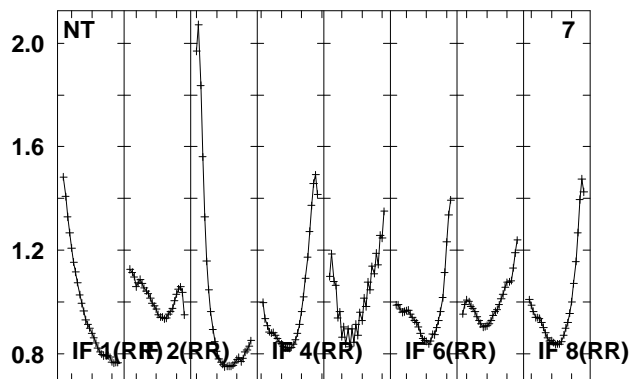
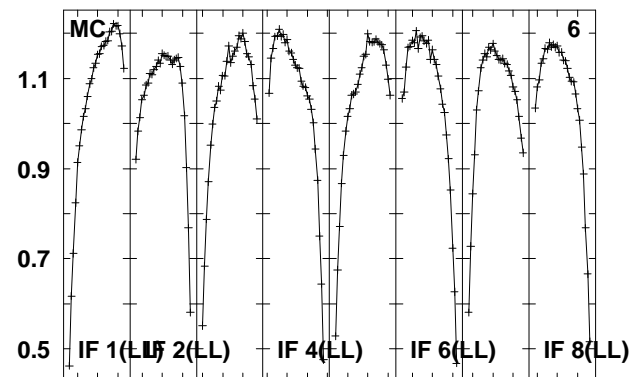
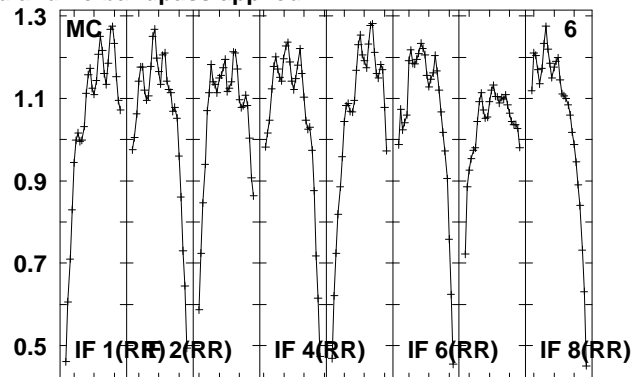
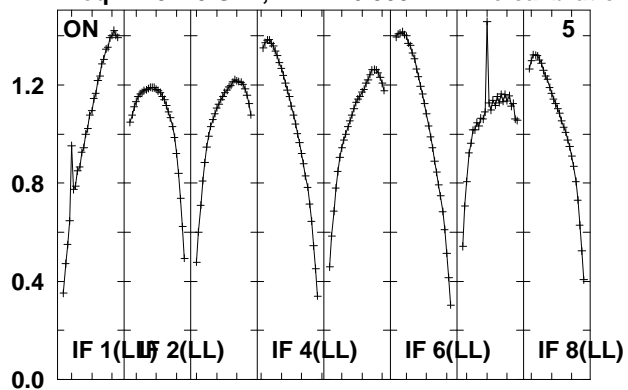

Lower frame: Real Jy

Total-power spectrum Antenna: *

Timerange: 00/11:04:42 to 00/11:06:10

Plot file version 291 created 14-MAY-2010 15:18:40

J0158+13 EO007.UVDATA.1

Freq = 4.9270 GHz, Bw = 16.000 MH No calibration applied and no bandpass applied

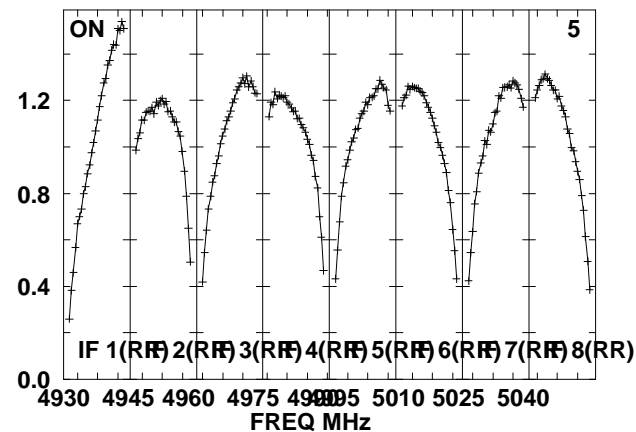
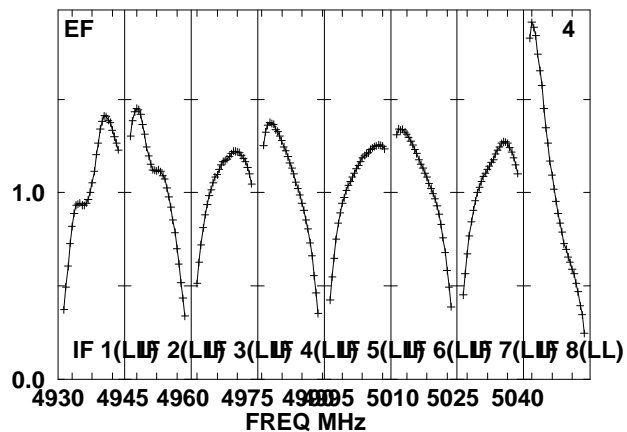
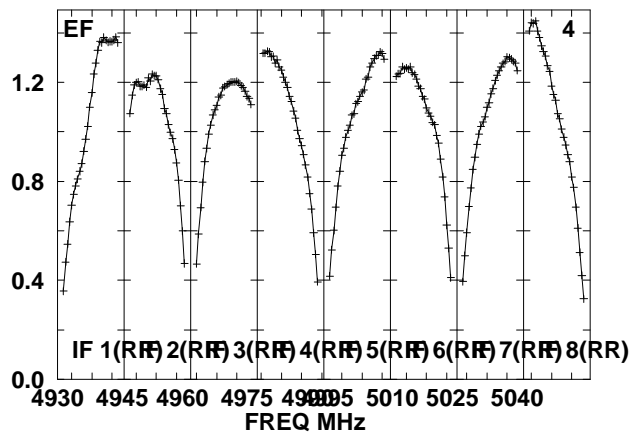
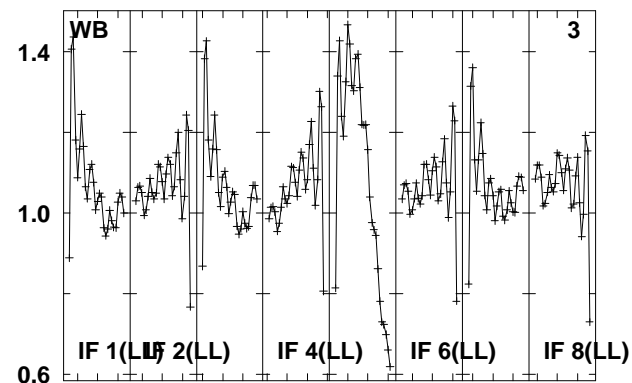
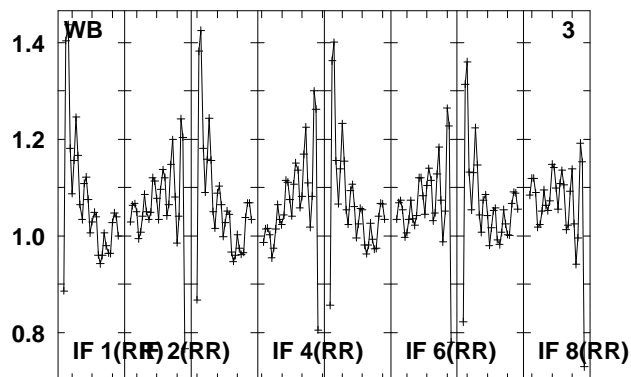
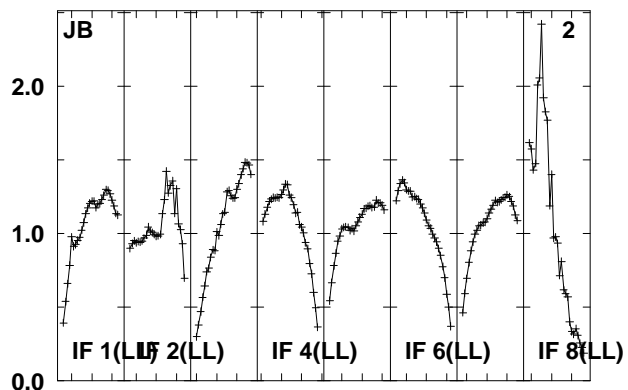
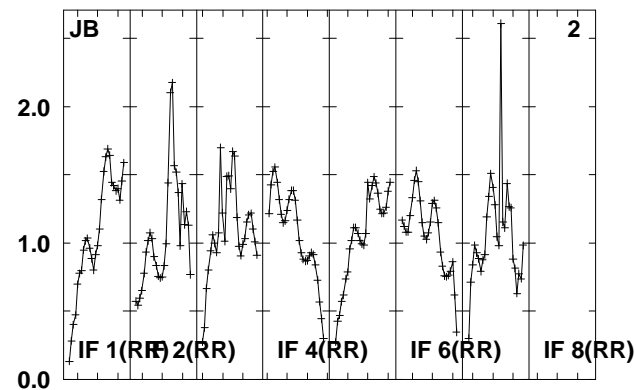
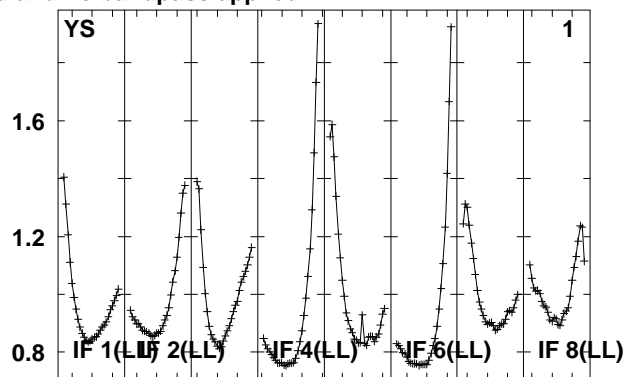
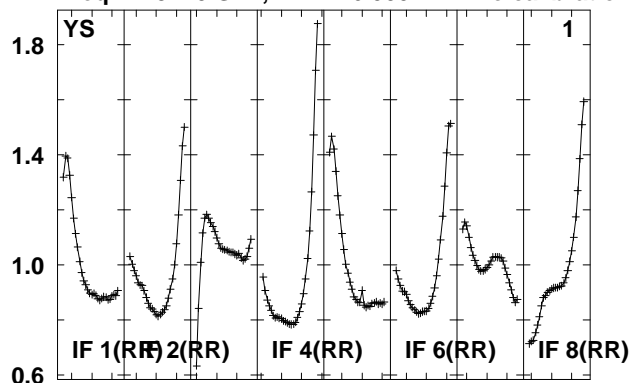

Lower frame: Real Jy

Total-power spectrum Antenna: *

Timerange: 00/11:06:48 to 00/11:08:14

Plot file version 292 created 14-MAY-2010 15:18:40

J0158+13 EO007.UVDATA.1

Freq = 4.9270 GHz, Bw = 16.000 MH No calibration applied and no bandpass applied

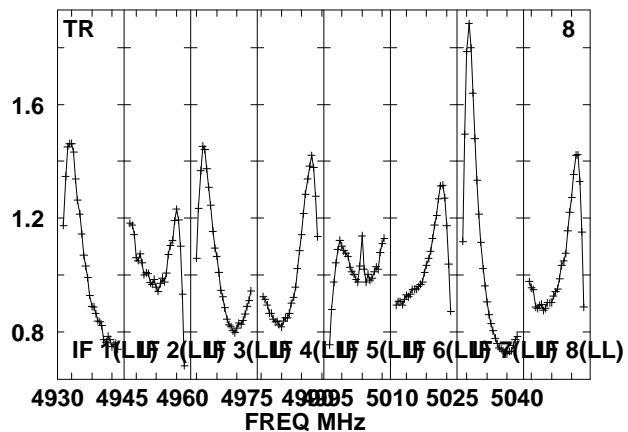
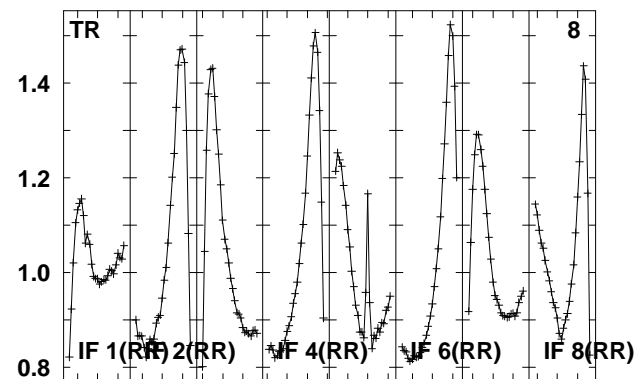
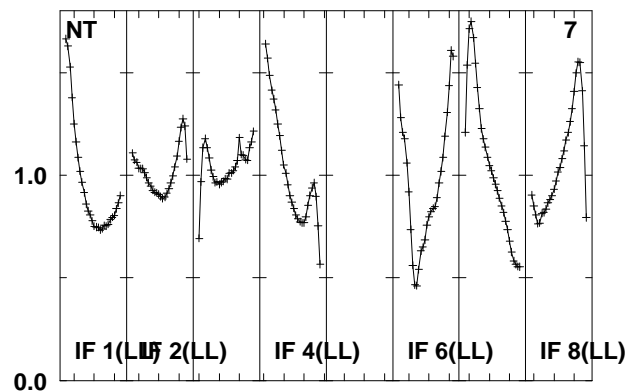
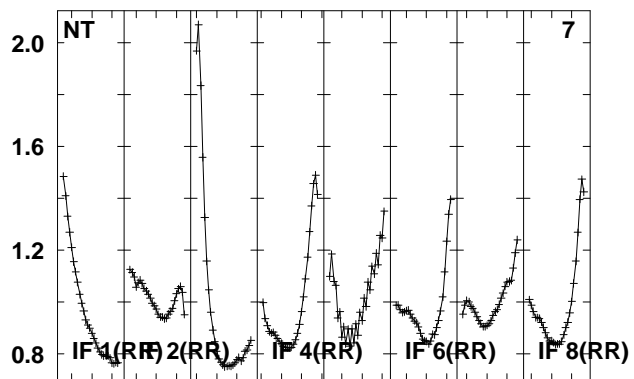
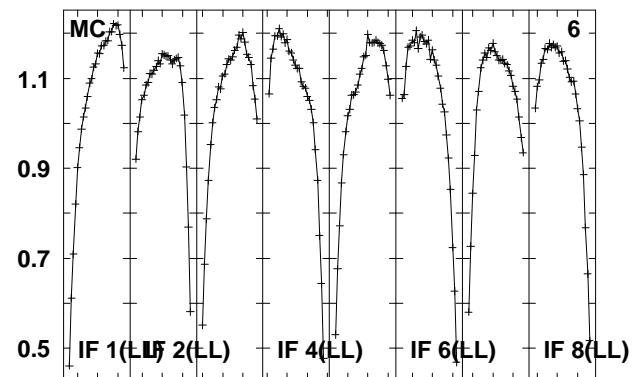
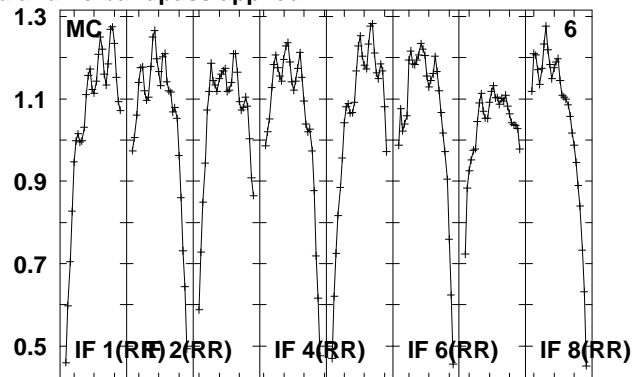
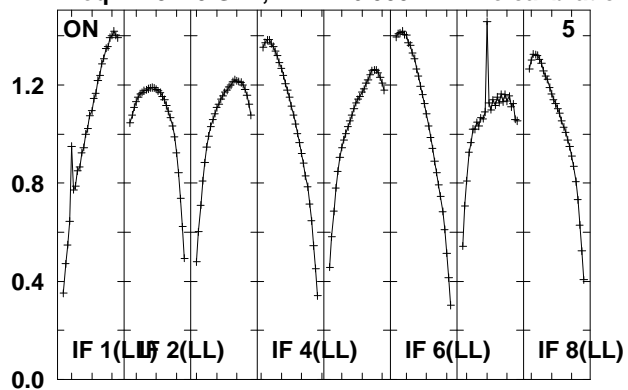

Lower frame: Real Jy

Total-power spectrum Antenna: *

Timerange: 00/11:06:48 to 00/11:08:14

Plot file version 293 created 14-MAY-2010 15:18:41
 J015028 EO007.UVDATA.1
 Freq = 4.9270 GHz, Bw = 16.000 MH No calibration applied and no bandpass applied

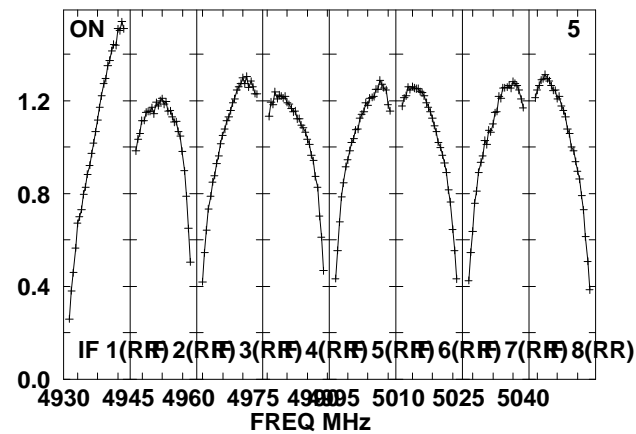
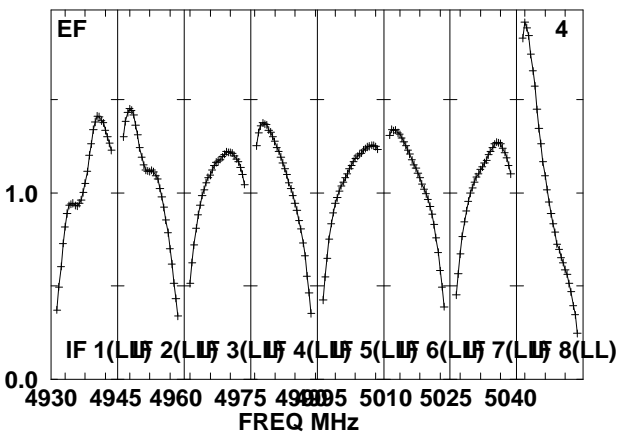
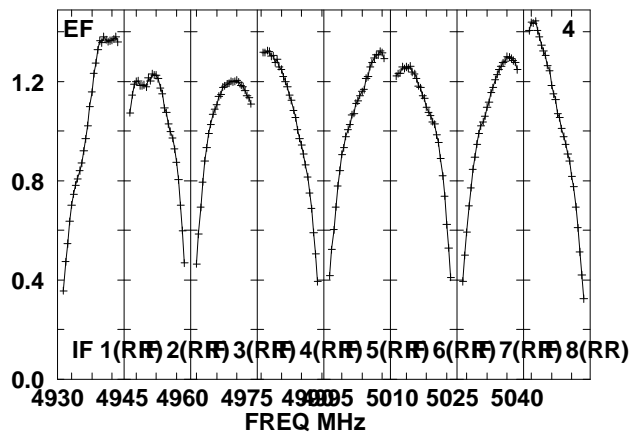
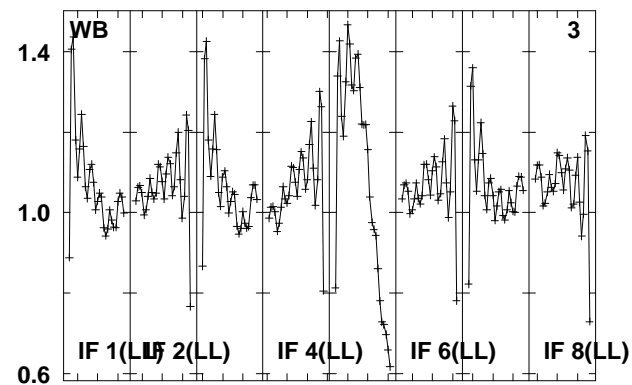
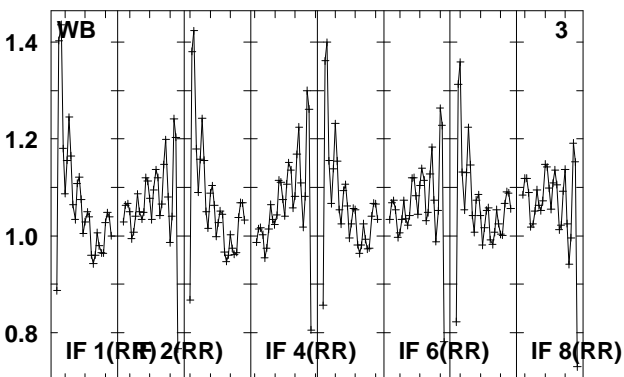
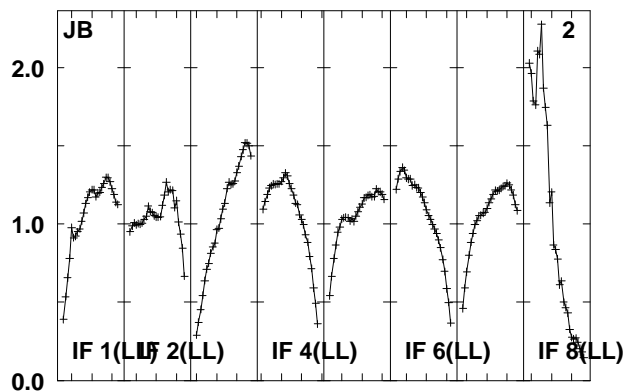
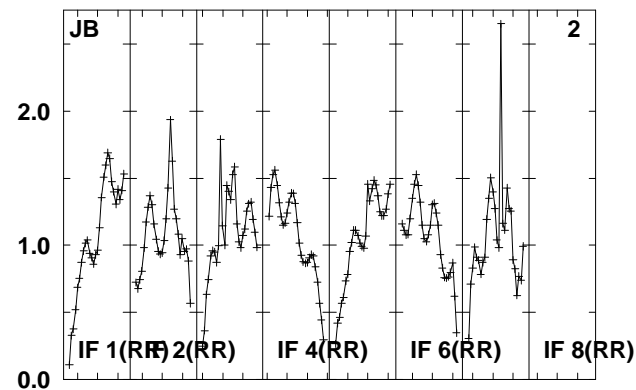
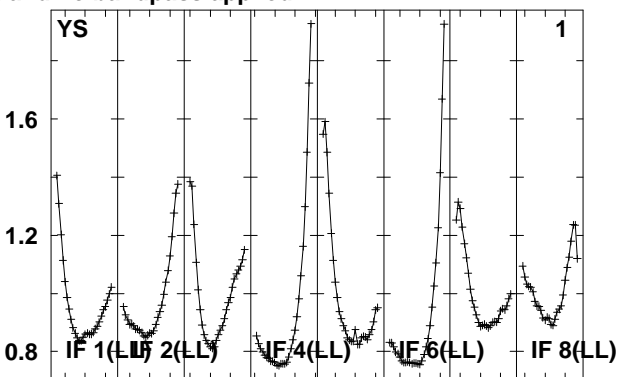
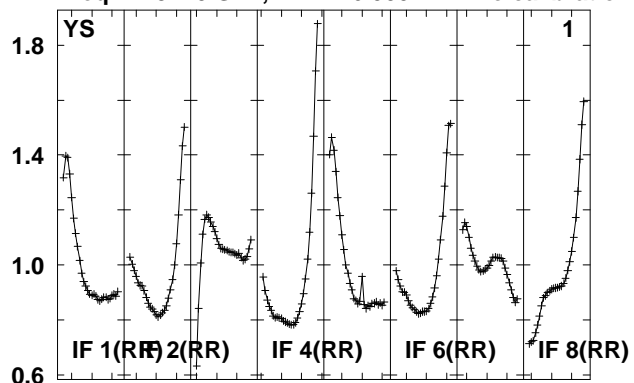

Lower frame: Real Jy
 Total-power spectrum Antenna: *
 Timerange: 00/11:08:49 to 00/11:13:47

Plot file version 294 created 14-MAY-2010 15:18:41

J015028 EO007.UVDATA.1

Freq = 4.9270 GHz, Bw = 16.000 MH No calibration applied and no bandpass applied

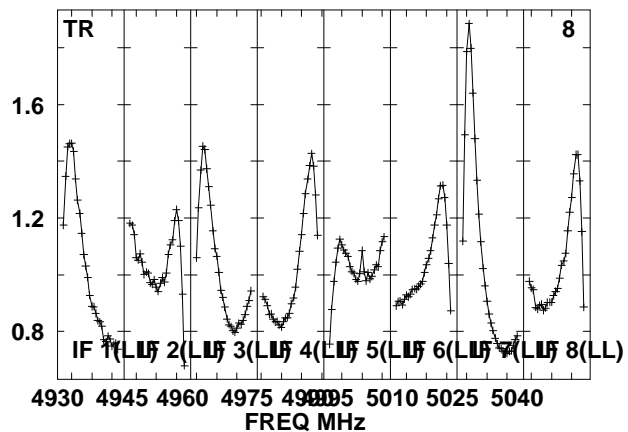
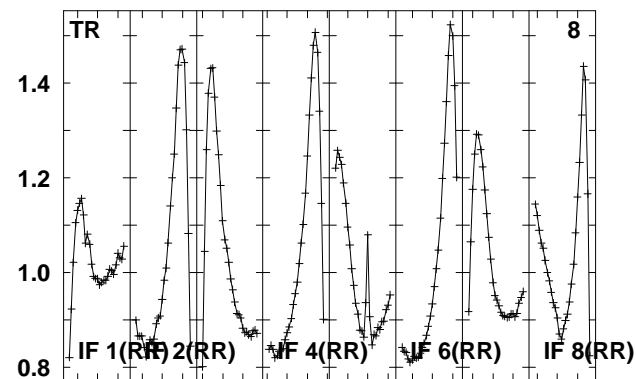
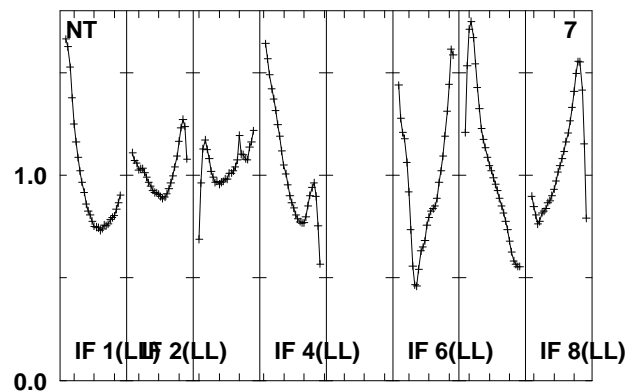
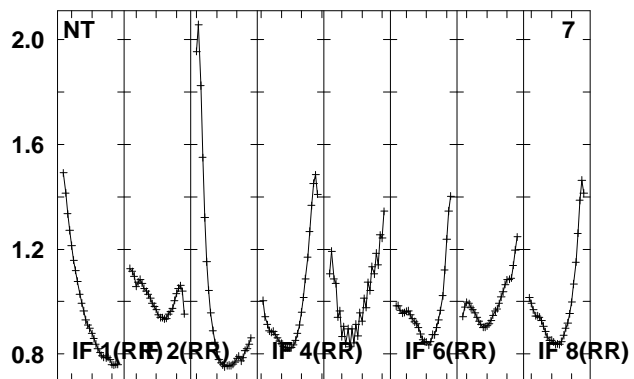
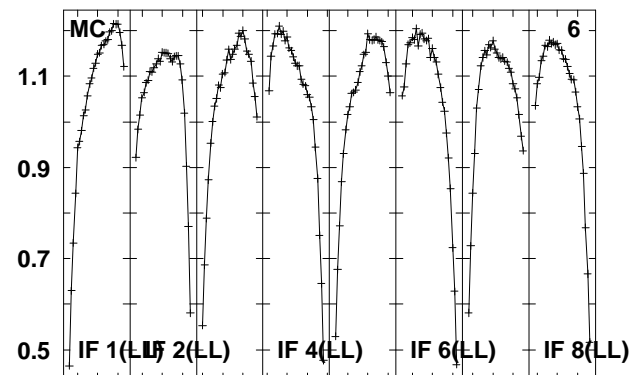
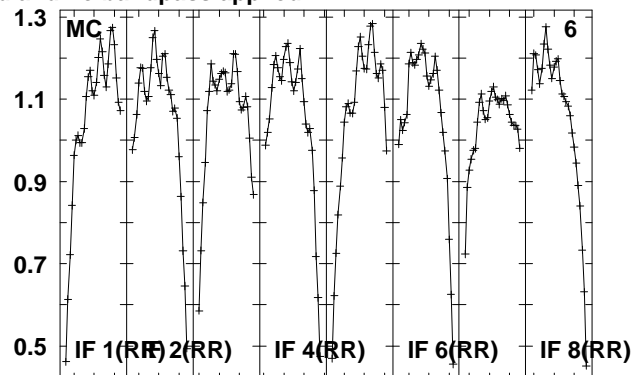
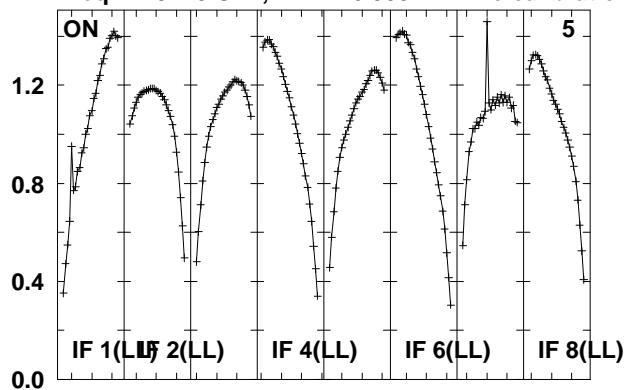

Lower frame: Real Jy

Total-power spectrum Antenna: *

Timerange: 00/11:08:49 to 00/11:13:47

Plot file version 295 created 14-MAY-2010 15:18:42

J0158+13 EO007.UVDATA.1

Freq = 4.9270 GHz, Bw = 16.000 MH No calibration applied and no bandpass applied

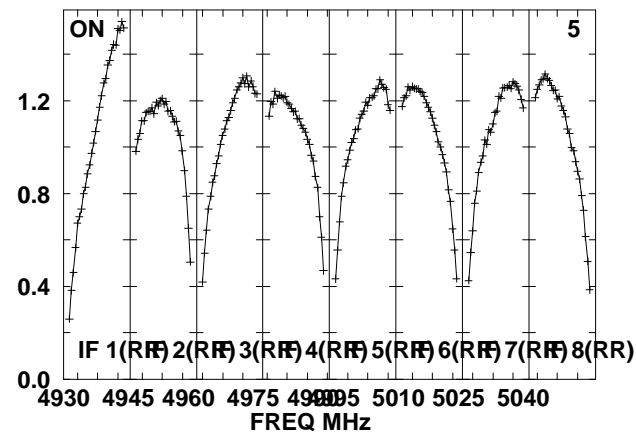
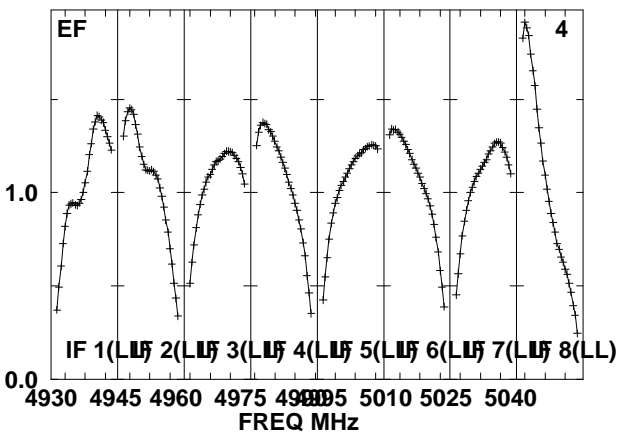
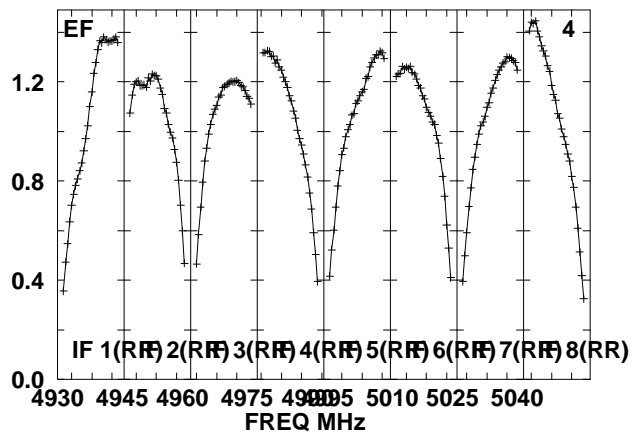
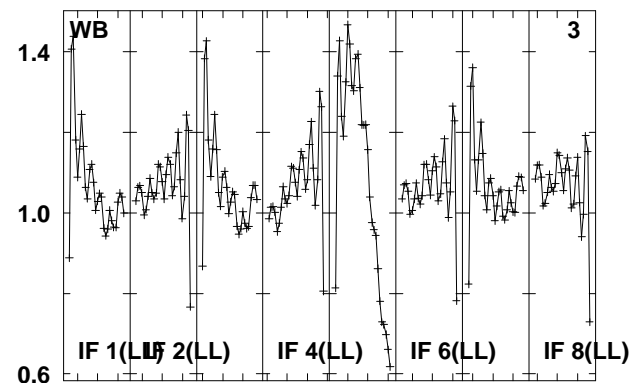
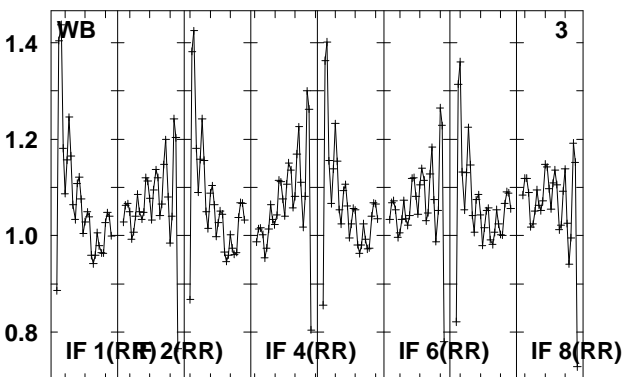
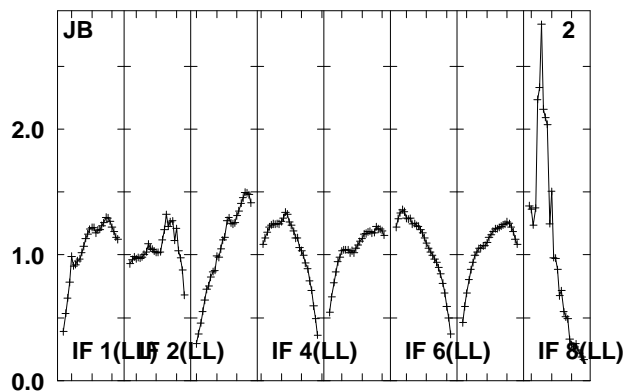
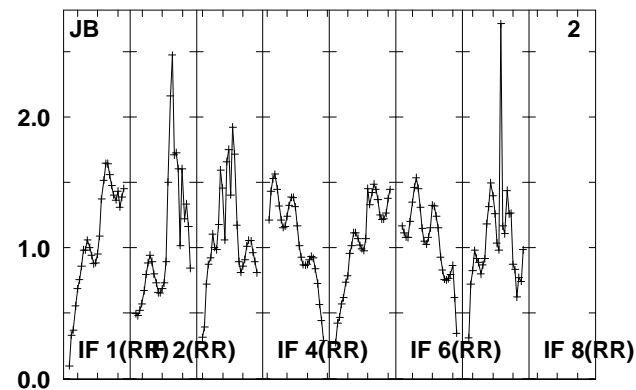
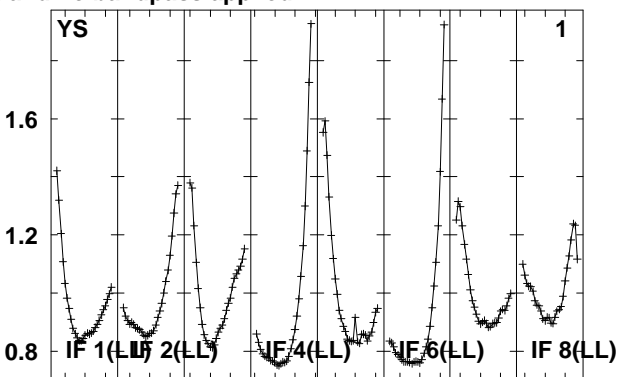
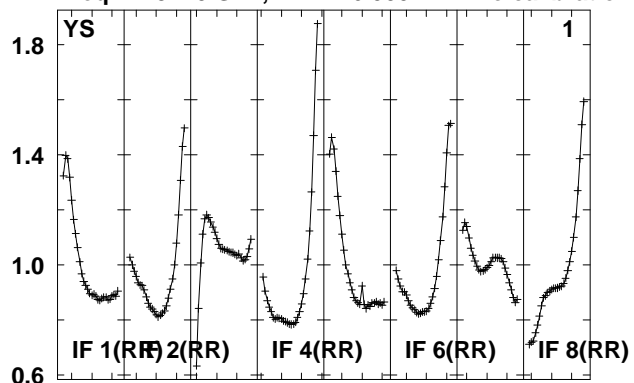

Lower frame: Real Jy

Total-power spectrum Antenna: *

Timerange: 00/11:14:19 to 00/11:15:45

Plot file version 296 created 14-MAY-2010 15:18:42

J0158+13 EO007.UVDATA.1

Freq = 4.9270 GHz, Bw = 16.000 MH No calibration applied and no bandpass applied

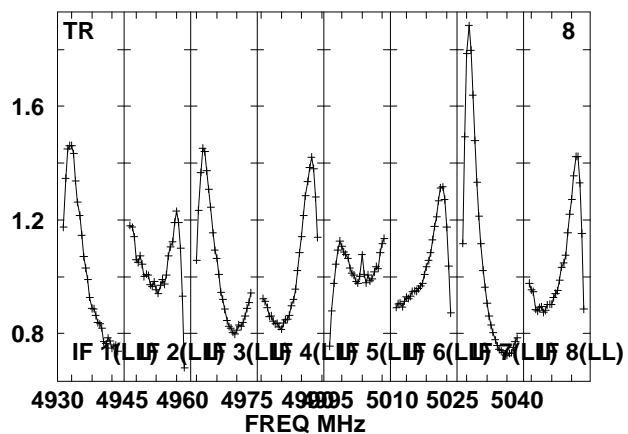
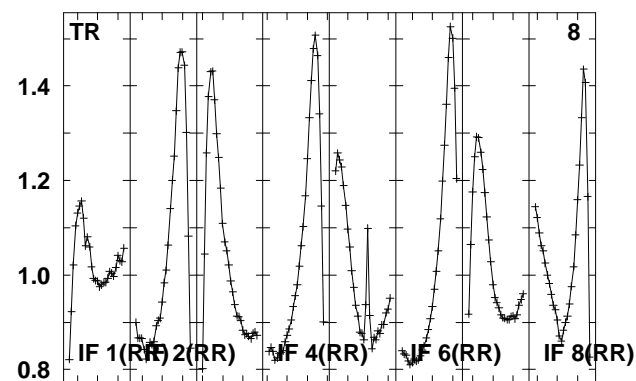
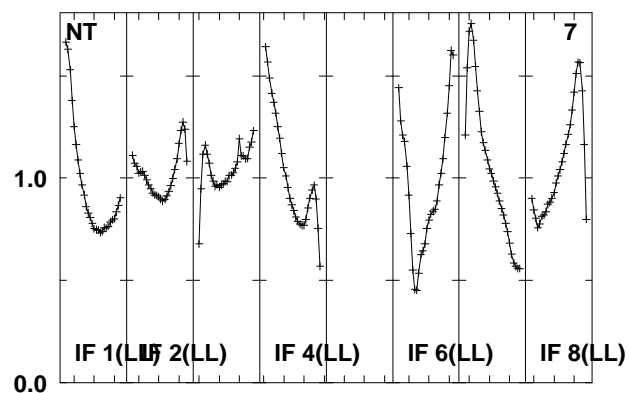
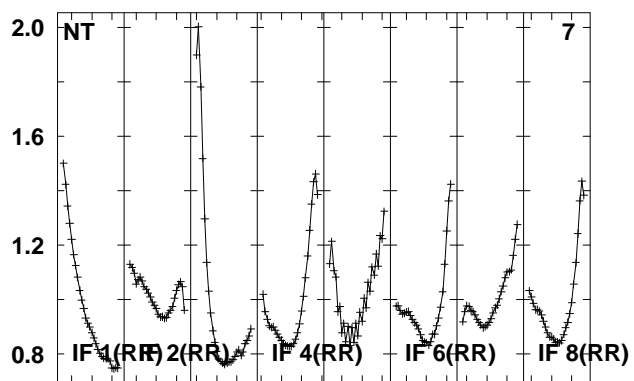
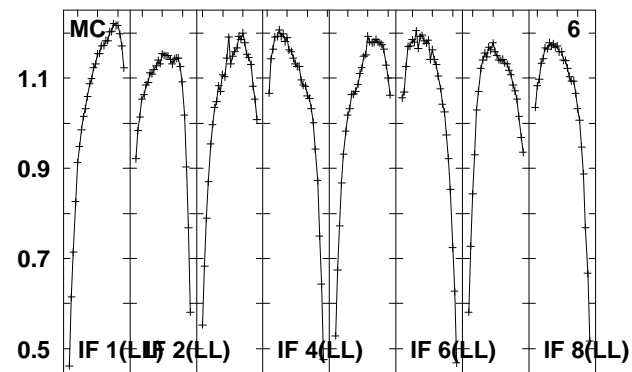
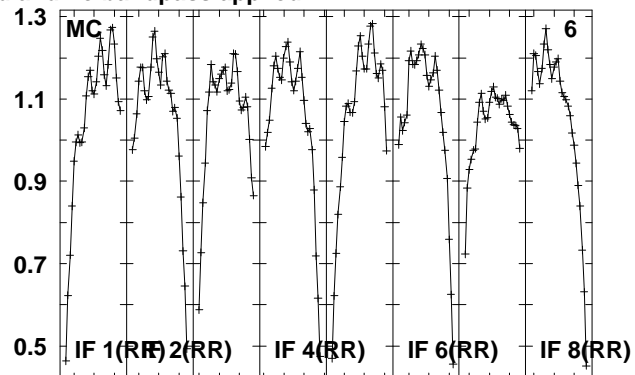
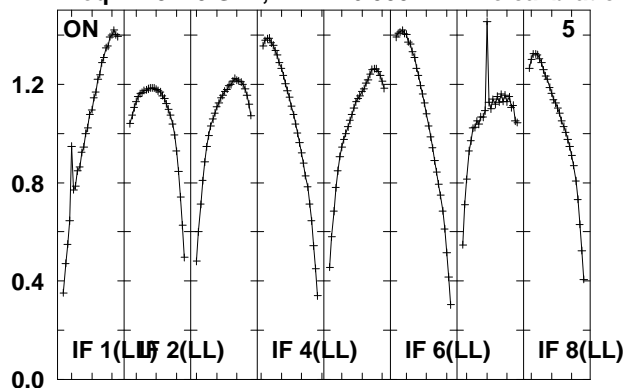

Lower frame: Real Jy

Total-power spectrum Antenna: *

Timerange: 00/11:14:19 to 00/11:15:45

Plot file version 297 created 14-MAY-2010 15:18:42
 J015028 EO007.UVDATA.1
 Freq = 4.9270 GHz, Bw = 16.000 MH No calibration applied and no bandpass applied

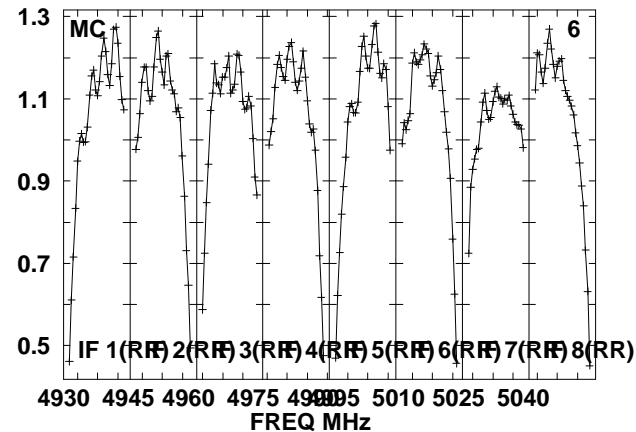
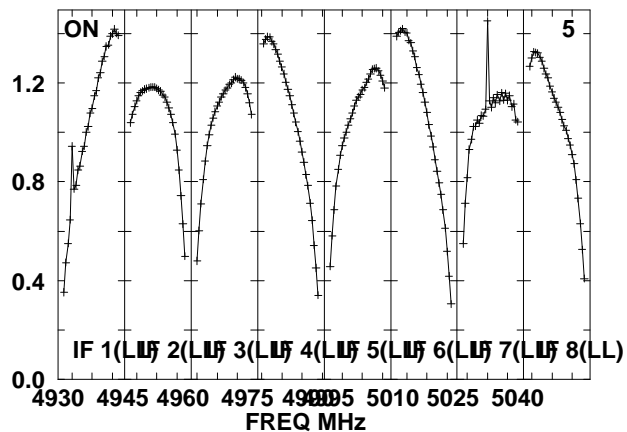
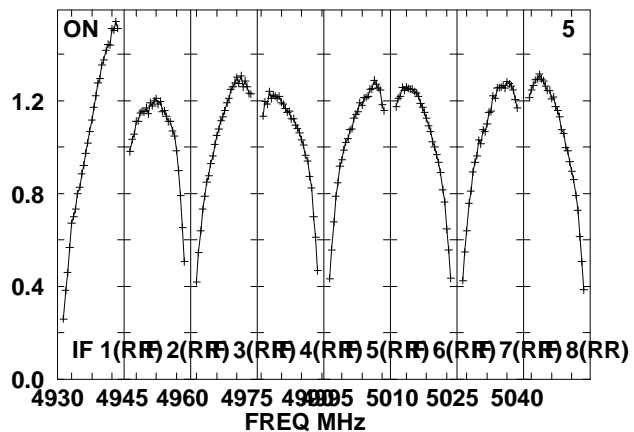
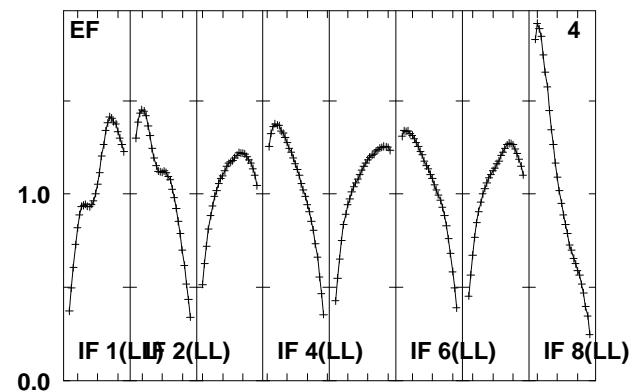
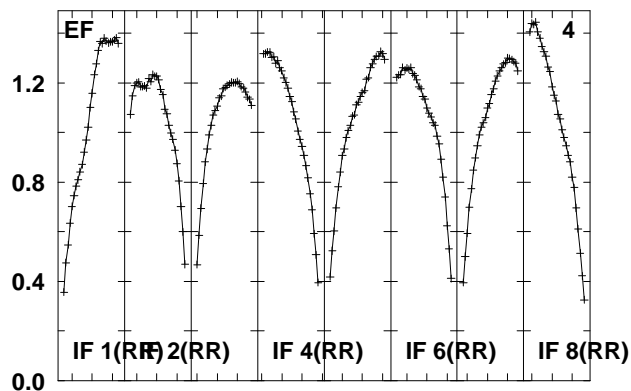
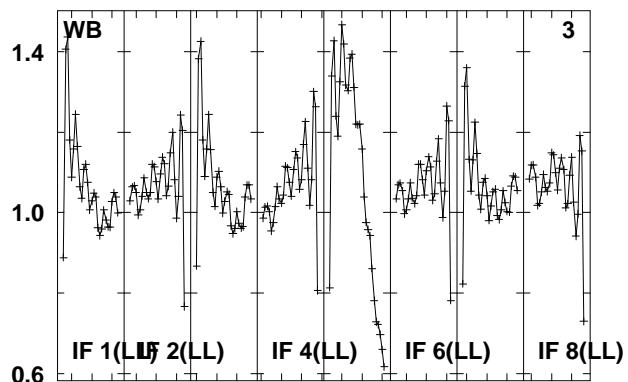
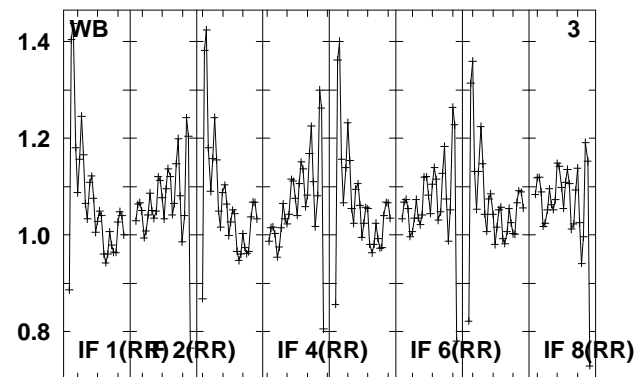
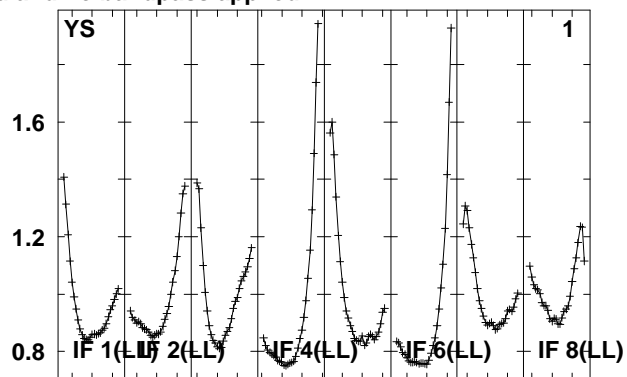
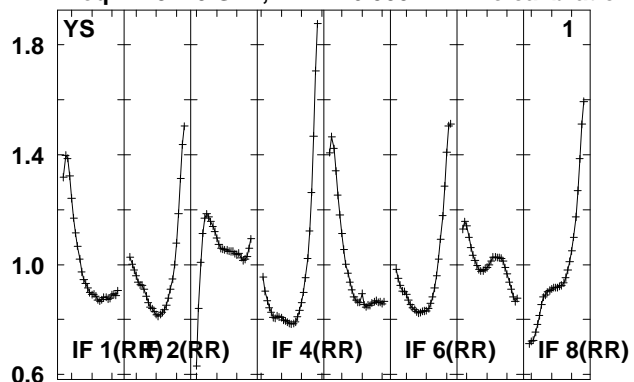

Lower frame: Real Jy
 Total-power spectrum Antenna: *
 Timerange: 00/11:16:21 to 00/11:21:19

Plot file version 298 created 14-MAY-2010 15:18:43

J015028 EO007.UVDATA.1

Freq = 4.9270 GHz, Bw = 16.000 MH No calibration applied and no bandpass applied

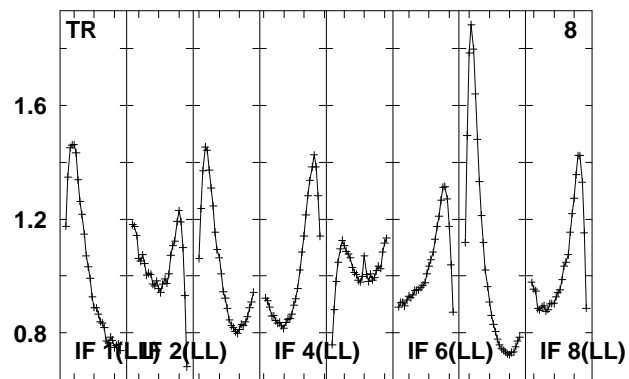
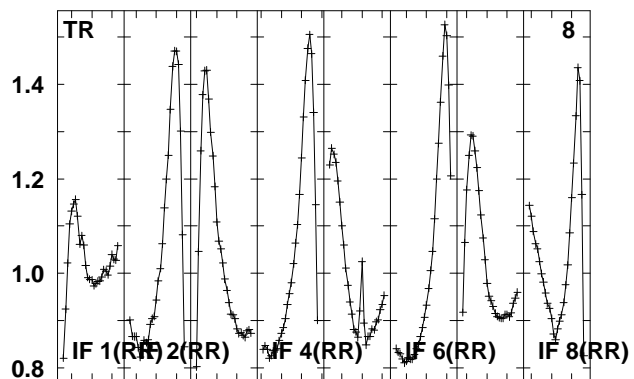
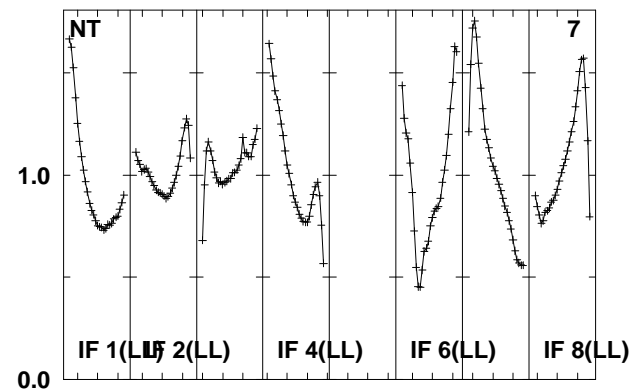
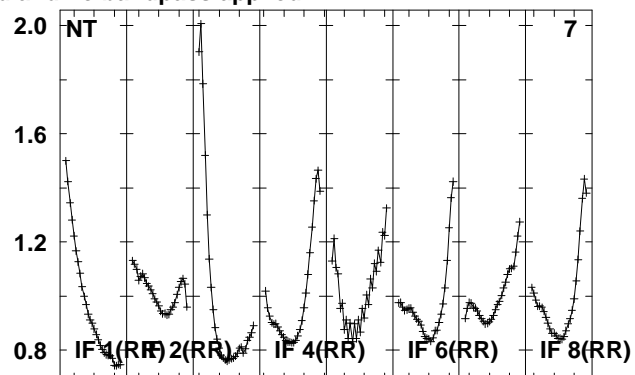
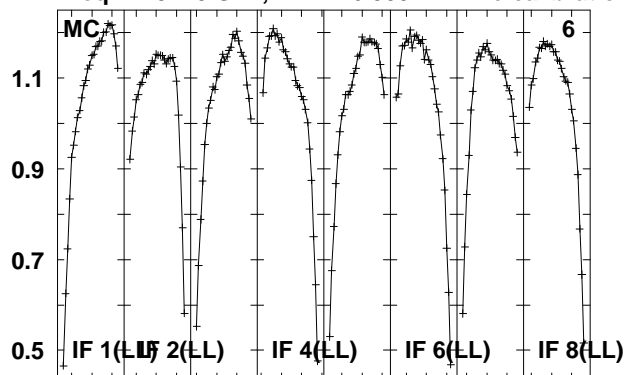

Lower frame: Real Jy
Total-power spectrum Antenna: *
Timerange: 00/11:16:21 to 00/11:21:19

Plot file version 299 created 14-MAY-2010 15:18:43

J0158+13 EO007.UVDATA.1

Freq = 4.9270 GHz, Bw = 16.000 MH No calibration applied and no bandpass applied

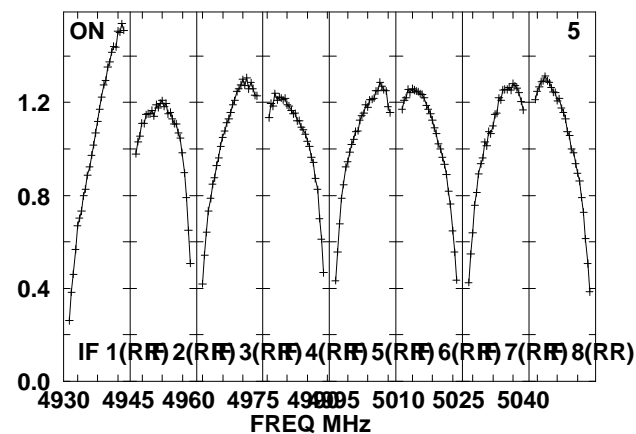
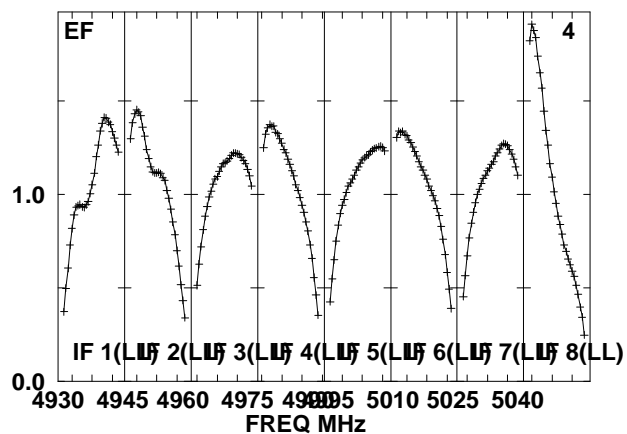
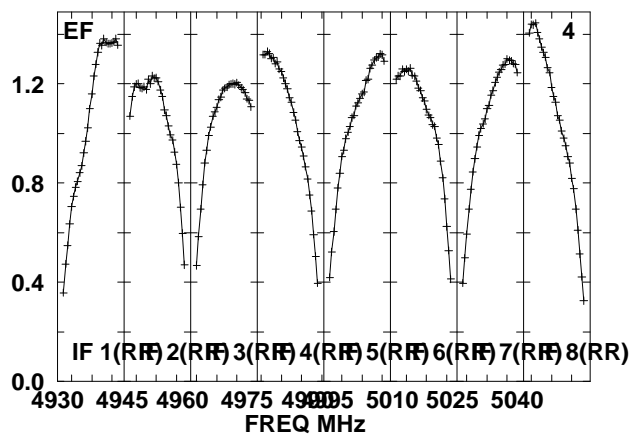
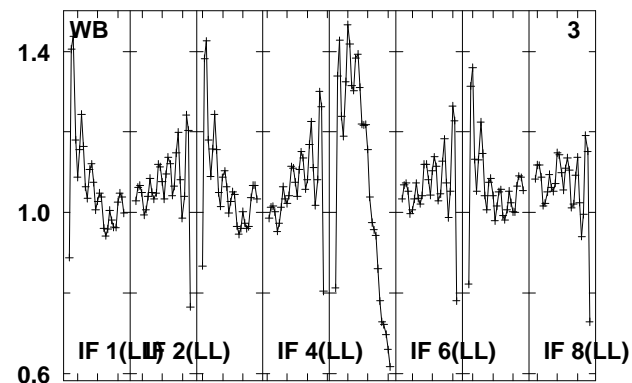
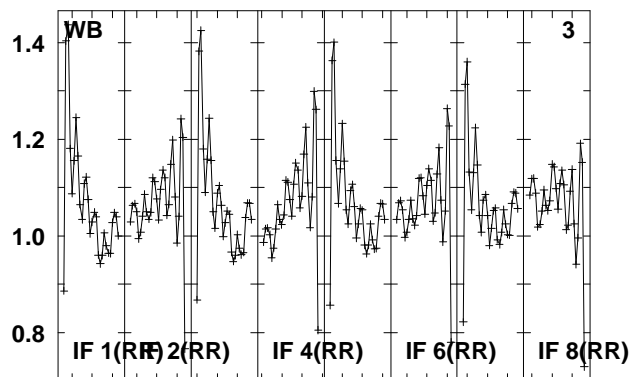
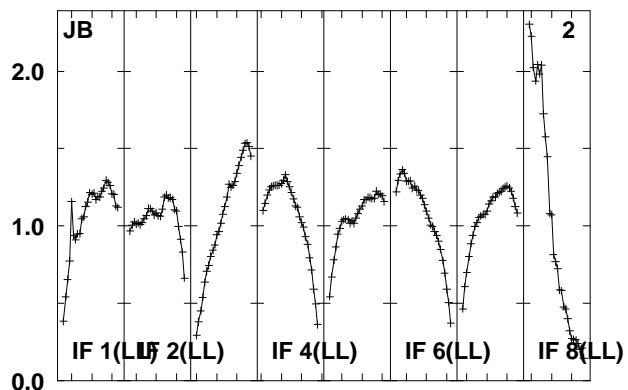
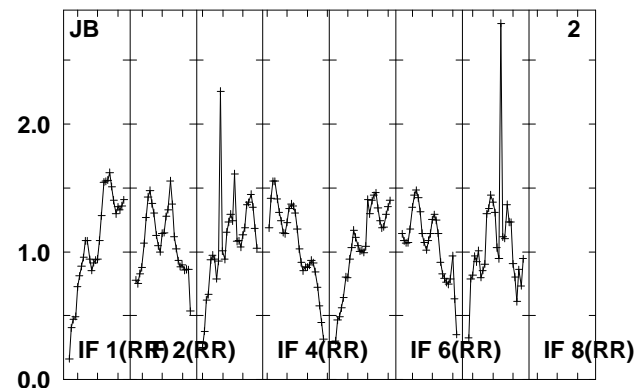
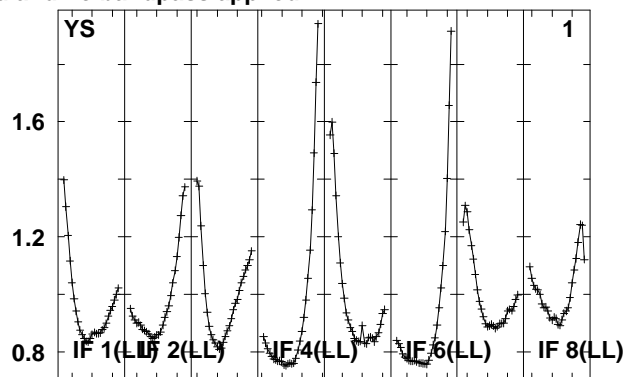
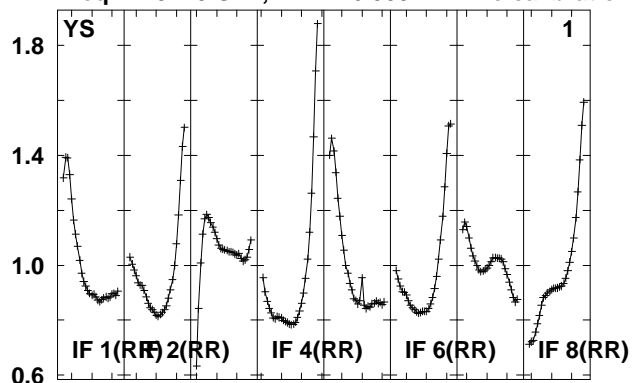

Lower frame: Real Jy

Total-power spectrum Antenna: *

Timerange: 00/11:21:51 to 00/11:23:19

Plot file version 300 created 14-MAY-2010 15:18:43

J0158+13 EO007.UVDATA.1

Freq = 4.9270 GHz, Bw = 16.000 MH No calibration applied and no bandpass applied

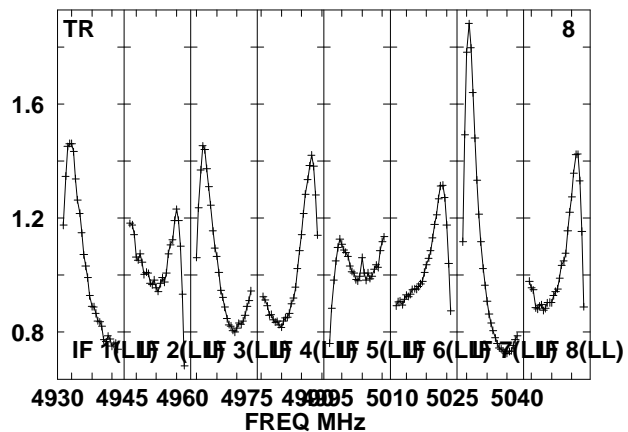
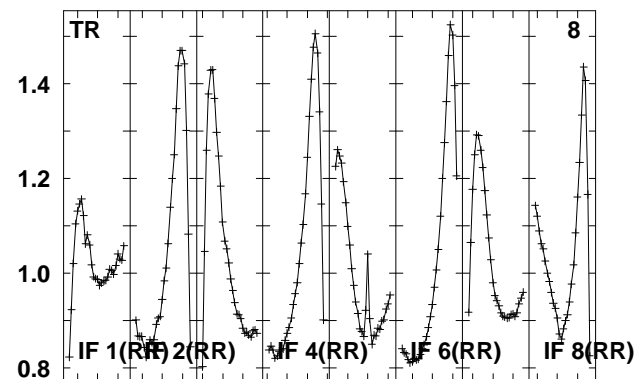
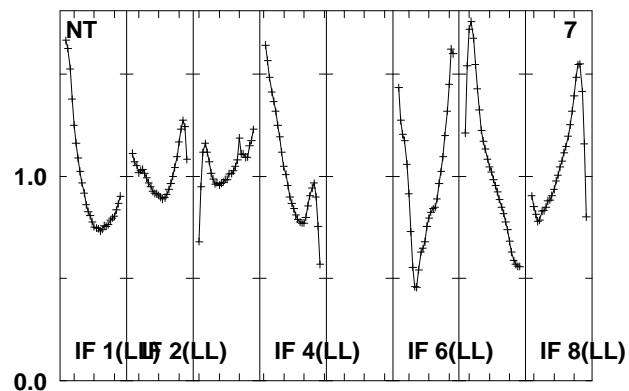
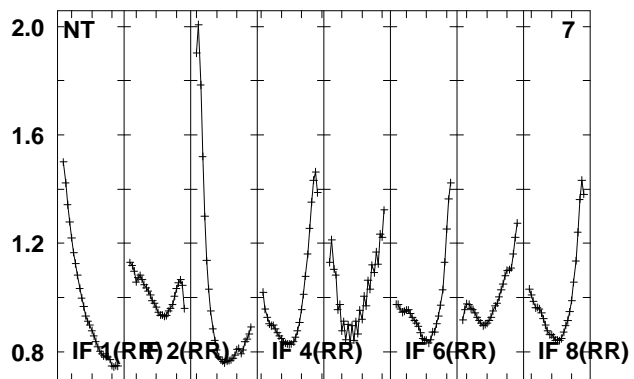
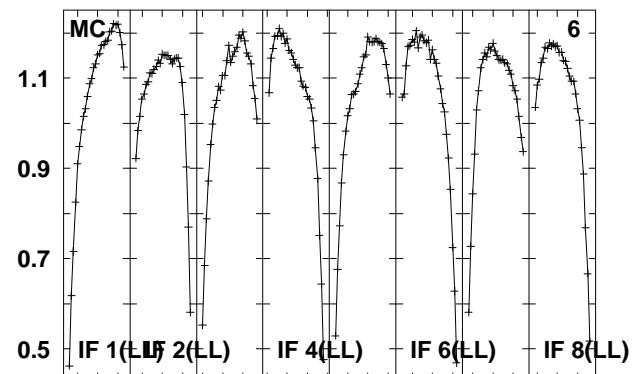
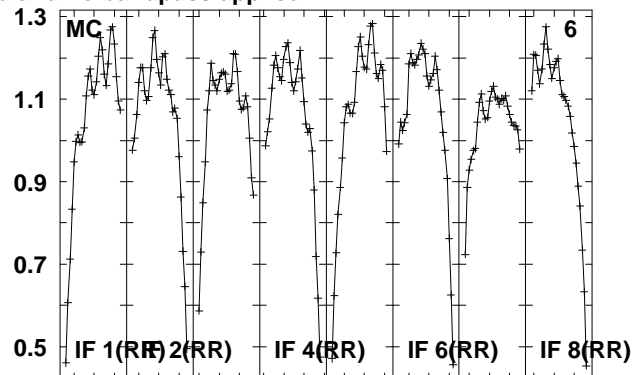
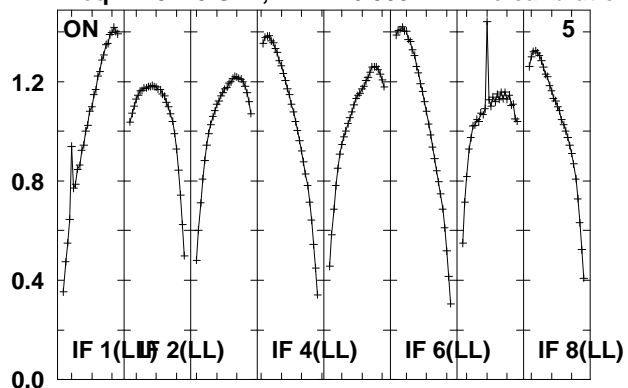

Lower frame: Real Jy

Total-power spectrum Antenna: *

Timerange: 00/11:21:51 to 00/11:23:19

Plot file version 301 created 14-MAY-2010 15:18:43

J0209+13 EO007.UVDATA.1

Freq = 4.9270 GHz, Bw = 16.000 MH No calibration applied and no bandpass applied

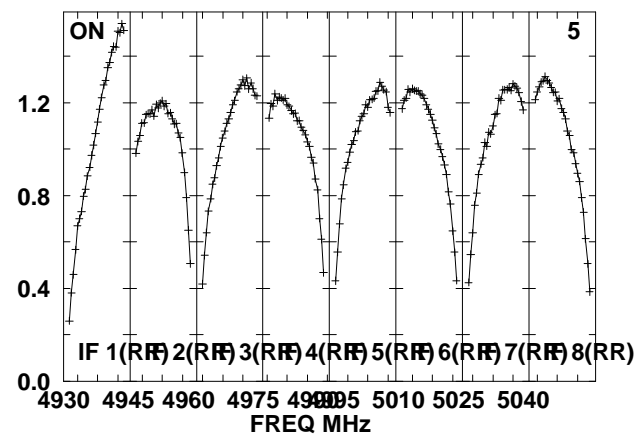
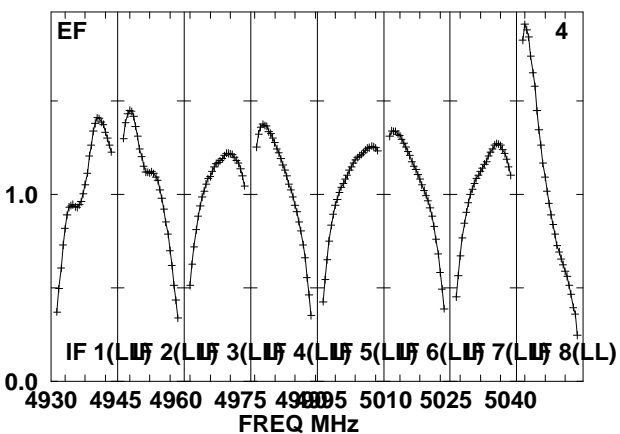
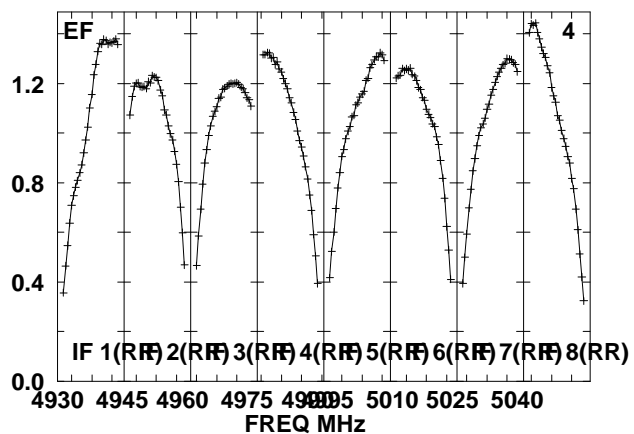
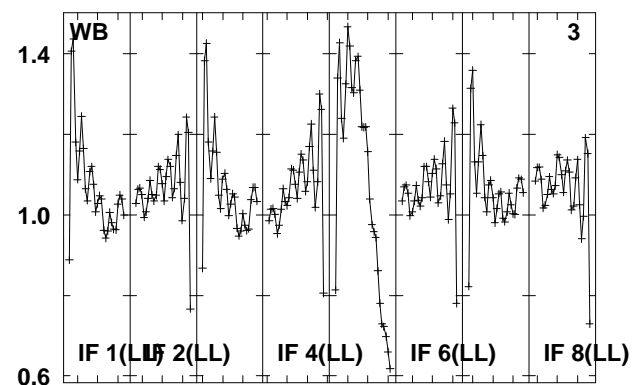
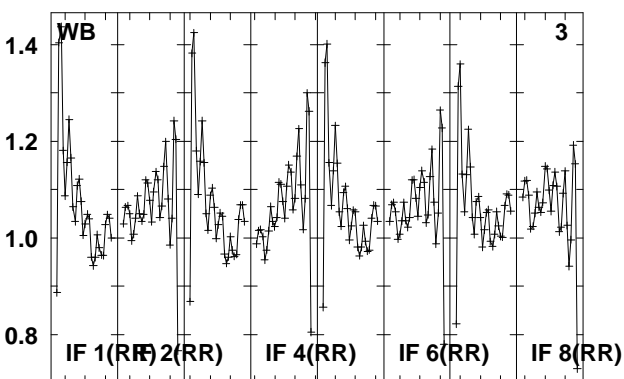
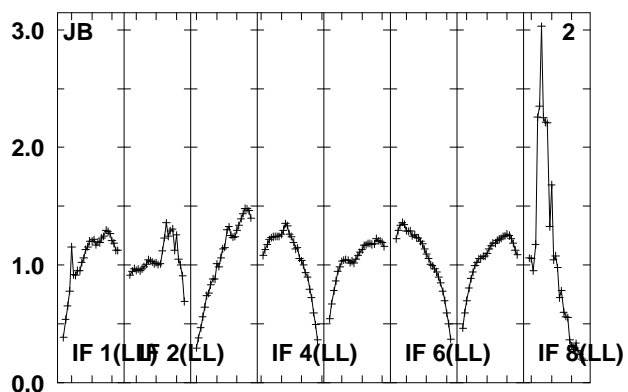
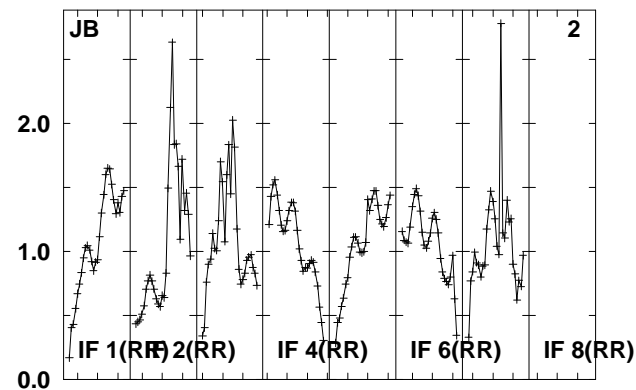
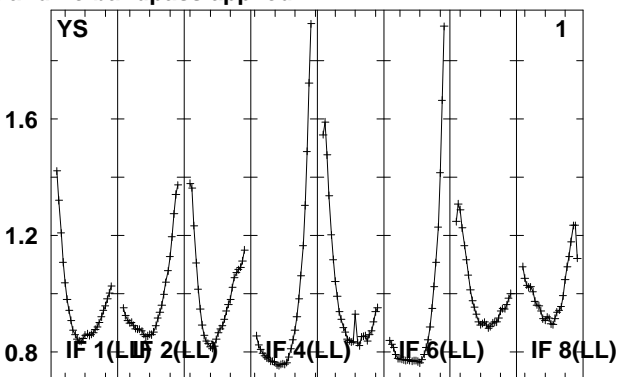
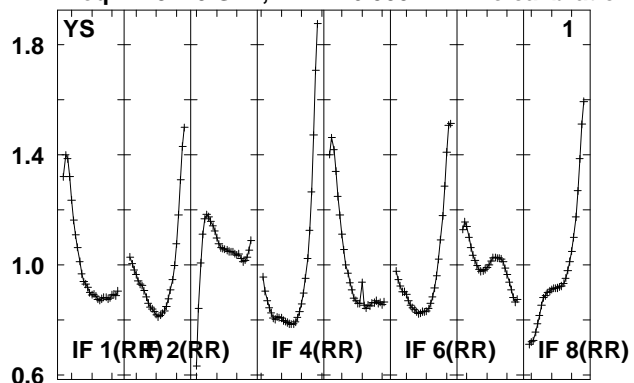

Lower frame: Real Jy
Total-power spectrum Antenna: *
Timerange: 00/11:23:57 to 00/11:25:23

Plot file version 302 created 14-MAY-2010 15:18:44

J0209+13 EO007.UVDATA.1

Freq = 4.9270 GHz, Bw = 16.000 MH No calibration applied and no bandpass applied

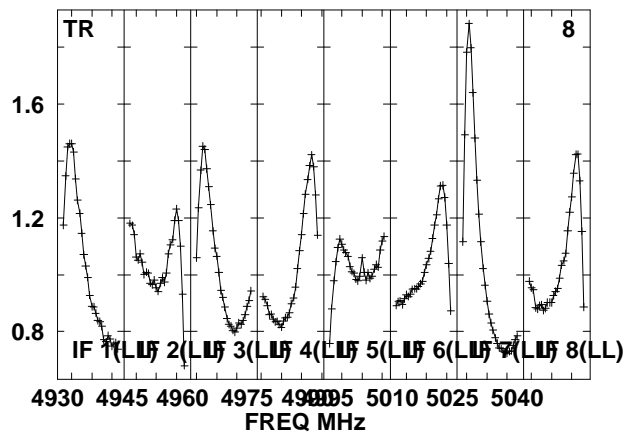
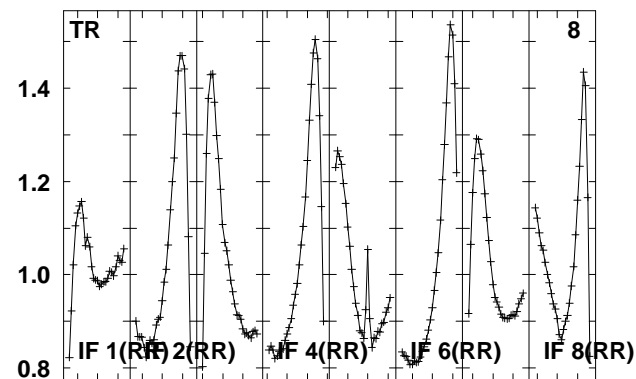
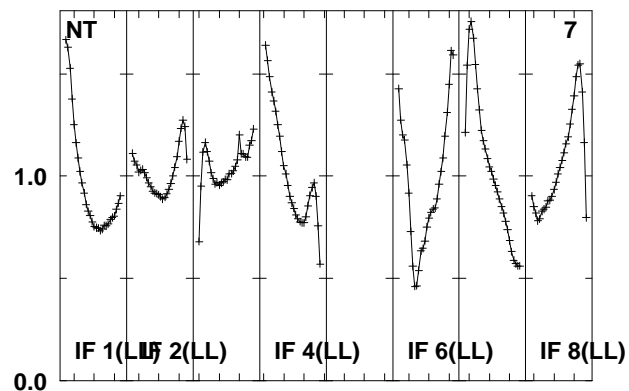
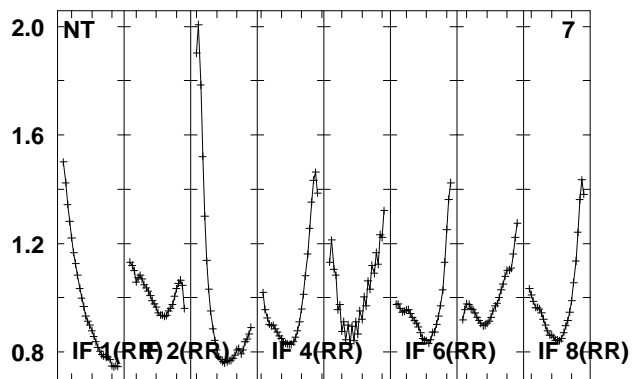
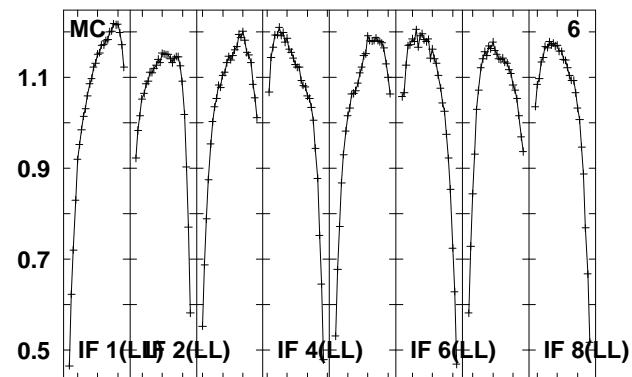
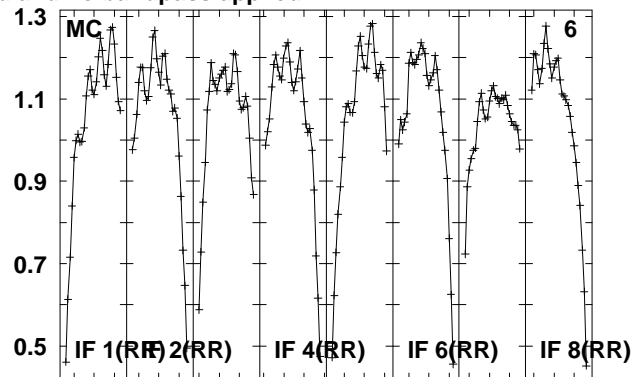
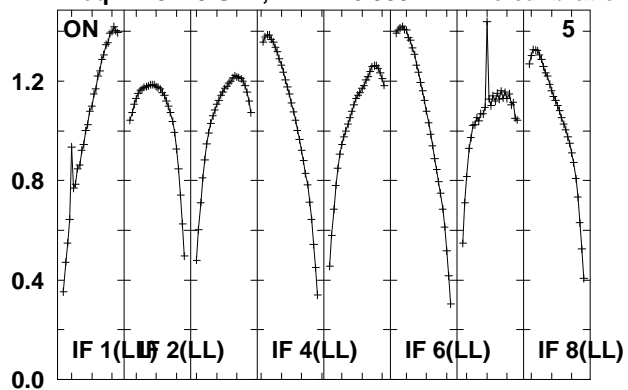

Lower frame: Real Jy

Total-power spectrum Antenna: *

Timerange: 00/11:23:57 to 00/11:25:23

Plot file version 303 created 14-MAY-2010 15:18:44

J021348 EO007.UVDATA.1

Freq = 4.9270 GHz, Bw = 16.000 MH No calibration applied and no bandpass applied

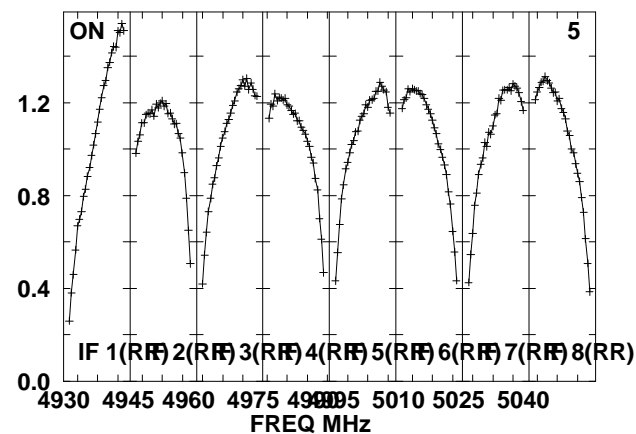
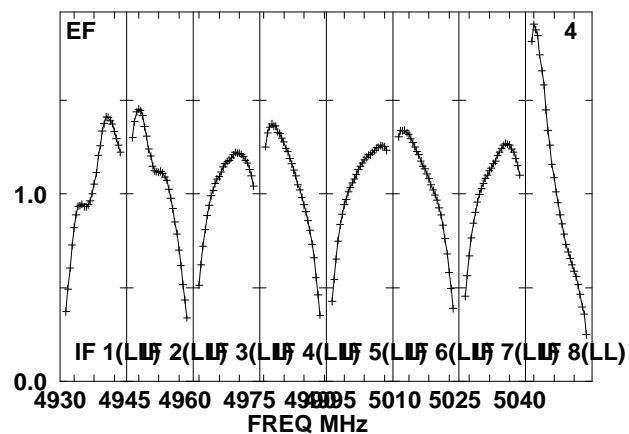
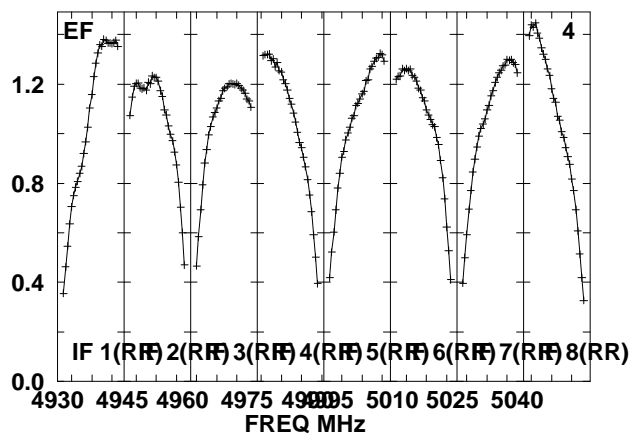
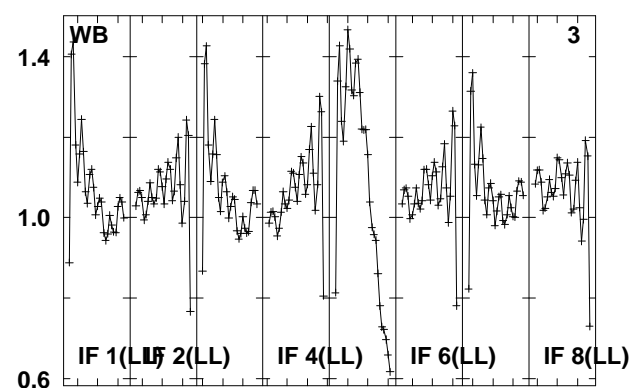
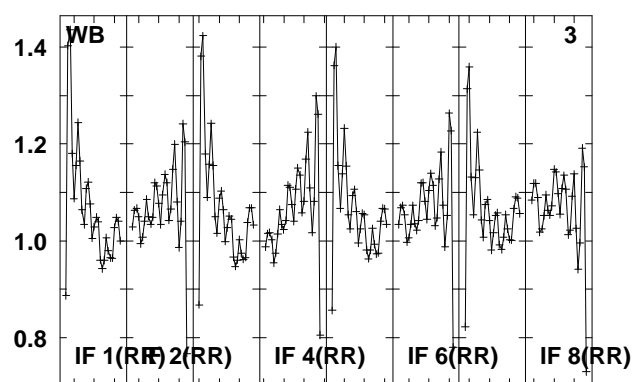
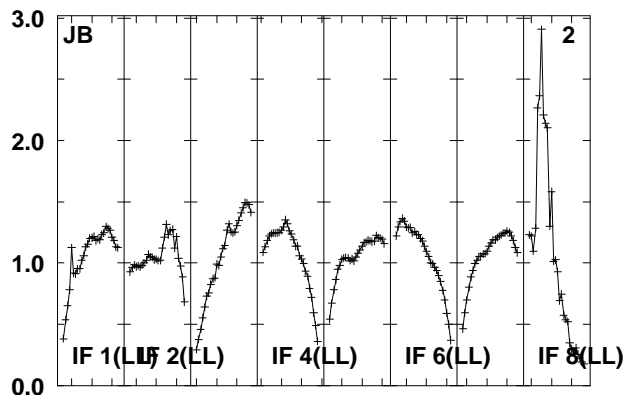
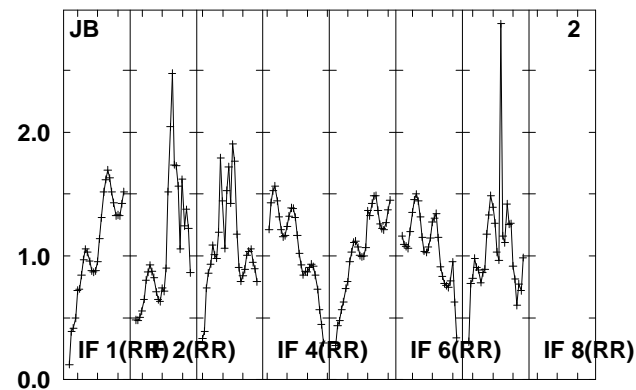
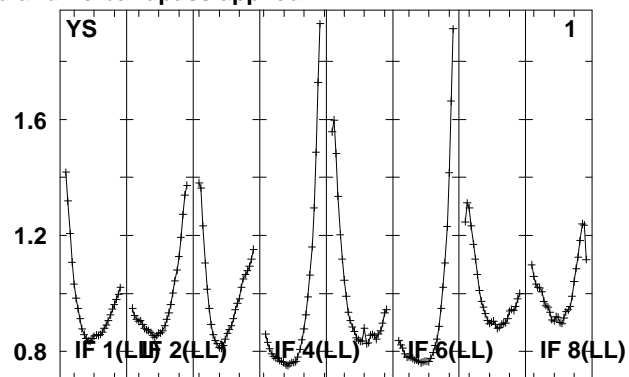
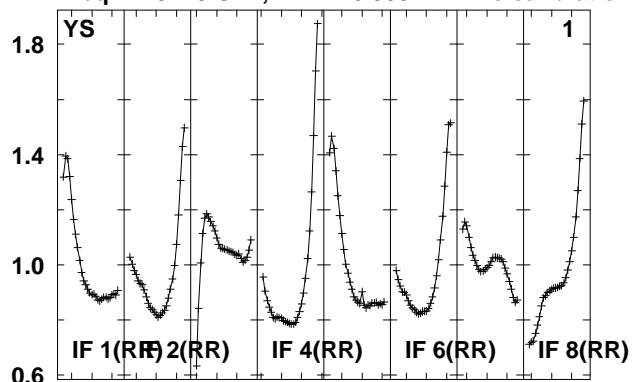

Lower frame: Real Jy
Total-power spectrum Antenna: *
Timerange: 00/11:25:51 to 00/11:30:49

Plot file version 304 created 14-MAY-2010 15:18:45

J021348 EO007.UVDATA.1

Freq = 4.9270 GHz, Bw = 16.000 MH No calibration applied and no bandpass applied

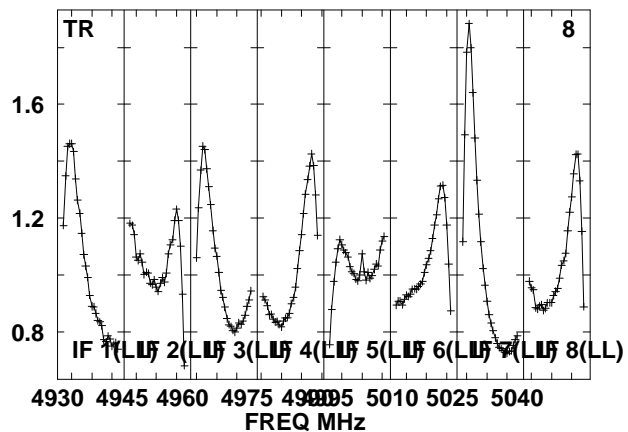
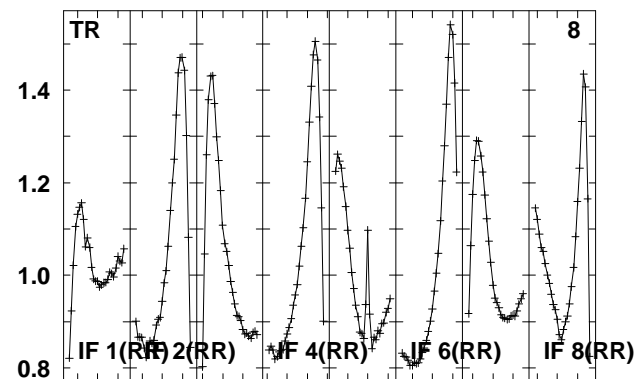
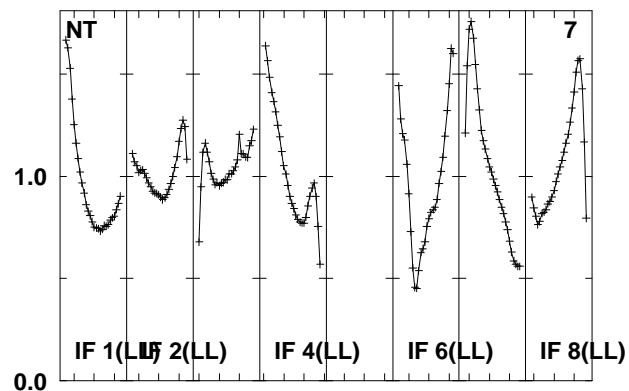
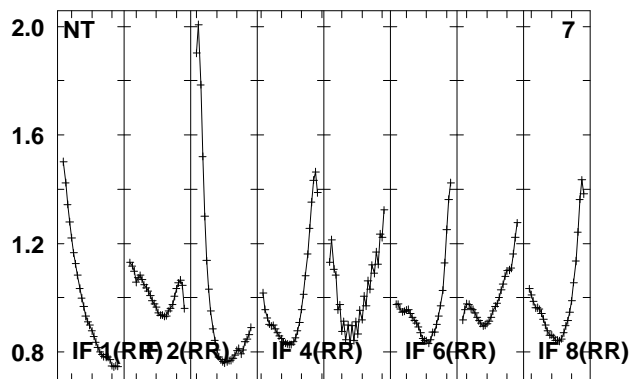
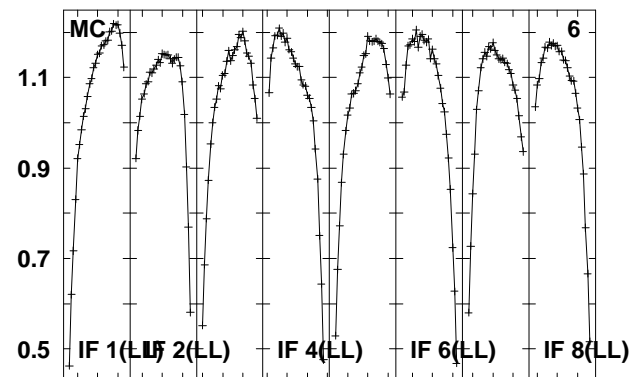
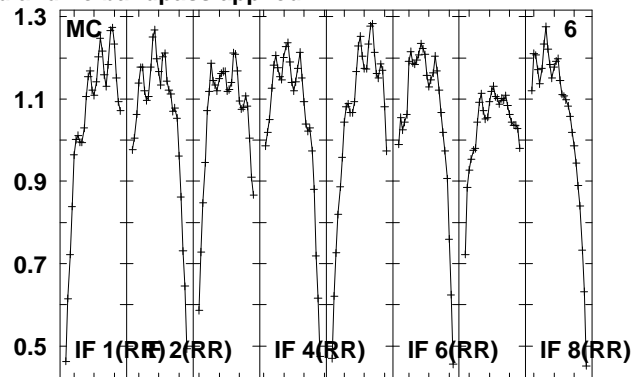
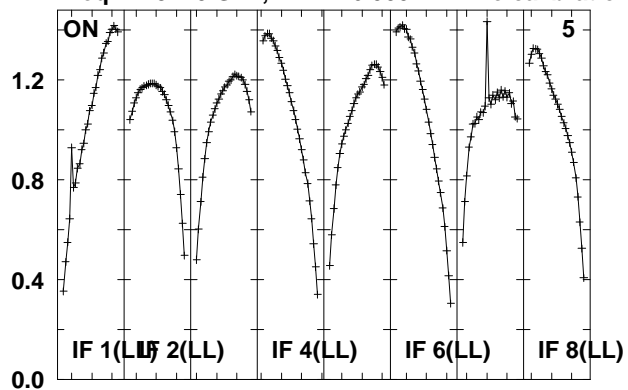

Lower frame: Real Jy

Total-power spectrum Antenna: *

Timerange: 00/11:25:51 to 00/11:30:49

Plot file version 305 created 14-MAY-2010 15:18:45

J0209+13 EO007.UVDATA.1

Freq = 4.9270 GHz, Bw = 16.000 MH No calibration applied and no bandpass applied

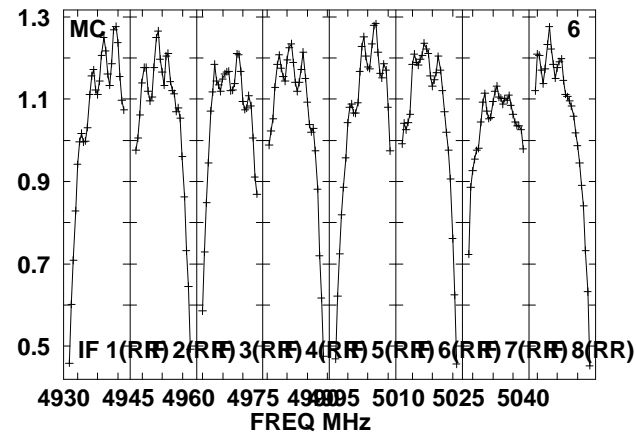
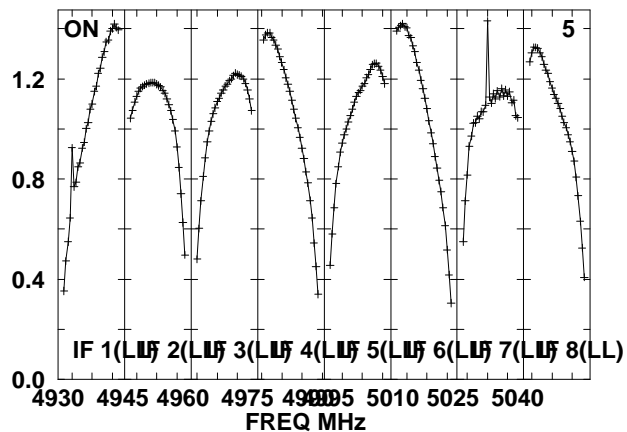
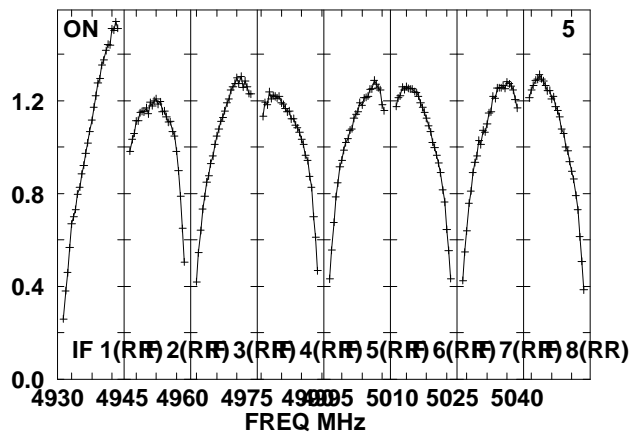
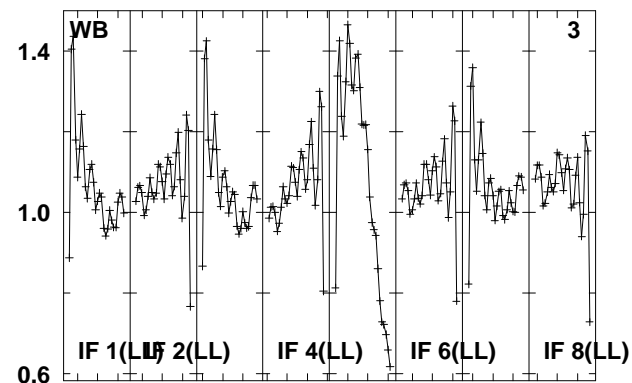
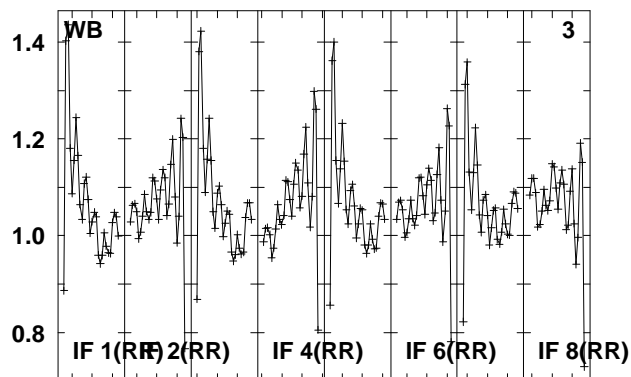
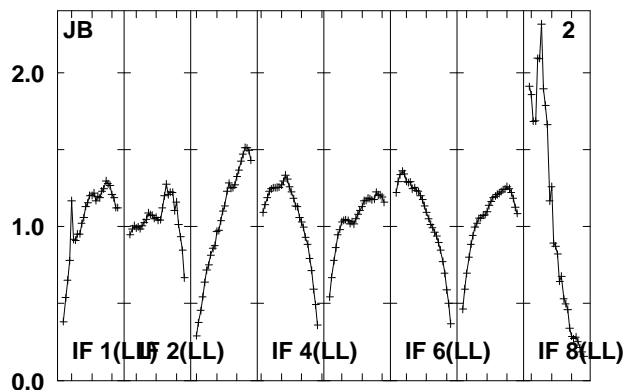
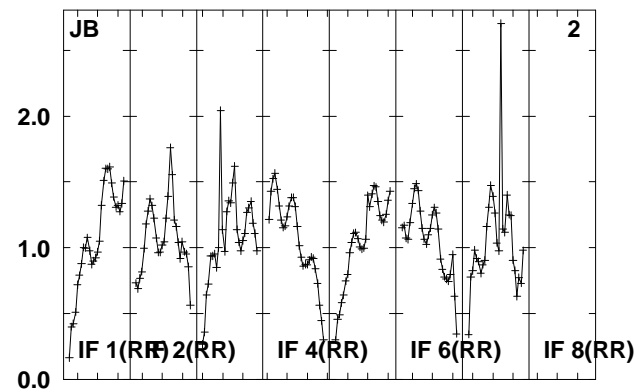
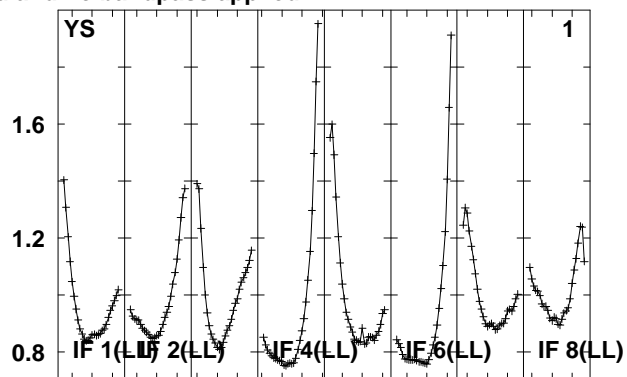
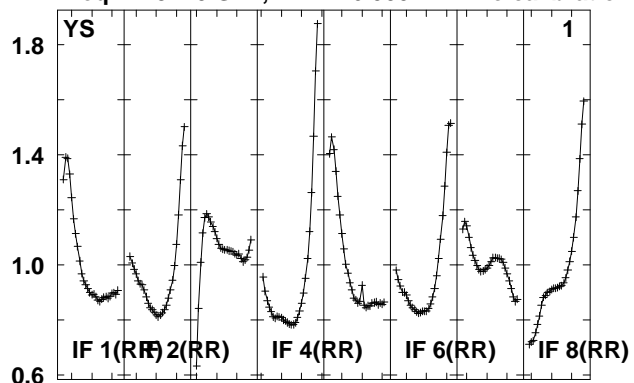

Lower frame: Real Jy

Total-power spectrum Antenna: *

Timerange: 00/11:31:17 to 00/11:32:43

Plot file version 306 created 14-MAY-2010 15:18:45

J0209+13 EO007.UVDATA.1

Freq = 4.9270 GHz, Bw = 16.000 MH No calibration applied and no bandpass applied

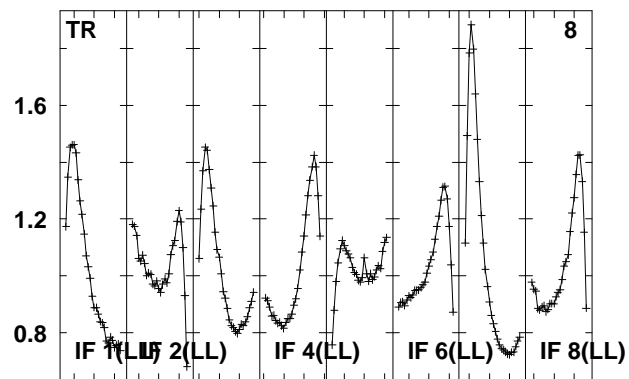
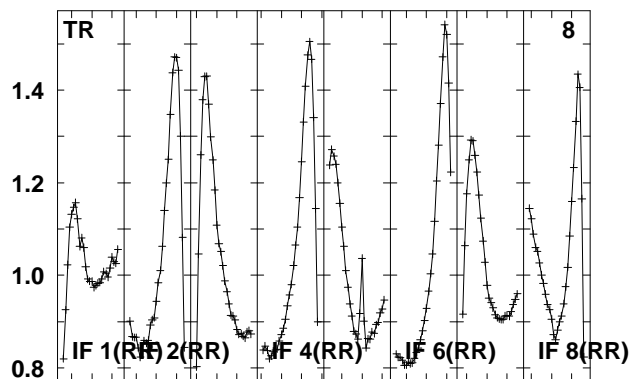
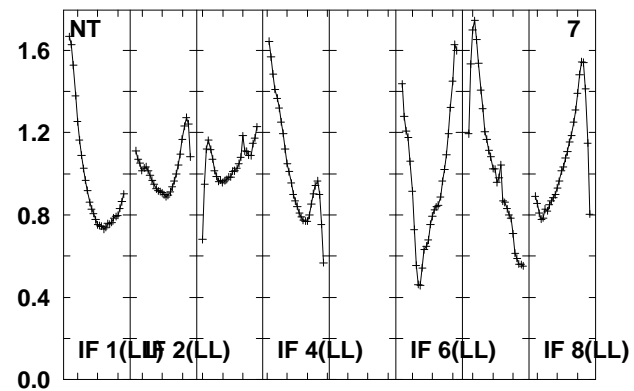
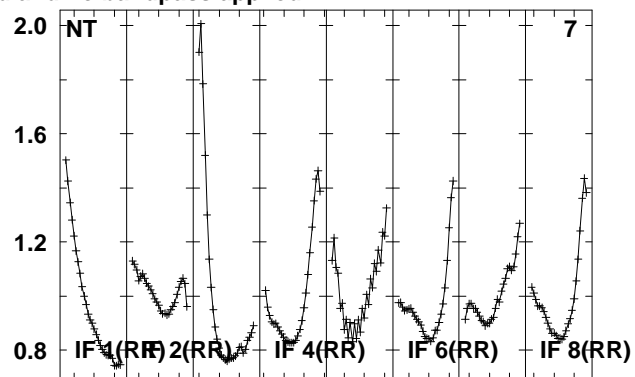
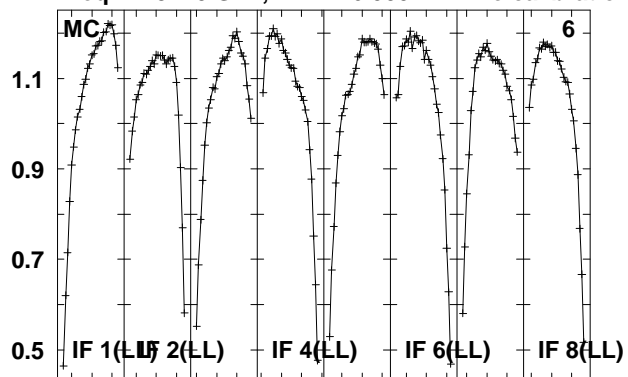

Lower frame: Real Jy
Total-power spectrum Antenna: *
Timerange: 00/11:31:17 to 00/11:32:43

Plot file version 307 created 14-MAY-2010 15:18:46
 J021348 EO007.UVDATA.1
 Freq = 4.9270 GHz, Bw = 16.000 MH No calibration applied and no bandpass applied

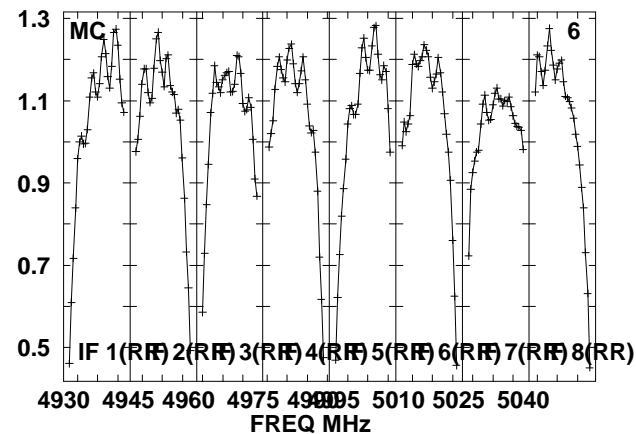
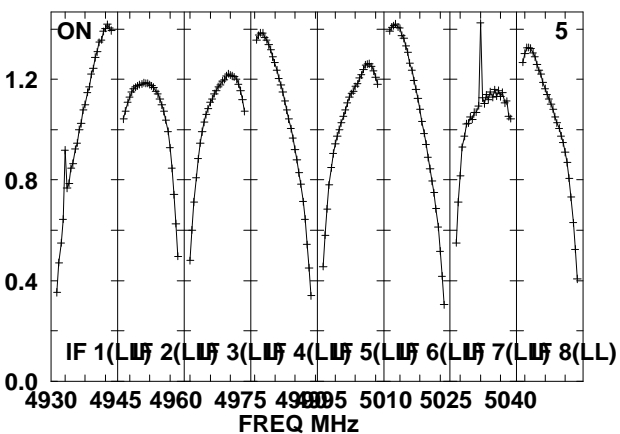
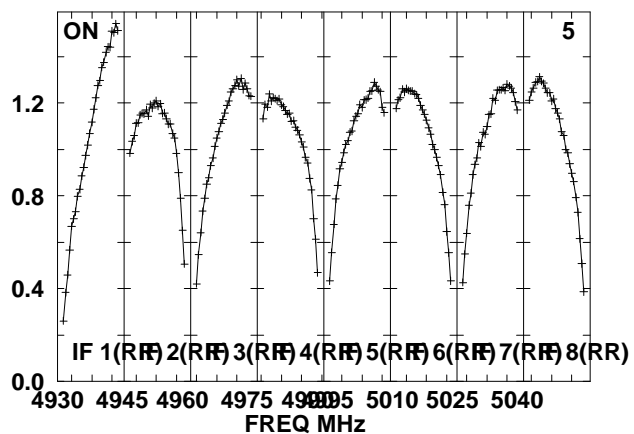
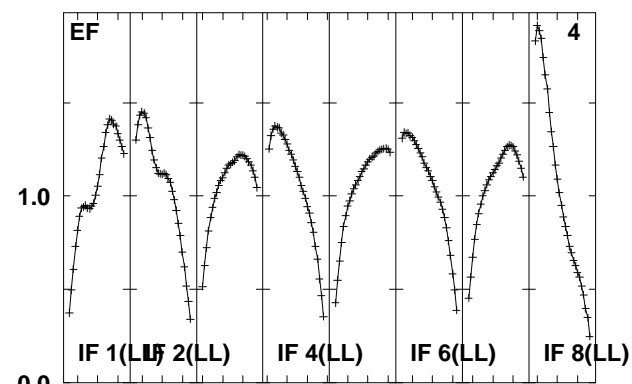
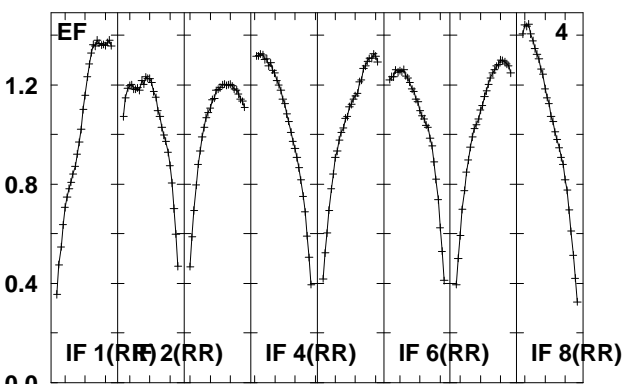
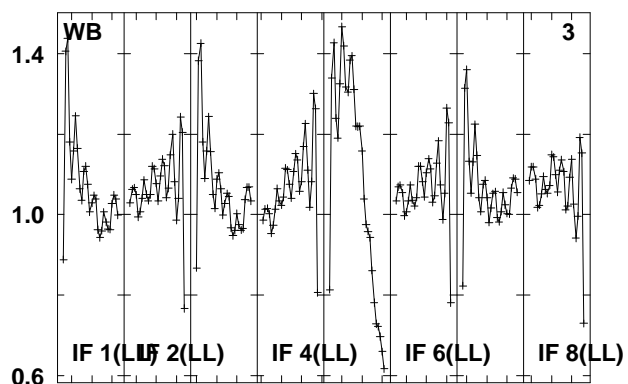
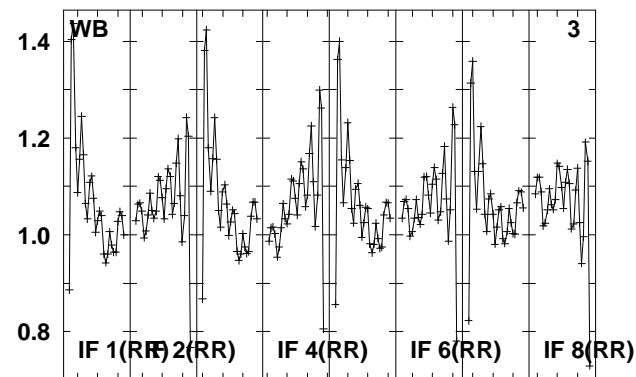
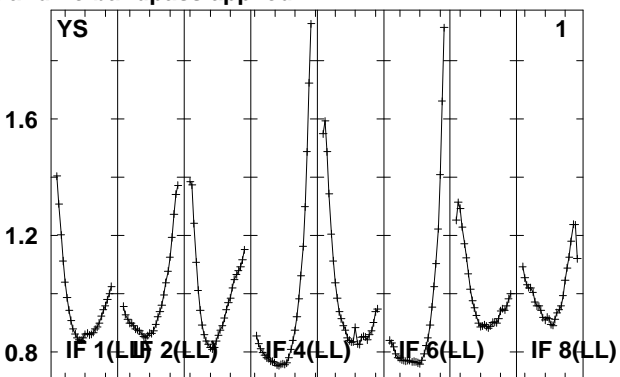
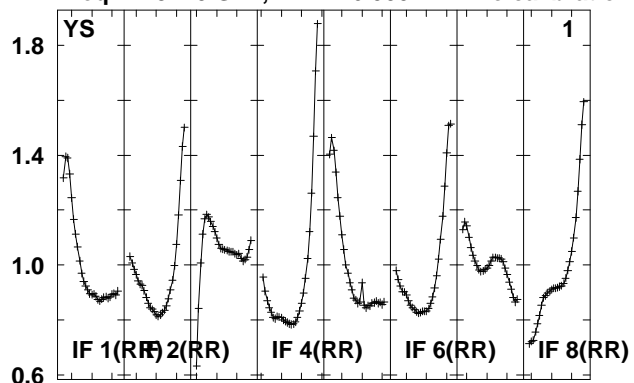

Lower frame: Real Jy
 Total-power spectrum Antenna: *
 Timerange: 00/11:33:11 to 00/11:38:09

Plot file version 308 created 14-MAY-2010 15:18:46

J021348 EO007.UVDATA.1

Freq = 4.9270 GHz, Bw = 16.000 MH No calibration applied and no bandpass applied

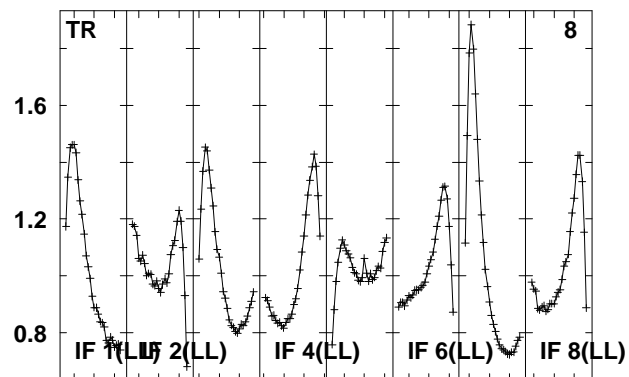
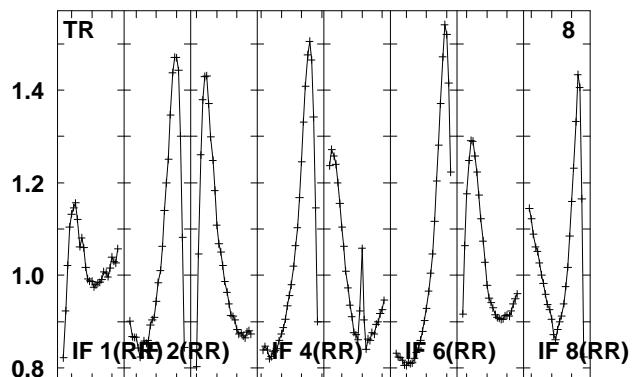
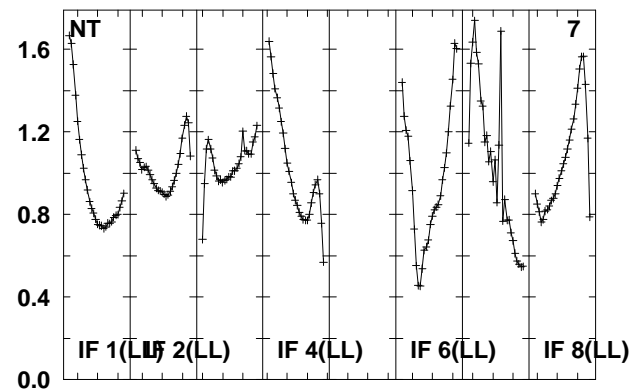
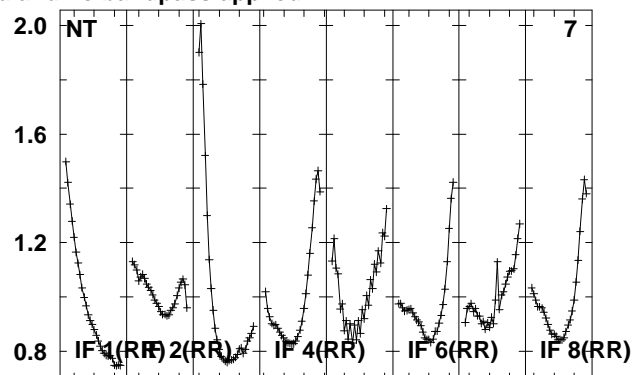
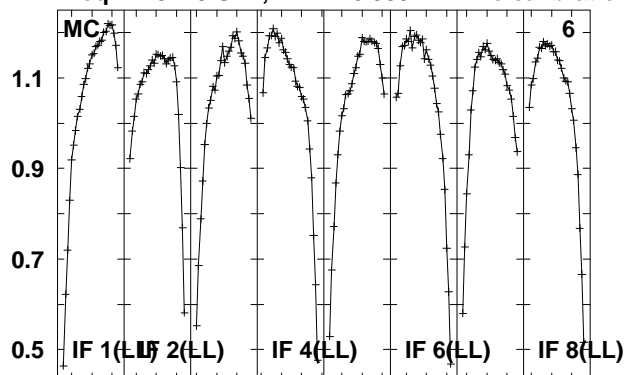

Lower frame: Real Jy
Total-power spectrum Antenna: *
Timerange: 00/11:33:11 to 00/11:38:09

Plot file version 309 created 14-MAY-2010 15:18:46

J0209+13 EO007.UVDATA.1

Freq = 4.9270 GHz, Bw = 16.000 MH No calibration applied and no bandpass applied

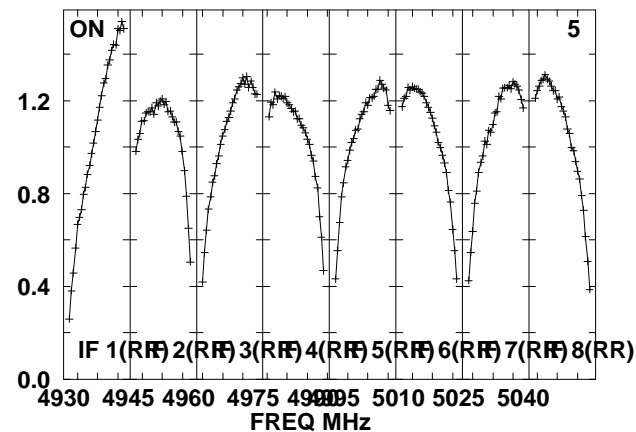
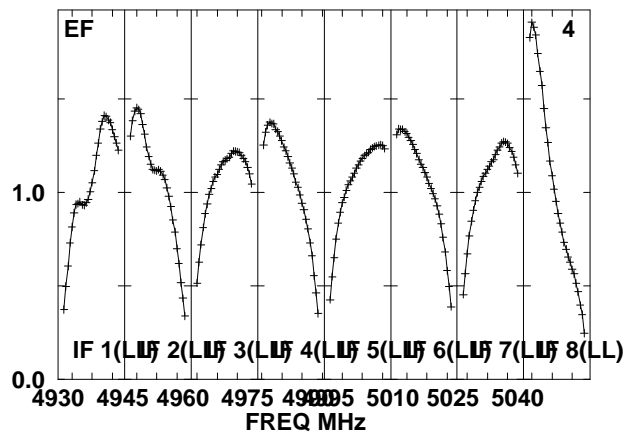
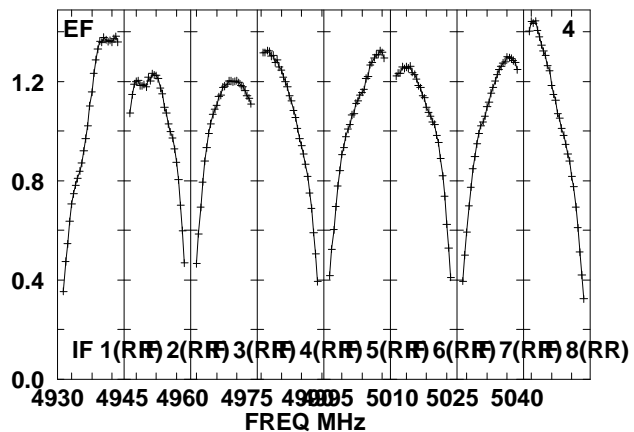
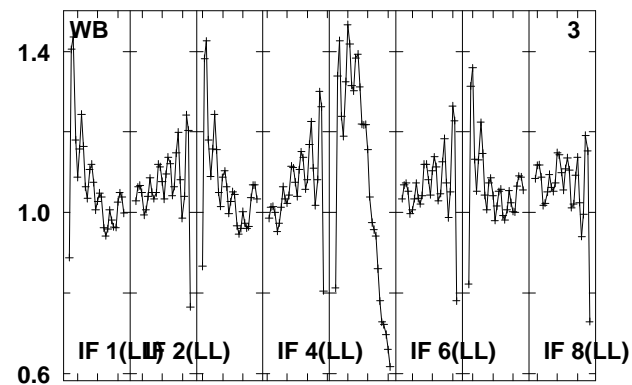
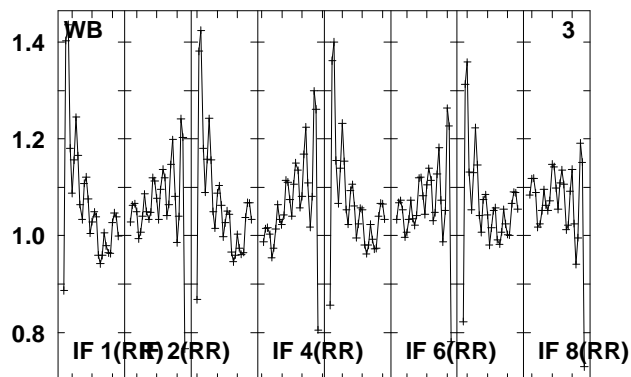
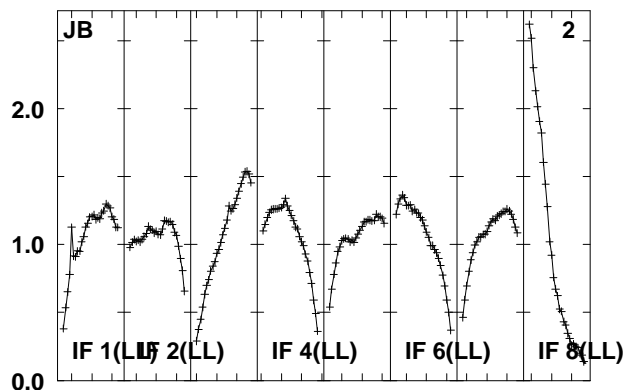
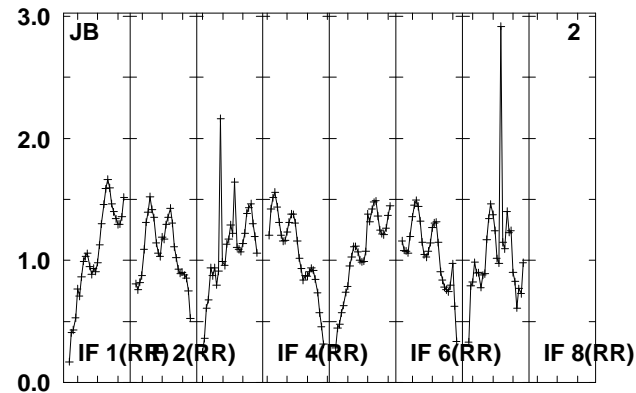
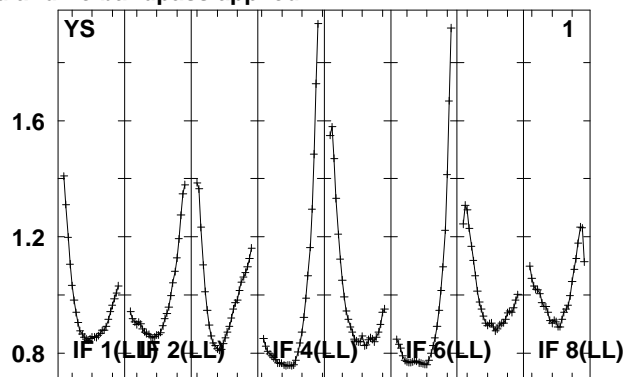
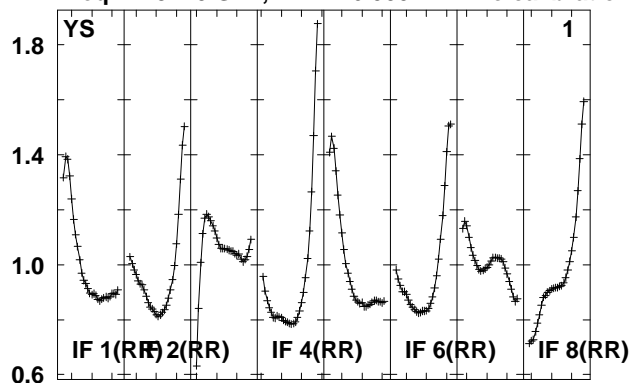

Lower frame: Real Jy

Total-power spectrum Antenna: *

Timerange: 00/11:38:37 to 00/11:40:01

Plot file version 310 created 14-MAY-2010 15:18:47

J0209+13 EO007.UVDATA.1

Freq = 4.9270 GHz, Bw = 16.000 MH No calibration applied and no bandpass applied

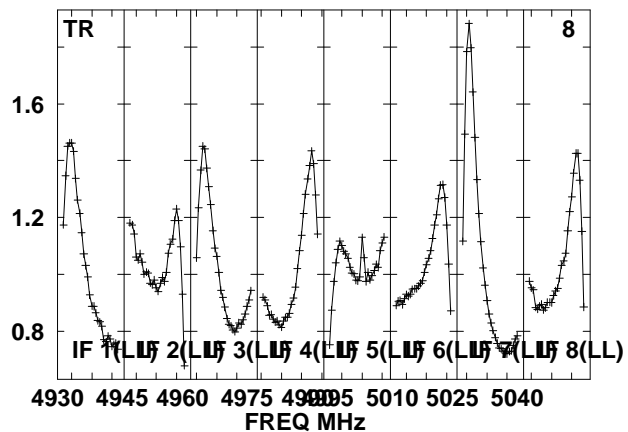
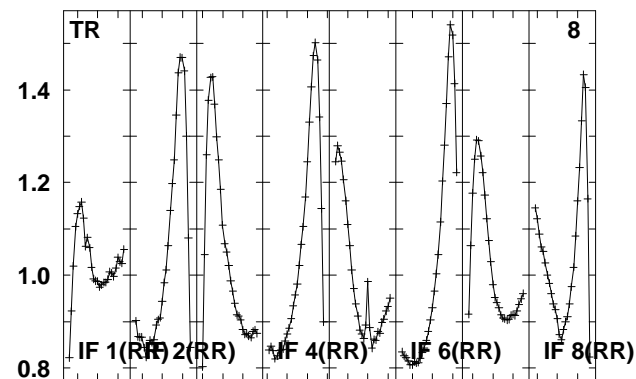
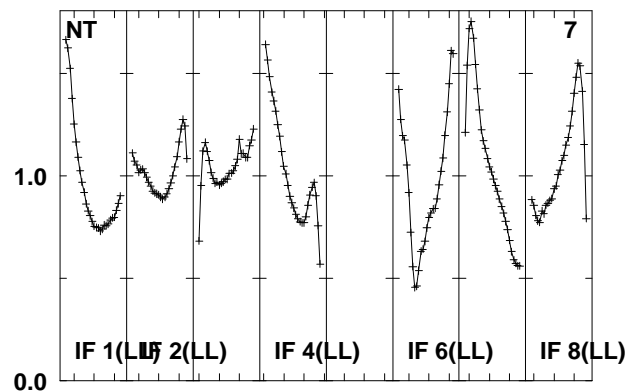
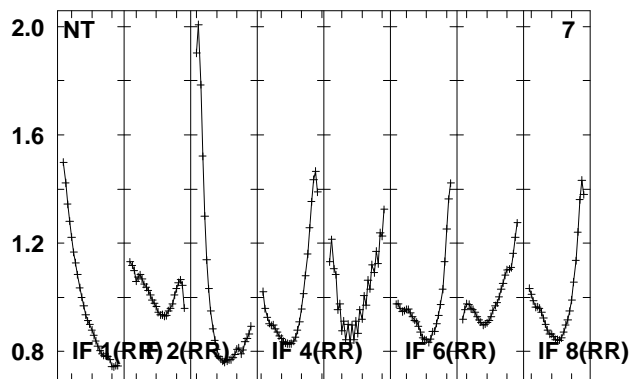
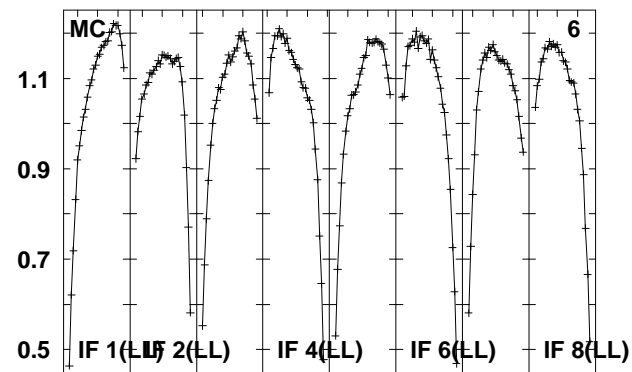
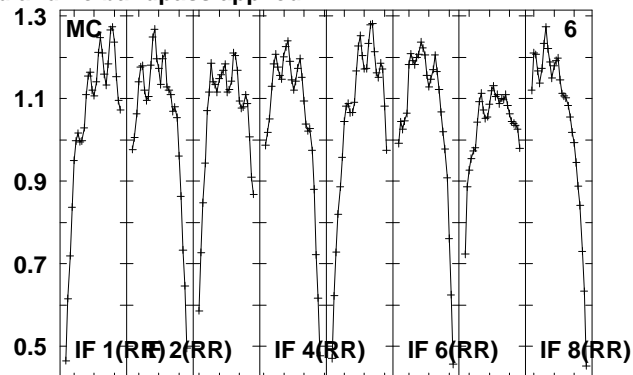
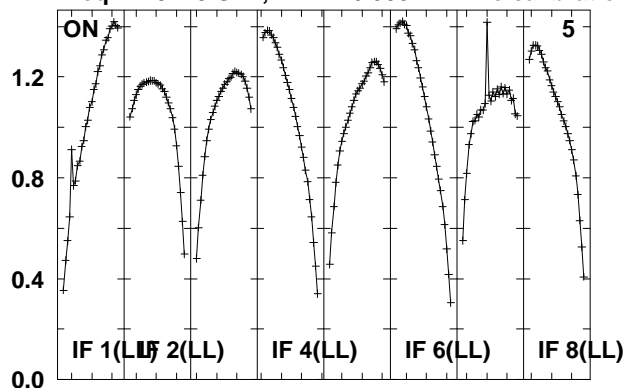

Lower frame: Real Jy

Total-power spectrum Antenna: *

Timerange: 00/11:38:37 to 00/11:40:01

Plot file version 311 created 14-MAY-2010 15:18:47

J0158+13 EO007.UVDATA.1

Freq = 4.9270 GHz, Bw = 16.000 MH No calibration applied and no bandpass applied

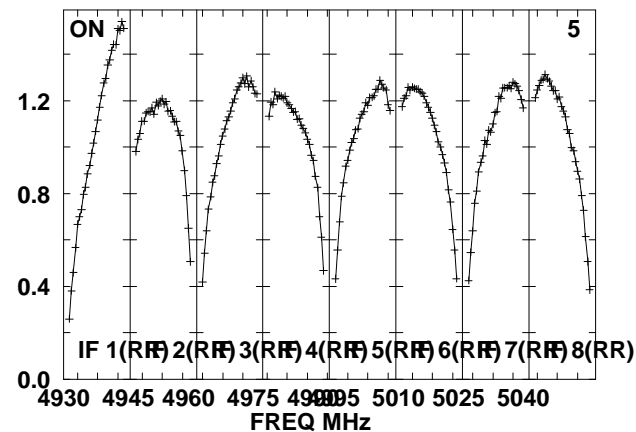
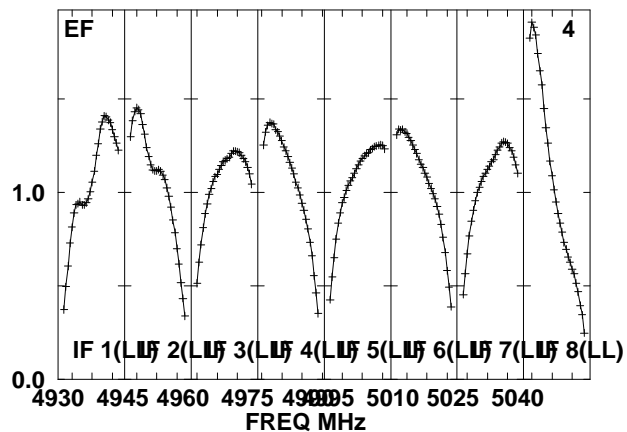
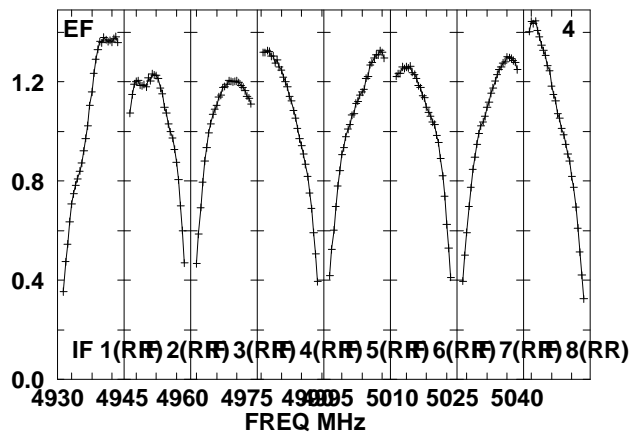
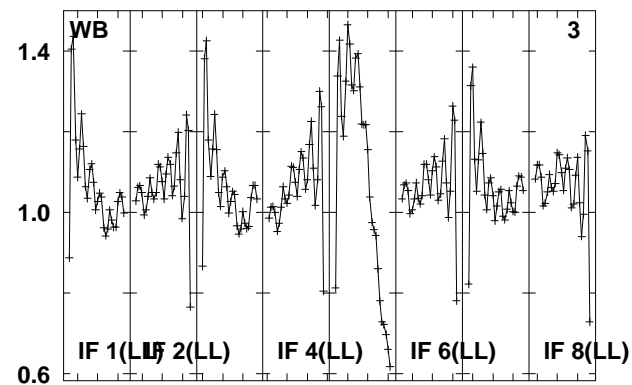
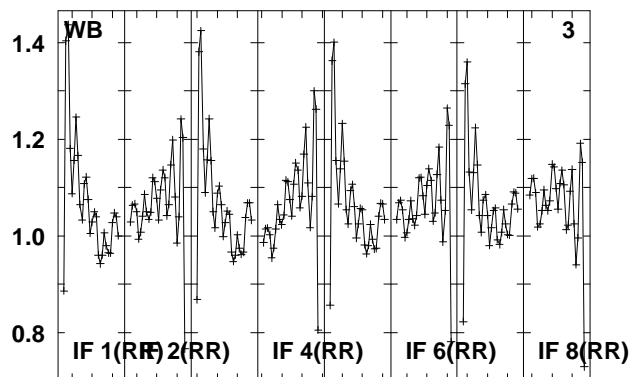
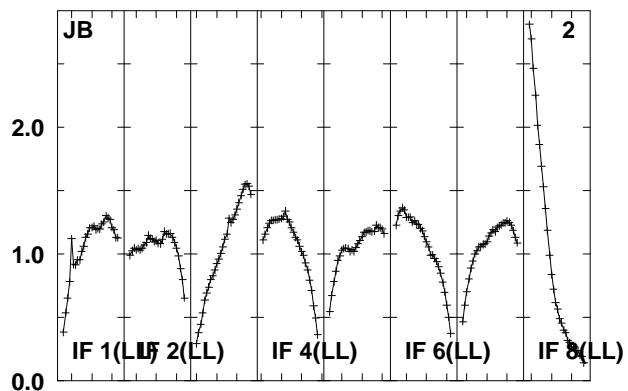
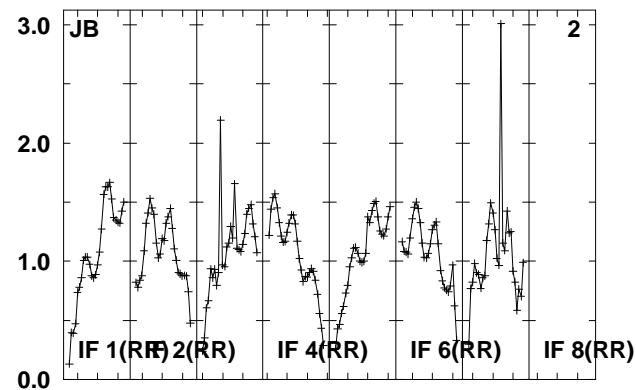
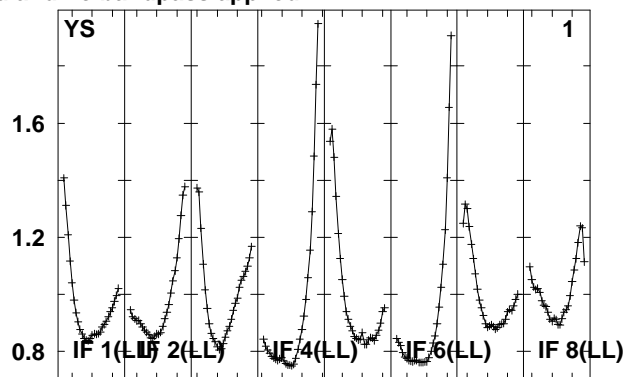
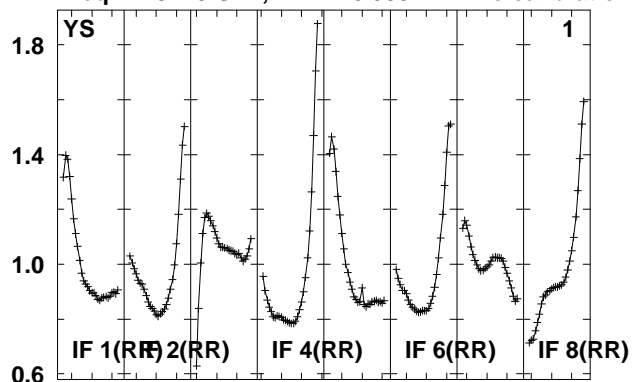

Lower frame: Real Jy

Total-power spectrum Antenna: *

Timerange: 00/11:40:43 to 00/11:42:09

Plot file version 312 created 14-MAY-2010 15:18:47

J0158+13 EO007.UVDATA.1

Freq = 4.9270 GHz, Bw = 16.000 MH No calibration applied and no bandpass applied

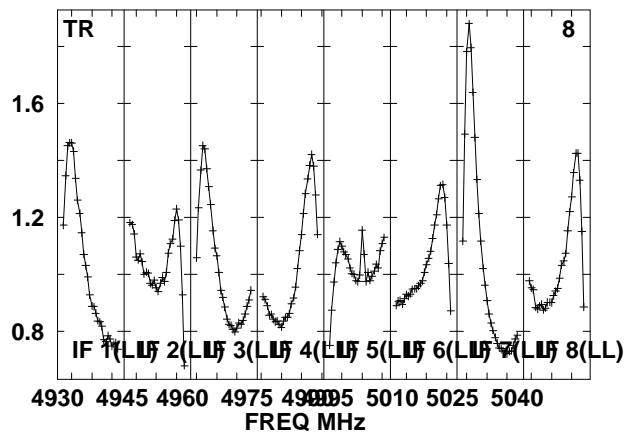
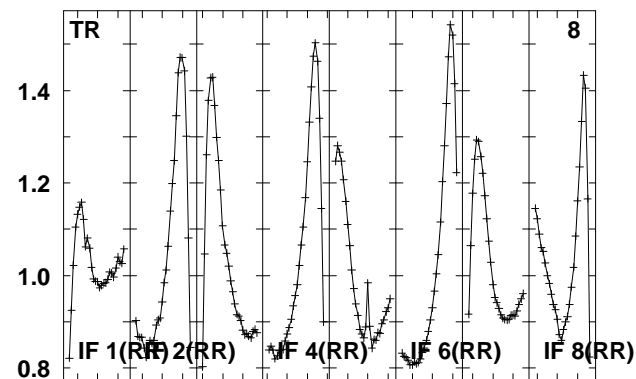
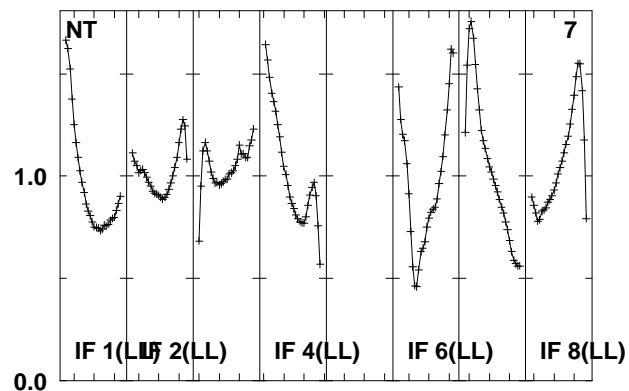
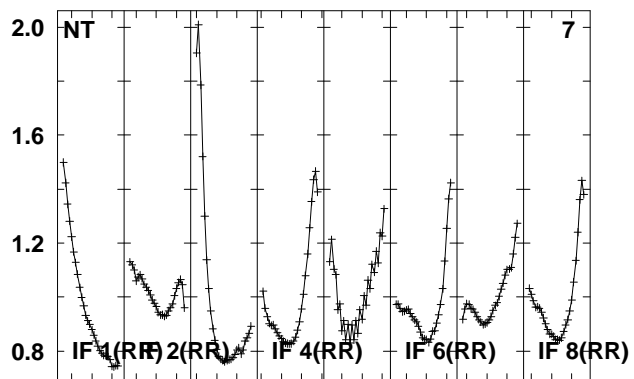
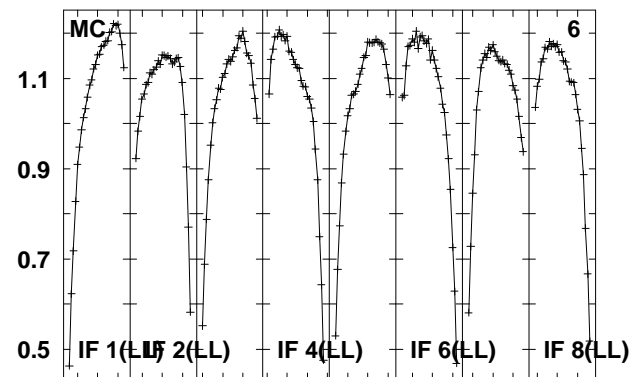
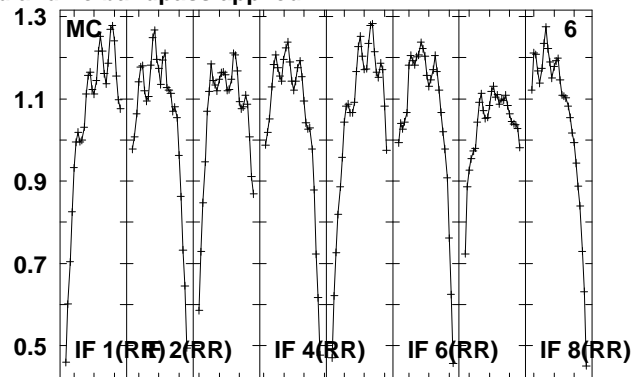
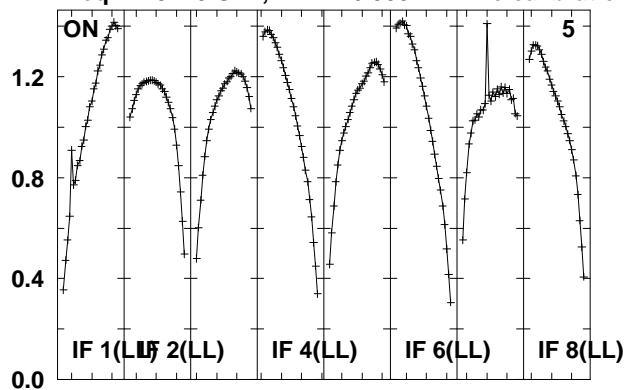

Lower frame: Real Jy

Total-power spectrum Antenna: *

Timerange: 00/11:40:43 to 00/11:42:09

Plot file version 313 created 14-MAY-2010 15:18:47

J015028 EO007.UVDATA.1

Freq = 4.9270 GHz, Bw = 16.000 MH No calibration applied and no bandpass applied

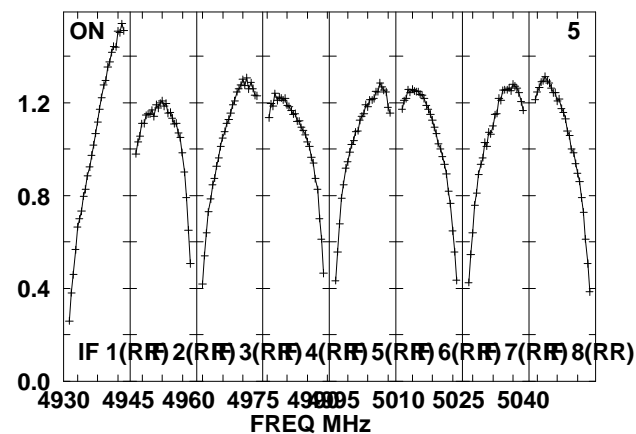
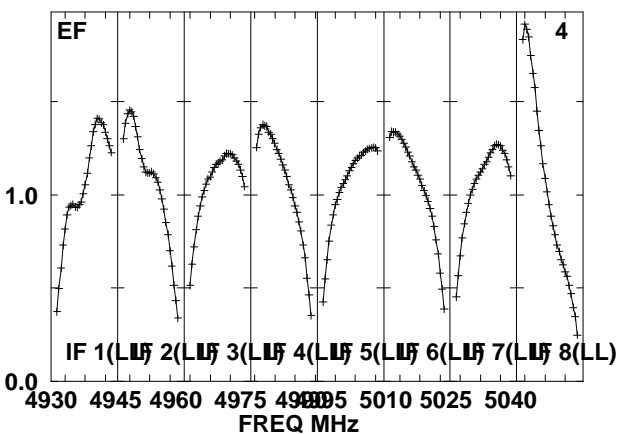
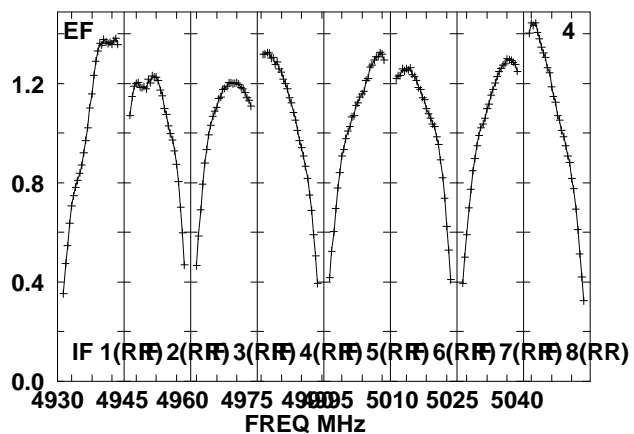
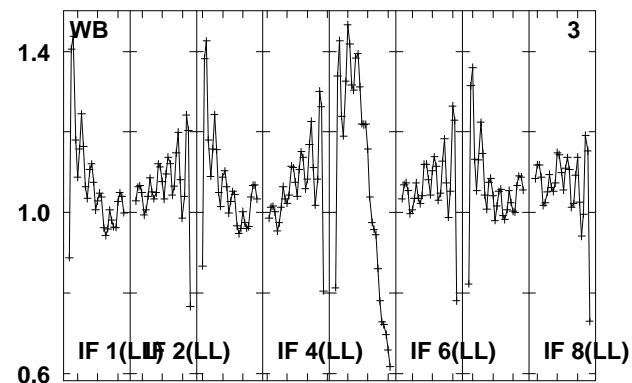
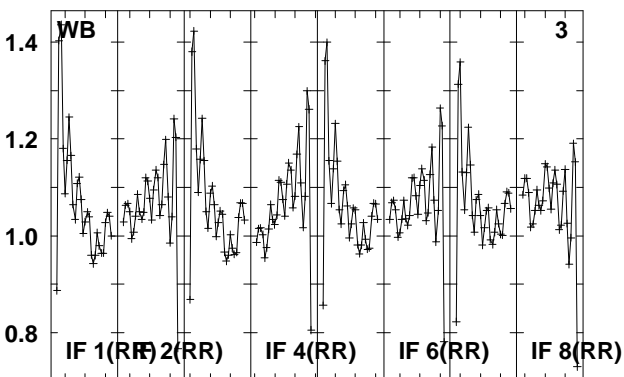
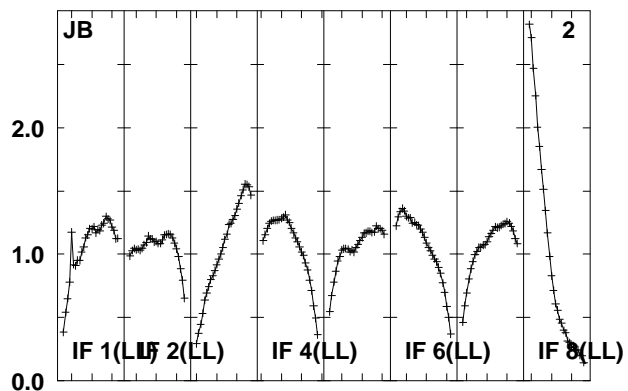
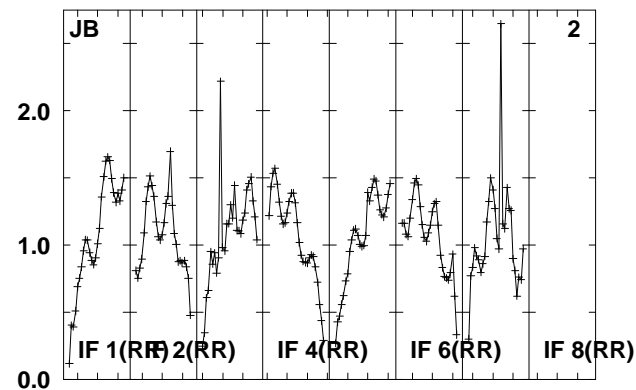
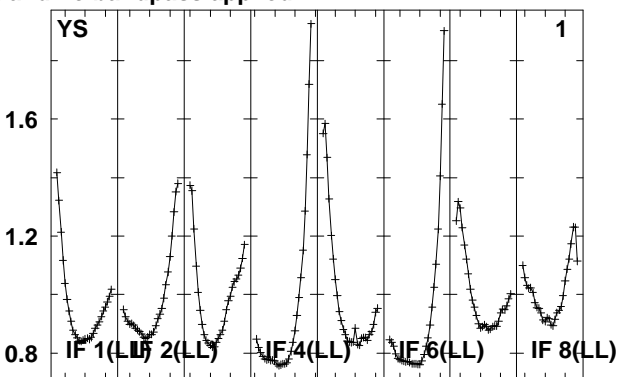
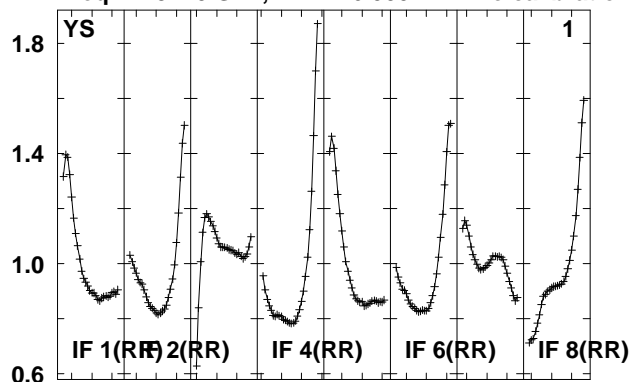

Lower frame: Real Jy
Total-power spectrum Antenna: *
Timerange: 00/11:42:46 to 00/11:47:44

Plot file version 314 created 14-MAY-2010 15:18:48

J015028 EO007.UVDATA.1

Freq = 4.9270 GHz, Bw = 16.000 MH No calibration applied and no bandpass applied

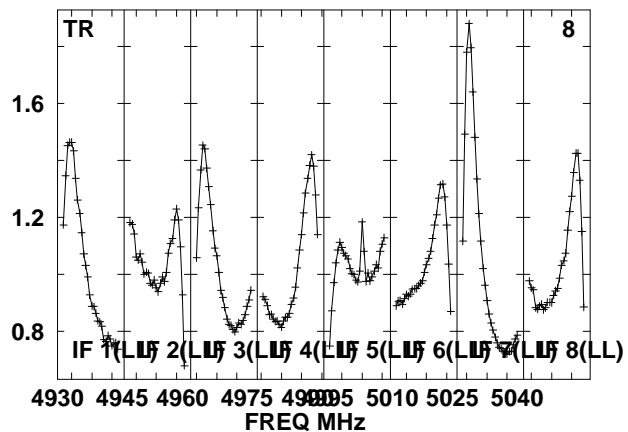
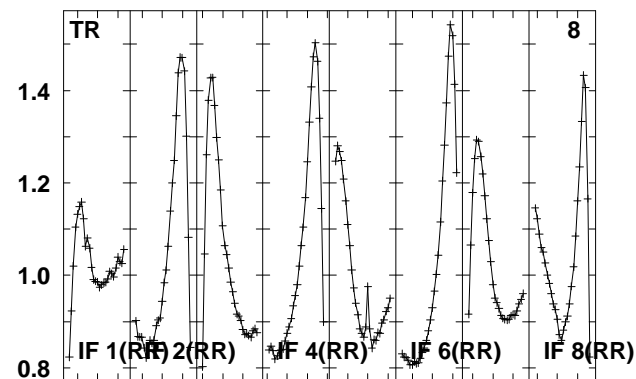
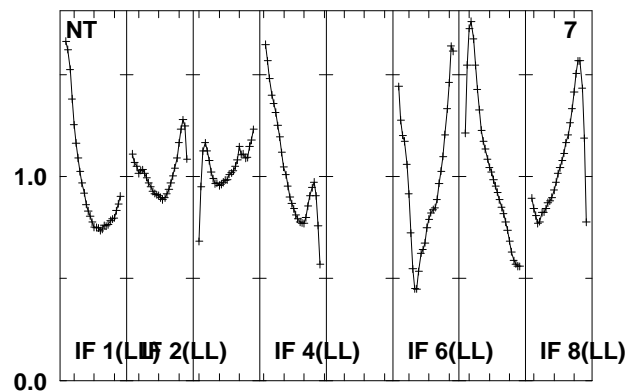
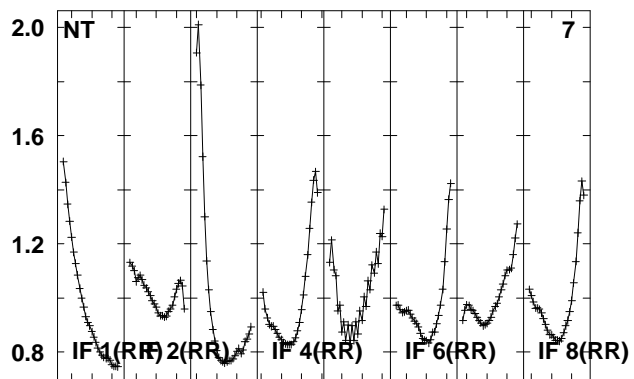
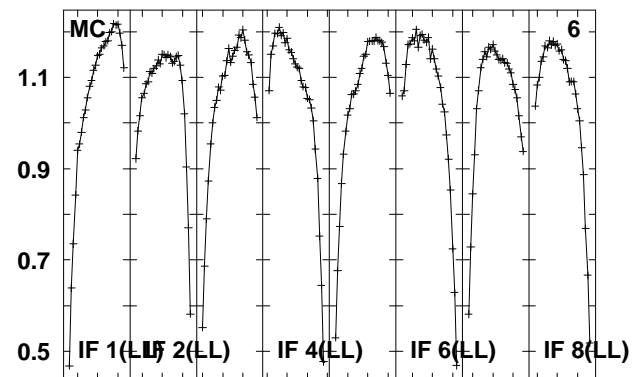
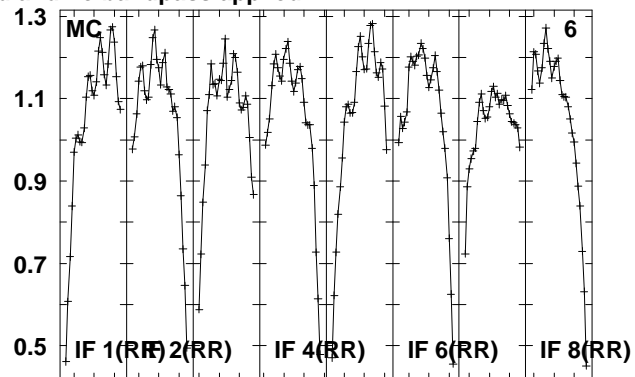
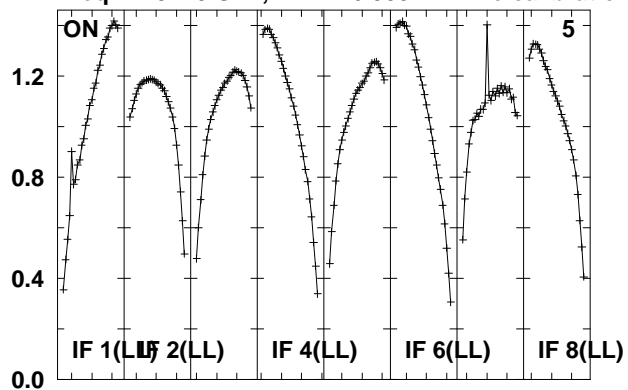

Lower frame: Real Jy

Total-power spectrum Antenna: *

Timerange: 00/11:42:46 to 00/11:47:44

Plot file version 315 created 14-MAY-2010 15:18:48

J0158+13 EO007.UVDATA.1

Freq = 4.9270 GHz, Bw = 16.000 MH No calibration applied and no bandpass applied

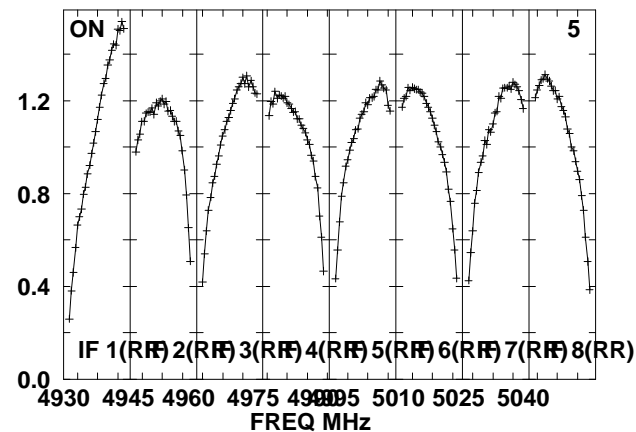
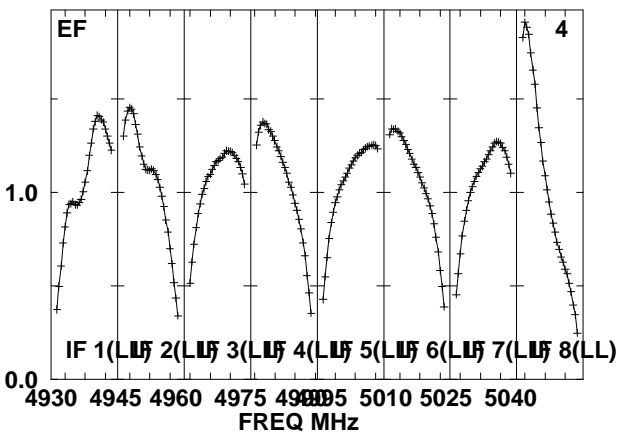
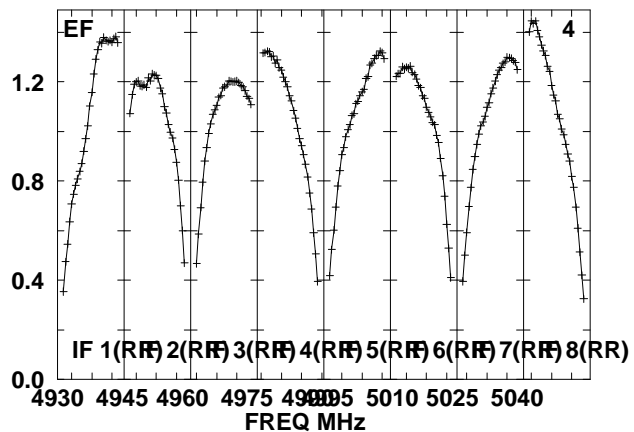
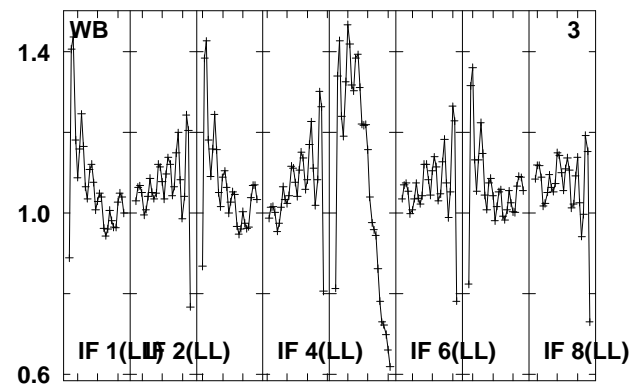
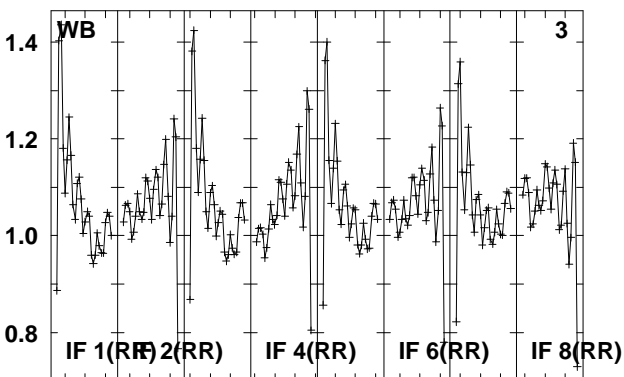
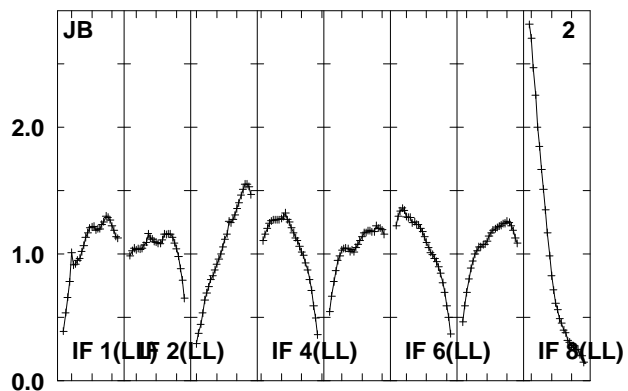
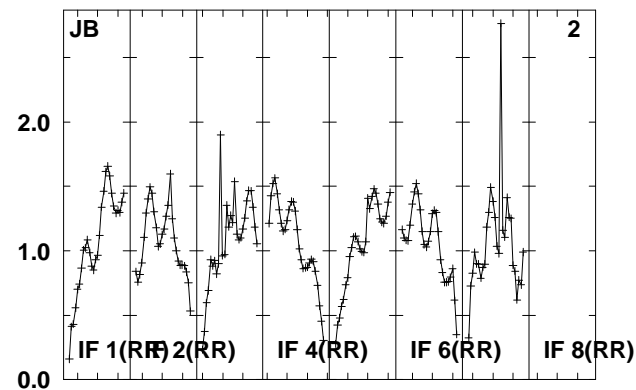
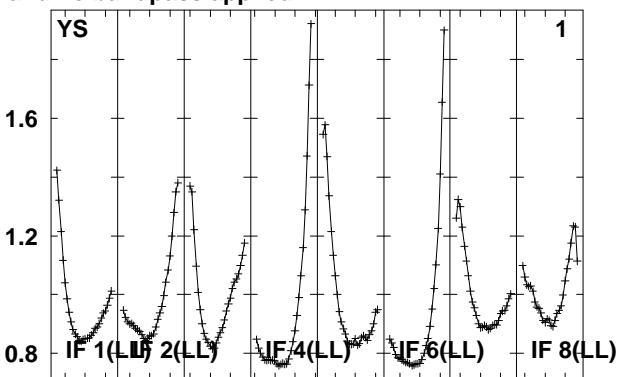
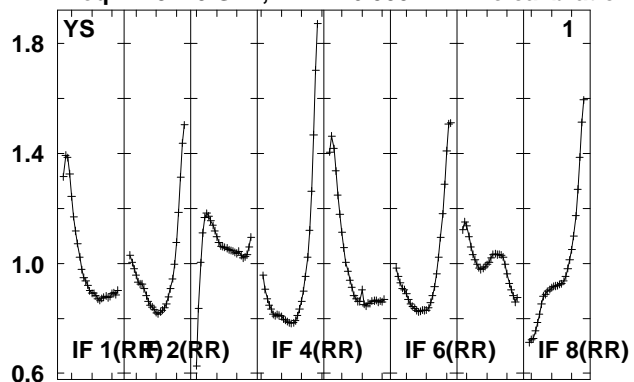

Lower frame: Real Jy

Total-power spectrum Antenna: *

Timerange: 00/11:48:16 to 00/11:49:46

Plot file version 316 created 14-MAY-2010 15:18:49

J0158+13 EO007.UVDATA.1

Freq = 4.9270 GHz, Bw = 16.000 MH No calibration applied and no bandpass applied

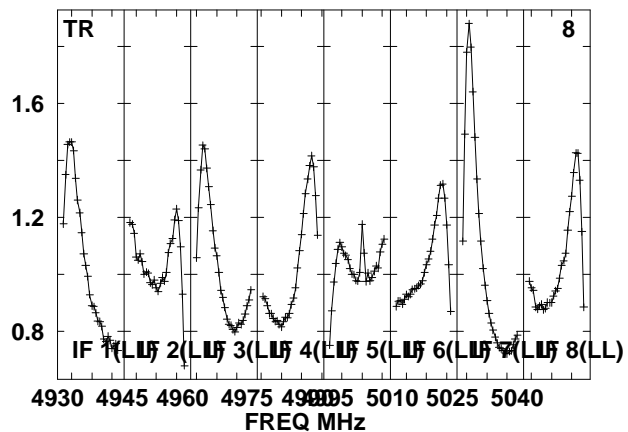
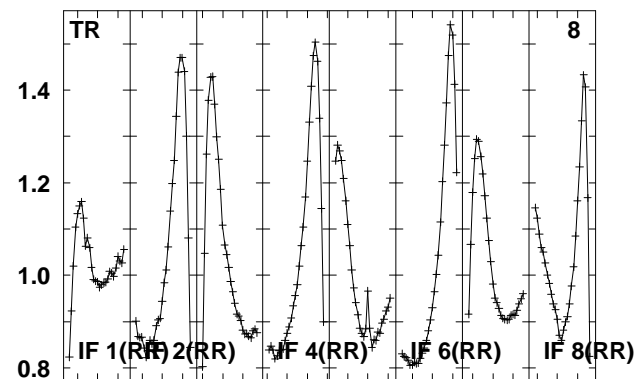
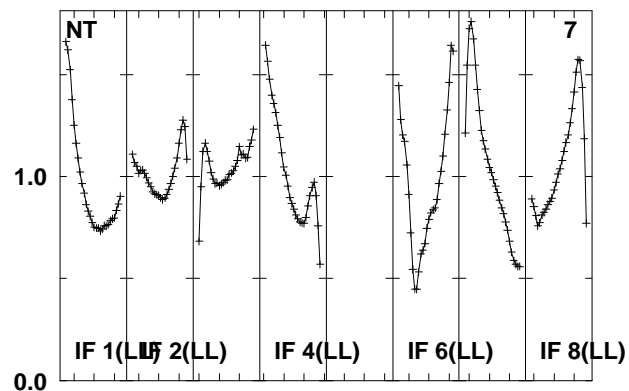
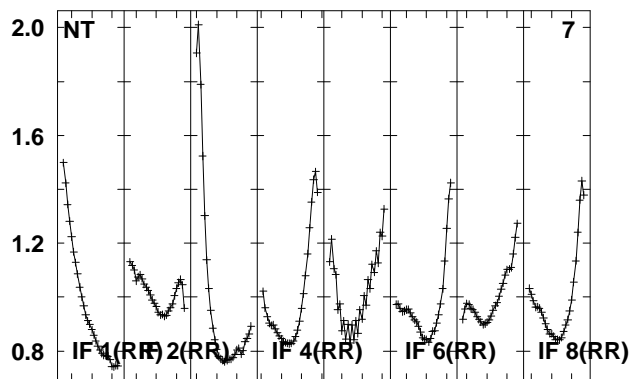
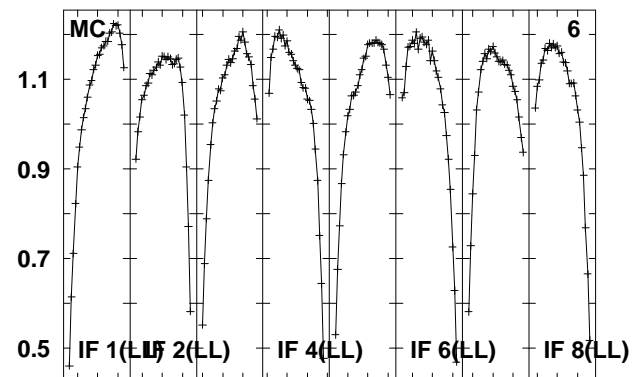
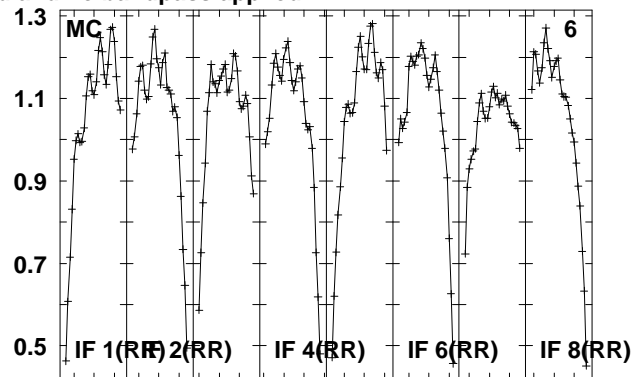
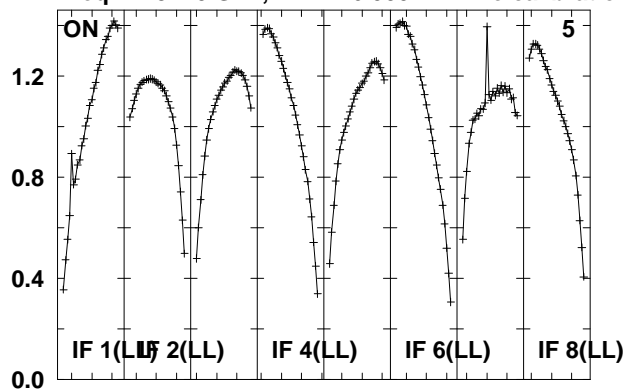

Lower frame: Real Jy

Total-power spectrum Antenna: *

Timerange: 00/11:48:16 to 00/11:49:46

Plot file version 317 created 14-MAY-2010 15:18:49
 J015028 EO007.UVDATA.1
 Freq = 4.9270 GHz, Bw = 16.000 MH No calibration applied and no bandpass applied

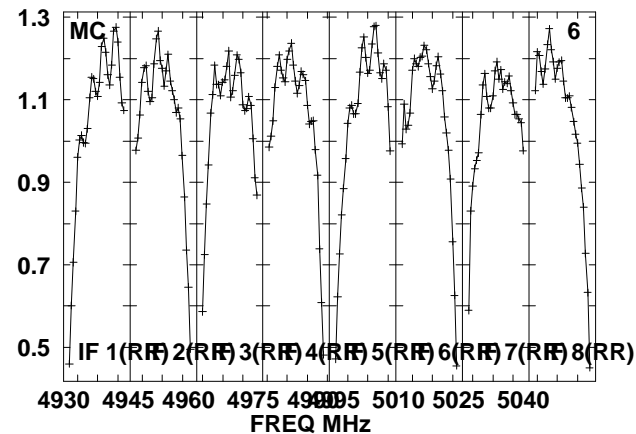
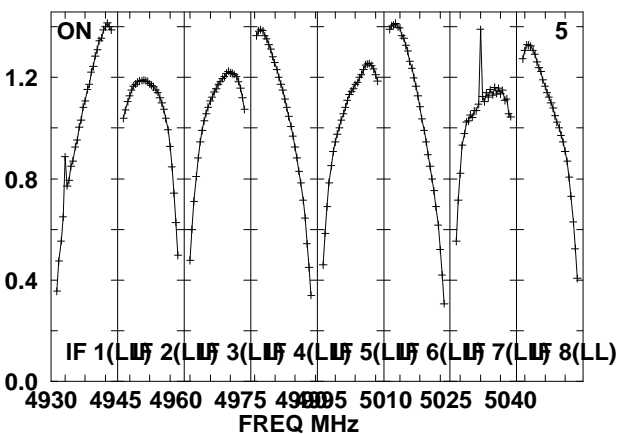
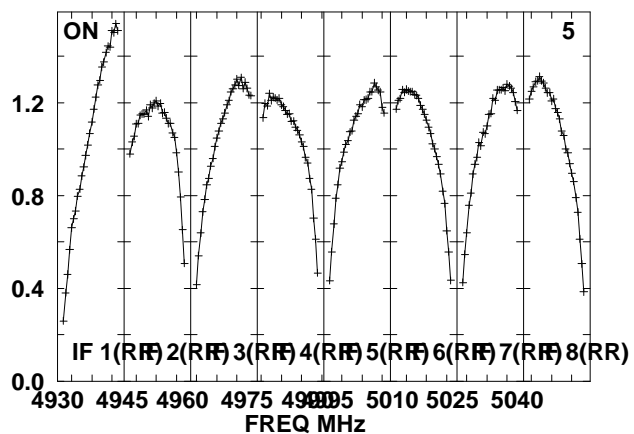
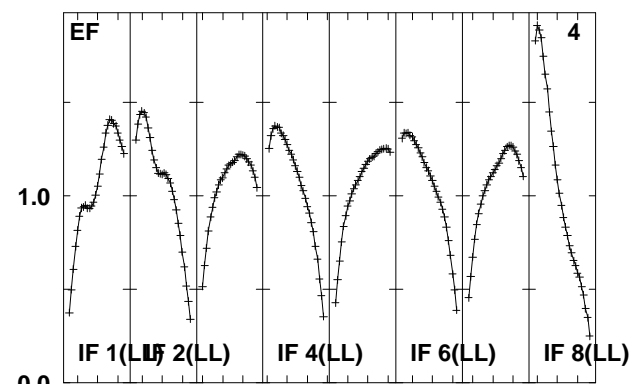
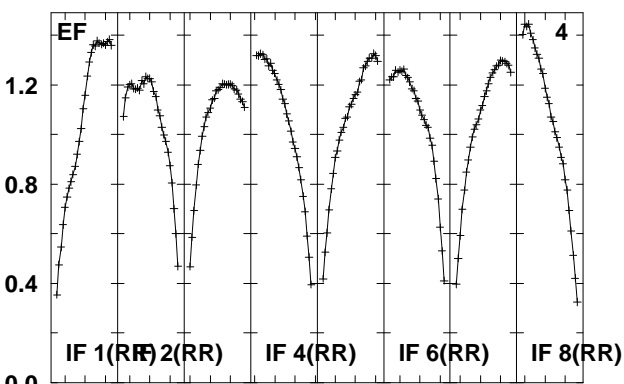
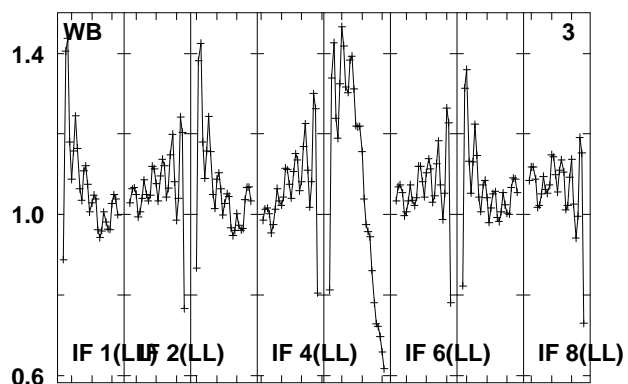
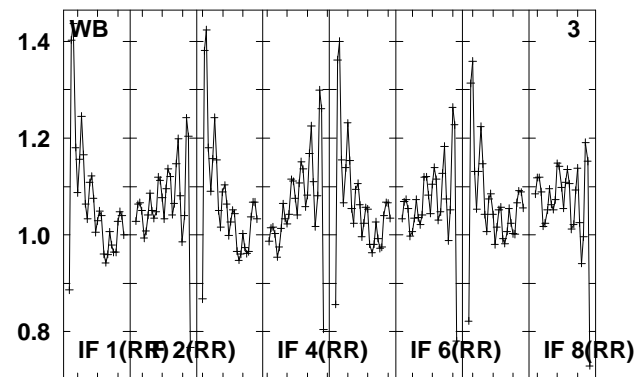
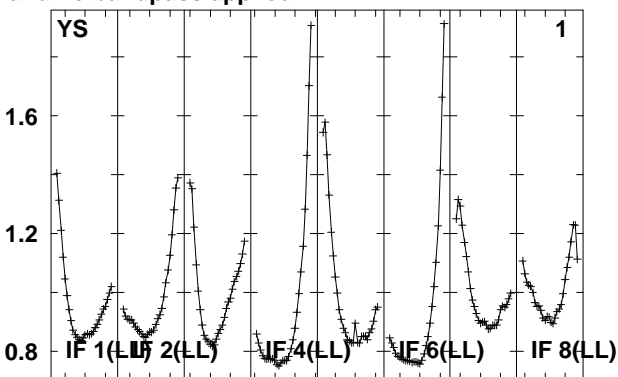
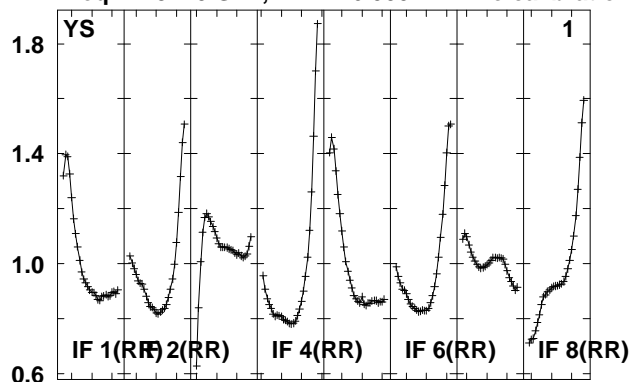

Lower frame: Real Jy
 Total-power spectrum Antenna: *
 Timerange: 00/11:50:20 to 00/11:55:16

Plot file version 318 created 14-MAY-2010 15:18:50

J015028 EO007.UVDATA.1

Freq = 4.9270 GHz, Bw = 16.000 MH No calibration applied and no bandpass applied

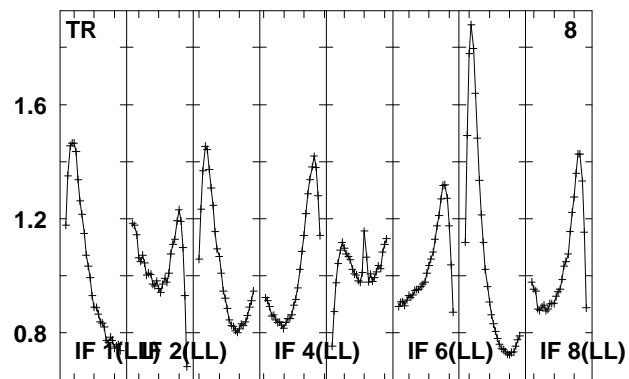
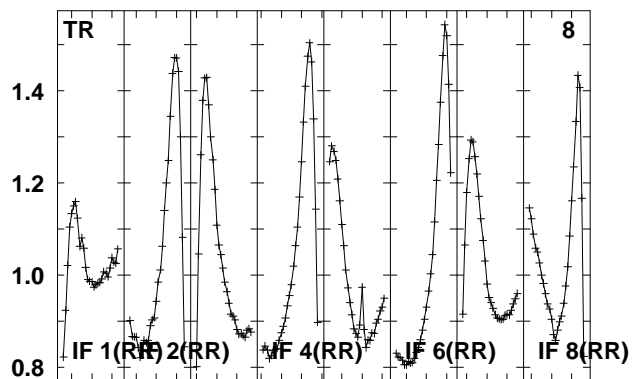
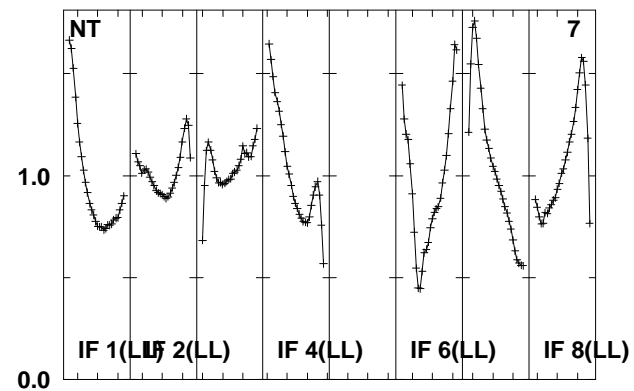
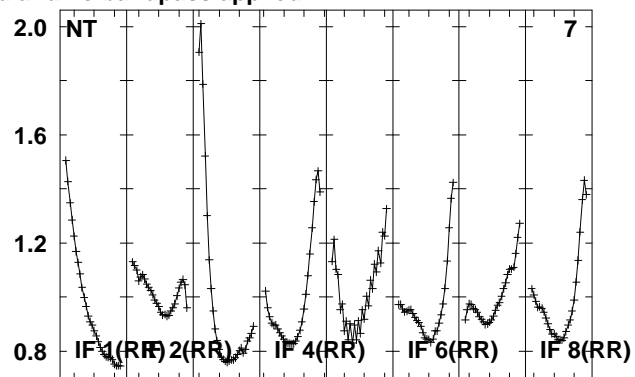
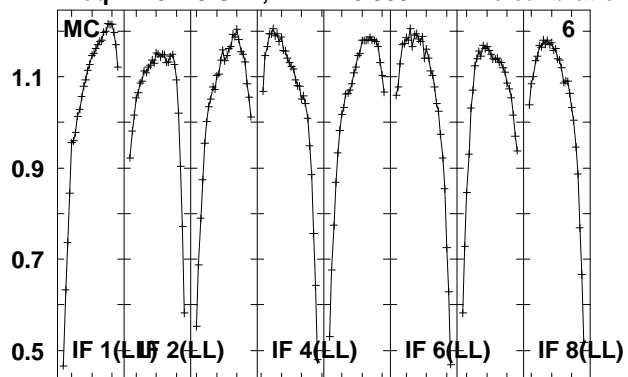

Lower frame: Real Jy
Total-power spectrum Antenna: *
Timerange: 00/11:50:20 to 00/11:55:16

Plot file version 319 created 14-MAY-2010 15:18:50
 J0158+13 EO007.UVDATA.1
 Freq = 4.9270 GHz, Bw = 16.000 MH No calibration applied and no bandpass applied

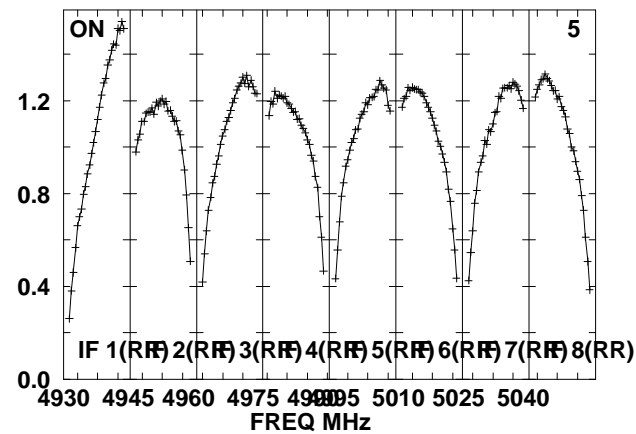
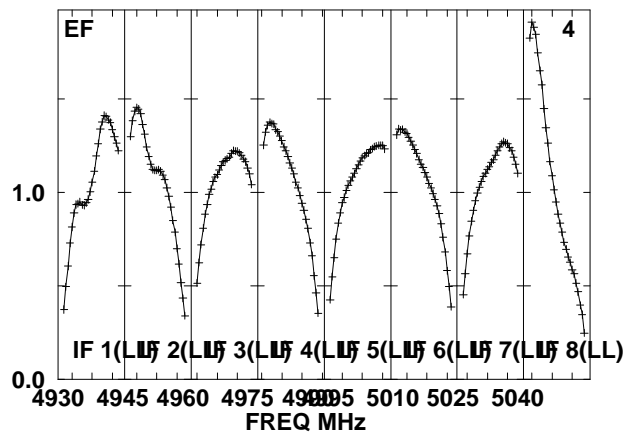
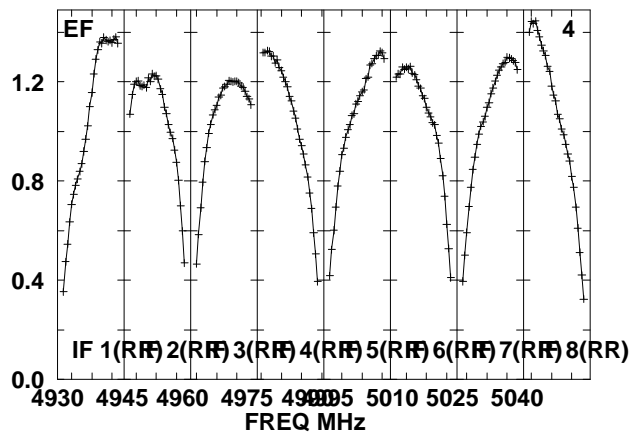
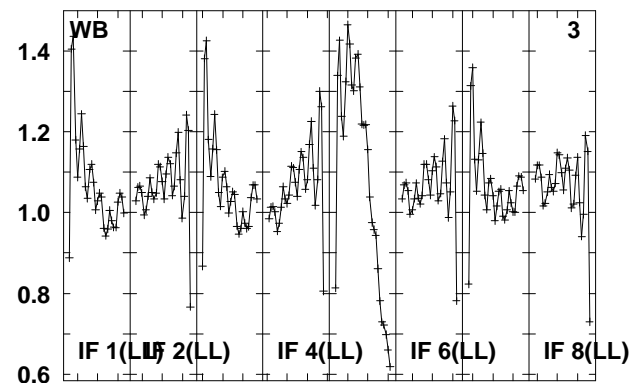
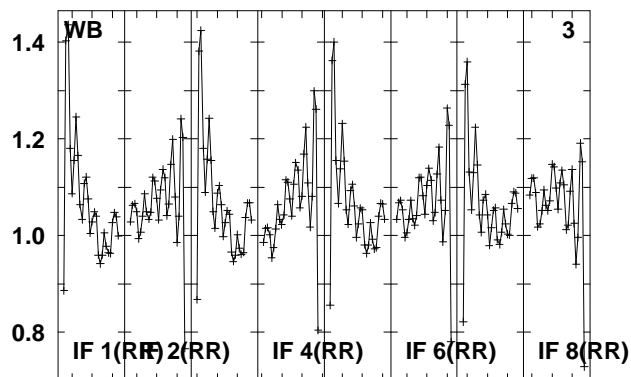
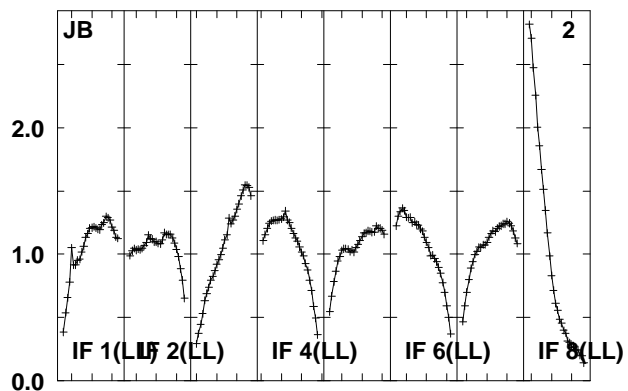
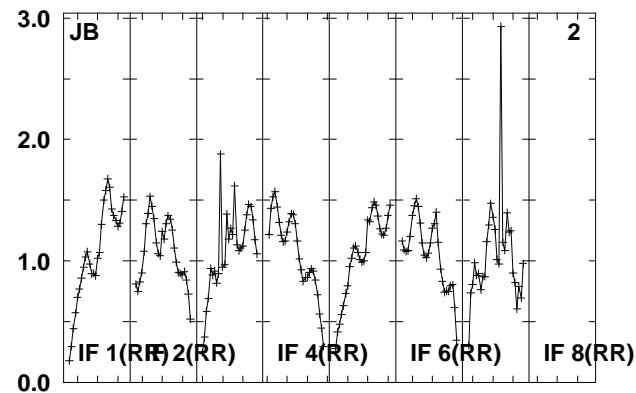
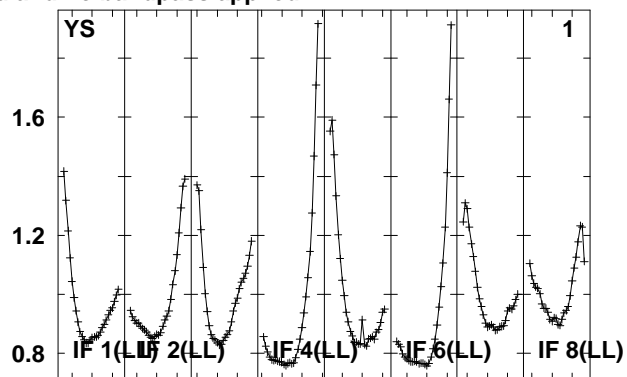
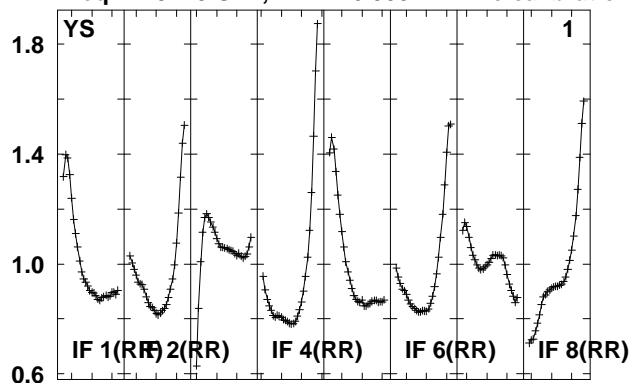

Lower frame: Real Jy
 Total-power spectrum Antenna: *
 Timerange: 00/11:55:51 to 00/11:57:19

Plot file version 320 created 14-MAY-2010 15:18:50

J0158+13 EO007.UVDATA.1

Freq = 4.9270 GHz, Bw = 16.000 MH No calibration applied and no bandpass applied

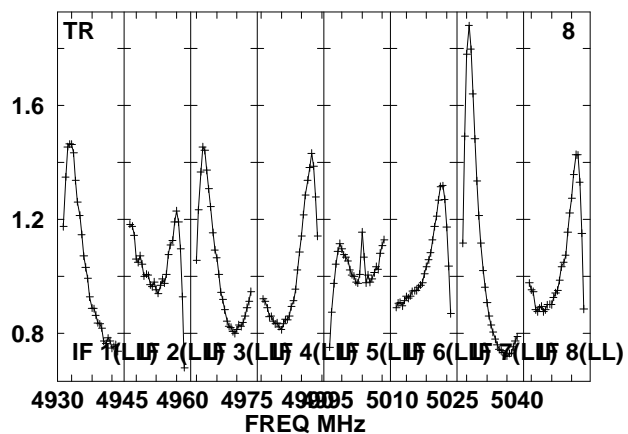
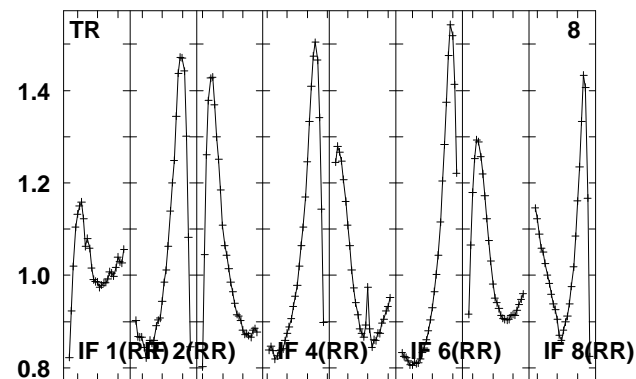
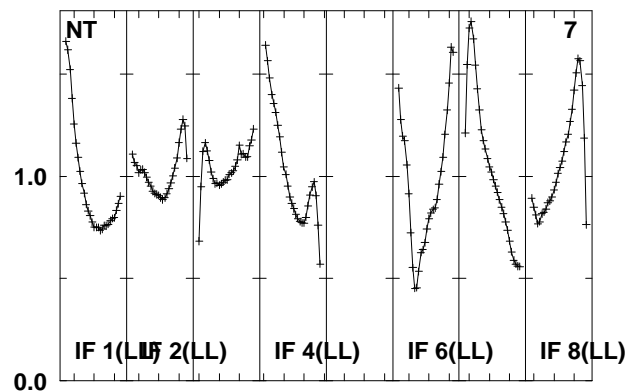
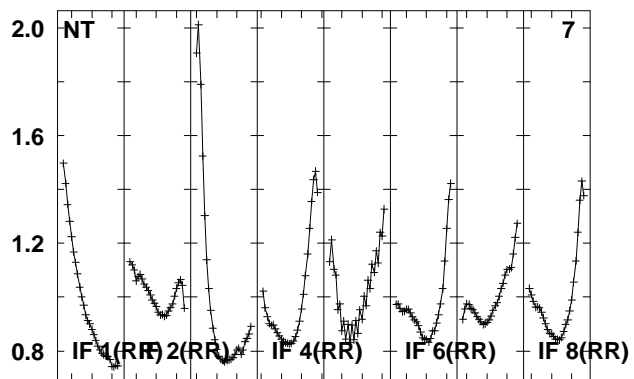
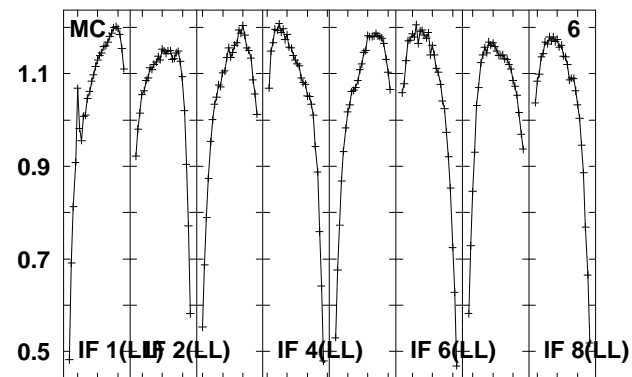
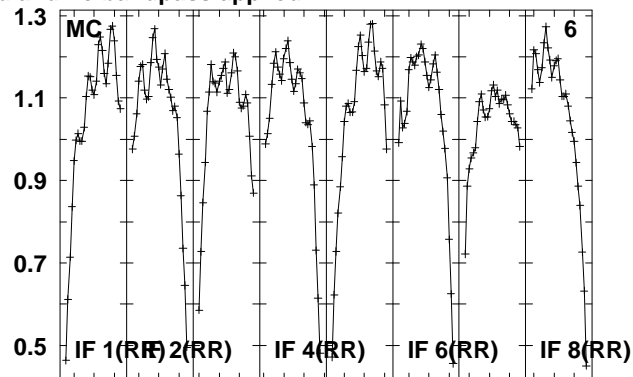
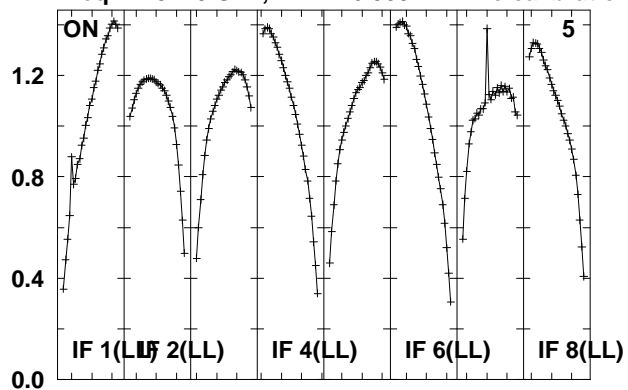

Lower frame: Real Jy

Total-power spectrum Antenna: *

Timerange: 00/11:55:51 to 00/11:57:19

Plot file version 321 created 14-MAY-2010 15:18:51
 J0209+13 EO007.UVDATA.1
 Freq = 4.9270 GHz, Bw = 16.000 MH No calibration applied and no bandpass applied

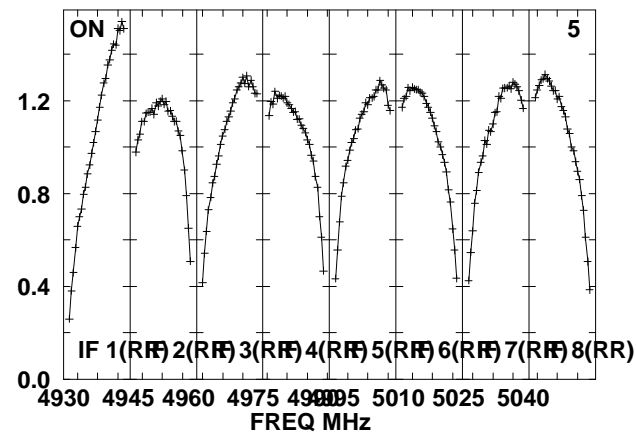
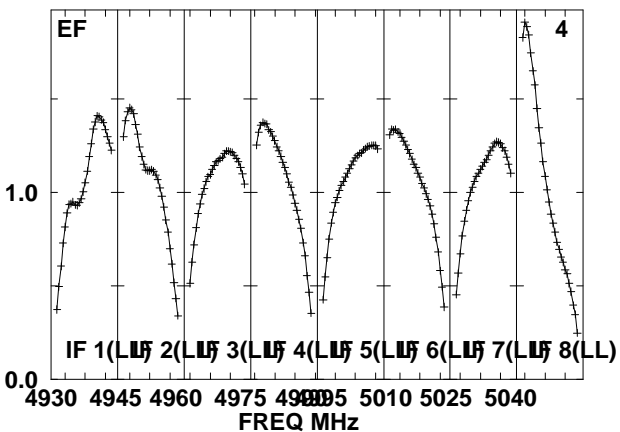
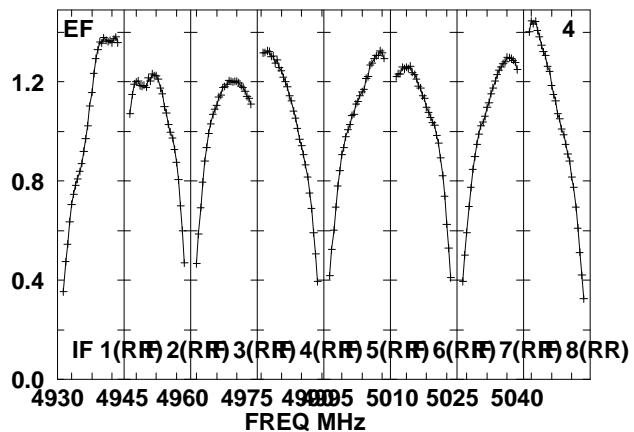
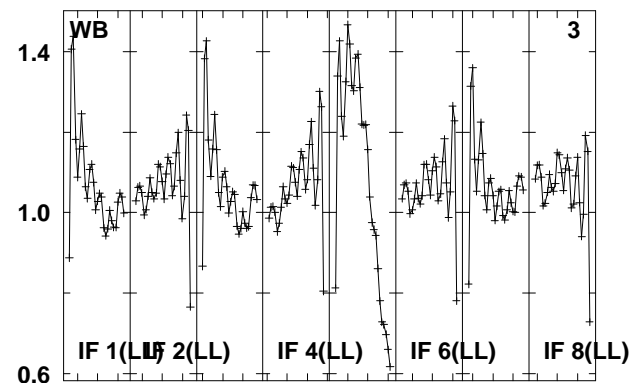
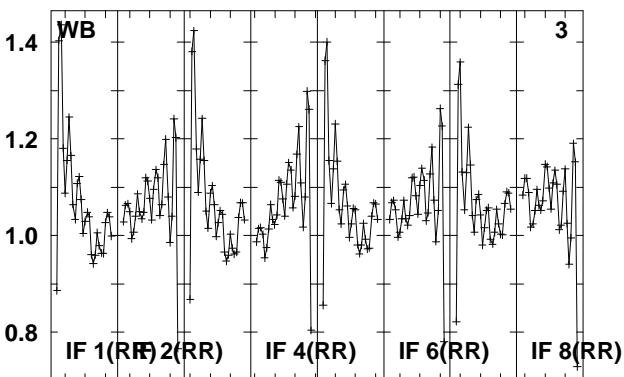
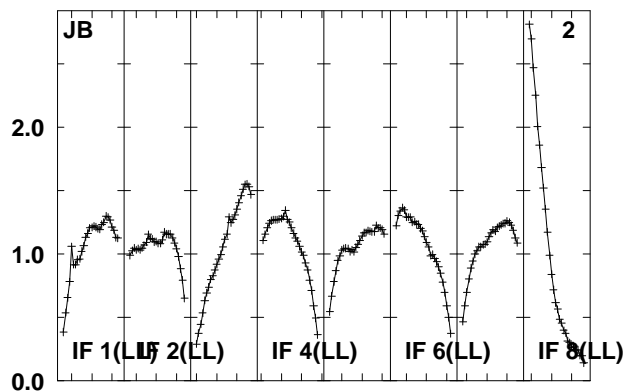
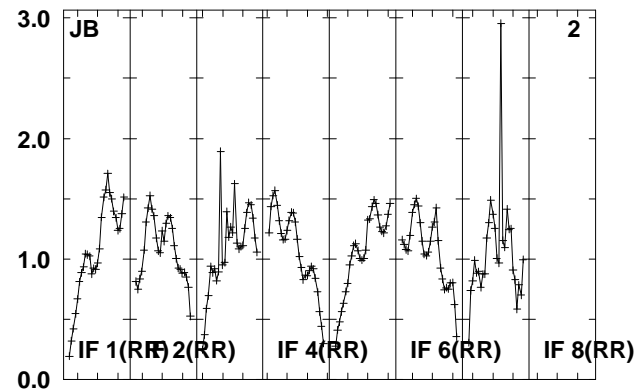
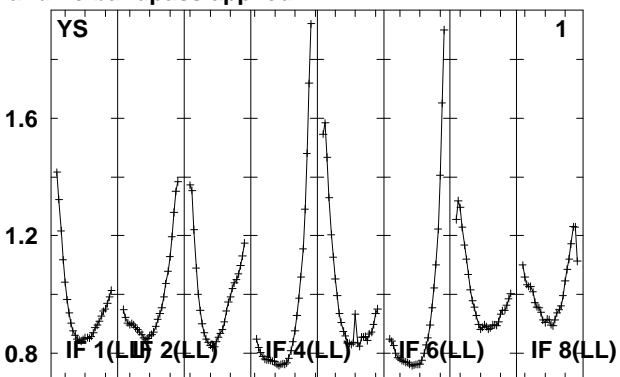
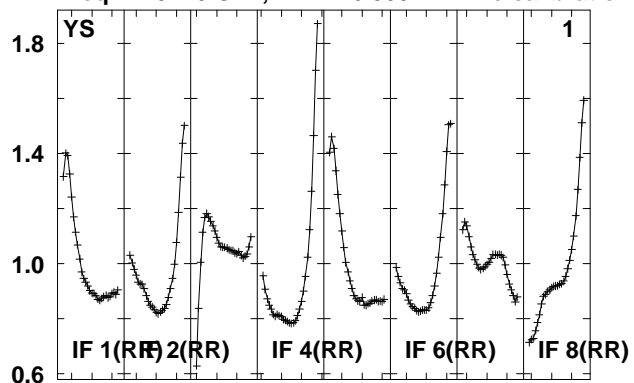

Lower frame: Real Jy
 Total-power spectrum Antenna: *
 Timerange: 00/11:57:58 to 00/11:59:26

Plot file version 322 created 14-MAY-2010 15:18:51

J0209+13 EO007.UVDATA.1

Freq = 4.9270 GHz, Bw = 16.000 MH No calibration applied and no bandpass applied

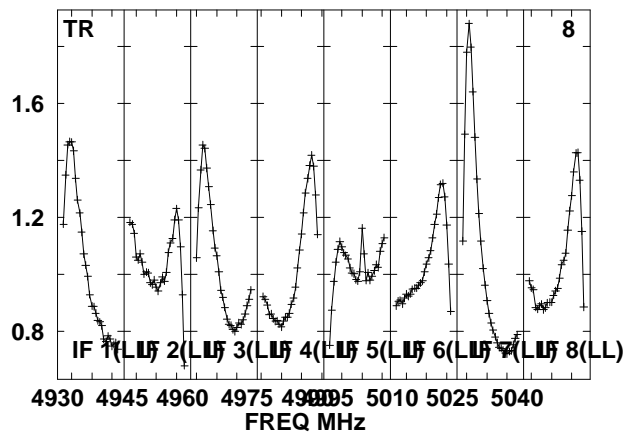
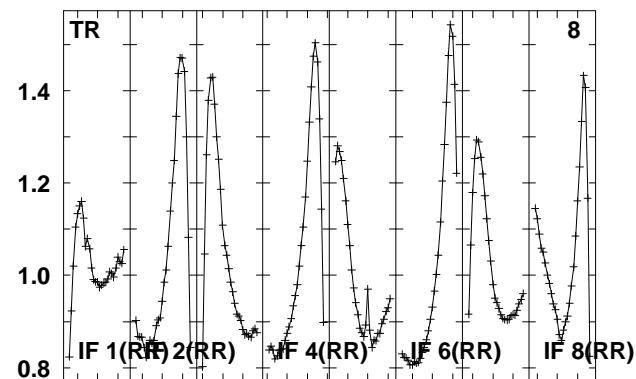
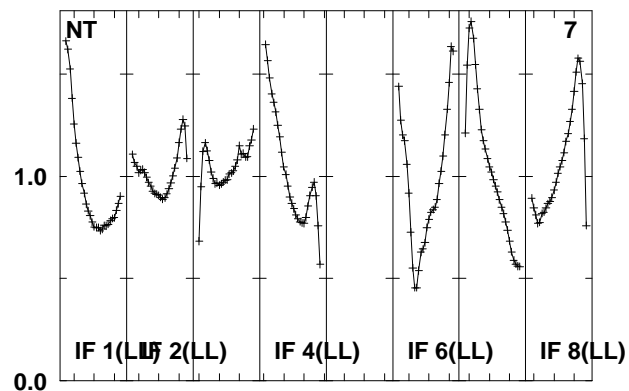
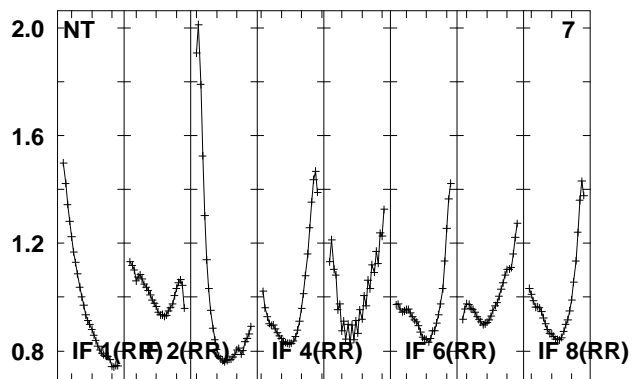
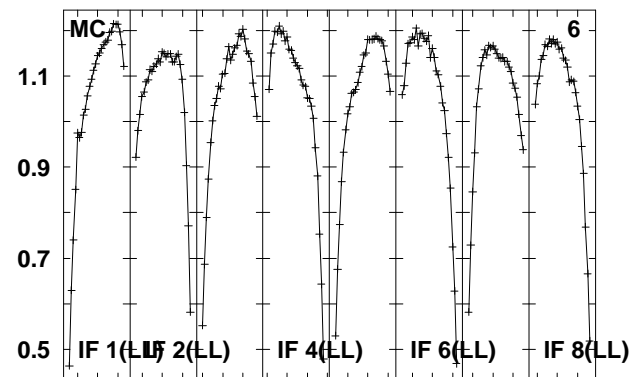
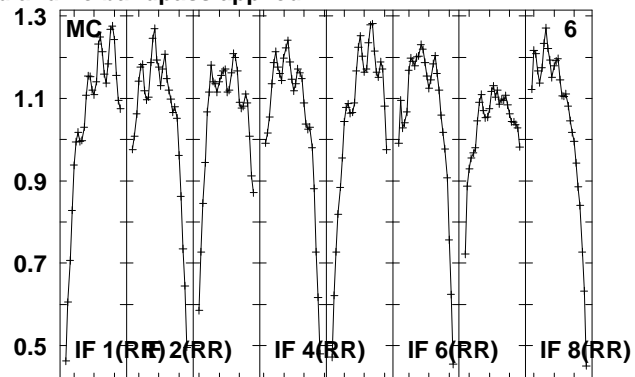
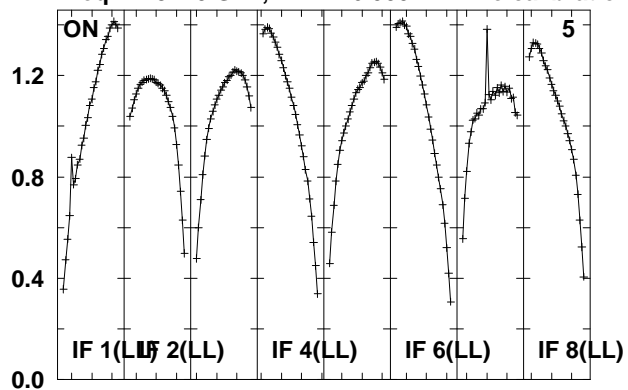

Lower frame: Real Jy

Total-power spectrum Antenna: *

Timerange: 00/11:57:58 to 00/11:59:26

Plot file version 323 created 14-MAY-2010 15:18:51
 J021348 EO007.UVDATA.1
 Freq = 4.9270 GHz, Bw = 16.000 MH No calibration applied and no bandpass applied

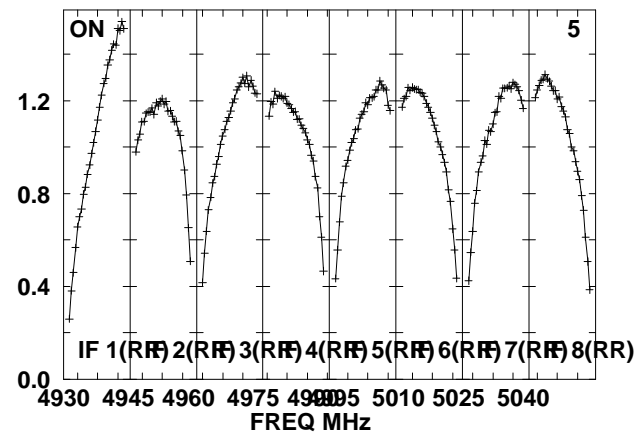
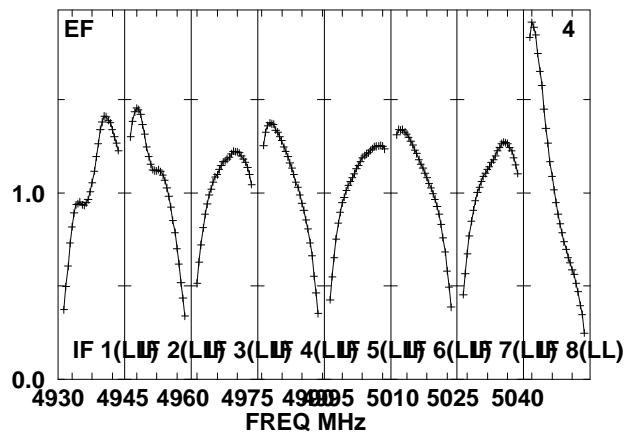
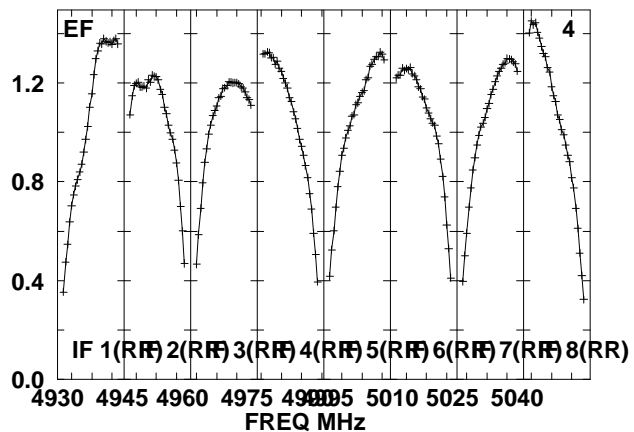
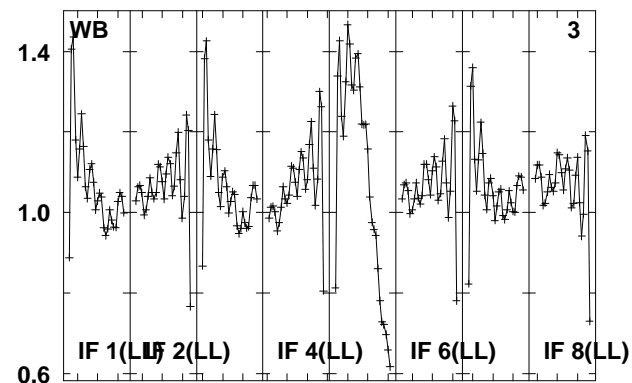
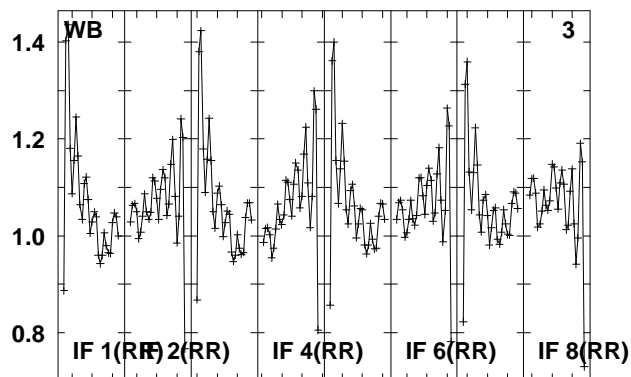
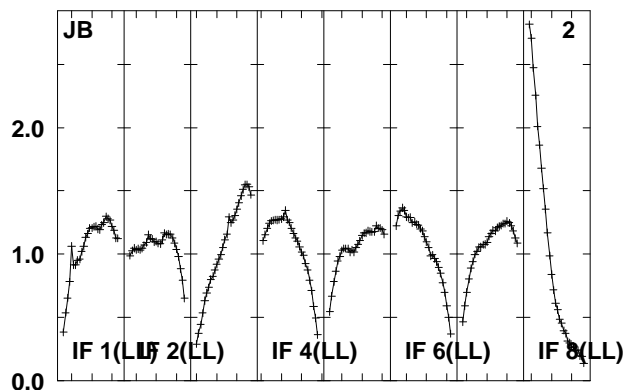
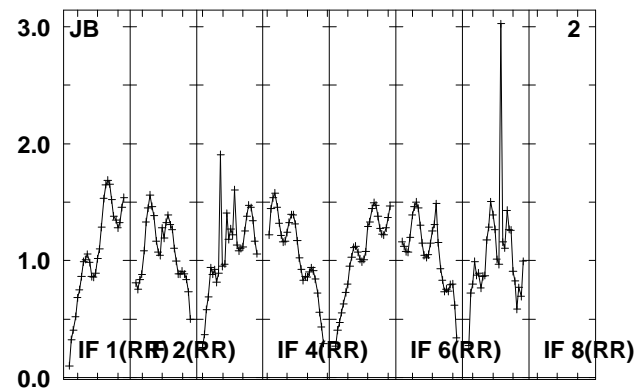
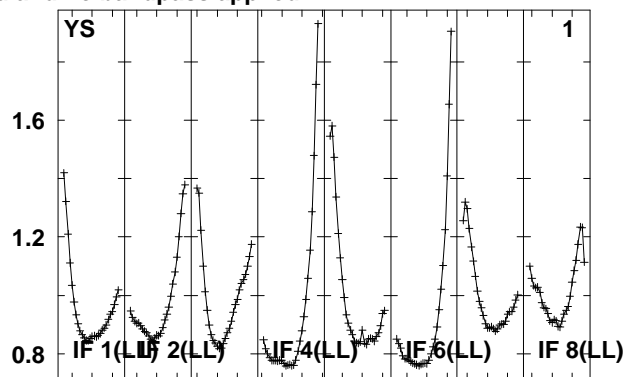
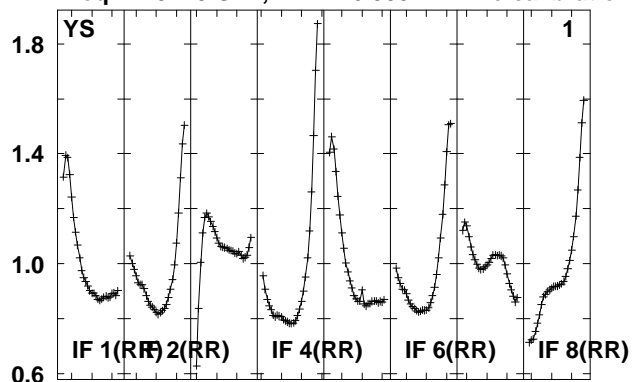

Lower frame: Real Jy
 Total-power spectrum Antenna: *
 Timerange: 00/11:59:52 to 00/12:04:50

Plot file version 324 created 14-MAY-2010 15:18:52

J021348 EO007.UVDATA.1

Freq = 4.9270 GHz, Bw = 16.000 MH No calibration applied and no bandpass applied

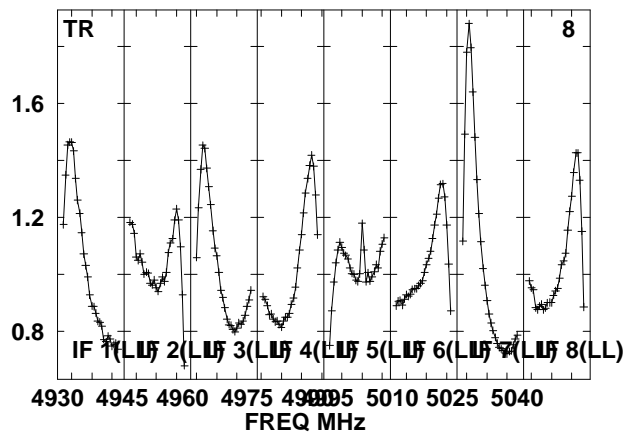
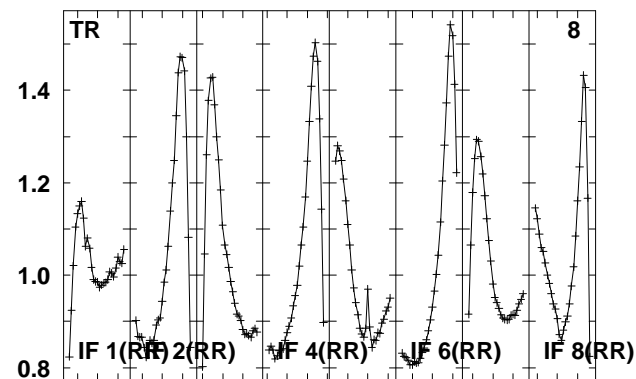
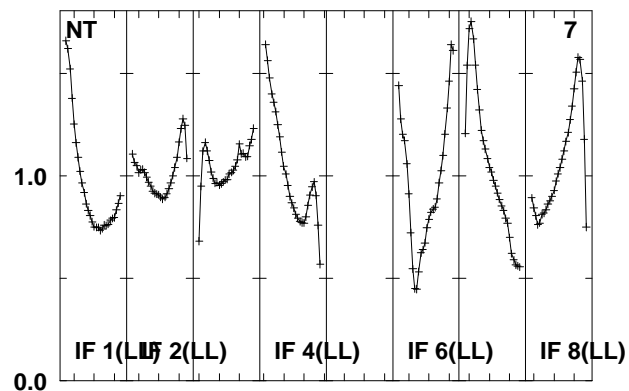
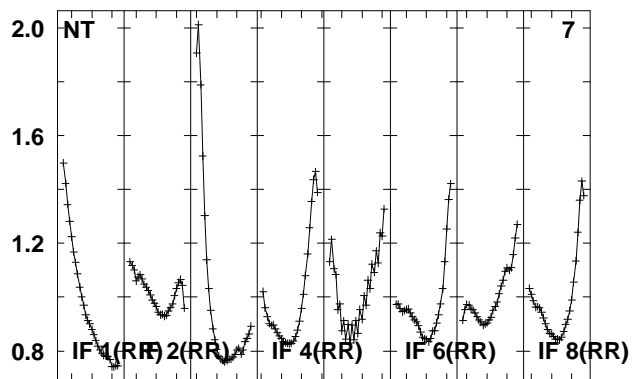
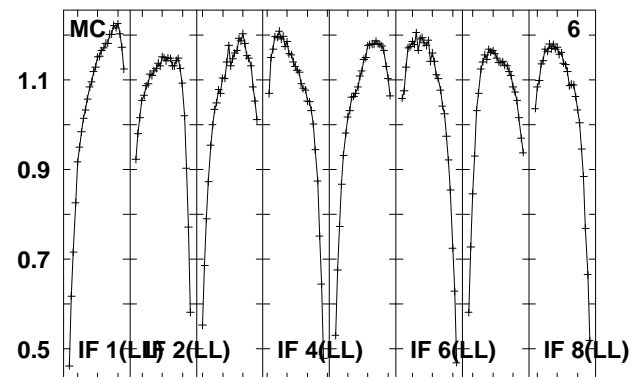
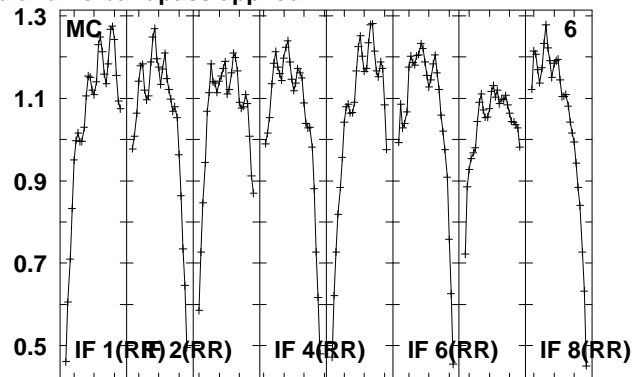
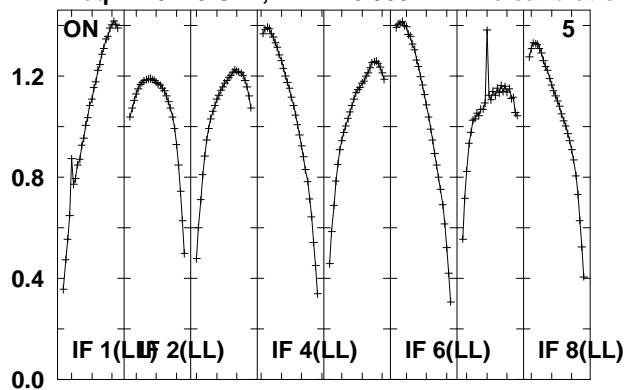

Lower frame: Real Jy

Total-power spectrum Antenna: *

Timerange: 00/11:59:52 to 00/12:04:50

Plot file version 325 created 14-MAY-2010 15:18:52

J0209+13 EO007.UVDATA.1

Freq = 4.9270 GHz, Bw = 16.000 MH No calibration applied and no bandpass applied

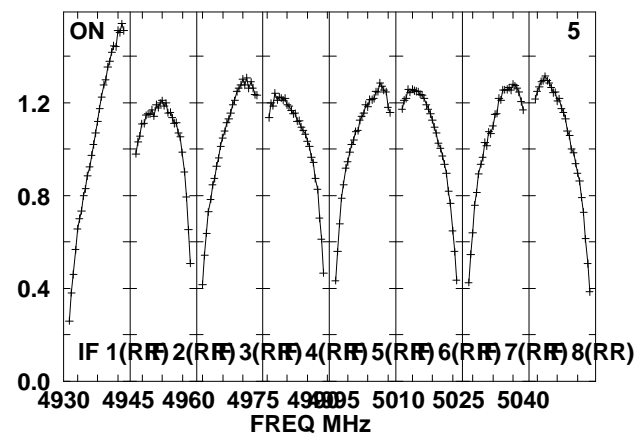
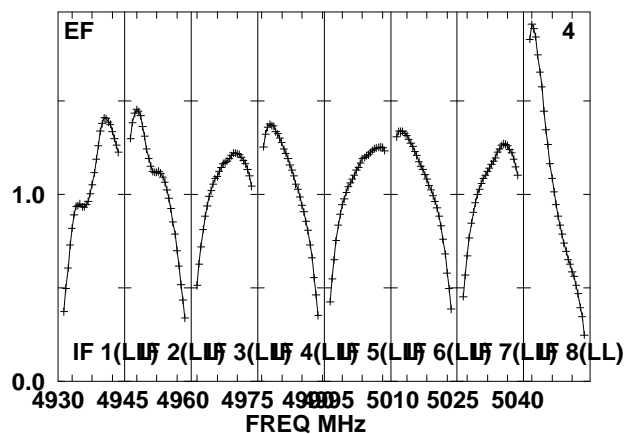
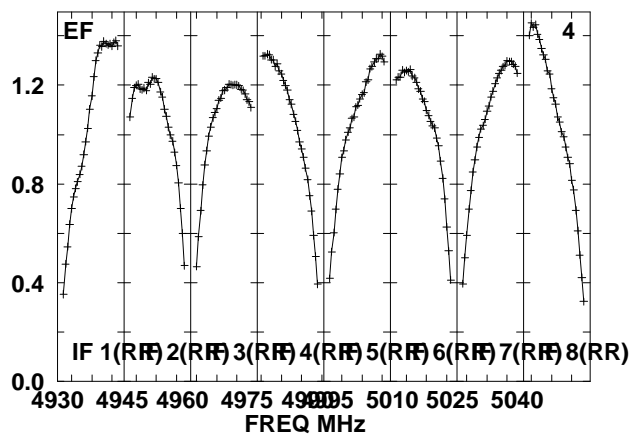
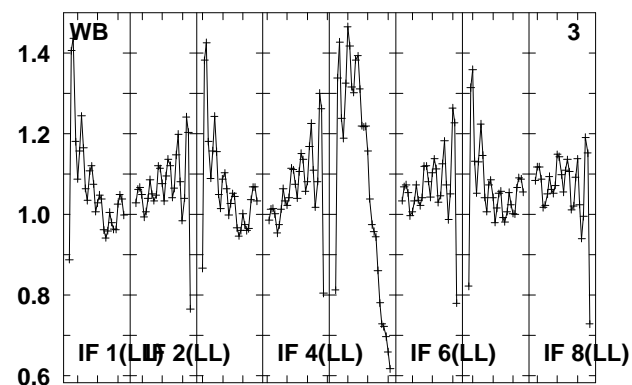
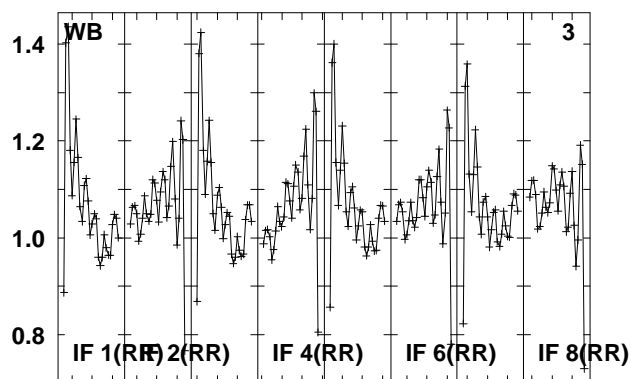
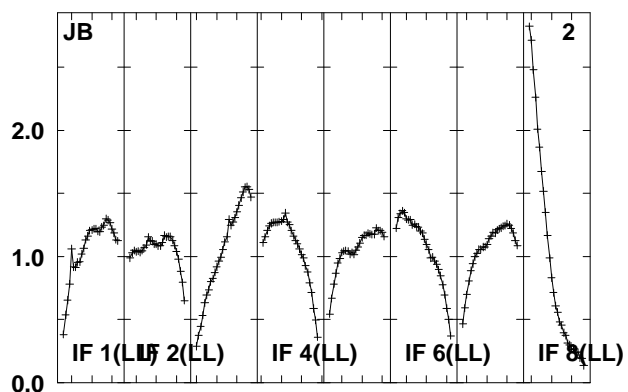
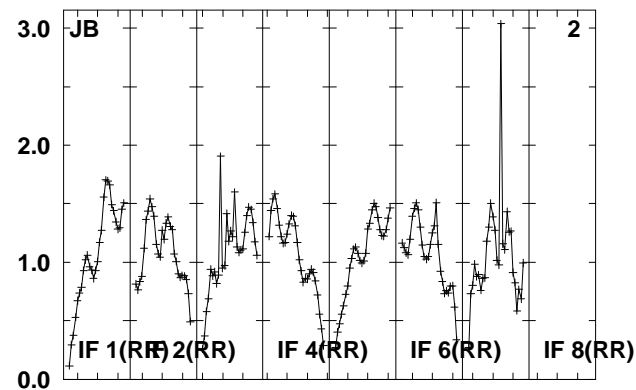
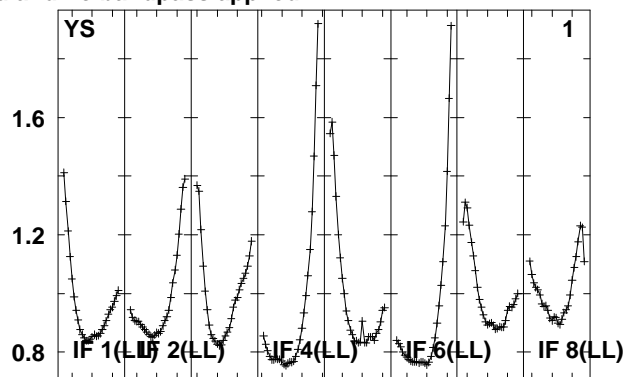
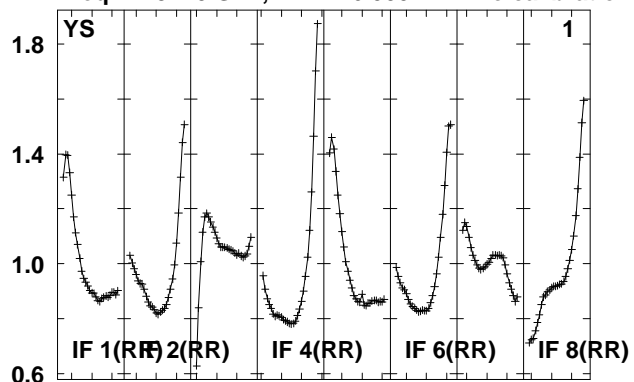

Lower frame: Real Jy

Total-power spectrum Antenna: *

Timerange: 00/12:05:18 to 00/12:06:44

Plot file version 326 created 14-MAY-2010 15:18:53

J0209+13 EO007.UVDATA.1

Freq = 4.9270 GHz, Bw = 16.000 MH No calibration applied and no bandpass applied

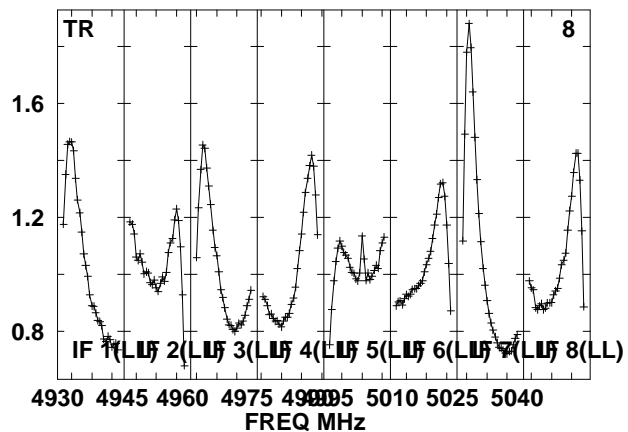
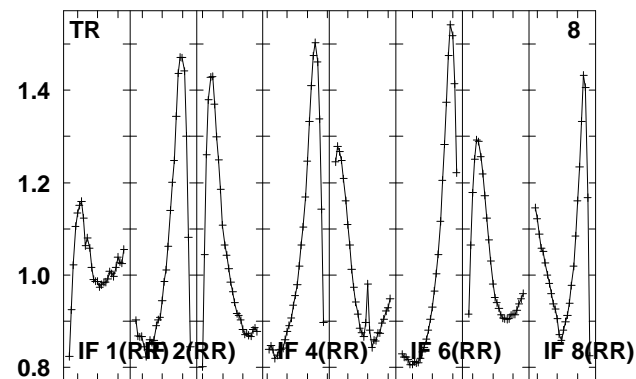
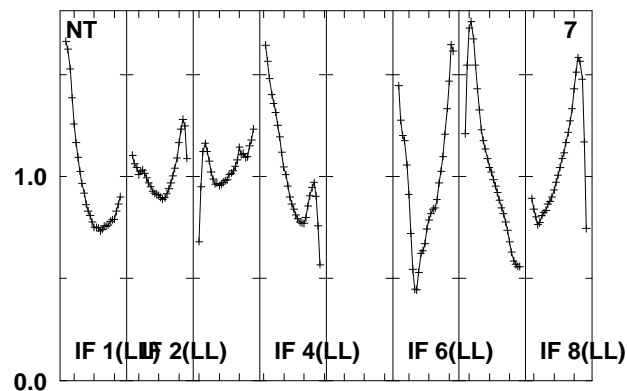
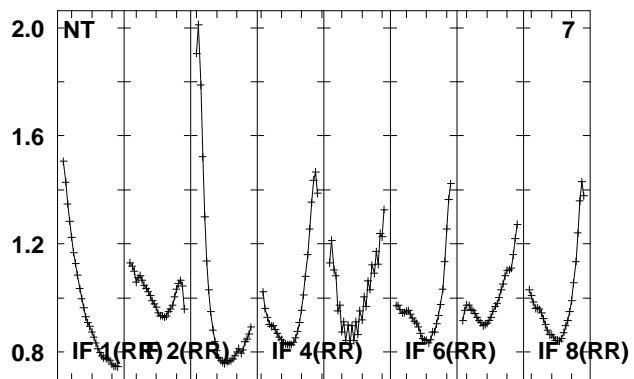
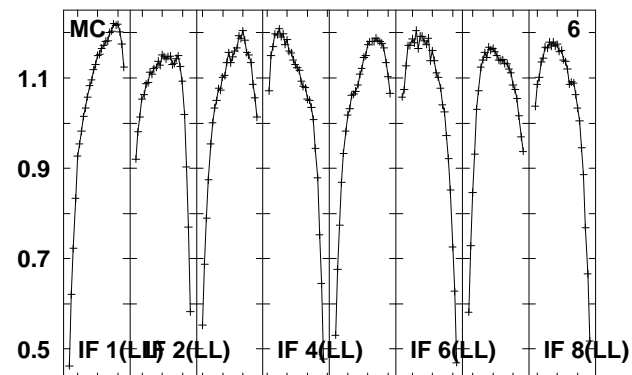
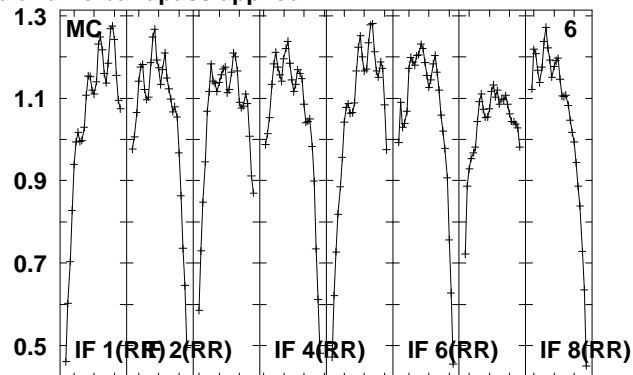
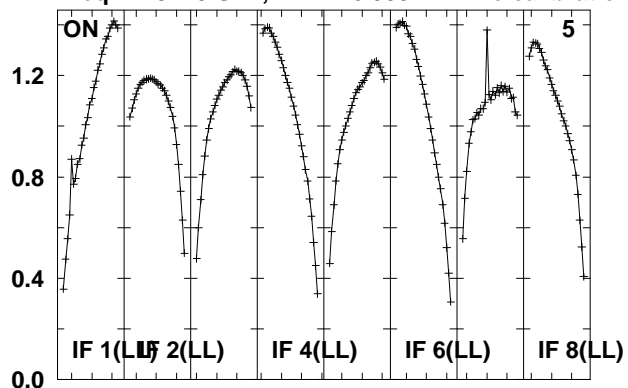

Lower frame: Real Jy

Total-power spectrum Antenna: *

Timerange: 00/12:05:18 to 00/12:06:44

Plot file version 327 created 14-MAY-2010 15:18:53

J021348 EO007.UVDATA.1

Freq = 4.9270 GHz, Bw = 16.000 MH No calibration applied and no bandpass applied

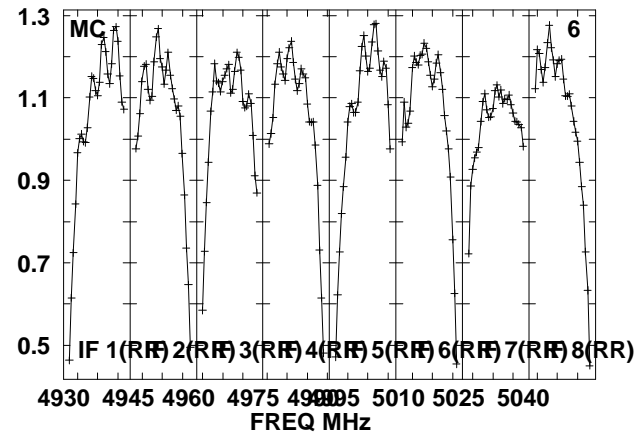
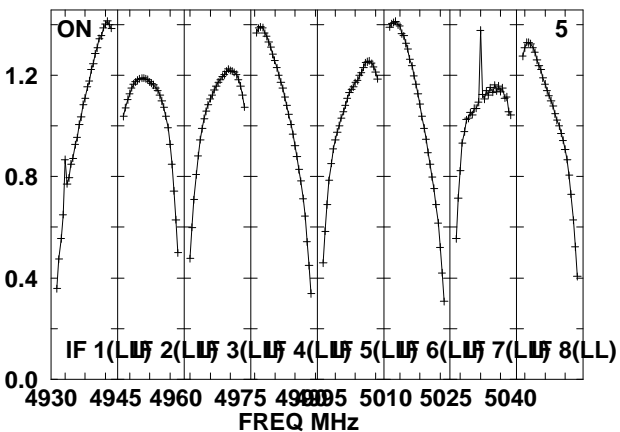
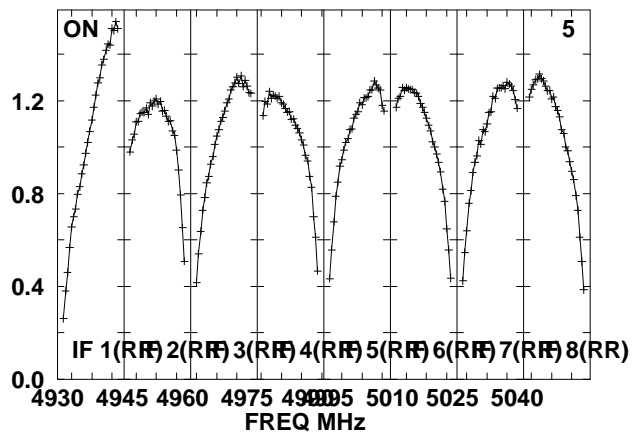
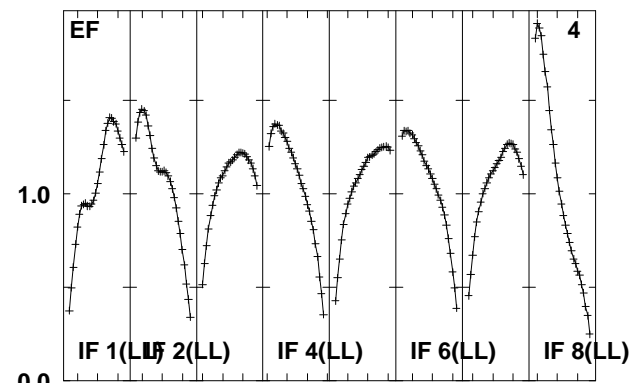
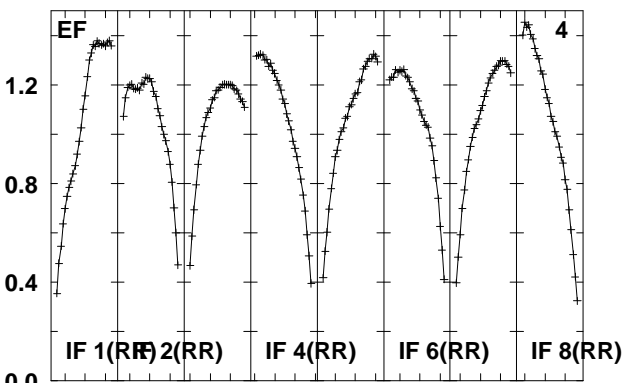
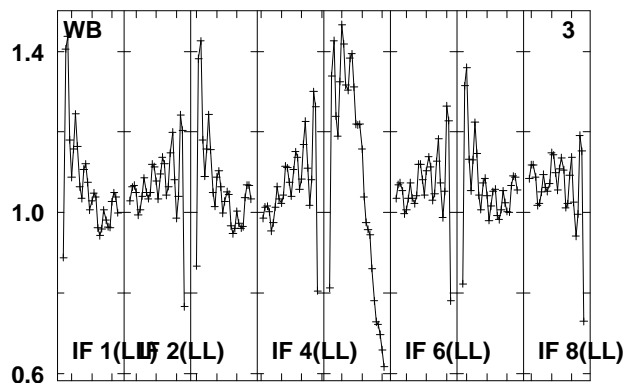
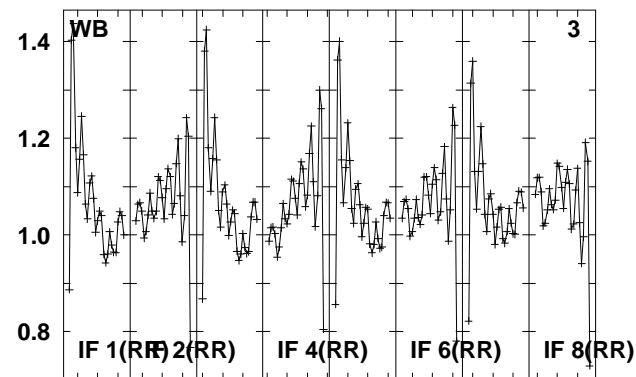
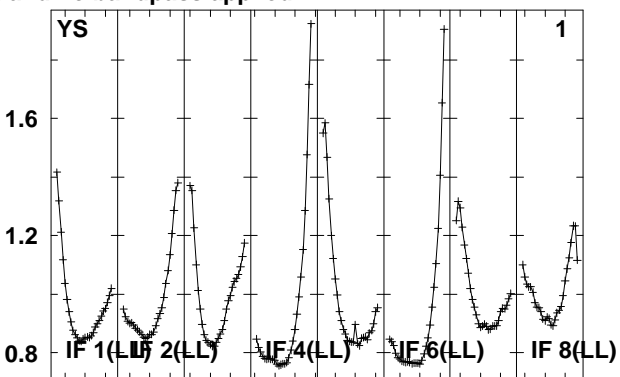
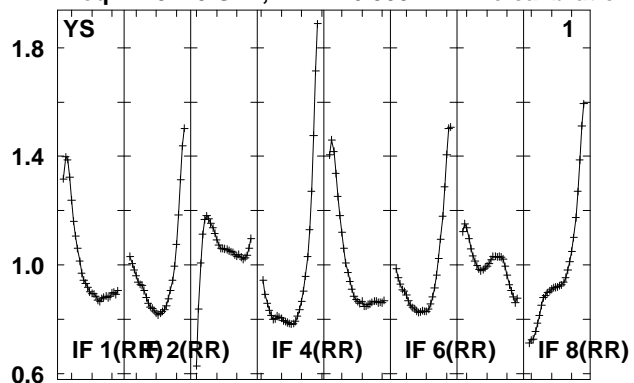

Lower frame: Real Jy
Total-power spectrum Antenna: *
Timerange: 00/12:07:10 to 00/12:12:08

Plot file version 328 created 14-MAY-2010 15:18:53

J021348 EO007.UVDATA.1

Freq = 4.9270 GHz, Bw = 16.000 MH No calibration applied and no bandpass applied

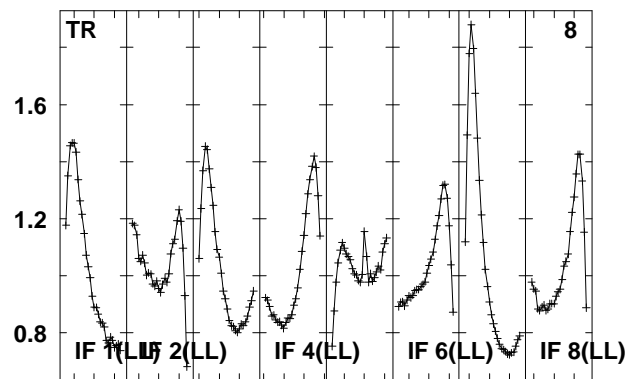
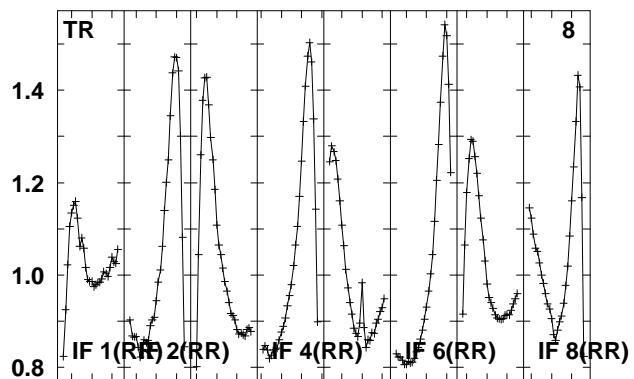
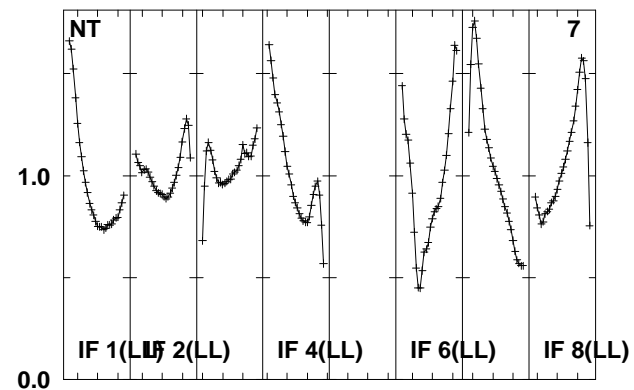
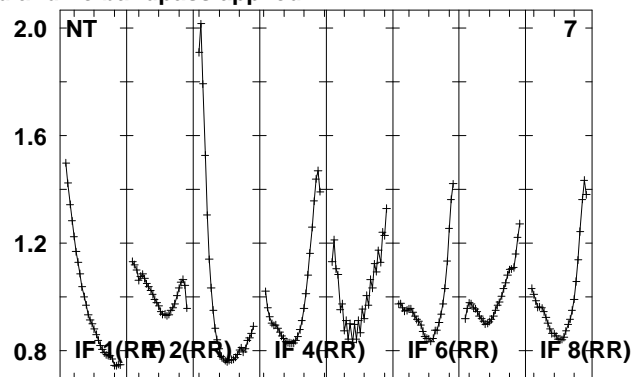
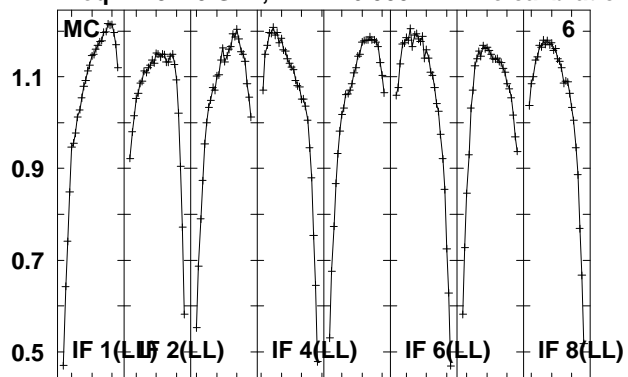

Lower frame: Real Jy
Total-power spectrum Antenna: *
Timerange: 00/12:07:10 to 00/12:12:08

Plot file version 329 created 14-MAY-2010 15:18:54

J0209+13 EO007.UVDATA.1

Freq = 4.9270 GHz, Bw = 16.000 MH No calibration applied and no bandpass applied

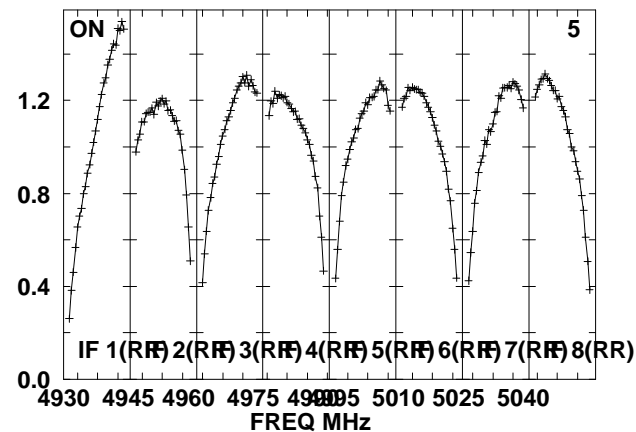
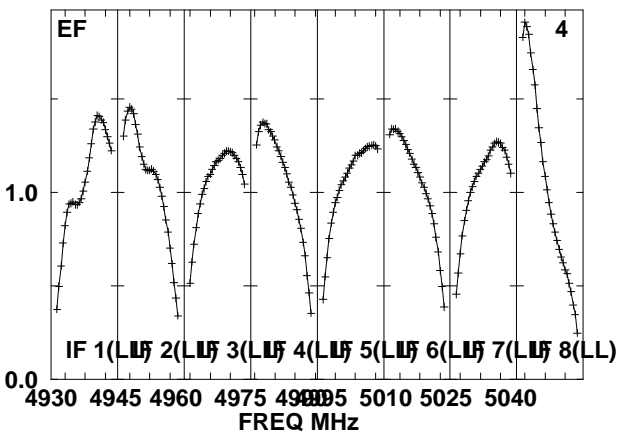
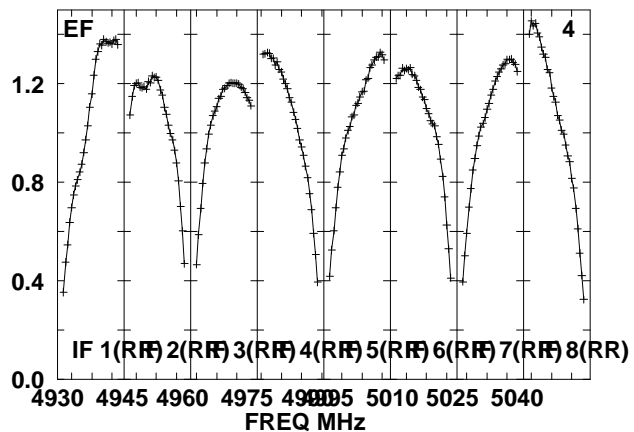
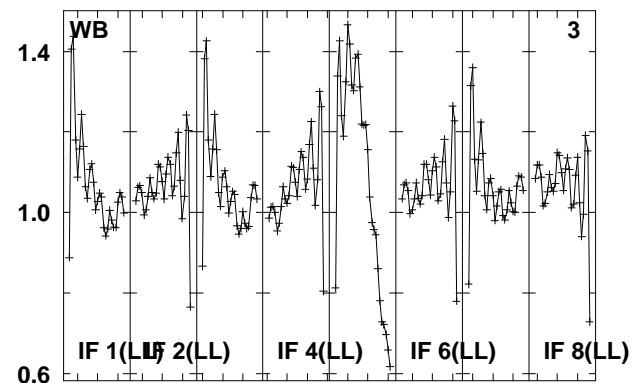
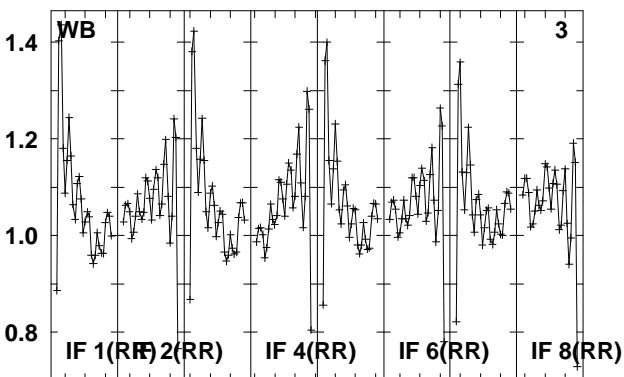
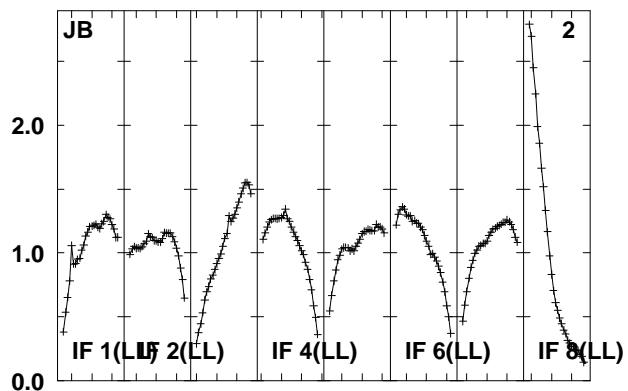
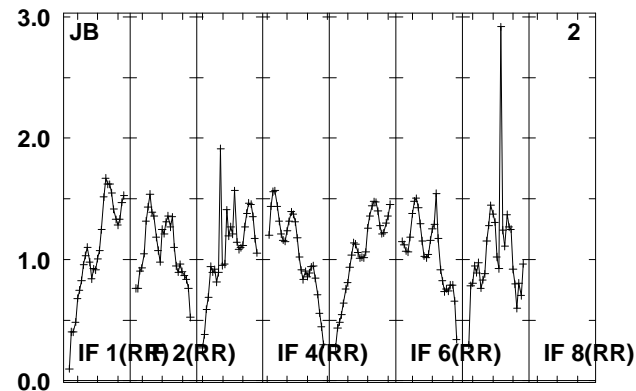
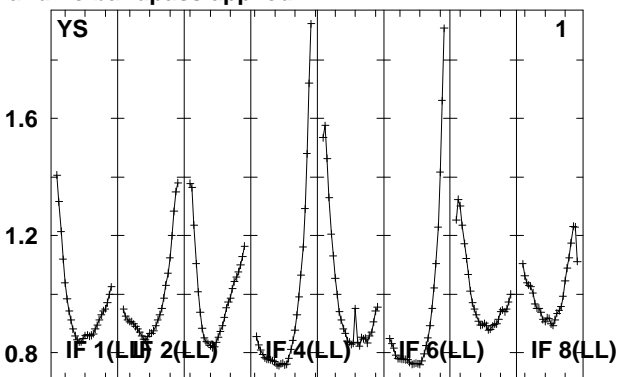
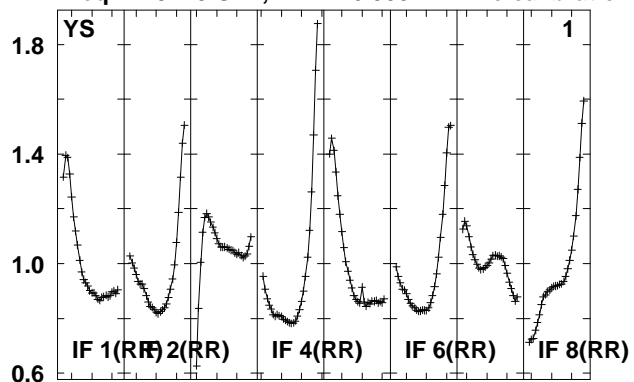

Lower frame: Real Jy

Total-power spectrum Antenna: *

Timerange: 00/12:12:36 to 00/12:14:04

Plot file version 330 created 14-MAY-2010 15:18:54

J0209+13 EO007.UVDATA.1

Freq = 4.9270 GHz, Bw = 16.000 MH No calibration applied and no bandpass applied

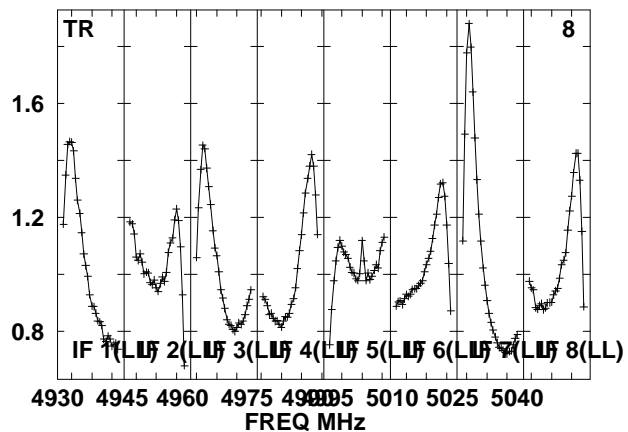
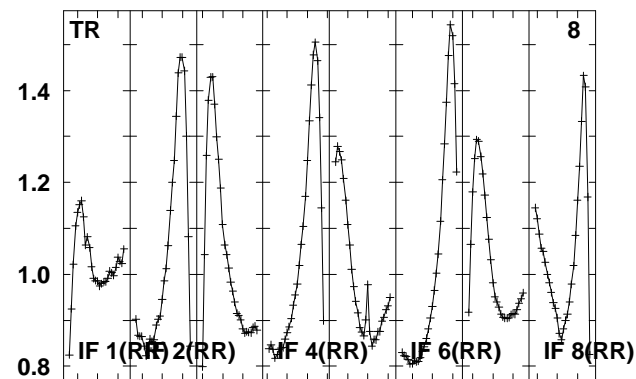
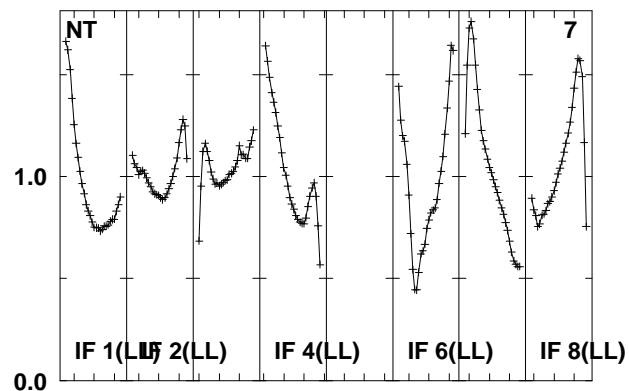
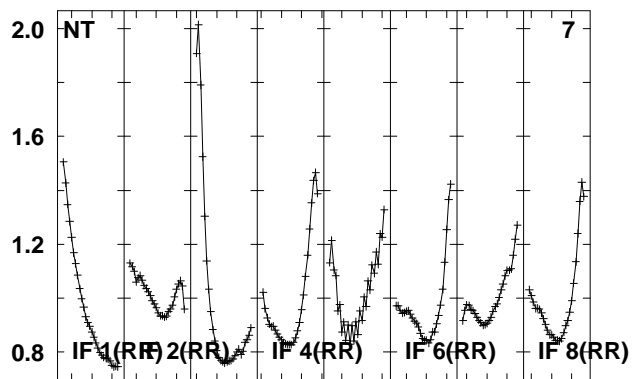
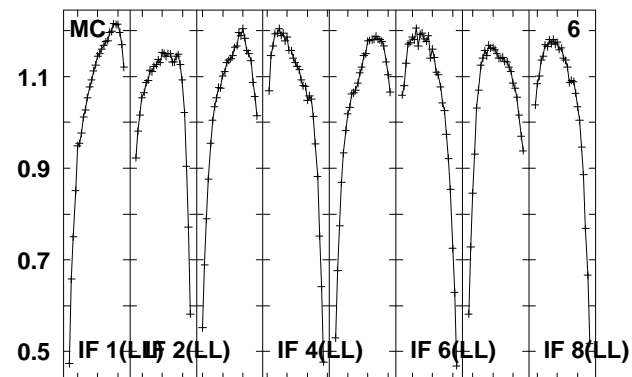
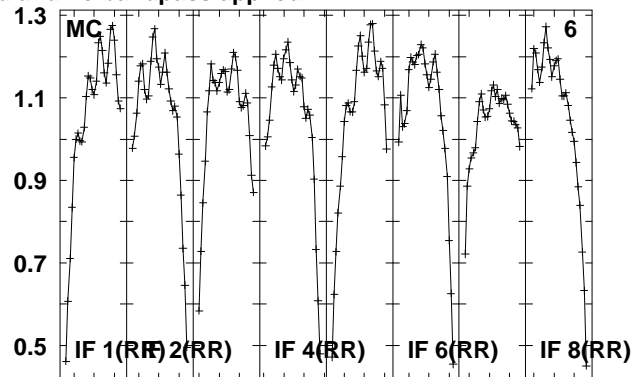
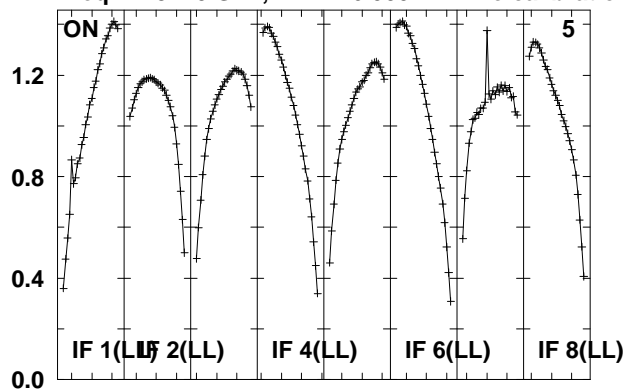

Lower frame: Real Jy

Total-power spectrum Antenna: *

Timerange: 00/12:12:36 to 00/12:14:04

Plot file version 331 created 14-MAY-2010 15:18:54

J0158+13 EO007.UVDATA.1

Freq = 4.9270 GHz, Bw = 16.000 MH No calibration applied and no bandpass applied

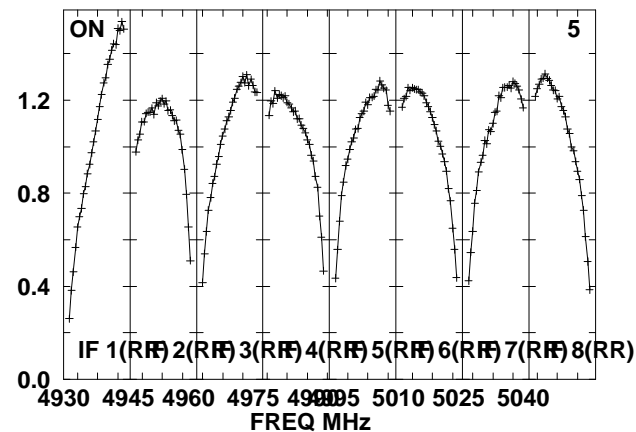
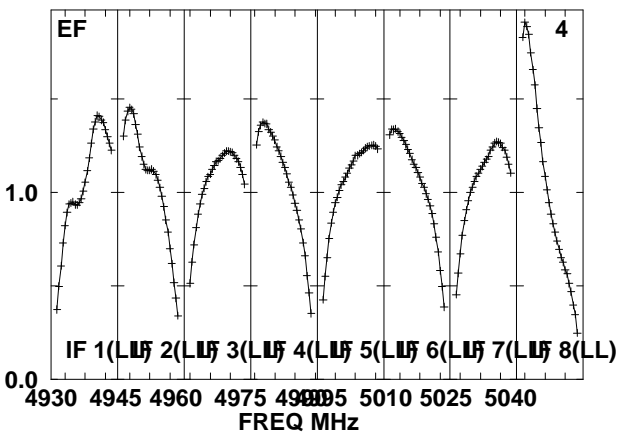
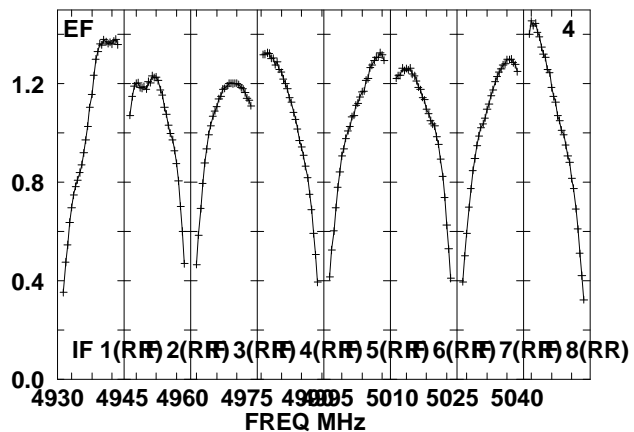
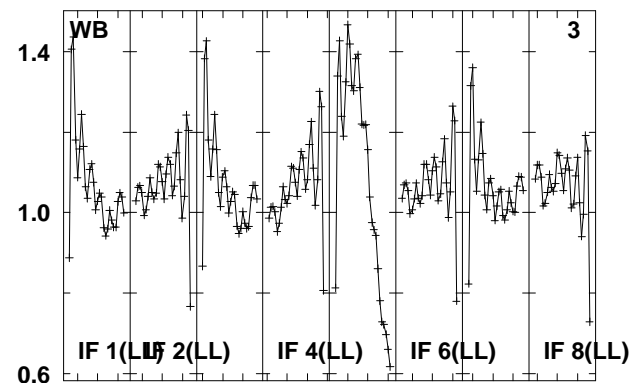
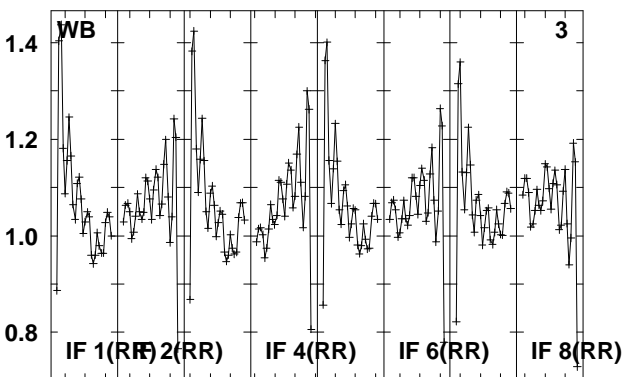
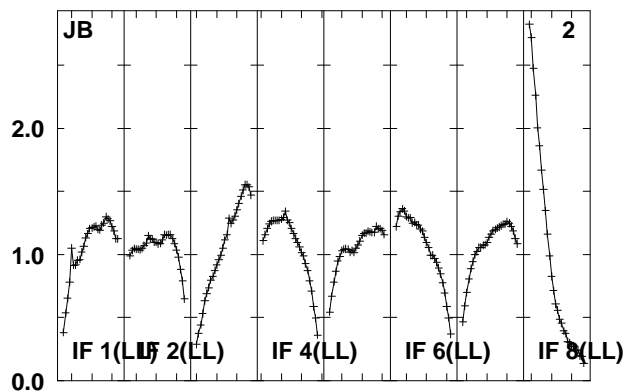
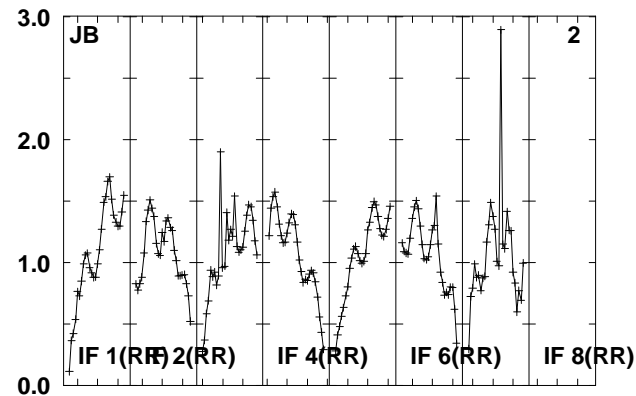
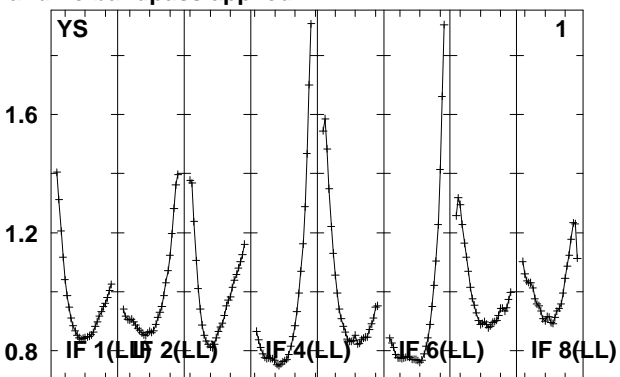
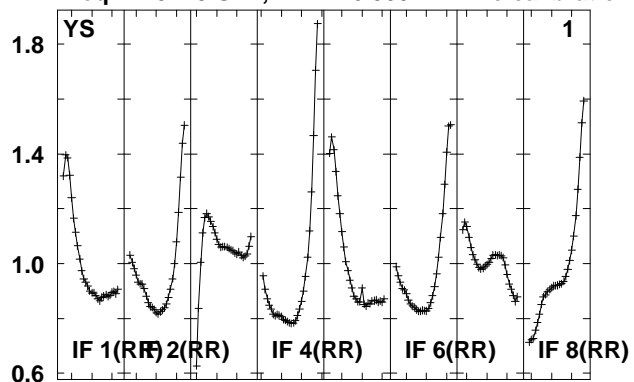

Lower frame: Real Jy
Total-power spectrum Antenna: *
Timerange: 00/12:14:44 to 00/12:16:12

Plot file version 332 created 14-MAY-2010 15:18:55

J0158+13 EO007.UVDATA.1

Freq = 4.9270 GHz, Bw = 16.000 MH No calibration applied and no bandpass applied

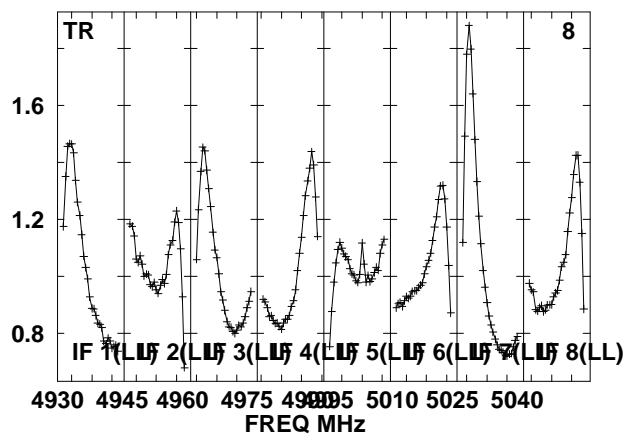
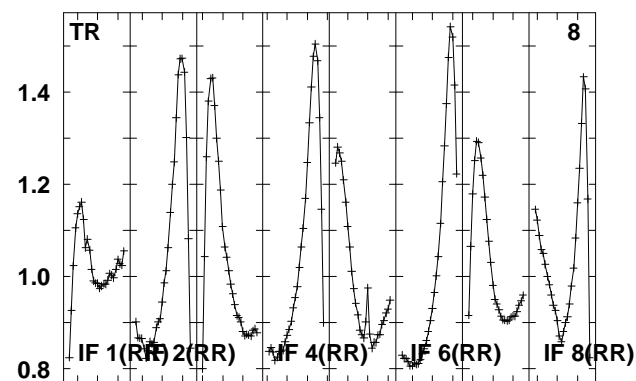
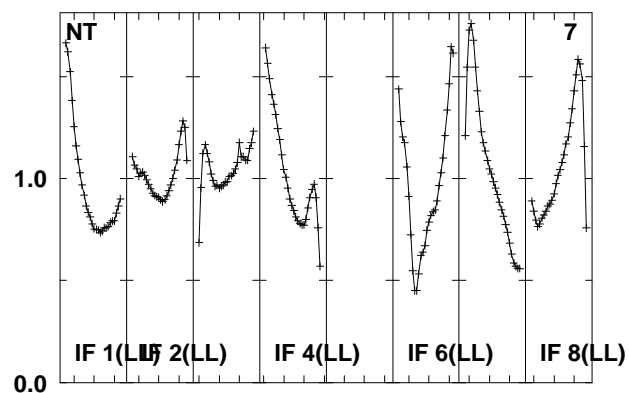
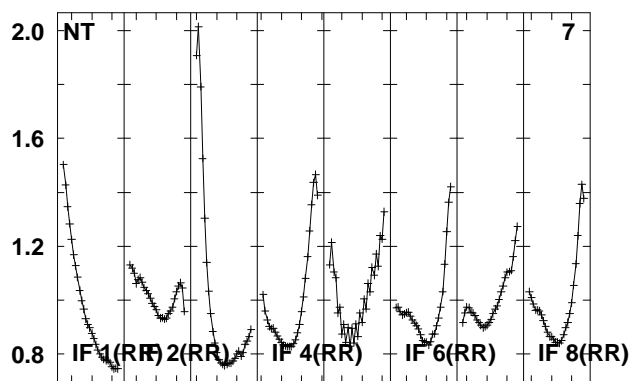
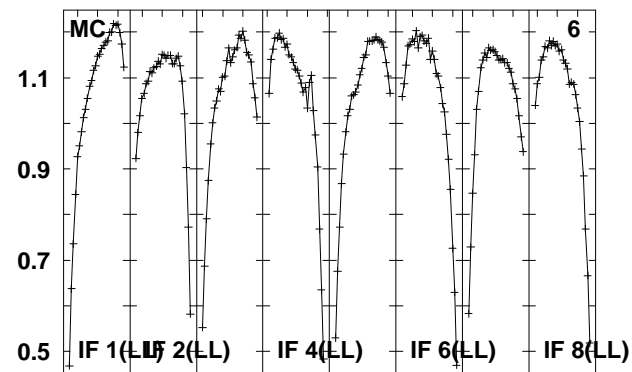
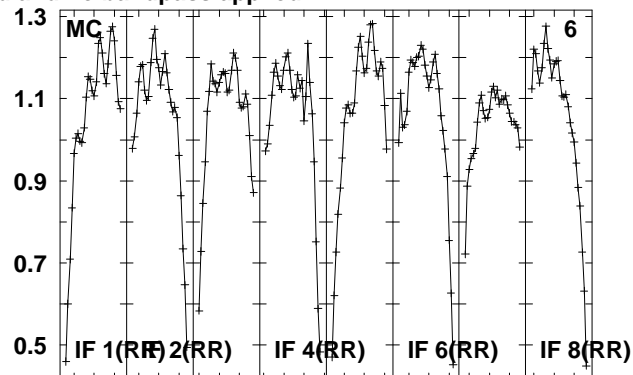
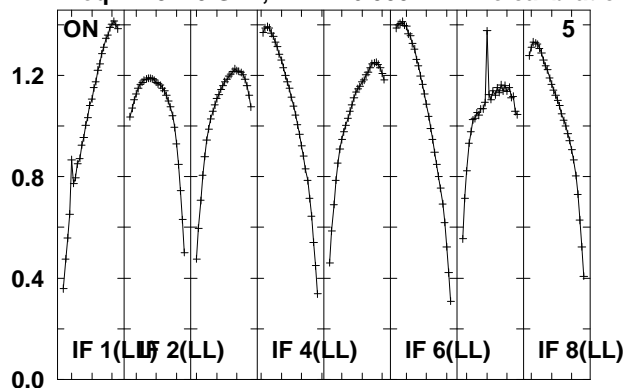

Lower frame: Real Jy

Total-power spectrum Antenna: *

Timerange: 00/12:14:44 to 00/12:16:12

Plot file version 333 created 14-MAY-2010 15:18:55
 J015028 EO007.UVDATA.1
 Freq = 4.9270 GHz, Bw = 16.000 MH No calibration applied and no bandpass applied

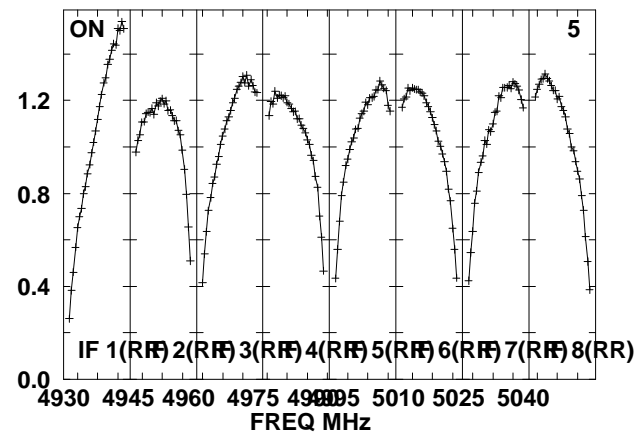
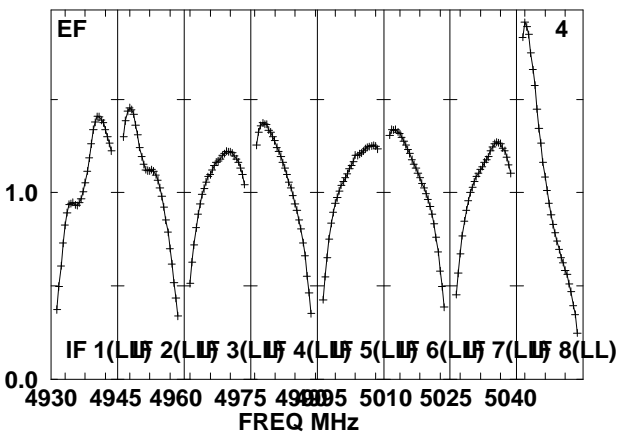
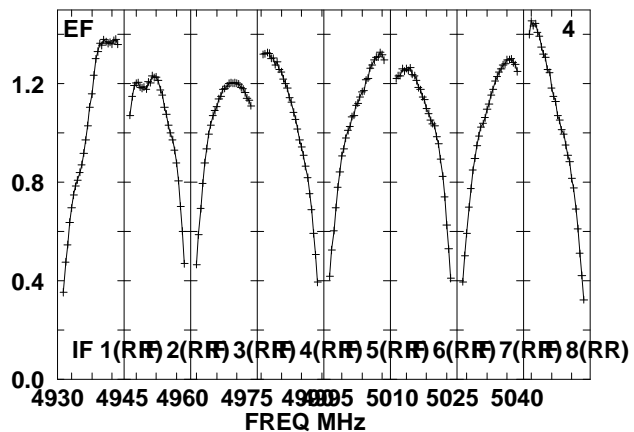
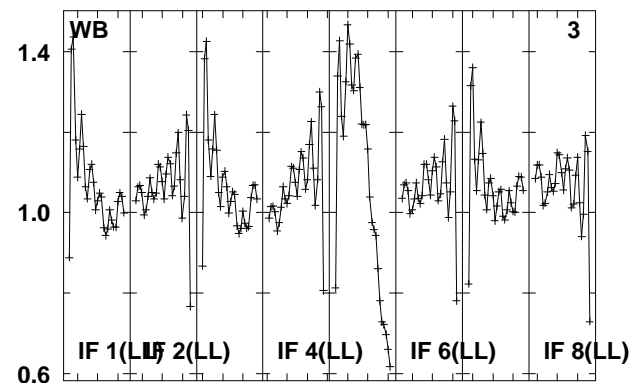
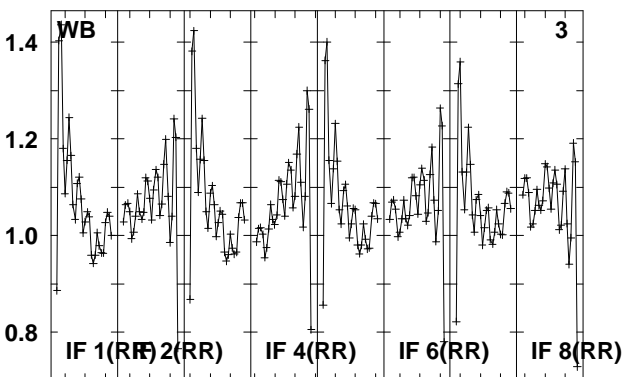
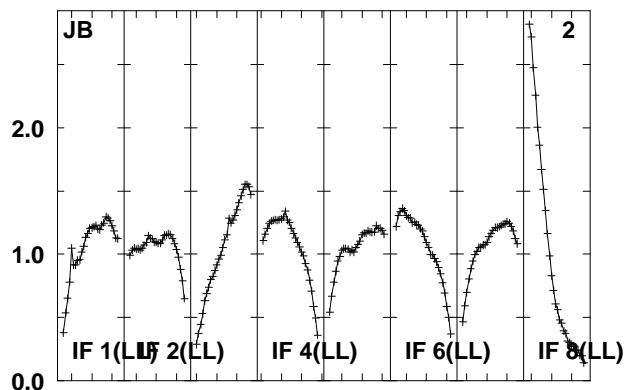
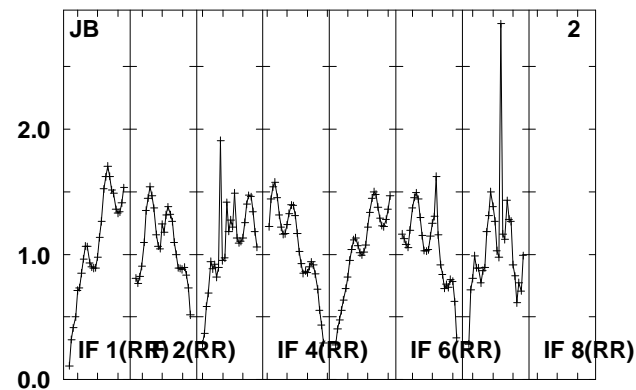
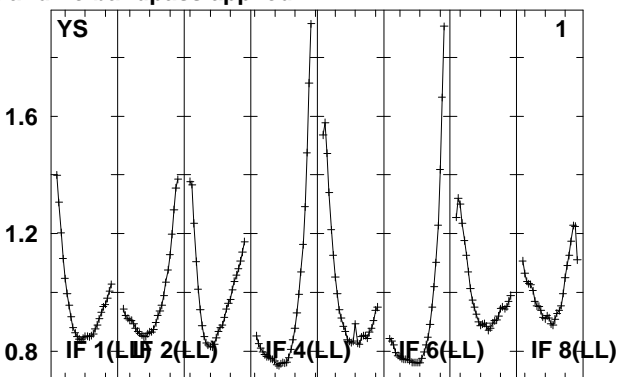
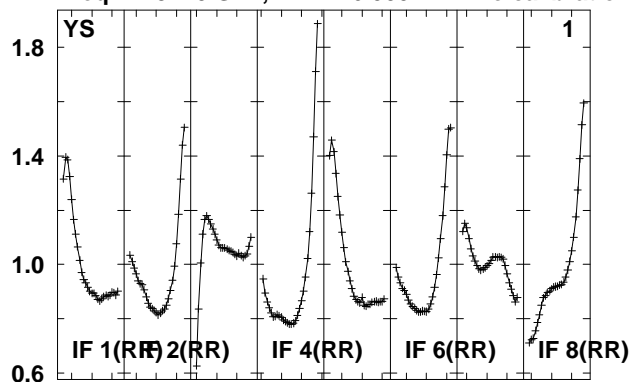

Lower frame: Real Jy
 Total-power spectrum Antenna: *
 Timerange: 00/12:16:48 to 00/12:21:46

Plot file version 334 created 14-MAY-2010 15:18:56

J015028 EO007.UVDATA.1

Freq = 4.9270 GHz, Bw = 16.000 MH No calibration applied and no bandpass applied

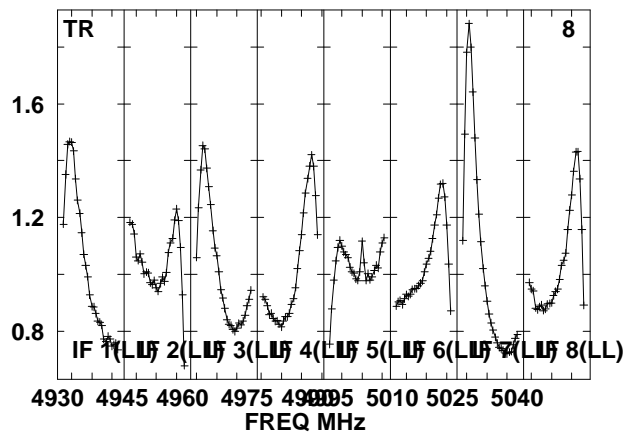
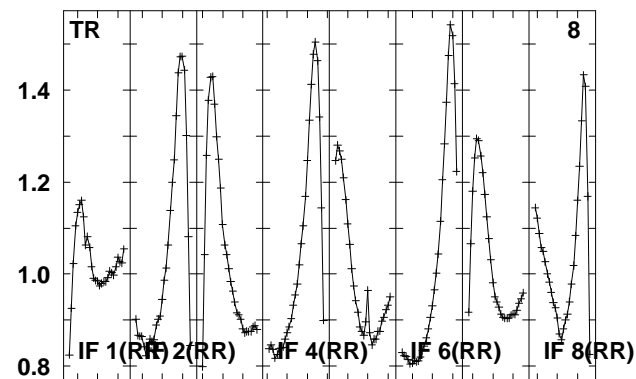
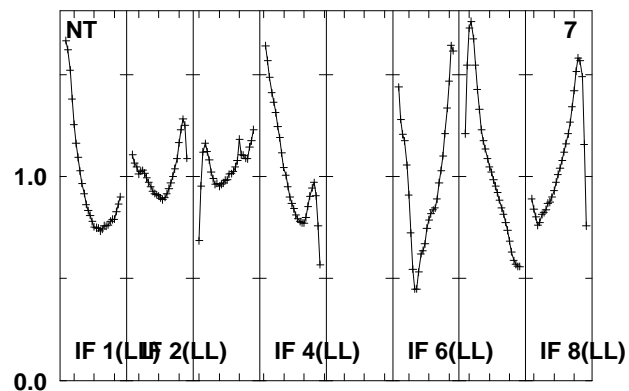
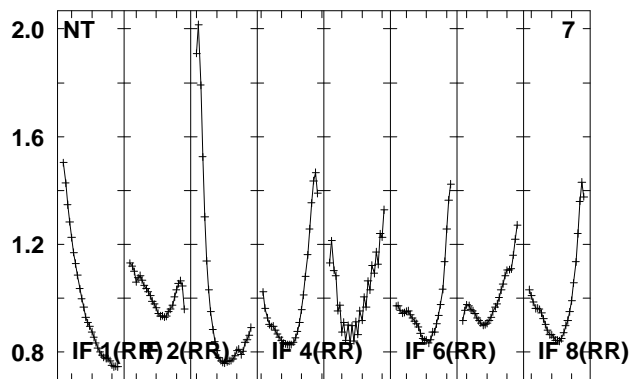
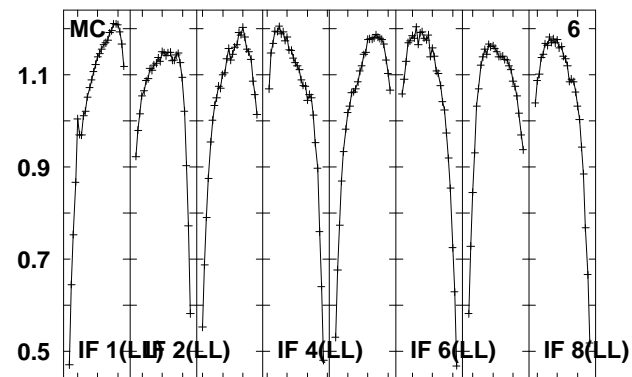
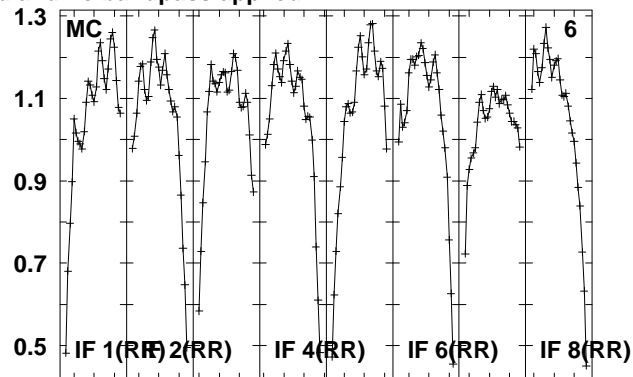
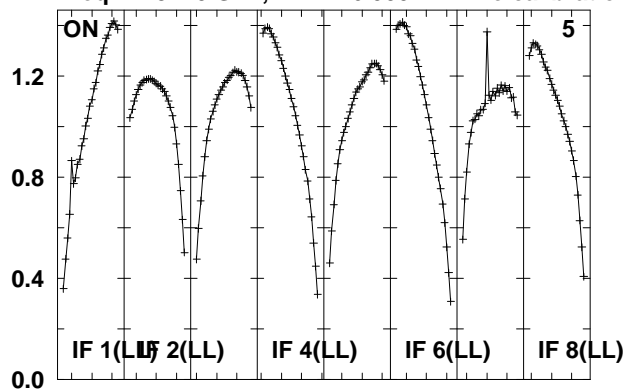

Lower frame: Real Jy

Total-power spectrum Antenna: *

Timerange: 00/12:16:48 to 00/12:21:46

Plot file version 335 created 14-MAY-2010 15:18:56

J0158+13 EO007.UVDATA.1

Freq = 4.9270 GHz, Bw = 16.000 MH No calibration applied and no bandpass applied

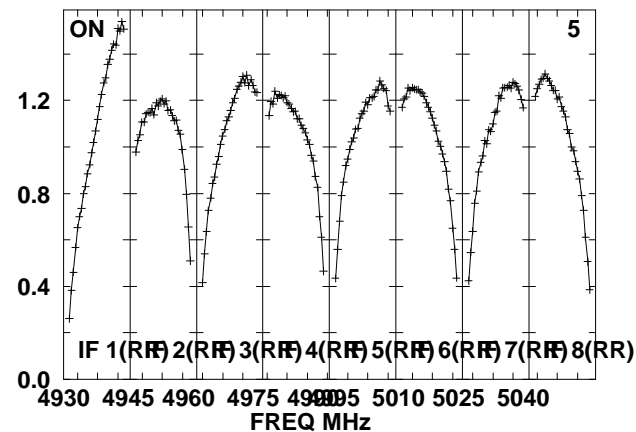
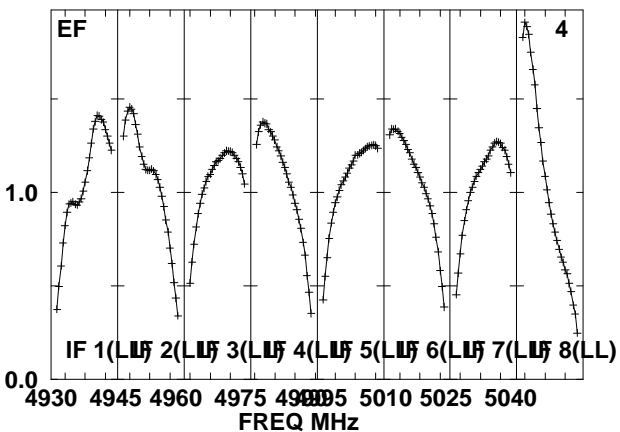
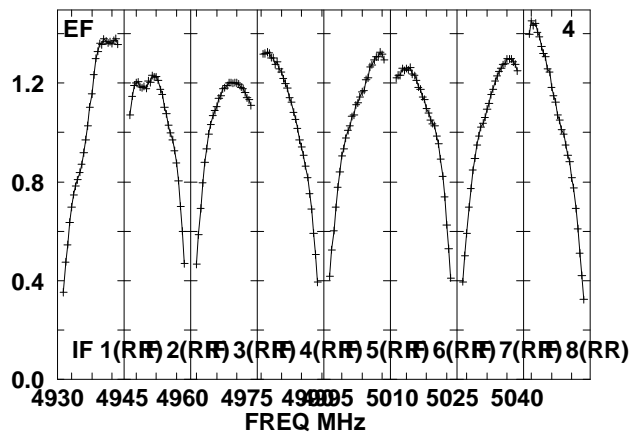
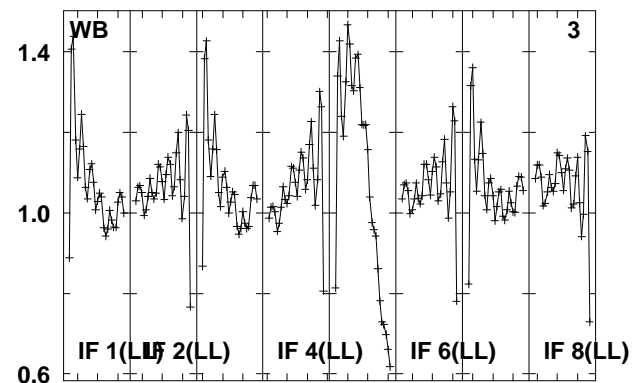
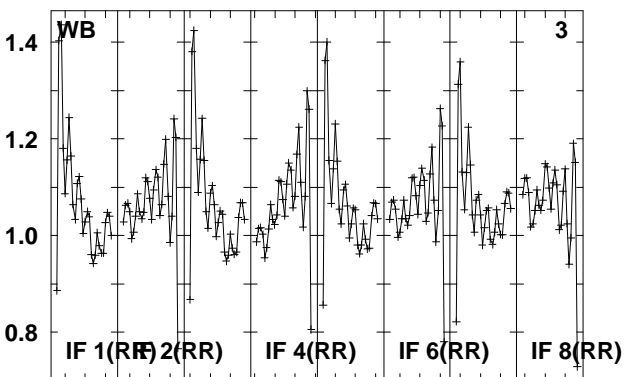
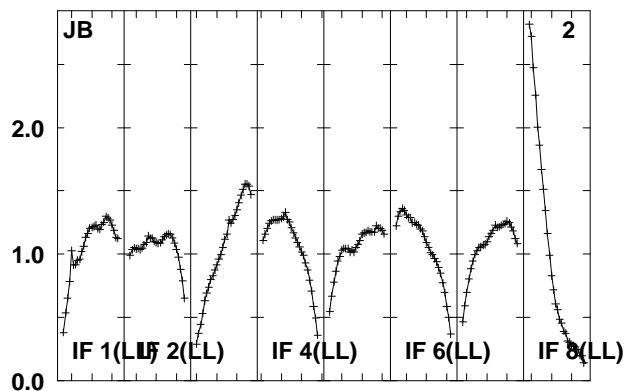
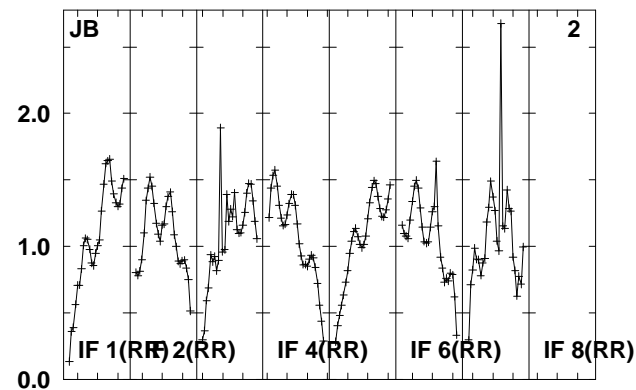
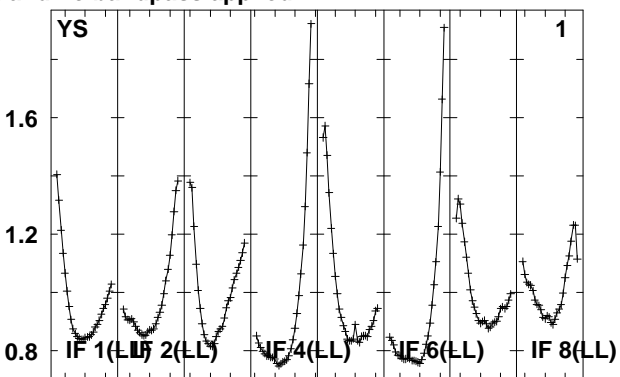
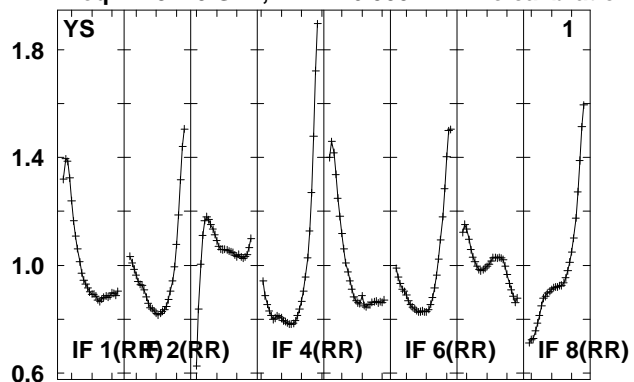

Lower frame: Real Jy
Total-power spectrum Antenna: *
Timerange: 00/12:22:22 to 00/12:23:50

Plot file version 336 created 14-MAY-2010 15:18:56

J0158+13 EO007.UVDATA.1

Freq = 4.9270 GHz, Bw = 16.000 MH No calibration applied and no bandpass applied

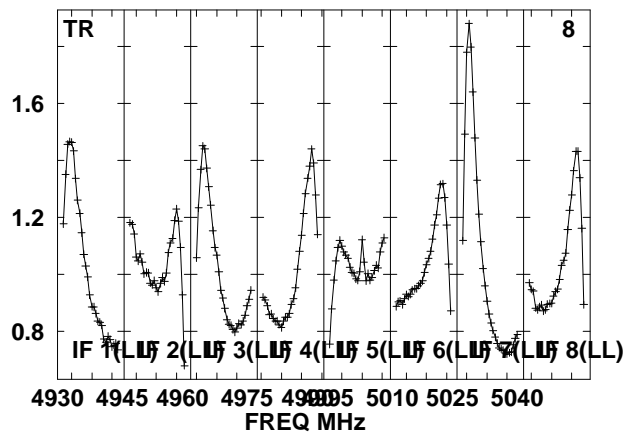
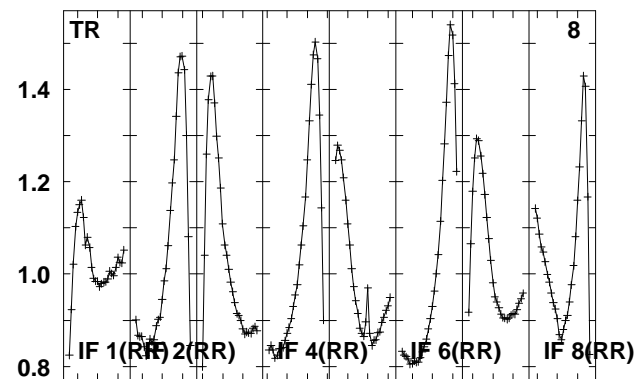
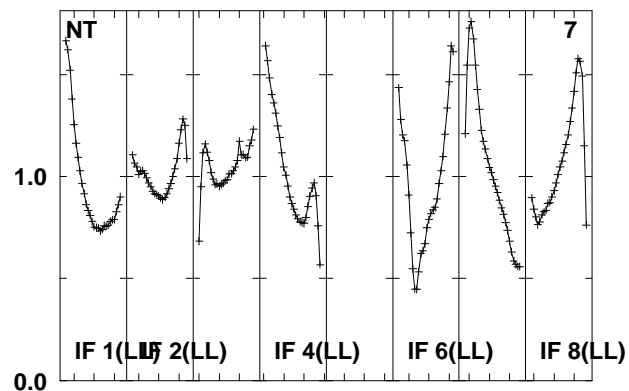
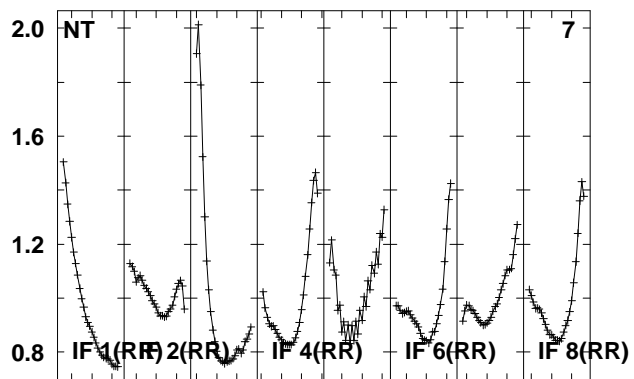
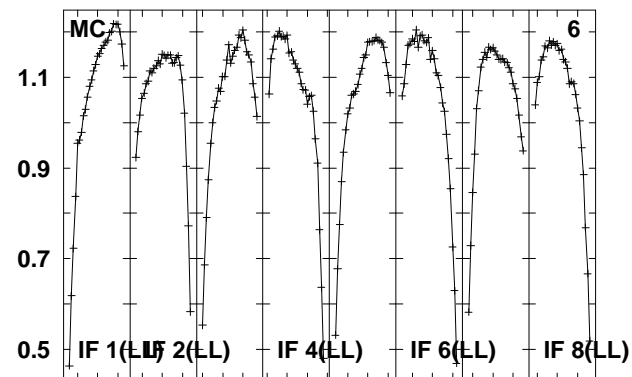
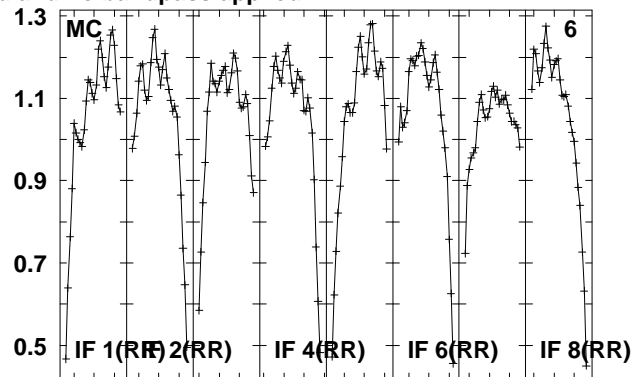
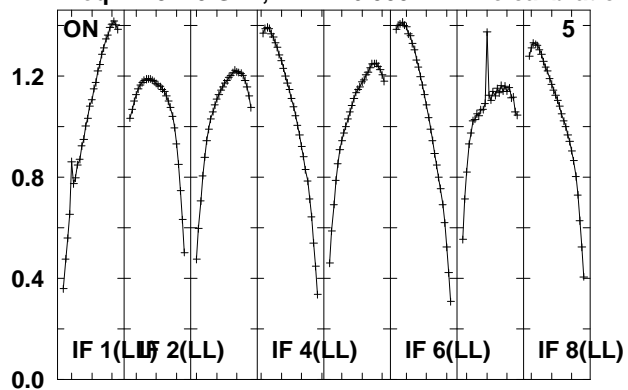

Lower frame: Real Jy

Total-power spectrum Antenna: *

Timerange: 00/12:22:22 to 00/12:23:50

Plot file version 337 created 14-MAY-2010 15:18:57
 J015028 EO007.UVDATA.1
 Freq = 4.9270 GHz, Bw = 16.000 MH No calibration applied and no bandpass applied

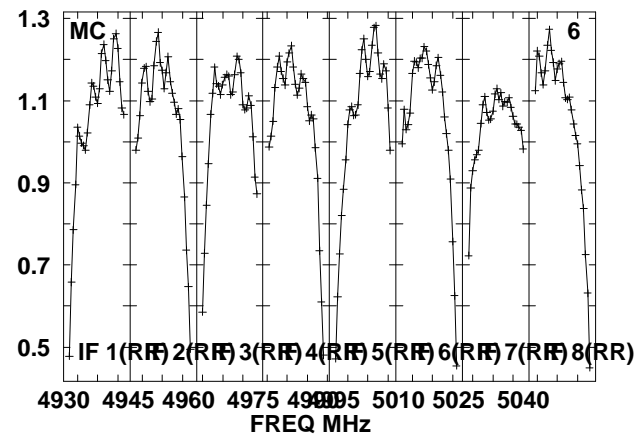
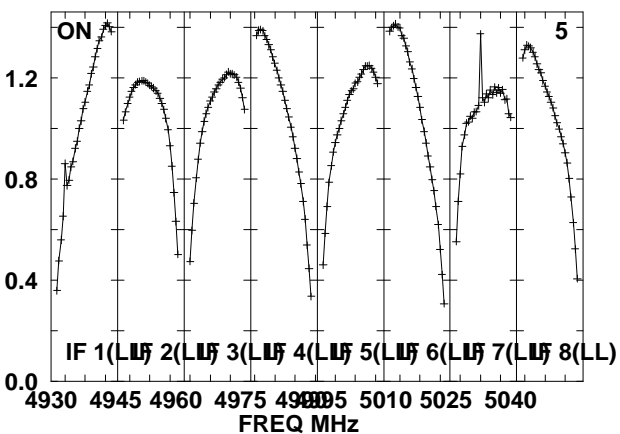
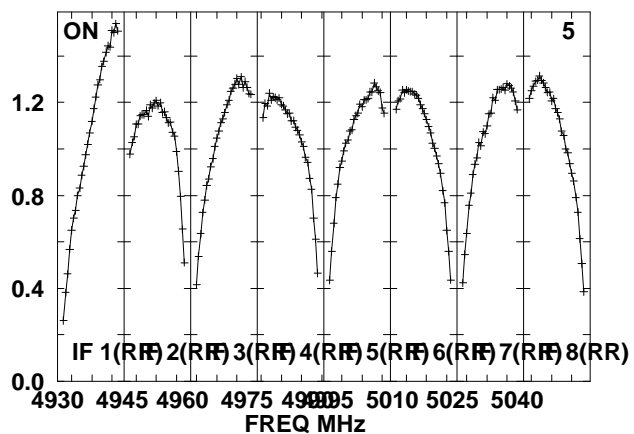
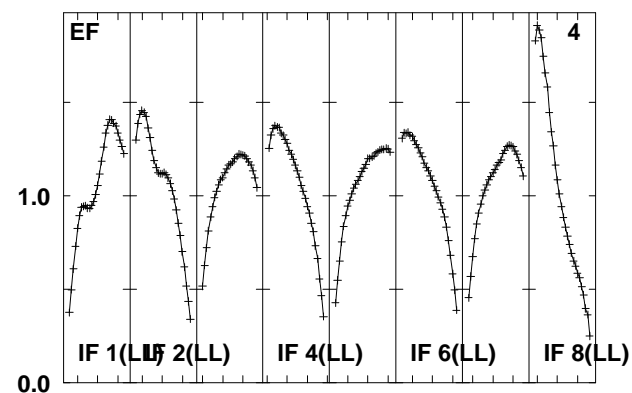
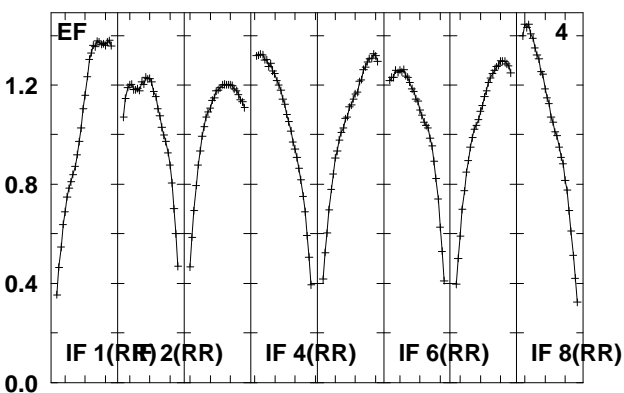
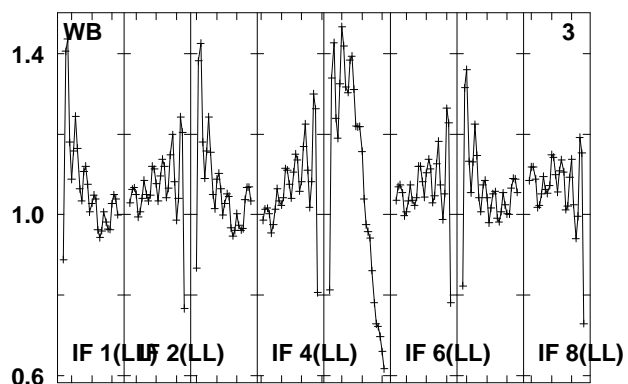
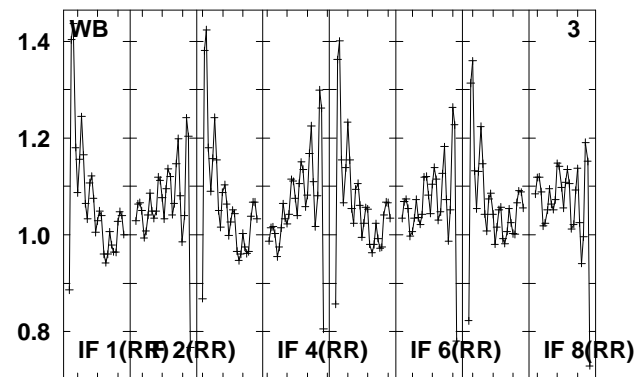
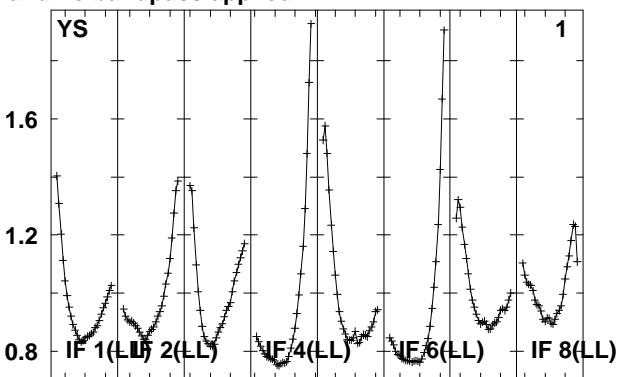
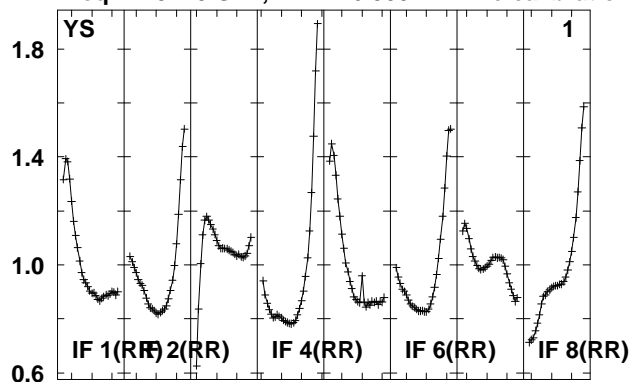

Lower frame: Real Jy
 Total-power spectrum Antenna: *
 Timerange: 00/12:24:24 to 00/12:29:24

Plot file version 338 created 14-MAY-2010 15:18:57

J015028 EO007.UVDATA.1

Freq = 4.9270 GHz, Bw = 16.000 MH No calibration applied and no bandpass applied

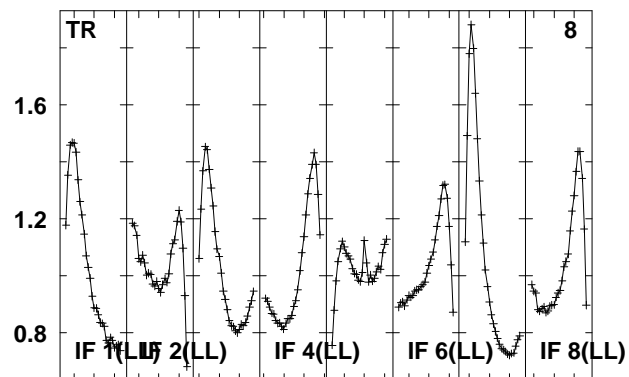
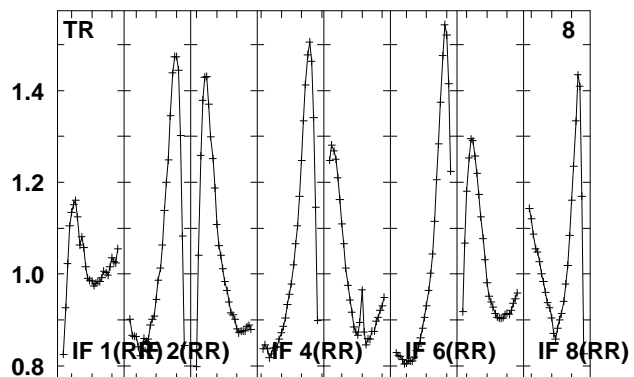
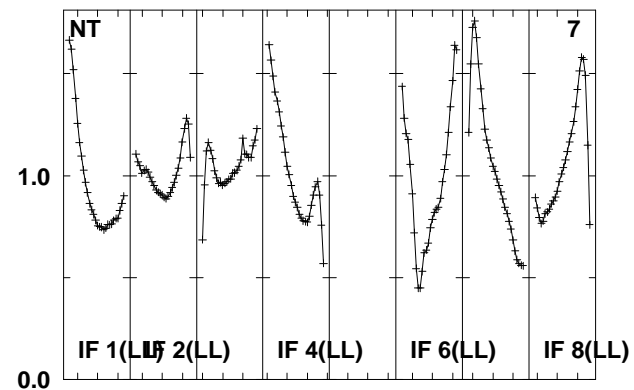
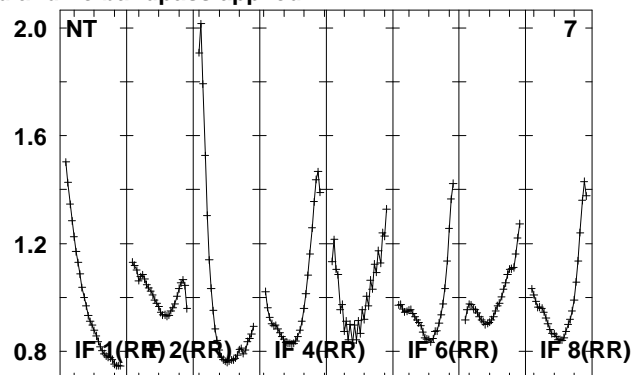
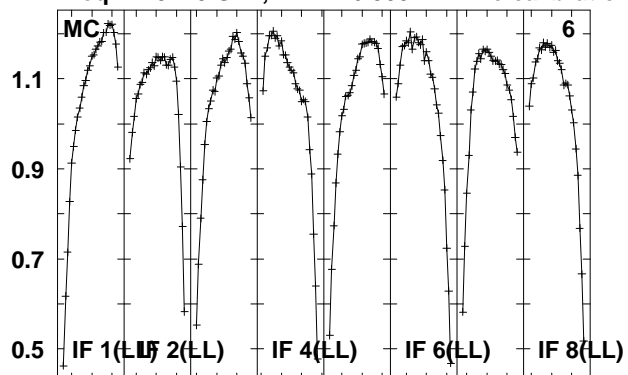

Lower frame: Real Jy
Total-power spectrum Antenna: *
Timerange: 00/12:24:24 to 00/12:29:24

Plot file version 339 created 14-MAY-2010 15:18:57

J0158+13 EO007.UVDATA.1

Freq = 4.9270 GHz, Bw = 16.000 MH No calibration applied and no bandpass applied

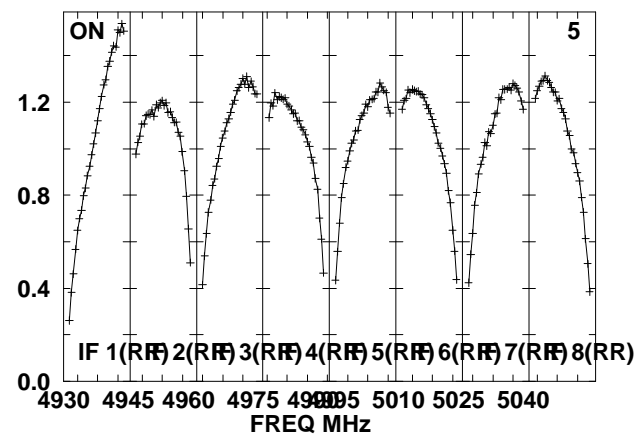
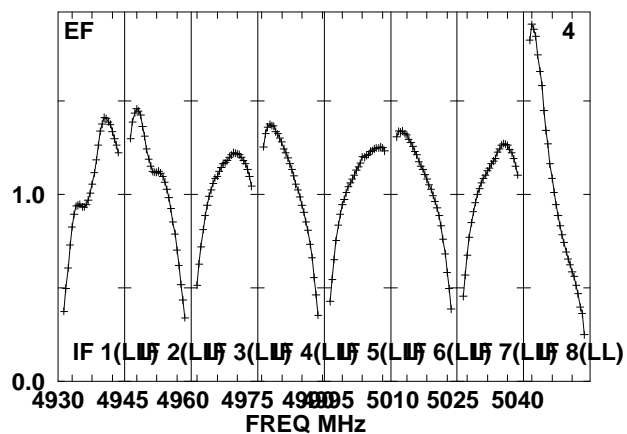
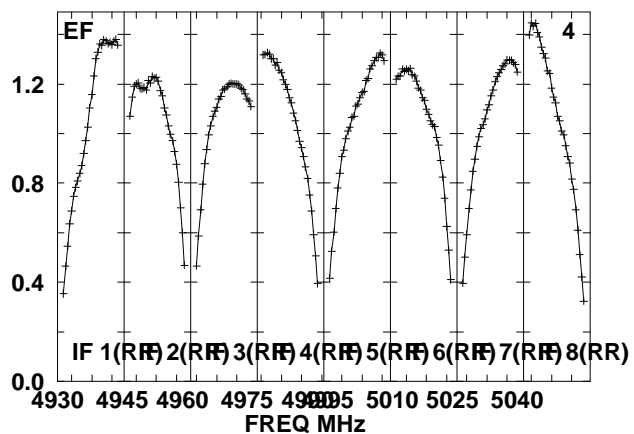
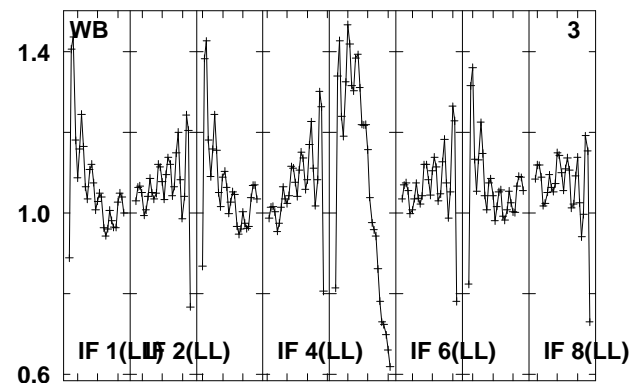
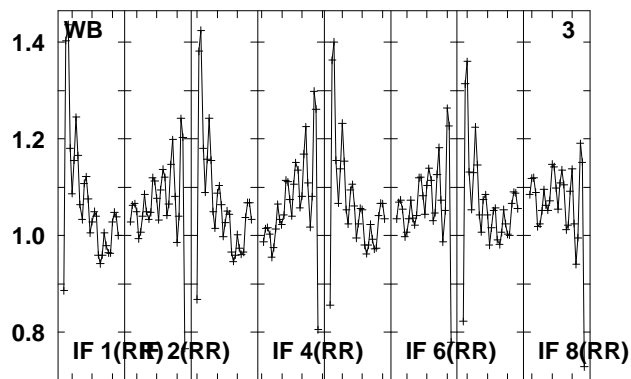
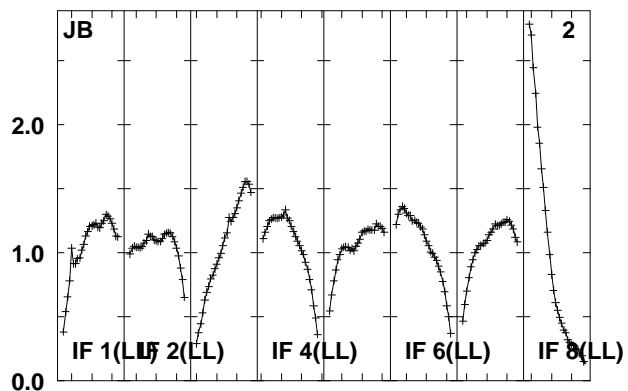
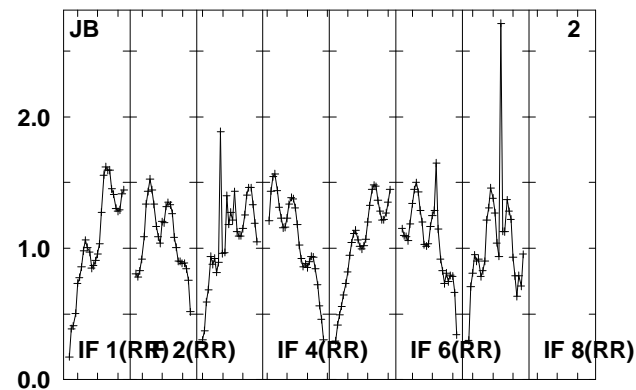
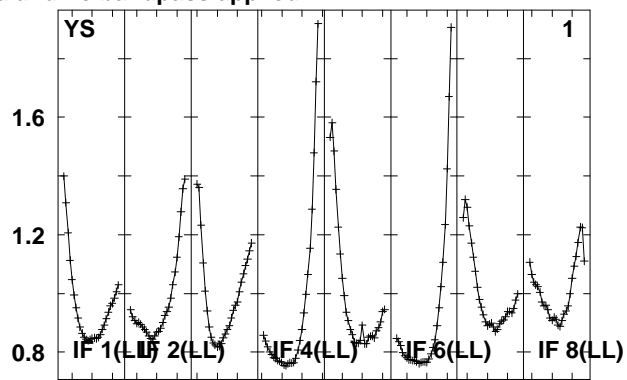
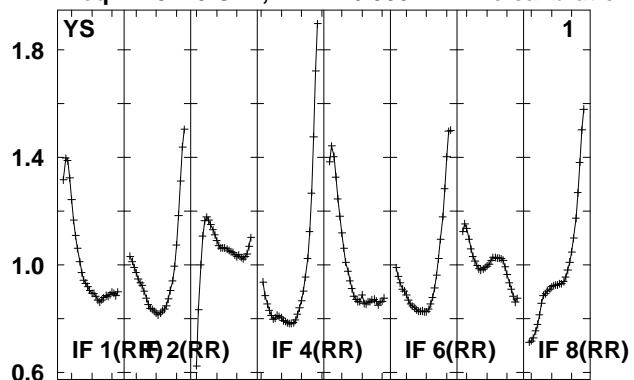

Lower frame: Real Jy
Total-power spectrum Antenna: *
Timerange: 00/12:29:58 to 00/12:31:24

Plot file version 340 created 14-MAY-2010 15:18:58

J0158+13 EO007.UVDATA.1

Freq = 4.9270 GHz, Bw = 16.000 MH No calibration applied and no bandpass applied

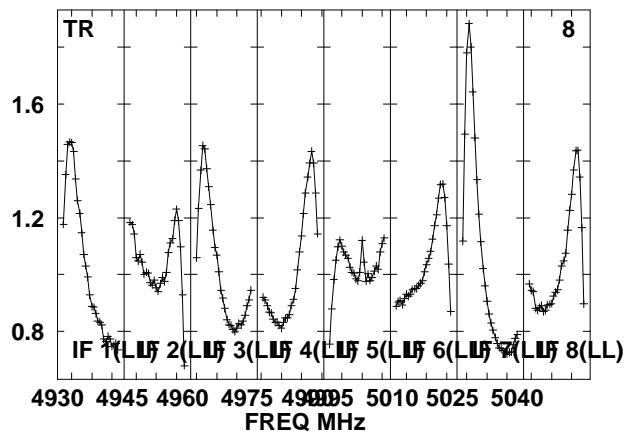
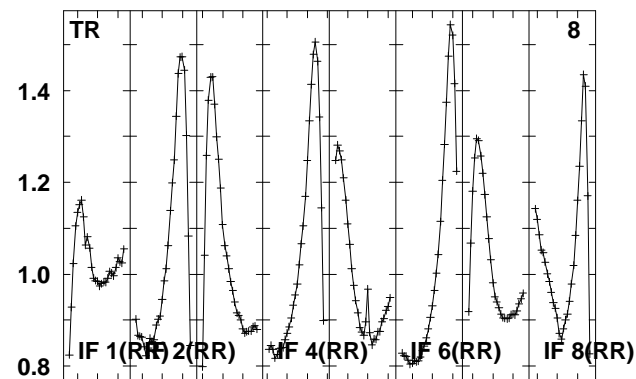
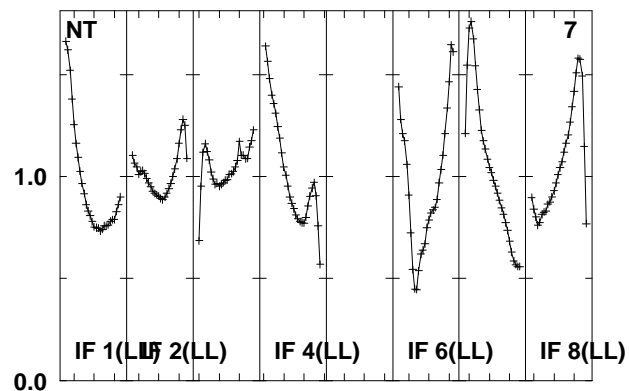
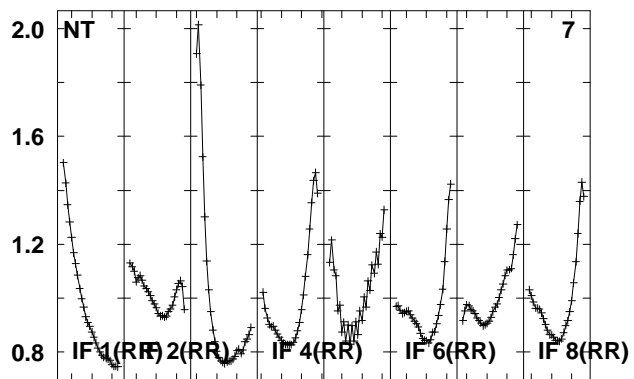
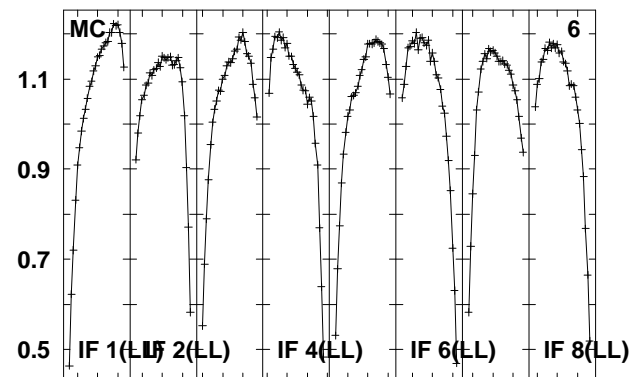
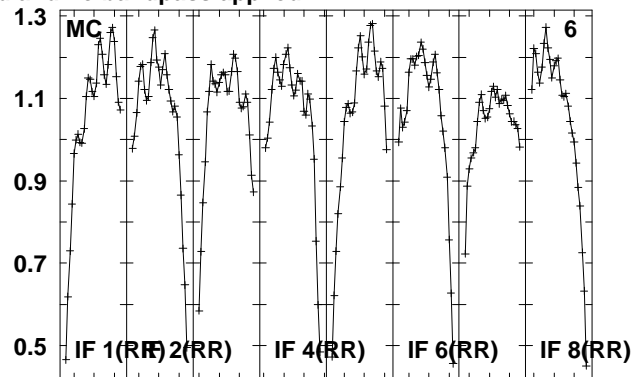
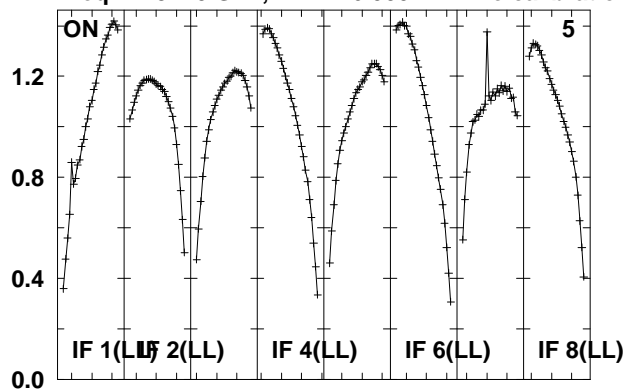

Lower frame: Real Jy

Total-power spectrum Antenna: *

Timerange: 00/12:29:58 to 00/12:31:24

Plot file version 341 created 14-MAY-2010 15:18:58

J0209+13 EO007.UVDATA.1

Freq = 4.9270 GHz, Bw = 16.000 MH No calibration applied and no bandpass applied

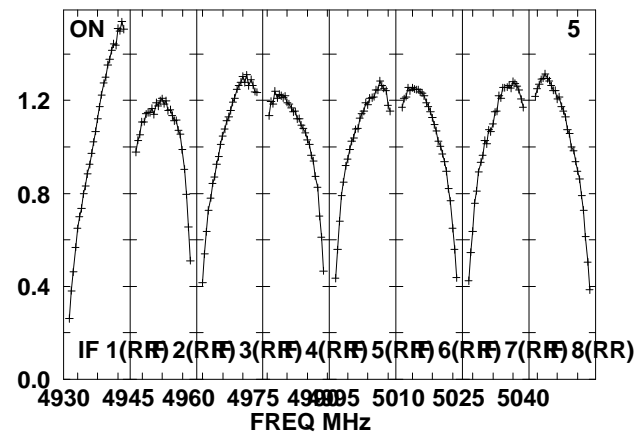
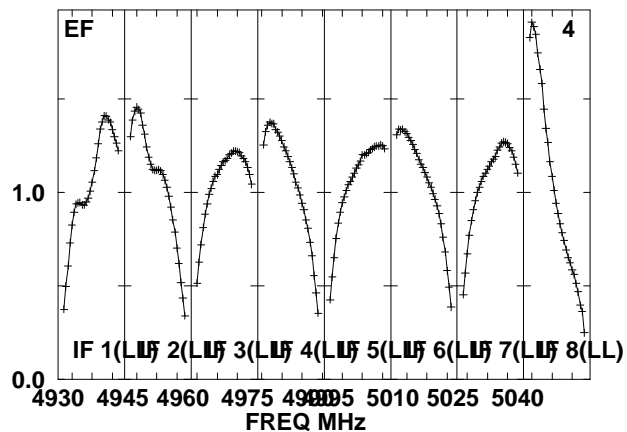
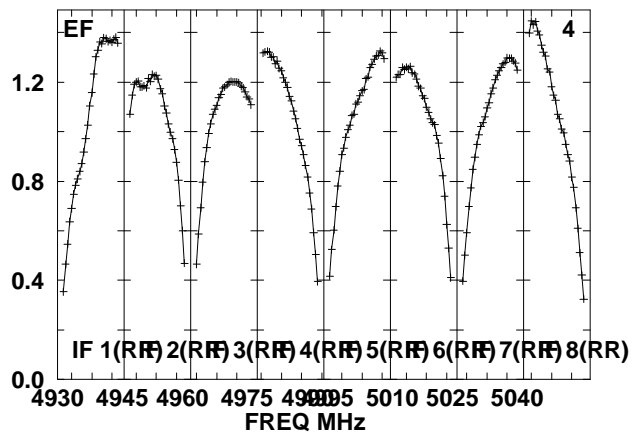
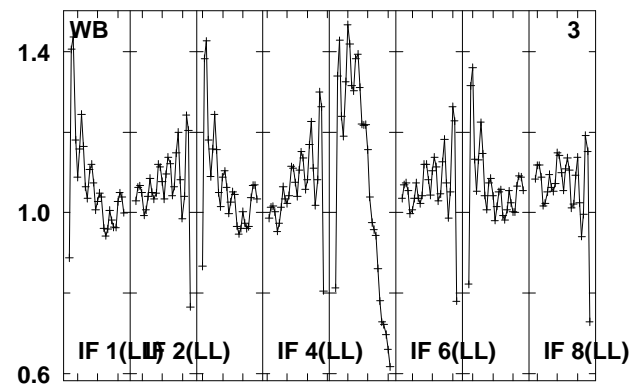
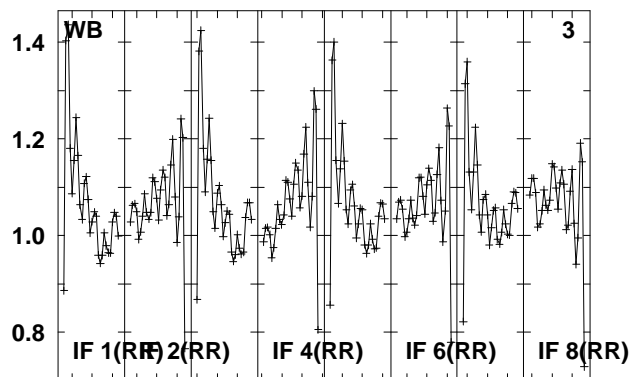
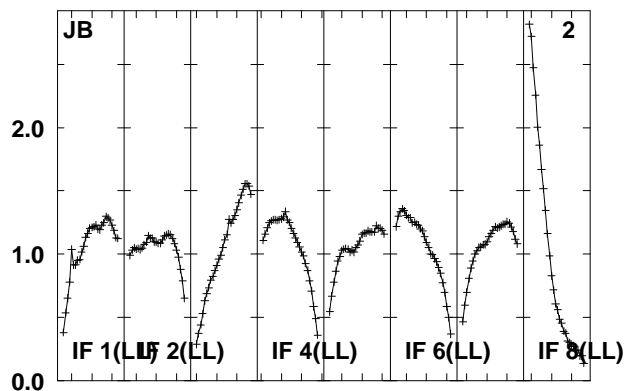
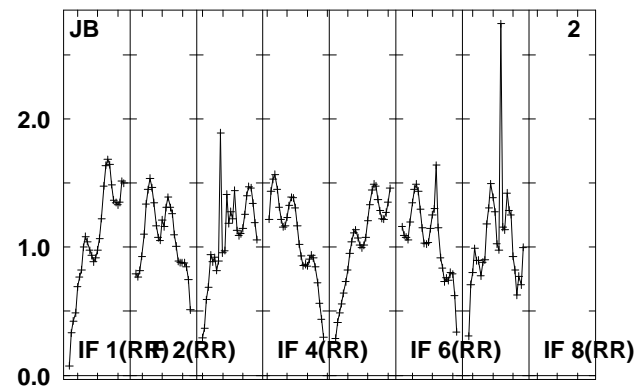
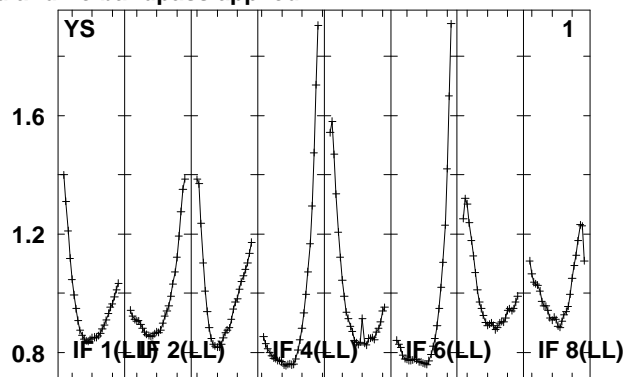
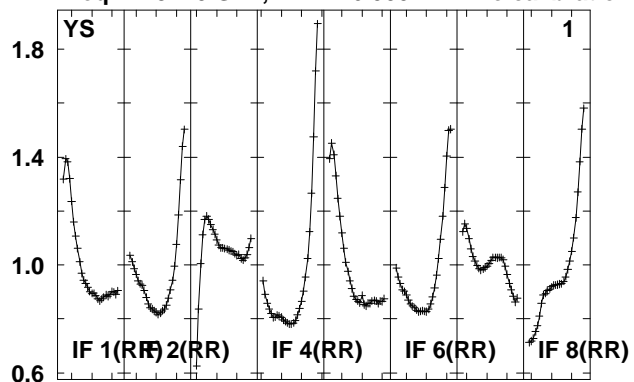

Lower frame: Real Jy
Total-power spectrum Antenna: *
Timerange: 00/12:32:05 to 00/12:33:33

Plot file version 342 created 14-MAY-2010 15:18:58

J0209+13 EO007.UVDATA.1

Freq = 4.9270 GHz, Bw = 16.000 MH No calibration applied and no bandpass applied

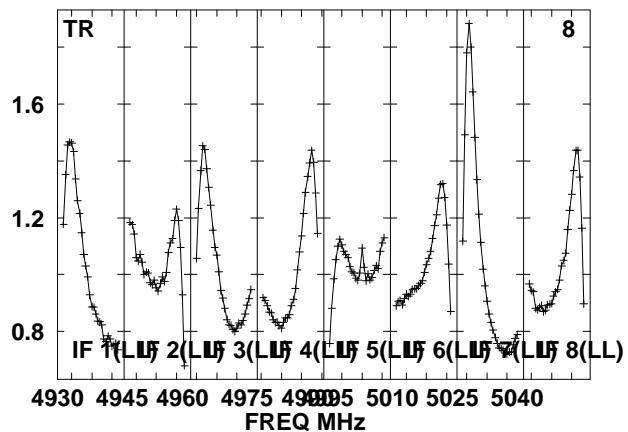
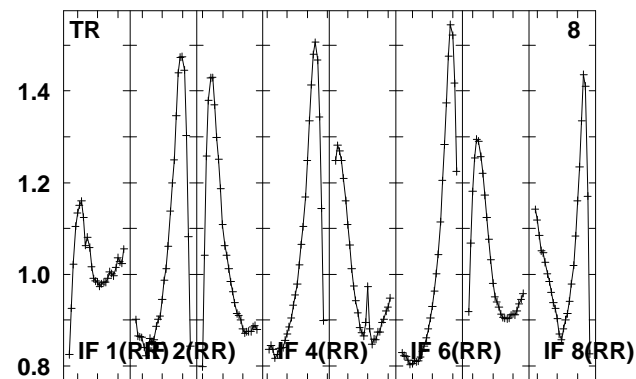
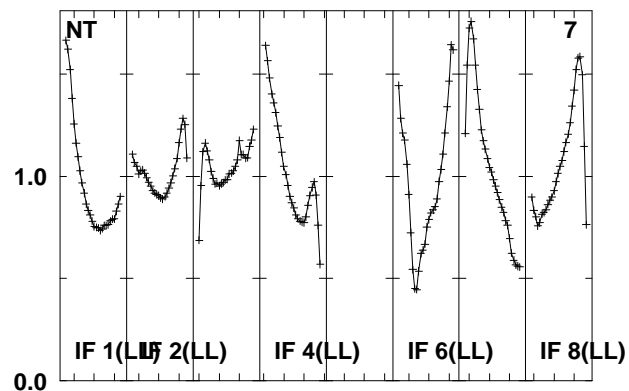
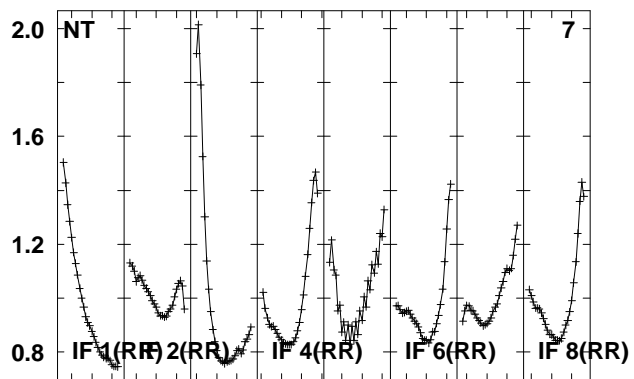
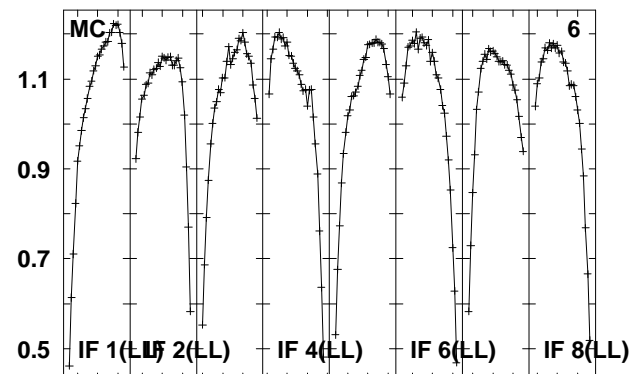
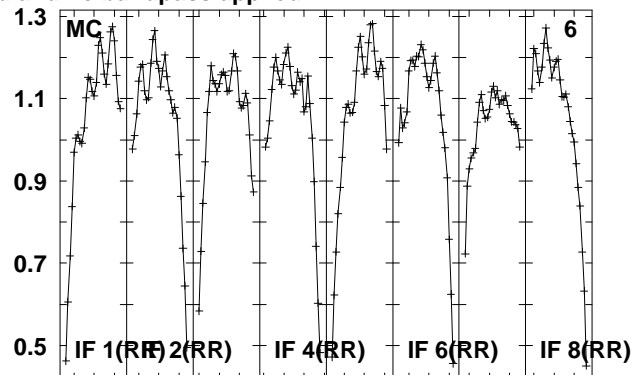
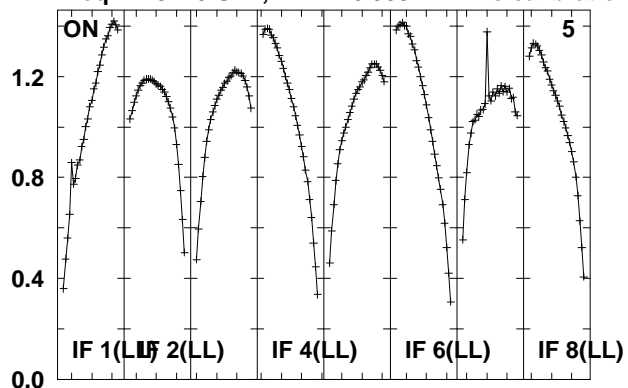

Lower frame: Real Jy

Total-power spectrum Antenna: *

Timerange: 00/12:32:05 to 00/12:33:33

Plot file version 343 created 14-MAY-2010 15:18:58

J021348 EO007.UVDATA.1

Freq = 4.9270 GHz, Bw = 16.000 MH No calibration applied and no bandpass applied

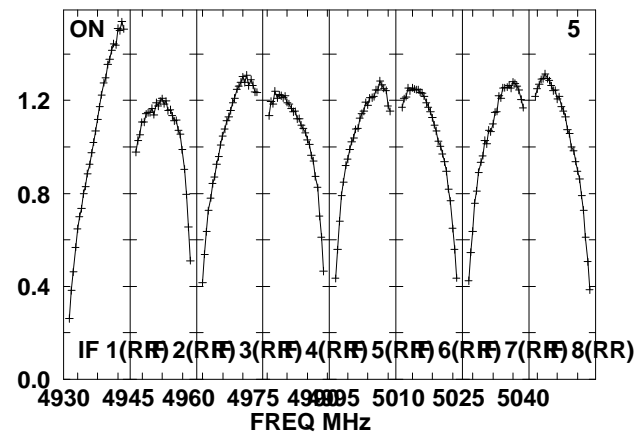
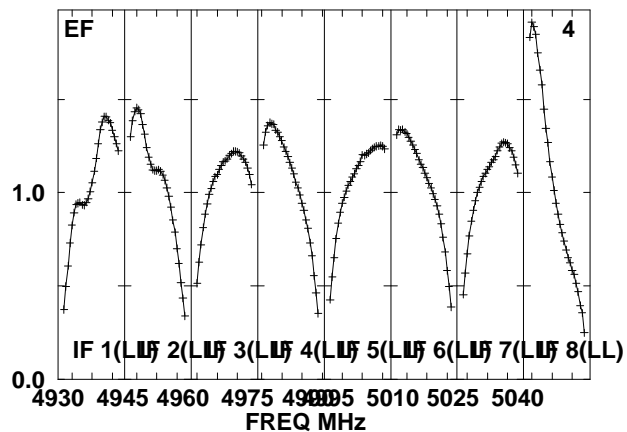
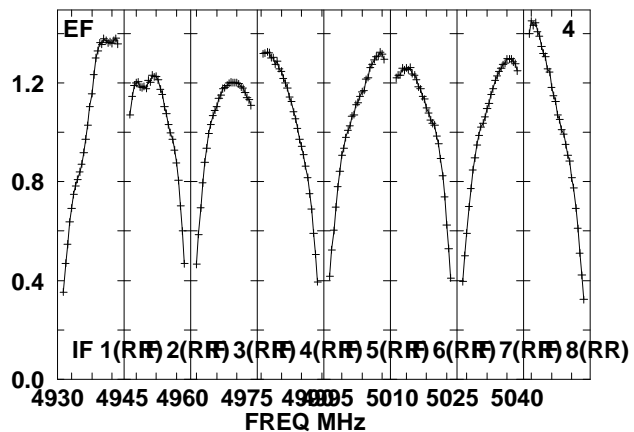
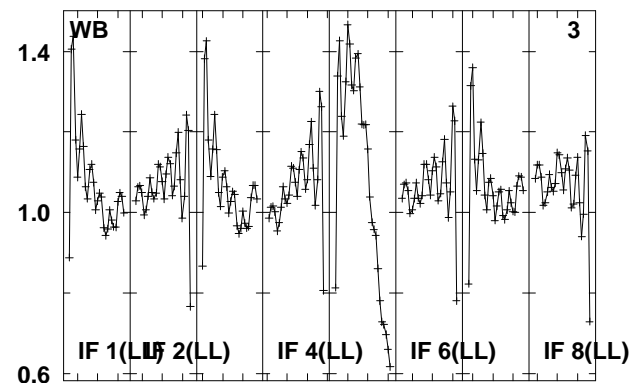
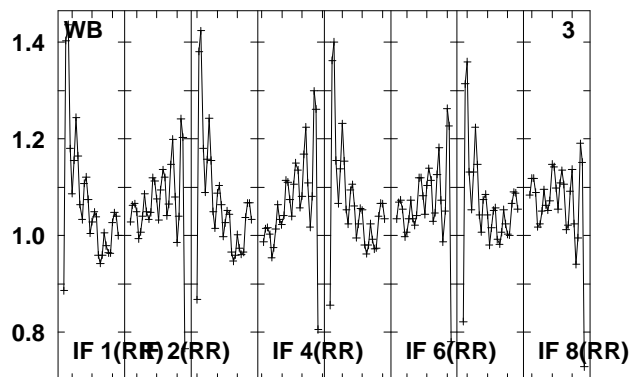
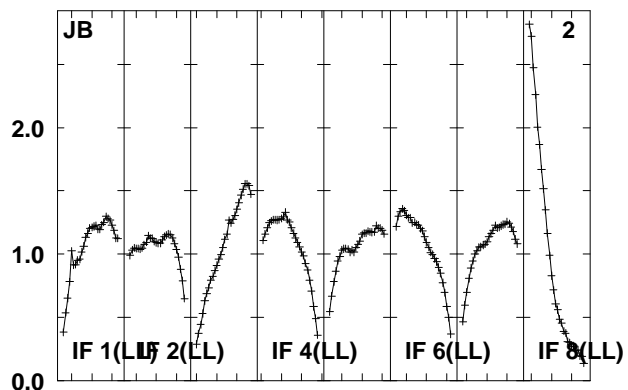
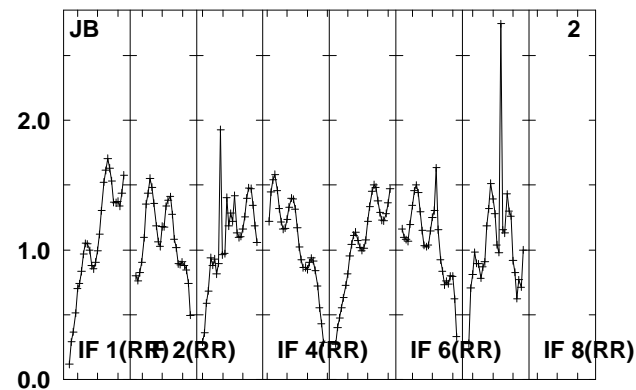
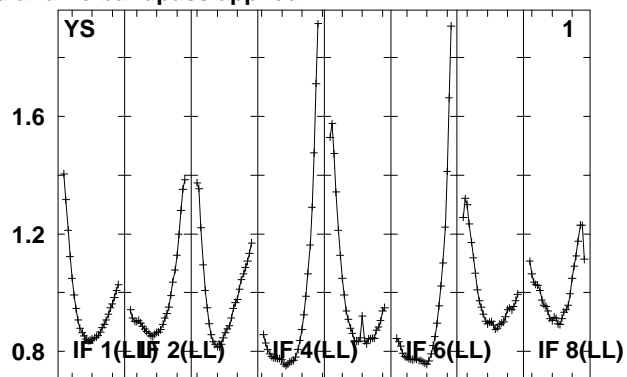
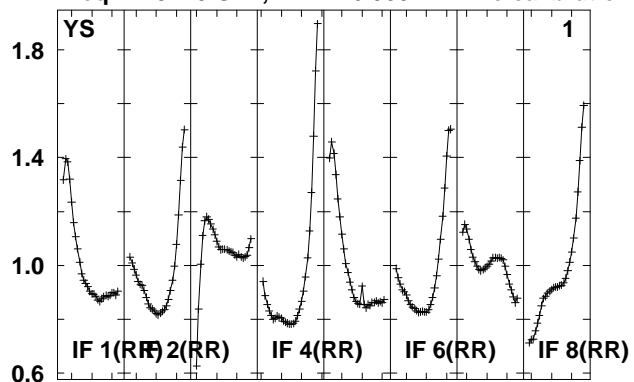

Lower frame: Real Jy

Total-power spectrum Antenna: *

Timerange: 00/12:34:01 to 00/12:38:59

Plot file version 344 created 14-MAY-2010 15:18:59

J021348 EO007.UVDATA.1

Freq = 4.9270 GHz, Bw = 16.000 MH No calibration applied and no bandpass applied

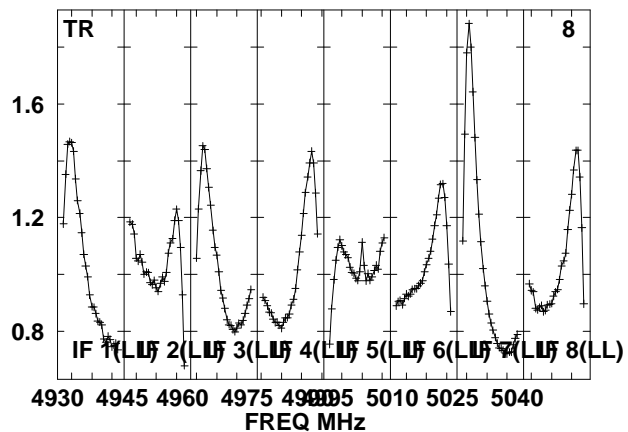
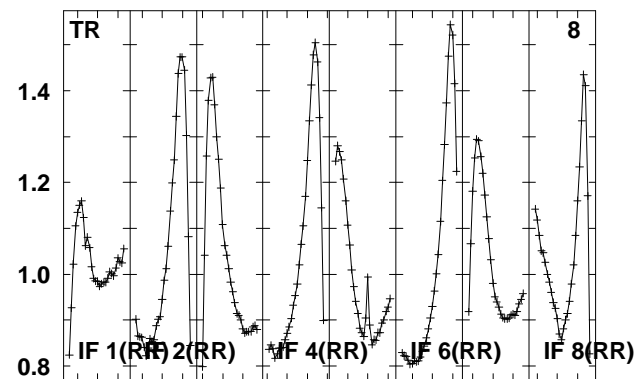
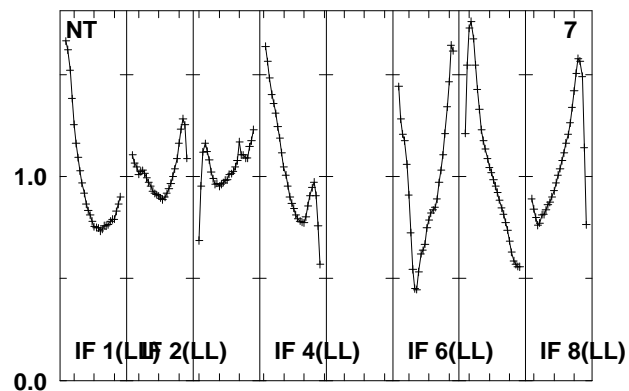
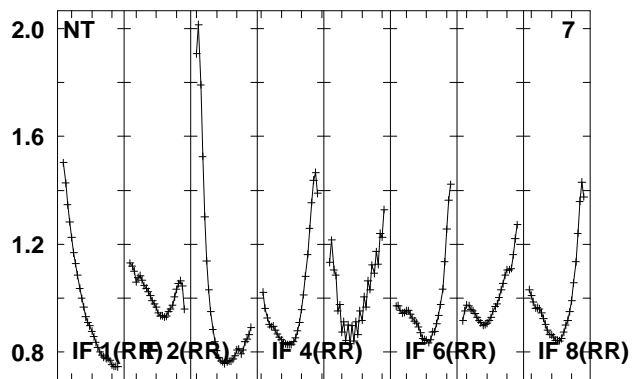
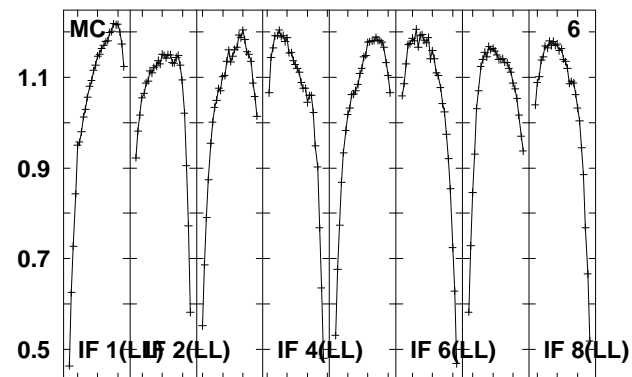
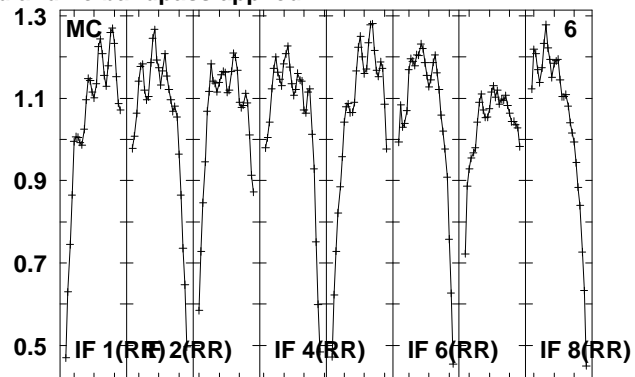
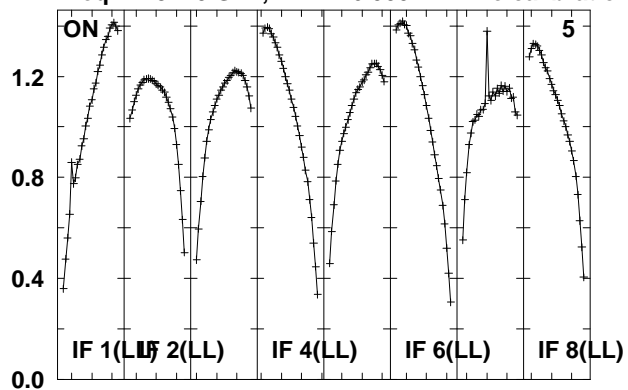

Lower frame: Real Jy

Total-power spectrum Antenna: *

Timerange: 00/12:34:01 to 00/12:38:59

Plot file version 345 created 14-MAY-2010 15:19:00

J0209+13 EO007.UVDATA.1

Freq = 4.9270 GHz, Bw = 16.000 MH No calibration applied and no bandpass applied

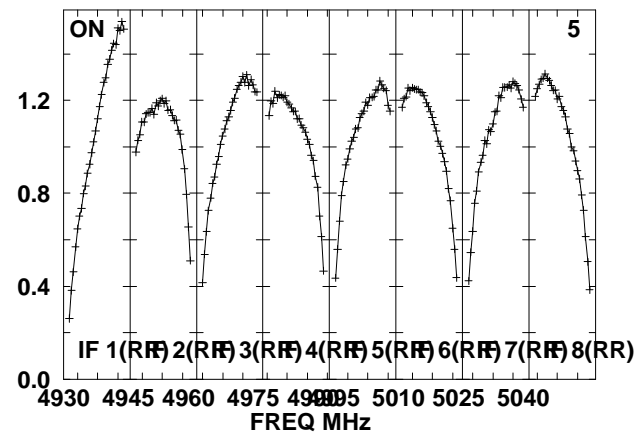
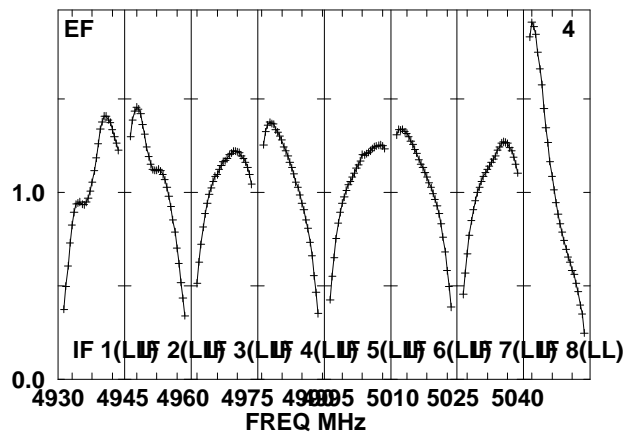
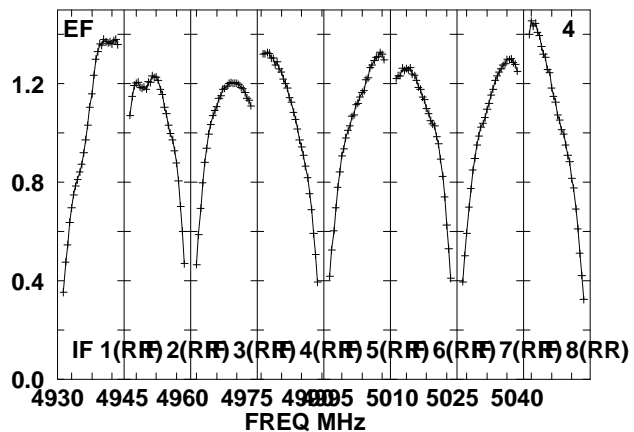
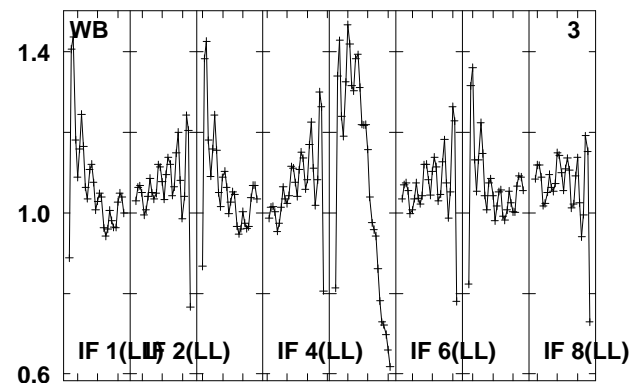
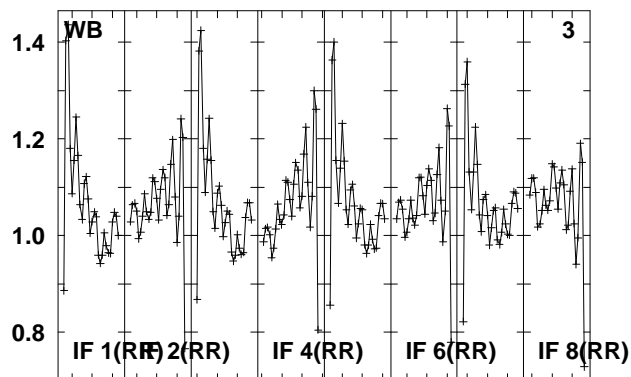
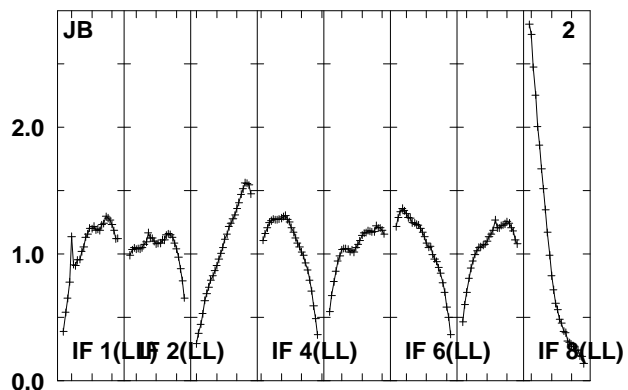
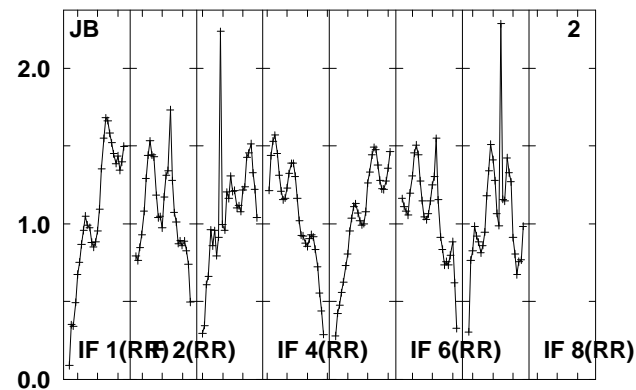
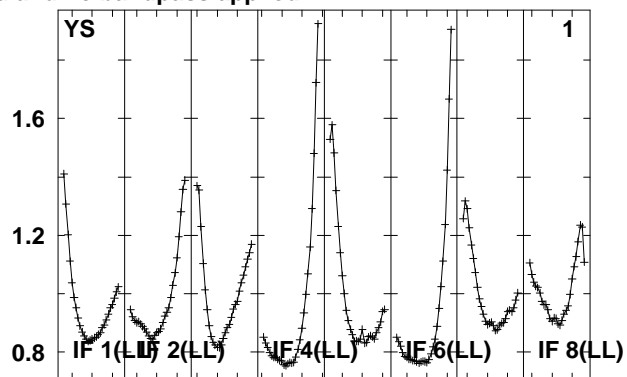
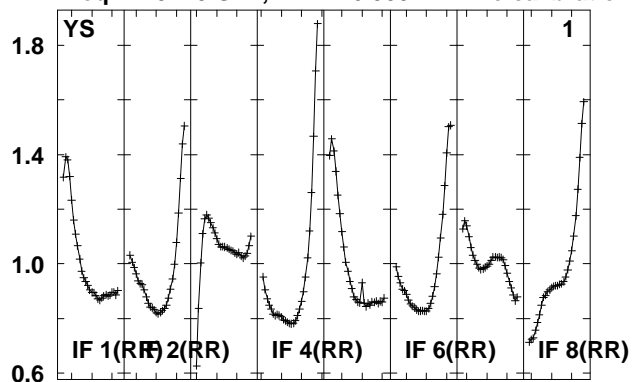

Lower frame: Real Jy

Total-power spectrum Antenna: *

Timerange: 00/12:39:25 to 00/12:40:51

Plot file version 346 created 14-MAY-2010 15:19:00

J0209+13 EO007.UVDATA.1

Freq = 4.9270 GHz, Bw = 16.000 MH No calibration applied and no bandpass applied

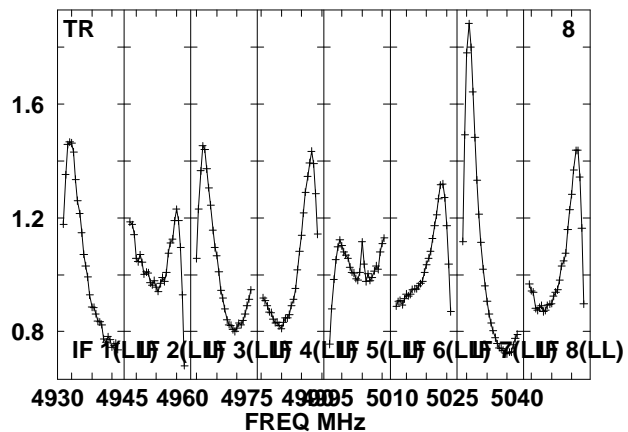
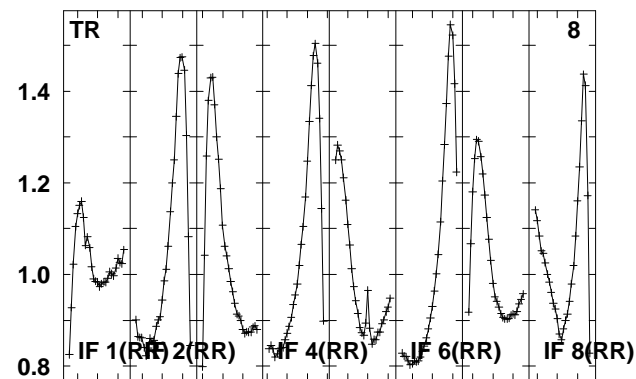
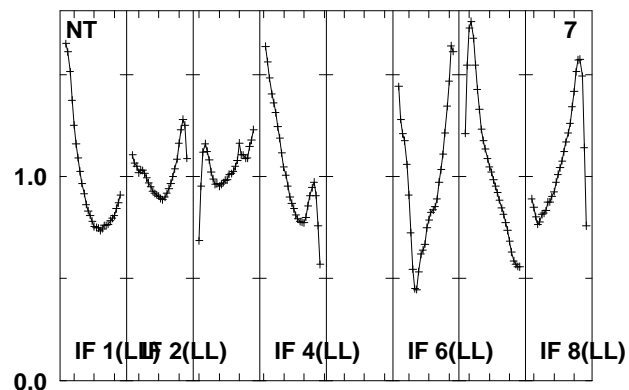
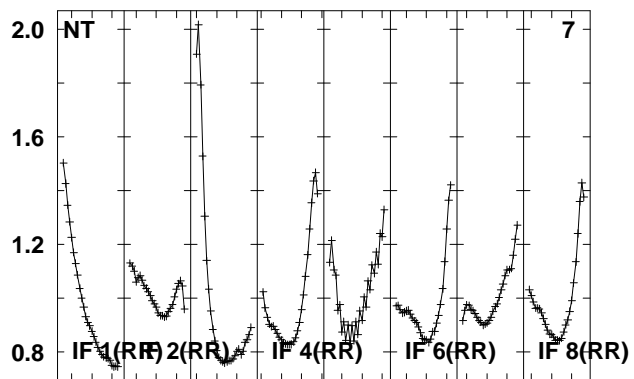
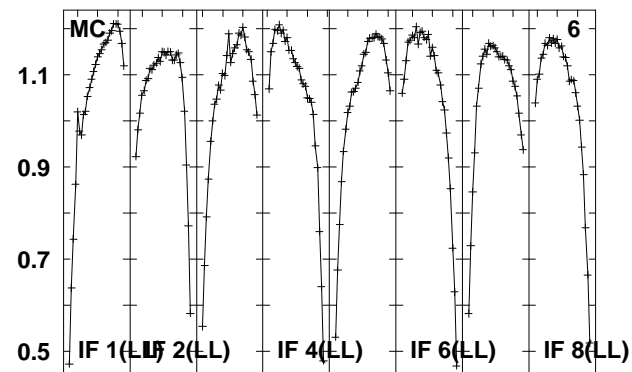
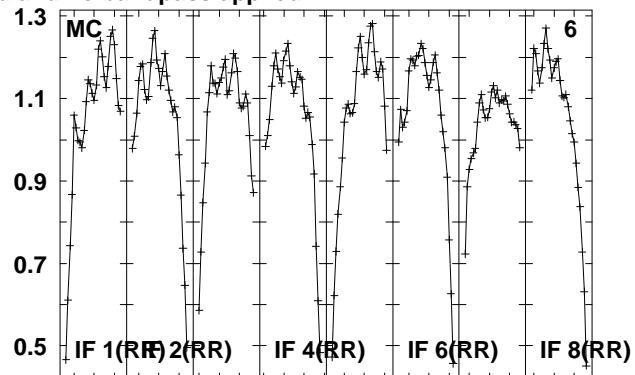
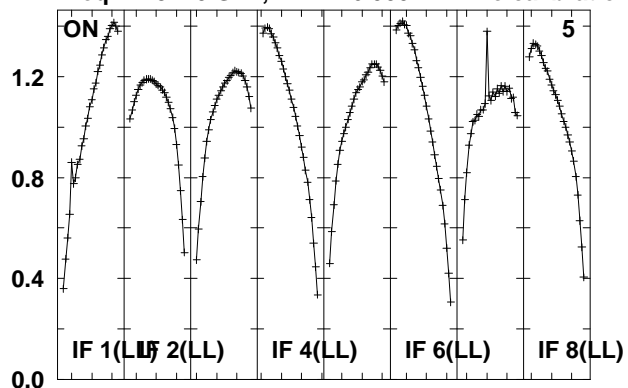

Lower frame: Real Jy

Total-power spectrum Antenna: *

Timerange: 00/12:39:25 to 00/12:40:51

Plot file version 347 created 14-MAY-2010 15:19:00
 J021348 EO007.UVDATA.1
 Freq = 4.9270 GHz, Bw = 16.000 MH No calibration applied and no bandpass applied

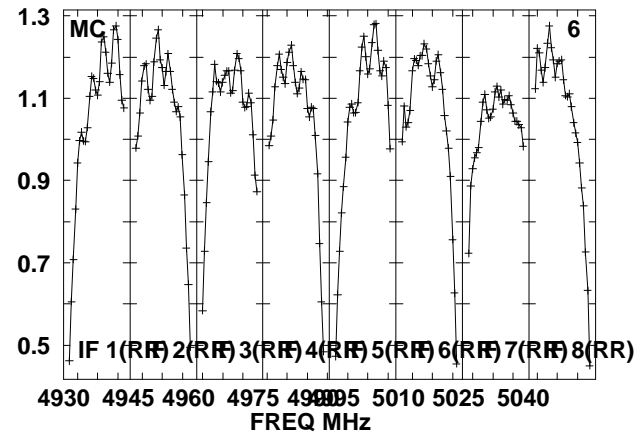
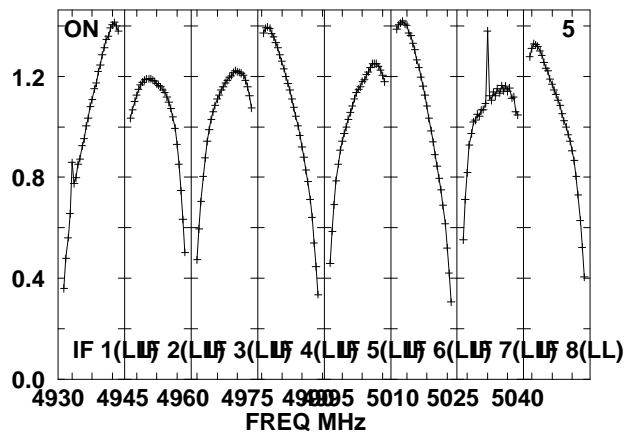
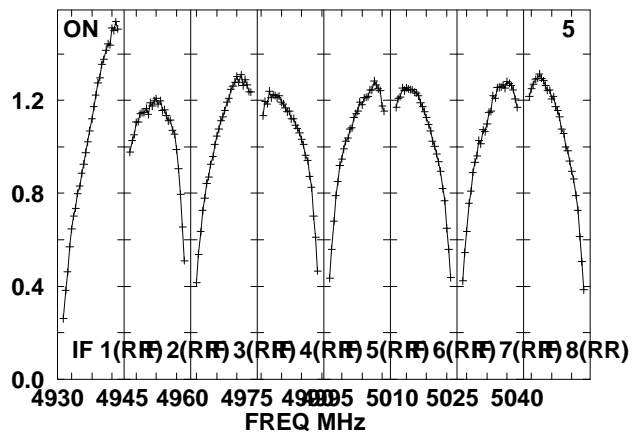
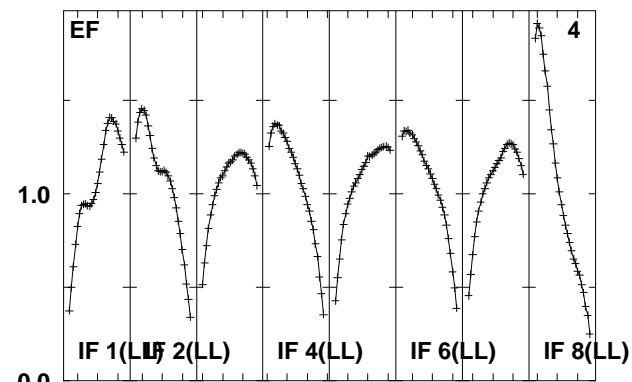
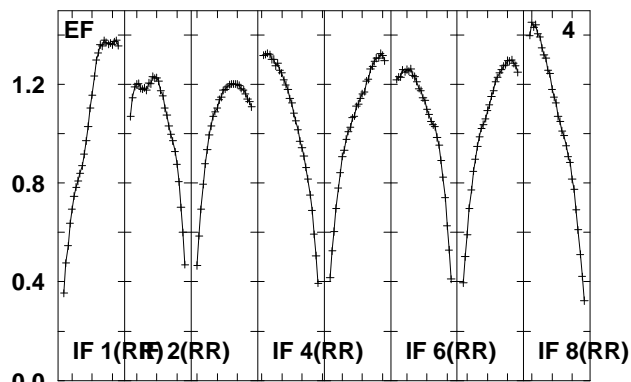
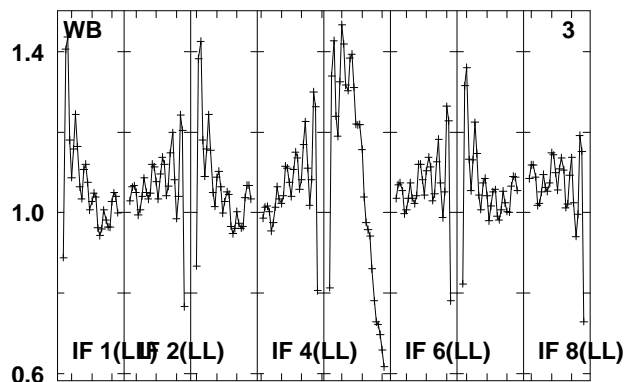
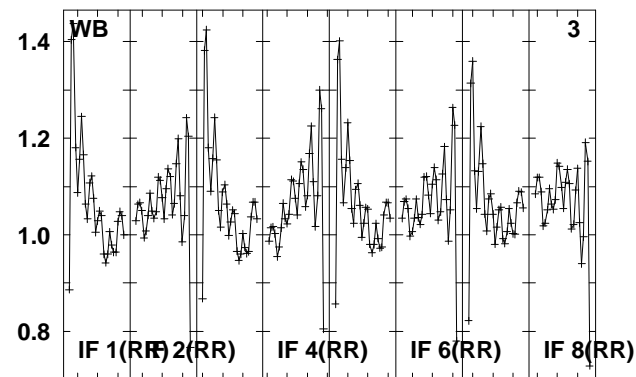
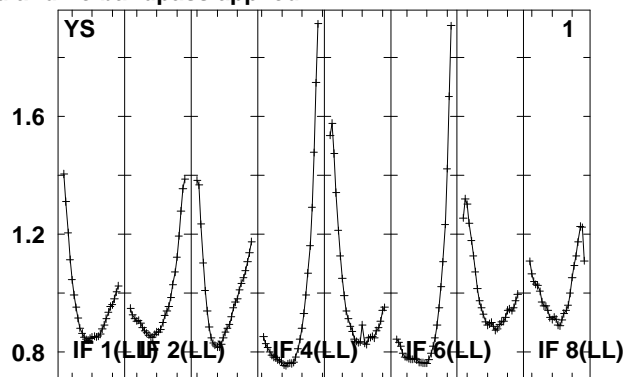
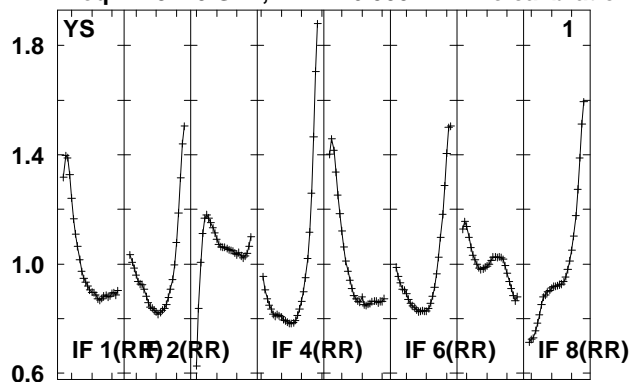

Lower frame: Real Jy
 Total-power spectrum Antenna: *
 Timerange: 00/12:41:17 to 00/12:46:15

Plot file version 348 created 14-MAY-2010 15:19:01

J021348 EO007.UVDATA.1

Freq = 4.9270 GHz, Bw = 16.000 MH No calibration applied and no bandpass applied

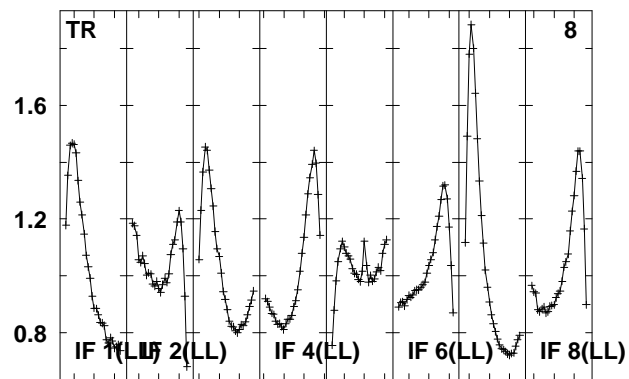
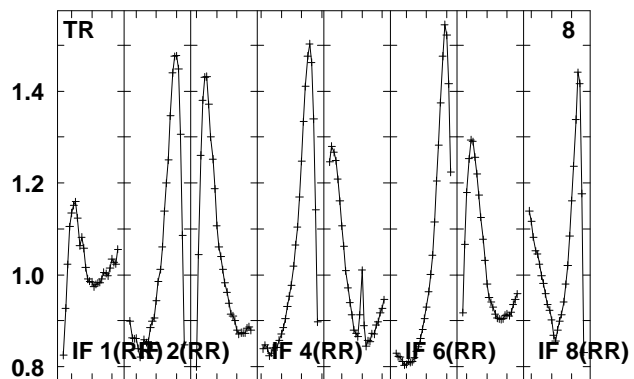
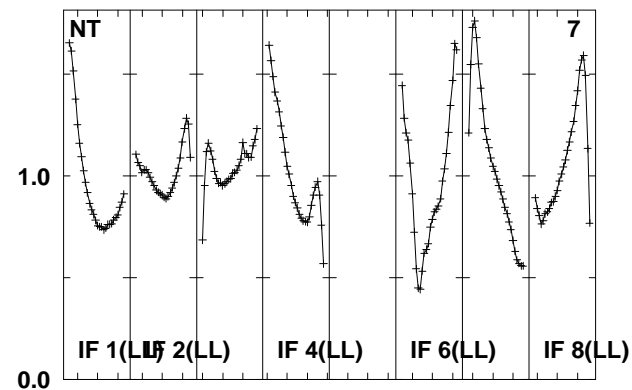
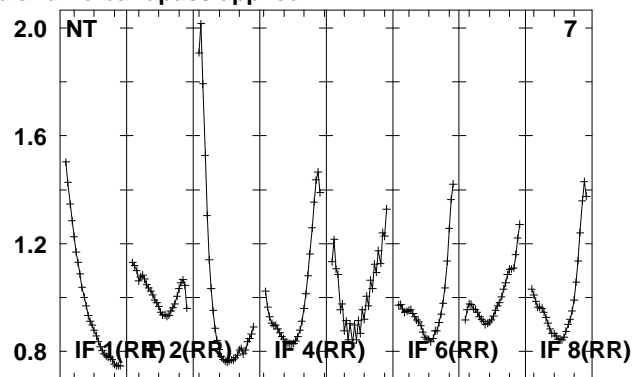
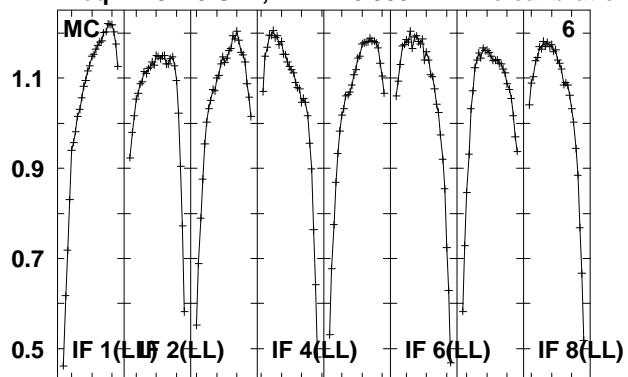

Lower frame: Real Jy
Total-power spectrum Antenna: *
Timerange: 00/12:41:17 to 00/12:46:15

Plot file version 349 created 14-MAY-2010 15:19:01
 J0209+13 EO007.UVDATA.1
 Freq = 4.9270 GHz, Bw = 16.000 MH No calibration applied and no bandpass applied

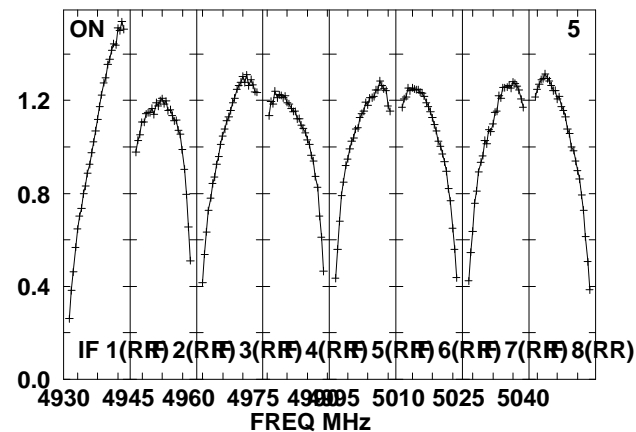
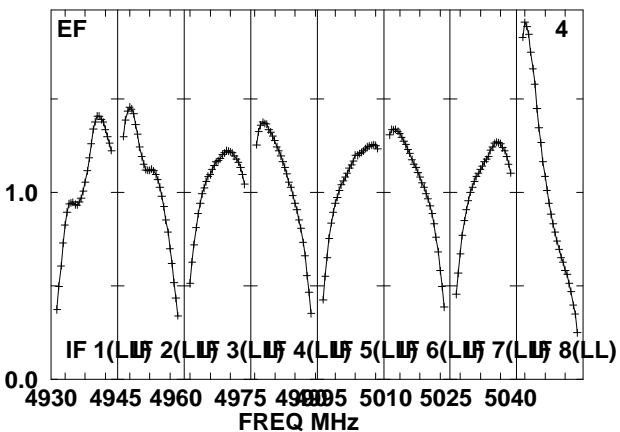
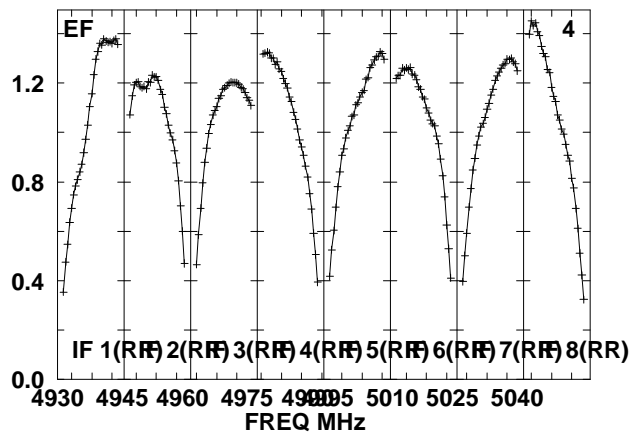
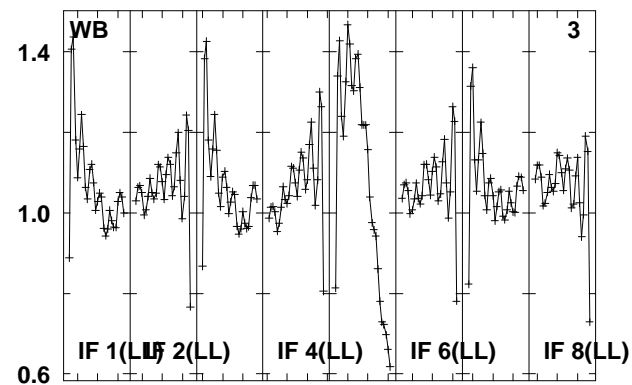
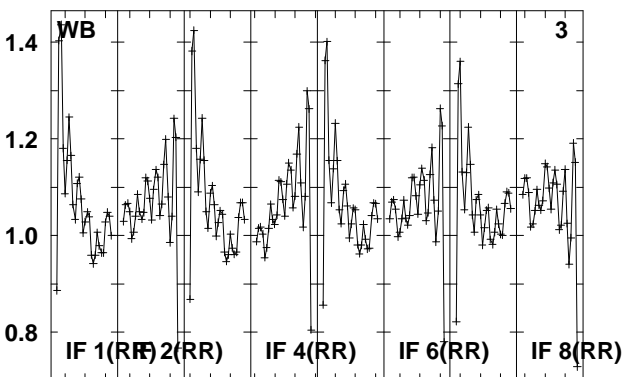
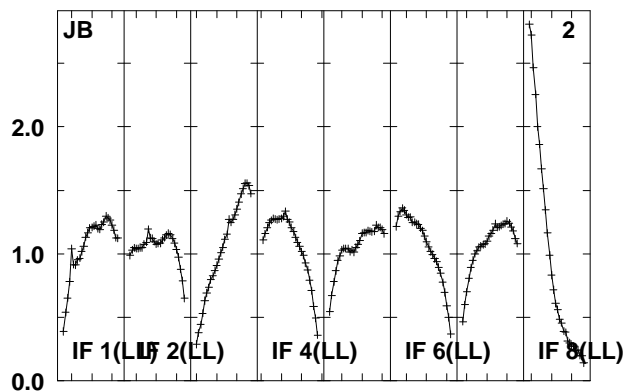
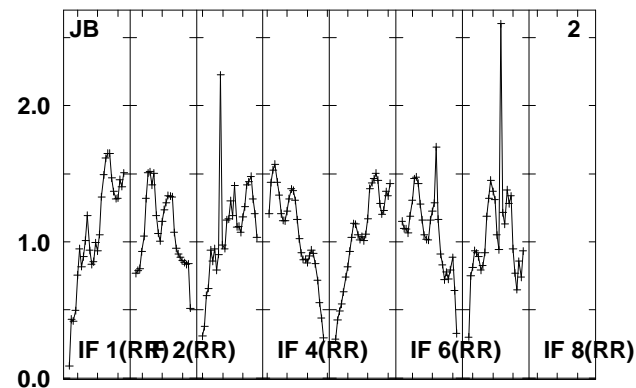
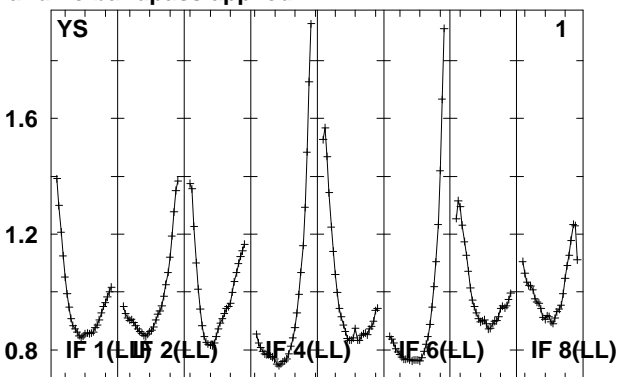
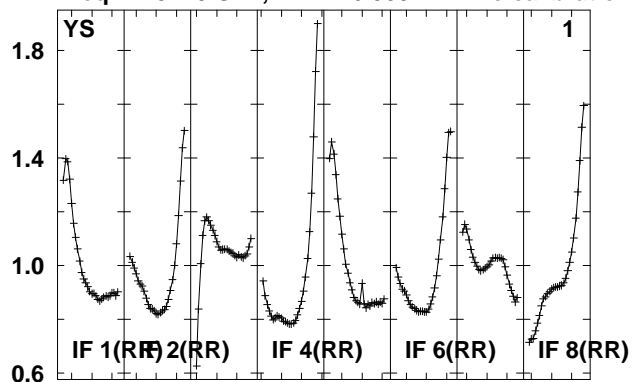

Lower frame: Real Jy
 Total-power spectrum Antenna: *
 Timerange: 00/12:46:43 to 00/12:48:11

Plot file version 350 created 14-MAY-2010 15:19:01

J0209+13 EO007.UVDATA.1

Freq = 4.9270 GHz, Bw = 16.000 MH No calibration applied and no bandpass applied

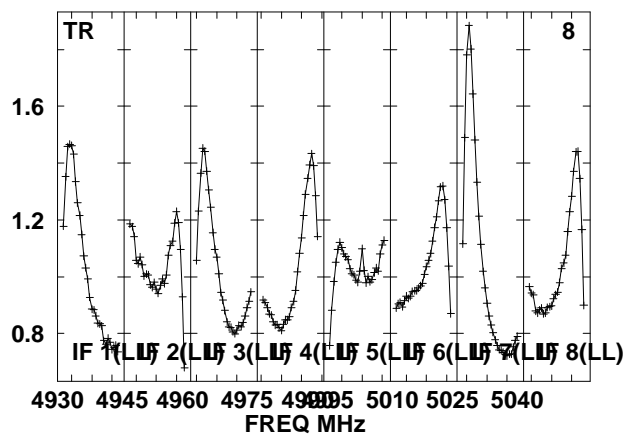
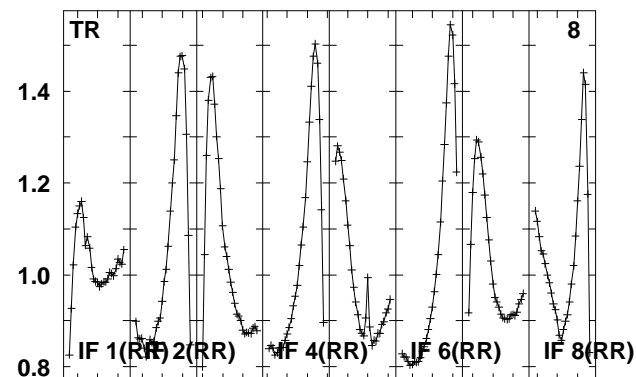
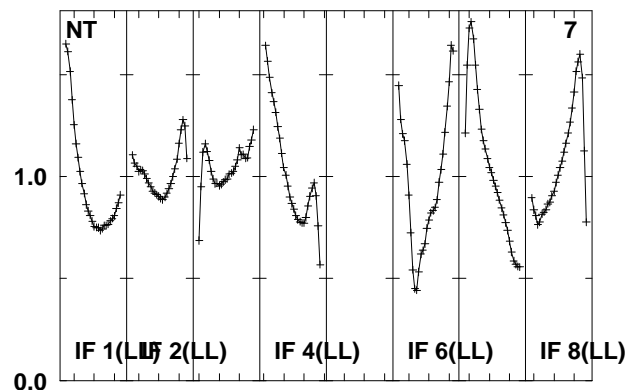
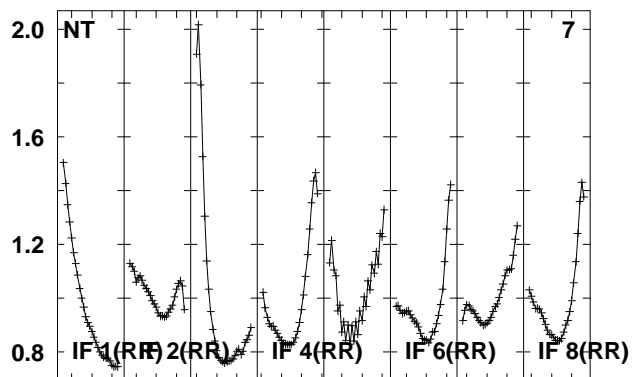
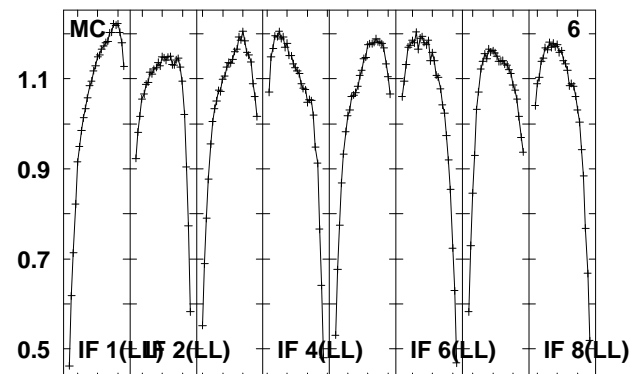
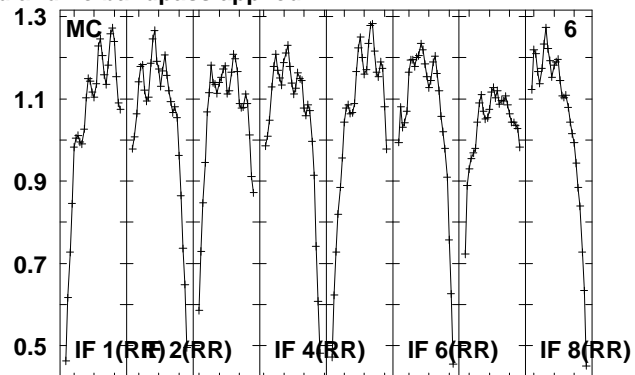
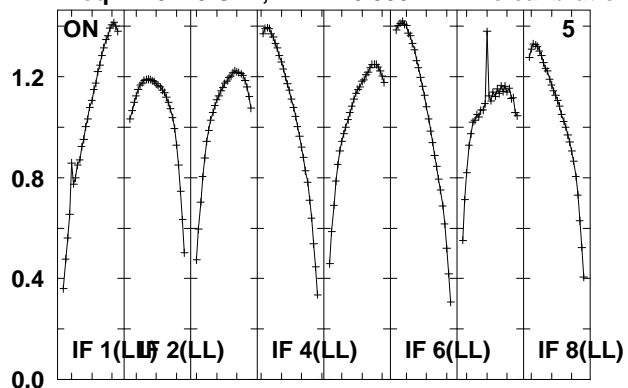

Lower frame: Real Jy

Total-power spectrum Antenna: *

Timerange: 00/12:46:43 to 00/12:48:11

Plot file version 351 created 14-MAY-2010 15:19:02

J0158+13 EO007.UVDATA.1

Freq = 4.9270 GHz, Bw = 16.000 MH No calibration applied and no bandpass applied

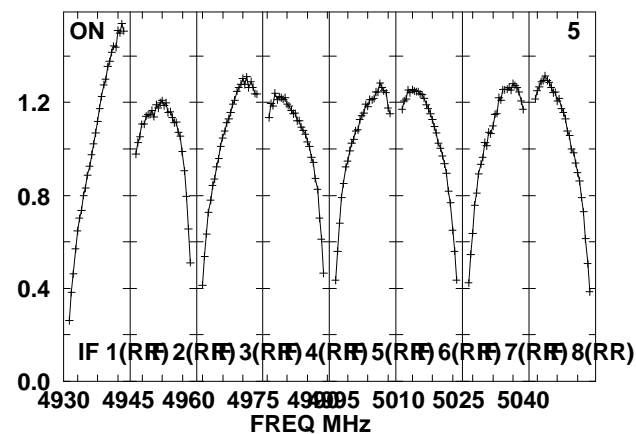
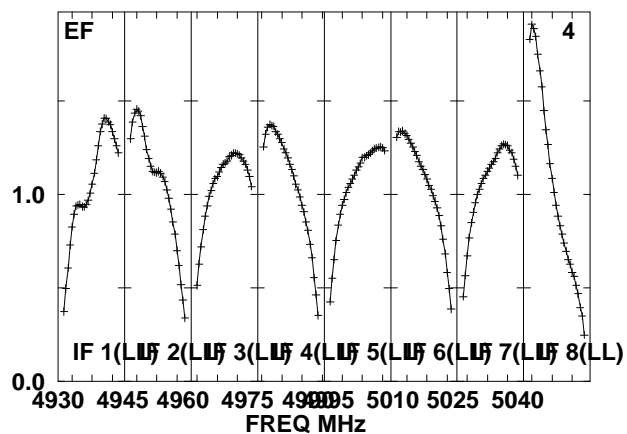
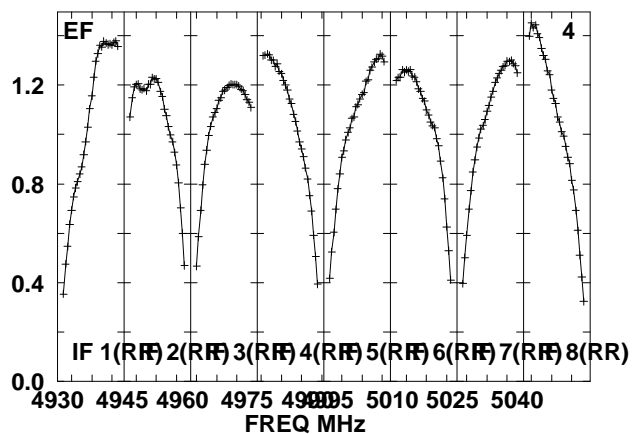
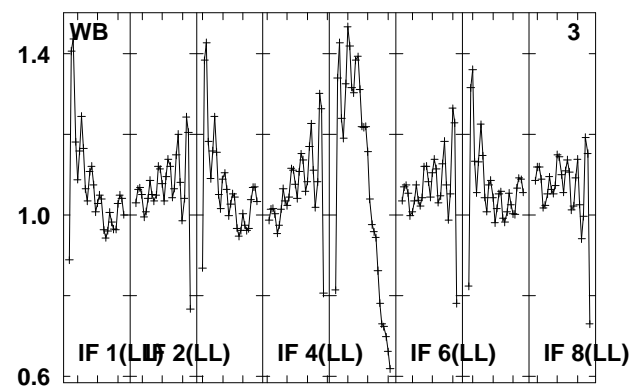
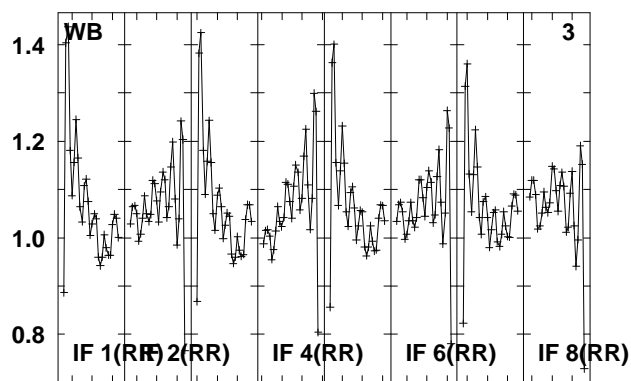
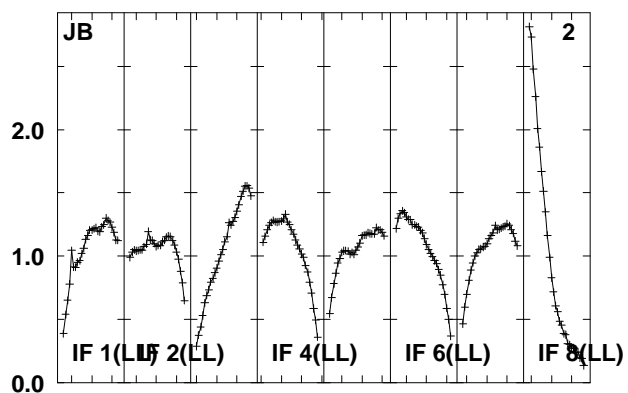
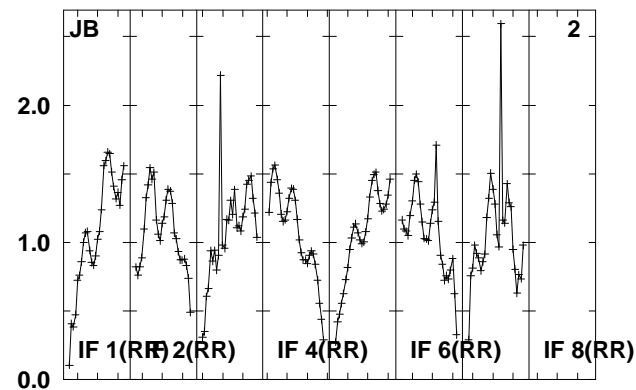
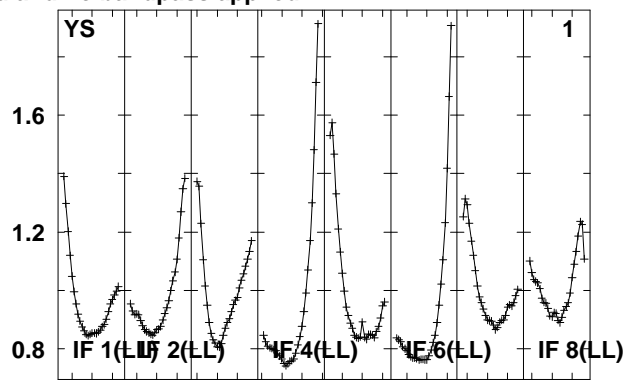
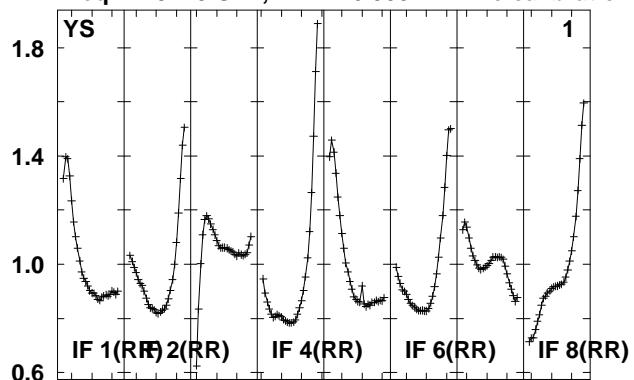

Lower frame: Real Jy
Total-power spectrum Antenna: *
Timerange: 00/12:48:51 to 00/12:50:19

Plot file version 352 created 14-MAY-2010 15:19:02

J0158+13 EO007.UVDATA.1

Freq = 4.9270 GHz, Bw = 16.000 MH No calibration applied and no bandpass applied

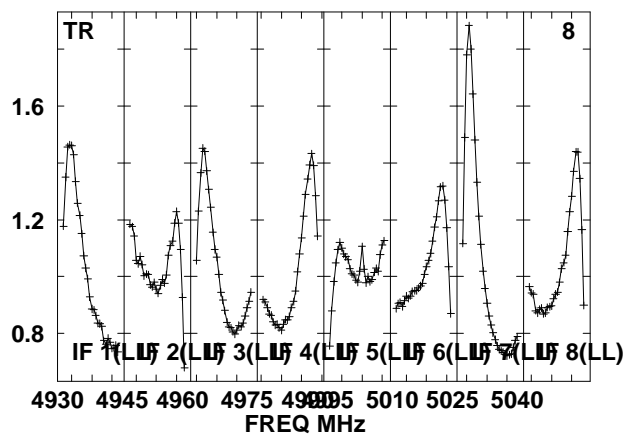
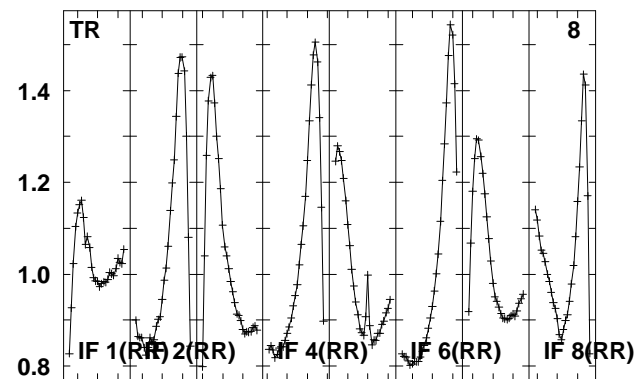
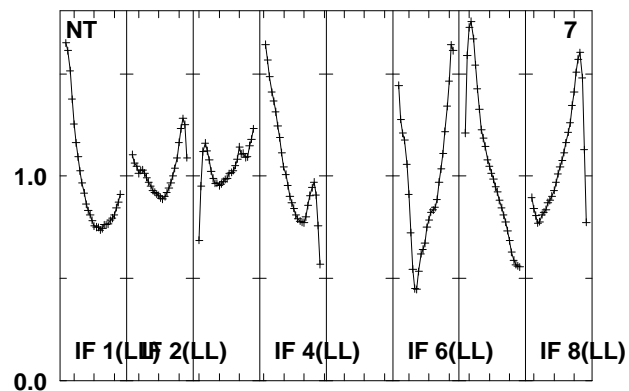
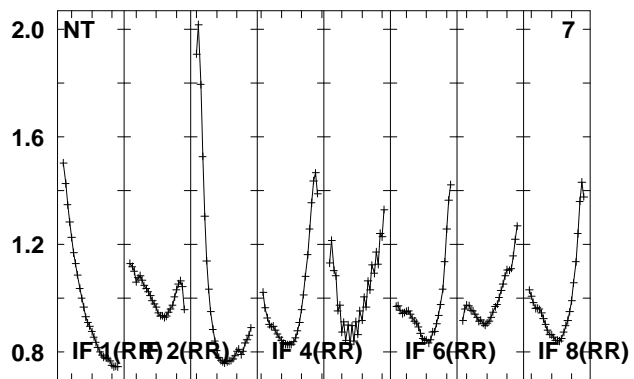
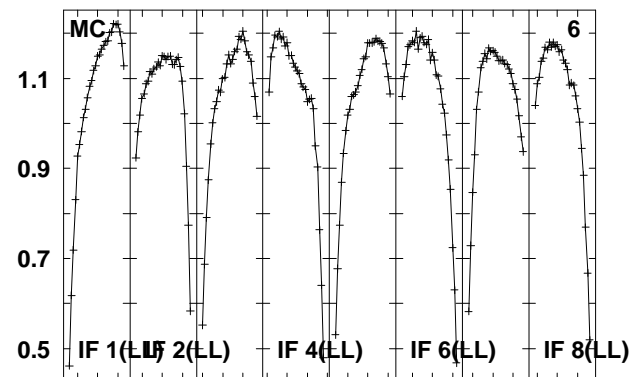
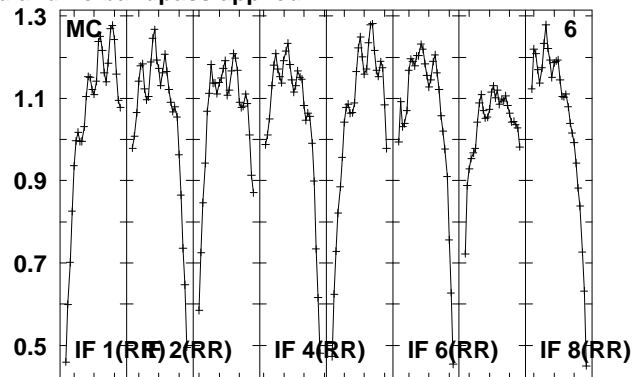
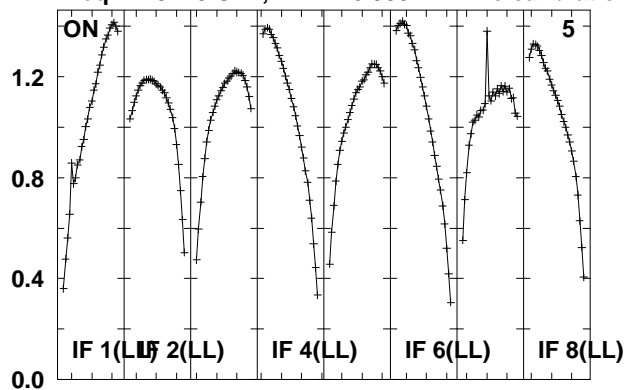

Lower frame: Real Jy

Total-power spectrum Antenna: *

Timerange: 00/12:48:51 to 00/12:50:19

Plot file version 353 created 14-MAY-2010 15:19:02
 J015028 EO007.UVDATA.1
 Freq = 4.9270 GHz, Bw = 16.000 MH No calibration applied and no bandpass applied

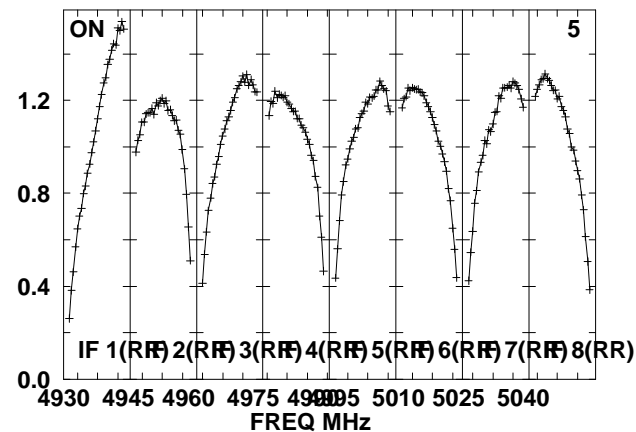
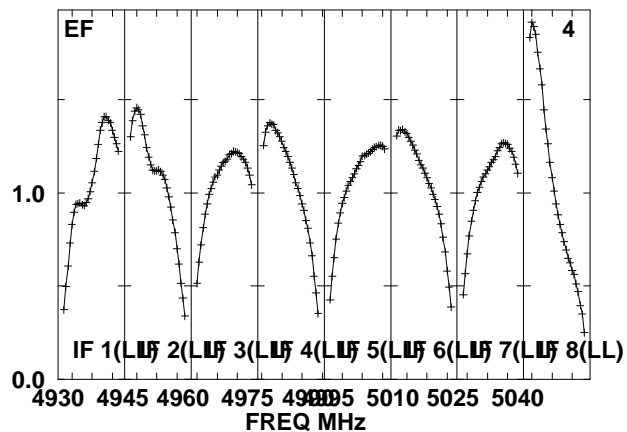
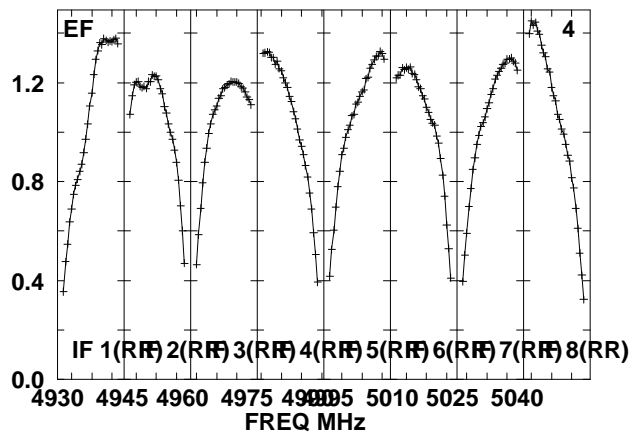
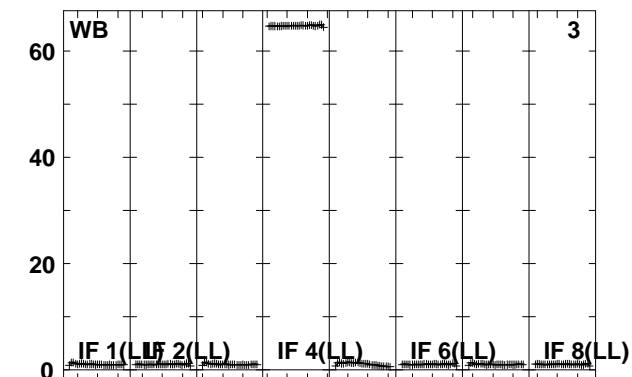
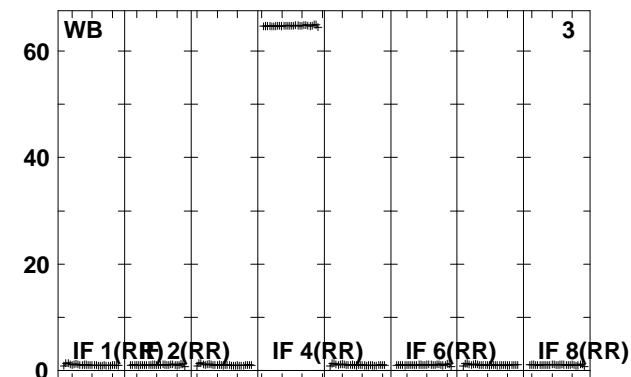
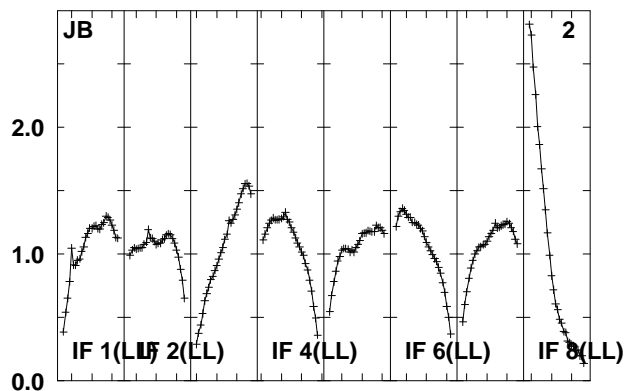
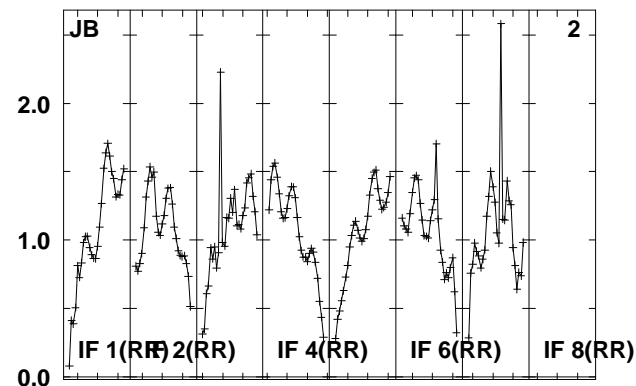
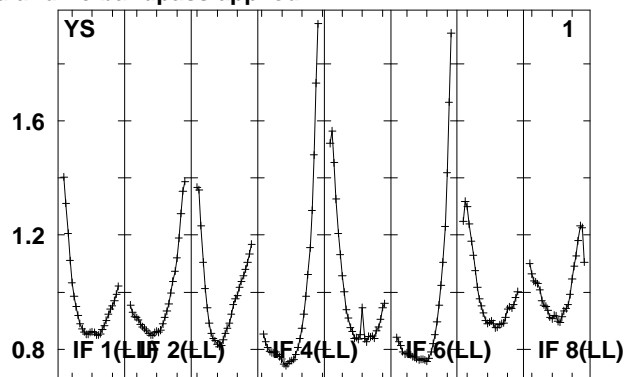
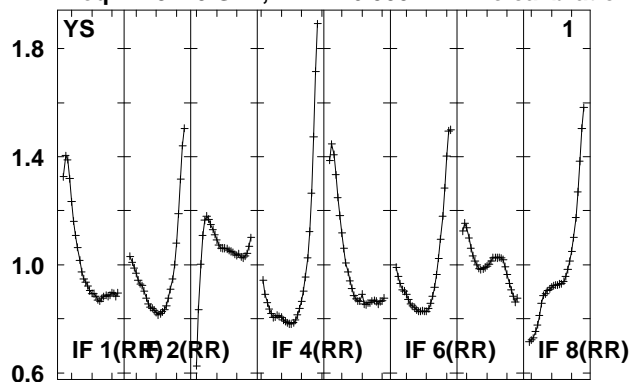

Lower frame: Real Jy
 Total-power spectrum Antenna: *
 Timerange: 00/12:50:57 to 00/12:55:55

Plot file version 354 created 14-MAY-2010 15:19:03

J015028 EO007.UVDATA.1

Freq = 4.9270 GHz, Bw = 16.000 MH No calibration applied and no bandpass applied

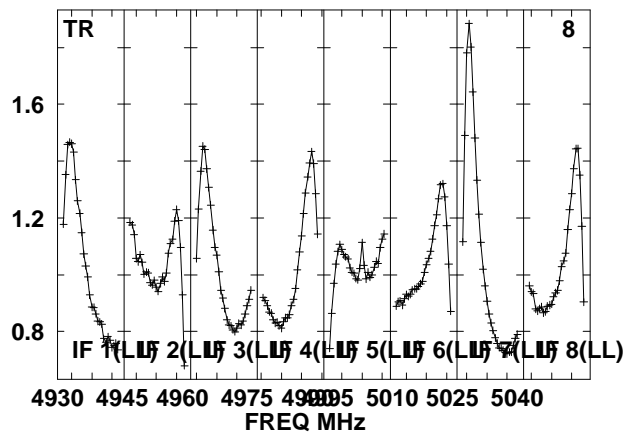
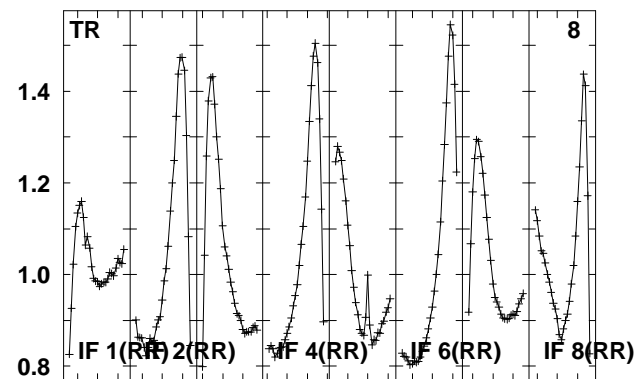
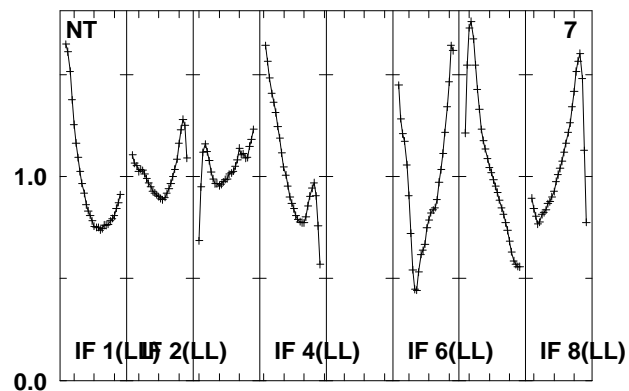
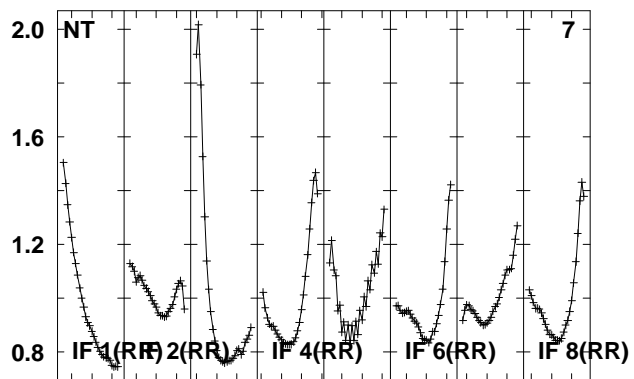
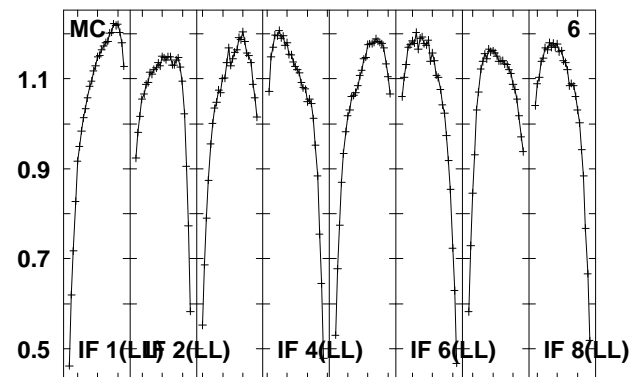
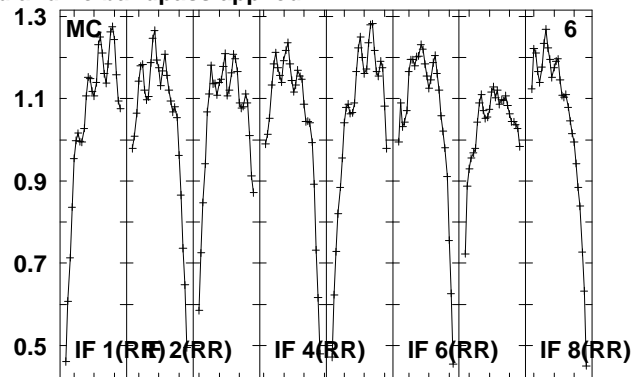
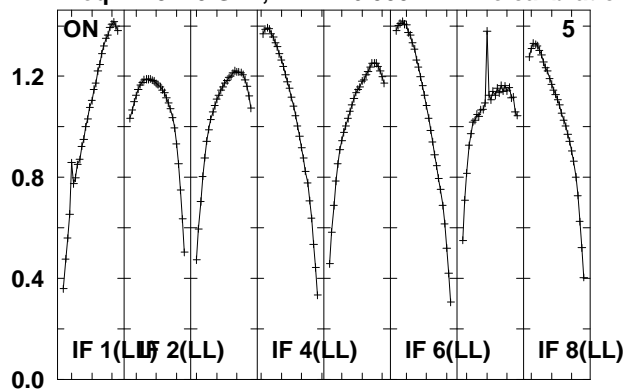

Lower frame: Real Jy

Total-power spectrum Antenna: *

Timerange: 00/12:50:57 to 00/12:55:55

Plot file version 355 created 14-MAY-2010 15:19:03

J0158+13 EO007.UVDATA.1

Freq = 4.9270 GHz, Bw = 16.000 MH No calibration applied and no bandpass applied

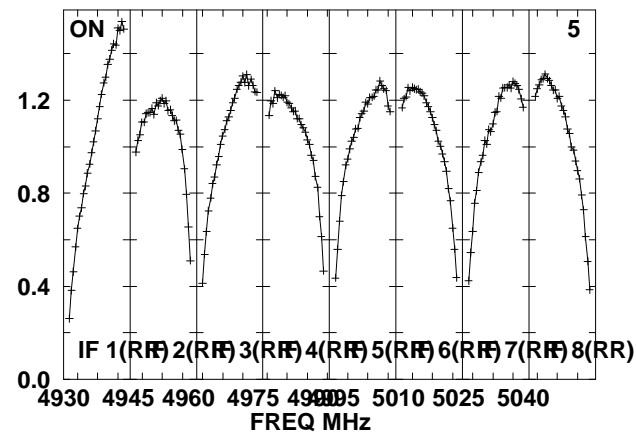
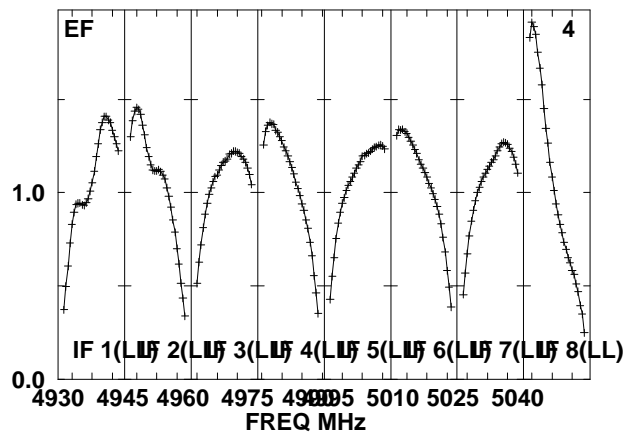
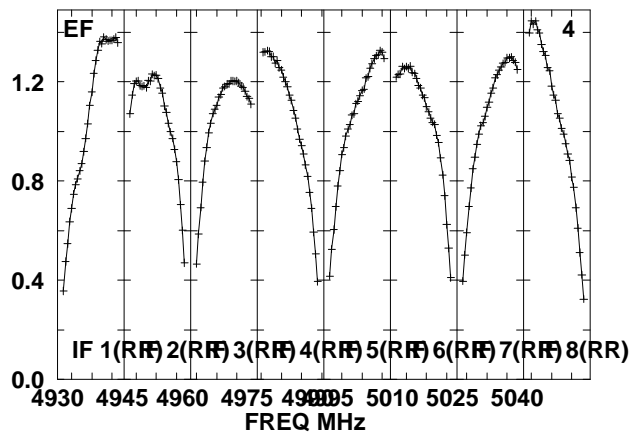
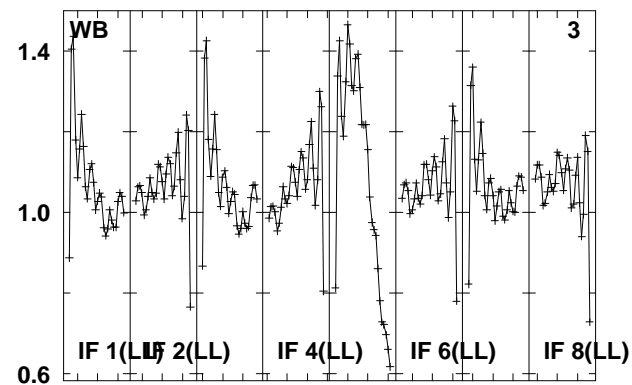
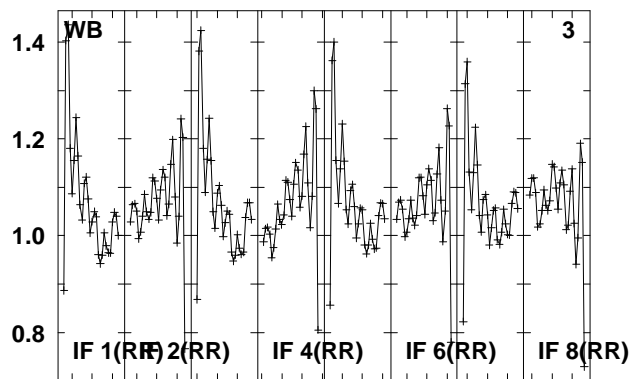
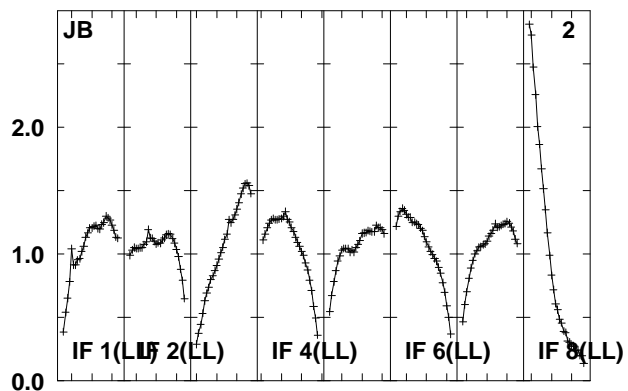
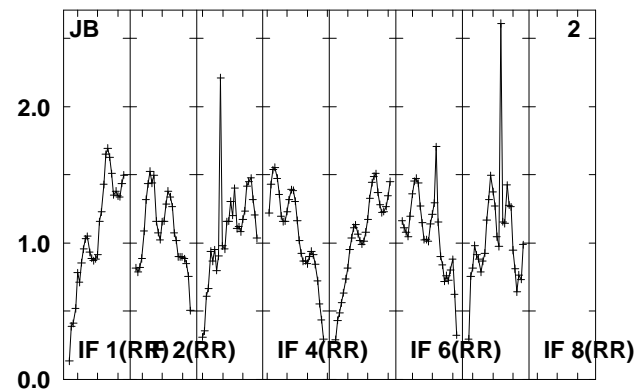
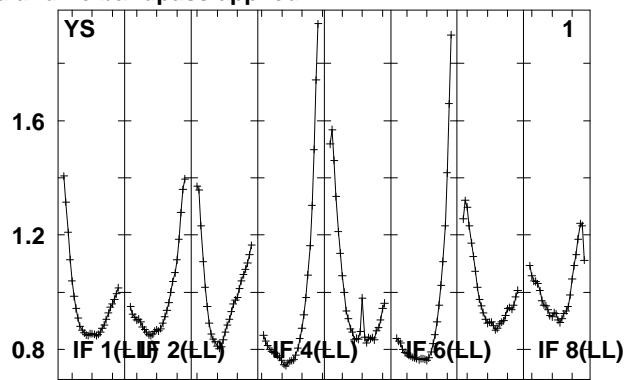
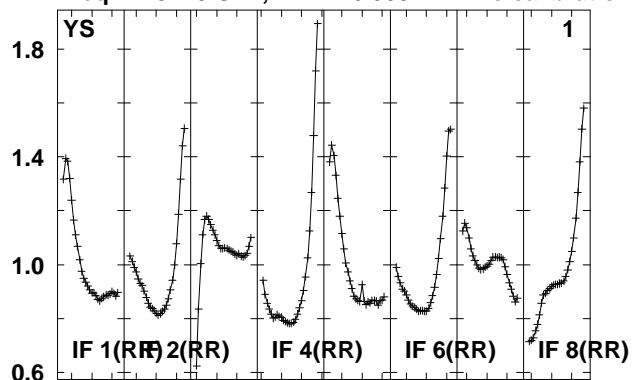

Lower frame: Real Jy
Total-power spectrum Antenna: *
Timerange: 00/12:56:31 to 00/12:57:59

Plot file version 356 created 14-MAY-2010 15:19:03

J0158+13 EO007.UVDATA.1

Freq = 4.9270 GHz, Bw = 16.000 MH No calibration applied and no bandpass applied

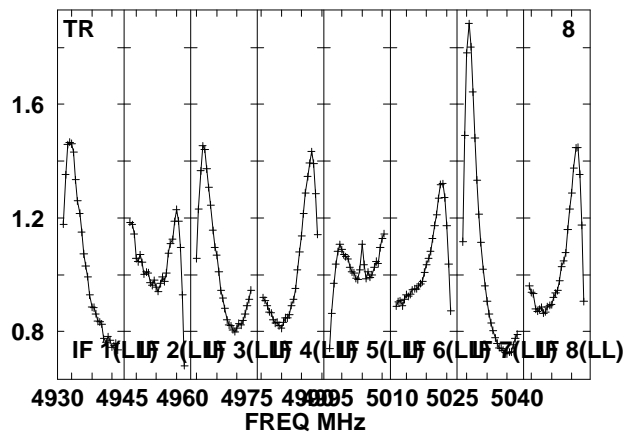
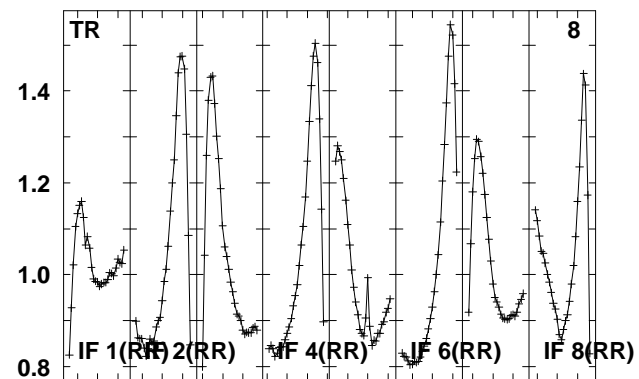
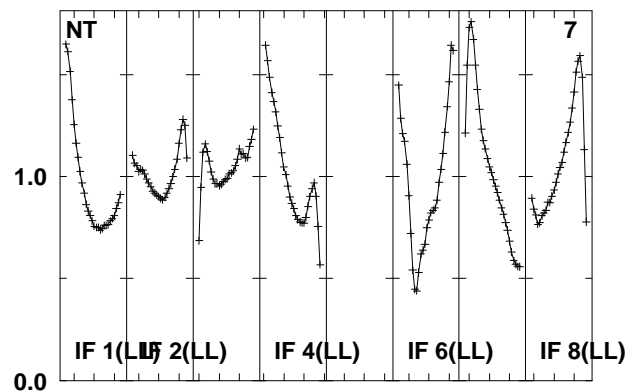
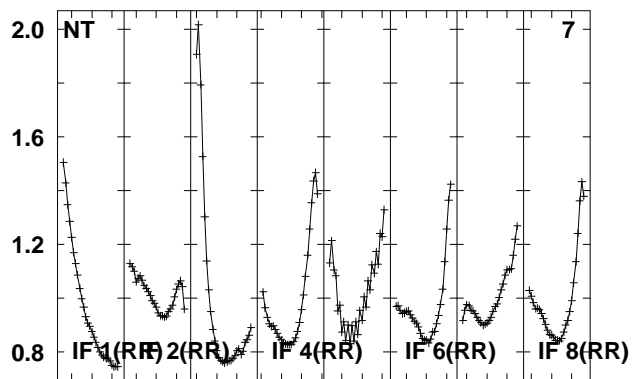
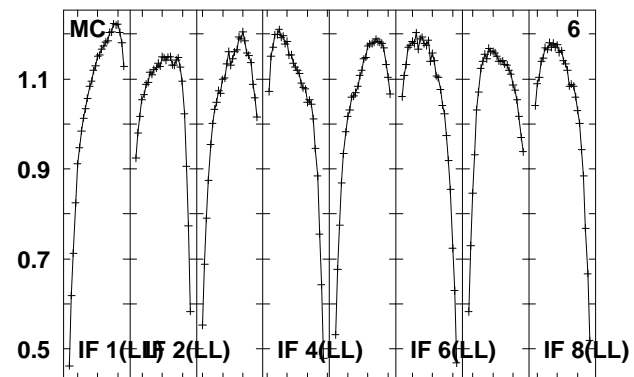
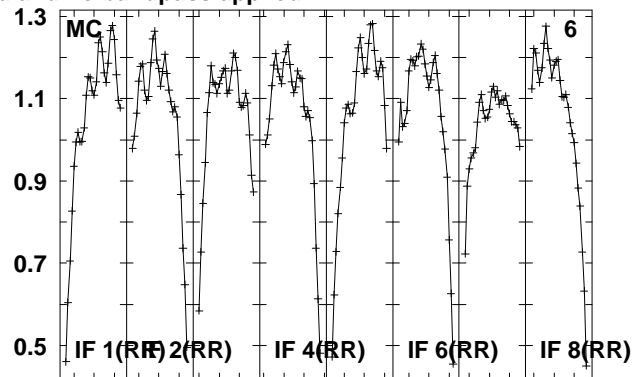
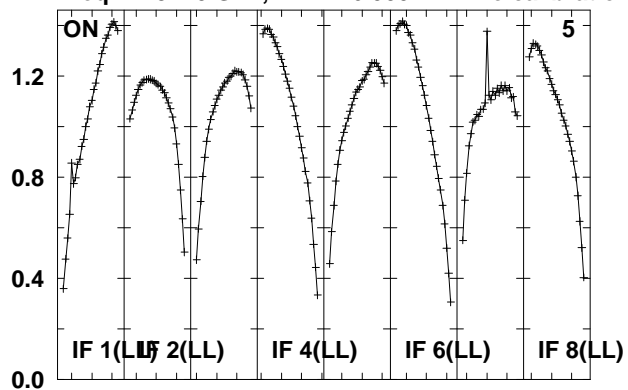

Lower frame: Real Jy

Total-power spectrum Antenna: *

Timerange: 00/12:56:31 to 00/12:57:59

Plot file version 357 created 14-MAY-2010 15:19:04
 J015028 EO007.UVDATA.1
 Freq = 4.9270 GHz, Bw = 16.000 MH No calibration applied and no bandpass applied

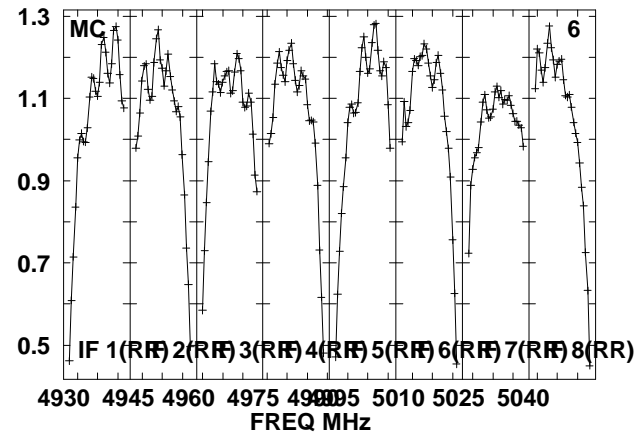
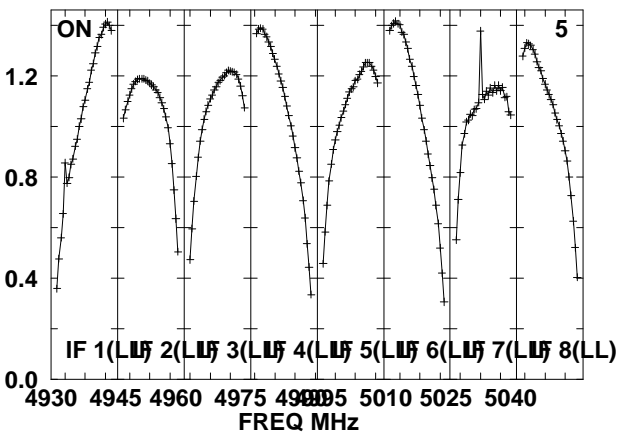
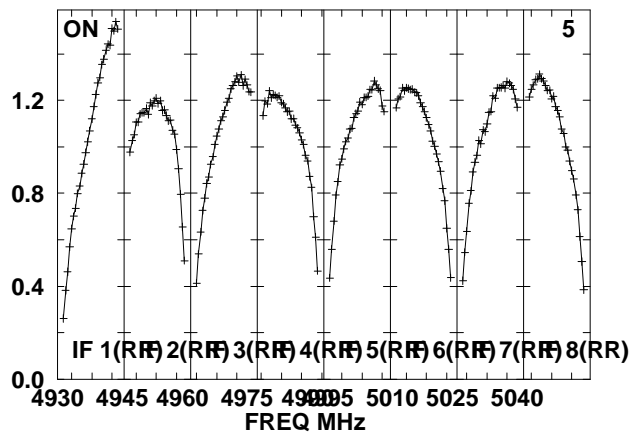
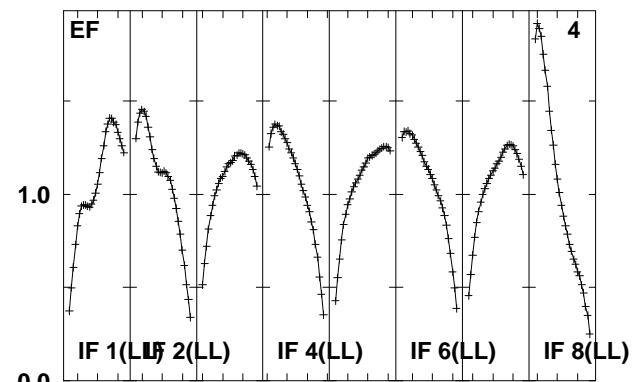
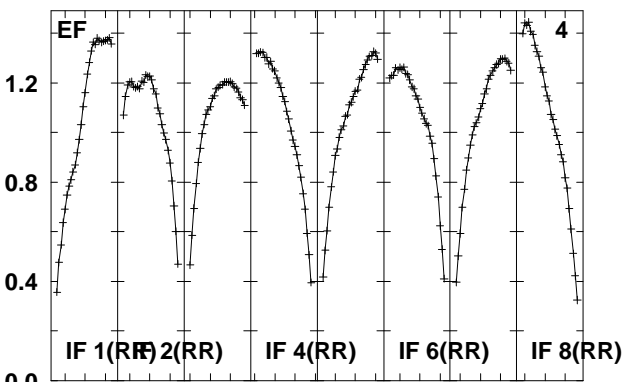
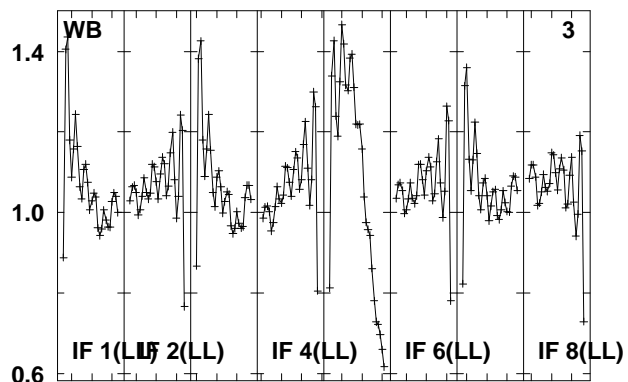
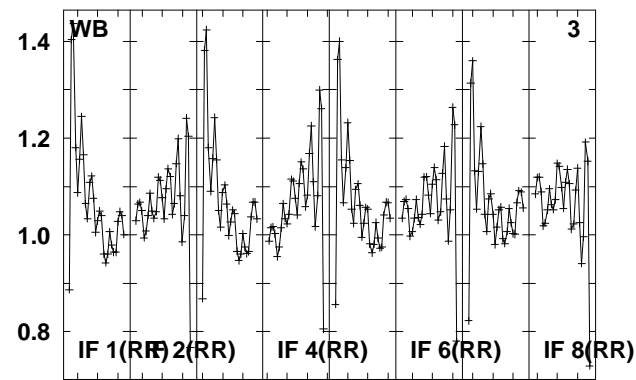
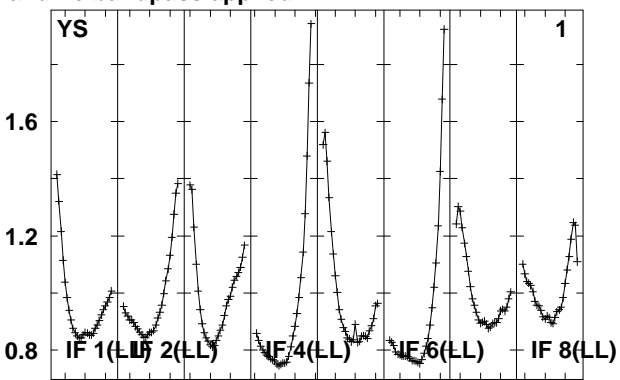
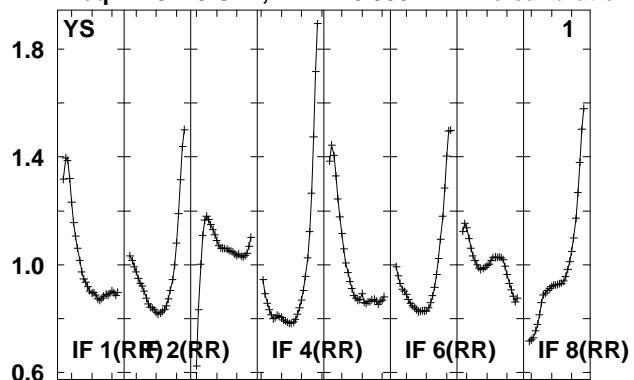

Lower frame: Real Jy
 Total-power spectrum Antenna: *
 Timerange: 00/12:58:35 to 00/13:03:33

Plot file version 358 created 14-MAY-2010 15:19:04

J015028 EO007.UVDATA.1

Freq = 4.9270 GHz, Bw = 16.000 MH No calibration applied and no bandpass applied

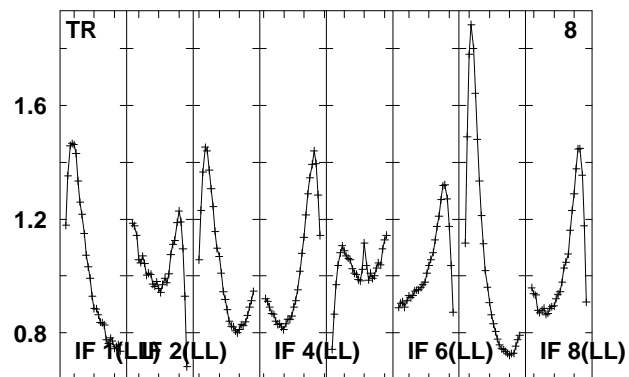
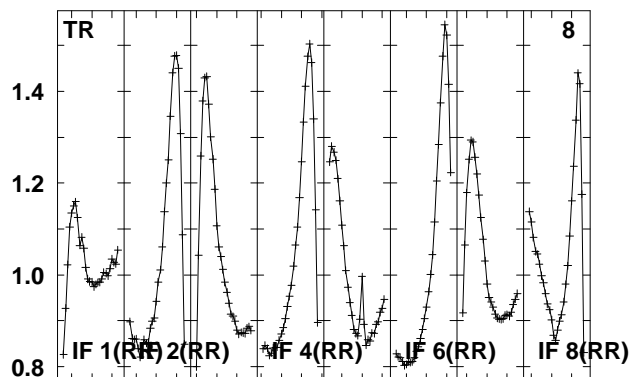
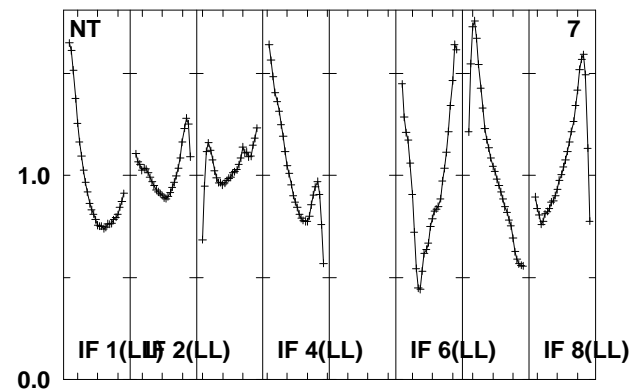
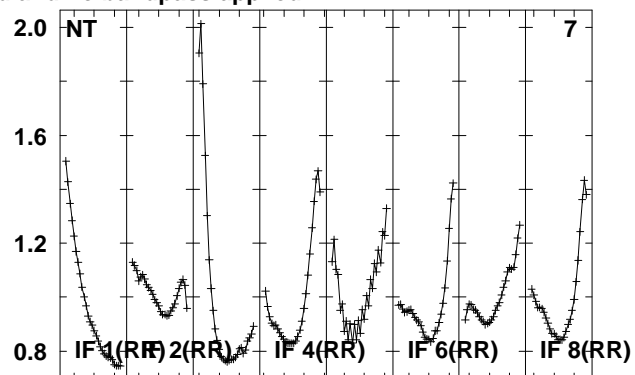
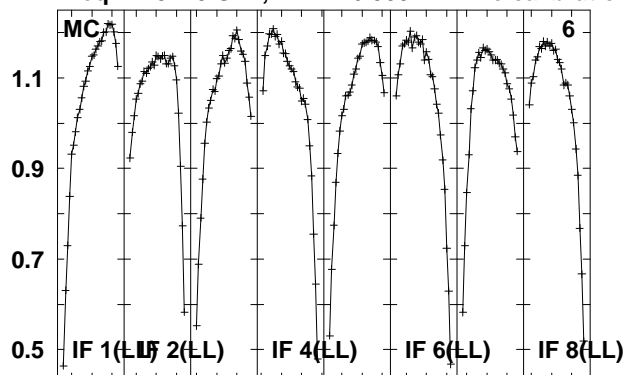

Lower frame: Real Jy
Total-power spectrum Antenna: *
Timerange: 00/12:58:35 to 00/13:03:33

Plot file version 359 created 14-MAY-2010 15:19:05
 J0158+13 EO007.UVDATA.1
 Freq = 4.9270 GHz, Bw = 16.000 MH No calibration applied and no bandpass applied

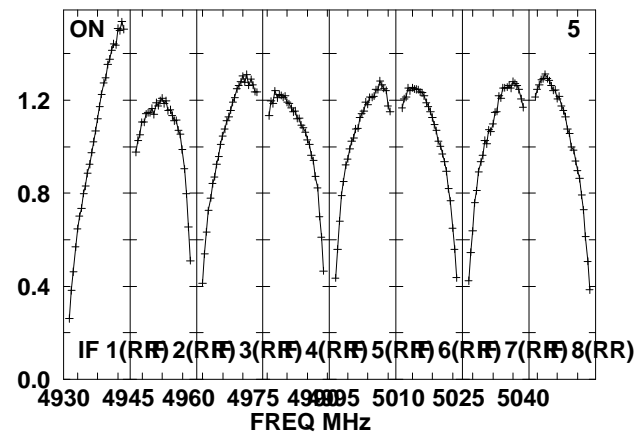
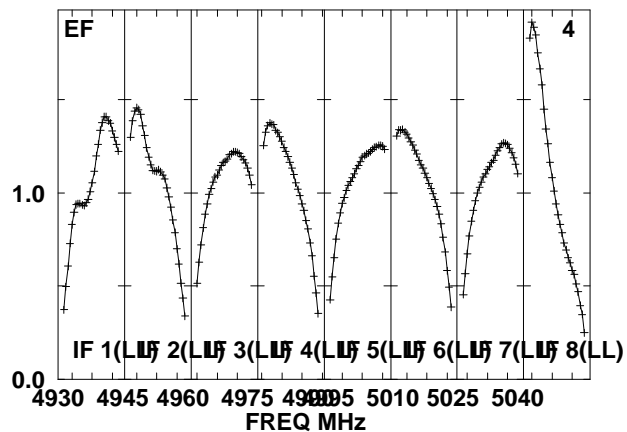
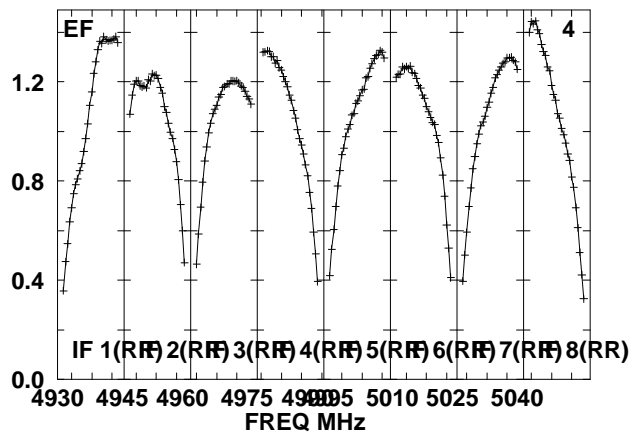
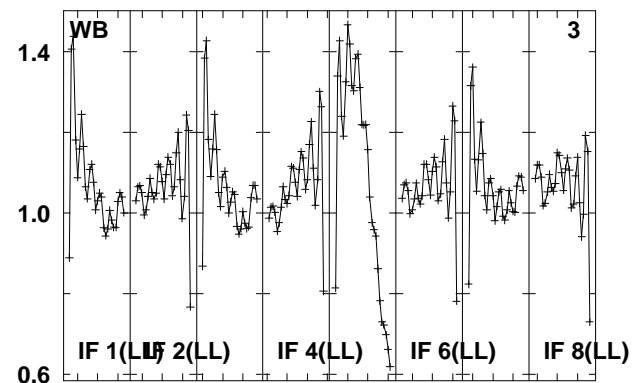
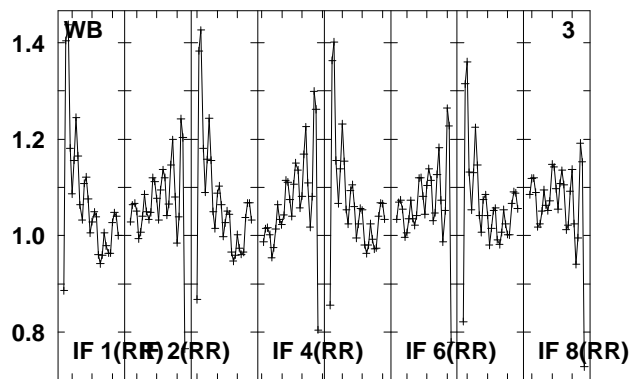
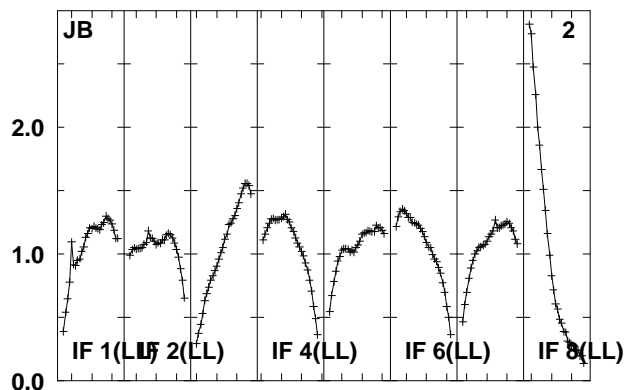
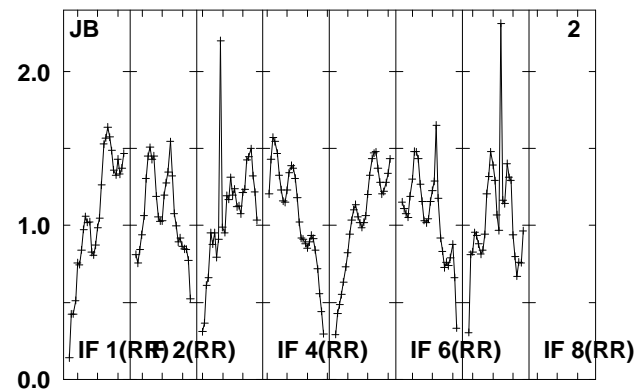
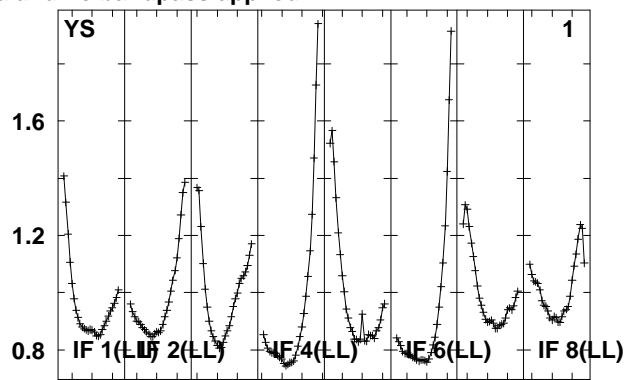
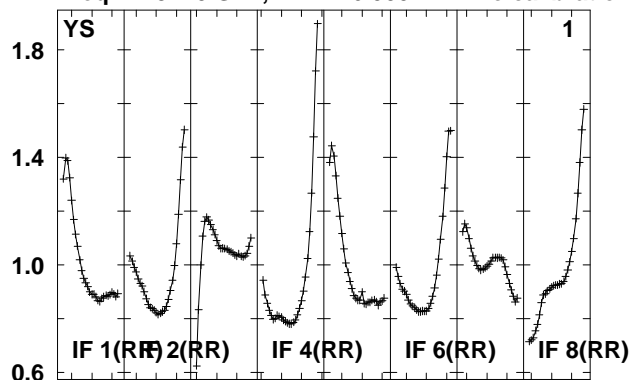

Lower frame: Real Jy
 Total-power spectrum Antenna: *
 Timerange: 00/13:04:09 to 00/13:05:39

Plot file version 360 created 14-MAY-2010 15:19:05

J0158+13 EO007.UVDATA.1

Freq = 4.9270 GHz, Bw = 16.000 MH No calibration applied and no bandpass applied

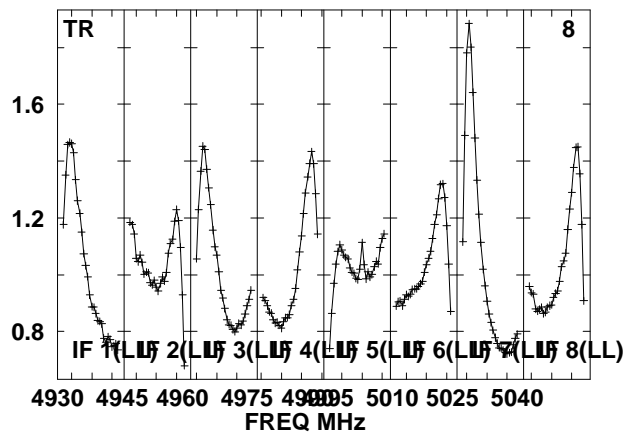
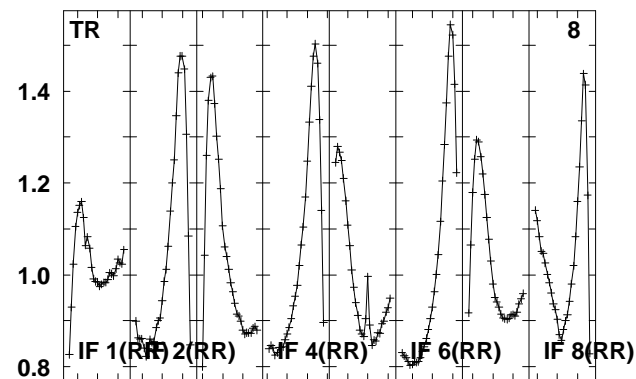
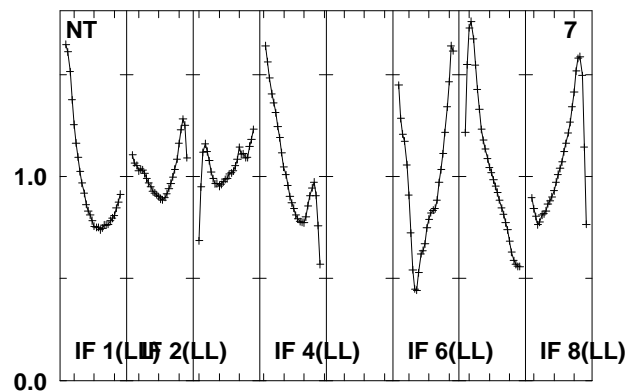
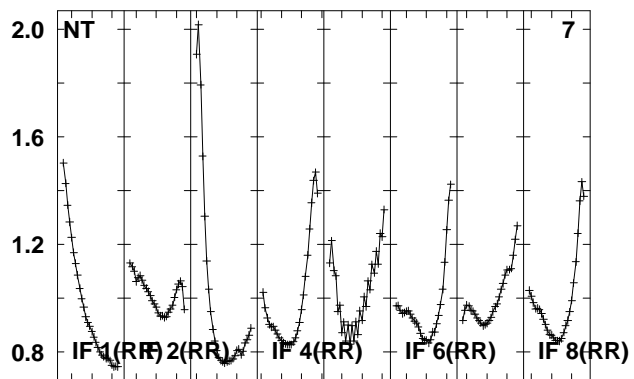
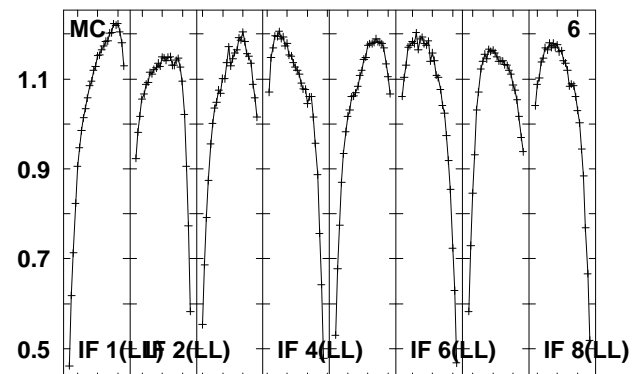
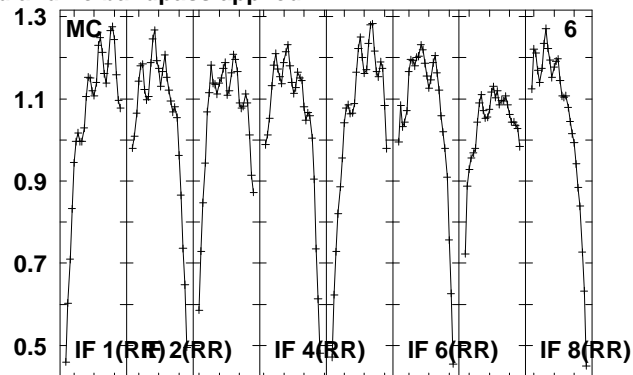
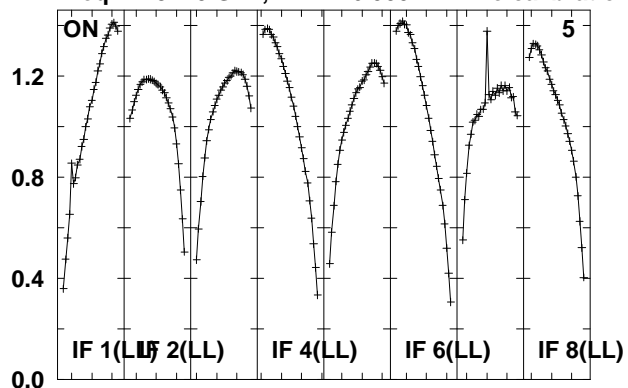

Lower frame: Real Jy

Total-power spectrum Antenna: *

Timerange: 00/13:04:09 to 00/13:05:39

Plot file version 361 created 14-MAY-2010 15:19:05
 J0209+13 EO007.UVDATA.1
 Freq = 4.9270 GHz, Bw = 16.000 MH No calibration applied and no bandpass applied

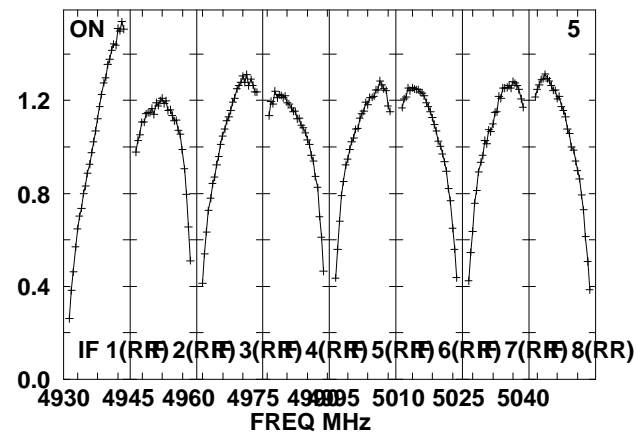
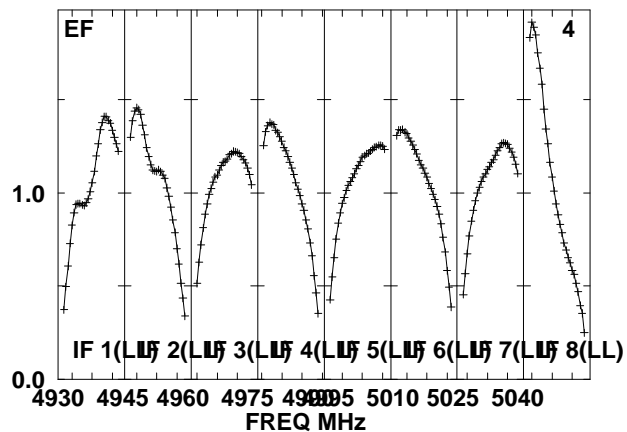
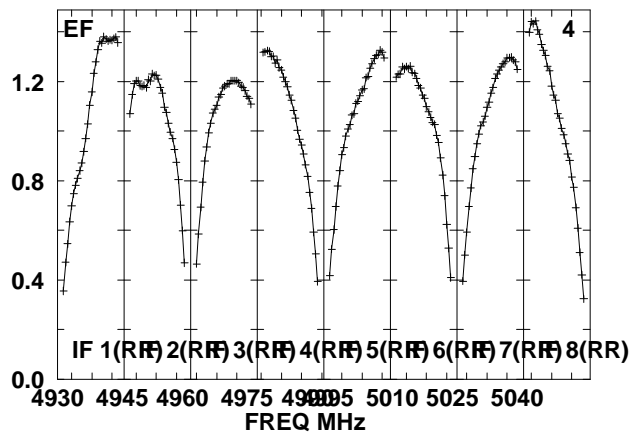
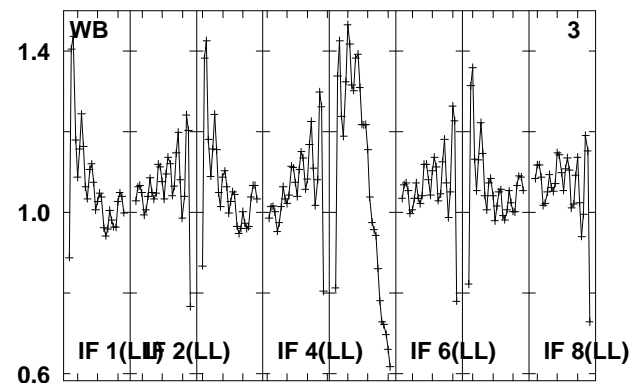
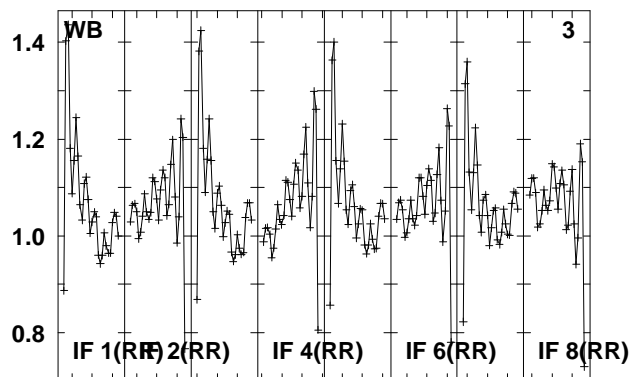
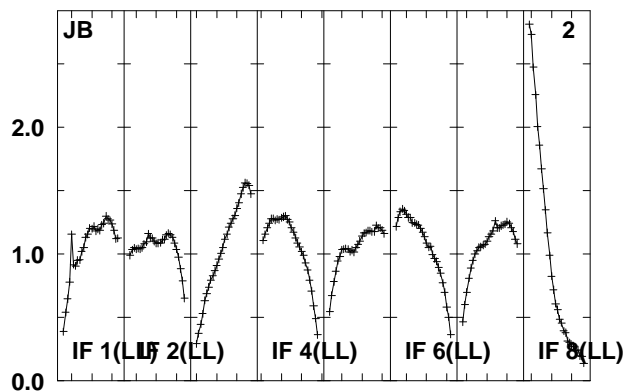
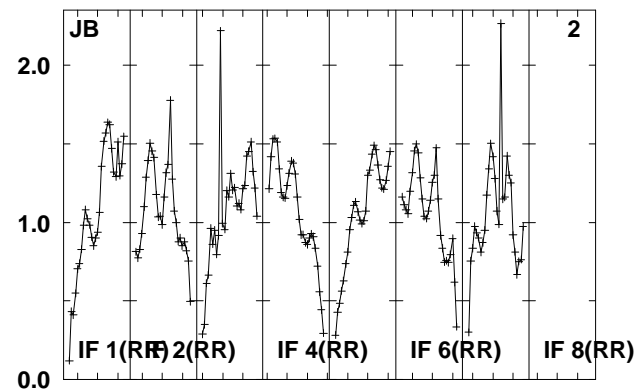
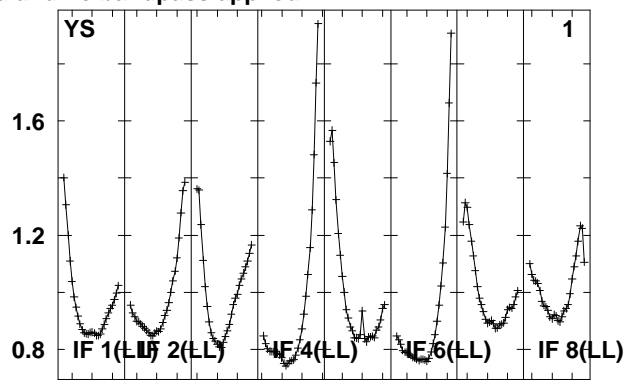
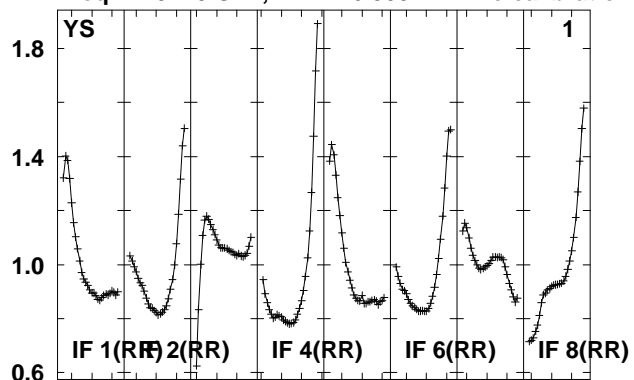

Lower frame: Real Jy
 Total-power spectrum Antenna: *
 Timerange: 00/13:06:17 to 00/13:07:45

Plot file version 362 created 14-MAY-2010 15:19:05

J0209+13 EO007.UVDATA.1

Freq = 4.9270 GHz, Bw = 16.000 MH No calibration applied and no bandpass applied

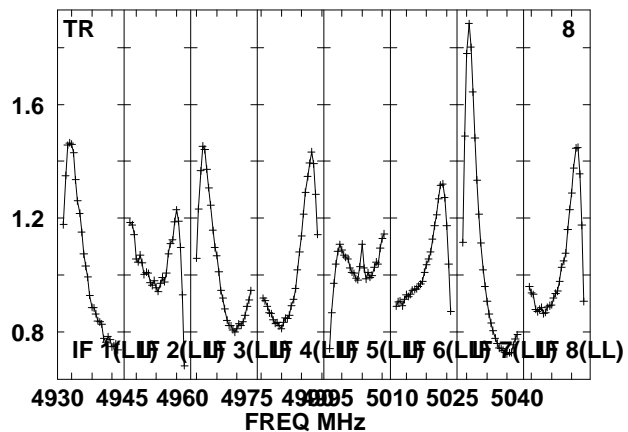
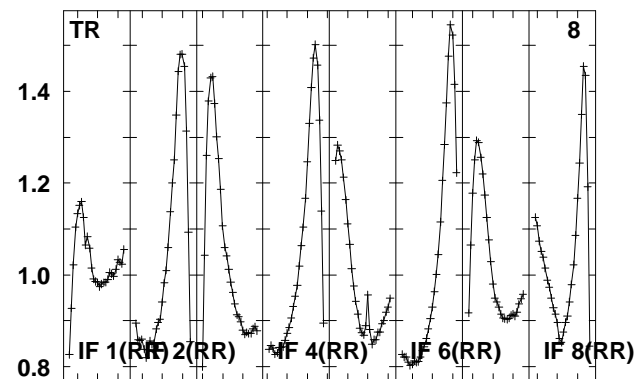
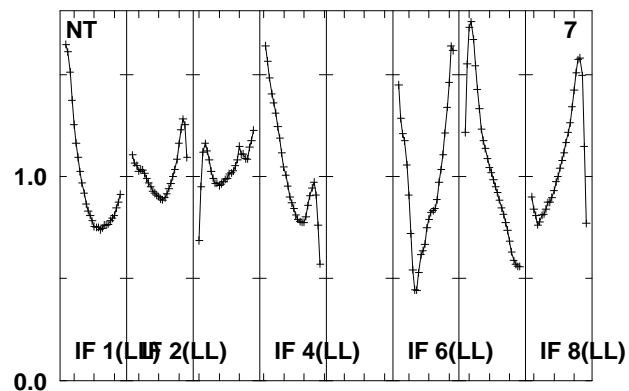
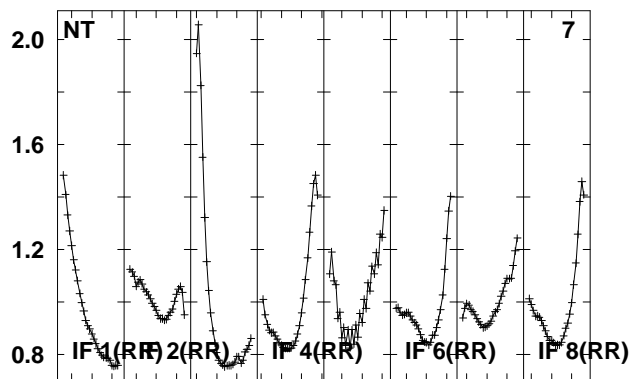
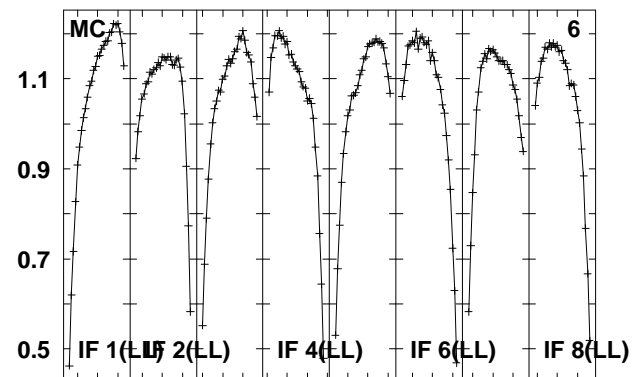
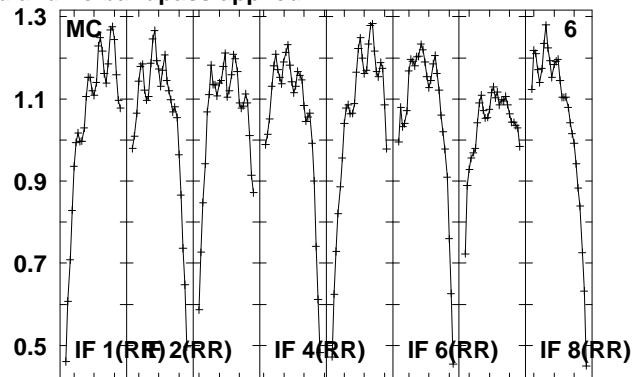
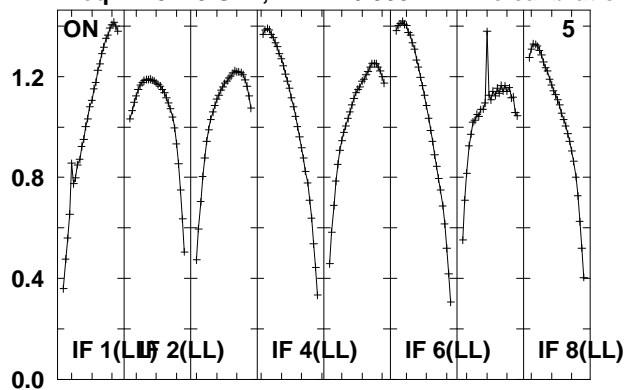

Lower frame: Real Jy

Total-power spectrum Antenna: *

Timerange: 00/13:06:17 to 00/13:07:45

Plot file version 363 created 14-MAY-2010 15:19:06

J021348 EO007.UVDATA.1

Freq = 4.9270 GHz, Bw = 16.000 MH No calibration applied and no bandpass applied

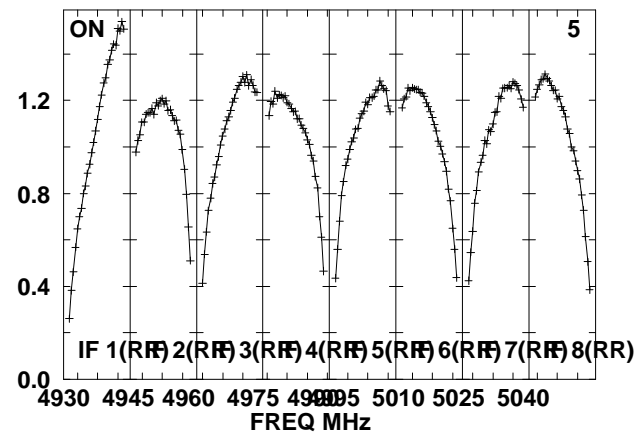
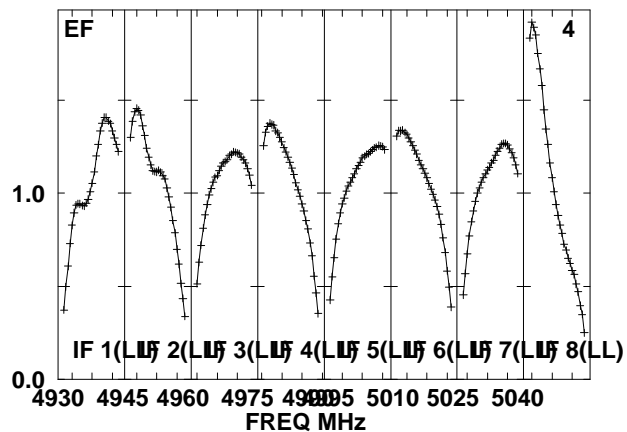
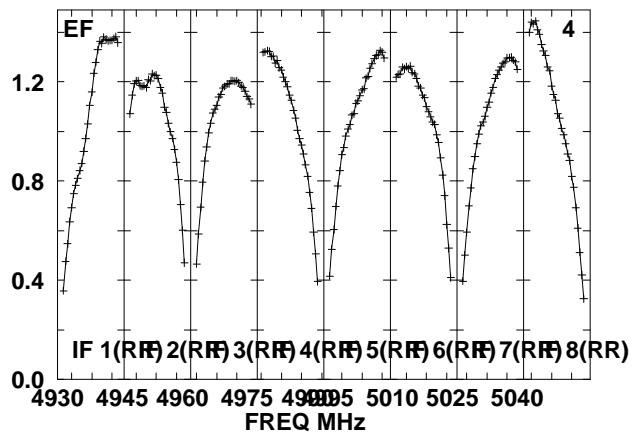
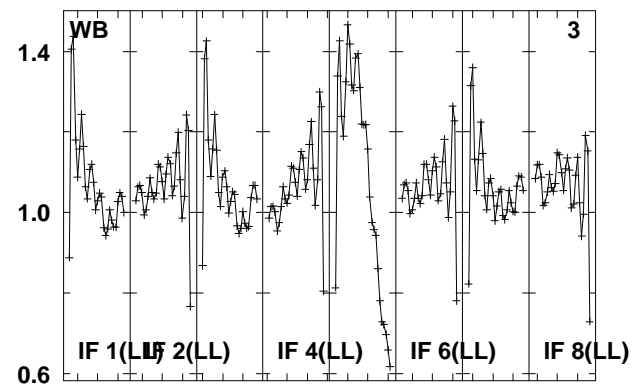
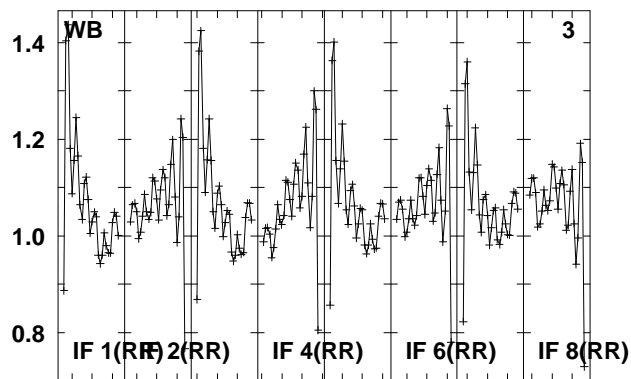
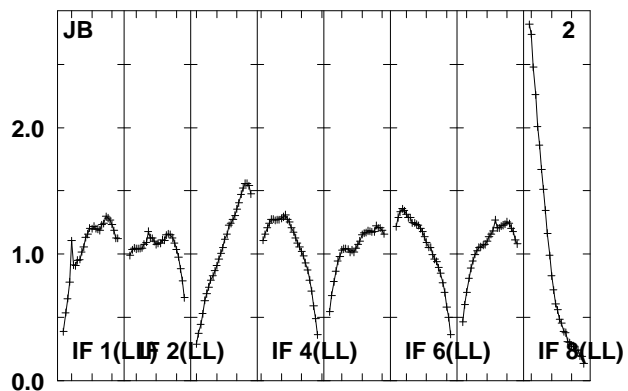
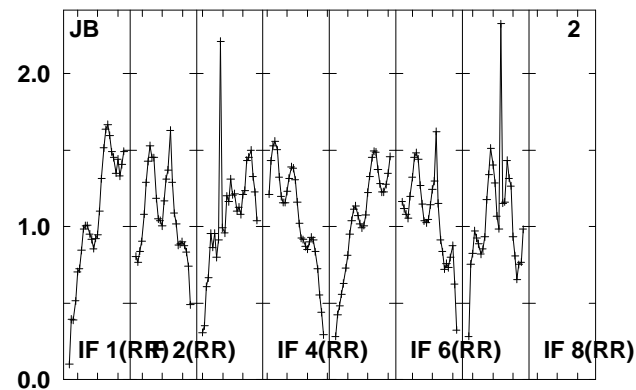
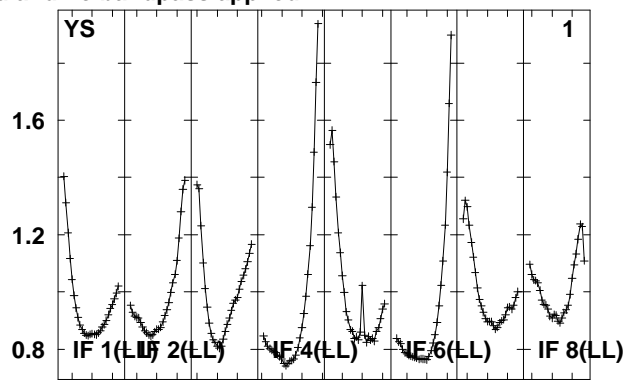
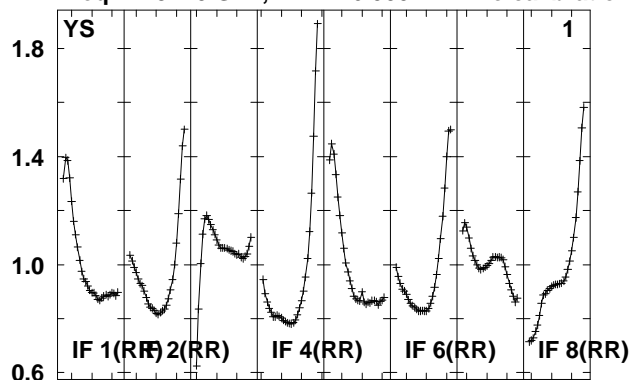

Lower frame: Real Jy

Total-power spectrum Antenna: *

Timerange: 00/13:08:13 to 00/13:13:11

Plot file version 364 created 14-MAY-2010 15:19:06

J021348 EO007.UVDATA.1

Freq = 4.9270 GHz, Bw = 16.000 MH No calibration applied and no bandpass applied

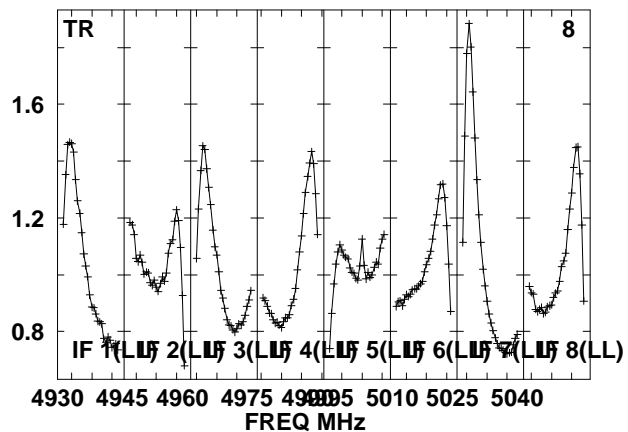
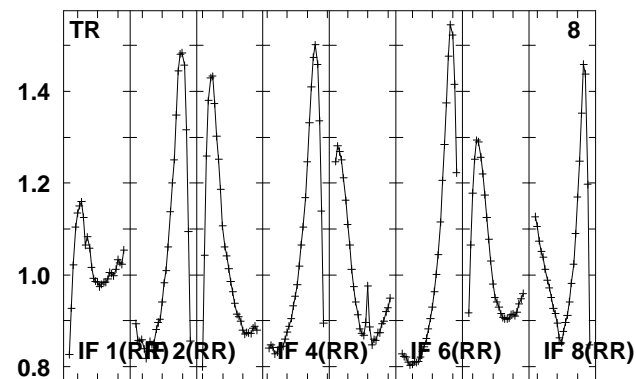
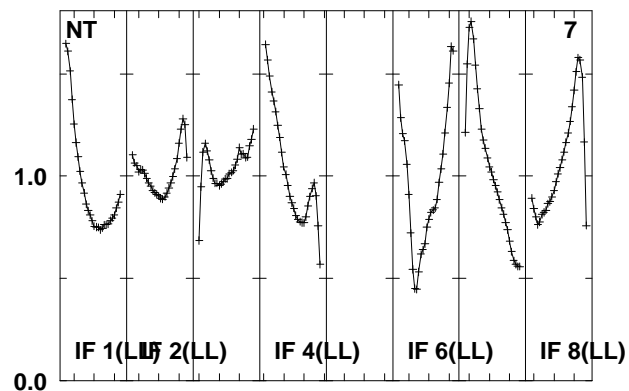
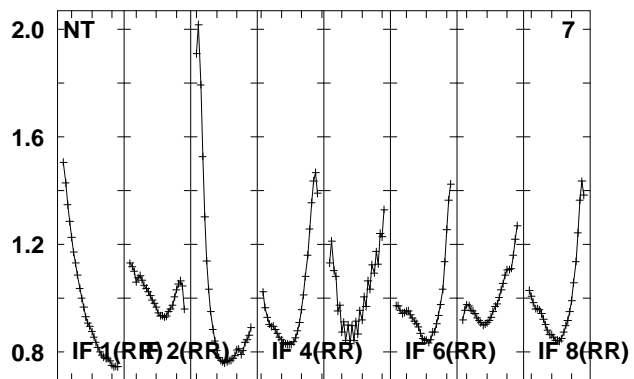
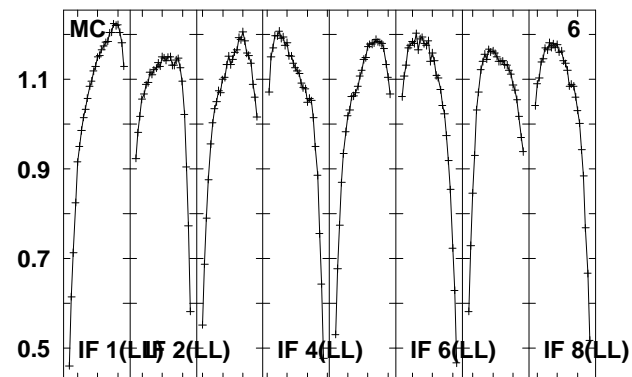
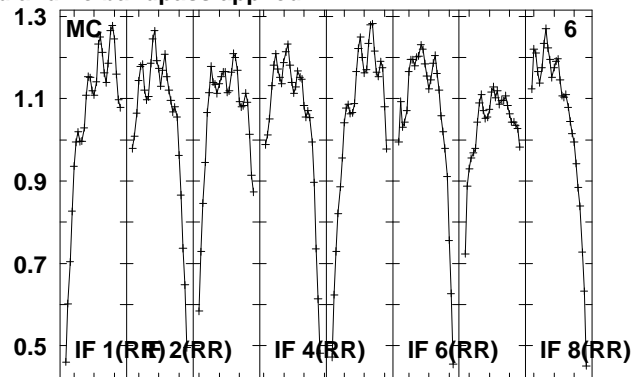
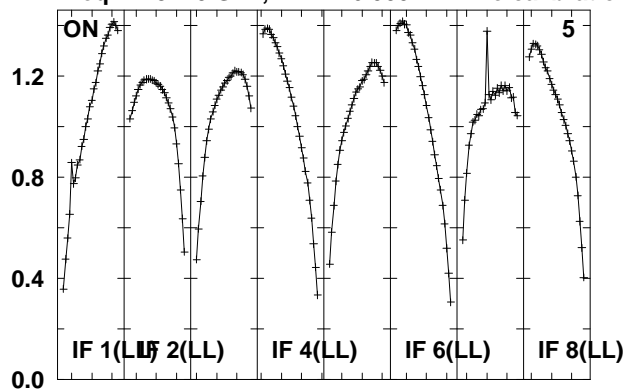

Lower frame: Real Jy

Total-power spectrum Antenna: *

Timerange: 00/13:08:13 to 00/13:13:11

Plot file version 365 created 14-MAY-2010 15:19:07

J0209+13 EO007.UVDATA.1

Freq = 4.9270 GHz, Bw = 16.000 MH No calibration applied and no bandpass applied

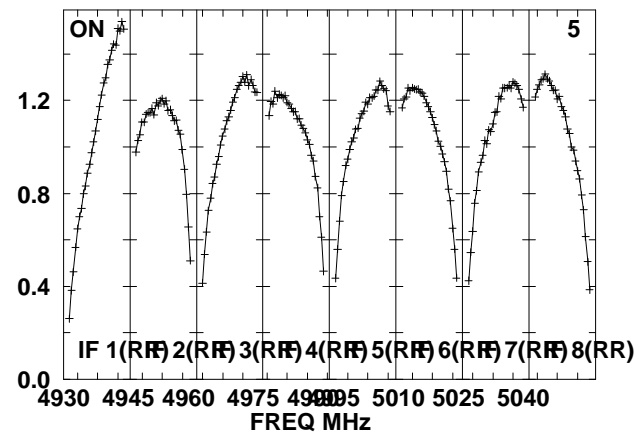
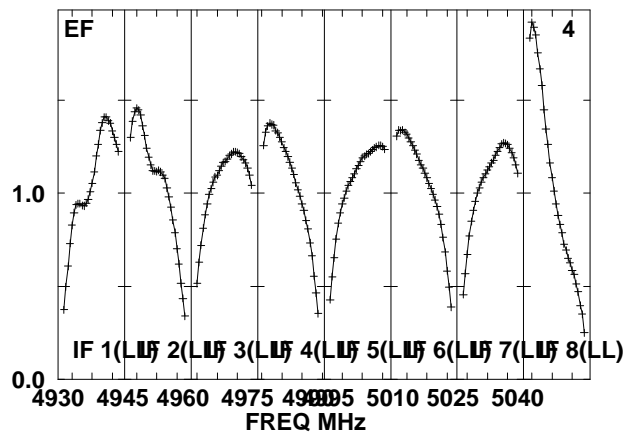
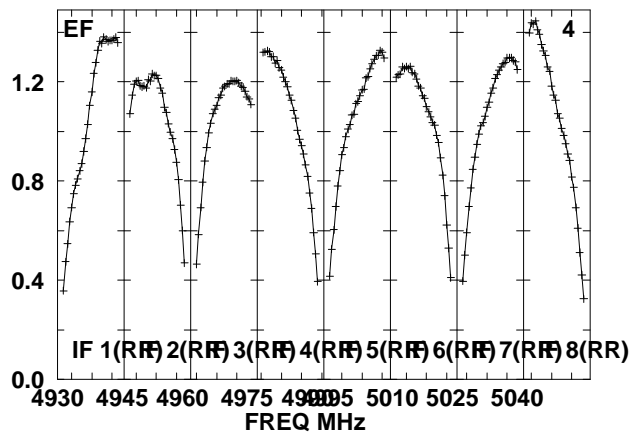
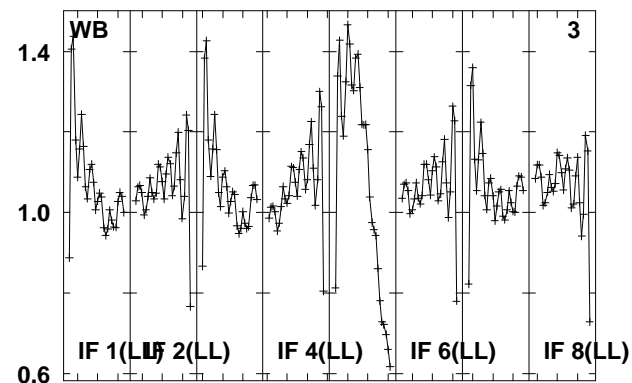
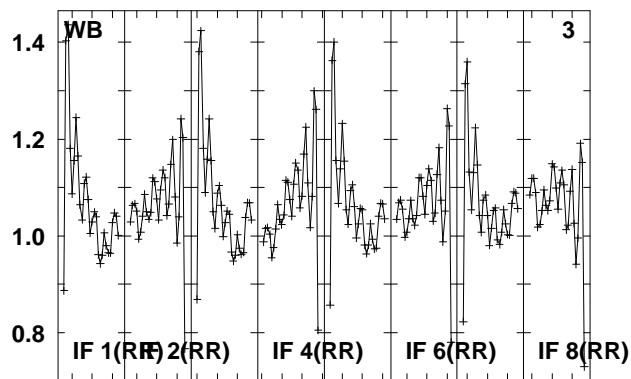
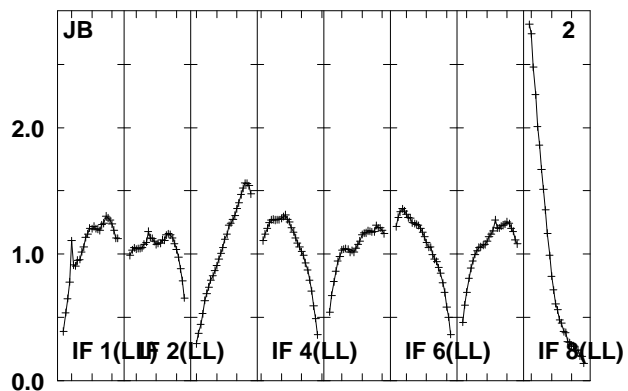
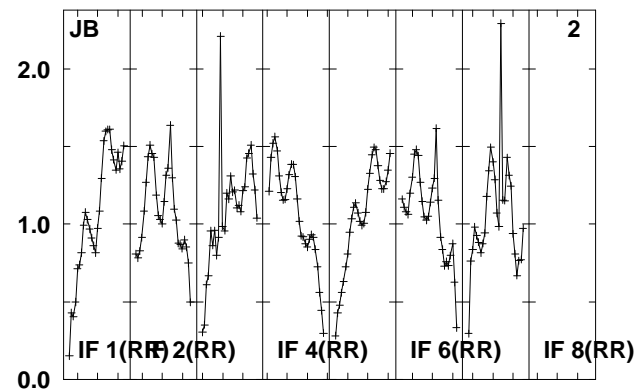
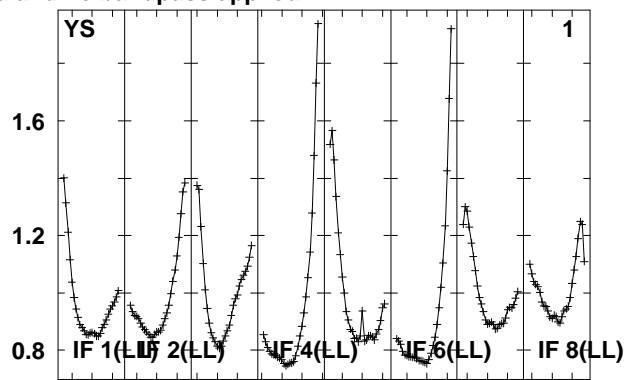
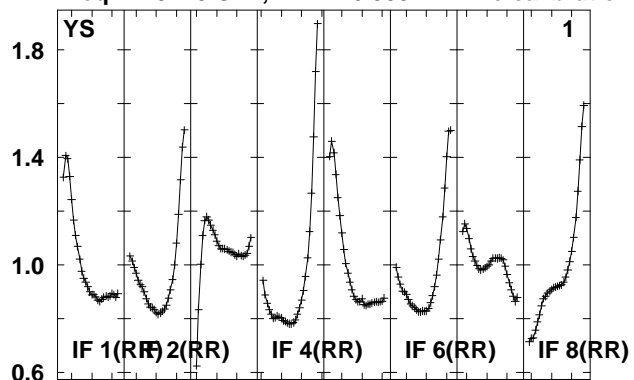

Lower frame: Real Jy
Total-power spectrum Antenna: *
Timerange: 00/13:13:39 to 00/13:15:05

Plot file version 366 created 14-MAY-2010 15:19:07

J0209+13 EO007.UVDATA.1

Freq = 4.9270 GHz, Bw = 16.000 MH No calibration applied and no bandpass applied

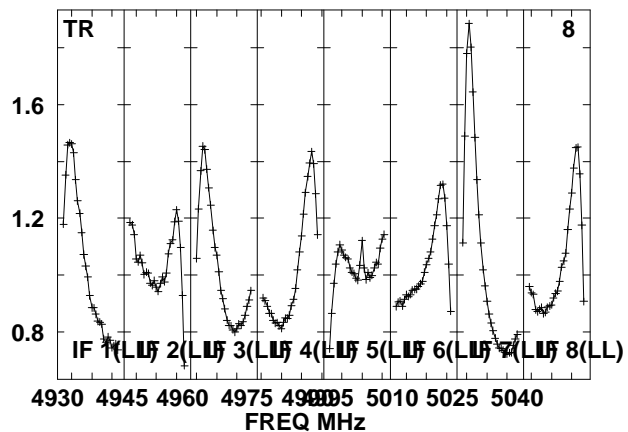
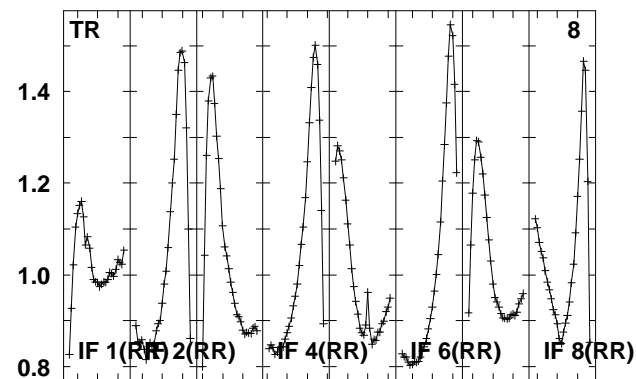
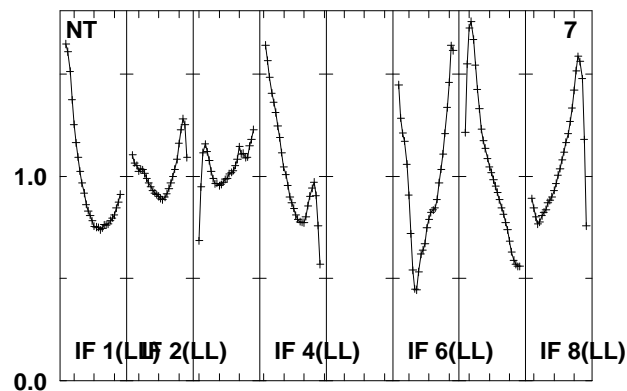
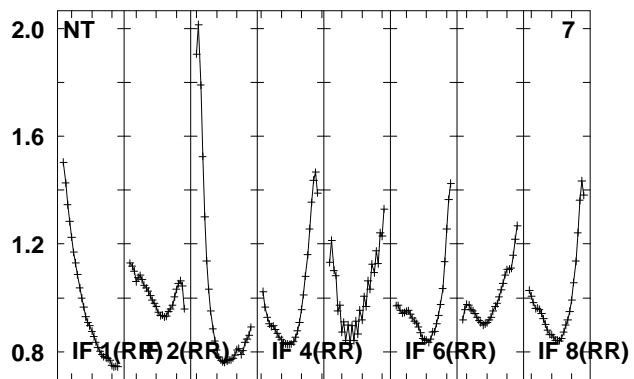
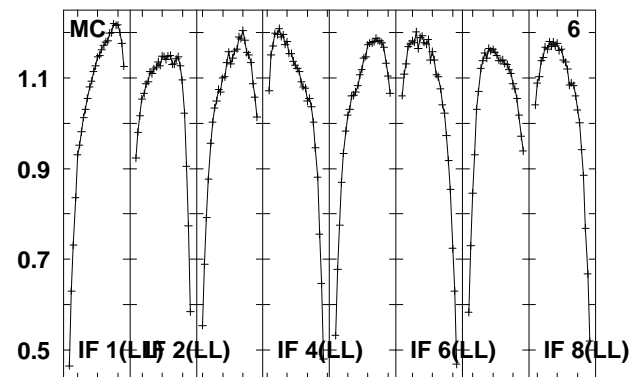
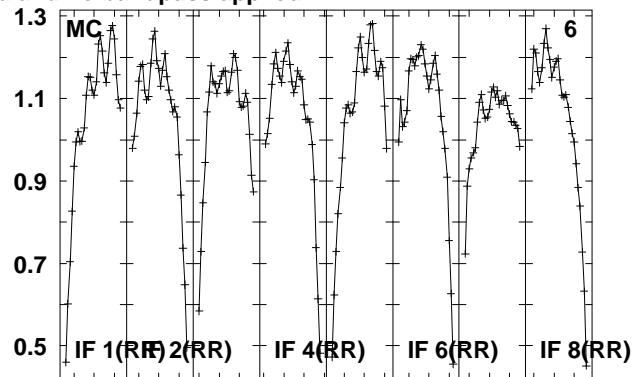
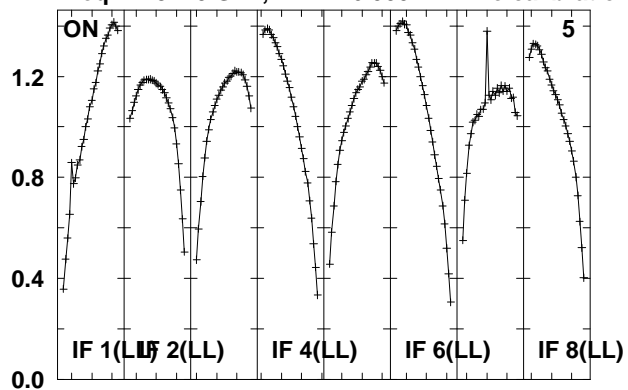

Lower frame: Real Jy

Total-power spectrum Antenna: *

Timerange: 00/13:13:39 to 00/13:15:05

Plot file version 367 created 14-MAY-2010 15:19:07
 J021348 EO007.UVDATA.1
 Freq = 4.9270 GHz, Bw = 16.000 MH No calibration applied and no bandpass applied

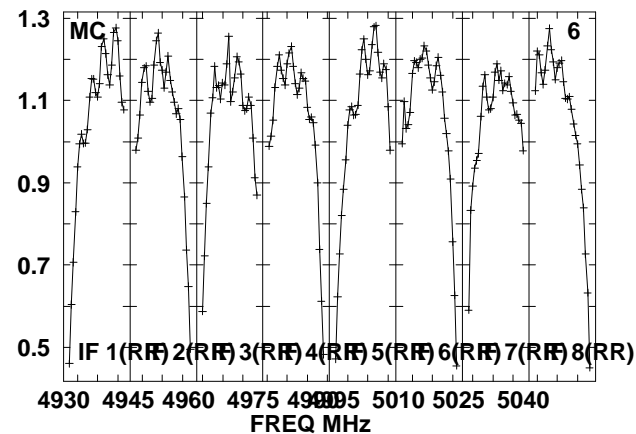
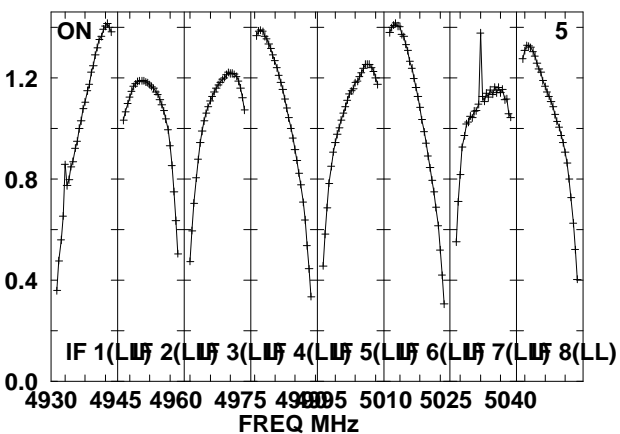
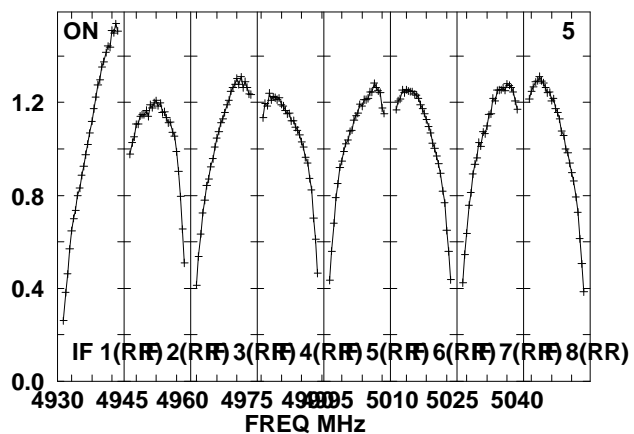
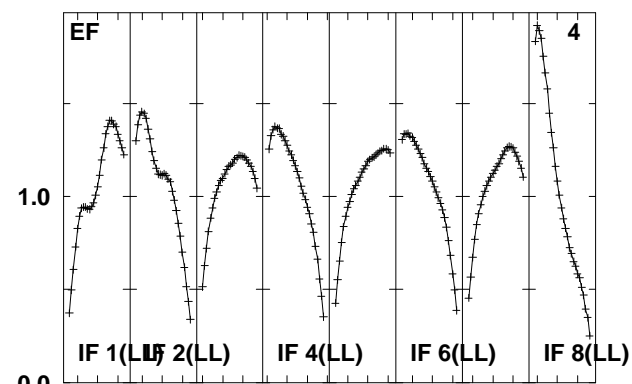
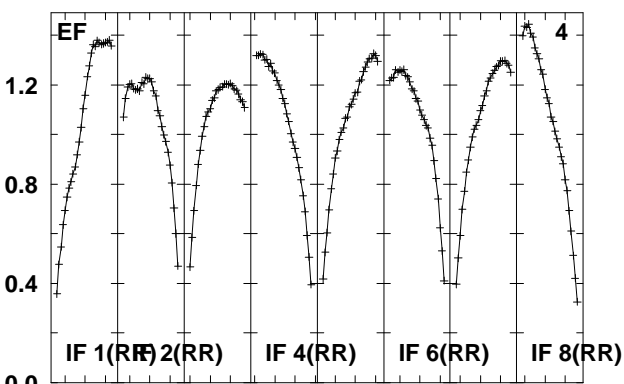
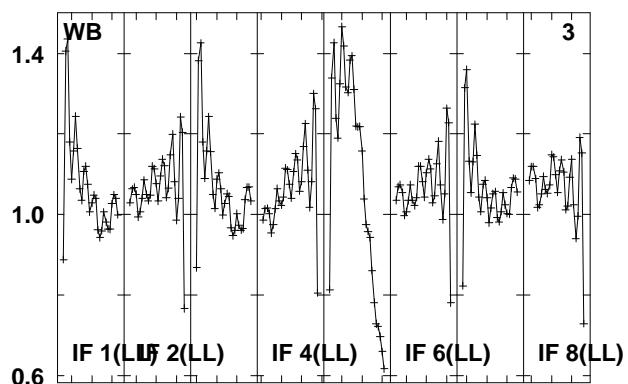
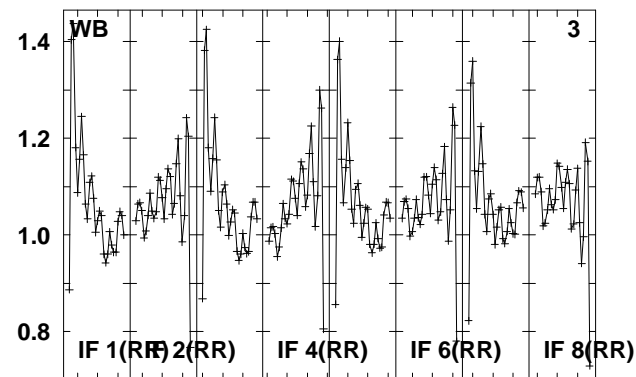
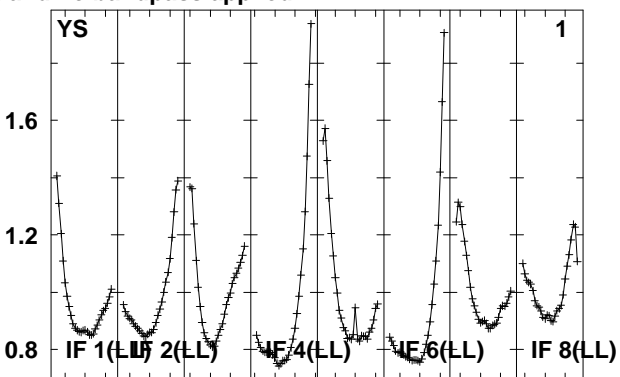
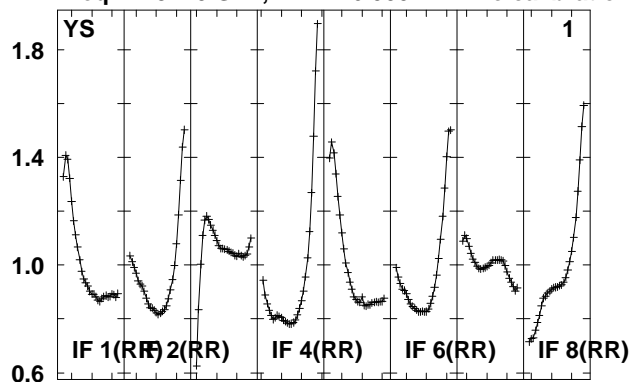

Lower frame: Real Jy
 Total-power spectrum Antenna: *
 Timerange: 00/13:15:33 to 00/13:20:29

Plot file version 368 created 14-MAY-2010 15:19:08

J021348 EO007.UVDATA.1

Freq = 4.9270 GHz, Bw = 16.000 MH No calibration applied and no bandpass applied

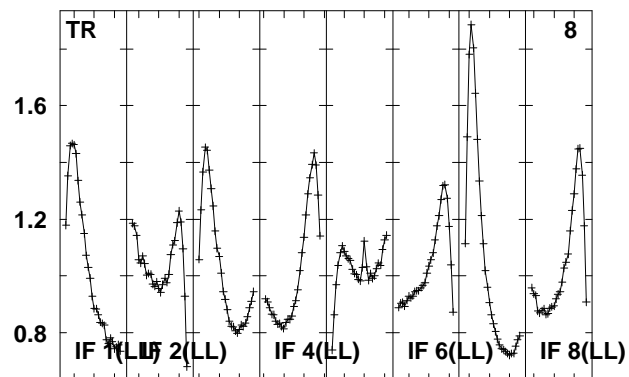
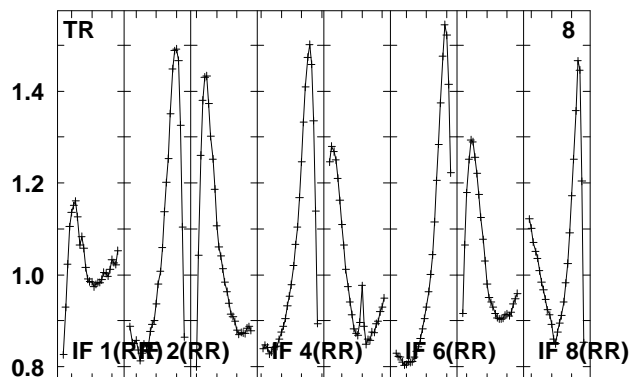
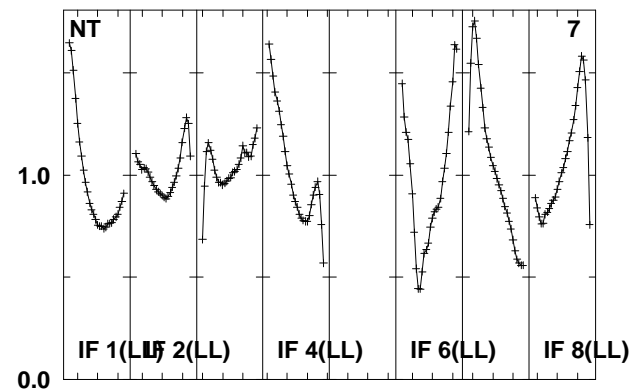
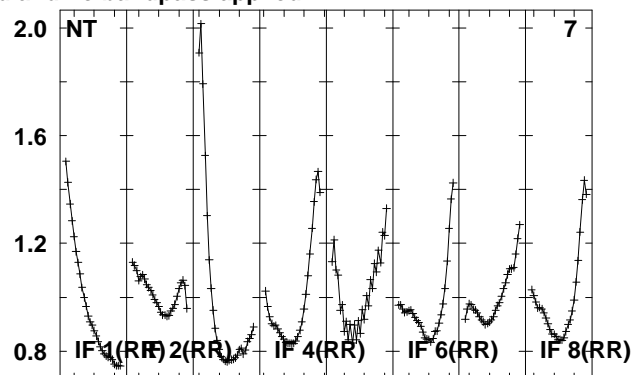
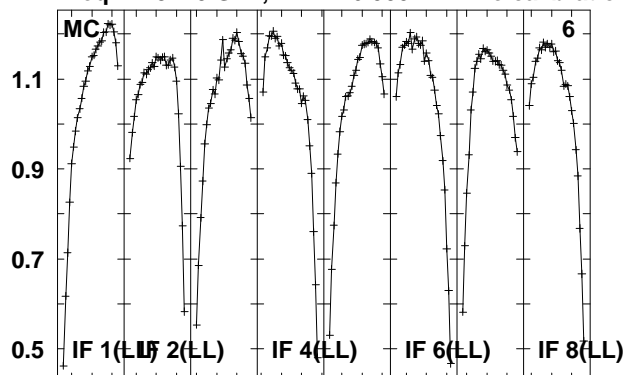

Lower frame: Real Jy
Total-power spectrum Antenna: *
Timerange: 00/13:15:33 to 00/13:20:29

Plot file version 369 created 14-MAY-2010 15:19:08
 J0209+13 EO007.UVDATA.1
 Freq = 4.9270 GHz, Bw = 16.000 MH No calibration applied and no bandpass applied

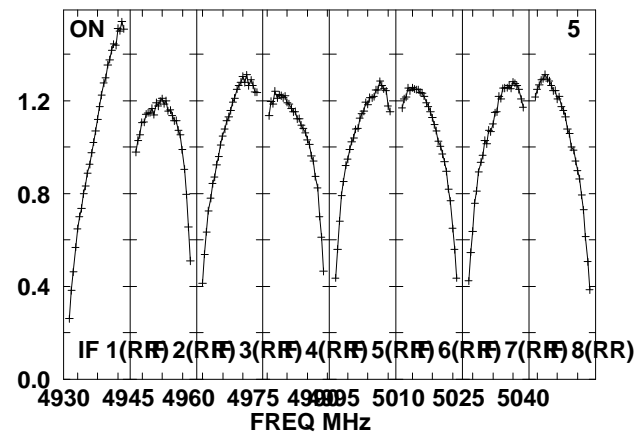
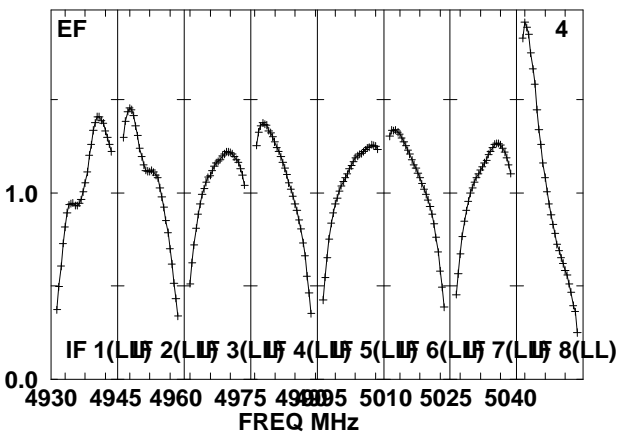
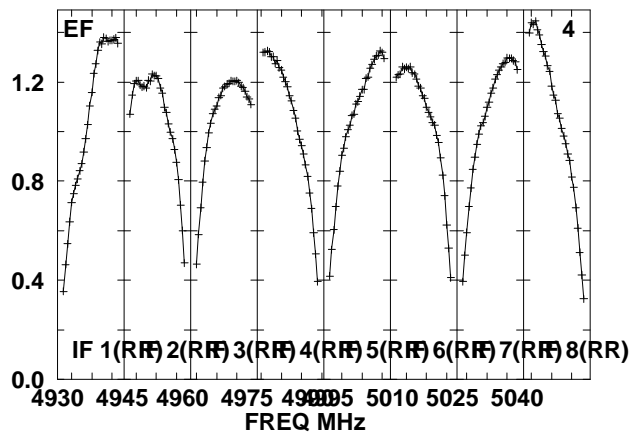
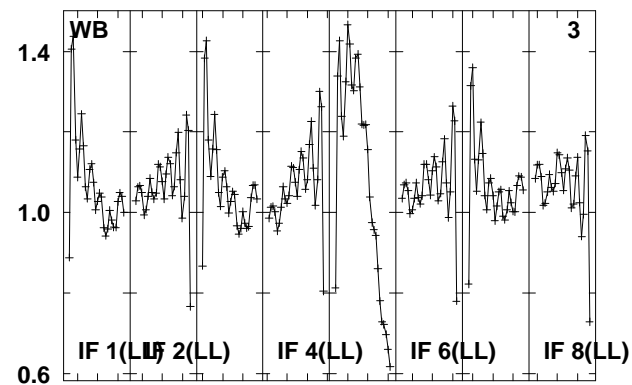
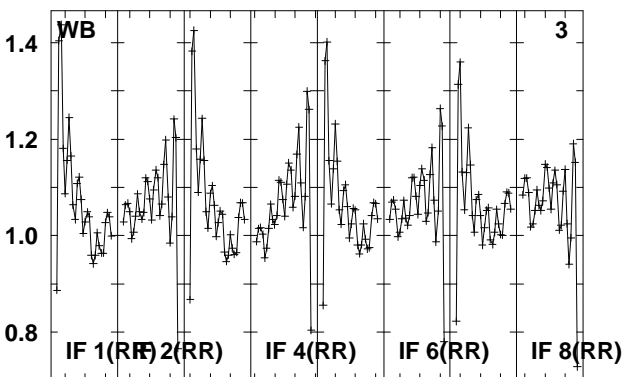
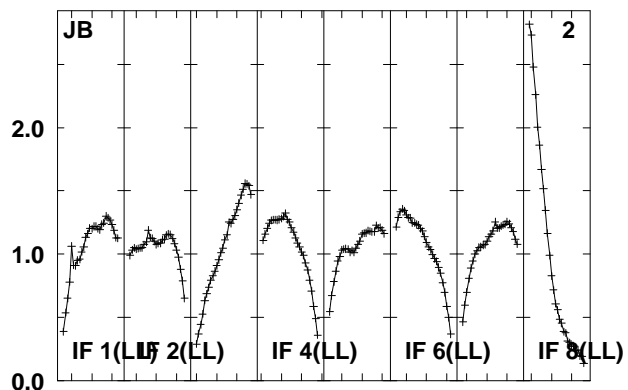
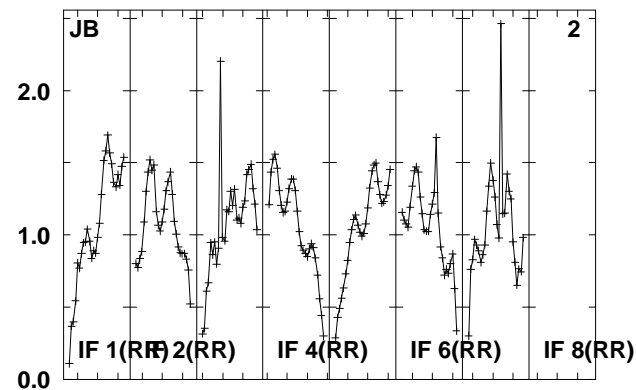
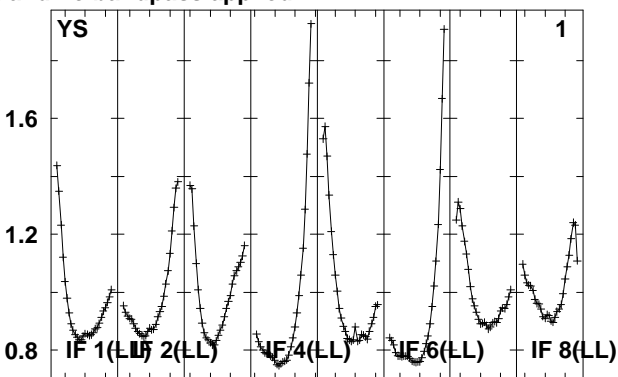
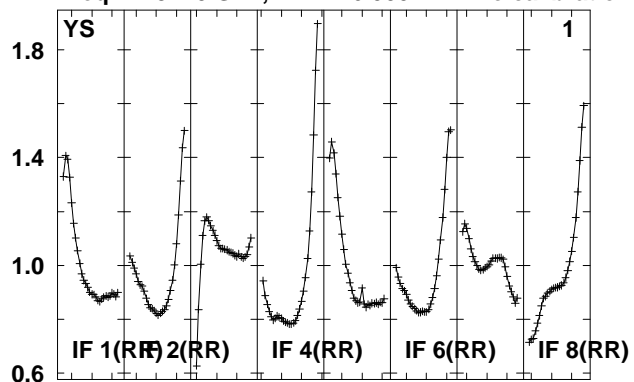

Lower frame: Real Jy
 Total-power spectrum Antenna: *
 Timerange: 00/13:21:00 to 00/13:22:28

Plot file version 370 created 14-MAY-2010 15:19:08

J0209+13 EO007.UVDATA.1

Freq = 4.9270 GHz, Bw = 16.000 MH No calibration applied and no bandpass applied

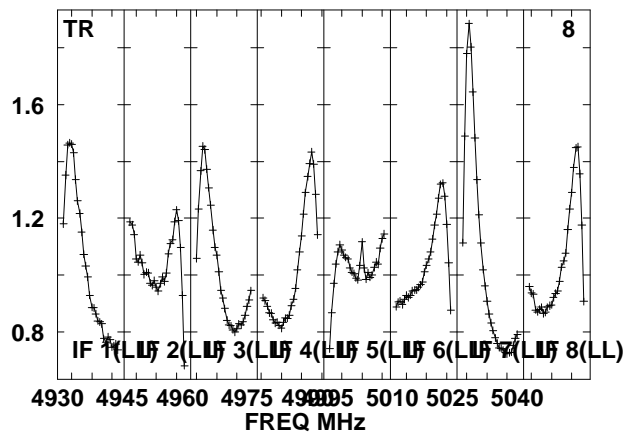
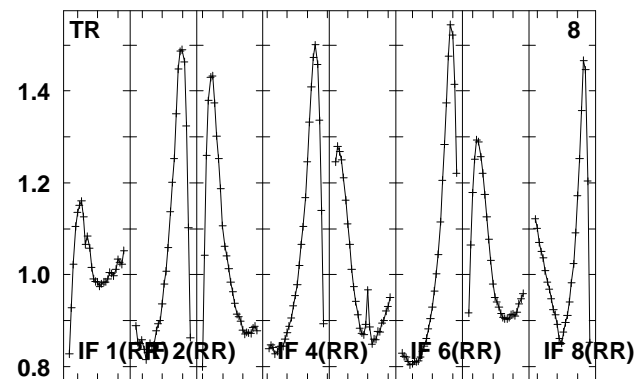
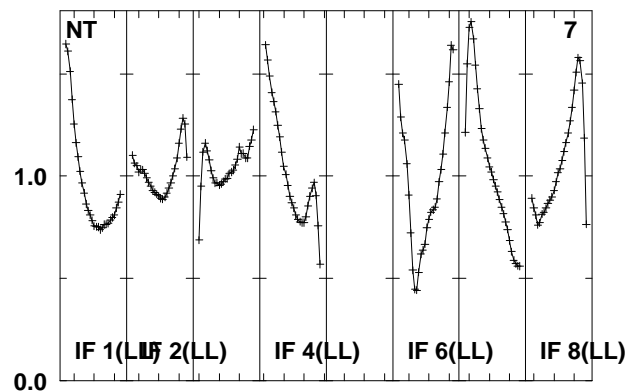
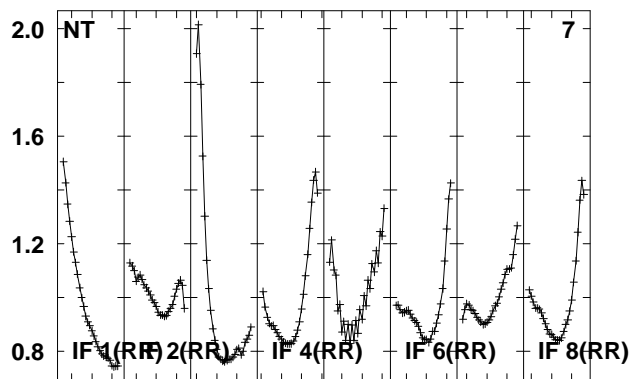
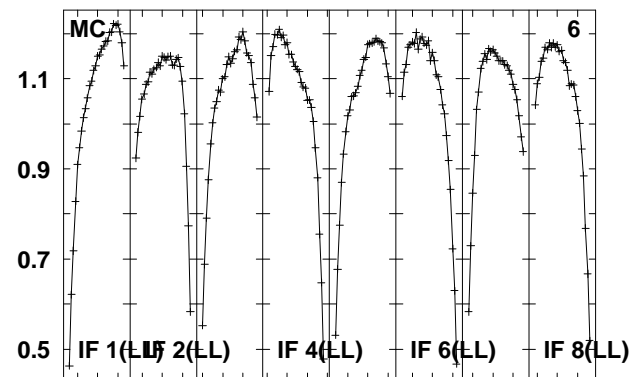
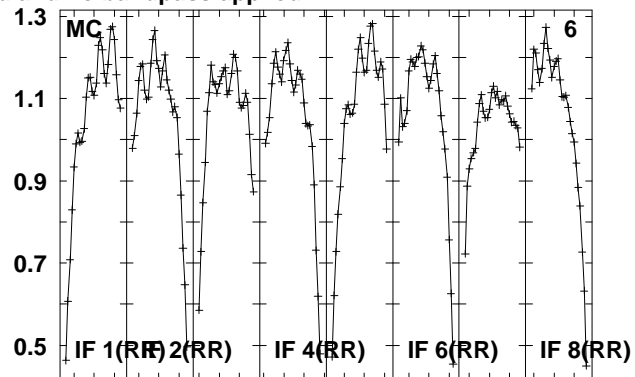
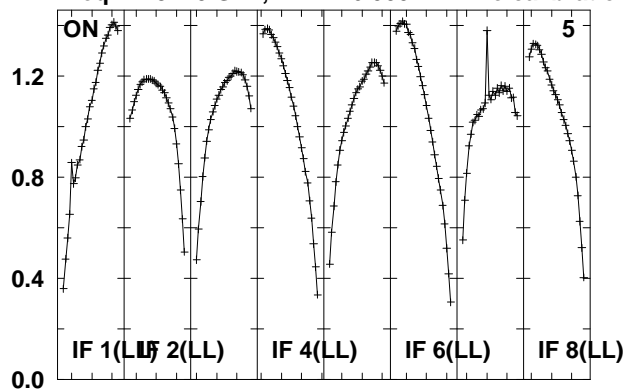

Lower frame: Real Jy

Total-power spectrum Antenna: *

Timerange: 00/13:21:00 to 00/13:22:28

Plot file version 371 created 14-MAY-2010 15:19:08

J0158+13 EO007.UVDATA.1

Freq = 4.9270 GHz, Bw = 16.000 MH No calibration applied and no bandpass applied

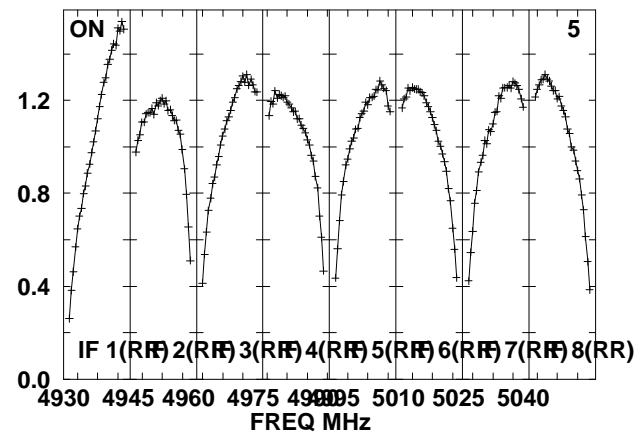
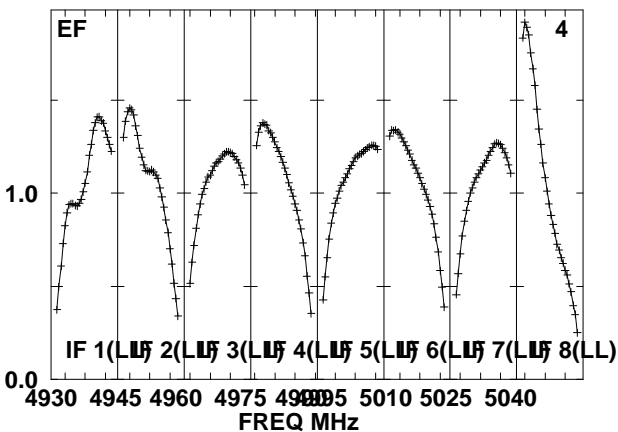
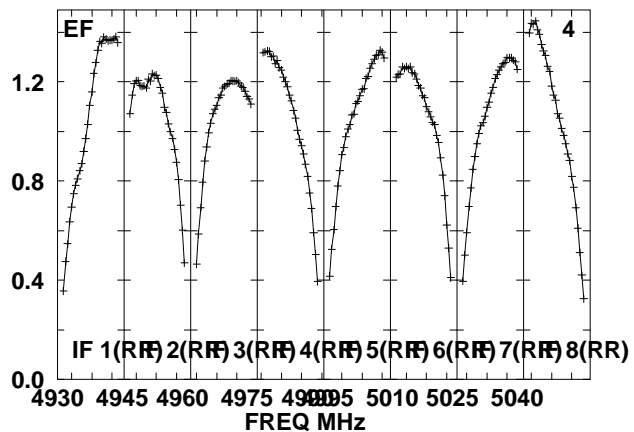
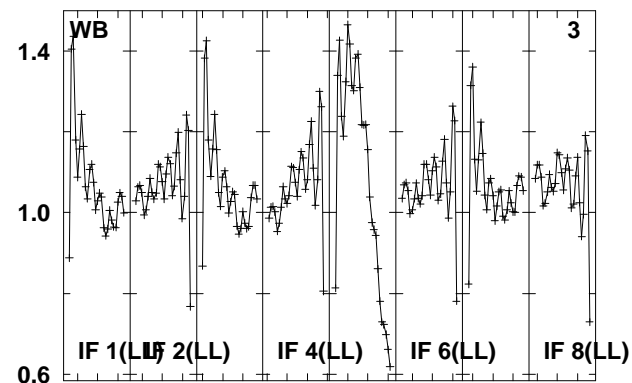
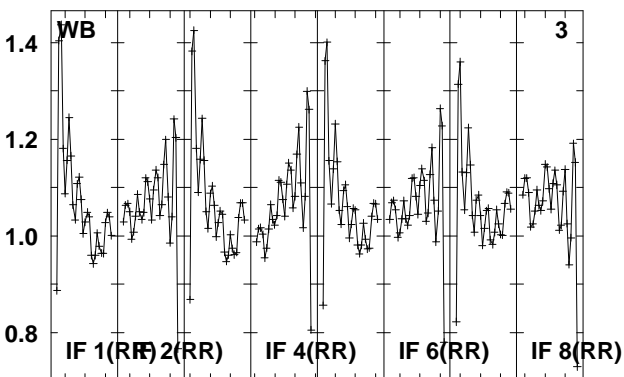
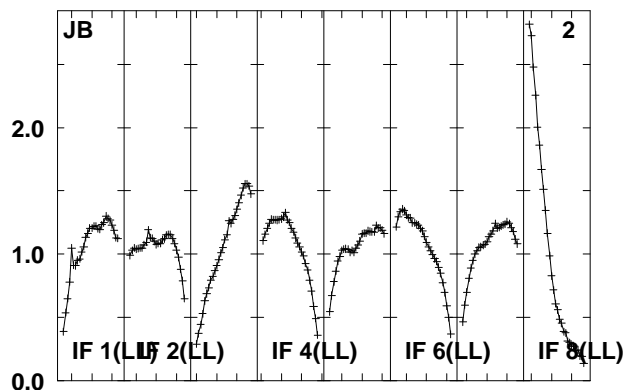
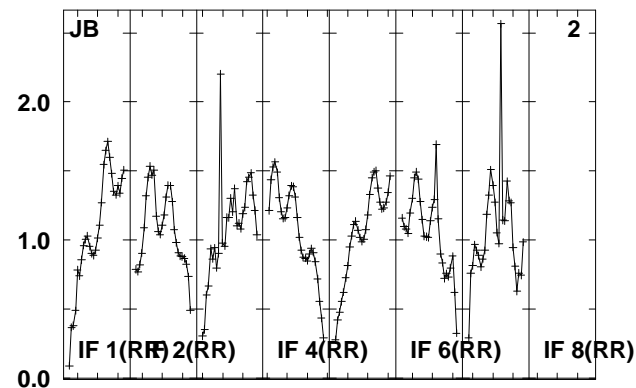
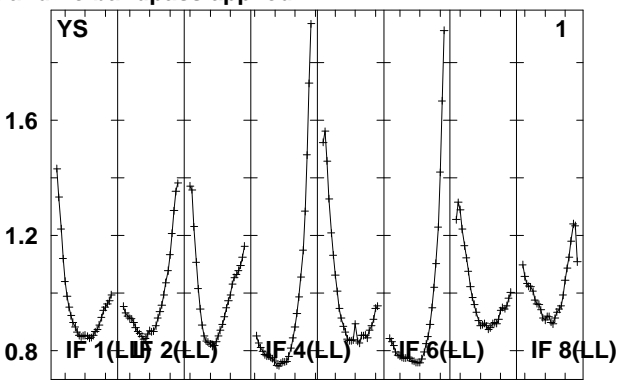
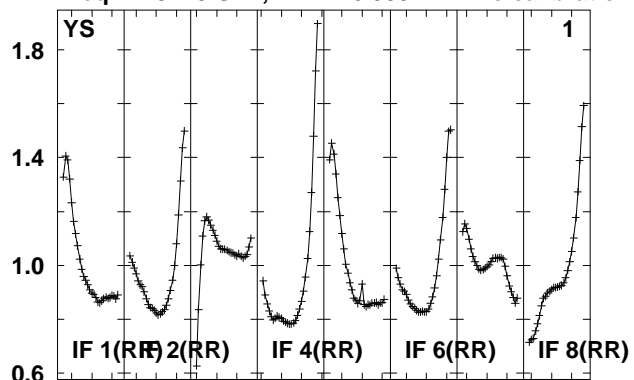

Lower frame: Real Jy
Total-power spectrum Antenna: *
Timerange: 00/13:23:09 to 00/13:24:35

Plot file version 372 created 14-MAY-2010 15:19:09

J0158+13 EO007.UVDATA.1

Freq = 4.9270 GHz, Bw = 16.000 MH No calibration applied and no bandpass applied

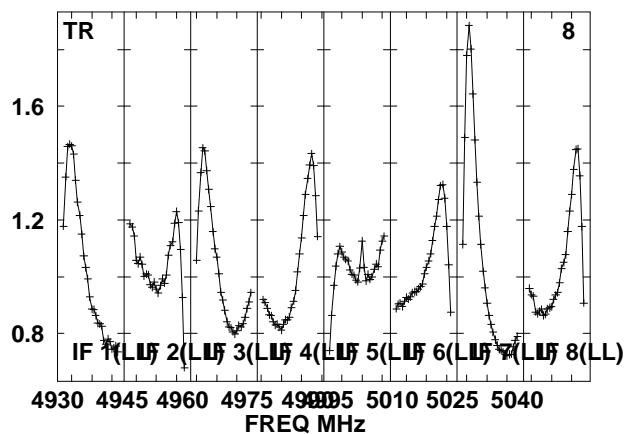
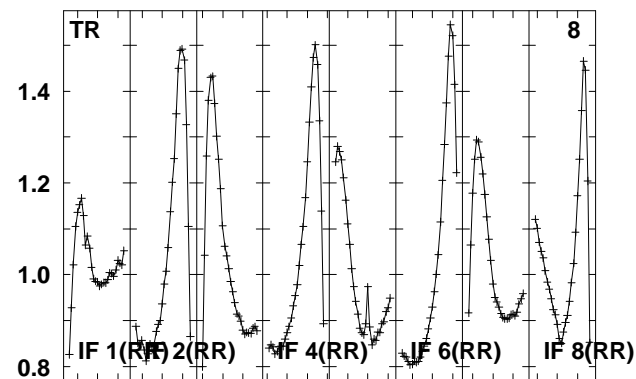
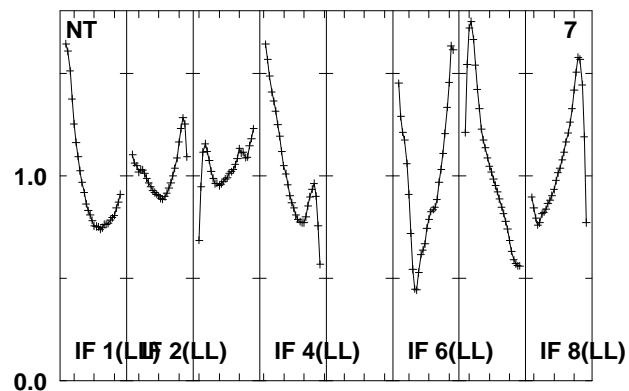
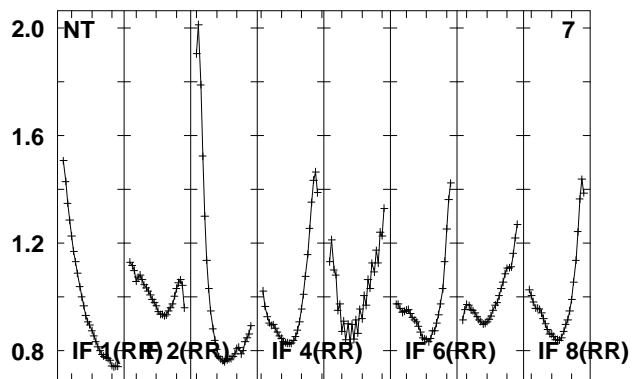
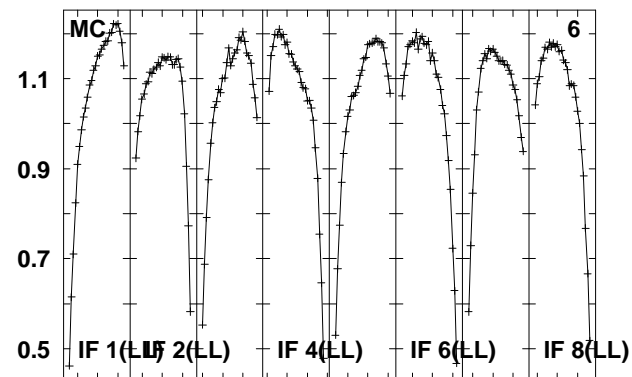
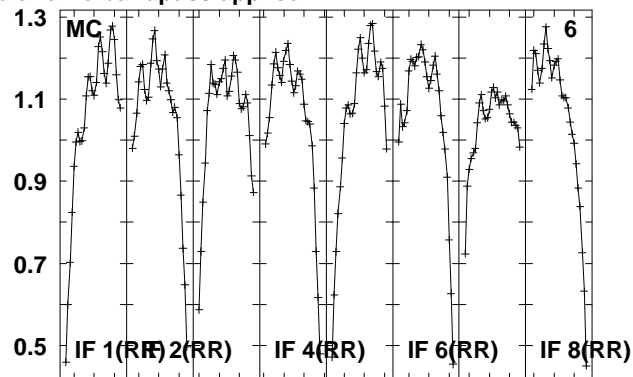
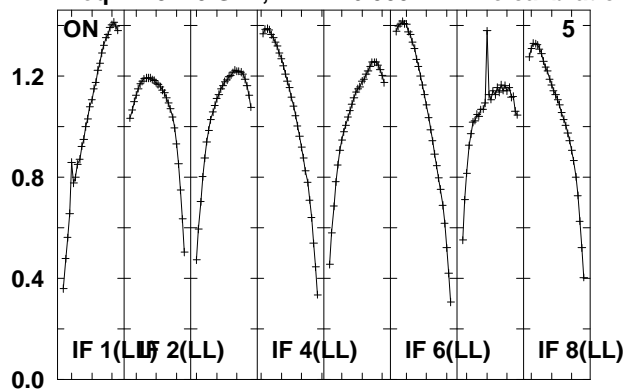

Lower frame: Real Jy

Total-power spectrum Antenna: *

Timerange: 00/13:23:09 to 00/13:24:35

Plot file version 373 created 14-MAY-2010 15:19:09
 J015028 EO007.UVDATA.1
 Freq = 4.9270 GHz, Bw = 16.000 MH No calibration applied and no bandpass applied

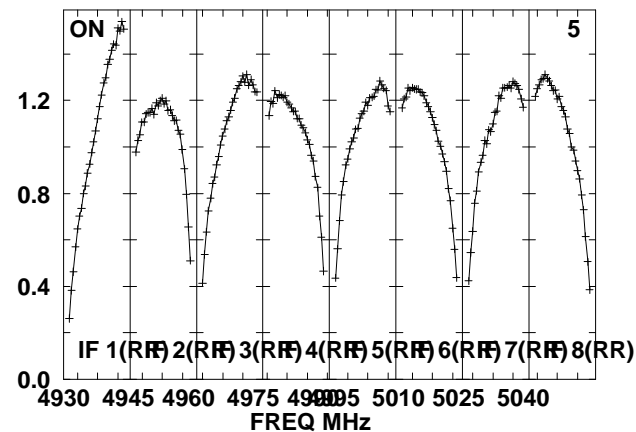
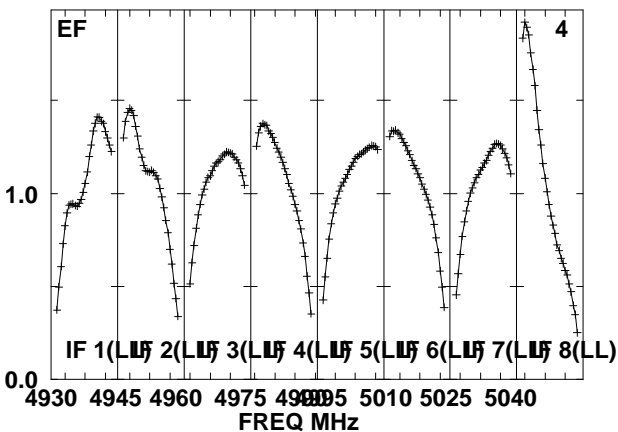
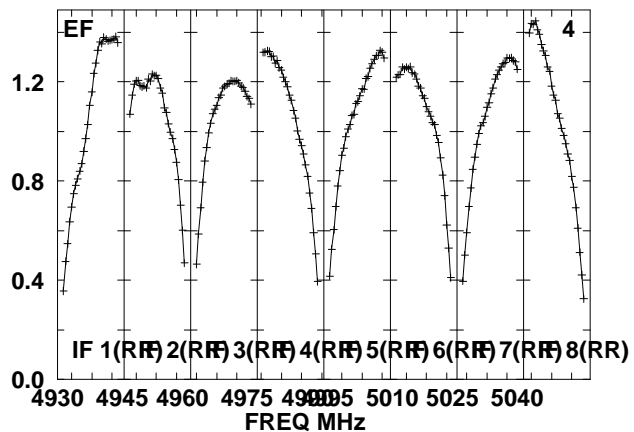
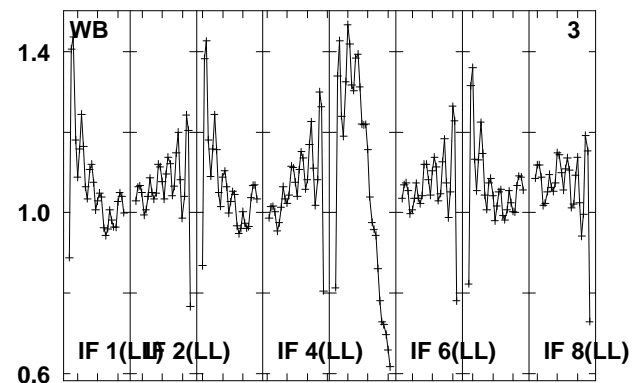
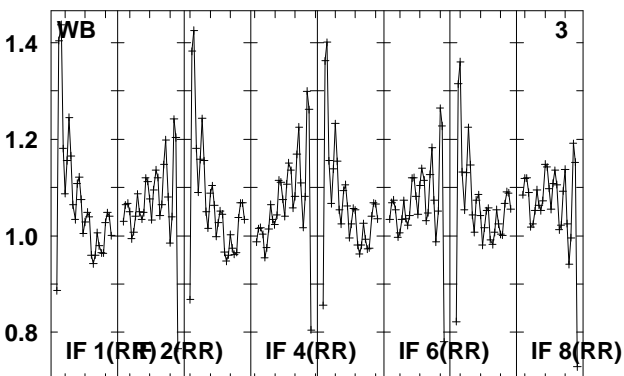
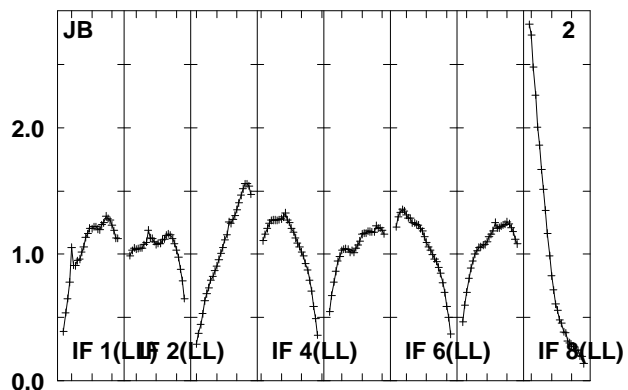
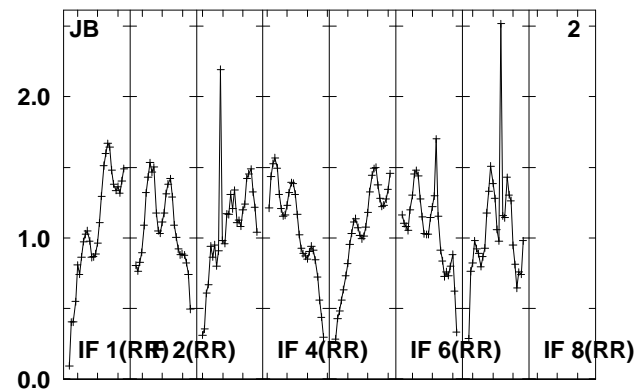
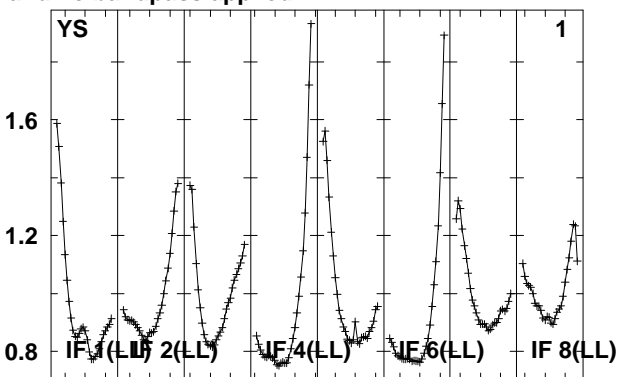
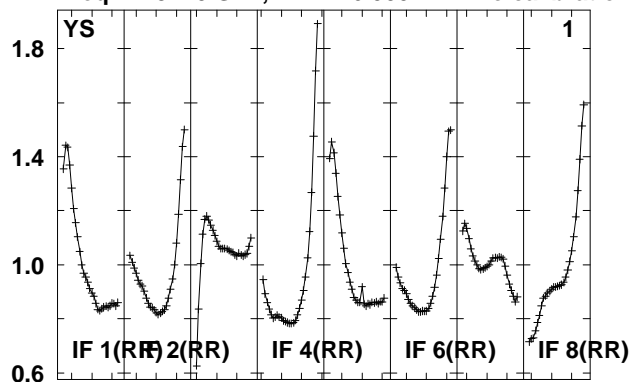

Lower frame: Real Jy
 Total-power spectrum Antenna: *
 Timerange: 00/13:25:14 to 00/13:30:12

Plot file version 374 created 14-MAY-2010 15:19:10

J015028 EO007.UVDATA.1

Freq = 4.9270 GHz, Bw = 16.000 MH No calibration applied and no bandpass applied

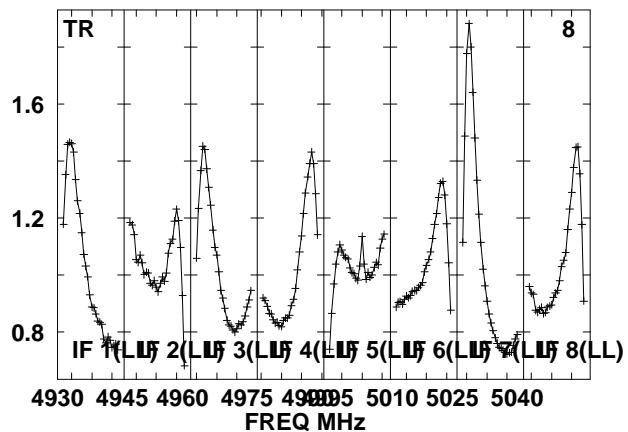
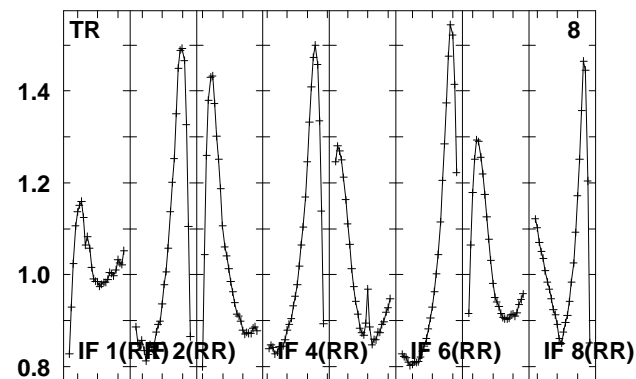
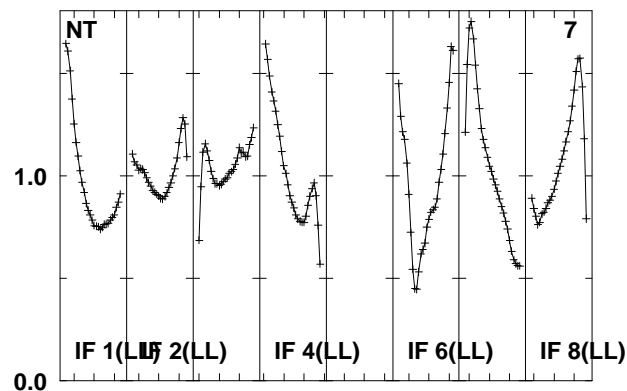
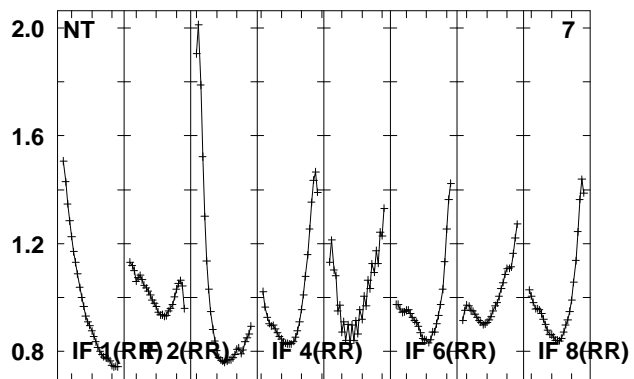
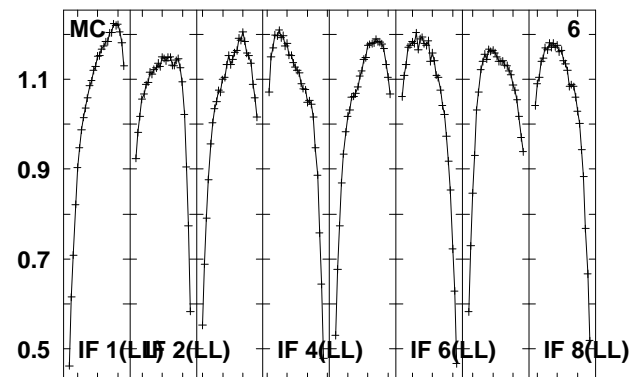
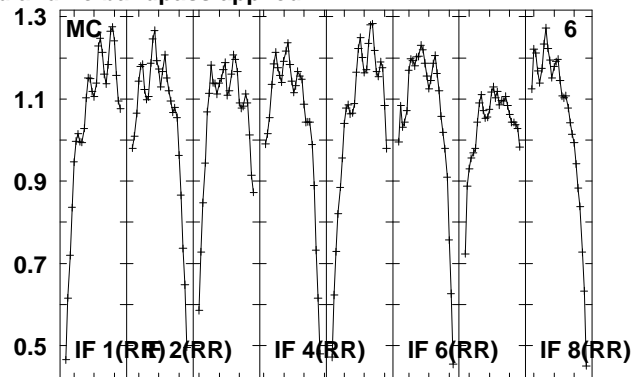
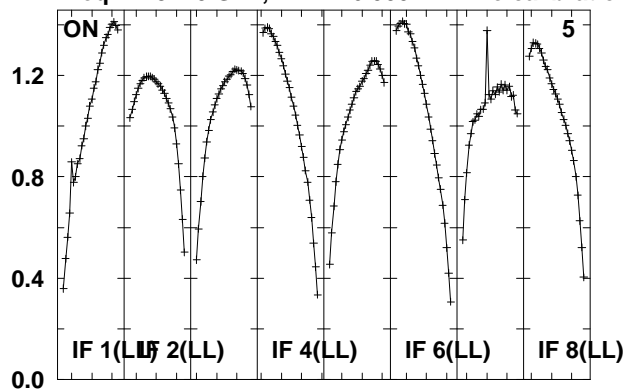

Lower frame: Real Jy

Total-power spectrum Antenna: *

Timerange: 00/13:25:14 to 00/13:30:12

Plot file version 375 created 14-MAY-2010 15:19:10

J0158+13 EO007.UVDATA.1

Freq = 4.9270 GHz, Bw = 16.000 MH No calibration applied and no bandpass applied

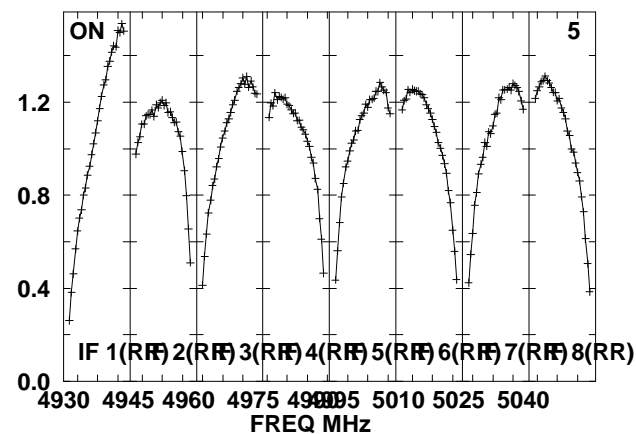
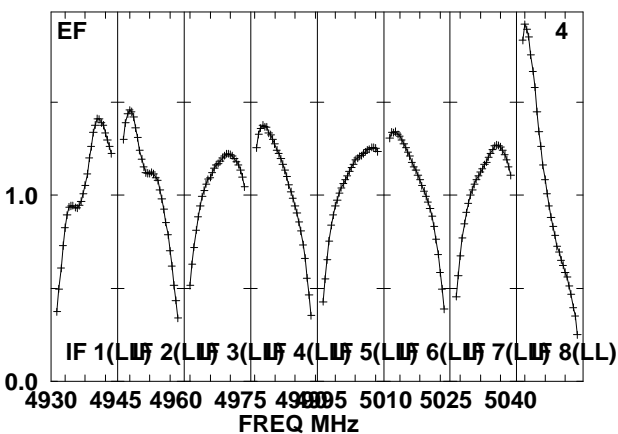
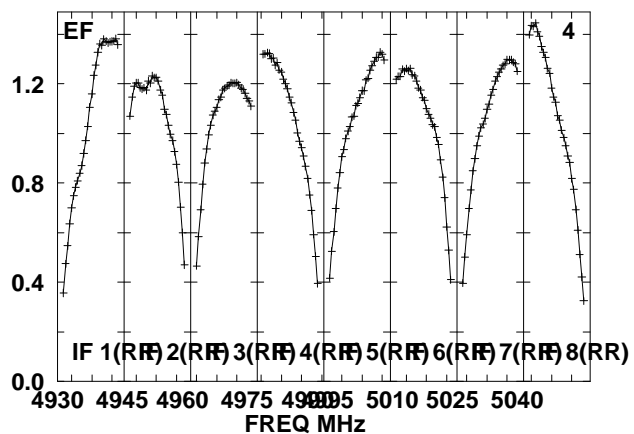
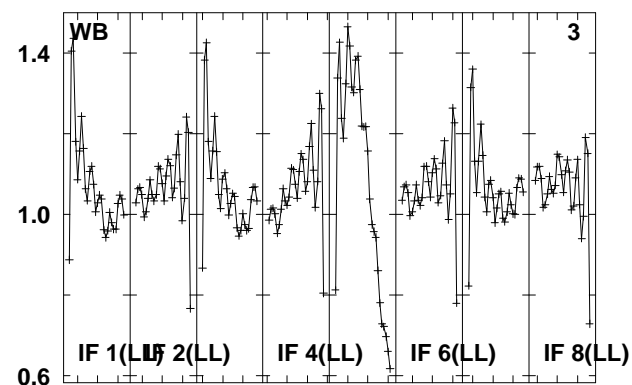
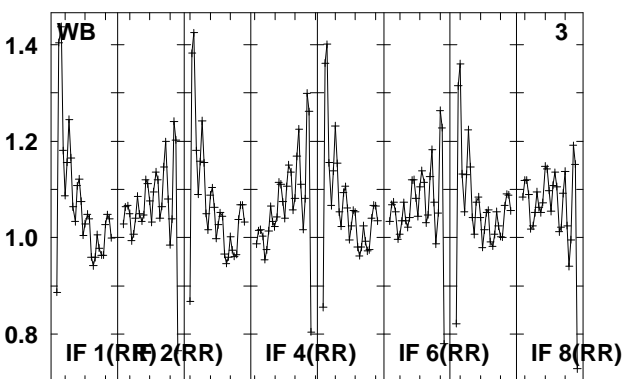
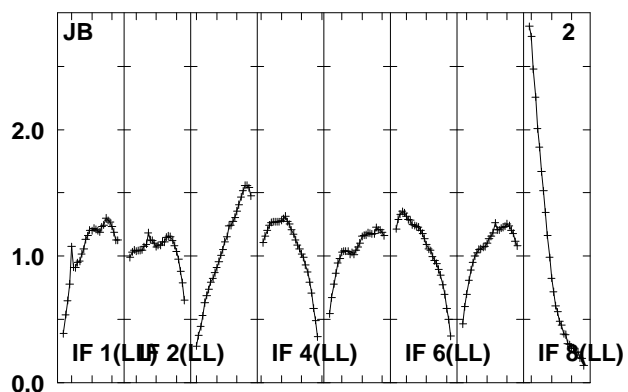
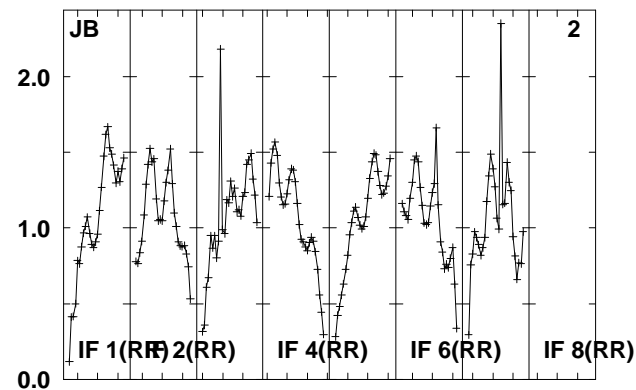
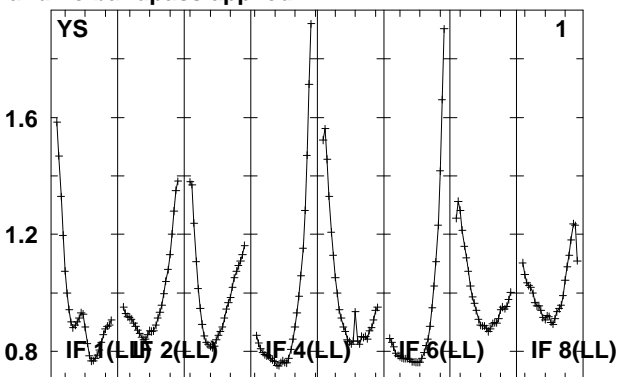
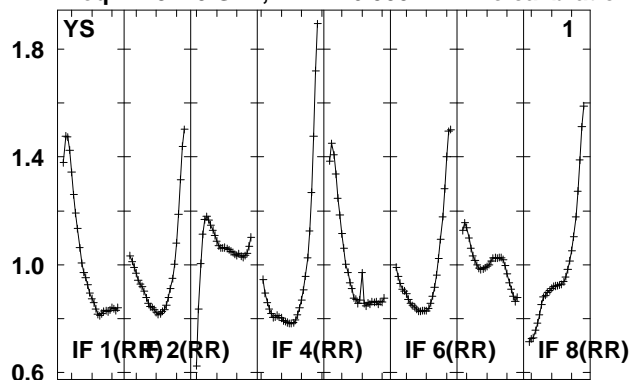

Lower frame: Real Jy
Total-power spectrum Antenna: *
Timerange: 00/13:30:49 to 00/13:32:17

Plot file version 376 created 14-MAY-2010 15:19:11

J0158+13 EO007.UVDATA.1

Freq = 4.9270 GHz, Bw = 16.000 MH No calibration applied and no bandpass applied

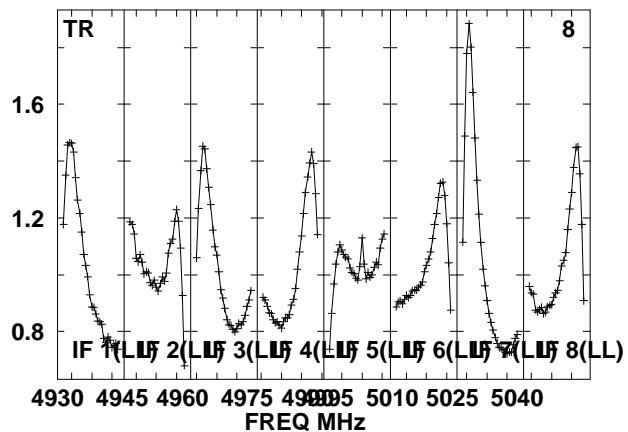
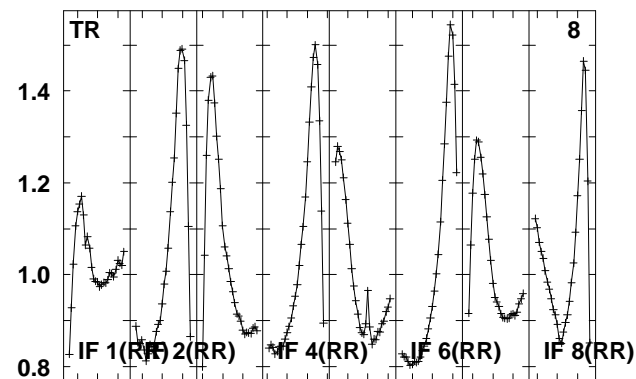
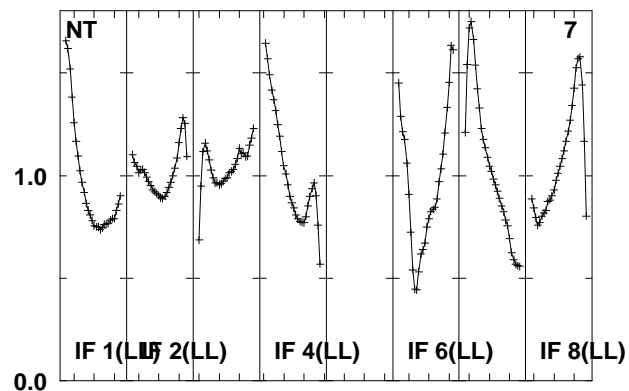
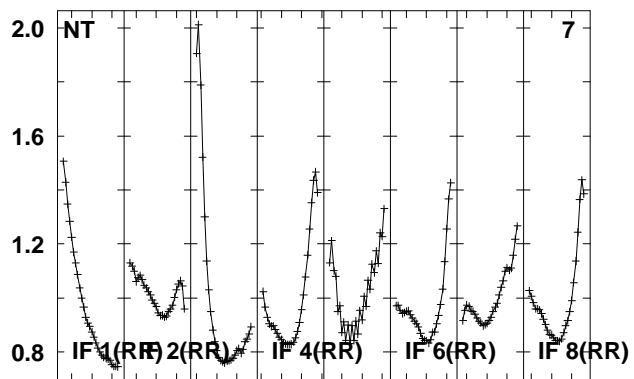
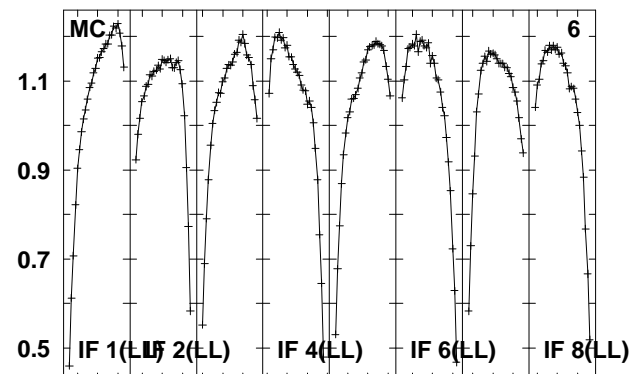
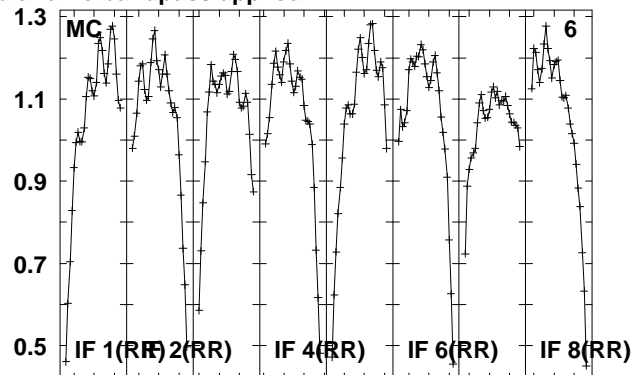
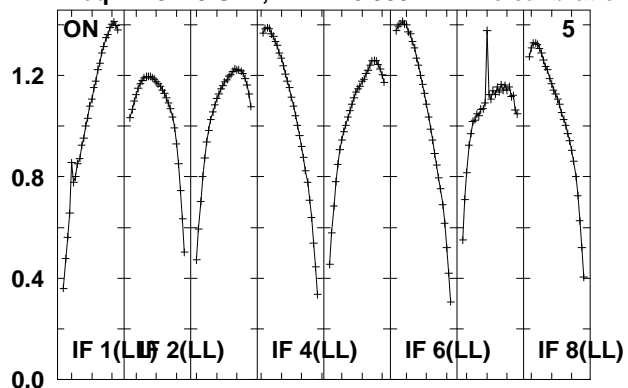

Lower frame: Real Jy

Total-power spectrum Antenna: *

Timerange: 00/13:30:49 to 00/13:32:17

Plot file version 377 created 14-MAY-2010 15:19:11
 J015028 EO007.UVDATA.1
 Freq = 4.9270 GHz, Bw = 16.000 MH No calibration applied and no bandpass applied

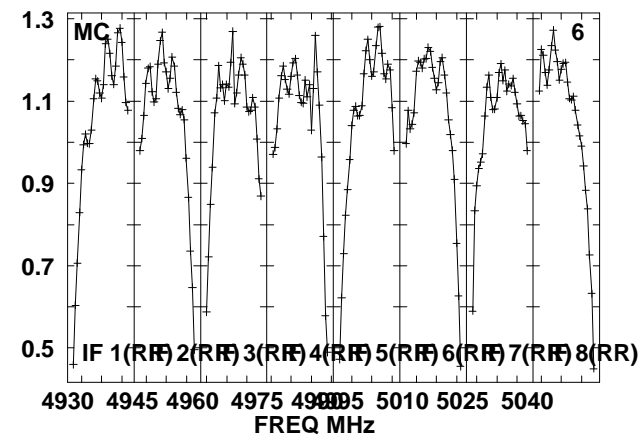
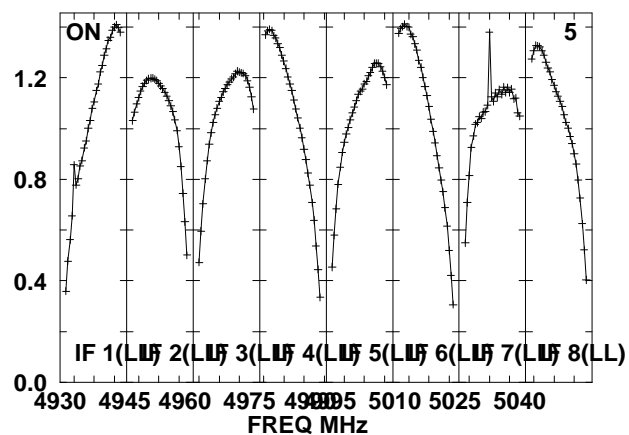
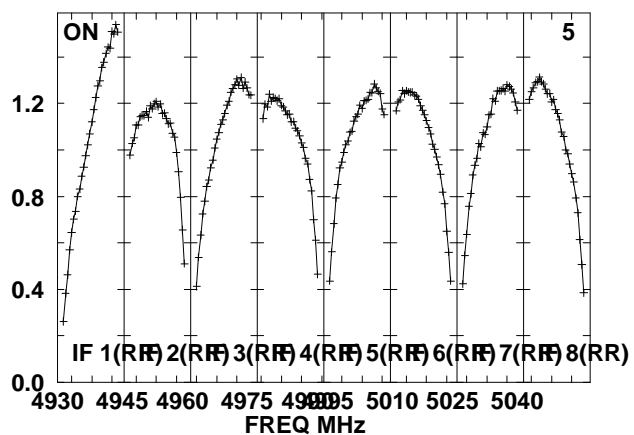
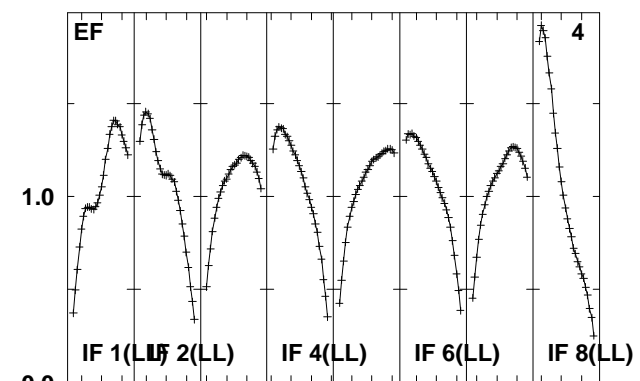
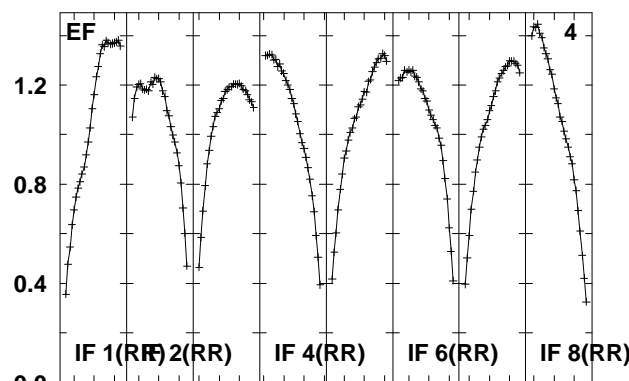
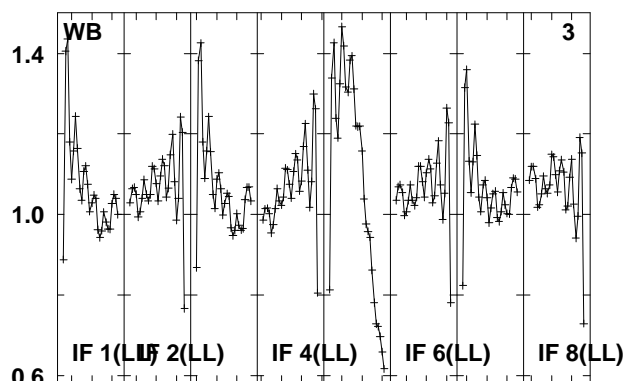
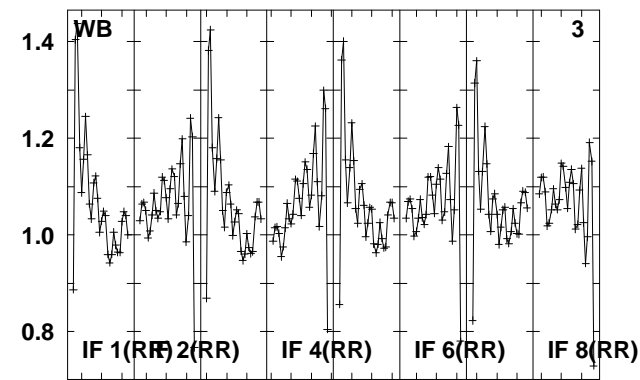
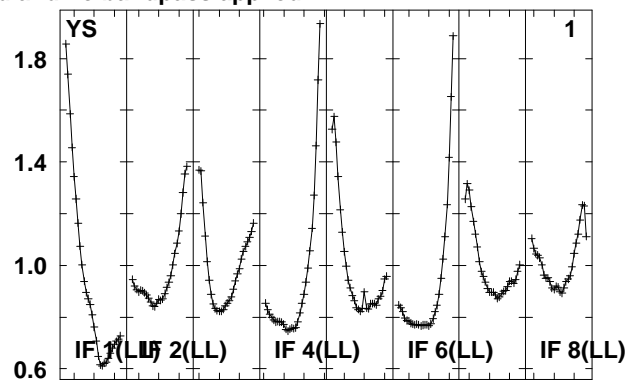
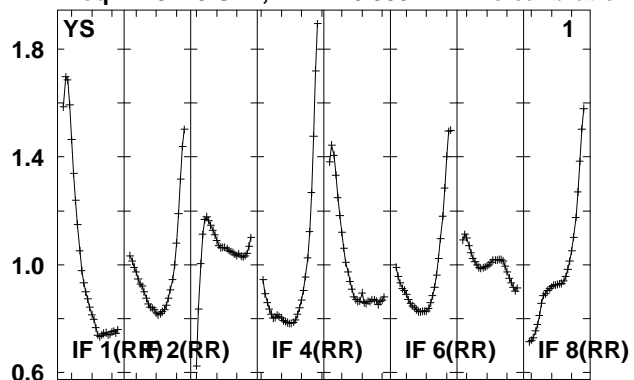

Lower frame: Real Jy
 Total-power spectrum Antenna: *
 Timerange: 00/13:32:55 to 00/13:37:51

Plot file version 378 created 14-MAY-2010 15:19:11

J015028 EO007.UVDATA.1

Freq = 4.9270 GHz, Bw = 16.000 MH No calibration applied and no bandpass applied

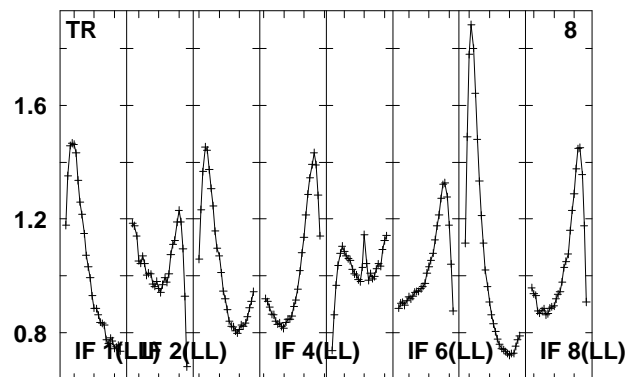
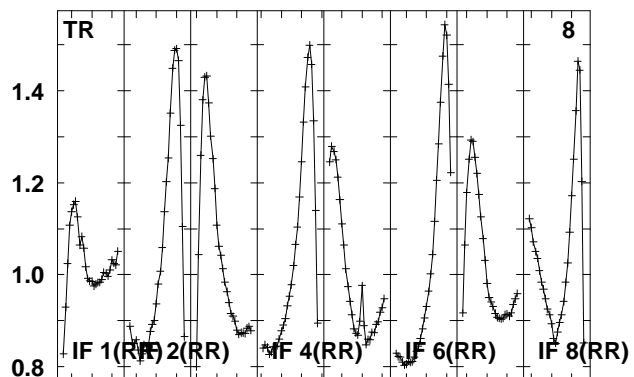
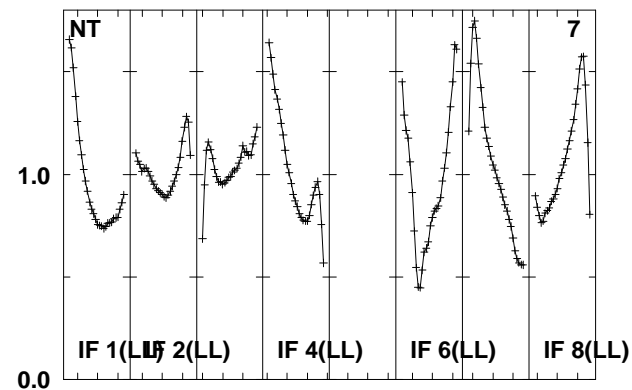
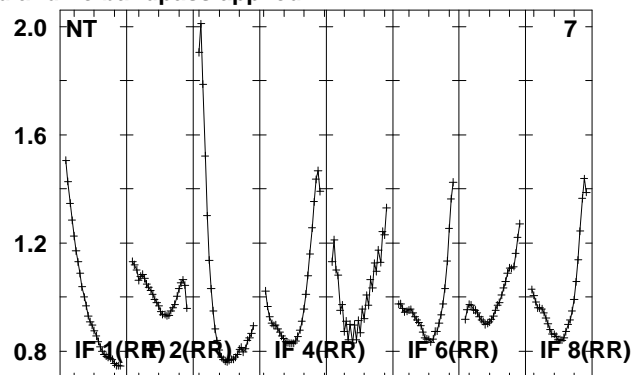
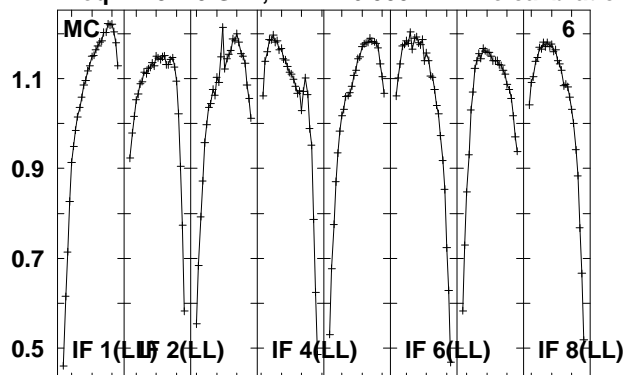

Lower frame: Real Jy
Total-power spectrum Antenna: *
Timerange: 00/13:32:55 to 00/13:37:51

Plot file version 379 created 14-MAY-2010 15:19:12

J0158+13 EO007.UVDATA.1

Freq = 4.9270 GHz, Bw = 16.000 MH No calibration applied and no bandpass applied

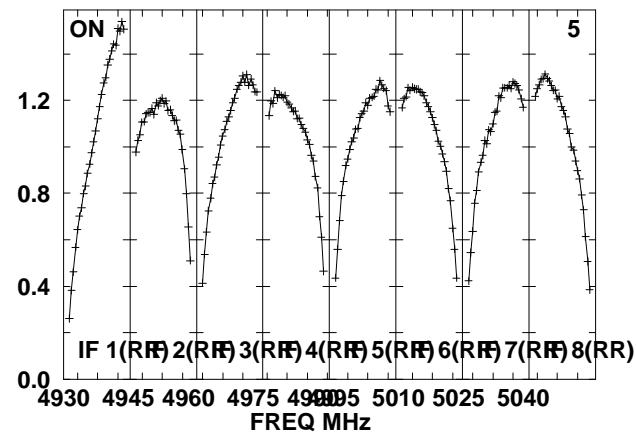
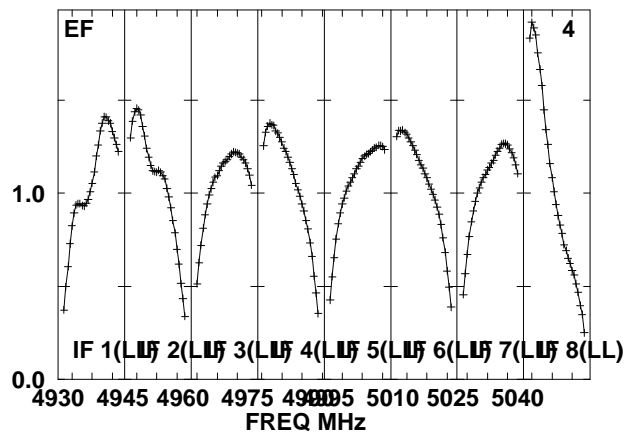
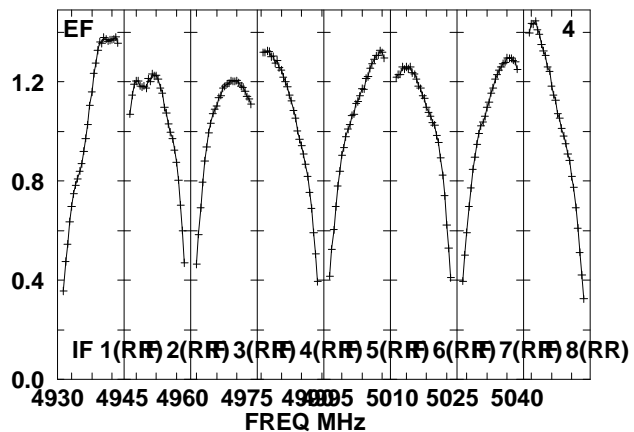
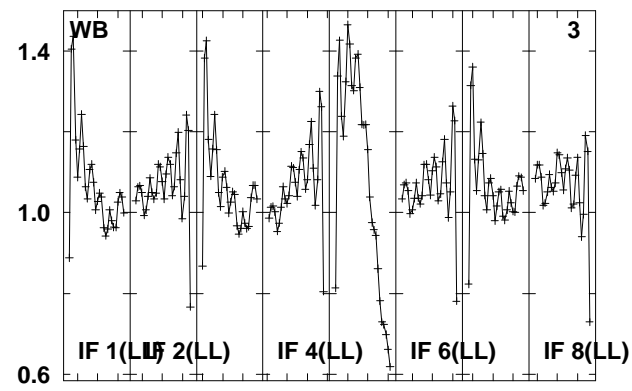
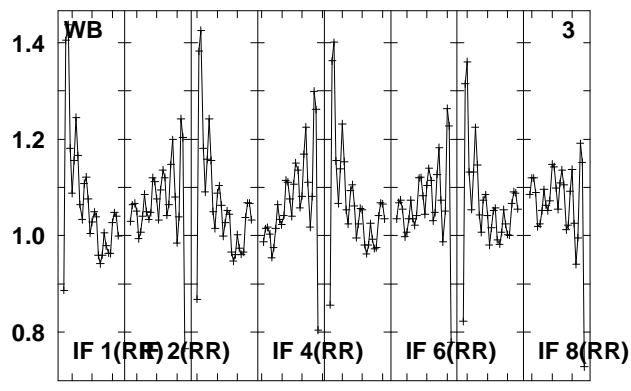
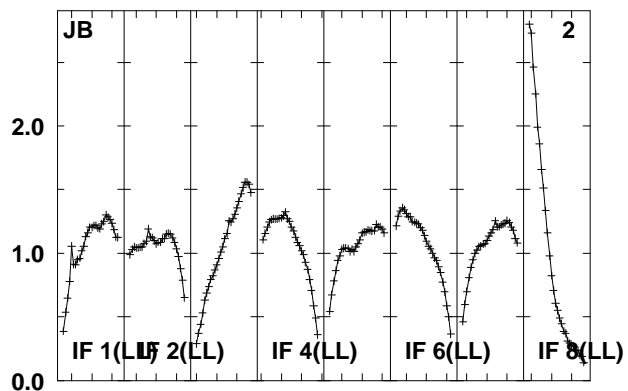
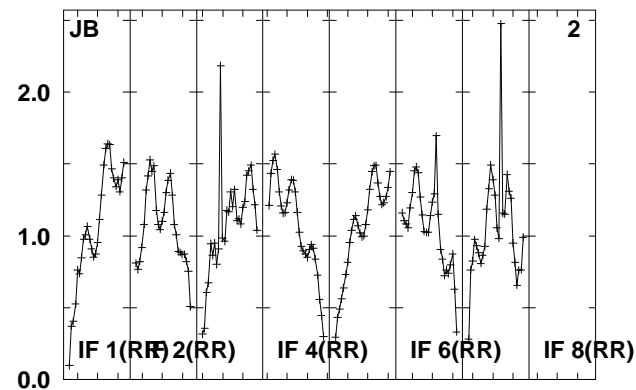
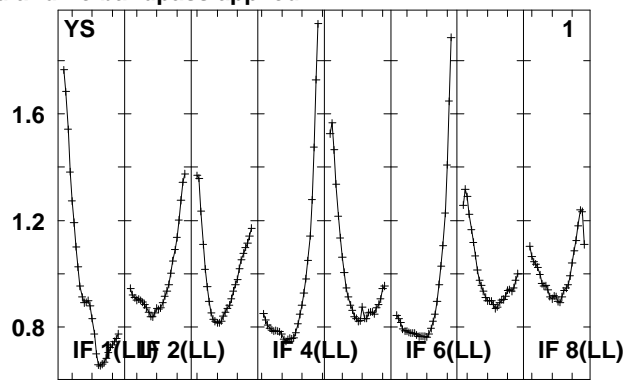
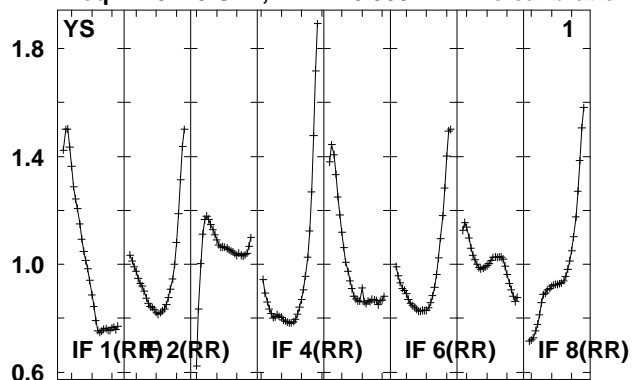

Lower frame: Real Jy
Total-power spectrum Antenna: *
Timerange: 00/13:38:29 to 00/13:39:57

Plot file version 380 created 14-MAY-2010 15:19:12

J0158+13 EO007.UVDATA.1

Freq = 4.9270 GHz, Bw = 16.000 MH No calibration applied and no bandpass applied

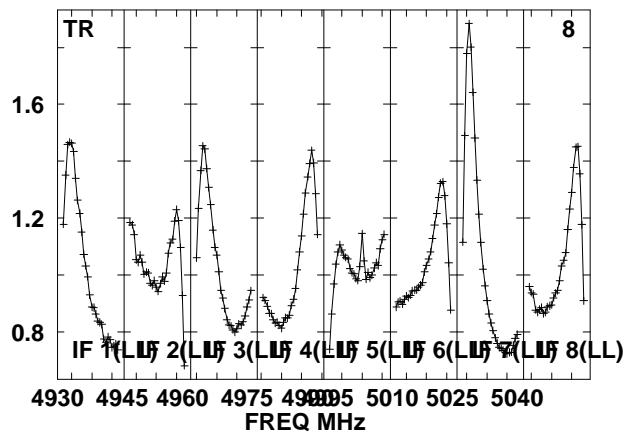
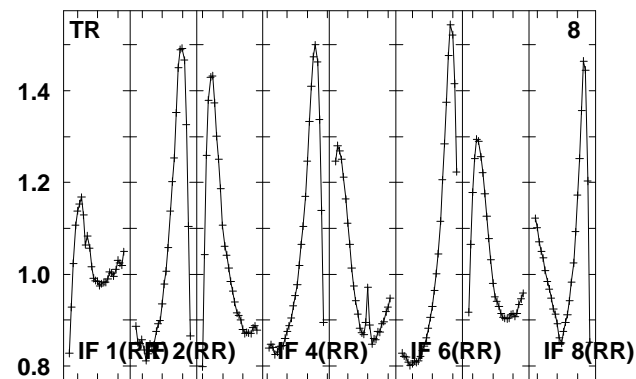
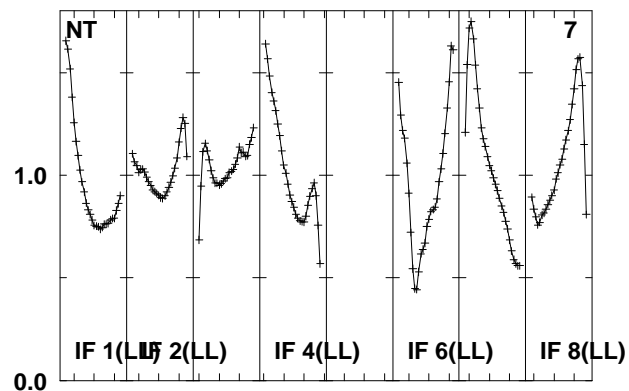
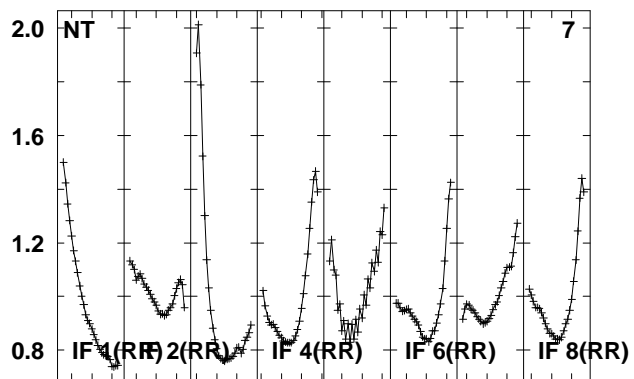
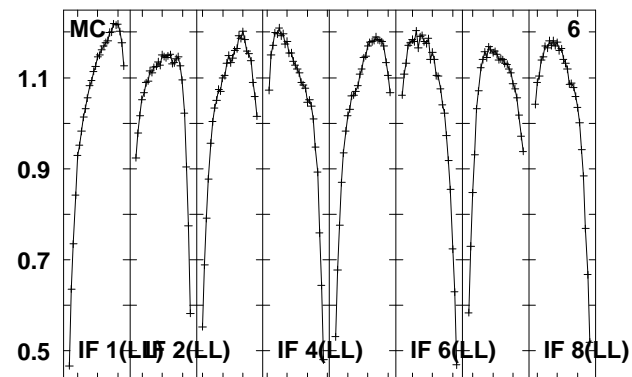
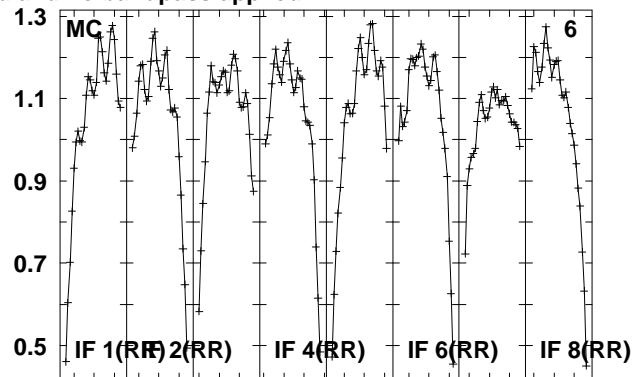
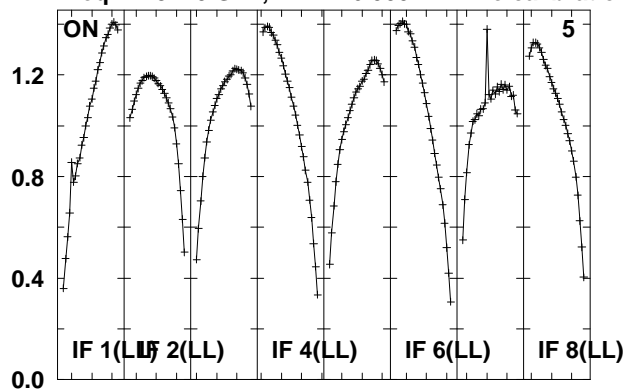

Lower frame: Real Jy

Total-power spectrum Antenna: *

Timerange: 00/13:38:29 to 00/13:39:57

Plot file version 381 created 14-MAY-2010 15:19:12

J0209+13 EO007.UVDATA.1

Freq = 4.9270 GHz, Bw = 16.000 MH No calibration applied and no bandpass applied

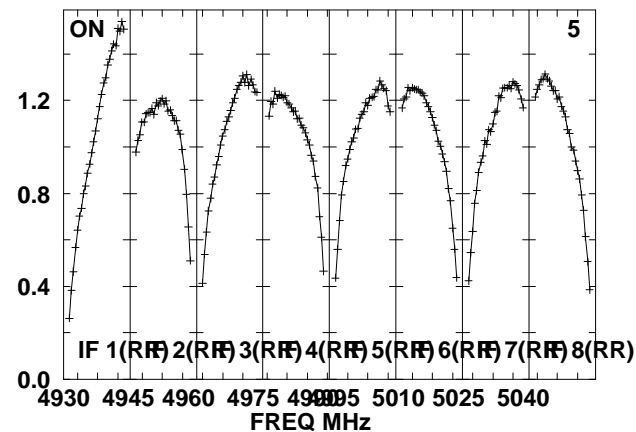
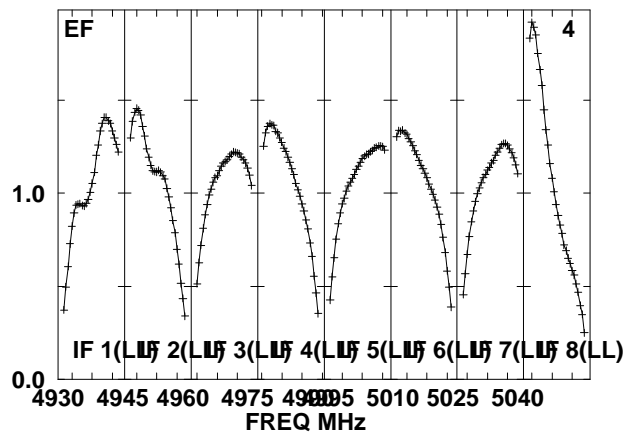
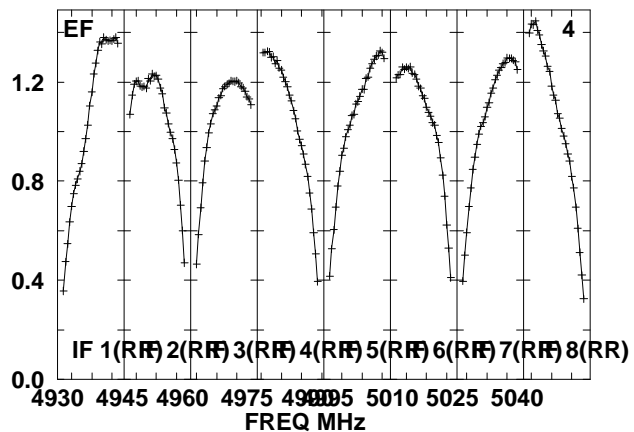
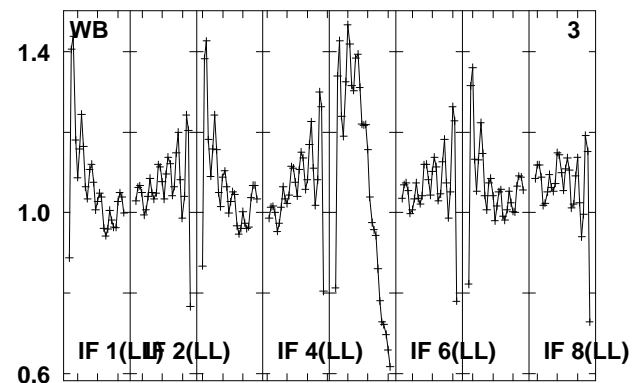
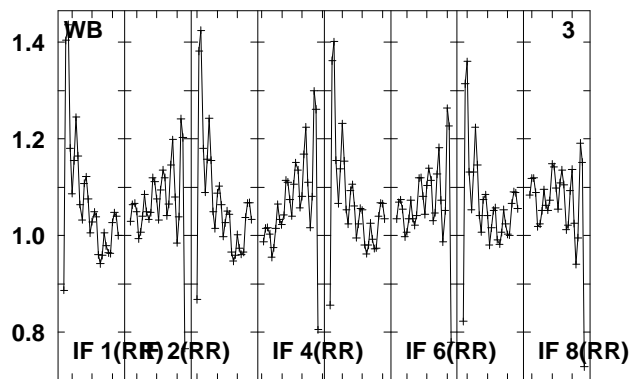
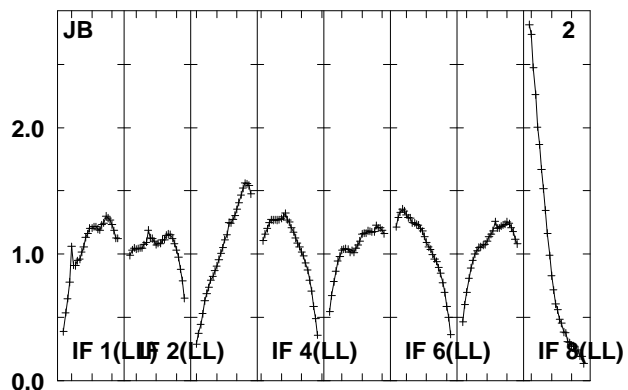
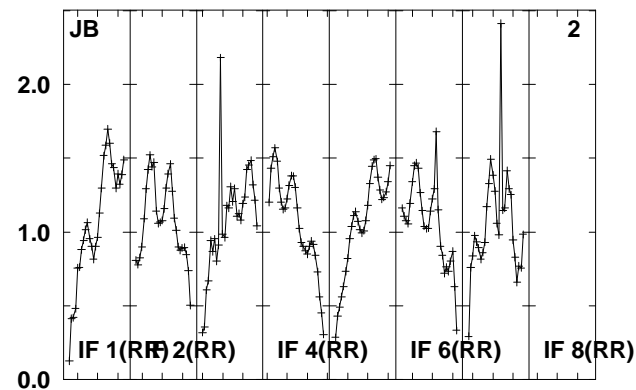
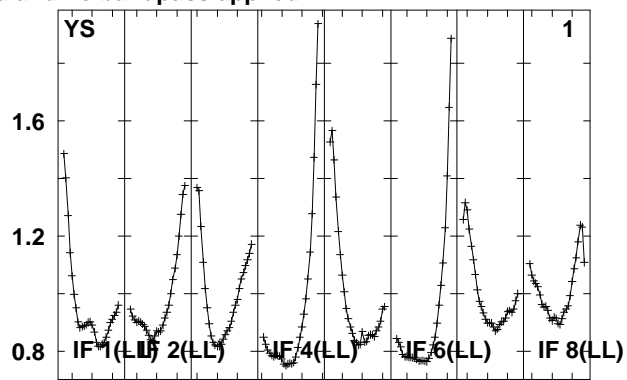
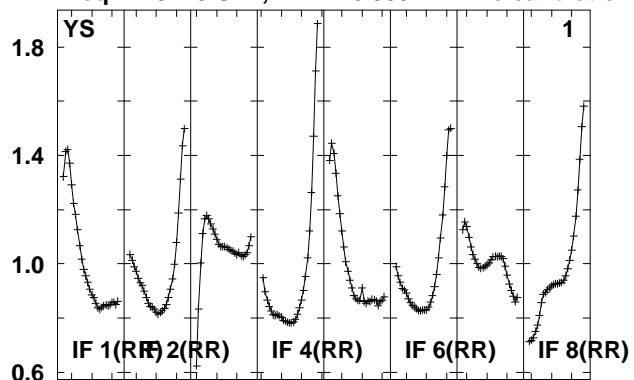

Lower frame: Real Jy
Total-power spectrum Antenna: *
Timerange: 00/13:40:37 to 00/13:42:05

Plot file version 382 created 14-MAY-2010 15:19:12

J0209+13 EO007.UVDATA.1

Freq = 4.9270 GHz, Bw = 16.000 MH No calibration applied and no bandpass applied

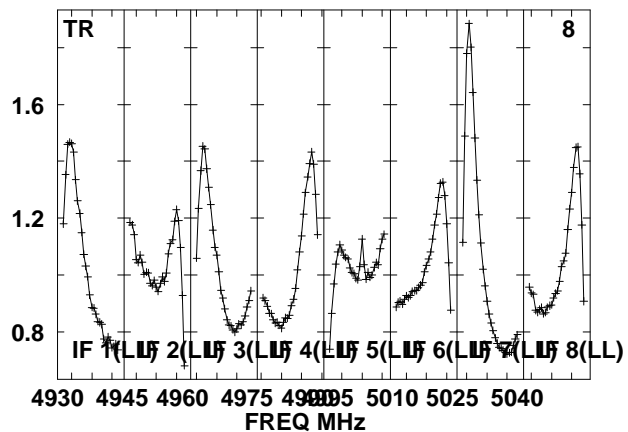
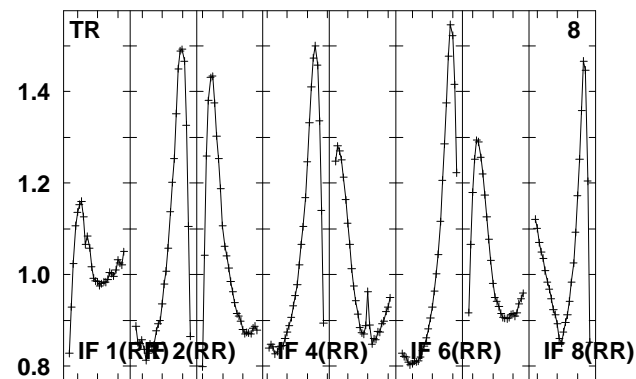
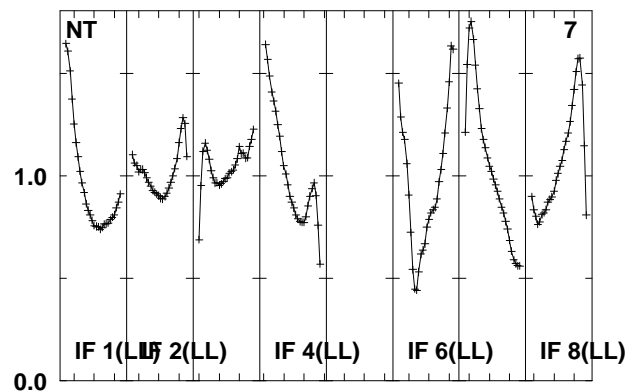
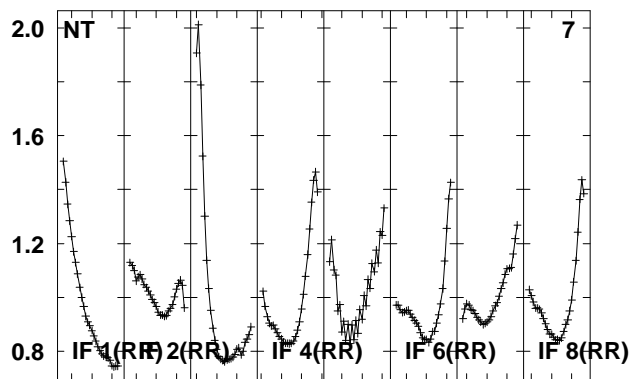
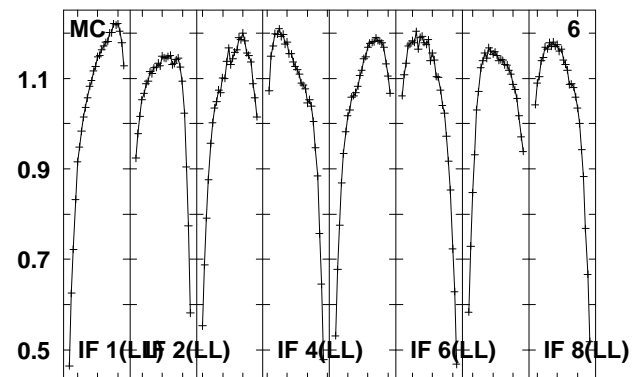
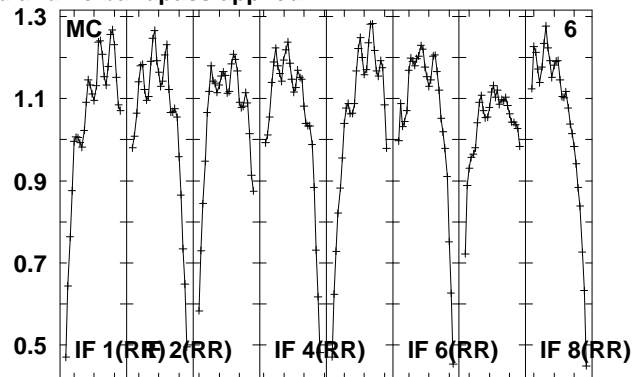
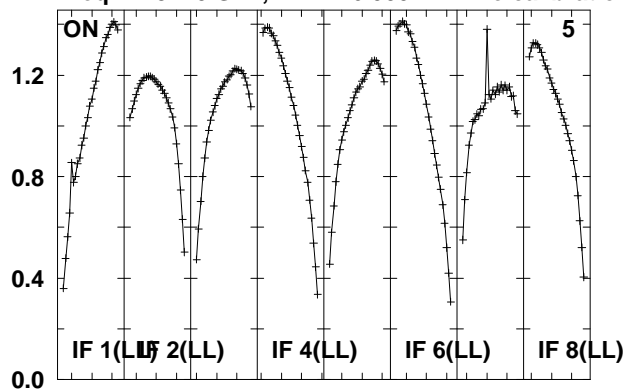

Lower frame: Real Jy

Total-power spectrum Antenna: *

Timerange: 00/13:40:37 to 00/13:42:05

Plot file version 383 created 14-MAY-2010 15:19:13

J021348 EO007.UVDATA.1

Freq = 4.9270 GHz, Bw = 16.000 MH No calibration applied and no bandpass applied

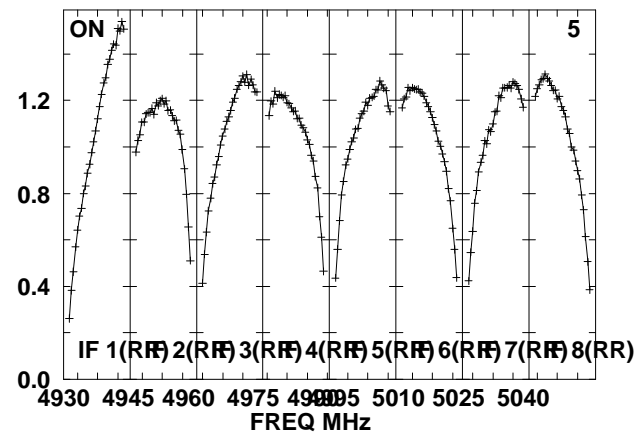
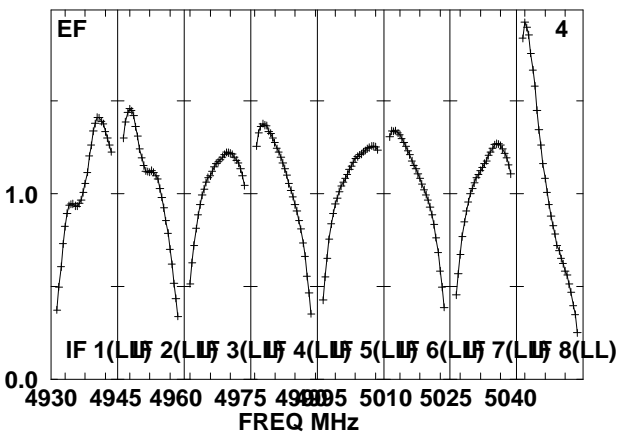
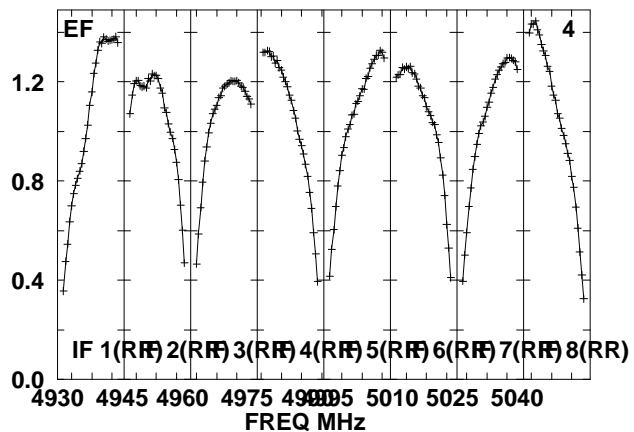
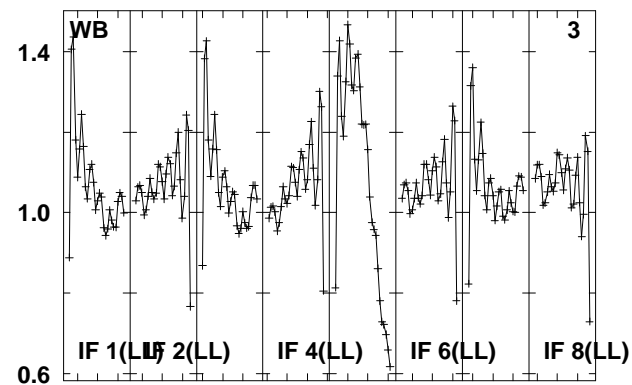
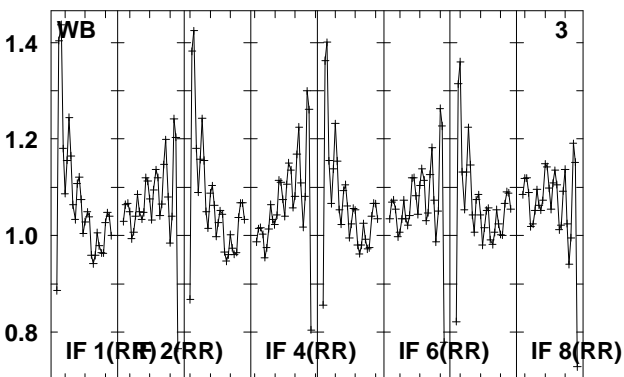
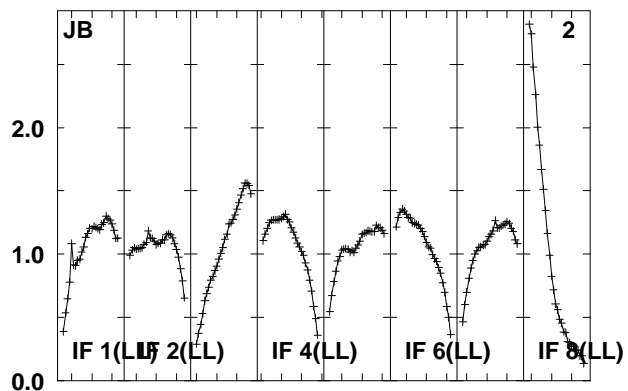
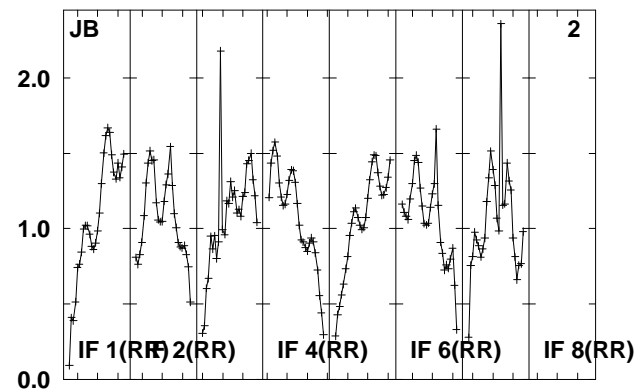
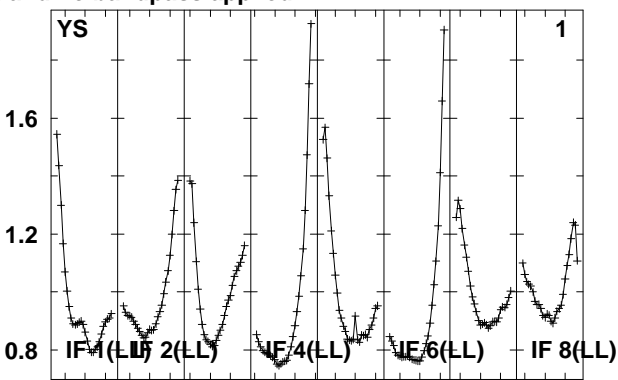
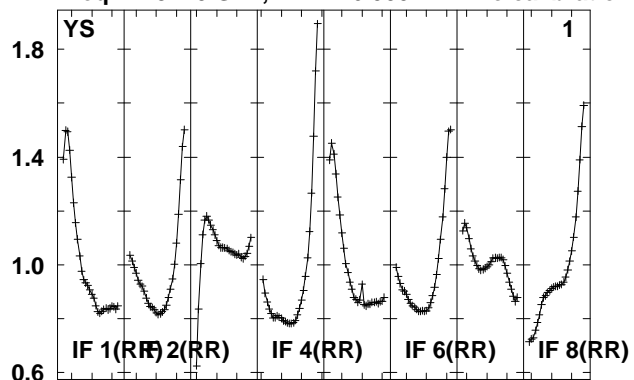

Lower frame: Real Jy
Total-power spectrum Antenna: *
Timerange: 00/13:42:33 to 00/13:47:31

Plot file version 384 created 14-MAY-2010 15:19:13

J021348 EO007.UVDATA.1

Freq = 4.9270 GHz, Bw = 16.000 MH No calibration applied and no bandpass applied

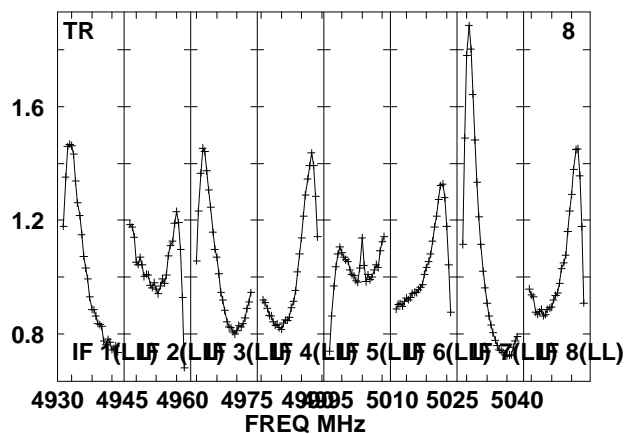
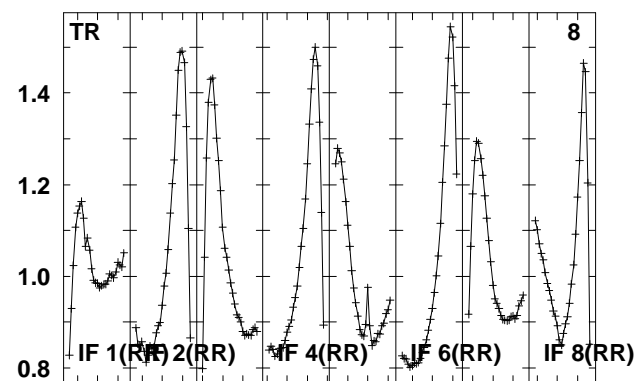
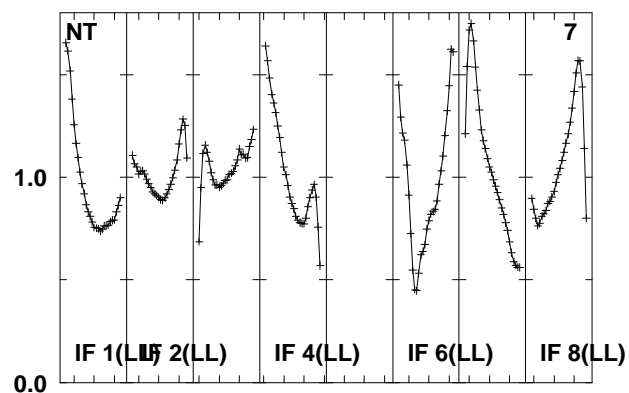
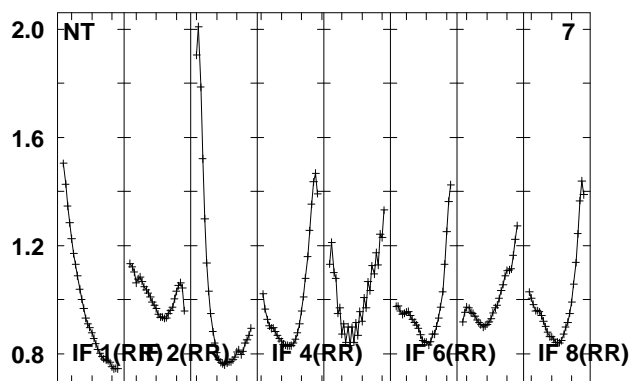
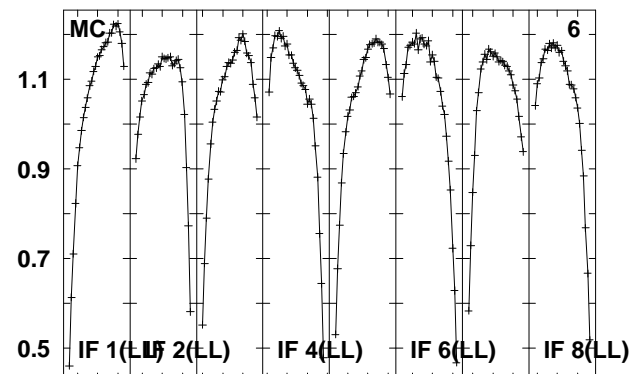
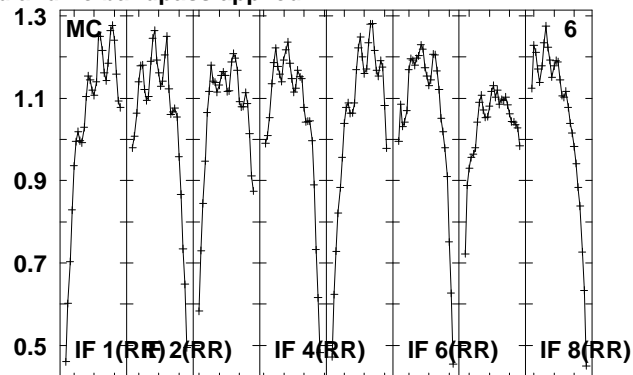
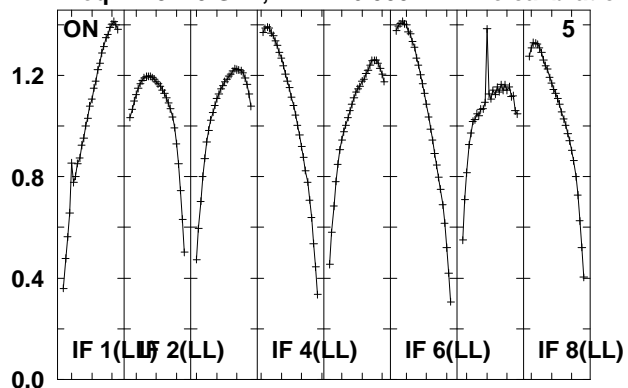

Lower frame: Real Jy

Total-power spectrum Antenna: *

Timerange: 00/13:42:33 to 00/13:47:31

Plot file version 385 created 14-MAY-2010 15:19:14

J0209+13 EO007.UVDATA.1

Freq = 4.9270 GHz, Bw = 16.000 MH No calibration applied and no bandpass applied

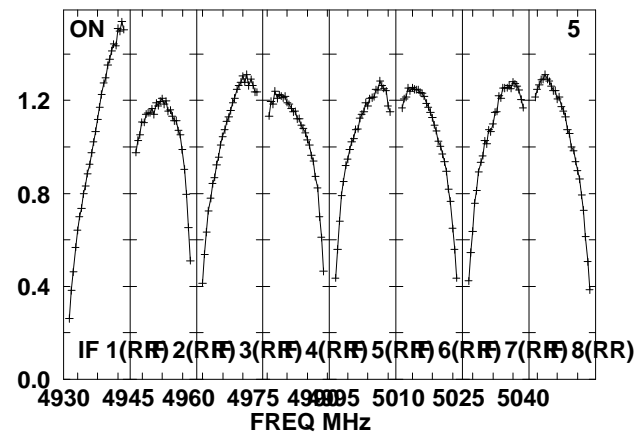
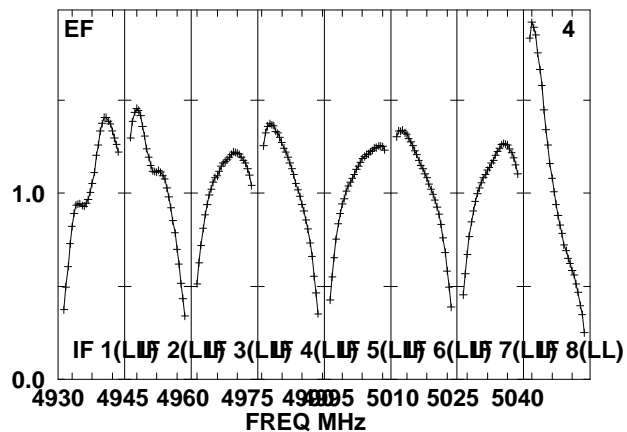
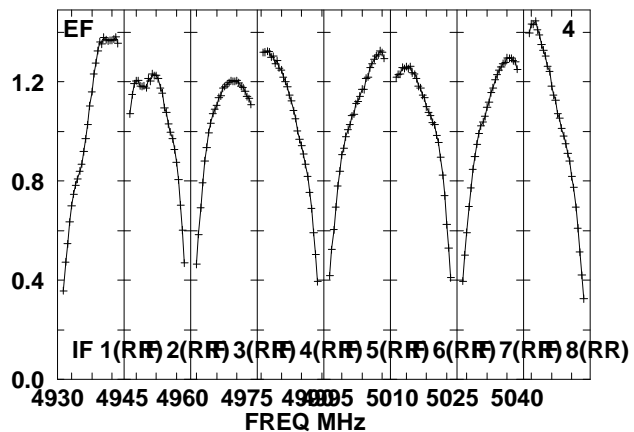
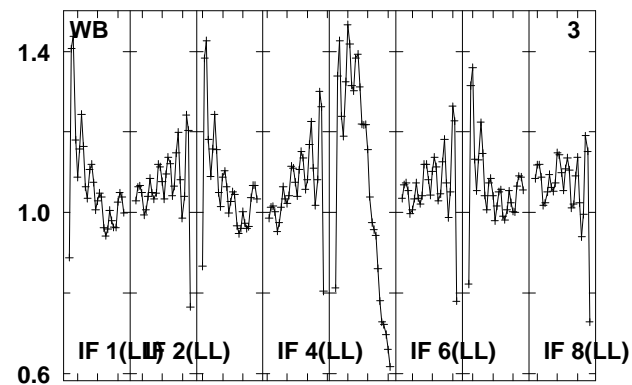
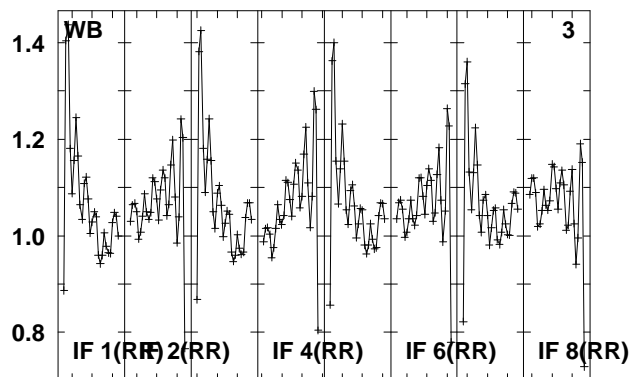
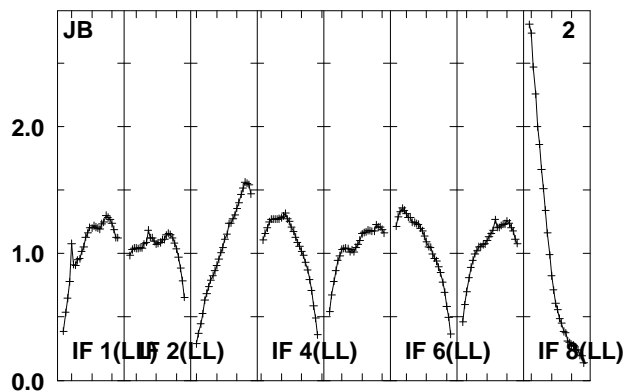
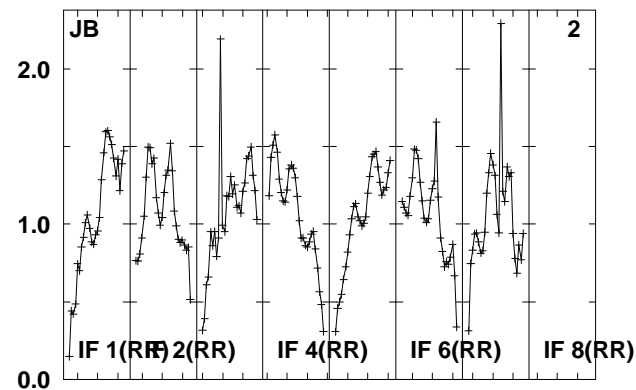
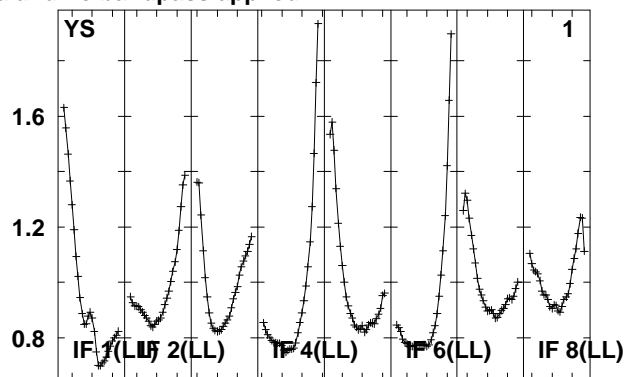
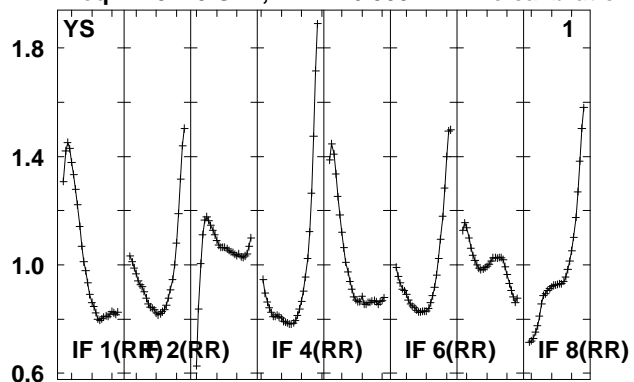

Lower frame: Real Jy

Total-power spectrum Antenna: *

Timerange: 00/13:48:01 to 00/13:49:29

Plot file version 386 created 14-MAY-2010 15:19:14

J0209+13 EO007.UVDATA.1

Freq = 4.9270 GHz, Bw = 16.000 MH No calibration applied and no bandpass applied

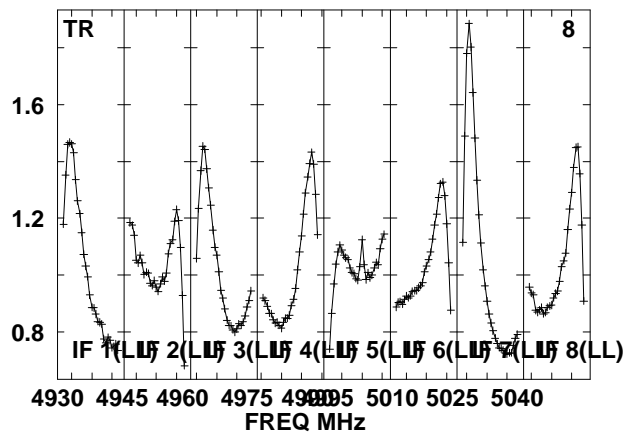
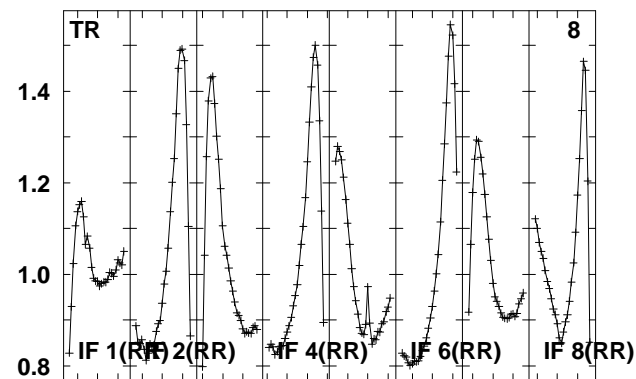
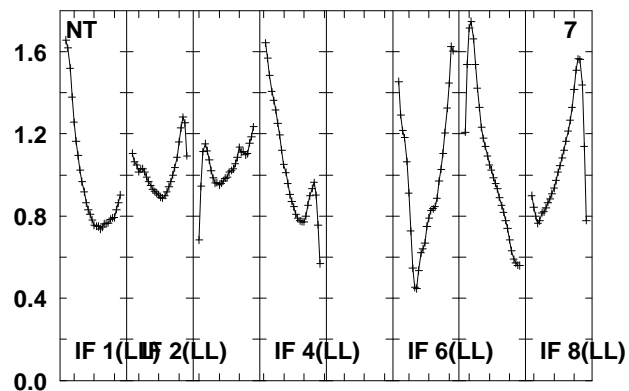
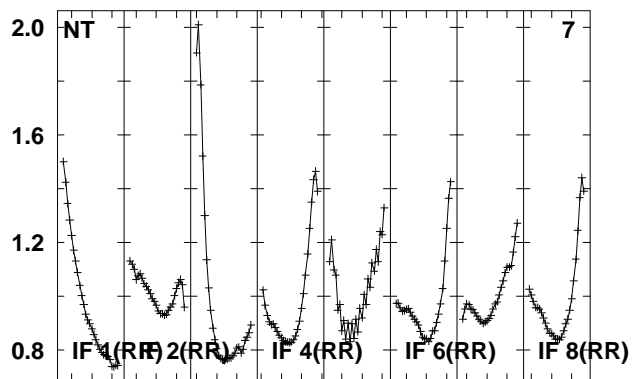
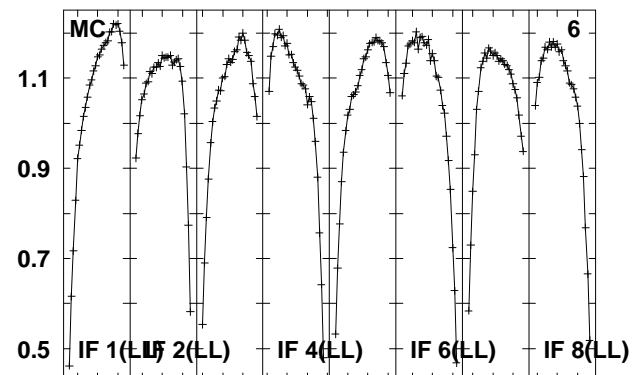
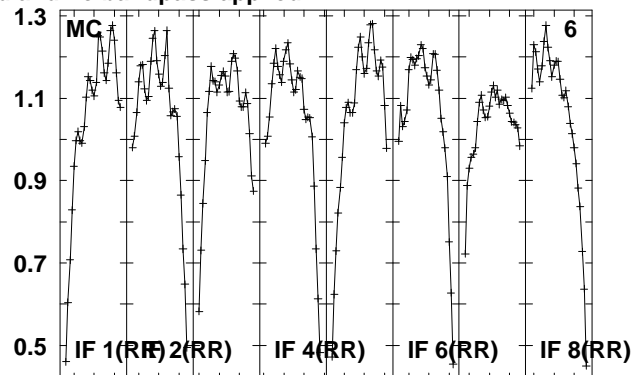
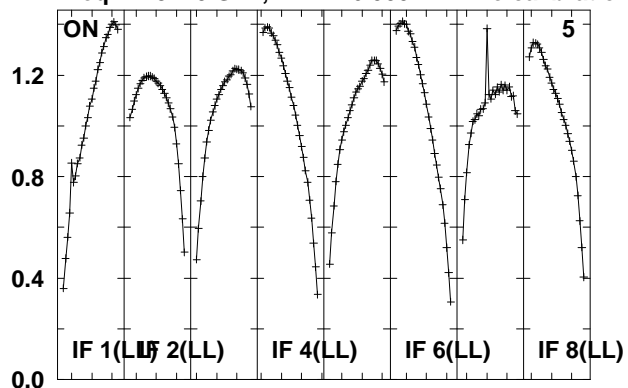

Lower frame: Real Jy

Total-power spectrum Antenna: *

Timerange: 00/13:48:01 to 00/13:49:29

Plot file version 387 created 14-MAY-2010 15:19:14
 J021348 EO007.UVDATA.1
 Freq = 4.9270 GHz, Bw = 16.000 MH No calibration applied and no bandpass applied

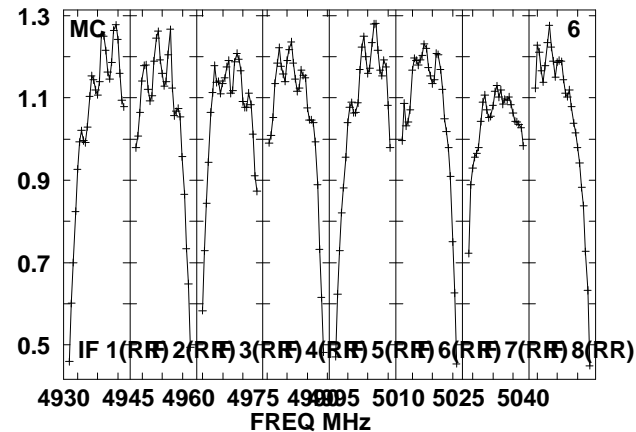
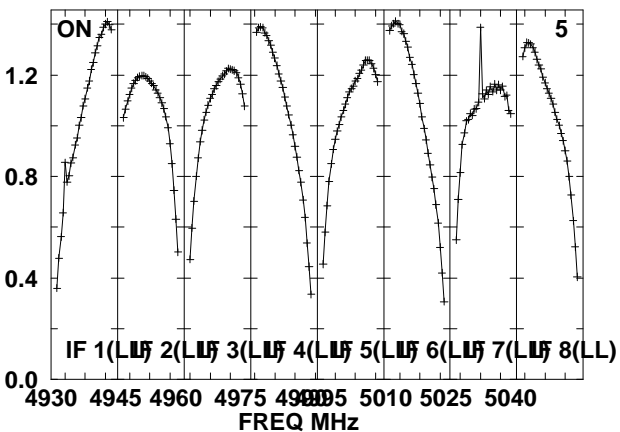
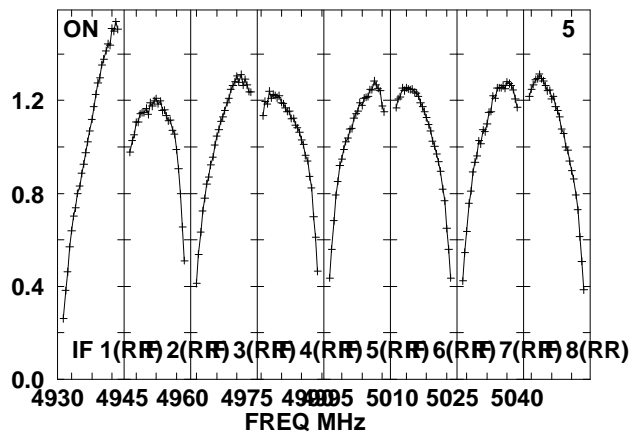
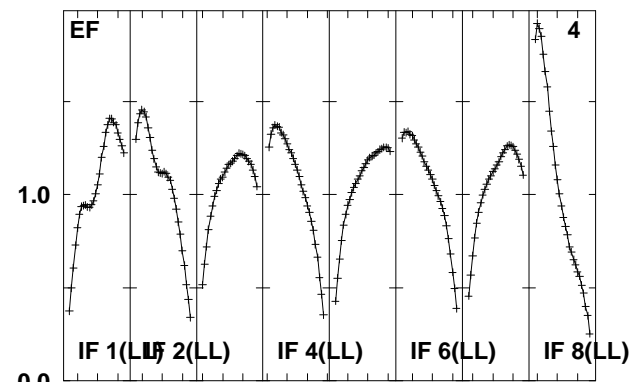
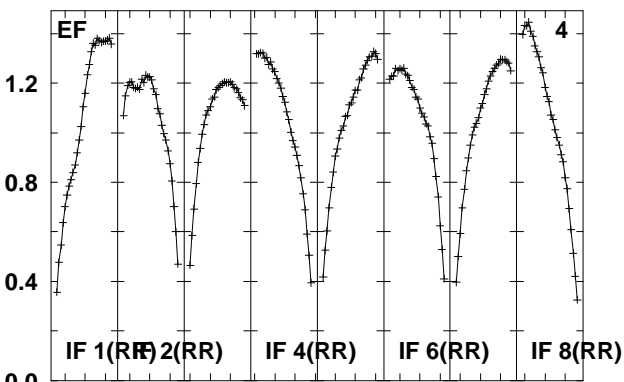
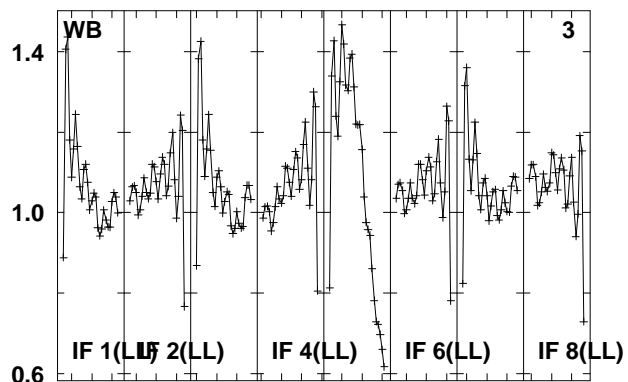
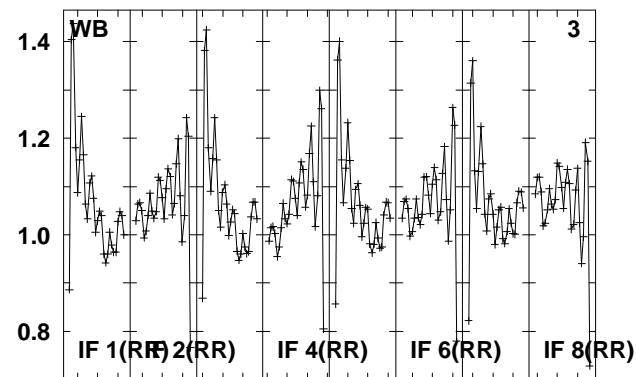
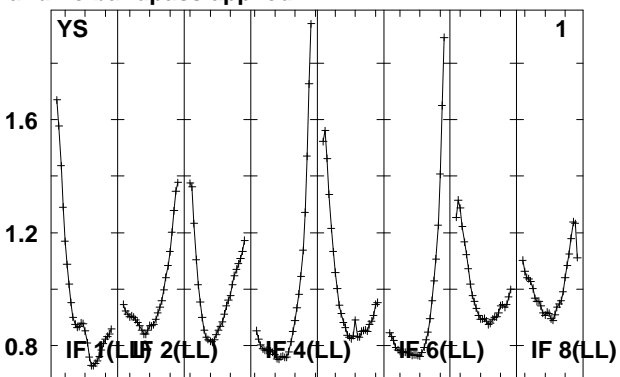
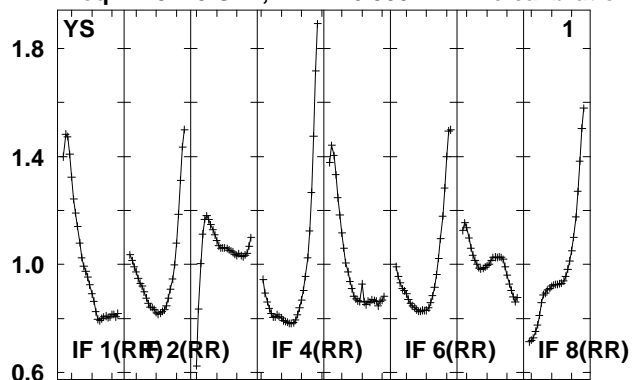

Lower frame: Real Jy
 Total-power spectrum Antenna: *
 Timerange: 00/13:49:57 to 00/13:54:55

Plot file version 388 created 14-MAY-2010 15:19:15

J021348 EO007.UVDATA.1

Freq = 4.9270 GHz, Bw = 16.000 MH No calibration applied and no bandpass applied

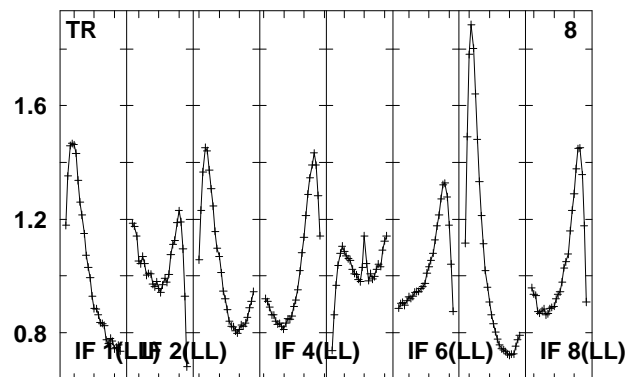
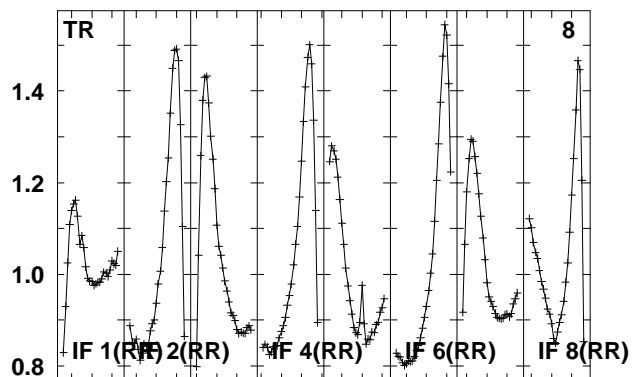
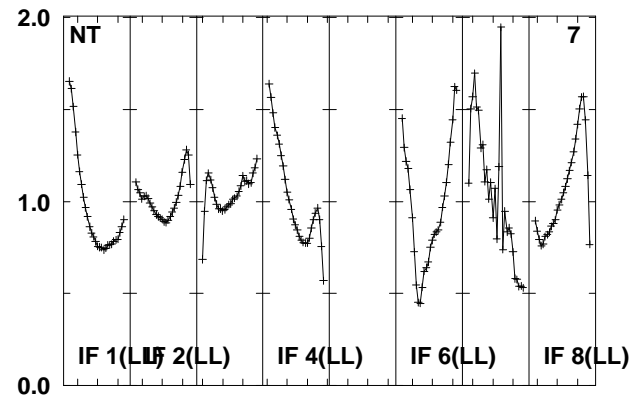
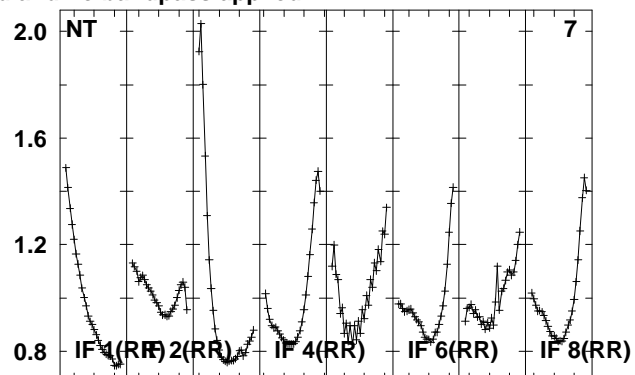
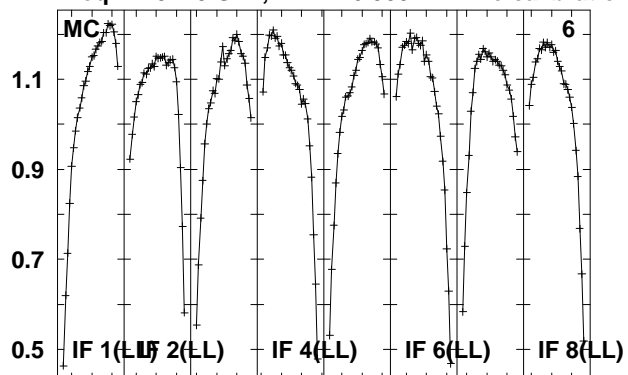

Lower frame: Real Jy
Total-power spectrum Antenna: *
Timerange: 00/13:49:57 to 00/13:54:55

Plot file version 389 created 14-MAY-2010 15:19:15

J0209+13 EO007.UVDATA.1

Freq = 4.9270 GHz, Bw = 16.000 MH No calibration applied and no bandpass applied

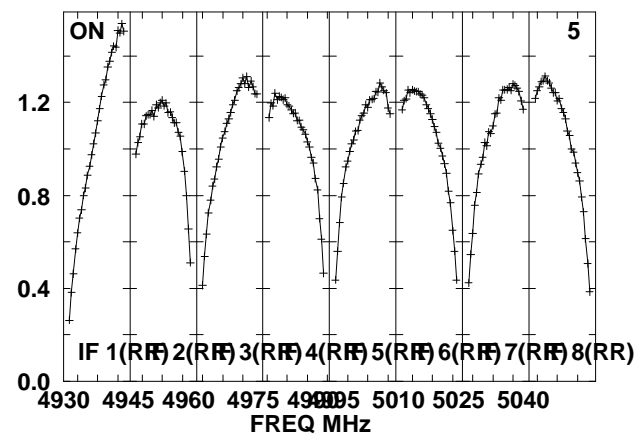
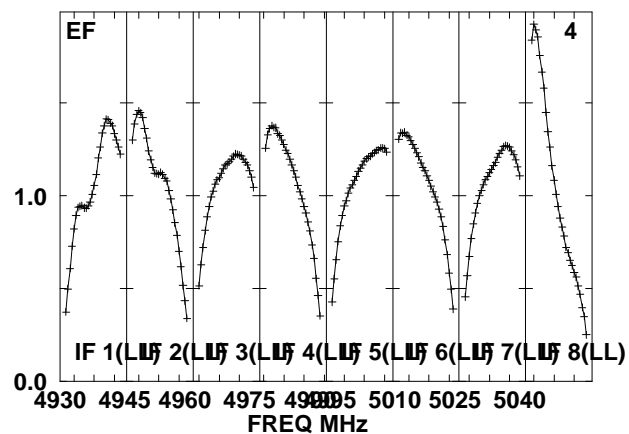
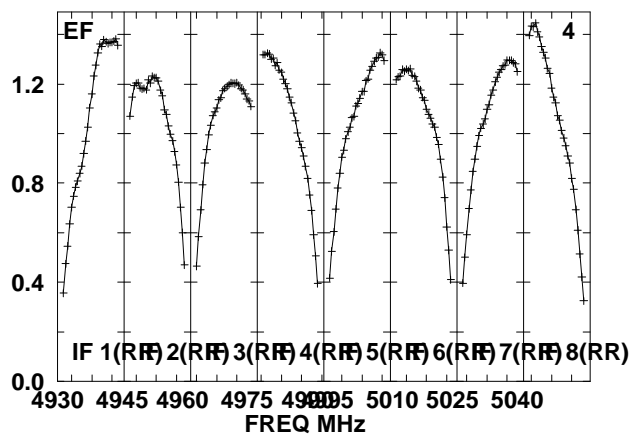
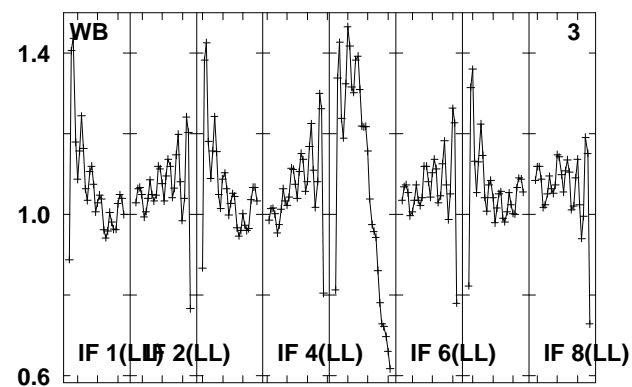
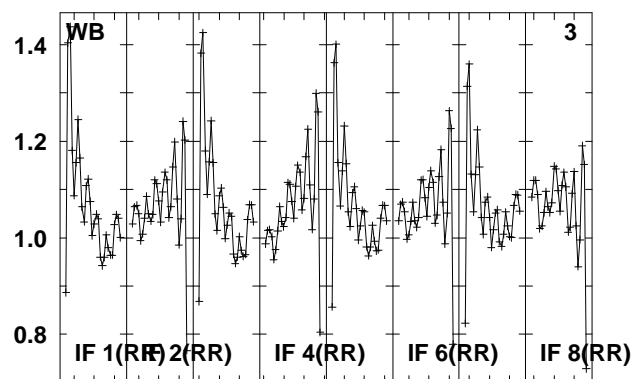
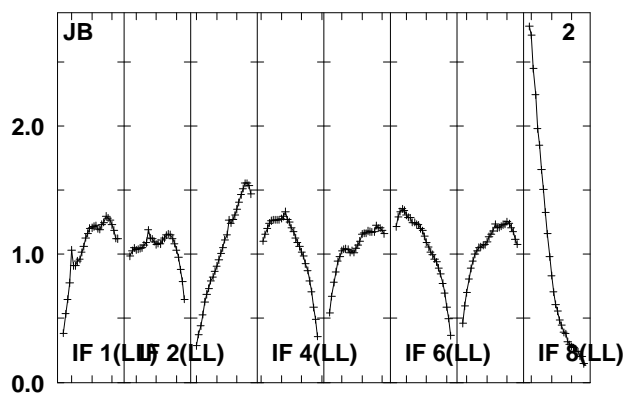
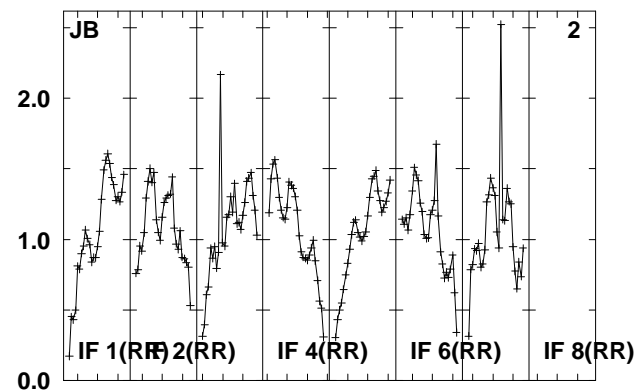
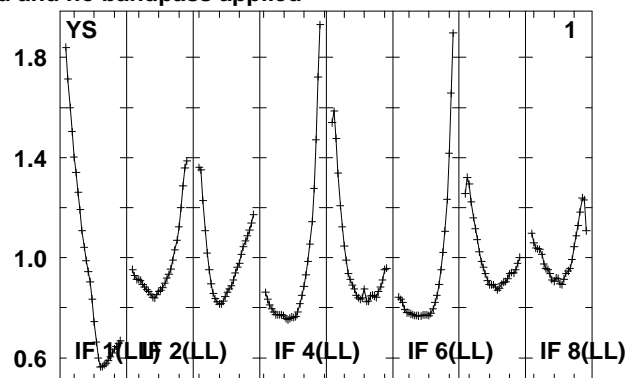
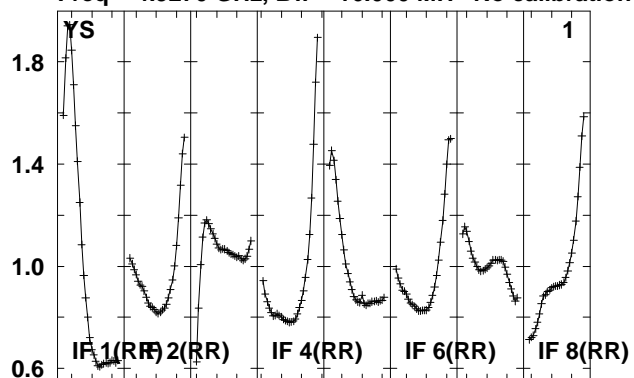

Lower frame: Real Jy

Total-power spectrum Antenna: *

Timerange: 00/13:55:25 to 00/13:56:53

Plot file version 390 created 14-MAY-2010 15:19:15

J0209+13 EO007.UVDATA.1

Freq = 4.9270 GHz, Bw = 16.000 MH No calibration applied and no bandpass applied

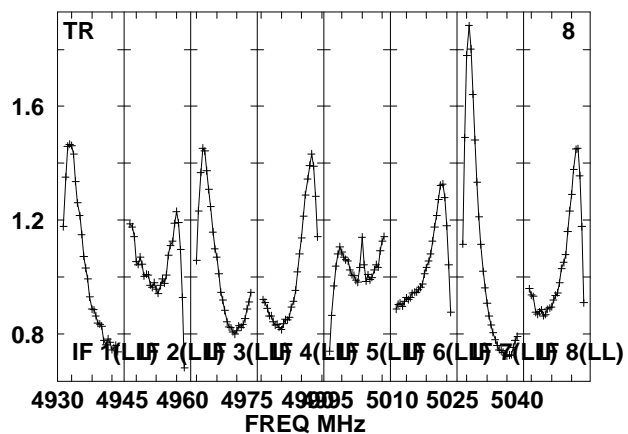
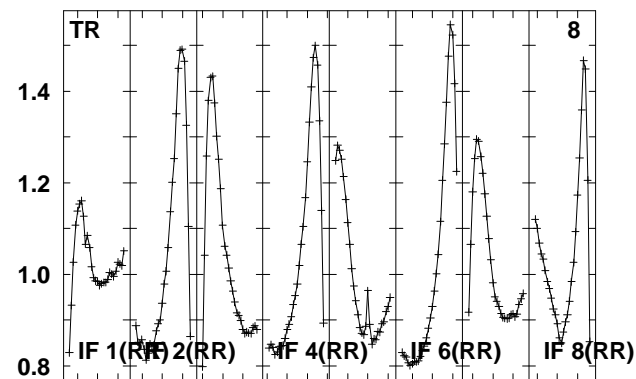
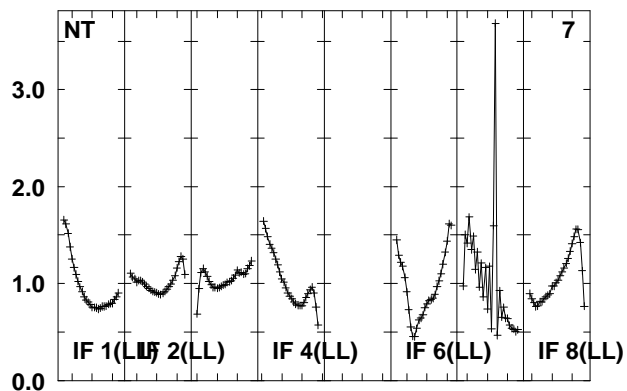
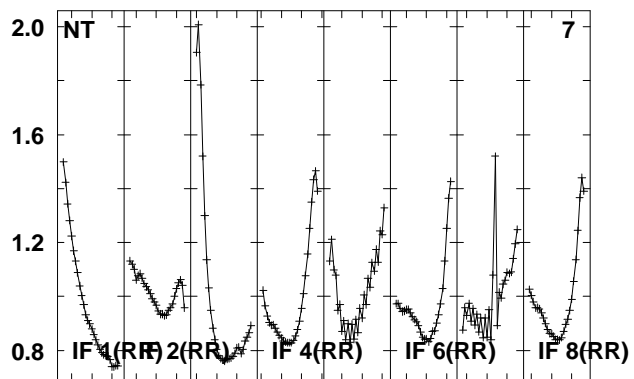
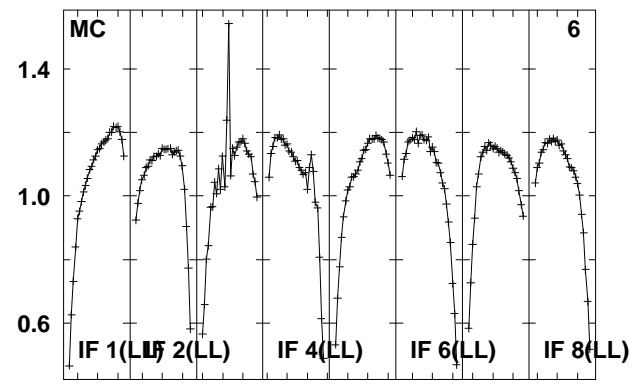
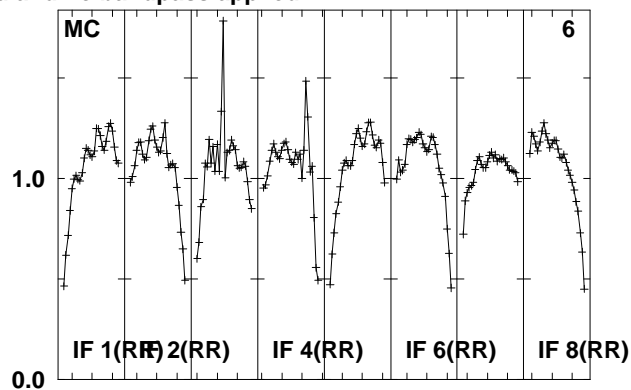
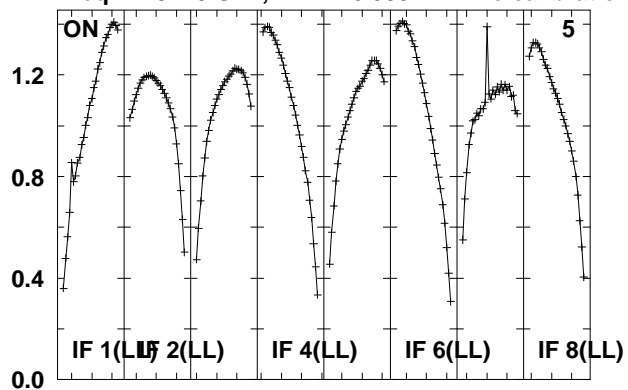

Lower frame: Real Jy

Total-power spectrum Antenna: *

Timerange: 00/13:55:25 to 00/13:56:53

Plot file version 391 created 14-MAY-2010 15:19:16

J0158+13 EO007.UVDATA.1

Freq = 4.9270 GHz, Bw = 16.000 MH No calibration applied and no bandpass applied

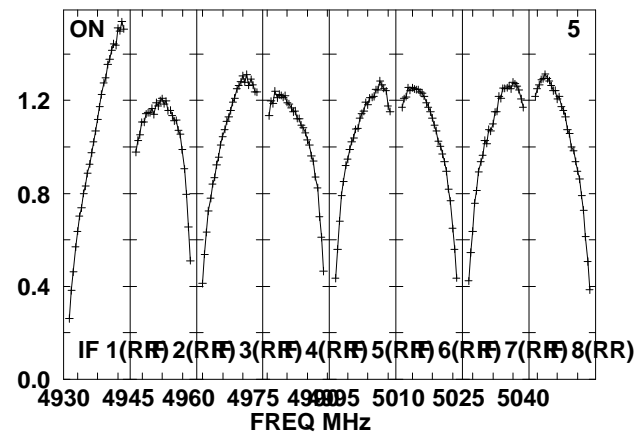
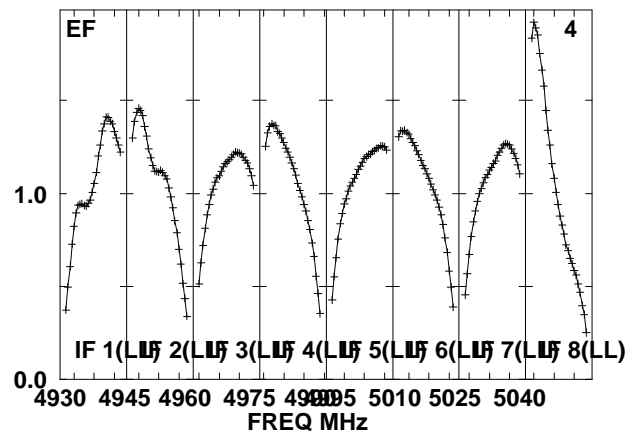
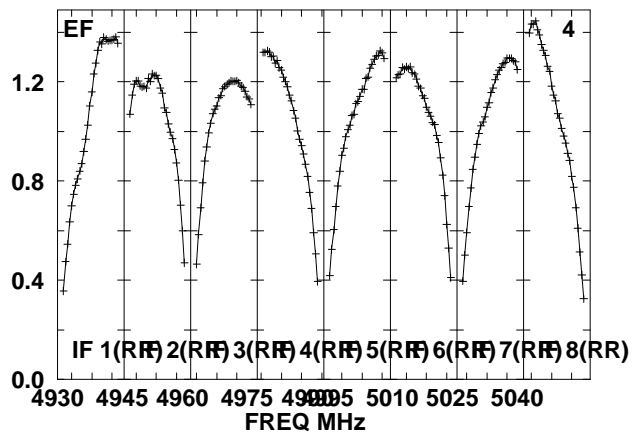
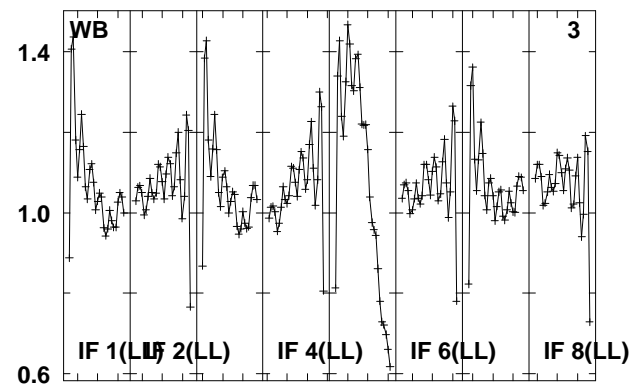
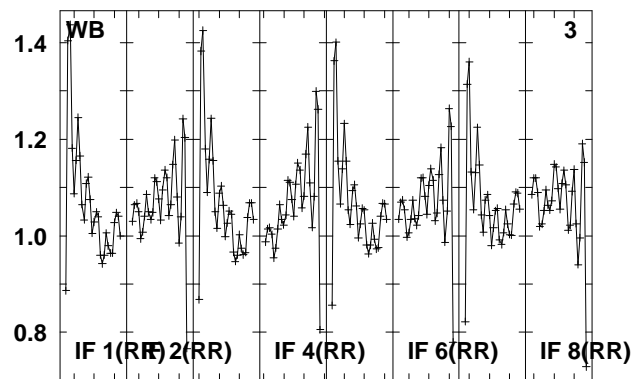
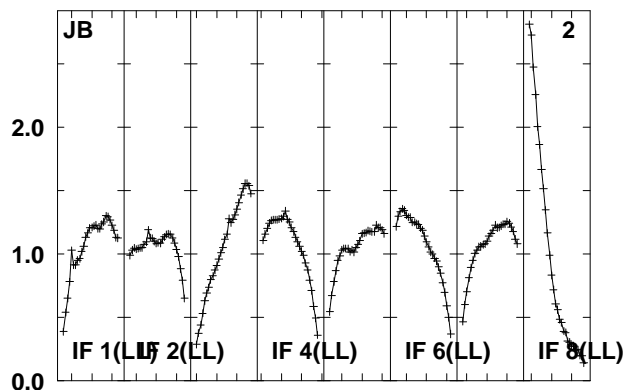
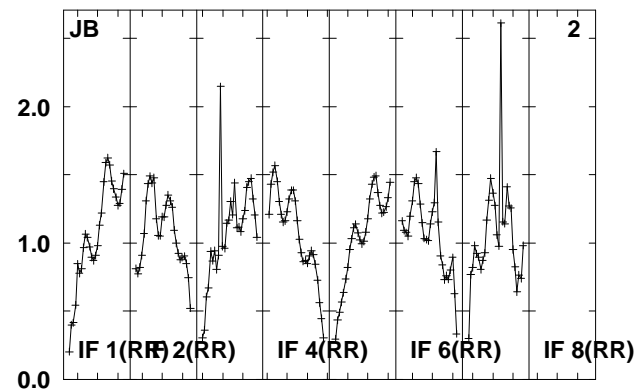
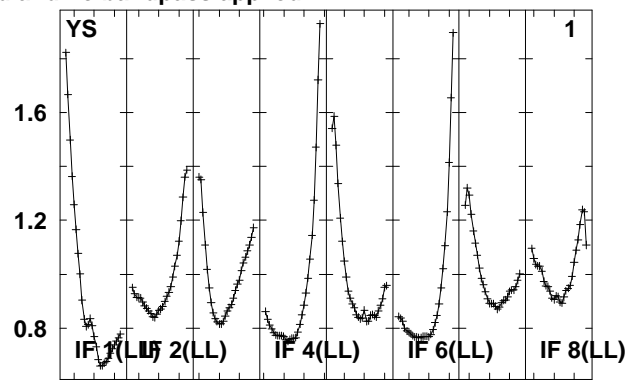
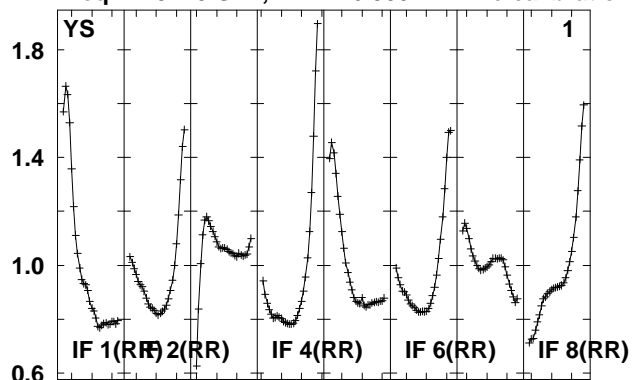

Lower frame: Real Jy
Total-power spectrum Antenna: *
Timerange: 00/13:57:33 to 00/13:59:01

Plot file version 392 created 14-MAY-2010 15:19:16

J0158+13 EO007.UVDATA.1

Freq = 4.9270 GHz, Bw = 16.000 MH No calibration applied and no bandpass applied

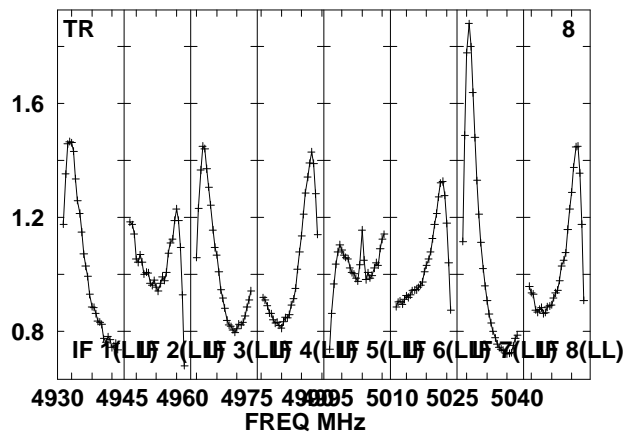
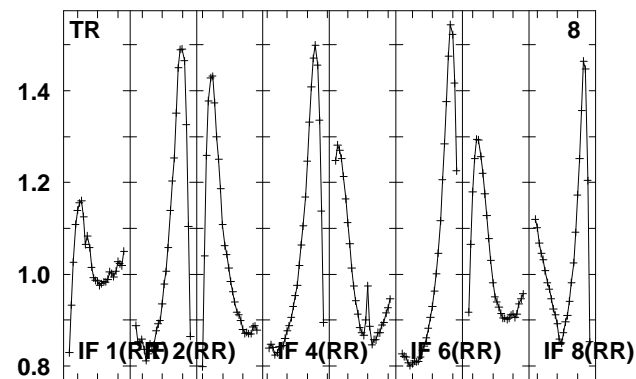
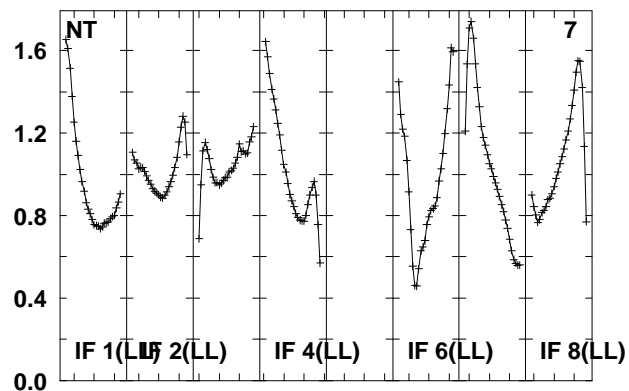
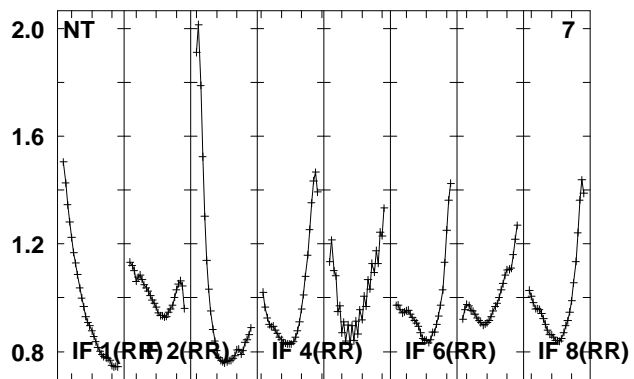
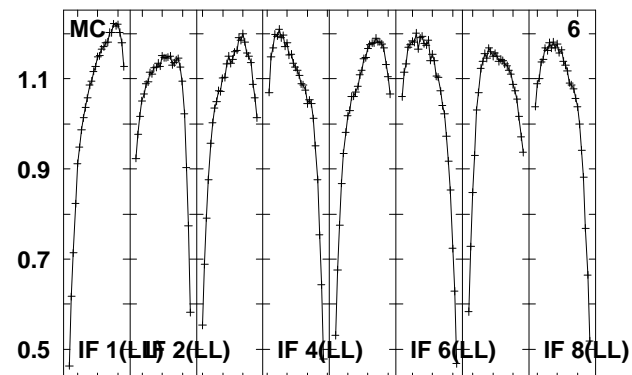
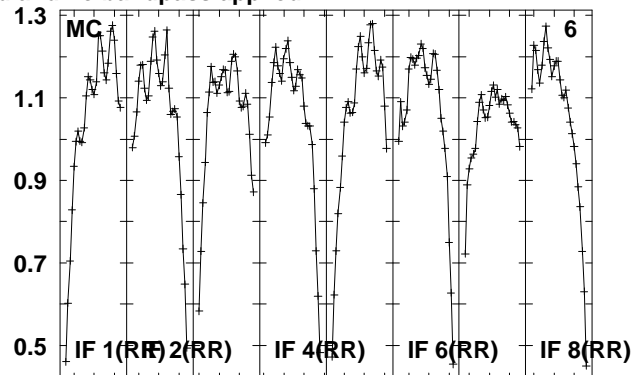
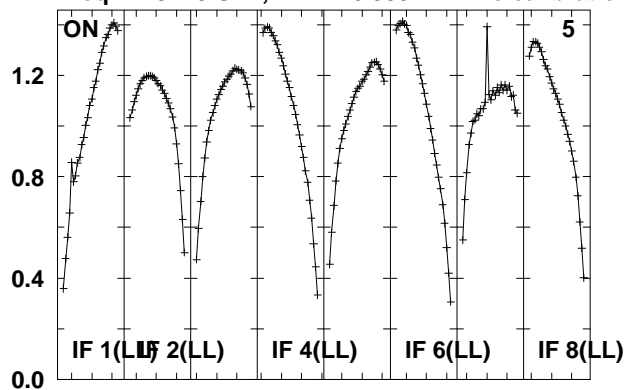

Lower frame: Real Jy

Total-power spectrum Antenna: *

Timerange: 00/13:57:33 to 00/13:59:01

Plot file version 393 created 14-MAY-2010 15:19:16

J015028 EO007.UVDATA.1

Freq = 4.9270 GHz, Bw = 16.000 MH No calibration applied and no bandpass applied

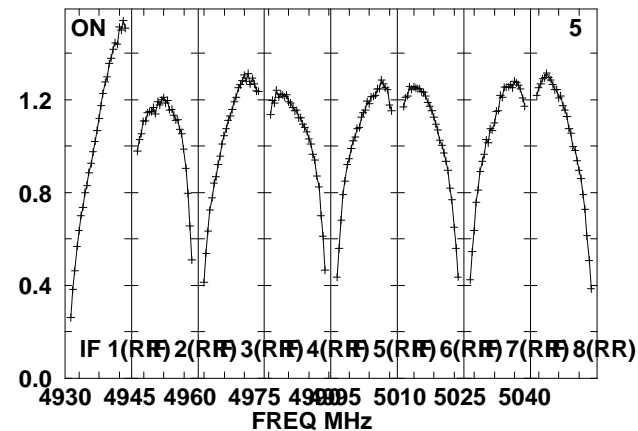
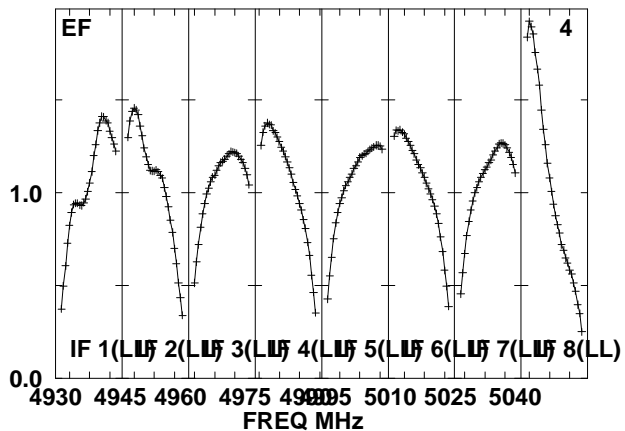
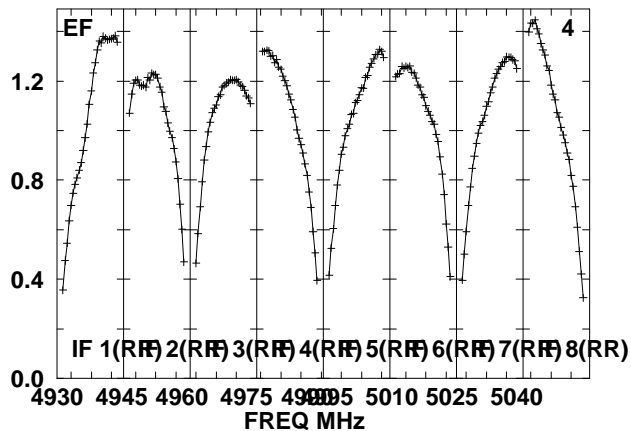
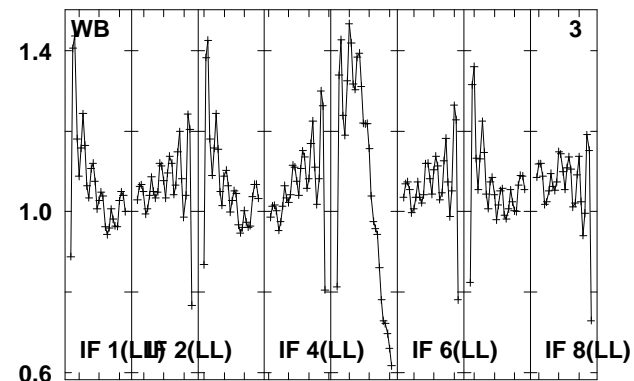
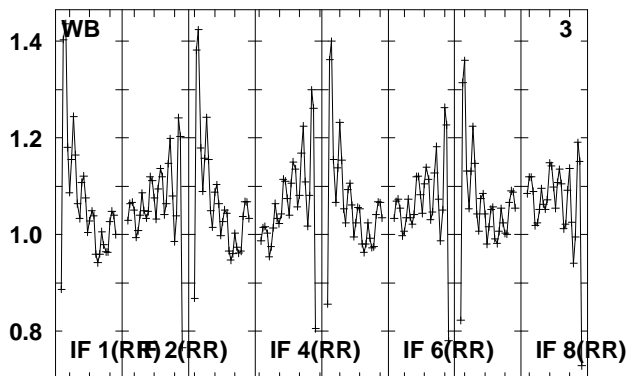
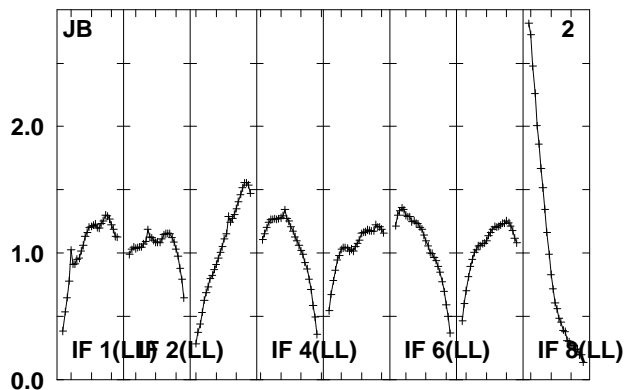
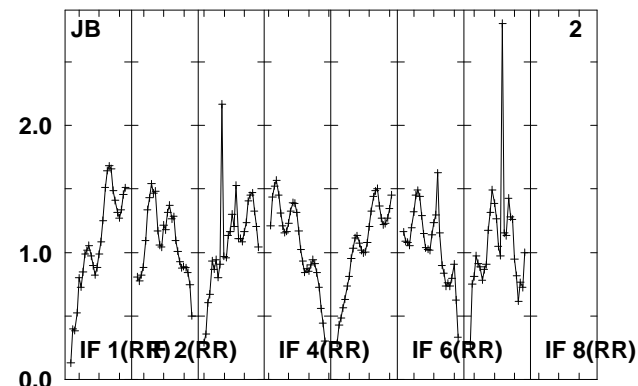
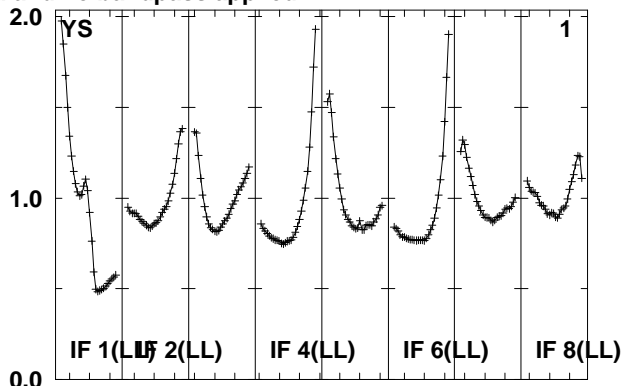
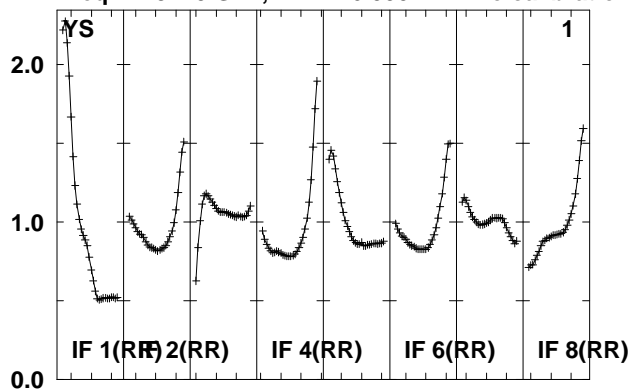

Lower frame: Real Jy

Total-power spectrum Antenna: *

Timerange: 00/13:59:41 to 00/14:04:37

Plot file version 394 created 14-MAY-2010 15:19:17

J015028 EO007.UVDATA.1

Freq = 4.9270 GHz, Bw = 16.000 MH No calibration applied and no bandpass applied

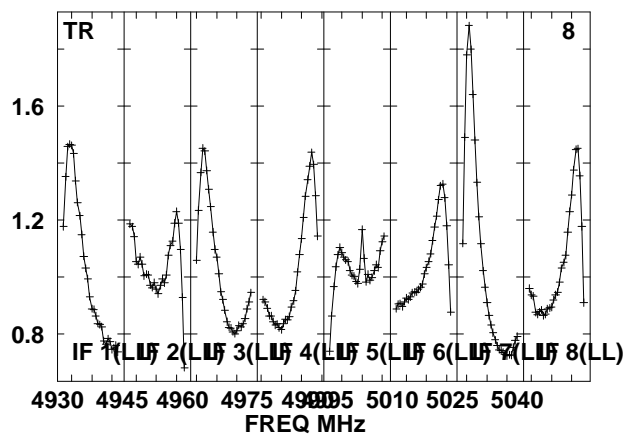
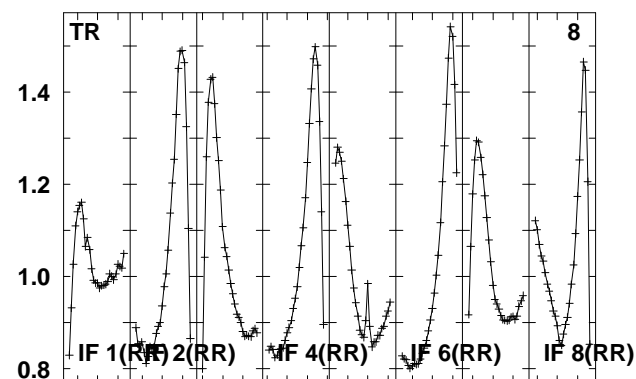
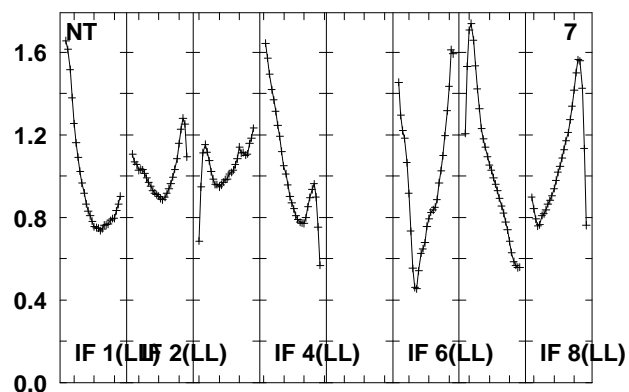
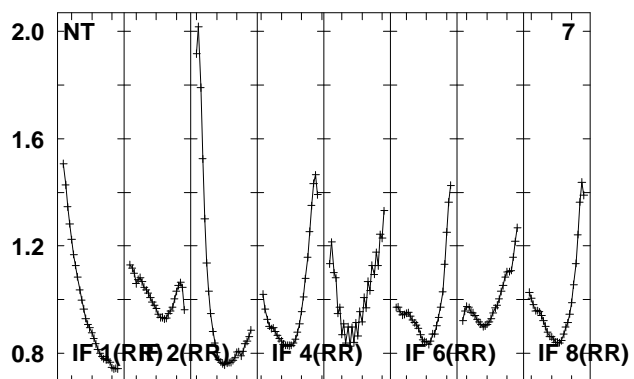
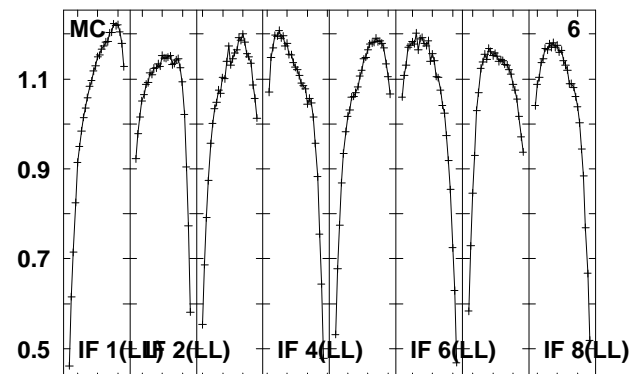
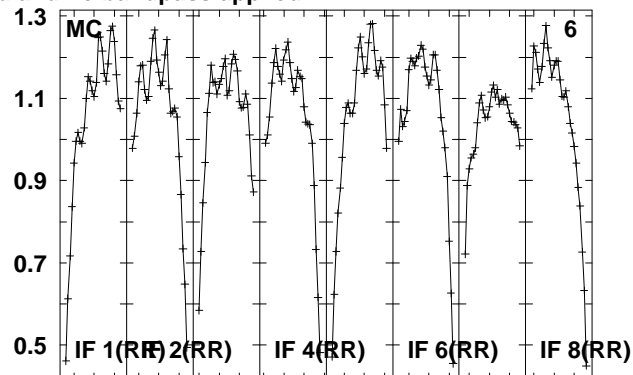
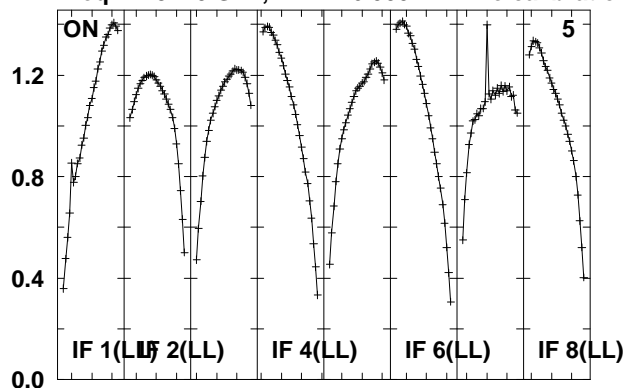

Lower frame: Real Jy

Total-power spectrum Antenna: *

Timerange: 00/13:59:41 to 00/14:04:37

Plot file version 395 created 14-MAY-2010 15:19:17

J0158+13 EO007.UVDATA.1

Freq = 4.9270 GHz, Bw = 16.000 MH No calibration applied and no bandpass applied

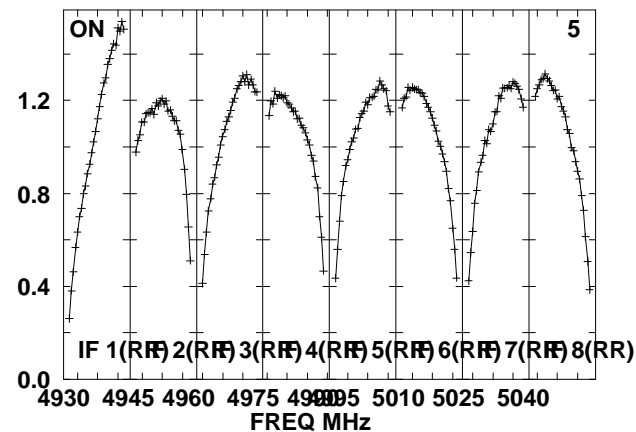
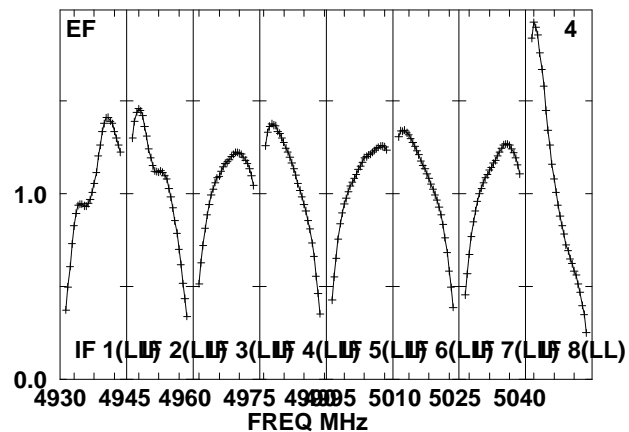
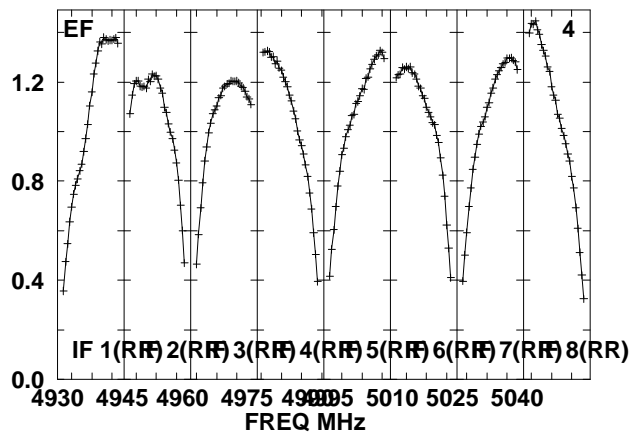
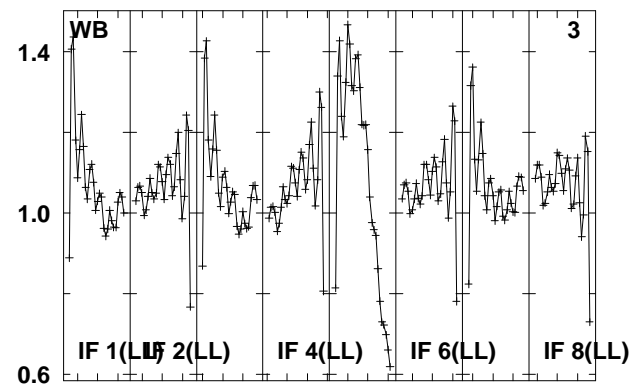
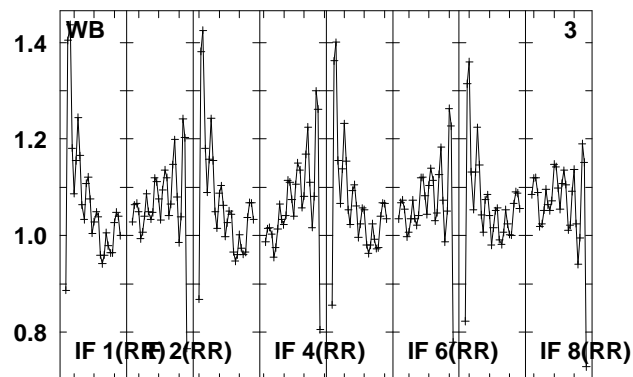
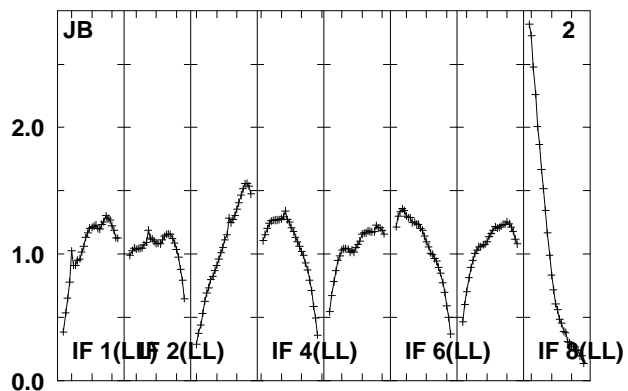
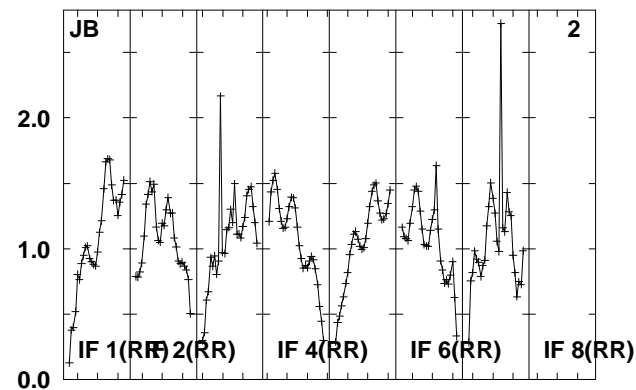
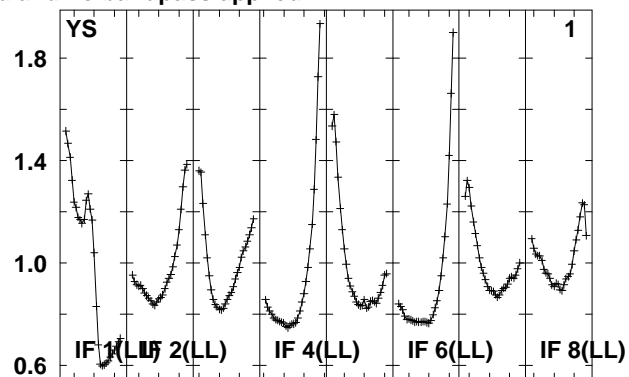
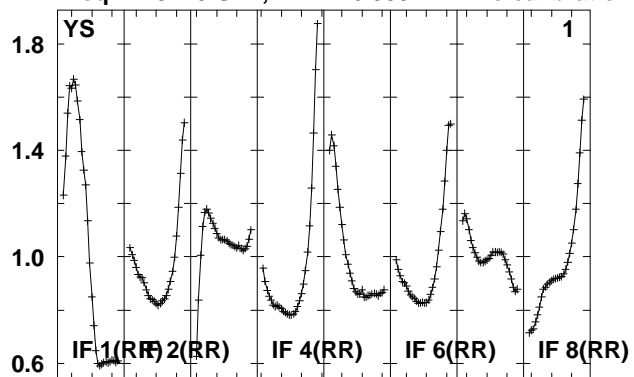

Lower frame: Real Jy
Total-power spectrum Antenna: *
Timerange: 00/14:05:14 to 00/14:06:42

Plot file version 396 created 14-MAY-2010 15:19:17

J0158+13 EO007.UVDATA.1

Freq = 4.9270 GHz, Bw = 16.000 MH No calibration applied and no bandpass applied

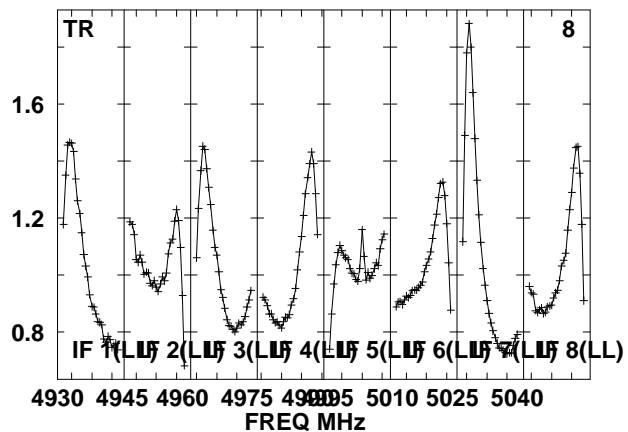
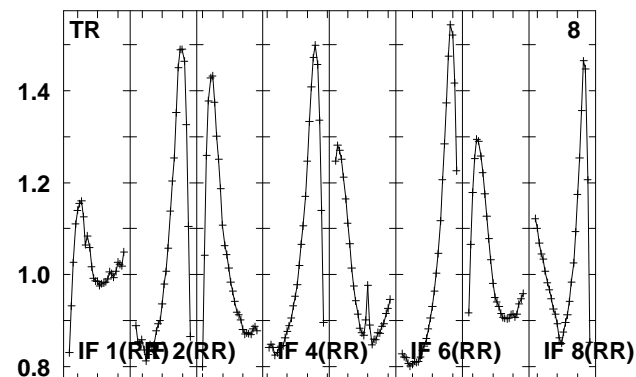
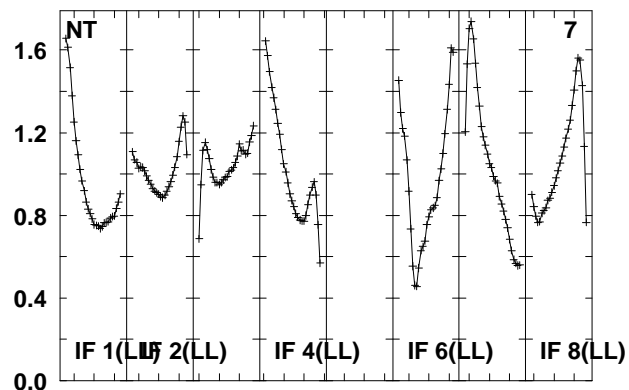
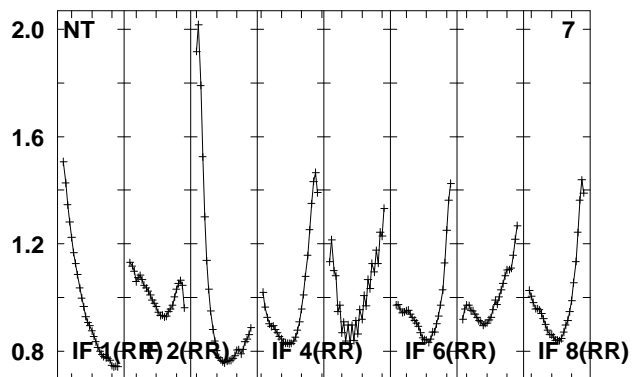
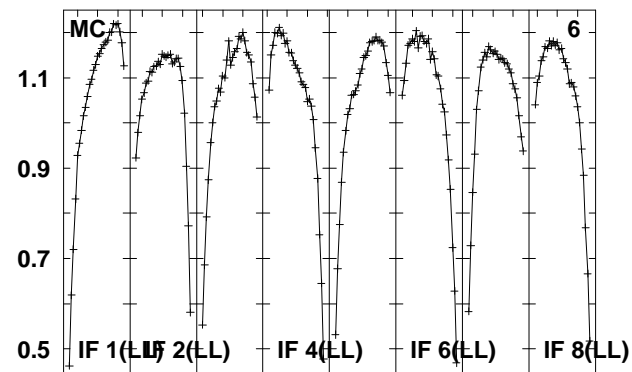
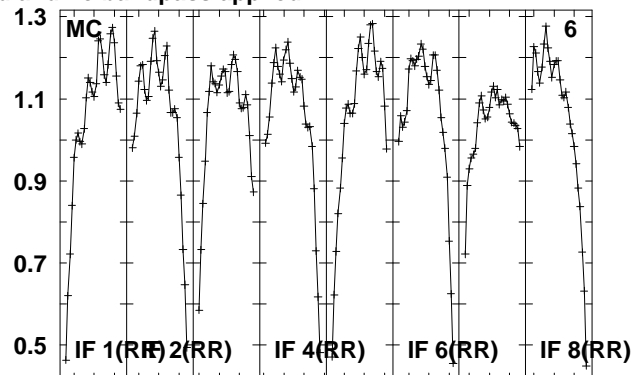
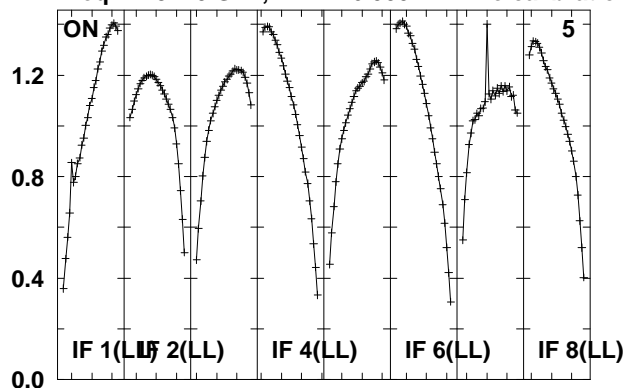

Lower frame: Real Jy

Total-power spectrum Antenna: *

Timerange: 00/14:05:14 to 00/14:06:42

Plot file version 397 created 14-MAY-2010 15:19:18
 J015028 EO007.UVDATA.1
 Freq = 4.9270 GHz, Bw = 16.000 MH No calibration applied and no bandpass applied

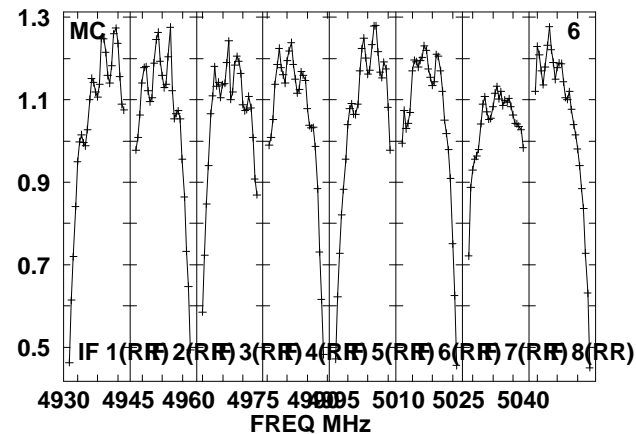
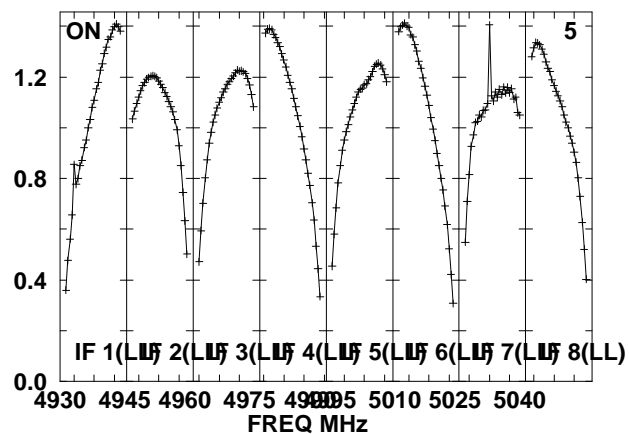
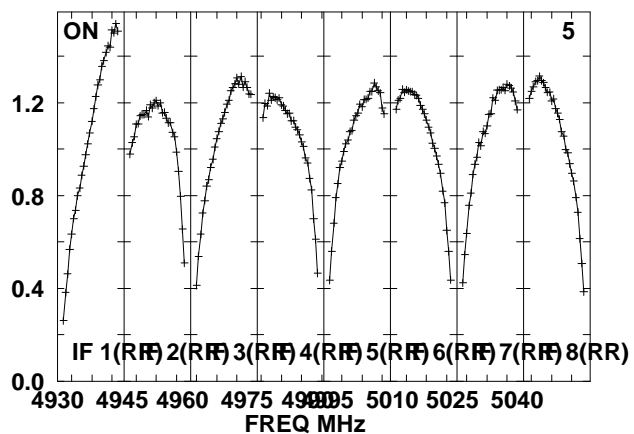
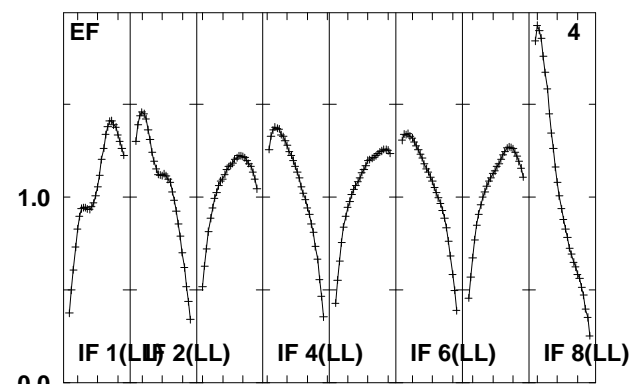
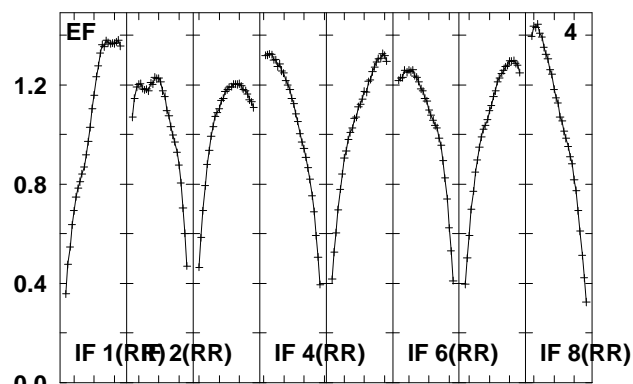
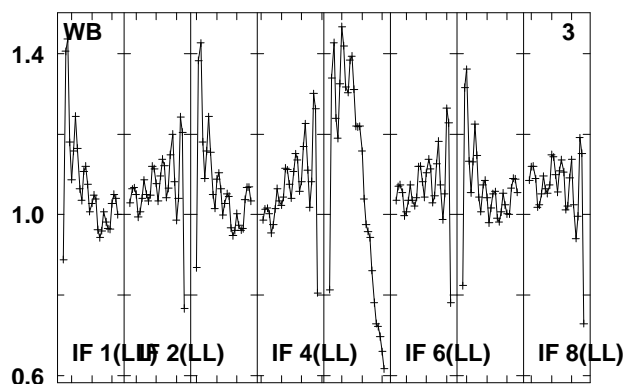
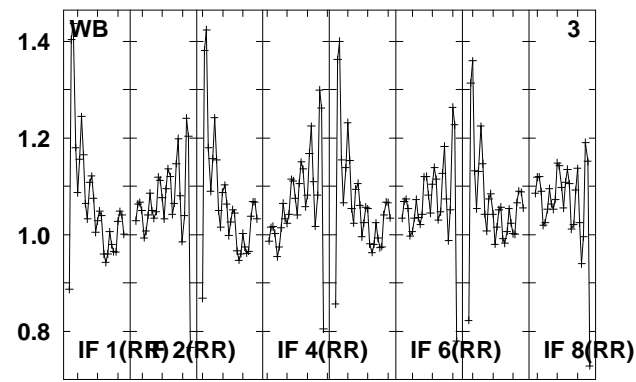
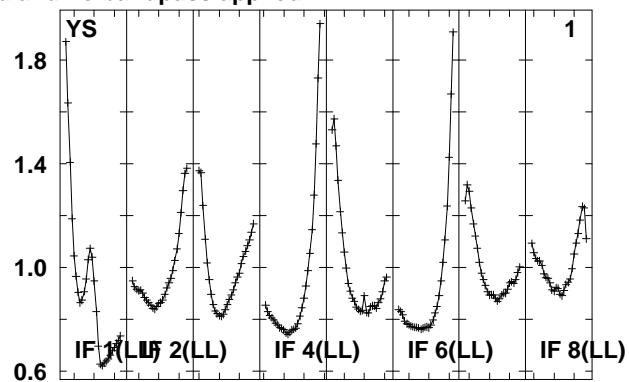
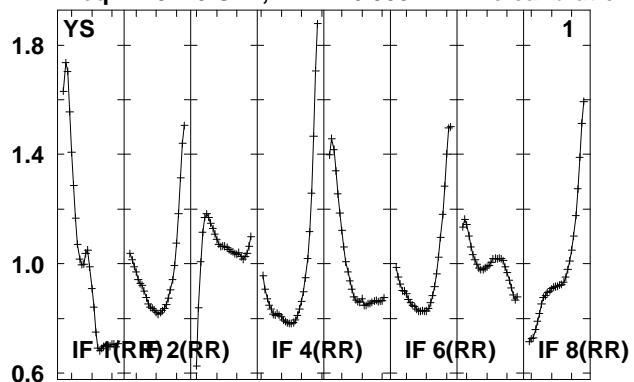

Lower frame: Real Jy
 Total-power spectrum Antenna: *
 Timerange: 00/14:07:20 to 00/14:12:18

Plot file version 398 created 14-MAY-2010 15:19:18

J015028 EO007.UVDATA.1

Freq = 4.9270 GHz, Bw = 16.000 MH No calibration applied and no bandpass applied

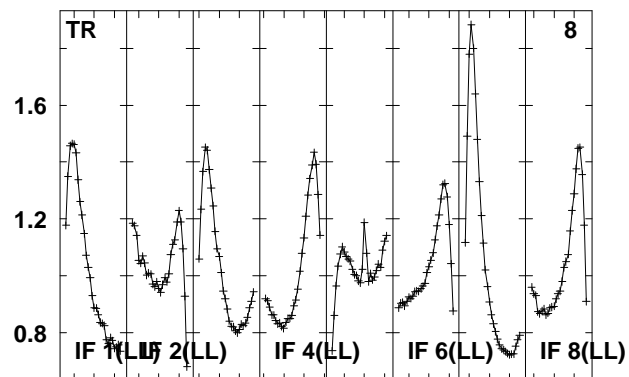
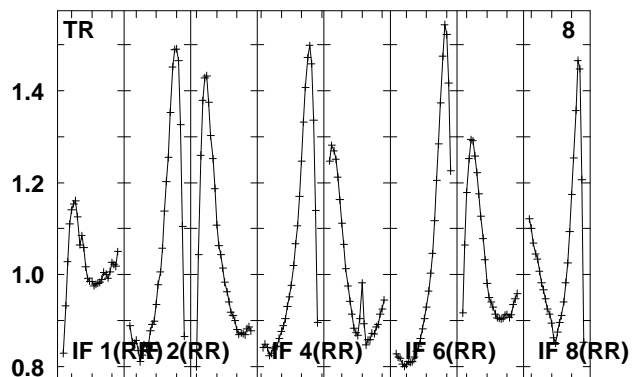
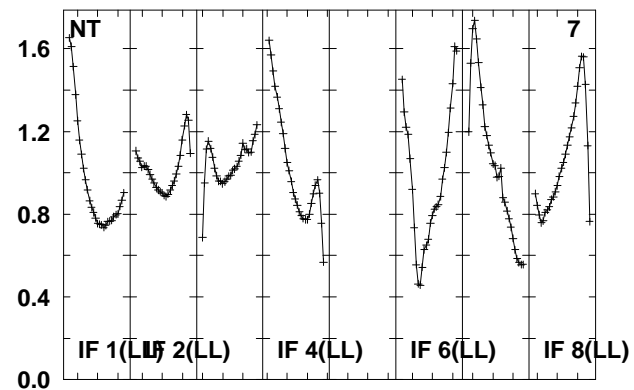
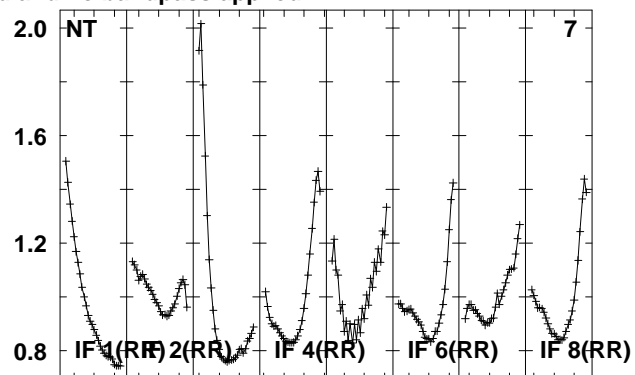
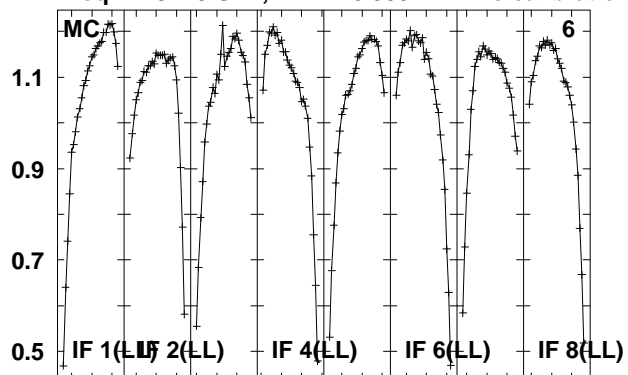

Lower frame: Real Jy
Total-power spectrum Antenna: *
Timerange: 00/14:07:20 to 00/14:12:18

Plot file version 399 created 14-MAY-2010 15:19:19

J0158+13 EO007.UVDATA.1

Freq = 4.9270 GHz, Bw = 16.000 MH No calibration applied and no bandpass applied

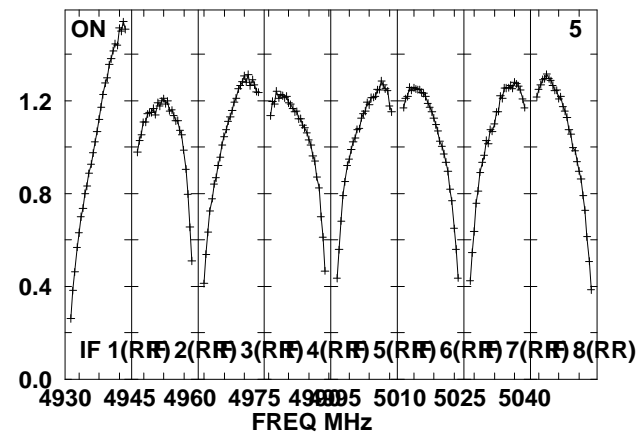
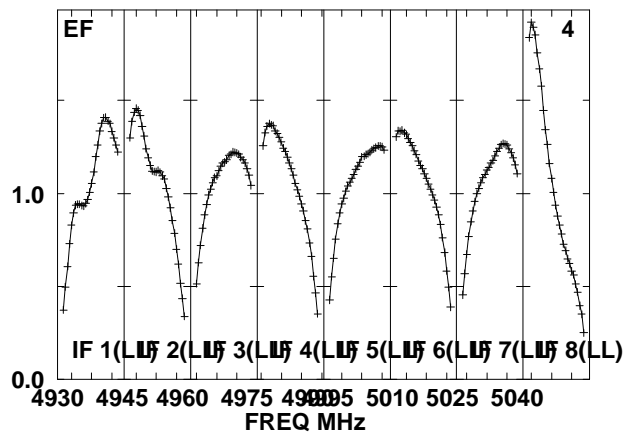
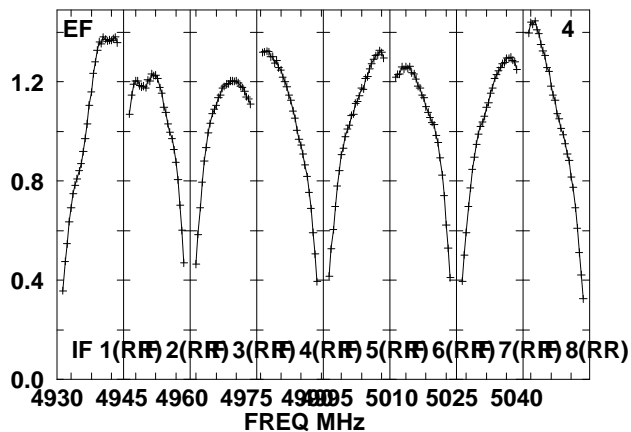
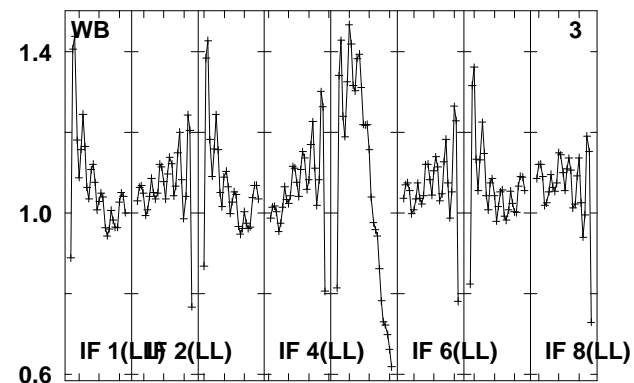
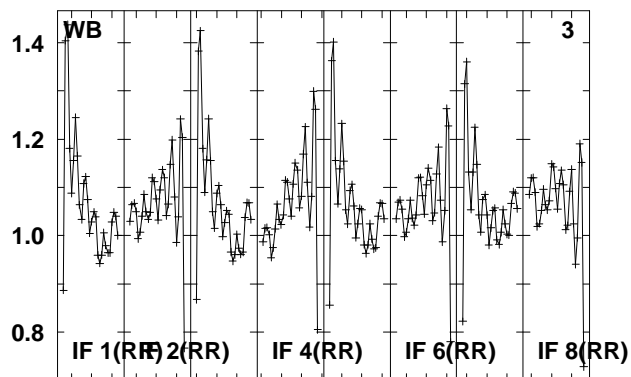
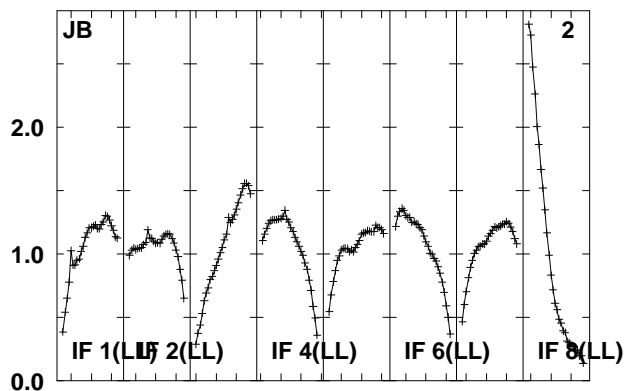
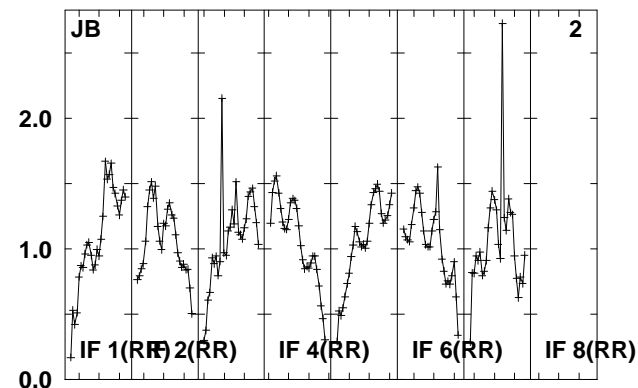
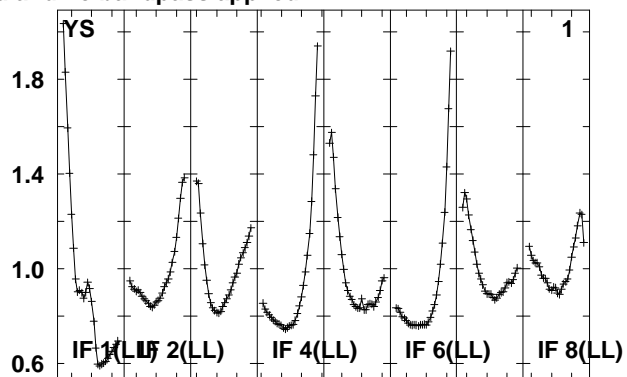
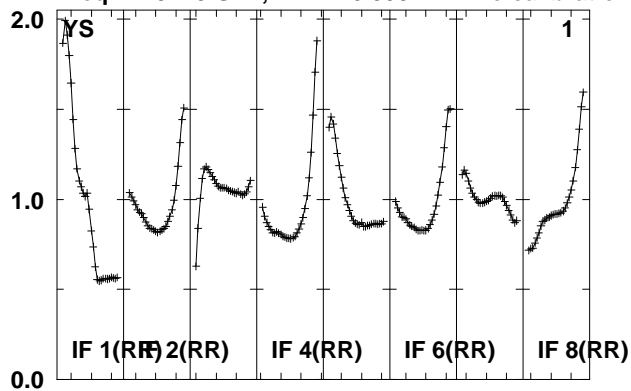

Lower frame: Real Jy
Total-power spectrum Antenna: *
Timerange: 00/14:12:54 to 00/14:14:22

Plot file version 400 created 14-MAY-2010 15:19:19

J0158+13 EO007.UVDATA.1

Freq = 4.9270 GHz, Bw = 16.000 MH No calibration applied and no bandpass applied

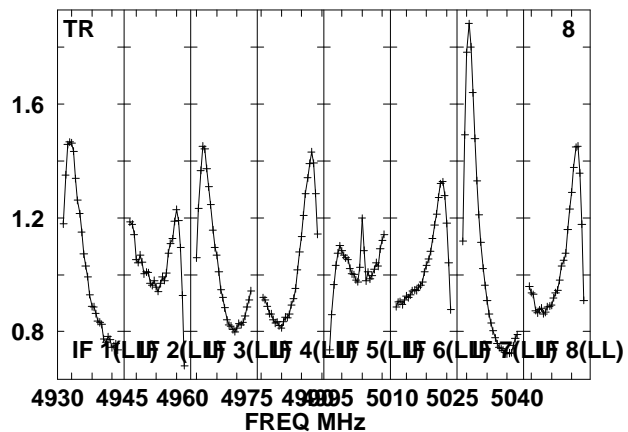
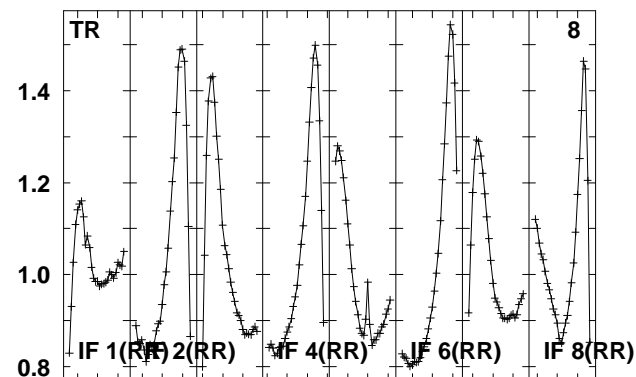
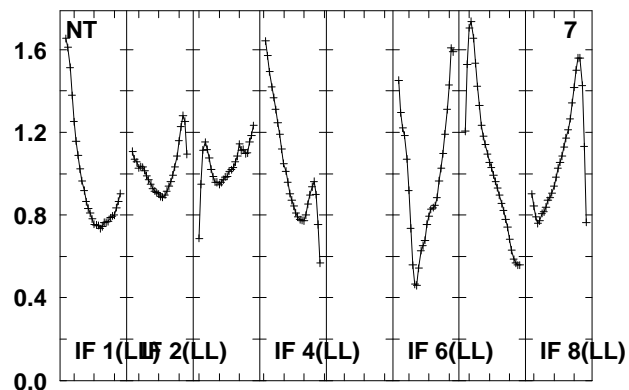
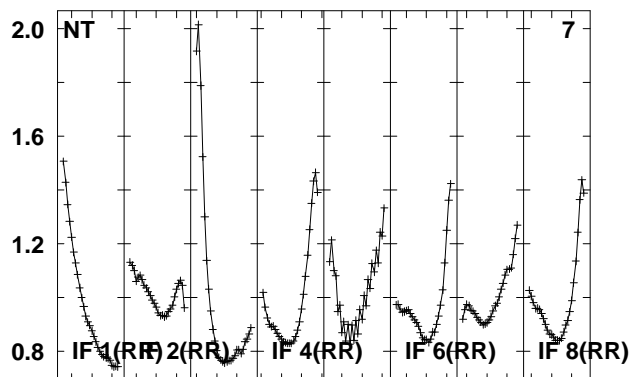
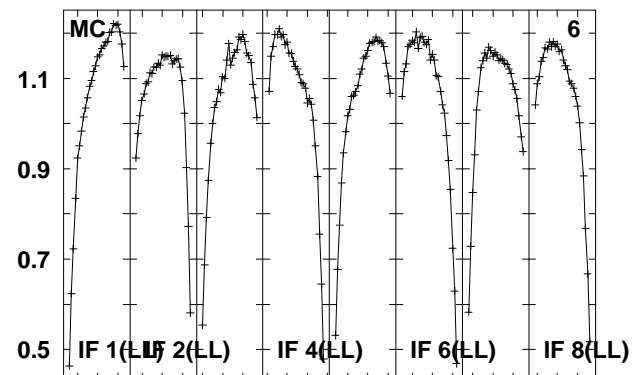
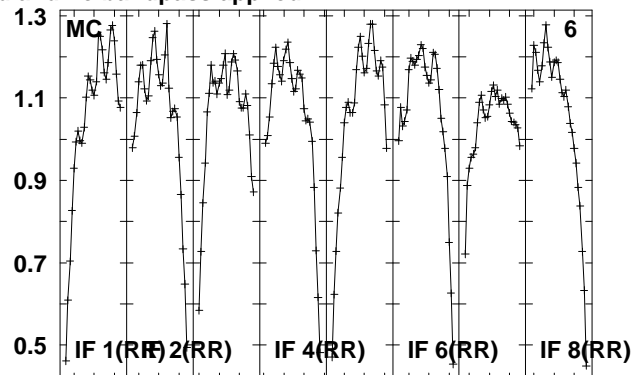
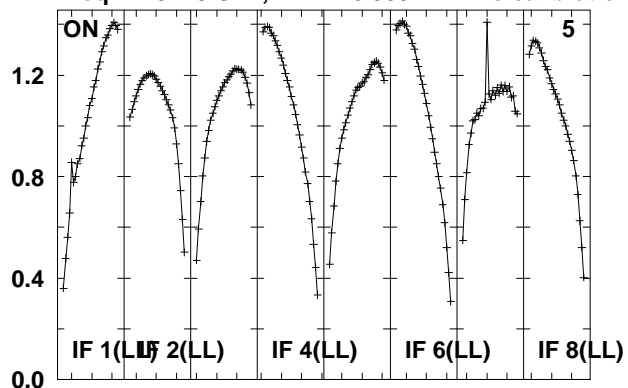

Lower frame: Real Jy

Total-power spectrum Antenna: *

Timerange: 00/14:12:54 to 00/14:14:22

Plot file version 401 created 14-MAY-2010 15:19:19

J0209+13 EO007.UVDATA.1

Freq = 4.9270 GHz, Bw = 16.000 MH No calibration applied and no bandpass applied

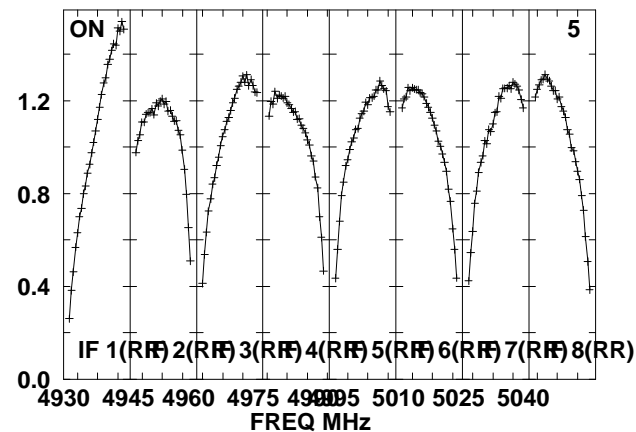
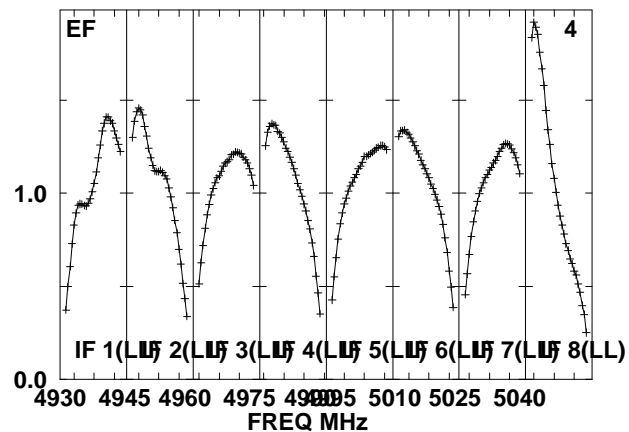
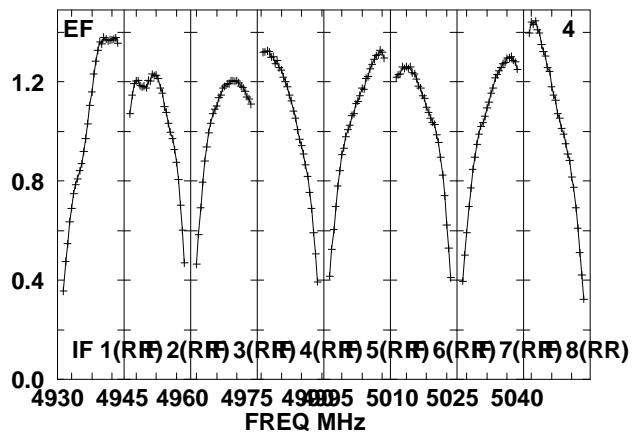
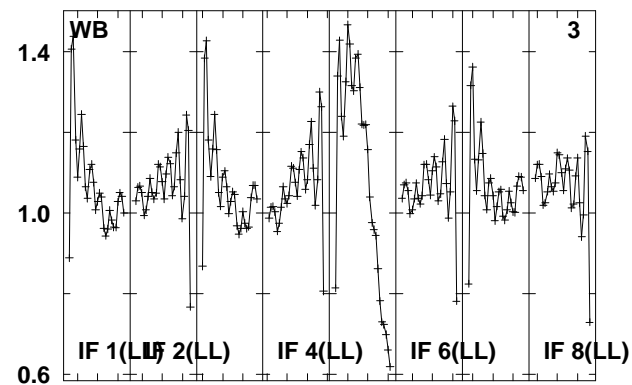
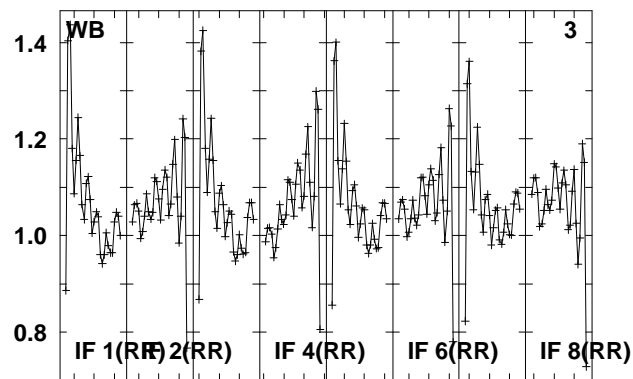
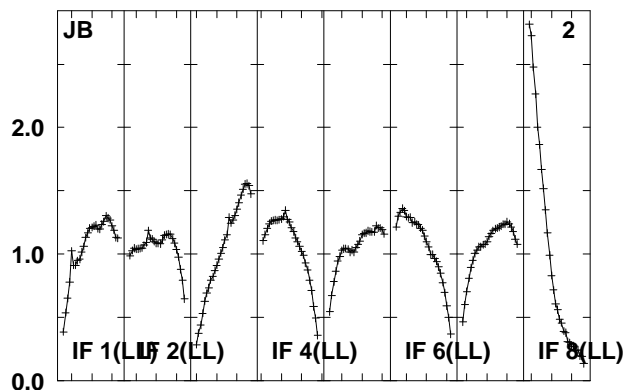
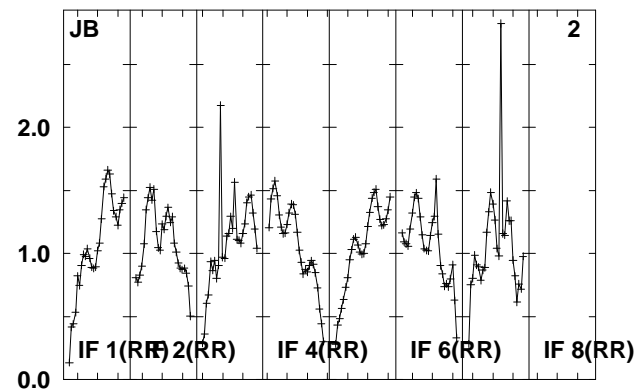
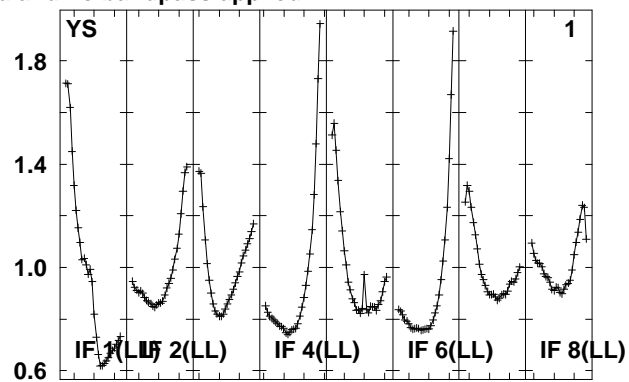
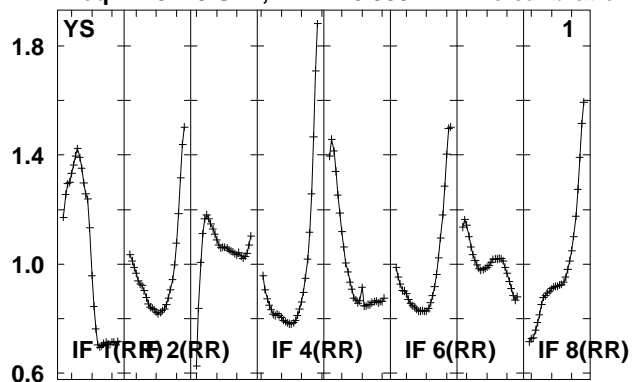

Lower frame: Real Jy
Total-power spectrum Antenna: *
Timerange: 00/14:15:00 to 00/14:16:26

Plot file version 402 created 14-MAY-2010 15:19:20

J0209+13 EO007.UVDATA.1

Freq = 4.9270 GHz, Bw = 16.000 MH No calibration applied and no bandpass applied

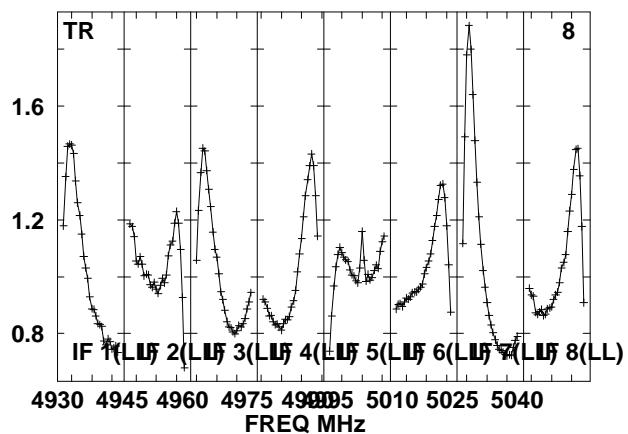
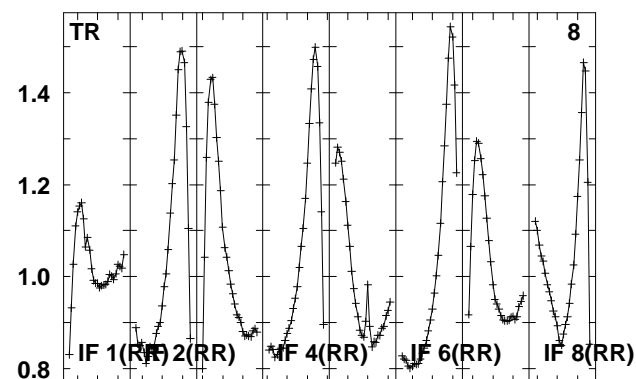
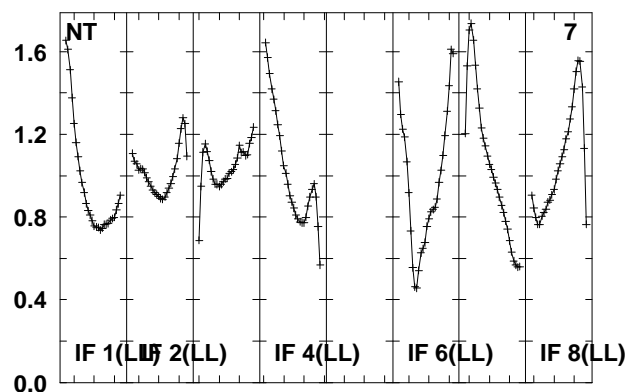
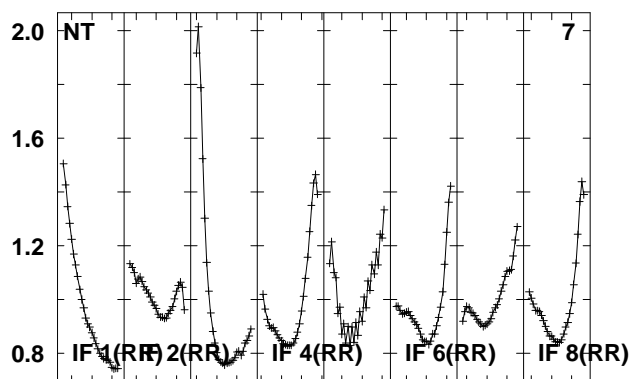
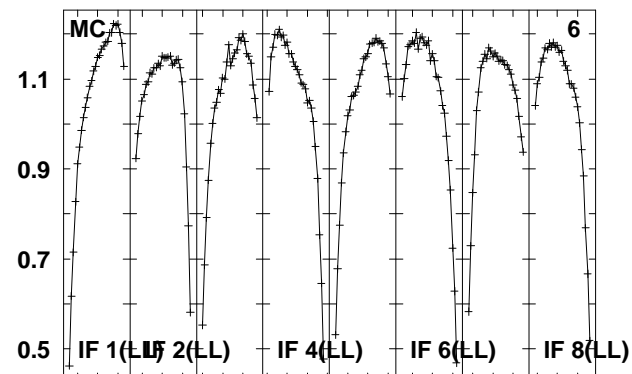
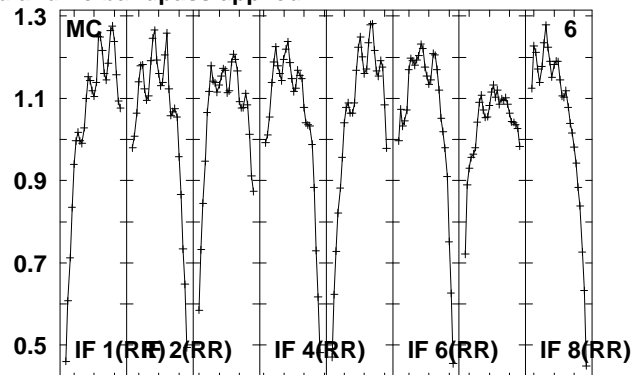
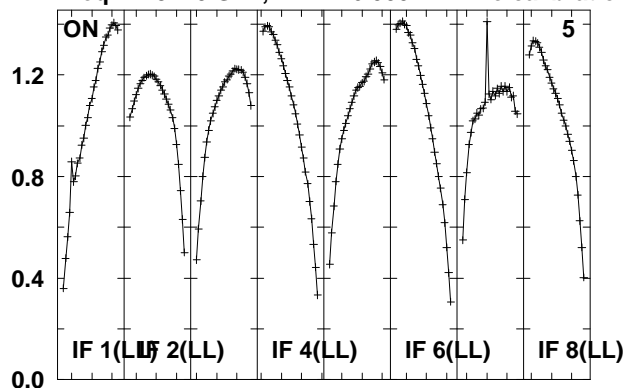

Lower frame: Real Jy

Total-power spectrum Antenna: *

Timerange: 00/14:15:00 to 00/14:16:26

Plot file version 403 created 14-MAY-2010 15:19:20

J021348 EO007.UVDATA.1

Freq = 4.9270 GHz, Bw = 16.000 MH No calibration applied and no bandpass applied

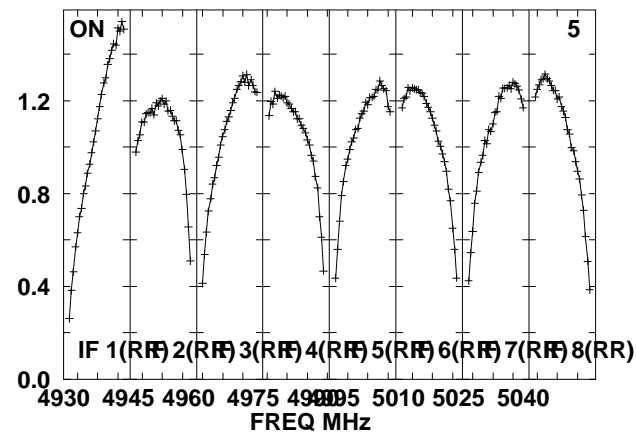
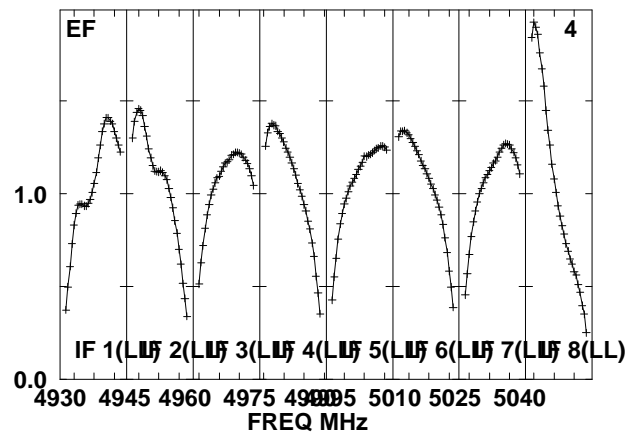
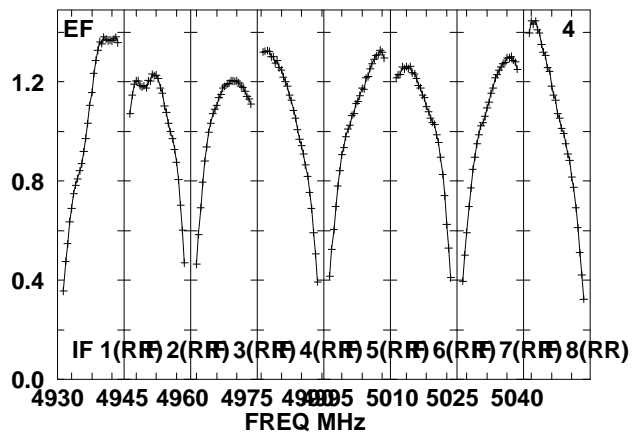
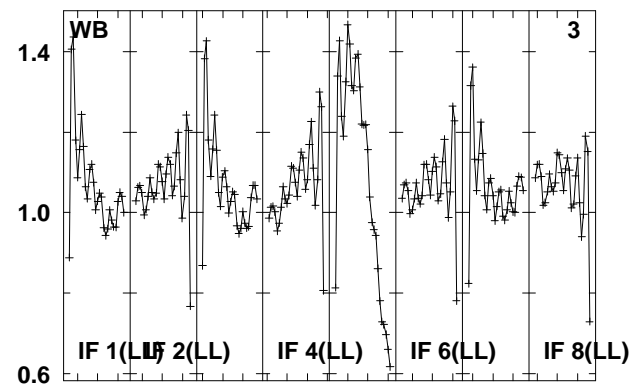
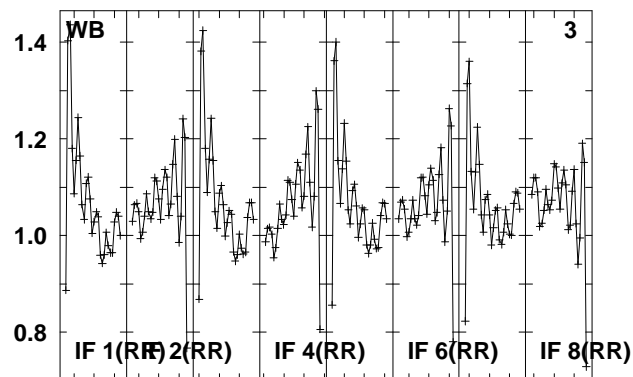
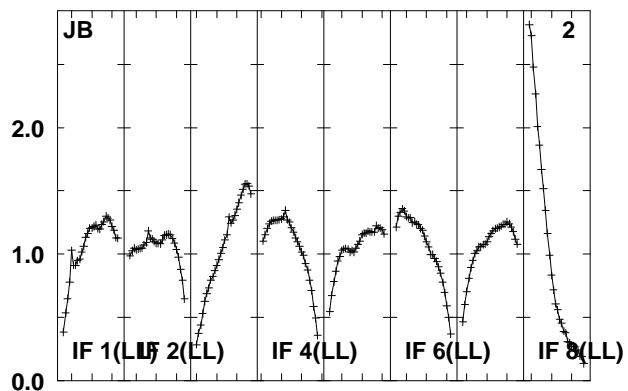
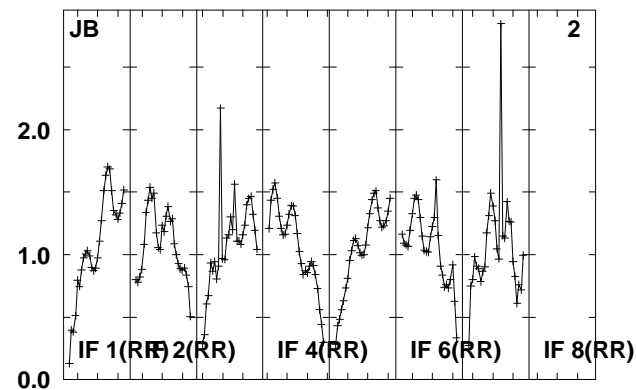
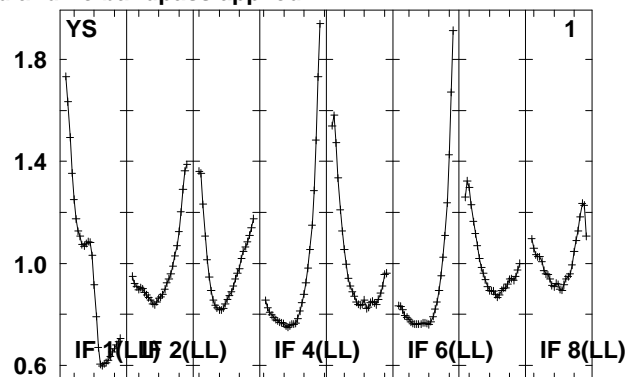
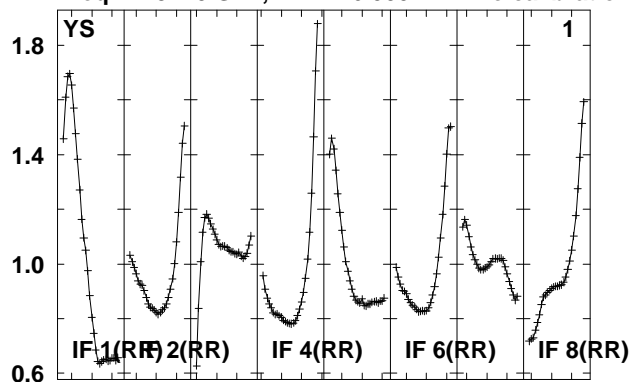

Lower frame: Real Jy
Total-power spectrum Antenna: *
Timerange: 00/14:16:57 to 00/14:21:55

Plot file version 404 created 14-MAY-2010 15:19:20

J021348 EO007.UVDATA.1

Freq = 4.9270 GHz, Bw = 16.000 MH No calibration applied and no bandpass applied

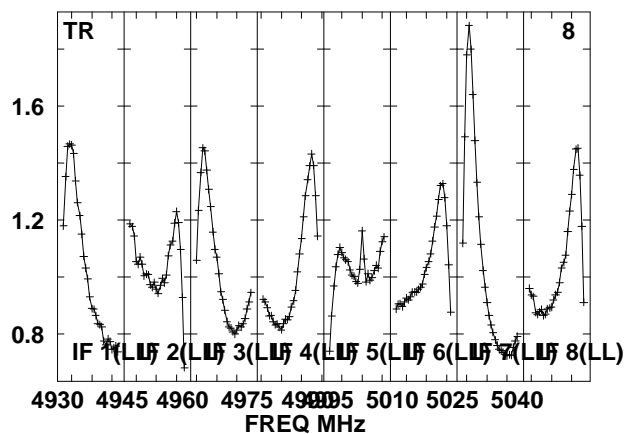
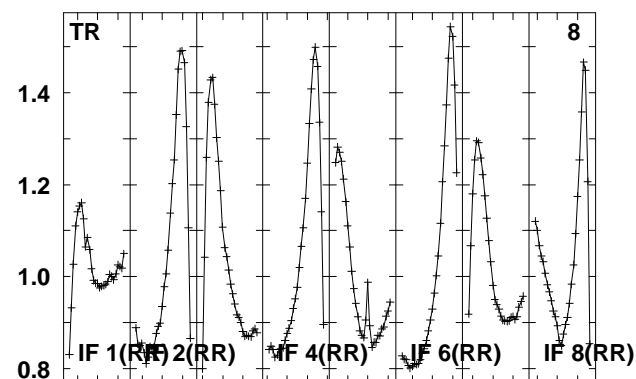
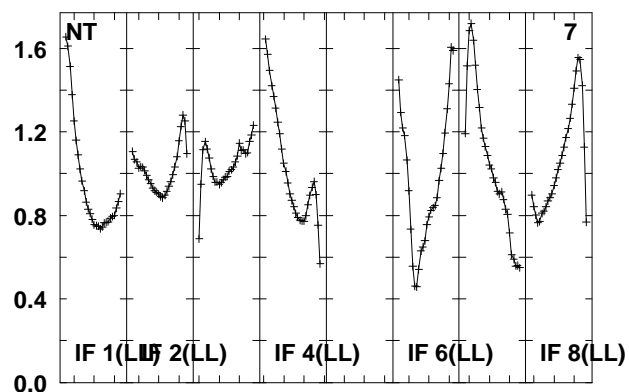
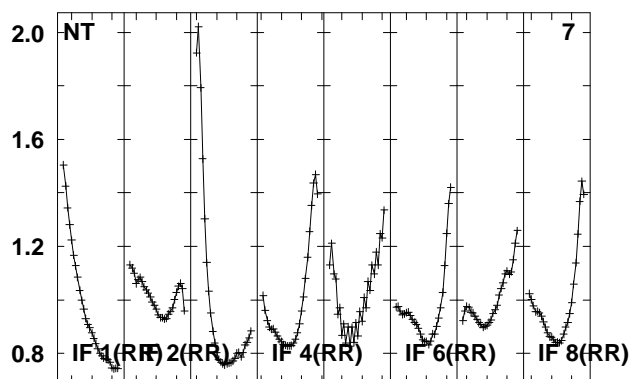
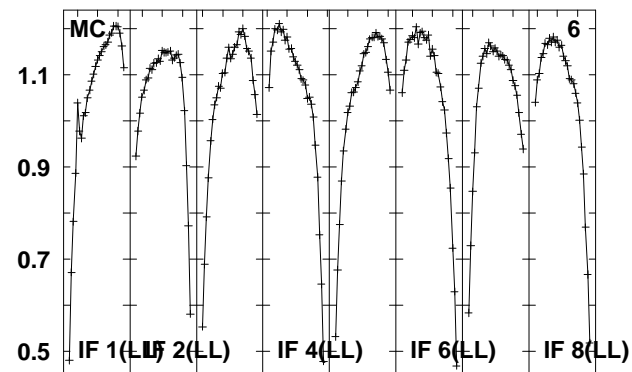
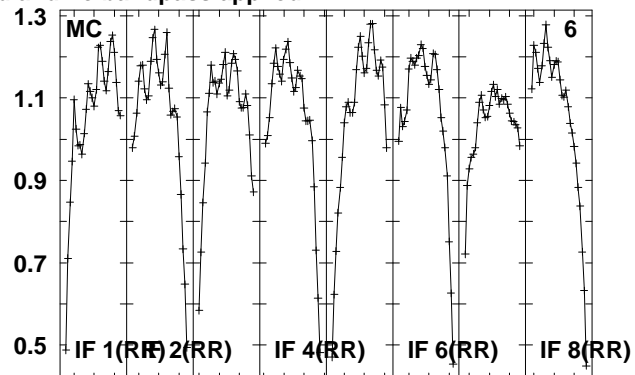
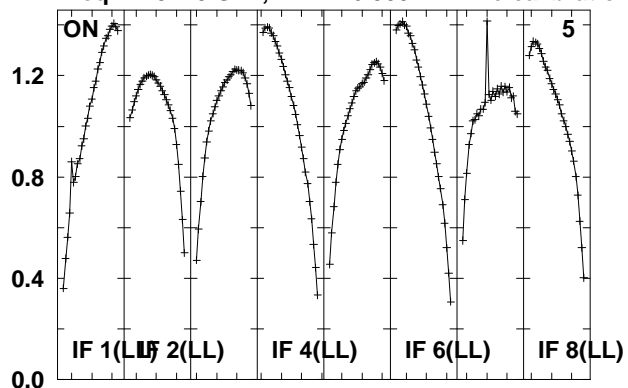

Lower frame: Real Jy

Total-power spectrum Antenna: *

Timerange: 00/14:16:57 to 00/14:21:55

Plot file version 405 created 14-MAY-2010 15:19:21
 J0209+13 EO007.UVDATA.1
 Freq = 4.9270 GHz, Bw = 16.000 MH No calibration applied and no bandpass applied

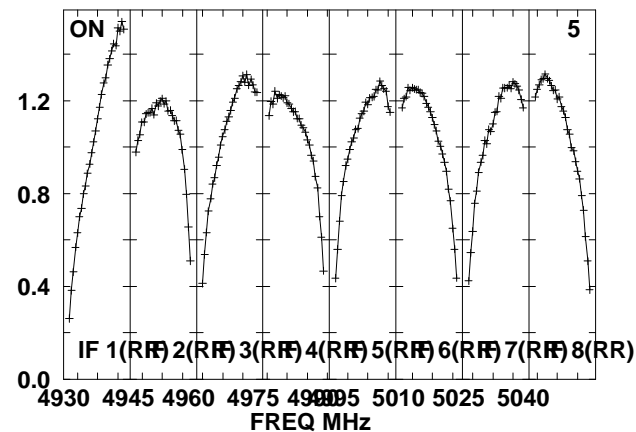
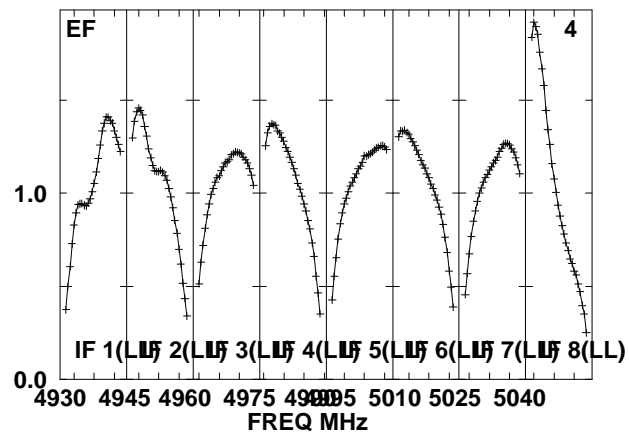
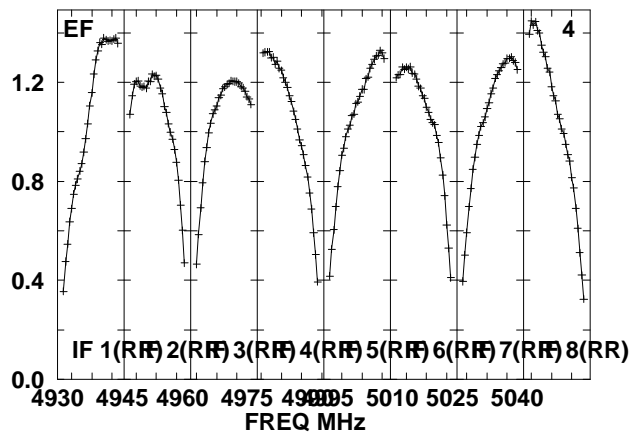
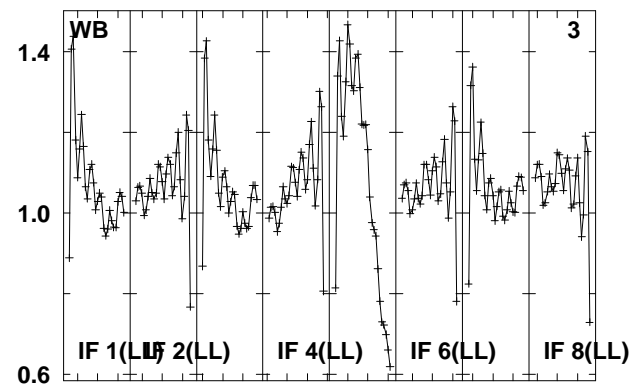
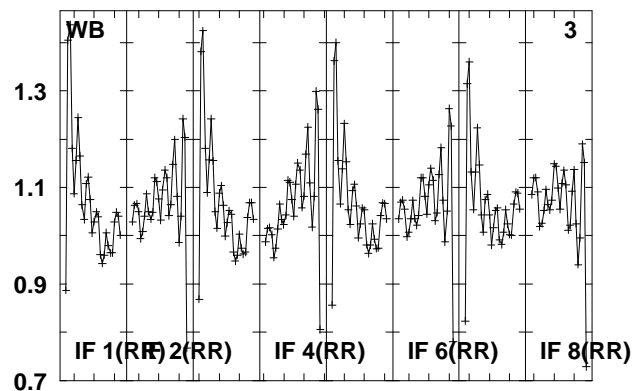
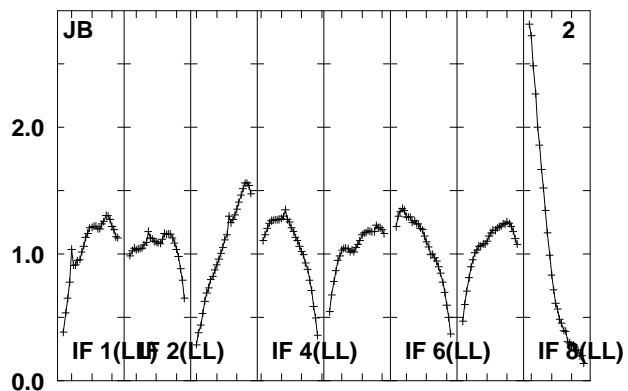
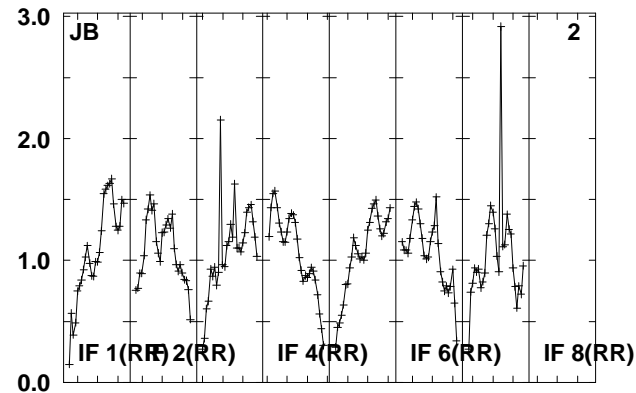
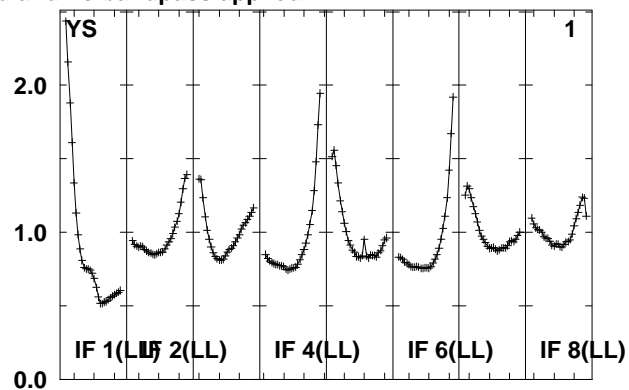
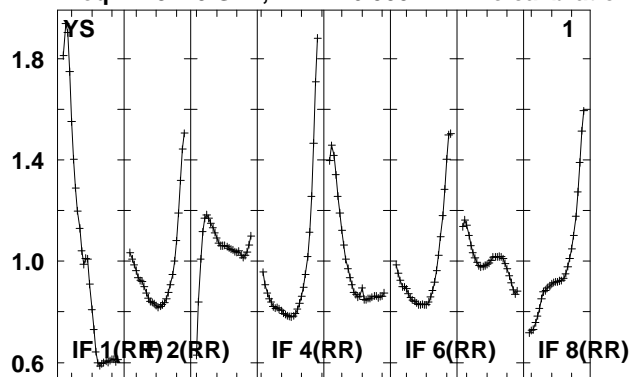

Lower frame: Real Jy
 Total-power spectrum Antenna: *
 Timerange: 00/14:22:27 to 00/14:23:55

Plot file version 406 created 14-MAY-2010 15:19:21

J0209+13 EO007.UVDATA.1

Freq = 4.9270 GHz, Bw = 16.000 MH No calibration applied and no bandpass applied

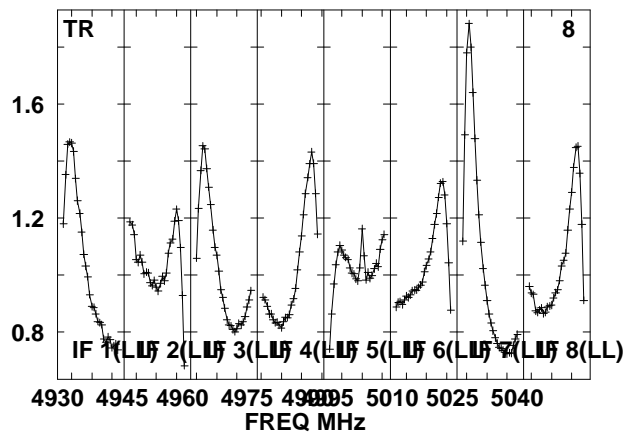
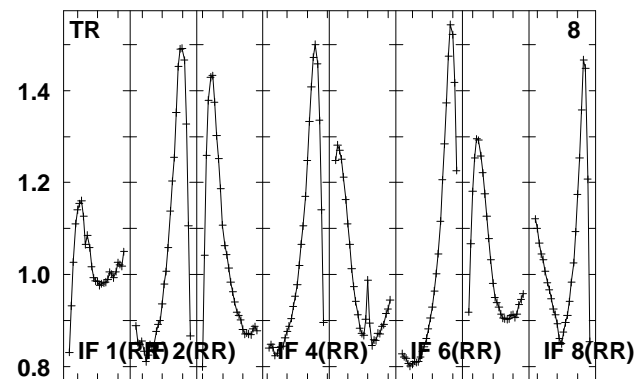
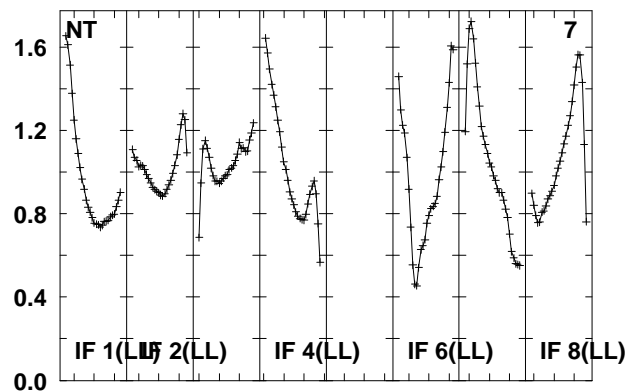
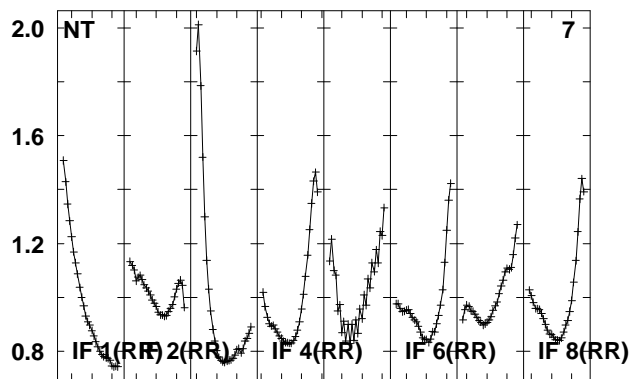
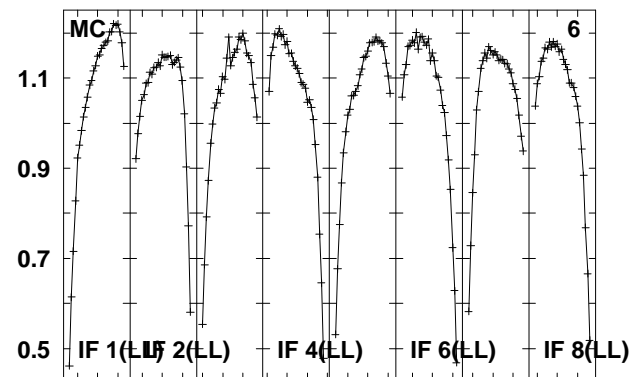
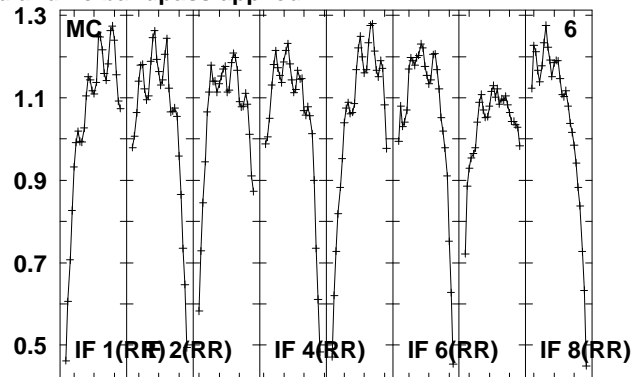
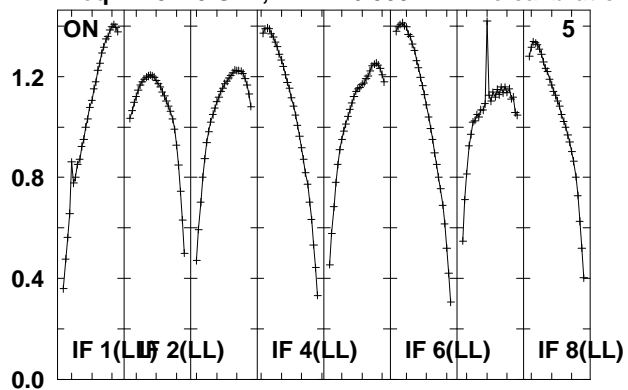

Lower frame: Real Jy

Total-power spectrum Antenna: *

Timerange: 00/14:22:27 to 00/14:23:55

Plot file version 407 created 14-MAY-2010 15:19:21

J021348 EO007.UVDATA.1

Freq = 4.9270 GHz, Bw = 16.000 MH No calibration applied and no bandpass applied

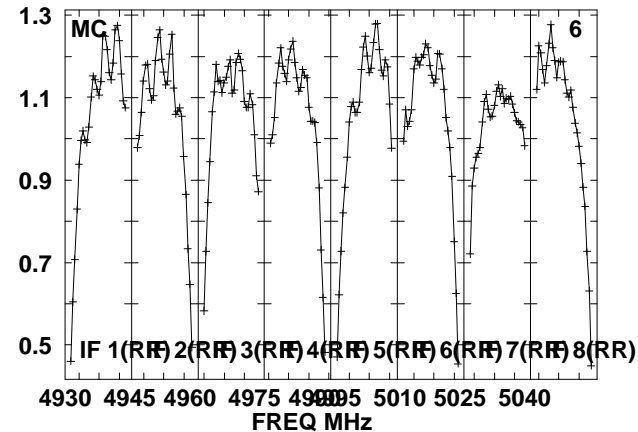
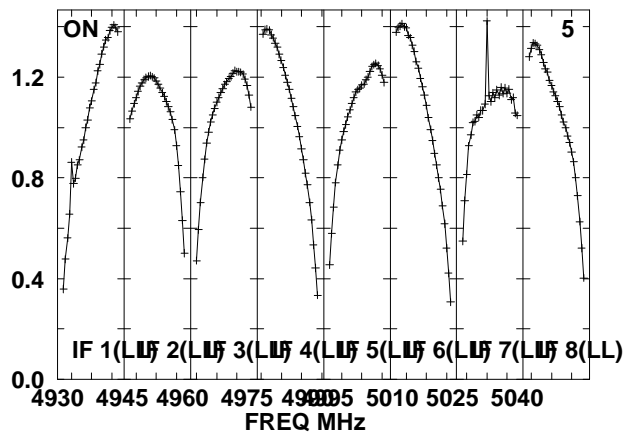
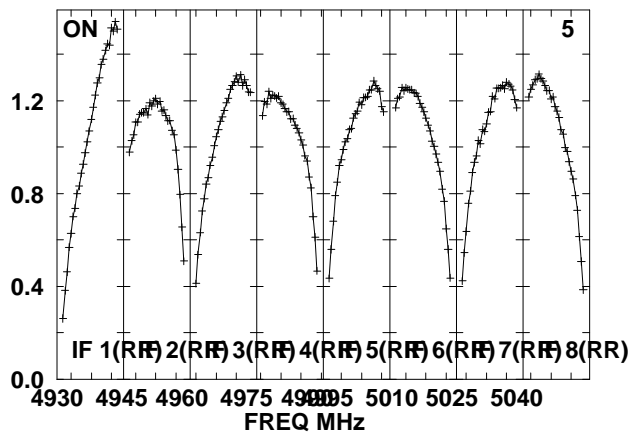
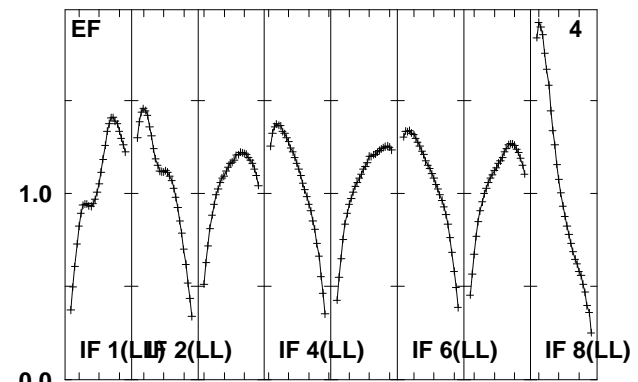
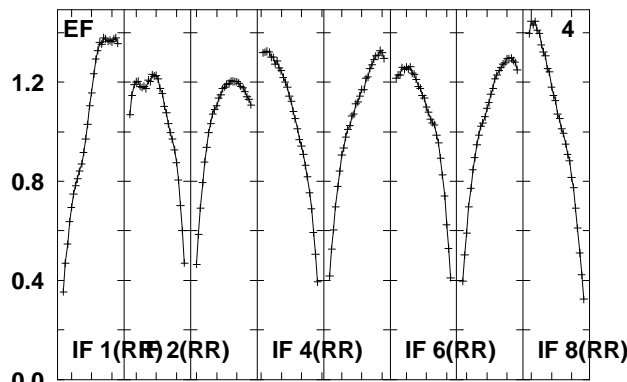
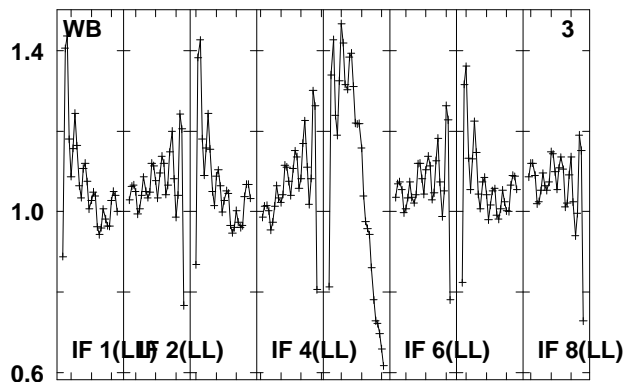
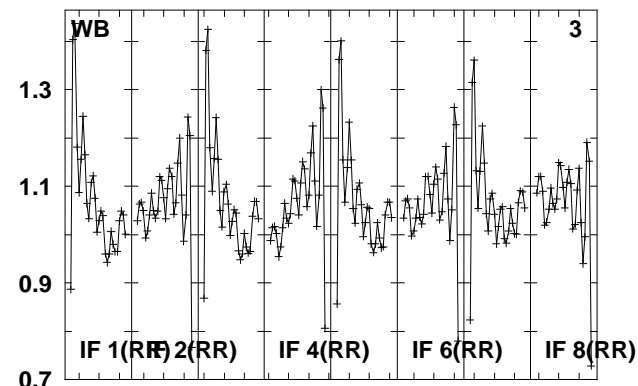
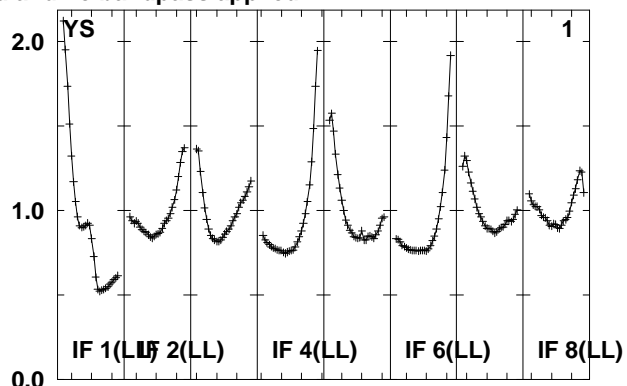
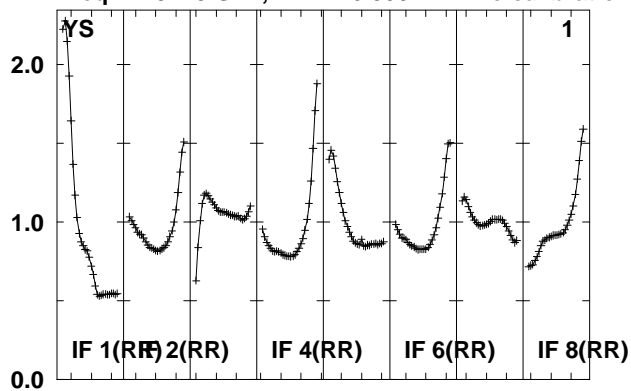

Lower frame: Real Jy
Total-power spectrum Antenna: *
Timerange: 00/14:24:23 to 00/14:29:23

Plot file version 408 created 14-MAY-2010 15:19:22

J021348 EO007.UVDATA.1

Freq = 4.9270 GHz, Bw = 16.000 MH No calibration applied and no bandpass applied

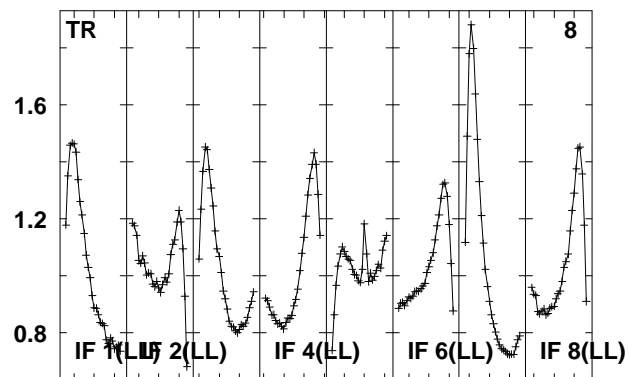
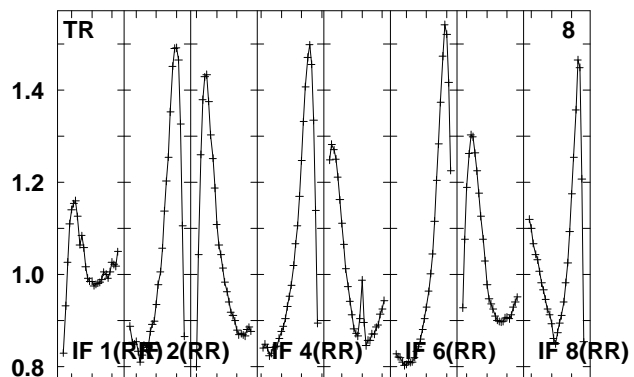
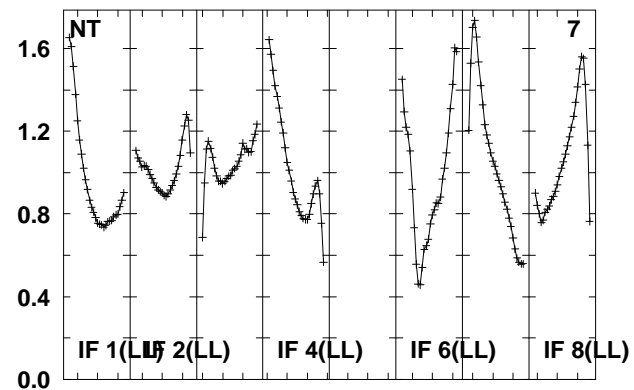
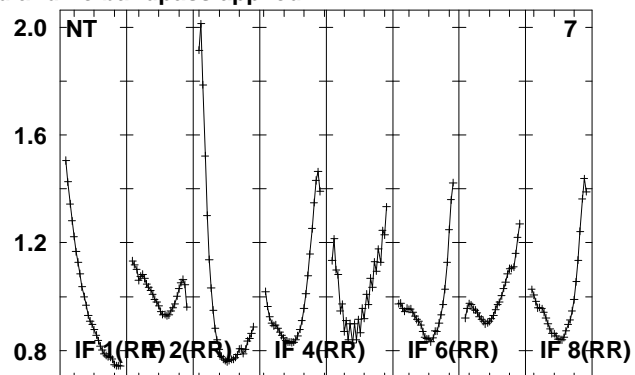
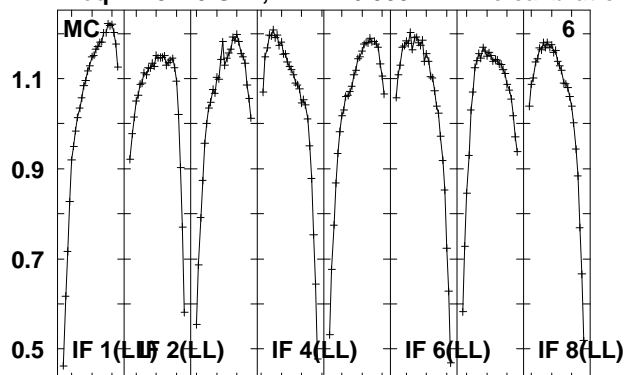

Lower frame: Real Jy
Total-power spectrum Antenna: *
Timerange: 00/14:24:23 to 00/14:29:23

Plot file version 409 created 14-MAY-2010 15:19:22

J0209+13 EO007.UVDATA.1

Freq = 4.9270 GHz, Bw = 16.000 MH No calibration applied and no bandpass applied

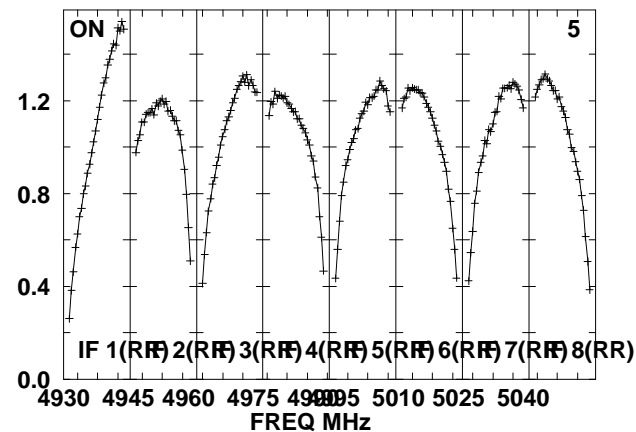
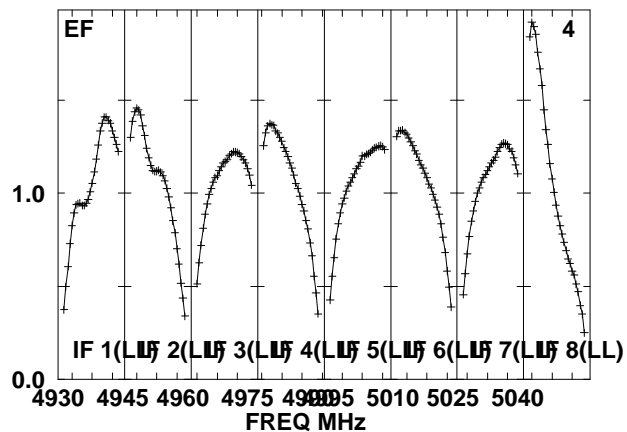
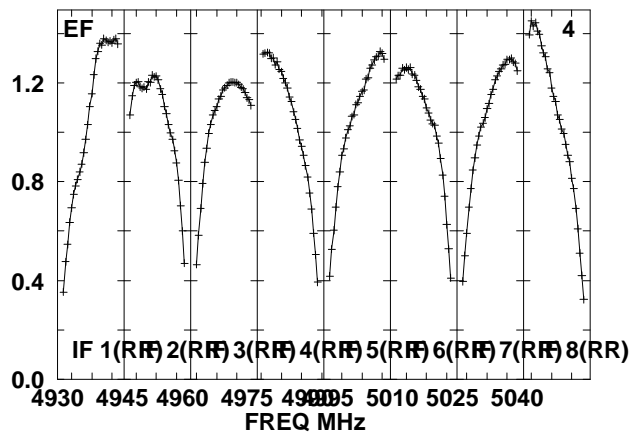
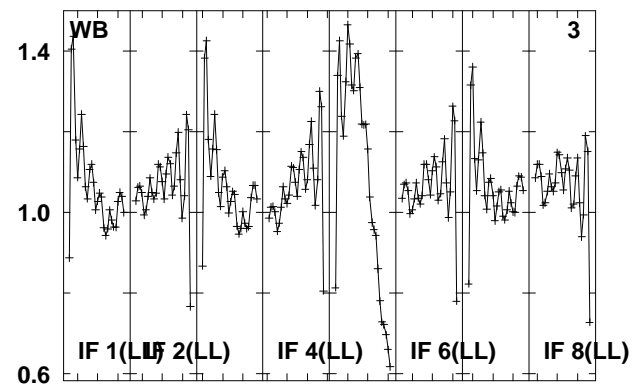
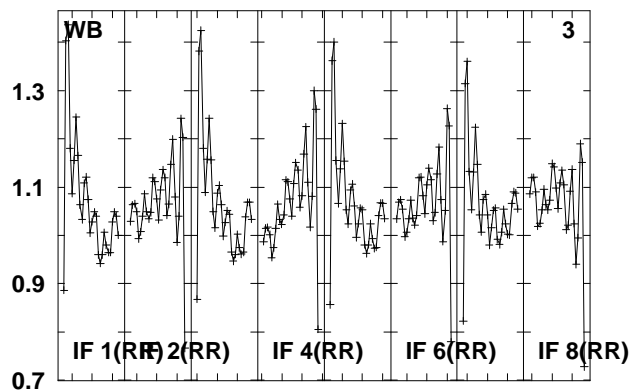
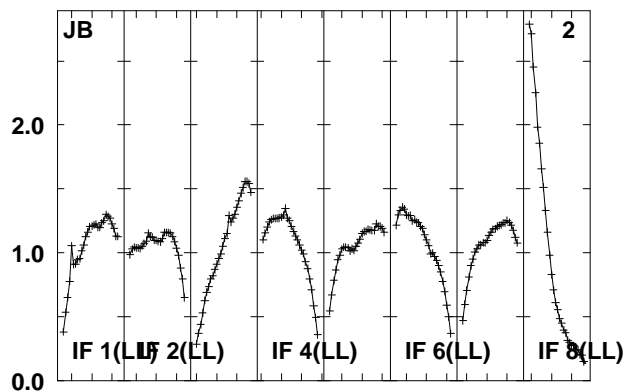
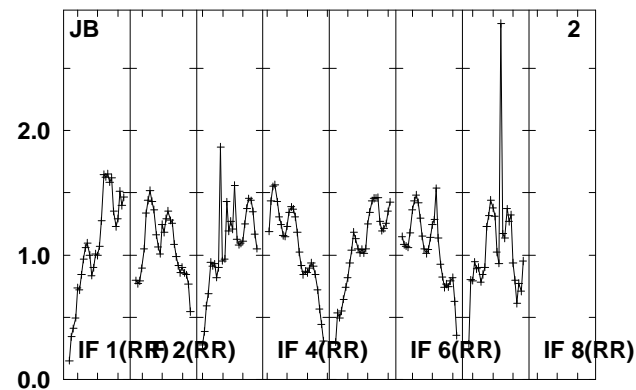
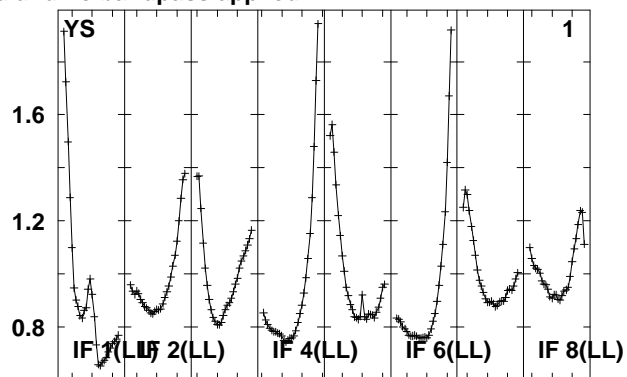
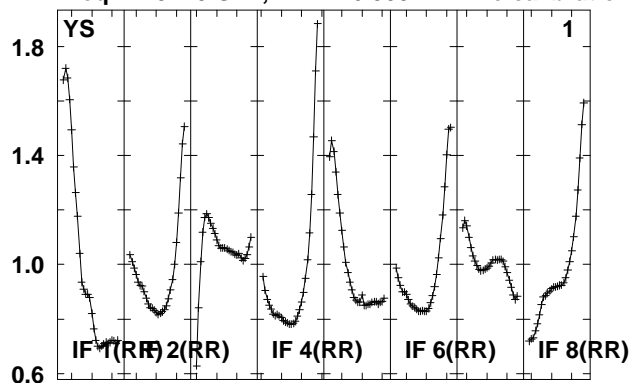

Lower frame: Real Jy
Total-power spectrum Antenna: *
Timerange: 00/14:29:53 to 00/14:31:21

Plot file version 410 created 14-MAY-2010 15:19:22

J0209+13 EO007.UVDATA.1

Freq = 4.9270 GHz, Bw = 16.000 MH No calibration applied and no bandpass applied

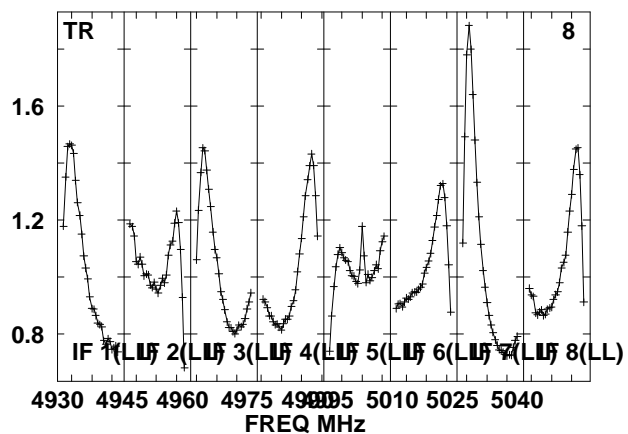
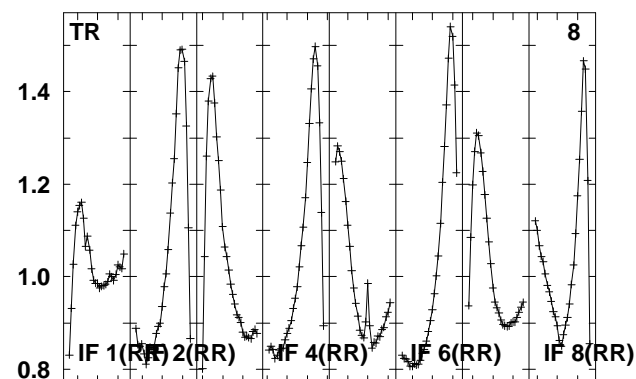
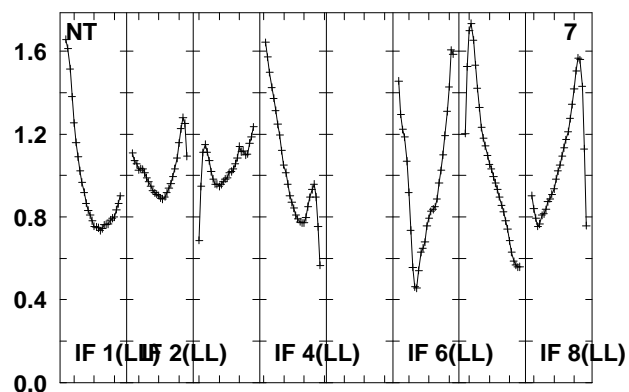
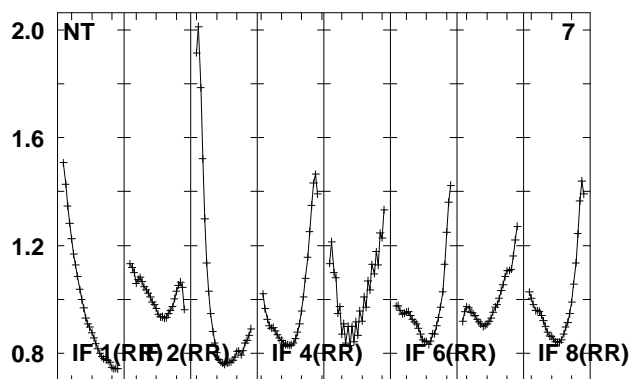
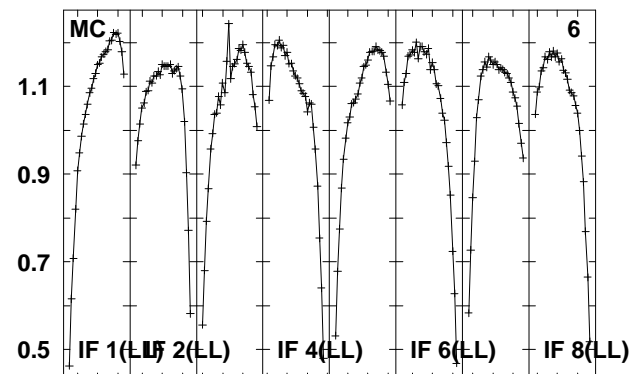
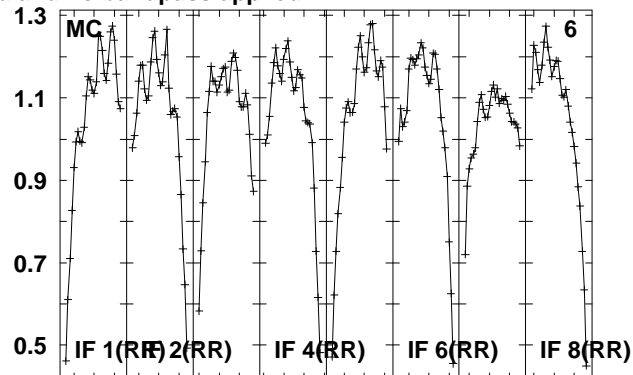
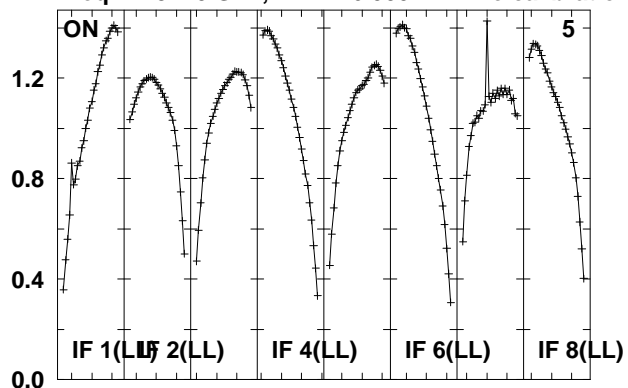

Lower frame: Real Jy

Total-power spectrum Antenna: *

Timerange: 00/14:29:53 to 00/14:31:21

Plot file version 411 created 14-MAY-2010 15:19:23

J0808+40 EO007.UVDATA.1

Freq = 4.9270 GHz, Bw = 16.000 MH No calibration applied and no bandpass applied

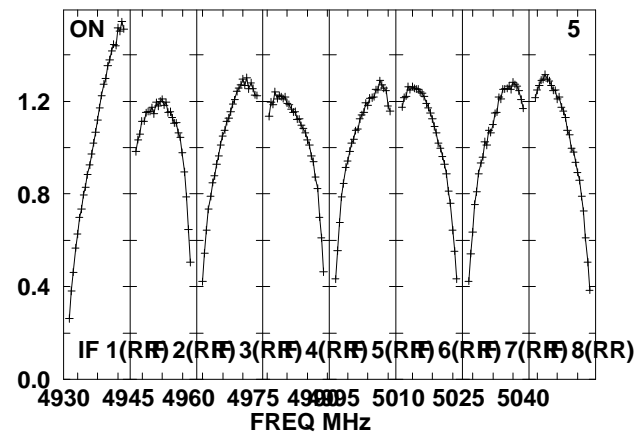
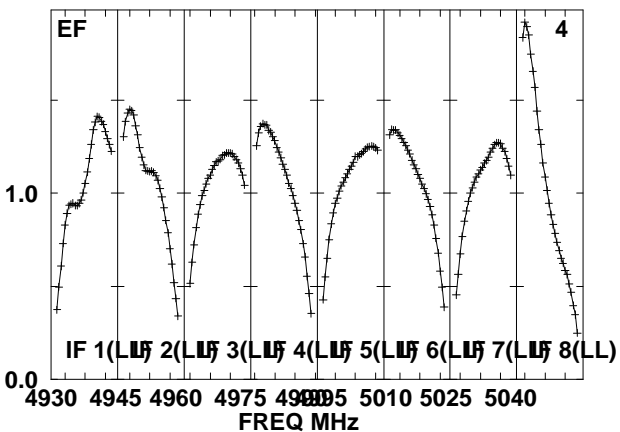
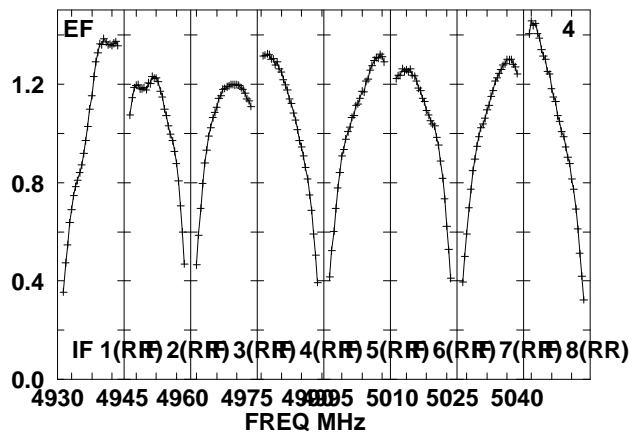
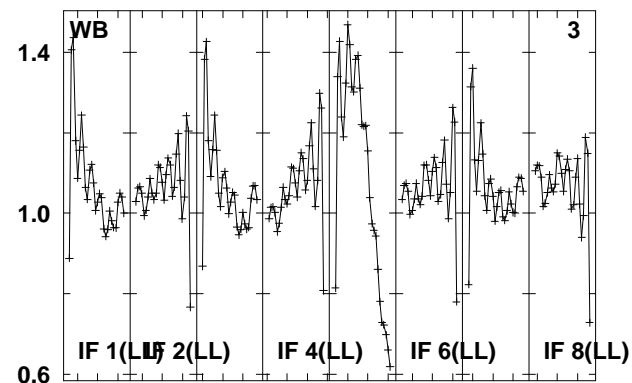
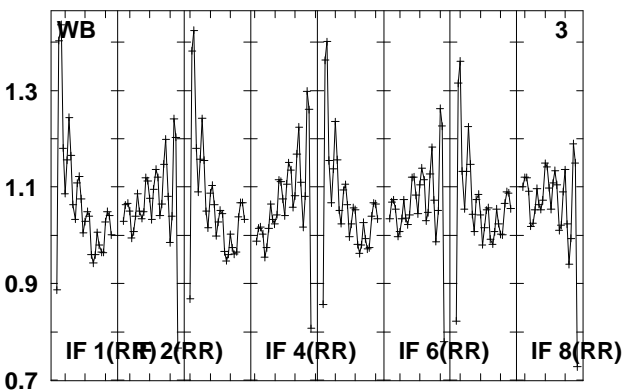
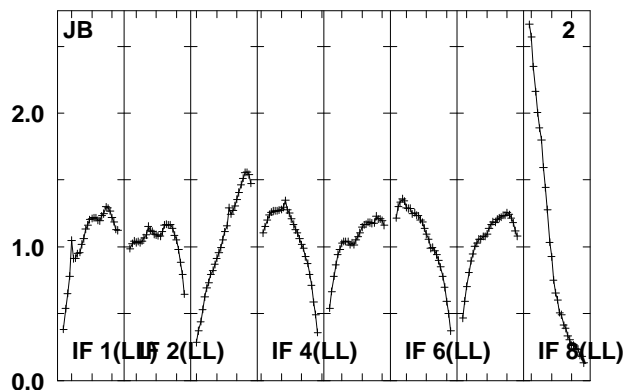
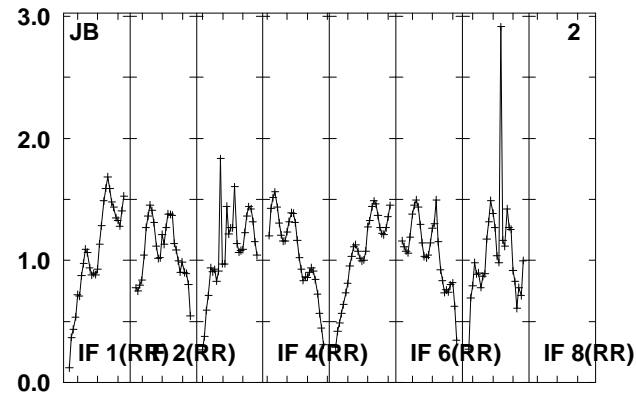
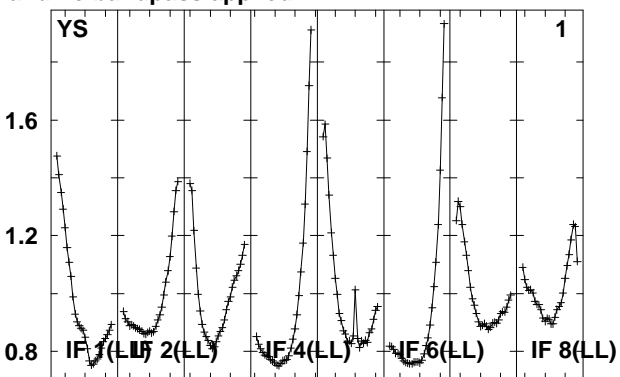
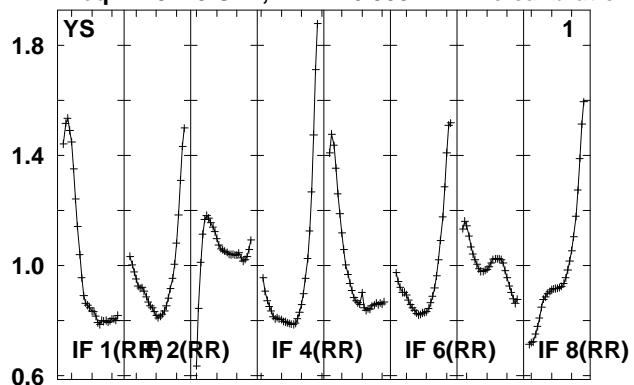

Lower frame: Real Jy

Total-power spectrum Antenna: *

Timerange: 00/14:39:27 to 00/14:40:55

Plot file version 412 created 14-MAY-2010 15:19:23

J0808+40 EO007.UVDATA.1

Freq = 4.9270 GHz, Bw = 16.000 MH No calibration applied and no bandpass applied

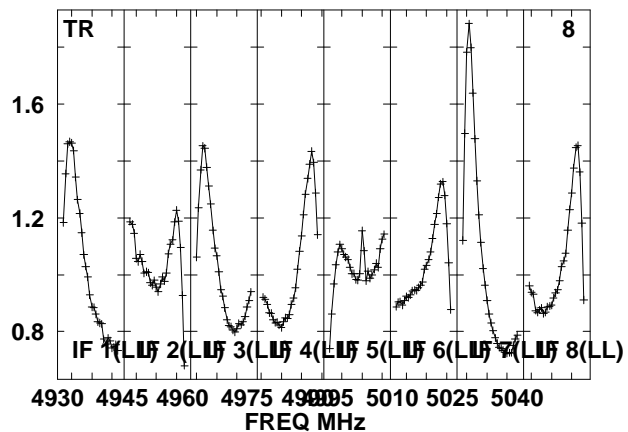
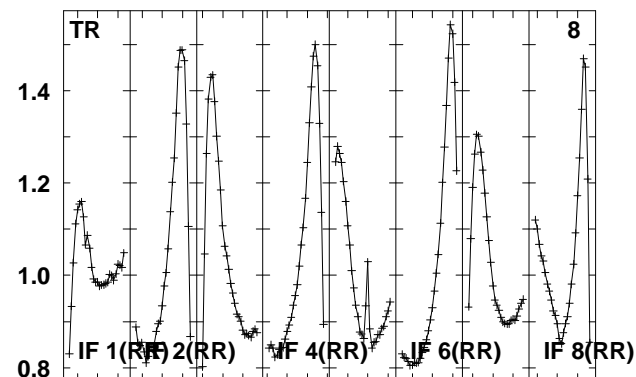
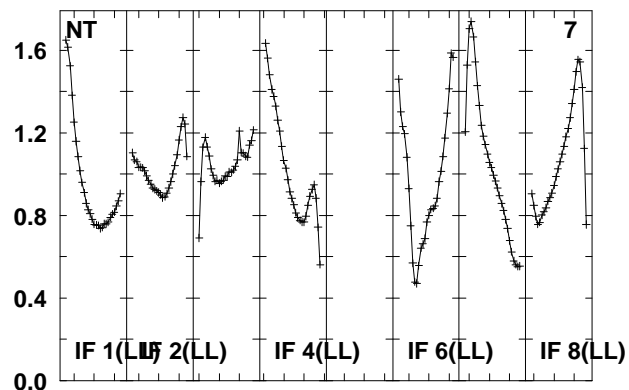
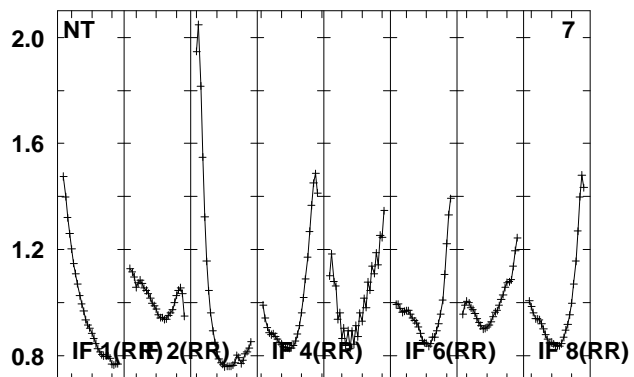
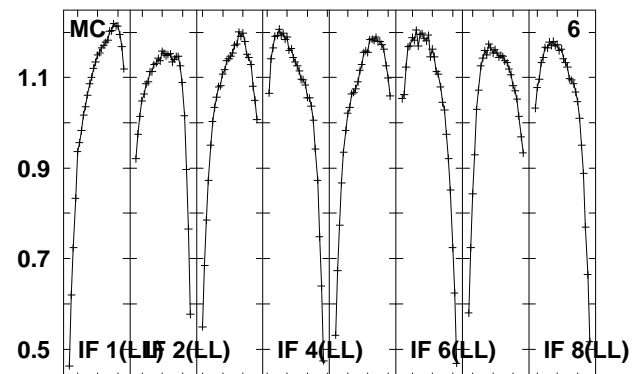
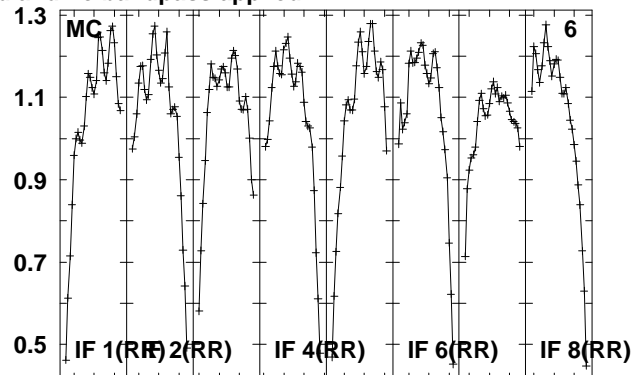
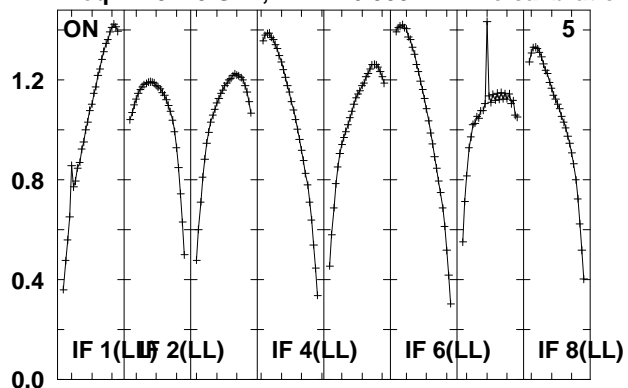

Lower frame: Real Jy

Total-power spectrum Antenna: *

Timerange: 00/14:39:27 to 00/14:40:55

Plot file version 413 created 14-MAY-2010 15:19:23
 J080844 EO007.UVDATA.1
 Freq = 4.9270 GHz, Bw = 16.000 MH No calibration applied and no bandpass applied

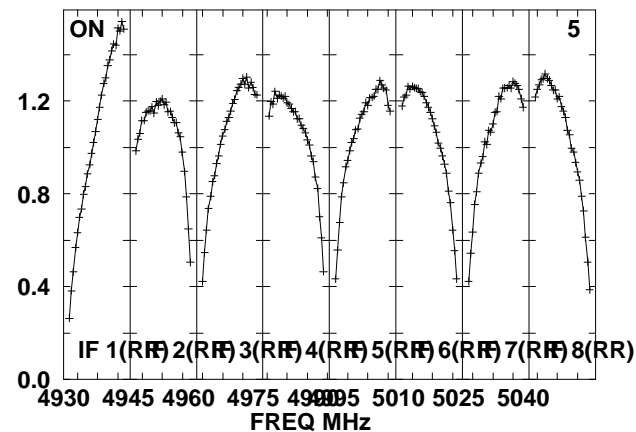
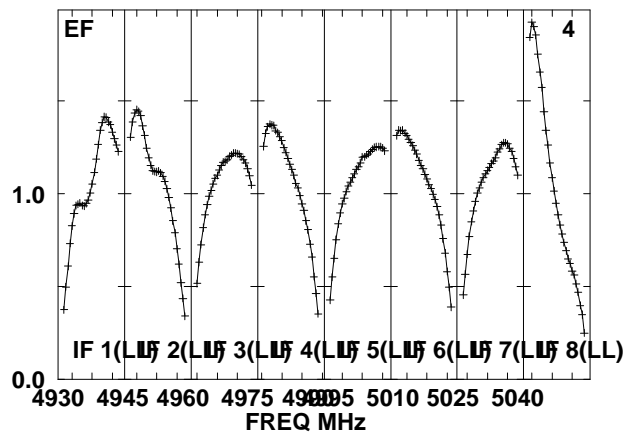
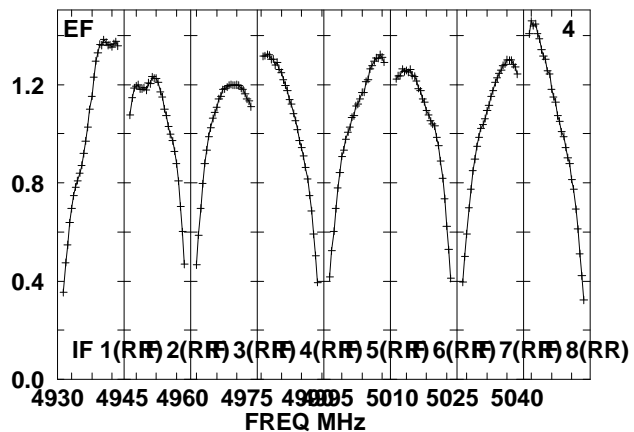
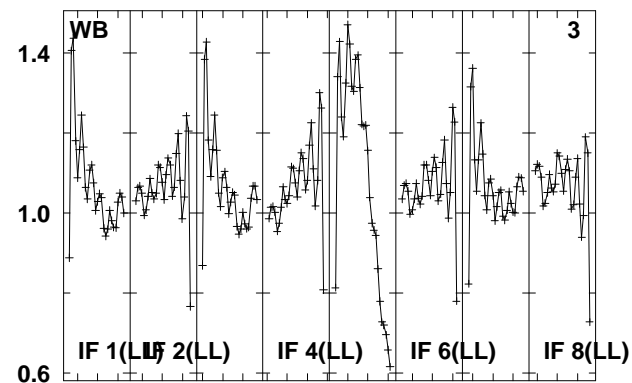
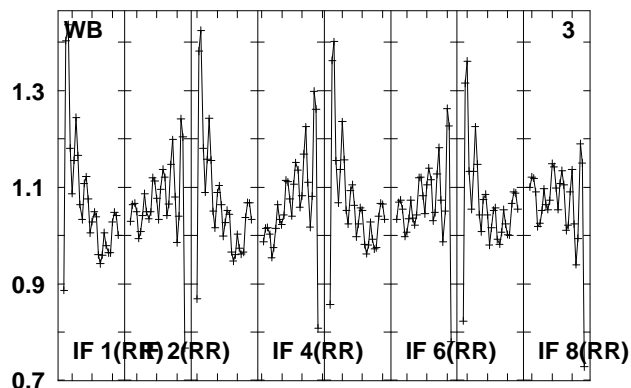
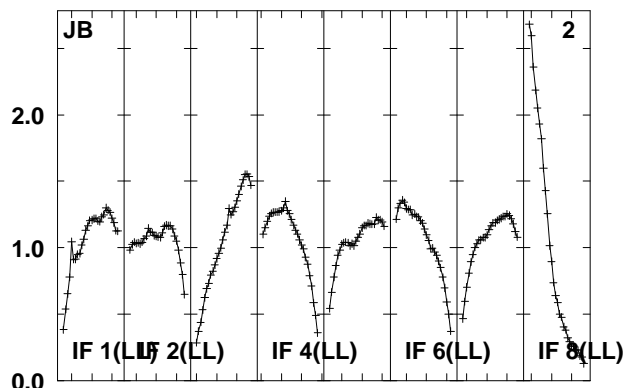
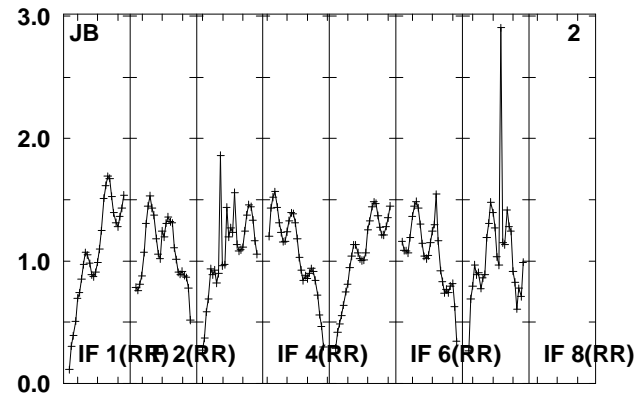
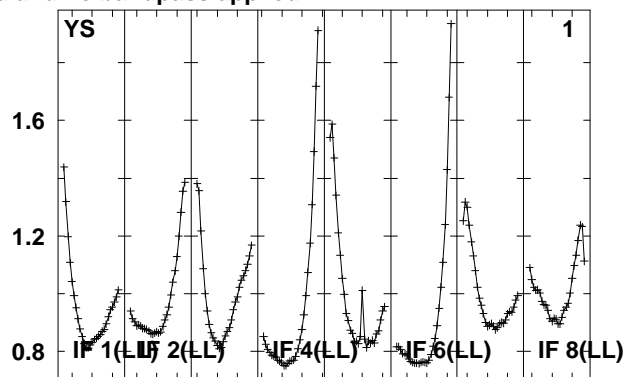
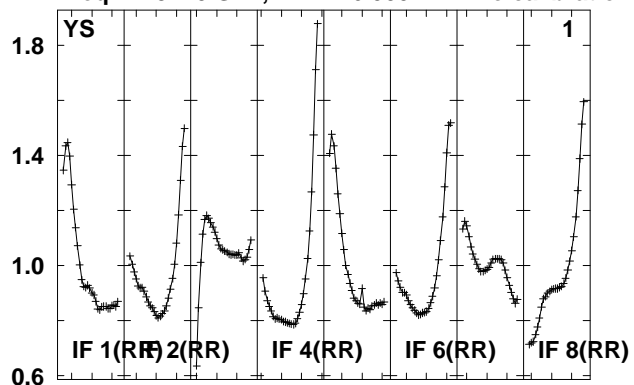

Lower frame: Real Jy
 Total-power spectrum Antenna: *
 Timerange: 00/14:41:21 to 00/14:46:19

Plot file version 414 created 14-MAY-2010 15:19:24

J080844 EO007.UVDATA.1

Freq = 4.9270 GHz, Bw = 16.000 MH No calibration applied and no bandpass applied

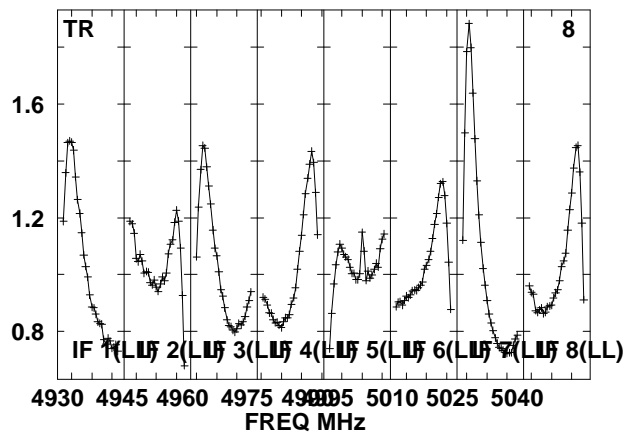
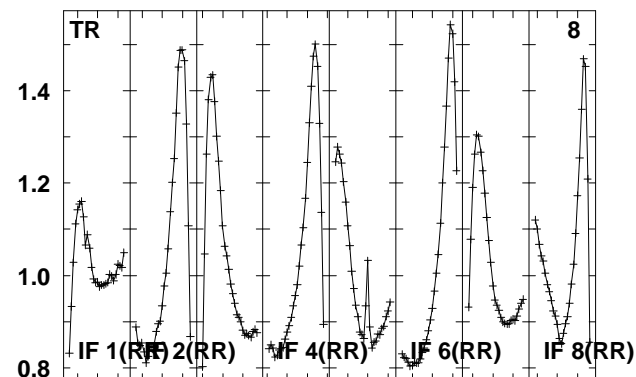
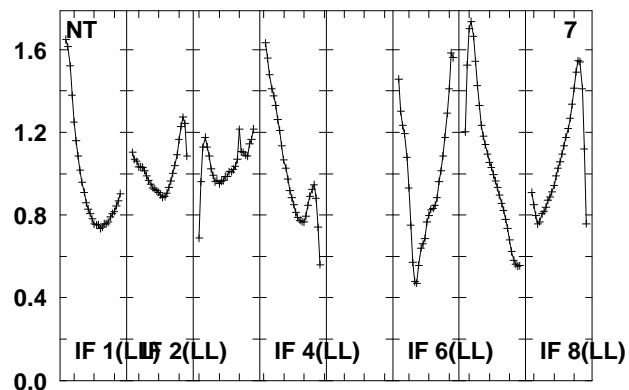
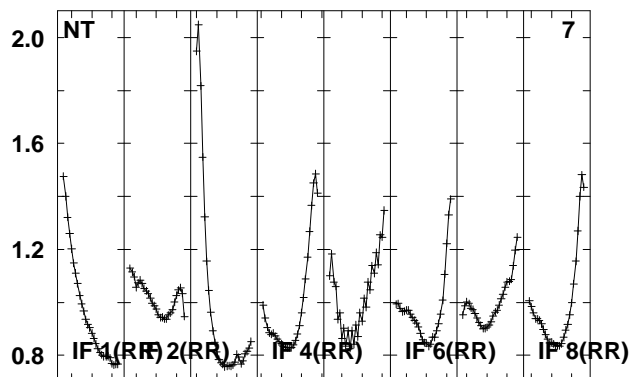
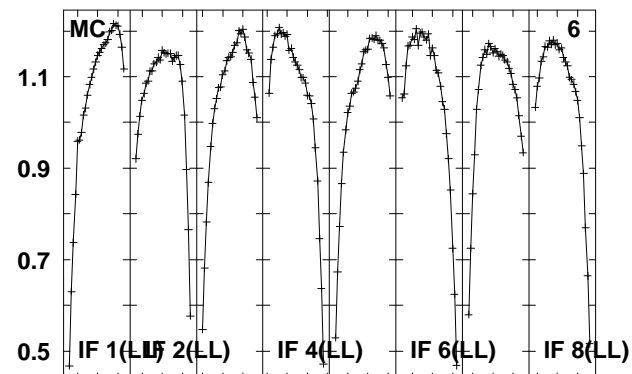
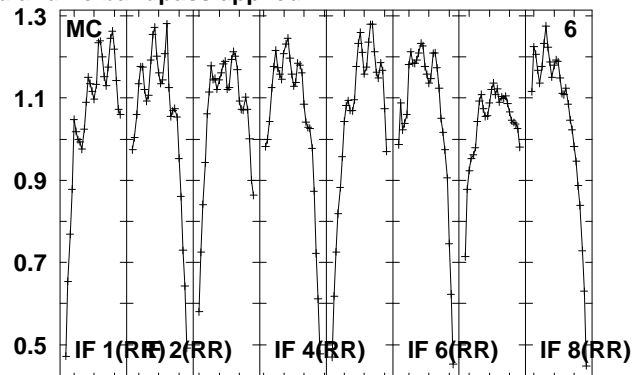
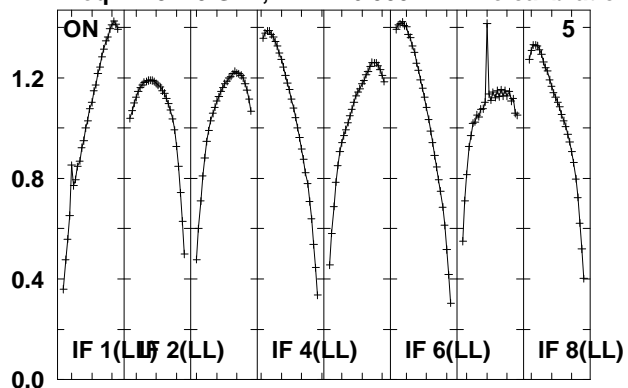

Lower frame: Real Jy

Total-power spectrum Antenna: *

Timerange: 00/14:41:21 to 00/14:46:19

Plot file version 415 created 14-MAY-2010 15:19:24

J0808+40 EO007.UVDATA.1

Freq = 4.9270 GHz, Bw = 16.000 MH No calibration applied and no bandpass applied

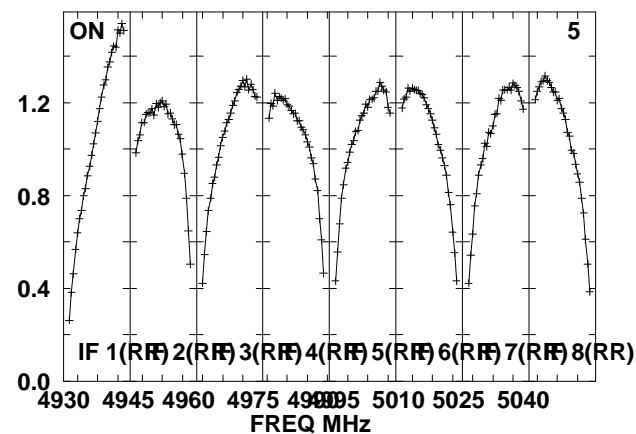
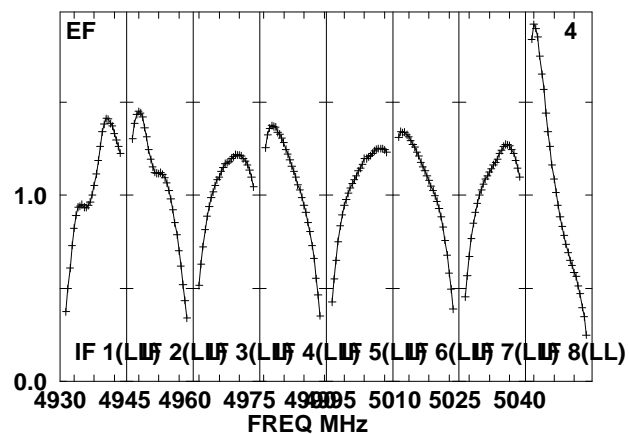
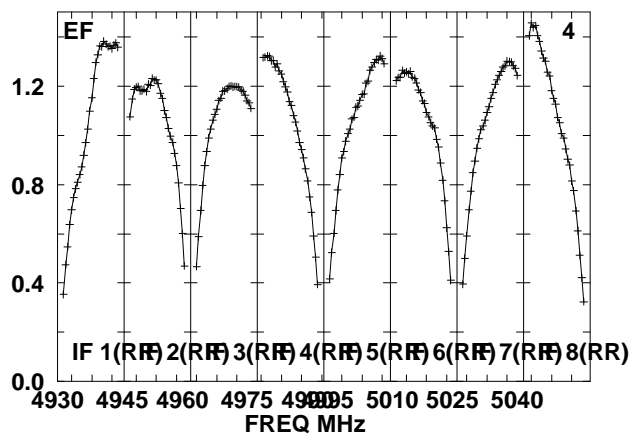
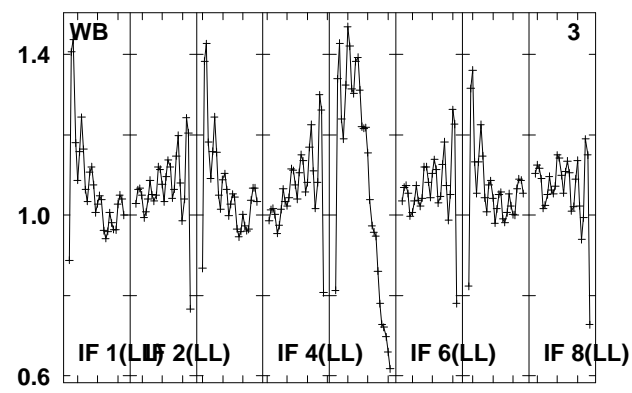
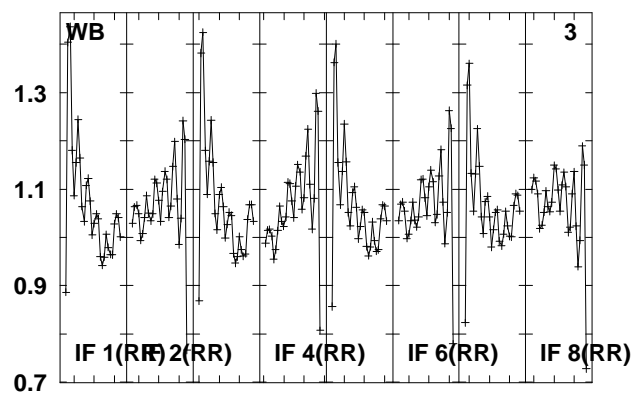
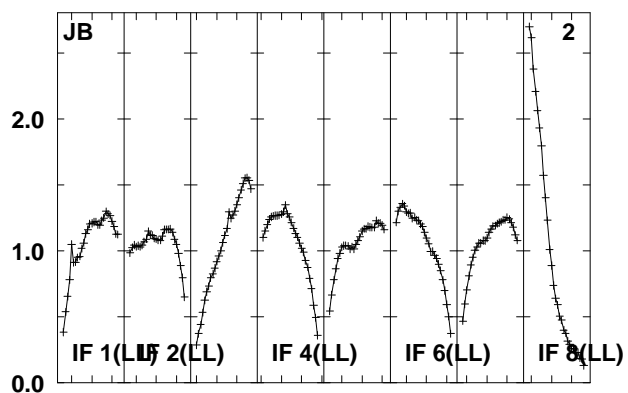
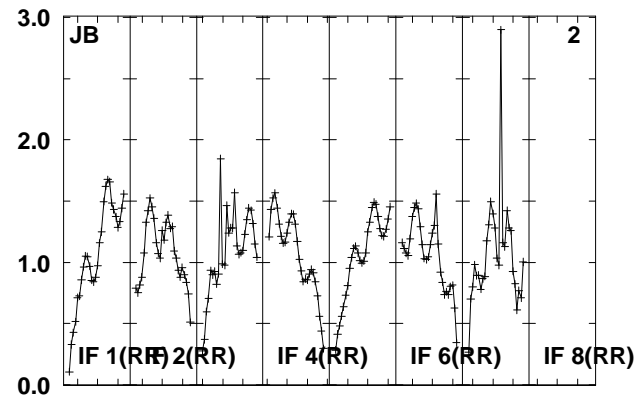
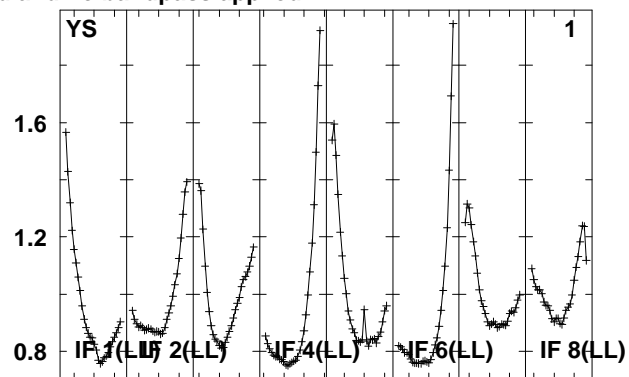
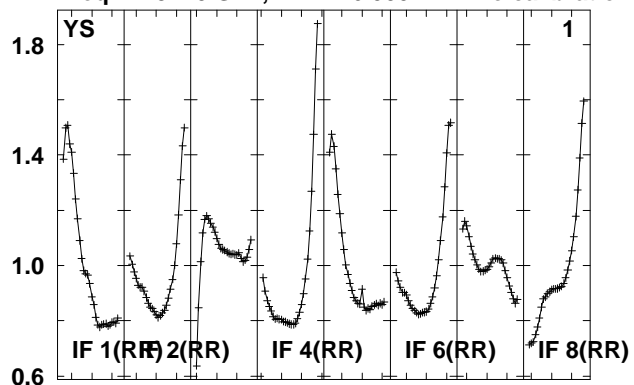

Lower frame: Real Jy
Total-power spectrum Antenna: *
Timerange: 00/14:46:43 to 00/14:48:11

Plot file version 416 created 14-MAY-2010 15:19:25

J0808+40 EO007.UVDATA.1

Freq = 4.9270 GHz, Bw = 16.000 MH No calibration applied and no bandpass applied

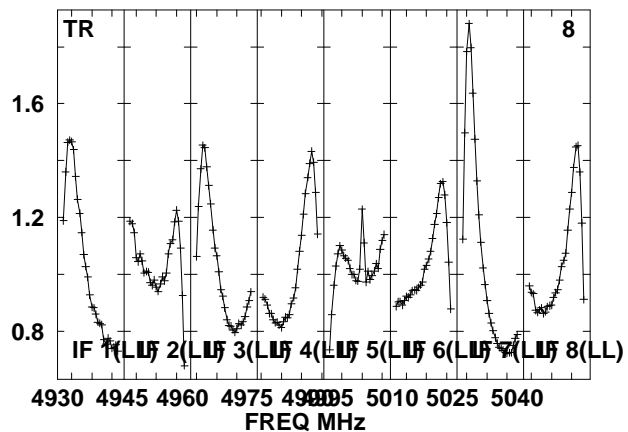
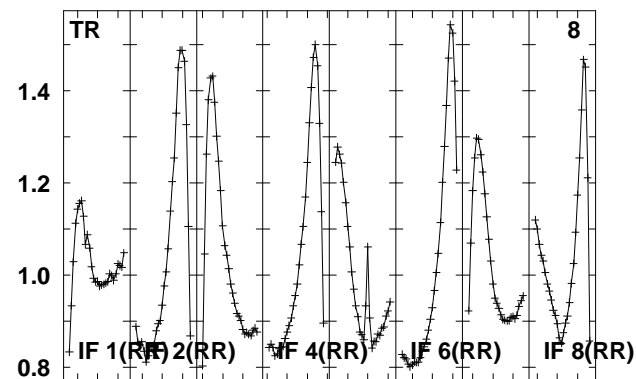
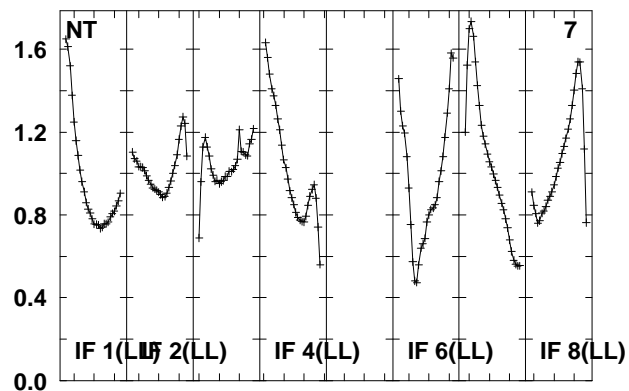
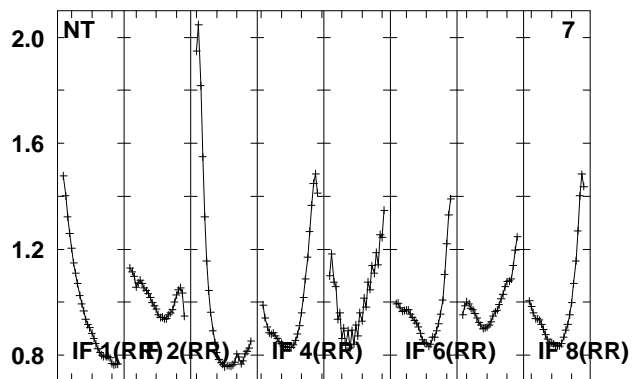
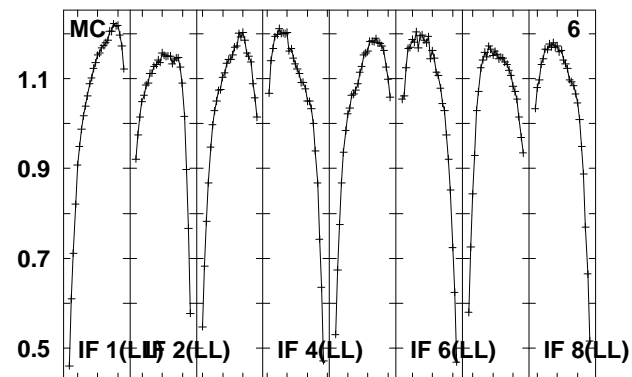
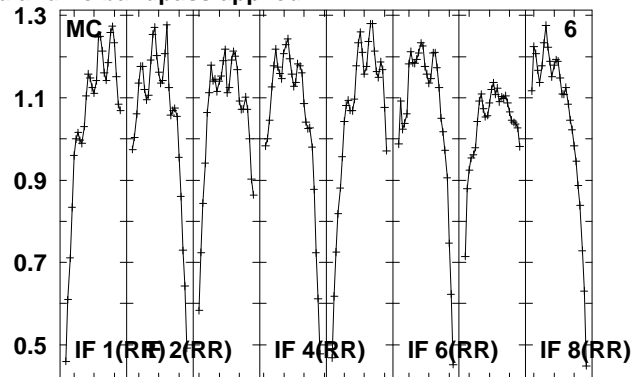
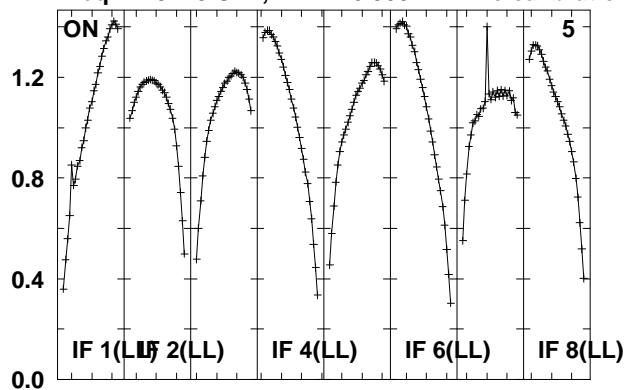

Lower frame: Real Jy

Total-power spectrum Antenna: *

Timerange: 00/14:46:43 to 00/14:48:11

Plot file version 417 created 14-MAY-2010 15:19:25

J080844 EO007.UVDATA.1

Freq = 4.9270 GHz, Bw = 16.000 MH No calibration applied and no bandpass applied

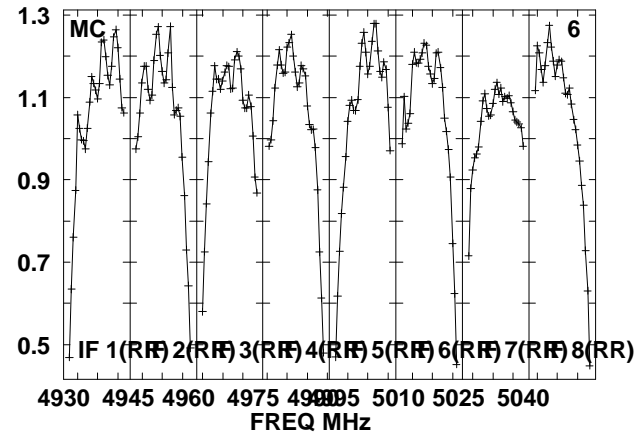
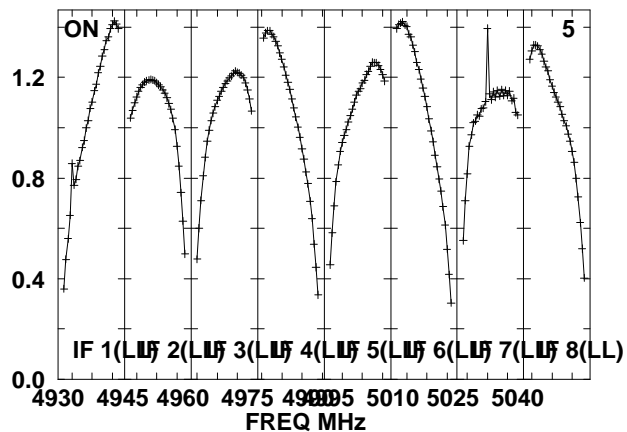
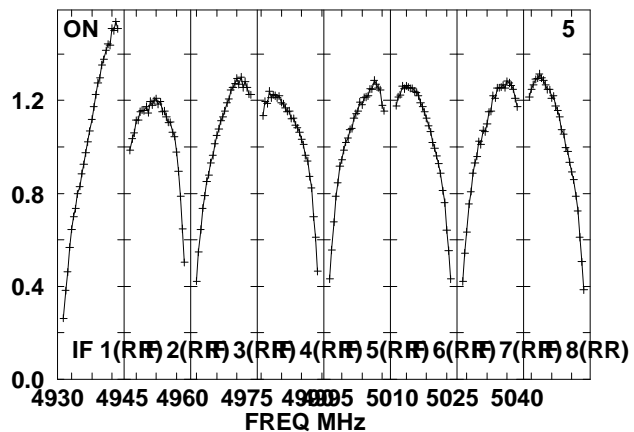
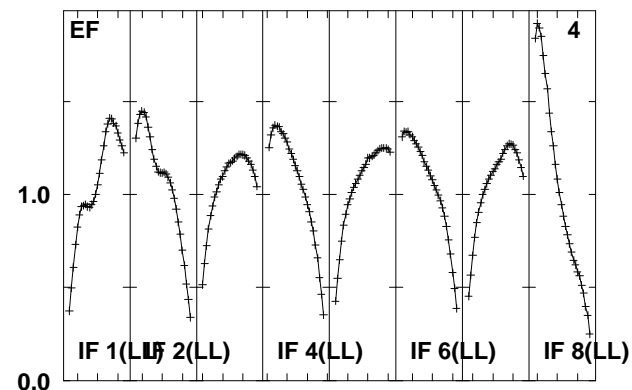
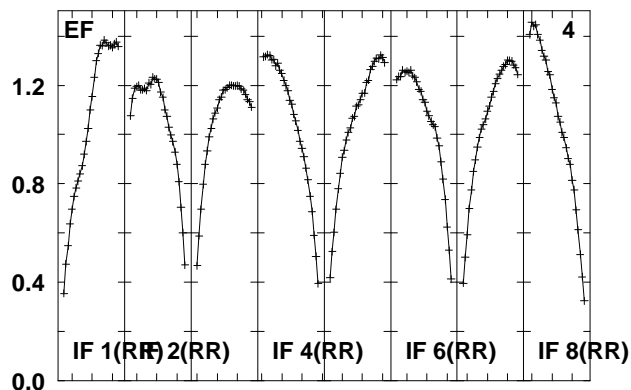
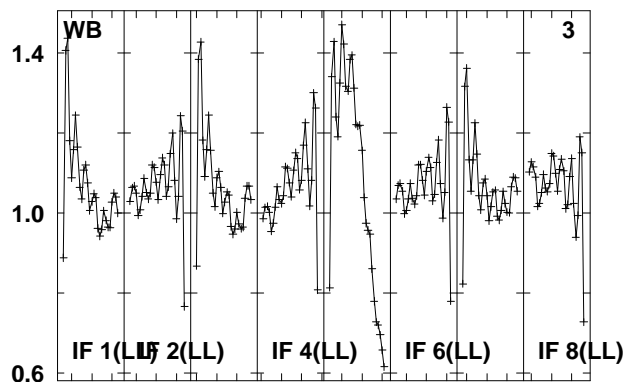
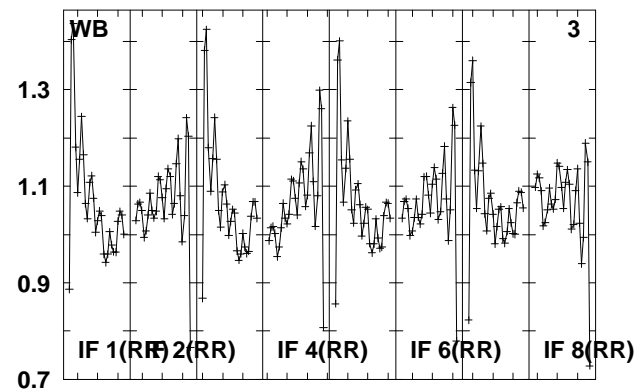
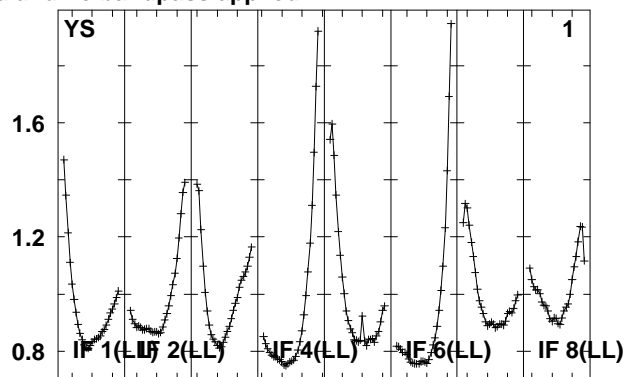
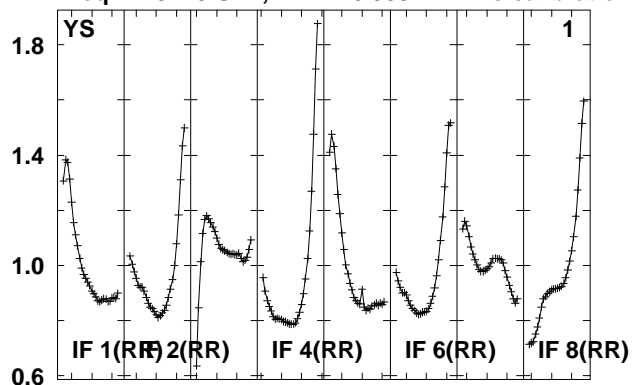

Lower frame: Real Jy
Total-power spectrum Antenna: *
Timerange: 00/14:48:39 to 00/14:53:37

Plot file version 418 created 14-MAY-2010 15:19:26

J080844 EO007.UVDATA.1

Freq = 4.9270 GHz, Bw = 16.000 MH No calibration applied and no bandpass applied

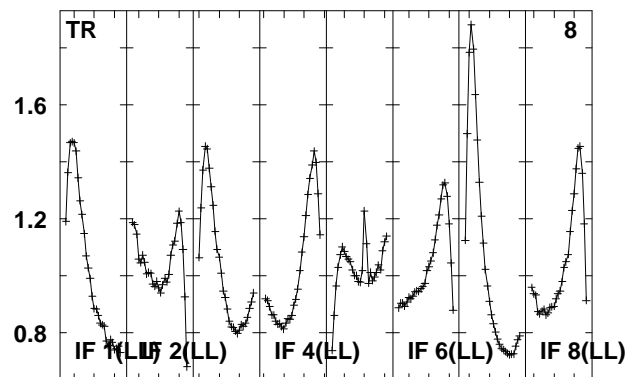
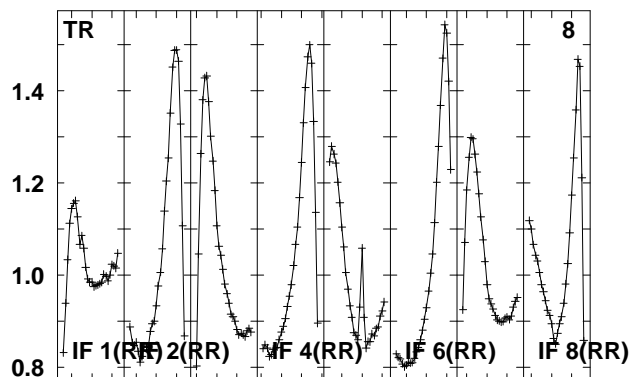
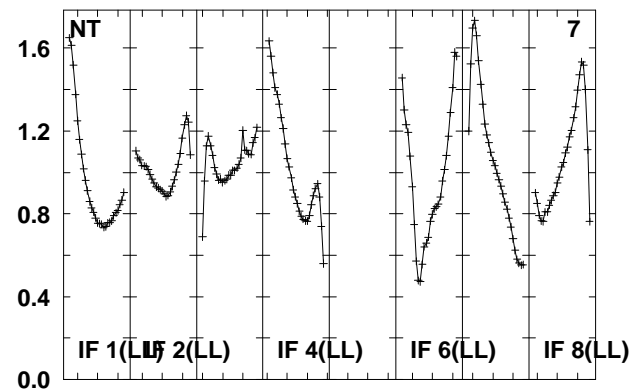
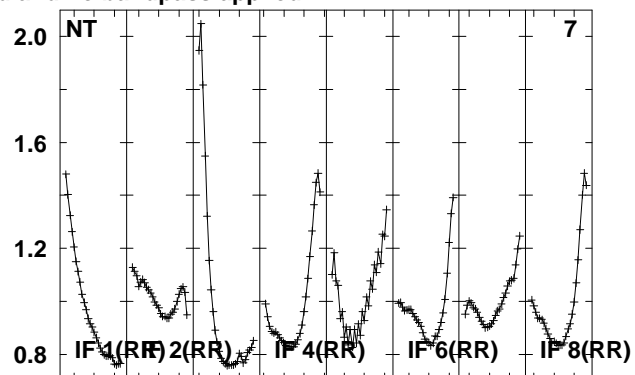
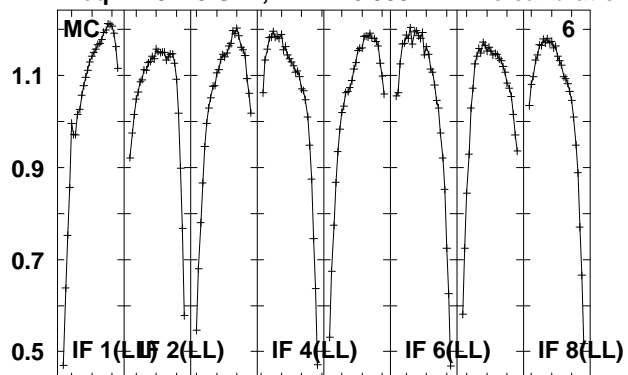

Lower frame: Real Jy
Total-power spectrum Antenna: *
Timerange: 00/14:48:39 to 00/14:53:37

Plot file version 419 created 14-MAY-2010 15:19:26
 J0808+40 EO007.UVDATA.1
 Freq = 4.9270 GHz, Bw = 16.000 MH No calibration applied and no bandpass applied

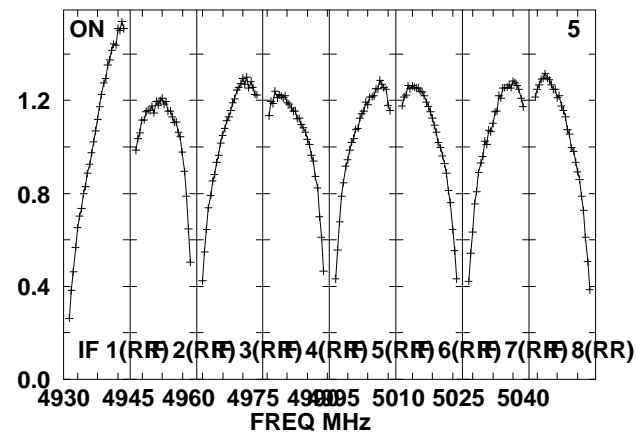
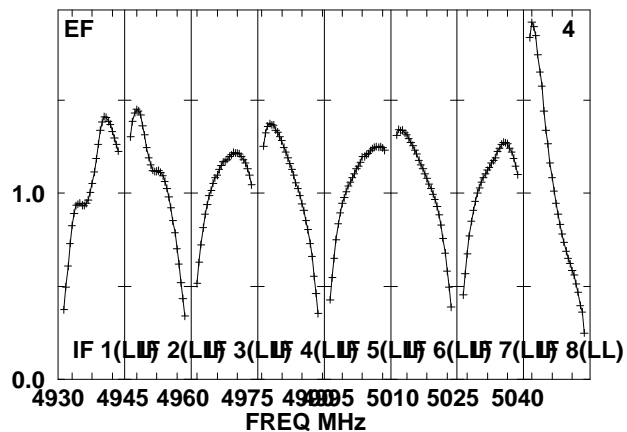
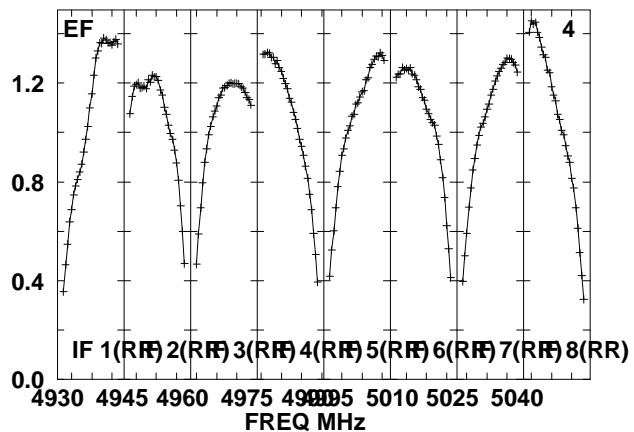
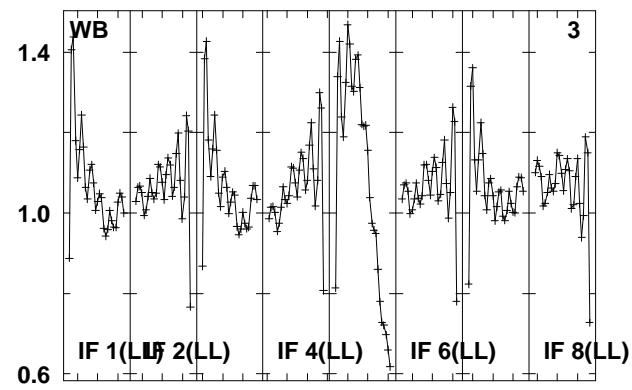
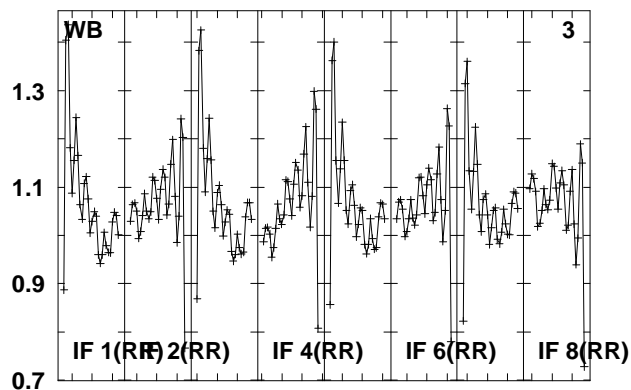
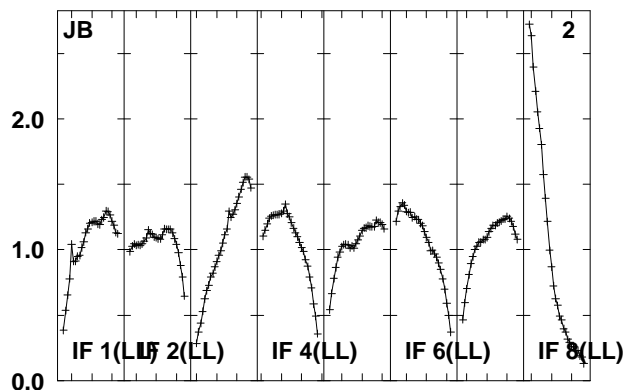
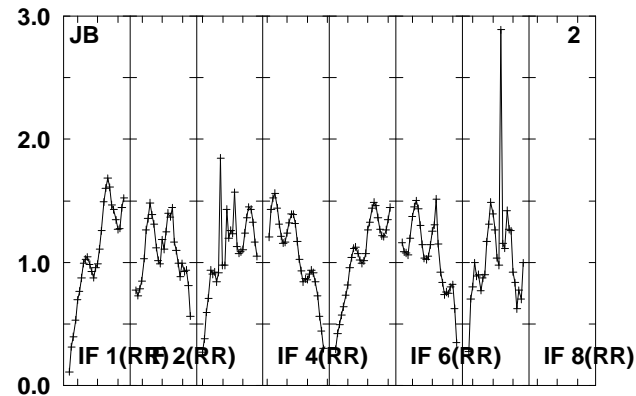
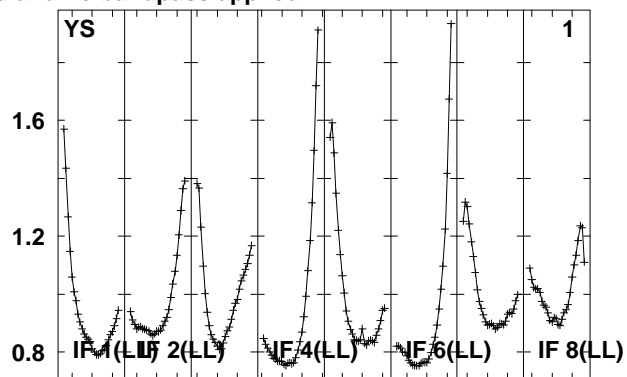
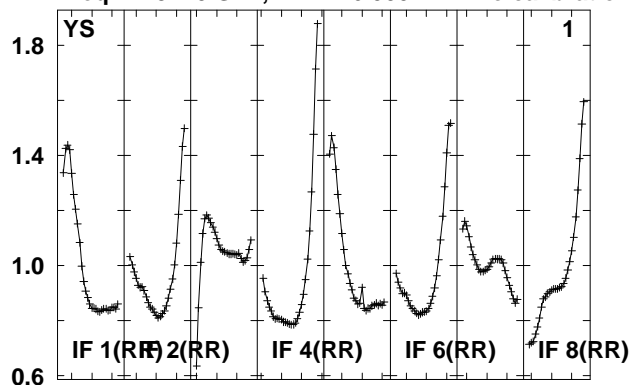

Lower frame: Real Jy
 Total-power spectrum Antenna: *
 Timerange: 00/14:54:03 to 00/14:55:27

Plot file version 420 created 14-MAY-2010 15:19:26

J0808+40 EO007.UVDATA.1

Freq = 4.9270 GHz, Bw = 16.000 MH No calibration applied and no bandpass applied

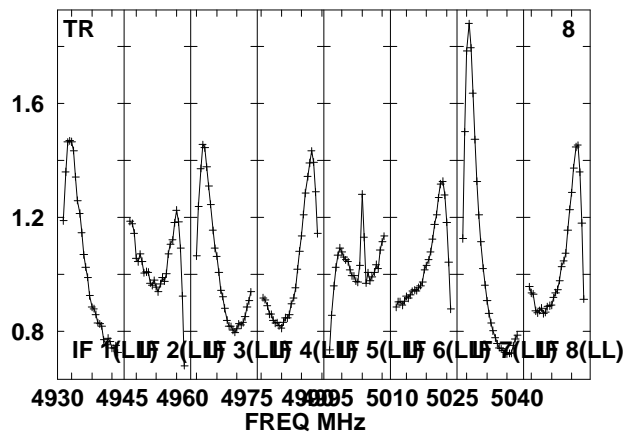
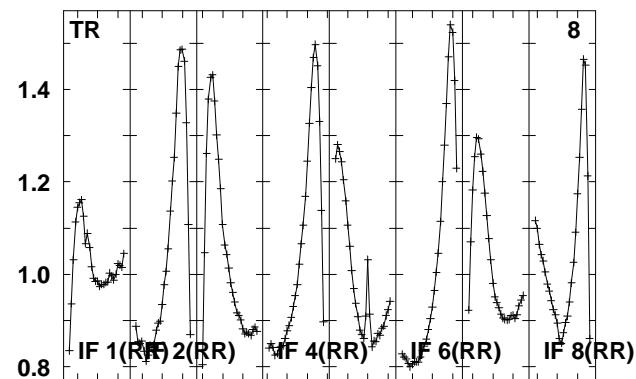
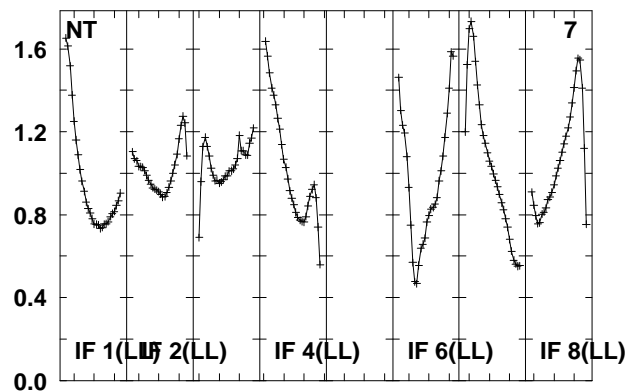
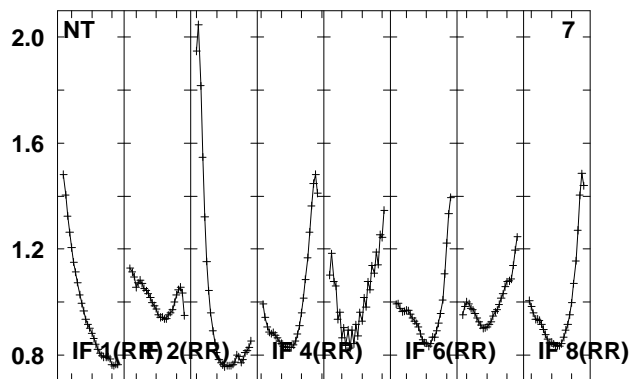
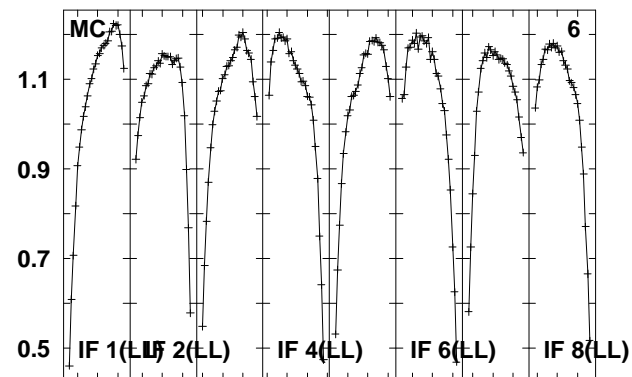
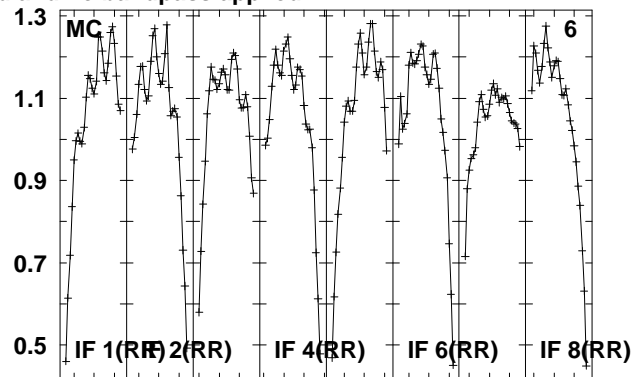
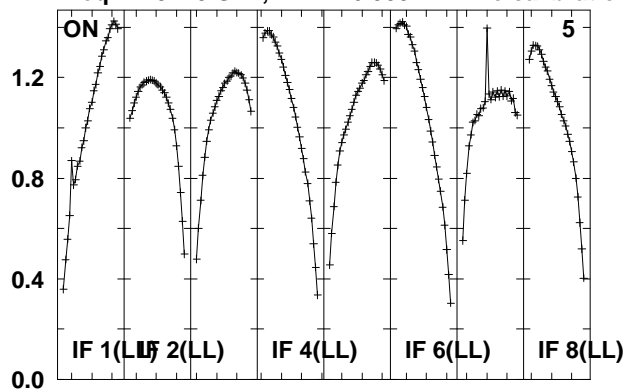

Lower frame: Real Jy

Total-power spectrum Antenna: *

Timerange: 00/14:54:03 to 00/14:55:27

Plot file version 421 created 14-MAY-2010 15:19:26

J0808+49 EO007.UVDATA.1

Freq = 4.9270 GHz, Bw = 16.000 MH No calibration applied and no bandpass applied

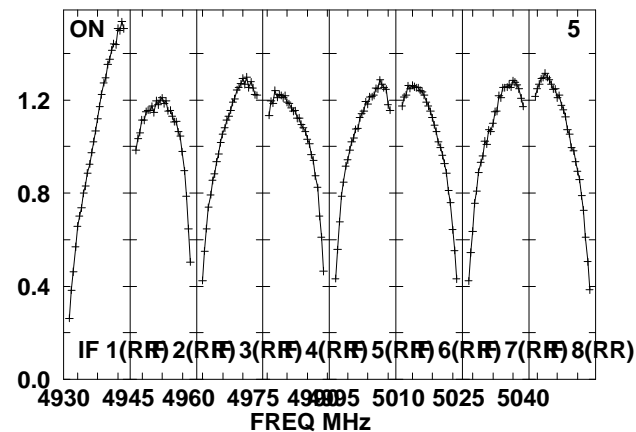
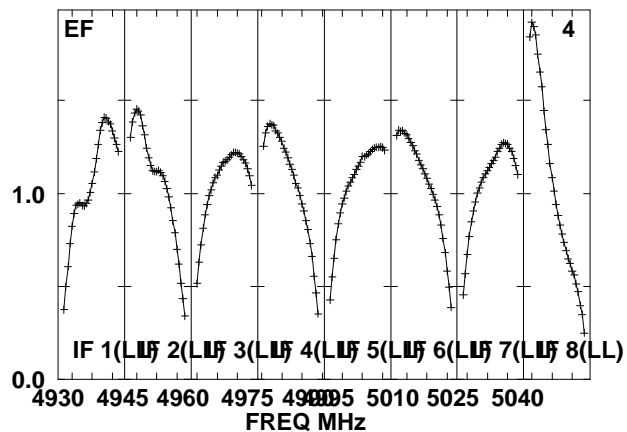
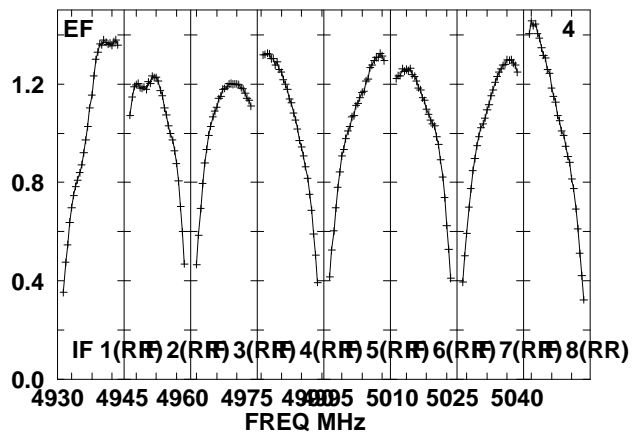
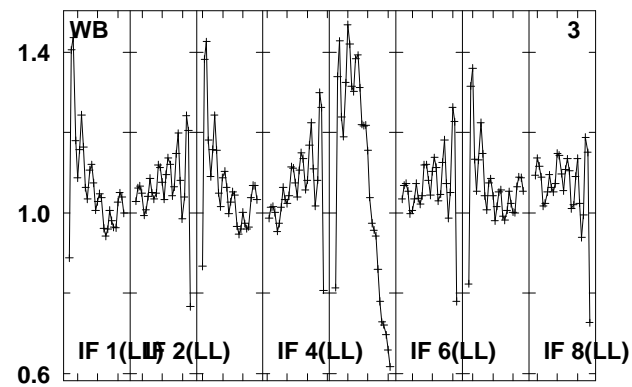
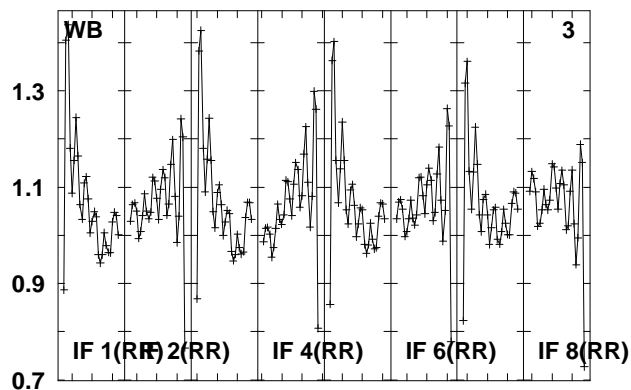
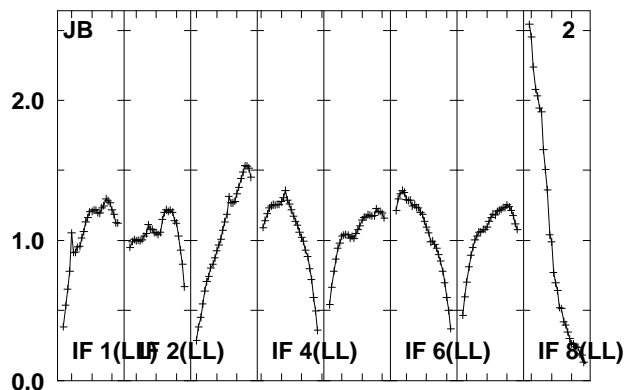
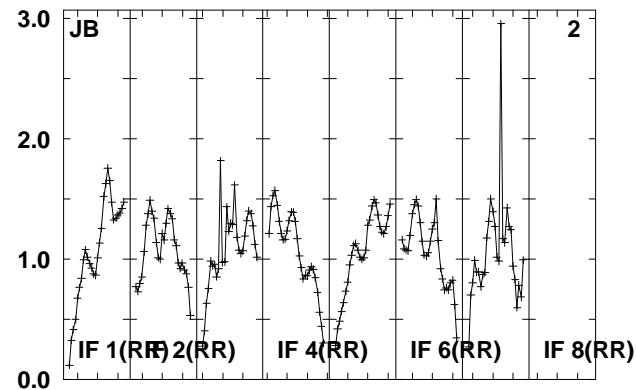
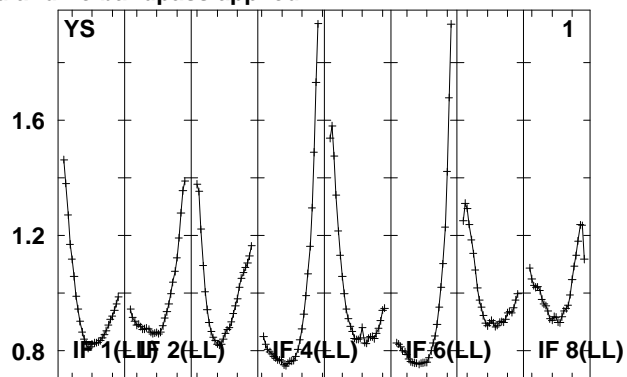
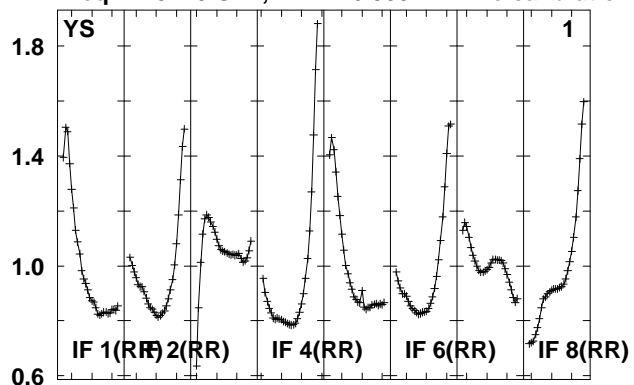

Lower frame: Real Jy

Total-power spectrum Antenna: *

Timerange: 00/14:56:25 to 00/14:57:51

Plot file version 422 created 14-MAY-2010 15:19:26

J0808+49 EO007.UVDATA.1

Freq = 4.9270 GHz, Bw = 16.000 MH No calibration applied and no bandpass applied

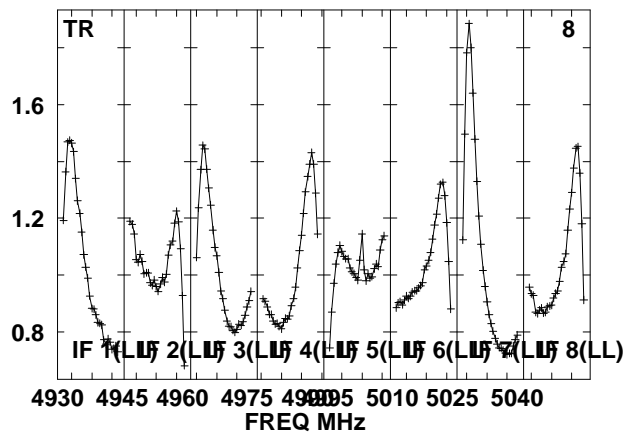
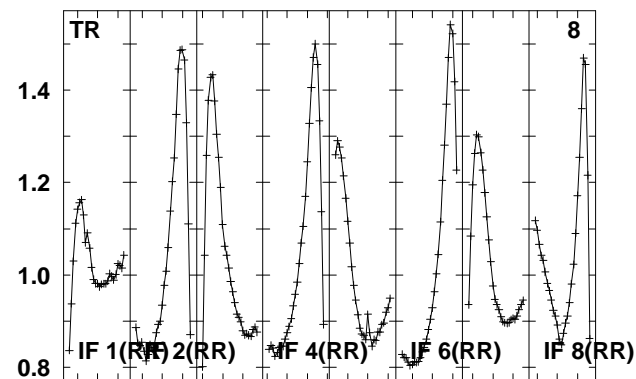
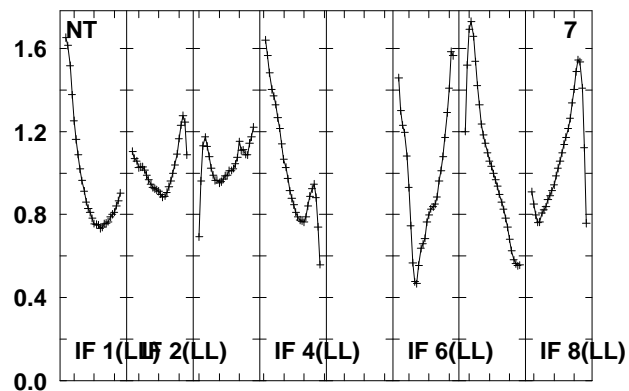
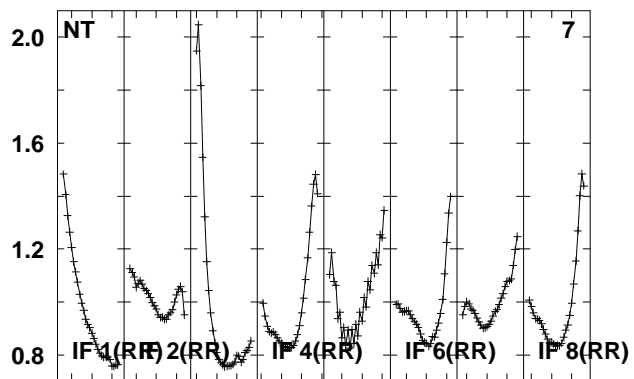
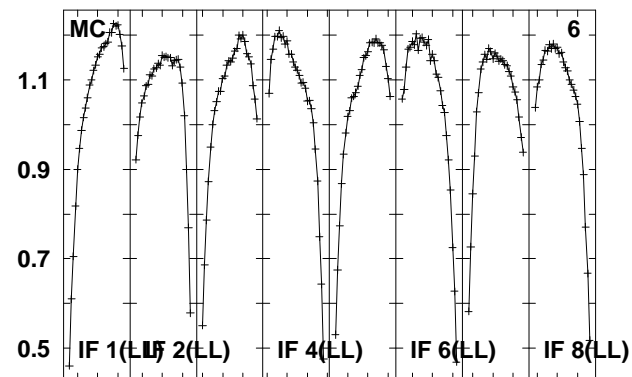
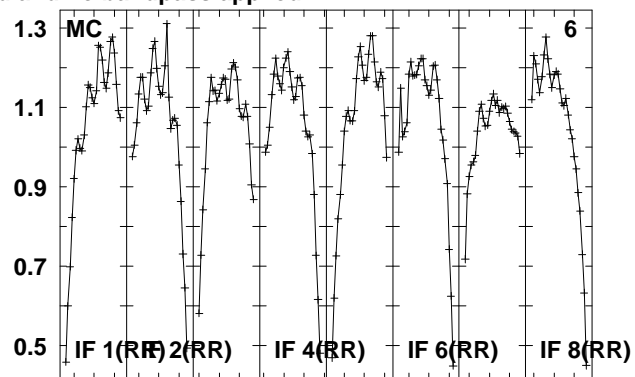
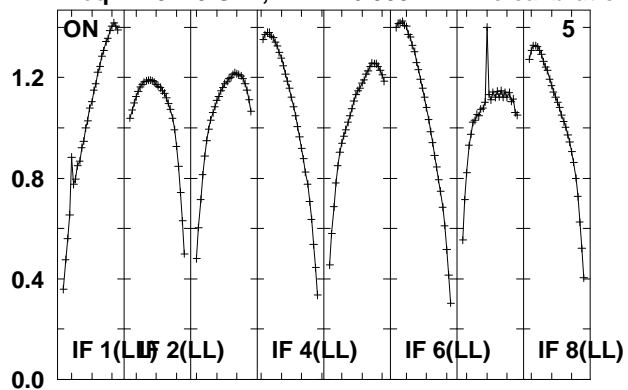

Lower frame: Real Jy

Total-power spectrum Antenna: *

Timerange: 00/14:56:25 to 00/14:57:51

Plot file version 423 created 14-MAY-2010 15:19:27

J081523 EO007.UVDATA.1

Freq = 4.9270 GHz, Bw = 16.000 MH No calibration applied and no bandpass applied

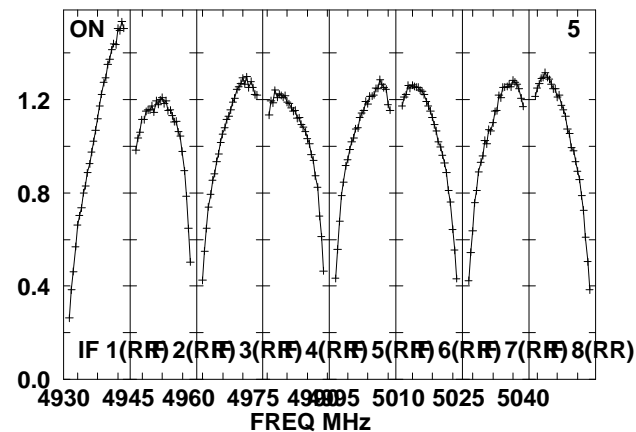
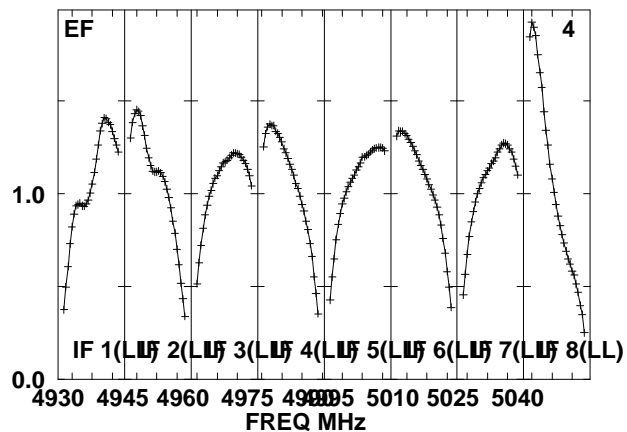
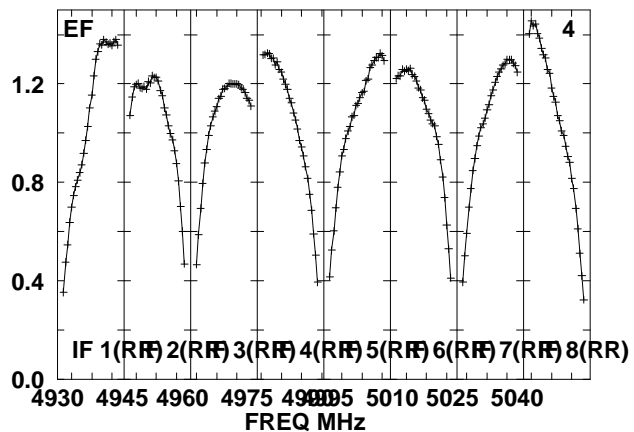
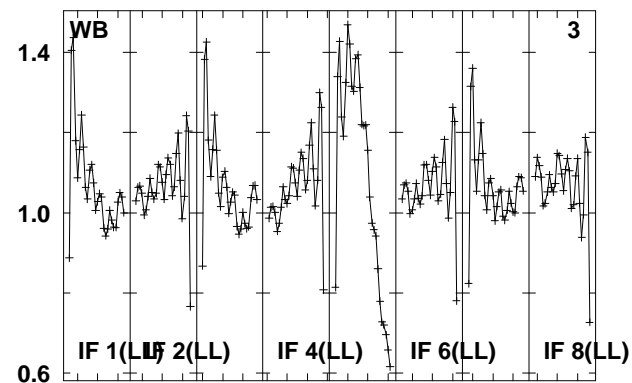
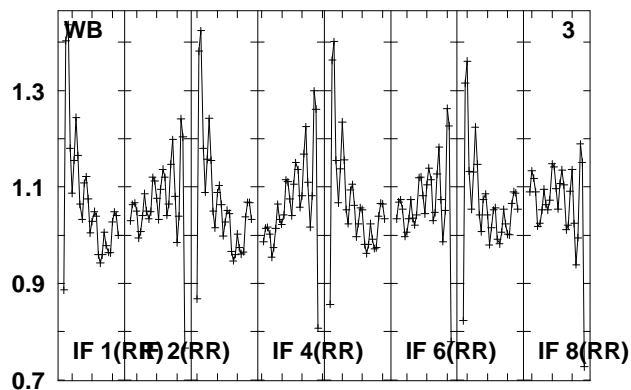
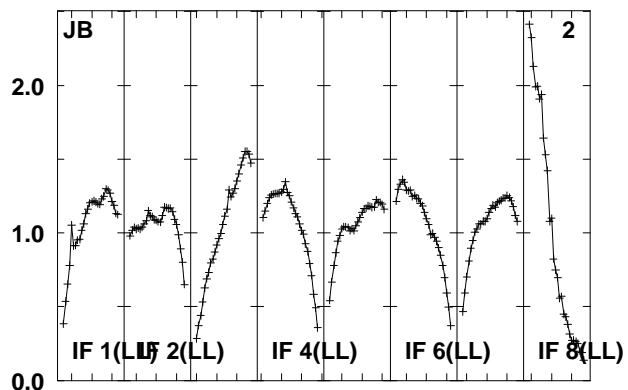
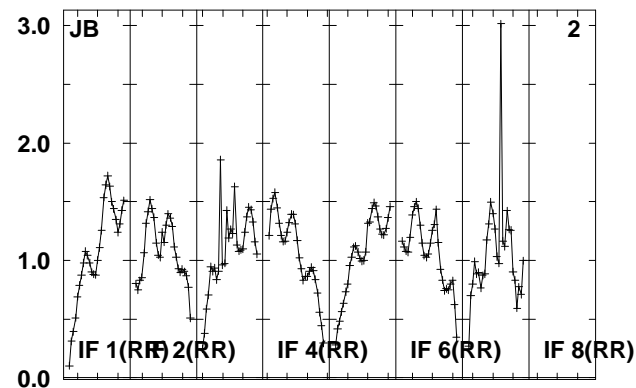
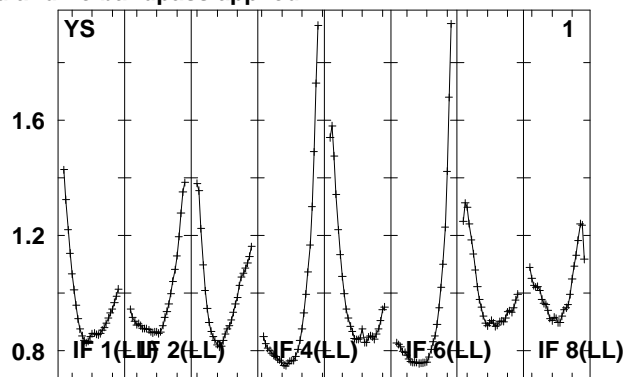
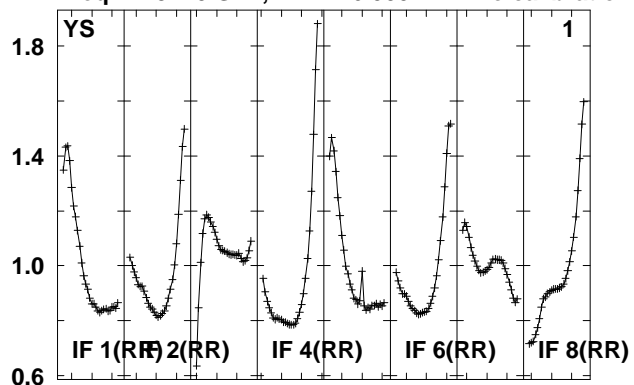

Lower frame: Real Jy

Total-power spectrum Antenna: *

Timerange: 00/14:58:17 to 00/15:03:15

Plot file version 424 created 14-MAY-2010 15:19:27

J081523 EO007.UVDATA.1

Freq = 4.9270 GHz, Bw = 16.000 MH No calibration applied and no bandpass applied

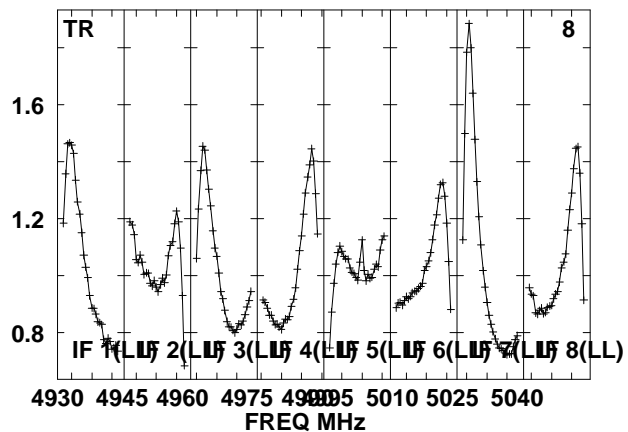
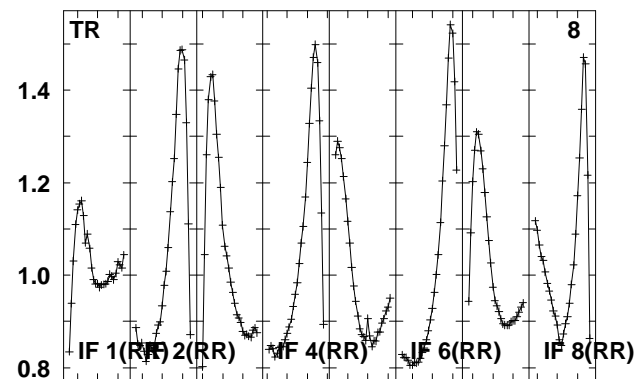
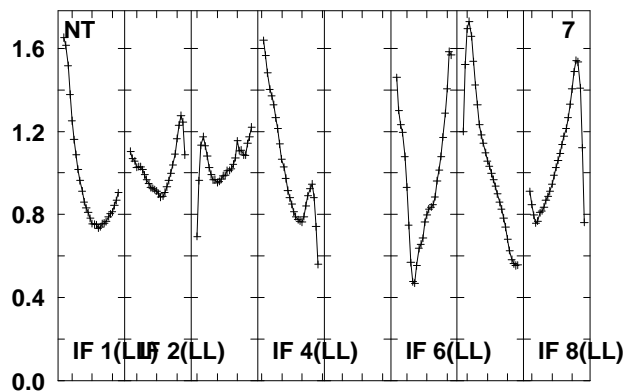
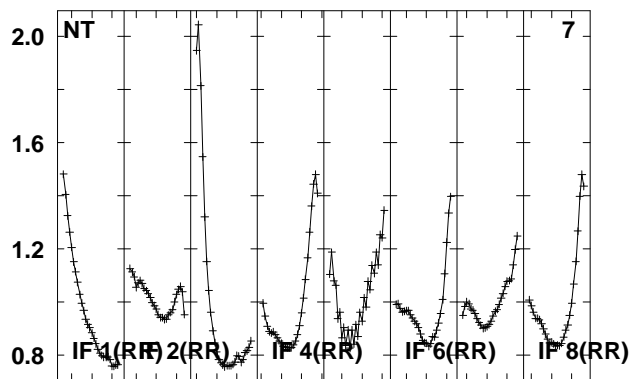
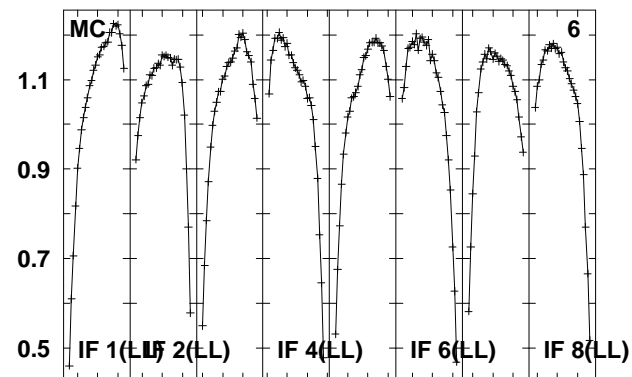
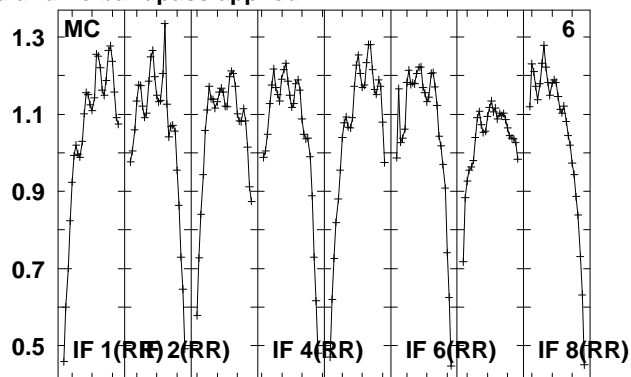
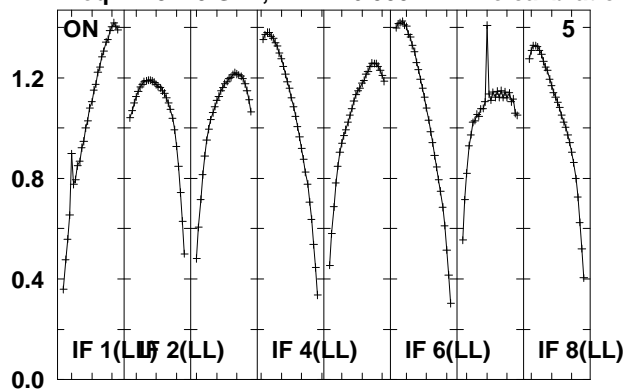

Lower frame: Real Jy

Total-power spectrum Antenna: *

Timerange: 00/14:58:17 to 00/15:03:15

Plot file version 425 created 14-MAY-2010 15:19:28

J0808+49 EO007.UVDATA.1

Freq = 4.9270 GHz, Bw = 16.000 MH No calibration applied and no bandpass applied

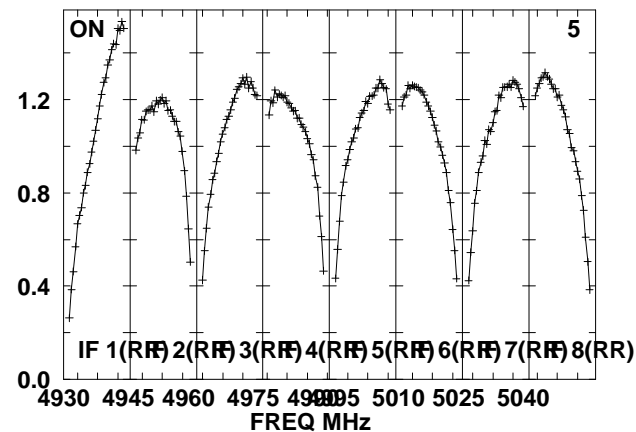
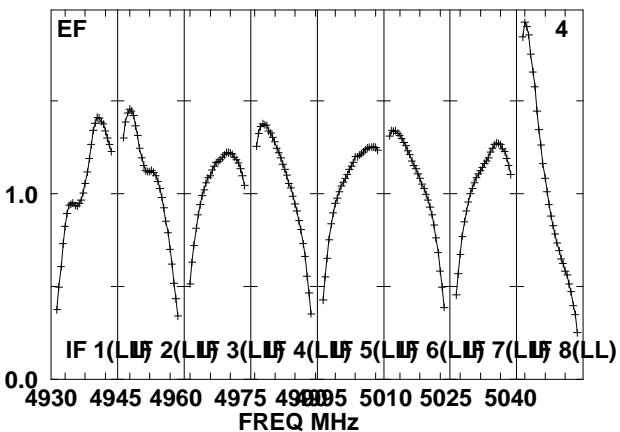
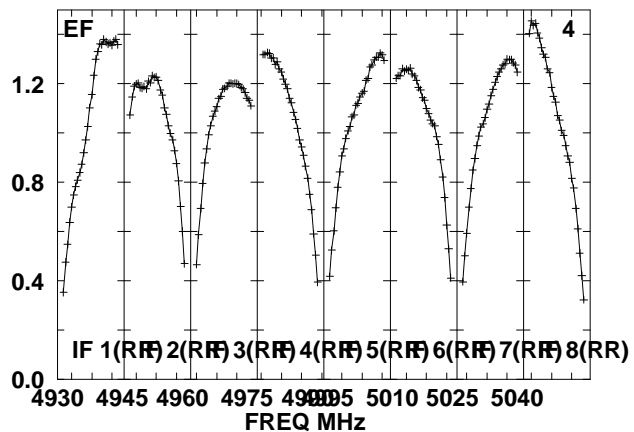
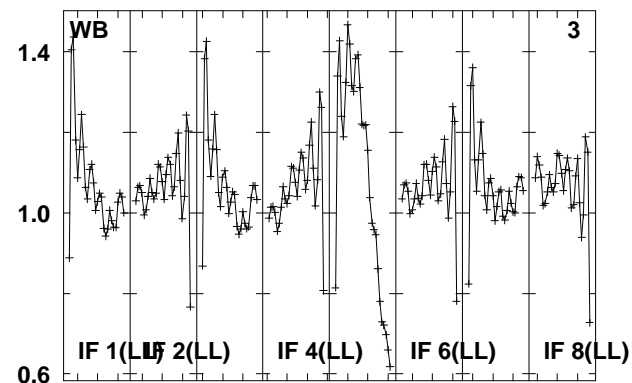
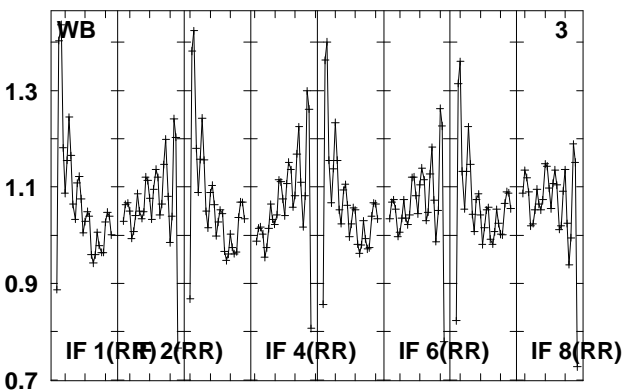
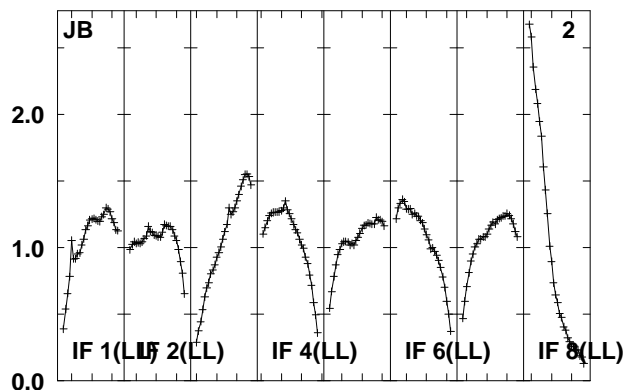
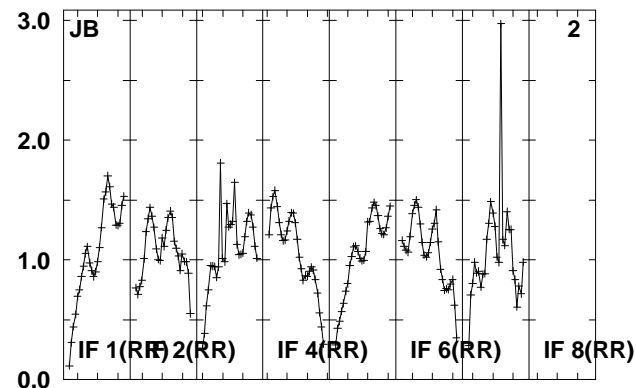
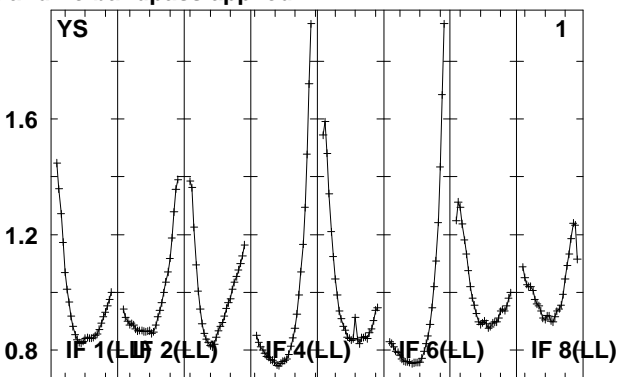
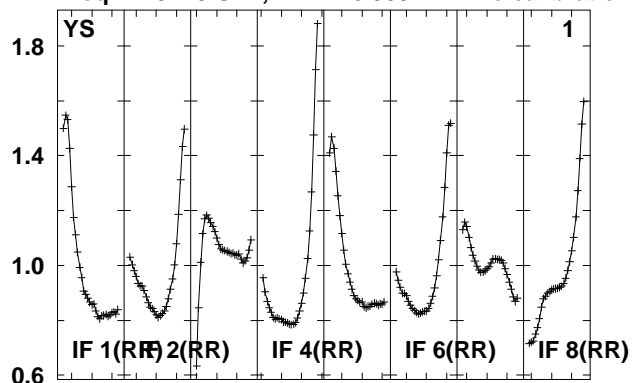

Lower frame: Real Jy
Total-power spectrum Antenna: *
Timerange: 00/15:03:41 to 00/15:05:07

Plot file version 426 created 14-MAY-2010 15:19:28

J0808+49 EO007.UVDATA.1

Freq = 4.9270 GHz, Bw = 16.000 MH No calibration applied and no bandpass applied

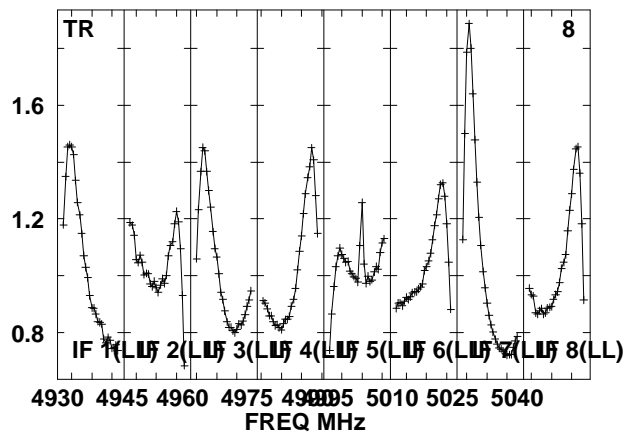
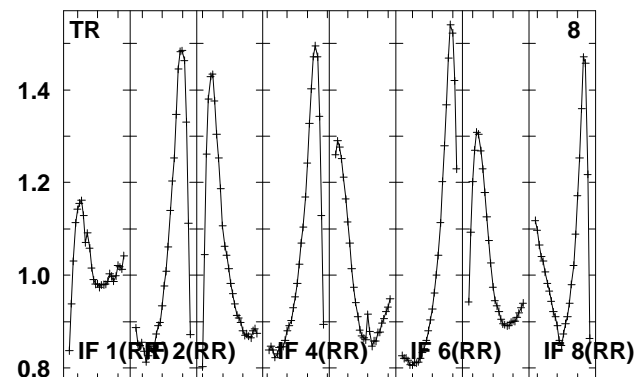
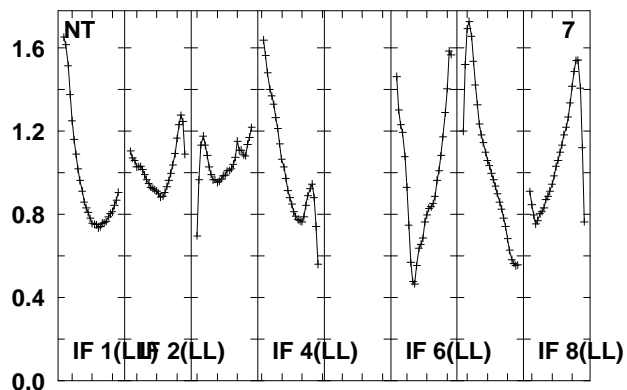
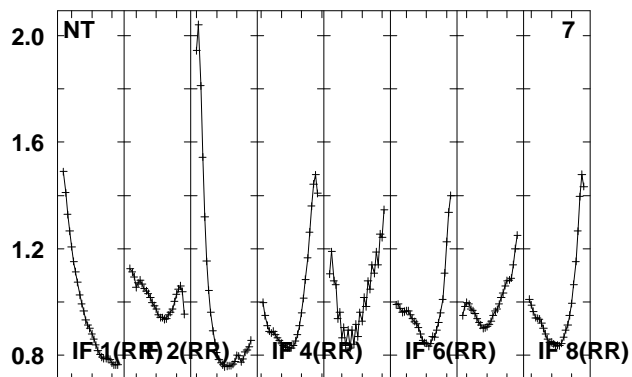
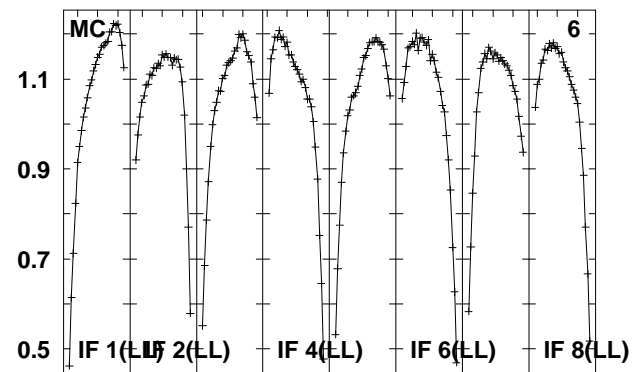
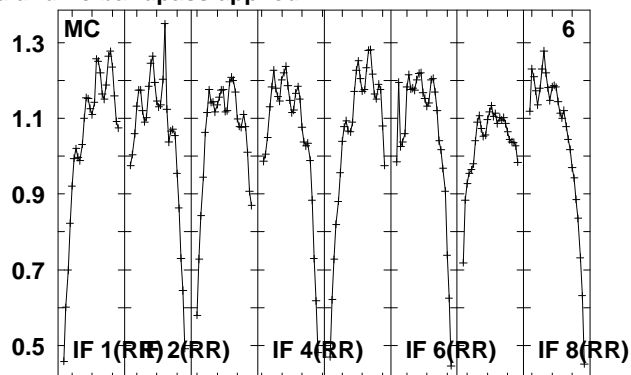
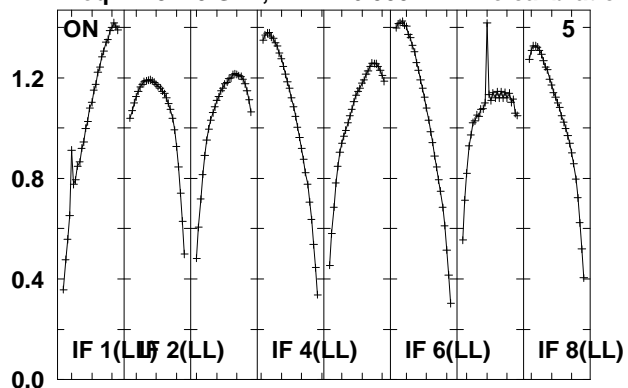

Lower frame: Real Jy

Total-power spectrum Antenna: *

Timerange: 00/15:03:41 to 00/15:05:07

Plot file version 427 created 14-MAY-2010 15:19:28

J081523 EO007.UVDATA.1

Freq = 4.9270 GHz, Bw = 16.000 MH No calibration applied and no bandpass applied

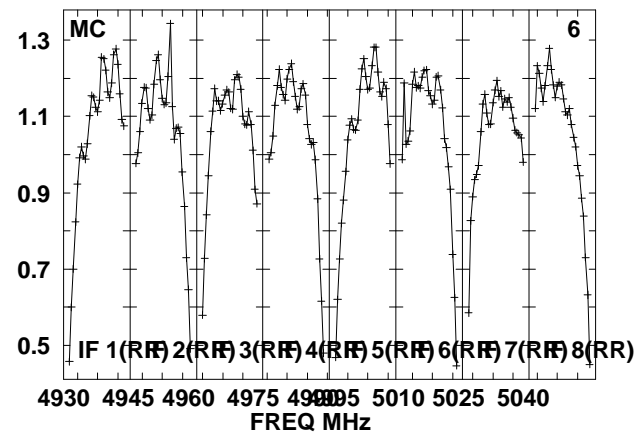
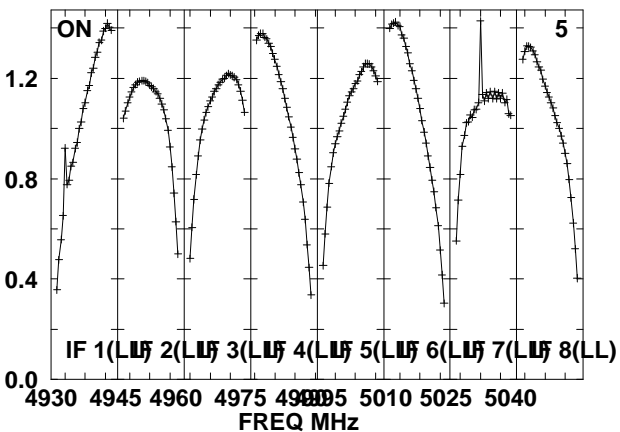
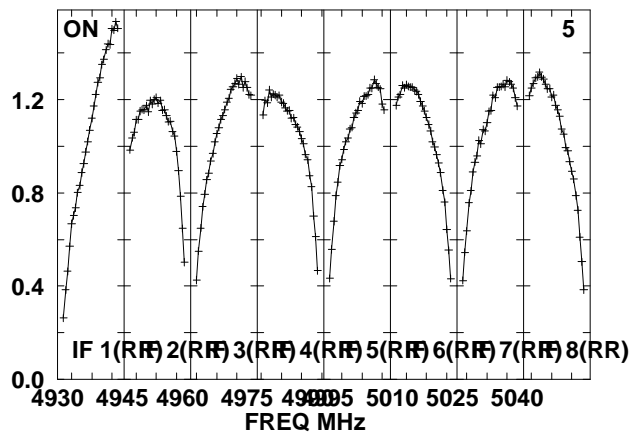
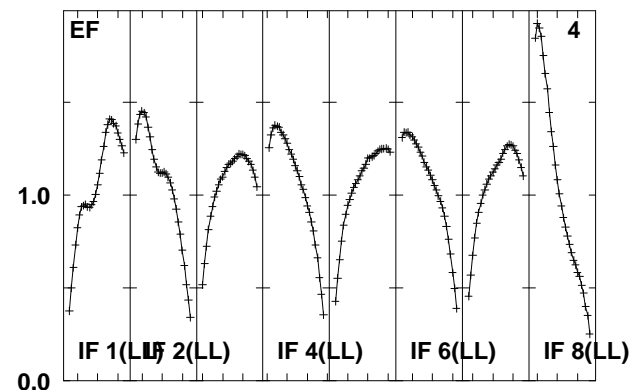
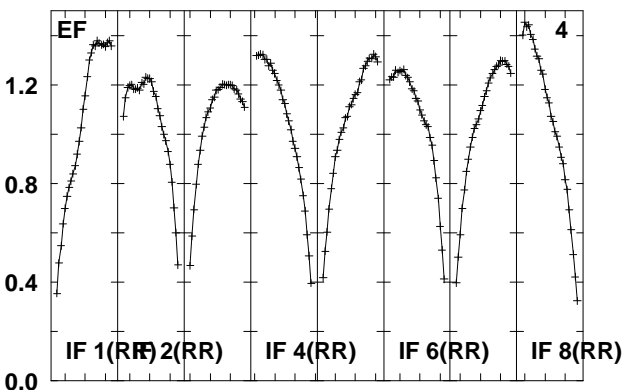
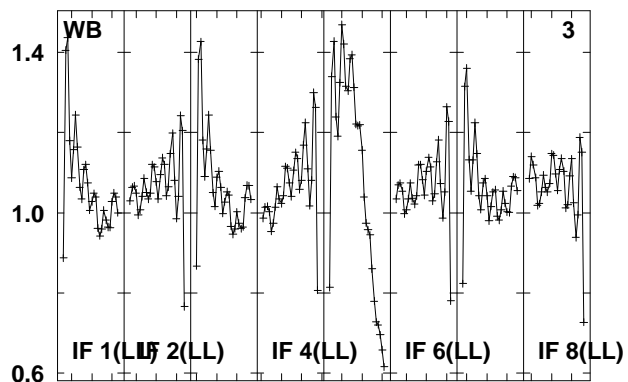
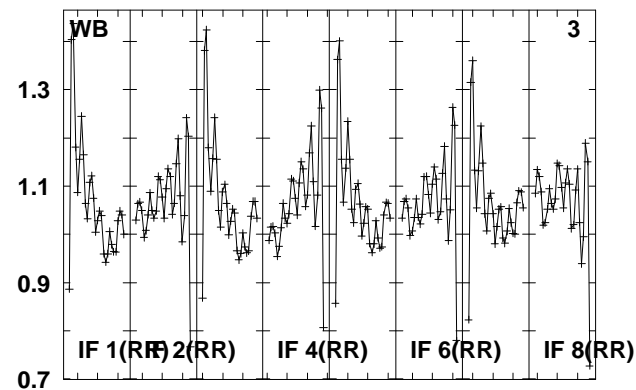
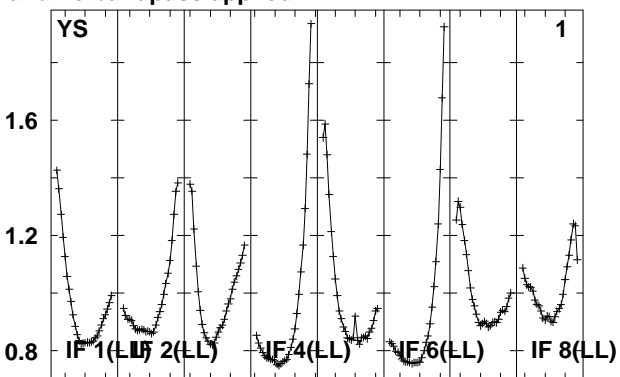
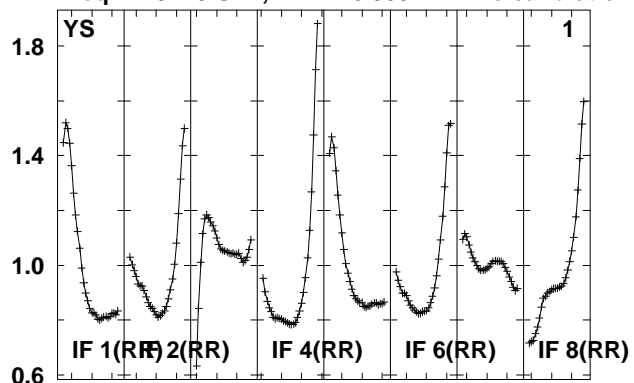

Lower frame: Real Jy
Total-power spectrum Antenna: *
Timerange: 00/15:05:35 to 00/15:10:33

Plot file version 428 created 14-MAY-2010 15:19:29

J081523 EO007.UVDATA.1

Freq = 4.9270 GHz, Bw = 16.000 MH No calibration applied and no bandpass applied

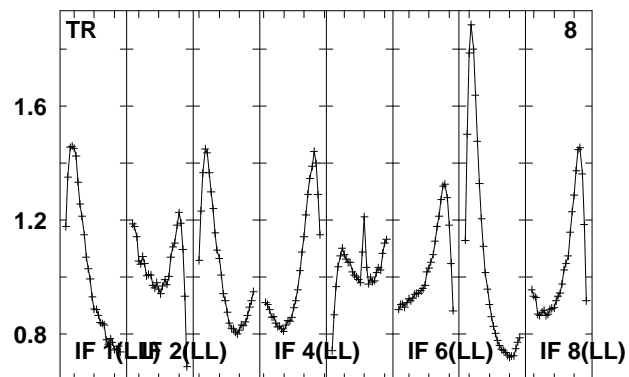
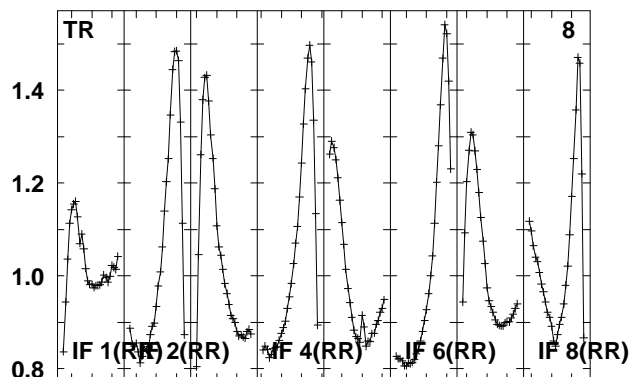
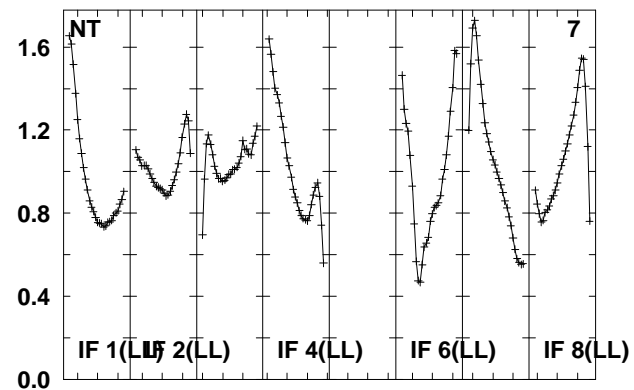
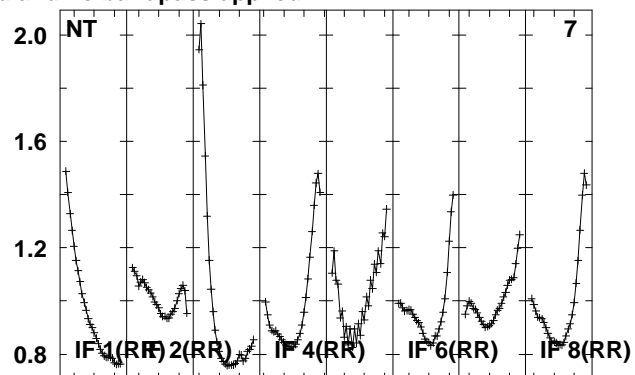
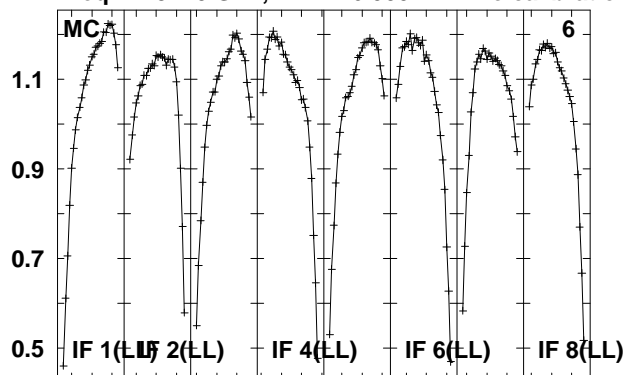

Lower frame: Real Jy
Total-power spectrum Antenna: *
Timerange: 00/15:05:35 to 00/15:10:33

Plot file version 429 created 14-MAY-2010 15:19:30

J0808+49 EO007.UVDATA.1

Freq = 4.9270 GHz, Bw = 16.000 MH No calibration applied and no bandpass applied

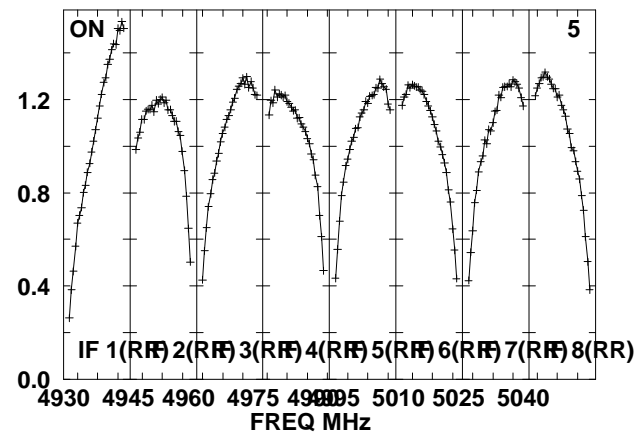
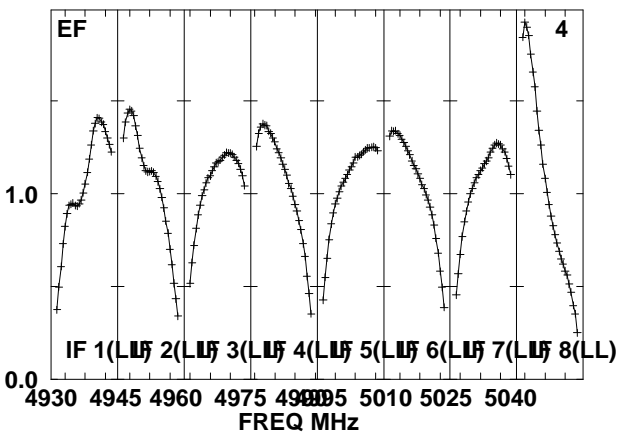
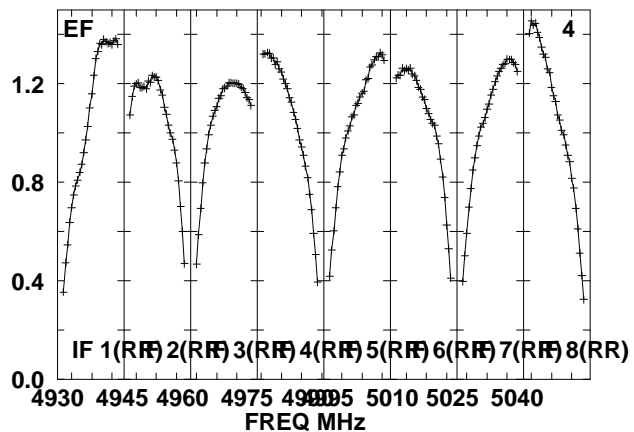
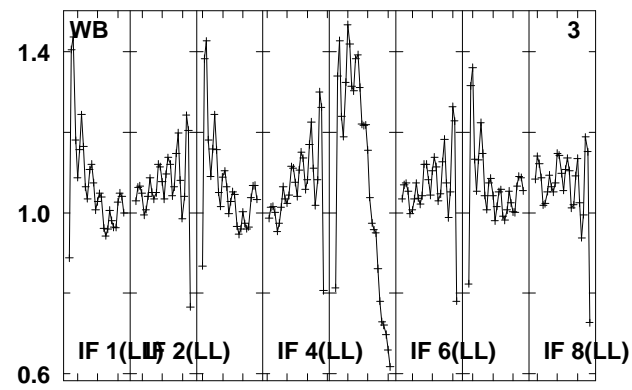
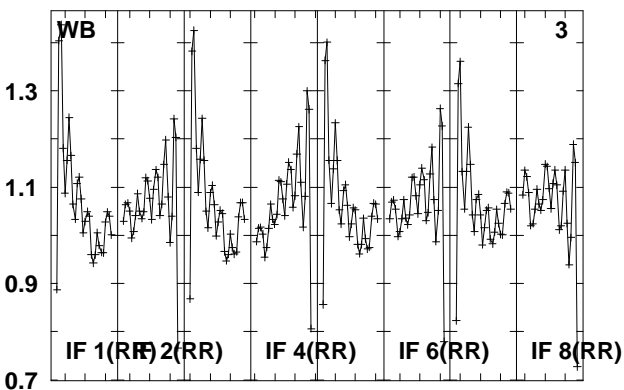
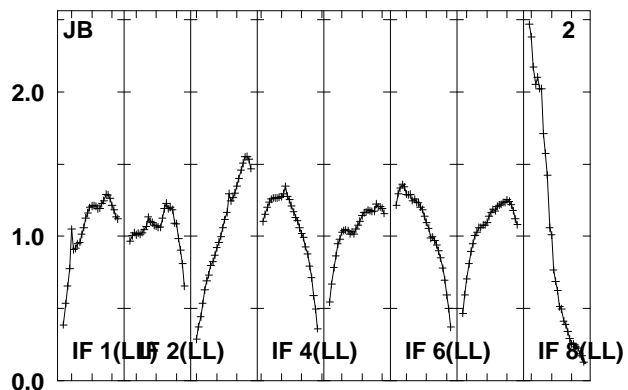
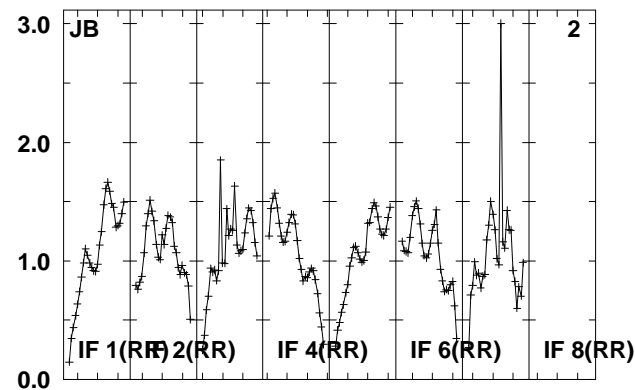
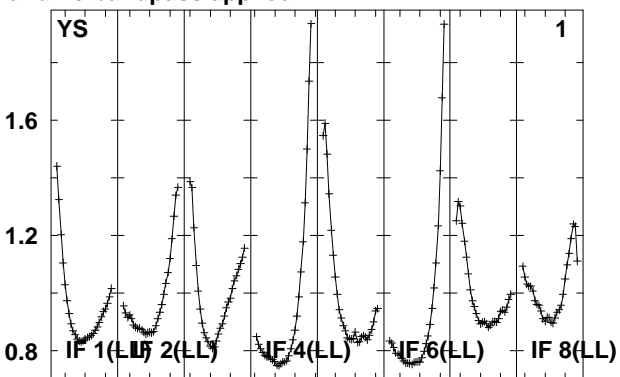
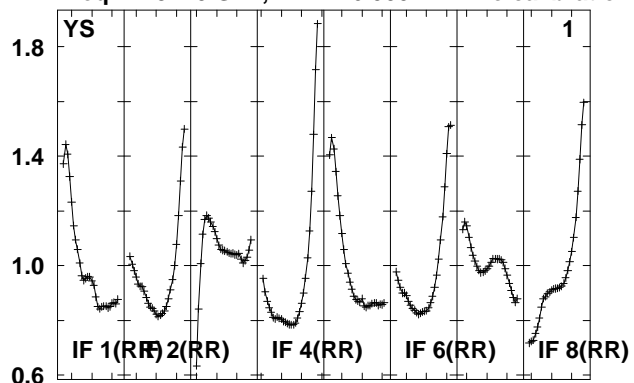

Lower frame: Real Jy
Total-power spectrum Antenna: *
Timerange: 00/15:10:59 to 00/15:12:27

Plot file version 430 created 14-MAY-2010 15:19:30

J0808+49 EO007.UVDATA.1

Freq = 4.9270 GHz, Bw = 16.000 MH No calibration applied and no bandpass applied

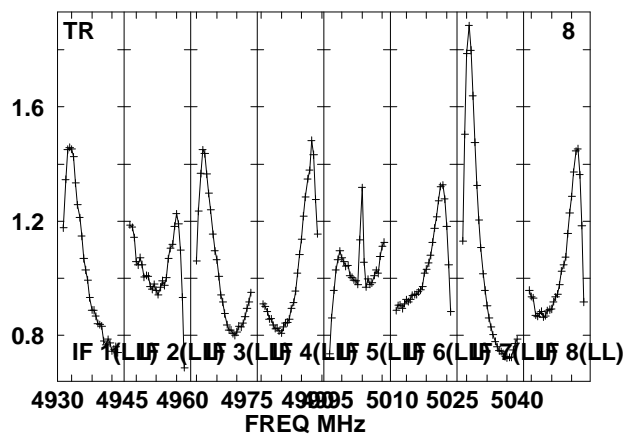
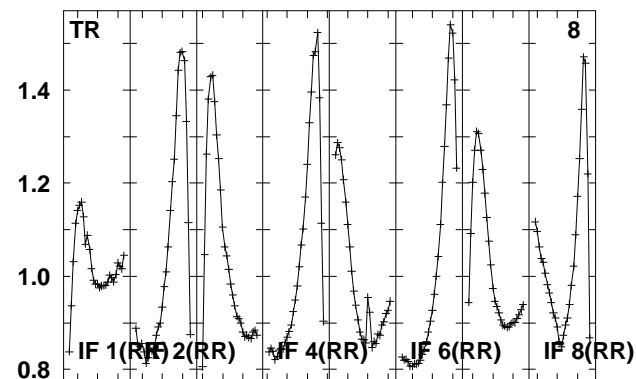
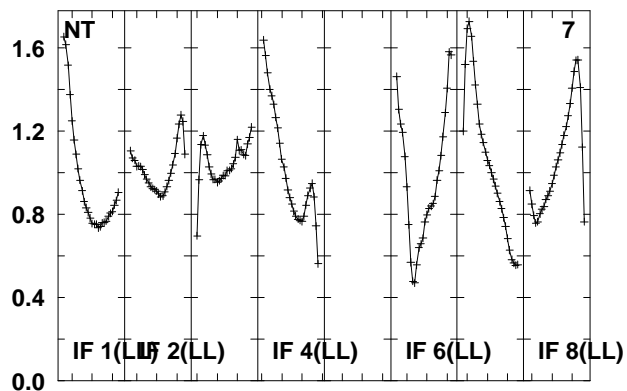
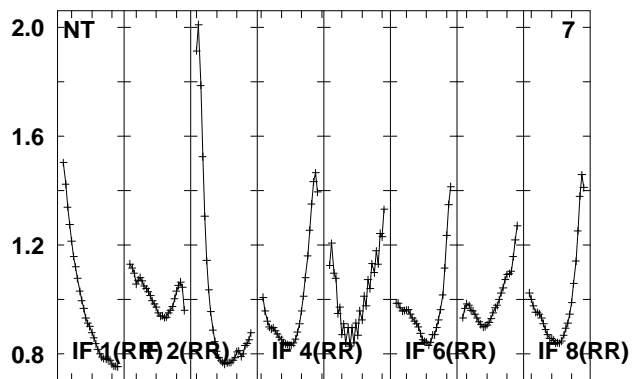
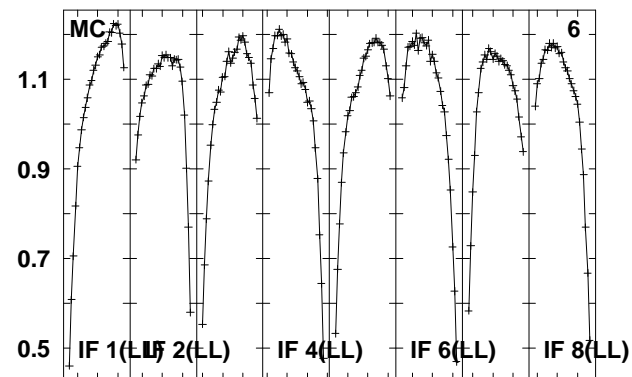
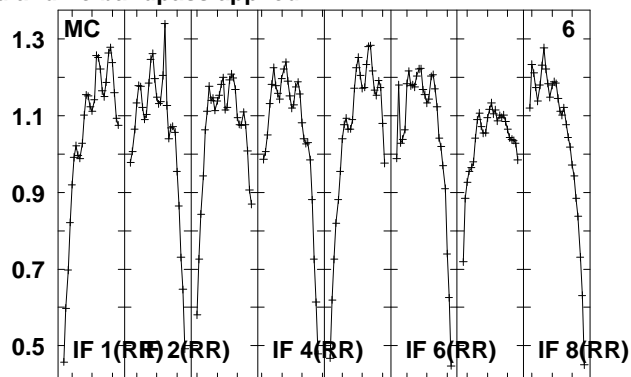
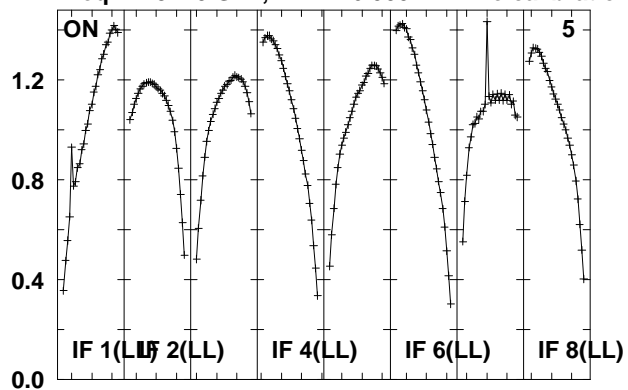

Lower frame: Real Jy

Total-power spectrum Antenna: *

Timerange: 00/15:10:59 to 00/15:12:27

Plot file version 431 created 14-MAY-2010 15:19:30

J0808+40 EO007.UVDATA.1

Freq = 4.9270 GHz, Bw = 16.000 MH No calibration applied and no bandpass applied

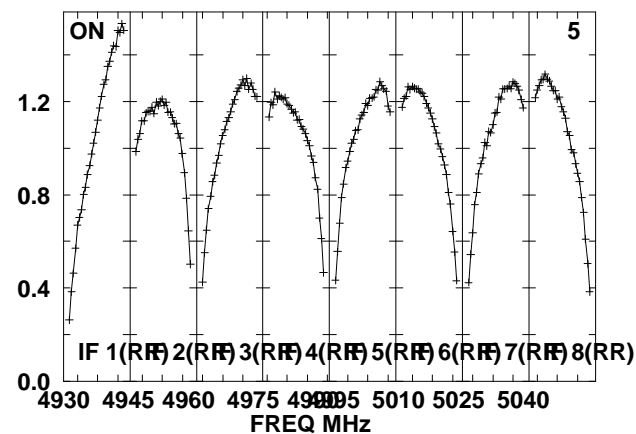
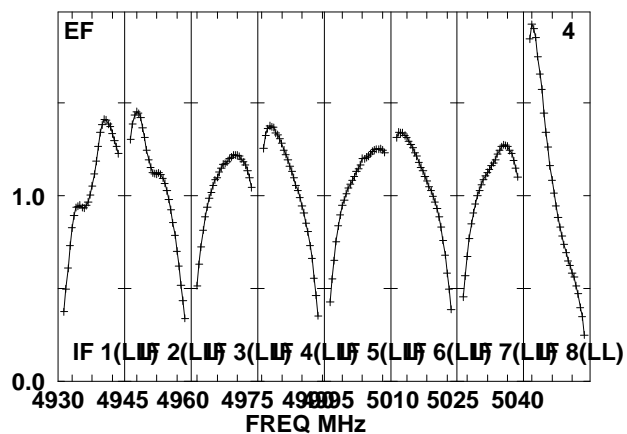
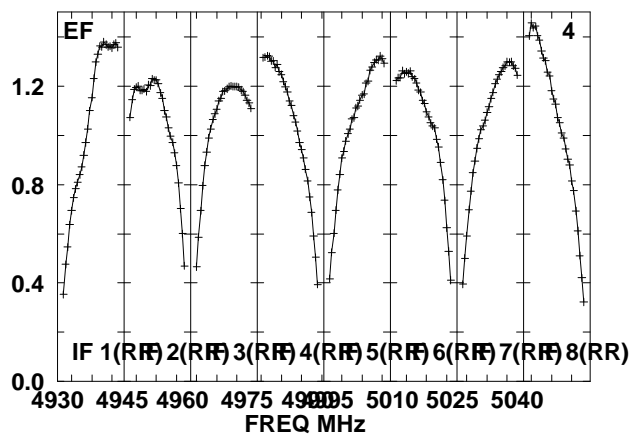
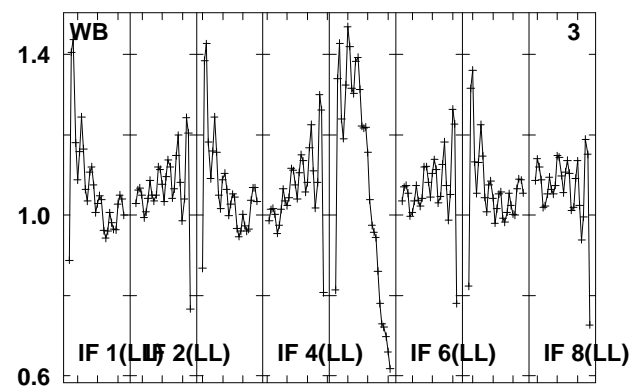
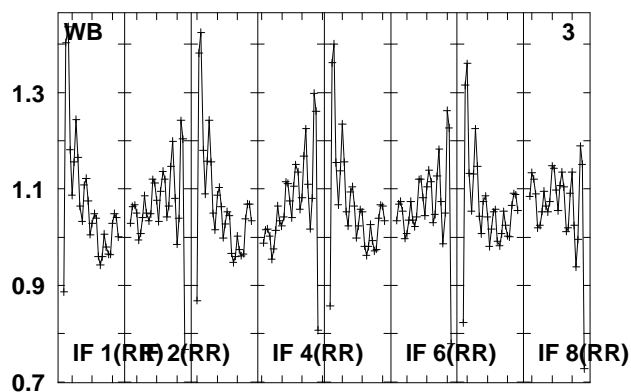
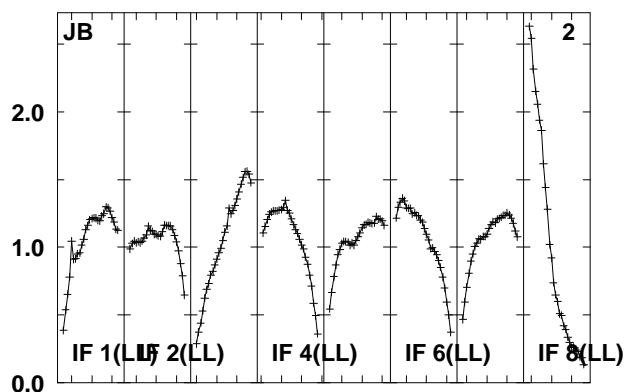
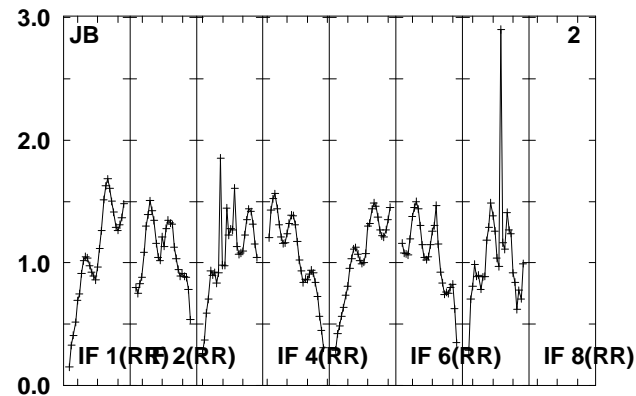
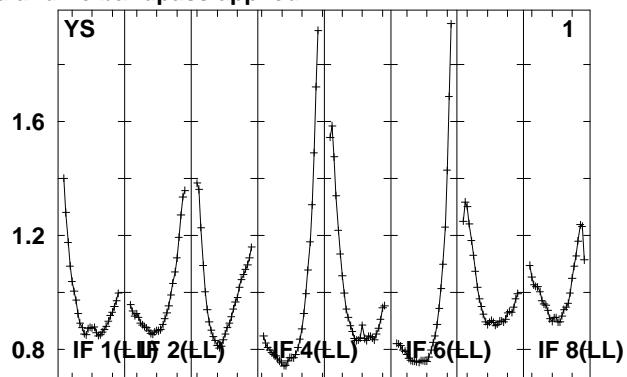
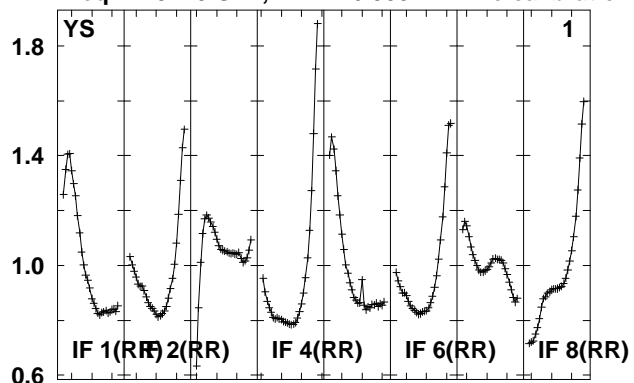

Lower frame: Real Jy

Total-power spectrum Antenna: *

Timerange: 00/15:13:25 to 00/15:14:51

Plot file version 432 created 14-MAY-2010 15:19:30

J0808+40 EO007.UVDATA.1

Freq = 4.9270 GHz, Bw = 16.000 MH No calibration applied and no bandpass applied

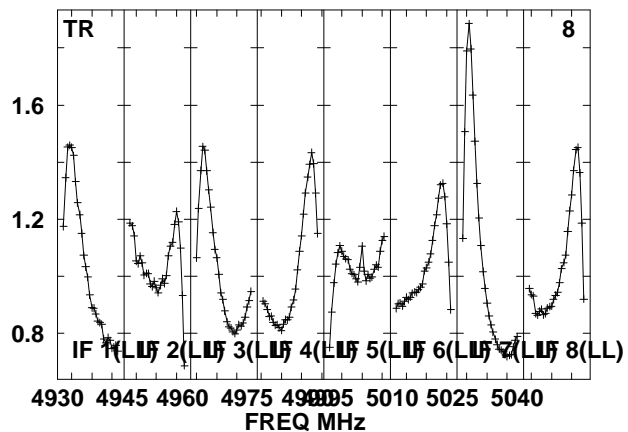
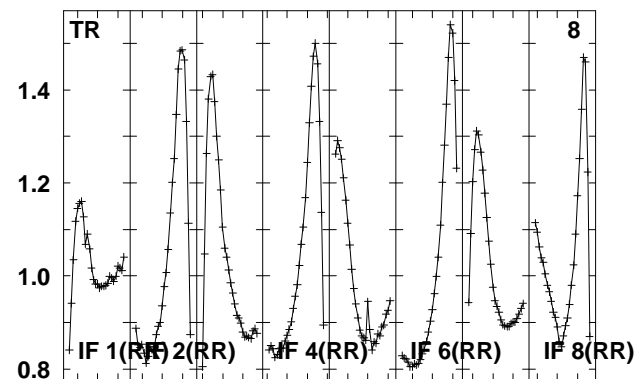
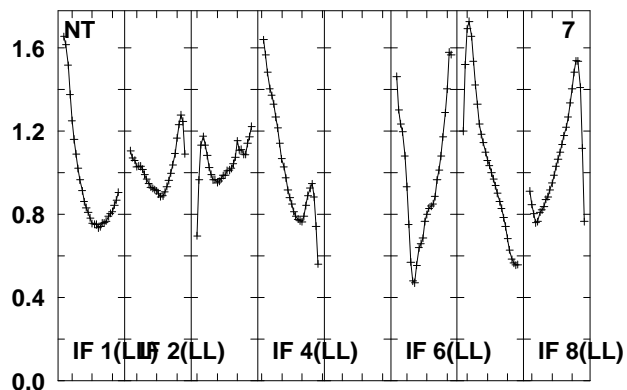
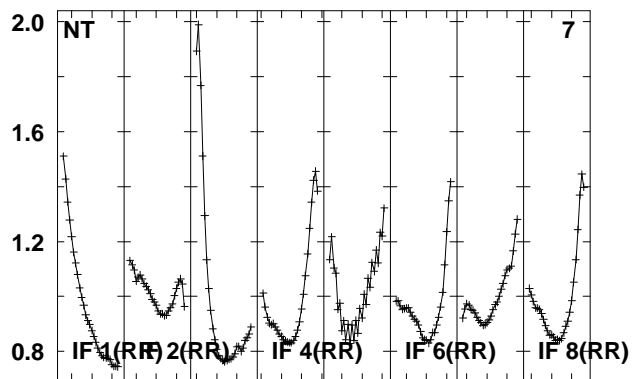
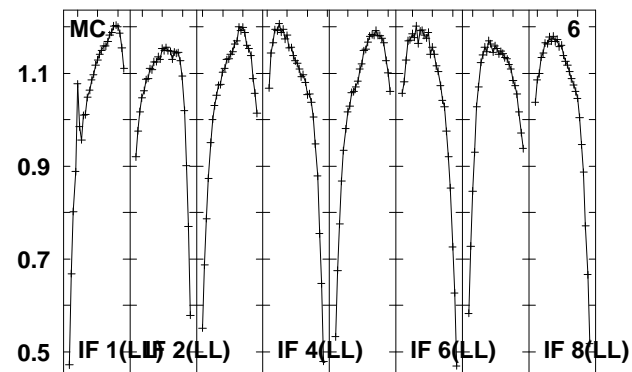
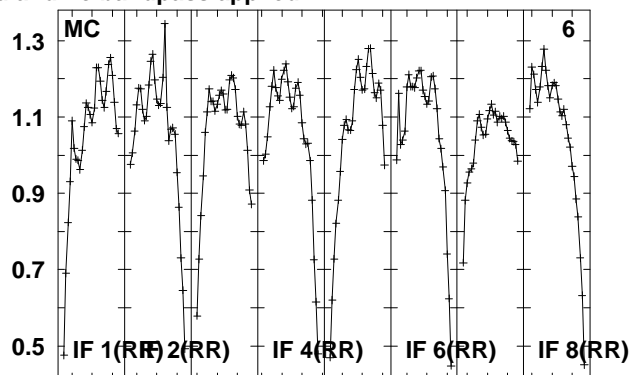
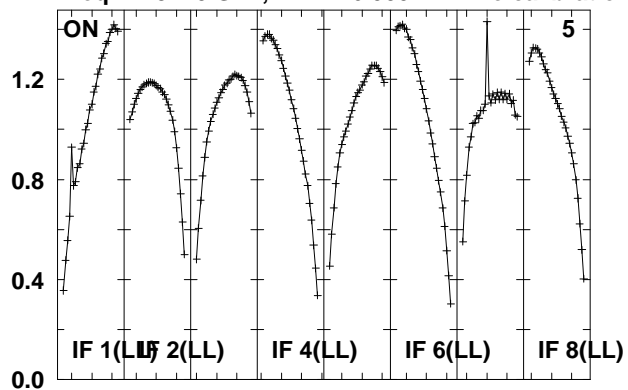

Lower frame: Real Jy

Total-power spectrum Antenna: *

Timerange: 00/15:13:25 to 00/15:14:51

Plot file version 433 created 14-MAY-2010 15:19:30
 J080844 EO007.UVDATA.1
 Freq = 4.9270 GHz, Bw = 16.000 MH No calibration applied and no bandpass applied

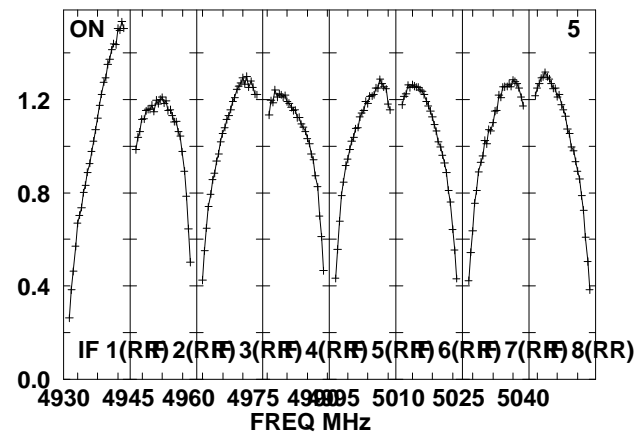
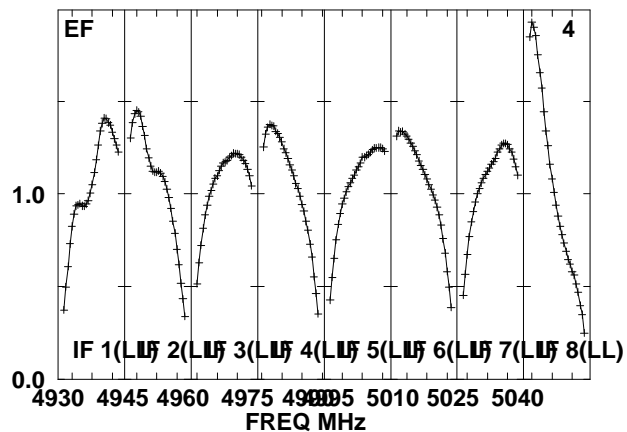
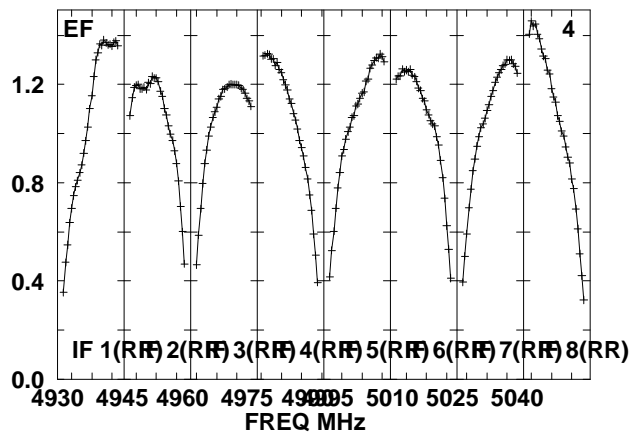
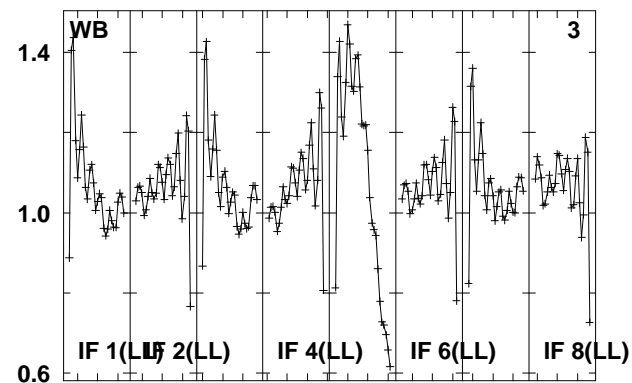
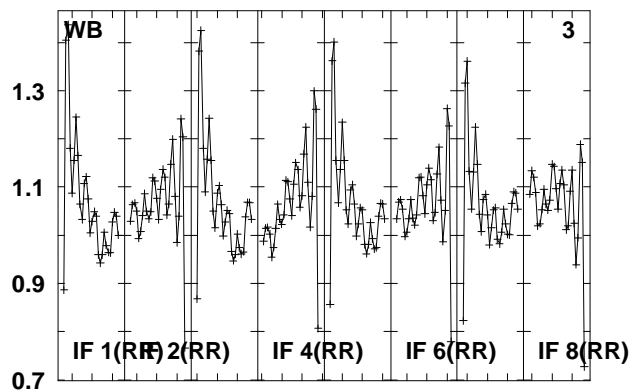
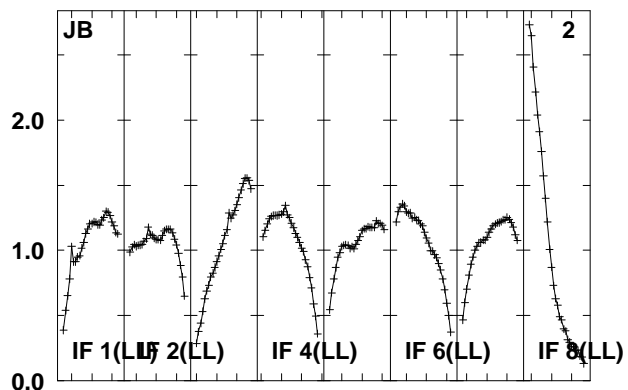
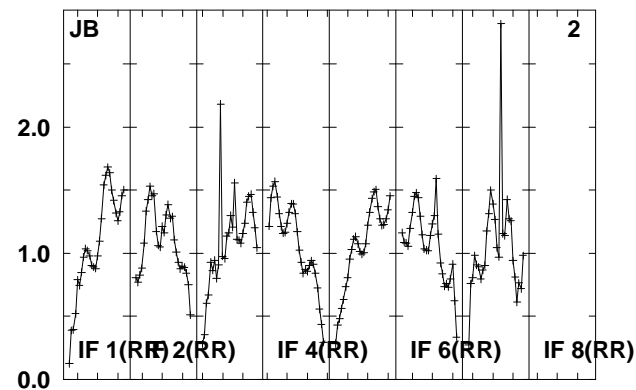
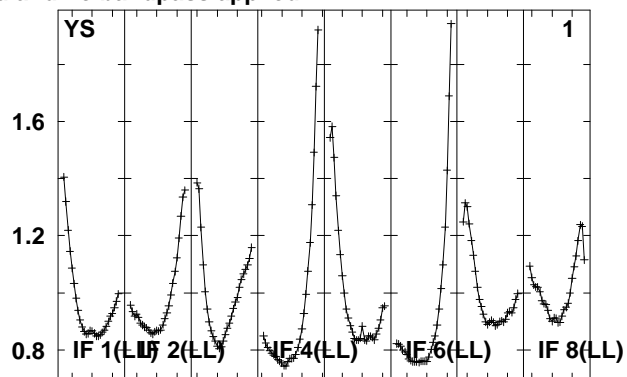
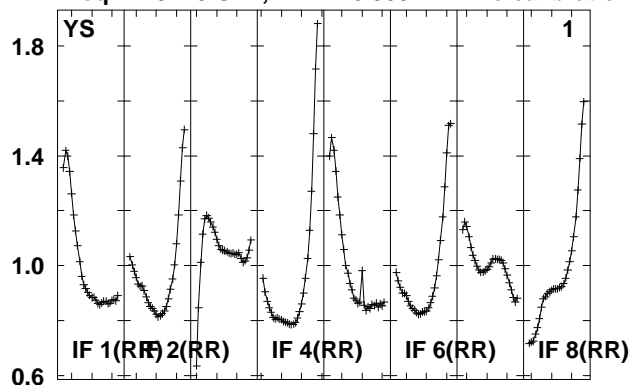

Lower frame: Real Jy
 Total-power spectrum Antenna: *
 Timerange: 00/15:15:20 to 00/15:20:16

Plot file version 434 created 14-MAY-2010 15:19:31

J080844 EO007.UVDATA.1

Freq = 4.9270 GHz, Bw = 16.000 MH No calibration applied and no bandpass applied

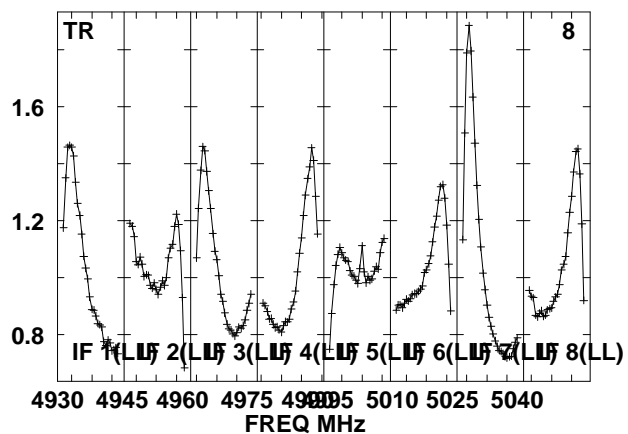
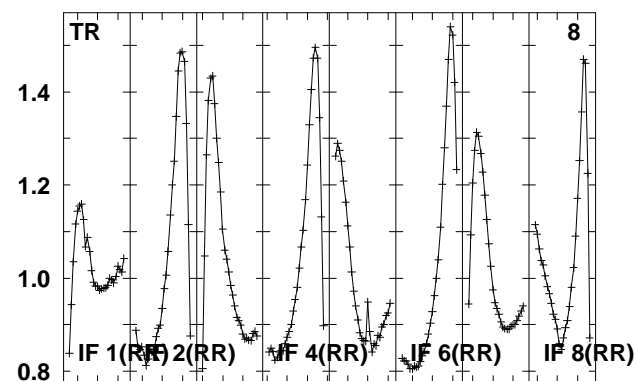
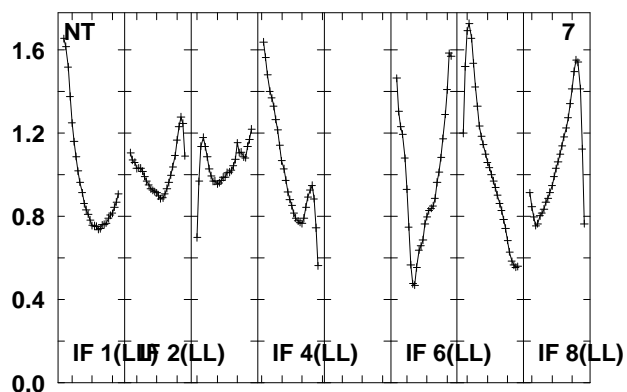
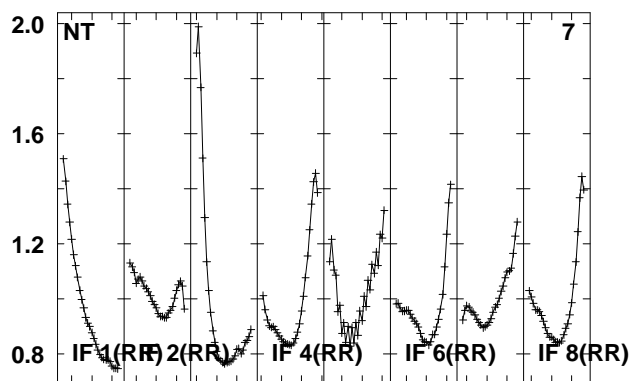
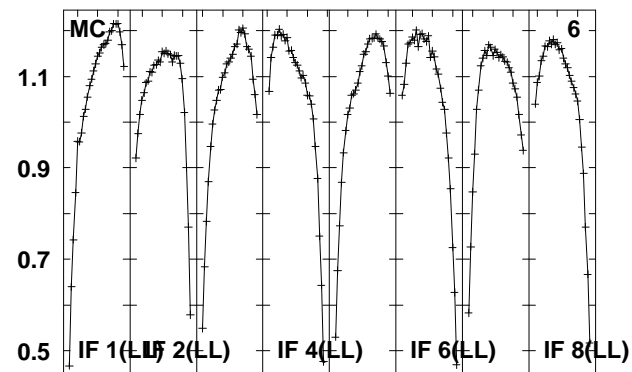
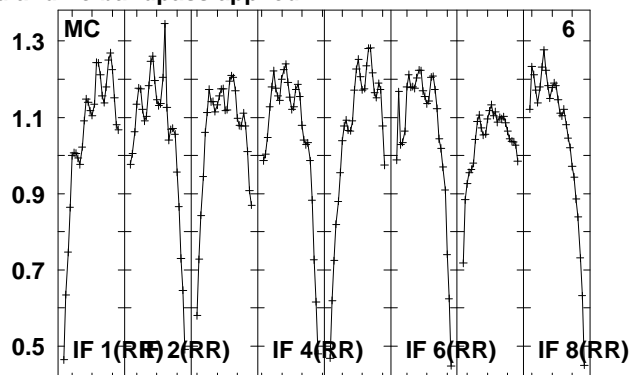
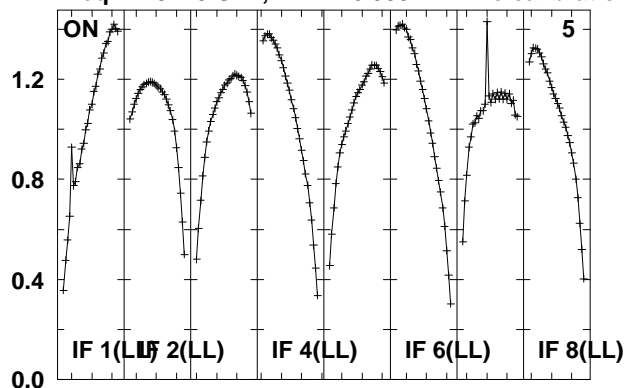

Lower frame: Real Jy

Total-power spectrum Antenna: *

Timerange: 00/15:15:20 to 00/15:20:16

Plot file version 435 created 14-MAY-2010 15:19:32

J0808+40 EO007.UVDATA.1

Freq = 4.9270 GHz, Bw = 16.000 MH No calibration applied and no bandpass applied

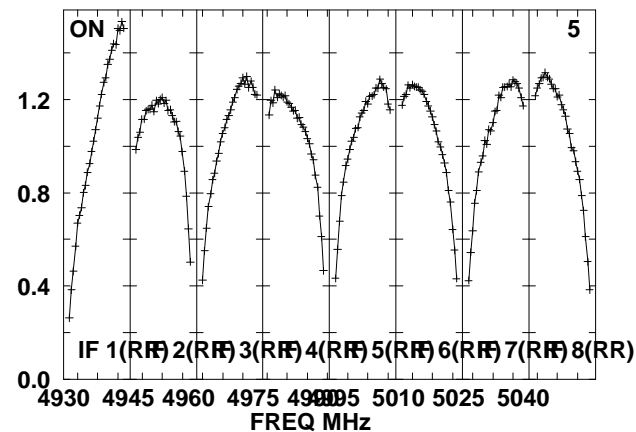
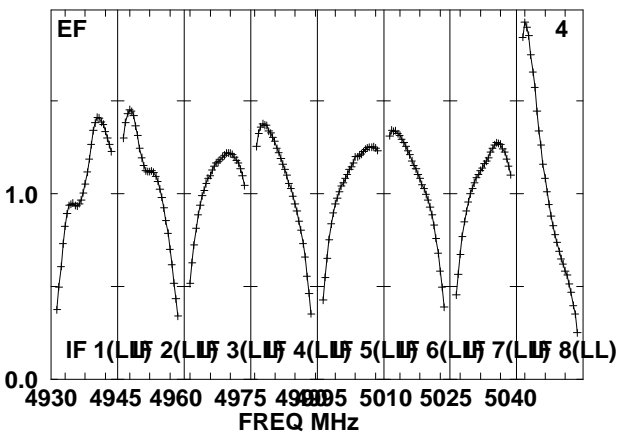
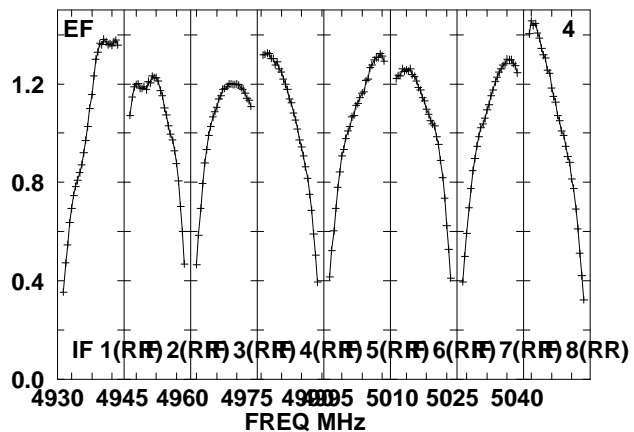
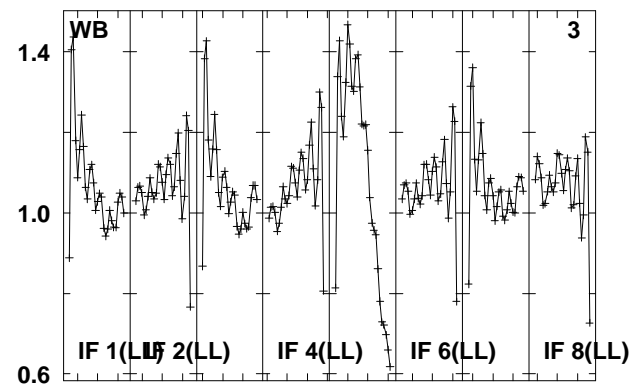
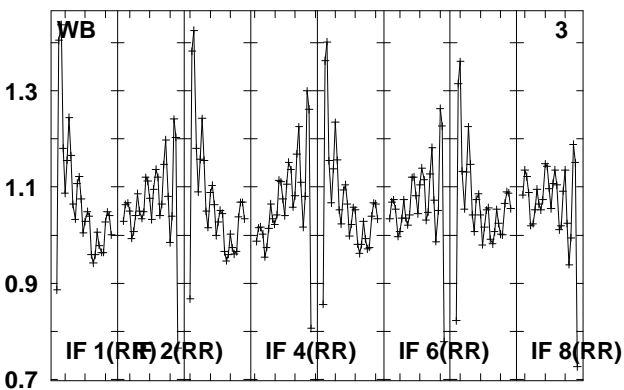
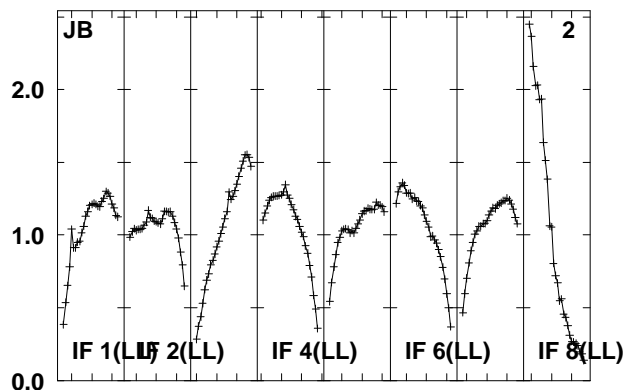
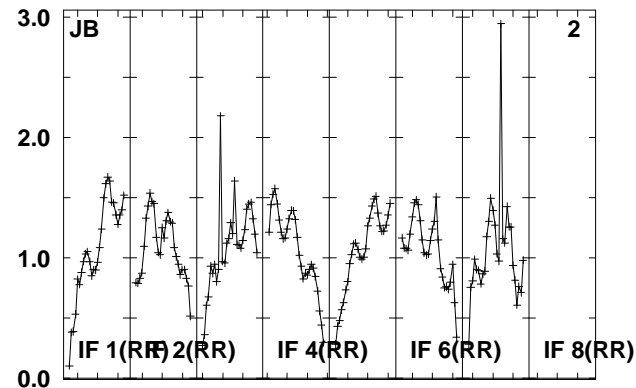
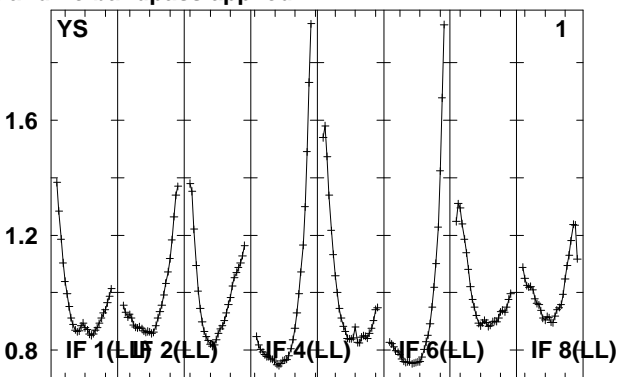
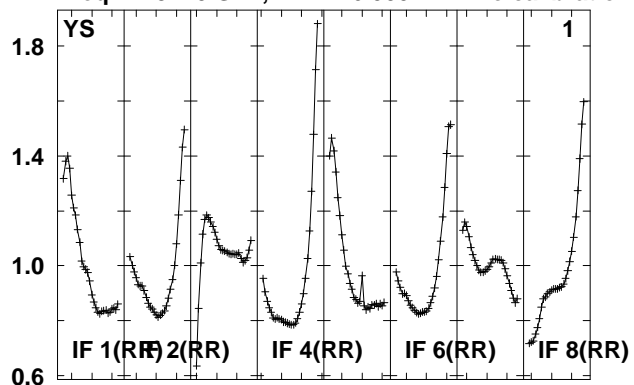

Lower frame: Real Jy

Total-power spectrum Antenna: *

Timerange: 00/15:20:44 to 00/15:22:12

Plot file version 436 created 14-MAY-2010 15:19:32

J0808+40 EO007.UVDATA.1

Freq = 4.9270 GHz, Bw = 16.000 MH No calibration applied and no bandpass applied

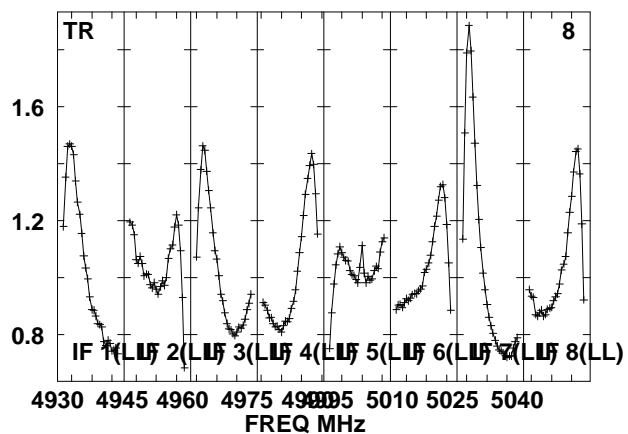
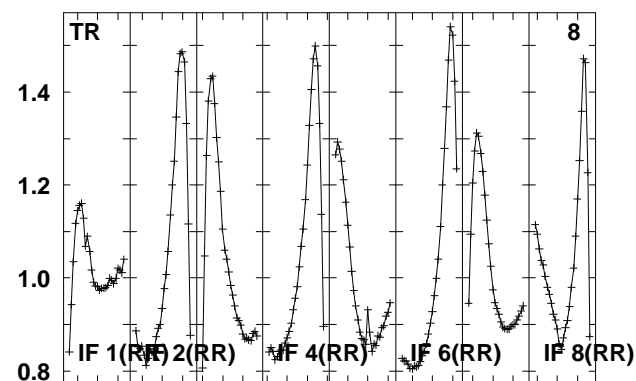
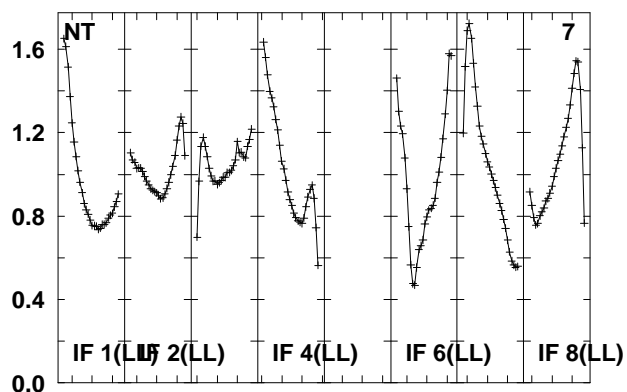
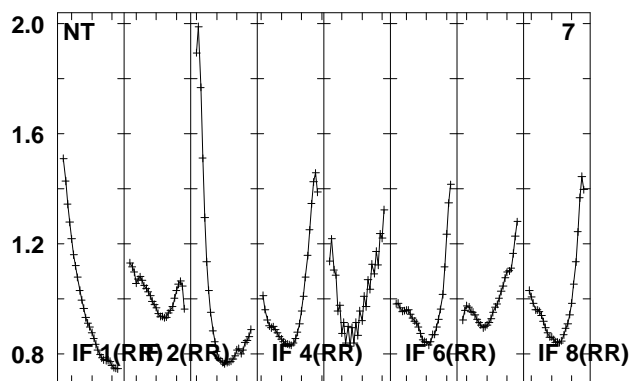
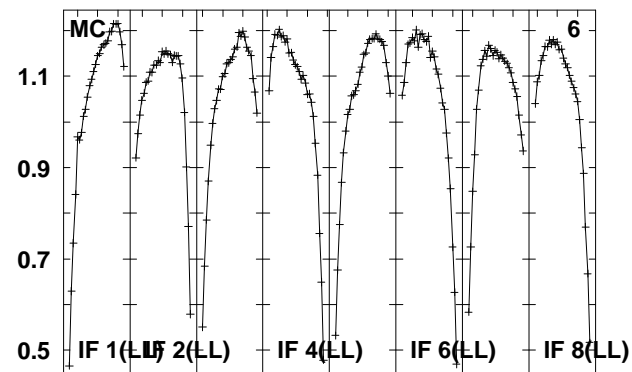
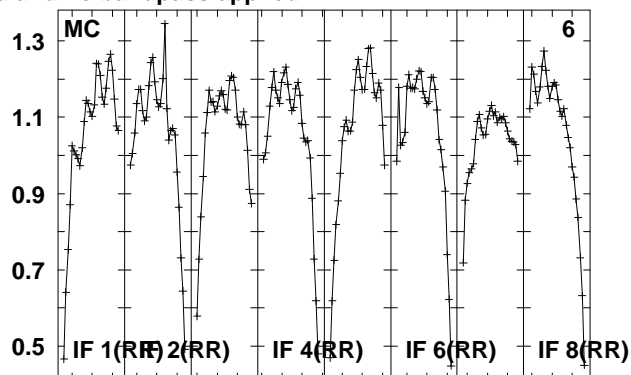
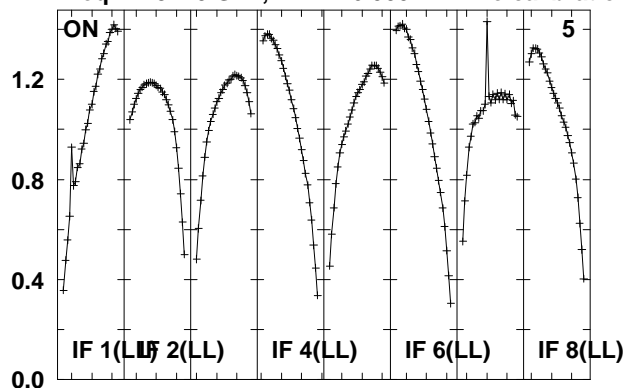

Lower frame: Real Jy

Total-power spectrum Antenna: *

Timerange: 00/15:20:44 to 00/15:22:12

Plot file version 437 created 14-MAY-2010 15:19:32
 J080844 EO007.UVDATA.1
 Freq = 4.9270 GHz, Bw = 16.000 MH No calibration applied and no bandpass applied

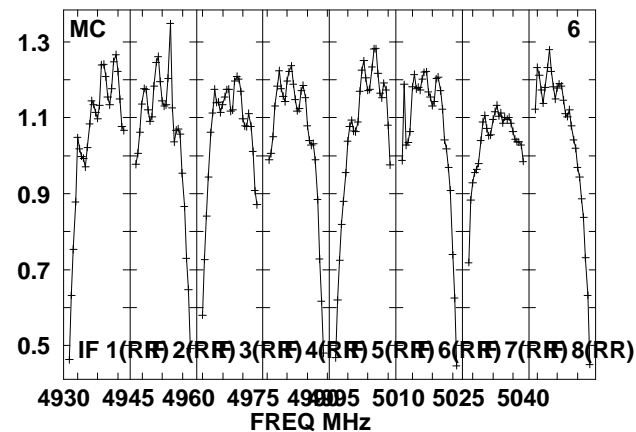
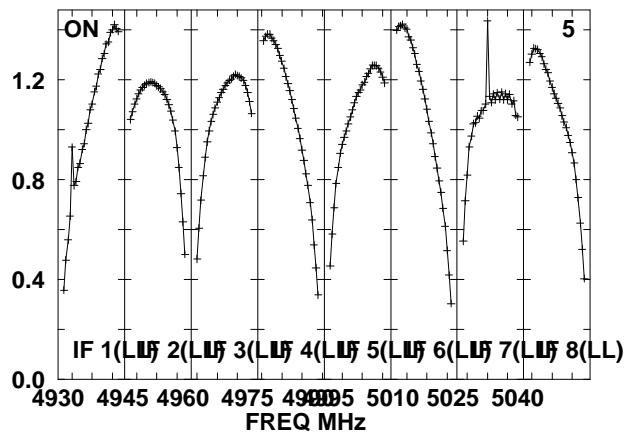
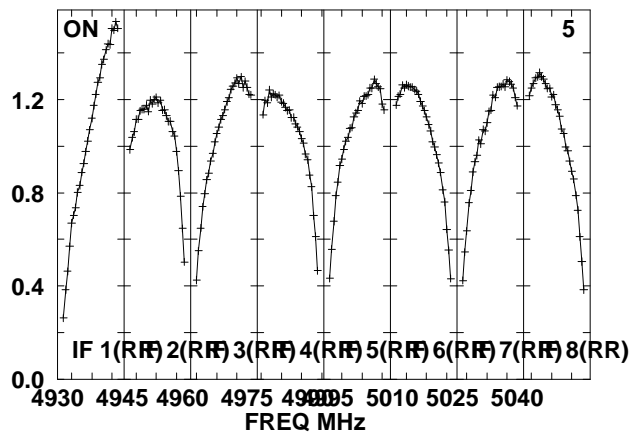
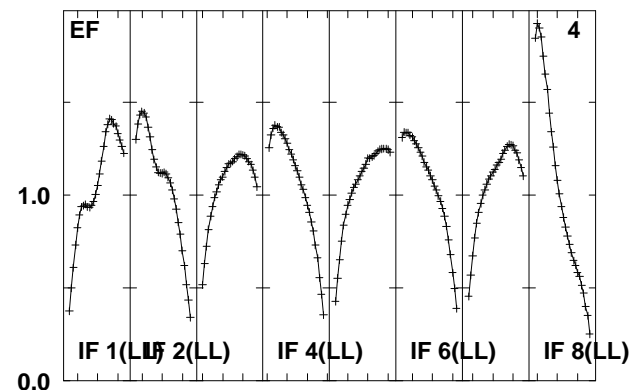
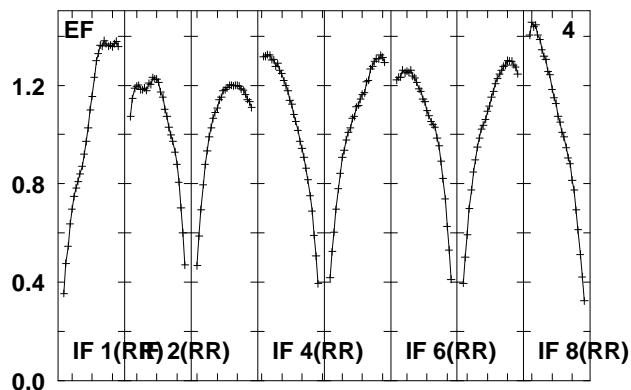
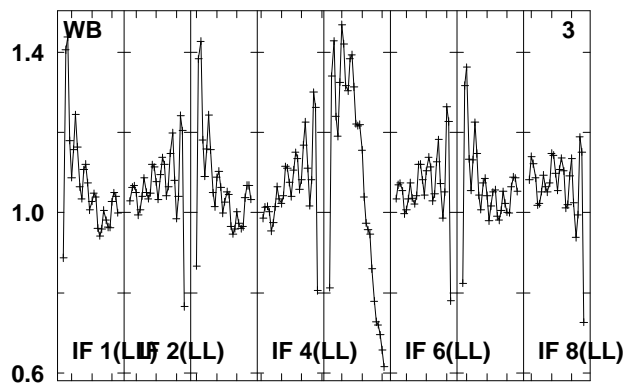
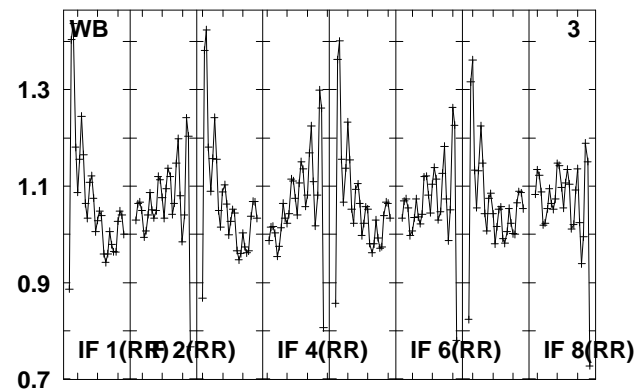
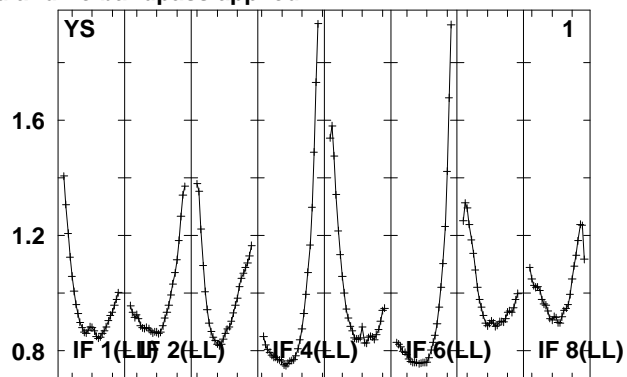
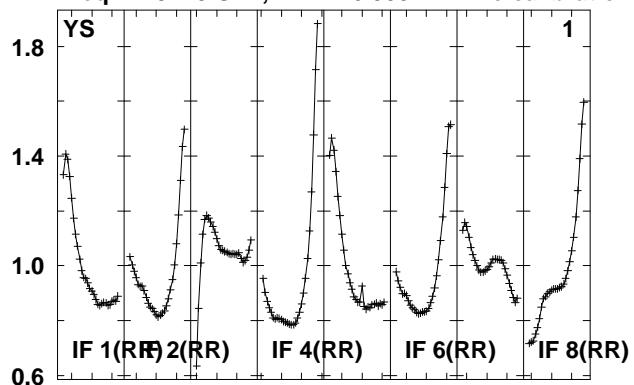

Lower frame: Real Jy
 Total-power spectrum Antenna: *
 Timerange: 00/15:22:38 to 00/15:27:36

Plot file version 438 created 14-MAY-2010 15:19:33

J080844 EO007.UVDATA.1

Freq = 4.9270 GHz, Bw = 16.000 MH No calibration applied and no bandpass applied

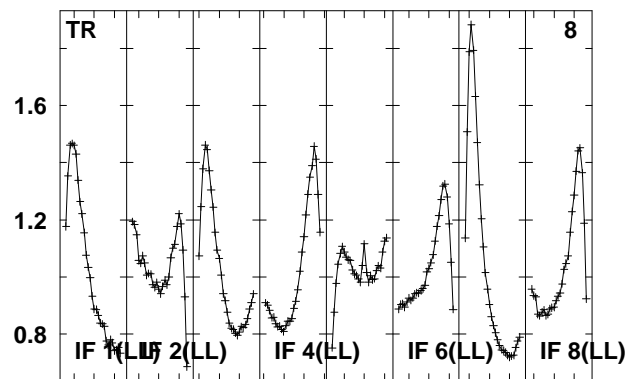
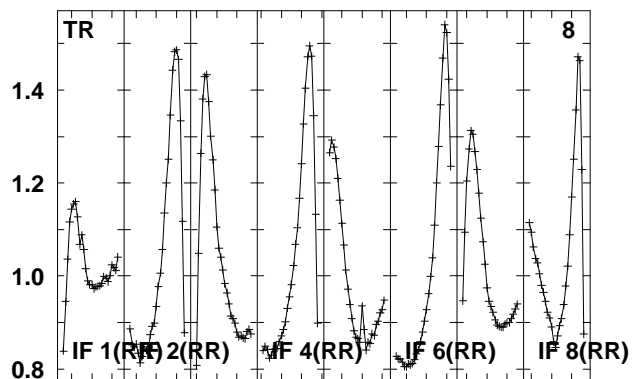
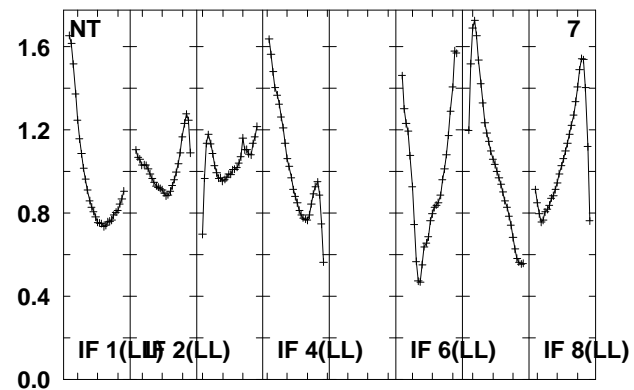
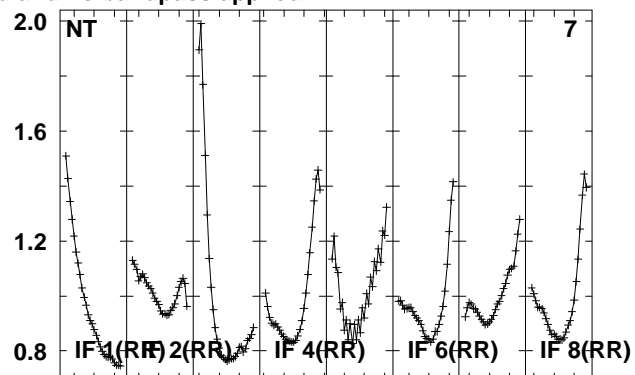
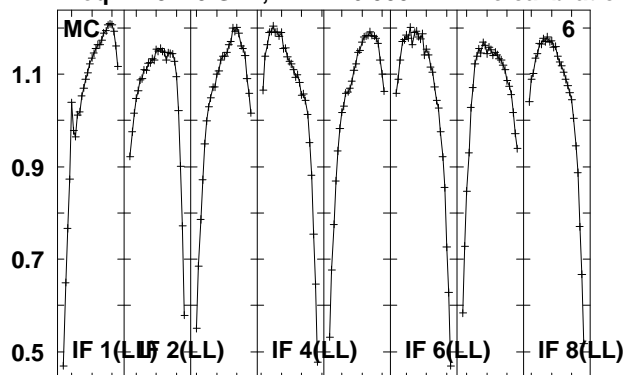

Lower frame: Real Jy
Total-power spectrum Antenna: *
Timerange: 00/15:22:38 to 00/15:27:36

Plot file version 439 created 14-MAY-2010 15:19:33
 J0808+40 EO007.UVDATA.1
 Freq = 4.9270 GHz, Bw = 16.000 MH No calibration applied and no bandpass applied

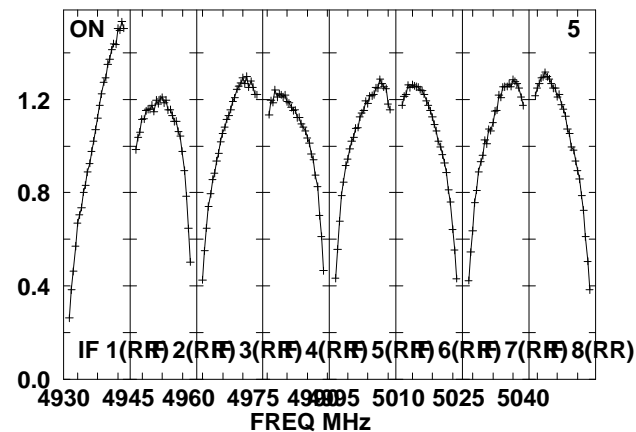
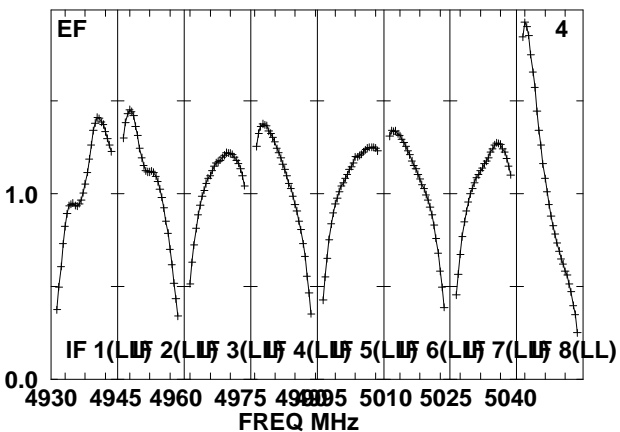
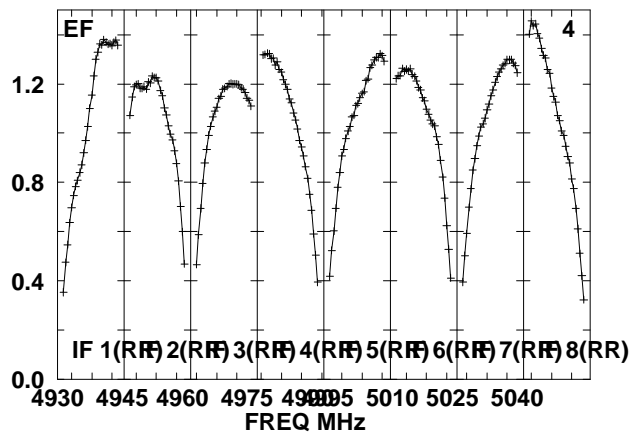
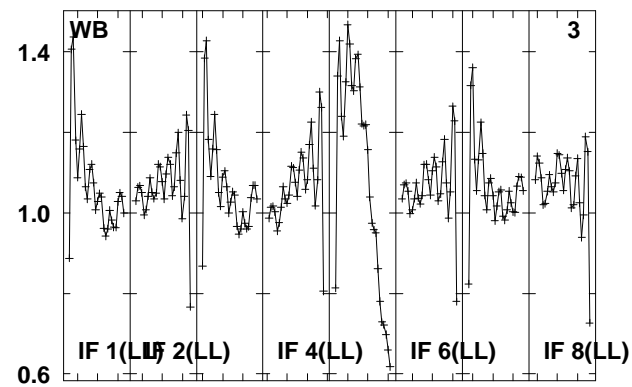
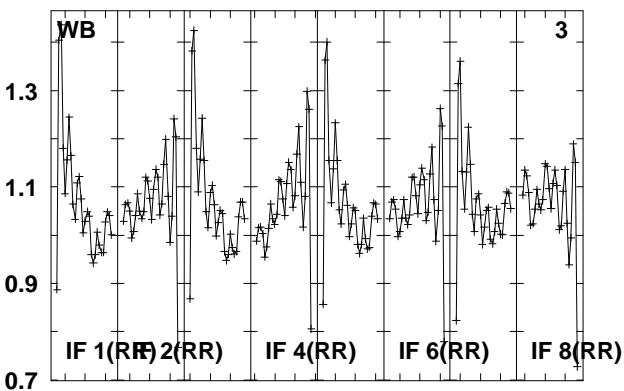
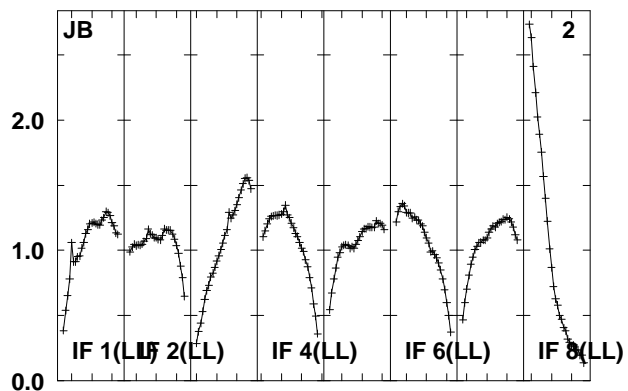
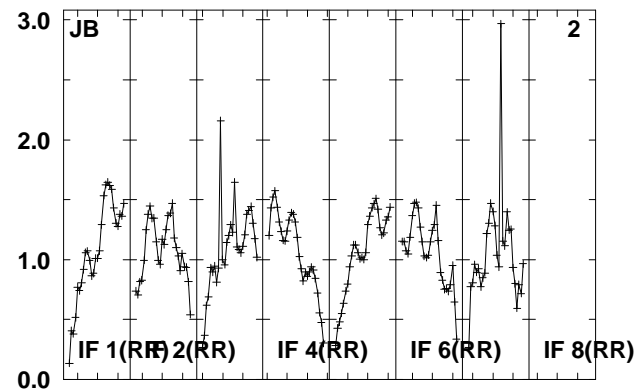
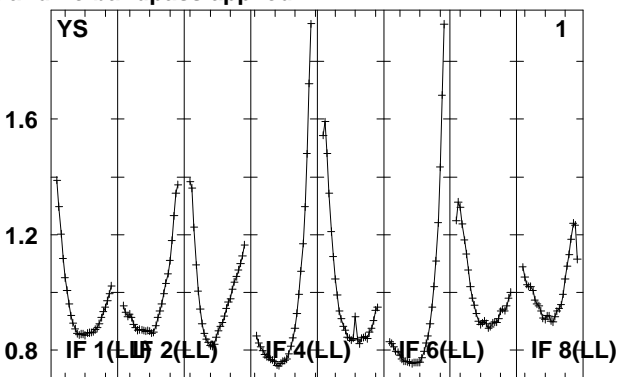
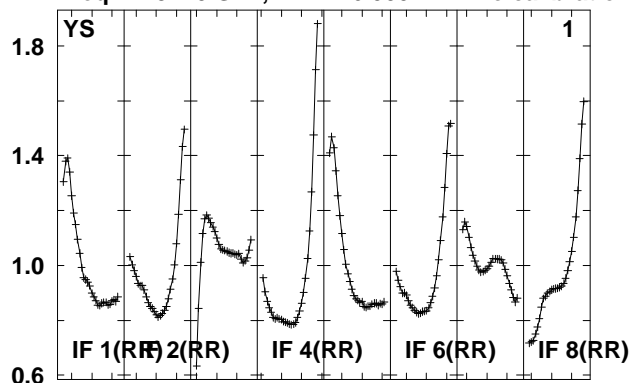

Lower frame: Real Jy
 Total-power spectrum Antenna: *
 Timerange: 00/15:28:02 to 00/15:29:28

Plot file version 440 created 14-MAY-2010 15:19:33

J0808+40 EO007.UVDATA.1

Freq = 4.9270 GHz, Bw = 16.000 MH No calibration applied and no bandpass applied

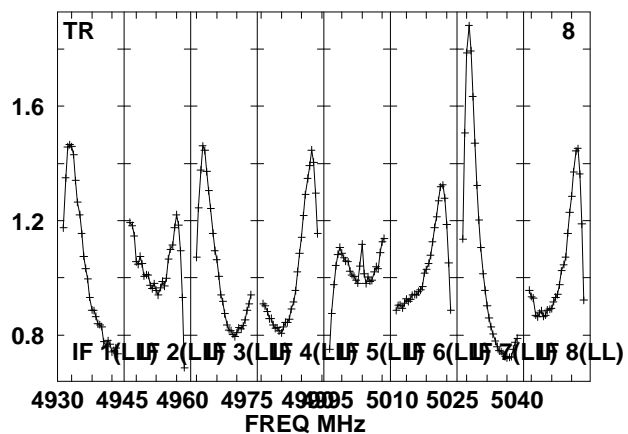
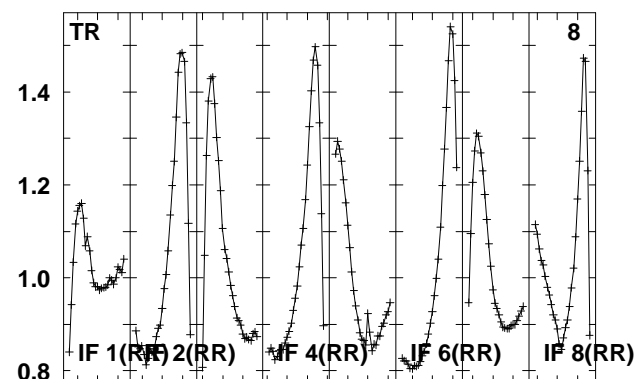
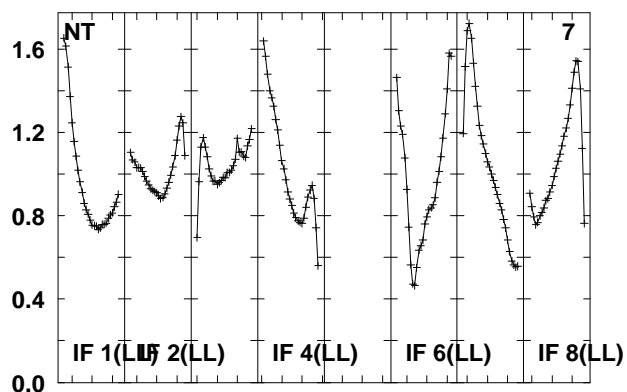
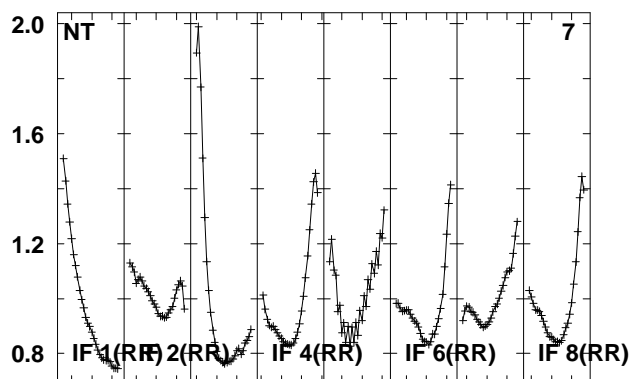
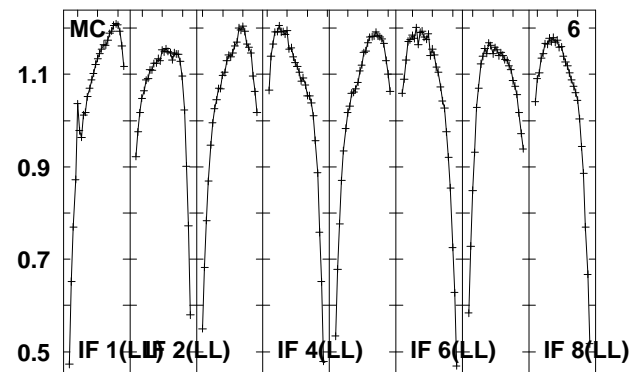
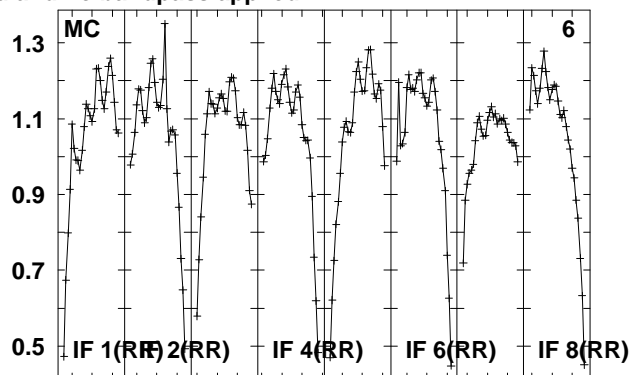
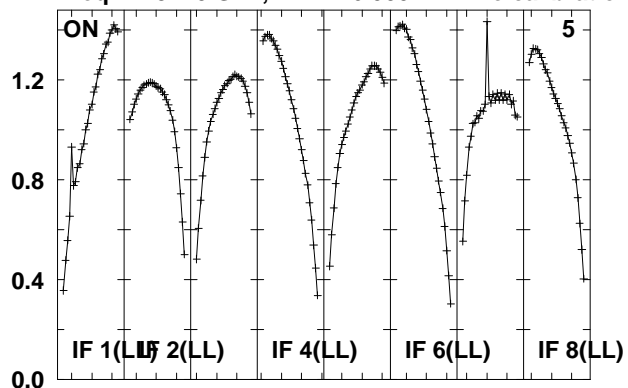

Lower frame: Real Jy

Total-power spectrum Antenna: *

Timerange: 00/15:28:02 to 00/15:29:28

Plot file version 441 created 14-MAY-2010 15:19:33

J0808+49 EO007.UVDATA.1

Freq = 4.9270 GHz, Bw = 16.000 MH No calibration applied and no bandpass applied

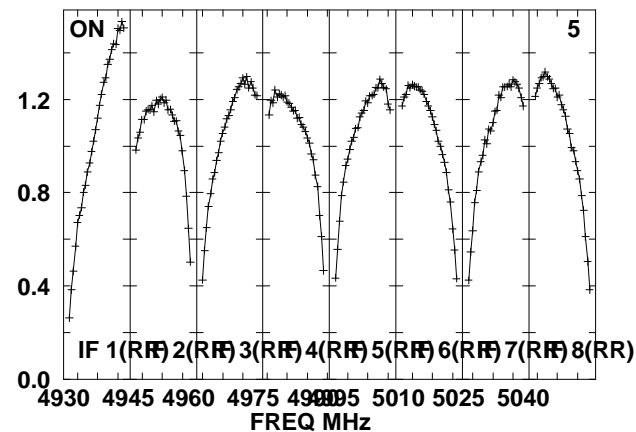
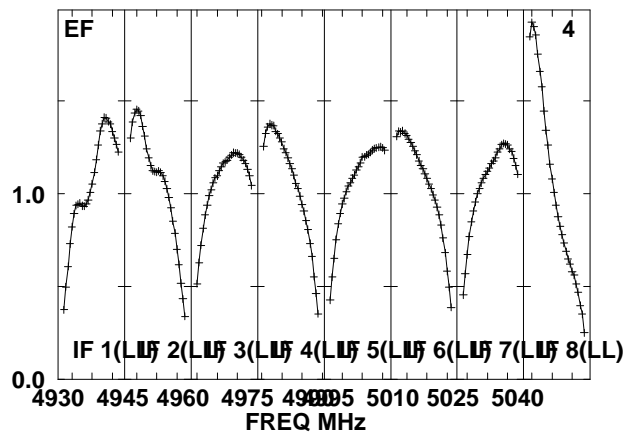
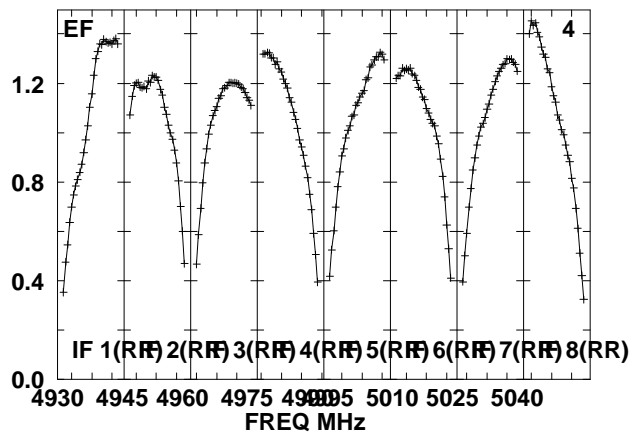
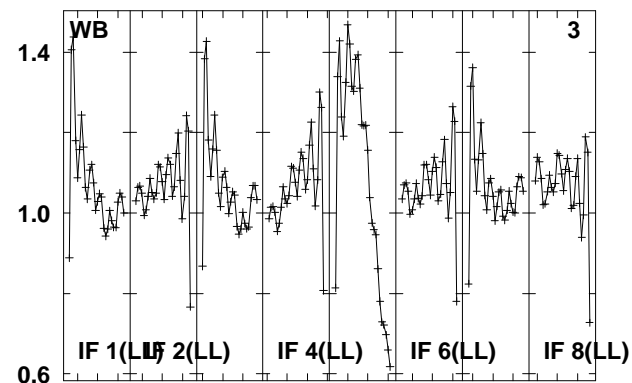
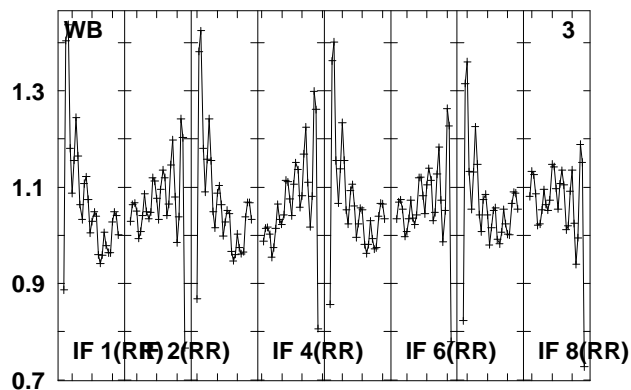
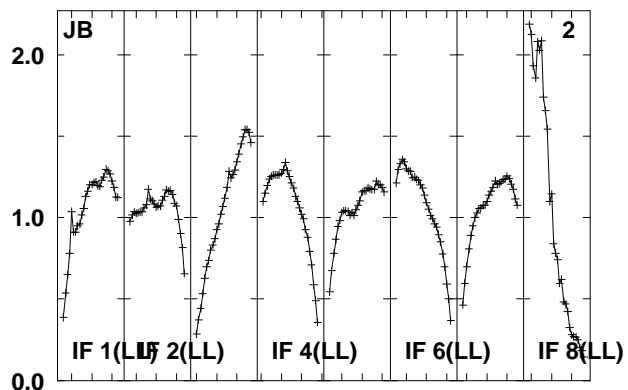
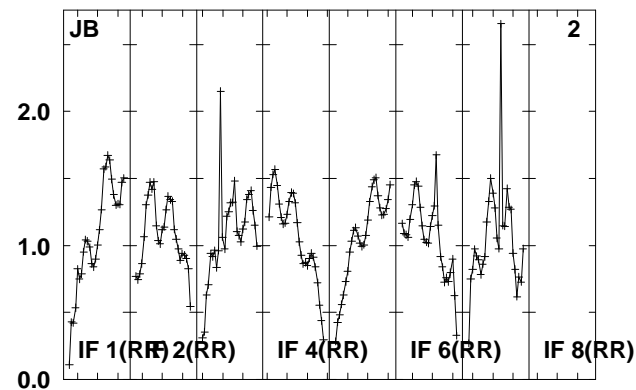
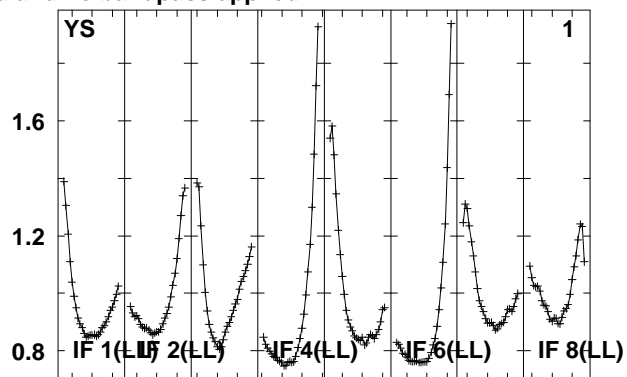
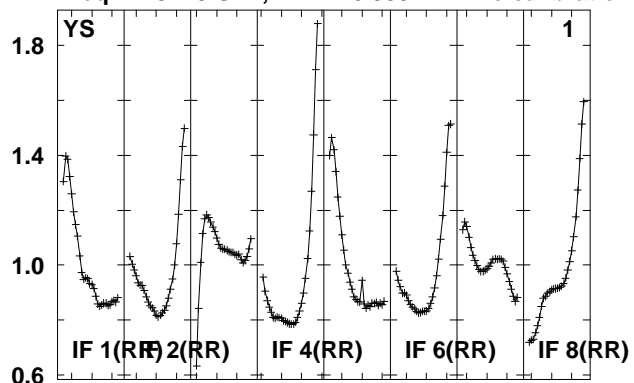

Lower frame: Real Jy

Total-power spectrum Antenna: *

Timerange: 00/15:30:31 to 00/15:31:59

Plot file version 442 created 14-MAY-2010 15:19:34

J0808+49 EO007.UVDATA.1

Freq = 4.9270 GHz, Bw = 16.000 MH No calibration applied and no bandpass applied

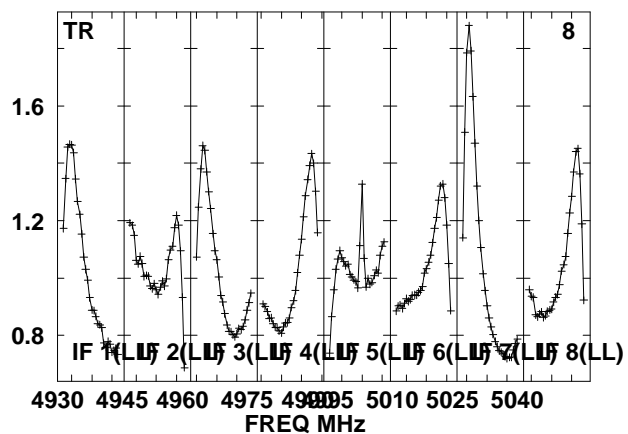
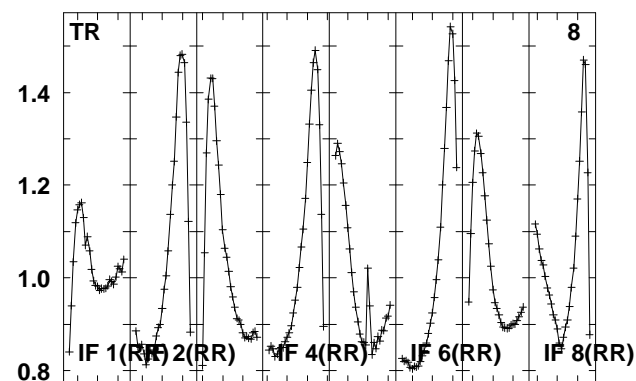
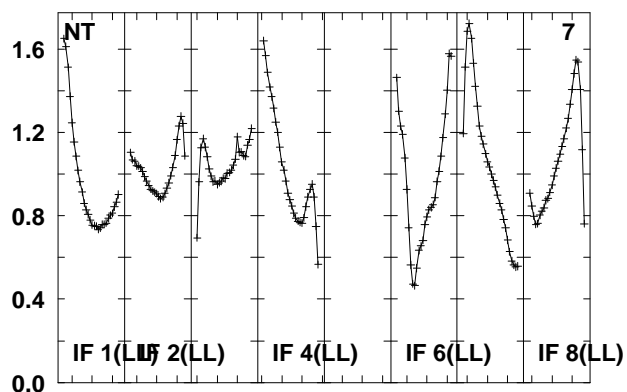
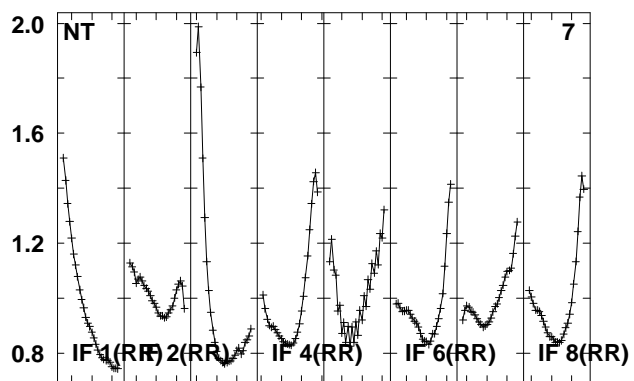
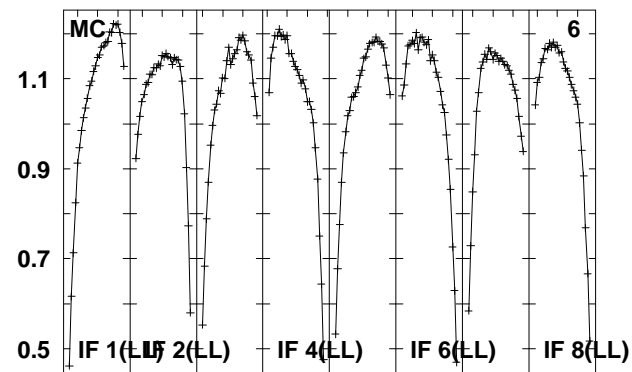
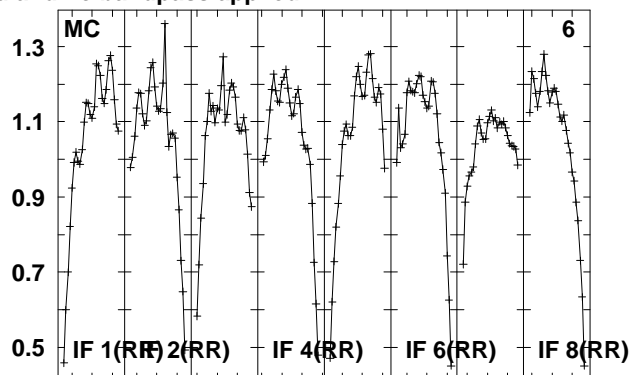
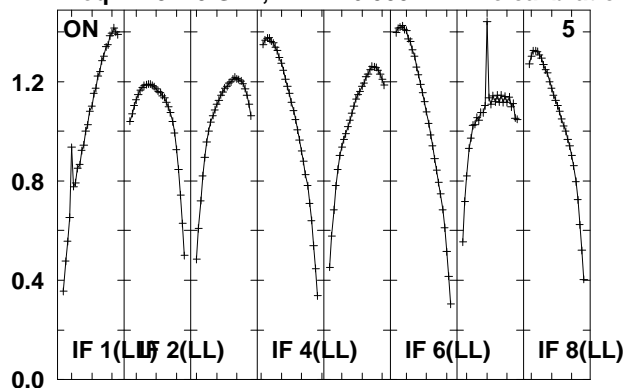

Lower frame: Real Jy

Total-power spectrum Antenna: *

Timerange: 00/15:30:31 to 00/15:31:59

Plot file version 443 created 14-MAY-2010 15:19:34
 J081523 EO007.UVDATA.1
 Freq = 4.9270 GHz, Bw = 16.000 MH No calibration applied and no bandpass applied

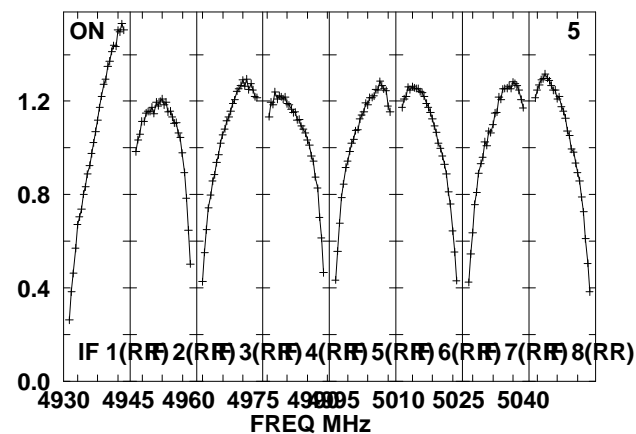
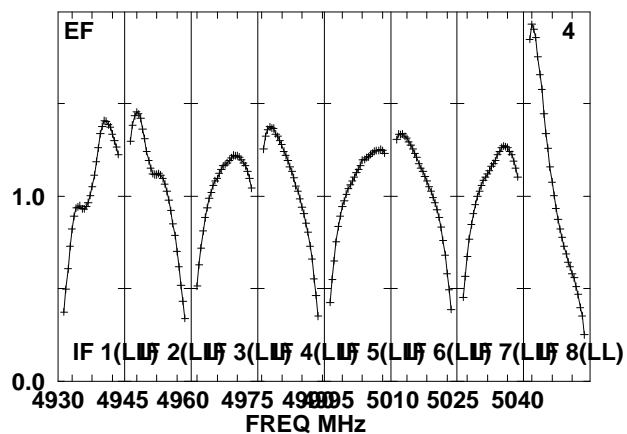
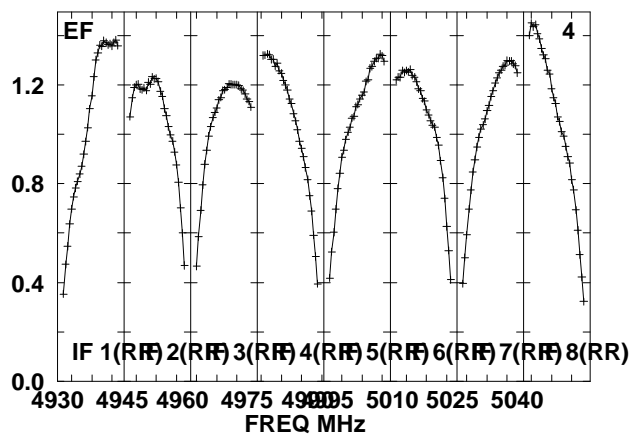
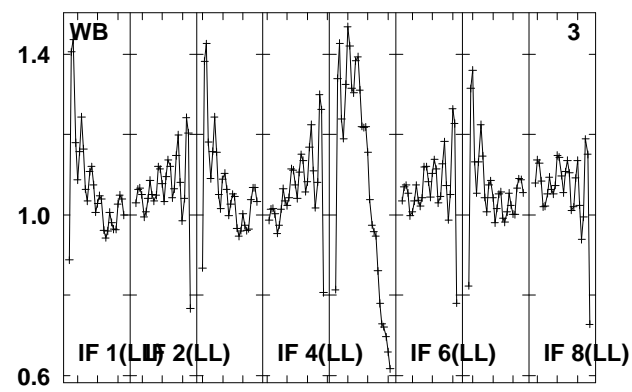
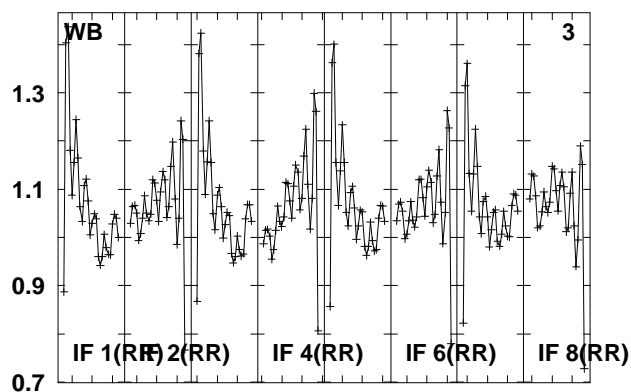
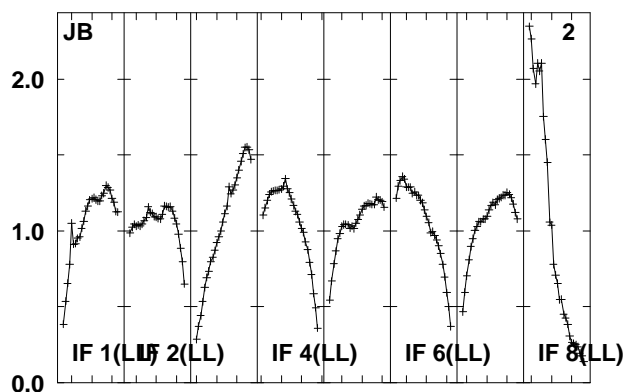
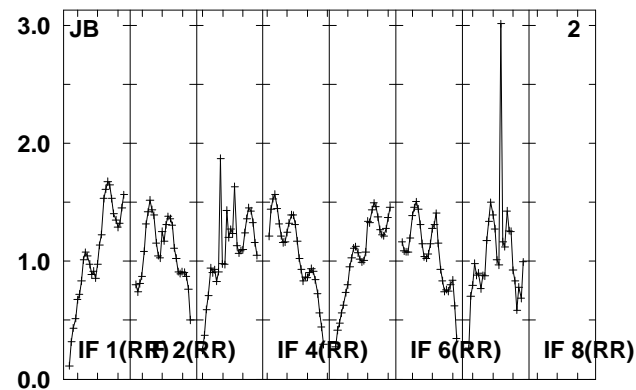
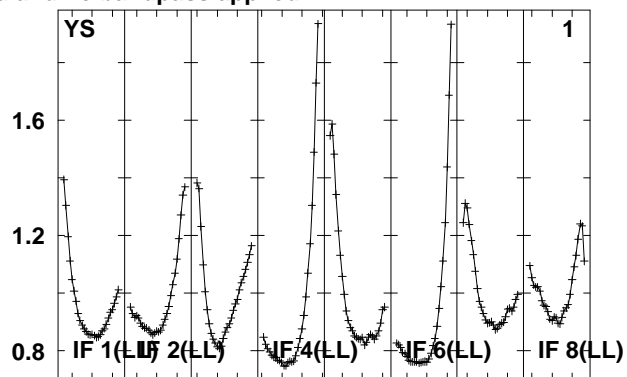
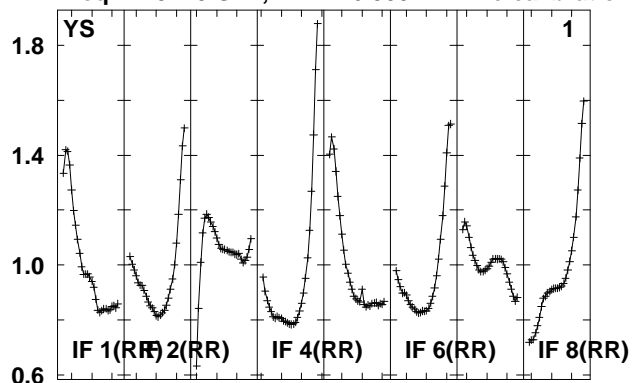

Lower frame: Real Jy
 Total-power spectrum Antenna: *
 Timerange: 00/15:32:24 to 00/15:37:22

Plot file version 444 created 14-MAY-2010 15:19:35

J081523 EO007.UVDATA.1

Freq = 4.9270 GHz, Bw = 16.000 MH No calibration applied and no bandpass applied

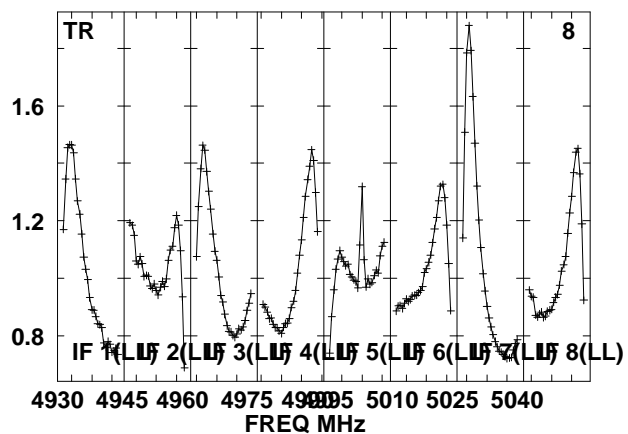
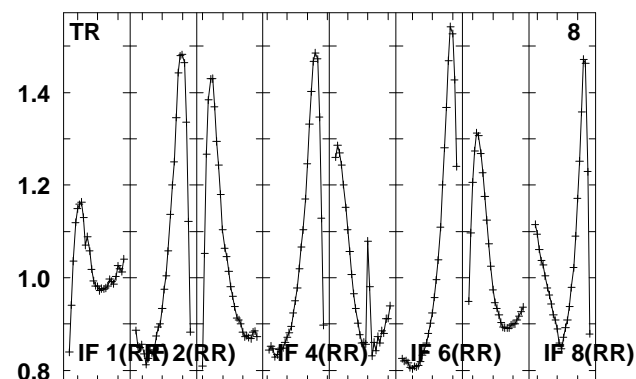
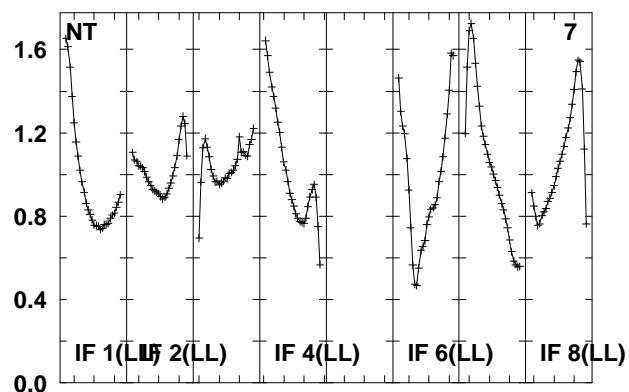
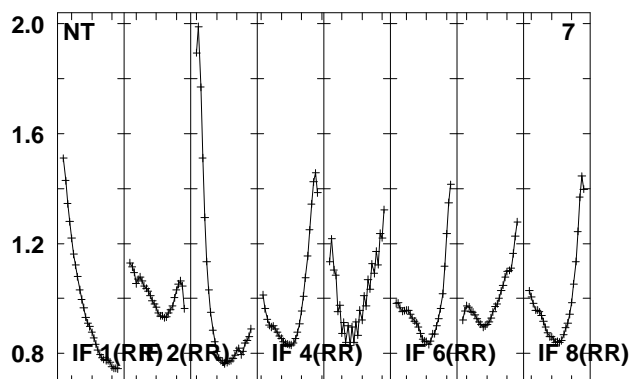
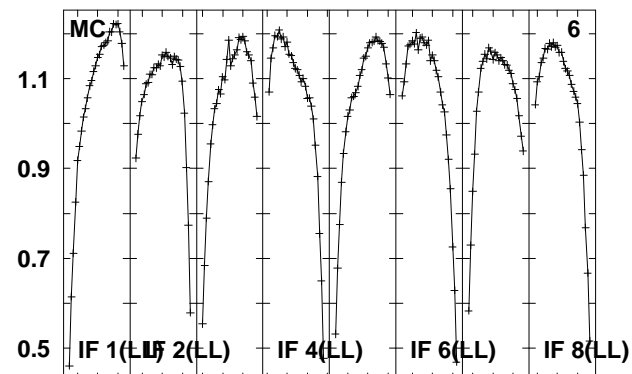
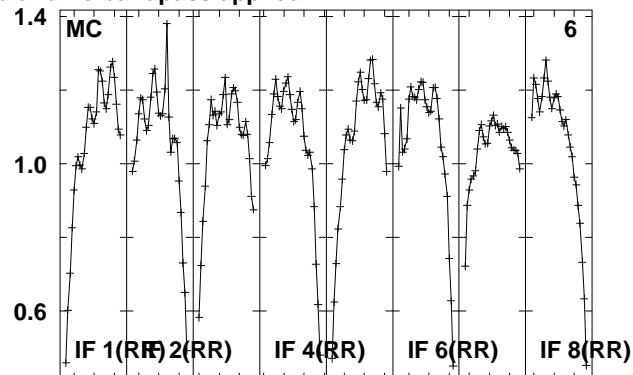
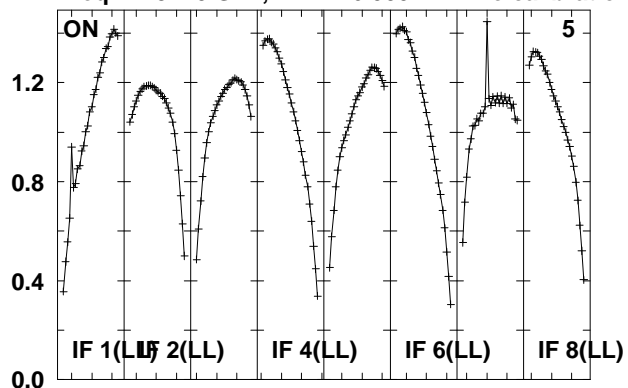

Lower frame: Real Jy

Total-power spectrum Antenna: *

Timerange: 00/15:32:24 to 00/15:37:22

Plot file version 445 created 14-MAY-2010 15:19:35

J0808+49 EO007.UVDATA.1

Freq = 4.9270 GHz, Bw = 16.000 MH No calibration applied and no bandpass applied

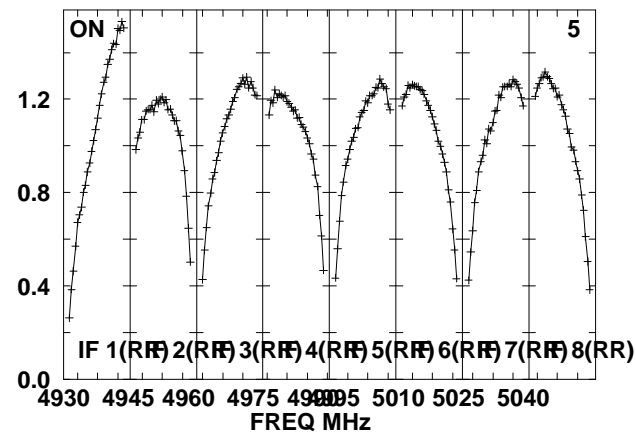
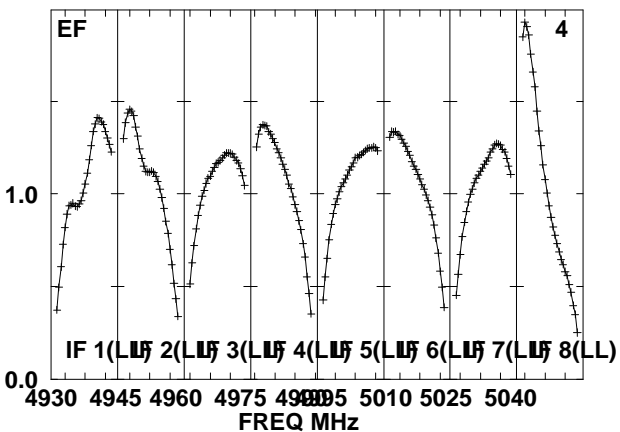
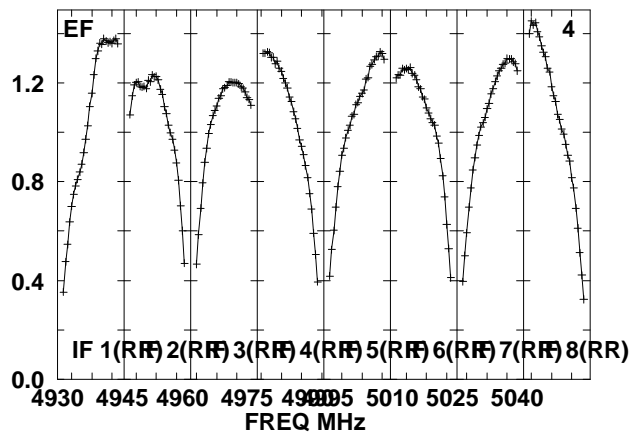
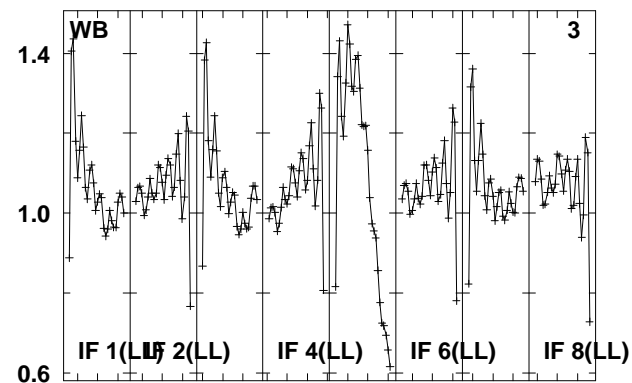
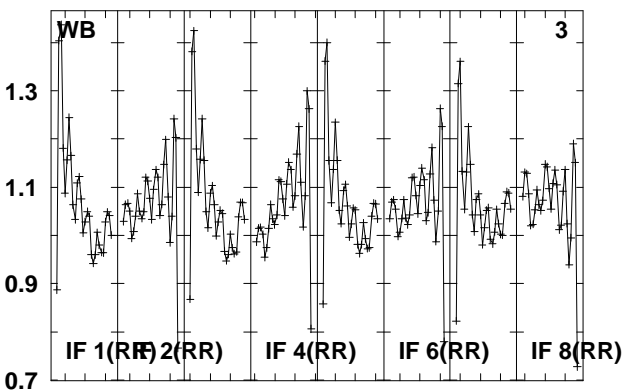
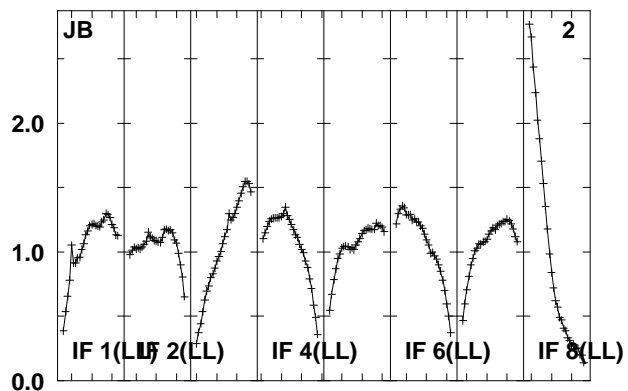
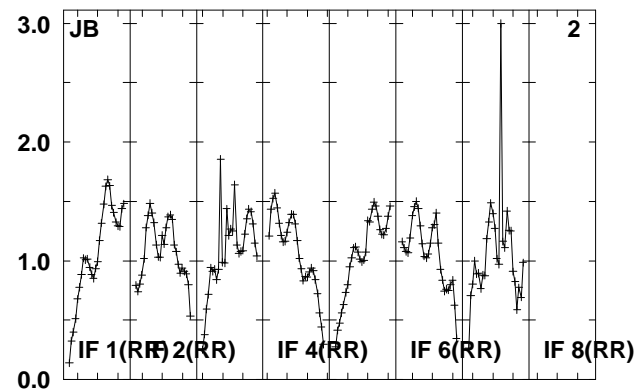
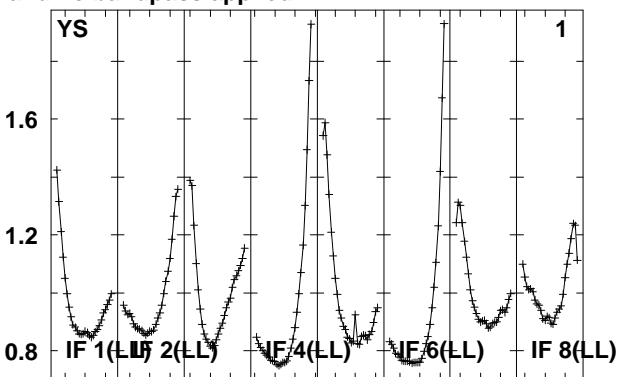
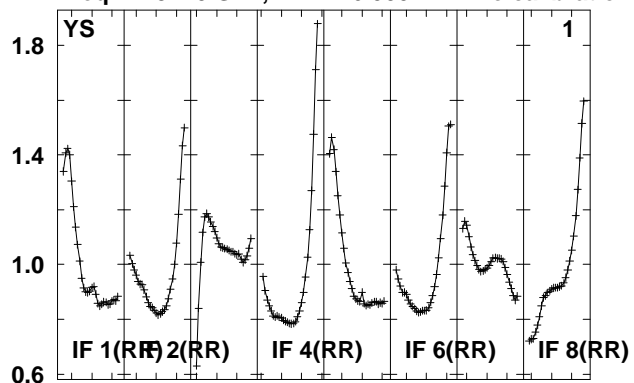

Lower frame: Real Jy
Total-power spectrum Antenna: *
Timerange: 00/15:37:48 to 00/15:39:16

Plot file version 446 created 14-MAY-2010 15:19:35

J0808+49 EO007.UVDATA.1

Freq = 4.9270 GHz, Bw = 16.000 MH No calibration applied and no bandpass applied

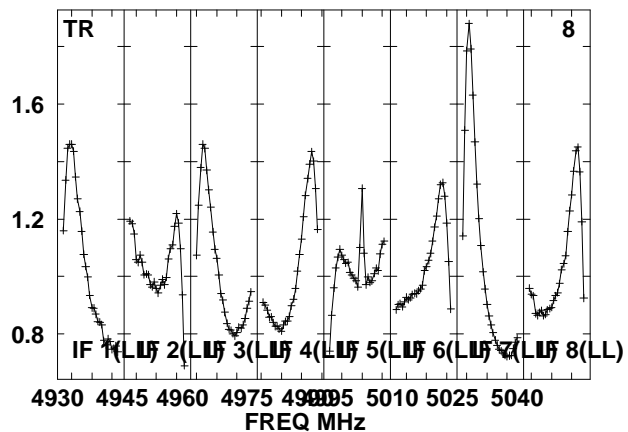
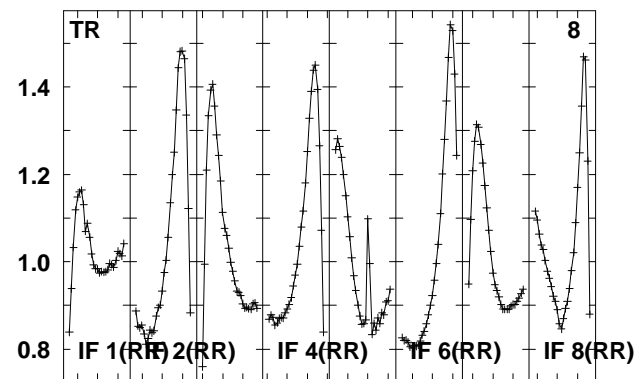
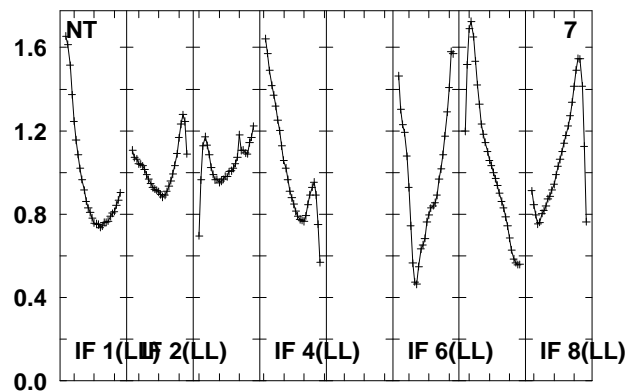
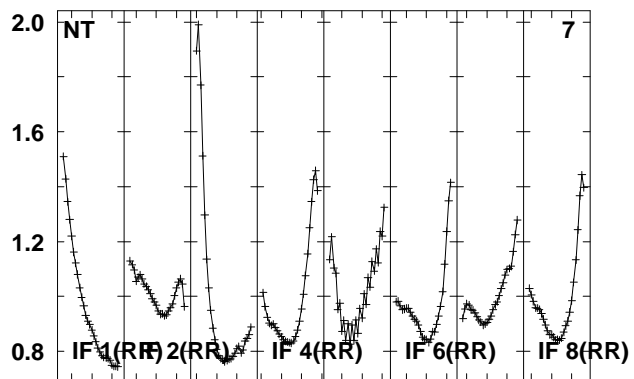
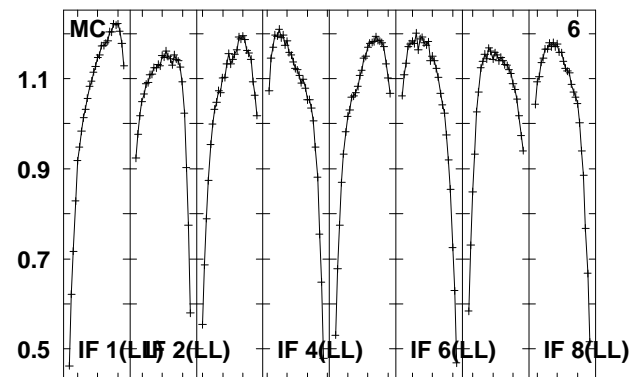
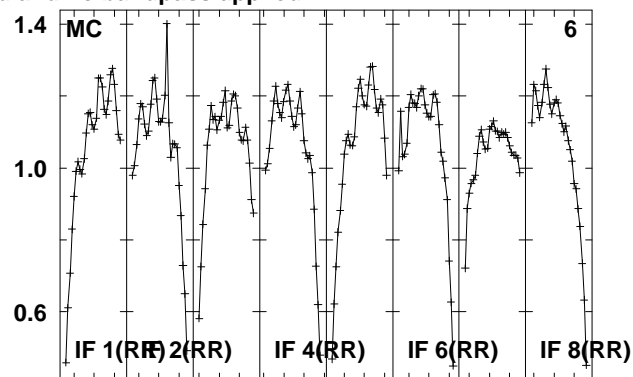
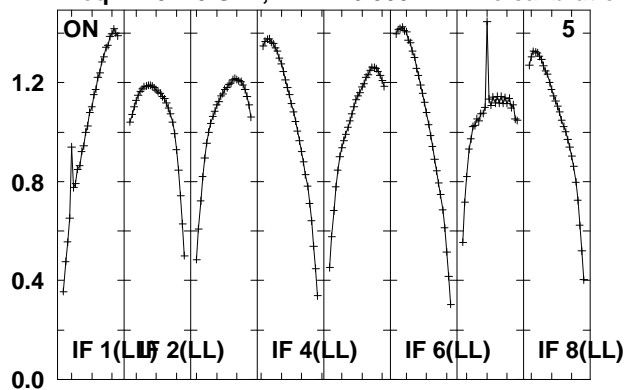

Lower frame: Real Jy

Total-power spectrum Antenna: *

Timerange: 00/15:37:48 to 00/15:39:16

Plot file version 447 created 14-MAY-2010 15:19:36

J081523 EO007.UVDATA.1

Freq = 4.9270 GHz, Bw = 16.000 MH No calibration applied and no bandpass applied

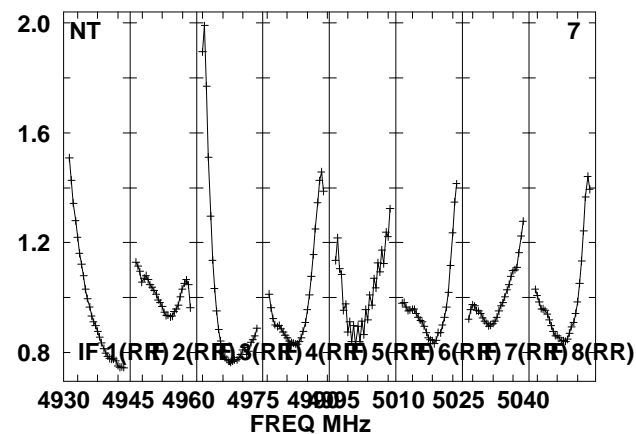
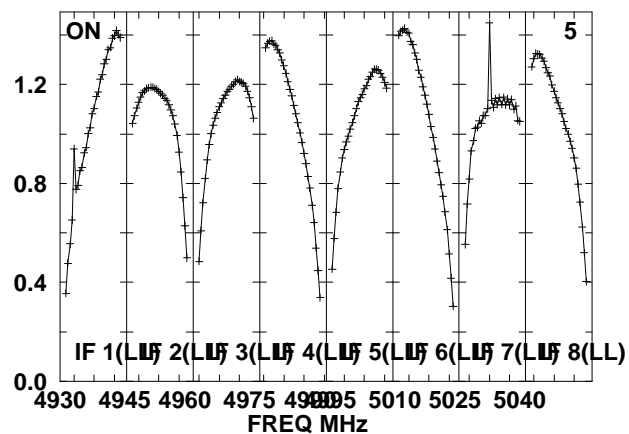
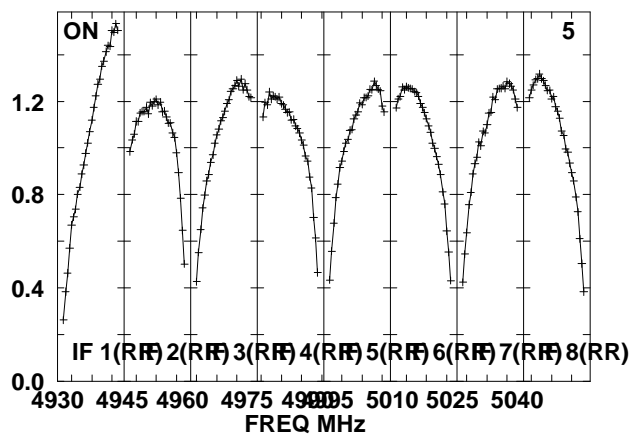
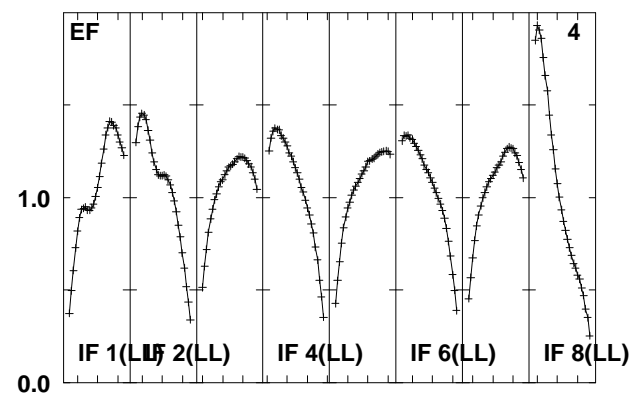
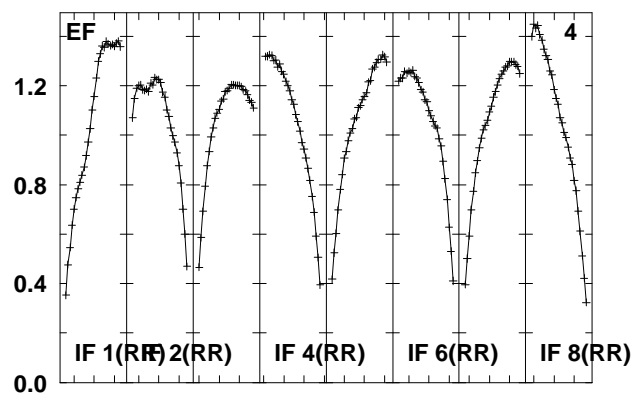
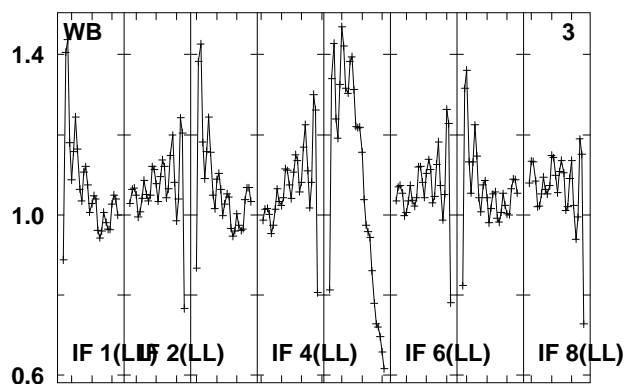
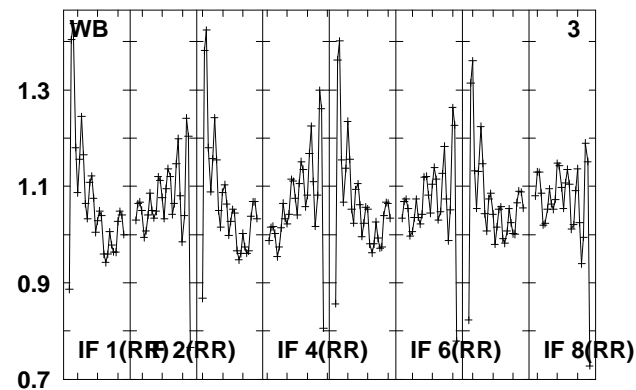
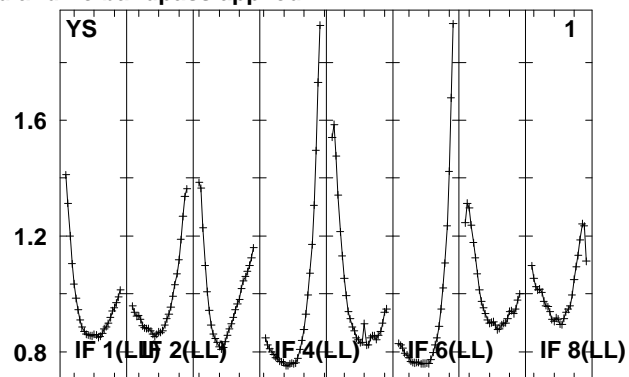
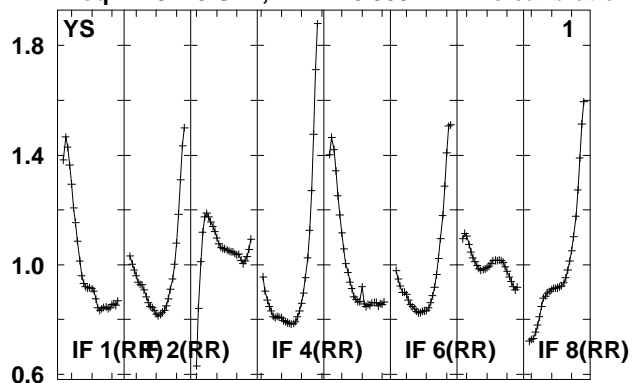

Lower frame: Real Jy

Total-power spectrum Antenna: *

Timerange: 00/15:39:41 to 00/15:44:37

Plot file version 448 created 14-MAY-2010 15:19:36

J081523 EO007.UVDATA.1

Freq = 4.9270 GHz, Bw = 16.000 MH No calibration applied and no bandpass applied

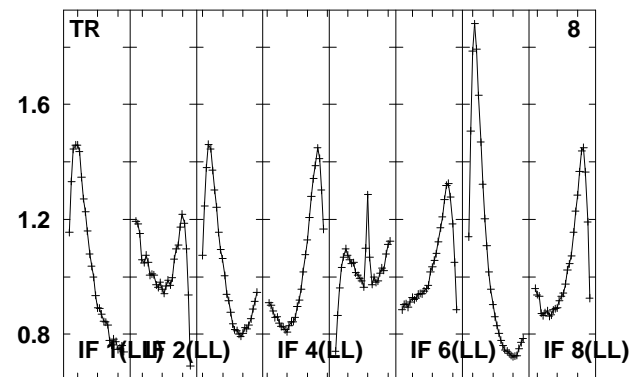
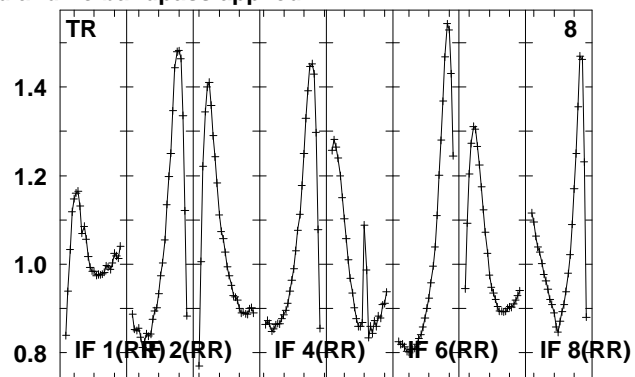
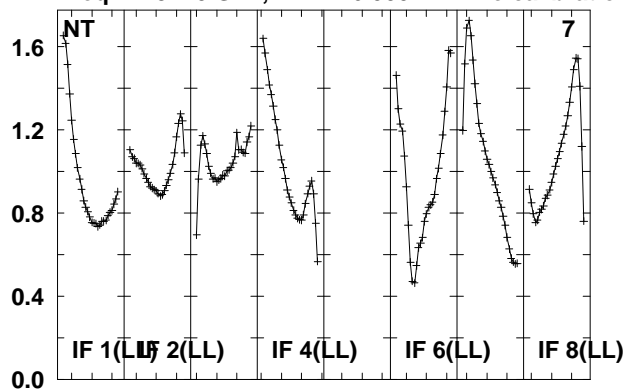

Lower frame: Real Jy
Total-power spectrum Antenna: *
Timerange: 00/15:39:41 to 00/15:44:37

Plot file version 449 created 14-MAY-2010 15:19:37

J0808+49 EO007.UVDATA.1

Freq = 4.9270 GHz, Bw = 16.000 MH No calibration applied and no bandpass applied

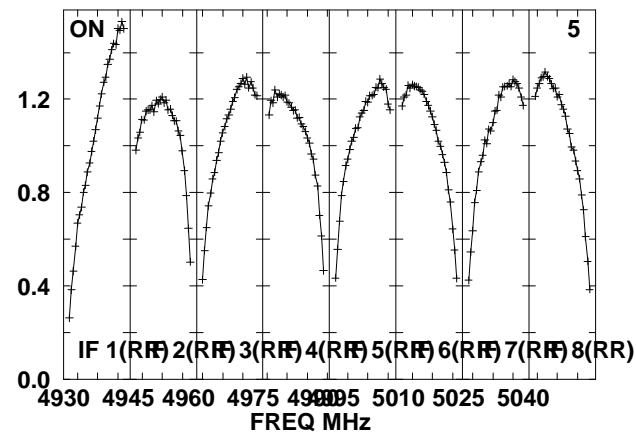
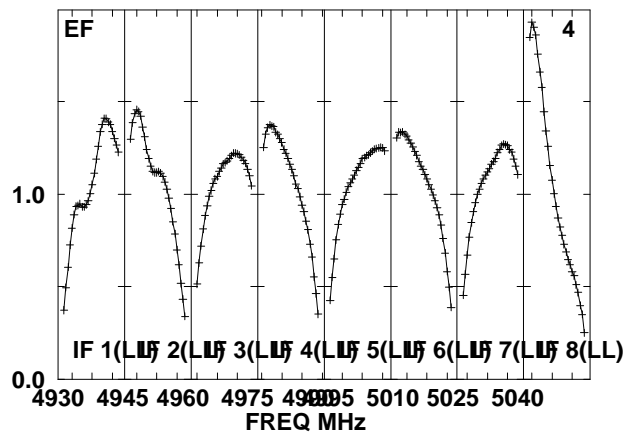
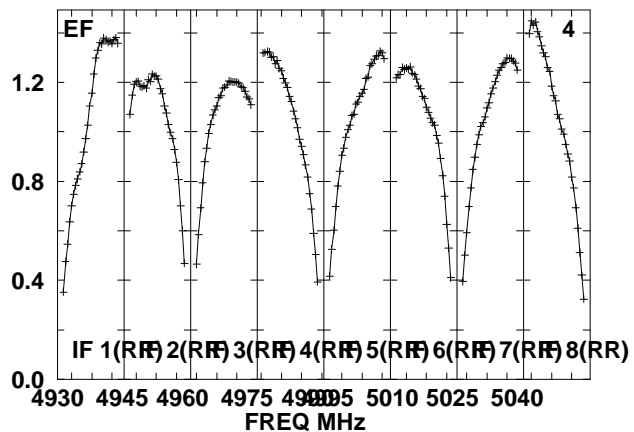
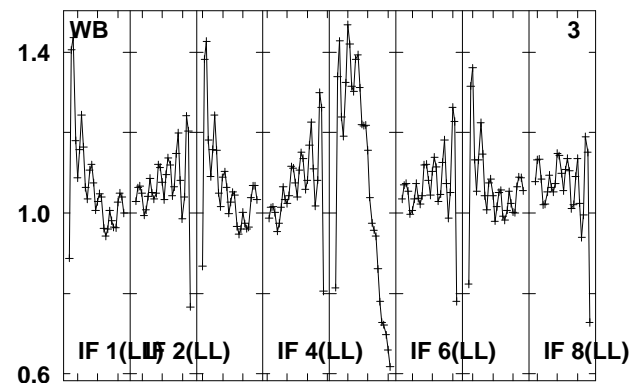
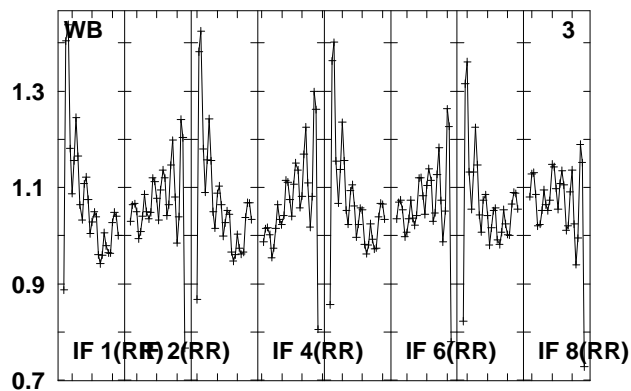
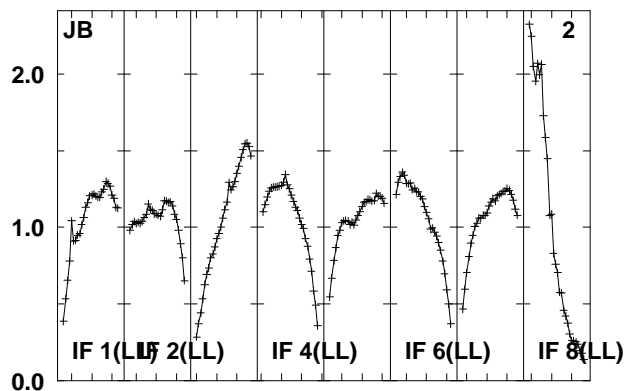
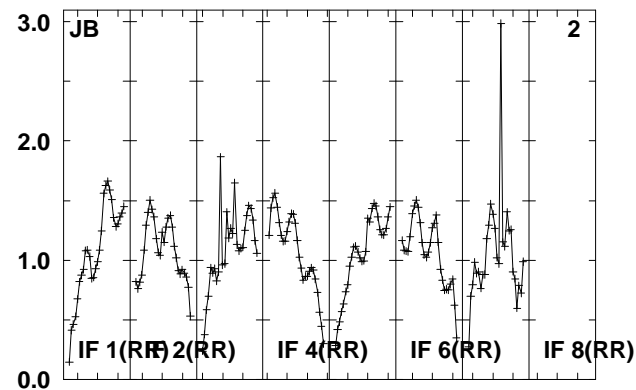
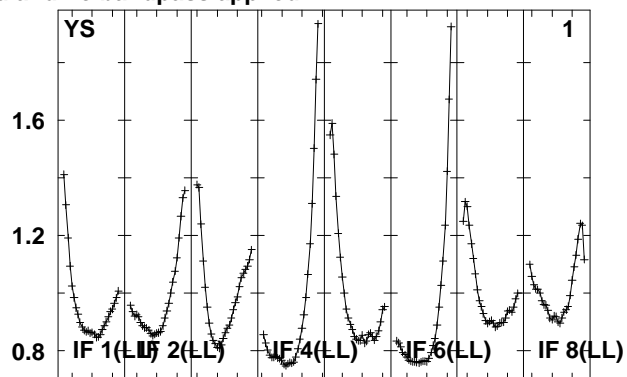
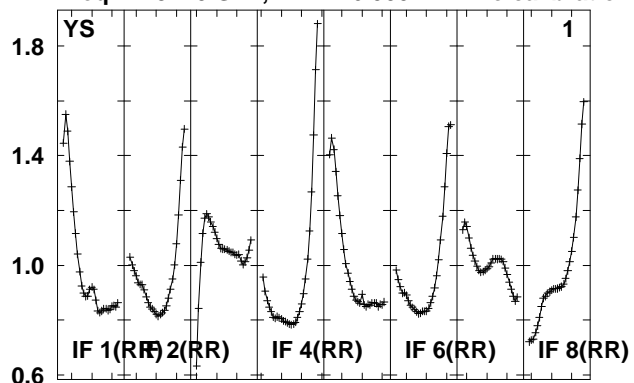

Lower frame: Real Jy
Total-power spectrum Antenna: *
Timerange: 00/15:45:05 to 00/15:46:33

Plot file version 450 created 14-MAY-2010 15:19:37

J0808+49 EO007.UVDATA.1

Freq = 4.9270 GHz, Bw = 16.000 MH No calibration applied and no bandpass applied

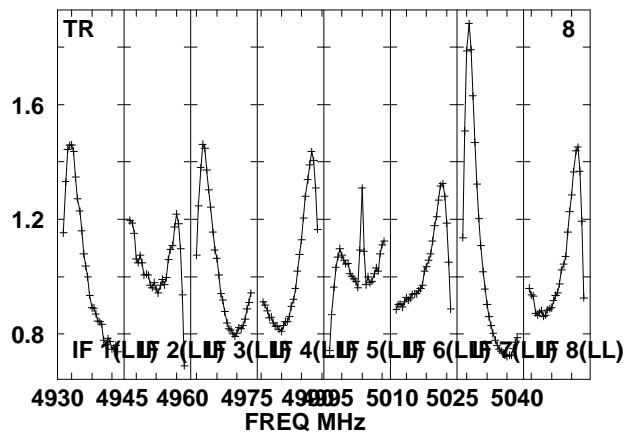
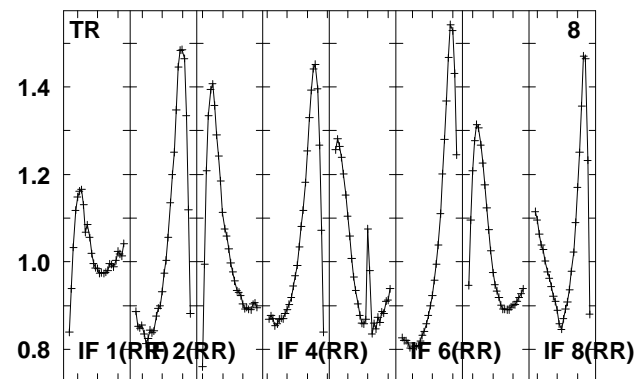
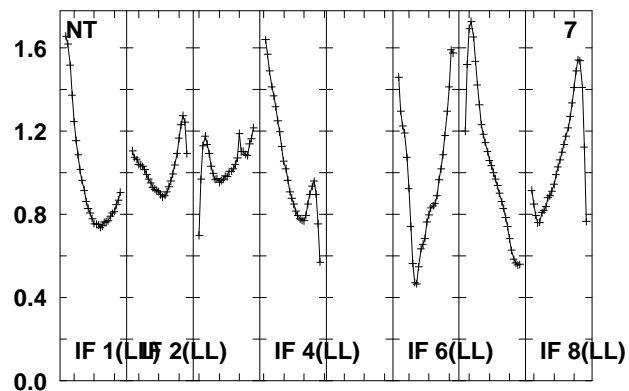
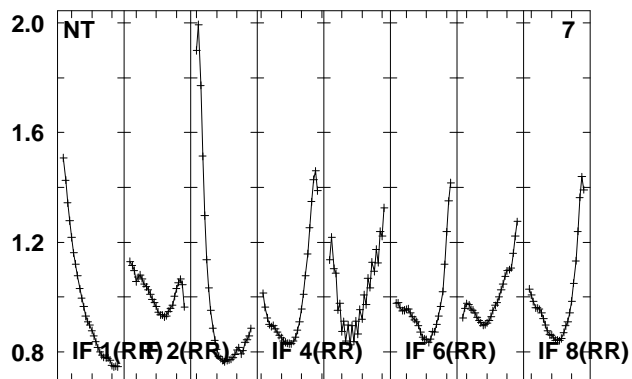
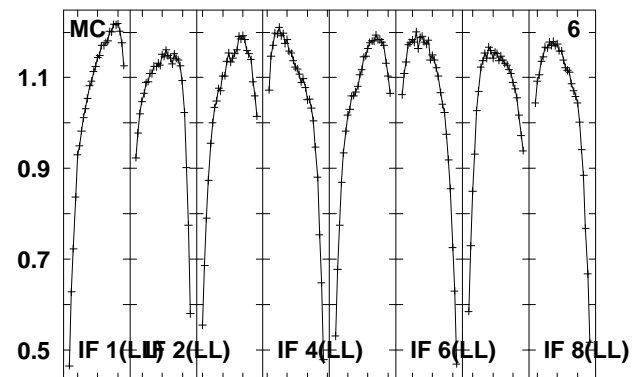
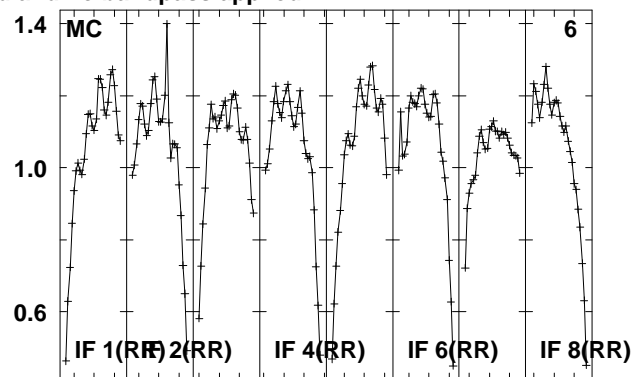
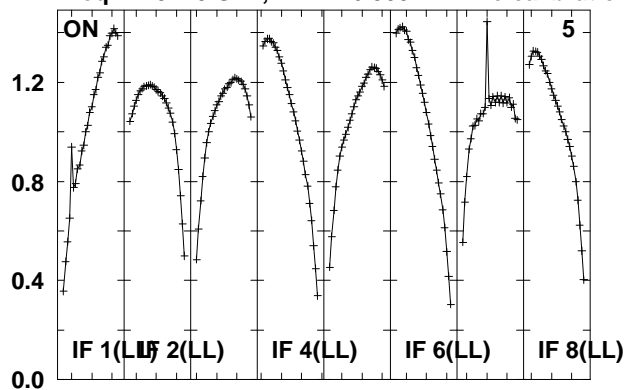

Lower frame: Real Jy

Total-power spectrum Antenna: *

Timerange: 00/15:45:05 to 00/15:46:33

Plot file version 451 created 14-MAY-2010 15:19:37

J0808+40 EO007.UVDATA.1

Freq = 4.9270 GHz, Bw = 16.000 MH No calibration applied and no bandpass applied

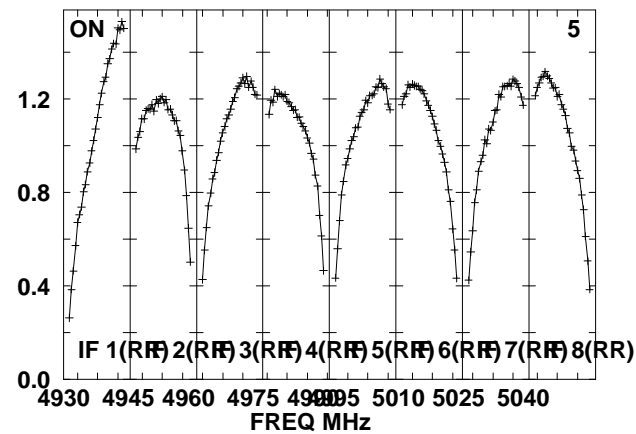
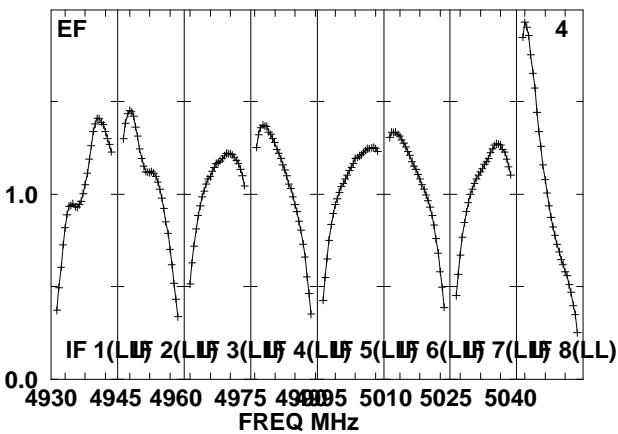
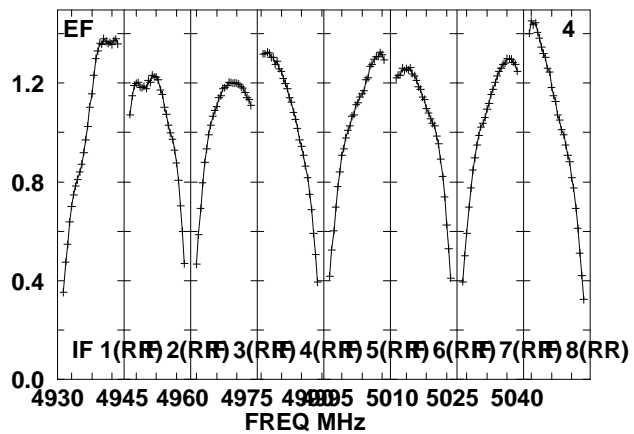
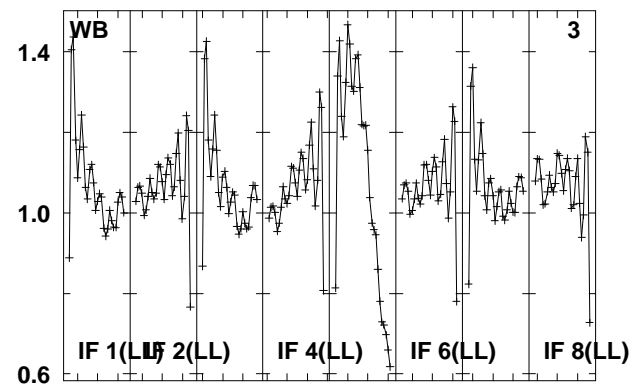
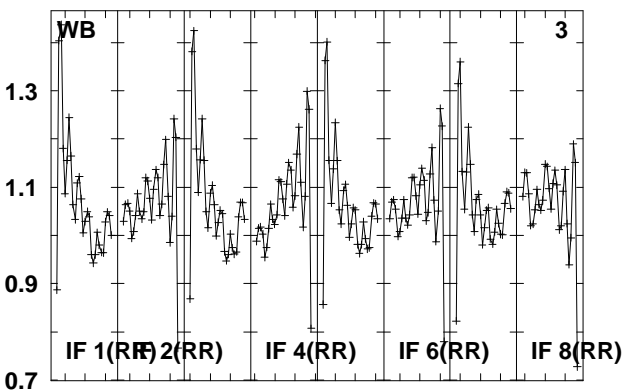
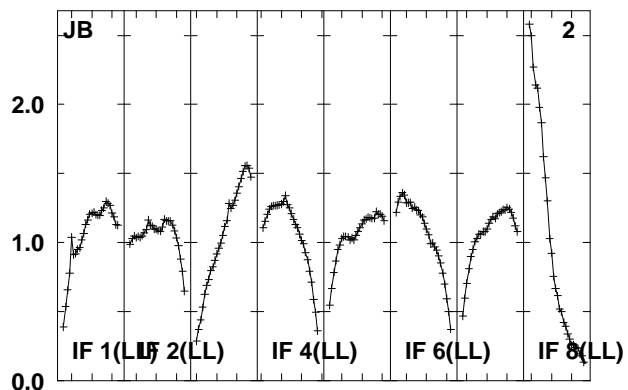
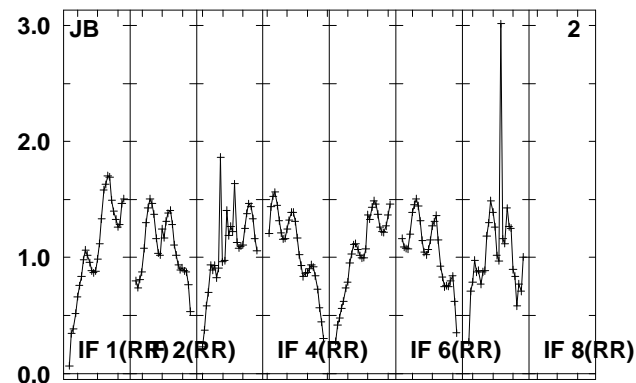
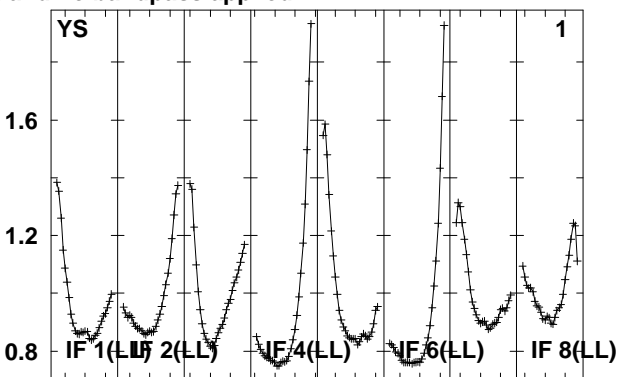
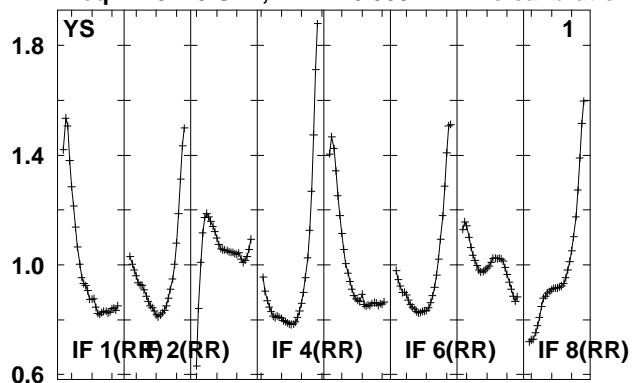

Lower frame: Real Jy
Total-power spectrum Antenna: *
Timerange: 00/15:47:35 to 00/15:49:03

Plot file version 452 created 14-MAY-2010 15:19:37

J0808+40 EO007.UVDATA.1

Freq = 4.9270 GHz, Bw = 16.000 MH No calibration applied and no bandpass applied

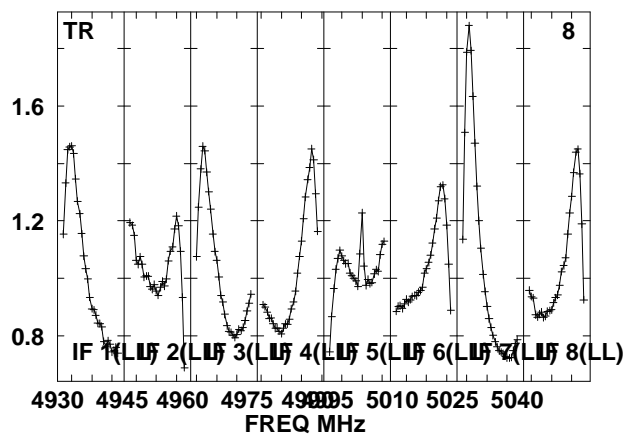
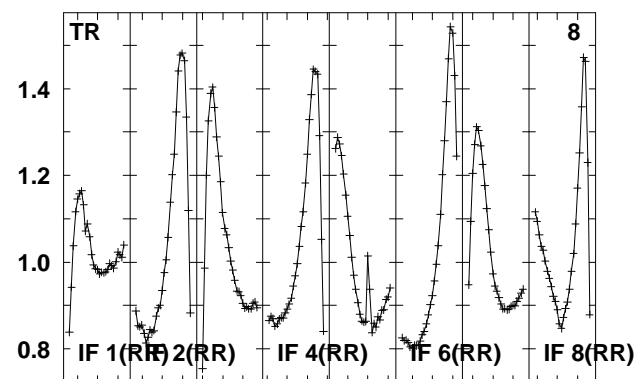
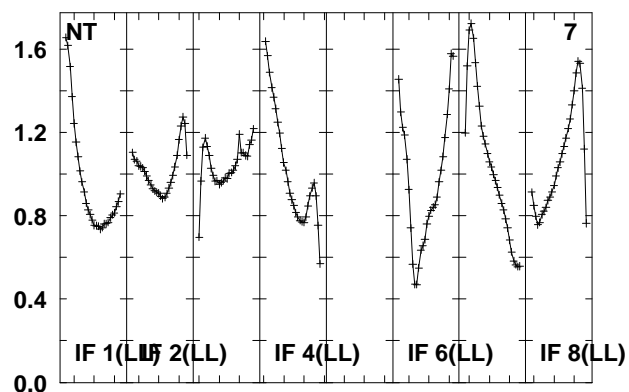
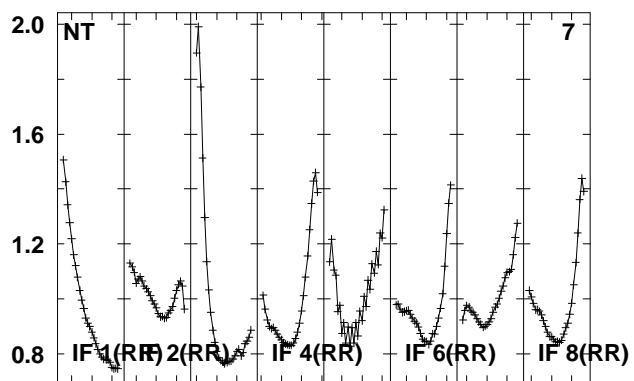
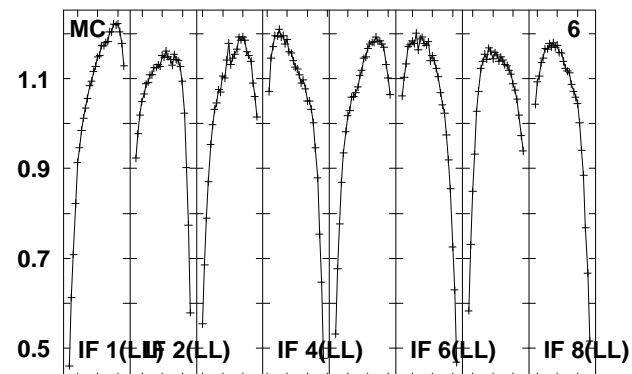
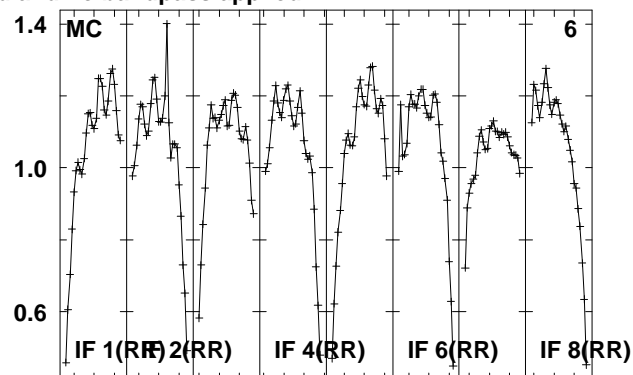
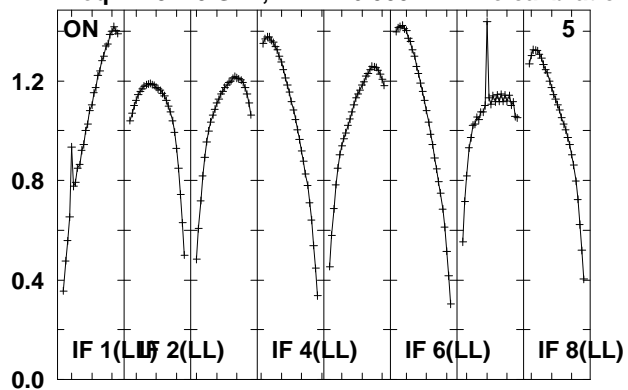

Lower frame: Real Jy

Total-power spectrum Antenna: *

Timerange: 00/15:47:35 to 00/15:49:03

Plot file version 453 created 14-MAY-2010 15:19:38
 J080844 EO007.UVDATA.1
 Freq = 4.9270 GHz, Bw = 16.000 MH No calibration applied and no bandpass applied

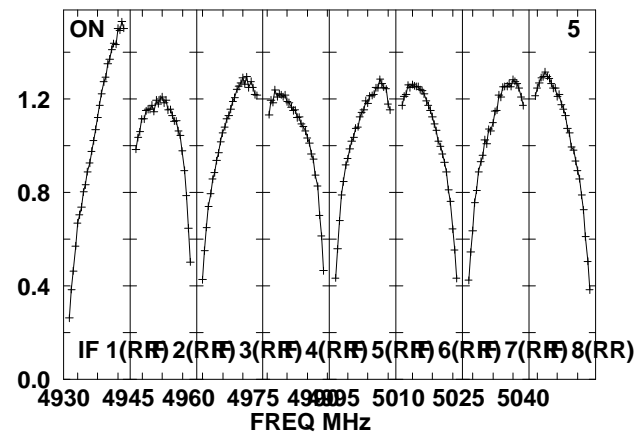
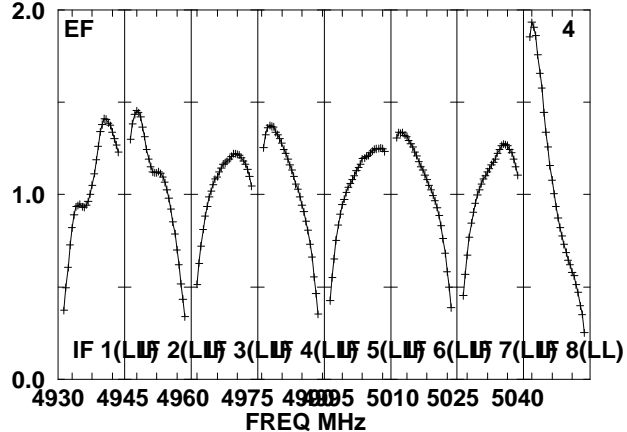
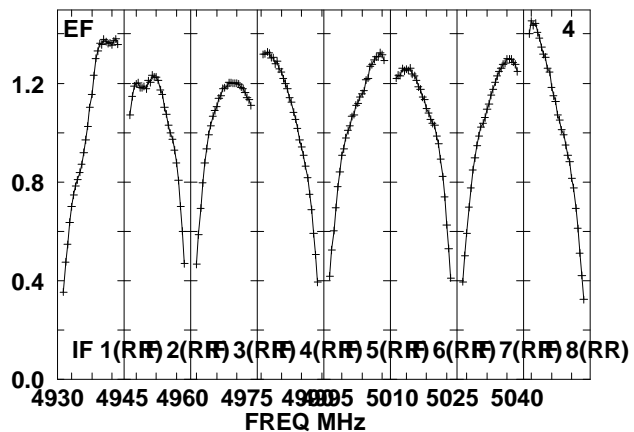
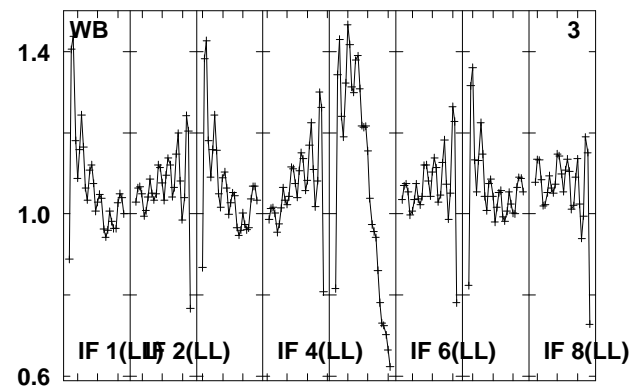
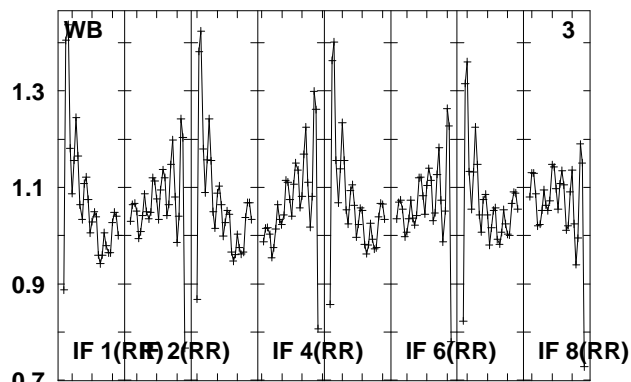
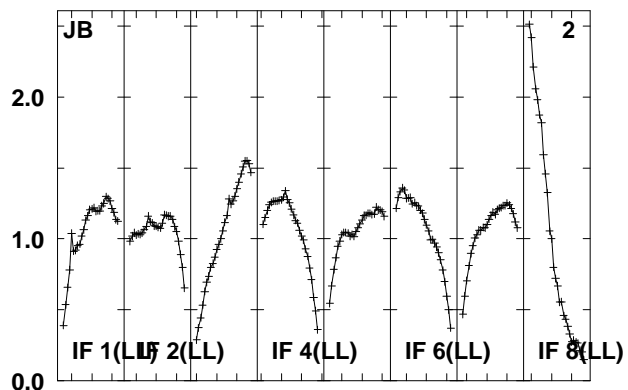
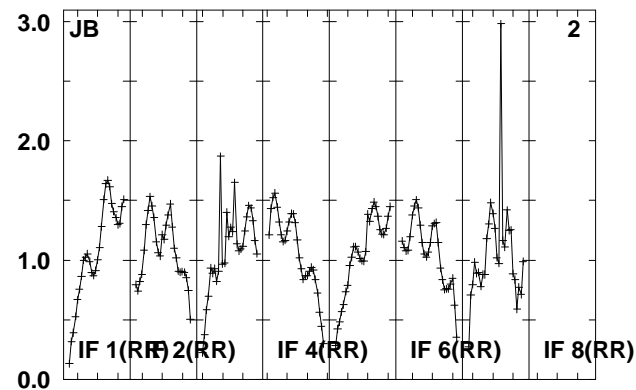
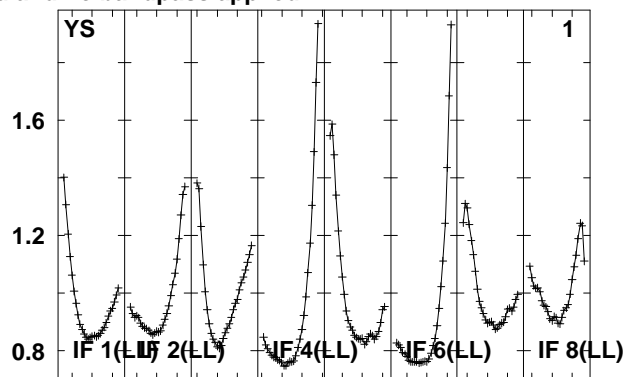
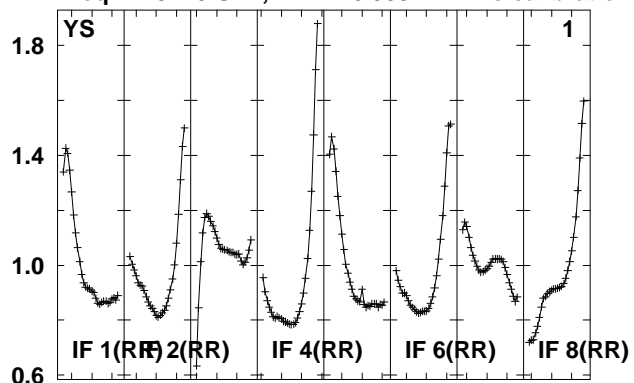

Lower frame: Real Jy
 Total-power spectrum Antenna: *
 Timerange: 00/15:49:32 to 00/15:54:30

Plot file version 454 created 14-MAY-2010 15:19:38

J080844 EO007.UVDATA.1

Freq = 4.9270 GHz, Bw = 16.000 MH No calibration applied and no bandpass applied

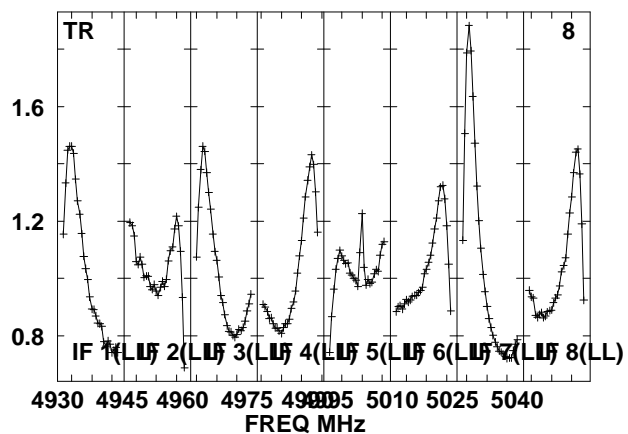
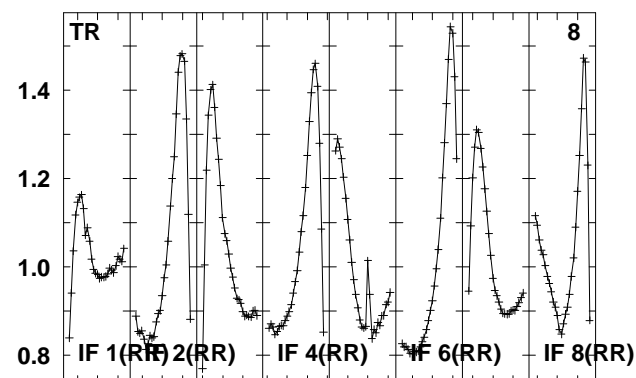
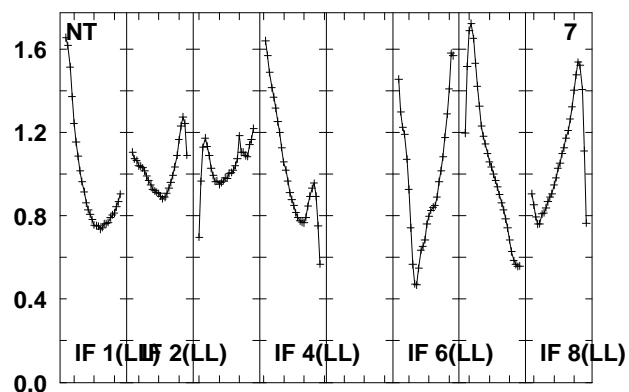
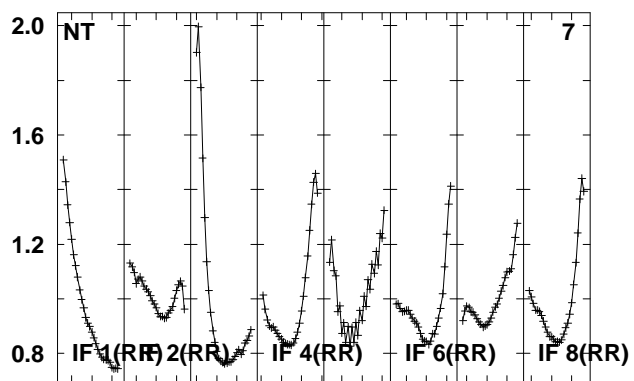
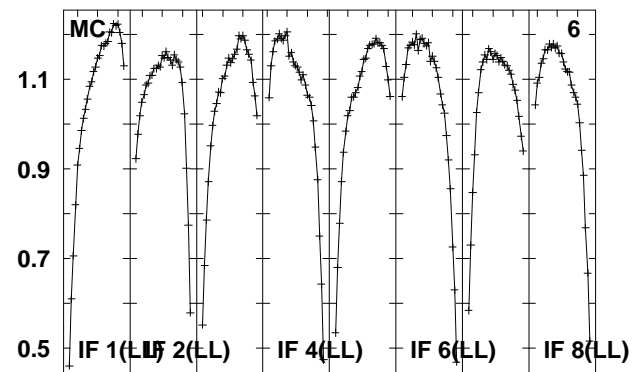
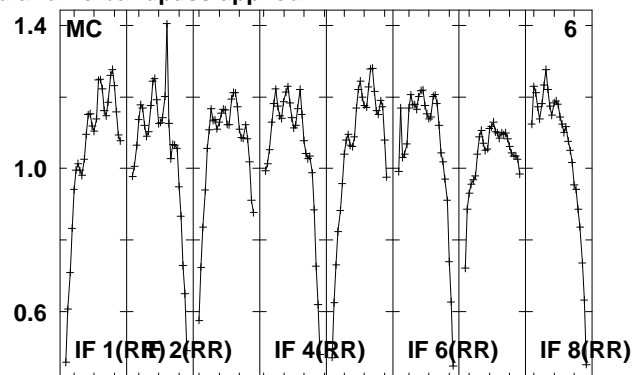
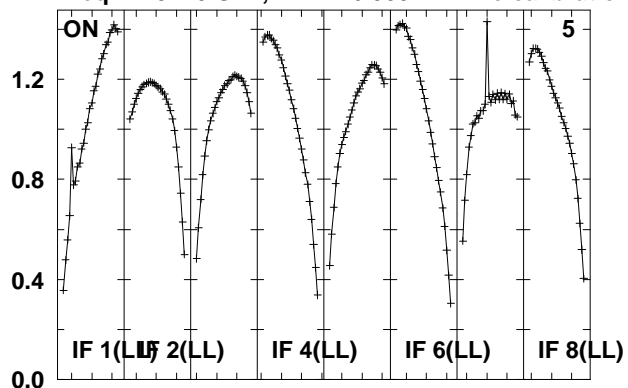

Lower frame: Real Jy

Total-power spectrum Antenna: *

Timerange: 00/15:49:32 to 00/15:54:30

Plot file version 455 created 14-MAY-2010 15:19:39
 J0808+40 EO07.UVDATA.1
 Freq = 4.9270 GHz, Bw = 16.000 MH No calibration applied and no bandpass applied

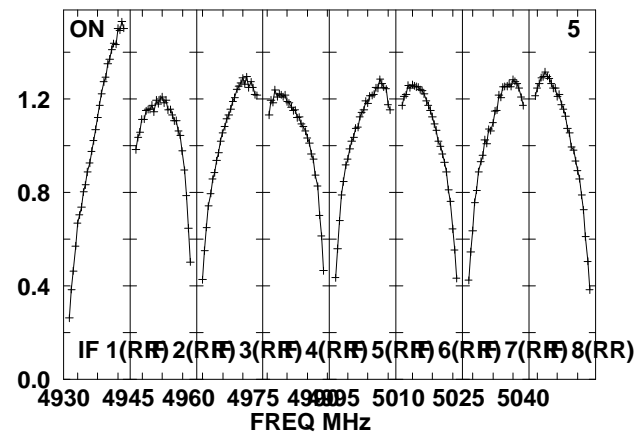
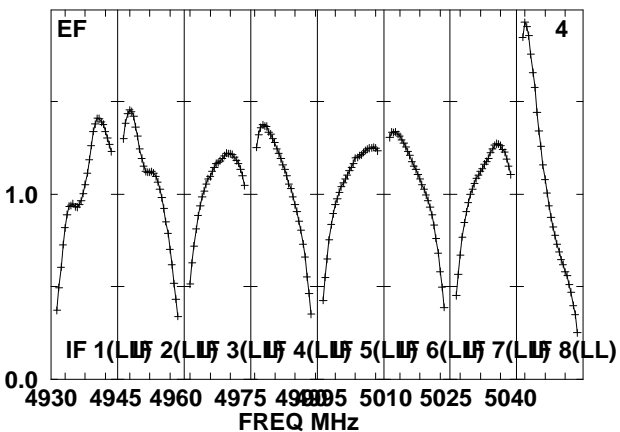
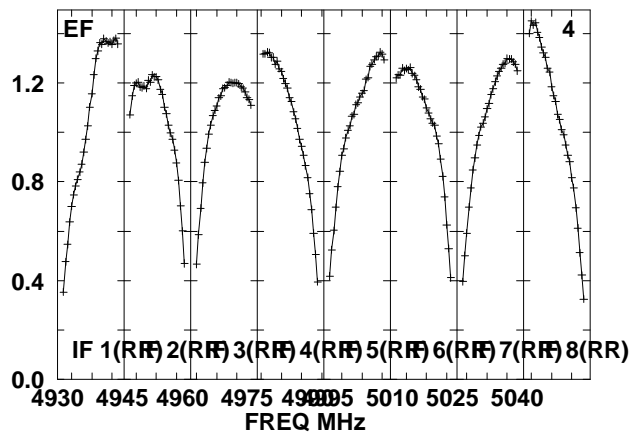
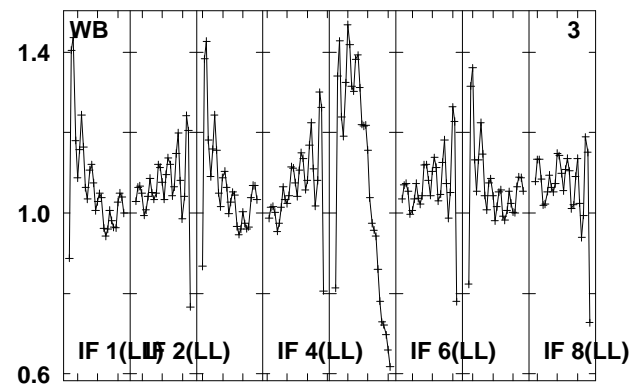
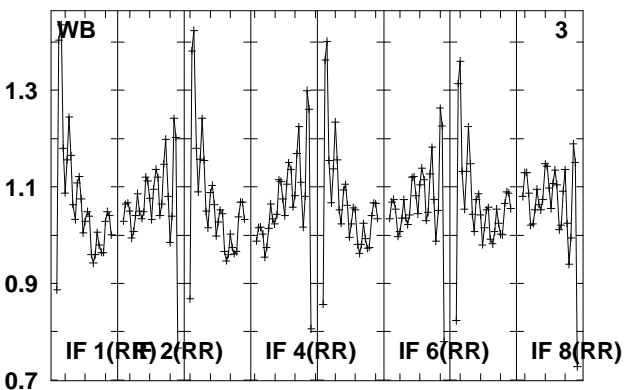
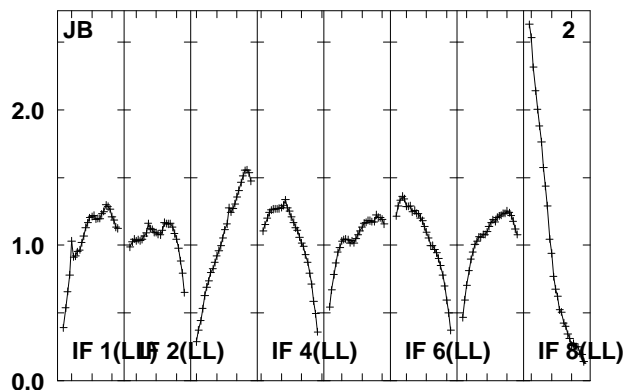
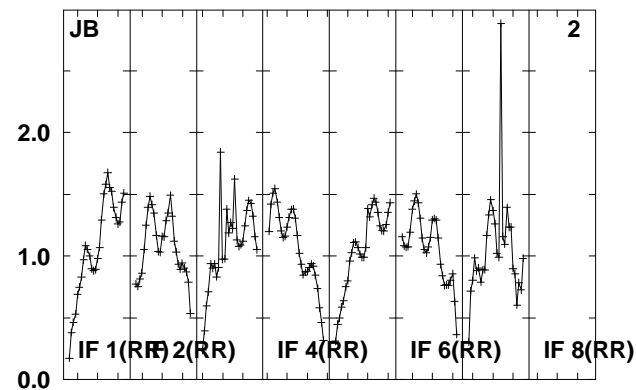
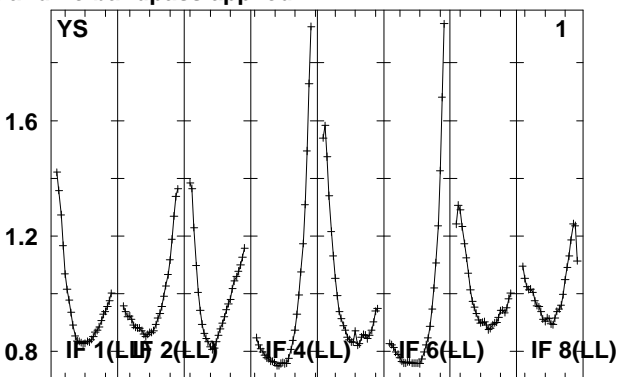
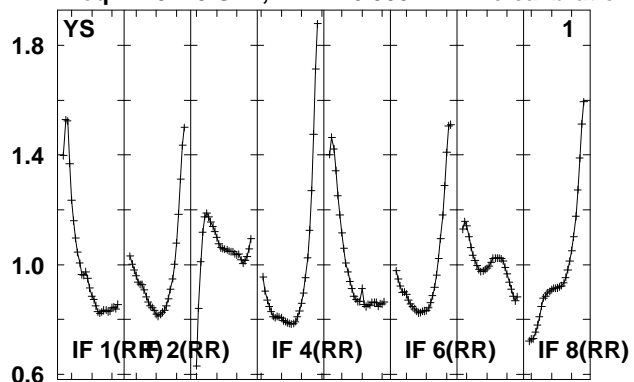

Lower frame: Real Jy
 Total-power spectrum Antenna: *
 Timerange: 00/15:54:58 to 00/15:56:22

Plot file version 456 created 14-MAY-2010 15:19:39

J0808+40 EO007.UVDATA.1

Freq = 4.9270 GHz, Bw = 16.000 MH No calibration applied and no bandpass applied

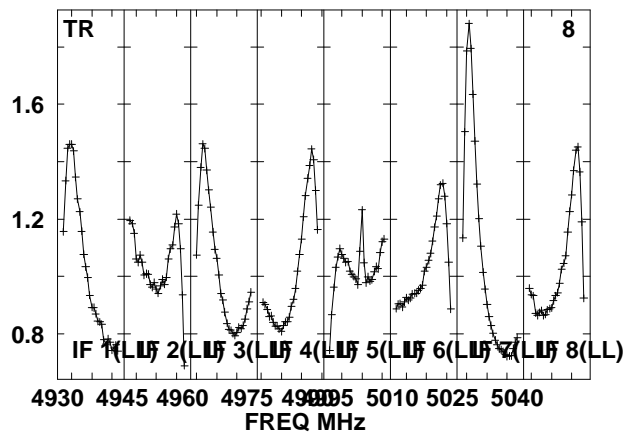
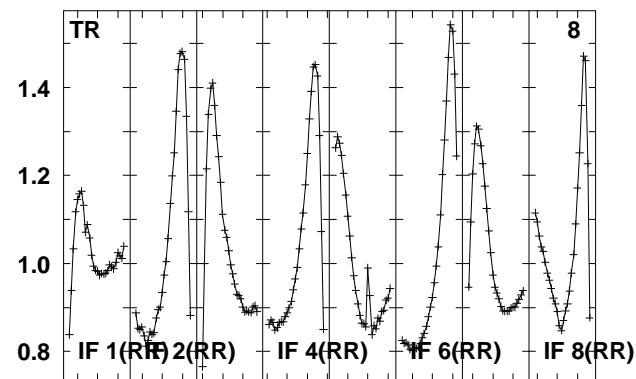
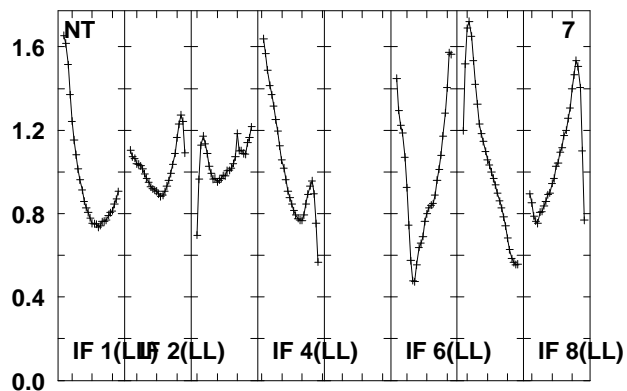
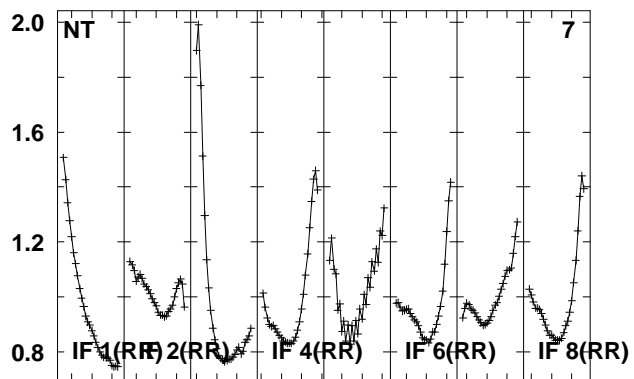
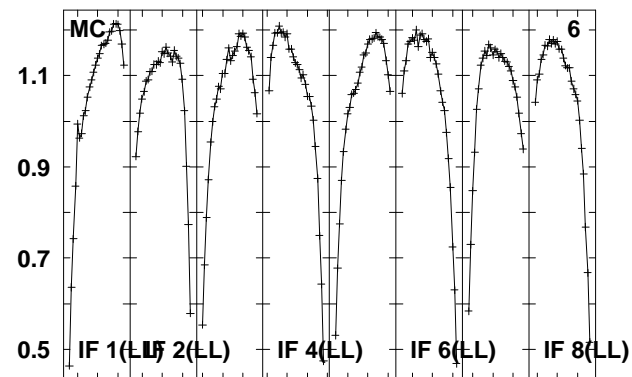
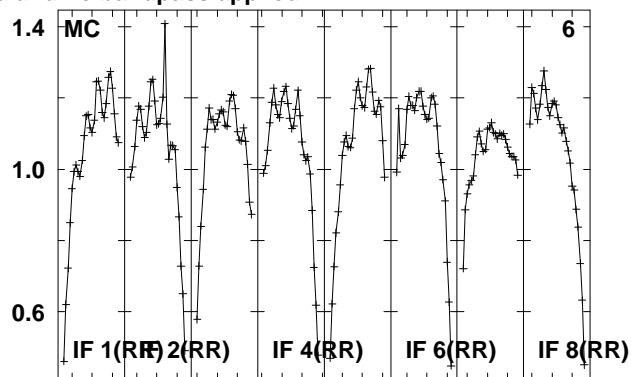
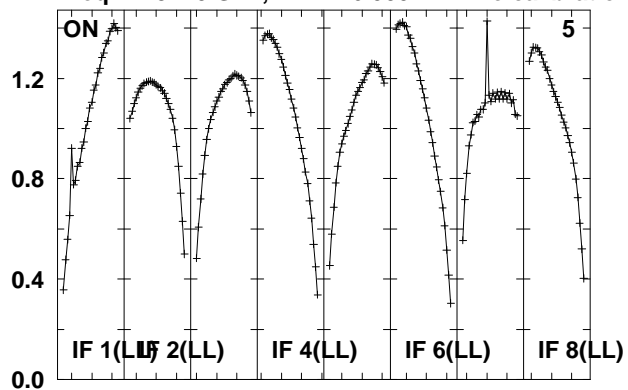

Lower frame: Real Jy

Total-power spectrum Antenna: *

Timerange: 00/15:54:58 to 00/15:56:22

Plot file version 457 created 14-MAY-2010 15:19:39

J080844 EO007.UVDATA.1

Freq = 4.9270 GHz, Bw = 16.000 MH No calibration applied and no bandpass applied

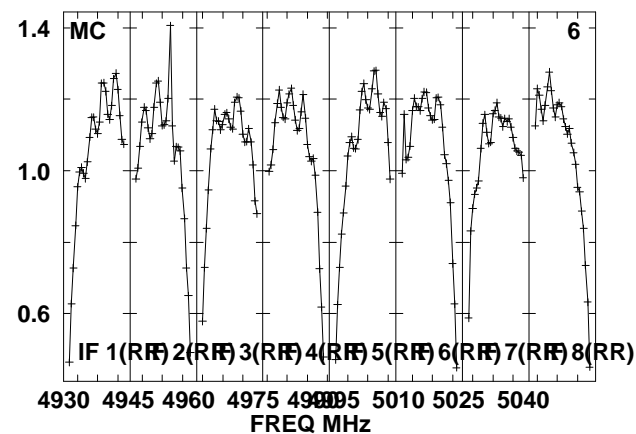
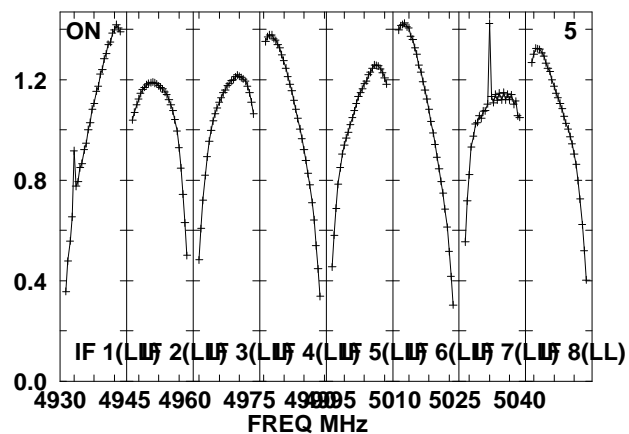
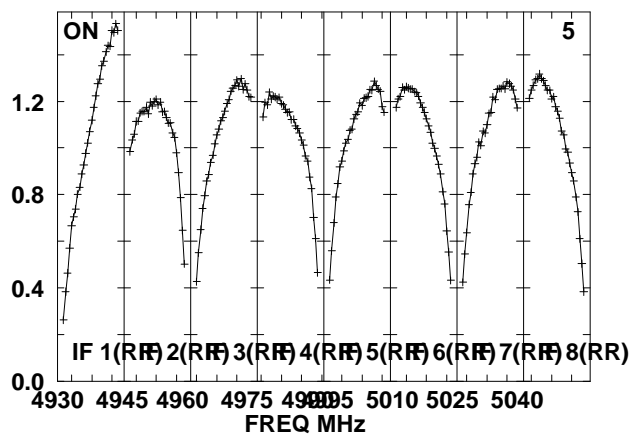
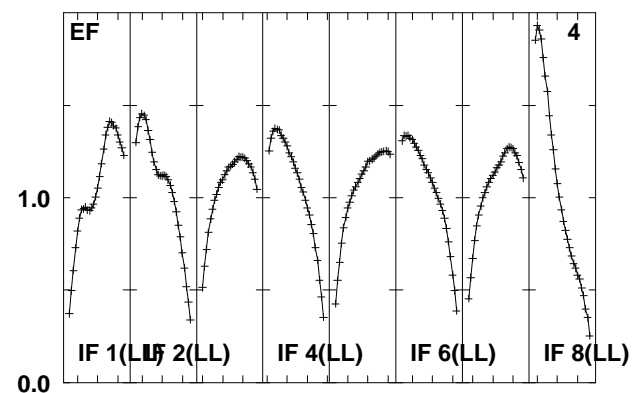
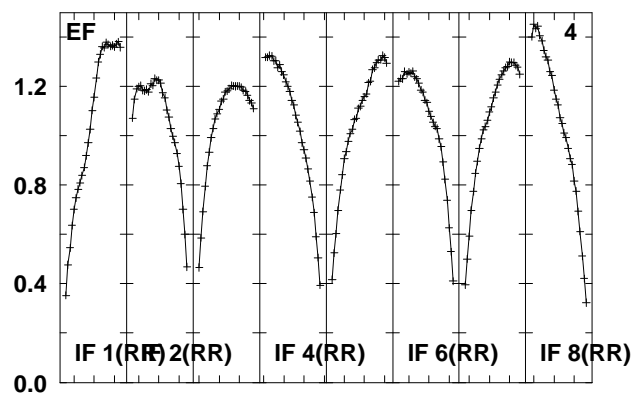
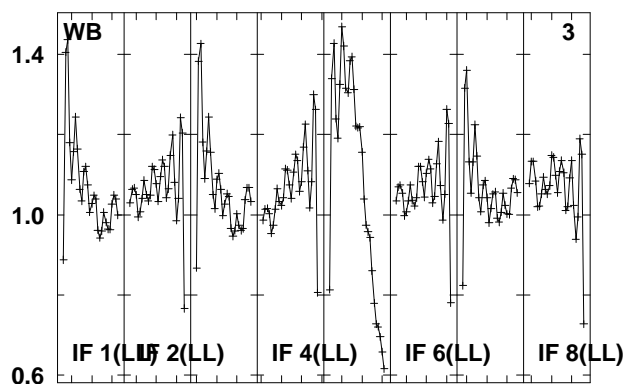
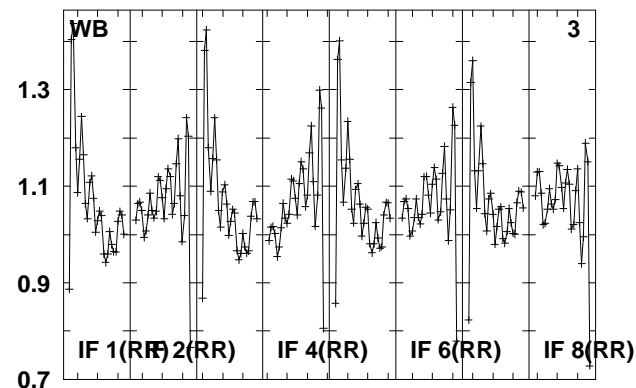
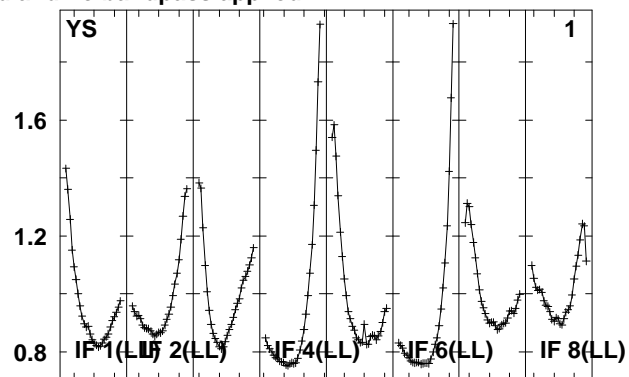
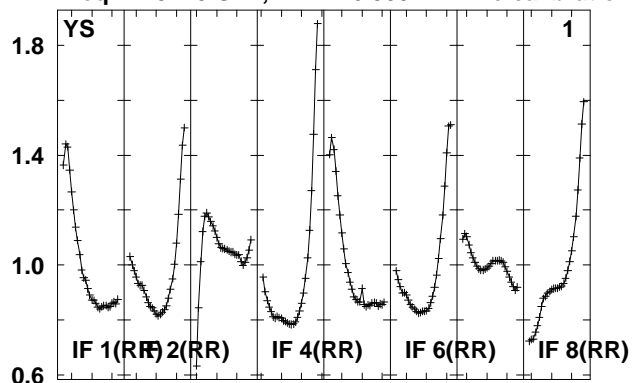

Lower frame: Real Jy

Total-power spectrum Antenna: *

Timerange: 00/15:56:53 to 00/16:01:51

Plot file version 458 created 14-MAY-2010 15:19:40

J080844 EO007.UVDATA.1

Freq = 4.9270 GHz, Bw = 16.000 MH No calibration applied and no bandpass applied

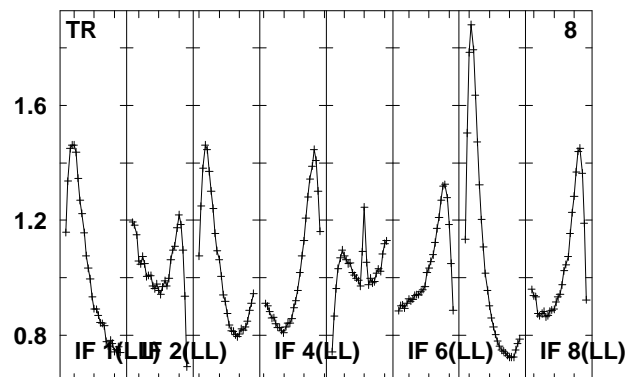
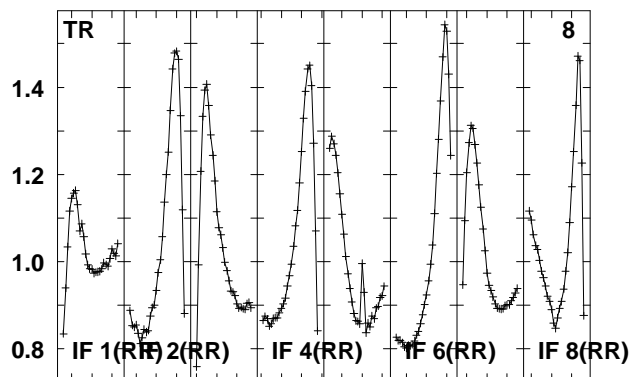
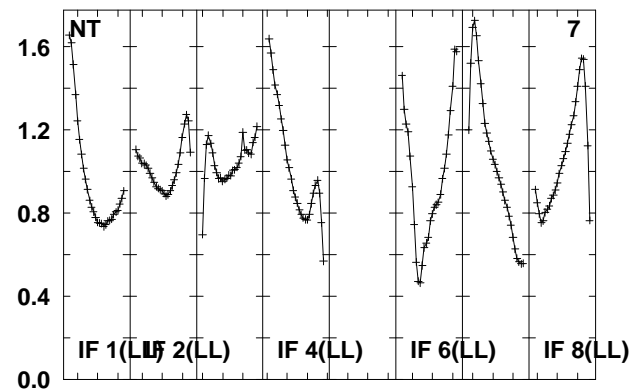
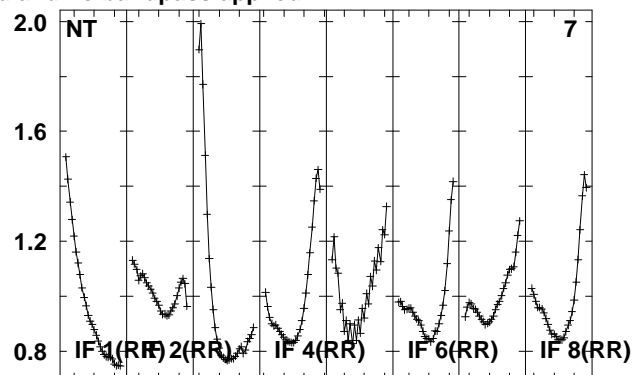
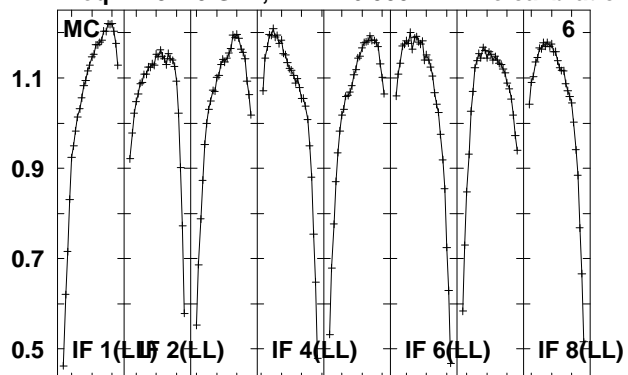

Lower frame: Real Jy
Total-power spectrum Antenna: *
Timerange: 00/15:56:53 to 00/16:01:51

Plot file version 459 created 14-MAY-2010 15:19:40

J0808+40 EO007.UVDATA.1

Freq = 4.9270 GHz, Bw = 16.000 MH No calibration applied and no bandpass applied

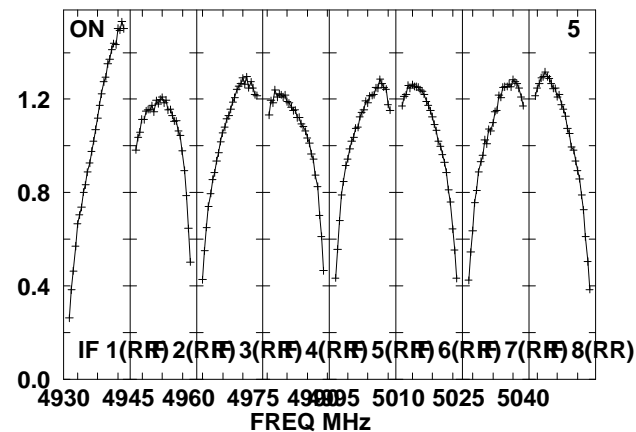
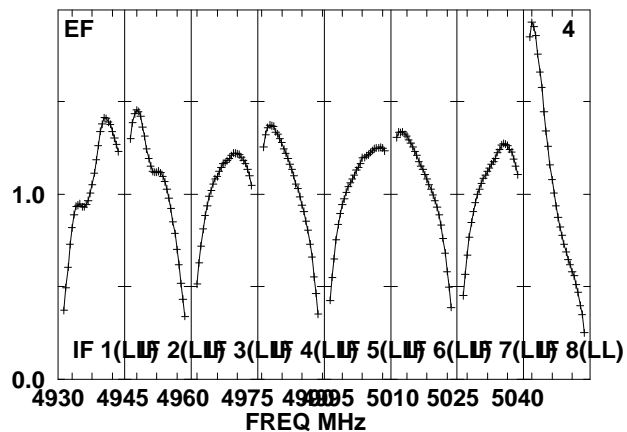
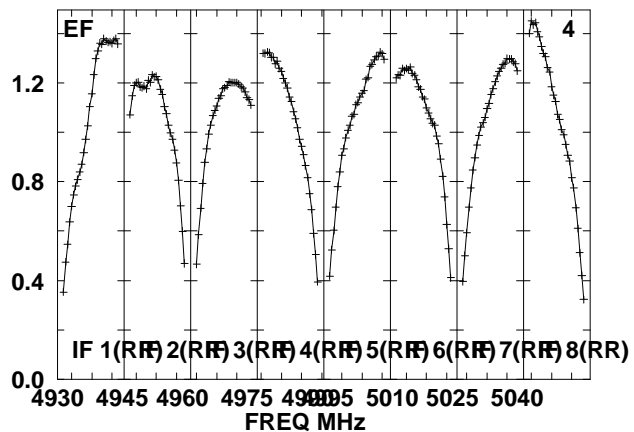
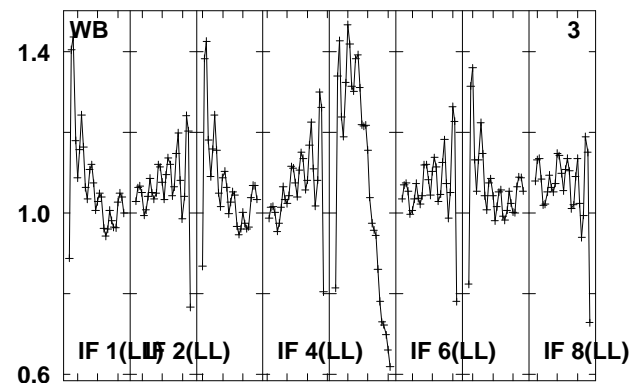
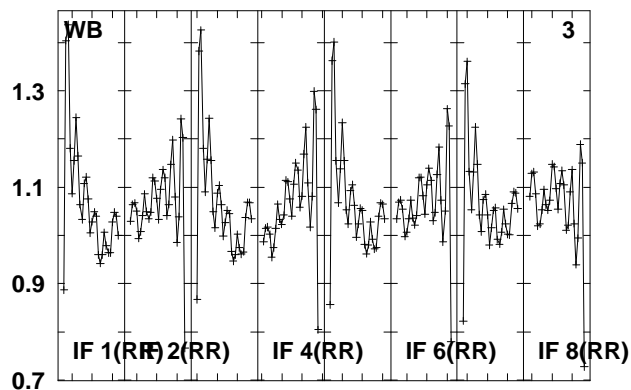
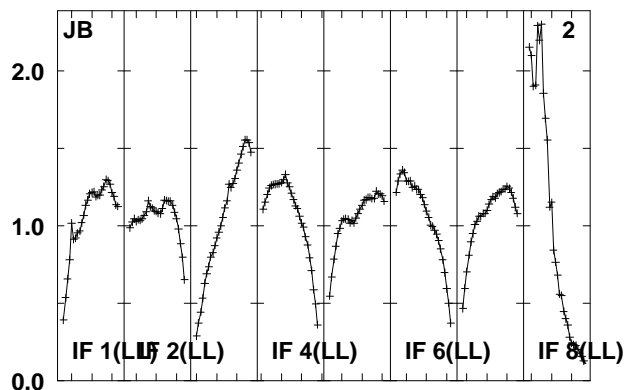
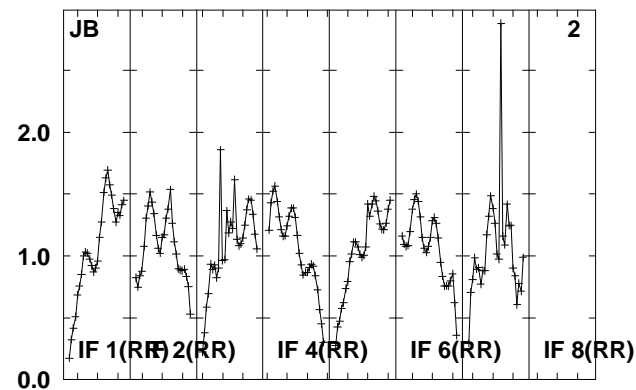
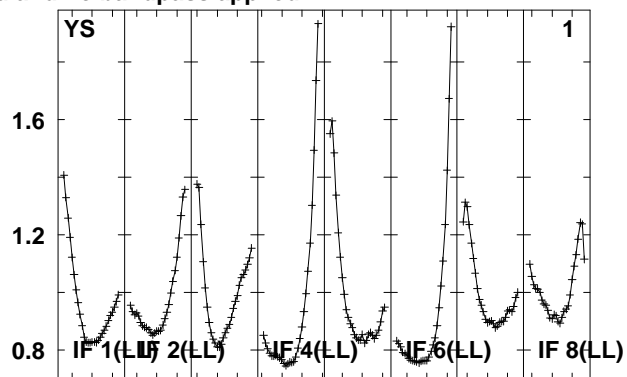
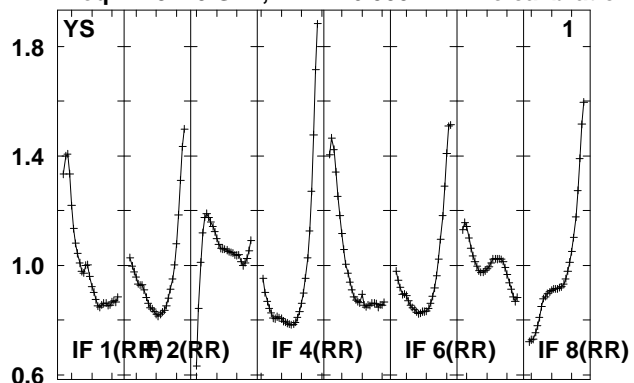

Lower frame: Real Jy

Total-power spectrum Antenna: *

Timerange: 00/16:02:18 to 00/16:03:46

Plot file version 460 created 14-MAY-2010 15:19:40

J0808+40 EO007.UVDATA.1

Freq = 4.9270 GHz, Bw = 16.000 MH No calibration applied and no bandpass applied

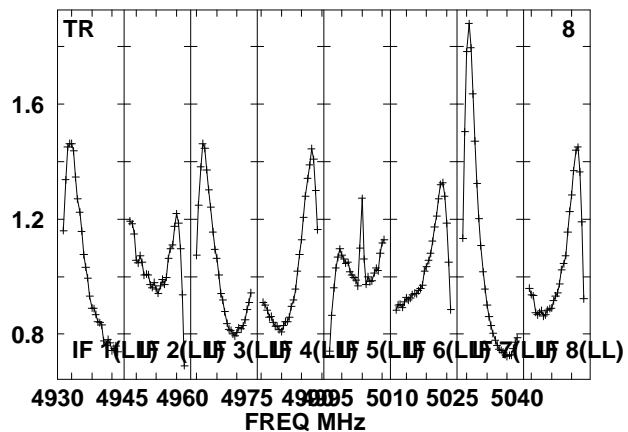
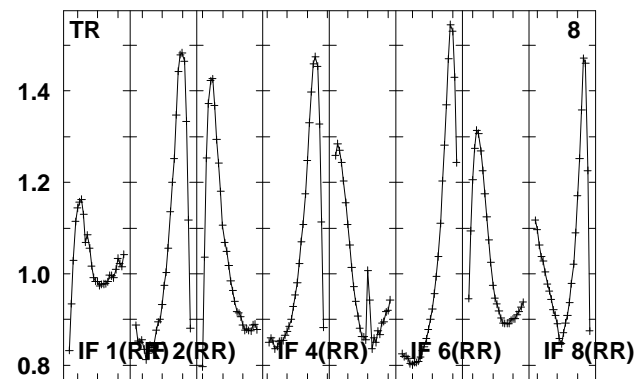
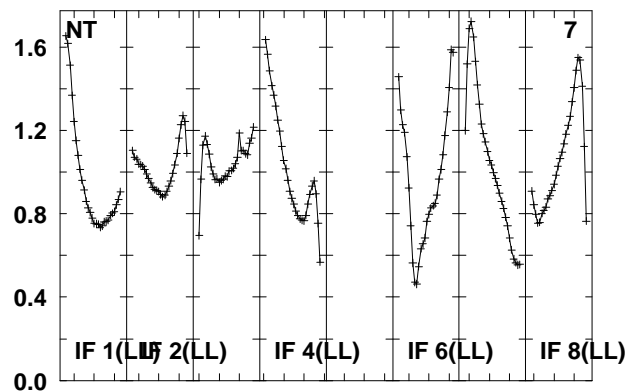
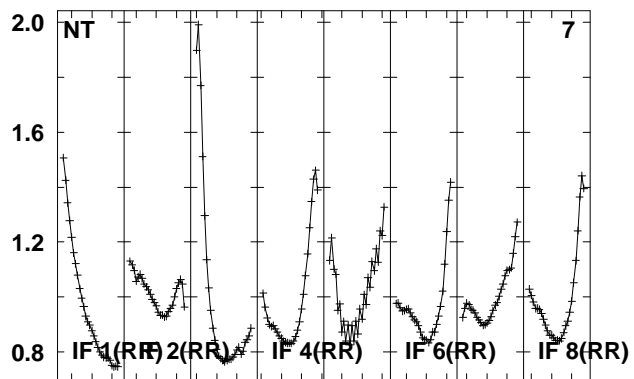
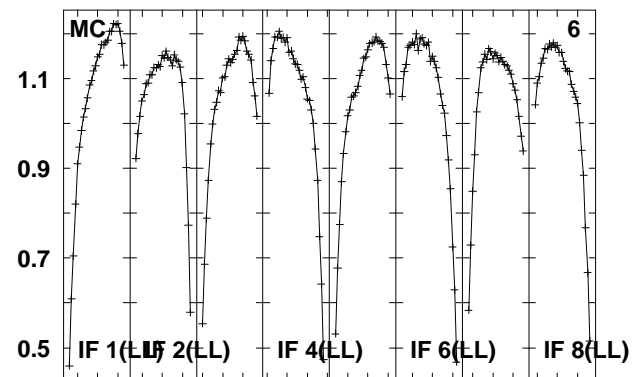
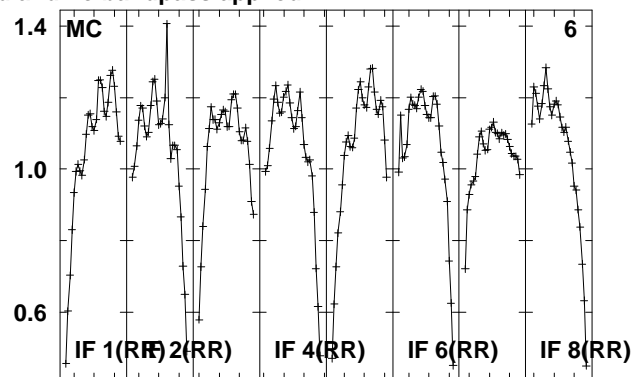
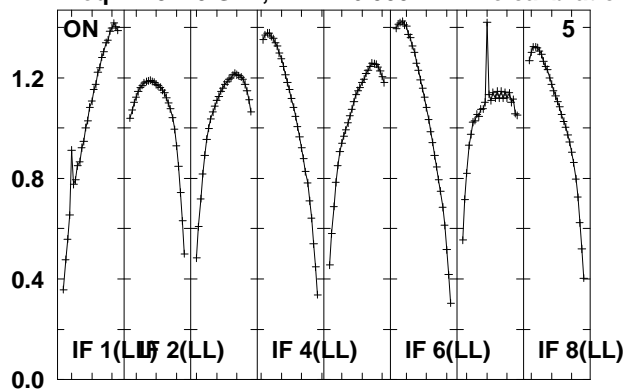

Lower frame: Real Jy

Total-power spectrum Antenna: *

Timerange: 00/16:02:18 to 00/16:03:46

Plot file version 461 created 14-MAY-2010 15:19:40

J0808+49 EO007.UVDATA.1

Freq = 4.9270 GHz, Bw = 16.000 MH No calibration applied and no bandpass applied

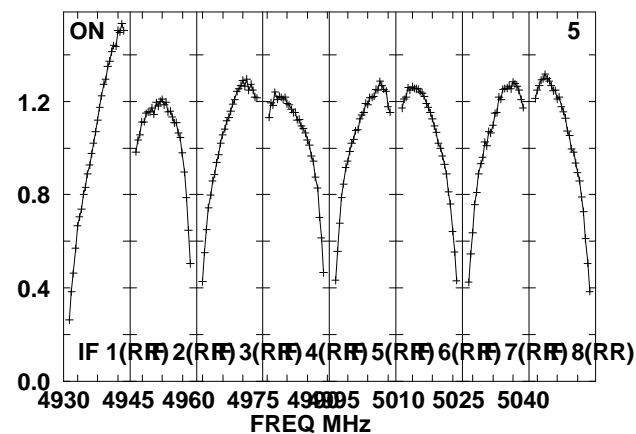
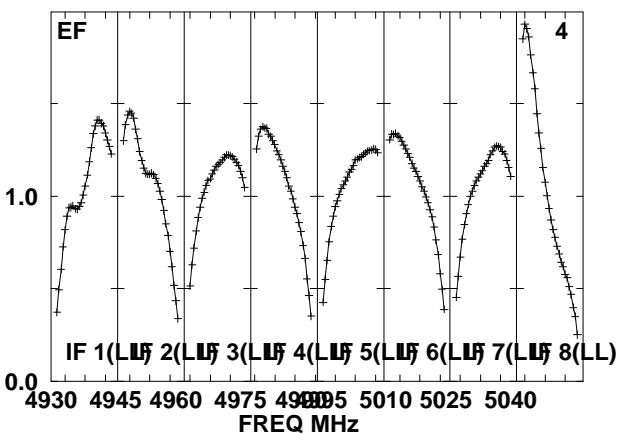
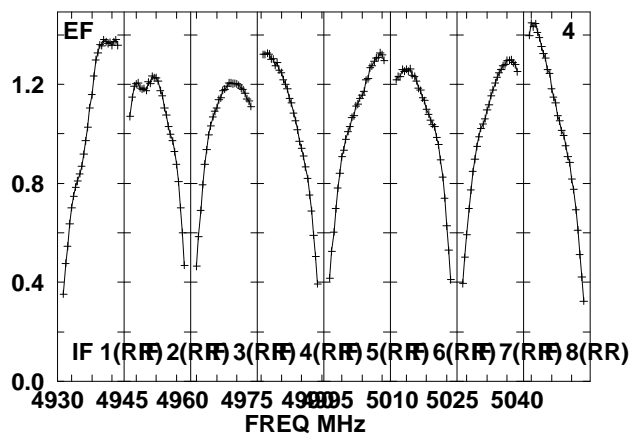
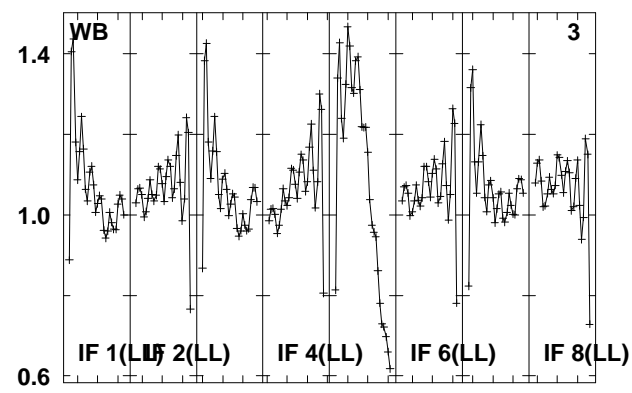
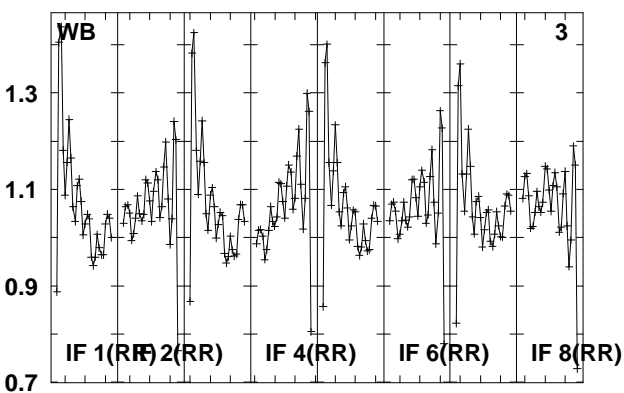
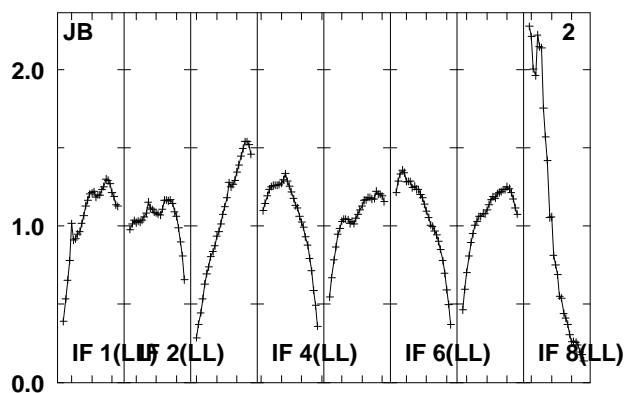
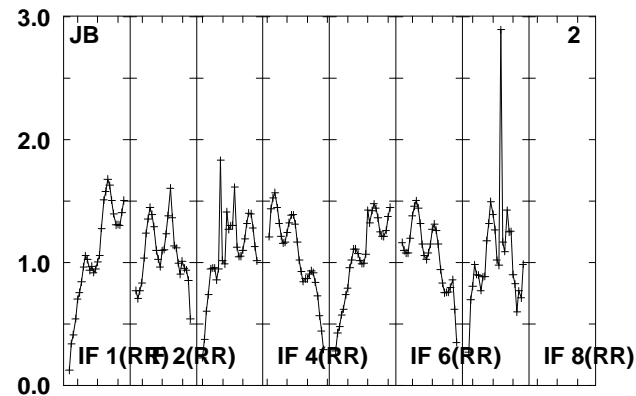
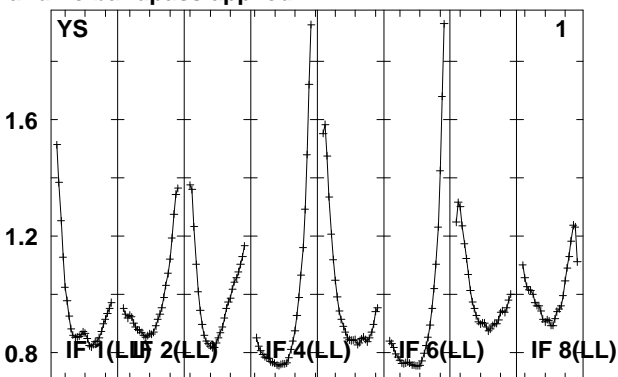
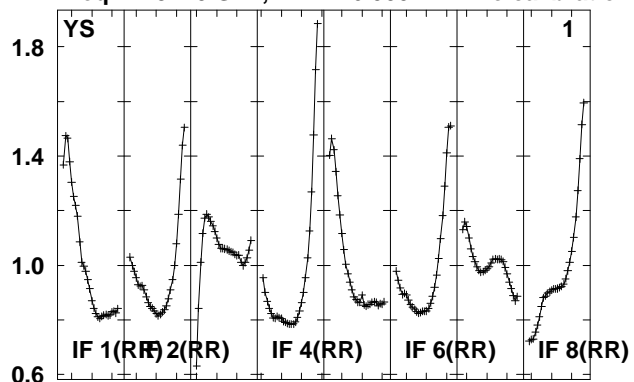

Lower frame: Real Jy
Total-power spectrum Antenna: *
Timerange: 00/16:04:50 to 00/16:06:16

Plot file version 462 created 14-MAY-2010 15:19:41

J0808+49 EO007.UVDATA.1

Freq = 4.9270 GHz, Bw = 16.000 MH No calibration applied and no bandpass applied

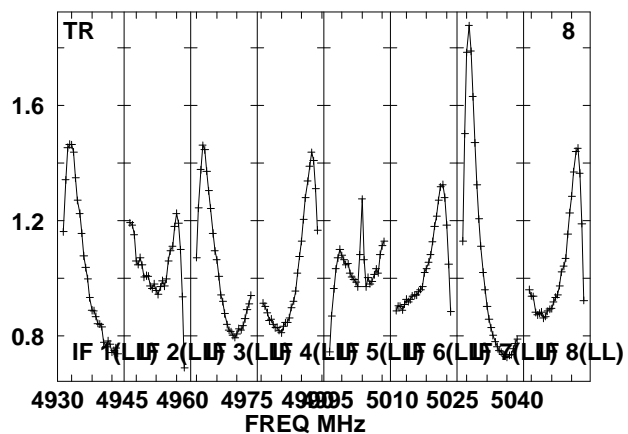
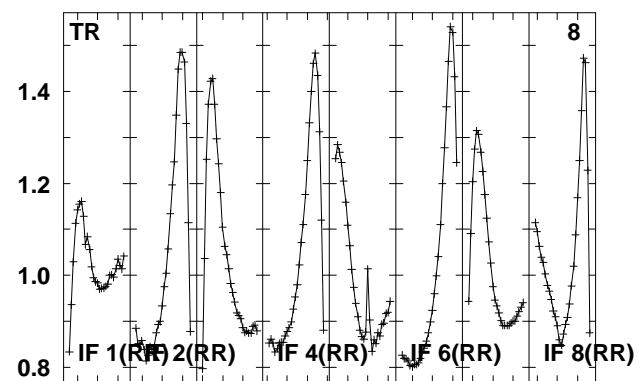
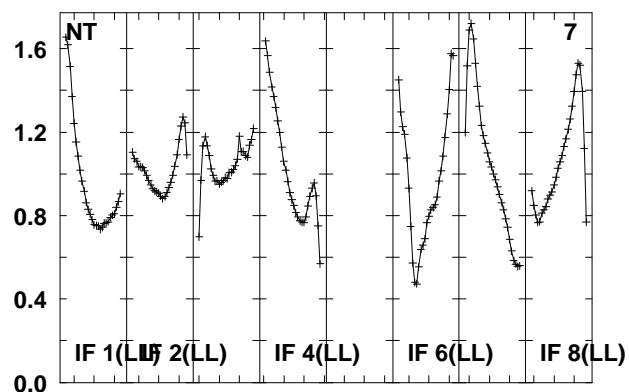
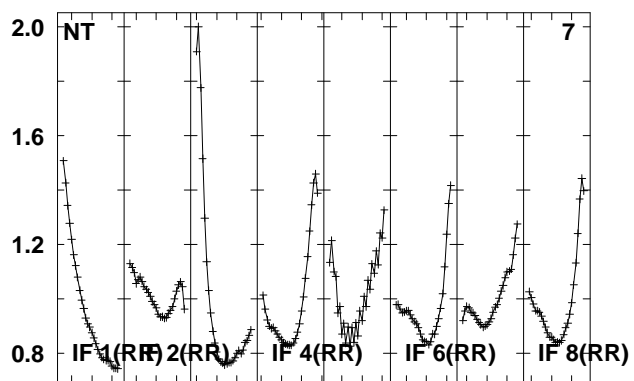
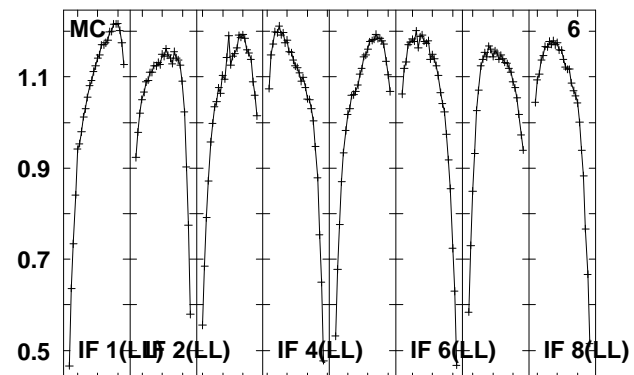
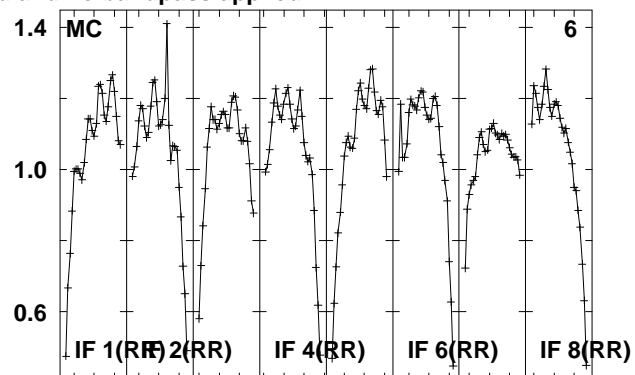
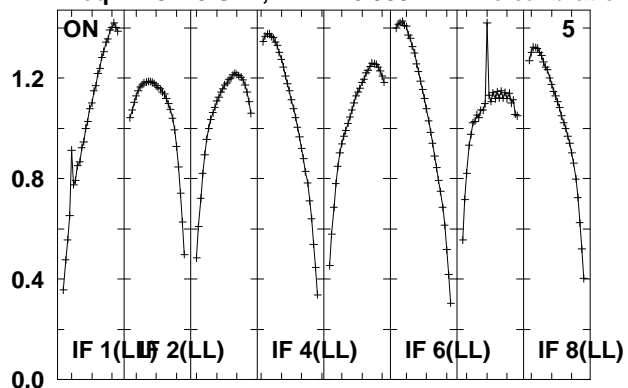

Lower frame: Real Jy

Total-power spectrum Antenna: *

Timerange: 00/16:04:50 to 00/16:06:16

Plot file version 463 created 14-MAY-2010 15:19:41
 J081523 EO007.UVDATA.1
 Freq = 4.9270 GHz, Bw = 16.000 MH No calibration applied and no bandpass applied

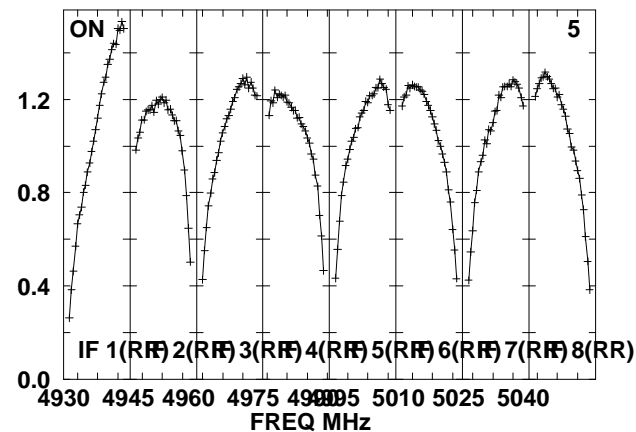
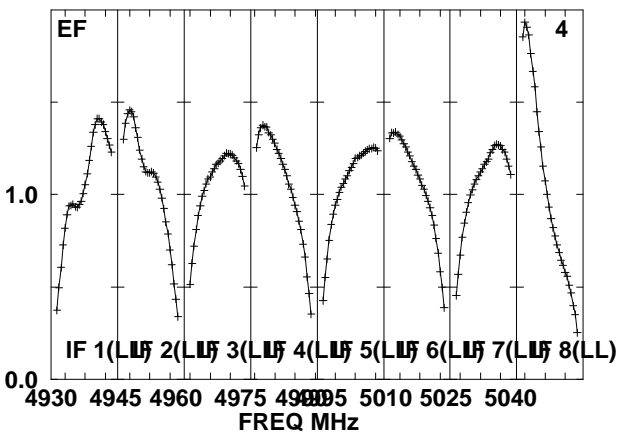
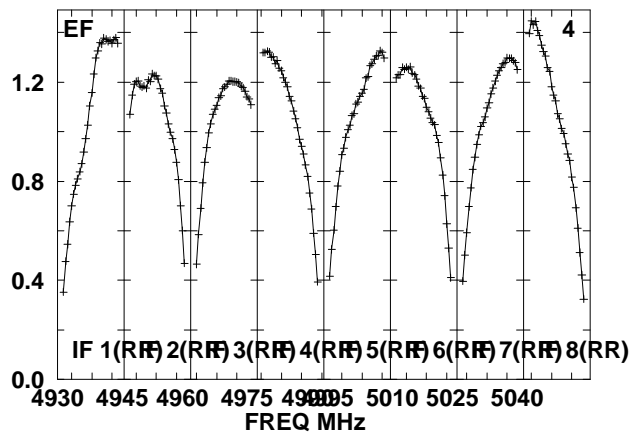
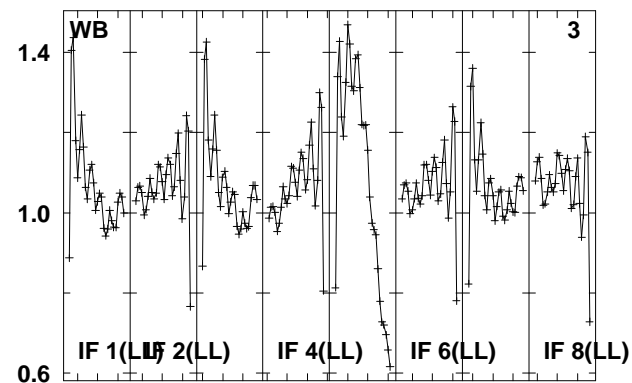
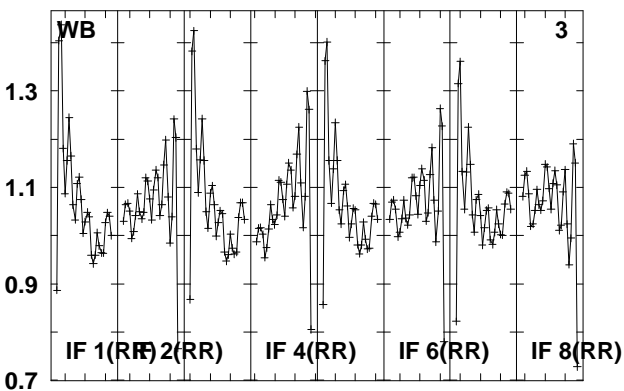
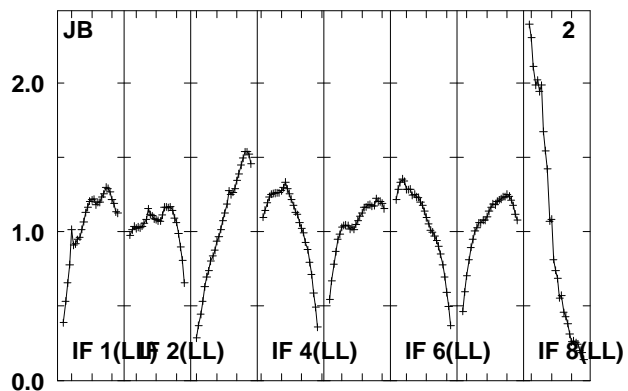
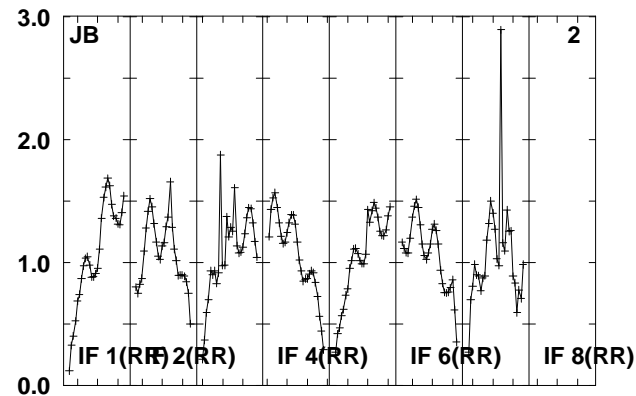
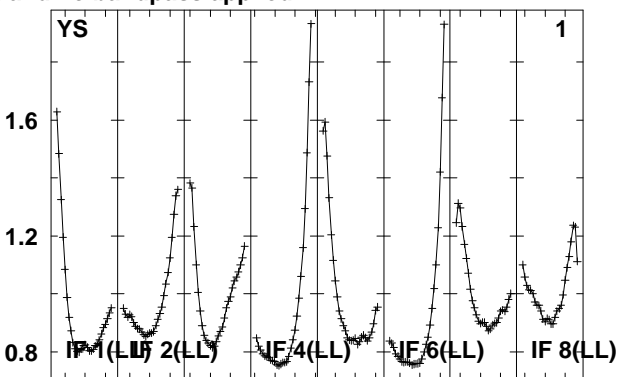
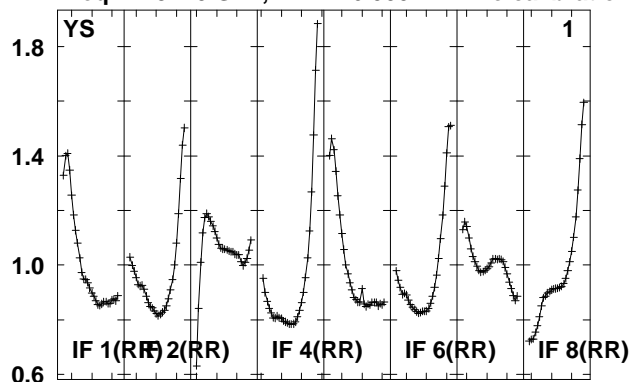

Lower frame: Real Jy
 Total-power spectrum Antenna: *
 Timerange: 00/16:06:42 to 00/16:11:42

Plot file version 464 created 14-MAY-2010 15:19:41

J081523 EO007.UVDATA.1

Freq = 4.9270 GHz, Bw = 16.000 MH No calibration applied and no bandpass applied

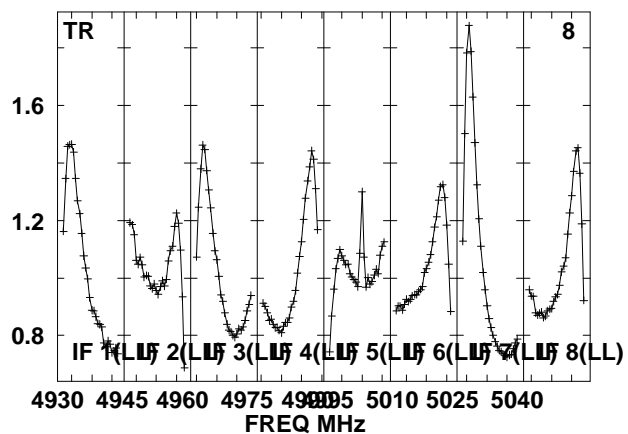
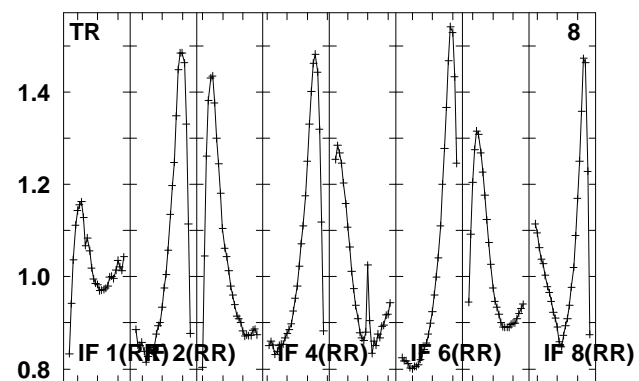
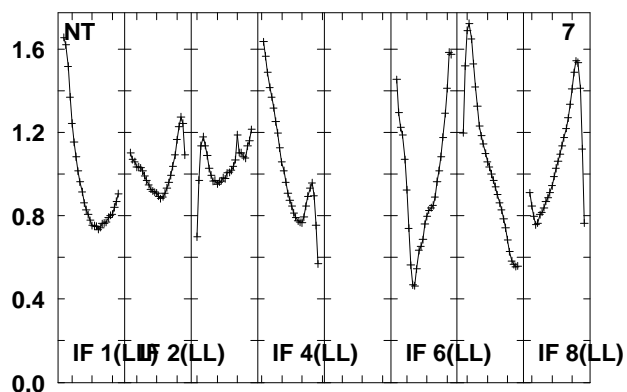
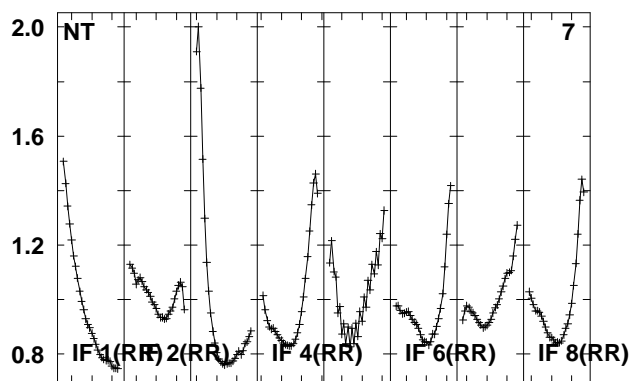
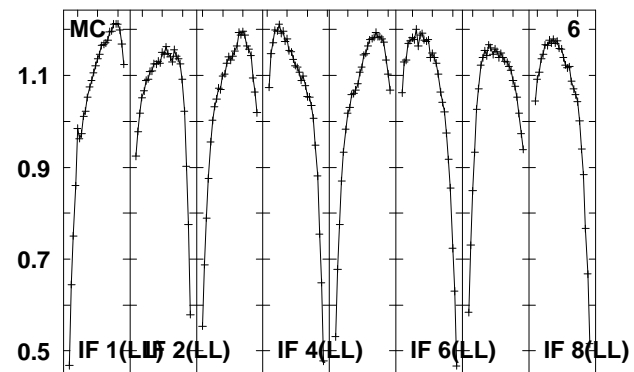
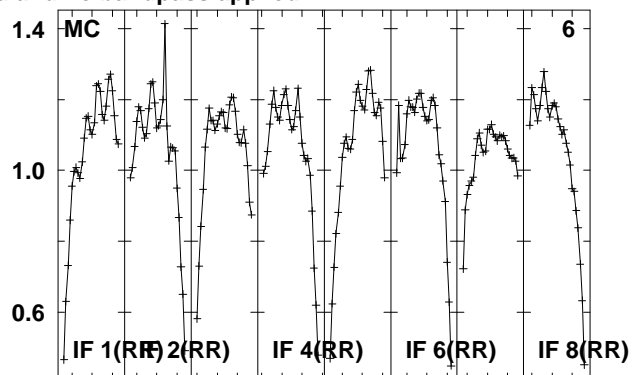
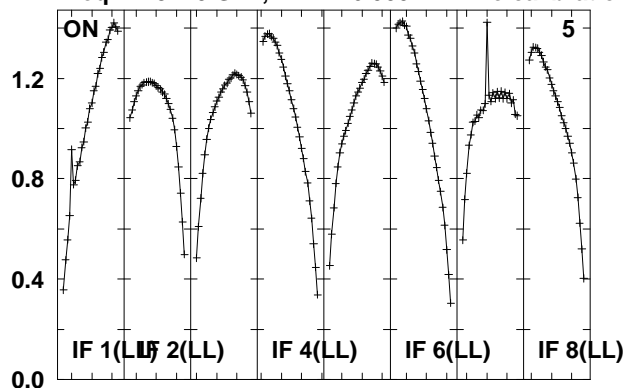

Lower frame: Real Jy

Total-power spectrum Antenna: *

Timerange: 00/16:06:42 to 00/16:11:42

Plot file version 465 created 14-MAY-2010 15:19:42

J0808+49 EO007.UVDATA.1

Freq = 4.9270 GHz, Bw = 16.000 MH No calibration applied and no bandpass applied

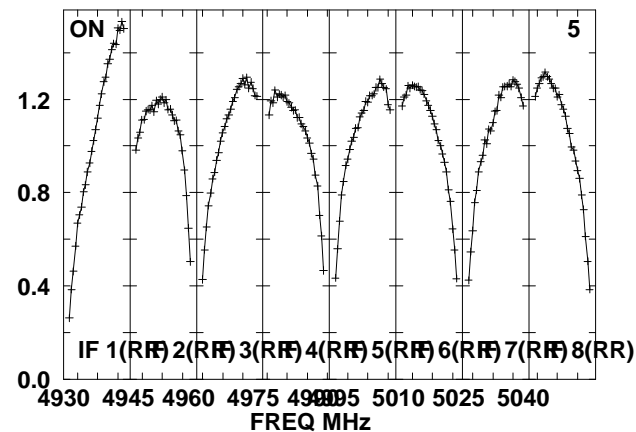
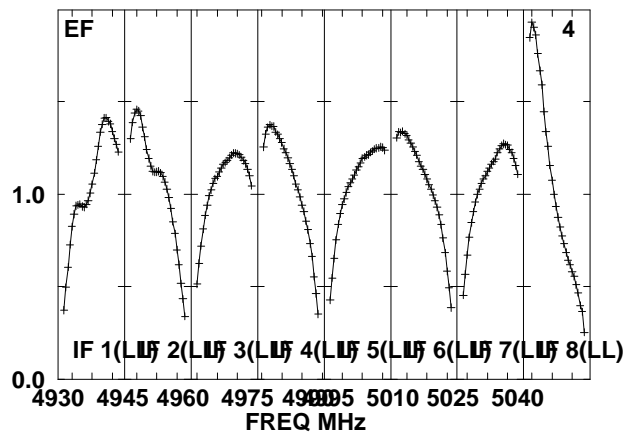
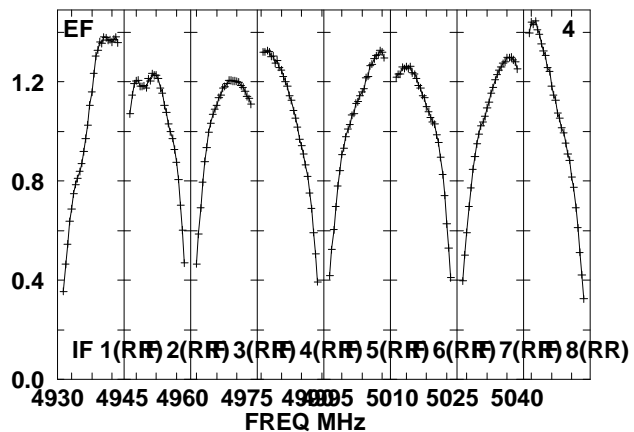
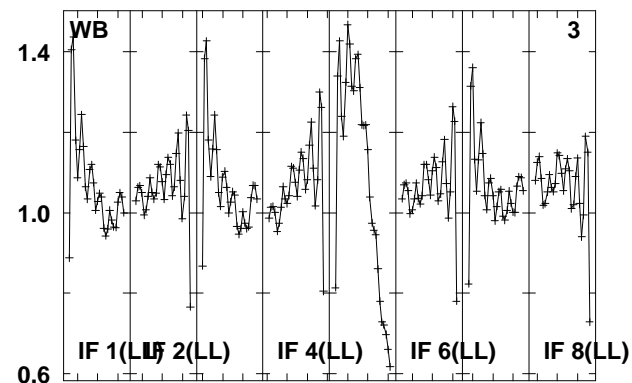
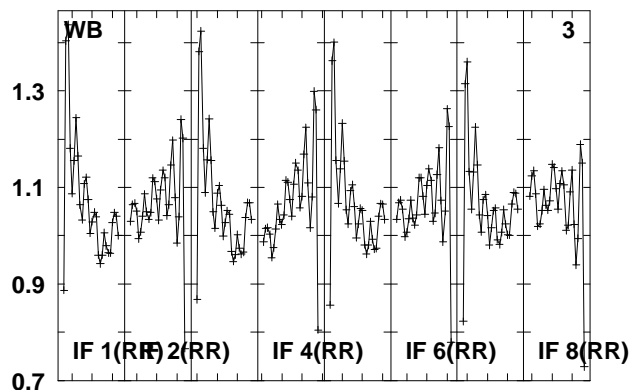
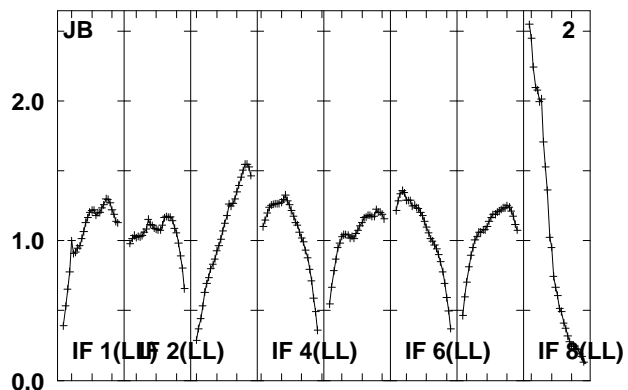
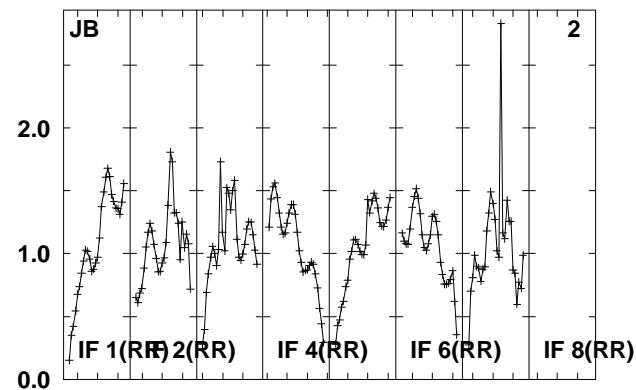
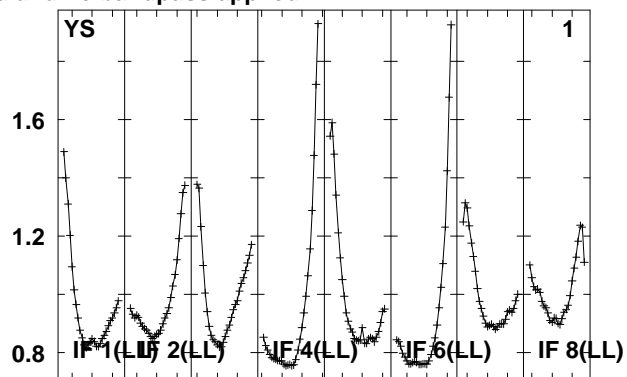
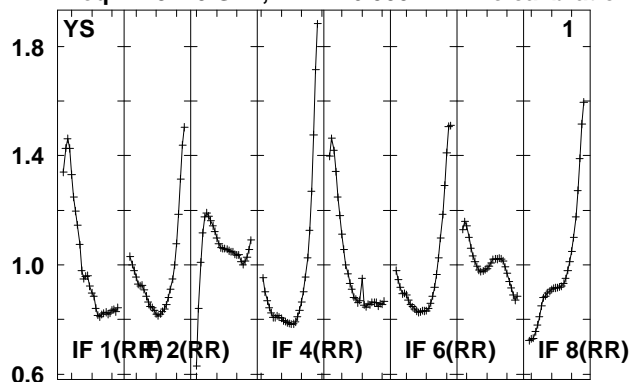

Lower frame: Real Jy

Total-power spectrum Antenna: *

Timerange: 00/16:12:06 to 00/16:13:34

Plot file version 466 created 14-MAY-2010 15:19:42

J0808+49 EO007.UVDATA.1

Freq = 4.9270 GHz, Bw = 16.000 MH No calibration applied and no bandpass applied

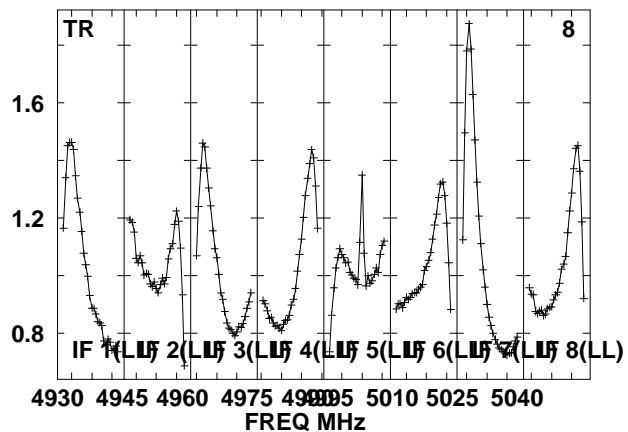
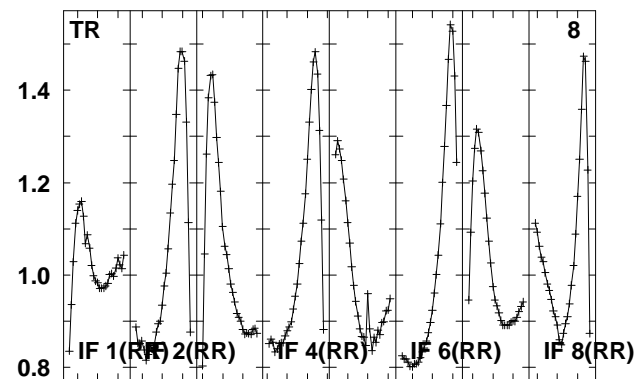
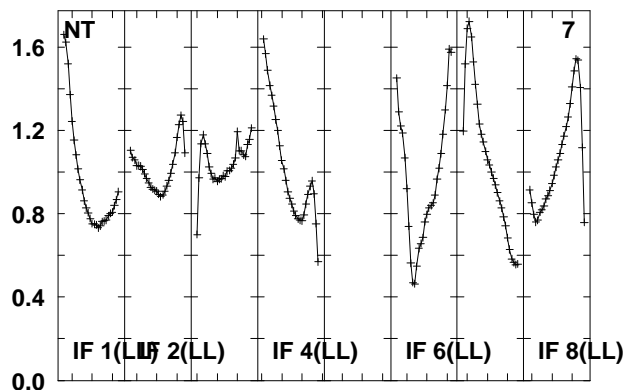
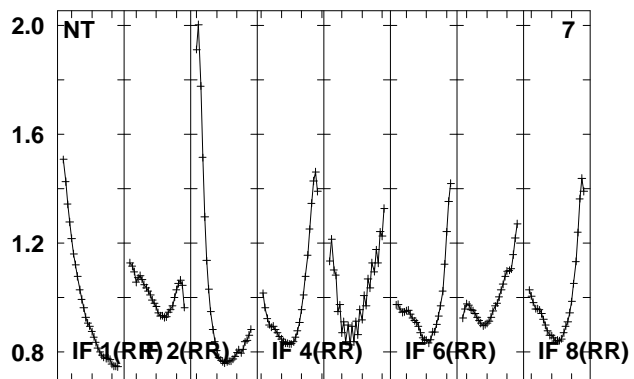
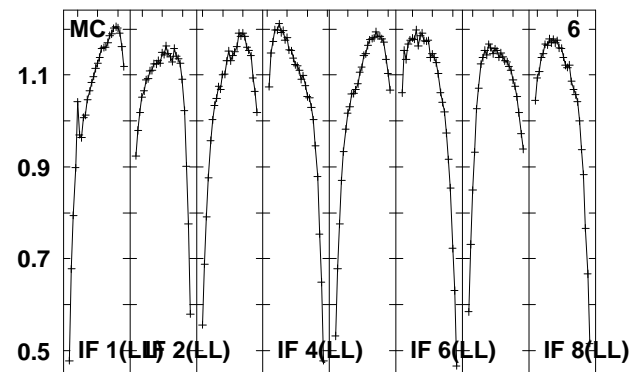
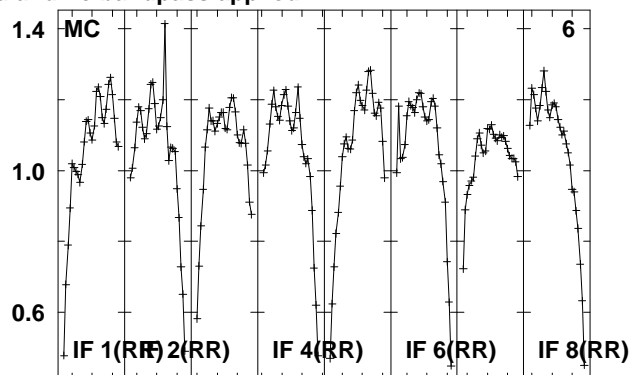
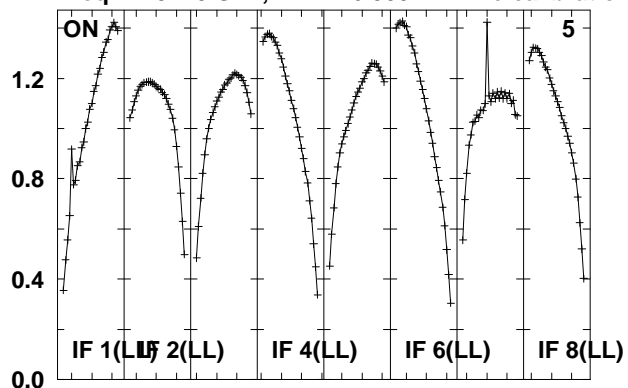

Lower frame: Real Jy

Total-power spectrum Antenna: *

Timerange: 00/16:12:06 to 00/16:13:34

Plot file version 467 created 14-MAY-2010 15:19:42
 J081523 EO007.UVDATA.1
 Freq = 4.9270 GHz, Bw = 16.000 MH No calibration applied and no bandpass applied

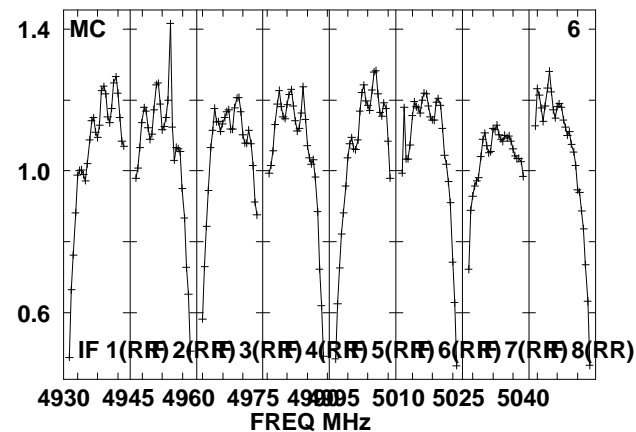
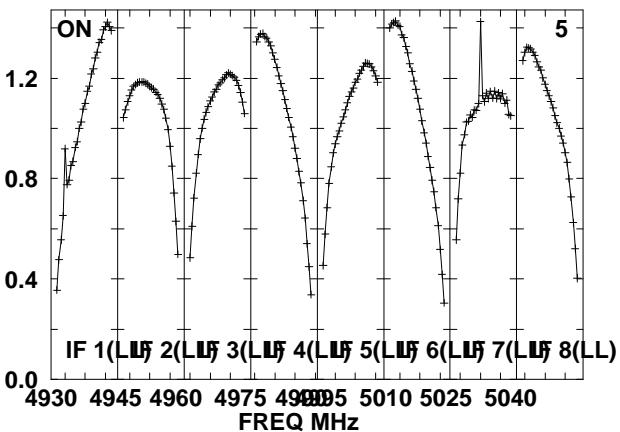
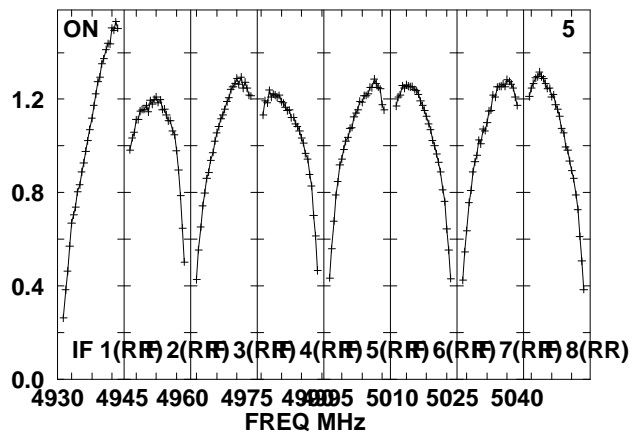
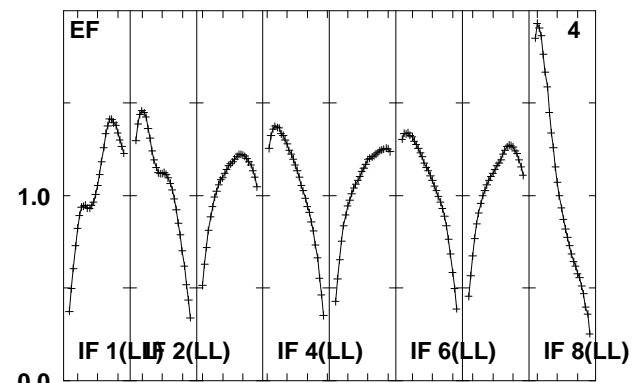
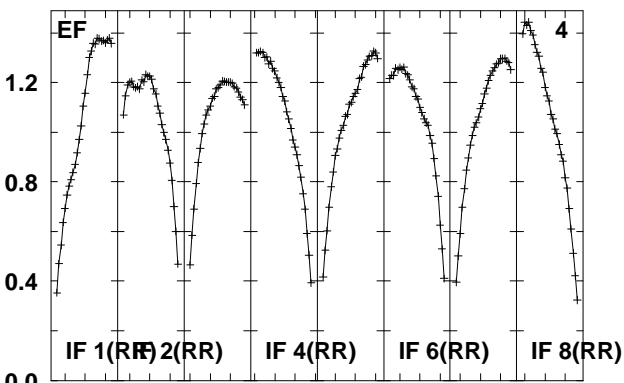
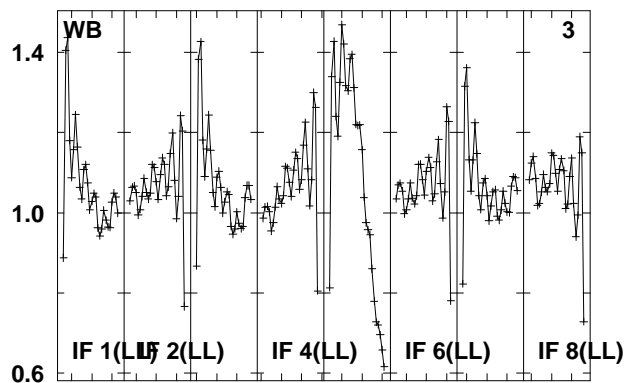
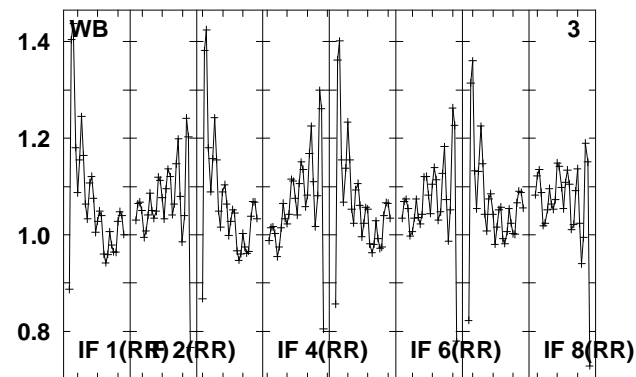
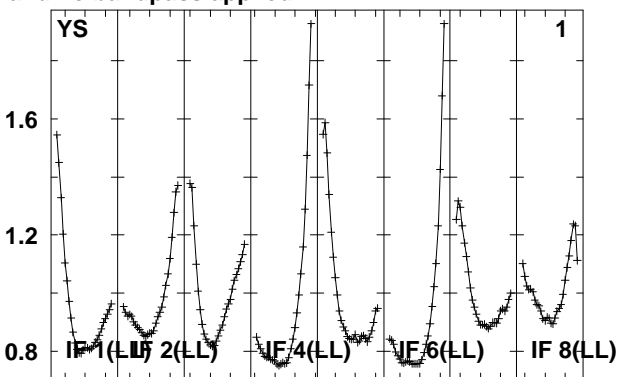
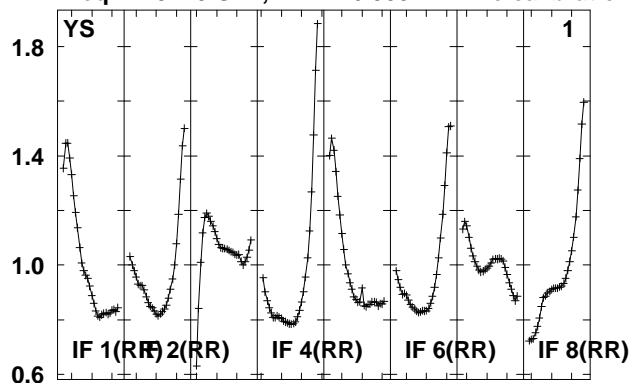

Lower frame: Real Jy
 Total-power spectrum Antenna: *
 Timerange: 00/16:14:02 to 00/16:18:58

Plot file version 468 created 14-MAY-2010 15:19:43

J081523 EO007.UVDATA.1

Freq = 4.9270 GHz, Bw = 16.000 MH No calibration applied and no bandpass applied

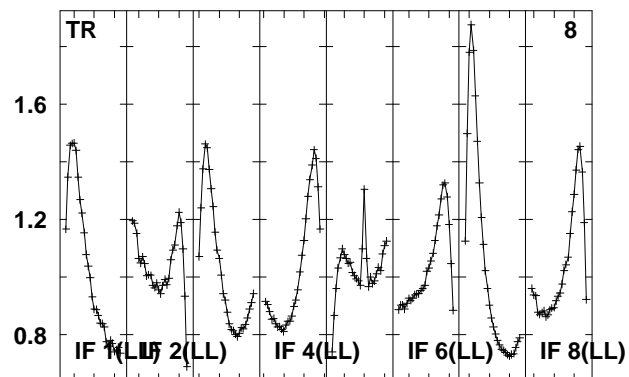
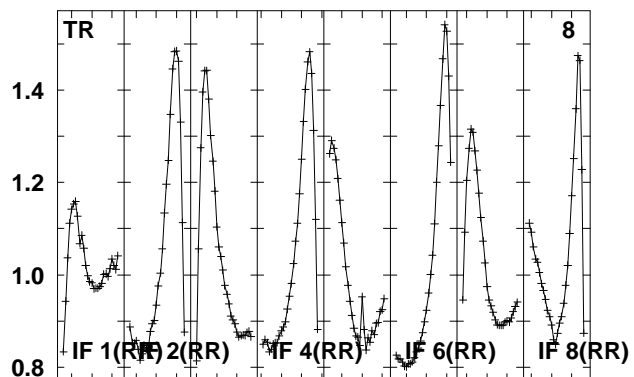
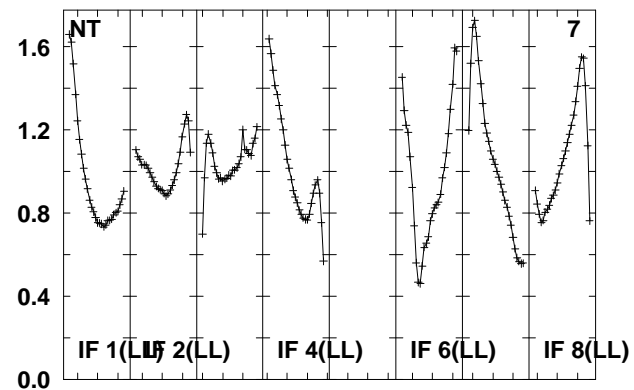
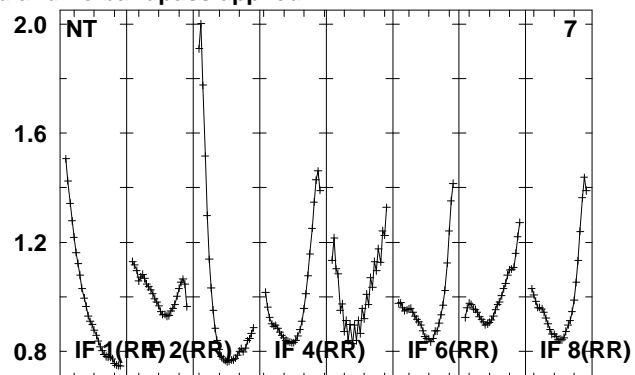
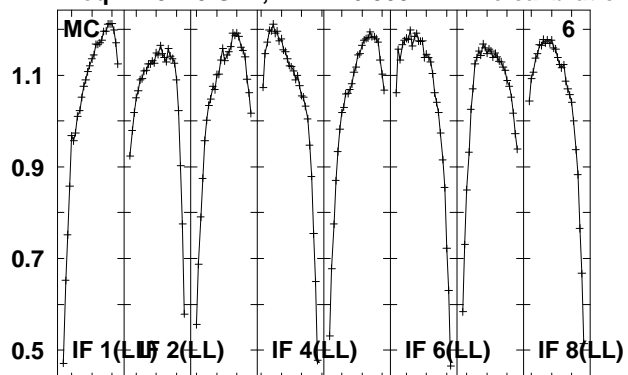

Lower frame: Real Jy
Total-power spectrum Antenna: *
Timerange: 00/16:14:02 to 00/16:18:58

Plot file version 469 created 14-MAY-2010 15:19:43

J0808+49 EO007.UVDATA.1

Freq = 4.9270 GHz, Bw = 16.000 MH No calibration applied and no bandpass applied

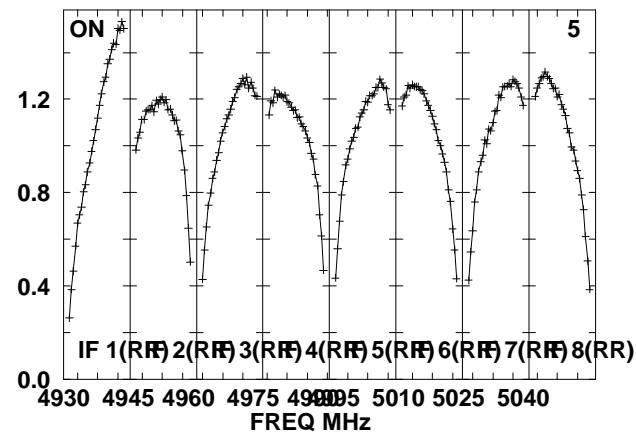
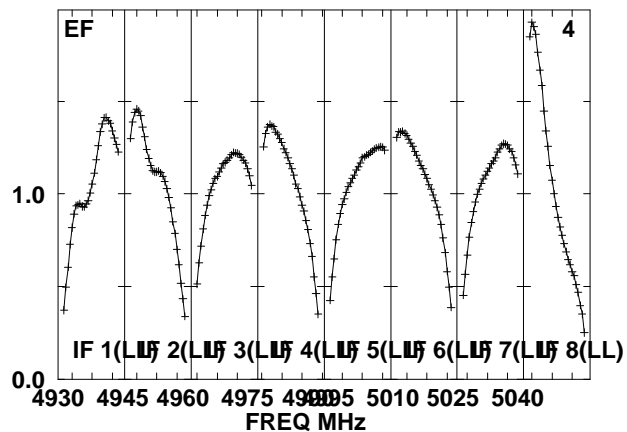
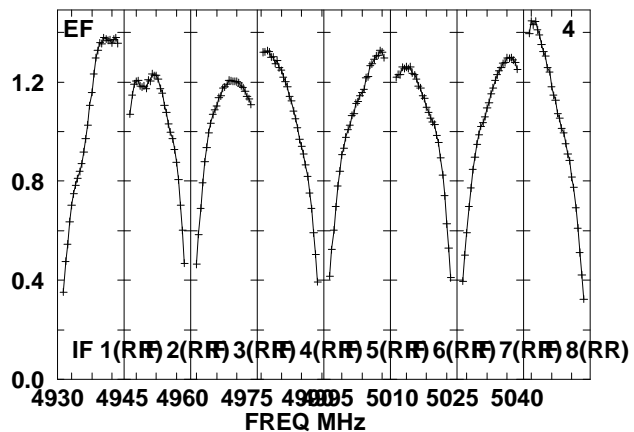
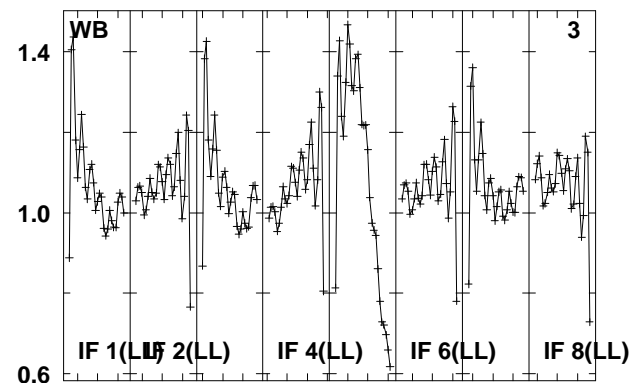
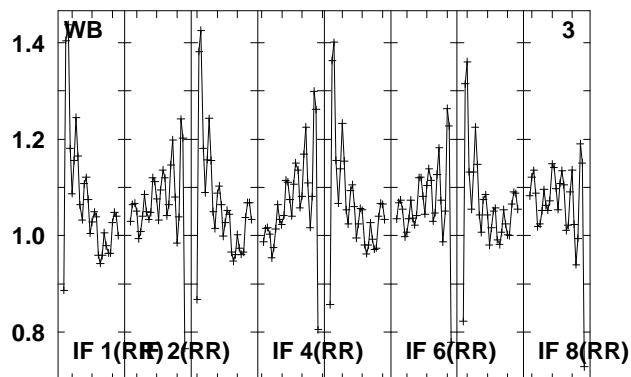
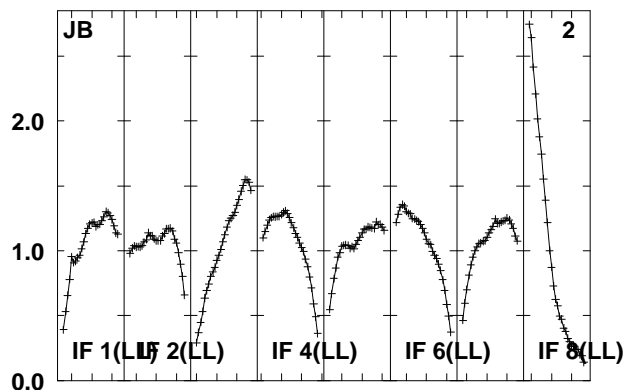
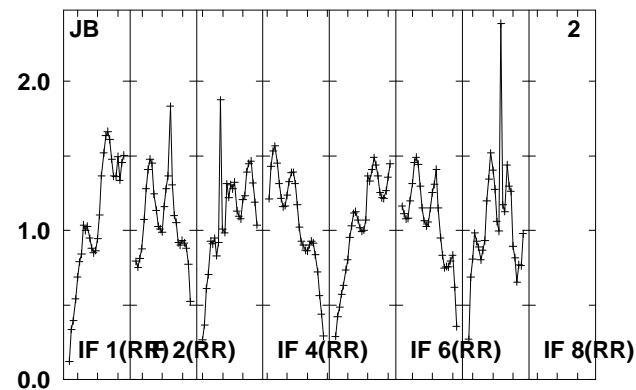
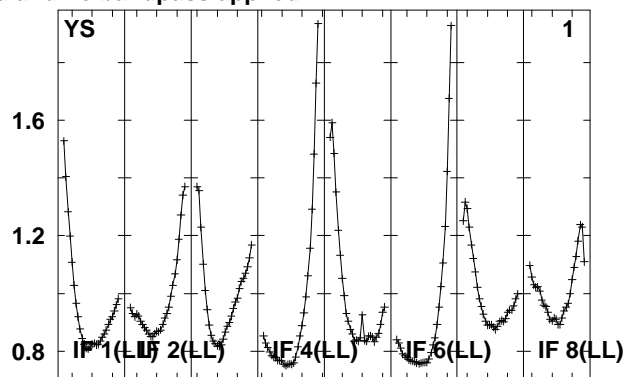
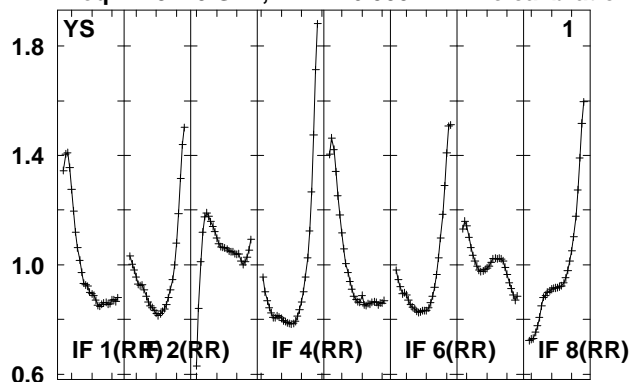

Lower frame: Real Jy

Total-power spectrum Antenna: *

Timerange: 00/16:19:26 to 00/16:20:52

Plot file version 470 created 14-MAY-2010 15:19:44

J0808+49 EO007.UVDATA.1

Freq = 4.9270 GHz, Bw = 16.000 MH No calibration applied and no bandpass applied

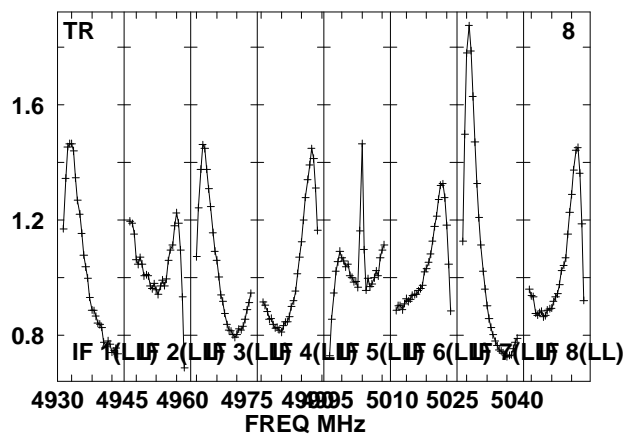
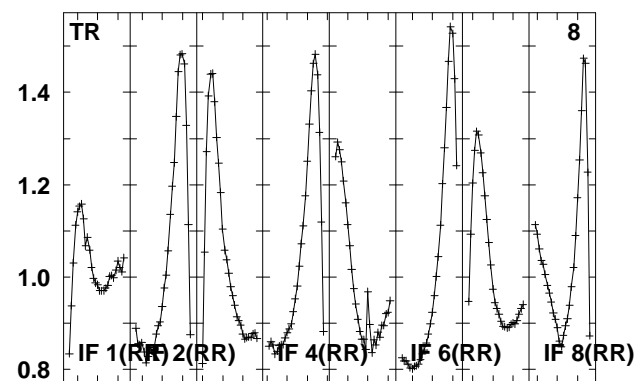
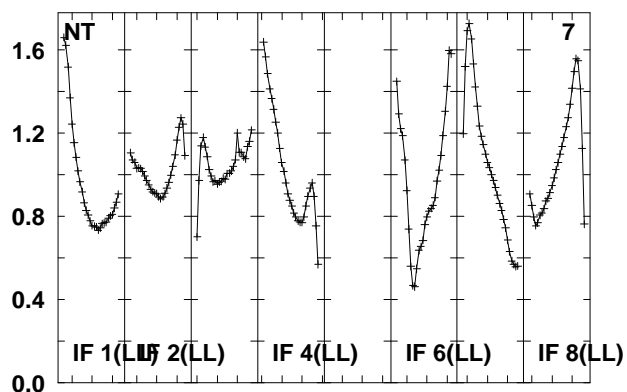
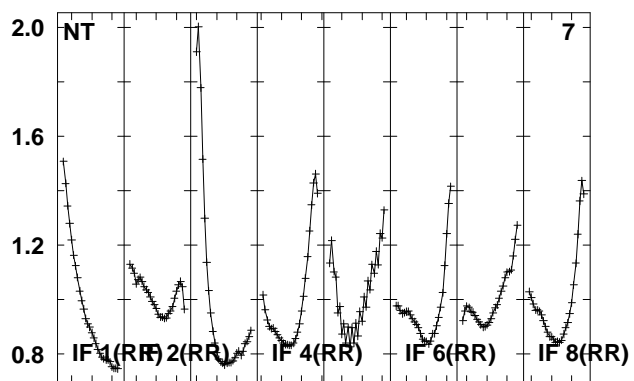
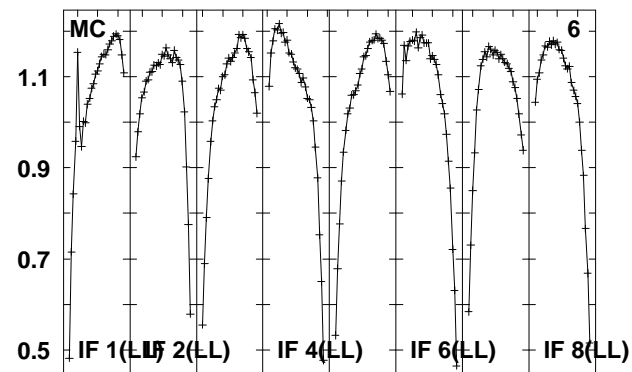
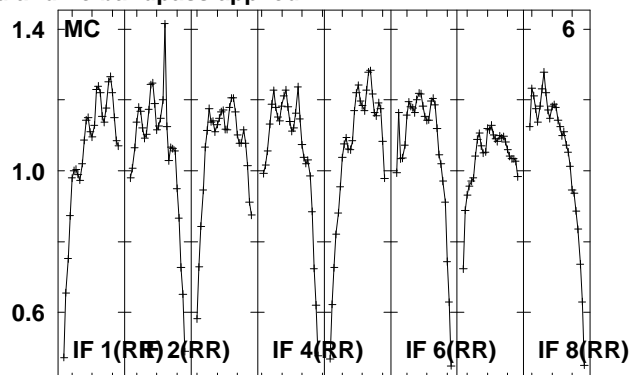
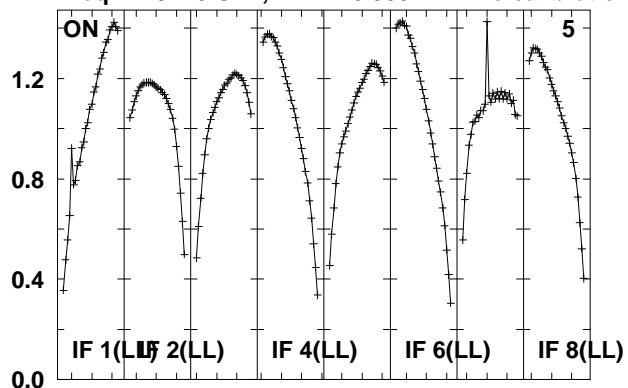

Lower frame: Real Jy

Total-power spectrum Antenna: *

Timerange: 00/16:19:26 to 00/16:20:52

Plot file version 471 created 14-MAY-2010 15:19:44

J0808+40 EO007.UVDATA.1

Freq = 4.9270 GHz, Bw = 16.000 MH No calibration applied and no bandpass applied

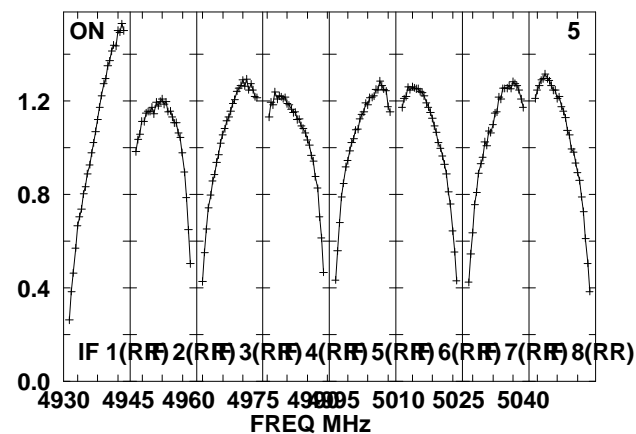
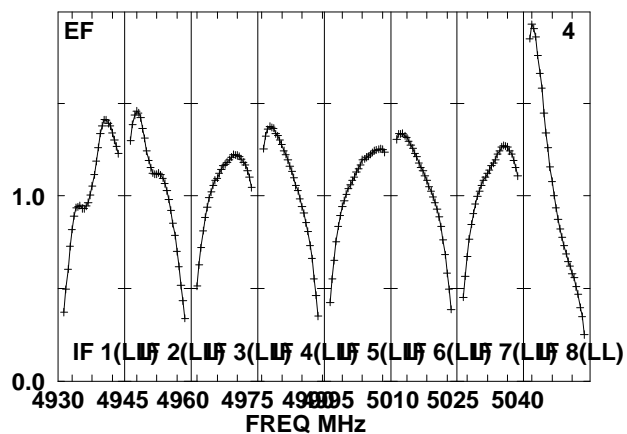
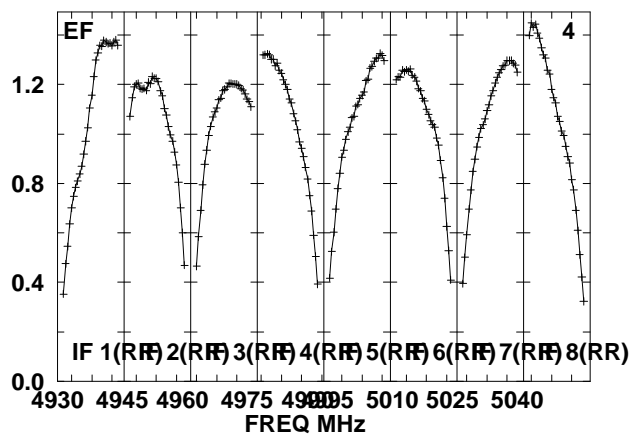
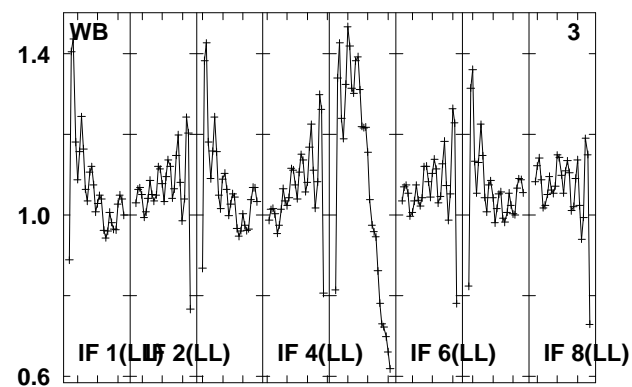
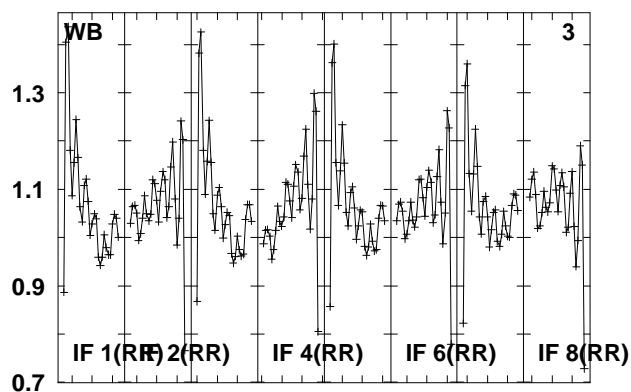
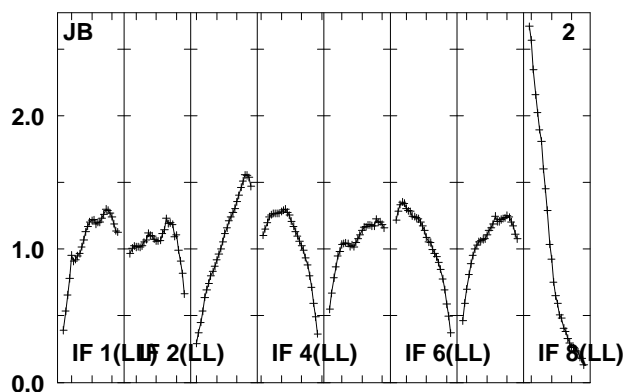
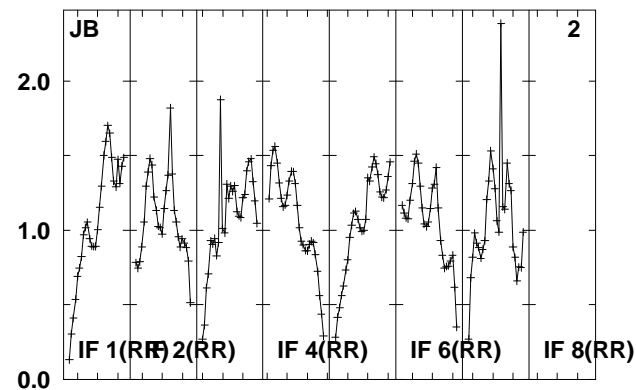
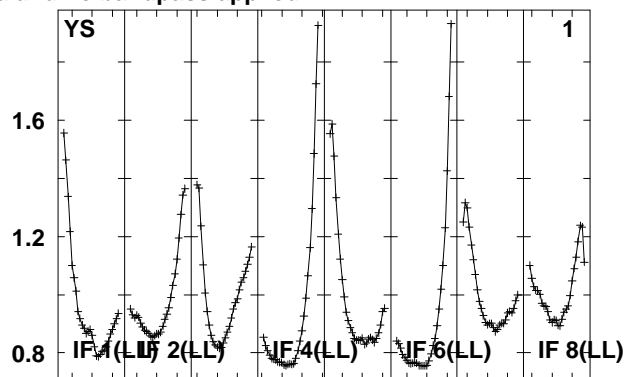
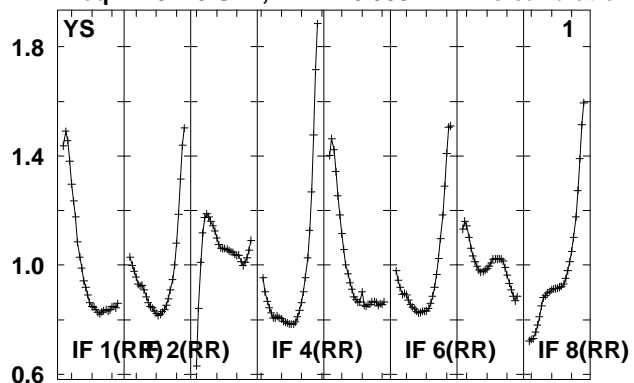

Lower frame: Real Jy

Total-power spectrum Antenna: *

Timerange: 00/16:22:00 to 00/16:23:28

Plot file version 472 created 14-MAY-2010 15:19:44

J0808+40 EO007.UVDATA.1

Freq = 4.9270 GHz, Bw = 16.000 MH No calibration applied and no bandpass applied

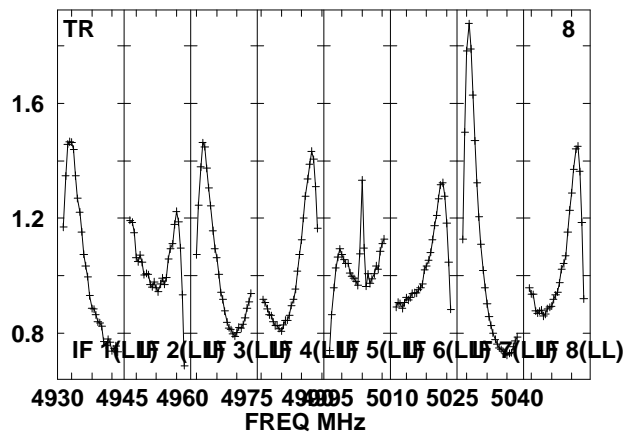
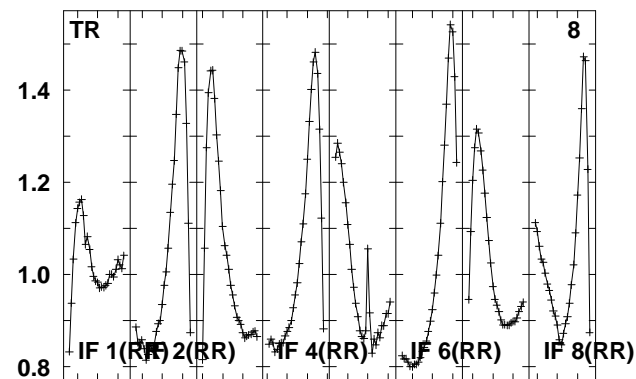
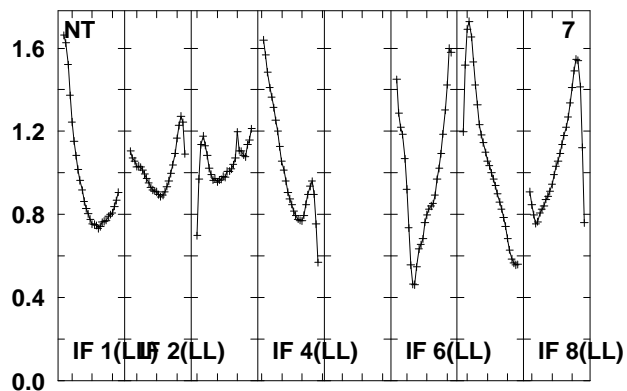
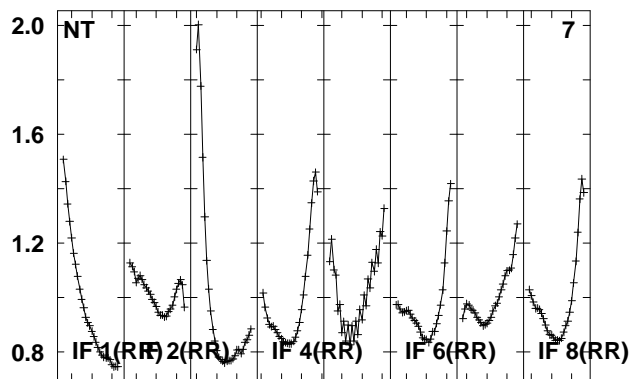
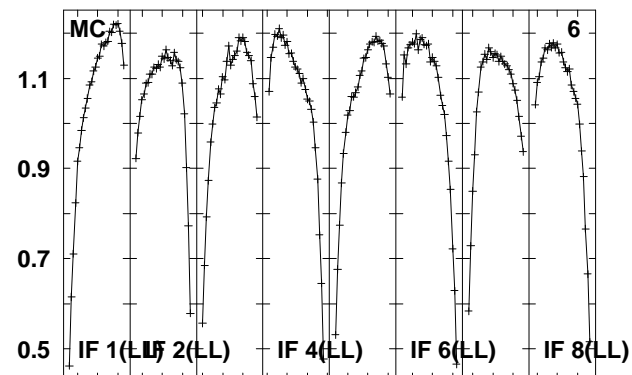
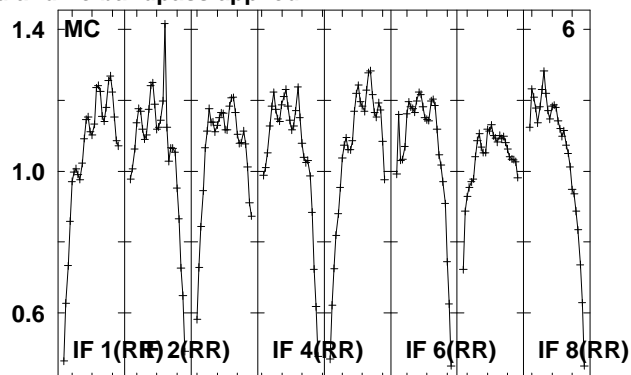
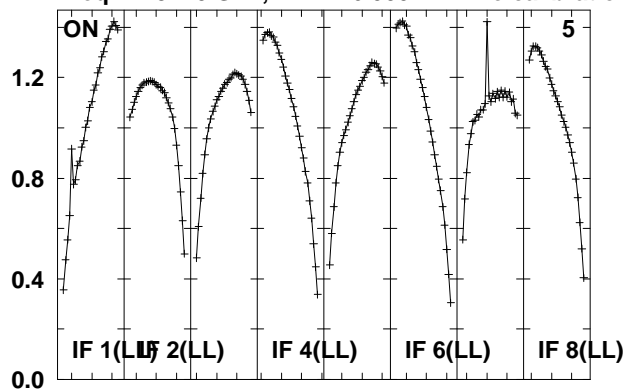

Lower frame: Real Jy

Total-power spectrum Antenna: *

Timerange: 00/16:22:00 to 00/16:23:28

Plot file version 473 created 14-MAY-2010 15:19:44
 J080844_EO007.UVDATA.1
 Freq = 4.9270 GHz, Bw = 16.000 MH No calibration applied and no bandpass applied

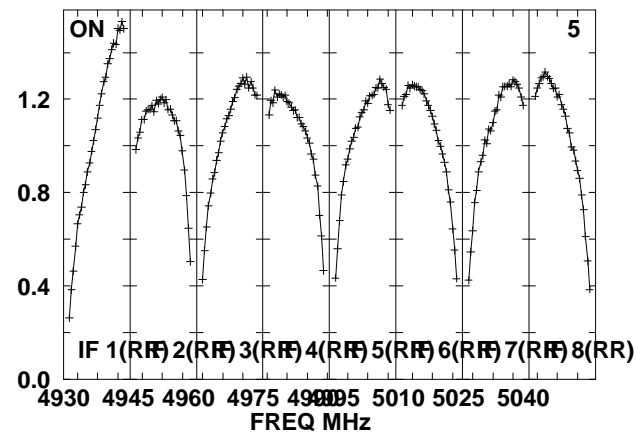
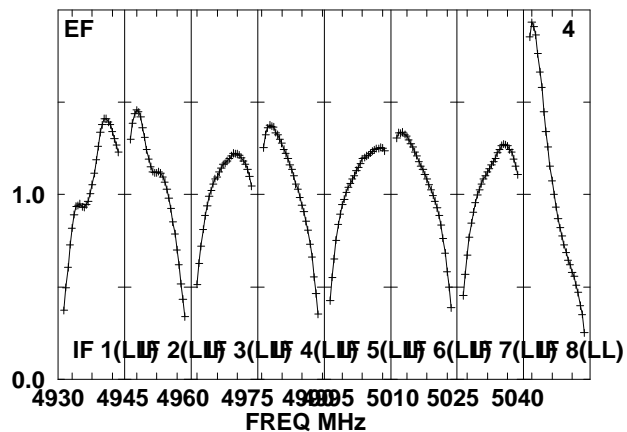
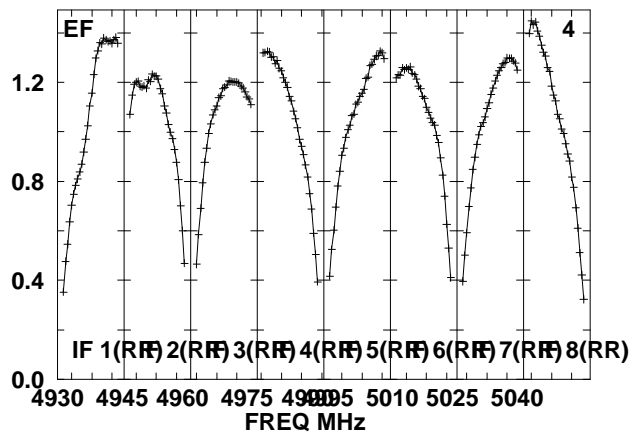
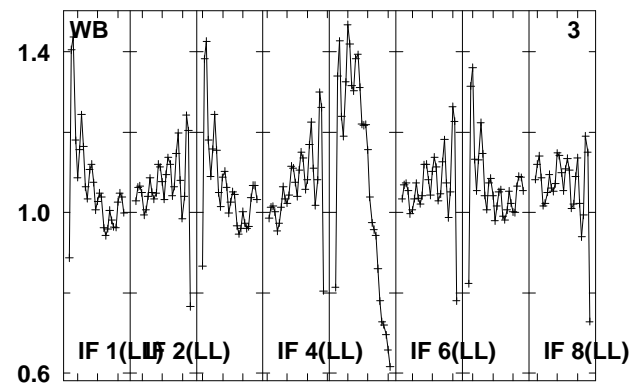
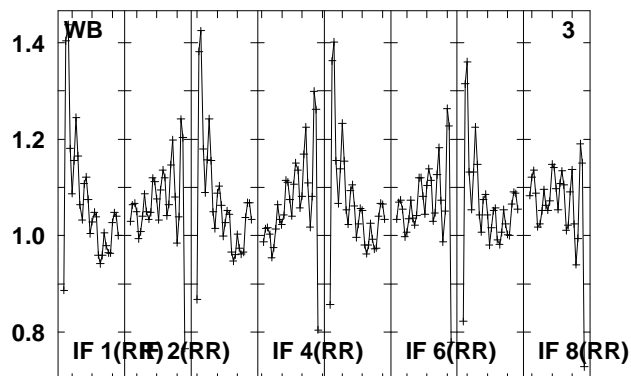
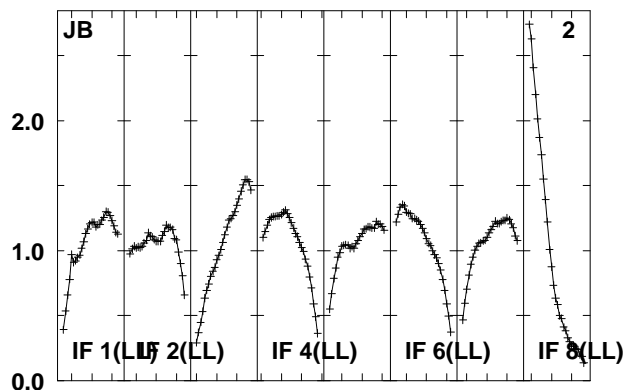
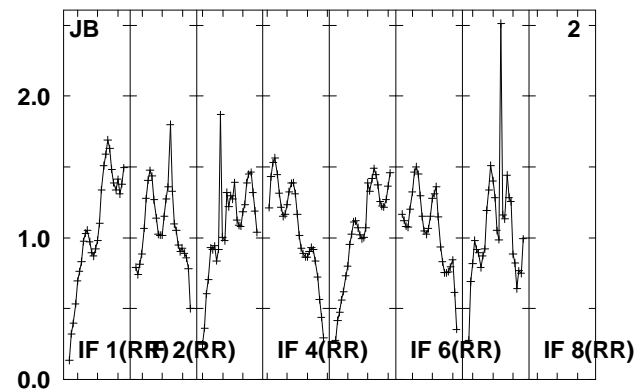
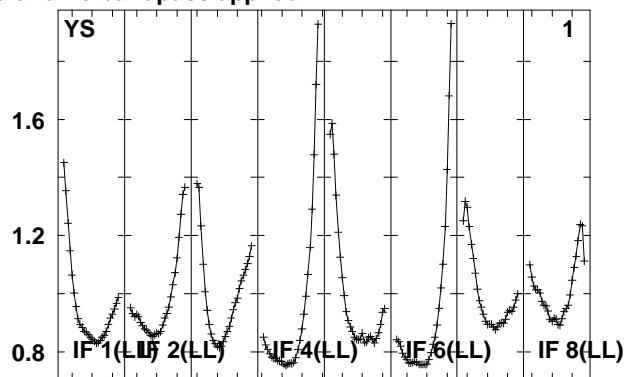
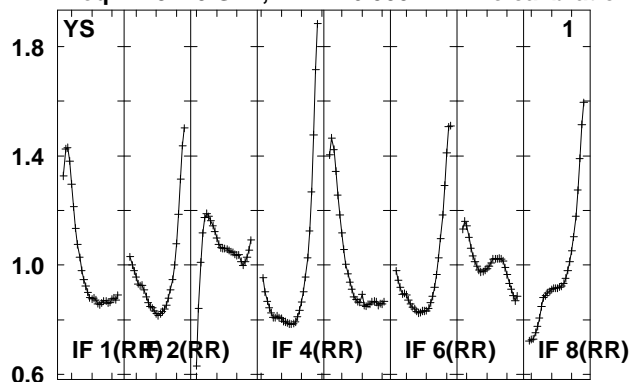

Lower frame: Real Jy
 Total-power spectrum Antenna: *
 Timerange: 00/16:23:58 to 00/16:28:56

Plot file version 474 created 14-MAY-2010 15:19:45

J080844 EO007.UVDATA.1

Freq = 4.9270 GHz, Bw = 16.000 MH No calibration applied and no bandpass applied

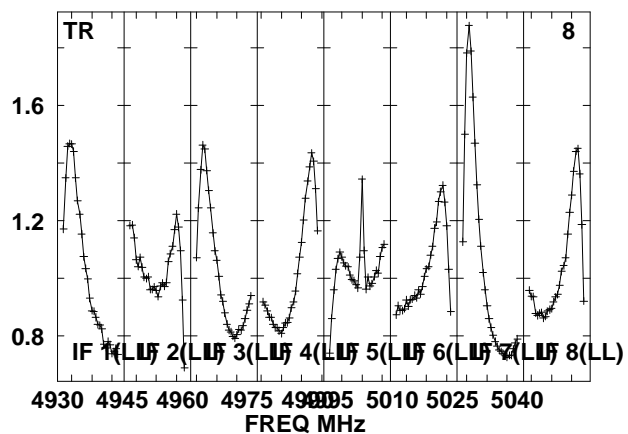
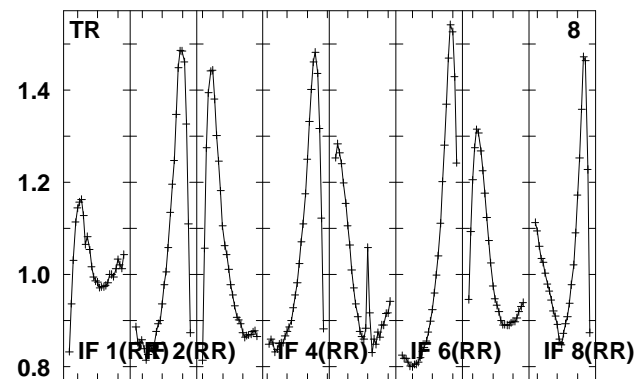
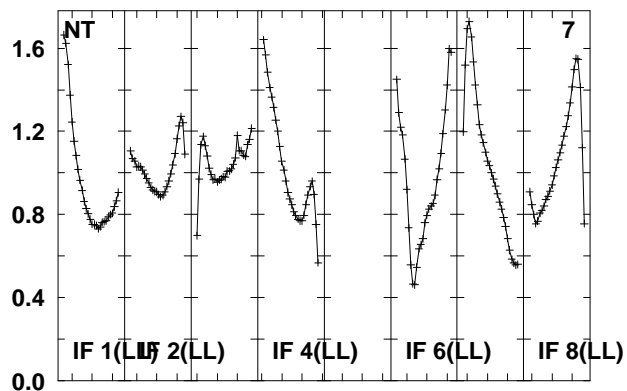
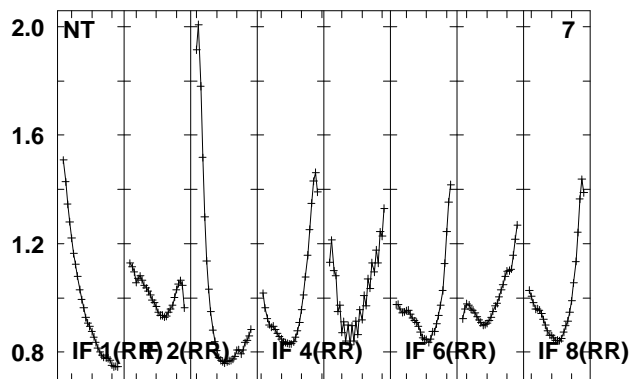
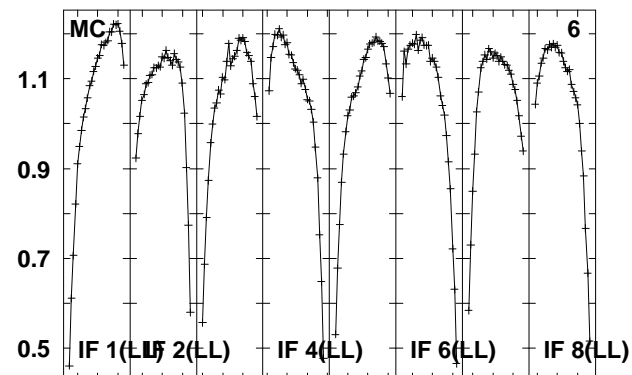
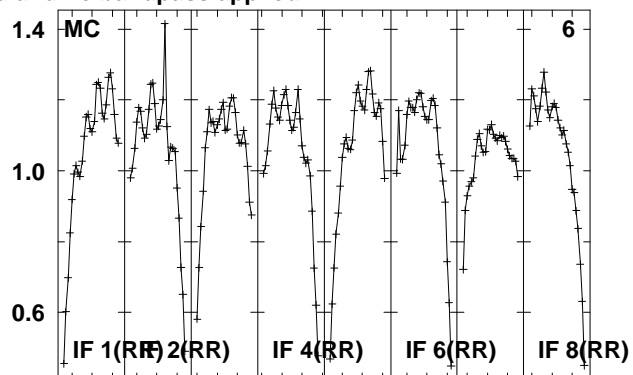
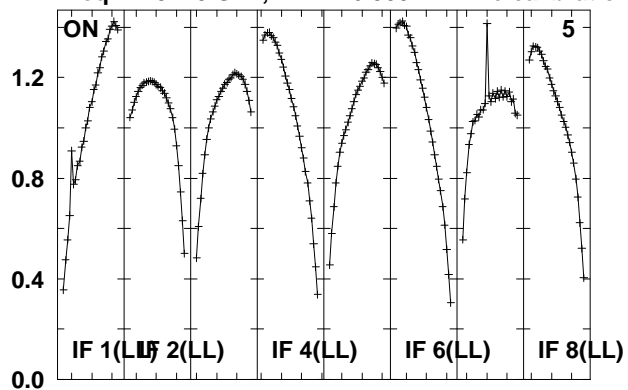

Lower frame: Real Jy

Total-power spectrum Antenna: *

Timerange: 00/16:23:58 to 00/16:28:56

Plot file version 475 created 14-MAY-2010 15:19:45
 J0808+40 EO007.UVDATA.1
 Freq = 4.9270 GHz, Bw = 16.000 MH No calibration applied and no bandpass applied

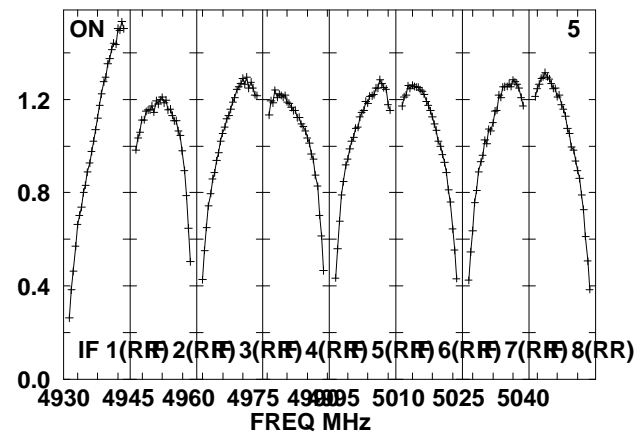
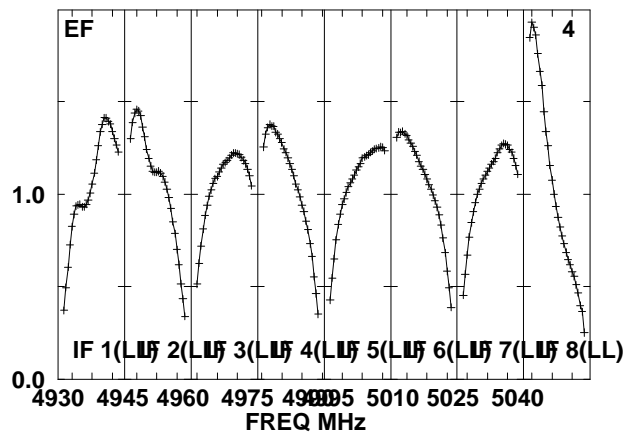
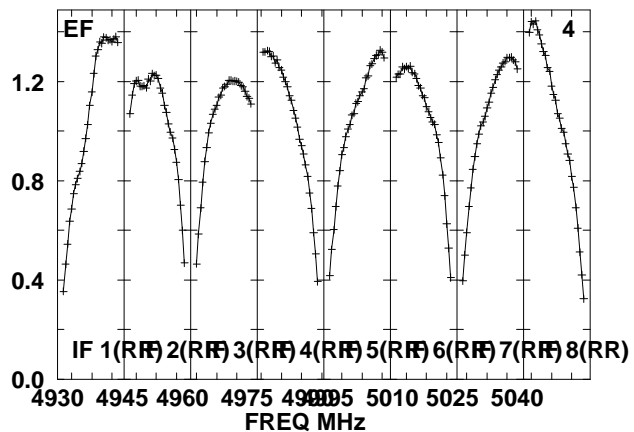
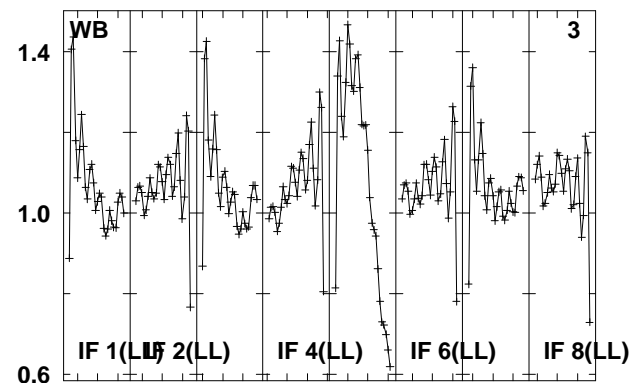
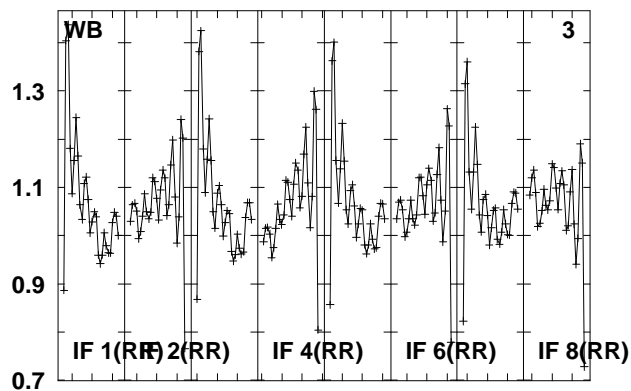
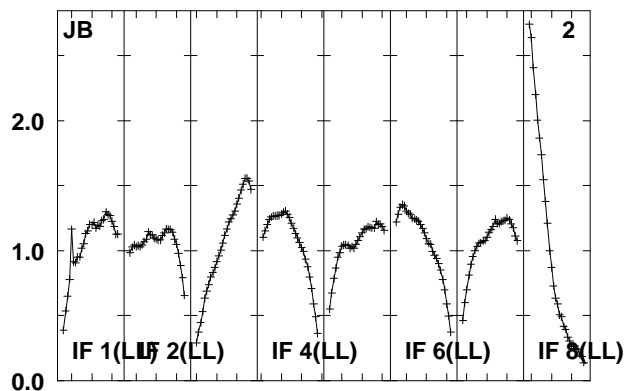
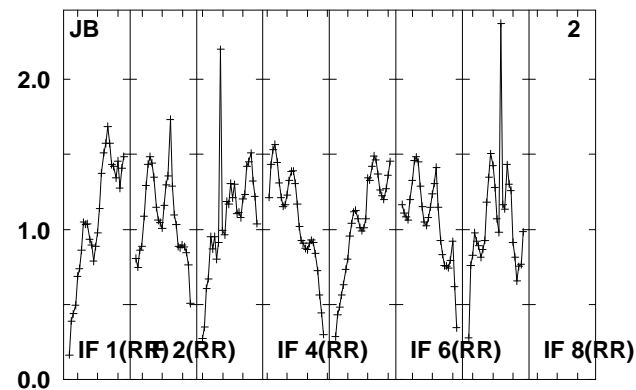
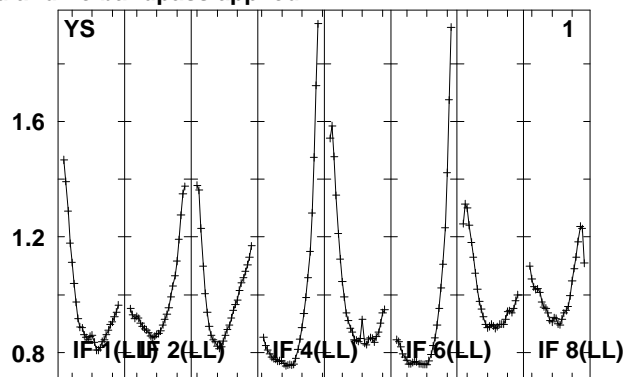
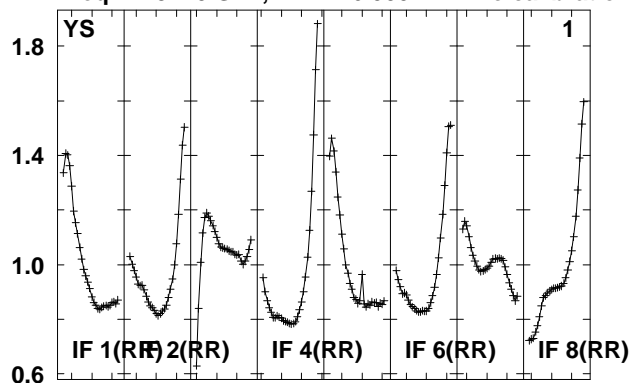

Lower frame: Real Jy
 Total-power spectrum Antenna: *
 Timerange: 00/16:29:24 to 00/16:30:52

Plot file version 476 created 14-MAY-2010 15:19:46

J0808+40 EO007.UVDATA.1

Freq = 4.9270 GHz, Bw = 16.000 MH No calibration applied and no bandpass applied

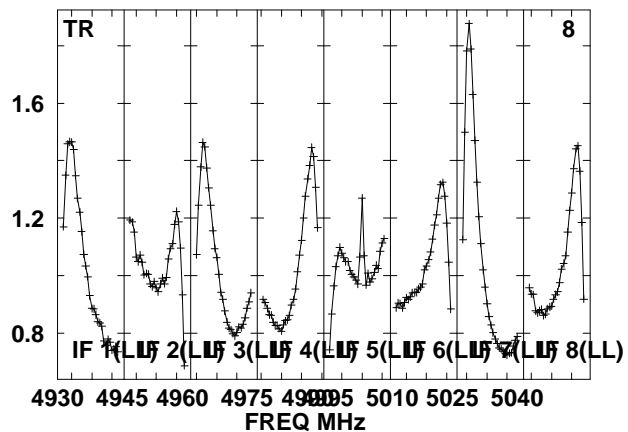
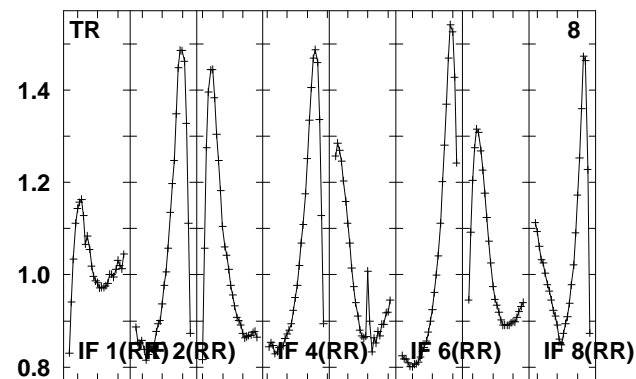
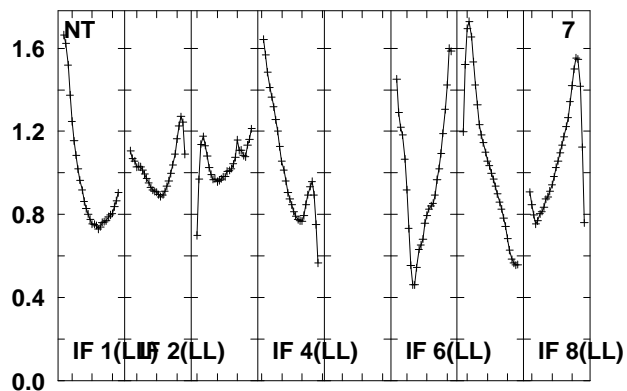
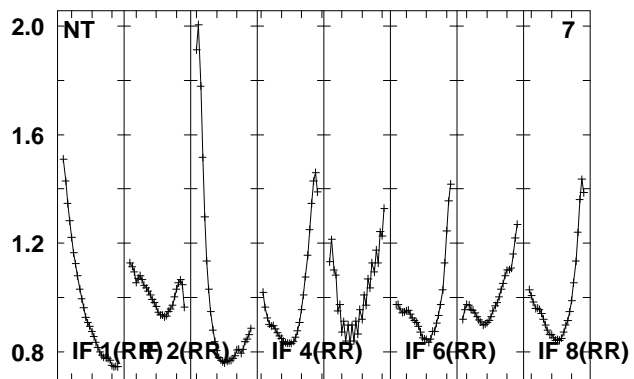
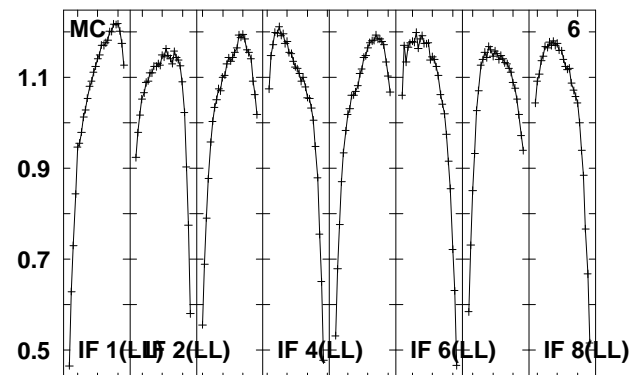
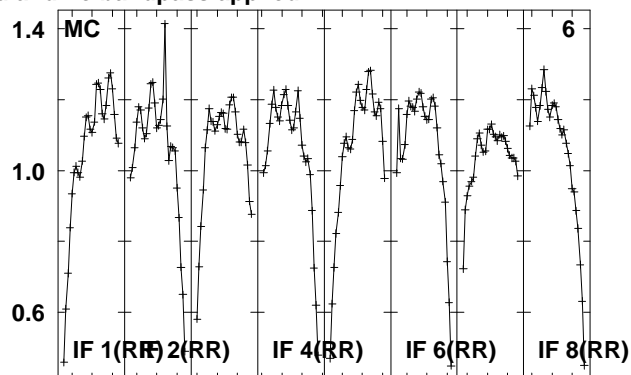
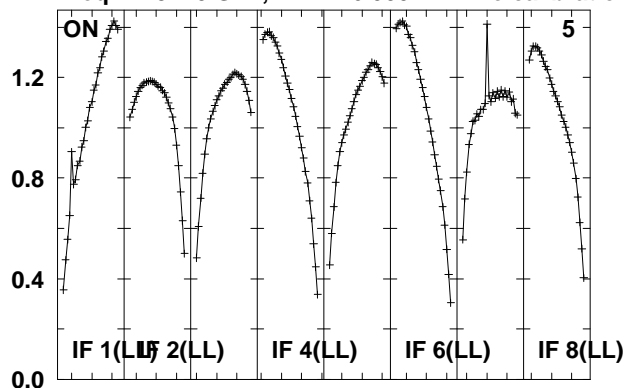

Lower frame: Real Jy

Total-power spectrum Antenna: *

Timerange: 00/16:29:24 to 00/16:30:52

Plot file version 477 created 14-MAY-2010 15:19:46
 J080844 EO007.UVDATA.1
 Freq = 4.9270 GHz, Bw = 16.000 MH No calibration applied and no bandpass applied

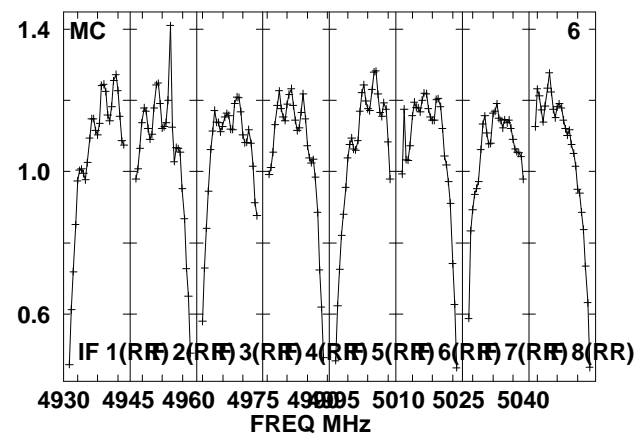
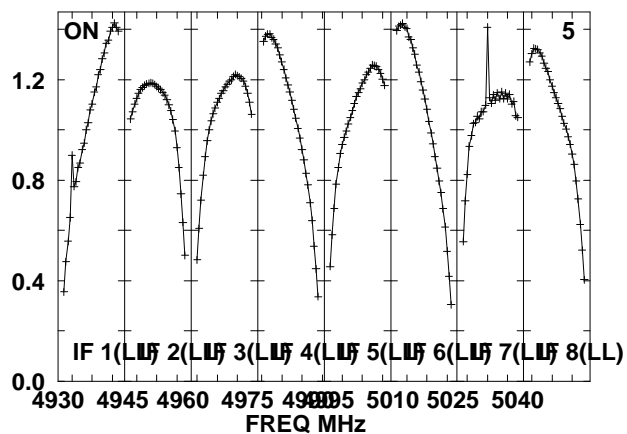
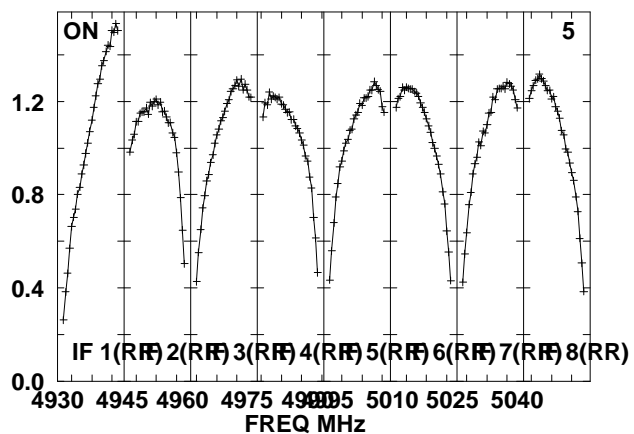
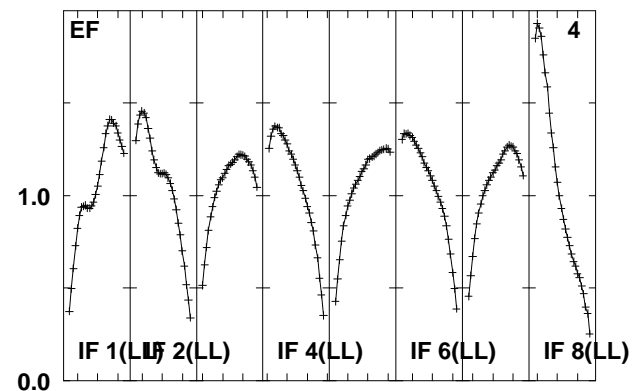
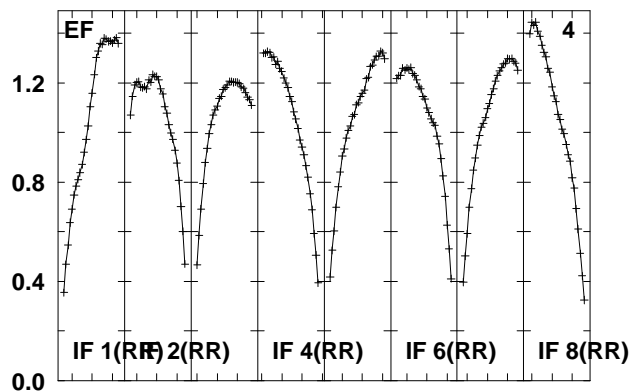
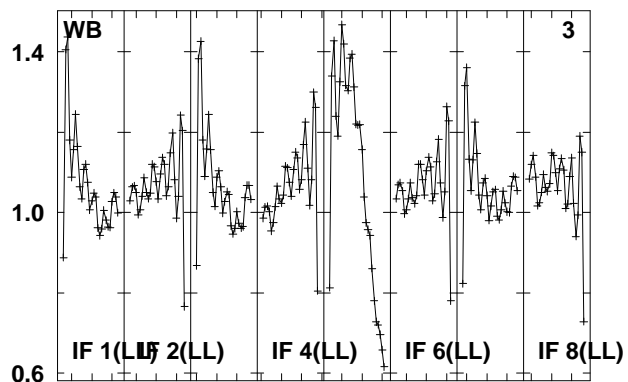
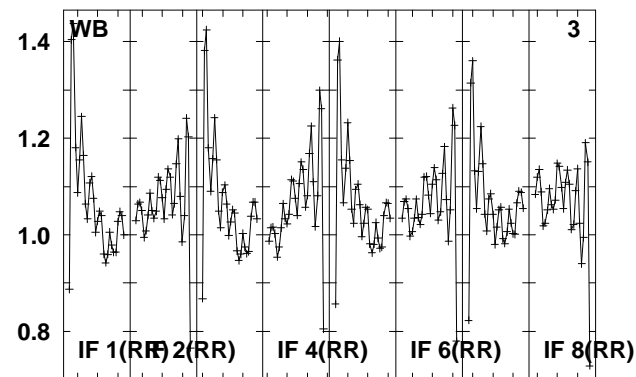
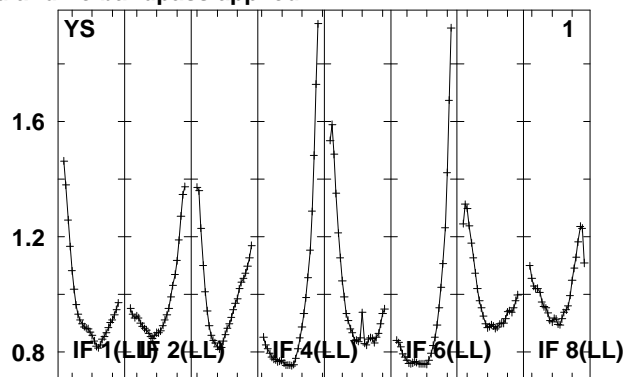
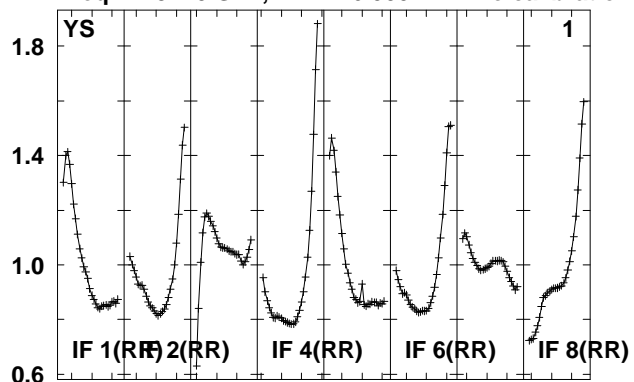

Lower frame: Real Jy
 Total-power spectrum Antenna: *
 Timerange: 00/16:31:21 to 00/16:36:17

Plot file version 478 created 14-MAY-2010 15:19:46

J080844 EO007.UVDATA.1

Freq = 4.9270 GHz, Bw = 16.000 MH No calibration applied and no bandpass applied

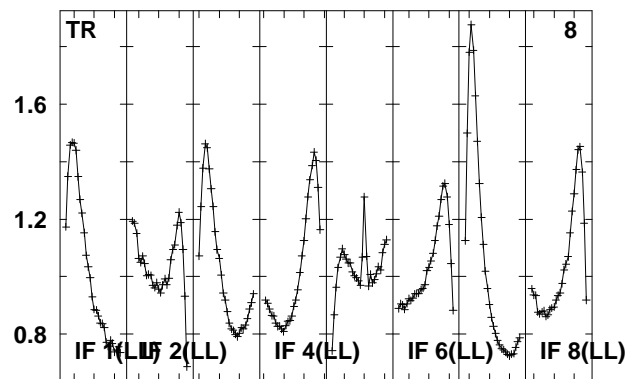
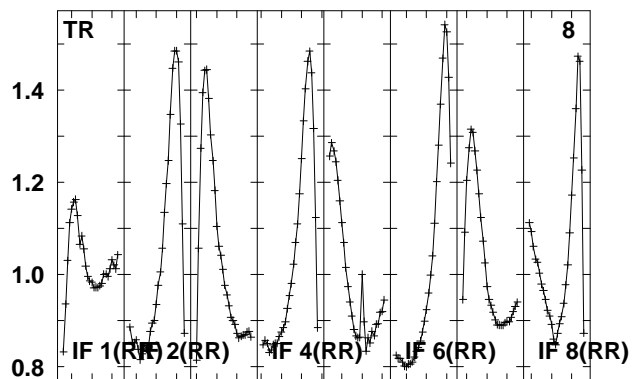
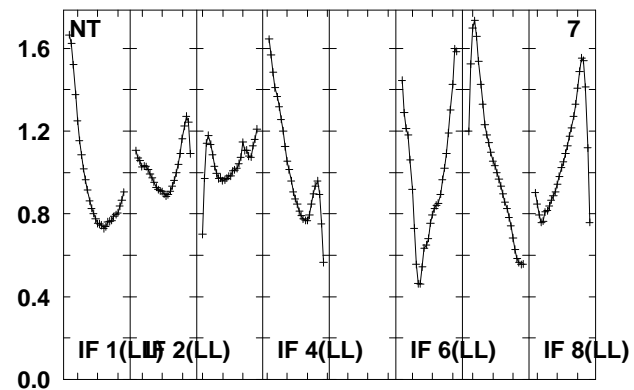
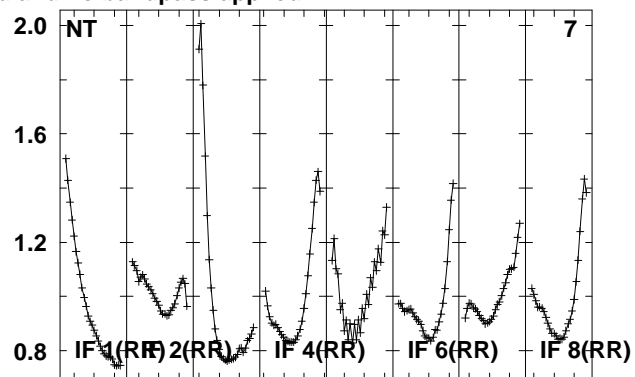
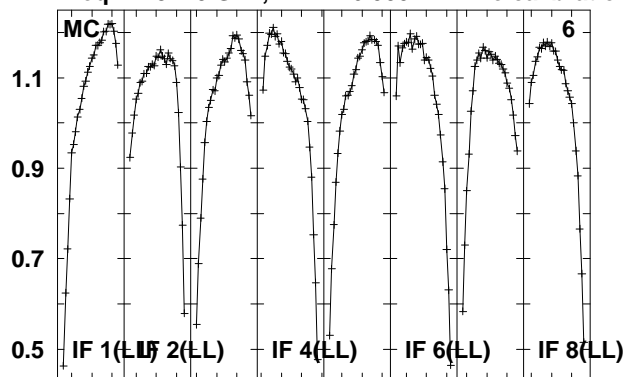

Lower frame: Real Jy
Total-power spectrum Antenna: *
Timerange: 00/16:31:21 to 00/16:36:17

Plot file version 479 created 14-MAY-2010 15:19:47

J0808+40 EO007.UVDATA.1

Freq = 4.9270 GHz, Bw = 16.000 MH No calibration applied and no bandpass applied

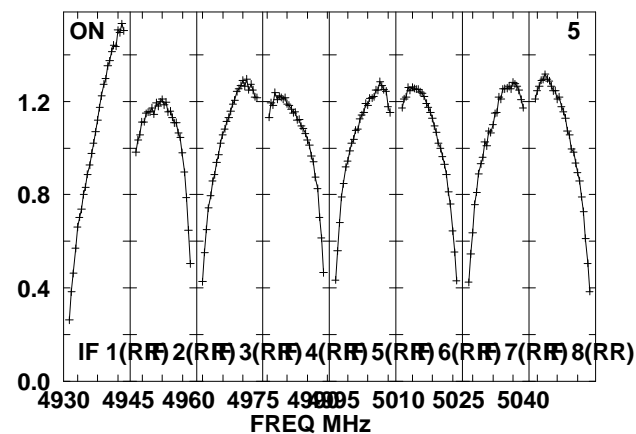
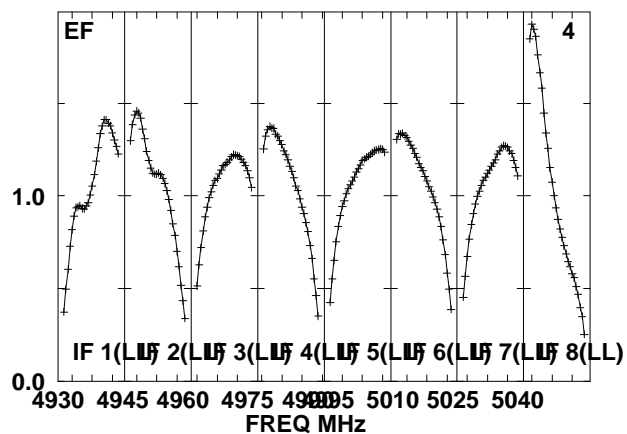
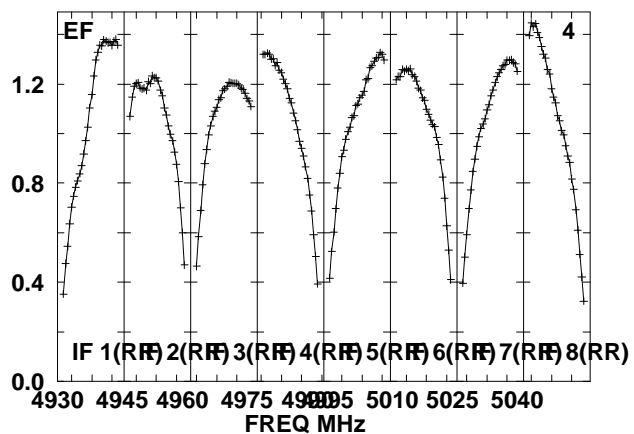
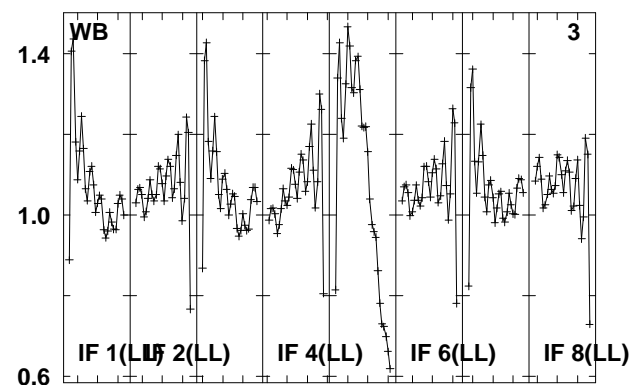
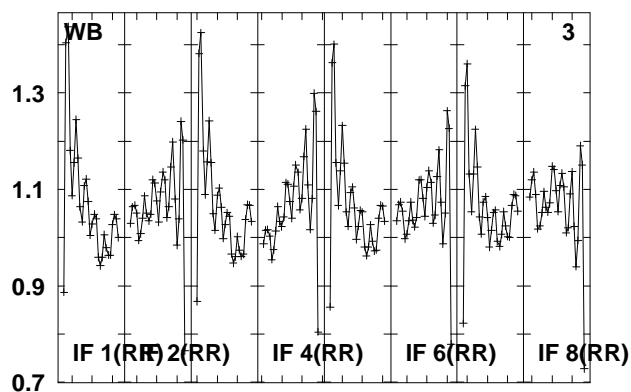
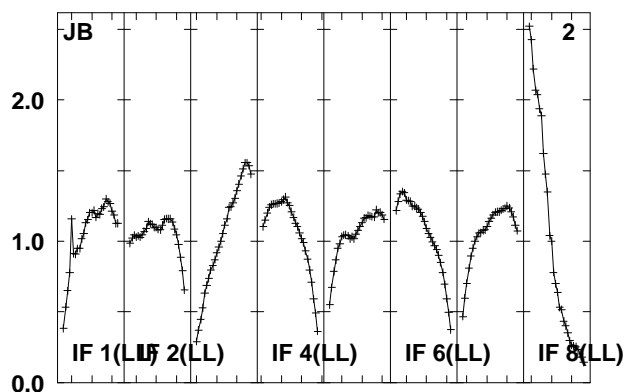
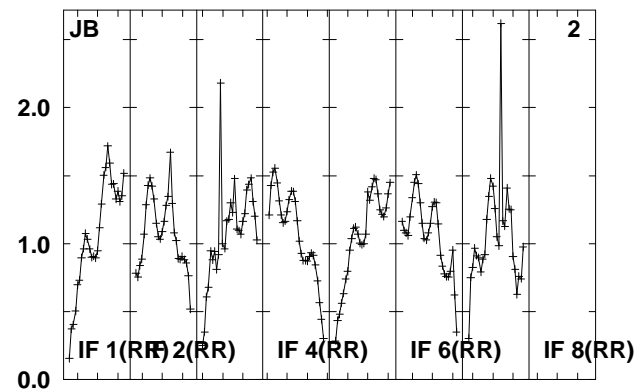
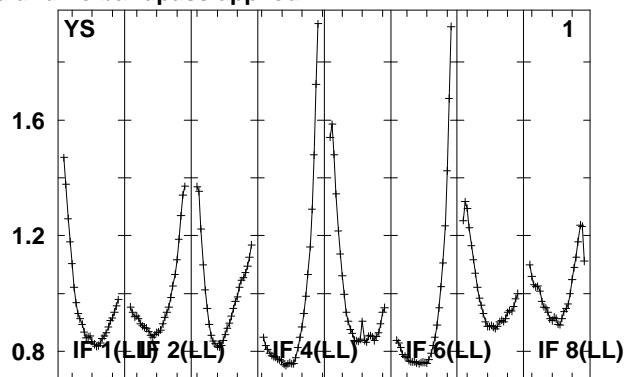
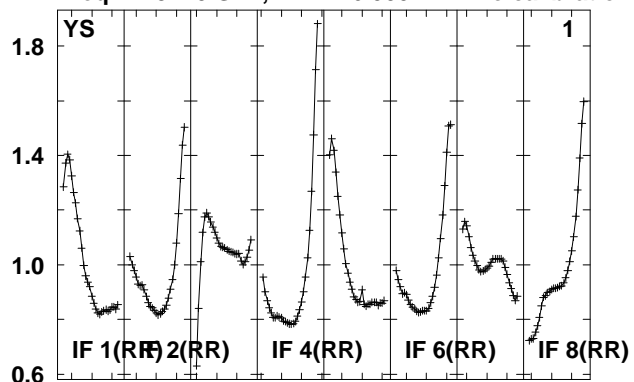

Lower frame: Real Jy

Total-power spectrum Antenna: *

Timerange: 00/16:36:47 to 00/16:38:15

Plot file version 480 created 14-MAY-2010 15:19:47

J0808+40 EO007.UVDATA.1

Freq = 4.9270 GHz, Bw = 16.000 MH No calibration applied and no bandpass applied

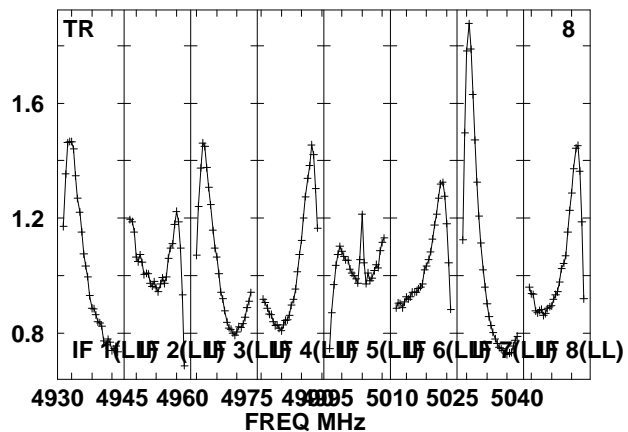
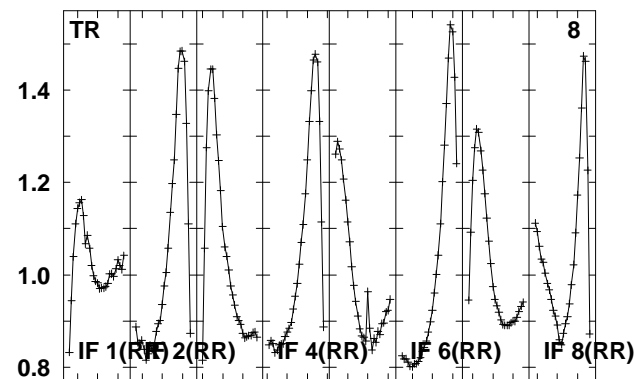
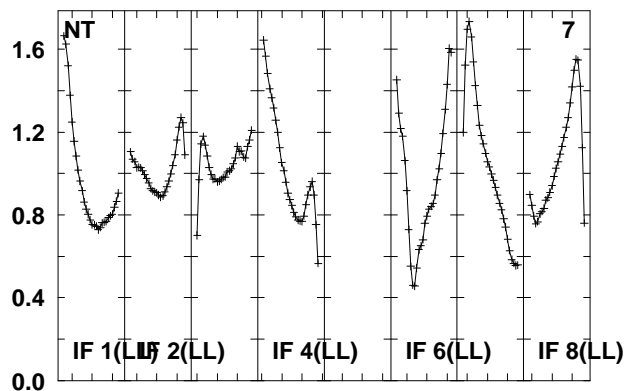
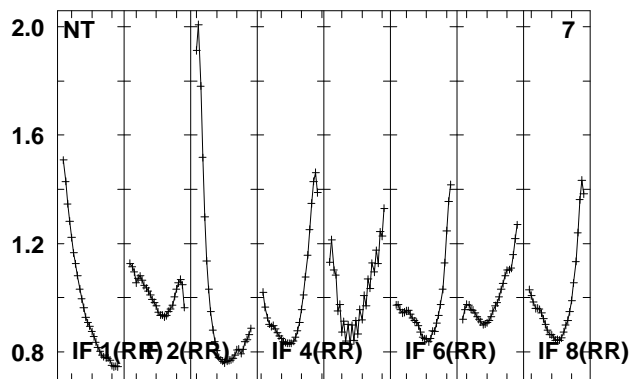
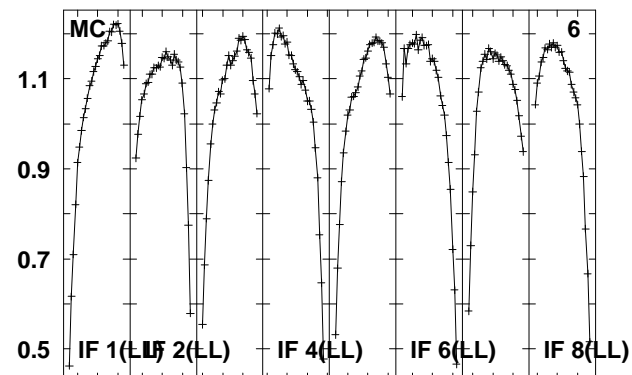
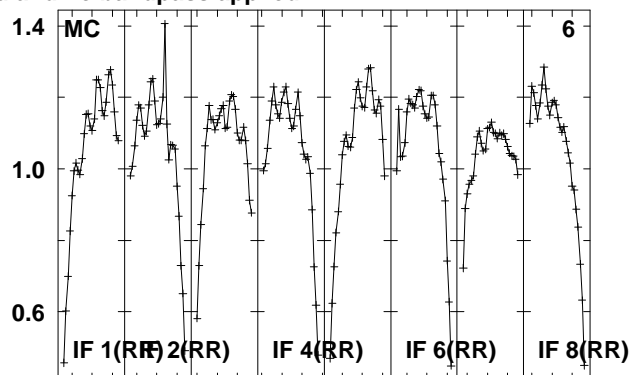
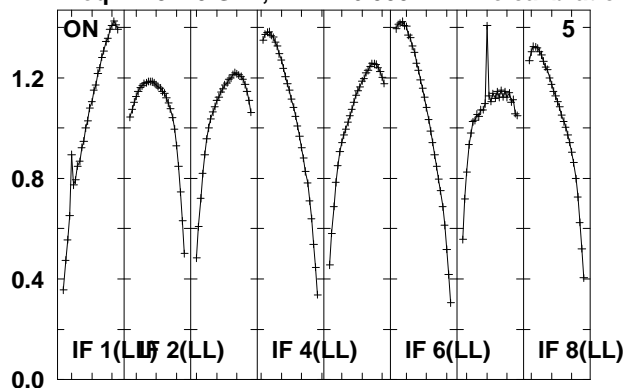

Lower frame: Real Jy

Total-power spectrum Antenna: *

Timerange: 00/16:36:47 to 00/16:38:15

Plot file version 481 created 14-MAY-2010 15:19:47

J0808+49 EO007.UVDATA.1

Freq = 4.9270 GHz, Bw = 16.000 MH No calibration applied and no bandpass applied

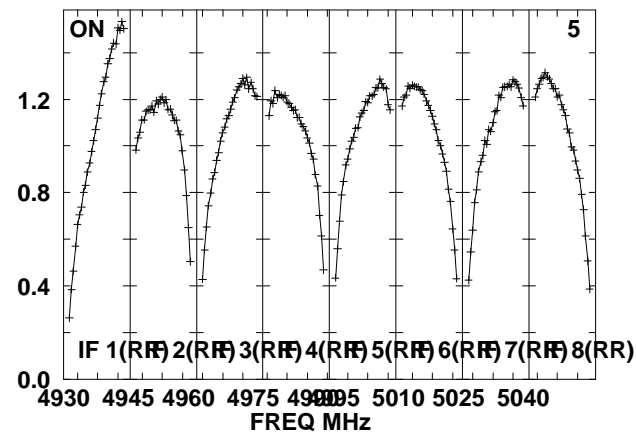
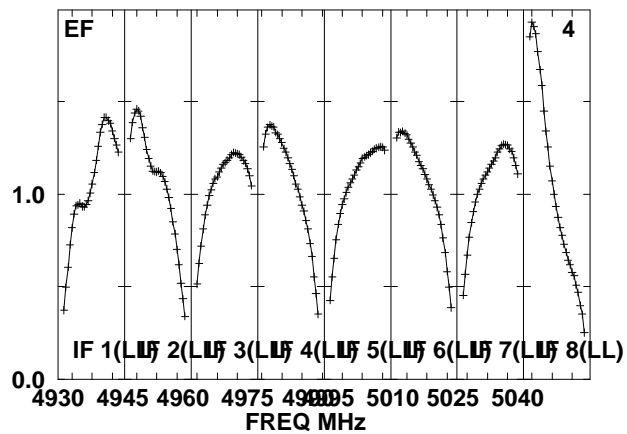
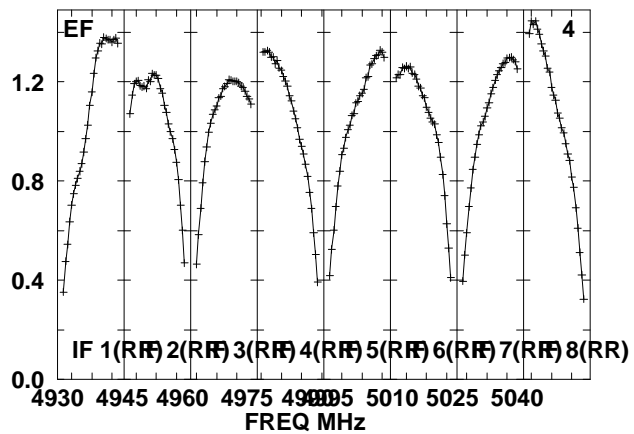
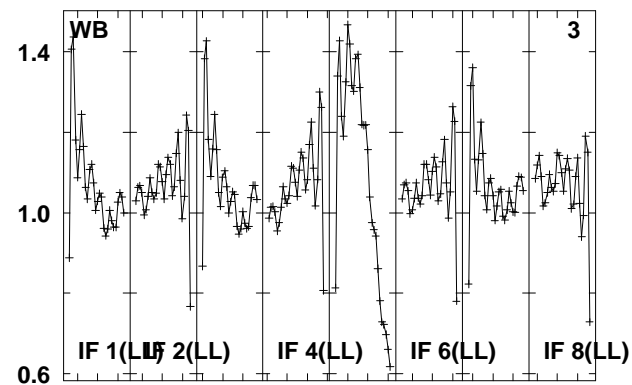
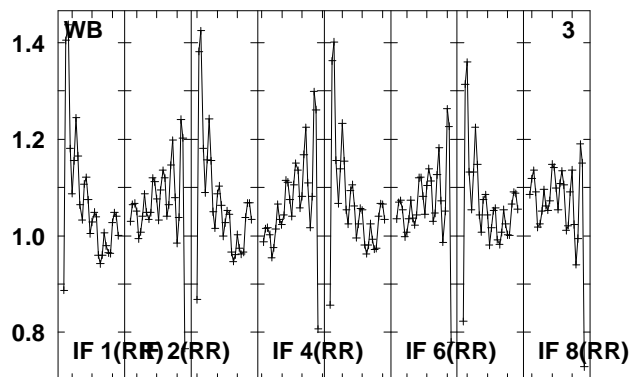
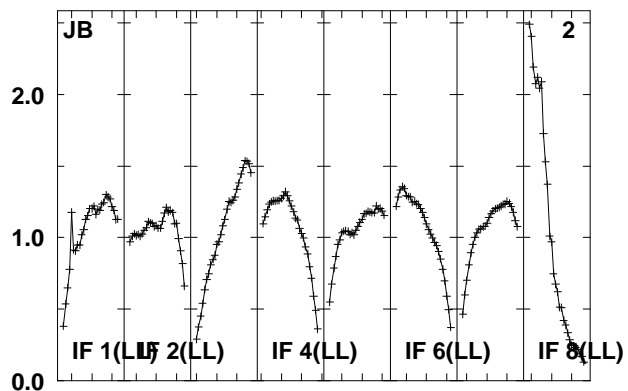
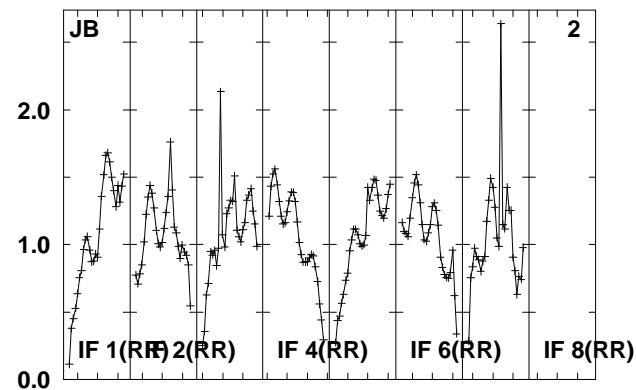
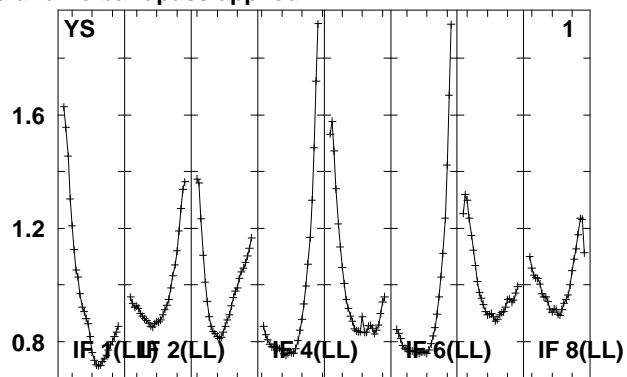
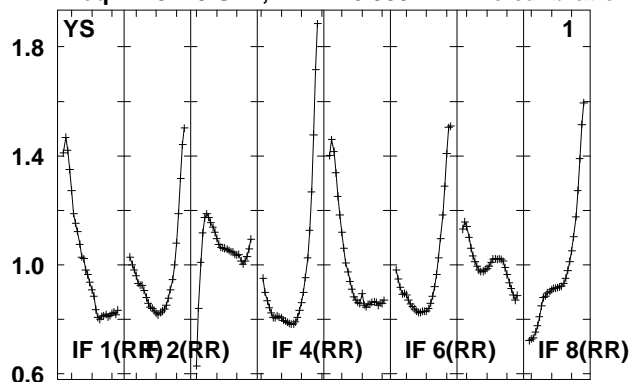

Lower frame: Real Jy

Total-power spectrum Antenna: *

Timerange: 00/16:39:25 to 00/16:40:53

Plot file version 482 created 14-MAY-2010 15:19:47

J0808+49 EO007.UVDATA.1

Freq = 4.9270 GHz, Bw = 16.000 MH No calibration applied and no bandpass applied

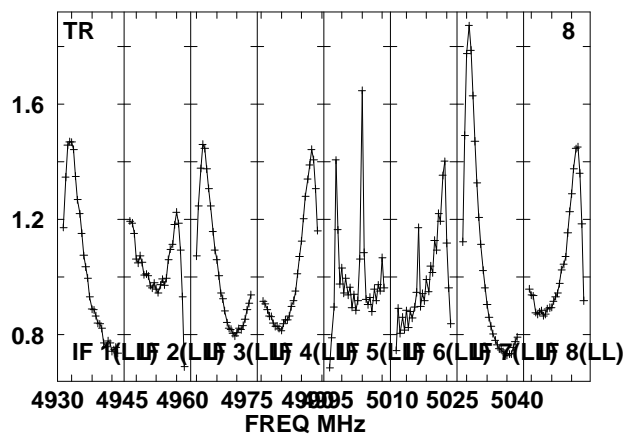
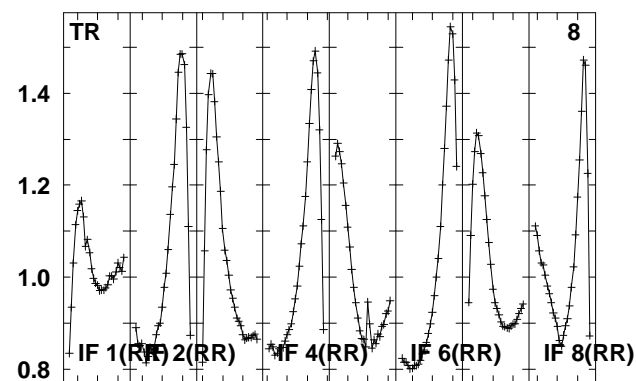
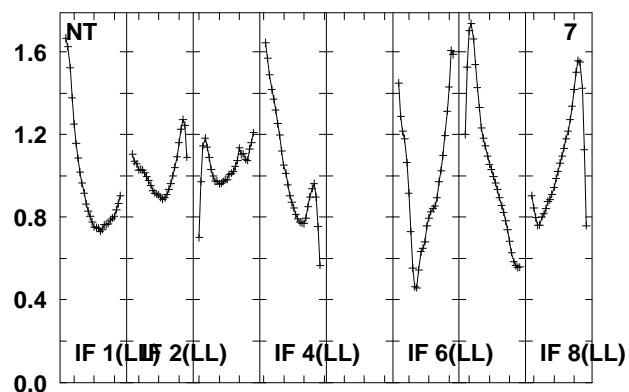
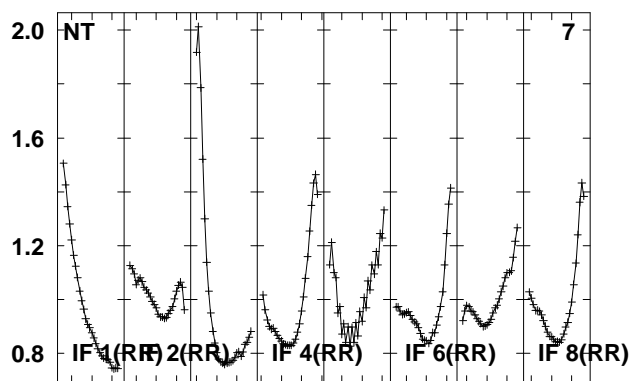
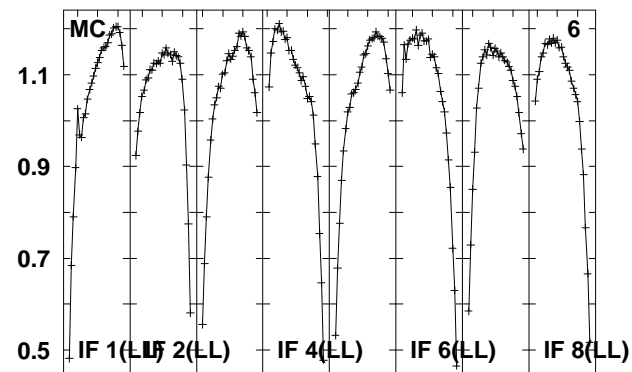
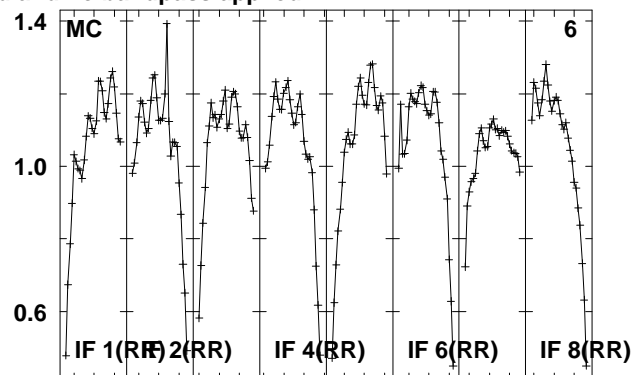
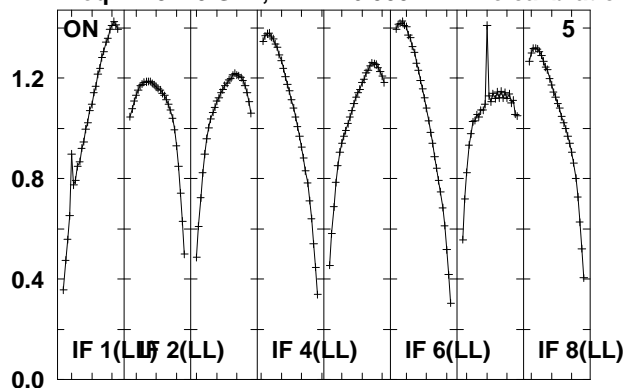

Lower frame: Real Jy

Total-power spectrum Antenna: *

Timerange: 00/16:39:25 to 00/16:40:53

Plot file version 483 created 14-MAY-2010 15:19:48
 J081523 EO007.UVDATA.1
 Freq = 4.9270 GHz, Bw = 16.000 MH No calibration applied and no bandpass applied

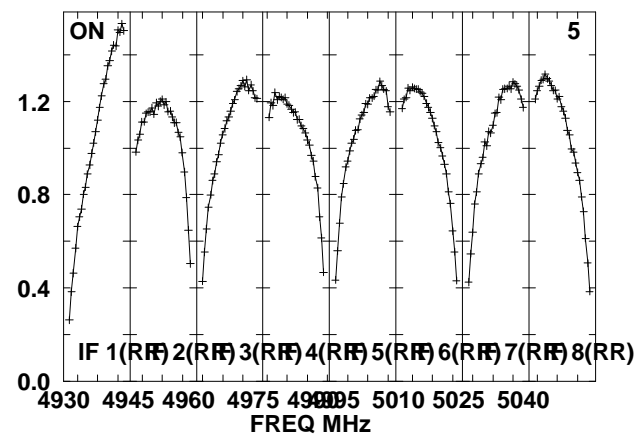
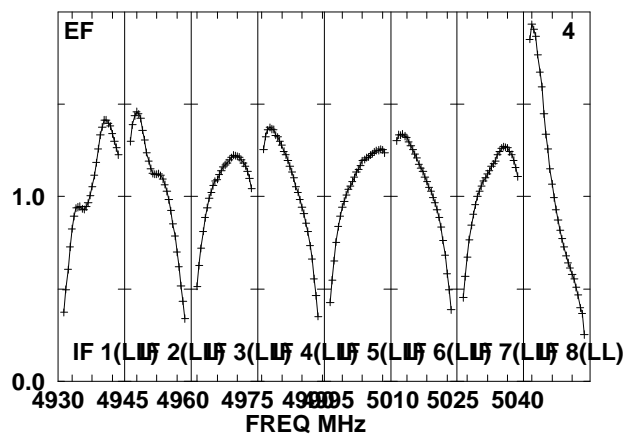
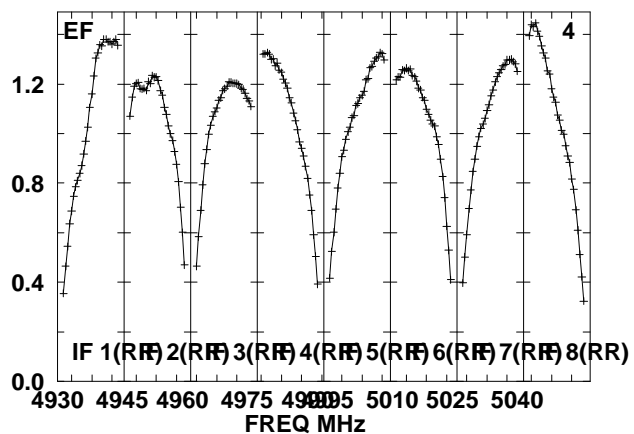
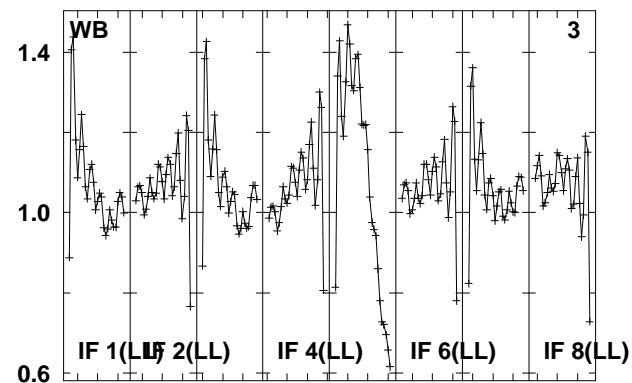
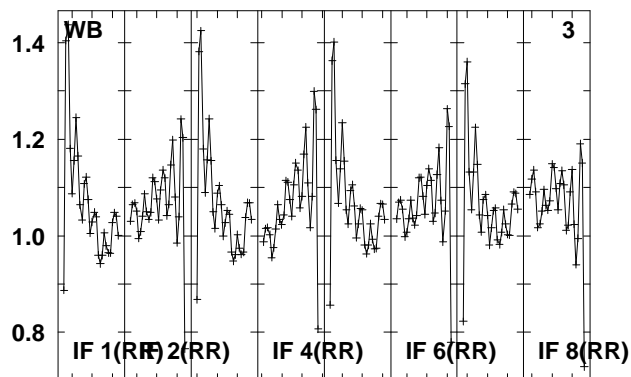
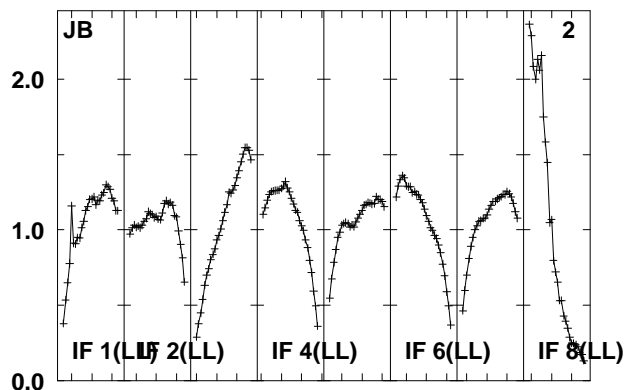
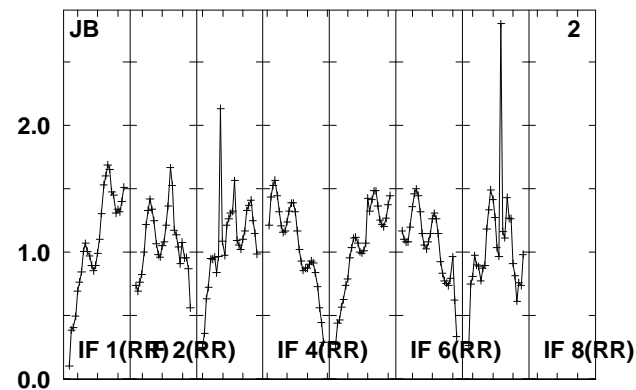
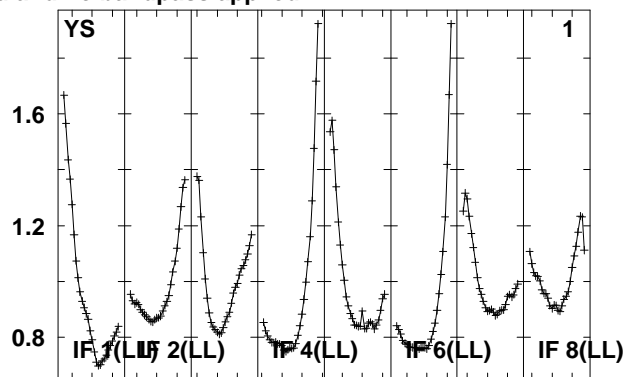
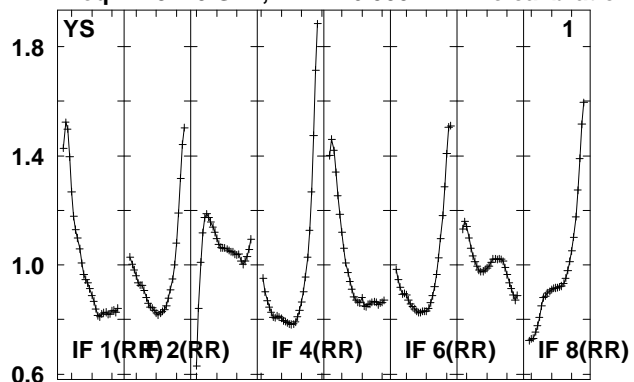

Lower frame: Real Jy
 Total-power spectrum Antenna: *
 Timerange: 00/16:41:19 to 00/16:46:17

Plot file version 484 created 14-MAY-2010 15:19:48

J081523 EO007.UVDATA.1

Freq = 4.9270 GHz, Bw = 16.000 MH No calibration applied and no bandpass applied

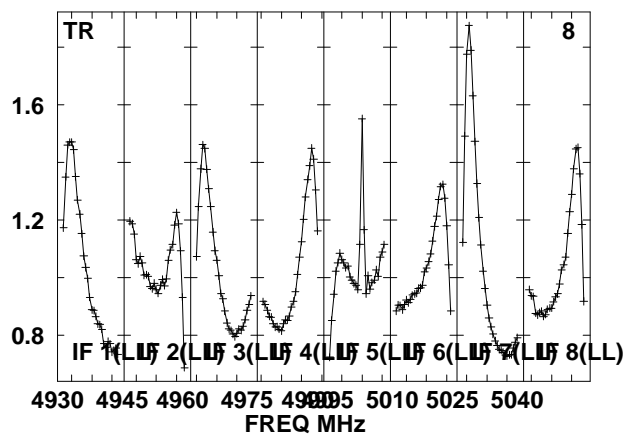
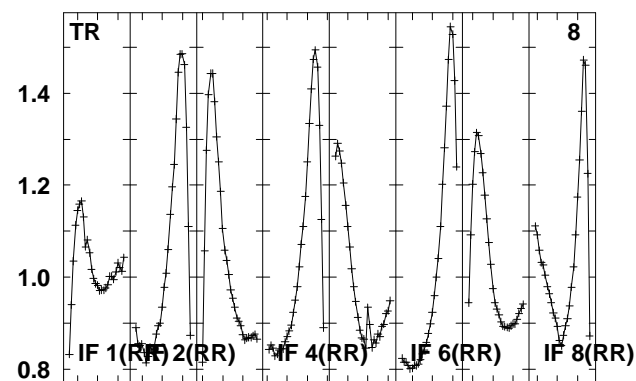
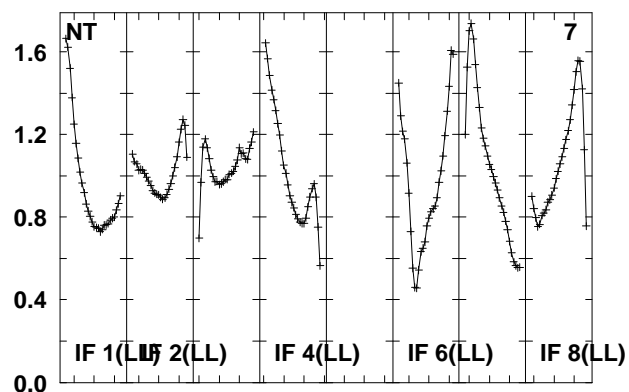
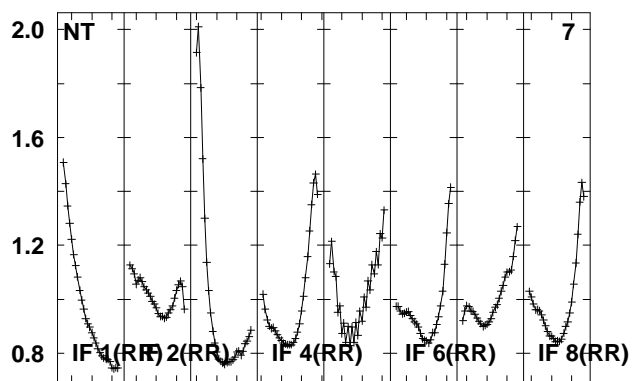
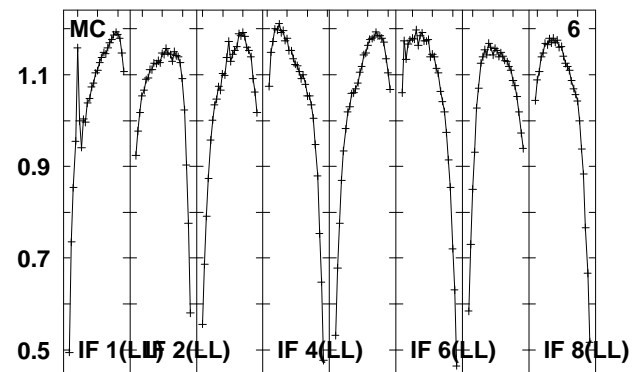
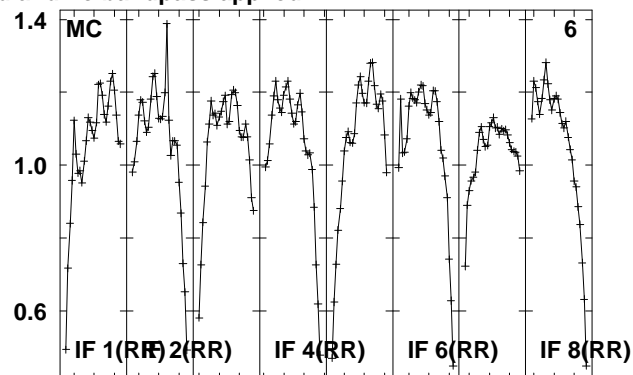
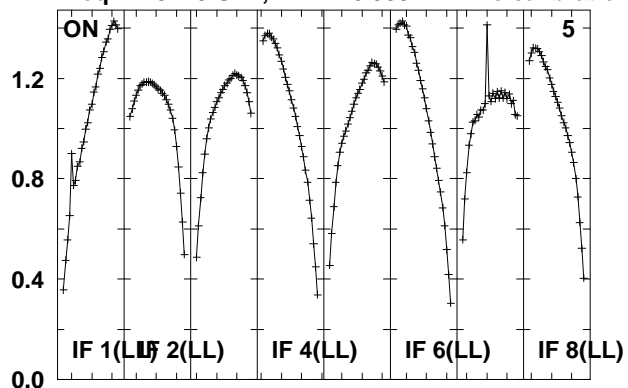

Lower frame: Real Jy

Total-power spectrum Antenna: *

Timerange: 00/16:41:19 to 00/16:46:17

Plot file version 485 created 14-MAY-2010 15:19:49
 J0808+49 EO007.UVDATA.1
 Freq = 4.9270 GHz, Bw = 16.000 MH No calibration applied and no bandpass applied

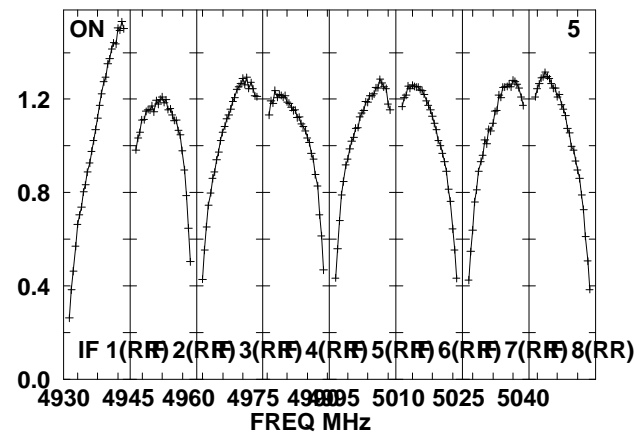
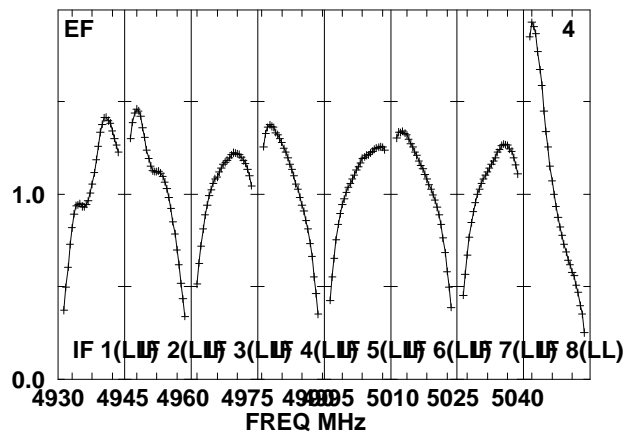
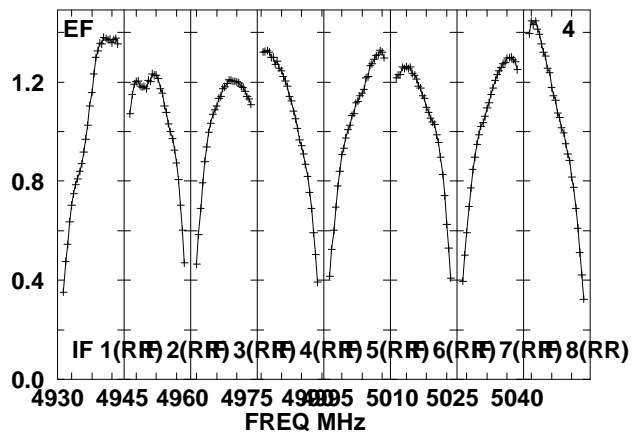
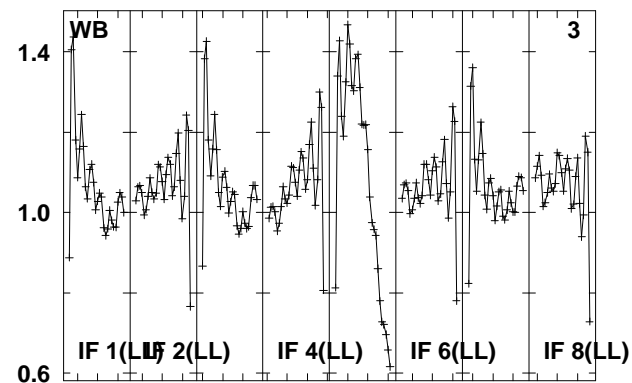
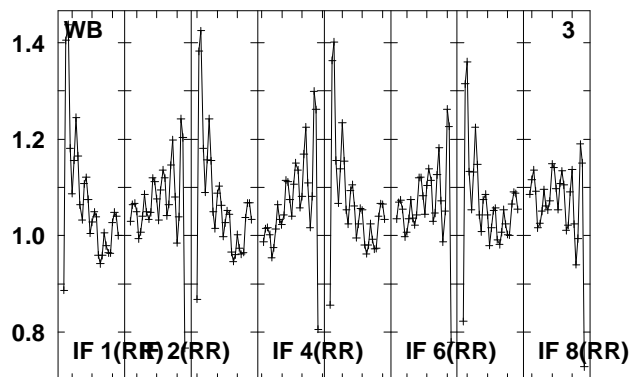
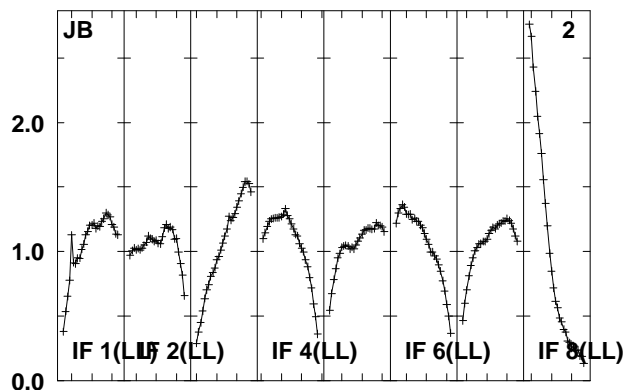
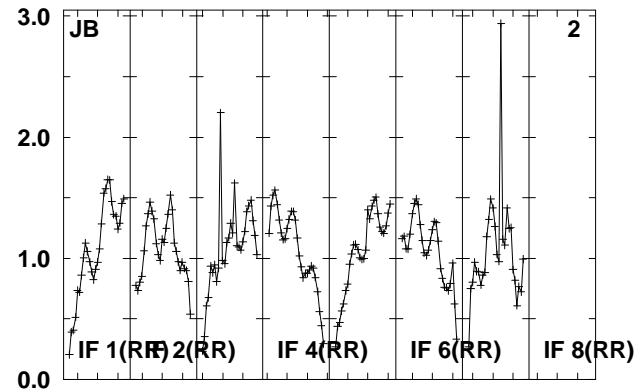
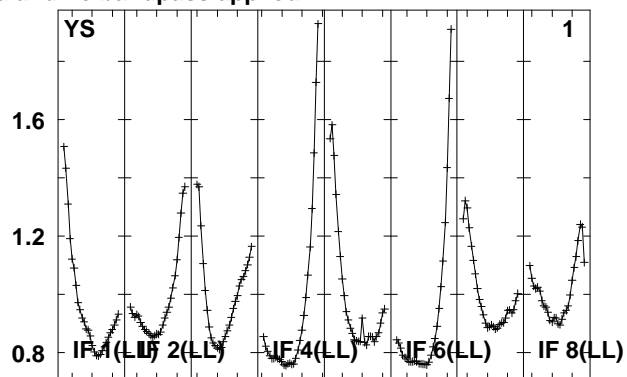
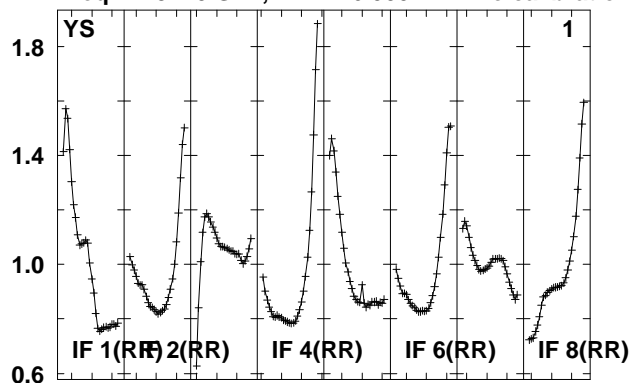

Lower frame: Real Jy
 Total-power spectrum Antenna: *
 Timerange: 00/16:46:45 to 00/16:48:11

Plot file version 486 created 14-MAY-2010 15:19:49

J0808+49 EO07.UVDATA.1

Freq = 4.9270 GHz, Bw = 16.000 MH No calibration applied and no bandpass applied

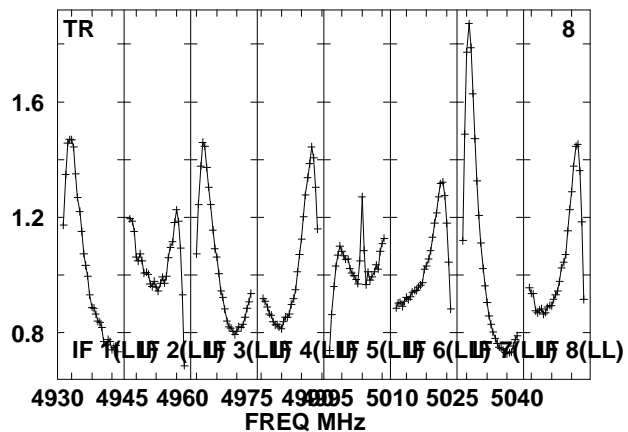
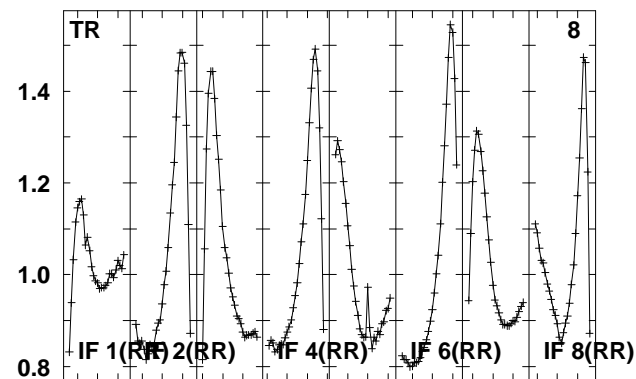
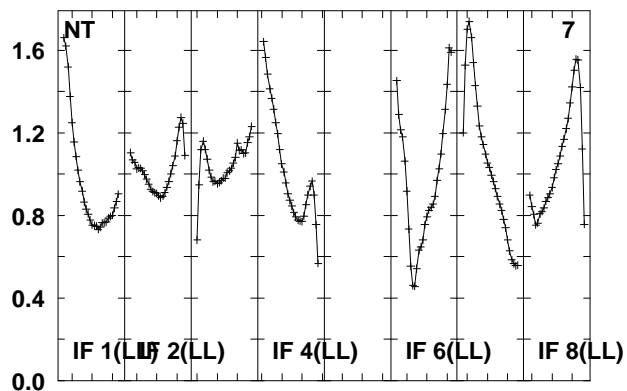
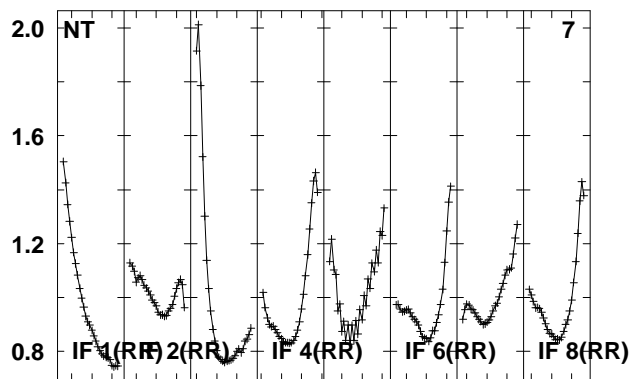
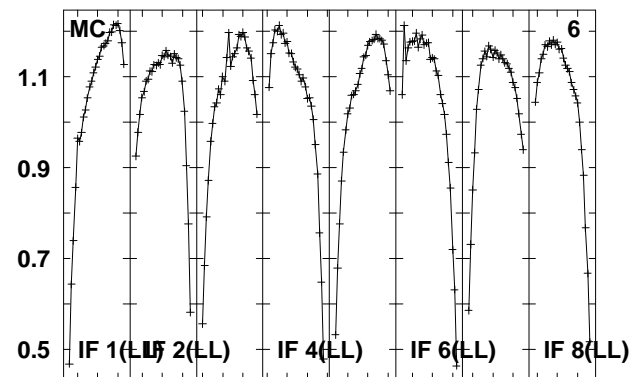
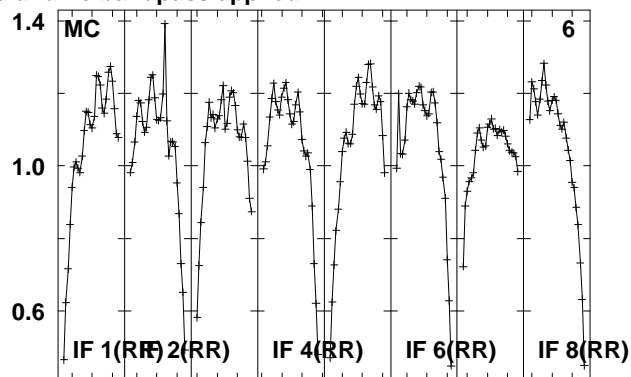
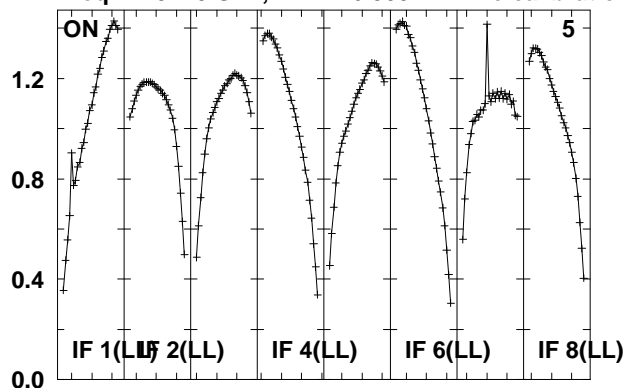

Lower frame: Real Jy

Total-power spectrum Antenna: *

Timerange: 00/16:46:45 to 00/16:48:11

Plot file version 487 created 14-MAY-2010 15:19:49
 J081523 EO007.UVDATA.1
 Freq = 4.9270 GHz, Bw = 16.000 MH No calibration applied and no bandpass applied

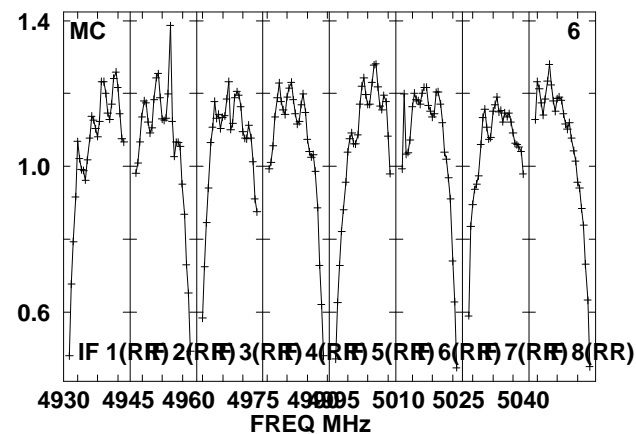
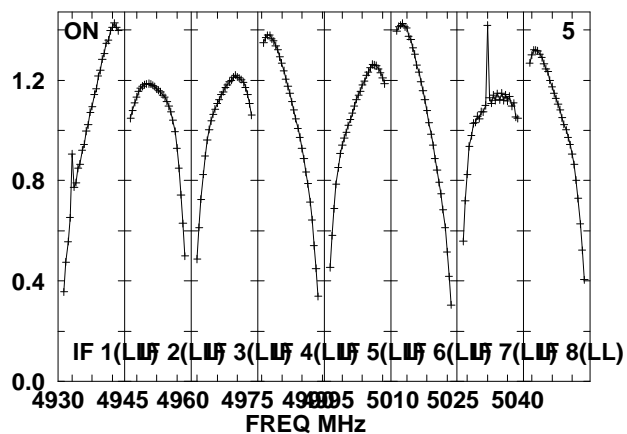
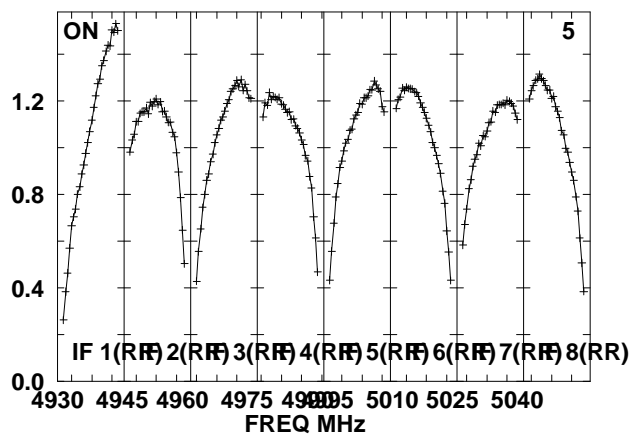
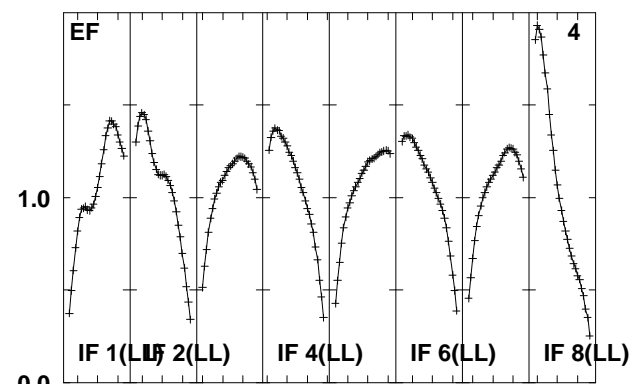
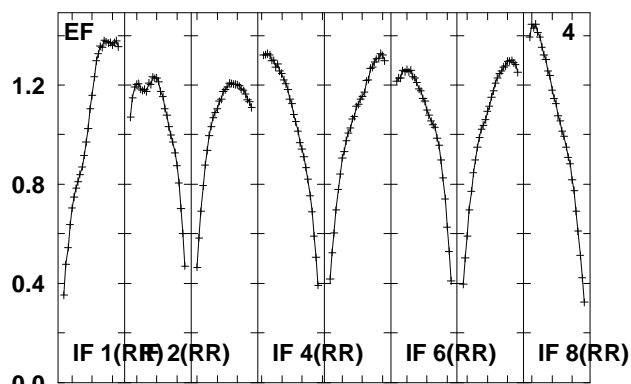
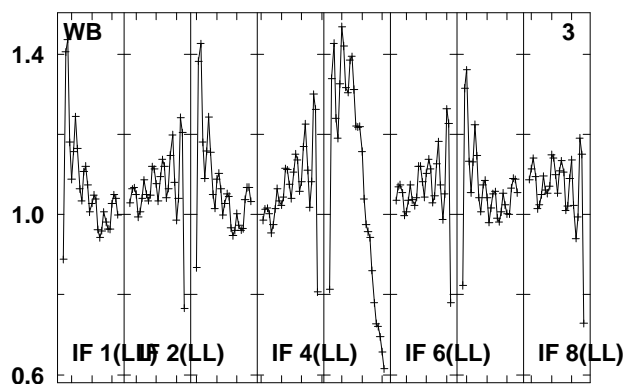
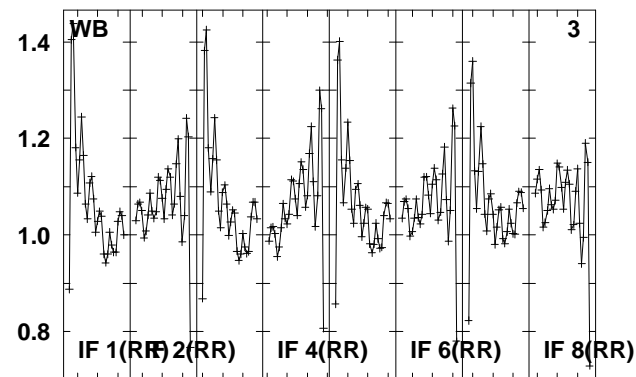
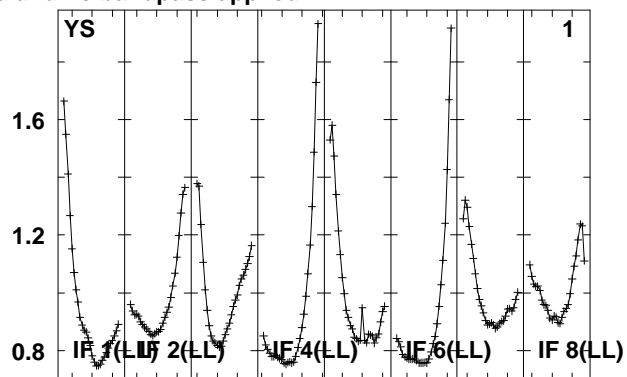
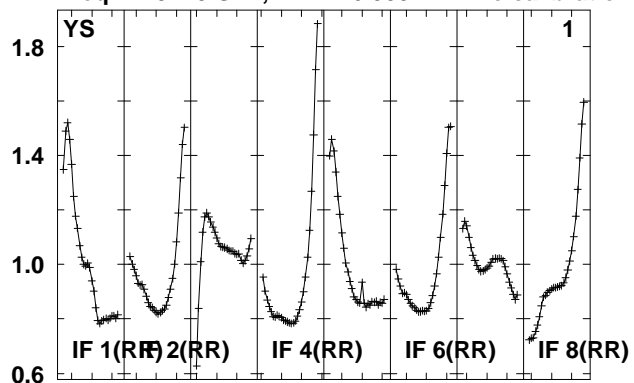

Lower frame: Real Jy
 Total-power spectrum Antenna: *
 Timerange: 00/16:48:38 to 00/16:53:34

Plot file version 488 created 14-MAY-2010 15:19:50

J081523 EO007.UVDATA.1

Freq = 4.9270 GHz, Bw = 16.000 MH No calibration applied and no bandpass applied

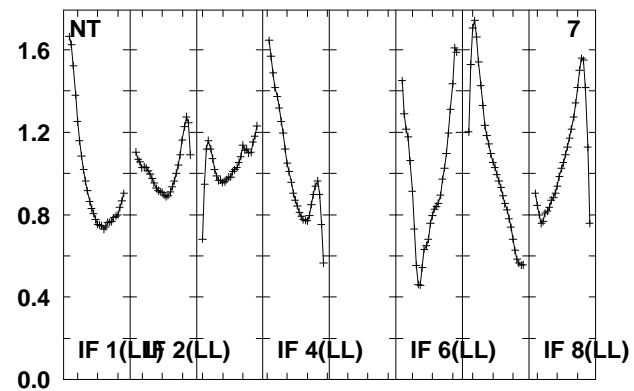
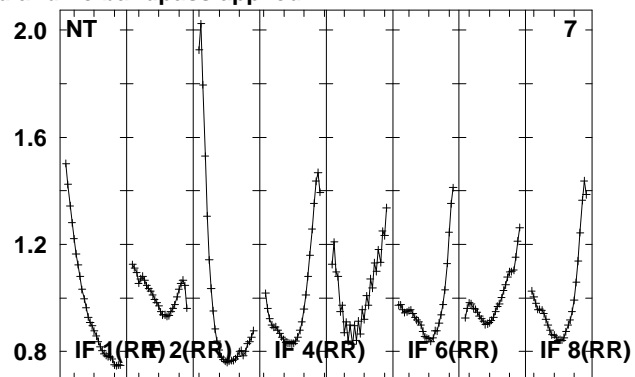
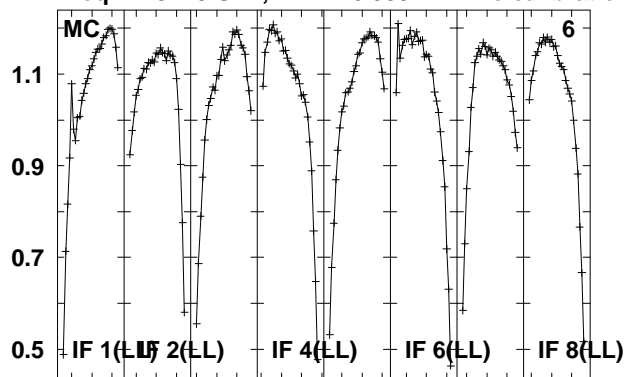

Lower frame: Real Jy
Total-power spectrum Antenna: *
Timerange: 00/16:48:38 to 00/16:53:34

Plot file version 489 created 14-MAY-2010 15:19:50
 J0808+49 EO007.UVDATA.1
 Freq = 4.9270 GHz, Bw = 16.000 MH No calibration applied and no bandpass applied

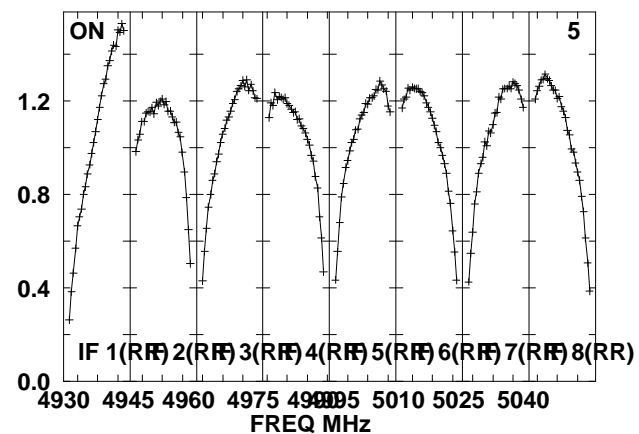
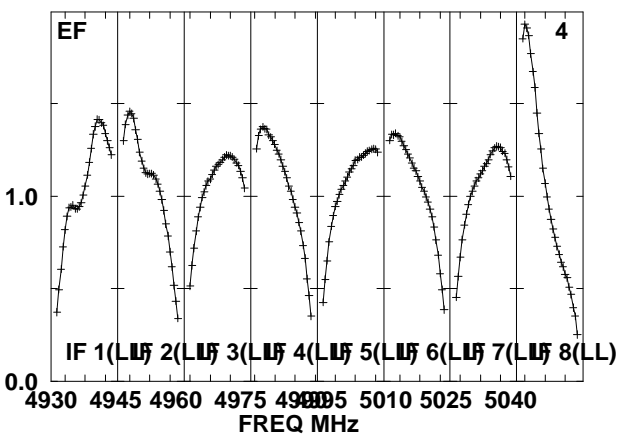
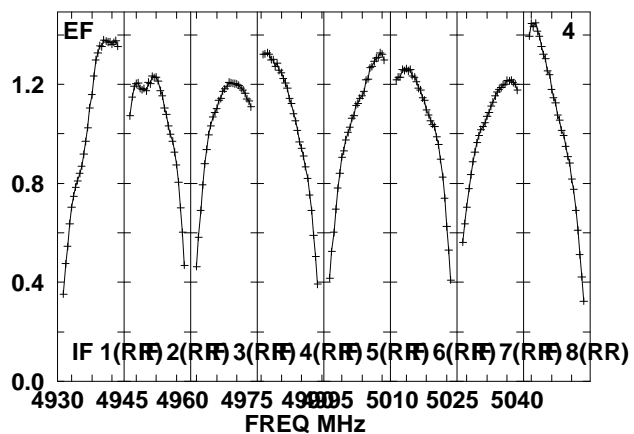
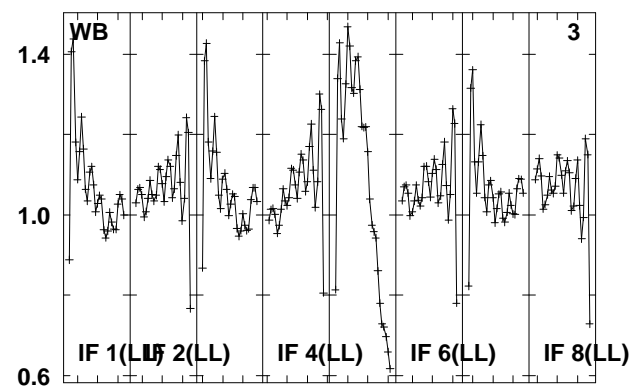
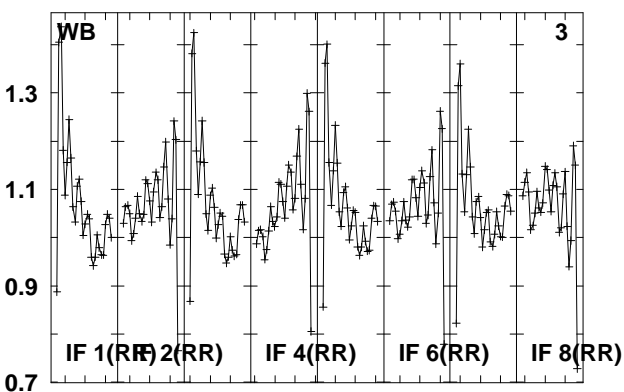
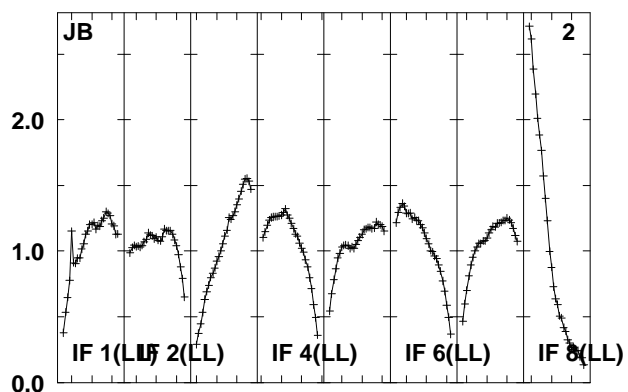
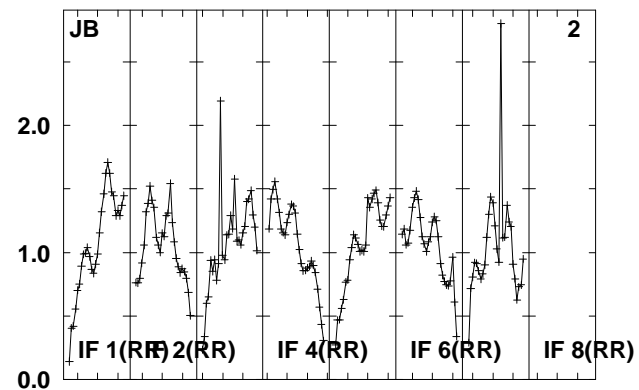
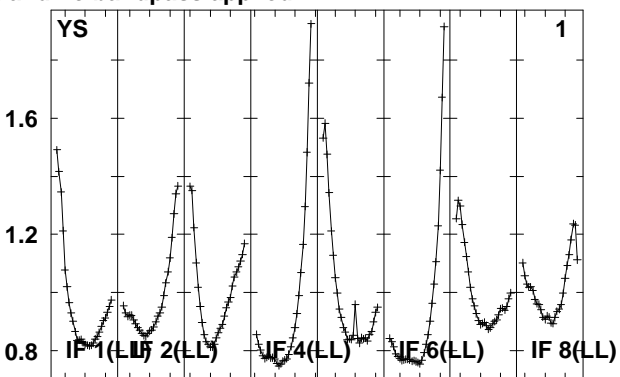
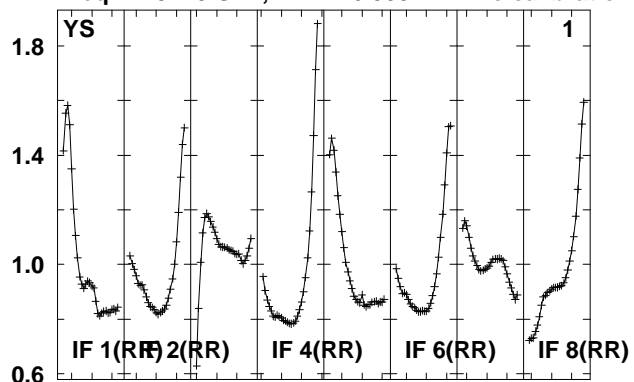

Lower frame: Real Jy
 Total-power spectrum Antenna: *
 Timerange: 00/16:54:02 to 00/16:55:30

Plot file version 490 created 14-MAY-2010 15:19:50

J0808+49 EO007.UVDATA.1

Freq = 4.9270 GHz, Bw = 16.000 MH No calibration applied and no bandpass applied

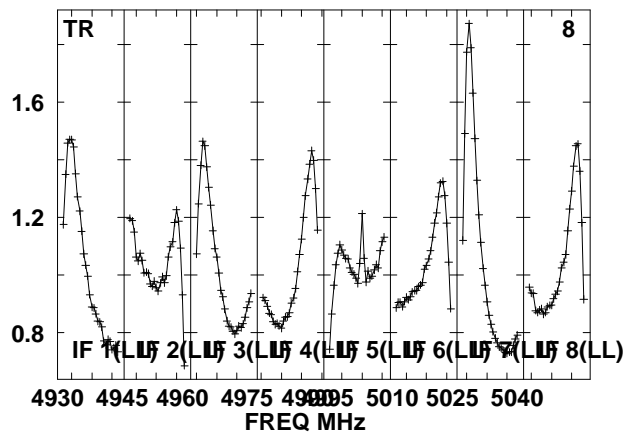
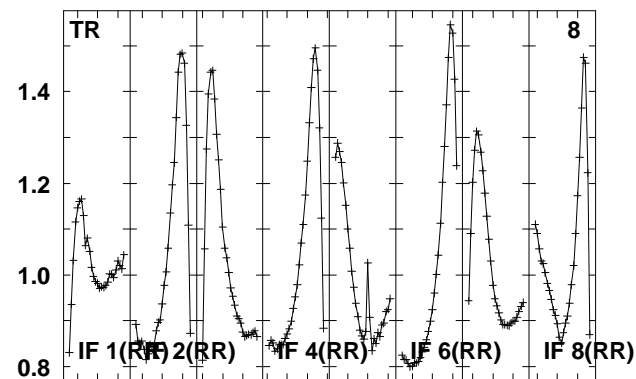
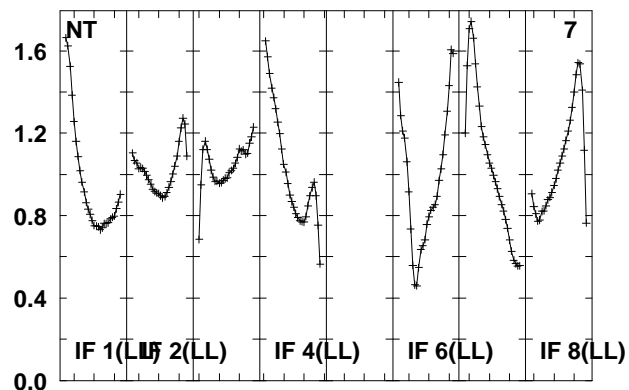
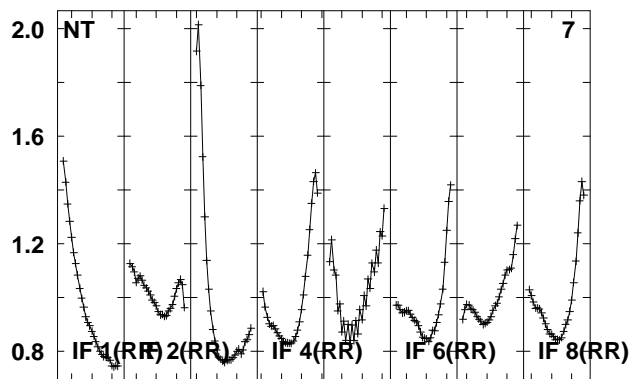
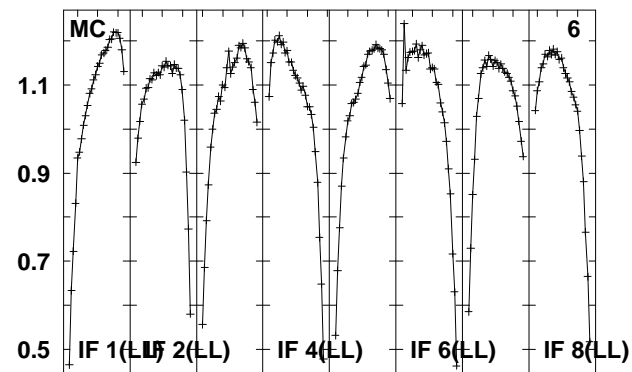
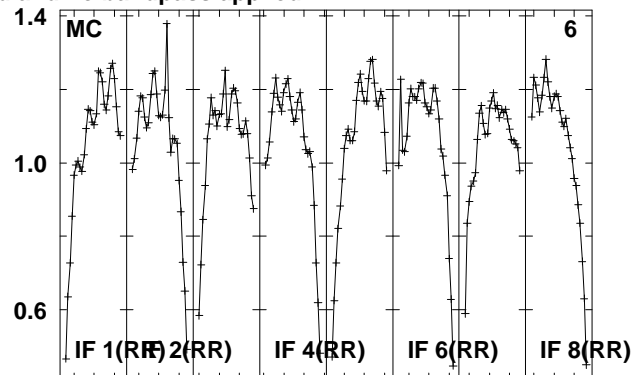
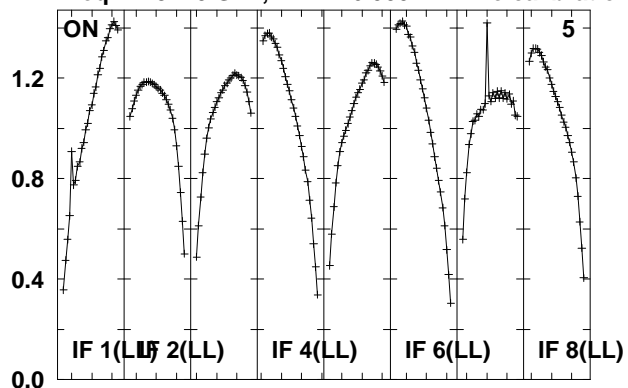

Lower frame: Real Jy

Total-power spectrum Antenna: *

Timerange: 00/16:54:02 to 00/16:55:30

Plot file version 491 created 14-MAY-2010 15:19:51

J0927+39 EO007.UVDATA.1

Freq = 4.9270 GHz, Bw = 16.000 MH No calibration applied and no bandpass applied

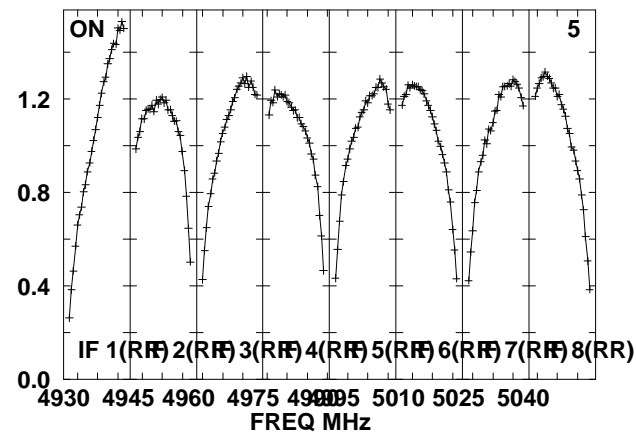
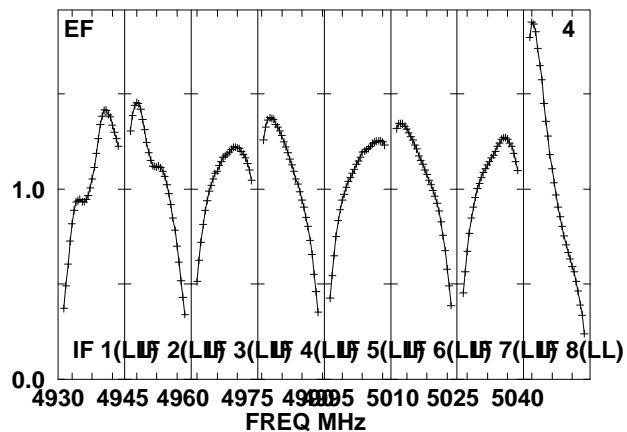
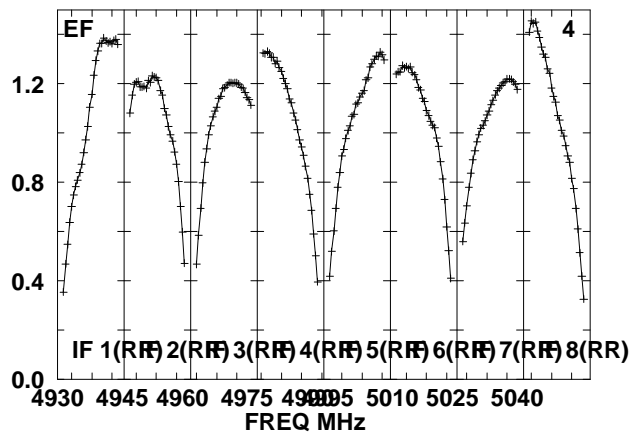
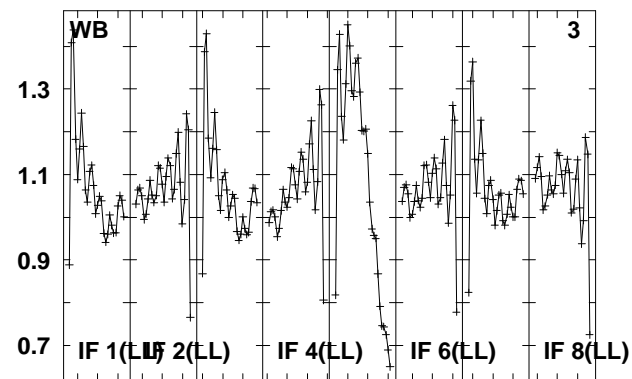
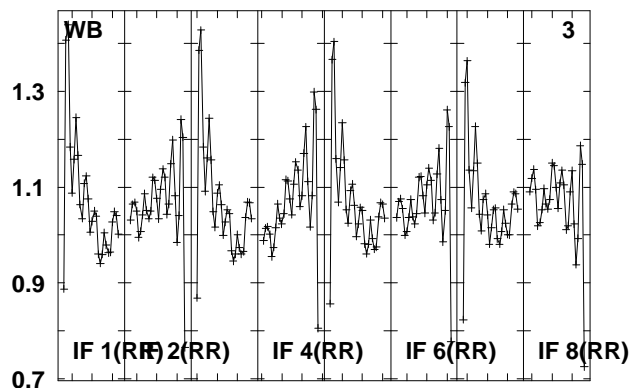
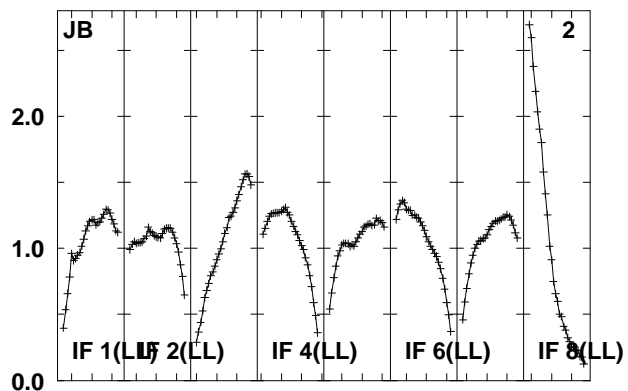
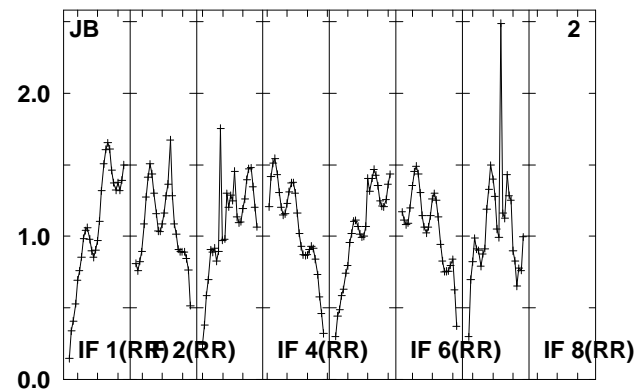
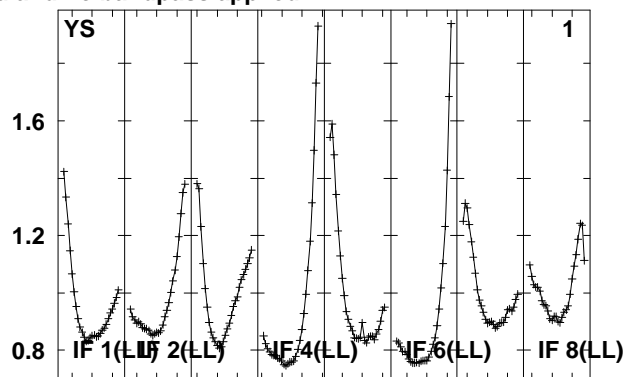
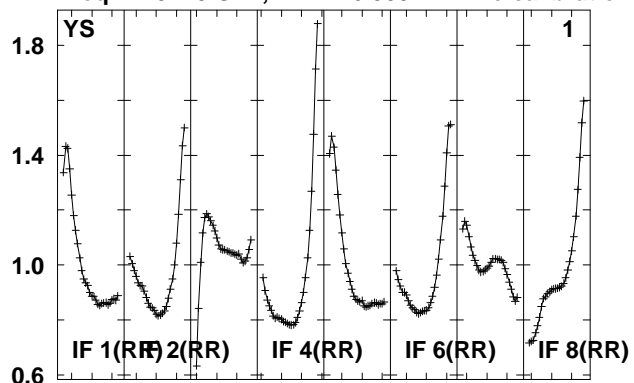

Lower frame: Real Jy

Total-power spectrum Antenna: *

Timerange: 00/16:57:32 to 00/17:02:30

Plot file version 492 created 14-MAY-2010 15:19:51

J0927+39 EO007.UVDATA.1

Freq = 4.9270 GHz, Bw = 16.000 MH No calibration applied and no bandpass applied

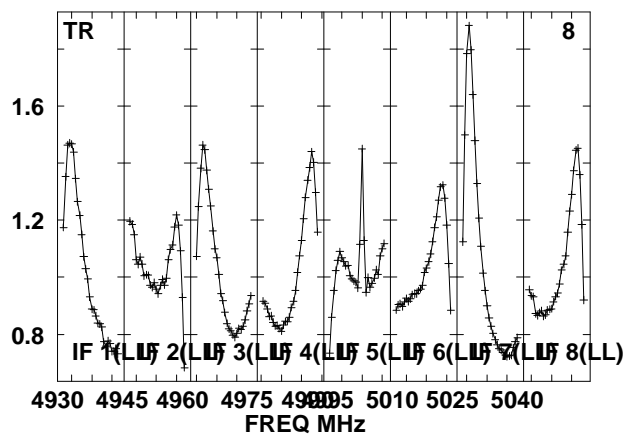
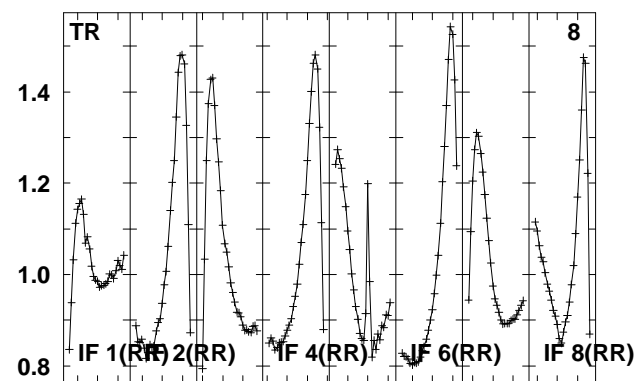
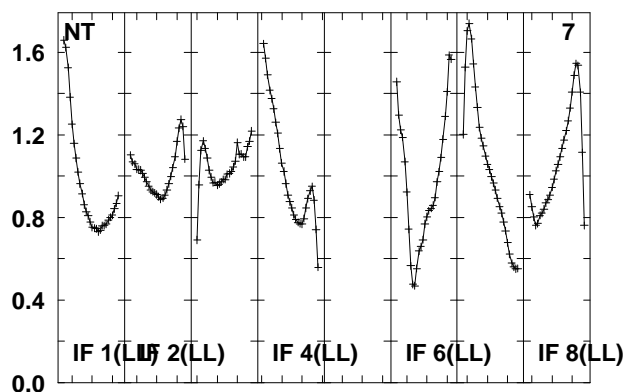
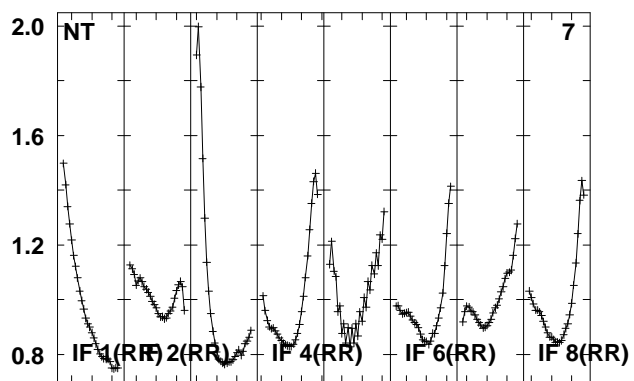
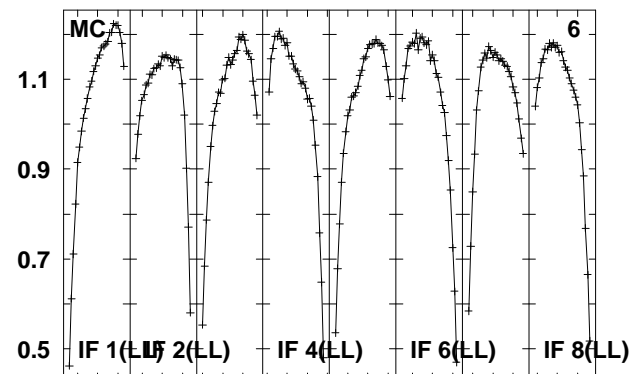
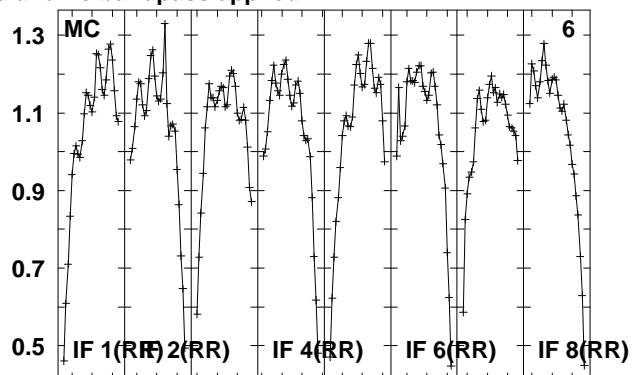
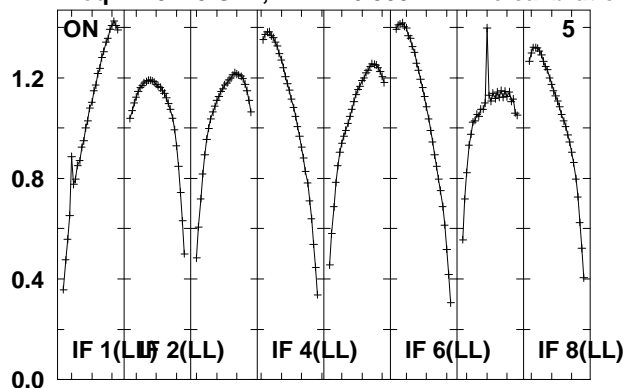

Lower frame: Real Jy

Total-power spectrum Antenna: *

Timerange: 00/16:57:32 to 00/17:02:30

Plot file version 493 created 14-MAY-2010 15:19:52

J0920+44 EO007.UVDATA.1

Freq = 4.9270 GHz, Bw = 16.000 MH No calibration applied and no bandpass applied

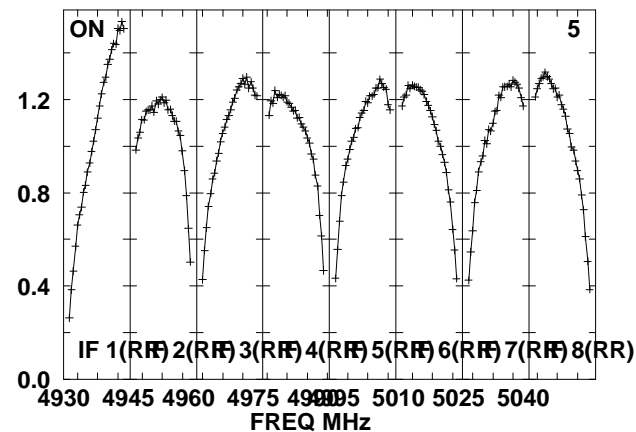
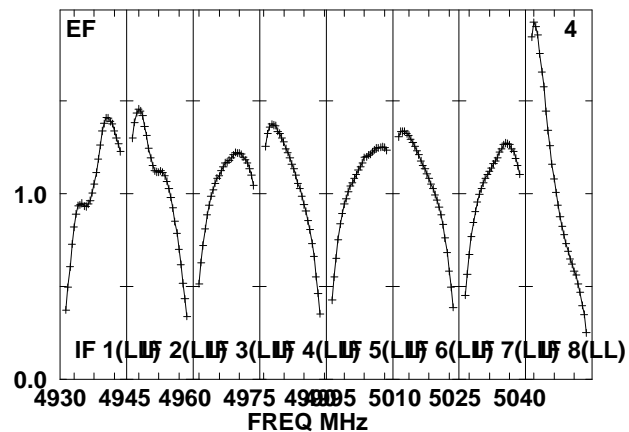
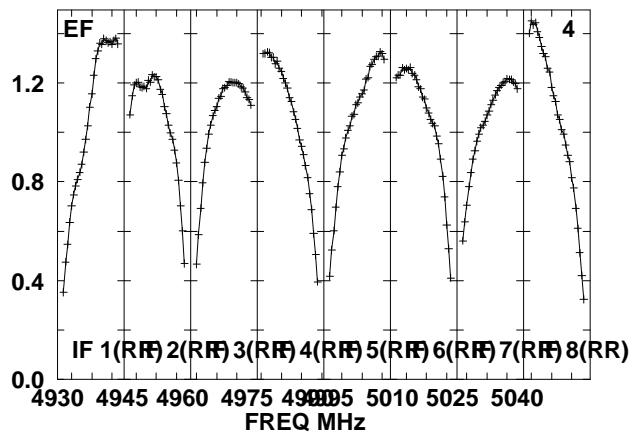
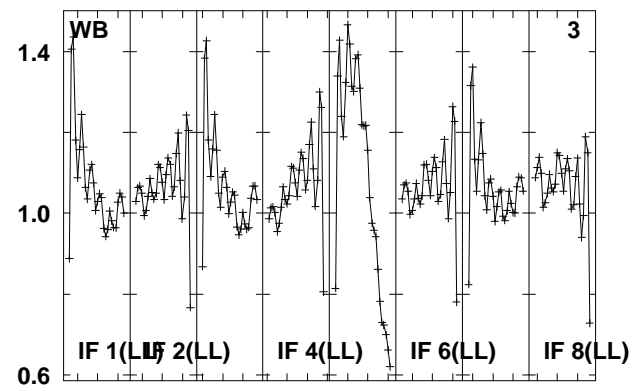
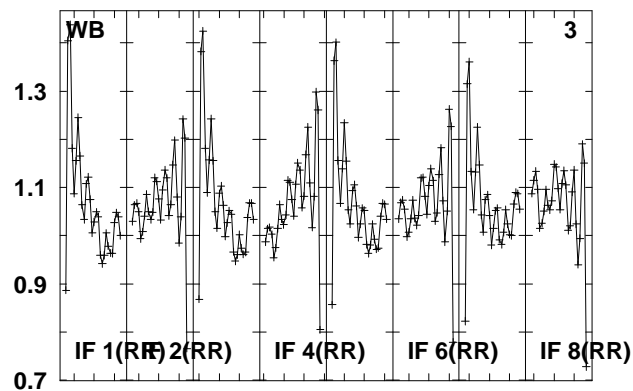
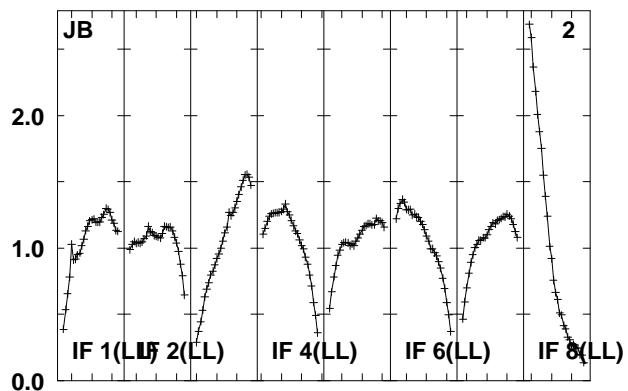
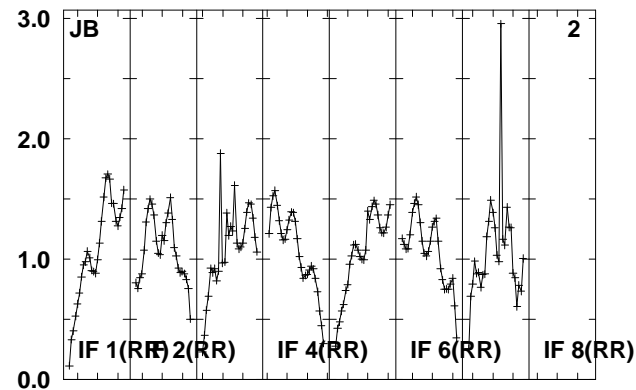
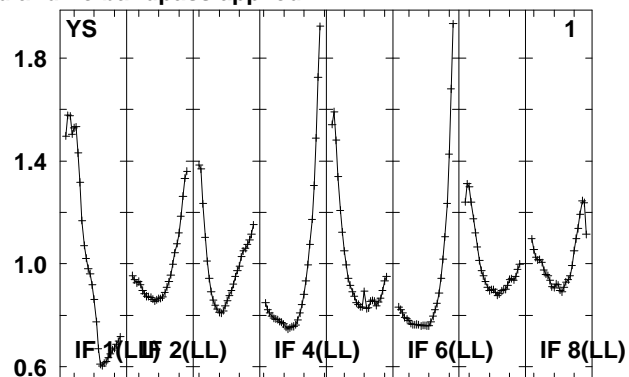
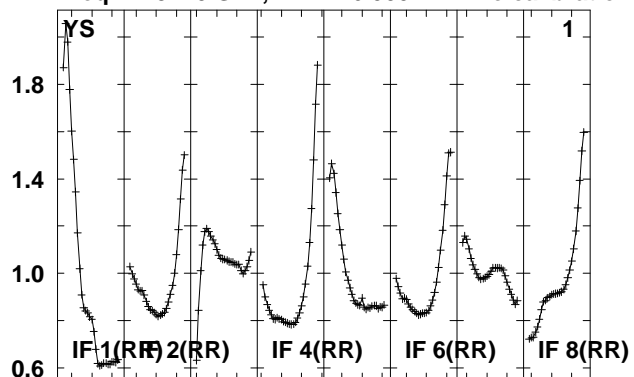

Lower frame: Real Jy
Total-power spectrum Antenna: *
Timerange: 00/17:03:18 to 00/17:04:46

Plot file version 494 created 14-MAY-2010 15:19:52

J0920+44 EO007.UVDATA.1

Freq = 4.9270 GHz, Bw = 16.000 MH No calibration applied and no bandpass applied

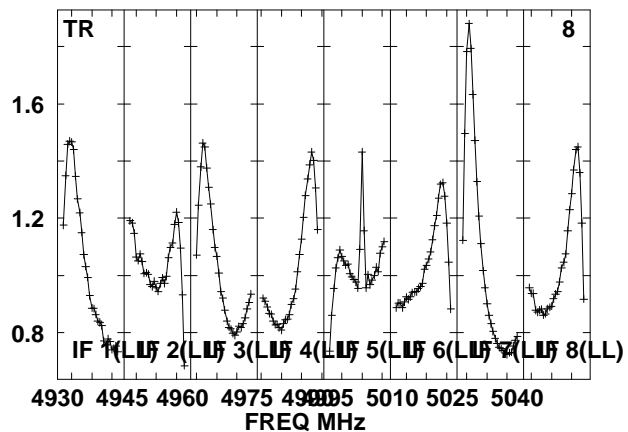
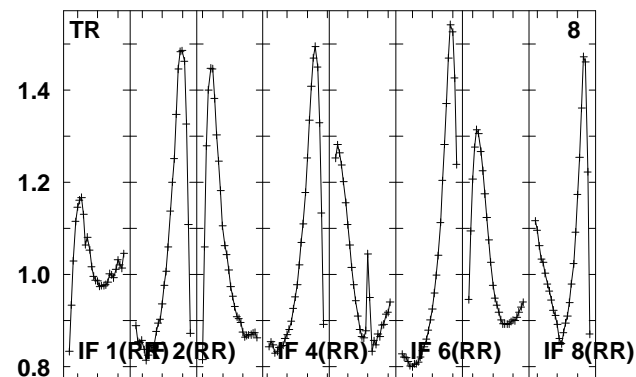
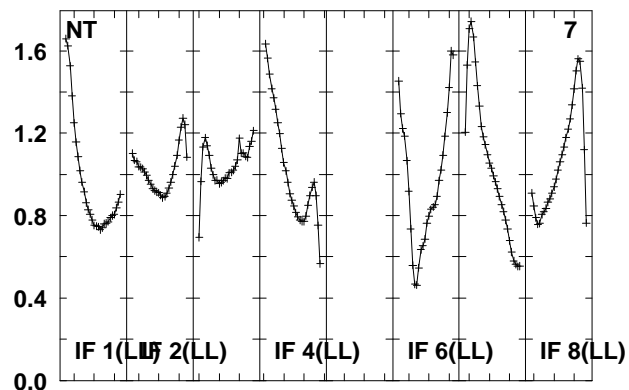
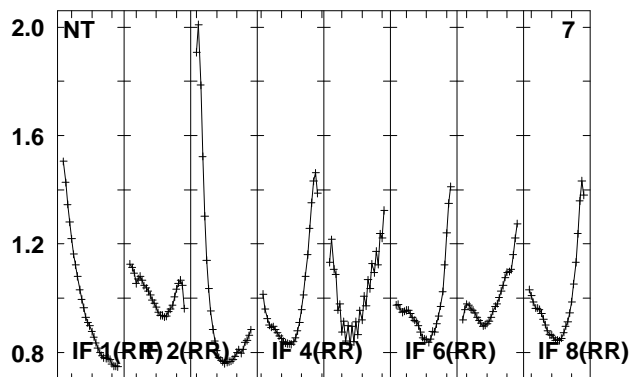
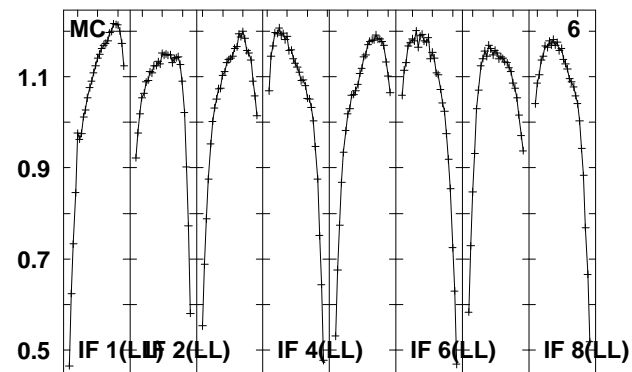
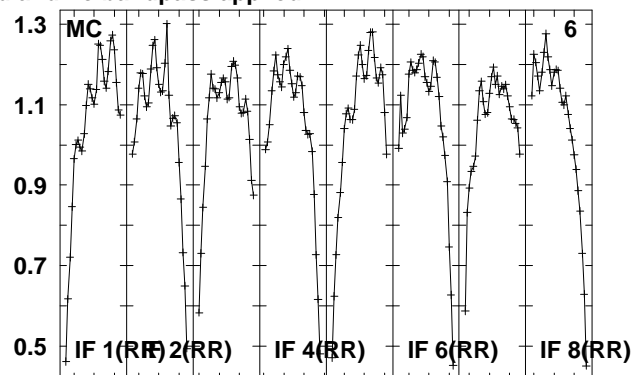
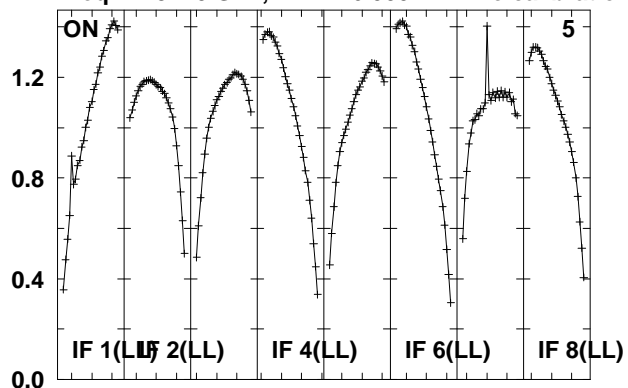

Lower frame: Real Jy

Total-power spectrum Antenna: *

Timerange: 00/17:03:18 to 00/17:04:46

Plot file version 495 created 14-MAY-2010 15:19:52
 J092159 EO007.UVDATA.1
 Freq = 4.9270 GHz, Bw = 16.000 MH No calibration applied and no bandpass applied

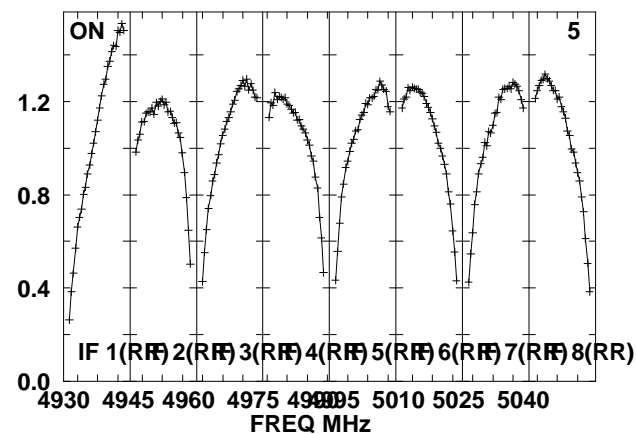
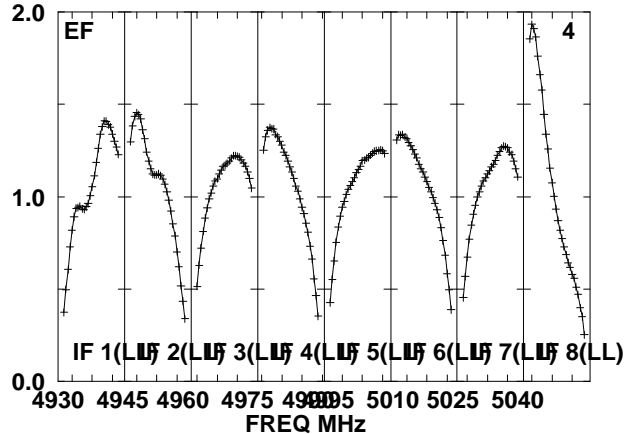
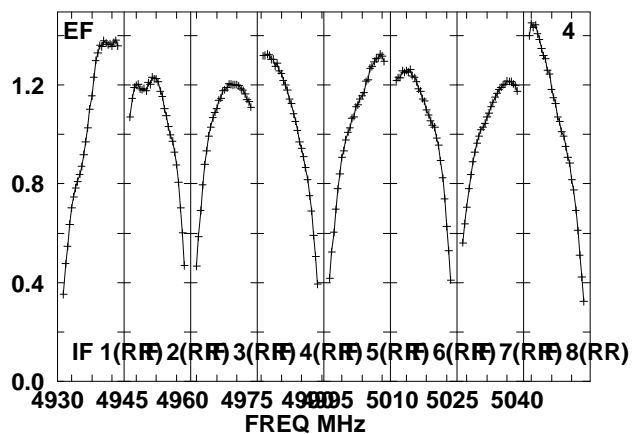
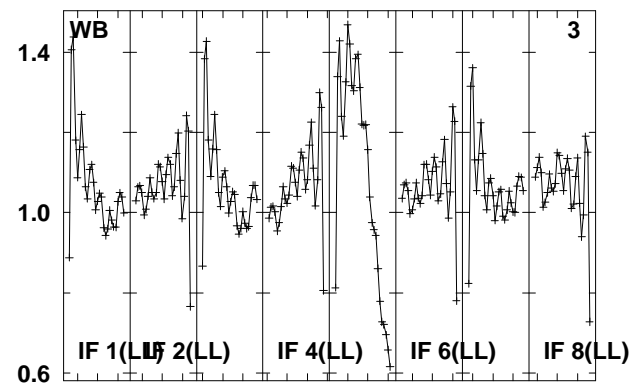
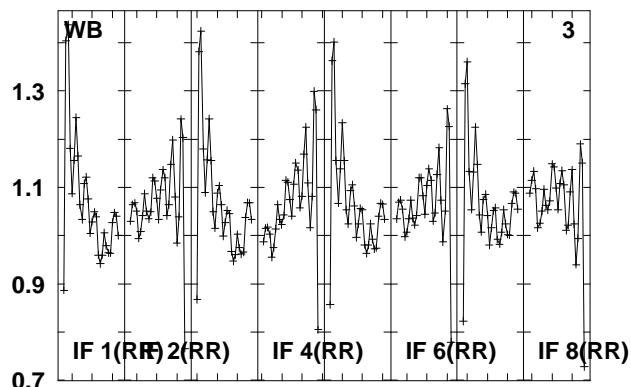
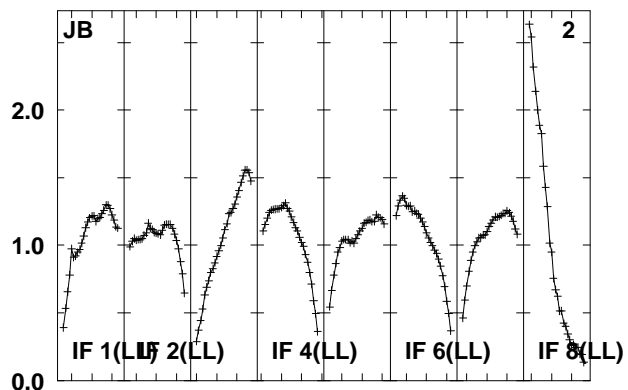
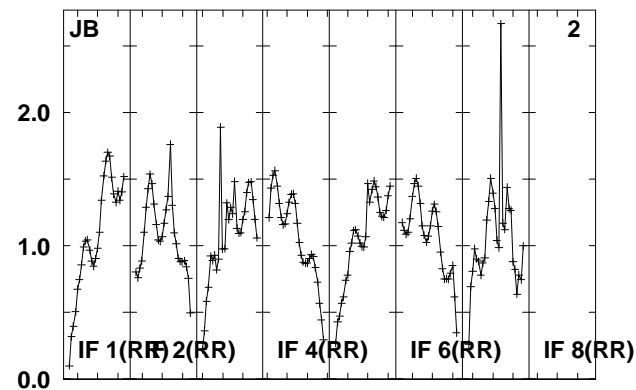
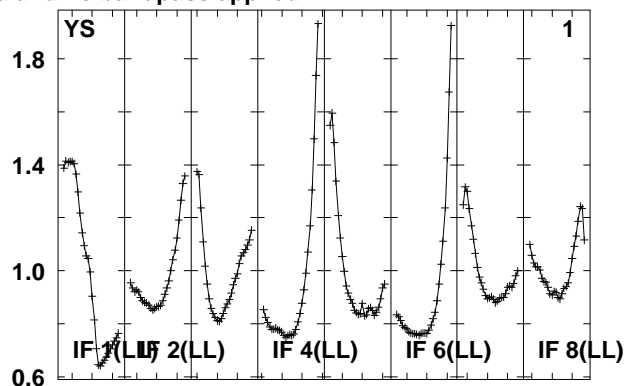
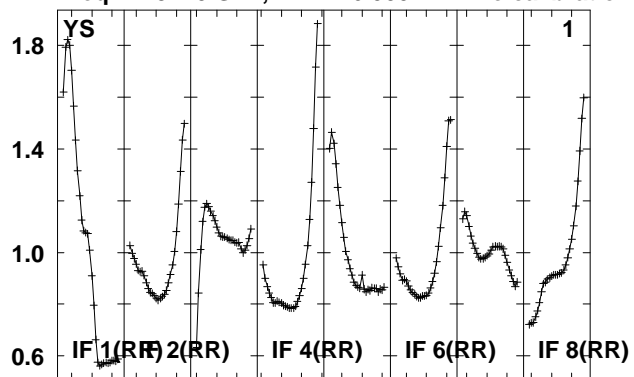

Lower frame: Real Jy
 Total-power spectrum Antenna: *
 Timerange: 00/17:05:09 to 00/17:10:07

Plot file version 496 created 14-MAY-2010 15:19:53

J092159 EO007.UVDATA.1

Freq = 4.9270 GHz, Bw = 16.000 MH No calibration applied and no bandpass applied

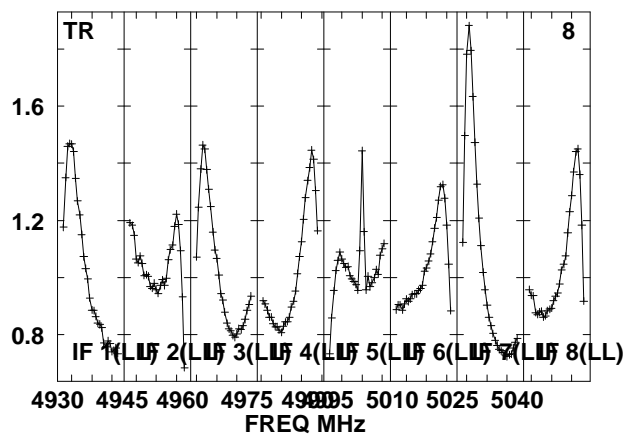
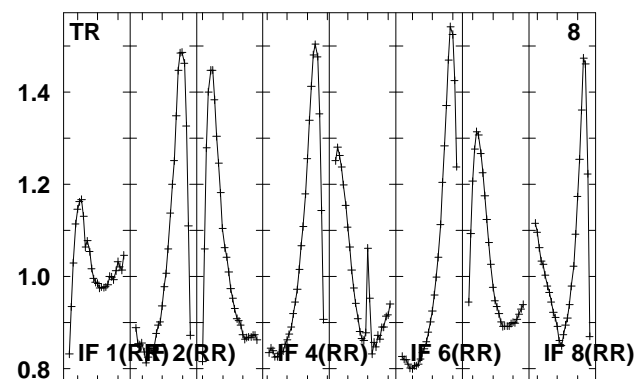
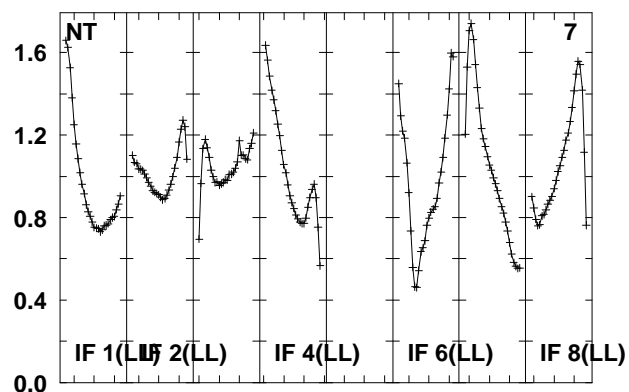
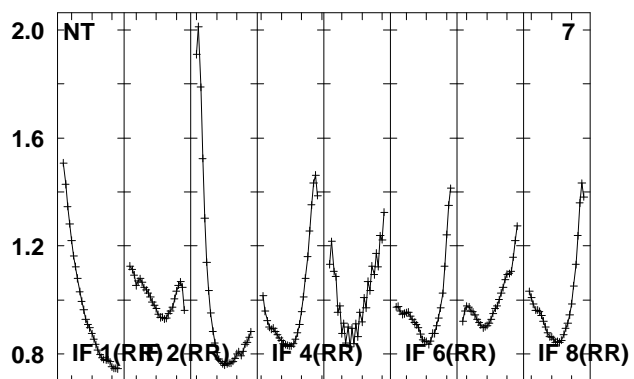
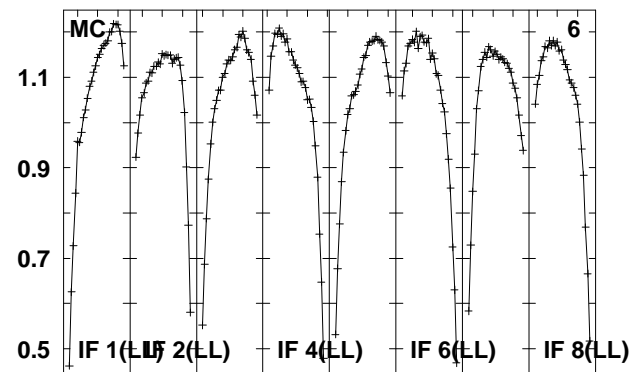
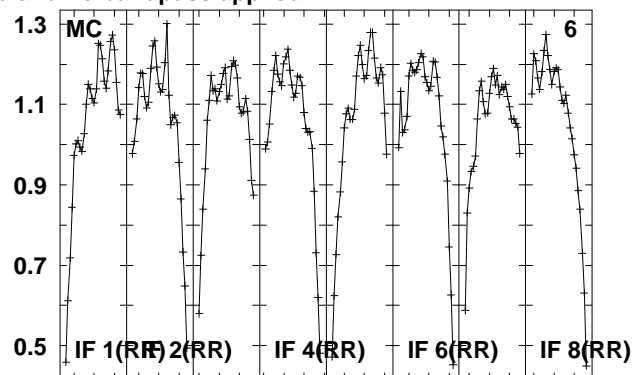
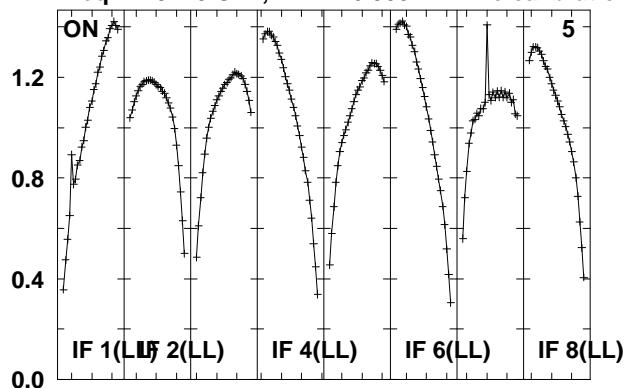

Lower frame: Real Jy

Total-power spectrum Antenna: *

Timerange: 00/17:05:09 to 00/17:10:07

Plot file version 497 created 14-MAY-2010 15:19:53

J0920+44 EO007.UVDATA.1

Freq = 4.9270 GHz, Bw = 16.000 MH No calibration applied and no bandpass applied

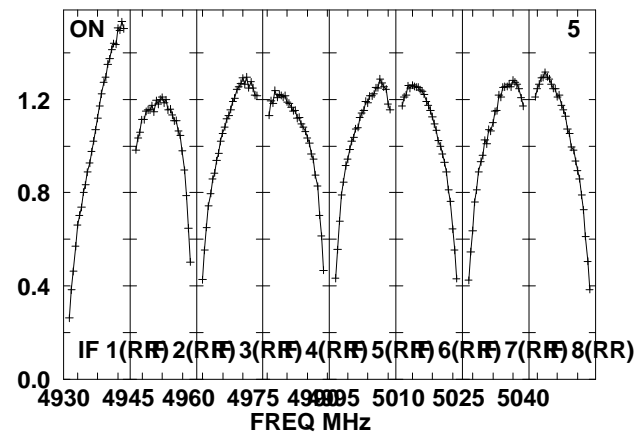
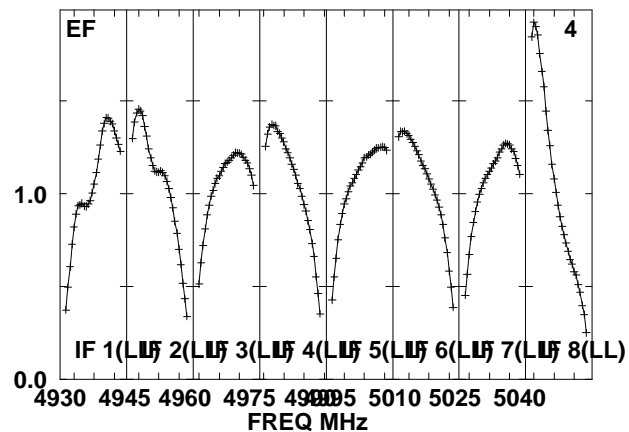
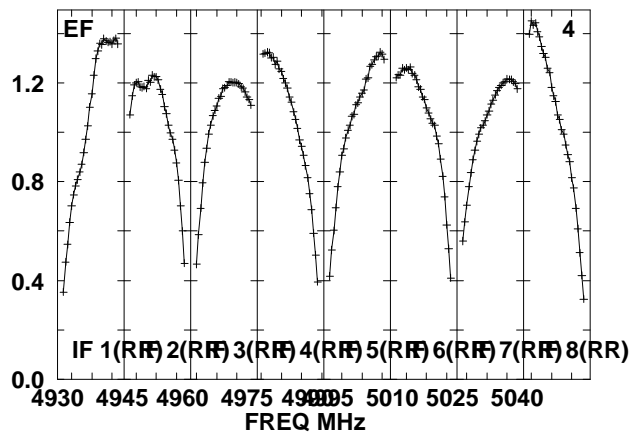
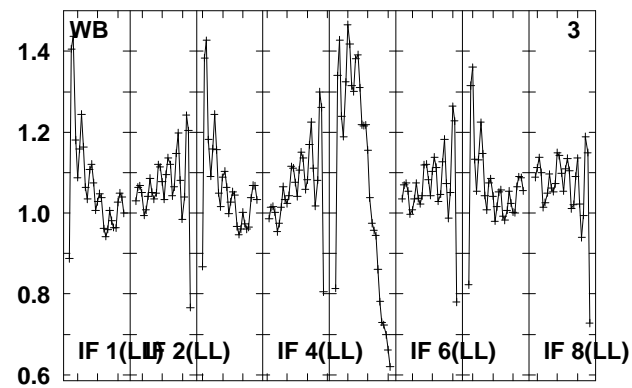
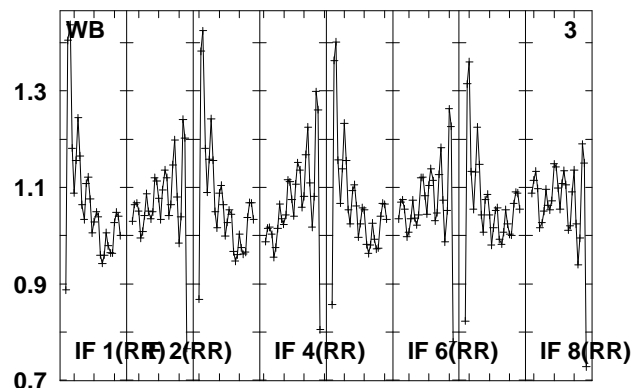
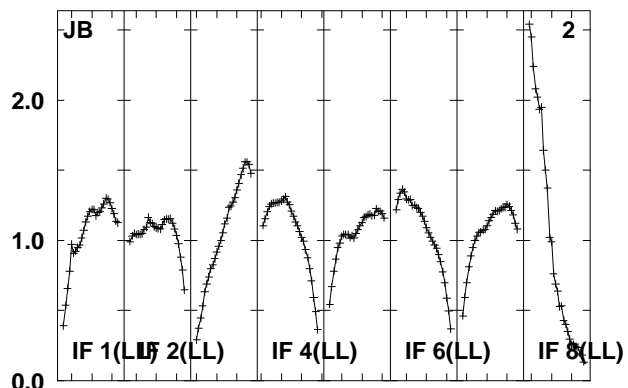
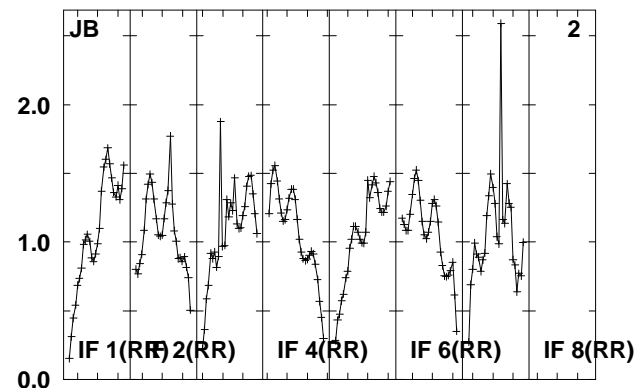
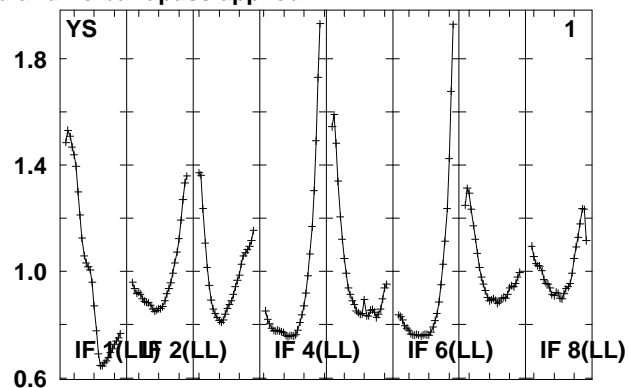
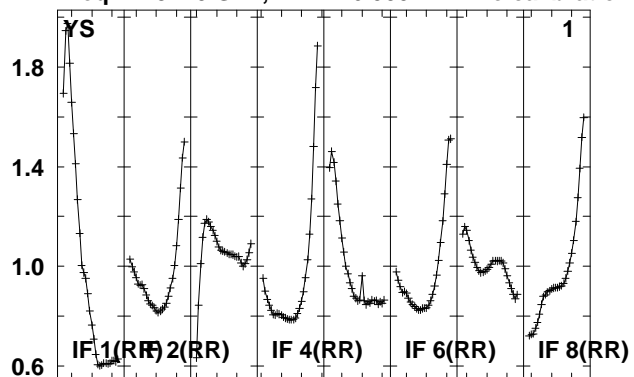

Lower frame: Real Jy

Total-power spectrum Antenna: *

Timerange: 00/17:10:30 to 00/17:11:56

Plot file version 498 created 14-MAY-2010 15:19:54

J0920+44 EO007.UVDATA.1

Freq = 4.9270 GHz, Bw = 16.000 MH No calibration applied and no bandpass applied

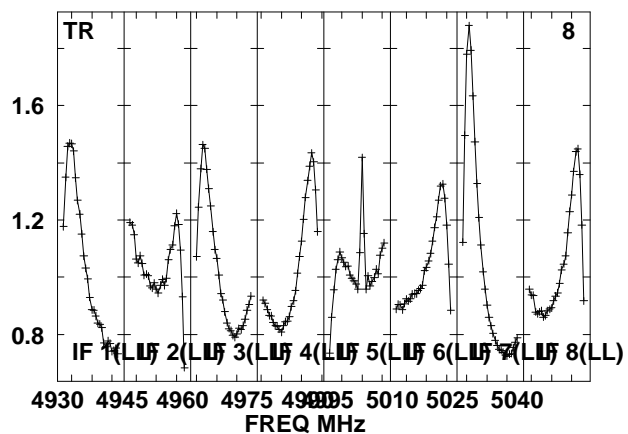
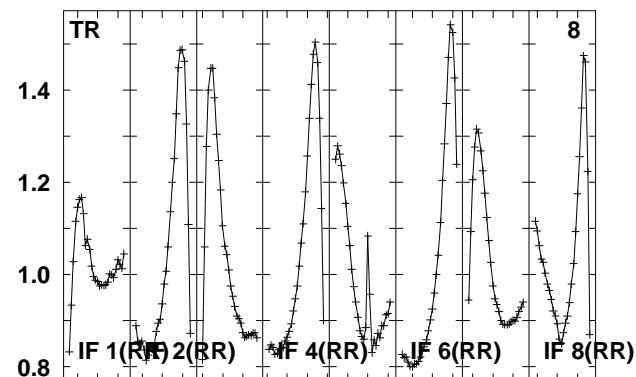
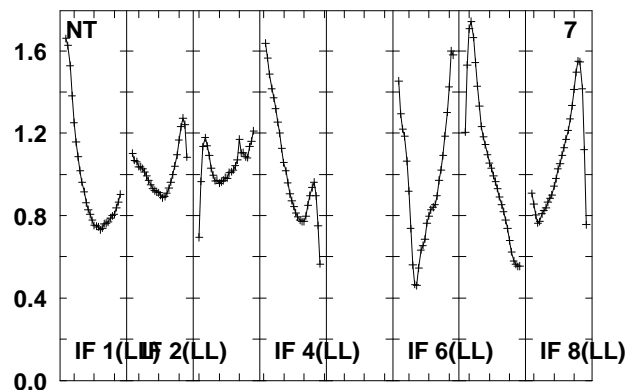
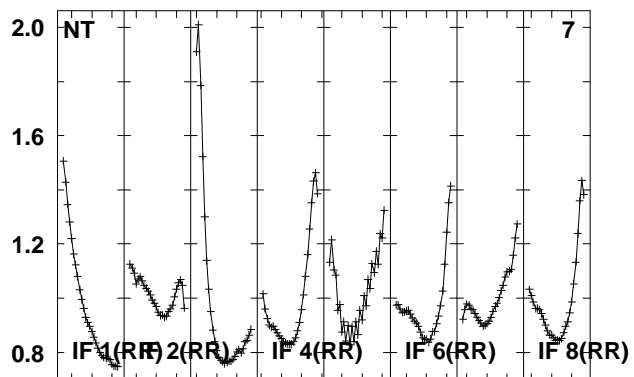
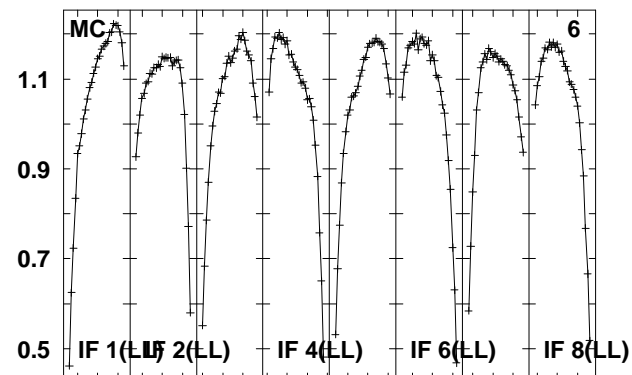
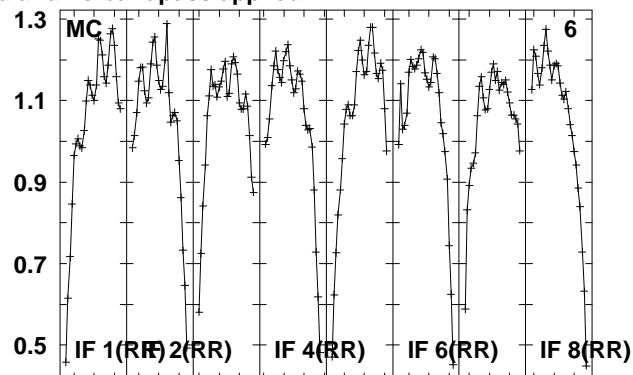
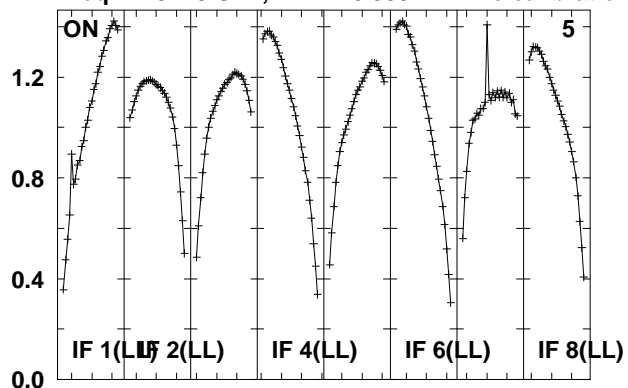

Lower frame: Real Jy

Total-power spectrum Antenna: *

Timerange: 00/17:10:30 to 00/17:11:56

Plot file version 499 created 14-MAY-2010 15:19:54

J092159 EO007.UVDATA.1

Freq = 4.9270 GHz, Bw = 16.000 MH No calibration applied and no bandpass applied

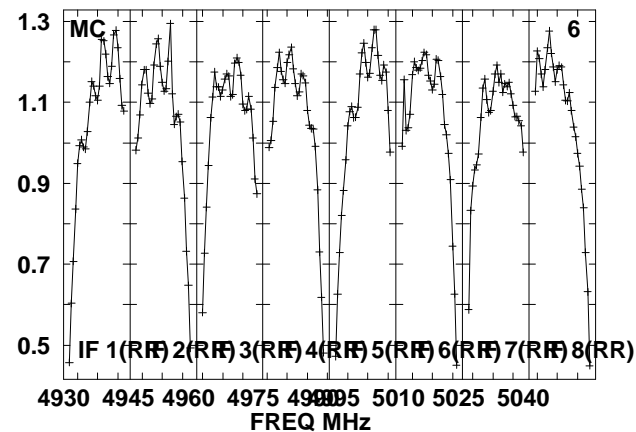
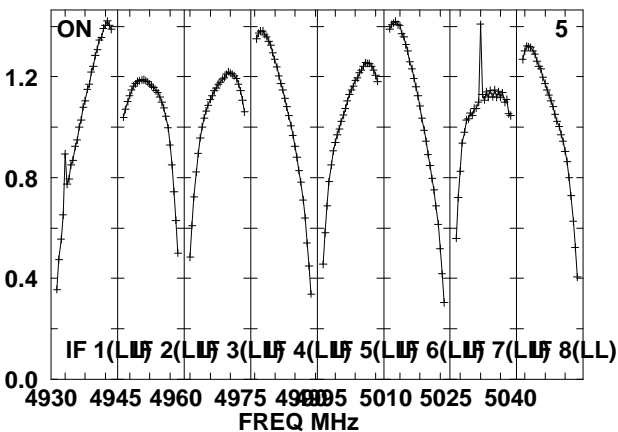
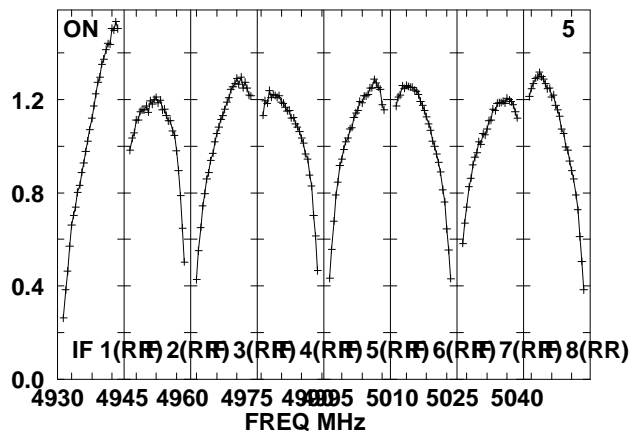
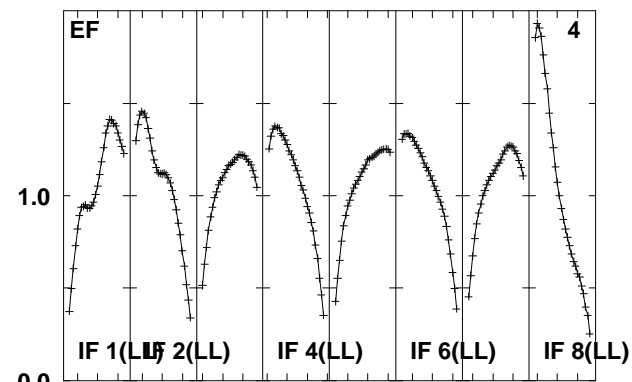
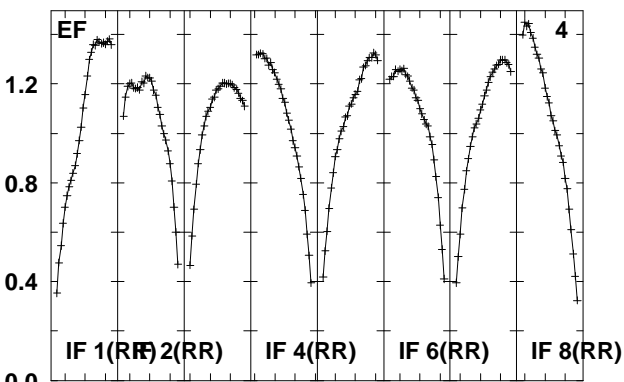
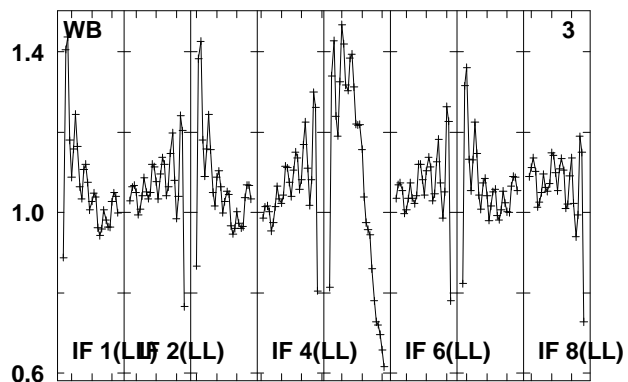
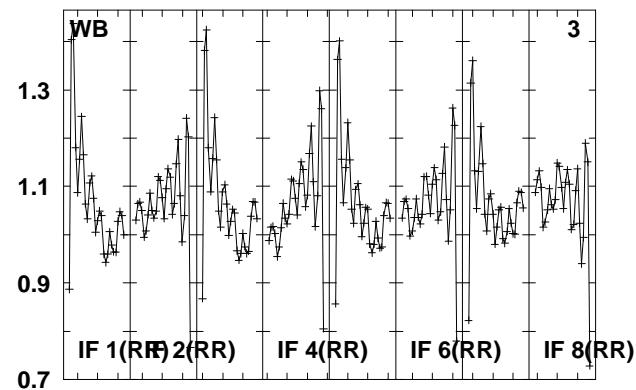
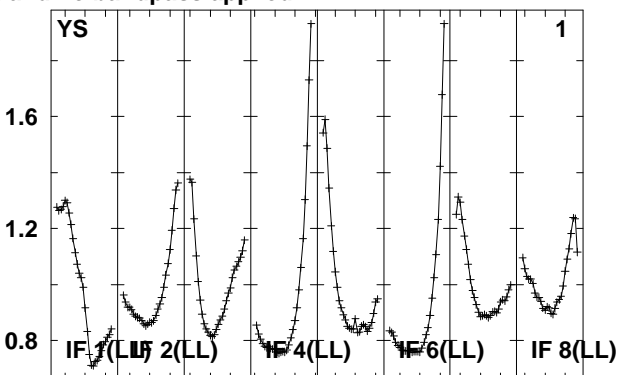
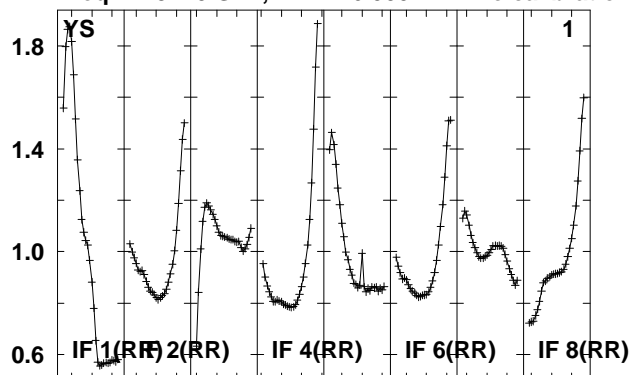

Lower frame: Real Jy
Total-power spectrum Antenna: *
Timerange: 00/17:12:21 to 00/17:17:17

Plot file version 500 created 14-MAY-2010 15:19:55

J092159 EO007.UVDATA.1

Freq = 4.9270 GHz, Bw = 16.000 MH No calibration applied and no bandpass applied

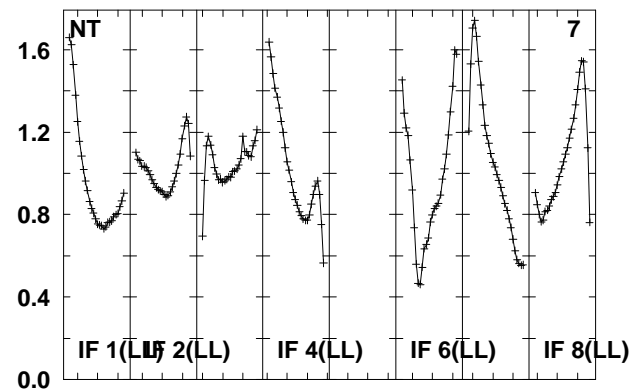
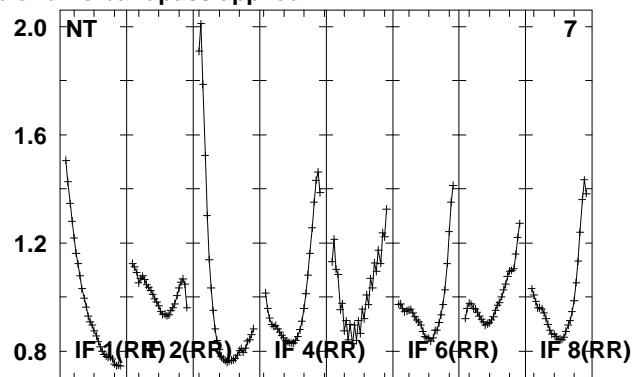
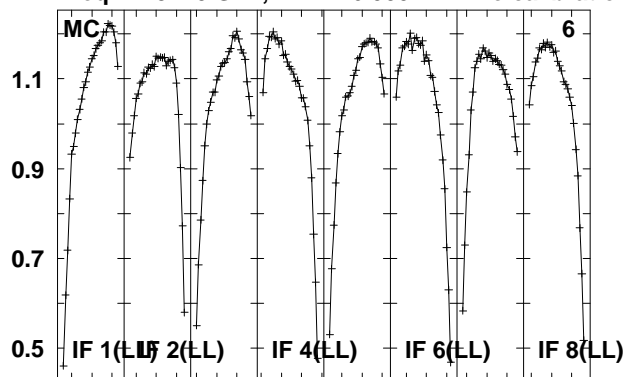

Lower frame: Real Jy
Total-power spectrum Antenna: *
Timerange: 00/17:12:21 to 00/17:17:17

Plot file version 501 created 14-MAY-2010 15:19:55

J0920+44 EO007.UVDATA.1

Freq = 4.9270 GHz, Bw = 16.000 MH No calibration applied and no bandpass applied

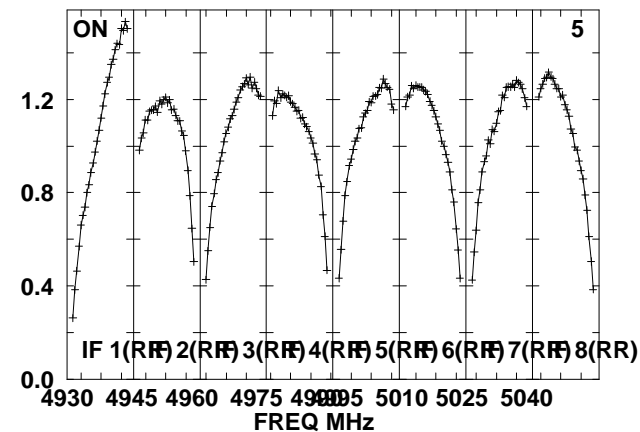
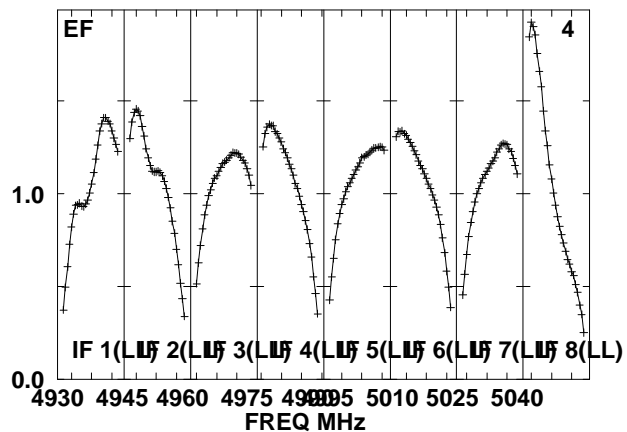
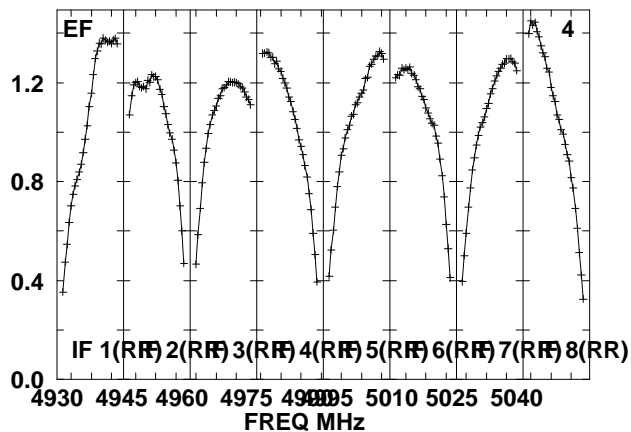
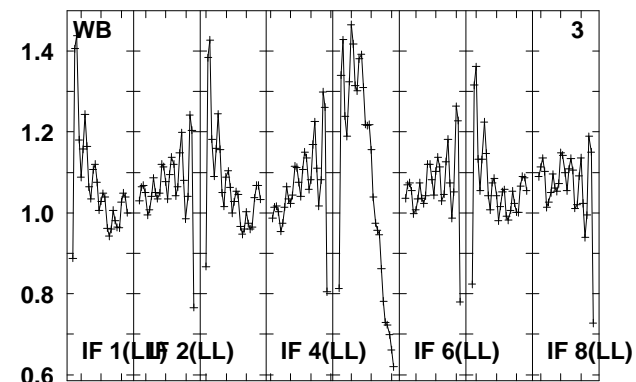
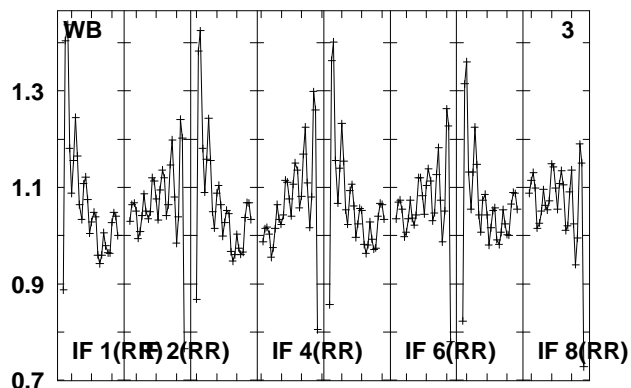
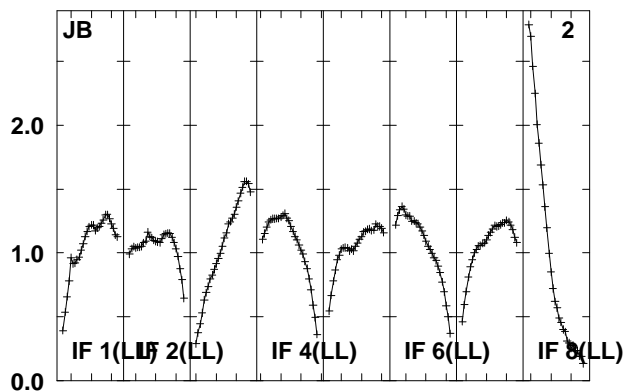
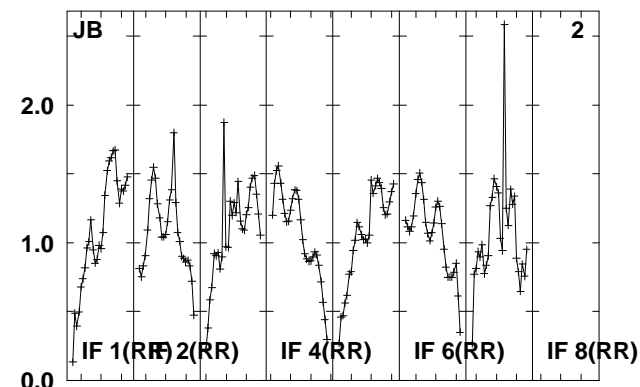
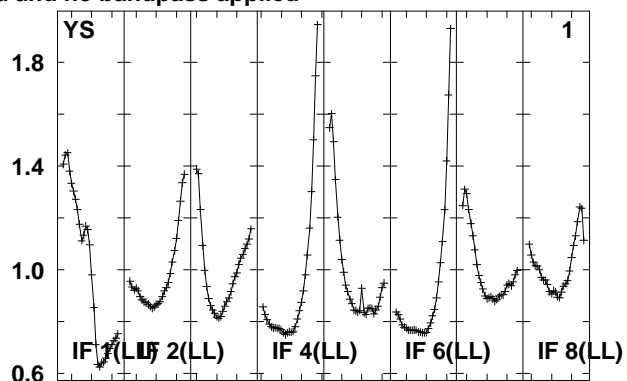
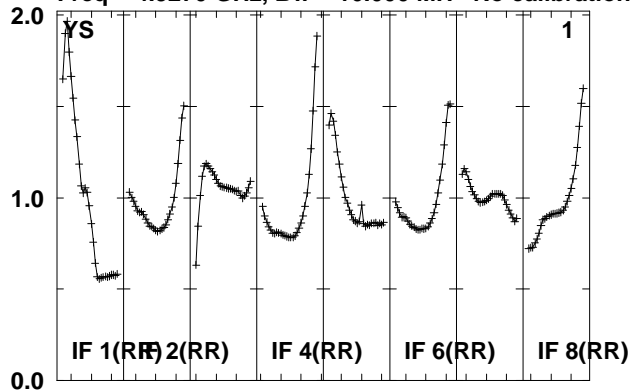

Lower frame: Real Jy
Total-power spectrum Antenna: *
Timerange: 00/17:17:43 to 00/17:19:11

Plot file version 502 created 14-MAY-2010 15:19:55

J0920+44 EO007.UVDATA.1

Freq = 4.9270 GHz, Bw = 16.000 MH No calibration applied and no bandpass applied

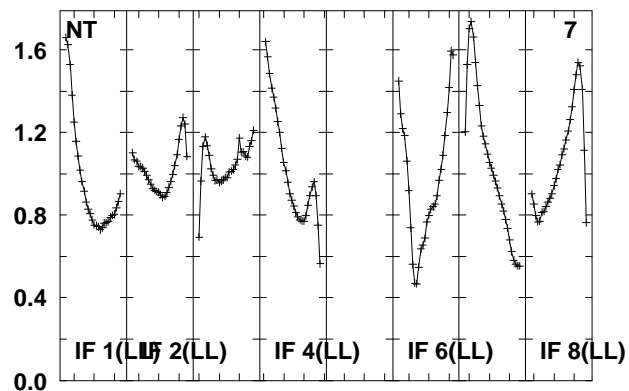
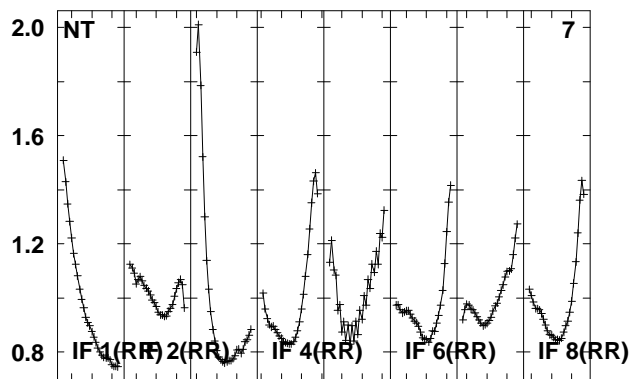
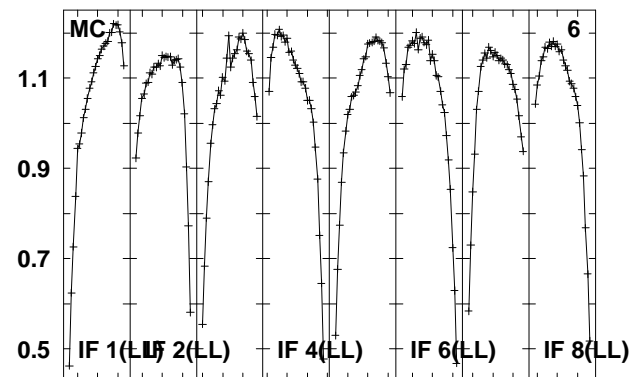
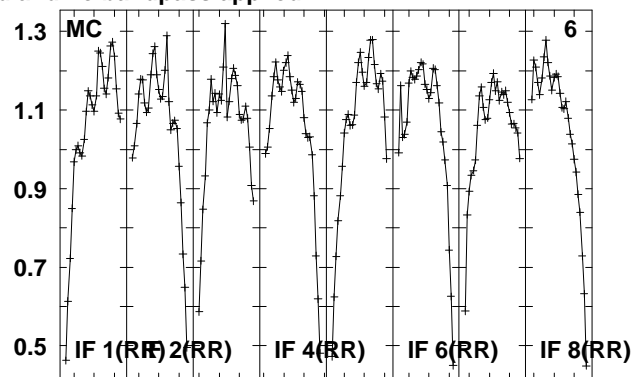
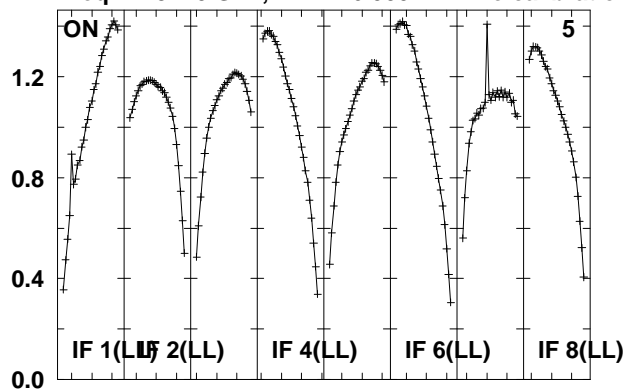

Lower frame: Real Jy
Total-power spectrum Antenna: *
Timerange: 00/17:17:43 to 00/17:19:11

Plot file version 503 created 14-MAY-2010 15:19:55

J1027+48 EO007.UVDATA.1

Freq = 4.9270 GHz, Bw = 16.000 MH No calibration applied and no bandpass applied

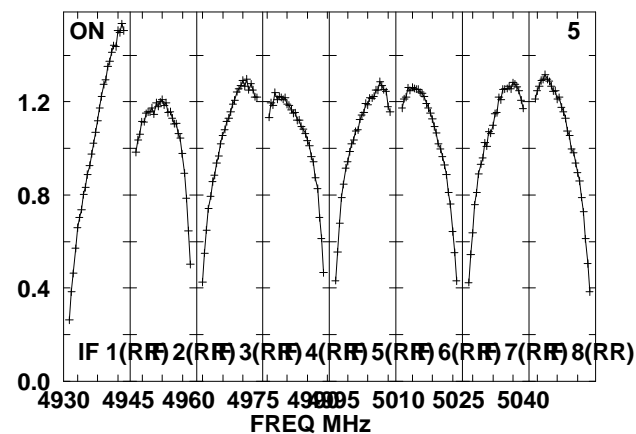
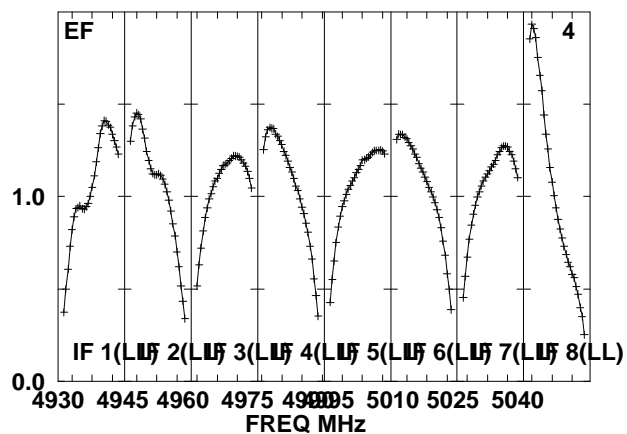
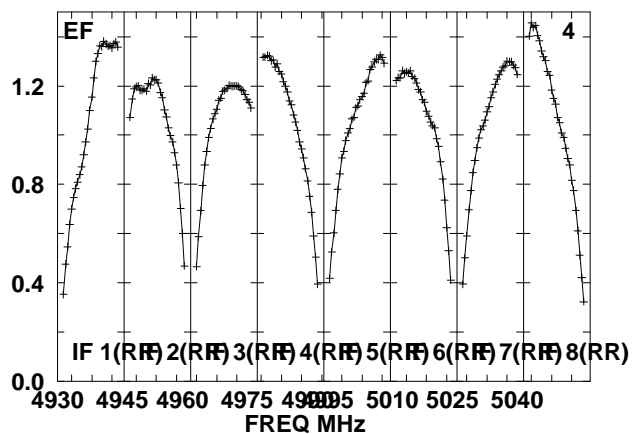
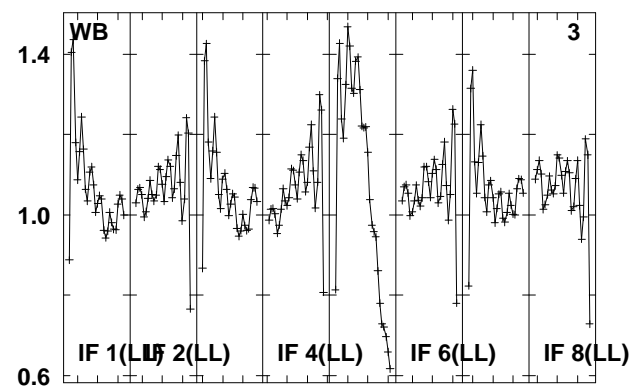
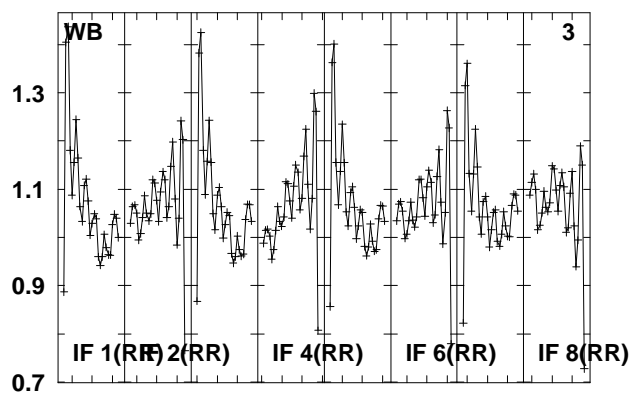
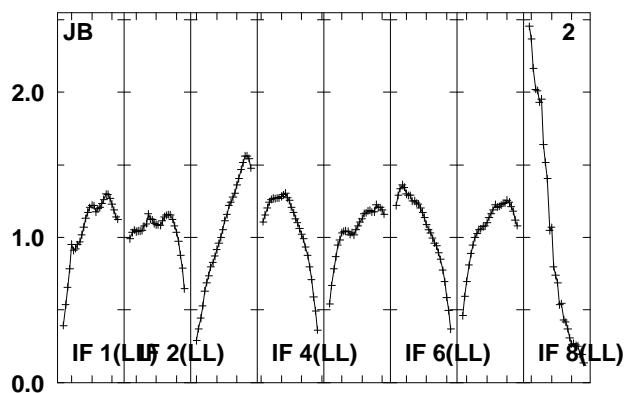
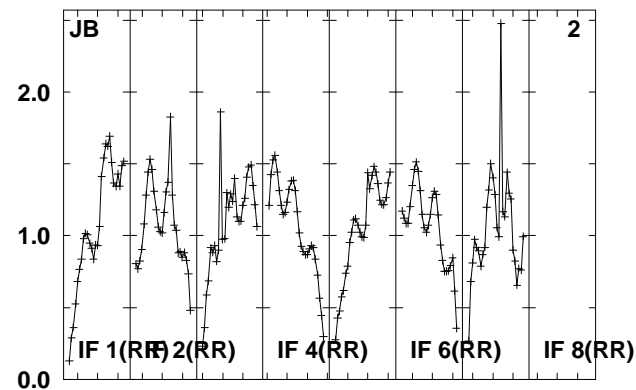
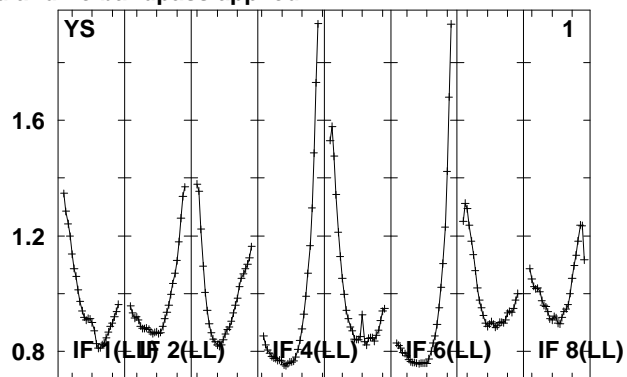
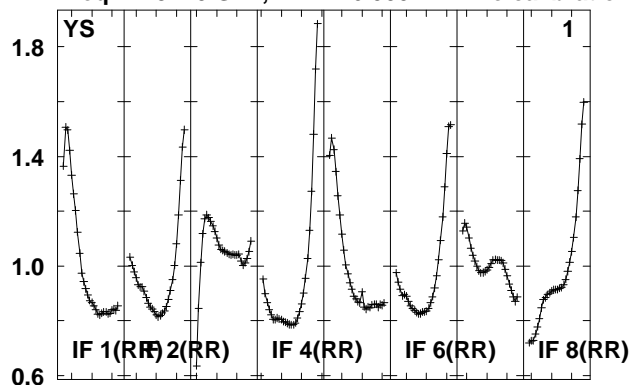

Lower frame: Real Jy
Total-power spectrum Antenna: *
Timerange: 00/17:20:26 to 00/17:21:54

Plot file version 504 created 14-MAY-2010 15:19:55

J1027+48 EO007.UVDATA.1

Freq = 4.9270 GHz, Bw = 16.000 MH No calibration applied and no bandpass applied

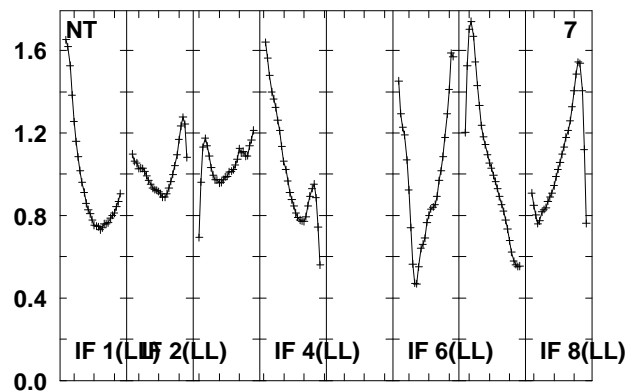
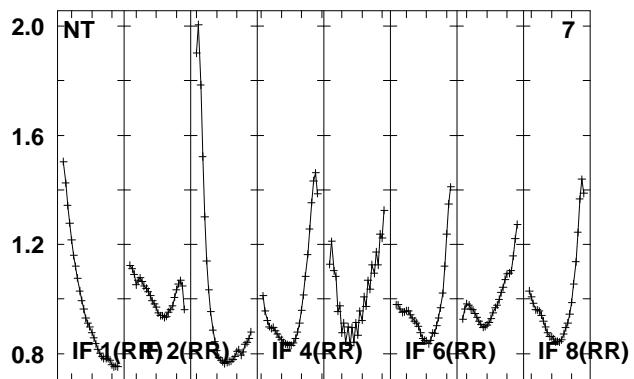
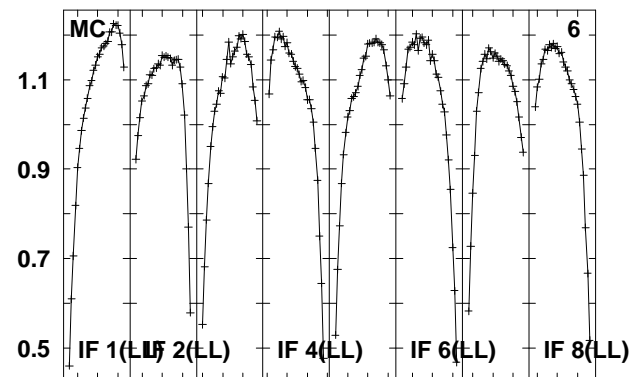
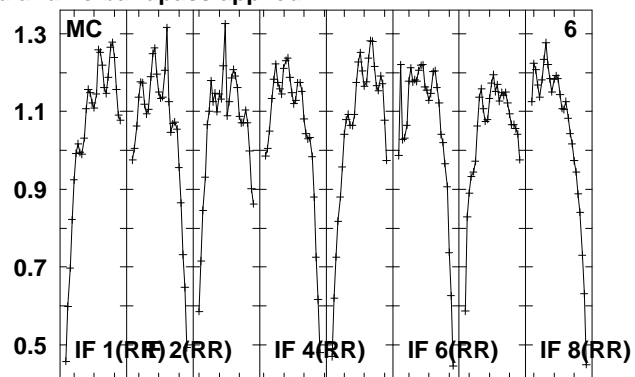
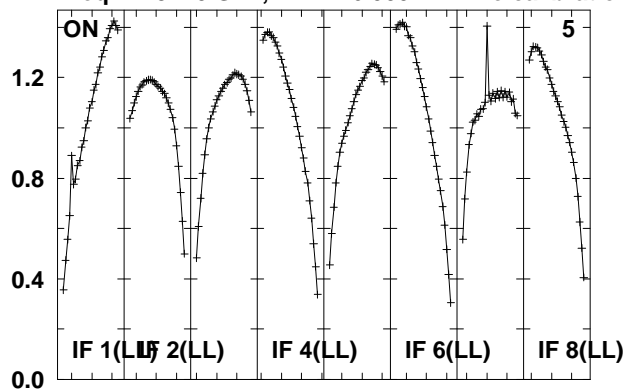

Lower frame: Real Jy
Total-power spectrum Antenna: *
Timerange: 00/17:20:26 to 00/17:21:54

Plot file version 505 created 14-MAY-2010 15:19:56
 J102959 EO007.UVDATA.1
 Freq = 4.9270 GHz, Bw = 16.000 MH No calibration applied and no bandpass applied

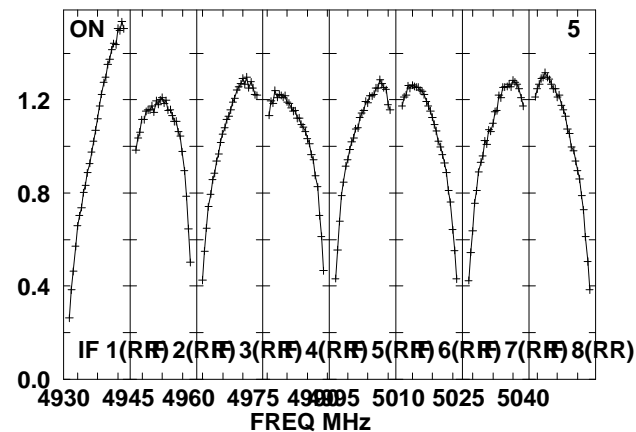
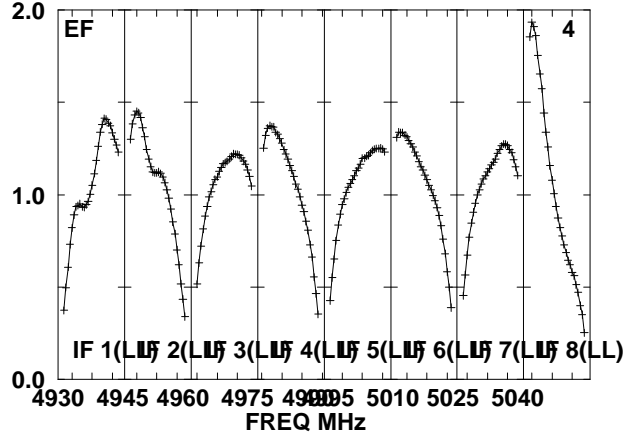
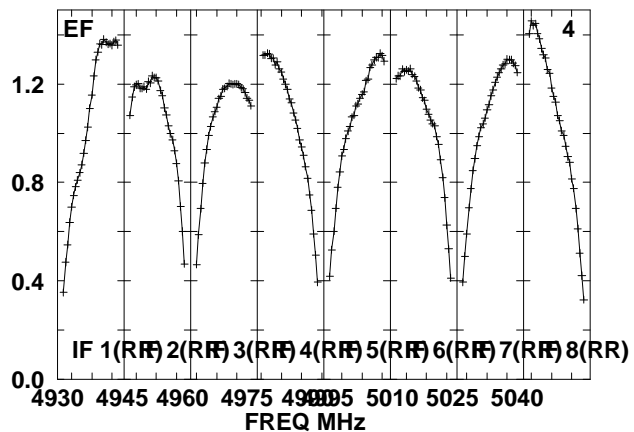
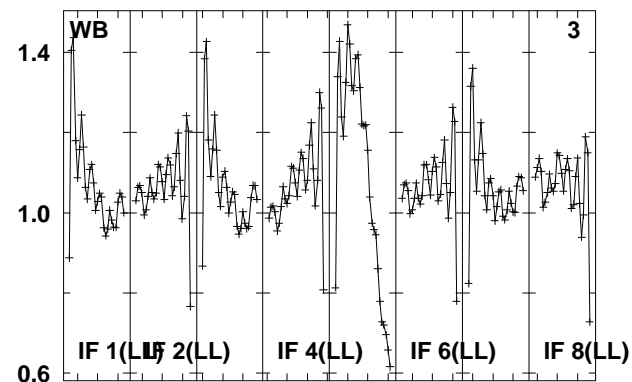
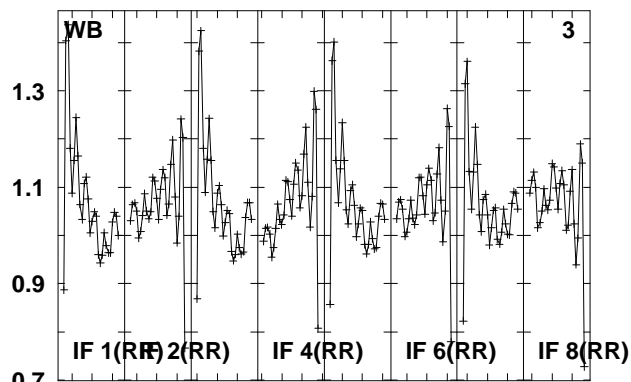
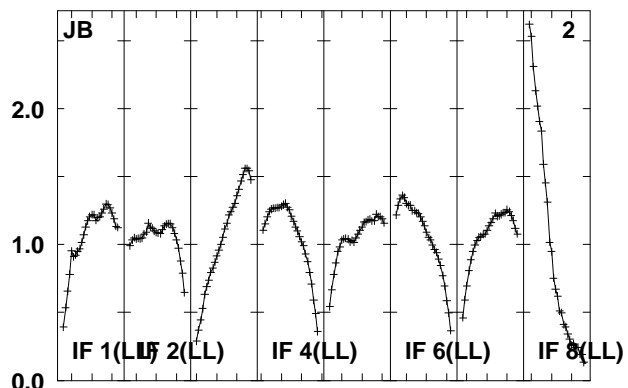
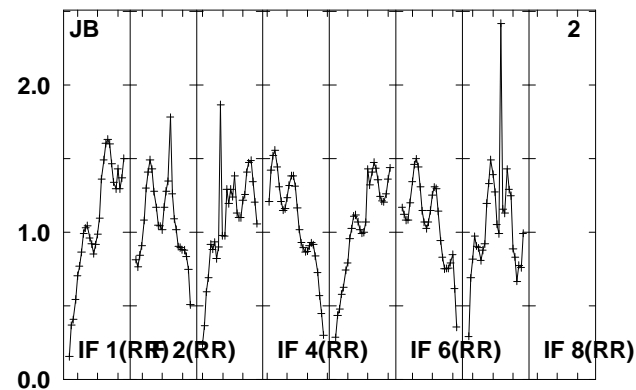
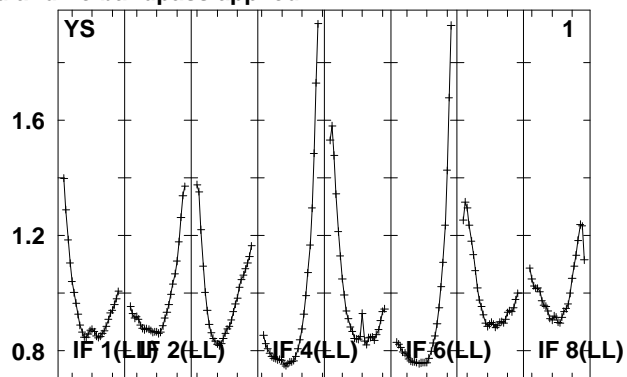
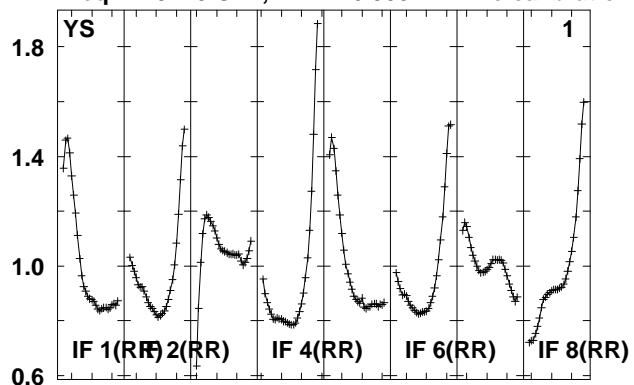

Lower frame: Real Jy
 Total-power spectrum Antenna: *
 Timerange: 00/17:22:18 to 00/17:27:16

Plot file version 506 created 14-MAY-2010 15:19:56

J102959 EO007.UVDATA.1

Freq = 4.9270 GHz, Bw = 16.000 MH No calibration applied and no bandpass applied

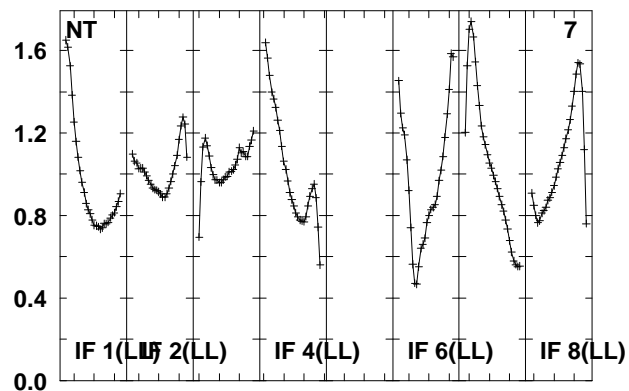
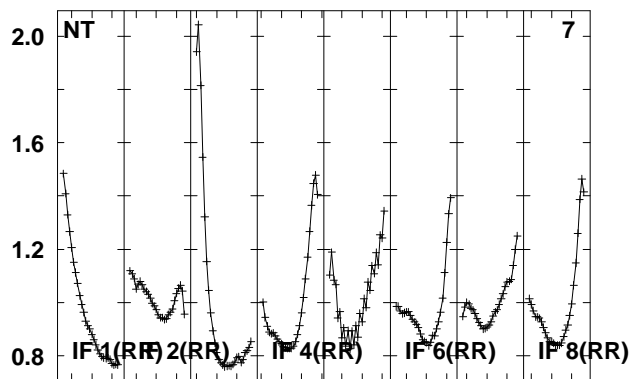
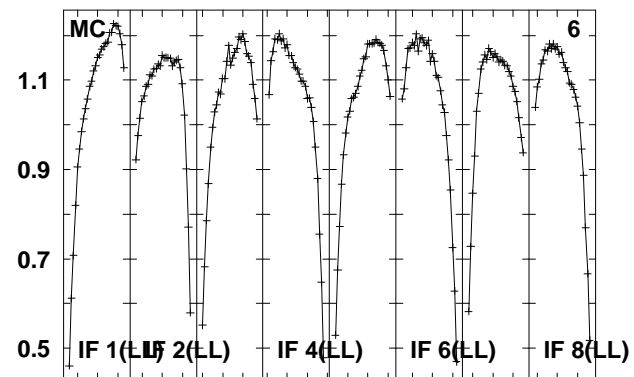
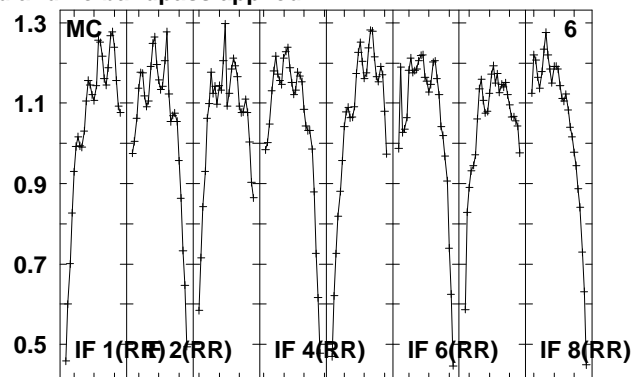
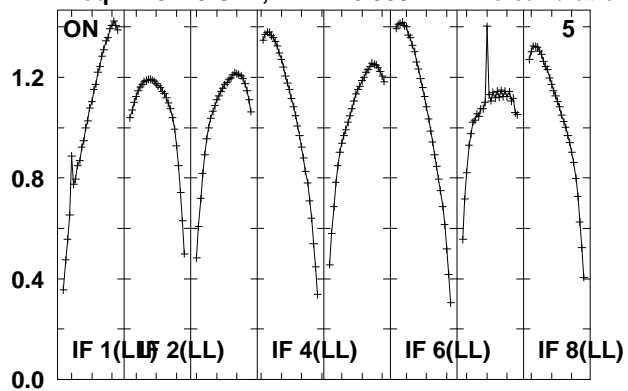

Lower frame: Real Jy
Total-power spectrum Antenna: *
Timerange: 00/17:22:18 to 00/17:27:16

Plot file version 507 created 14-MAY-2010 15:19:57

J1027+48 EO007.UVDATA.1

Freq = 4.9270 GHz, Bw = 16.000 MH No calibration applied and no bandpass applied

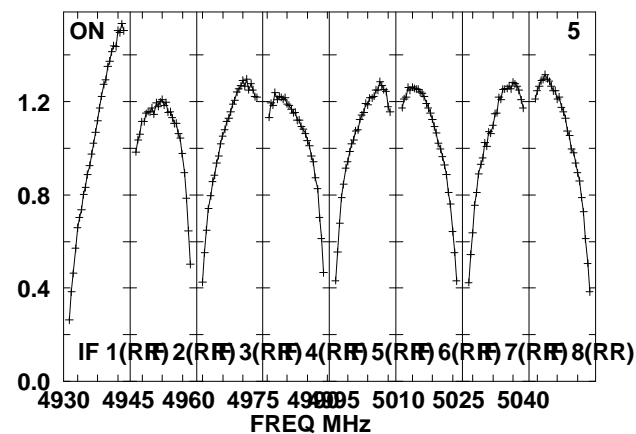
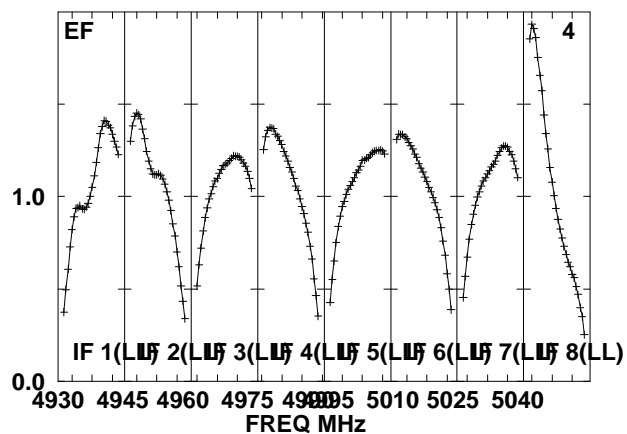
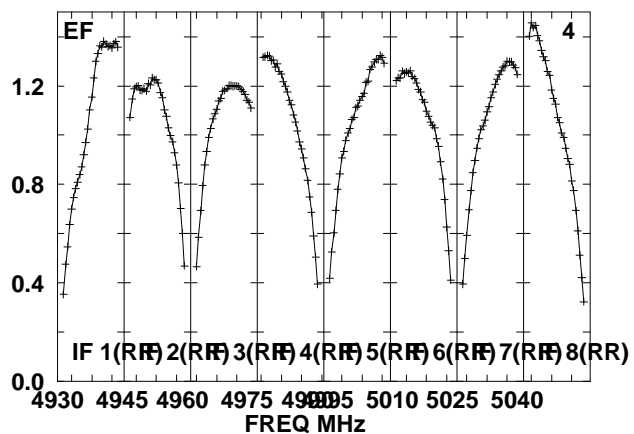
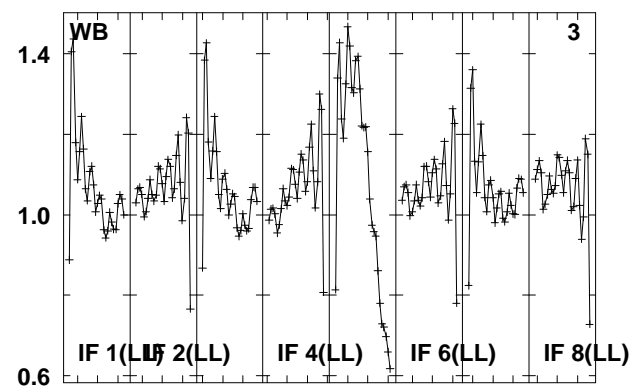
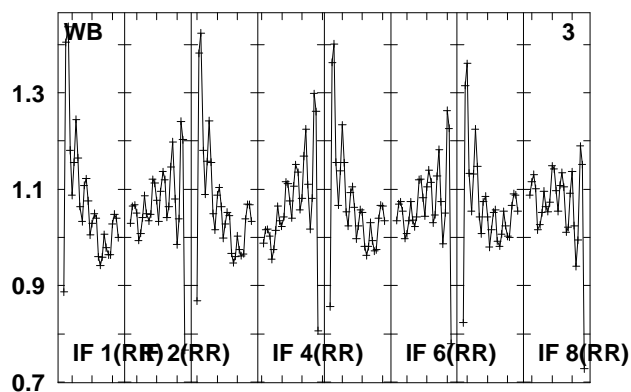
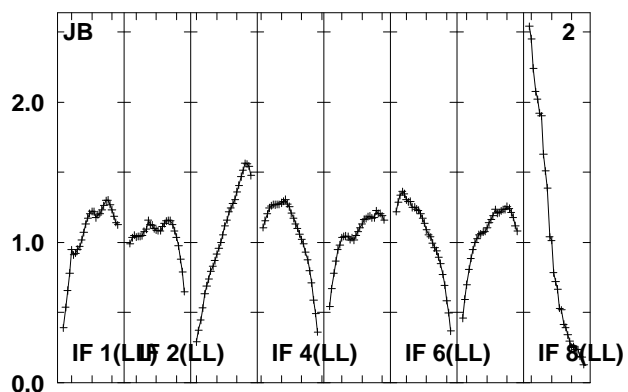
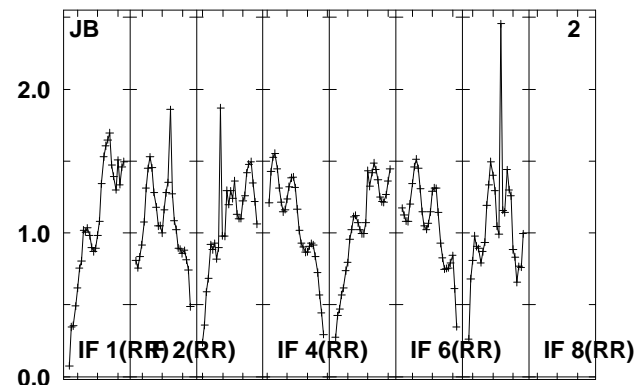
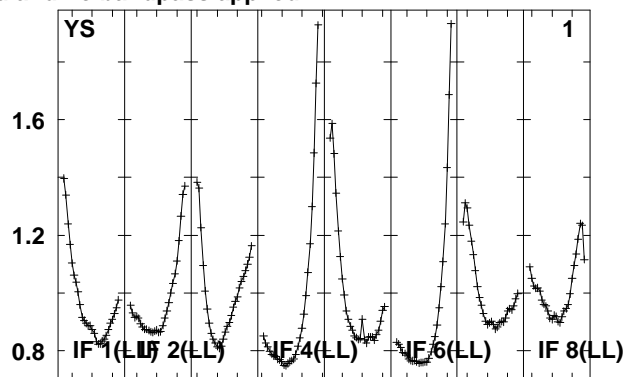
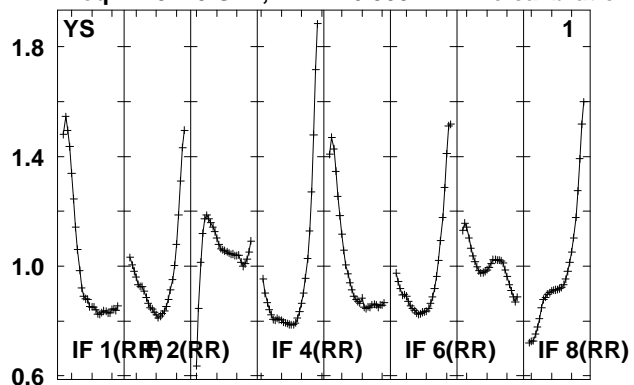

Lower frame: Real Jy
Total-power spectrum Antenna: *
Timerange: 00/17:27:40 to 00/17:29:08

Plot file version 508 created 14-MAY-2010 15:19:57

J1027+48 EO007.UVDATA.1

Freq = 4.9270 GHz, Bw = 16.000 MH No calibration applied and no bandpass applied

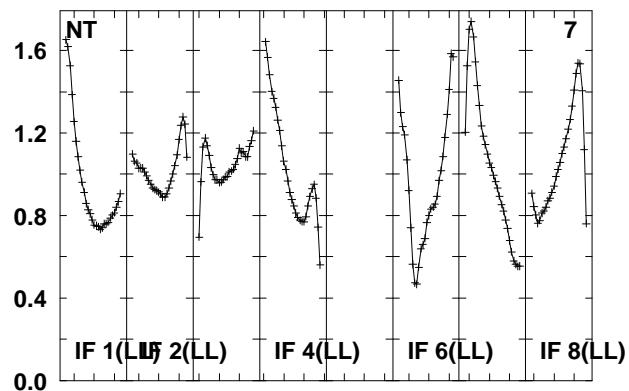
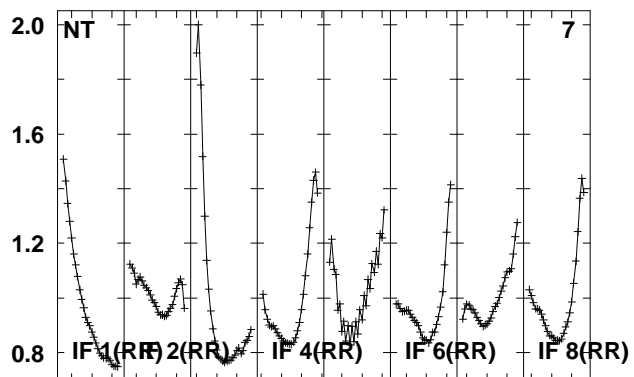
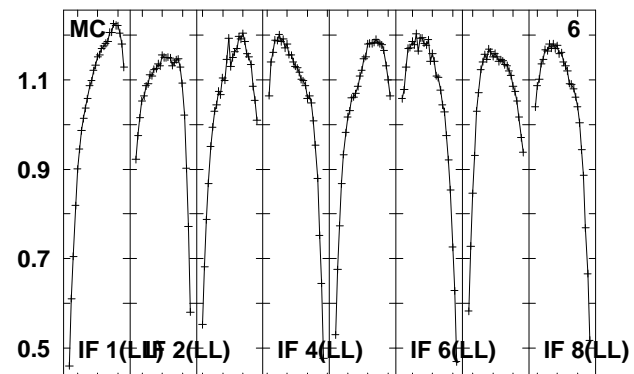
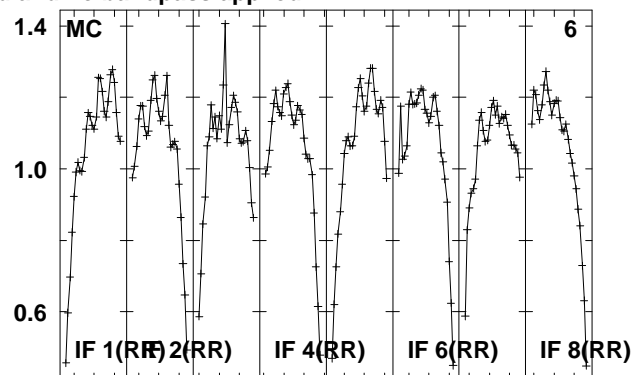
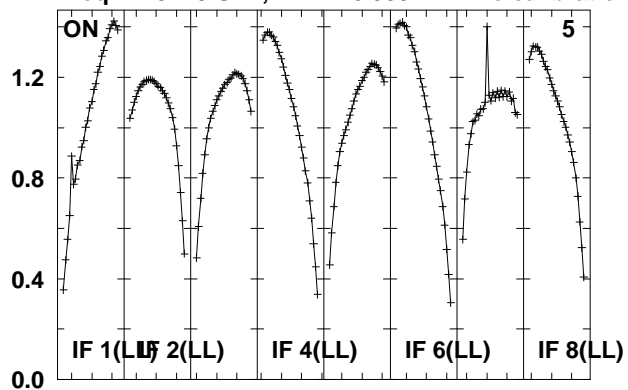

Lower frame: Real Jy
Total-power spectrum Antenna: *
Timerange: 00/17:27:40 to 00/17:29:08

Plot file version 509 created 14-MAY-2010 15:19:57

J102959 EO007.UVDATA.1

Freq = 4.9270 GHz, Bw = 16.000 MH No calibration applied and no bandpass applied

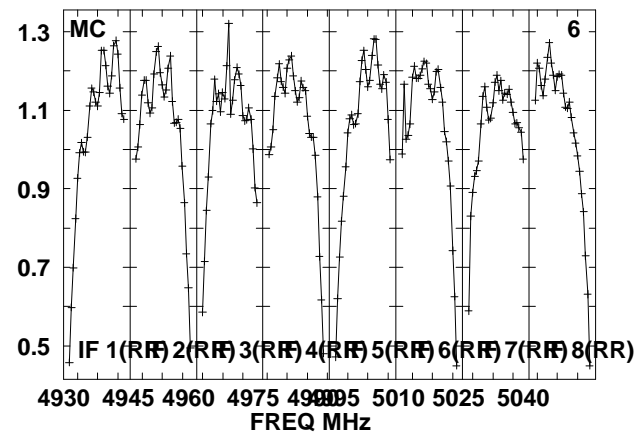
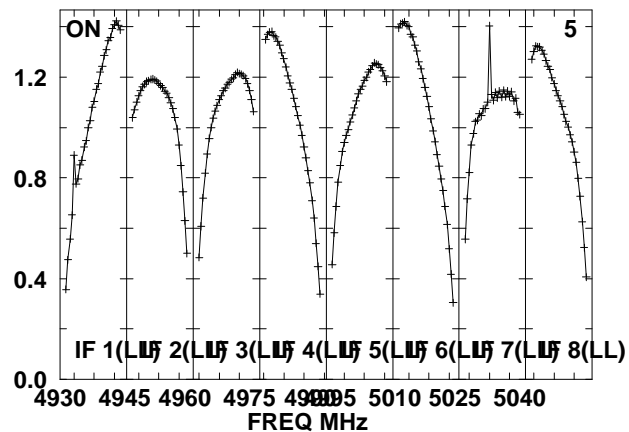
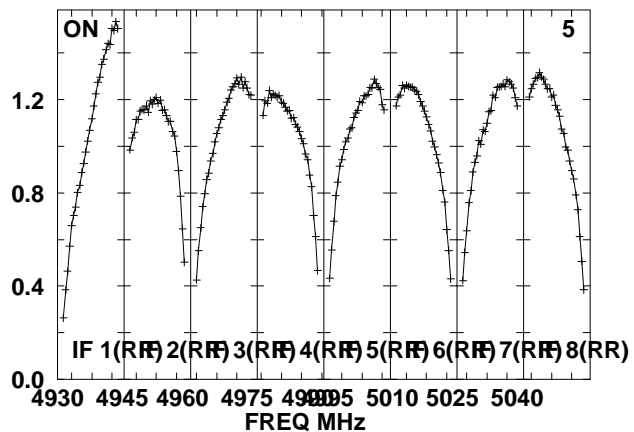
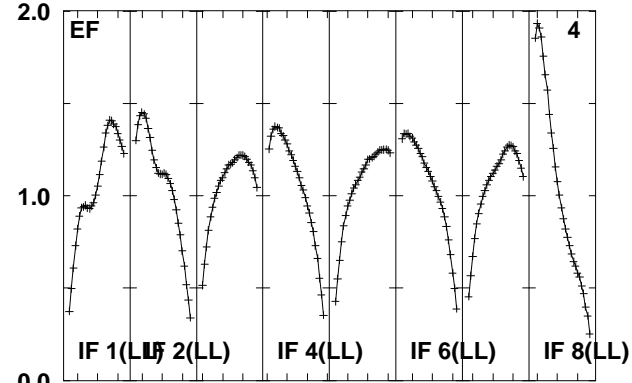
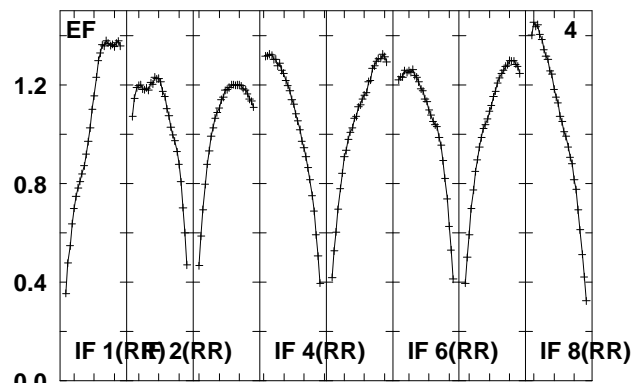
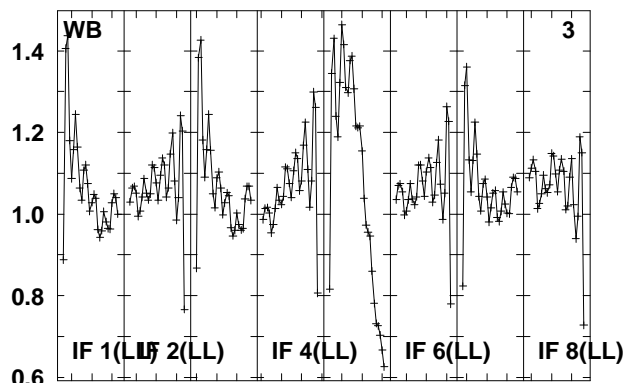
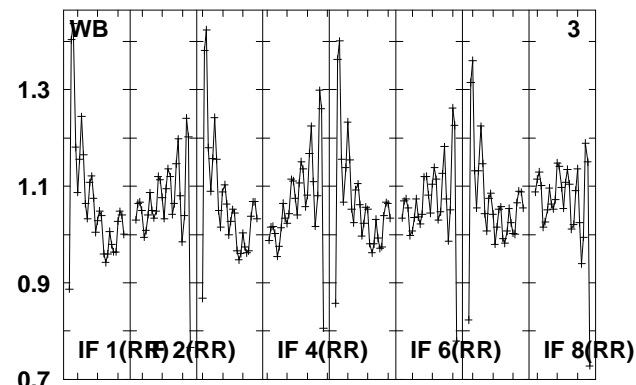
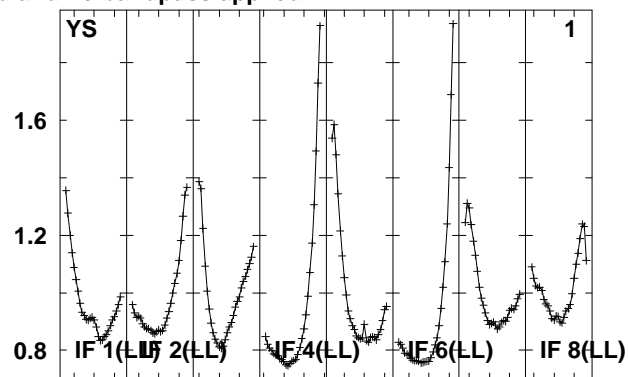
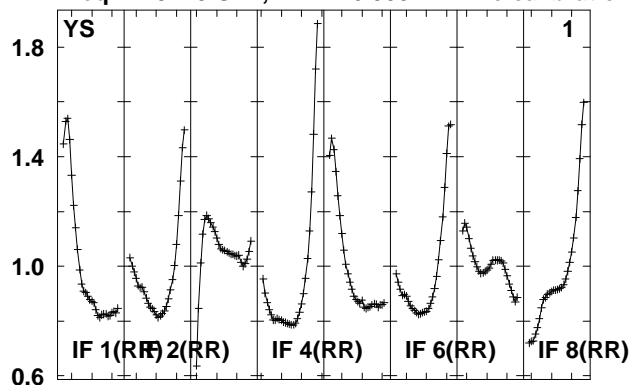

Lower frame: Real Jy

Total-power spectrum Antenna: *

Timerange: 00/17:29:32 to 00/17:34:30

Plot file version 510 created 14-MAY-2010 15:19:58

J102959 EO007.UVDATA.1

Freq = 4.9270 GHz, Bw = 16.000 MH No calibration applied and no bandpass applied

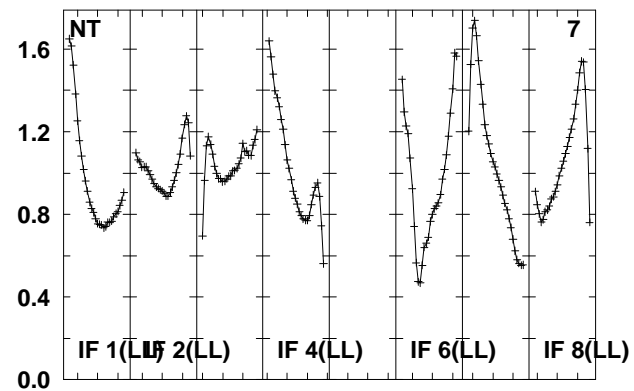
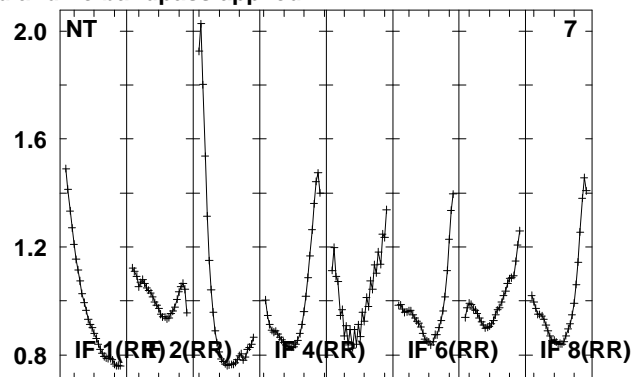
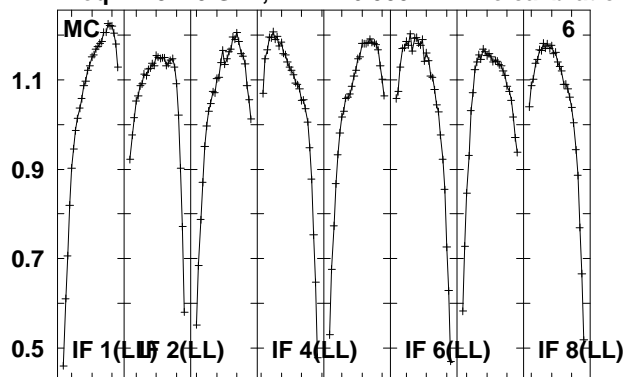

Lower frame: Real Jy
Total-power spectrum Antenna: *
Timerange: 00/17:29:32 to 00/17:34:30

Plot file version 511 created 14-MAY-2010 15:19:58

J1027+48 EO007.UVDATA.1

Freq = 4.9270 GHz, Bw = 16.000 MH No calibration applied and no bandpass applied

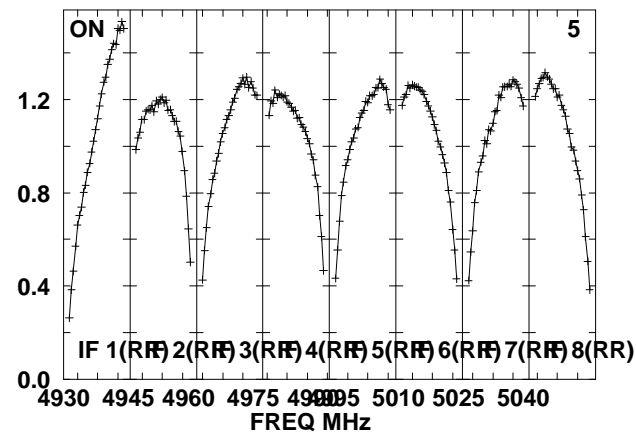
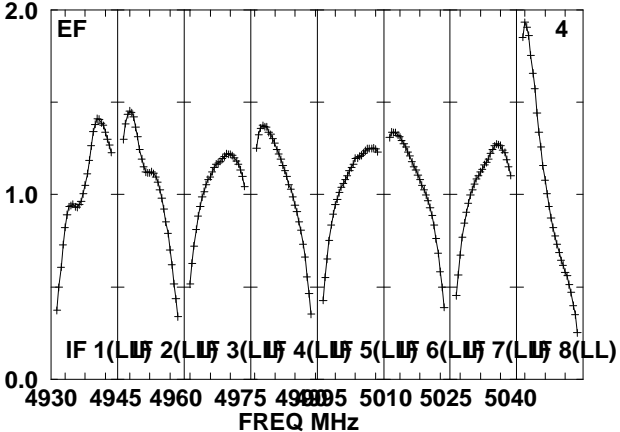
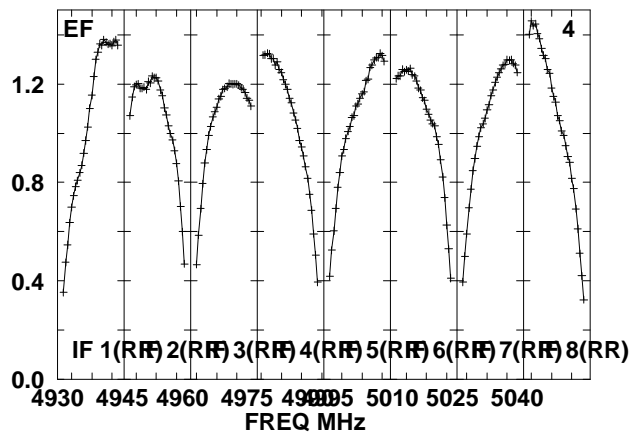
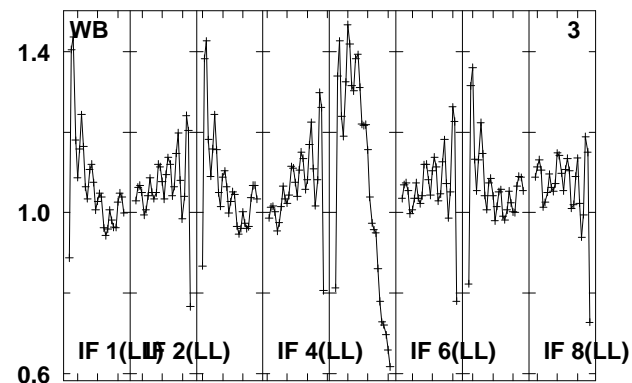
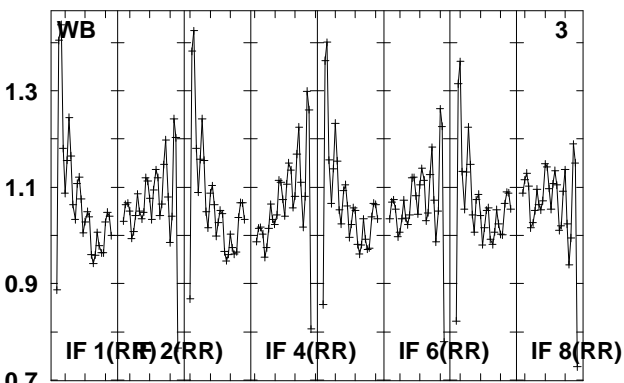
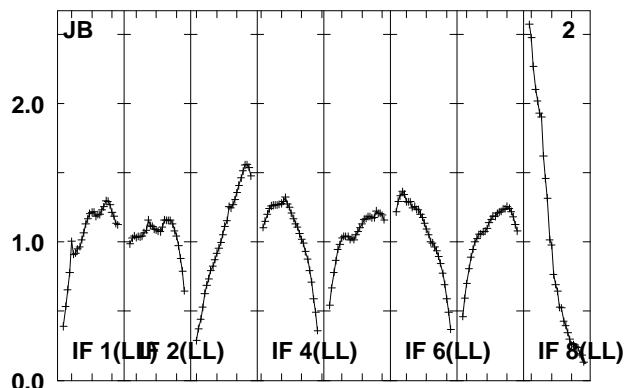
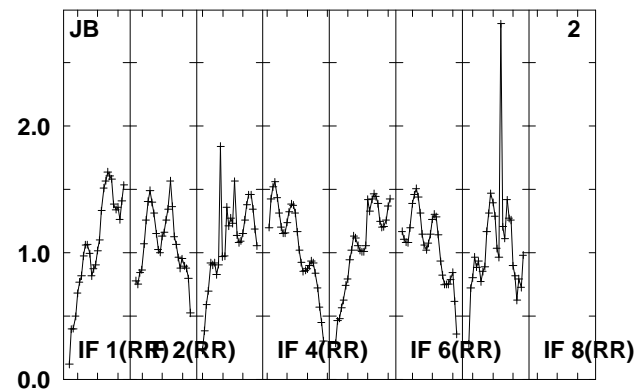
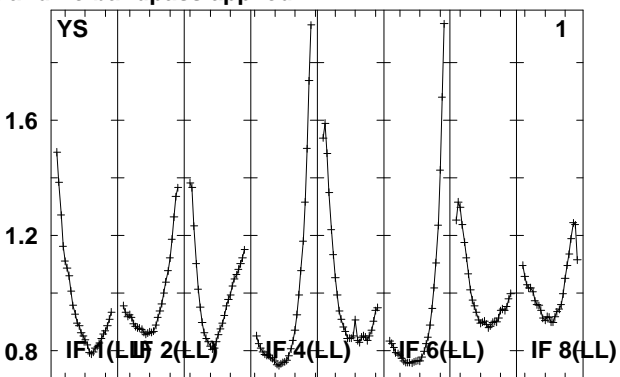
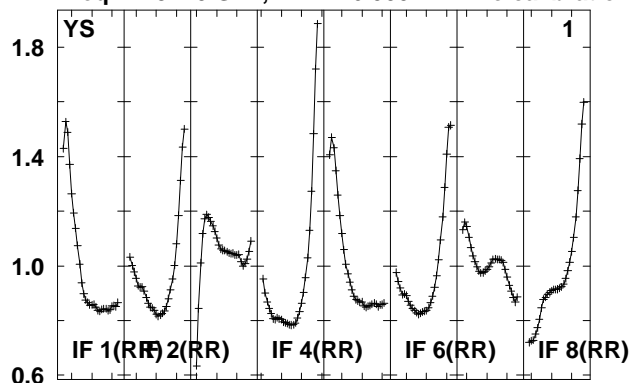

Lower frame: Real Jy

Total-power spectrum Antenna: *

Timerange: 00/17:34:54 to 00/17:36:22

Plot file version 512 created 14-MAY-2010 15:19:58

J1027+48 EO007.UVDATA.1

Freq = 4.9270 GHz, Bw = 16.000 MH No calibration applied and no bandpass applied

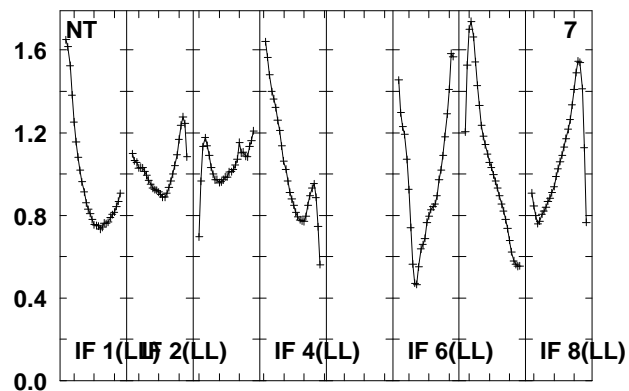
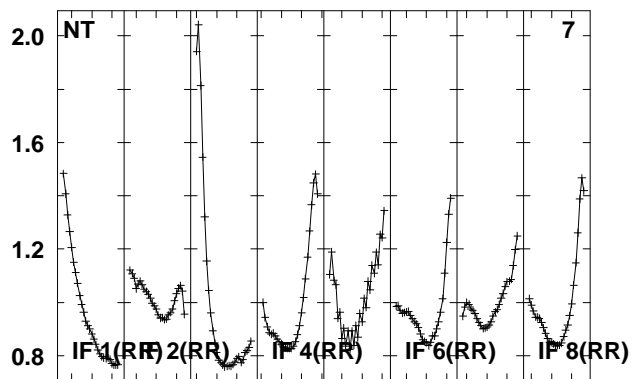
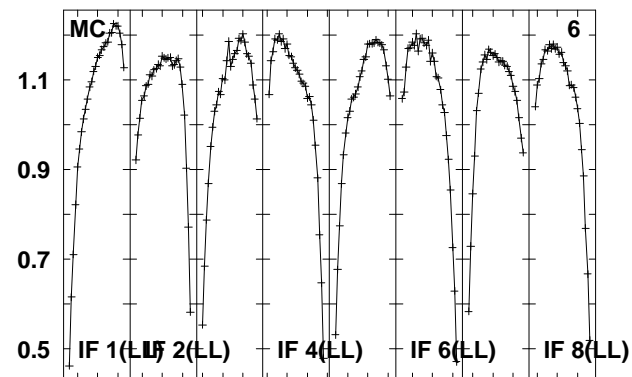
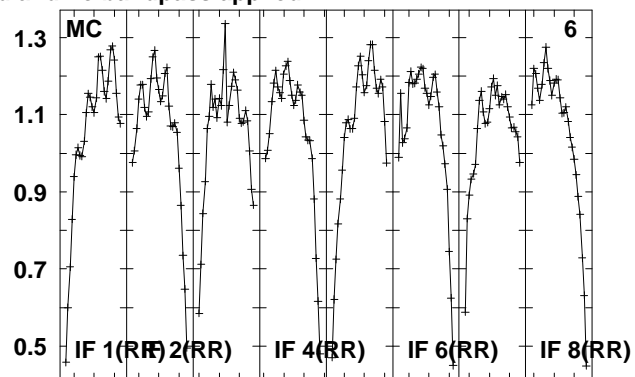
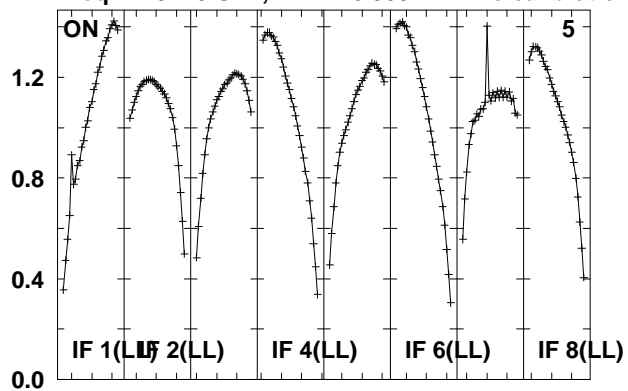

Lower frame: Real Jy
Total-power spectrum Antenna: *
Timerange: 00/17:34:54 to 00/17:36:22

Plot file version 513 created 14-MAY-2010 15:19:58

J0808+40 EO007.UVDATA.1

Freq = 4.9270 GHz, Bw = 16.000 MH No calibration applied and no bandpass applied

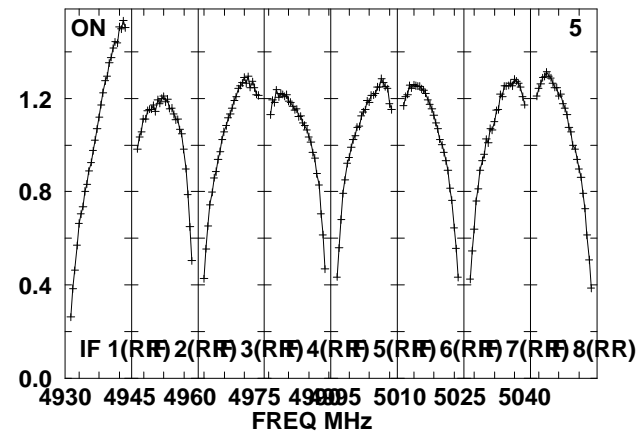
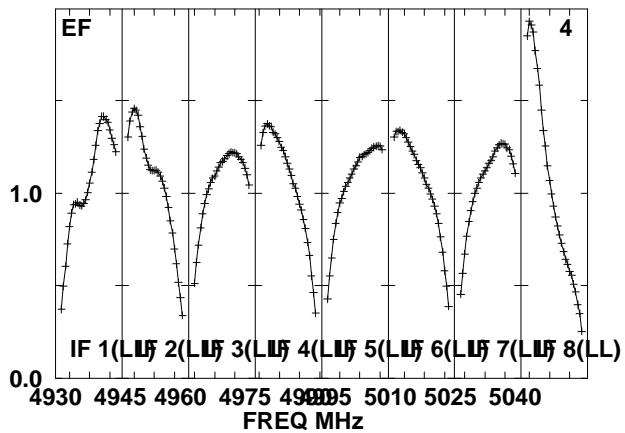
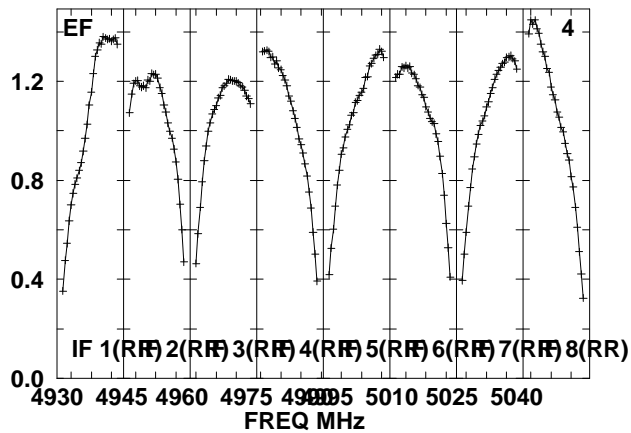
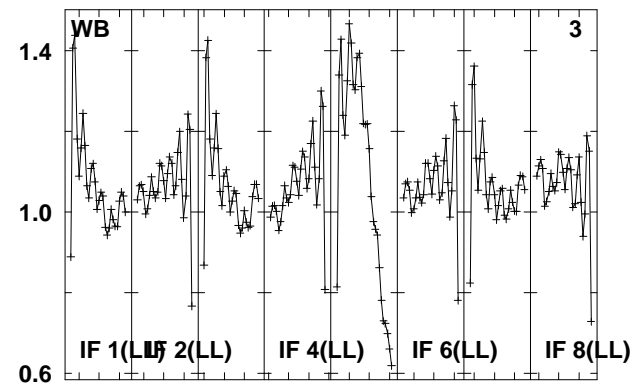
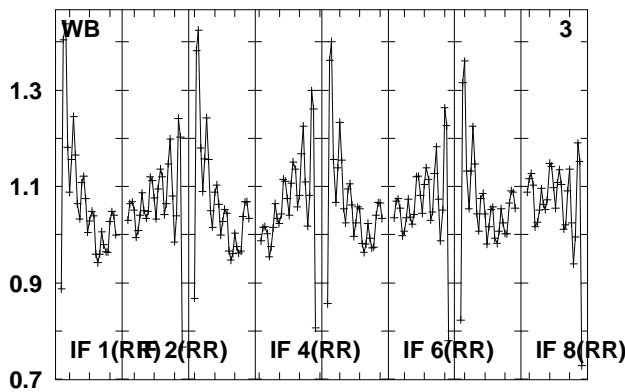
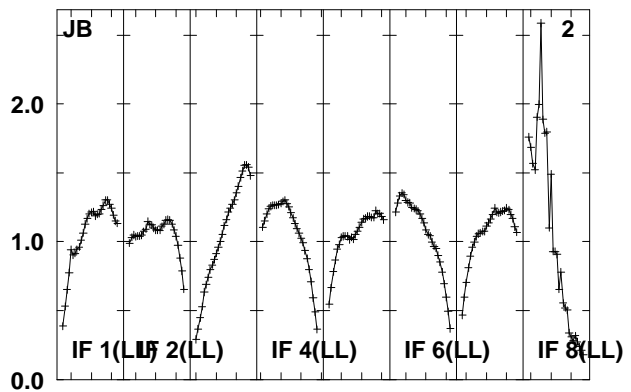
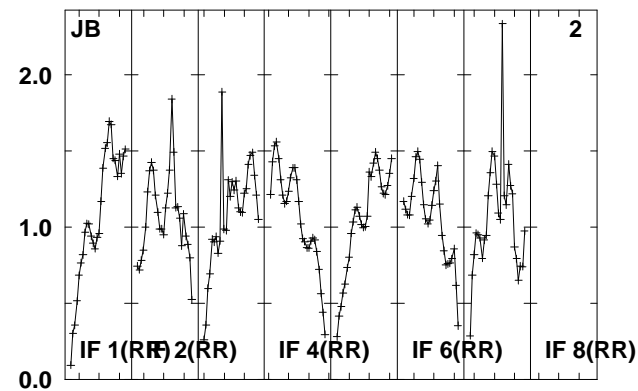
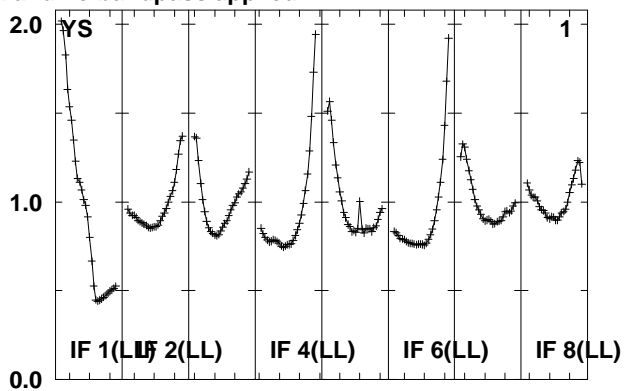
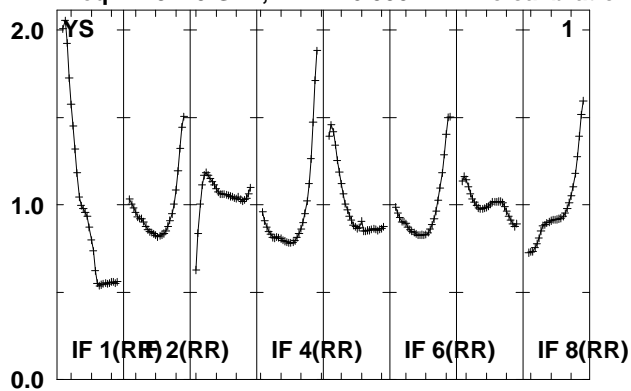

Lower frame: Real Jy
Total-power spectrum Antenna: *
Timerange: 00/17:38:56 to 00/17:40:24

Plot file version 514 created 14-MAY-2010 15:19:59

J0808+40 EO007.UVDATA.1

Freq = 4.9270 GHz, Bw = 16.000 MH No calibration applied and no bandpass applied

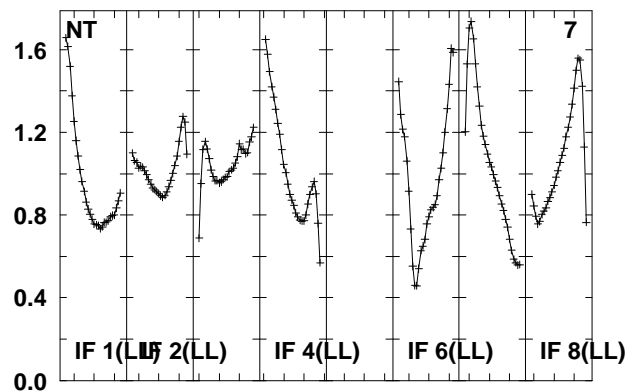
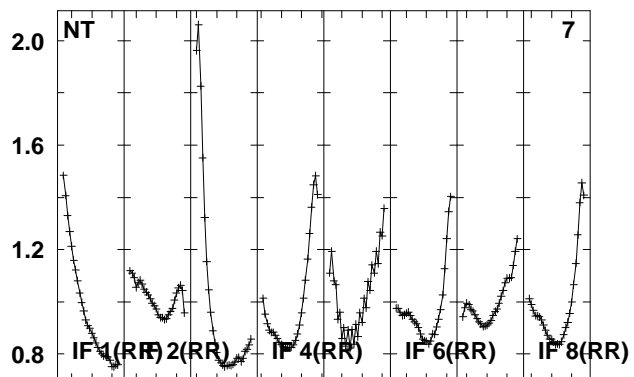
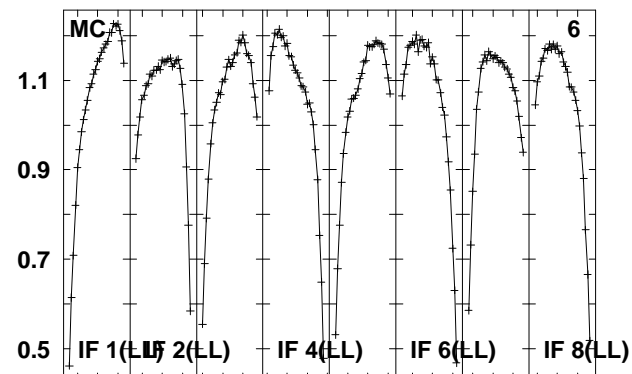
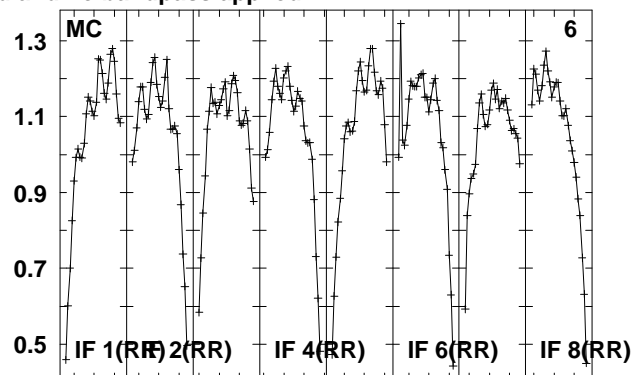
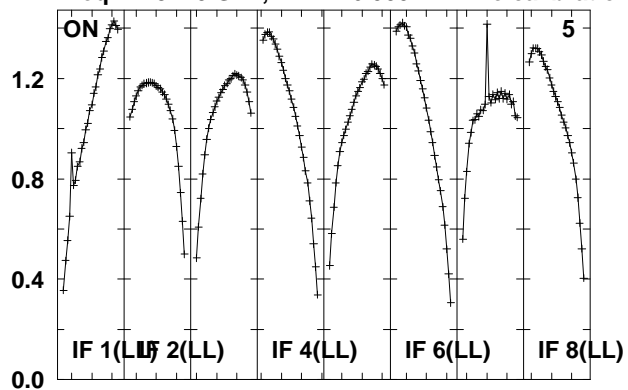

Lower frame: Real Jy
Total-power spectrum Antenna: *
Timerange: 00/17:38:56 to 00/17:40:24

Plot file version 515 created 14-MAY-2010 15:19:59

J080844 EO007.UVDATA.1

Freq = 4.9270 GHz, Bw = 16.000 MH No calibration applied and no bandpass applied

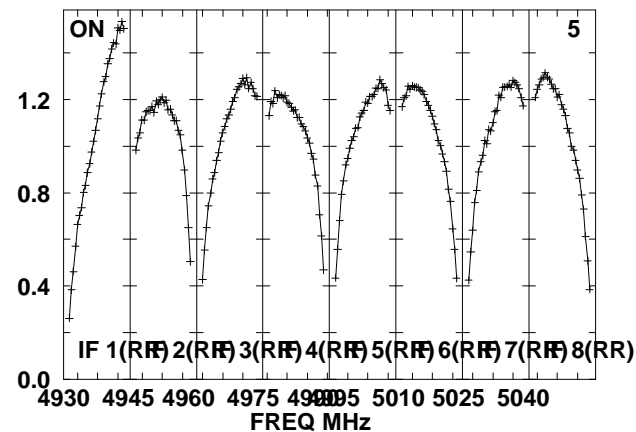
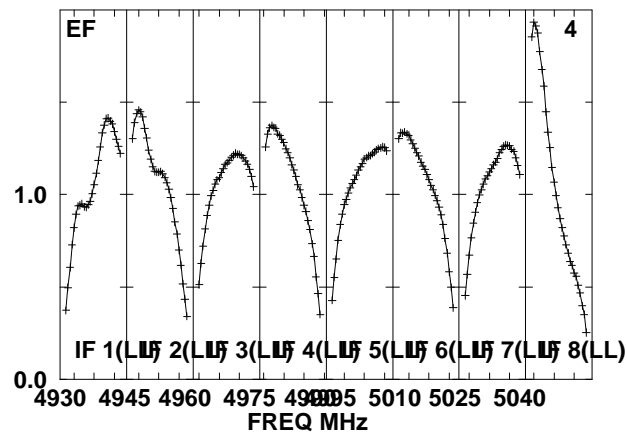
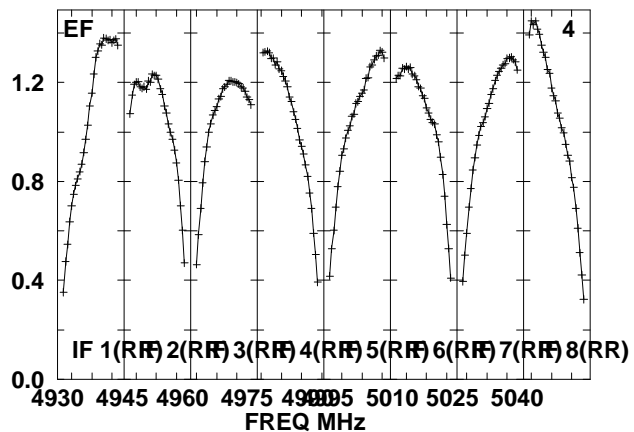
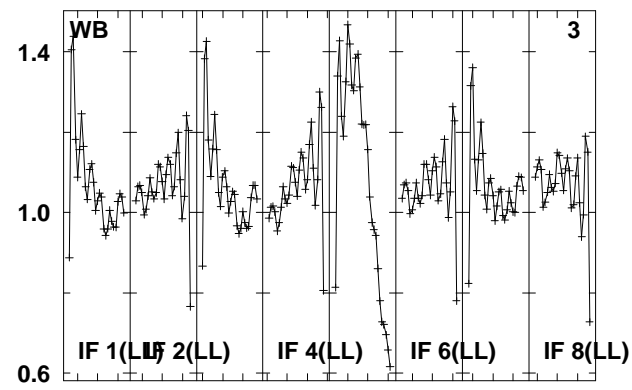
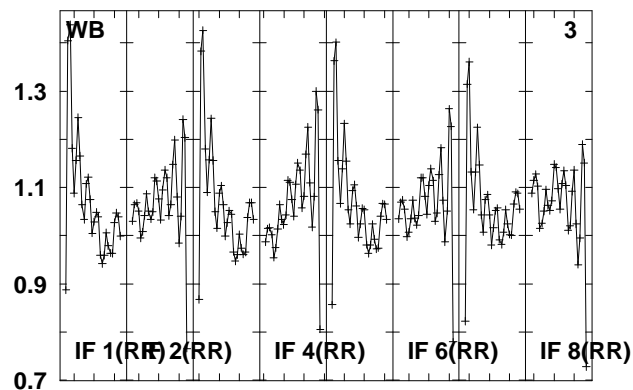
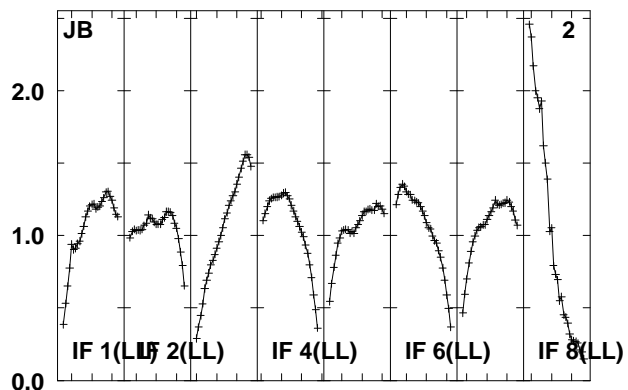
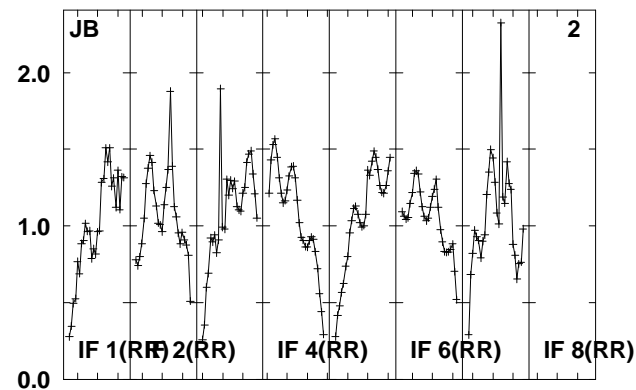
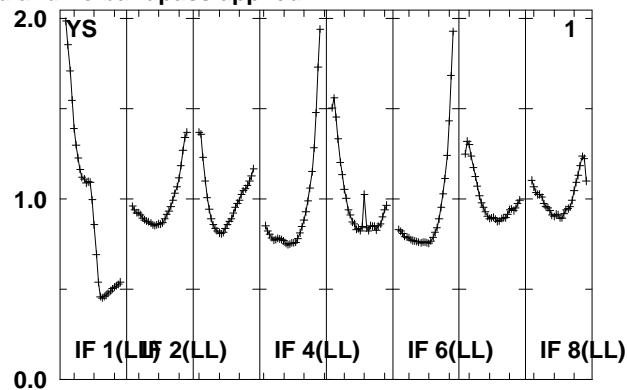
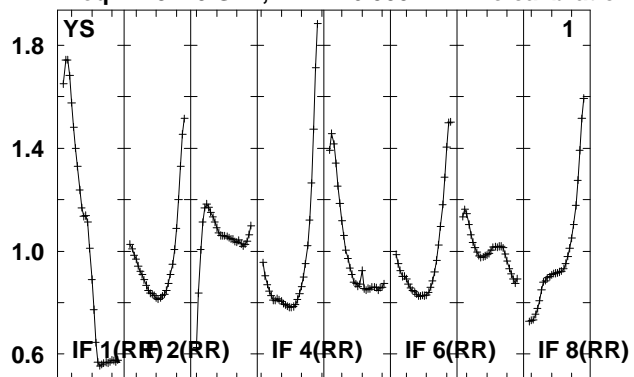

Lower frame: Real Jy
Total-power spectrum Antenna: *
Timerange: 00/17:40:56 to 00/17:45:54

Plot file version 516 created 14-MAY-2010 15:20:00

J080844 EO007.UVDATA.1

Freq = 4.9270 GHz, Bw = 16.000 MH No calibration applied and no bandpass applied

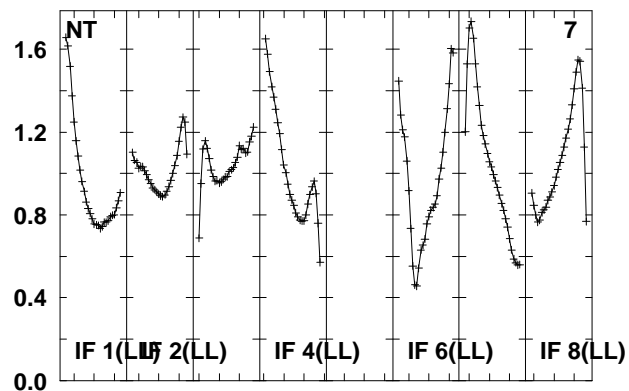
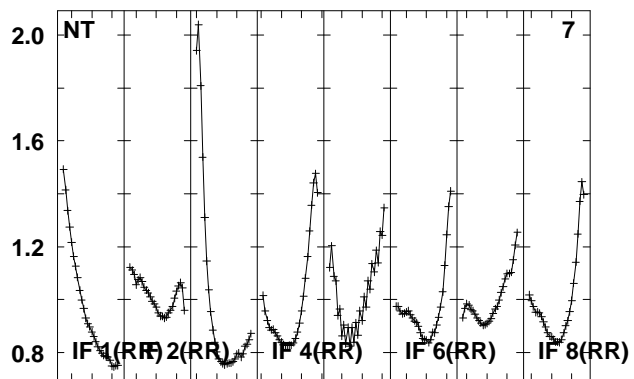
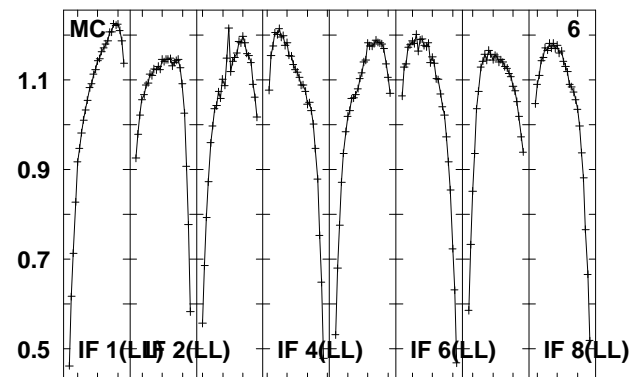
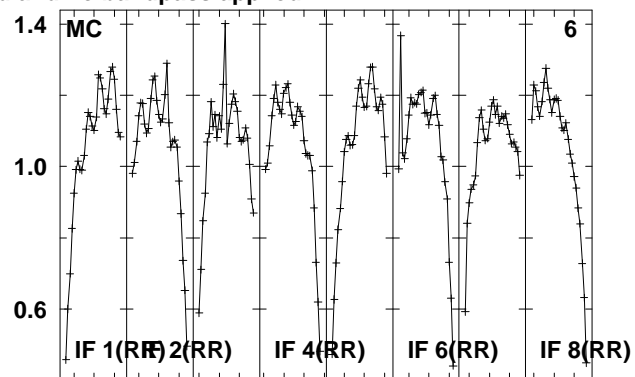
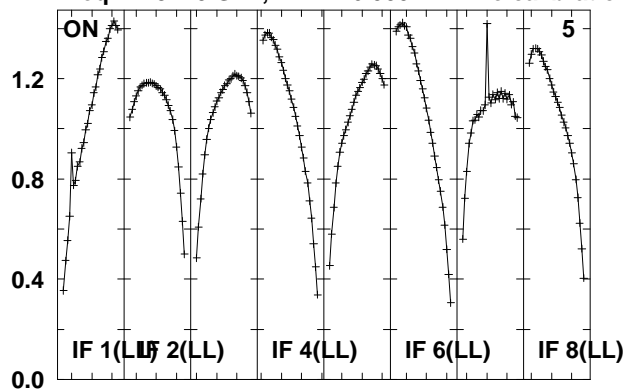

Lower frame: Real Jy
Total-power spectrum Antenna: *
Timerange: 00/17:40:56 to 00/17:45:54

Plot file version 517 created 14-MAY-2010 15:20:00

J0808+40 EO007.UVDATA.1

Freq = 4.9270 GHz, Bw = 16.000 MH No calibration applied and no bandpass applied

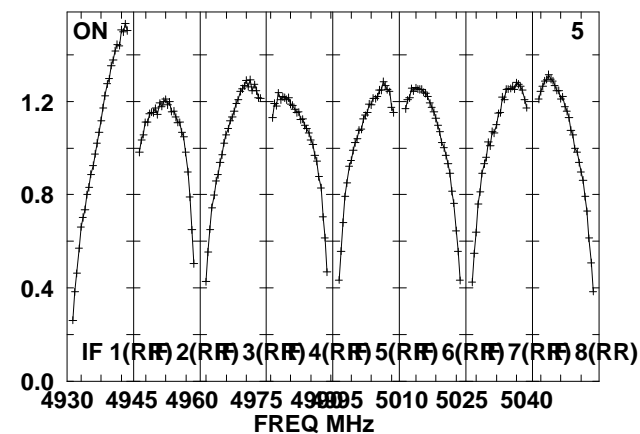
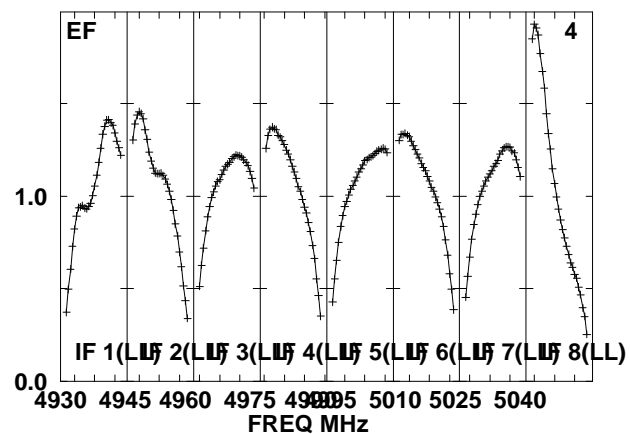
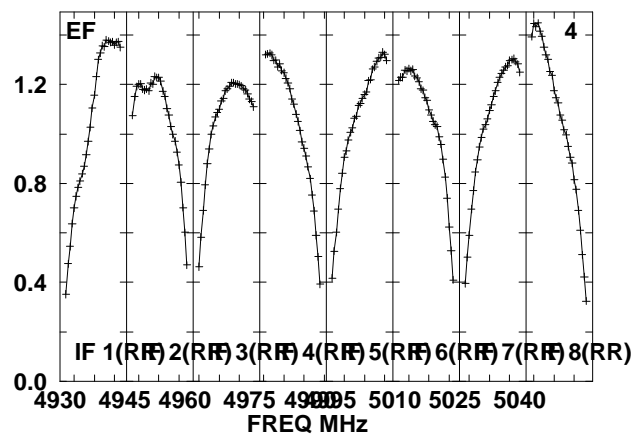
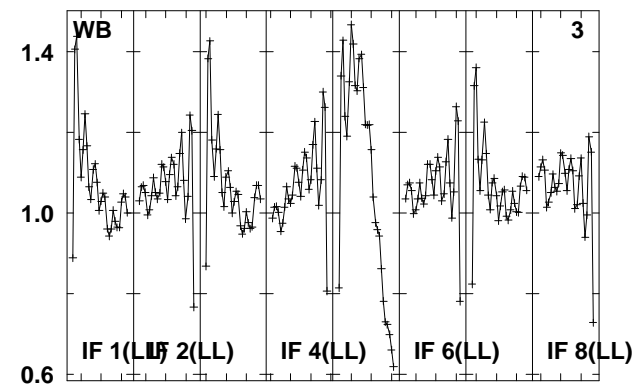
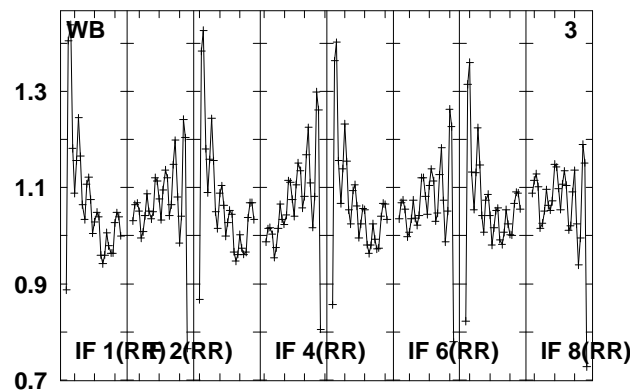
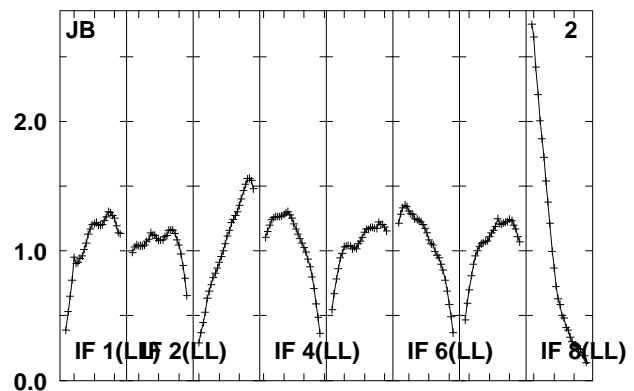
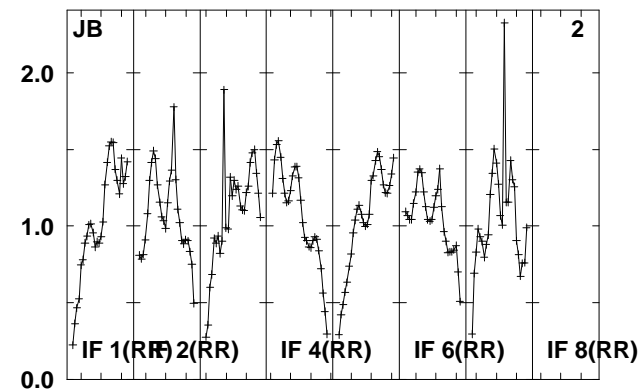
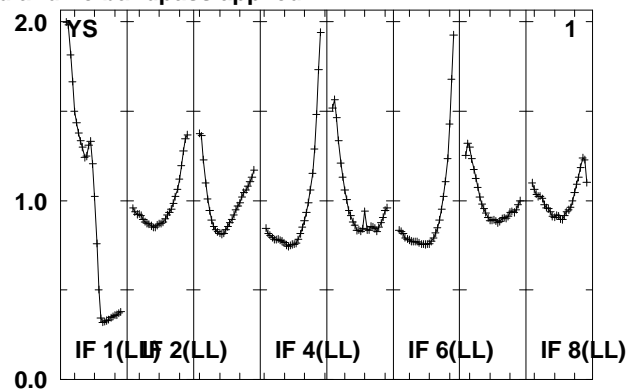
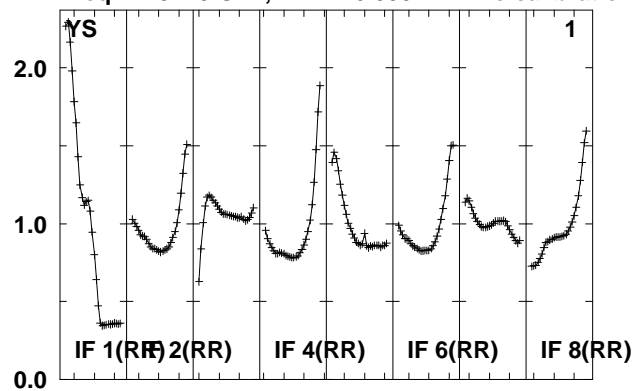

Lower frame: Real Jy
Total-power spectrum Antenna: *
Timerange: 00/17:46:26 to 00/17:47:50

Plot file version 518 created 14-MAY-2010 15:20:00

J0808+40 EO007.UVDATA.1

Freq = 4.9270 GHz, Bw = 16.000 MH No calibration applied and no bandpass applied

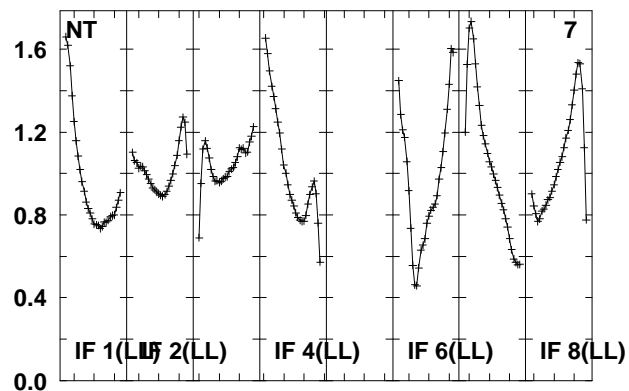
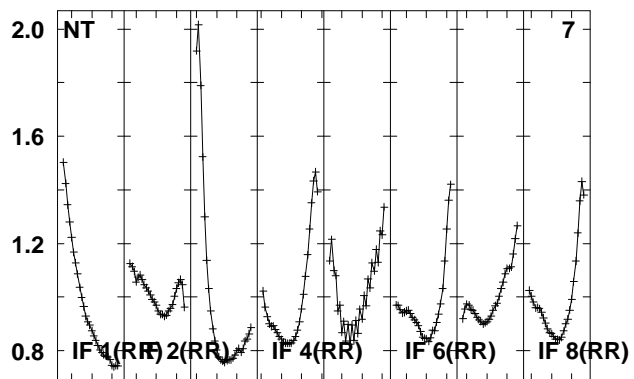
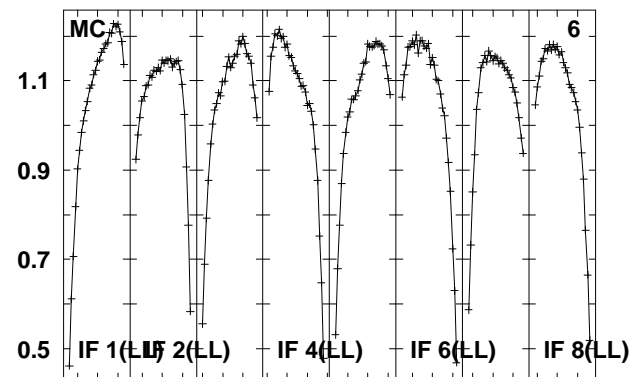
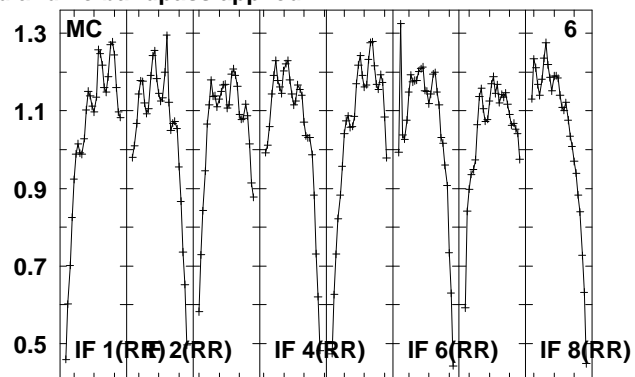
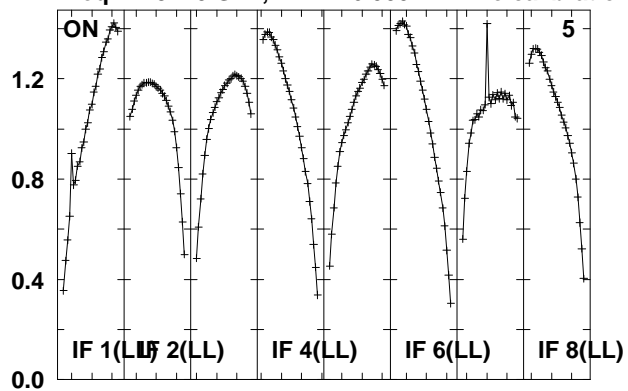

Lower frame: Real Jy
Total-power spectrum Antenna: *
Timerange: 00/17:46:26 to 00/17:47:50

Plot file version 519 created 14-MAY-2010 15:20:00

J080844 EO007.UVDATA.1

Freq = 4.9270 GHz, Bw = 16.000 MH No calibration applied and no bandpass applied

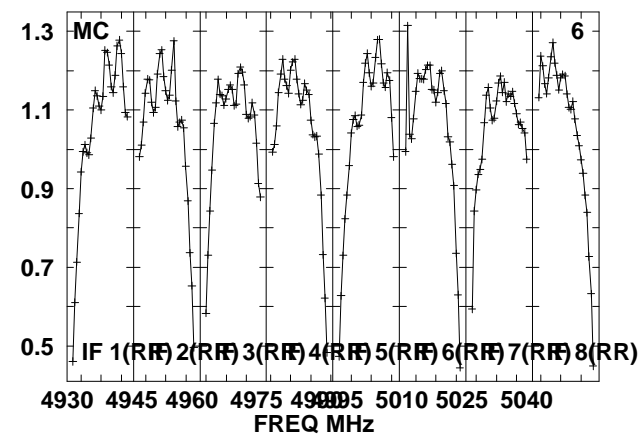
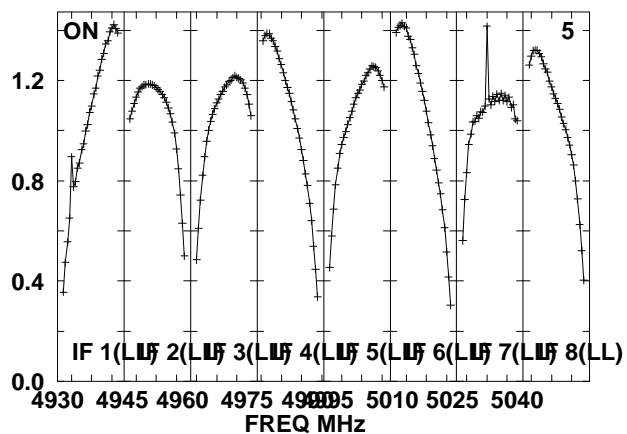
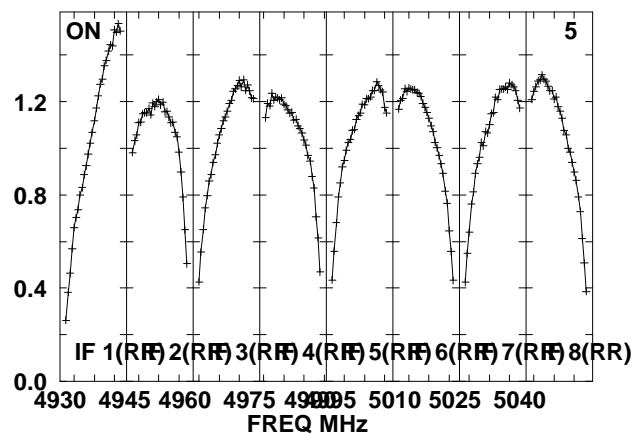
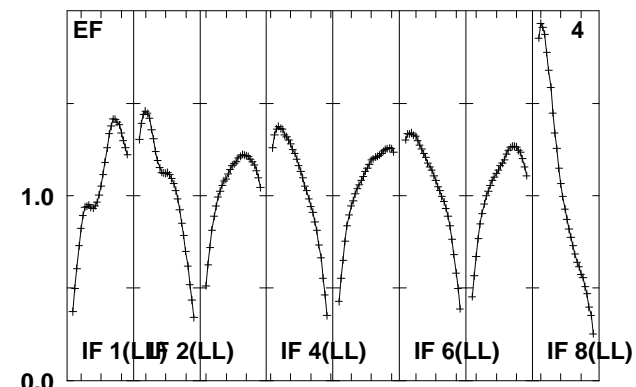
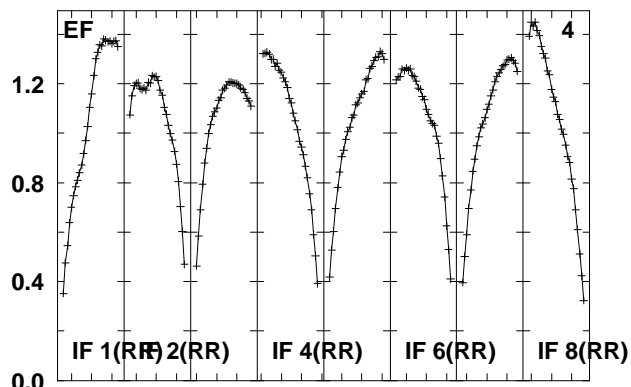
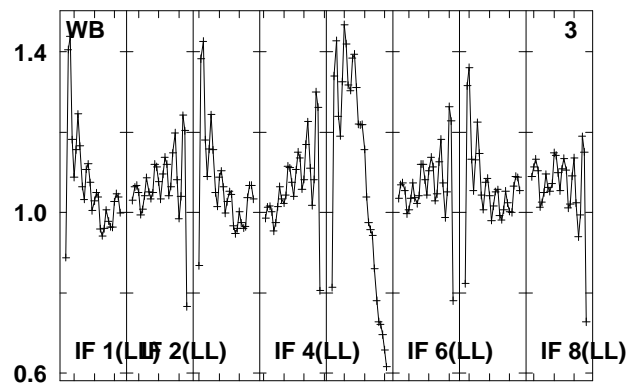
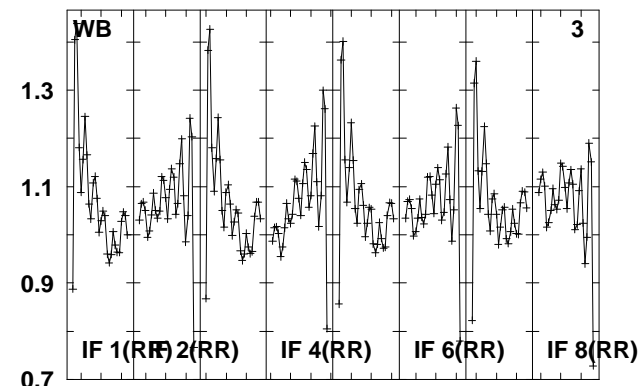
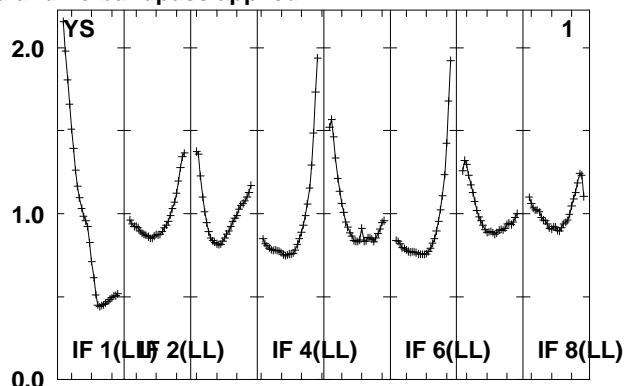
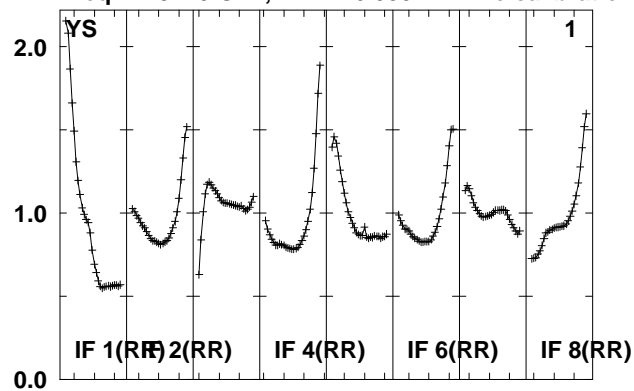

Lower frame: Real Jy
Total-power spectrum Antenna: *
Timerange: 00/17:48:25 to 00/17:53:21

Plot file version 520 created 14-MAY-2010 15:20:01

J080844 EO007.UVDATA.1

Freq = 4.9270 GHz, Bw = 16.000 MH No calibration applied and no bandpass applied

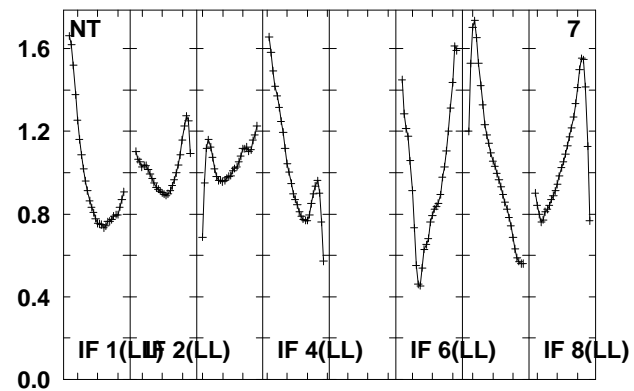
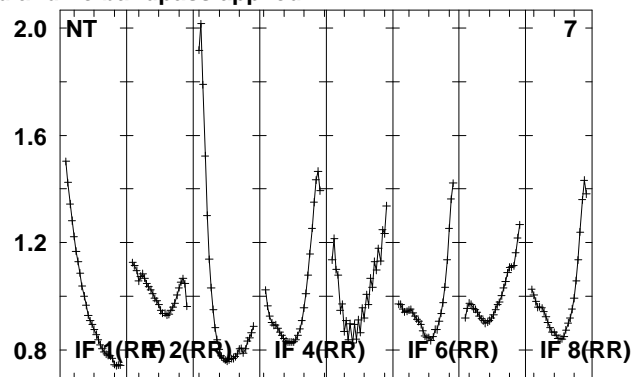
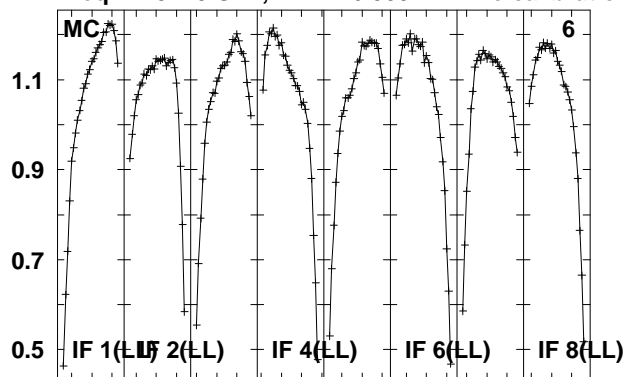

Lower frame: Real Jy
Total-power spectrum Antenna: *
Timerange: 00/17:48:25 to 00/17:53:21

Plot file version 521 created 14-MAY-2010 15:20:01

J0808+40 EO007.UVDATA.1

Freq = 4.9270 GHz, Bw = 16.000 MH No calibration applied and no bandpass applied

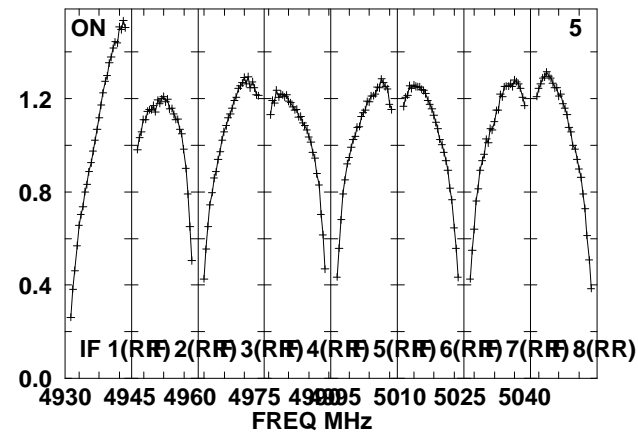
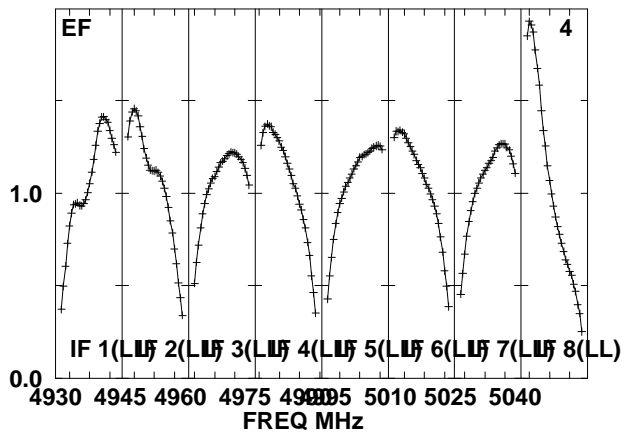
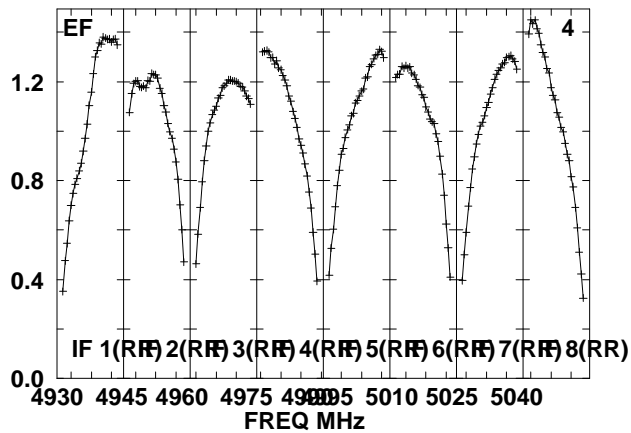
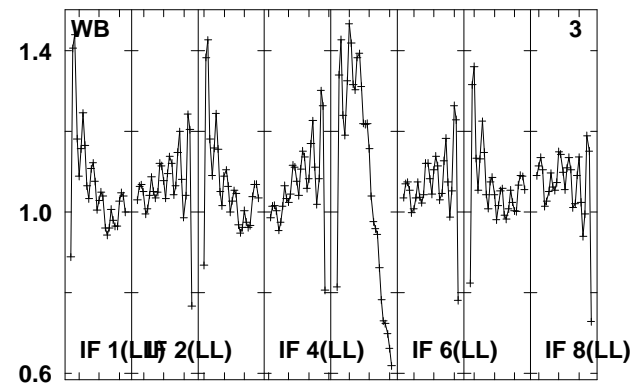
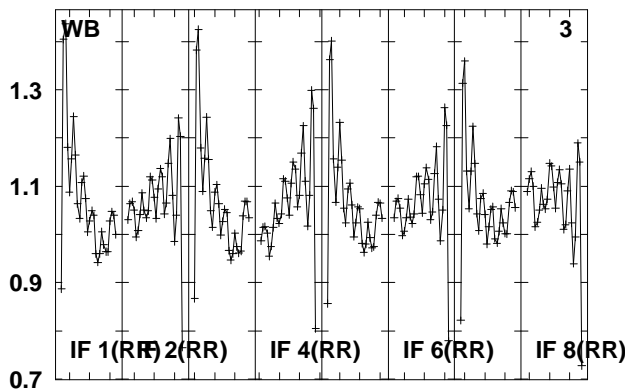
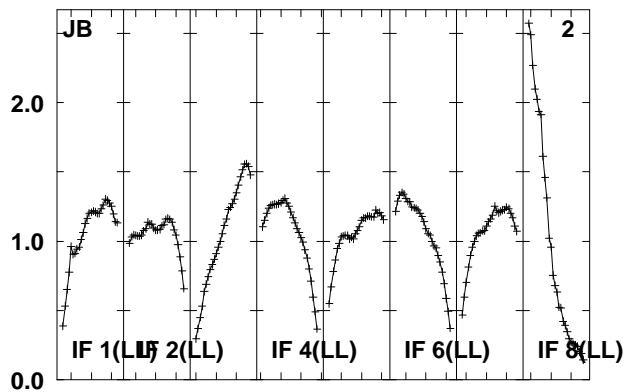
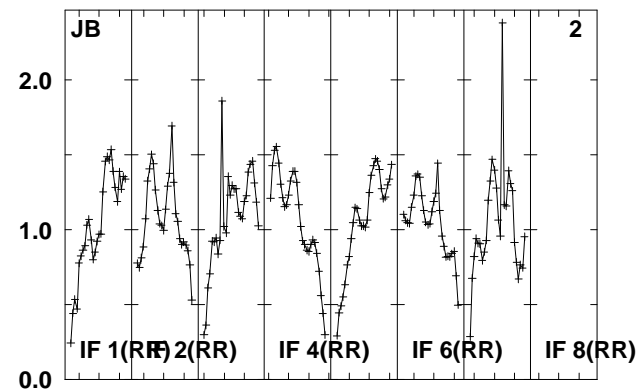
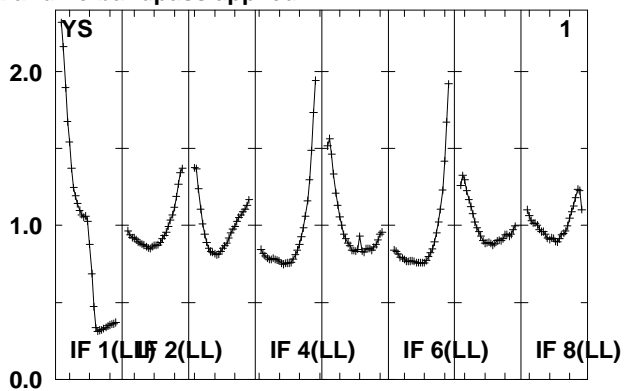
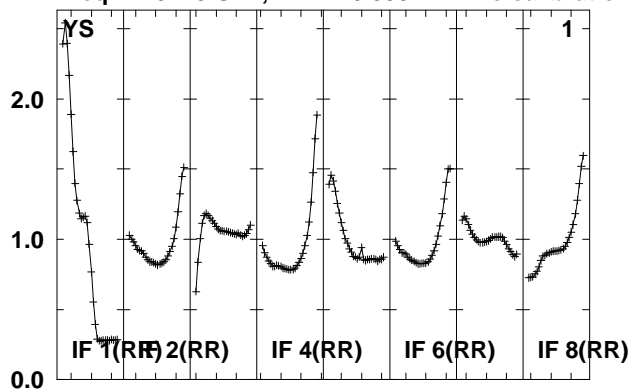

Lower frame: Real Jy
Total-power spectrum Antenna: *
Timerange: 00/17:53:55 to 00/17:55:23

Plot file version 522 created 14-MAY-2010 15:20:01

J0808+40 EO007.UVDATA.1

Freq = 4.9270 GHz, Bw = 16.000 MH No calibration applied and no bandpass applied

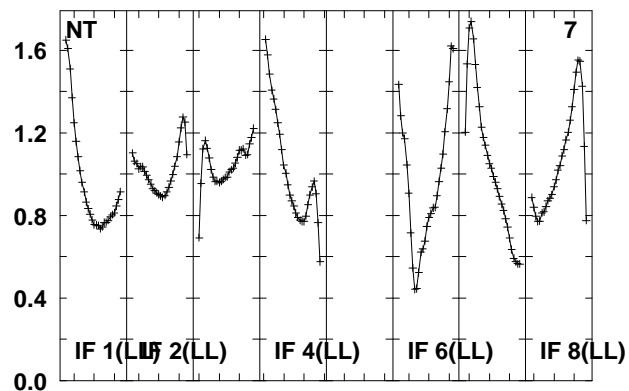
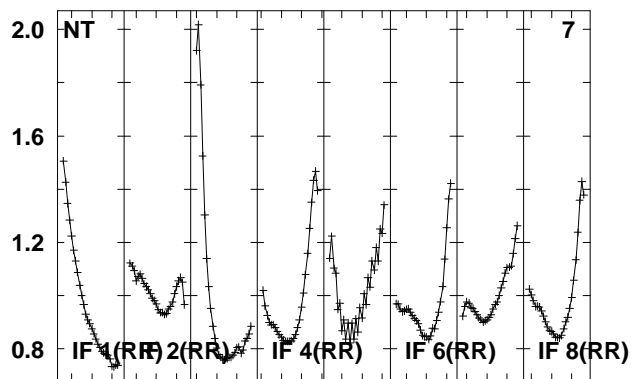
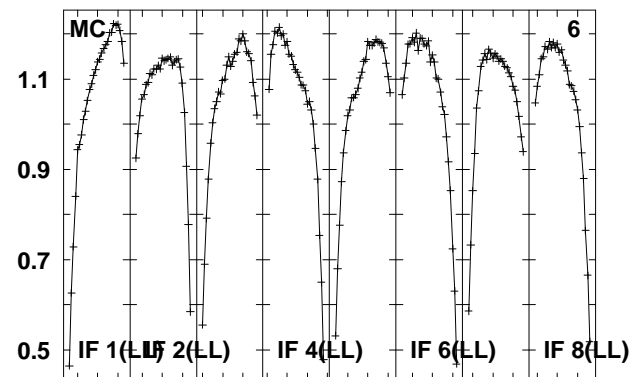
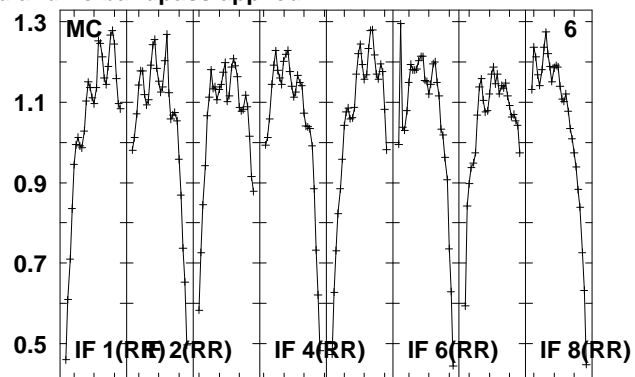
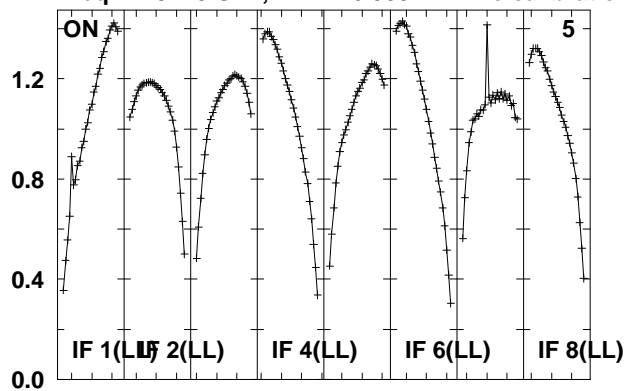

Lower frame: Real Jy
Total-power spectrum Antenna: *
Timerange: 00/17:53:55 to 00/17:55:23

Plot file version 523 created 14-MAY-2010 15:20:02

J0808+49 EO007.UVDATA.1

Freq = 4.9270 GHz, Bw = 16.000 MH No calibration applied and no bandpass applied

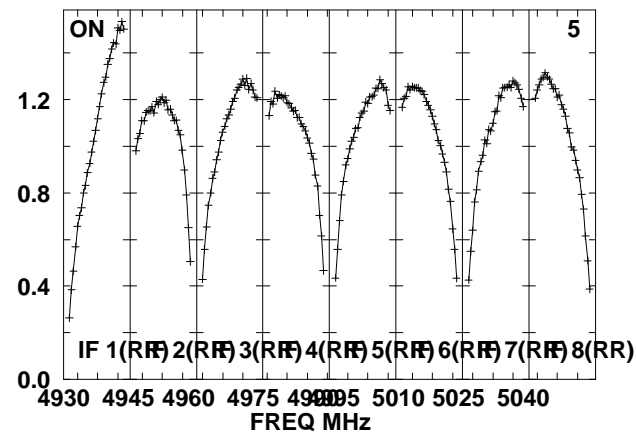
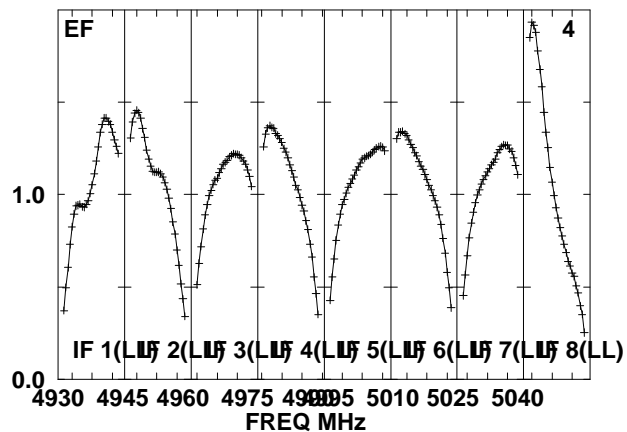
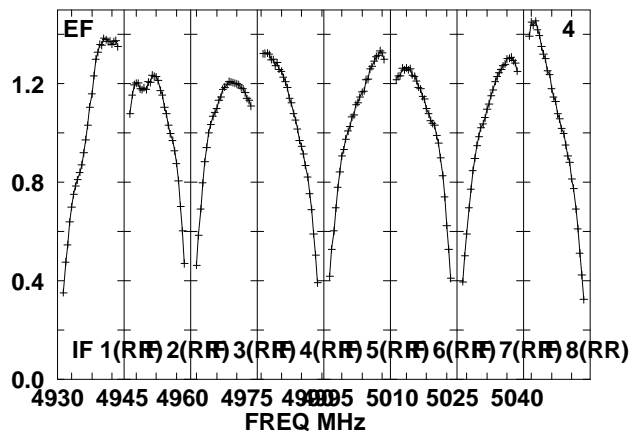
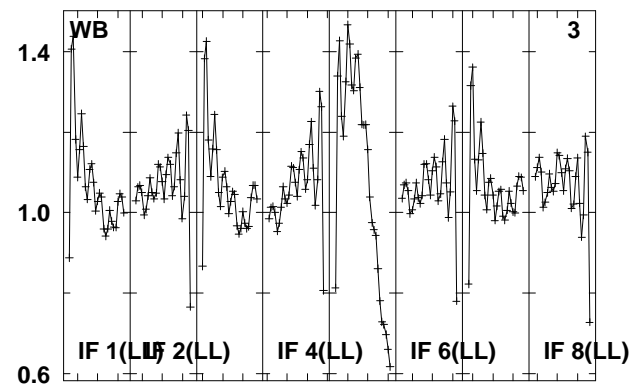
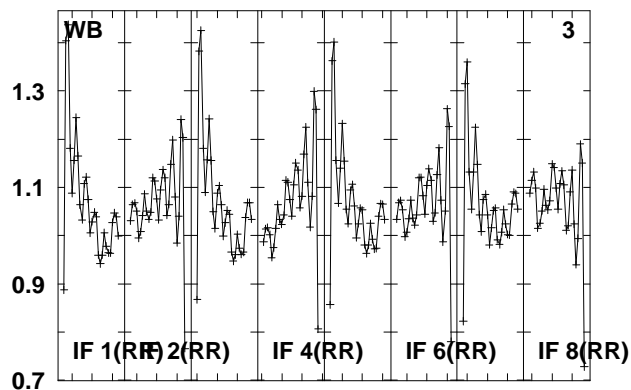
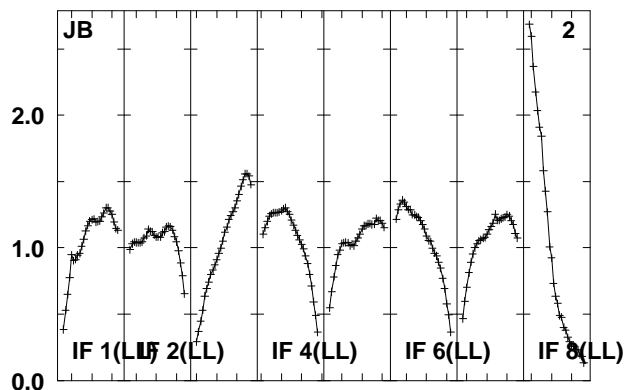
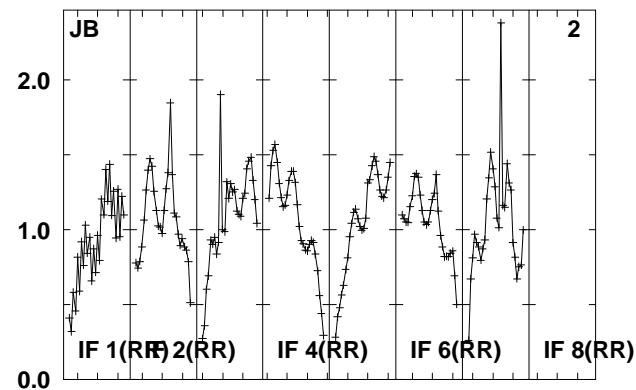
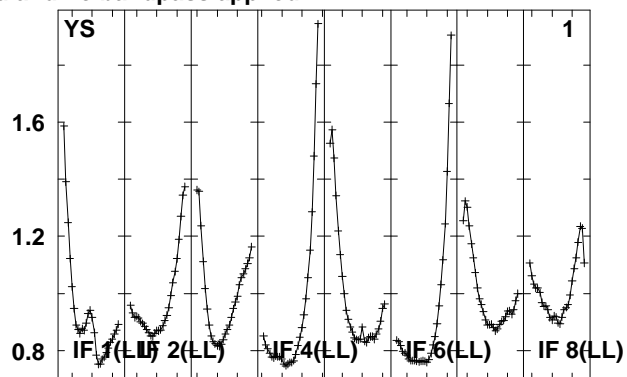
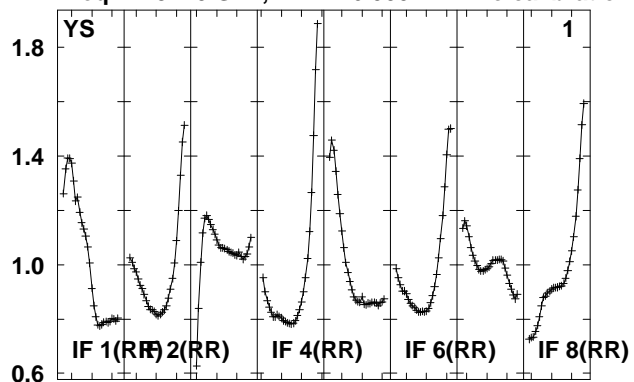

Lower frame: Real Jy
Total-power spectrum Antenna: *
Timerange: 00/17:56:53 to 00/17:58:21

Plot file version 524 created 14-MAY-2010 15:20:02

J0808+49 EO007.UVDATA.1

Freq = 4.9270 GHz, Bw = 16.000 MH No calibration applied and no bandpass applied

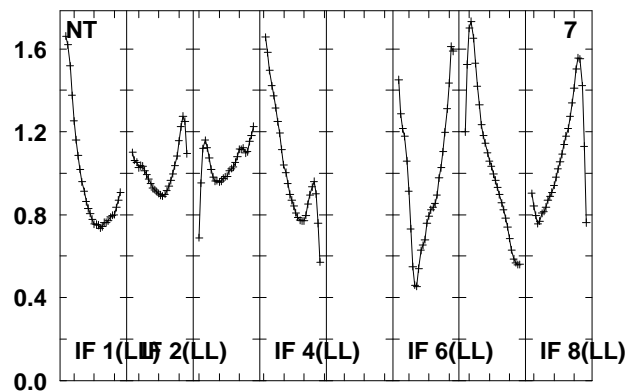
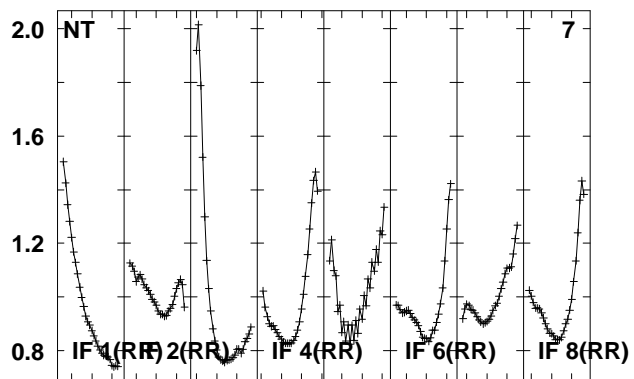
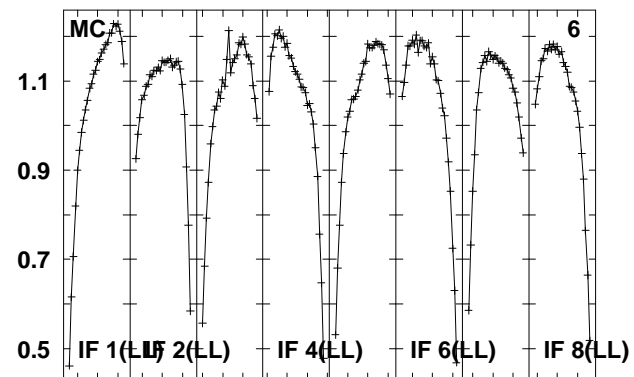
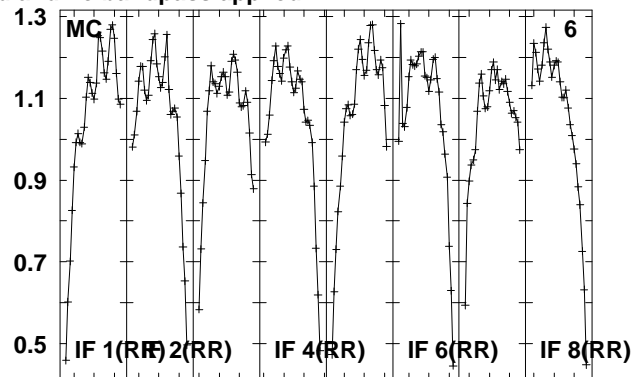
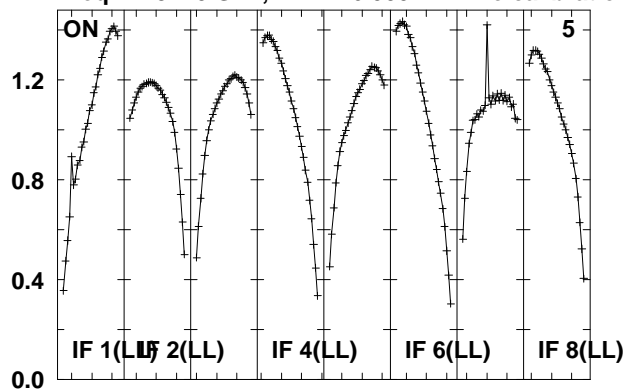

Lower frame: Real Jy
Total-power spectrum Antenna: *
Timerange: 00/17:56:53 to 00/17:58:21

Plot file version 525 created 14-MAY-2010 15:20:02

J081523 EO007.UVDATA.1

Freq = 4.9270 GHz, Bw = 16.000 MH No calibration applied and no bandpass applied

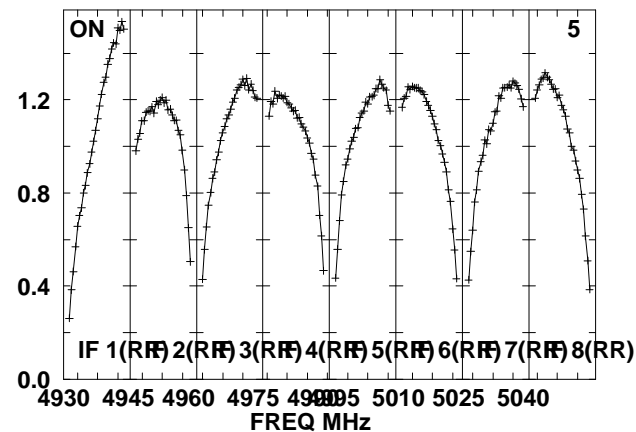
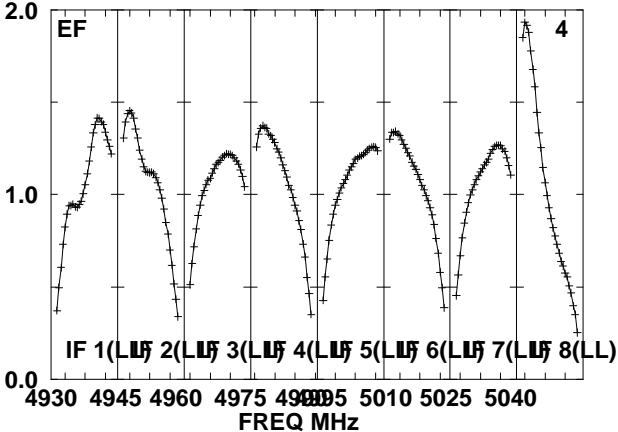
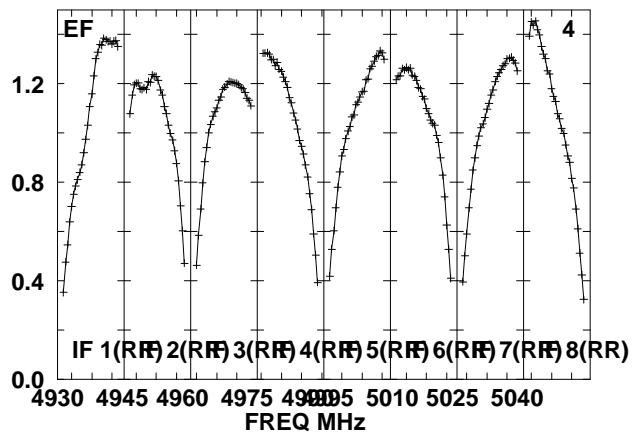
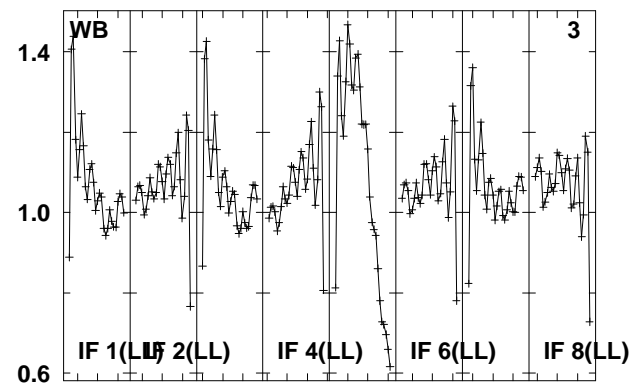
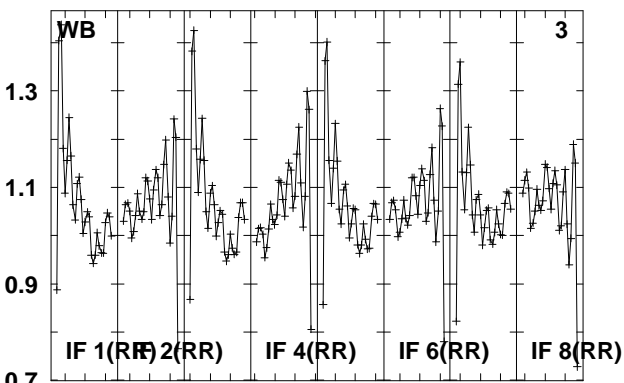
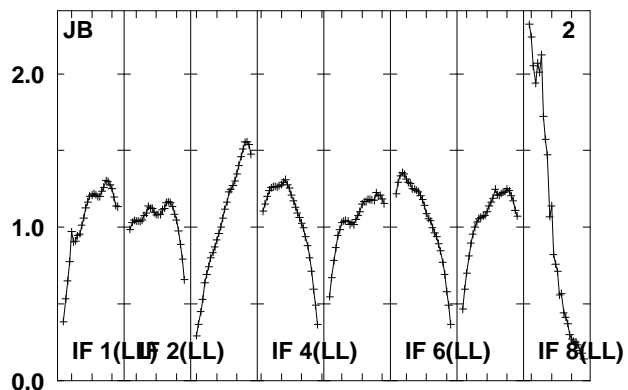
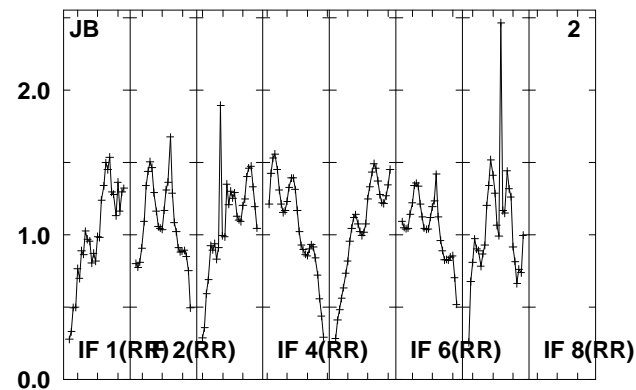
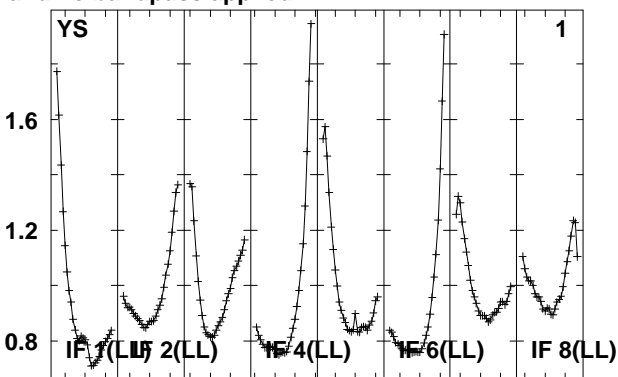
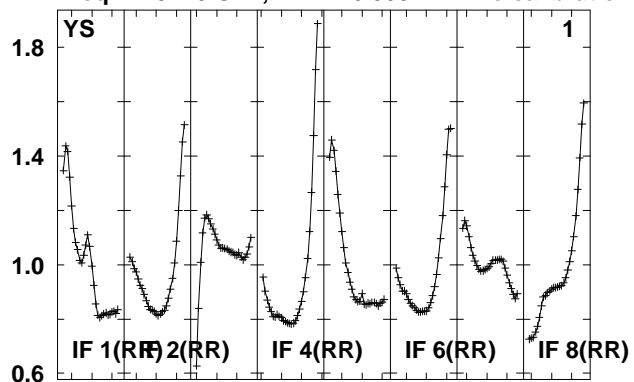

Lower frame: Real Jy
Total-power spectrum Antenna: *
Timerange: 00/17:58:49 to 00/18:03:47

Plot file version 526 created 14-MAY-2010 15:20:03

J081523 EO007.UVDATA.1

Freq = 4.9270 GHz, Bw = 16.000 MH No calibration applied and no bandpass applied

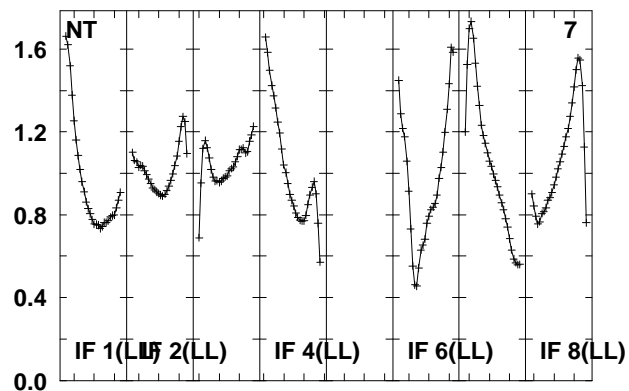
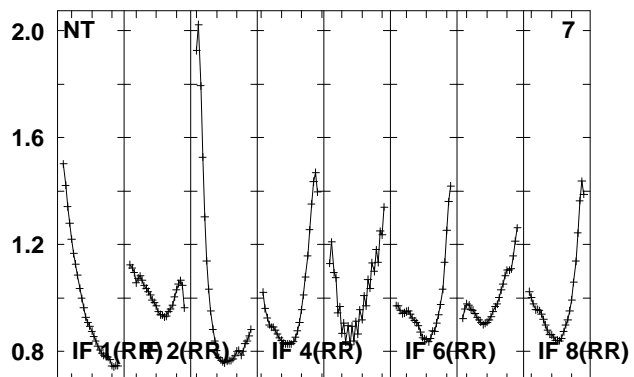
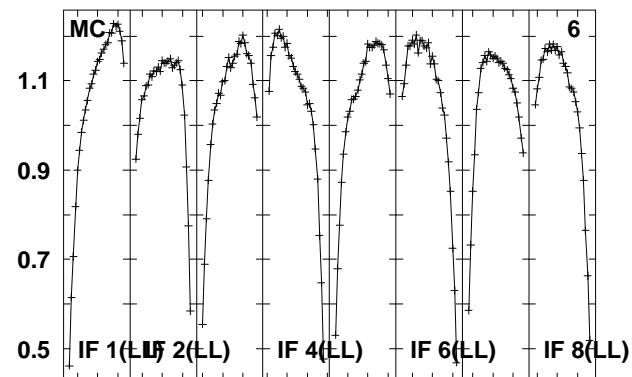
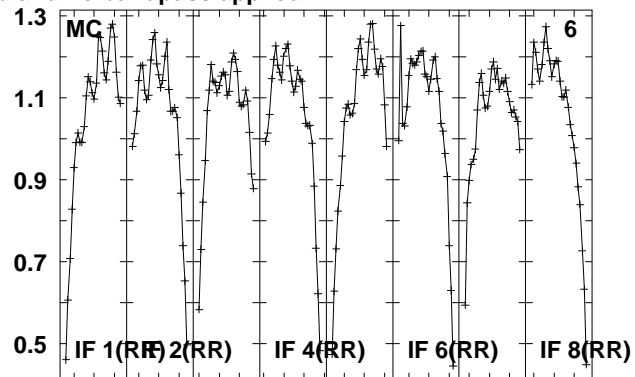
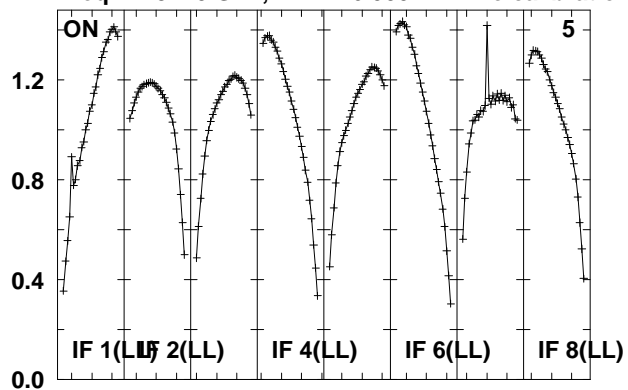

Lower frame: Real Jy
Total-power spectrum Antenna: *
Timerange: 00/17:58:49 to 00/18:03:47

Plot file version 527 created 14-MAY-2010 15:20:03

J0808+49 EO007.UVDATA.1

Freq = 4.9270 GHz, Bw = 16.000 MH No calibration applied and no bandpass applied

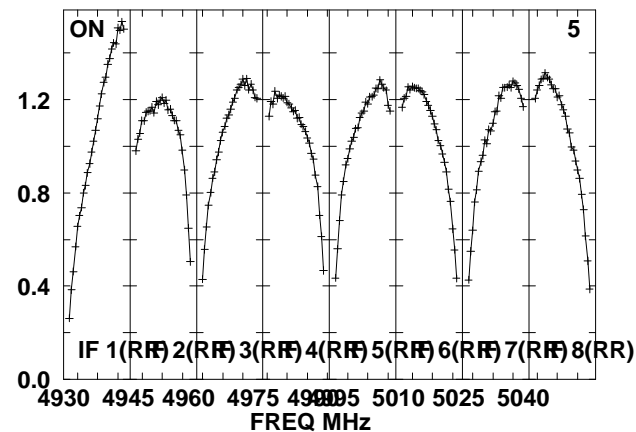
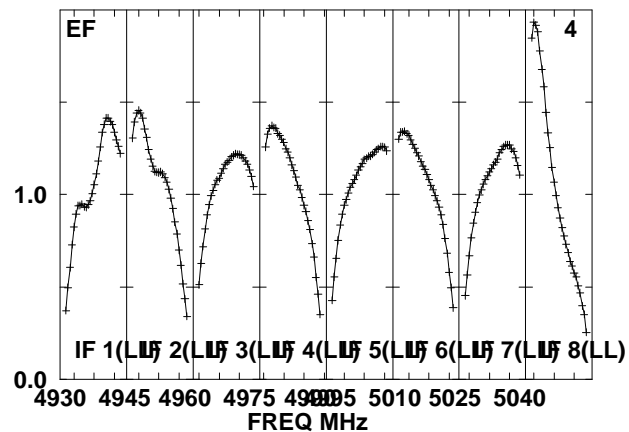
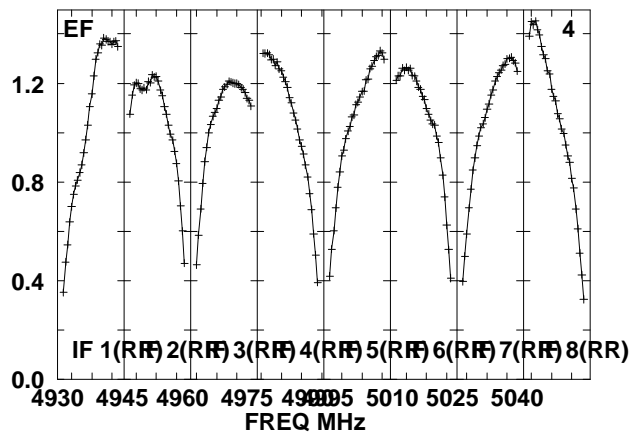
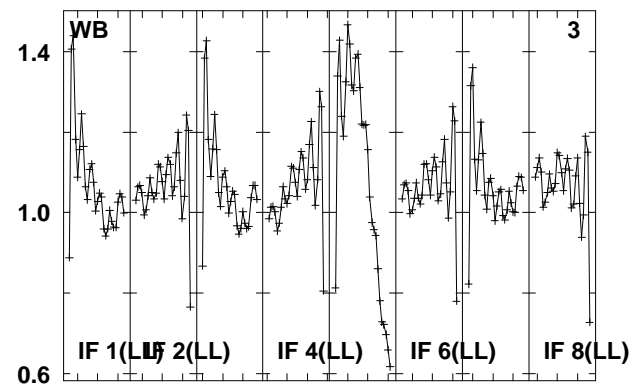
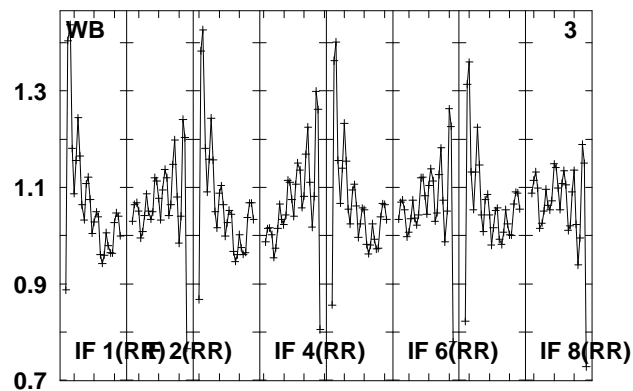
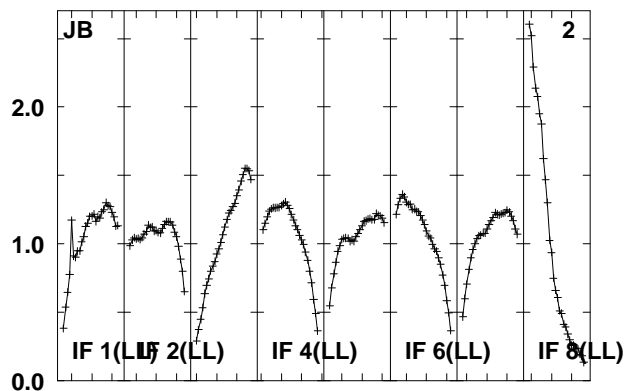
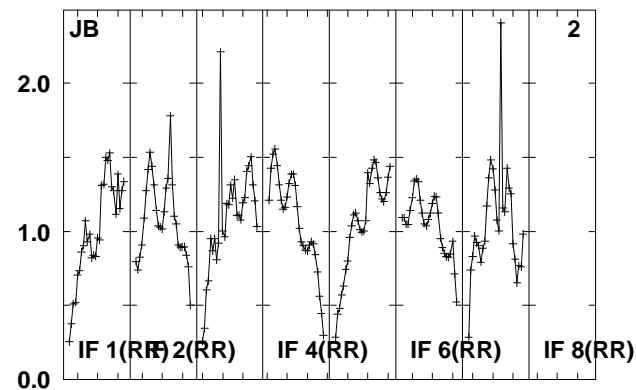
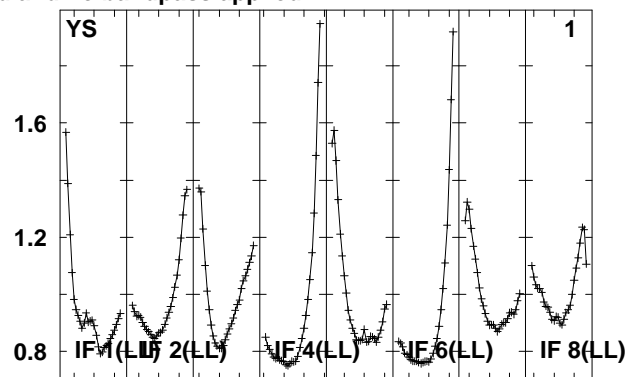
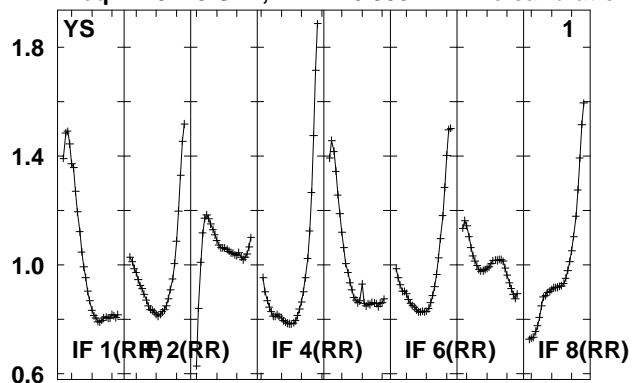

Lower frame: Real Jy
Total-power spectrum Antenna: *
Timerange: 00/18:04:15 to 00/18:05:43

Plot file version 528 created 14-MAY-2010 15:20:03

J0808+49 EO007.UVDATA.1

Freq = 4.9270 GHz, Bw = 16.000 MH No calibration applied and no bandpass applied

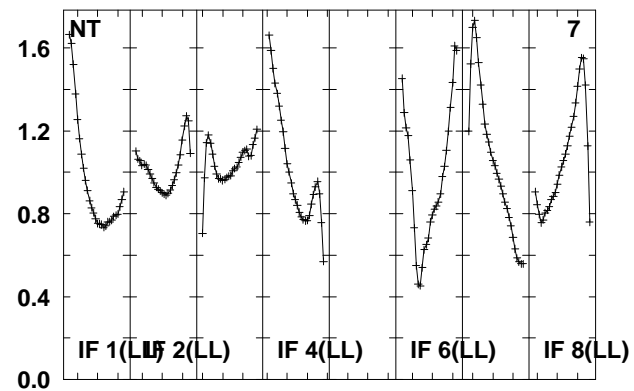
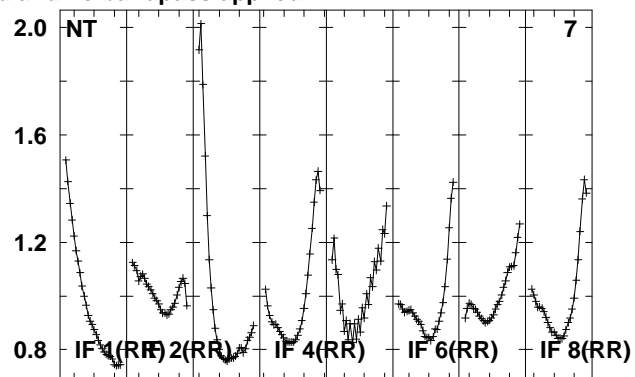
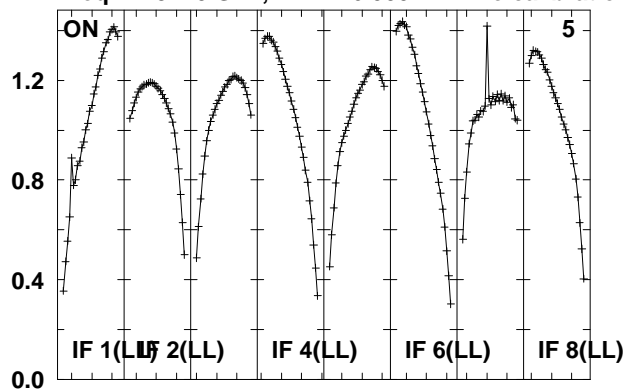

Lower frame: Real Jy
Total-power spectrum Antenna: *
Timerange: 00/18:04:15 to 00/18:05:43

Plot file version 529 created 14-MAY-2010 15:20:03

J081523 EO007.UVDATA.1

Freq = 4.9270 GHz, Bw = 16.000 MH No calibration applied and no bandpass applied

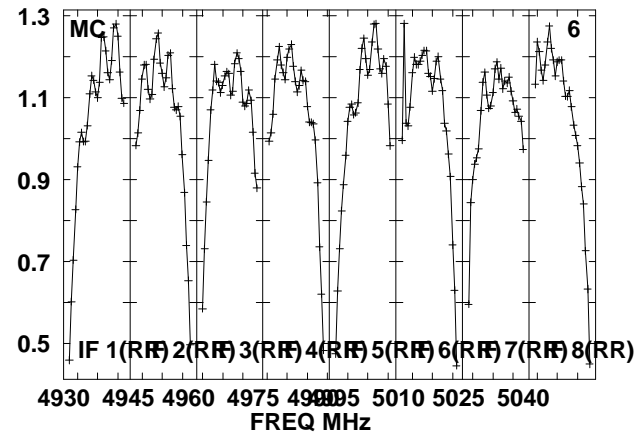
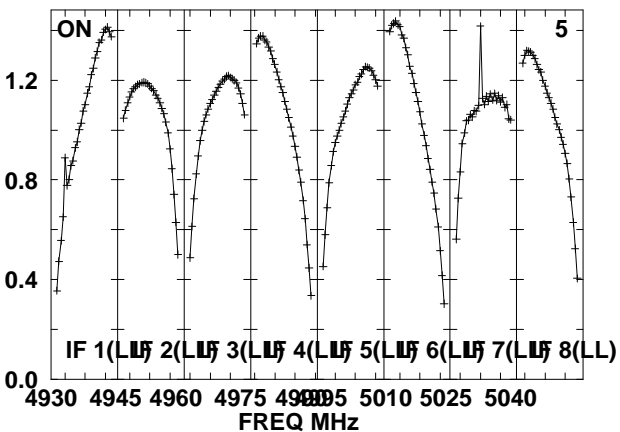
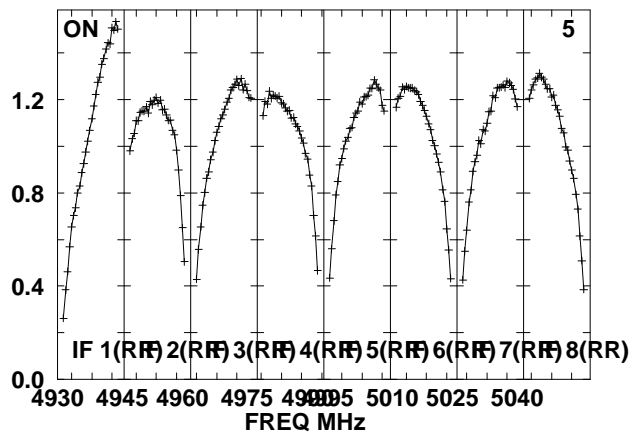
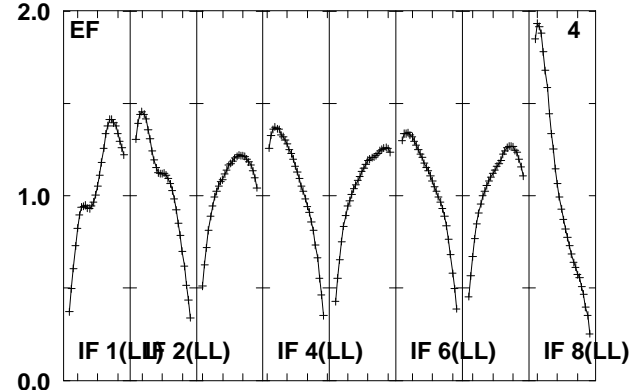
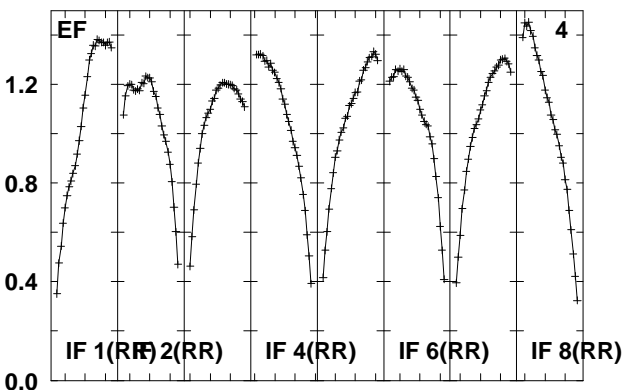
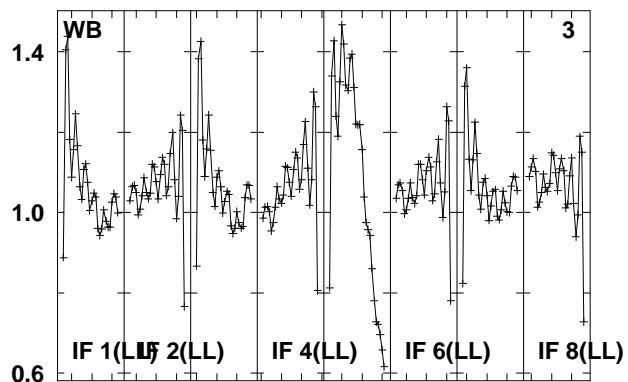
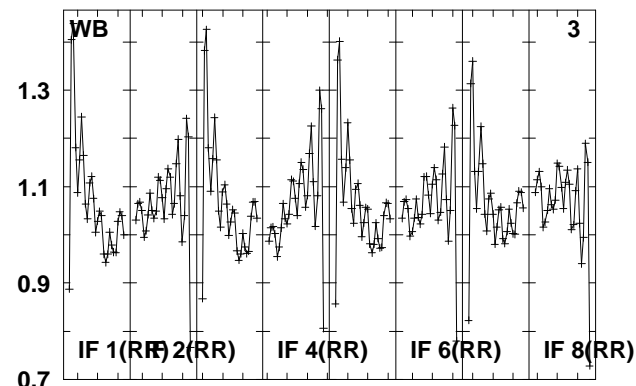
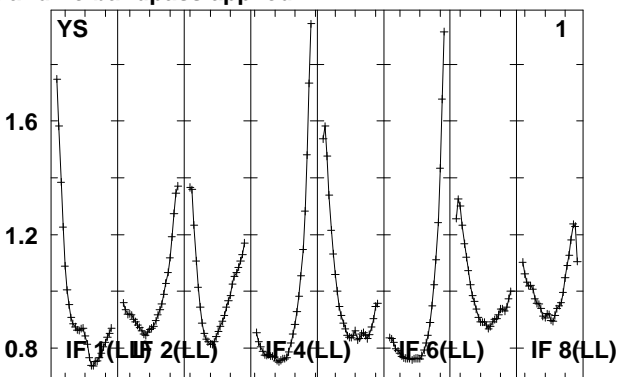
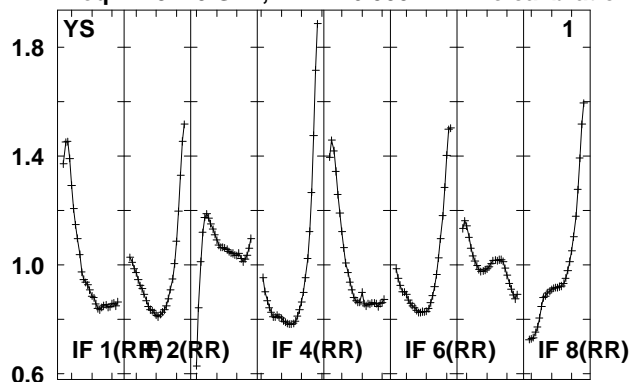

Lower frame: Real Jy
Total-power spectrum Antenna: *
Timerange: 00/18:06:11 to 00/18:11:09

Plot file version 530 created 14-MAY-2010 15:20:04

J081523 EO007.UVDATA.1

Freq = 4.9270 GHz, Bw = 16.000 MH No calibration applied and no bandpass applied

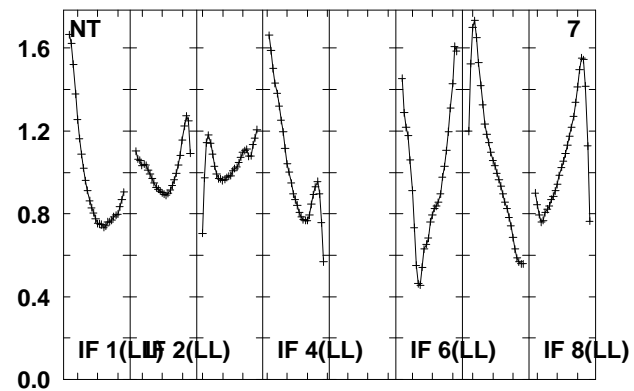
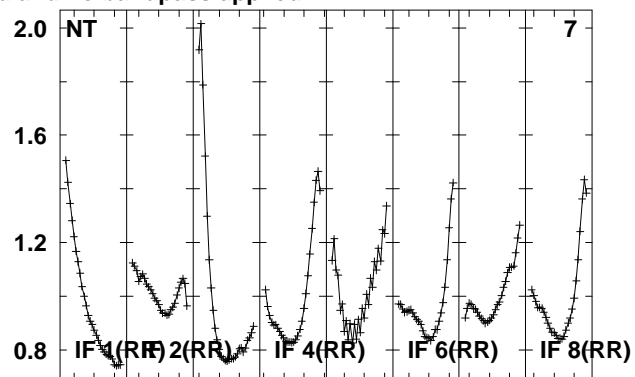
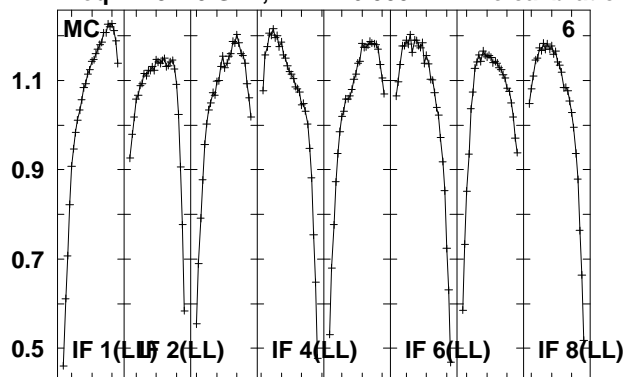

Lower frame: Real Jy
Total-power spectrum Antenna: *
Timerange: 00/18:06:11 to 00/18:11:09

Plot file version 531 created 14-MAY-2010 15:20:04

J0808+49 EO007.UVDATA.1

Freq = 4.9270 GHz, Bw = 16.000 MH No calibration applied and no bandpass applied

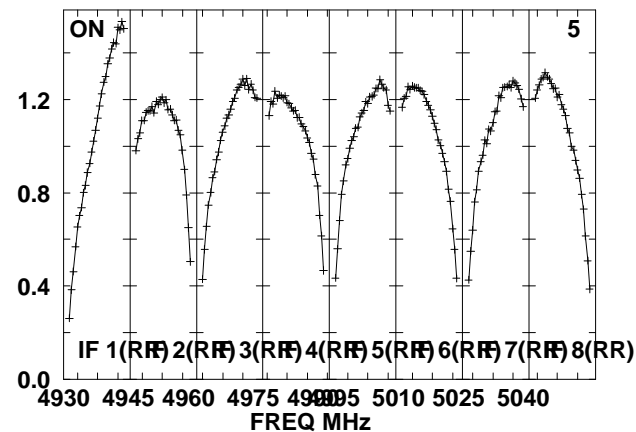
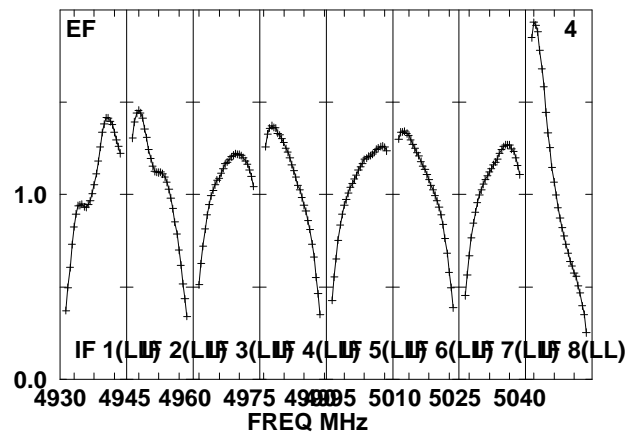
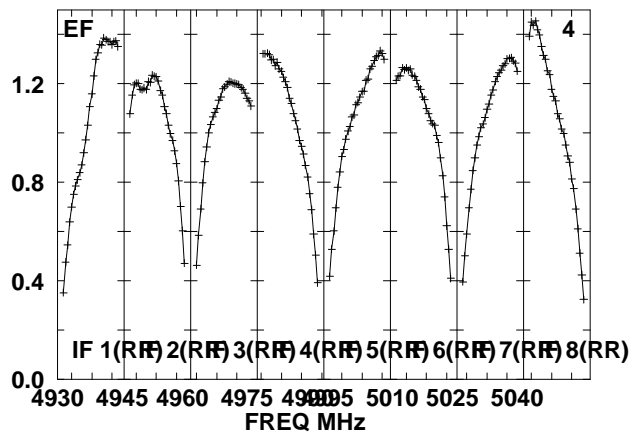
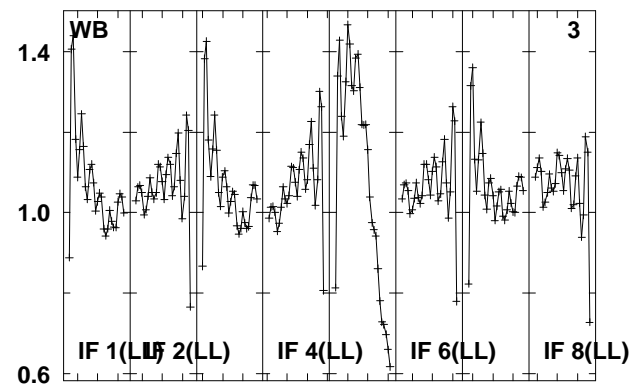
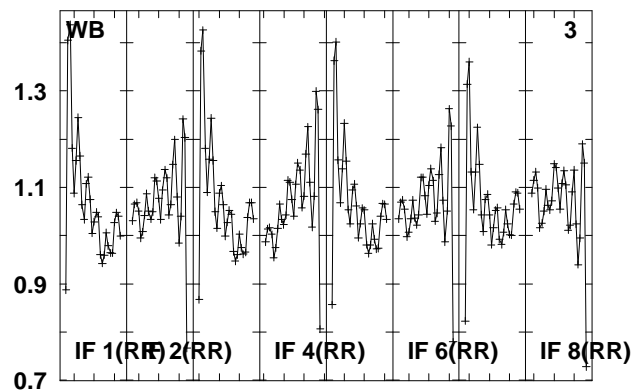
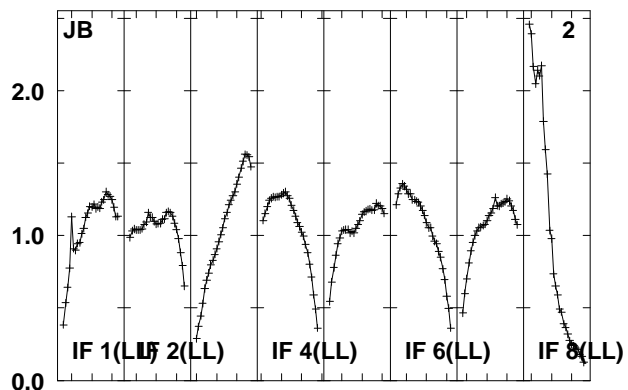
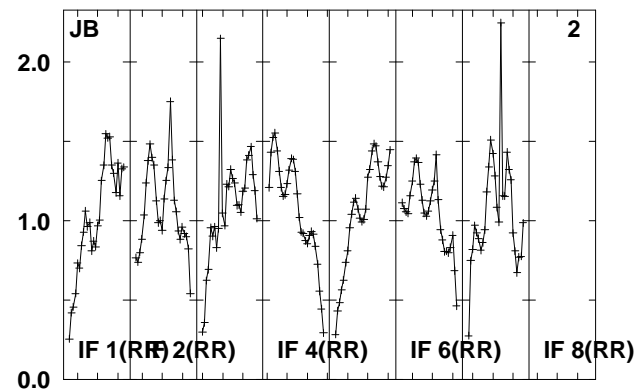
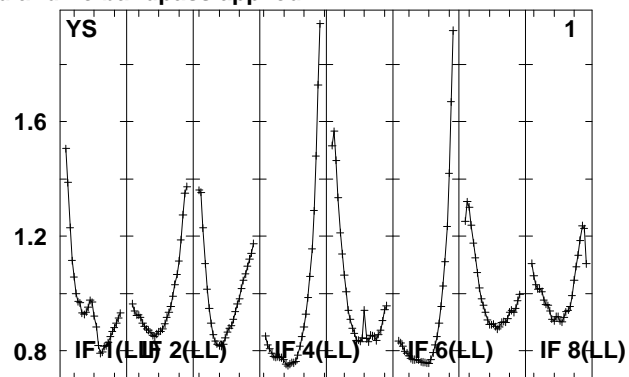
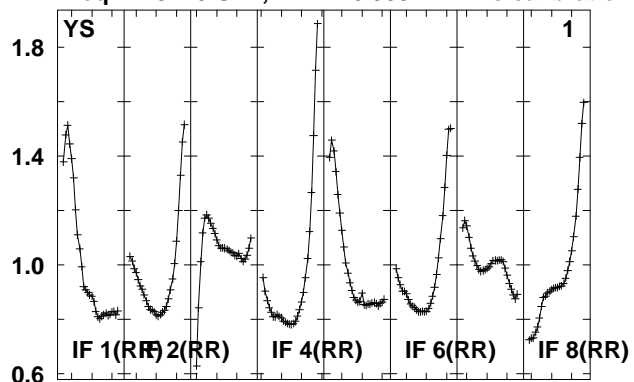

Lower frame: Real Jy
Total-power spectrum Antenna: *
Timerange: 00/18:11:39 to 00/18:13:07

Plot file version 532 created 14-MAY-2010 15:20:04

J0808+49 EO007.UVDATA.1

Freq = 4.9270 GHz, Bw = 16.000 MH No calibration applied and no bandpass applied

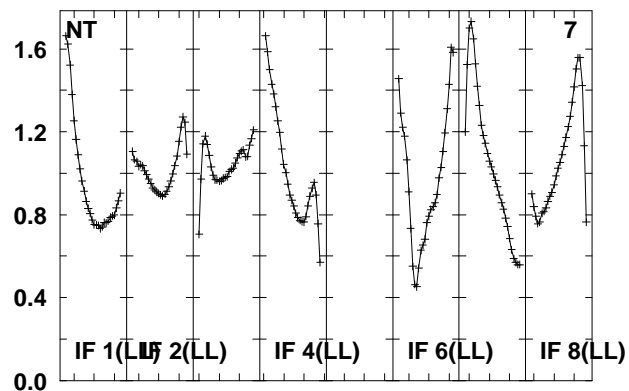
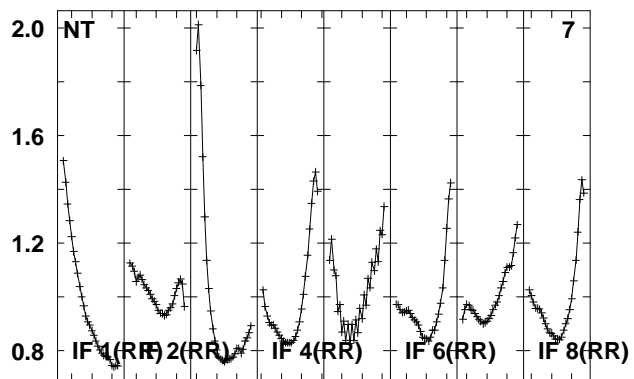
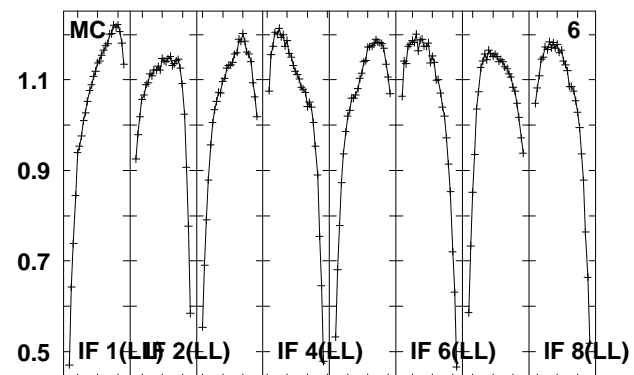
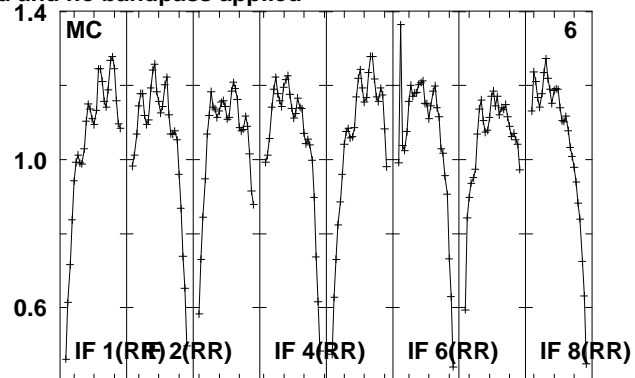
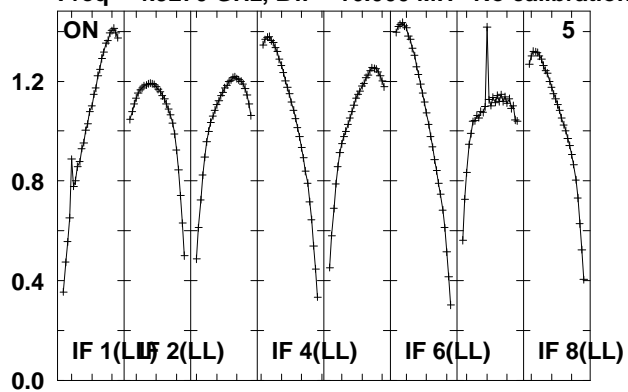

Lower frame: Real Jy
Total-power spectrum Antenna: *
Timerange: 00/18:11:39 to 00/18:13:07

Plot file version 533 created 14-MAY-2010 15:20:05

J0920+44 EO007.UVDATA.1

Freq = 4.9270 GHz, Bw = 16.000 MH No calibration applied and no bandpass applied

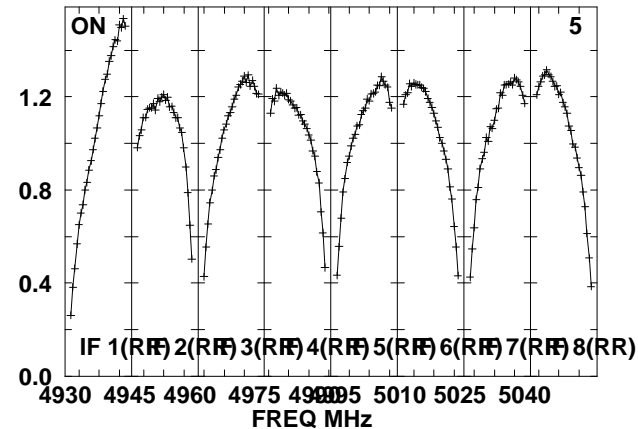
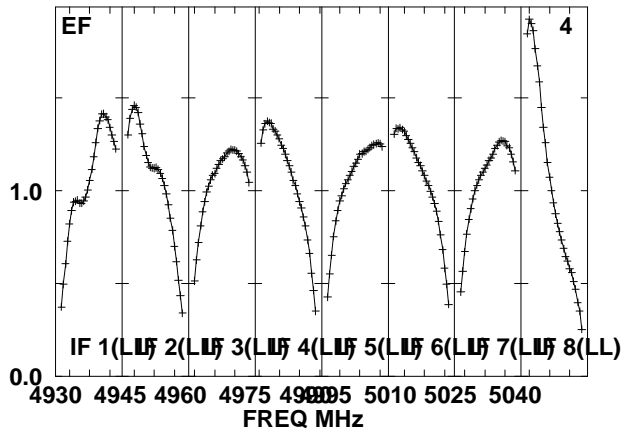
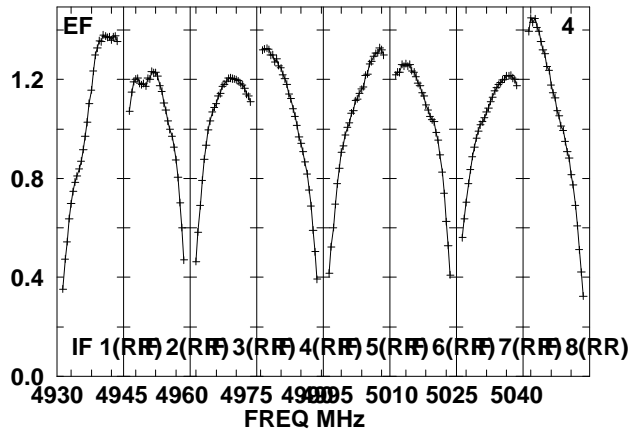
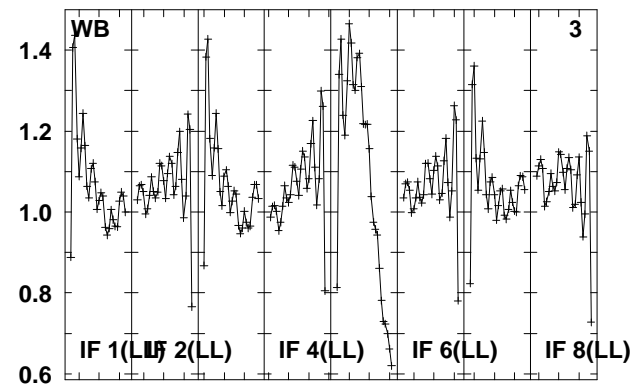
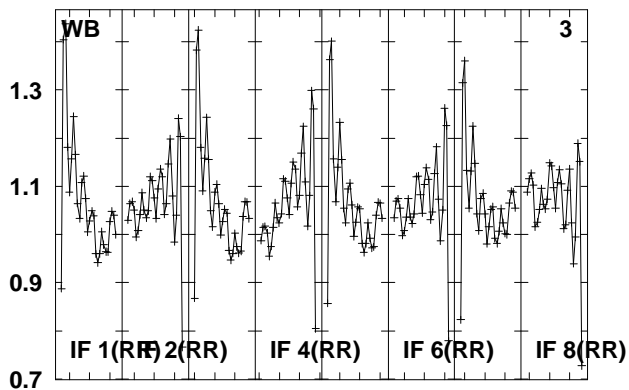
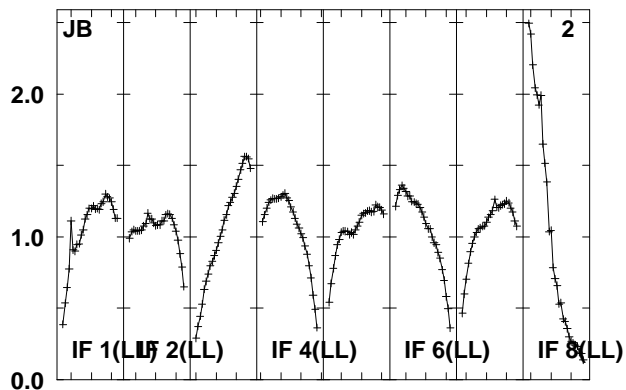
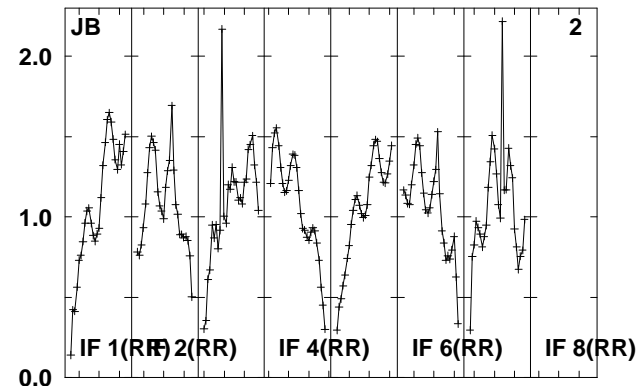
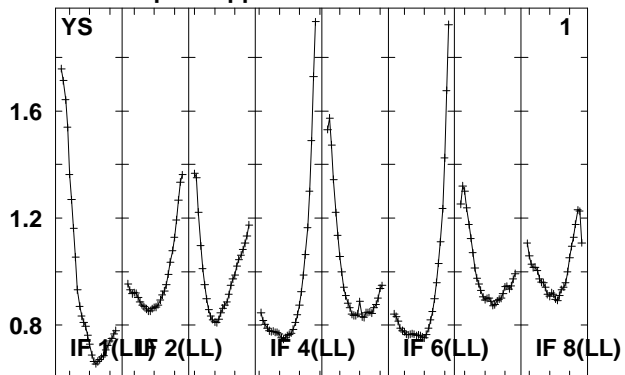
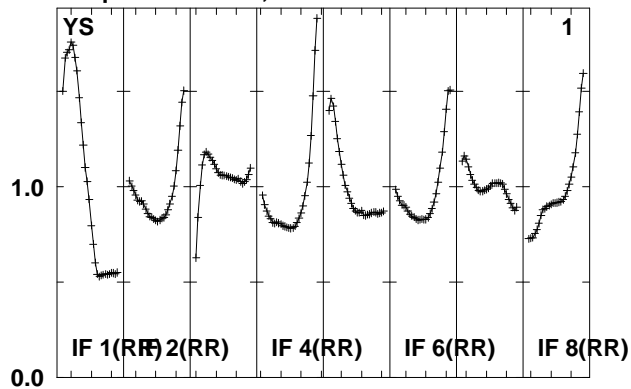

Lower frame: Real Jy

Total-power spectrum Antenna: *

Timerange: 00/18:14:43 to 00/18:16:11

Plot file version 534 created 14-MAY-2010 15:20:05

J0920+44 EO007.UVDATA.1

Freq = 4.9270 GHz, Bw = 16.000 MH No calibration applied and no bandpass applied

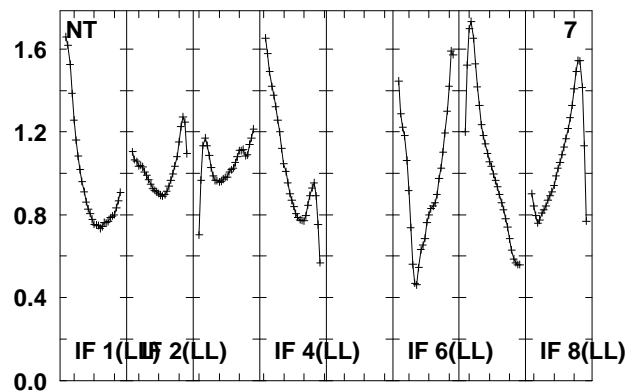
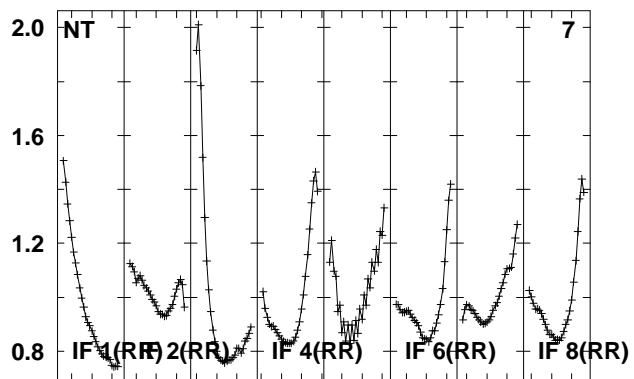
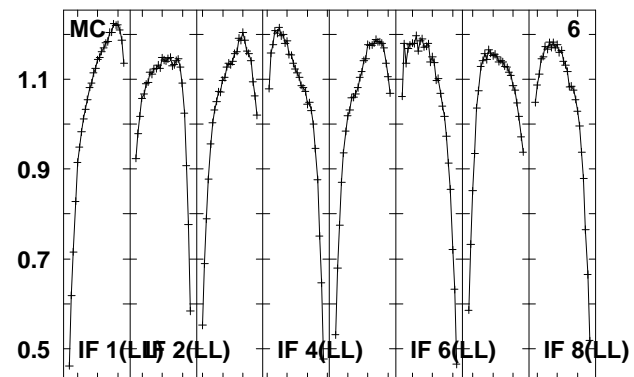
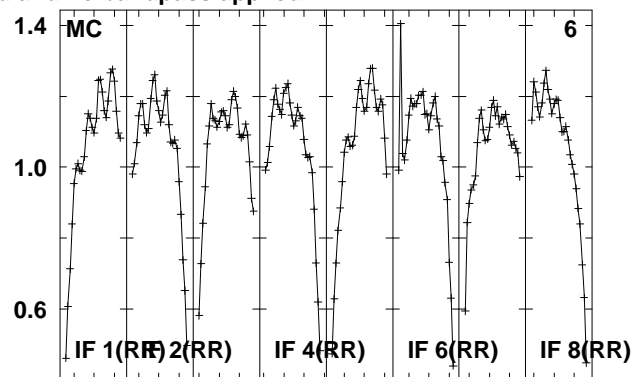
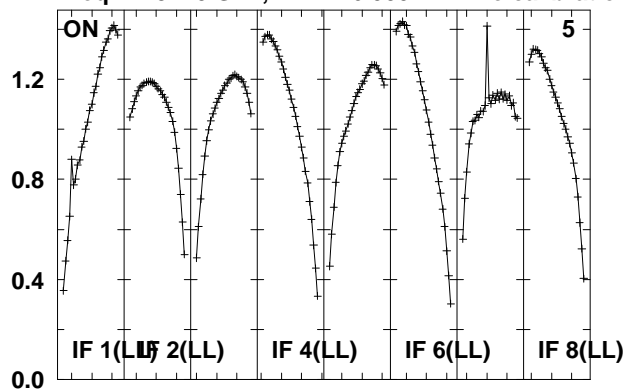

Lower frame: Real Jy
Total-power spectrum Antenna: *
Timerange: 00/18:14:43 to 00/18:16:11

Plot file version 535 created 14-MAY-2010 15:20:05

J092159 EO007.UVDATA.1

Freq = 4.9270 GHz, Bw = 16.000 MH No calibration applied and no bandpass applied

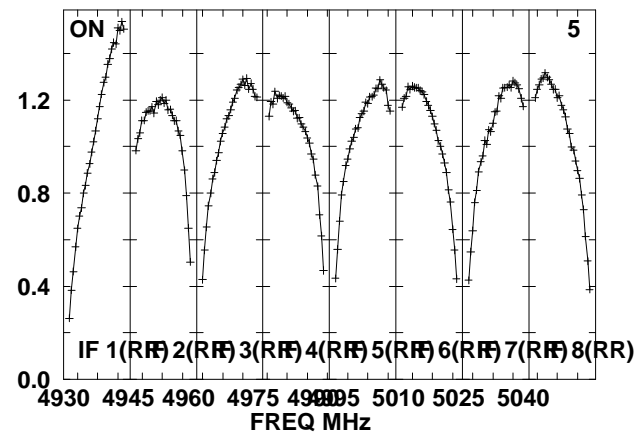
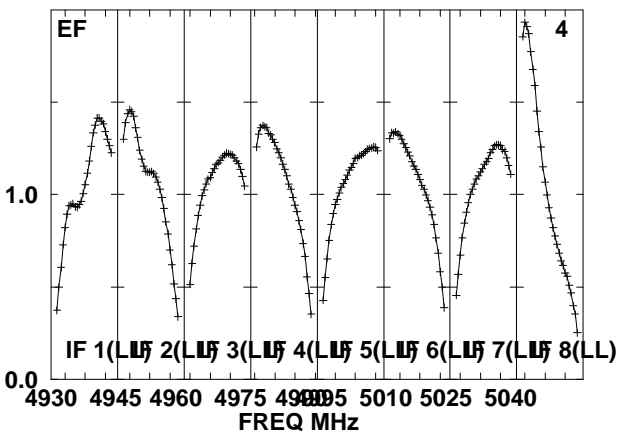
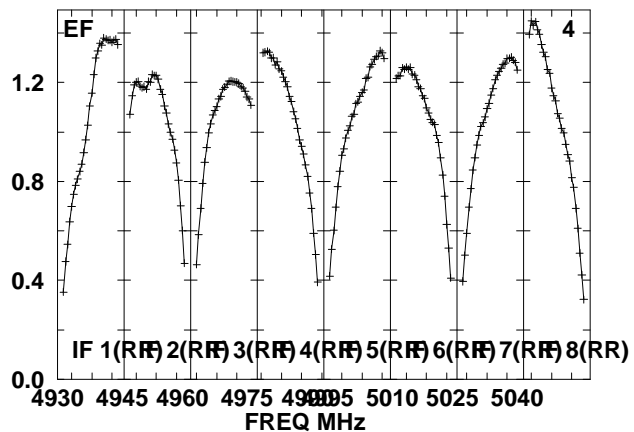
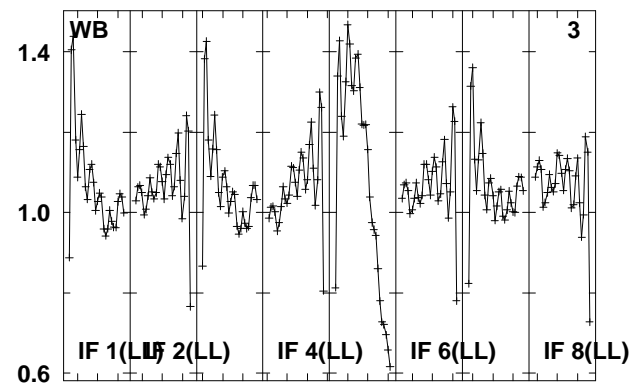
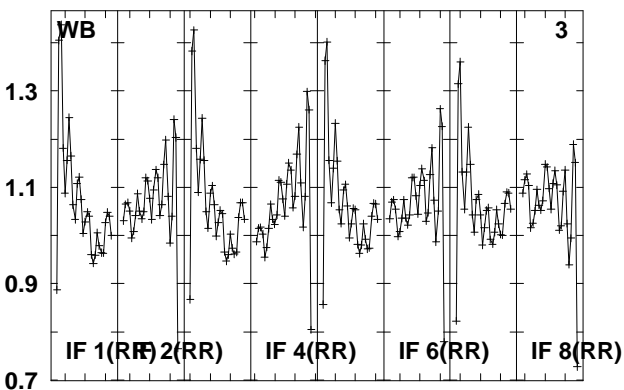
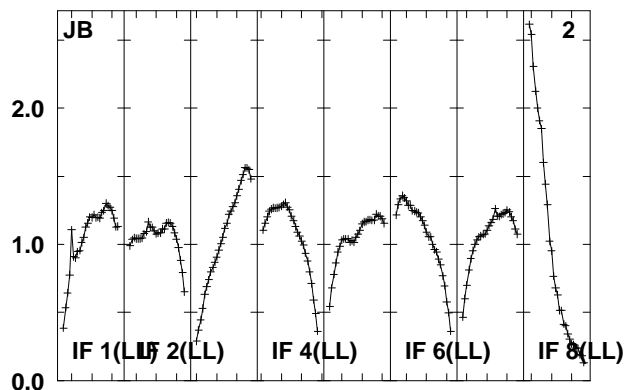
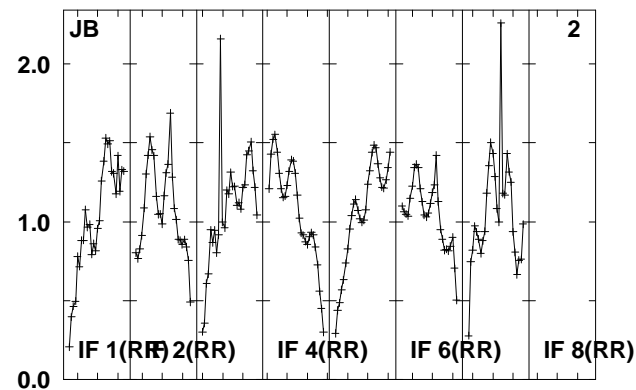
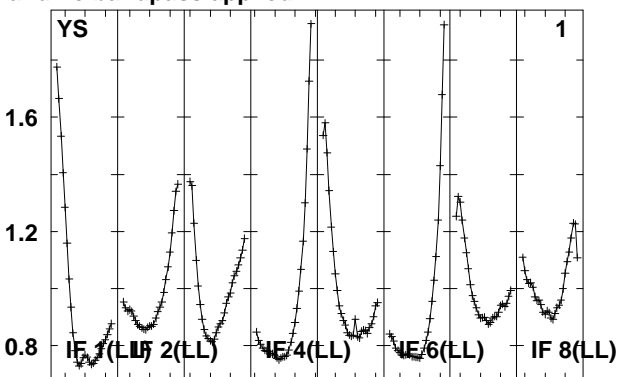
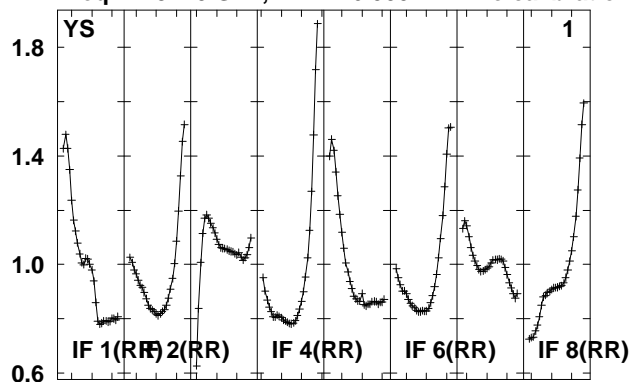

Lower frame: Real Jy

Total-power spectrum Antenna: *

Timerange: 00/18:16:35 to 00/18:21:35

Plot file version 536 created 14-MAY-2010 15:20:06

J092159 EO007.UVDATA.1

Freq = 4.9270 GHz, Bw = 16.000 MH No calibration applied and no bandpass applied

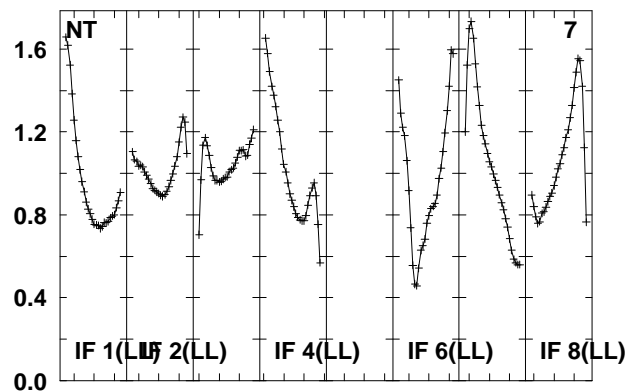
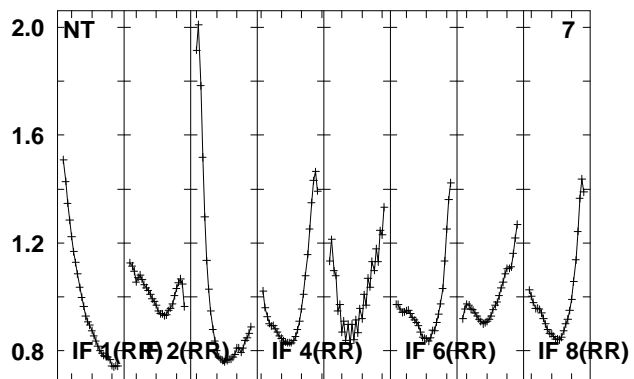
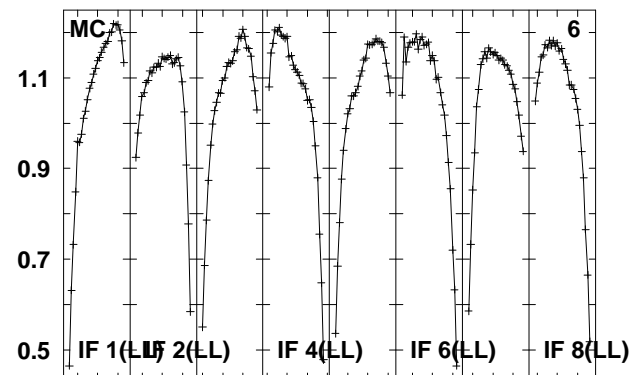
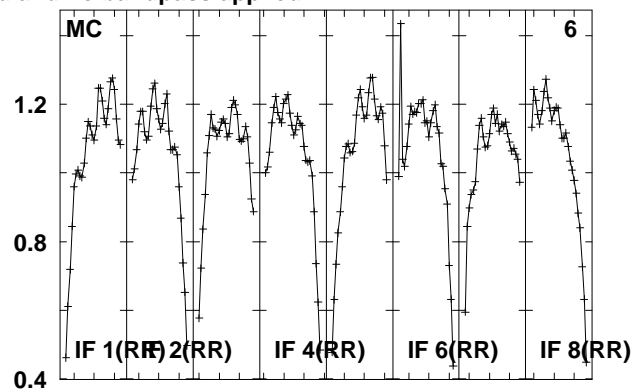
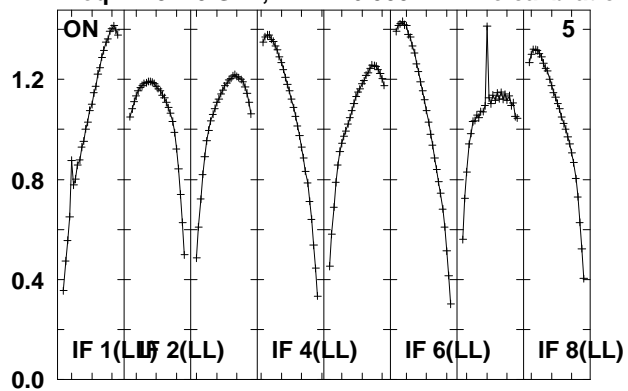

Lower frame: Real Jy
Total-power spectrum Antenna: *
Timerange: 00/18:16:35 to 00/18:21:35

Plot file version 537 created 14-MAY-2010 15:20:06

J0920+44 EO07.UVDATA.1

Freq = 4.9270 GHz, Bw = 16.000 MH No calibration applied and no bandpass applied

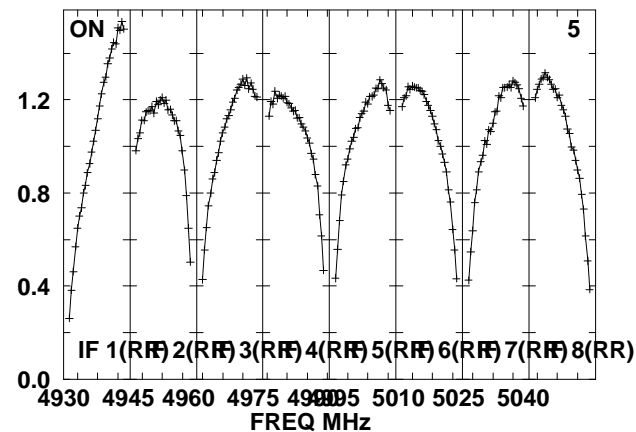
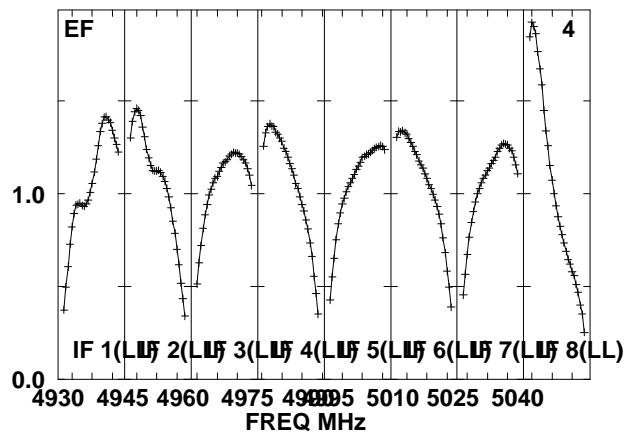
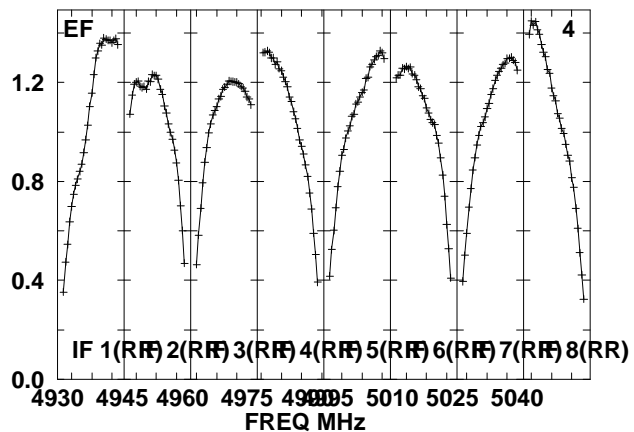
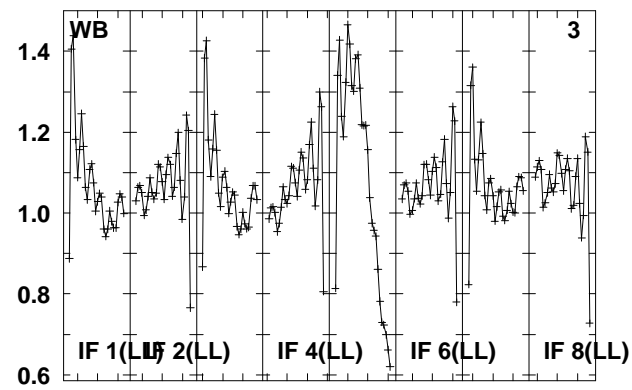
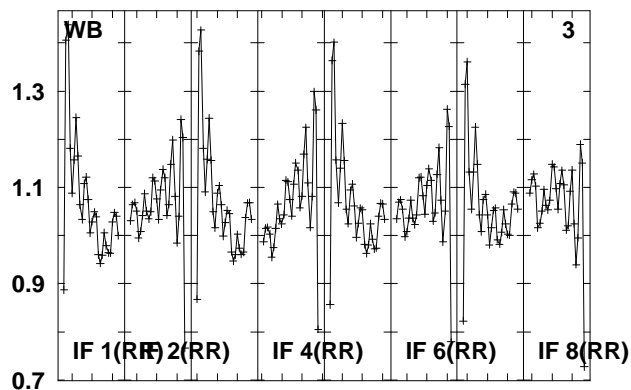
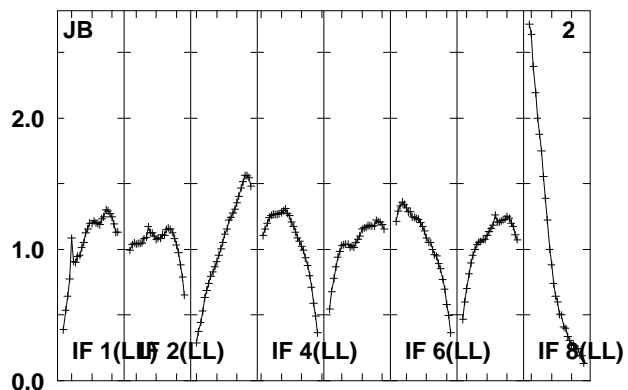
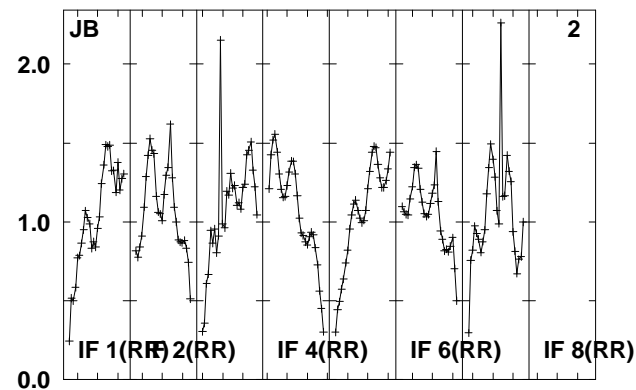
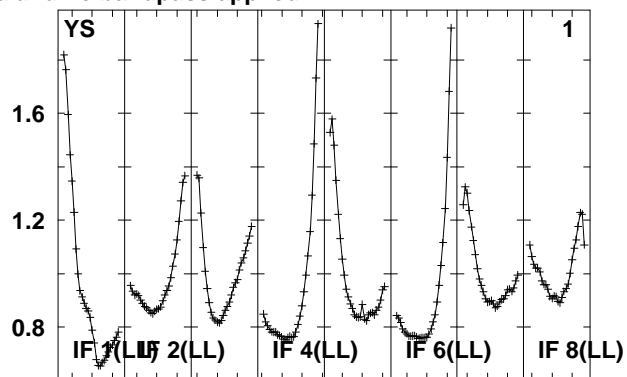
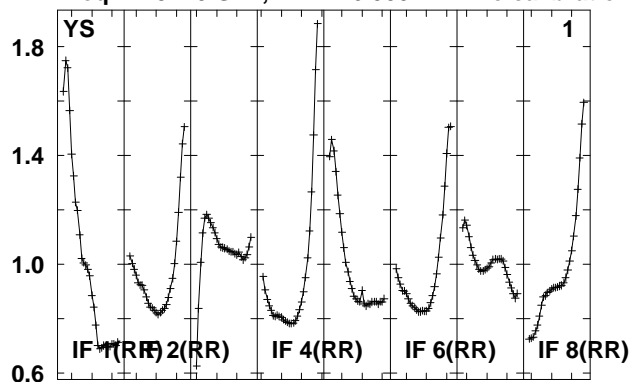

Lower frame: Real Jy
Total-power spectrum Antenna: *
Timerange: 00/18:21:59 to 00/18:23:27

Plot file version 538 created 14-MAY-2010 15:20:06

J0920+44 EO007.UVDATA.1

Freq = 4.9270 GHz, Bw = 16.000 MH No calibration applied and no bandpass applied

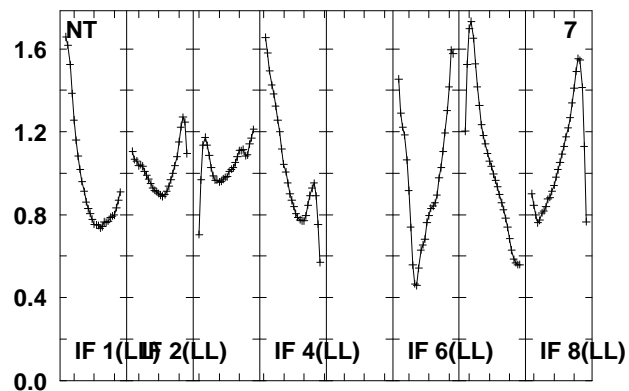
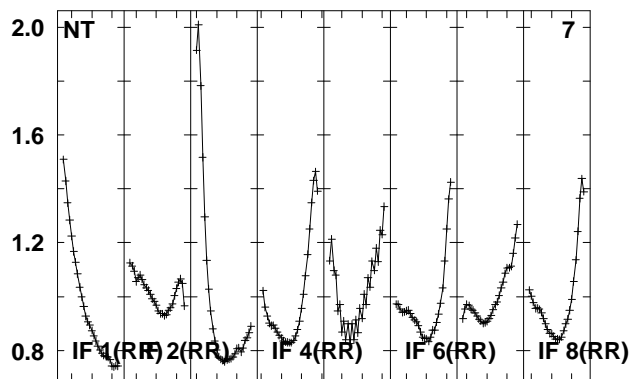
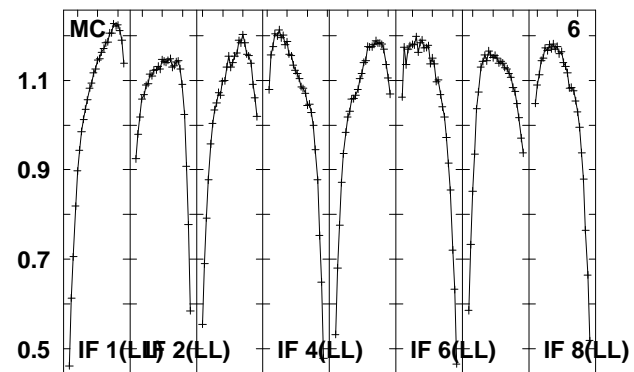
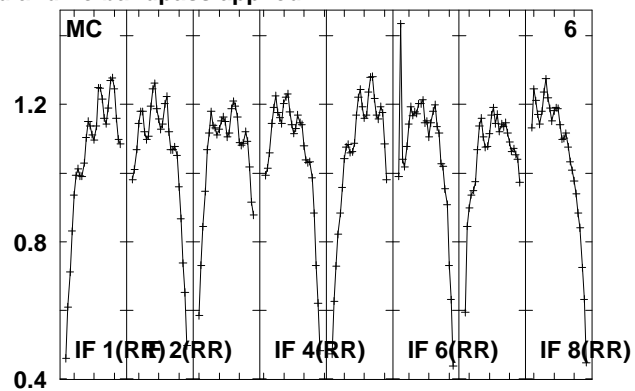
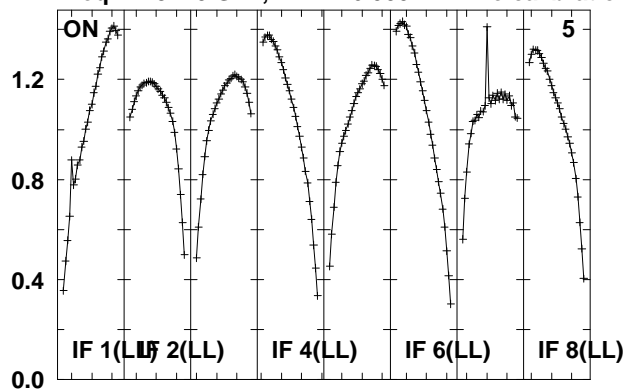

Lower frame: Real Jy
Total-power spectrum Antenna: *
Timerange: 00/18:21:59 to 00/18:23:27

Plot file version 539 created 14-MAY-2010 15:20:07

J092159 EO007.UVDATA.1

Freq = 4.9270 GHz, Bw = 16.000 MH No calibration applied and no bandpass applied

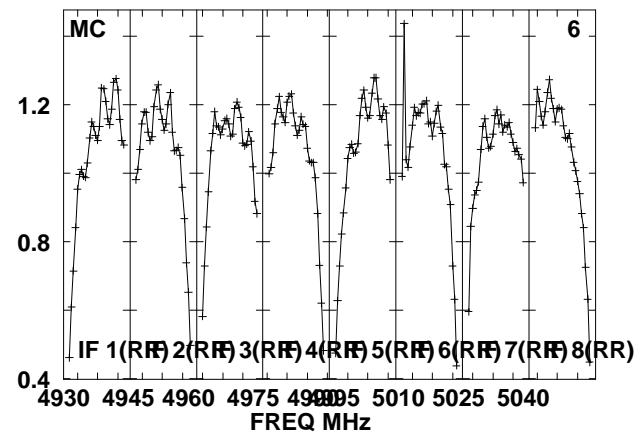
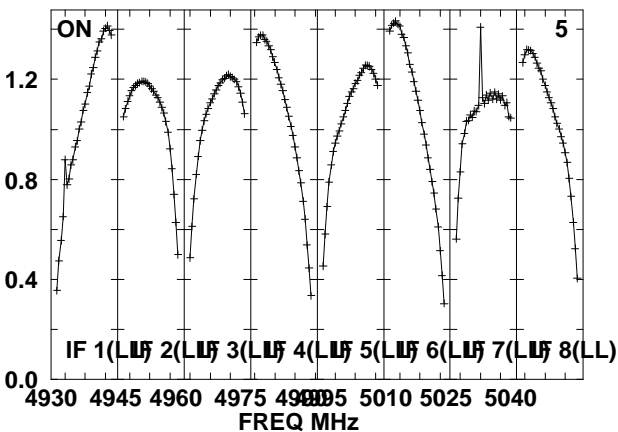
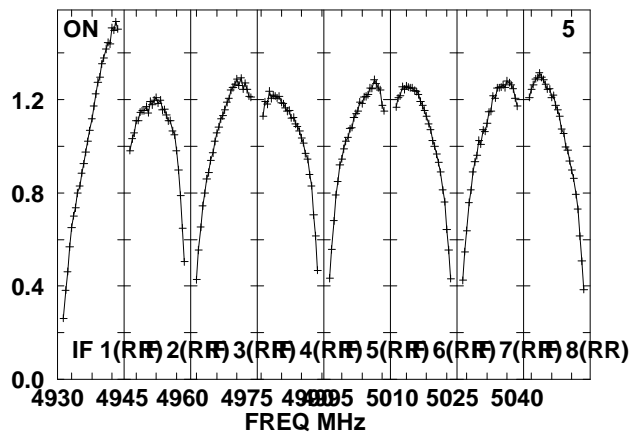
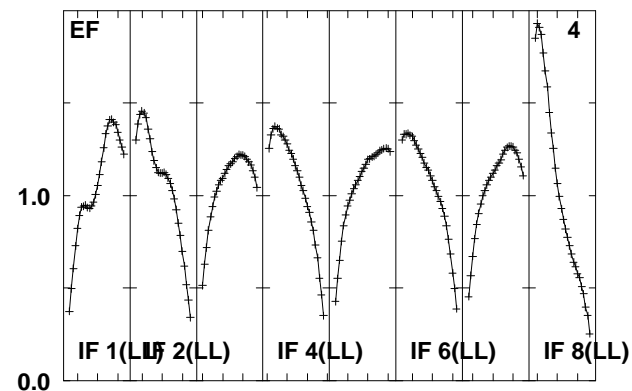
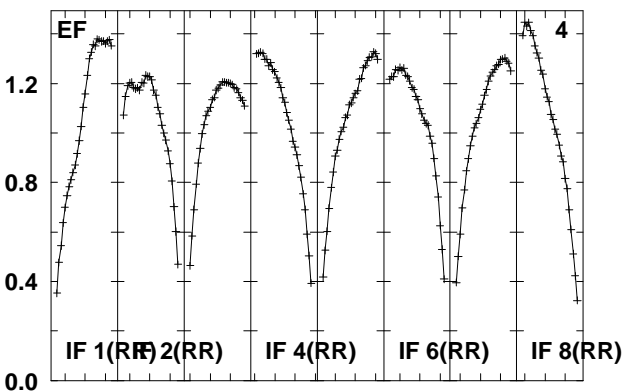
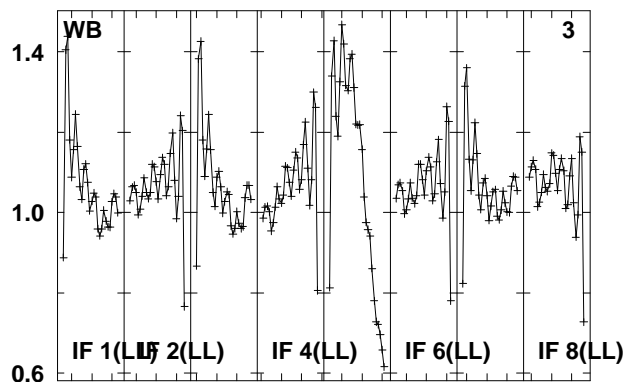
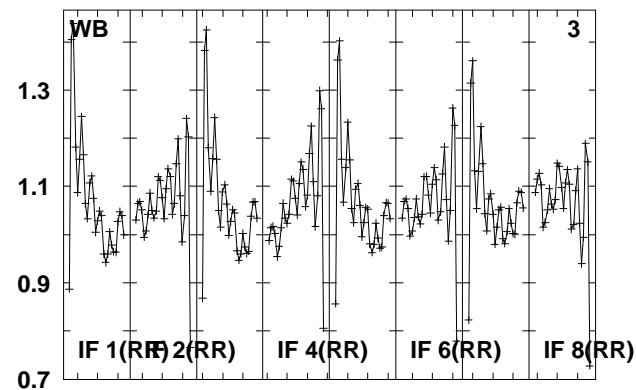
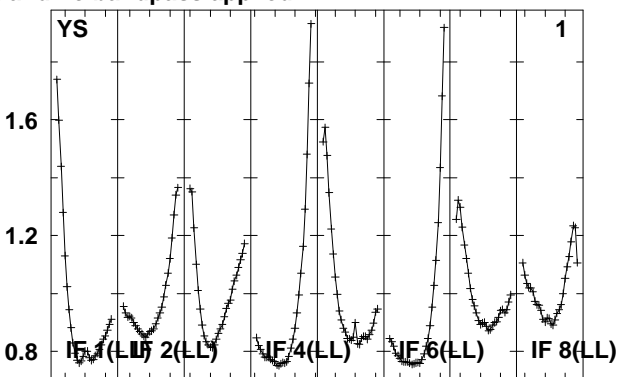
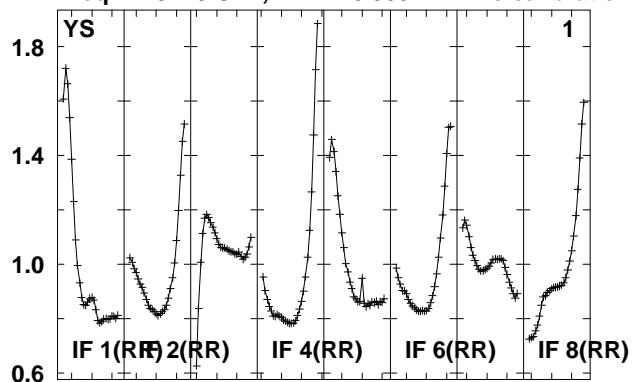

Lower frame: Real Jy
Total-power spectrum Antenna: *
Timerange: 00/18:23:53 to 00/18:28:49

Plot file version 540 created 14-MAY-2010 15:20:07

J092159 EO007.UVDATA.1

Freq = 4.9270 GHz, Bw = 16.000 MH No calibration applied and no bandpass applied

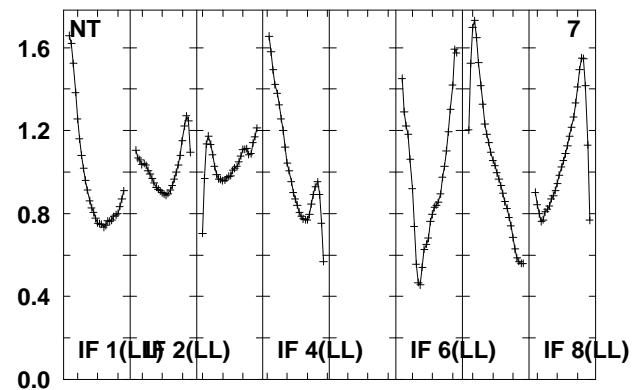
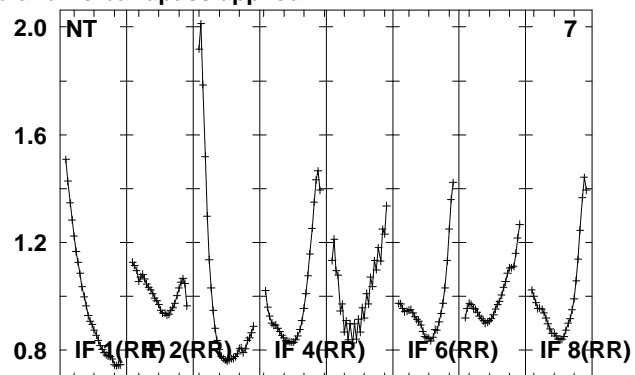
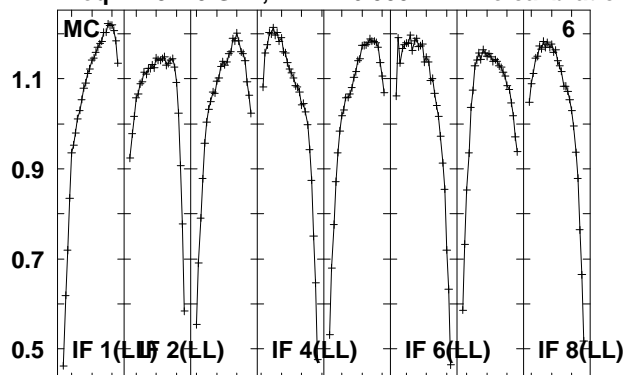

Lower frame: Real Jy
Total-power spectrum Antenna: *
Timerange: 00/18:23:53 to 00/18:28:49

Plot file version 541 created 14-MAY-2010 15:20:07

J0920+44 EO007.UVDATA.1

Freq = 4.9270 GHz, Bw = 16.000 MH No calibration applied and no bandpass applied

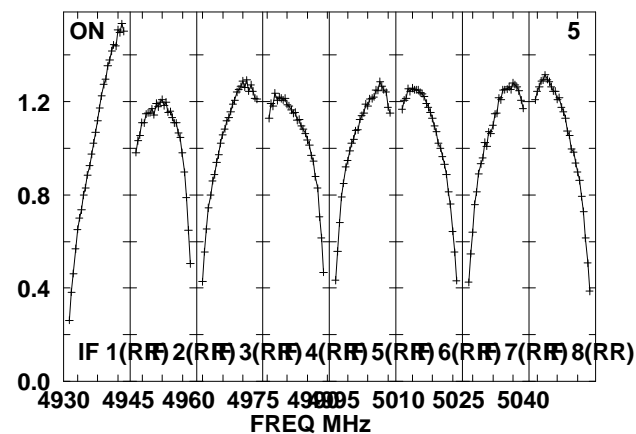
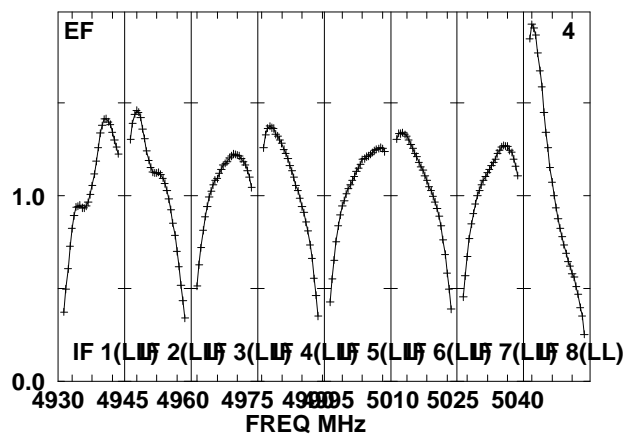
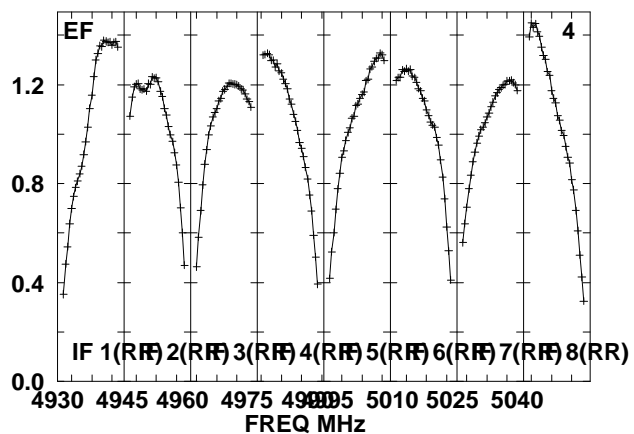
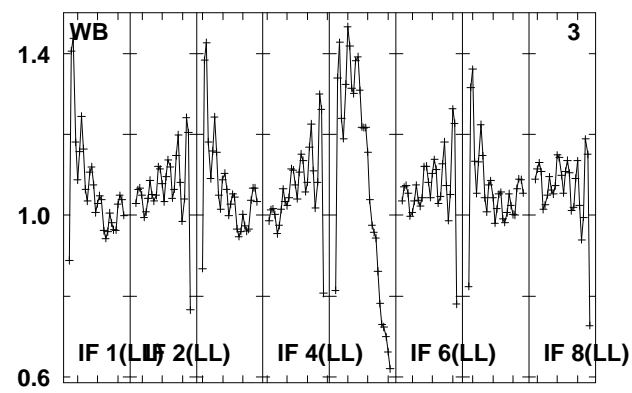
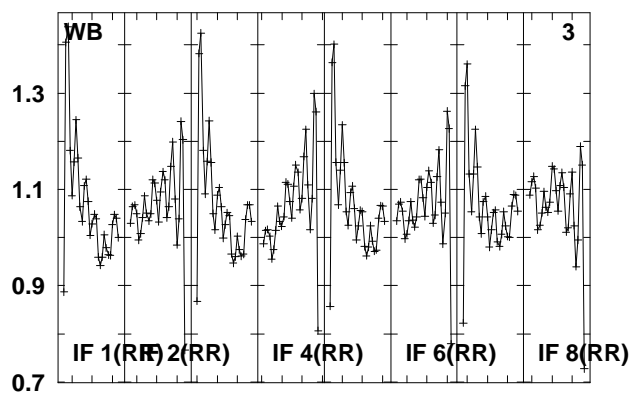
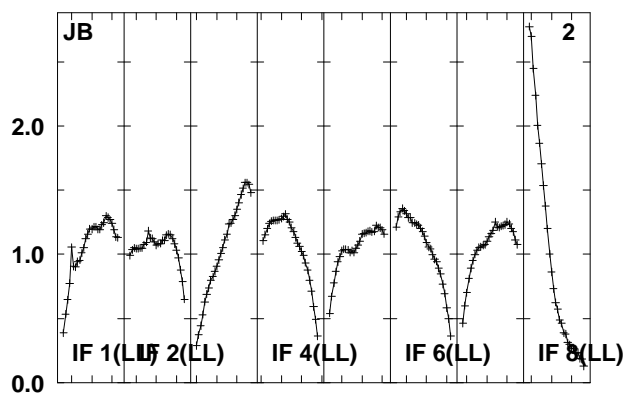
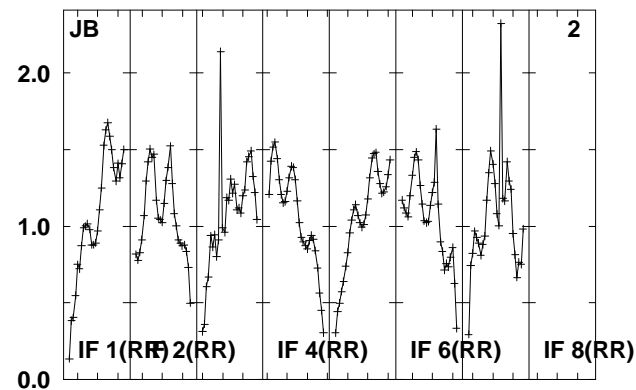
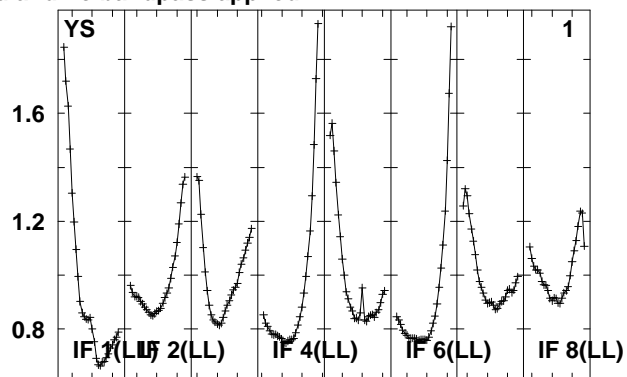
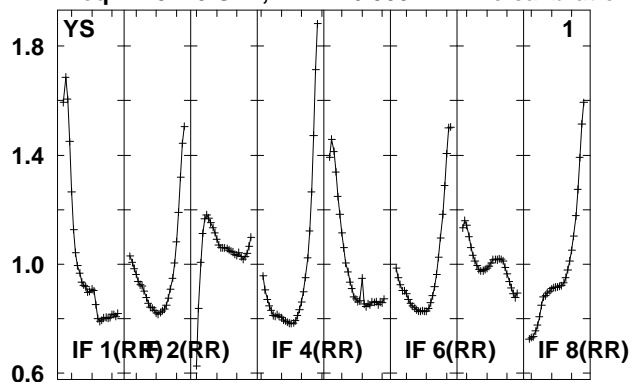

Lower frame: Real Jy
Total-power spectrum Antenna: *
Timerange: 00/18:29:17 to 00/18:30:43

Plot file version 542 created 14-MAY-2010 15:20:08

J0920+44 EO007.UVDATA.1

Freq = 4.9270 GHz, Bw = 16.000 MH No calibration applied and no bandpass applied

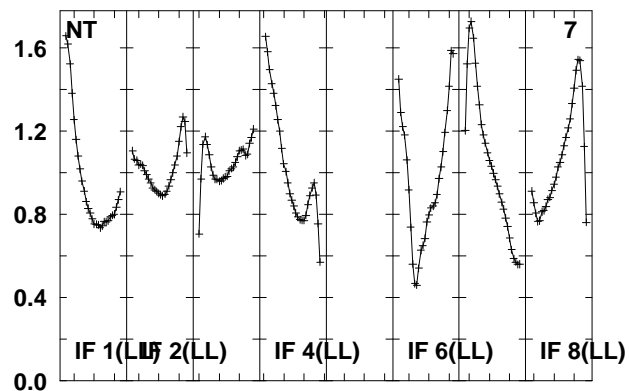
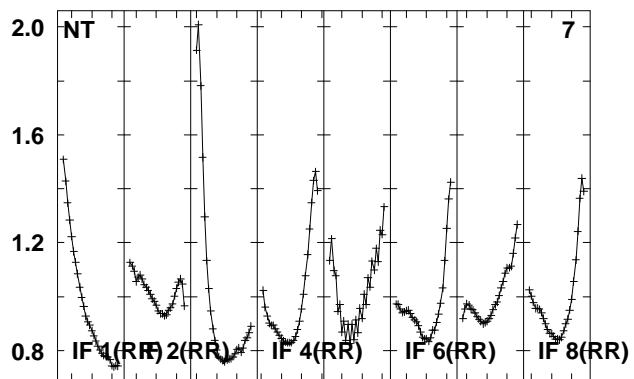
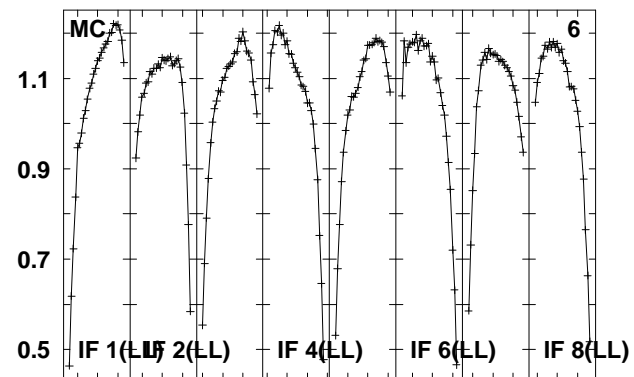
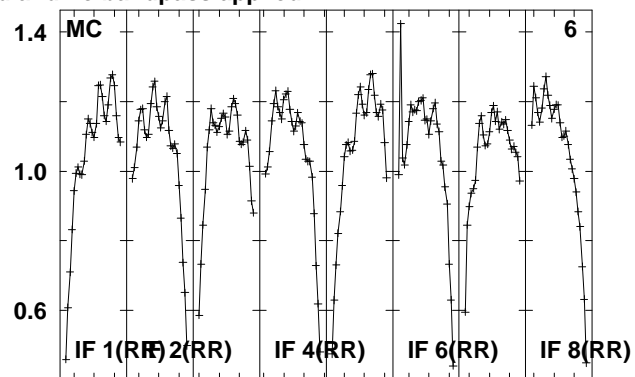
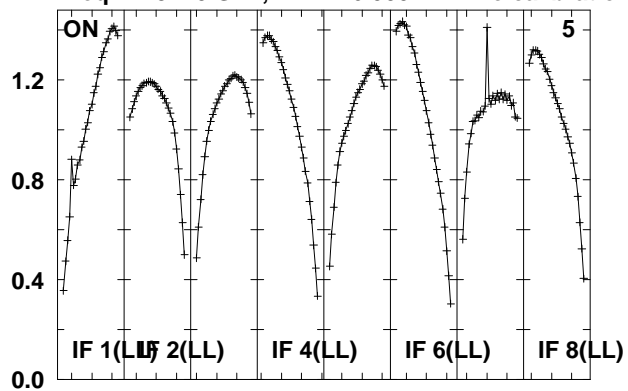

Lower frame: Real Jy
Total-power spectrum Antenna: *
Timerange: 00/18:29:17 to 00/18:30:43

Plot file version 543 created 14-MAY-2010 15:20:08

J1027+48 EO007.UVDATA.1

Freq = 4.9270 GHz, Bw = 16.000 MH No calibration applied and no bandpass applied

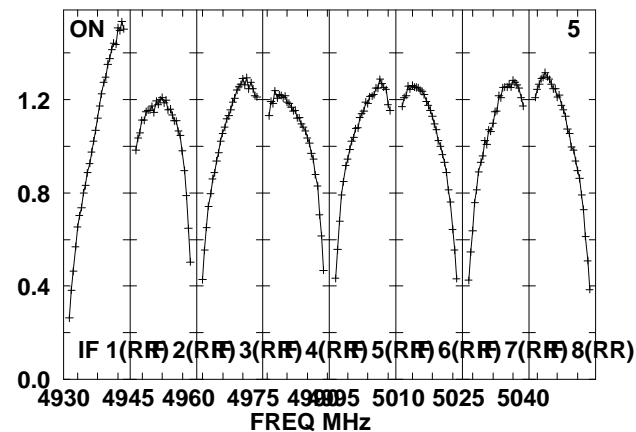
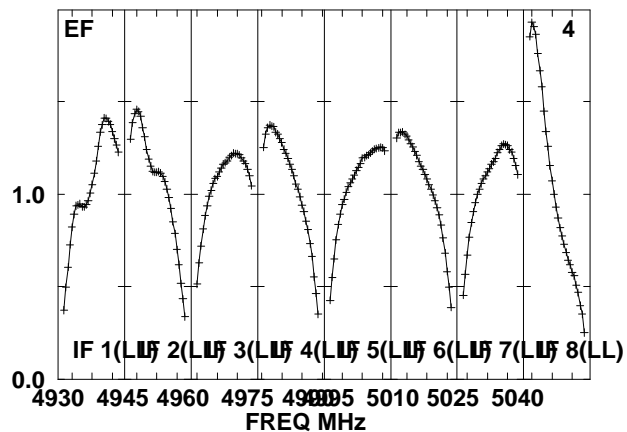
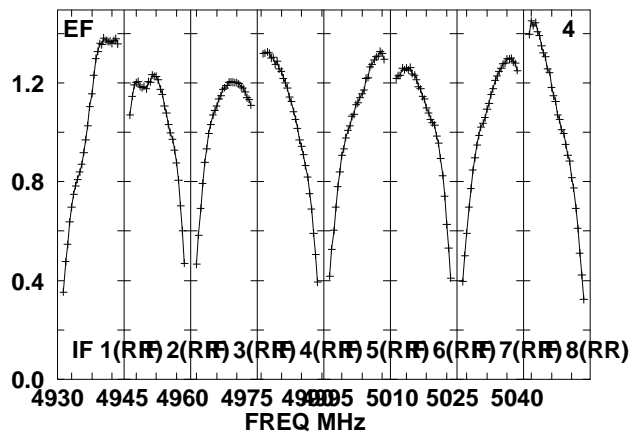
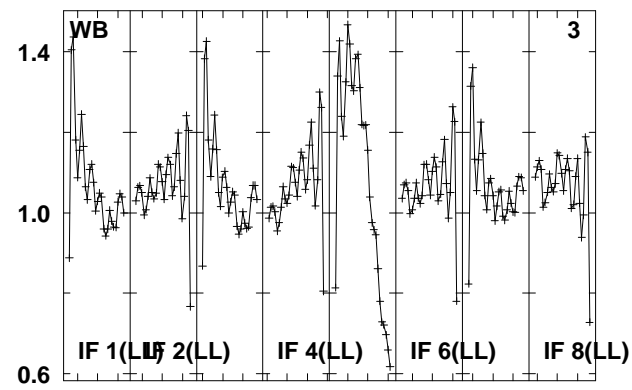
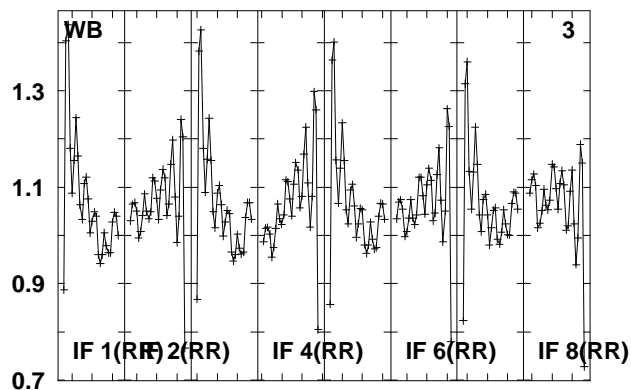
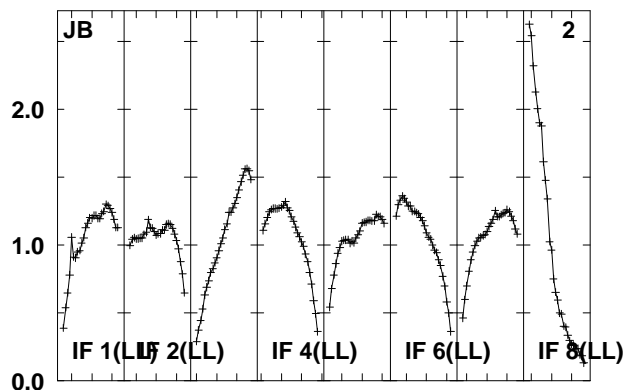
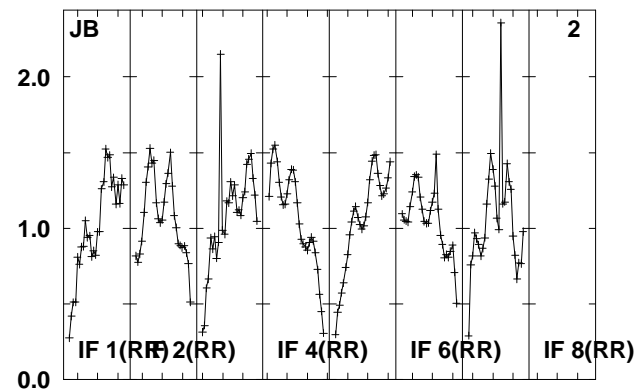
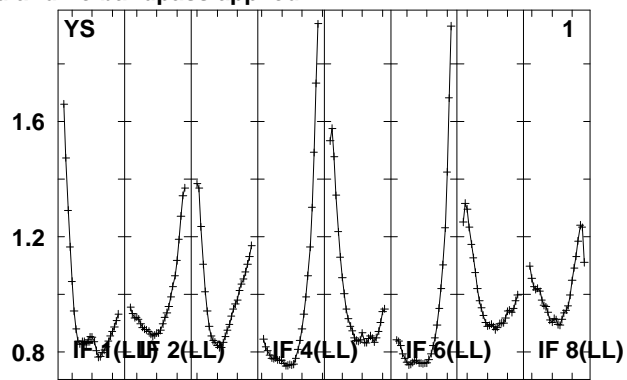
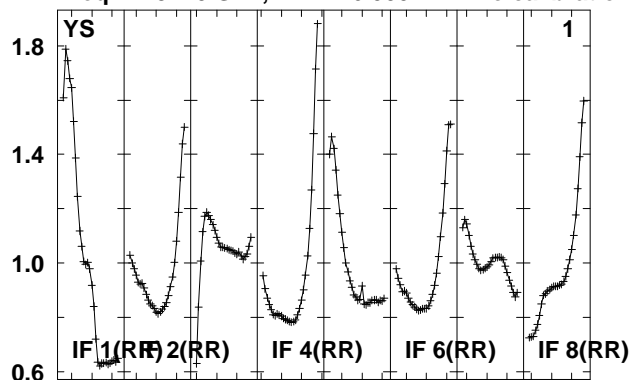

Lower frame: Real Jy
Total-power spectrum Antenna: *
Timerange: 00/18:32:07 to 00/18:33:35

Plot file version 544 created 14-MAY-2010 15:20:08

J1027+48 EO007.UVDATA.1

Freq = 4.9270 GHz, Bw = 16.000 MH No calibration applied and no bandpass applied

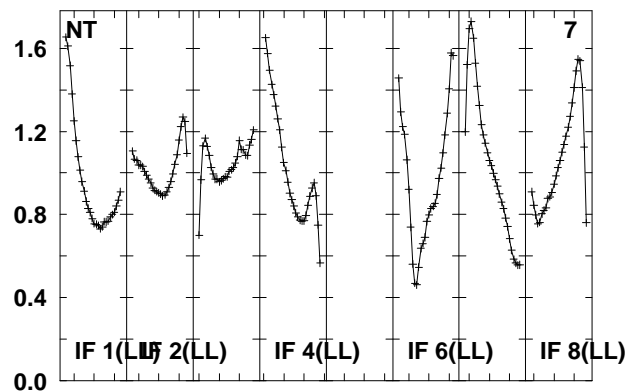
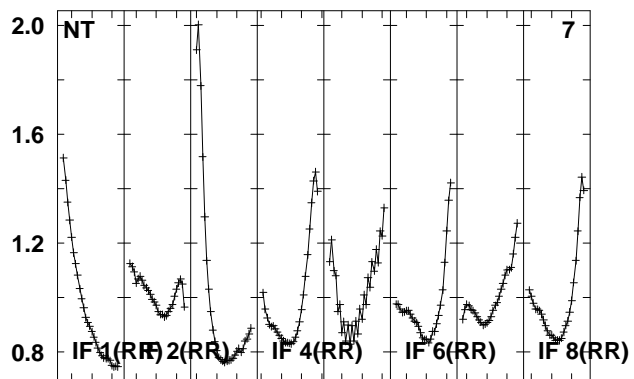
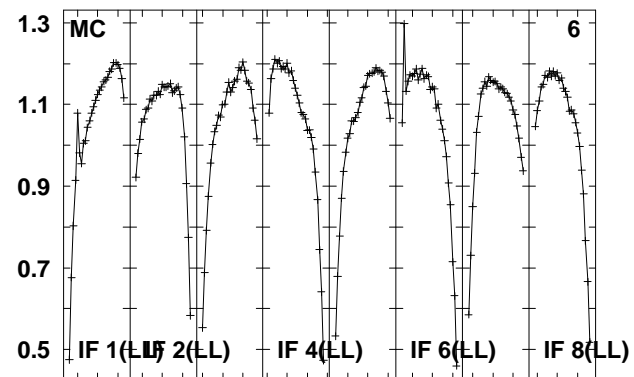
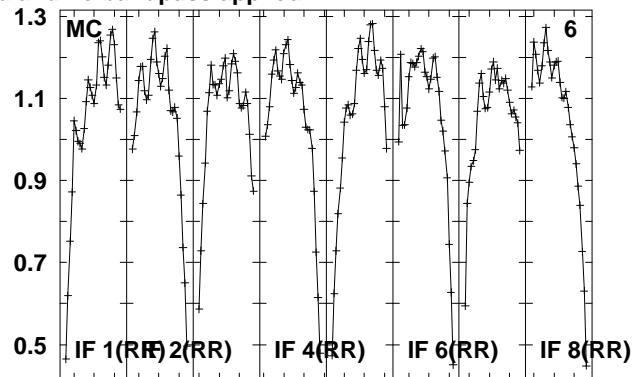
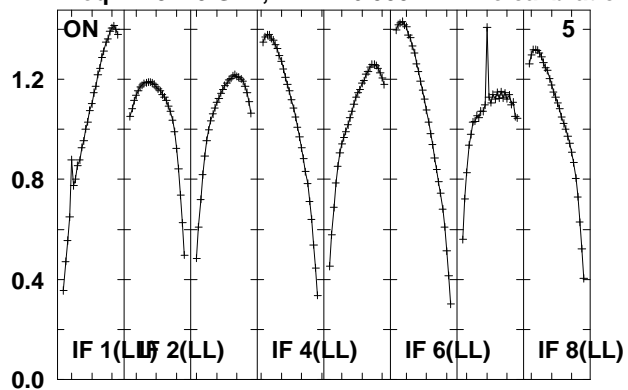

Lower frame: Real Jy
Total-power spectrum Antenna: *
Timerange: 00/18:32:07 to 00/18:33:35

Plot file version 545 created 14-MAY-2010 15:20:08
 J102959 EO007.UVDATA.1
 Freq = 4.9270 GHz, Bw = 16.000 MH No calibration applied and no bandpass applied

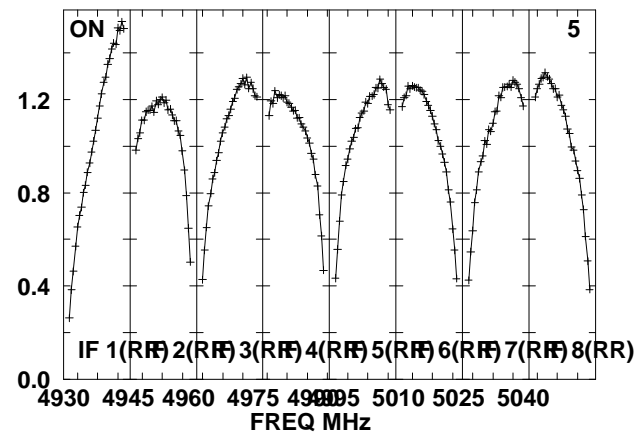
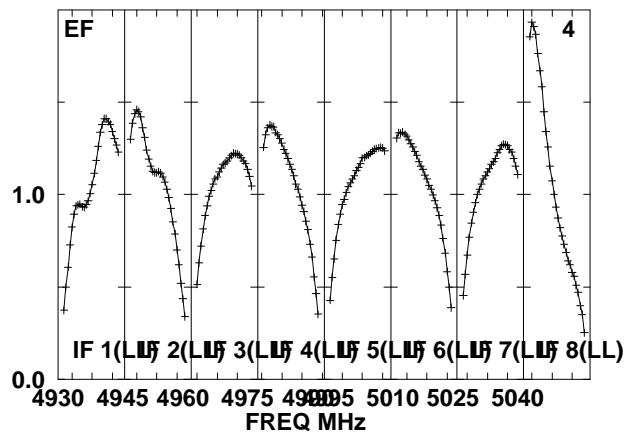
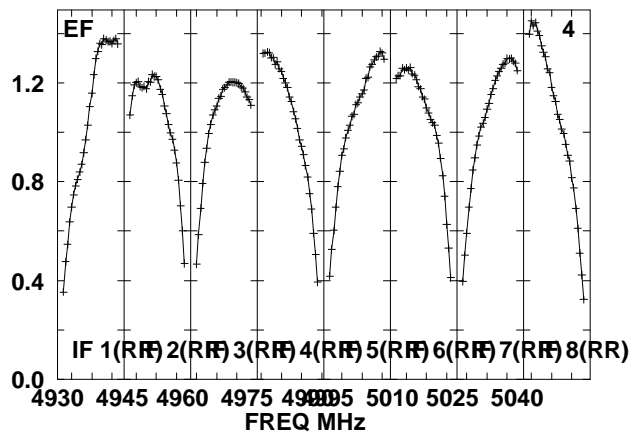
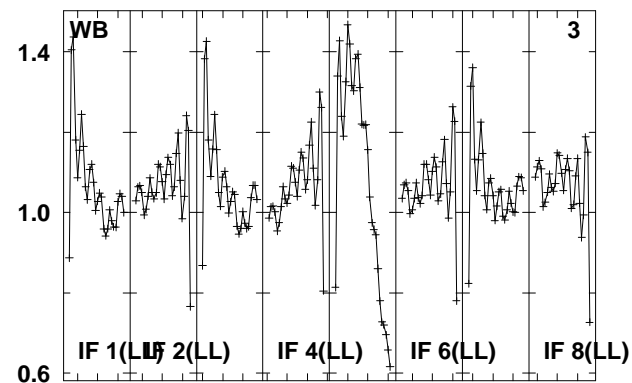
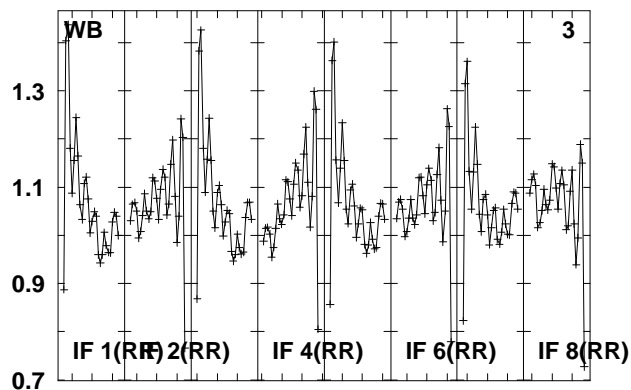
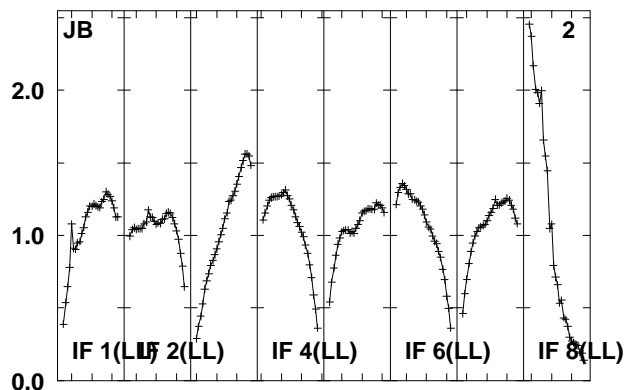
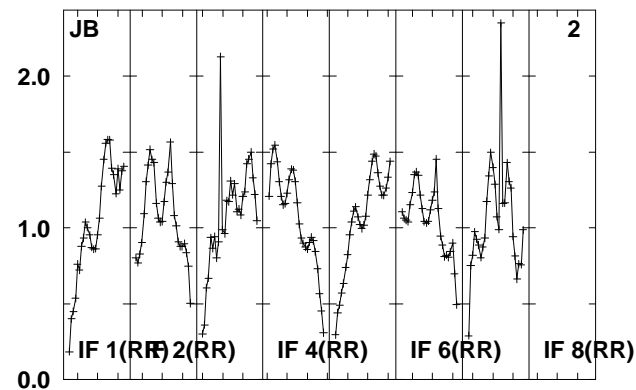
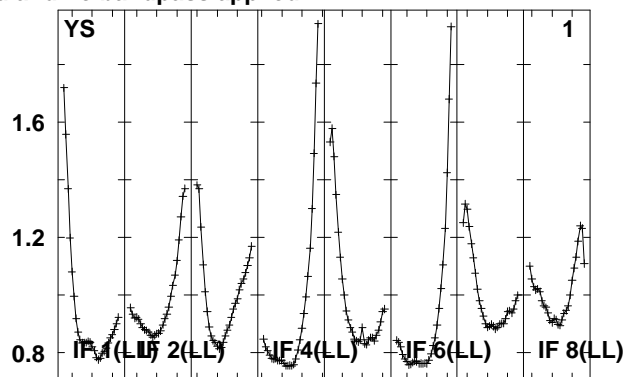
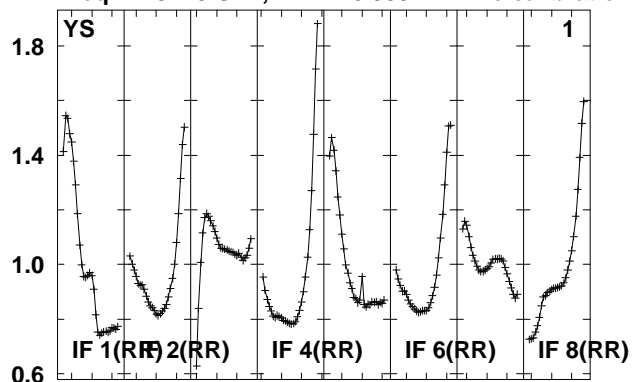

Lower frame: Real Jy
 Total-power spectrum Antenna: *
 Timerange: 00/18:34:01 to 00/18:38:59

Plot file version 546 created 14-MAY-2010 15:20:09

J102959 EO007.UVDATA.1

Freq = 4.9270 GHz, Bw = 16.000 MH No calibration applied and no bandpass applied

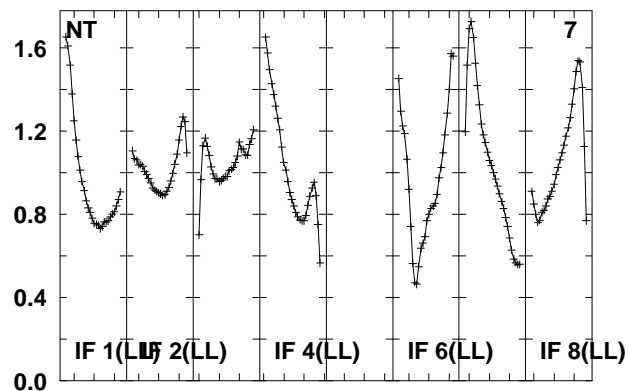
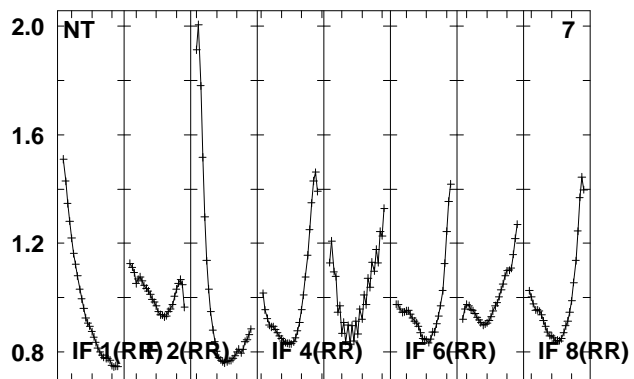
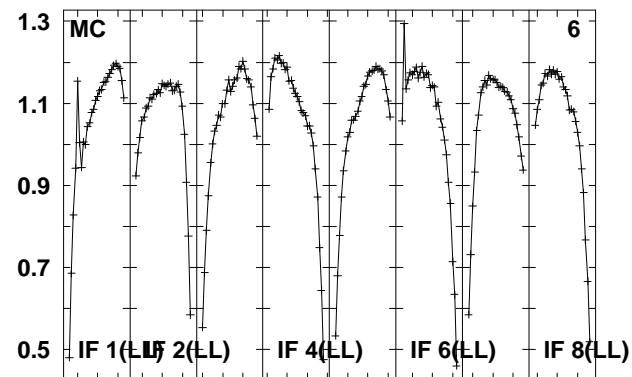
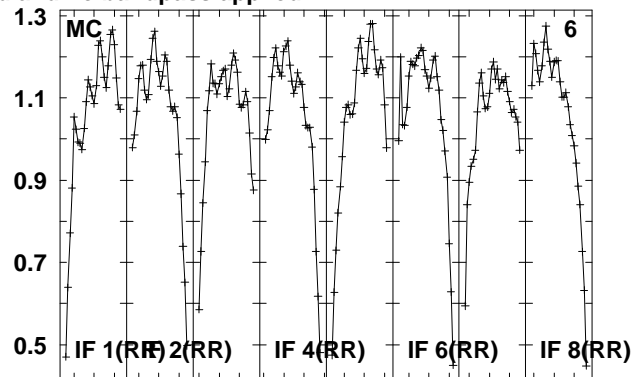
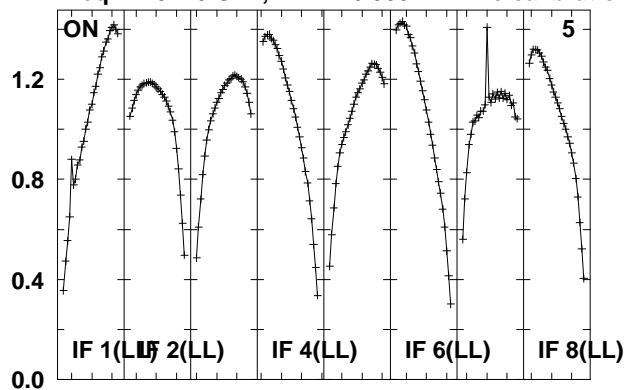

Lower frame: Real Jy
Total-power spectrum Antenna: *
Timerange: 00/18:34:01 to 00/18:38:59

Plot file version 547 created 14-MAY-2010 15:20:10

J1027+48 EO007.UVDATA.1

Freq = 4.9270 GHz, Bw = 16.000 MH No calibration applied and no bandpass applied

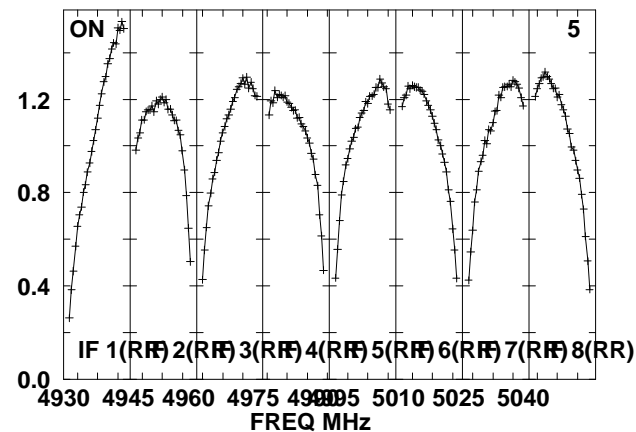
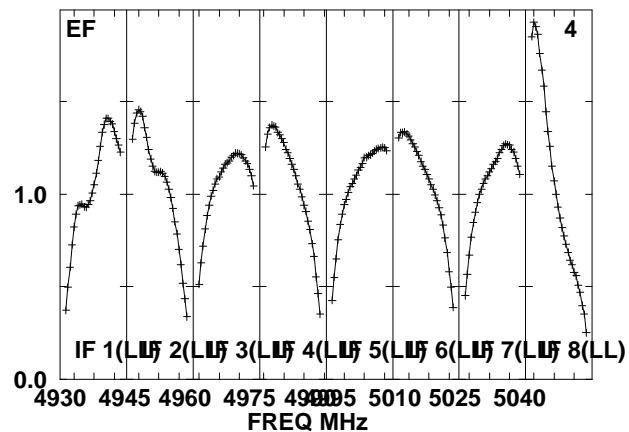
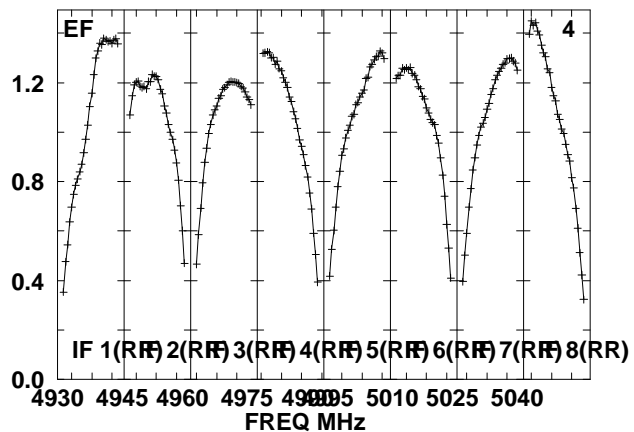
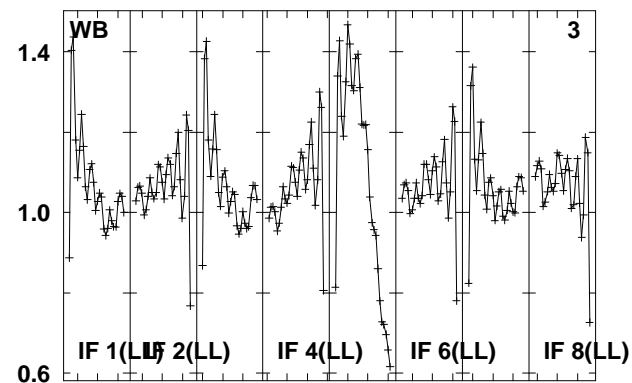
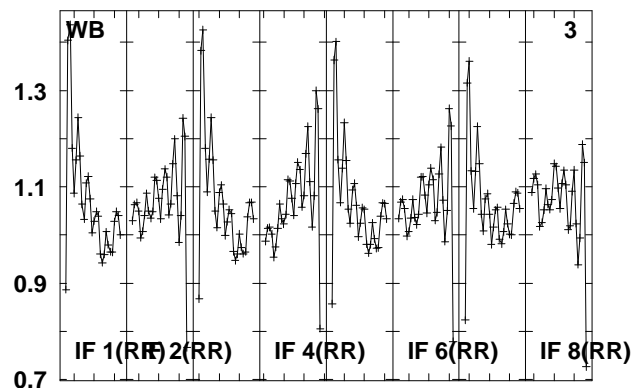
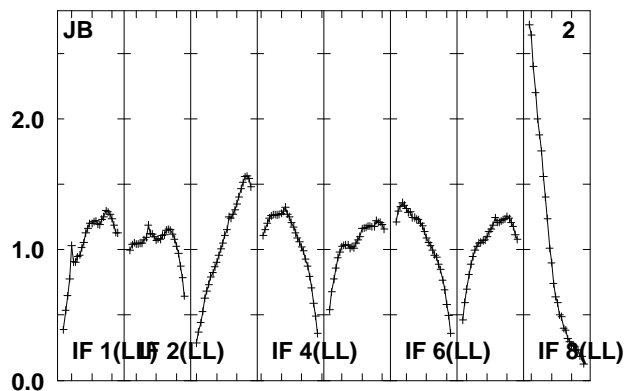
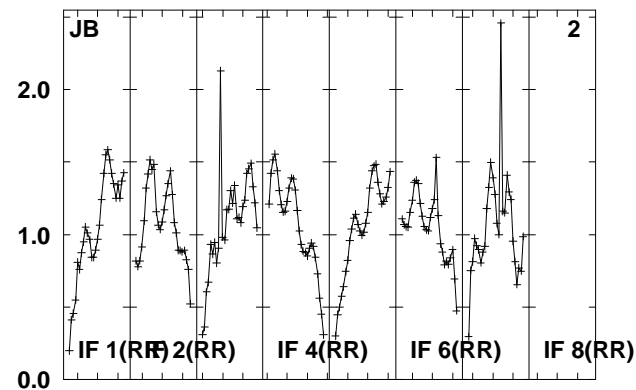
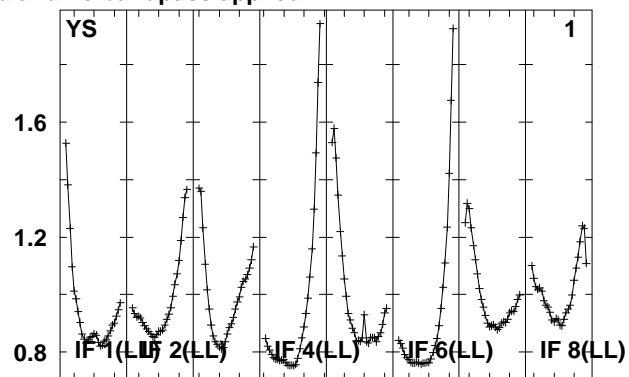
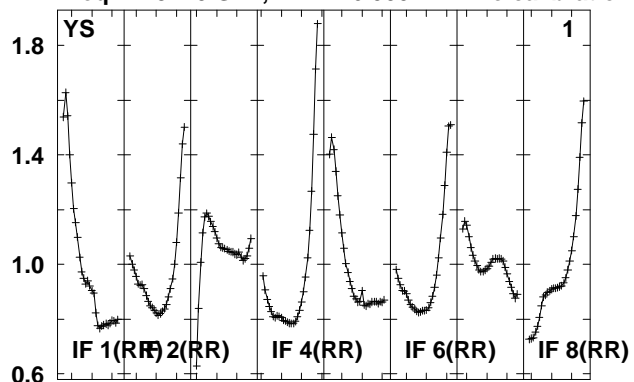

Lower frame: Real Jy

Total-power spectrum Antenna: *

Timerange: 00/18:39:25 to 00/18:40:49

Plot file version 548 created 14-MAY-2010 15:20:10

J1027+48 EO007.UVDATA.1

Freq = 4.9270 GHz, Bw = 16.000 MH No calibration applied and no bandpass applied

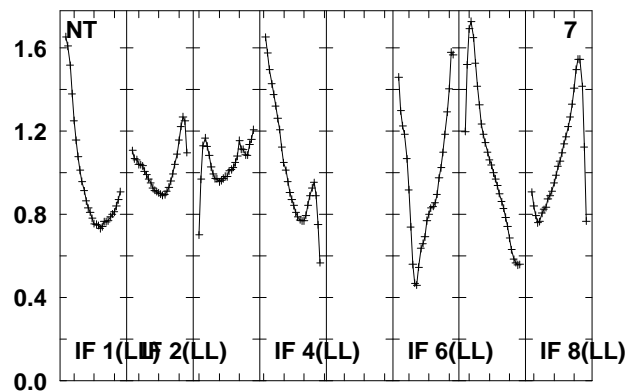
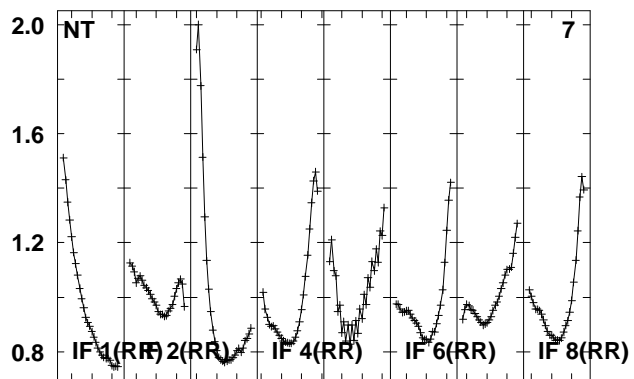
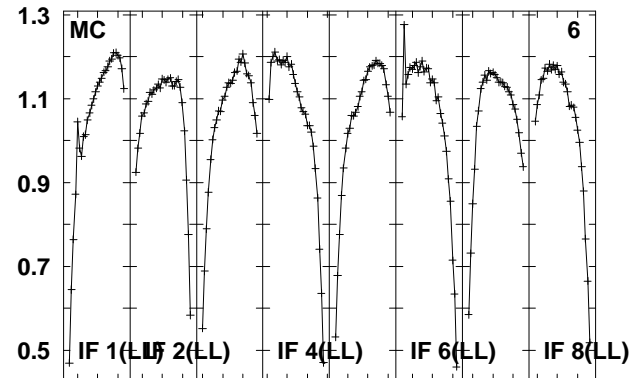
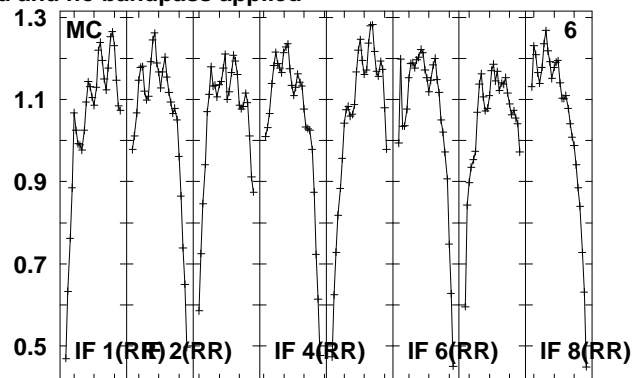
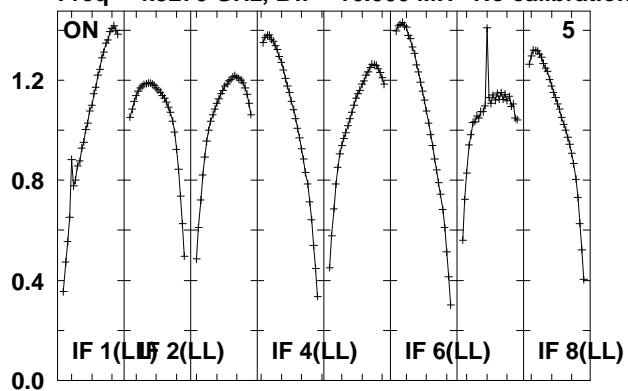

Lower frame: Real Jy
Total-power spectrum Antenna: *
Timerange: 00/18:39:25 to 00/18:40:49

Plot file version 549 created 14-MAY-2010 15:20:10
 J102959 EO007.UVDATA.1
 Freq = 4.9270 GHz, Bw = 16.000 MH No calibration applied and no bandpass applied

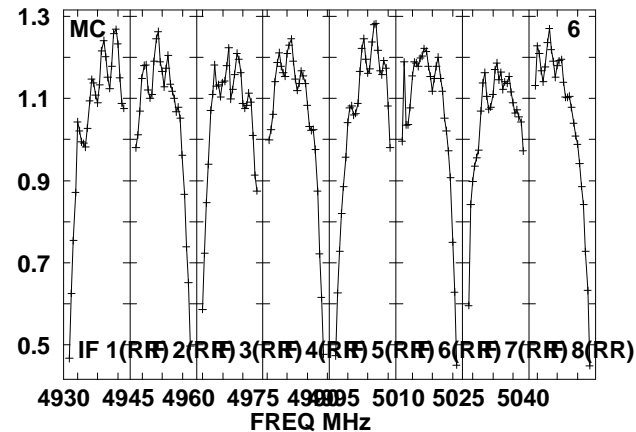
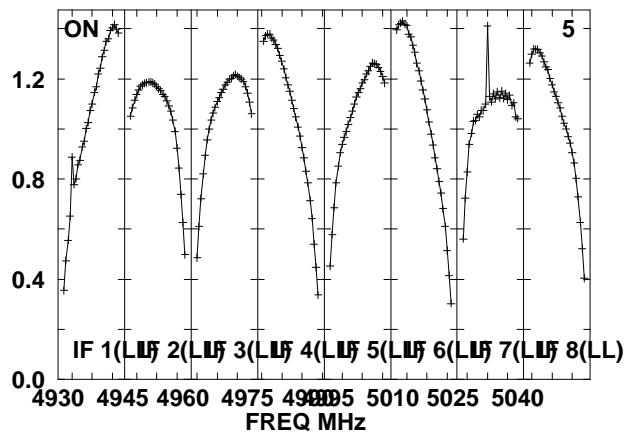
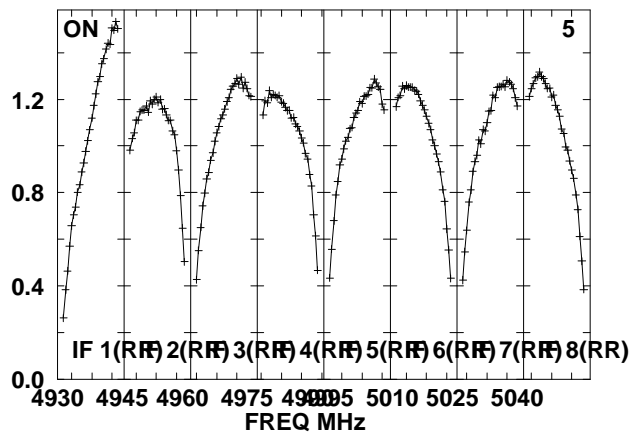
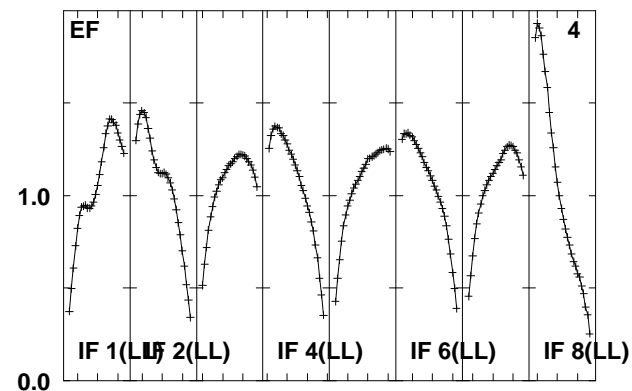
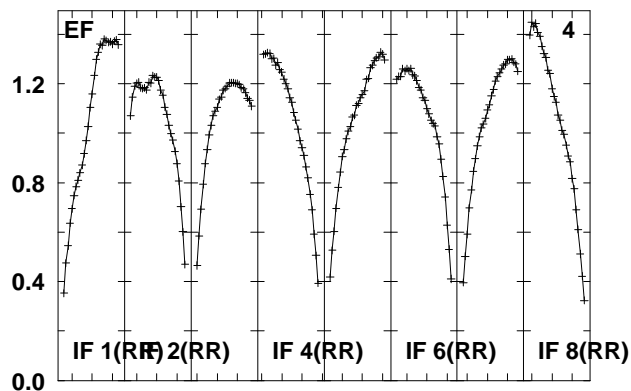
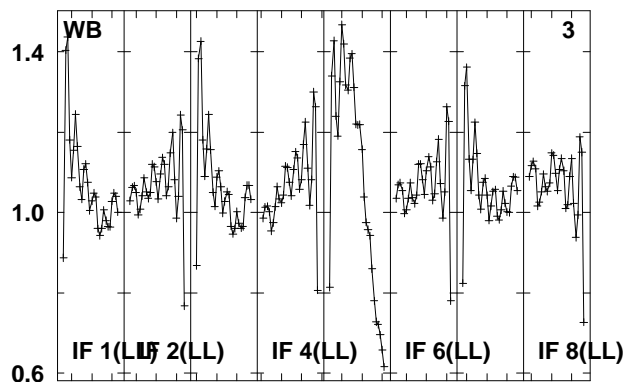
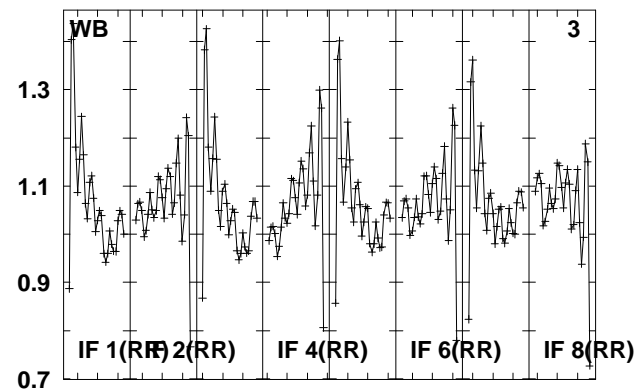
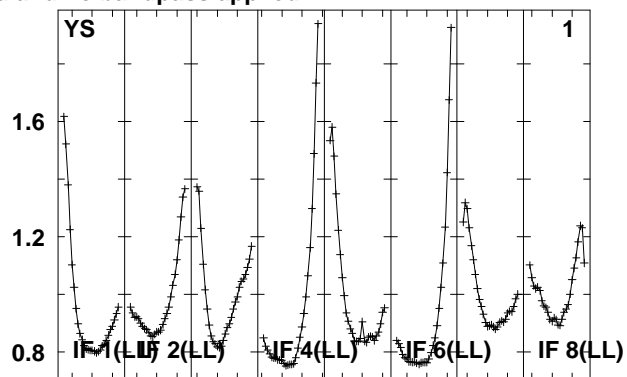
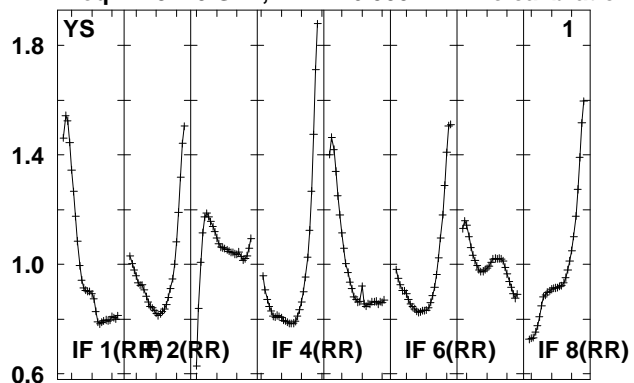

Lower frame: Real Jy
 Total-power spectrum Antenna: *
 Timerange: 00/18:41:18 to 00/18:46:14

Plot file version 550 created 14-MAY-2010 15:20:11

J102959 EO007.UVDATA.1

Freq = 4.9270 GHz, Bw = 16.000 MH No calibration applied and no bandpass applied

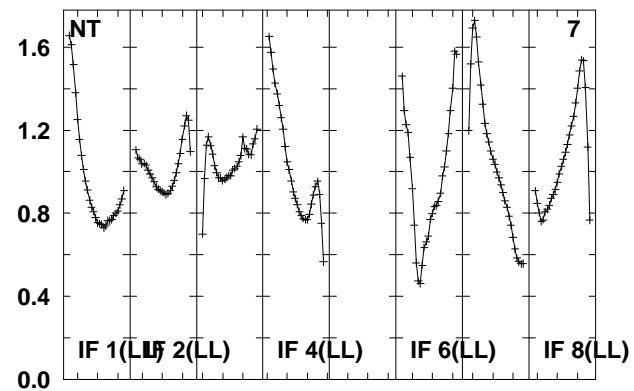
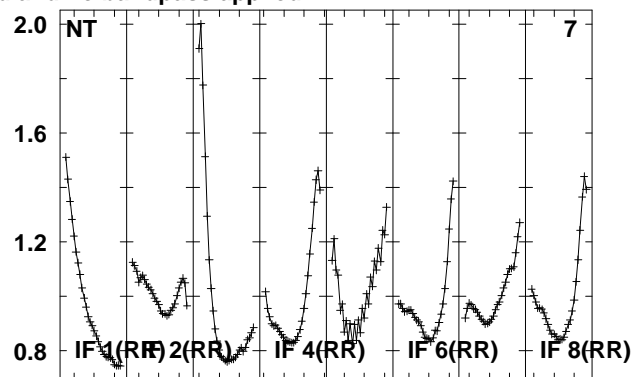
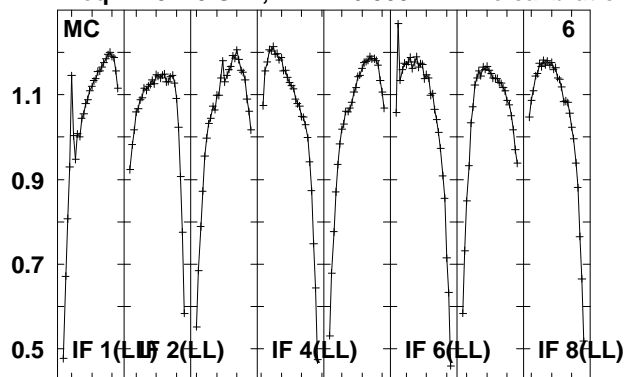

Lower frame: Real Jy
Total-power spectrum Antenna: *
Timerange: 00/18:41:18 to 00/18:46:14

Plot file version 551 created 14-MAY-2010 15:20:11
 J1027+48 EO007.UVDATA.1
 Freq = 4.9270 GHz, Bw = 16.000 MH No calibration applied and no bandpass applied

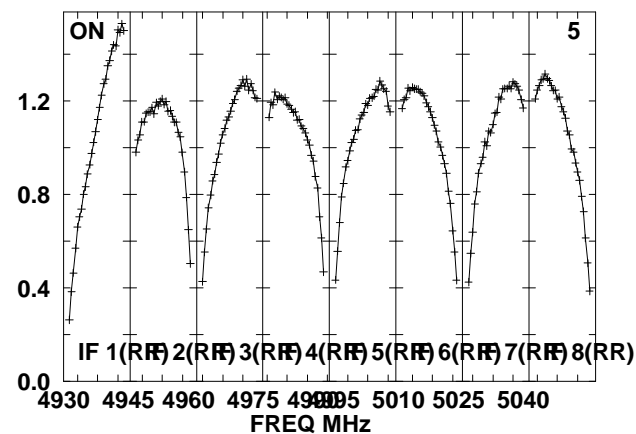
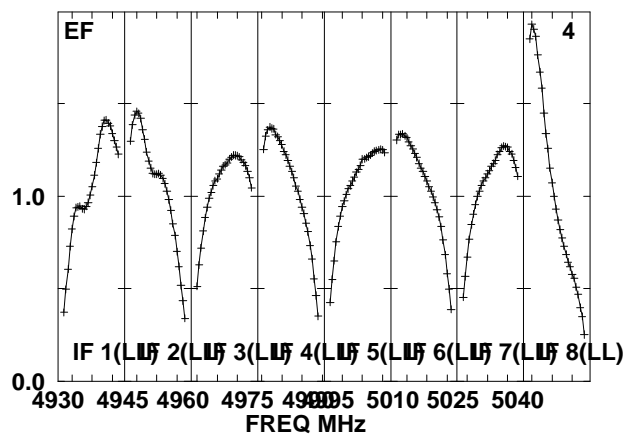
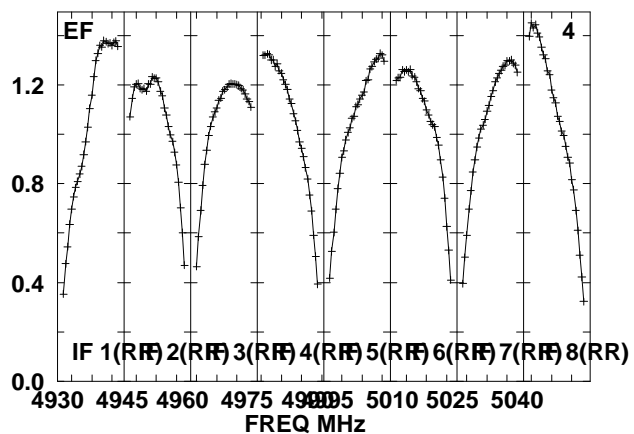
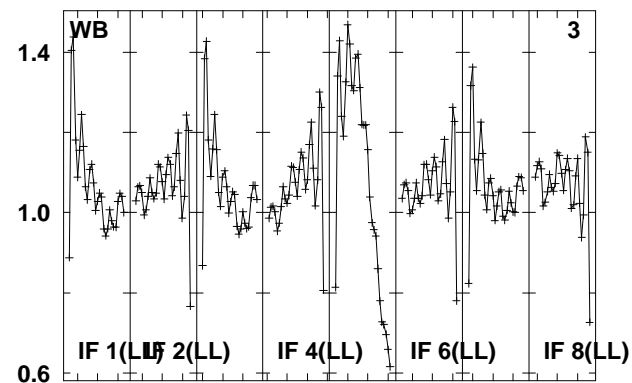
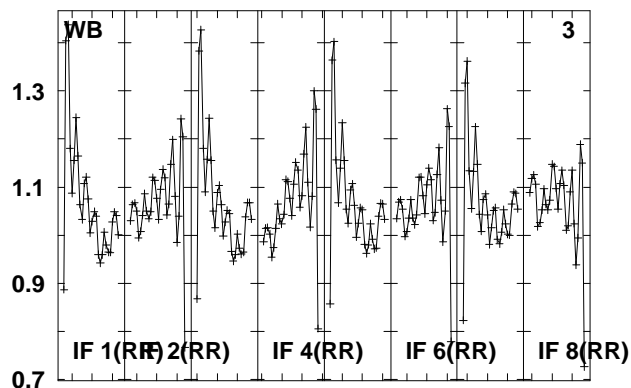
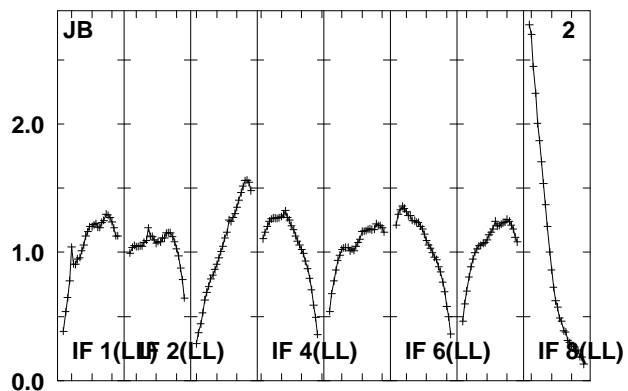
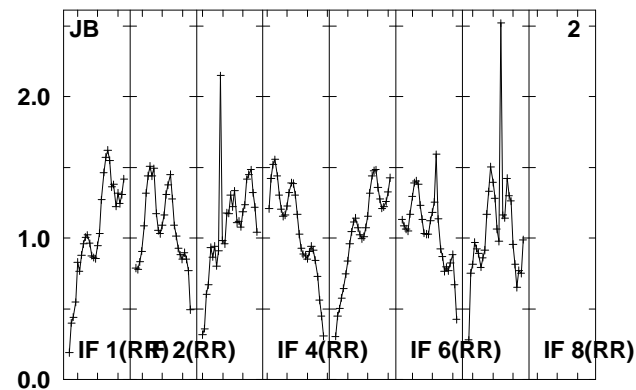
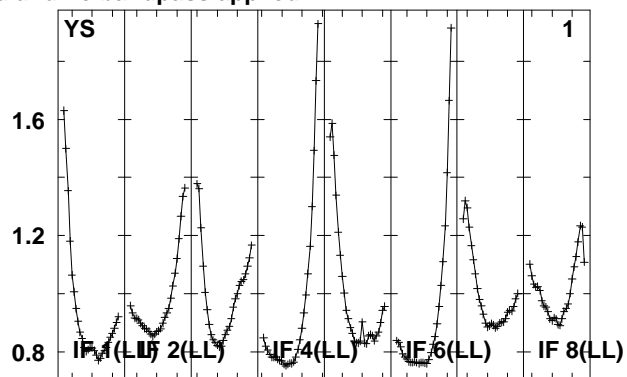
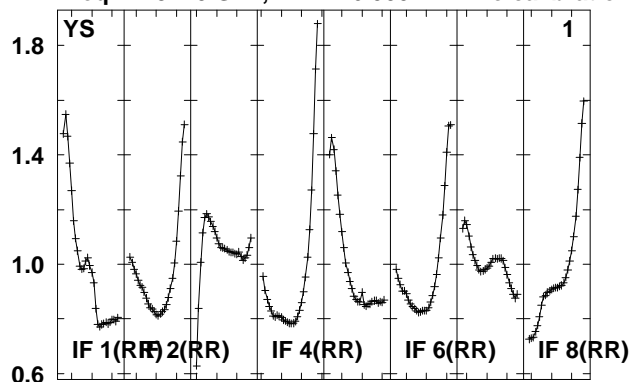

Lower frame: Real Jy
 Total-power spectrum Antenna: *
 Timerange: 00/18:46:42 to 00/18:48:10

Plot file version 552 created 14-MAY-2010 15:20:11

J1027+48 EO007.UVDATA.1

Freq = 4.9270 GHz, Bw = 16.000 MH No calibration applied and no bandpass applied

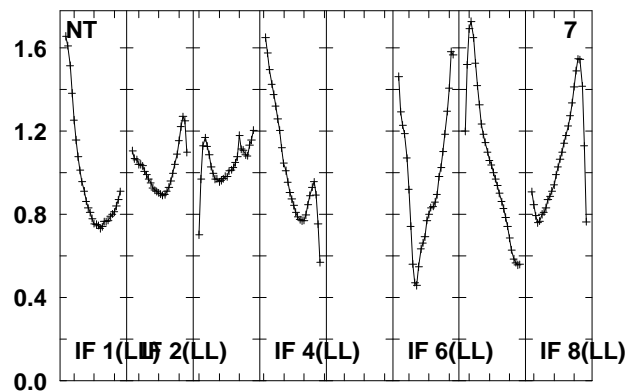
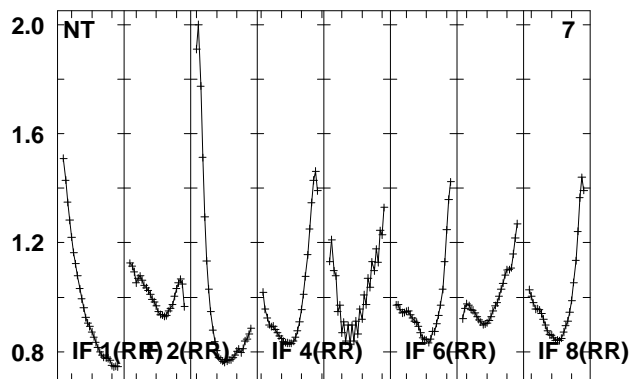
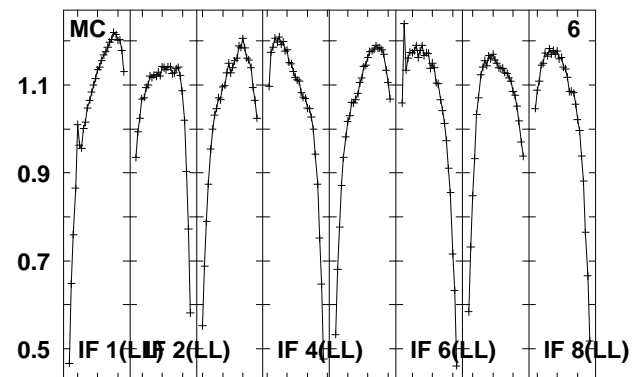
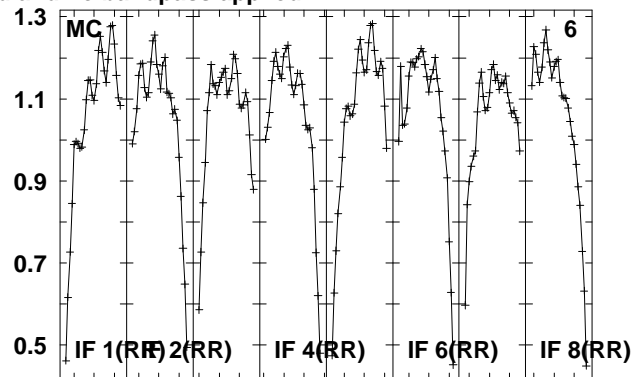
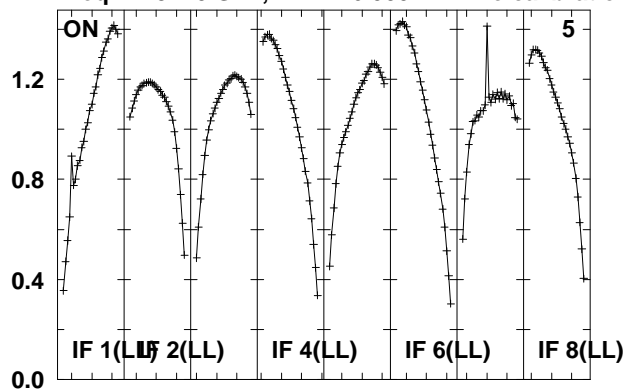

Lower frame: Real Jy
Total-power spectrum Antenna: *
Timerange: 00/18:46:42 to 00/18:48:10

Plot file version 553 created 14-MAY-2010 15:20:11
 J0808+40 EO007.UVDATA.1
 Freq = 4.9270 GHz, Bw = 16.000 MH No calibration applied and no bandpass applied

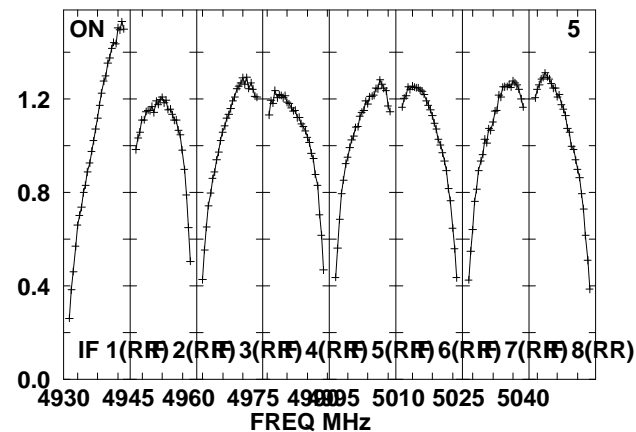
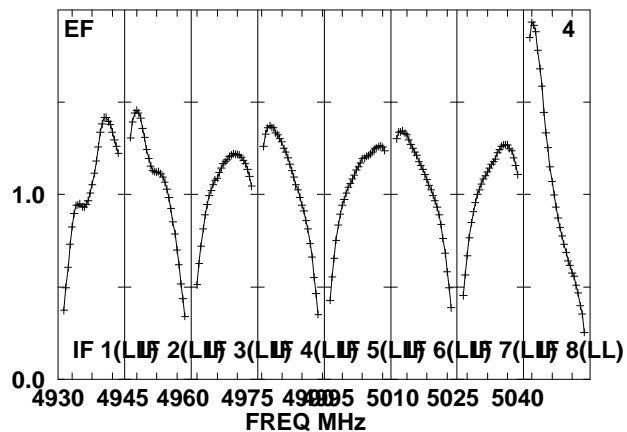
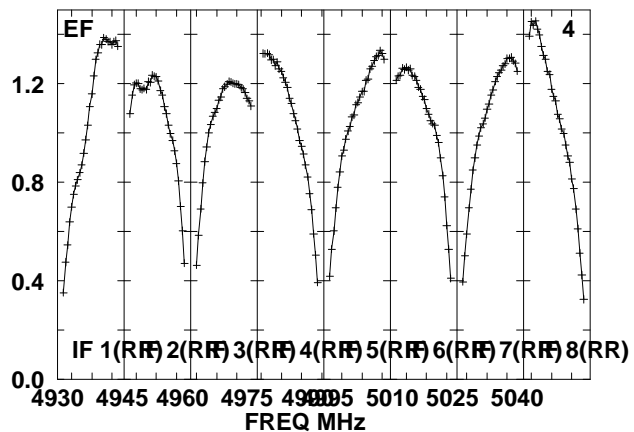
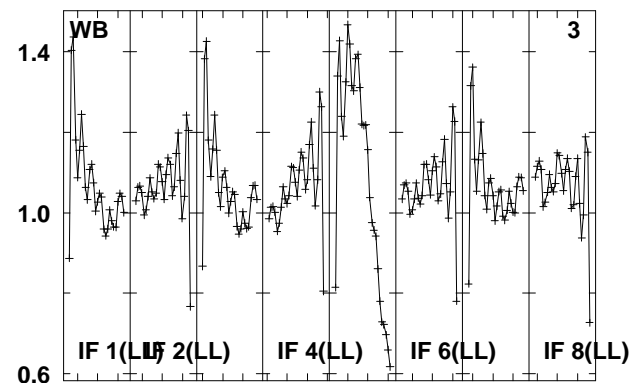
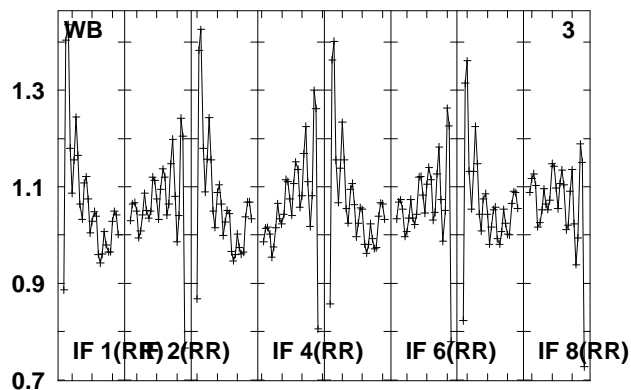
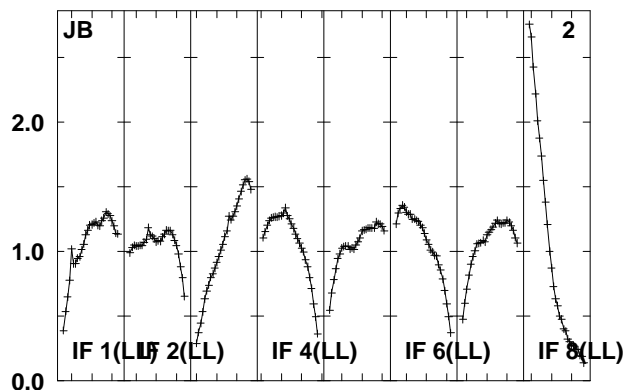
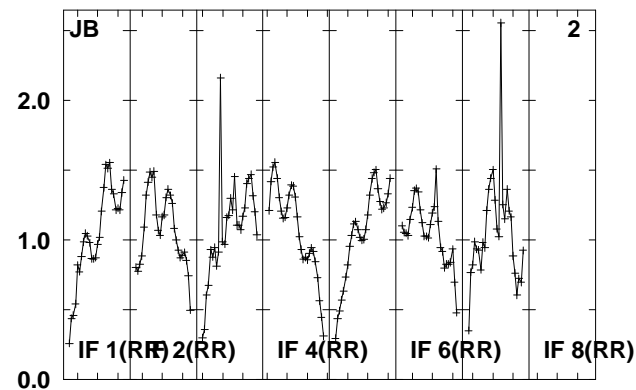
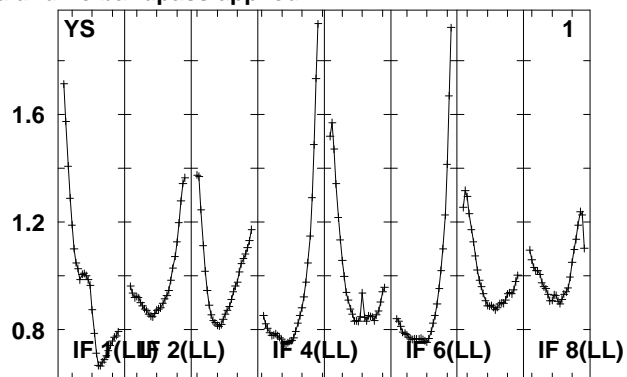
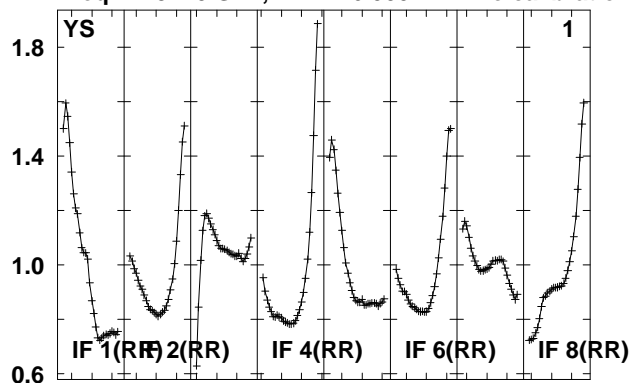

Lower frame: Real Jy
 Total-power spectrum Antenna: *
 Timerange: 00/18:51:26 to 00/18:52:54

Plot file version 554 created 14-MAY-2010 15:20:12

J0808+40 EO007.UVDATA.1

Freq = 4.9270 GHz, Bw = 16.000 MH No calibration applied and no bandpass applied

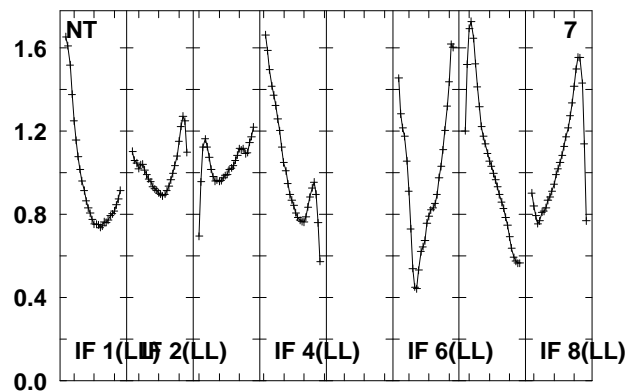
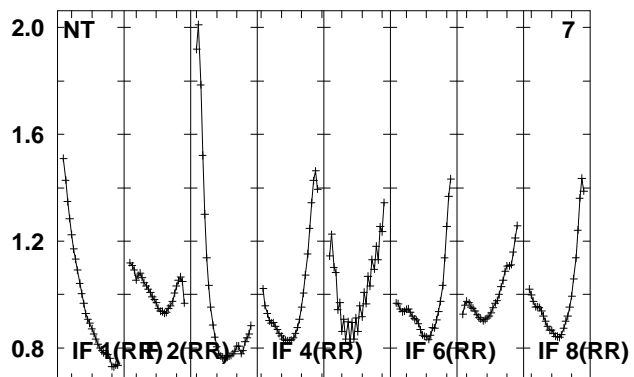
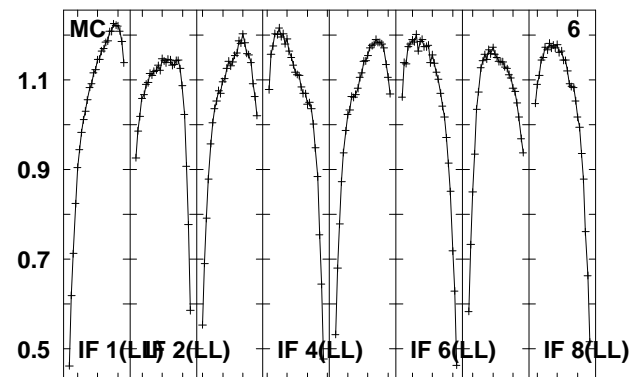
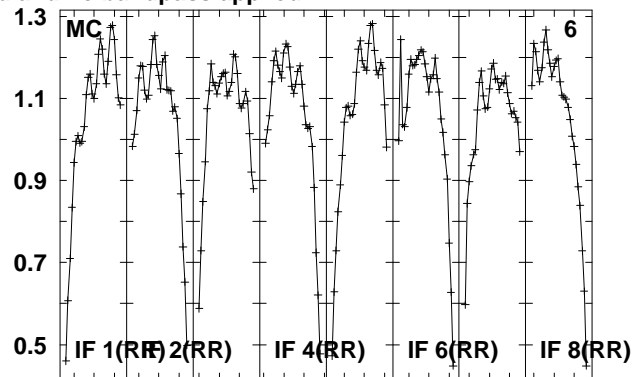
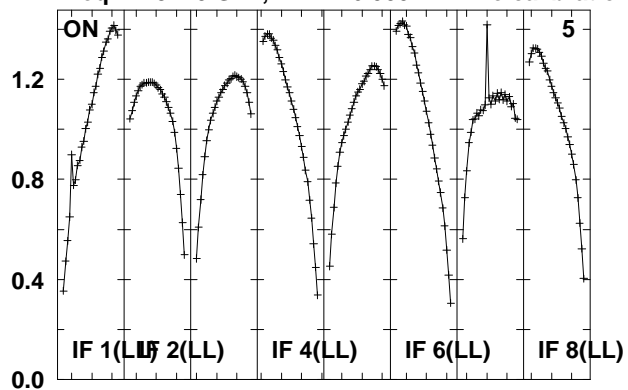

Lower frame: Real Jy
Total-power spectrum Antenna: *
Timerange: 00/18:51:26 to 00/18:52:54

Plot file version 555 created 14-MAY-2010 15:20:12
 J080844 EO007.UVDATA.1
 Freq = 4.9270 GHz, Bw = 16.000 MH No calibration applied and no bandpass applied

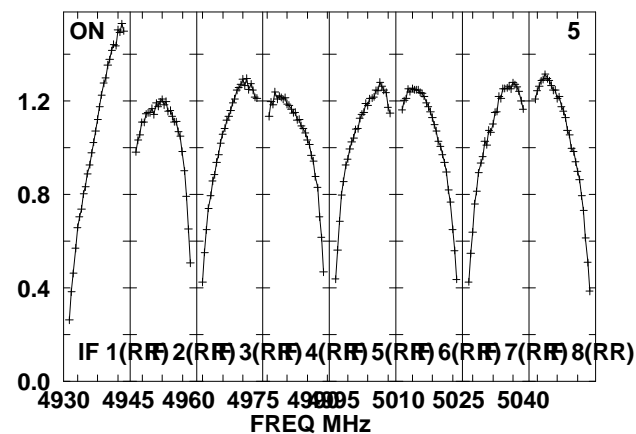
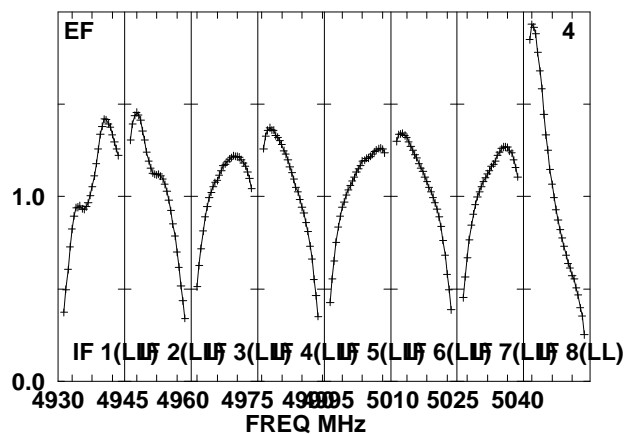
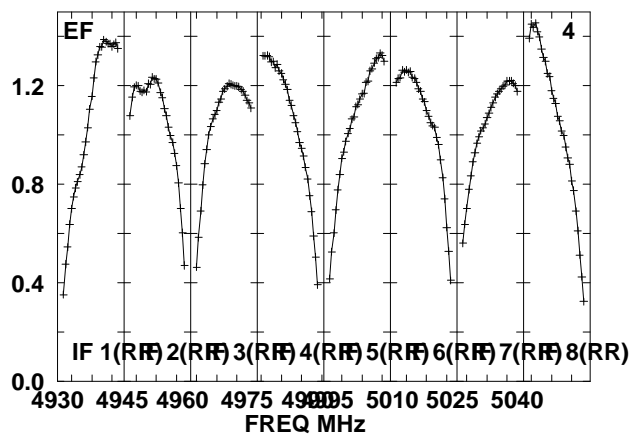
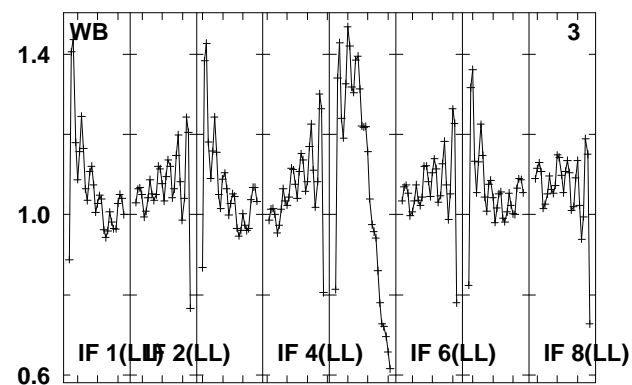
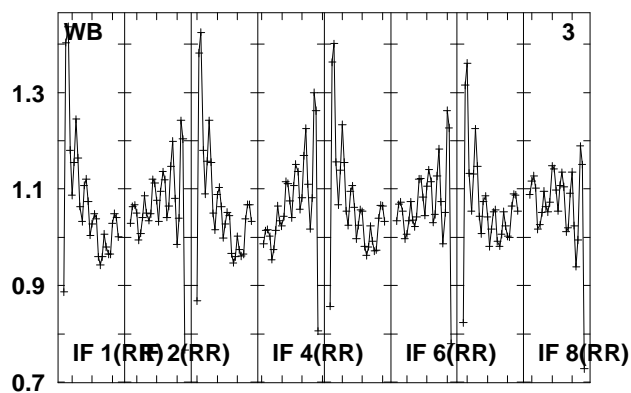
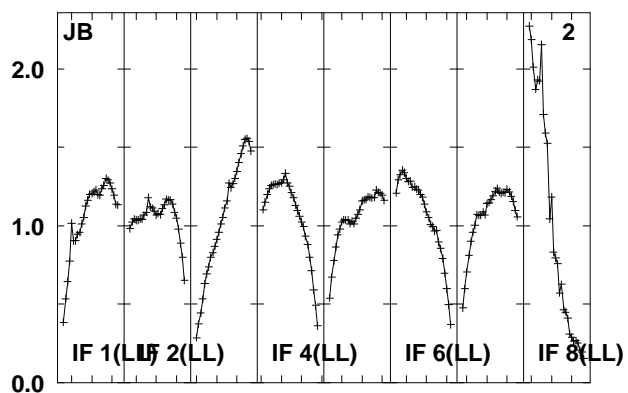
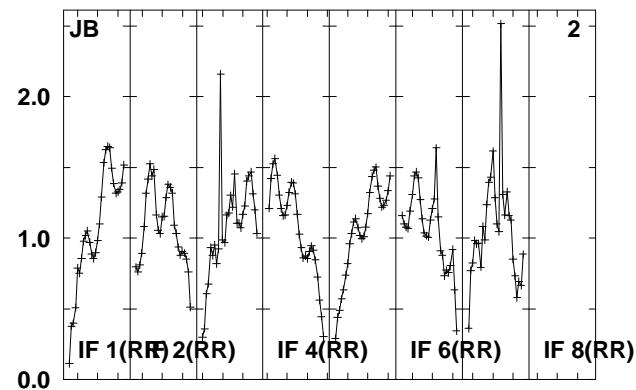
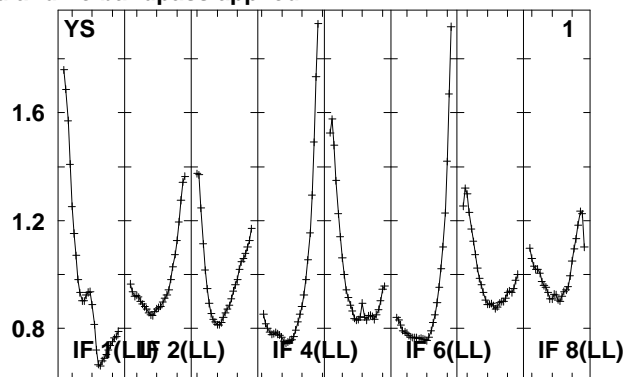
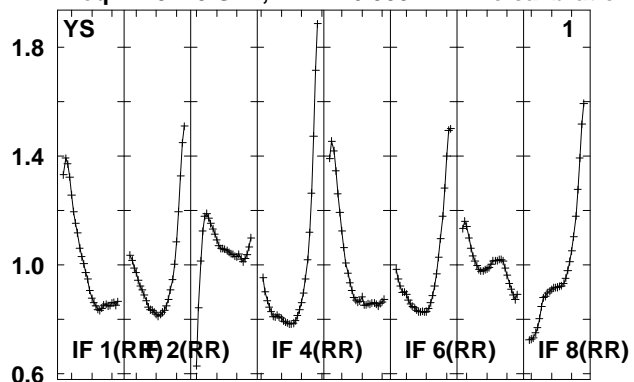

Lower frame: Real Jy
 Total-power spectrum Antenna: *
 Timerange: 00/18:53:30 to 00/18:58:26

Plot file version 556 created 14-MAY-2010 15:20:12

J080844 EO007.UVDATA.1

Freq = 4.9270 GHz, Bw = 16.000 MH No calibration applied and no bandpass applied

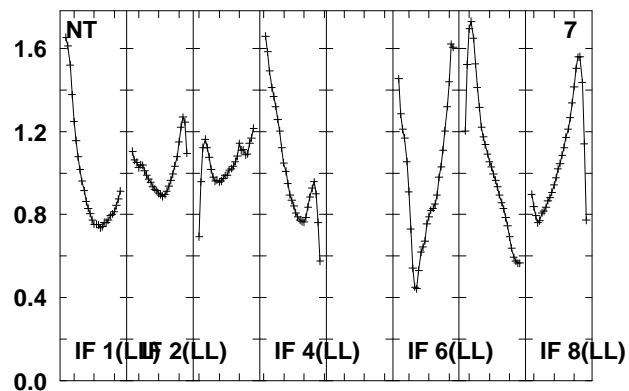
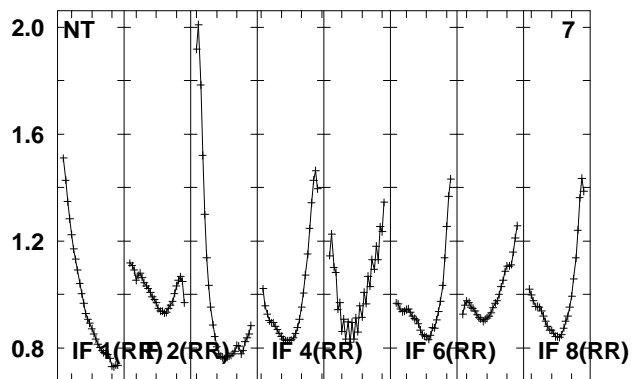
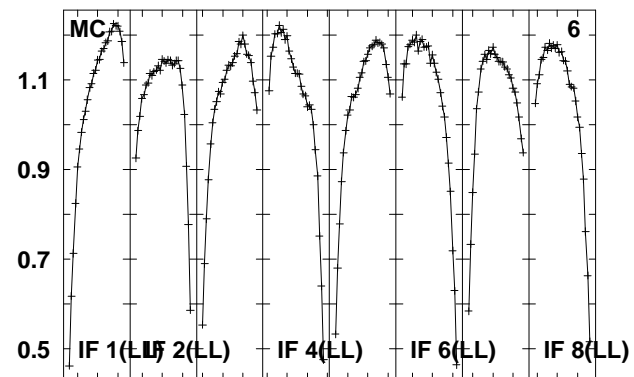
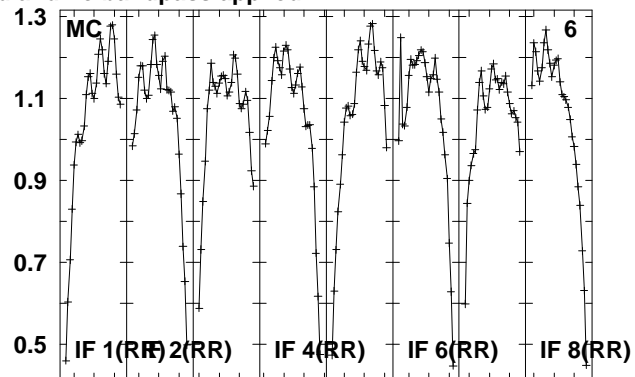
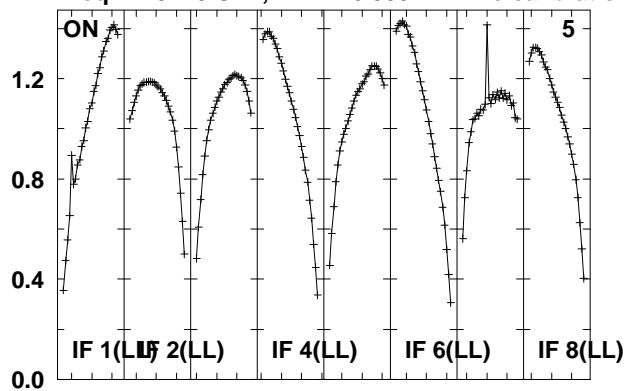

Lower frame: Real Jy
Total-power spectrum Antenna: *
Timerange: 00/18:53:30 to 00/18:58:26

Plot file version 557 created 14-MAY-2010 15:20:13

J0808+40 EO007.UVDATA.1

Freq = 4.9270 GHz, Bw = 16.000 MH No calibration applied and no bandpass applied

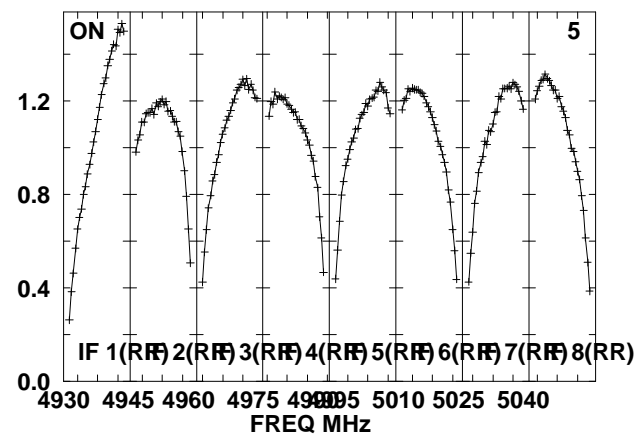
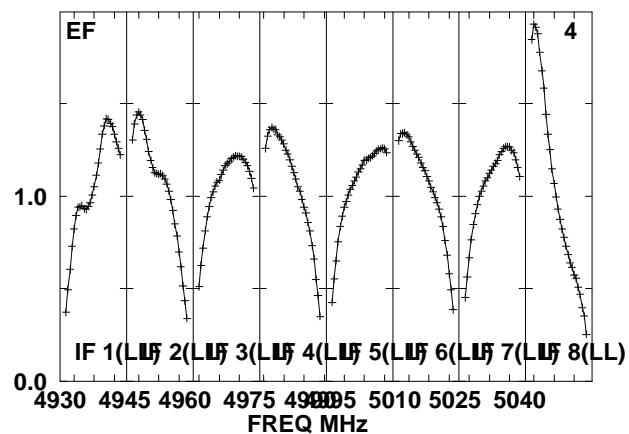
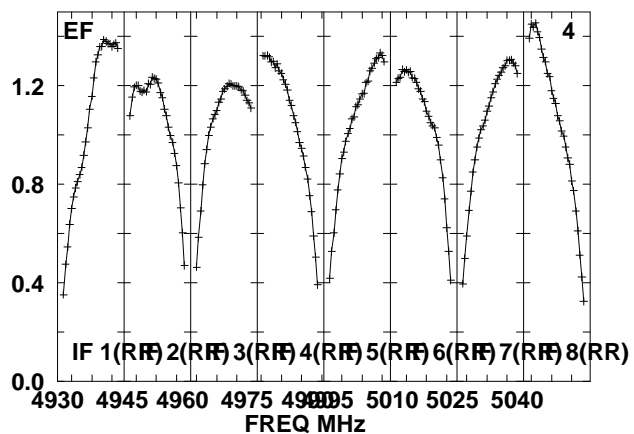
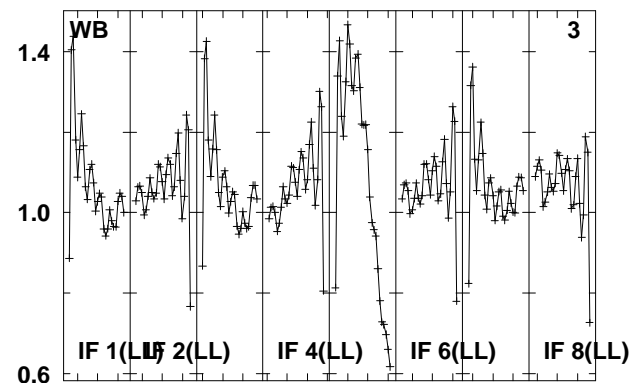
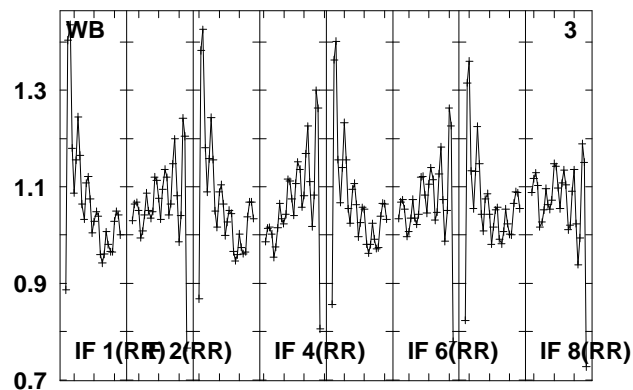
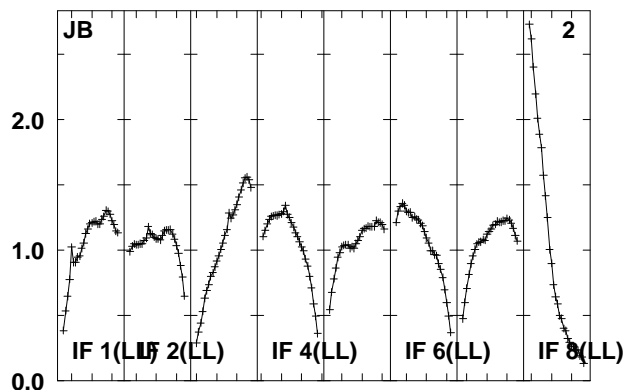
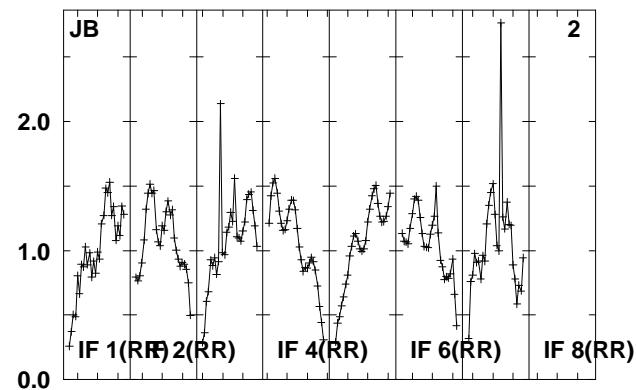
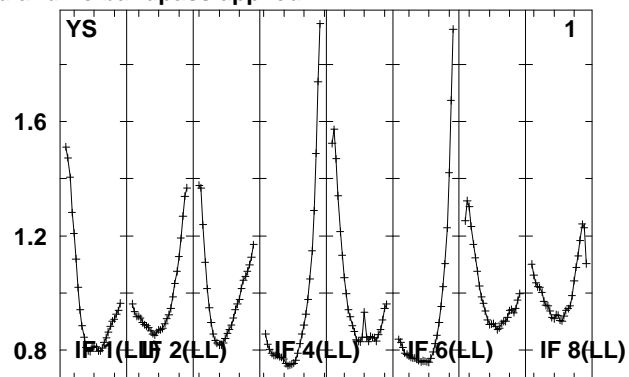
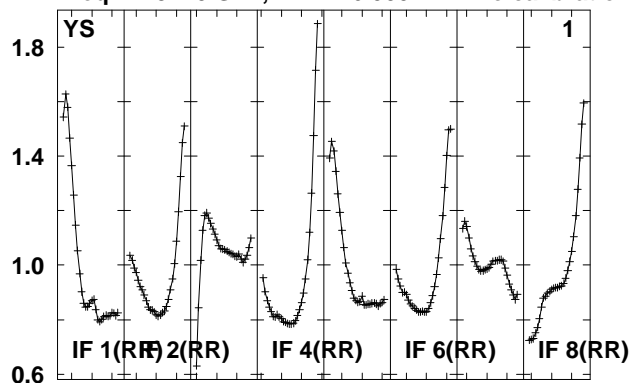

Lower frame: Real Jy
Total-power spectrum Antenna: *
Timerange: 00/18:59:02 to 00/19:00:30

Plot file version 558 created 14-MAY-2010 15:20:13

J0808+40 EO007.UVDATA.1

Freq = 4.9270 GHz, Bw = 16.000 MH No calibration applied and no bandpass applied

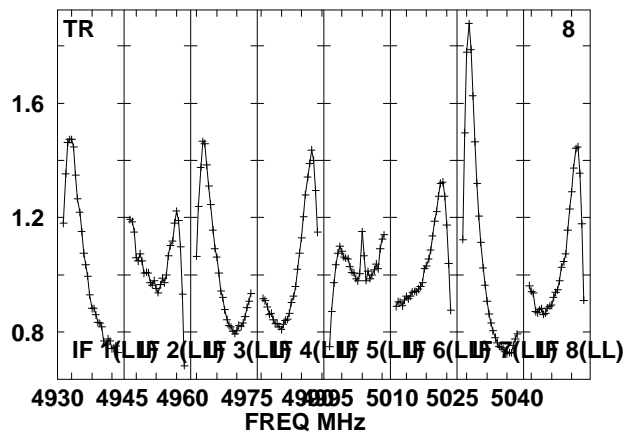
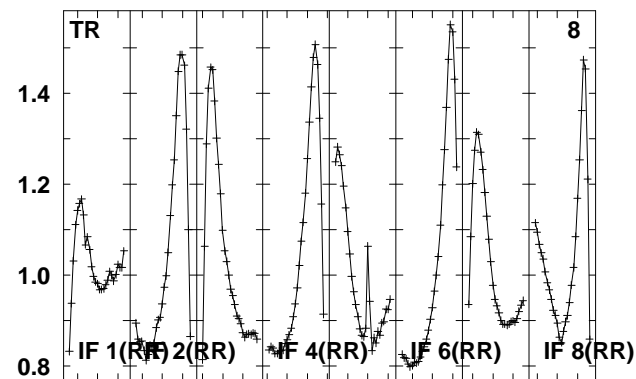
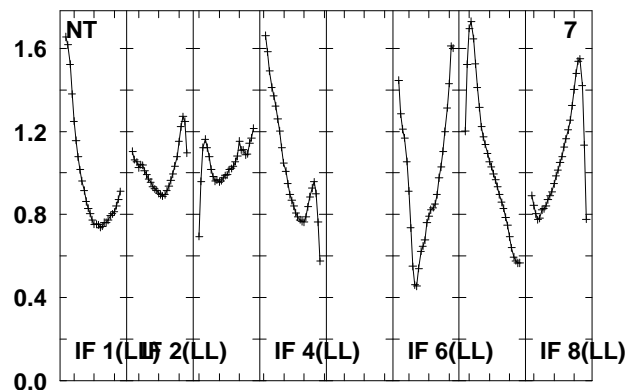
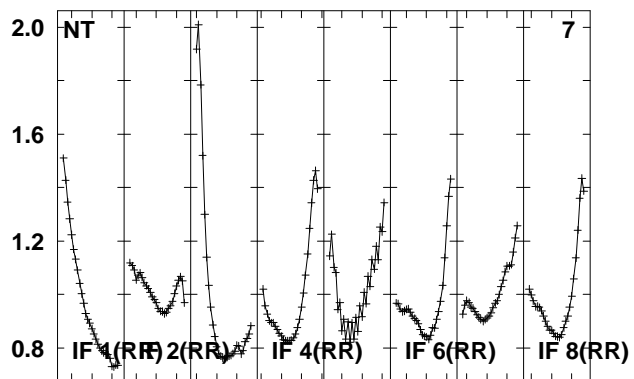
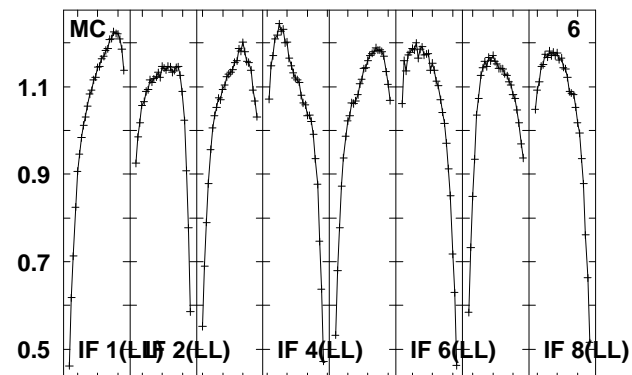
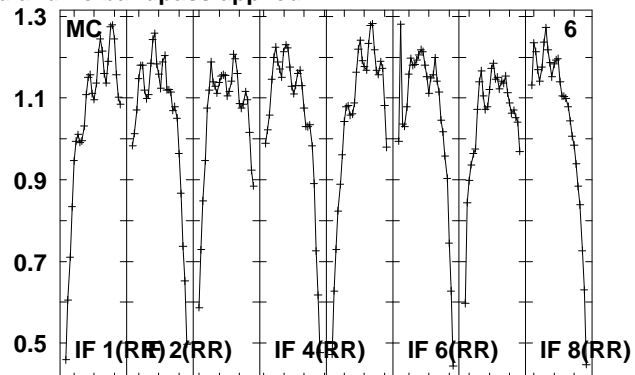
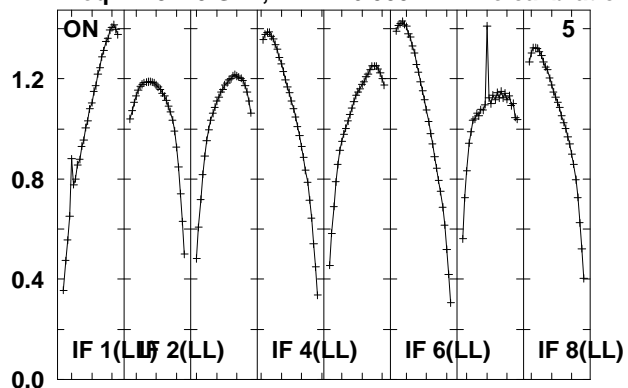

Lower frame: Real Jy

Total-power spectrum Antenna: *

Timerange: 00/18:59:02 to 00/19:00:30

Plot file version 559 created 14-MAY-2010 15:20:13
 J080844 EO007.UVDATA.1
 Freq = 4.9270 GHz, Bw = 16.000 MH No calibration applied and no bandpass applied

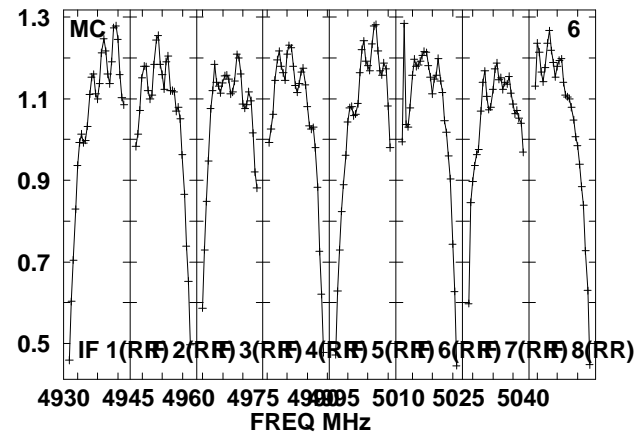
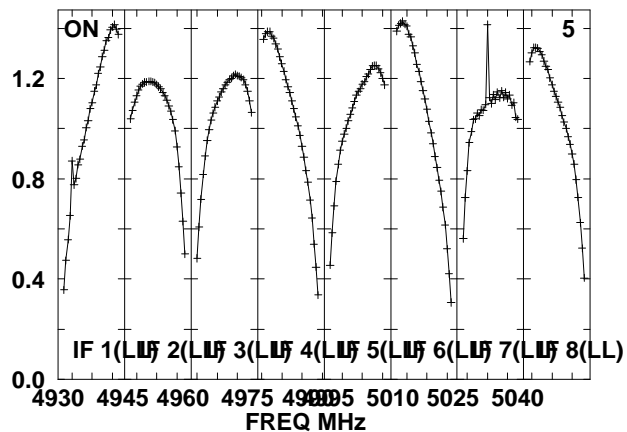
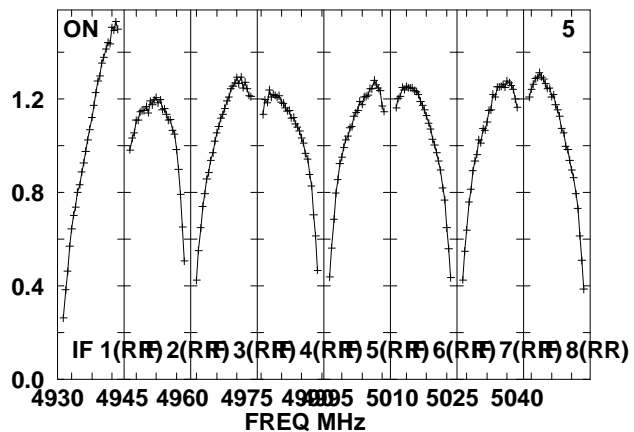
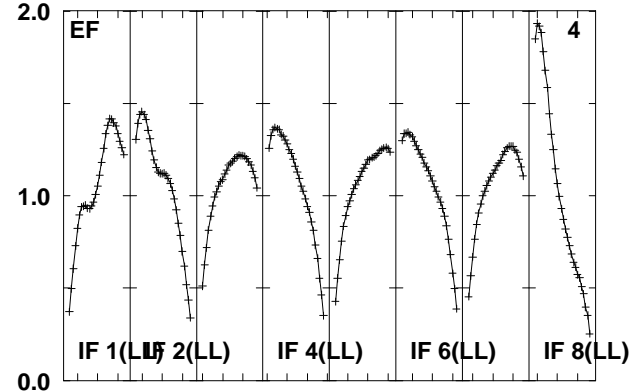
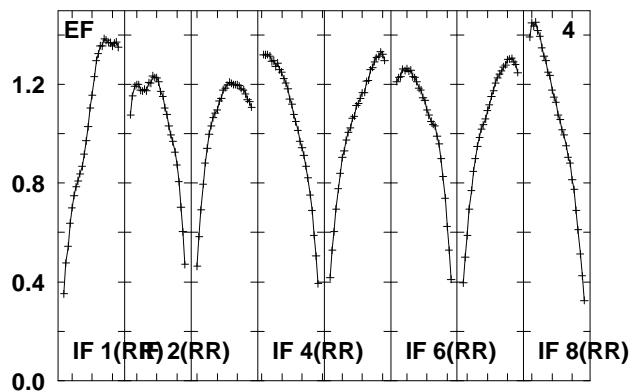
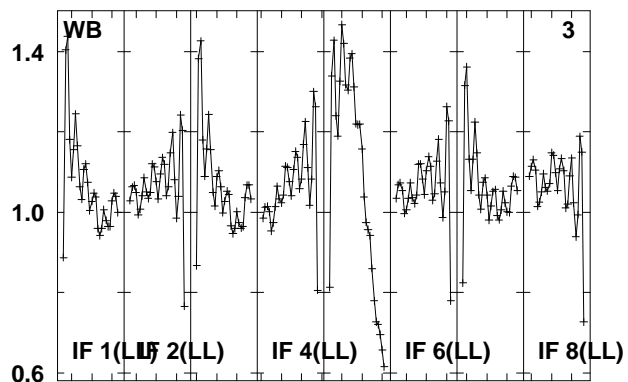
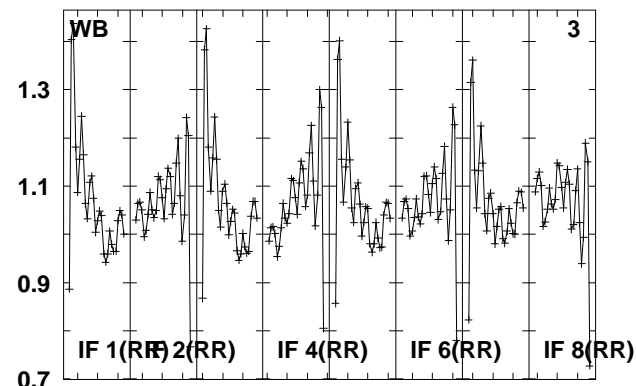
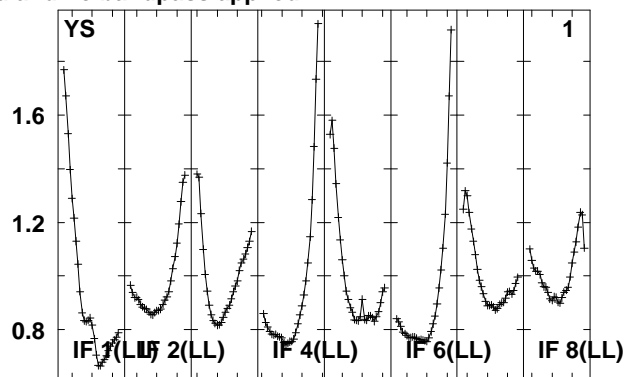
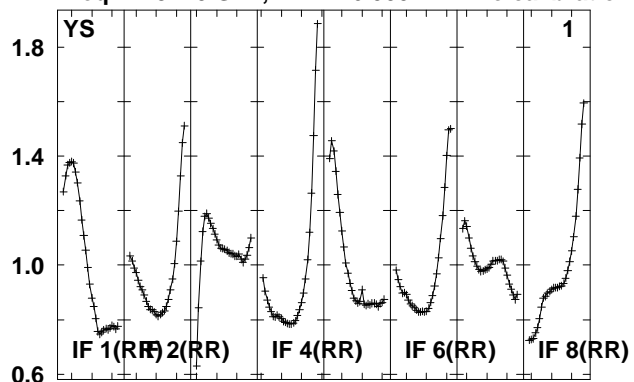

Lower frame: Real Jy
 Total-power spectrum Antenna: *
 Timerange: 00/19:01:06 to 00/19:06:04

Plot file version 560 created 14-MAY-2010 15:20:14

J080844 EO007.UVDATA.1

Freq = 4.9270 GHz, Bw = 16.000 MH No calibration applied and no bandpass applied

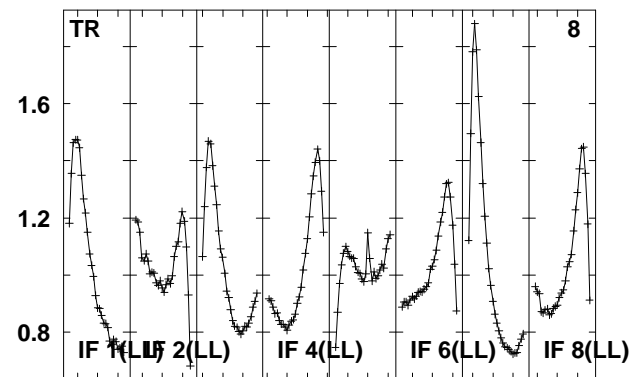
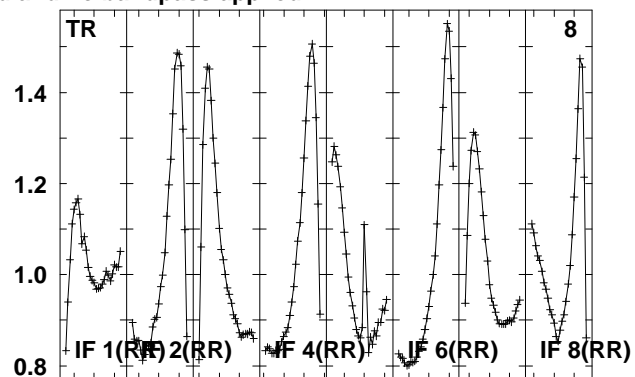
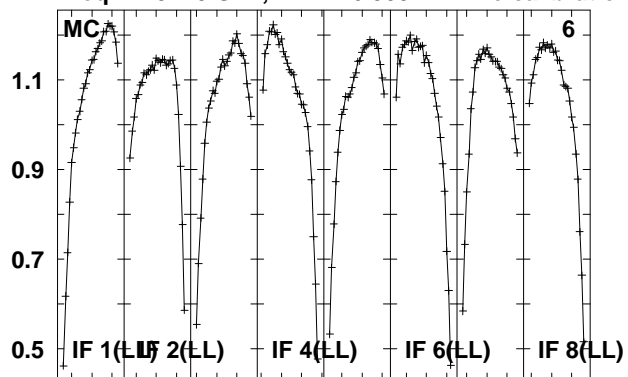

Lower frame: Real Jy
Total-power spectrum Antenna: *
Timerange: 00/19:01:06 to 00/19:06:04

Plot file version 561 created 14-MAY-2010 15:20:14

J0808+40 EO007.UVDATA.1

Freq = 4.9270 GHz, Bw = 16.000 MH No calibration applied and no bandpass applied

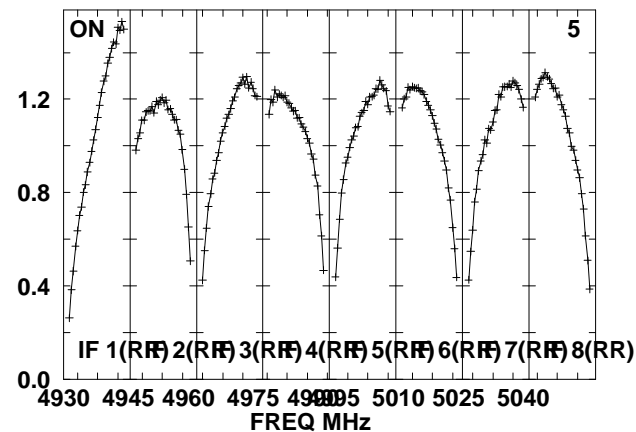
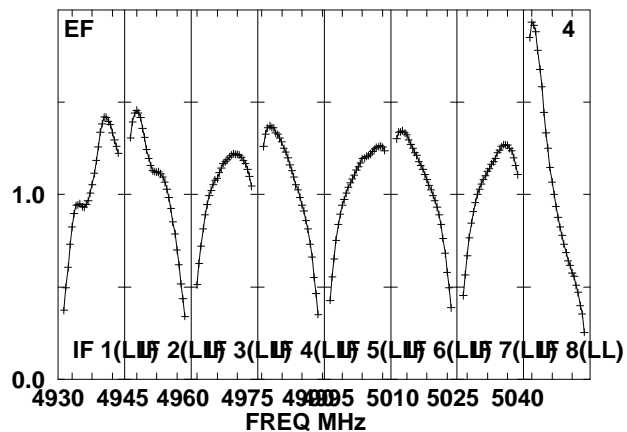
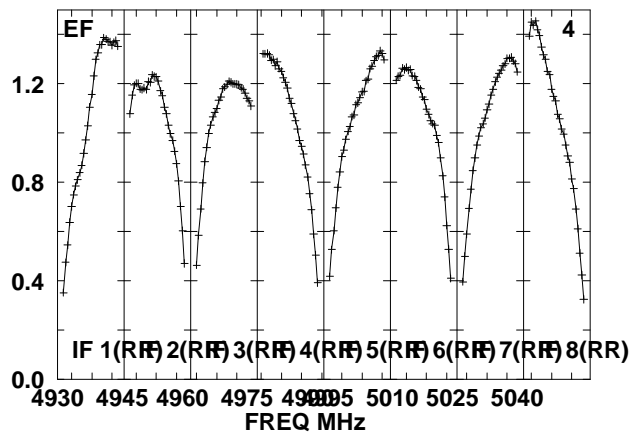
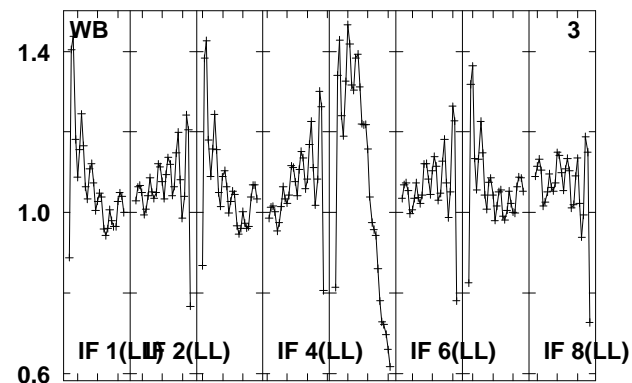
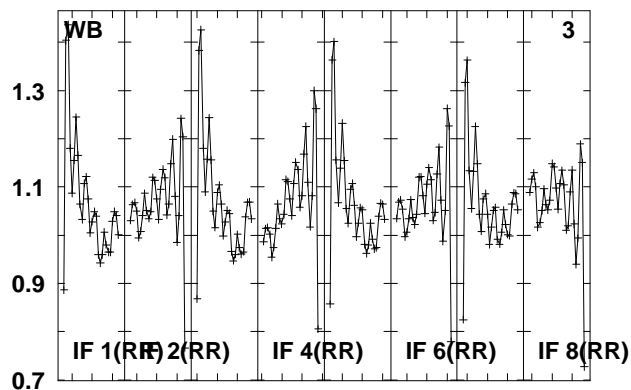
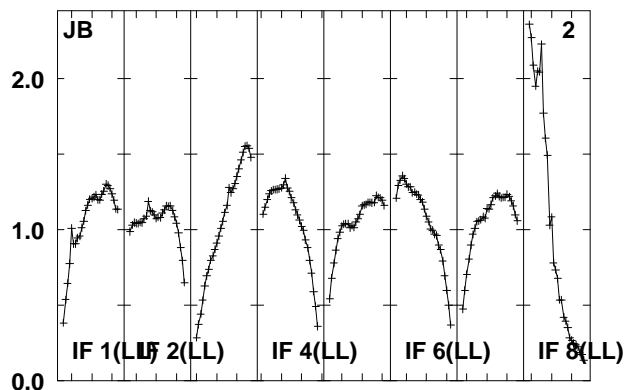
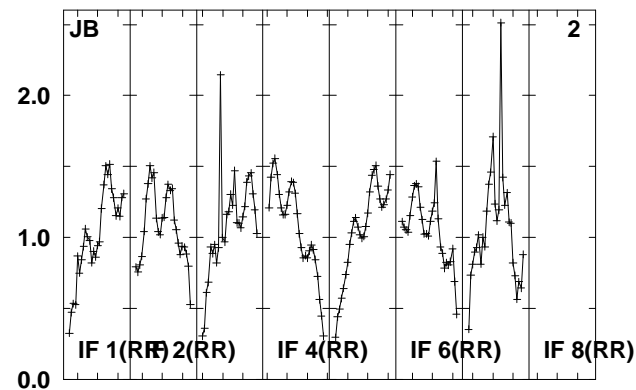
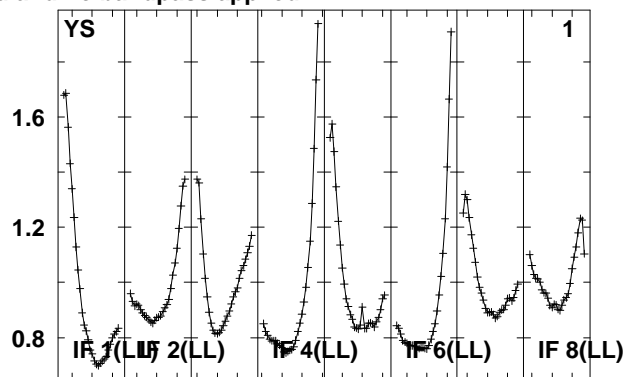
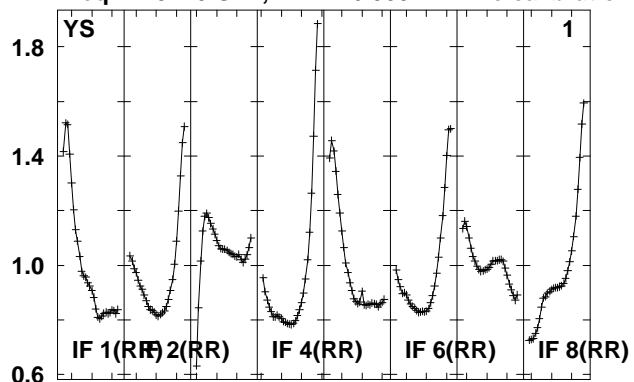

Lower frame: Real Jy
Total-power spectrum Antenna: *
Timerange: 00/19:06:38 to 00/19:08:04

Plot file version 562 created 14-MAY-2010 15:20:14

J0808+40 EO007.UVDATA.1

Freq = 4.9270 GHz, Bw = 16.000 MH No calibration applied and no bandpass applied

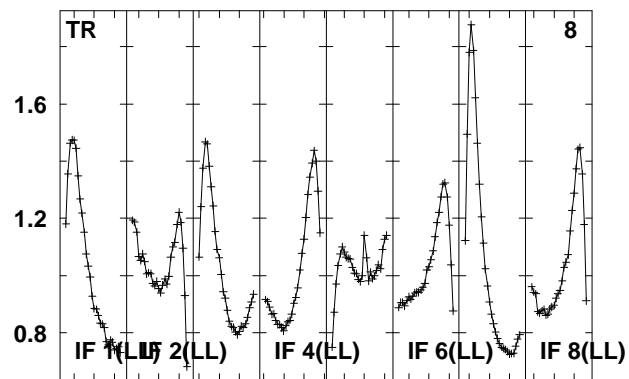
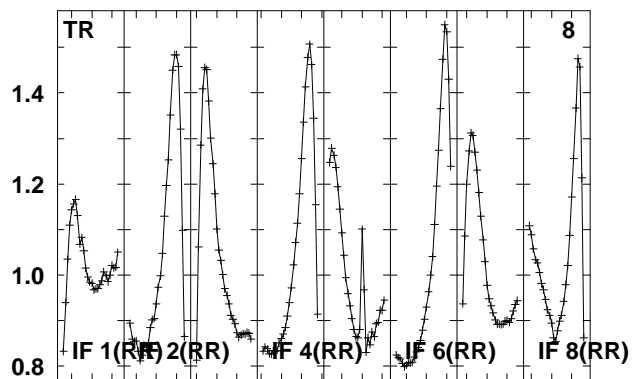
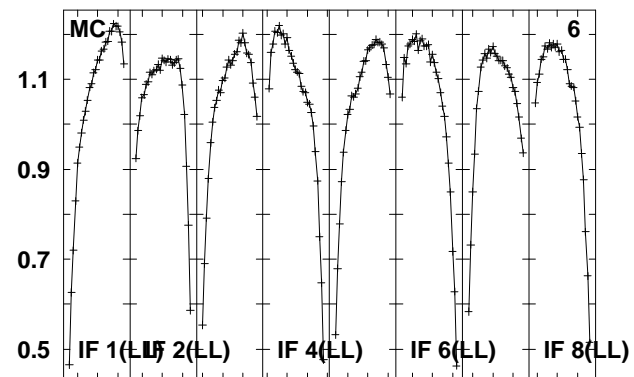
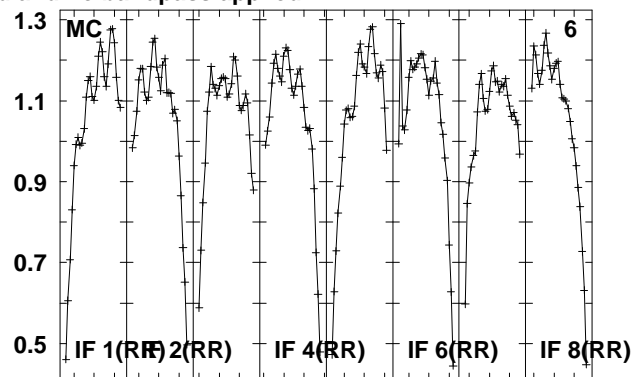
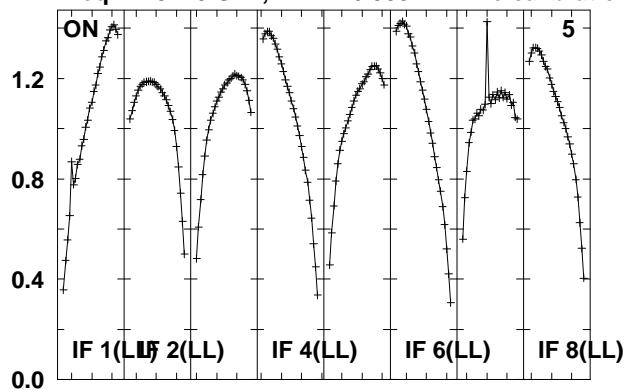

Lower frame: Real Jy
Total-power spectrum Antenna: *
Timerange: 00/19:06:38 to 00/19:08:04

Plot file version 563 created 14-MAY-2010 15:20:15

J0808+49 EO007.UVDATA.1

Freq = 4.9270 GHz, Bw = 16.000 MH No calibration applied and no bandpass applied

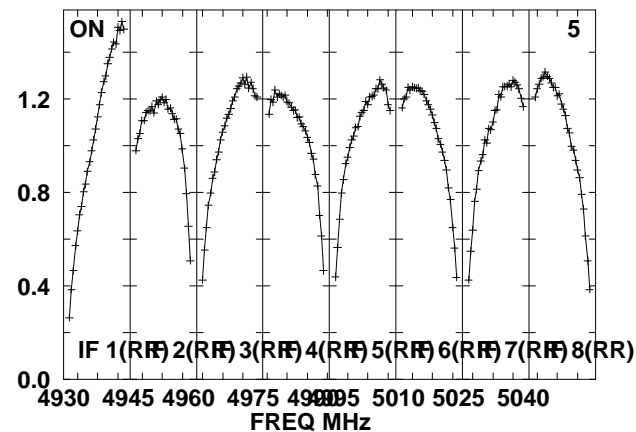
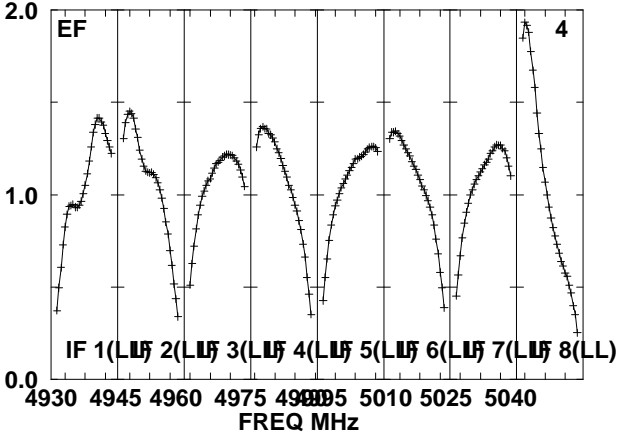
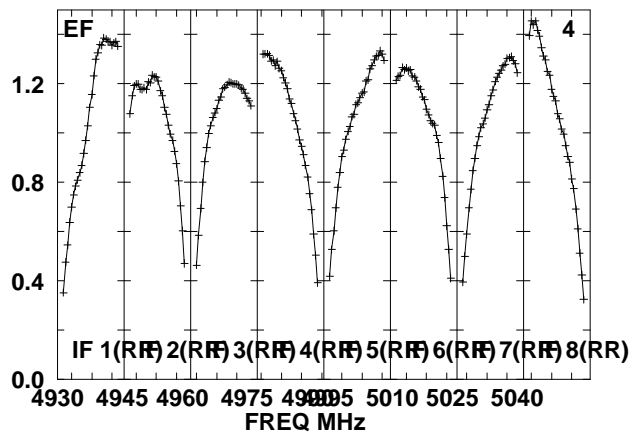
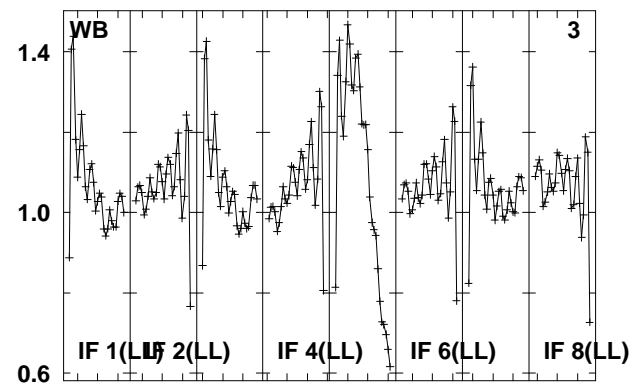
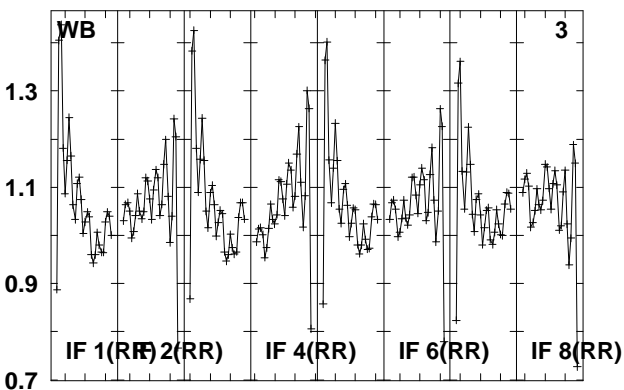
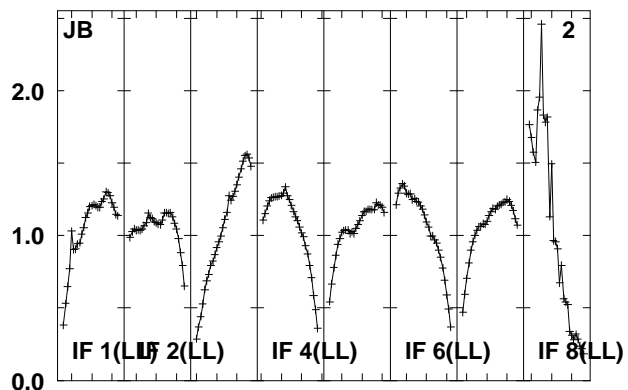
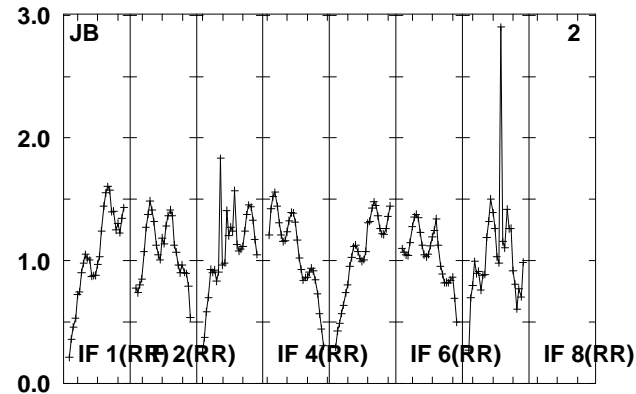
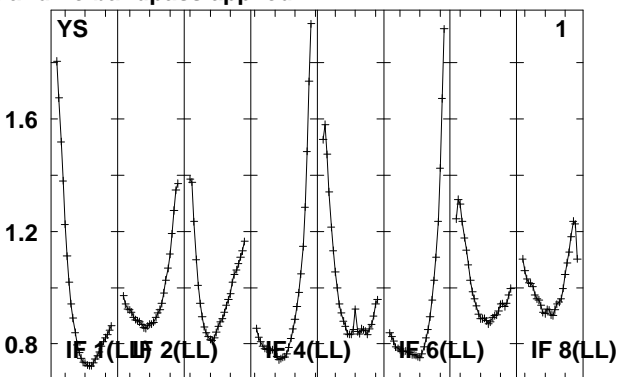
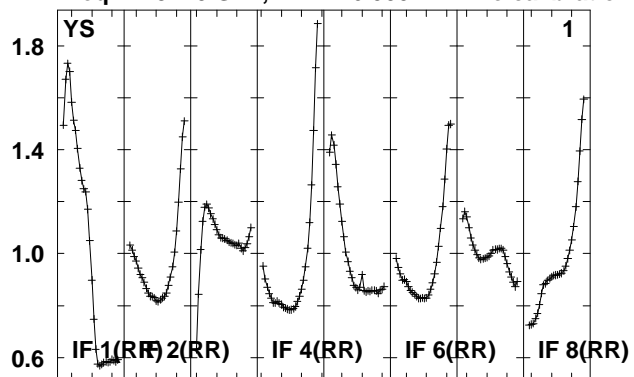

Lower frame: Real Jy
Total-power spectrum Antenna: *
Timerange: 00/19:10:26 to 00/19:11:50

Plot file version 564 created 14-MAY-2010 15:20:15

J0808+49 EO007.UVDATA.1

Freq = 4.9270 GHz, Bw = 16.000 MH No calibration applied and no bandpass applied

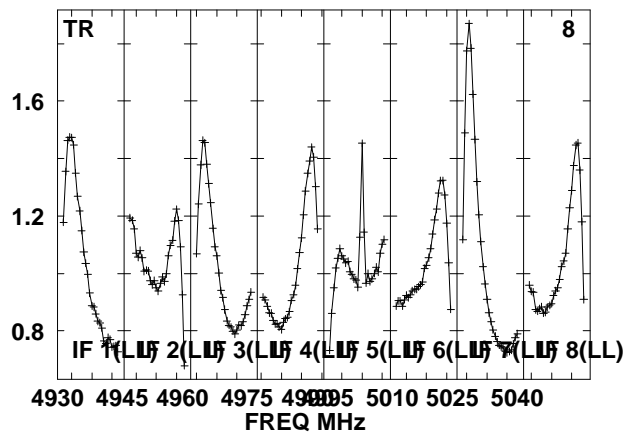
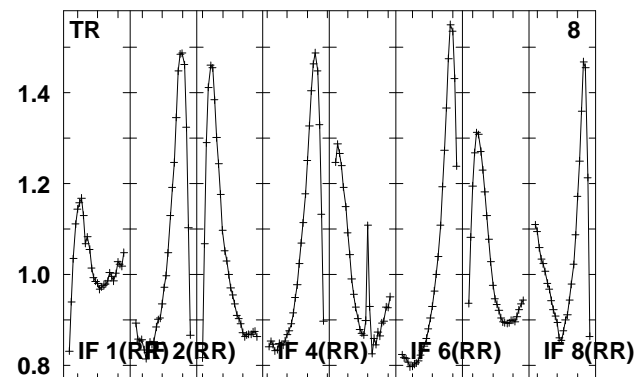
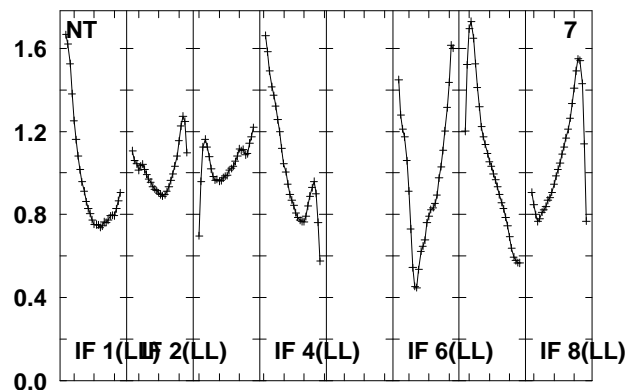
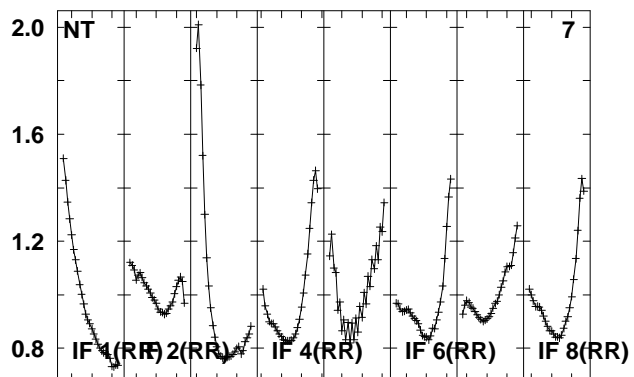
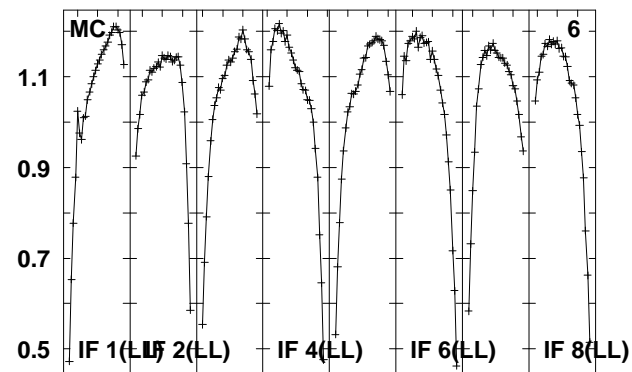
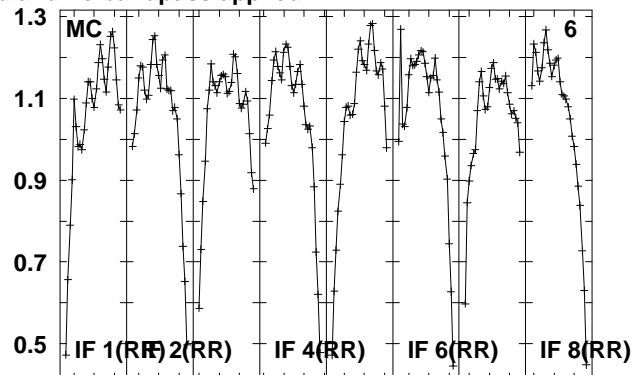
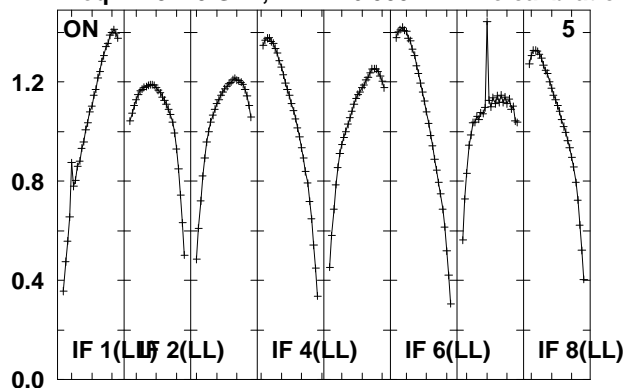

Lower frame: Real Jy

Total-power spectrum Antenna: *

Timerange: 00/19:10:26 to 00/19:11:50

Plot file version 565 created 14-MAY-2010 15:20:15
 J081523 EO007.UVDATA.1
 Freq = 4.9270 GHz, Bw = 16.000 MH No calibration applied and no bandpass applied

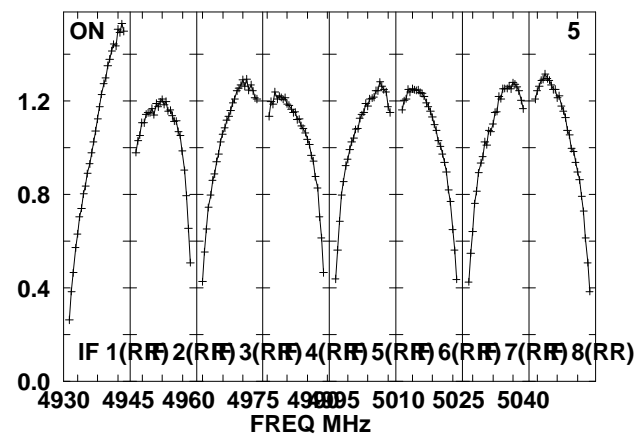
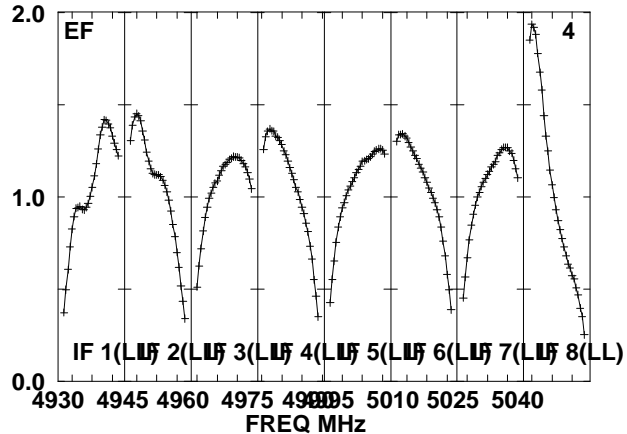
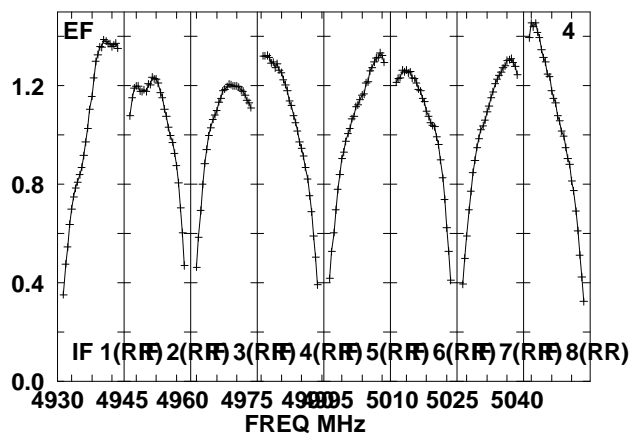
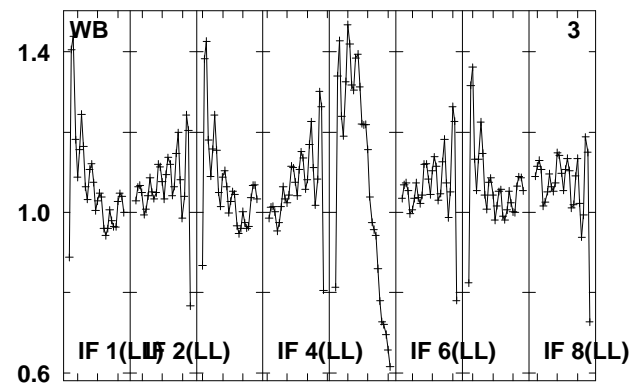
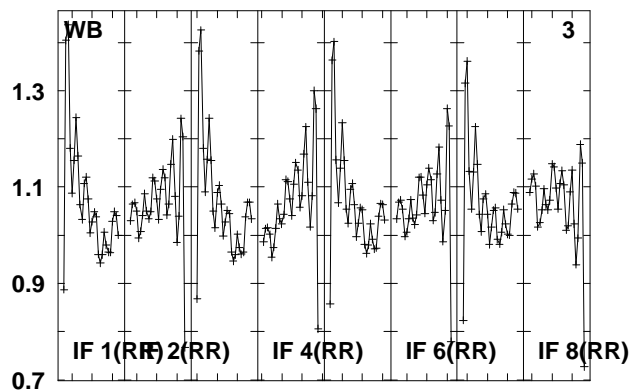
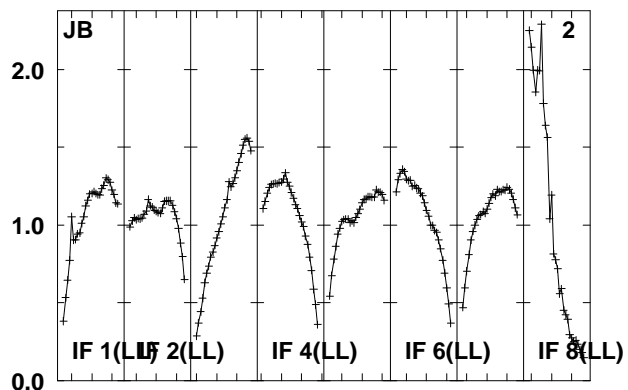
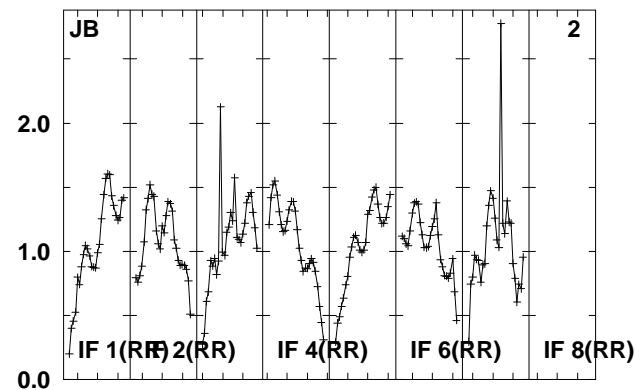
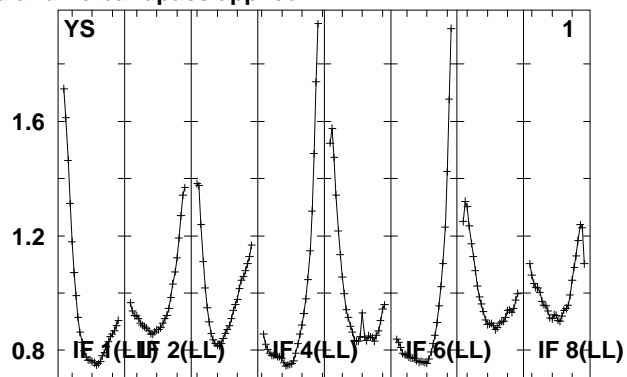
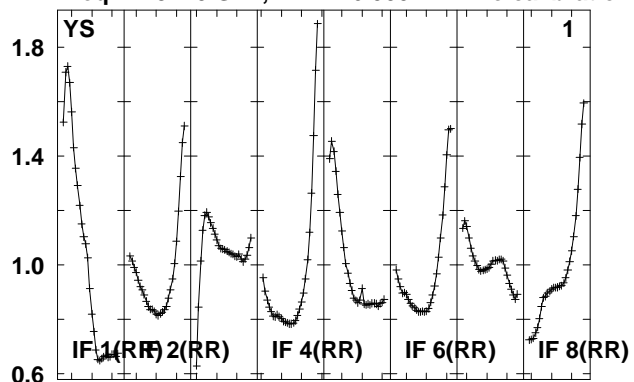

Lower frame: Real Jy
 Total-power spectrum Antenna: *
 Timerange: 00/19:12:42 to 00/19:17:38

Plot file version 566 created 14-MAY-2010 15:20:16

J081523 EO007.UVDATA.1

Freq = 4.9270 GHz, Bw = 16.000 MH No calibration applied and no bandpass applied

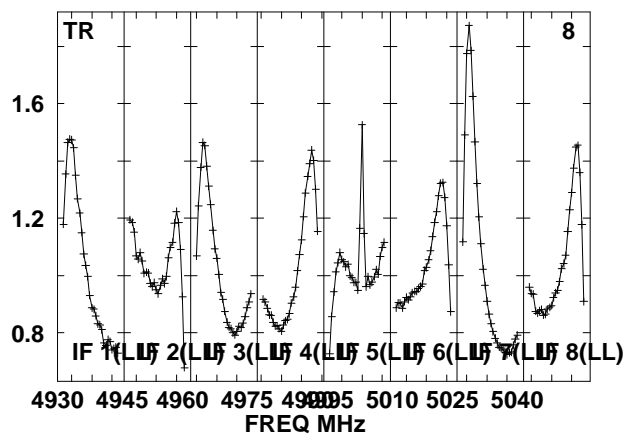
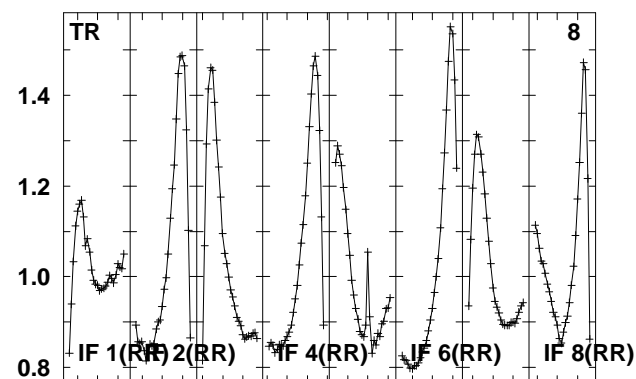
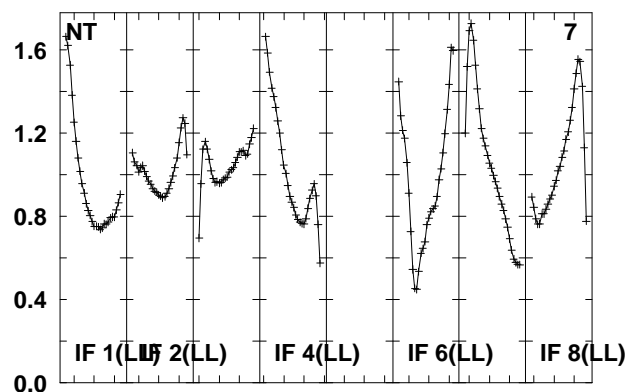
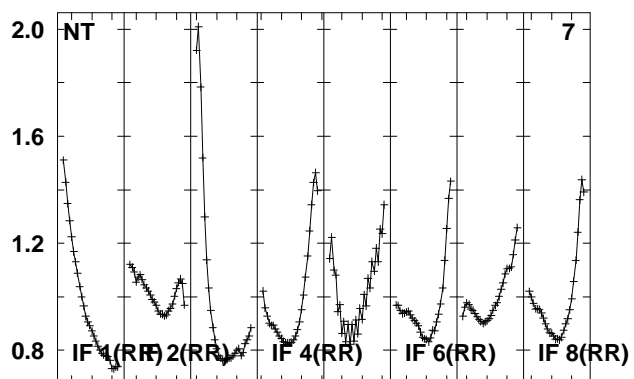
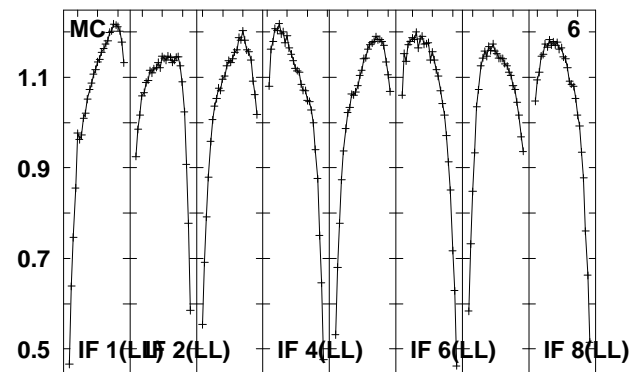
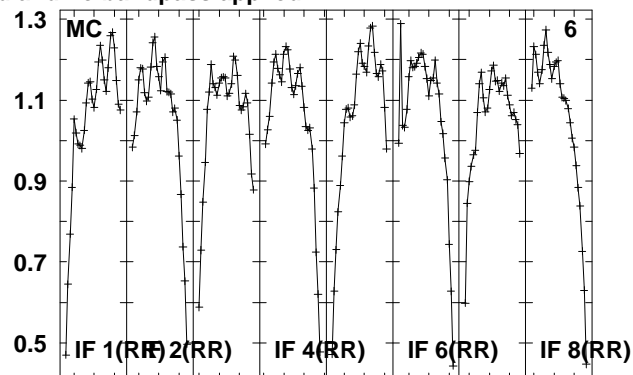
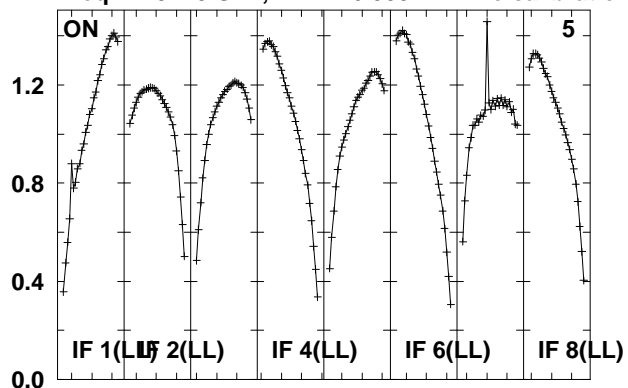

Lower frame: Real Jy

Total-power spectrum Antenna: *

Timerange: 00/19:12:42 to 00/19:17:38

Plot file version 567 created 14-MAY-2010 15:20:16

J0808+49 EO007.UVDATA.1

Freq = 4.9270 GHz, Bw = 16.000 MH No calibration applied and no bandpass applied

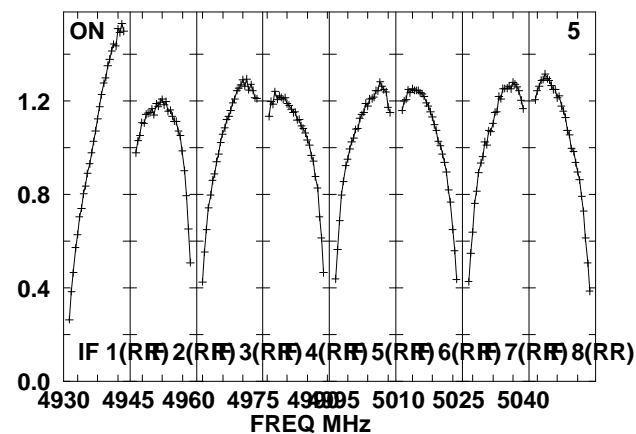
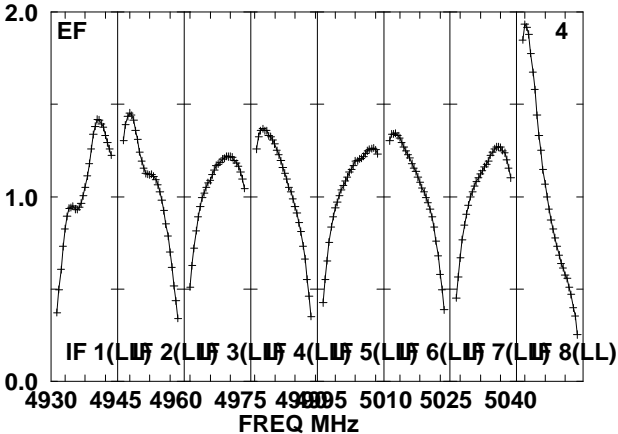
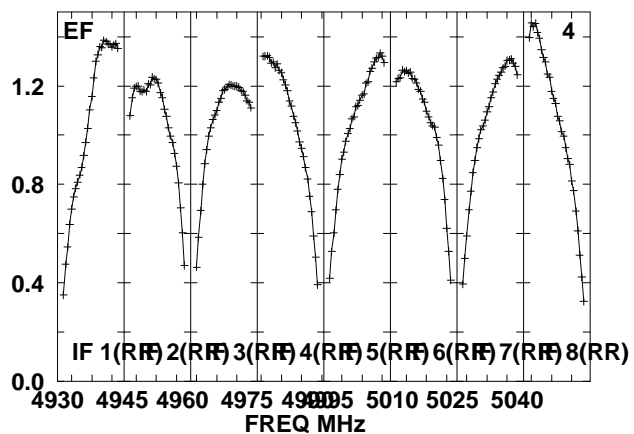
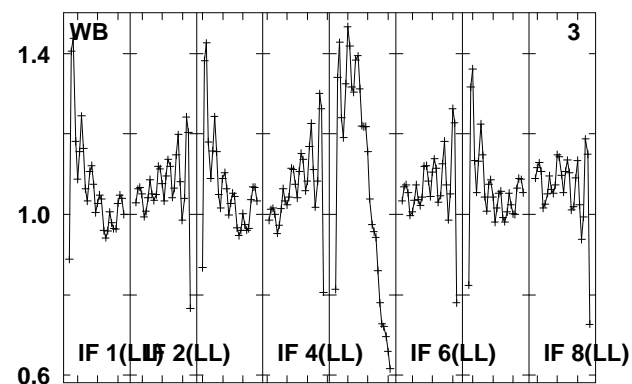
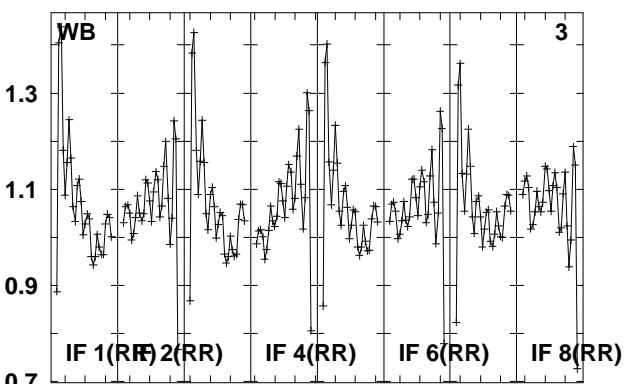
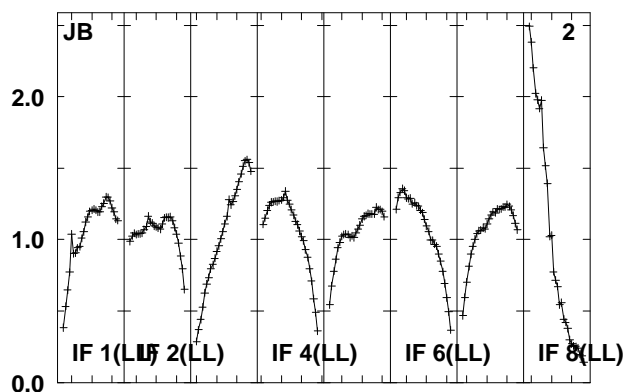
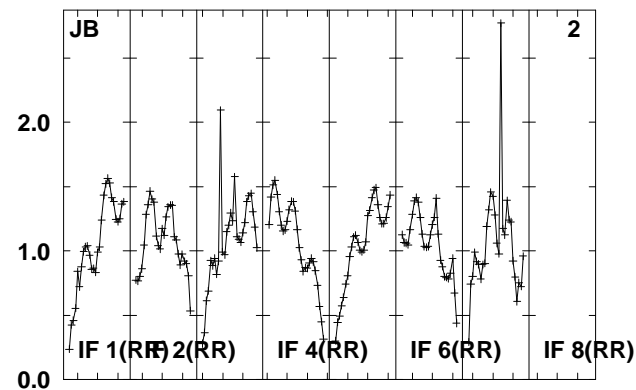
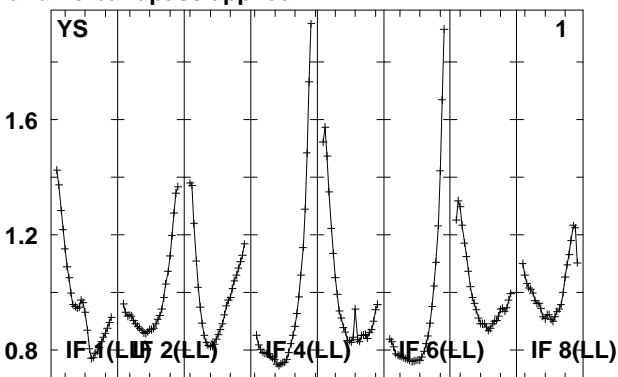
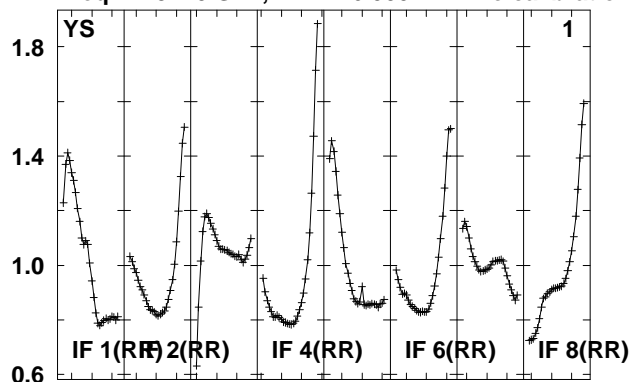

Lower frame: Real Jy
Total-power spectrum Antenna: *
Timerange: 00/19:18:32 to 00/19:19:58

Plot file version 568 created 14-MAY-2010 15:20:16

J0808+49 EO007.UVDATA.1

Freq = 4.9270 GHz, Bw = 16.000 MH No calibration applied and no bandpass applied

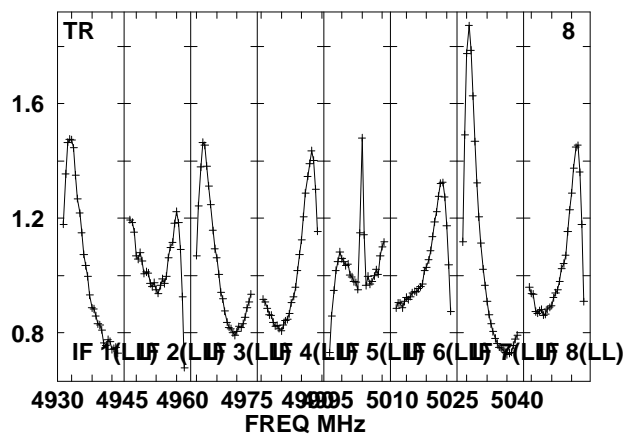
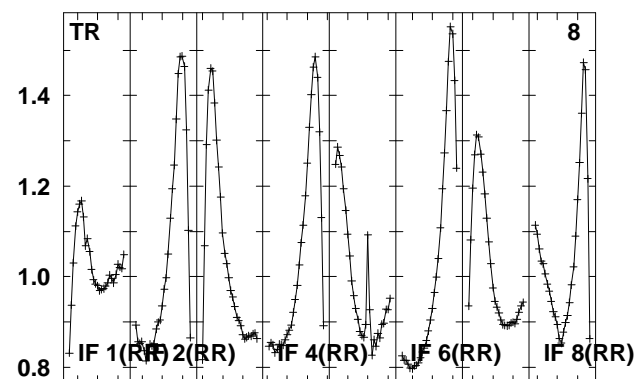
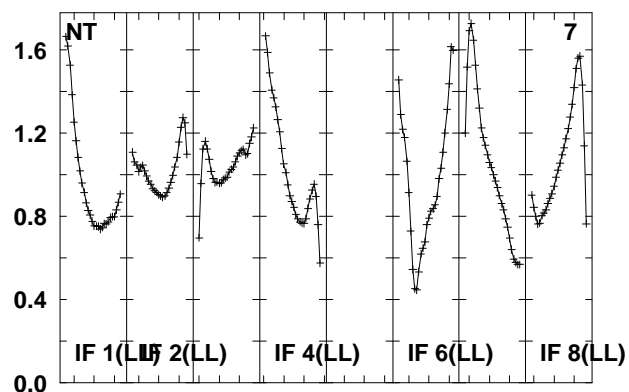
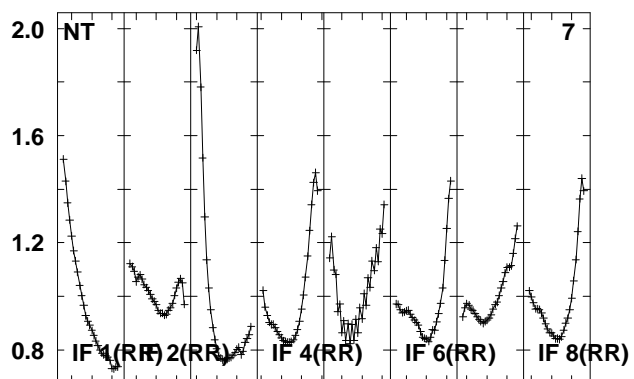
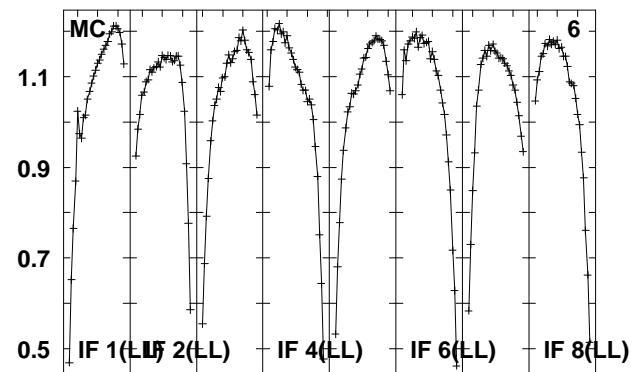
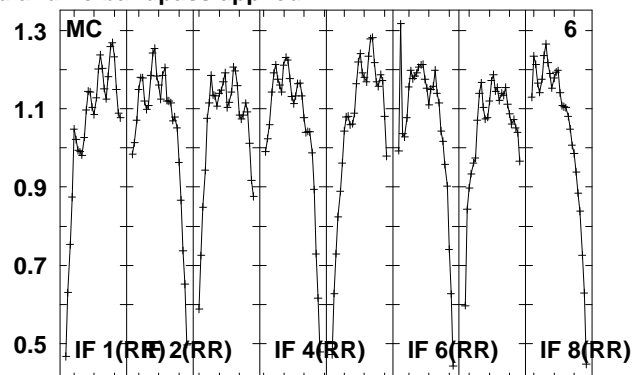
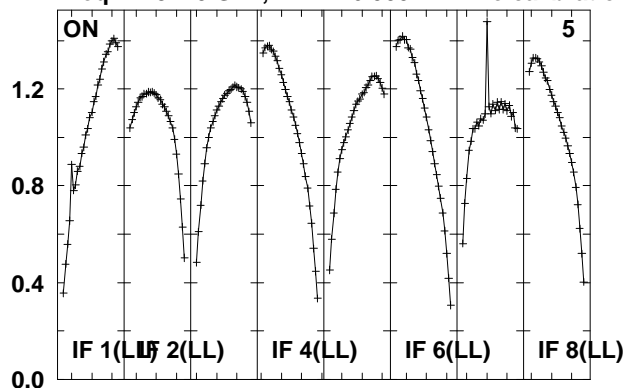

Lower frame: Real Jy

Total-power spectrum Antenna: *

Timerange: 00/19:18:32 to 00/19:19:58

Plot file version 569 created 14-MAY-2010 15:20:17
 J081523 EO007.UVDATA.1
 Freq = 4.9270 GHz, Bw = 16.000 MH No calibration applied and no bandpass applied

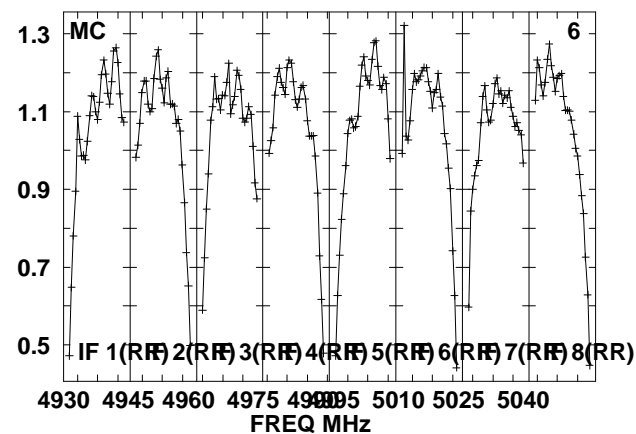
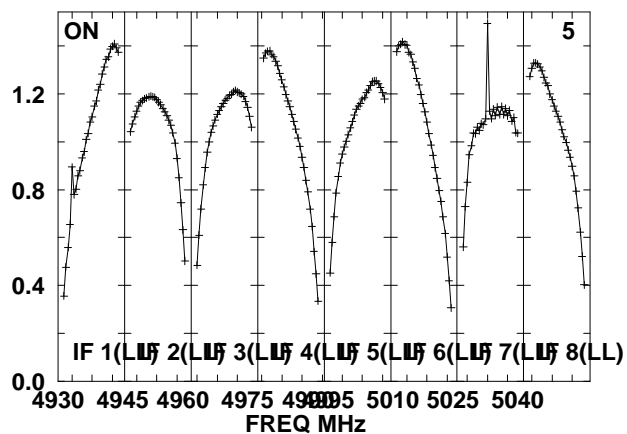
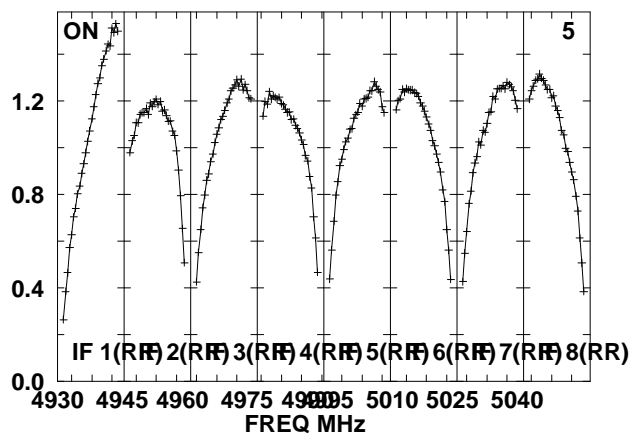
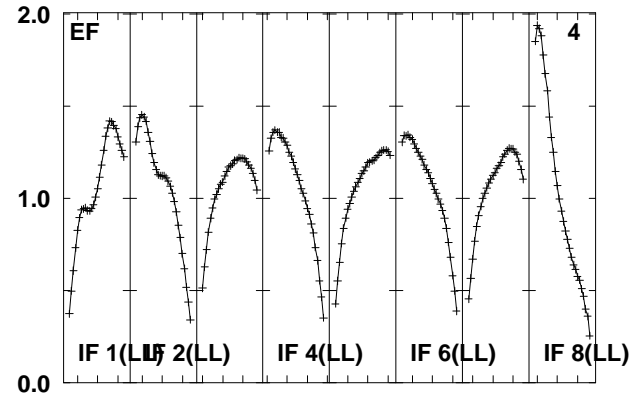
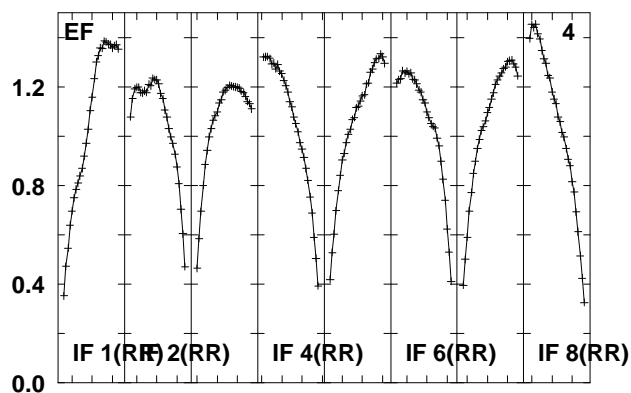
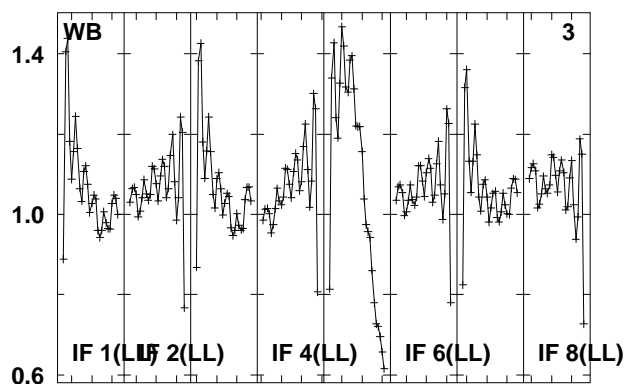
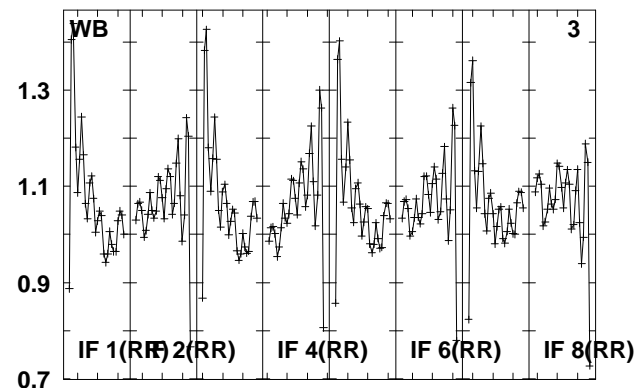
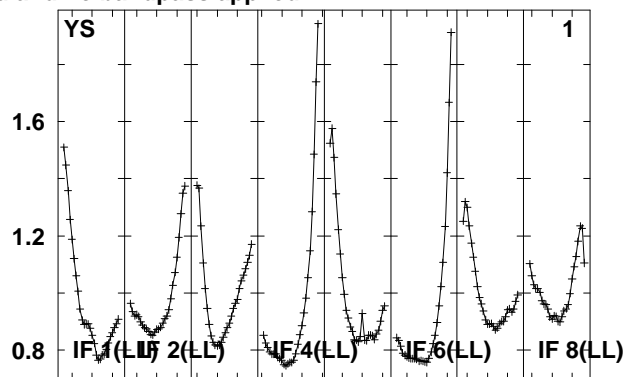
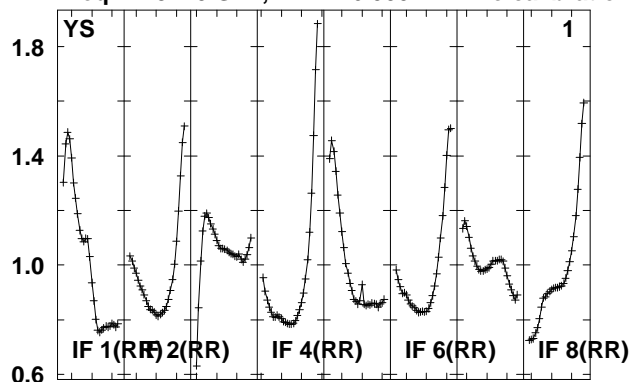

Lower frame: Real Jy
 Total-power spectrum Antenna: *
 Timerange: 00/19:20:42 to 00/19:25:38

Plot file version 570 created 14-MAY-2010 15:20:17

J081523 EO007.UVDATA.1

Freq = 4.9270 GHz, Bw = 16.000 MH No calibration applied and no bandpass applied

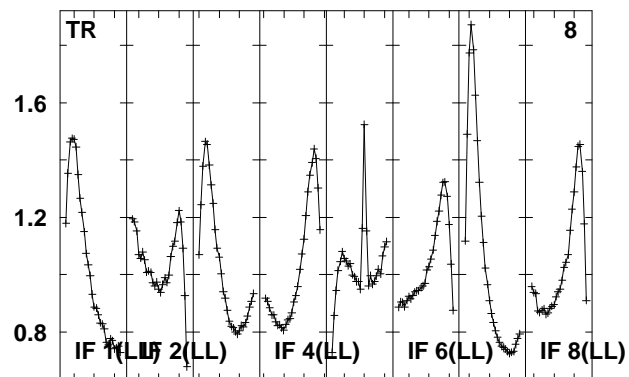
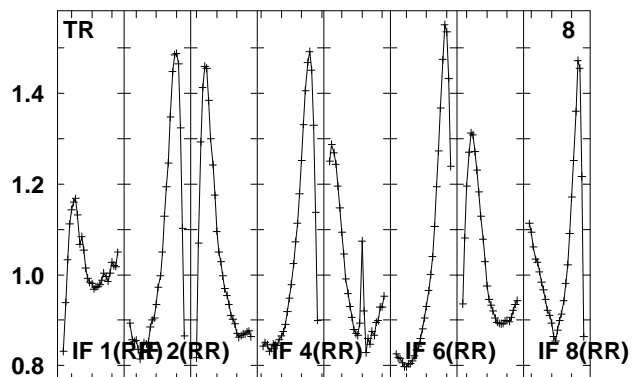
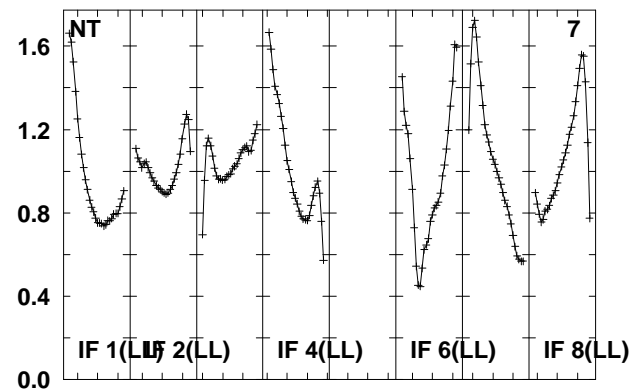
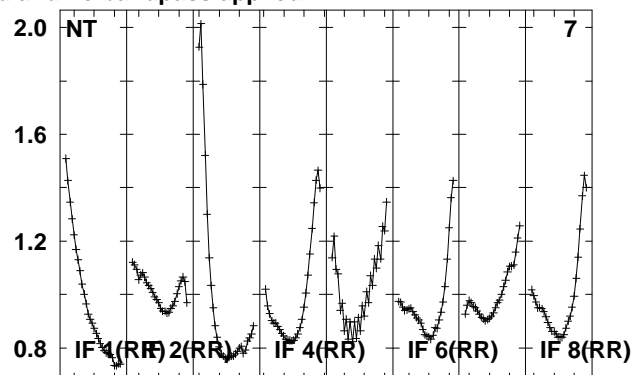
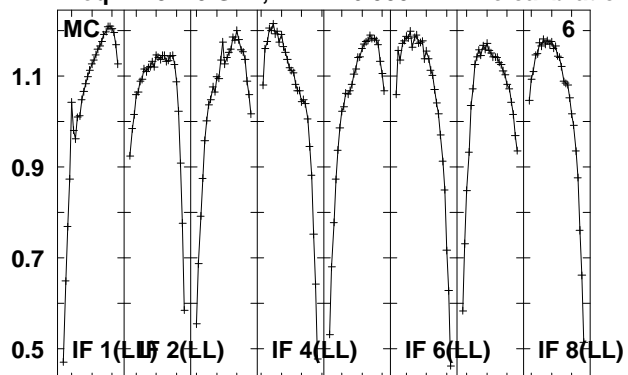

Lower frame: Real Jy
Total-power spectrum Antenna: *
Timerange: 00/19:20:42 to 00/19:25:38

Plot file version 571 created 14-MAY-2010 15:20:18
 J0808+49 EO007.UVDATA.1
 Freq = 4.9270 GHz, Bw = 16.000 MH No calibration applied and no bandpass applied

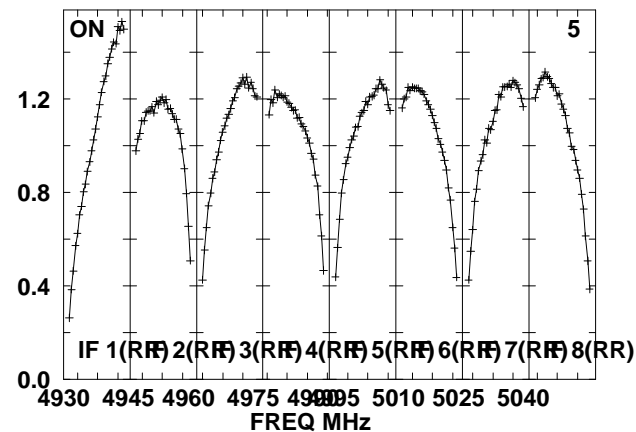
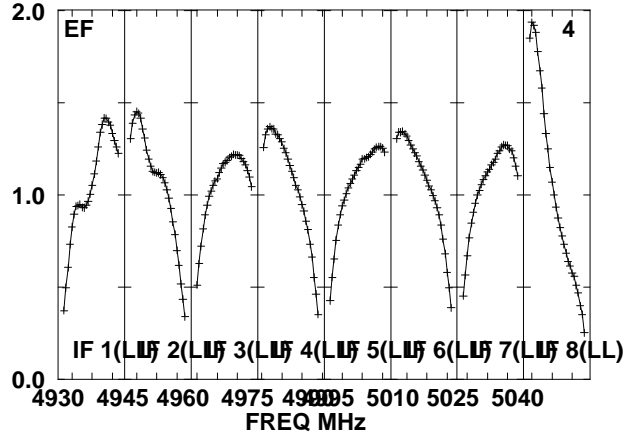
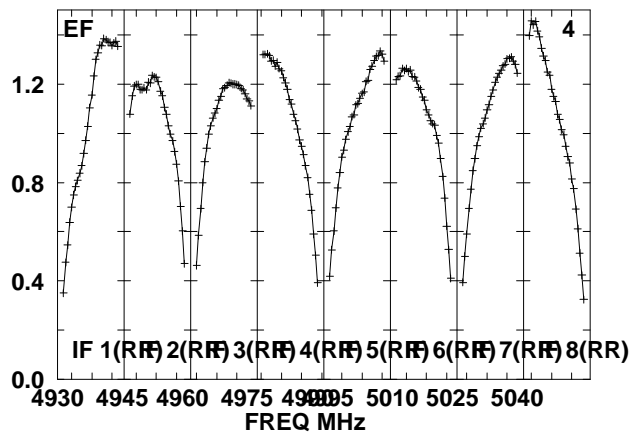
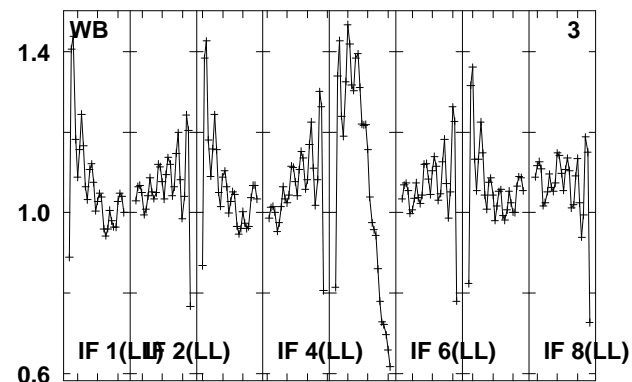
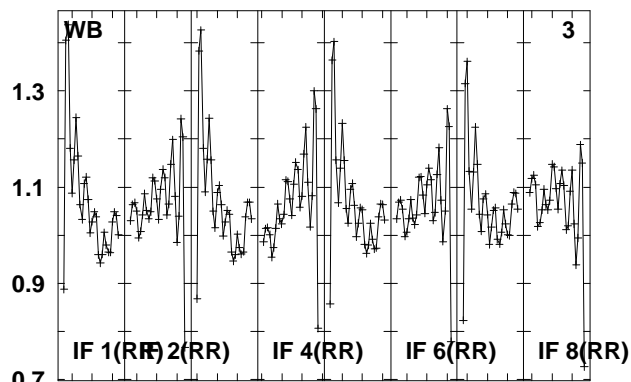
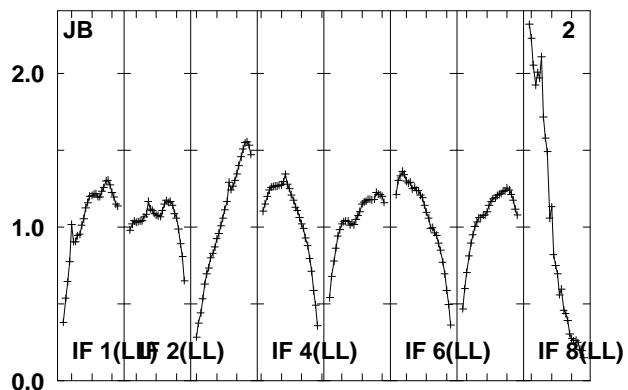
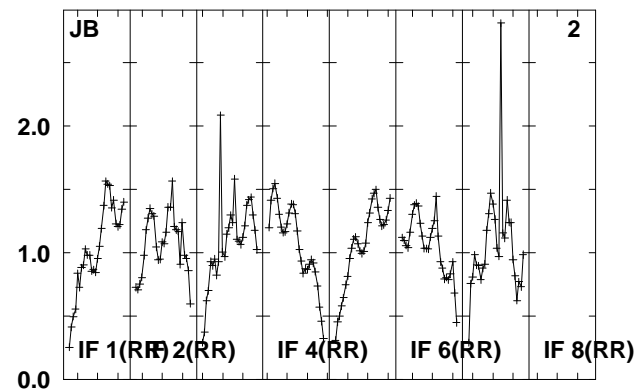
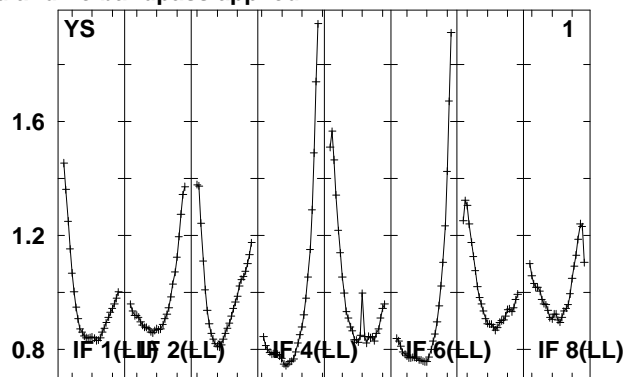
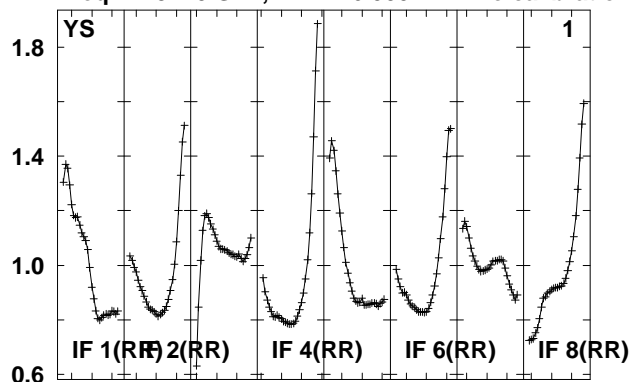

Lower frame: Real Jy
 Total-power spectrum Antenna: *
 Timerange: 00/19:26:22 to 00/19:27:50

Plot file version 572 created 14-MAY-2010 15:20:18

J0808+49 EO007.UVDATA.1

Freq = 4.9270 GHz, Bw = 16.000 MH No calibration applied and no bandpass applied

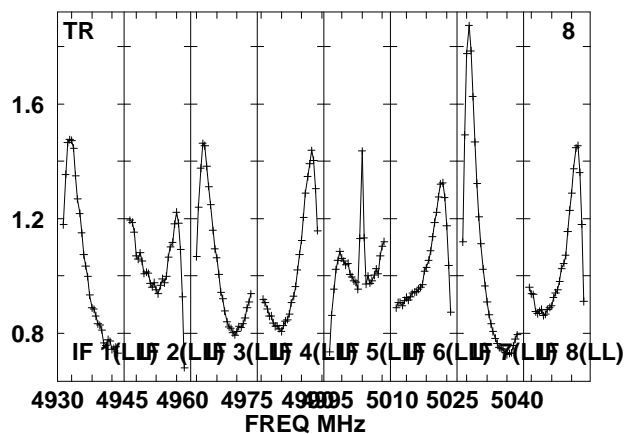
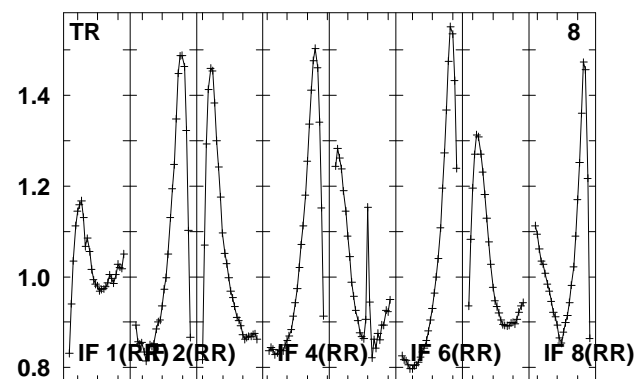
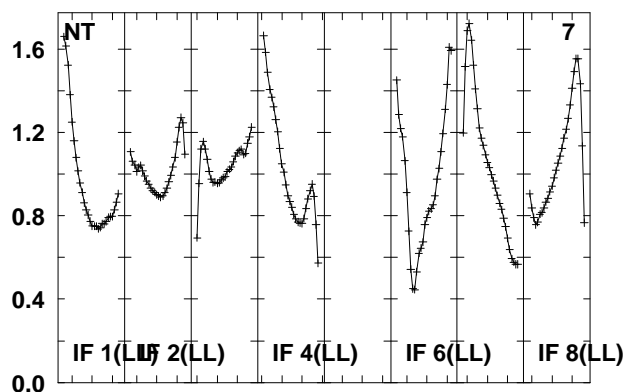
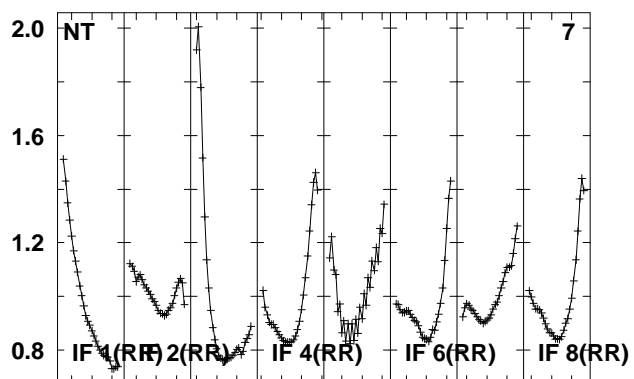
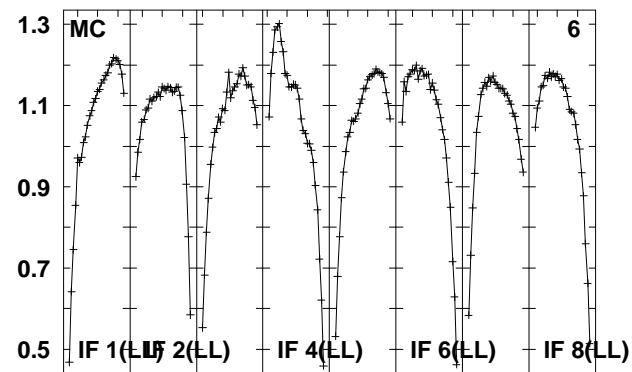
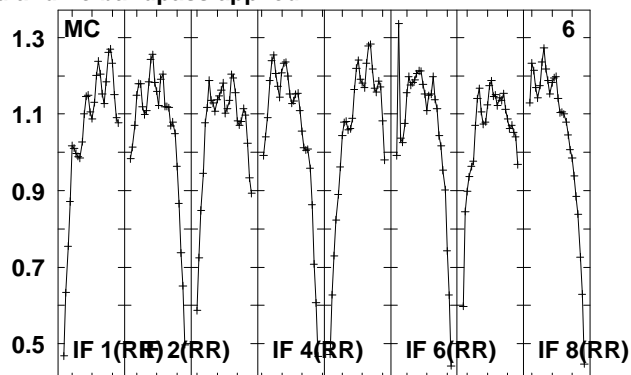
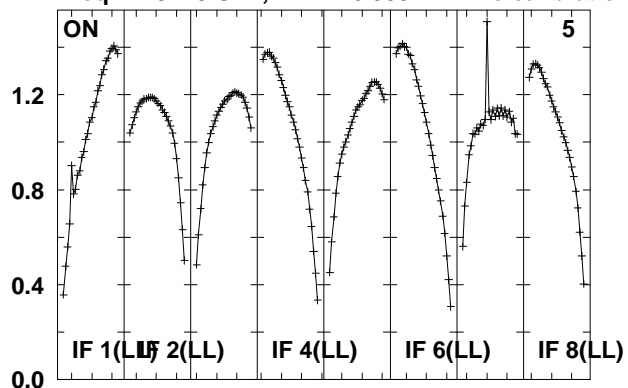

Lower frame: Real Jy

Total-power spectrum Antenna: *

Timerange: 00/19:26:22 to 00/19:27:50

Plot file version 573 created 14-MAY-2010 15:20:18

J0927+39 EO007.UVDATA.1

Freq = 4.9270 GHz, Bw = 16.000 MH No calibration applied and no bandpass applied

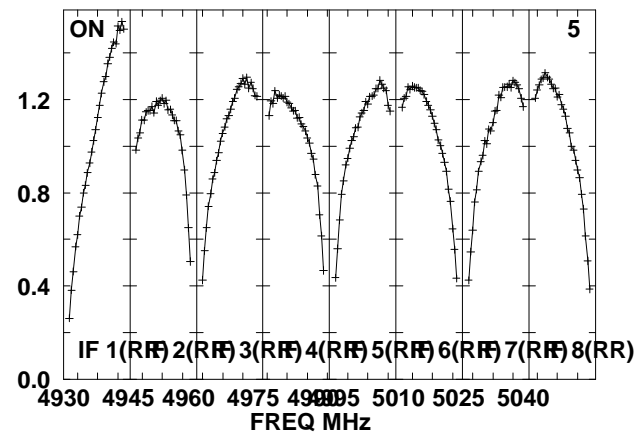
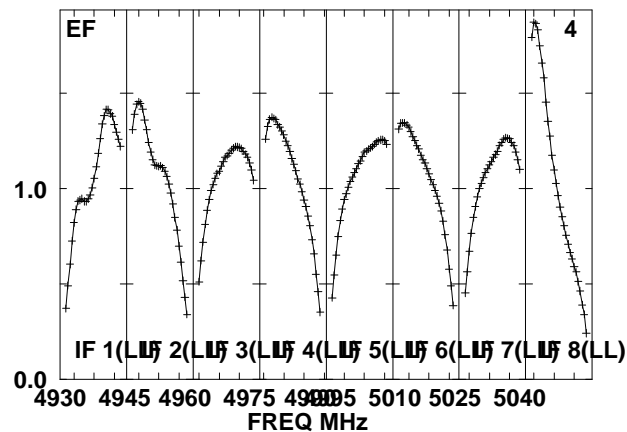
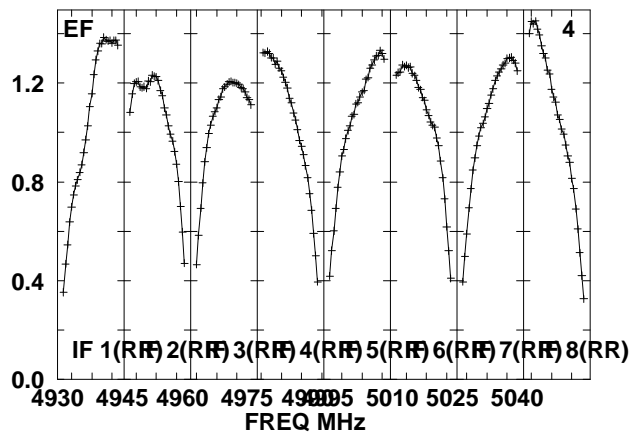
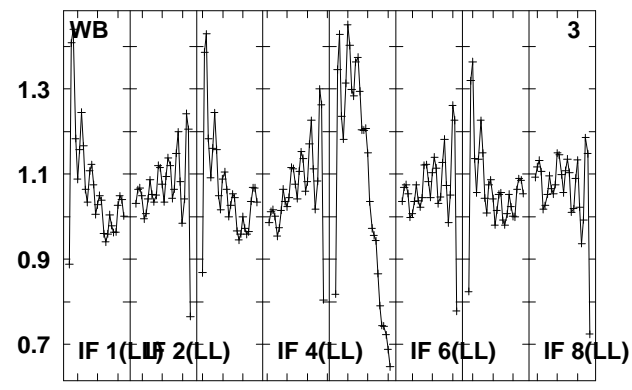
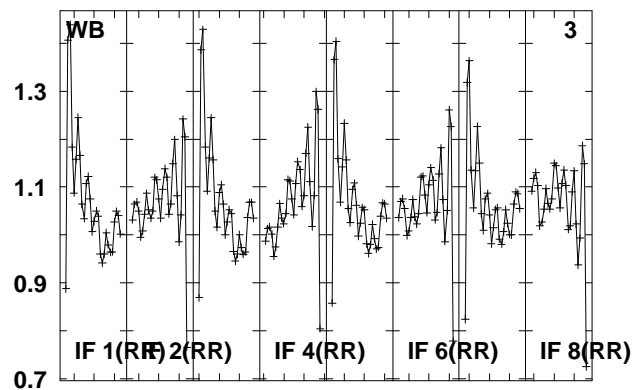
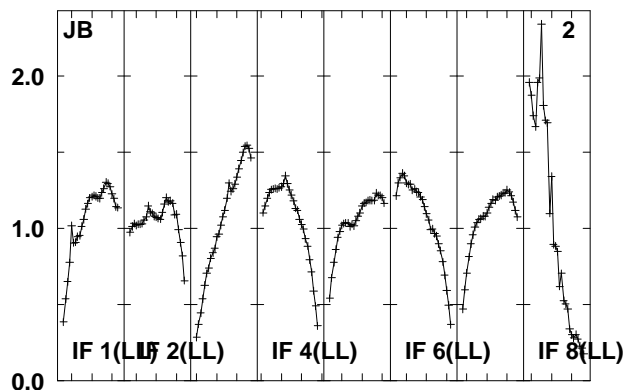
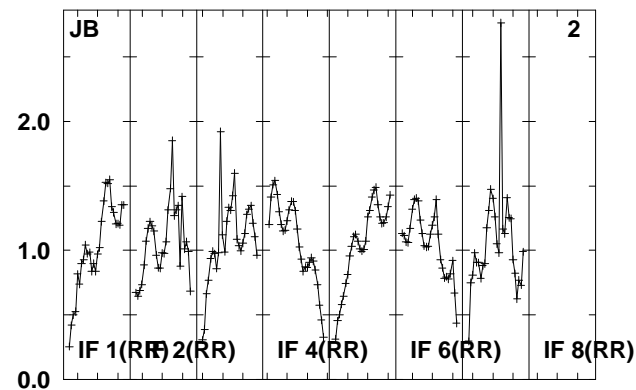
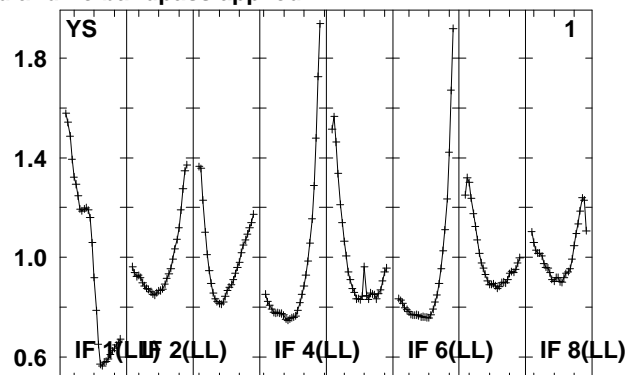
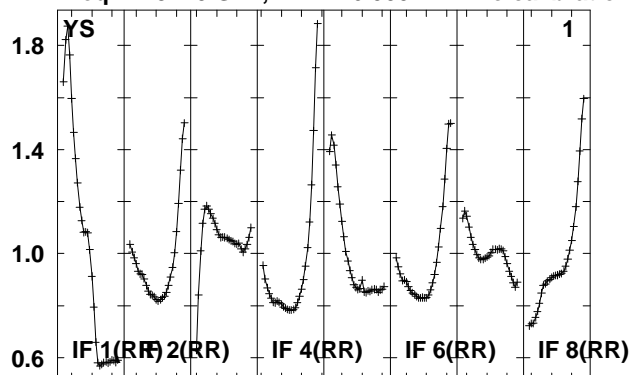

Lower frame: Real Jy
Total-power spectrum Antenna: *
Timerange: 00/19:31:00 to 00/19:35:58

Plot file version 574 created 14-MAY-2010 15:20:19

J0927+39 EO007.UVDATA.1

Freq = 4.9270 GHz, Bw = 16.000 MH No calibration applied and no bandpass applied

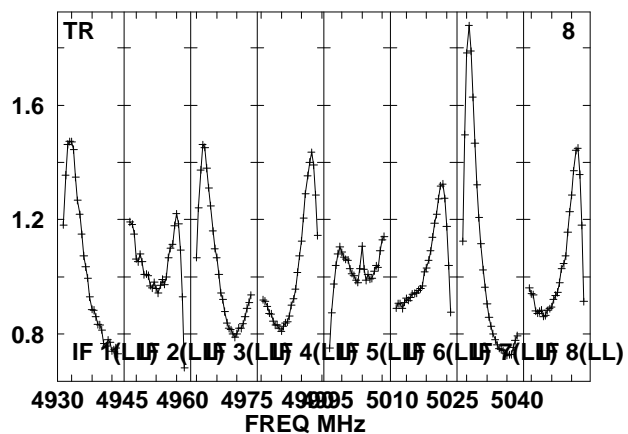
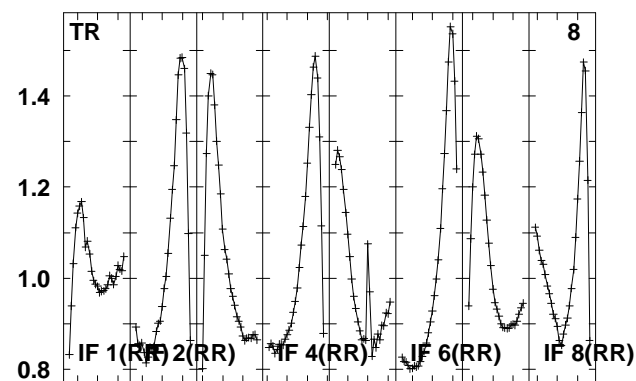
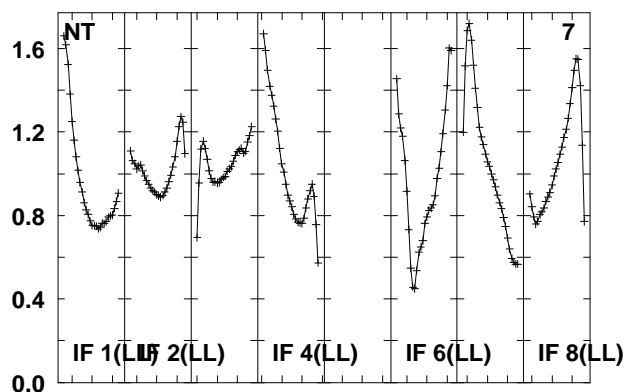
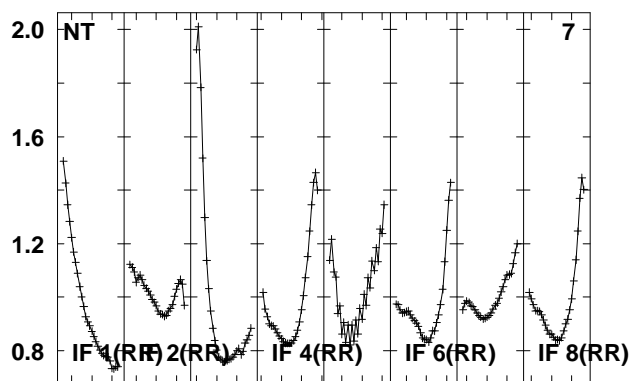
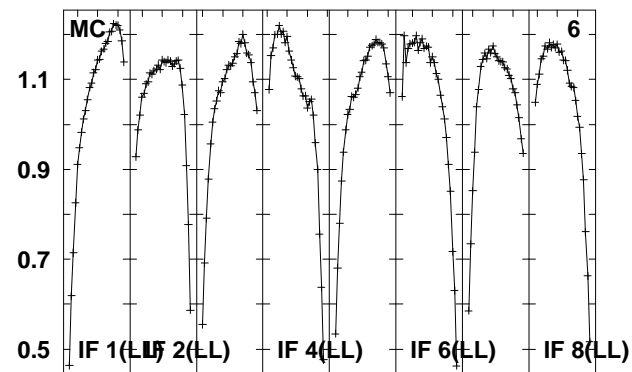
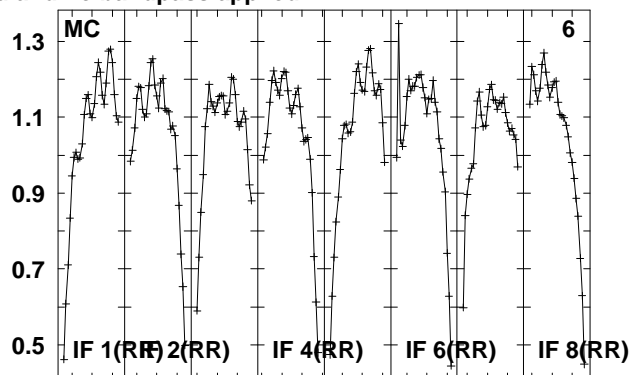
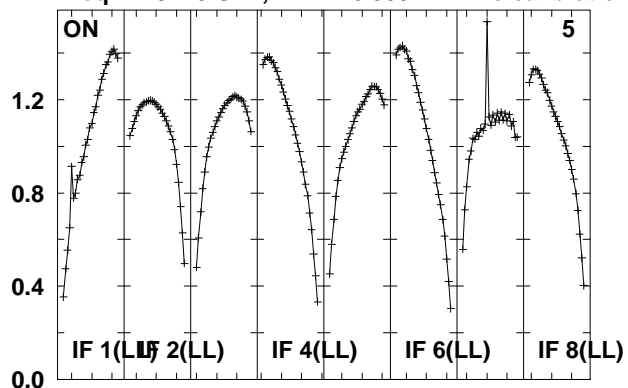

Lower frame: Real Jy

Total-power spectrum Antenna: *

Timerange: 00/19:31:00 to 00/19:35:58

Plot file version 575 created 14-MAY-2010 15:20:19

J0920+44 EO007.UVDATA.1

Freq = 4.9270 GHz, Bw = 16.000 MH No calibration applied and no bandpass applied

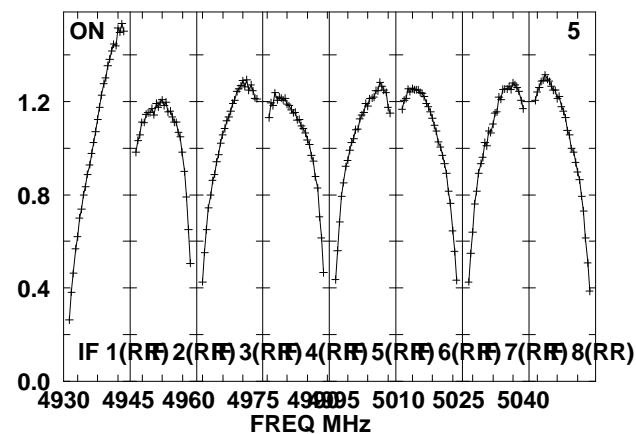
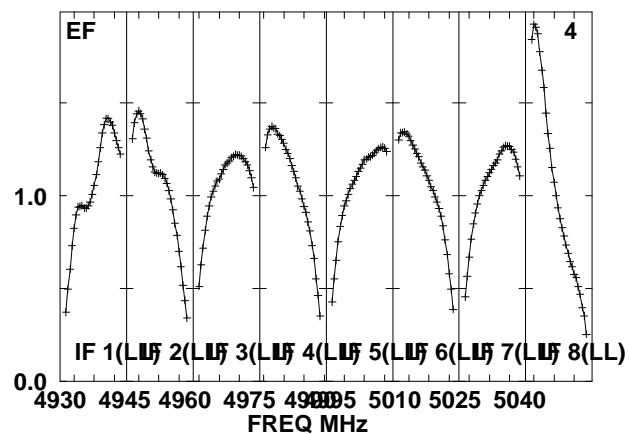
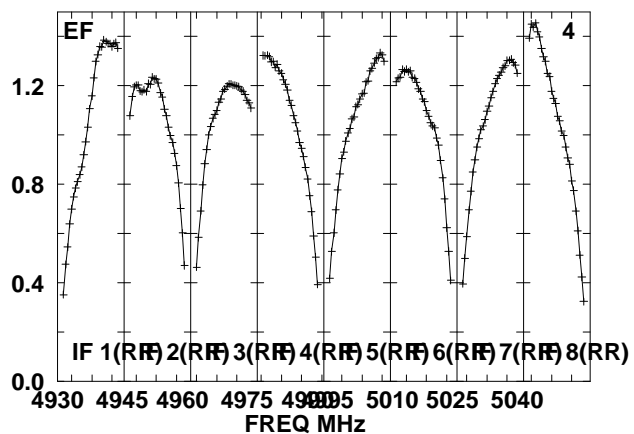
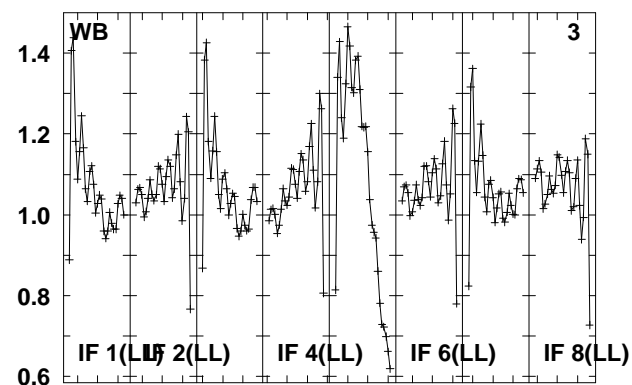
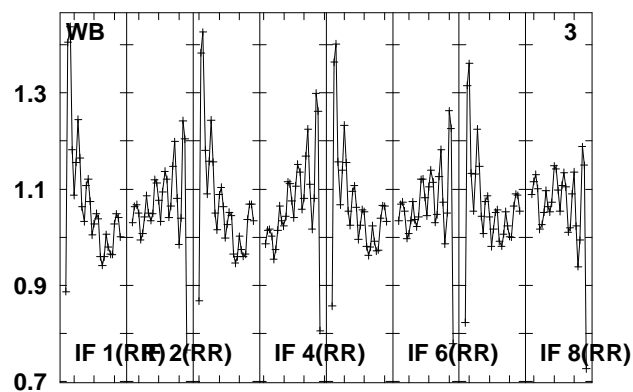
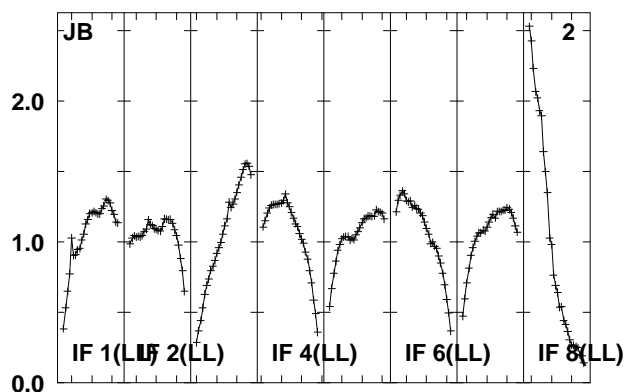
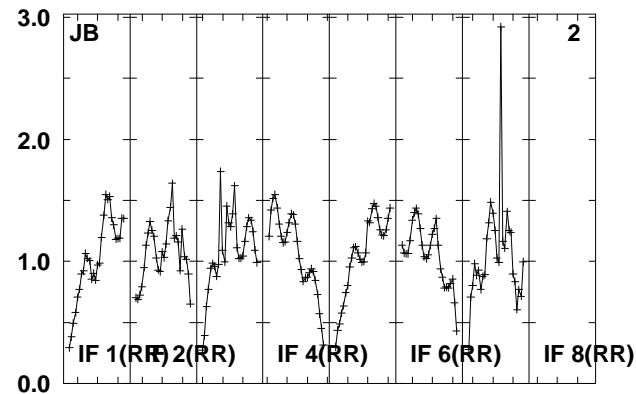
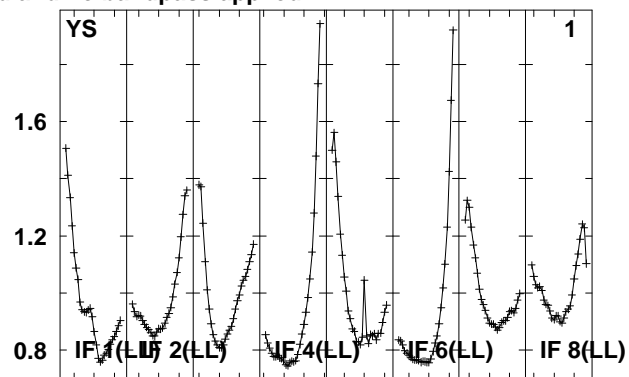
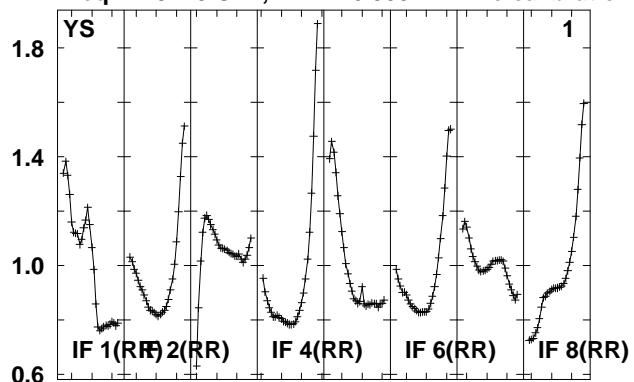

Lower frame: Real Jy
Total-power spectrum Antenna: *
Timerange: 00/19:36:59 to 00/19:38:27

Plot file version 576 created 14-MAY-2010 15:20:20

J0920+44 EO007.UVDATA.1

Freq = 4.9270 GHz, Bw = 16.000 MH No calibration applied and no bandpass applied

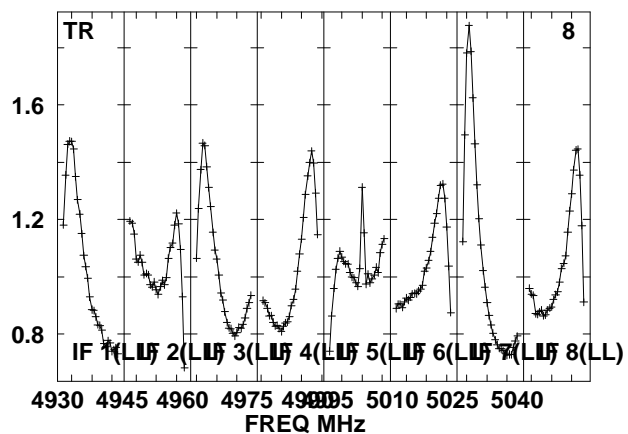
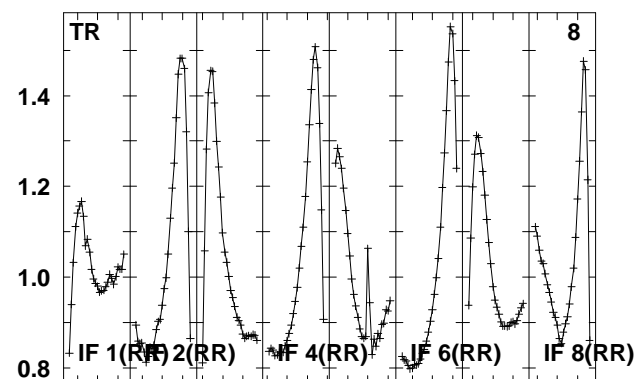
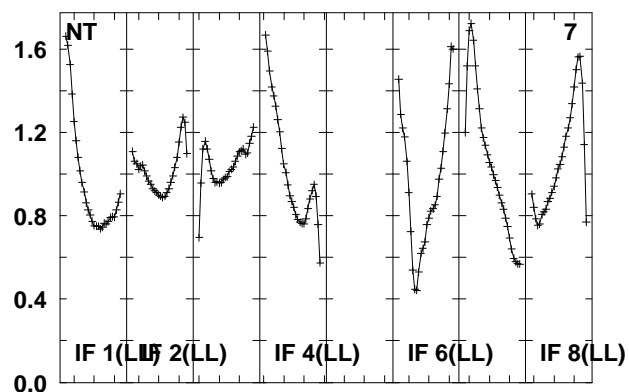
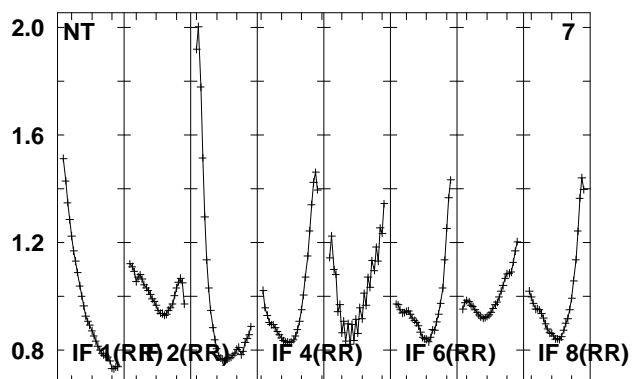
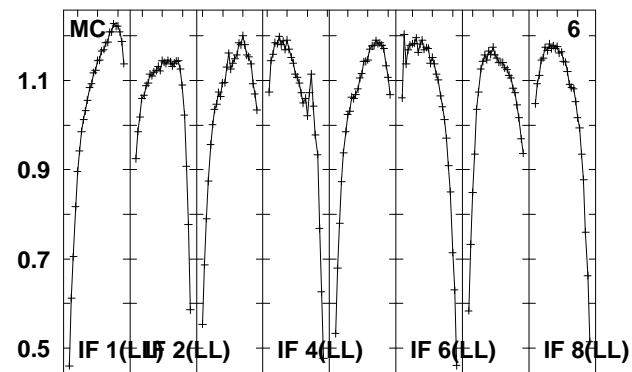
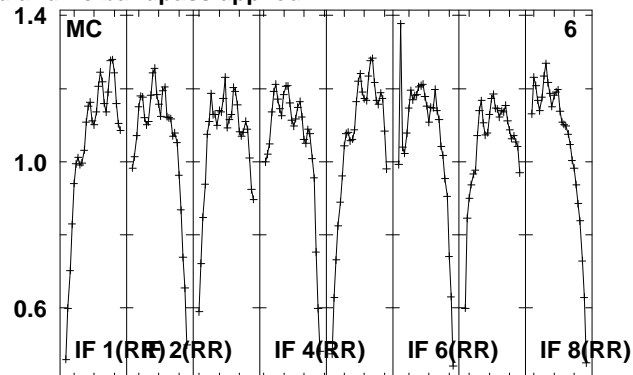
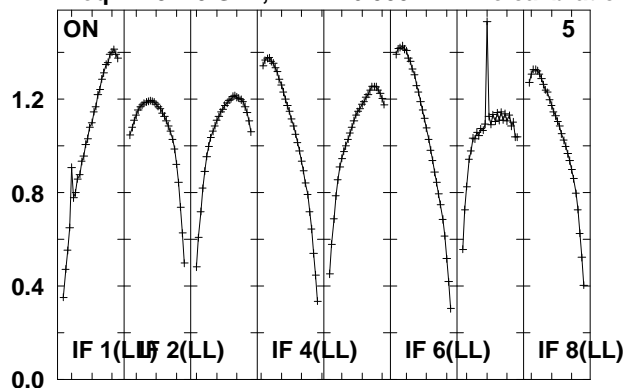

Lower frame: Real Jy

Total-power spectrum Antenna: *

Timerange: 00/19:36:59 to 00/19:38:27

Plot file version 577 created 14-MAY-2010 15:20:20
 J092159 EO007.UVDATA.1
 Freq = 4.9270 GHz, Bw = 16.000 MH No calibration applied and no bandpass applied

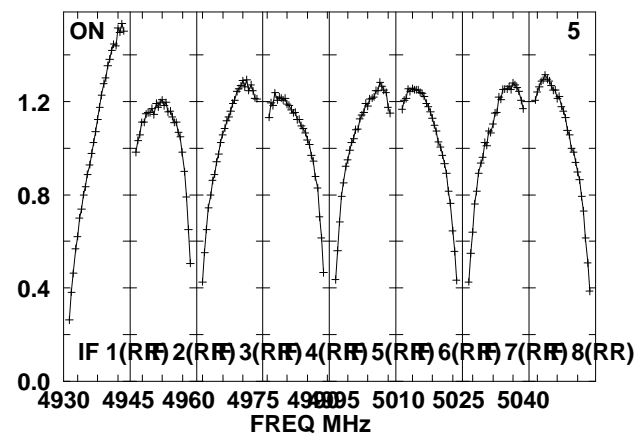
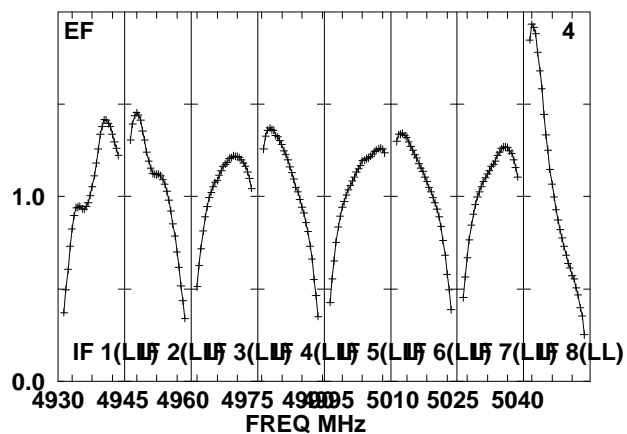
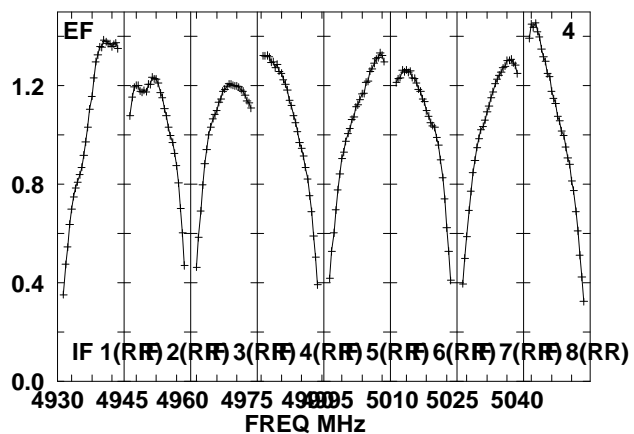
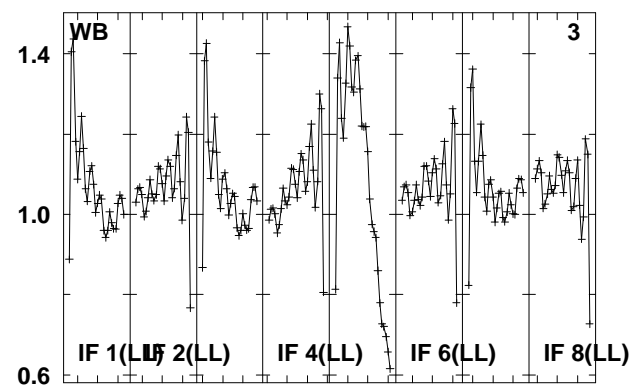
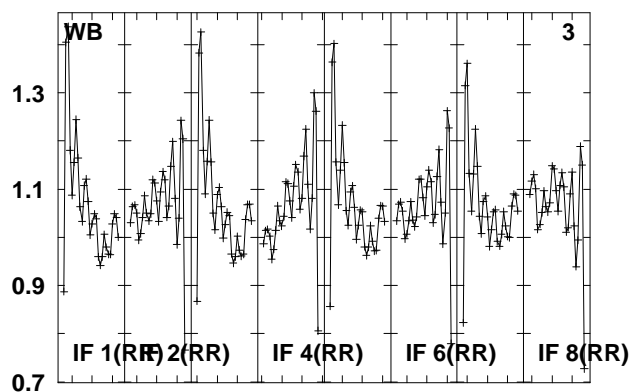
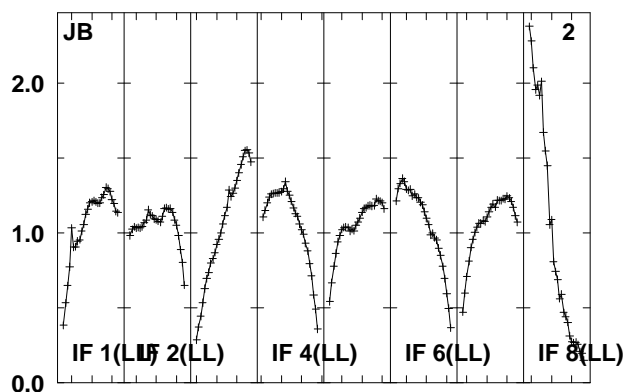
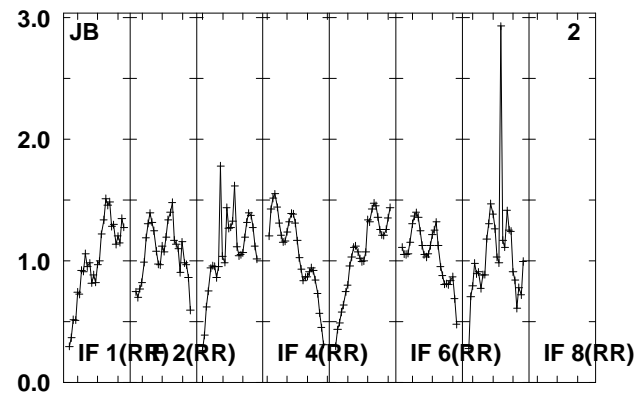
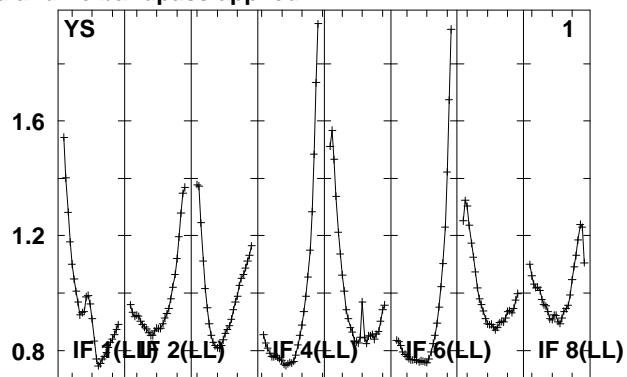
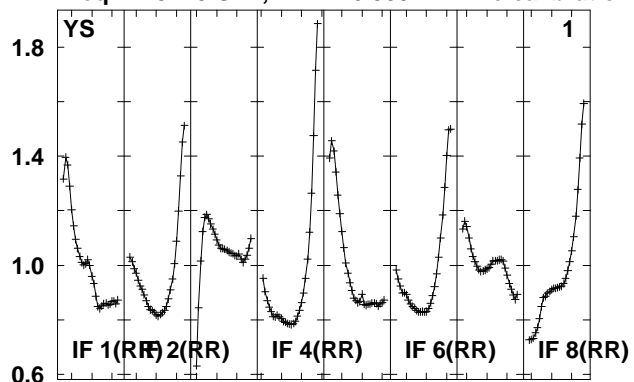

Lower frame: Real Jy
 Total-power spectrum Antenna: *
 Timerange: 00/19:38:56 to 00/19:43:54

Plot file version 578 created 14-MAY-2010 15:20:20

J092159 EO007.UVDATA.1

Freq = 4.9270 GHz, Bw = 16.000 MH No calibration applied and no bandpass applied

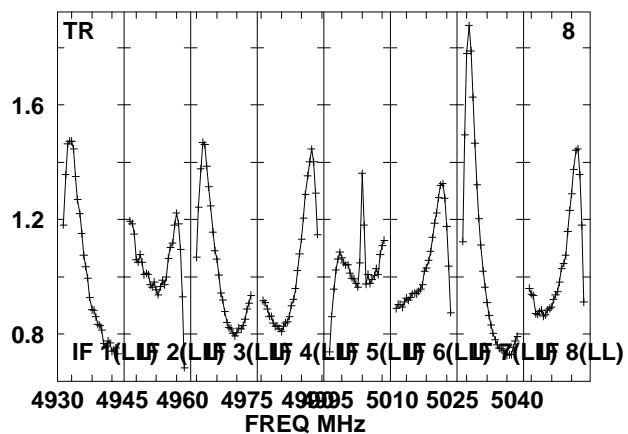
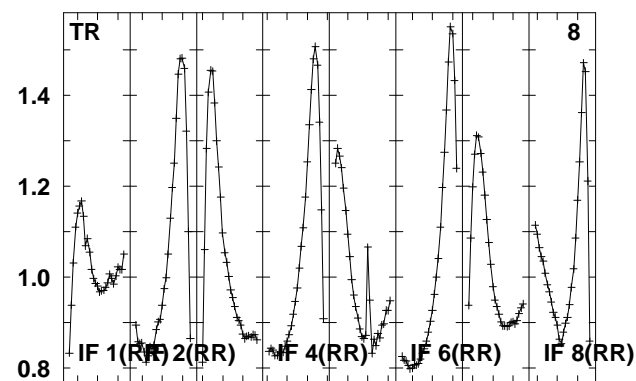
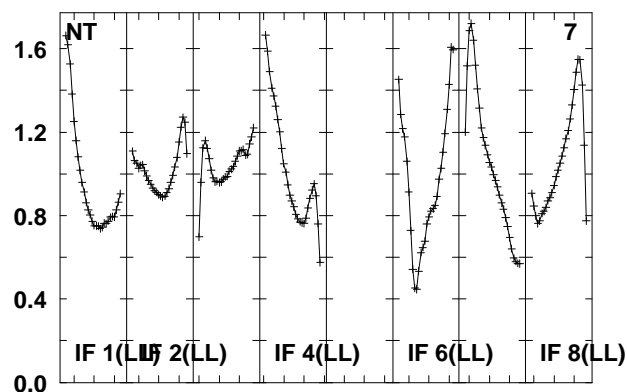
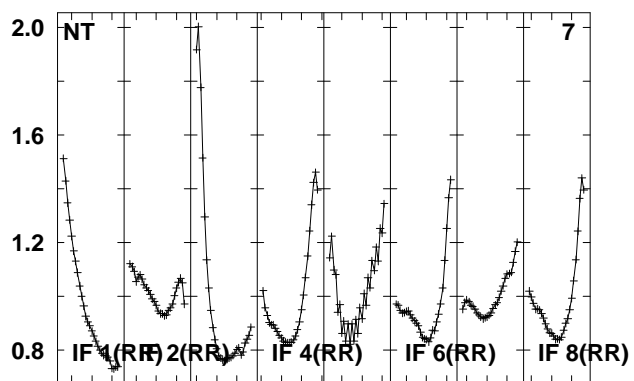
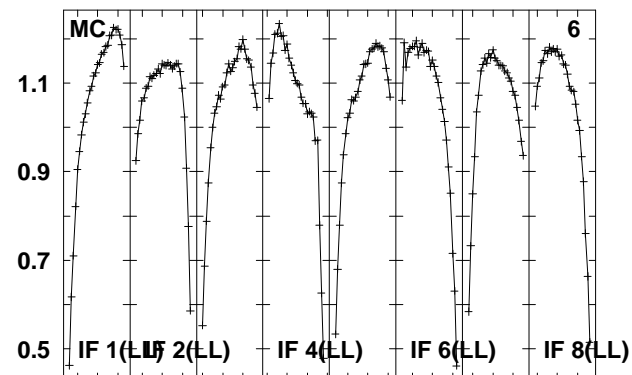
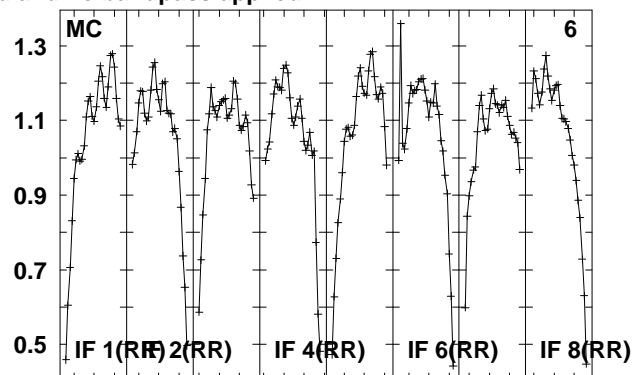
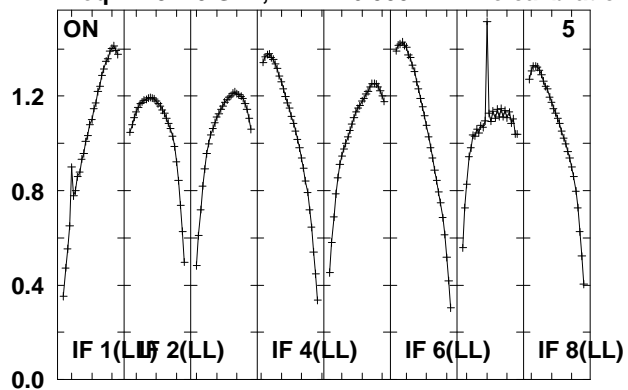

Lower frame: Real Jy

Total-power spectrum Antenna: *

Timerange: 00/19:38:56 to 00/19:43:54

Plot file version 579 created 14-MAY-2010 15:20:21

J0920+44 EO007.UVDATA.1

Freq = 4.9270 GHz, Bw = 16.000 MH No calibration applied and no bandpass applied

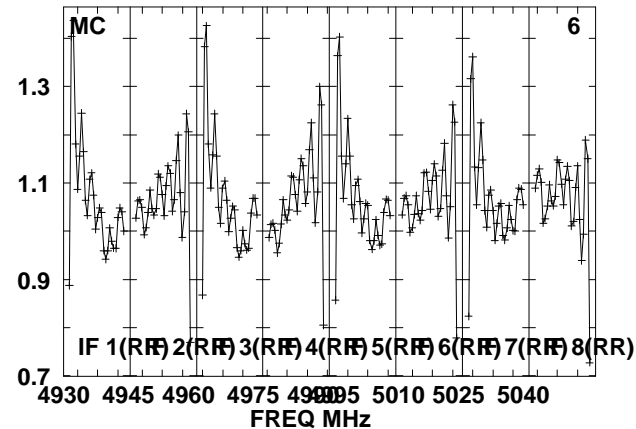
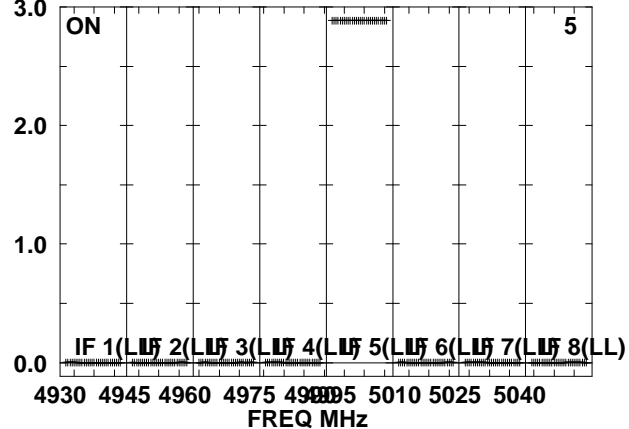
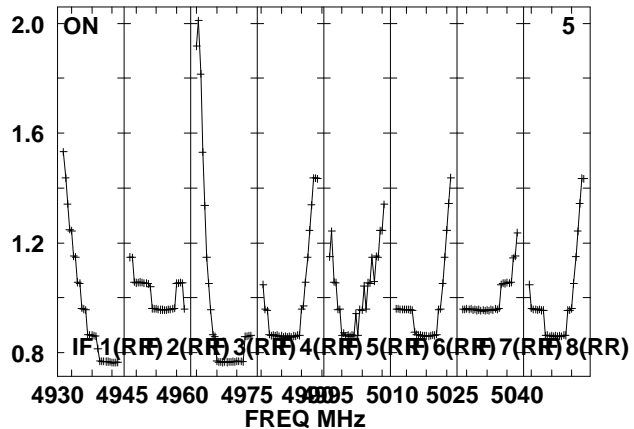
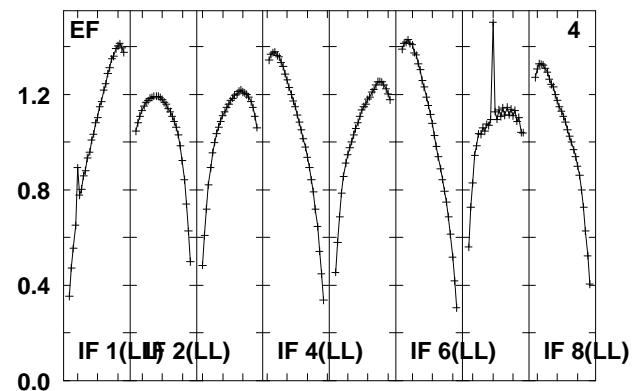
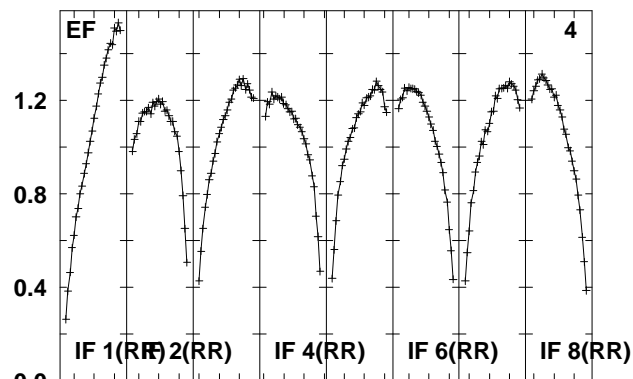
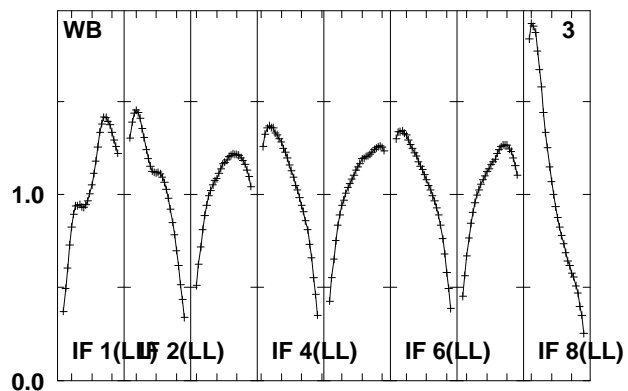
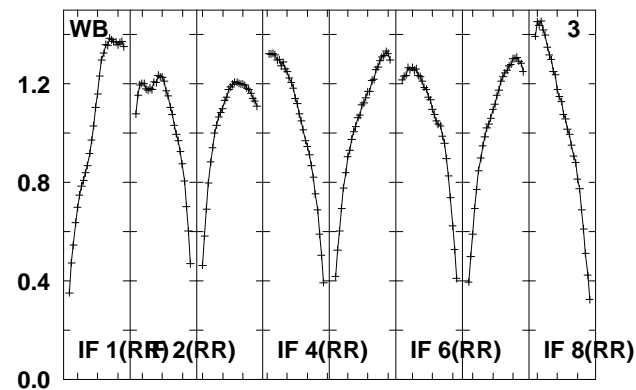
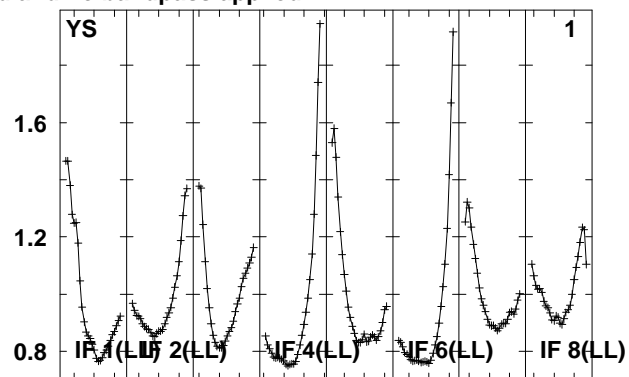
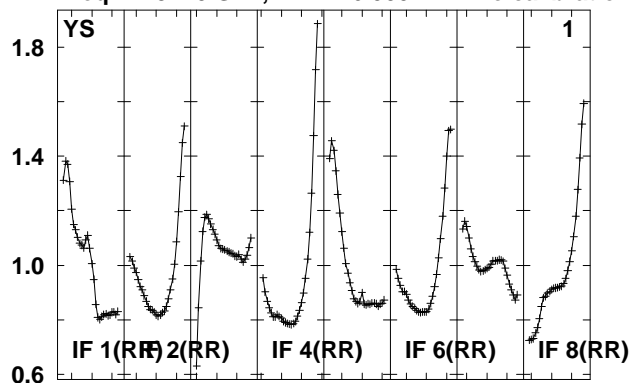

Lower frame: Real Jy

Total-power spectrum Antenna: *

Timerange: 00/19:44:26 to 00/19:45:52

Plot file version 580 created 14-MAY-2010 15:20:21

J0920+44 EO007.UVDATA.1

Freq = 4.9270 GHz, Bw = 16.000 MH No calibration applied and no bandpass applied

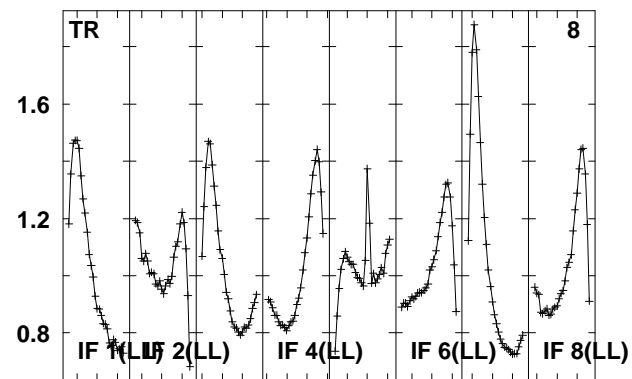
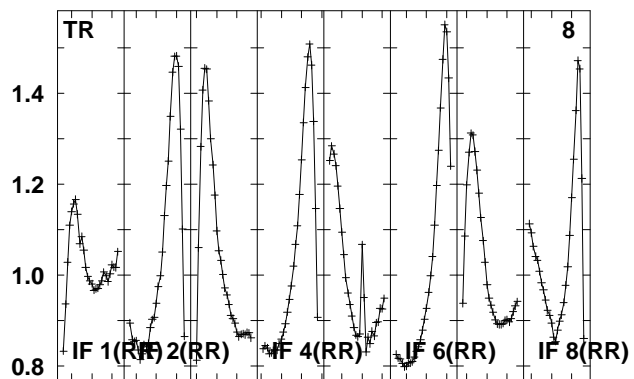
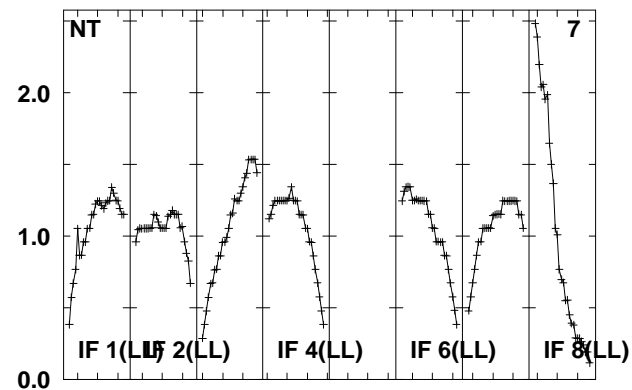
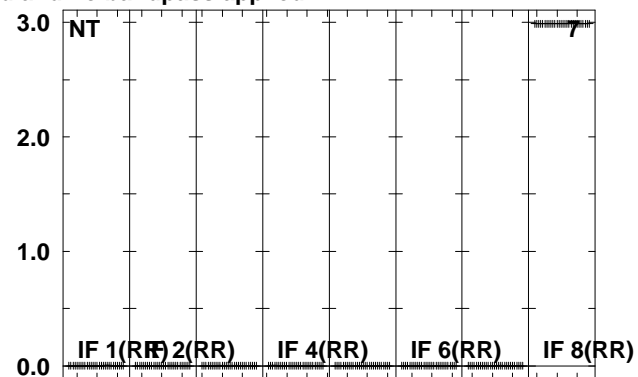
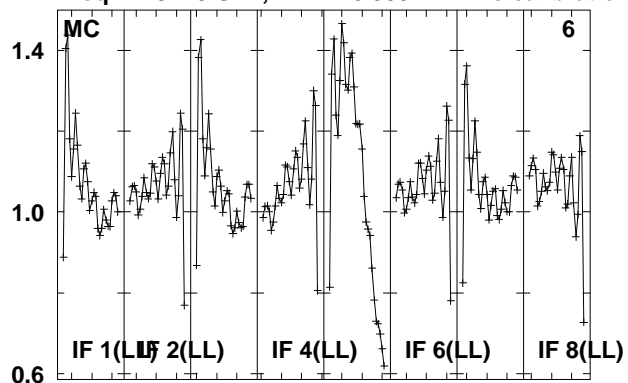

Lower frame: Real Jy
Total-power spectrum Antenna: *
Timerange: 00/19:44:26 to 00/19:45:52

Plot file version 581 created 14-MAY-2010 15:20:21
 J092159 EO007.UVDATA.1
 Freq = 4.9270 GHz, Bw = 16.000 MH No calibration applied and no bandpass applied

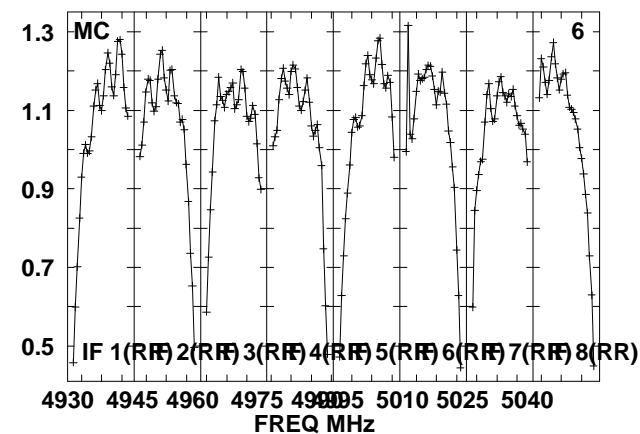
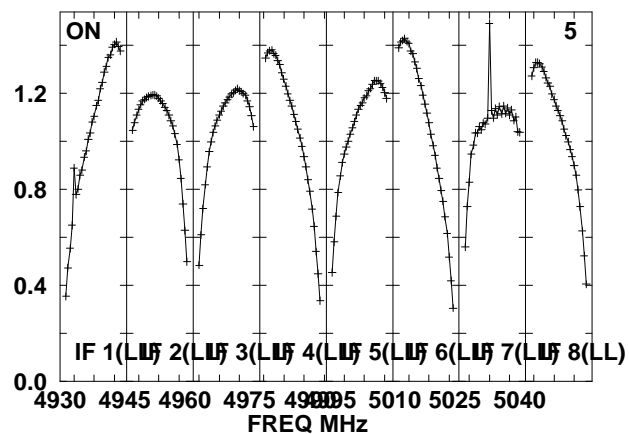
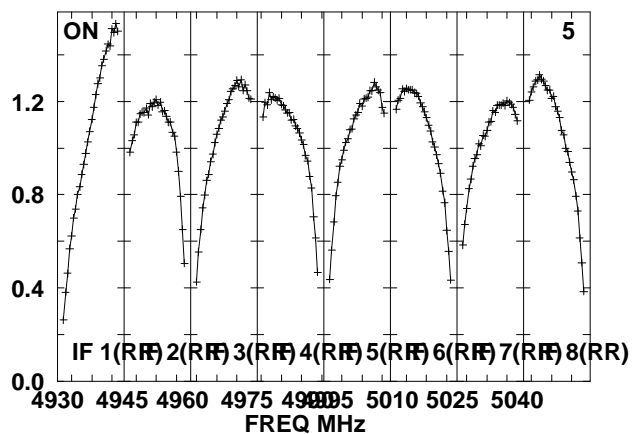
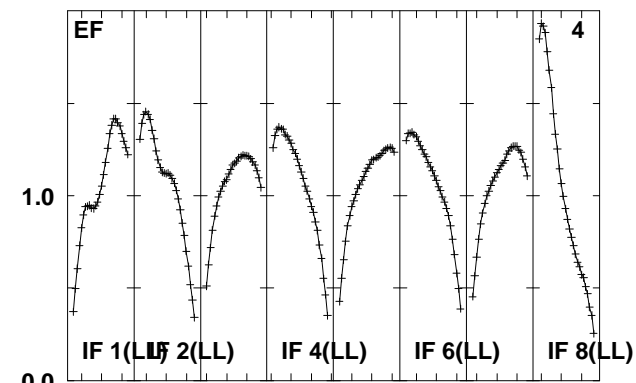
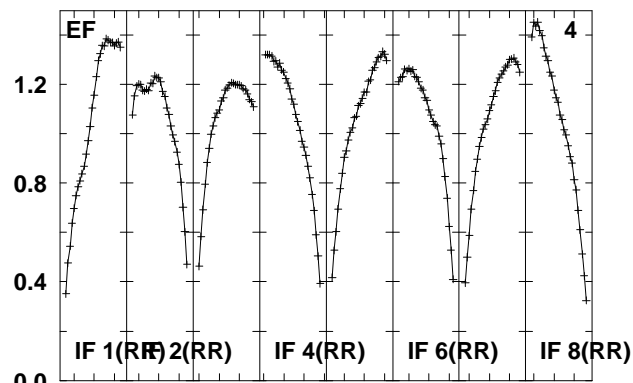
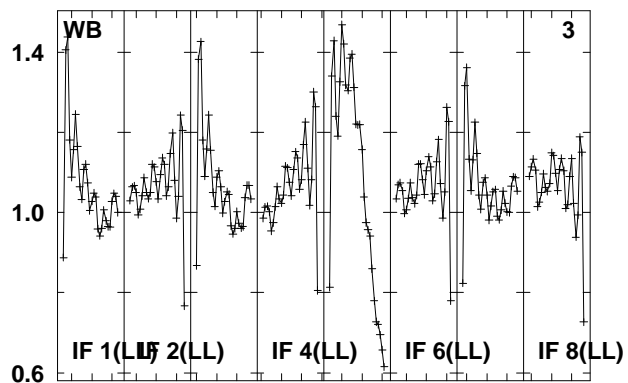
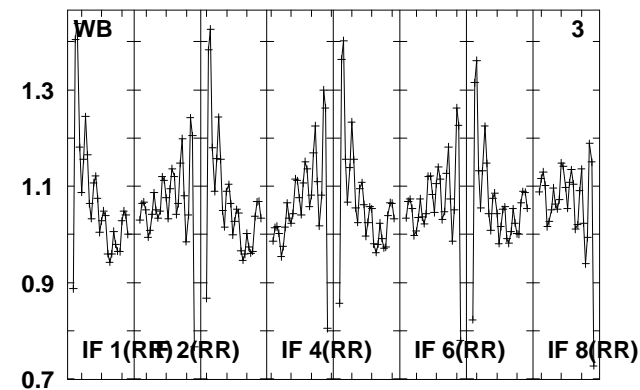
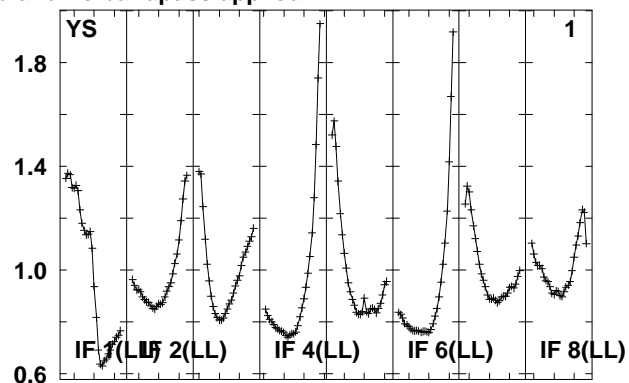
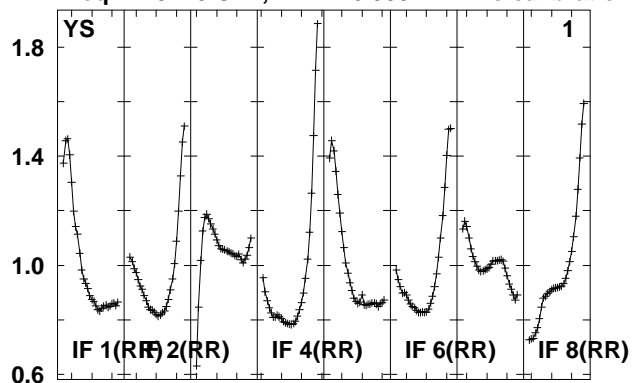

Lower frame: Real Jy
 Total-power spectrum Antenna: *
 Timerange: 00/19:46:24 to 00/19:51:20

Plot file version 582 created 14-MAY-2010 15:20:22

J092159 EO007.UVDATA.1

Freq = 4.9270 GHz, Bw = 16.000 MH No calibration applied and no bandpass applied

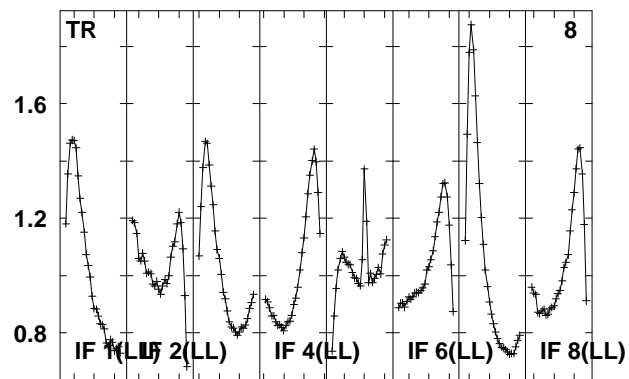
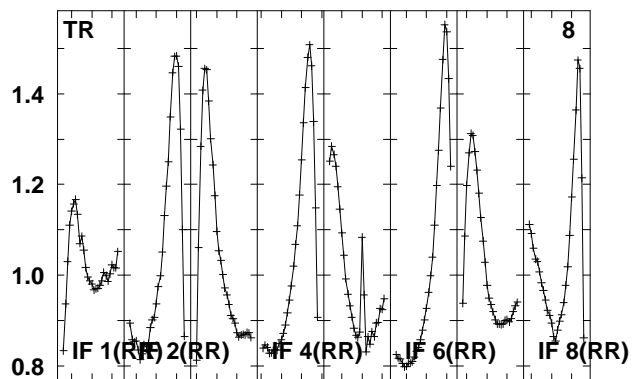
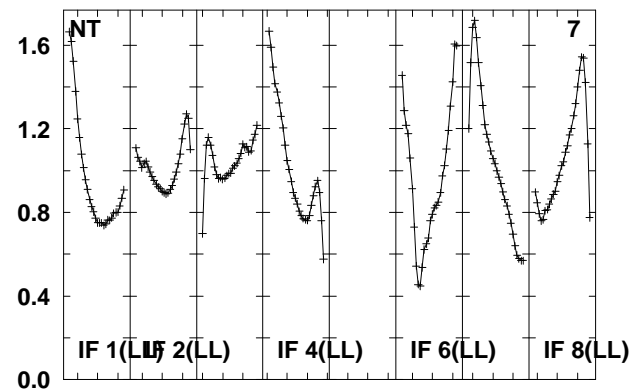
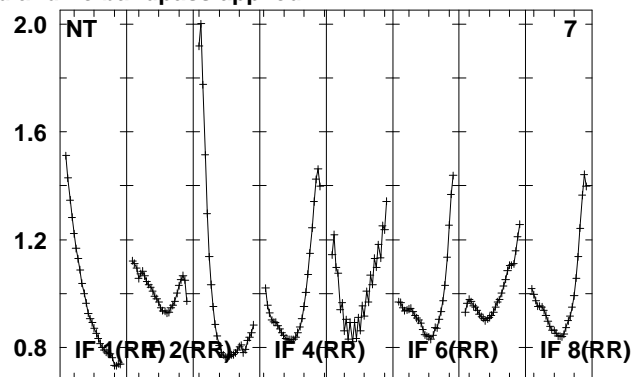
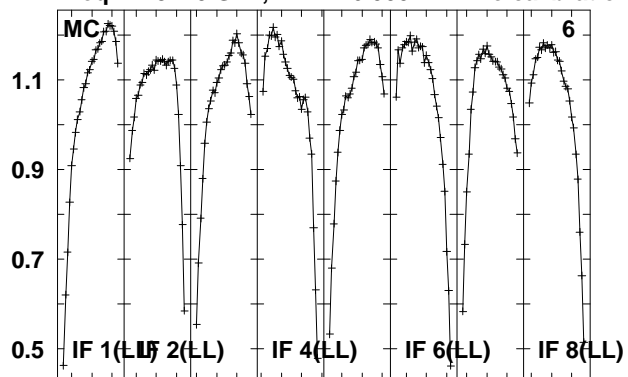

Lower frame: Real Jy
Total-power spectrum Antenna: *
Timerange: 00/19:46:24 to 00/19:51:20

Plot file version 583 created 14-MAY-2010 15:20:22

J0920+44 EO007.UVDATA.1

Freq = 4.9270 GHz, Bw = 16.000 MH No calibration applied and no bandpass applied

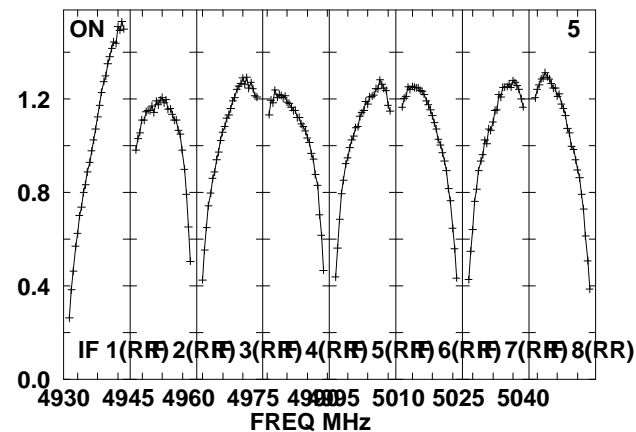
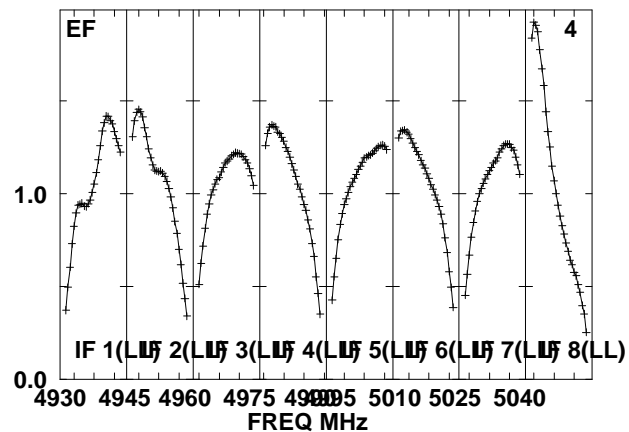
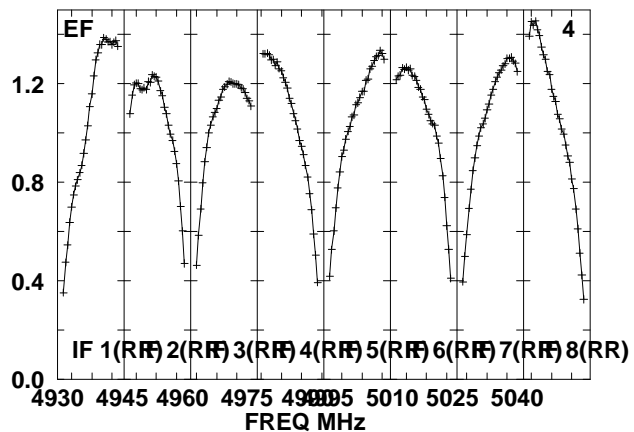
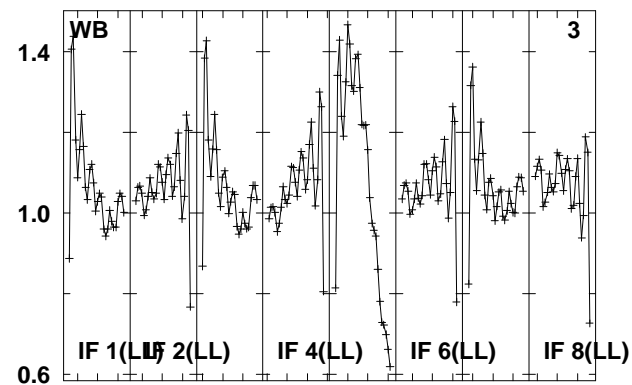
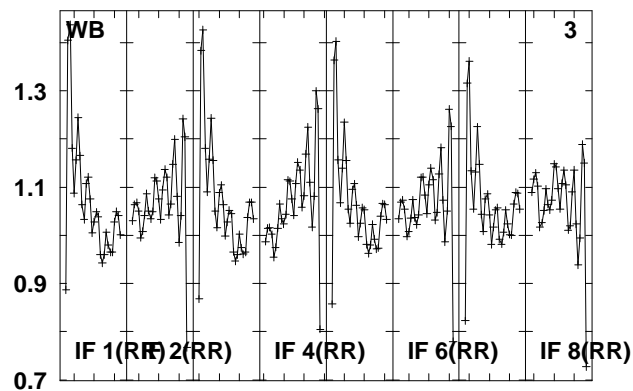
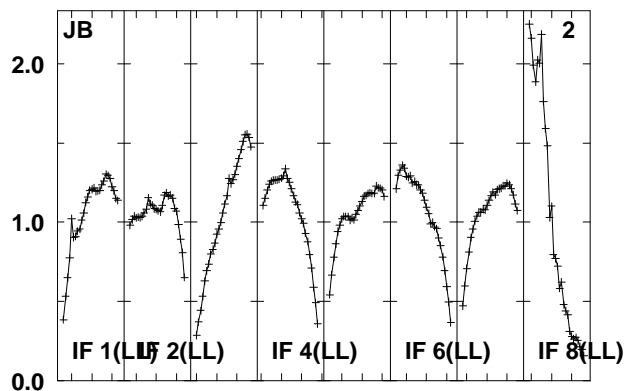
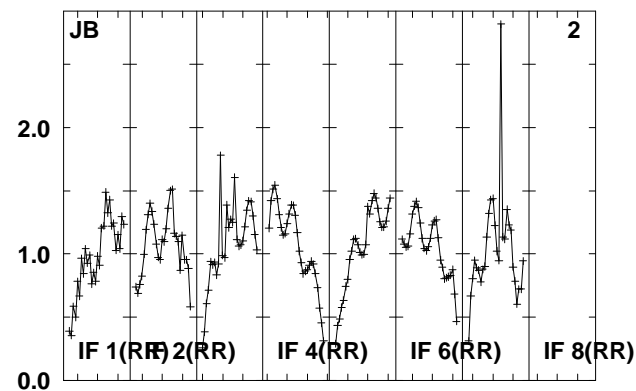
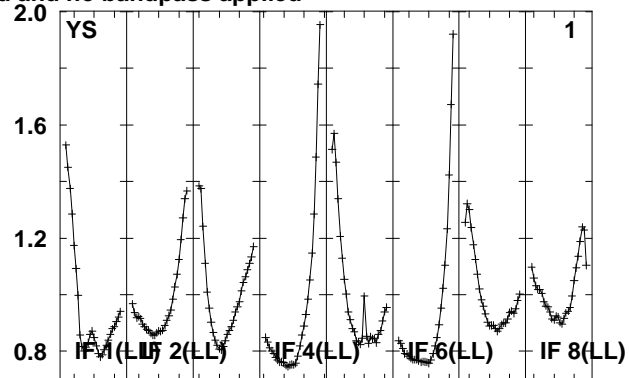
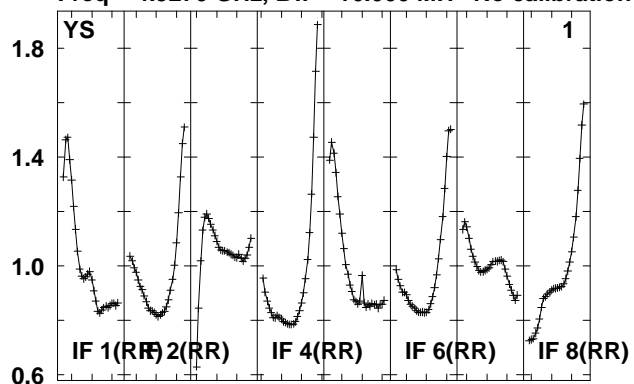

Lower frame: Real Jy

Total-power spectrum Antenna: *

Timerange: 00/19:51:54 to 00/19:53:22

Plot file version 584 created 14-MAY-2010 15:20:22

J0920+44 EO007.UVDATA.1

Freq = 4.9270 GHz, Bw = 16.000 MH No calibration applied and no bandpass applied

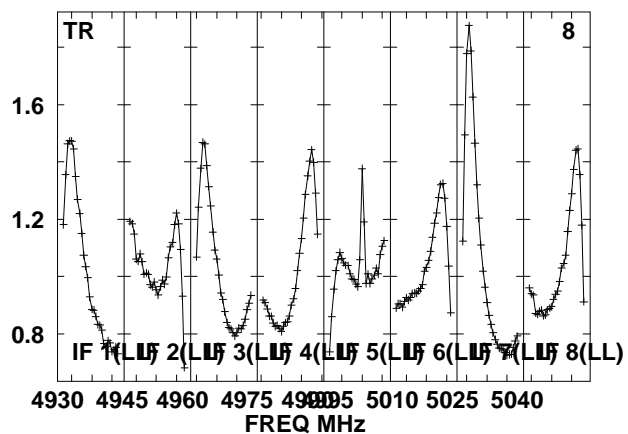
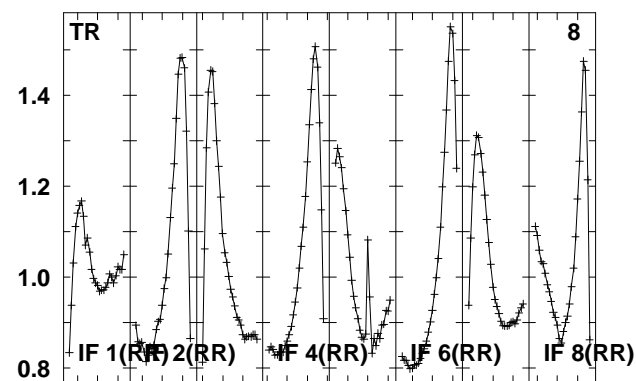
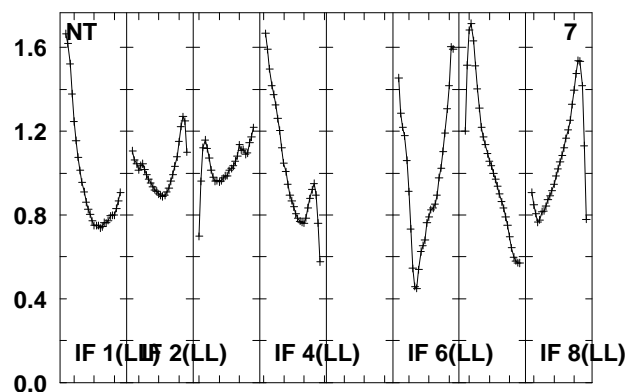
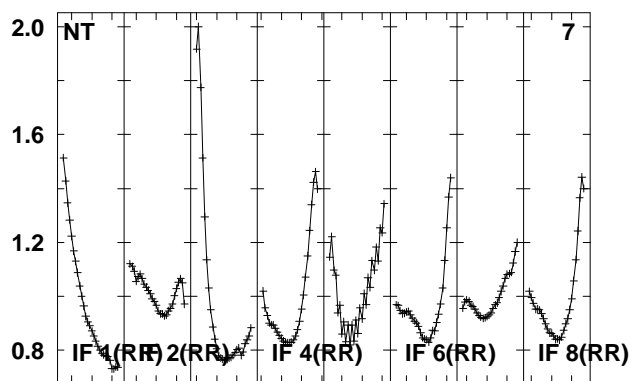
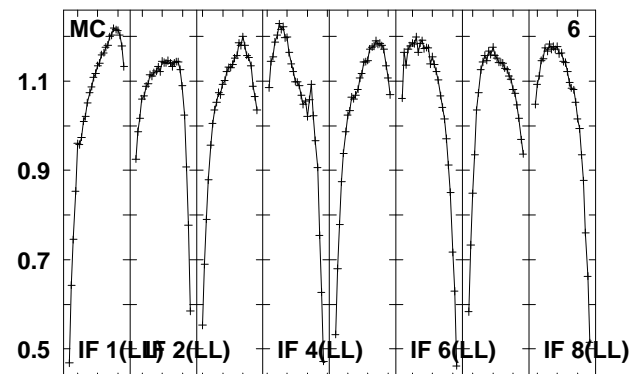
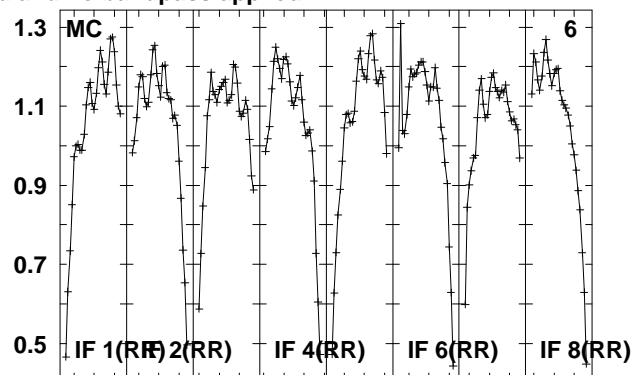
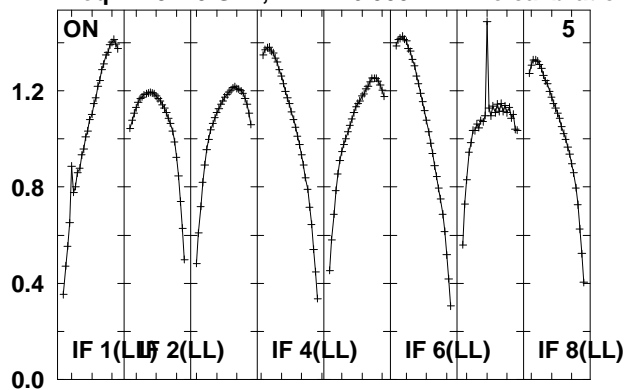

Lower frame: Real Jy

Total-power spectrum Antenna: *

Timerange: 00/19:51:54 to 00/19:53:22

Plot file version 585 created 14-MAY-2010 15:20:23

J1027+48 EO007.UVDATA.1

Freq = 4.9270 GHz, Bw = 16.000 MH No calibration applied and no bandpass applied

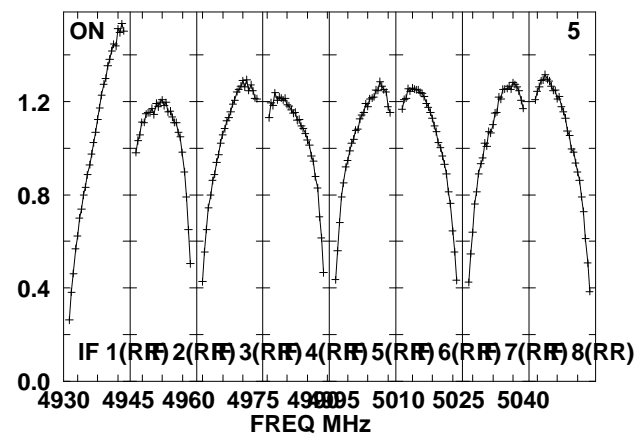
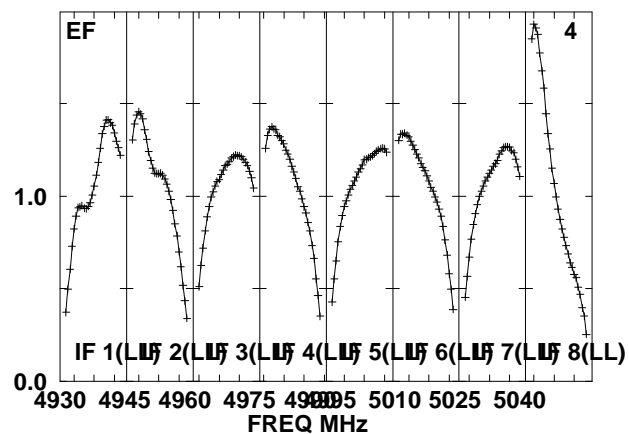
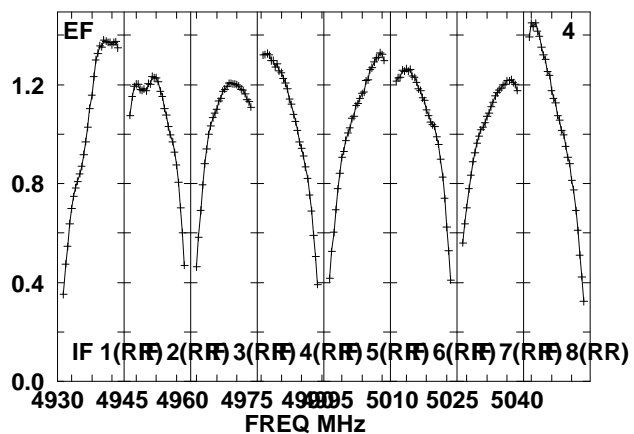
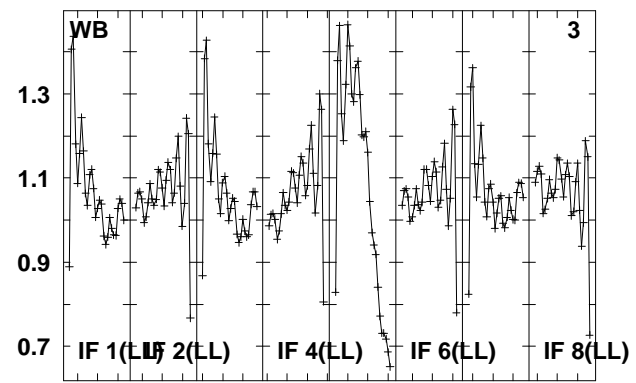
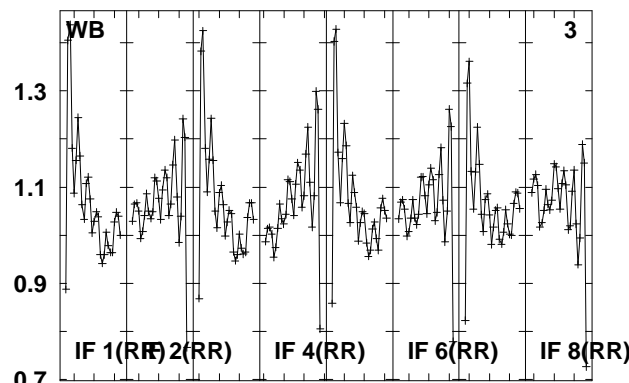
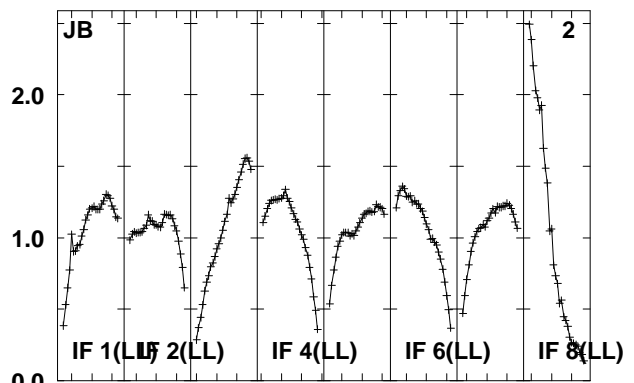
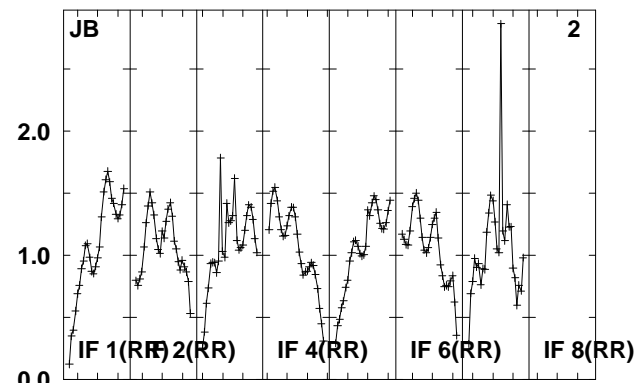
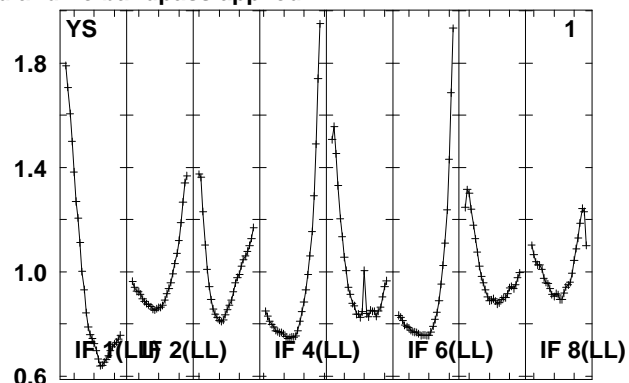
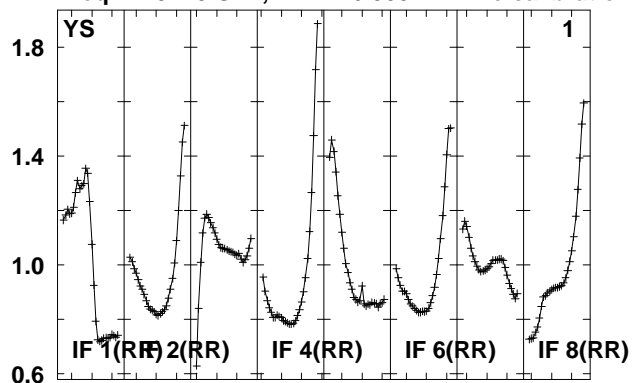

Lower frame: Real Jy
Total-power spectrum Antenna: *
Timerange: 00/19:55:20 to 00/19:56:46

Plot file version 586 created 14-MAY-2010 15:20:23

J1027+48 EO007.UVDATA.1

Freq = 4.9270 GHz, Bw = 16.000 MH No calibration applied and no bandpass applied

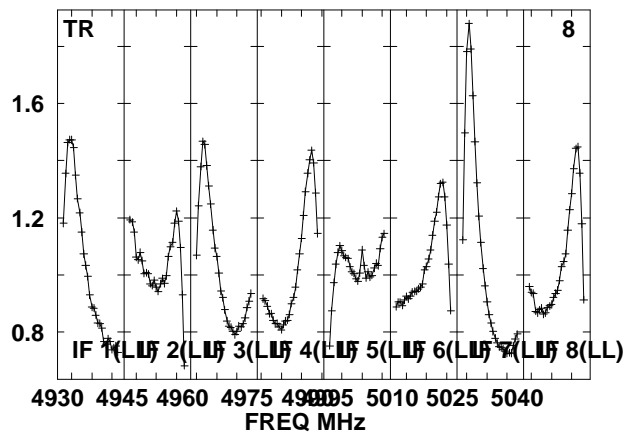
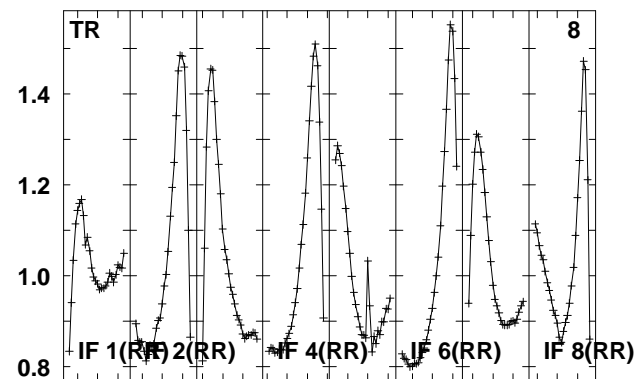
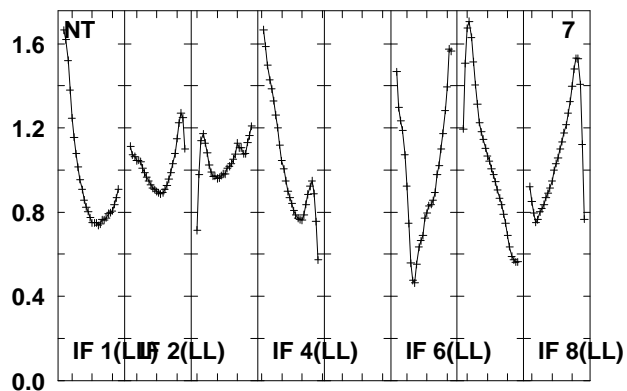
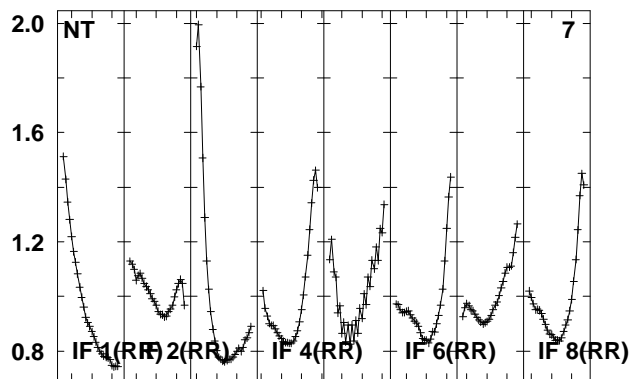
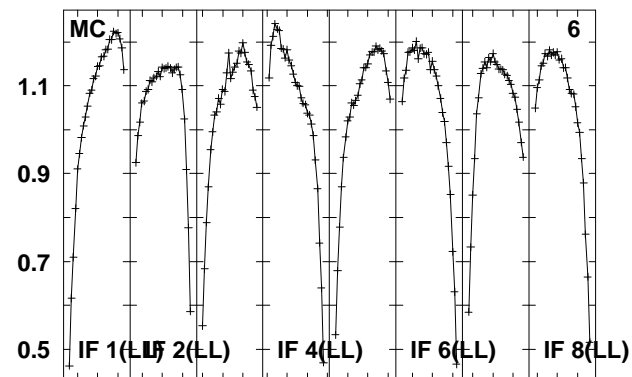
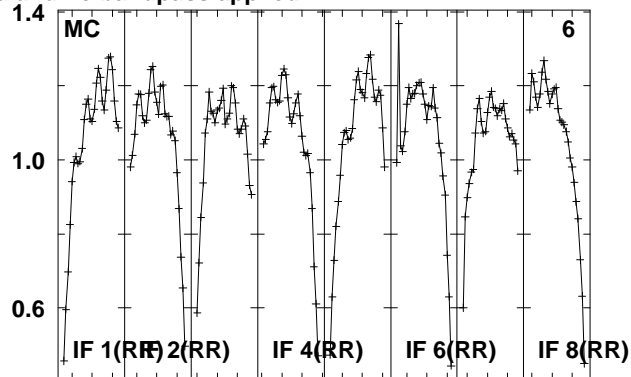
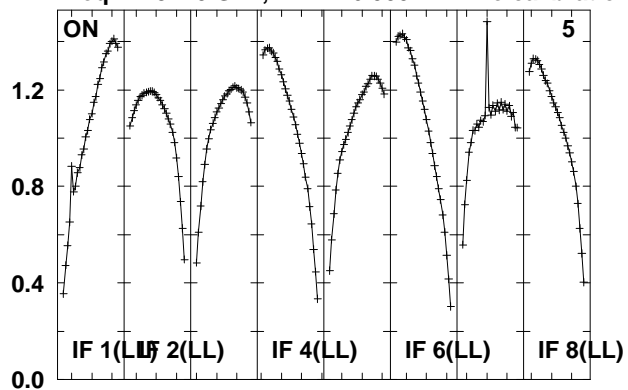

Lower frame: Real Jy

Total-power spectrum Antenna: *

Timerange: 00/19:55:20 to 00/19:56:46

Plot file version 587 created 14-MAY-2010 15:20:23

J102959 EO007.UVDATA.1

Freq = 4.9270 GHz, Bw = 16.000 MH No calibration applied and no bandpass applied

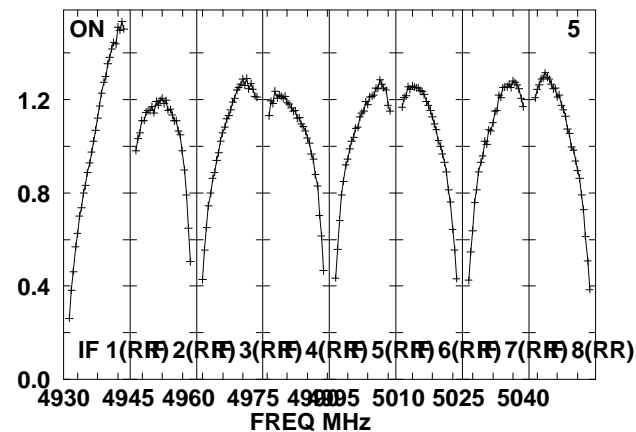
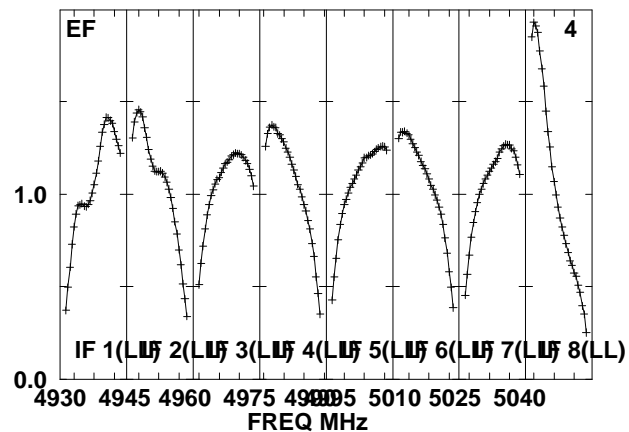
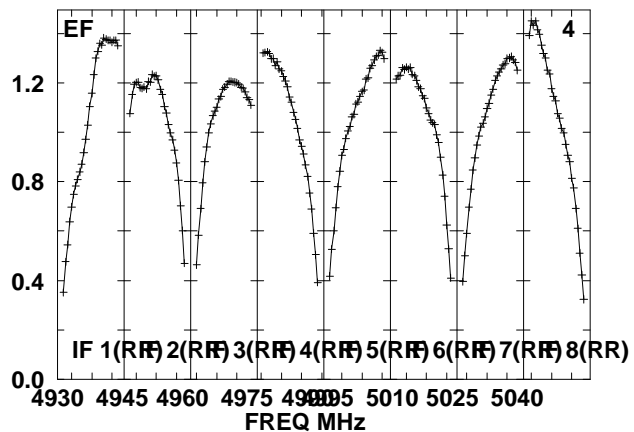
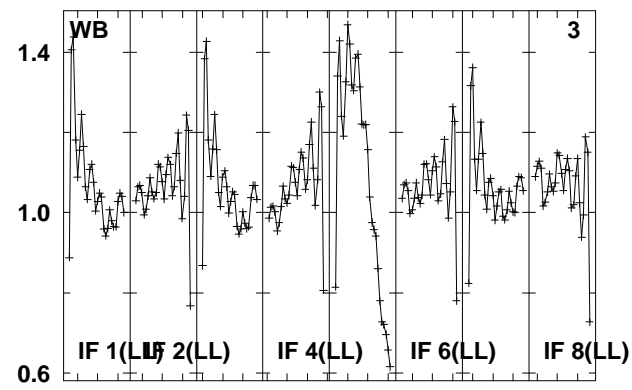
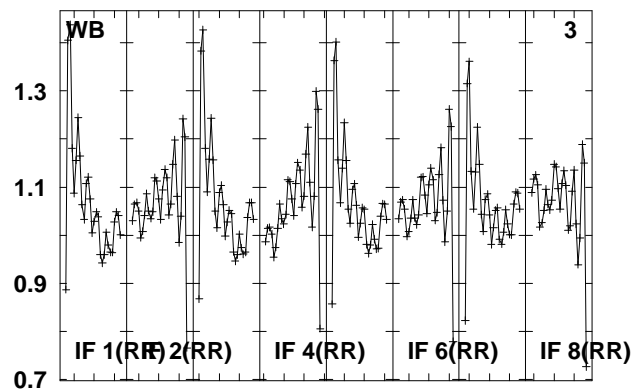
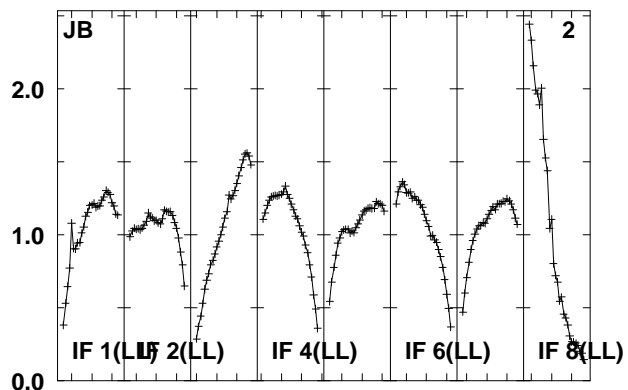
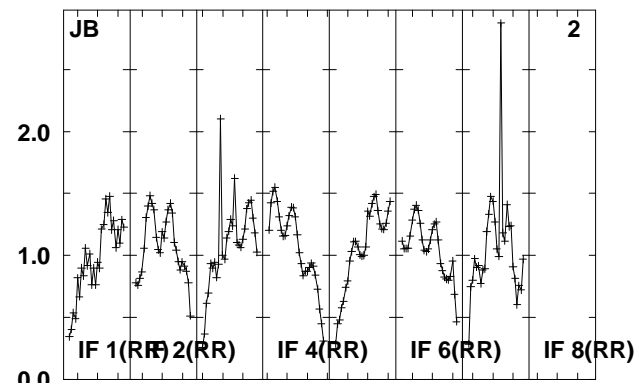
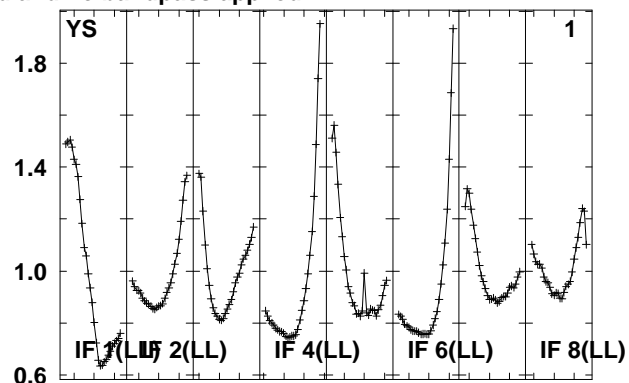
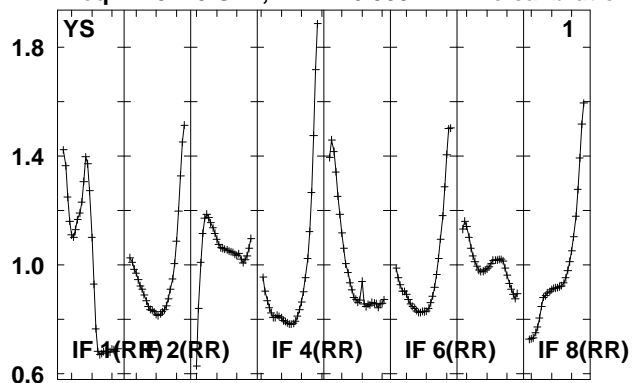

Lower frame: Real Jy

Total-power spectrum Antenna: *

Timerange: 00/19:57:16 to 00/20:02:14

Plot file version 588 created 14-MAY-2010 15:20:24

J102959 EO007.UVDATA.1

Freq = 4.9270 GHz, Bw = 16.000 MH No calibration applied and no bandpass applied

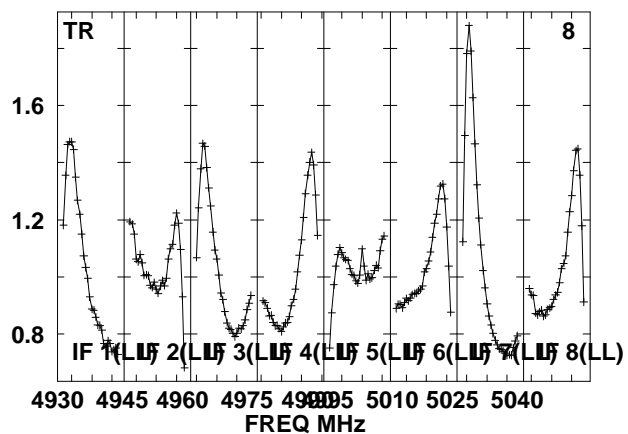
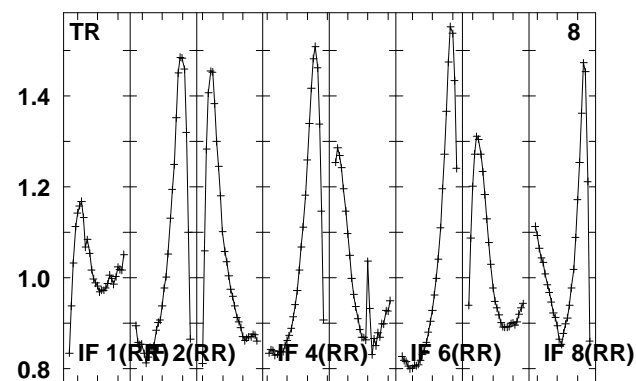
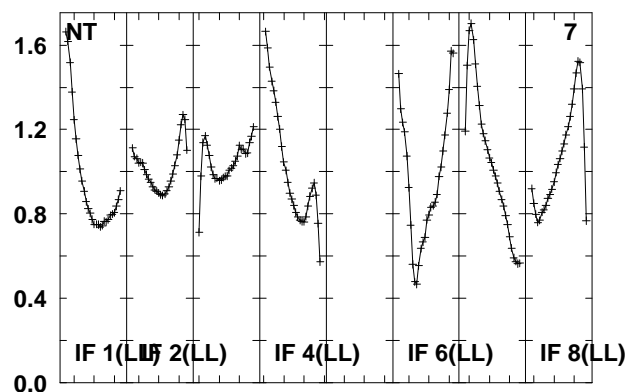
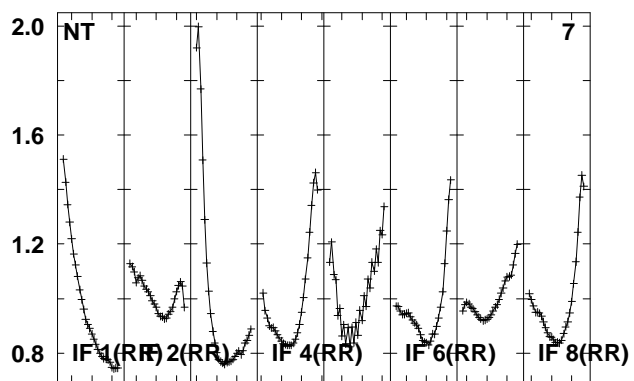
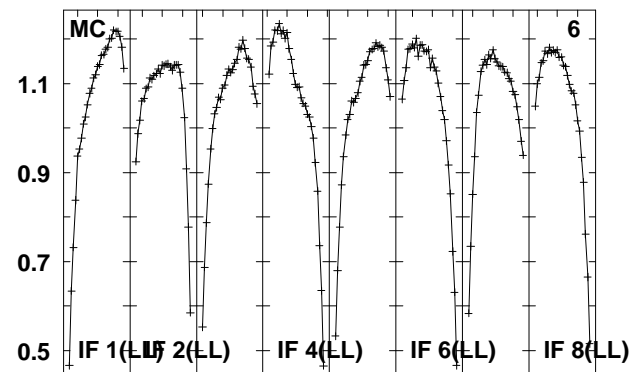
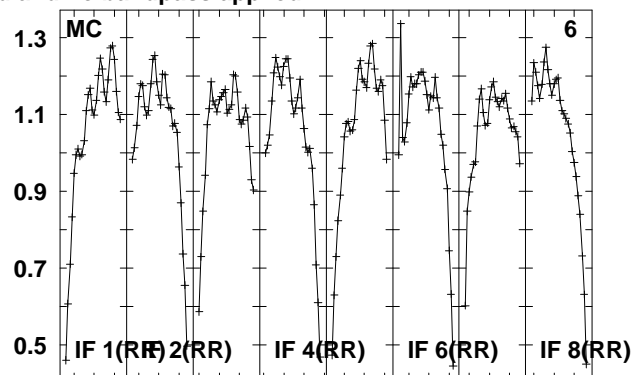
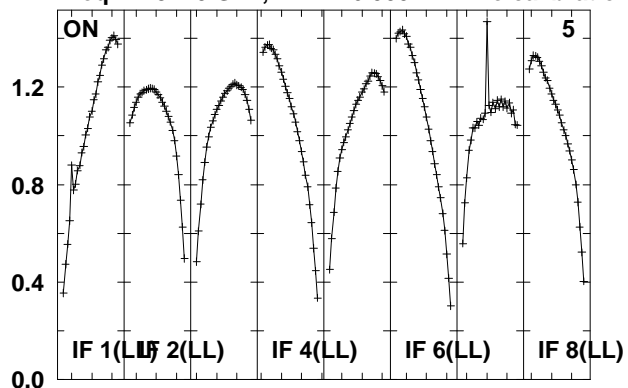

Lower frame: Real Jy

Total-power spectrum Antenna: *

Timerange: 00/19:57:16 to 00/20:02:14

Plot file version 589 created 14-MAY-2010 15:20:25

J1027+48 EO007.UVDATA.1

Freq = 4.9270 GHz, Bw = 16.000 MH No calibration applied and no bandpass applied

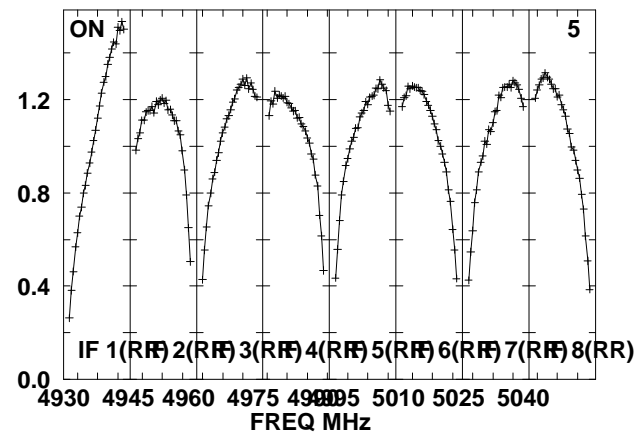
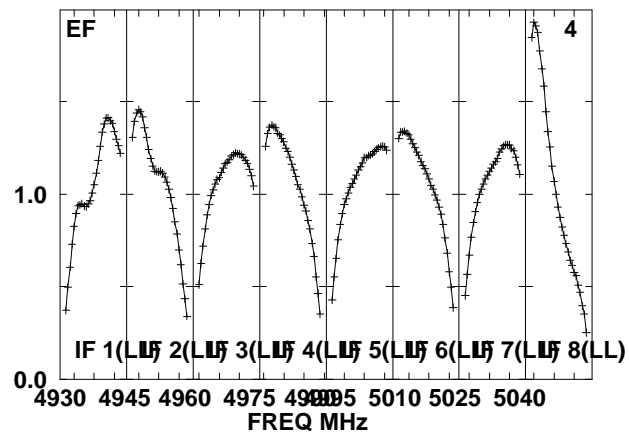
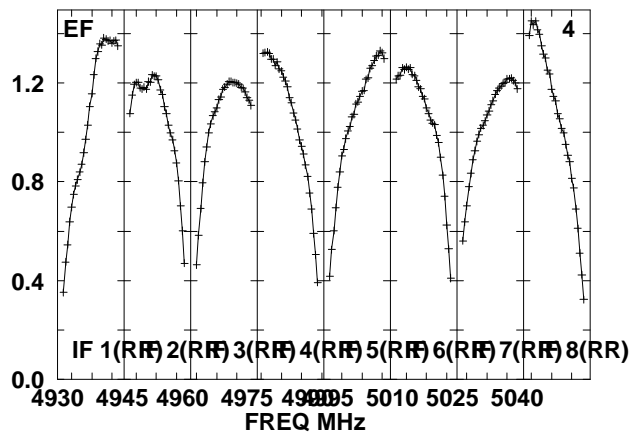
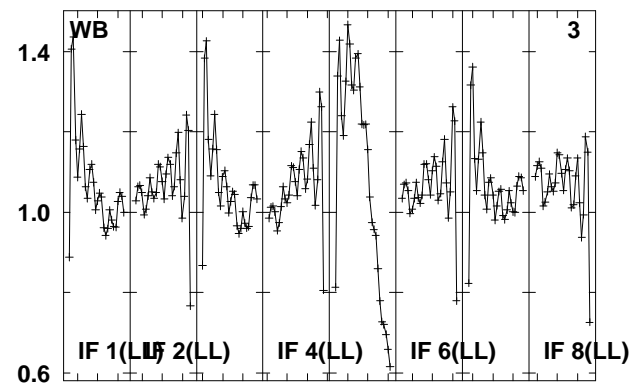
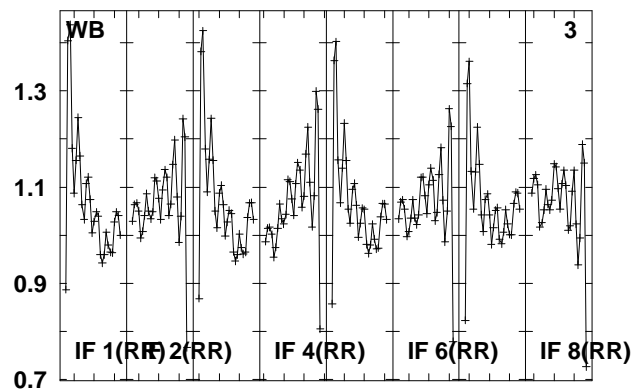
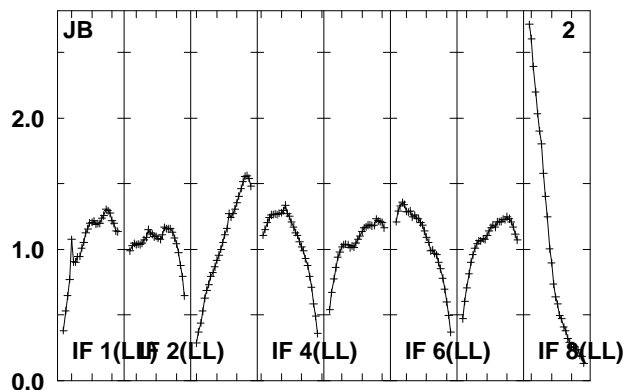
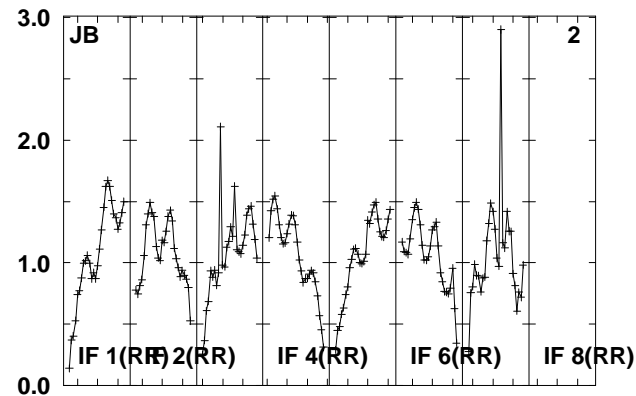
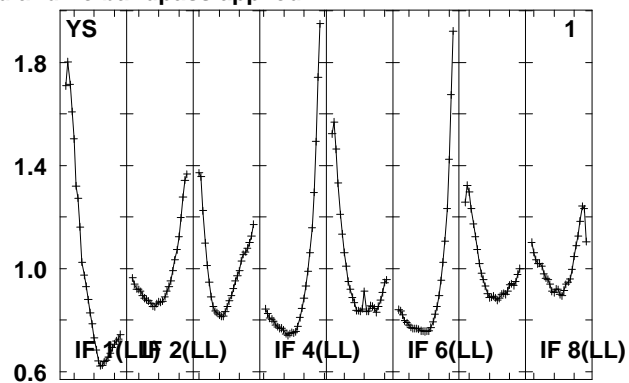
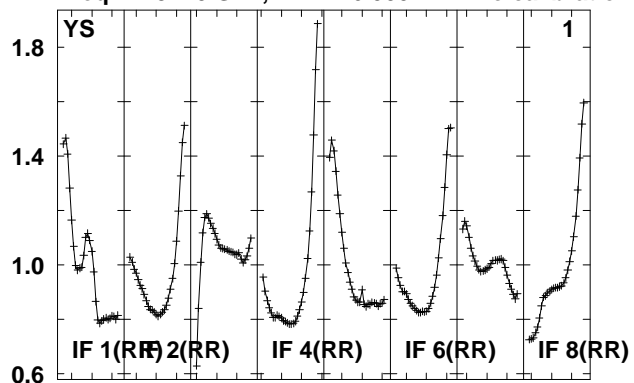

Lower frame: Real Jy
Total-power spectrum Antenna: *
Timerange: 00/20:02:43 to 00/20:04:09

Plot file version 590 created 14-MAY-2010 15:20:25

J1027+48 EO007.UVDATA.1

Freq = 4.9270 GHz, Bw = 16.000 MH No calibration applied and no bandpass applied

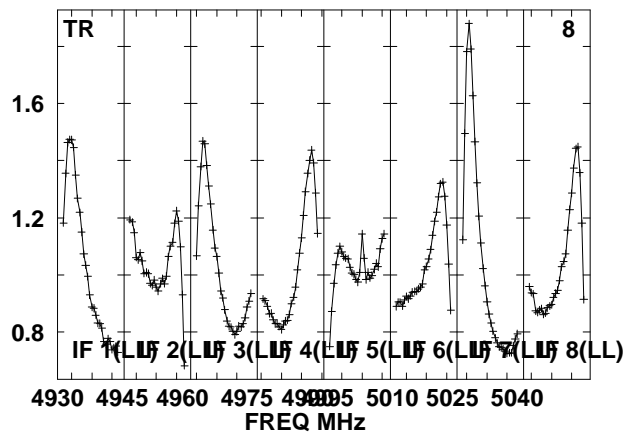
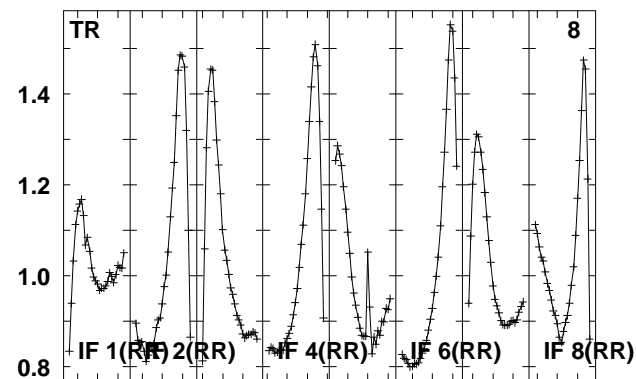
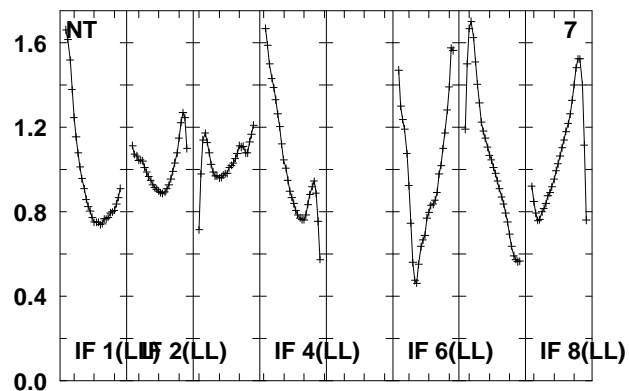
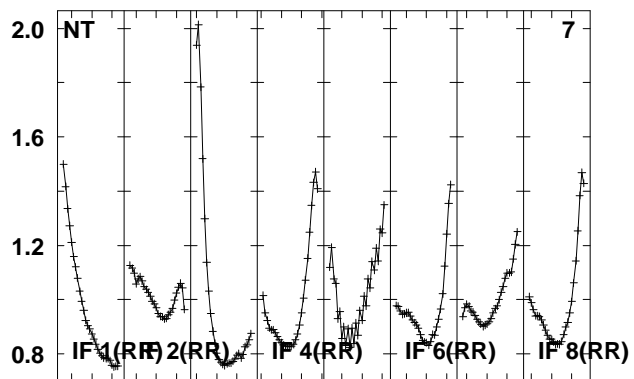
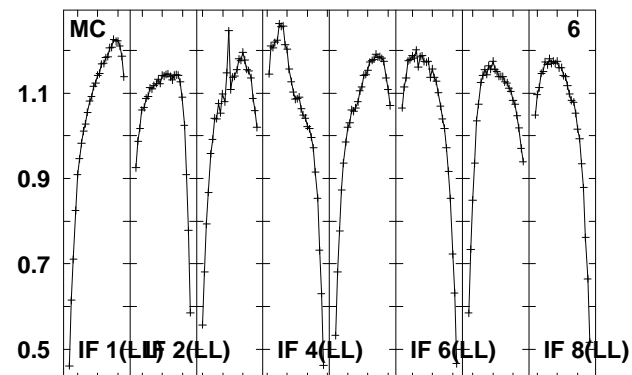
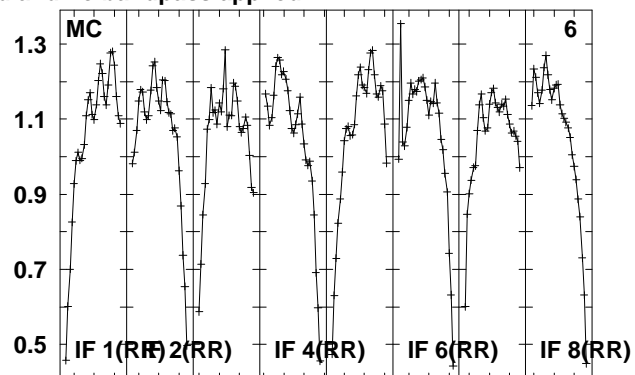
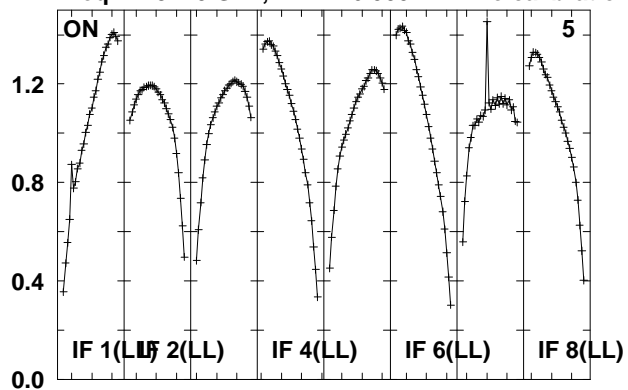

Lower frame: Real Jy

Total-power spectrum Antenna: *

Timerange: 00/20:02:43 to 00/20:04:09

Plot file version 591 created 14-MAY-2010 15:20:25

J102959 EO007.UVDATA.1

Freq = 4.9270 GHz, Bw = 16.000 MH No calibration applied and no bandpass applied

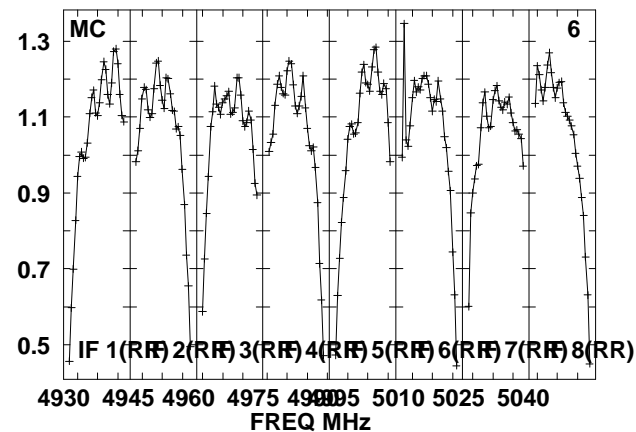
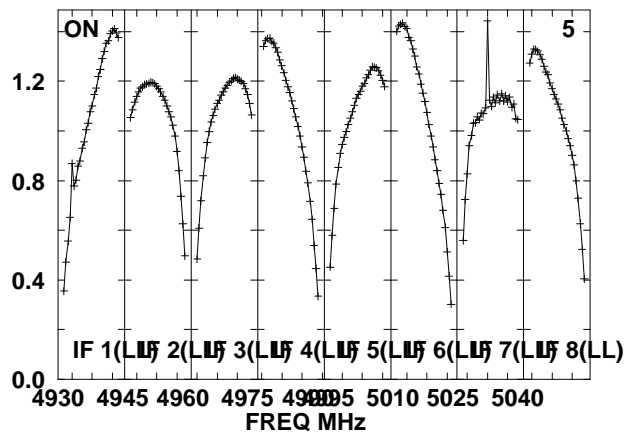
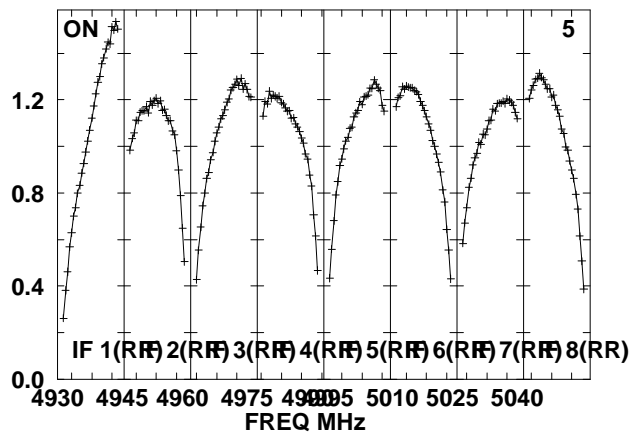
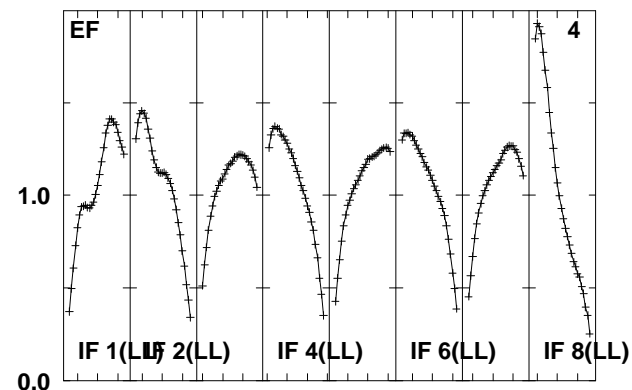
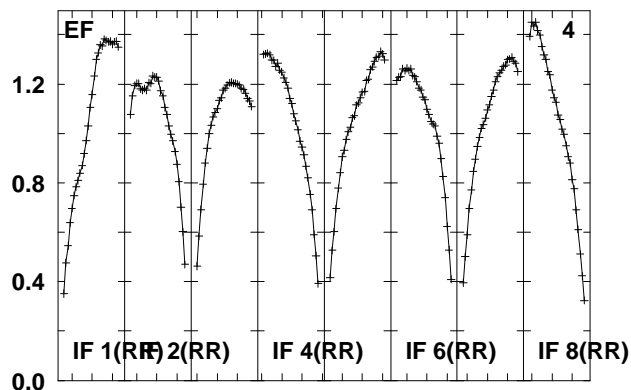
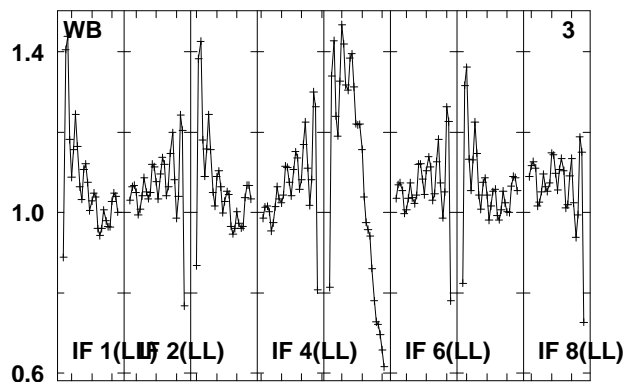
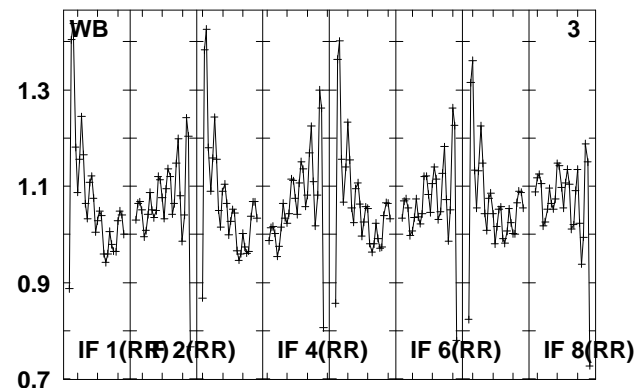
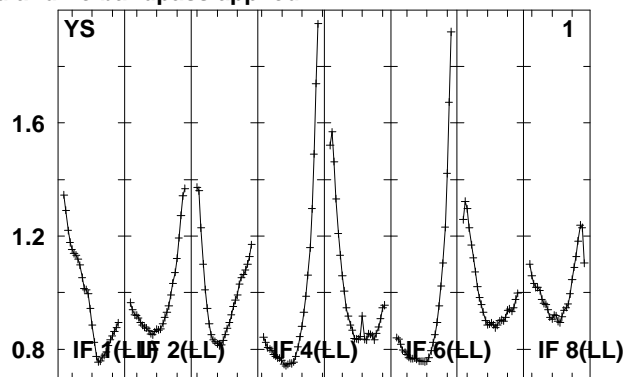
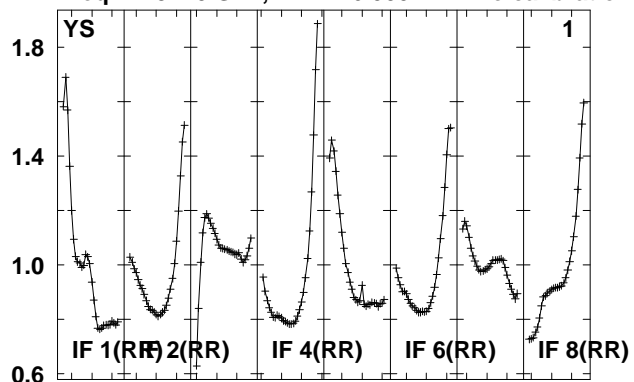

Lower frame: Real Jy

Total-power spectrum Antenna: *

Timerange: 00/20:04:40 to 00/20:09:36

Plot file version 592 created 14-MAY-2010 15:20:26

J102959 EO007.UVDATA.1

Freq = 4.9270 GHz, Bw = 16.000 MH No calibration applied and no bandpass applied

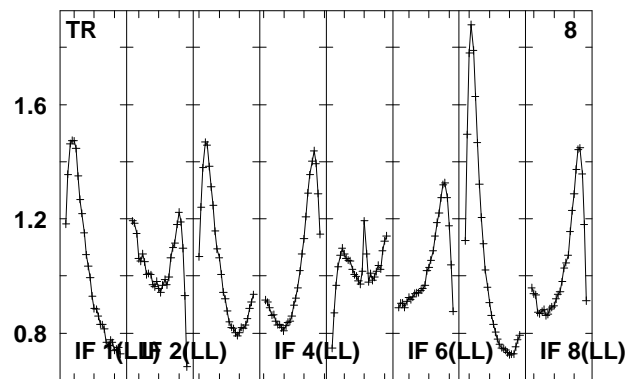
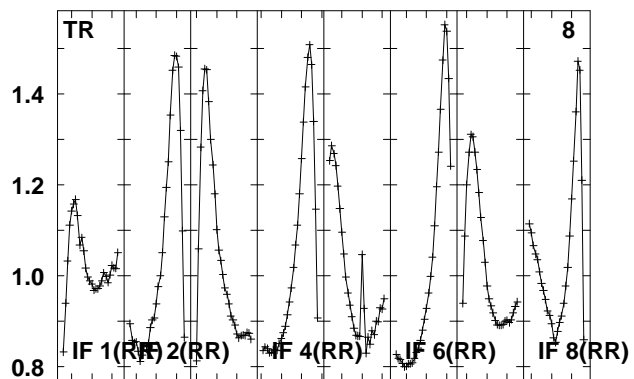
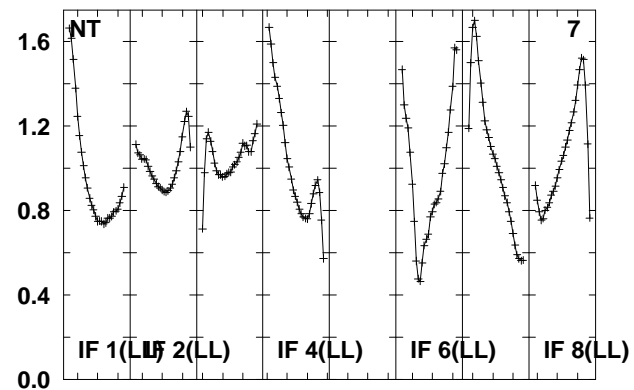
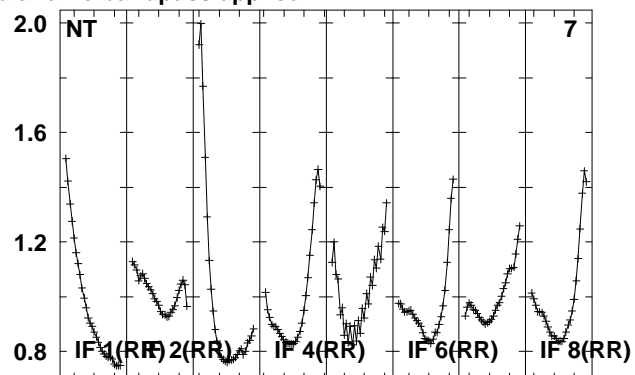
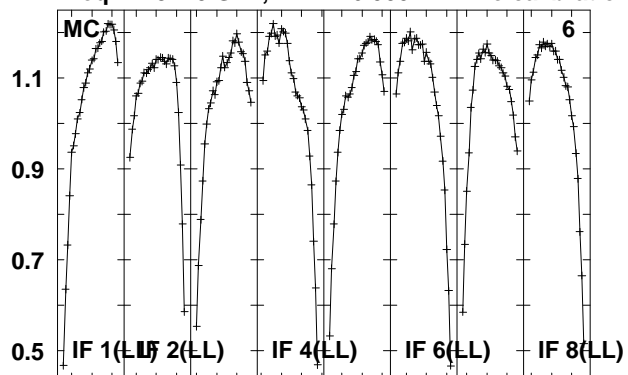

Lower frame: Real Jy
Total-power spectrum Antenna: *
Timerange: 00/20:04:40 to 00/20:09:36

Plot file version 593 created 14-MAY-2010 15:20:26

J1027+48 EO007.UVDATA.1

Freq = 4.9270 GHz, Bw = 16.000 MH No calibration applied and no bandpass applied

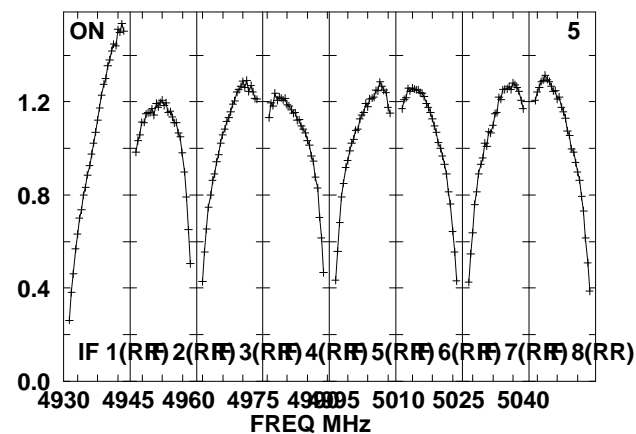
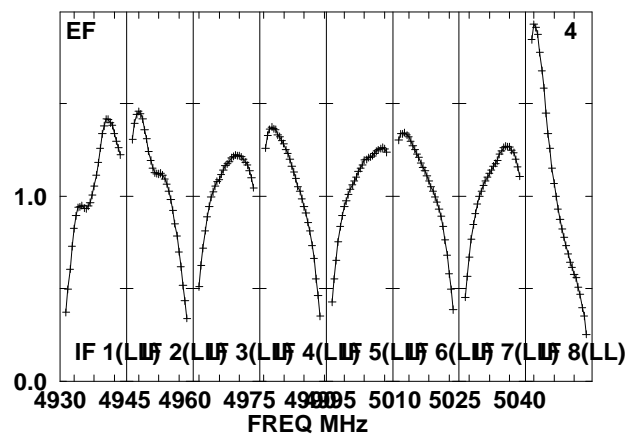
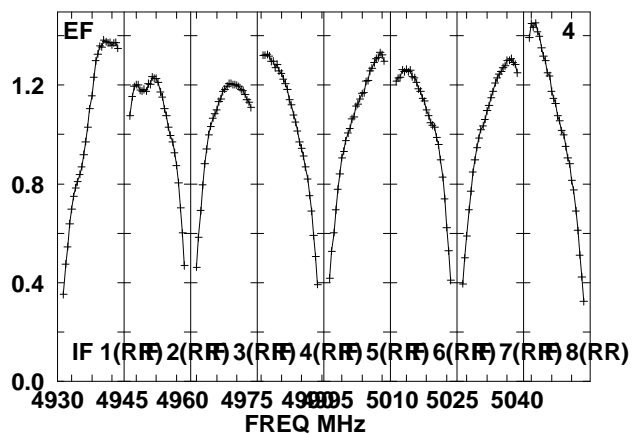
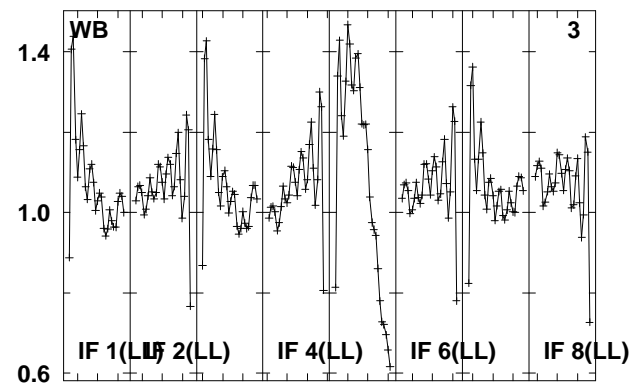
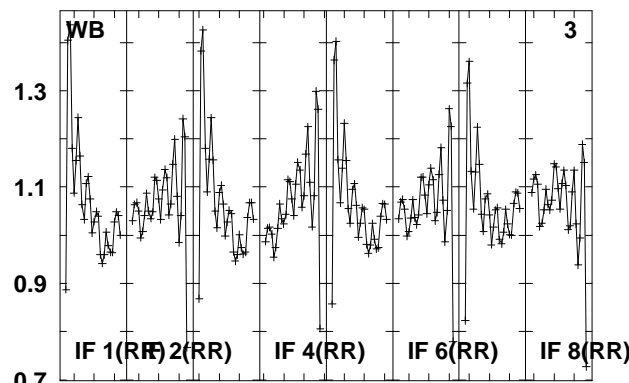
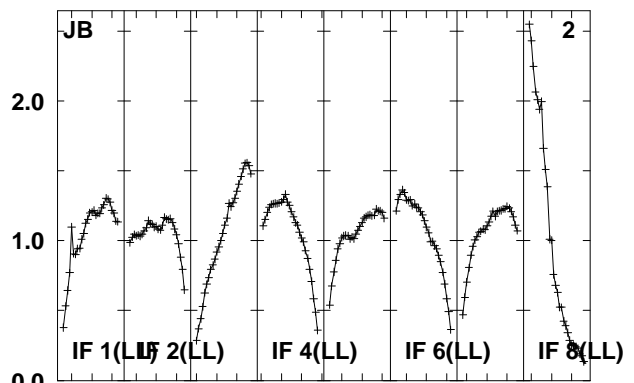
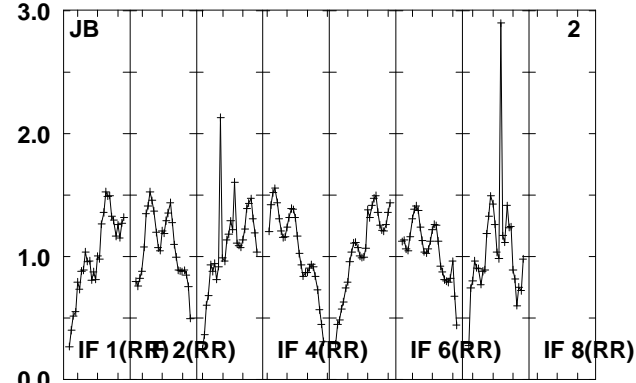
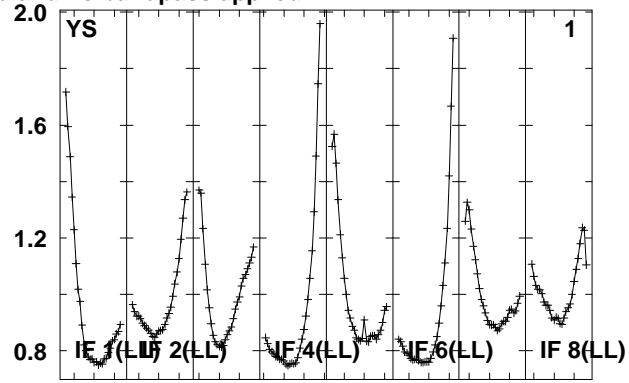
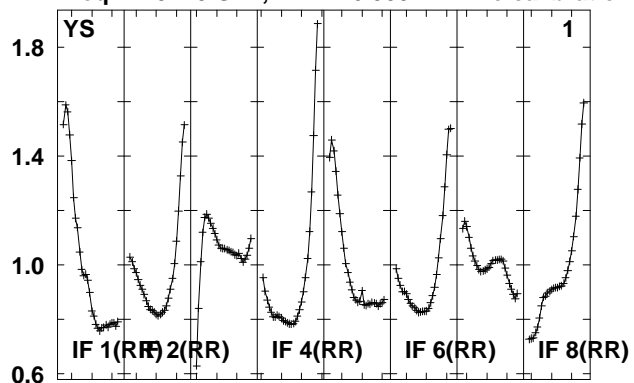

Lower frame: Real Jy
Total-power spectrum Antenna: *
Timerange: 00/20:10:07 to 00/20:11:35

Plot file version 594 created 14-MAY-2010 15:20:26

J1027+48 EO007.UVDATA.1

Freq = 4.9270 GHz, Bw = 16.000 MH No calibration applied and no bandpass applied

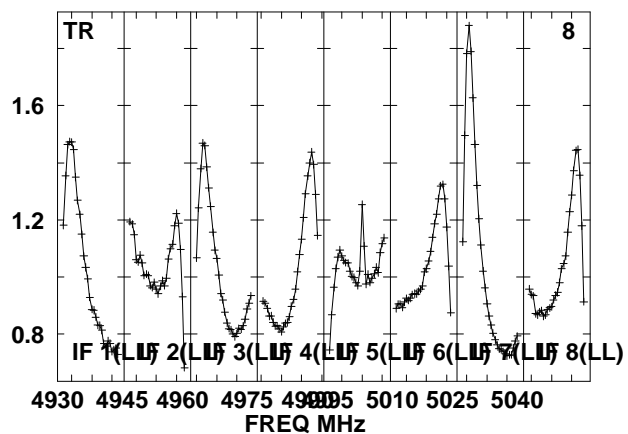
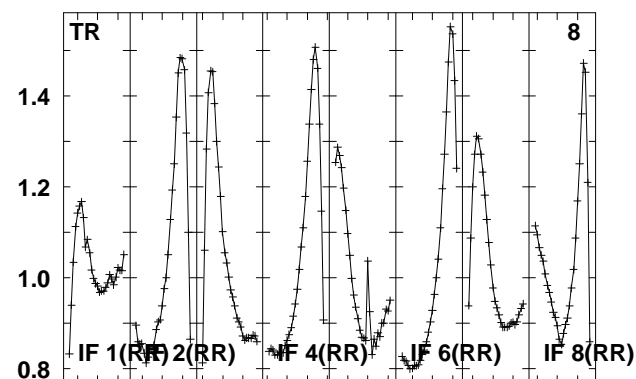
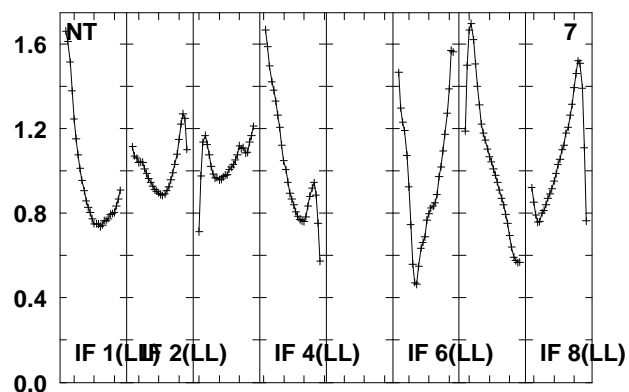
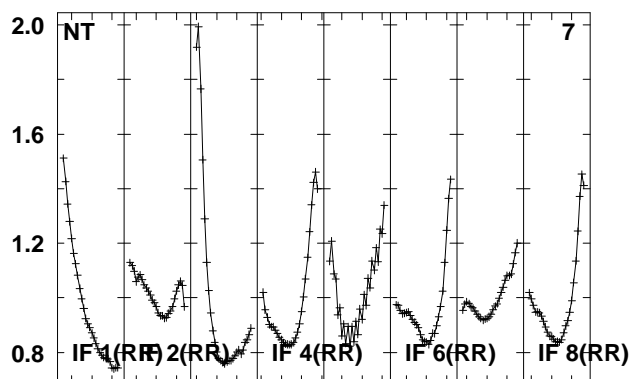
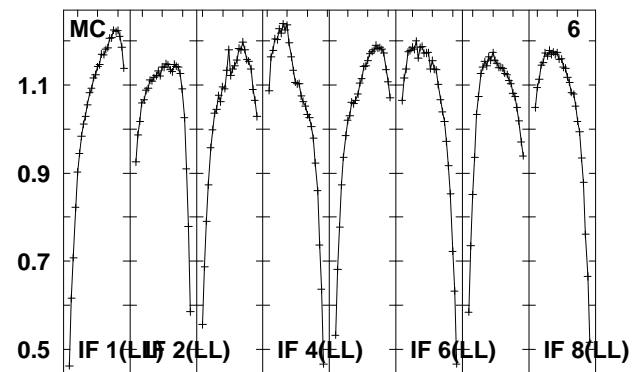
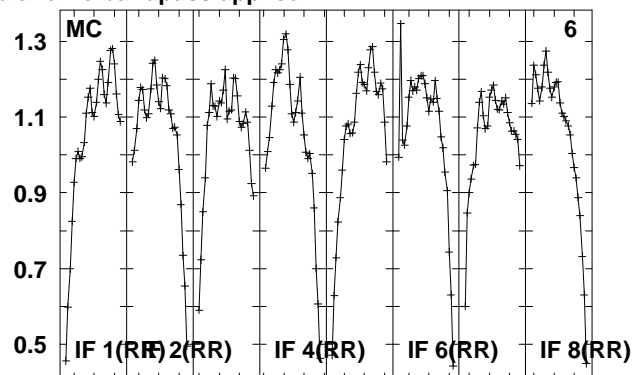
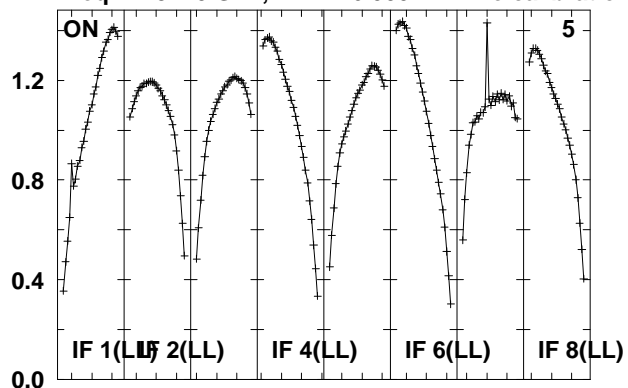

Lower frame: Real Jy

Total-power spectrum Antenna: *

Timerange: 00/20:10:07 to 00/20:11:35

Plot file version 595 created 14-MAY-2010 15:20:26

J0920+44 EO007.UVDATA.1

Freq = 4.9270 GHz, Bw = 16.000 MH No calibration applied and no bandpass applied

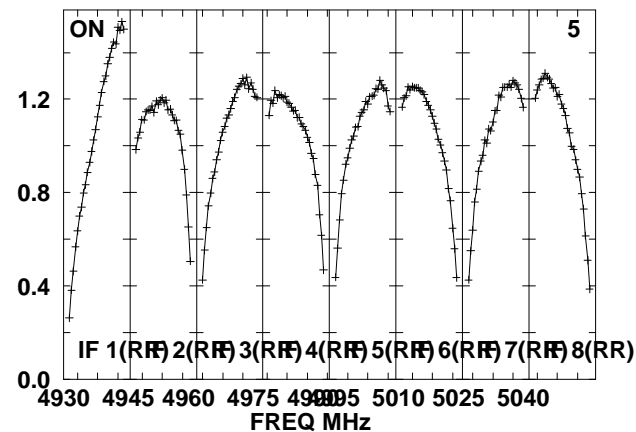
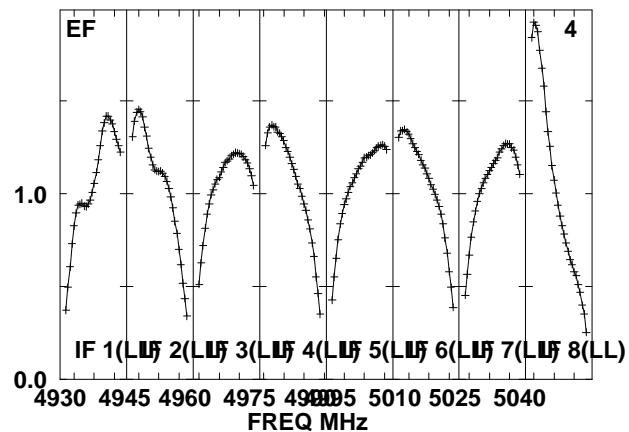
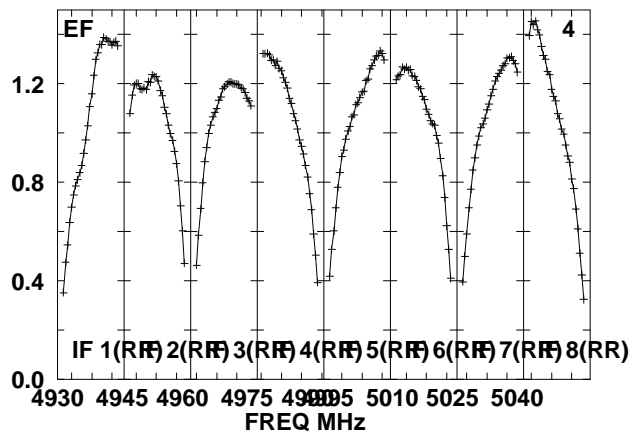
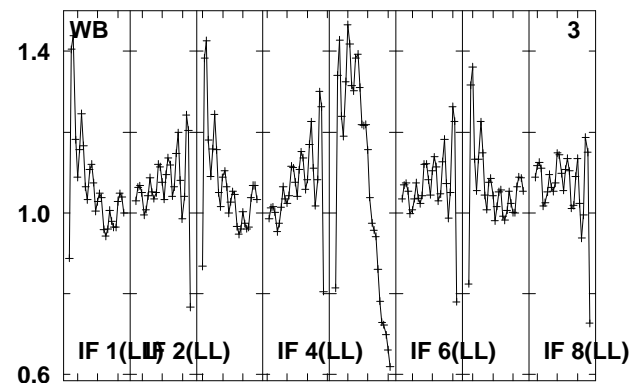
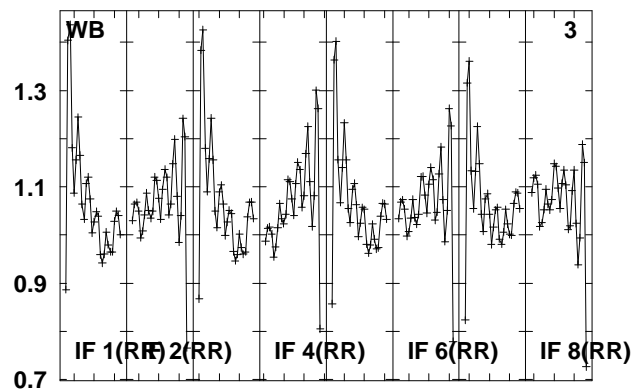
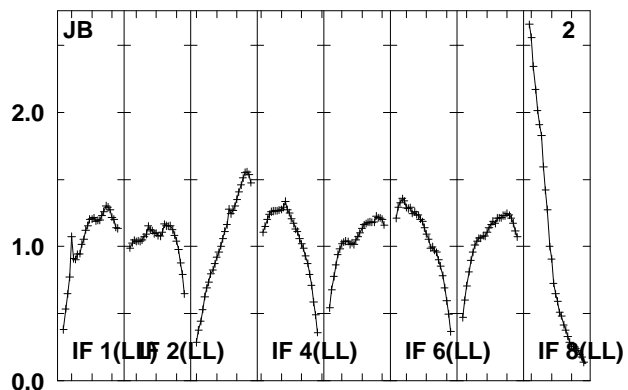
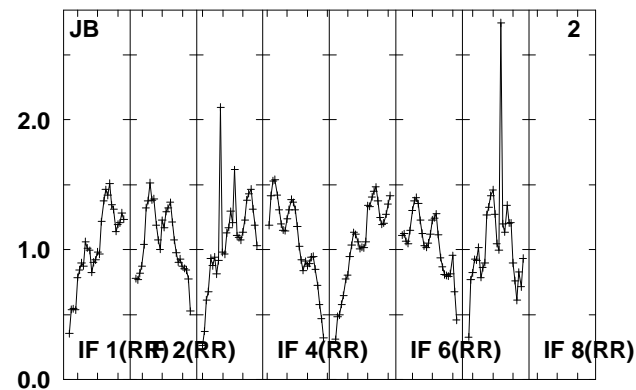
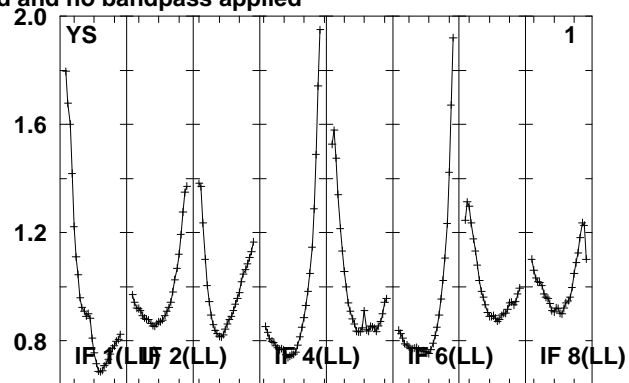
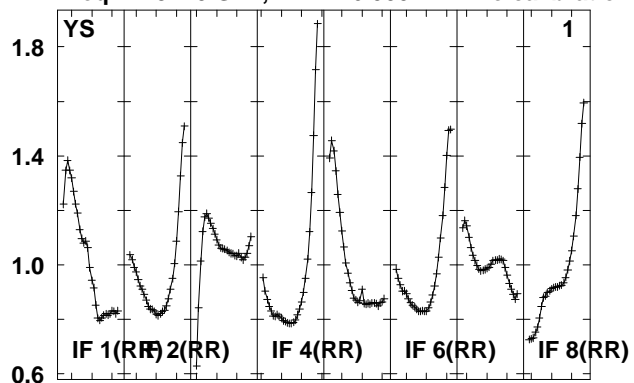

Lower frame: Real Jy

Total-power spectrum Antenna: *

Timerange: 00/20:14:09 to 00/20:15:37

Plot file version 596 created 14-MAY-2010 15:20:27

J0920+44 EO007.UVDATA.1

Freq = 4.9270 GHz, Bw = 16.000 MH No calibration applied and no bandpass applied

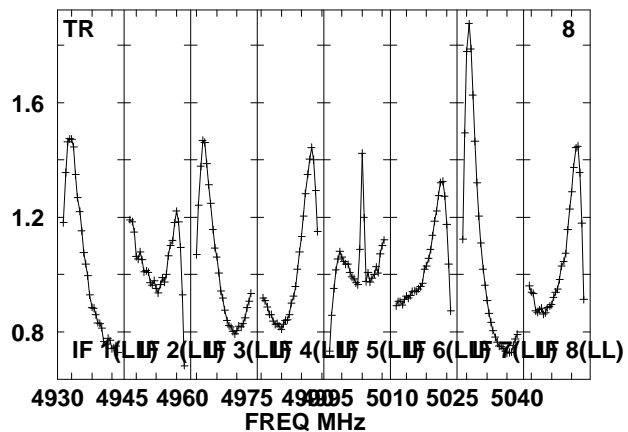
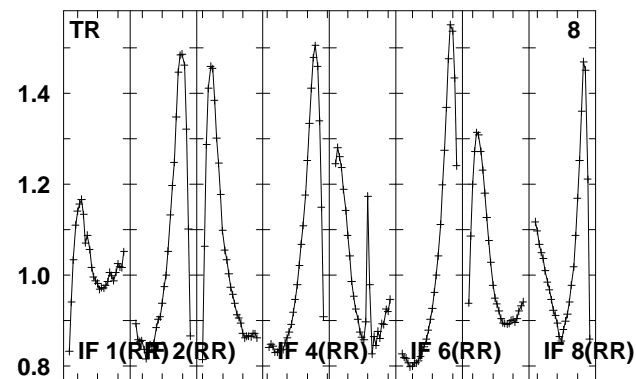
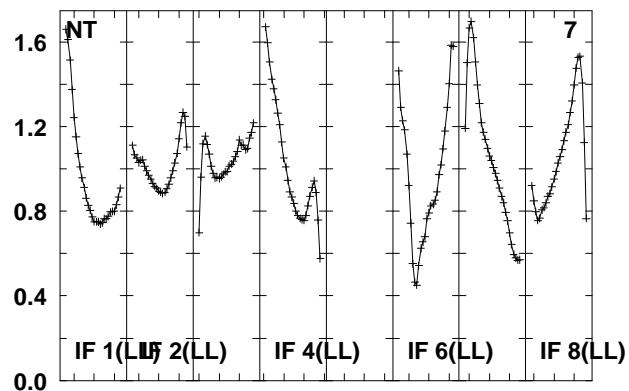
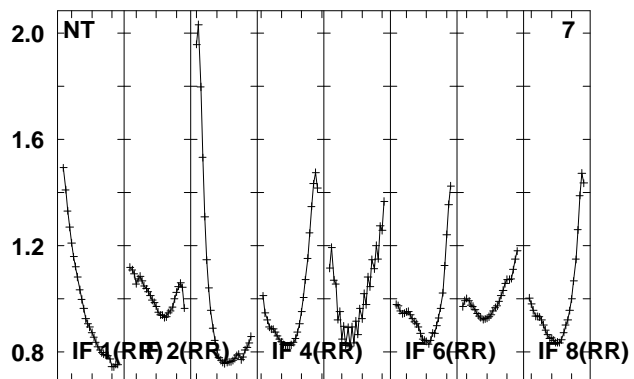
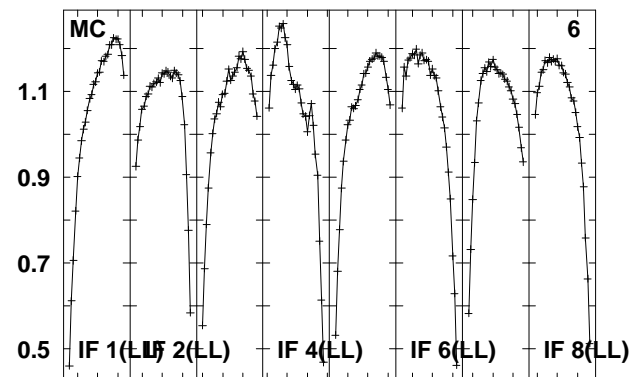
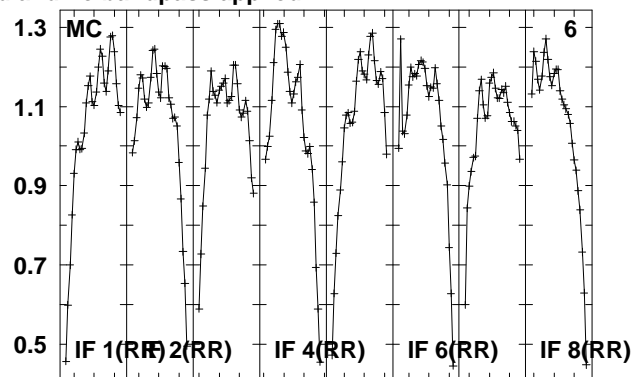
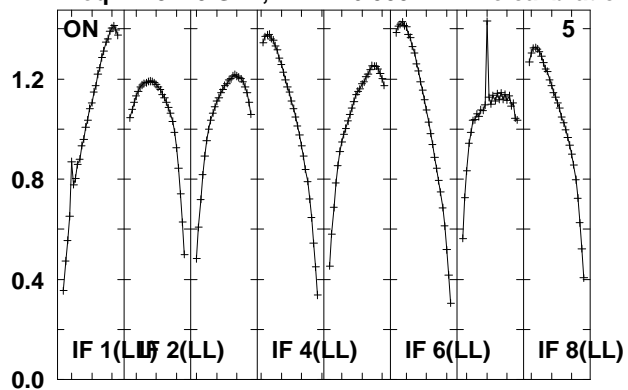

Lower frame: Real Jy

Total-power spectrum Antenna: *

Timerange: 00/20:14:09 to 00/20:15:37

Plot file version 597 created 14-MAY-2010 15:20:27

J092159 EO007.UVDATA.1

Freq = 4.9270 GHz, Bw = 16.000 MH No calibration applied and no bandpass applied

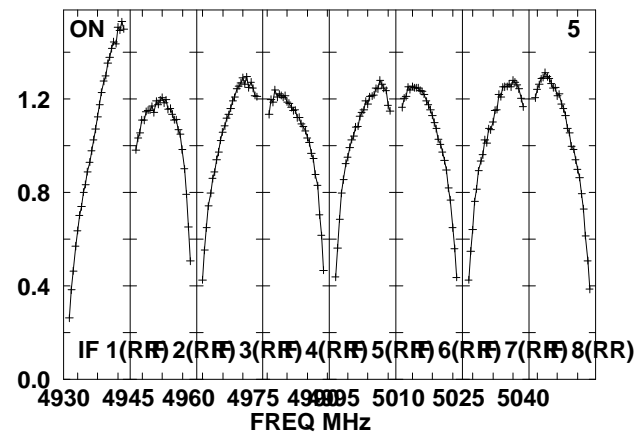
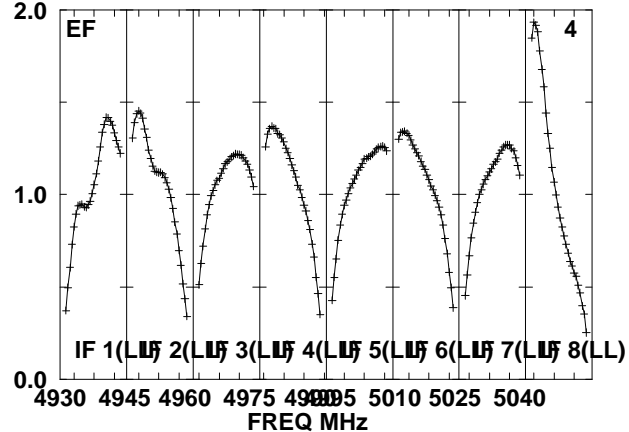
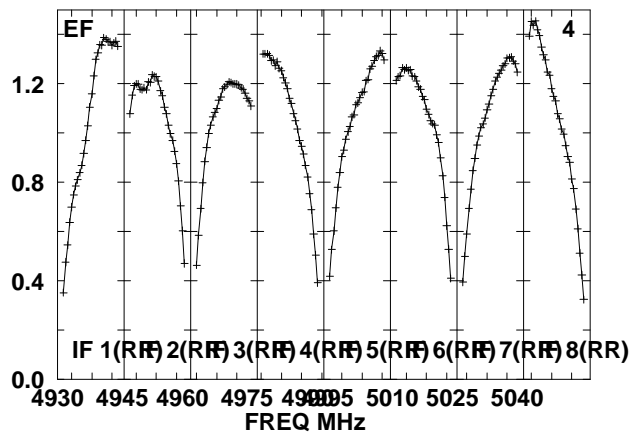
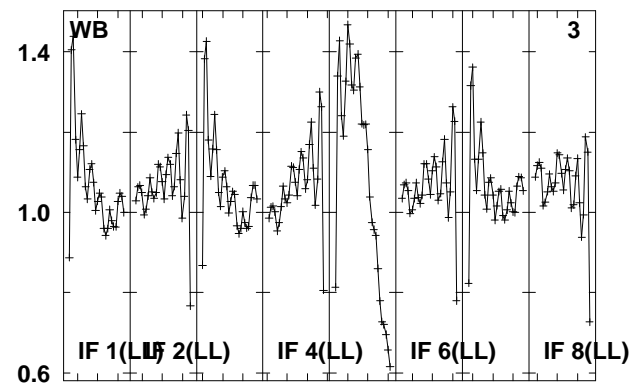
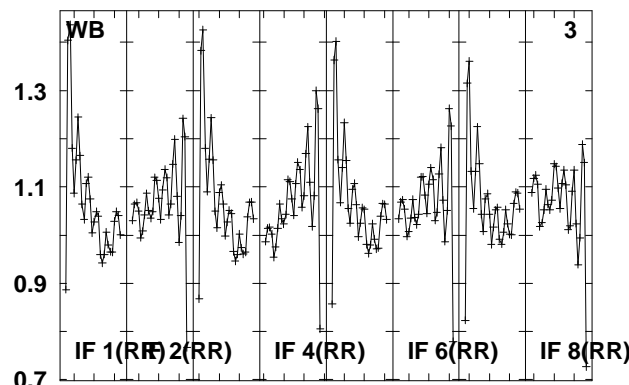
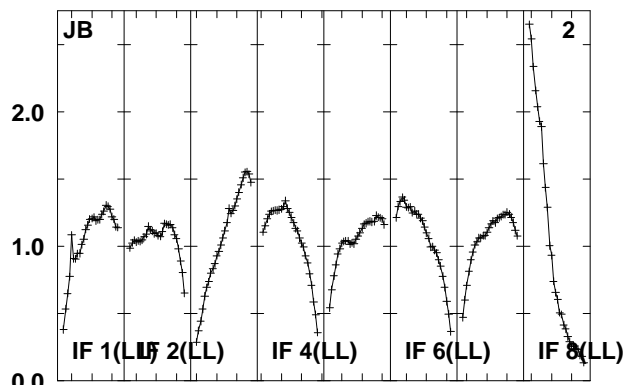
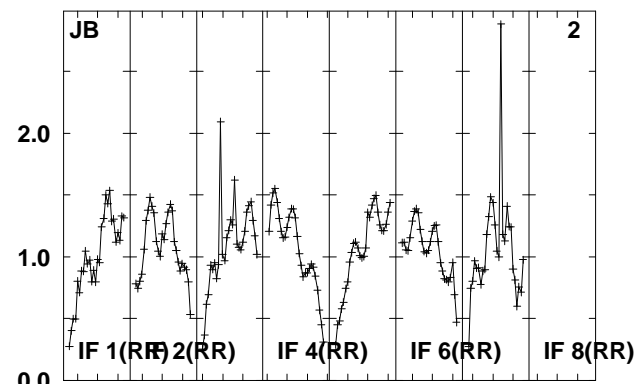
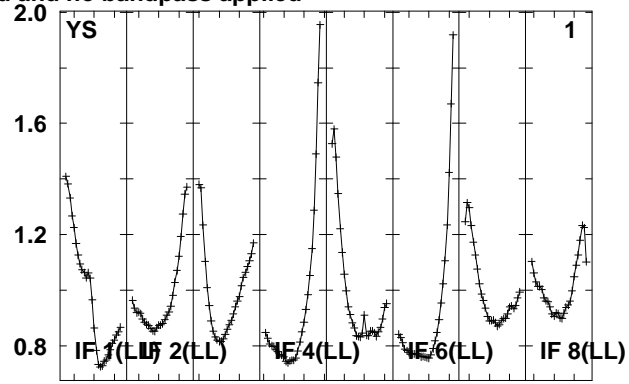
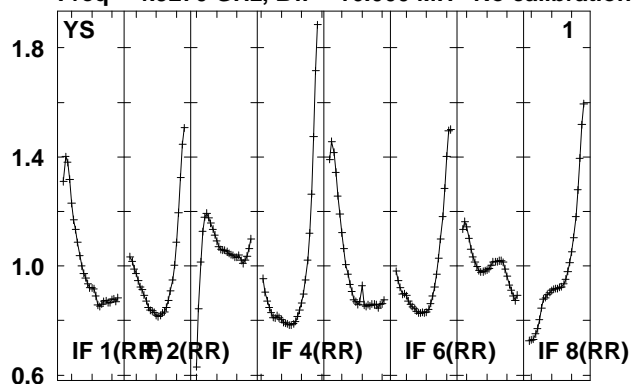

Lower frame: Real Jy
Total-power spectrum Antenna: *
Timerange: 00/20:16:09 to 00/20:21:07

Plot file version 598 created 14-MAY-2010 15:20:27

J092159 EO007.UVDATA.1

Freq = 4.9270 GHz, Bw = 16.000 MH No calibration applied and no bandpass applied

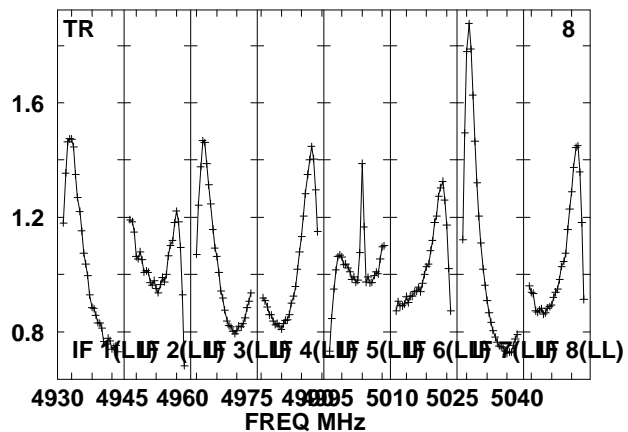
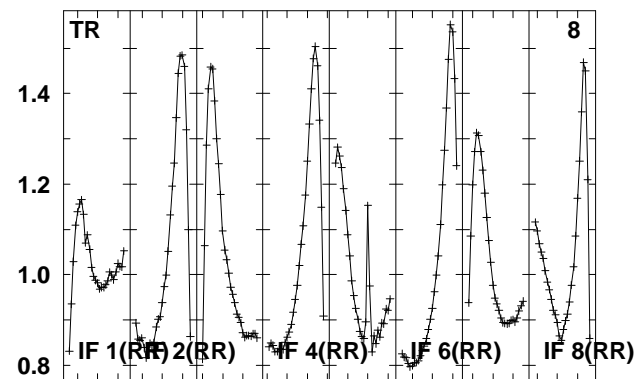
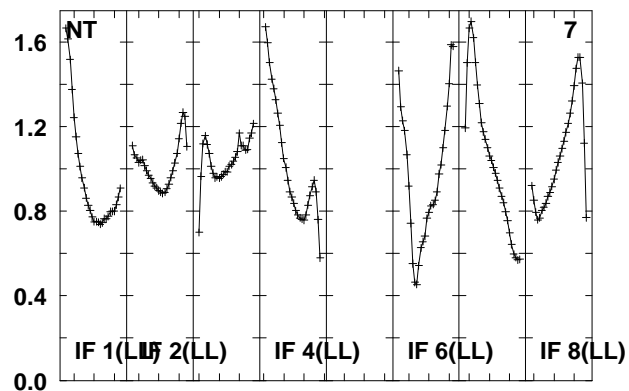
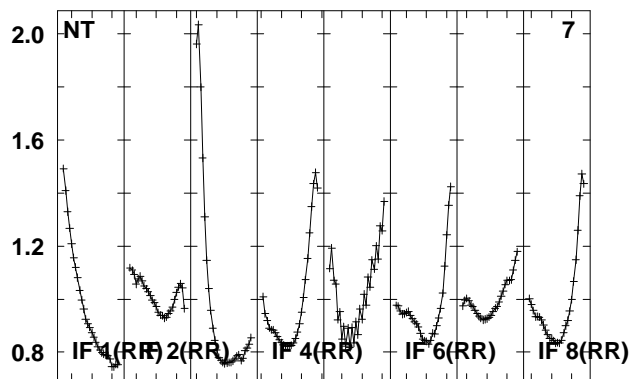
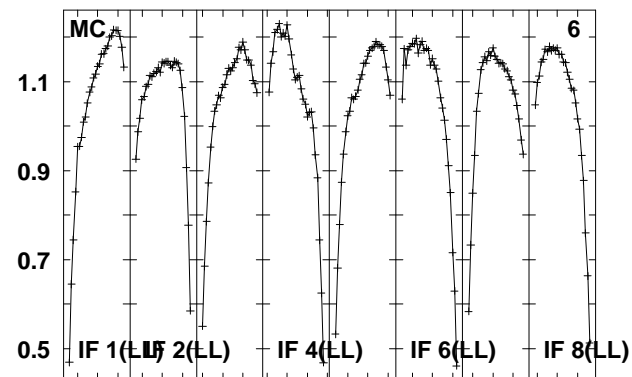
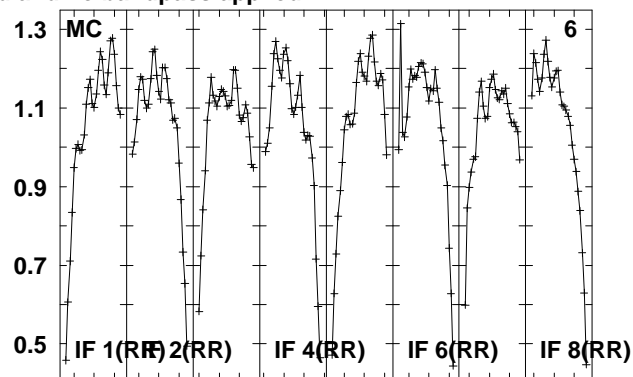
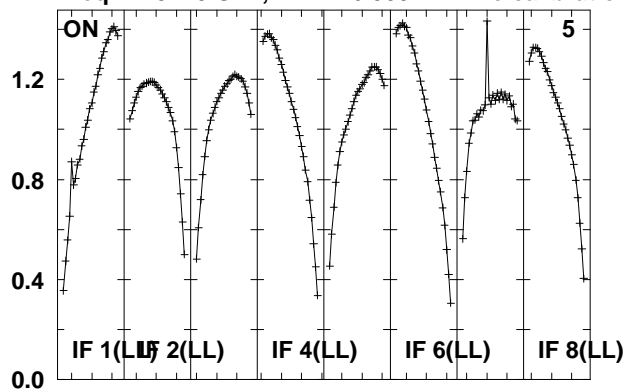

Lower frame: Real Jy

Total-power spectrum Antenna: *

Timerange: 00/20:16:09 to 00/20:21:07

Plot file version 599 created 14-MAY-2010 15:20:28
 J0920+44 EO007.UVDATA.1
 Freq = 4.9270 GHz, Bw = 16.000 MH No calibration applied and no bandpass applied

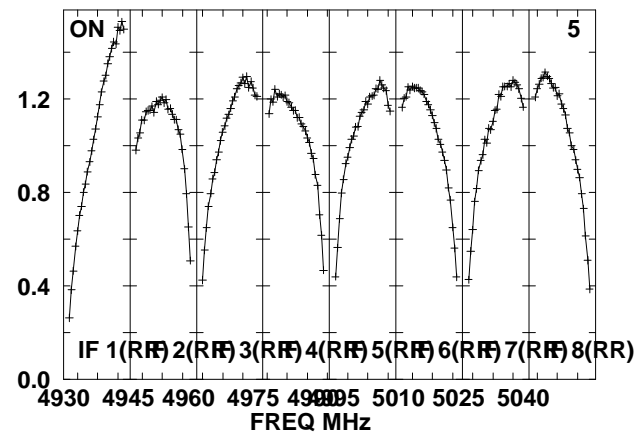
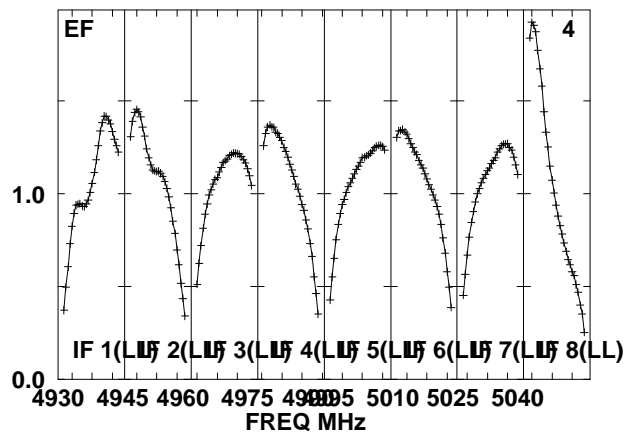
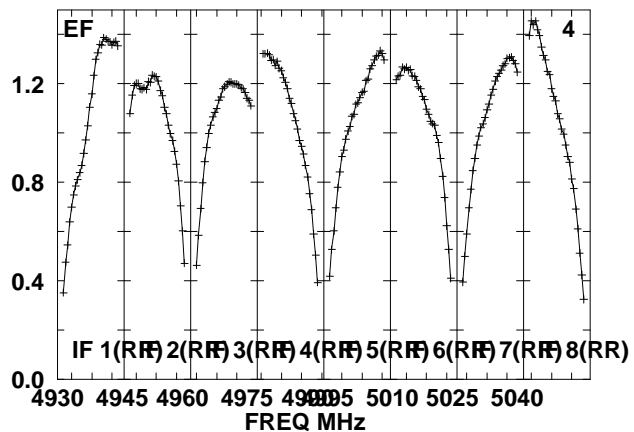
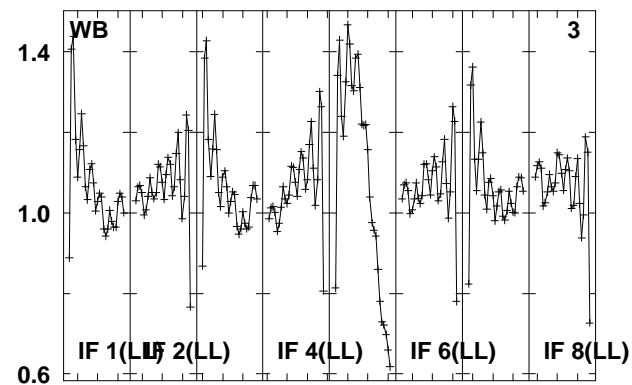
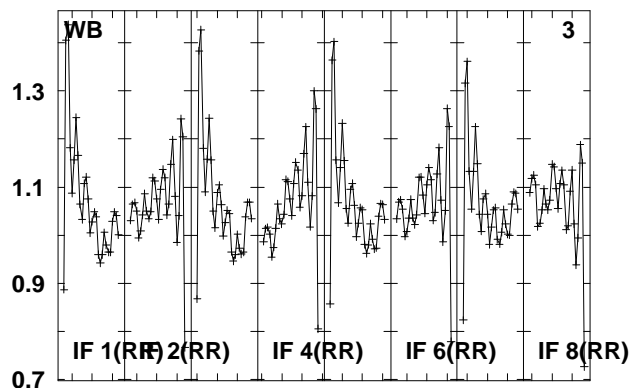
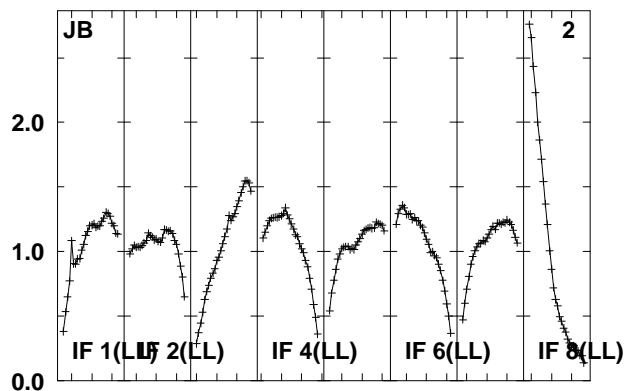
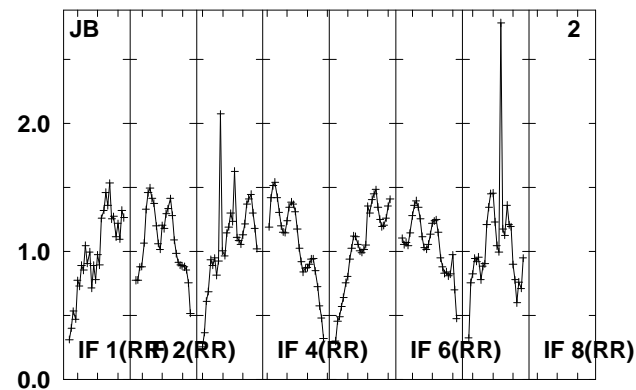
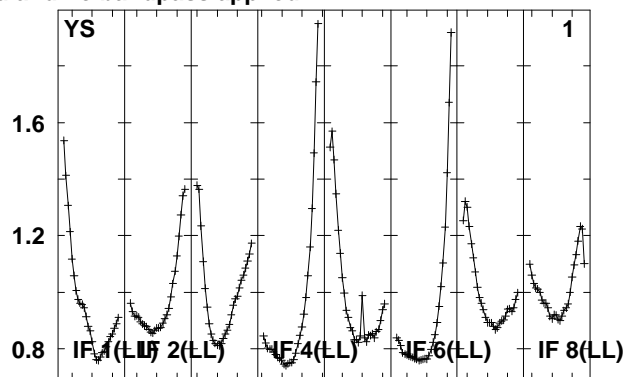
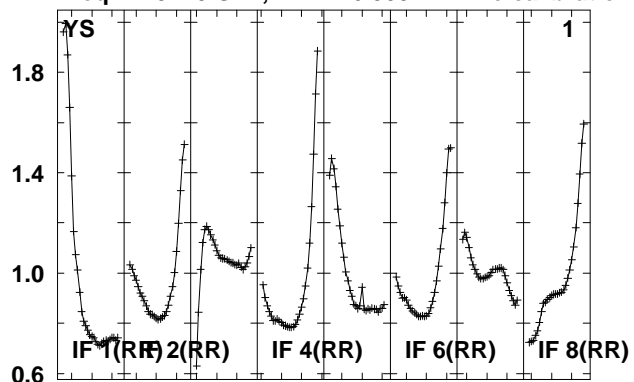

Lower frame: Real Jy
 Total-power spectrum Antenna: *
 Timerange: 00/20:21:43 to 00/20:23:11

Plot file version 600 created 14-MAY-2010 15:20:28

J0920+44 EO007.UVDATA.1

Freq = 4.9270 GHz, Bw = 16.000 MH No calibration applied and no bandpass applied

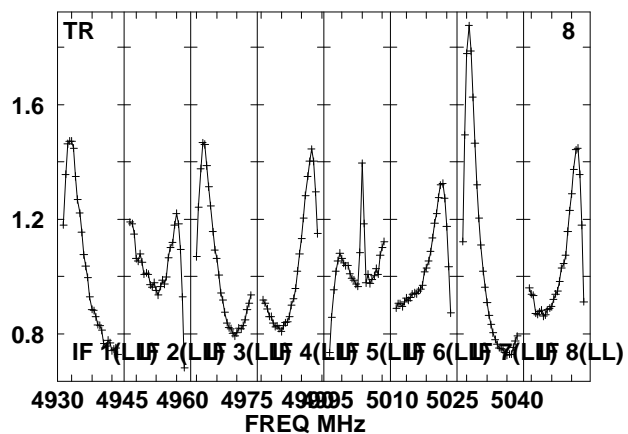
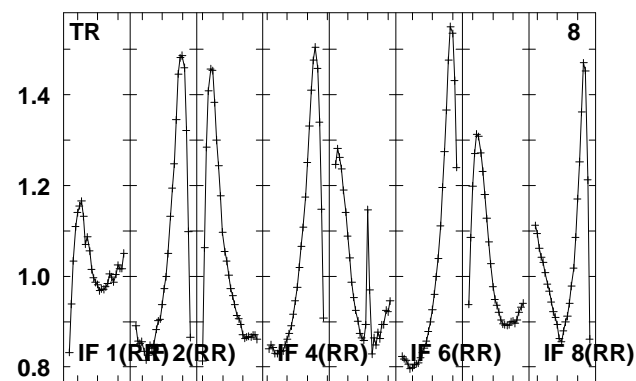
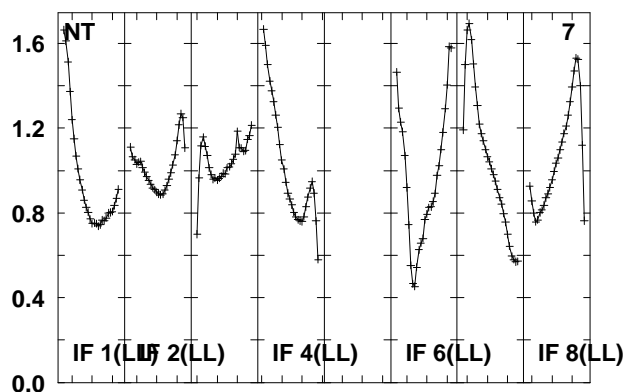
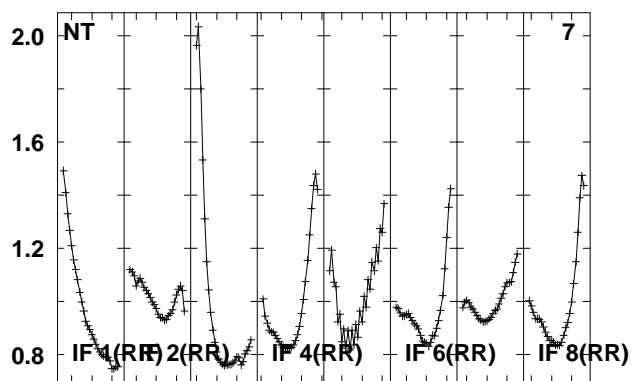
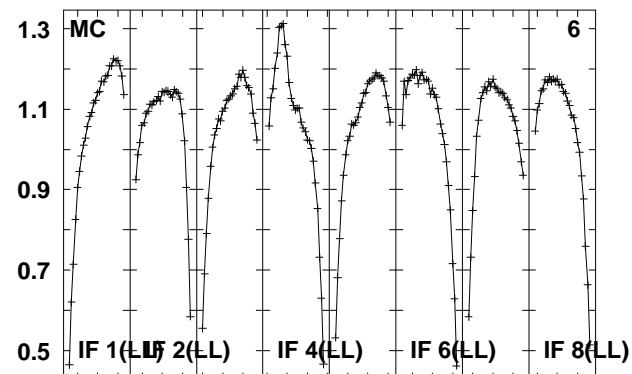
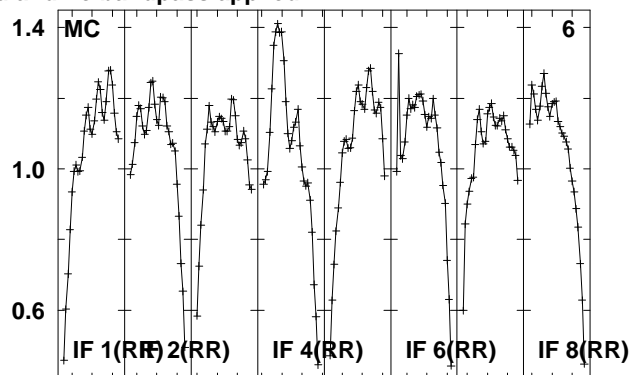
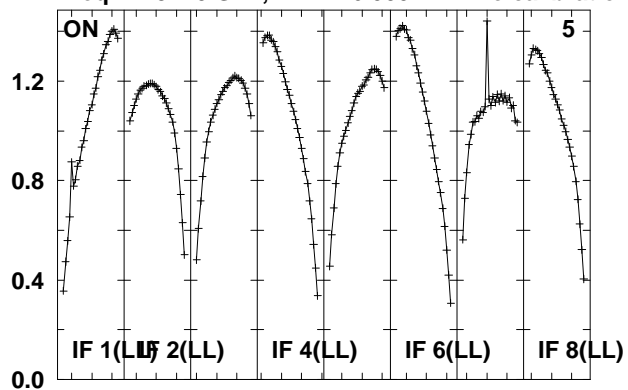

Lower frame: Real Jy

Total-power spectrum Antenna: *

Timerange: 00/20:21:43 to 00/20:23:11

Plot file version 601 created 14-MAY-2010 15:20:28

J092159 EO007.UVDATA.1

Freq = 4.9270 GHz, Bw = 16.000 MH No calibration applied and no bandpass applied

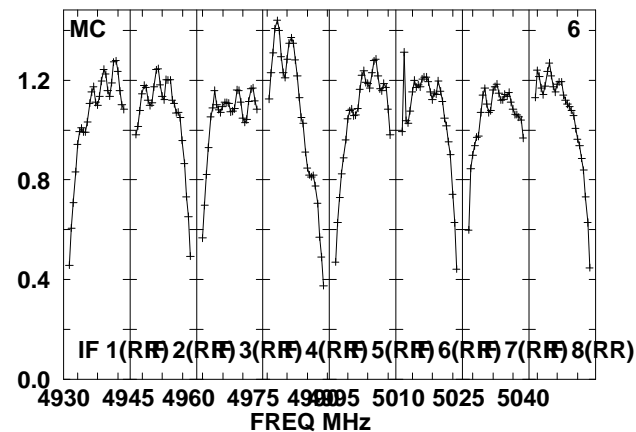
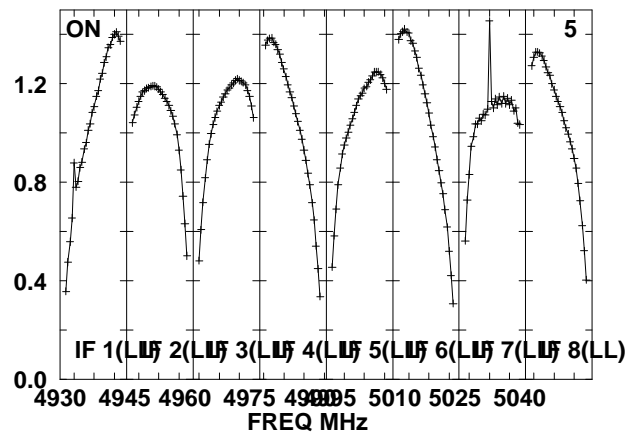
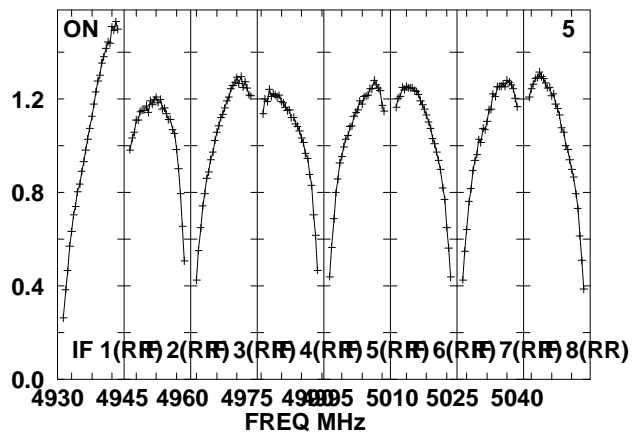
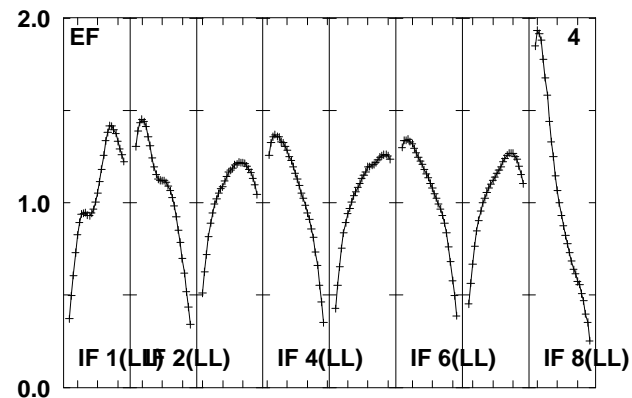
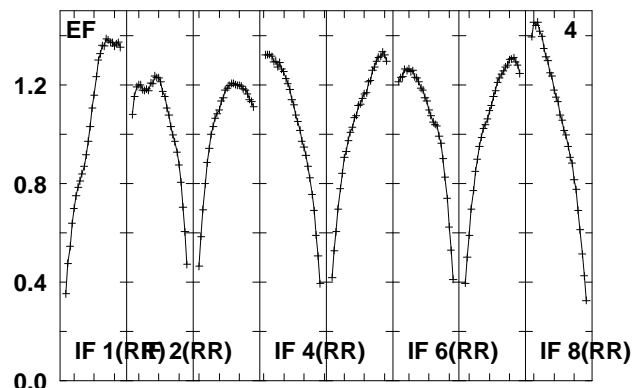
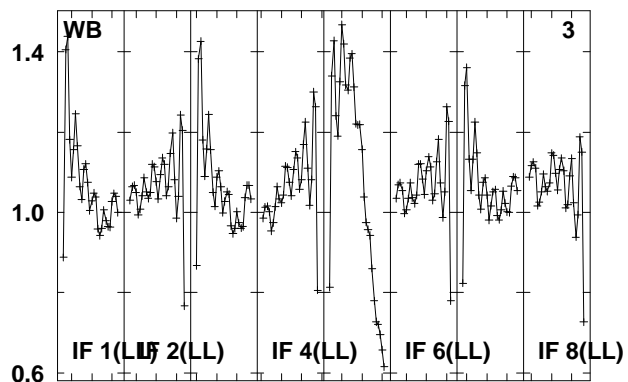
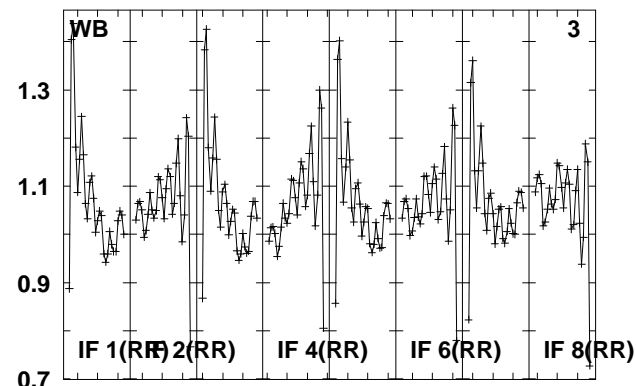
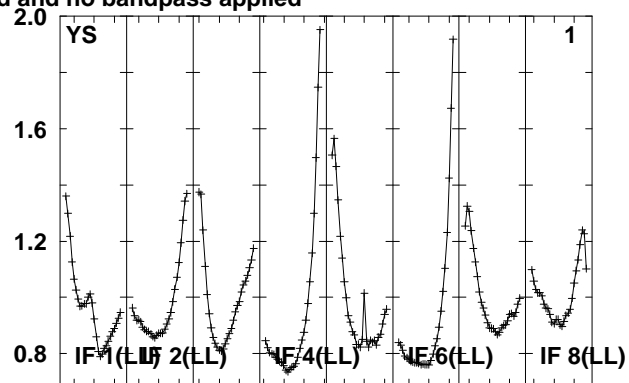
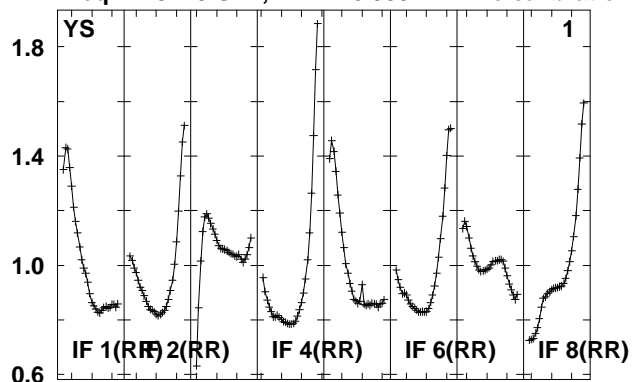

Lower frame: Real Jy
Total-power spectrum Antenna: *
Timerange: 00/20:23:45 to 00/20:28:43

Plot file version 602 created 14-MAY-2010 15:20:29

J092159 EO007.UVDATA.1

Freq = 4.9270 GHz, Bw = 16.000 MH No calibration applied and no bandpass applied

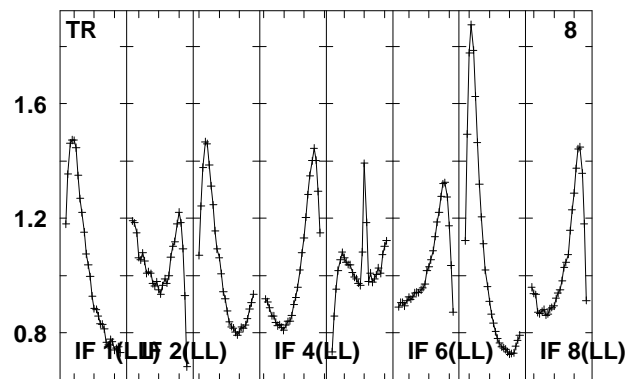
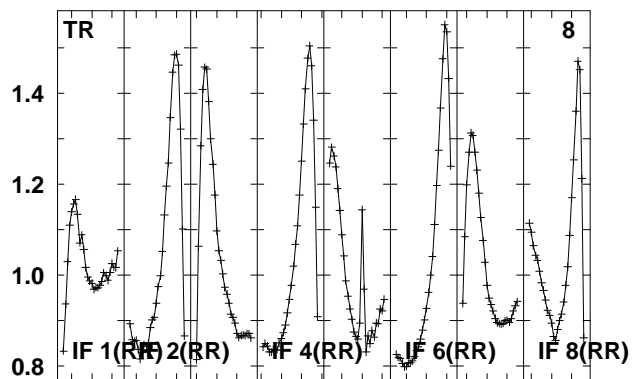
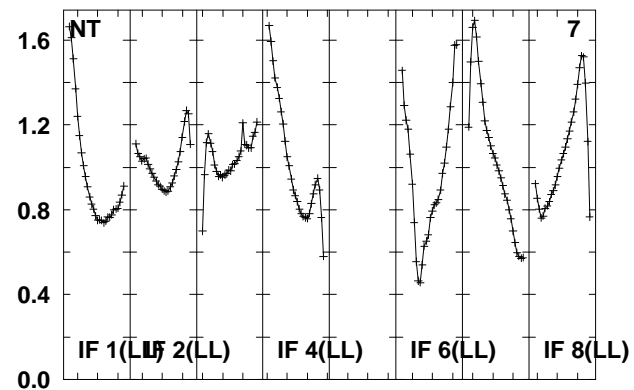
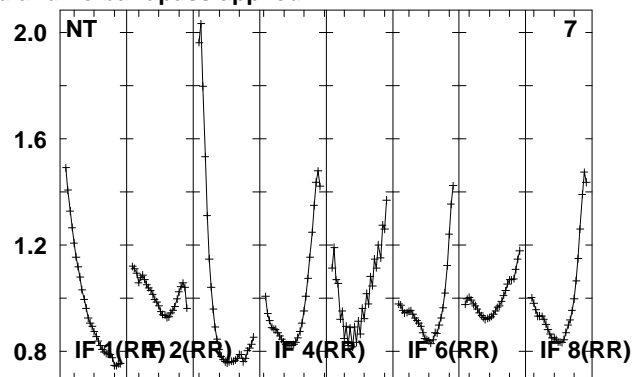
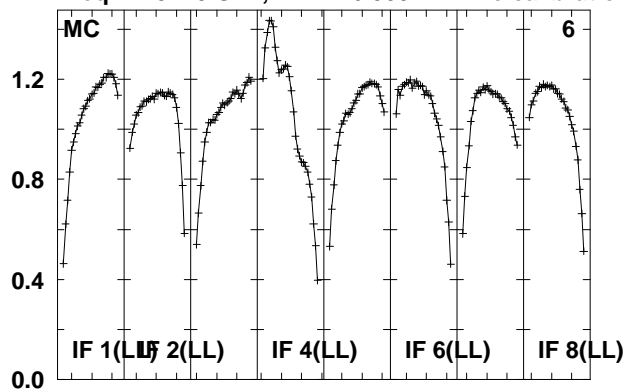

Lower frame: Real Jy
Total-power spectrum Antenna: *
Timerange: 00/20:23:45 to 00/20:28:43

Plot file version 603 created 14-MAY-2010 15:20:29

J0920+44 EO007.UVDATA.1

Freq = 4.9270 GHz, Bw = 16.000 MH No calibration applied and no bandpass applied

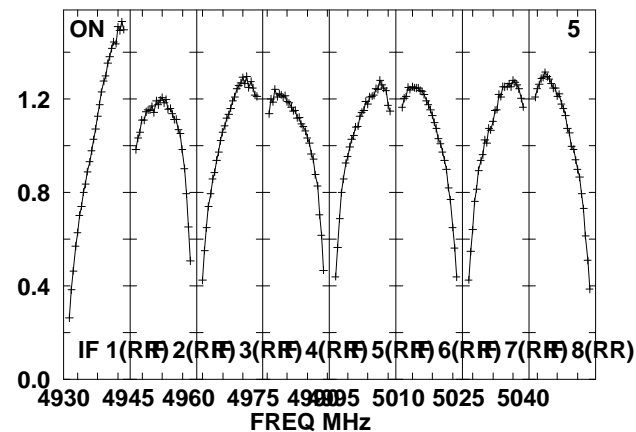
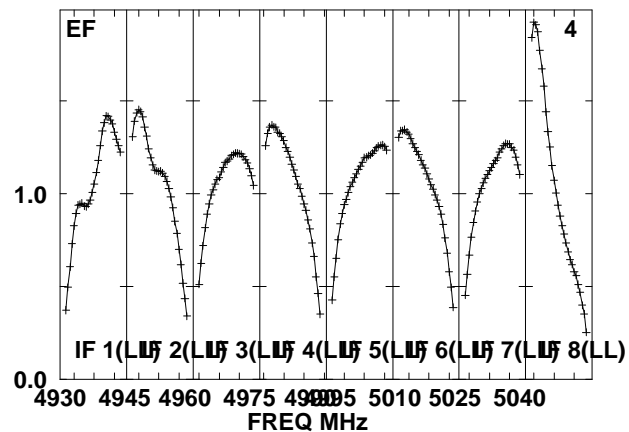
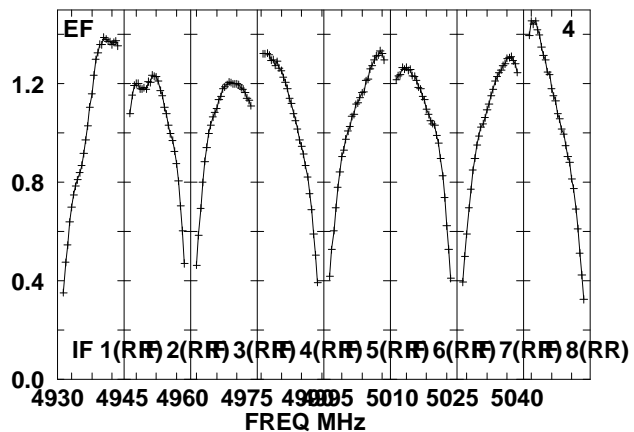
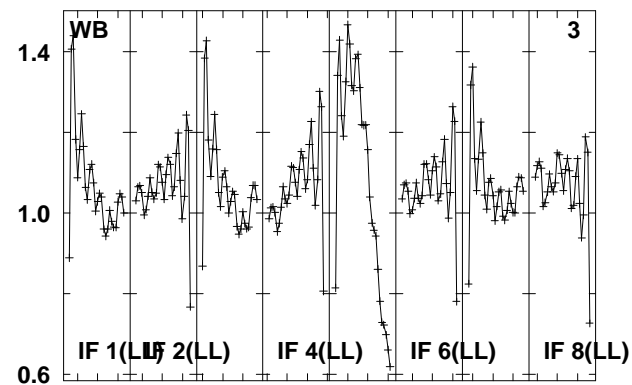
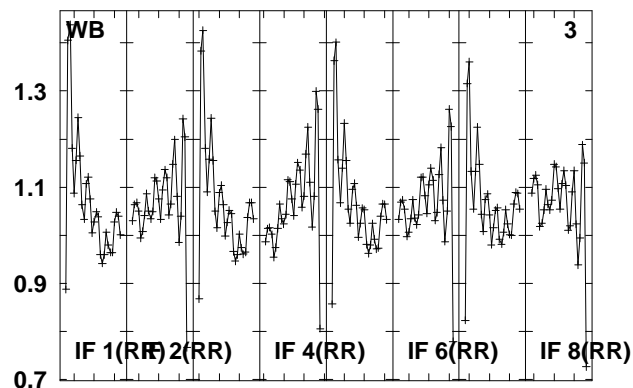
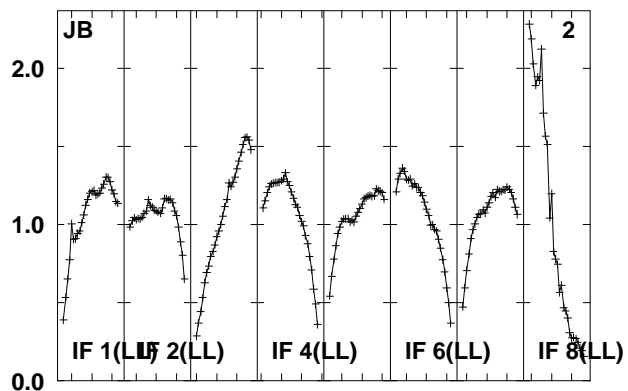
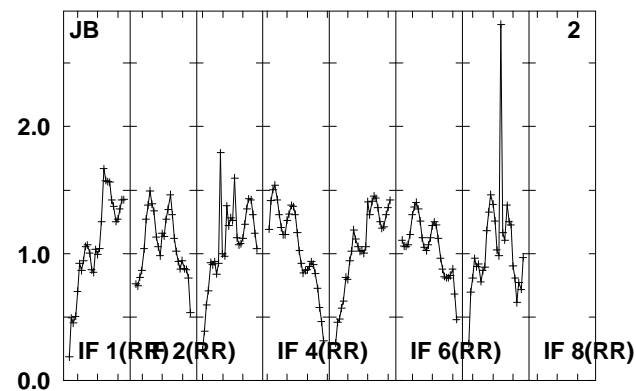
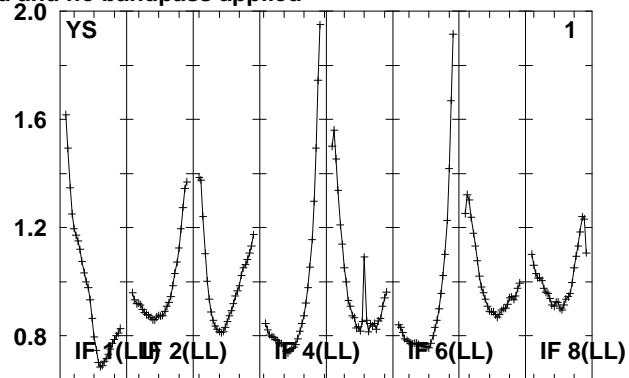
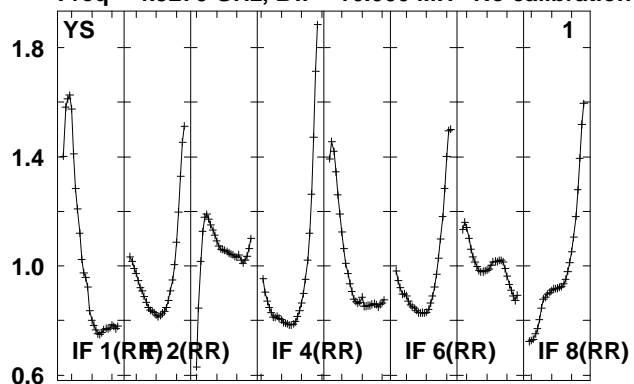

Lower frame: Real Jy
Total-power spectrum Antenna: *
Timerange: 00/20:29:21 to 00/20:30:47

Plot file version 604 created 14-MAY-2010 15:20:30

J0920+44 EO007.UVDATA.1

Freq = 4.9270 GHz, Bw = 16.000 MH No calibration applied and no bandpass applied

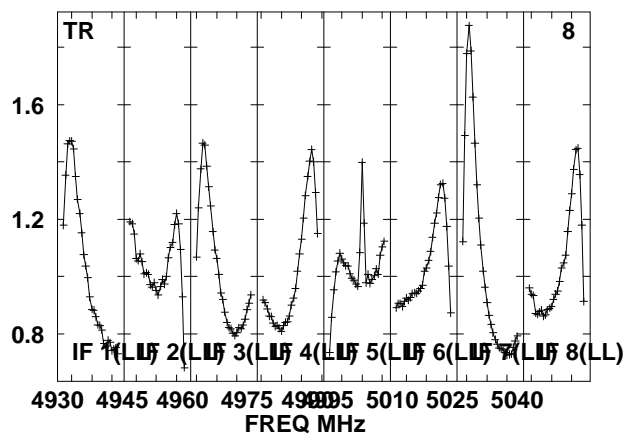
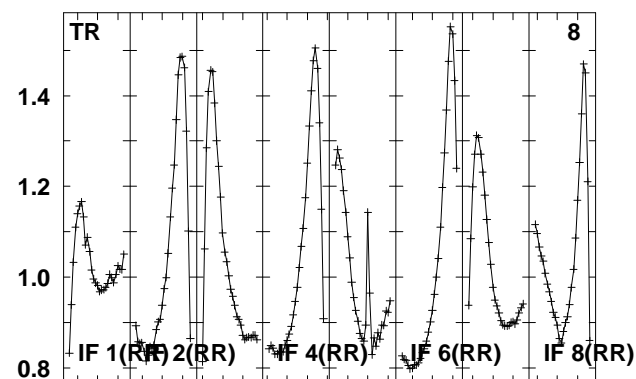
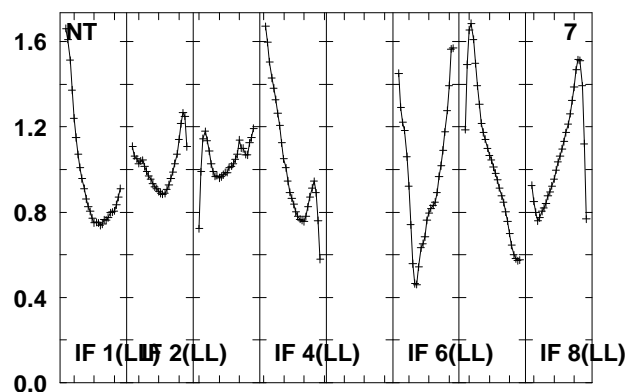
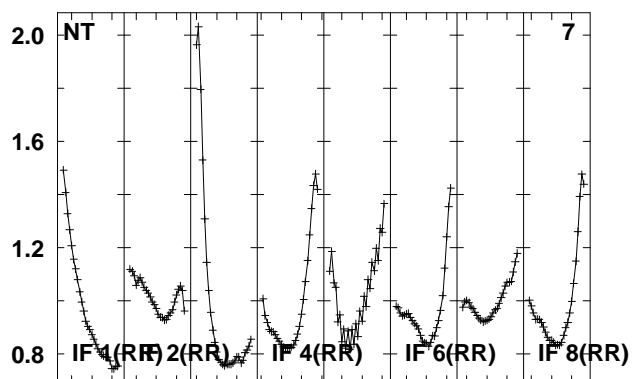
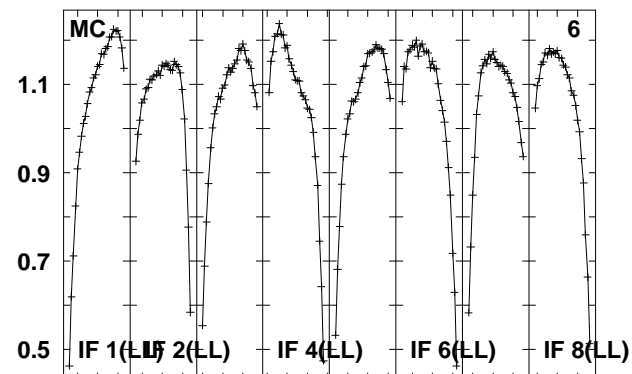
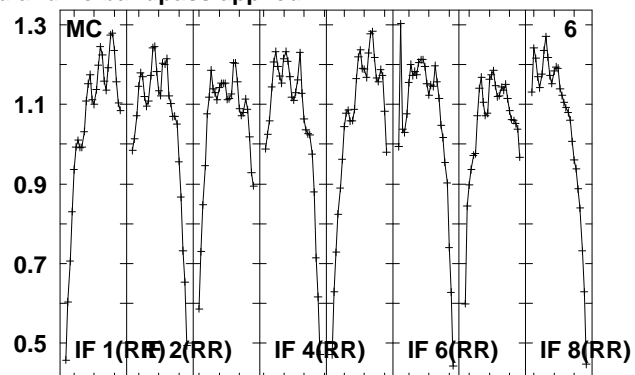
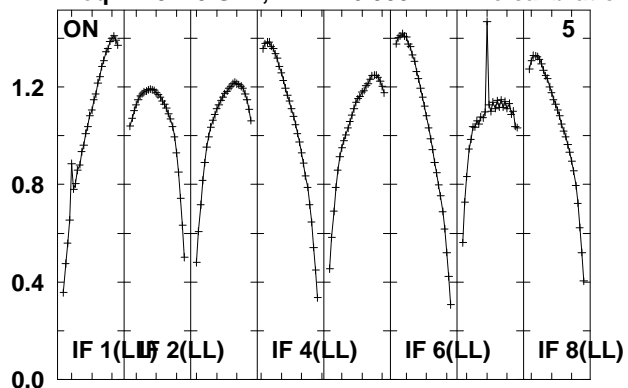

Lower frame: Real Jy

Total-power spectrum Antenna: *

Timerange: 00/20:29:21 to 00/20:30:47

Plot file version 605 created 14-MAY-2010 15:20:30

J1027+48 EO007.UVDATA.1

Freq = 4.9270 GHz, Bw = 16.000 MH No calibration applied and no bandpass applied

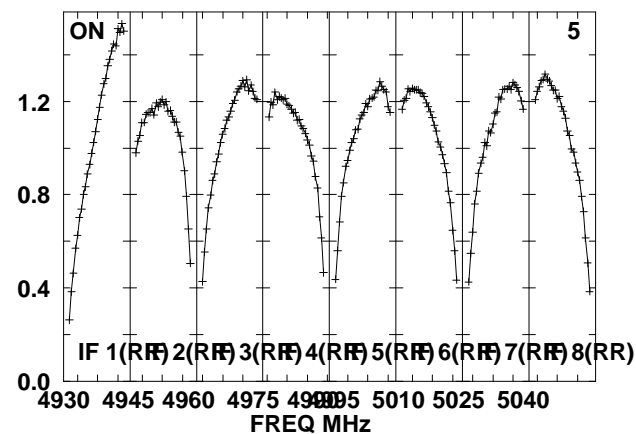
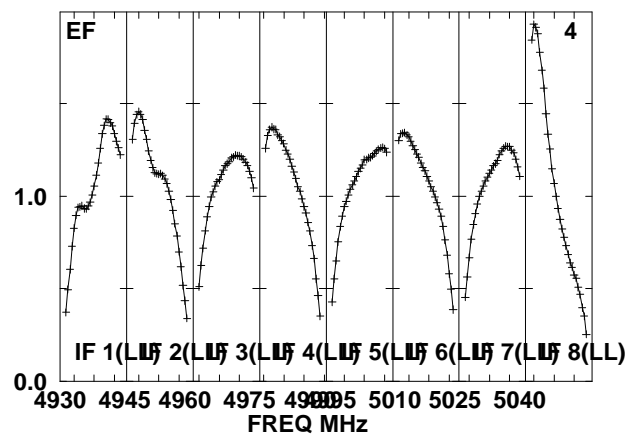
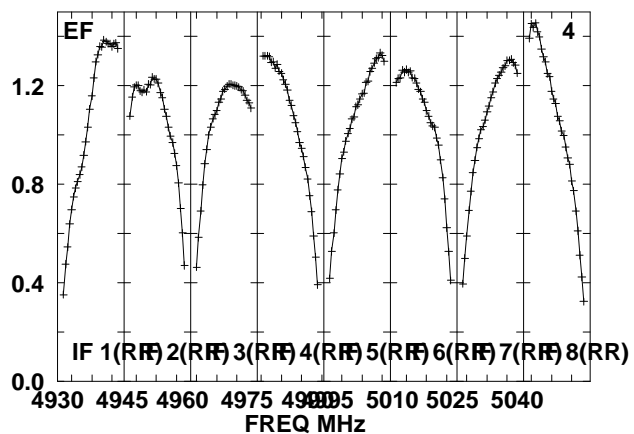
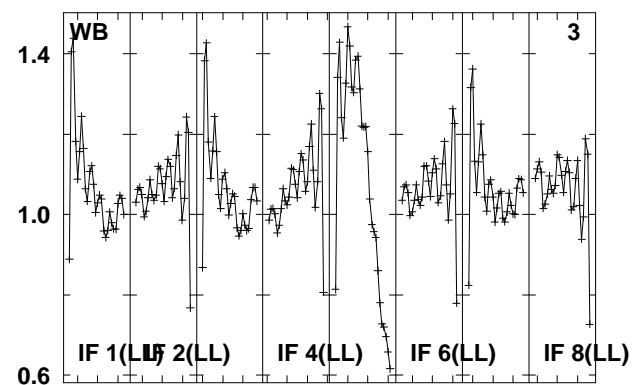
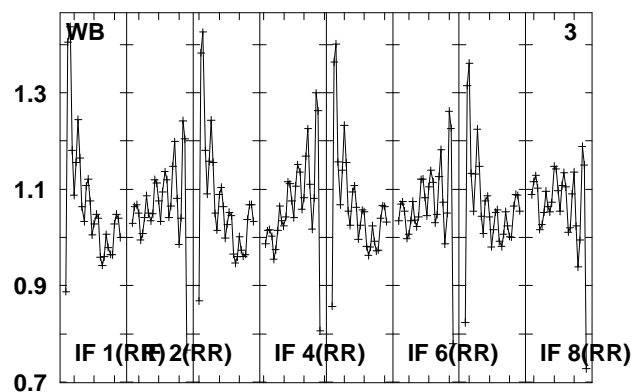
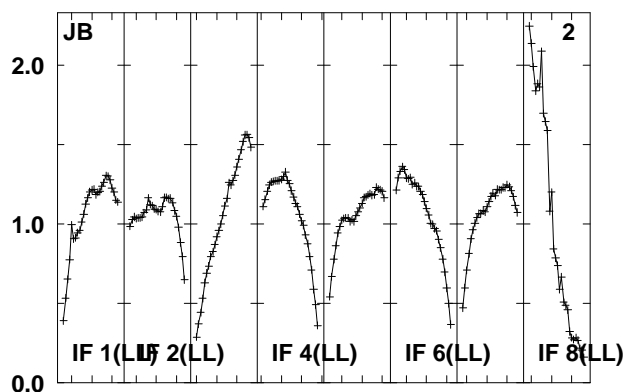
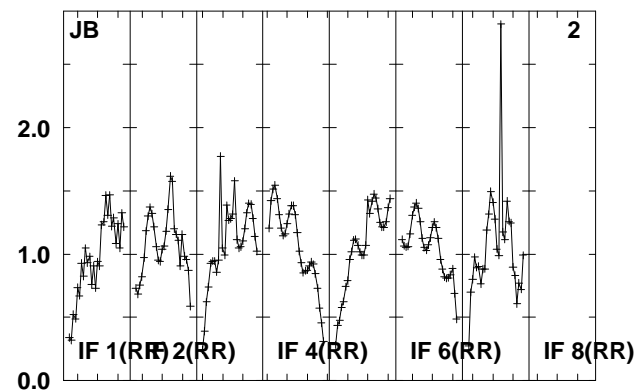
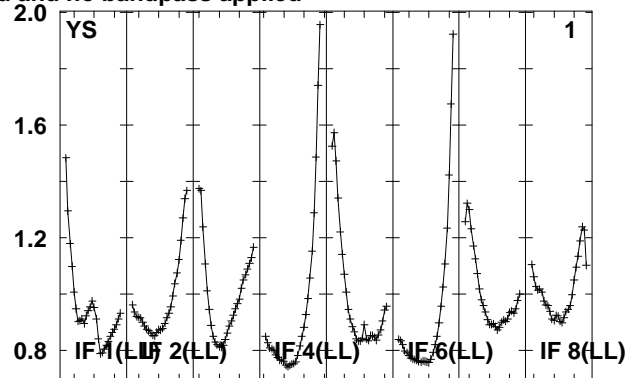
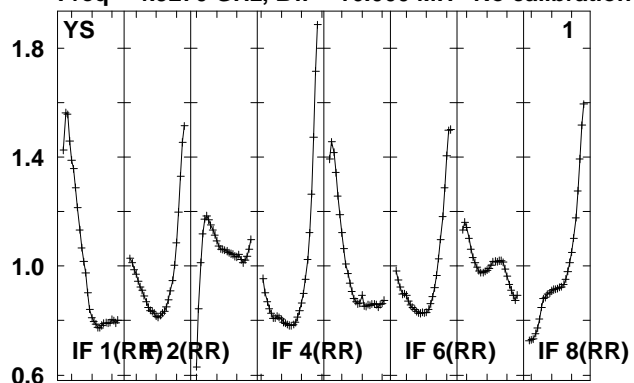

Lower frame: Real Jy
Total-power spectrum Antenna: *
Timerange: 00/20:33:41 to 00/20:35:09

Plot file version 606 created 14-MAY-2010 15:20:30

J1027+48 EO007.UVDATA.1

Freq = 4.9270 GHz, Bw = 16.000 MH No calibration applied and no bandpass applied

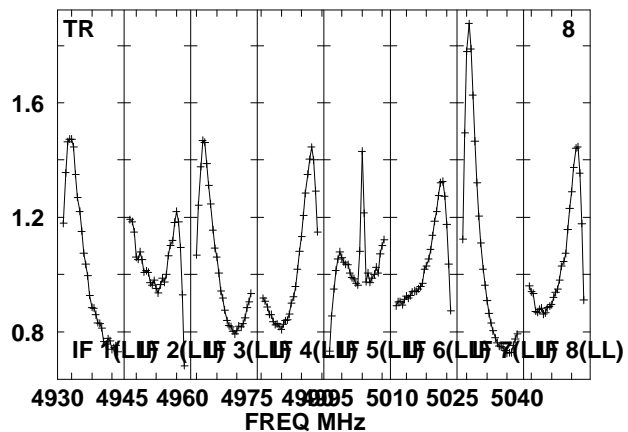
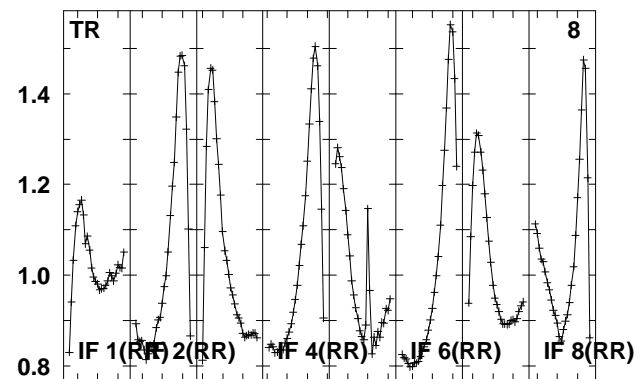
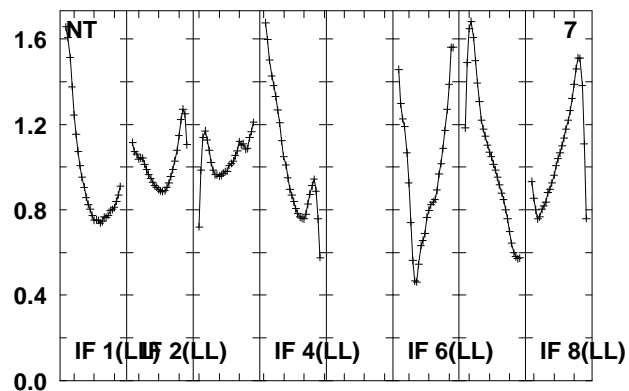
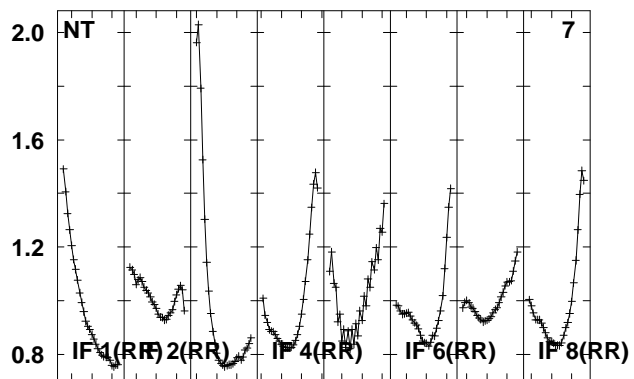
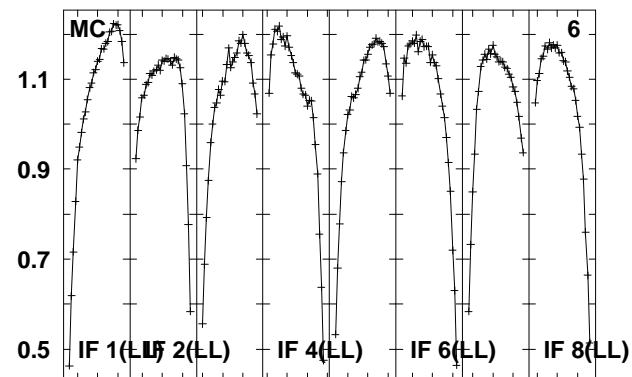
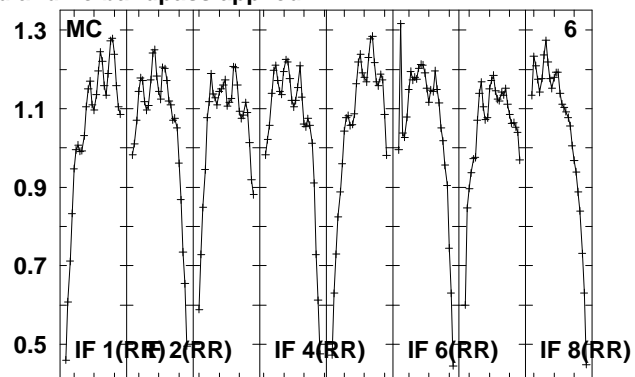
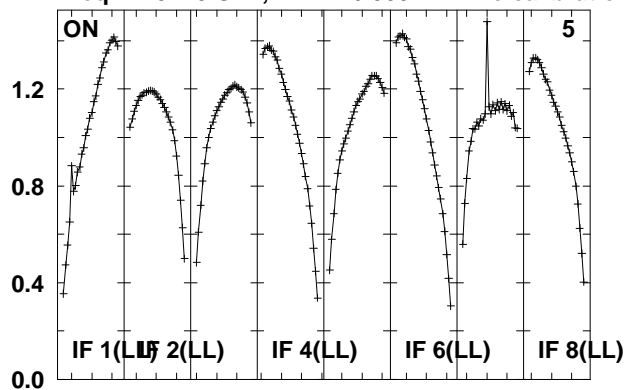

Lower frame: Real Jy

Total-power spectrum Antenna: *

Timerange: 00/20:33:41 to 00/20:35:09

Plot file version 607 created 14-MAY-2010 15:20:30
 J102959 EO007.UVDATA.1
 Freq = 4.9270 GHz, Bw = 16.000 MH No calibration applied and no bandpass applied

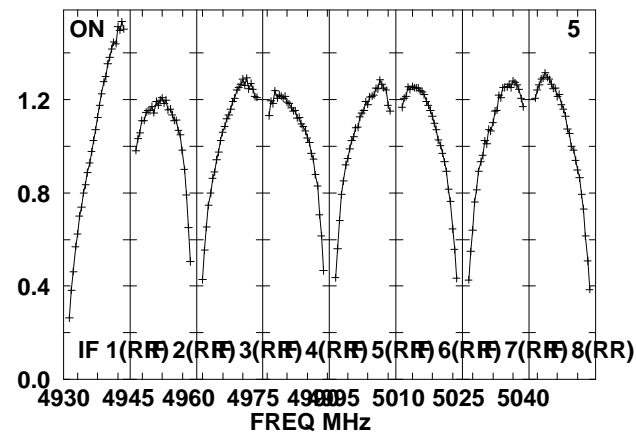
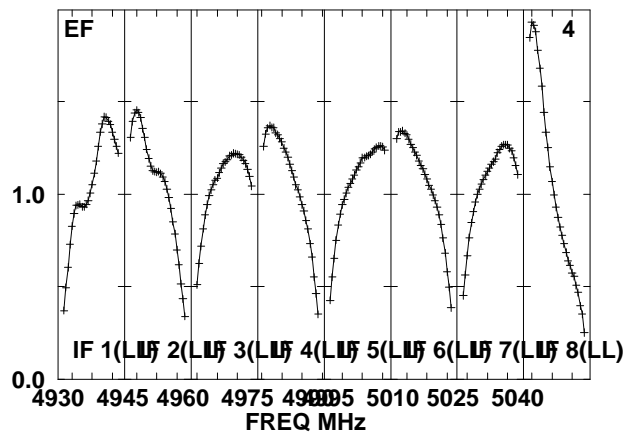
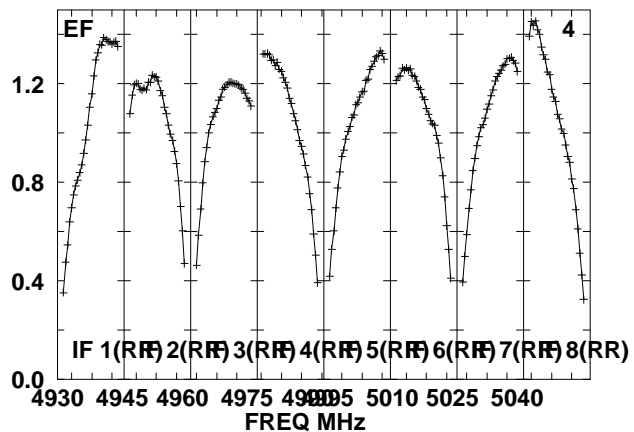
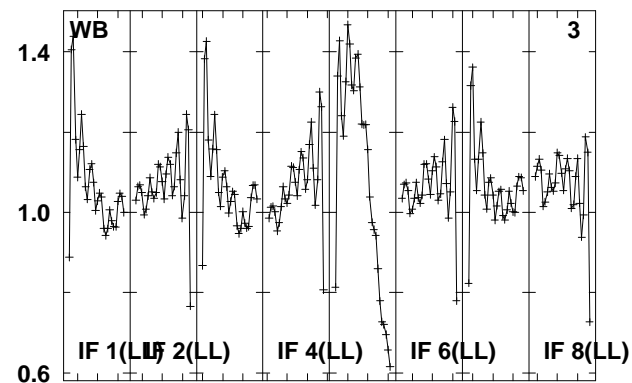
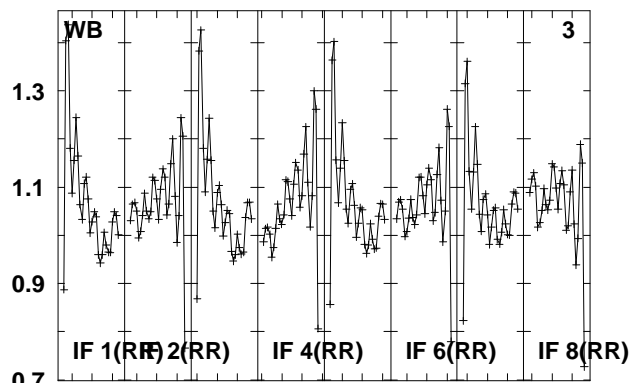
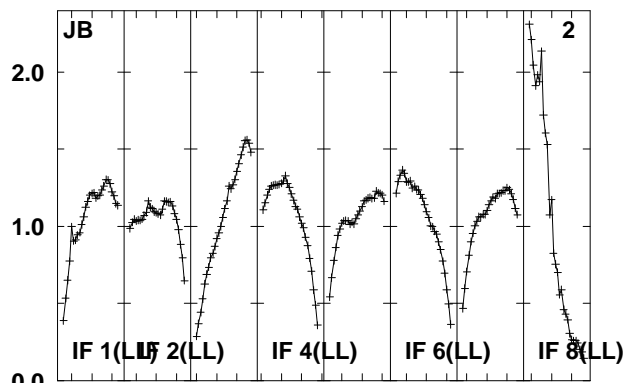
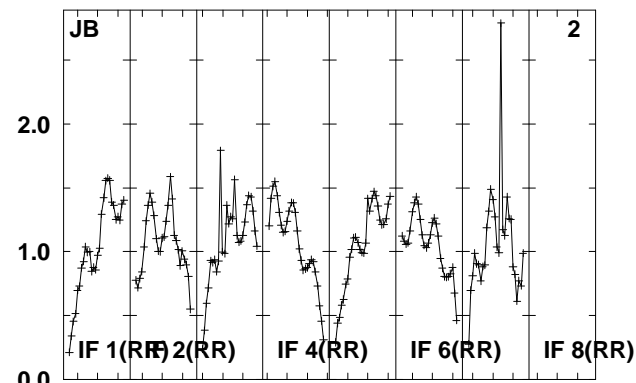
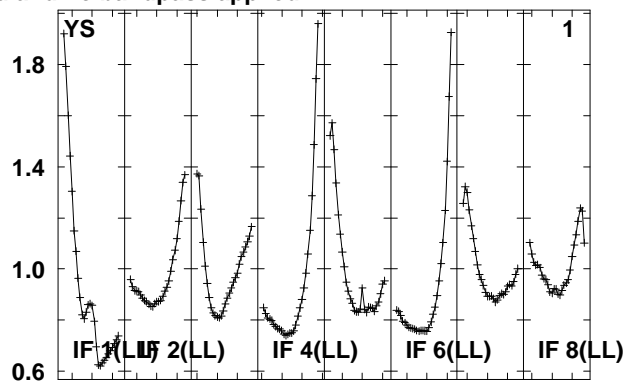
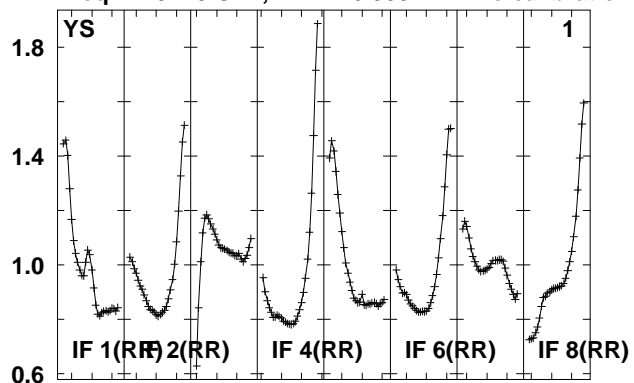

Lower frame: Real Jy
 Total-power spectrum Antenna: *
 Timerange: 00/20:35:41 to 00/20:40:37

Plot file version 608 created 14-MAY-2010 15:20:31

J102959 EO007.UVDATA.1

Freq = 4.9270 GHz, Bw = 16.000 MH No calibration applied and no bandpass applied

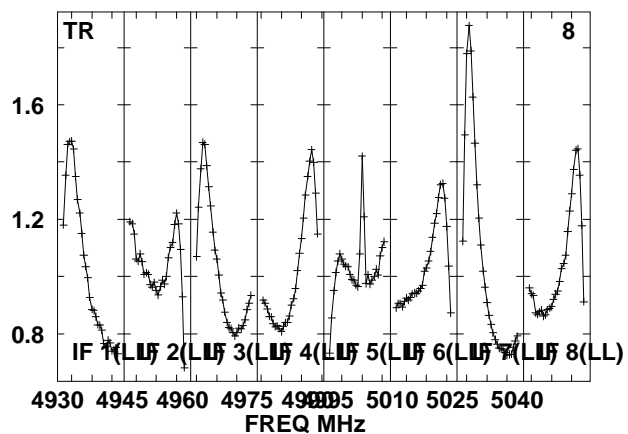
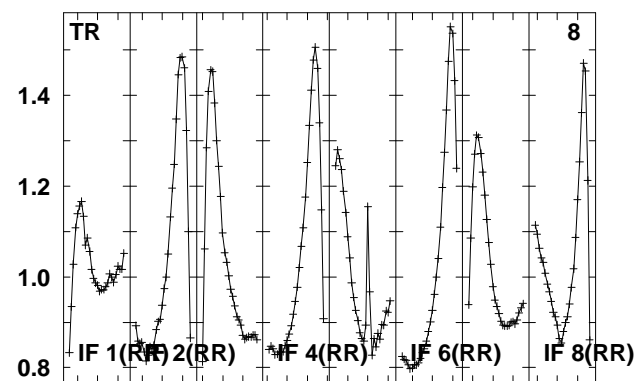
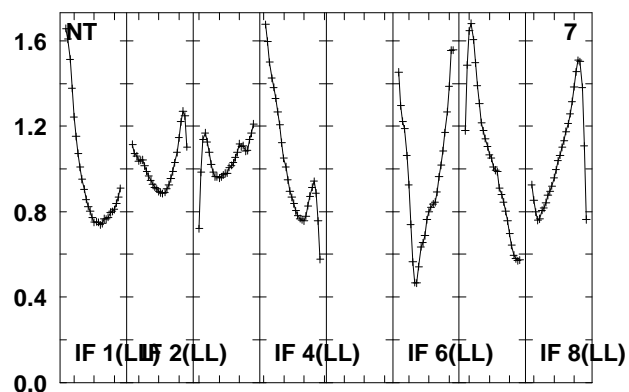
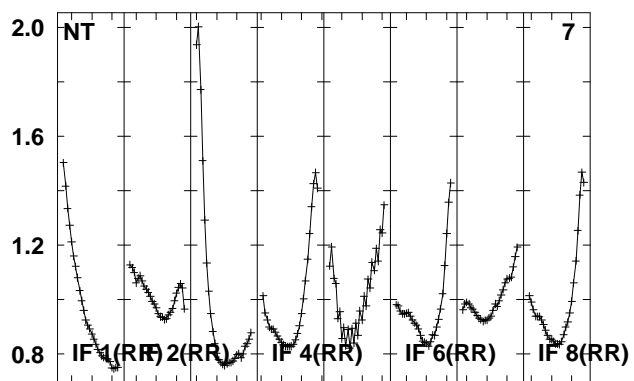
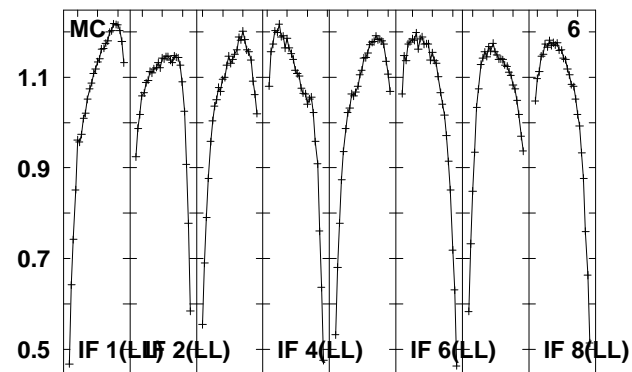
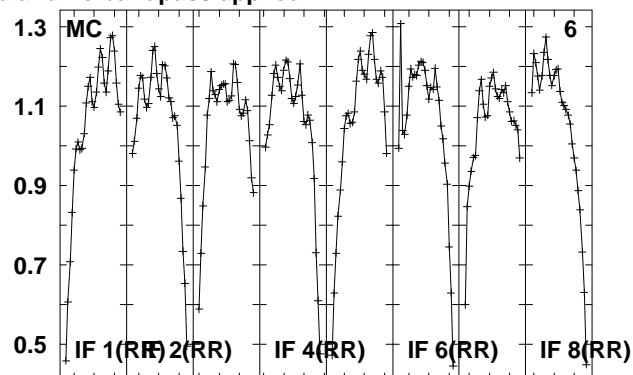
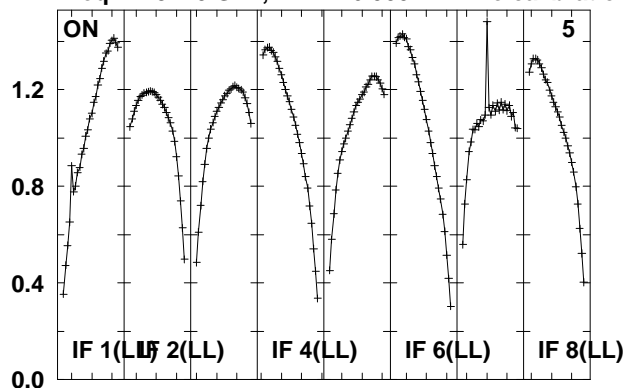

Lower frame: Real Jy

Total-power spectrum Antenna: *

Timerange: 00/20:35:41 to 00/20:40:37

Plot file version 609 created 14-MAY-2010 15:20:31

J1027+48 EO007.UVDATA.1

Freq = 4.9270 GHz, Bw = 16.000 MH No calibration applied and no bandpass applied

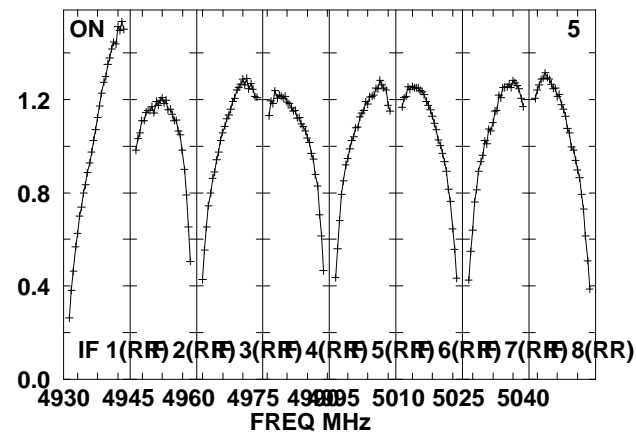
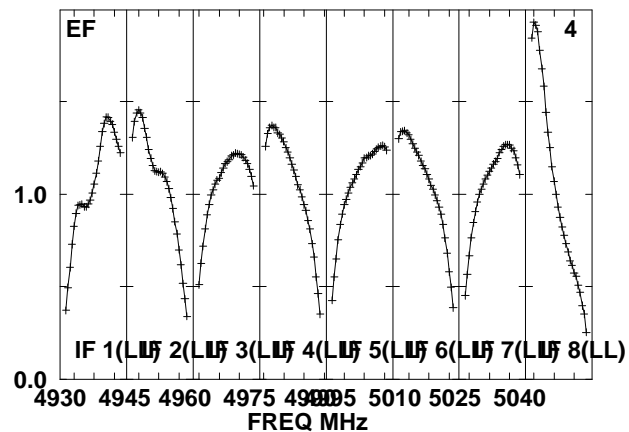
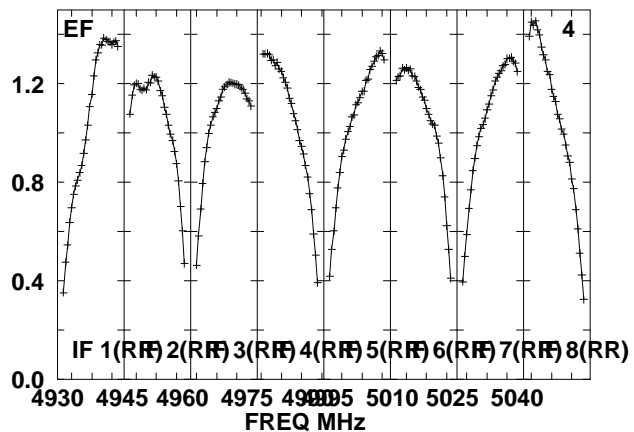
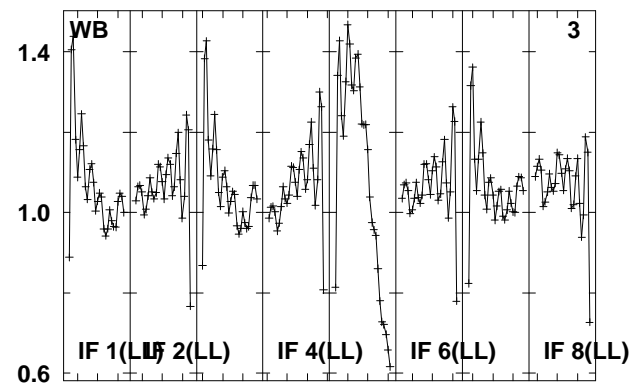
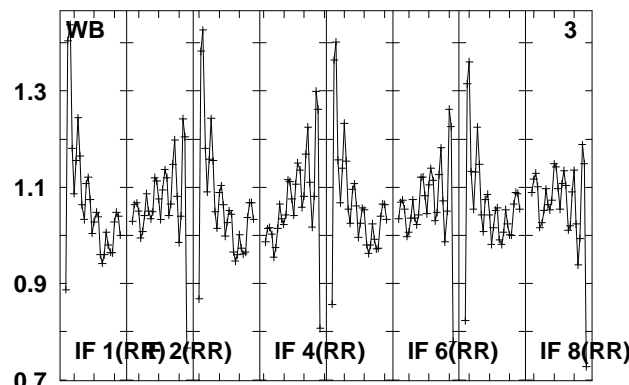
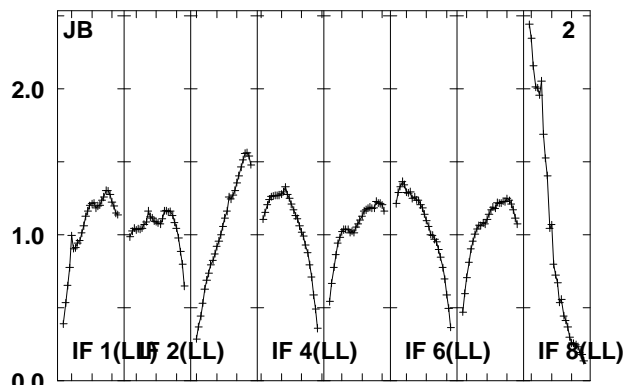
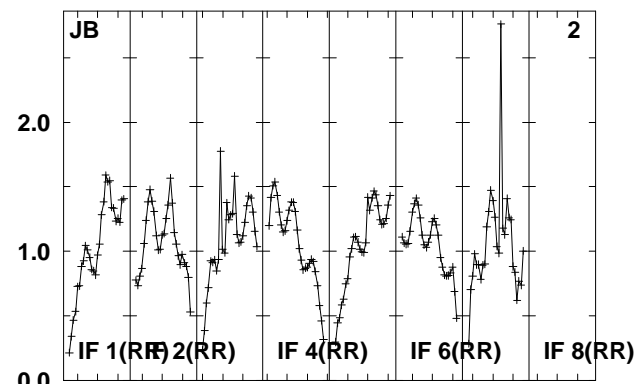
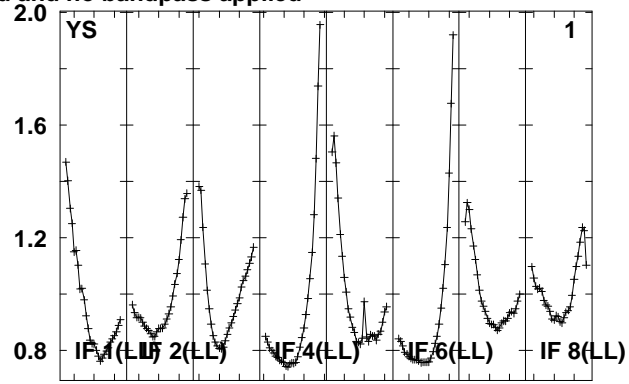
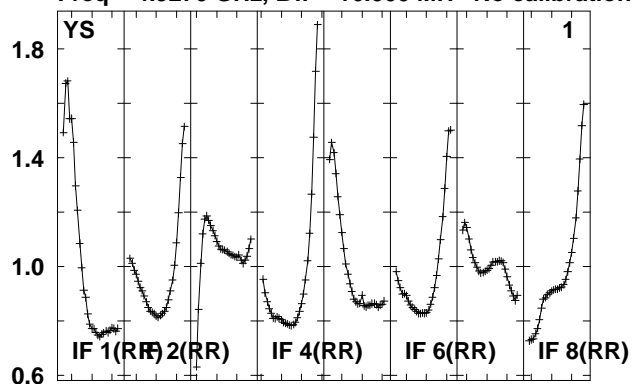

Lower frame: Real Jy
Total-power spectrum Antenna: *
Timerange: 00/20:41:09 to 00/20:42:39

Plot file version 610 created 14-MAY-2010 15:20:32

J1027+48 EO007.UVDATA.1

Freq = 4.9270 GHz, Bw = 16.000 MH No calibration applied and no bandpass applied

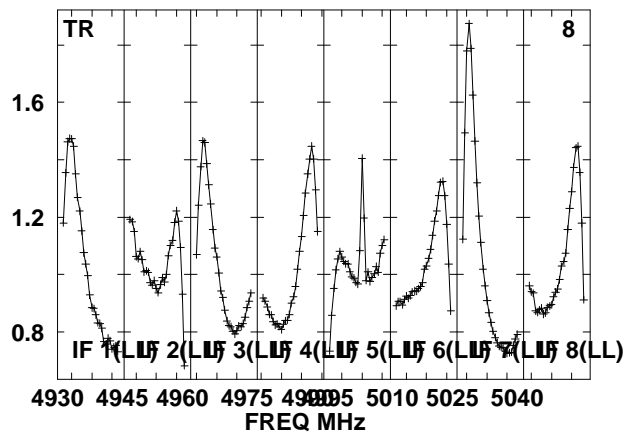
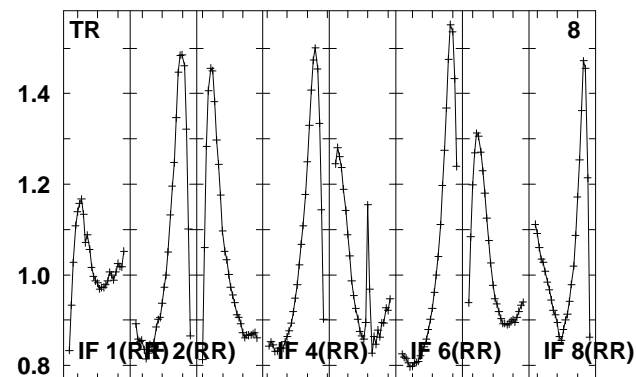
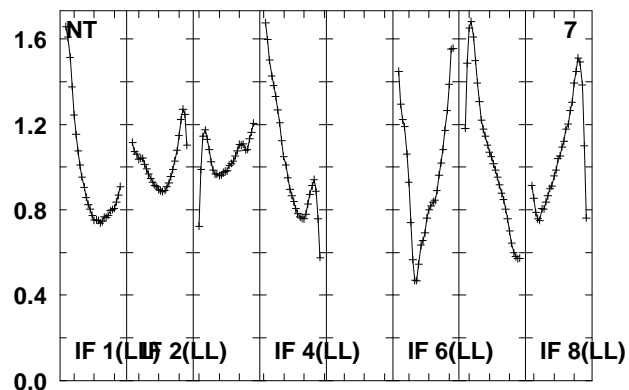
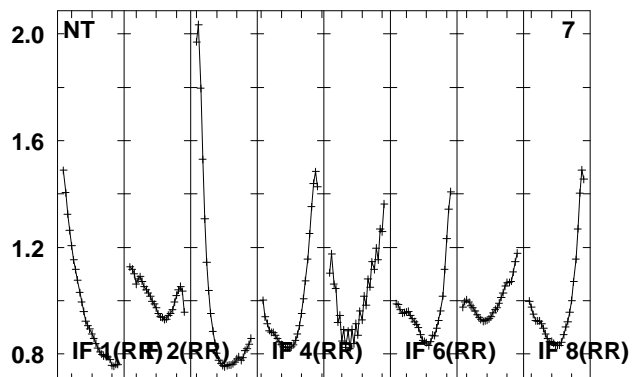
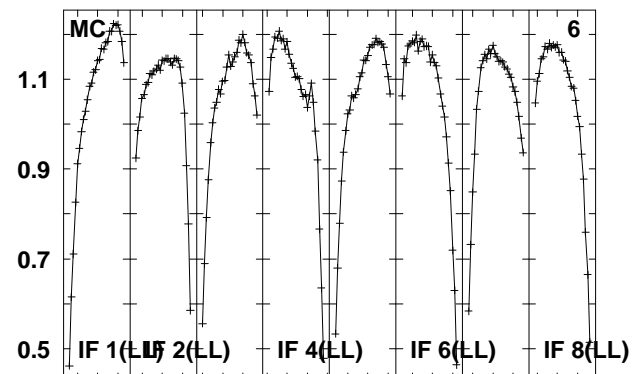
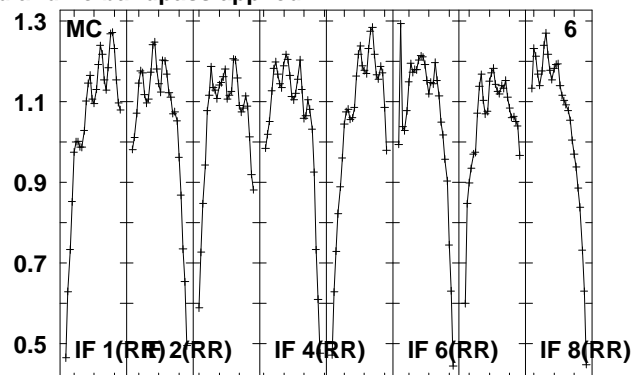
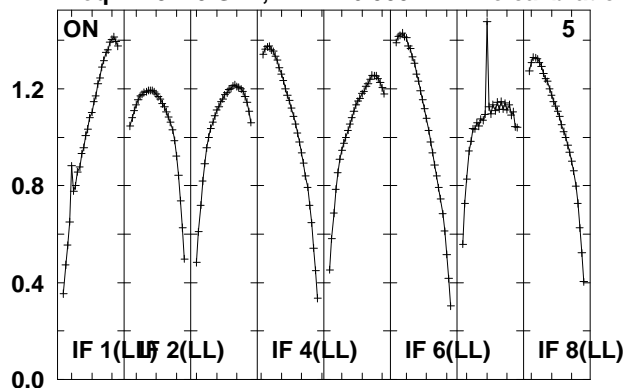

Lower frame: Real Jy

Total-power spectrum Antenna: *

Timerange: 00/20:41:09 to 00/20:42:39

Plot file version 611 created 14-MAY-2010 15:20:32

J102959 EO007.UVDATA.1

Freq = 4.9270 GHz, Bw = 16.000 MH No calibration applied and no bandpass applied

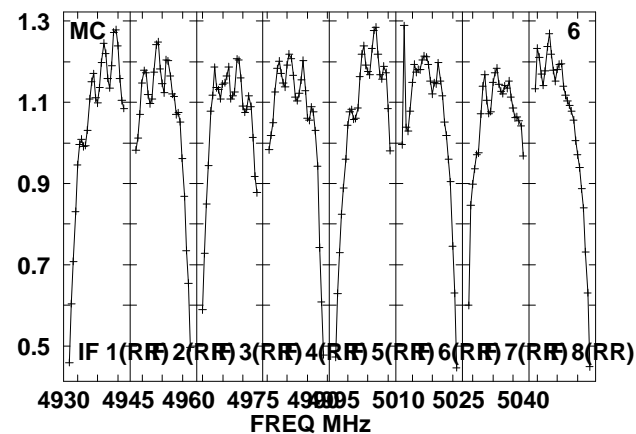
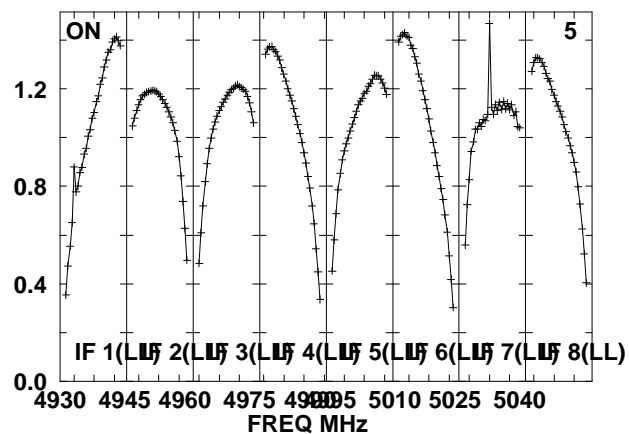
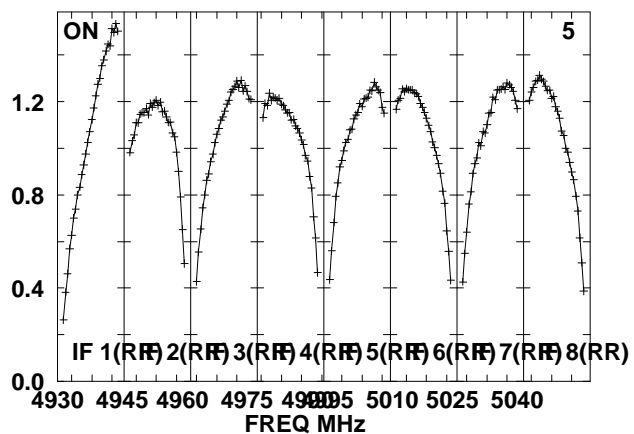
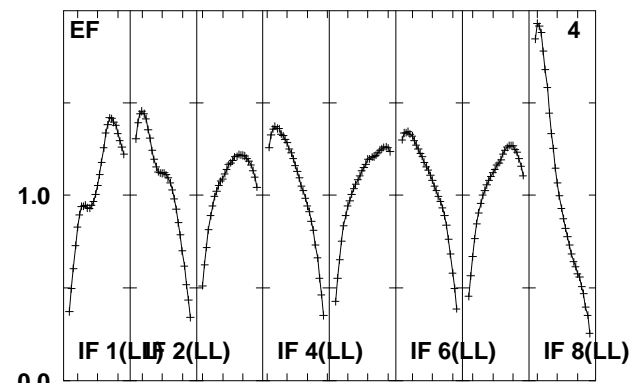
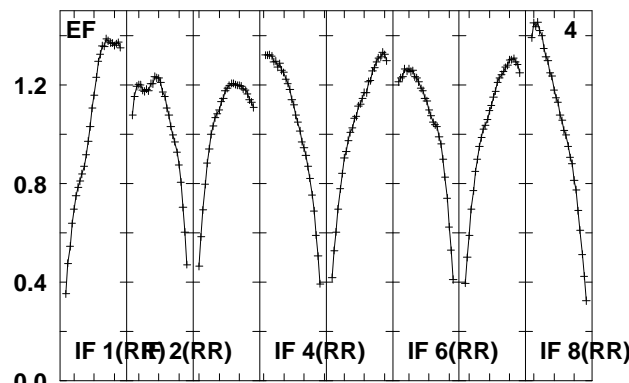
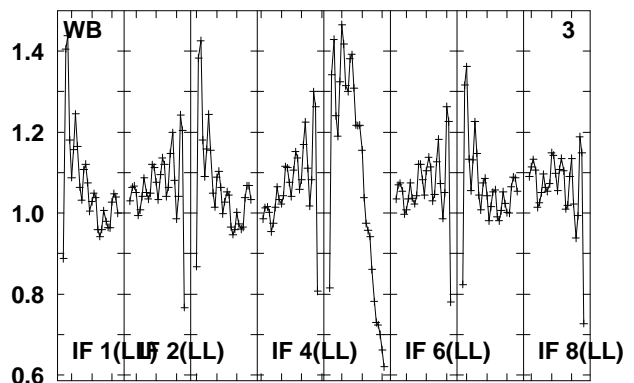
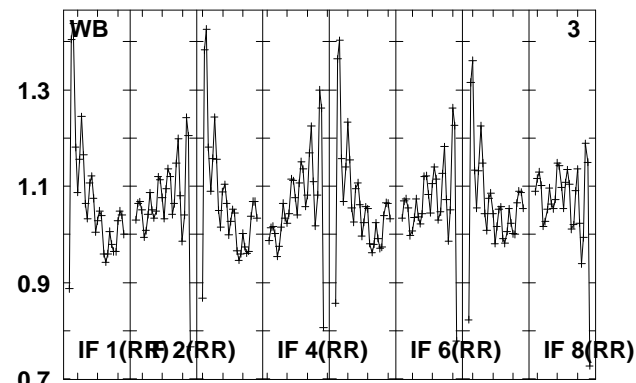
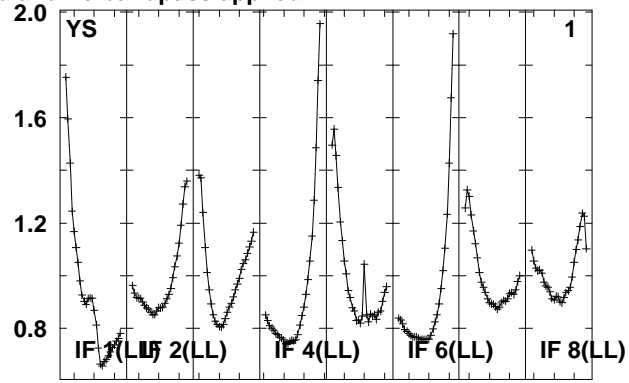
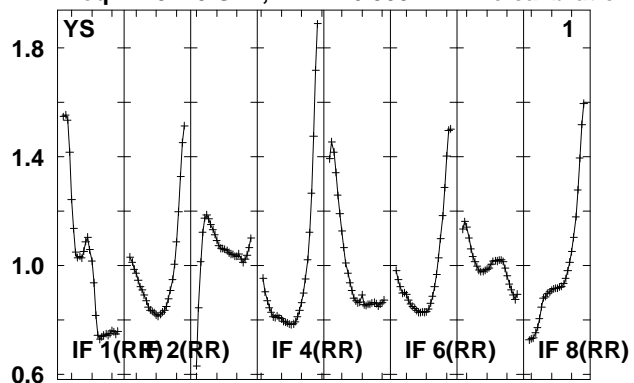

Lower frame: Real Jy
Total-power spectrum Antenna: *
Timerange: 00/20:43:09 to 00/20:48:07

Plot file version 612 created 14-MAY-2010 15:20:33

J102959 EO007.UVDATA.1

Freq = 4.9270 GHz, Bw = 16.000 MH No calibration applied and no bandpass applied

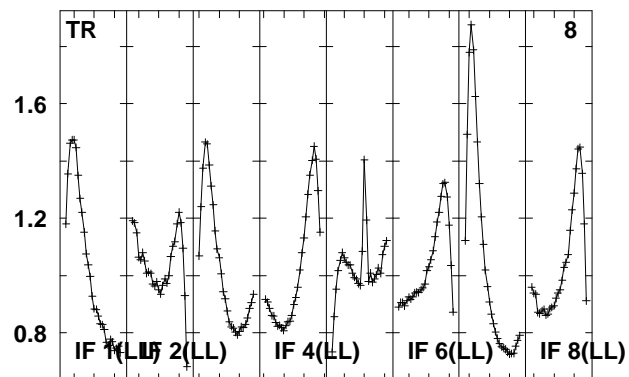
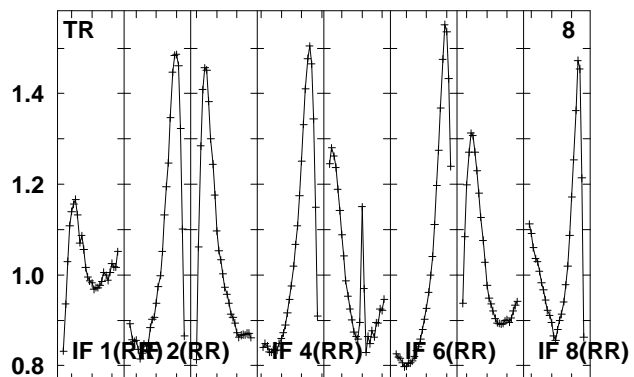
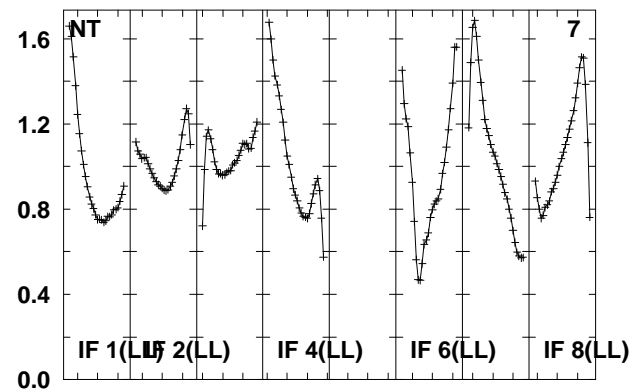
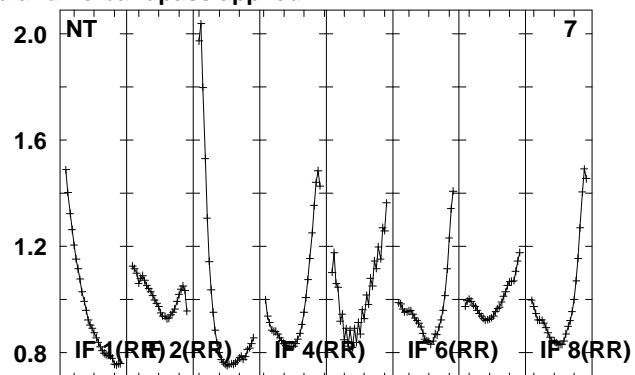
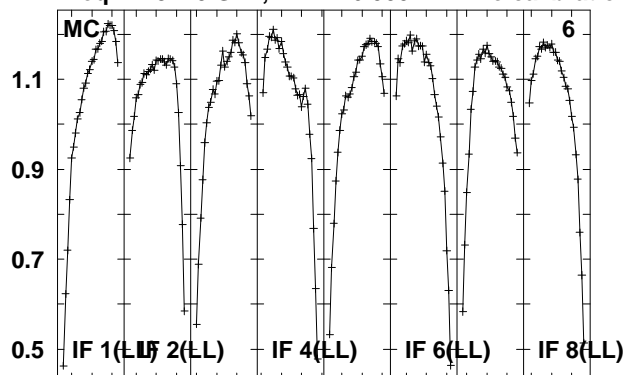

Lower frame: Real Jy
Total-power spectrum Antenna: *
Timerange: 00/20:43:09 to 00/20:48:07

Plot file version 613 created 14-MAY-2010 15:20:33

J1027+48 EO007.UVDATA.1

Freq = 4.9270 GHz, Bw = 16.000 MH No calibration applied and no bandpass applied

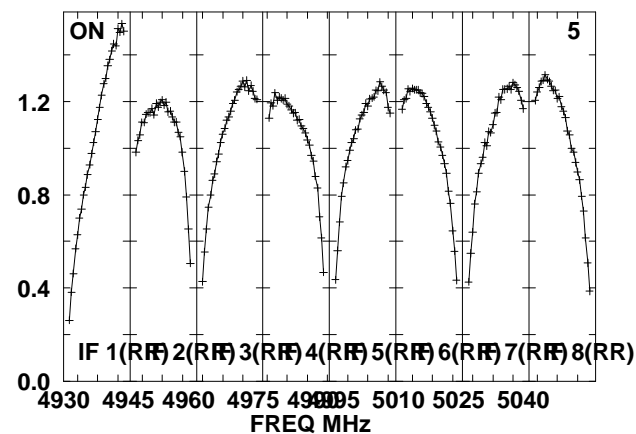
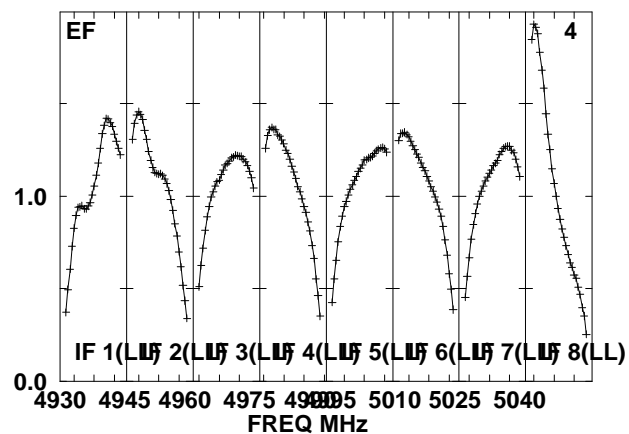
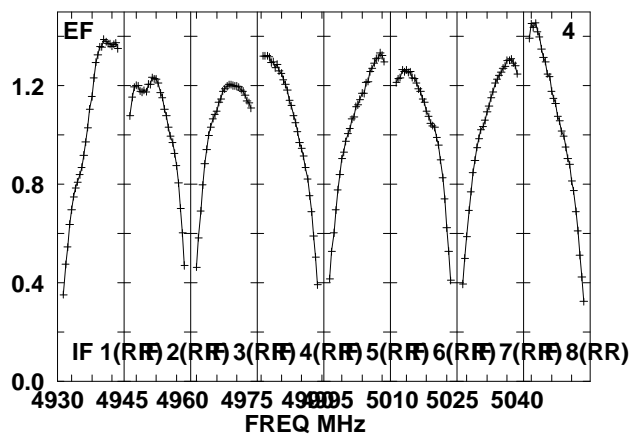
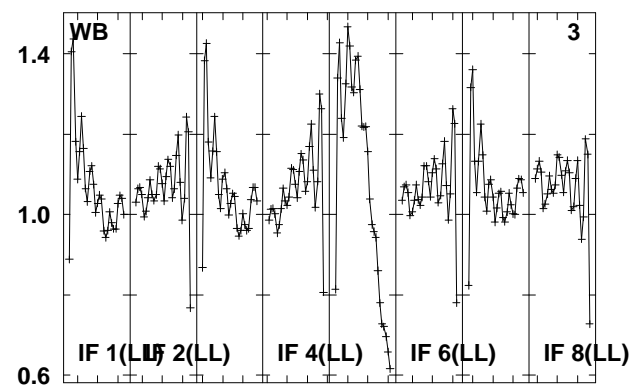
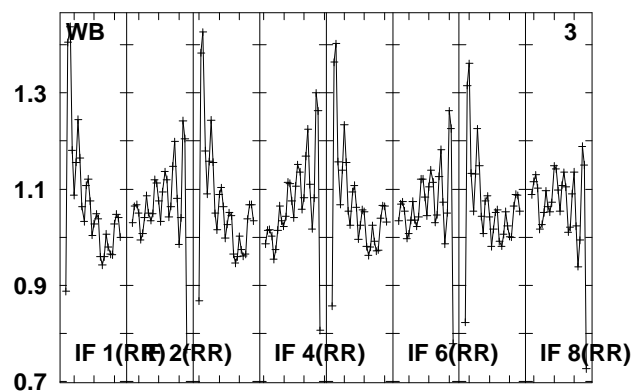
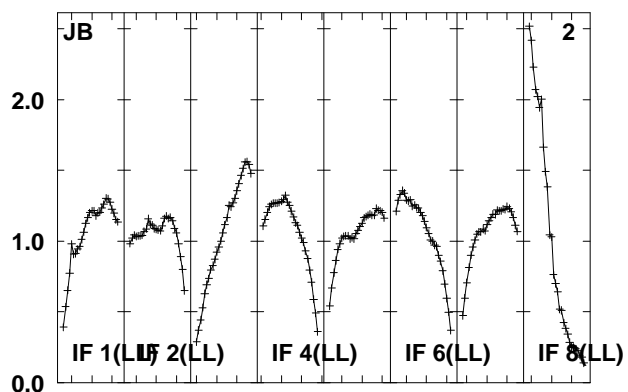
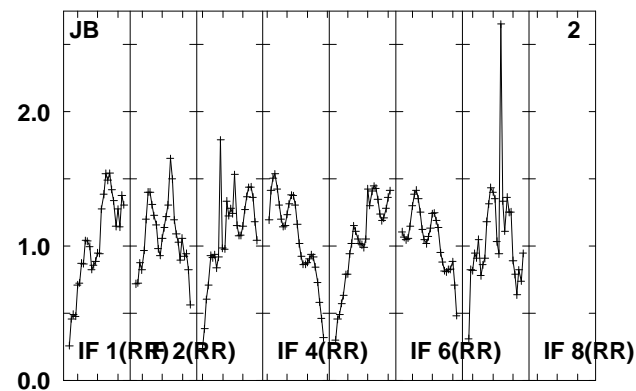
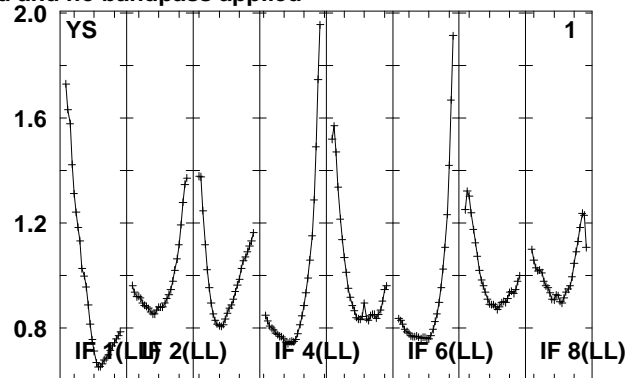
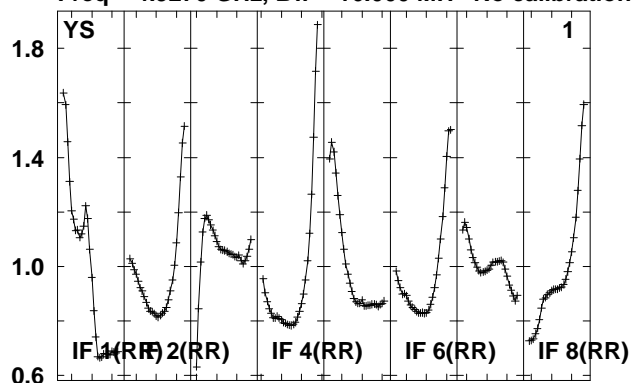

Lower frame: Real Jy

Total-power spectrum Antenna: *

Timerange: 00/20:48:41 to 00/20:50:09

Plot file version 614 created 14-MAY-2010 15:20:33

J1027+48 EO007.UVDATA.1

Freq = 4.9270 GHz, Bw = 16.000 MH No calibration applied and no bandpass applied

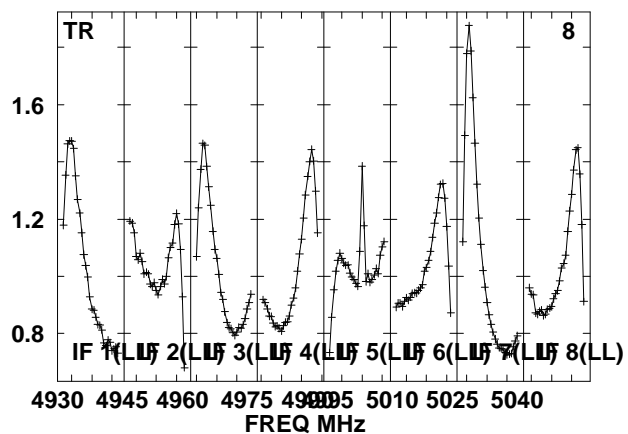
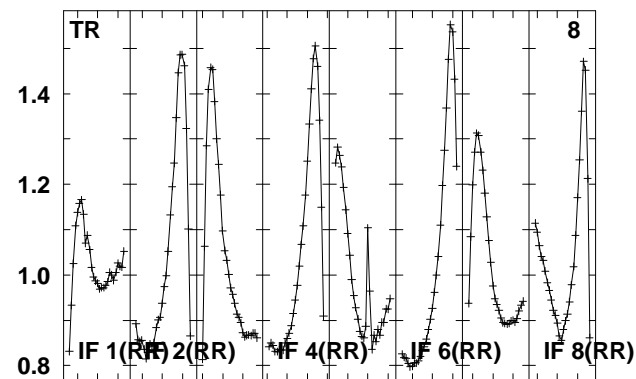
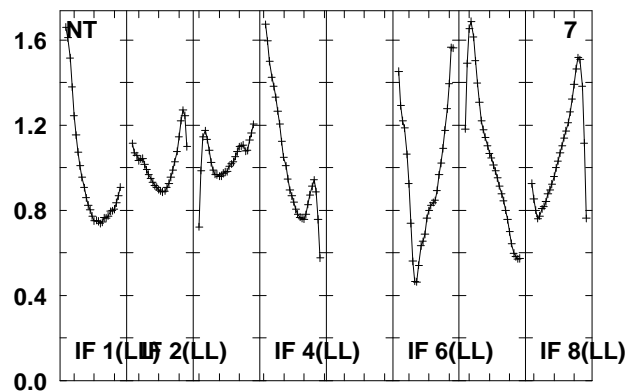
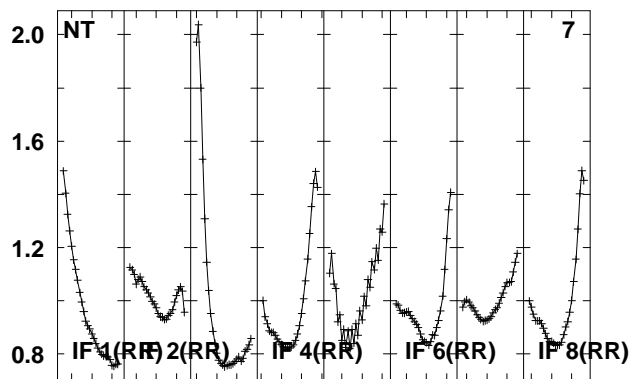
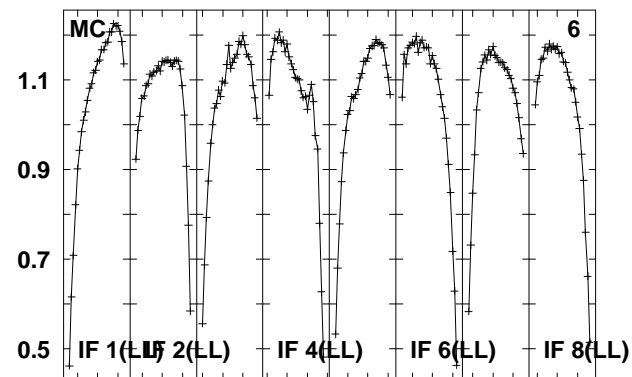
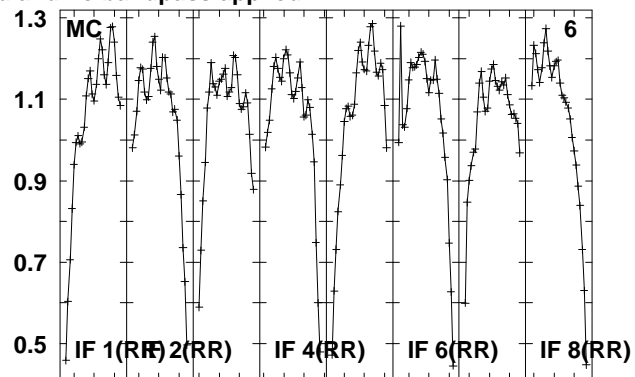
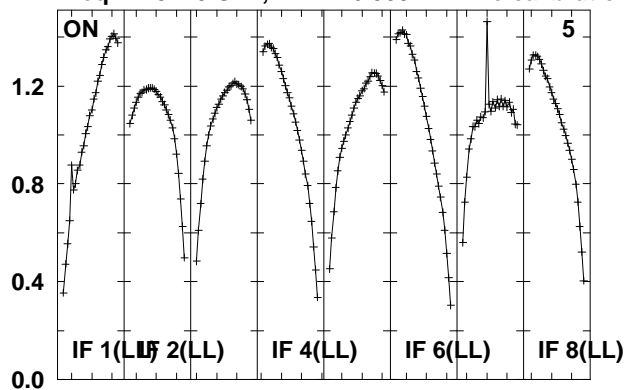

Lower frame: Real Jy

Total-power spectrum Antenna: *

Timerange: 00/20:48:41 to 00/20:50:09

Plot file version 615 created 14-MAY-2010 15:20:33

J0920+44 EO007.UVDATA.1

Freq = 4.9270 GHz, Bw = 16.000 MH No calibration applied and no bandpass applied

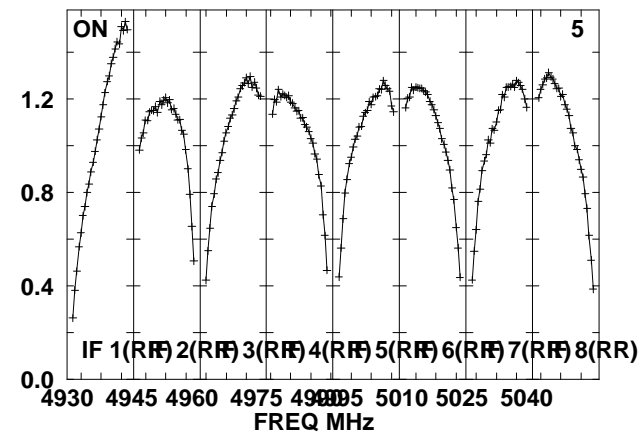
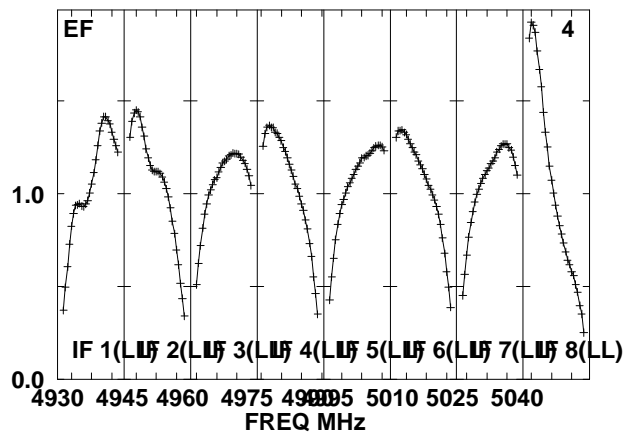
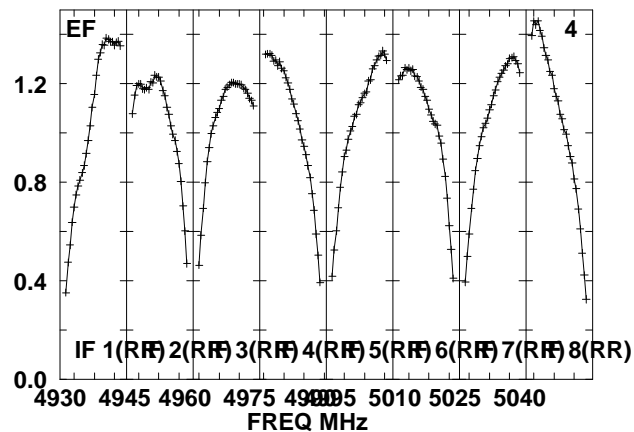
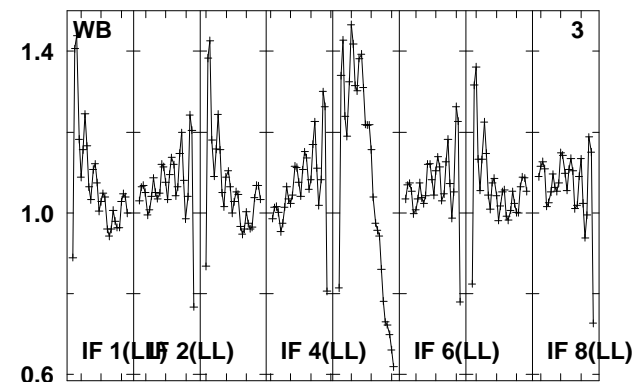
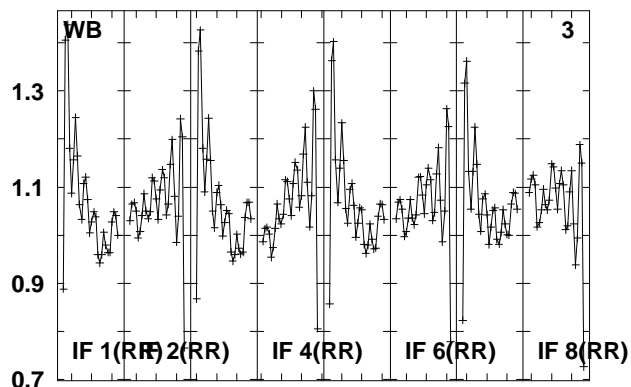
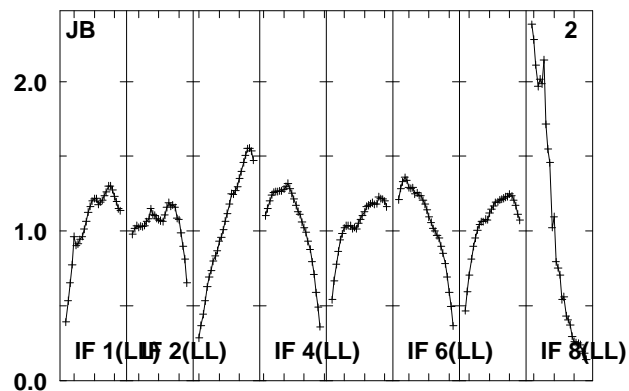
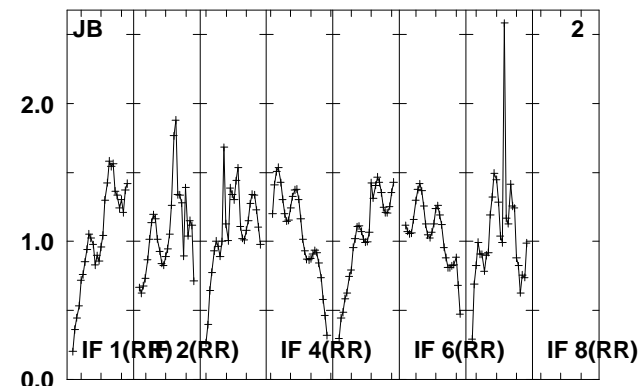
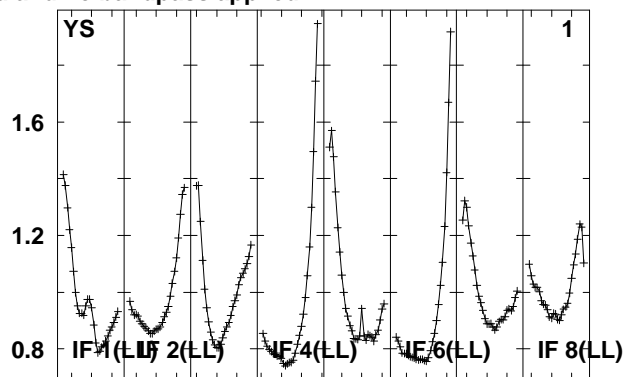
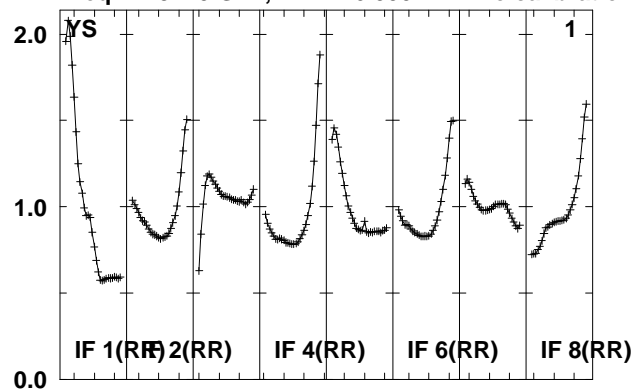

Lower frame: Real Jy
Total-power spectrum Antenna: *
Timerange: 00/20:53:21 to 00/20:54:49

Plot file version 616 created 14-MAY-2010 15:20:34

J0920+44 EO007.UVDATA.1

Freq = 4.9270 GHz, Bw = 16.000 MH No calibration applied and no bandpass applied

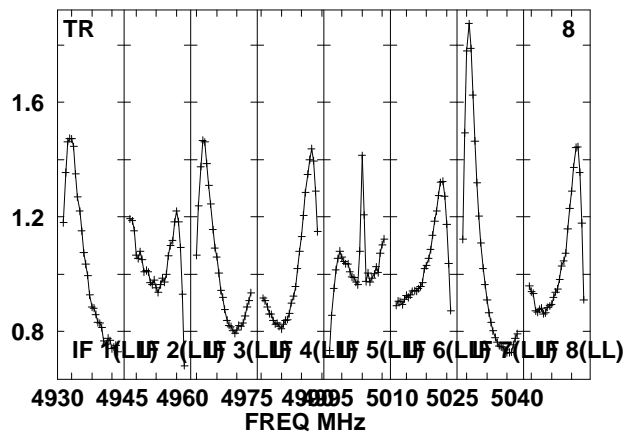
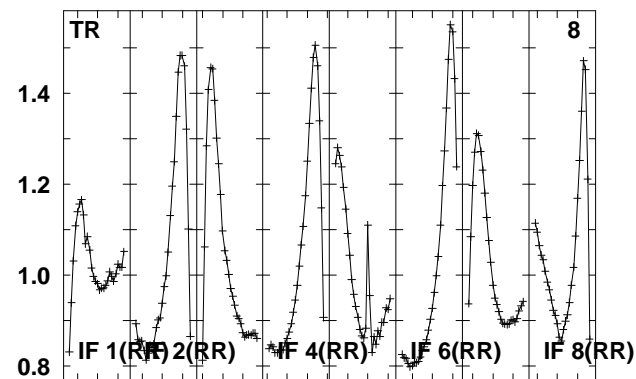
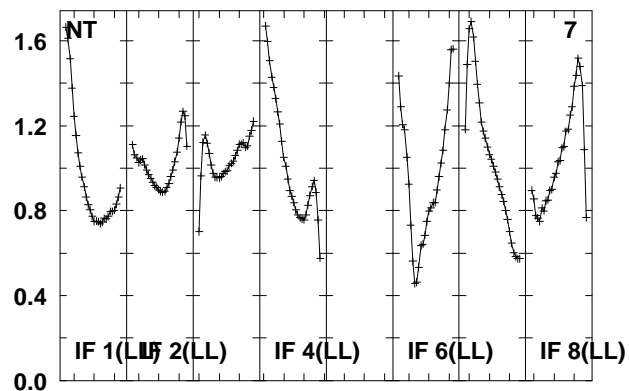
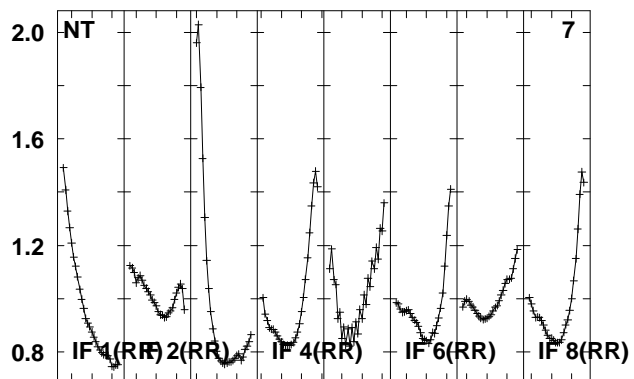
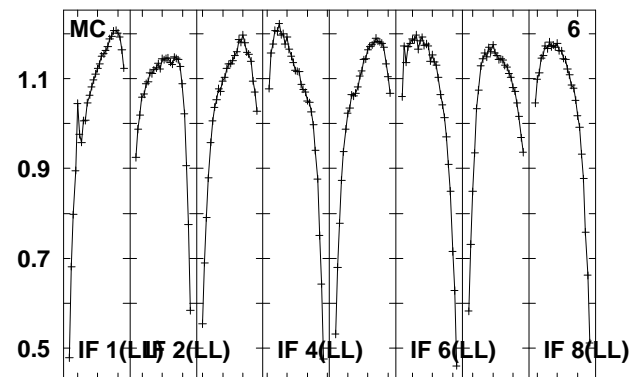
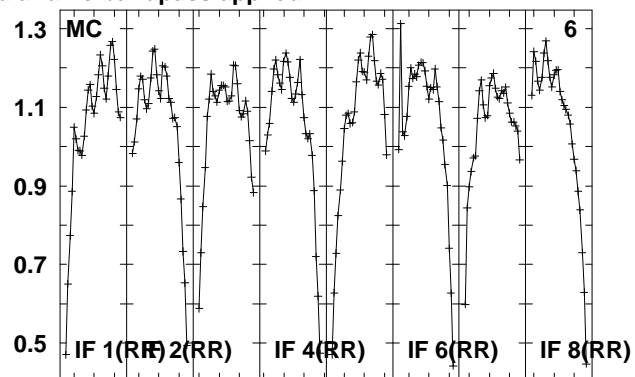
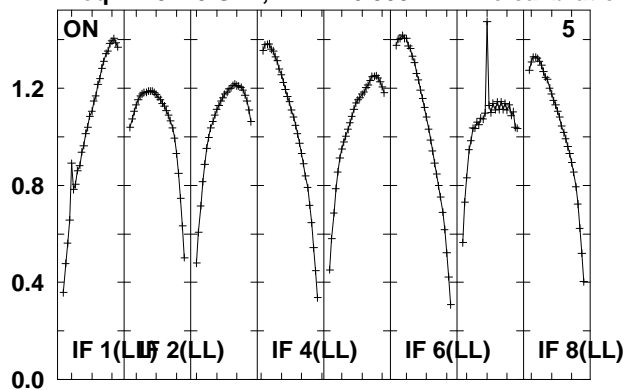

Lower frame: Real Jy

Total-power spectrum Antenna: *

Timerange: 00/20:53:21 to 00/20:54:49

Plot file version 617 created 14-MAY-2010 15:20:34

J092159 EO007.UVDATA.1

Freq = 4.9270 GHz, Bw = 16.000 MH No calibration applied and no bandpass applied

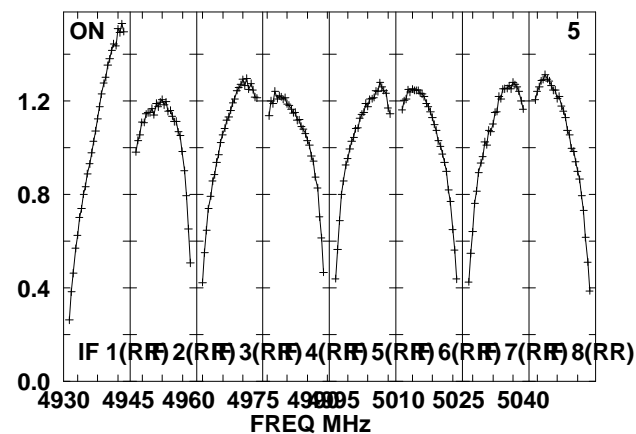
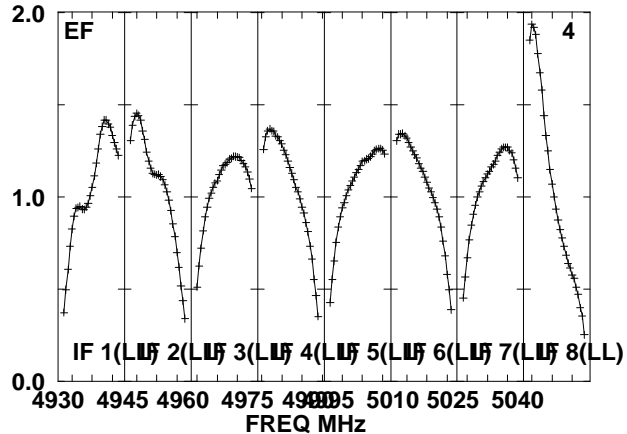
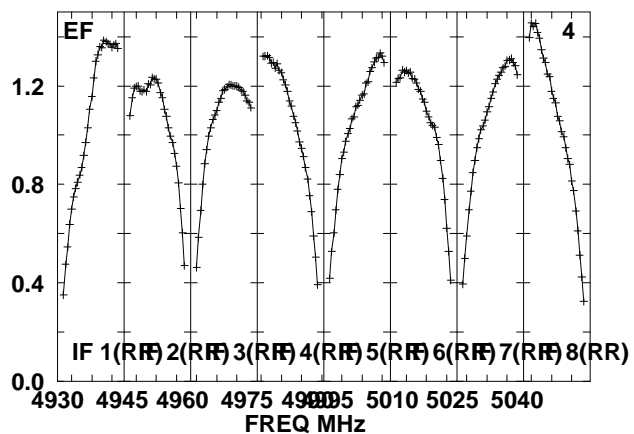
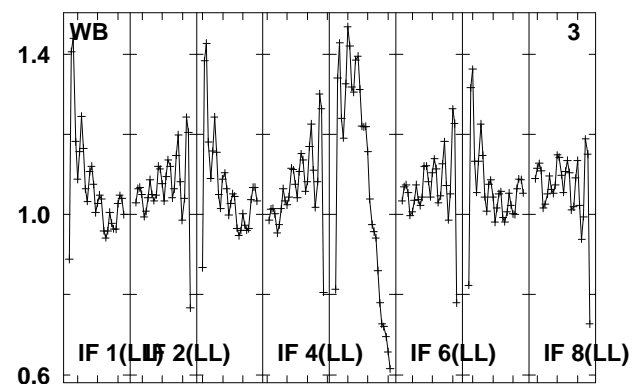
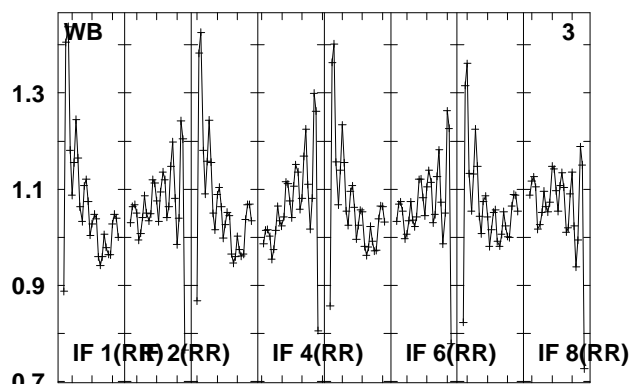
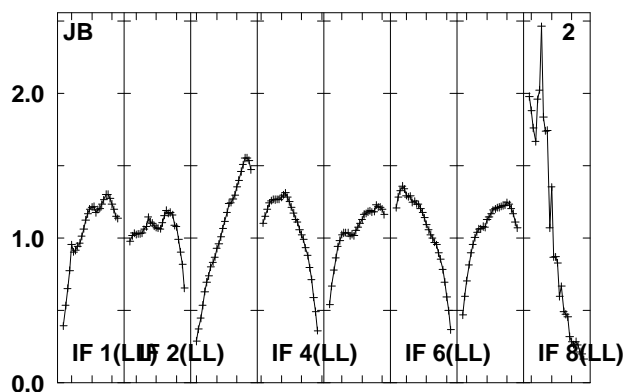
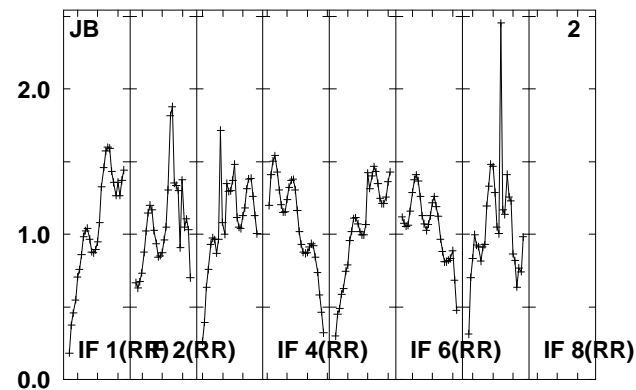
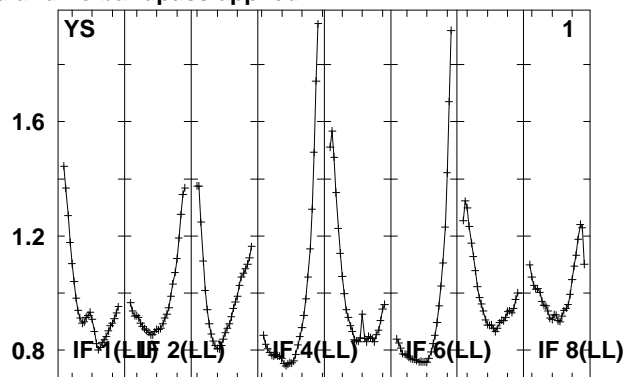
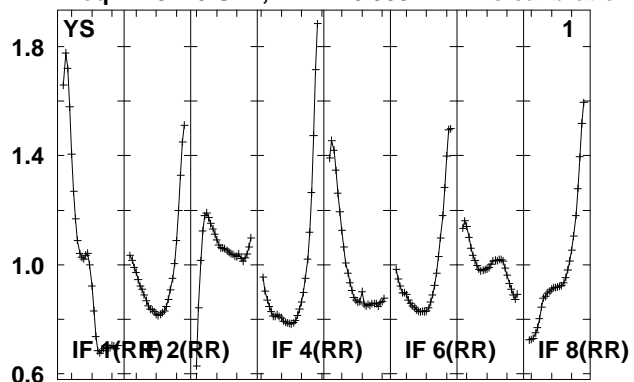

Lower frame: Real Jy
Total-power spectrum Antenna: *
Timerange: 00/20:55:21 to 00/21:00:17

Plot file version 618 created 14-MAY-2010 15:20:34

J092159 EO007.UVDATA.1

Freq = 4.9270 GHz, Bw = 16.000 MH No calibration applied and no bandpass applied

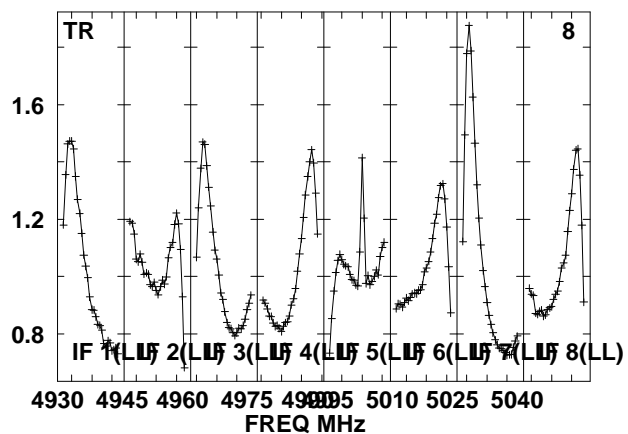
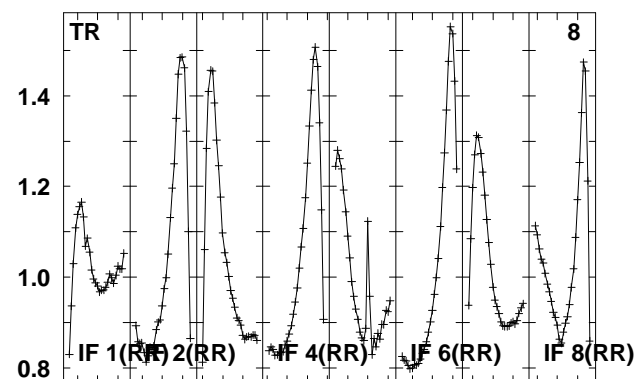
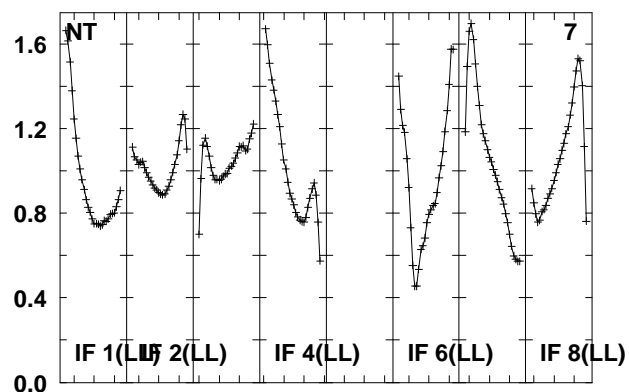
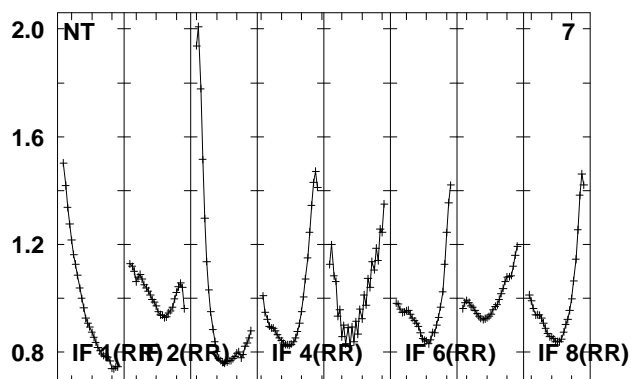
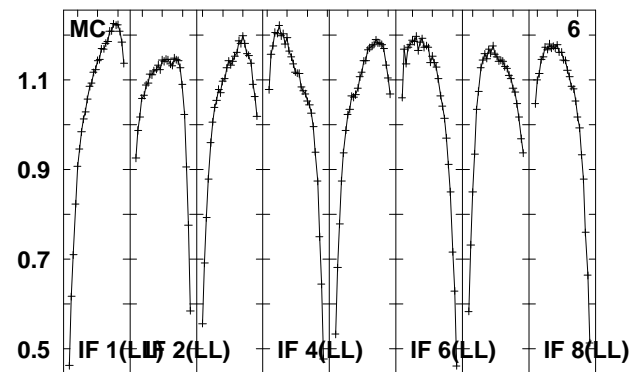
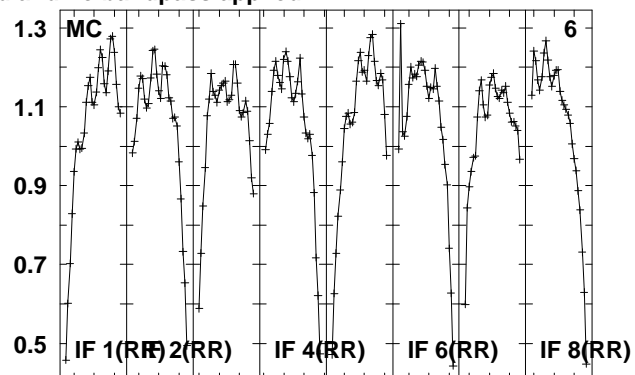
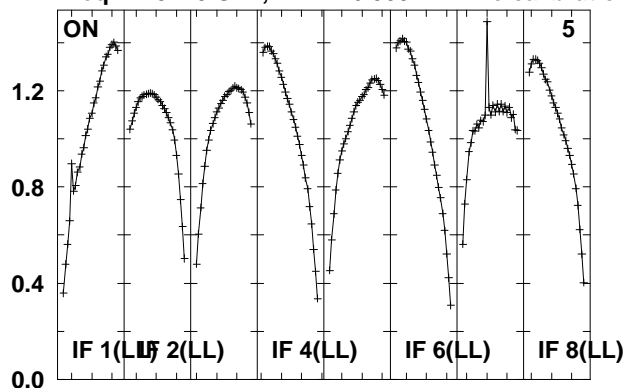

Lower frame: Real Jy

Total-power spectrum Antenna: *

Timerange: 00/20:55:21 to 00/21:00:17

Plot file version 619 created 14-MAY-2010 15:20:35

J0920+44 EO007.UVDATA.1

Freq = 4.9270 GHz, Bw = 16.000 MH No calibration applied and no bandpass applied

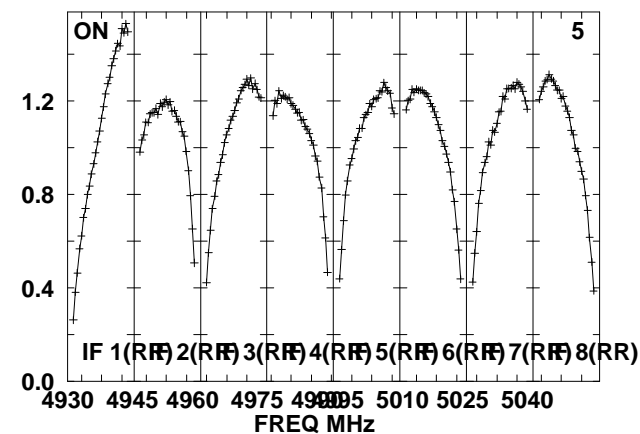
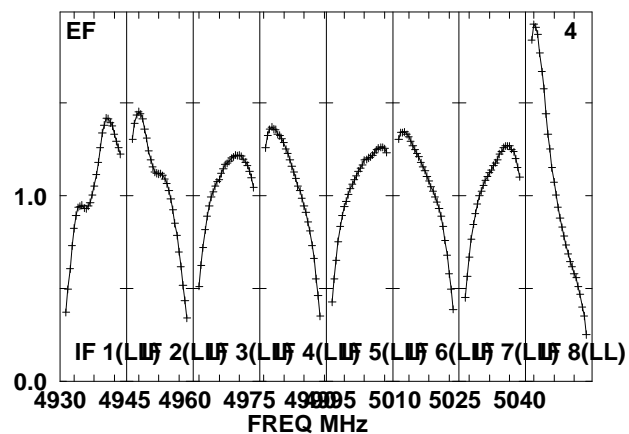
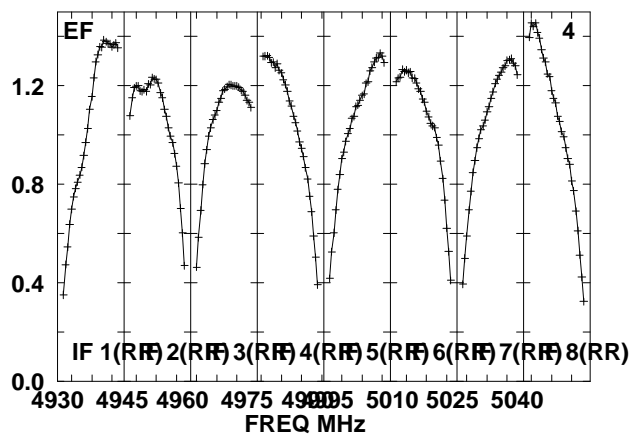
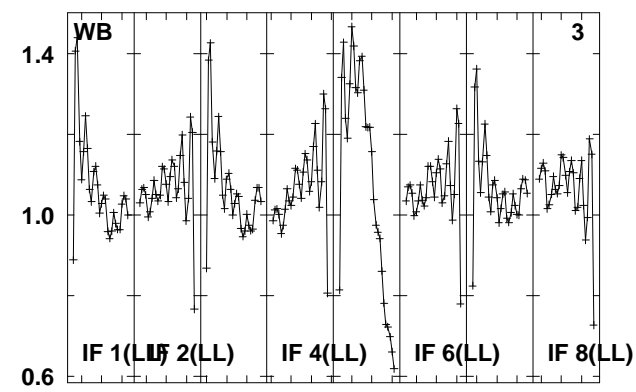
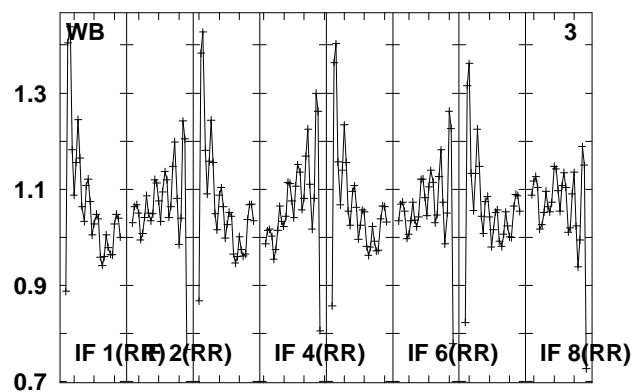
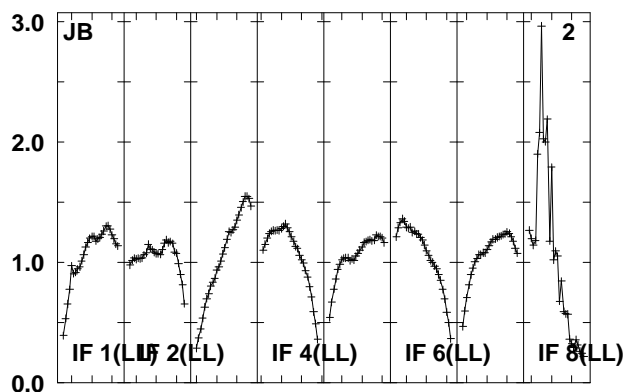
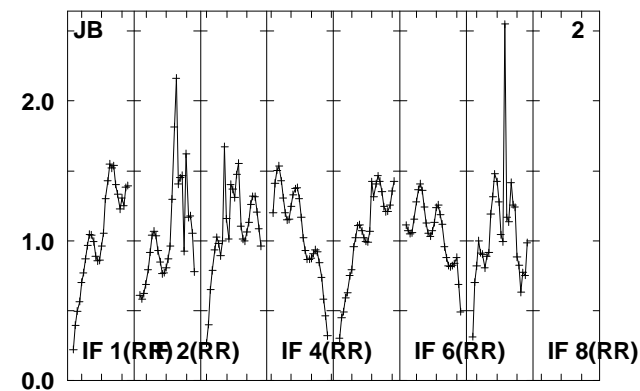
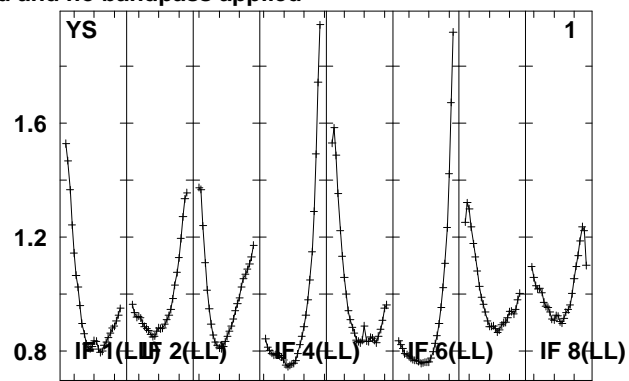
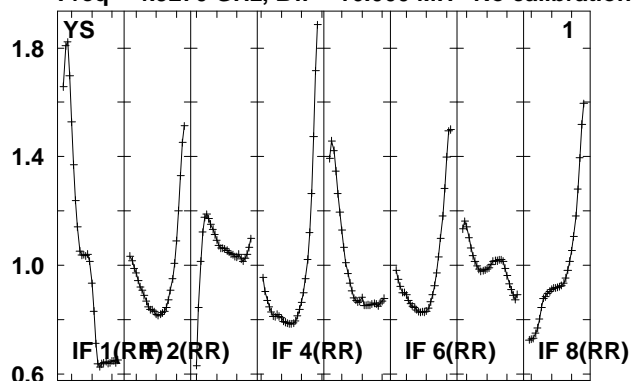

Lower frame: Real Jy
Total-power spectrum Antenna: *
Timerange: 00/21:00:56 to 00/21:02:24

Plot file version 620 created 14-MAY-2010 15:20:37

J0920+44 EO007.UVDATA.1

Freq = 4.9270 GHz, Bw = 16.000 MH No calibration applied and no bandpass applied

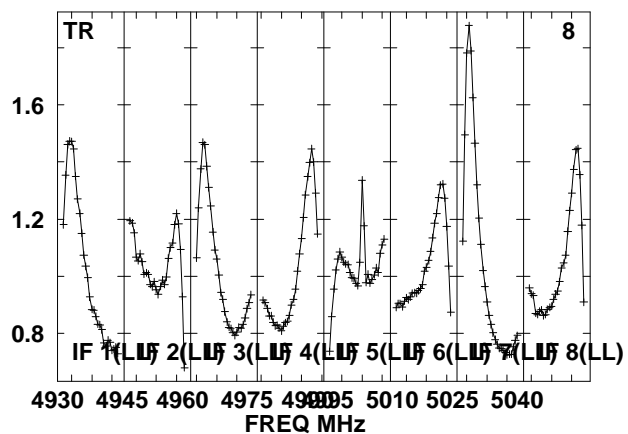
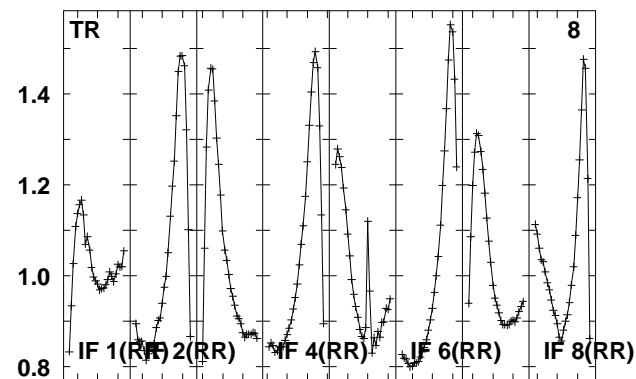
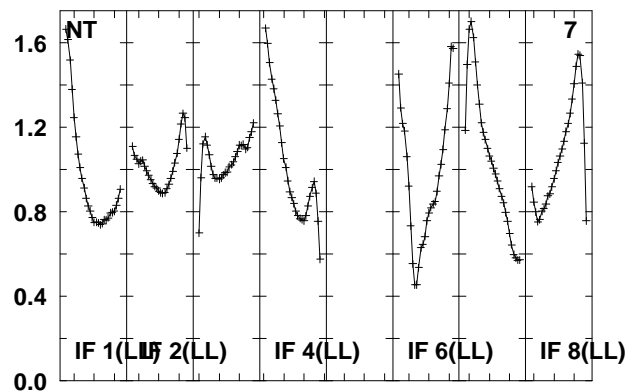
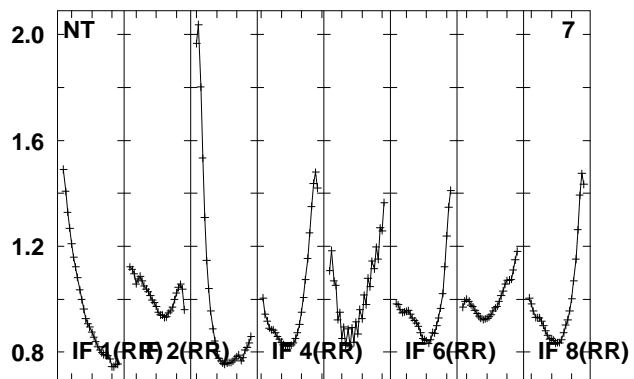
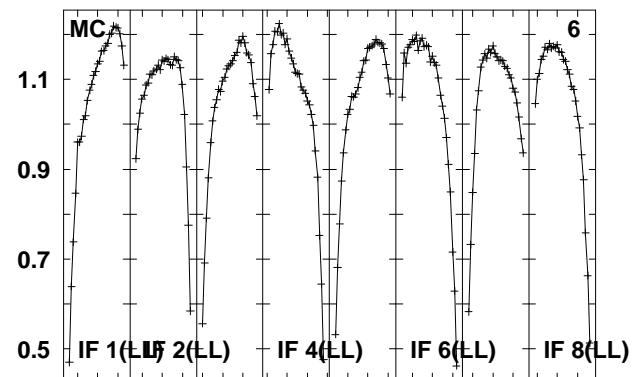
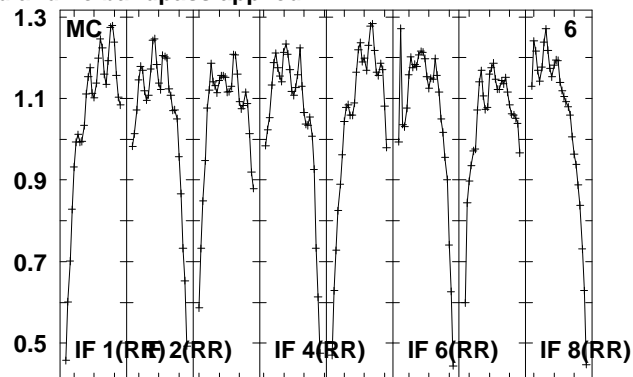
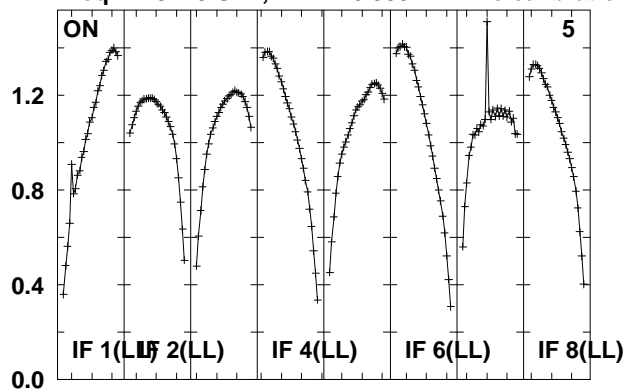

Lower frame: Real Jy

Total-power spectrum Antenna: *

Timerange: 00/21:00:56 to 00/21:02:24

Plot file version 621 created 14-MAY-2010 15:20:37
 J092159 EO007.UVDATA.1
 Freq = 4.9270 GHz, Bw = 16.000 MH No calibration applied and no bandpass applied

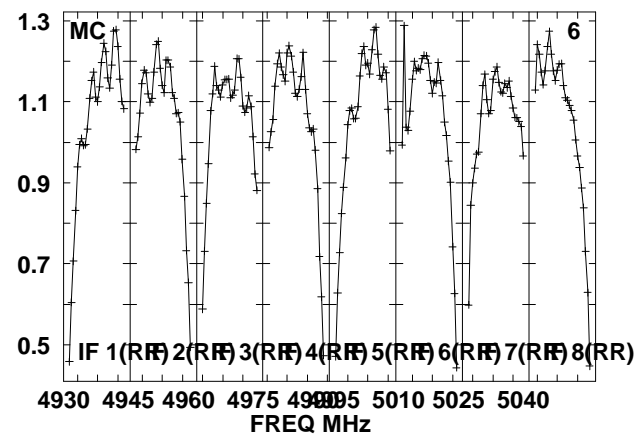
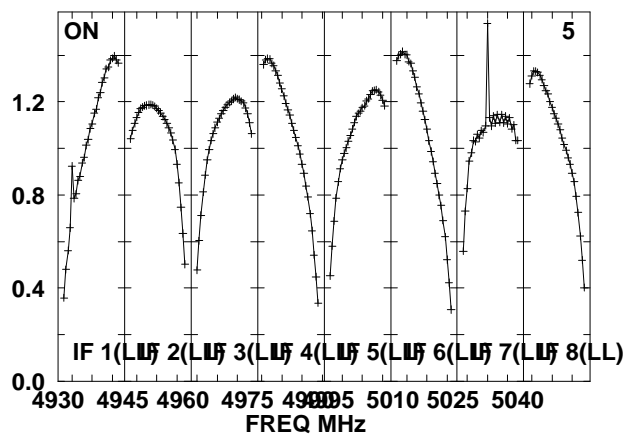
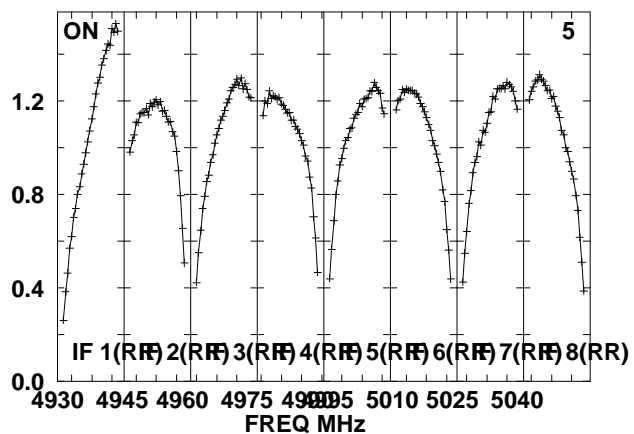
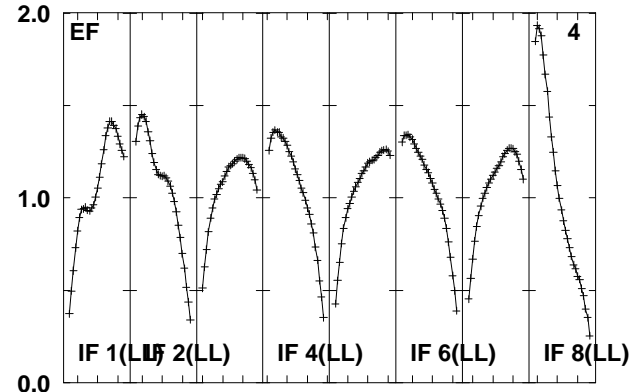
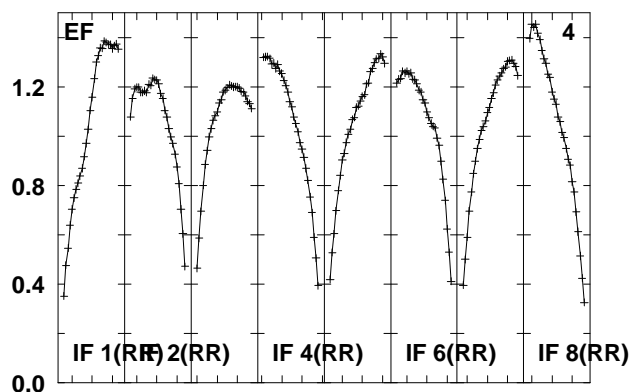
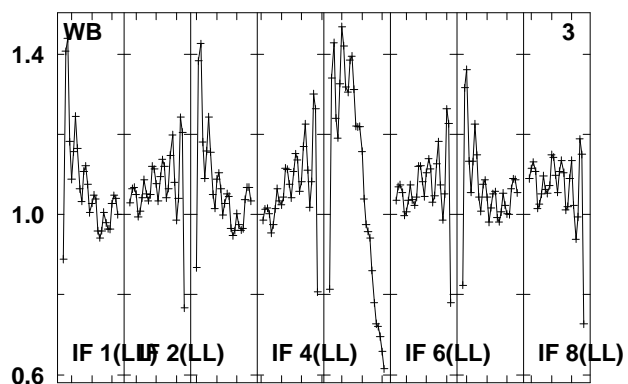
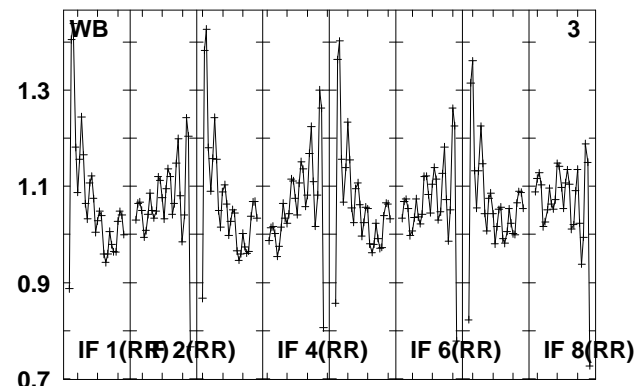
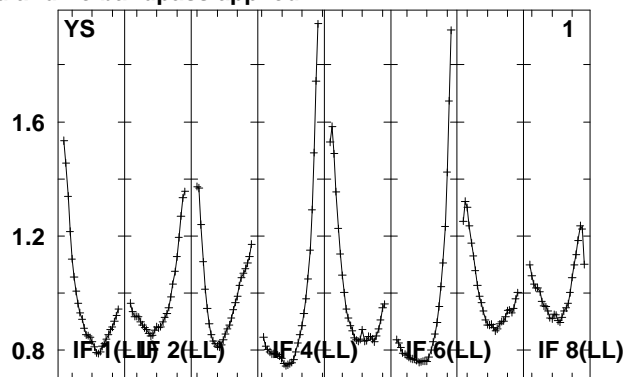
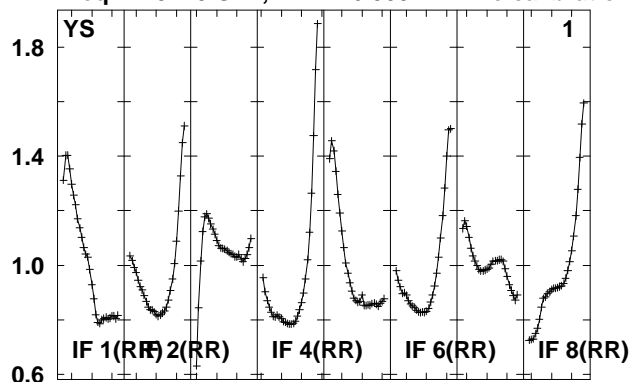

Lower frame: Real Jy
 Total-power spectrum Antenna: *
 Timerange: 00/21:02:50 to 00/21:07:48

Plot file version 622 created 14-MAY-2010 15:20:38

J092159 EO007.UVDATA.1

Freq = 4.9270 GHz, Bw = 16.000 MH No calibration applied and no bandpass applied

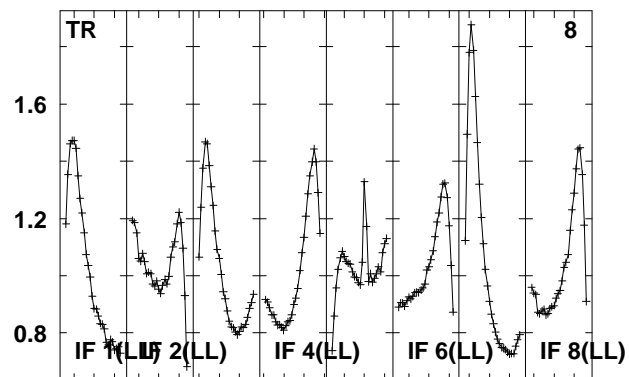
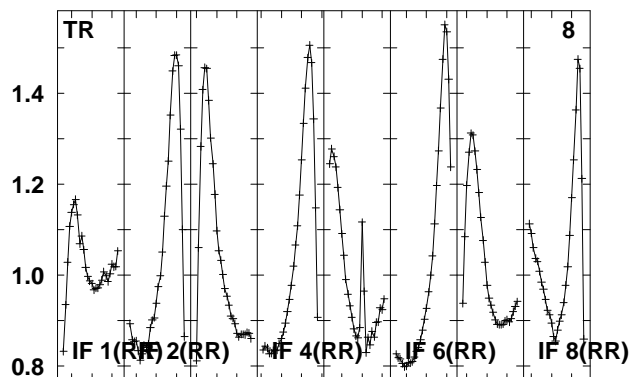
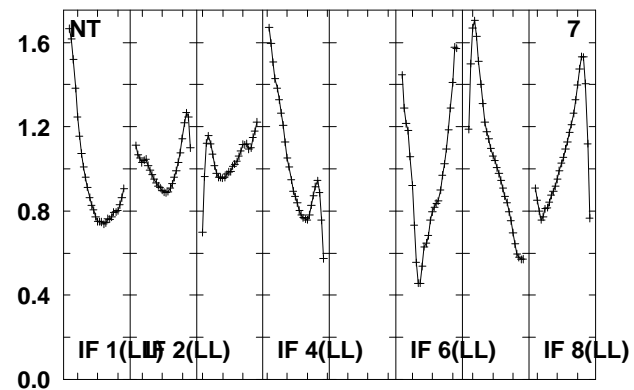
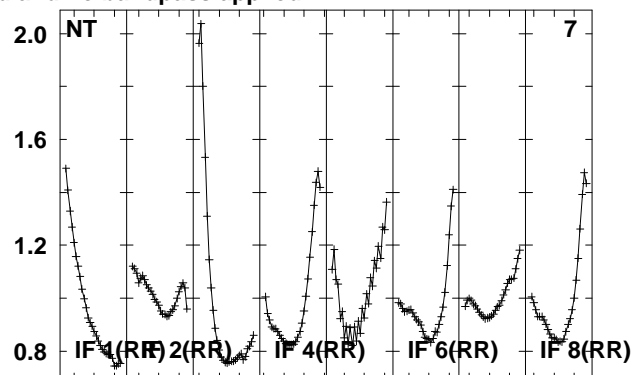
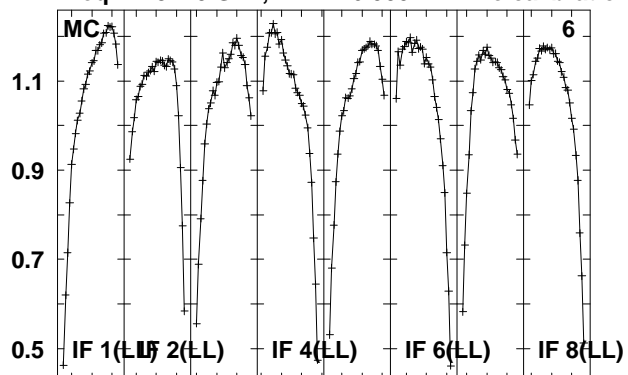

Lower frame: Real Jy
Total-power spectrum Antenna: *
Timerange: 00/21:02:50 to 00/21:07:48

Plot file version 623 created 14-MAY-2010 15:20:38

J0920+44 EO007.UVDATA.1

Freq = 4.9270 GHz, Bw = 16.000 MH No calibration applied and no bandpass applied

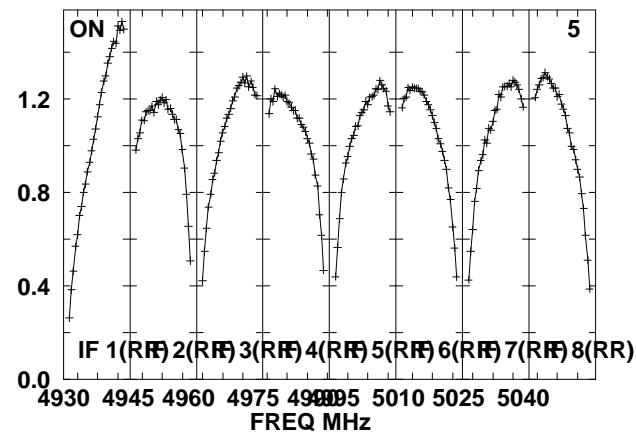
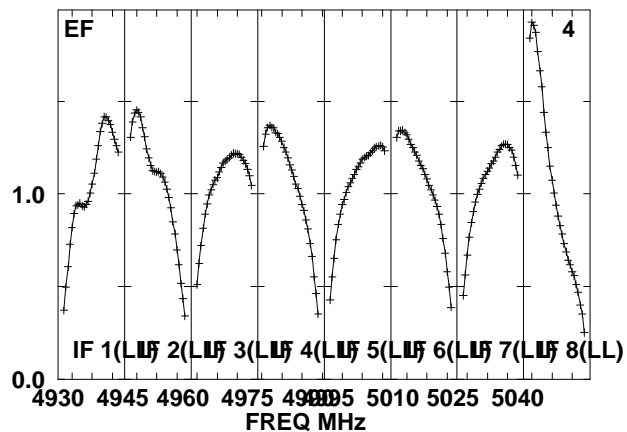
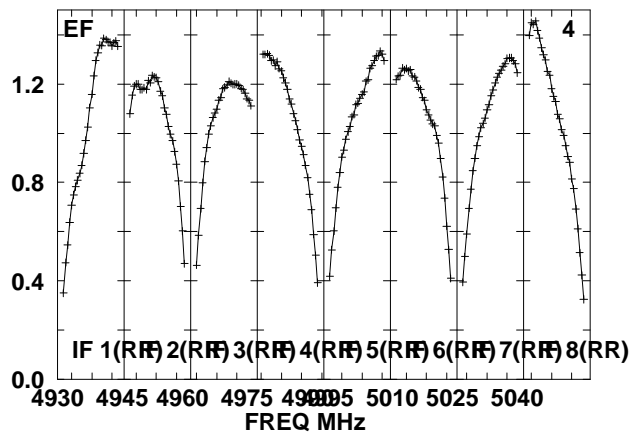
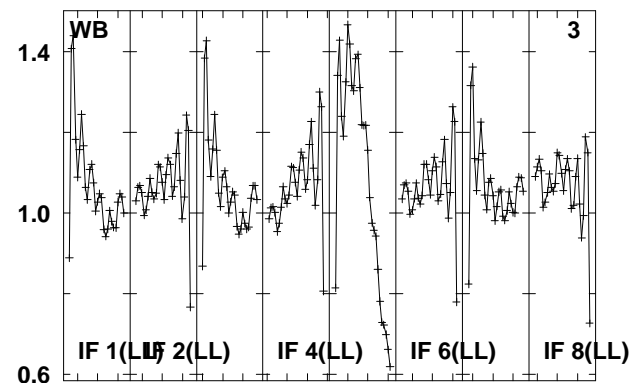
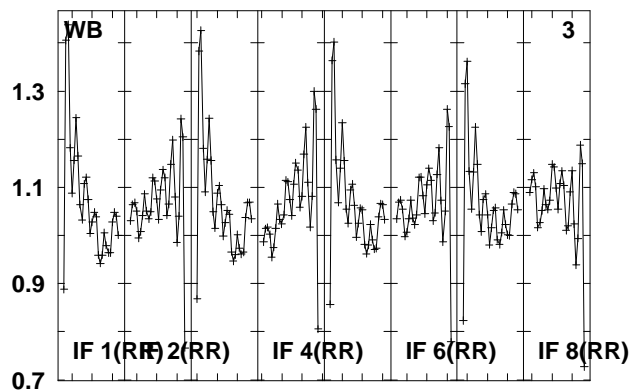
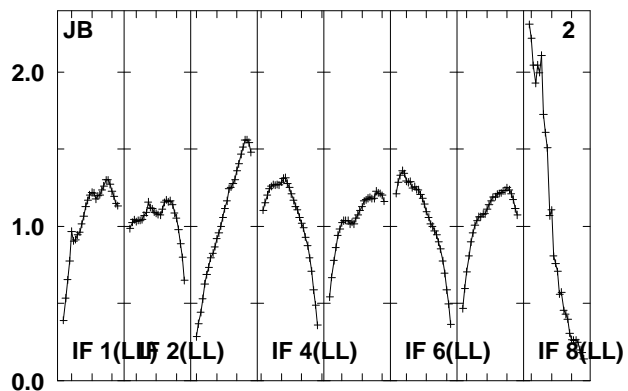
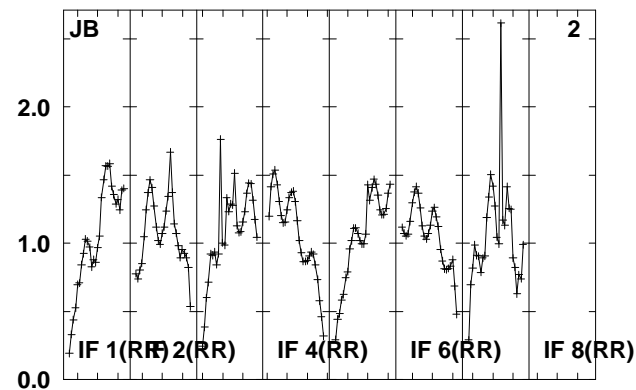
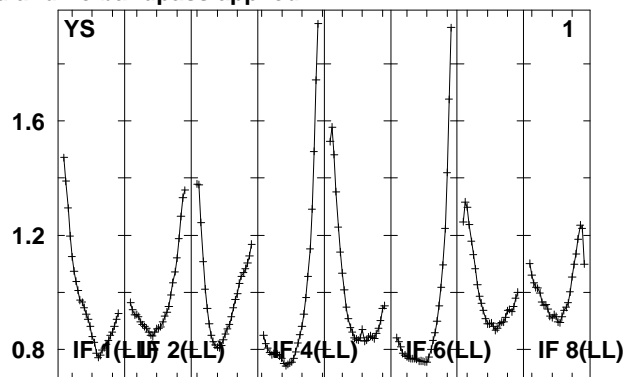
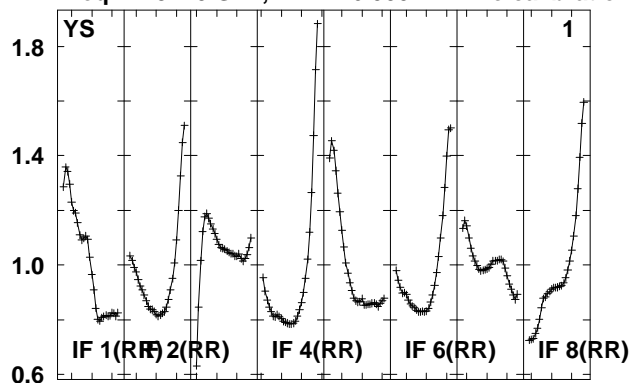

Lower frame: Real Jy
Total-power spectrum Antenna: *
Timerange: 00/21:08:22 to 00/21:09:48

Plot file version 624 created 14-MAY-2010 15:20:38

J0920+44 EO007.UVDATA.1

Freq = 4.9270 GHz, Bw = 16.000 MH No calibration applied and no bandpass applied

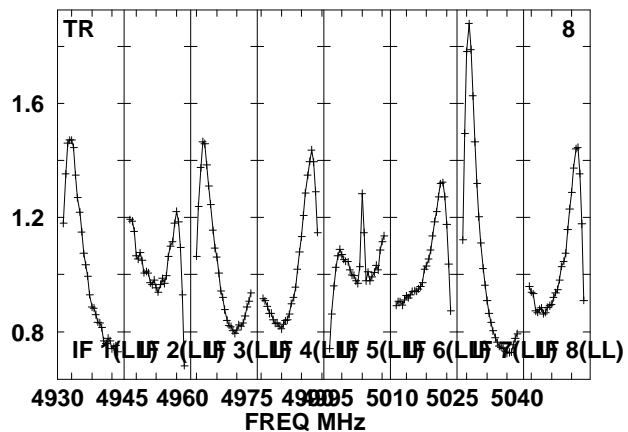
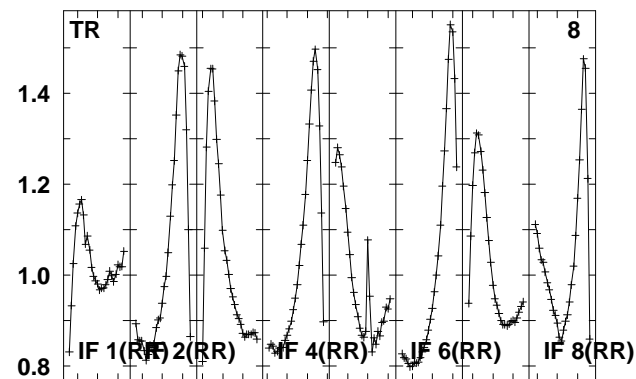
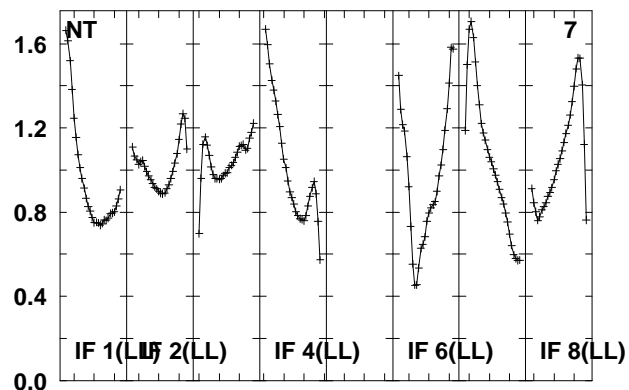
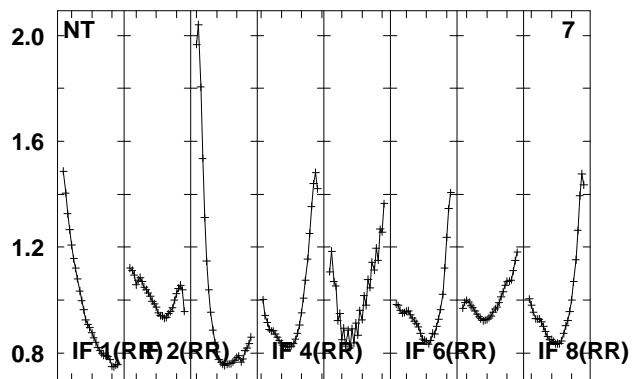
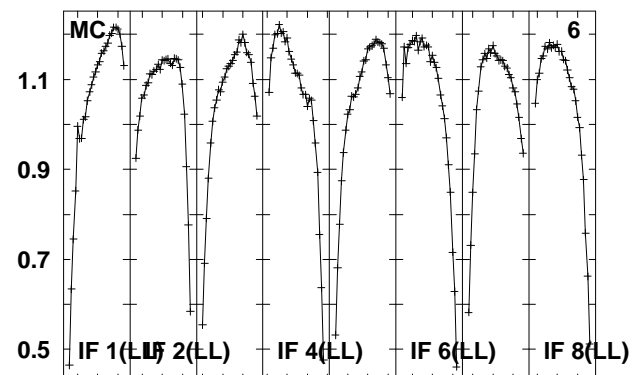
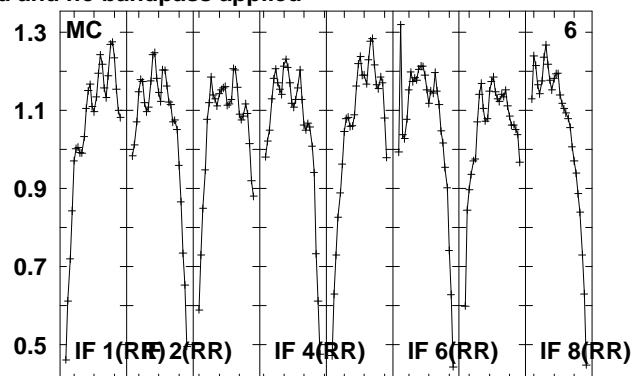
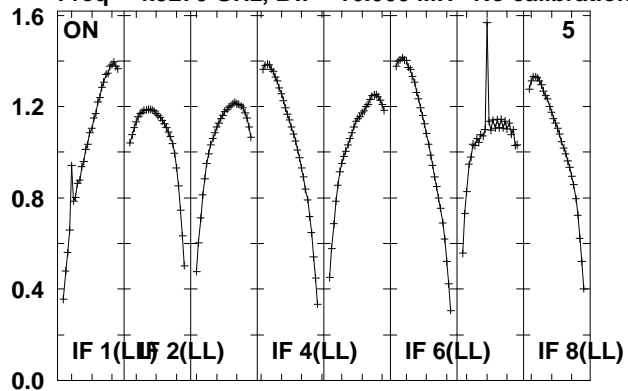

Lower frame: Real Jy

Total-power spectrum Antenna: *

Timerange: 00/21:08:22 to 00/21:09:48

Plot file version 625 created 14-MAY-2010 15:20:38

J1027+48 EO007.UVDATA.1

Freq = 4.9270 GHz, Bw = 16.000 MH No calibration applied and no bandpass applied

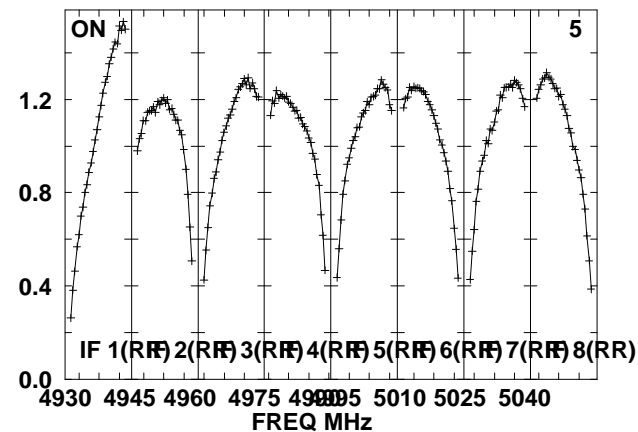
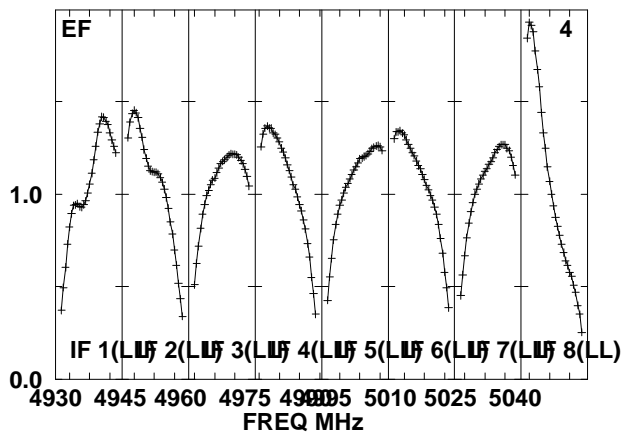
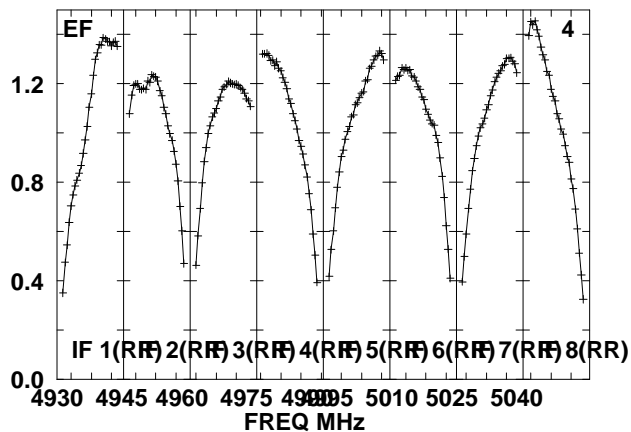
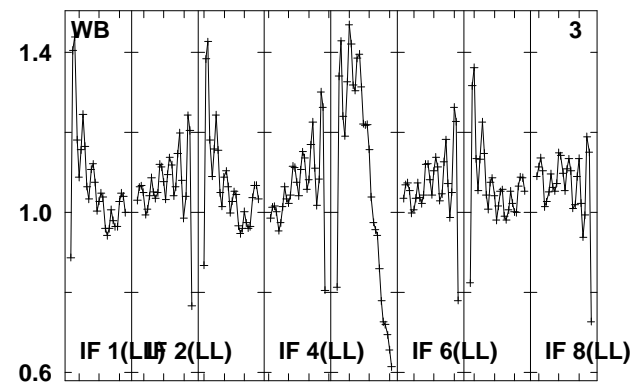
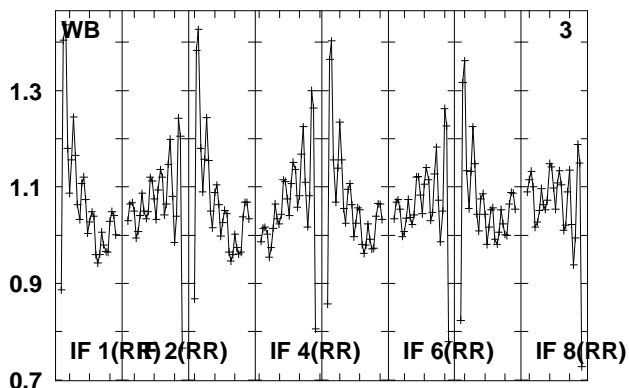
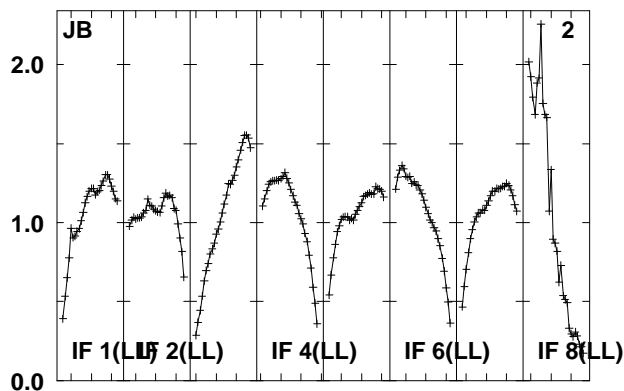
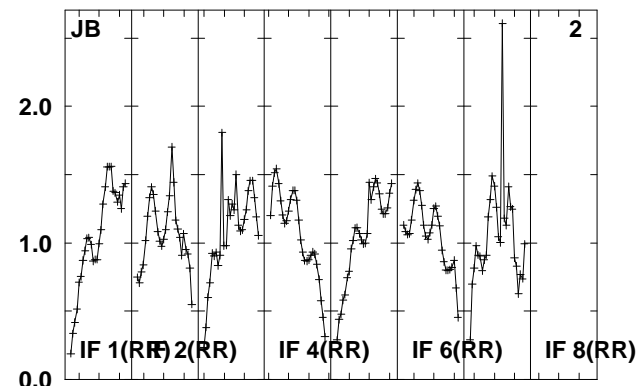
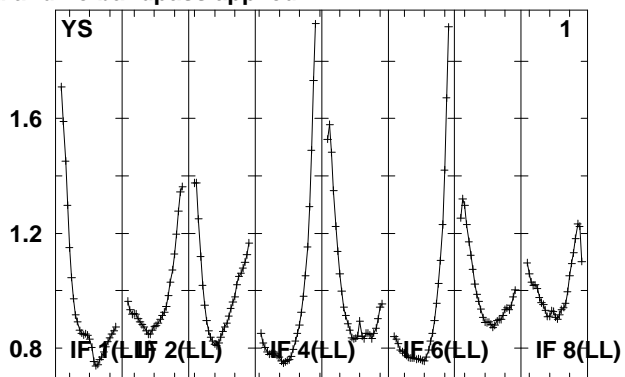
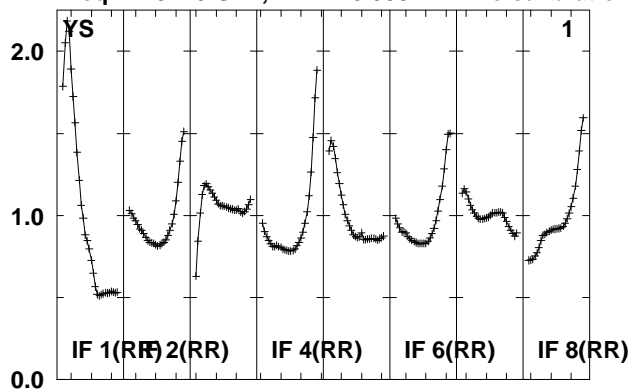

Lower frame: Real Jy
Total-power spectrum Antenna: *
Timerange: 00/21:13:54 to 00/21:15:22

Plot file version 626 created 14-MAY-2010 15:20:39

J1027+48 EO007.UVDATA.1

Freq = 4.9270 GHz, Bw = 16.000 MH No calibration applied and no bandpass applied

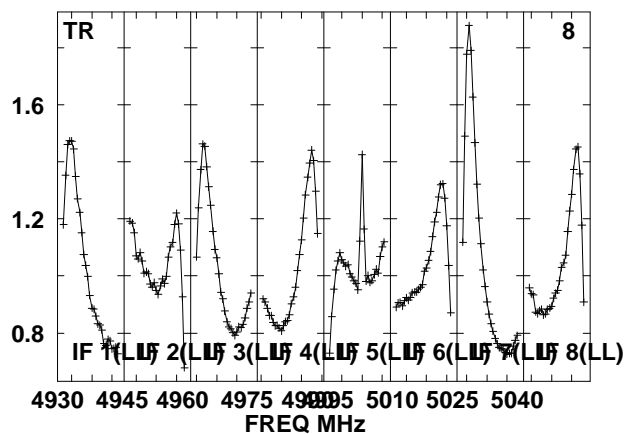
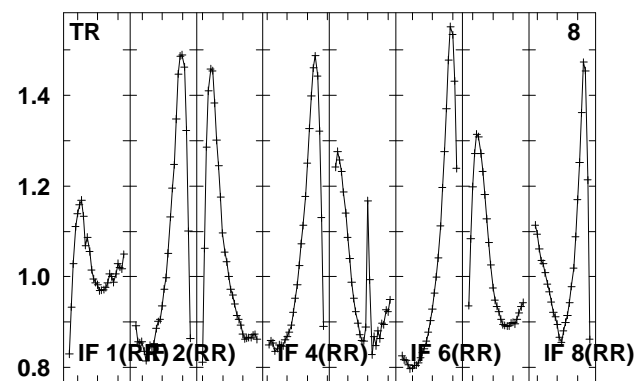
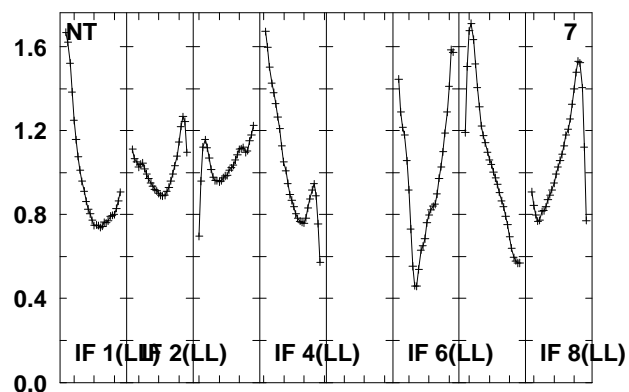
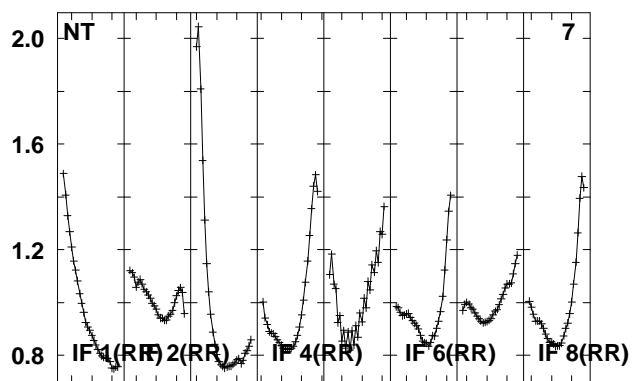
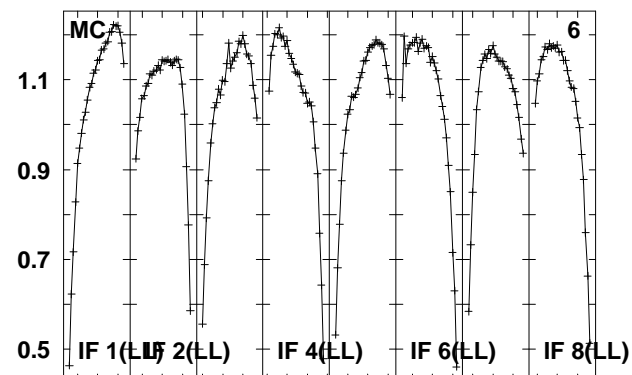
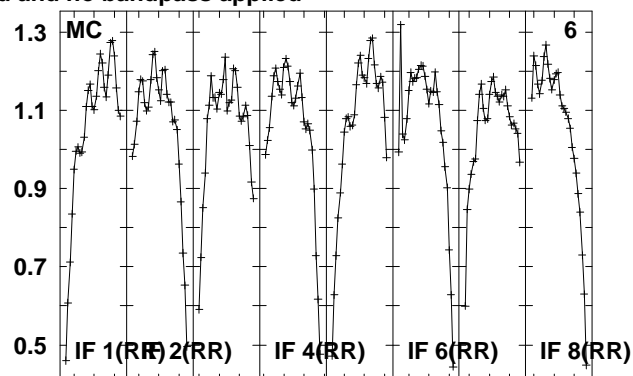
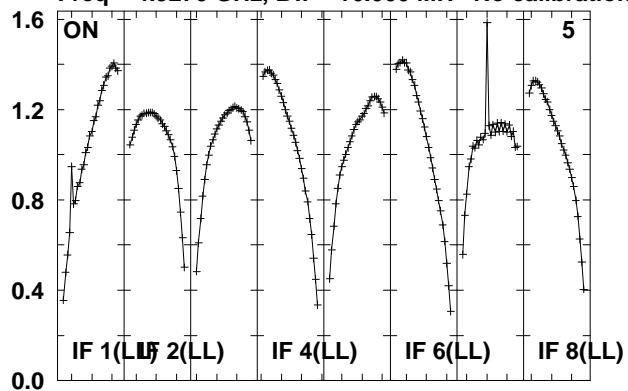

Lower frame: Real Jy

Total-power spectrum Antenna: *

Timerange: 00/21:13:54 to 00/21:15:22

Plot file version 627 created 14-MAY-2010 15:20:39

J102959 EO007.UVDATA.1

Freq = 4.9270 GHz, Bw = 16.000 MH No calibration applied and no bandpass applied

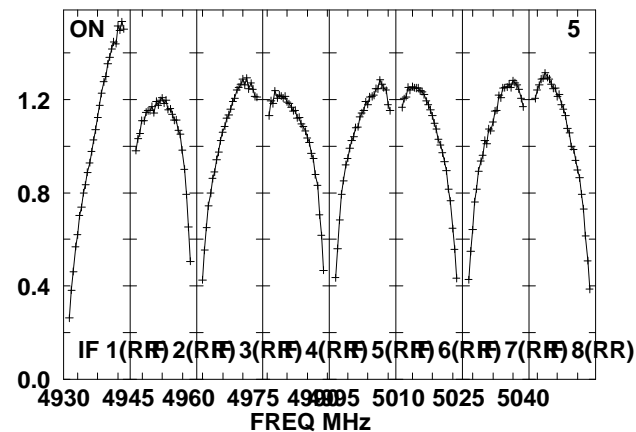
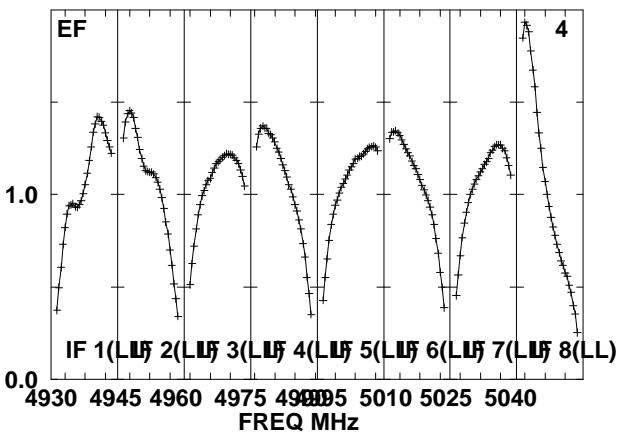
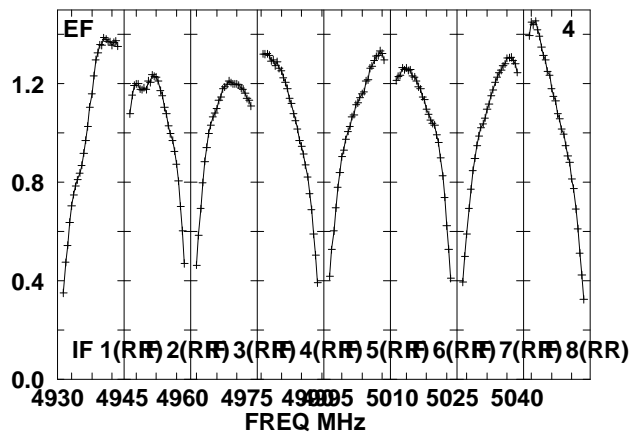
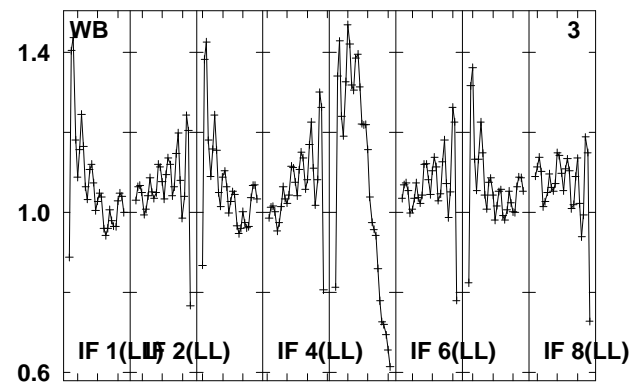
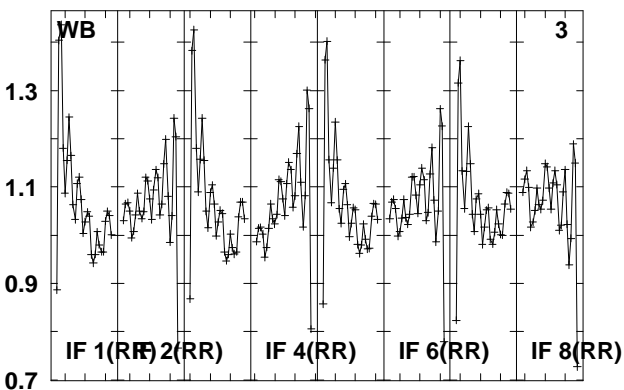
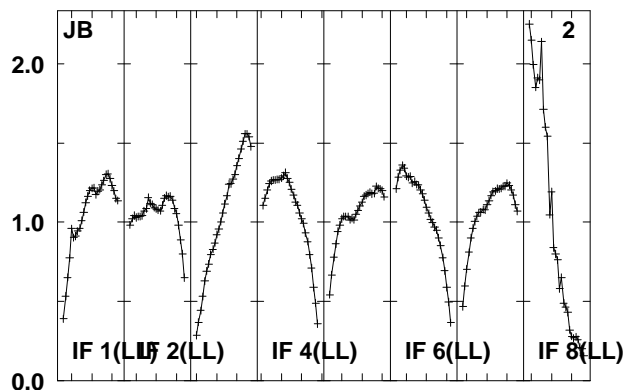
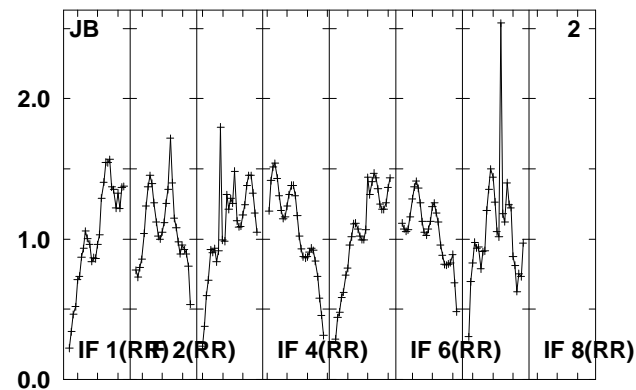
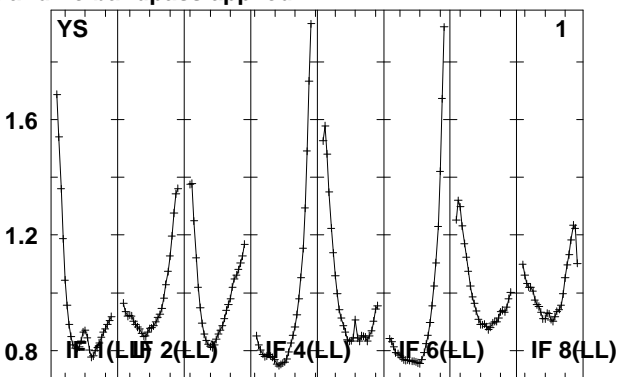
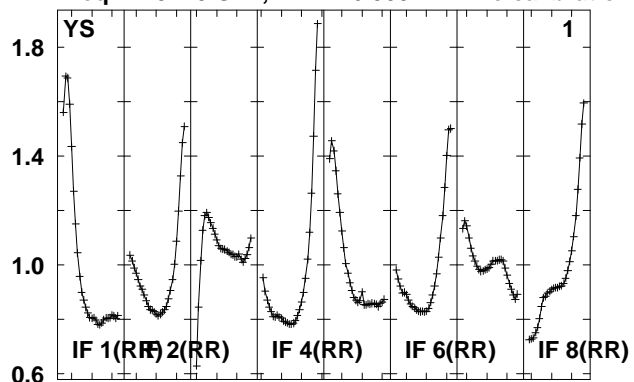

Lower frame: Real Jy
Total-power spectrum Antenna: *
Timerange: 00/21:15:58 to 00/21:20:58

Plot file version 628 created 14-MAY-2010 15:20:40

J102959 EO007.UVDATA.1

Freq = 4.9270 GHz, Bw = 16.000 MH No calibration applied and no bandpass applied

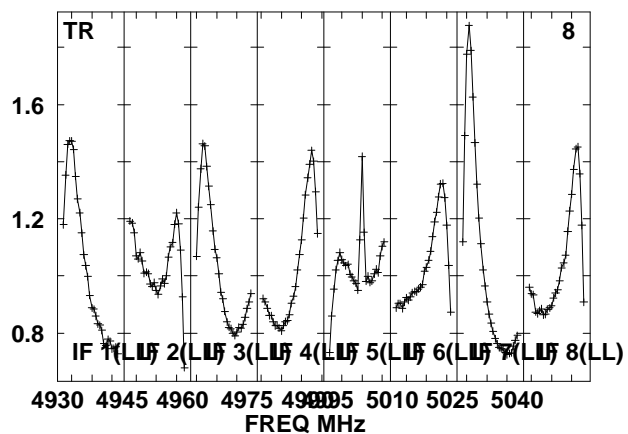
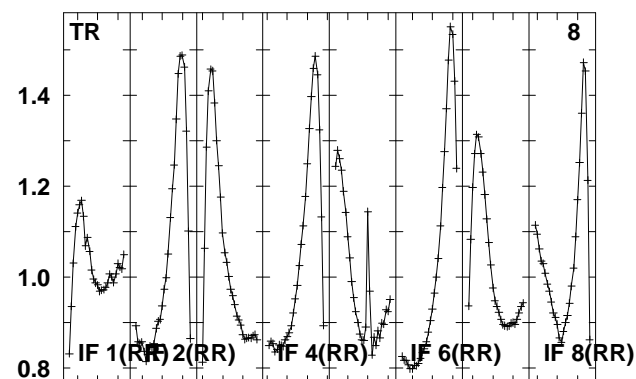
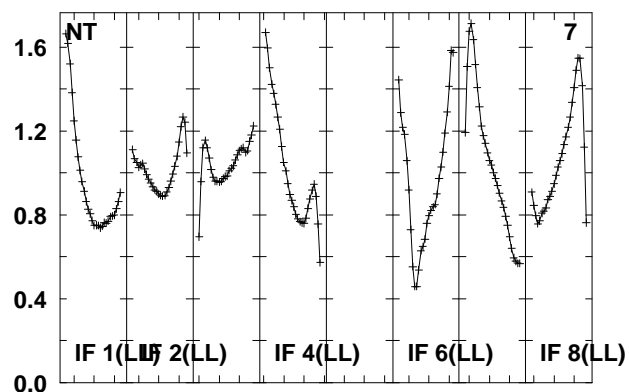
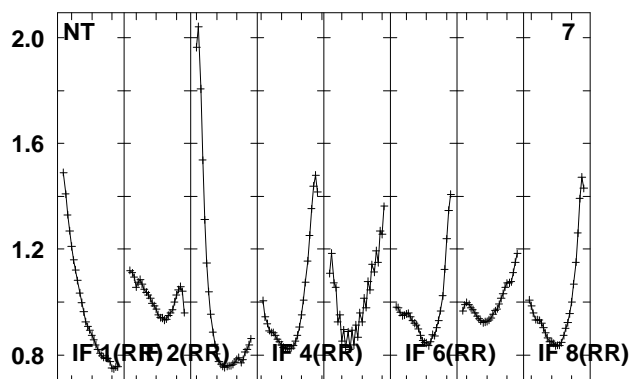
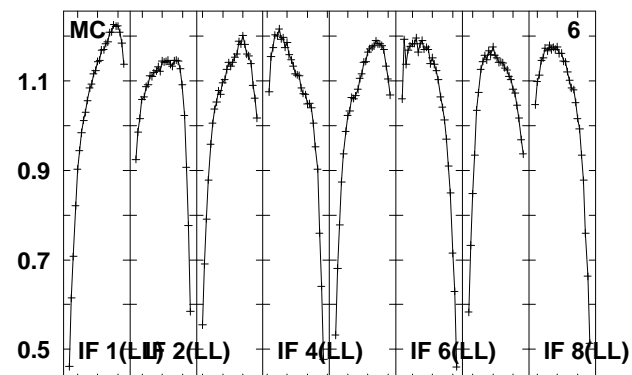
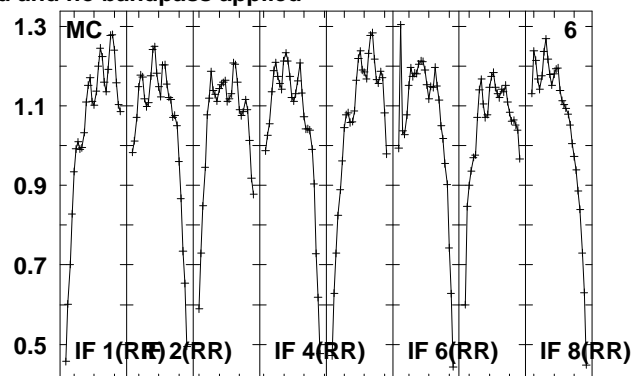
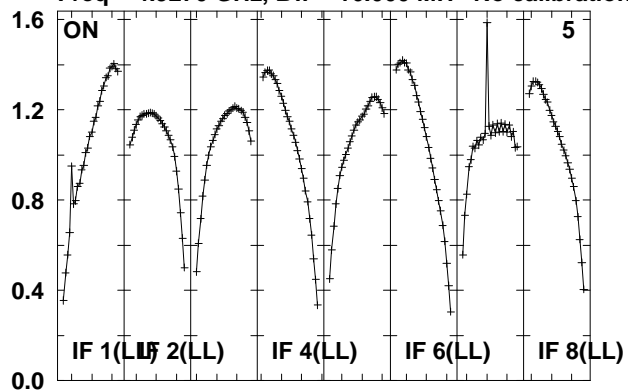

Lower frame: Real Jy

Total-power spectrum Antenna: *

Timerange: 00/21:15:58 to 00/21:20:58

Plot file version 629 created 14-MAY-2010 15:20:40

J1027+48 EO007.UVDATA.1

Freq = 4.9270 GHz, Bw = 16.000 MH No calibration applied and no bandpass applied

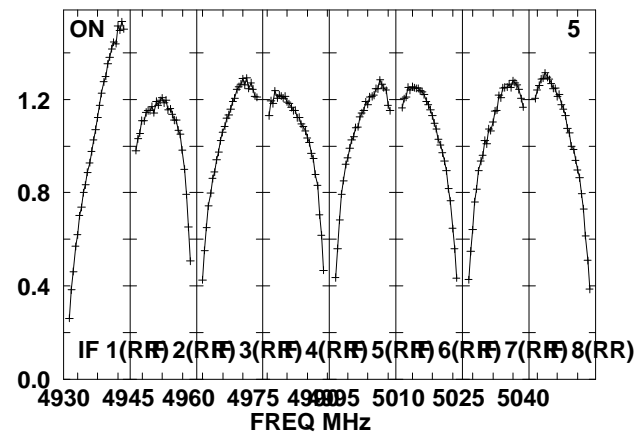
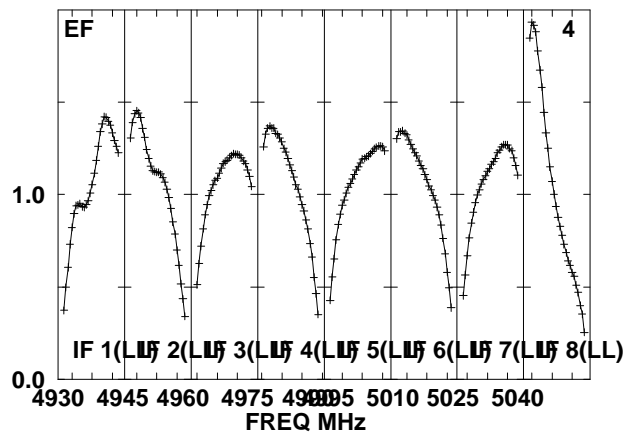
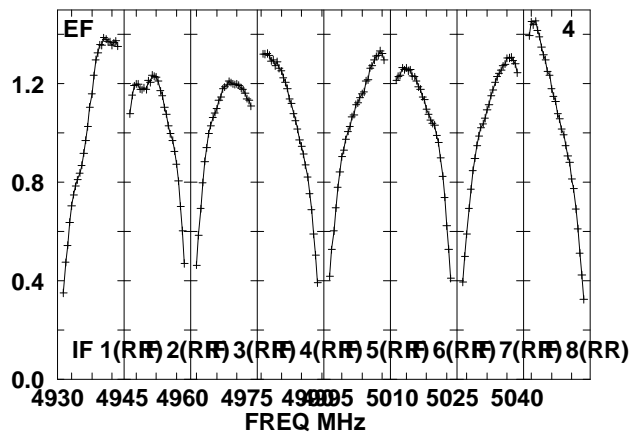
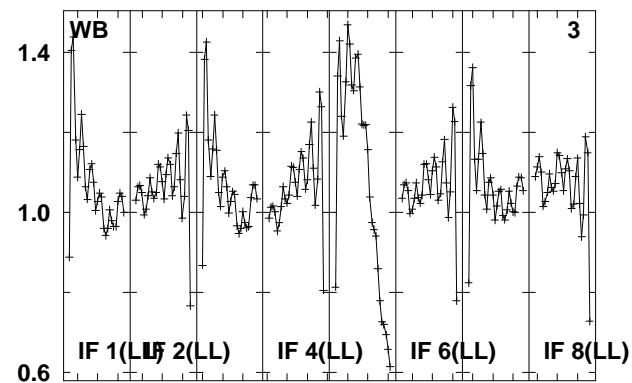
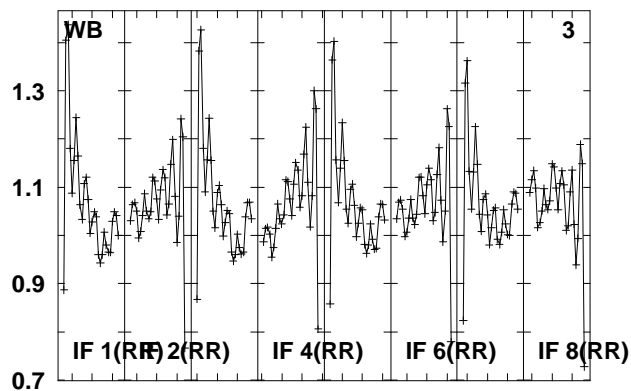
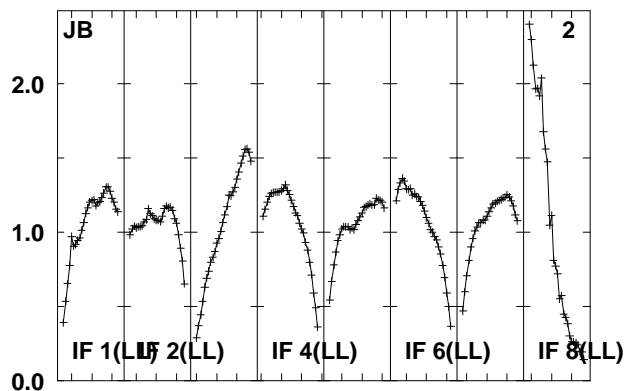
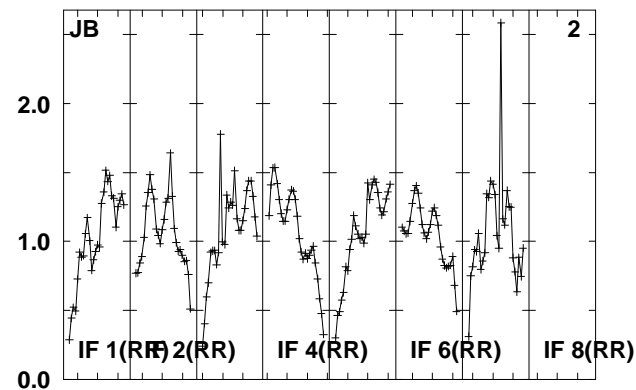
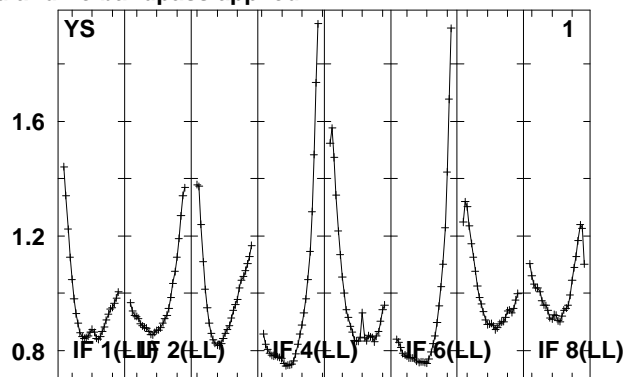
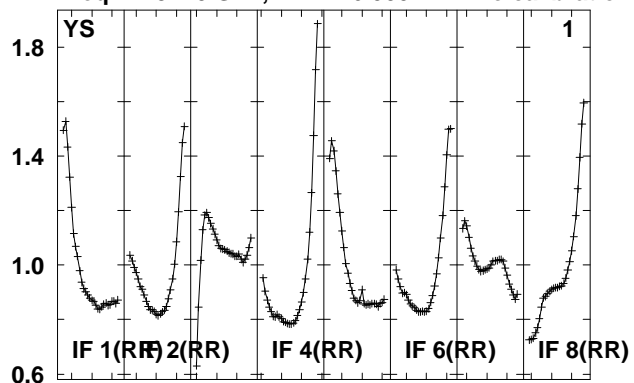

Lower frame: Real Jy
Total-power spectrum Antenna: *
Timerange: 00/21:21:36 to 00/21:23:04

Plot file version 630 created 14-MAY-2010 15:20:40

J1027+48 EO007.UVDATA.1

Freq = 4.9270 GHz, Bw = 16.000 MH No calibration applied and no bandpass applied

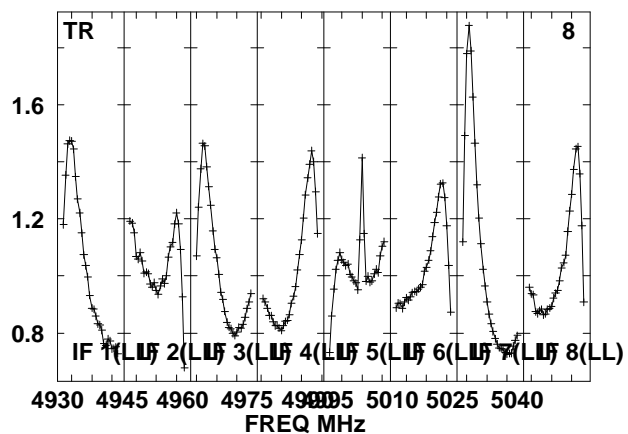
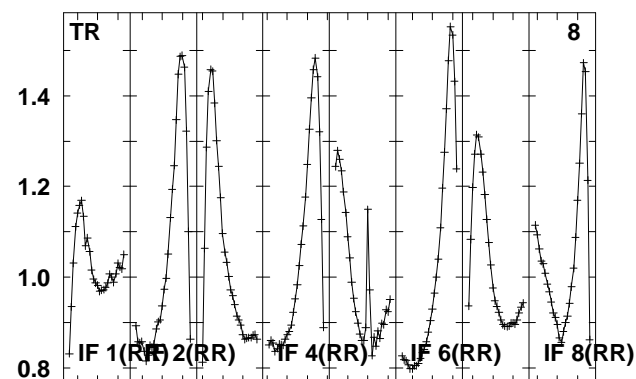
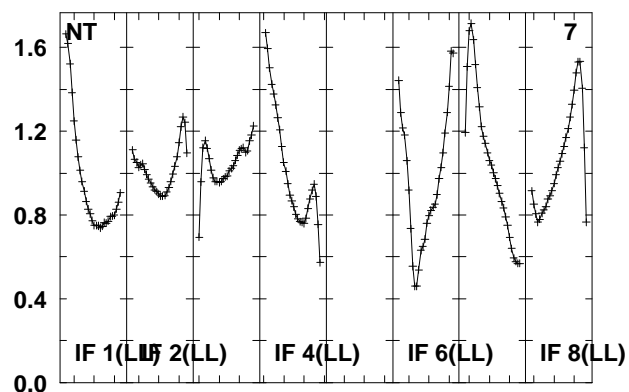
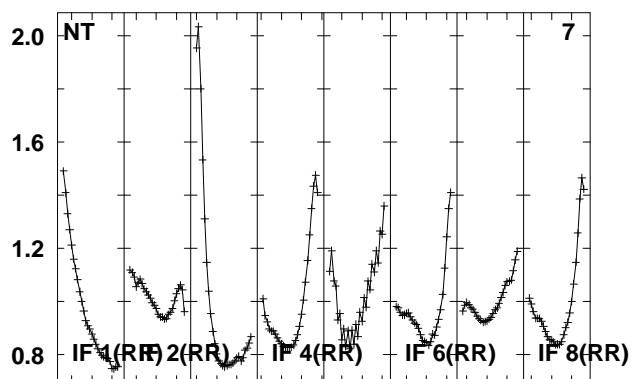
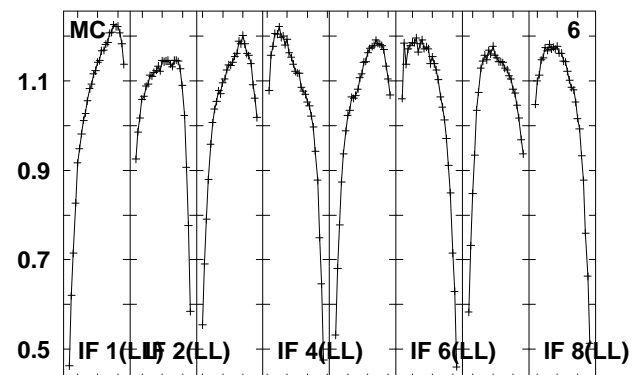
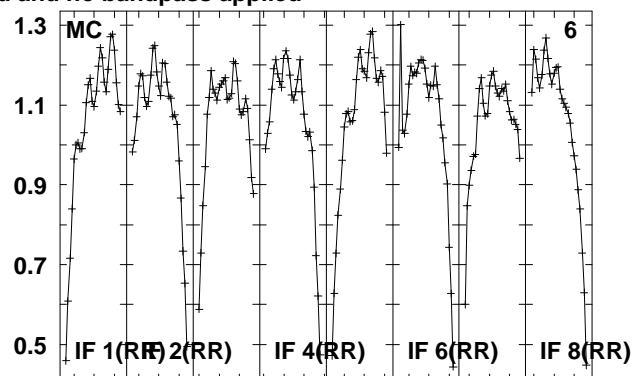
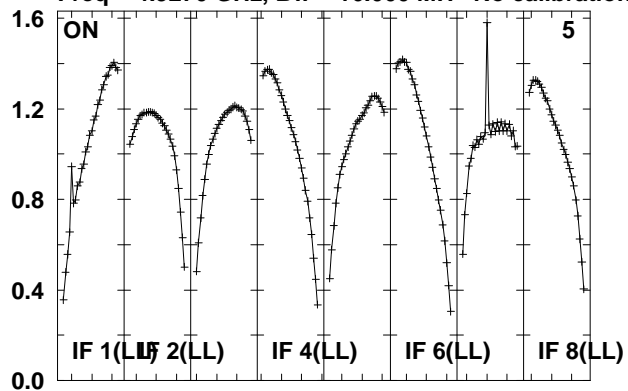

Lower frame: Real Jy

Total-power spectrum Antenna: *

Timerange: 00/21:21:36 to 00/21:23:04

Plot file version 631 created 14-MAY-2010 15:20:41
 J102959 EO007.UVDATA.1
 Freq = 4.9270 GHz, Bw = 16.000 MH No calibration applied and no bandpass applied

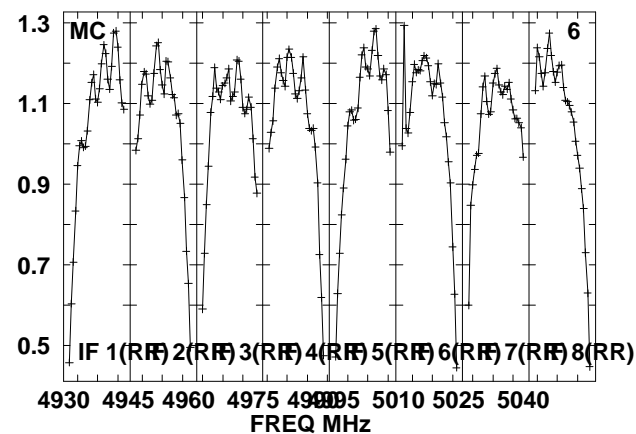
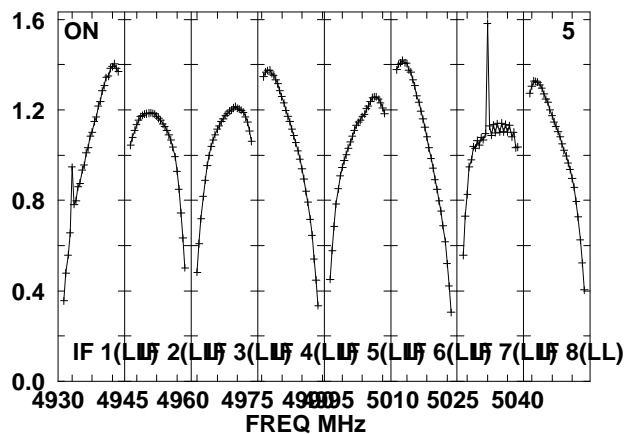
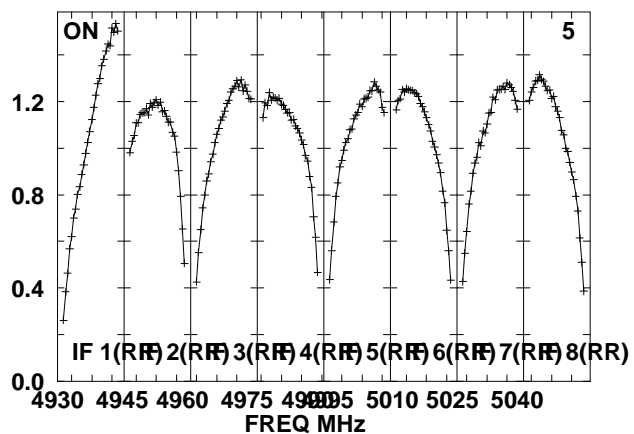
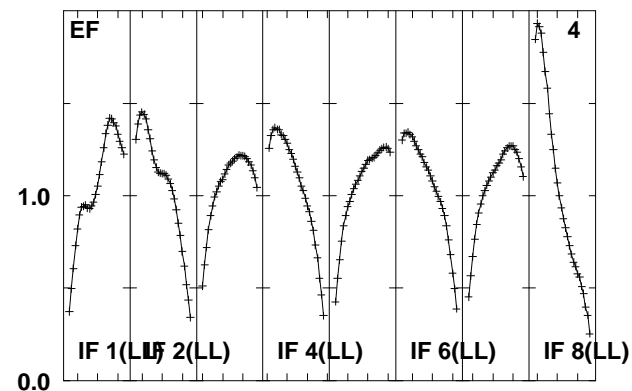
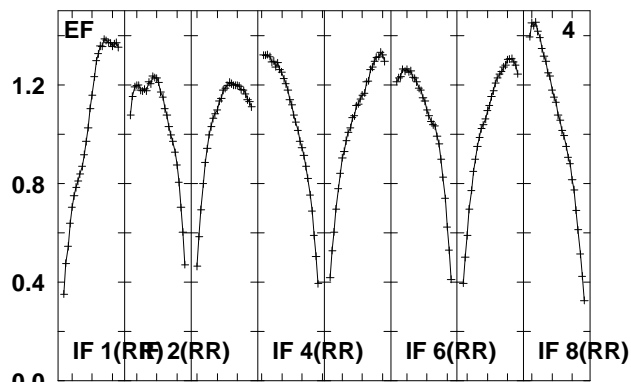
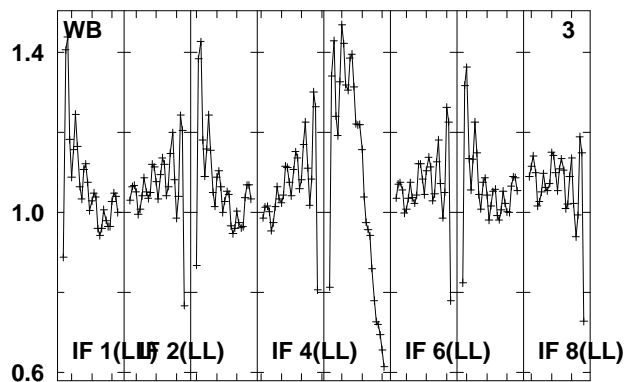
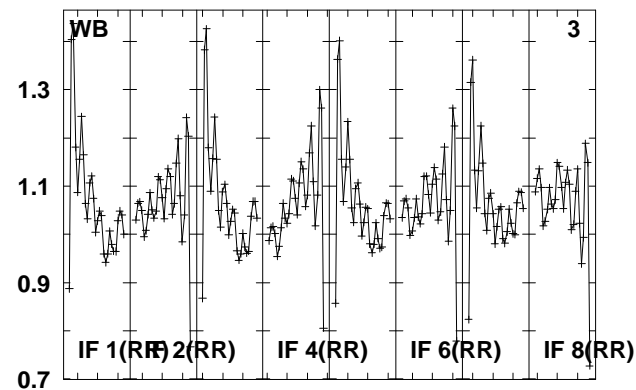
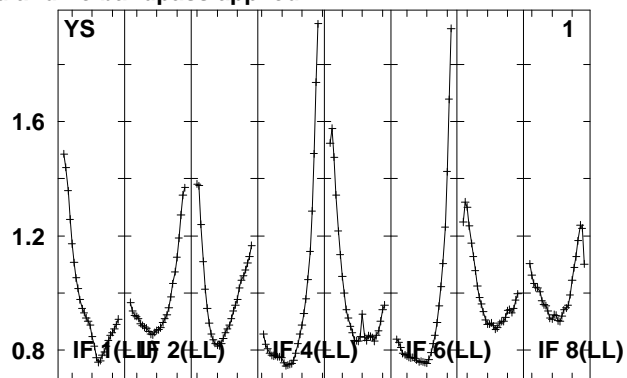
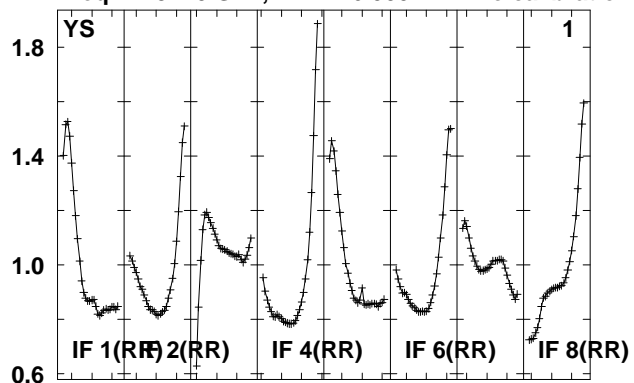

Lower frame: Real Jy
 Total-power spectrum Antenna: *
 Timerange: 00/21:23:42 to 00/21:28:40

Plot file version 632 created 14-MAY-2010 15:20:41

J102959 EO007.UVDATA.1

Freq = 4.9270 GHz, Bw = 16.000 MH No calibration applied and no bandpass applied

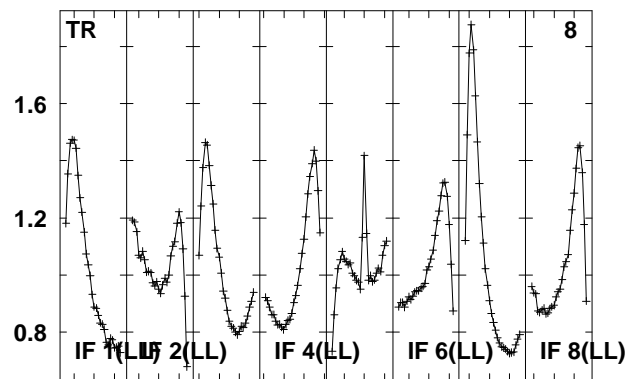
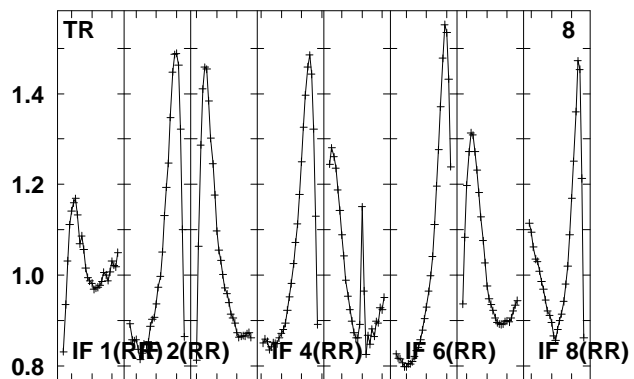
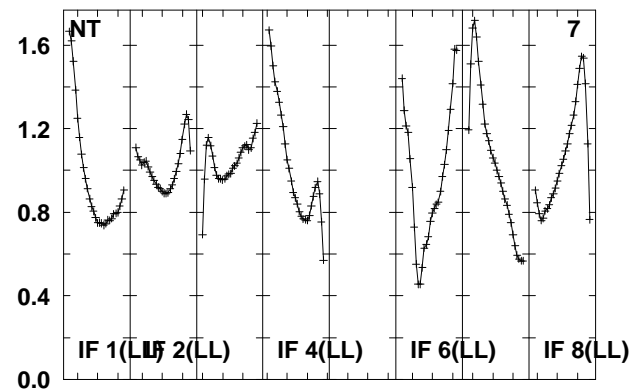
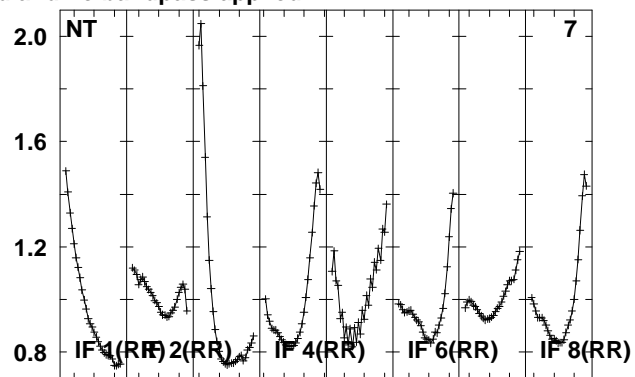
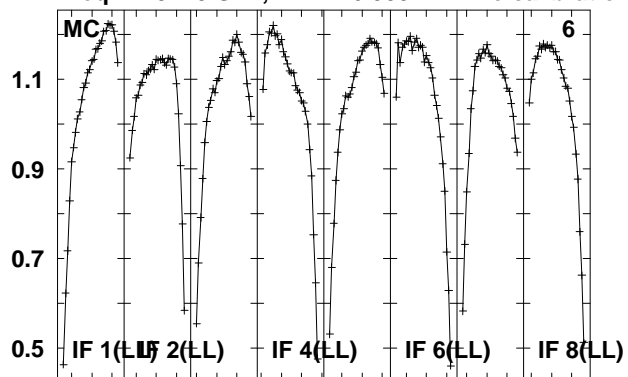

Lower frame: Real Jy
Total-power spectrum Antenna: *
Timerange: 00/21:23:42 to 00/21:28:40

Plot file version 633 created 14-MAY-2010 15:20:42

J1027+48 EO007.UVDATA.1

Freq = 4.9270 GHz, Bw = 16.000 MH No calibration applied and no bandpass applied

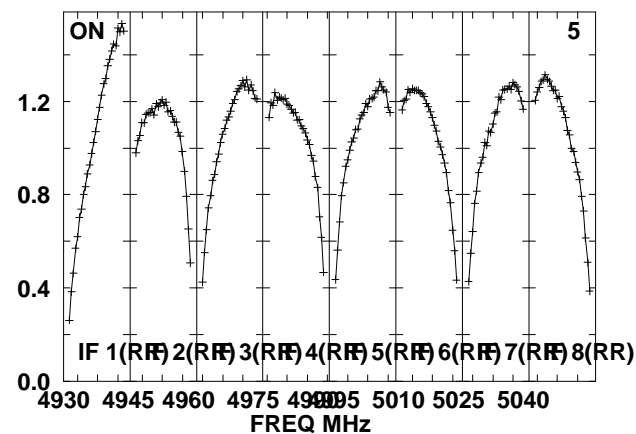
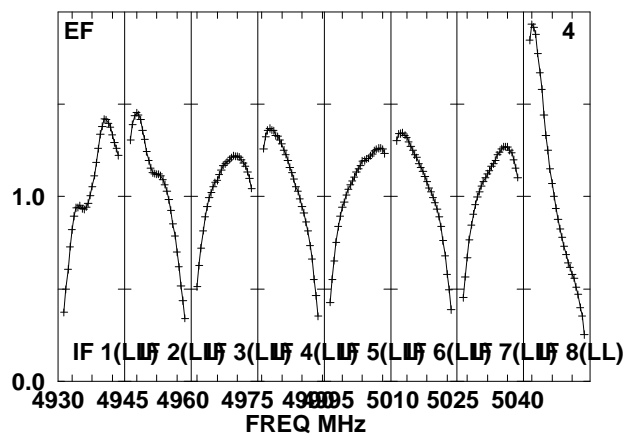
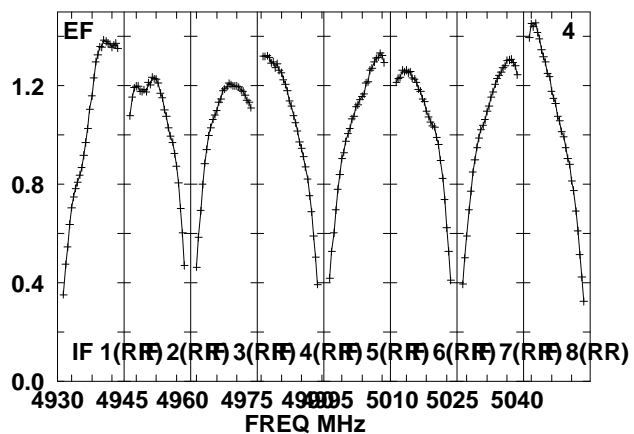
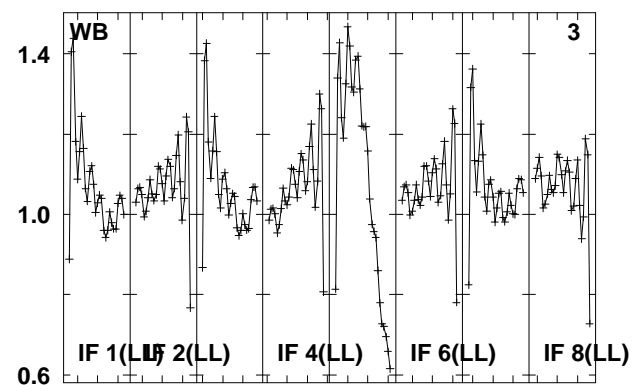
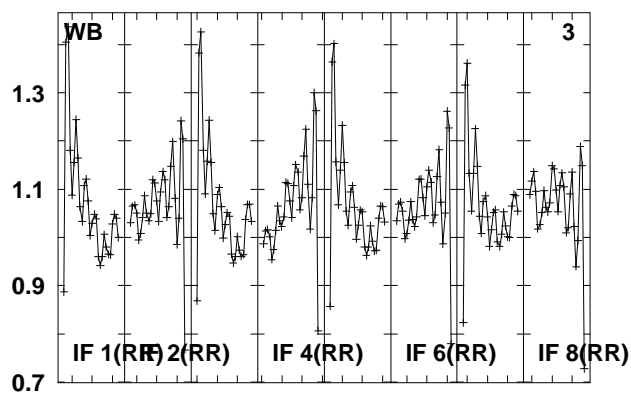
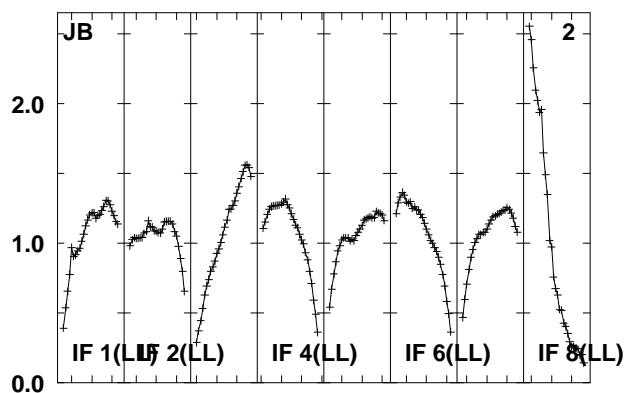
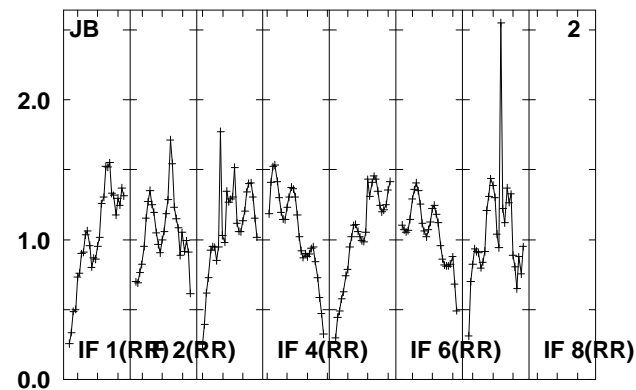
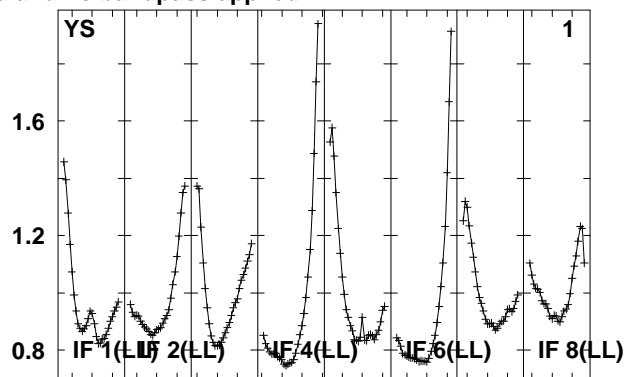
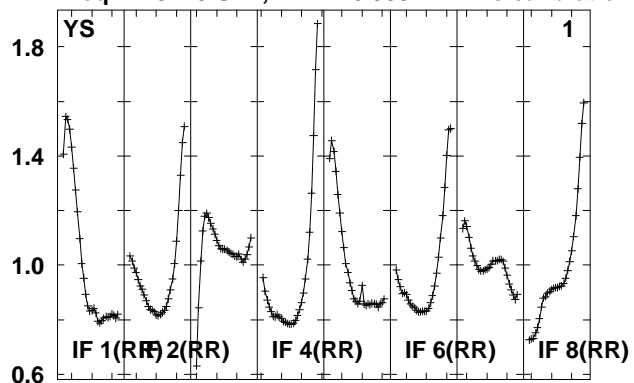

Lower frame: Real Jy
Total-power spectrum Antenna: *
Timerange: 00/21:29:22 to 00/21:30:50

Plot file version 634 created 14-MAY-2010 15:20:42

J1027+48 EO007.UVDATA.1

Freq = 4.9270 GHz, Bw = 16.000 MH No calibration applied and no bandpass applied

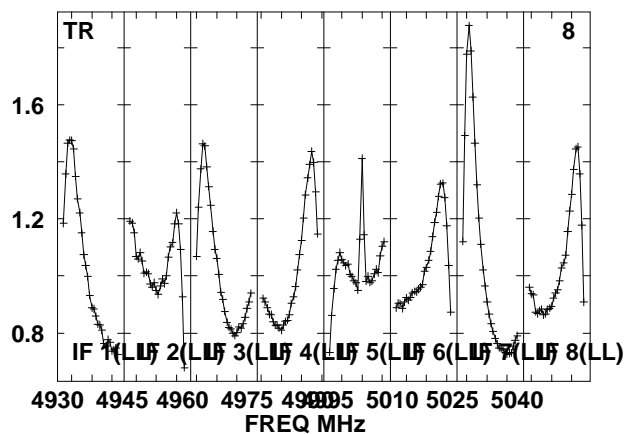
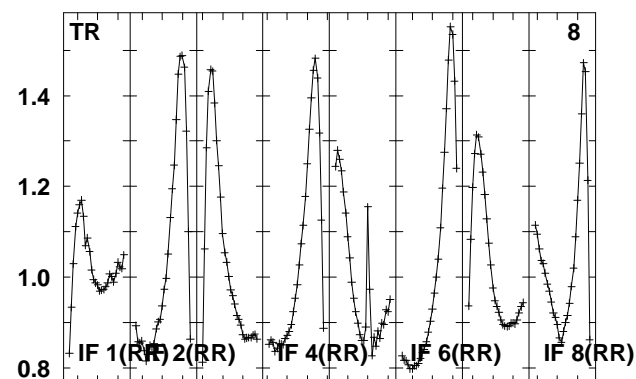
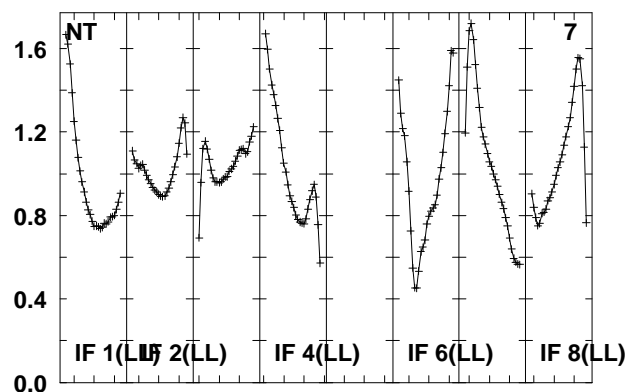
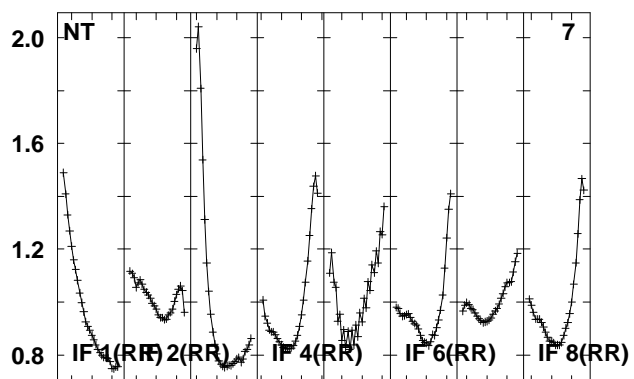
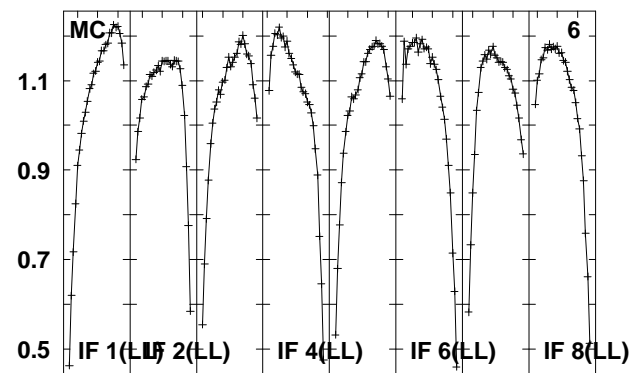
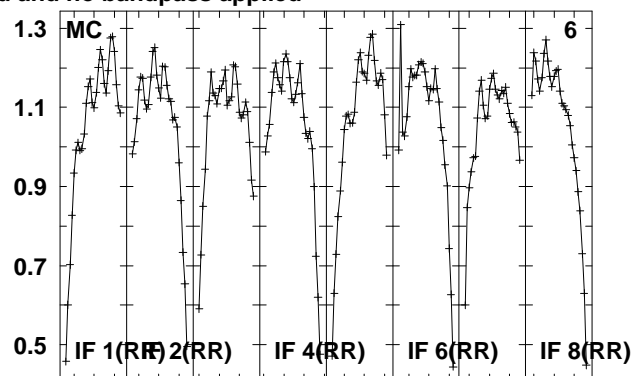
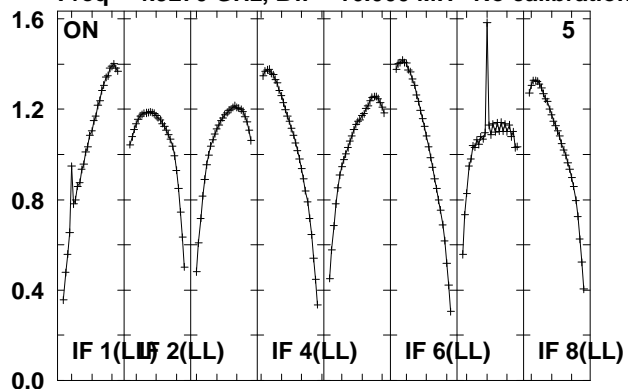

Lower frame: Real Jy

Total-power spectrum Antenna: *

Timerange: 00/21:29:22 to 00/21:30:50

Plot file version 635 created 14-MAY-2010 15:20:42

J0920+44 EO007.UVDATA.1

Freq = 4.9270 GHz, Bw = 16.000 MH No calibration applied and no bandpass applied

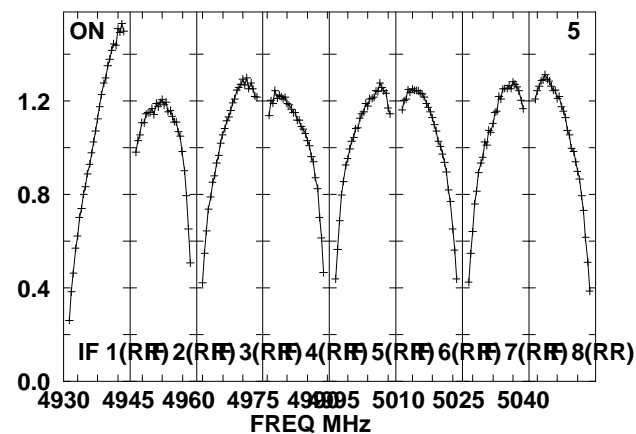
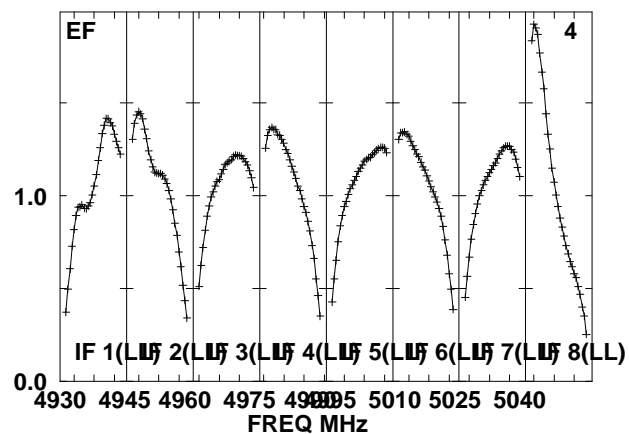
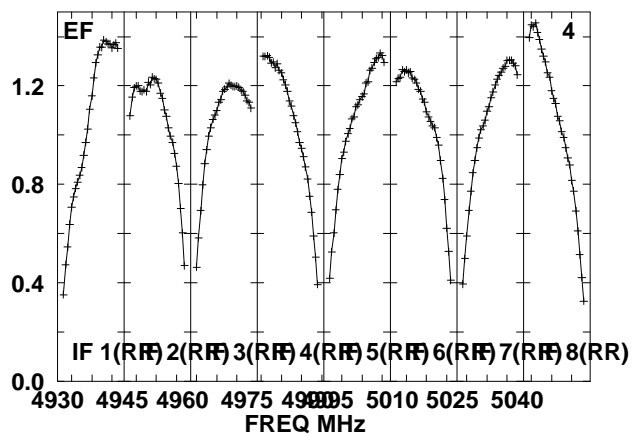
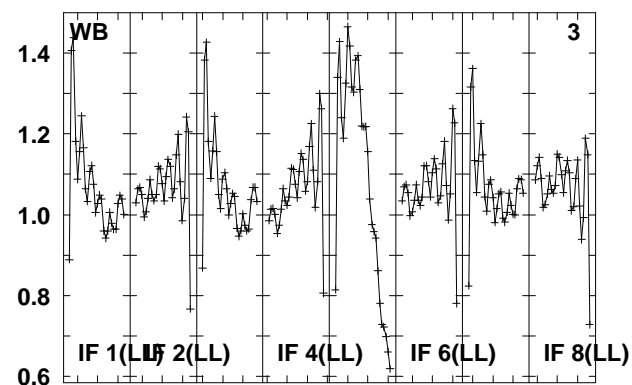
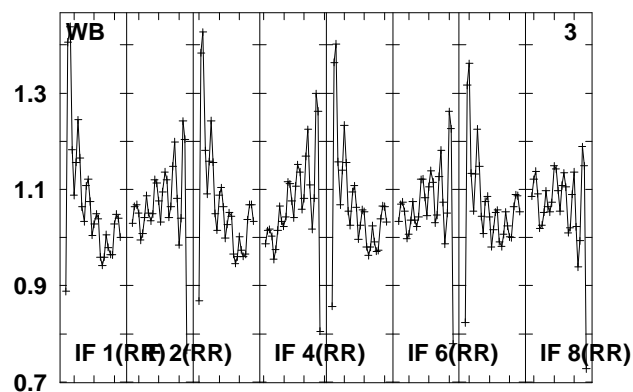
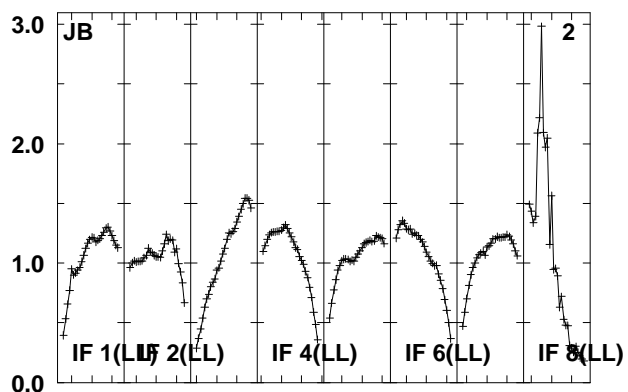
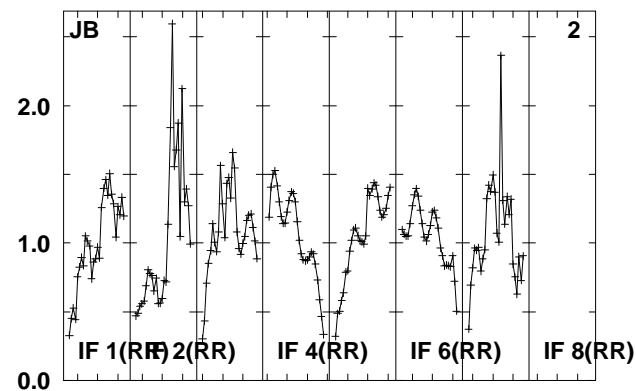
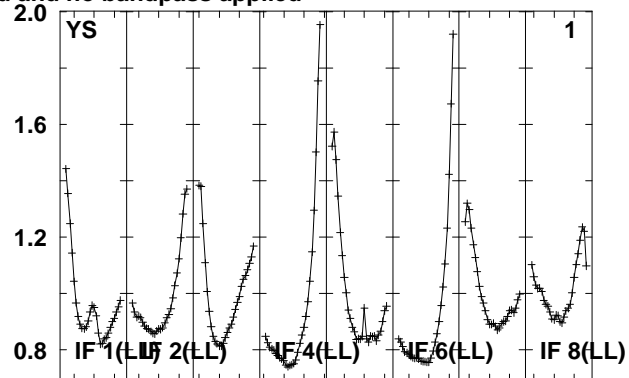
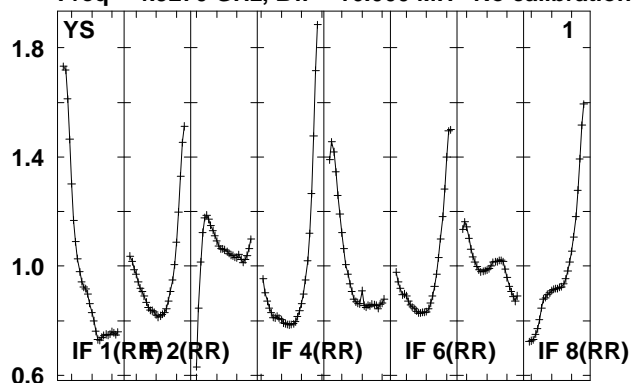

Lower frame: Real Jy
Total-power spectrum Antenna: *
Timerange: 00/21:36:04 to 00/21:37:32

Plot file version 636 created 14-MAY-2010 15:20:42

J0920+44 EO007.UVDATA.1

Freq = 4.9270 GHz, Bw = 16.000 MH No calibration applied and no bandpass applied

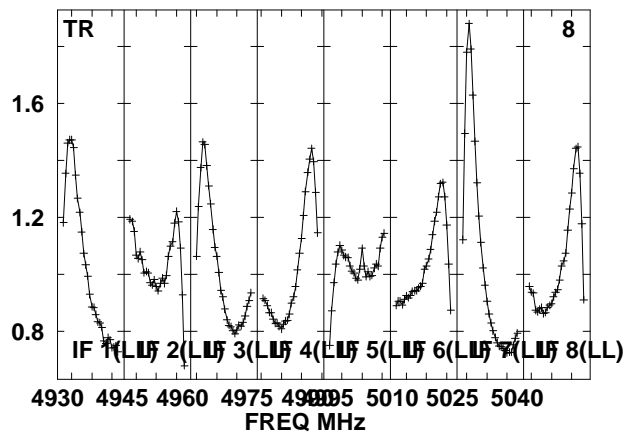
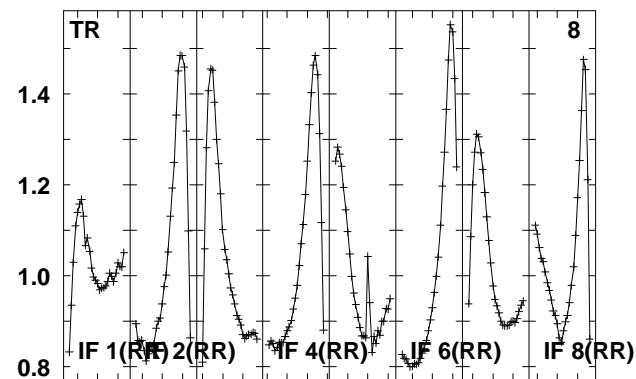
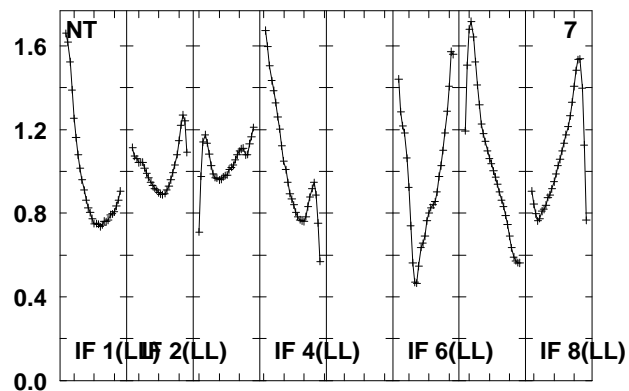
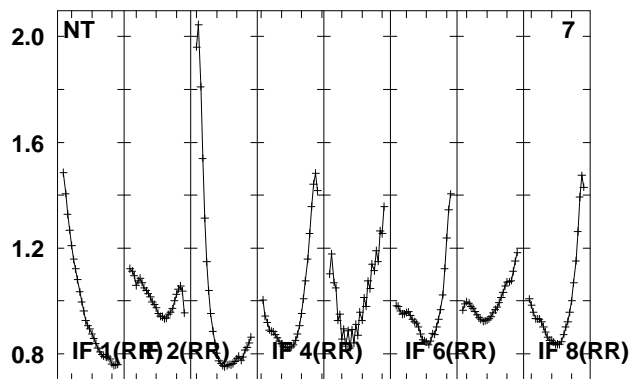
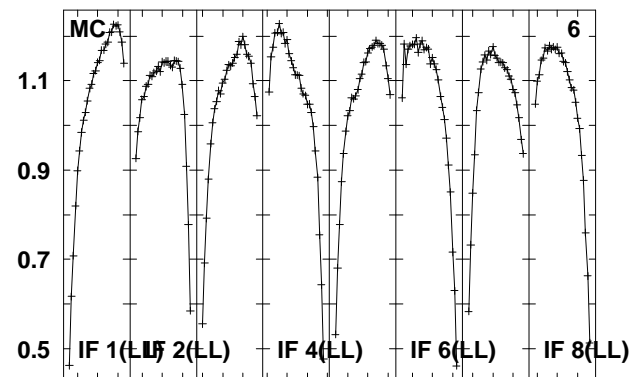
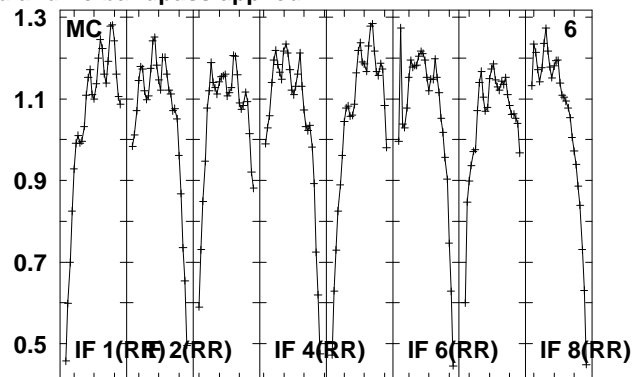
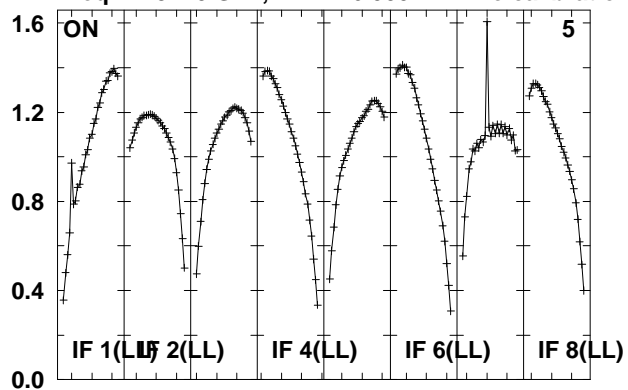

Lower frame: Real Jy

Total-power spectrum Antenna: *

Timerange: 00/21:36:04 to 00/21:37:32

Plot file version 637 created 14-MAY-2010 15:20:43

J092159 EO007.UVDATA.1

Freq = 4.9270 GHz, Bw = 16.000 MH No calibration applied and no bandpass applied

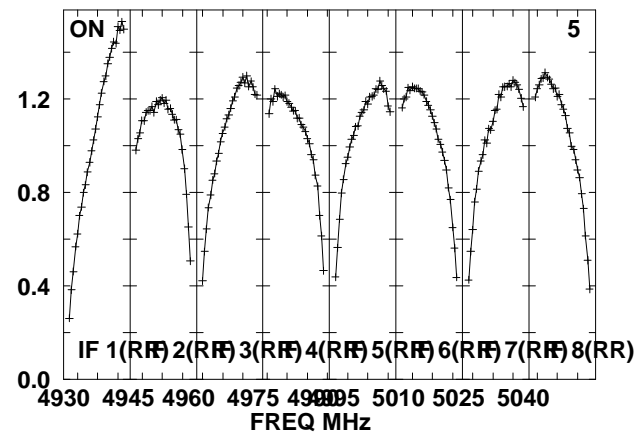
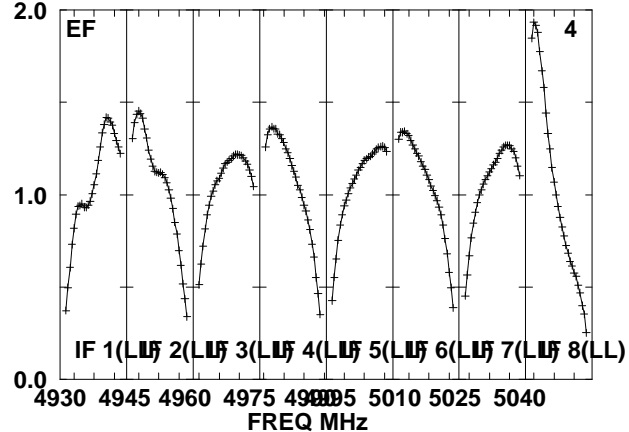
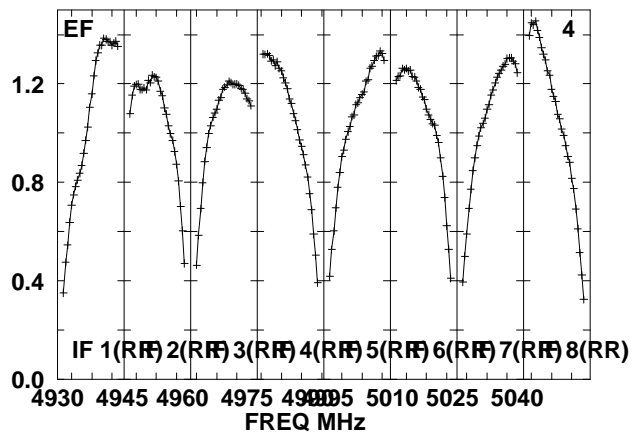
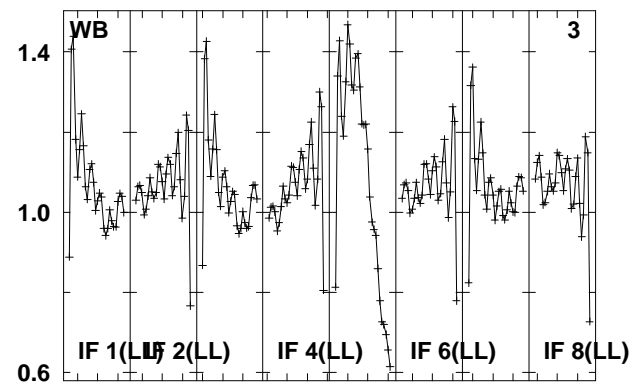
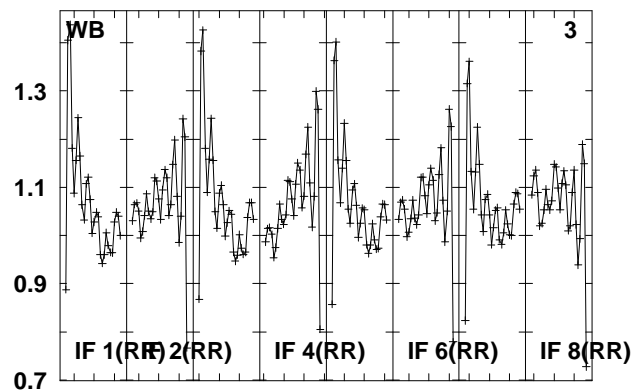
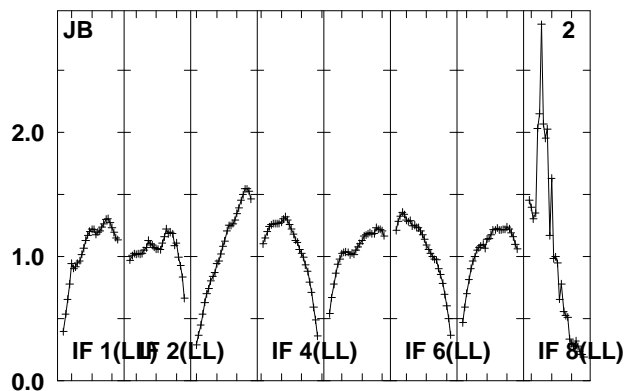
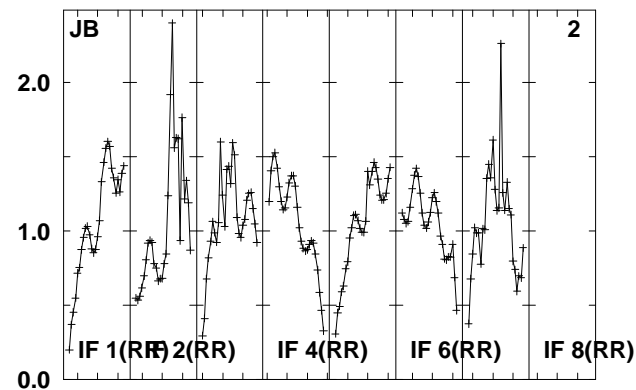
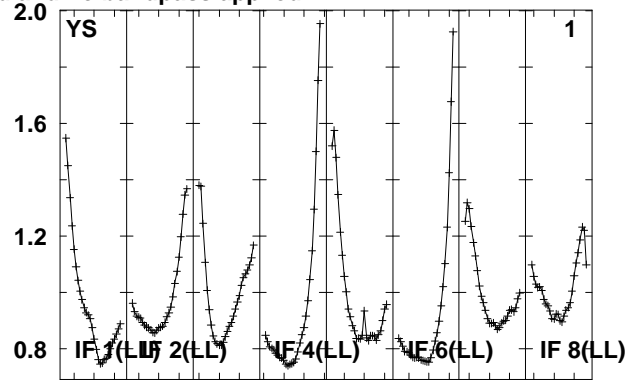
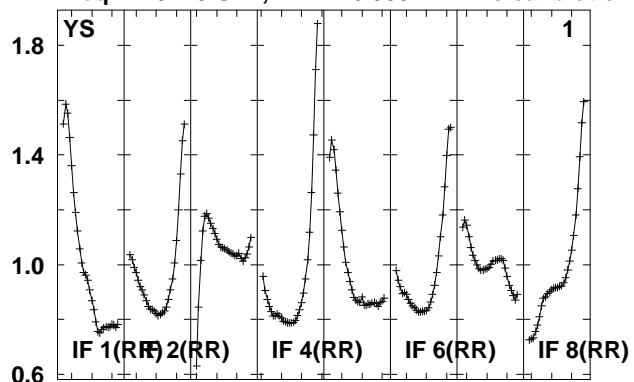

Lower frame: Real Jy

Total-power spectrum Antenna: *

Timerange: 00/21:38:01 to 00/21:42:59

Plot file version 638 created 14-MAY-2010 15:20:43

J092159 EO007.UVDATA.1

Freq = 4.9270 GHz, Bw = 16.000 MH No calibration applied and no bandpass applied

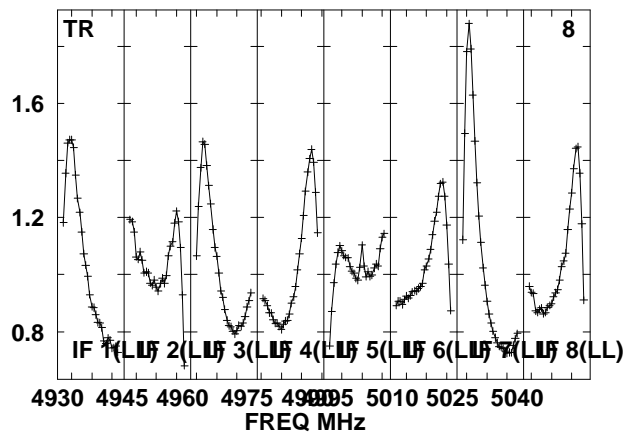
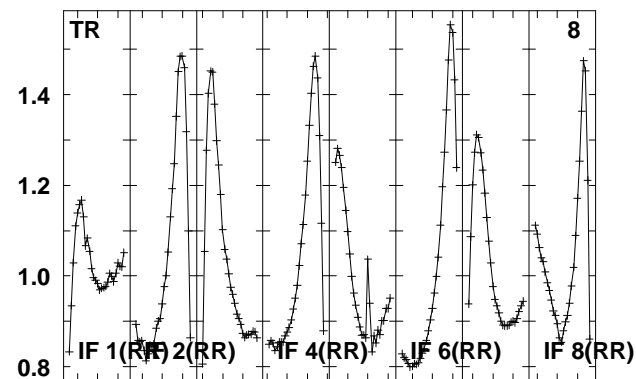
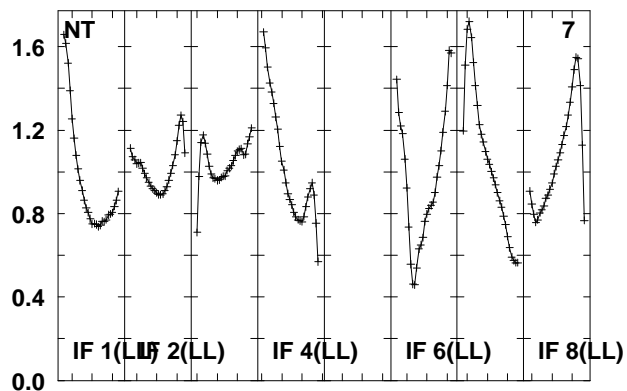
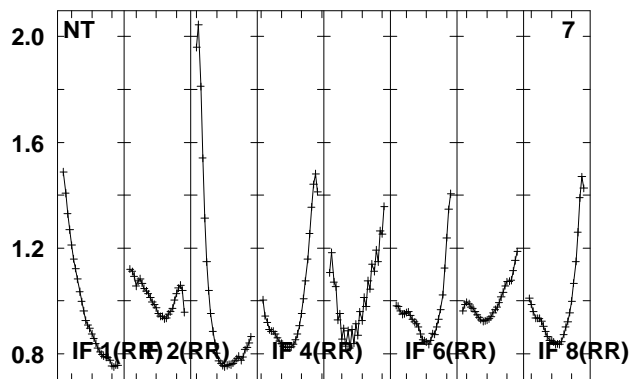
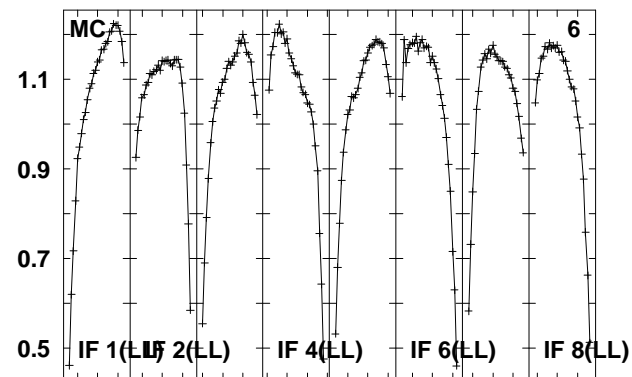
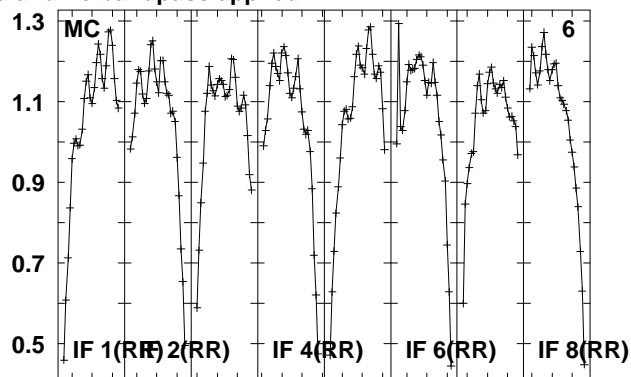
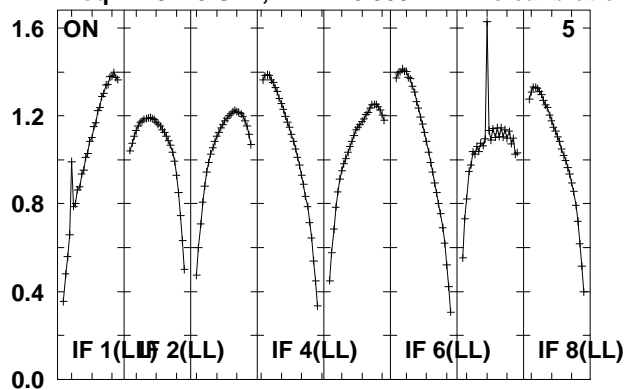

Lower frame: Real Jy

Total-power spectrum Antenna: *

Timerange: 00/21:38:01 to 00/21:42:59

Plot file version 639 created 14-MAY-2010 15:20:44

J0920+44 EO007.UVDATA.1

Freq = 4.9270 GHz, Bw = 16.000 MH No calibration applied and no bandpass applied

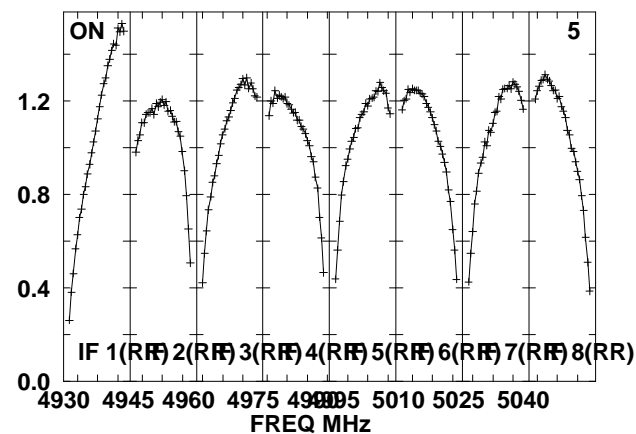
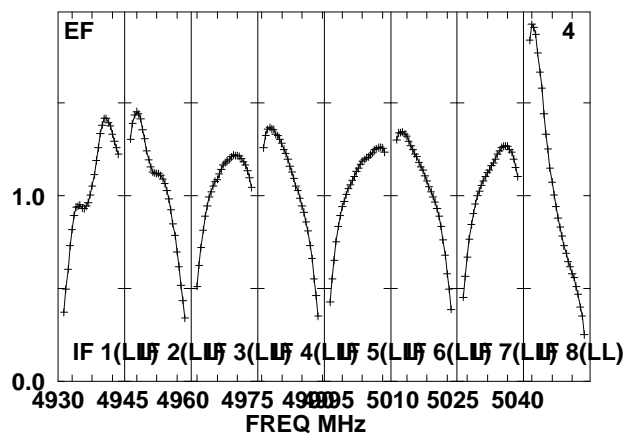
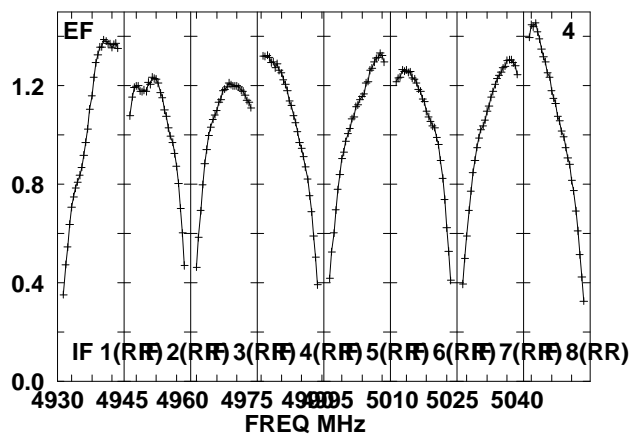
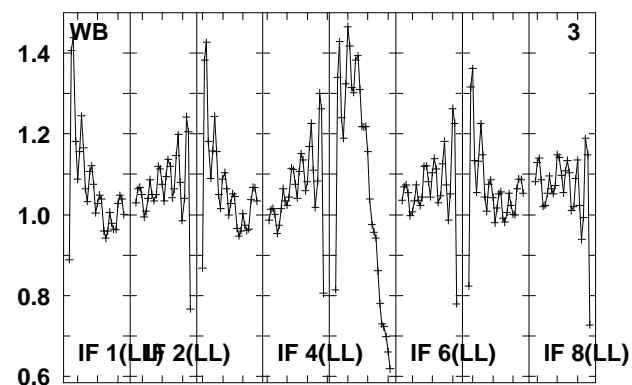
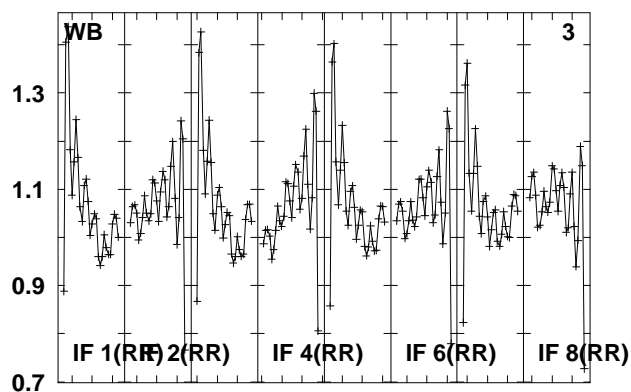
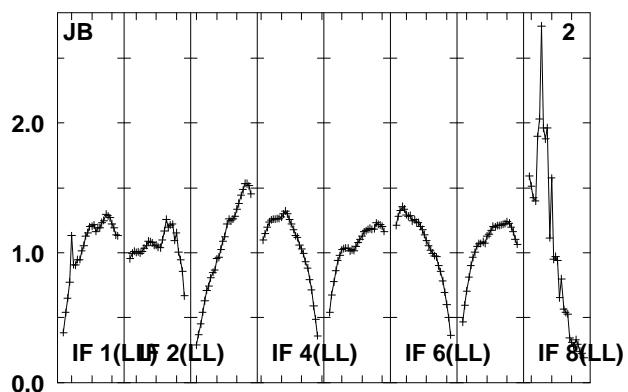
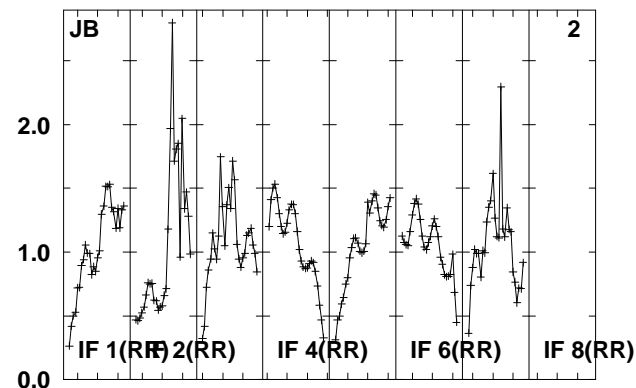
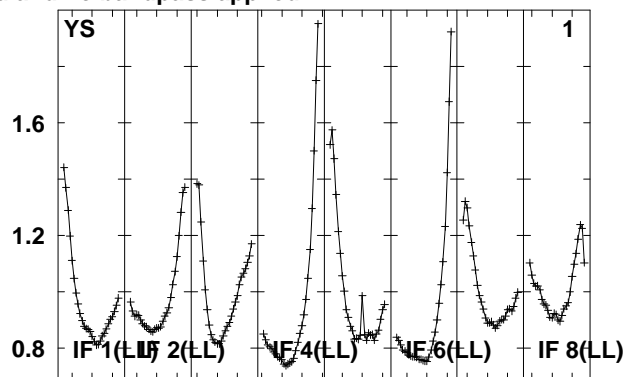
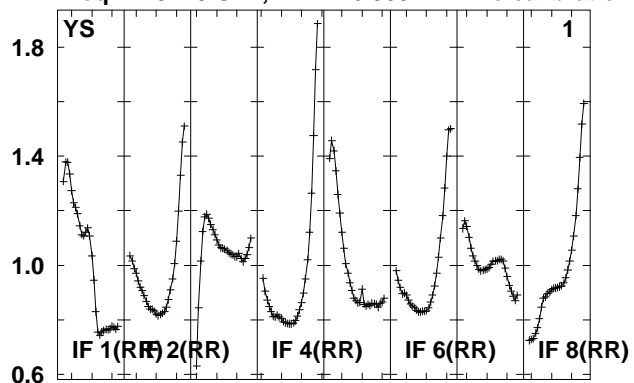

Lower frame: Real Jy
Total-power spectrum Antenna: *
Timerange: 00/21:43:27 to 00/21:44:55

Plot file version 640 created 14-MAY-2010 15:20:44

J0920+44 EO007.UVDATA.1

Freq = 4.9270 GHz, Bw = 16.000 MH No calibration applied and no bandpass applied

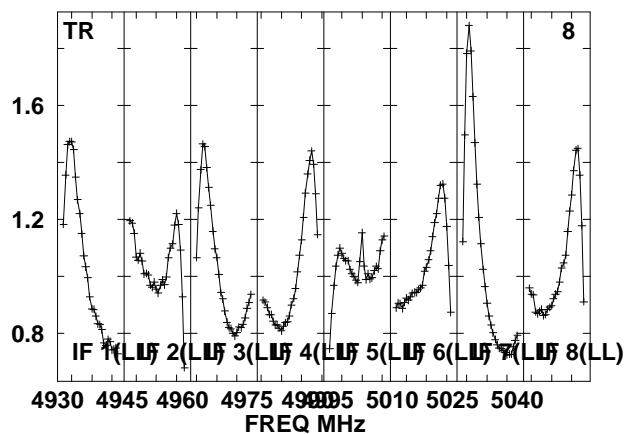
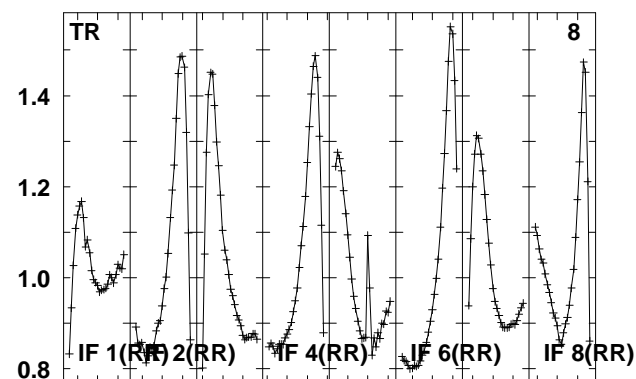
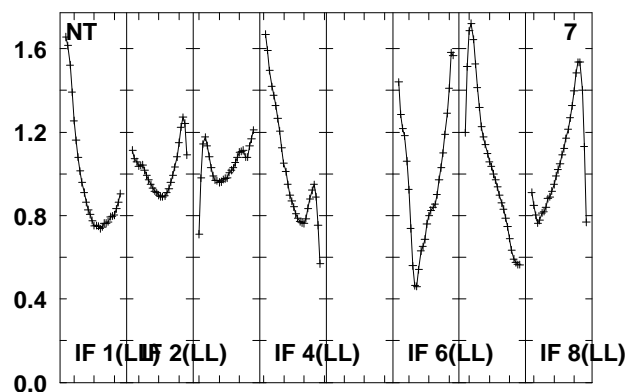
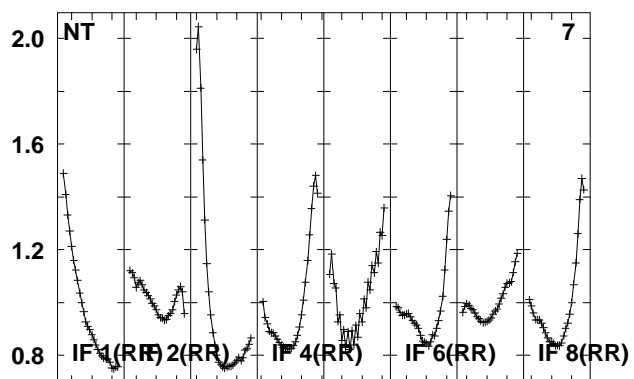
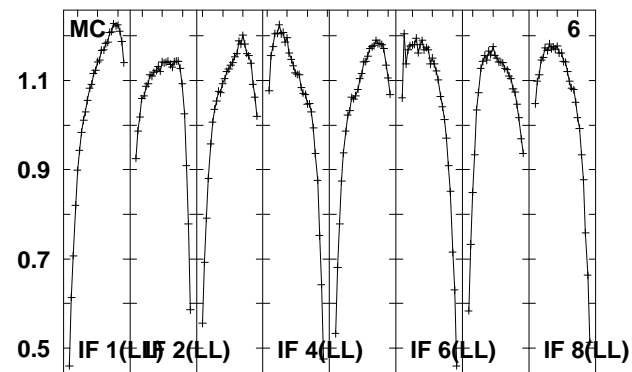
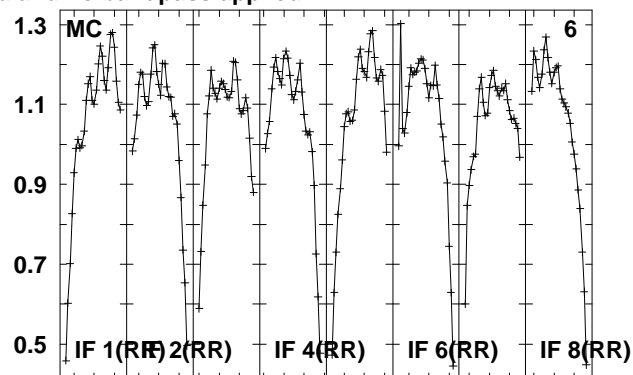
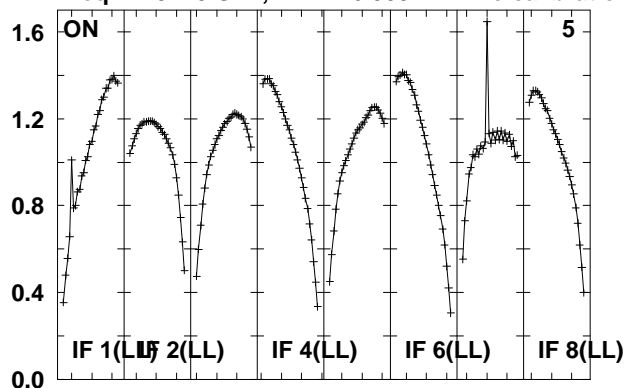

Lower frame: Real Jy

Total-power spectrum Antenna: *

Timerange: 00/21:43:27 to 00/21:44:55

Plot file version 641 created 14-MAY-2010 15:20:44

J092159 EO007.UVDATA.1

Freq = 4.9270 GHz, Bw = 16.000 MH No calibration applied and no bandpass applied

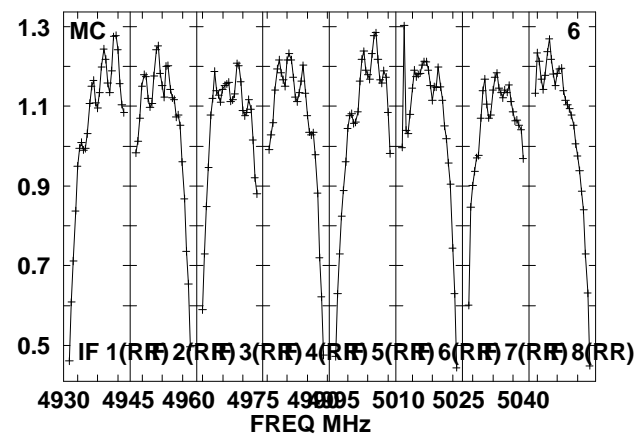
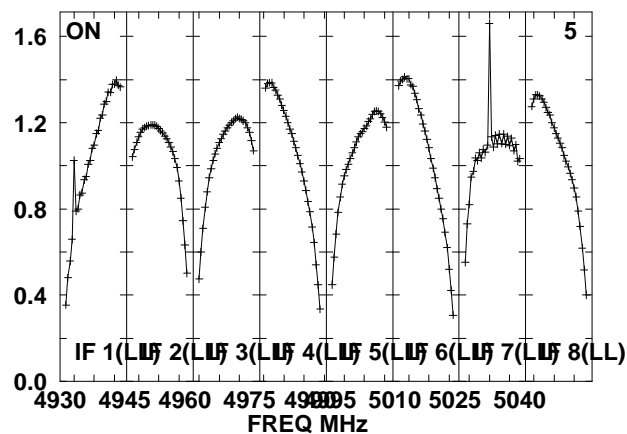
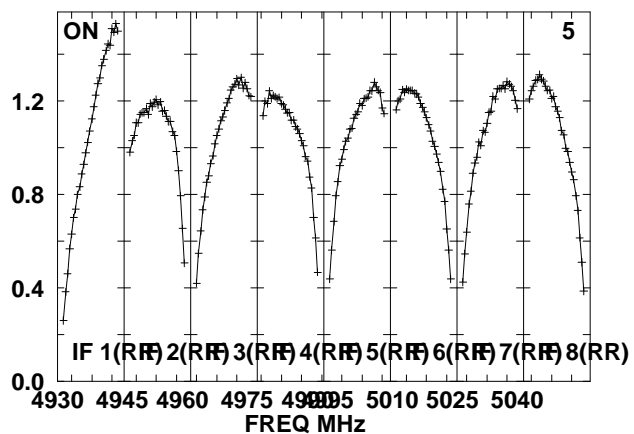
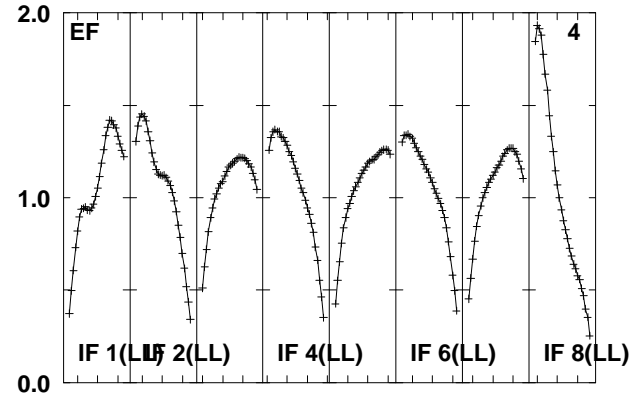
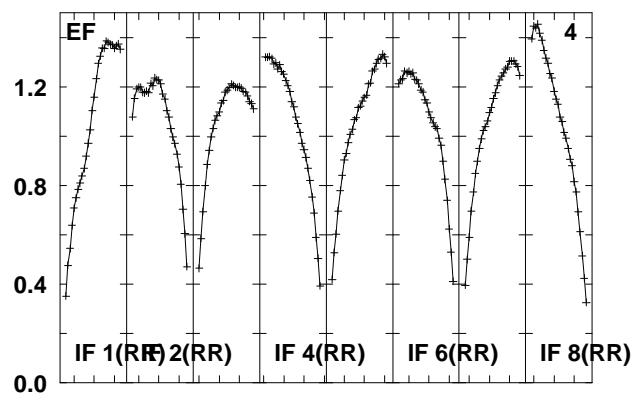
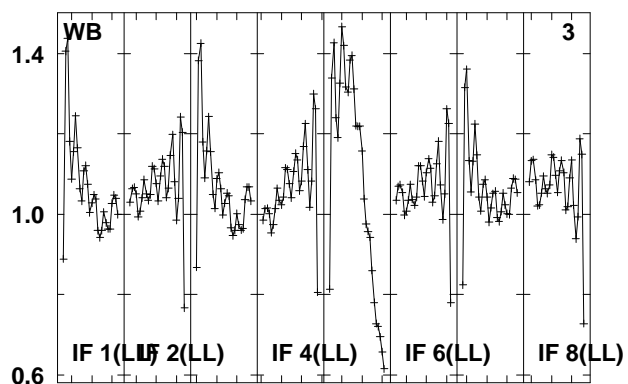
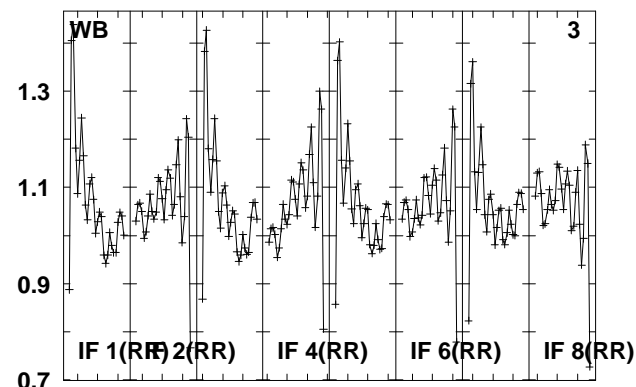
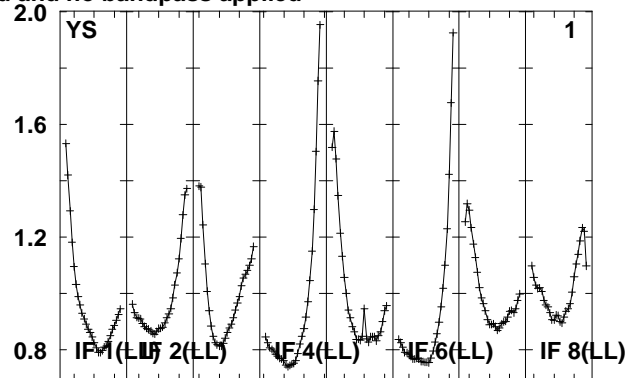
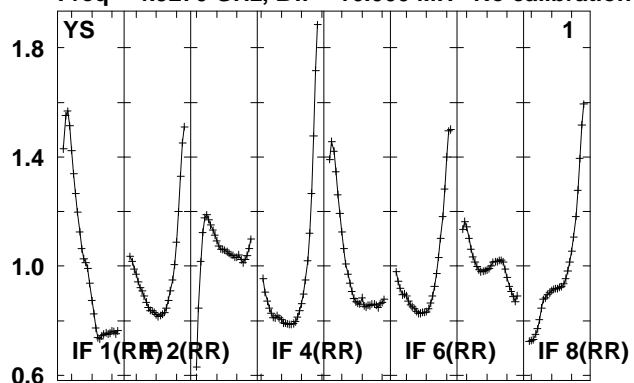

Lower frame: Real Jy
Total-power spectrum Antenna: *
Timerange: 00/21:45:23 to 00/21:50:21

Plot file version 642 created 14-MAY-2010 15:20:45

J092159 EO007.UVDATA.1

Freq = 4.9270 GHz, Bw = 16.000 MH No calibration applied and no bandpass applied

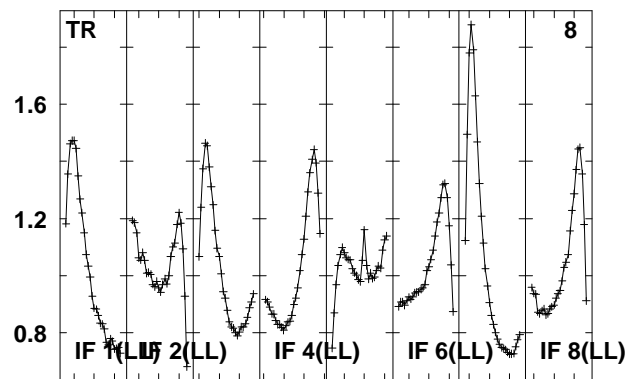
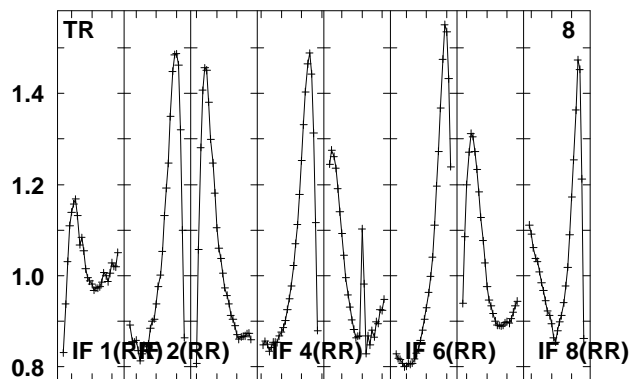
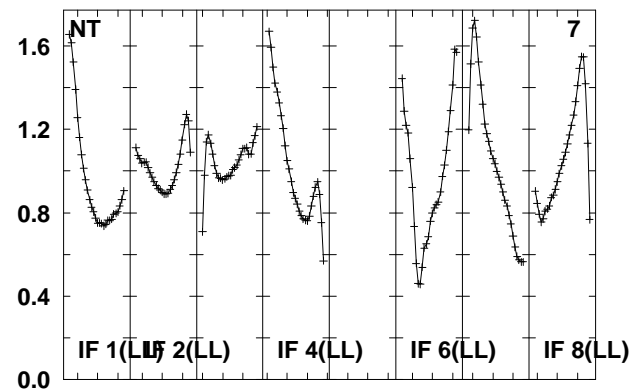
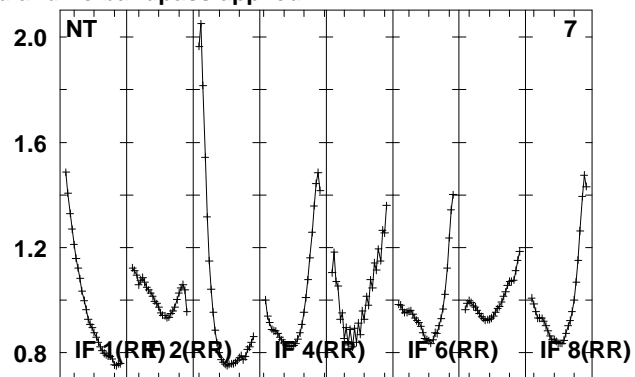
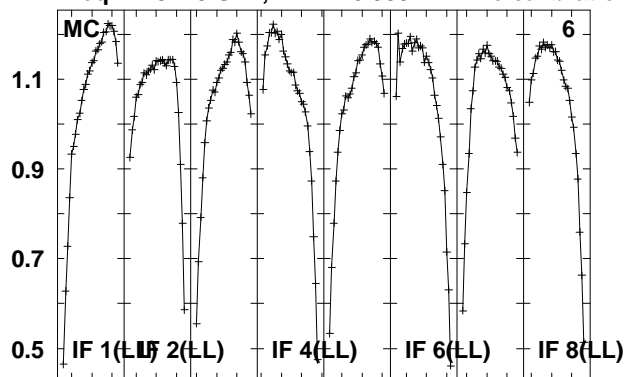

Lower frame: Real Jy
Total-power spectrum Antenna: *
Timerange: 00/21:45:23 to 00/21:50:21

Plot file version 643 created 14-MAY-2010 15:20:45

J0920+44 EO007.UVDATA.1

Freq = 4.9270 GHz, Bw = 16.000 MH No calibration applied and no bandpass applied

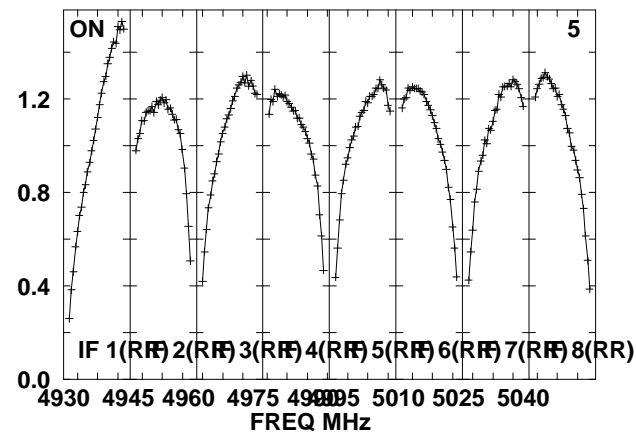
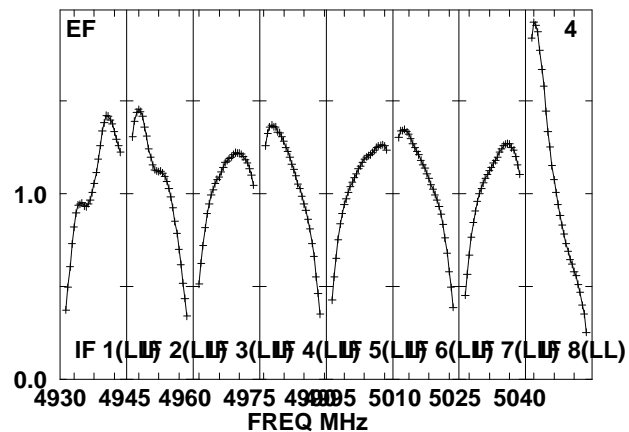
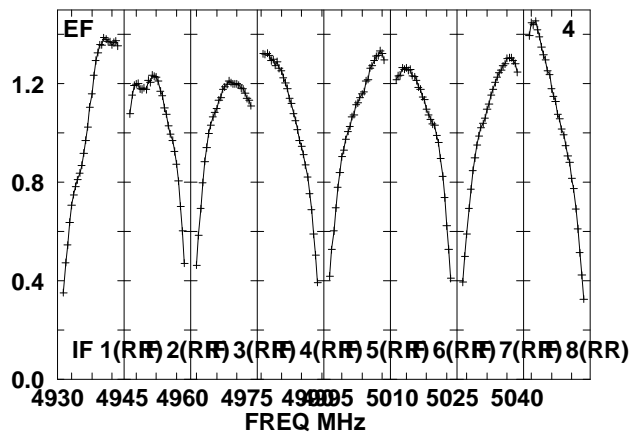
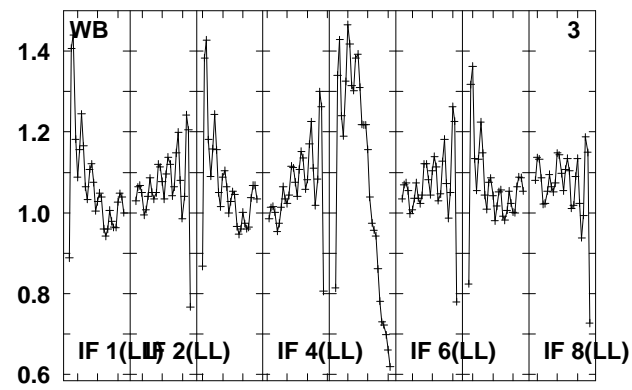
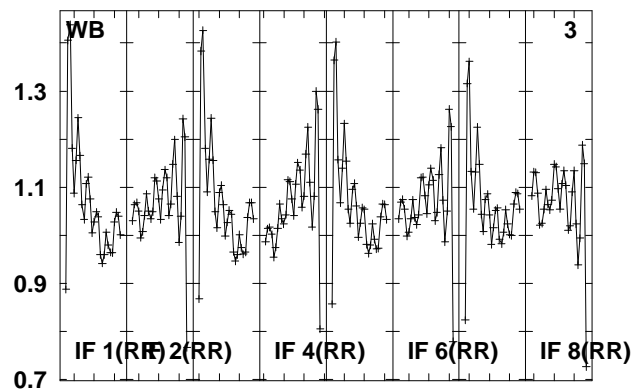
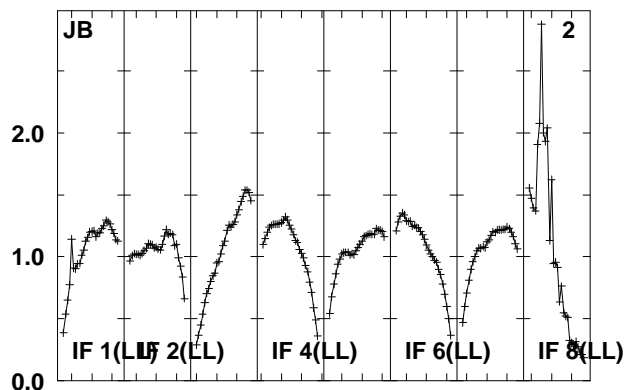
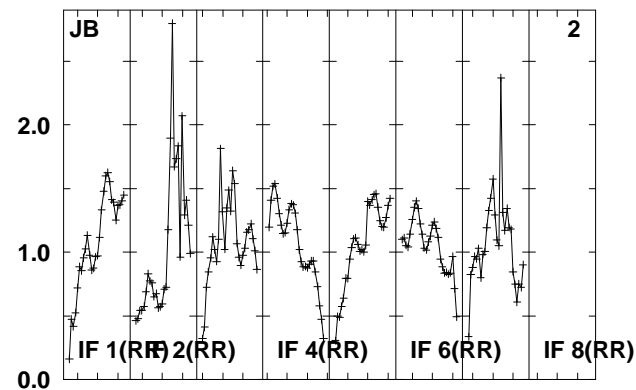
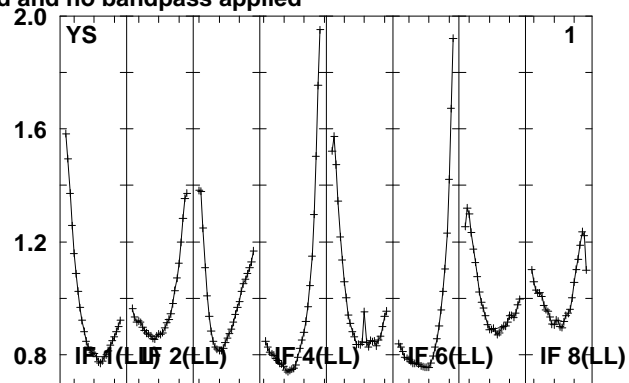
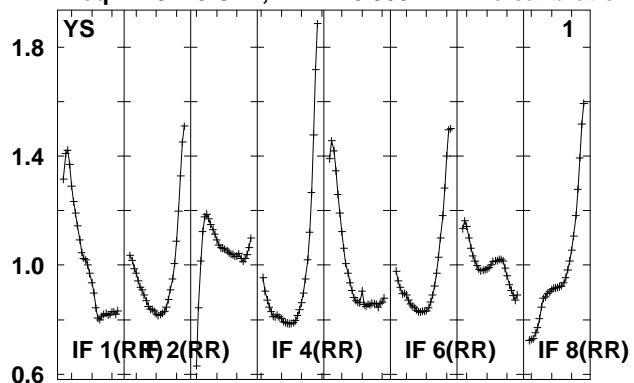

Lower frame: Real Jy
Total-power spectrum Antenna: *
Timerange: 00/21:50:47 to 00/21:52:15

Plot file version 644 created 14-MAY-2010 15:20:45

J0920+44 EO007.UVDATA.1

Freq = 4.9270 GHz, Bw = 16.000 MH No calibration applied and no bandpass applied

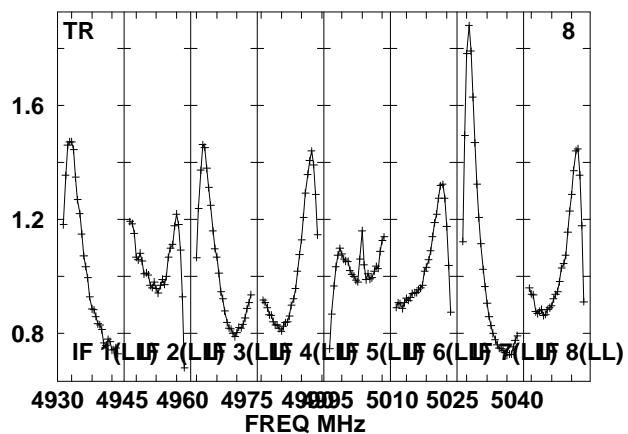
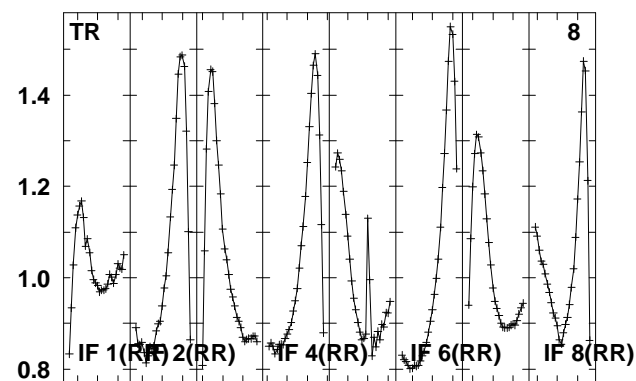
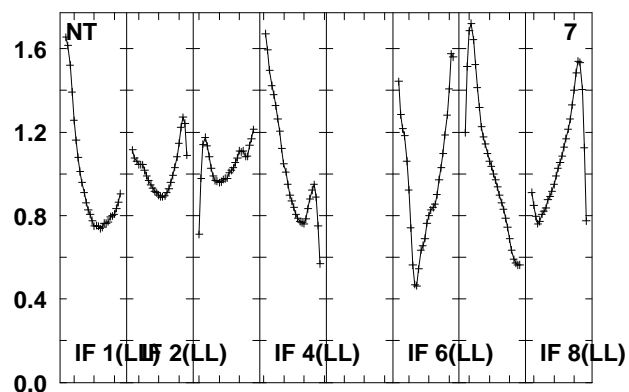
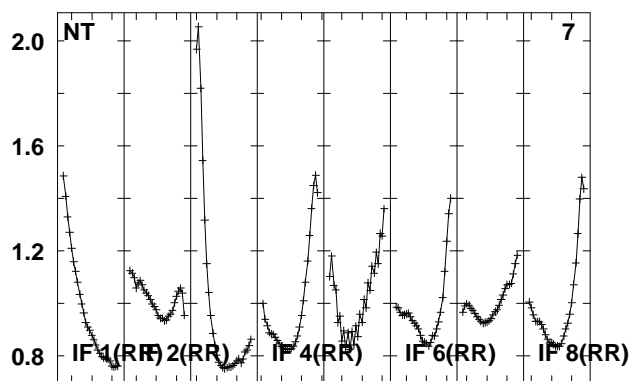
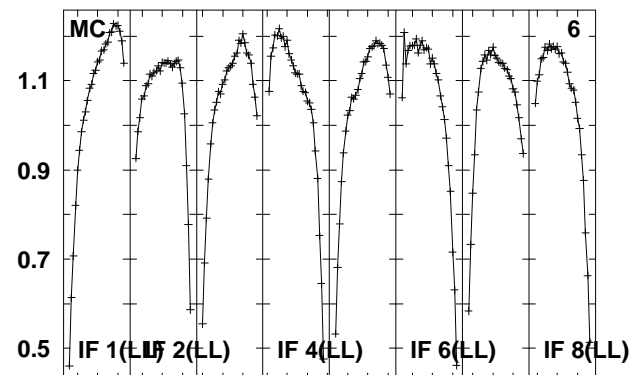
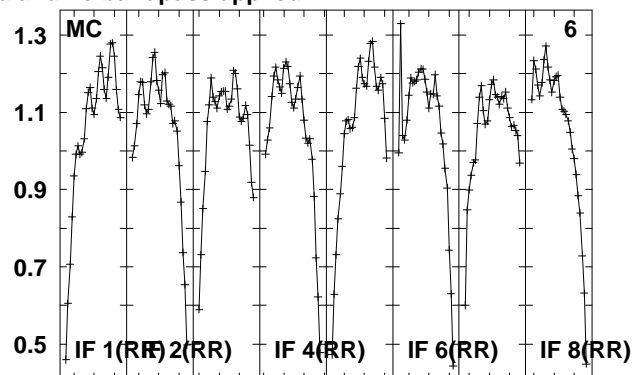
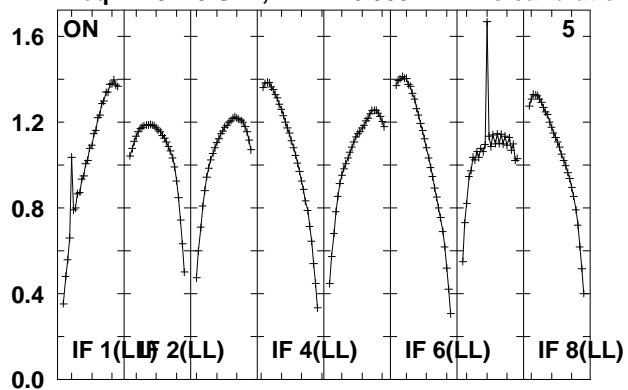

Lower frame: Real Jy

Total-power spectrum Antenna: *

Timerange: 00/21:50:47 to 00/21:52:15

Plot file version 645 created 14-MAY-2010 15:20:45

J1027+48 EO007.UVDATA.1

Freq = 4.9270 GHz, Bw = 16.000 MH No calibration applied and no bandpass applied

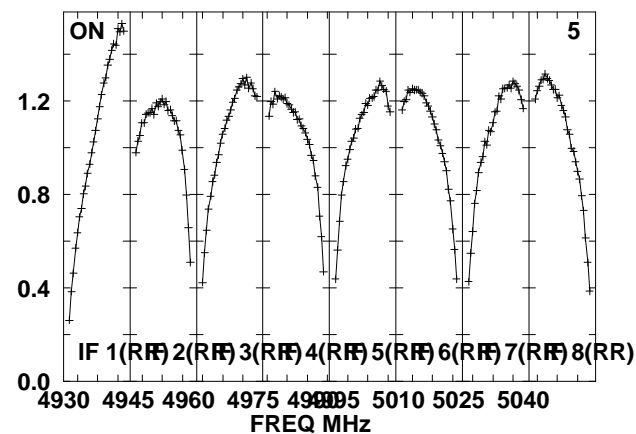
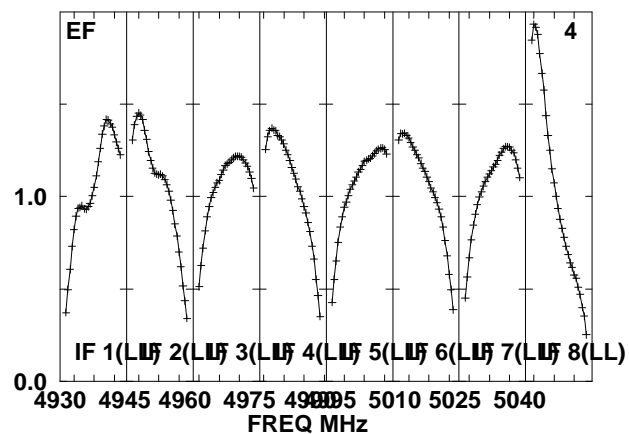
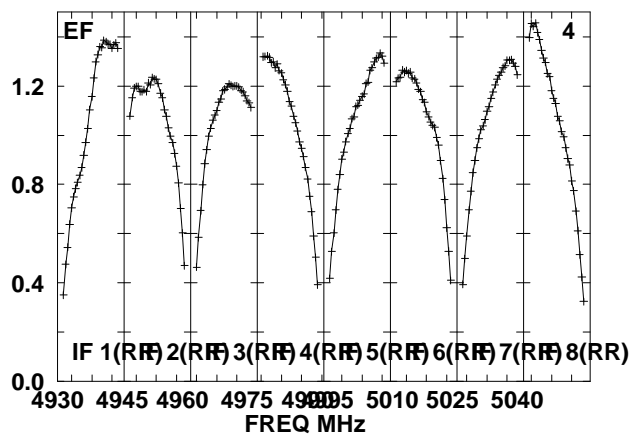
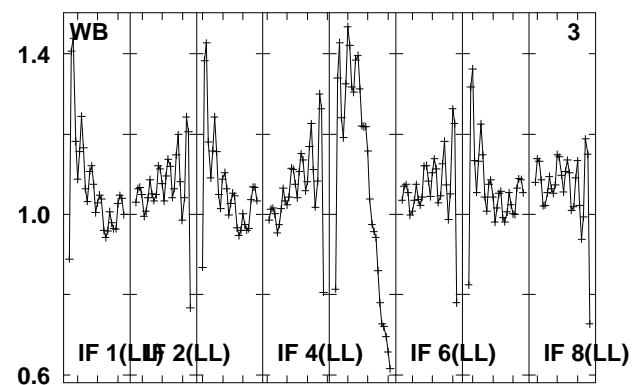
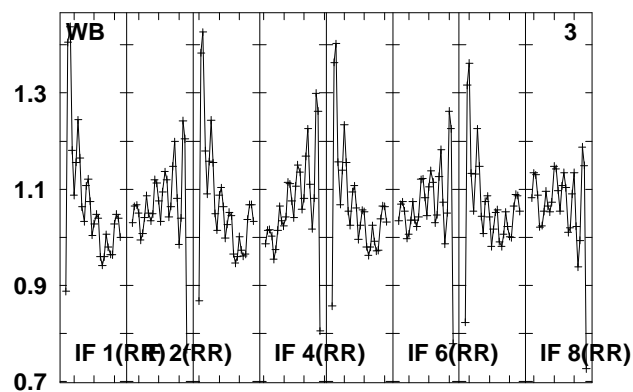
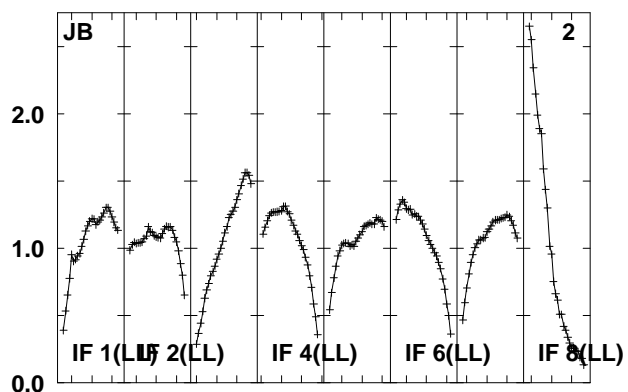
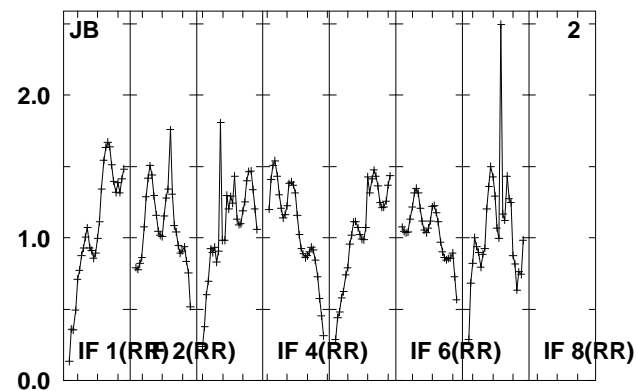
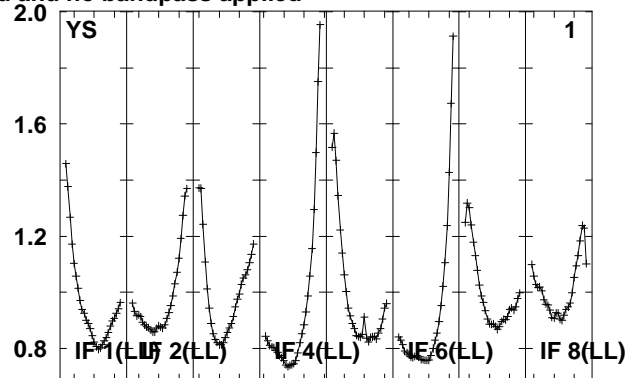
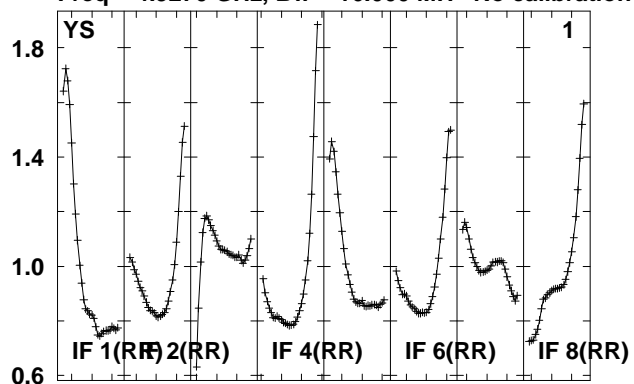

Lower frame: Real Jy

Total-power spectrum Antenna: *

Timerange: 00/21:57:35 to 00/21:59:01

Plot file version 646 created 14-MAY-2010 15:20:46

J1027+48 EO007.UVDATA.1

Freq = 4.9270 GHz, Bw = 16.000 MH No calibration applied and no bandpass applied

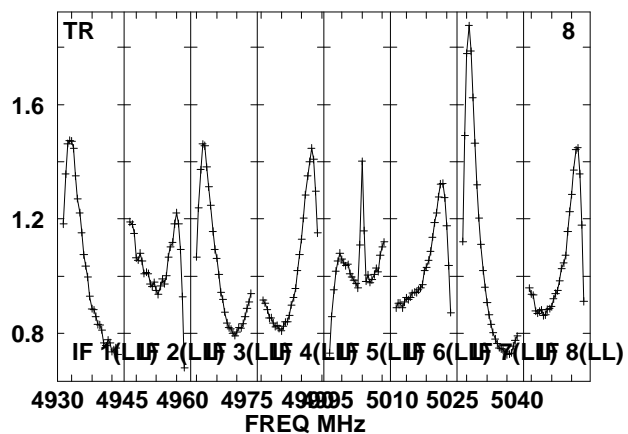
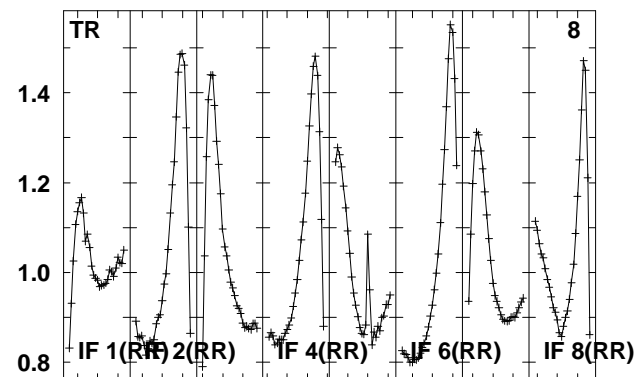
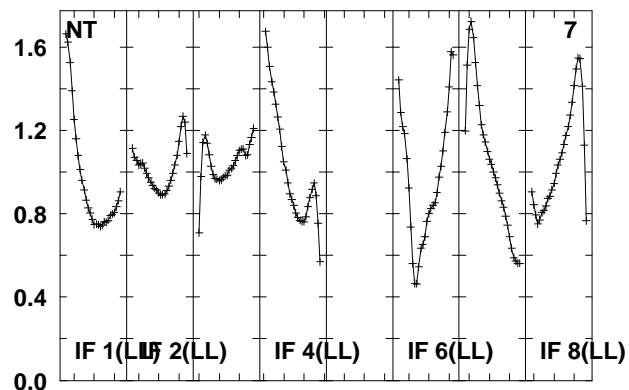
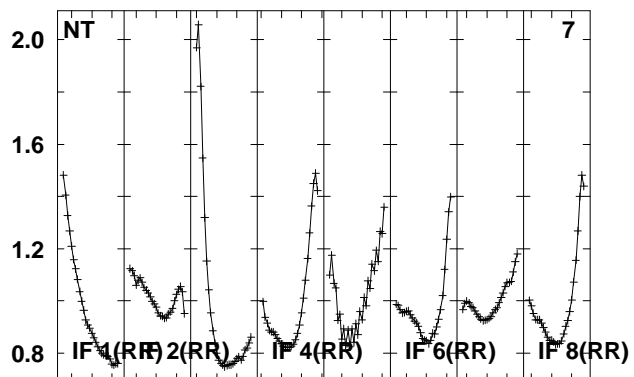
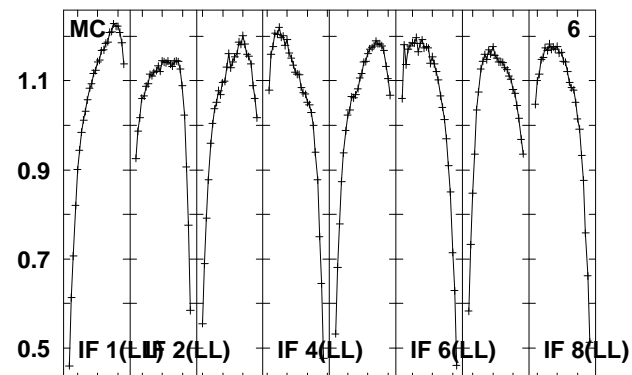
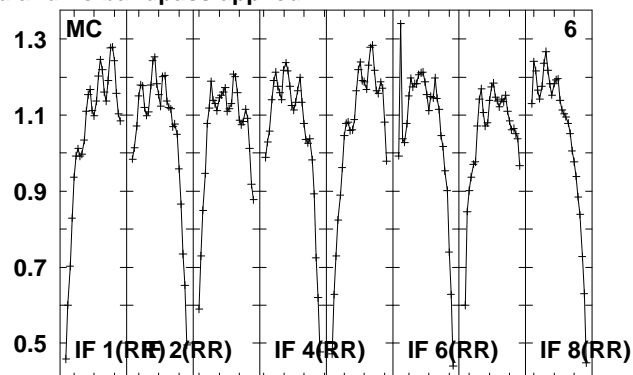
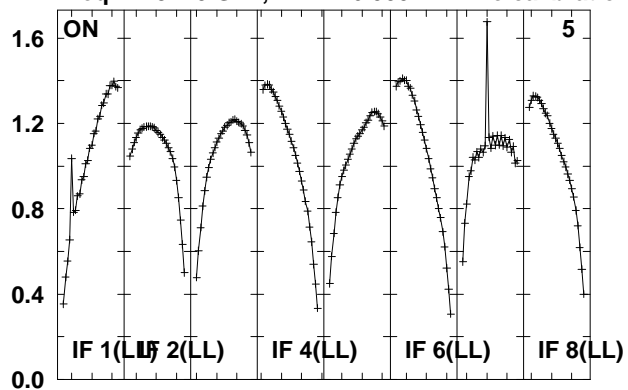

Lower frame: Real Jy

Total-power spectrum Antenna: *

Timerange: 00/21:57:35 to 00/21:59:01

Plot file version 647 created 14-MAY-2010 15:20:46

J102959 EO007.UVDATA.1

Freq = 4.9270 GHz, Bw = 16.000 MH No calibration applied and no bandpass applied

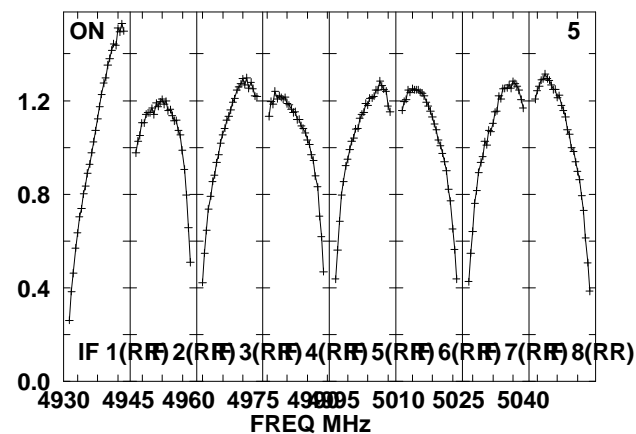
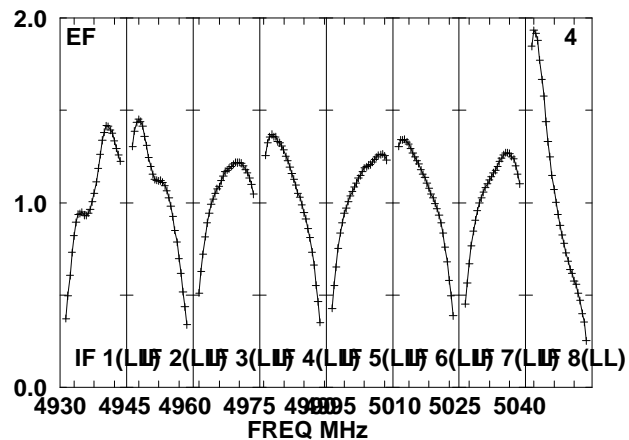
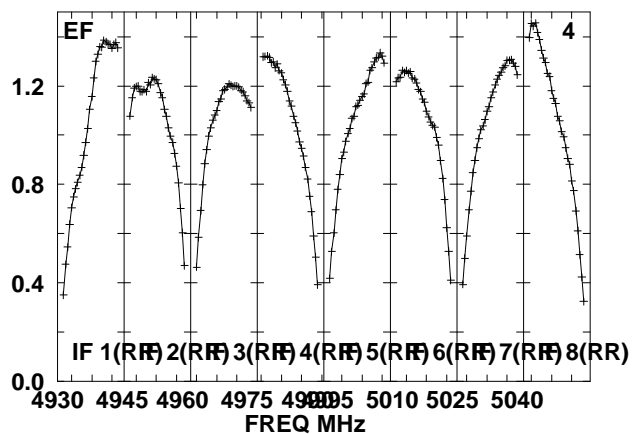
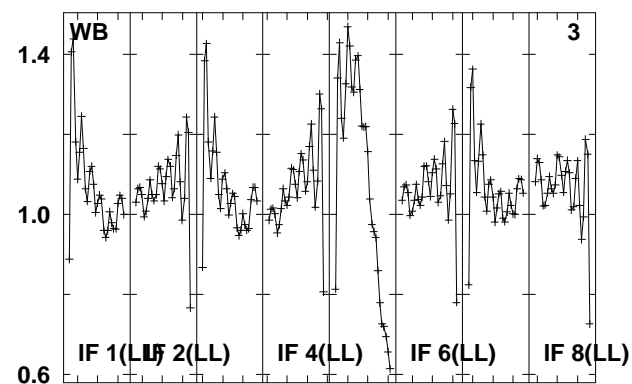
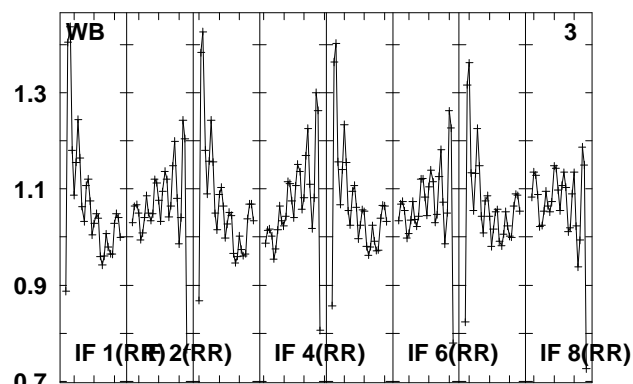
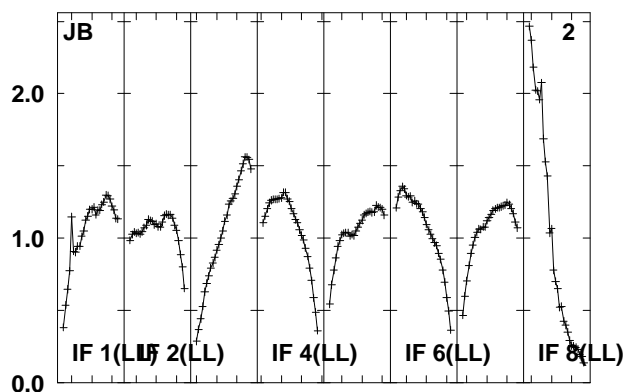
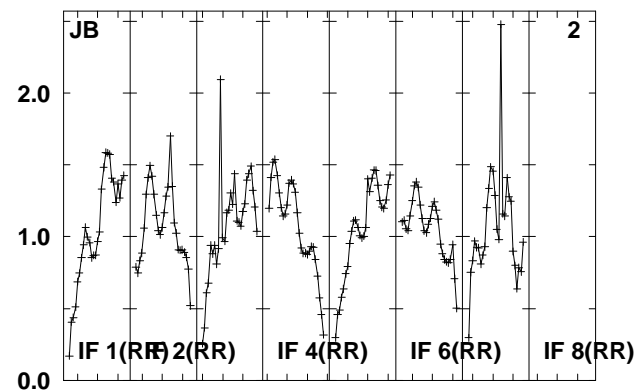
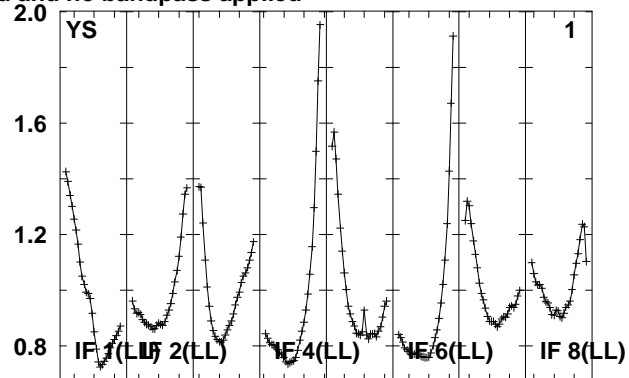
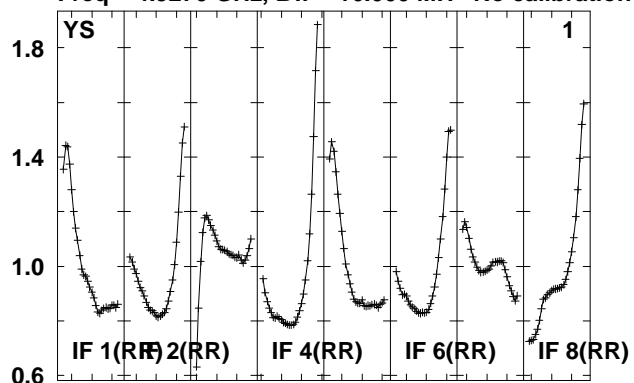

Lower frame: Real Jy

Total-power spectrum Antenna: *

Timerange: 00/21:59:57 to 00/22:04:55

Plot file version 648 created 14-MAY-2010 15:20:47

J102959 EO007.UVDATA.1

Freq = 4.9270 GHz, Bw = 16.000 MH No calibration applied and no bandpass applied

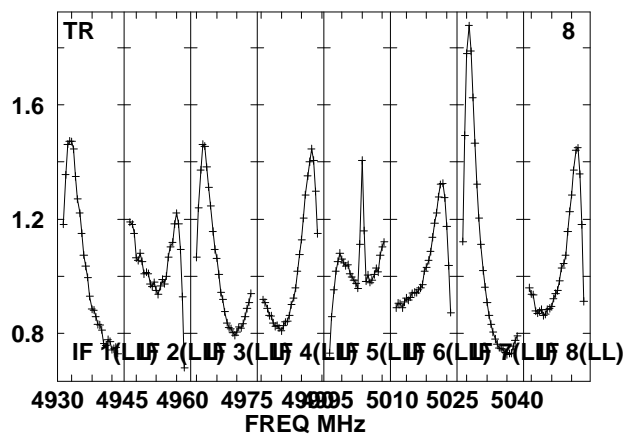
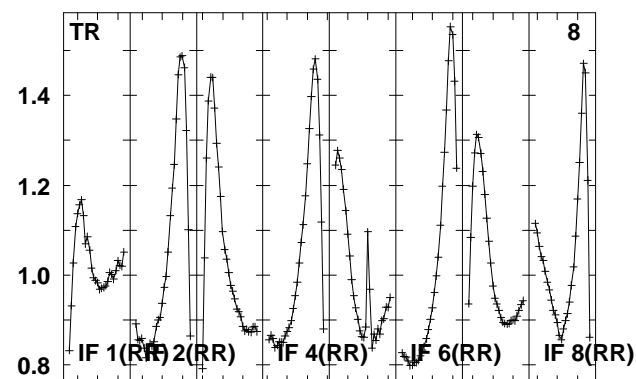
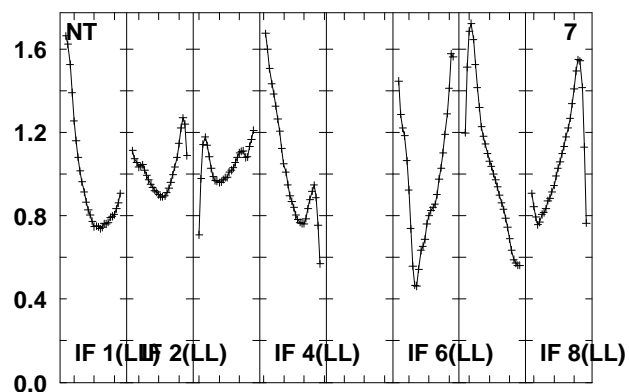
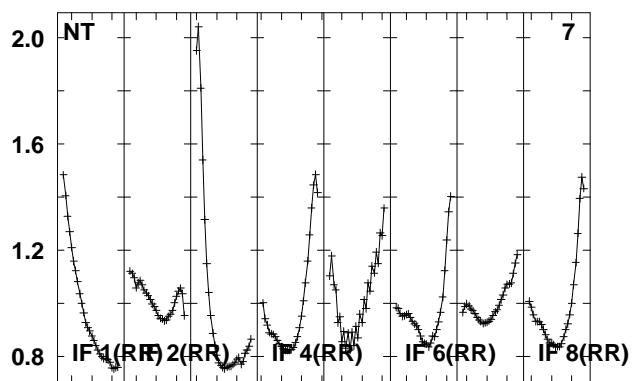
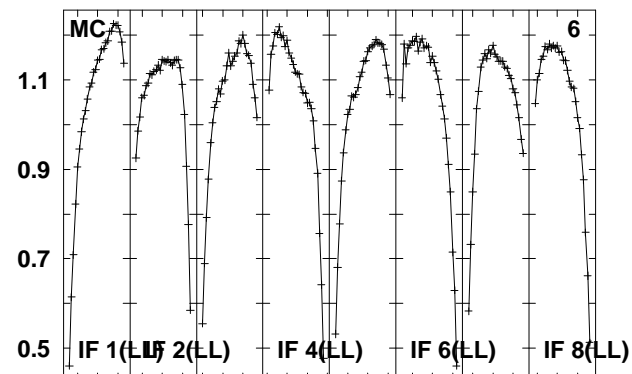
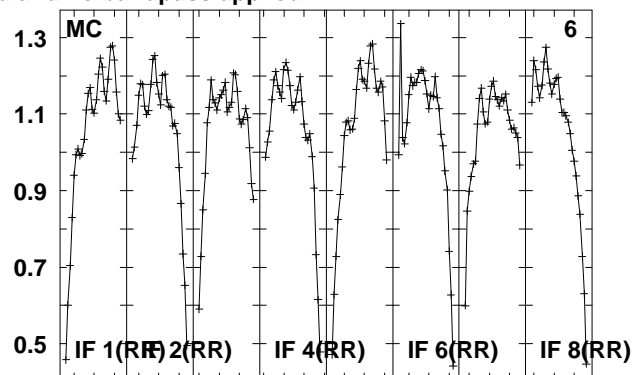
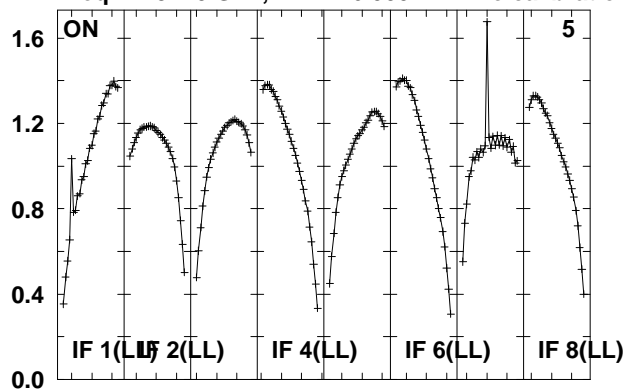

Lower frame: Real Jy

Total-power spectrum Antenna: *

Timerange: 00/21:59:57 to 00/22:04:55

Plot file version 649 created 14-MAY-2010 15:20:47

J1027+48 EO007.UVDATA.1

Freq = 4.9270 GHz, Bw = 16.000 MH No calibration applied and no bandpass applied

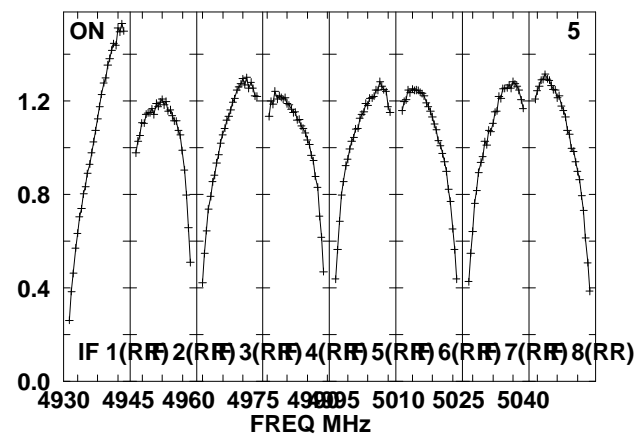
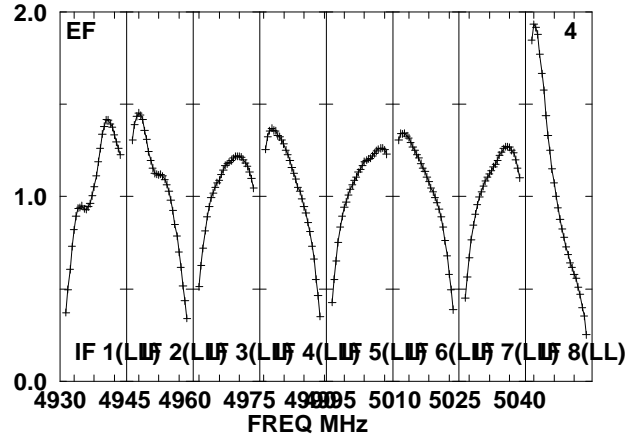
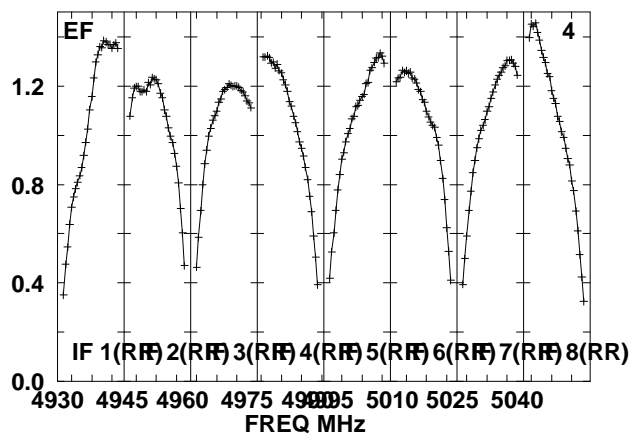
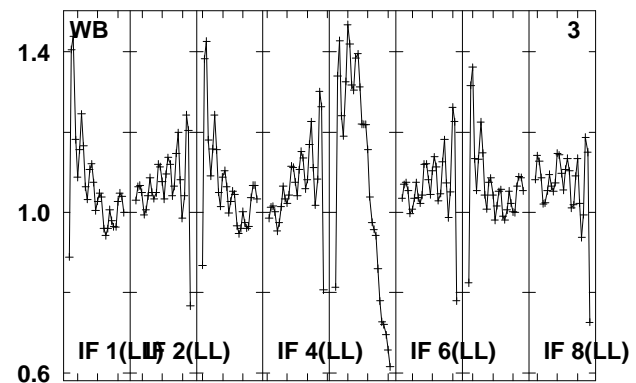
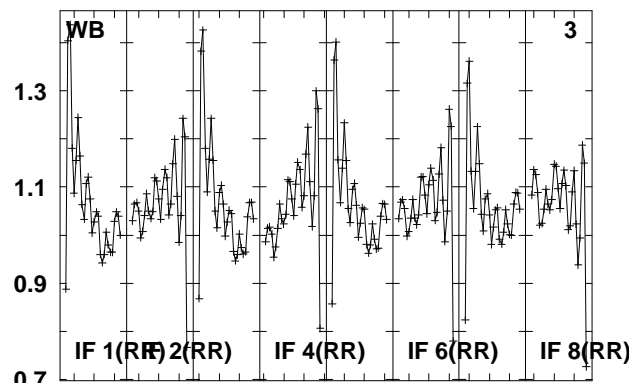
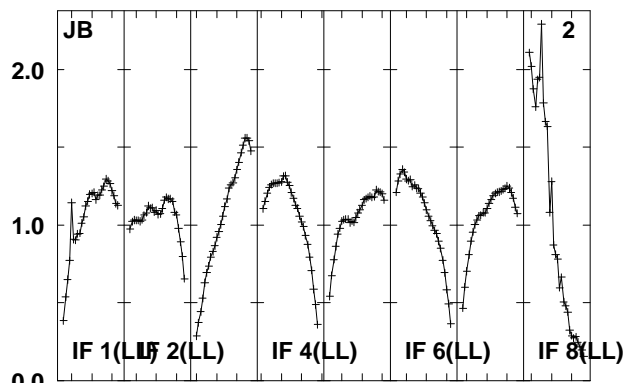
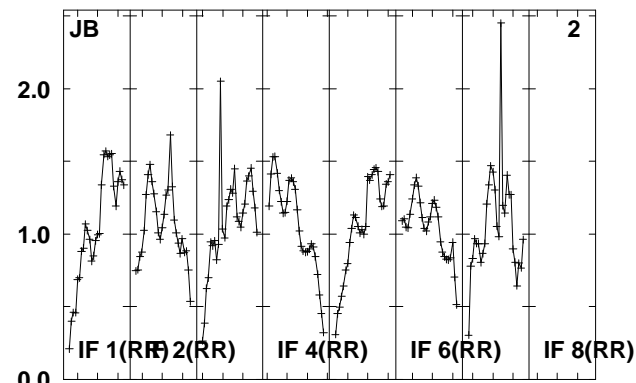
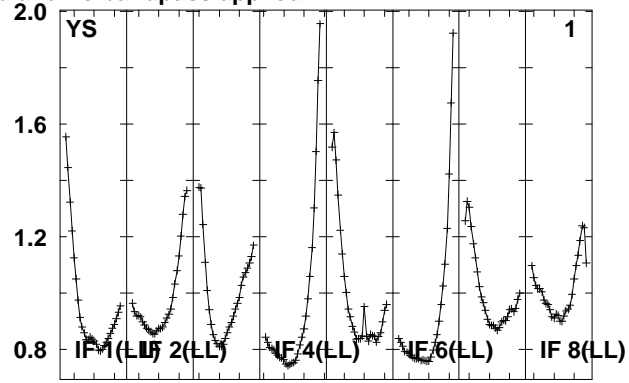
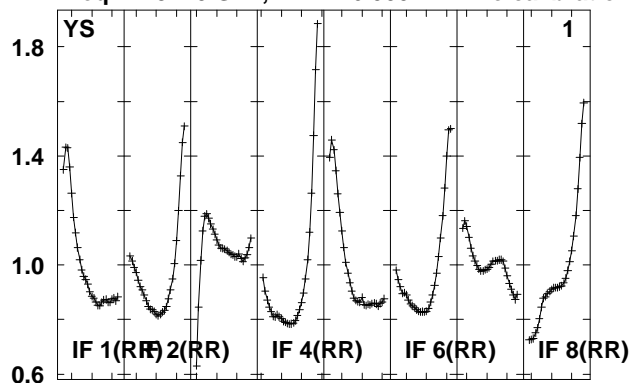

Lower frame: Real Jy

Total-power spectrum Antenna: *

Timerange: 00/22:06:07 to 00/22:07:35

Plot file version 650 created 14-MAY-2010 15:20:47

J1027+48 EO007.UVDATA.1

Freq = 4.9270 GHz, Bw = 16.000 MH No calibration applied and no bandpass applied

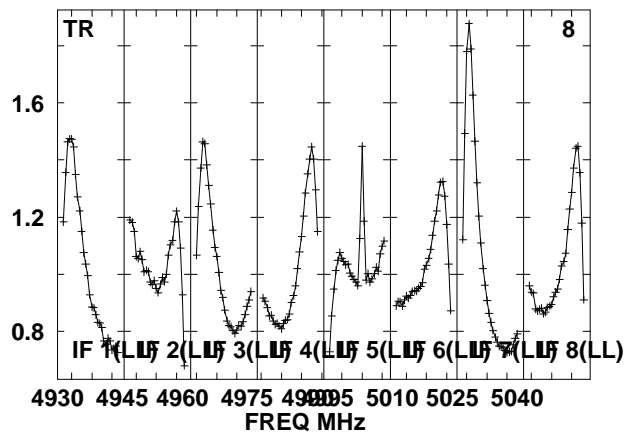
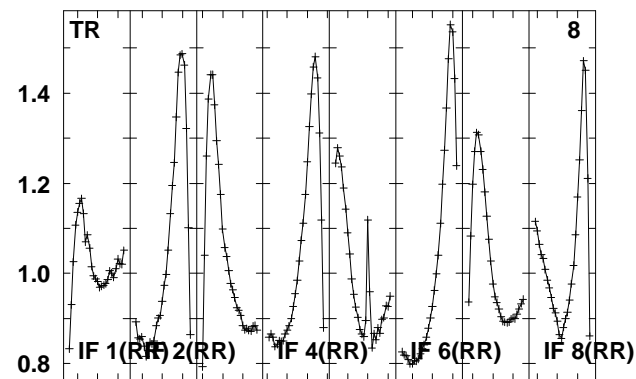
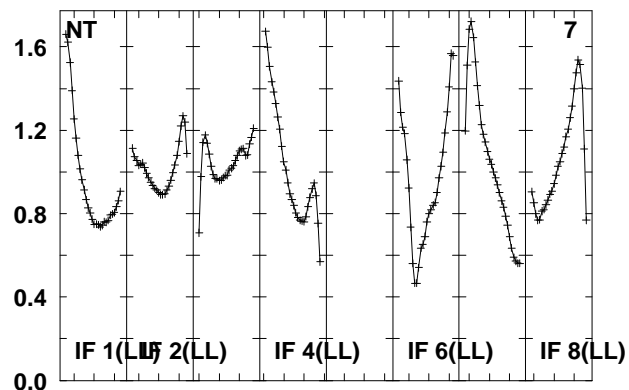
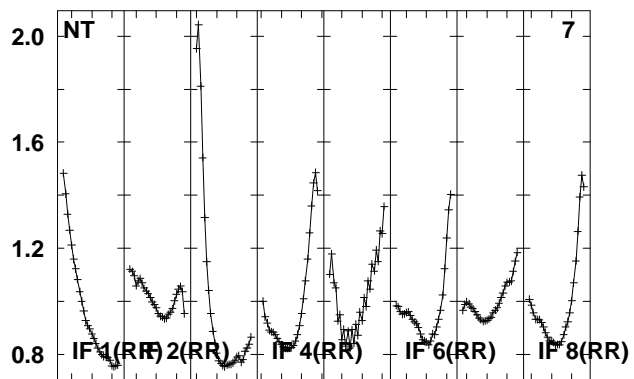
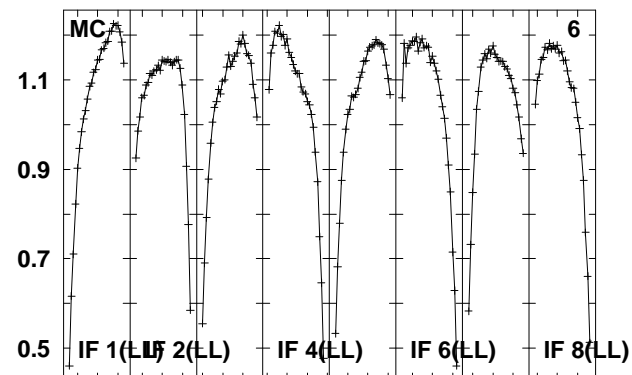
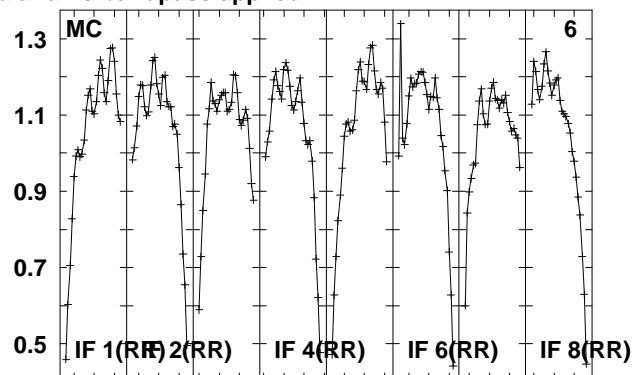
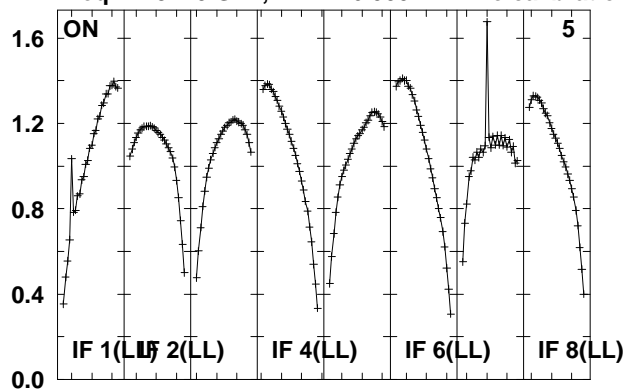

Lower frame: Real Jy

Total-power spectrum Antenna: *

Timerange: 00/22:06:07 to 00/22:07:35

Plot file version 651 created 14-MAY-2010 15:20:48

J102959 EO007.UVDATA.1

Freq = 4.9270 GHz, Bw = 16.000 MH No calibration applied and no bandpass applied

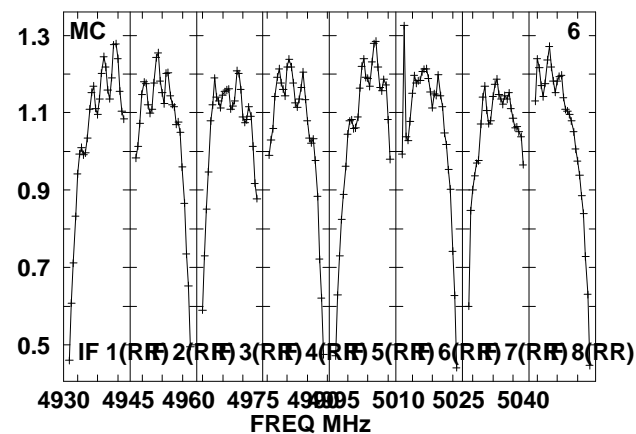
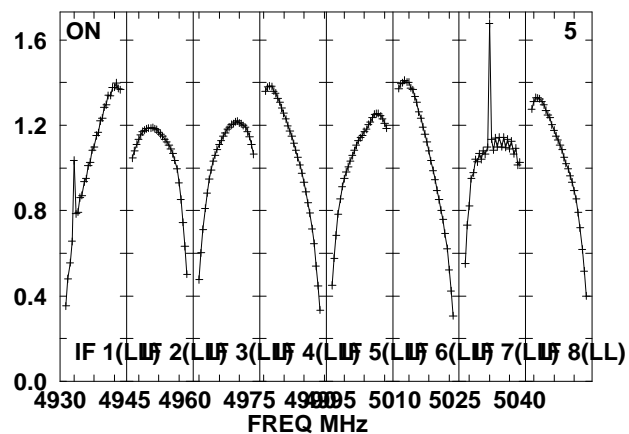
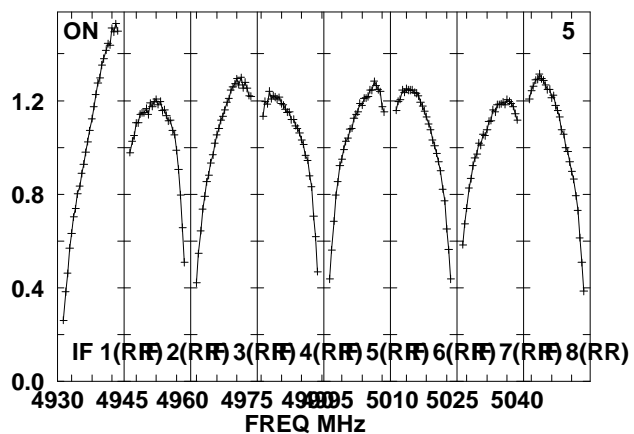
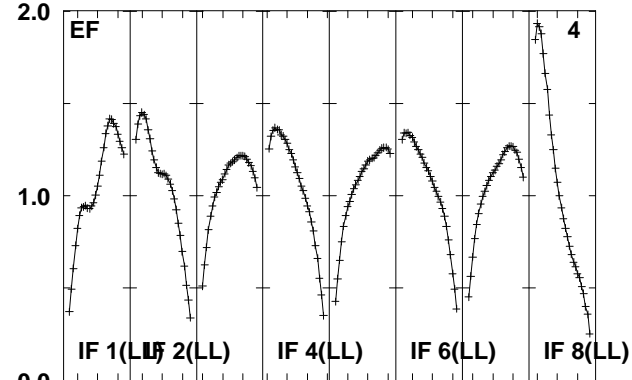
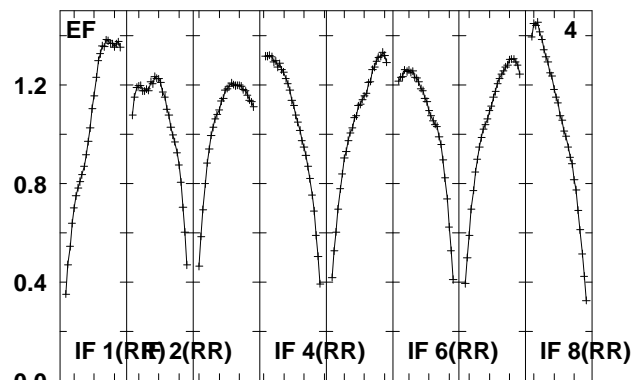
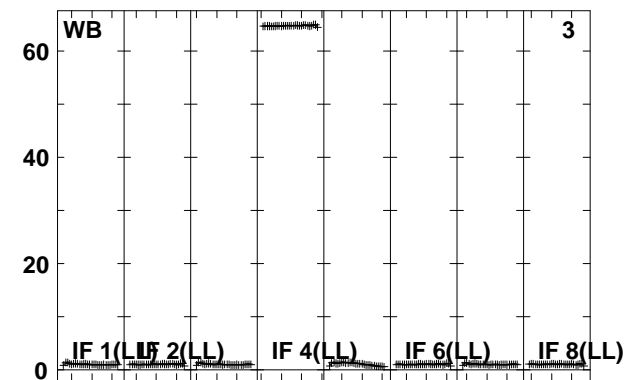
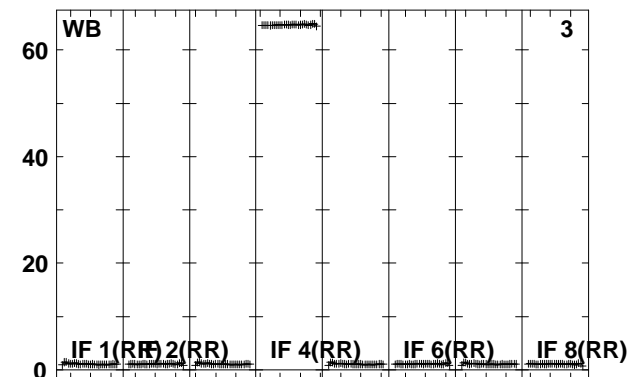
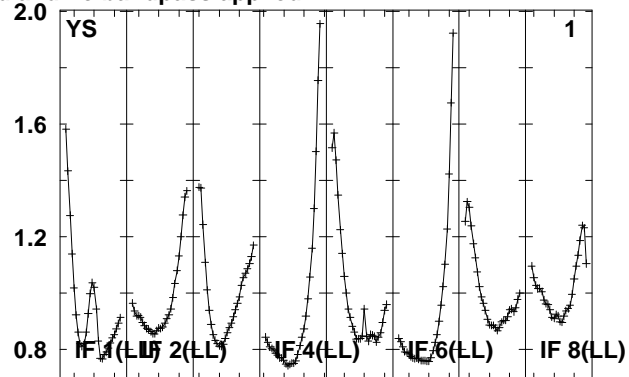
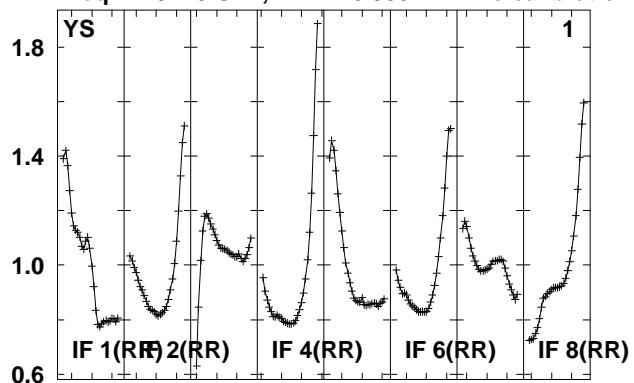

Lower frame: Real Jy
Total-power spectrum Antenna: *
Timerange: 00/22:08:30 to 00/22:13:26

Plot file version 652 created 14-MAY-2010 15:20:48

J102959 EO007.UVDATA.1

Freq = 4.9270 GHz, Bw = 16.000 MH No calibration applied and no bandpass applied

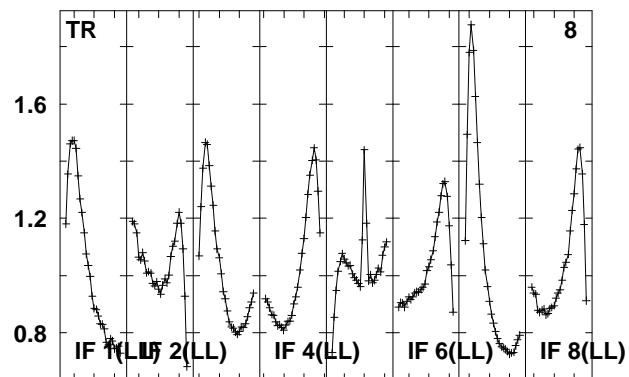
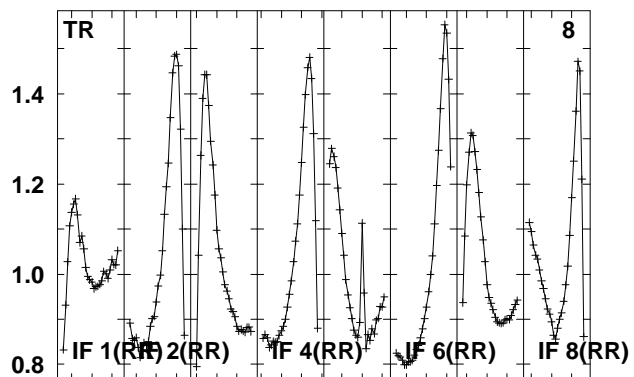
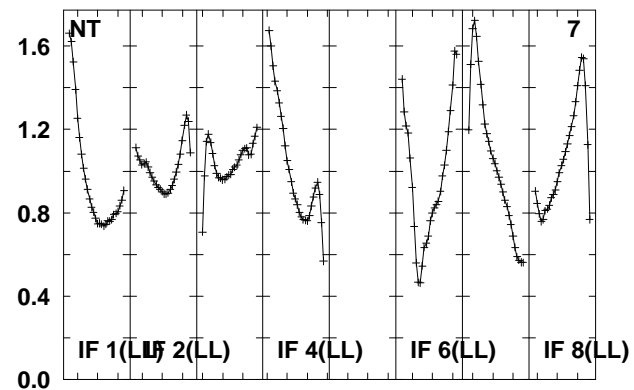
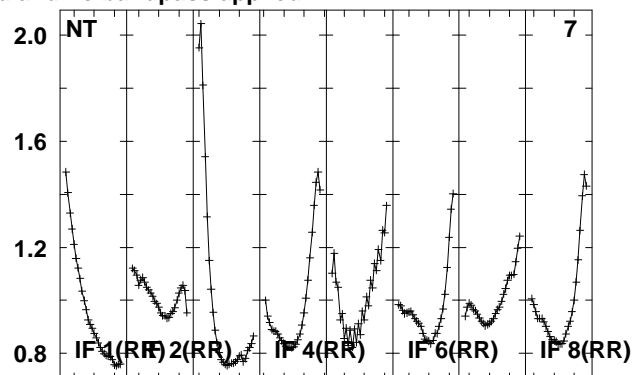
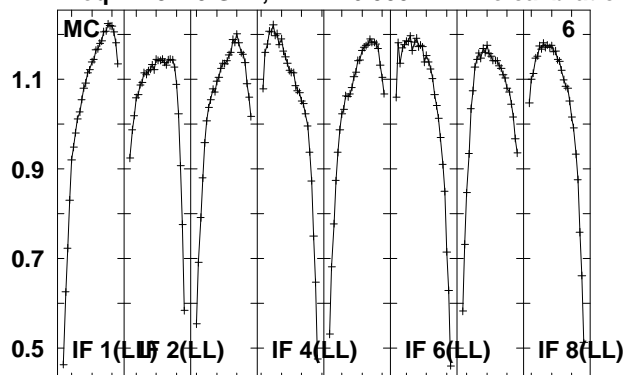

Lower frame: Real Jy
Total-power spectrum Antenna: *
Timerange: 00/22:08:30 to 00/22:13:26

Plot file version 653 created 14-MAY-2010 15:20:48

J1027+48 EO007.UVDATA.1

Freq = 4.9270 GHz, Bw = 16.000 MH No calibration applied and no bandpass applied

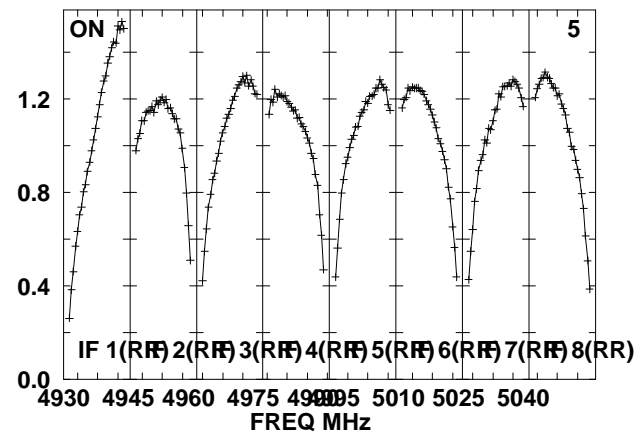
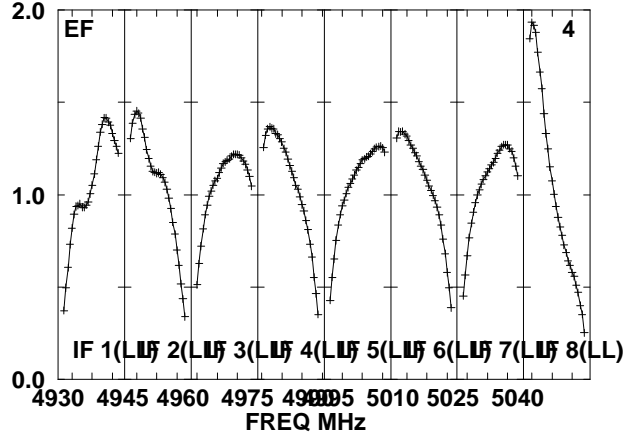
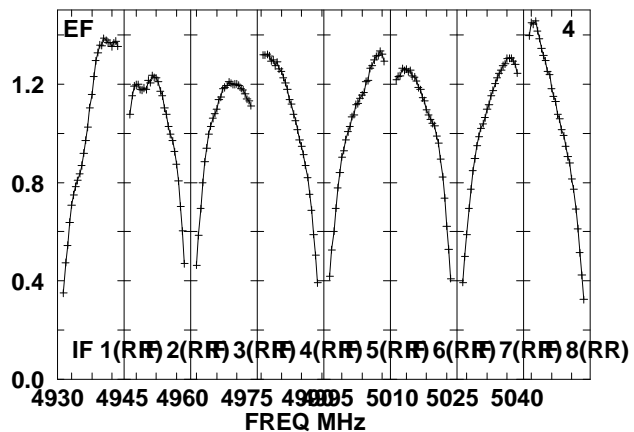
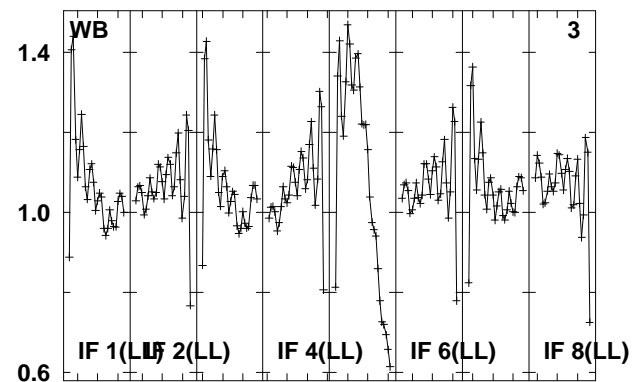
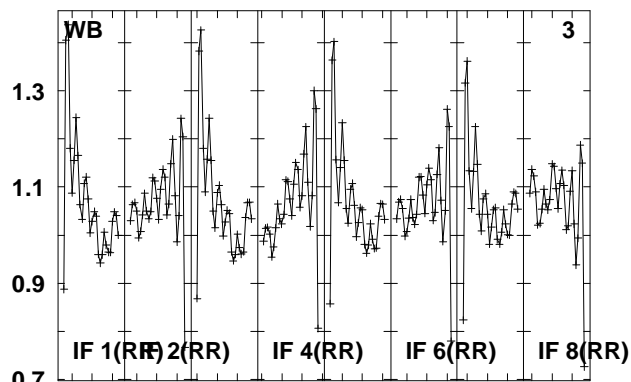
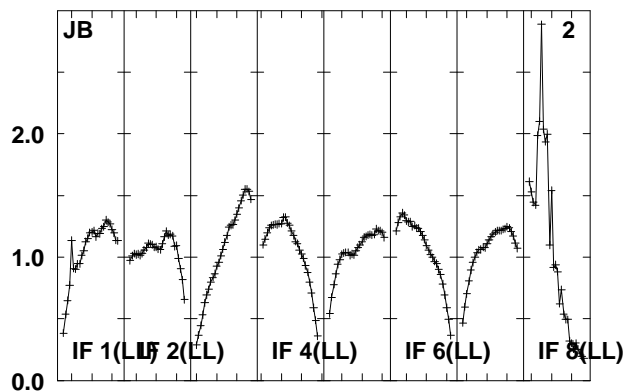
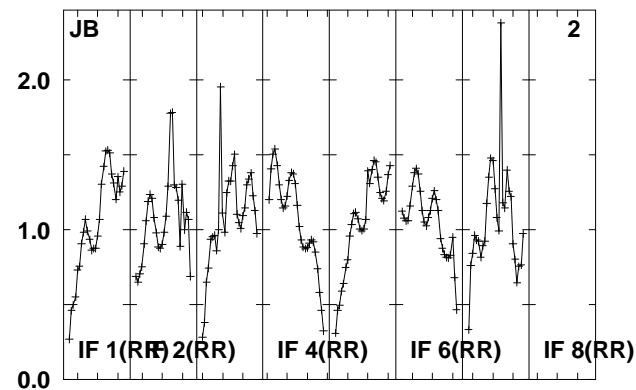
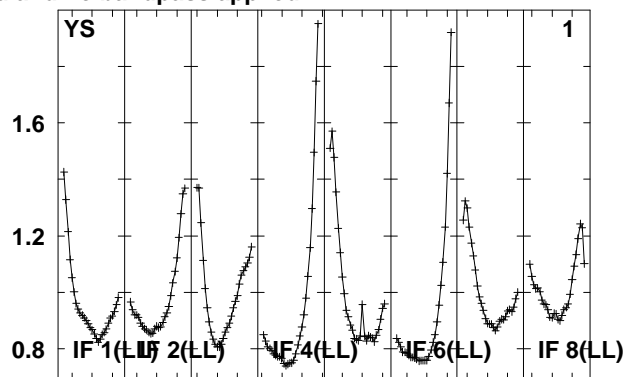
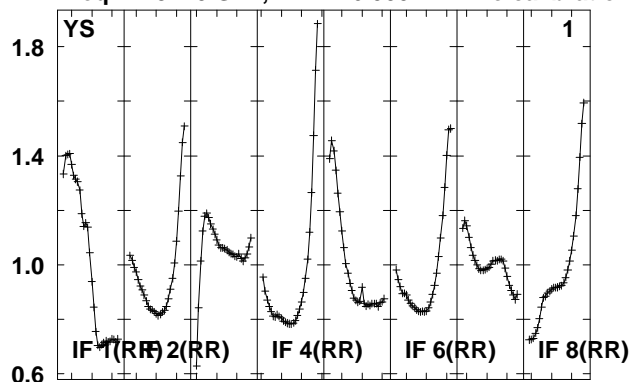

Lower frame: Real Jy
Total-power spectrum Antenna: *
Timerange: 00/22:14:34 to 00/22:16:02

Plot file version 654 created 14-MAY-2010 15:20:49

J1027+48 EO007.UVDATA.1

Freq = 4.9270 GHz, Bw = 16.000 MH No calibration applied and no bandpass applied

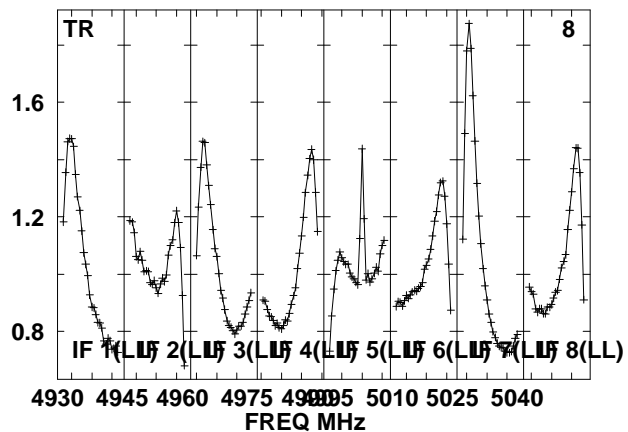
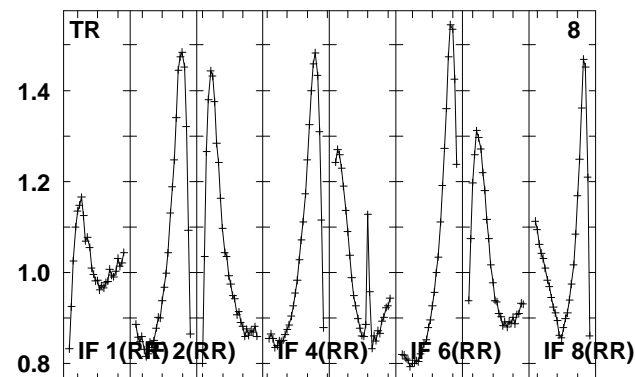
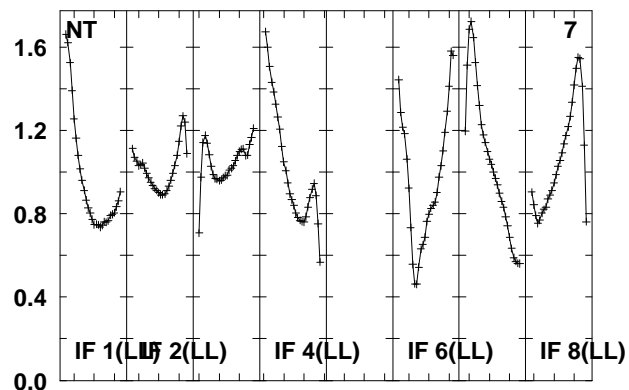
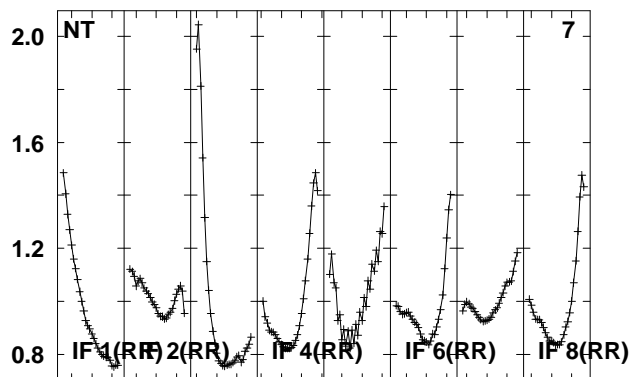
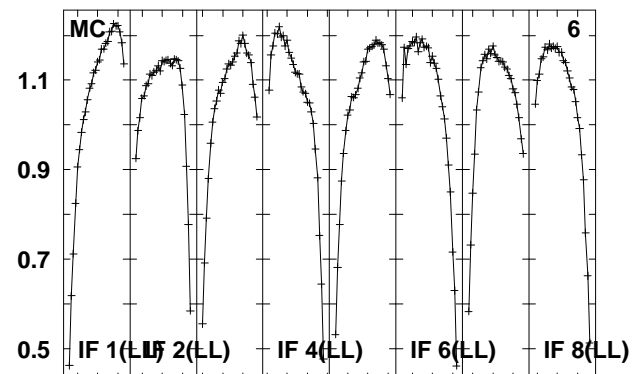
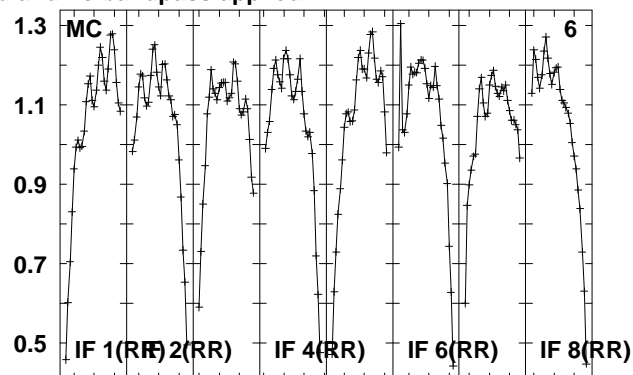
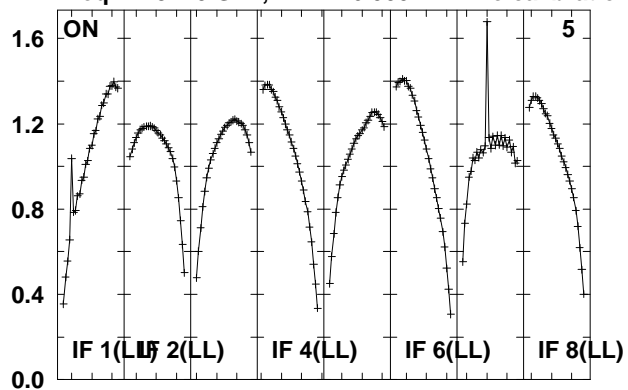

Lower frame: Real Jy

Total-power spectrum Antenna: *

Timerange: 00/22:14:34 to 00/22:16:02

Plot file version 655 created 14-MAY-2010 15:20:49
 J0920+44 EO007.UVDATA.1
 Freq = 4.9270 GHz, Bw = 16.000 MH No calibration applied and no bandpass applied

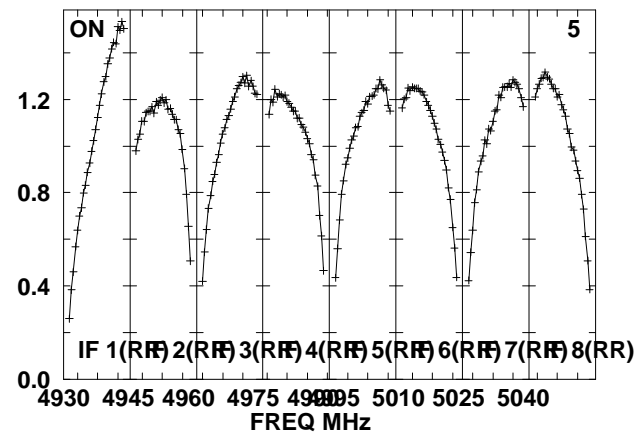
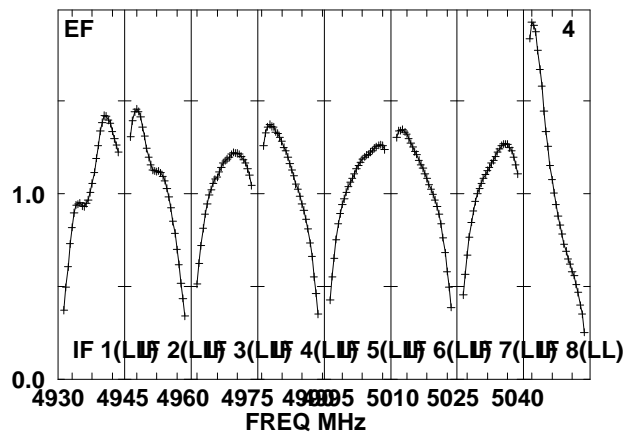
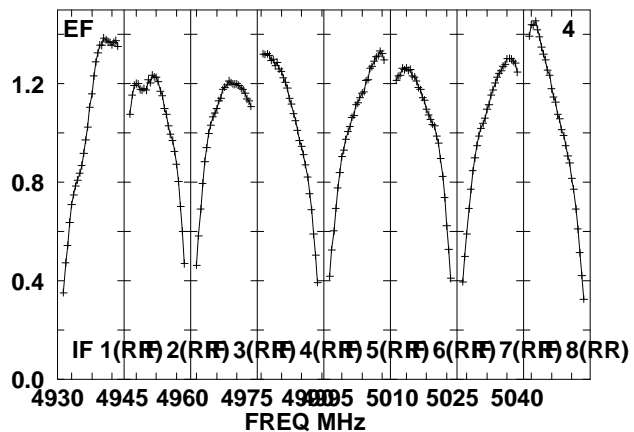
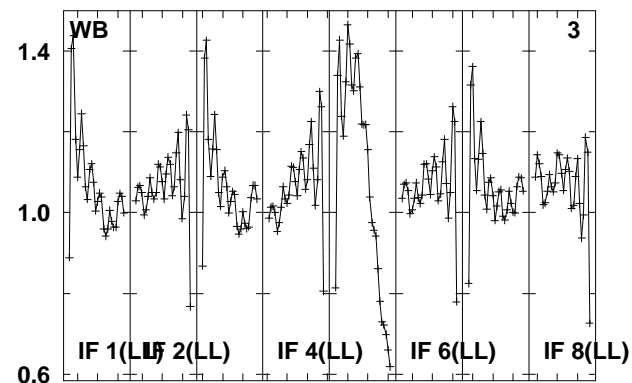
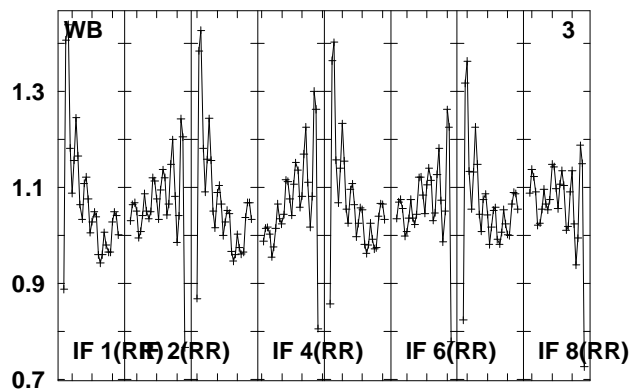
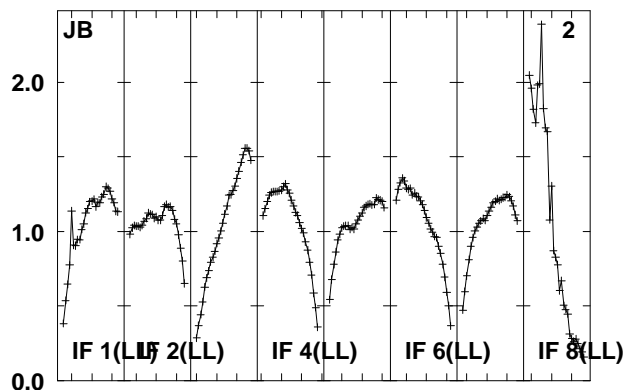
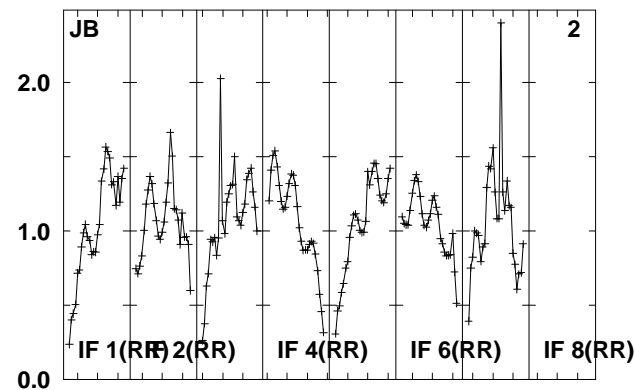
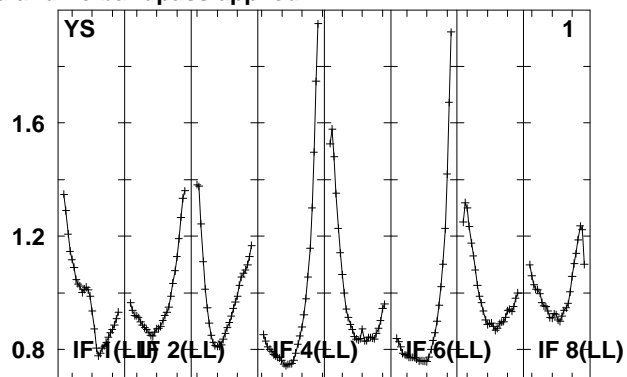
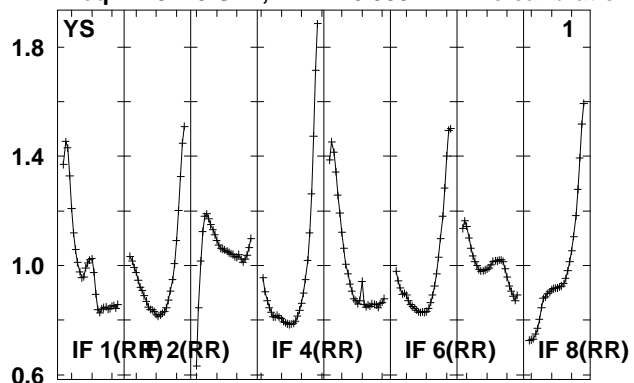

Lower frame: Real Jy
 Total-power spectrum Antenna: *
 Timerange: 00/22:22:18 to 00/22:23:46

Plot file version 656 created 14-MAY-2010 15:20:49

J0920+44 EO007.UVDATA.1

Freq = 4.9270 GHz, Bw = 16.000 MH No calibration applied and no bandpass applied

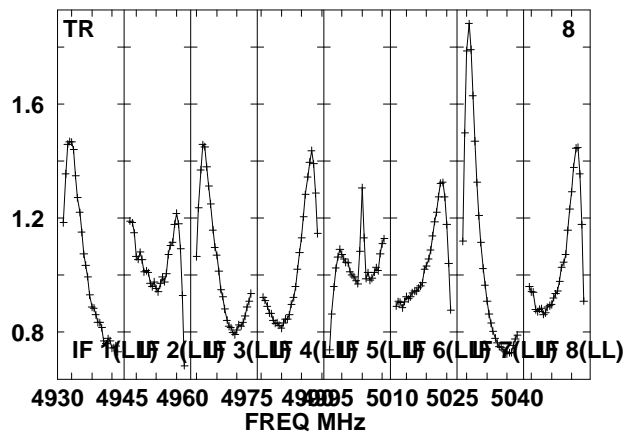
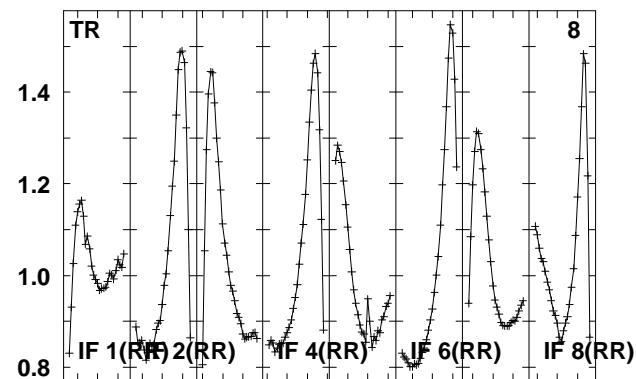
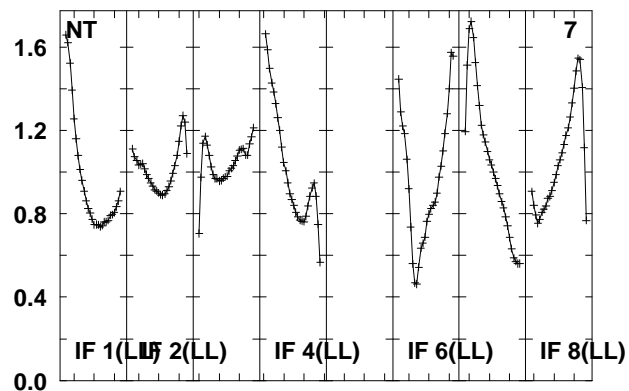
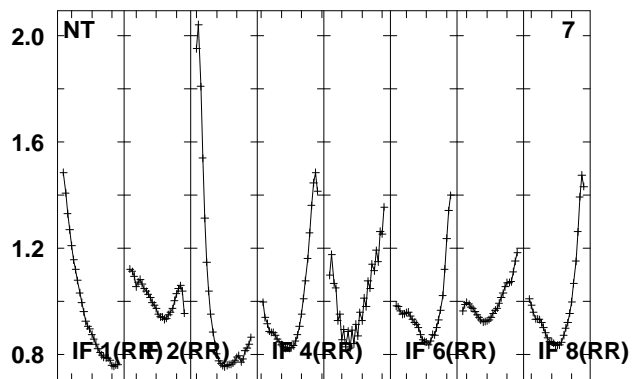
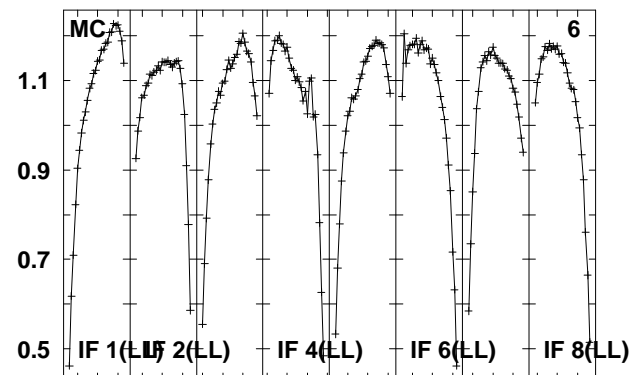
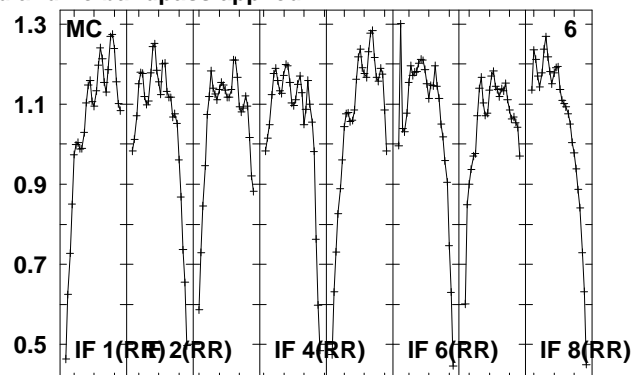
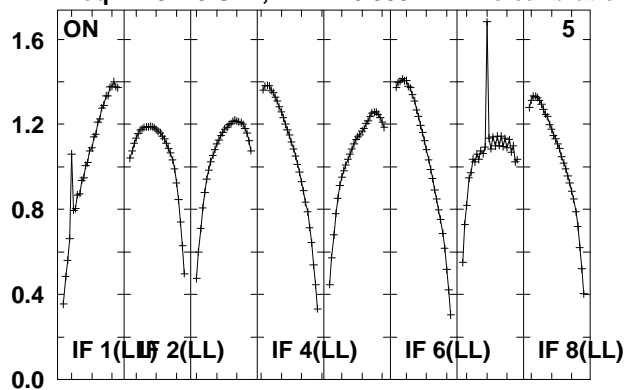

Lower frame: Real Jy

Total-power spectrum Antenna: *

Timerange: 00/22:22:18 to 00/22:23:46

Plot file version 657 created 14-MAY-2010 15:20:49

J092159 EO007.UVDATA.1

Freq = 4.9270 GHz, Bw = 16.000 MH No calibration applied and no bandpass applied

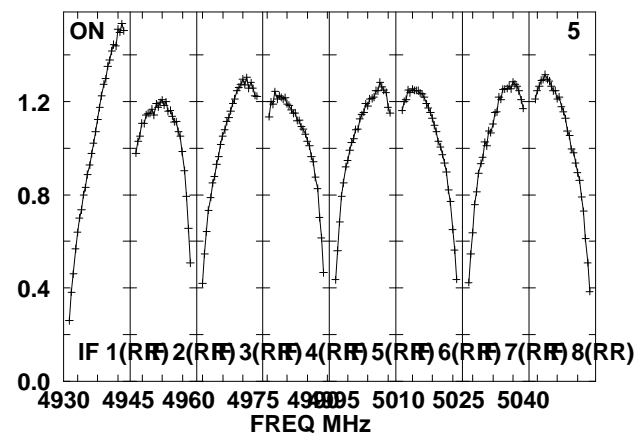
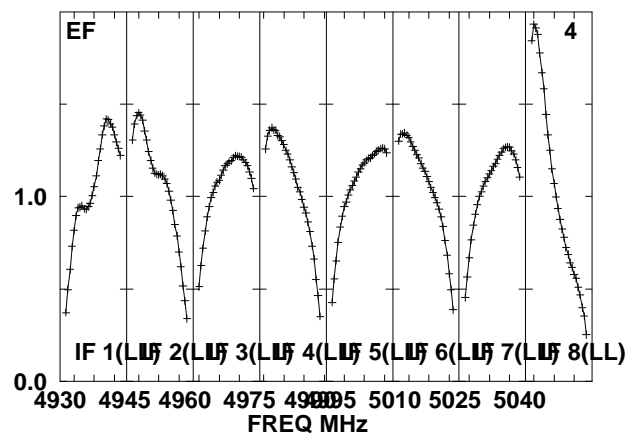
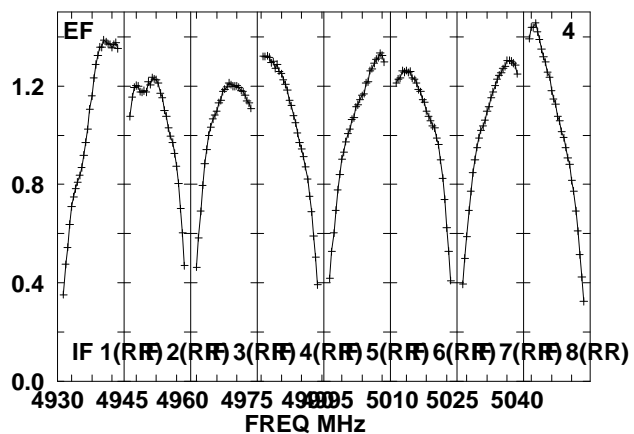
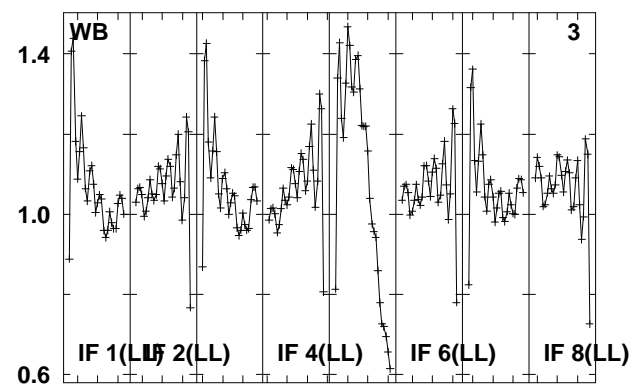
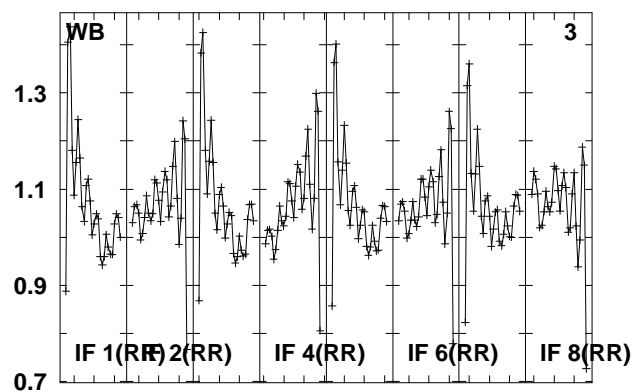
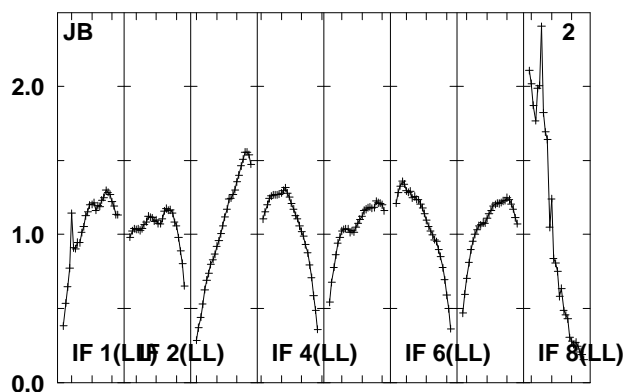
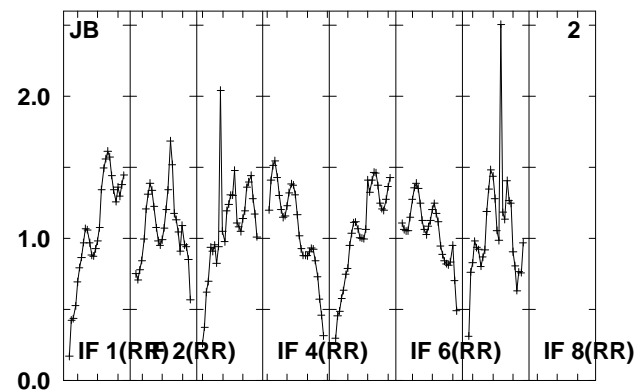
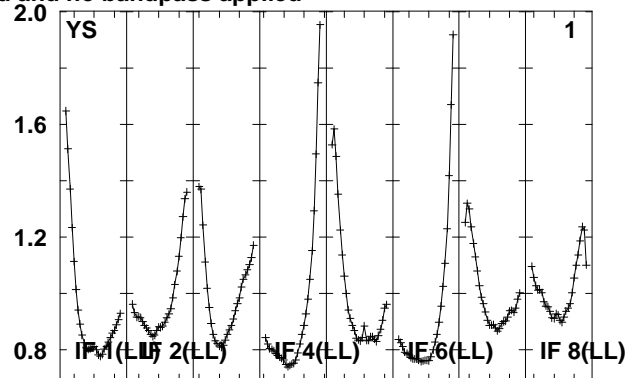
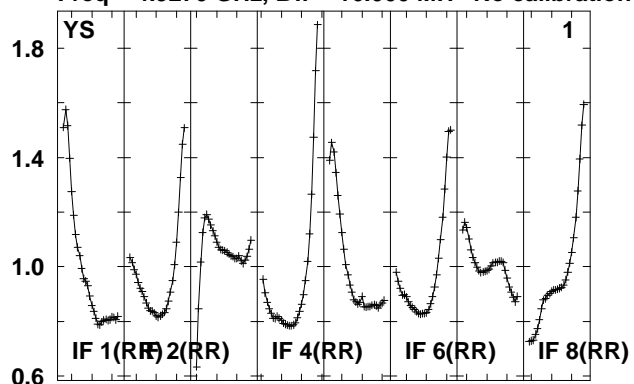

Lower frame: Real Jy

Total-power spectrum Antenna: *

Timerange: 00/22:24:12 to 00/22:29:10

Plot file version 658 created 14-MAY-2010 15:20:50

J092159 EO007.UVDATA.1

Freq = 4.9270 GHz, Bw = 16.000 MH No calibration applied and no bandpass applied

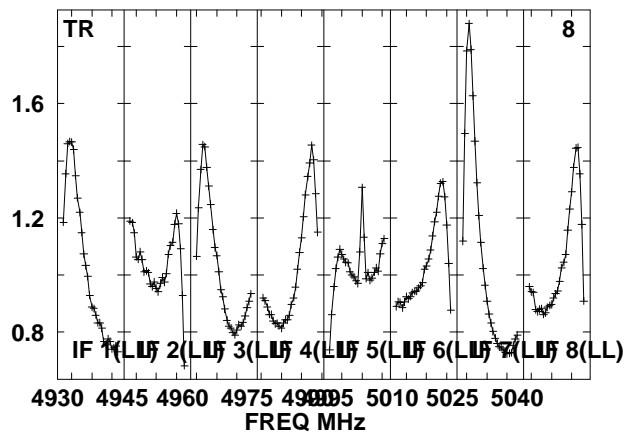
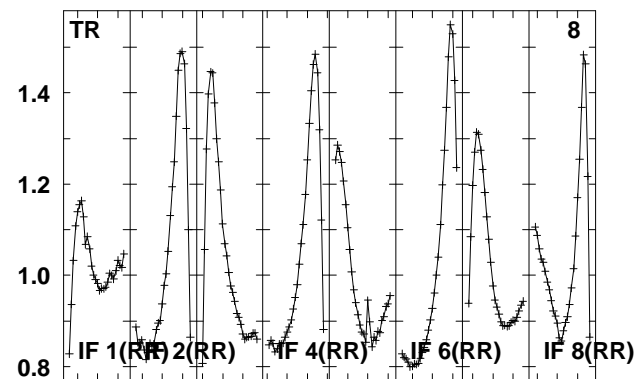
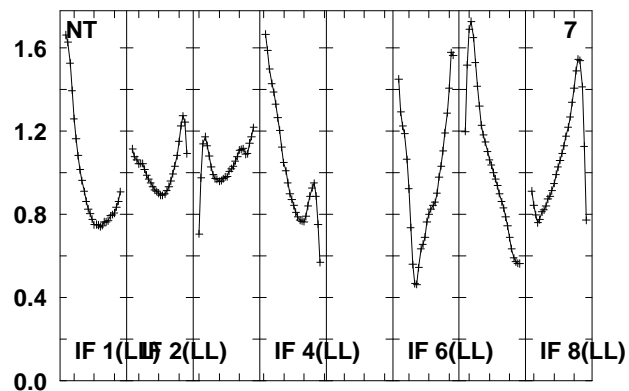
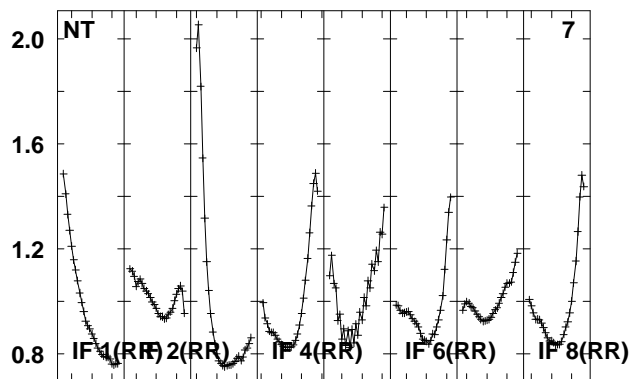
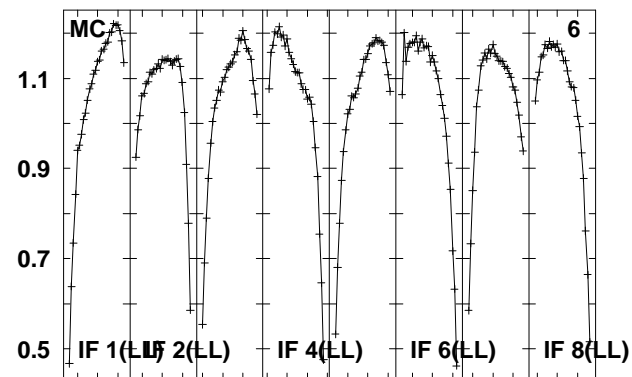
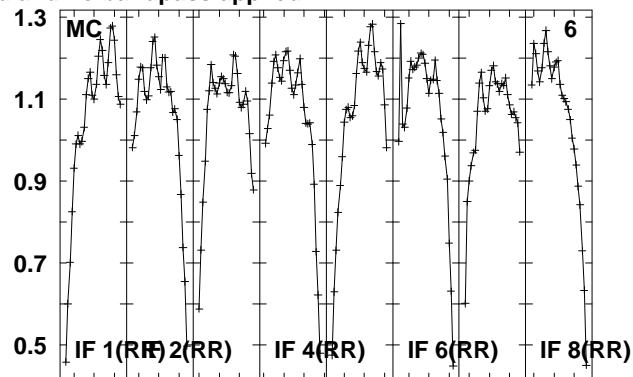
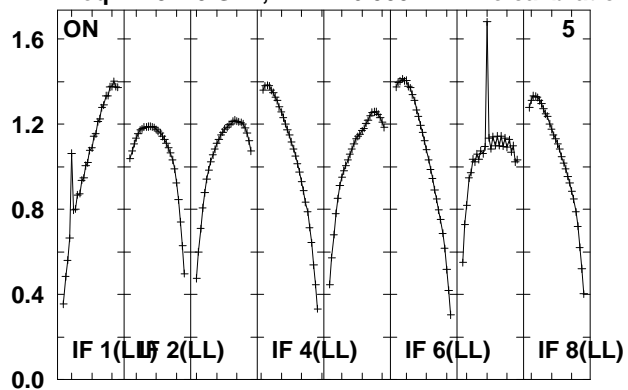

Lower frame: Real Jy

Total-power spectrum Antenna: *

Timerange: 00/22:24:12 to 00/22:29:10

Plot file version 659 created 14-MAY-2010 15:20:50

J0920+44 EO007.UVDATA.1

Freq = 4.9270 GHz, Bw = 16.000 MH No calibration applied and no bandpass applied

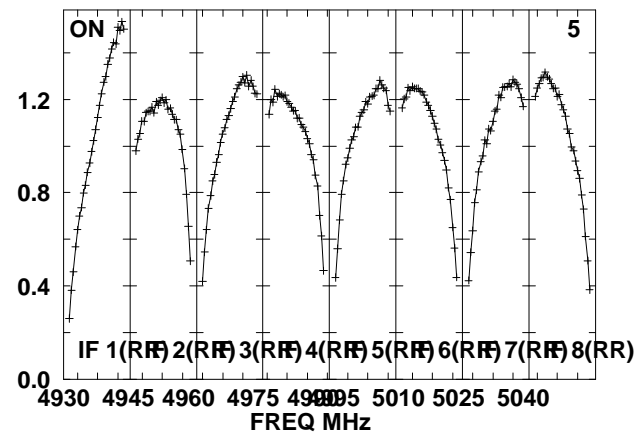
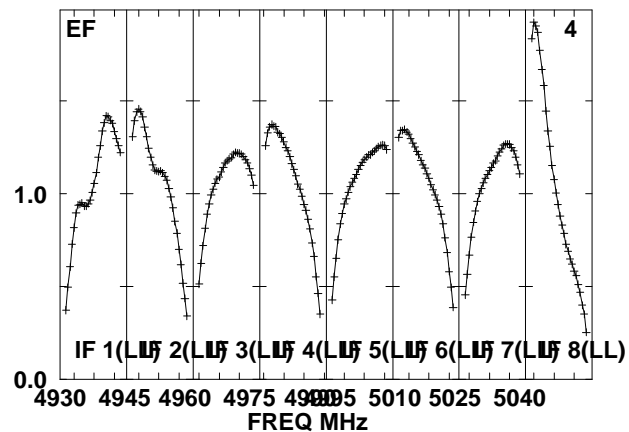
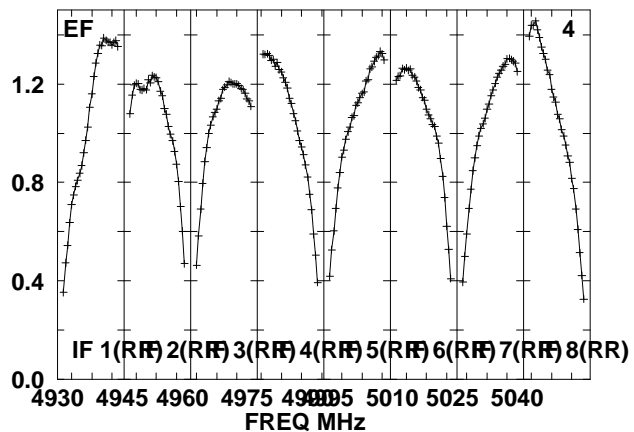
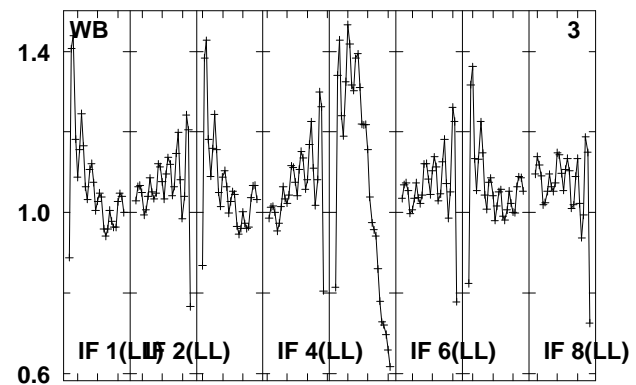
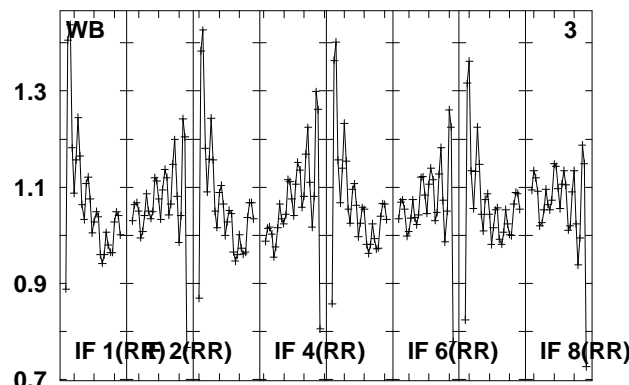
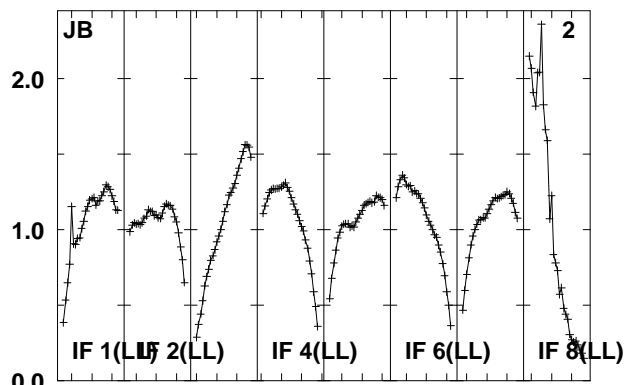
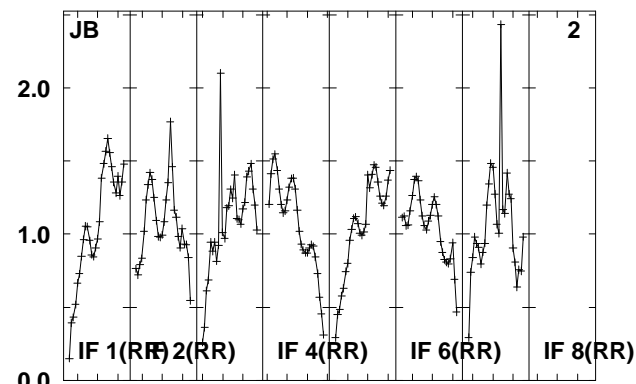
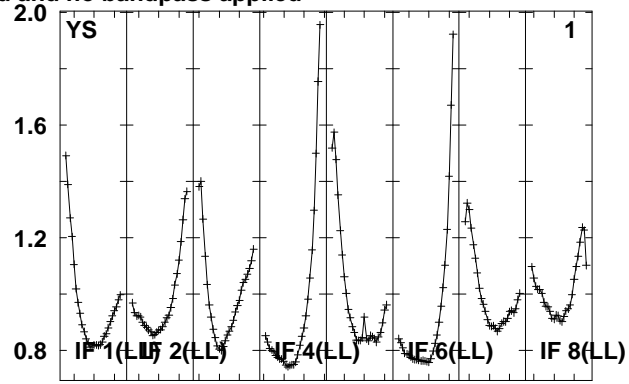
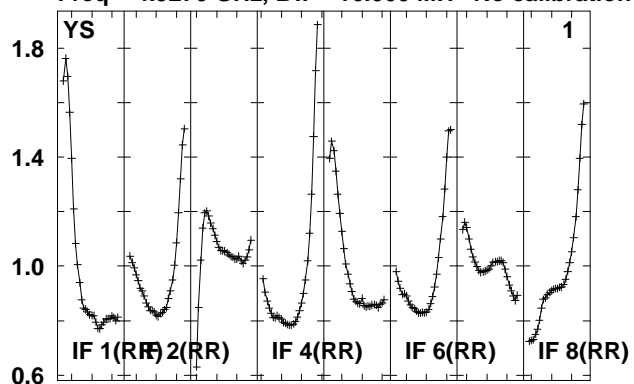

Lower frame: Real Jy
Total-power spectrum Antenna: *
Timerange: 00/22:35:23 to 00/22:36:51

Plot file version 660 created 14-MAY-2010 15:20:51

J0920+44 EO007.UVDATA.1

Freq = 4.9270 GHz, Bw = 16.000 MH No calibration applied and no bandpass applied

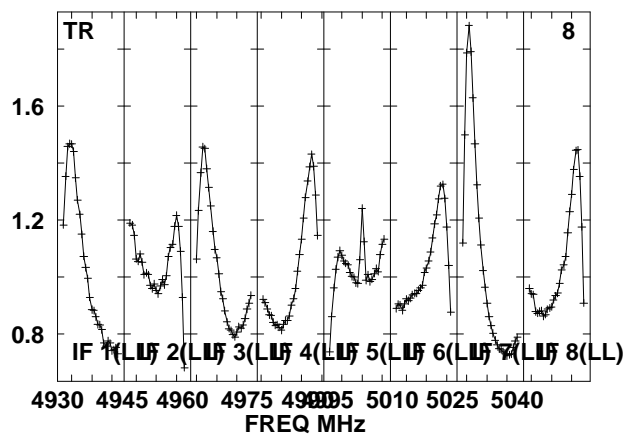
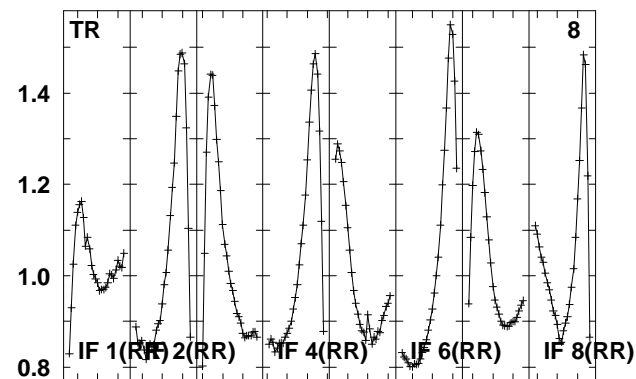
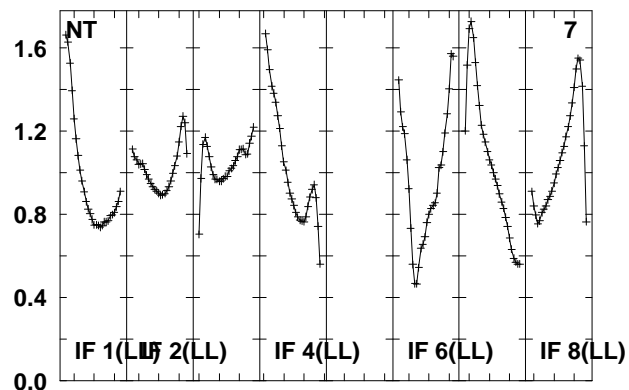
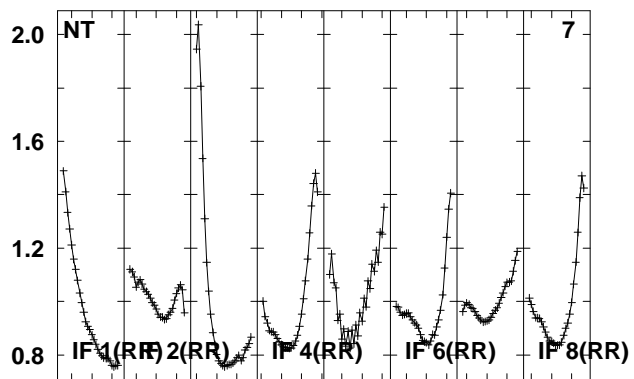
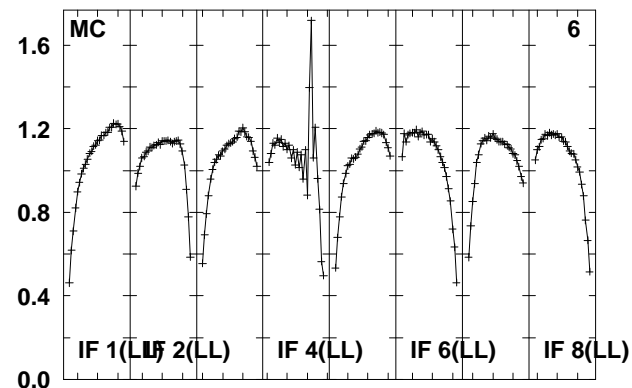
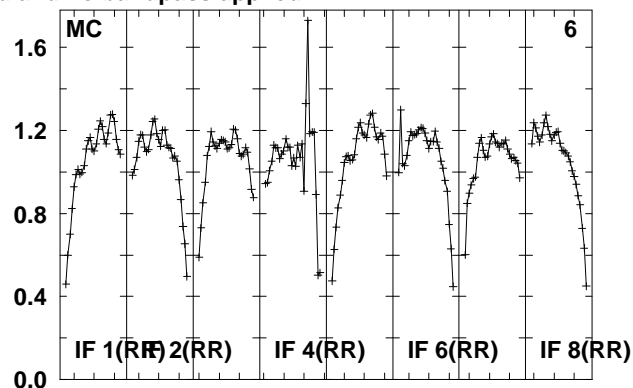
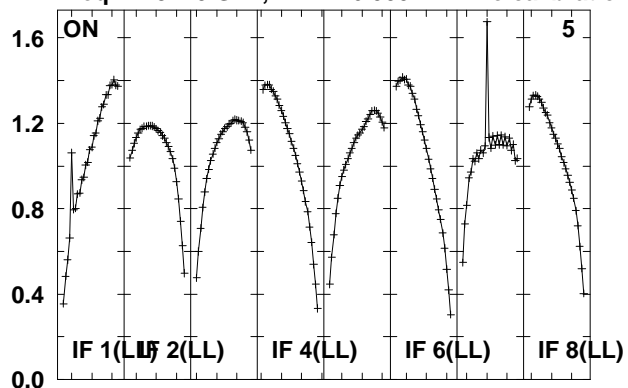

Lower frame: Real Jy

Total-power spectrum Antenna: *

Timerange: 00/22:35:23 to 00/22:36:51

Plot file version 661 created 14-MAY-2010 15:20:51
 J092159 EO007.UVDATA.1
 Freq = 4.9270 GHz, Bw = 16.000 MH No calibration applied and no bandpass applied

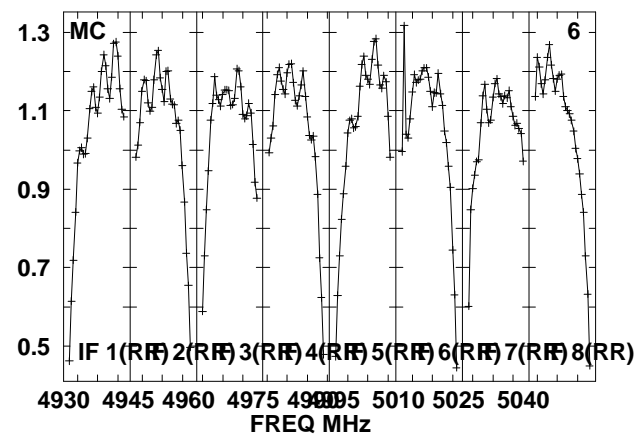
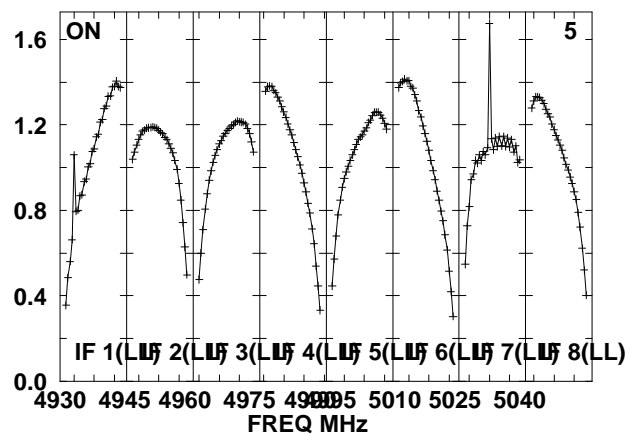
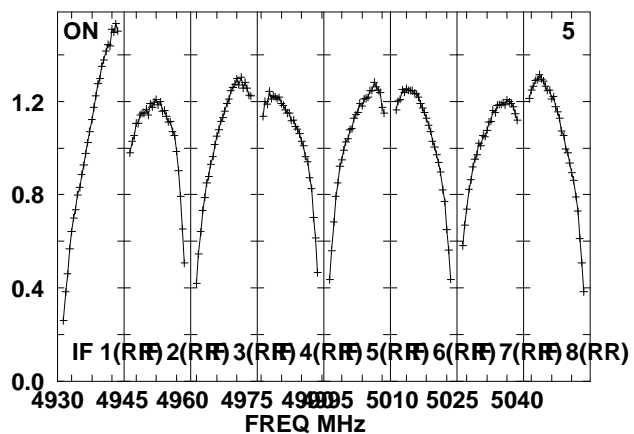
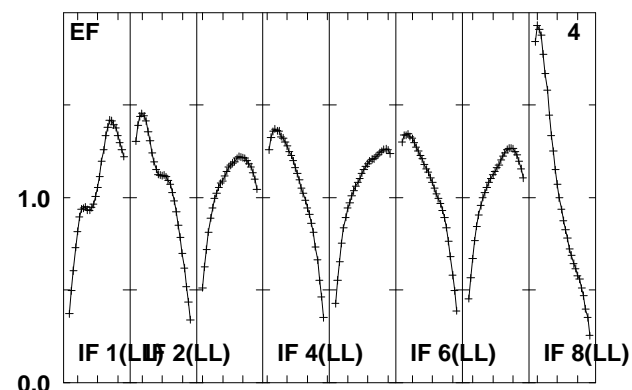
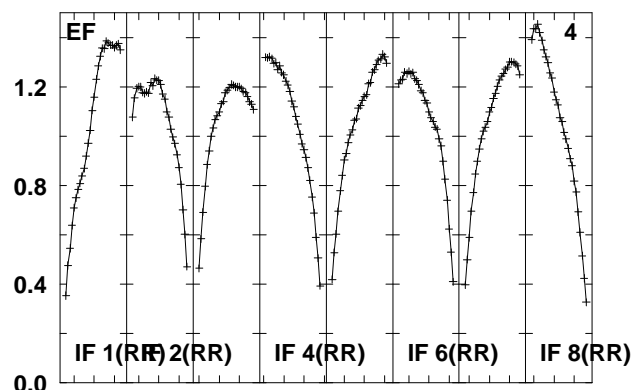
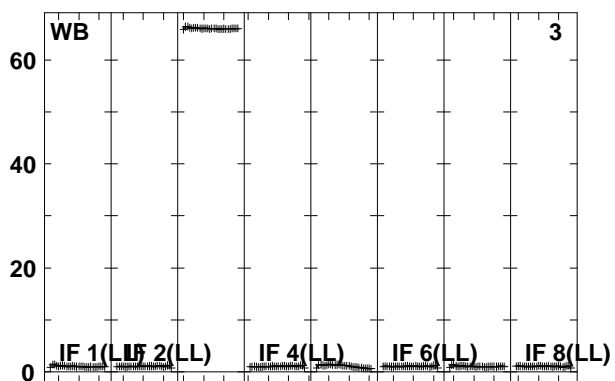
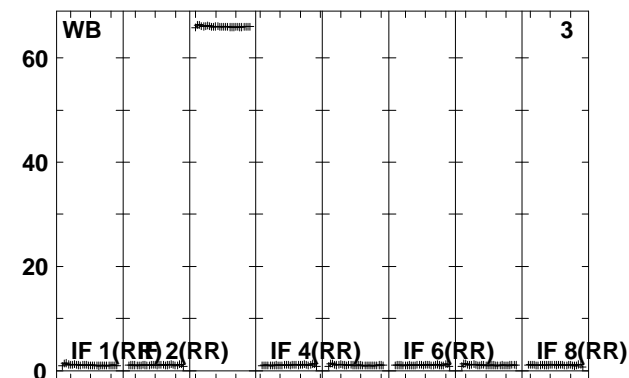
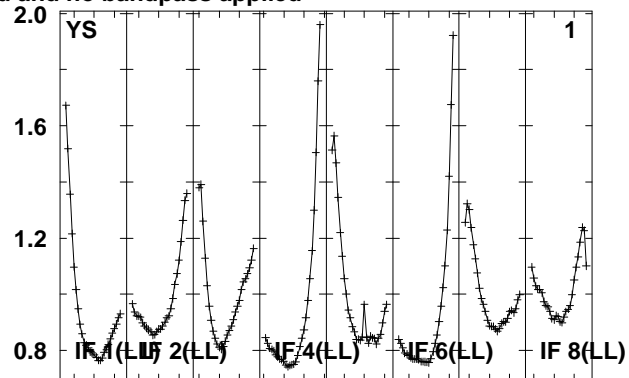
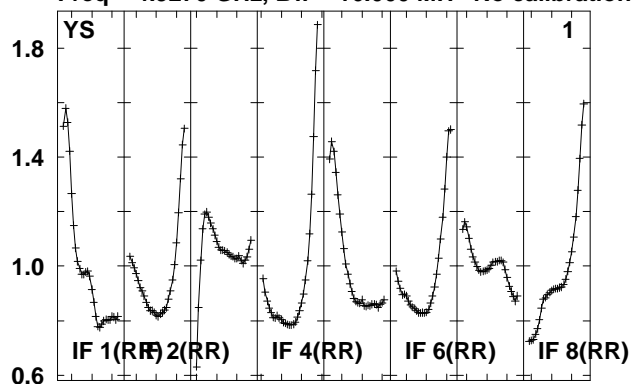

Lower frame: Real Jy
 Total-power spectrum Antenna: *
 Timerange: 00/22:37:18 to 00/22:42:14

Plot file version 662 created 14-MAY-2010 15:20:51

J092159 EO007.UVDATA.1

Freq = 4.9270 GHz, Bw = 16.000 MH No calibration applied and no bandpass applied

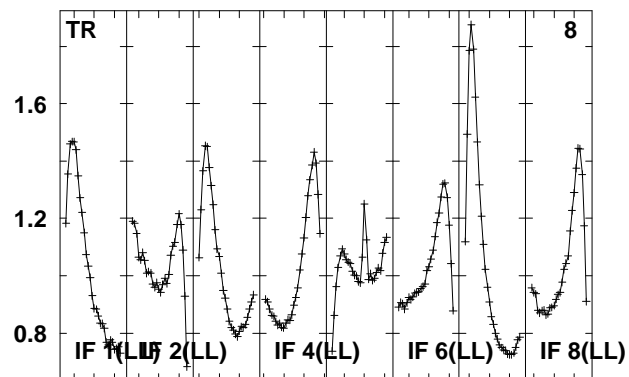
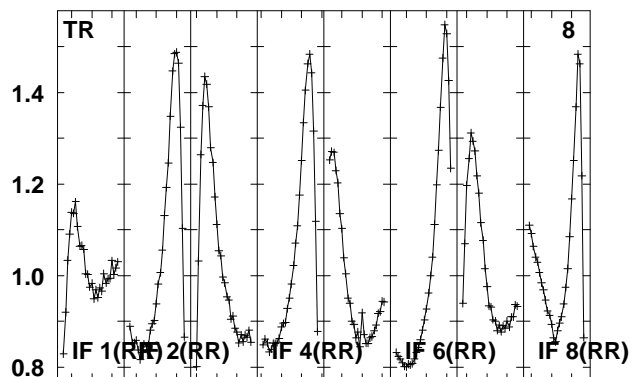
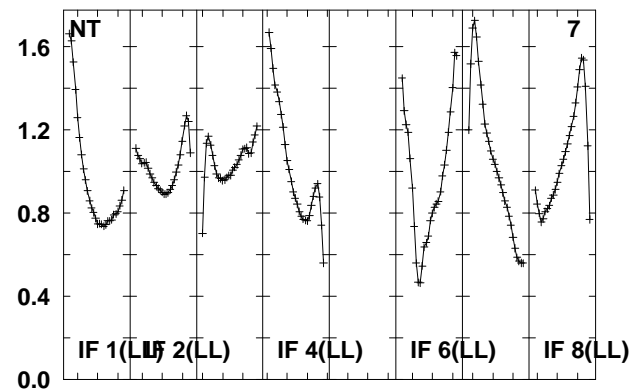
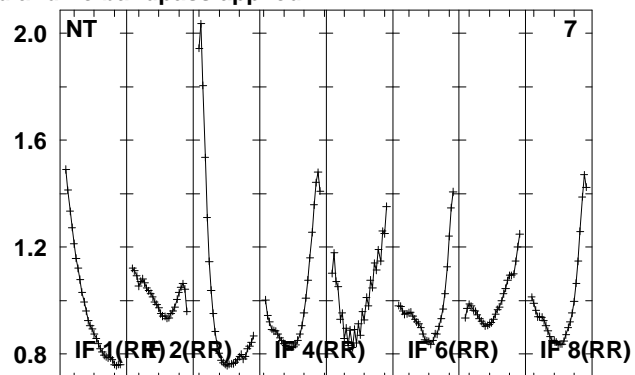
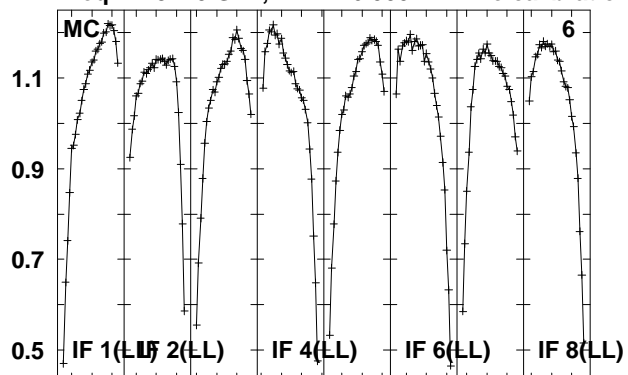

Lower frame: Real Jy
Total-power spectrum Antenna: *
Timerange: 00/22:37:18 to 00/22:42:14

Plot file version 663 created 14-MAY-2010 15:20:52

J0920+44 EO007.UVDATA.1

Freq = 4.9270 GHz, Bw = 16.000 MH No calibration applied and no bandpass applied

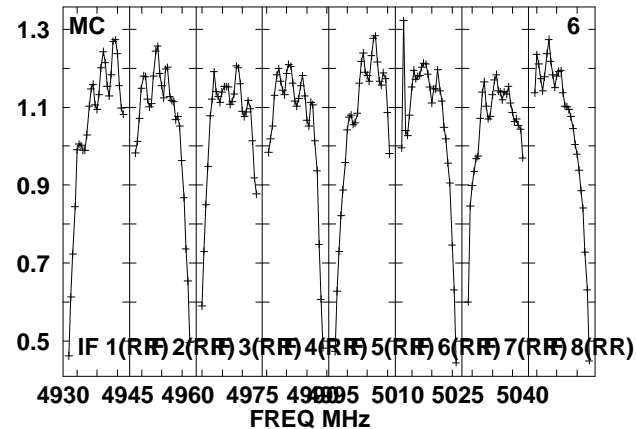
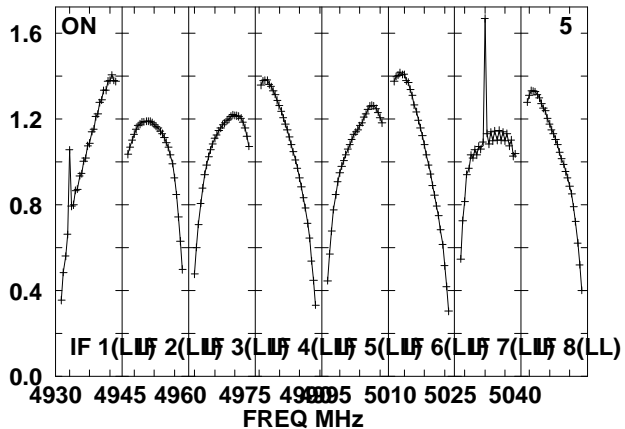
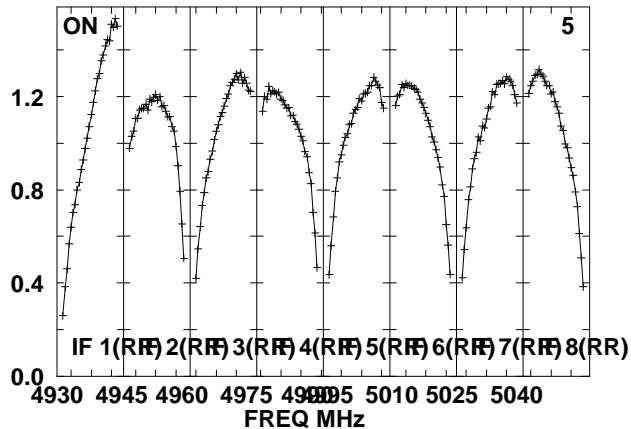
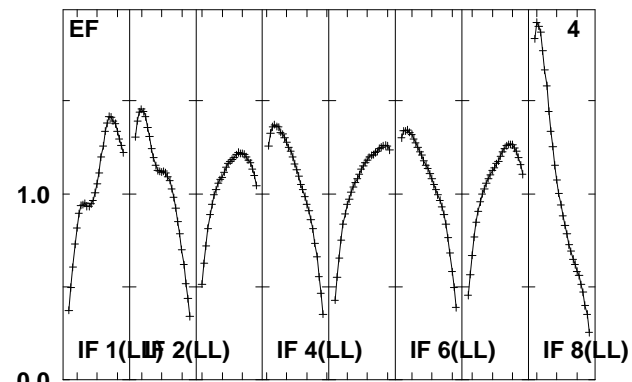
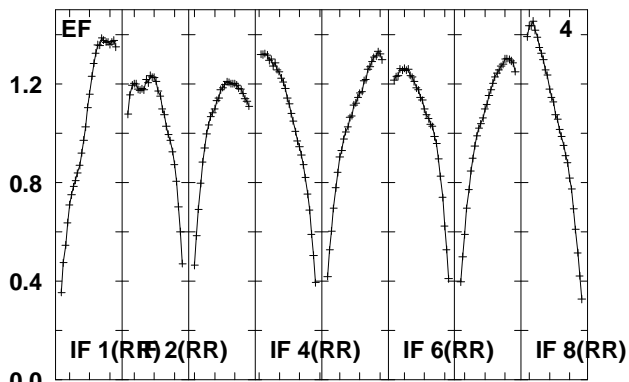
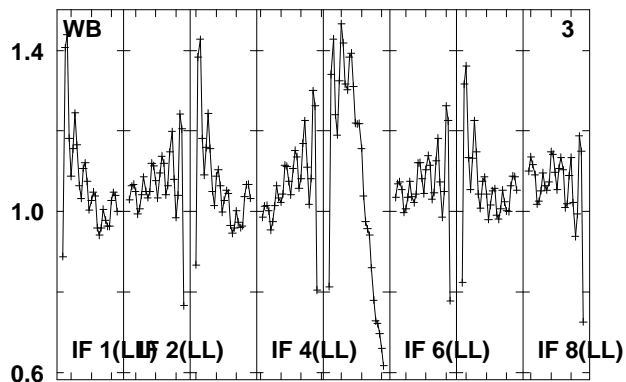
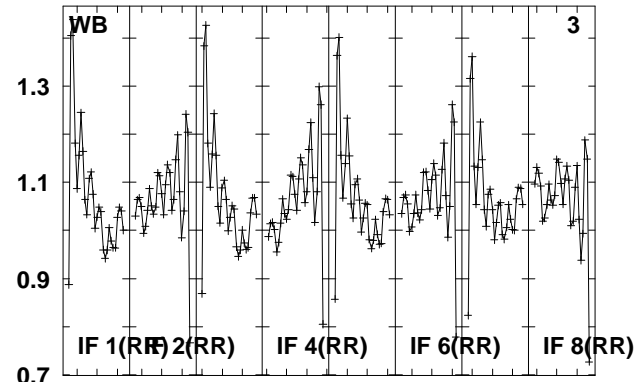
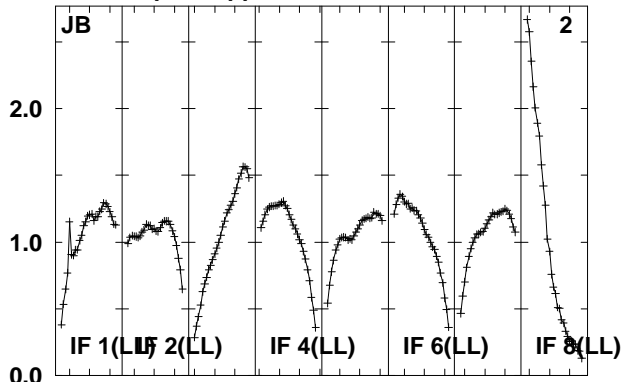
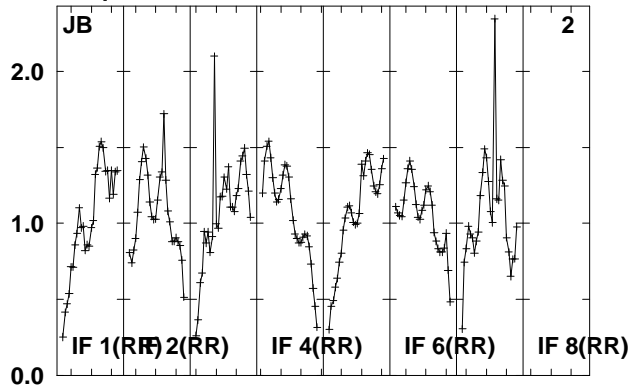

Lower frame: Real Jy

Total-power spectrum Antenna: *

Timerange: 00/22:42:41 to 00/22:44:09

Plot file version 664 created 14-MAY-2010 15:20:52

J0920+44 EO007.UVDATA.1

Freq = 4.9270 GHz, Bw = 16.000 MH No calibration applied and no bandpass applied

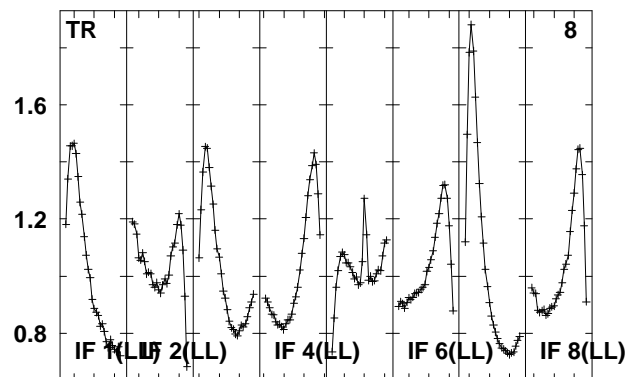
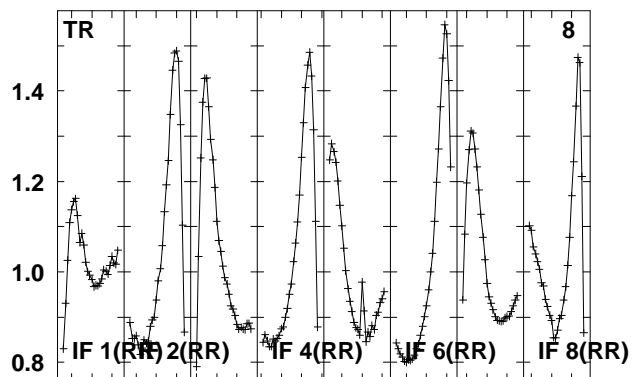
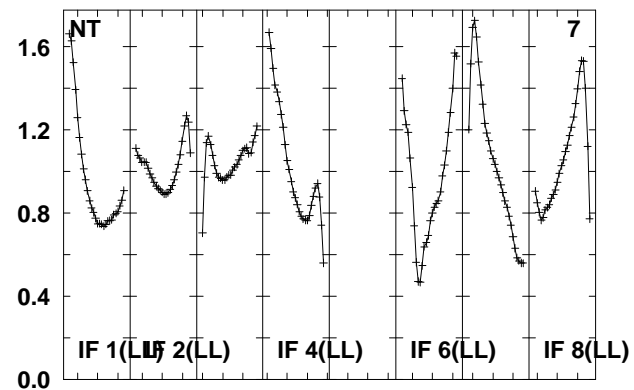
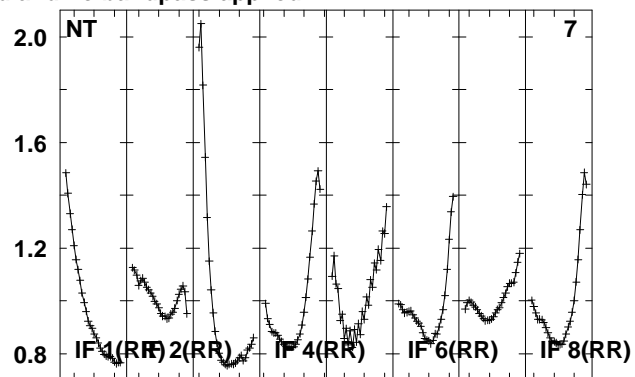
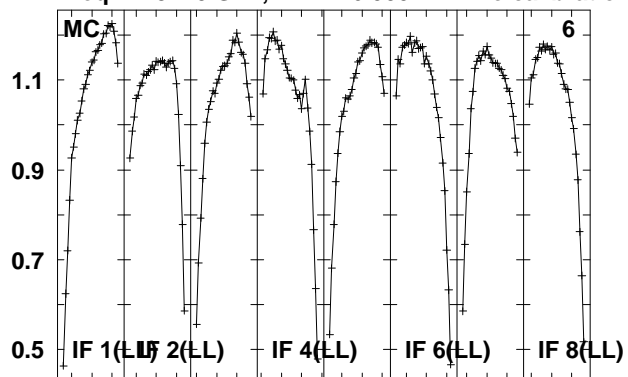

Lower frame: Real Jy
Total-power spectrum Antenna: *
Timerange: 00/22:42:41 to 00/22:44:09

Plot file version 665 created 14-MAY-2010 15:20:52

J1027+48 EO007.UVDATA.1

Freq = 4.9270 GHz, Bw = 16.000 MH No calibration applied and no bandpass applied

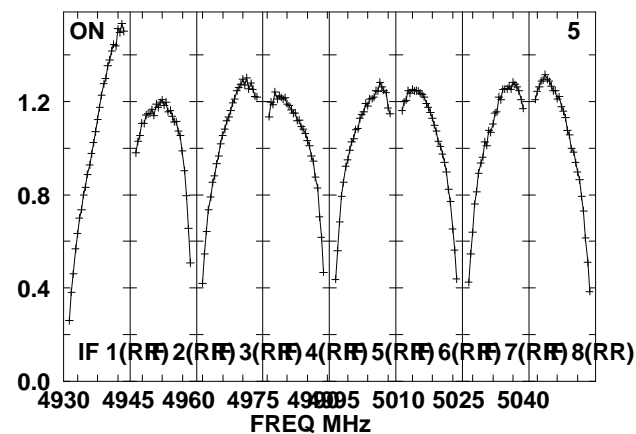
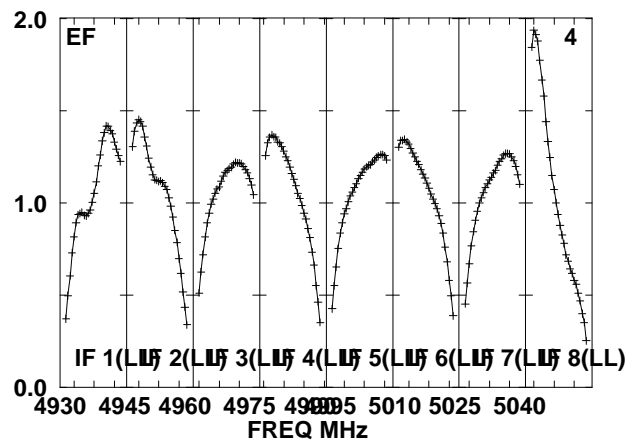
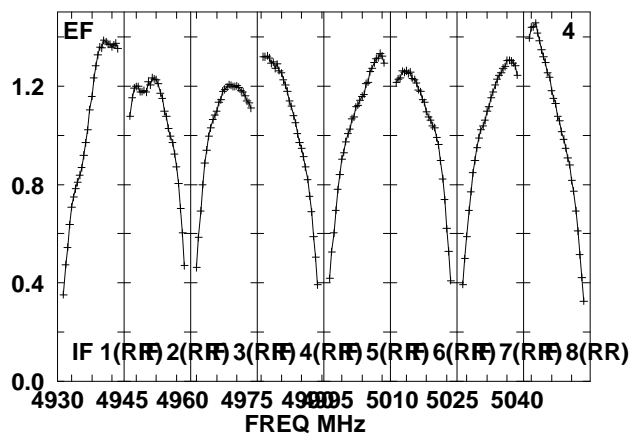
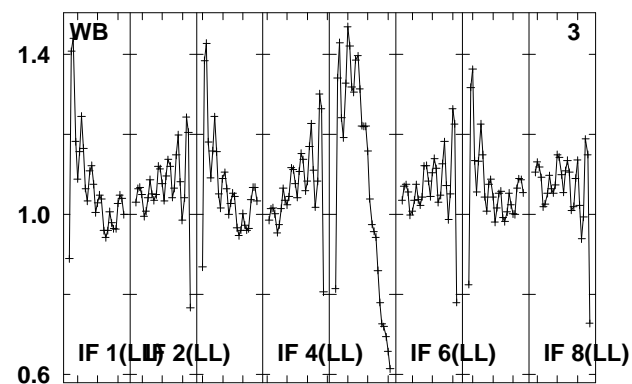
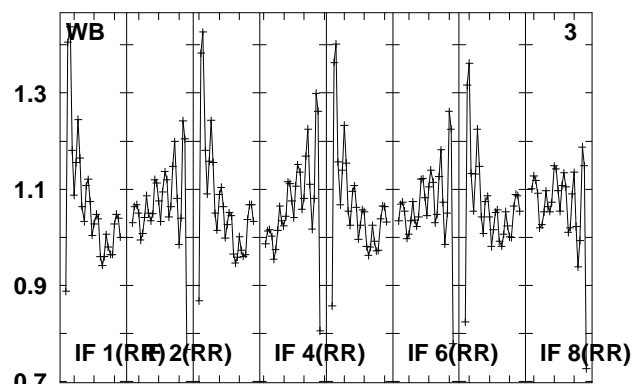
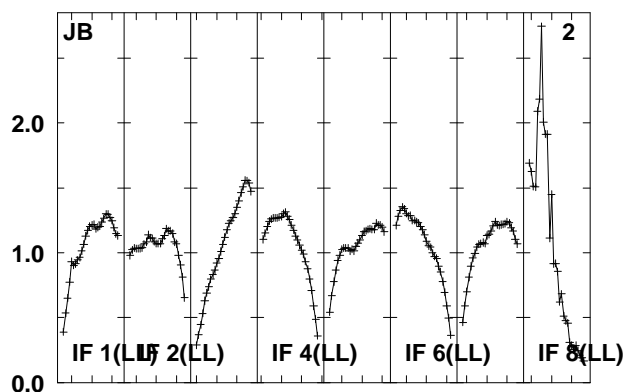
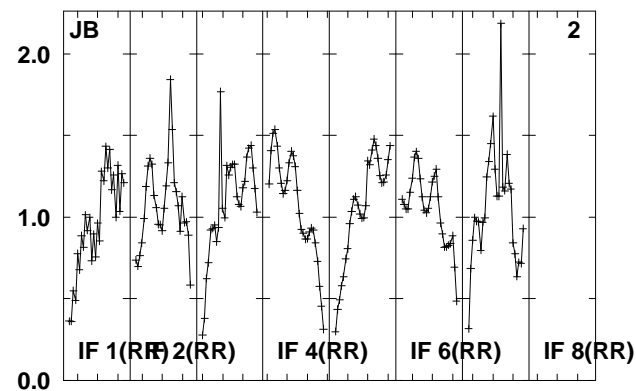
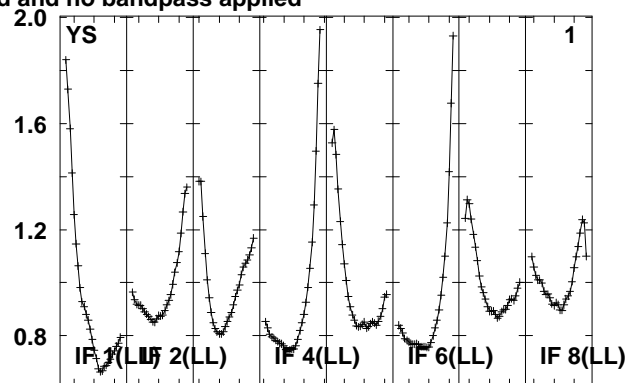
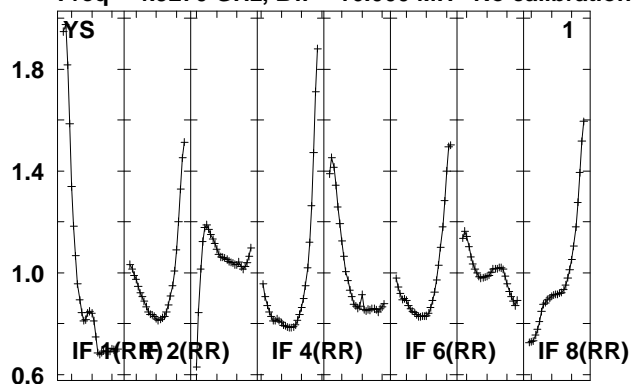

Lower frame: Real Jy

Total-power spectrum Antenna: *

Timerange: 00/22:48:08 to 00/22:49:36

Plot file version 666 created 14-MAY-2010 15:20:52

J1027+48 EO007.UVDATA.1

Freq = 4.9270 GHz, Bw = 16.000 MH No calibration applied and no bandpass applied

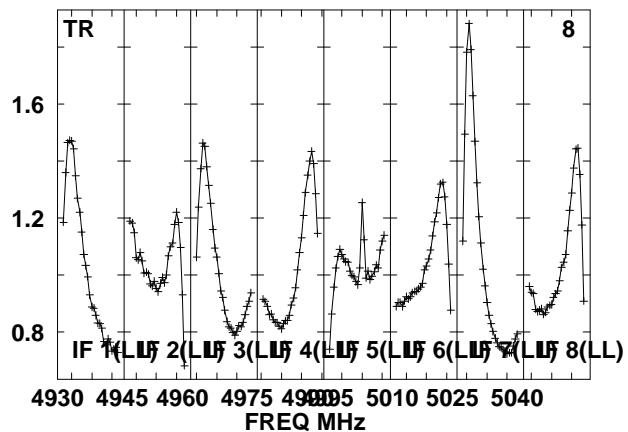
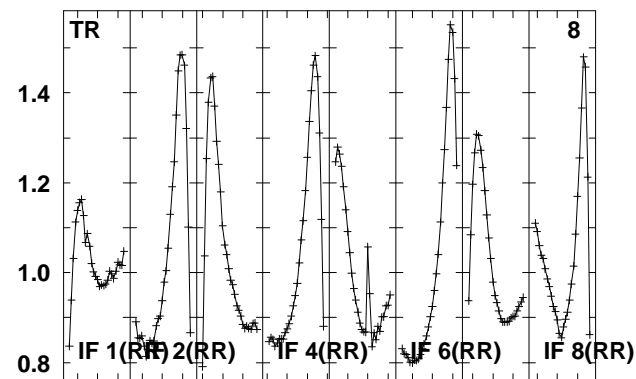
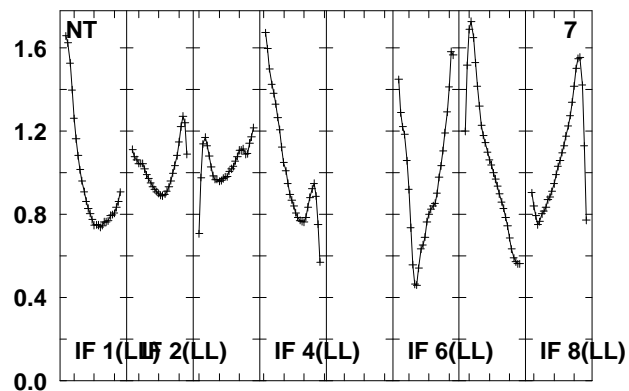
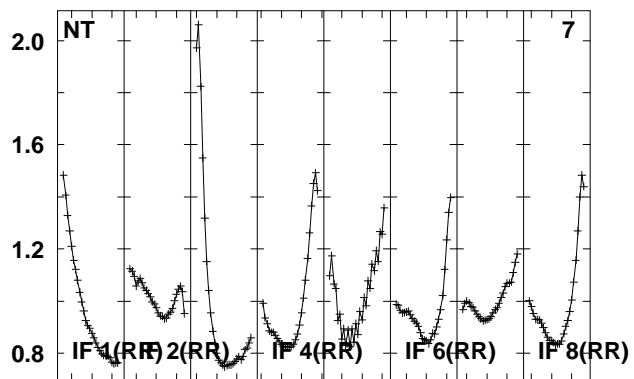
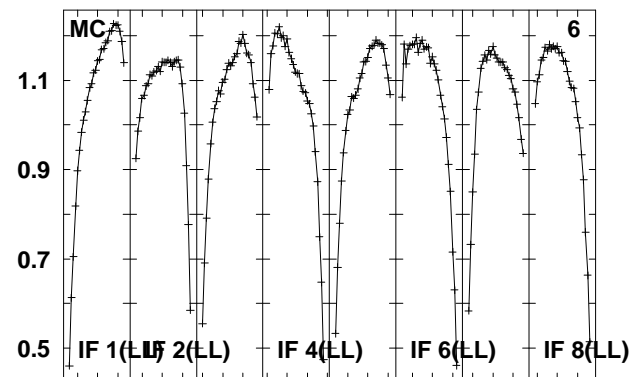
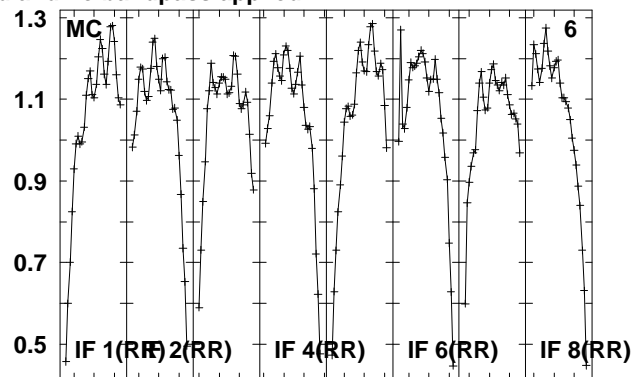
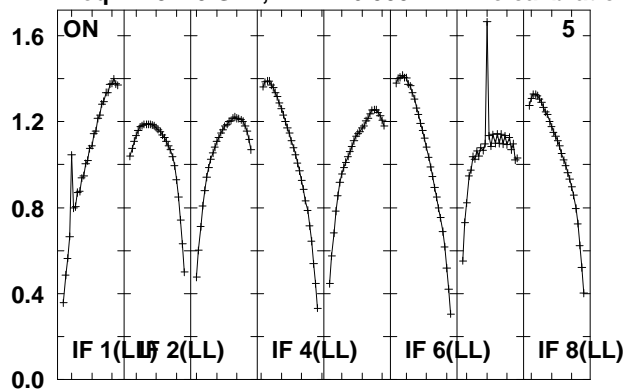

Lower frame: Real Jy

Total-power spectrum Antenna: *

Timerange: 00/22:48:08 to 00/22:49:36

Plot file version 667 created 14-MAY-2010 15:20:53
 J102959 EO007.UVDATA.1
 Freq = 4.9270 GHz, Bw = 16.000 MH No calibration applied and no bandpass applied

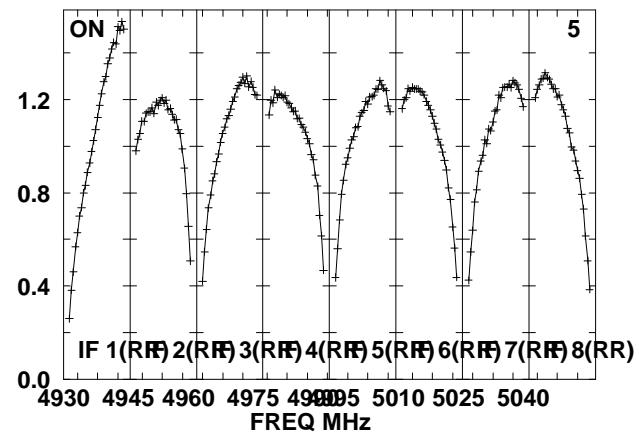
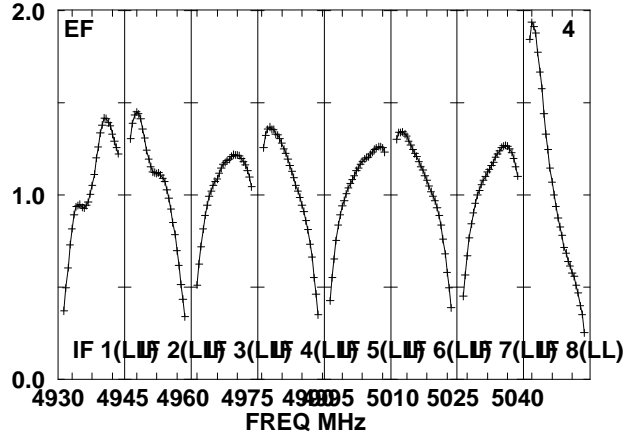
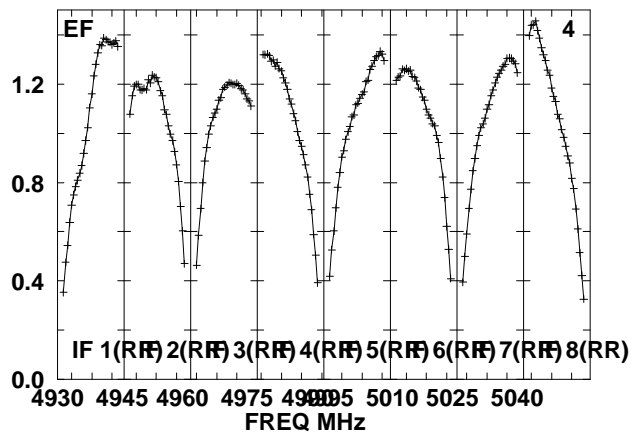
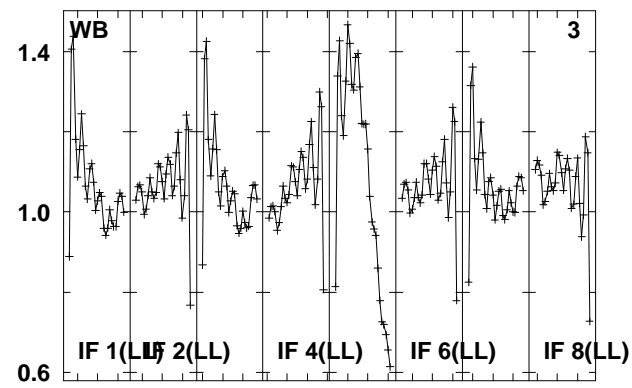
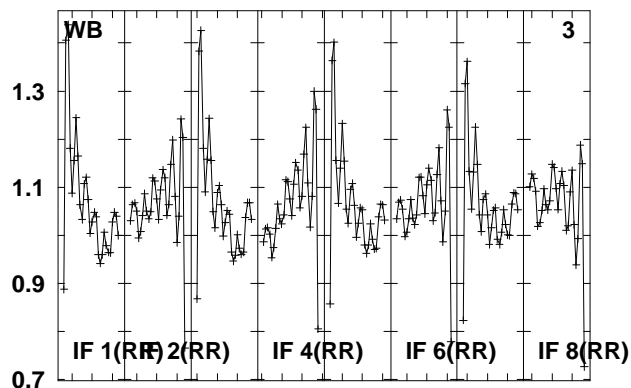
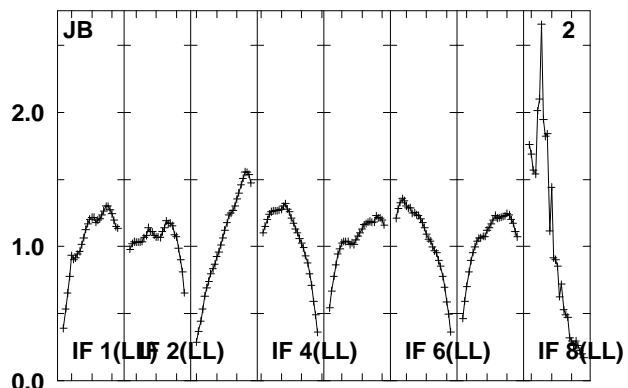
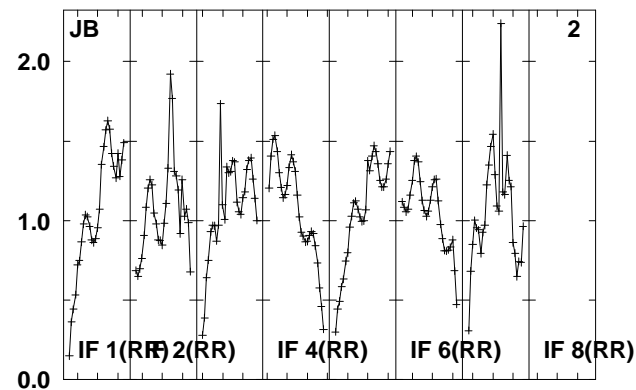
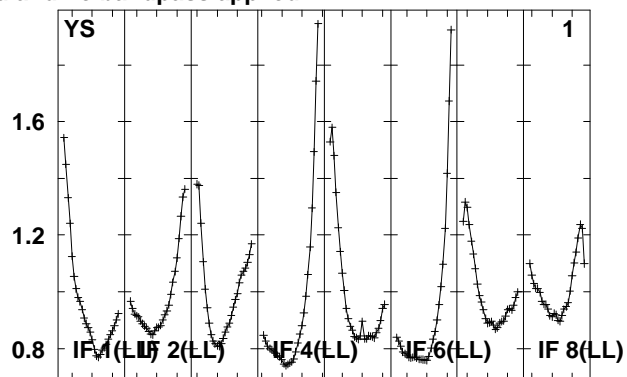
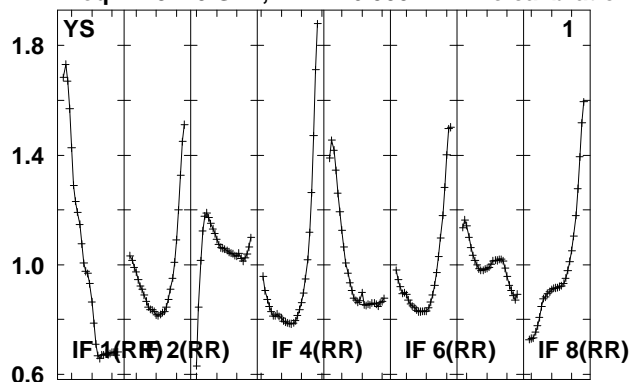

Lower frame: Real Jy
 Total-power spectrum Antenna: *
 Timerange: 00/22:50:13 to 00/22:55:11

Plot file version 668 created 14-MAY-2010 15:20:53

J102959 EO007.UVDATA.1

Freq = 4.9270 GHz, Bw = 16.000 MH No calibration applied and no bandpass applied

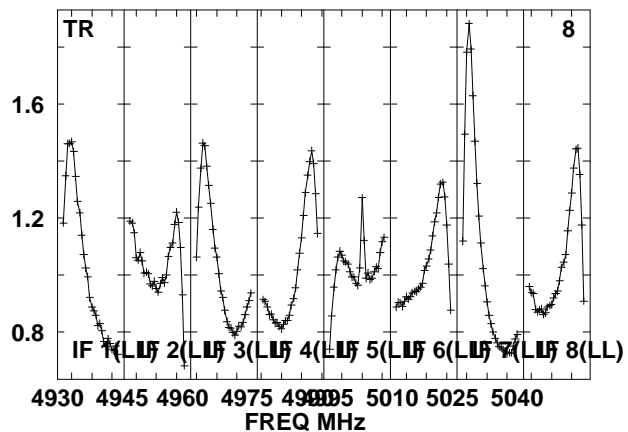
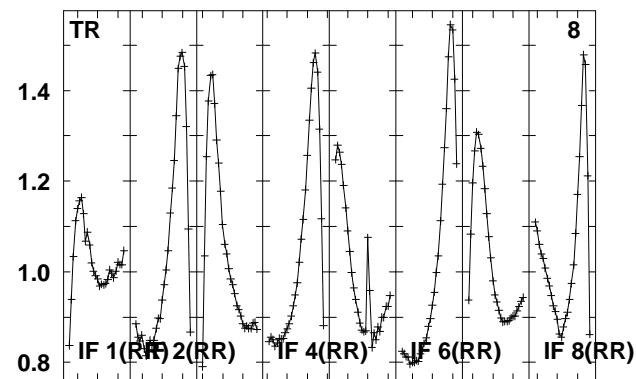
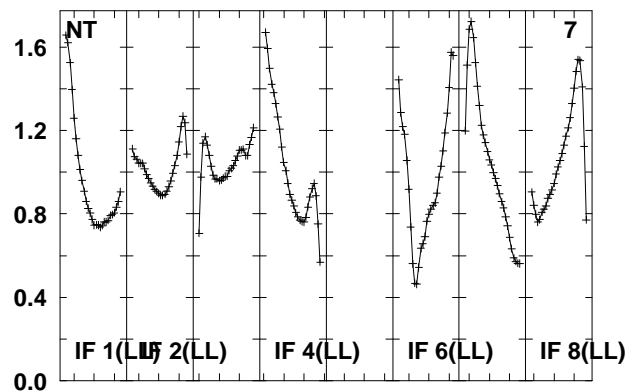
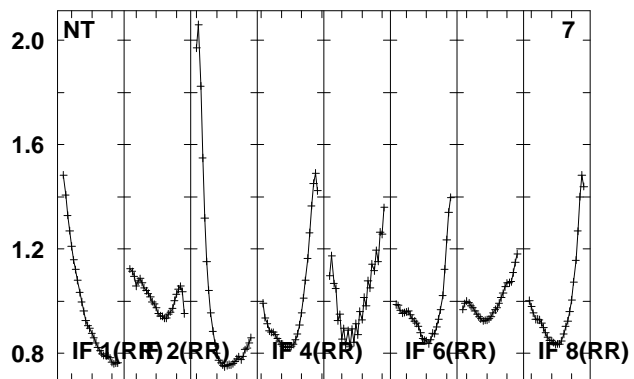
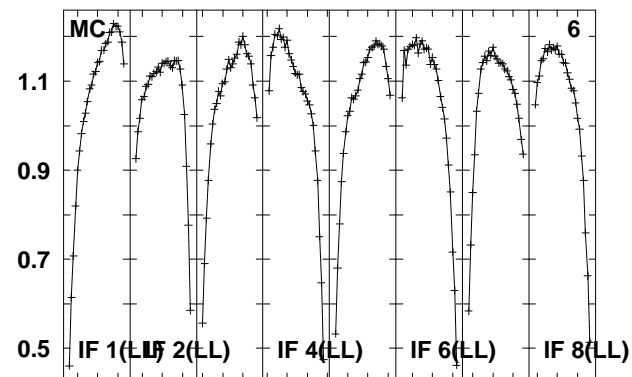
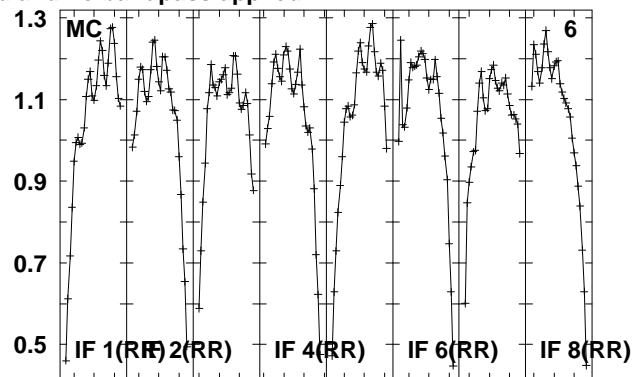
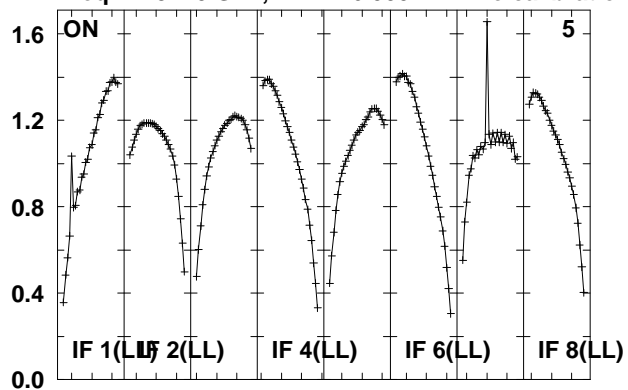

Lower frame: Real Jy

Total-power spectrum Antenna: *

Timerange: 00/22:50:13 to 00/22:55:11

Plot file version 669 created 14-MAY-2010 15:20:54

J1027+48 EO007.UVDATA.1

Freq = 4.9270 GHz, Bw = 16.000 MH No calibration applied and no bandpass applied

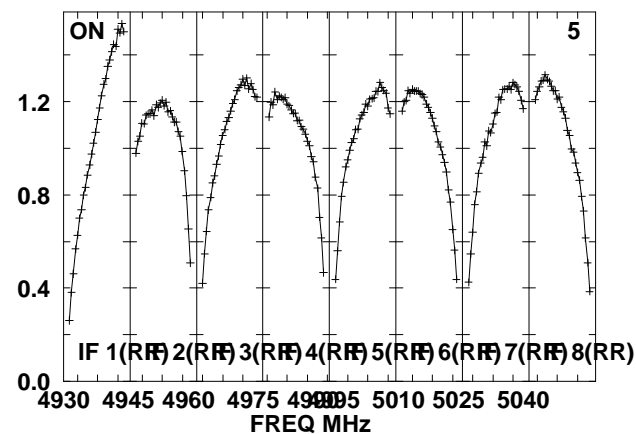
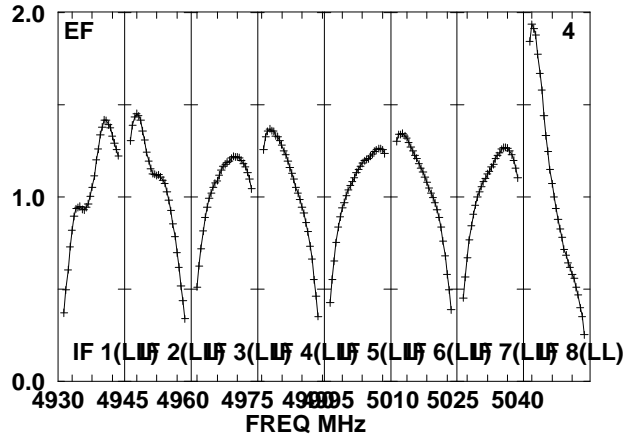
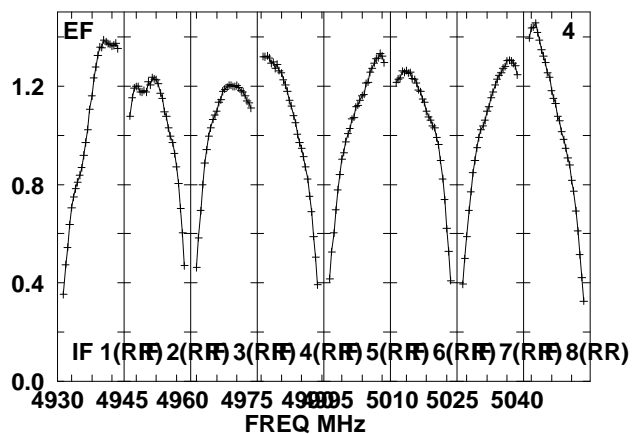
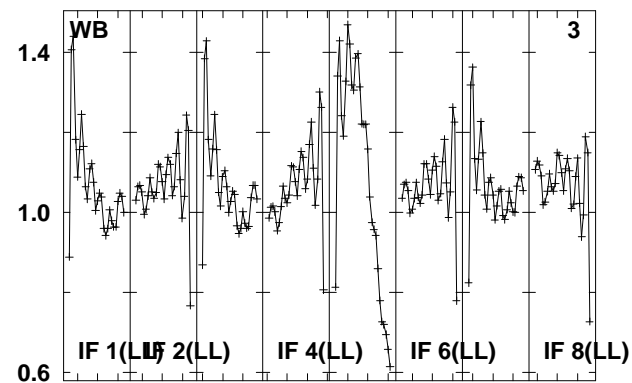
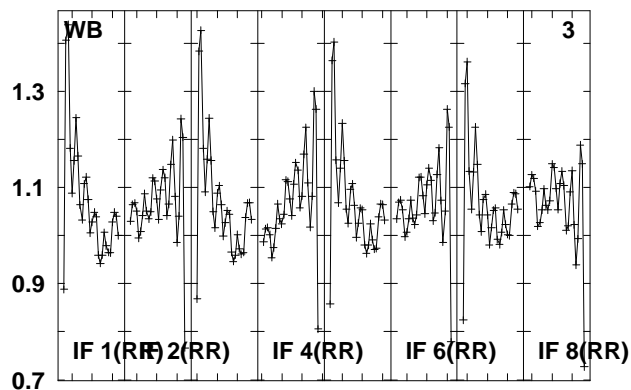
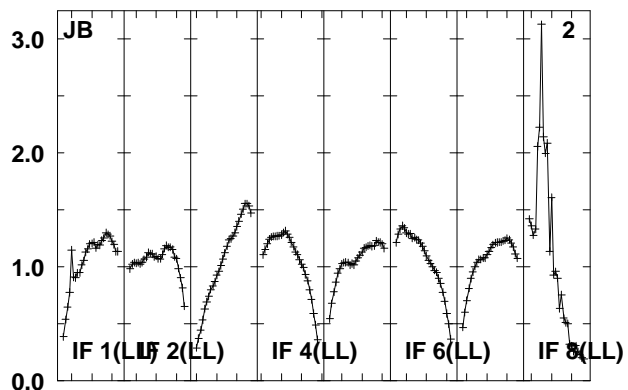
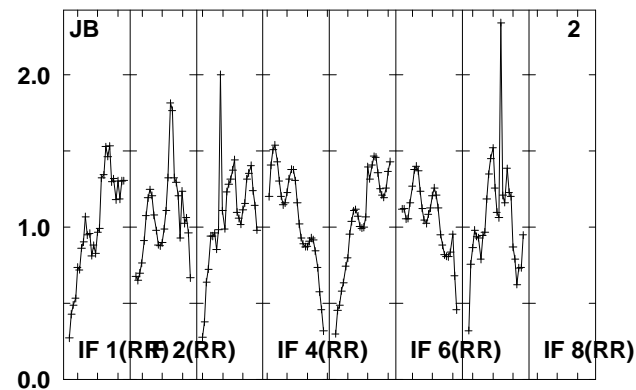
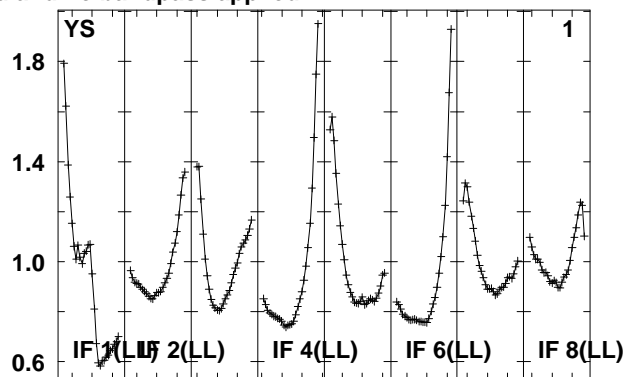
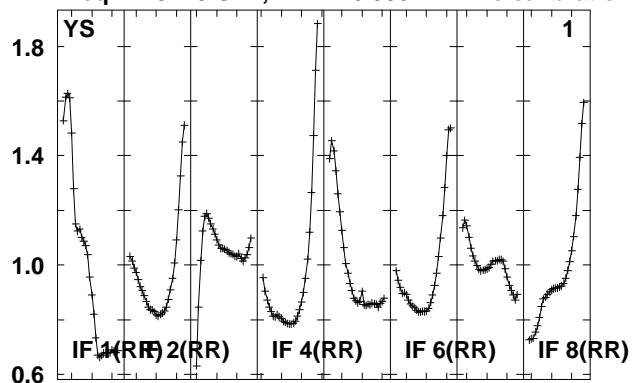

Lower frame: Real Jy
Total-power spectrum Antenna: *
Timerange: 00/22:55:54 to 00/22:57:22

Plot file version 670 created 14-MAY-2010 15:20:54

J1027+48 EO007.UVDATA.1

Freq = 4.9270 GHz, Bw = 16.000 MH No calibration applied and no bandpass applied

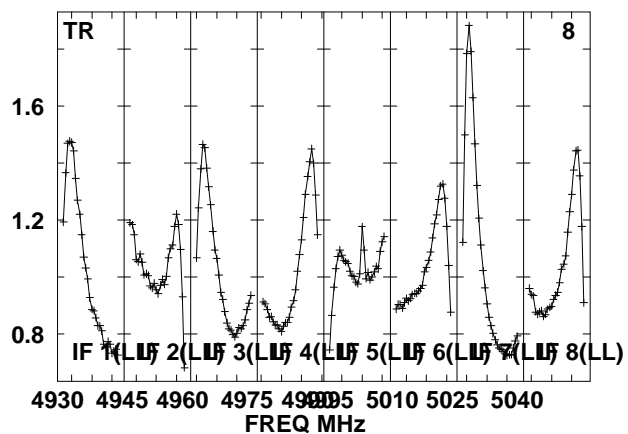
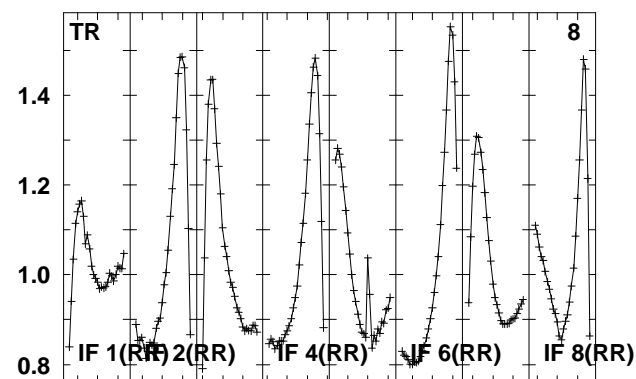
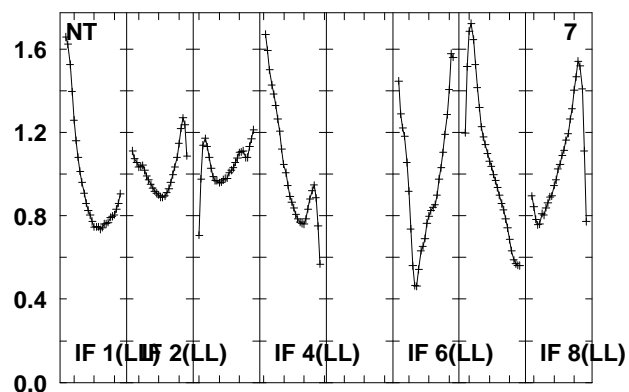
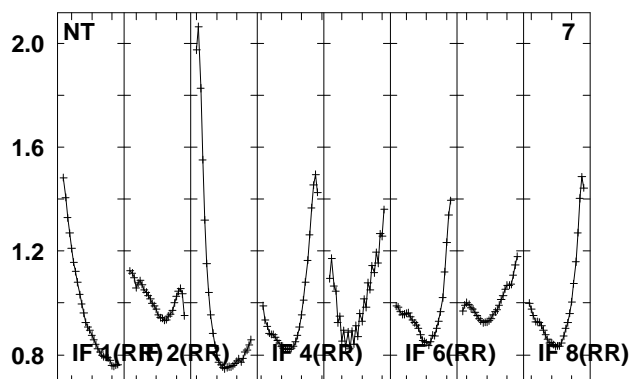
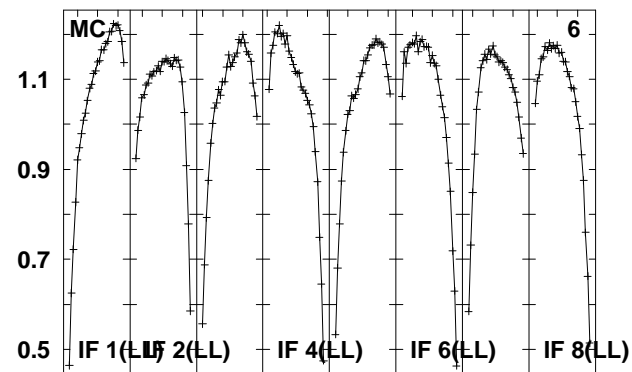
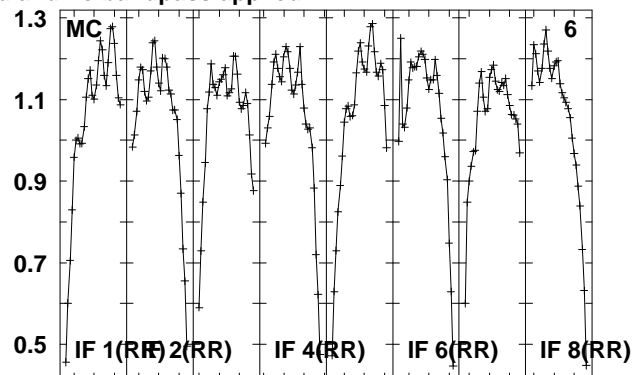
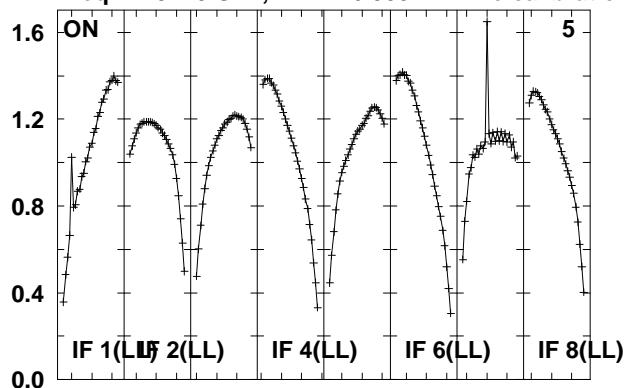

Lower frame: Real Jy

Total-power spectrum Antenna: *

Timerange: 00/22:55:54 to 00/22:57:22

Plot file version 671 created 14-MAY-2010 15:20:54

J102959 EO007.UVDATA.1

Freq = 4.9270 GHz, Bw = 16.000 MH No calibration applied and no bandpass applied

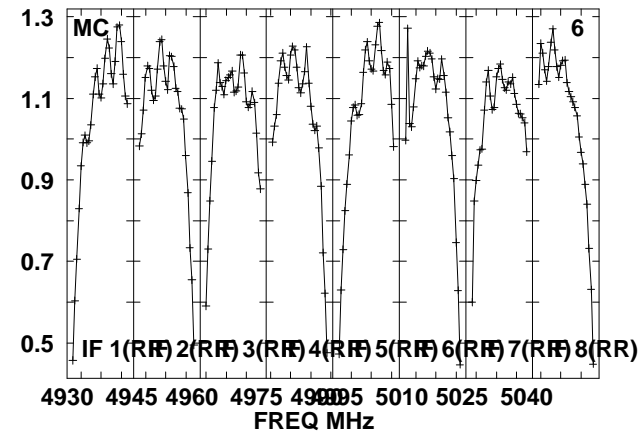
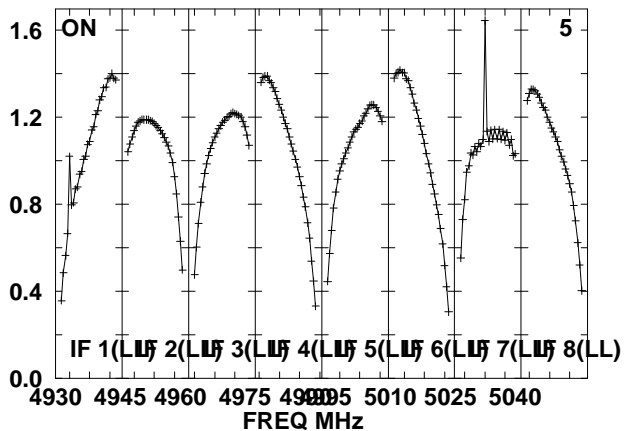
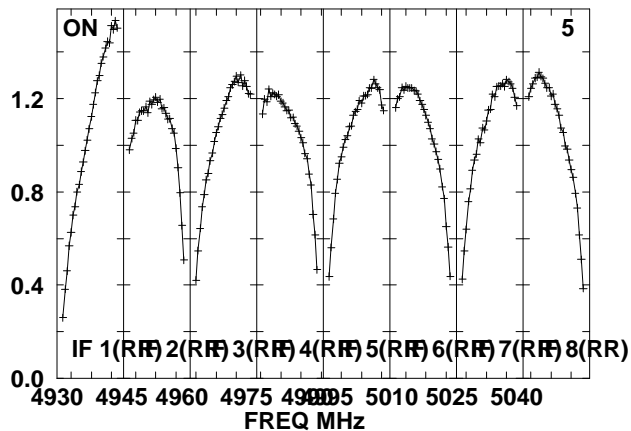
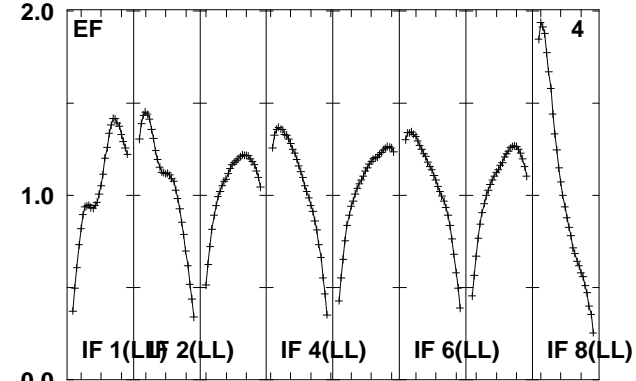
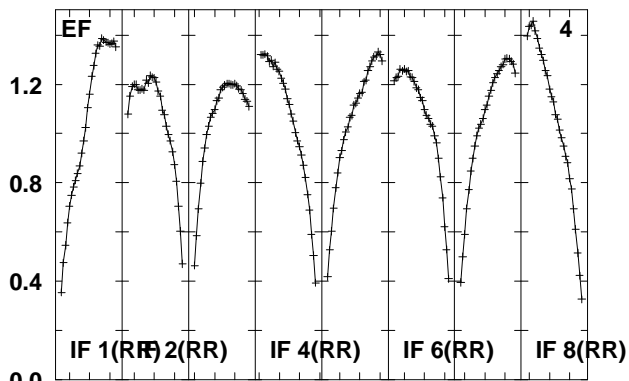
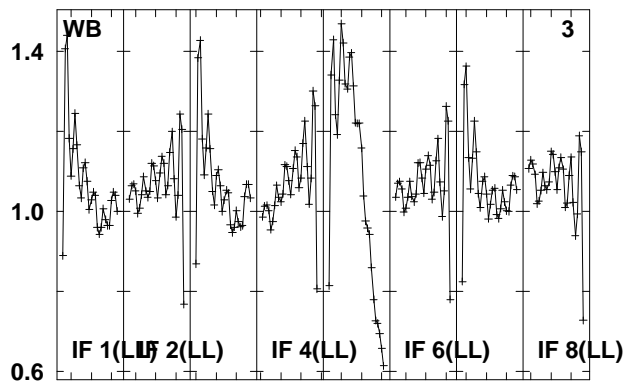
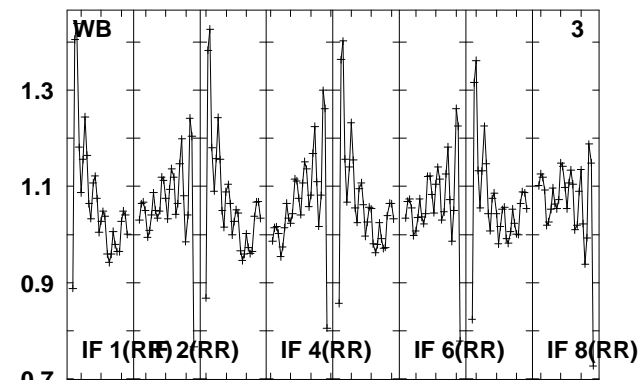
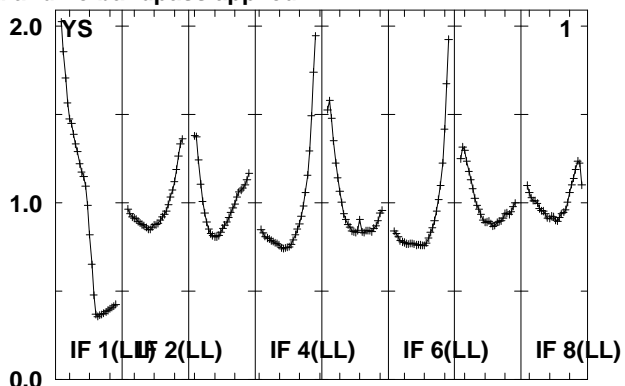
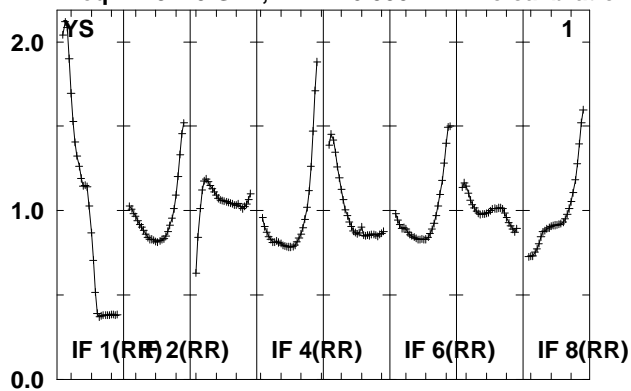

Lower frame: Real Jy
Total-power spectrum Antenna: *
Timerange: 00/22:57:52 to 00/23:02:50

Plot file version 672 created 14-MAY-2010 15:20:55

J102959 EO007.UVDATA.1

Freq = 4.9270 GHz, Bw = 16.000 MH No calibration applied and no bandpass applied

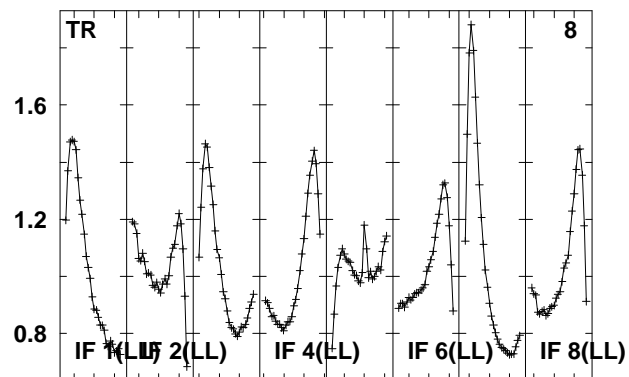
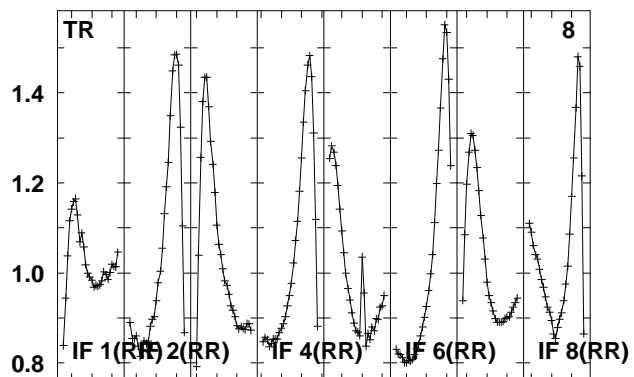
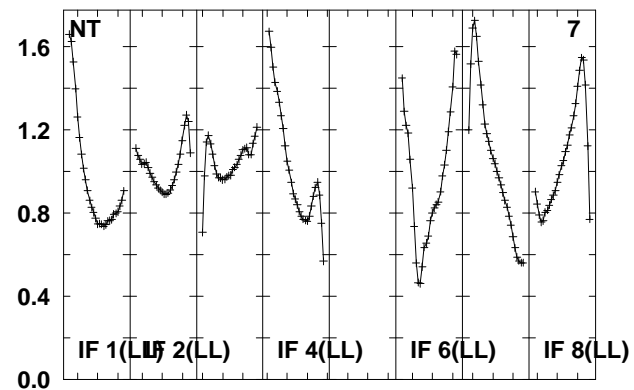
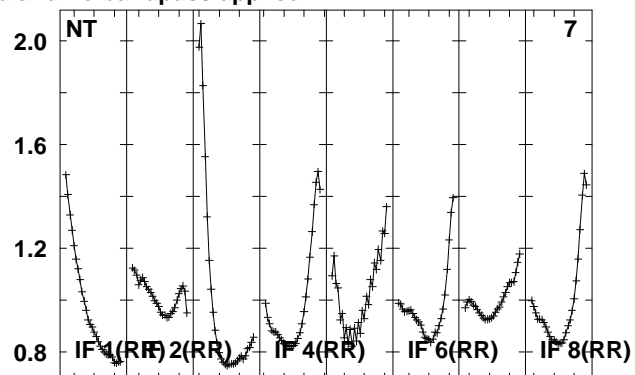
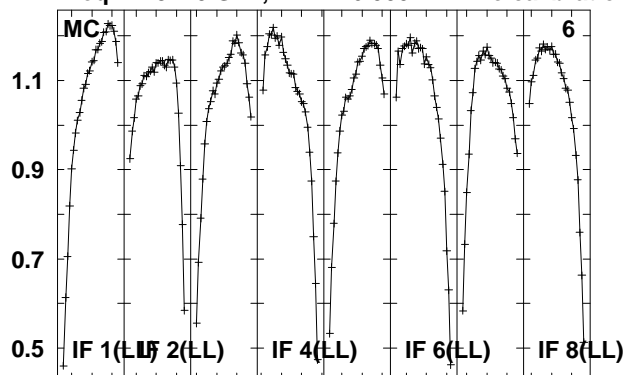

Lower frame: Real Jy
Total-power spectrum Antenna: *
Timerange: 00/22:57:52 to 00/23:02:50

Plot file version 673 created 14-MAY-2010 15:20:55

J1027+48 EO007.UVDATA.1

Freq = 4.9270 GHz, Bw = 16.000 MH No calibration applied and no bandpass applied

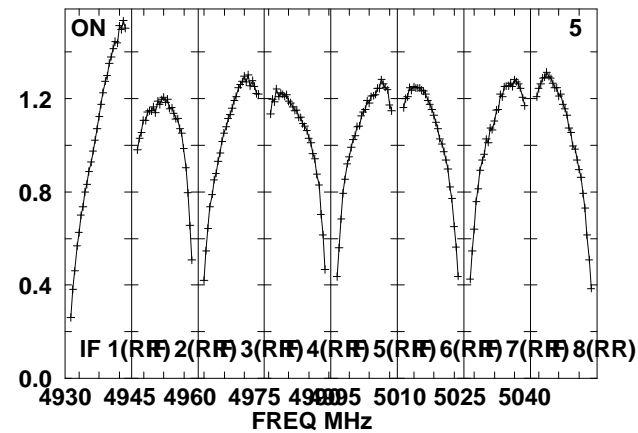
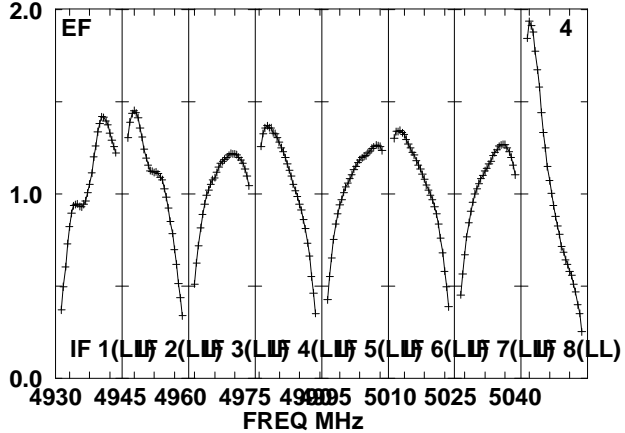
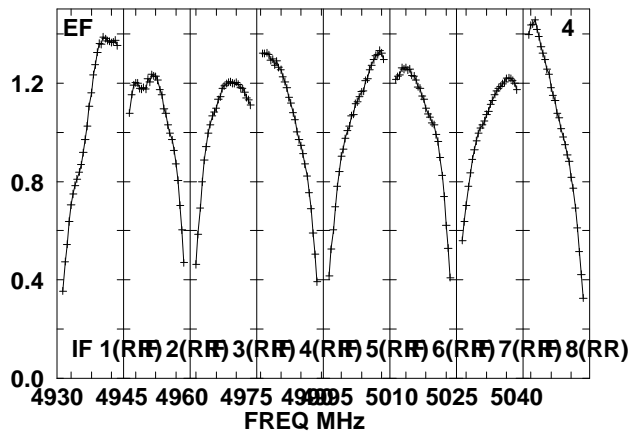
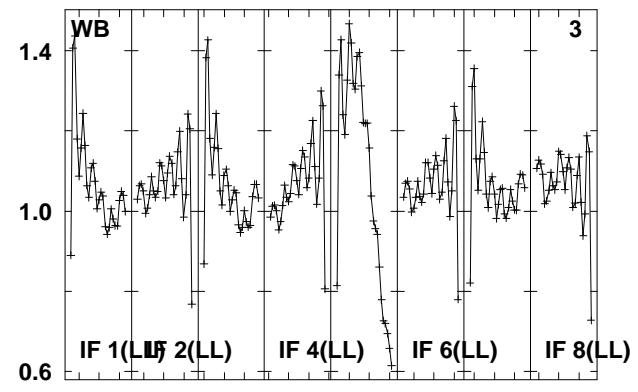
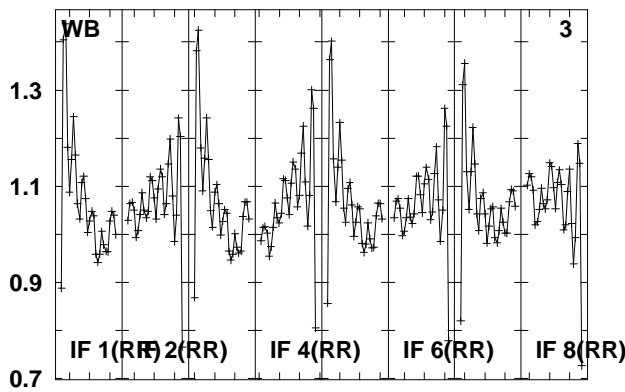
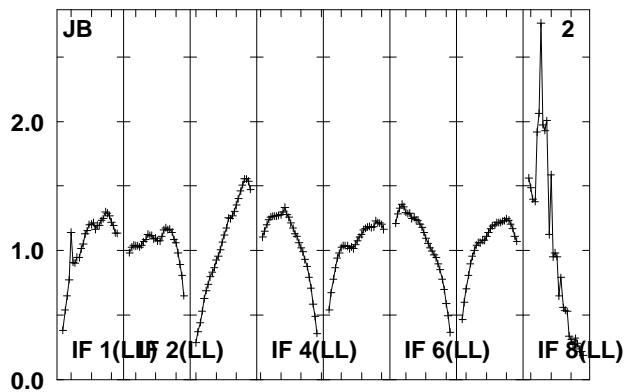
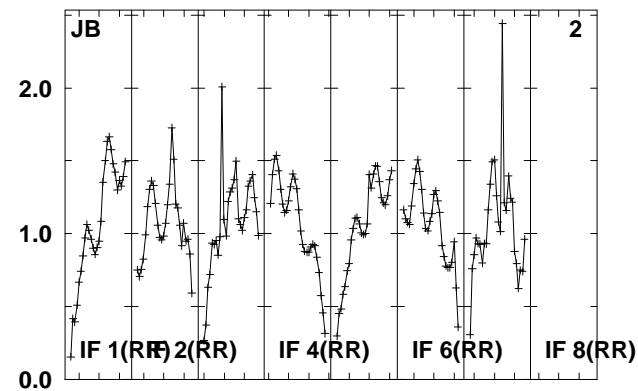
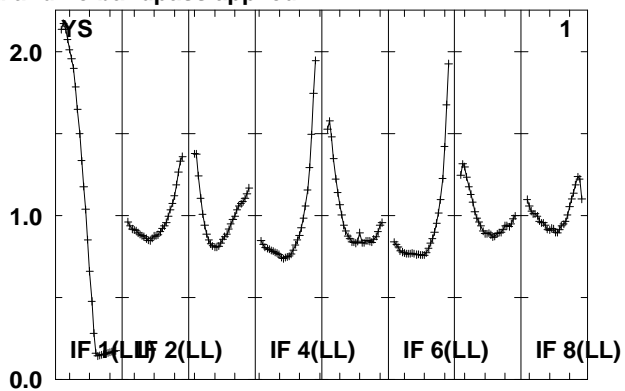
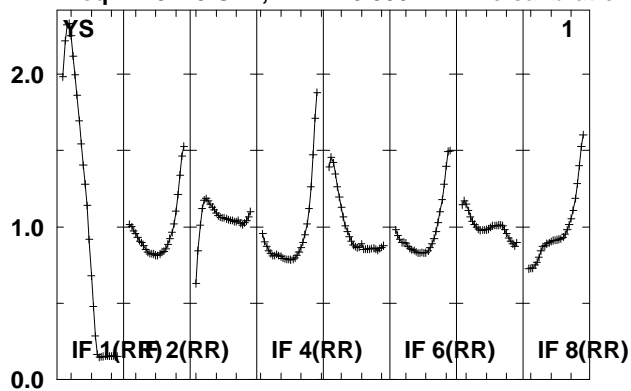

Lower frame: Real Jy
Total-power spectrum Antenna: *
Timerange: 00/23:03:19 to 00/23:04:45

Plot file version 674 created 14-MAY-2010 15:20:55

J1027+48 EO007.UVDATA.1

Freq = 4.9270 GHz, Bw = 16.000 MH No calibration applied and no bandpass applied

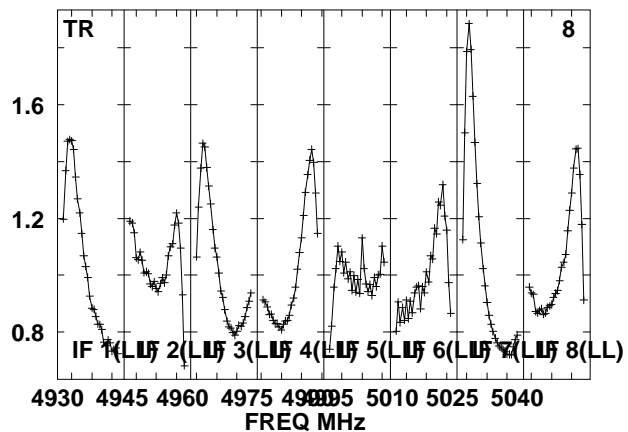
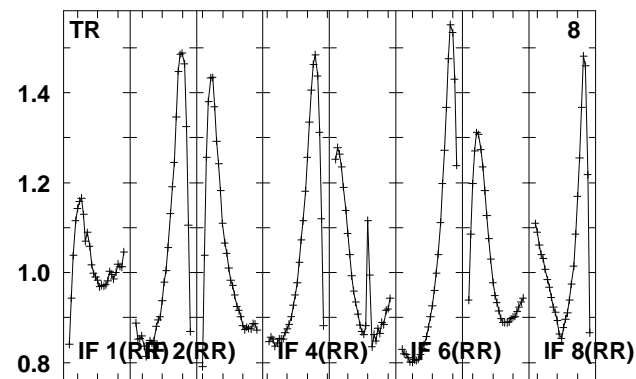
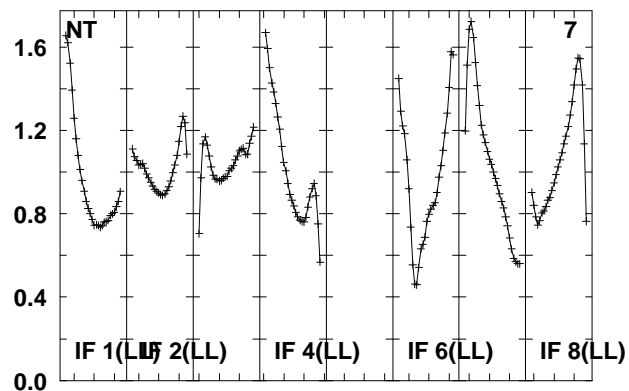
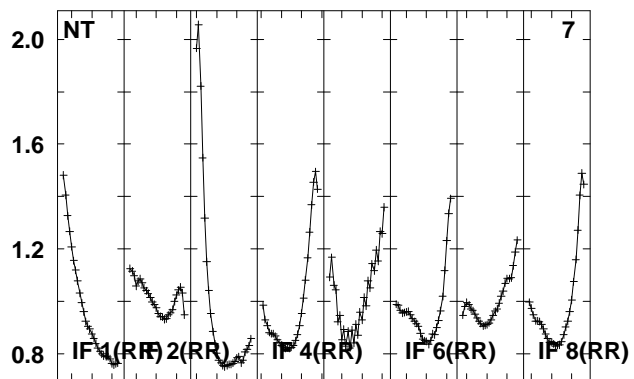
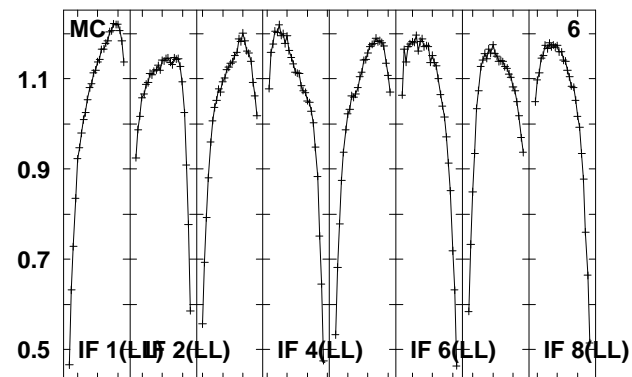
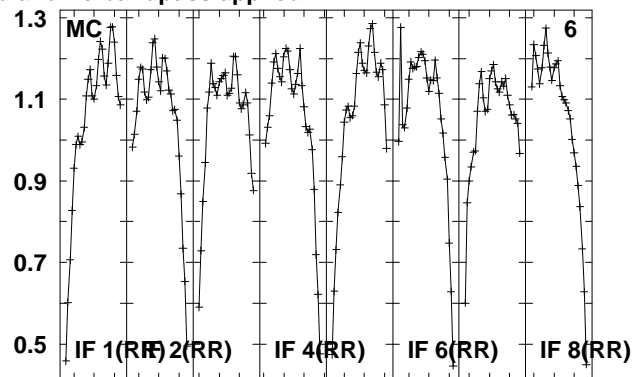
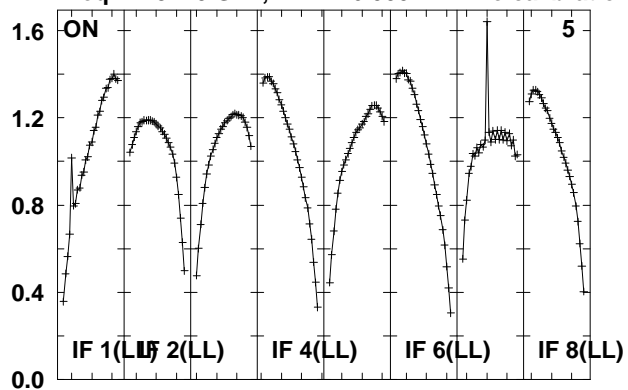

Lower frame: Real Jy

Total-power spectrum Antenna: *

Timerange: 00/23:03:19 to 00/23:04:45

Plot file version 675 created 14-MAY-2010 15:20:56

J0920+44 EO007.UVDATA.1

Freq = 4.9270 GHz, Bw = 16.000 MH No calibration applied and no bandpass applied

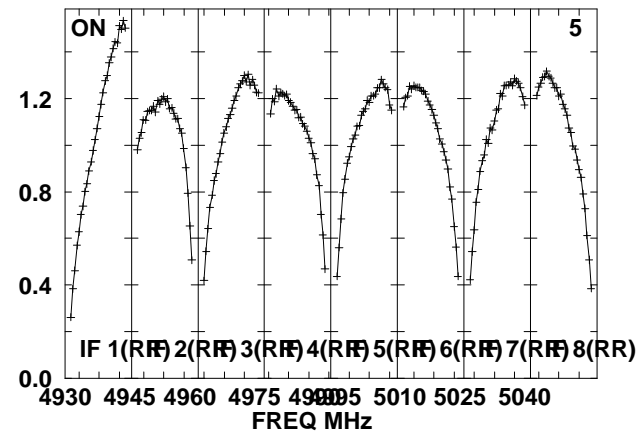
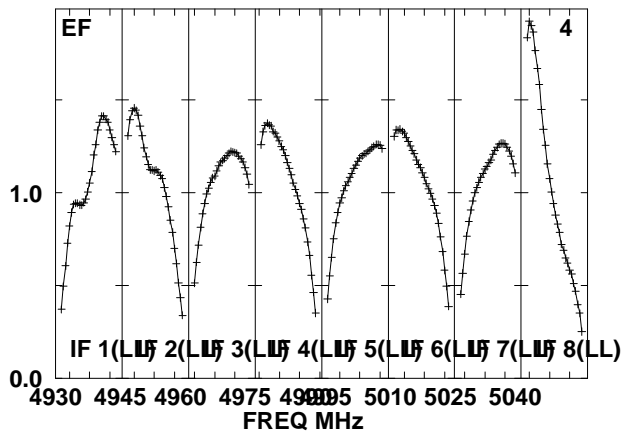
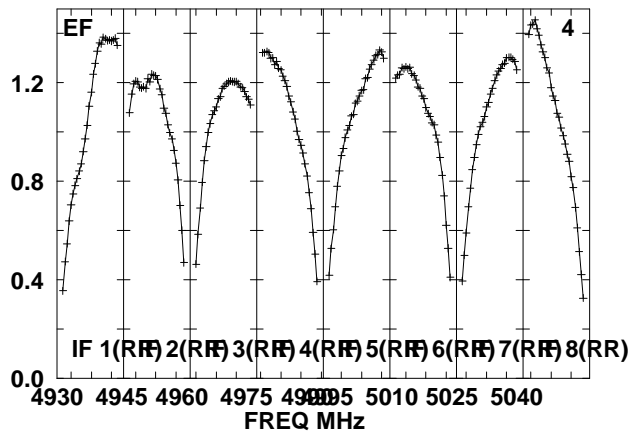
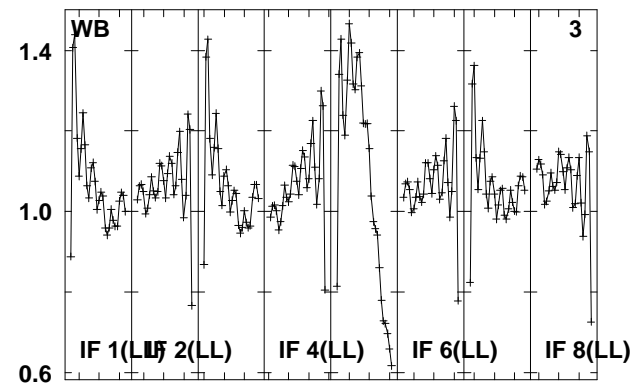
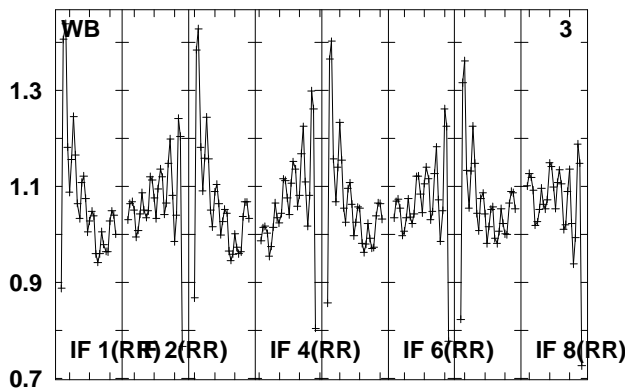
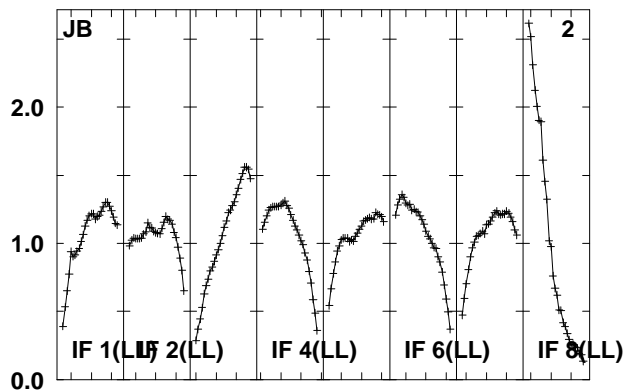
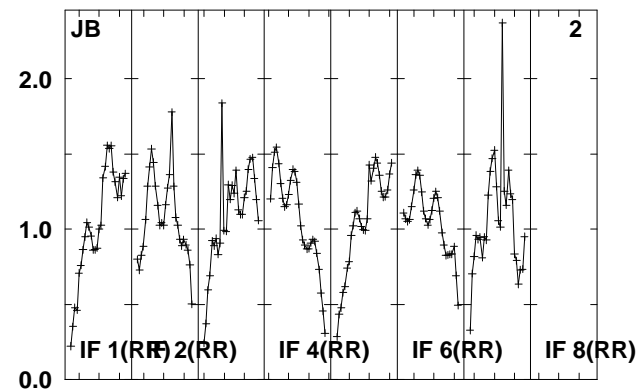
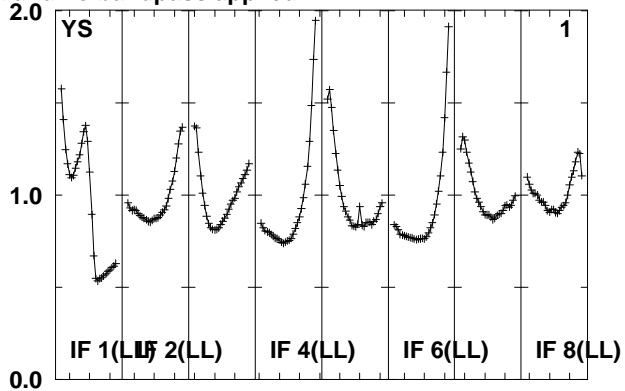
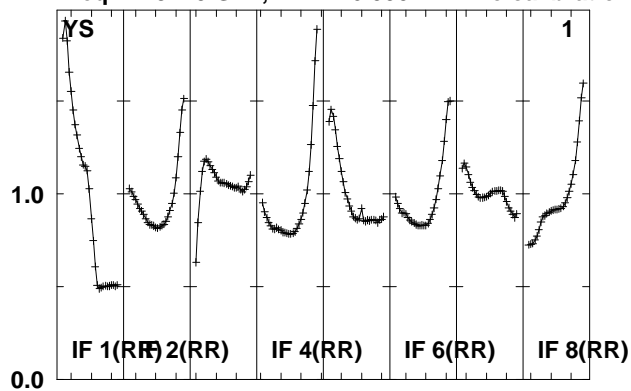

Lower frame: Real Jy
Total-power spectrum Antenna: *
Timerange: 00/23:07:41 to 00/23:09:09

Plot file version 676 created 14-MAY-2010 15:20:56

J0920+44 EO007.UVDATA.1

Freq = 4.9270 GHz, Bw = 16.000 MH No calibration applied and no bandpass applied

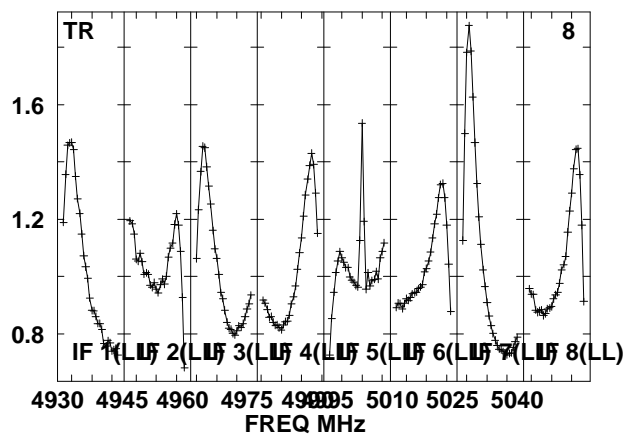
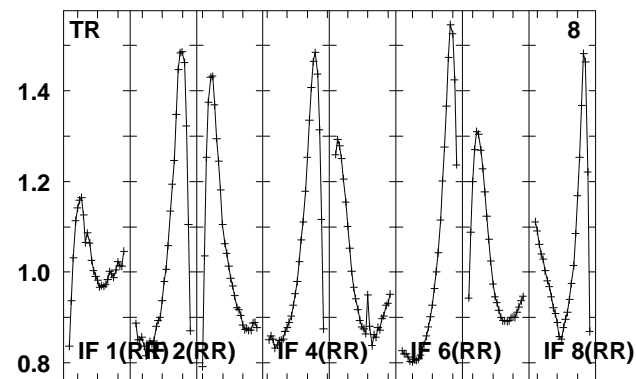
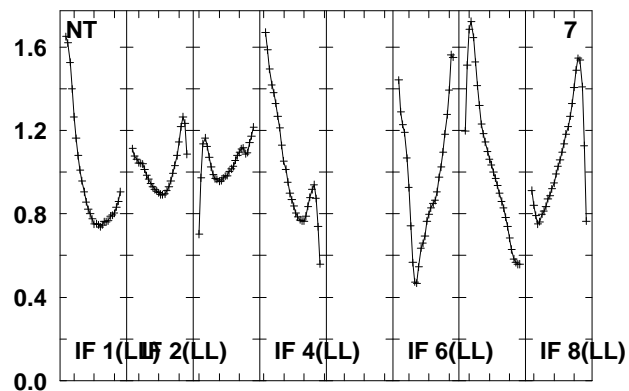
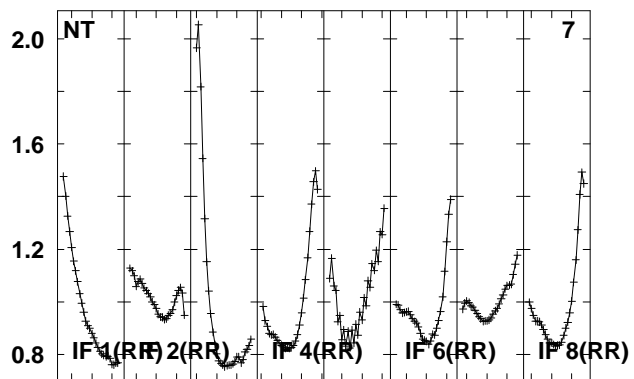
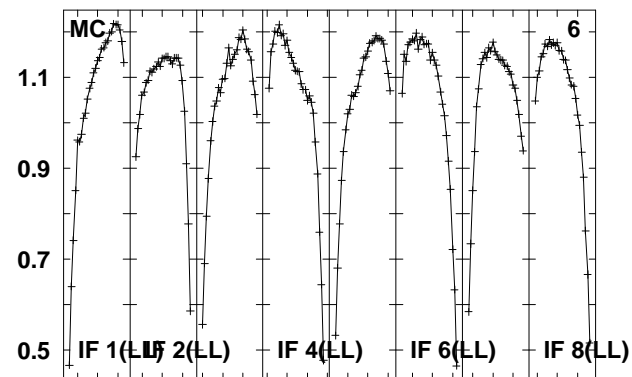
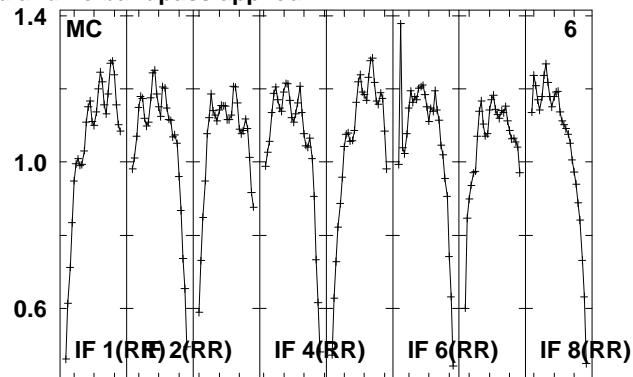
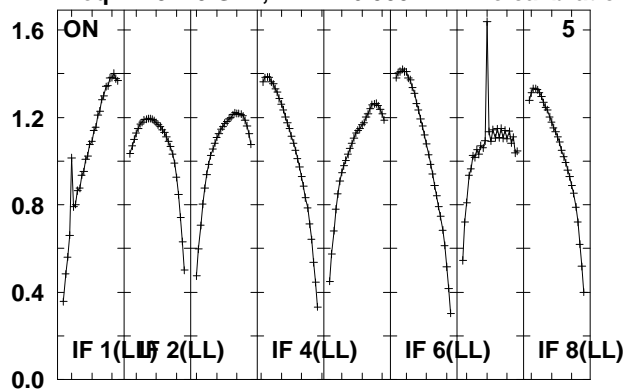

Lower frame: Real Jy

Total-power spectrum Antenna: *

Timerange: 00/23:07:41 to 00/23:09:09

Plot file version 677 created 14-MAY-2010 15:20:56

J092159 EO007.UVDATA.1

Freq = 4.9270 GHz, Bw = 16.000 MH No calibration applied and no bandpass applied

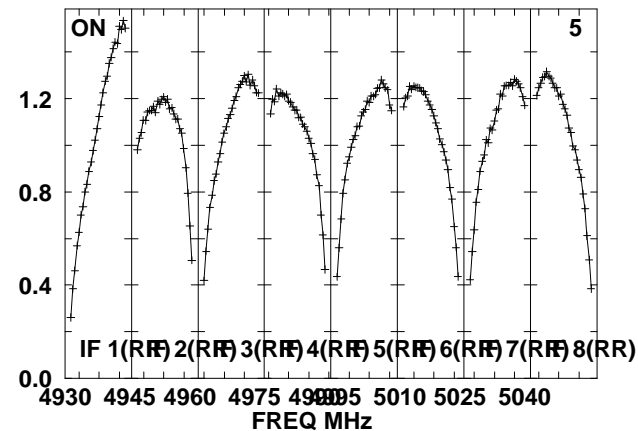
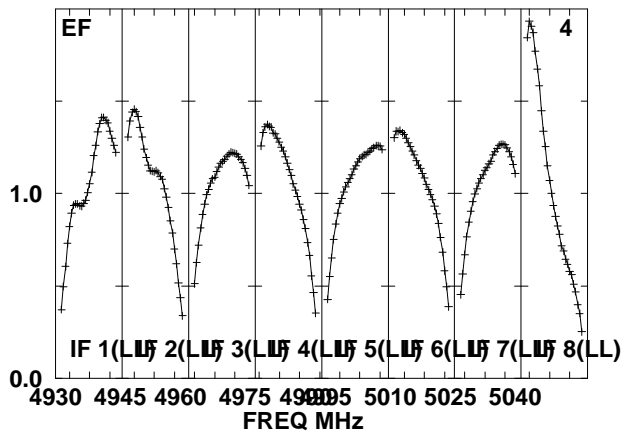
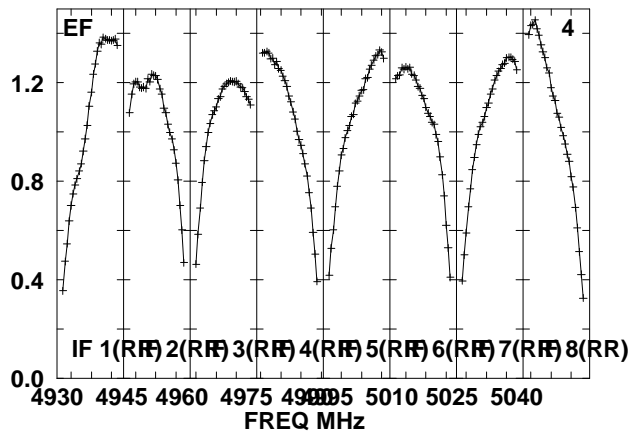
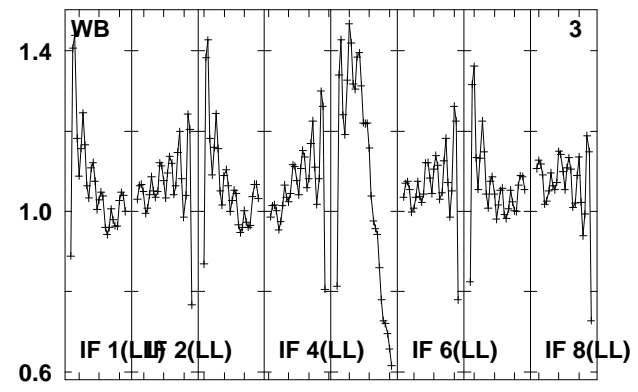
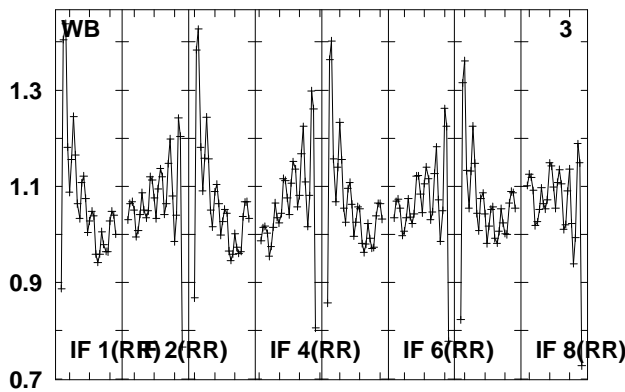
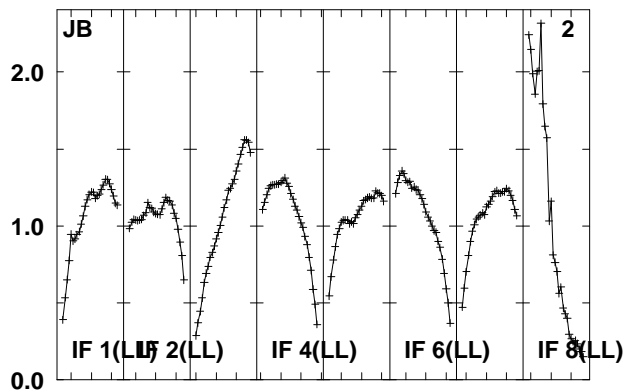
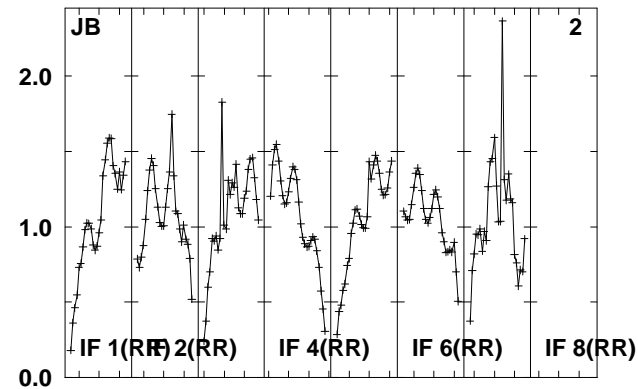
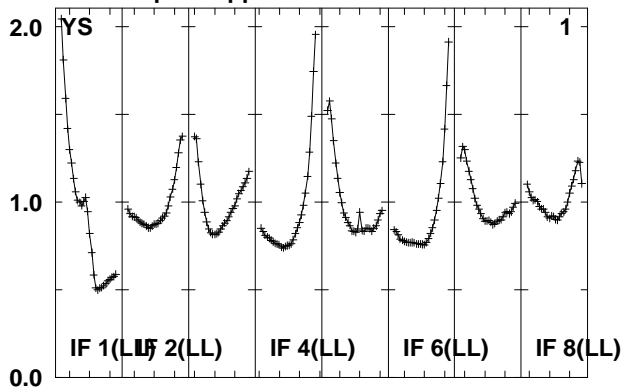
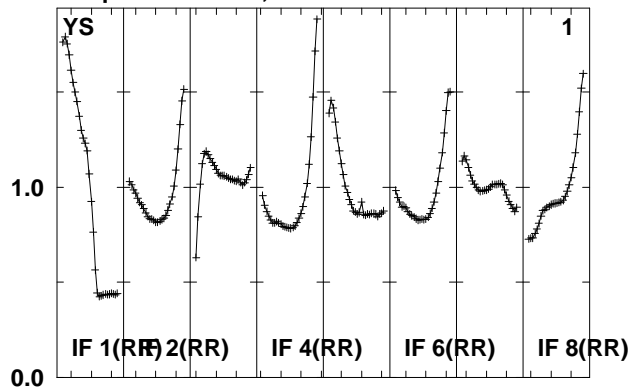

Lower frame: Real Jy

Total-power spectrum Antenna: *

Timerange: 00/23:09:35 to 00/23:14:31

Plot file version 678 created 14-MAY-2010 15:20:57

J092159 EO007.UVDATA.1

Freq = 4.9270 GHz, Bw = 16.000 MH No calibration applied and no bandpass applied

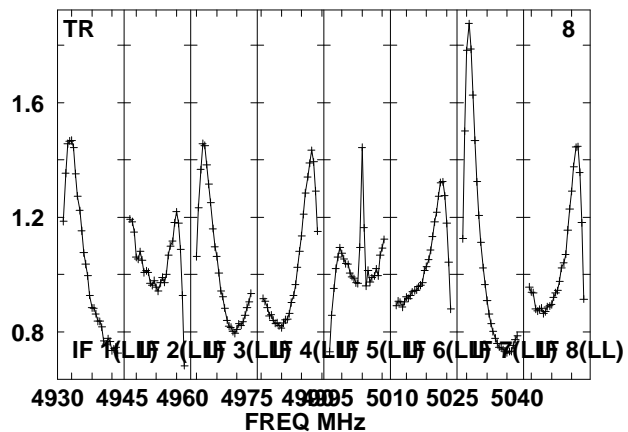
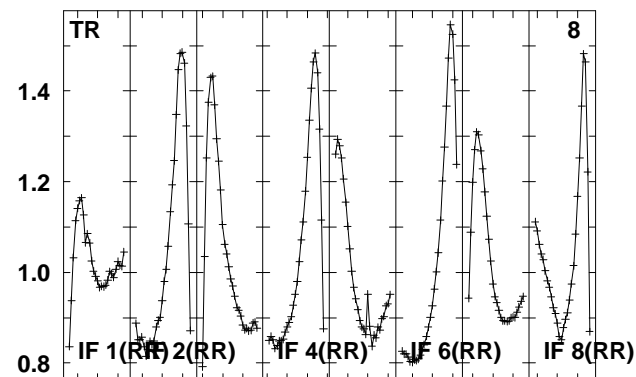
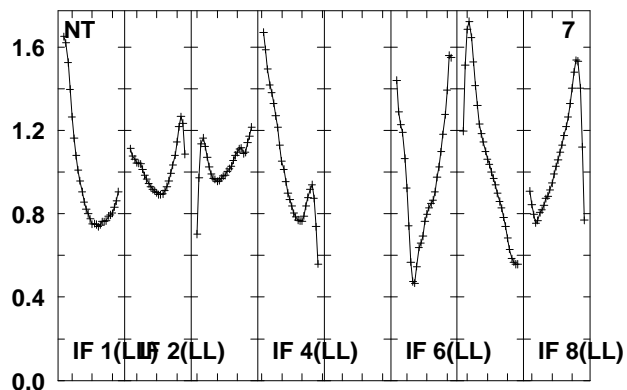
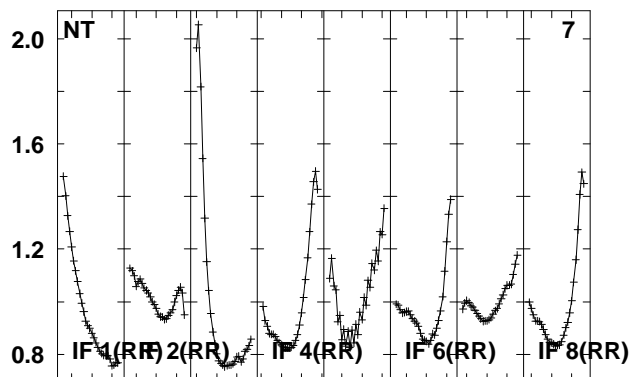
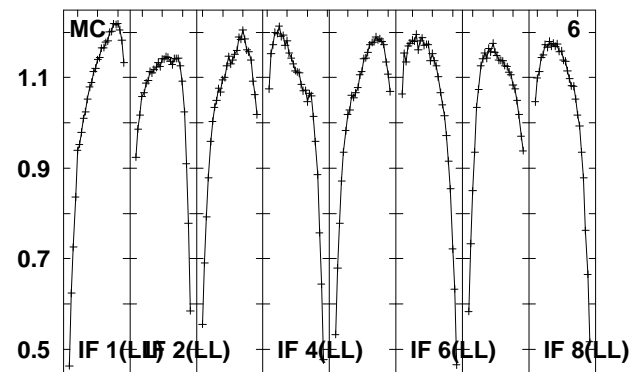
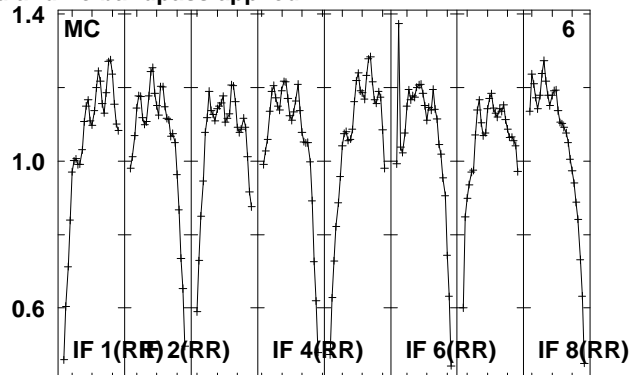
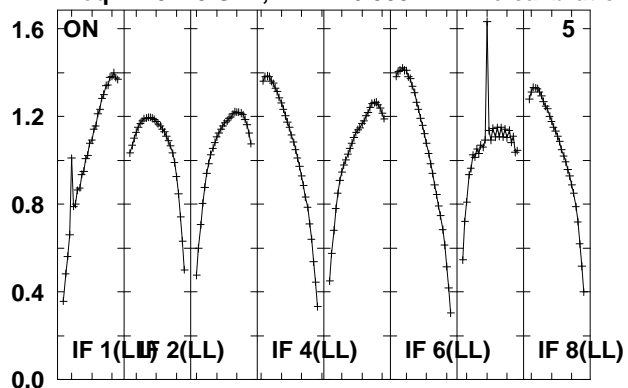

Lower frame: Real Jy

Total-power spectrum Antenna: *

Timerange: 00/23:09:35 to 00/23:14:31

Plot file version 679 created 14-MAY-2010 15:20:57

J0920+44 EO007.UVDATA.1

Freq = 4.9270 GHz, Bw = 16.000 MH No calibration applied and no bandpass applied

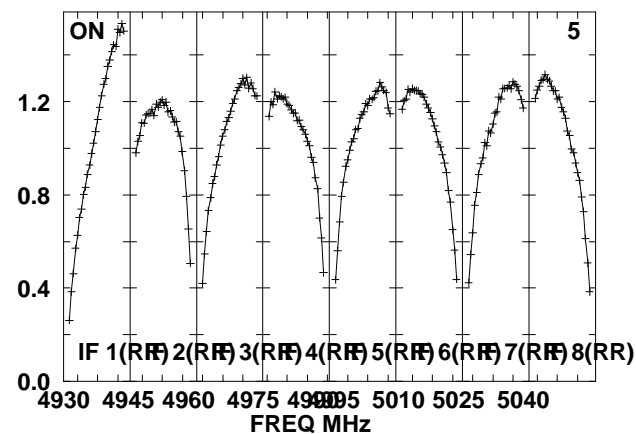
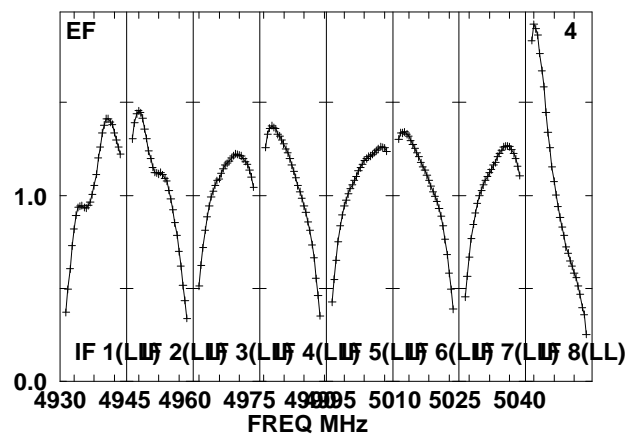
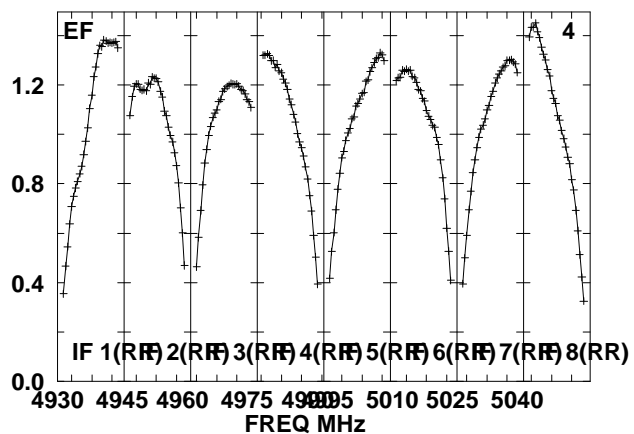
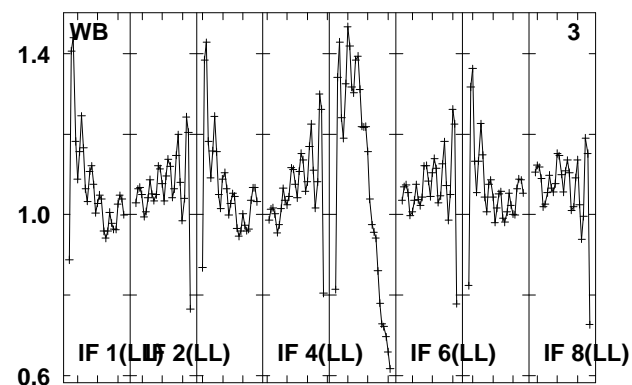
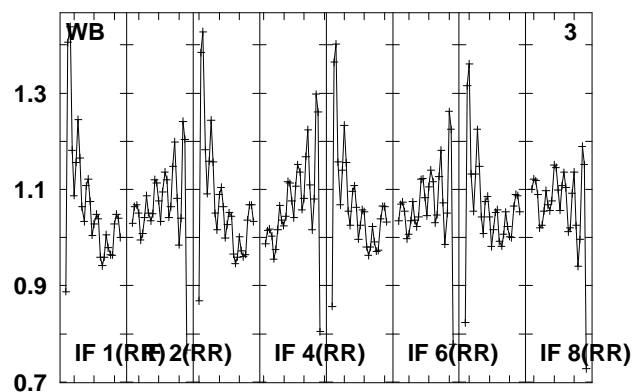
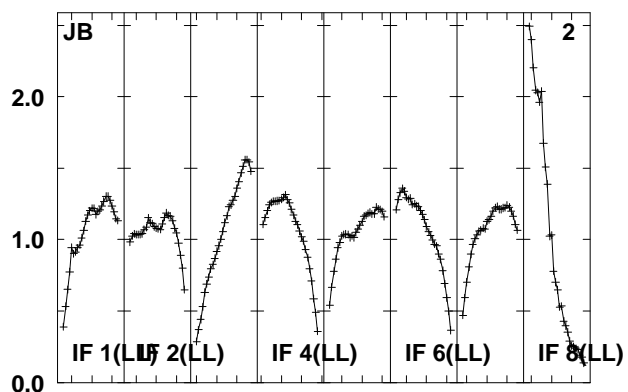
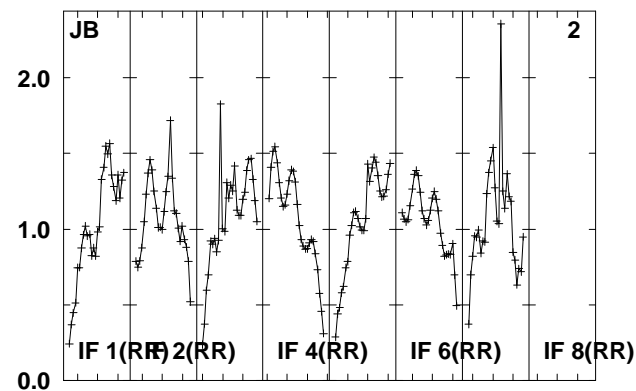
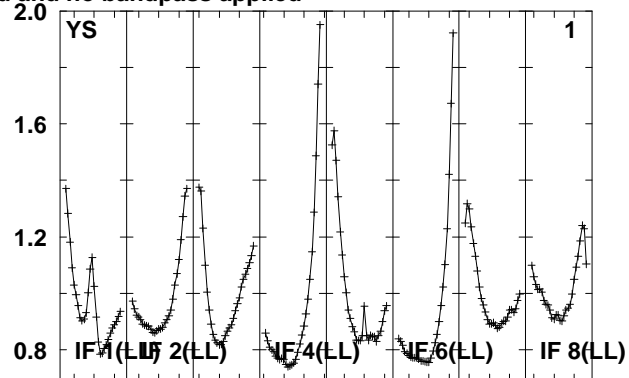
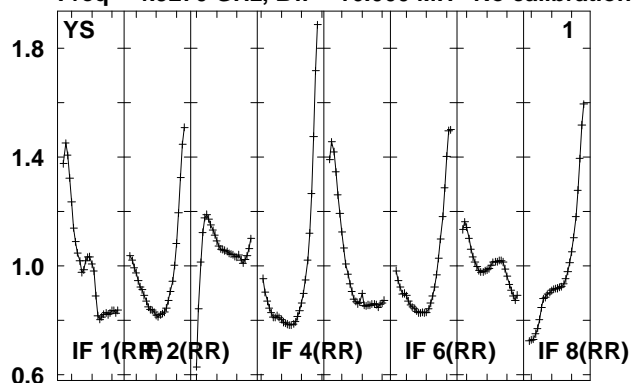

Lower frame: Real Jy

Total-power spectrum Antenna: *

Timerange: 00/23:14:57 to 00/23:16:25

Plot file version 680 created 14-MAY-2010 15:20:57

J0920+44 EO007.UVDATA.1

Freq = 4.9270 GHz, Bw = 16.000 MH No calibration applied and no bandpass applied

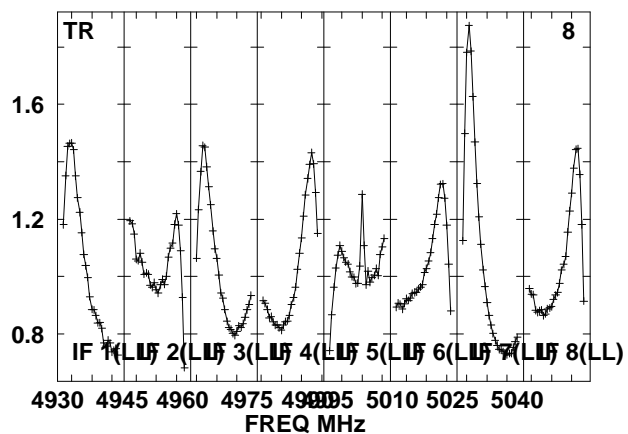
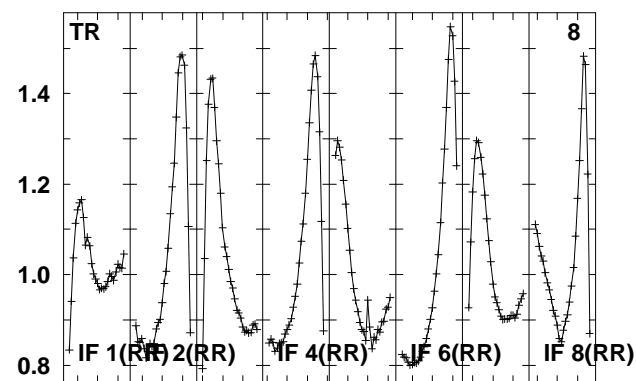
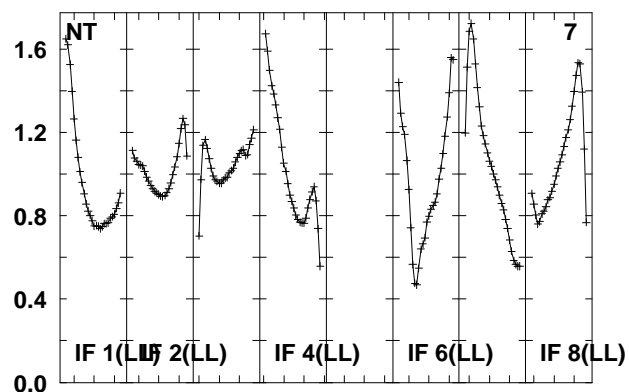
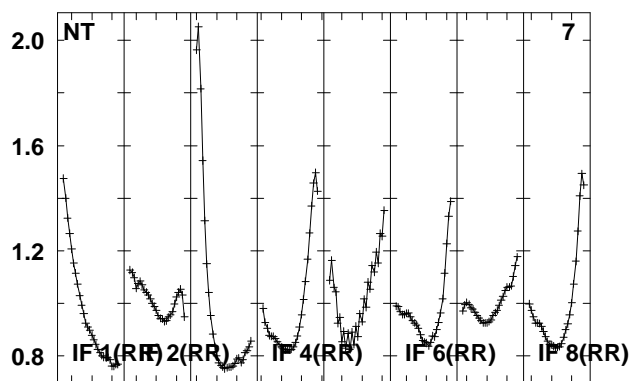
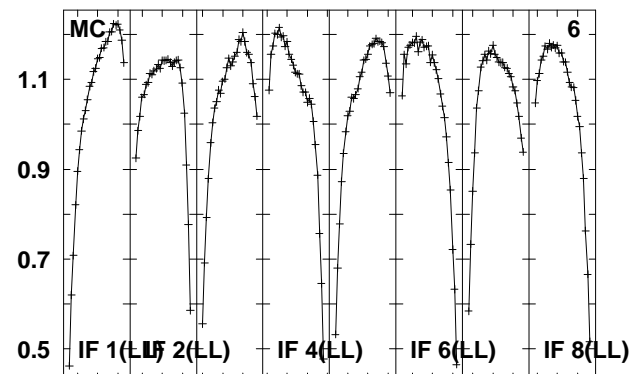
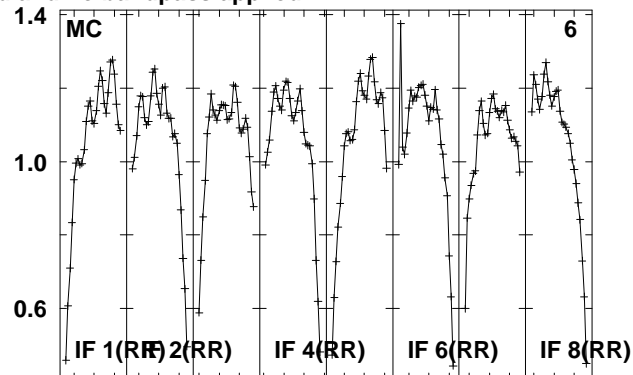
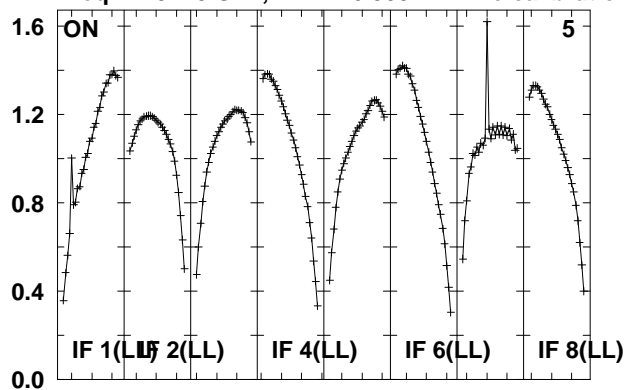

Lower frame: Real Jy

Total-power spectrum Antenna: *

Timerange: 00/23:14:57 to 00/23:16:25

Plot file version 681 created 14-MAY-2010 15:20:58

J092159 EO007.UVDATA.1

Freq = 4.9270 GHz, Bw = 16.000 MH No calibration applied and no bandpass applied

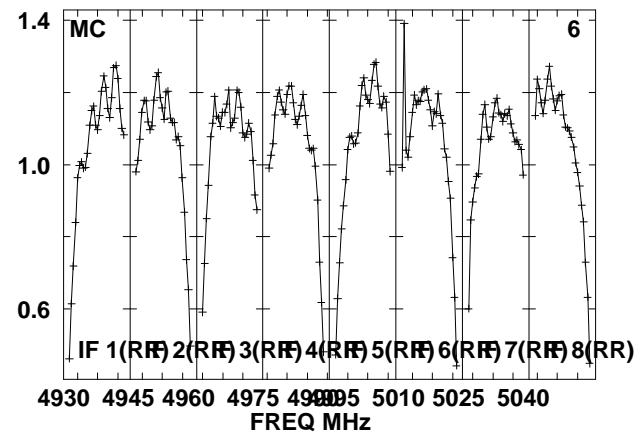
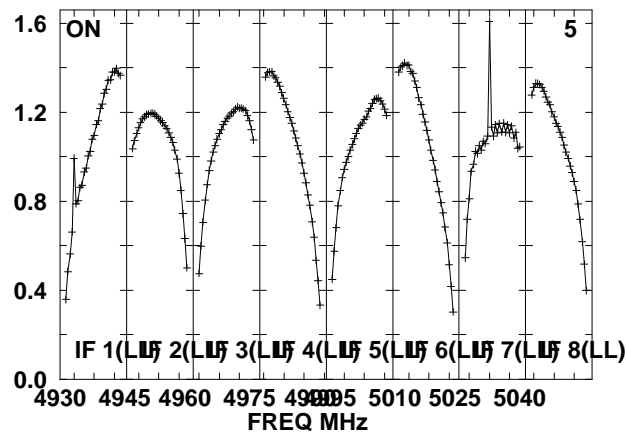
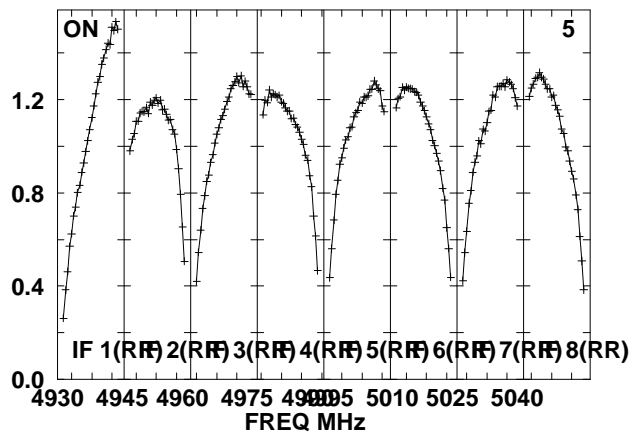
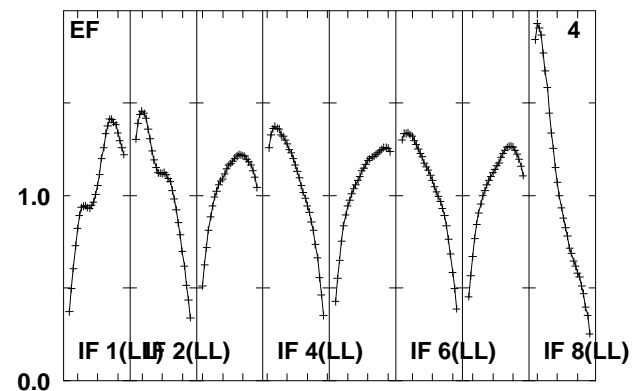
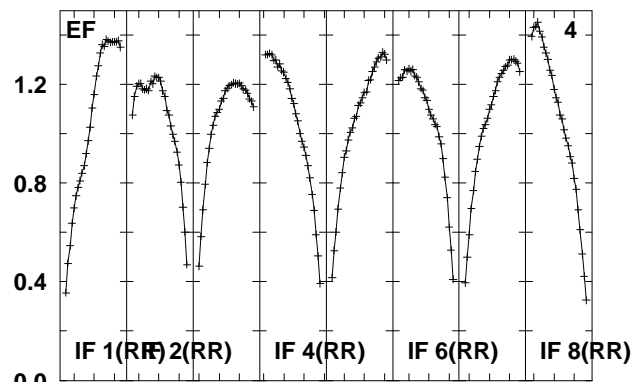
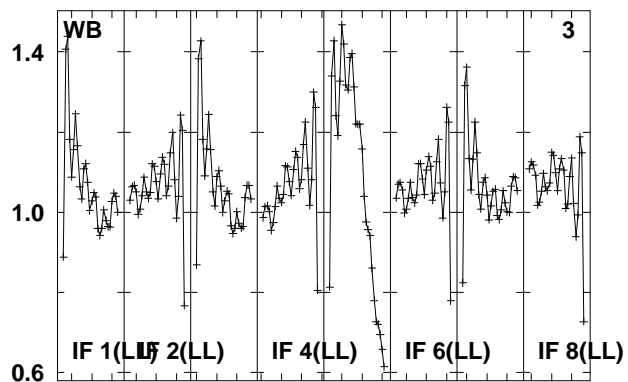
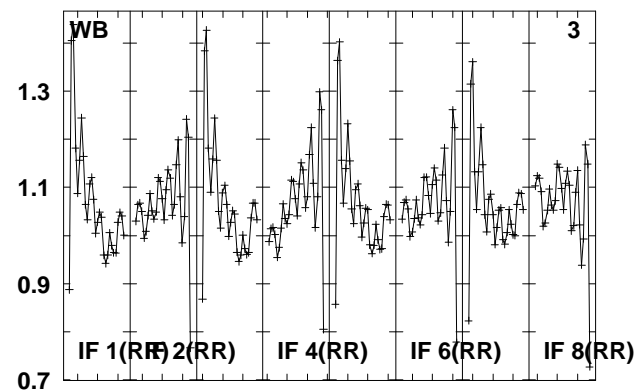
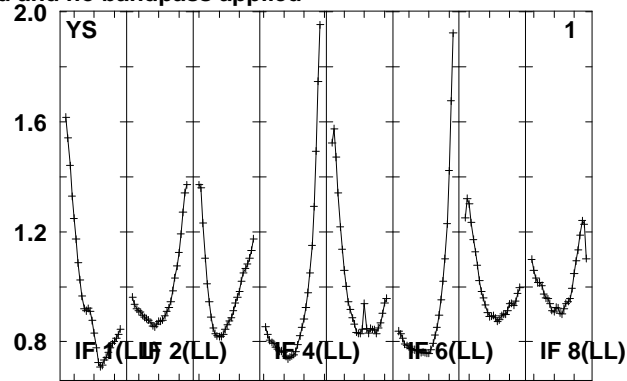
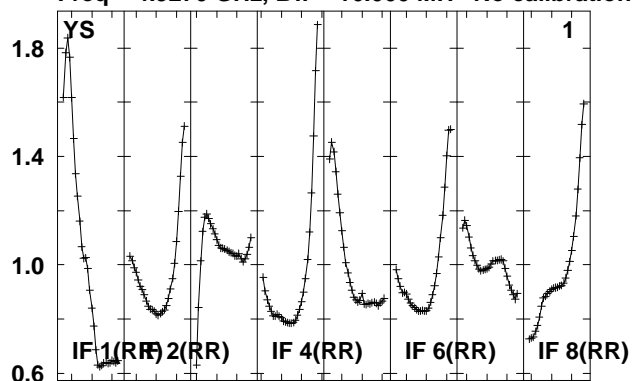

Lower frame: Real Jy
Total-power spectrum Antenna: *
Timerange: 00/23:16:49 to 00/23:21:45

Plot file version 682 created 14-MAY-2010 15:20:58

J092159 EO007.UVDATA.1

Freq = 4.9270 GHz, Bw = 16.000 MH No calibration applied and no bandpass applied

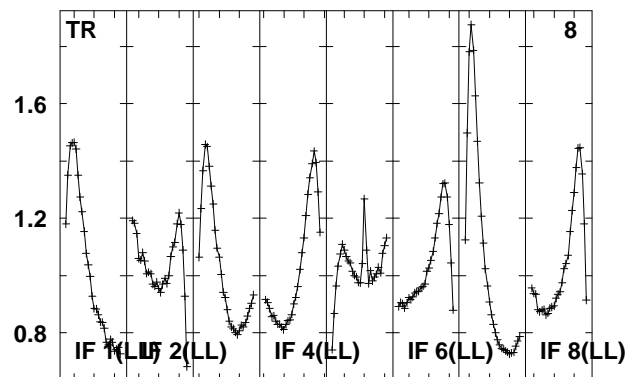
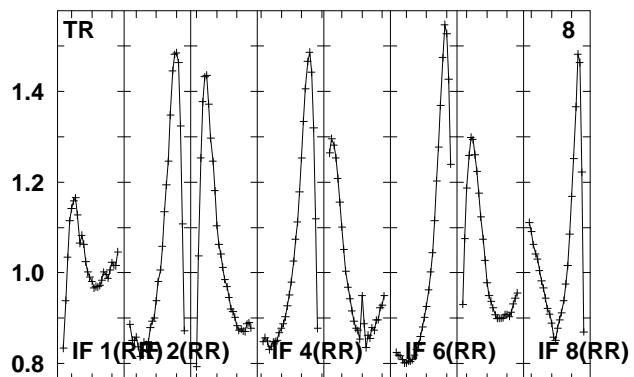
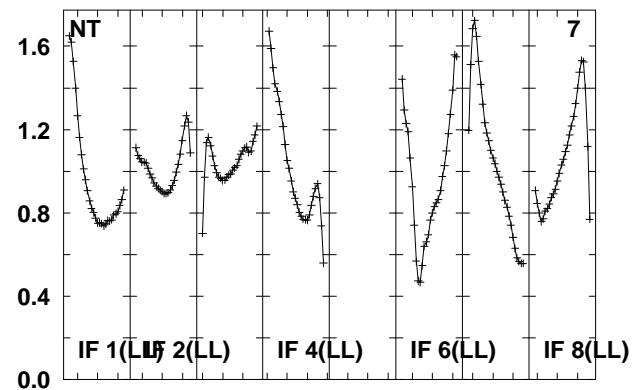
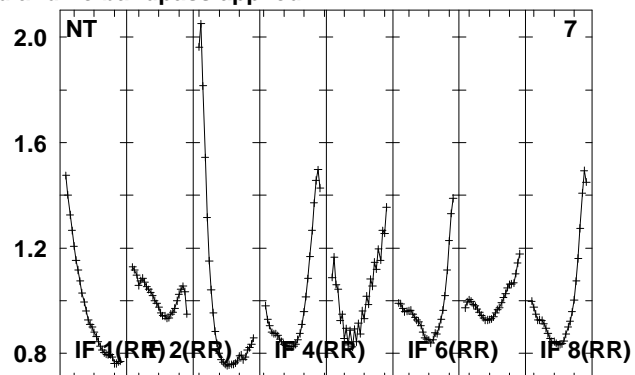
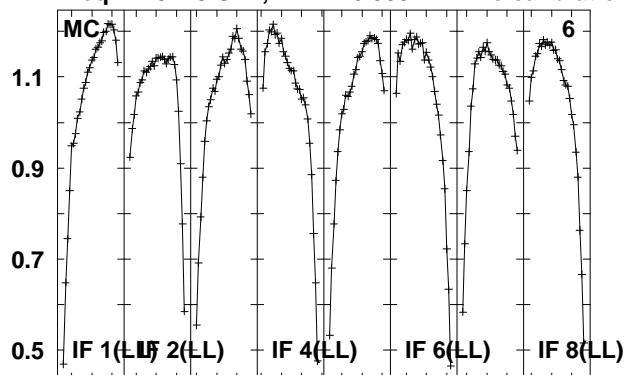

Lower frame: Real Jy
Total-power spectrum Antenna: *
Timerange: 00/23:16:49 to 00/23:21:45

Plot file version 683 created 14-MAY-2010 15:20:59

J0920+44 EO007.UVDATA.1

Freq = 4.9270 GHz, Bw = 16.000 MH No calibration applied and no bandpass applied

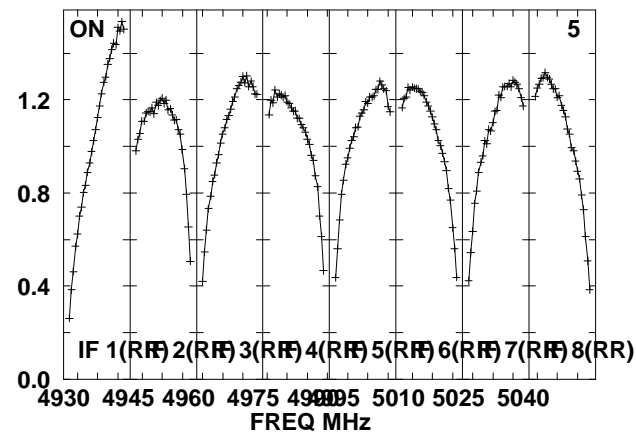
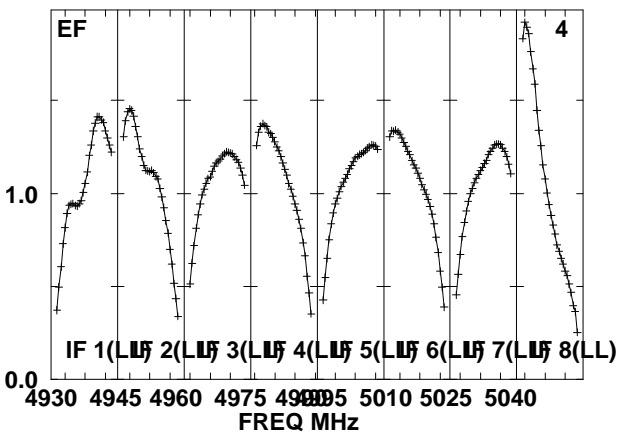
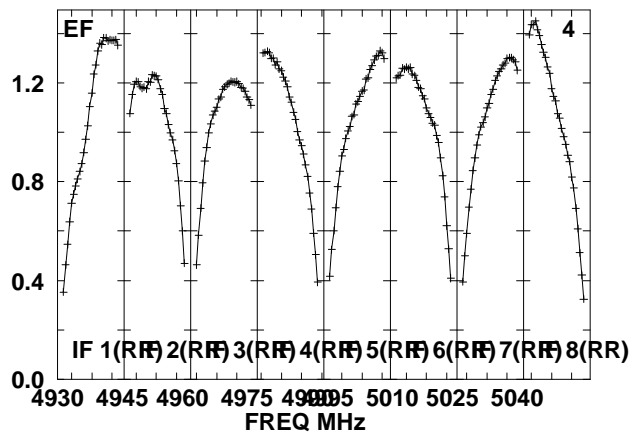
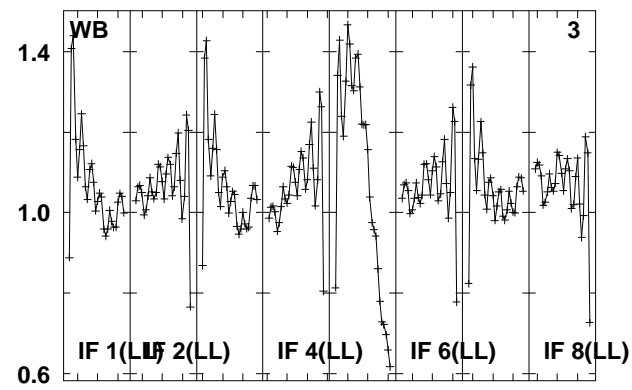
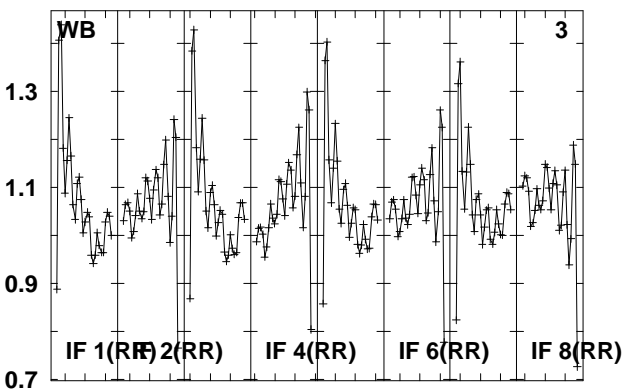
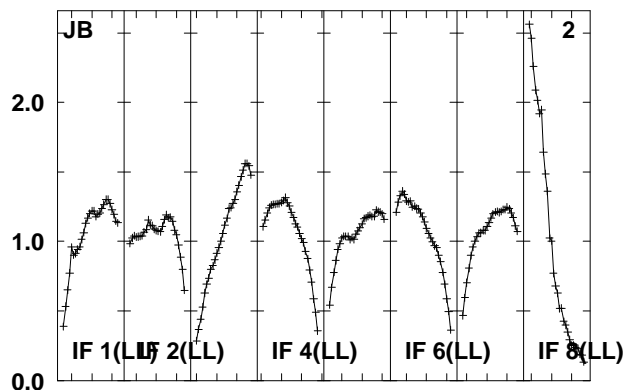
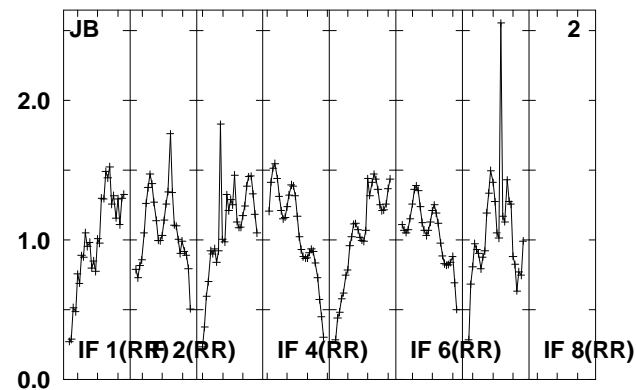
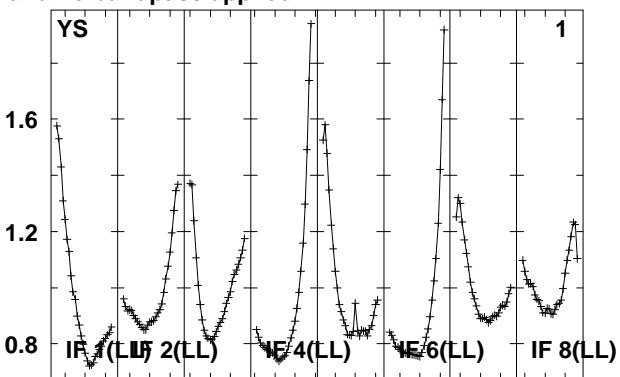
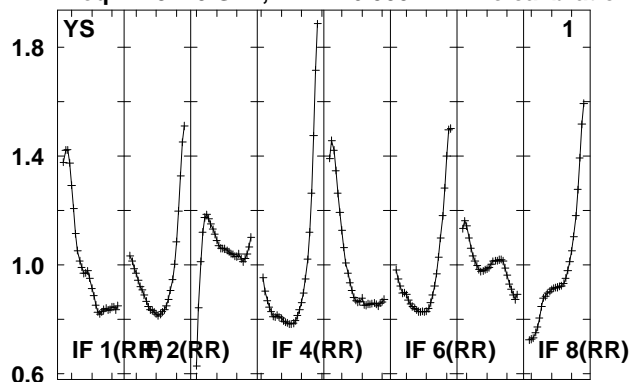

Lower frame: Real Jy
Total-power spectrum Antenna: *
Timerange: 00/23:22:11 to 00/23:23:35

Plot file version 684 created 14-MAY-2010 15:20:59

J0920+44 EO007.UVDATA.1

Freq = 4.9270 GHz, Bw = 16.000 MH No calibration applied and no bandpass applied

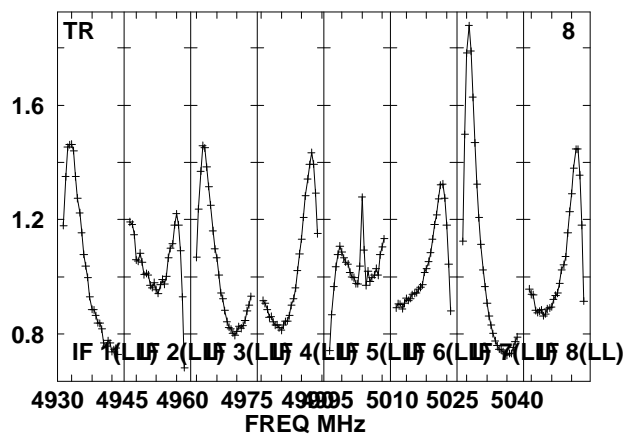
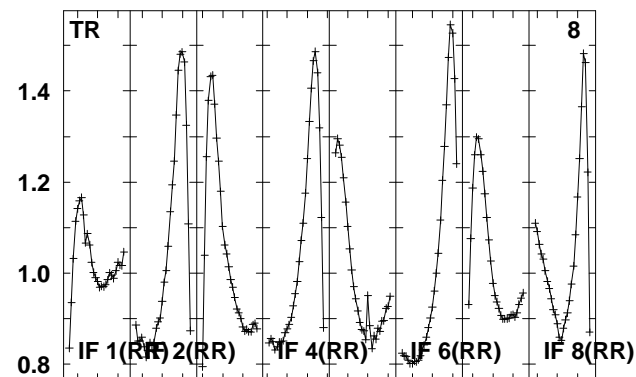
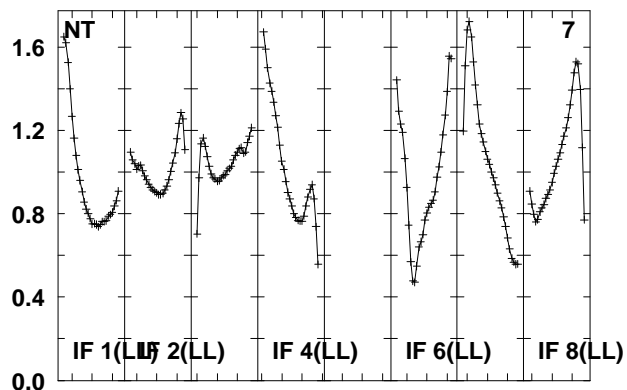
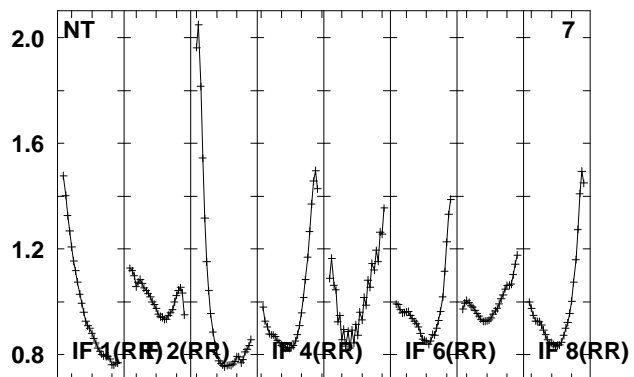
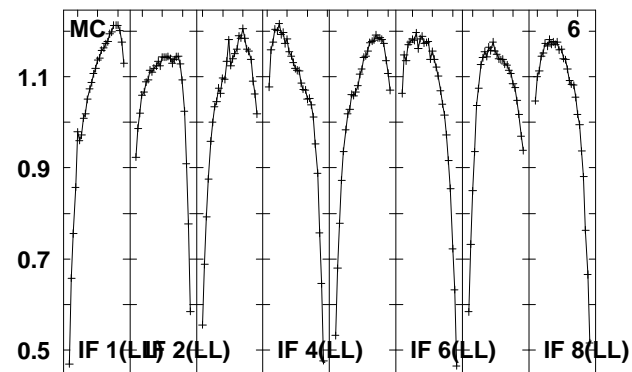
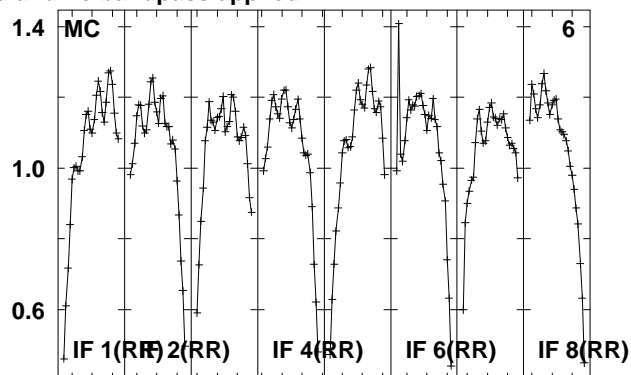
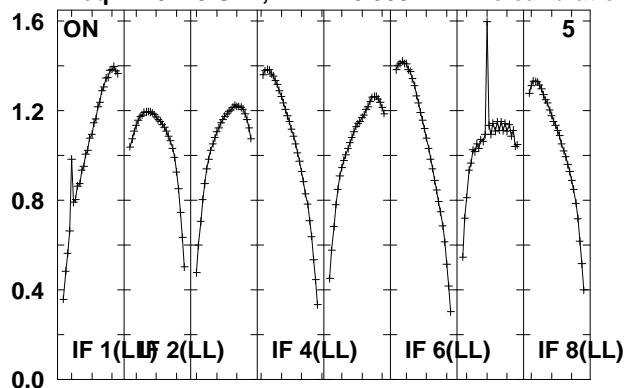

Lower frame: Real Jy

Total-power spectrum Antenna: *

Timerange: 00/23:22:11 to 00/23:23:35

Plot file version 685 created 14-MAY-2010 15:20:59

J1027+48 EO007.UVDATA.1

Freq = 4.9270 GHz, Bw = 16.000 MH No calibration applied and no bandpass applied

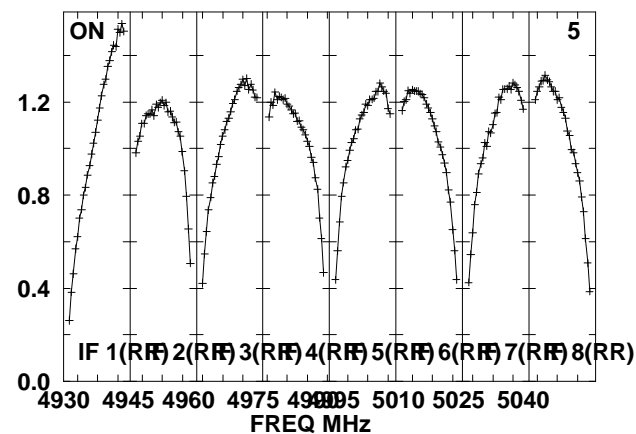
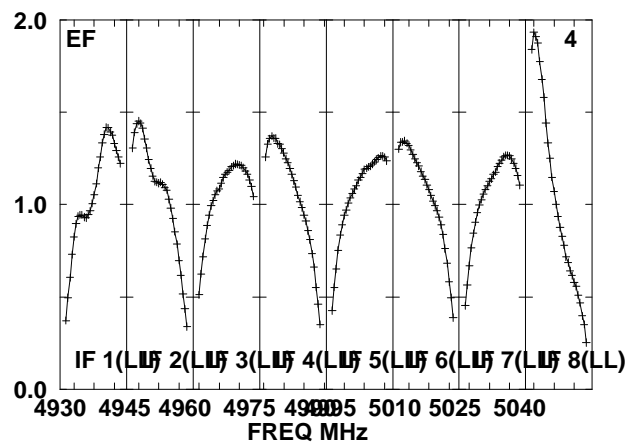
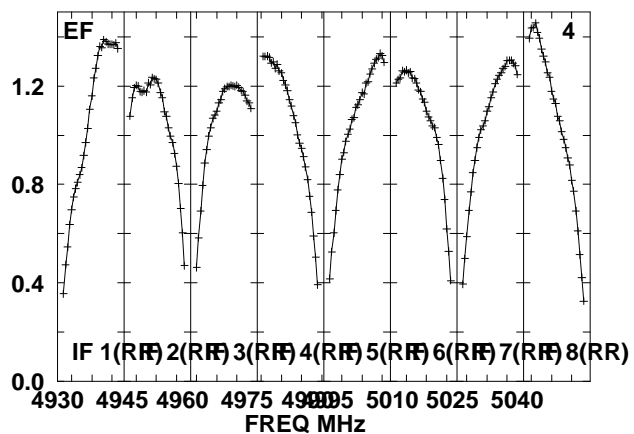
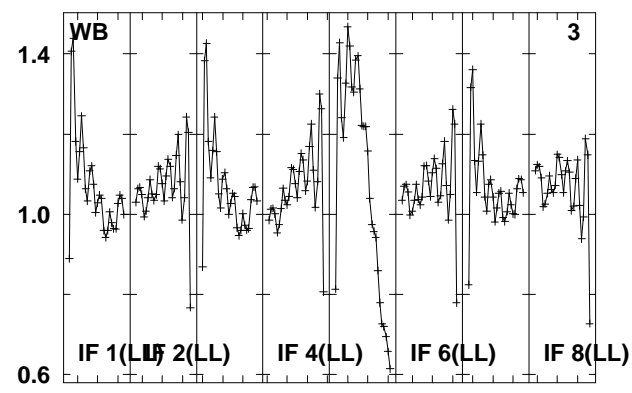
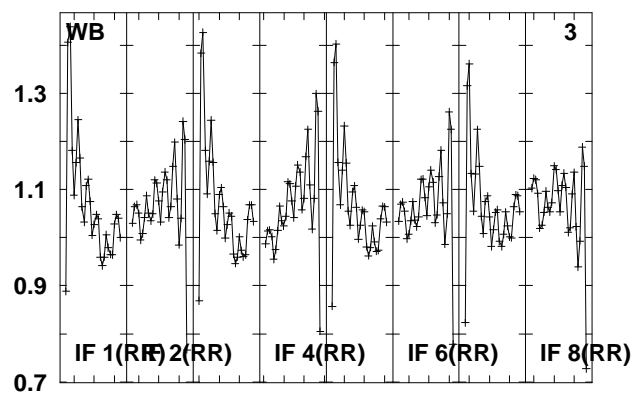
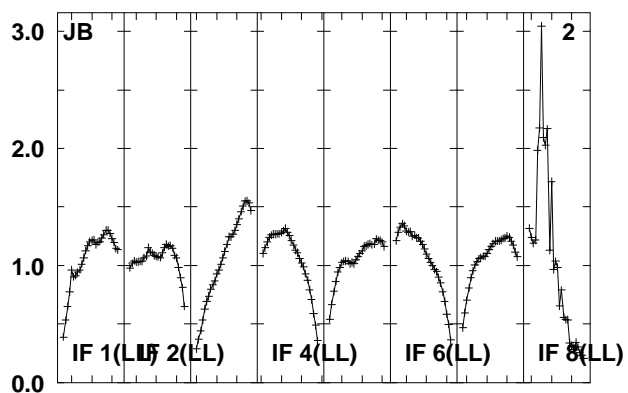
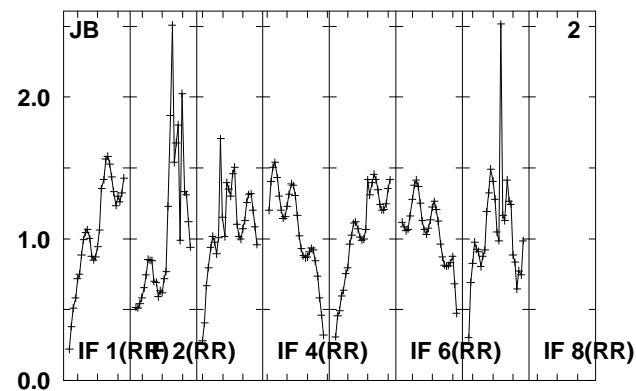
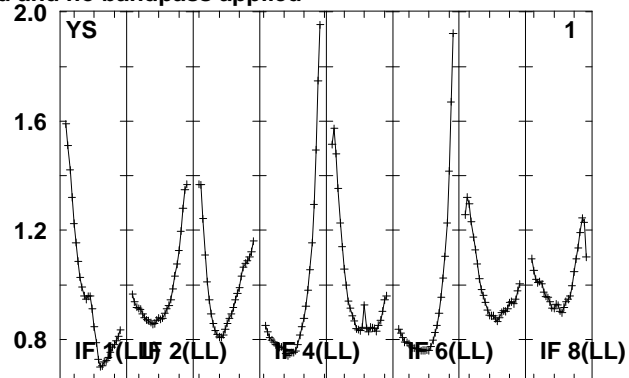
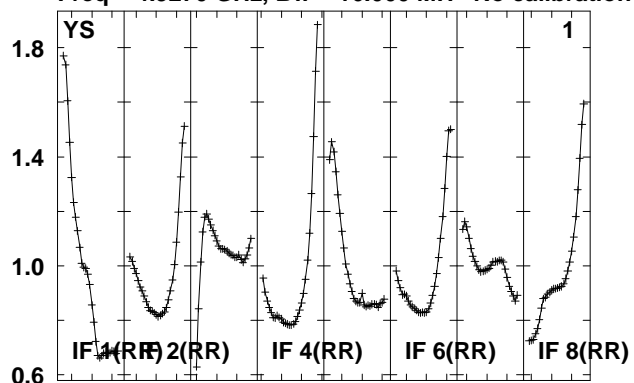

Lower frame: Real Jy
Total-power spectrum Antenna: *
Timerange: 00/23:25:21 to 00/23:26:49

Plot file version 686 created 14-MAY-2010 15:20:59

J1027+48 EO007.UVDATA.1

Freq = 4.9270 GHz, Bw = 16.000 MH No calibration applied and no bandpass applied

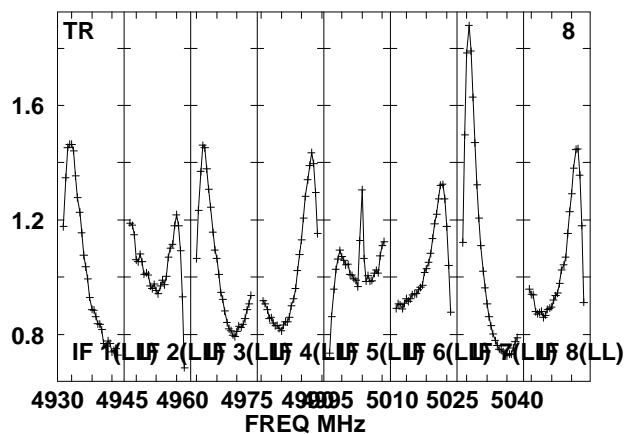
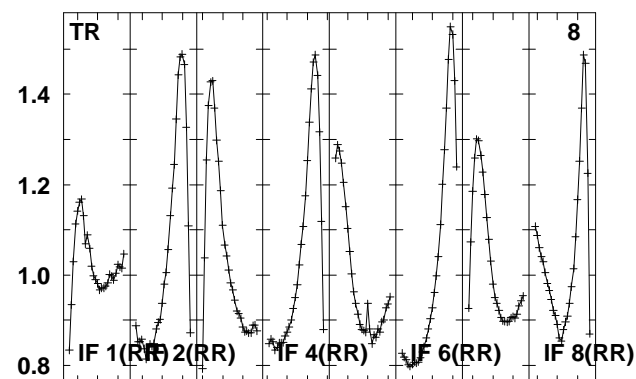
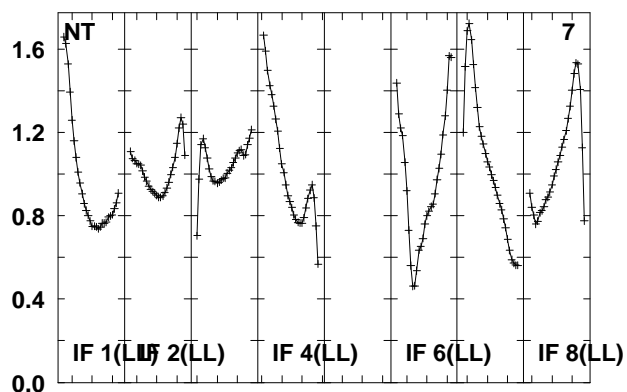
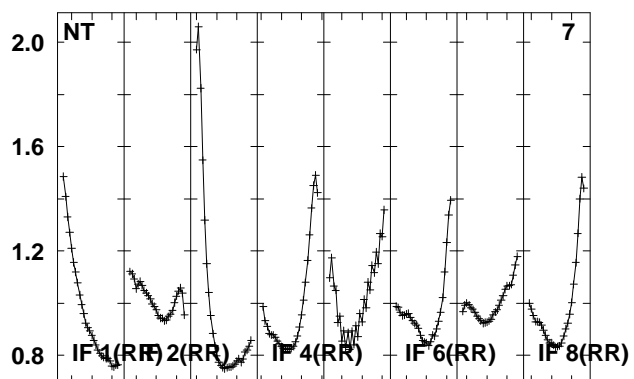
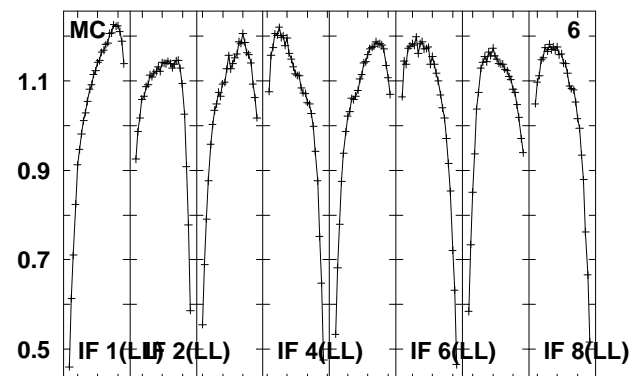
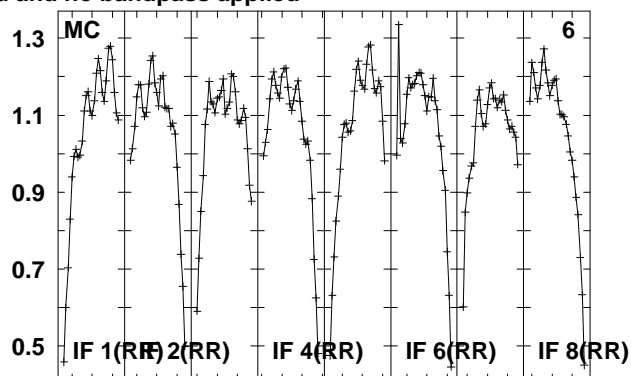
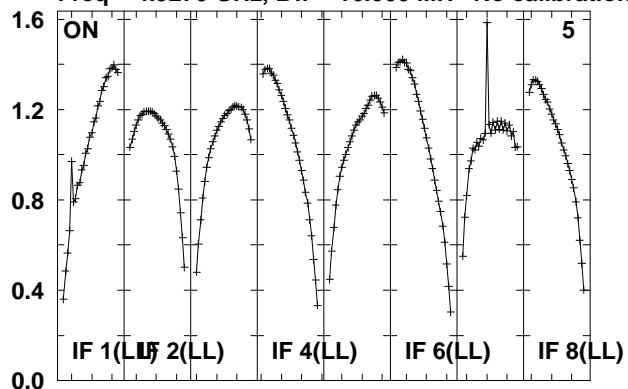

Lower frame: Real Jy

Total-power spectrum Antenna: *

Timerange: 00/23:25:21 to 00/23:26:49

Plot file version 687 created 14-MAY-2010 15:21:00

J102959 EO007.UVDATA.1

Freq = 4.9270 GHz, Bw = 16.000 MH No calibration applied and no bandpass applied

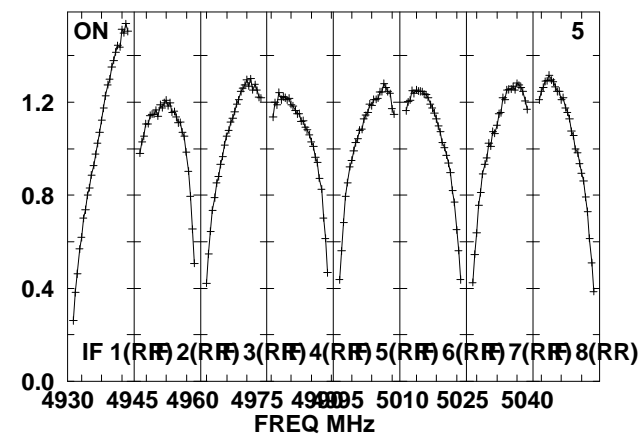
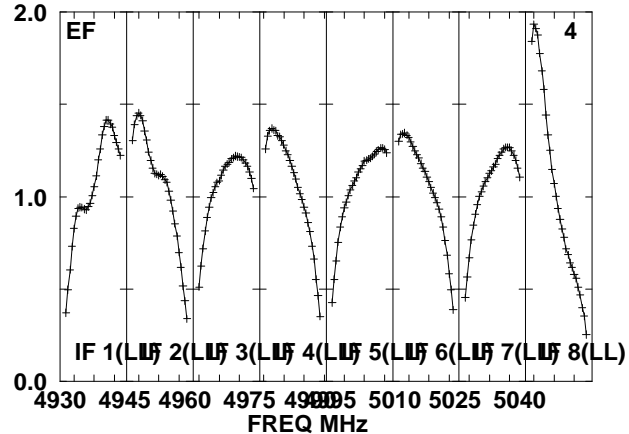
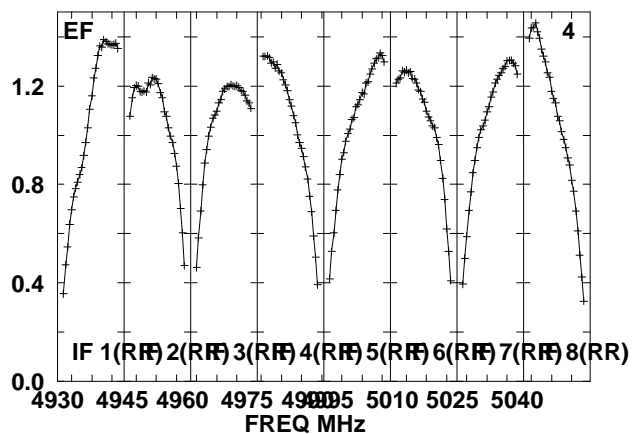
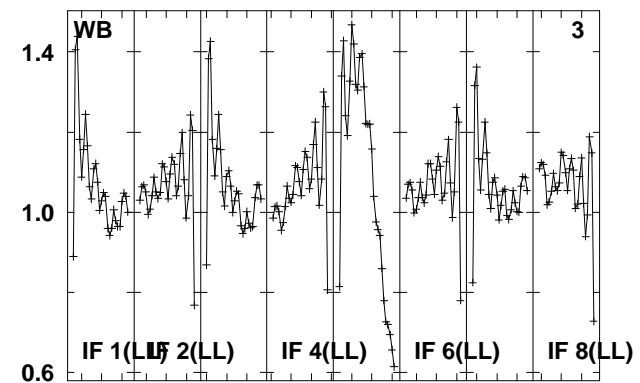
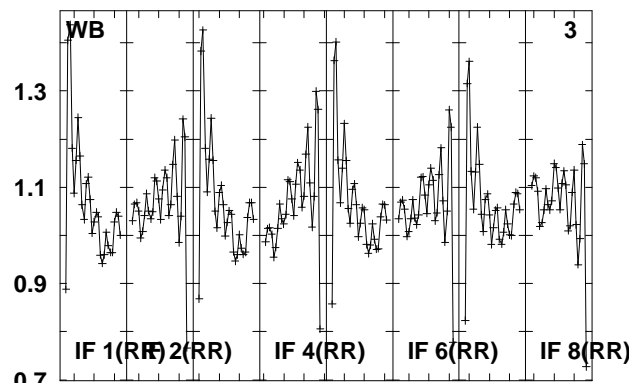
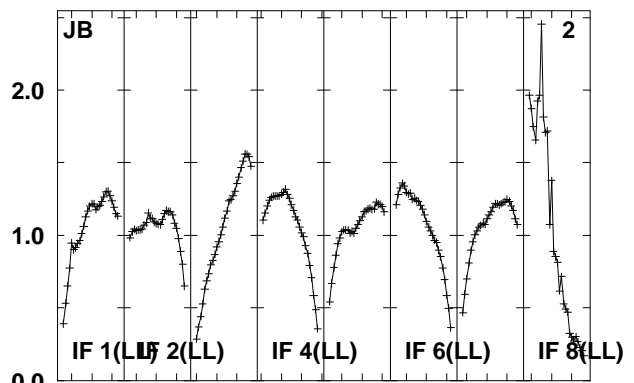
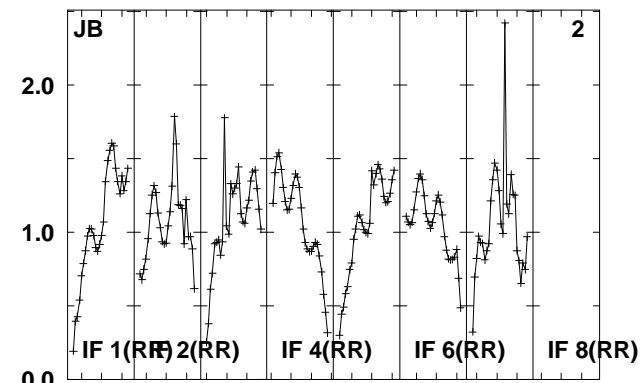
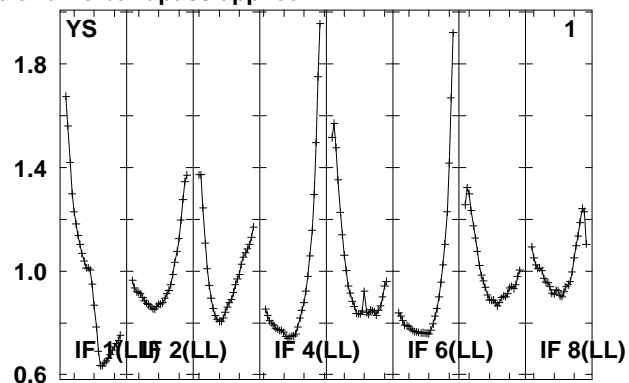
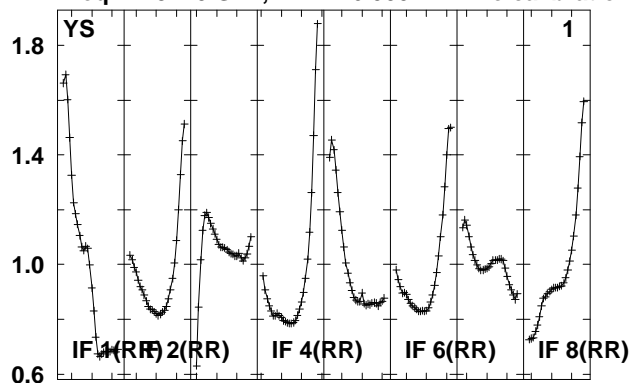

Lower frame: Real Jy
Total-power spectrum Antenna: *
Timerange: 00/23:27:17 to 00/23:32:15

Plot file version 688 created 14-MAY-2010 15:21:00

J102959 EO007.UVDATA.1

Freq = 4.9270 GHz, Bw = 16.000 MH No calibration applied and no bandpass applied

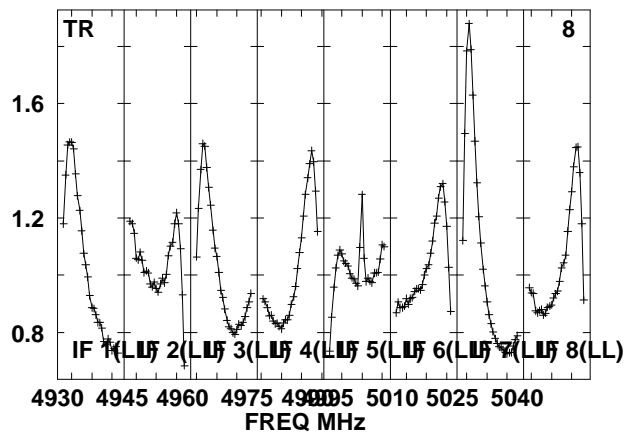
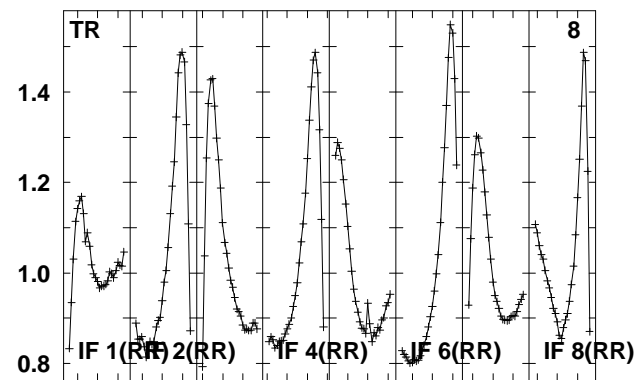
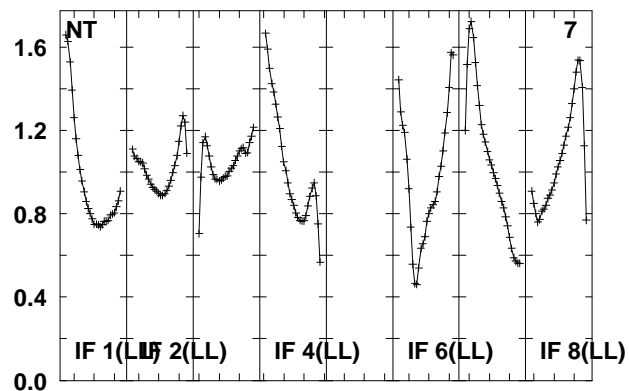
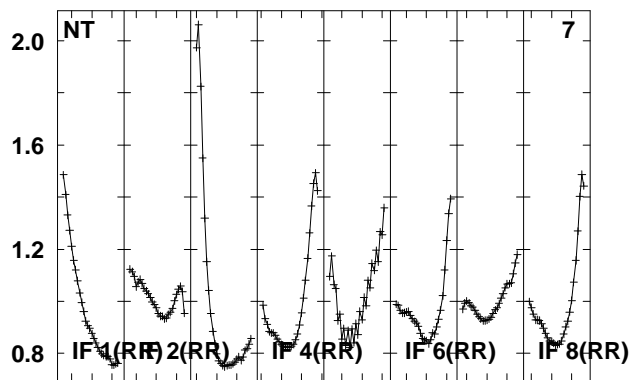
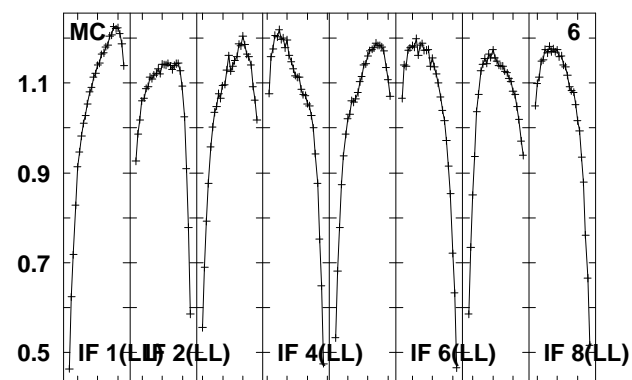
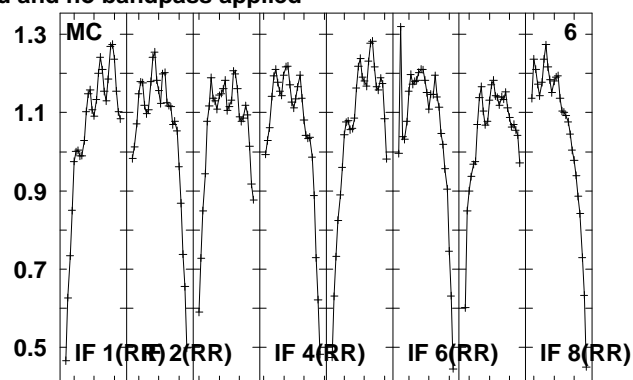
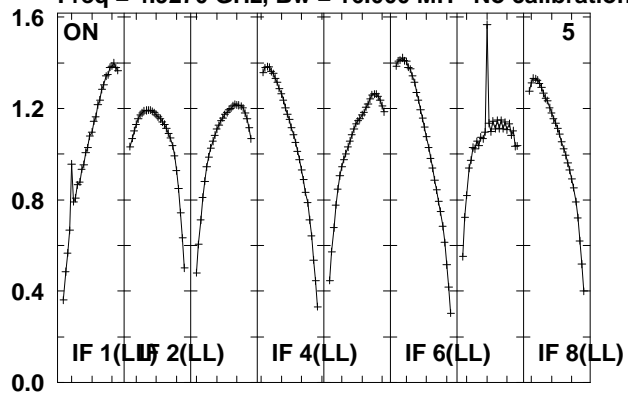

Lower frame: Real Jy

Total-power spectrum Antenna: *

Timerange: 00/23:27:17 to 00/23:32:15

Plot file version 689 created 14-MAY-2010 15:21:01

J1027+48 EO007.UVDATA.1

Freq = 4.9270 GHz, Bw = 16.000 MH No calibration applied and no bandpass applied

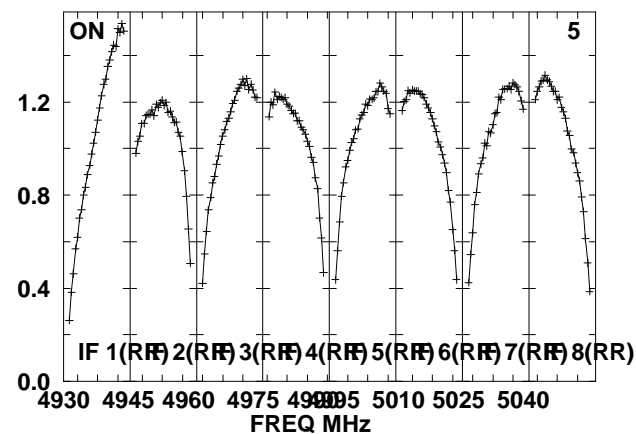
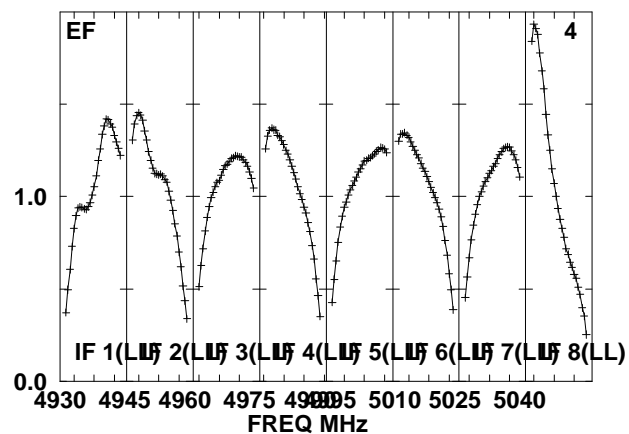
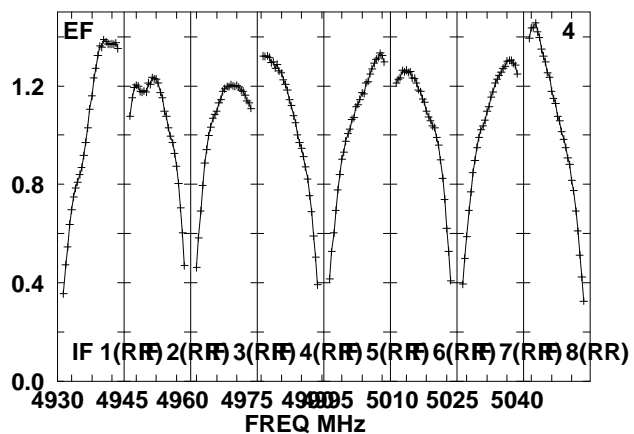
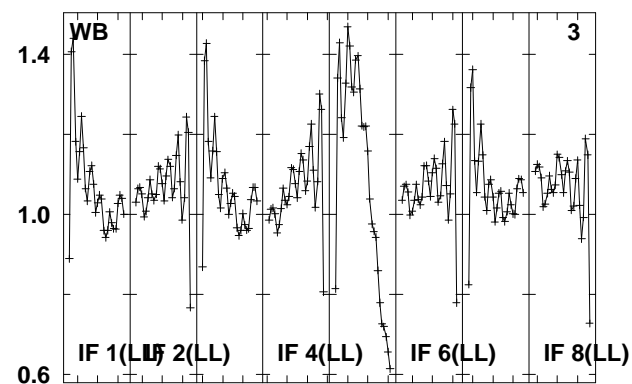
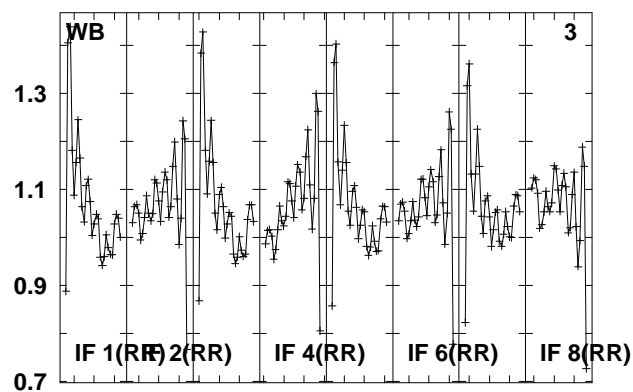
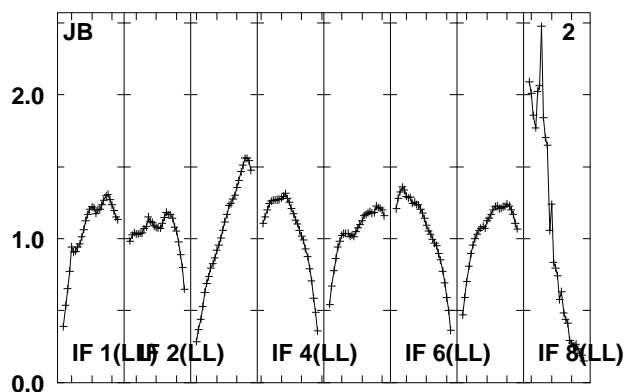
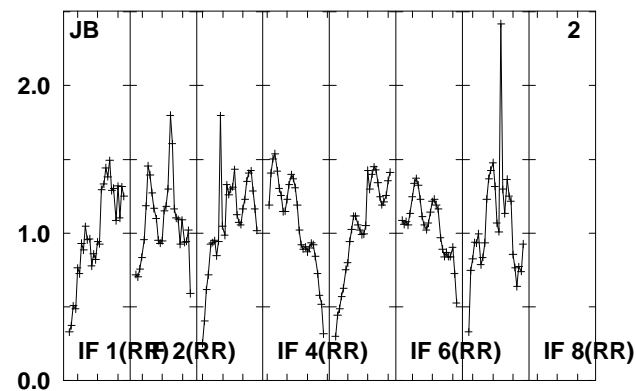
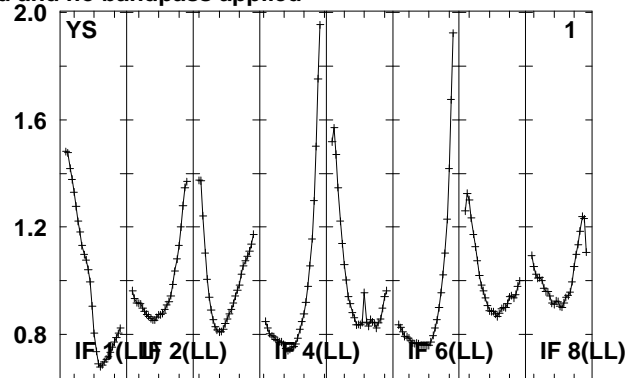
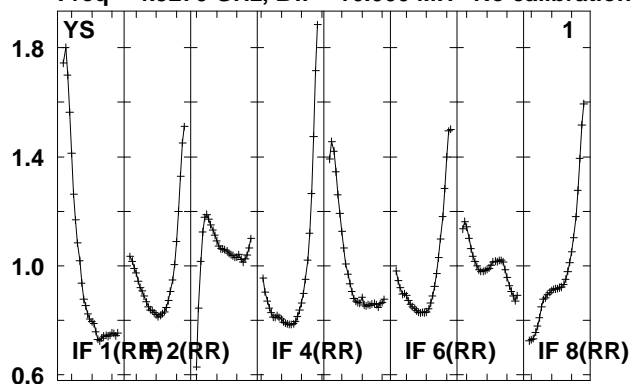

Lower frame: Real Jy

Total-power spectrum Antenna: *

Timerange: 00/23:32:41 to 00/23:34:09

Plot file version 690 created 14-MAY-2010 15:21:01

J1027+48 EO007.UVDATA.1

Freq = 4.9270 GHz, Bw = 16.000 MH No calibration applied and no bandpass applied

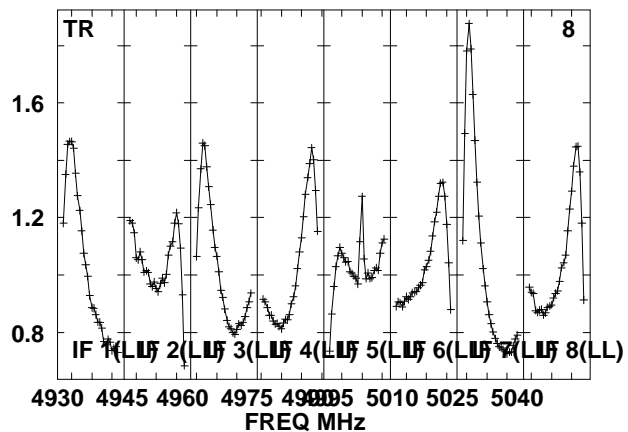
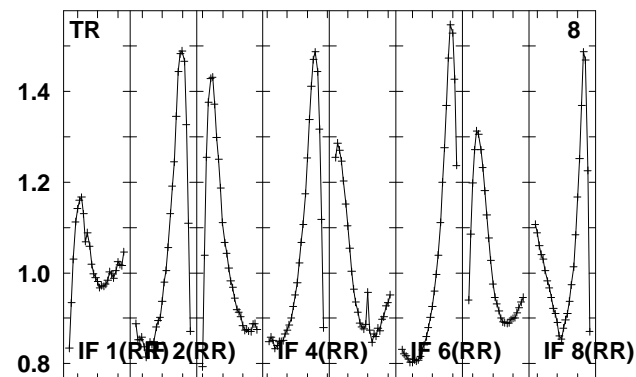
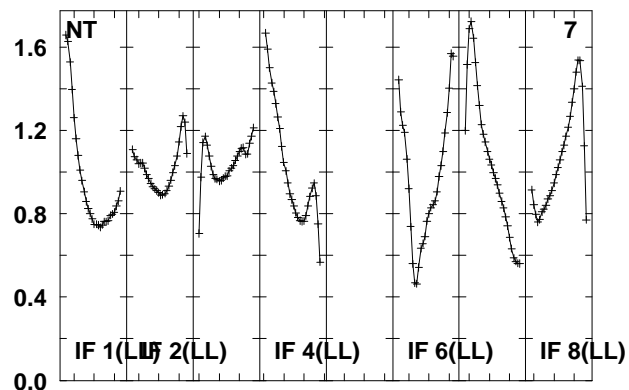
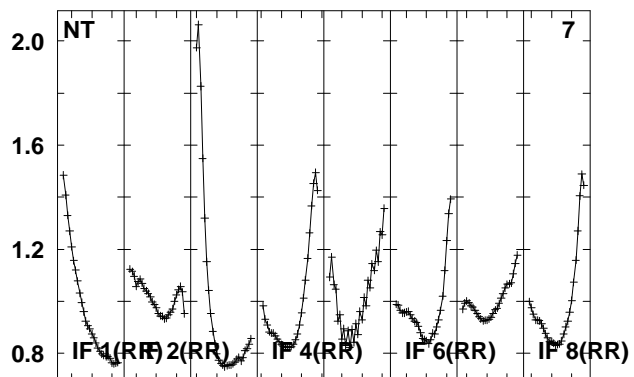
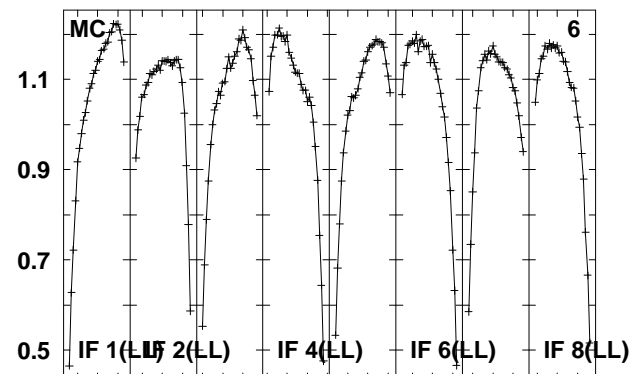
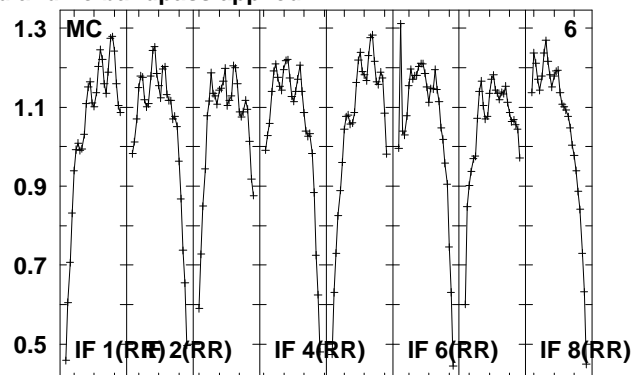
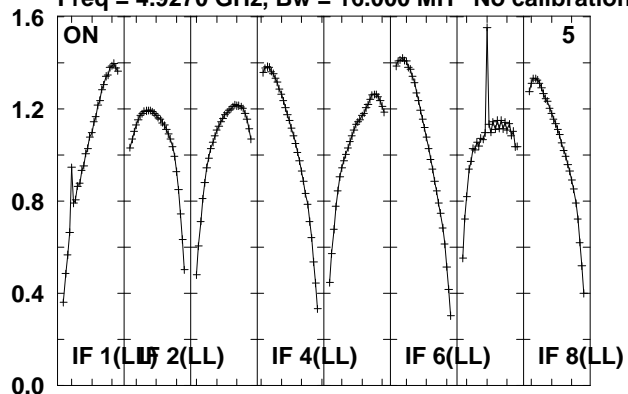

Lower frame: Real Jy

Total-power spectrum Antenna: *

Timerange: 00/23:32:41 to 00/23:34:09

Plot file version 691 created 14-MAY-2010 15:21:01
 J102959 EO007.UVDATA.1
 Freq = 4.9270 GHz, Bw = 16.000 MH No calibration applied and no bandpass applied

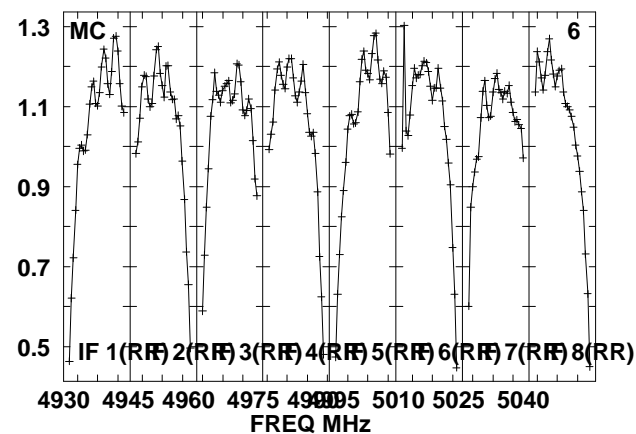
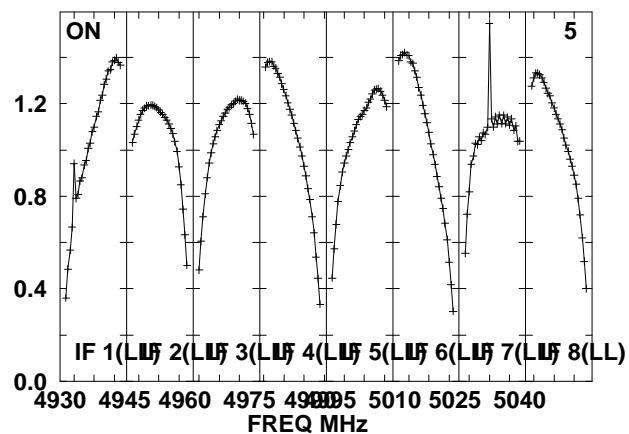
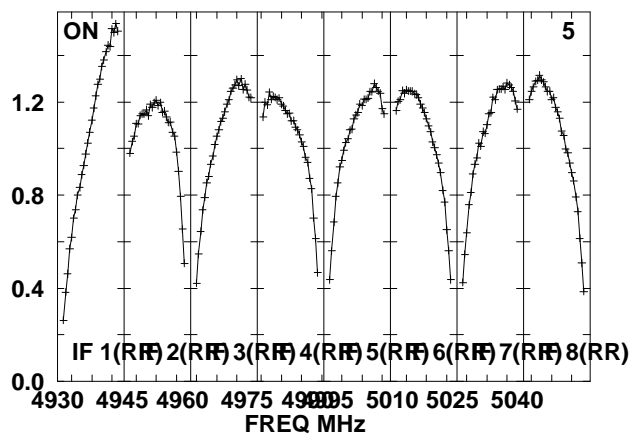
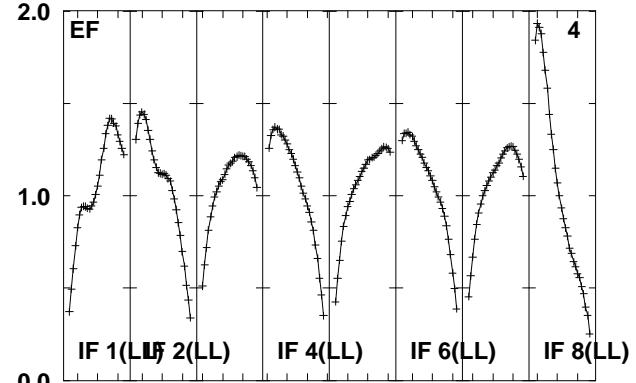
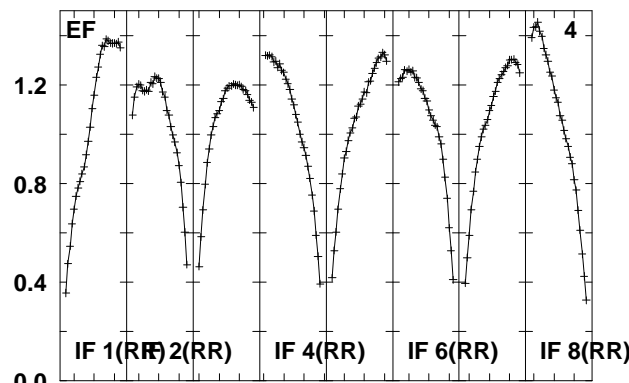
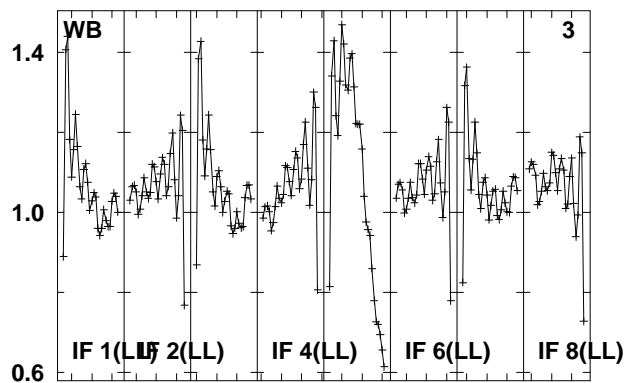
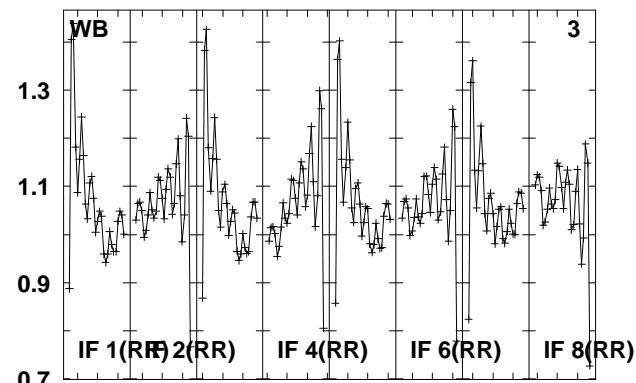
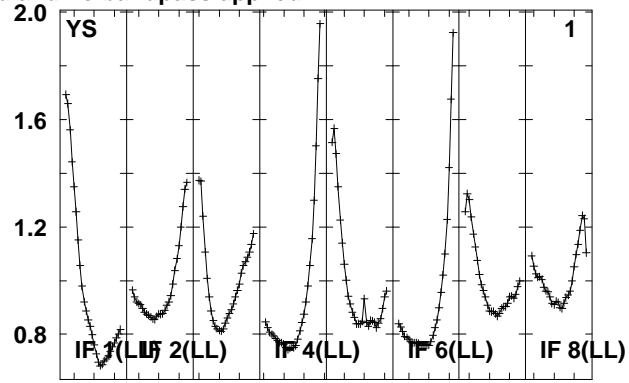
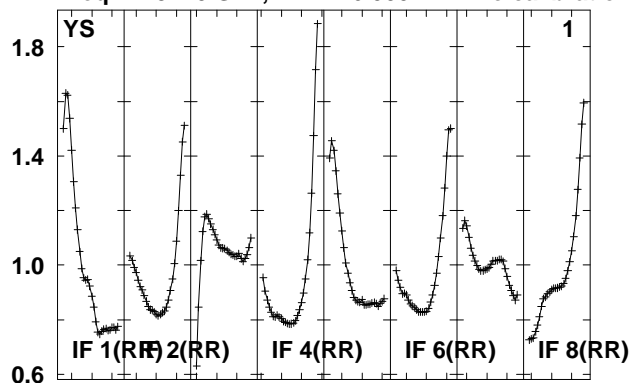

Lower frame: Real Jy
 Total-power spectrum Antenna: *
 Timerange: 00/23:34:37 to 00/23:39:33

Plot file version 692 created 14-MAY-2010 15:21:02

J102959 EO007.UVDATA.1

Freq = 4.9270 GHz, Bw = 16.000 MH No calibration applied and no bandpass applied

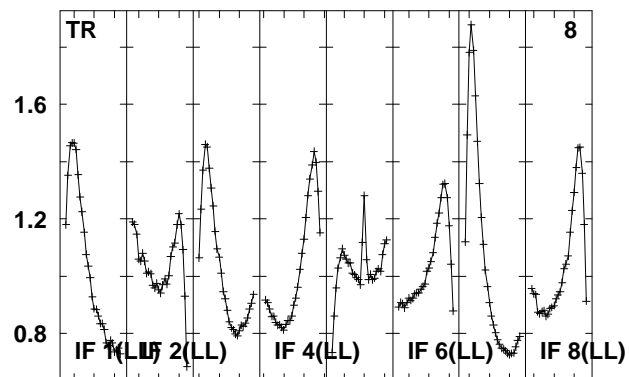
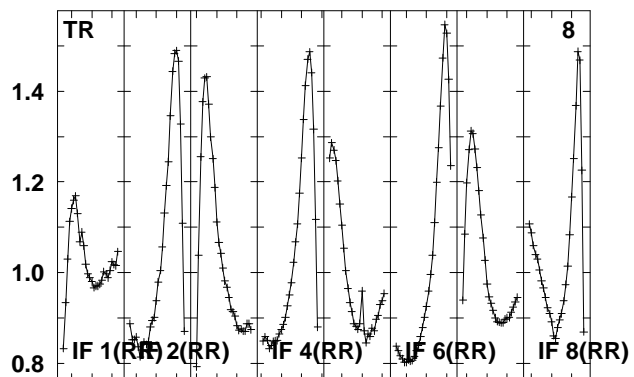
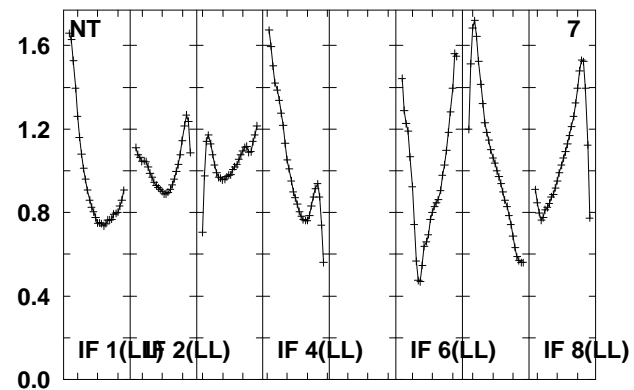
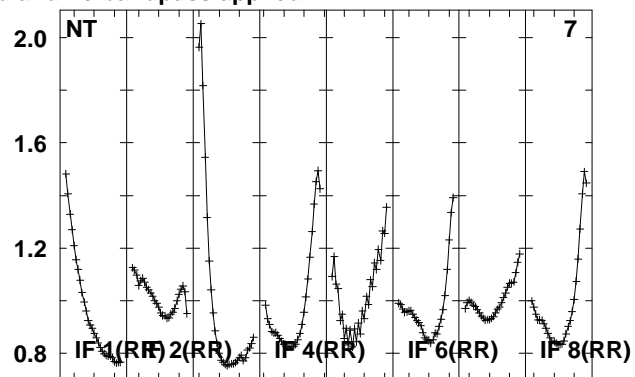
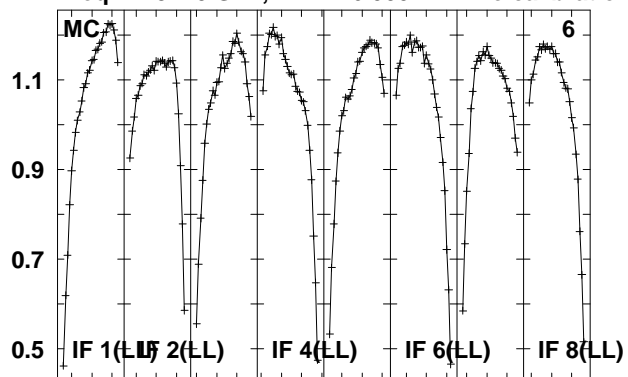

Lower frame: Real Jy
Total-power spectrum Antenna: *
Timerange: 00/23:34:37 to 00/23:39:33

Plot file version 693 created 14-MAY-2010 15:21:02

J1027+48 EO007.UVDATA.1

Freq = 4.9270 GHz, Bw = 16.000 MH No calibration applied and no bandpass applied

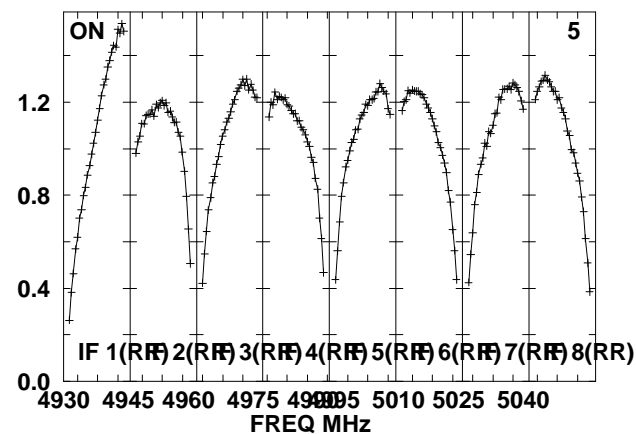
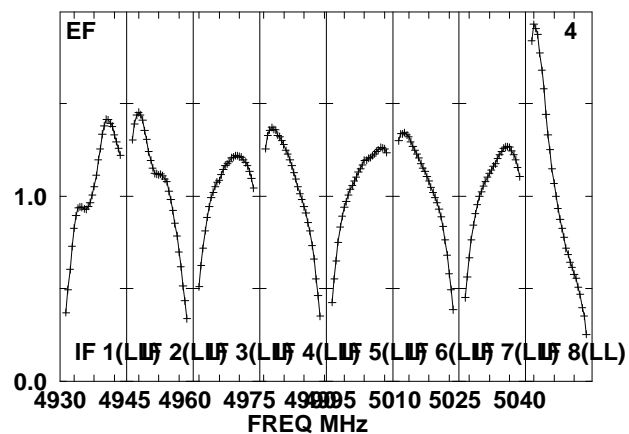
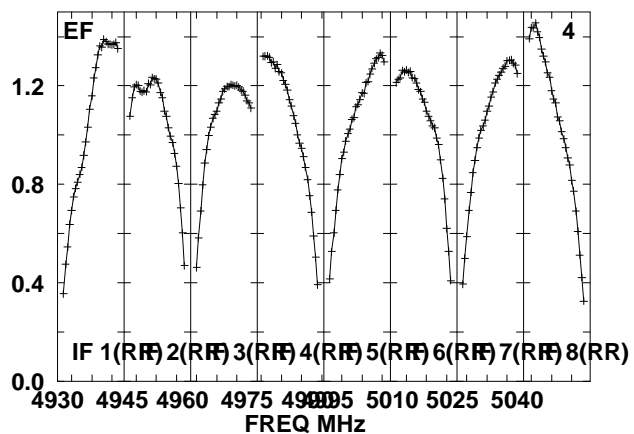
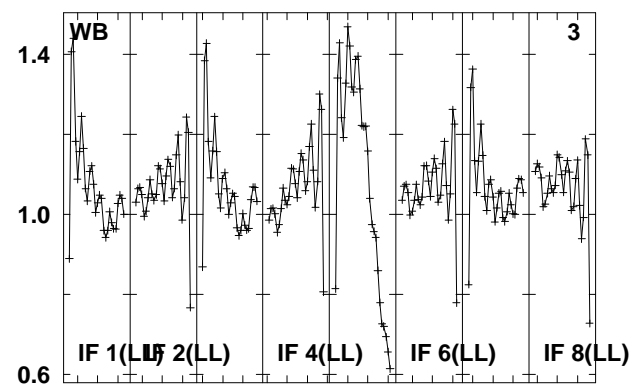
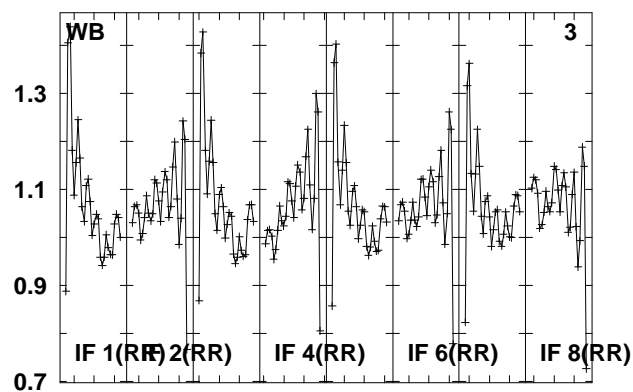
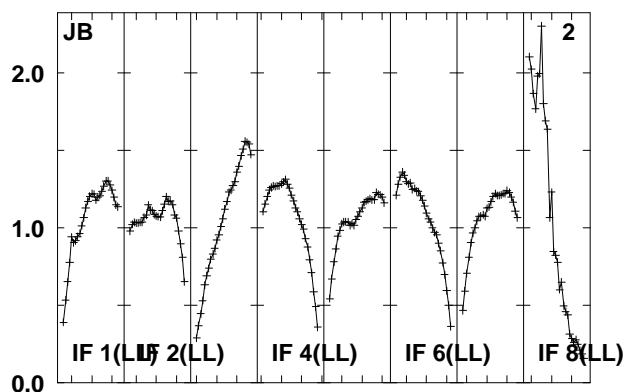
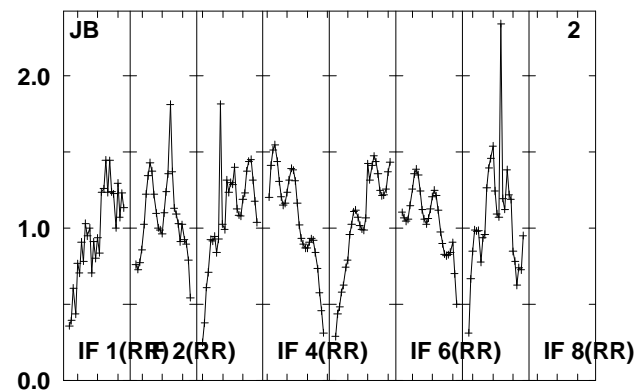
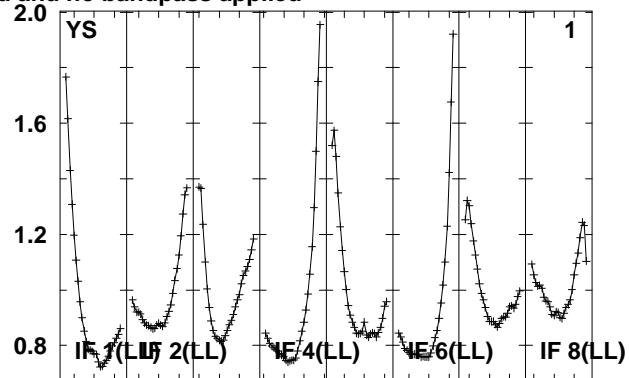
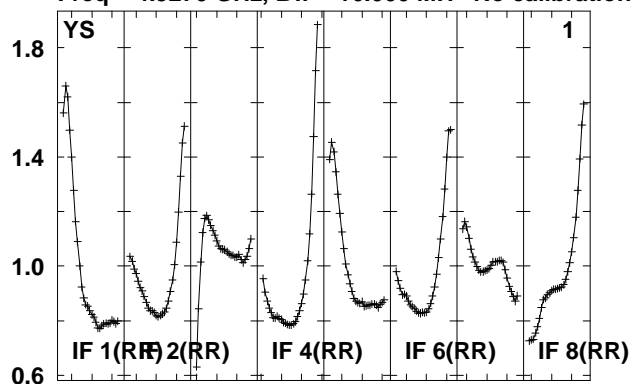

Lower frame: Real Jy

Total-power spectrum Antenna: *

Timerange: 00/23:39:59 to 00/23:41:27

Plot file version 694 created 14-MAY-2010 15:21:02

J1027+48 EO007.UVDATA.1

Freq = 4.9270 GHz, Bw = 16.000 MH No calibration applied and no bandpass applied

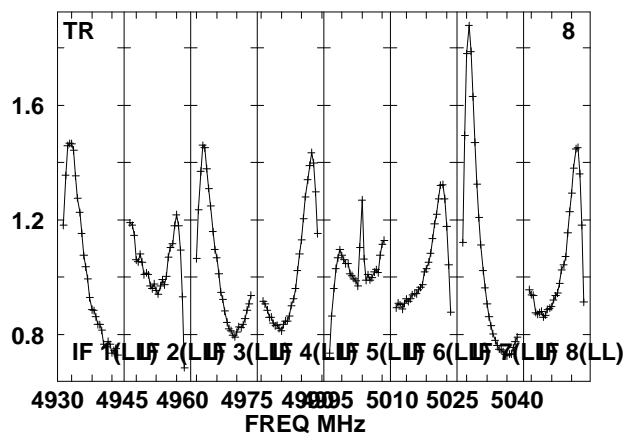
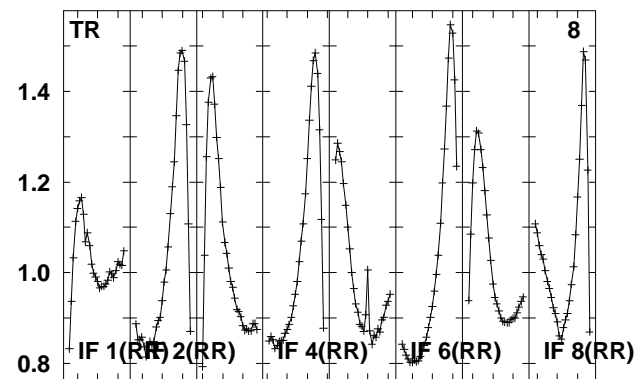
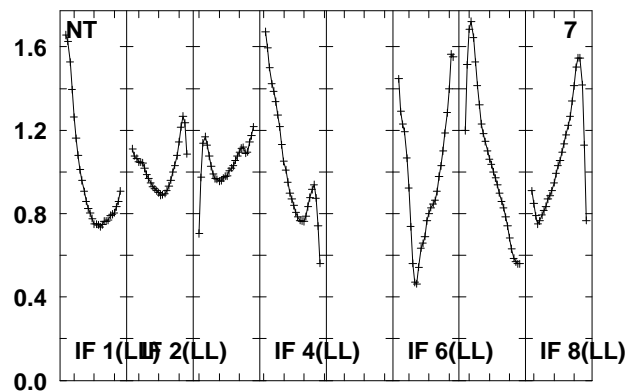
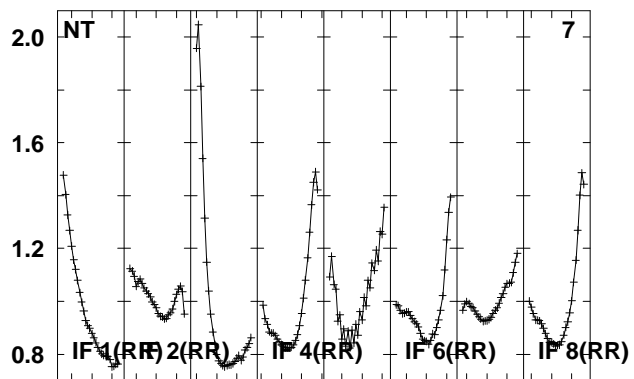
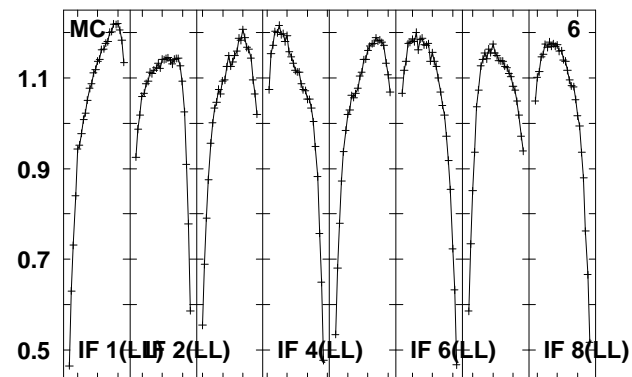
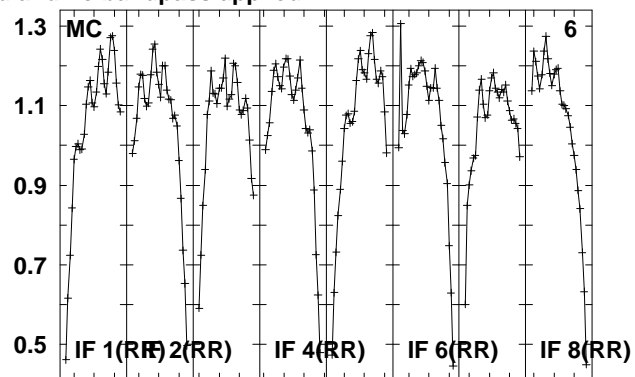
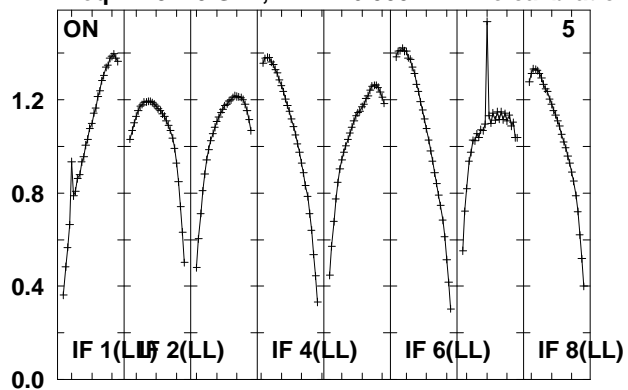

4930 4945 4960 4975 4990 5005 5010 5025 5040
FREQ MHz

Lower frame: Real Jy

Total-power spectrum Antenna: *

Timerange: 00/23:39:59 to 00/23:41:27

Plot file version 695 created 14-MAY-2010 15:21:02

J0920+44 EO007.UVDATA.1

Freq = 4.9270 GHz, Bw = 16.000 MH No calibration applied and no bandpass applied

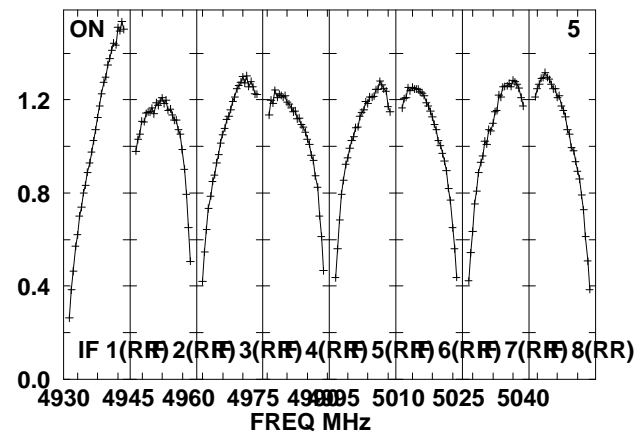
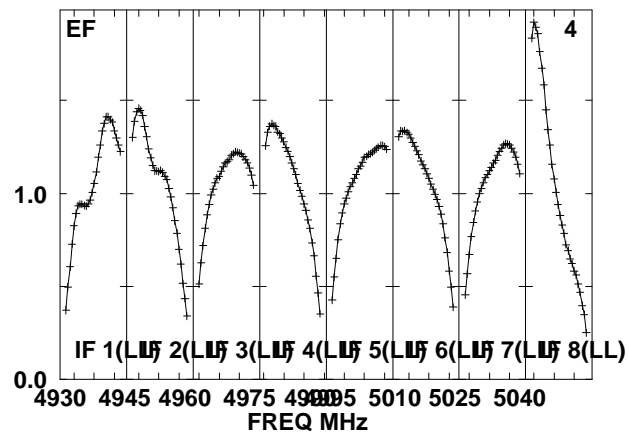
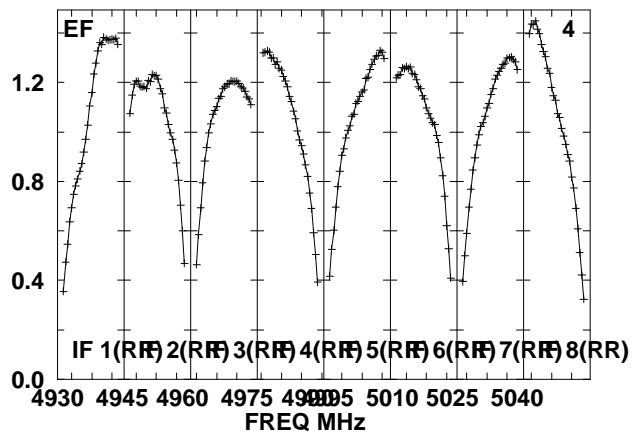
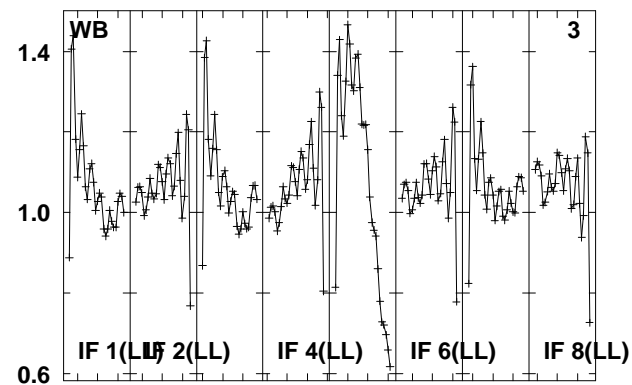
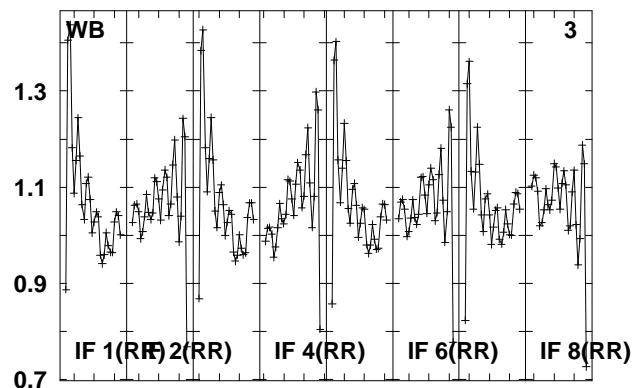
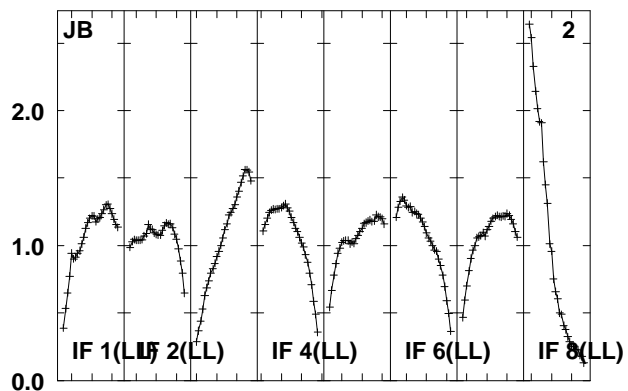
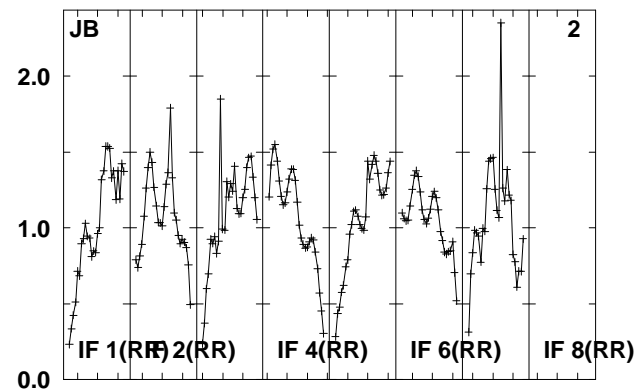
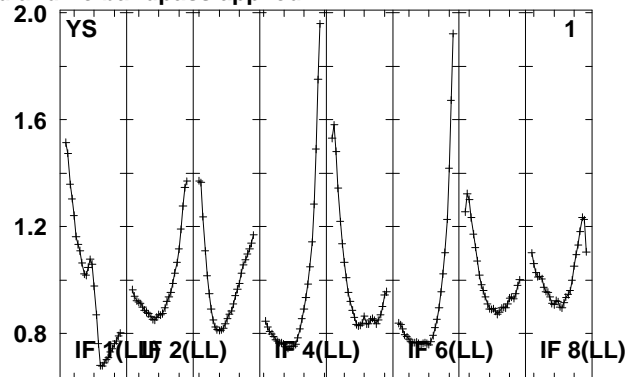
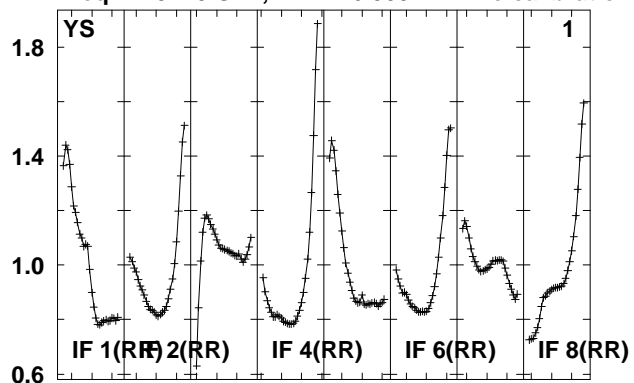

Lower frame: Real Jy

Total-power spectrum Antenna: *

Timerange: 00/23:42:55 to 00/23:44:23

Plot file version 696 created 14-MAY-2010 15:21:03

J0920+44 EO007.UVDATA.1

Freq = 4.9270 GHz, Bw = 16.000 MH No calibration applied and no bandpass applied

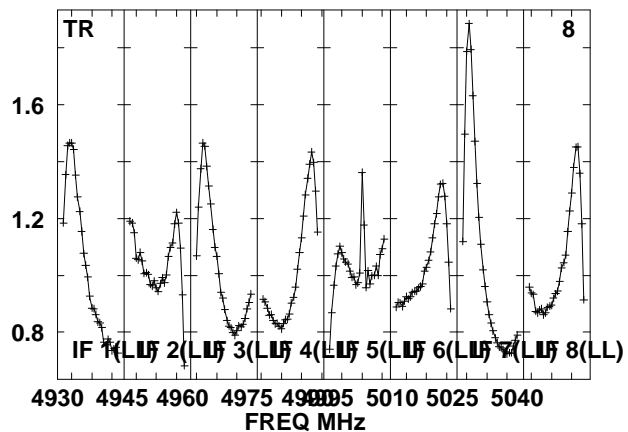
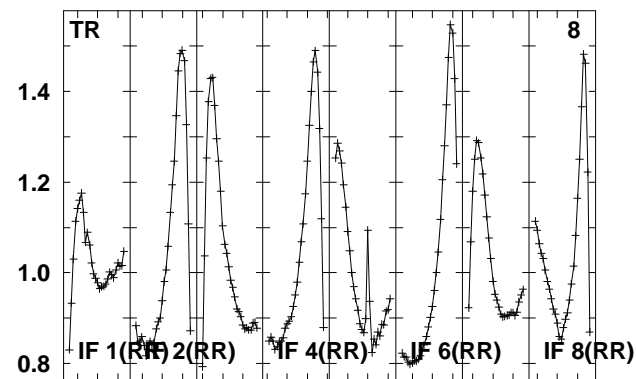
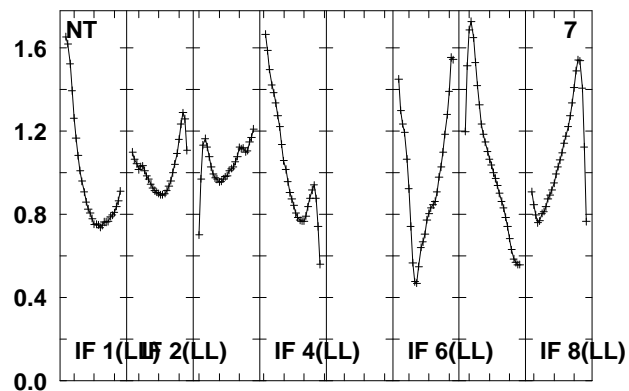
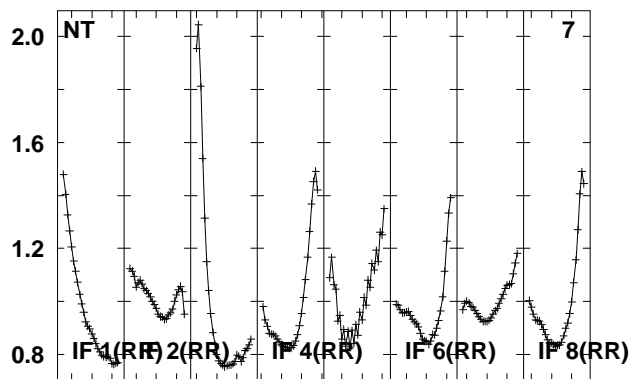
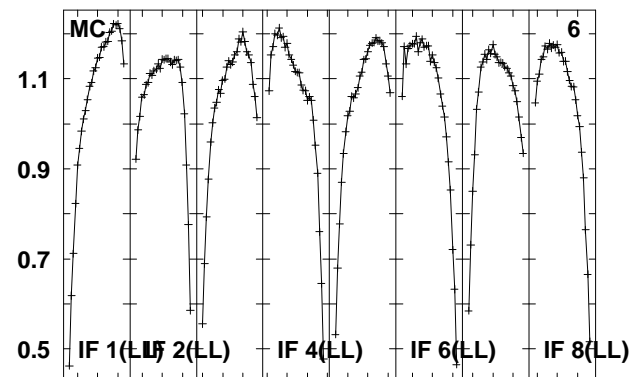
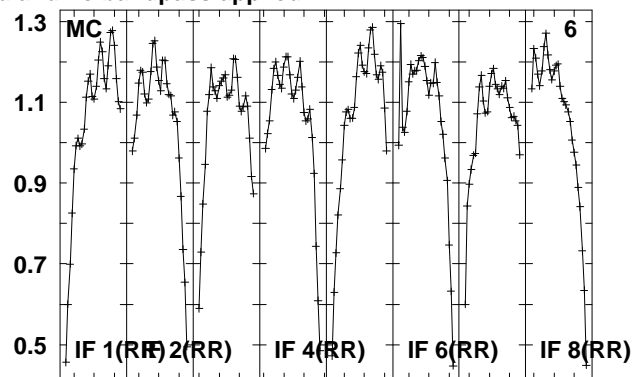
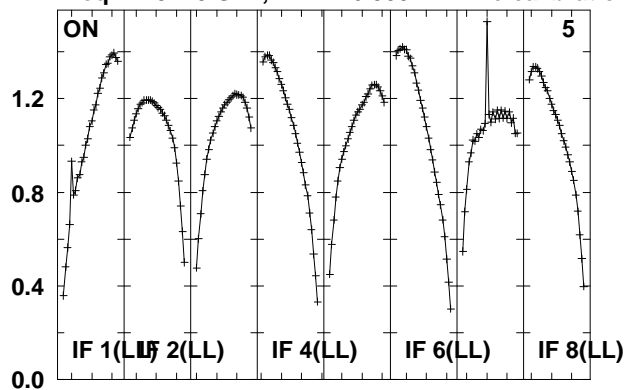

Lower frame: Real Jy

Total-power spectrum Antenna: *

Timerange: 00/23:42:55 to 00/23:44:23

Plot file version 697 created 14-MAY-2010 15:21:03

J092159 EO007.UVDATA.1

Freq = 4.9270 GHz, Bw = 16.000 MH No calibration applied and no bandpass applied

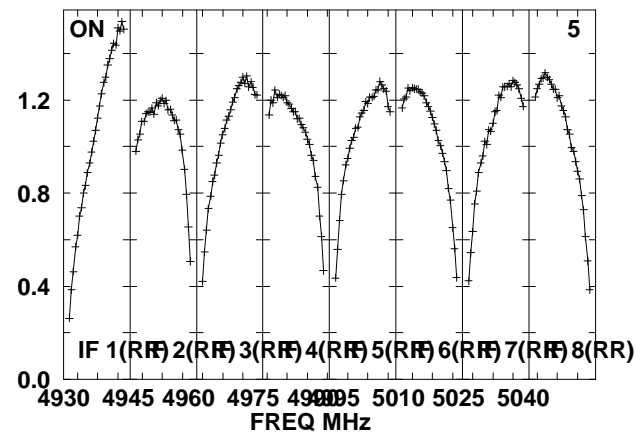
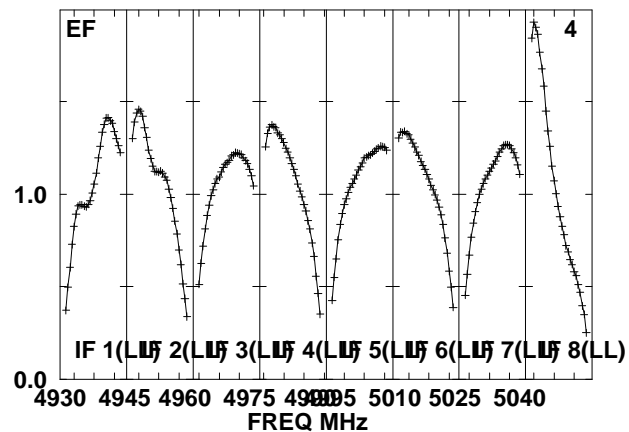
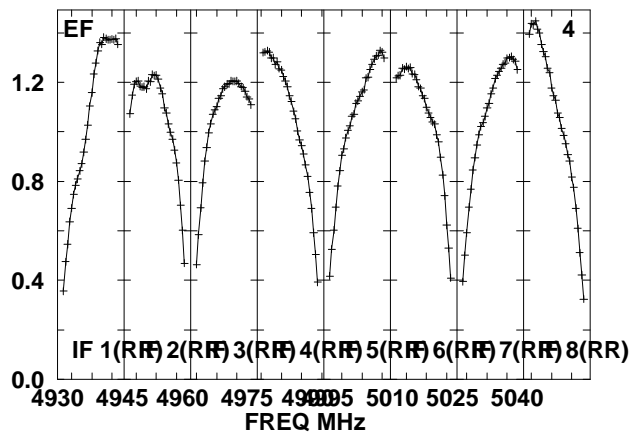
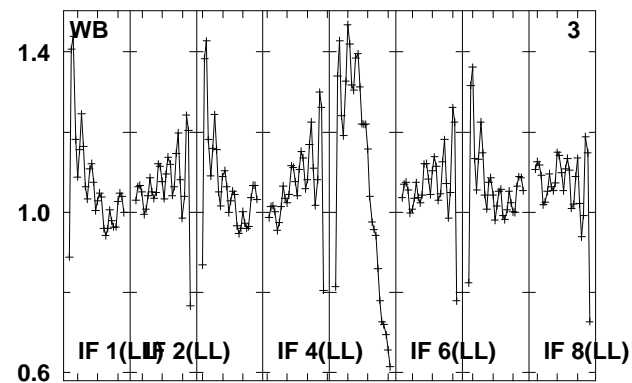
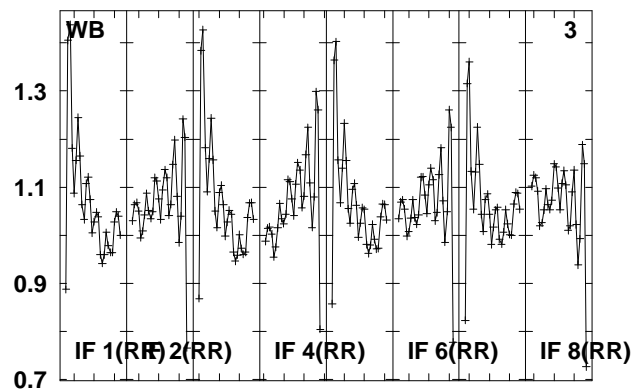
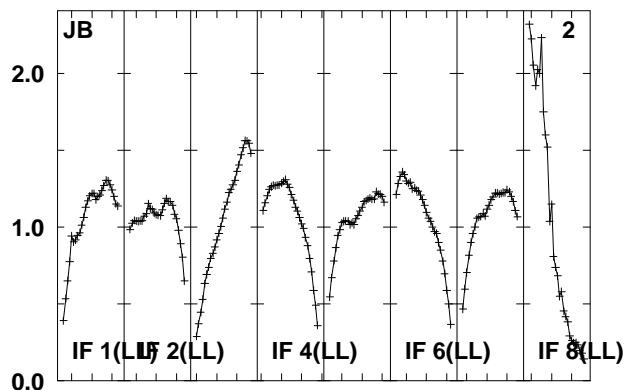
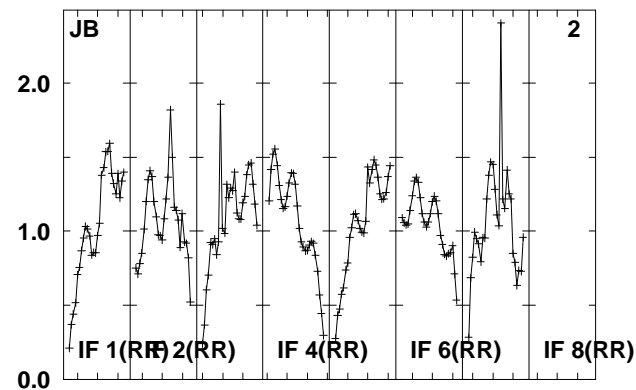
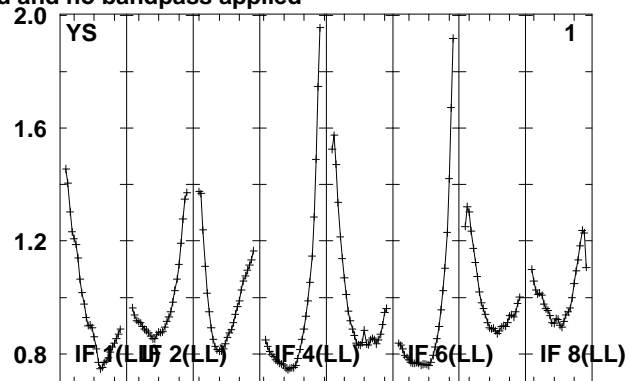
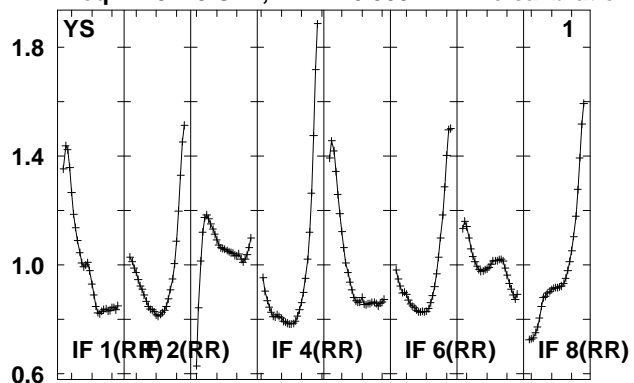

Lower frame: Real Jy
Total-power spectrum Antenna: *
Timerange: 00/23:44:47 to 00/23:49:45

Plot file version 698 created 14-MAY-2010 15:21:03

J092159 EO007.UVDATA.1

Freq = 4.9270 GHz, Bw = 16.000 MH No calibration applied and no bandpass applied

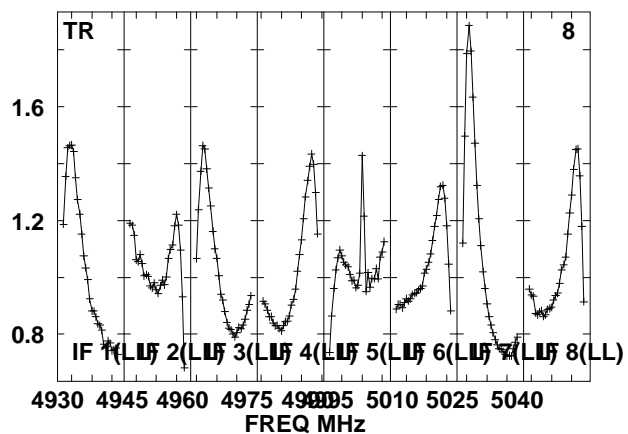
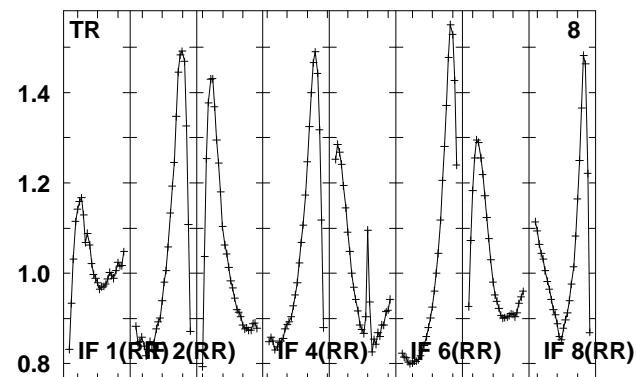
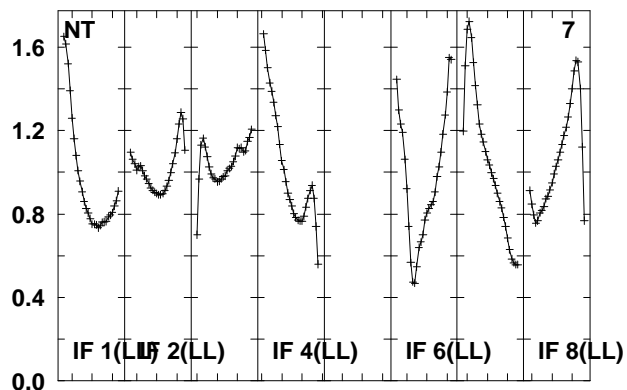
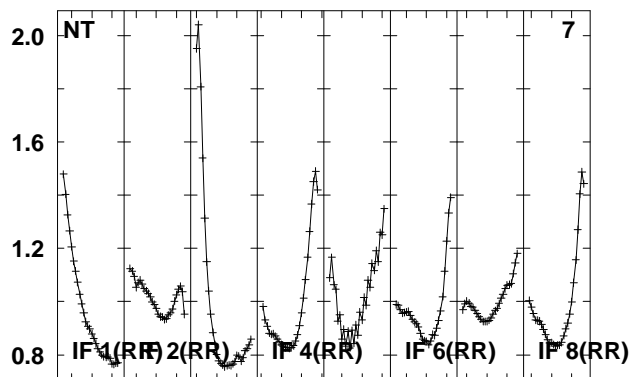
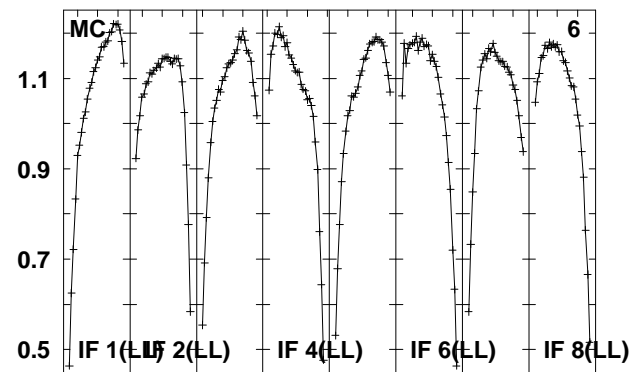
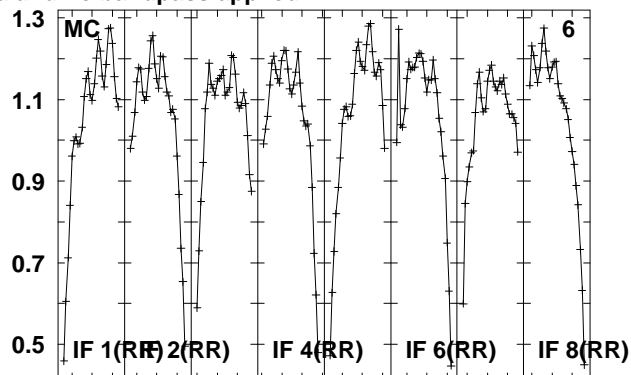
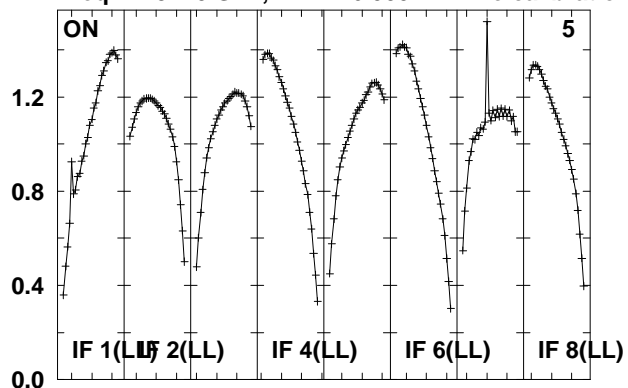

Lower frame: Real Jy

Total-power spectrum Antenna: *

Timerange: 00/23:44:47 to 00/23:49:45

Plot file version 699 created 14-MAY-2010 15:21:04

J0920+44 EO007.UVDATA.1

Freq = 4.9270 GHz, Bw = 16.000 MH No calibration applied and no bandpass applied

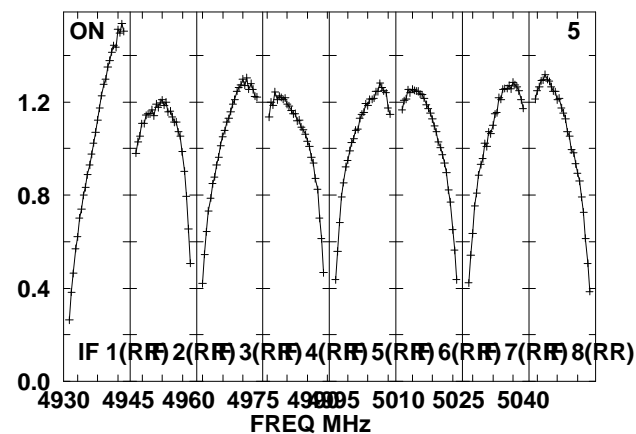
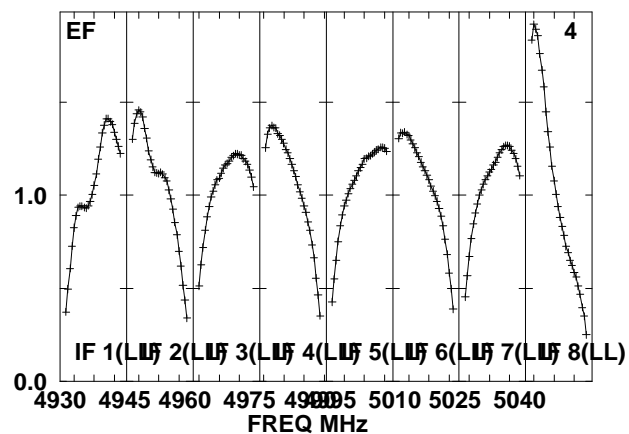
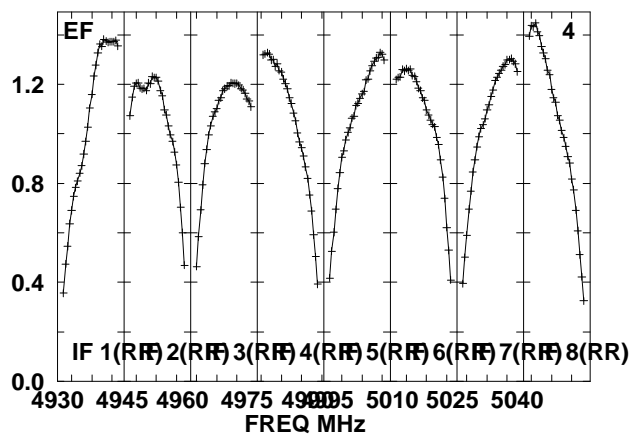
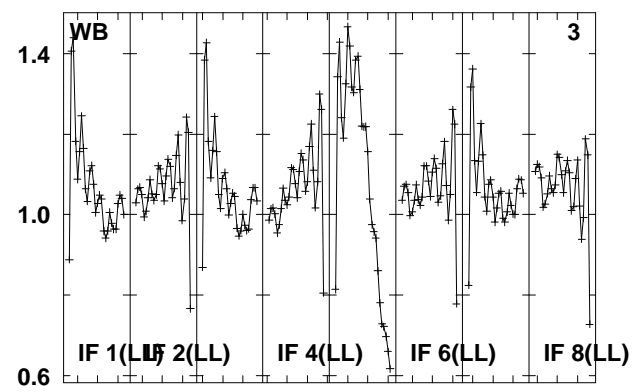
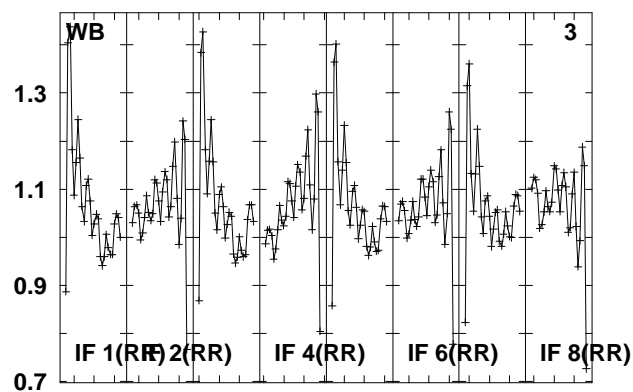
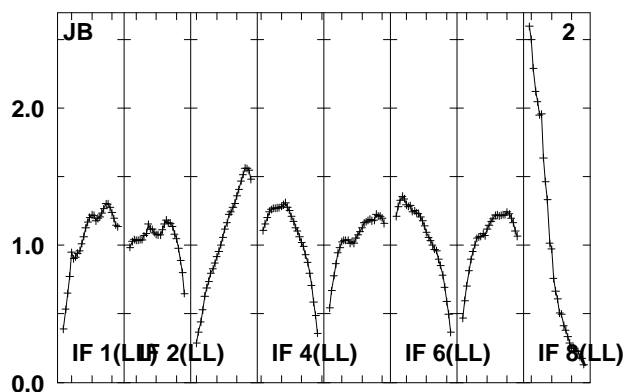
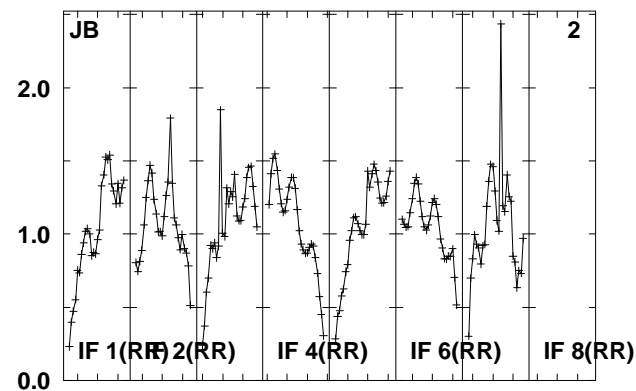
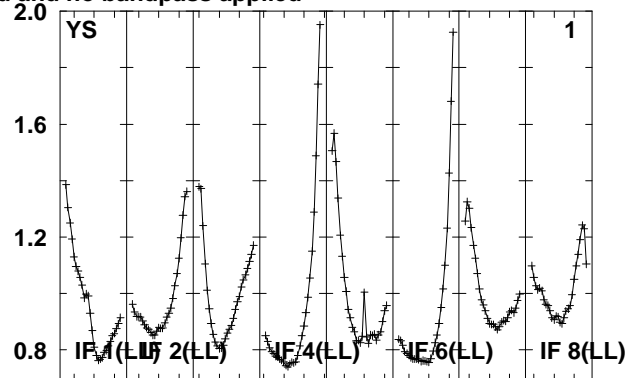
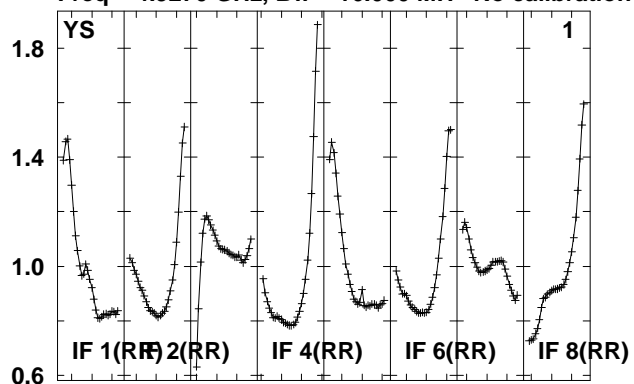

Lower frame: Real Jy

Total-power spectrum Antenna: *

Timerange: 00/23:50:07 to 00/23:51:33

Plot file version 700 created 14-MAY-2010 15:21:04

J0920+44 EO007.UVDATA.1

Freq = 4.9270 GHz, Bw = 16.000 MH No calibration applied and no bandpass applied

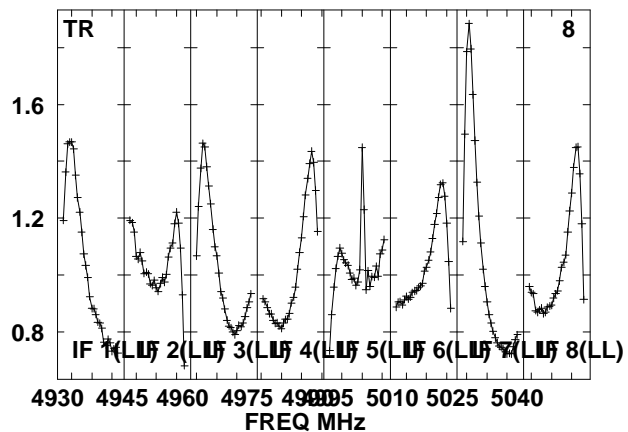
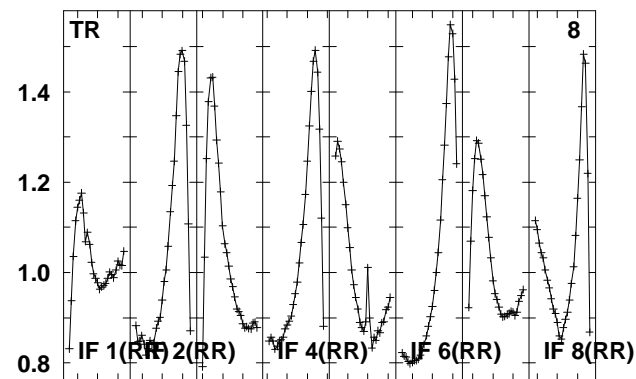
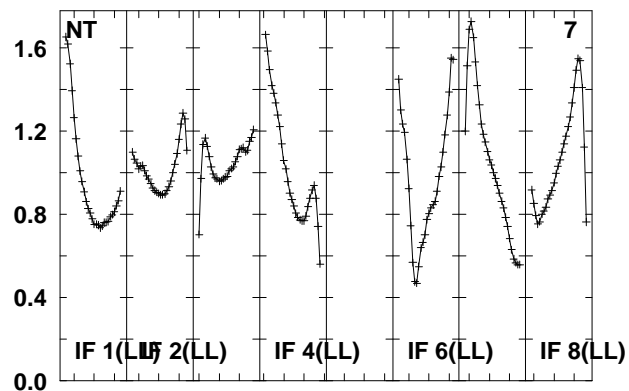
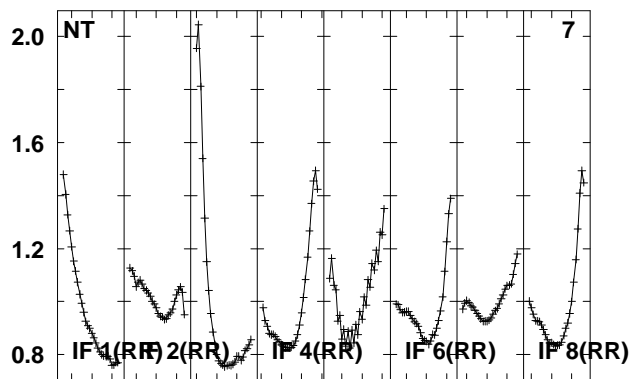
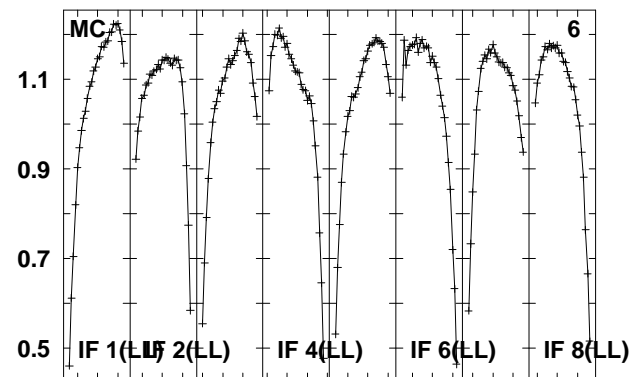
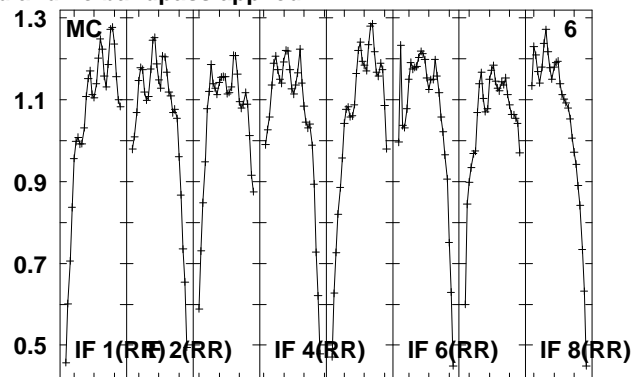
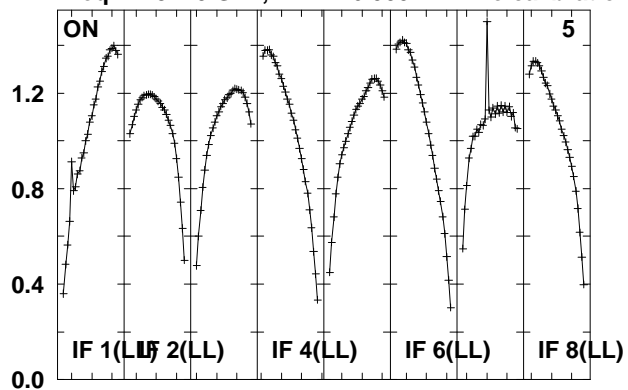

Lower frame: Real Jy

Total-power spectrum Antenna: *

Timerange: 00/23:50:07 to 00/23:51:33

Plot file version 701 created 14-MAY-2010 15:21:04

J092159 EO007.UVDATA.1

Freq = 4.9270 GHz, Bw = 16.000 MH No calibration applied and no bandpass applied

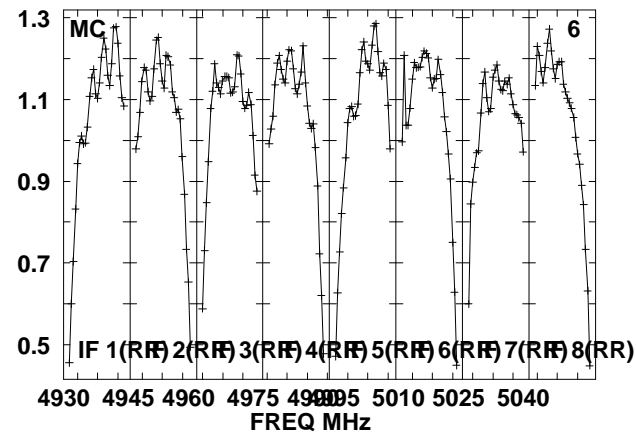
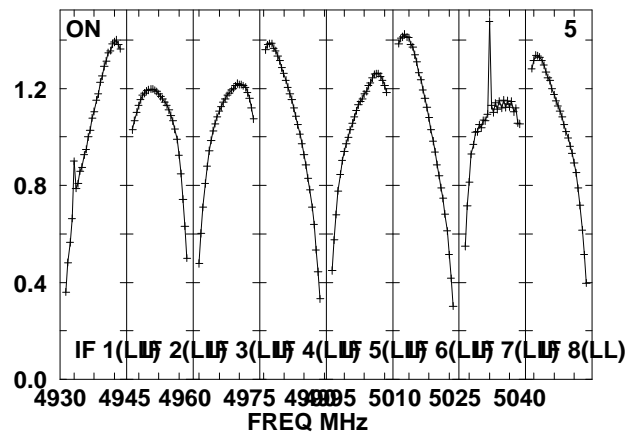
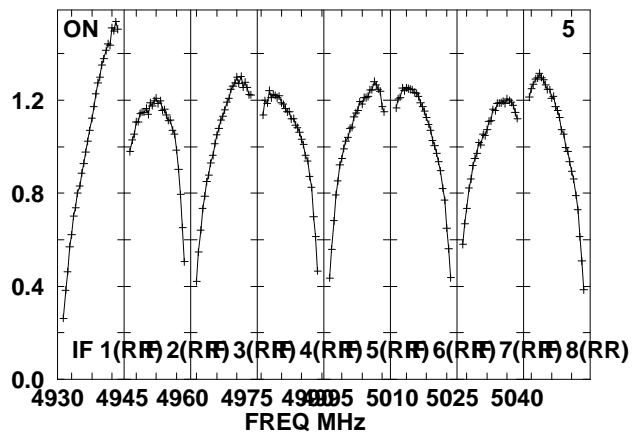
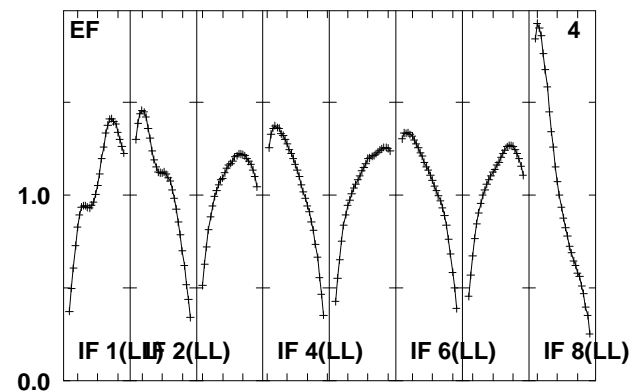
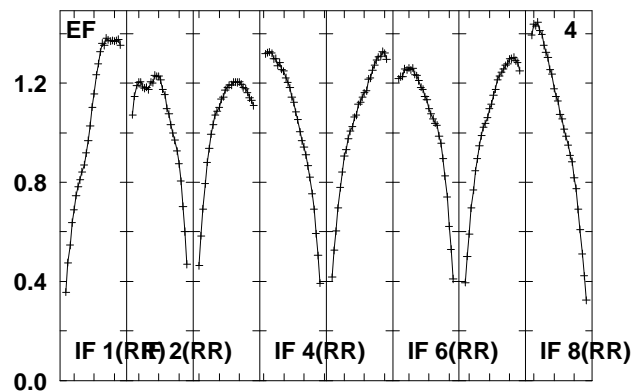
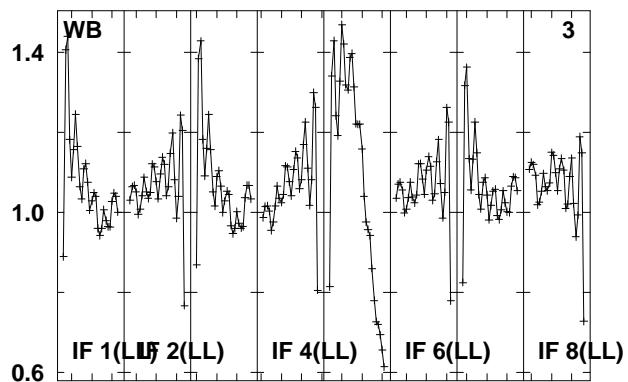
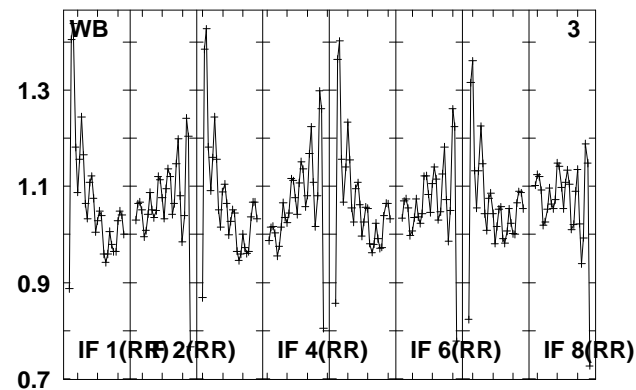
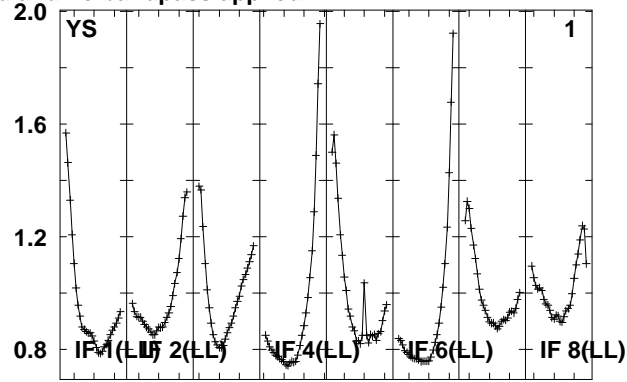
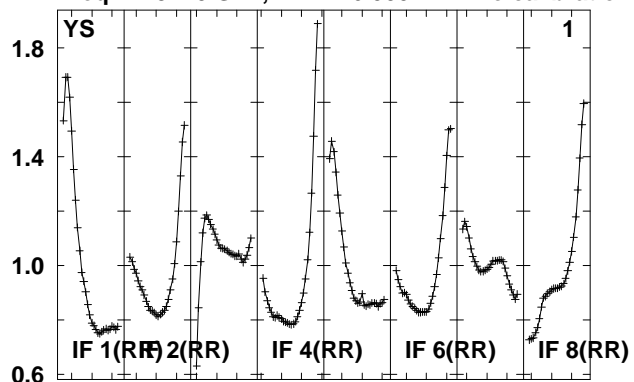

Lower frame: Real Jy
Total-power spectrum Antenna: *
Timerange: 00/23:51:58 to 00/23:56:54

Plot file version 702 created 14-MAY-2010 15:21:05

J092159 EO007.UVDATA.1

Freq = 4.9270 GHz, Bw = 16.000 MH No calibration applied and no bandpass applied

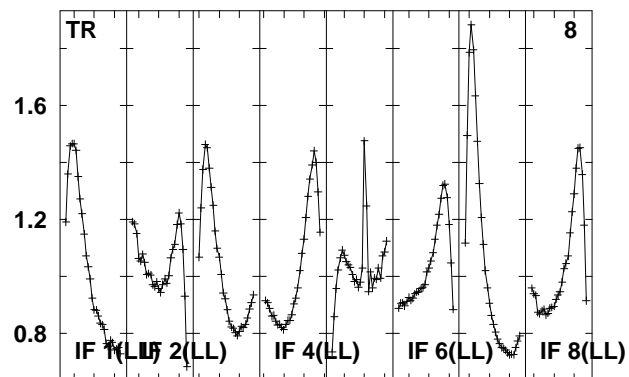
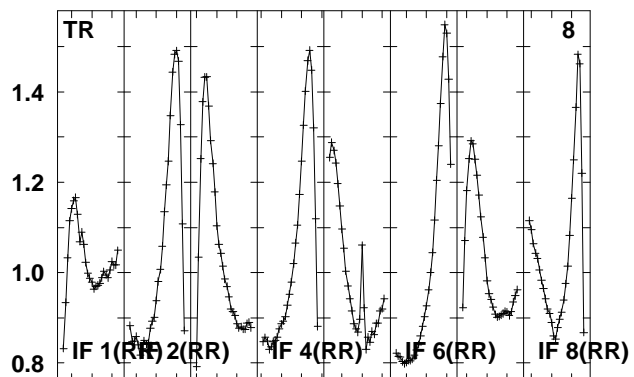
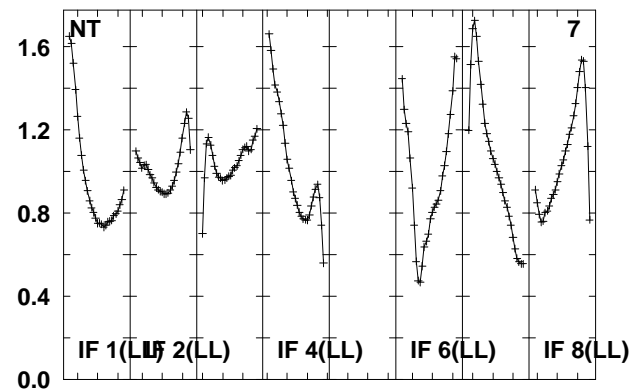
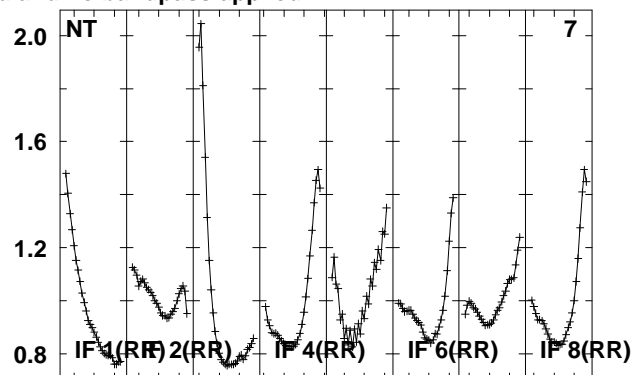
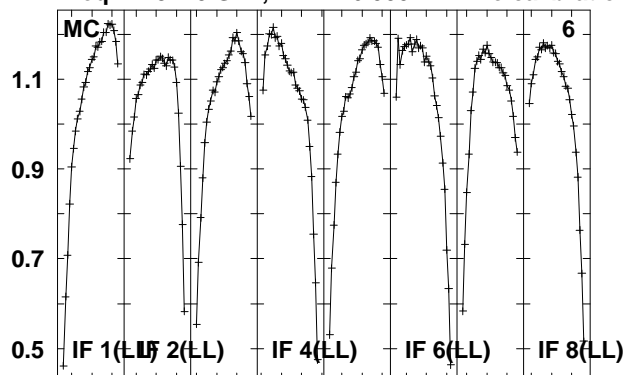

Lower frame: Real Jy
Total-power spectrum Antenna: *
Timerange: 00/23:51:58 to 00/23:56:54

Plot file version 703 created 14-MAY-2010 15:21:05

J0920+44 EO007.UVDATA.1

Freq = 4.9270 GHz, Bw = 16.000 MH No calibration applied and no bandpass applied

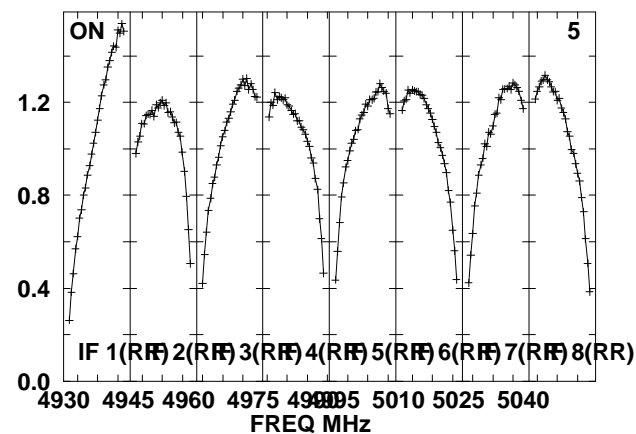
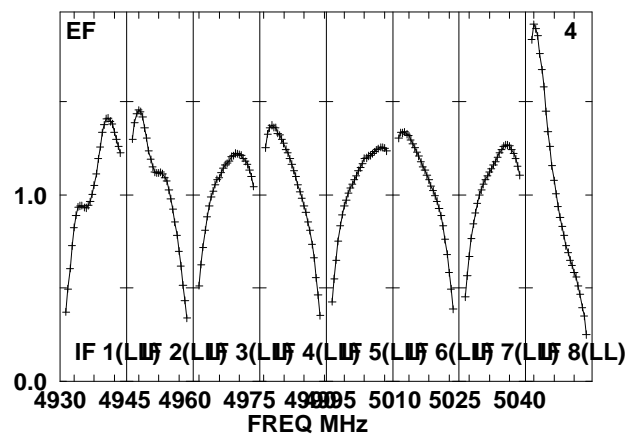
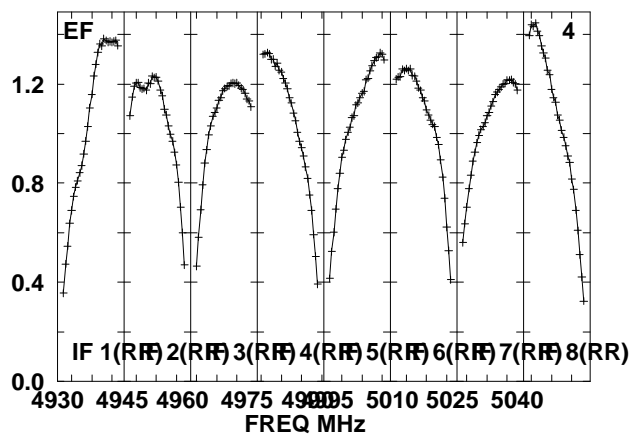
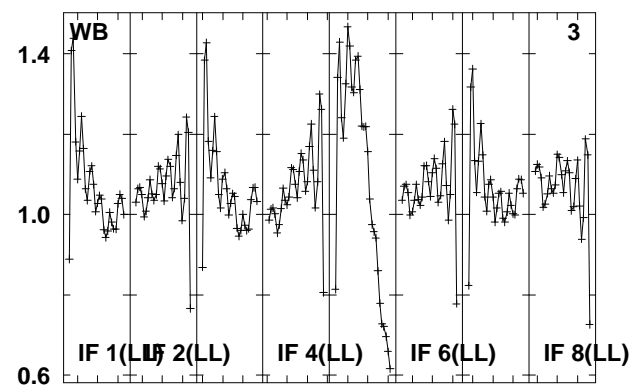
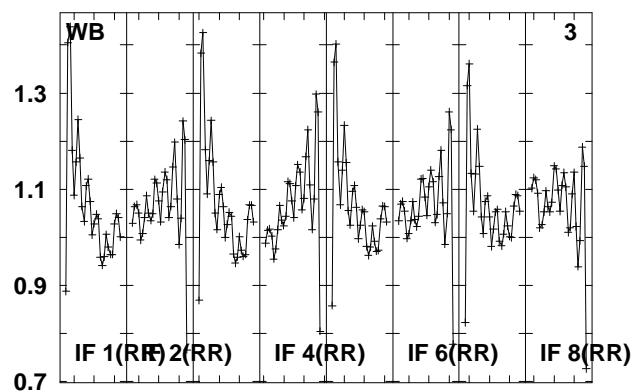
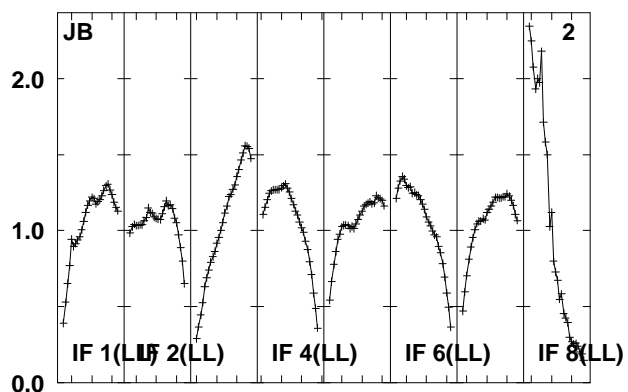
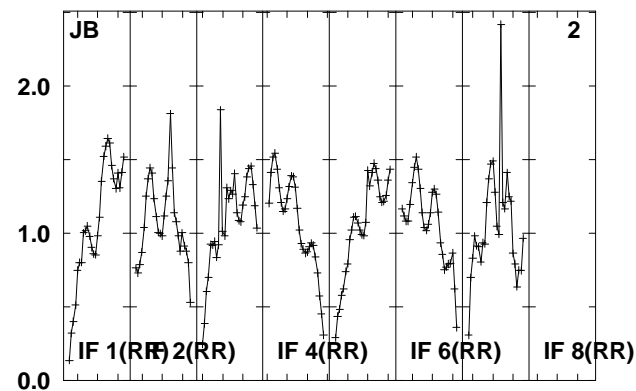
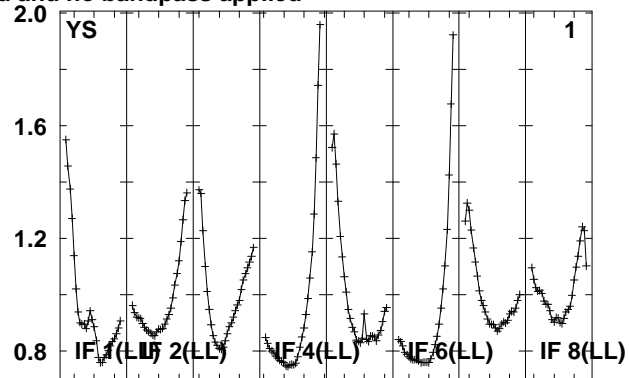
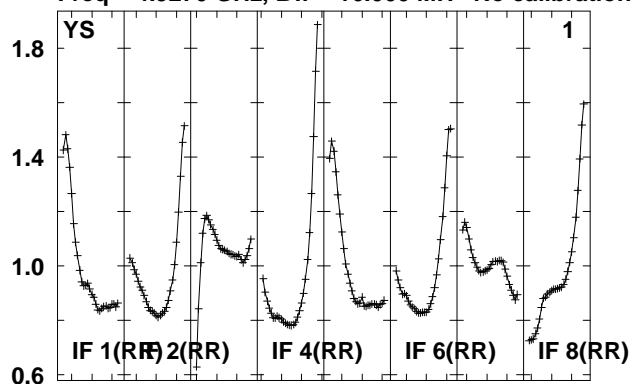

Lower frame: Real Jy
Total-power spectrum Antenna: *
Timerange: 00/23:57:19 to 00/23:58:47

Plot file version 704 created 14-MAY-2010 15:21:06

J0920+44 EO007.UVDATA.1

Freq = 4.9270 GHz, Bw = 16.000 MH No calibration applied and no bandpass applied

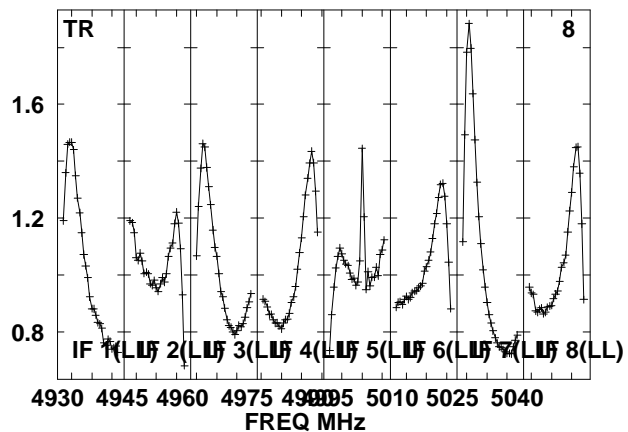
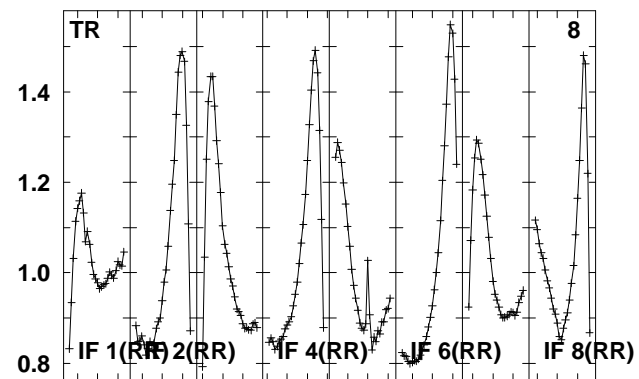
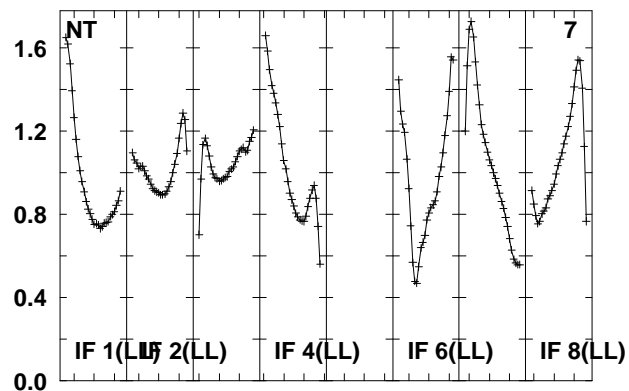
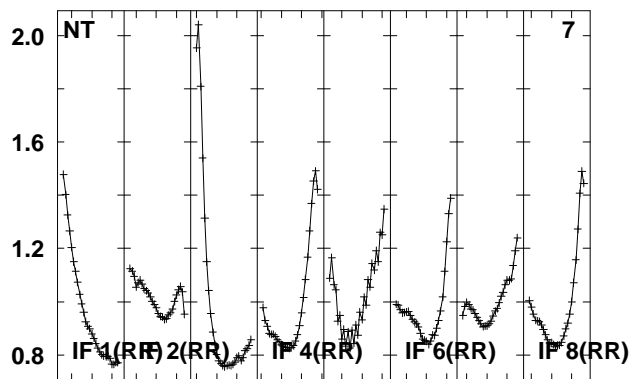
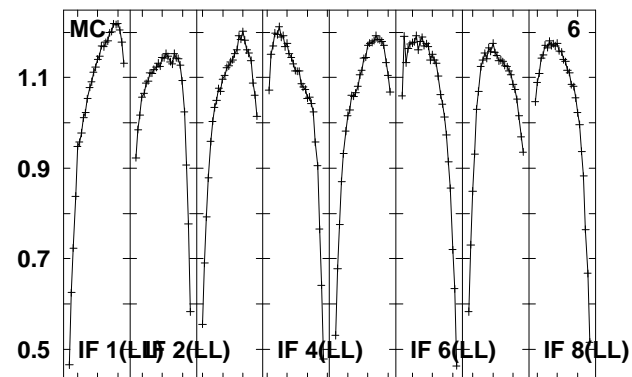
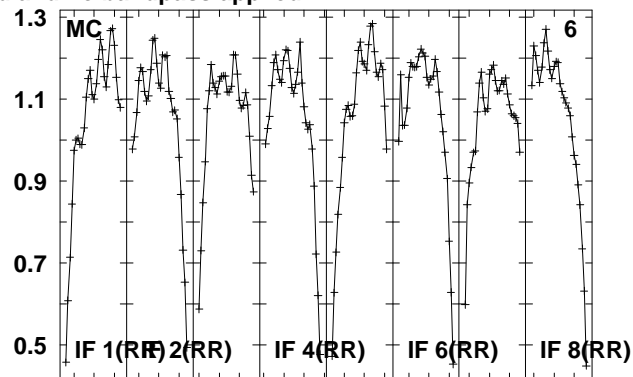
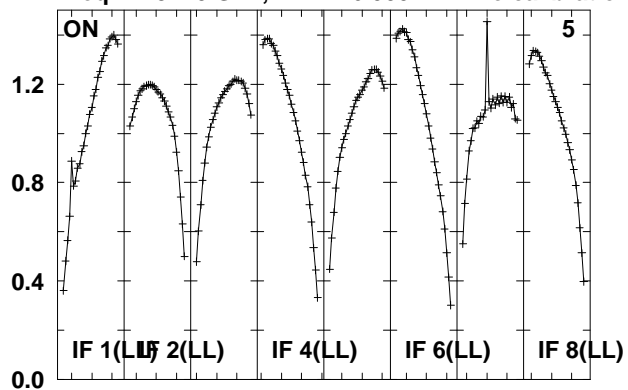

Lower frame: Real Jy

Total-power spectrum Antenna: *

Timerange: 00/23:57:19 to 00/23:58:47

Plot file version 705 created 14-MAY-2010 15:21:06

J1027+48 EO007.UVDATA.1

Freq = 4.9270 GHz, Bw = 16.000 MH No calibration applied and no bandpass applied

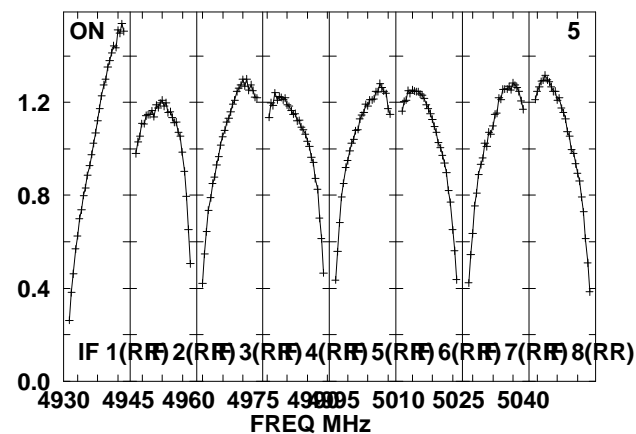
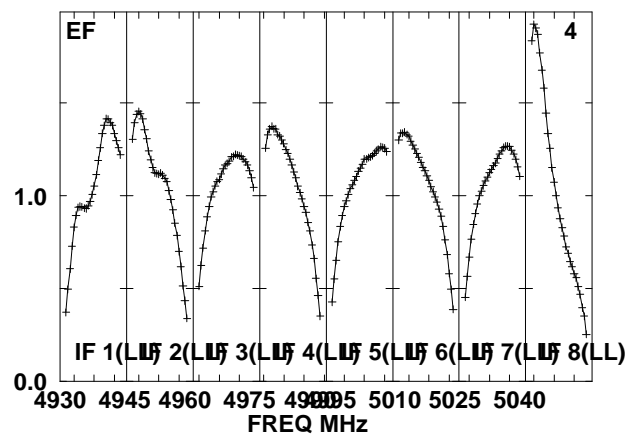
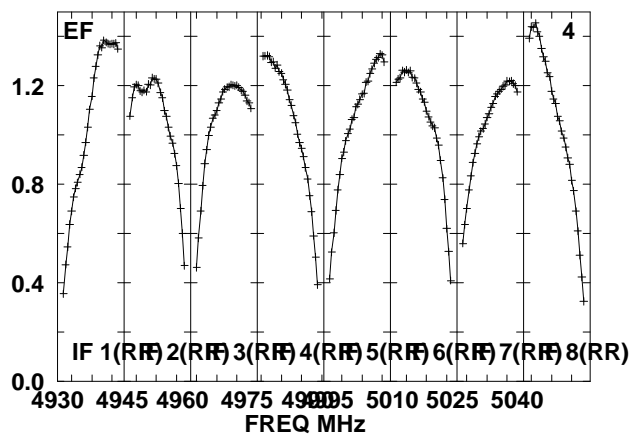
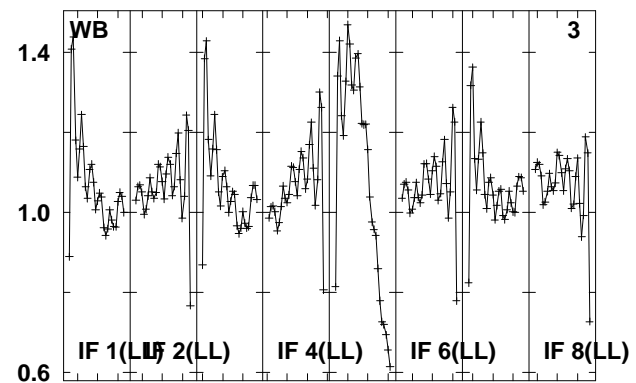
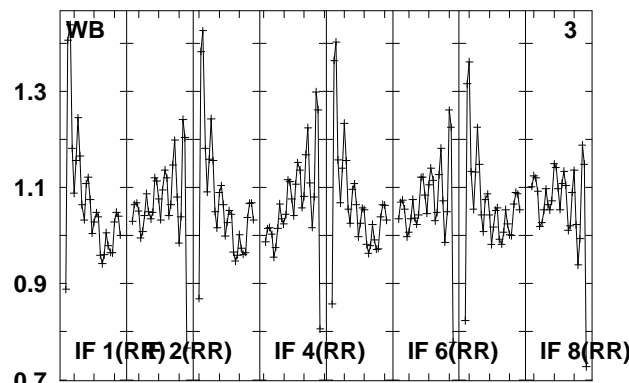
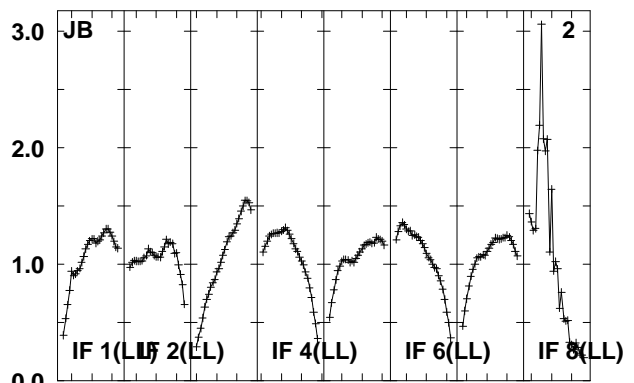
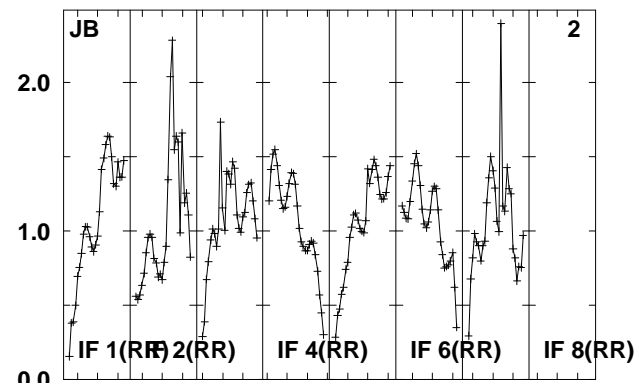
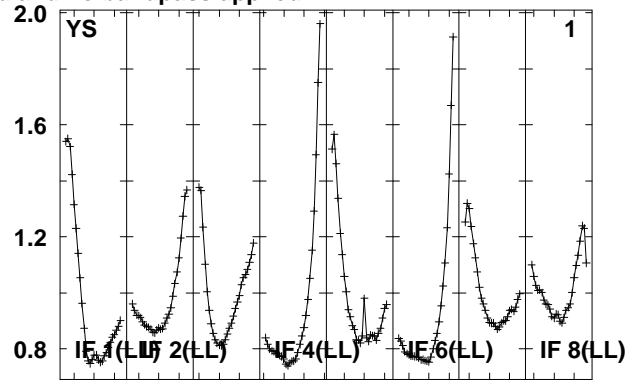
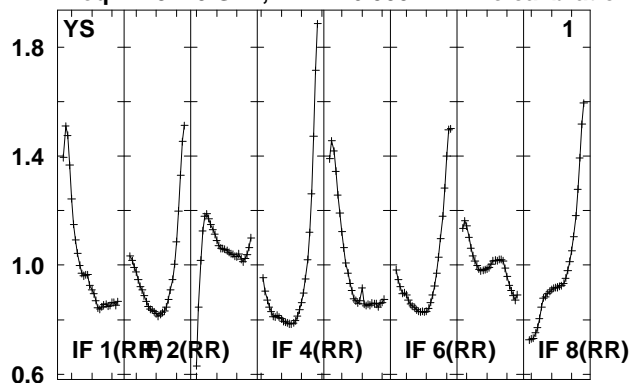

Lower frame: Real Jy

Total-power spectrum Antenna: *

Timerange: 01/00:00:13 to 01/00:01:39

Plot file version 706 created 14-MAY-2010 15:21:06

J1027+48 EO007.UVDATA.1

Freq = 4.9270 GHz, Bw = 16.000 MH No calibration applied and no bandpass applied

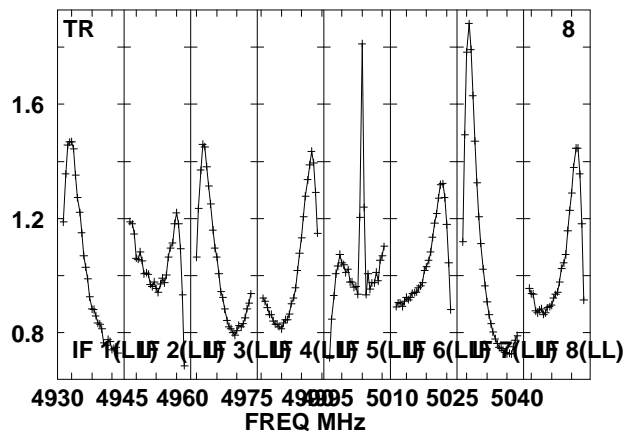
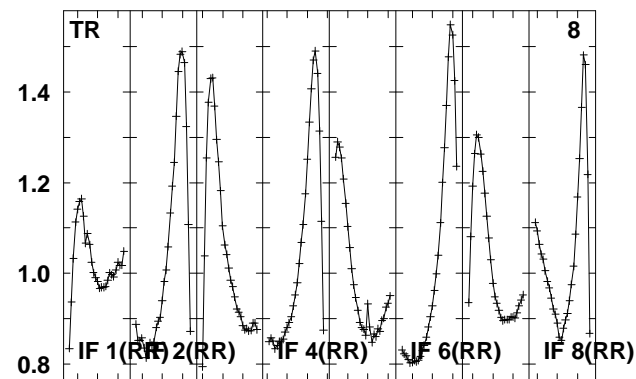
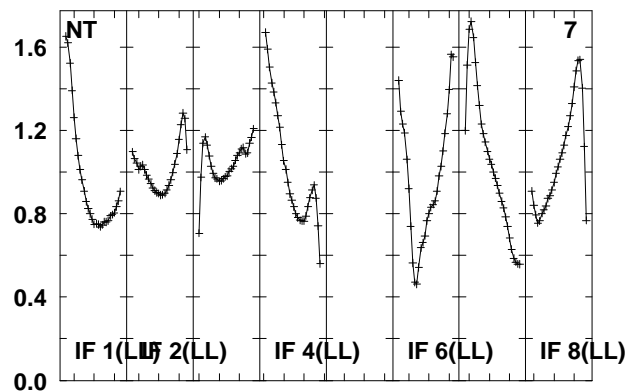
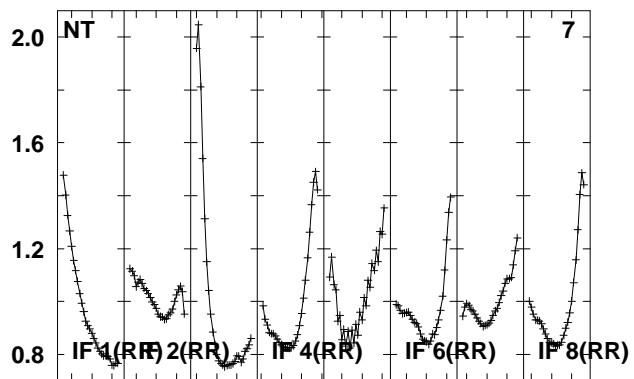
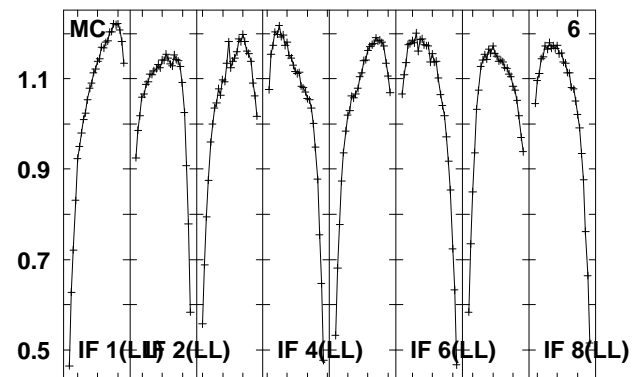
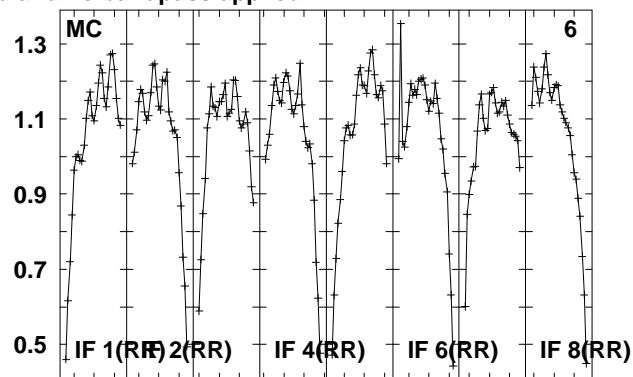
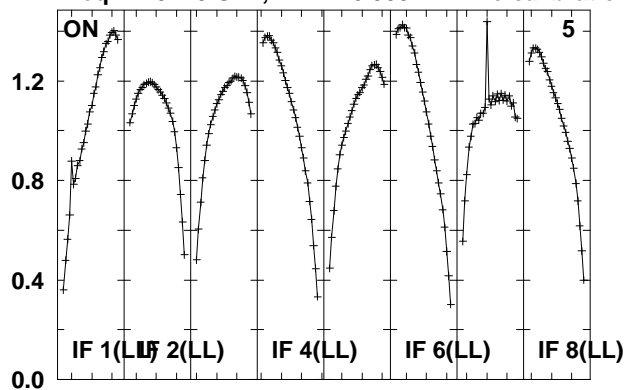

Lower frame: Real Jy

Total-power spectrum Antenna: *

Timerange: 01/00:00:13 to 01/00:01:39

Plot file version 707 created 14-MAY-2010 15:21:06

J102959 EO007.UVDATA.1

Freq = 4.9270 GHz, Bw = 16.000 MH No calibration applied and no bandpass applied

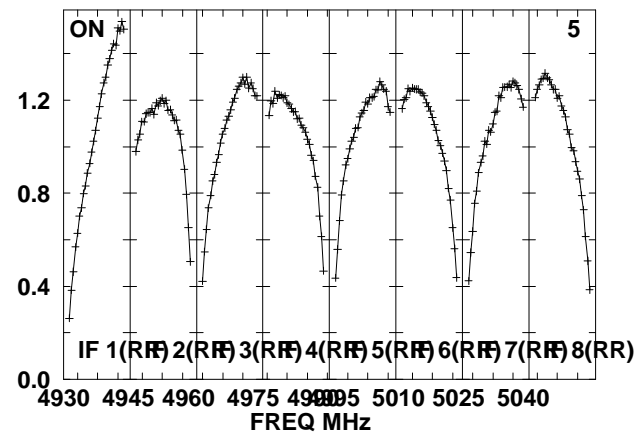
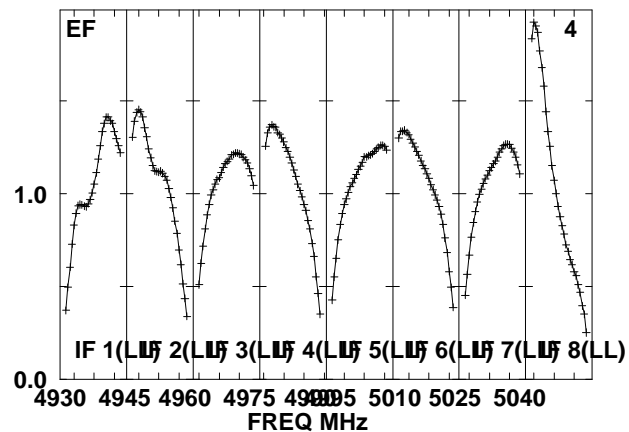
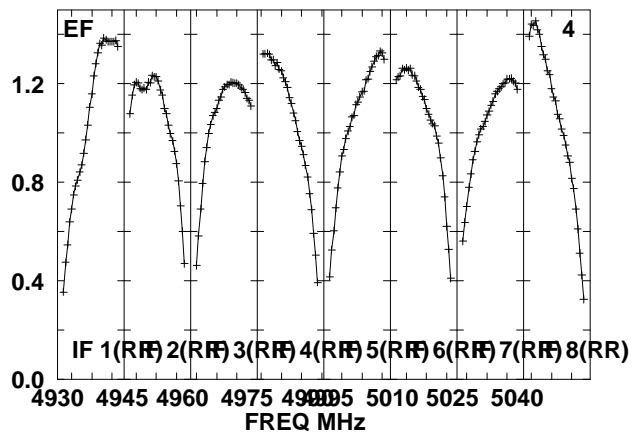
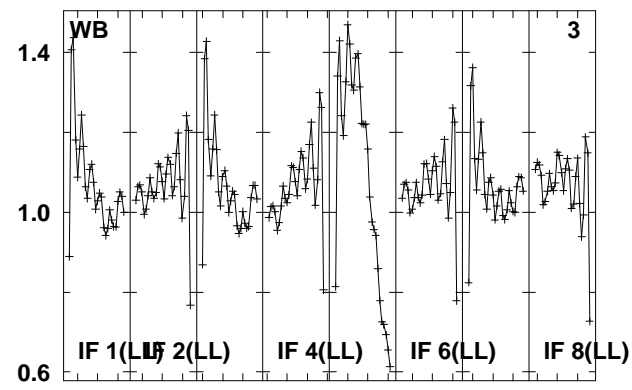
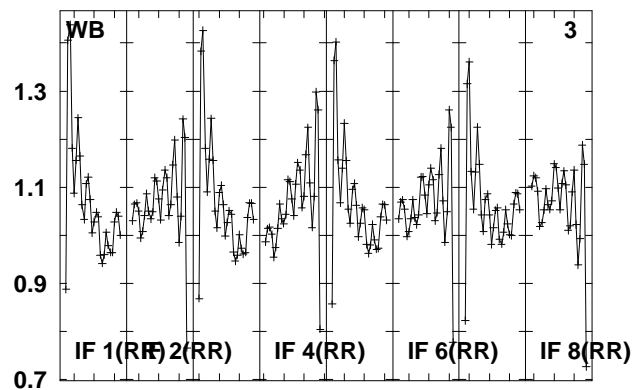
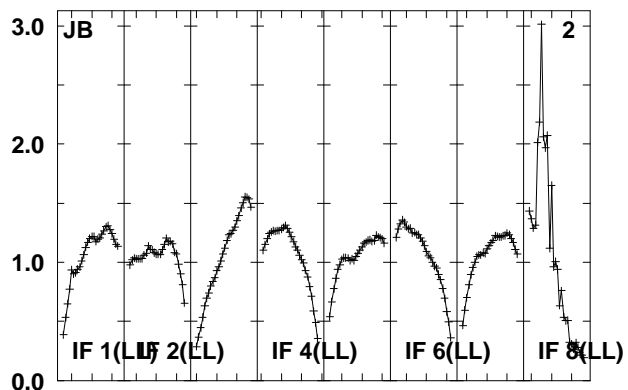
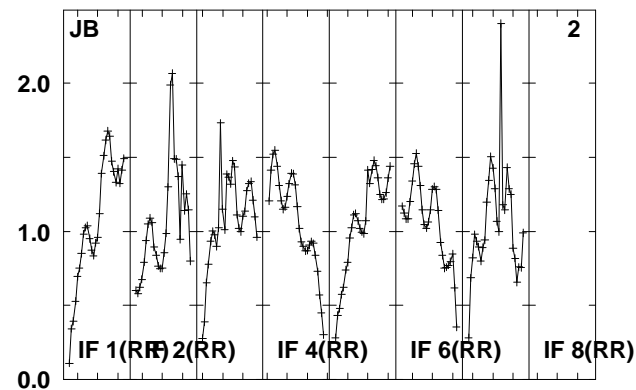
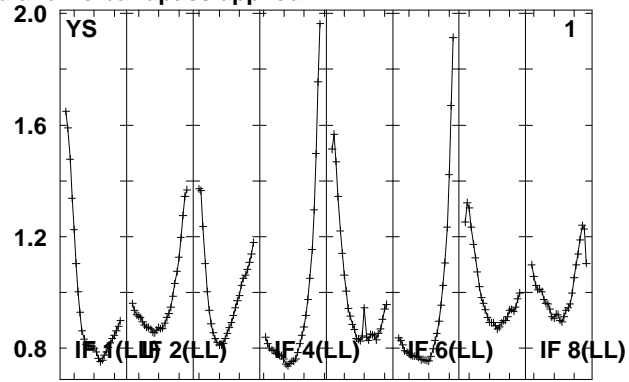
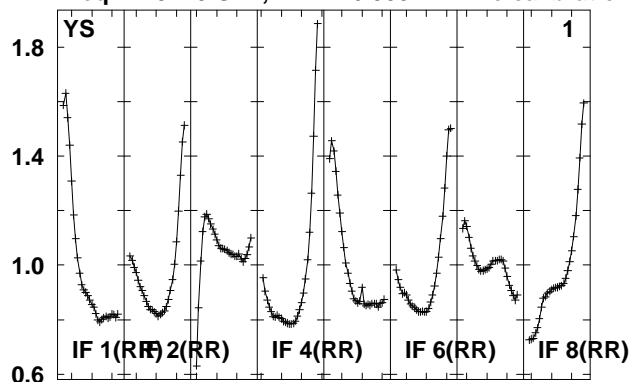

Lower frame: Real Jy

Total-power spectrum Antenna: *

Timerange: 01/00:02:07 to 01/00:07:03

Plot file version 708 created 14-MAY-2010 15:21:07

J102959 EO007.UVDATA.1

Freq = 4.9270 GHz, Bw = 16.000 MH No calibration applied and no bandpass applied

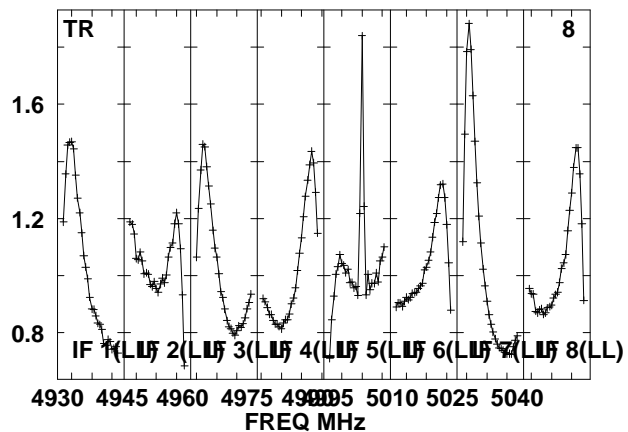
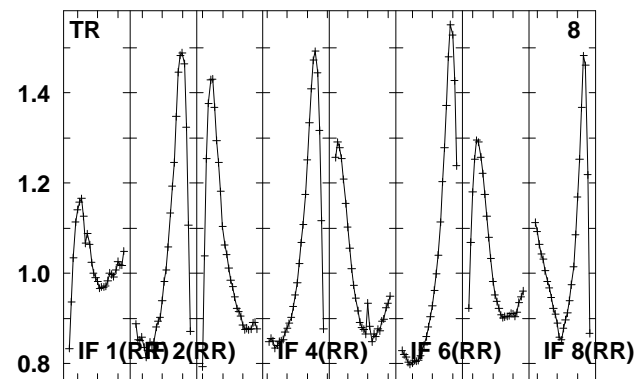
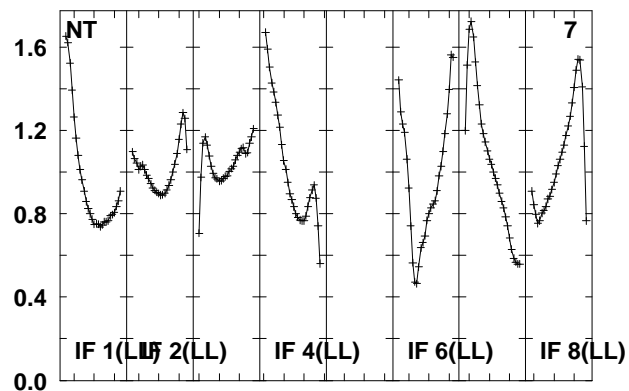
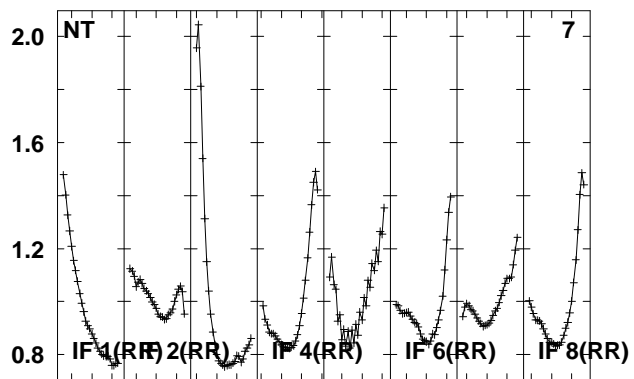
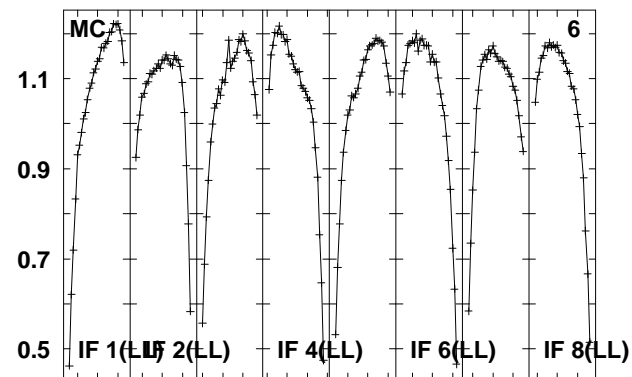
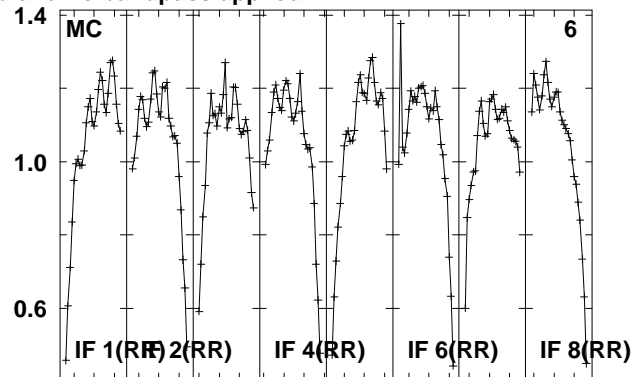
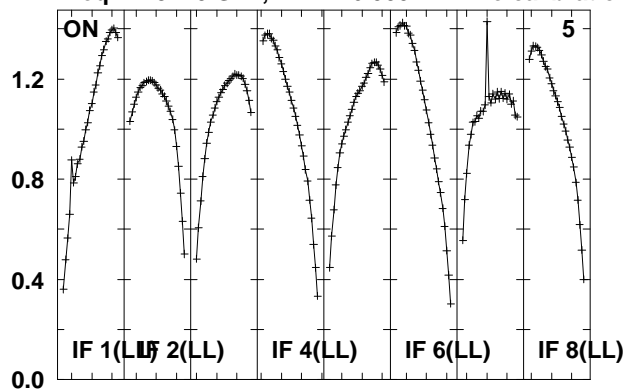

Lower frame: Real Jy

Total-power spectrum Antenna: *

Timerange: 01/00:02:07 to 01/00:07:03

Plot file version 709 created 14-MAY-2010 15:21:07

J1027+48 EO007.UVDATA.1

Freq = 4.9270 GHz, Bw = 16.000 MH No calibration applied and no bandpass applied

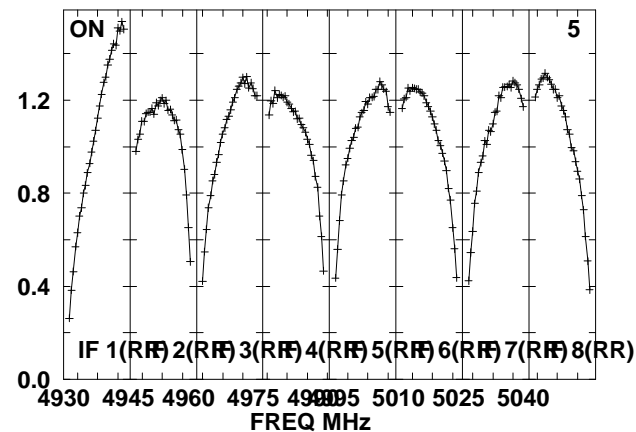
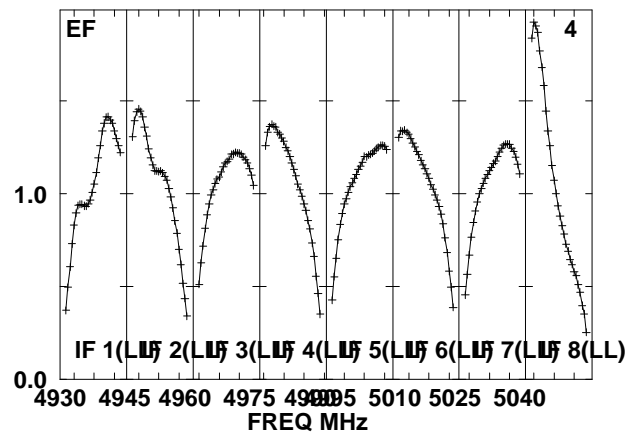
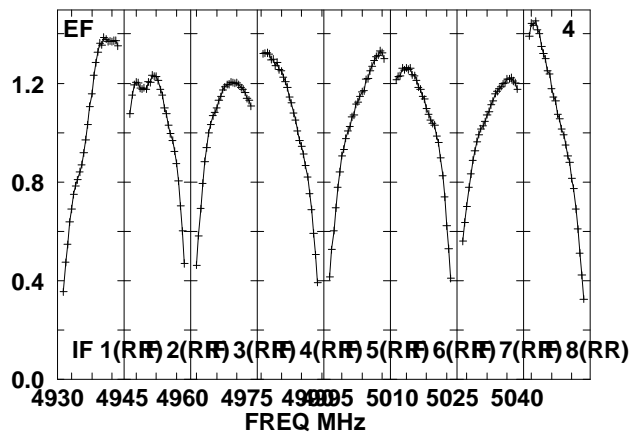
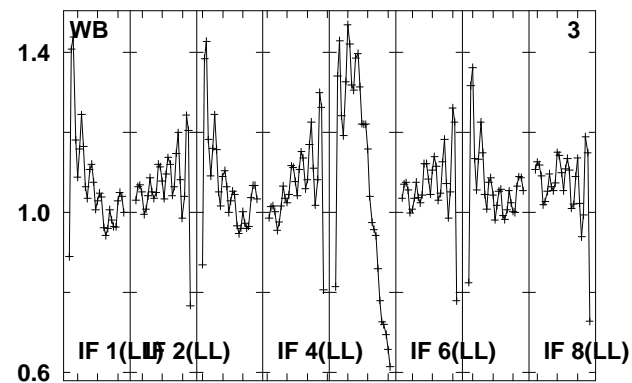
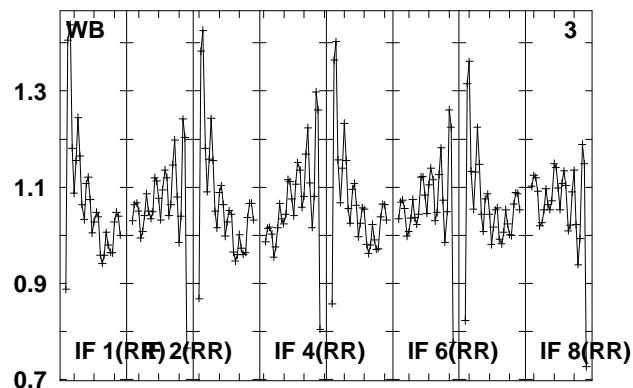
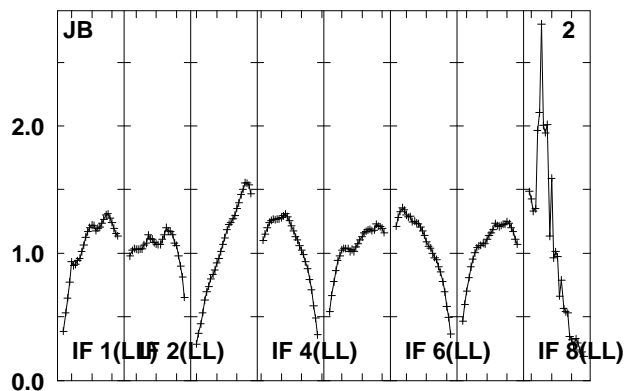
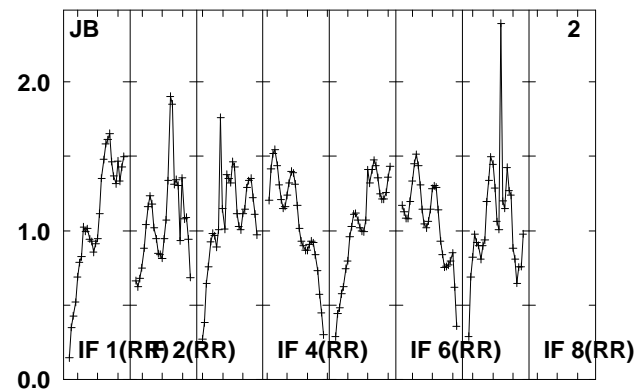
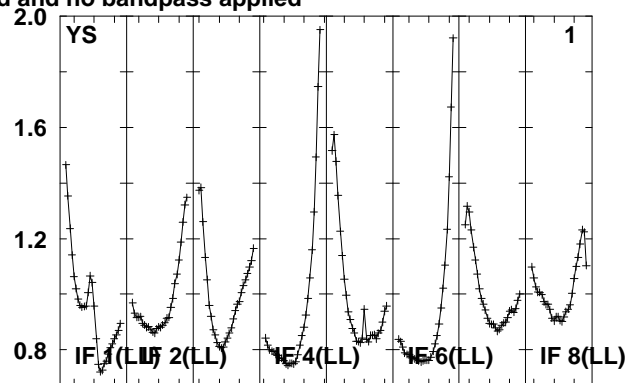
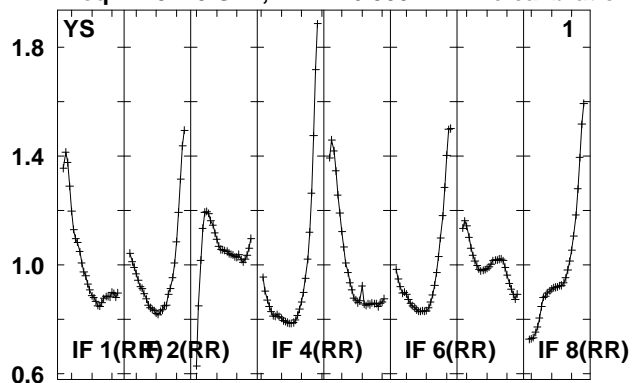

Lower frame: Real Jy

Total-power spectrum Antenna: *

Timerange: 01/00:07:27 to 01/00:08:53

Plot file version 710 created 14-MAY-2010 15:21:08

J1027+48 EO007.UVDATA.1

Freq = 4.9270 GHz, Bw = 16.000 MH No calibration applied and no bandpass applied

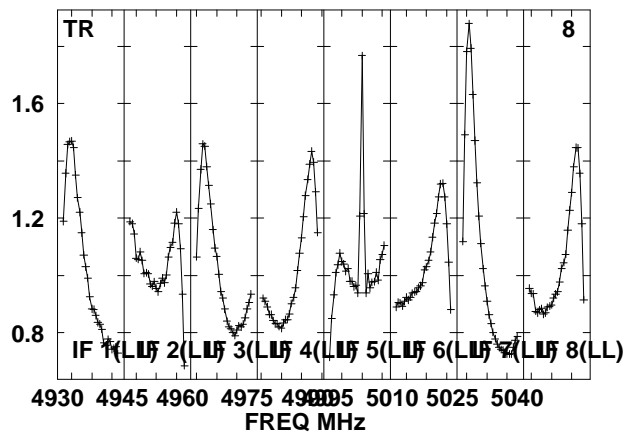
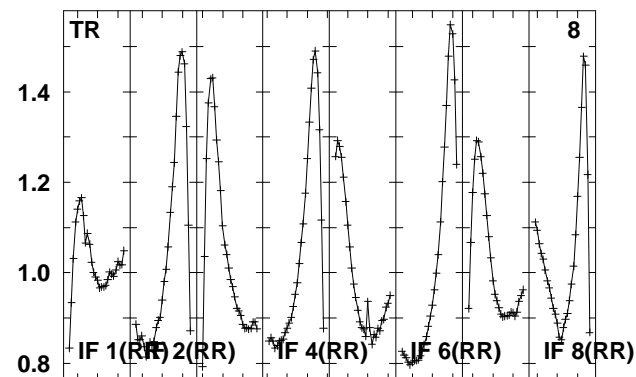
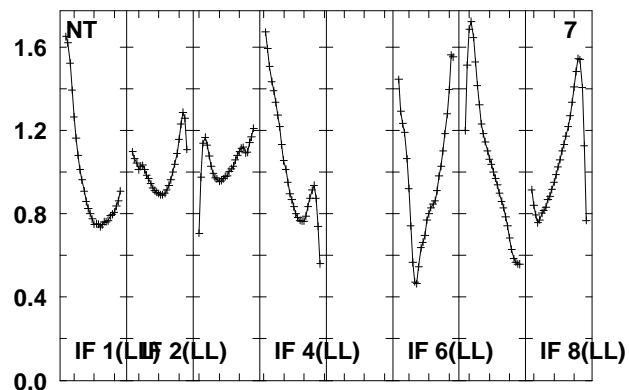
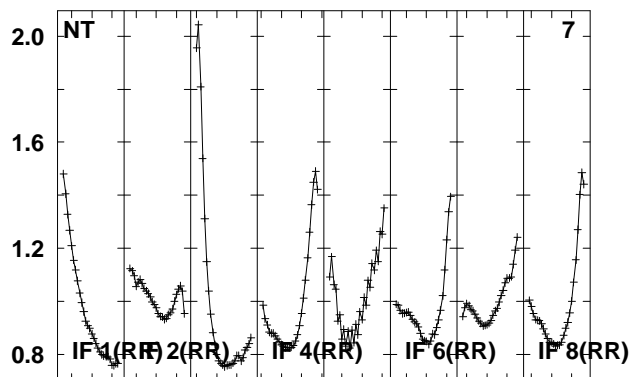
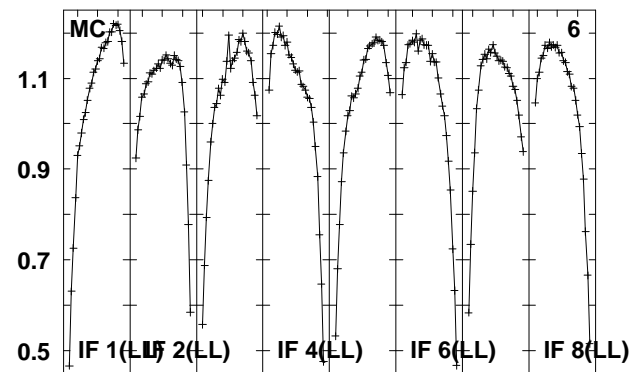
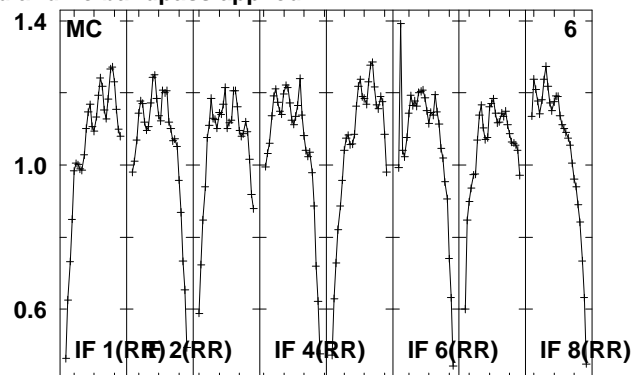
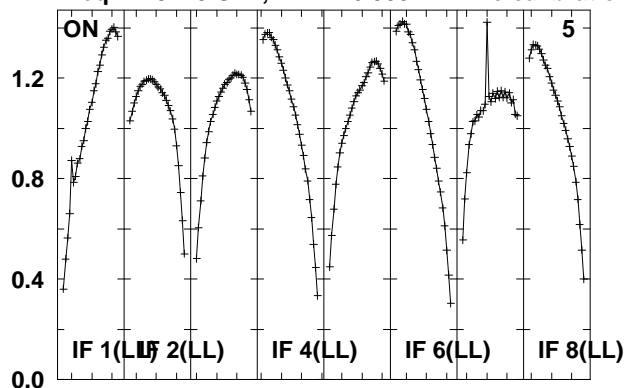

Lower frame: Real Jy

Total-power spectrum Antenna: *

Timerange: 01/00:07:27 to 01/00:08:53

Plot file version 711 created 14-MAY-2010 15:21:08
 J102959 EO007.UVDATA.1
 Freq = 4.9270 GHz, Bw = 16.000 MH No calibration applied and no bandpass applied

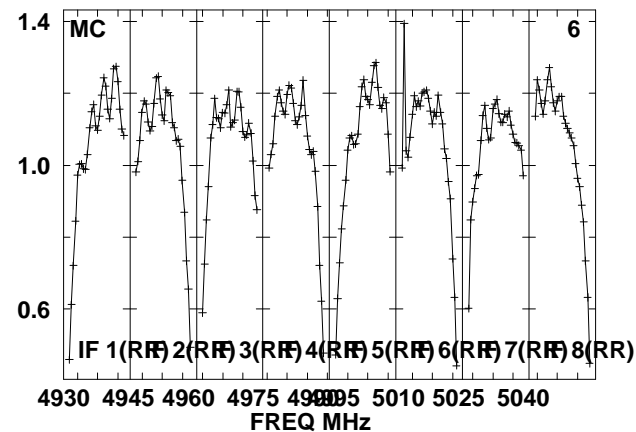
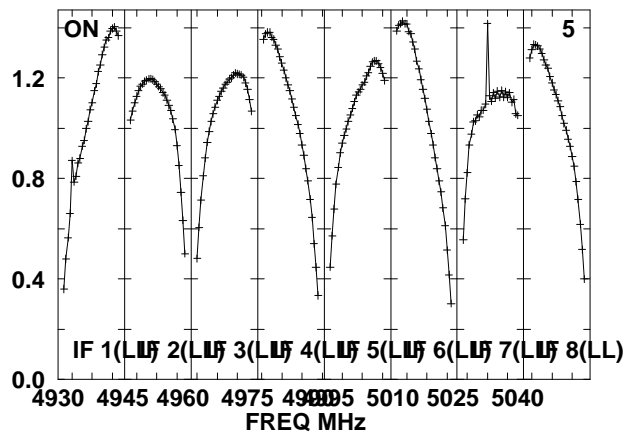
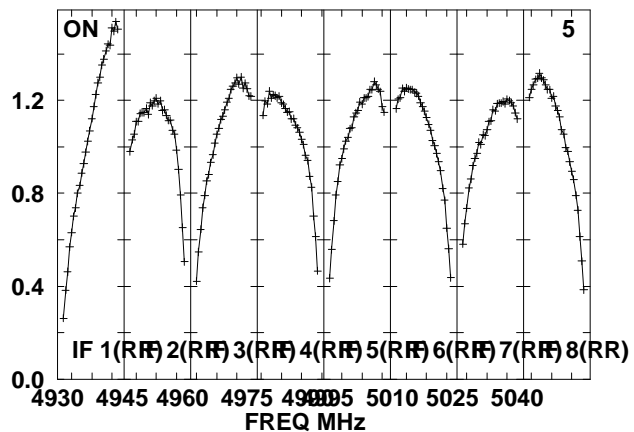
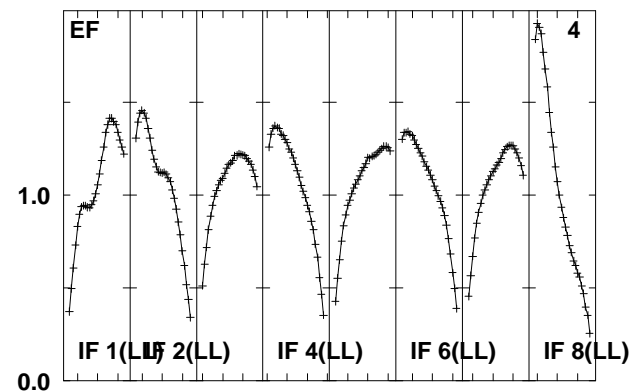
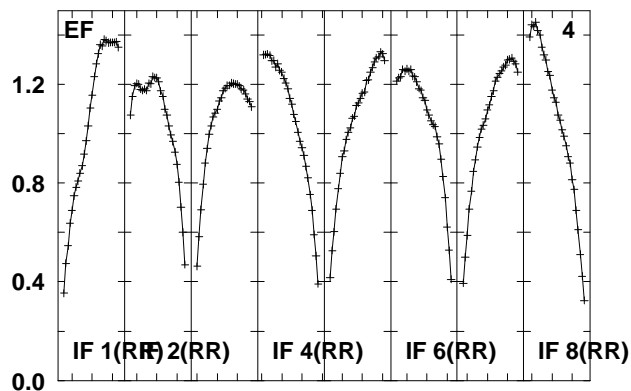
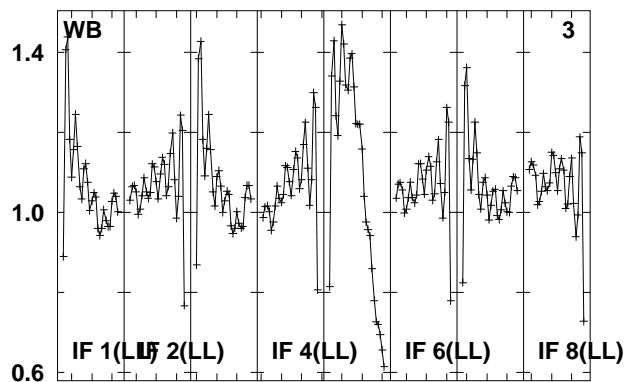
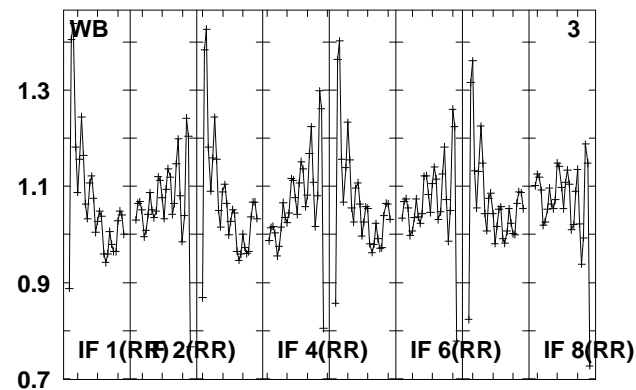
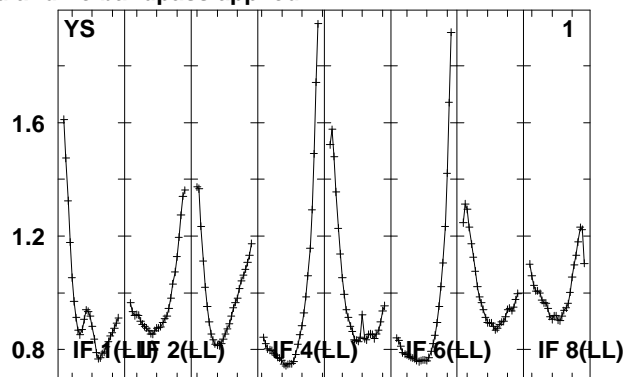
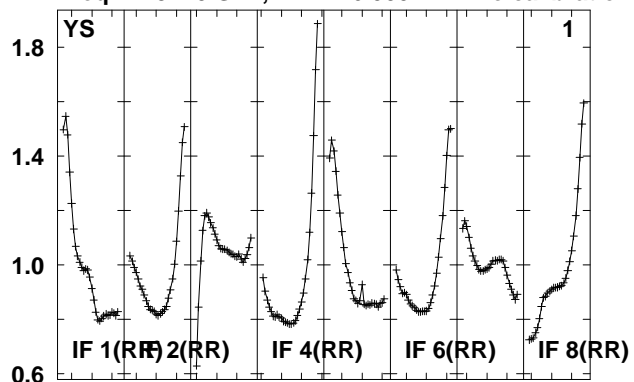

Lower frame: Real Jy
 Total-power spectrum Antenna: *
 Timerange: 01/00:09:20 to 01/00:14:16

Plot file version 712 created 14-MAY-2010 15:21:08

J102959 EO007.UVDATA.1

Freq = 4.9270 GHz, Bw = 16.000 MH No calibration applied and no bandpass applied

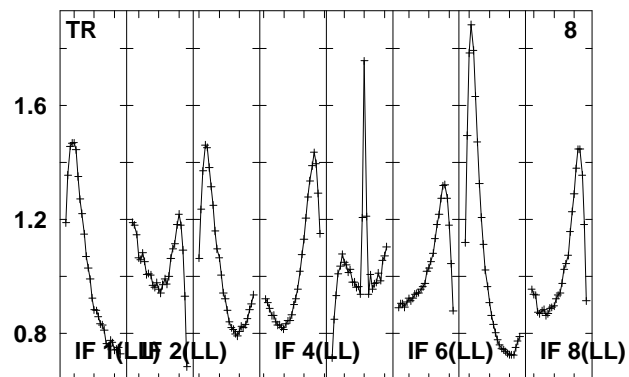
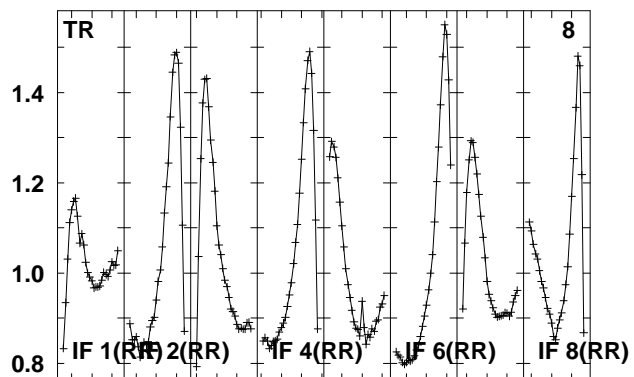
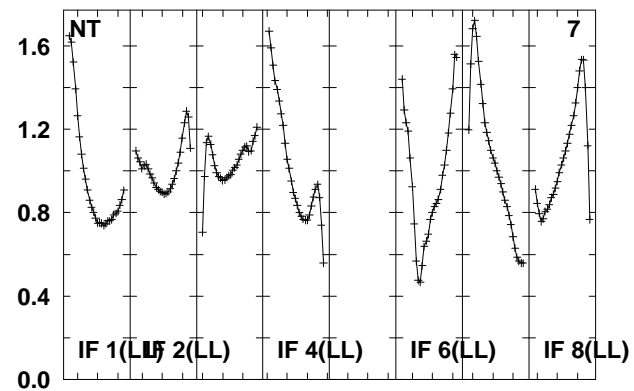
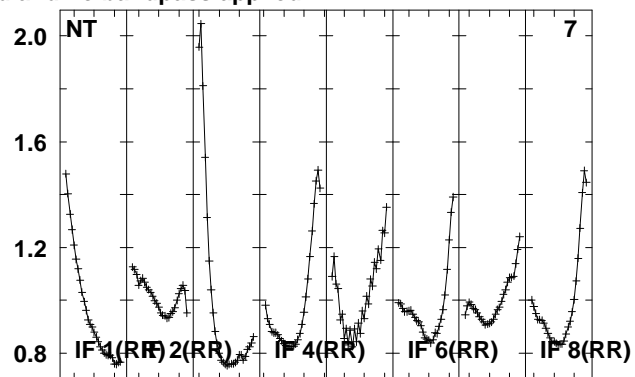
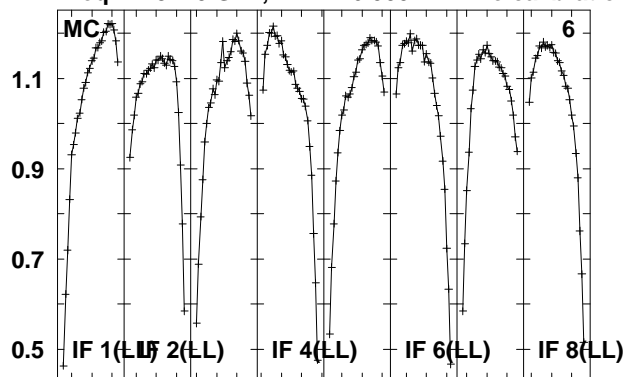

Lower frame: Real Jy
Total-power spectrum Antenna: *
Timerange: 01/00:09:20 to 01/00:14:16

Plot file version 713 created 14-MAY-2010 15:21:09

J1027+48 EO007.UVDATA.1

Freq = 4.9270 GHz, Bw = 16.000 MH No calibration applied and no bandpass applied

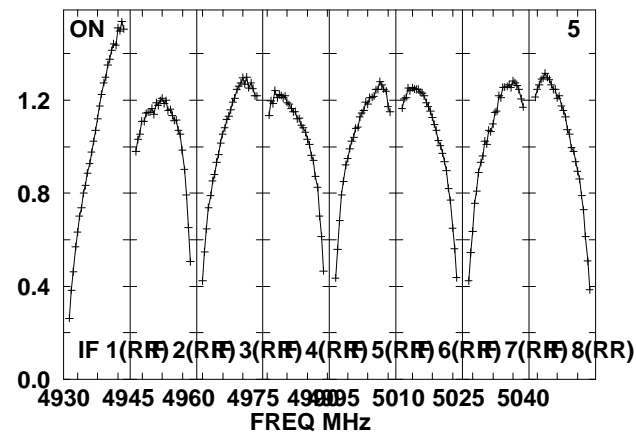
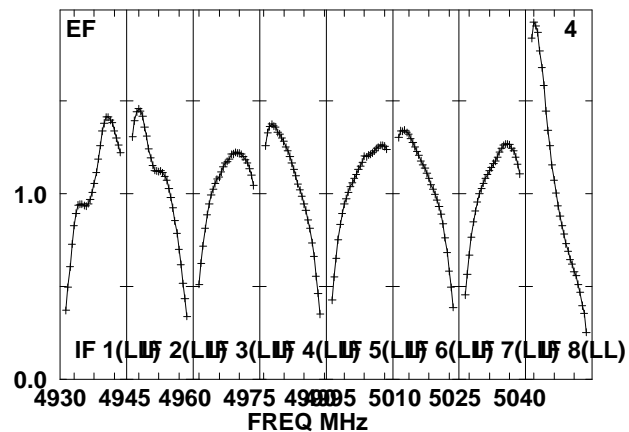
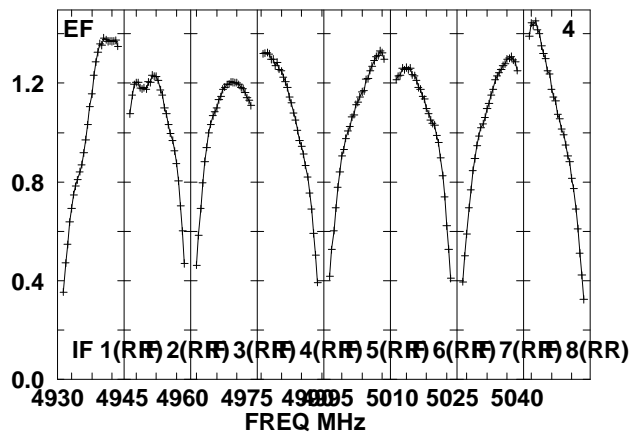
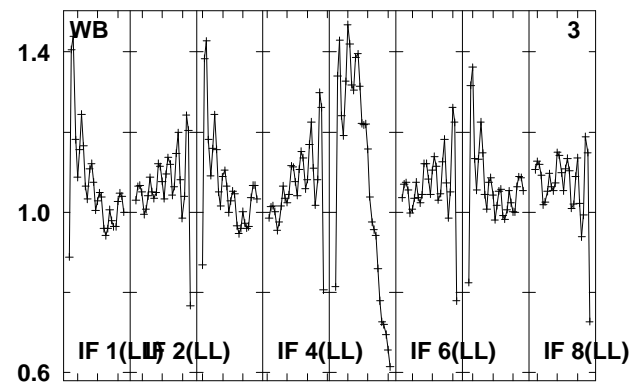
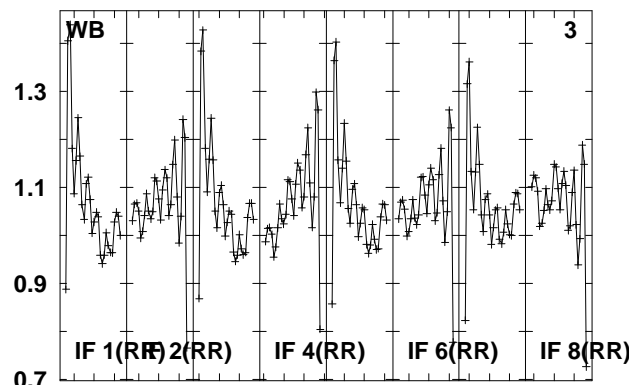
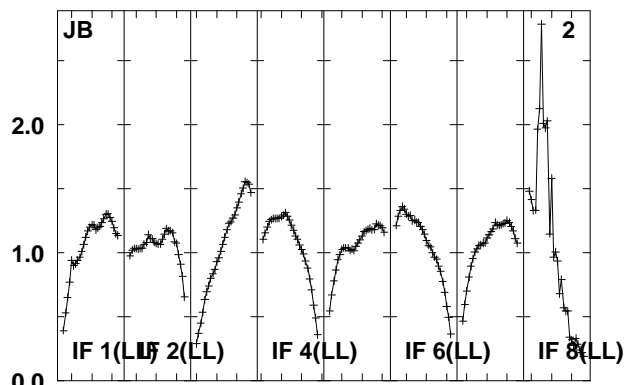
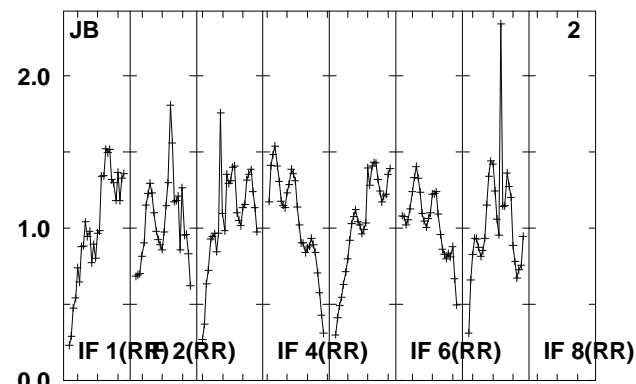
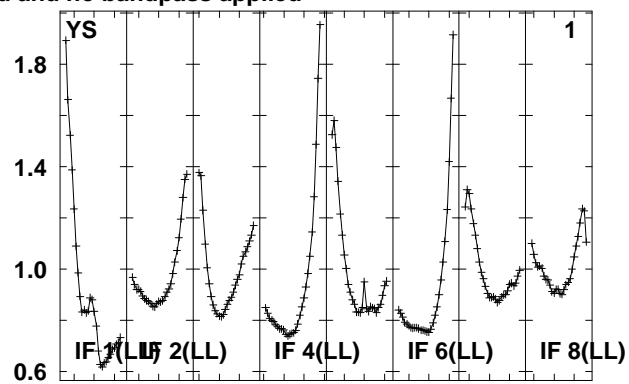
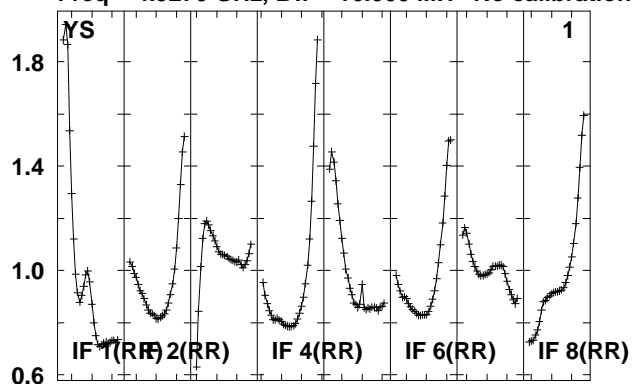

Lower frame: Real Jy
Total-power spectrum Antenna: *
Timerange: 01/00:14:41 to 01/00:16:09

Plot file version 714 created 14-MAY-2010 15:21:09

J1027+48 EO007.UVDATA.1

Freq = 4.9270 GHz, Bw = 16.000 MH No calibration applied and no bandpass applied

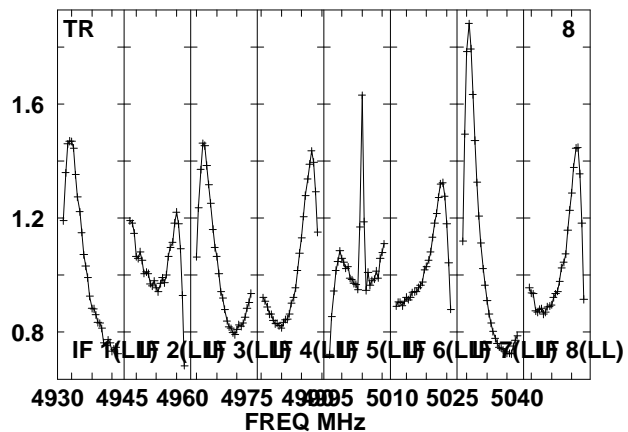
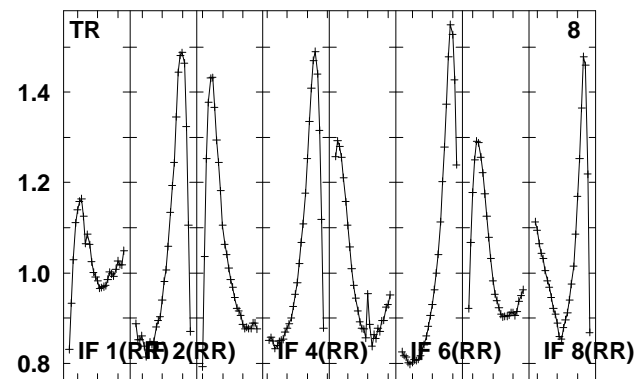
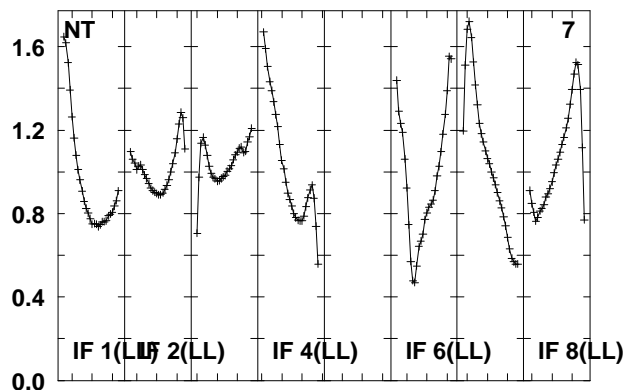
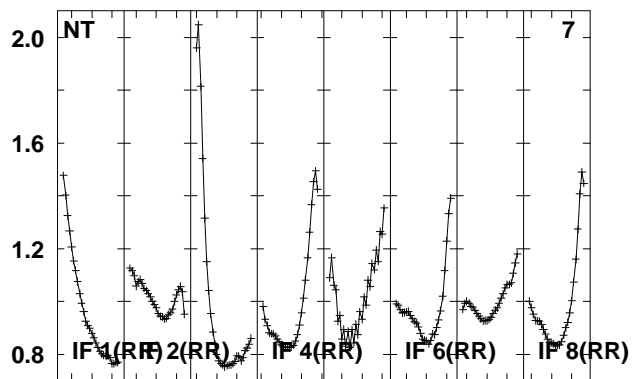
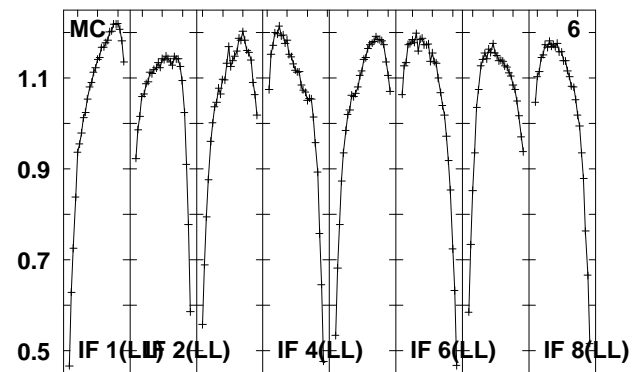
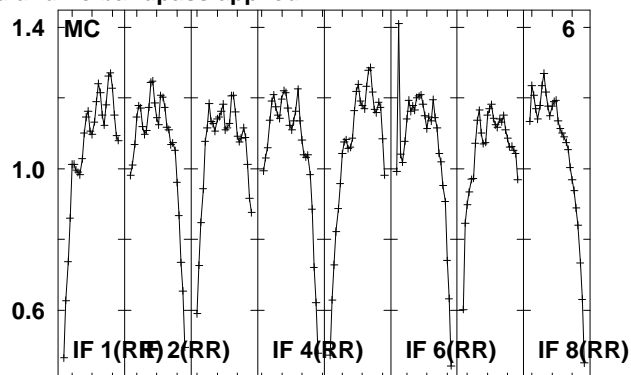
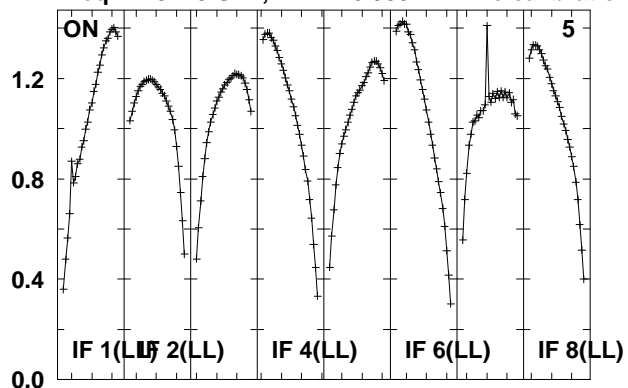

Lower frame: Real Jy

Total-power spectrum Antenna: *

Timerange: 01/00:14:41 to 01/00:16:09

Plot file version 715 created 14-MAY-2010 15:21:09

J0920+44 EO007.UVDATA.1

Freq = 4.9270 GHz, Bw = 16.000 MH No calibration applied and no bandpass applied

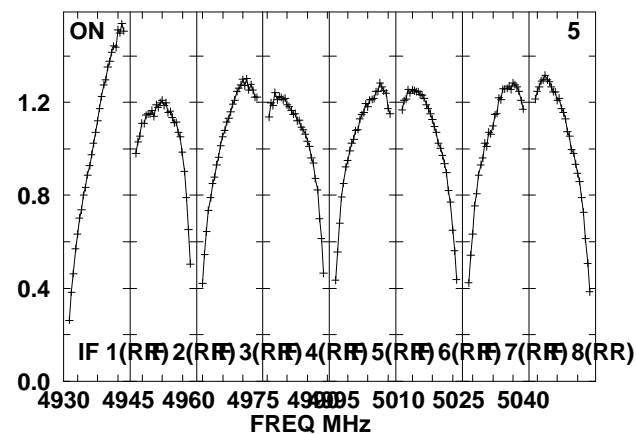
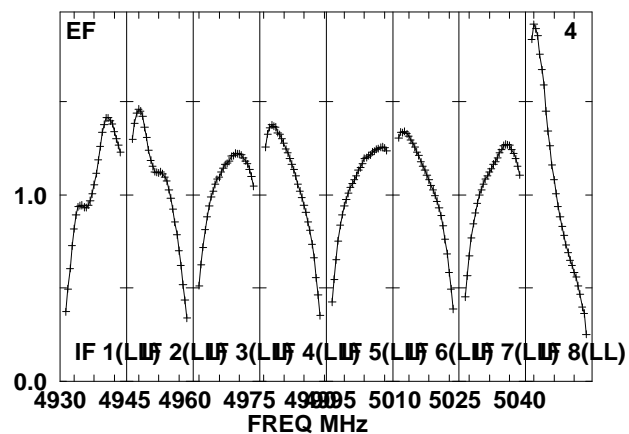
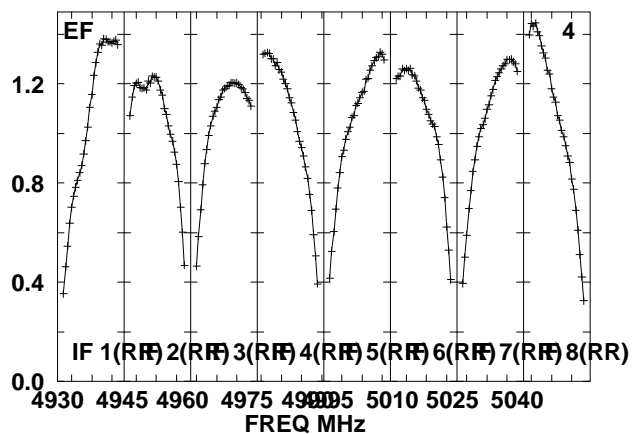
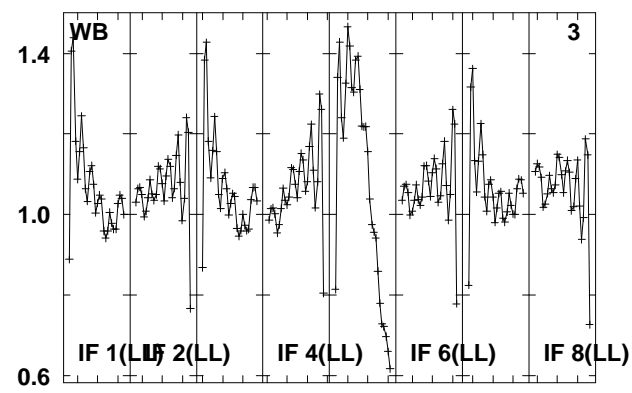
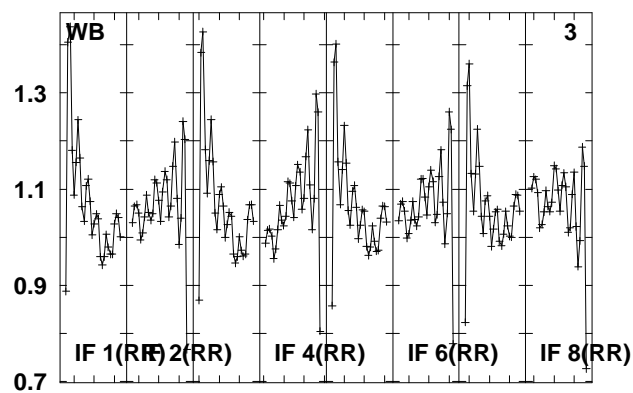
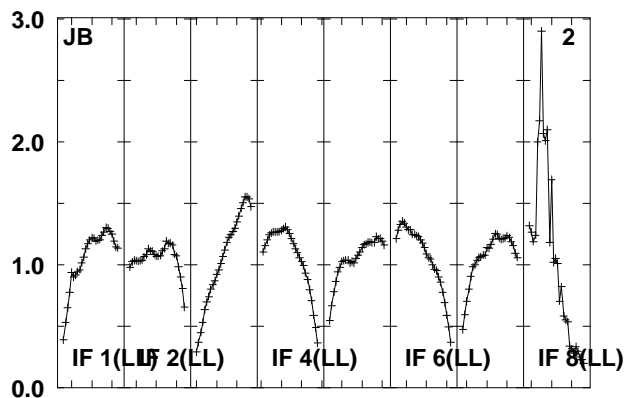
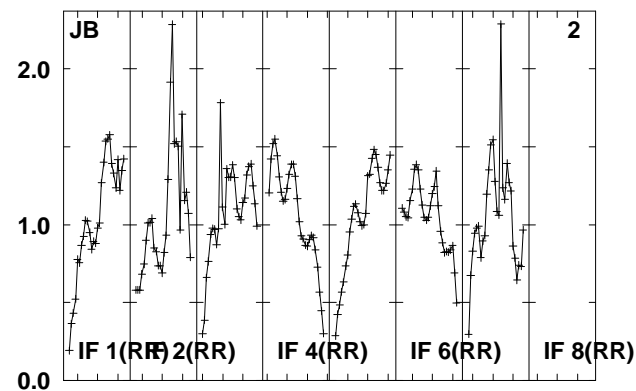
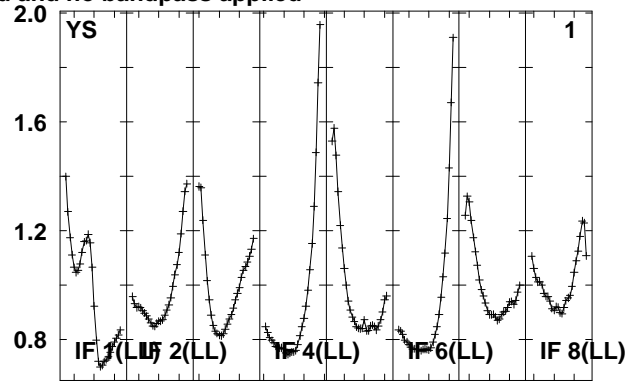
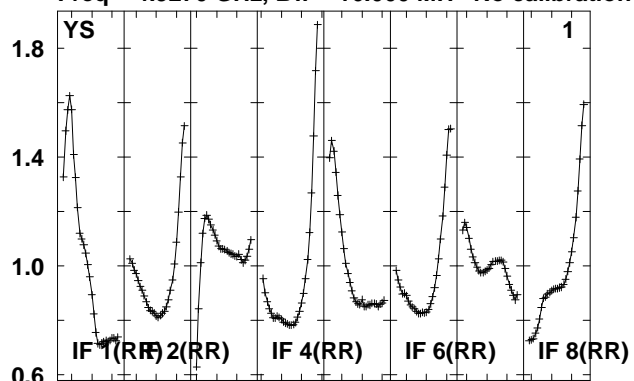

Lower frame: Real Jy
Total-power spectrum Antenna: *
Timerange: 01/00:17:39 to 01/00:19:05

Plot file version 716 created 14-MAY-2010 15:21:09

J0920+44 EO007.UVDATA.1

Freq = 4.9270 GHz, Bw = 16.000 MH No calibration applied and no bandpass applied

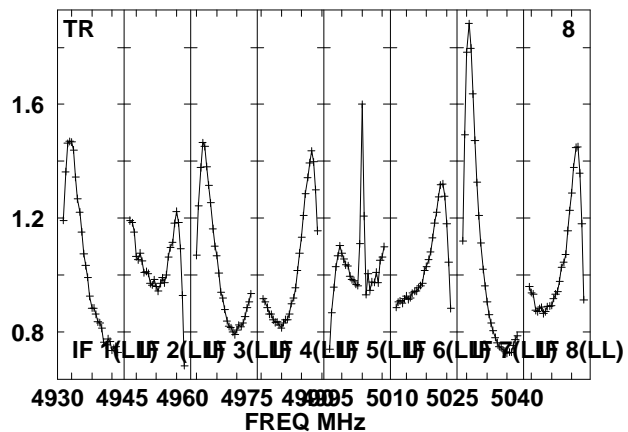
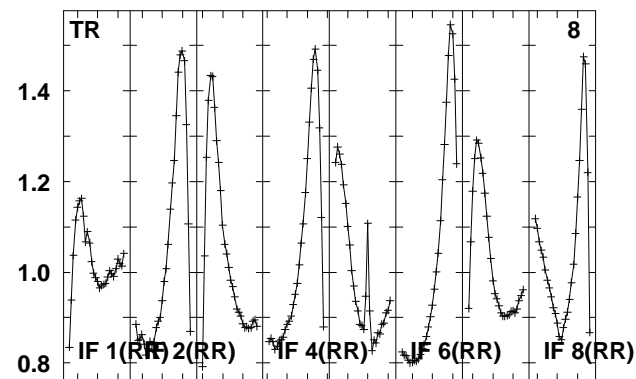
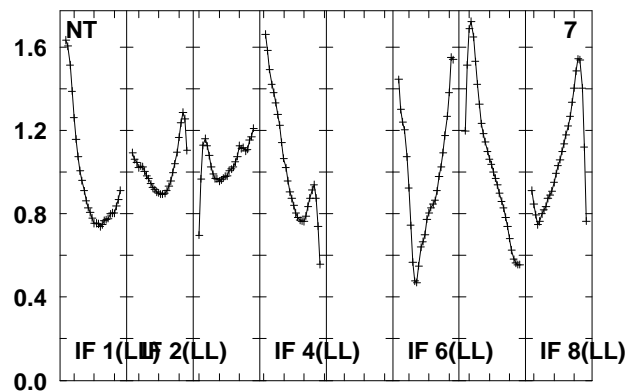
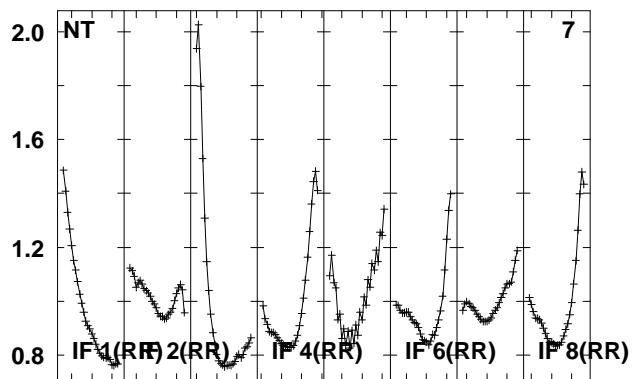
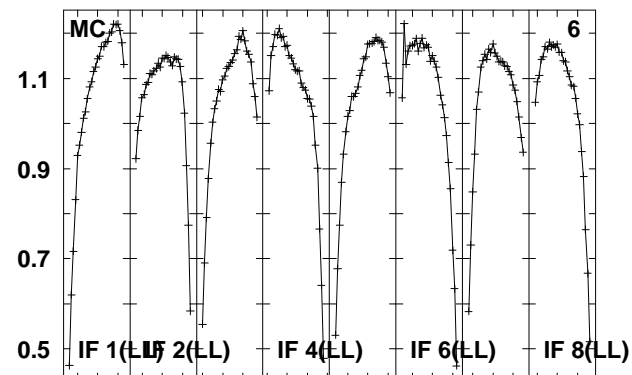
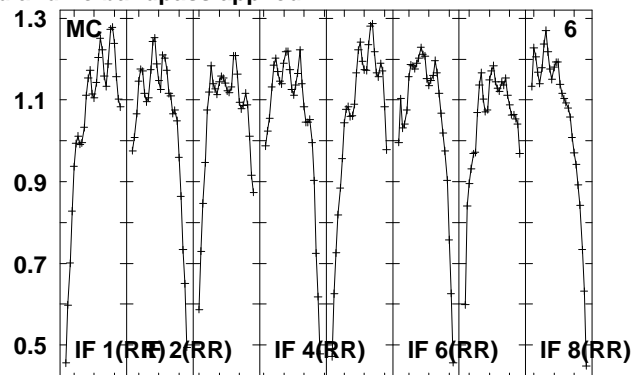
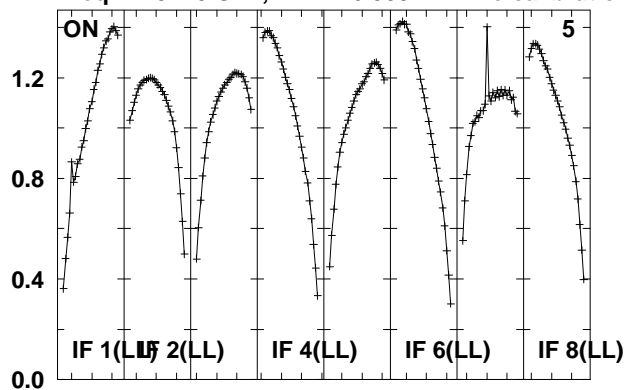

Lower frame: Real Jy

Total-power spectrum Antenna: *

Timerange: 01/00:17:39 to 01/00:19:05

Plot file version 717 created 14-MAY-2010 15:21:10
 J092159 EO007.UVDATA.1
 Freq = 4.9270 GHz, Bw = 16.000 MH No calibration applied and no bandpass applied

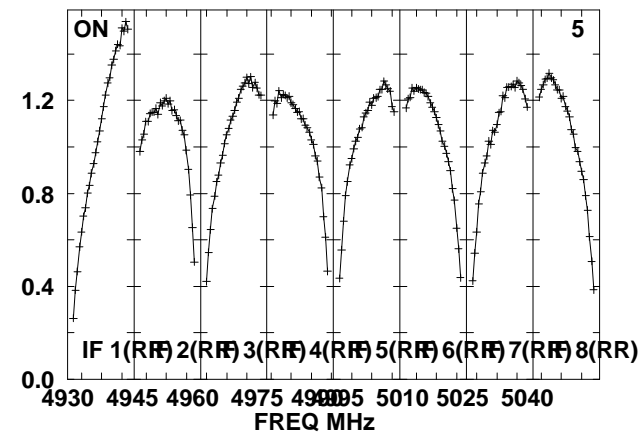
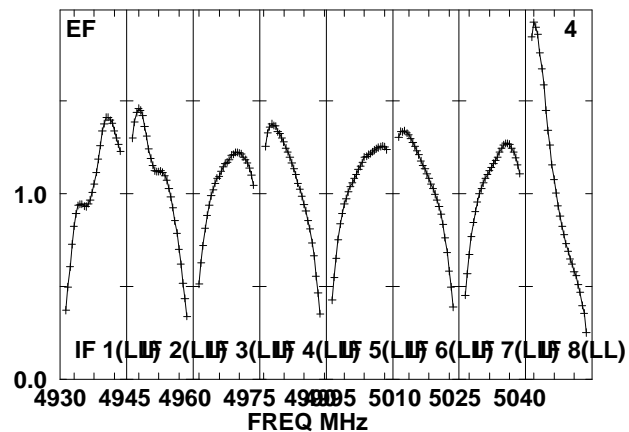
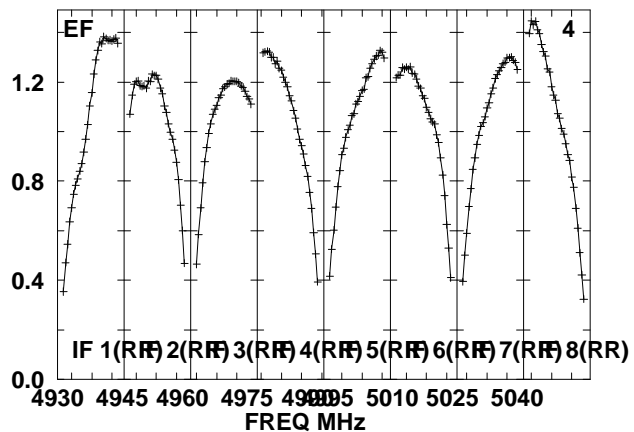
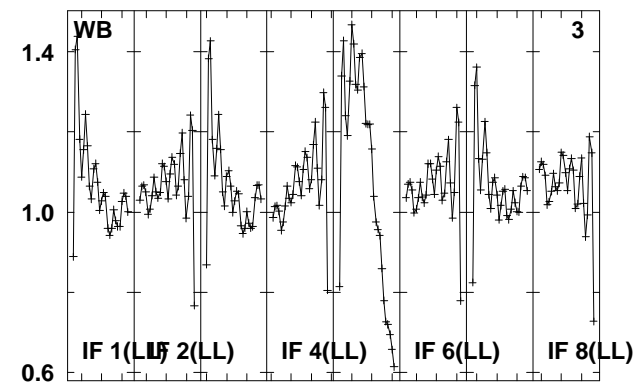
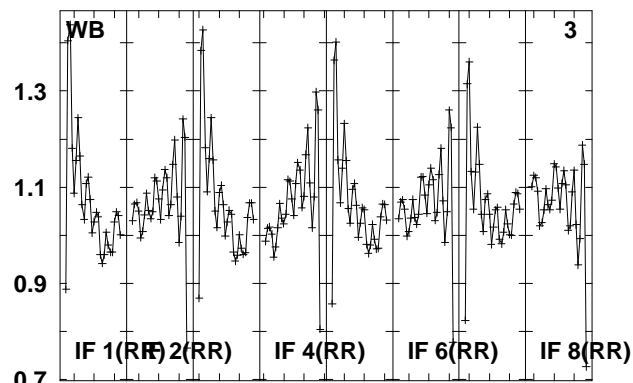
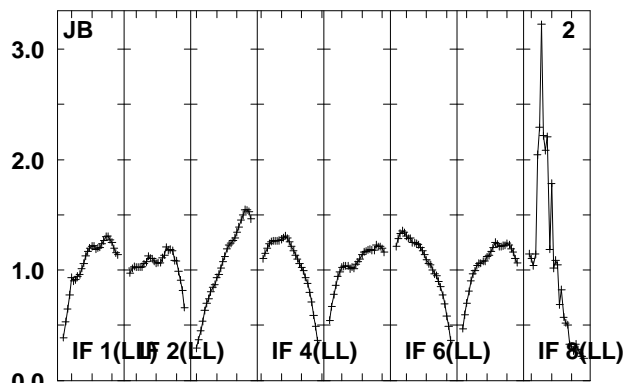
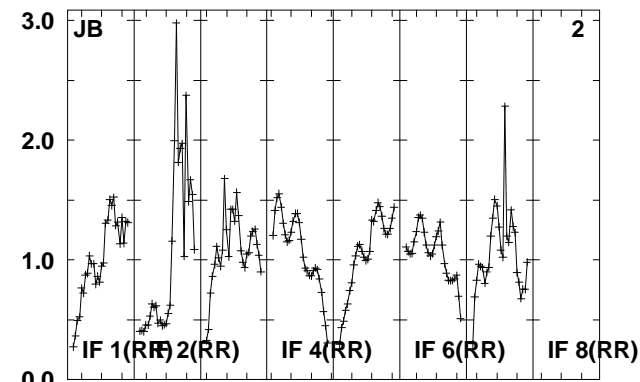
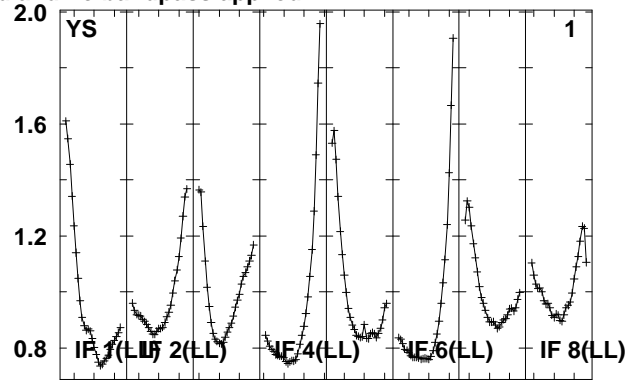
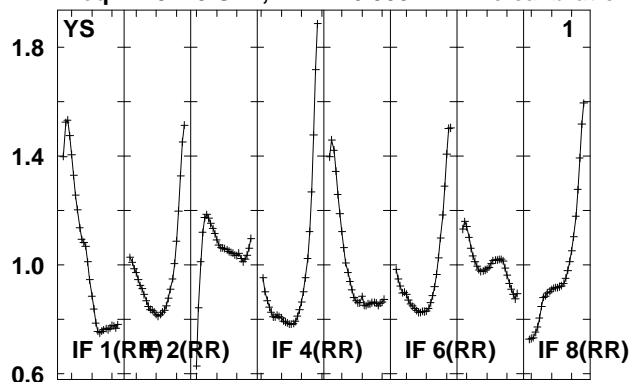

Lower frame: Real Jy
 Total-power spectrum Antenna: *
 Timerange: 01/00:19:29 to 01/00:24:27

Plot file version 718 created 14-MAY-2010 15:21:11

J092159 EO007.UVDATA.1

Freq = 4.9270 GHz, Bw = 16.000 MH No calibration applied and no bandpass applied

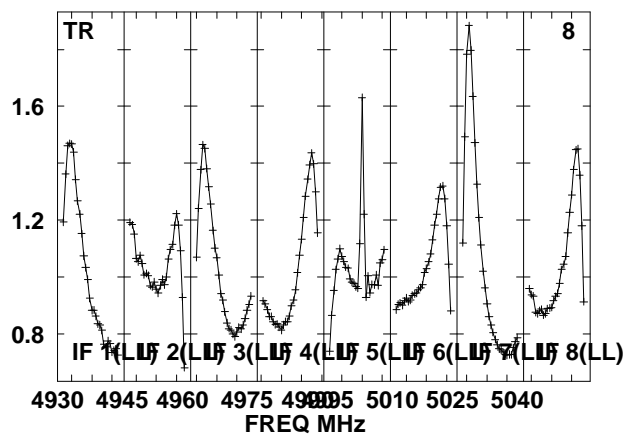
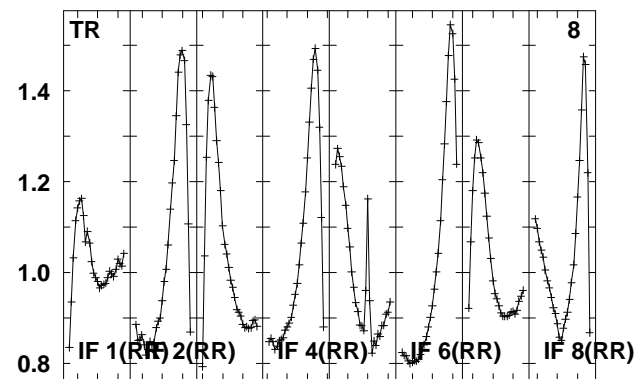
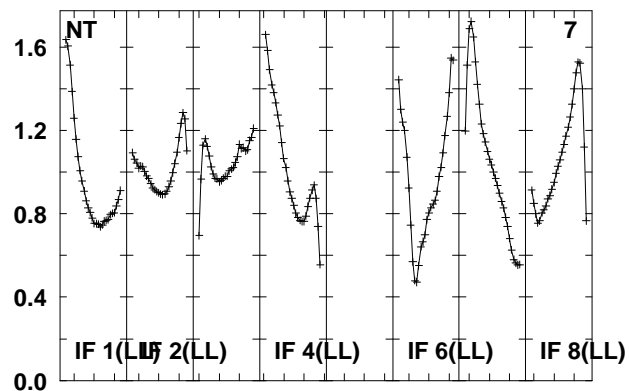
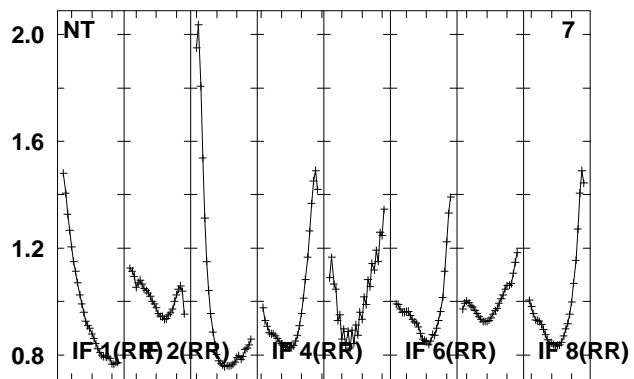
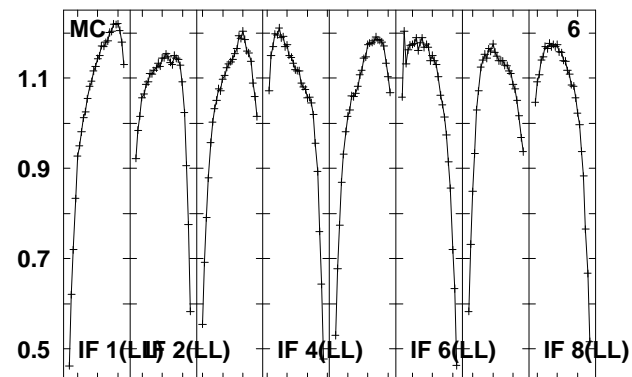
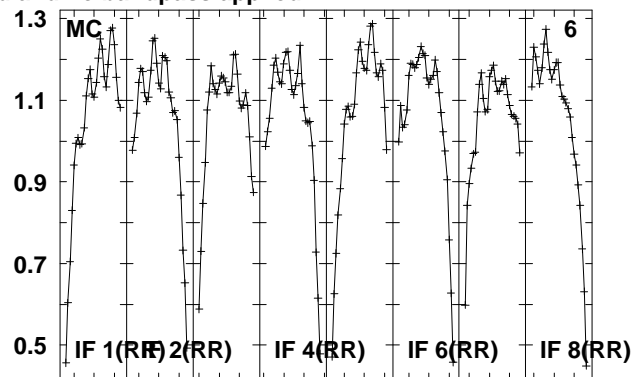
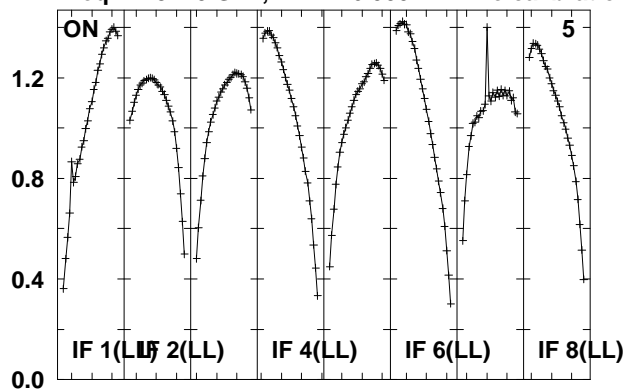

Lower frame: Real Jy

Total-power spectrum Antenna: *

Timerange: 01/00:19:29 to 01/00:24:27

Plot file version 719 created 14-MAY-2010 15:21:11
 J0920+44 EO007.UVDATA.1
 Freq = 4.9270 GHz, Bw = 16.000 MH No calibration applied and no bandpass applied

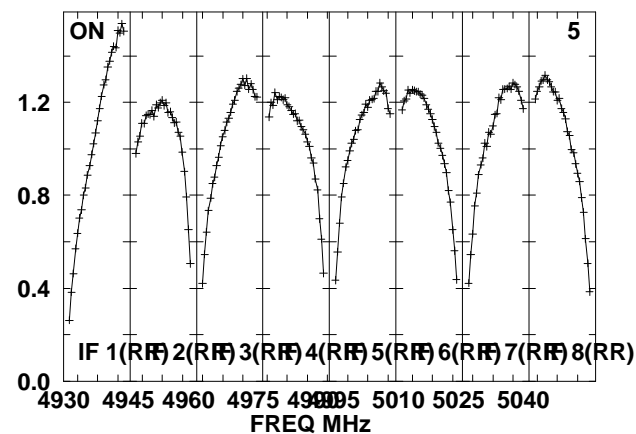
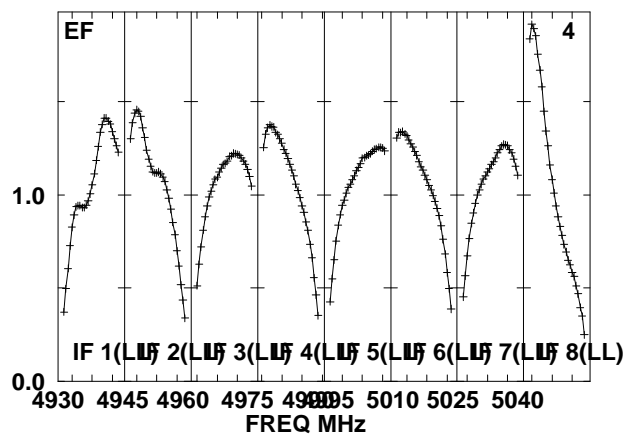
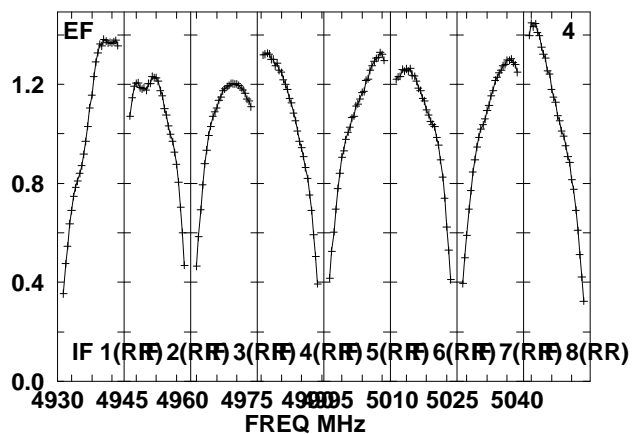
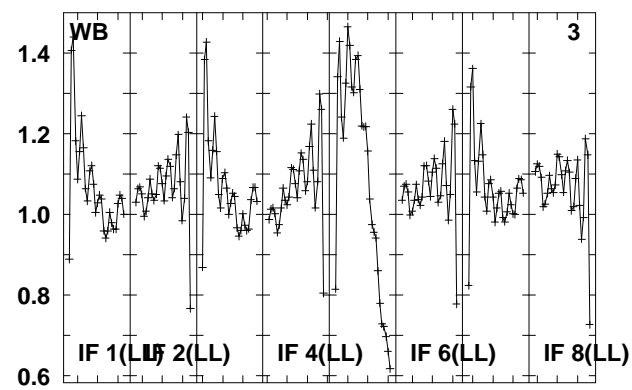
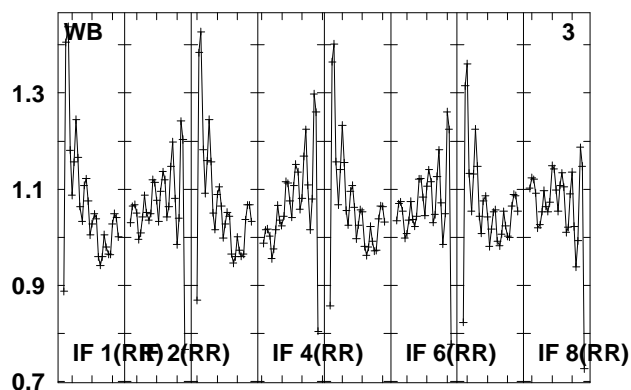
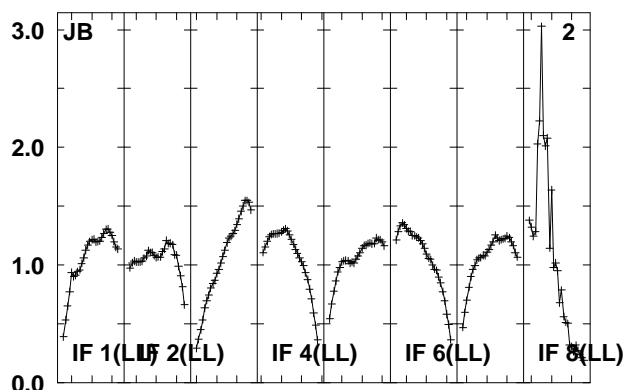
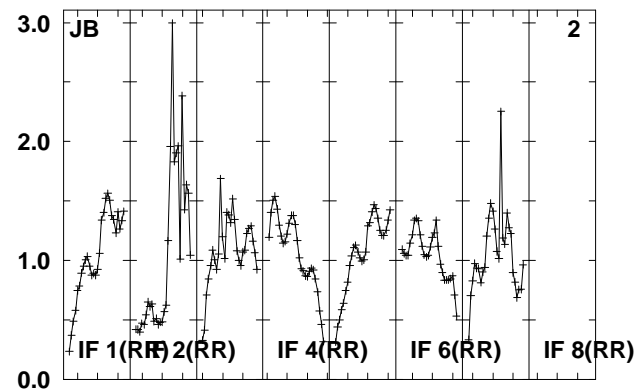
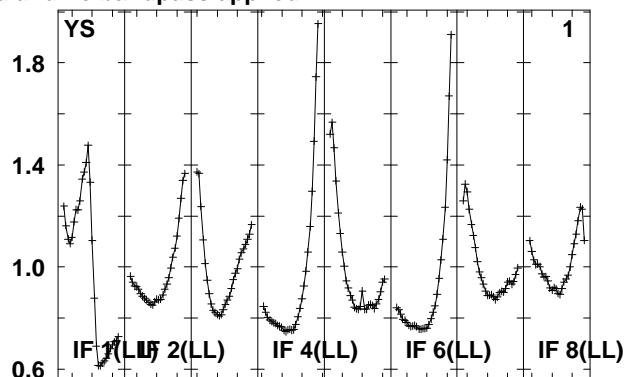
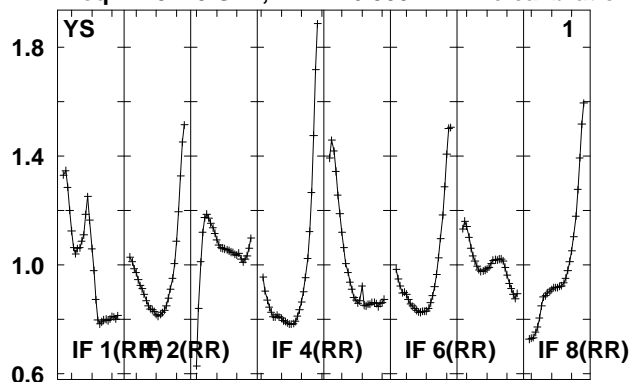

Lower frame: Real Jy
 Total-power spectrum Antenna: *
 Timerange: 01/00:24:49 to 01/00:26:17

Plot file version 720 created 14-MAY-2010 15:21:11

J0920+44 EO007.UVDATA.1

Freq = 4.9270 GHz, Bw = 16.000 MH No calibration applied and no bandpass applied

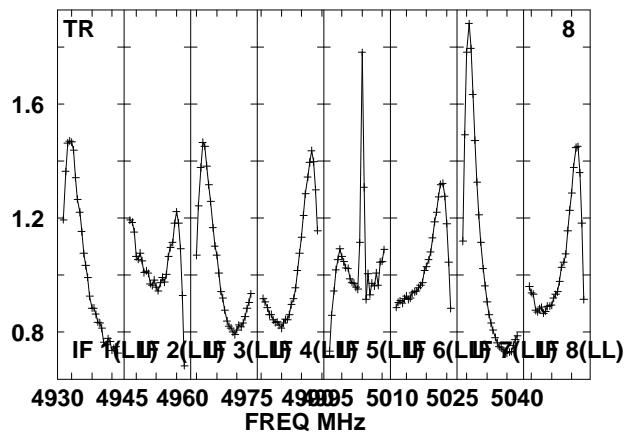
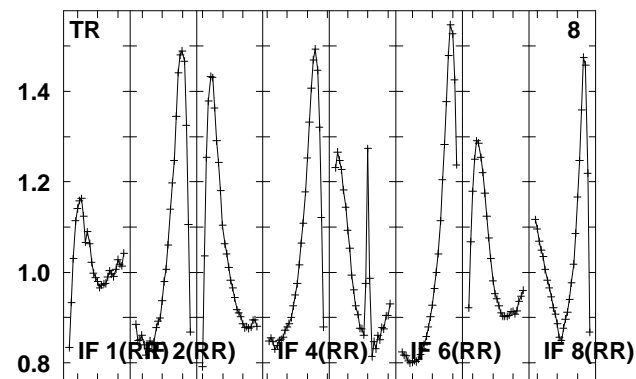
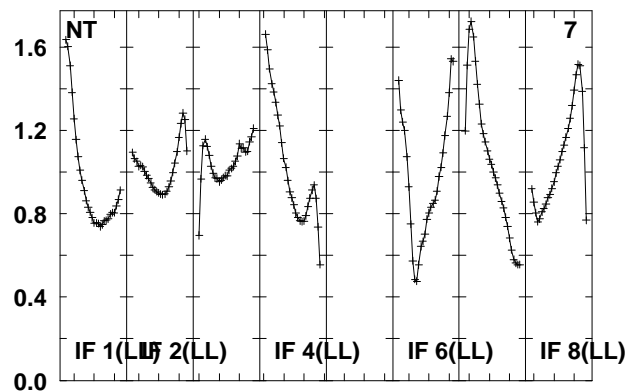
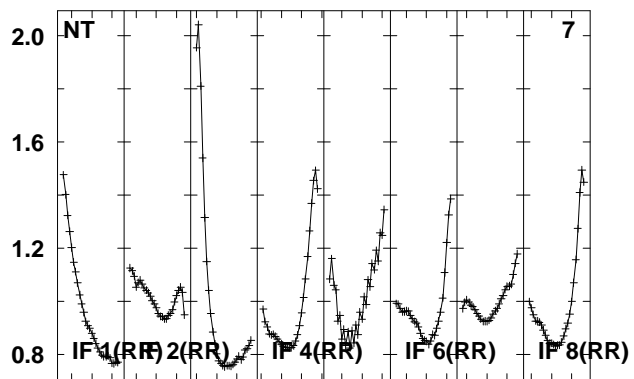
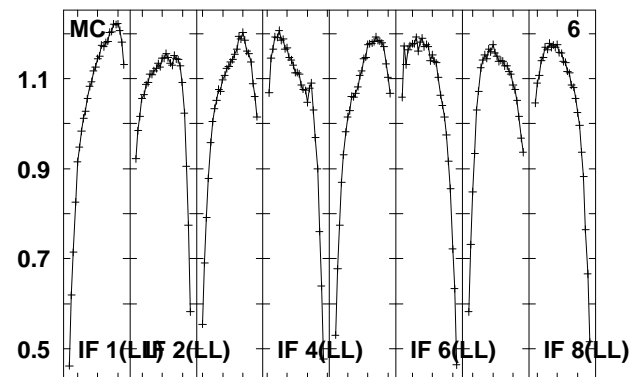
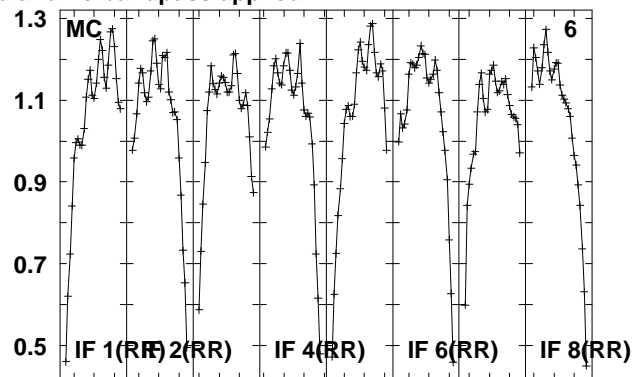
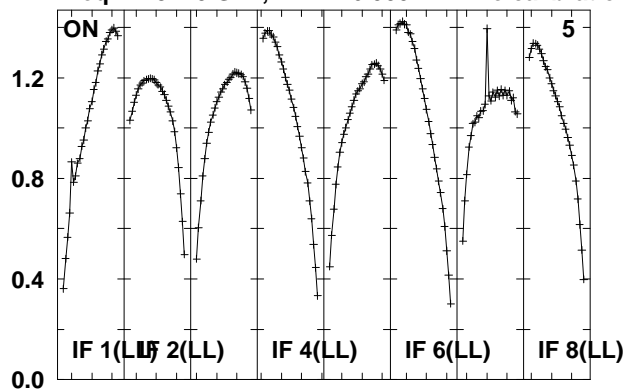

Lower frame: Real Jy

Total-power spectrum Antenna: *

Timerange: 01/00:24:49 to 01/00:26:17

Plot file version 721 created 14-MAY-2010 15:21:12

J092159 EO007.UVDATA.1

Freq = 4.9270 GHz, Bw = 16.000 MH No calibration applied and no bandpass applied

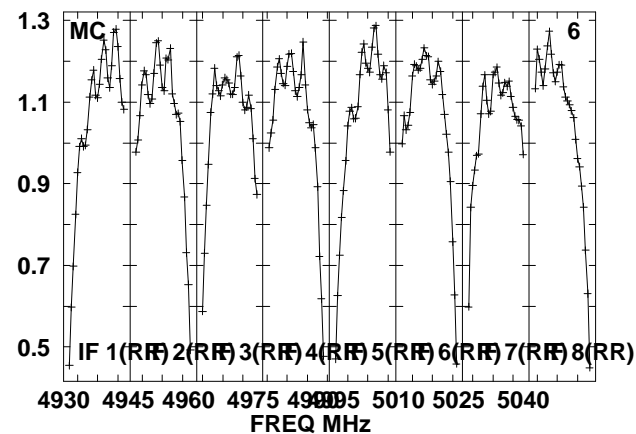
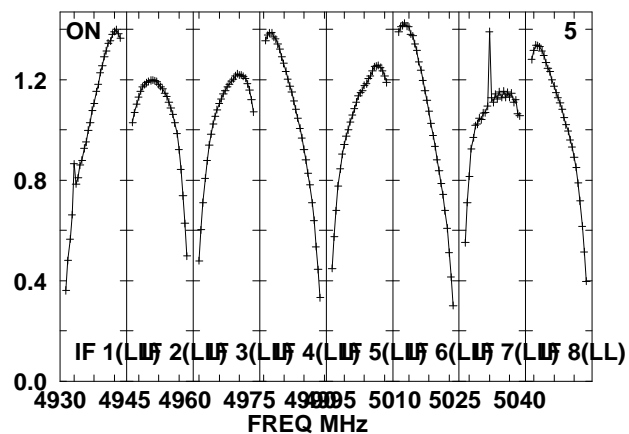
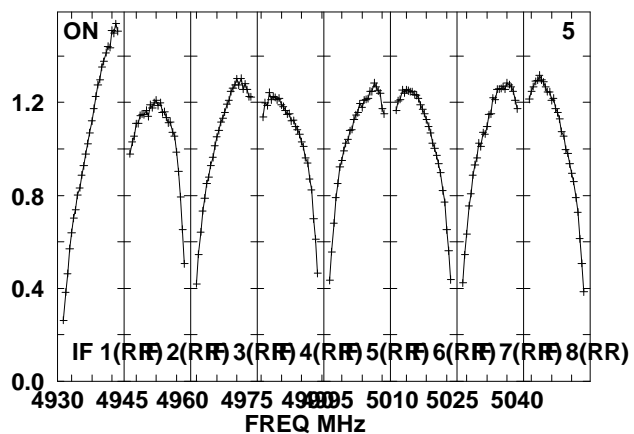
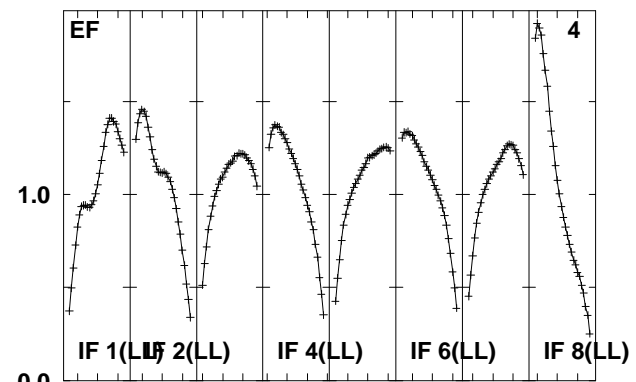
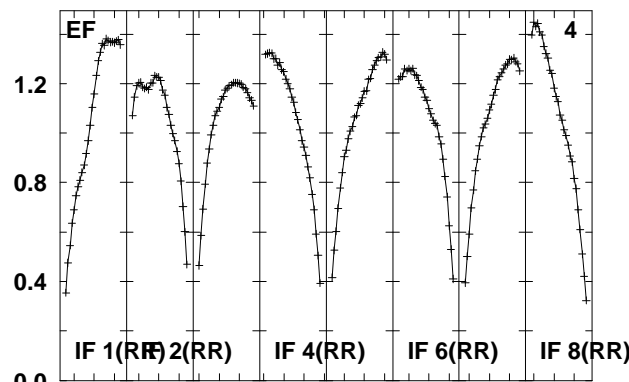
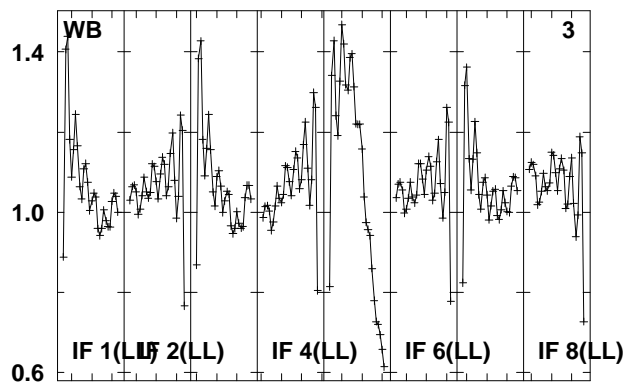
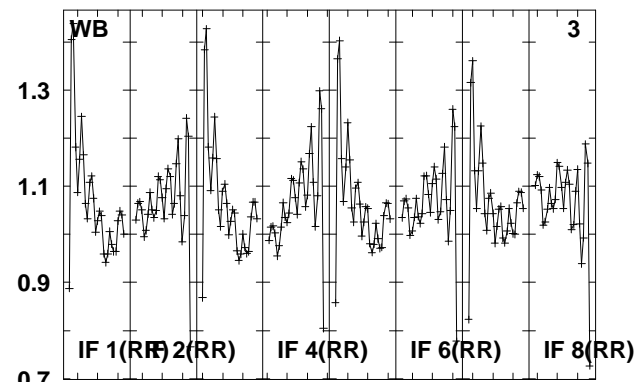
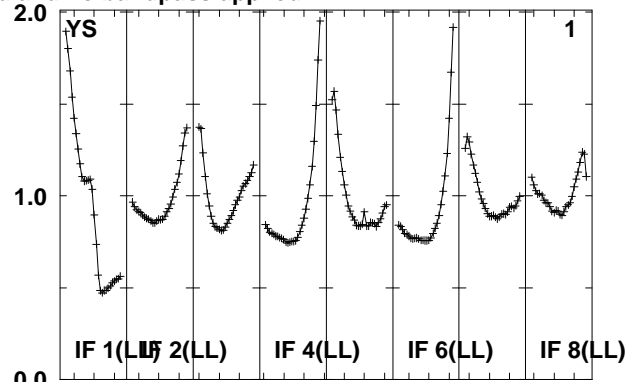
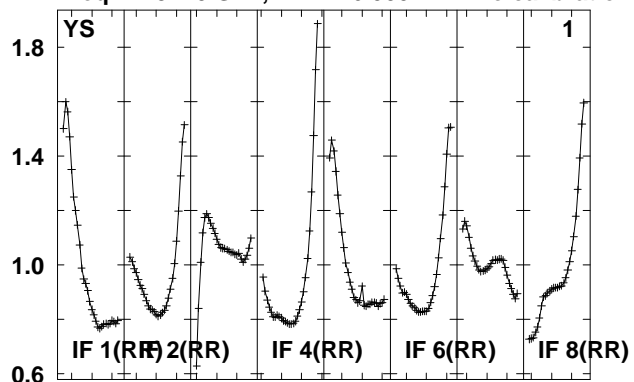

Lower frame: Real Jy
Total-power spectrum Antenna: *
Timerange: 01/00:26:39 to 01/00:31:37

Plot file version 722 created 14-MAY-2010 15:21:12

J092159 EO007.UVDATA.1

Freq = 4.9270 GHz, Bw = 16.000 MH No calibration applied and no bandpass applied

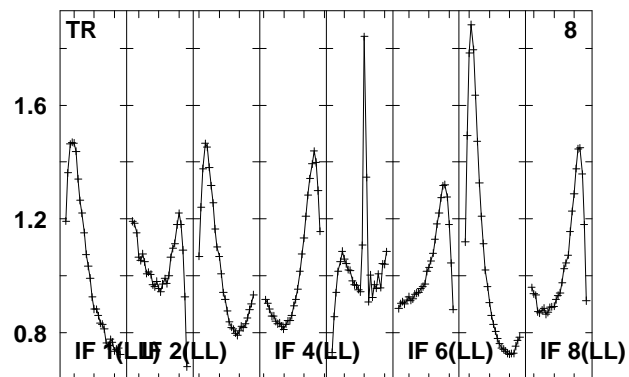
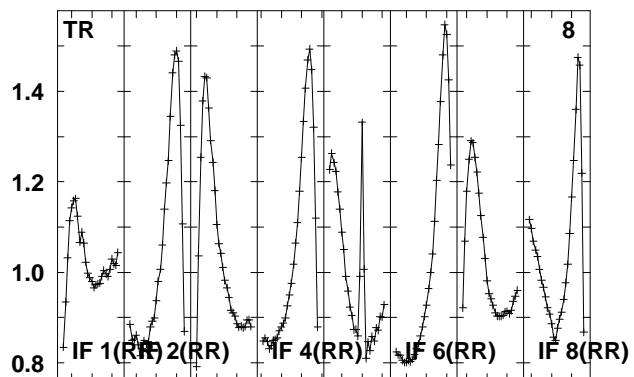
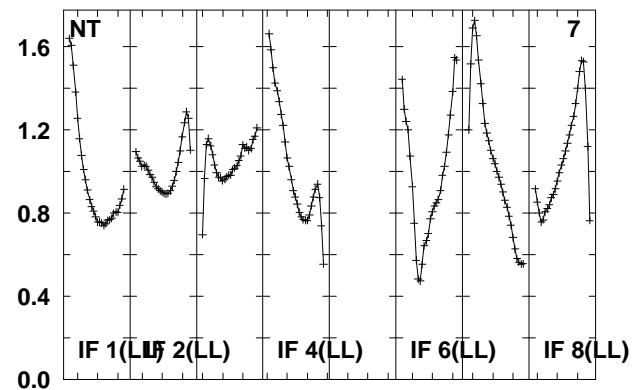
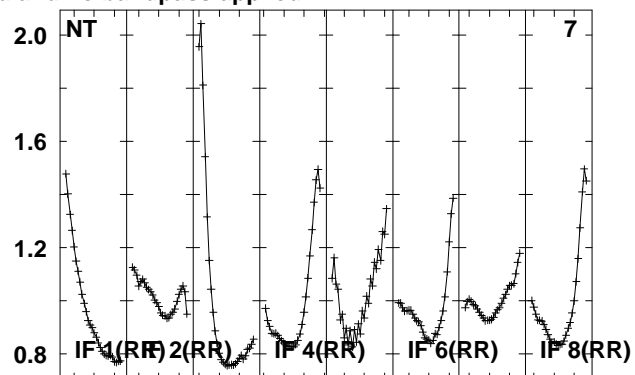
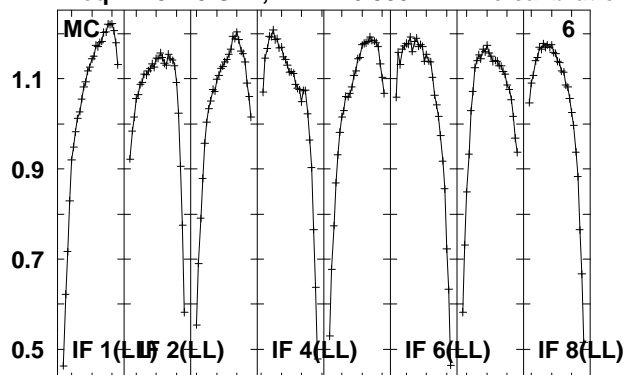

Lower frame: Real Jy
Total-power spectrum Antenna: *
Timerange: 01/00:26:39 to 01/00:31:37

Plot file version 723 created 14-MAY-2010 15:21:13

J0920+44 EO07.UVDATA.1

Freq = 4.9270 GHz, Bw = 16.000 MH No calibration applied and no bandpass applied

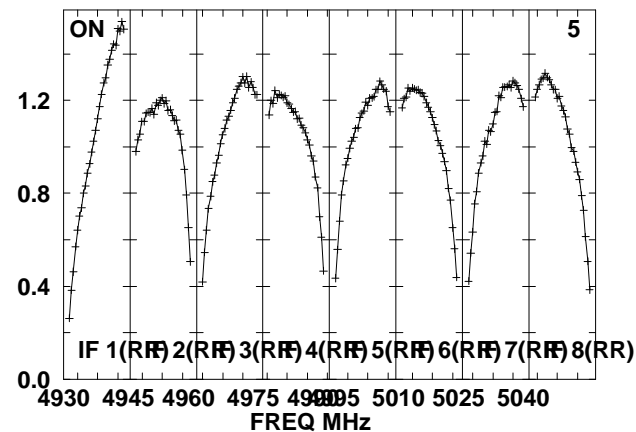
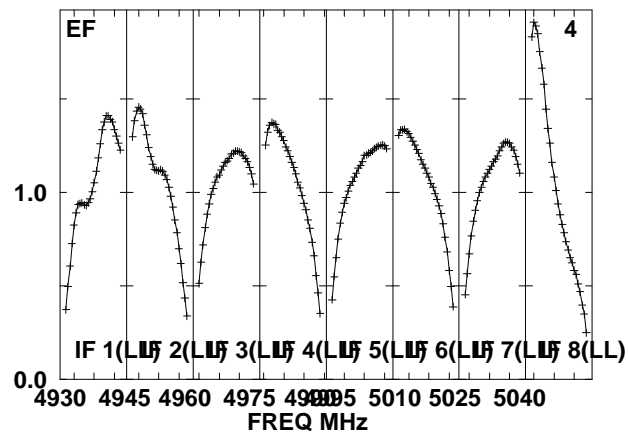
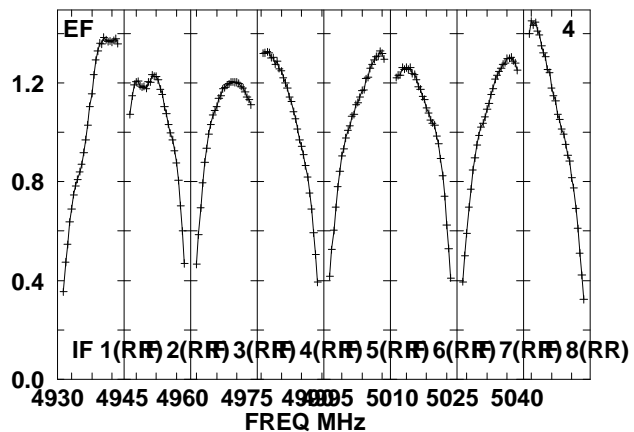
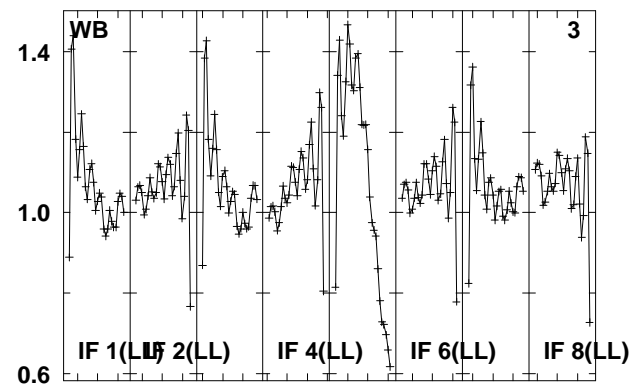
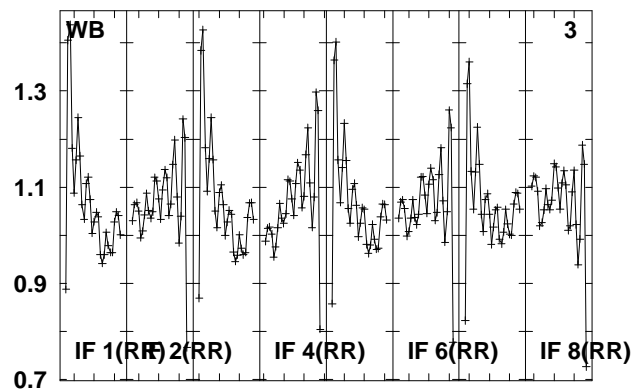
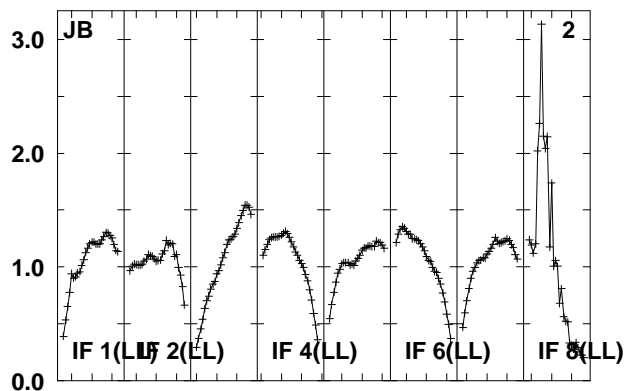
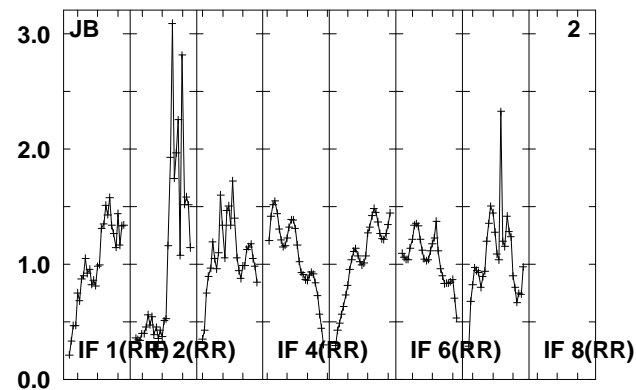
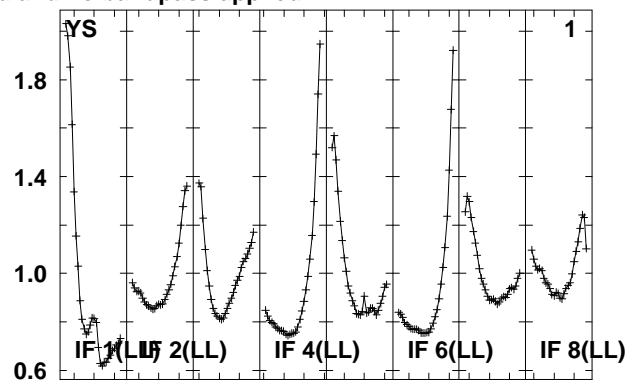
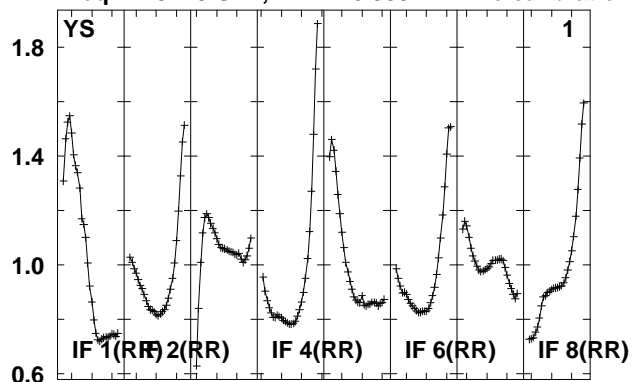

Lower frame: Real Jy

Total-power spectrum Antenna: *

Timerange: 01/00:31:59 to 01/00:33:25

Plot file version 724 created 14-MAY-2010 15:21:13

J0920+44 EO007.UVDATA.1

Freq = 4.9270 GHz, Bw = 16.000 MH No calibration applied and no bandpass applied

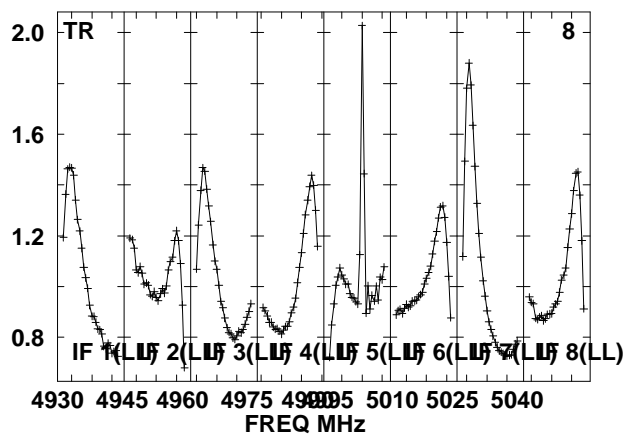
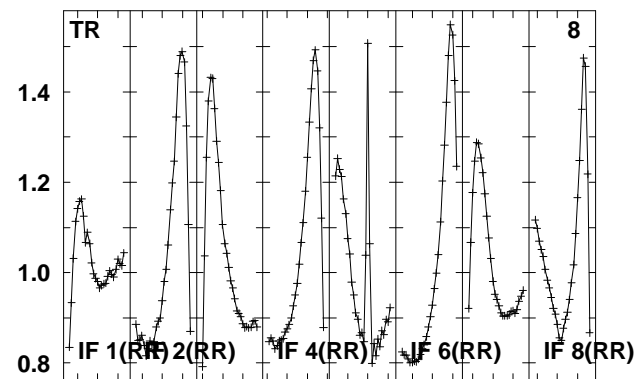
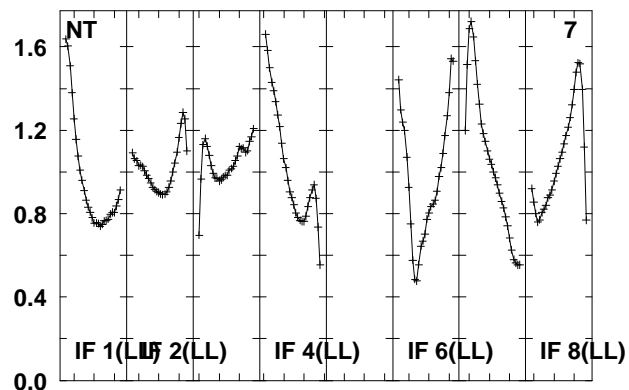
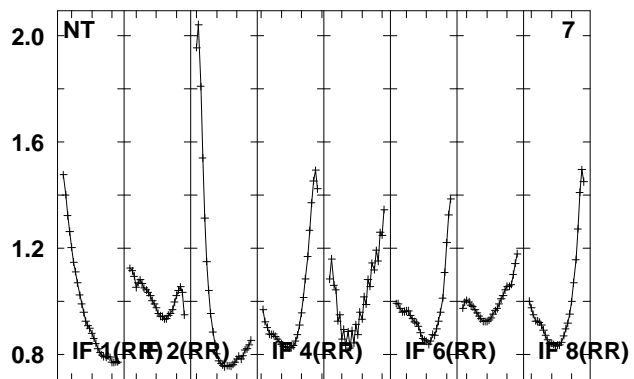
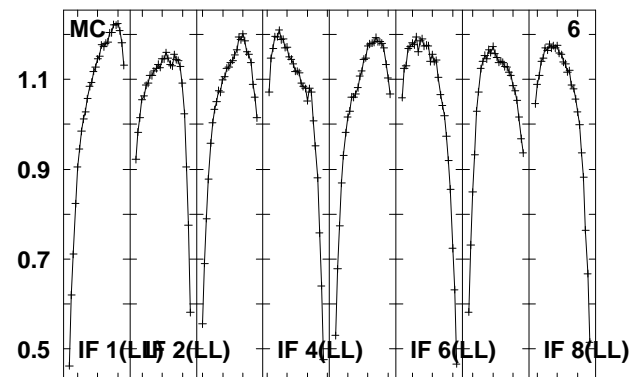
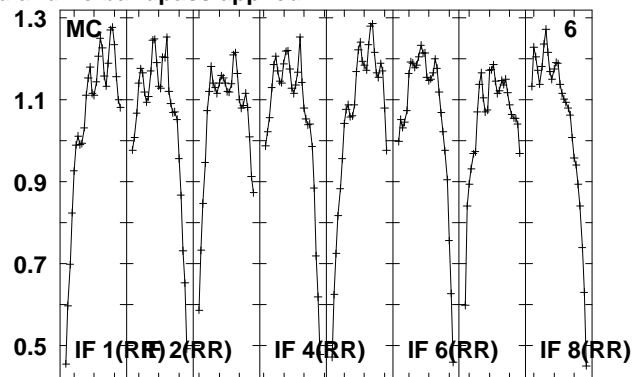
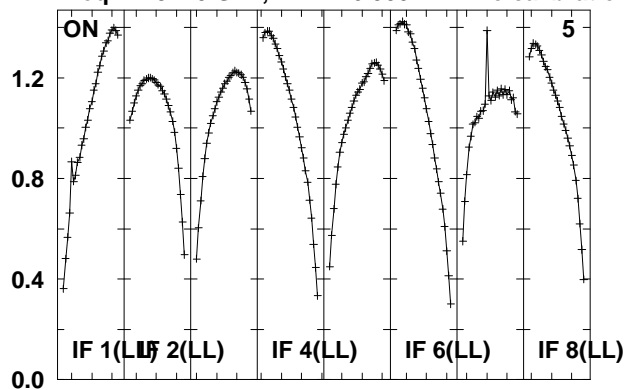

Lower frame: Real Jy

Total-power spectrum Antenna: *

Timerange: 01/00:31:59 to 01/00:33:25

Plot file version 725 created 14-MAY-2010 15:21:13

J1027+48 EO007.UVDATA.1

Freq = 4.9270 GHz, Bw = 16.000 MH No calibration applied and no bandpass applied

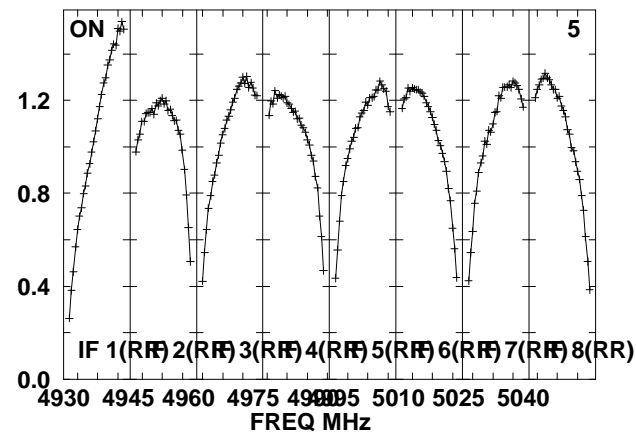
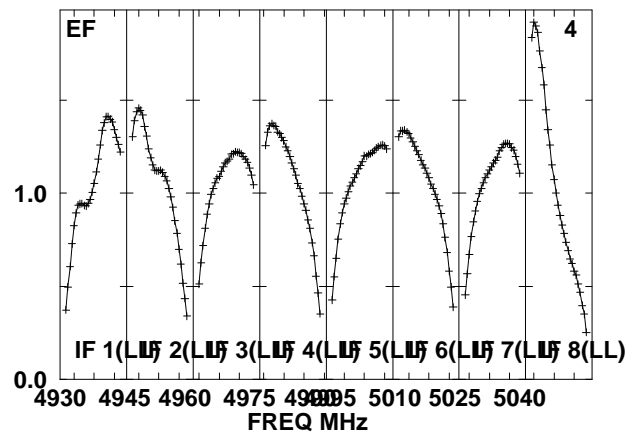
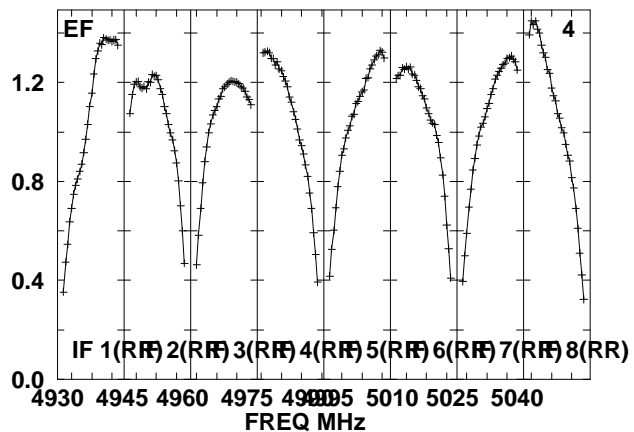
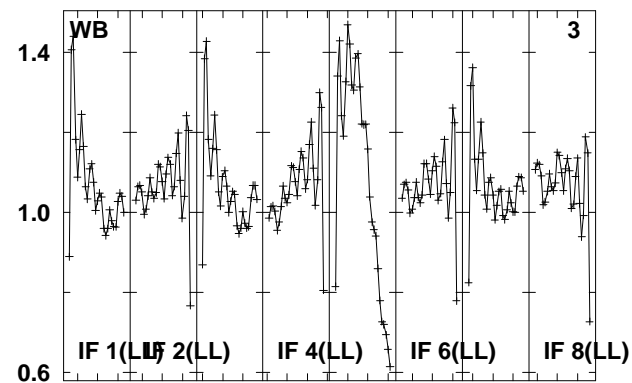
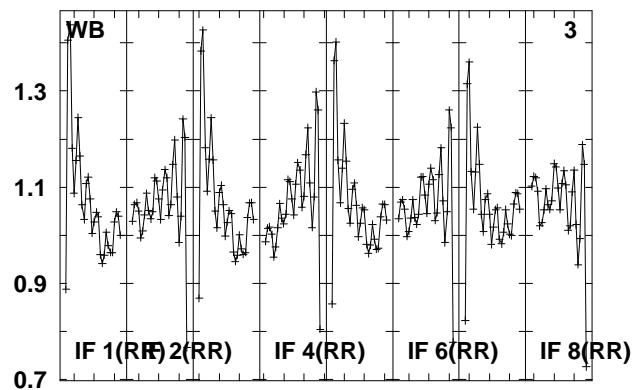
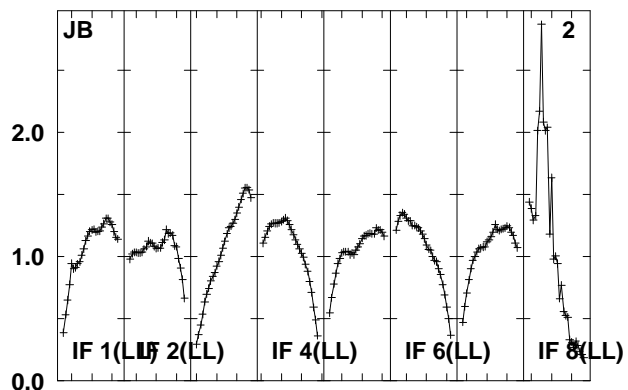
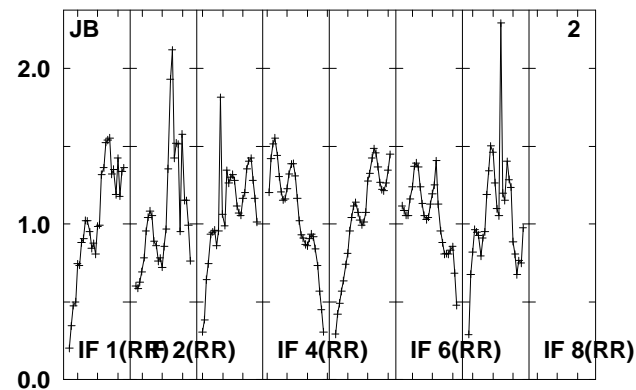
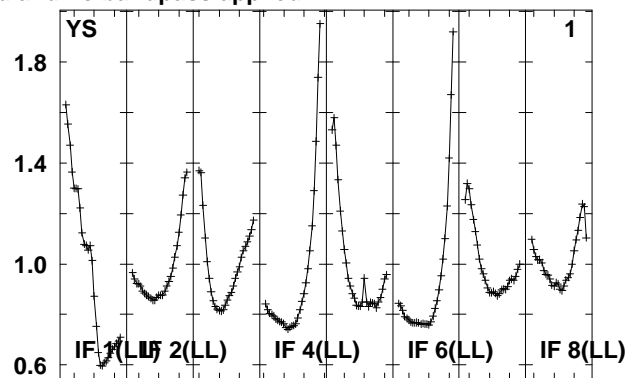
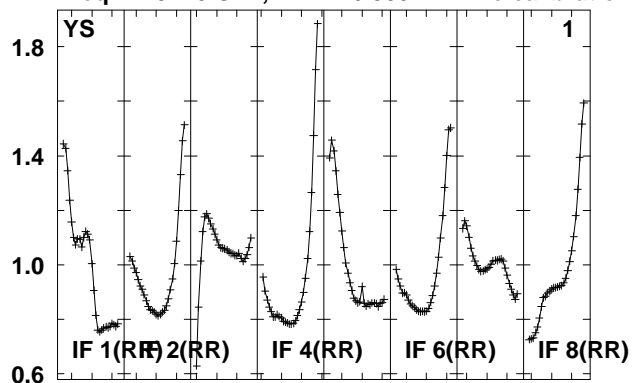

Lower frame: Real Jy
Total-power spectrum Antenna: *
Timerange: 01/00:34:53 to 01/00:36:19

Plot file version 726 created 14-MAY-2010 15:21:13

J1027+48 EO007.UVDATA.1

Freq = 4.9270 GHz, Bw = 16.000 MH No calibration applied and no bandpass applied

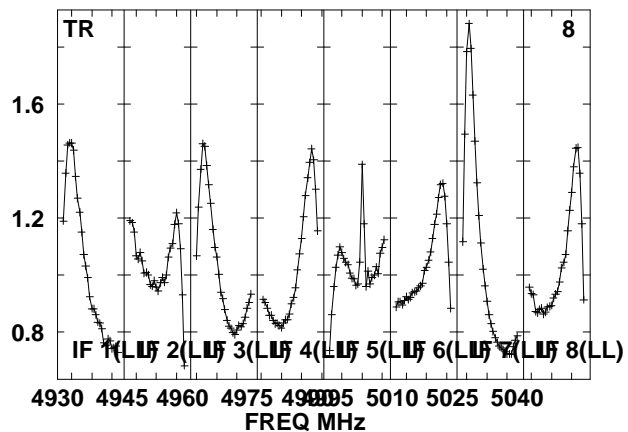
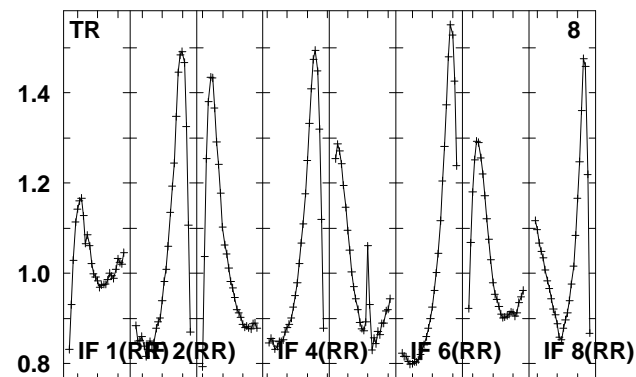
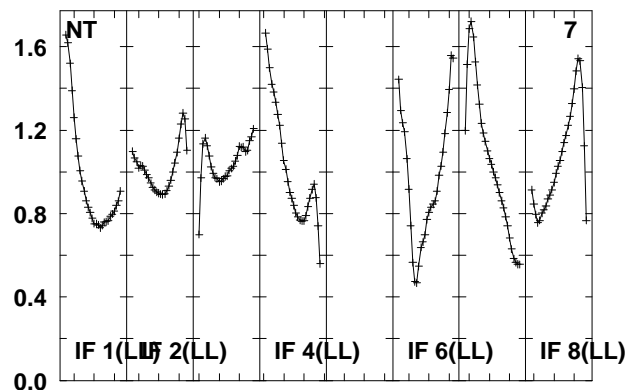
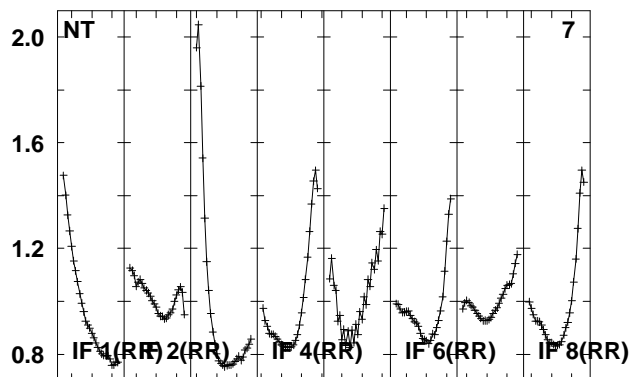
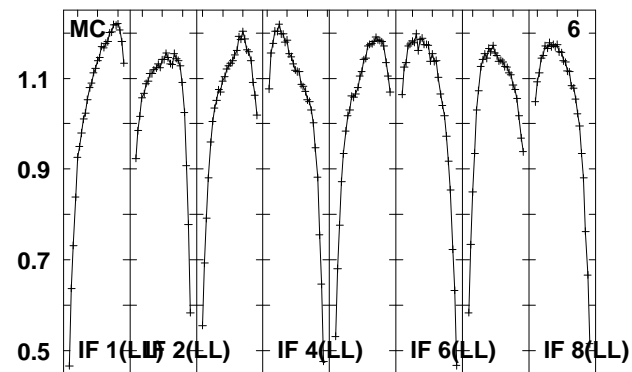
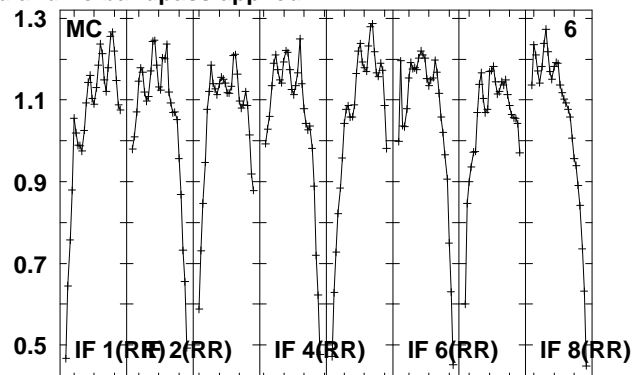
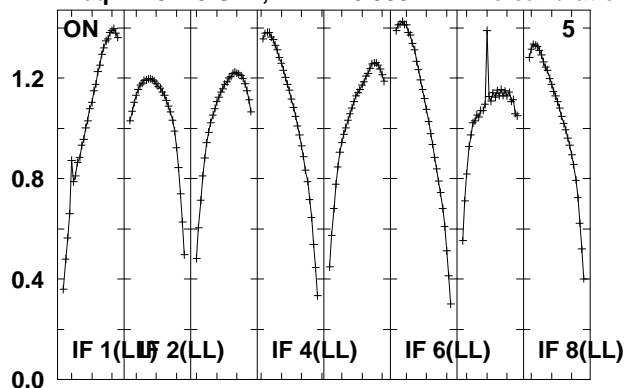

Lower frame: Real Jy

Total-power spectrum Antenna: *

Timerange: 01/00:34:53 to 01/00:36:19

Plot file version 727 created 14-MAY-2010 15:21:14

J102959 EO007.UVDATA.1

Freq = 4.9270 GHz, Bw = 16.000 MH No calibration applied and no bandpass applied

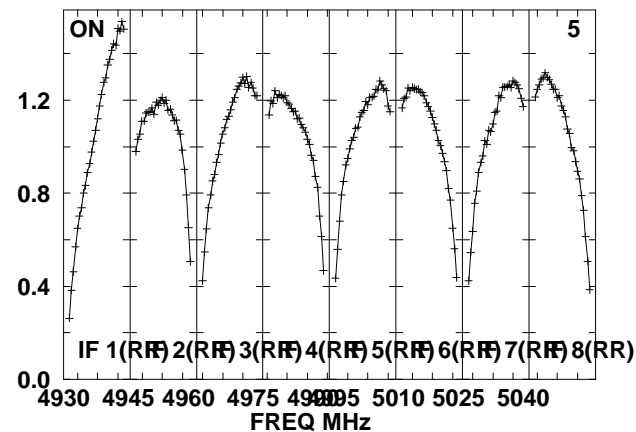
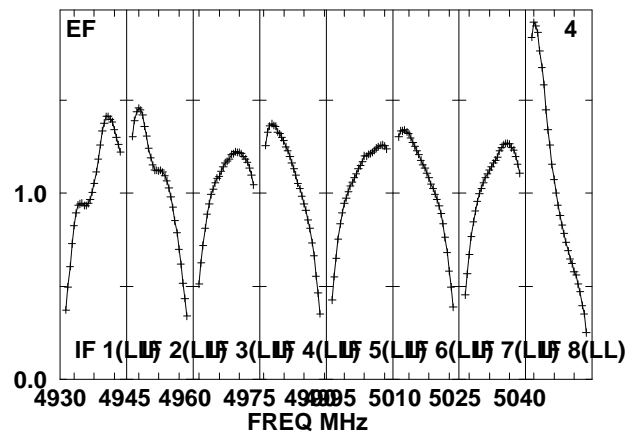
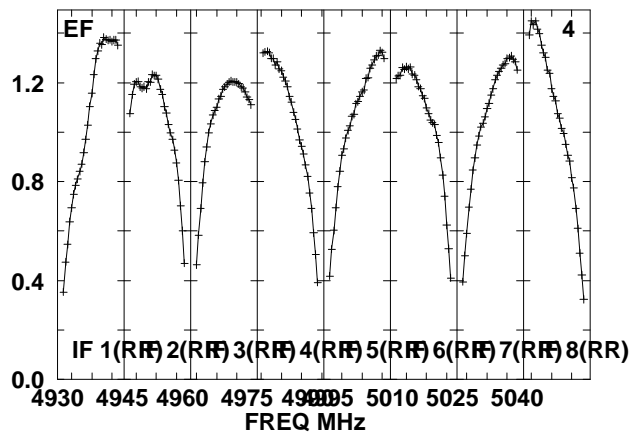
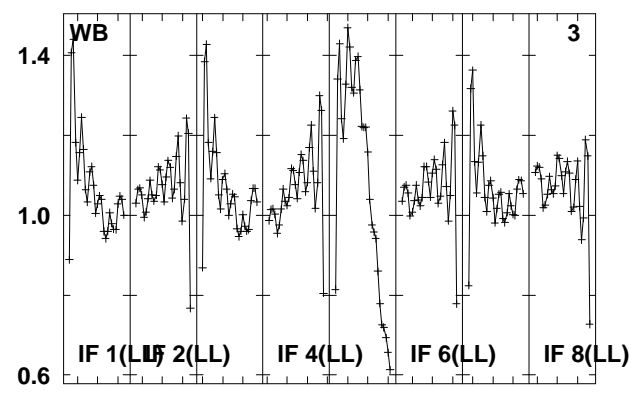
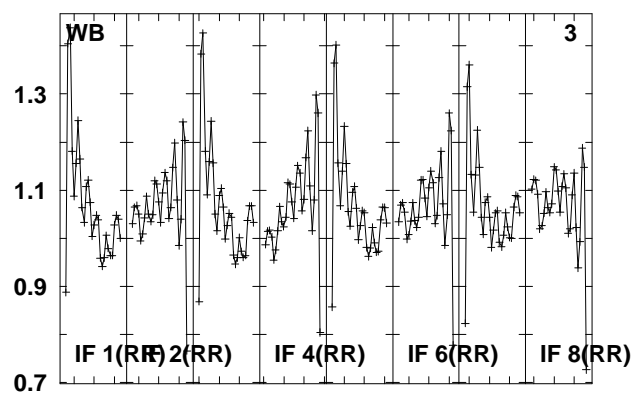
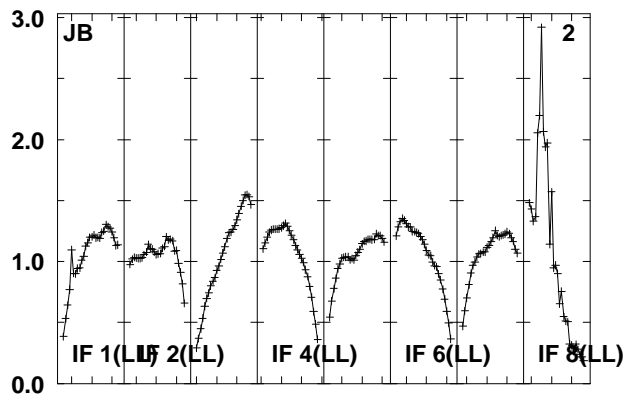
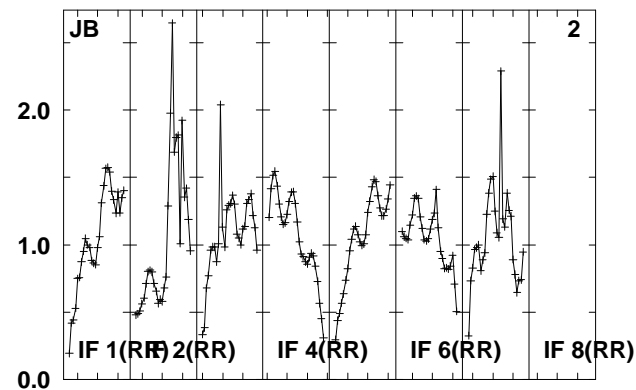
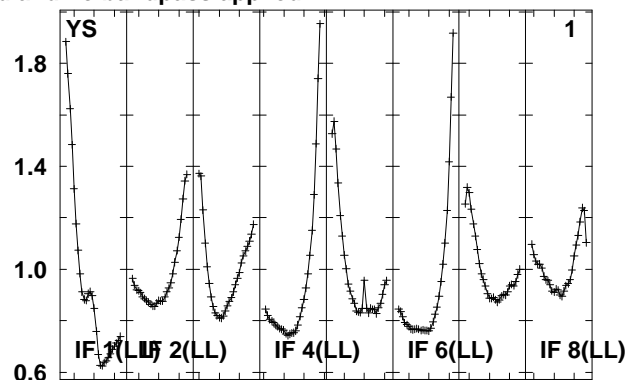
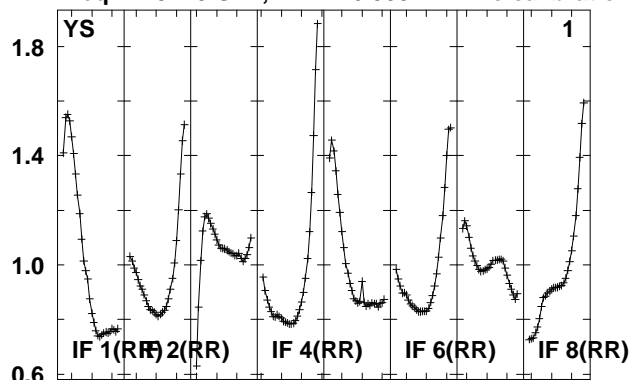

Lower frame: Real Jy

Total-power spectrum Antenna: *

Timerange: 01/00:36:45 to 01/00:41:43

Plot file version 728 created 14-MAY-2010 15:21:14

J102959 EO007.UVDATA.1

Freq = 4.9270 GHz, Bw = 16.000 MH No calibration applied and no bandpass applied

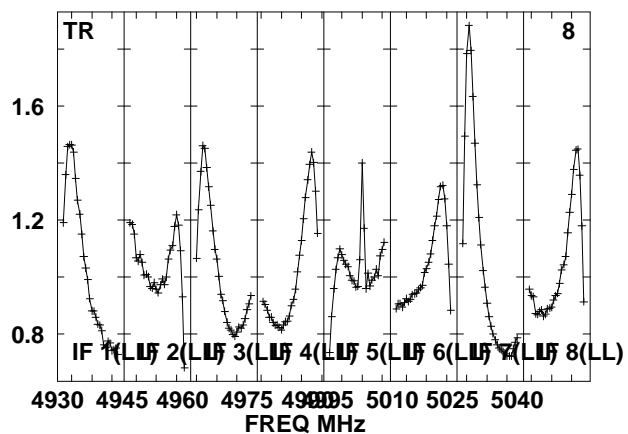
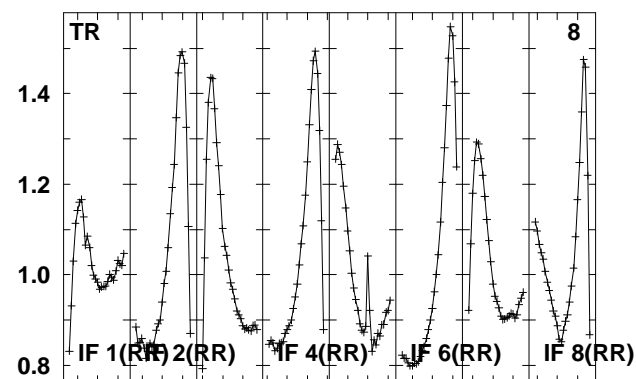
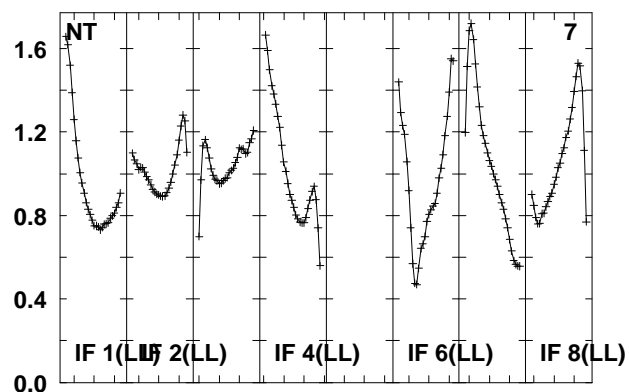
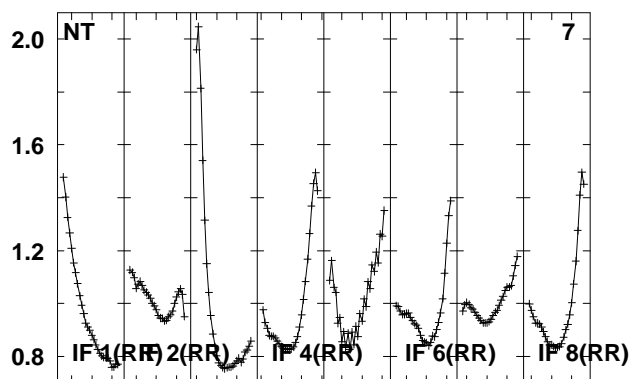
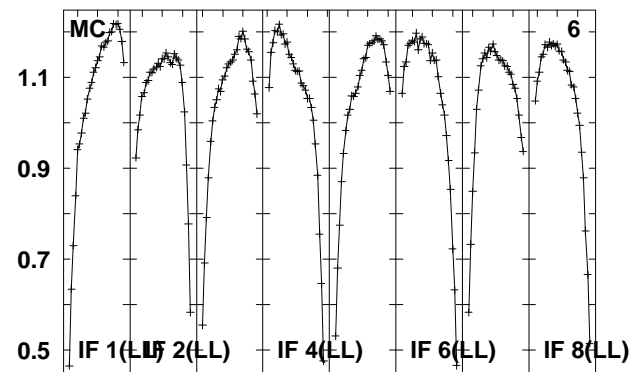
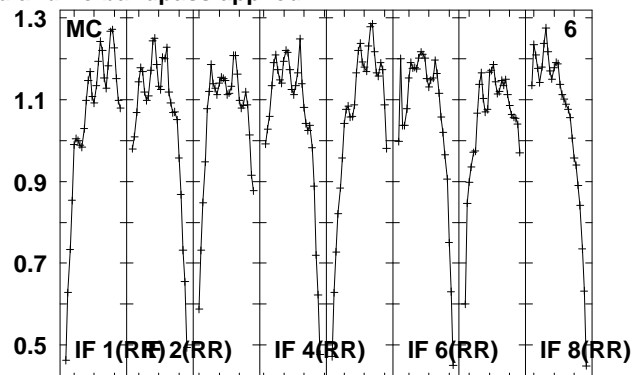
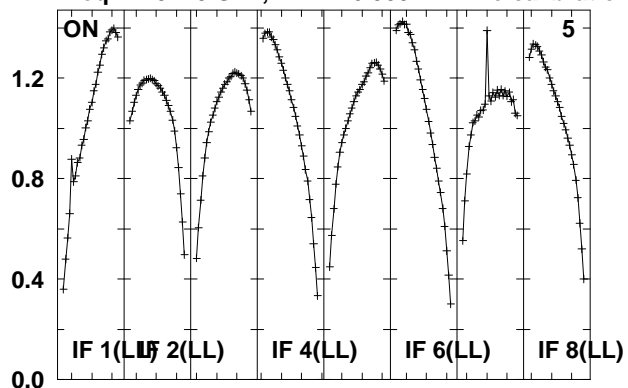

Lower frame: Real Jy

Total-power spectrum Antenna: *

Timerange: 01/00:36:45 to 01/00:41:43

Plot file version 729 created 14-MAY-2010 15:21:15

J1027+48 EO007.UVDATA.1

Freq = 4.9270 GHz, Bw = 16.000 MH No calibration applied and no bandpass applied

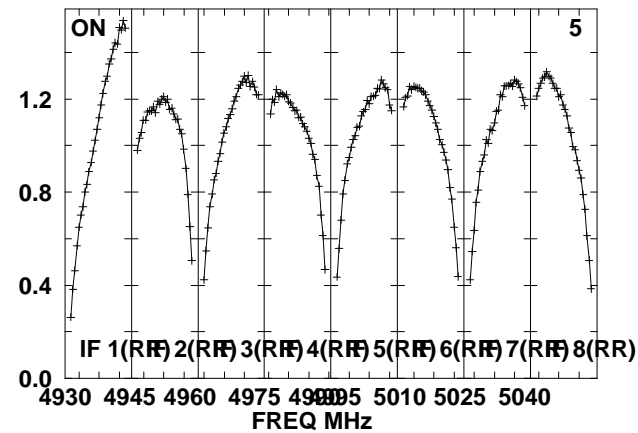
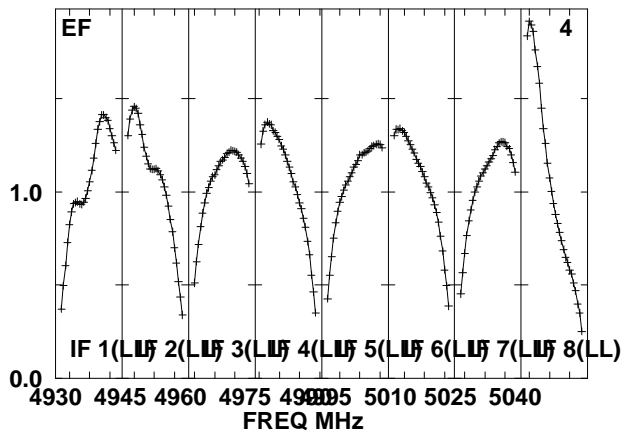
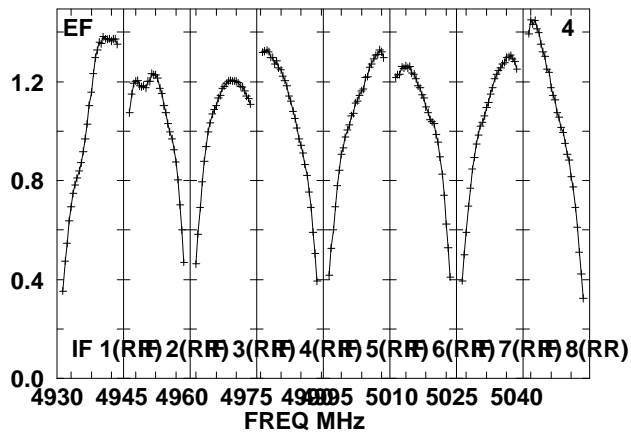
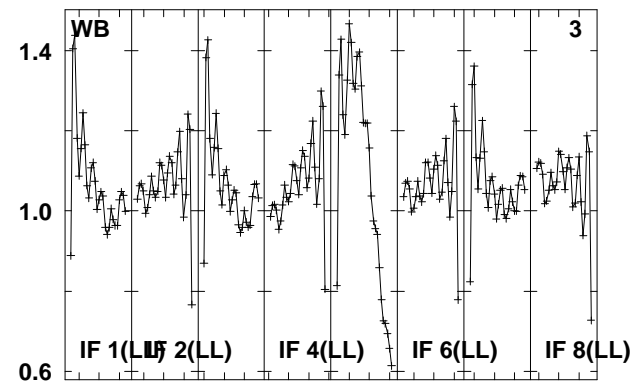
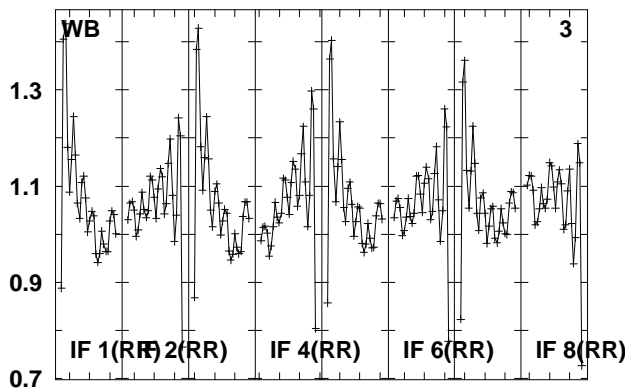
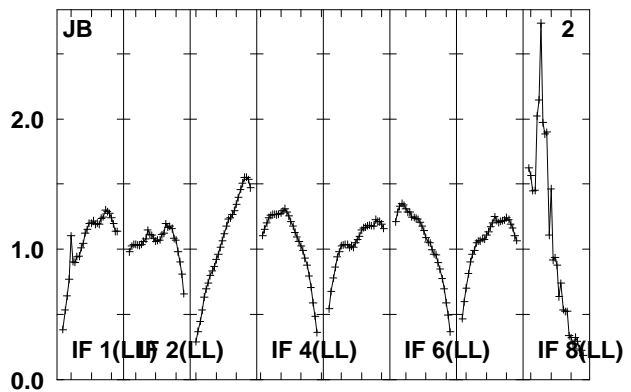
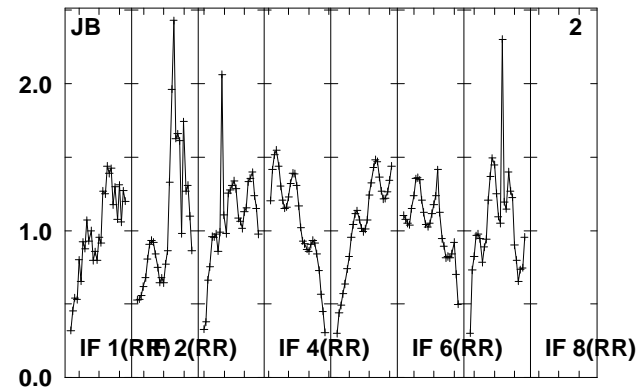
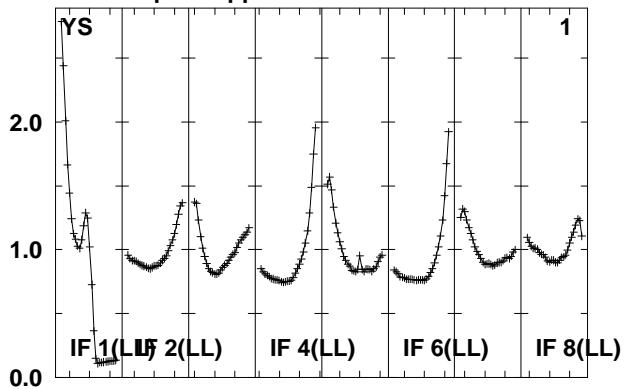
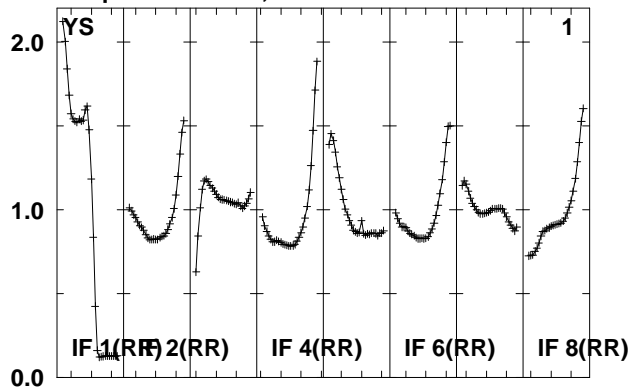

Lower frame: Real Jy
Total-power spectrum Antenna: *
Timerange: 01/00:42:05 to 01/00:43:33

Plot file version 730 created 14-MAY-2010 15:21:15

J1027+48 EO007.UVDATA.1

Freq = 4.9270 GHz, Bw = 16.000 MH No calibration applied and no bandpass applied

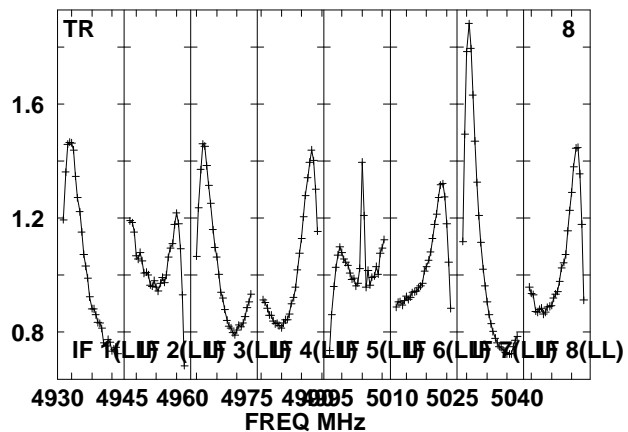
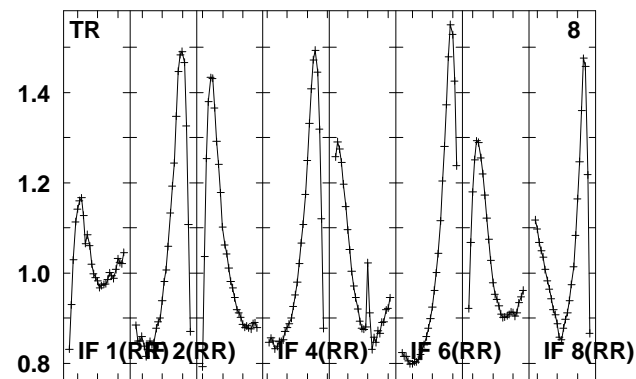
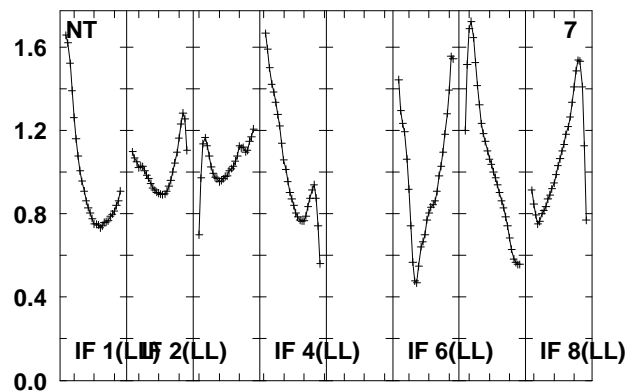
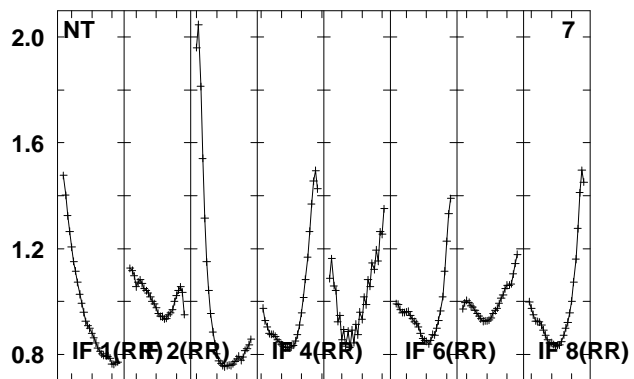
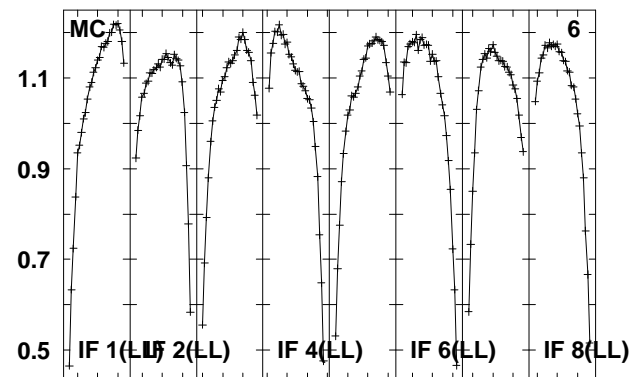
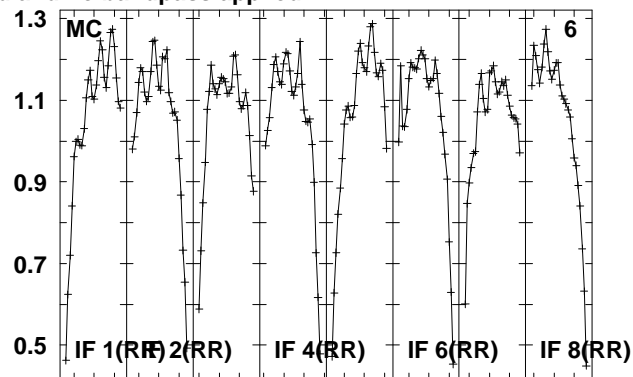
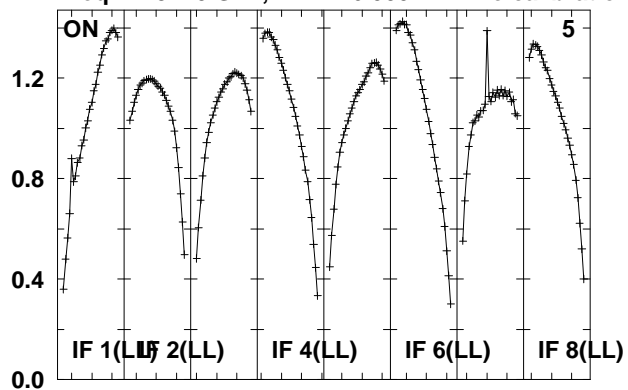

Lower frame: Real Jy

Total-power spectrum Antenna: *

Timerange: 01/00:42:05 to 01/00:43:33

Plot file version 731 created 14-MAY-2010 15:21:15

J102959 EO007.UVDATA.1

Freq = 4.9270 GHz, Bw = 16.000 MH No calibration applied and no bandpass applied

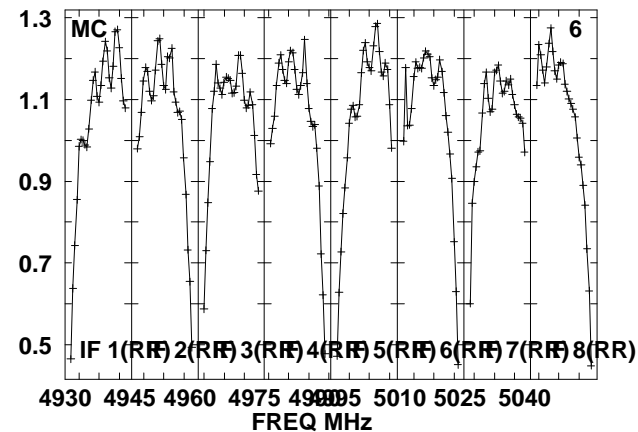
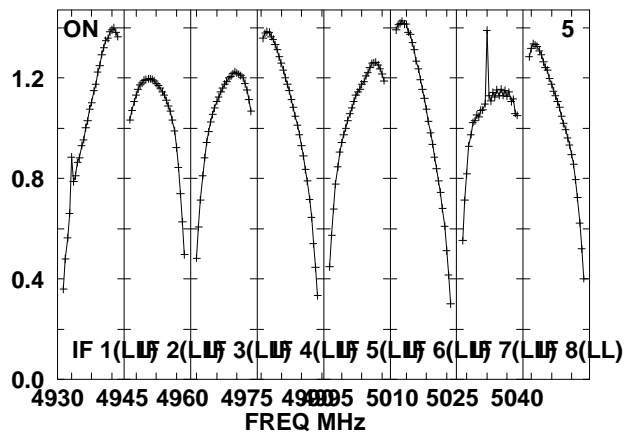
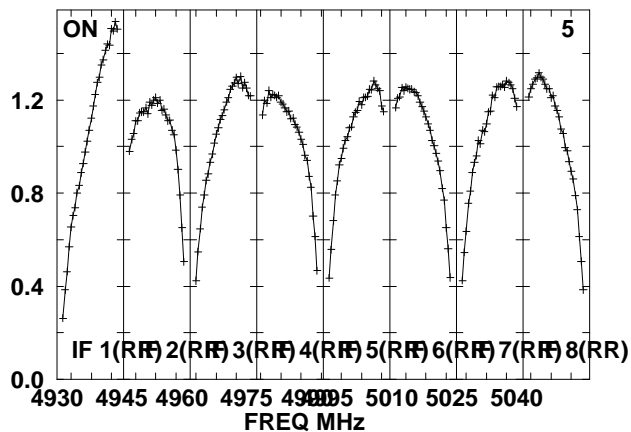
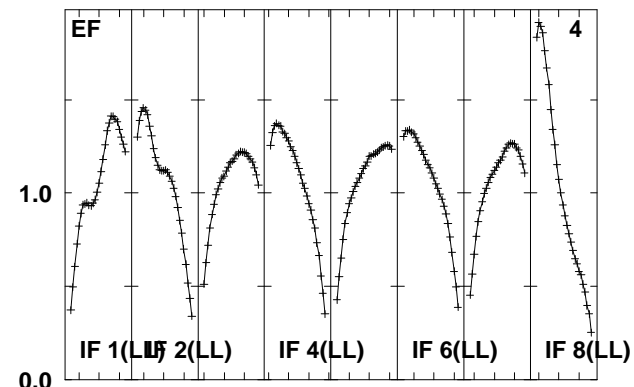
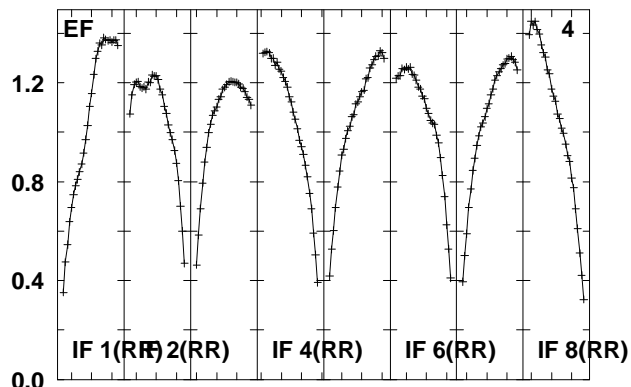
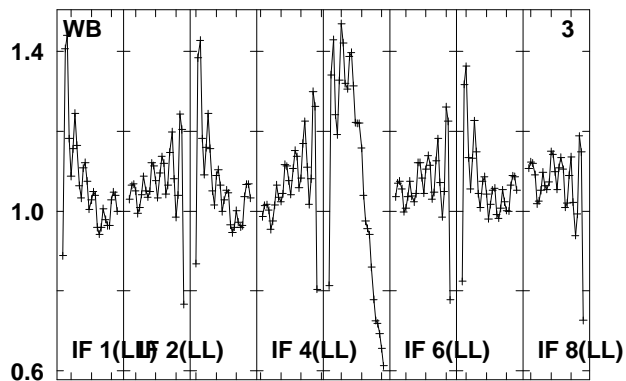
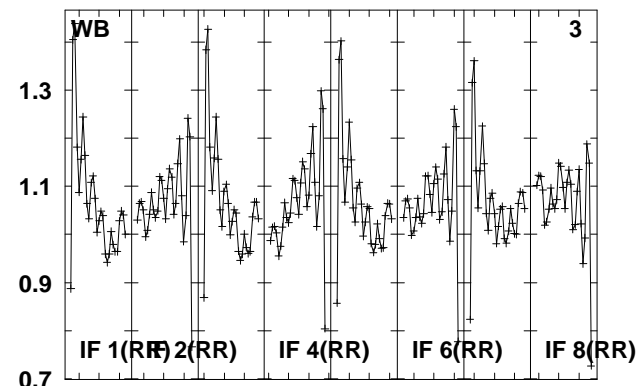
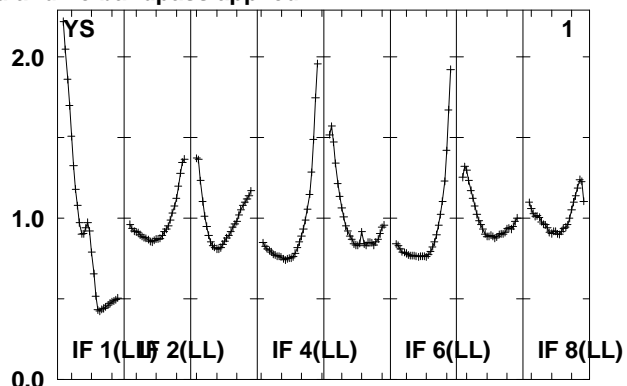
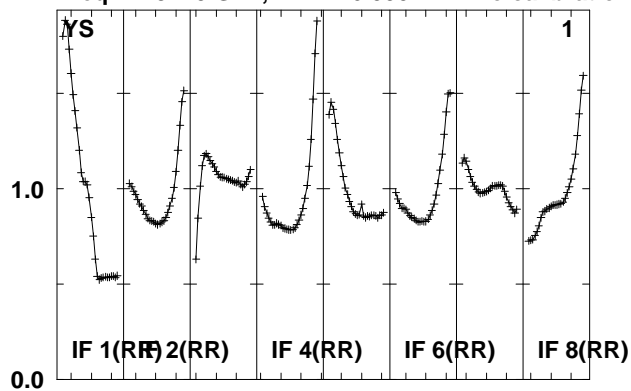

Lower frame: Real Jy
Total-power spectrum Antenna: *
Timerange: 01/00:43:57 to 01/00:48:53

Plot file version 732 created 14-MAY-2010 15:21:16

J102959 EO007.UVDATA.1

Freq = 4.9270 GHz, Bw = 16.000 MH No calibration applied and no bandpass applied

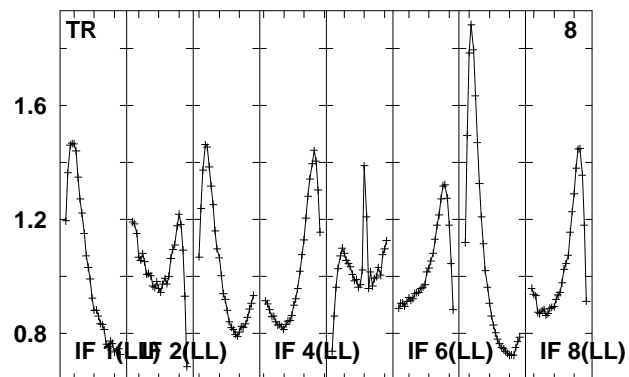
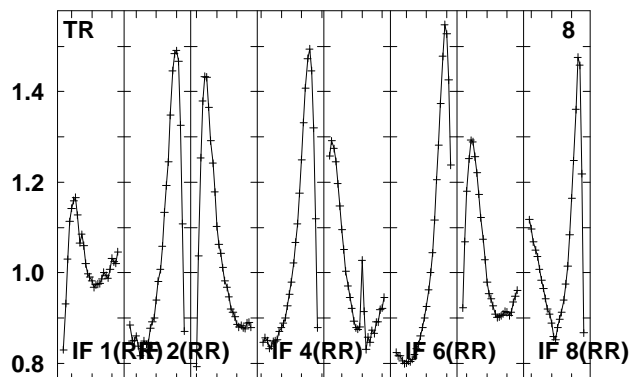
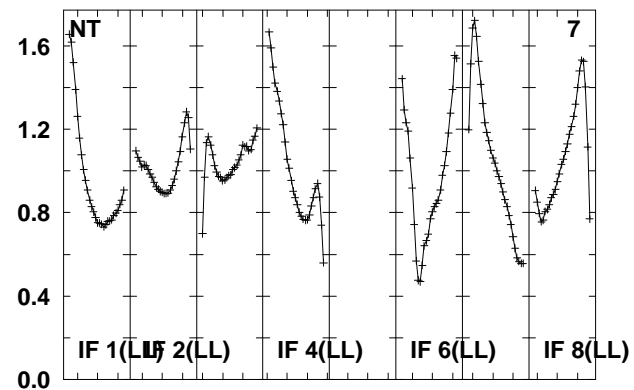
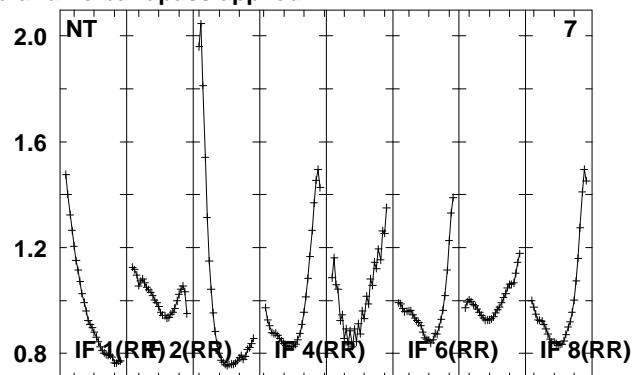
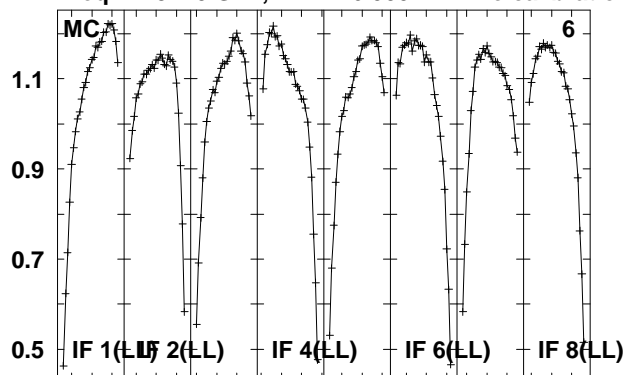

Lower frame: Real Jy
Total-power spectrum Antenna: *
Timerange: 01/00:43:57 to 01/00:48:53

Plot file version 733 created 14-MAY-2010 15:21:16

J1027+48 EO007.UVDATA.1

Freq = 4.9270 GHz, Bw = 16.000 MH No calibration applied and no bandpass applied

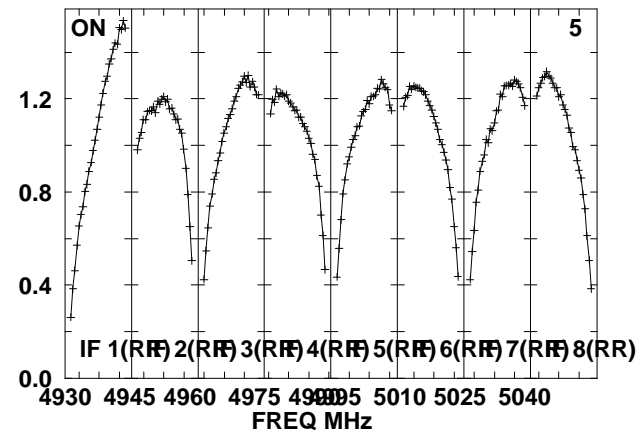
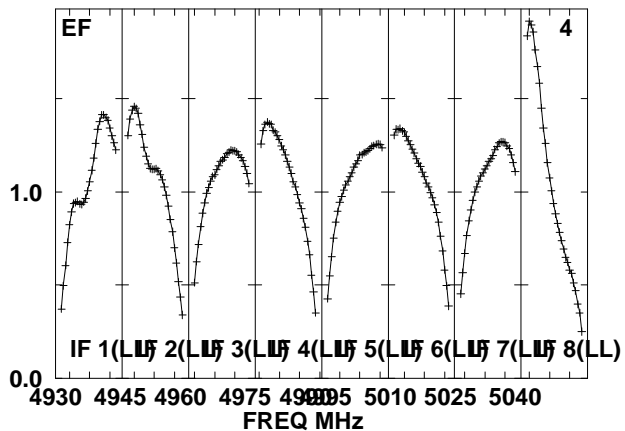
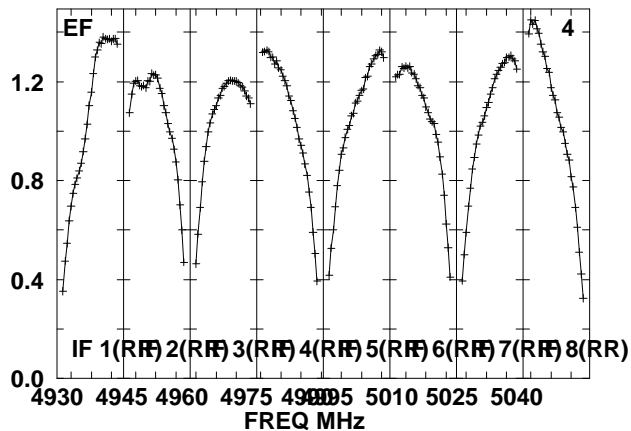
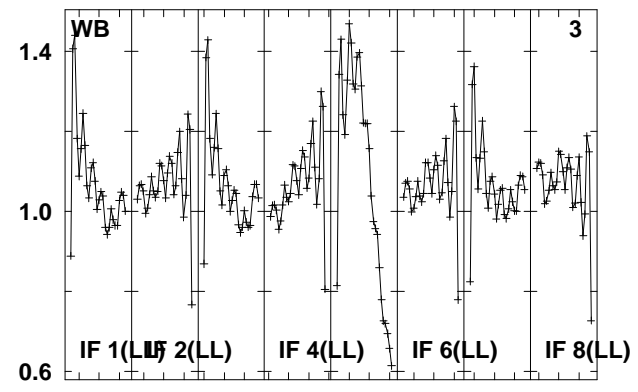
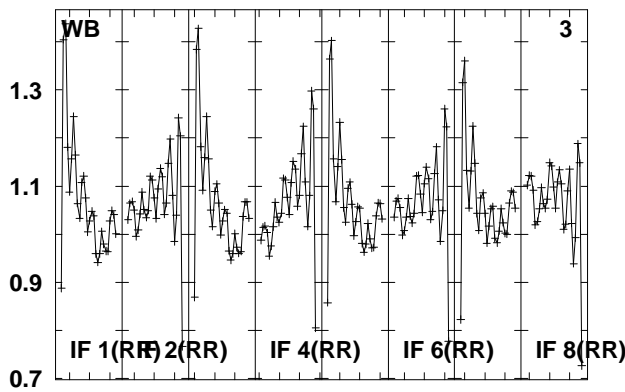
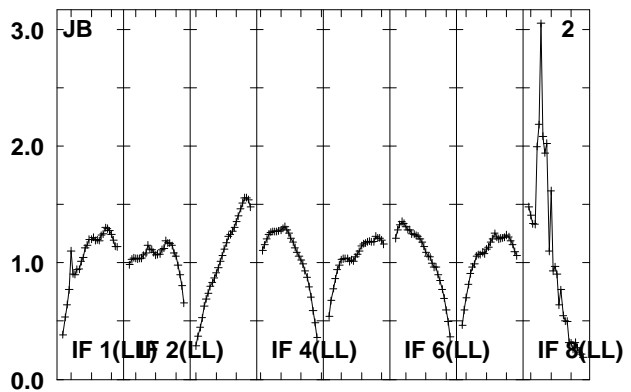
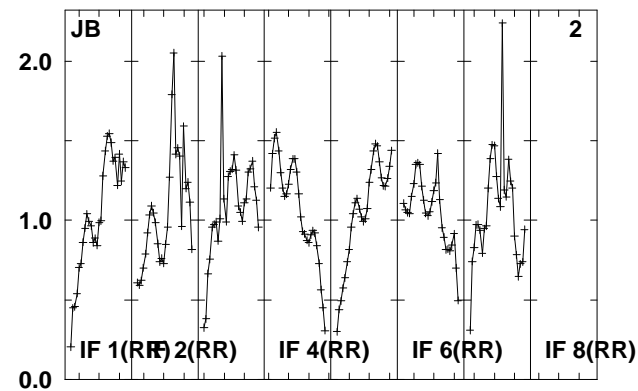
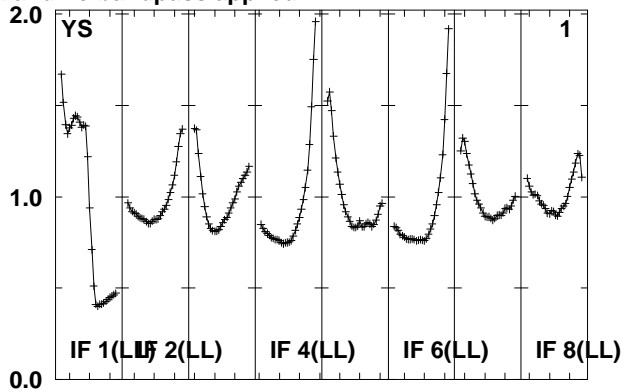
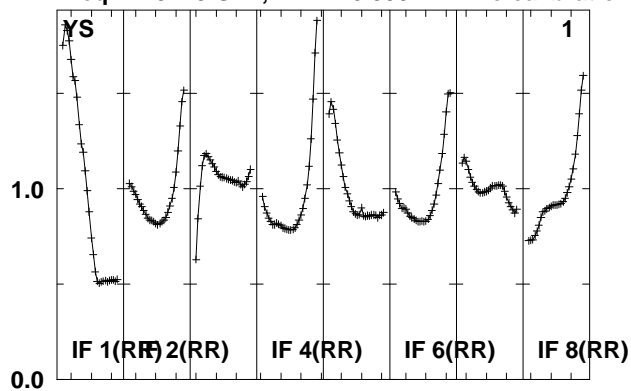

Lower frame: Real Jy
Total-power spectrum Antenna: *
Timerange: 01/00:49:17 to 01/00:50:43

Plot file version 734 created 14-MAY-2010 15:21:16

J1027+48 EO007.UVDATA.1

Freq = 4.9270 GHz, Bw = 16.000 MH No calibration applied and no bandpass applied

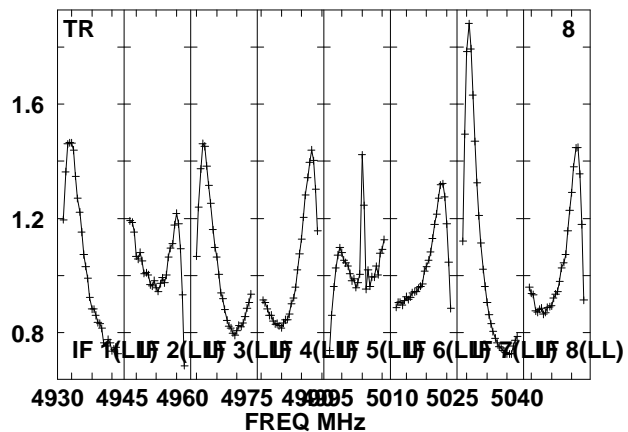
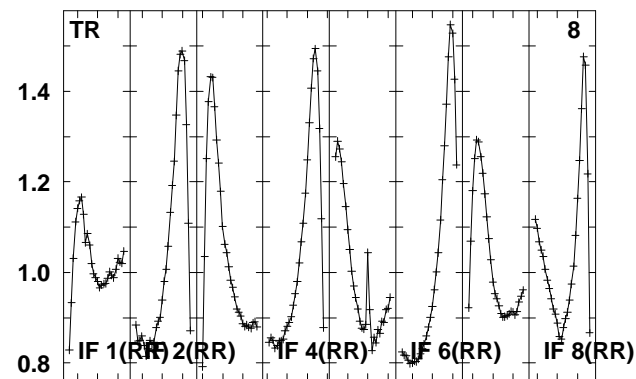
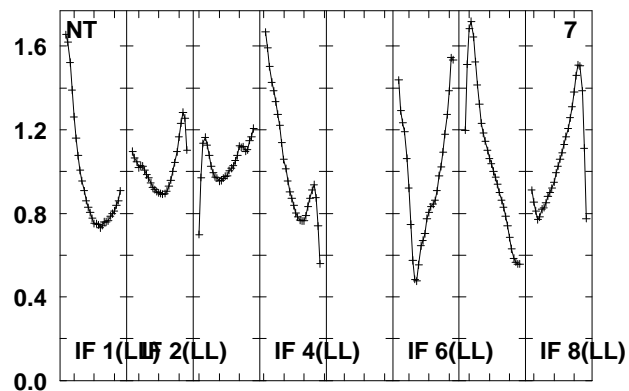
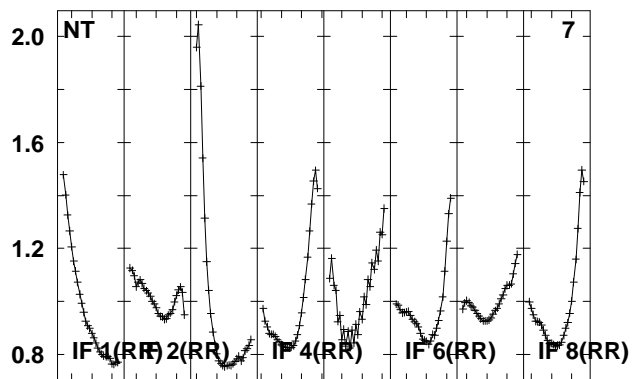
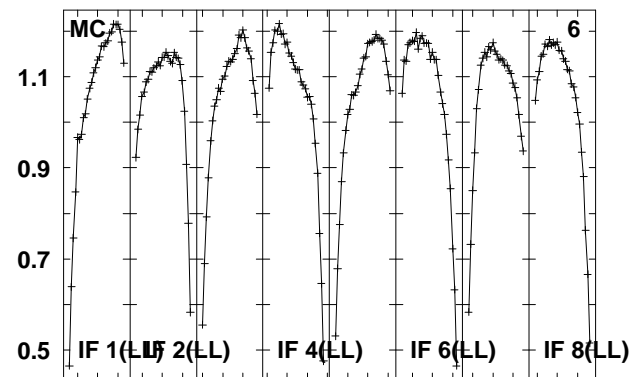
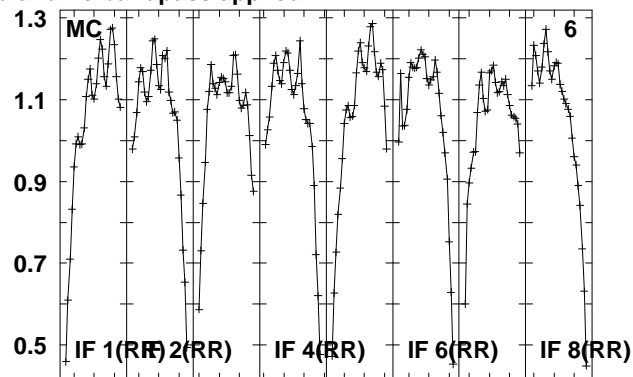
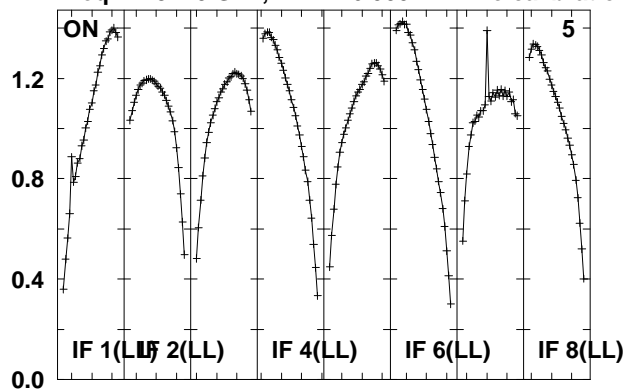

Lower frame: Real Jy

Total-power spectrum Antenna: *

Timerange: 01/00:49:17 to 01/00:50:43

Plot file version 735 created 14-MAY-2010 15:21:16

J0920+44 EO007.UVDATA.1

Freq = 4.9270 GHz, Bw = 16.000 MH No calibration applied and no bandpass applied

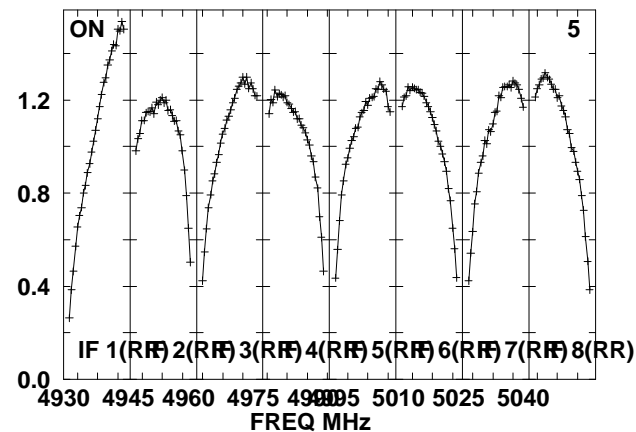
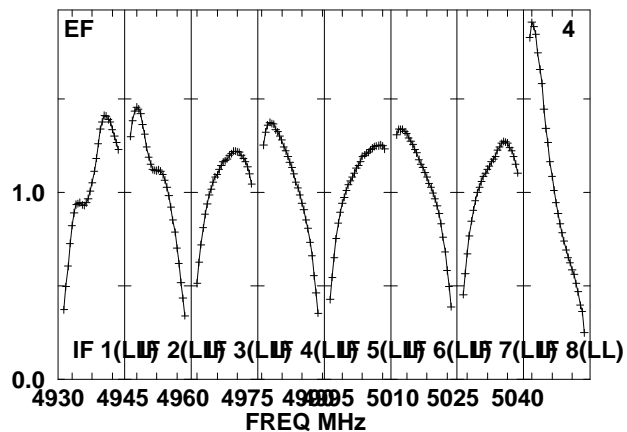
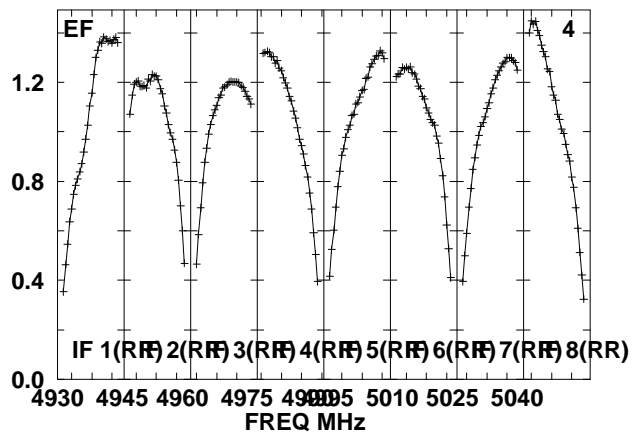
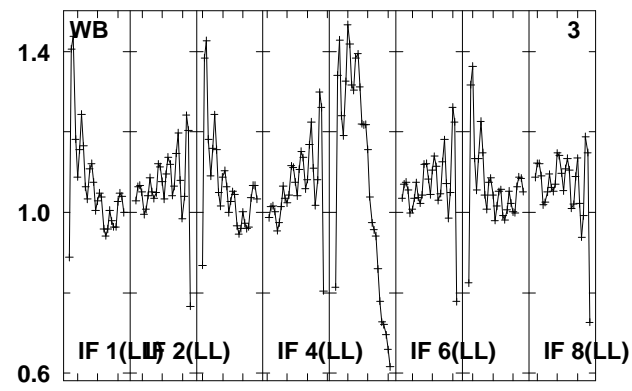
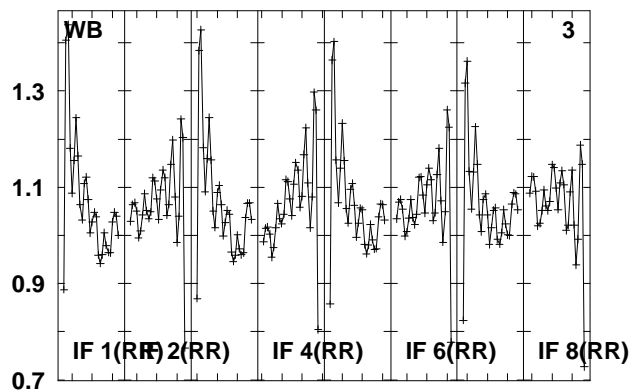
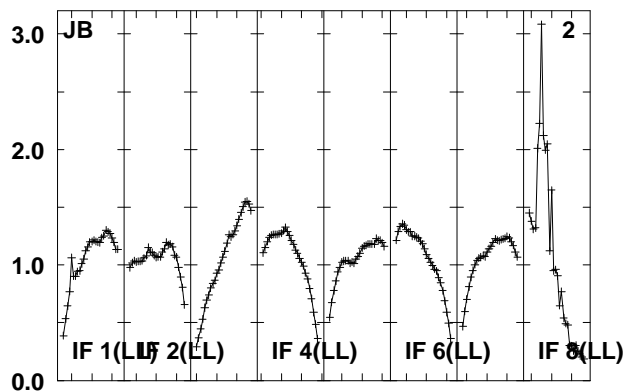
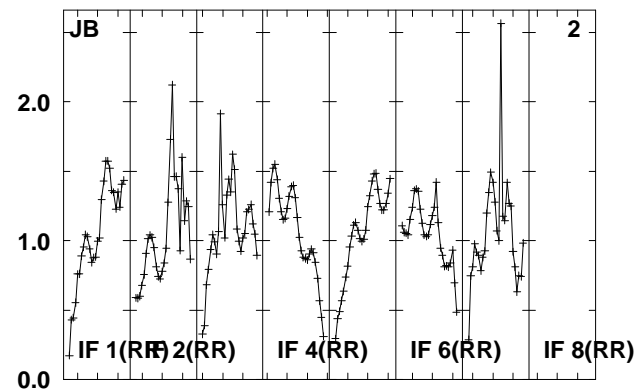
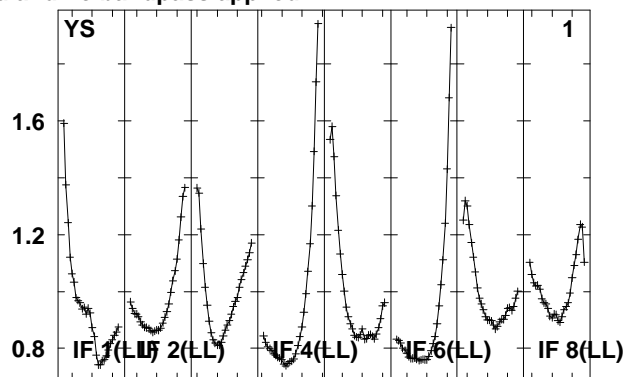
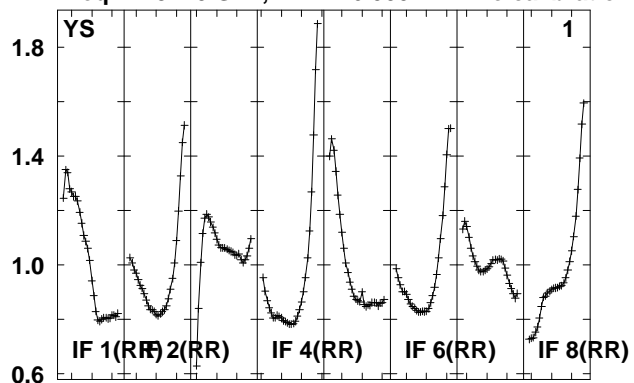

Lower frame: Real Jy
Total-power spectrum Antenna: *
Timerange: 01/00:52:13 to 01/00:53:39

Plot file version 736 created 14-MAY-2010 15:21:17

J0920+44 EO007.UVDATA.1

Freq = 4.9270 GHz, Bw = 16.000 MH No calibration applied and no bandpass applied

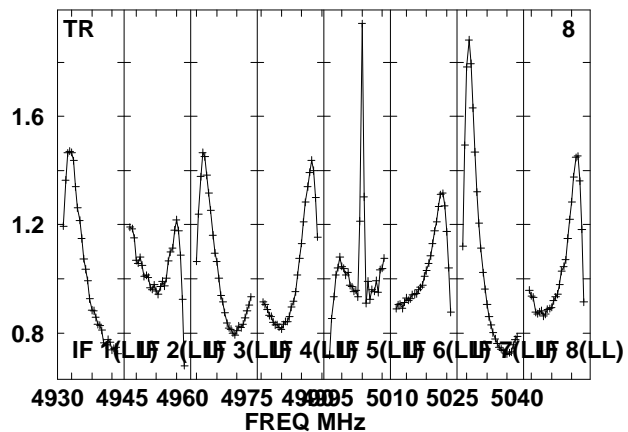
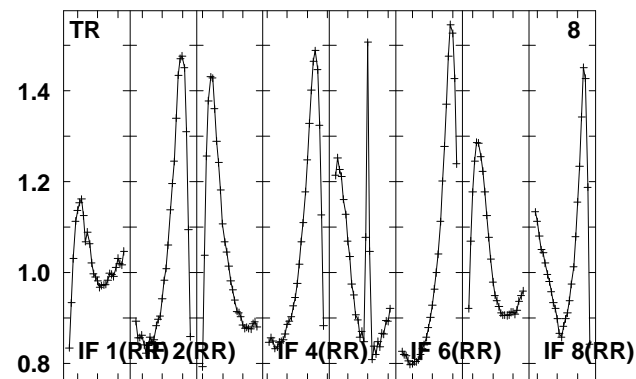
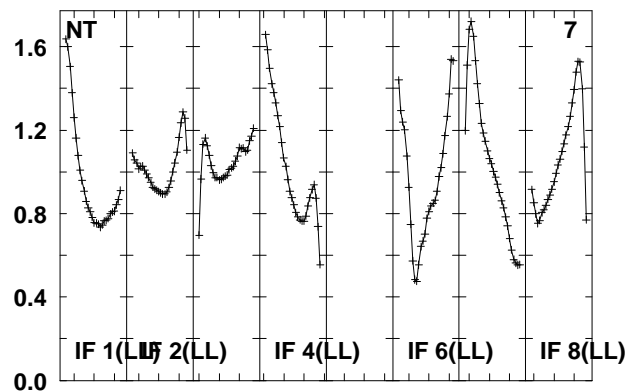
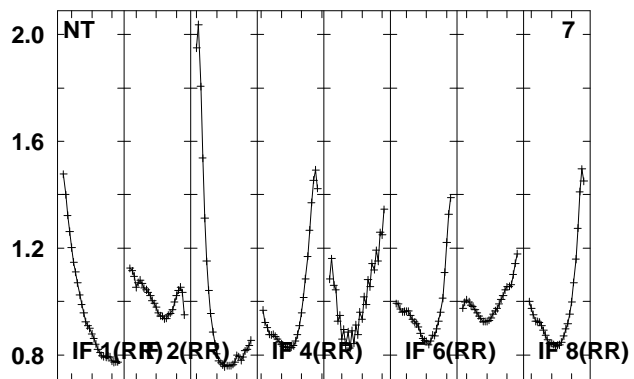
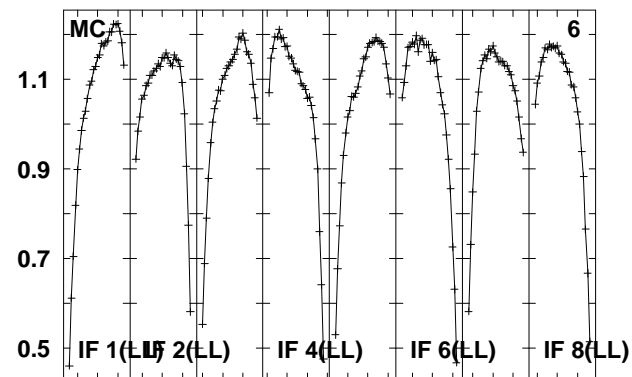
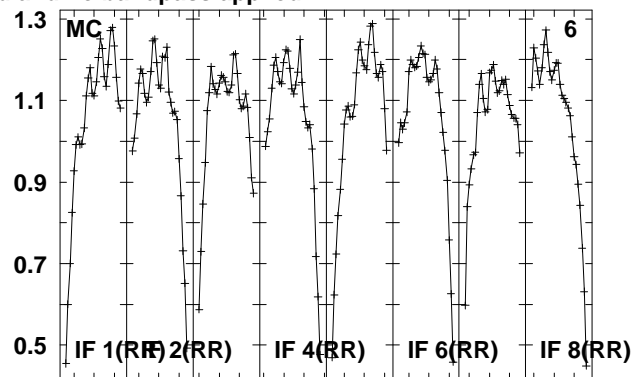
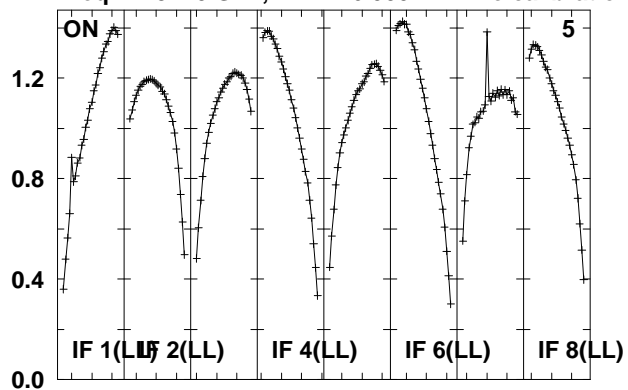

Lower frame: Real Jy

Total-power spectrum Antenna: *

Timerange: 01/00:52:13 to 01/00:53:39

Plot file version 737 created 14-MAY-2010 15:21:17
 J092159 EO007.UVDATA.1
 Freq = 4.9270 GHz, Bw = 16.000 MH No calibration applied and no bandpass applied

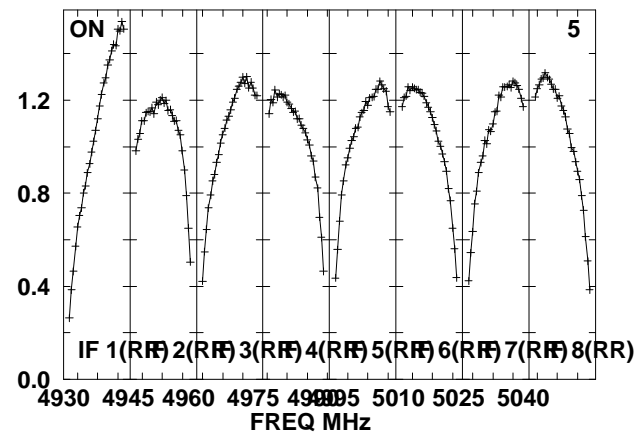
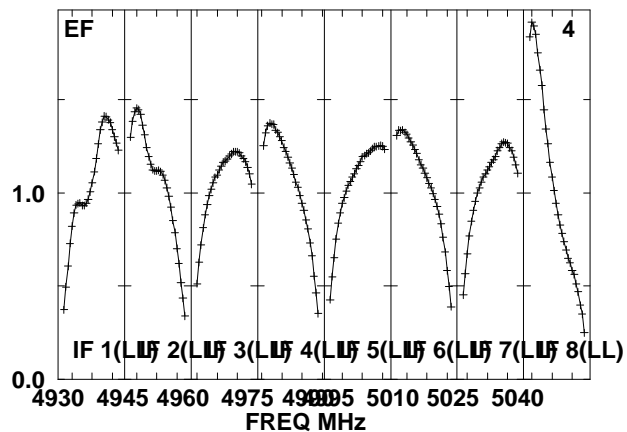
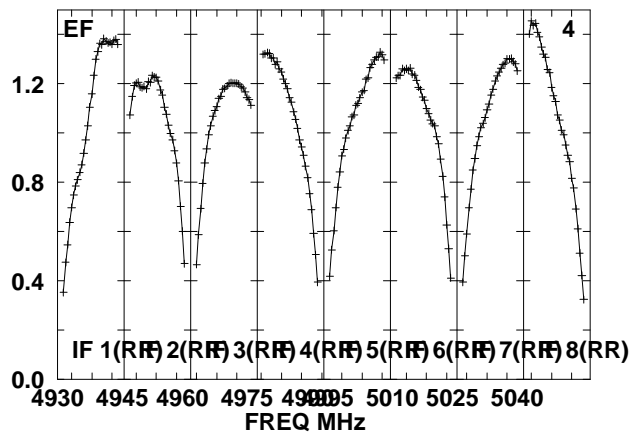
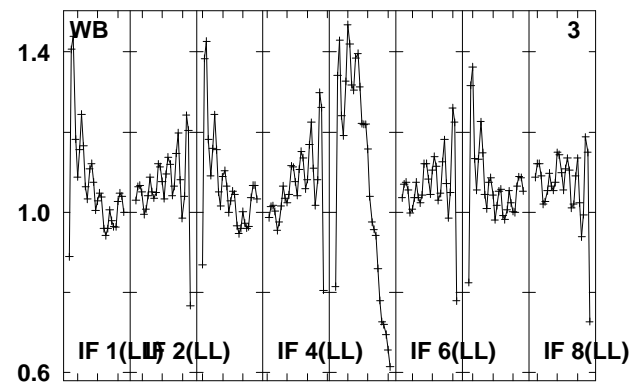
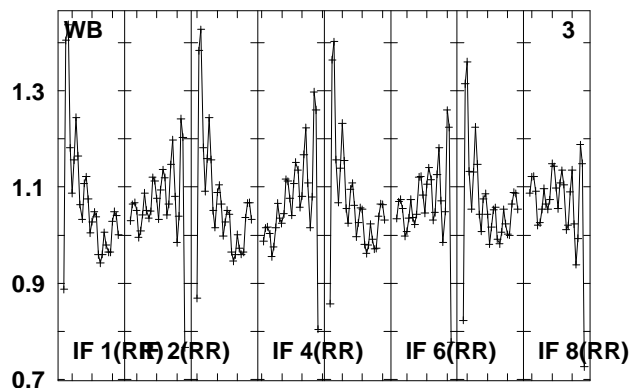
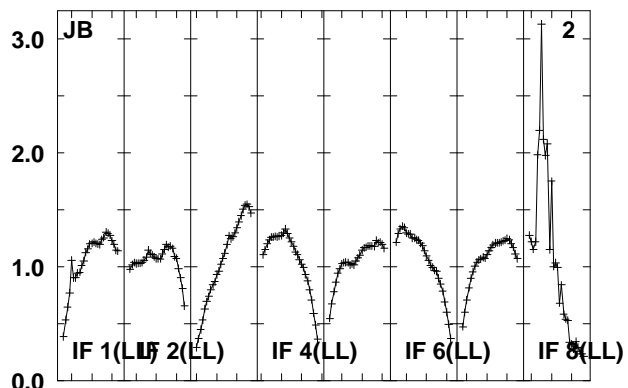
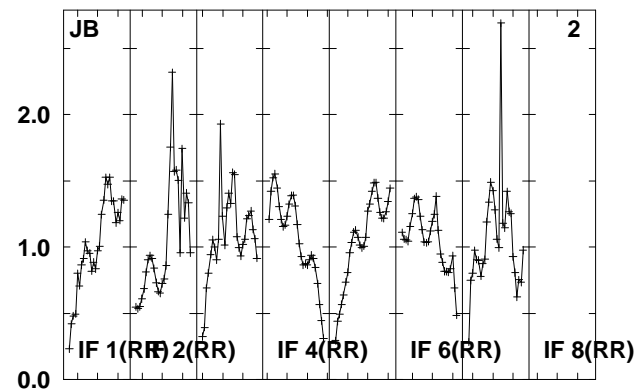
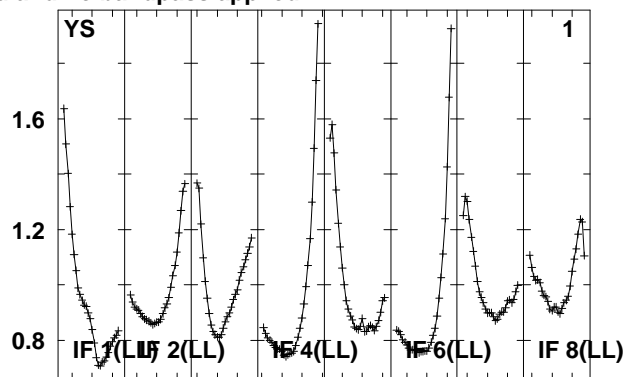
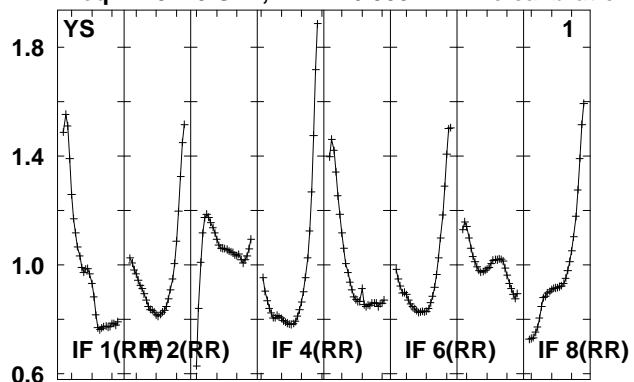

Lower frame: Real Jy
 Total-power spectrum Antenna: *
 Timerange: 01/00:54:04 to 01/00:58:58

Plot file version 738 created 14-MAY-2010 15:21:18

J092159 EO007.UVDATA.1

Freq = 4.9270 GHz, Bw = 16.000 MH No calibration applied and no bandpass applied

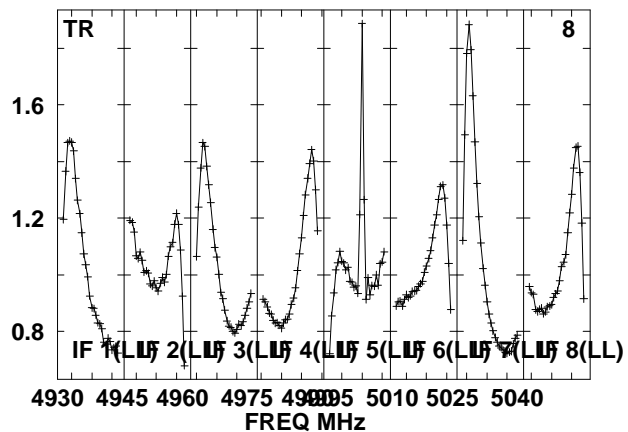
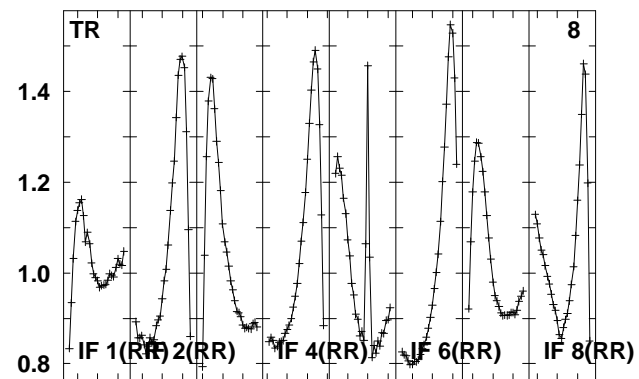
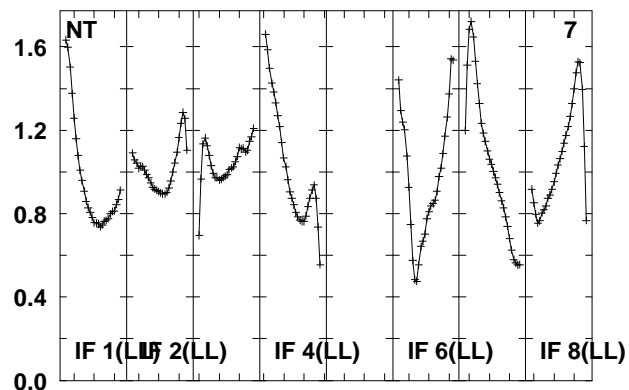
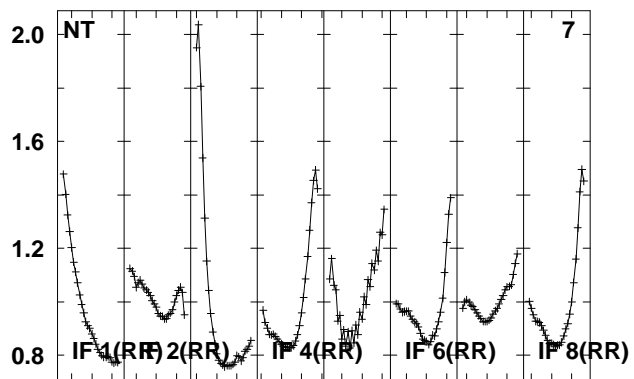
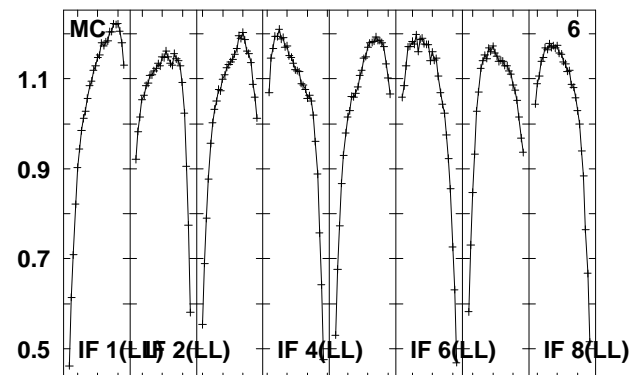
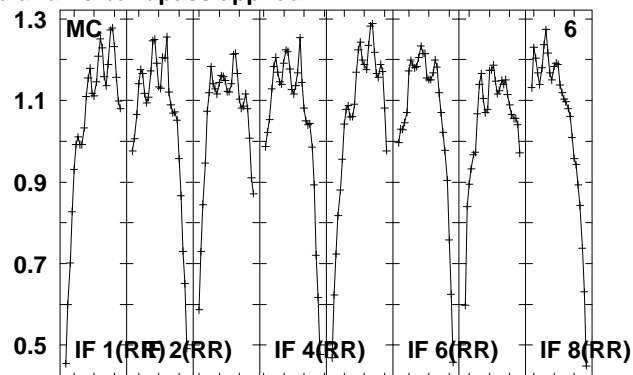
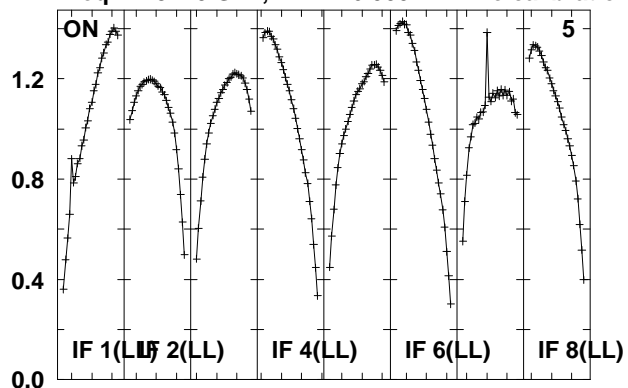

Lower frame: Real Jy

Total-power spectrum Antenna: *

Timerange: 01/00:54:04 to 01/00:58:58

Plot file version 739 created 14-MAY-2010 15:21:18
 J0920+44 EO007.UVDATA.1
 Freq = 4.9270 GHz, Bw = 16.000 MH No calibration applied and no bandpass applied

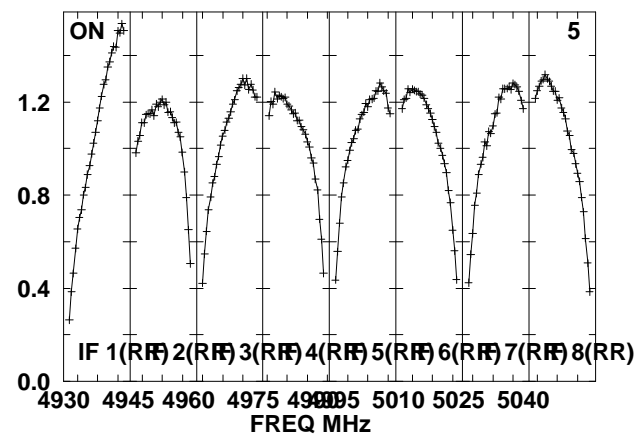
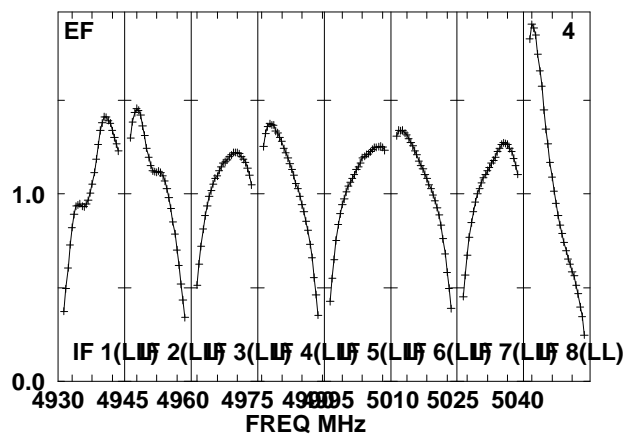
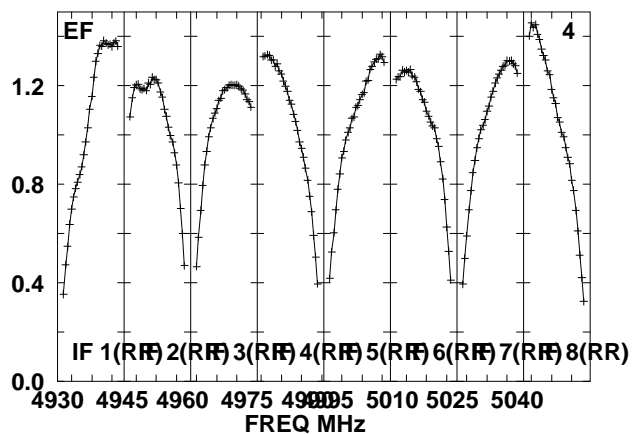
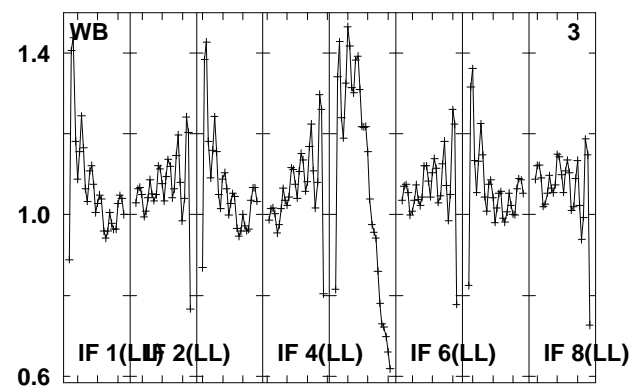
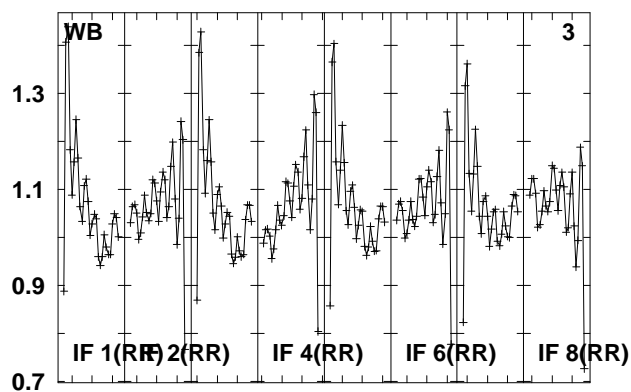
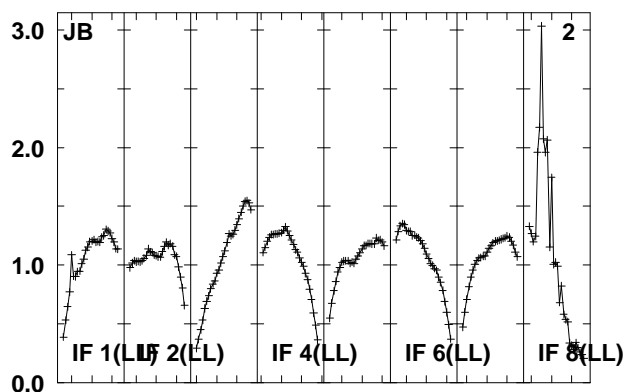
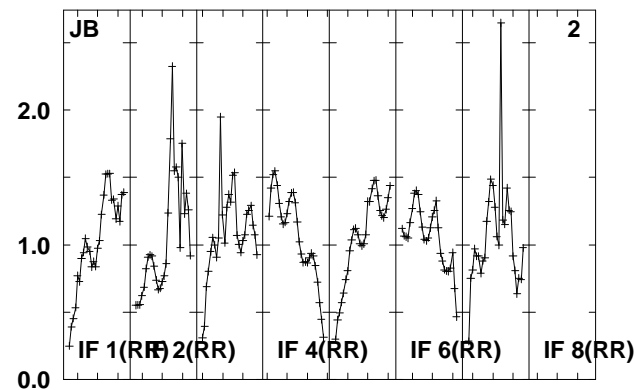
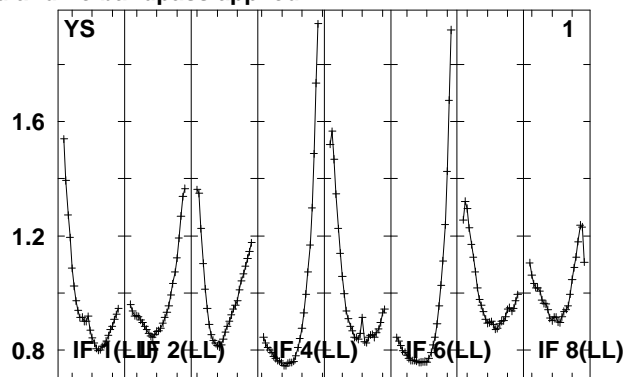
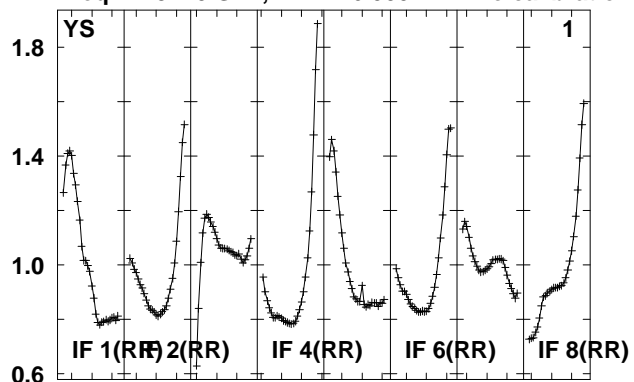

Lower frame: Real Jy
 Total-power spectrum Antenna: *
 Timerange: 01/00:59:22 to 01/01:00:48

Plot file version 740 created 14-MAY-2010 15:21:18

J0920+44 EO007.UVDATA.1

Freq = 4.9270 GHz, Bw = 16.000 MH No calibration applied and no bandpass applied

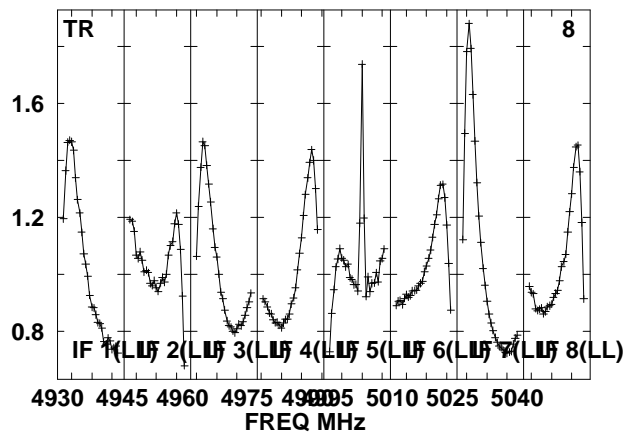
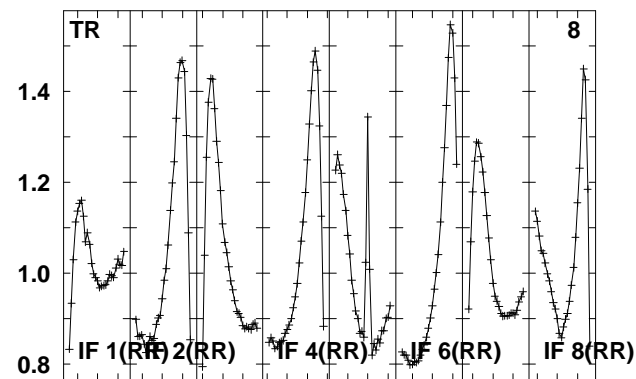
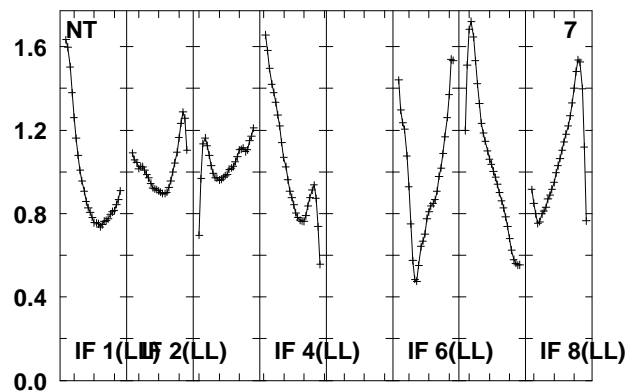
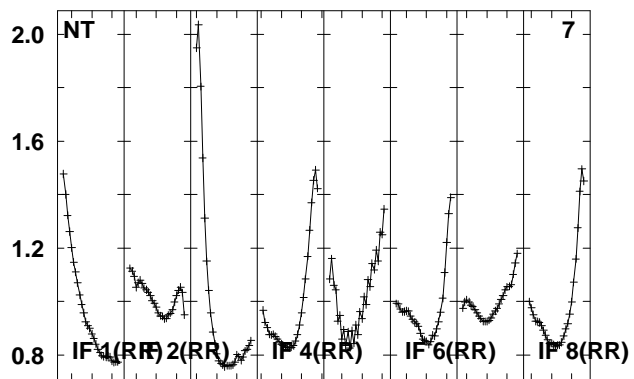
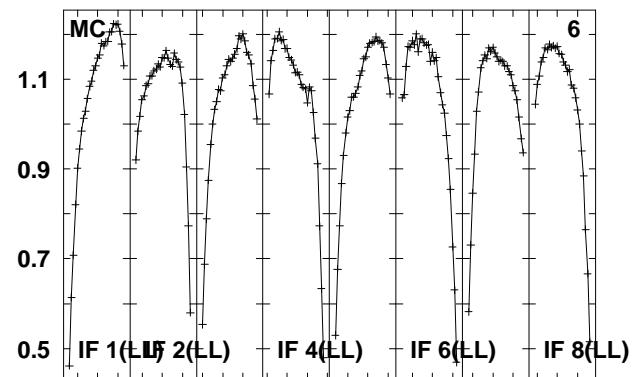
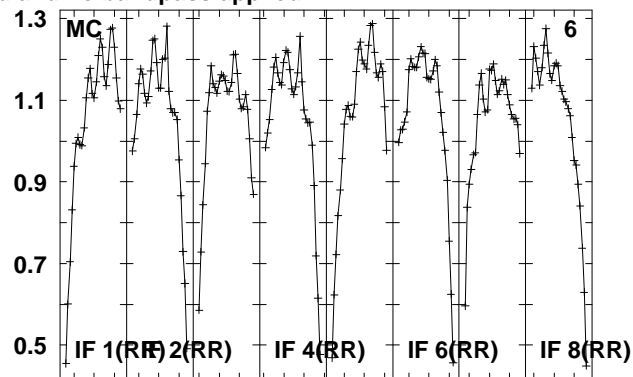
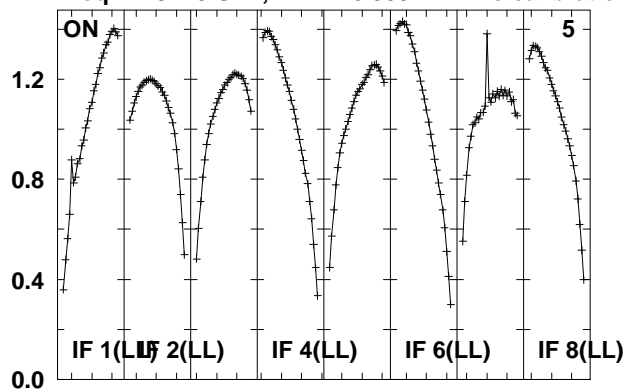

Lower frame: Real Jy

Total-power spectrum Antenna: *

Timerange: 01/00:59:22 to 01/01:00:48

Plot file version 741 created 14-MAY-2010 15:21:19

J092159 EO007.UVDATA.1

Freq = 4.9270 GHz, Bw = 16.000 MH No calibration applied and no bandpass applied

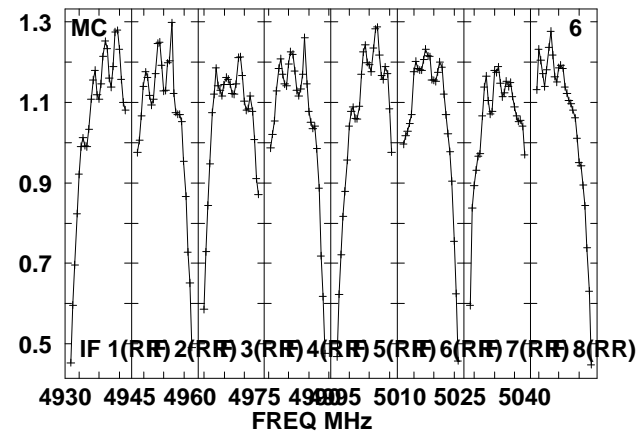
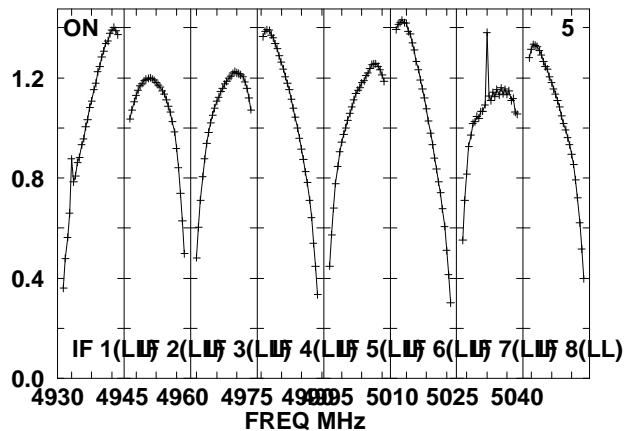
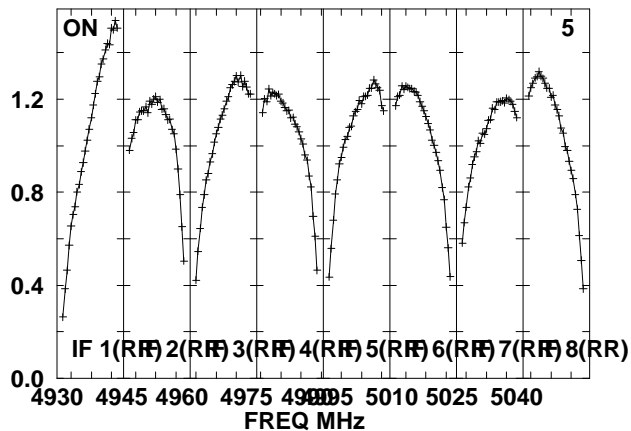
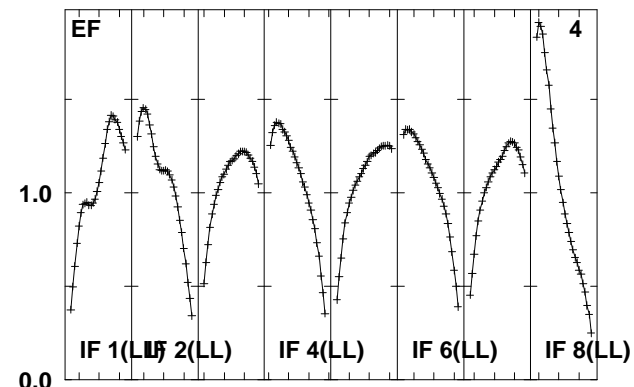
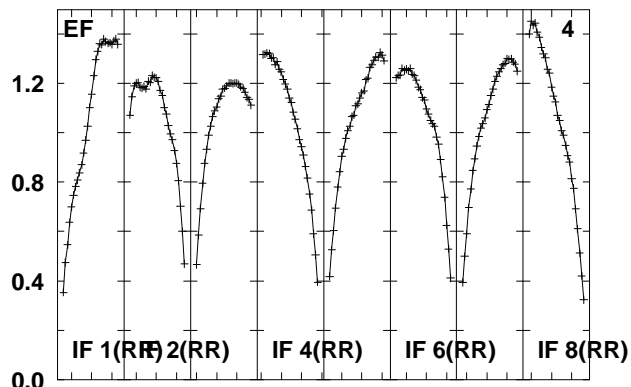
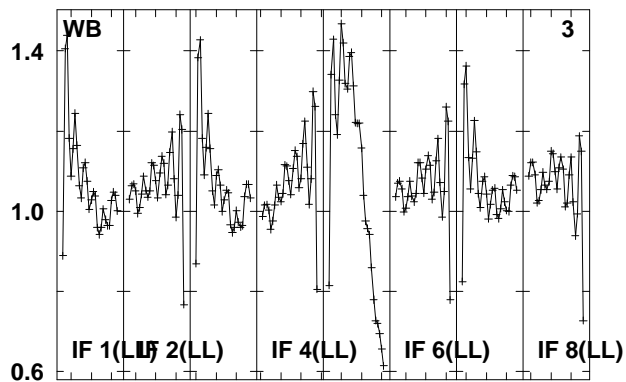
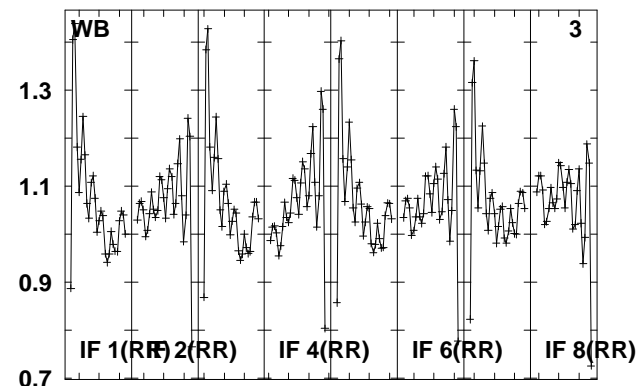
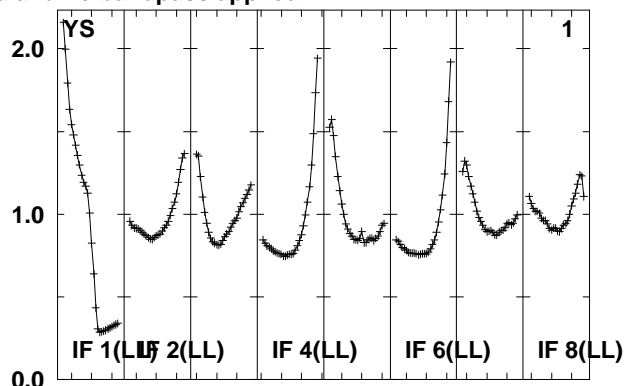
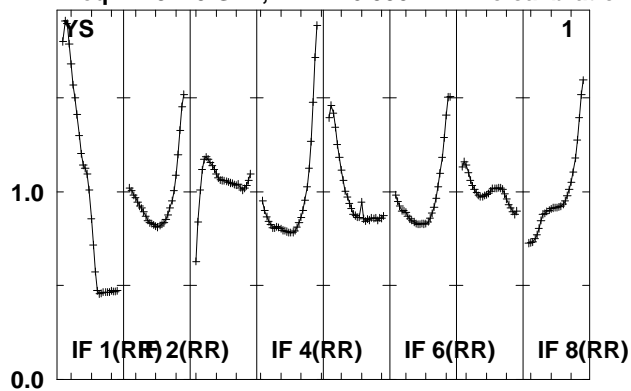

Lower frame: Real Jy
Total-power spectrum Antenna: *
Timerange: 01/01:01:12 to 01/01:06:06

Plot file version 742 created 14-MAY-2010 15:21:19

J092159 EO007.UVDATA.1

Freq = 4.9270 GHz, Bw = 16.000 MH No calibration applied and no bandpass applied

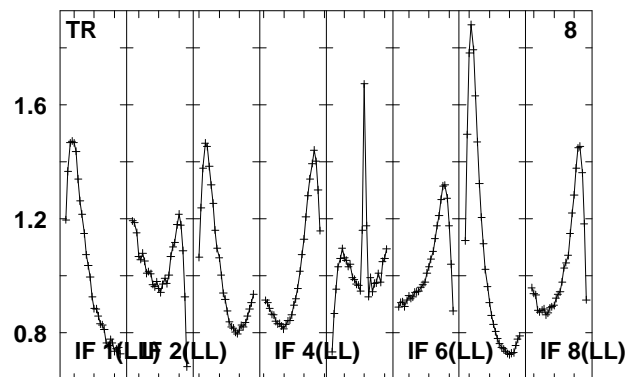
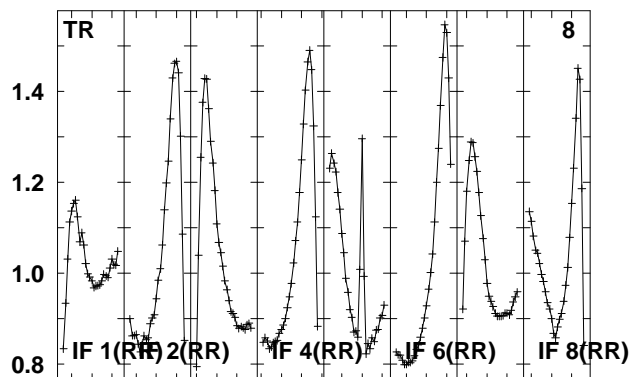
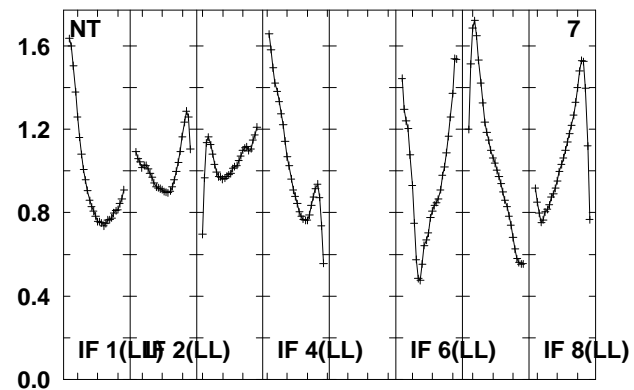
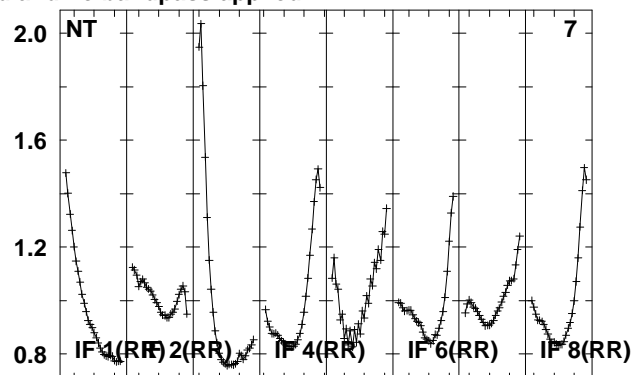
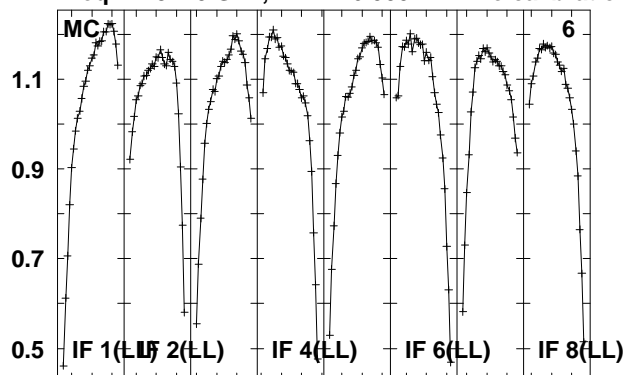

Lower frame: Real Jy
Total-power spectrum Antenna: *
Timerange: 01/01:01:12 to 01/01:06:06

Plot file version 743 created 14-MAY-2010 15:21:19

J0920+44 EO007.UVDATA.1

Freq = 4.9270 GHz, Bw = 16.000 MH No calibration applied and no bandpass applied

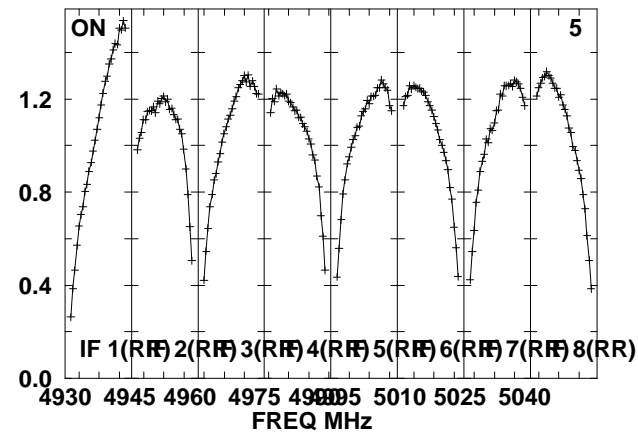
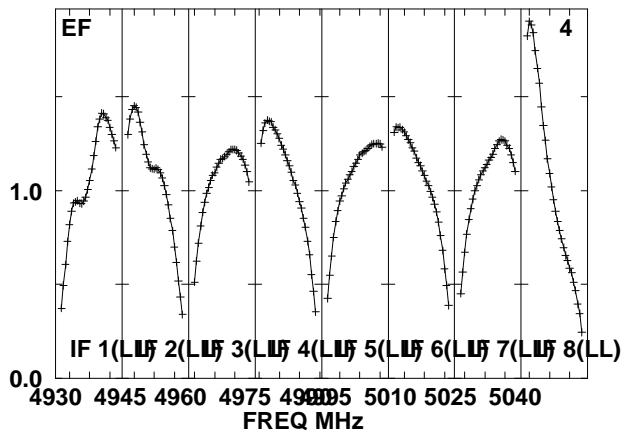
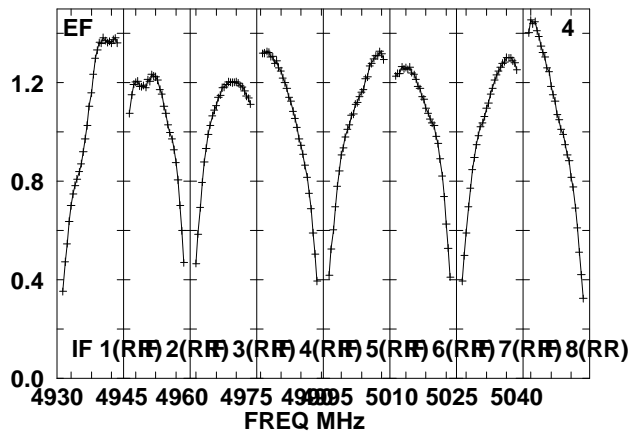
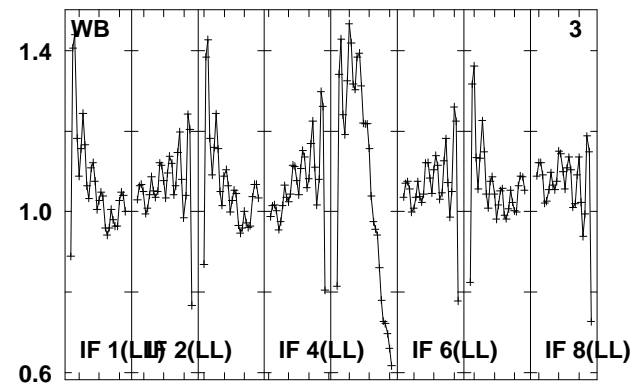
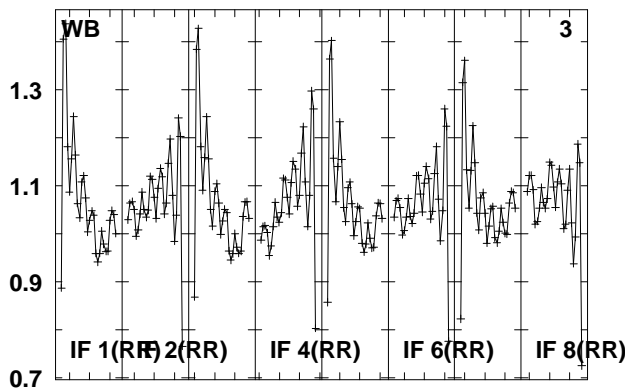
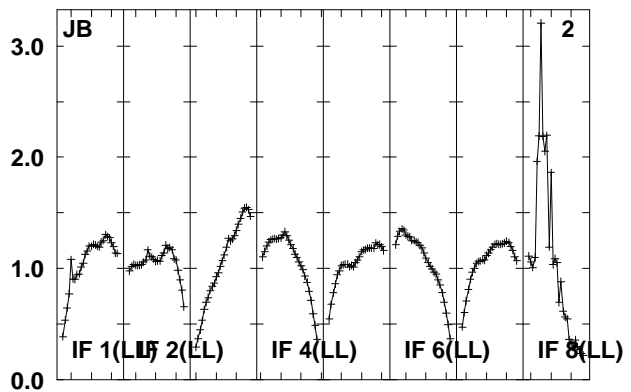
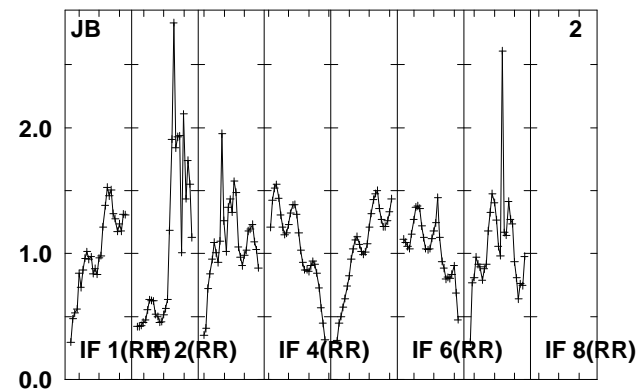
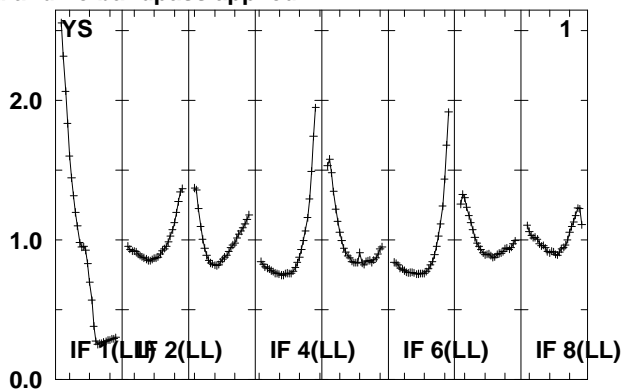
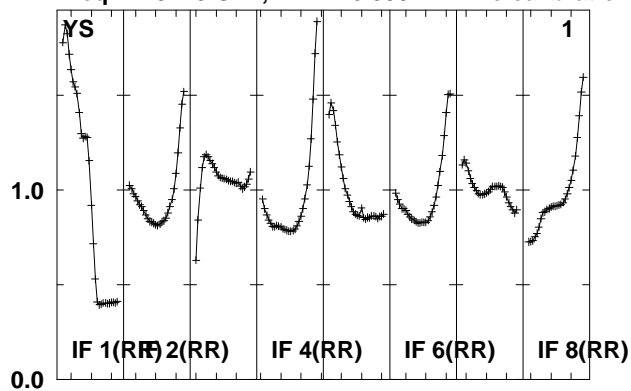

Lower frame: Real Jy
Total-power spectrum Antenna: *
Timerange: 01/01:06:30 to 01/01:07:56

Plot file version 744 created 14-MAY-2010 15:21:20

J0920+44 EO007.UVDATA.1

Freq = 4.9270 GHz, Bw = 16.000 MH No calibration applied and no bandpass applied

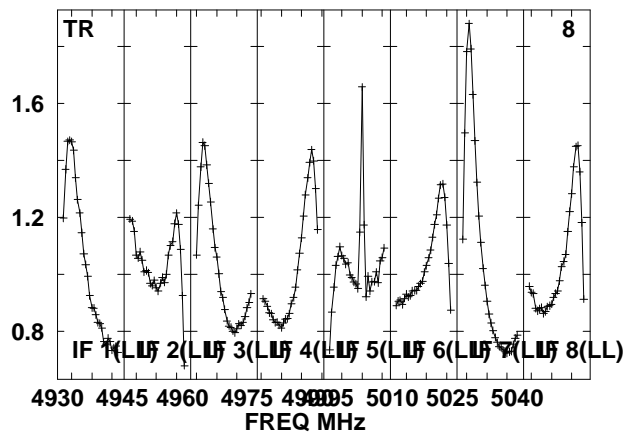
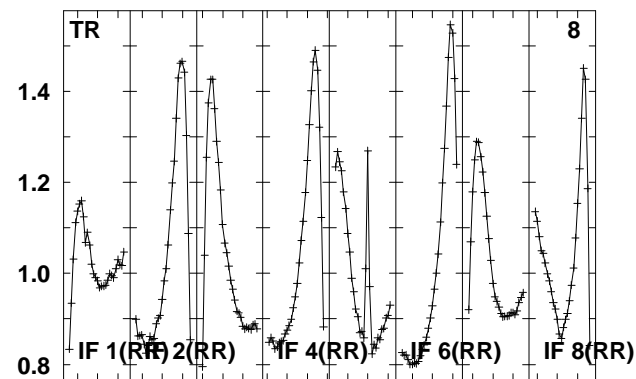
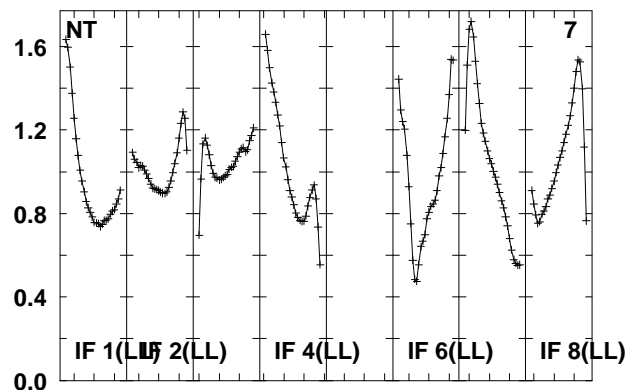
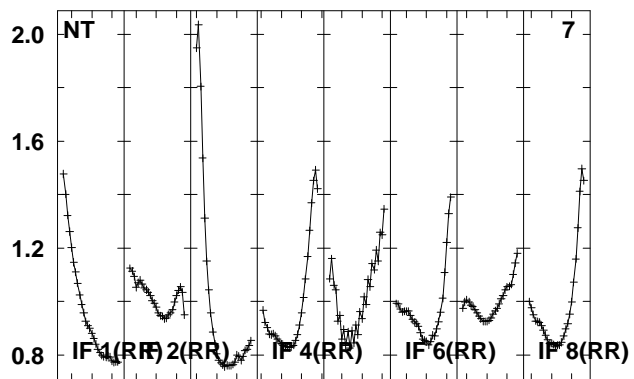
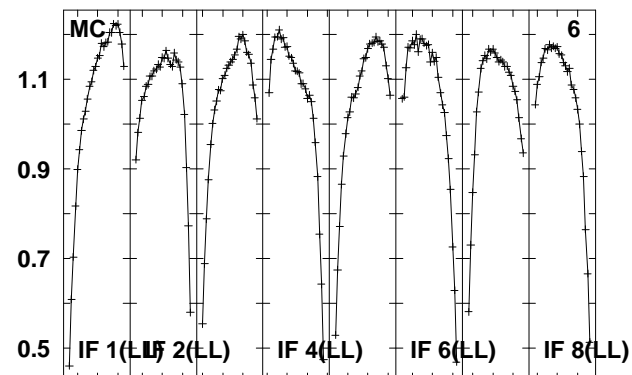
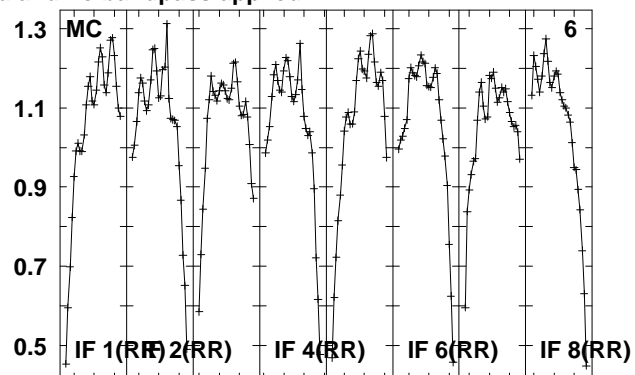
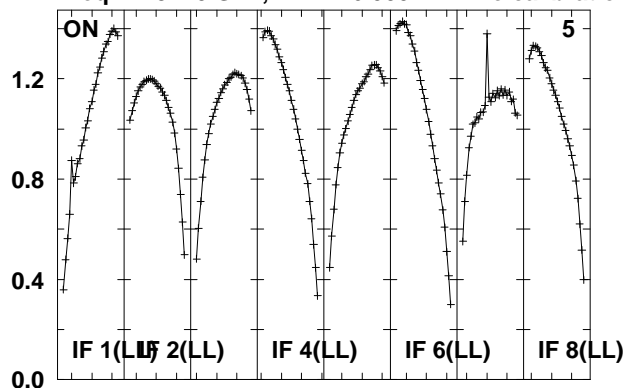

Lower frame: Real Jy

Total-power spectrum Antenna: *

Timerange: 01/01:06:30 to 01/01:07:56

Plot file version 745 created 14-MAY-2010 15:21:20

J1027+48 EO007.UVDATA.1

Freq = 4.9270 GHz, Bw = 16.000 MH No calibration applied and no bandpass applied

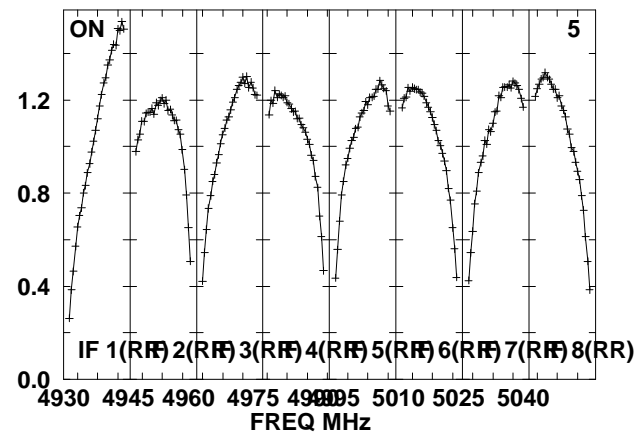
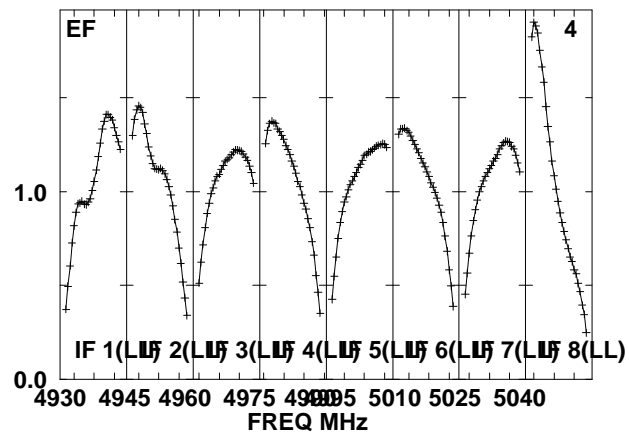
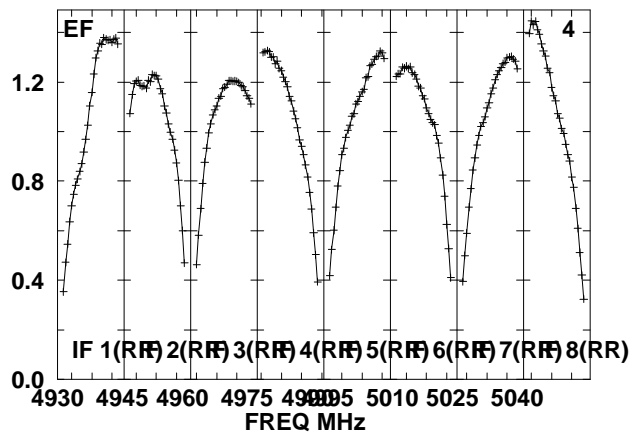
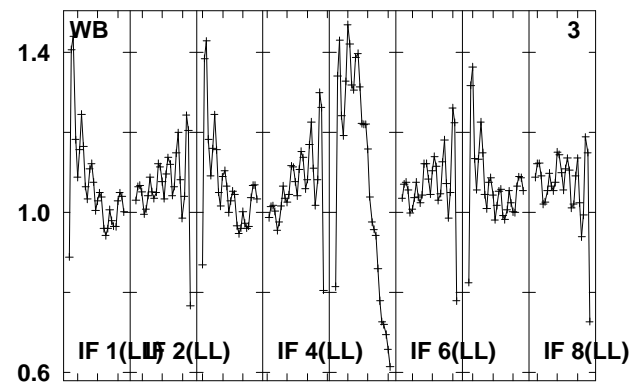
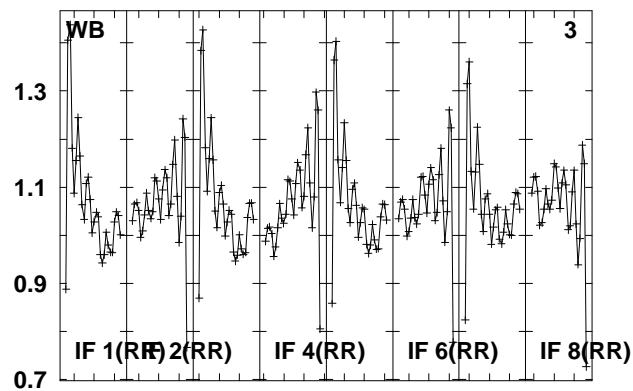
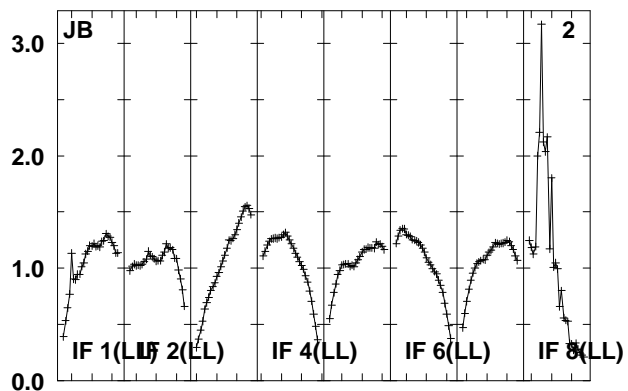
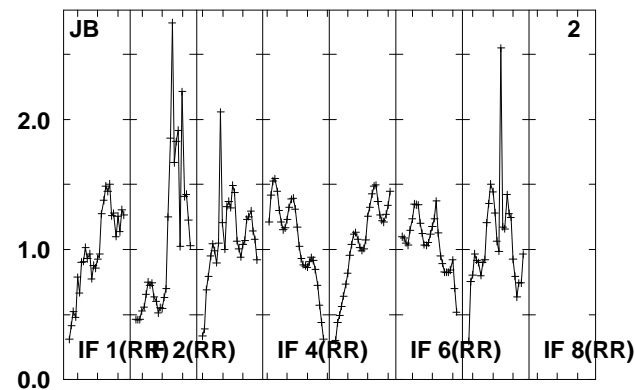
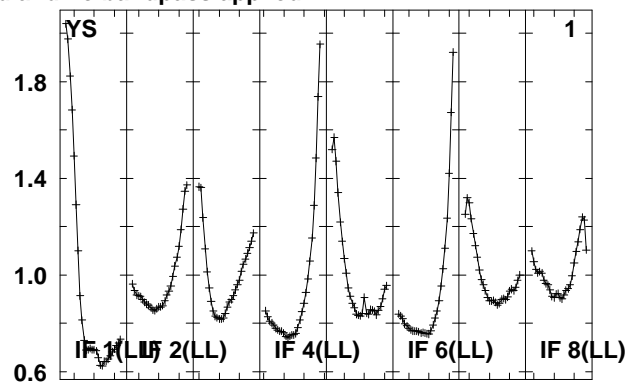
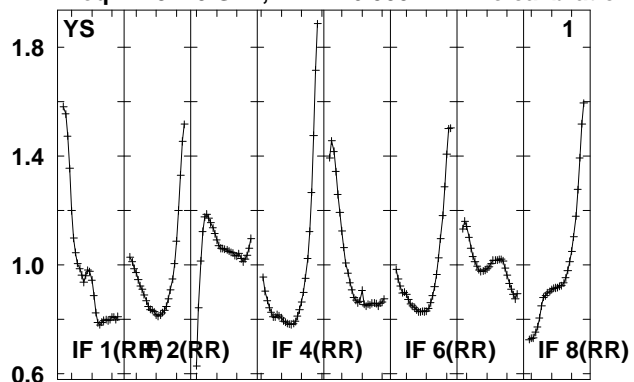

Lower frame: Real Jy
Total-power spectrum Antenna: *
Timerange: 01/01:09:25 to 01/01:10:53

Plot file version 746 created 14-MAY-2010 15:21:20

J1027+48 EO007.UVDATA.1

Freq = 4.9270 GHz, Bw = 16.000 MH No calibration applied and no bandpass applied

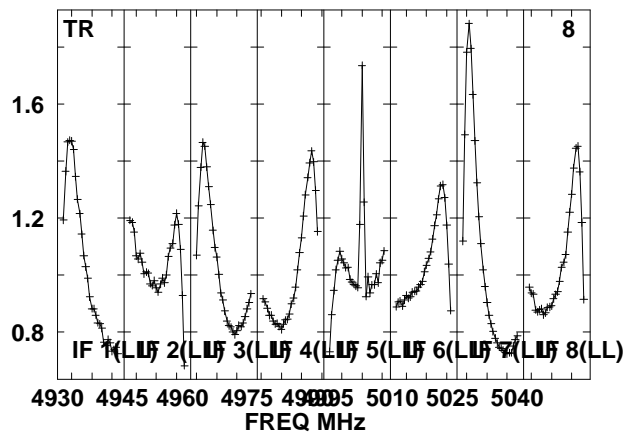
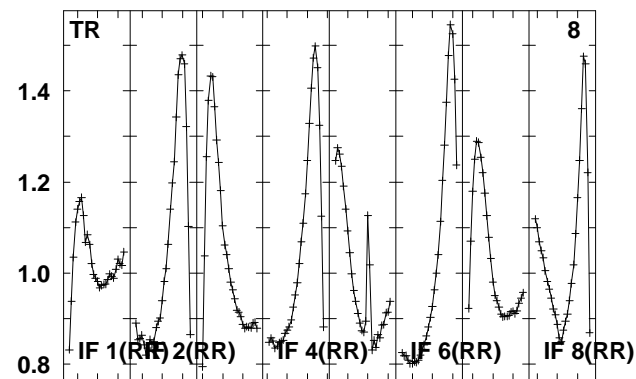
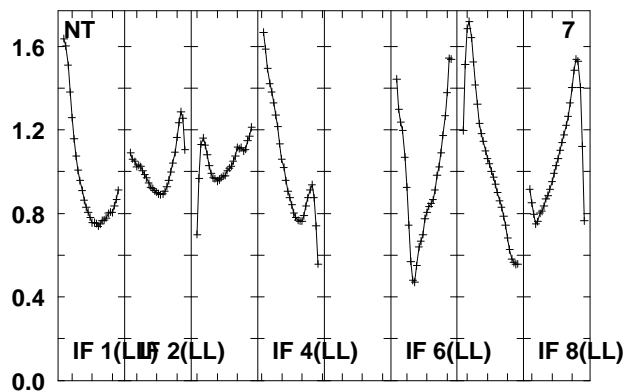
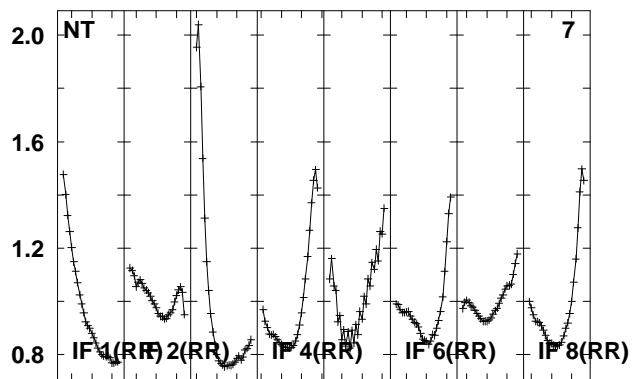
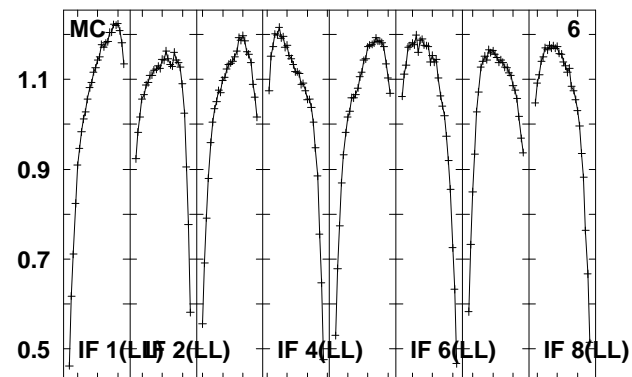
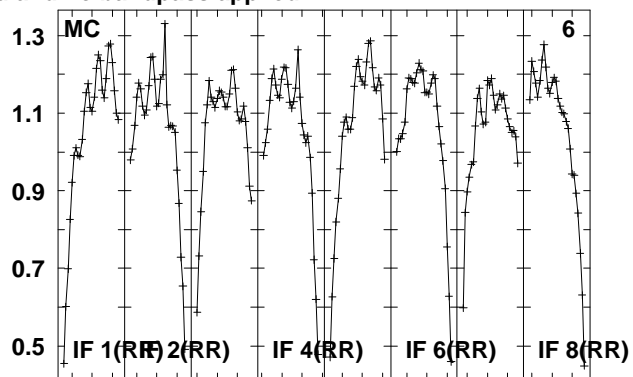
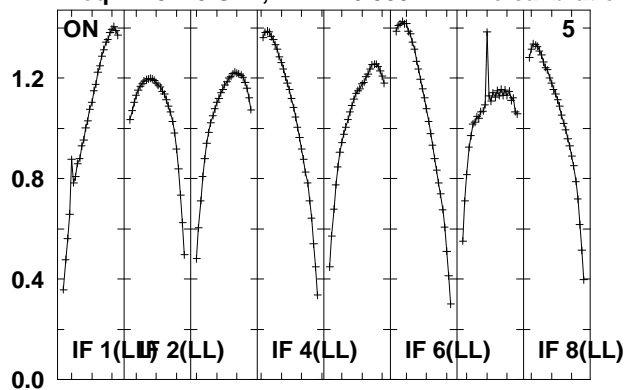

Lower frame: Real Jy

Total-power spectrum Antenna: *

Timerange: 01/01:09:25 to 01/01:10:53

Plot file version 747 created 14-MAY-2010 15:21:20

J102959 EO007.UVDATA.1

Freq = 4.9270 GHz, Bw = 16.000 MH No calibration applied and no bandpass applied

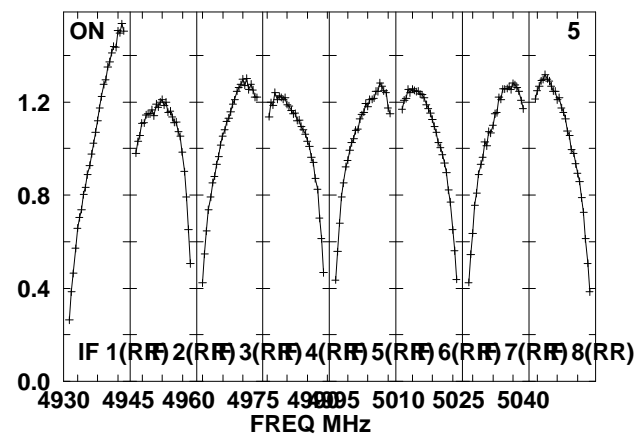
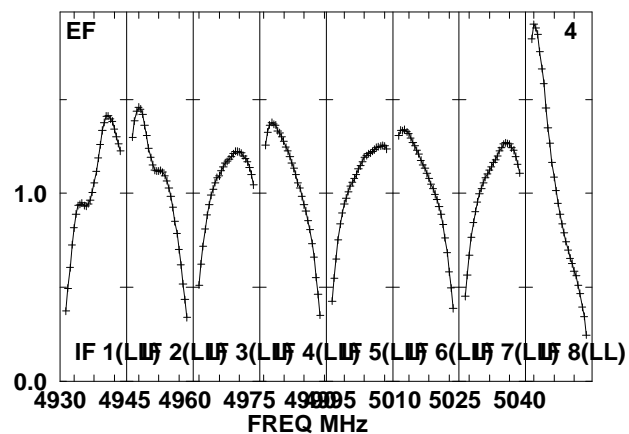
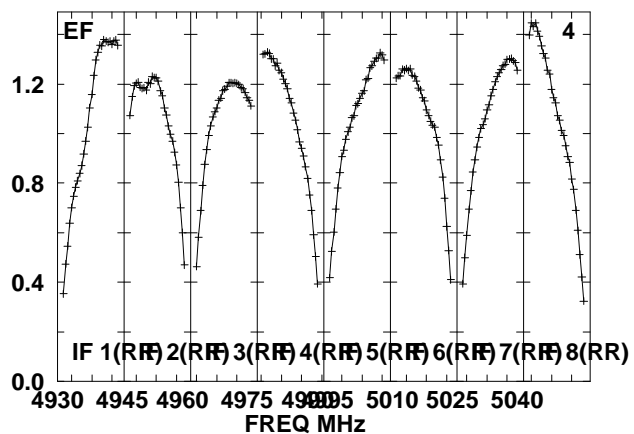
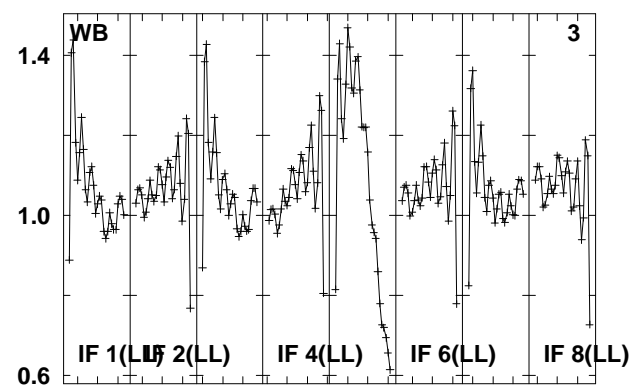
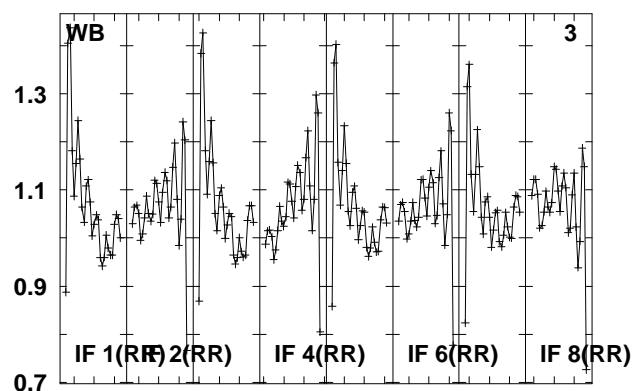
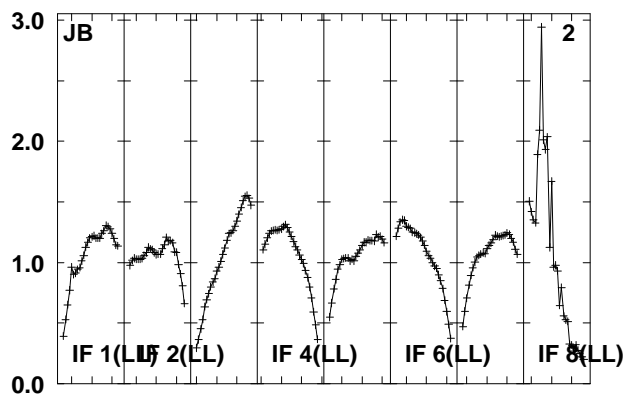
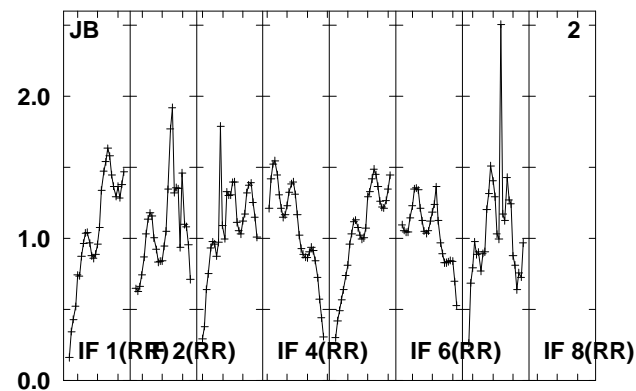
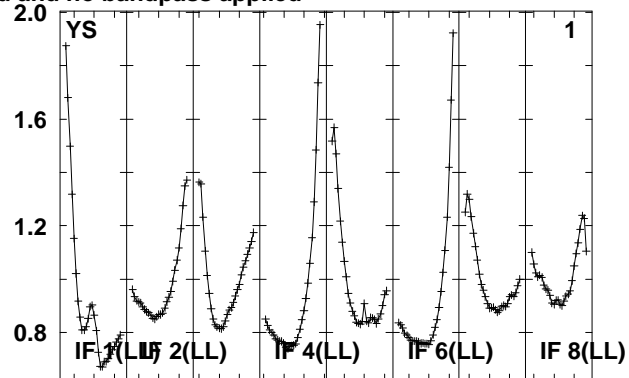
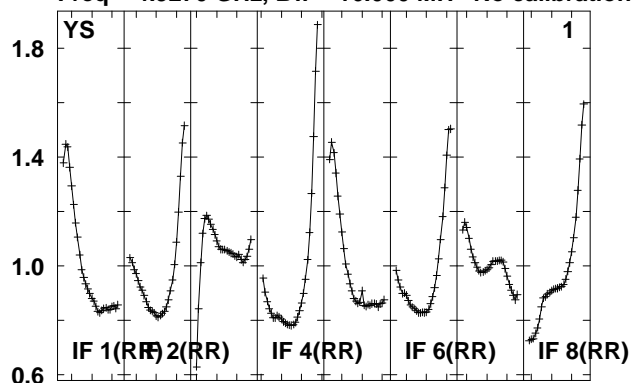

Lower frame: Real Jy

Total-power spectrum Antenna: *

Timerange: 01/01:11:15 to 01/01:16:13

Plot file version 748 created 14-MAY-2010 15:21:21

J102959 EO007.UVDATA.1

Freq = 4.9270 GHz, Bw = 16.000 MH No calibration applied and no bandpass applied

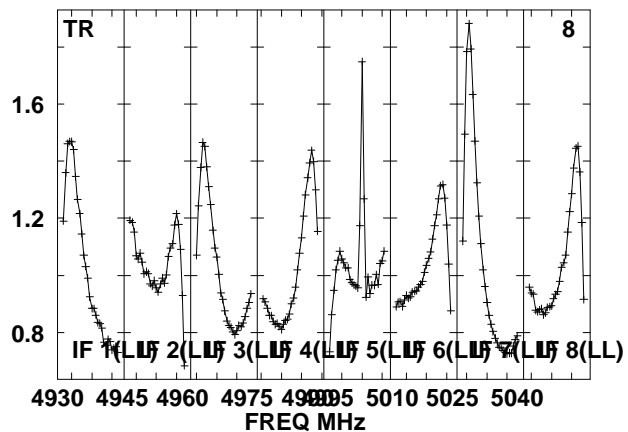
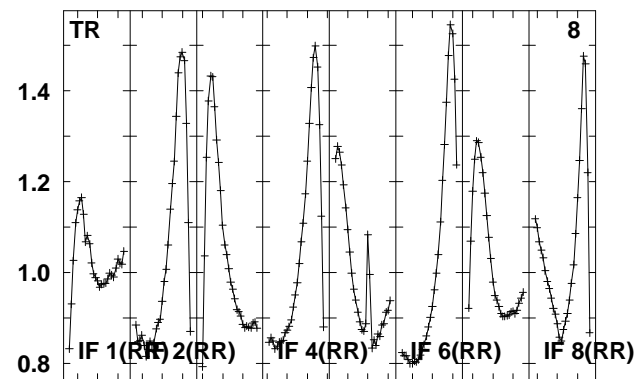
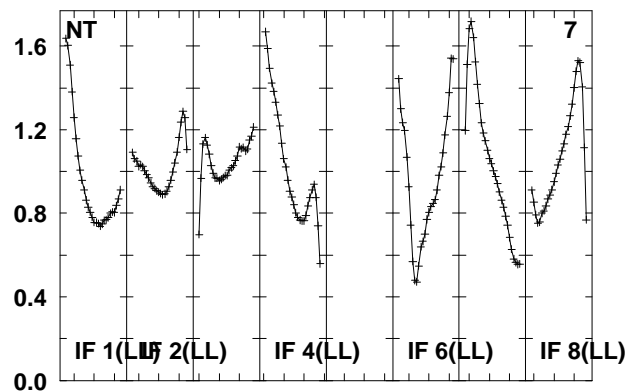
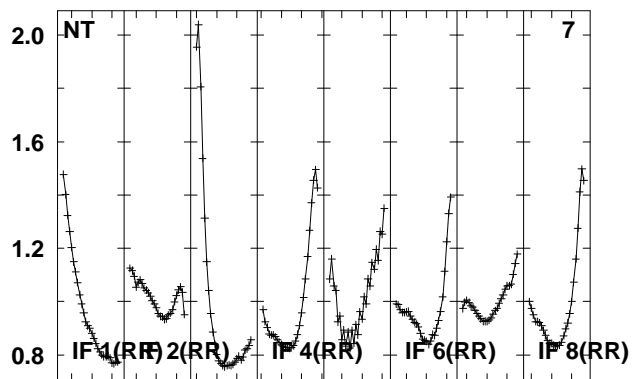
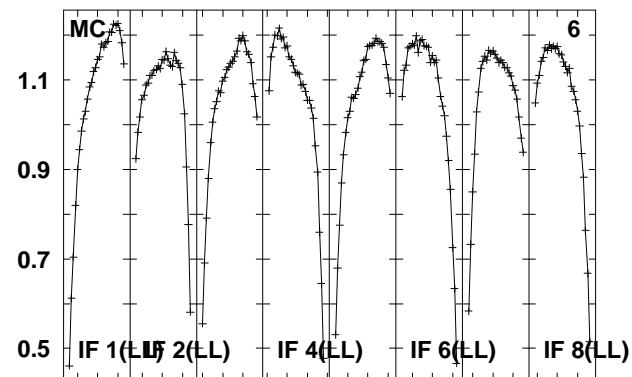
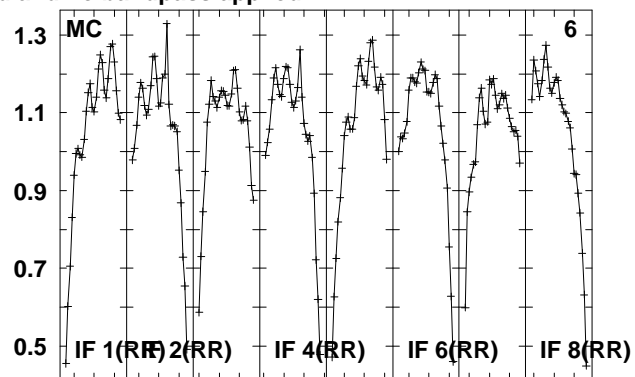
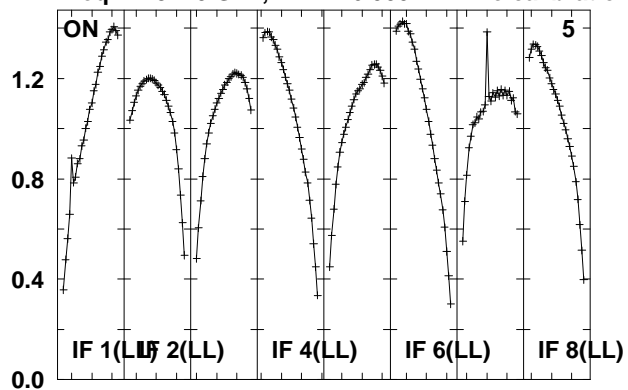

Lower frame: Real Jy

Total-power spectrum Antenna: *

Timerange: 01/01:11:15 to 01/01:16:13

Plot file version 749 created 14-MAY-2010 15:21:21

J1027+48 EO007.UVDATA.1

Freq = 4.9270 GHz, Bw = 16.000 MH No calibration applied and no bandpass applied

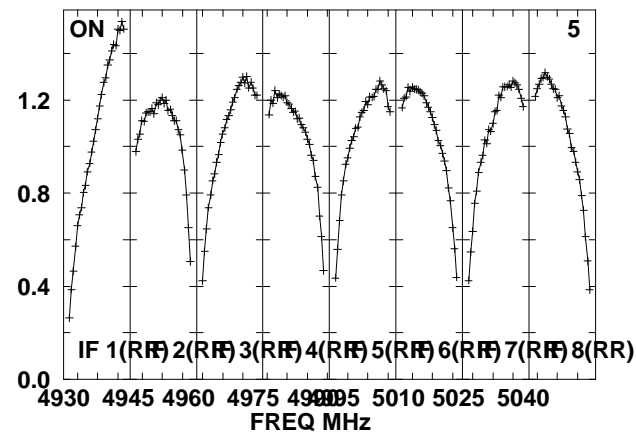
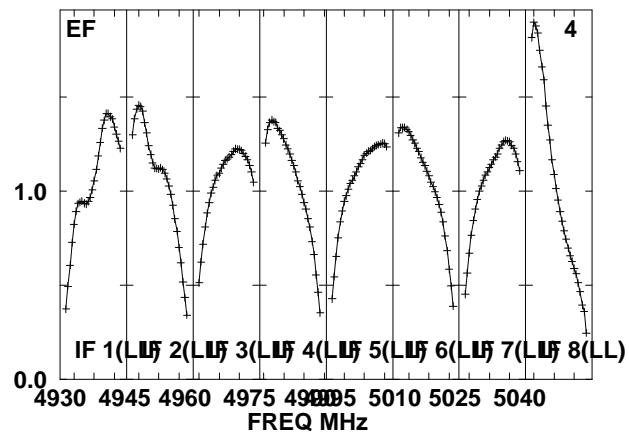
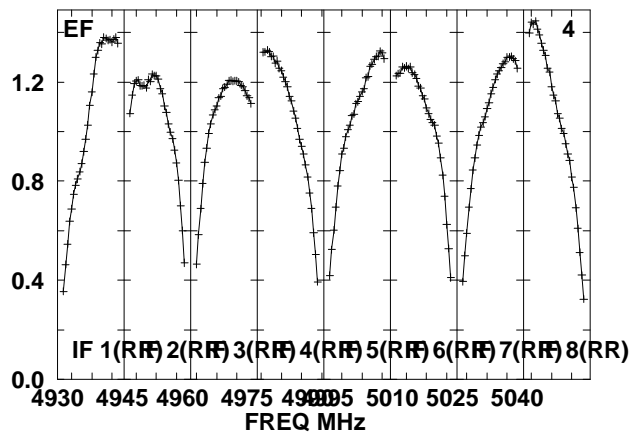
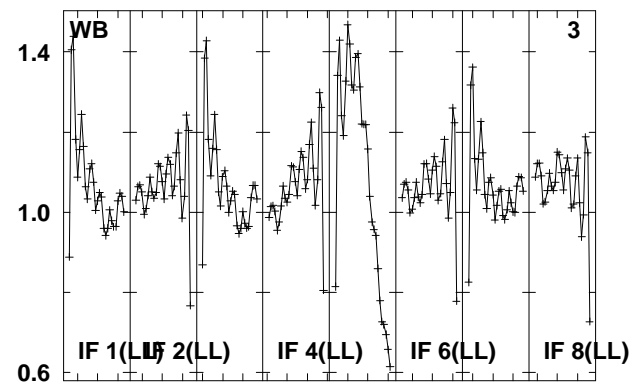
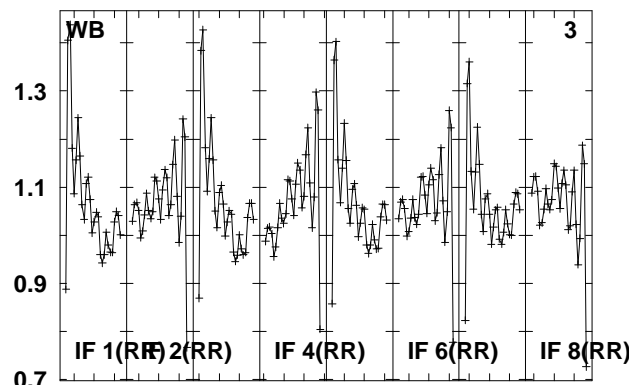
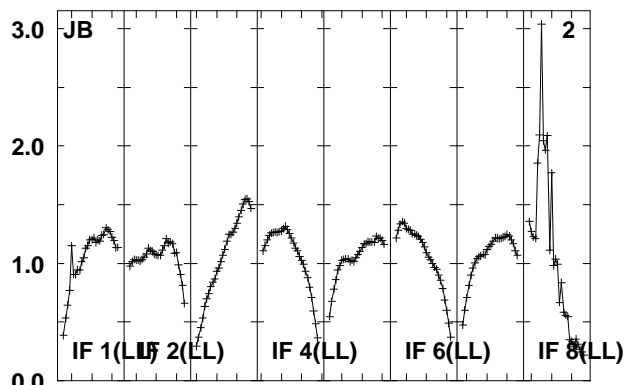
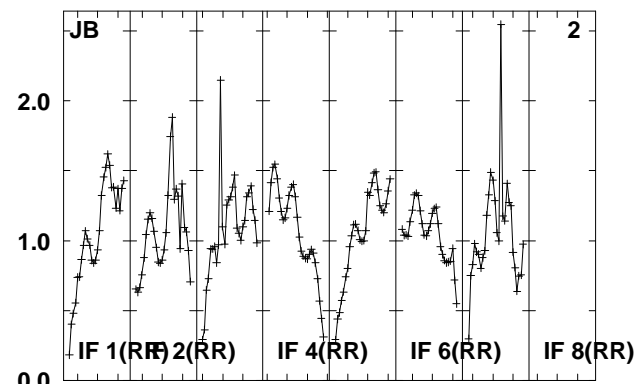
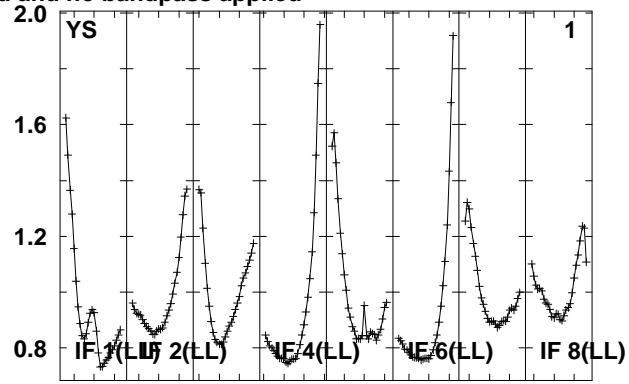
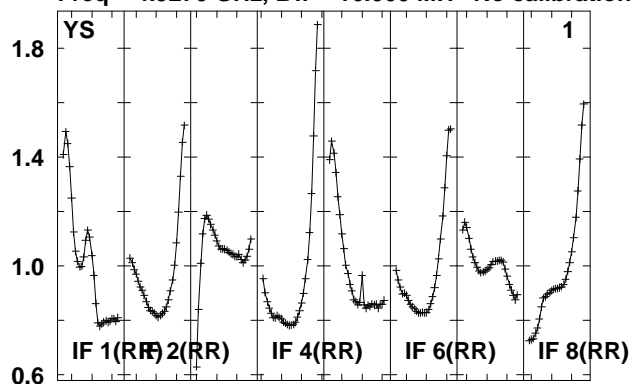

Lower frame: Real Jy
Total-power spectrum Antenna: *
Timerange: 01/01:16:35 to 01/01:18:03

Plot file version 750 created 14-MAY-2010 15:21:22

J1027+48 EO007.UVDATA.1

Freq = 4.9270 GHz, Bw = 16.000 MH No calibration applied and no bandpass applied

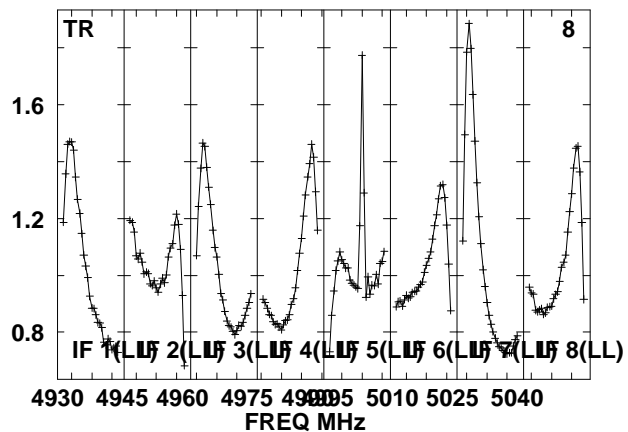
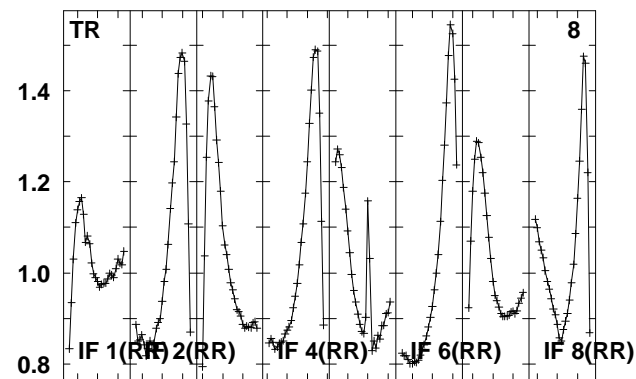
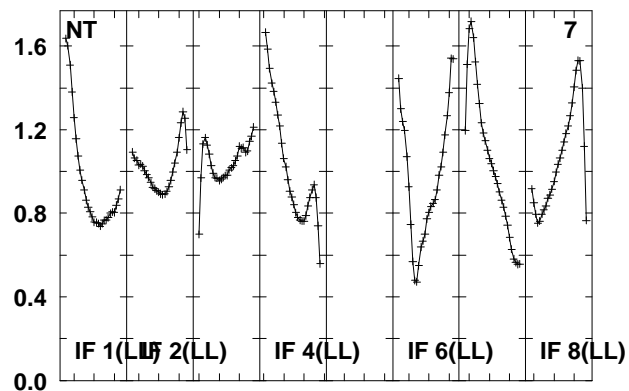
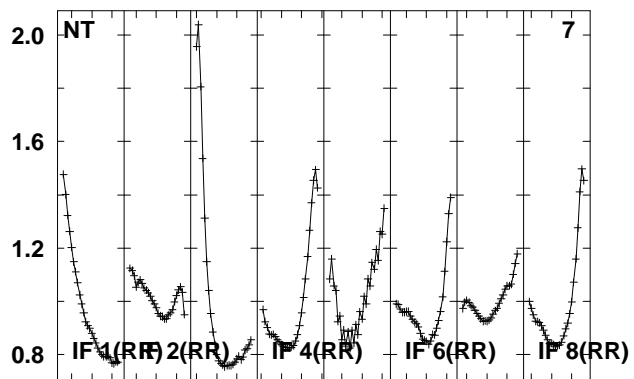
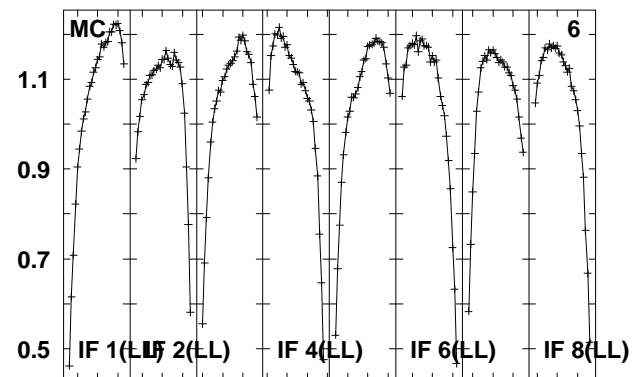
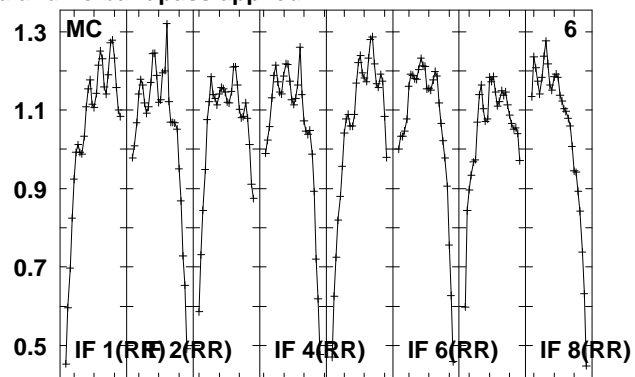
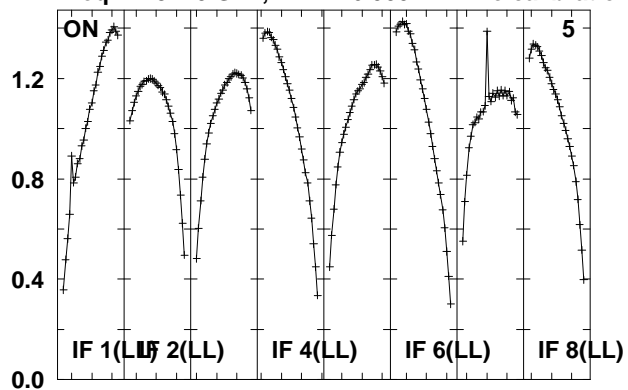

Lower frame: Real Jy

Total-power spectrum Antenna: *

Timerange: 01/01:16:35 to 01/01:18:03

Plot file version 751 created 14-MAY-2010 15:21:22

J102959 EO007.UVDATA.1

Freq = 4.9270 GHz, Bw = 16.000 MH No calibration applied and no bandpass applied

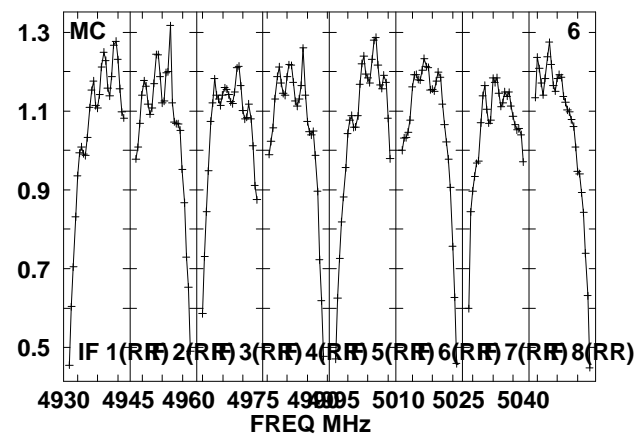
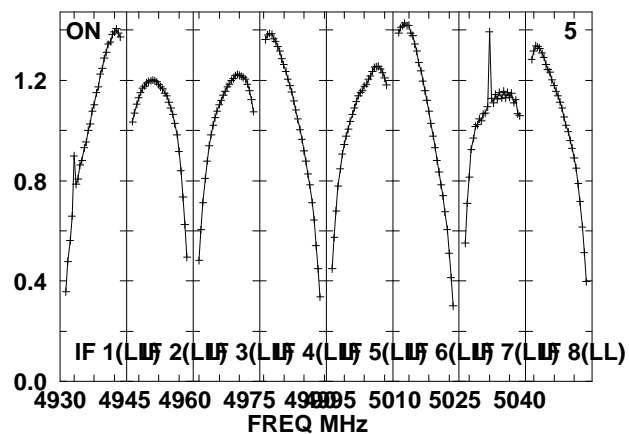
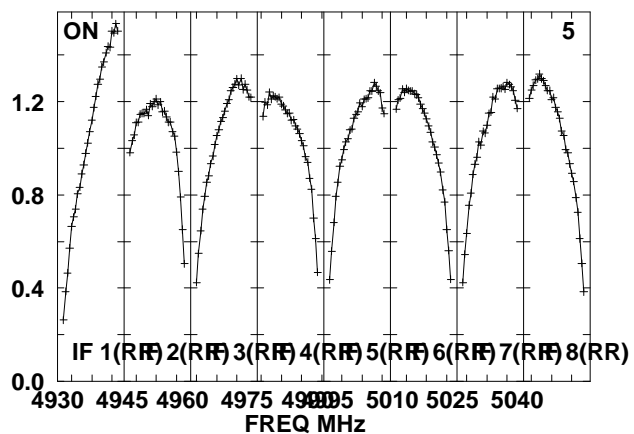
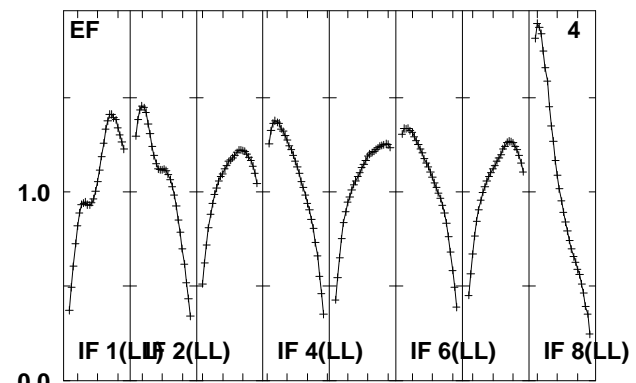
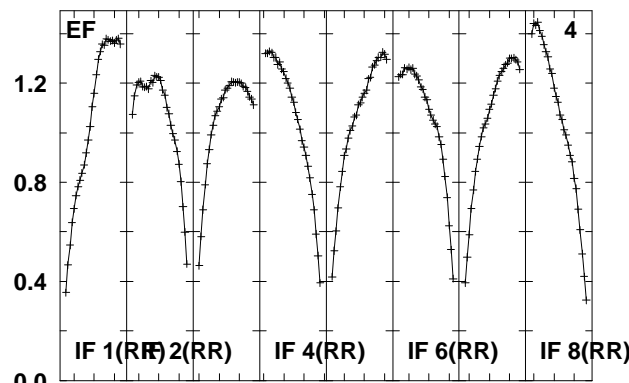
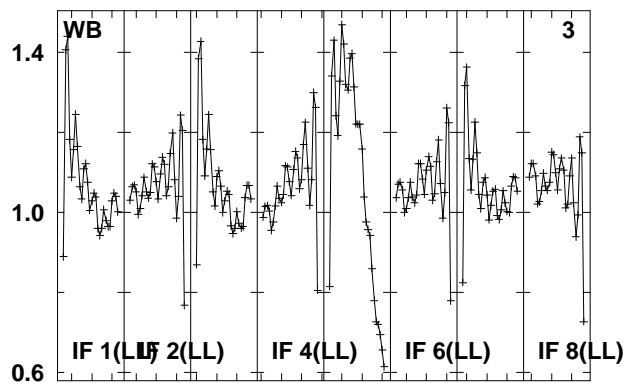
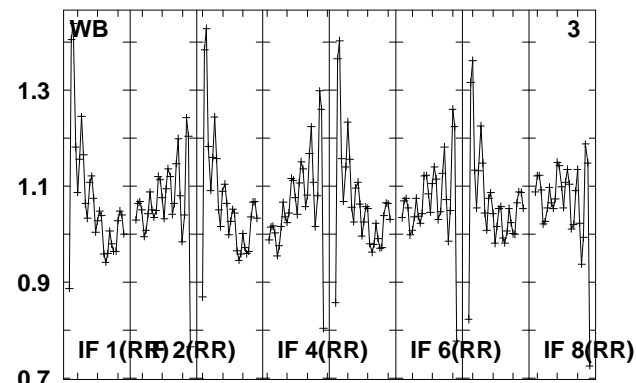
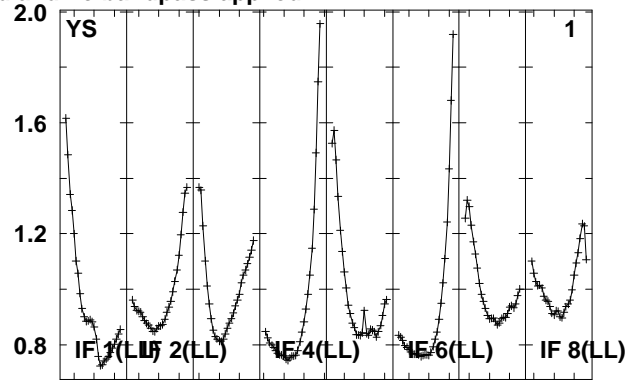
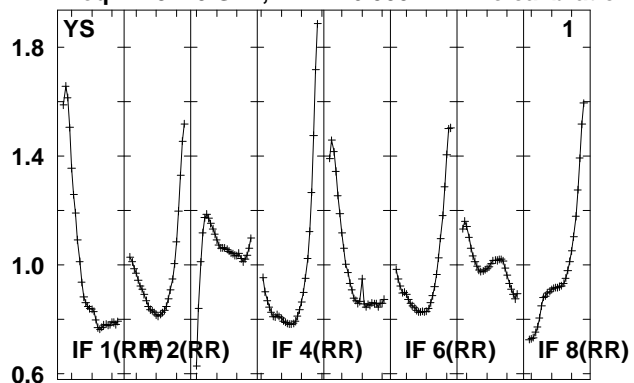

Lower frame: Real Jy
Total-power spectrum Antenna: *
Timerange: 01/01:18:25 to 01/01:23:23

Plot file version 752 created 14-MAY-2010 15:21:23

J102959 EO007.UVDATA.1

Freq = 4.9270 GHz, Bw = 16.000 MH No calibration applied and no bandpass applied

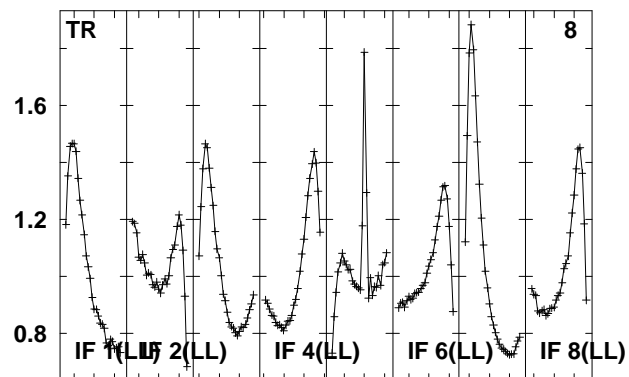
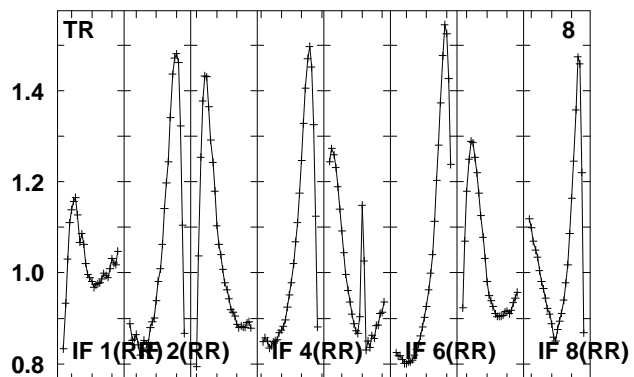
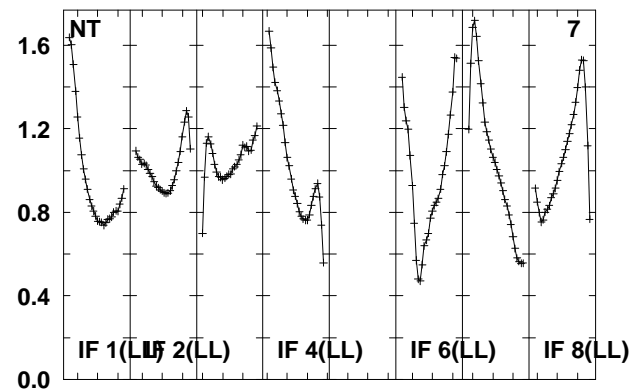
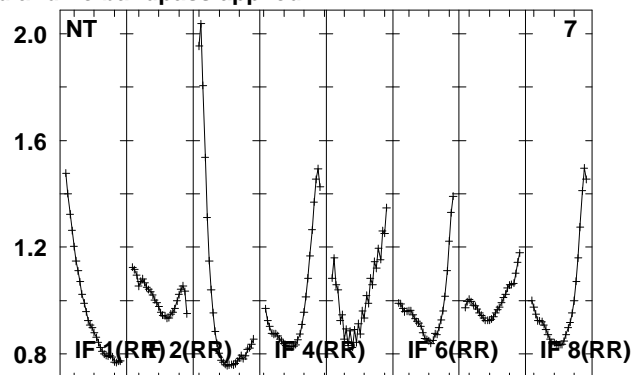
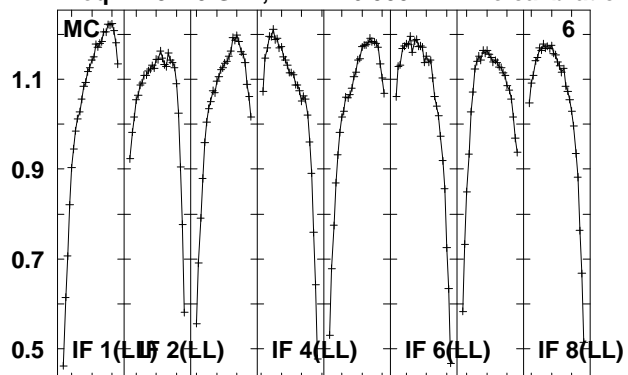

Lower frame: Real Jy
Total-power spectrum Antenna: *
Timerange: 01/01:18:25 to 01/01:23:23

Plot file version 753 created 14-MAY-2010 15:21:23

J1027+48 EO007.UVDATA.1

Freq = 4.9270 GHz, Bw = 16.000 MH No calibration applied and no bandpass applied

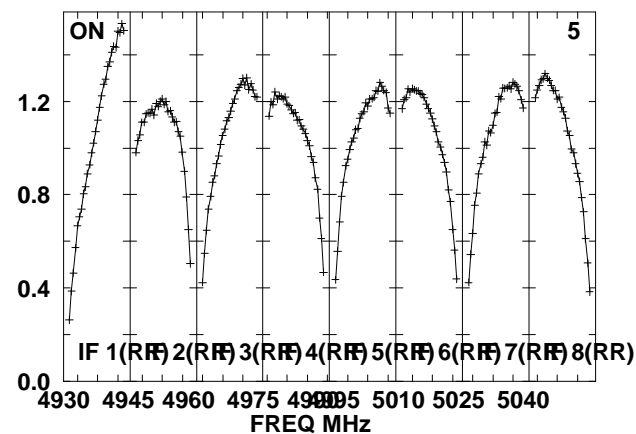
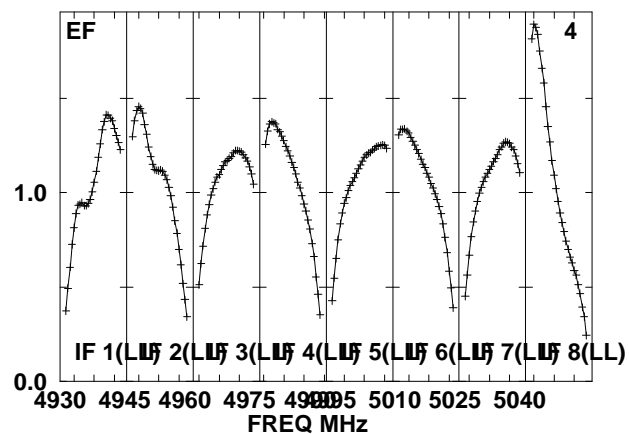
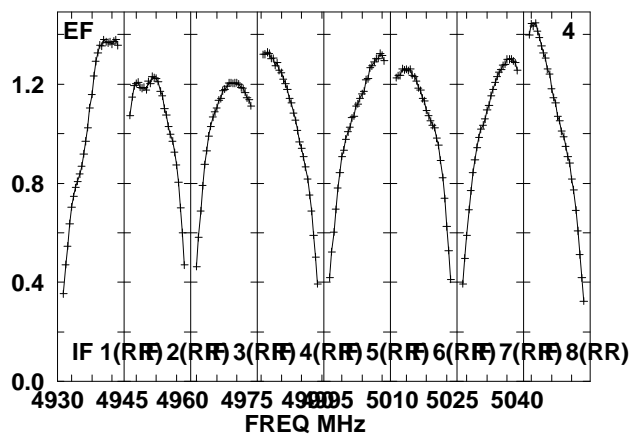
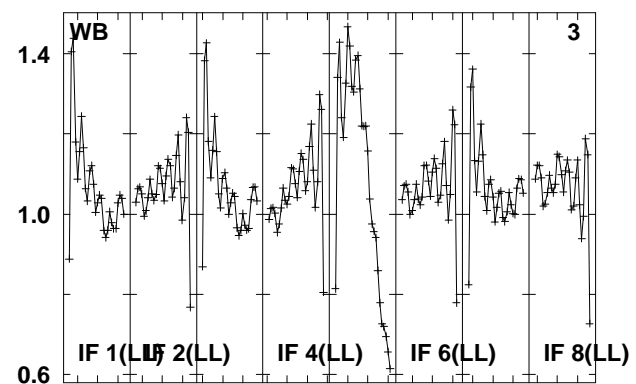
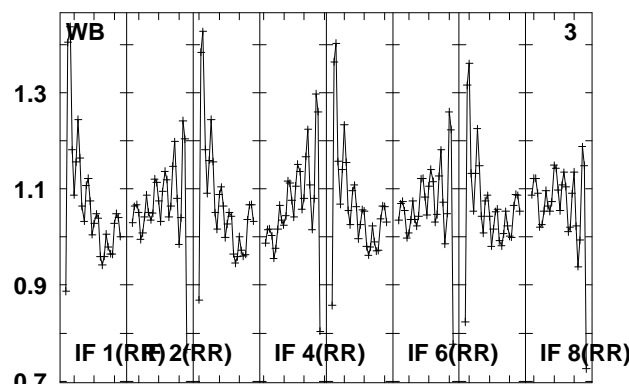
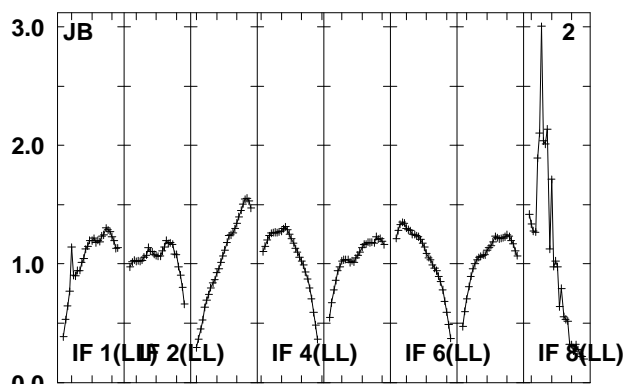
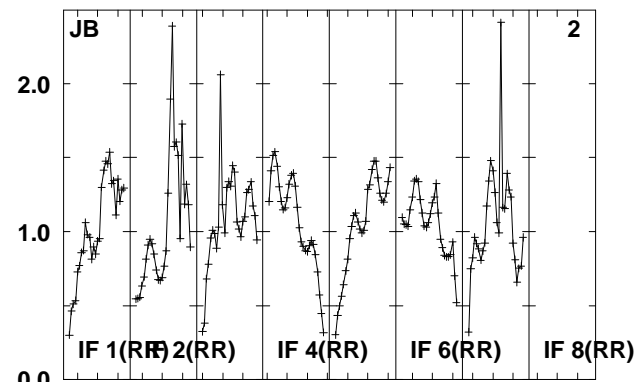
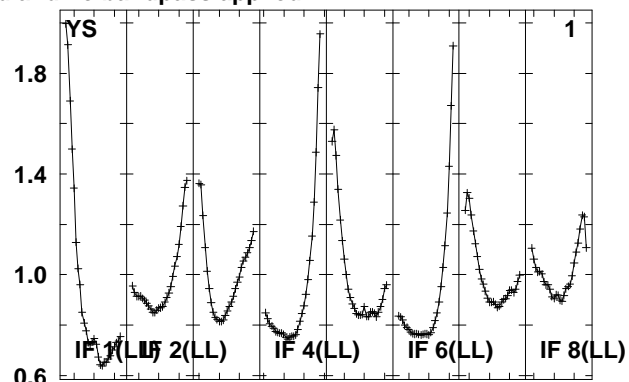
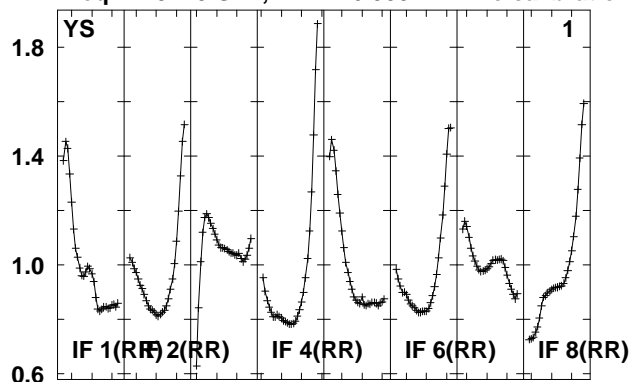

Lower frame: Real Jy

Total-power spectrum Antenna: *

Timerange: 01/01:23:45 to 01/01:25:11

Plot file version 754 created 14-MAY-2010 15:21:23

J1027+48 EO007.UVDATA.1

Freq = 4.9270 GHz, Bw = 16.000 MH No calibration applied and no bandpass applied

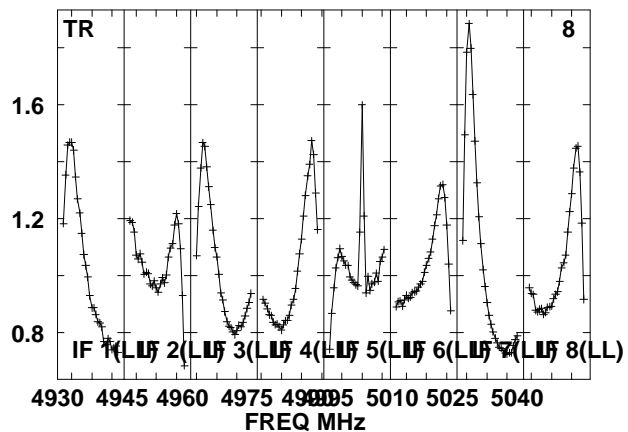
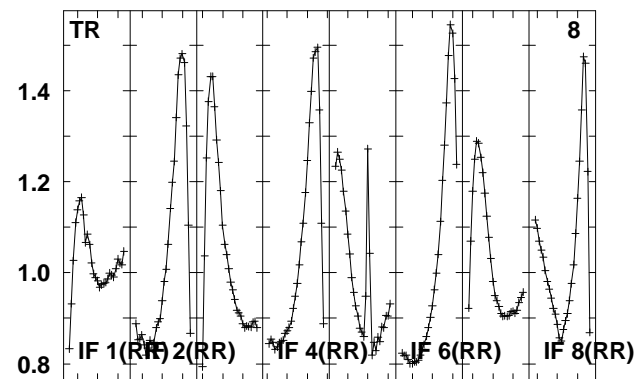
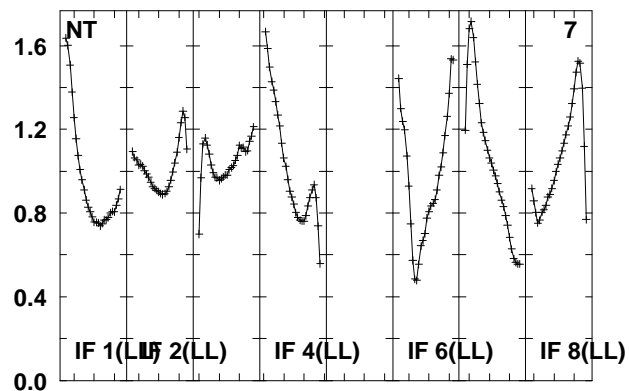
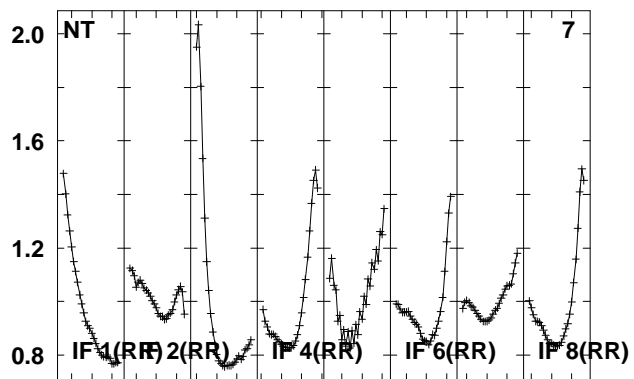
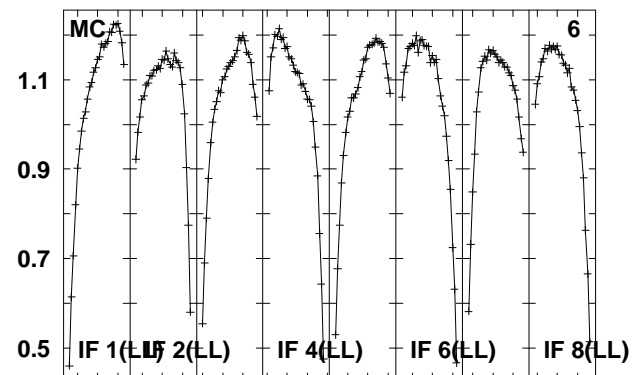
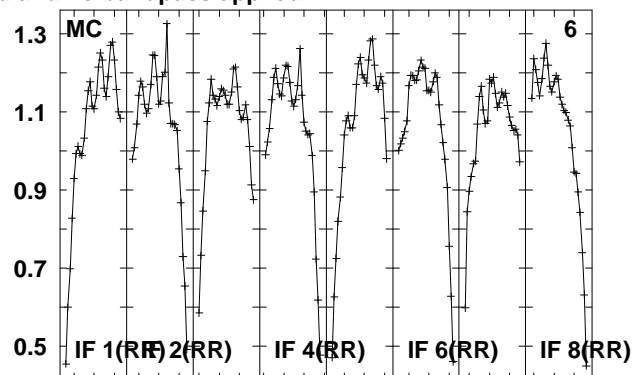
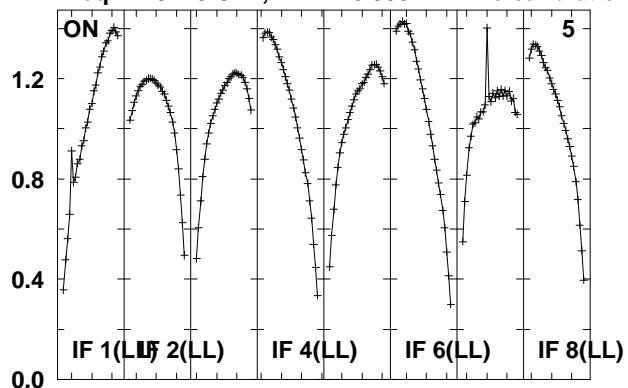

Lower frame: Real Jy

Total-power spectrum Antenna: *

Timerange: 01/01:23:45 to 01/01:25:11

Plot file version 755 created 14-MAY-2010 15:21:23

J102959 EO007.UVDATA.1

Freq = 4.9270 GHz, Bw = 16.000 MH No calibration applied and no bandpass applied

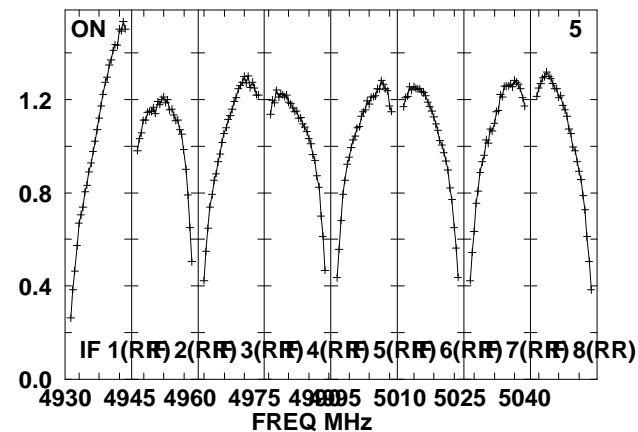
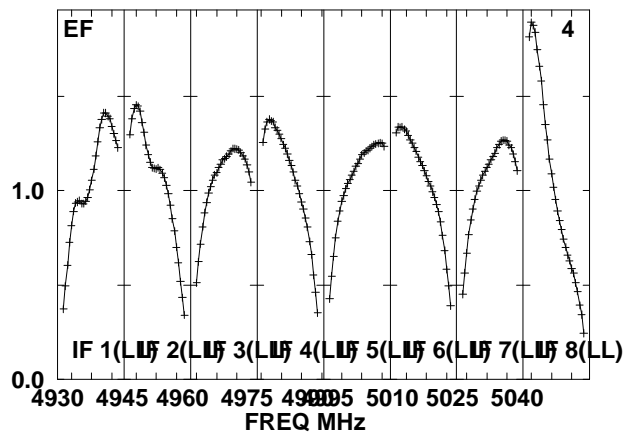
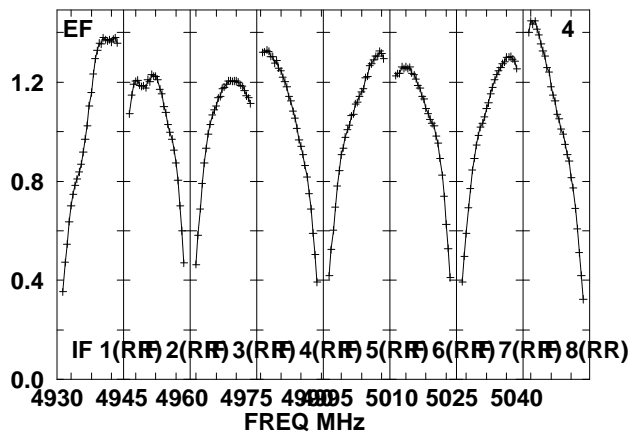
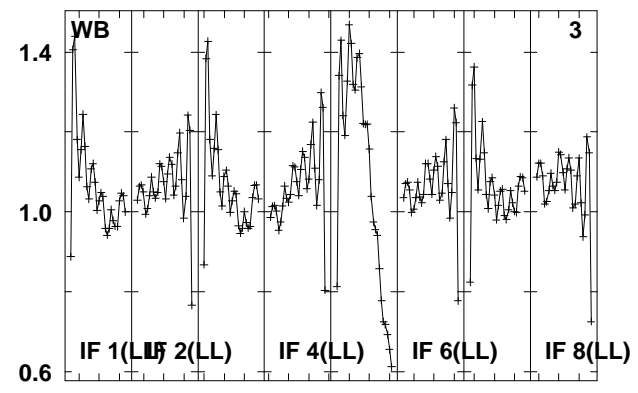
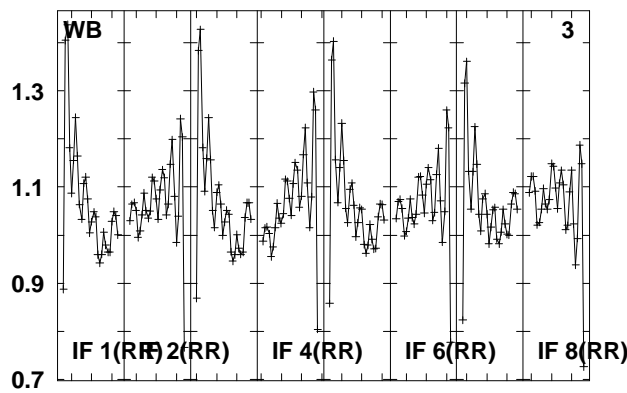
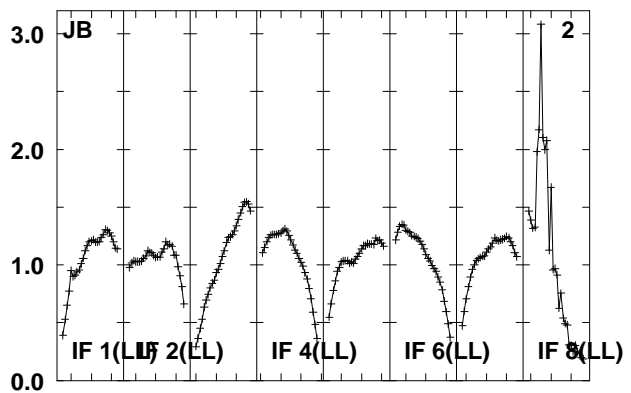
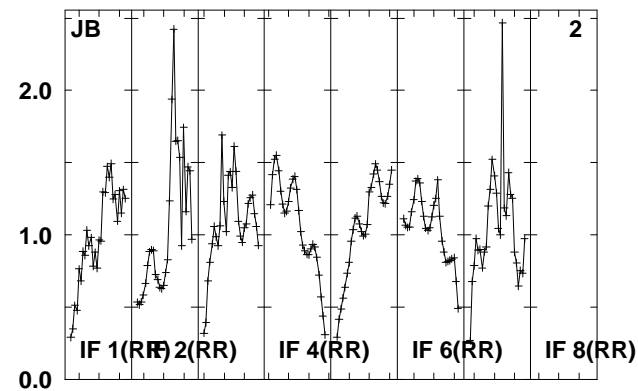
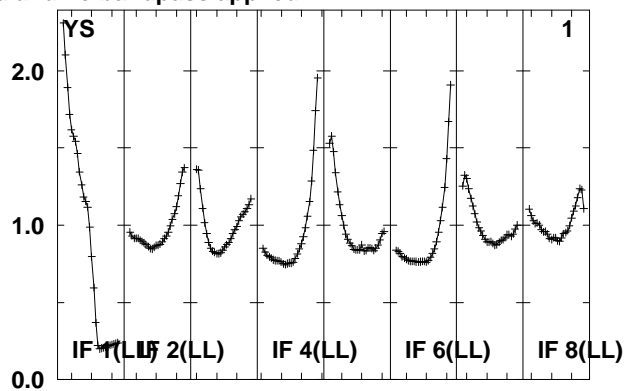
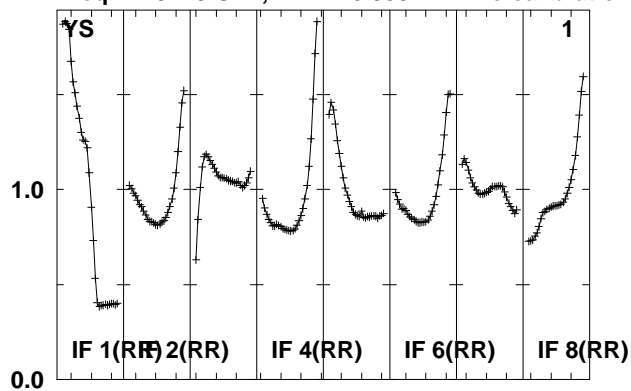

Lower frame: Real Jy
Total-power spectrum Antenna: *
Timerange: 01/01:25:35 to 01/01:30:33

Plot file version 756 created 14-MAY-2010 15:21:24

J102959 EO007.UVDATA.1

Freq = 4.9270 GHz, Bw = 16.000 MH No calibration applied and no bandpass applied

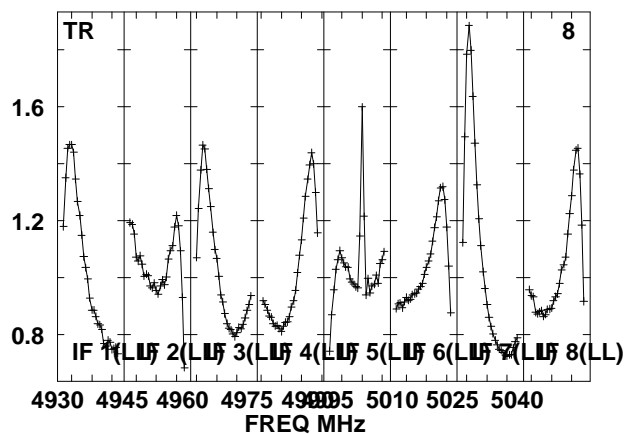
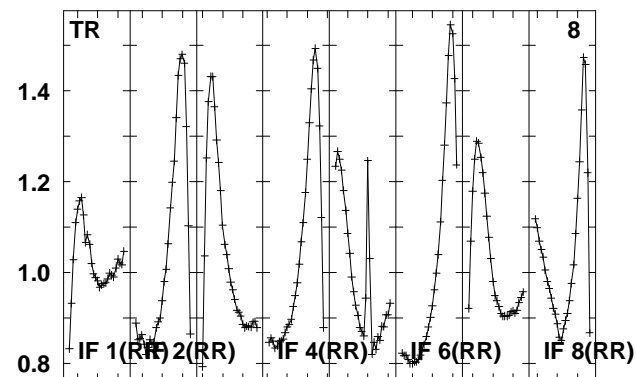
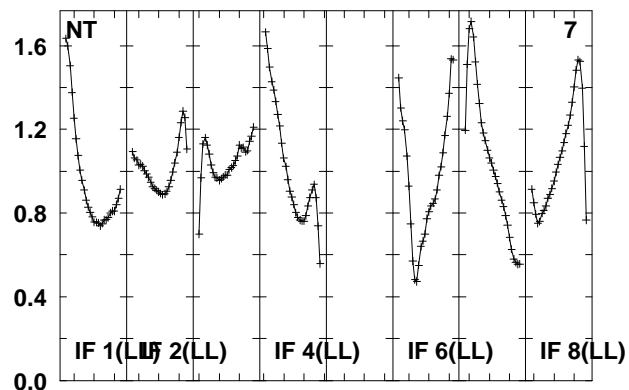
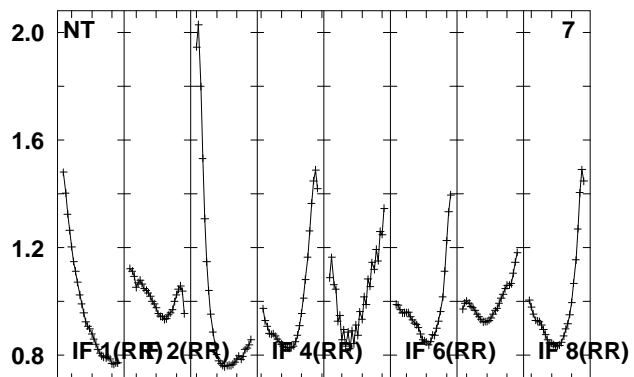
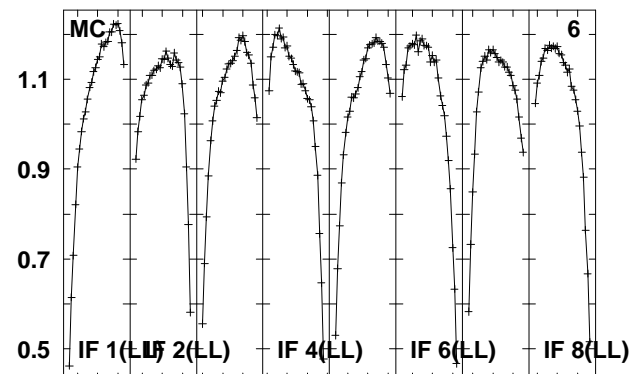
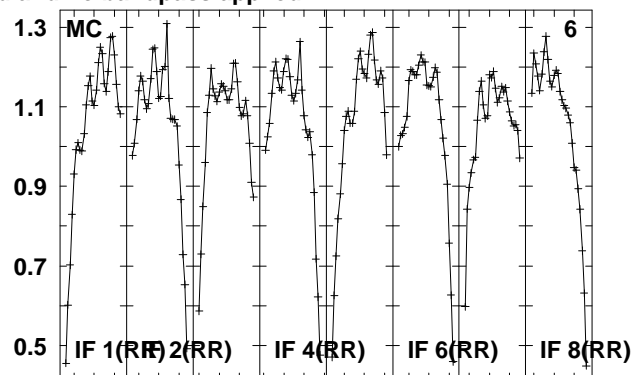
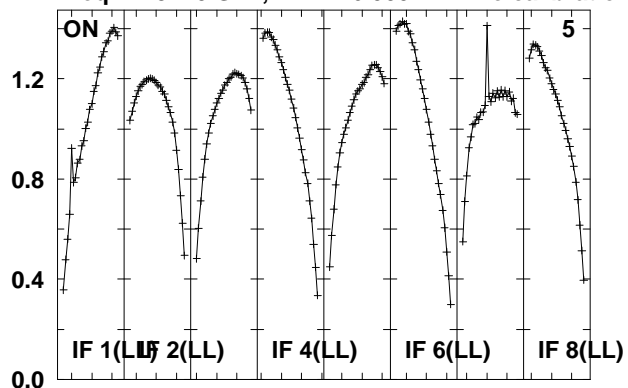

Lower frame: Real Jy

Total-power spectrum Antenna: *

Timerange: 01/01:25:35 to 01/01:30:33

Plot file version 757 created 14-MAY-2010 15:21:24

J1027+48 EO007.UVDATA.1

Freq = 4.9270 GHz, Bw = 16.000 MH No calibration applied and no bandpass applied

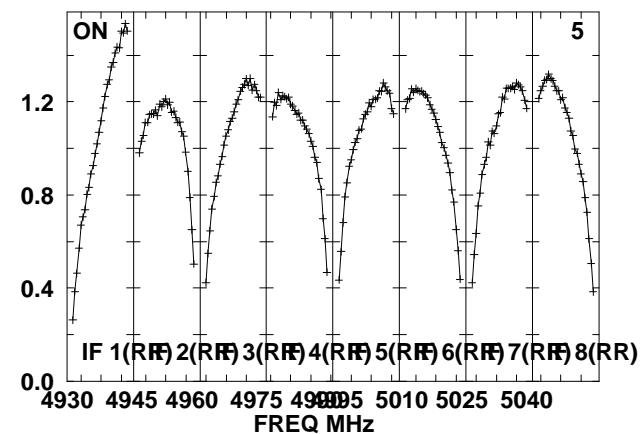
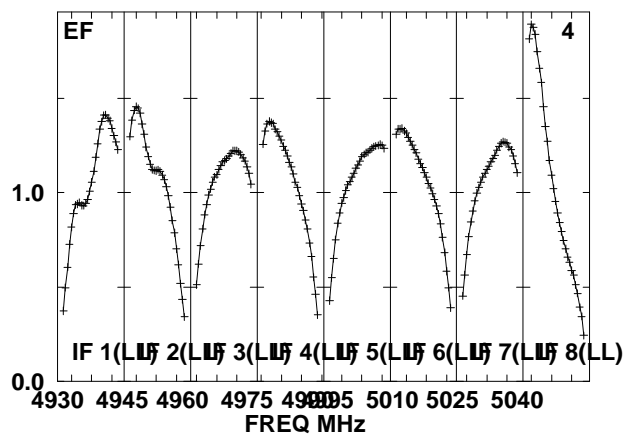
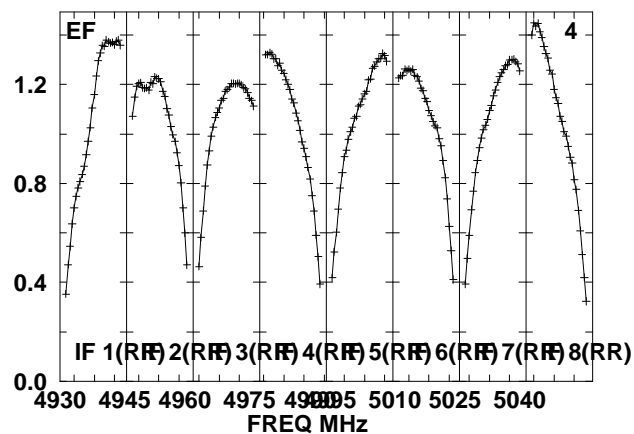
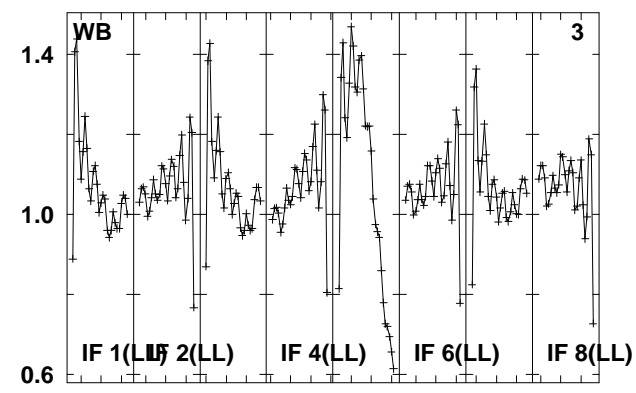
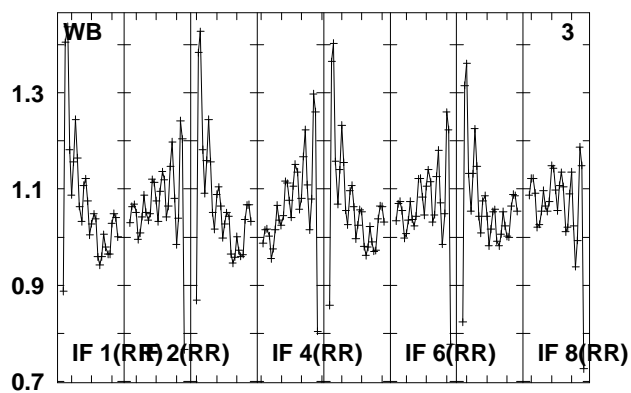
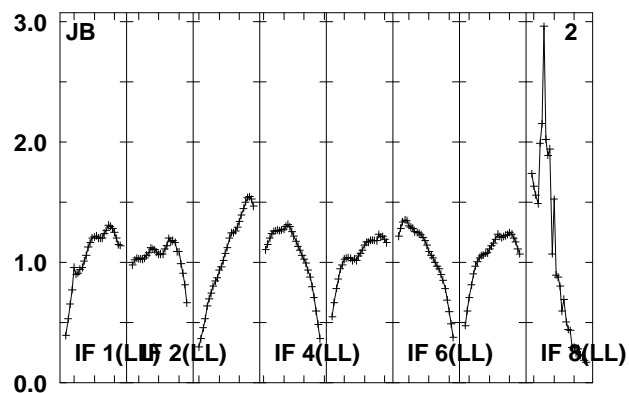
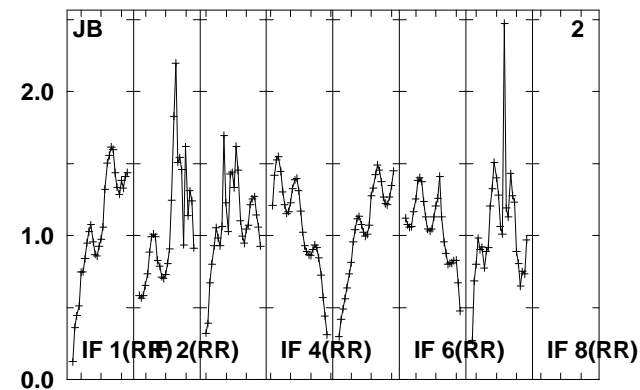
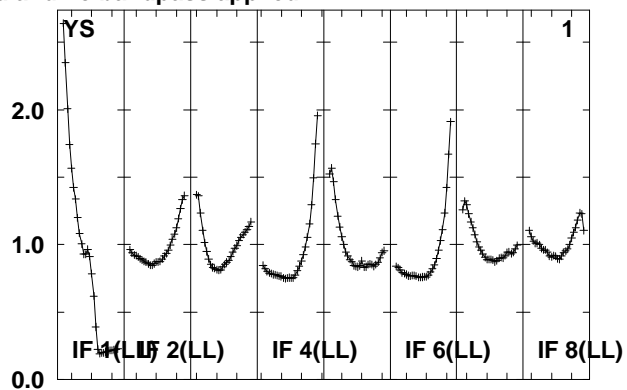
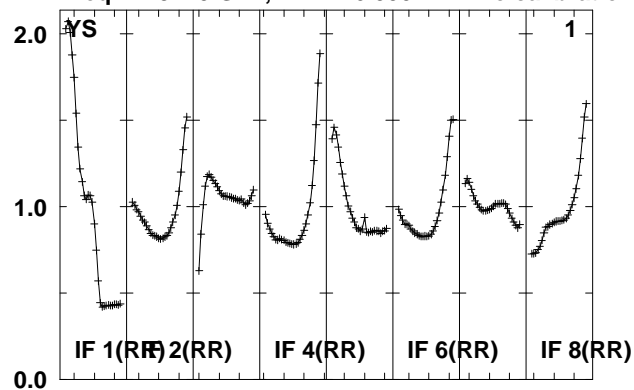

Lower frame: Real Jy
Total-power spectrum Antenna: *
Timerange: 01/01:30:55 to 01/01:32:23

Plot file version 758 created 14-MAY-2010 15:21:25

J1027+48 EO007.UVDATA.1

Freq = 4.9270 GHz, Bw = 16.000 MH No calibration applied and no bandpass applied

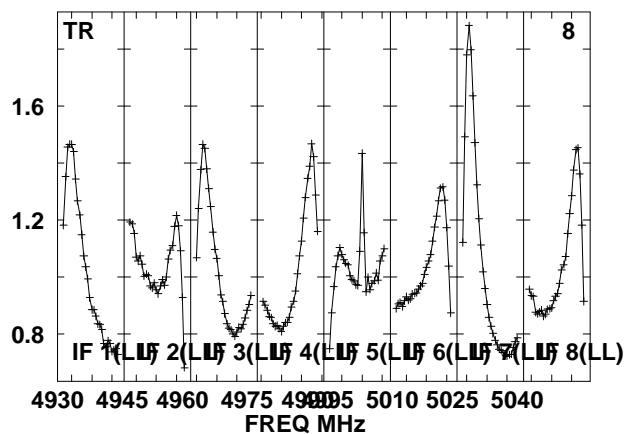
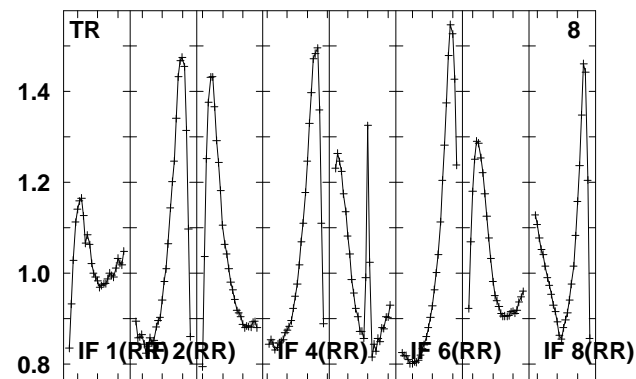
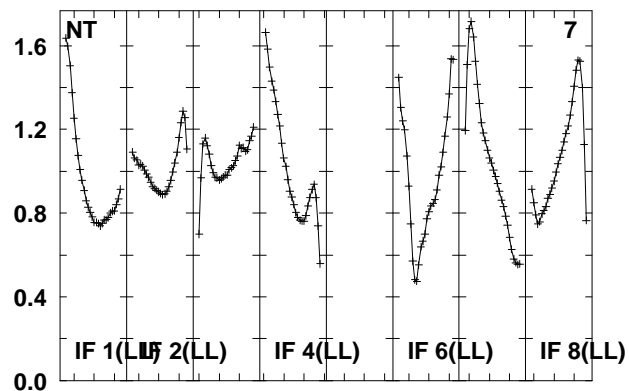
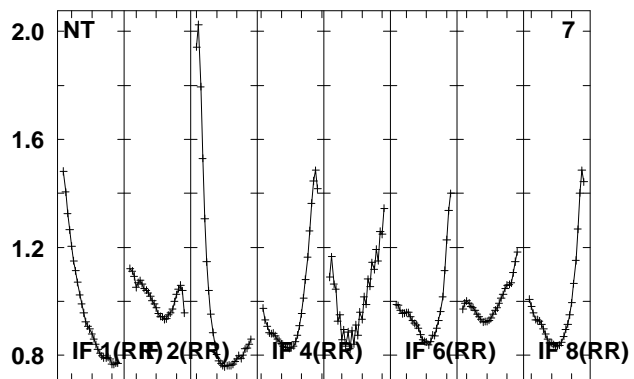
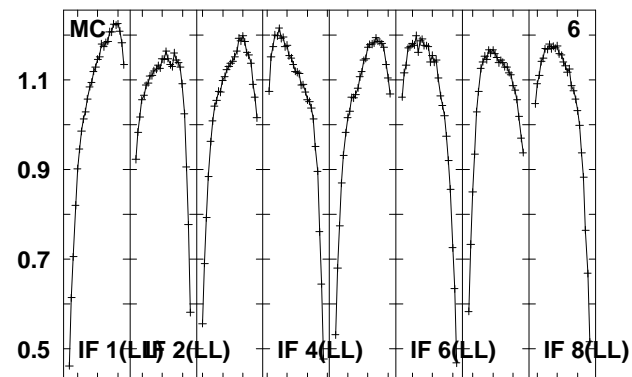
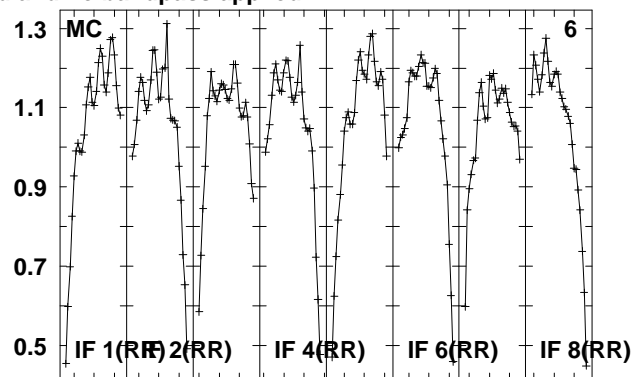
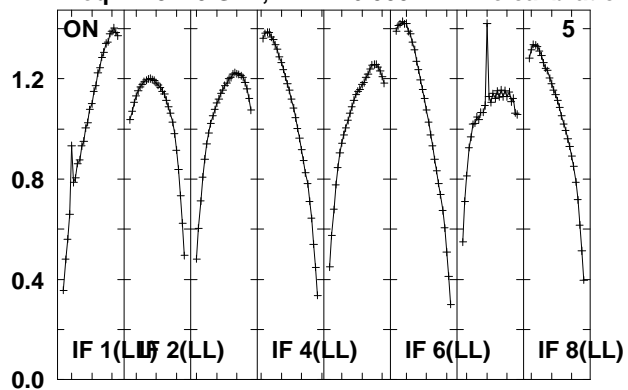

Lower frame: Real Jy

Total-power spectrum Antenna: *

Timerange: 01/01:30:55 to 01/01:32:23

Plot file version 759 created 14-MAY-2010 15:21:25
 J102959 EO007.UVDATA.1
 Freq = 4.9270 GHz, Bw = 16.000 MH No calibration applied and no bandpass applied

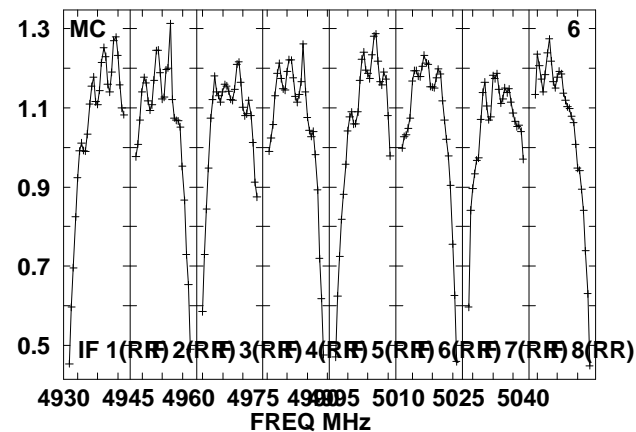
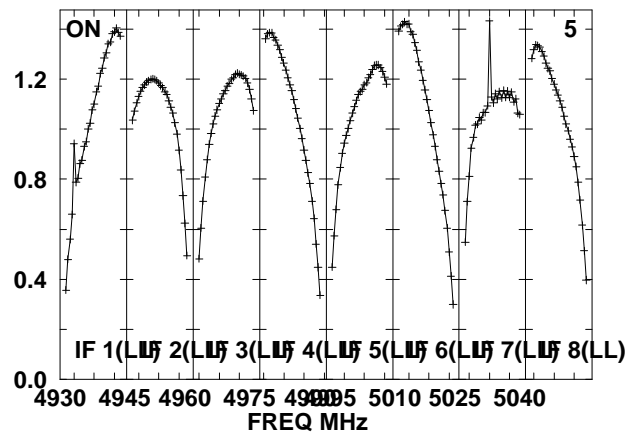
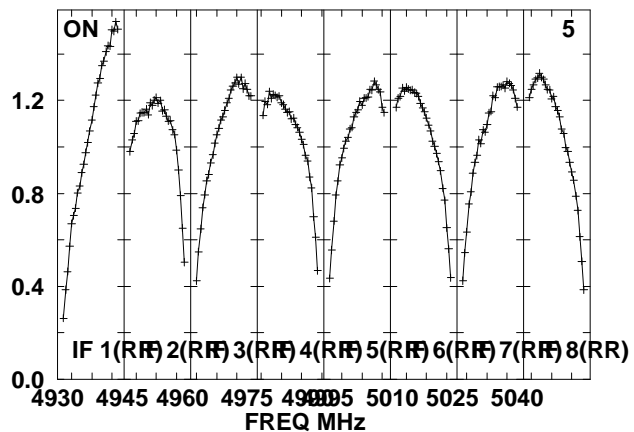
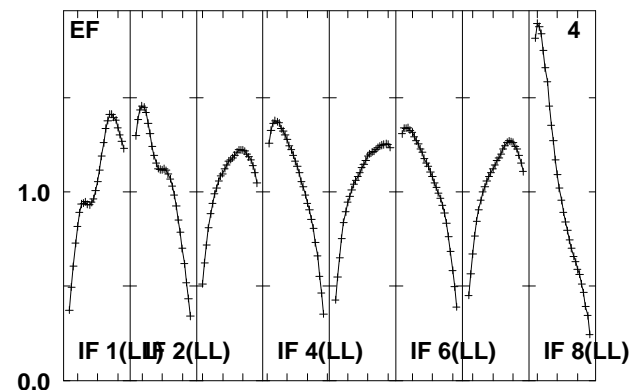
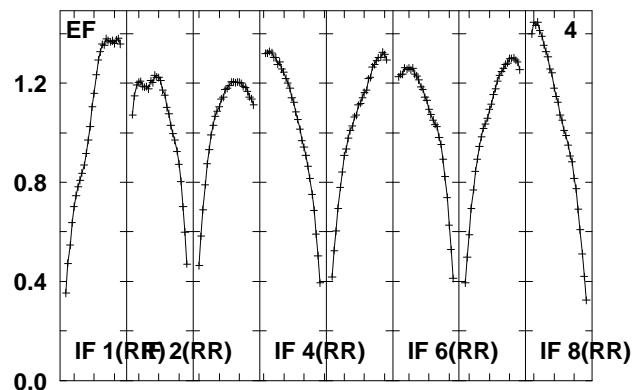
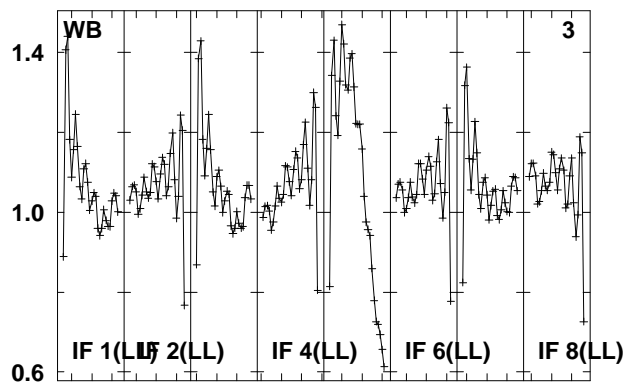
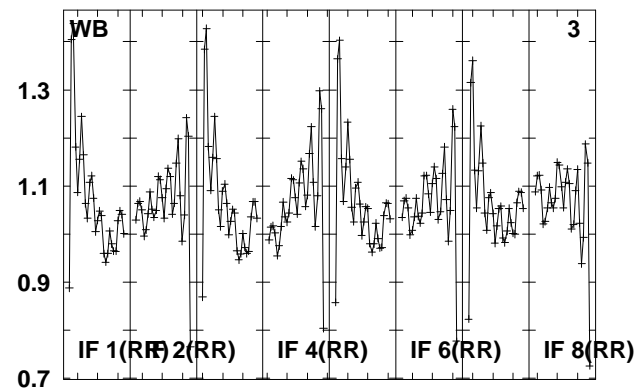
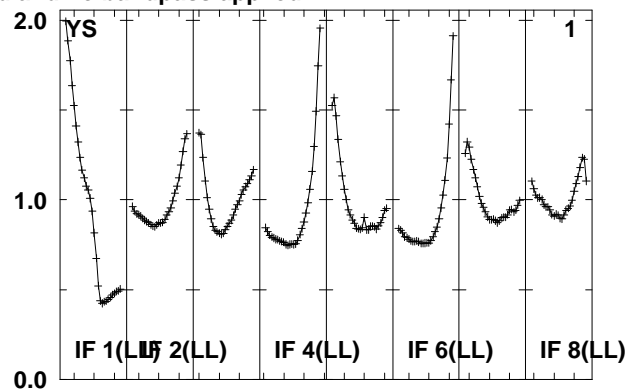
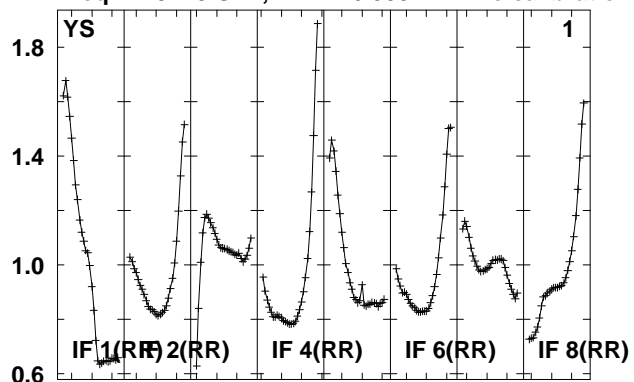

Lower frame: Real Jy
 Total-power spectrum Antenna: *
 Timerange: 01/01:32:45 to 01/01:37:43

Plot file version 760 created 14-MAY-2010 15:21:26

J102959 EO007.UVDATA.1

Freq = 4.9270 GHz, Bw = 16.000 MH No calibration applied and no bandpass applied

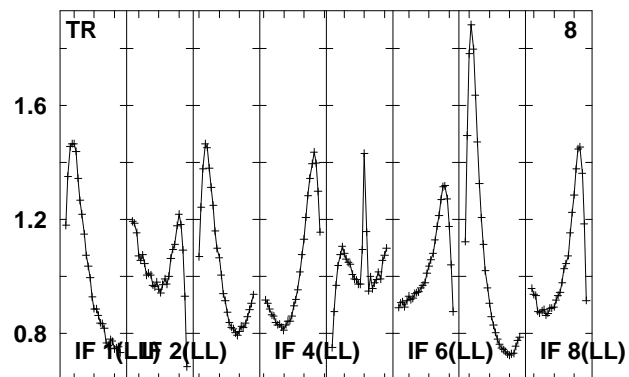
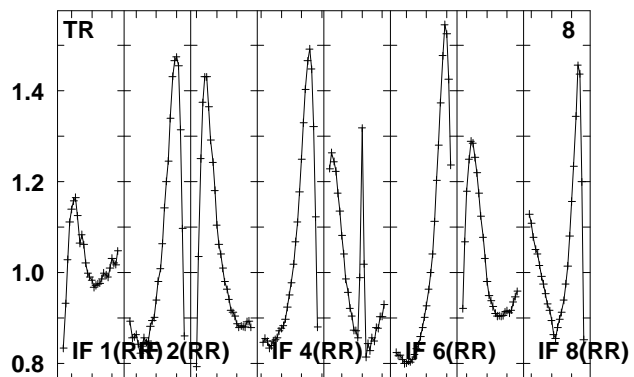
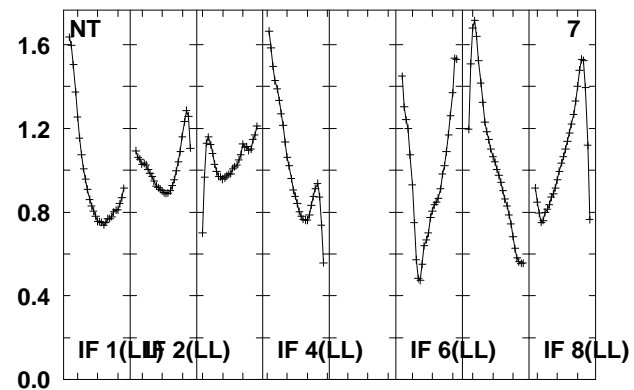
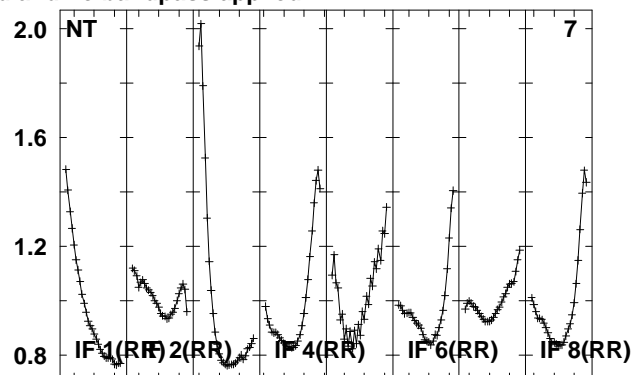
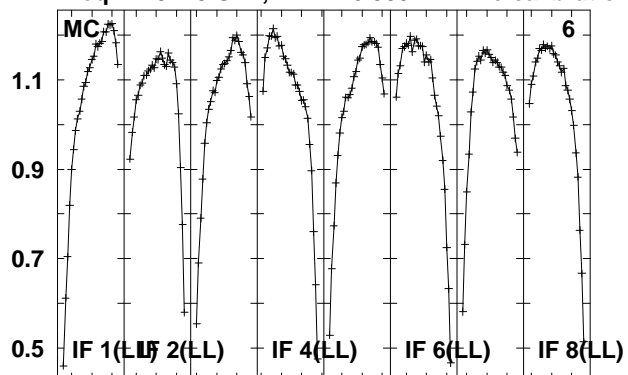

Lower frame: Real Jy
Total-power spectrum Antenna: *
Timerange: 01/01:32:45 to 01/01:37:43

Plot file version 761 created 14-MAY-2010 15:21:26

J1027+48 EO007.UVDATA.1

Freq = 4.9270 GHz, Bw = 16.000 MH No calibration applied and no bandpass applied

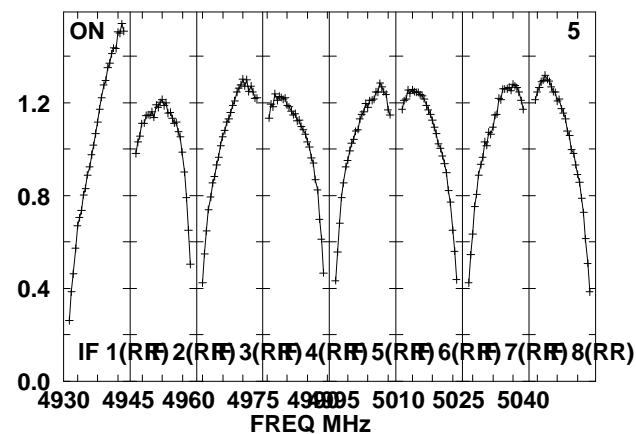
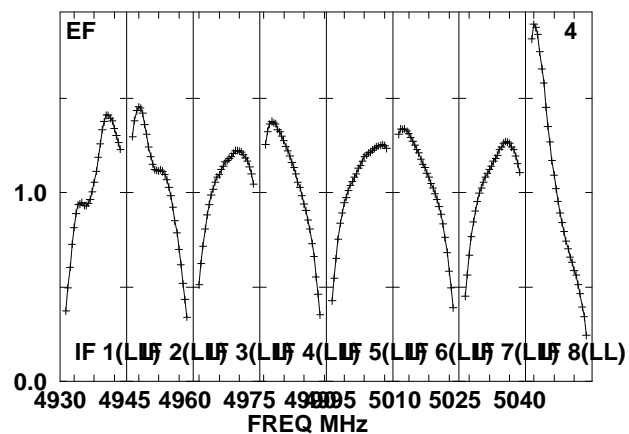
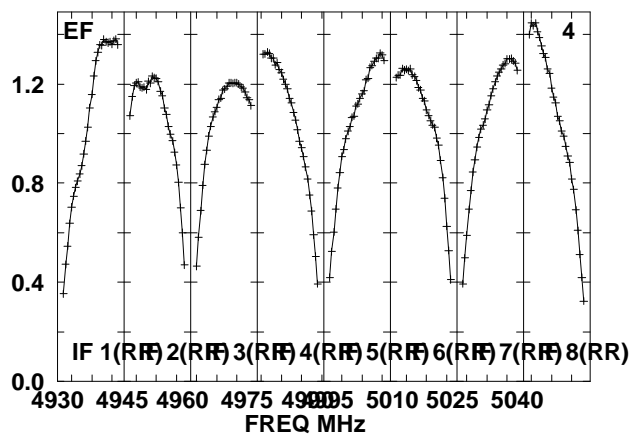
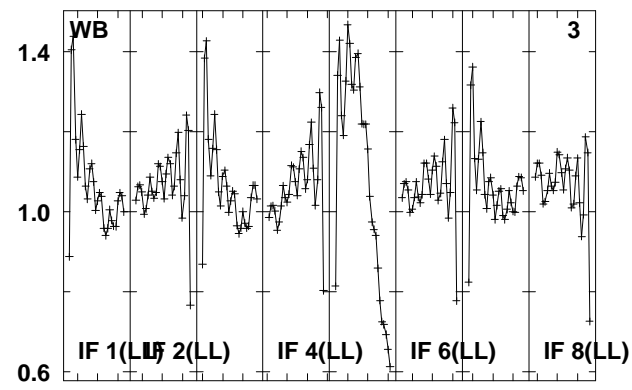
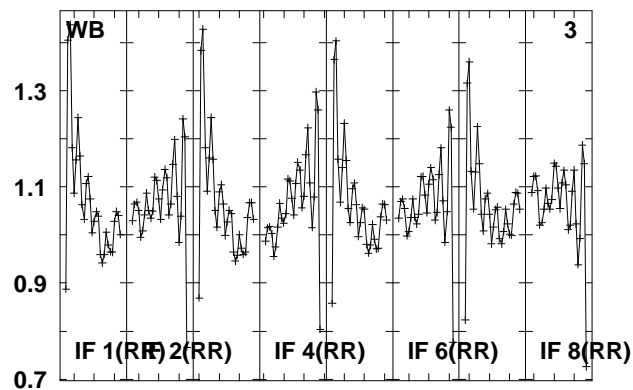
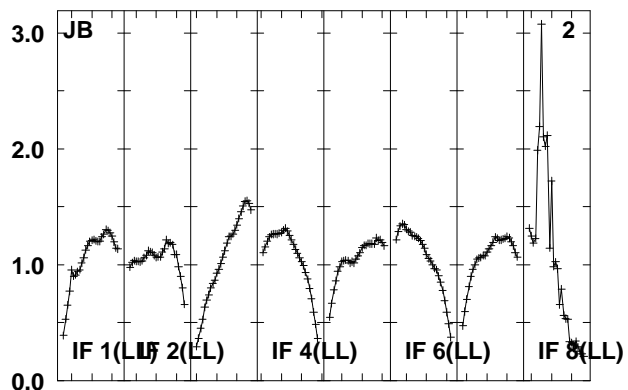
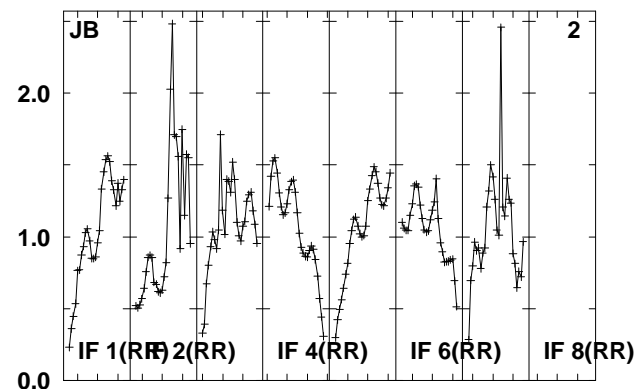
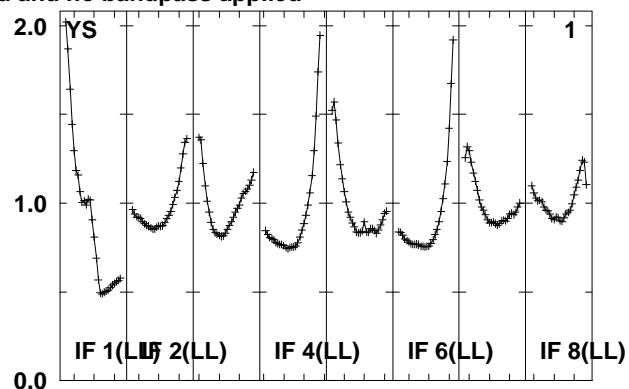
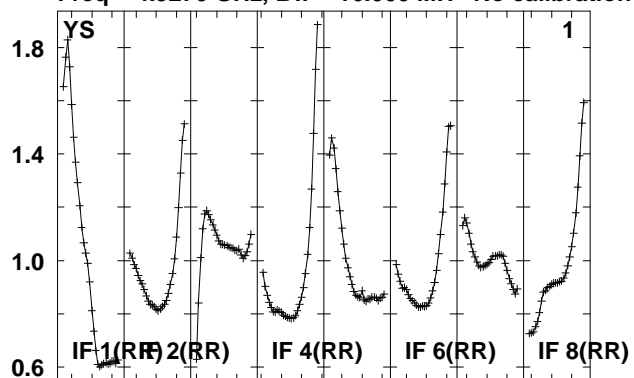

Lower frame: Real Jy
Total-power spectrum Antenna: *
Timerange: 01/01:38:07 to 01/01:39:33

Plot file version 762 created 14-MAY-2010 15:21:26

J1027+48 EO007.UVDATA.1

Freq = 4.9270 GHz, Bw = 16.000 MH No calibration applied and no bandpass applied

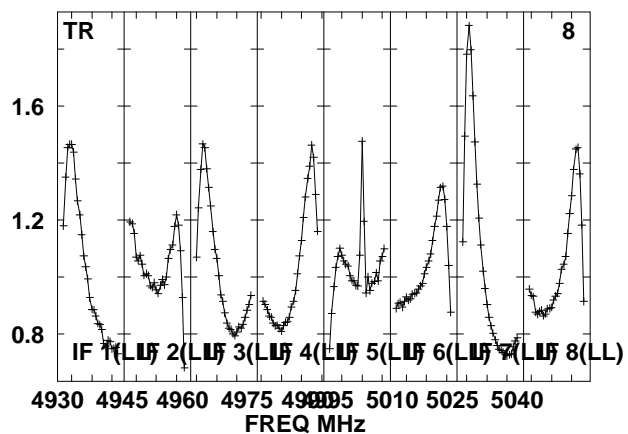
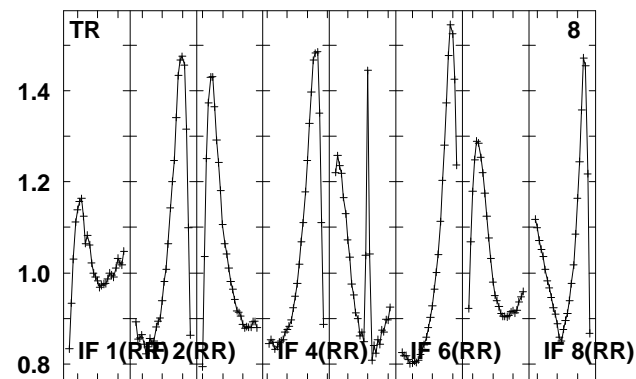
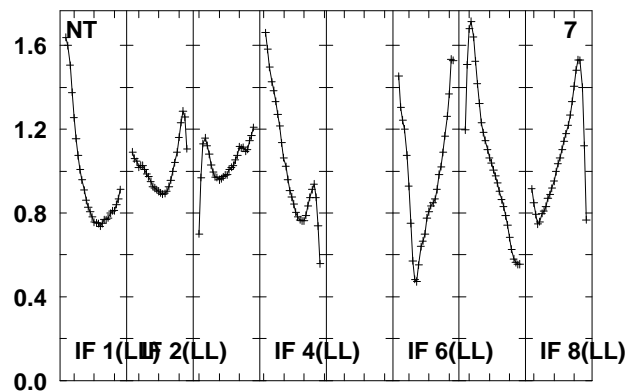
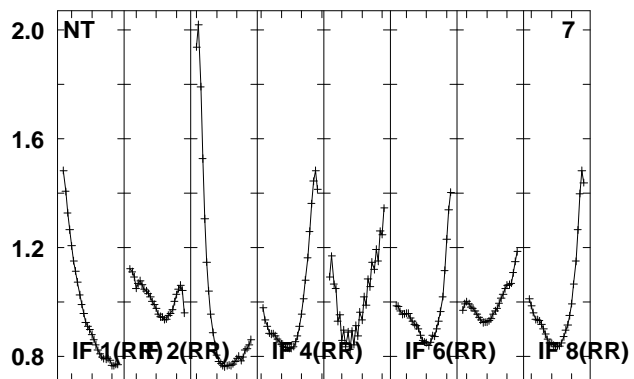
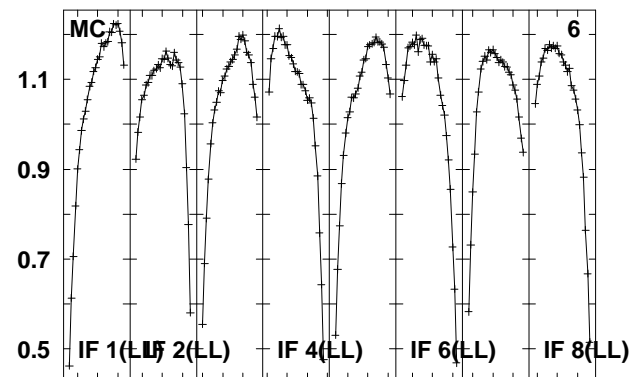
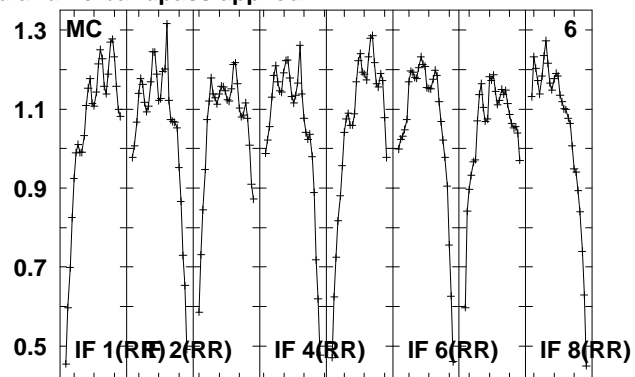
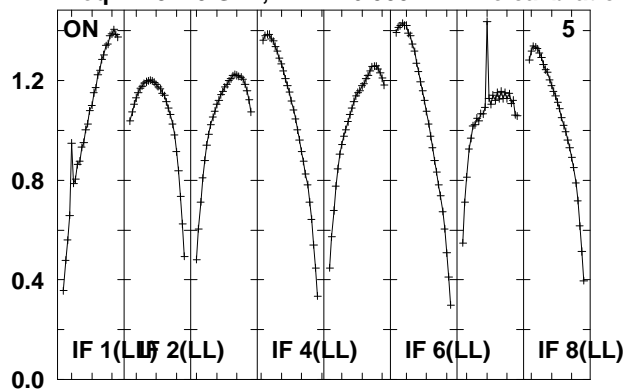

Lower frame: Real Jy

Total-power spectrum Antenna: *

Timerange: 01/01:38:07 to 01/01:39:33

Plot file version 763 created 14-MAY-2010 15:21:26

J102959 EO007.UVDATA.1

Freq = 4.9270 GHz, Bw = 16.000 MH No calibration applied and no bandpass applied

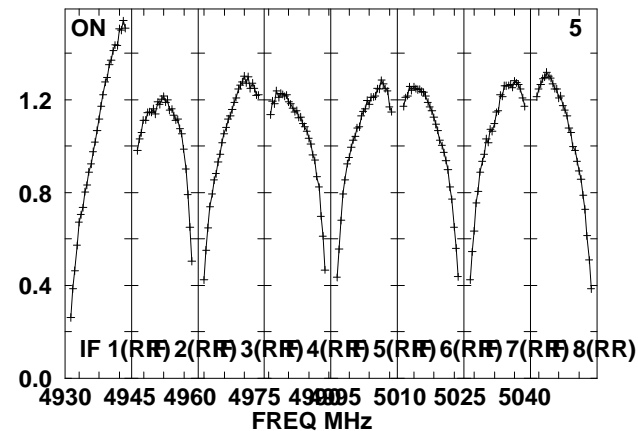
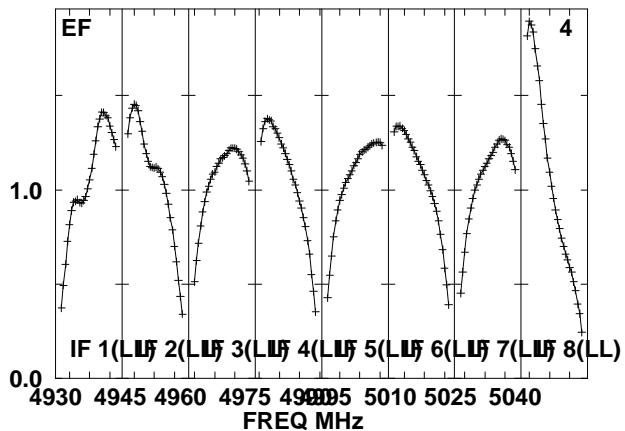
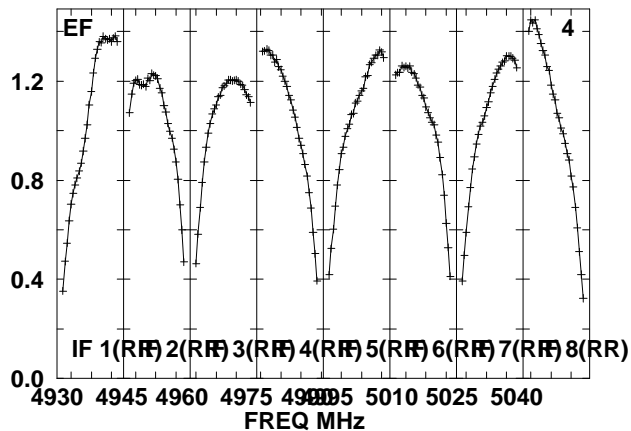
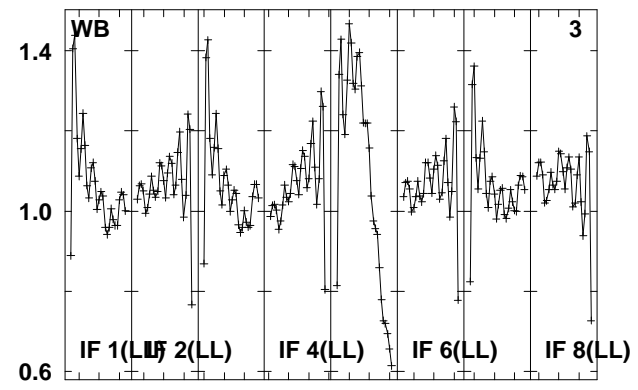
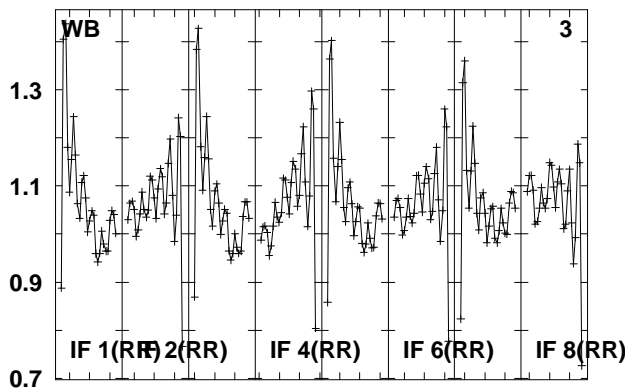
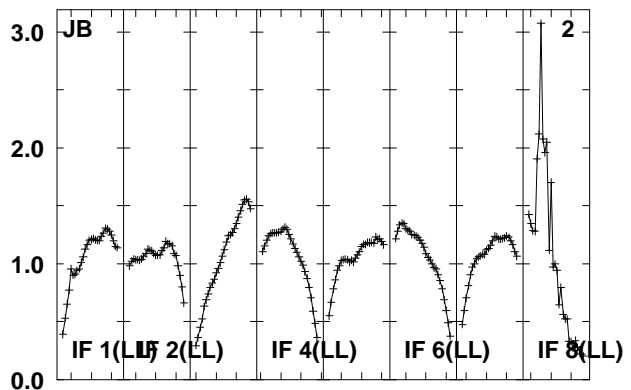
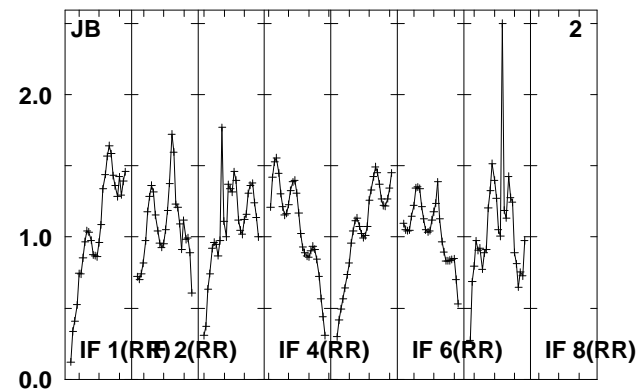
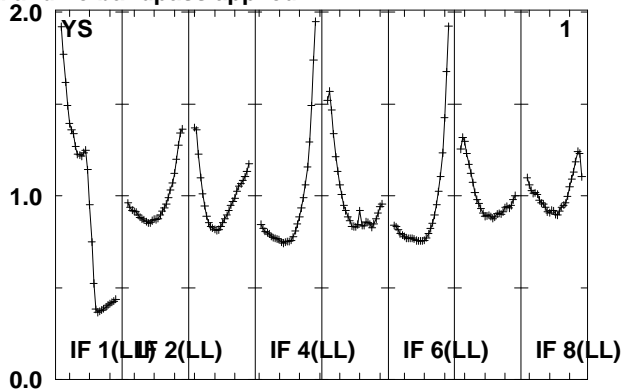
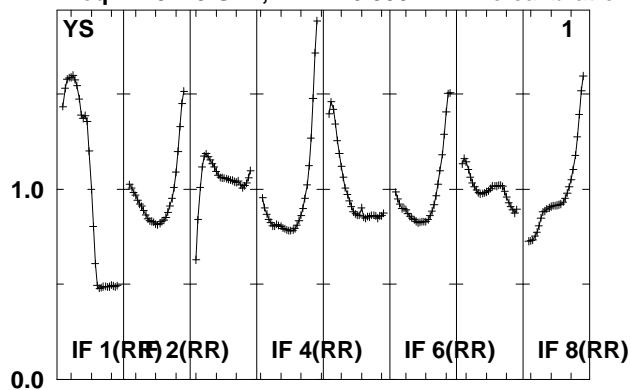

Lower frame: Real Jy

Total-power spectrum Antenna: *

Timerange: 01/01:39:55 to 01/01:44:55

Plot file version 764 created 14-MAY-2010 15:21:27

J102959 EO007.UVDATA.1

Freq = 4.9270 GHz, Bw = 16.000 MH No calibration applied and no bandpass applied

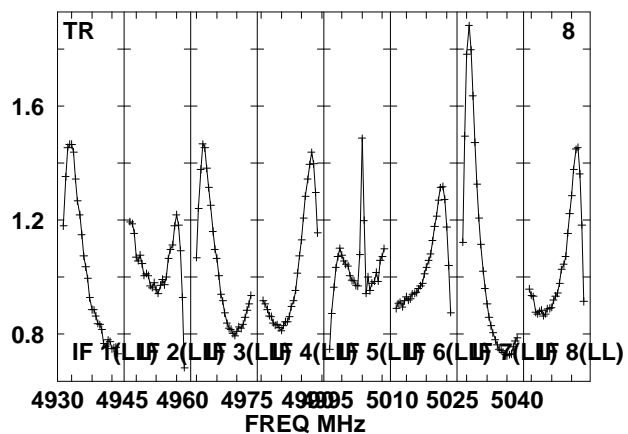
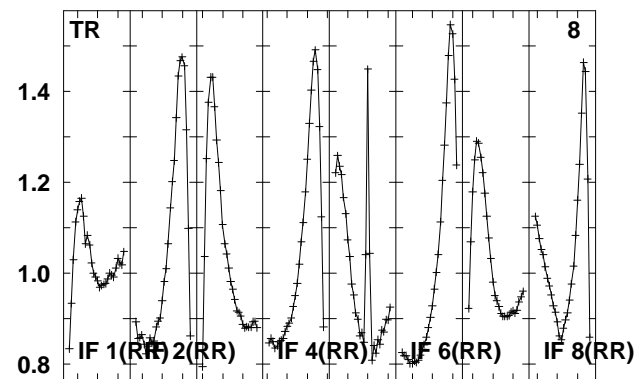
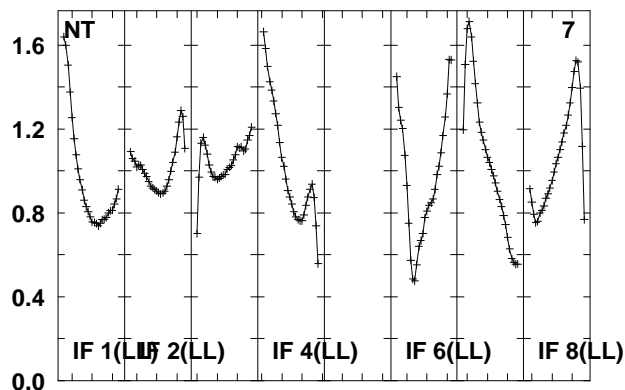
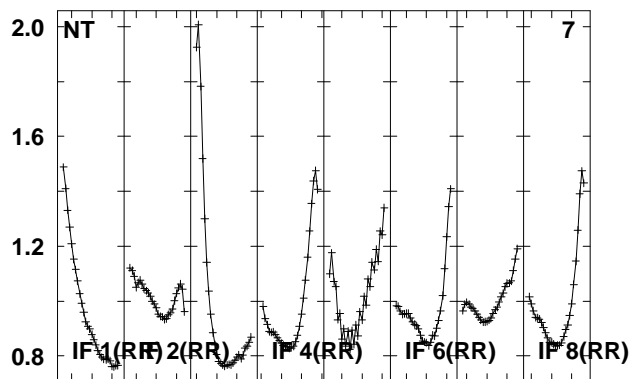
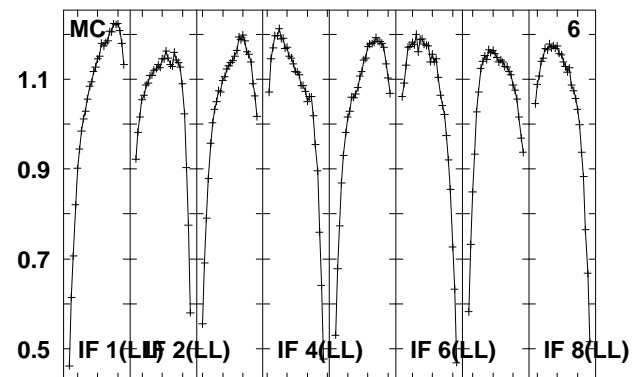
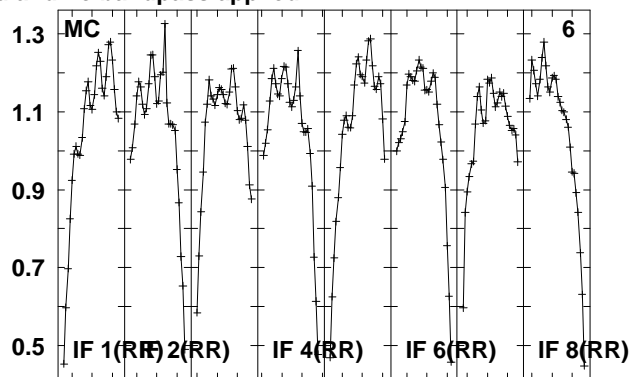
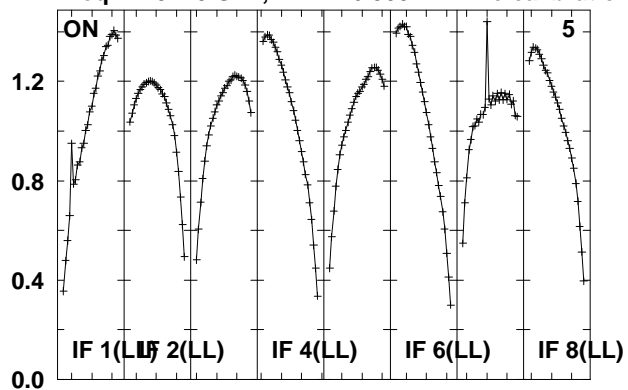

Lower frame: Real Jy

Total-power spectrum Antenna: *

Timerange: 01/01:39:55 to 01/01:44:55

Plot file version 765 created 14-MAY-2010 15:21:27

J1027+48 EO007.UVDATA.1

Freq = 4.9270 GHz, Bw = 16.000 MH No calibration applied and no bandpass applied

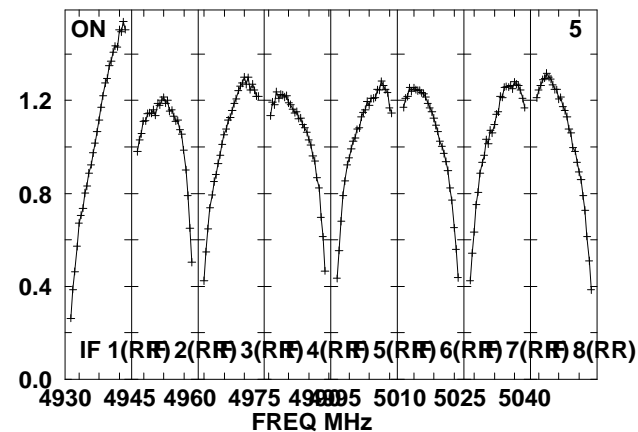
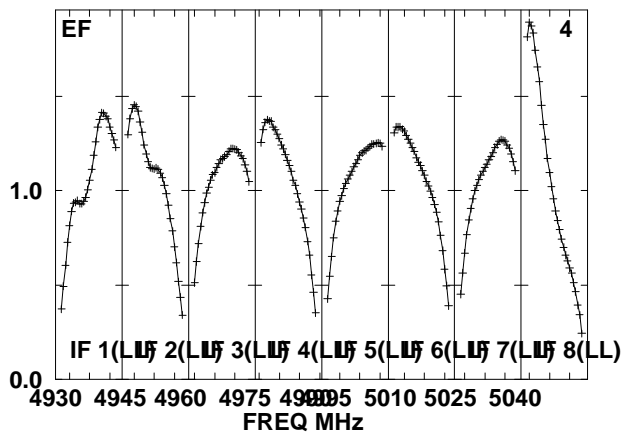
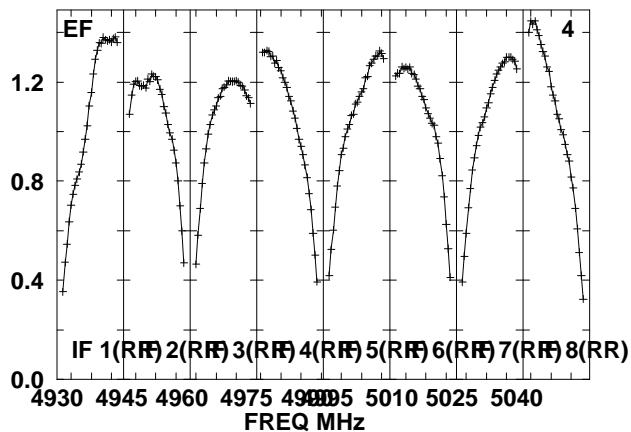
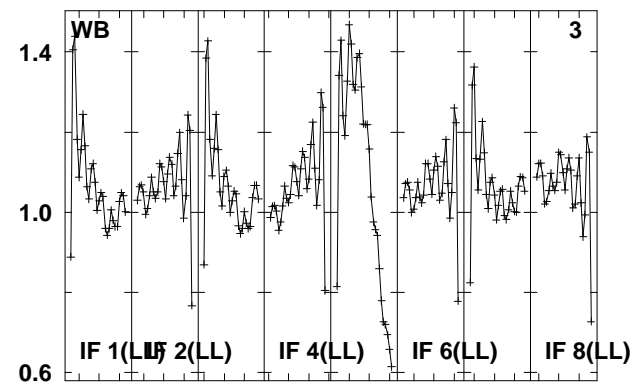
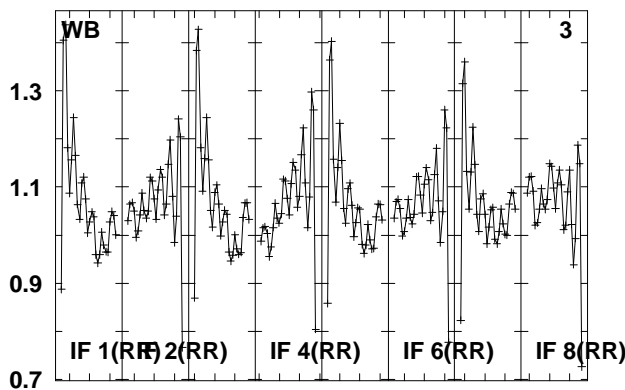
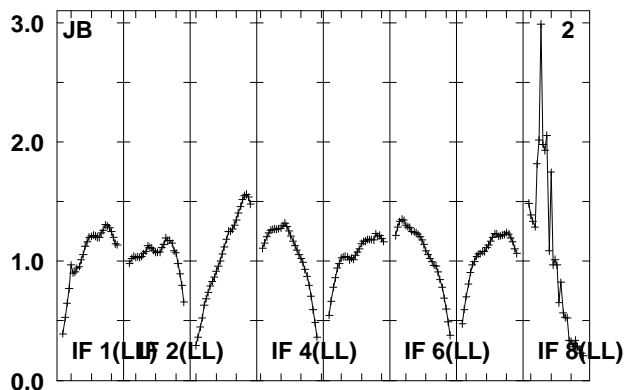
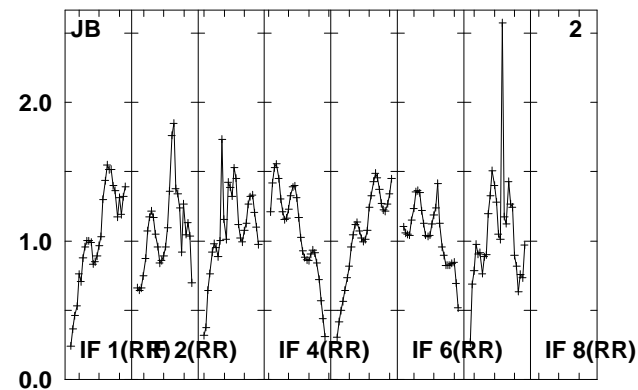
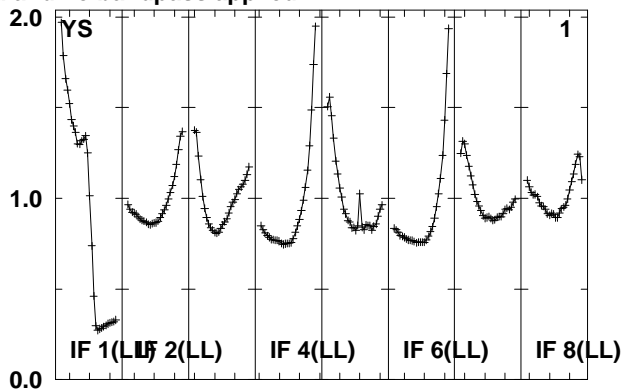
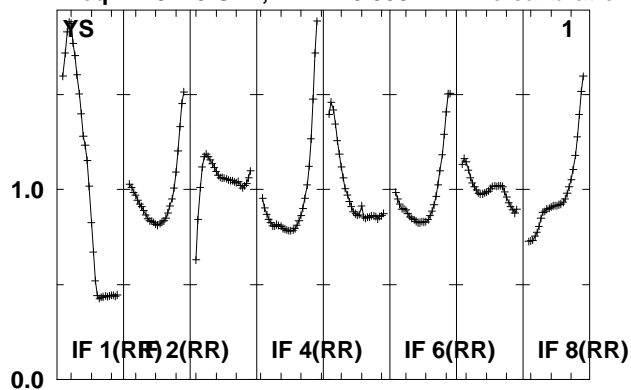

Lower frame: Real Jy
Total-power spectrum Antenna: *
Timerange: 01/01:45:17 to 01/01:46:45

Plot file version 766 created 14-MAY-2010 15:21:28

J1027+48 EO007.UVDATA.1

Freq = 4.9270 GHz, Bw = 16.000 MH No calibration applied and no bandpass applied

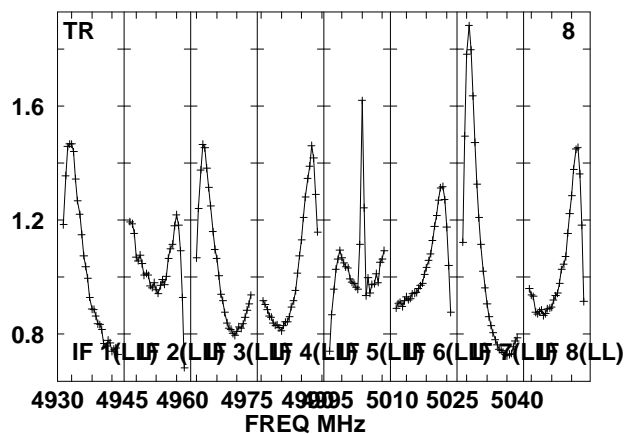
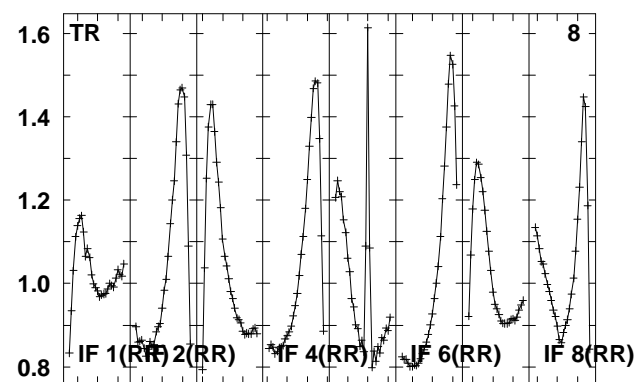
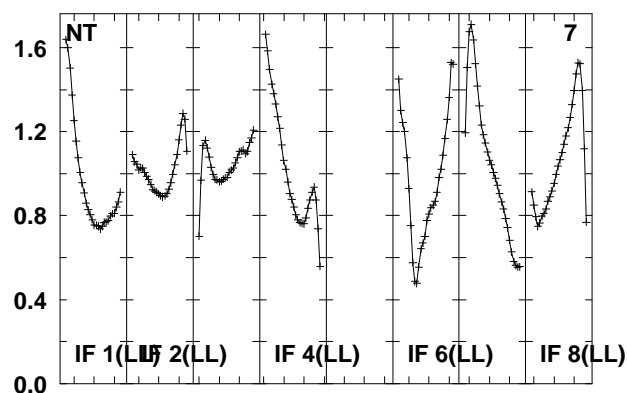
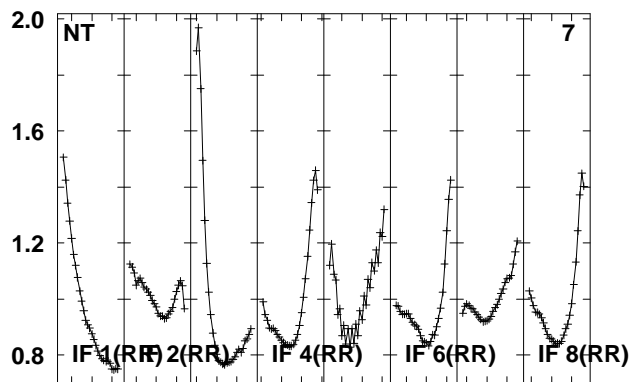
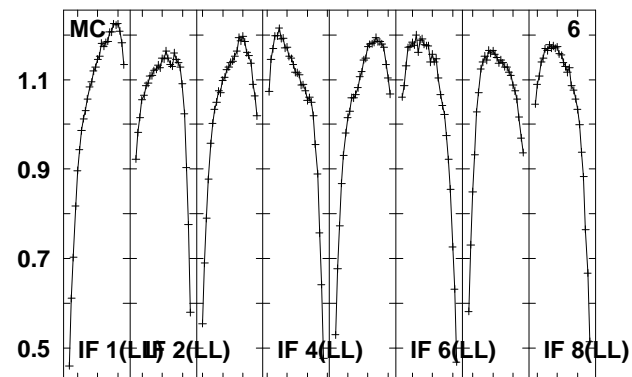
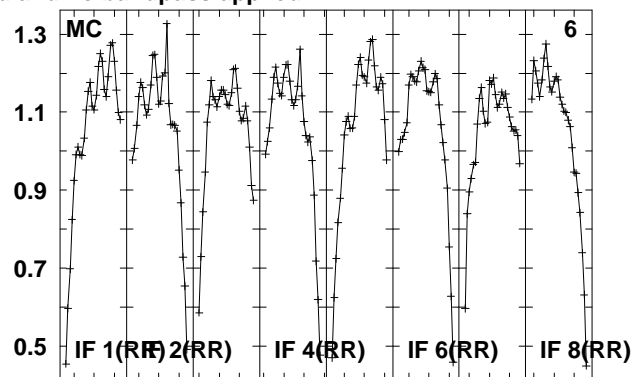
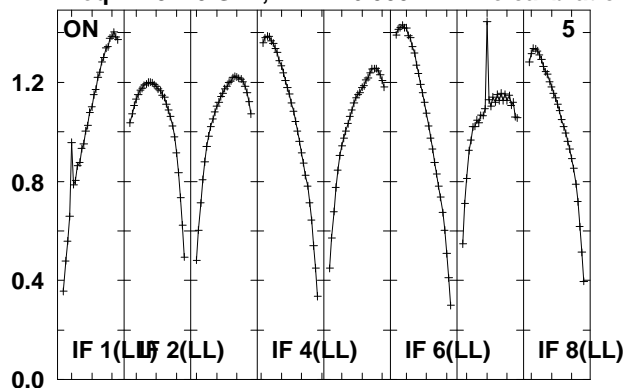

Lower frame: Real Jy

Total-power spectrum Antenna: *

Timerange: 01/01:45:17 to 01/01:46:45

Plot file version 767 created 14-MAY-2010 15:21:28
 J102959 EO007.UVDATA.1
 Freq = 4.9270 GHz, Bw = 16.000 MH No calibration applied and no bandpass applied

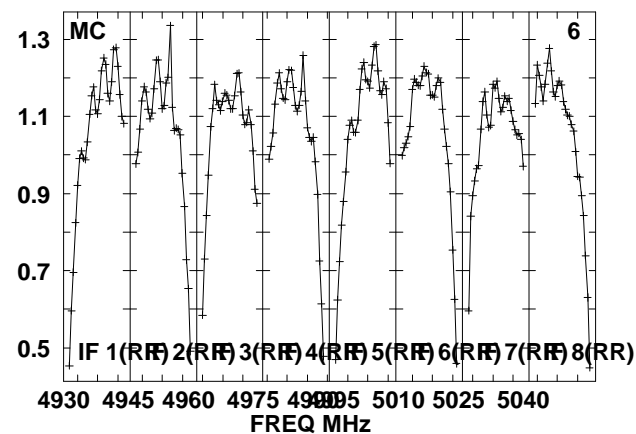
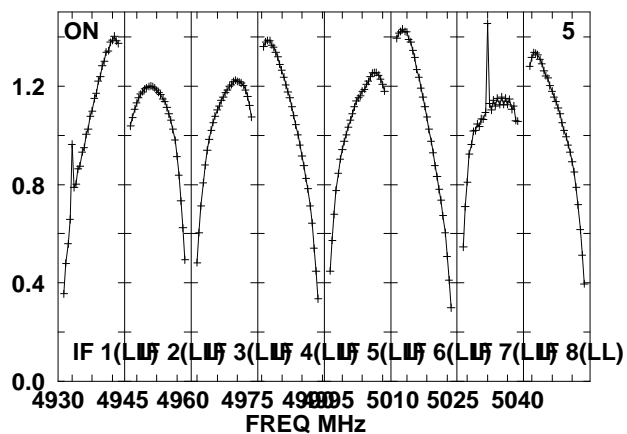
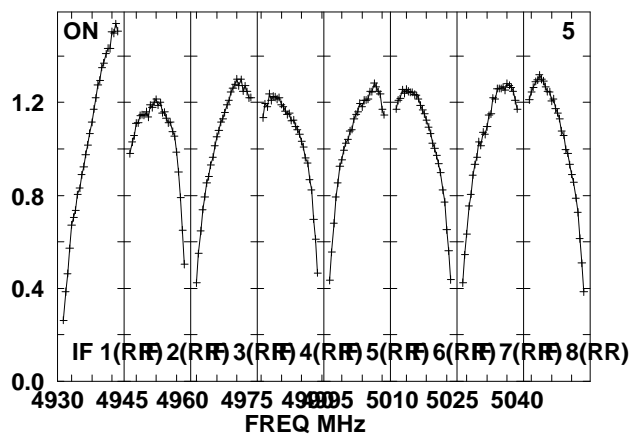
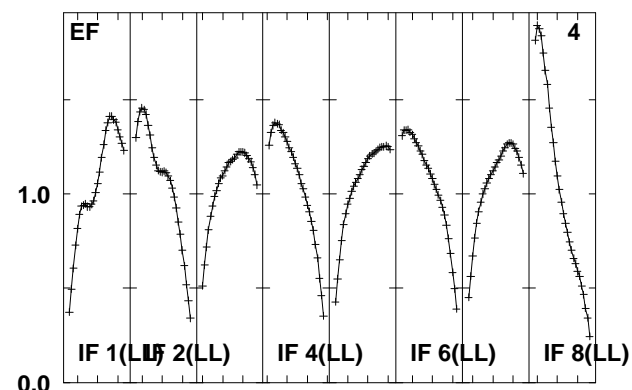
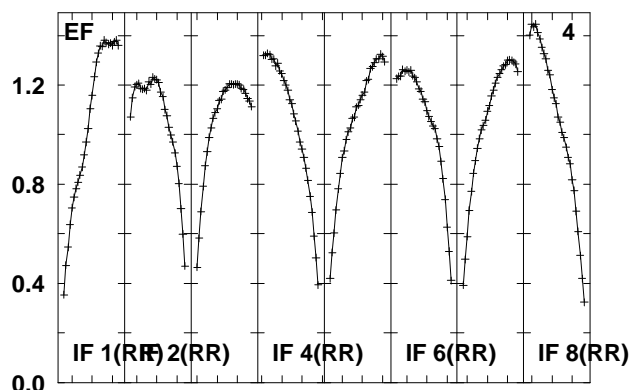
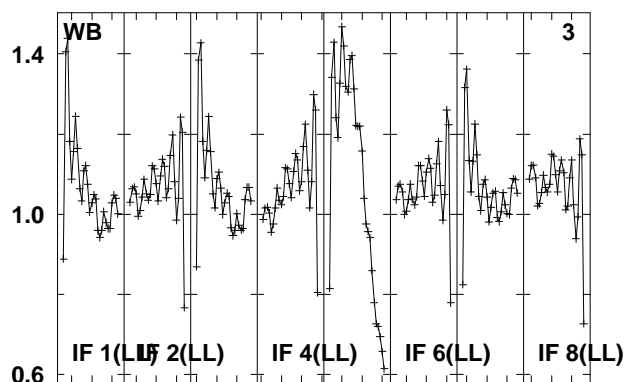
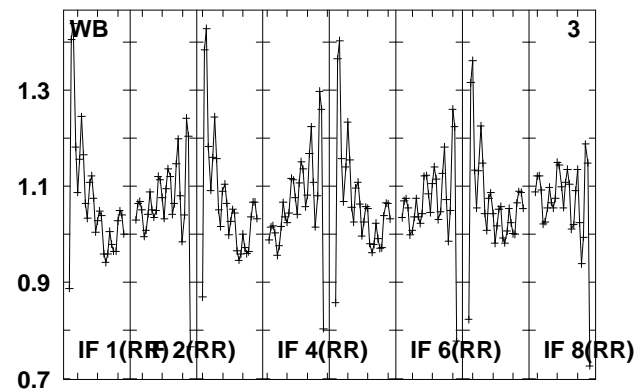
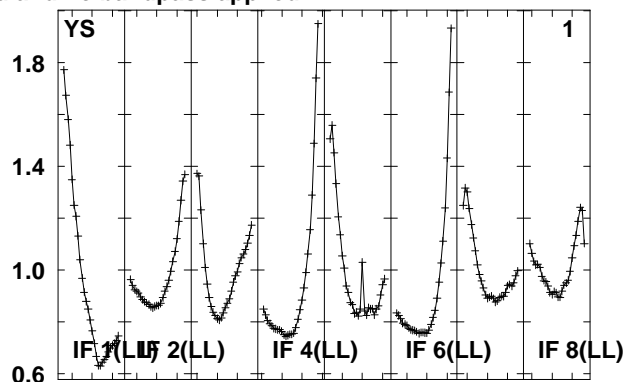
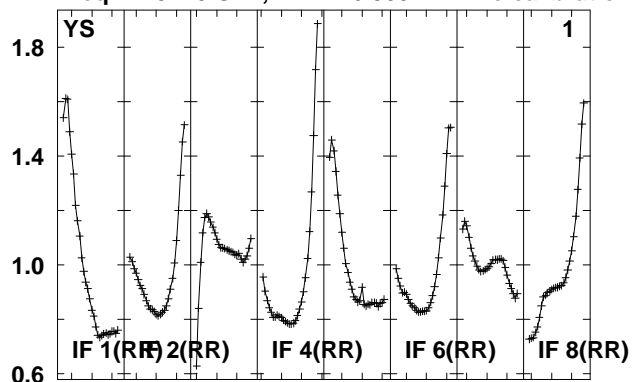

Lower frame: Real Jy
 Total-power spectrum Antenna: *
 Timerange: 01/01:47:07 to 01/01:52:05

Plot file version 768 created 14-MAY-2010 15:21:29

J102959 EO007.UVDATA.1

Freq = 4.9270 GHz, Bw = 16.000 MH No calibration applied and no bandpass applied

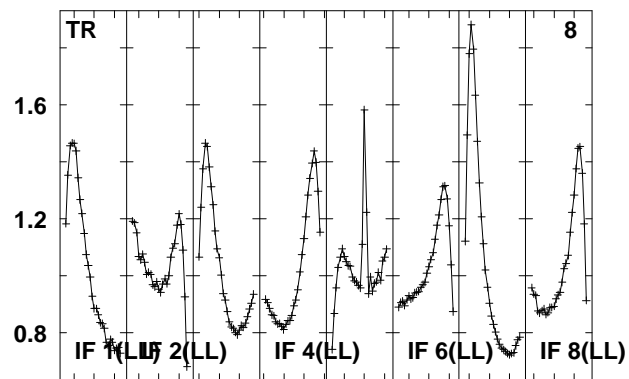
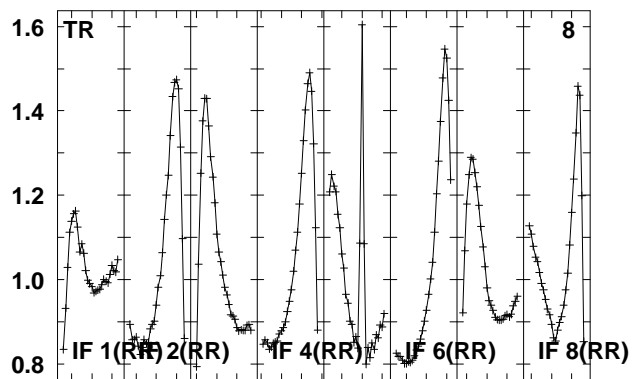
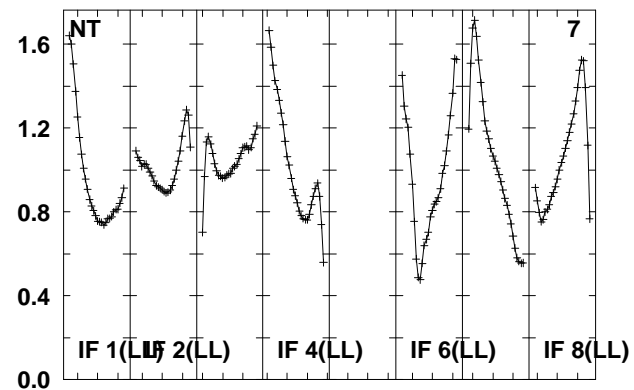
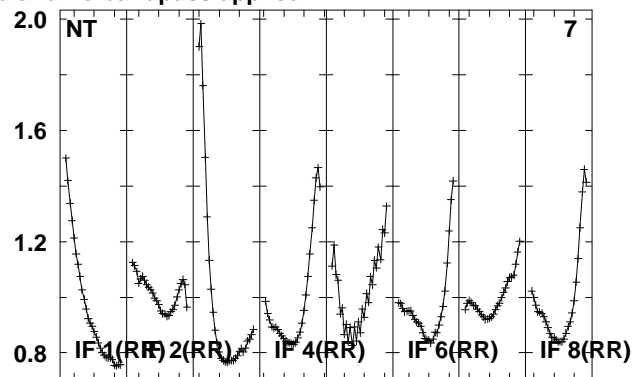
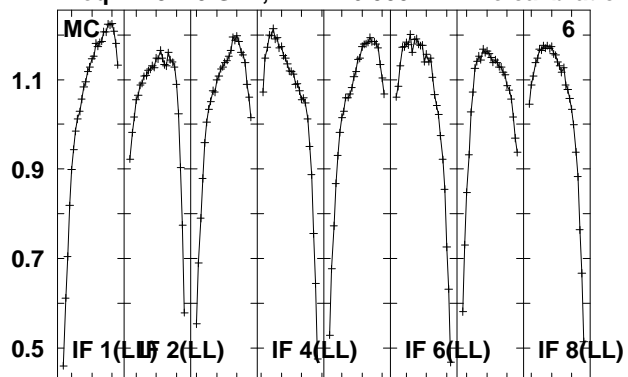

Lower frame: Real Jy
Total-power spectrum Antenna: *
Timerange: 01/01:47:07 to 01/01:52:05

Plot file version 769 created 14-MAY-2010 15:21:29

J1027+48 EO007.UVDATA.1

Freq = 4.9270 GHz, Bw = 16.000 MH No calibration applied and no bandpass applied

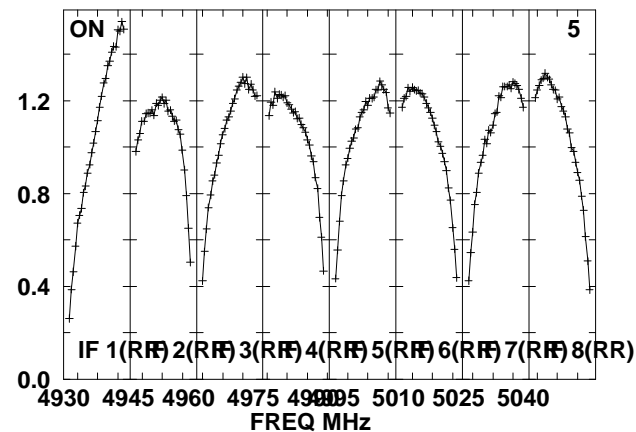
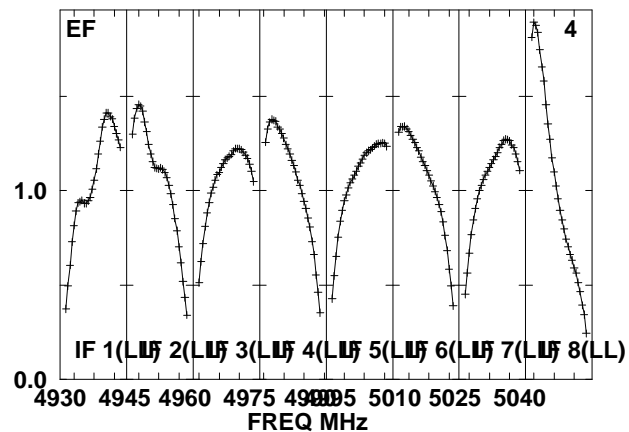
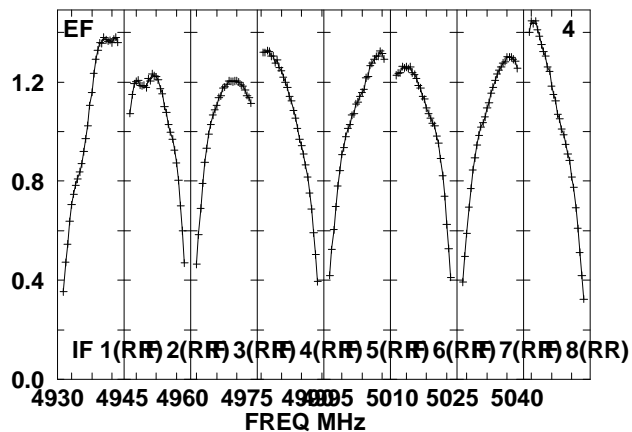
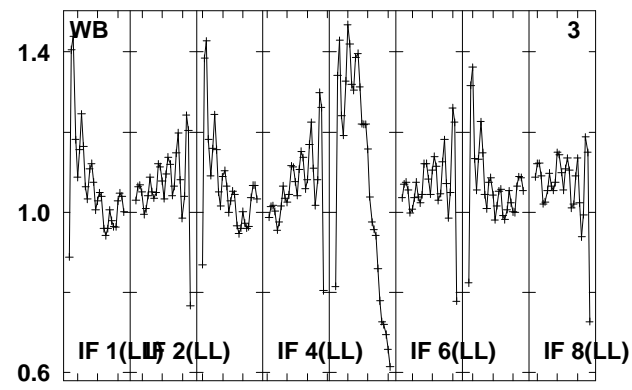
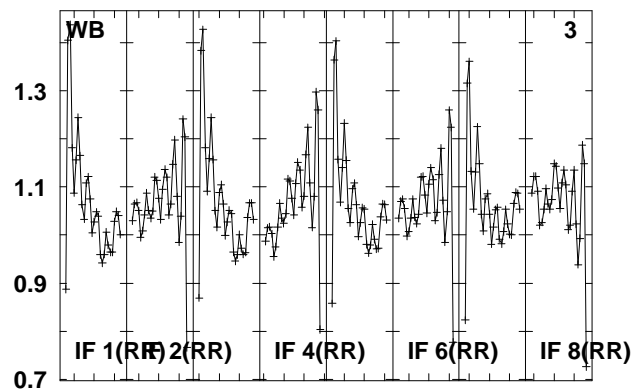
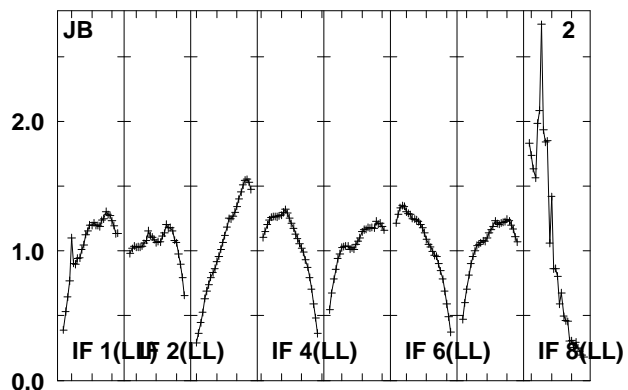
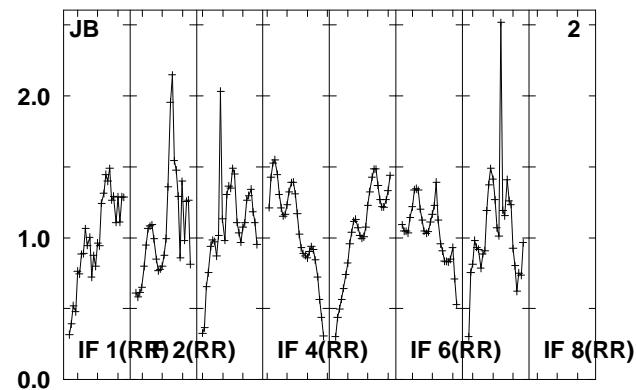
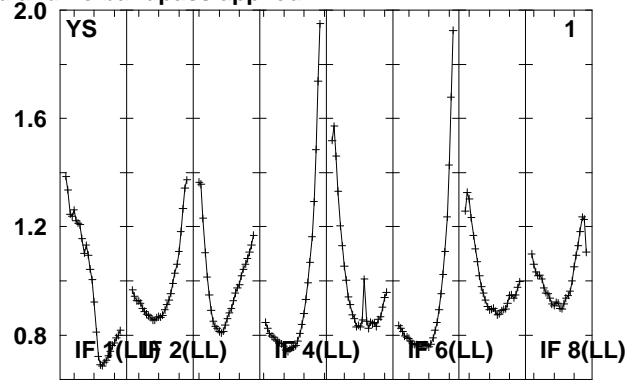
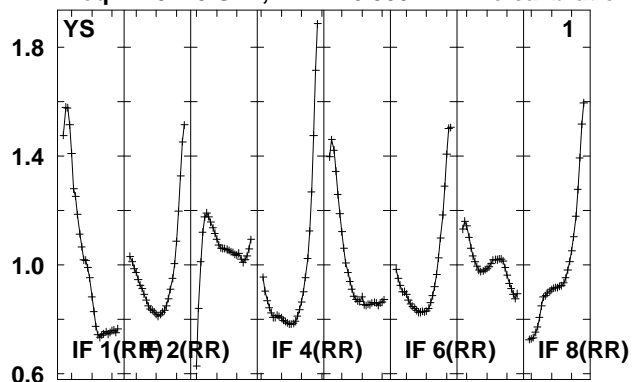

Lower frame: Real Jy
Total-power spectrum Antenna: *
Timerange: 01/01:52:27 to 01/01:53:53

Plot file version 770 created 14-MAY-2010 15:21:29

J1027+48 EO007.UVDATA.1

Freq = 4.9270 GHz, Bw = 16.000 MH No calibration applied and no bandpass applied

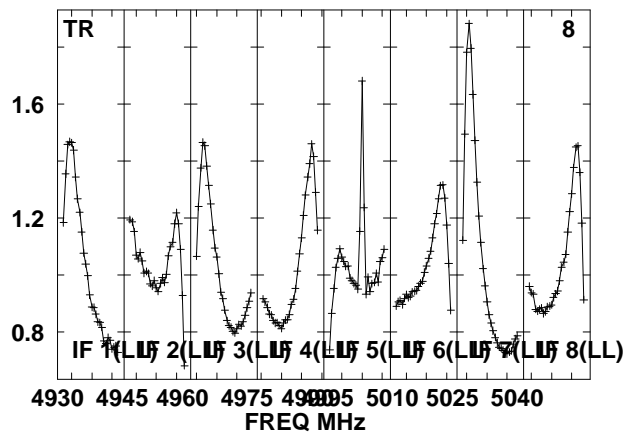
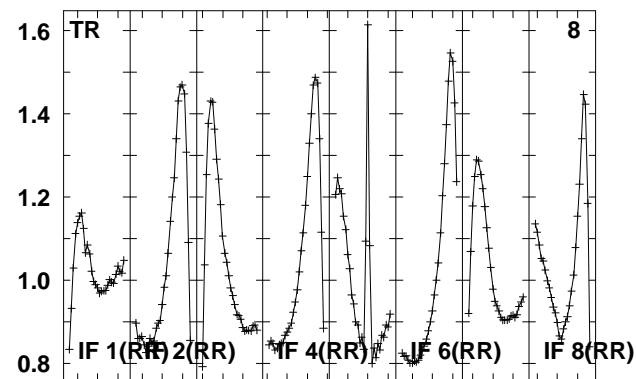
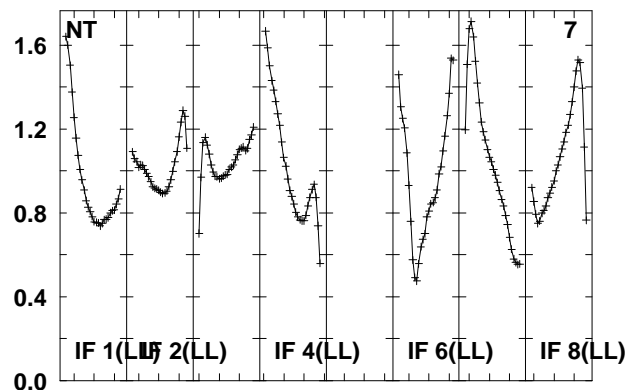
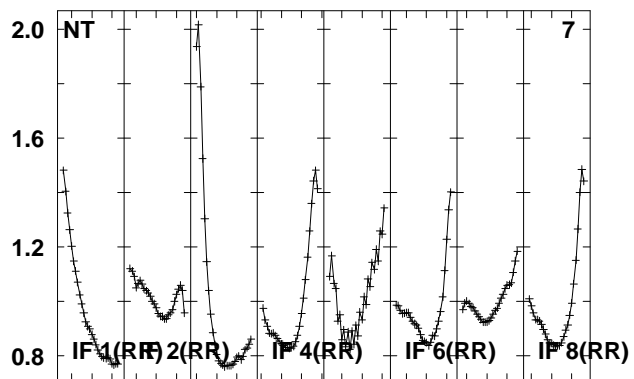
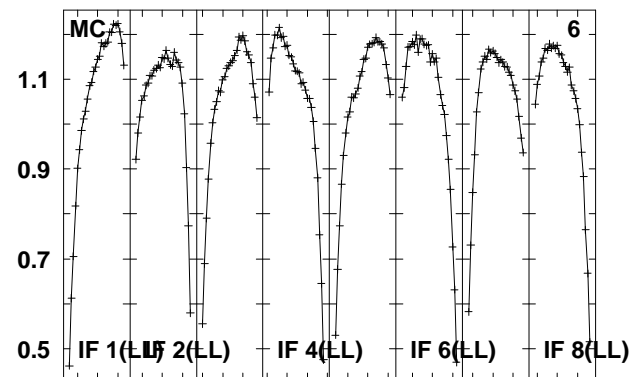
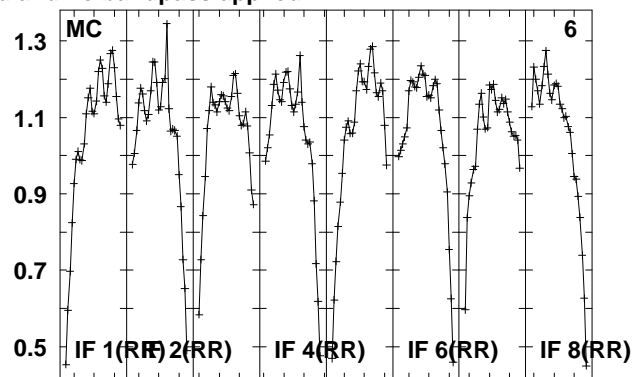
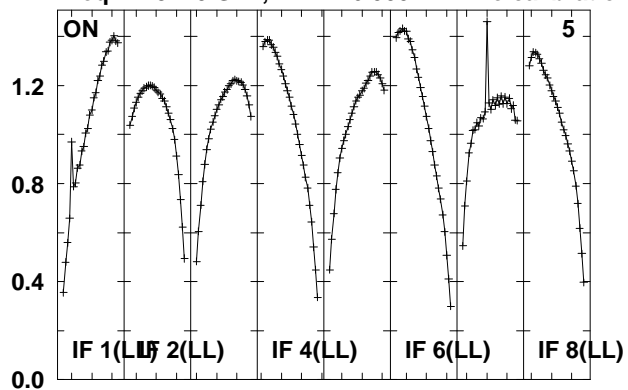

Lower frame: Real Jy

Total-power spectrum Antenna: *

Timerange: 01/01:52:27 to 01/01:53:53