

Plot file version 1 created 18-APR-2008 18:26:53

3C286 EP061A.UVDATA.1

Freq = 1.5950 GHz, Bw = 16.000 MH No calibration applied and no bandpass applied

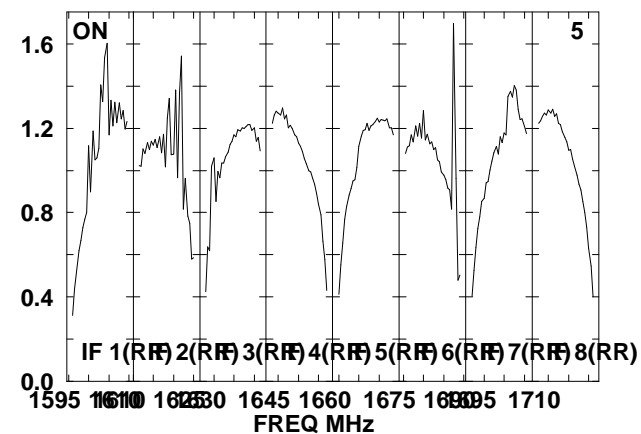
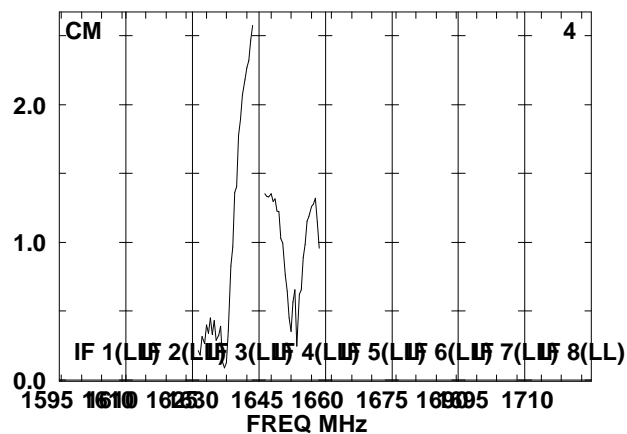
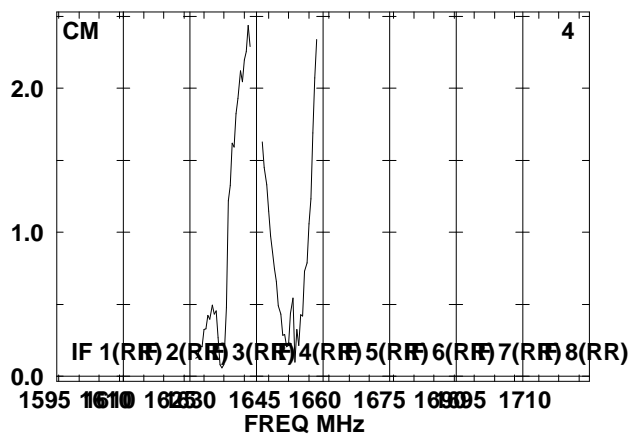
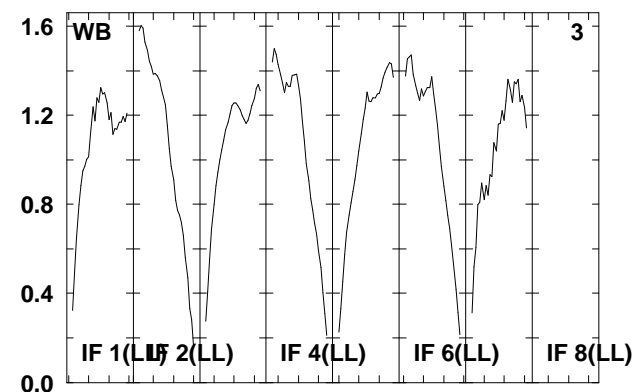
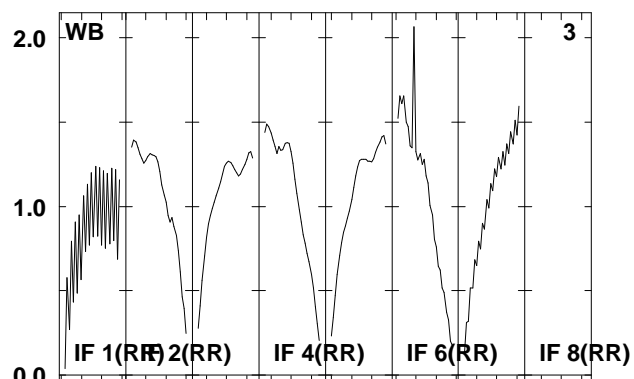
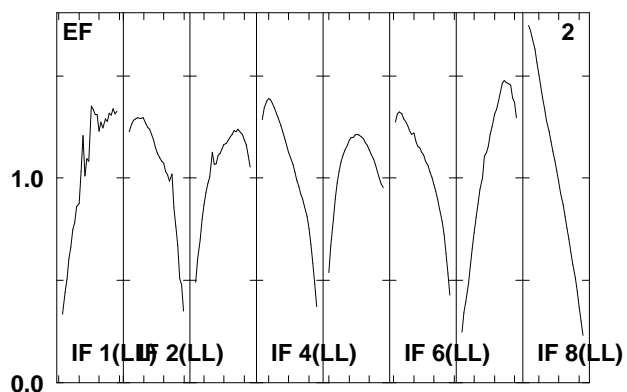
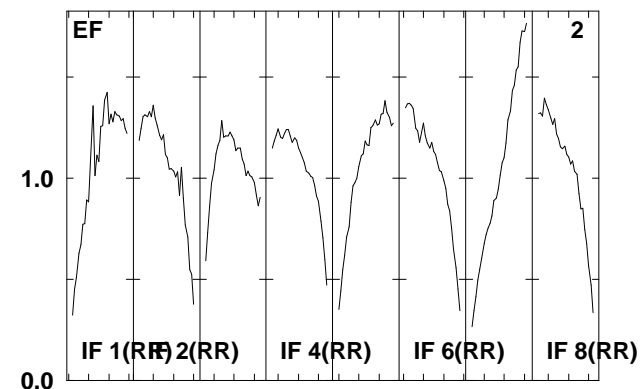
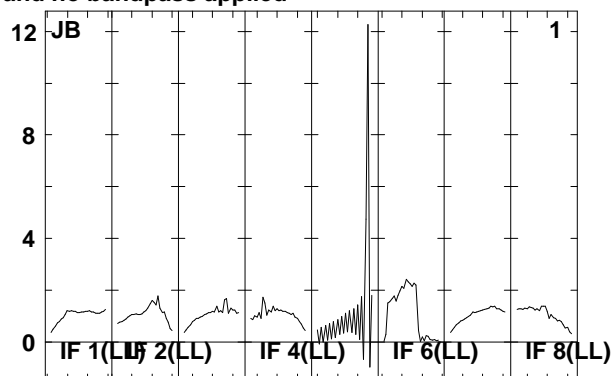
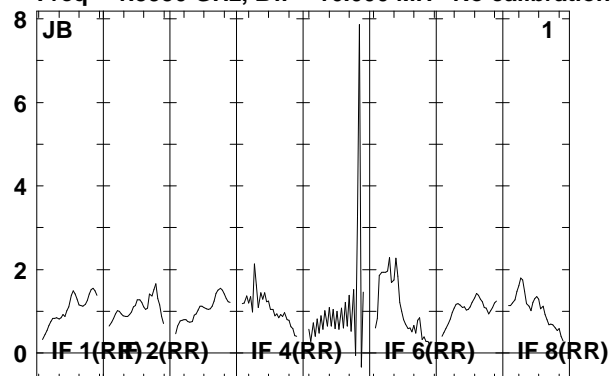

Lower frame: Real Jy

Total-power spectrum Antenna: *

Timerange: 00/07:30:02 to 00/07:34:56

Plot file version 2 created 18-APR-2008 18:26:54

3C286 EP061A.UVDATA.1

Freq = 1.5950 GHz, Bw = 16.000 MH No calibration applied and no bandpass applied

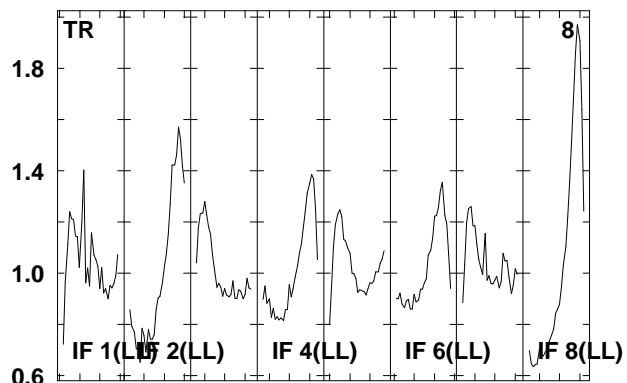
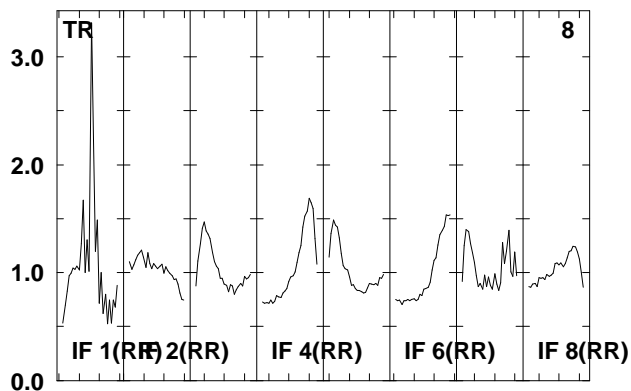
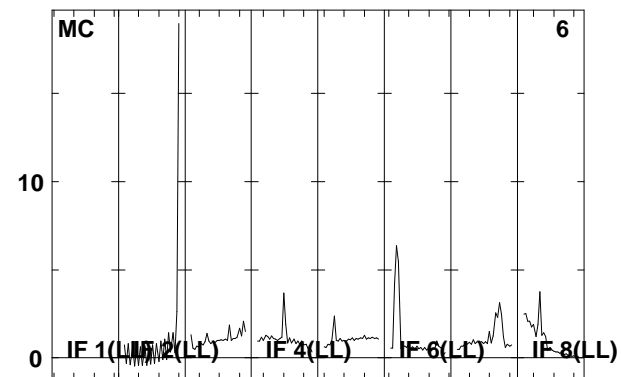
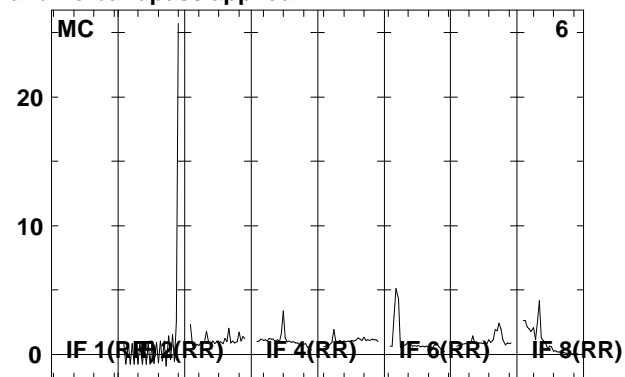
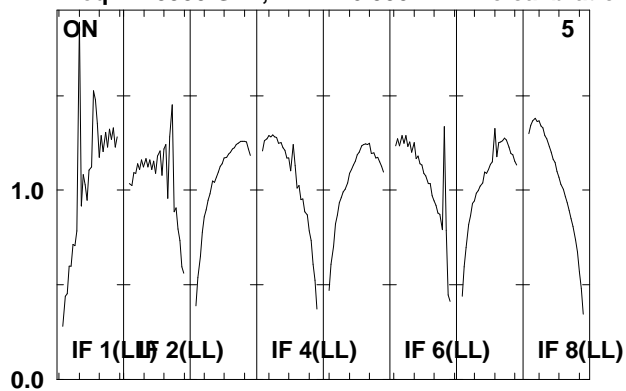

Lower frame: Real Jy
Total-power spectrum Antenna: *
Timerange: 00/07:30:02 to 00/07:34:56

Plot file version 3 created 18-APR-2008 18:26:56

2134+004 EP061A.UVDATA.1

Freq = 1.5950 GHz, Bw = 16.000 MH No calibration applied and no bandpass applied

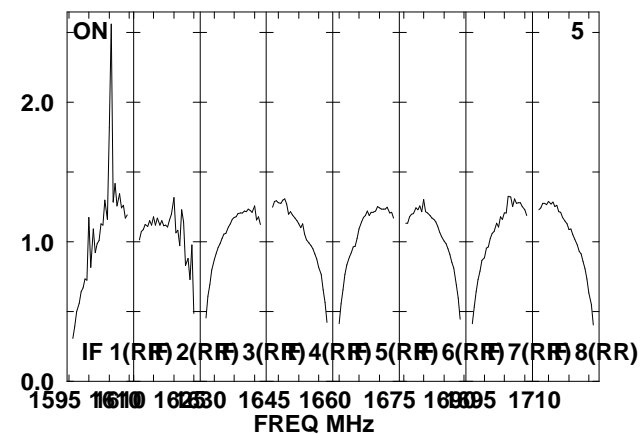
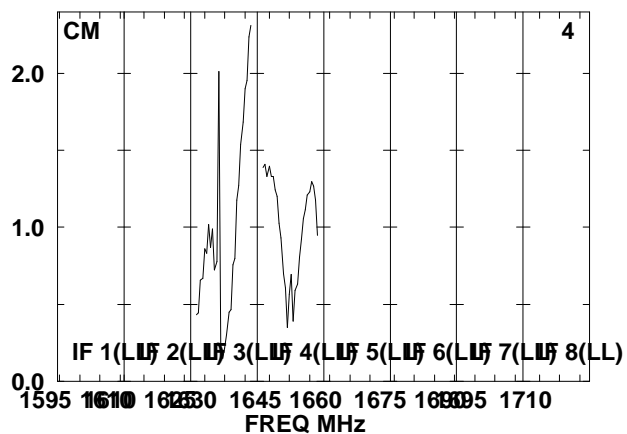
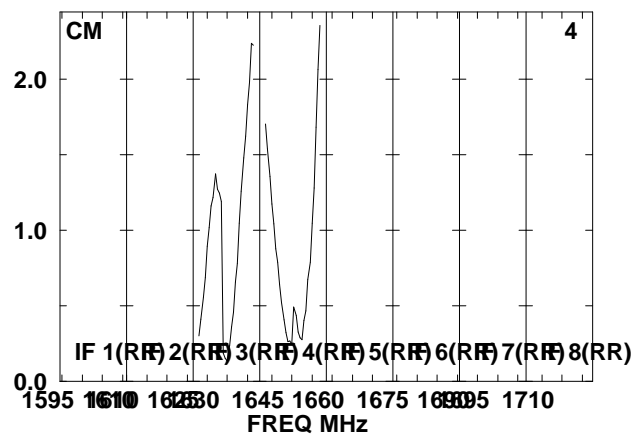
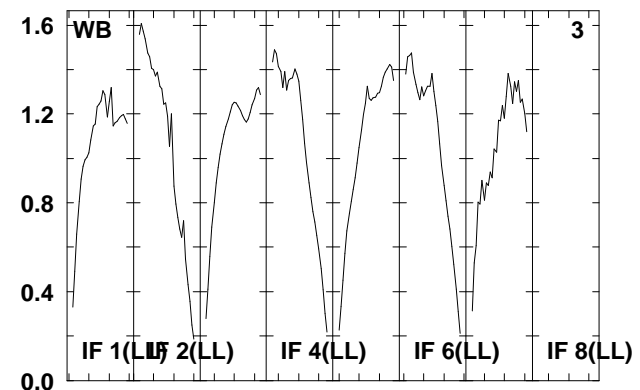
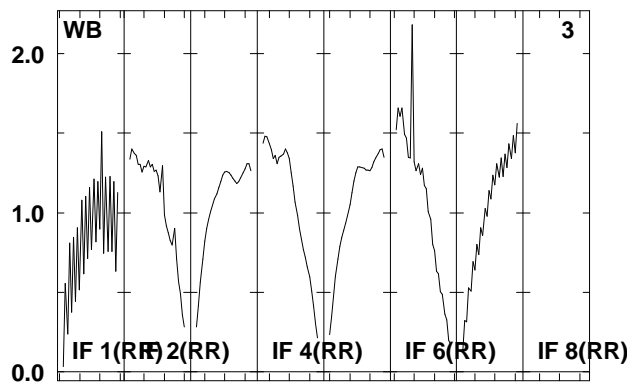
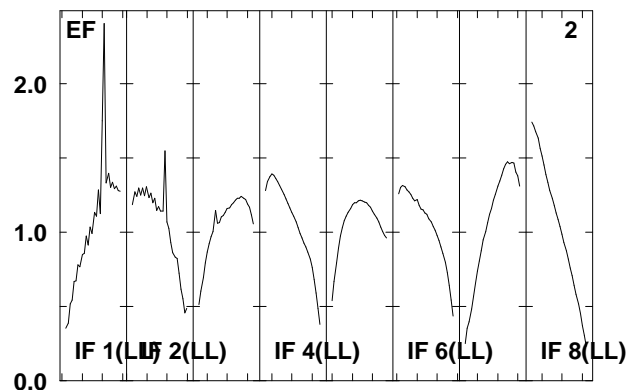
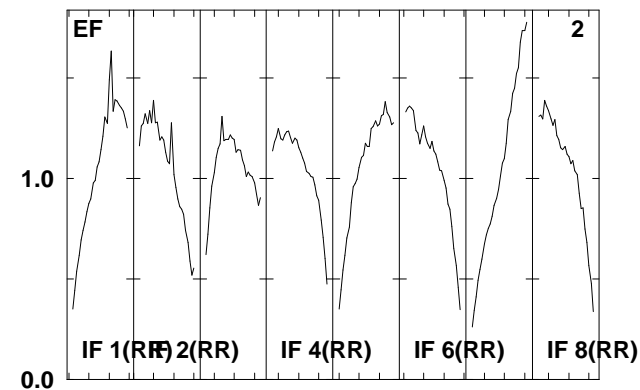
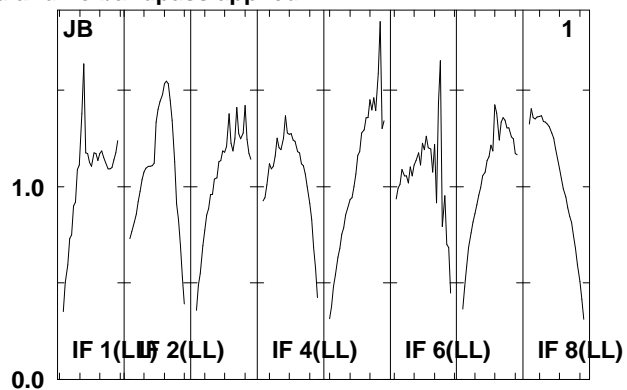
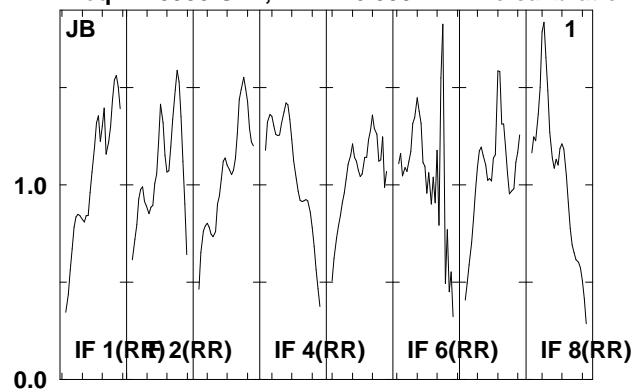

Lower frame: Real Jy
Total-power spectrum Antenna: *
Timerange: 00/07:42:02 to 00/07:47:30

Plot file version 4 created 18-APR-2008 18:26:57

2134+004 EP061A.UVDATA.1

Freq = 1.5950 GHz, Bw = 16.000 MH No calibration applied and no bandpass applied

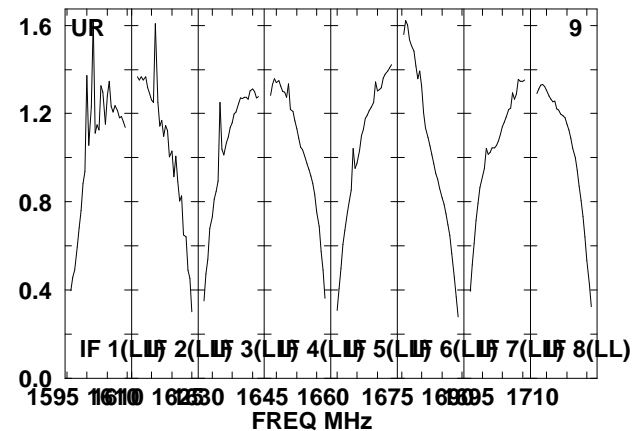
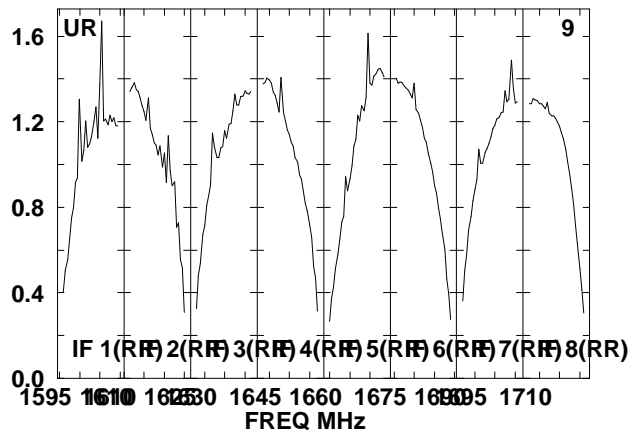
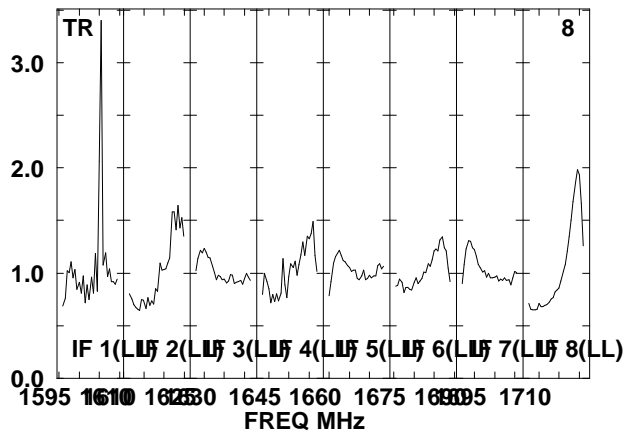
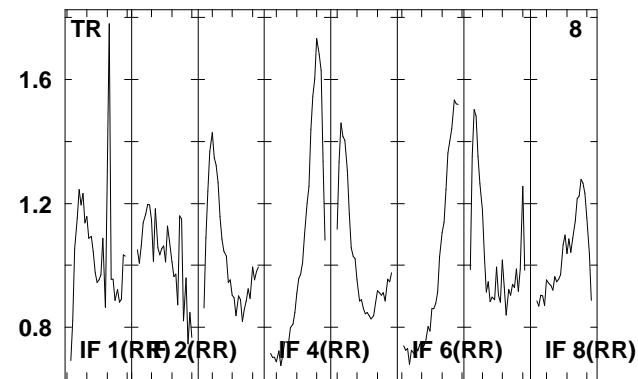
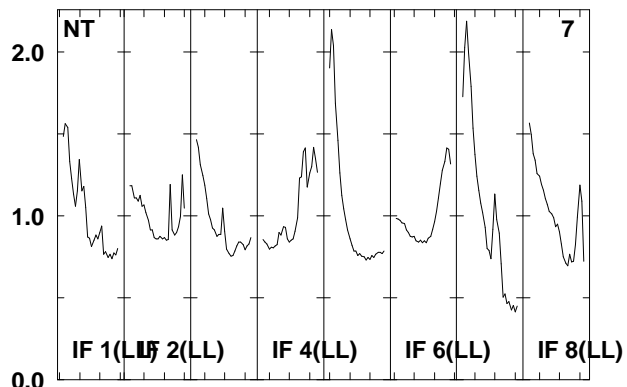
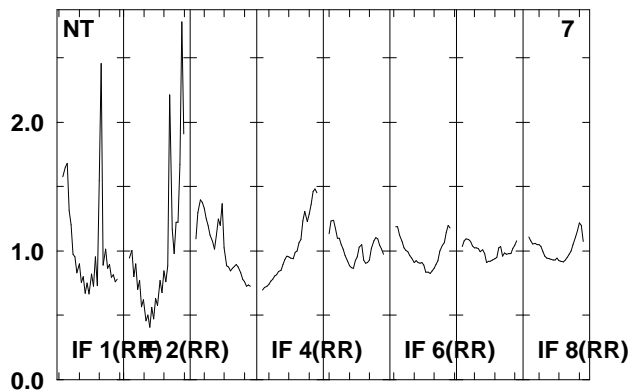
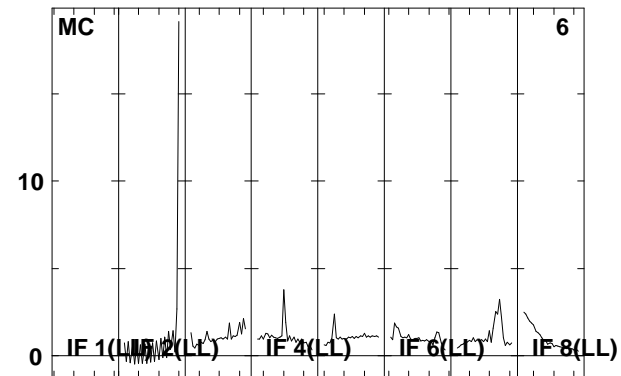
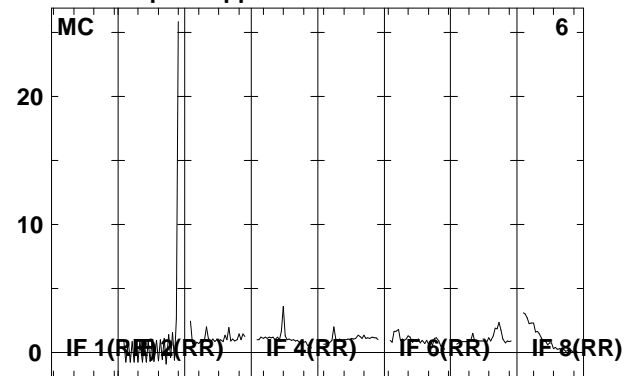
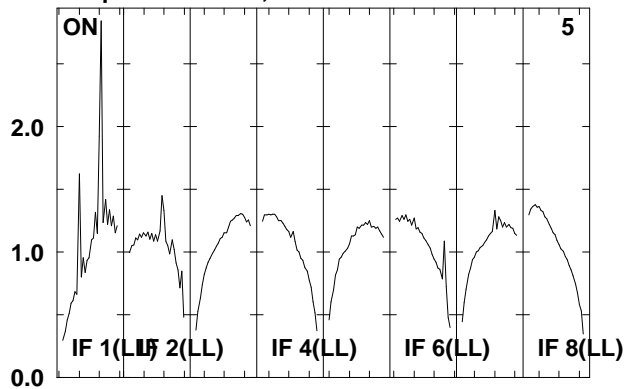

Lower frame: Real Jy
Total-power spectrum Antenna: *
Timerange: 00/07:42:02 to 00/07:47:30

Plot file version 5 created 18-APR-2008 18:26:58

3C454.3 EP061A.UVDATA.1

Freq = 1.5950 GHz, Bw = 16.000 MH No calibration applied and no bandpass applied

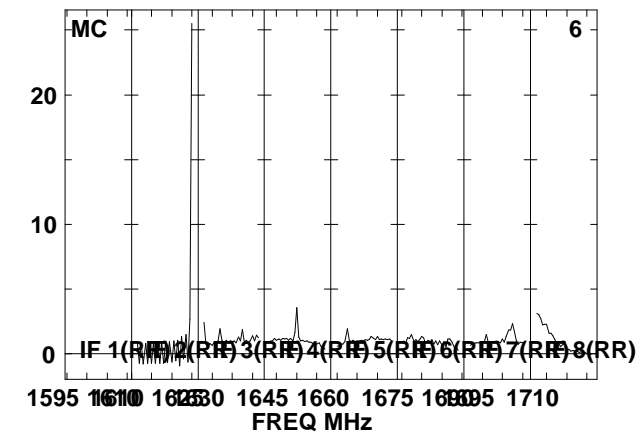
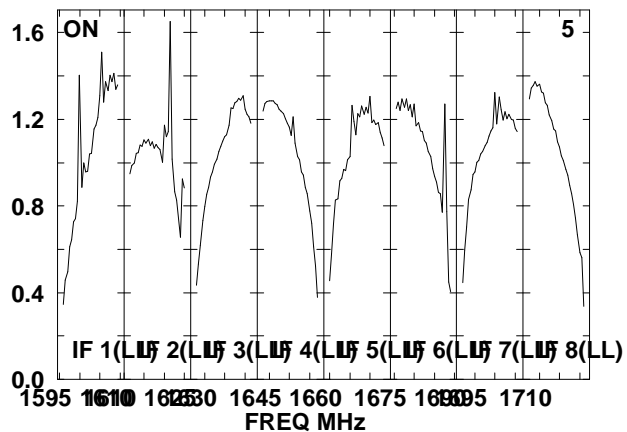
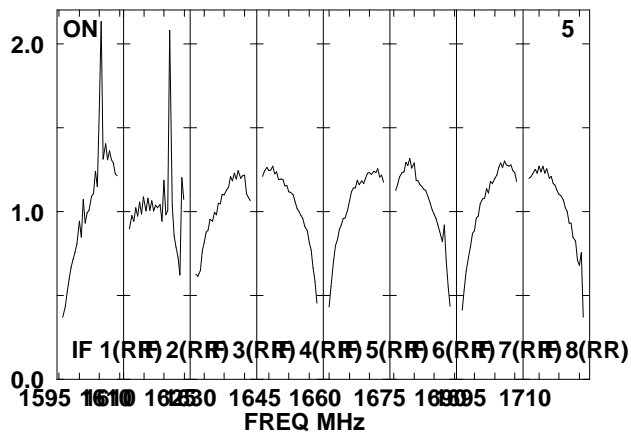
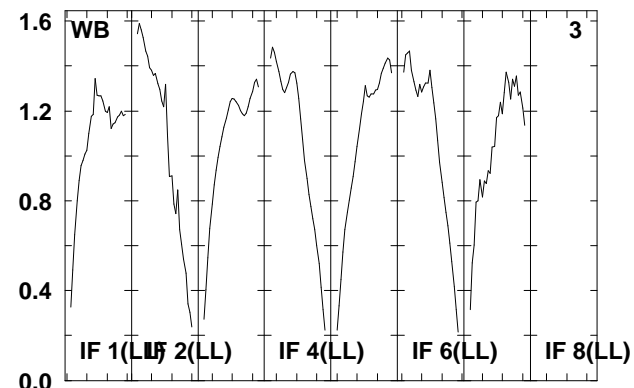
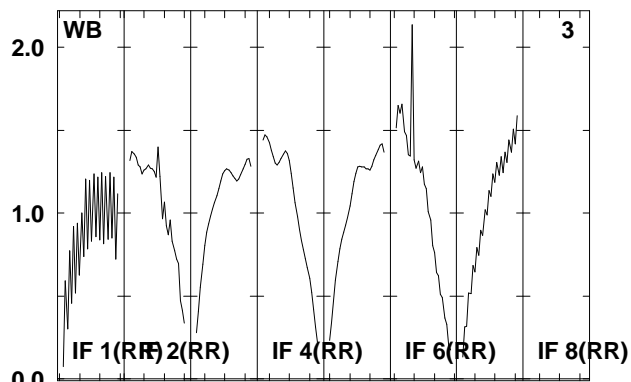
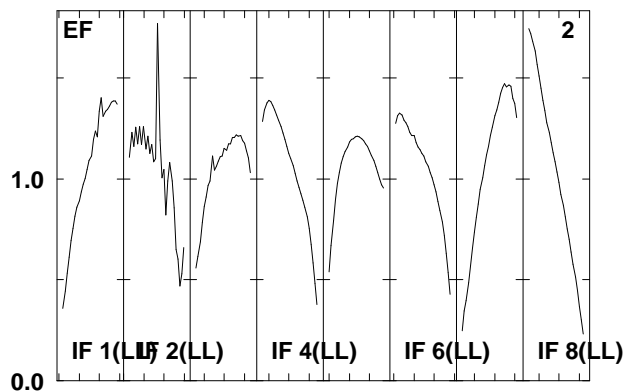
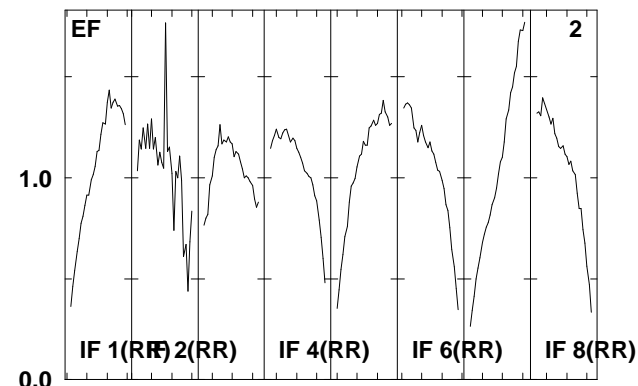
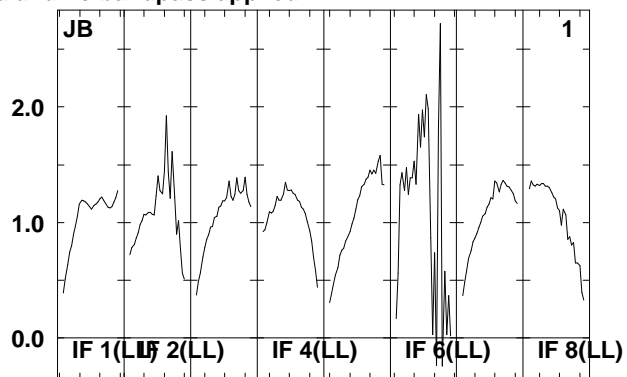
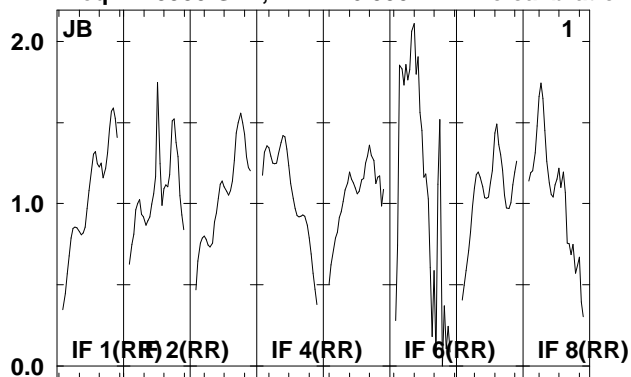

Lower frame: Real Jy

Total-power spectrum Antenna: *

Timerange: 00/07:47:32 to 00/07:53:00

Plot file version 6 created 18-APR-2008 18:26:59

3C454.3 EP061A.UVDATA.1

Freq = 1.5950 GHz, Bw = 16.000 MH No calibration applied and no bandpass applied

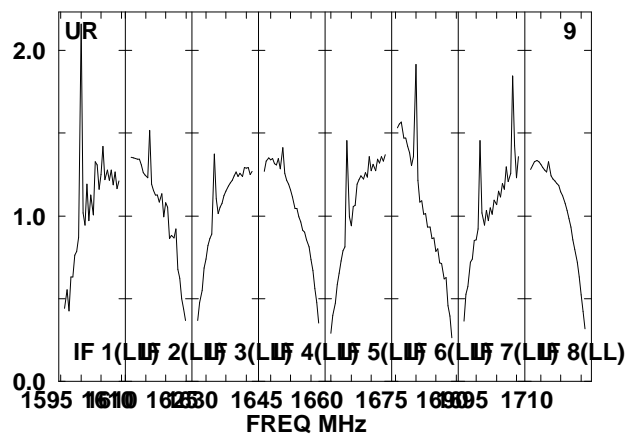
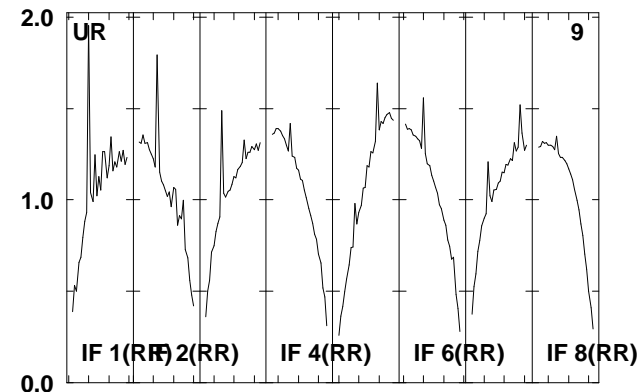
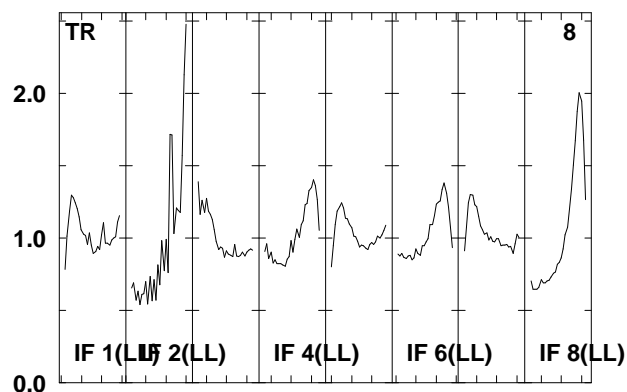
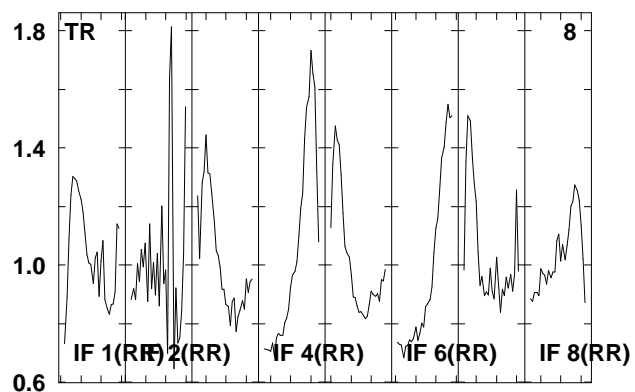
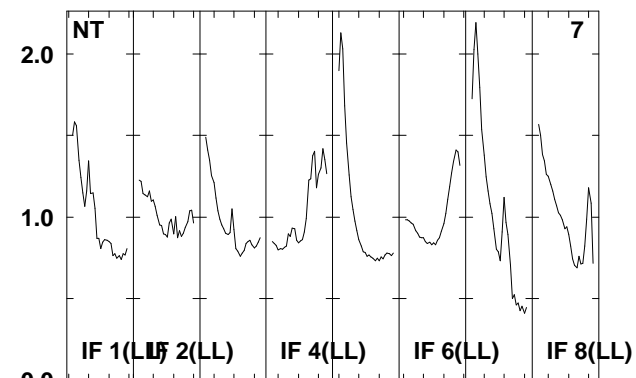
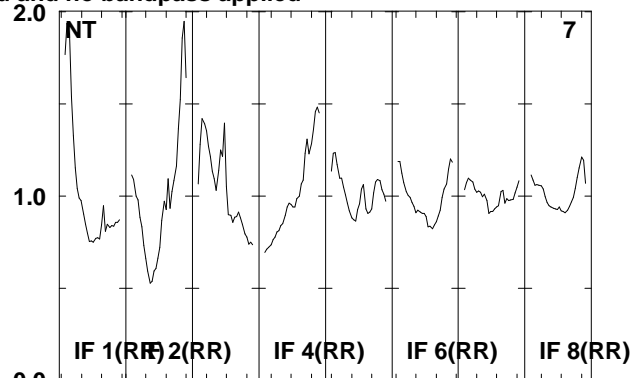
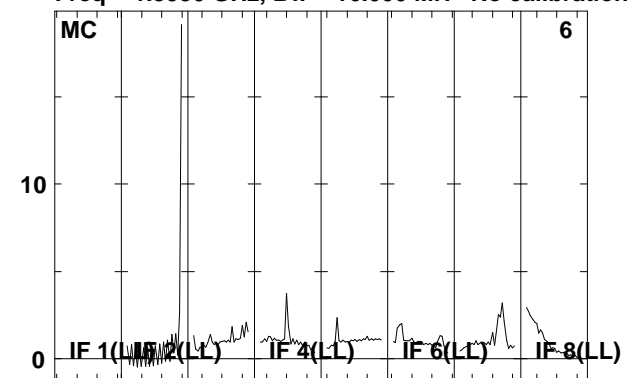

Lower frame: Real Jy

Total-power spectrum Antenna: *

Timerange: 00/07:47:32 to 00/07:53:00

Plot file version 7 created 18-APR-2008 18:27:00

J2333+39 EP061A.UVDATA.1

Freq = 1.5950 GHz, Bw = 16.000 MH No calibration applied and no bandpass applied

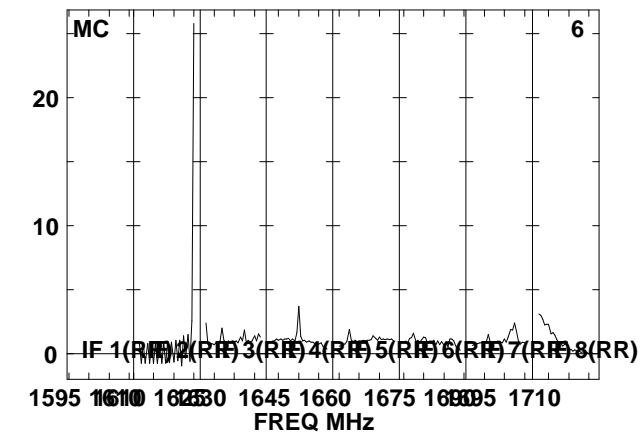
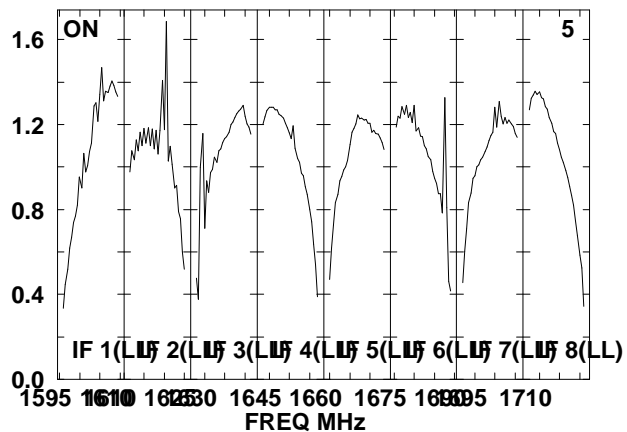
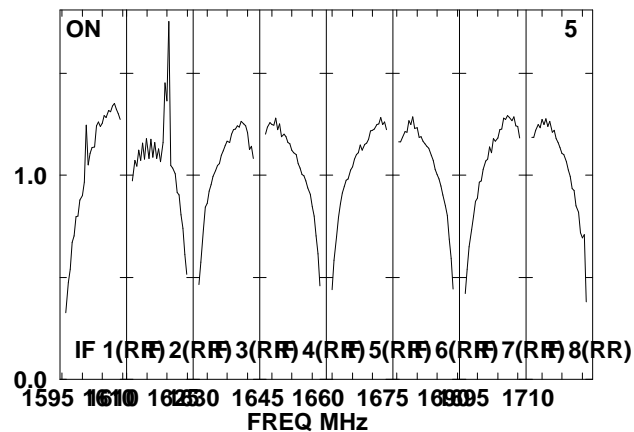
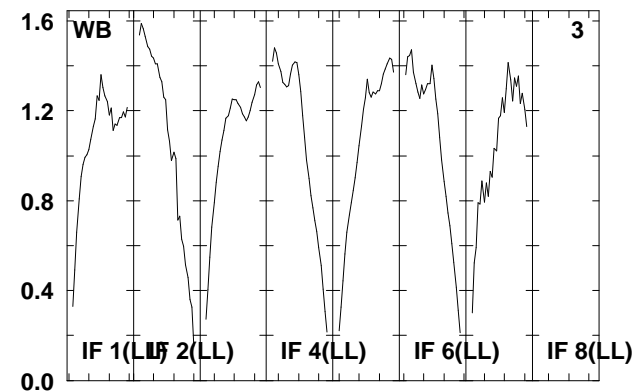
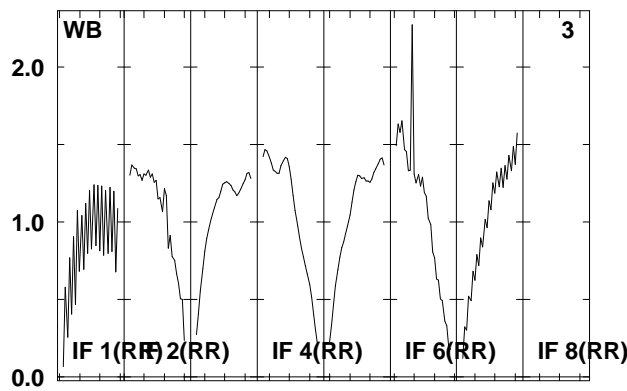
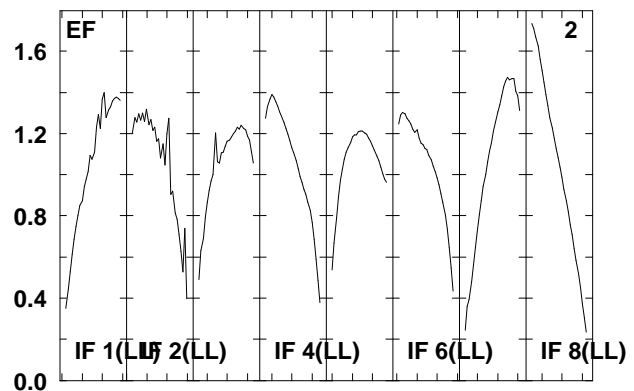
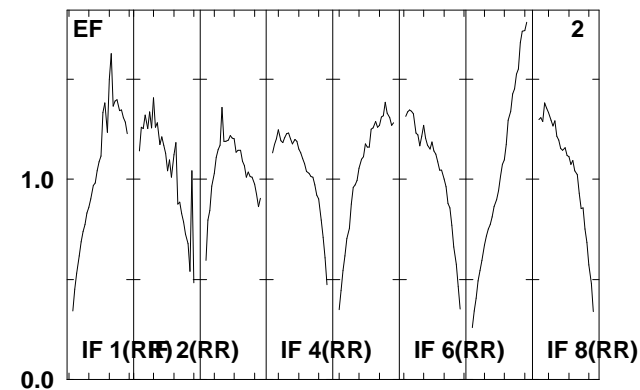
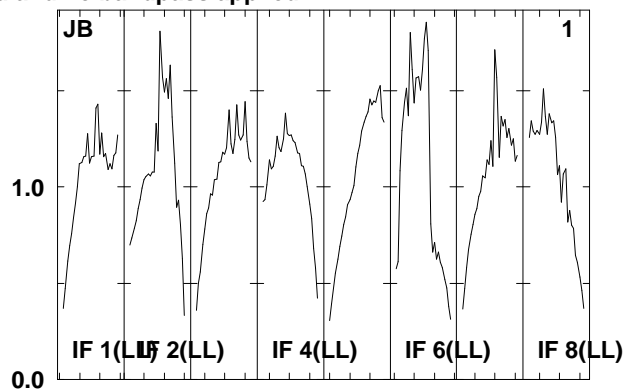
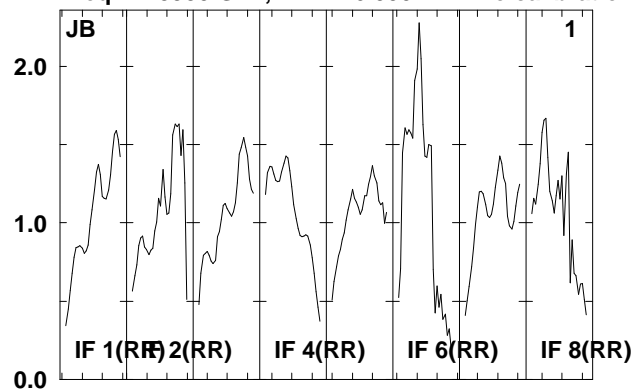

Lower frame: Real Jy
Total-power spectrum Antenna: *
Timerange: 00/07:54:02 to 00/07:55:30

Plot file version 8 created 18-APR-2008 18:27:01

J2333+39 EP061A.UVDATA.1

Freq = 1.5950 GHz, Bw = 16.000 MH No calibration applied and no bandpass applied

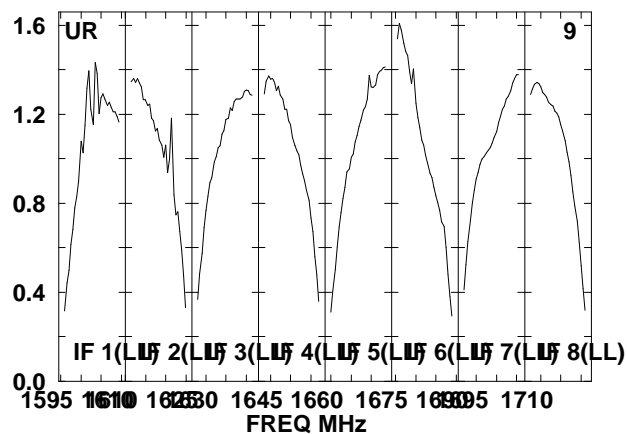
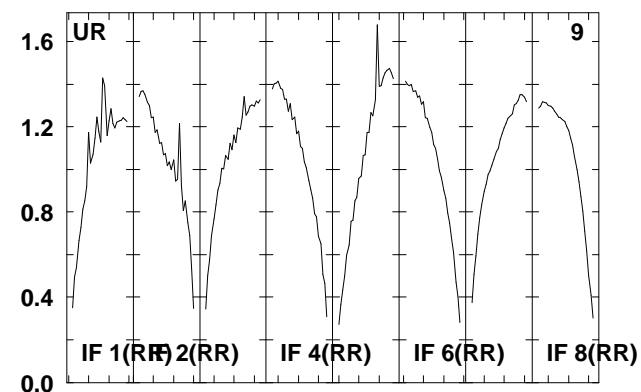
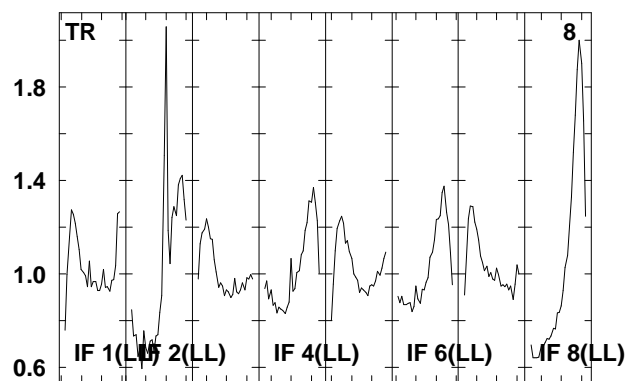
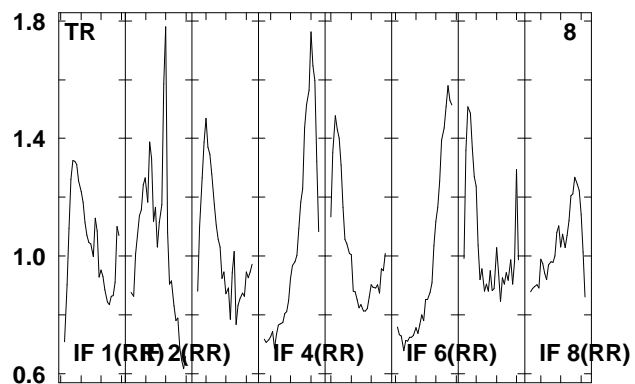
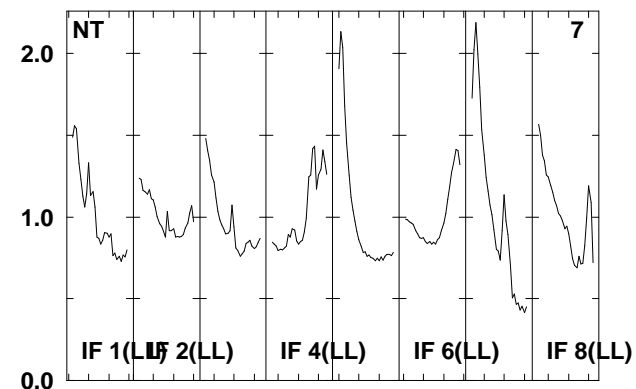
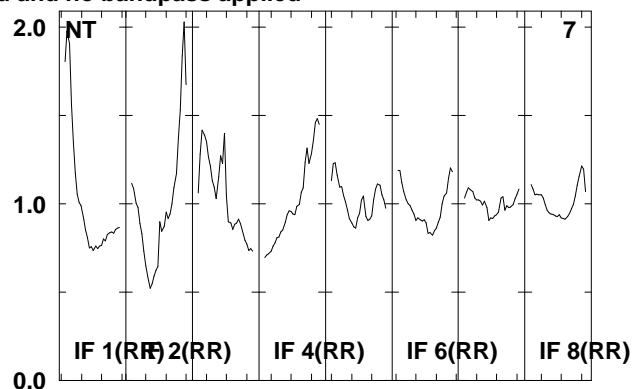
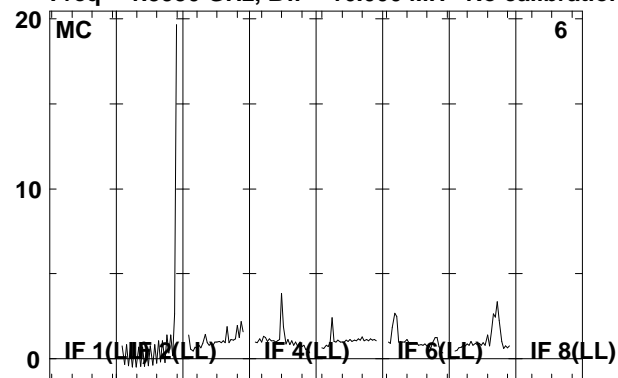

Lower frame: Real Jy

Total-power spectrum Antenna: *

Timerange: 00/07:54:02 to 00/07:55:30

Plot file version 9 created 18-APR-2008 18:27:01

IRAS2336 EP061A.UVDATA.1

Freq = 1.5950 GHz, Bw = 16.000 MH No calibration applied and no bandpass applied

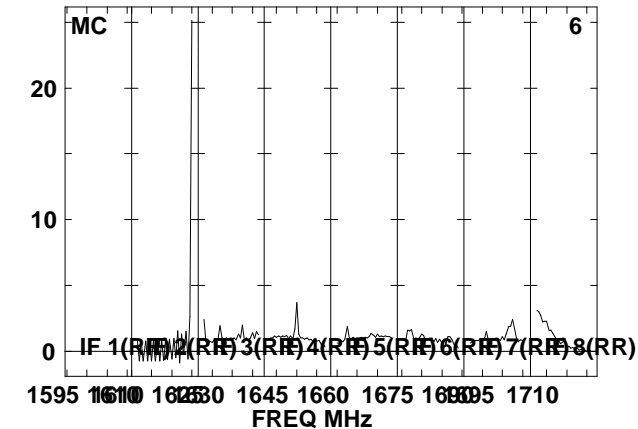
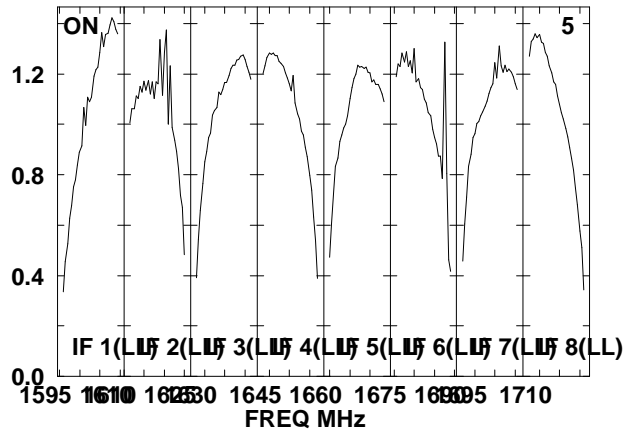
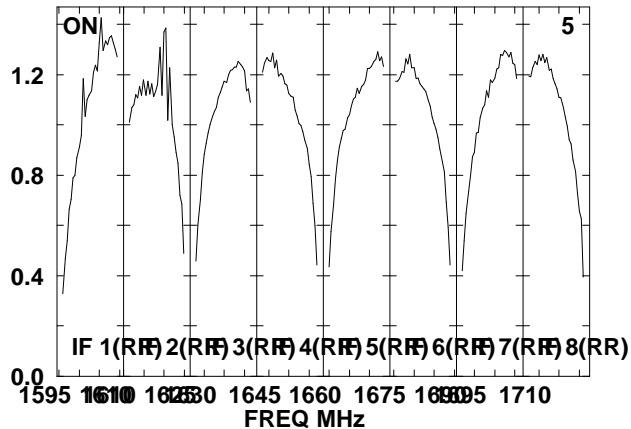
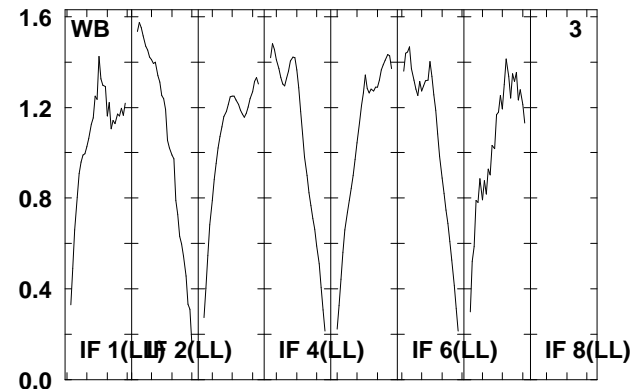
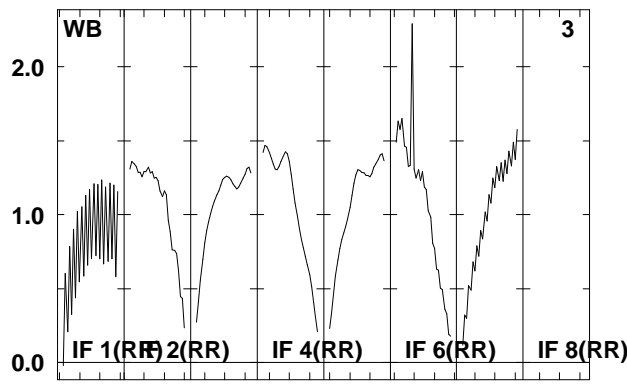
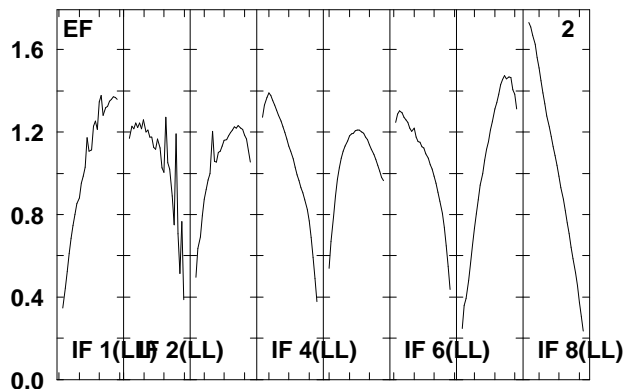
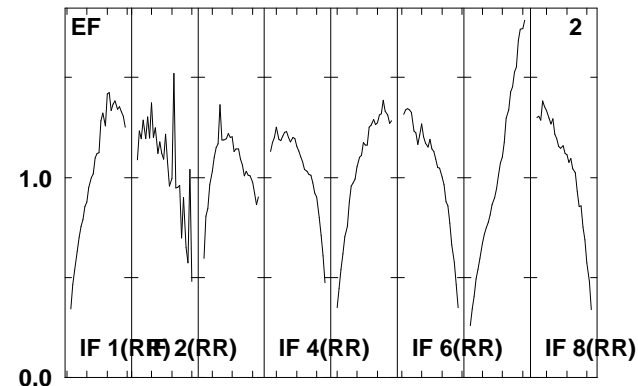
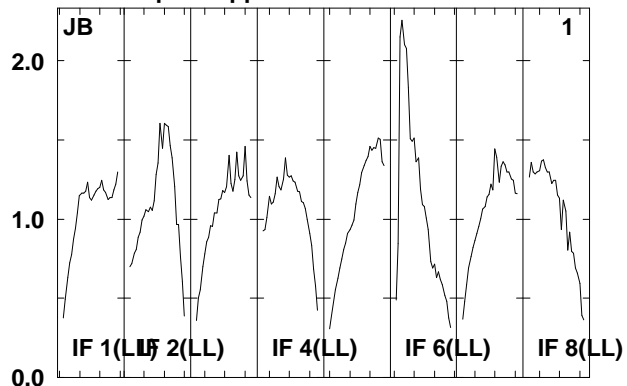
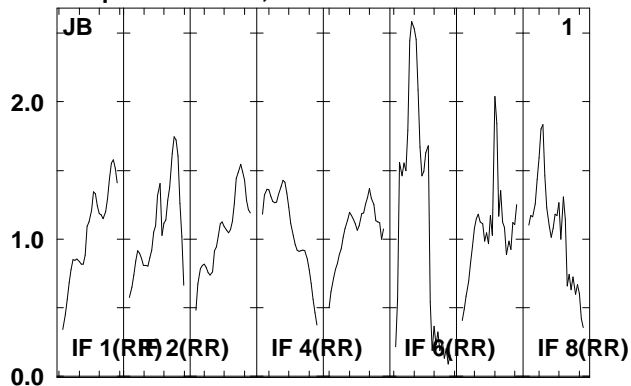

Lower frame: Real Jy
Total-power spectrum Antenna: *
Timerange: 00/07:55:32 to 00/07:59:00

Plot file version 10 created 18-APR-2008 18:27:02

IRAS2336 EP061A.UVDATA.1

Freq = 1.5950 GHz, Bw = 16.000 MH No calibration applied and no bandpass applied

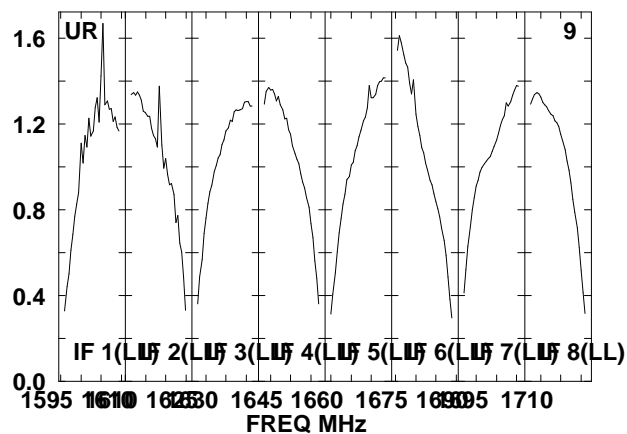
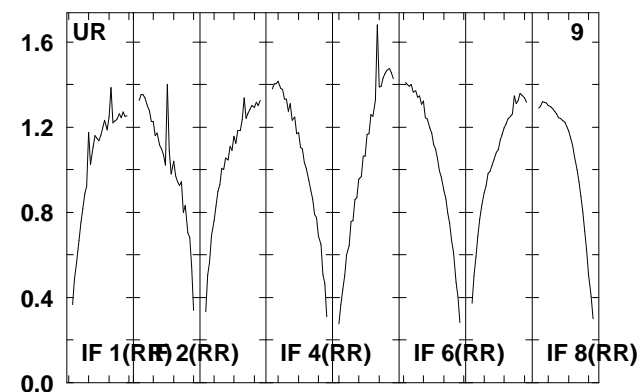
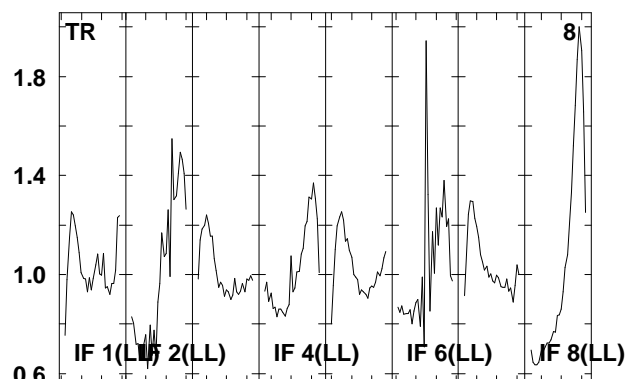
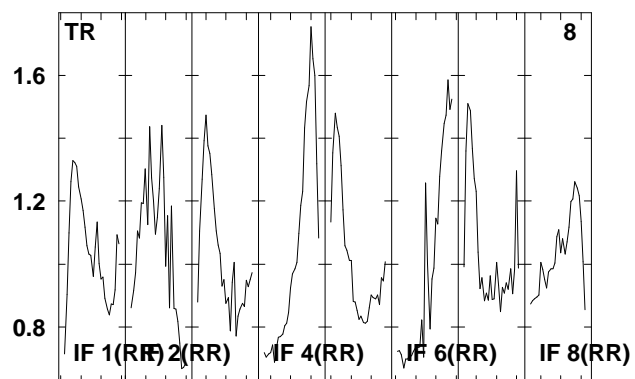
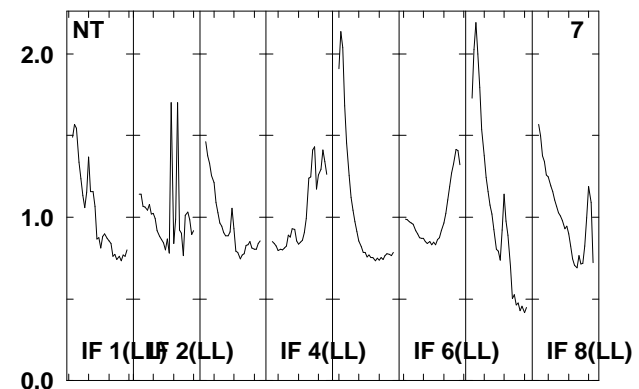
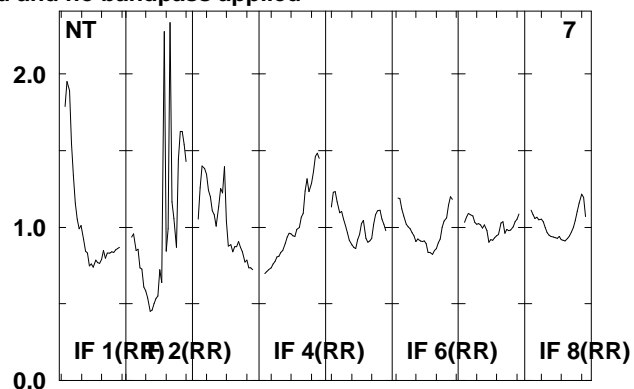
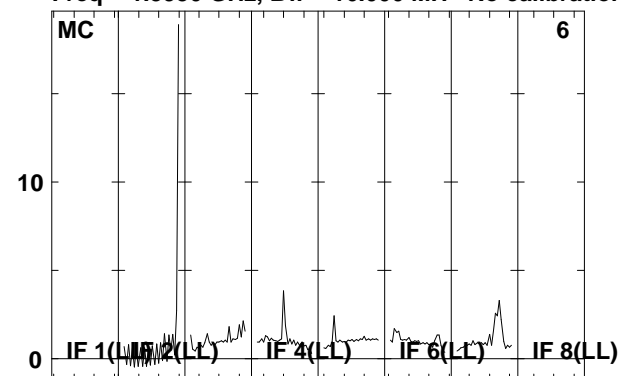

Lower frame: Real Jy

Total-power spectrum Antenna: *

Timerange: 00/07:55:32 to 00/07:59:00

Plot file version 11 created 18-APR-2008 18:27:03

J2333+39 EP061A.UVDATA.1

Freq = 1.5950 GHz, Bw = 16.000 MH No calibration applied and no bandpass applied

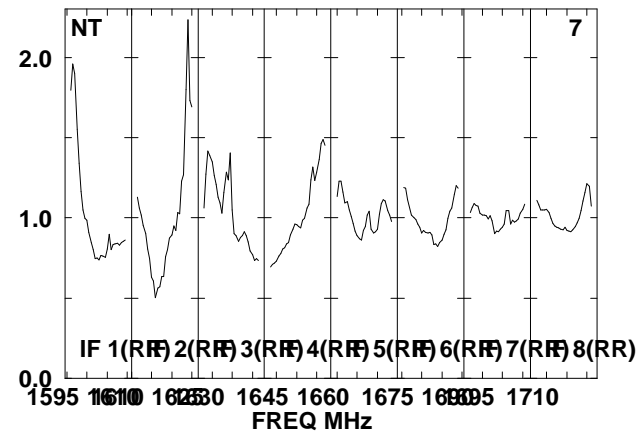
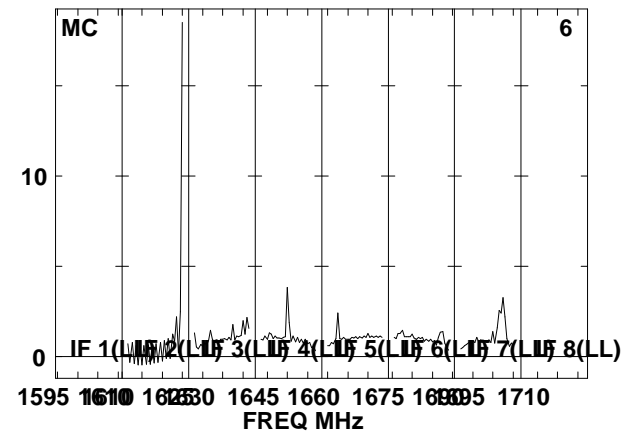
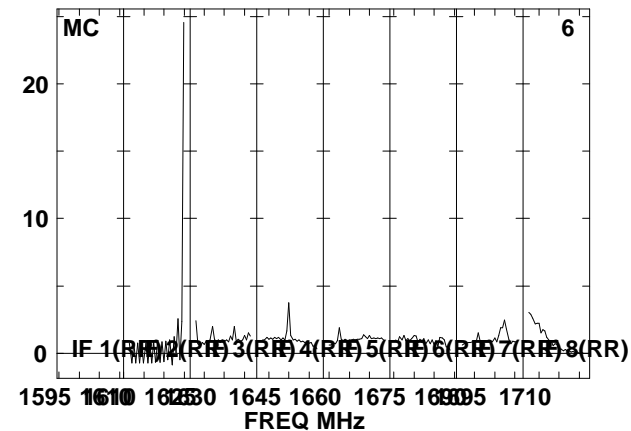
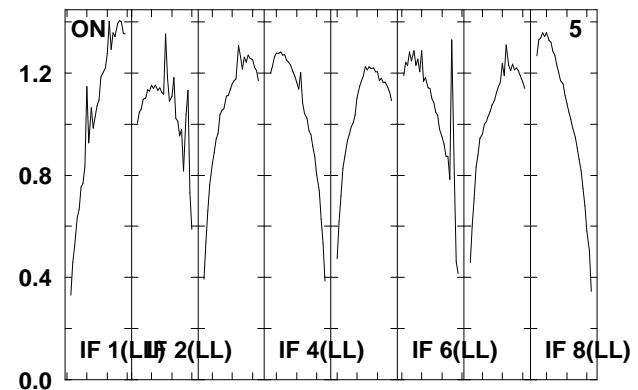
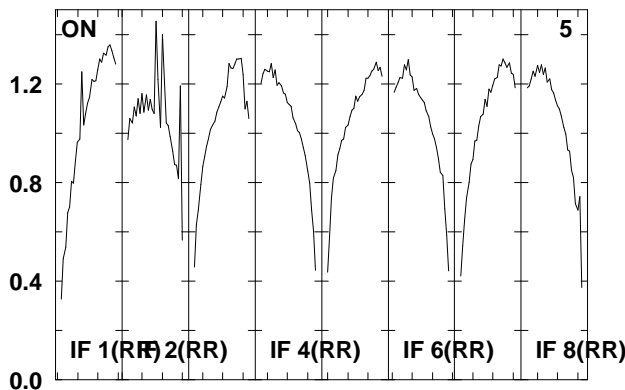
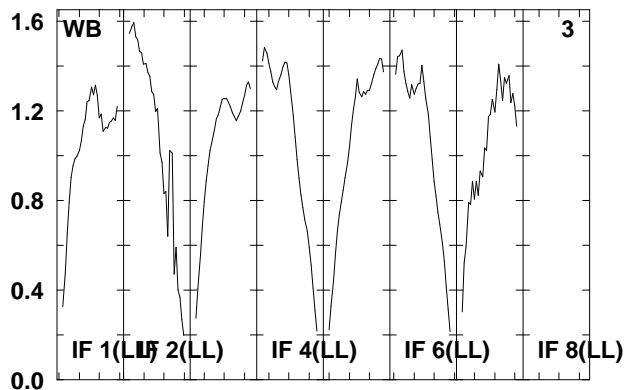
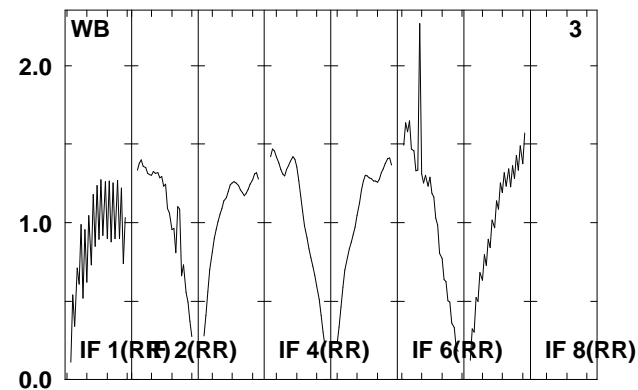
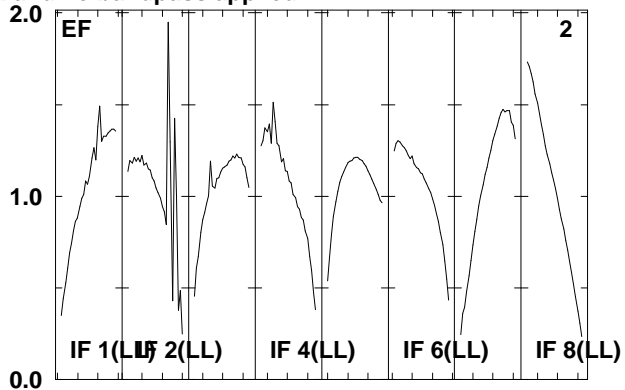
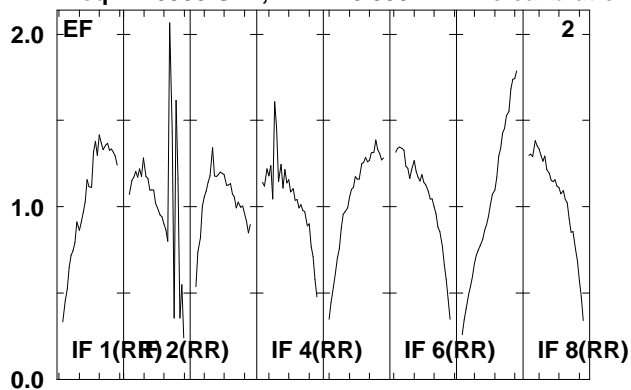

Lower frame: Real Jy
Total-power spectrum Antenna: *
Timerange: 00/07:59:02 to 00/08:00:28

Plot file version 12 created 18-APR-2008 18:27:03

J2333+39 EP061A.UVDATA.1

Freq = 1.5950 GHz, Bw = 16.000 MH No calibration applied and no bandpass applied

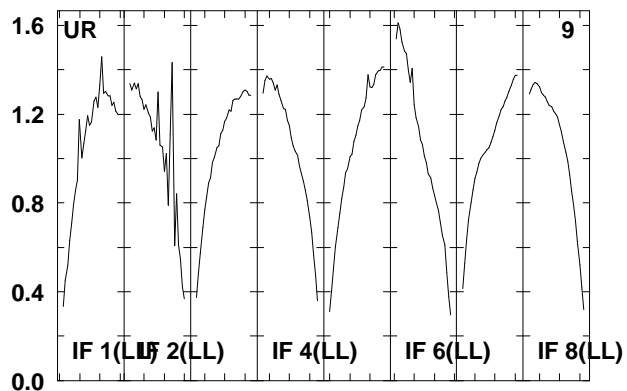
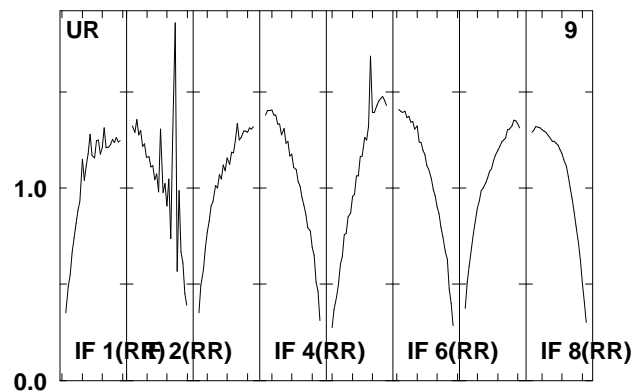
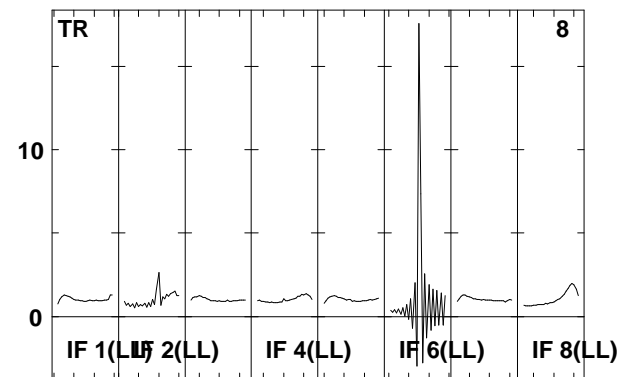
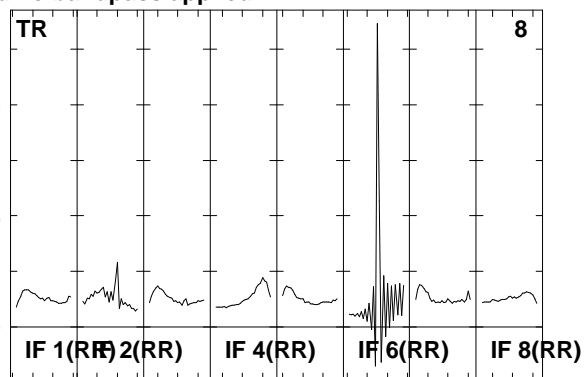
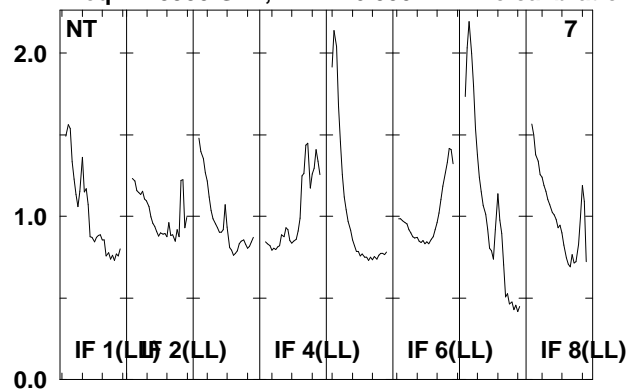

Lower frame: Real Jy
Total-power spectrum Antenna: *
Timerange: 00/07:59:02 to 00/08:00:28

Plot file version 13 created 18-APR-2008 18:27:04

IRAS2336 EP061A.UVDATA.1

Freq = 1.5950 GHz, Bw = 16.000 MH No calibration applied and no bandpass applied

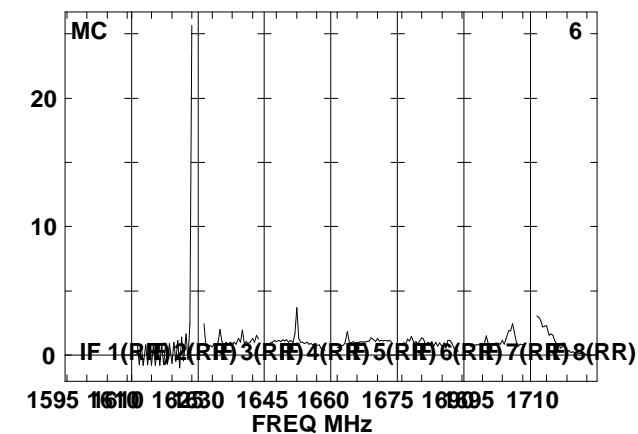
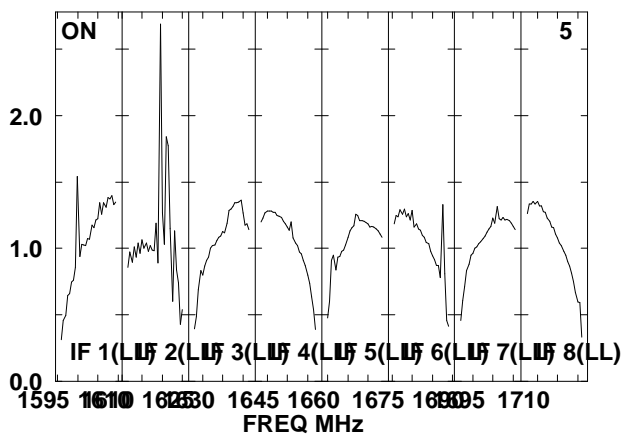
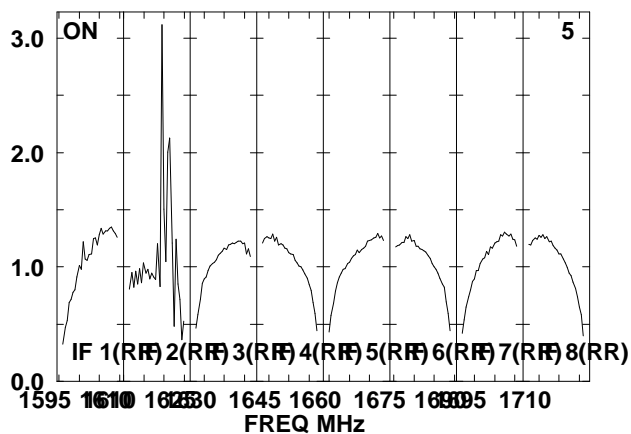
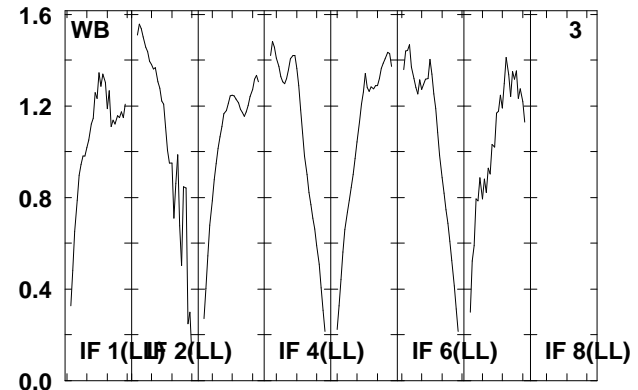
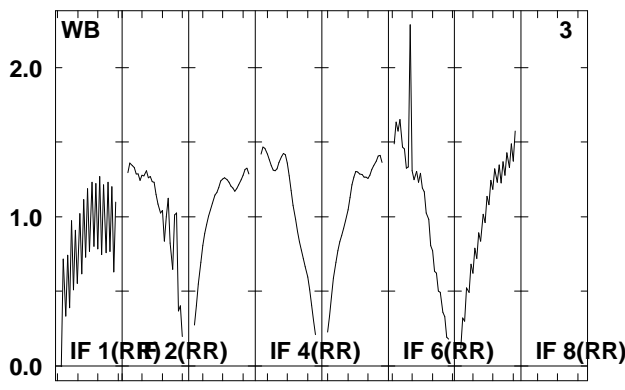
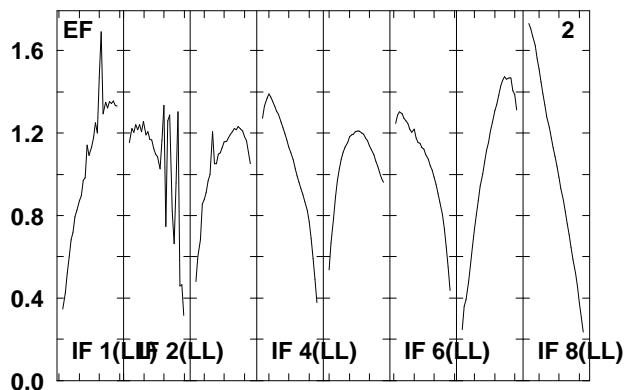
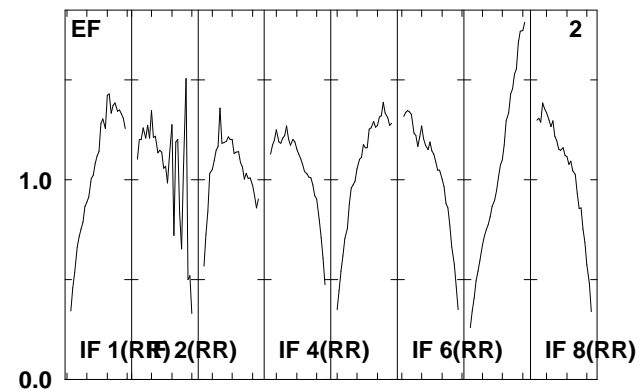
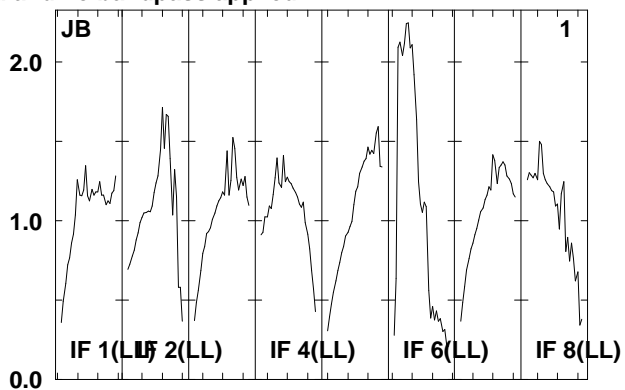
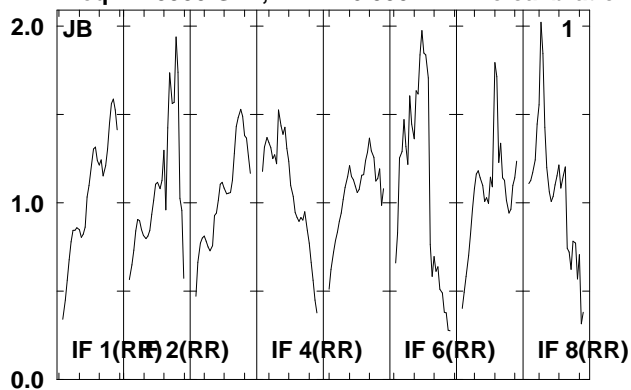

Lower frame: Real Jy
Total-power spectrum Antenna: *
Timerange: 00/08:00:30 to 00/08:04:00

Plot file version 14 created 18-APR-2008 18:27:05

IRAS2336 EP061A.UVDATA.1

Freq = 1.5950 GHz, Bw = 16.000 MH No calibration applied and no bandpass applied

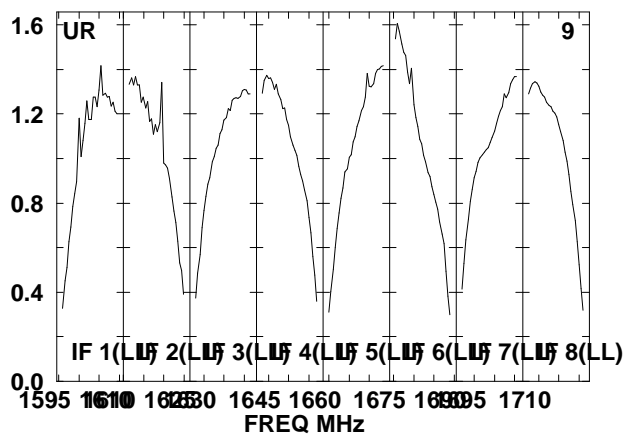
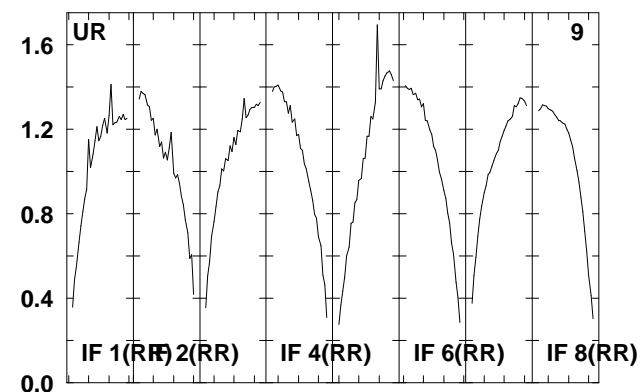
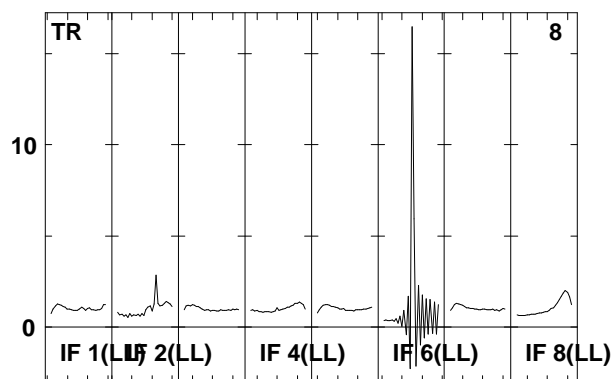
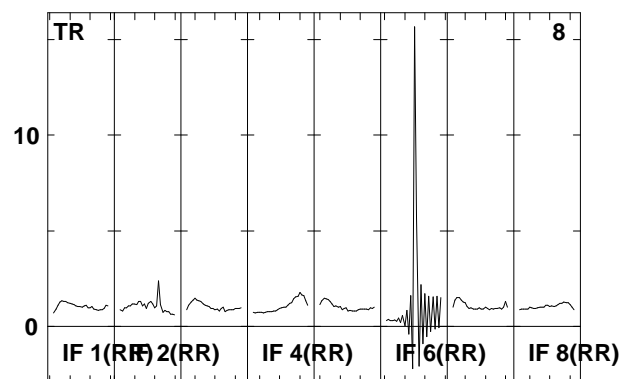
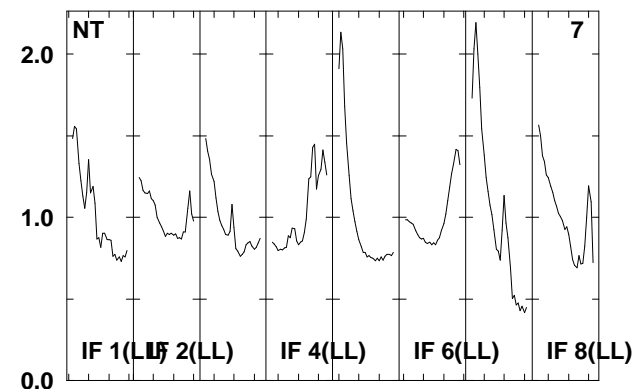
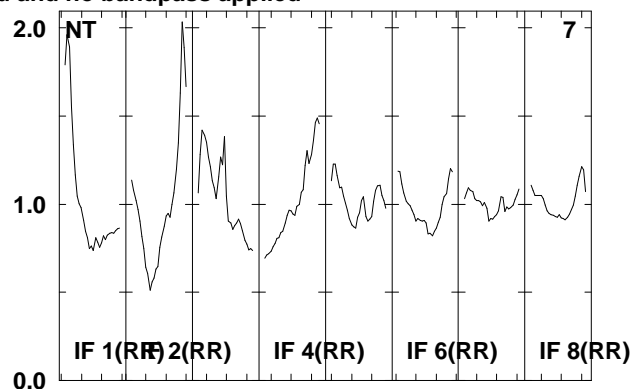
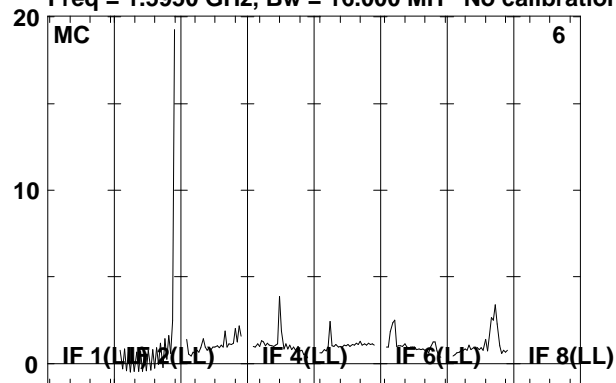

Lower frame: Real Jy

Total-power spectrum Antenna: *

Timerange: 00/08:00:30 to 00/08:04:00

Plot file version 15 created 18-APR-2008 18:27:06

J2333+39 EP061A.UVDATA.1

Freq = 1.5950 GHz, Bw = 16.000 MH No calibration applied and no bandpass applied

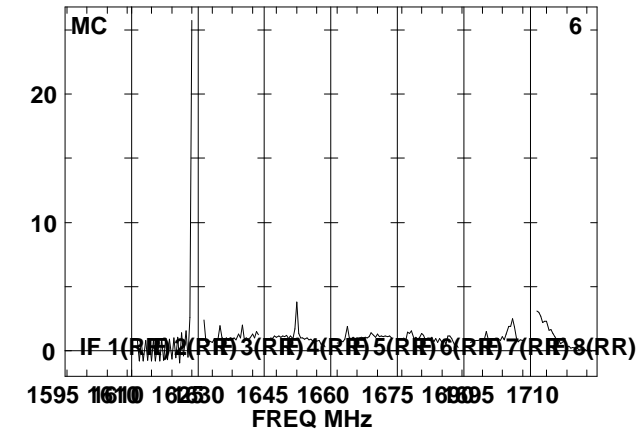
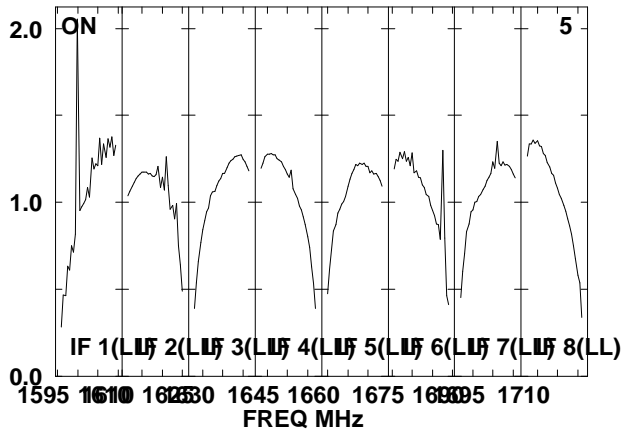
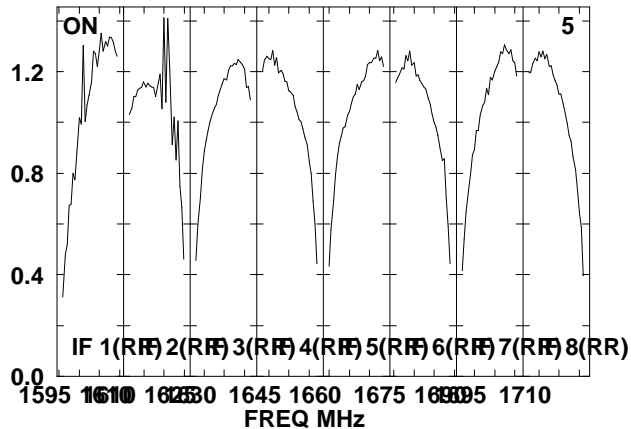
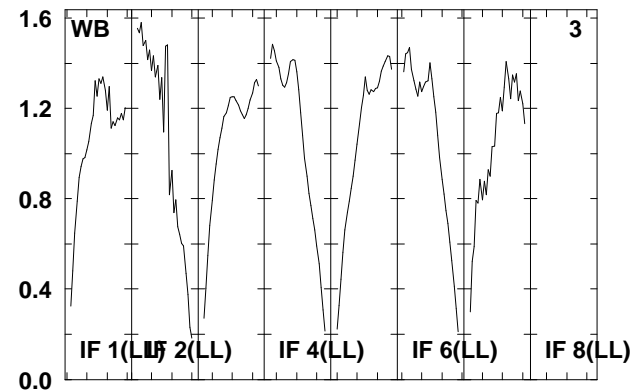
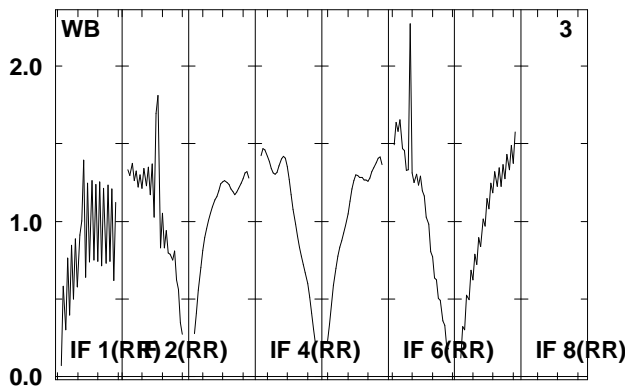
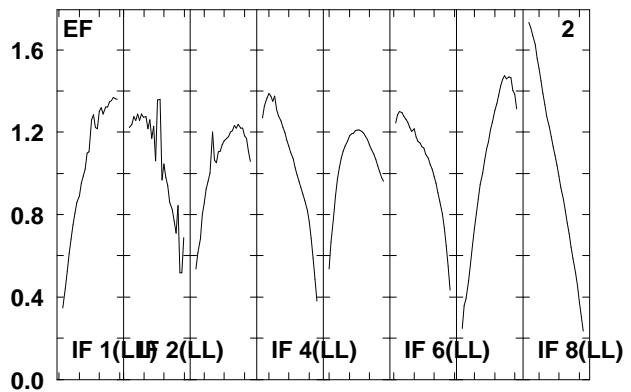
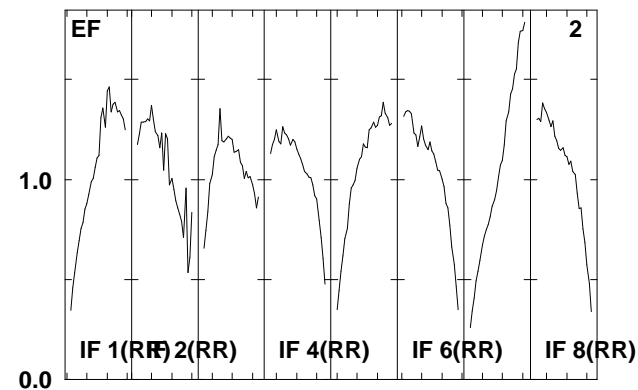
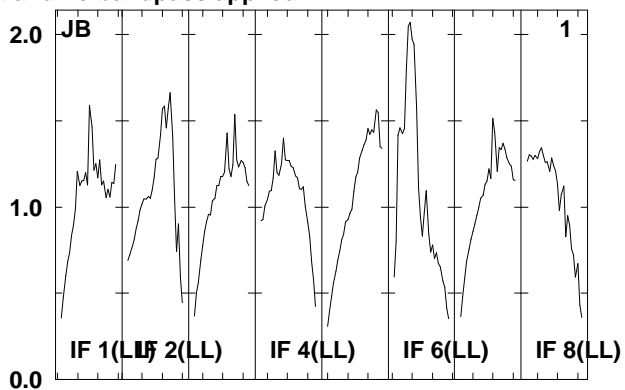
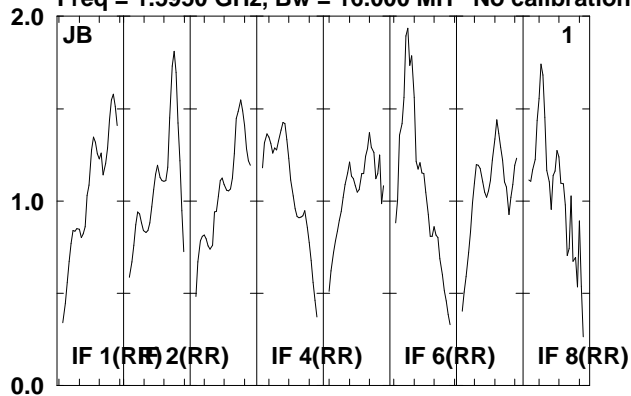

Lower frame: Real Jy
Total-power spectrum Antenna: *
Timerange: 00/08:04:02 to 00/08:05:30

Plot file version 16 created 18-APR-2008 18:27:06

J2333+39 EP061A.UVDATA.1

Freq = 1.5950 GHz, Bw = 16.000 MH No calibration applied and no bandpass applied

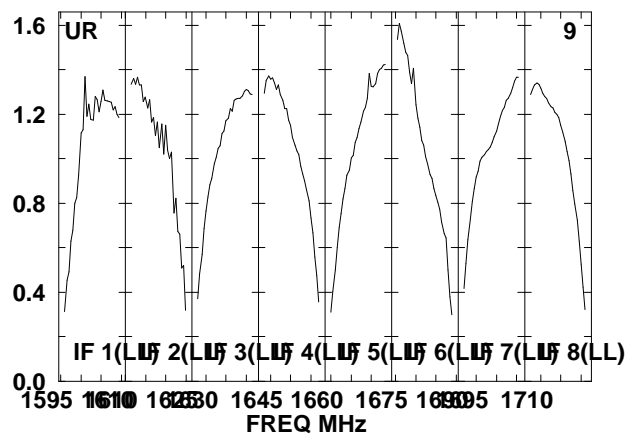
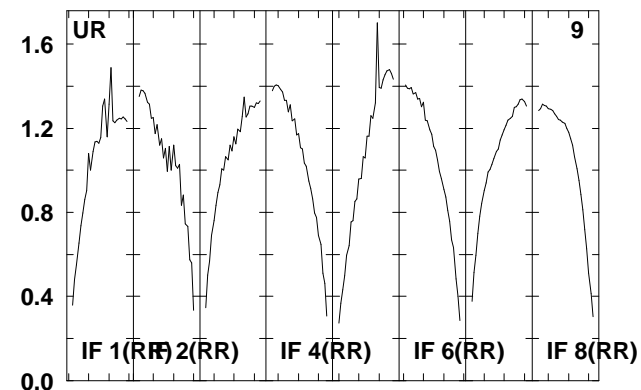
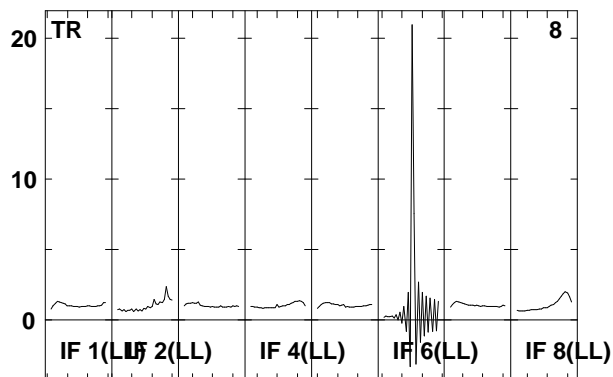
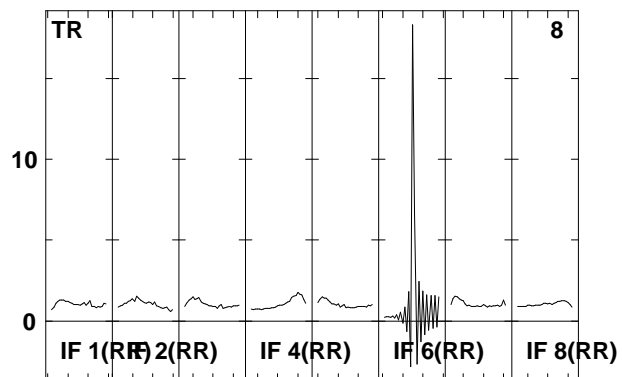
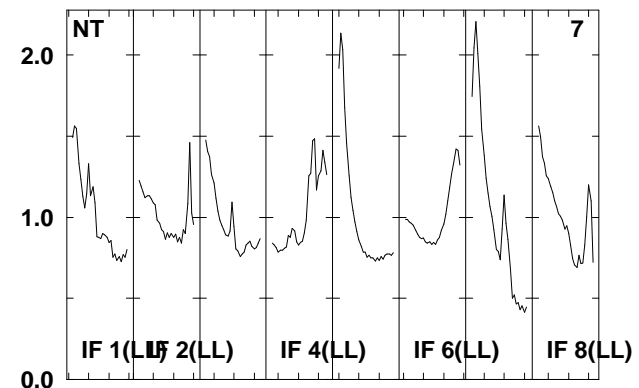
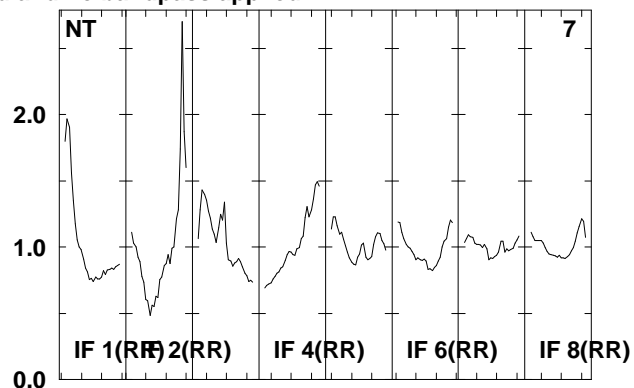
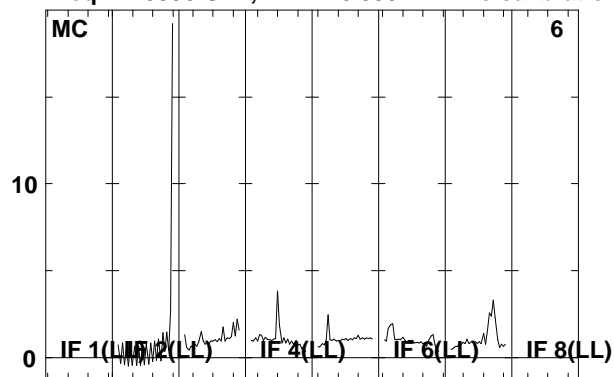

Lower frame: Real Jy

Total-power spectrum Antenna: *

Timerange: 00/08:04:02 to 00/08:05:30

Plot file version 17 created 18-APR-2008 18:27:07

IRAS2336 EP061A.UVDATA.1

Freq = 1.5950 GHz, Bw = 16.000 MH No calibration applied and no bandpass applied

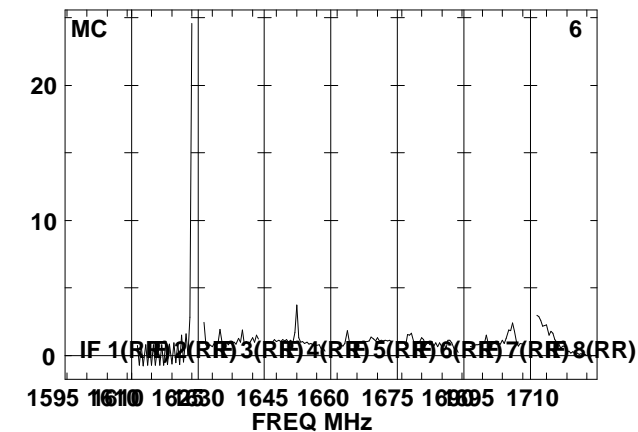
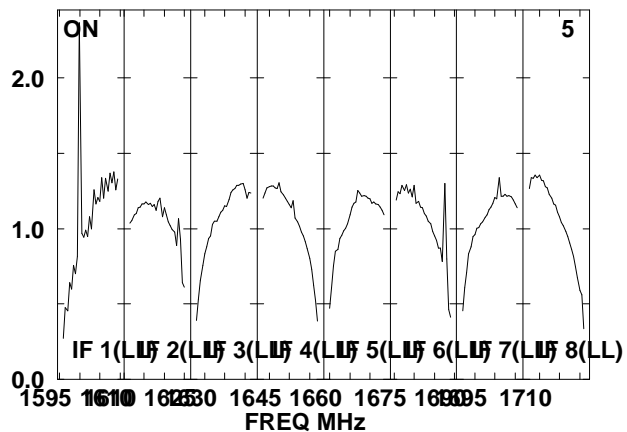
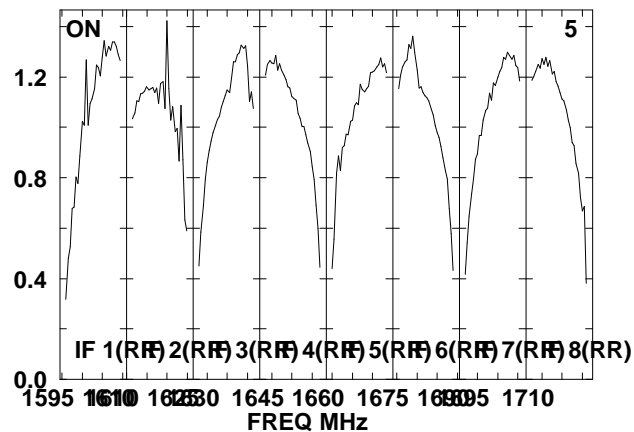
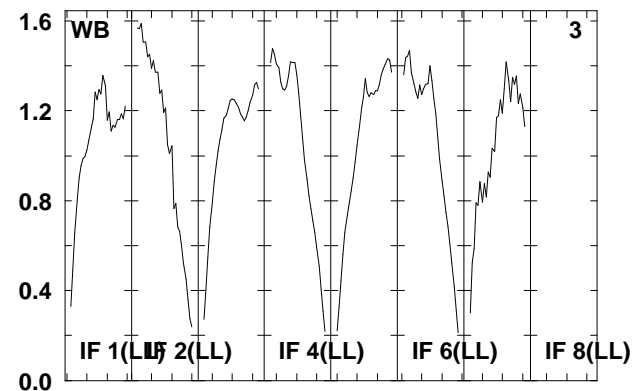
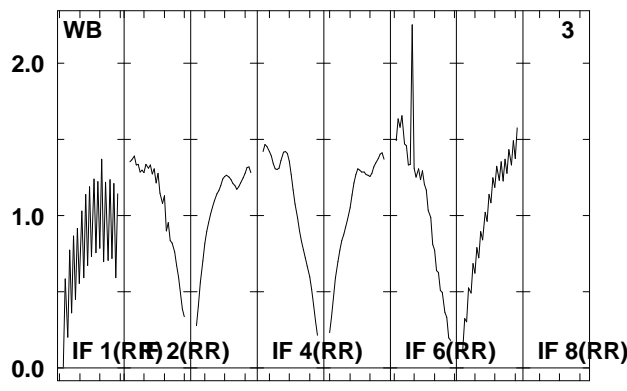
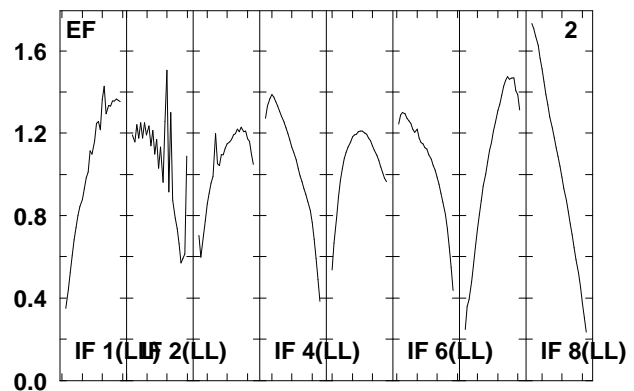
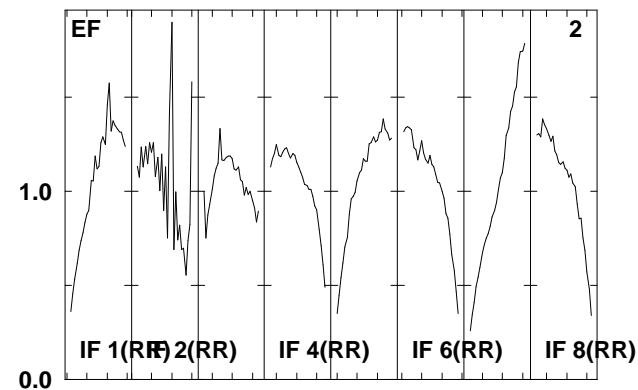
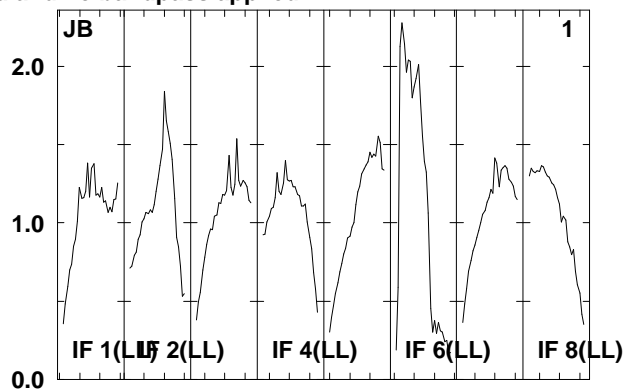
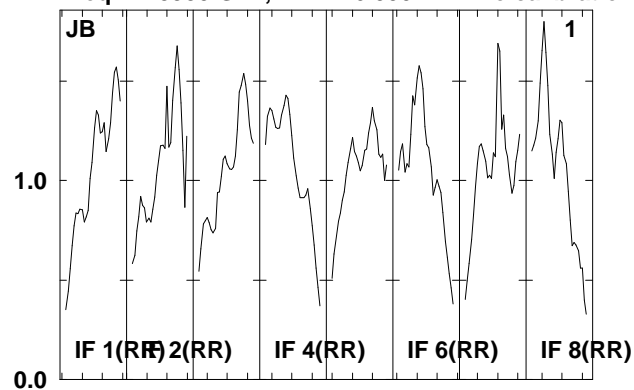

Lower frame: Real Jy
Total-power spectrum Antenna: *
Timerange: 00/08:05:32 to 00/08:08:58

Plot file version 18 created 18-APR-2008 18:27:08

IRAS2336 EP061A.UVDATA.1

Freq = 1.5950 GHz, Bw = 16.000 MH No calibration applied and no bandpass applied

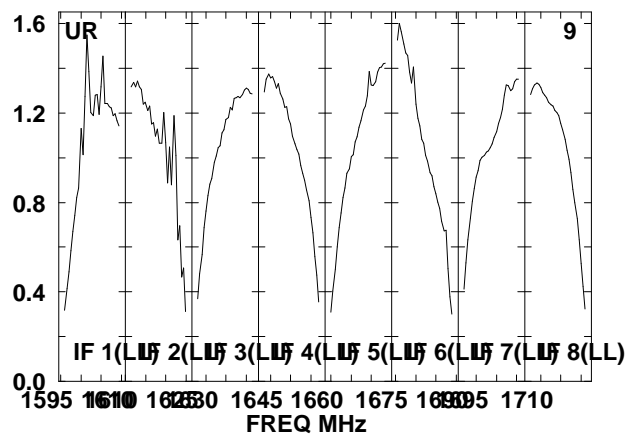
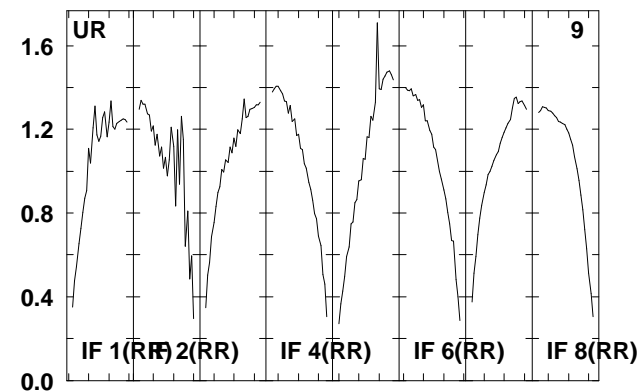
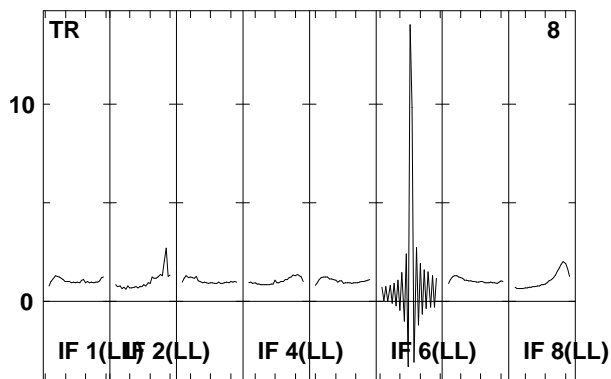
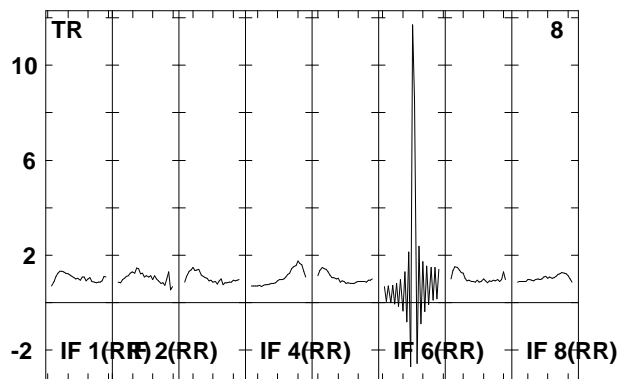
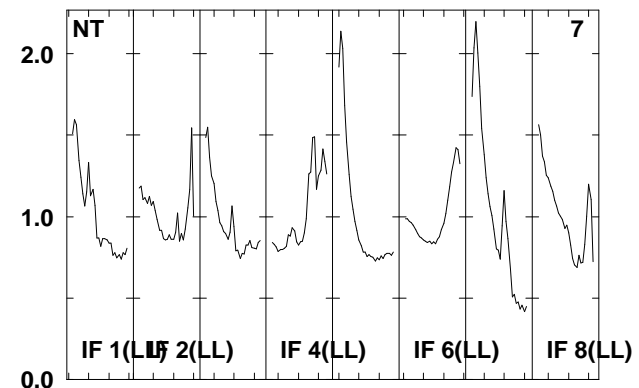
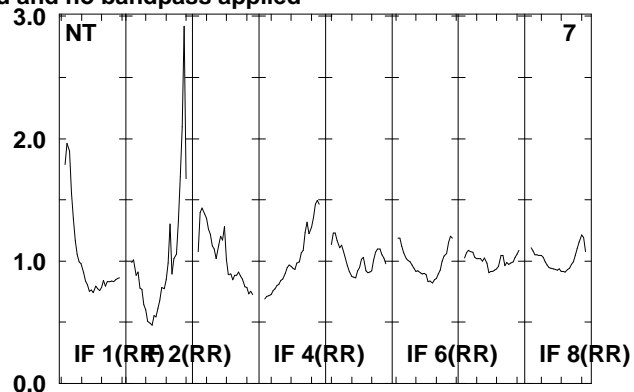
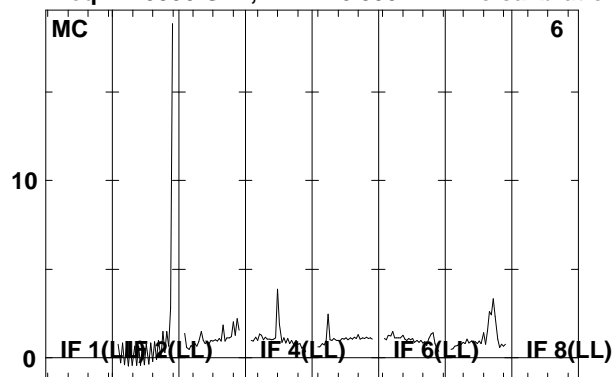

Lower frame: Real Jy

Total-power spectrum Antenna: *

Timerange: 00/08:05:32 to 00/08:08:58

Plot file version 19 created 18-APR-2008 18:27:09

J2333+39 EP061A.UVDATA.1

Freq = 1.5950 GHz, Bw = 16.000 MH No calibration applied and no bandpass applied

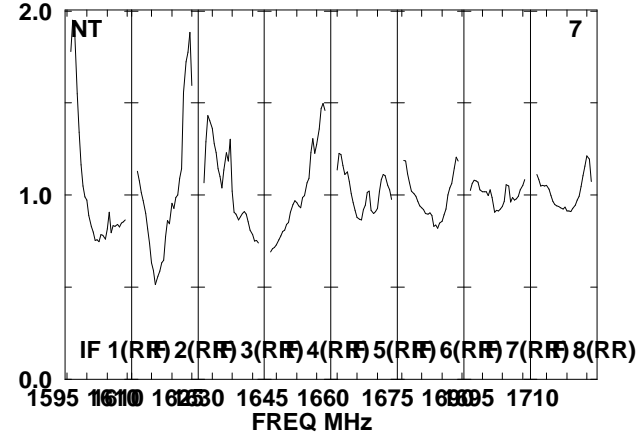
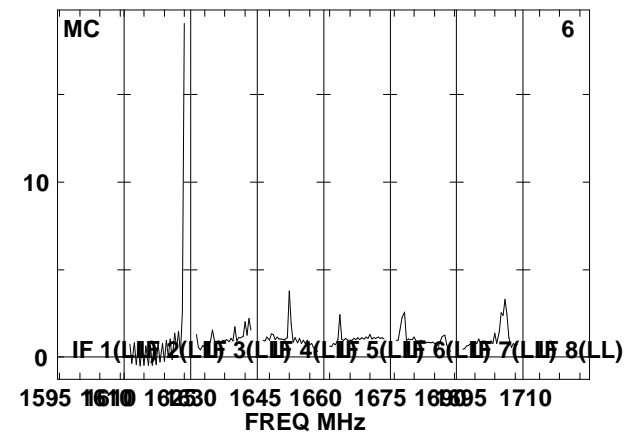
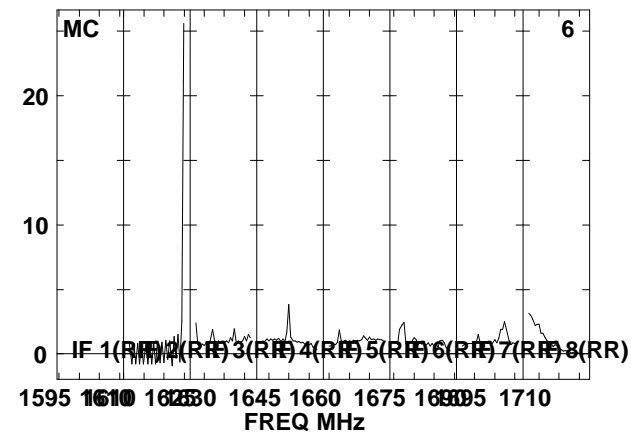
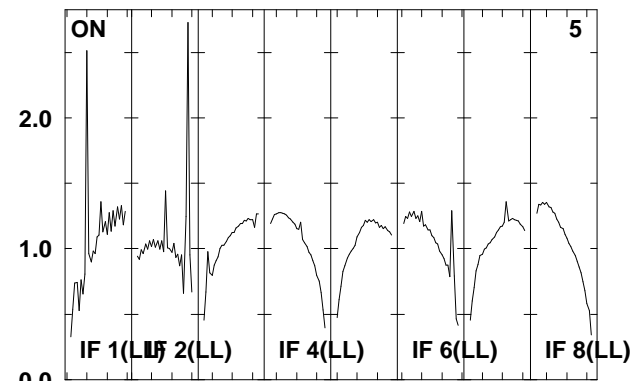
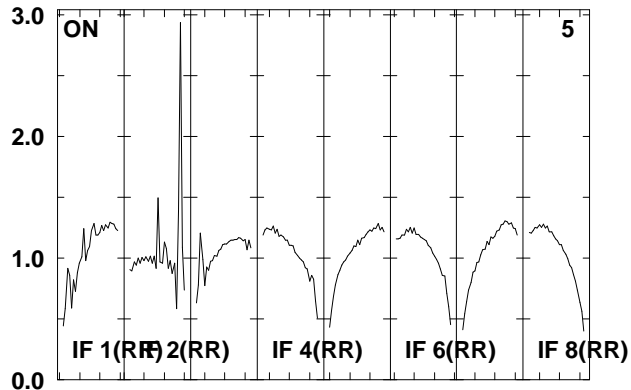
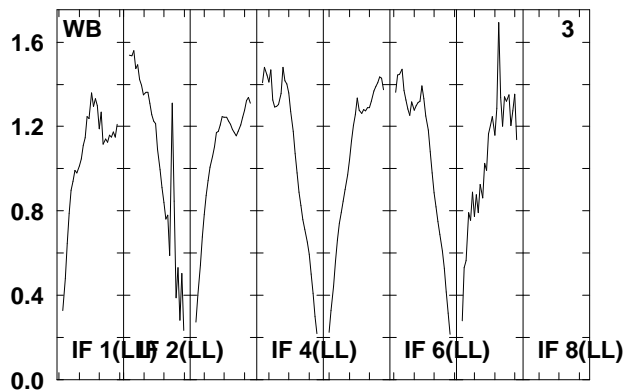
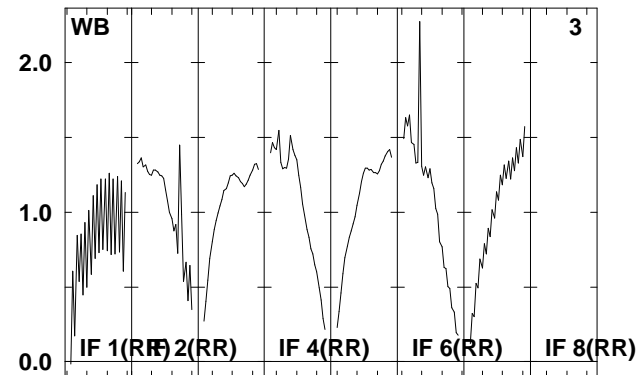
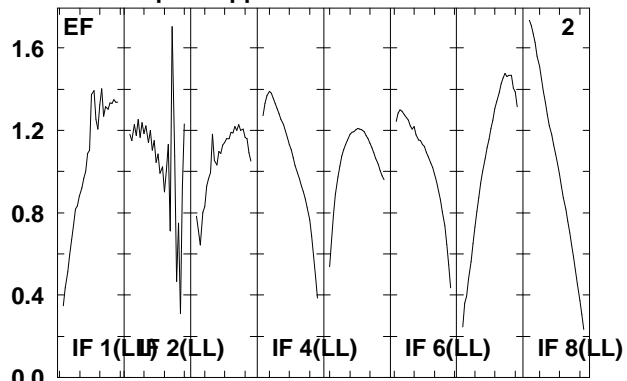
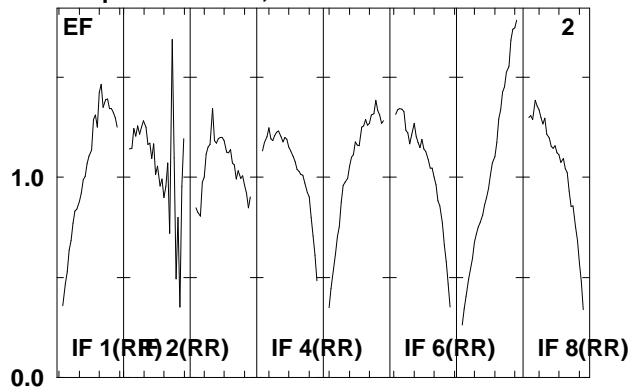

Lower frame: Real Jy
Total-power spectrum Antenna: *
Timerange: 00/08:10:02 to 00/08:11:28

Plot file version 20 created 18-APR-2008 18:27:09

J2333+39 EP061A.UVDATA.1

Freq = 1.5950 GHz, Bw = 16.000 MH No calibration applied and no bandpass applied

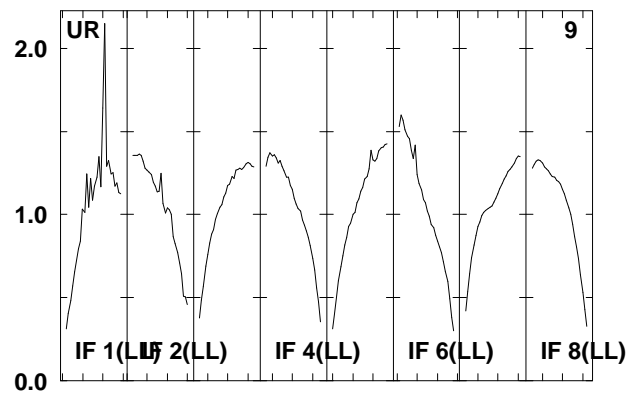
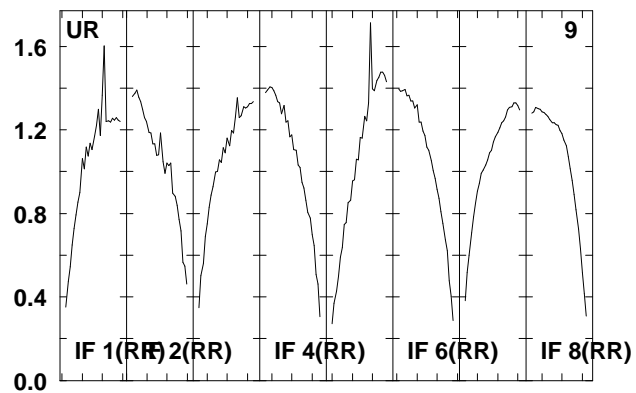
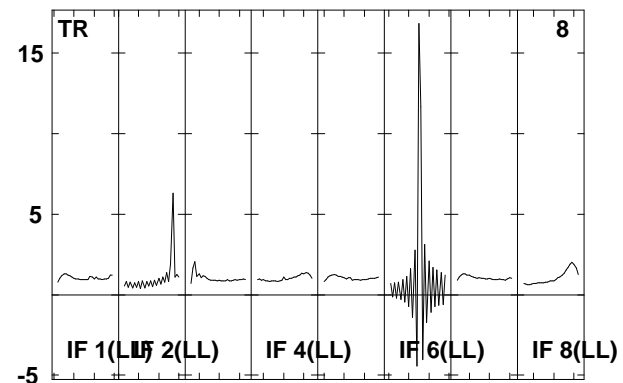
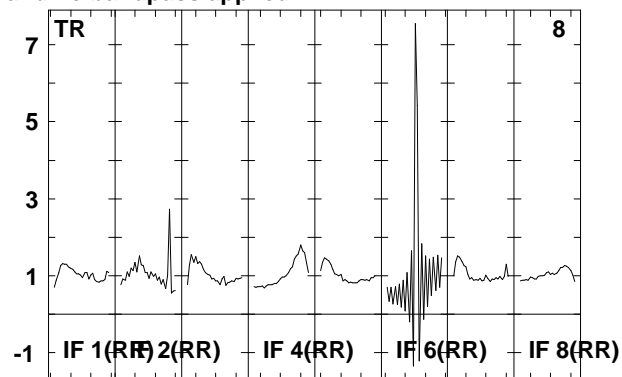
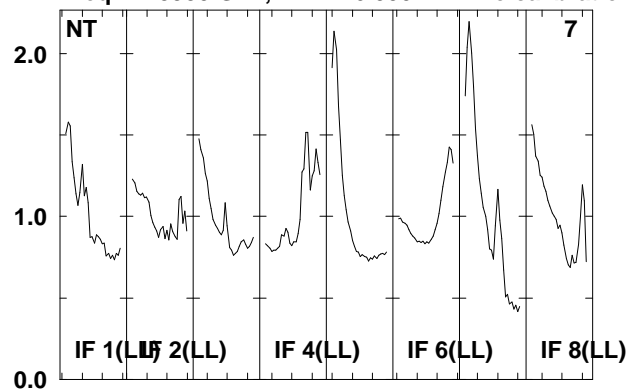

Lower frame: Real Jy
Total-power spectrum Antenna: *
Timerange: 00/08:10:02 to 00/08:11:28

Plot file version 21 created 18-APR-2008 18:27:10

IRAS2336 EP061A.UVDATA.1

Freq = 1.5950 GHz, Bw = 16.000 MH No calibration applied and no bandpass applied

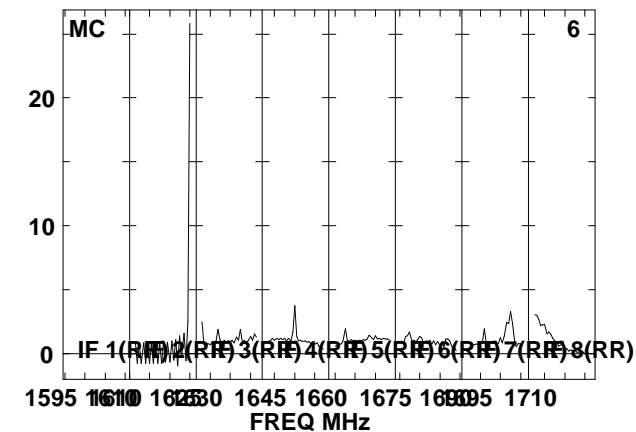
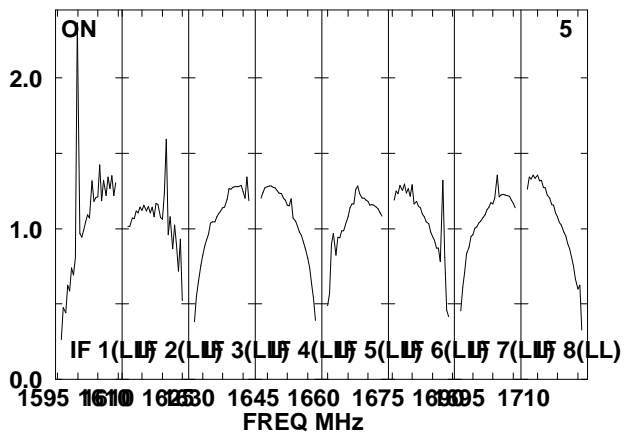
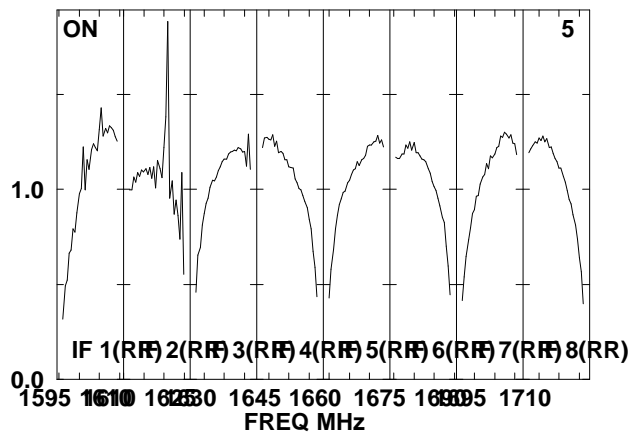
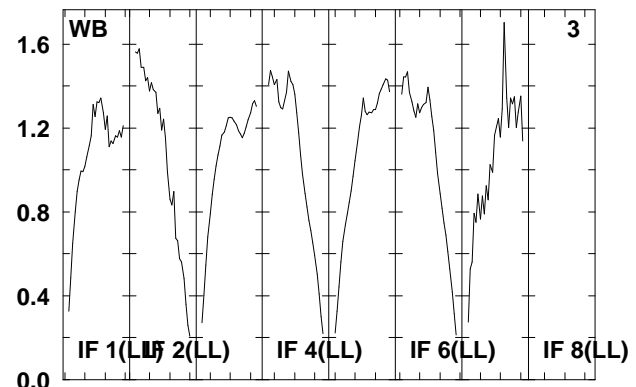
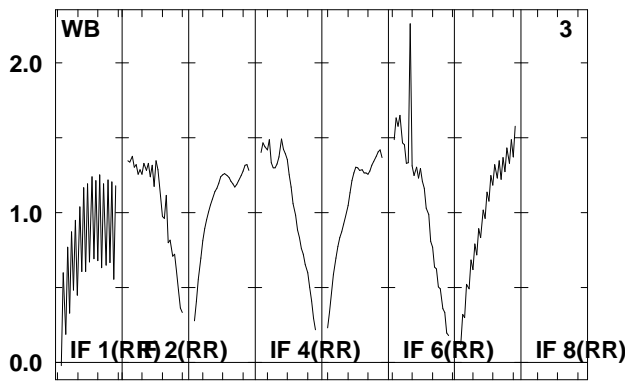
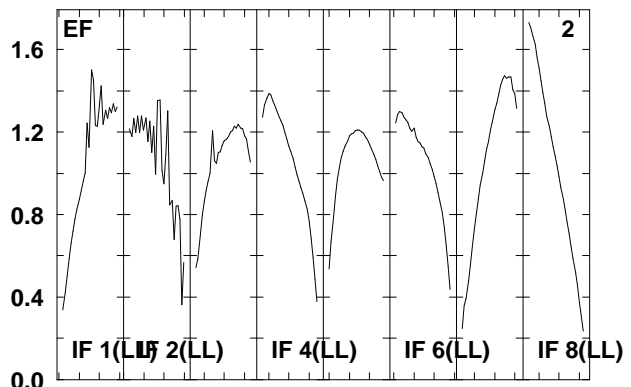
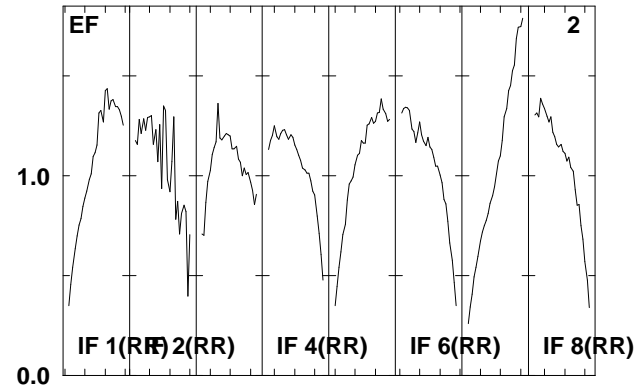
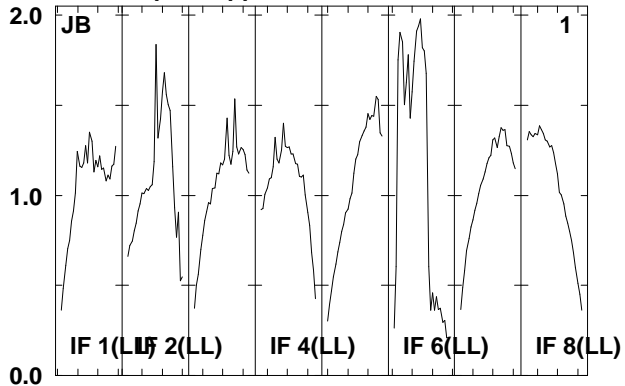
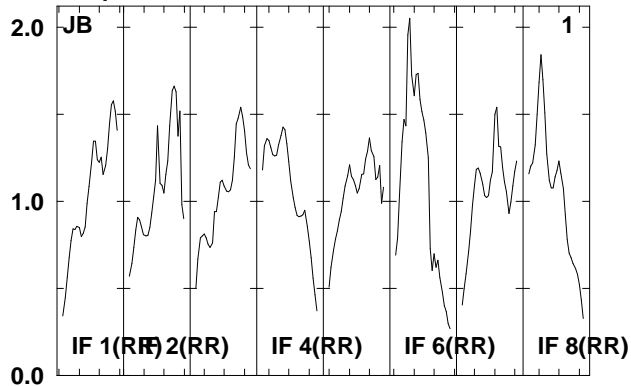

Lower frame: Real Jy
Total-power spectrum Antenna: *
Timerange: 00/08:11:32 to 00/08:14:56

Plot file version 22 created 18-APR-2008 18:27:11

IRAS2336 EP061A.UVDATA.1

Freq = 1.5950 GHz, Bw = 16.000 MH No calibration applied and no bandpass applied

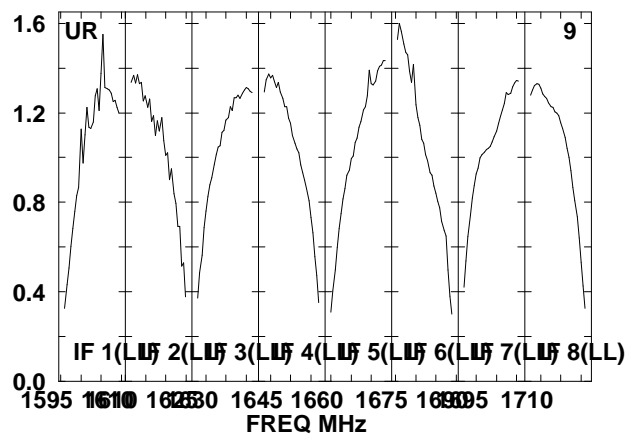
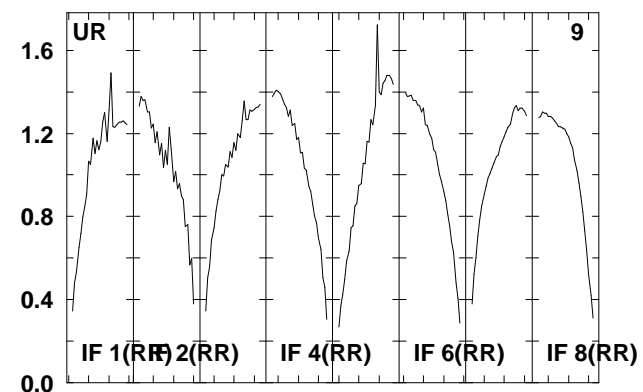
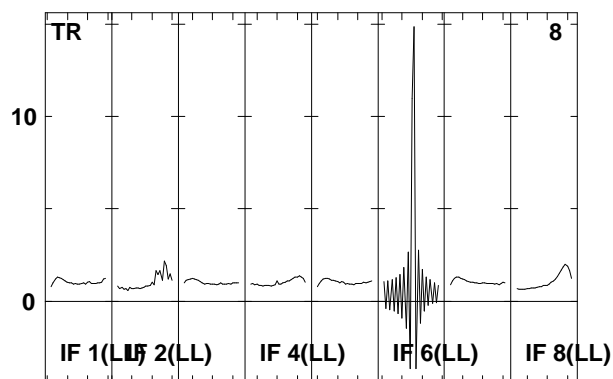
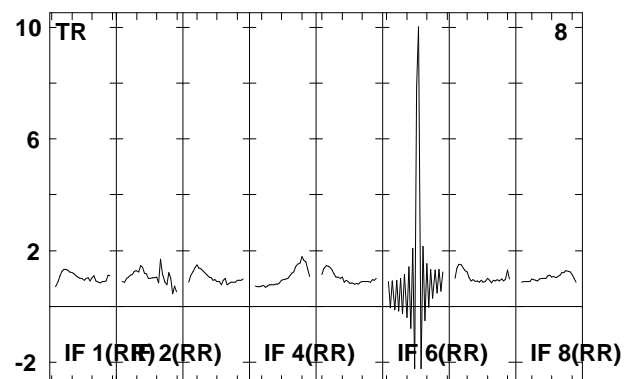
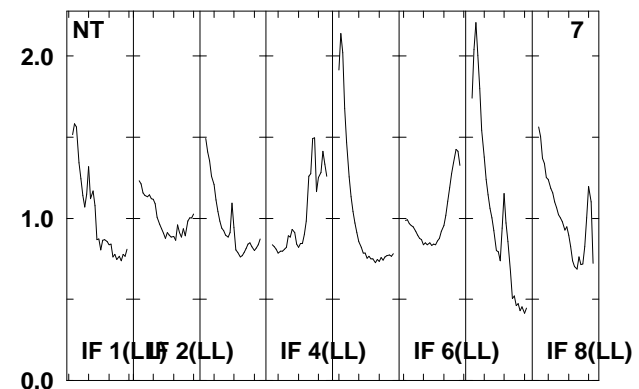
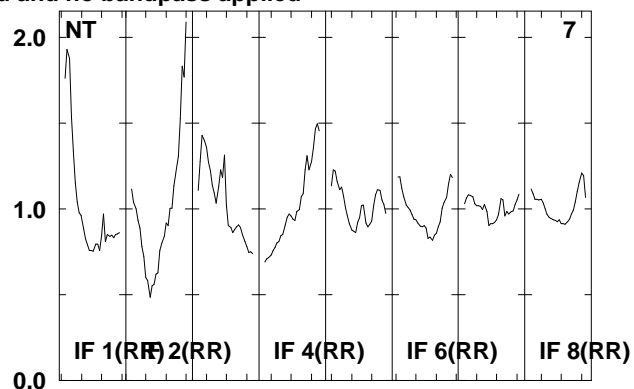
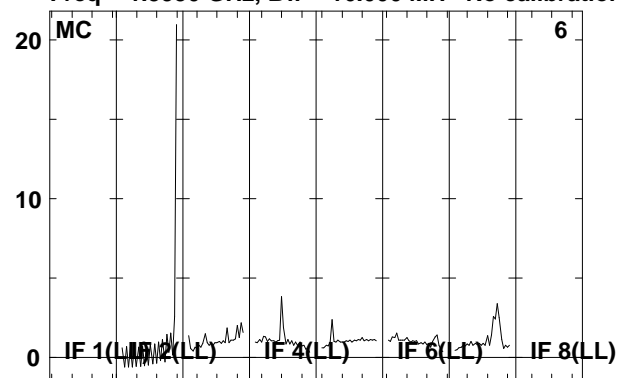

Lower frame: Real Jy

Total-power spectrum Antenna: *

Timerange: 00/08:11:32 to 00/08:14:56

Plot file version 23 created 18-APR-2008 18:27:12

J2333+39 EP061A.UVDATA.1

Freq = 1.5950 GHz, Bw = 16.000 MH No calibration applied and no bandpass applied

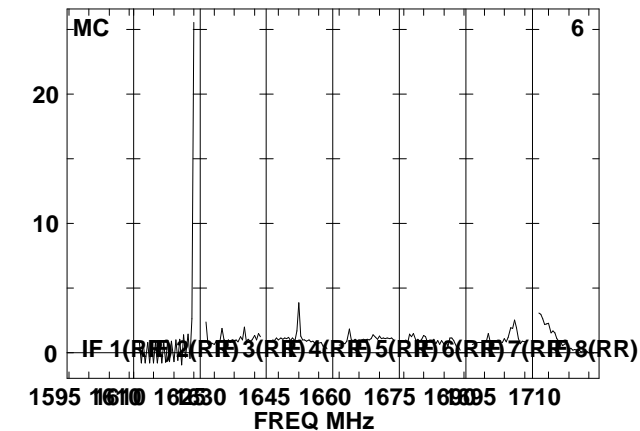
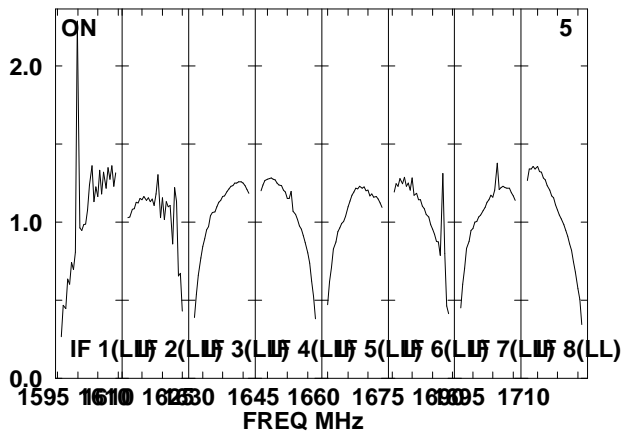
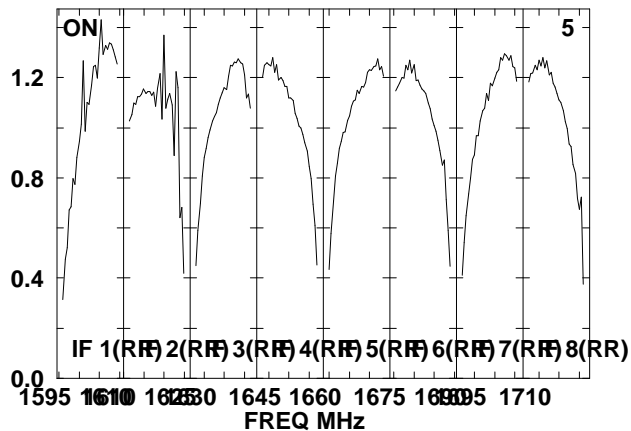
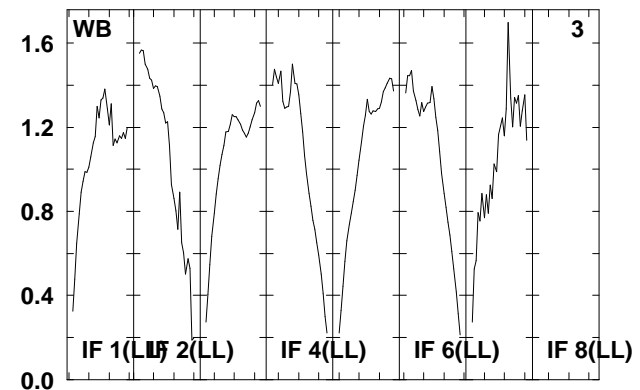
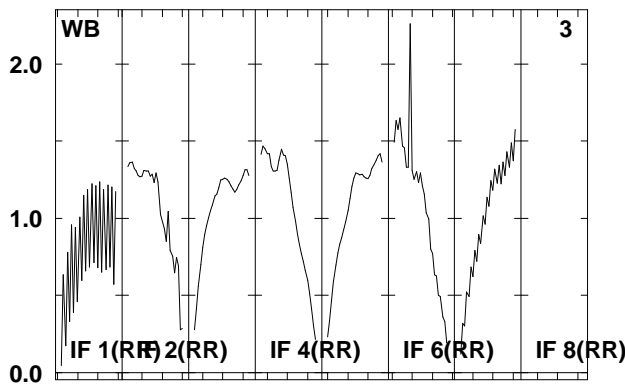
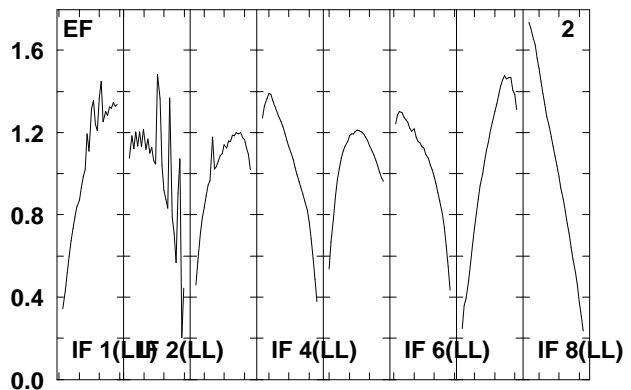
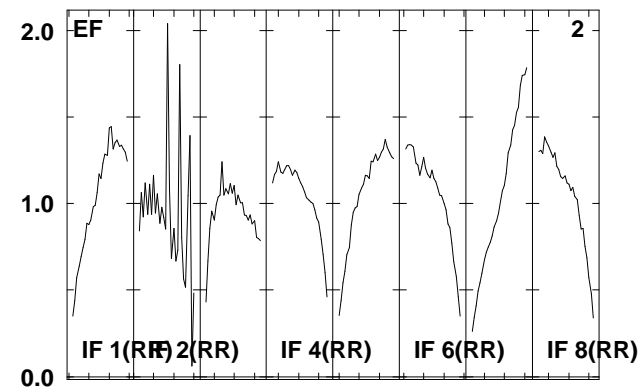
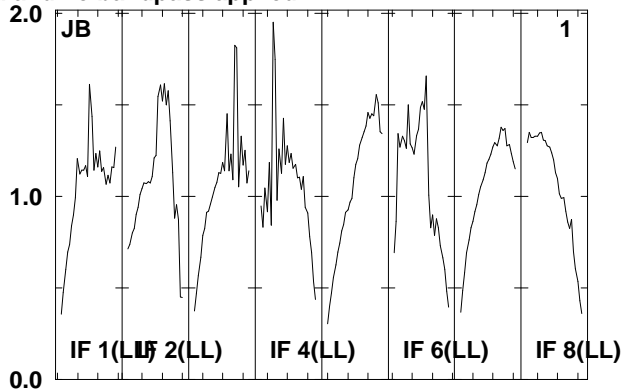
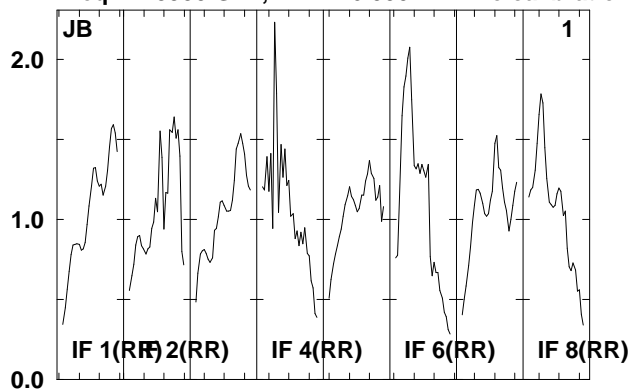

Lower frame: Real Jy
Total-power spectrum Antenna: *
Timerange: 00/08:15:06 to 00/08:16:30

Plot file version 24 created 18-APR-2008 18:27:12

J2333+39 EP061A.UVDATA.1

Freq = 1.5950 GHz, Bw = 16.000 MH No calibration applied and no bandpass applied

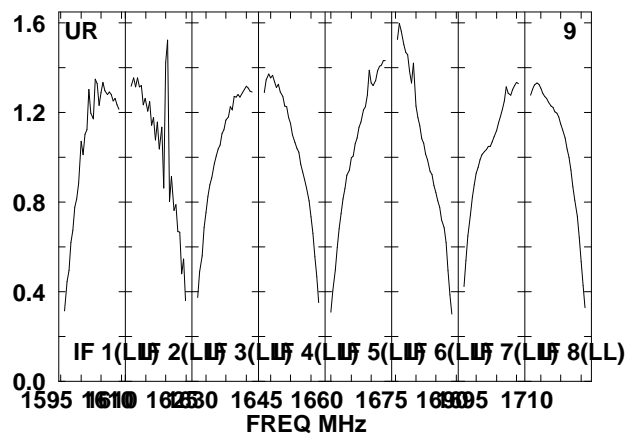
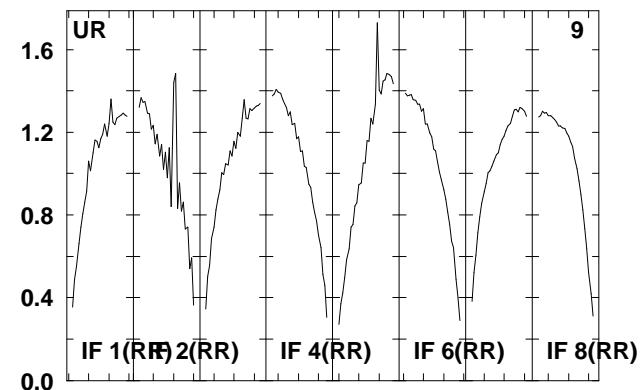
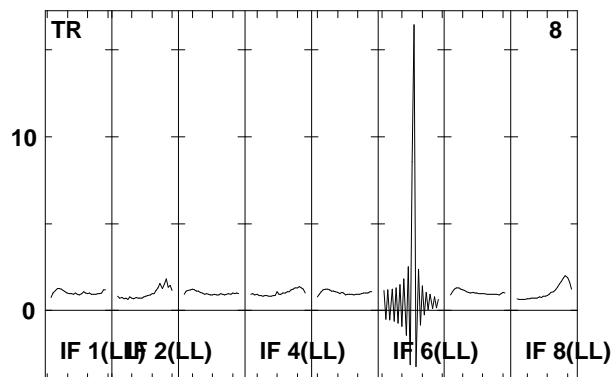
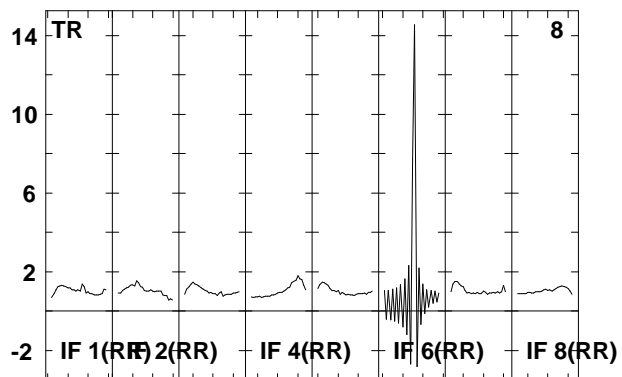
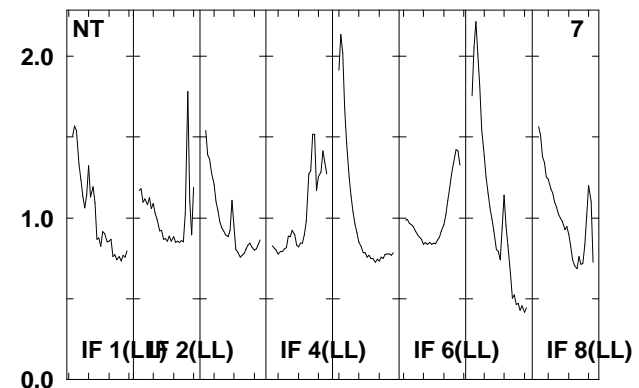
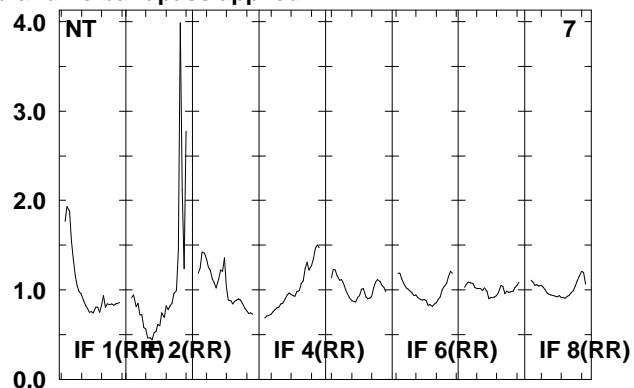
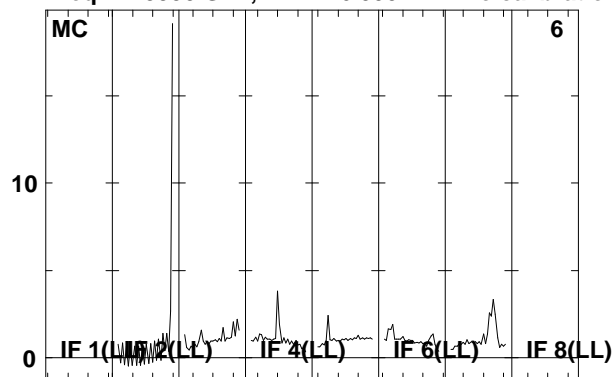

Lower frame: Real Jy

Total-power spectrum Antenna: *

Timerange: 00/08:15:06 to 00/08:16:30

Plot file version 25 created 18-APR-2008 18:27:12

IRAS2336 EP061A.UVDATA.1

Freq = 1.5950 GHz, Bw = 16.000 MH No calibration applied and no bandpass applied

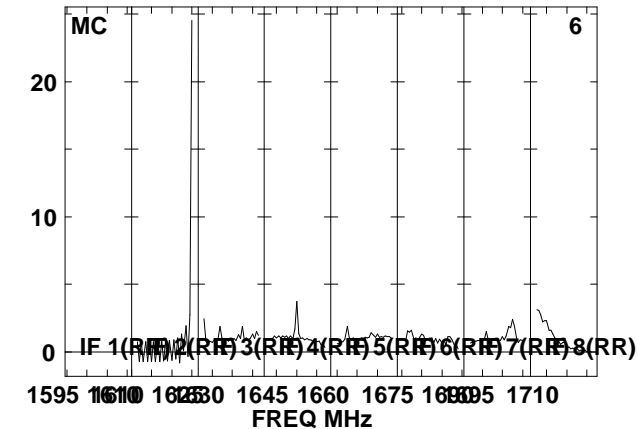
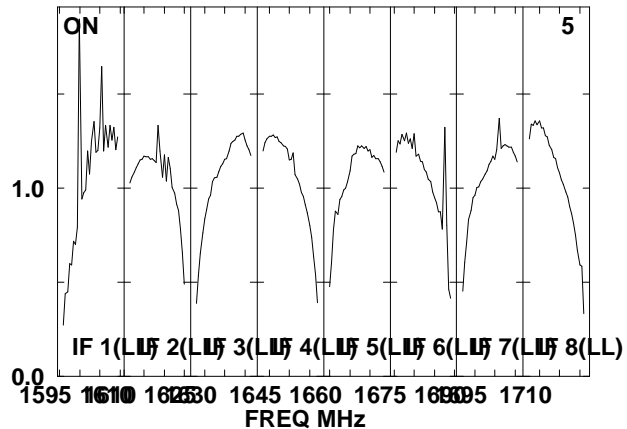
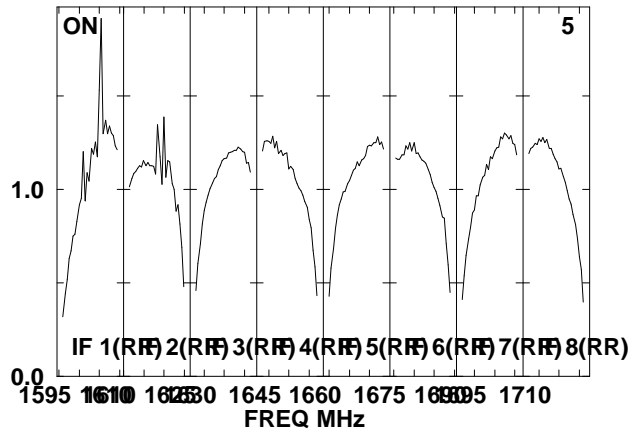
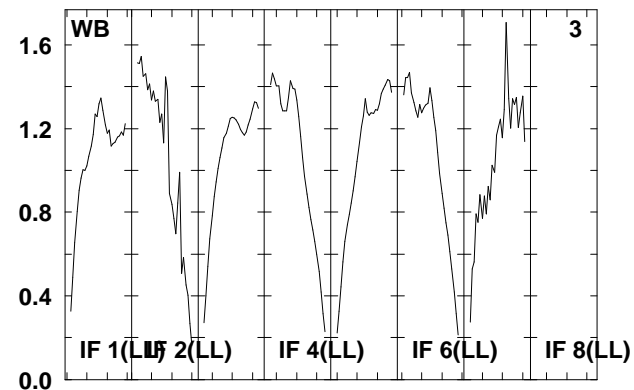
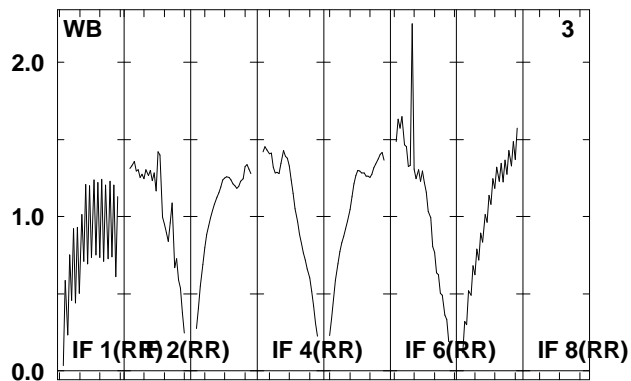
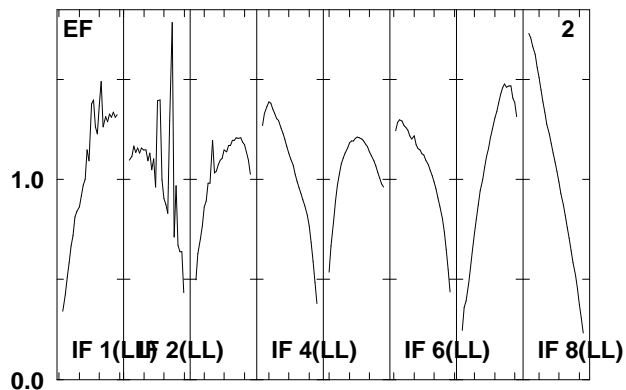
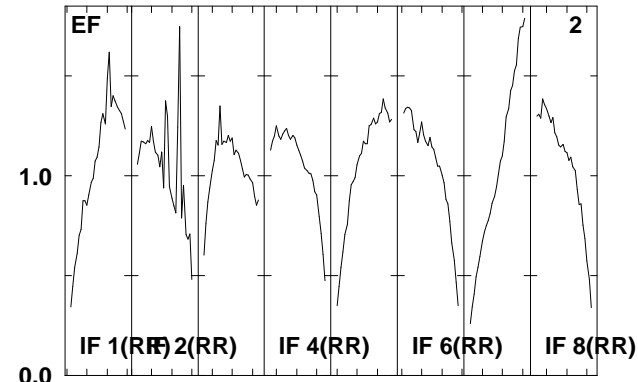
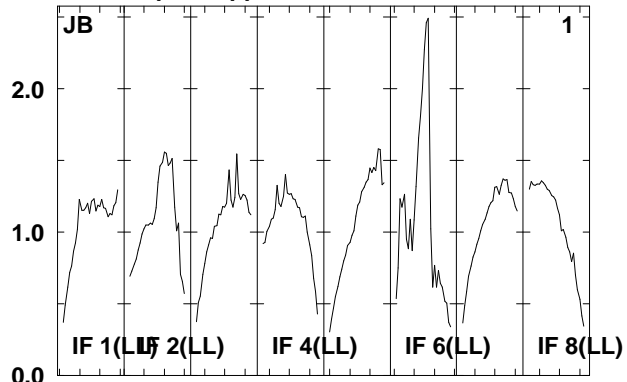
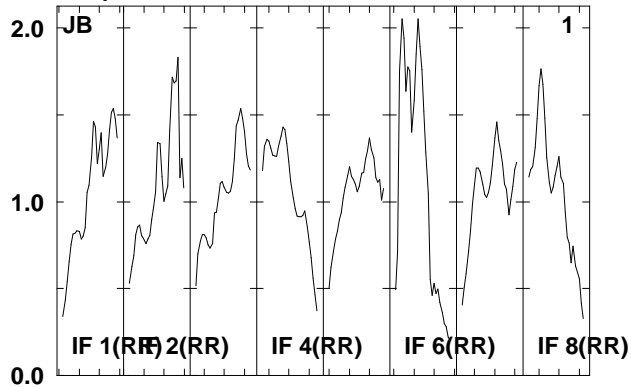

Lower frame: Real Jy
Total-power spectrum Antenna: *
Timerange: 00/08:16:32 to 00/08:20:00

Plot file version 26 created 18-APR-2008 18:27:13

IRAS2336 EP061A.UVDATA.1

Freq = 1.5950 GHz, Bw = 16.000 MH No calibration applied and no bandpass applied

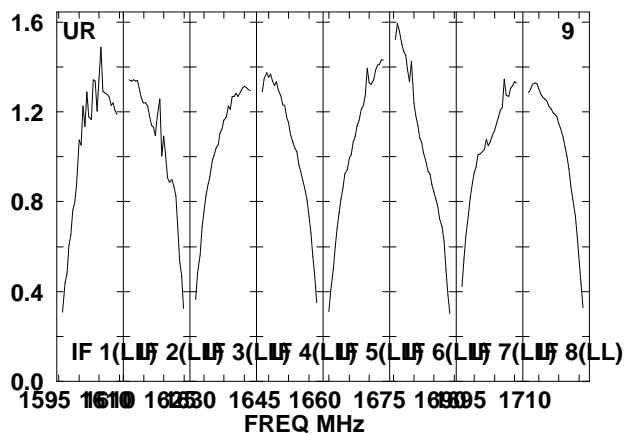
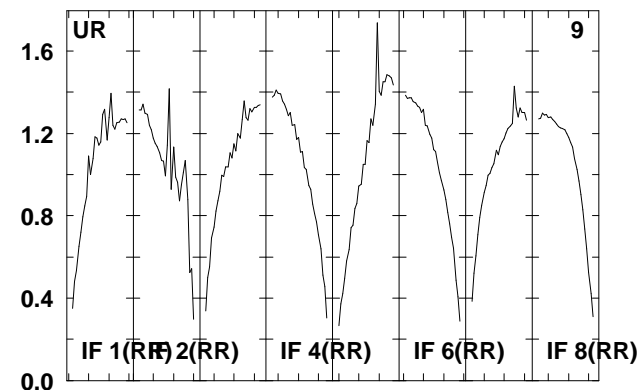
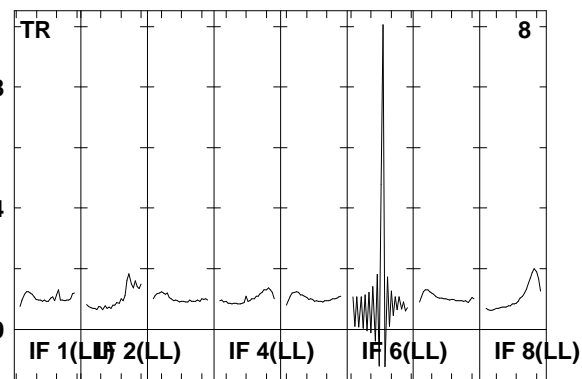
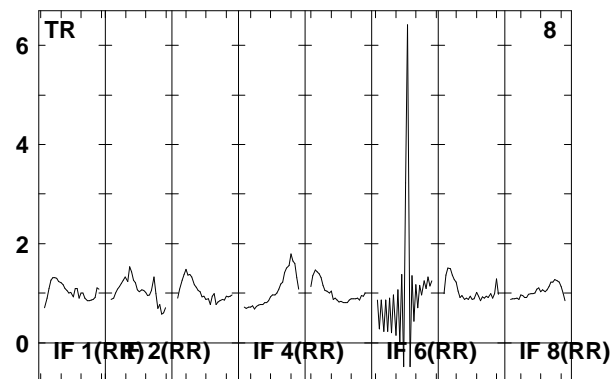
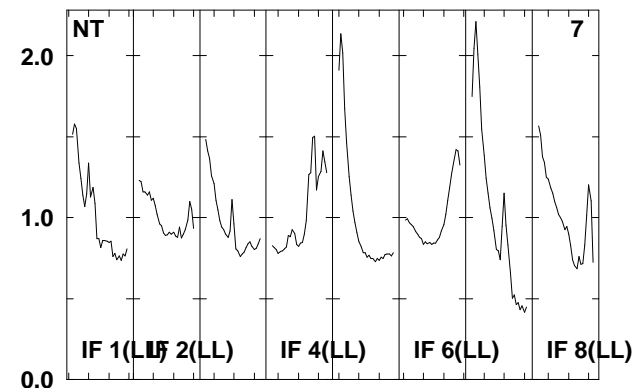
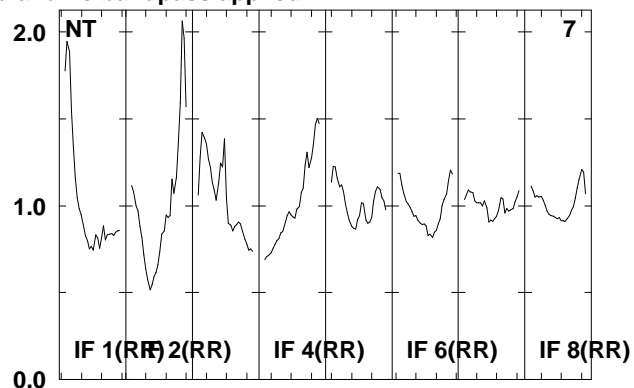
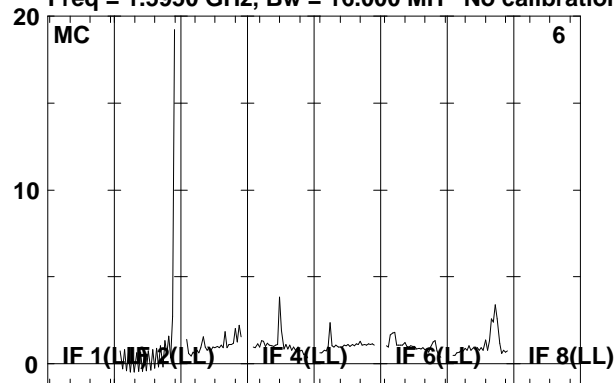

Lower frame: Real Jy

Total-power spectrum Antenna: *

Timerange: 00/08:16:32 to 00/08:20:00

Plot file version 27 created 18-APR-2008 18:27:14

J2333+39 EP061A.UVDATA.1

Freq = 1.5950 GHz, Bw = 16.000 MH No calibration applied and no bandpass applied

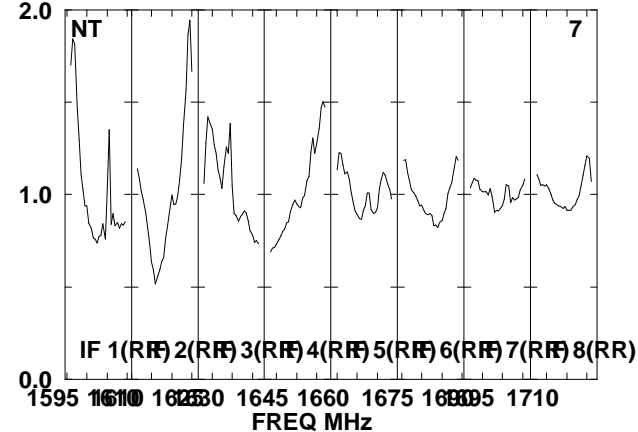
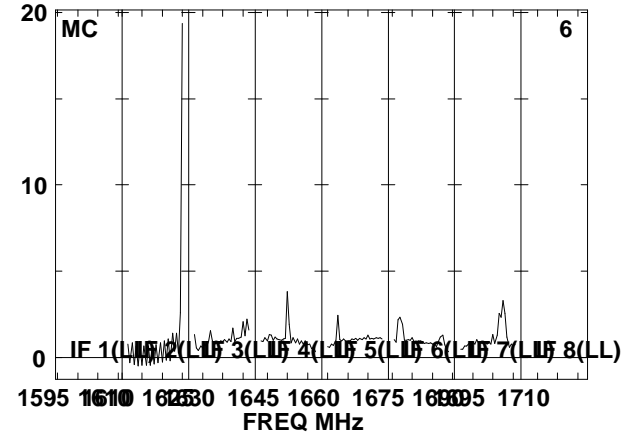
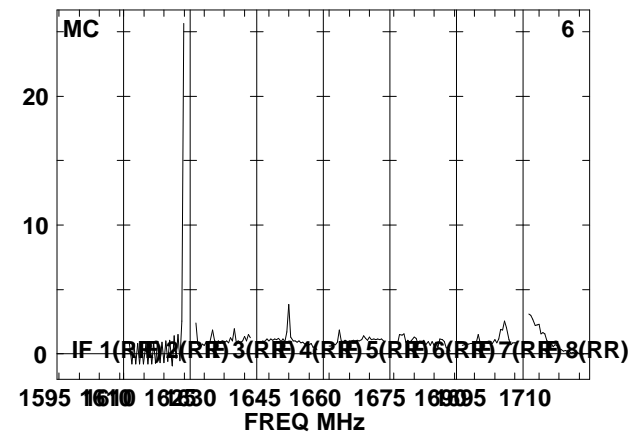
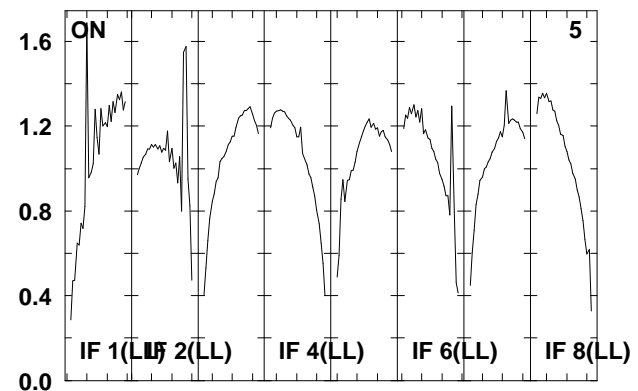
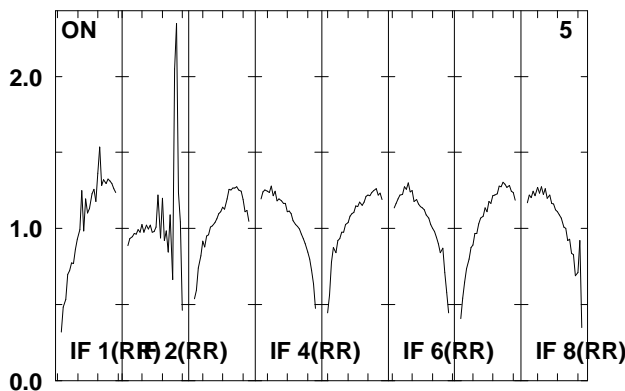
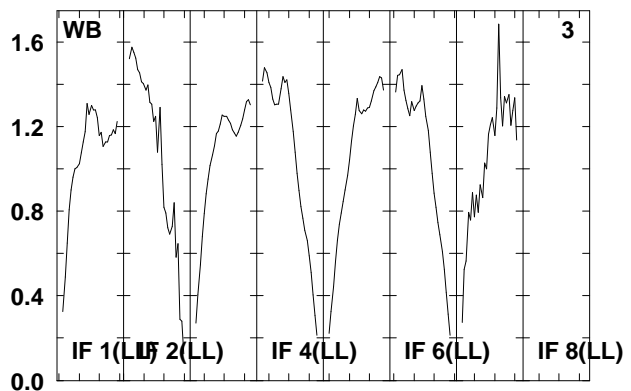
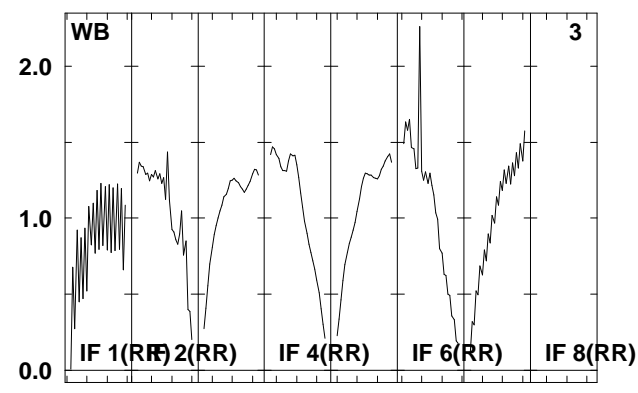
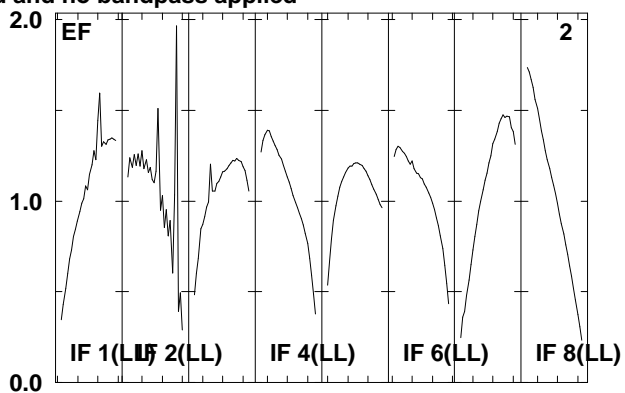
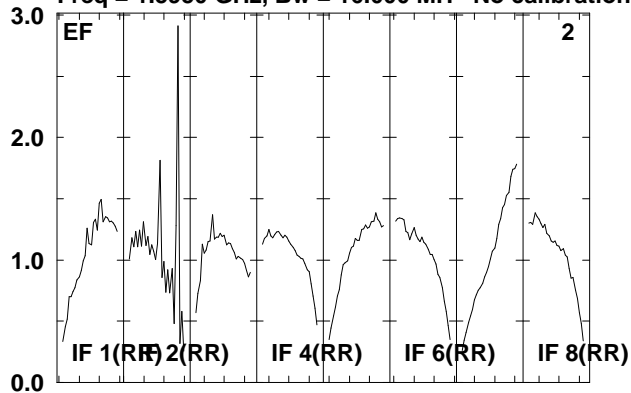

Lower frame: Real Jy
Total-power spectrum Antenna: *
Timerange: 00/08:20:02 to 00/08:21:28

Plot file version 28 created 18-APR-2008 18:27:14

J2333+39 EP061A.UVDATA.1

Freq = 1.5950 GHz, Bw = 16.000 MH No calibration applied and no bandpass applied

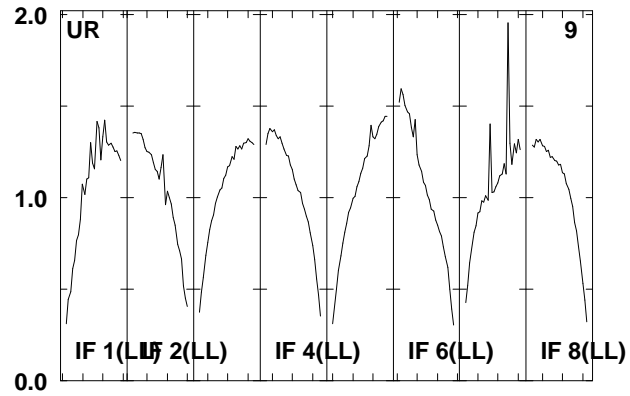
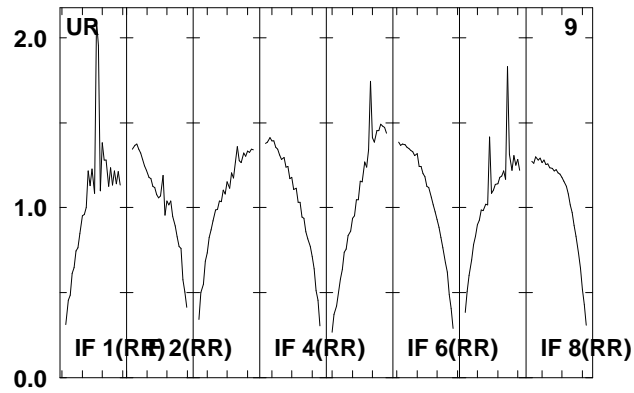
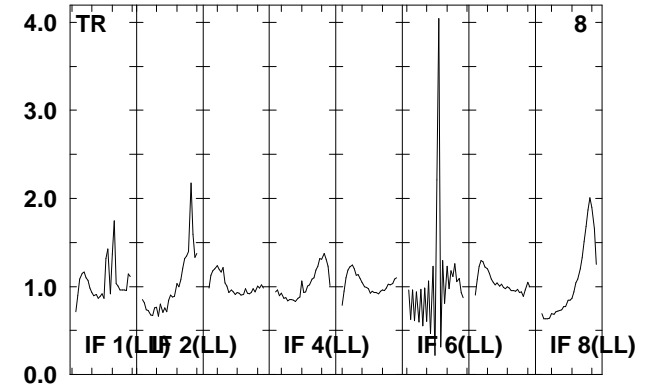
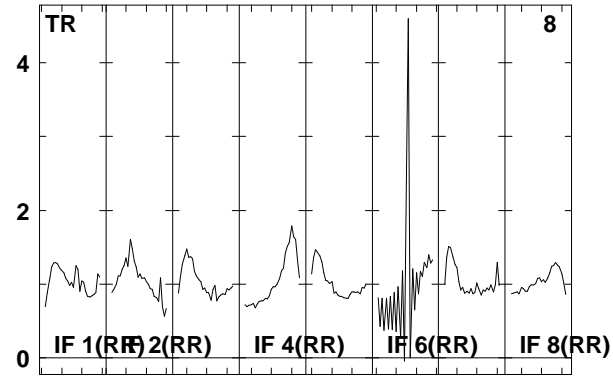
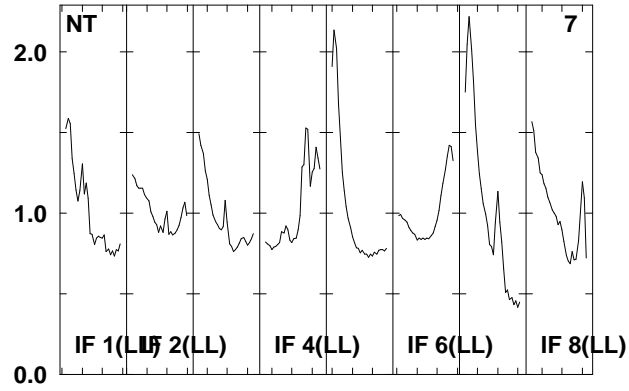

Lower frame: Real Jy
Total-power spectrum Antenna: *
Timerange: 00/08:20:02 to 00/08:21:28

Plot file version 29 created 18-APR-2008 18:27:15

IRAS2336 EP061A.UVDATA.1

Freq = 1.5950 GHz, Bw = 16.000 MH No calibration applied and no bandpass applied

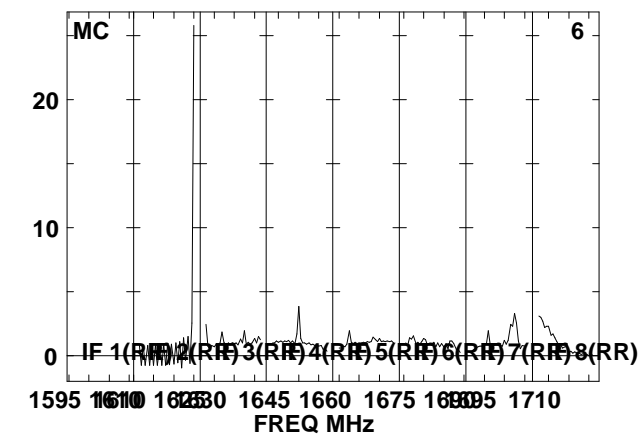
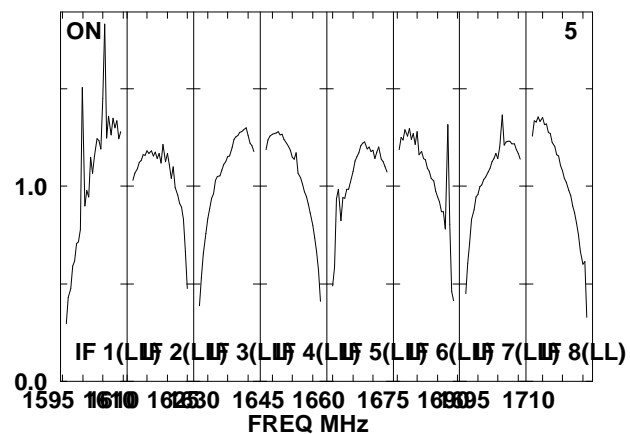
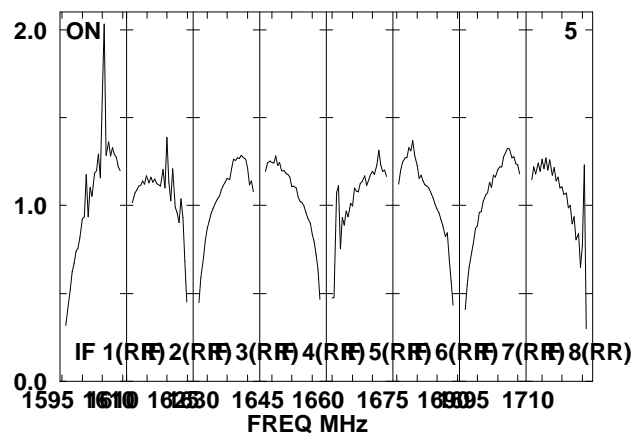
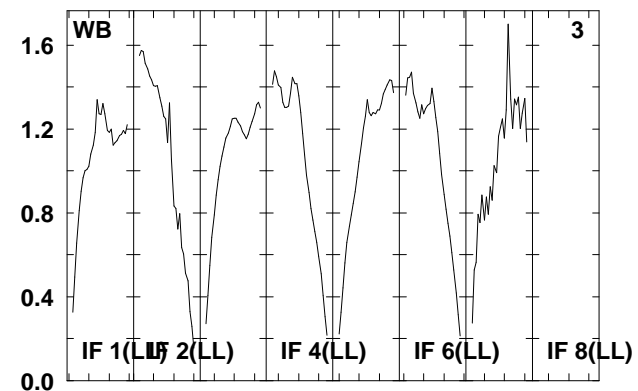
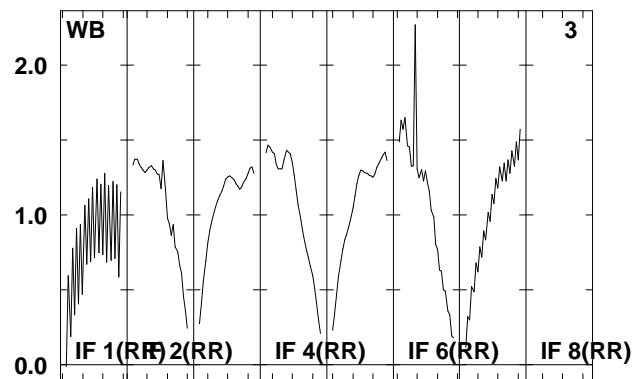
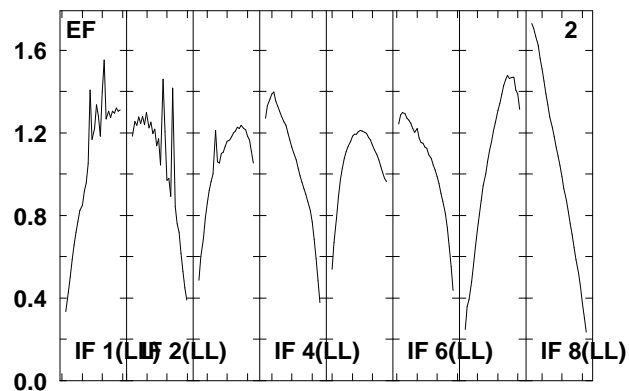
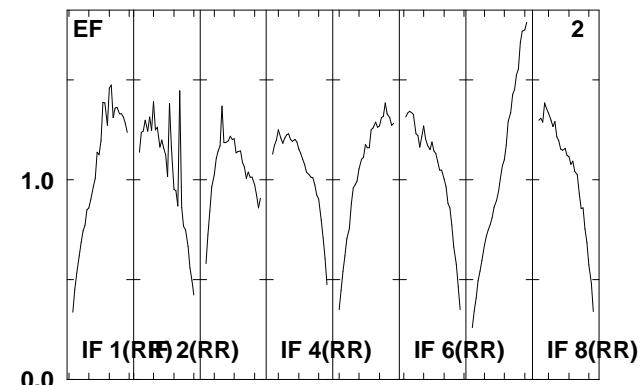
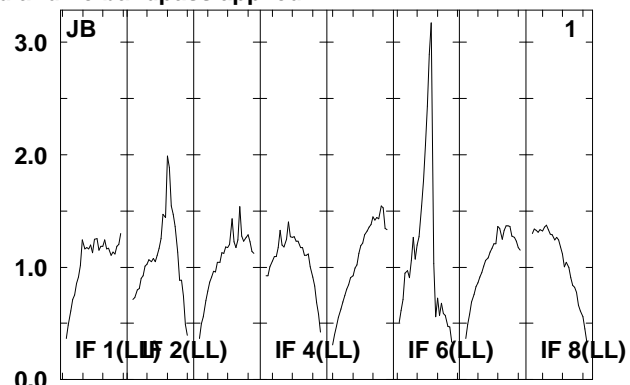
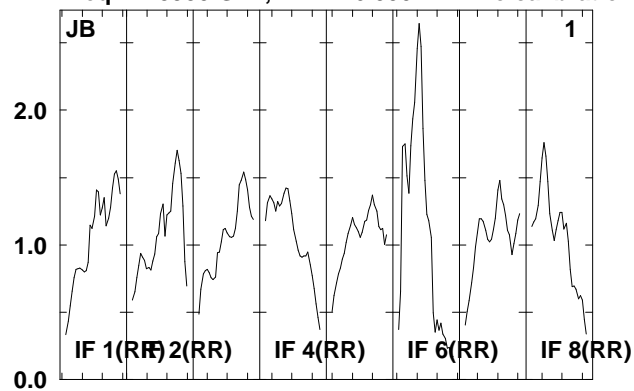

Lower frame: Real Jy
Total-power spectrum Antenna: *
Timerange: 00/08:21:32 to 00/08:24:58

Plot file version 30 created 18-APR-2008 18:27:16

IRAS2336 EP061A.UVDATA.1

Freq = 1.5950 GHz, Bw = 16.000 MH No calibration applied and no bandpass applied

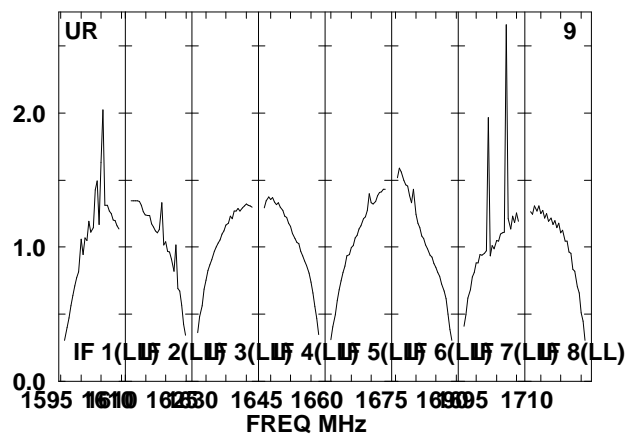
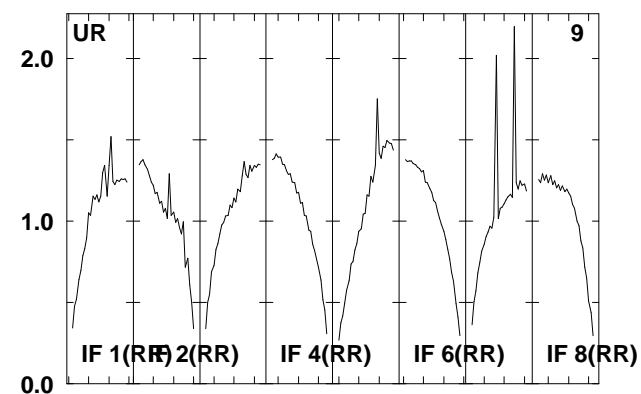
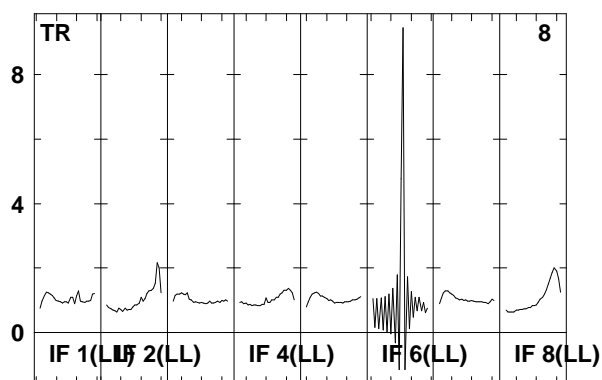
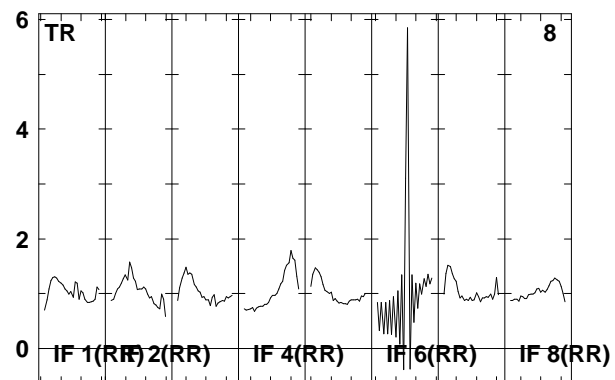
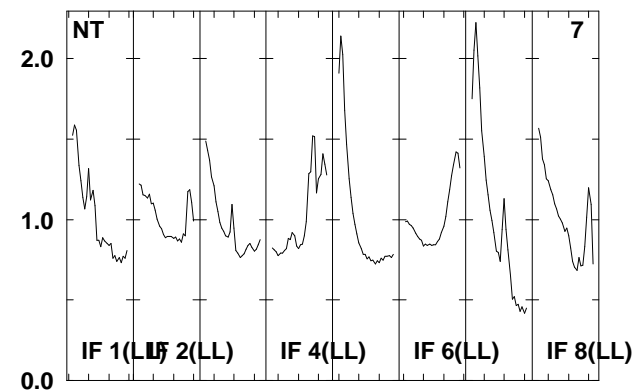
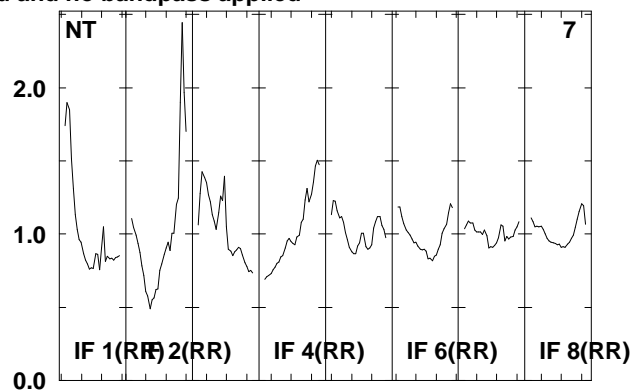
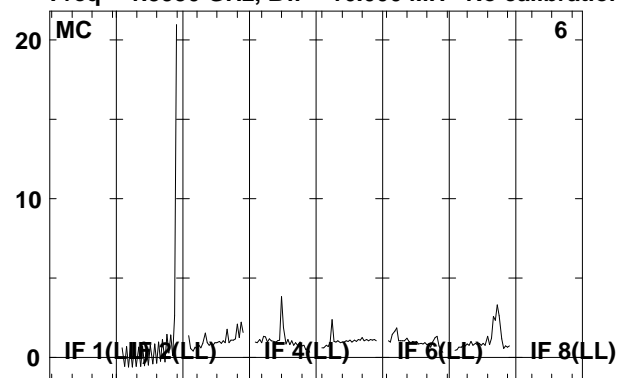

Lower frame: Real Jy

Total-power spectrum Antenna: *

Timerange: 00/08:21:32 to 00/08:24:58

Plot file version 31 created 18-APR-2008 18:27:17

J2333+39 EP061A.UVDATA.1

Freq = 1.5950 GHz, Bw = 16.000 MH No calibration applied and no bandpass applied

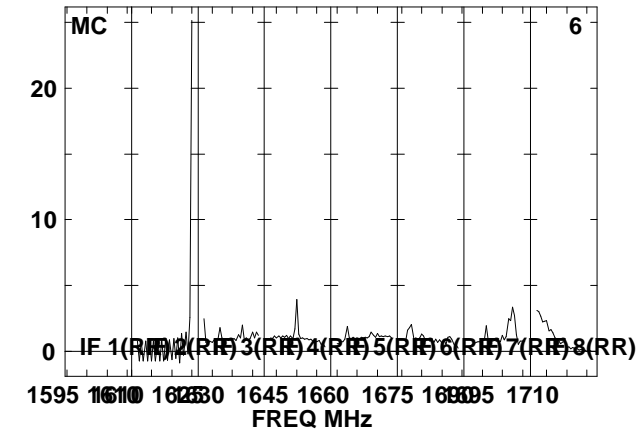
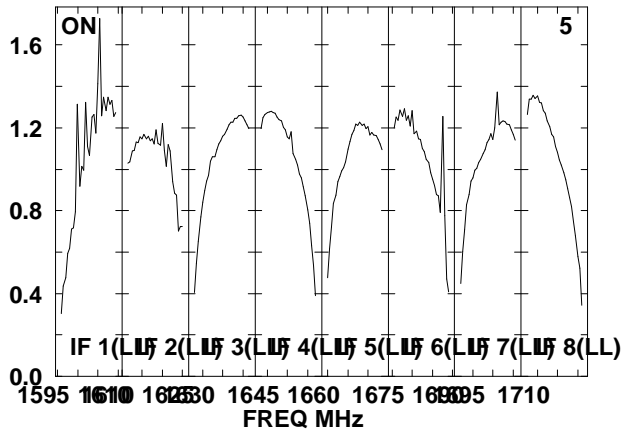
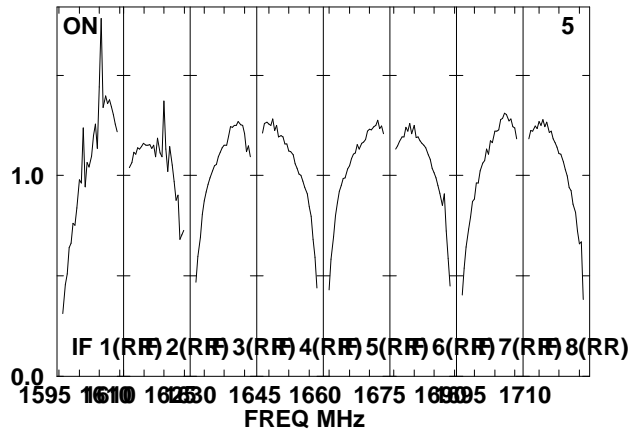
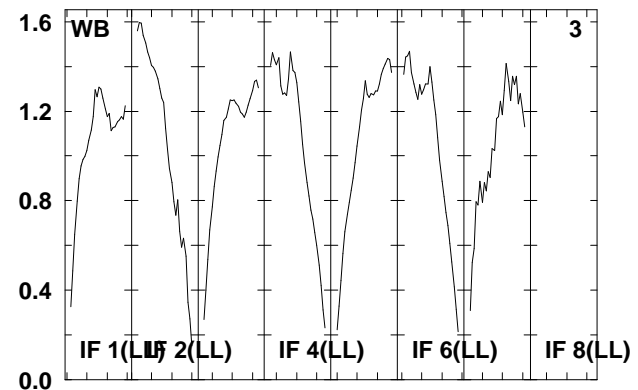
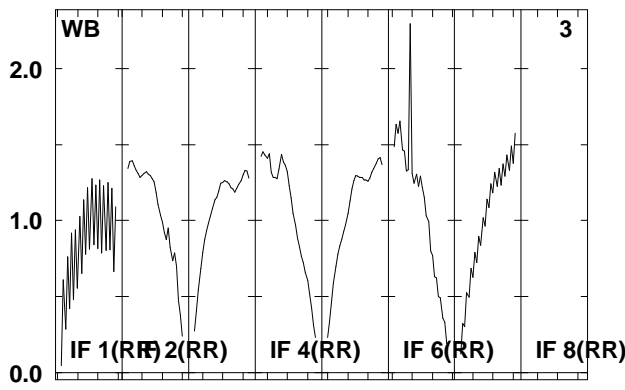
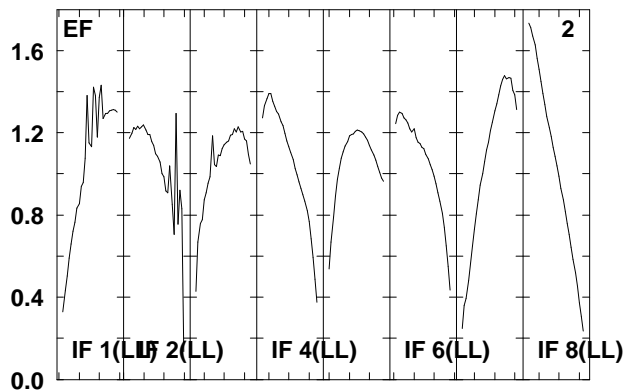
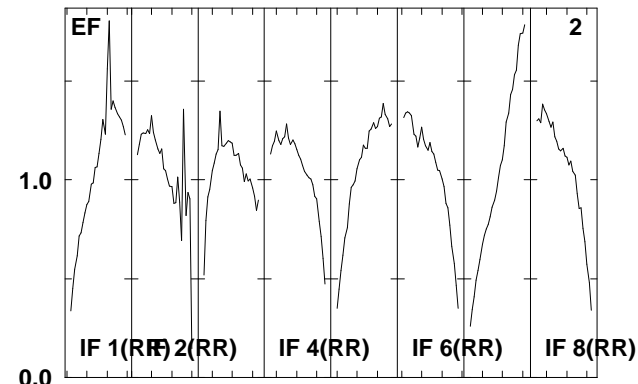
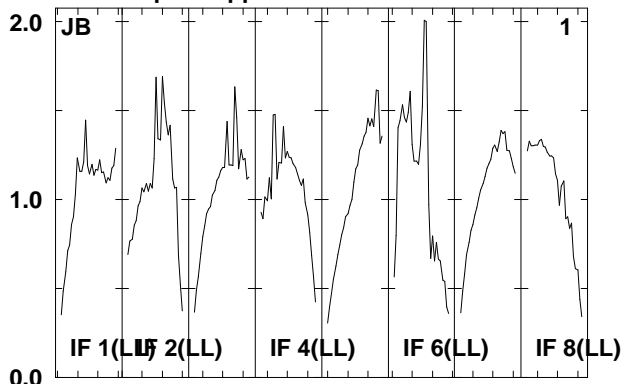
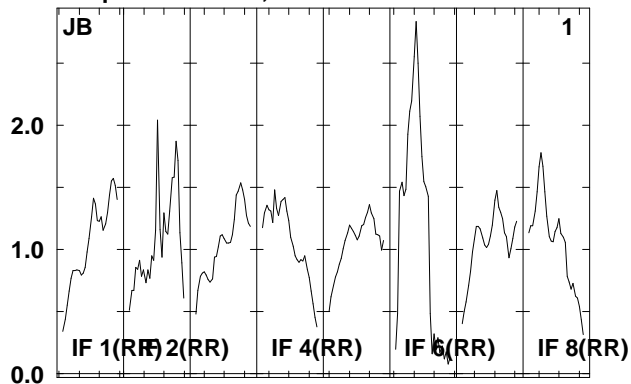

Lower frame: Real Jy
Total-power spectrum Antenna: *
Timerange: 00/08:26:02 to 00/08:27:30

Plot file version 32 created 18-APR-2008 18:27:17
 J2333+39 EP061A.UVDATA.1
 Freq = 1.5950 GHz, Bw = 16.000 MH No calibration applied and no bandpass applied

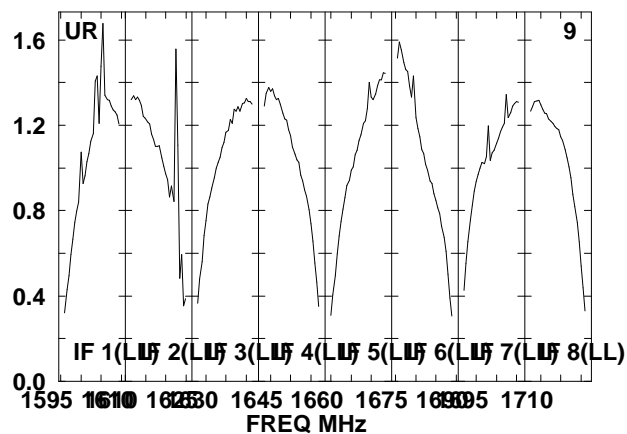
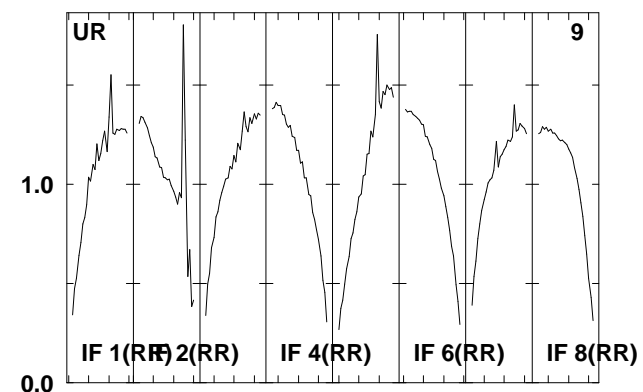
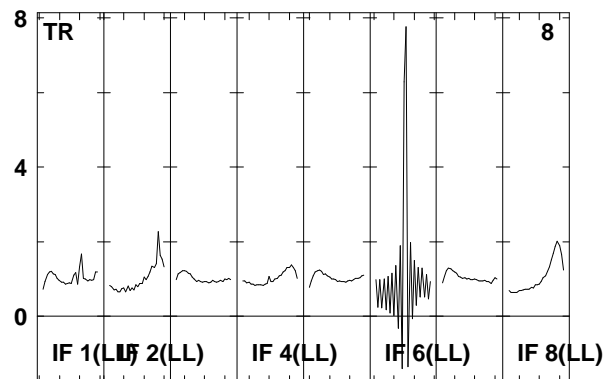
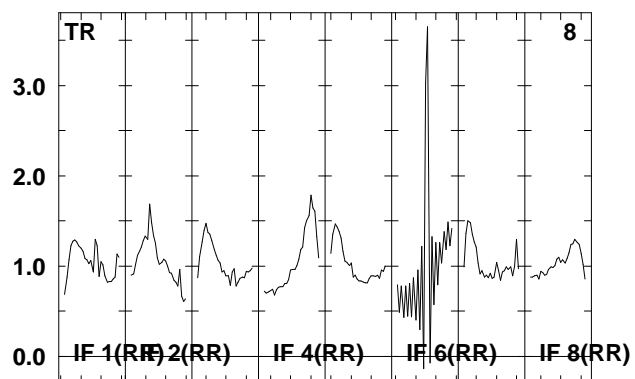
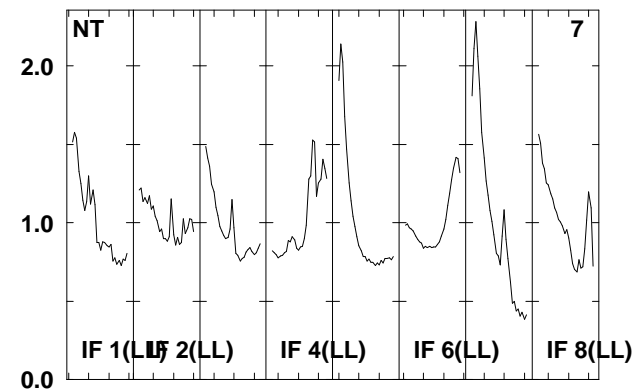
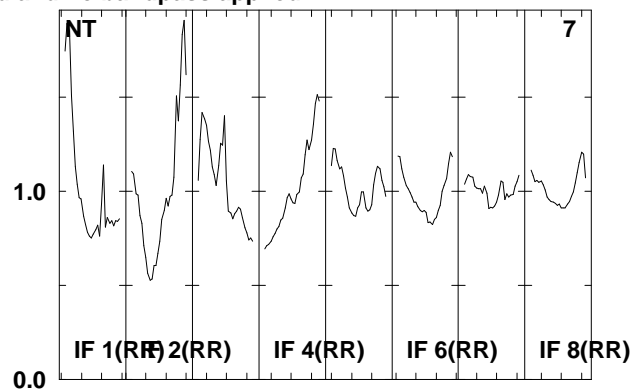
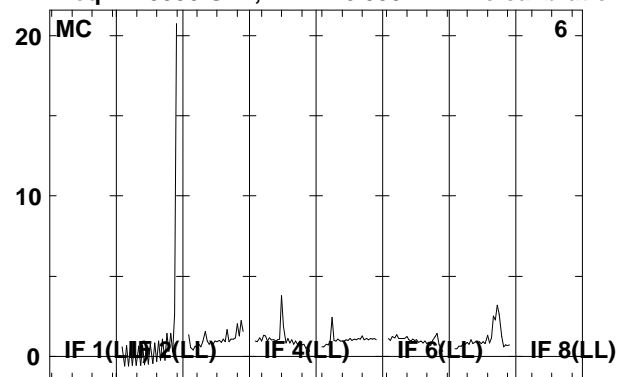

Lower frame: Real Jy
 Total-power spectrum Antenna: *
 Timerange: 00/08:26:02 to 00/08:27:30

Plot file version 33 created 18-APR-2008 18:27:17

IRAS2336 EP061A.UVDATA.1

Freq = 1.5950 GHz, Bw = 16.000 MH No calibration applied and no bandpass applied

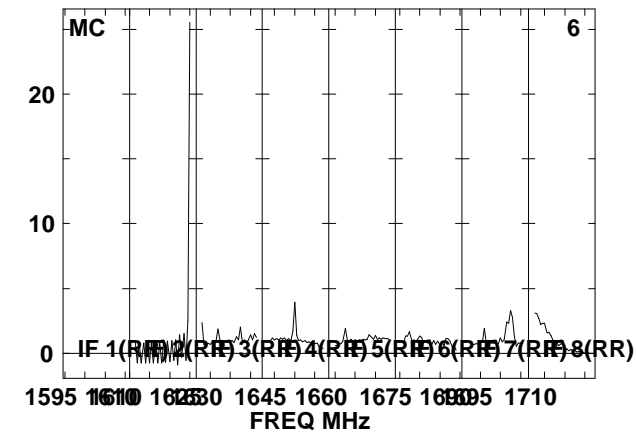
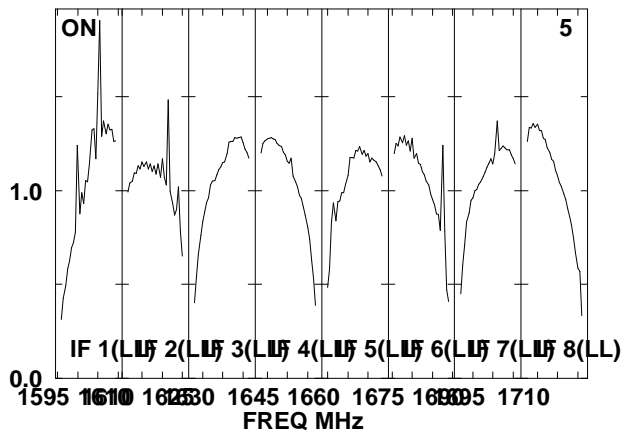
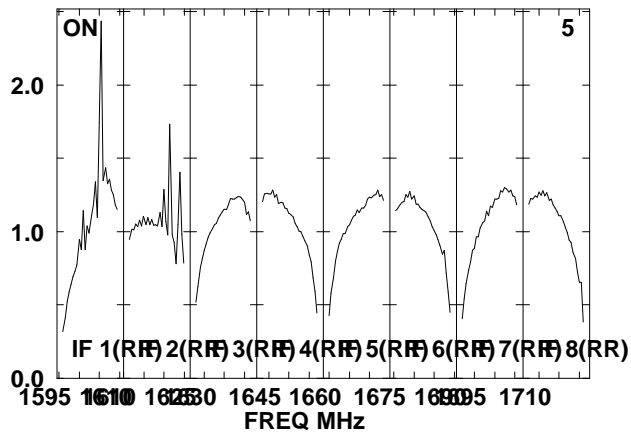
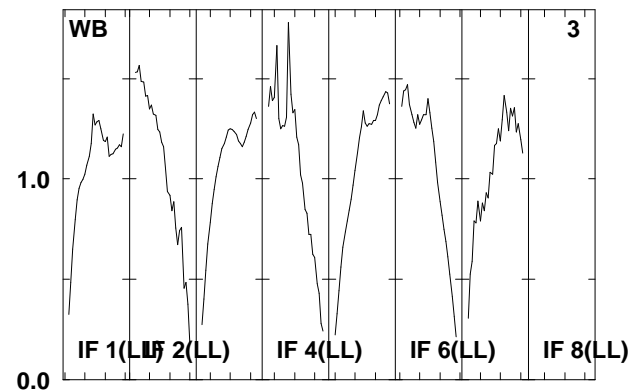
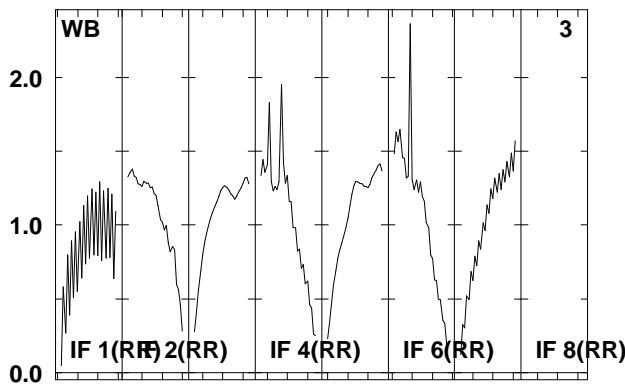
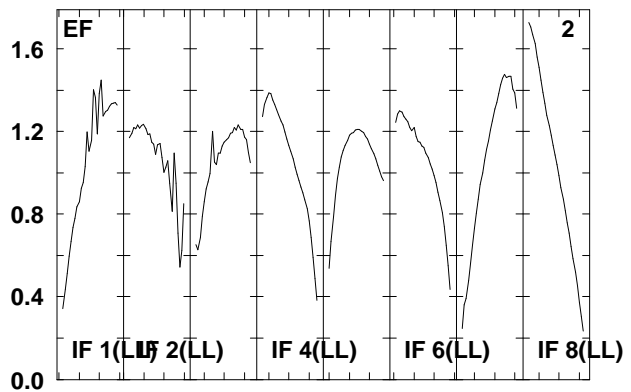
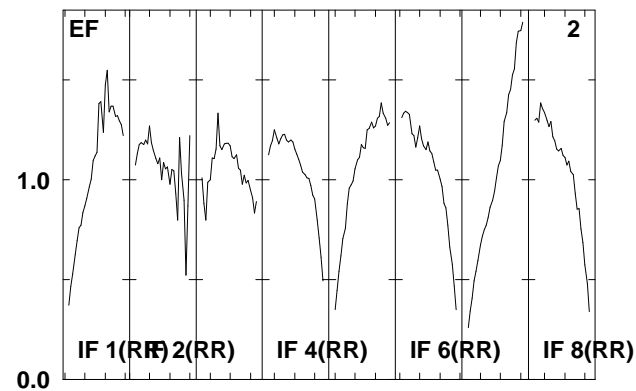
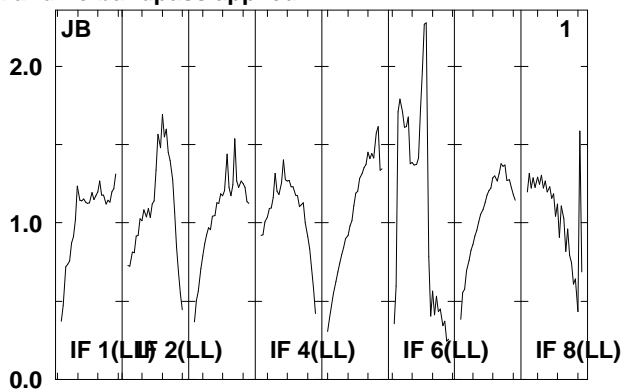
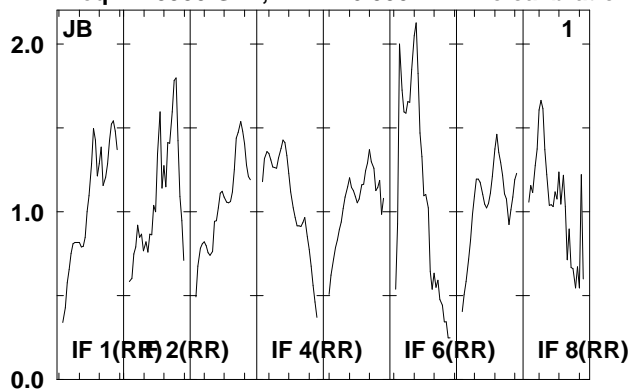

Lower frame: Real Jy
Total-power spectrum Antenna: *
Timerange: 00/08:27:32 to 00/08:31:00

Plot file version 34 created 18-APR-2008 18:27:18

IRAS2336 EP061A.UVDATA.1

Freq = 1.5950 GHz, Bw = 16.000 MH No calibration applied and no bandpass applied

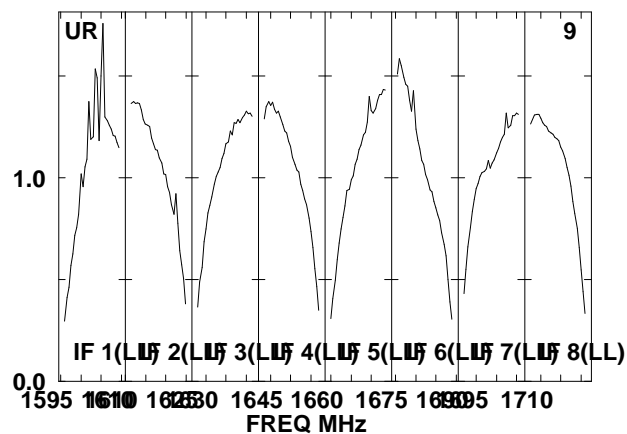
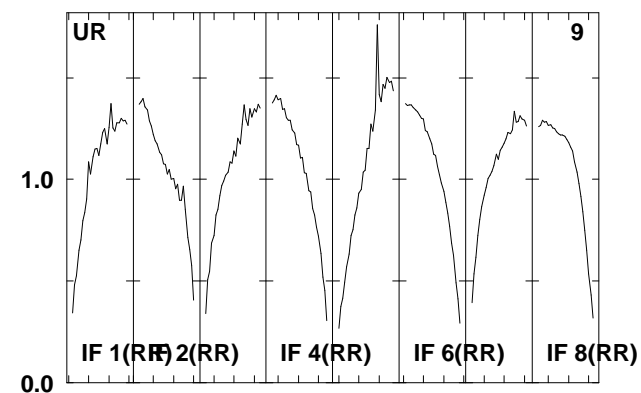
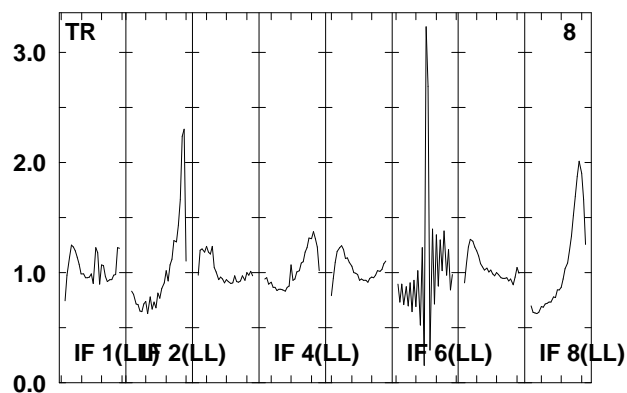
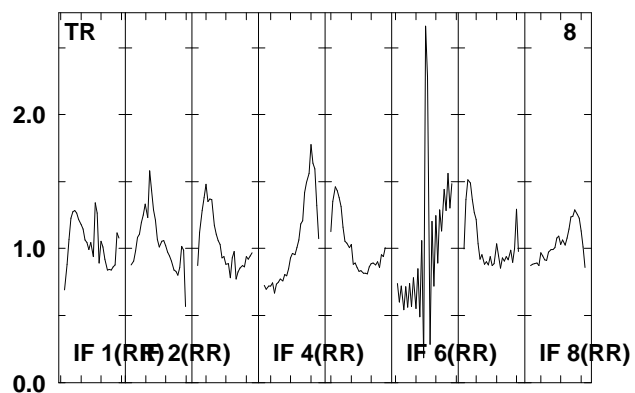
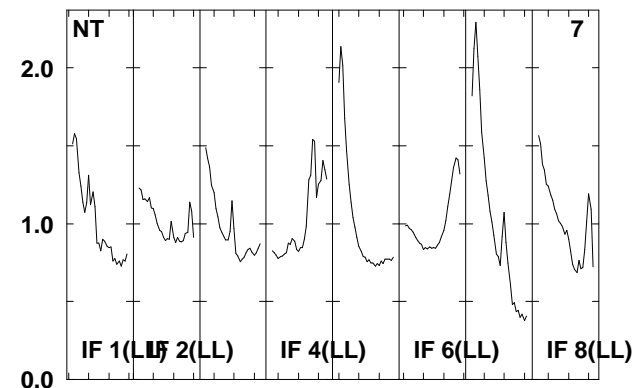
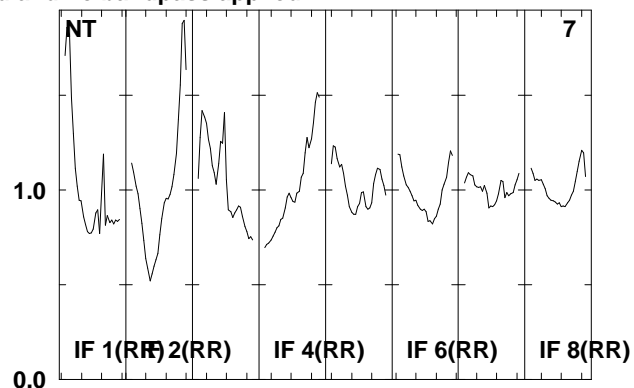
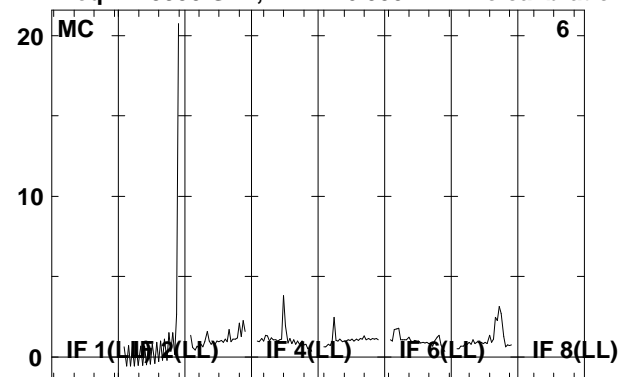

Lower frame: Real Jy

Total-power spectrum Antenna: *

Timerange: 00/08:27:32 to 00/08:31:00

Plot file version 35 created 18-APR-2008 18:27:20

J2333+39 EP061A.UVDATA.1

Freq = 1.5950 GHz, Bw = 16.000 MH No calibration applied and no bandpass applied

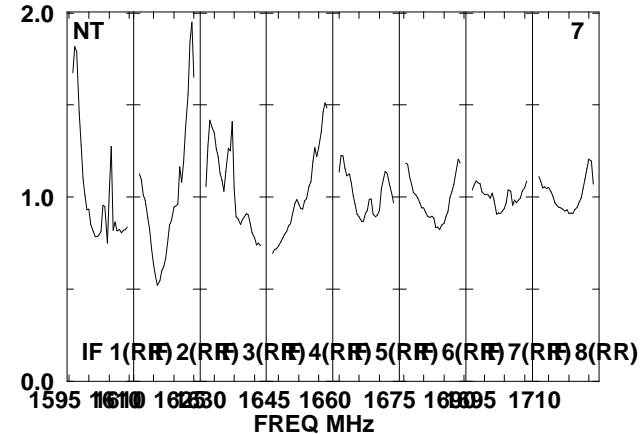
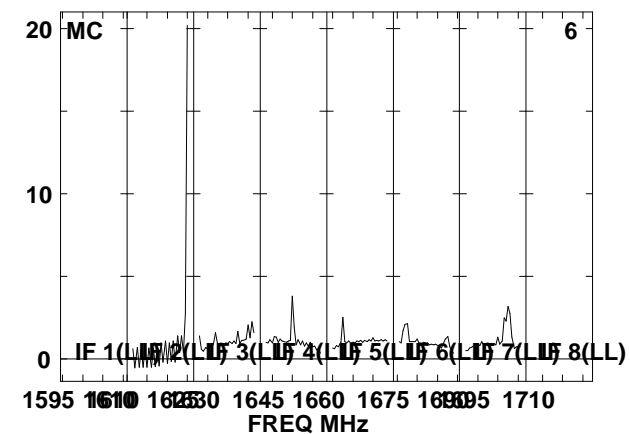
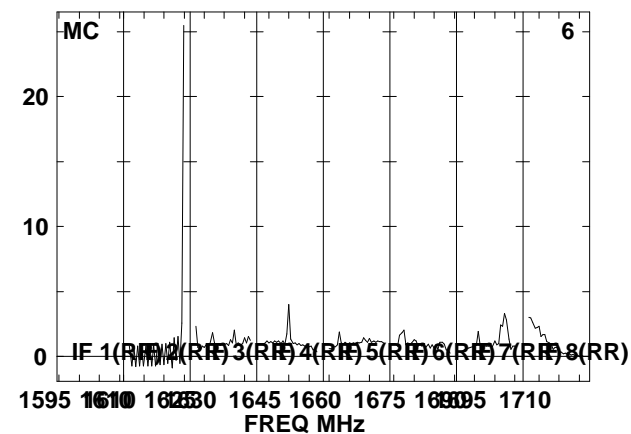
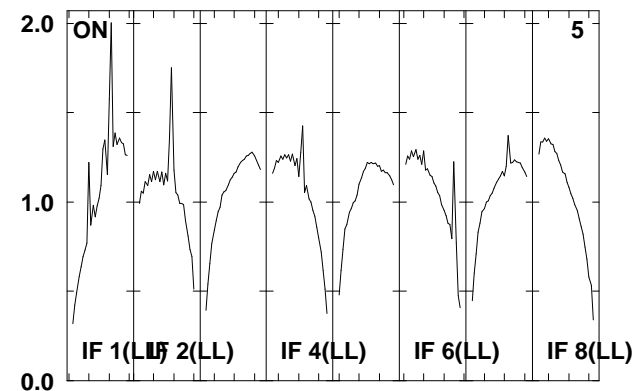
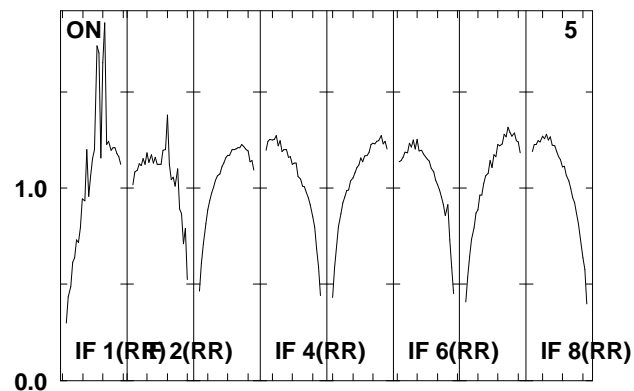
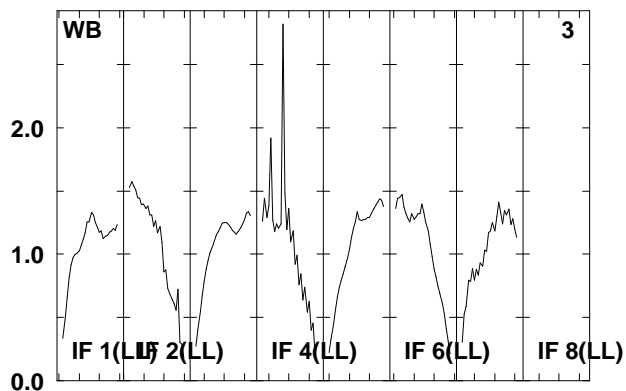
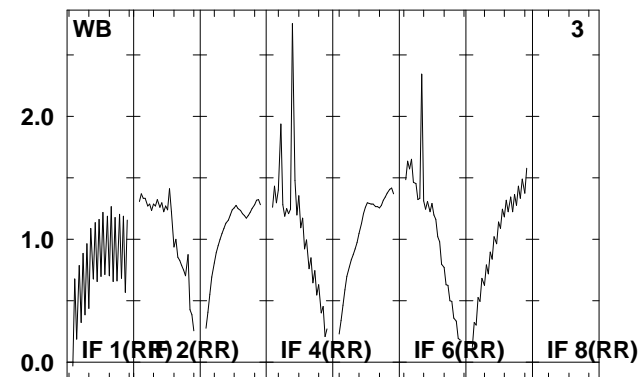
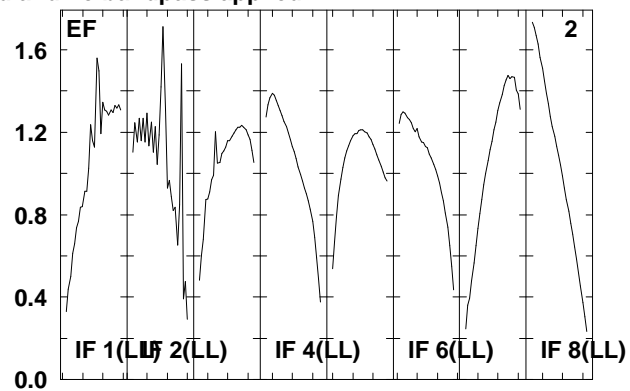
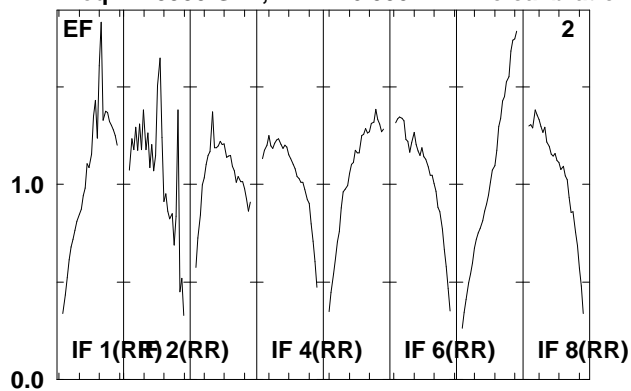

Lower frame: Real Jy
Total-power spectrum Antenna: *
Timerange: 00/08:31:02 to 00/08:32:28

Plot file version 36 created 18-APR-2008 18:27:20

J2333+39 EP061A.UVDATA.1

Freq = 1.5950 GHz, Bw = 16.000 MH No calibration applied and no bandpass applied

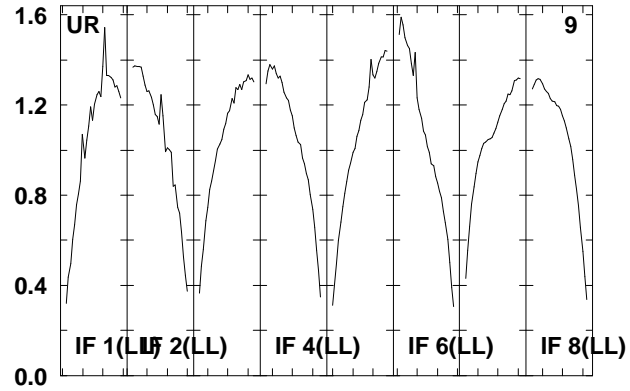
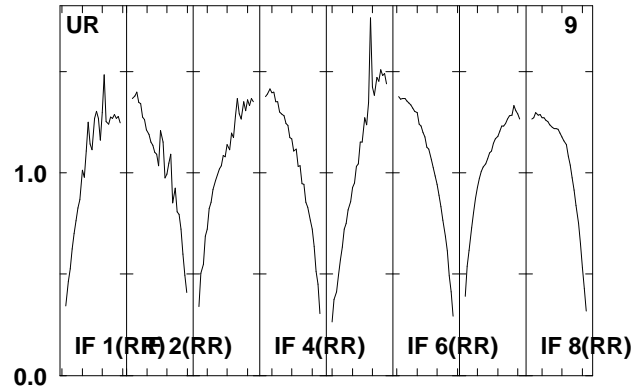
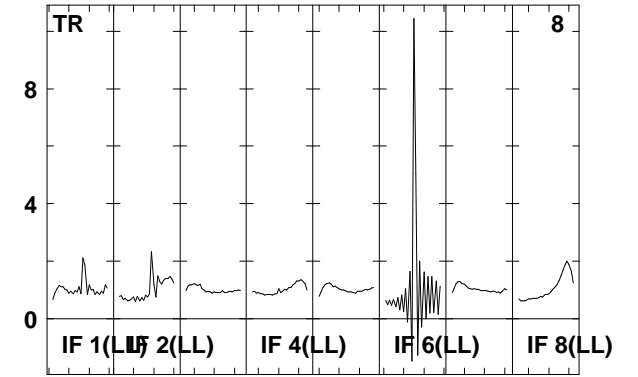
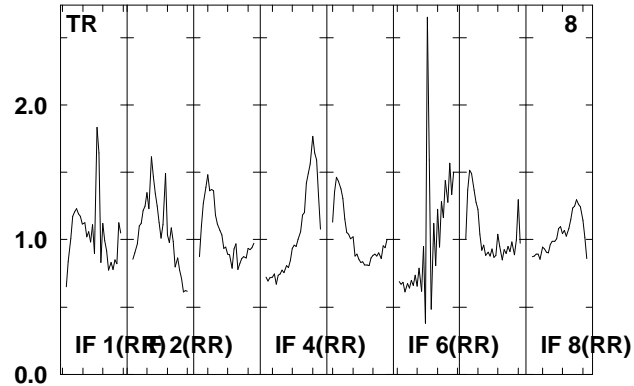
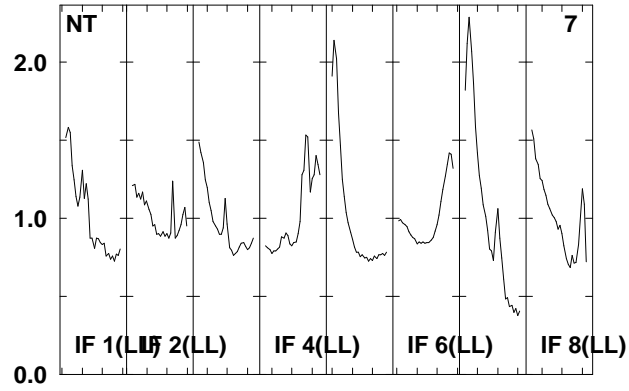

Lower frame: Real Jy
Total-power spectrum Antenna: *
Timerange: 00/08:31:02 to 00/08:32:28

Plot file version 37 created 18-APR-2008 18:27:21

IRAS2336 EP061A.UVDATA.1

Freq = 1.5950 GHz, Bw = 16.000 MH No calibration applied and no bandpass applied

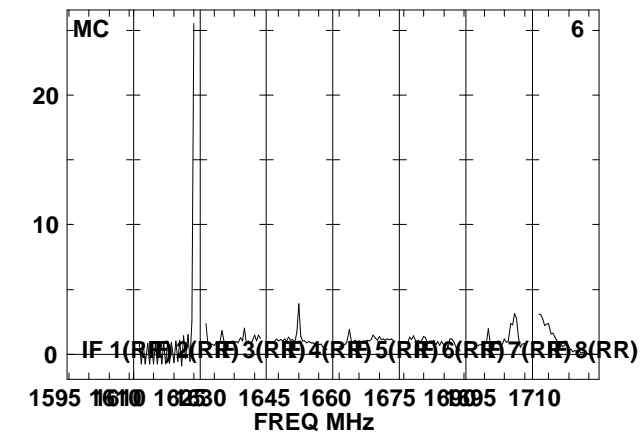
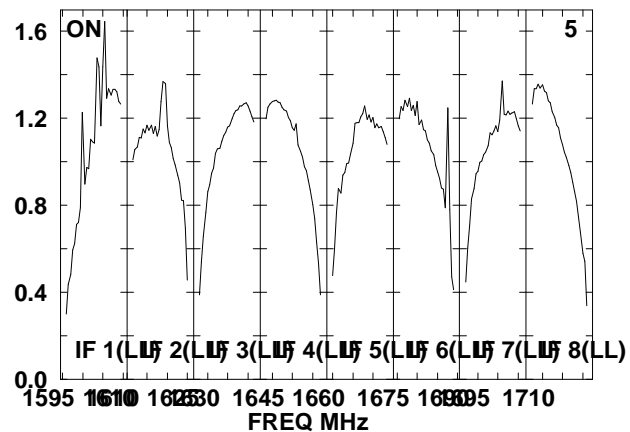
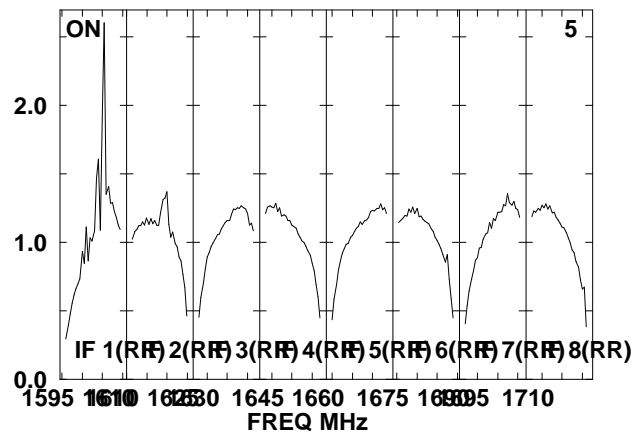
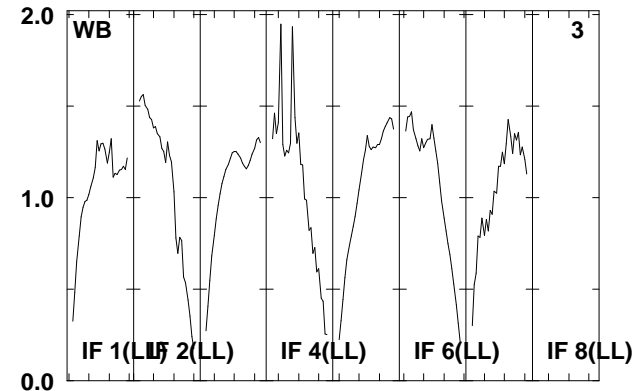
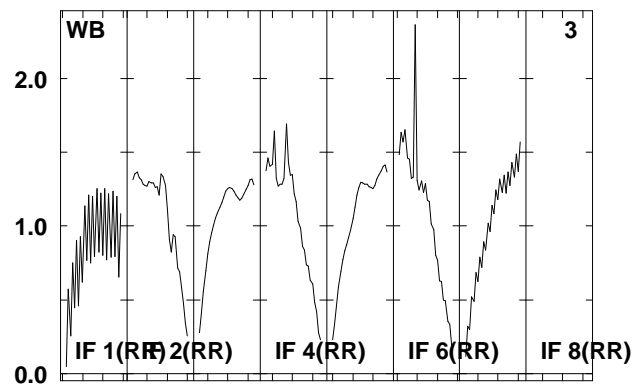
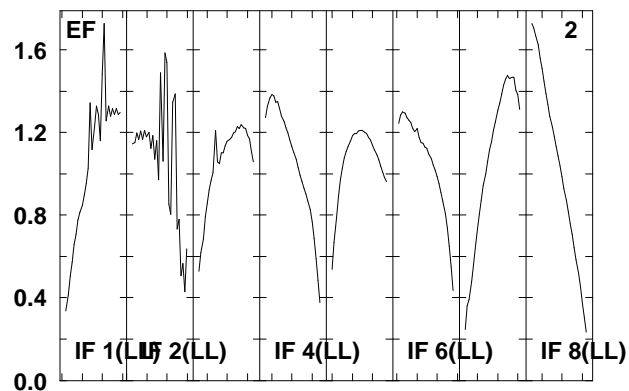
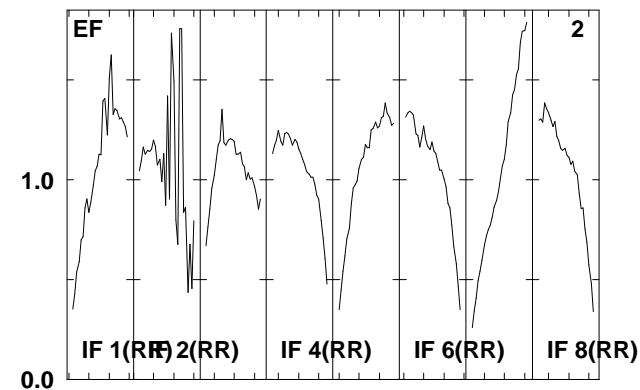
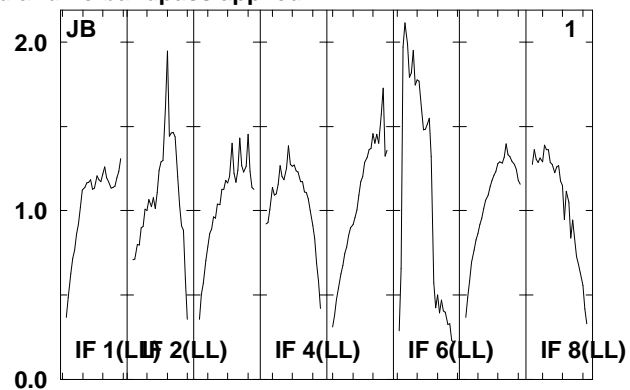
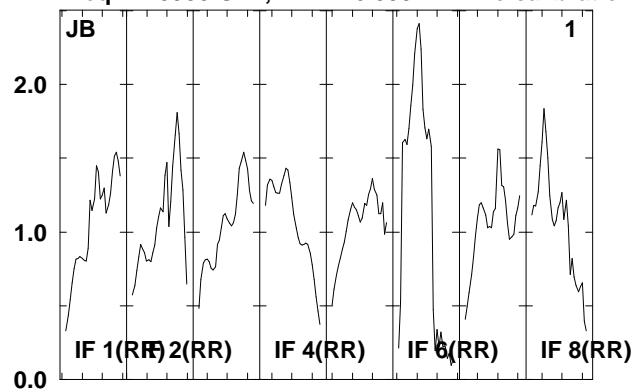

Lower frame: Real Jy
Total-power spectrum Antenna: *
Timerange: 00/08:32:30 to 00/08:36:00

Plot file version 38 created 18-APR-2008 18:27:22

IRAS2336 EP061A.UVDATA.1

Freq = 1.5950 GHz, Bw = 16.000 MH No calibration applied and no bandpass applied

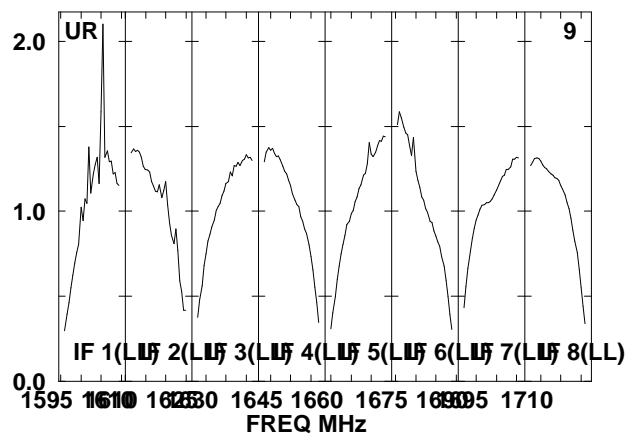
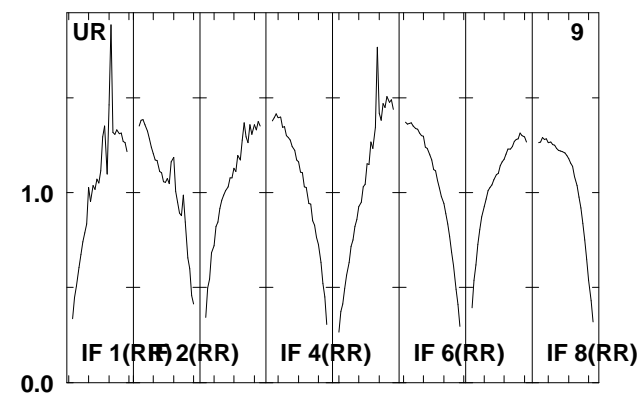
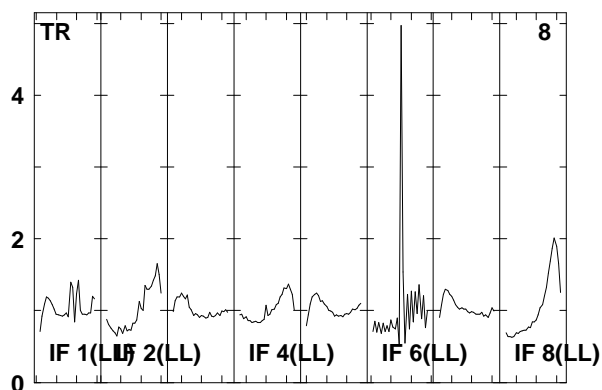
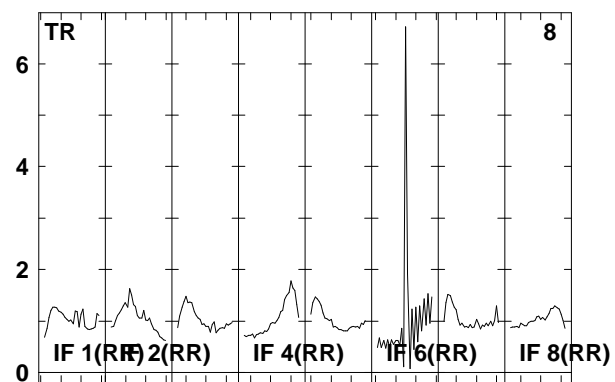
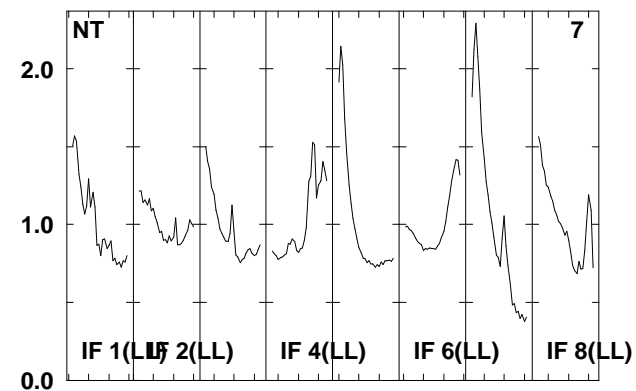
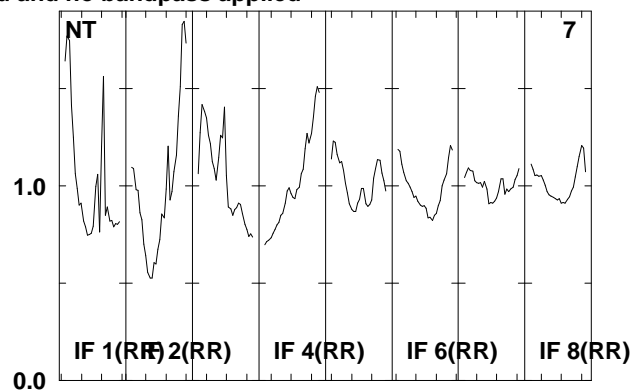
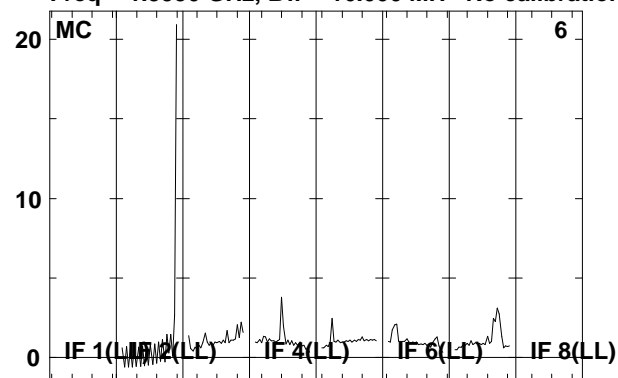

Lower frame: Real Jy

Total-power spectrum Antenna: *

Timerange: 00/08:32:30 to 00/08:36:00

Plot file version 39 created 18-APR-2008 18:27:23

J2333+39 EP061A.UVDATA.1

Freq = 1.5950 GHz, Bw = 16.000 MH No calibration applied and no bandpass applied

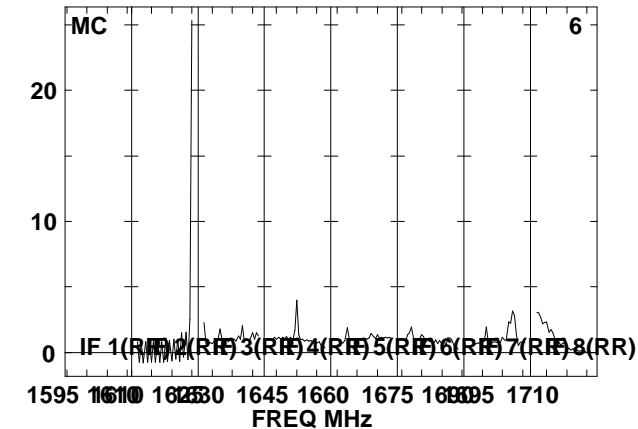
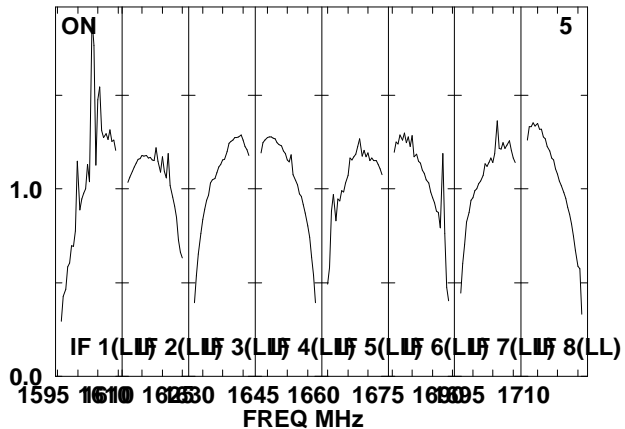
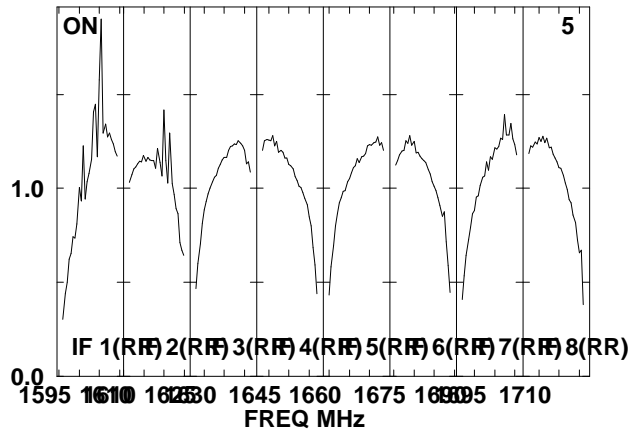
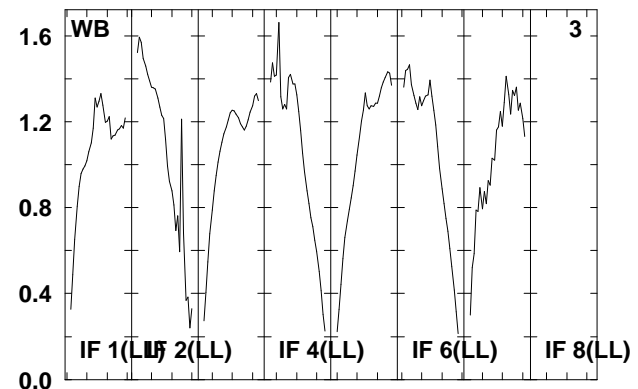
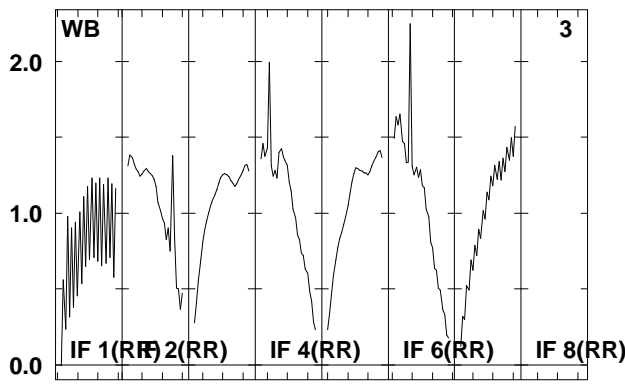
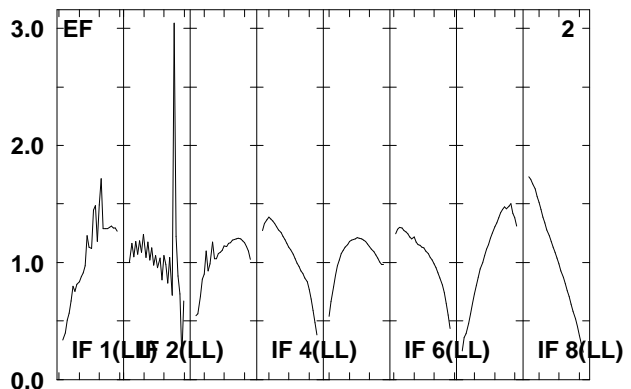
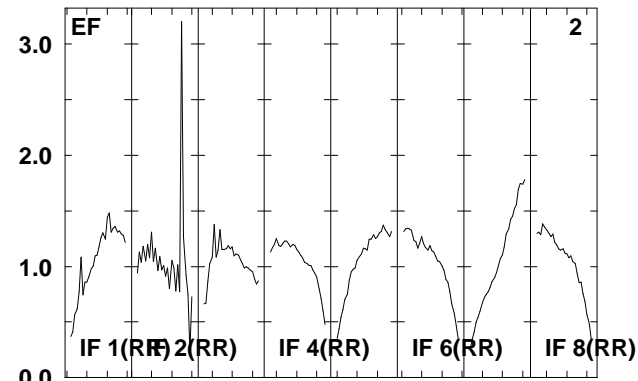
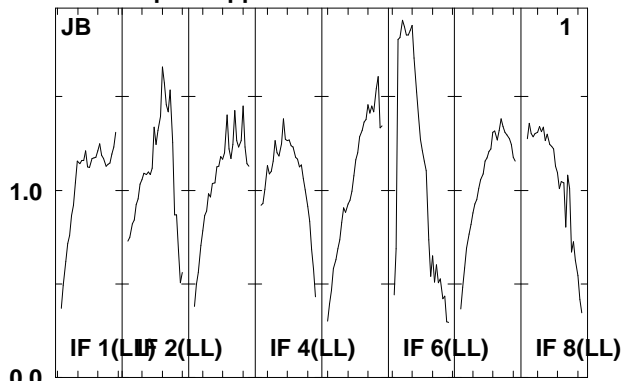
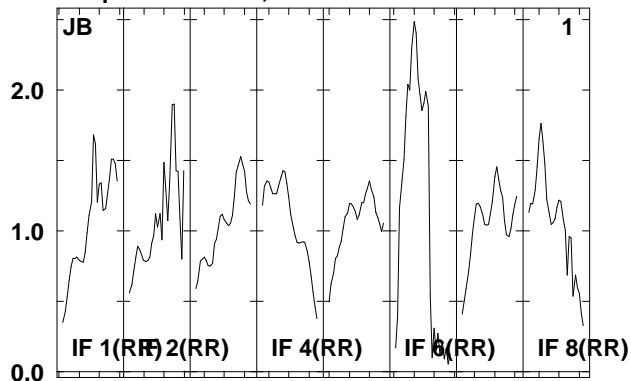

Lower frame: Real Jy

Total-power spectrum Antenna: *

Timerange: 00/08:36:02 to 00/08:37:30

Plot file version 40 created 18-APR-2008 18:27:23
 J2333+39 EP061A.UVDATA.1
 Freq = 1.5950 GHz, Bw = 16.000 MH No calibration applied and no bandpass applied

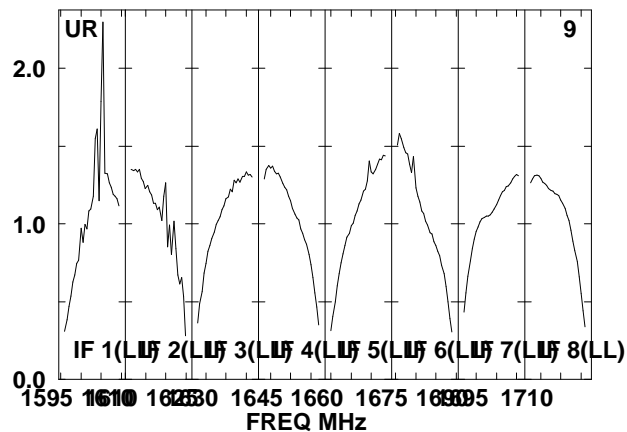
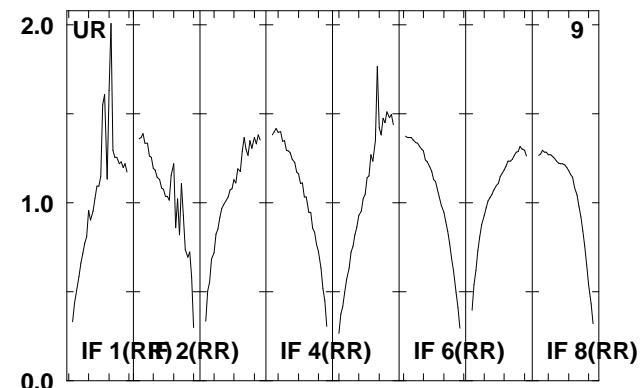
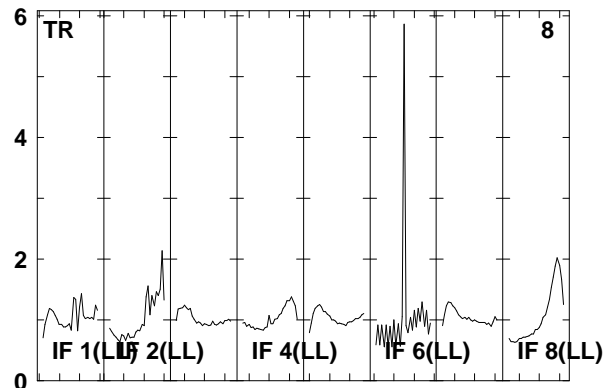
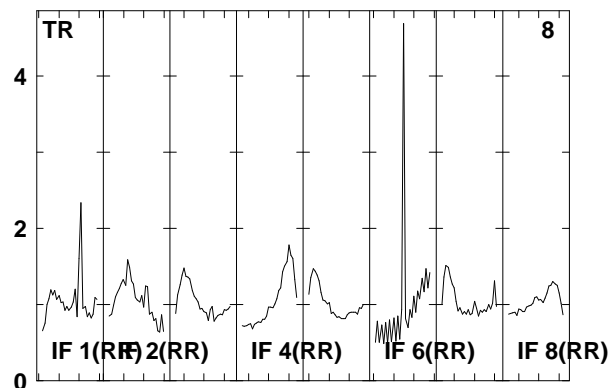
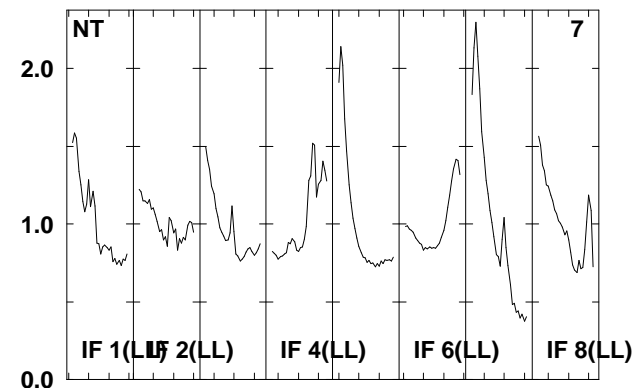
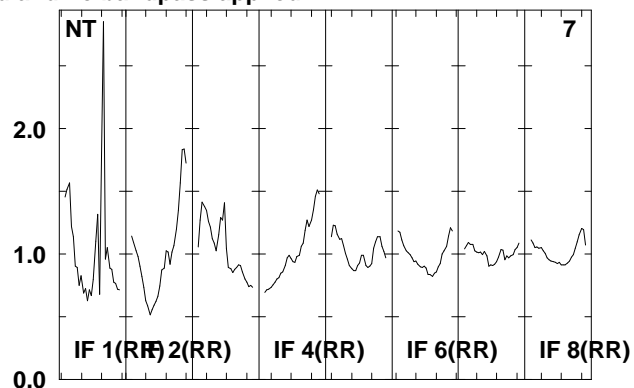
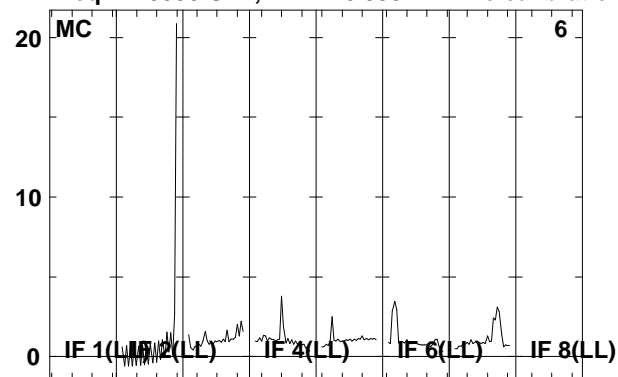

Lower frame: Real Jy
 Total-power spectrum Antenna: *
 Timerange: 00/08:36:02 to 00/08:37:30

Plot file version 41 created 18-APR-2008 18:27:24

IRAS2336 EP061A.UVDATA.1

Freq = 1.5950 GHz, Bw = 16.000 MH No calibration applied and no bandpass applied

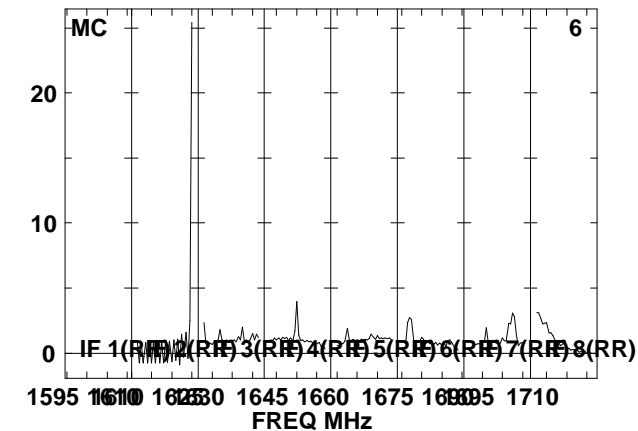
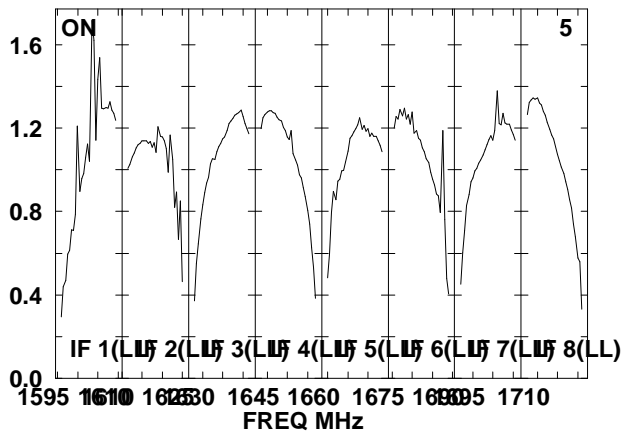
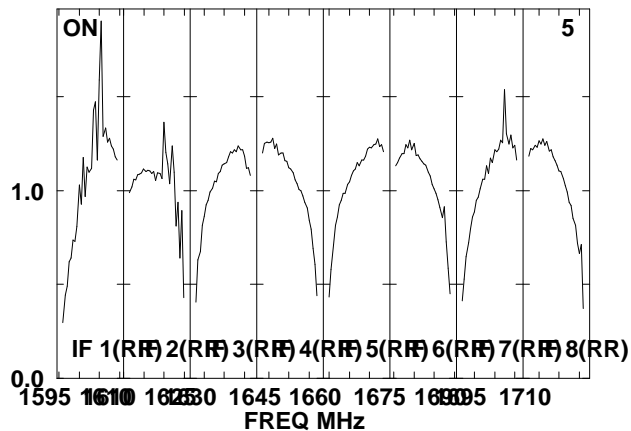
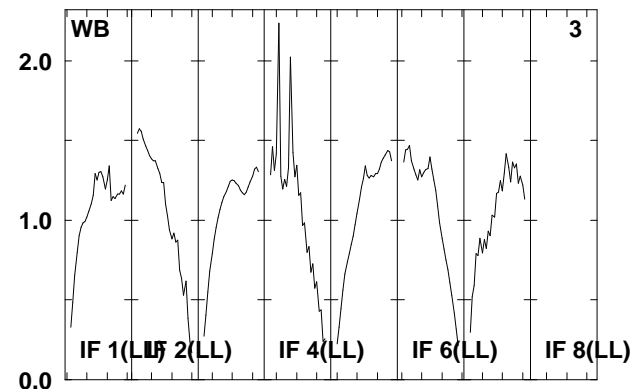
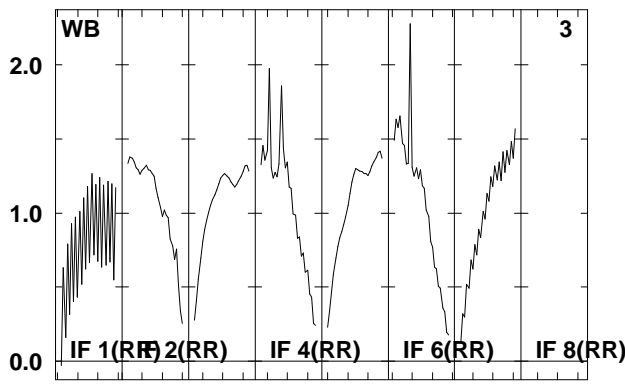
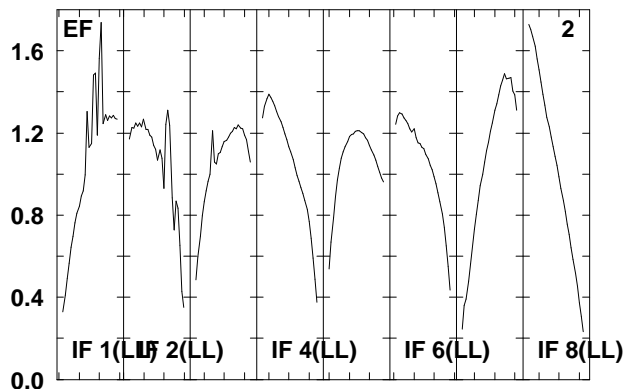
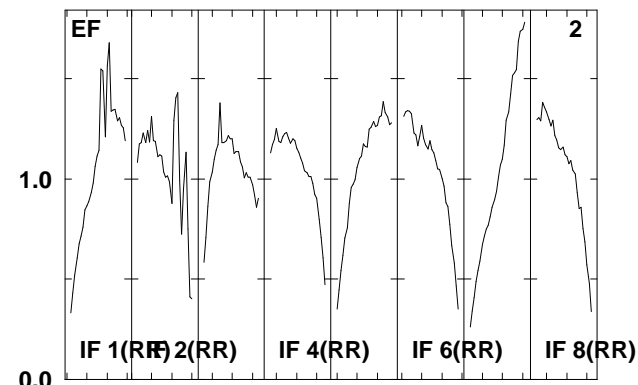
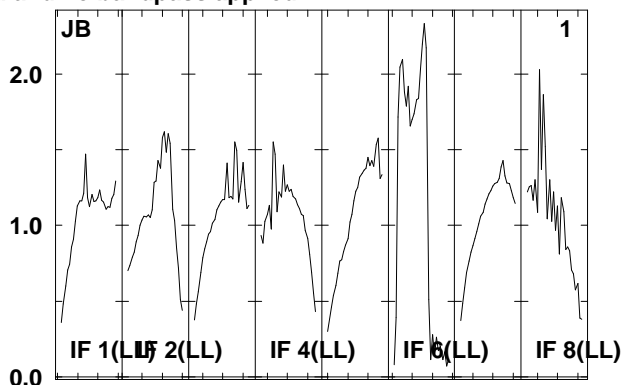
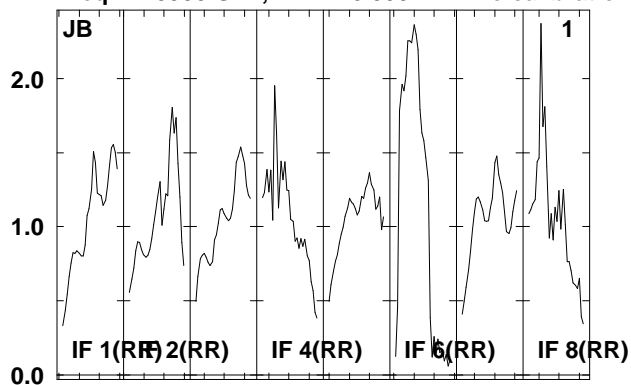

Lower frame: Real Jy

Total-power spectrum Antenna: *

Timerange: 00/08:37:38 to 00/08:40:56

Plot file version 42 created 18-APR-2008 18:27:25

IRAS2336 EP061A.UVDATA.1

Freq = 1.5950 GHz, Bw = 16.000 MH No calibration applied and no bandpass applied

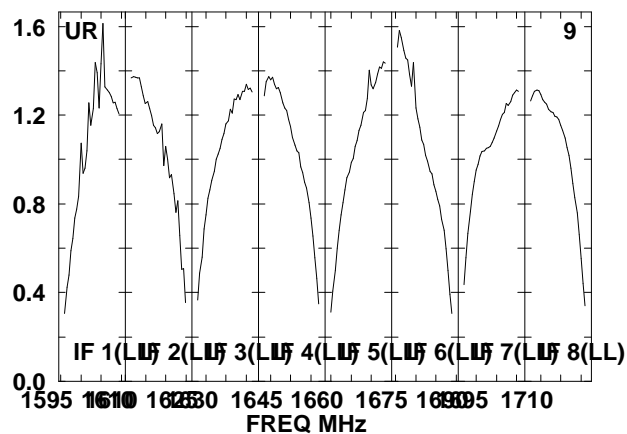
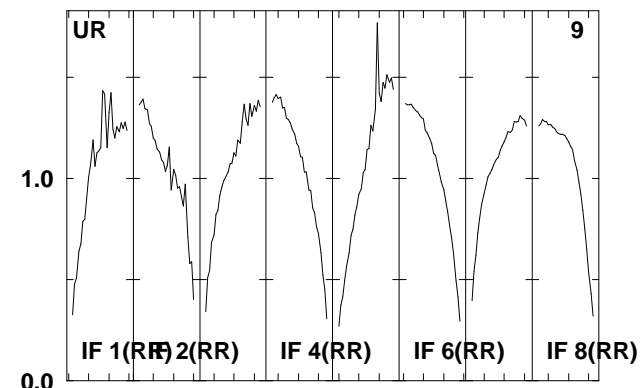
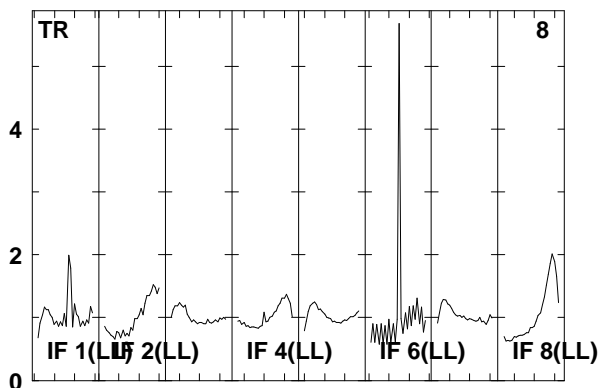
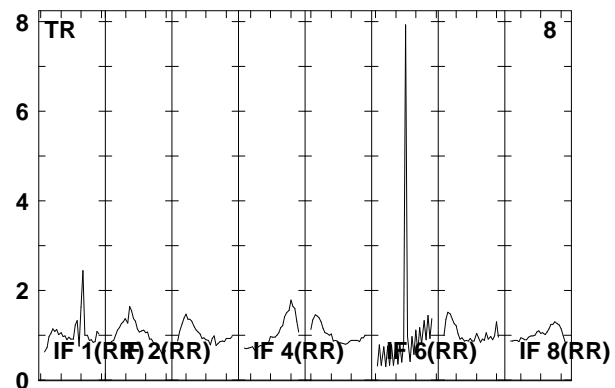
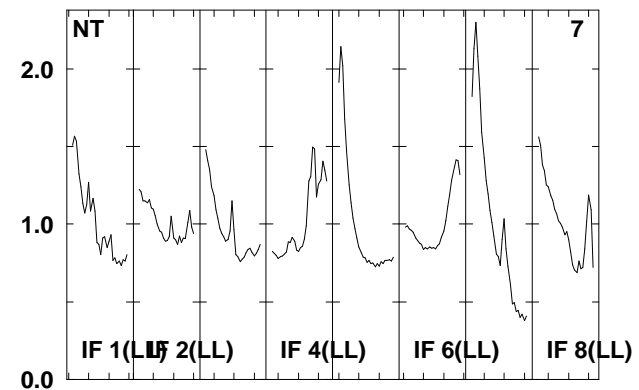
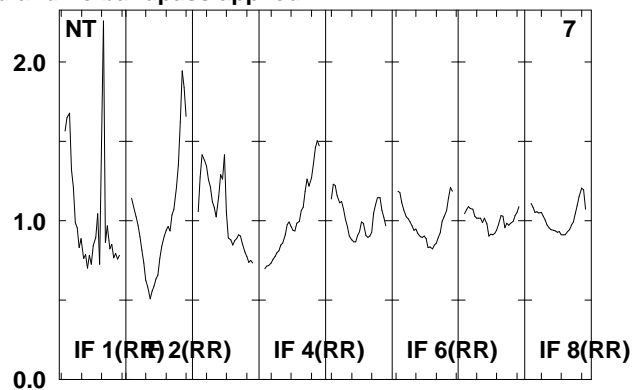
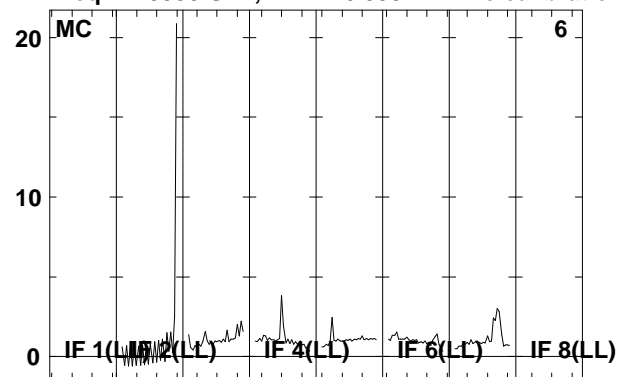

Lower frame: Real Jy

Total-power spectrum Antenna: *

Timerange: 00/08:37:38 to 00/08:40:56

Plot file version 43 created 18-APR-2008 18:27:26

J2333+39 EP061A.UVDATA.1

Freq = 1.5950 GHz, Bw = 16.000 MH No calibration applied and no bandpass applied

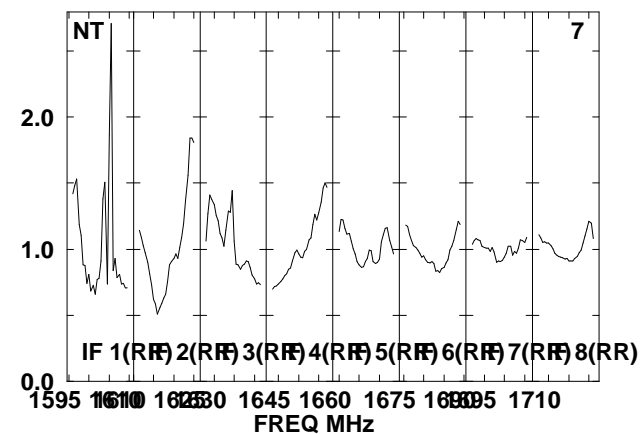
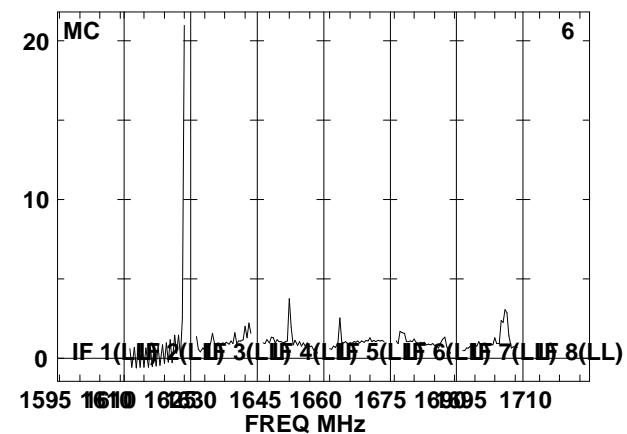
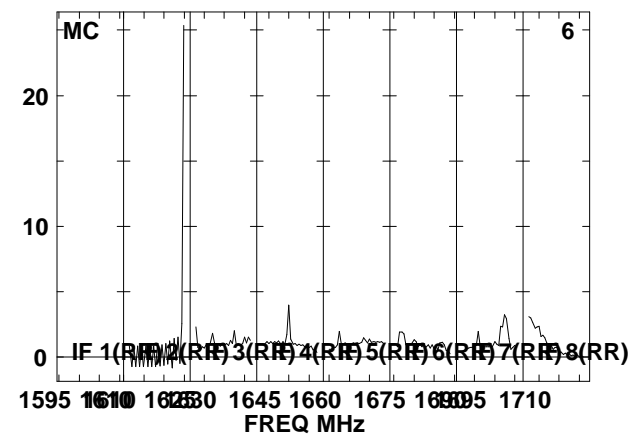
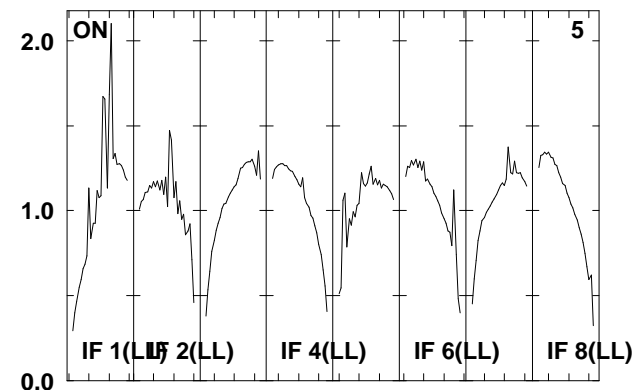
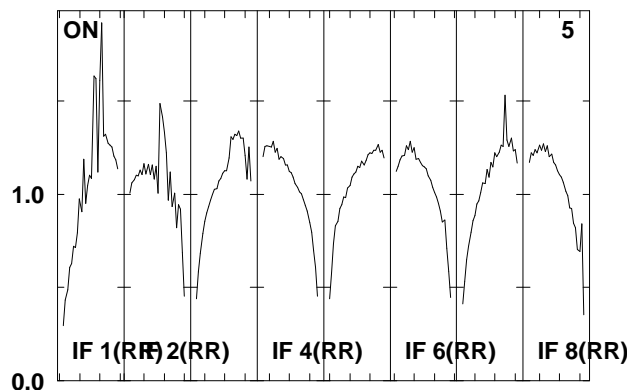
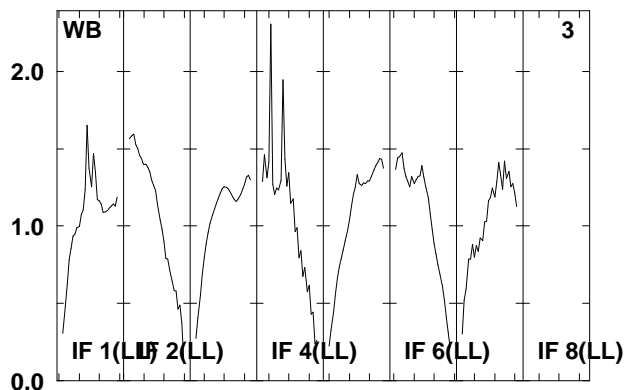
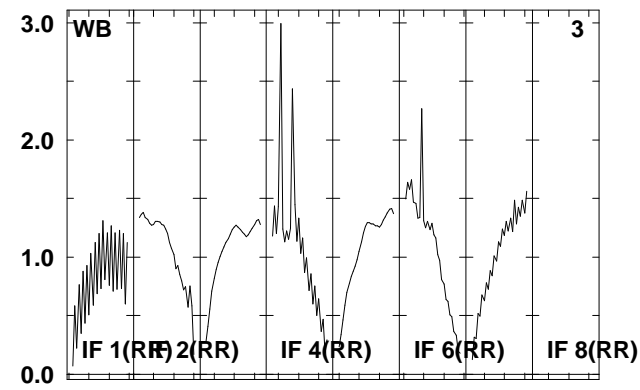
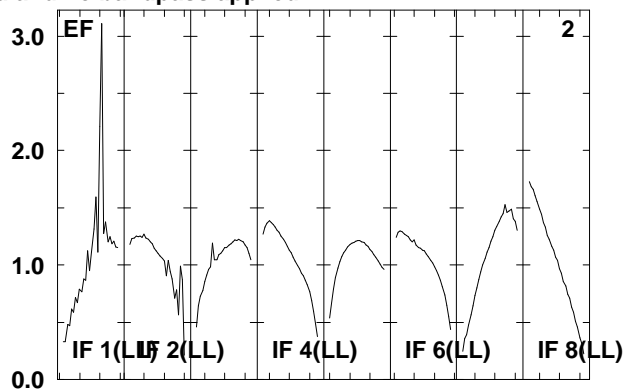
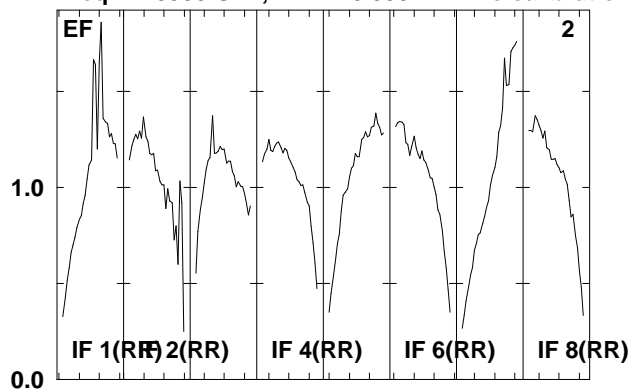

Lower frame: Real Jy
Total-power spectrum Antenna: *
Timerange: 00/08:42:02 to 00/08:43:28

Plot file version 44 created 18-APR-2008 18:27:26

J2333+39 EP061A.UVDATA.1

Freq = 1.5950 GHz, Bw = 16.000 MH No calibration applied and no bandpass applied

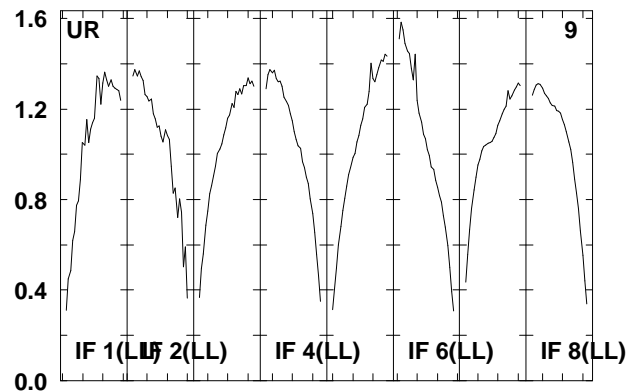
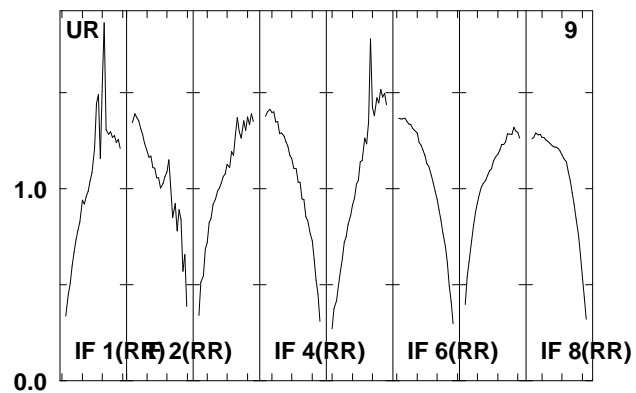
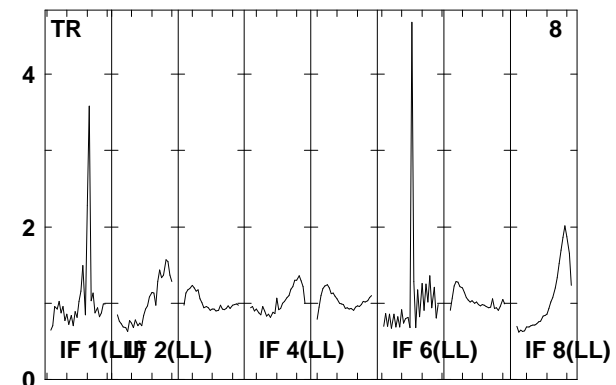
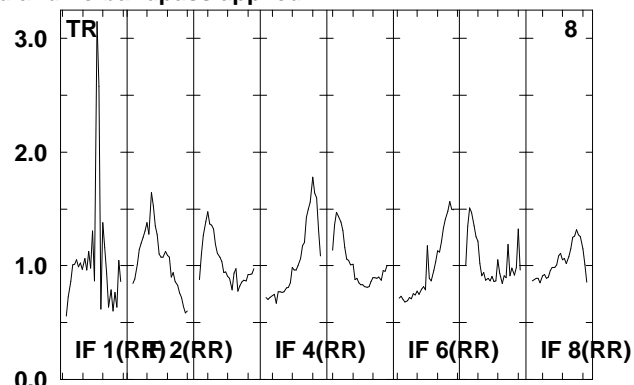
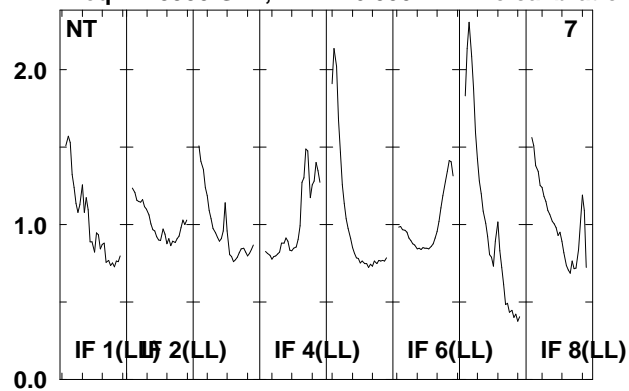

Lower frame: Real Jy
Total-power spectrum Antenna: *
Timerange: 00/08:42:02 to 00/08:43:28

Plot file version 45 created 18-APR-2008 18:27:27

IRAS2336 EP061A.UVDATA.1

Freq = 1.5950 GHz, Bw = 16.000 MH No calibration applied and no bandpass applied

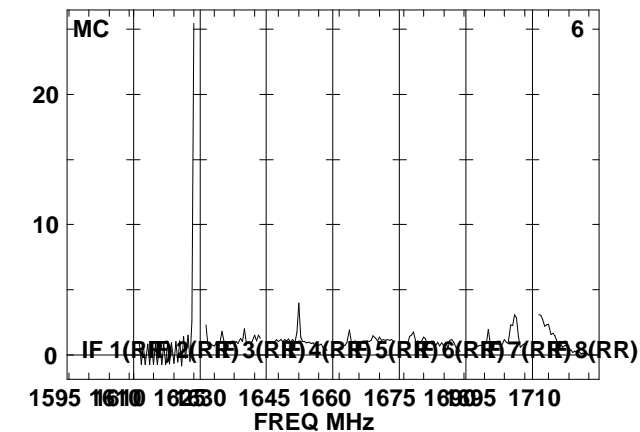
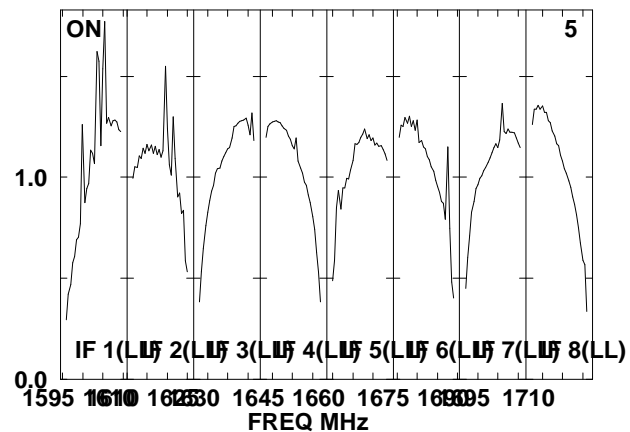
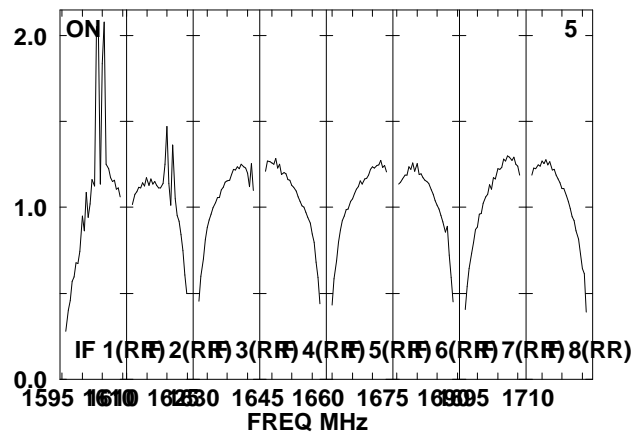
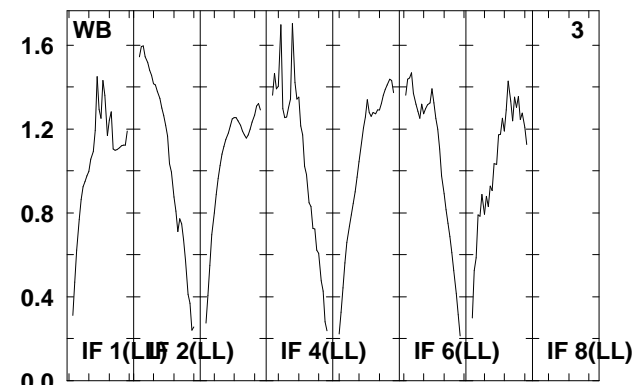
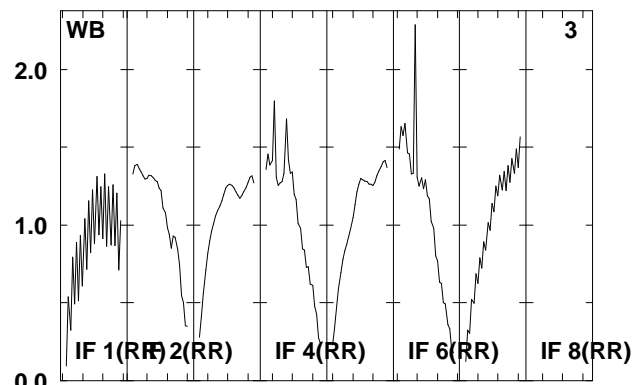
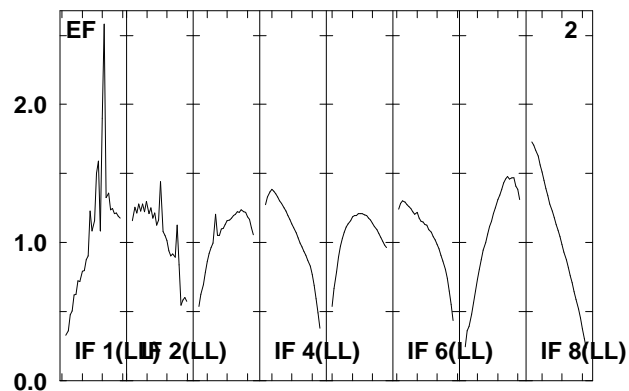
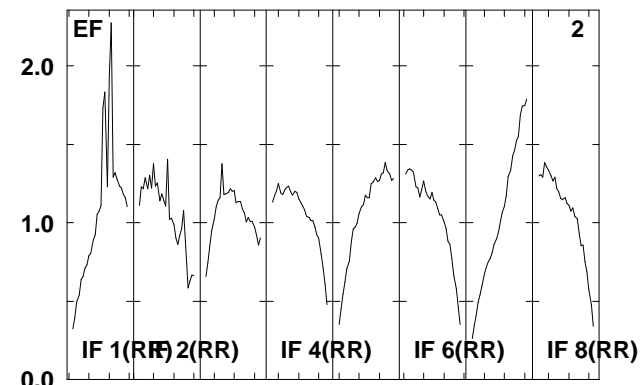
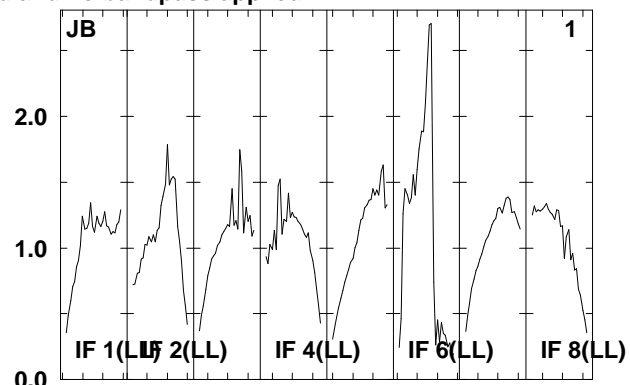
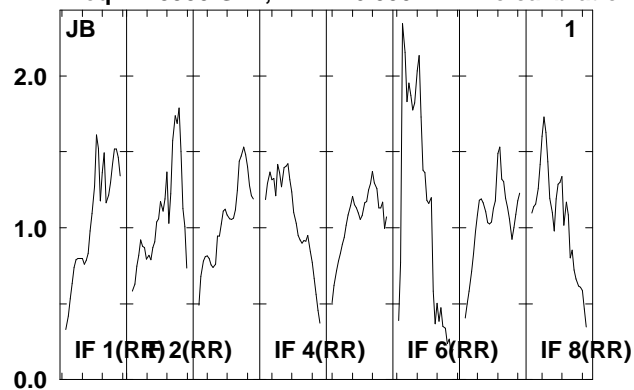

Lower frame: Real Jy
Total-power spectrum Antenna: *
Timerange: 00/08:43:30 to 00/08:47:00

Plot file version 46 created 18-APR-2008 18:27:28

IRAS2336 EP061A.UVDATA.1

Freq = 1.5950 GHz, Bw = 16.000 MH No calibration applied and no bandpass applied

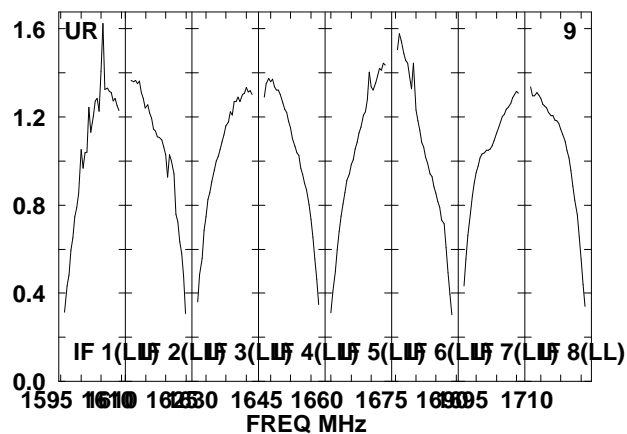
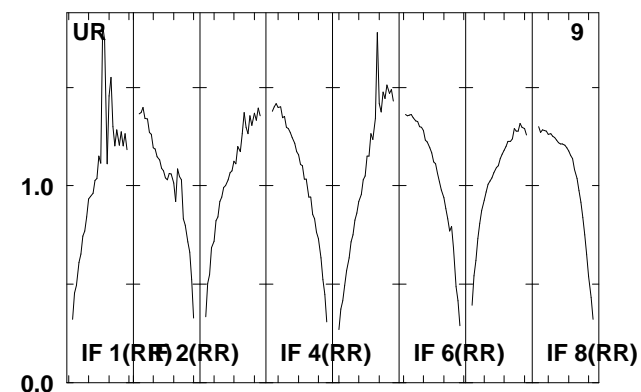
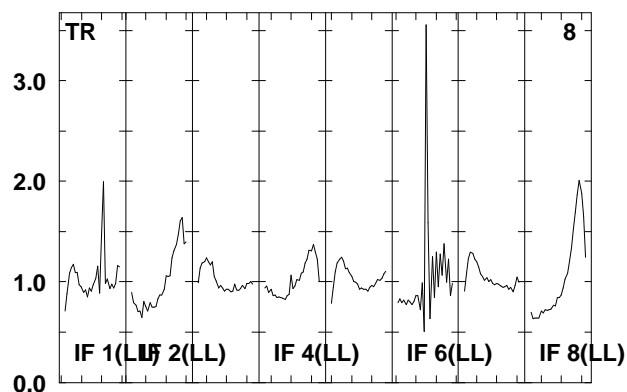
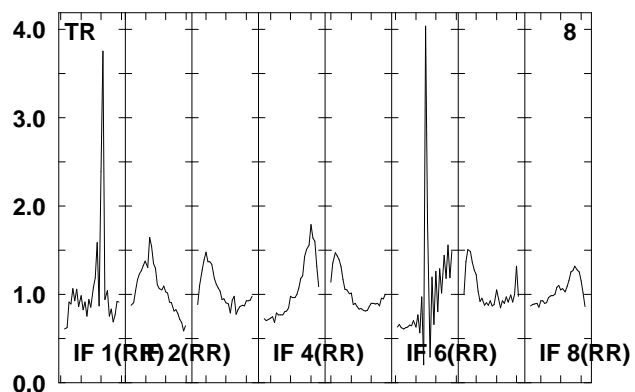
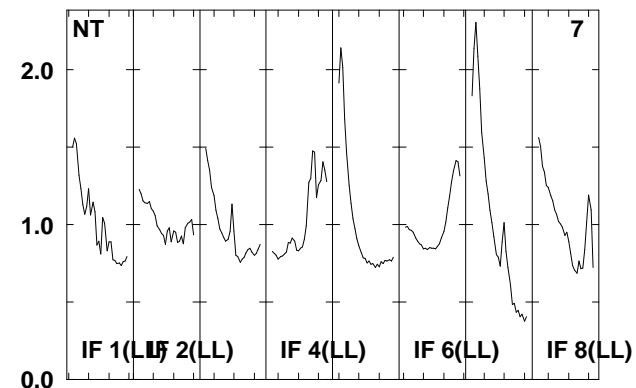
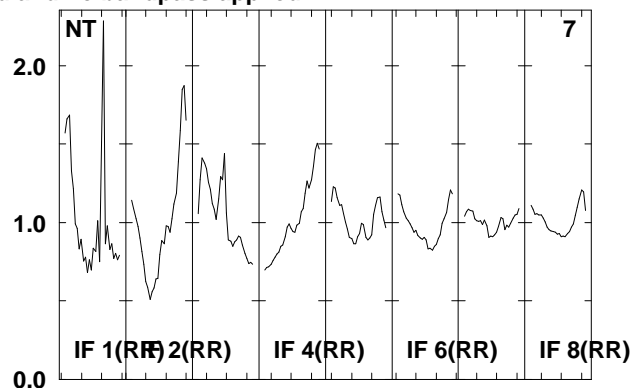
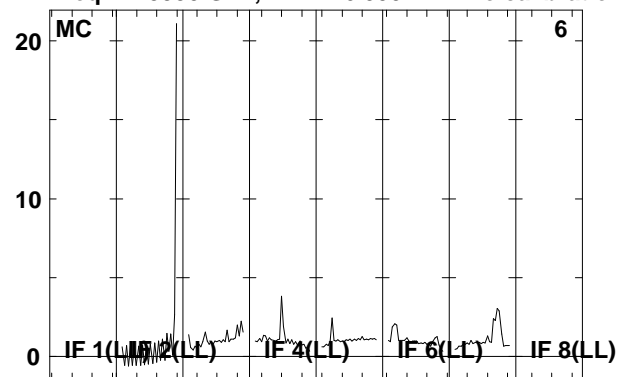

Lower frame: Real Jy

Total-power spectrum Antenna: *

Timerange: 00/08:43:30 to 00/08:47:00

Plot file version 47 created 18-APR-2008 18:27:28

J2333+39 EP061A.UVDATA.1

Freq = 1.5950 GHz, Bw = 16.000 MH No calibration applied and no bandpass applied

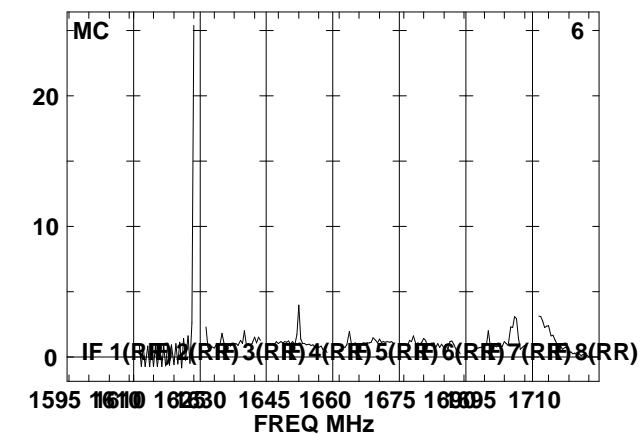
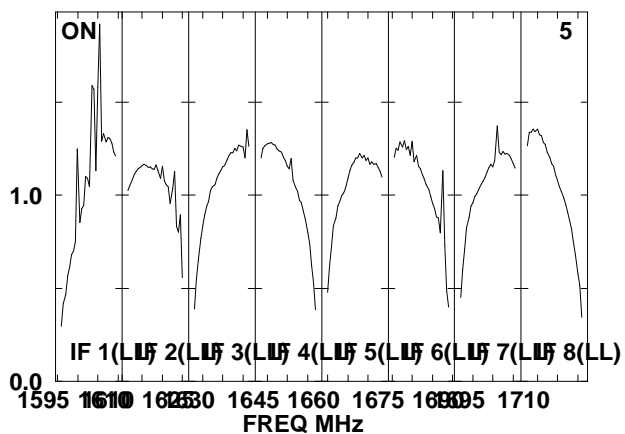
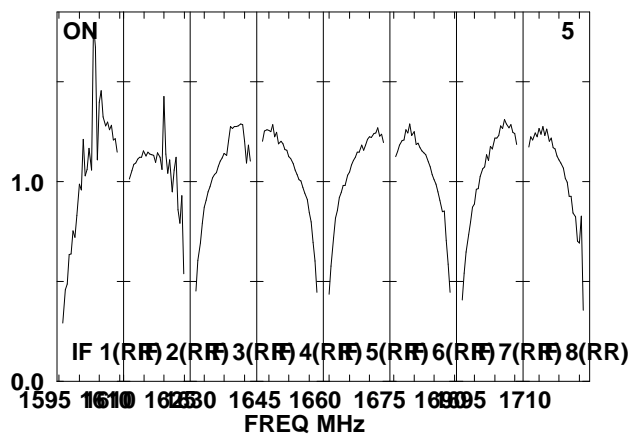
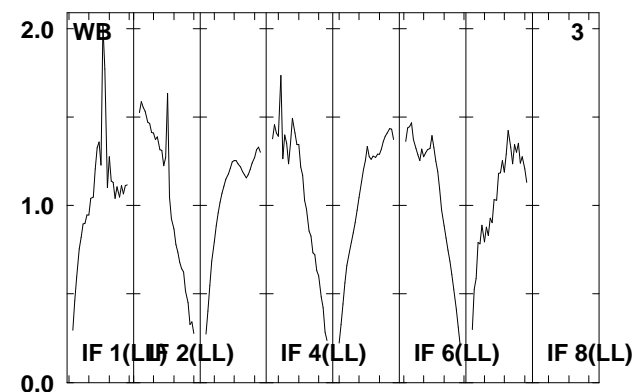
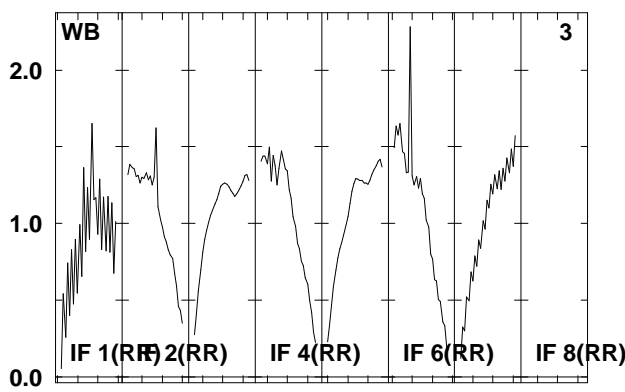
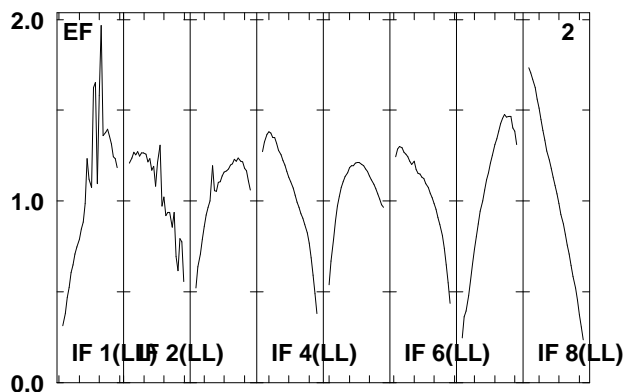
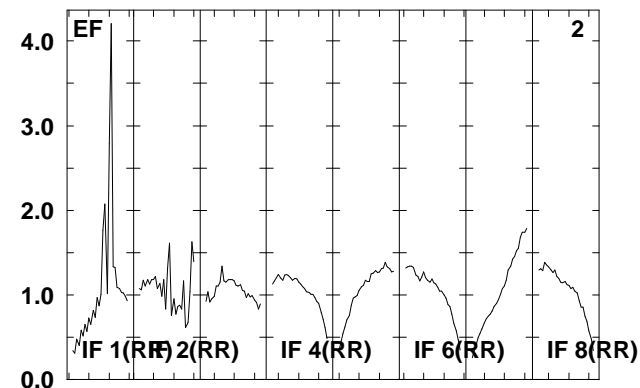
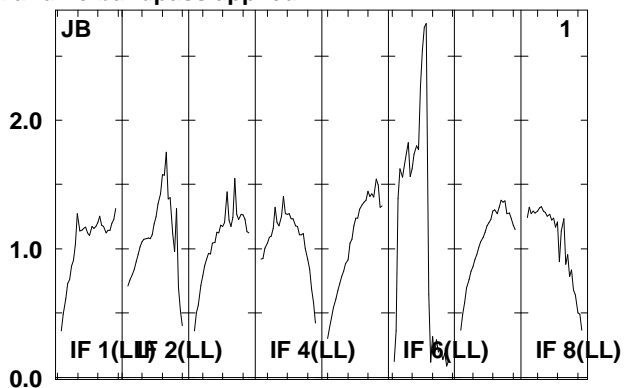
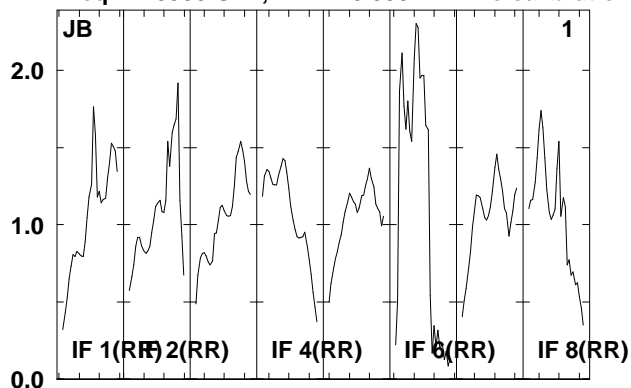

Lower frame: Real Jy
Total-power spectrum Antenna: *
Timerange: 00/08:47:02 to 00/08:48:26

Plot file version 48 created 18-APR-2008 18:27:29

J2333+39 EP061A.UVDATA.1

Freq = 1.5950 GHz, Bw = 16.000 MH No calibration applied and no bandpass applied

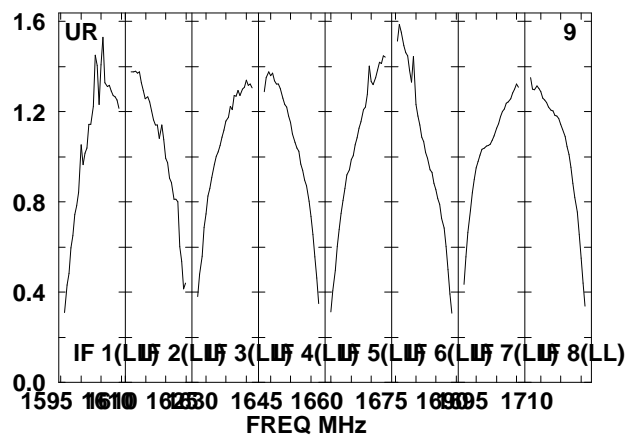
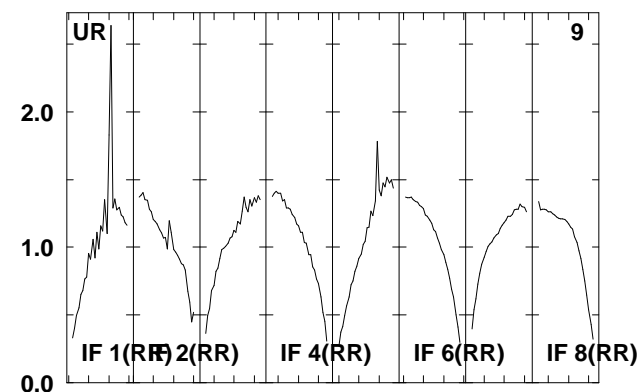
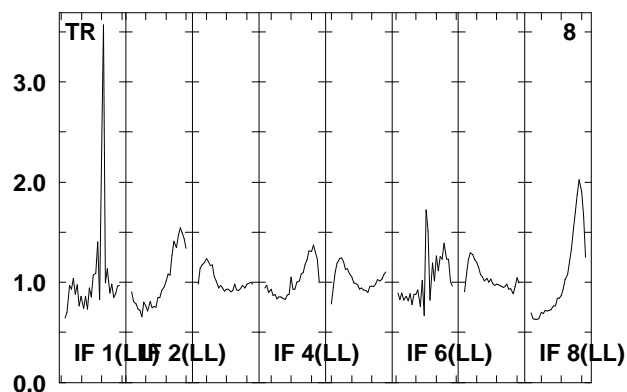
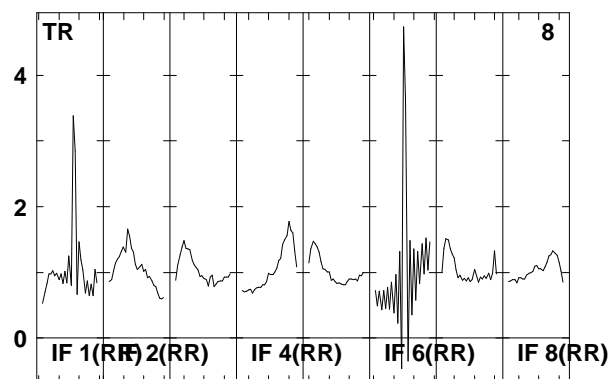
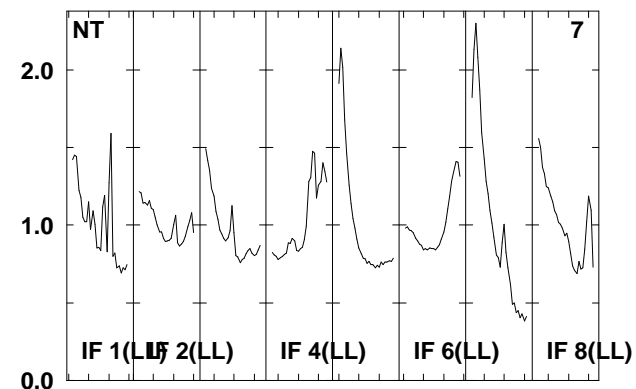
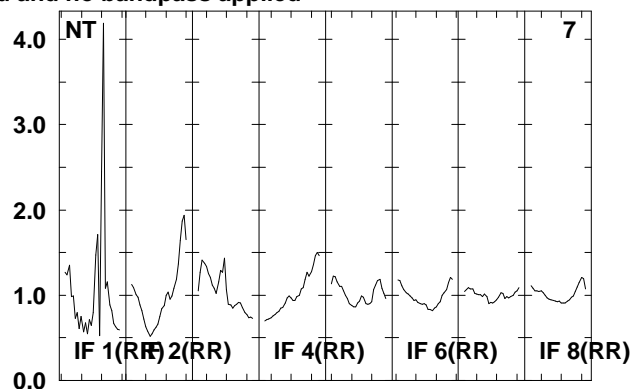
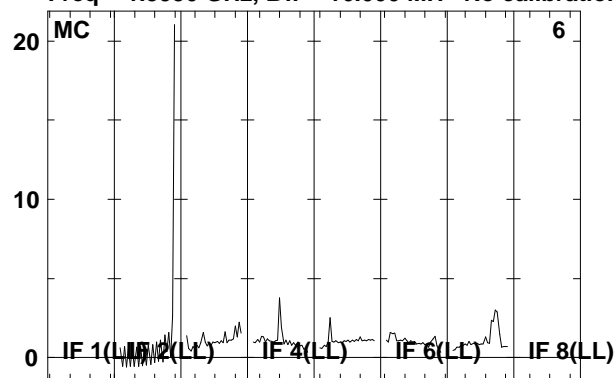

Lower frame: Real Jy

Total-power spectrum Antenna: *

Timerange: 00/08:47:02 to 00/08:48:26

Plot file version 49 created 18-APR-2008 18:27:29

IRAS2336 EP061A.UVDATA.1

Freq = 1.5950 GHz, Bw = 16.000 MH No calibration applied and no bandpass applied

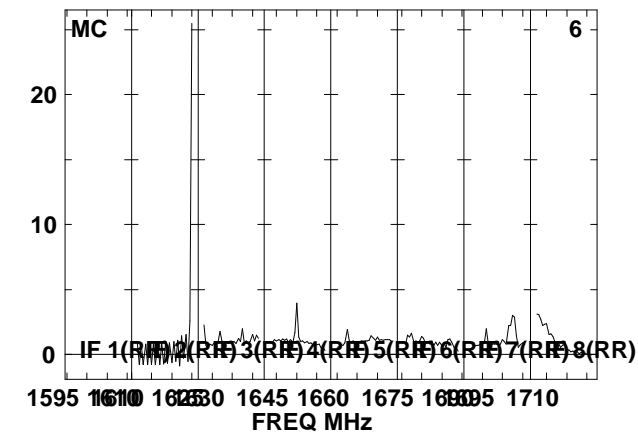
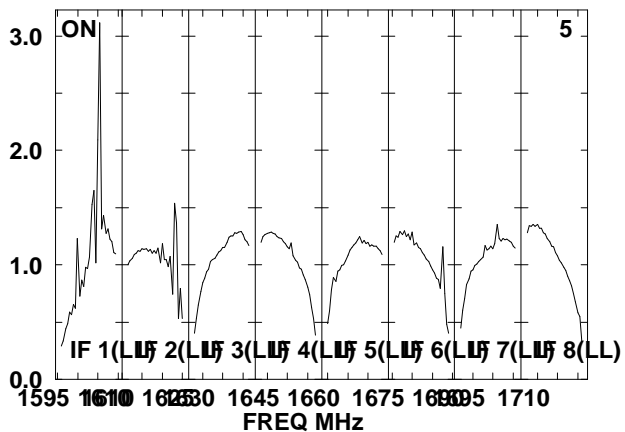
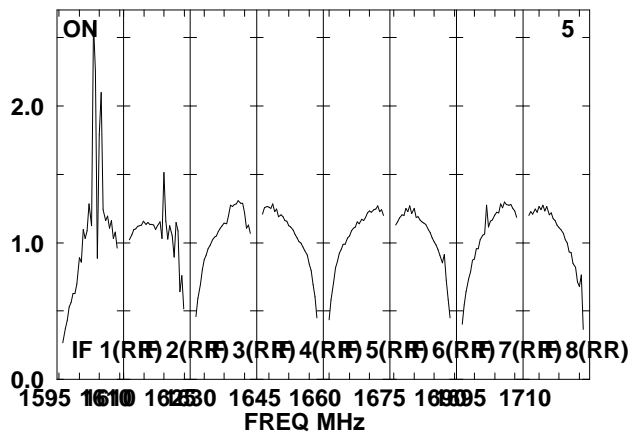
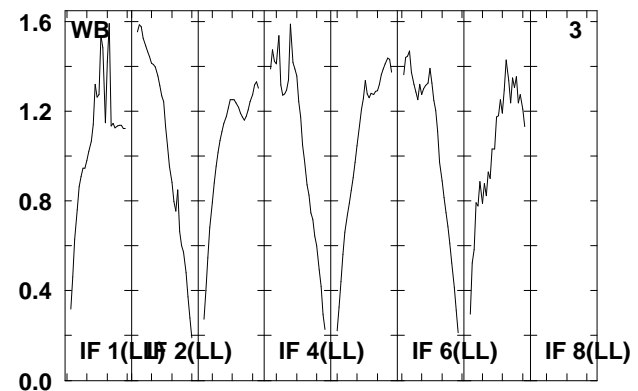
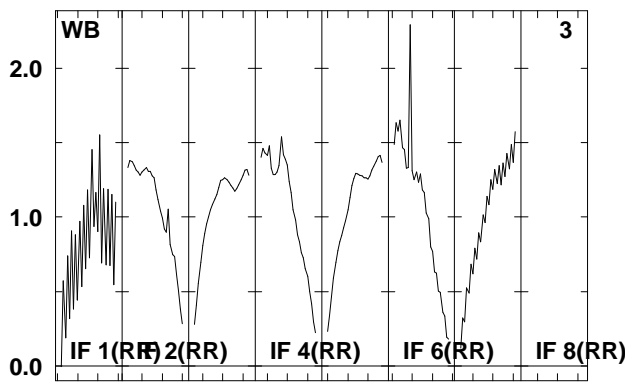
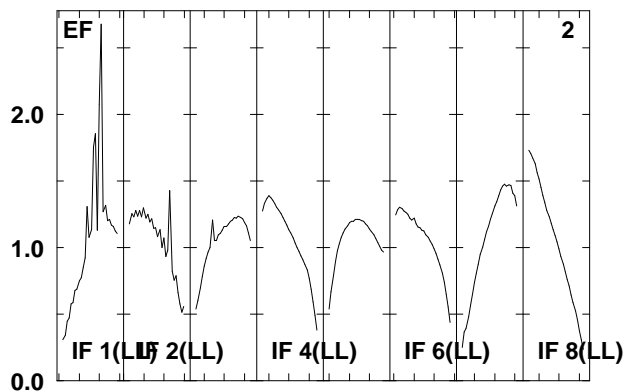
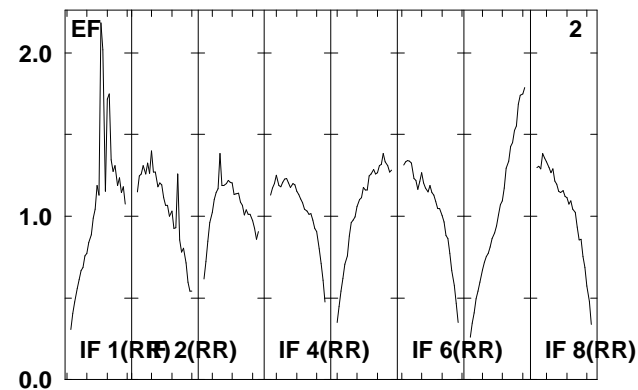
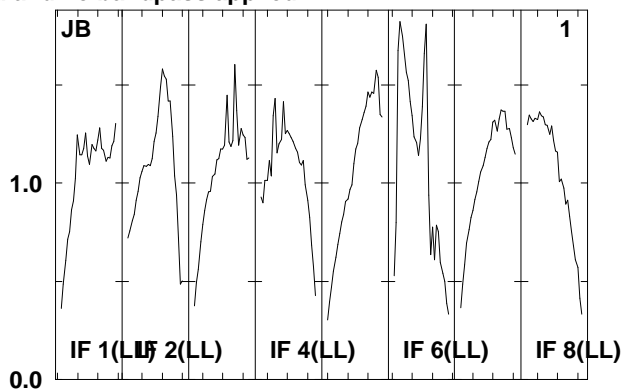
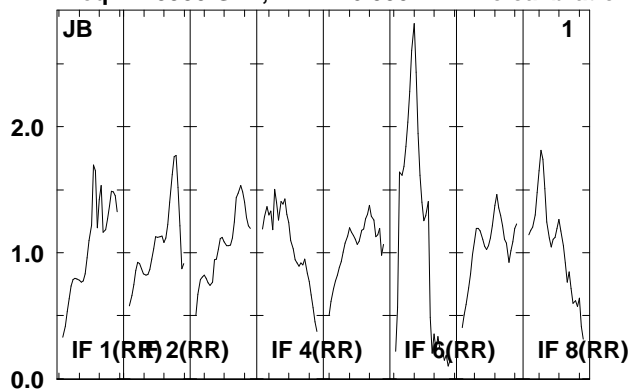

Lower frame: Real Jy
Total-power spectrum Antenna: *
Timerange: 00/08:48:38 to 00/08:52:00

Plot file version 50 created 18-APR-2008 18:27:30

IRAS2336 EP061A.UVDATA.1

Freq = 1.5950 GHz, Bw = 16.000 MH No calibration applied and no bandpass applied

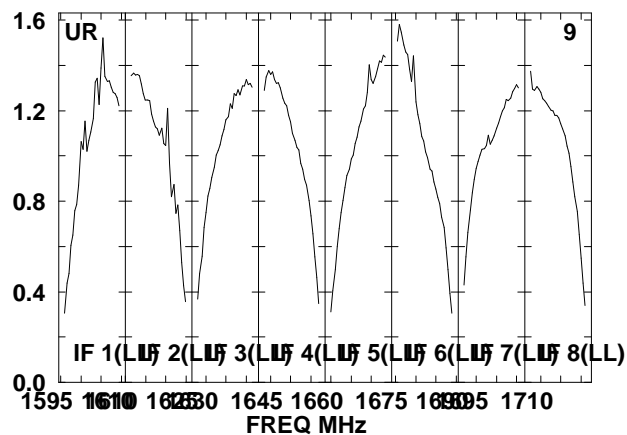
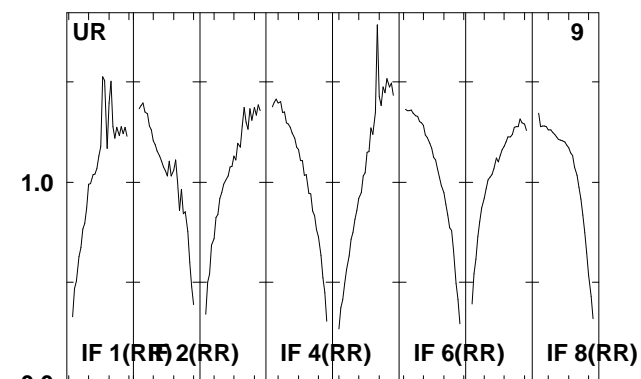
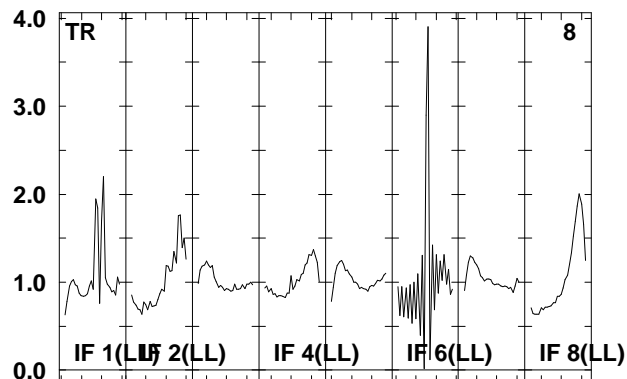
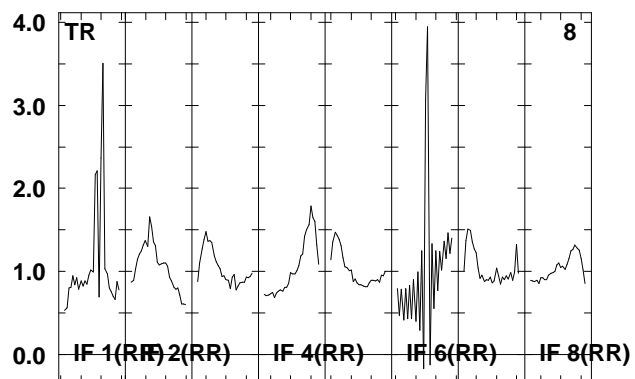
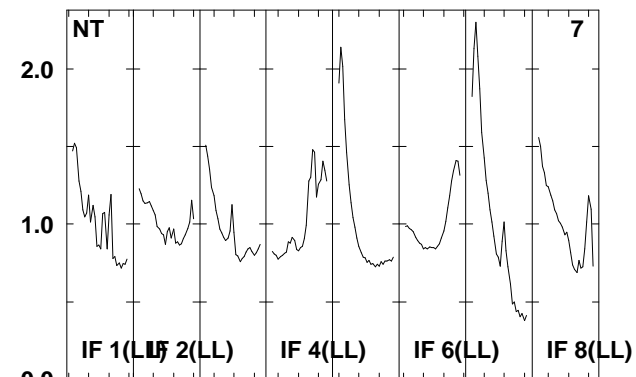
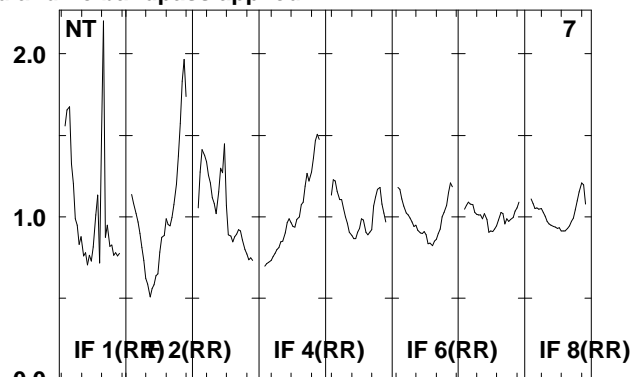
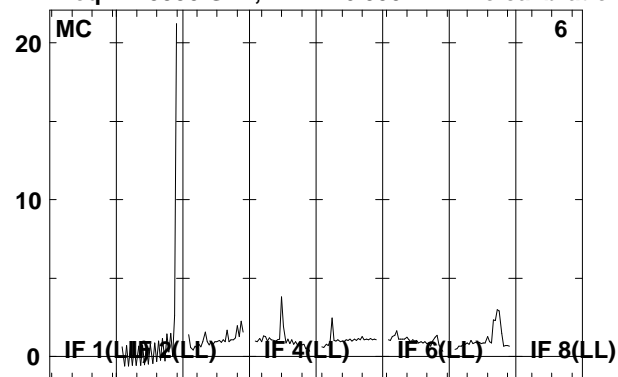

Lower frame: Real Jy

Total-power spectrum Antenna: *

Timerange: 00/08:48:38 to 00/08:52:00

Plot file version 51 created 18-APR-2008 18:27:31

J2333+39 EP061A.UVDATA.1

Freq = 1.5950 GHz, Bw = 16.000 MH No calibration applied and no bandpass applied

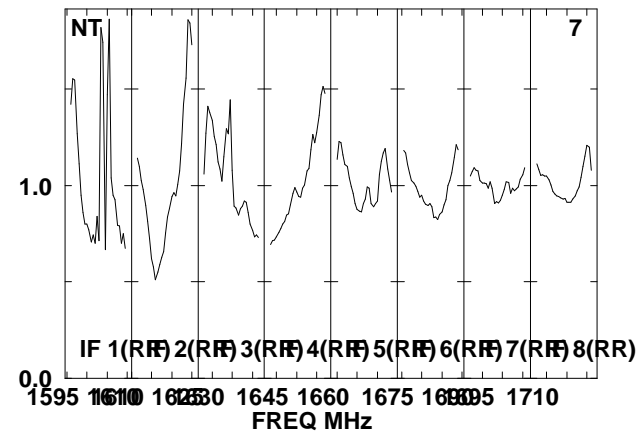
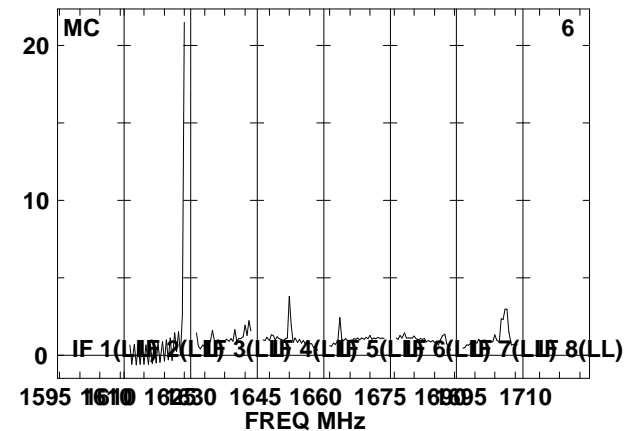
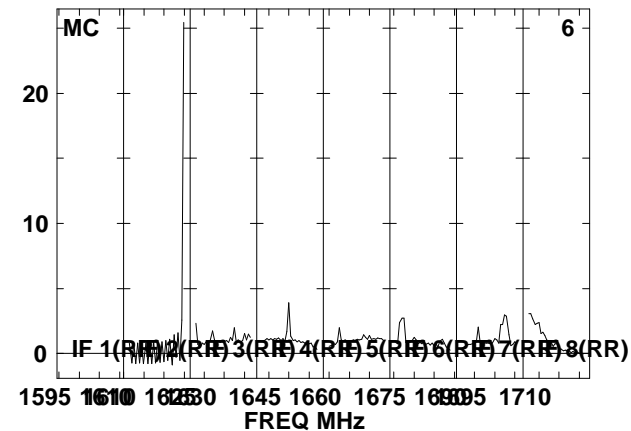
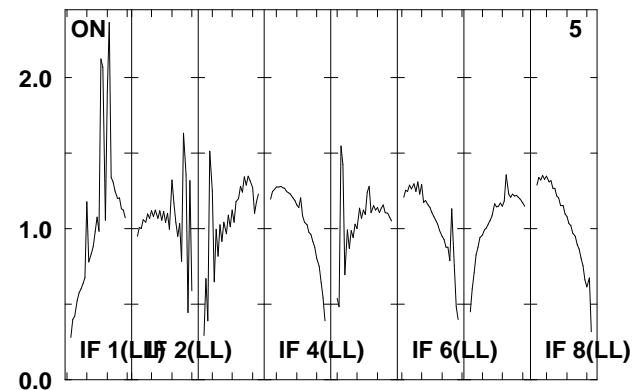
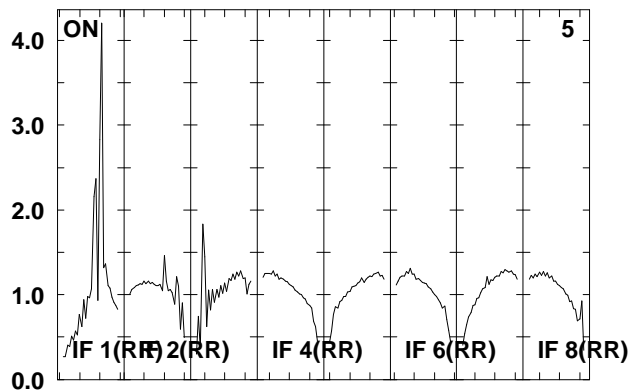
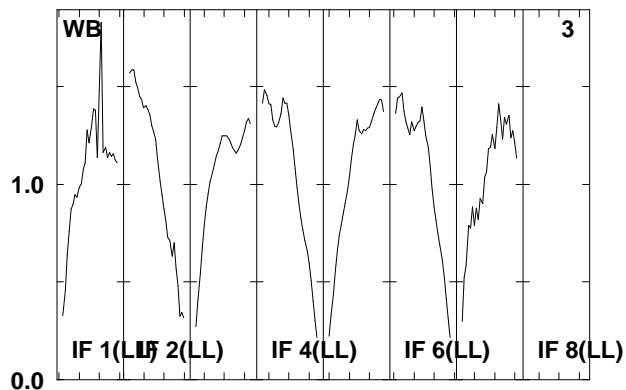
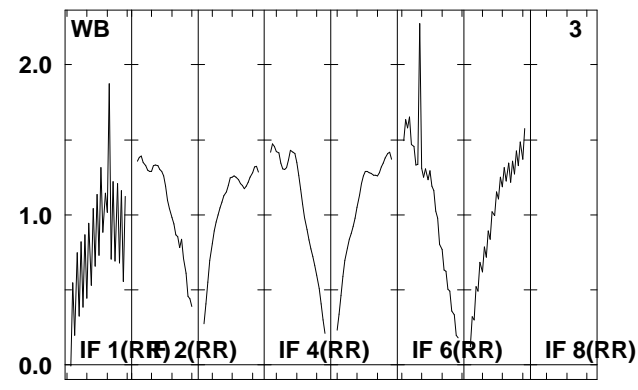
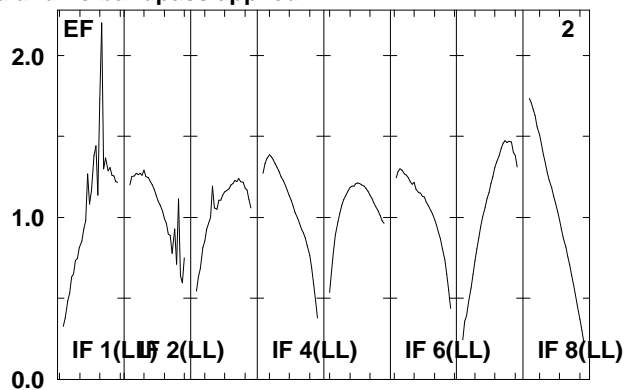
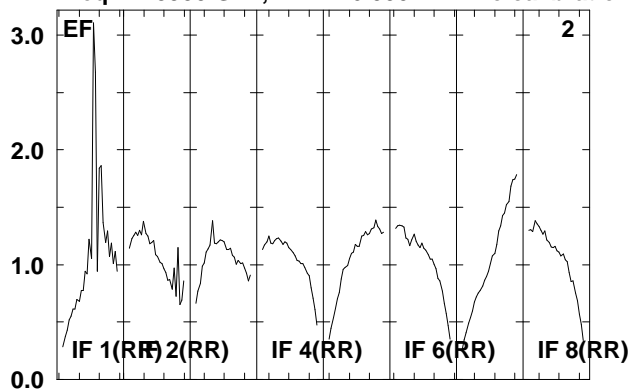

Lower frame: Real Jy

Total-power spectrum Antenna: *

Timerange: 00/08:52:02 to 00/08:53:28

Plot file version 52 created 18-APR-2008 18:27:31

J2333+39 EP061A.UVDATA.1

Freq = 1.5950 GHz, Bw = 16.000 MH No calibration applied and no bandpass applied

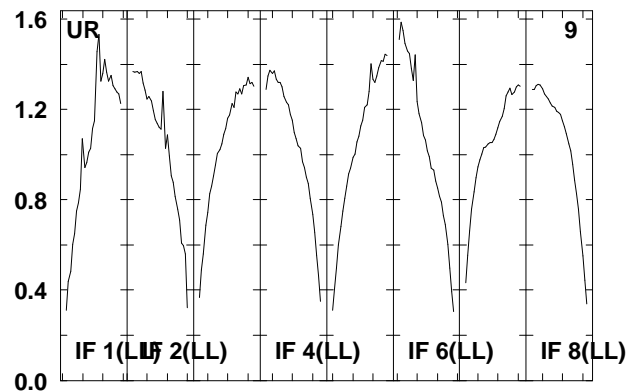
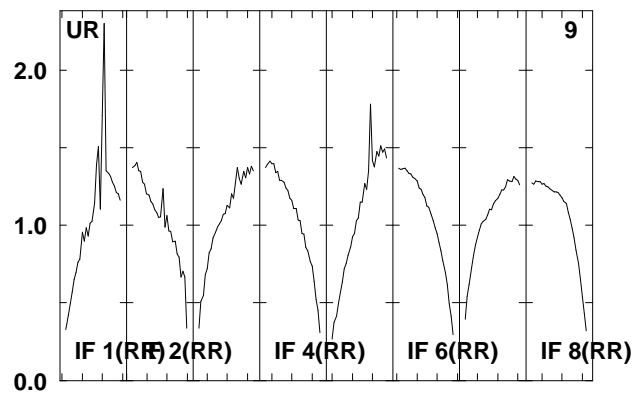
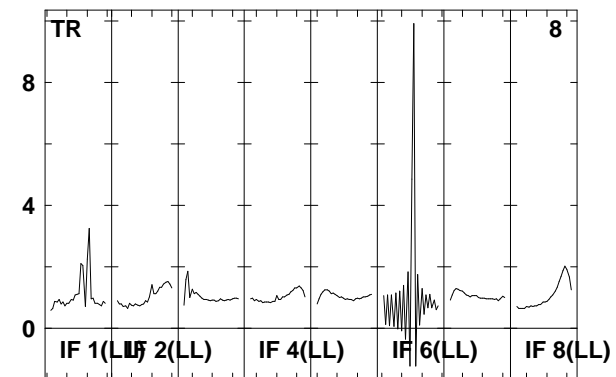
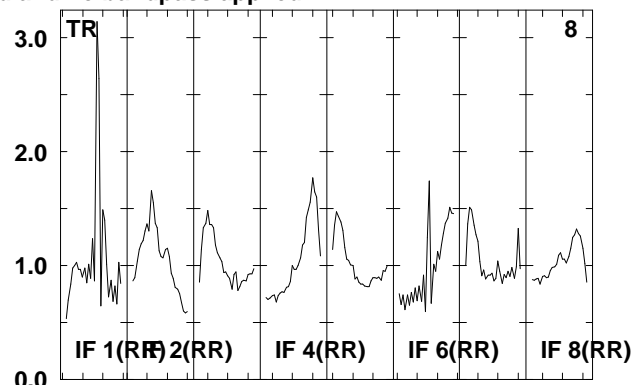
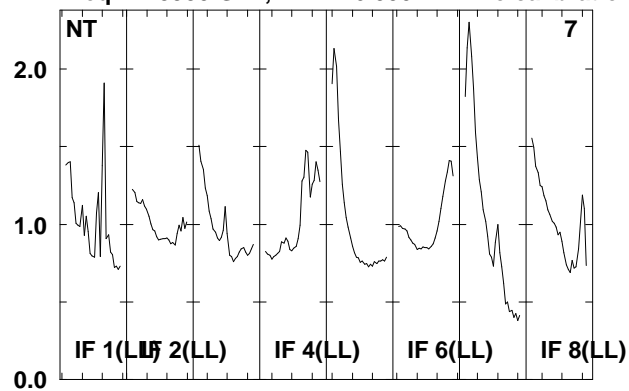

Lower frame: Real Jy
Total-power spectrum Antenna: *
Timerange: 00/08:52:02 to 00/08:53:28

Plot file version 53 created 18-APR-2008 18:27:32

IRAS2336 EP061A.UVDATA.1

Freq = 1.5950 GHz, Bw = 16.000 MH No calibration applied and no bandpass applied

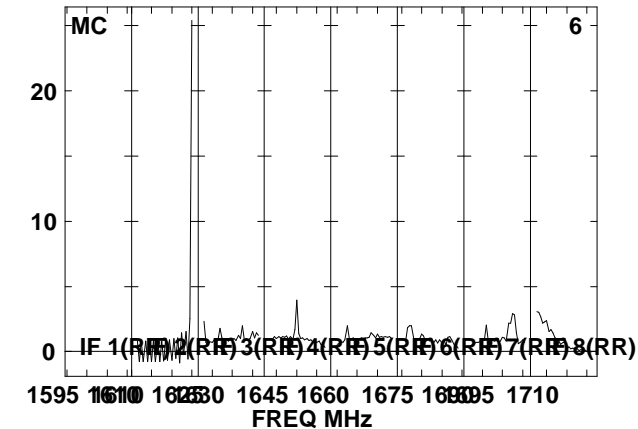
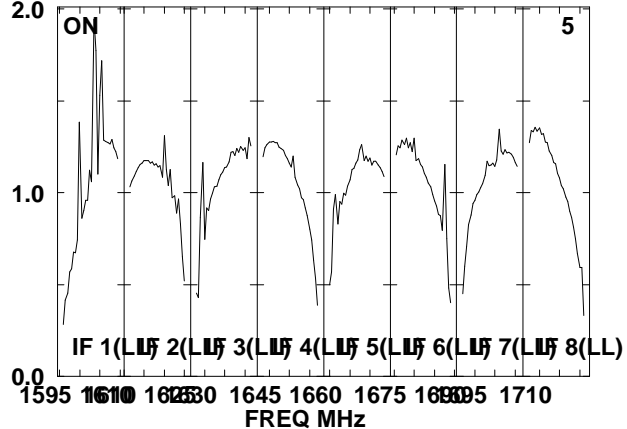
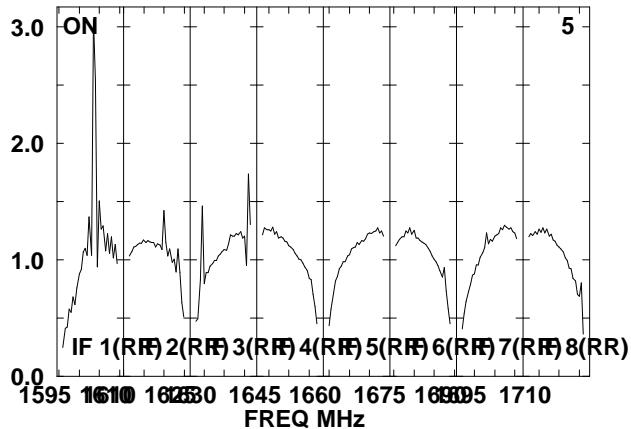
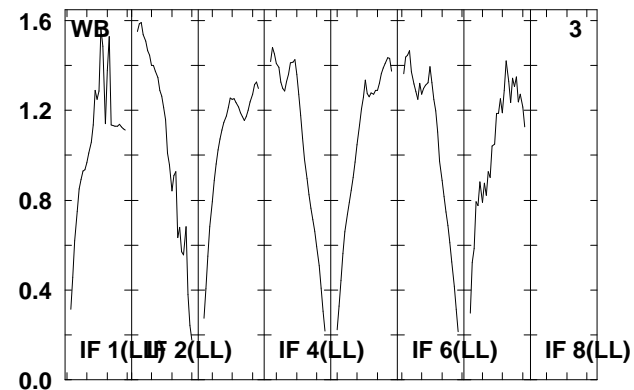
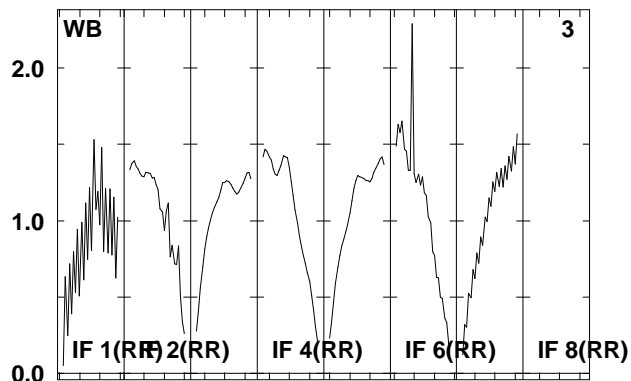
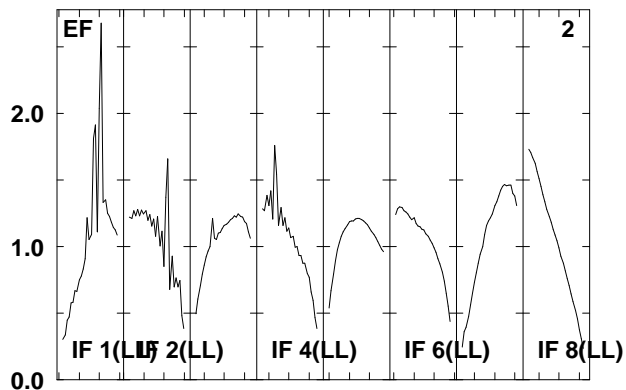
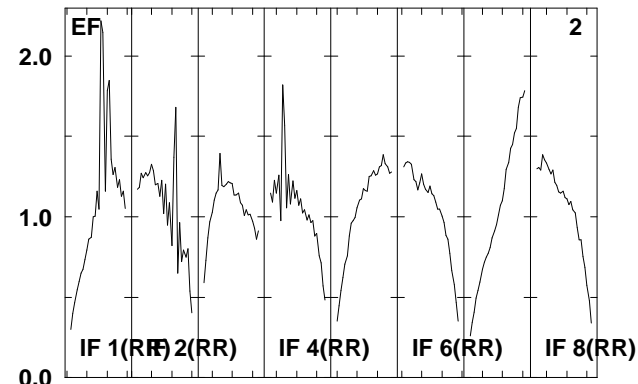
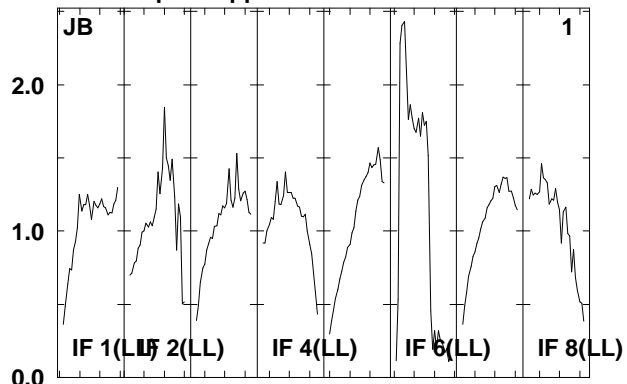
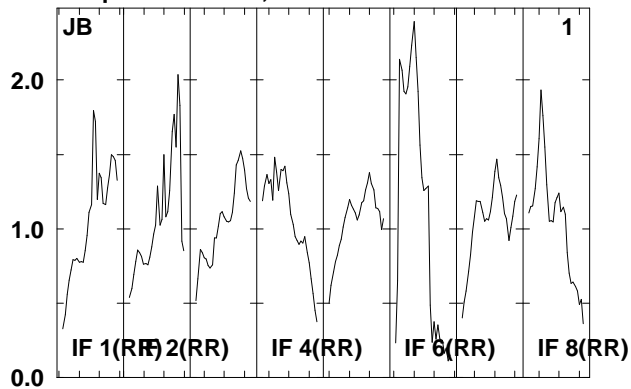

Lower frame: Real Jy
Total-power spectrum Antenna: *
Timerange: 00/08:53:32 to 00/08:56:58

Plot file version 54 created 18-APR-2008 18:27:33

IRAS2336 EP061A.UVDATA.1

Freq = 1.5950 GHz, Bw = 16.000 MH No calibration applied and no bandpass applied

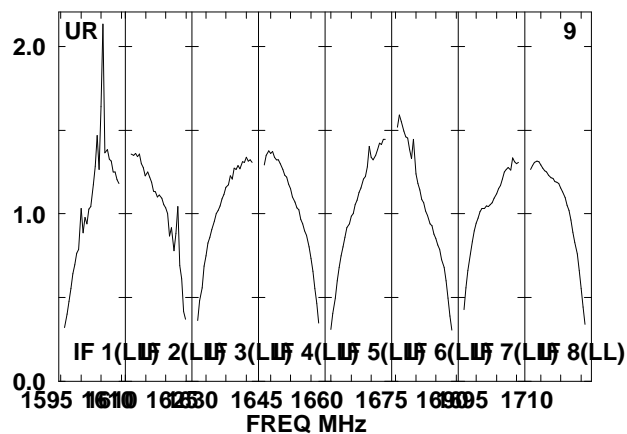
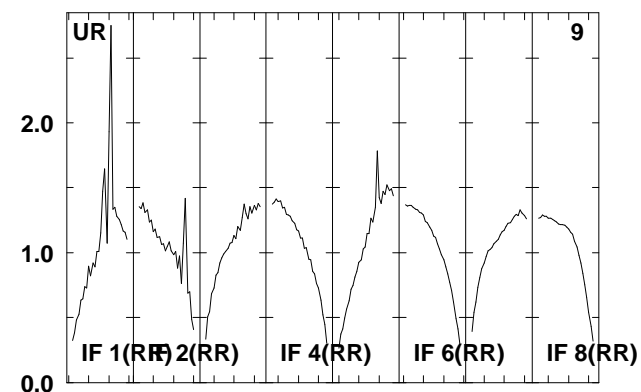
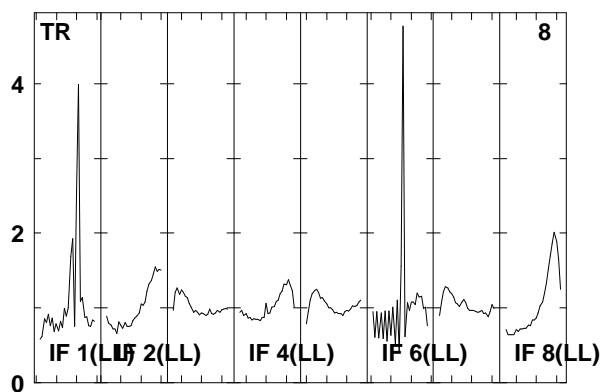
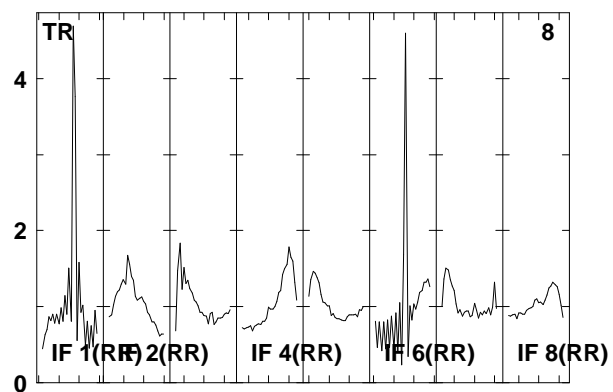
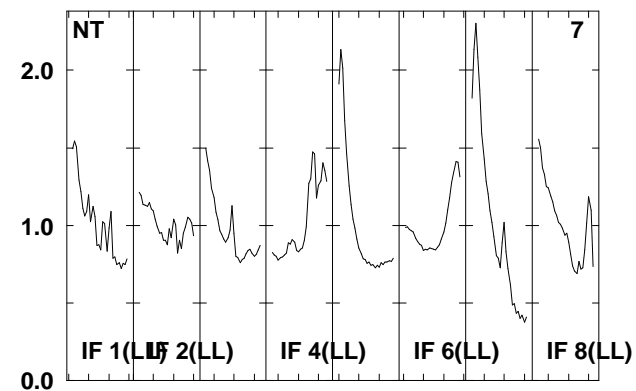
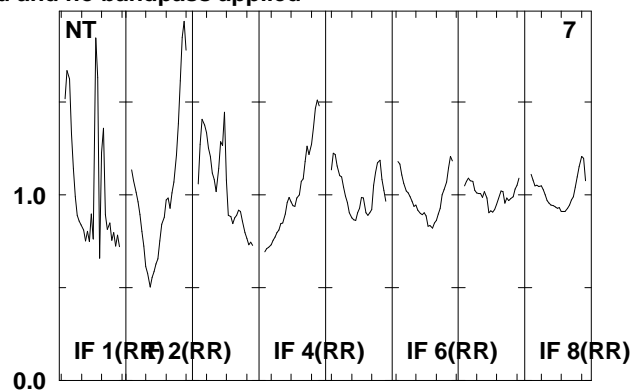
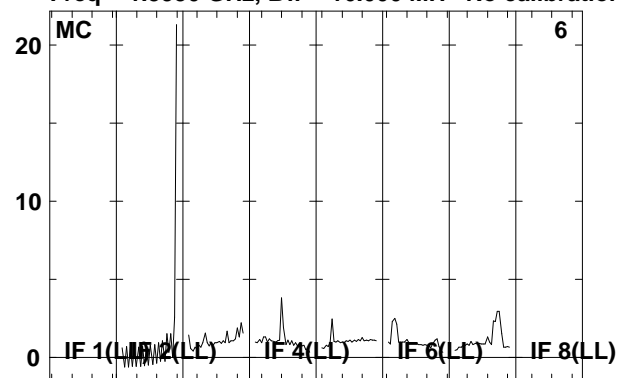

Lower frame: Real Jy

Total-power spectrum Antenna: *

Timerange: 00/08:53:32 to 00/08:56:58

Plot file version 55 created 18-APR-2008 18:27:34

J2333+39 EP061A.UVDATA.1

Freq = 1.5950 GHz, Bw = 16.000 MH No calibration applied and no bandpass applied

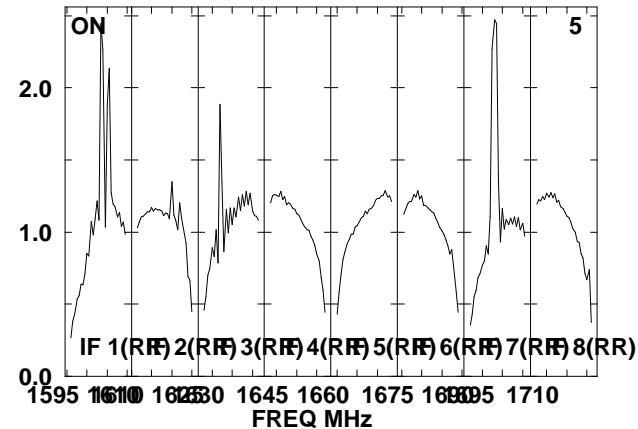
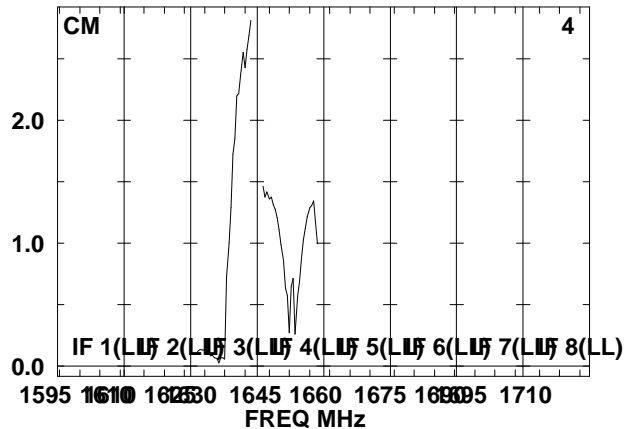
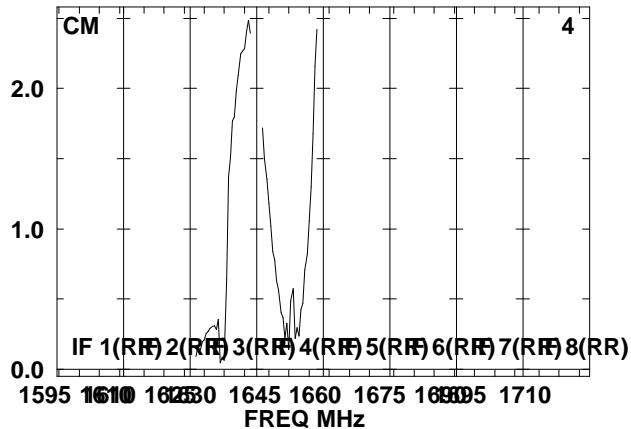
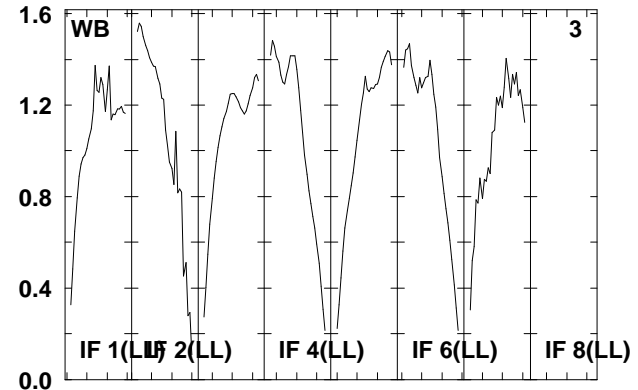
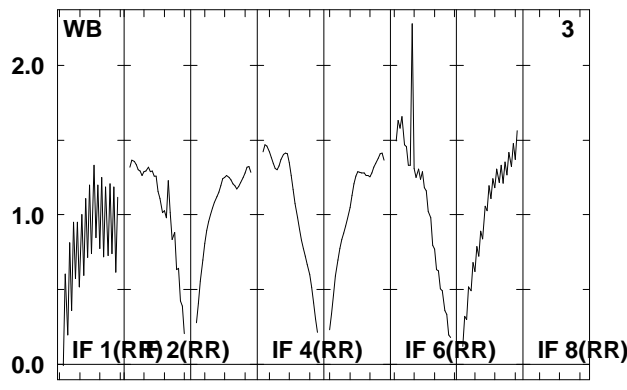
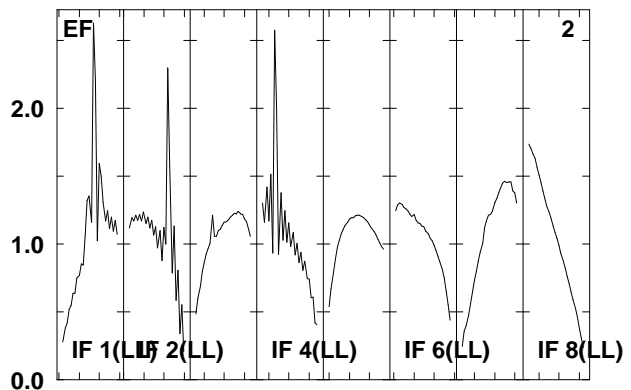
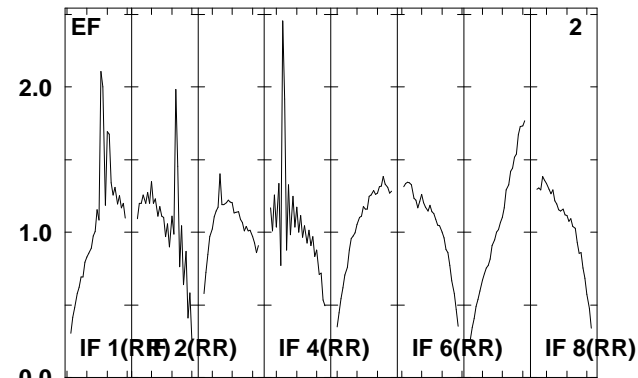
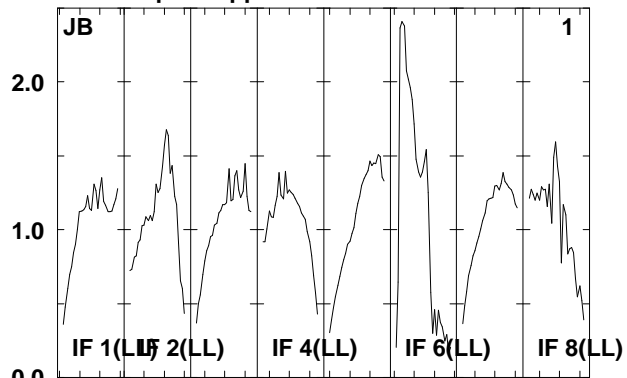
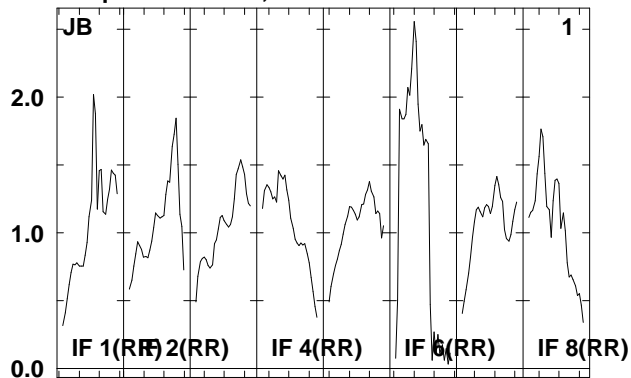

Lower frame: Real Jy
Total-power spectrum Antenna: *
Timerange: 00/08:58:02 to 00/08:59:30

Plot file version 56 created 18-APR-2008 18:27:34

J2333+39 EP061A.UVDATA.1

Freq = 1.5950 GHz, Bw = 16.000 MH No calibration applied and no bandpass applied

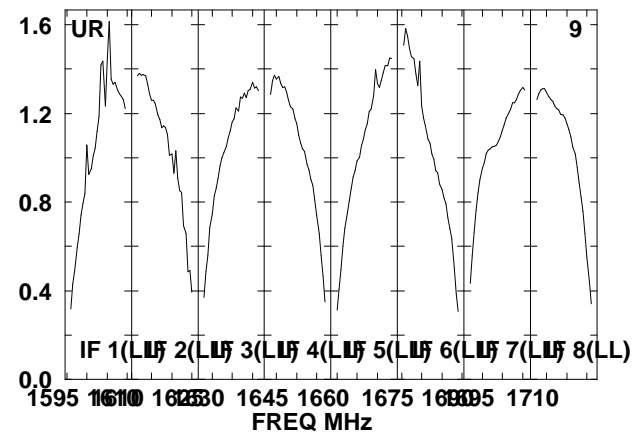
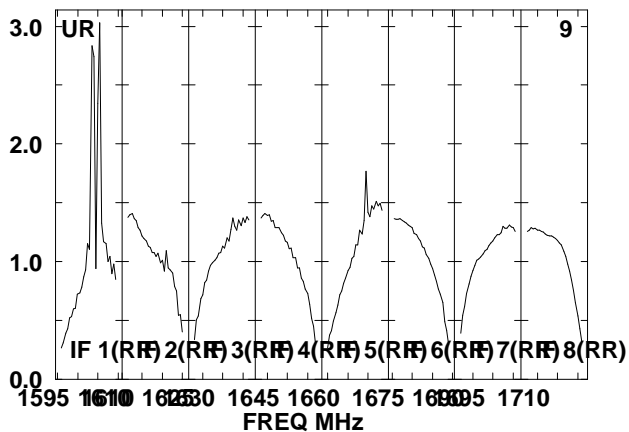
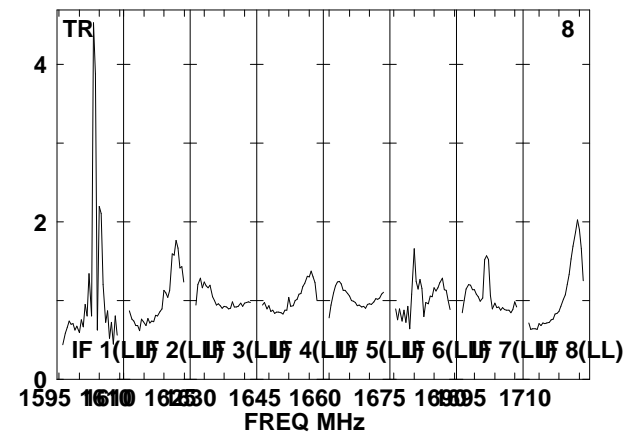
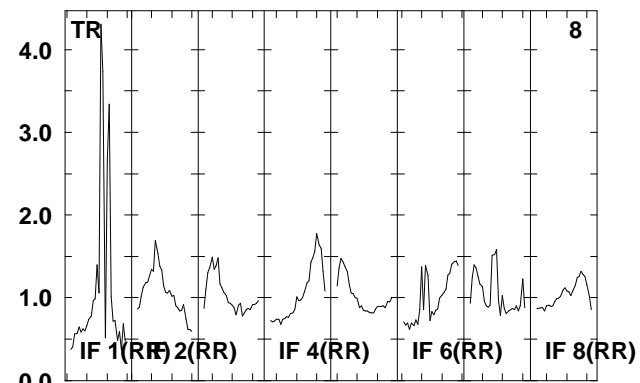
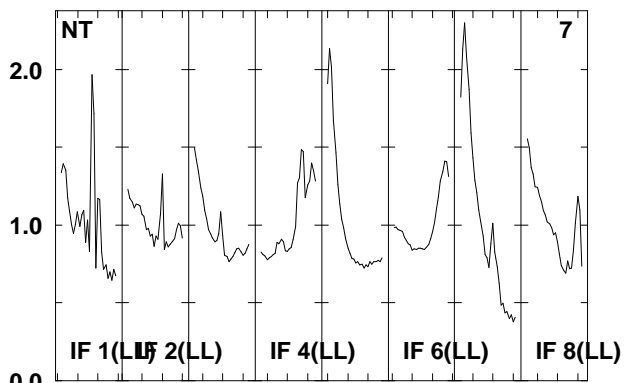
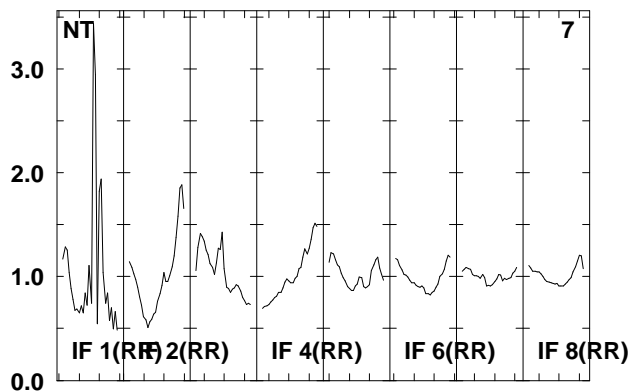
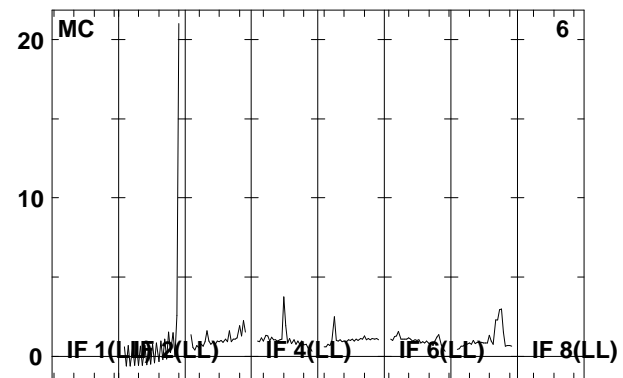
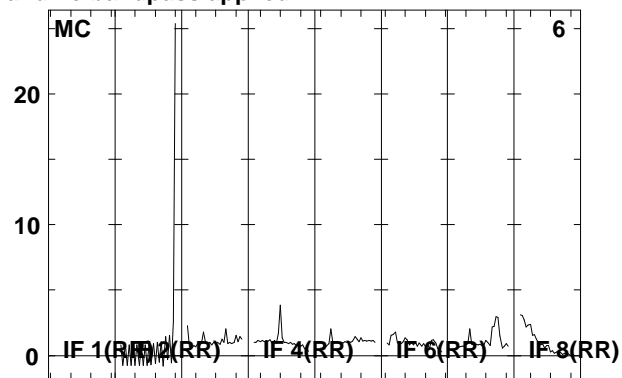
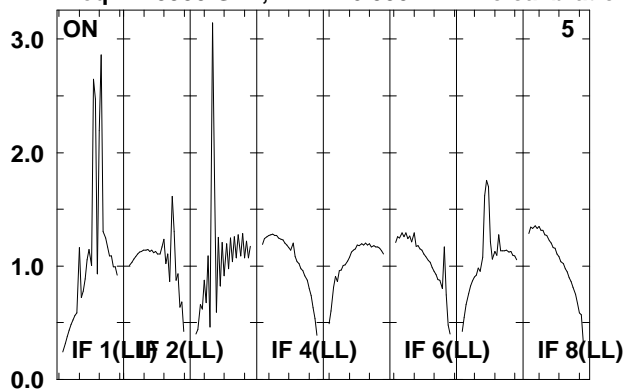

Lower frame: Real Jy
Total-power spectrum Antenna: *
Timerange: 00/08:58:02 to 00/08:59:30

Plot file version 57 created 18-APR-2008 18:27:35

IRAS2336 EP061A.UVDATA.1

Freq = 1.5950 GHz, Bw = 16.000 MH No calibration applied and no bandpass applied

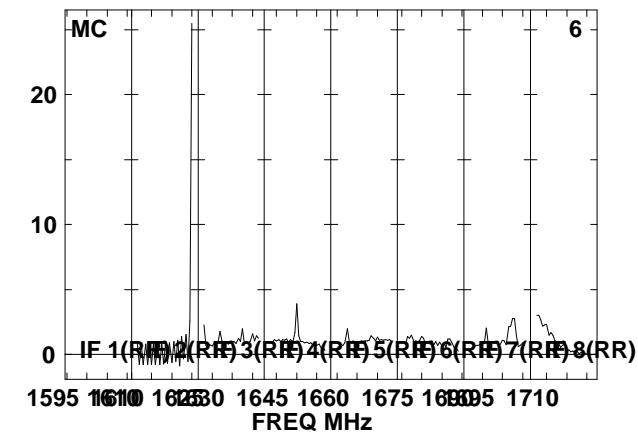
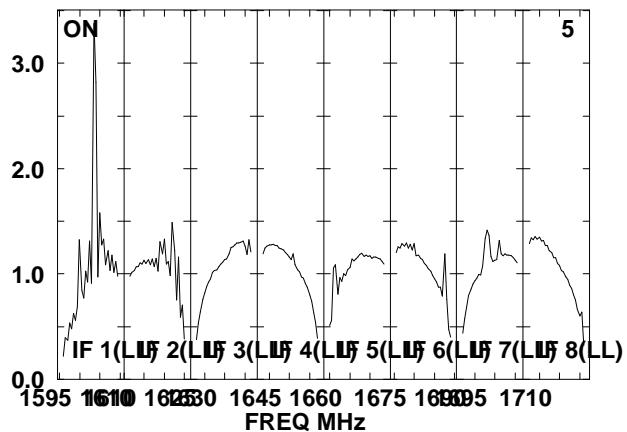
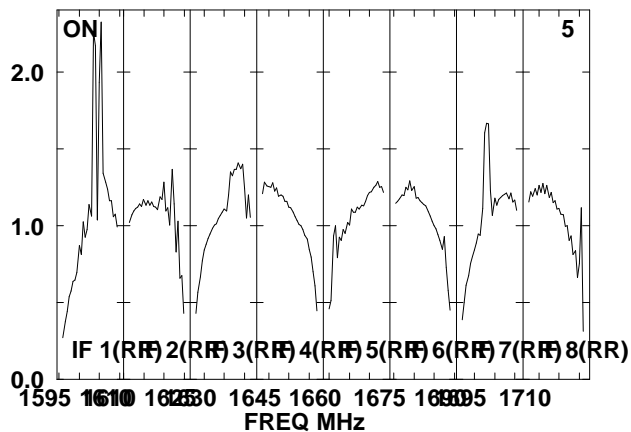
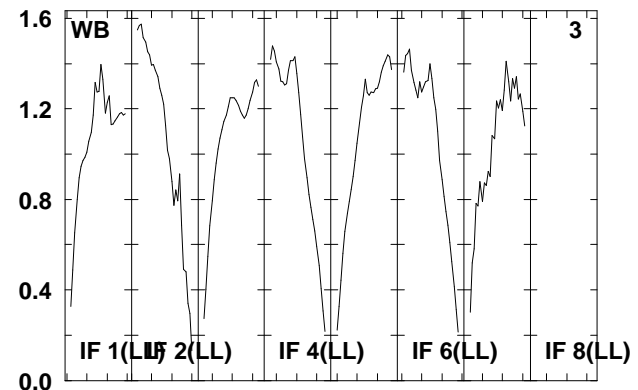
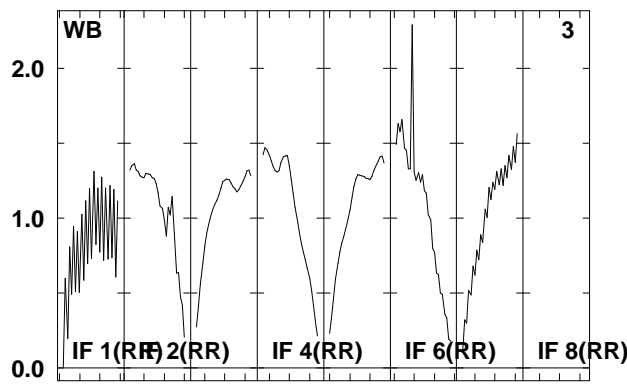
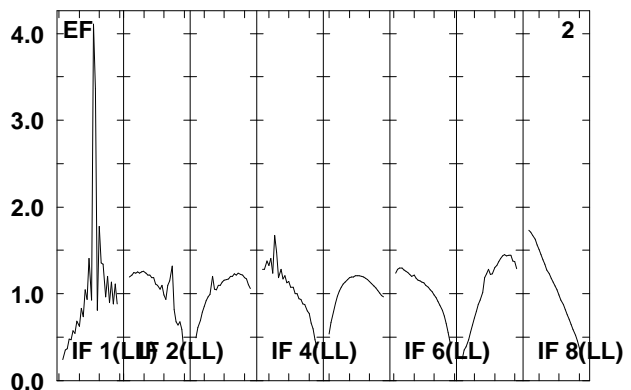
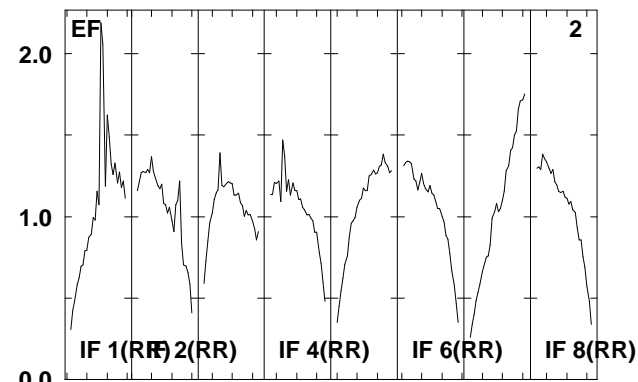
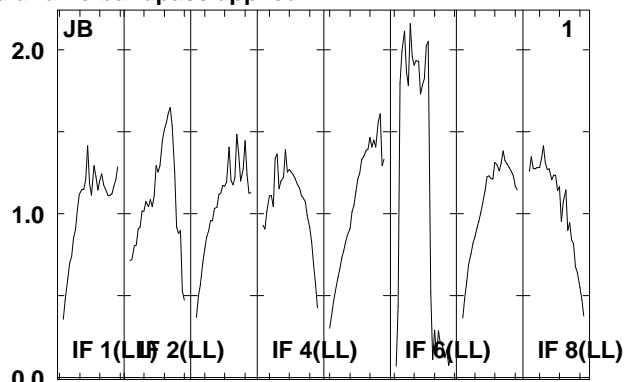
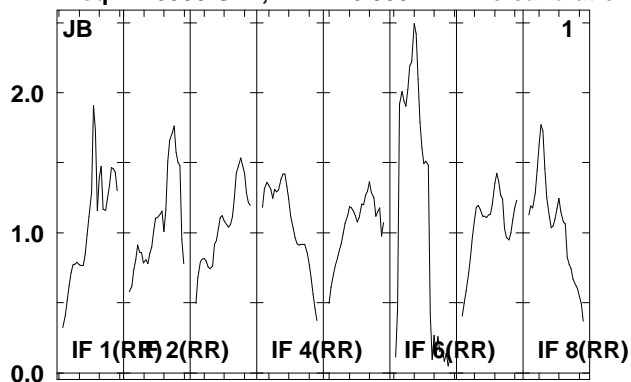

Lower frame: Real Jy
Total-power spectrum Antenna: *
Timerange: 00/08:59:32 to 00/09:03:00

Plot file version 58 created 18-APR-2008 18:27:35

IRAS2336 EP061A.UVDATA.1

Freq = 1.5950 GHz, Bw = 16.000 MH No calibration applied and no bandpass applied

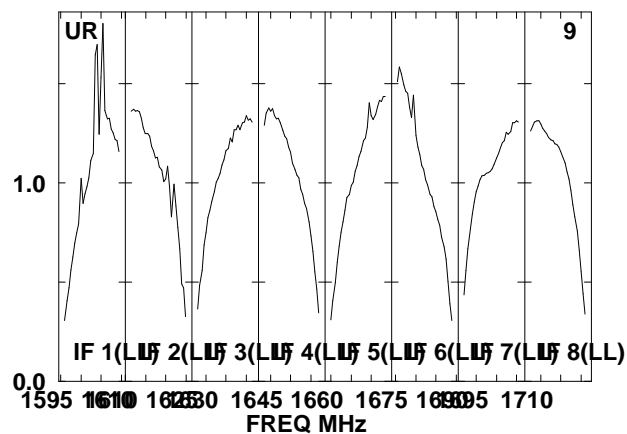
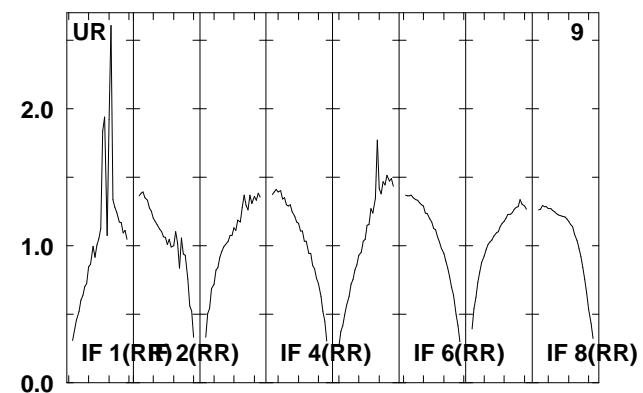
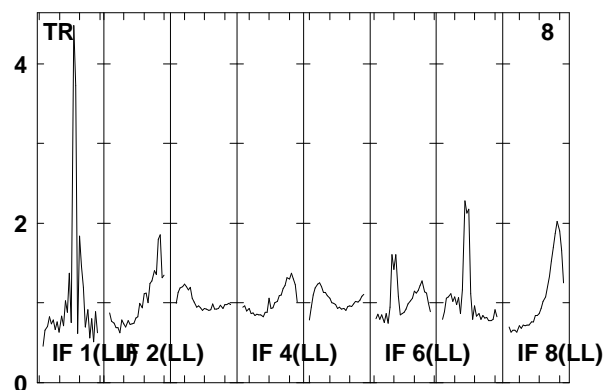
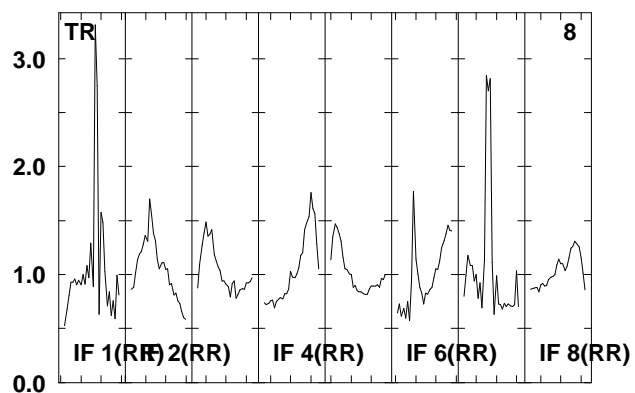
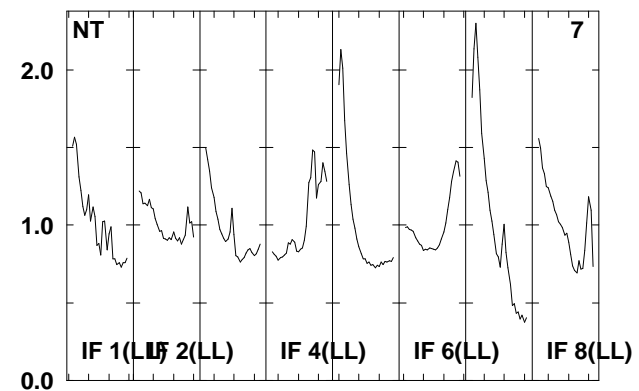
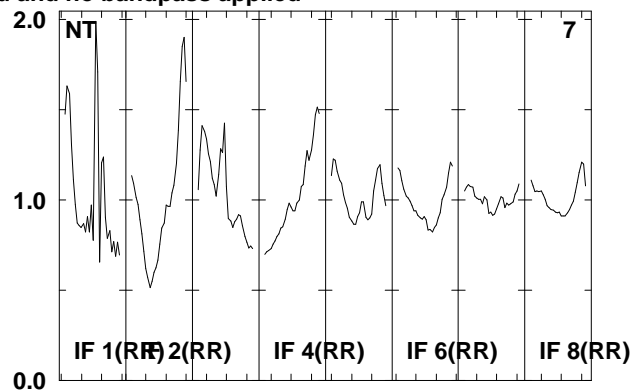
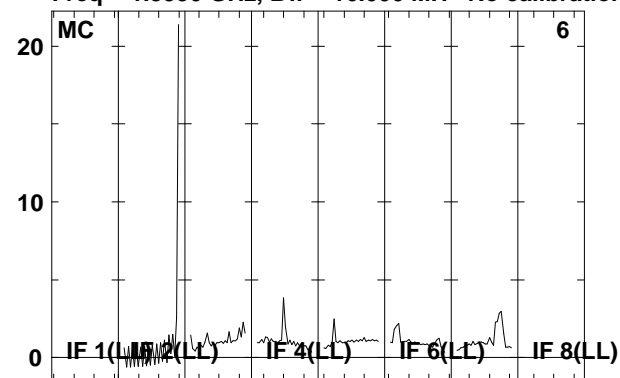

Lower frame: Real Jy

Total-power spectrum Antenna: *

Timerange: 00/08:59:32 to 00/09:03:00

Plot file version 59 created 18-APR-2008 18:27:36

J2333+39 EP061A.UVDATA.1

Freq = 1.5950 GHz, Bw = 16.000 MH No calibration applied and no bandpass applied

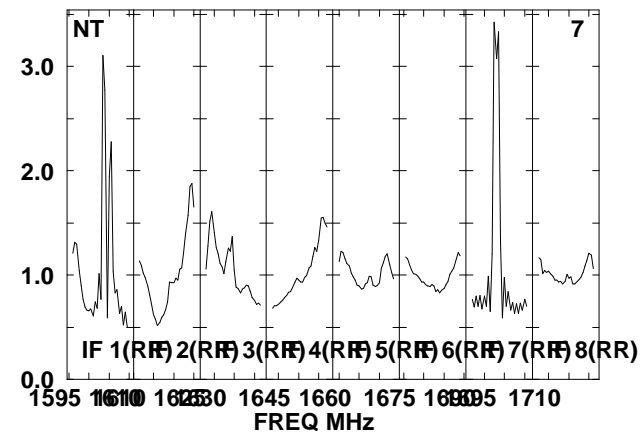
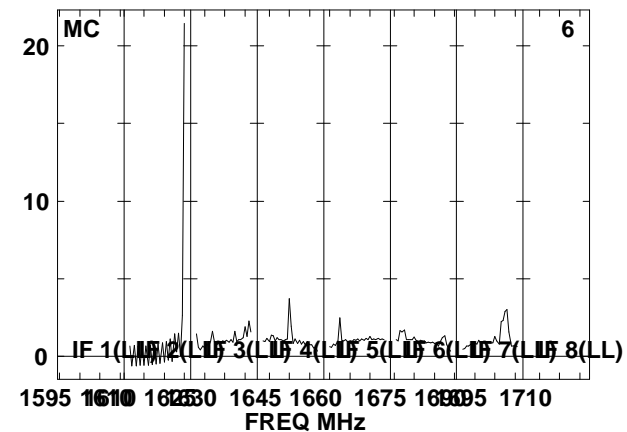
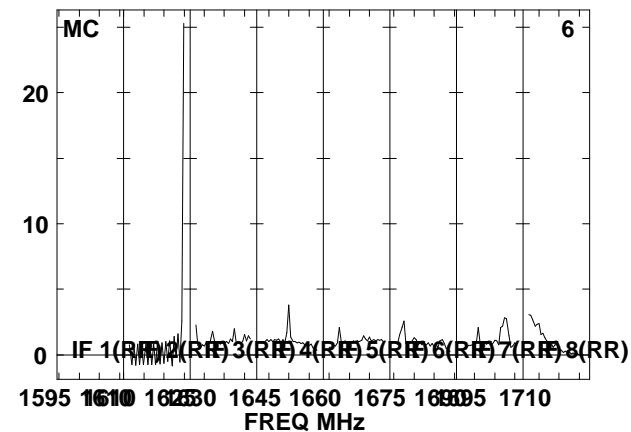
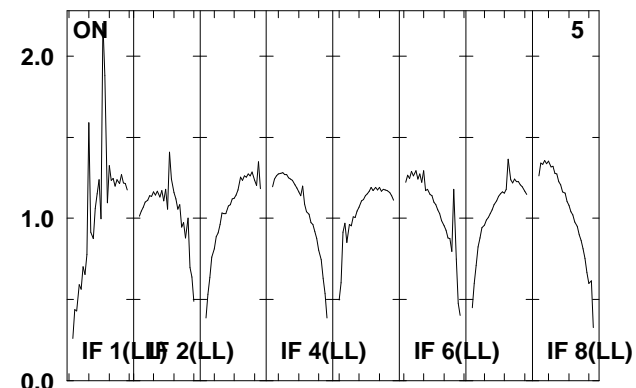
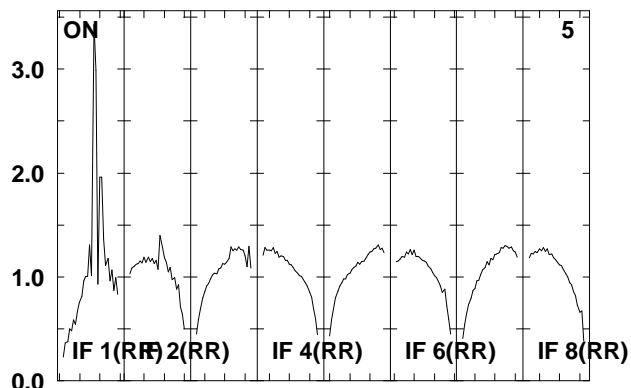
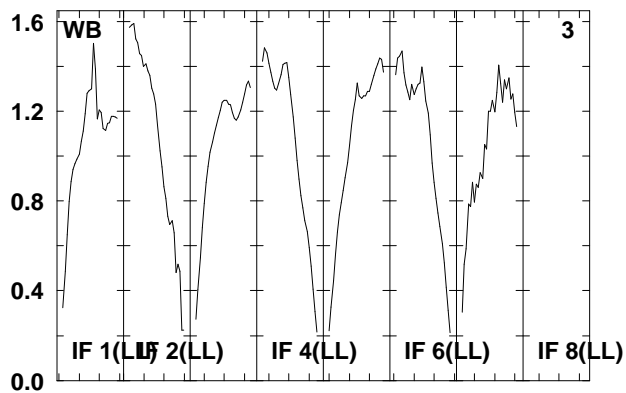
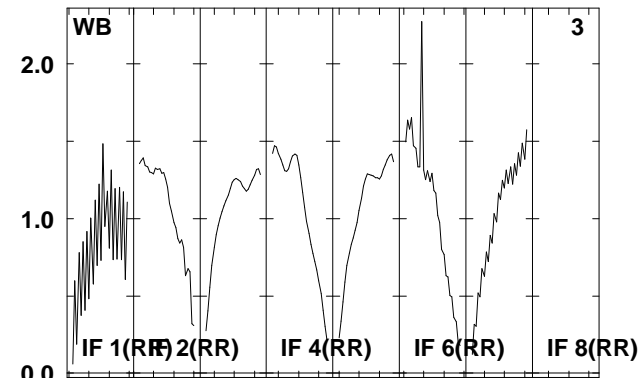
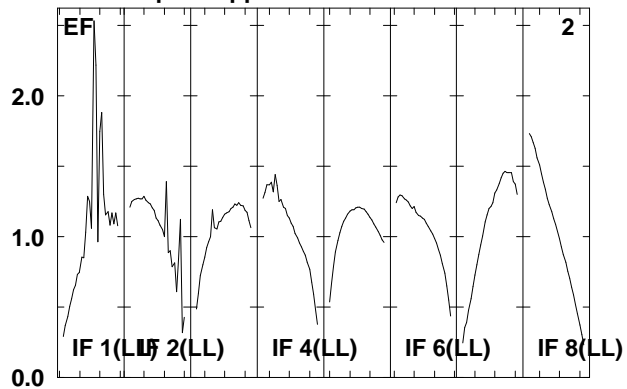
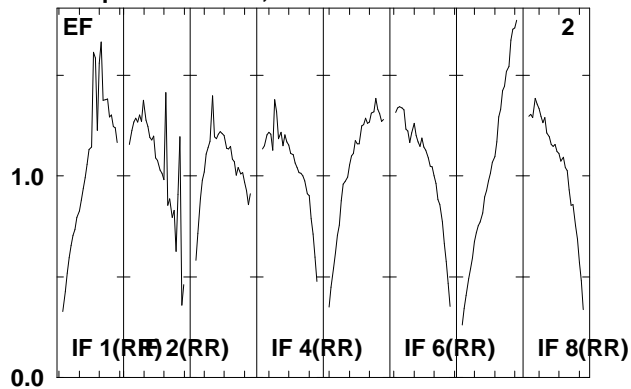

Lower frame: Real Jy
Total-power spectrum Antenna: *
Timerange: 00/09:03:08 to 00/09:04:26

Plot file version 60 created 18-APR-2008 18:27:37

J2333+39 EP061A.UVDATA.1

Freq = 1.5950 GHz, Bw = 16.000 MH No calibration applied and no bandpass applied

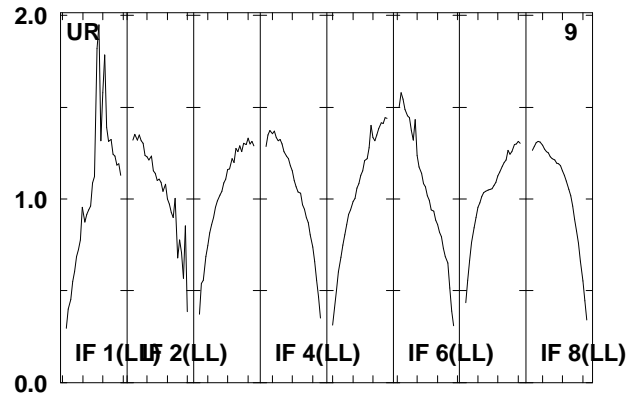
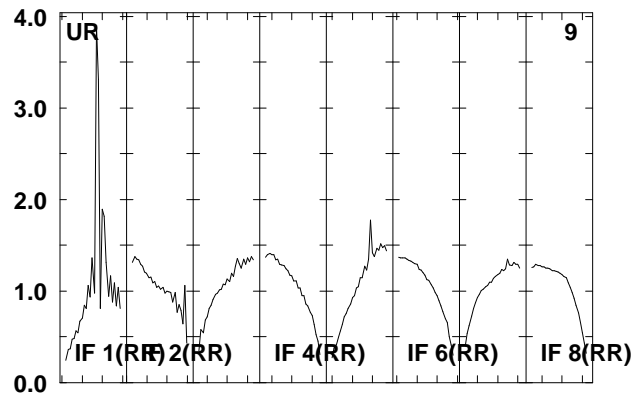
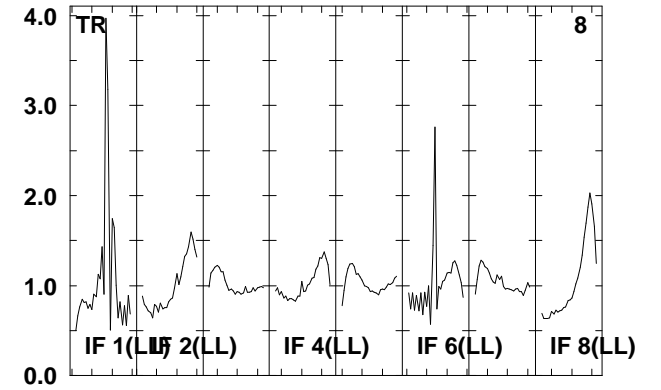
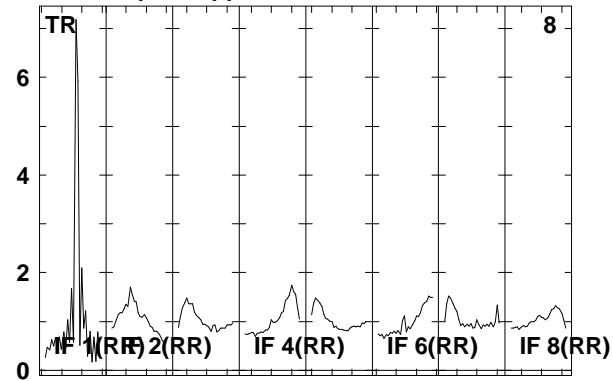
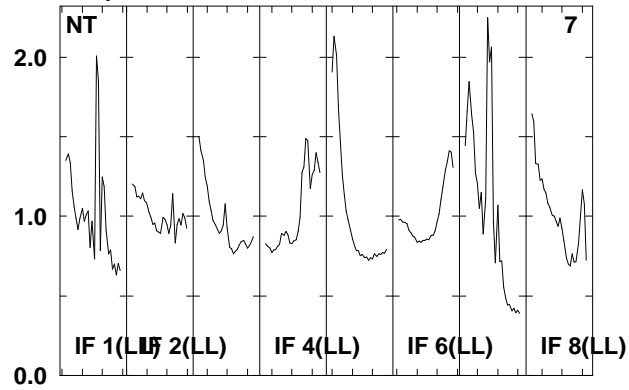

Lower frame: Real Jy
Total-power spectrum Antenna: *
Timerange: 00/09:03:08 to 00/09:04:26

Plot file version 61 created 18-APR-2008 18:27:37

IRAS2336 EP061A.UVDATA.1

Freq = 1.5950 GHz, Bw = 16.000 MH No calibration applied and no bandpass applied

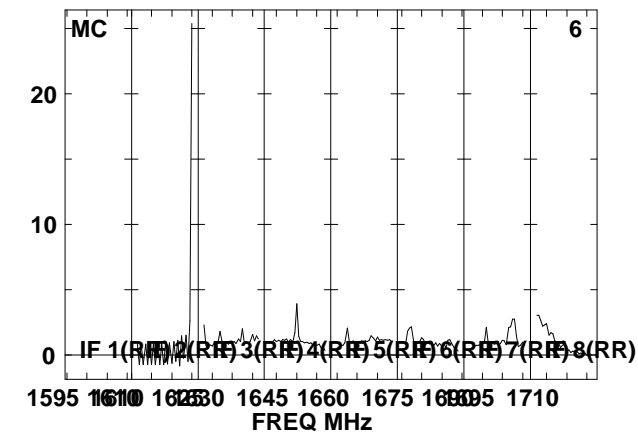
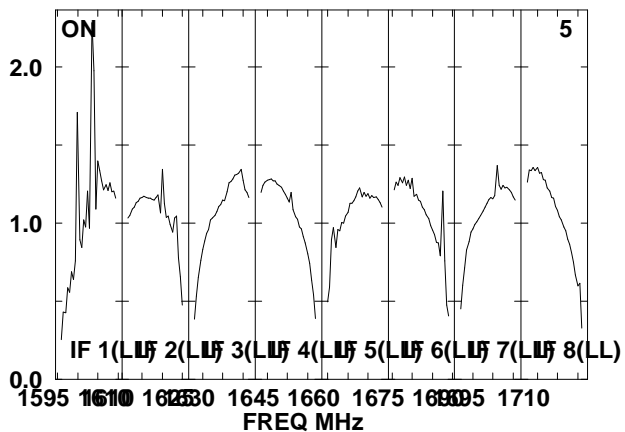
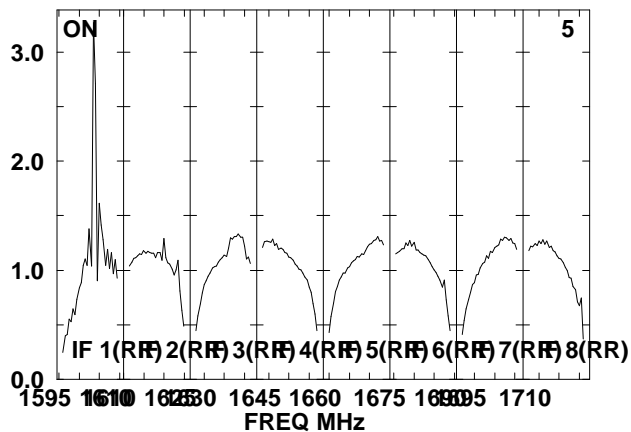
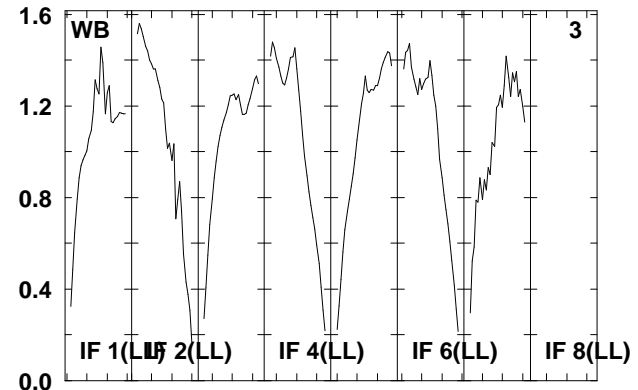
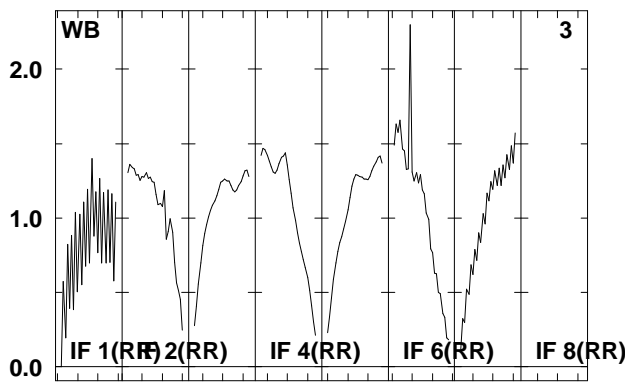
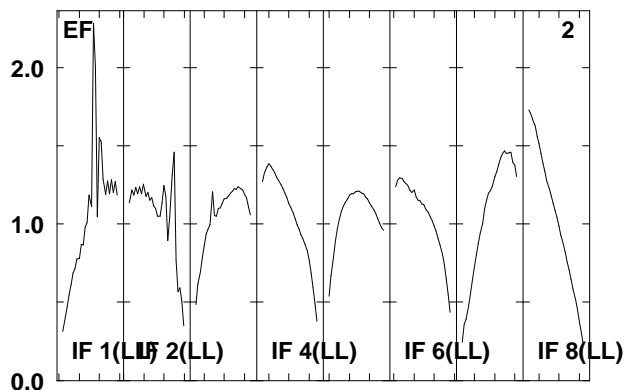
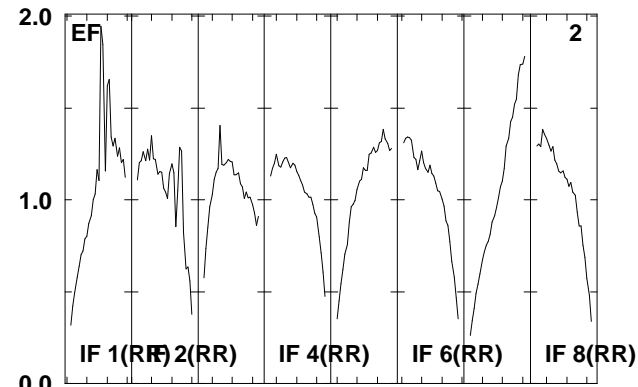
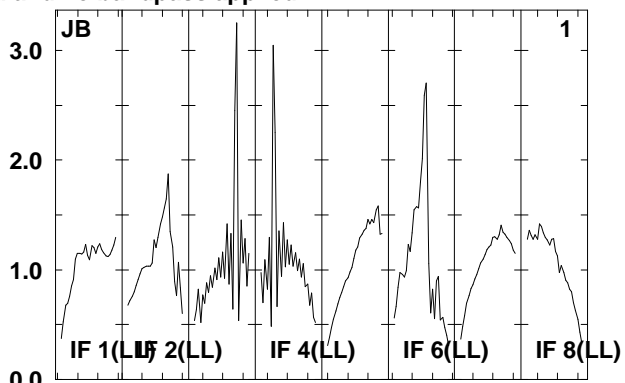
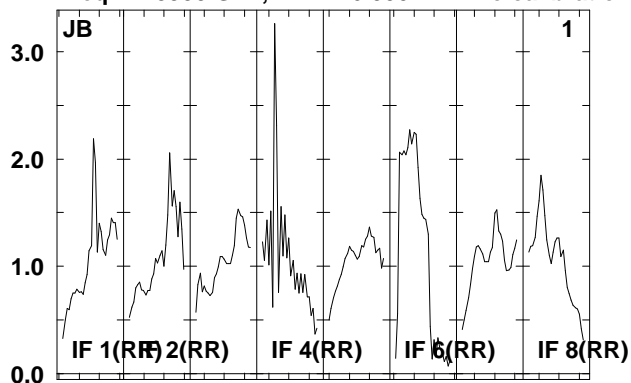

Lower frame: Real Jy
Total-power spectrum Antenna: *
Timerange: 00/09:04:32 to 00/09:08:00

Plot file version 62 created 18-APR-2008 18:27:38

IRAS2336 EP061A.UVDATA.1

Freq = 1.5950 GHz, Bw = 16.000 MH No calibration applied and no bandpass applied

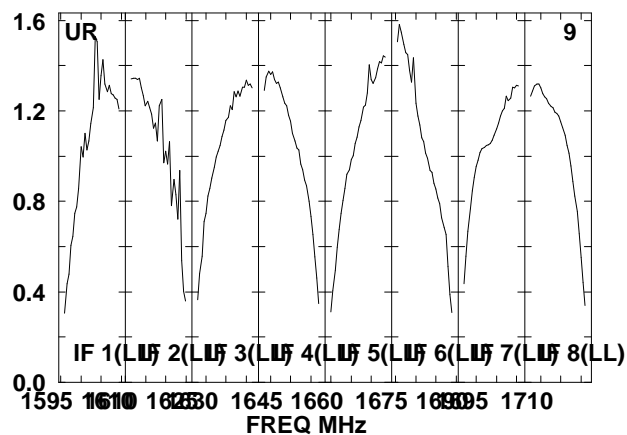
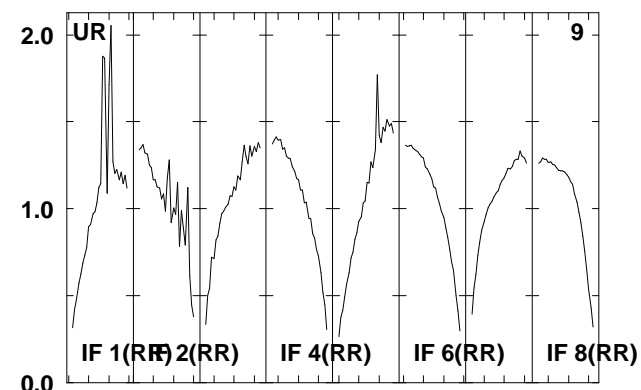
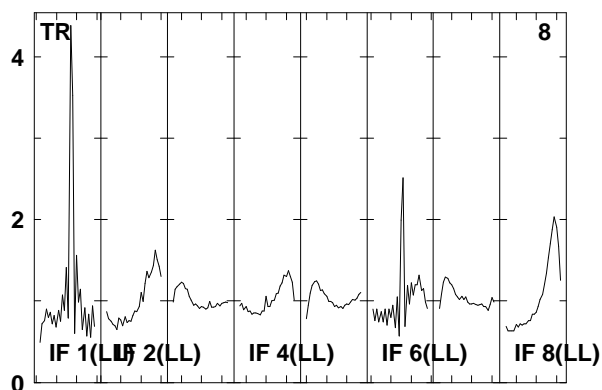
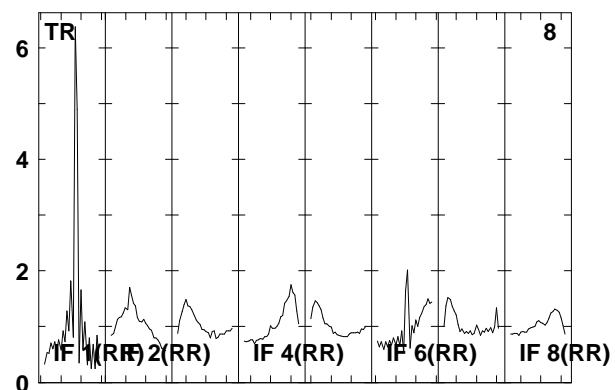
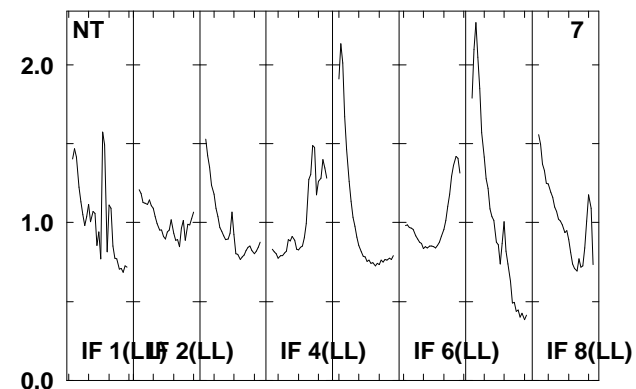
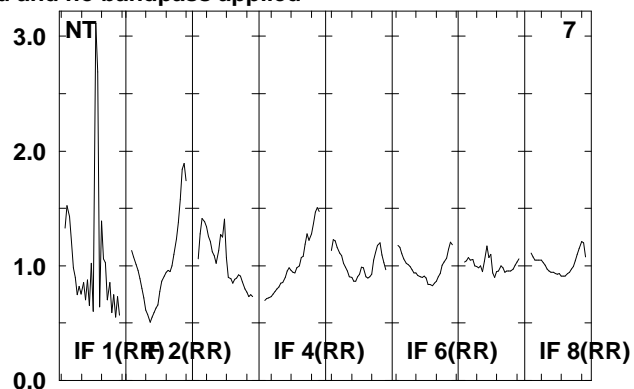
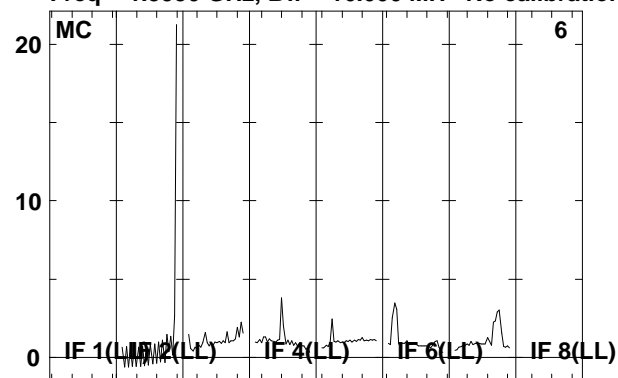

Lower frame: Real Jy

Total-power spectrum Antenna: *

Timerange: 00/09:04:32 to 00/09:08:00

Plot file version 63 created 18-APR-2008 18:27:39

J2333+39 EP061A.UVDATA.1

Freq = 1.5950 GHz, Bw = 16.000 MH No calibration applied and no bandpass applied

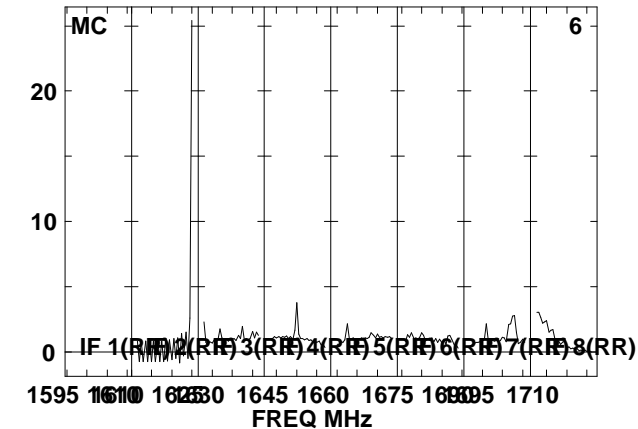
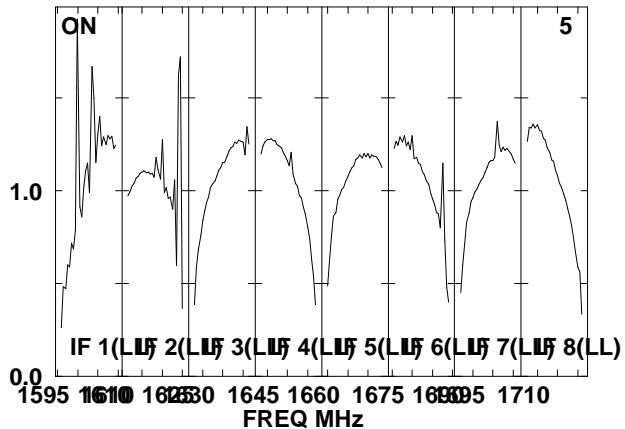
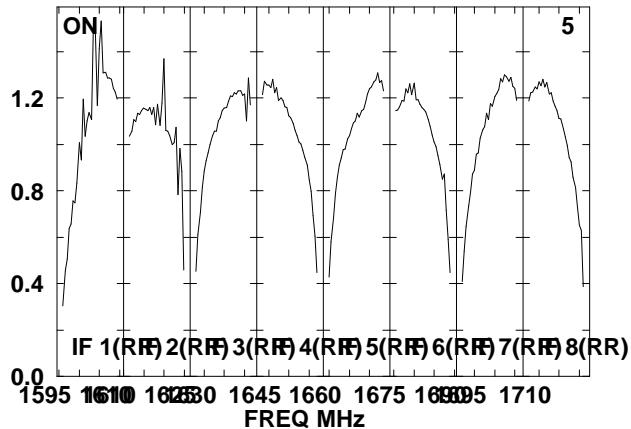
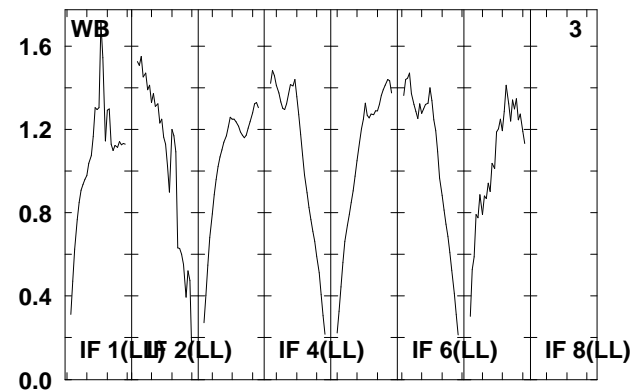
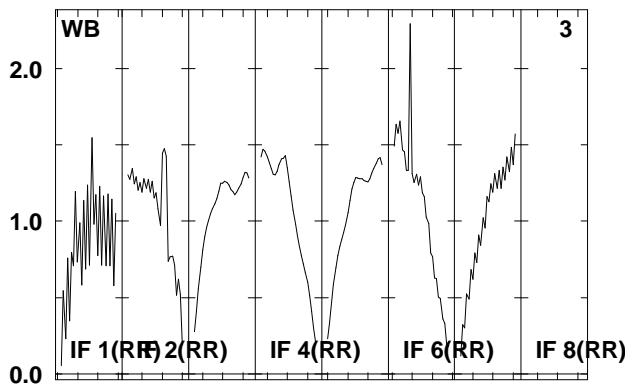
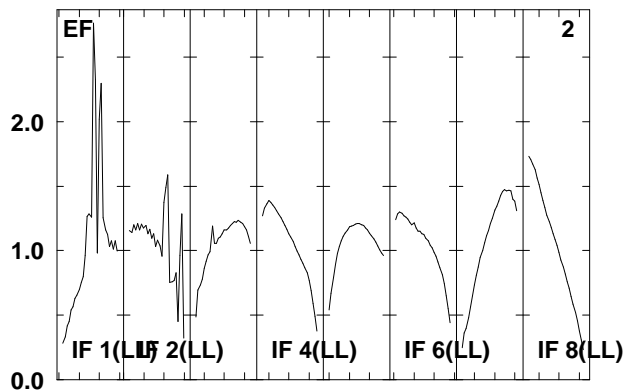
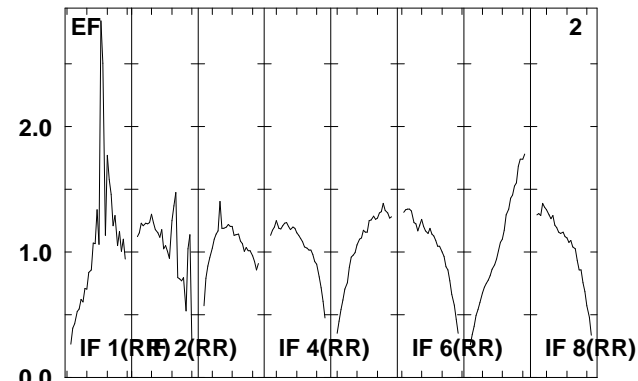
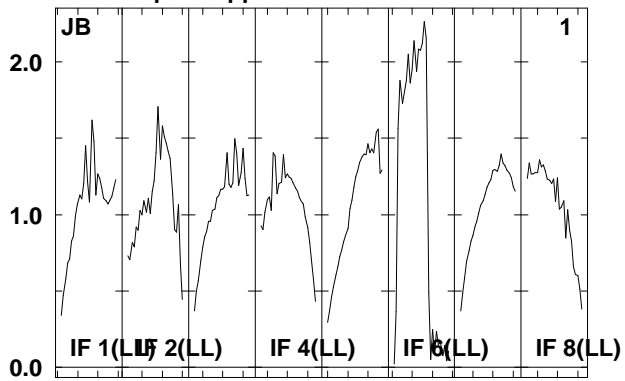
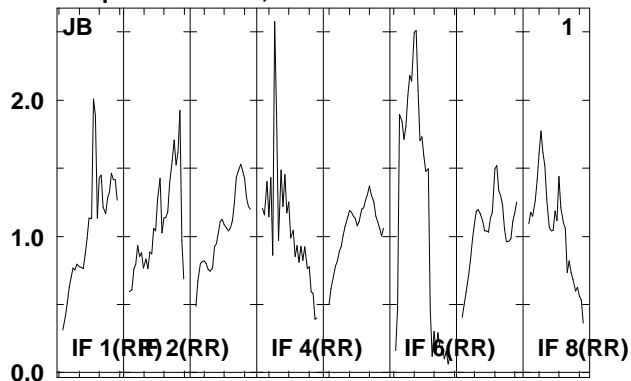

Lower frame: Real Jy
Total-power spectrum Antenna: *
Timerange: 00/09:08:02 to 00/09:09:30

Plot file version 64 created 18-APR-2008 18:27:39

J2333+39 EP061A.UVDATA.1

Freq = 1.5950 GHz, Bw = 16.000 MH No calibration applied and no bandpass applied

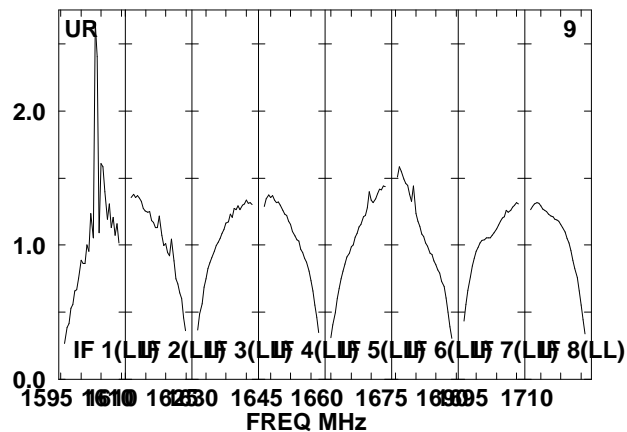
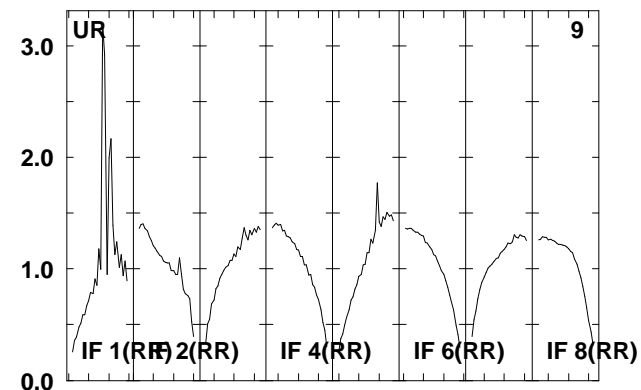
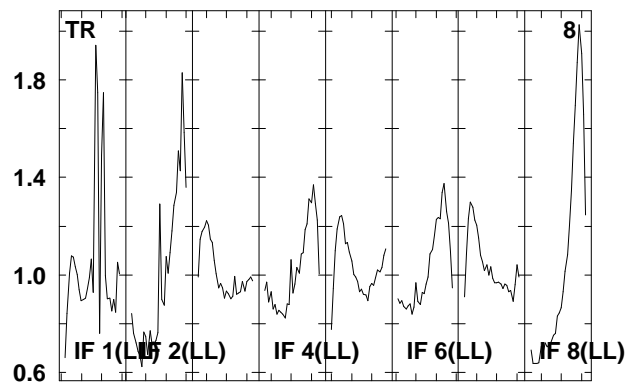
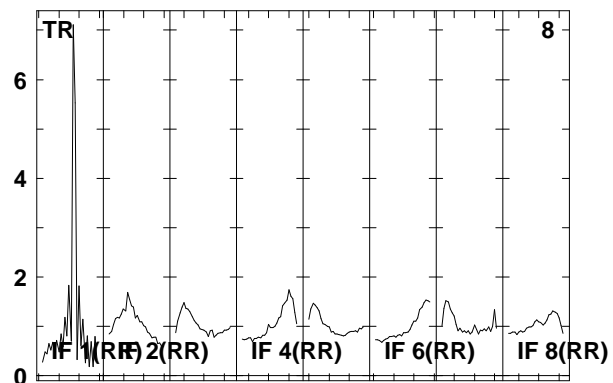
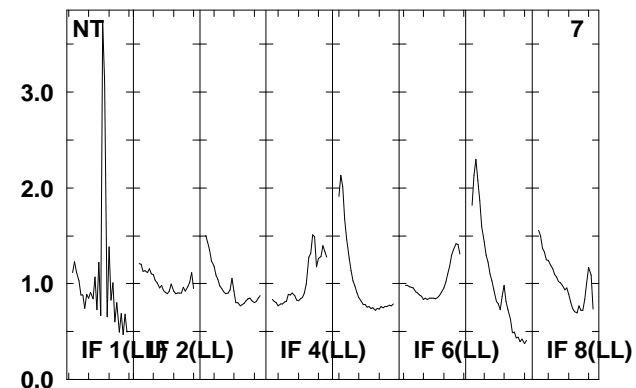
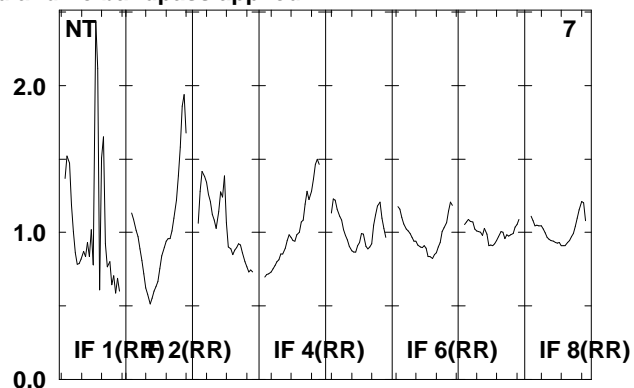
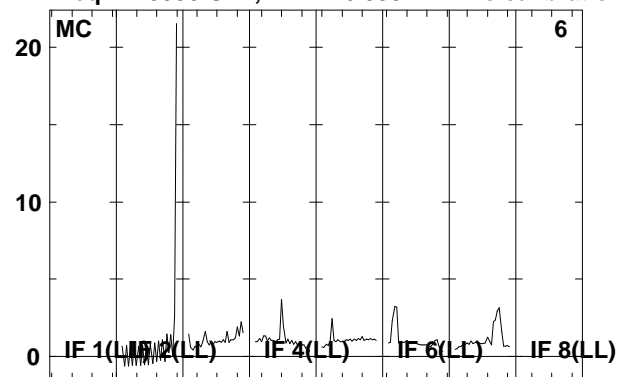

Lower frame: Real Jy

Total-power spectrum Antenna: *

Timerange: 00/09:08:02 to 00/09:09:30

Plot file version 65 created 18-APR-2008 18:27:40

IRAS2336 EP061A.UVDATA.1

Freq = 1.5950 GHz, Bw = 16.000 MH No calibration applied and no bandpass applied

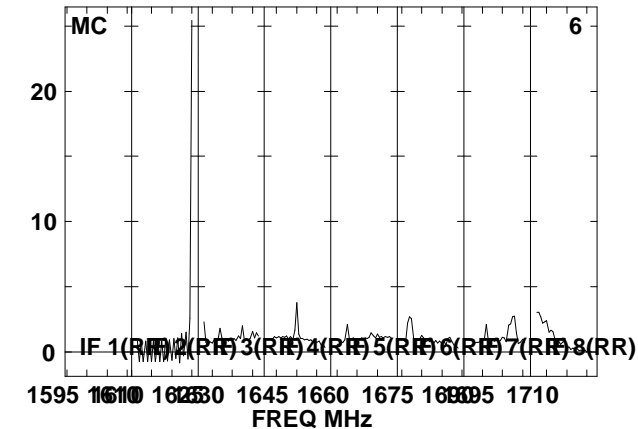
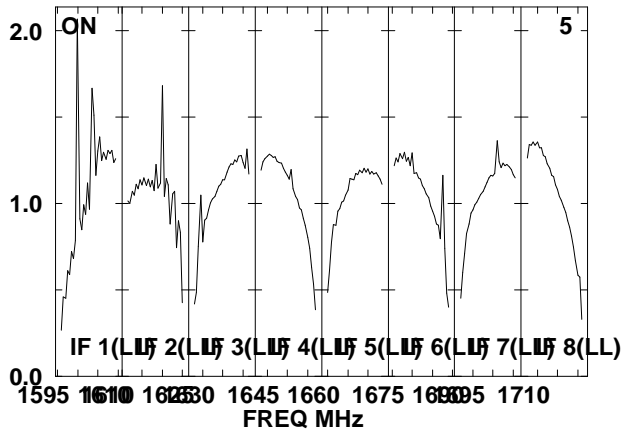
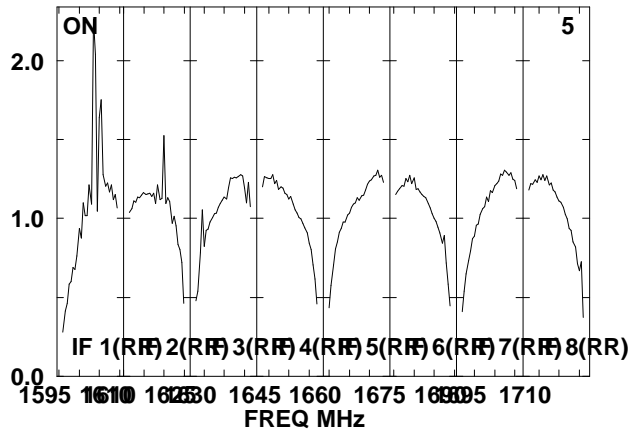
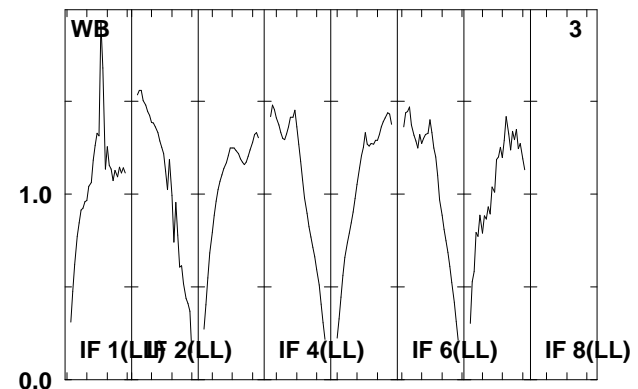
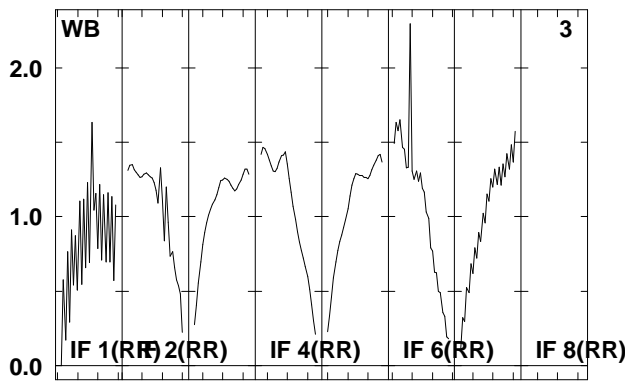
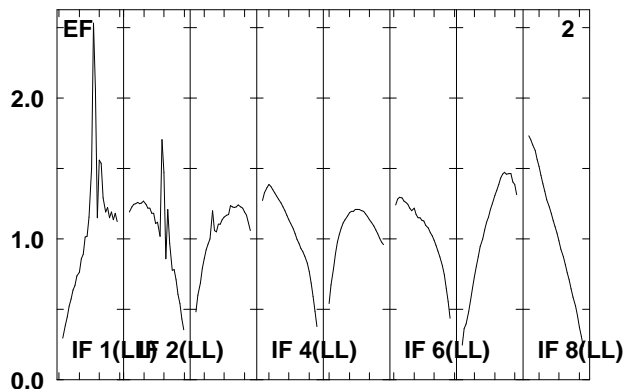
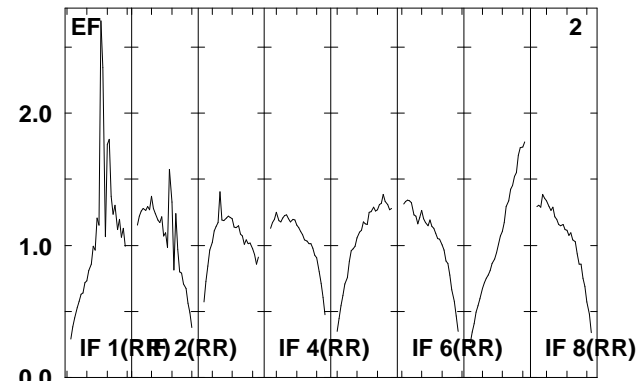
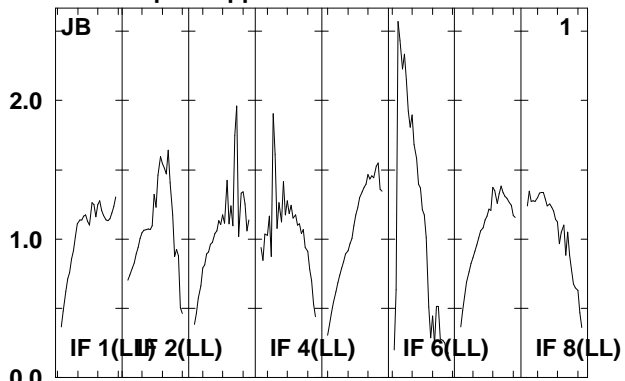
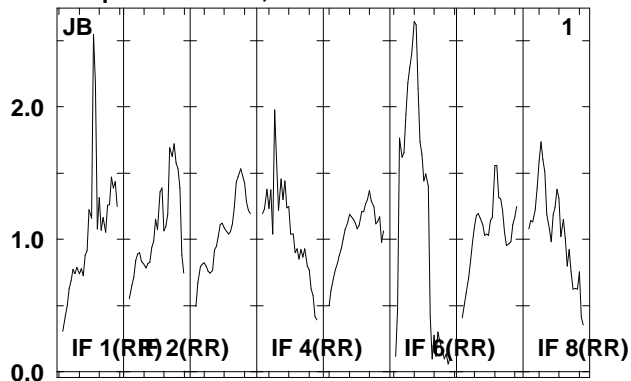

Lower frame: Real Jy
Total-power spectrum Antenna: *
Timerange: 00/09:09:32 to 00/09:12:58

Plot file version 66 created 18-APR-2008 18:27:41

IRAS2336 EP061A.UVDATA.1

Freq = 1.5950 GHz, Bw = 16.000 MH No calibration applied and no bandpass applied

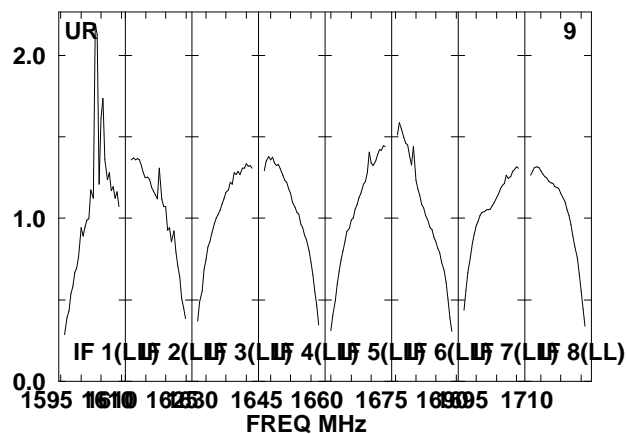
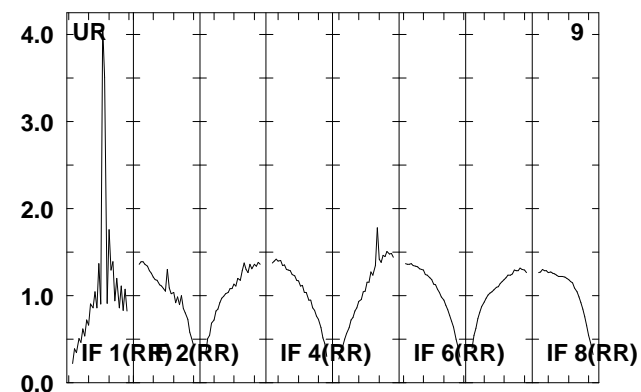
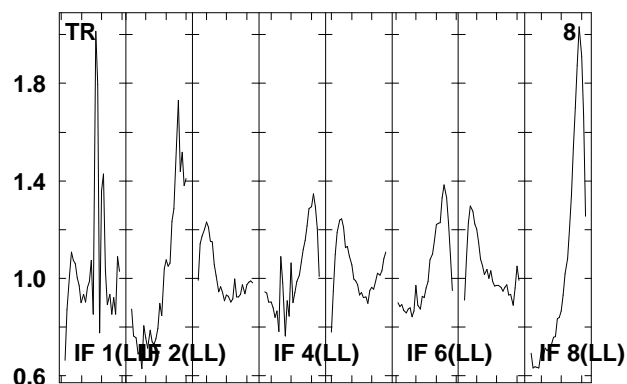
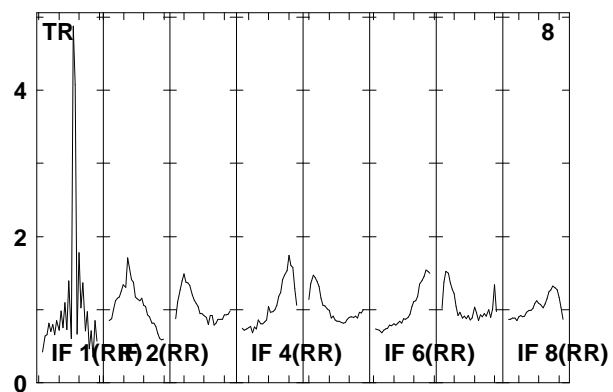
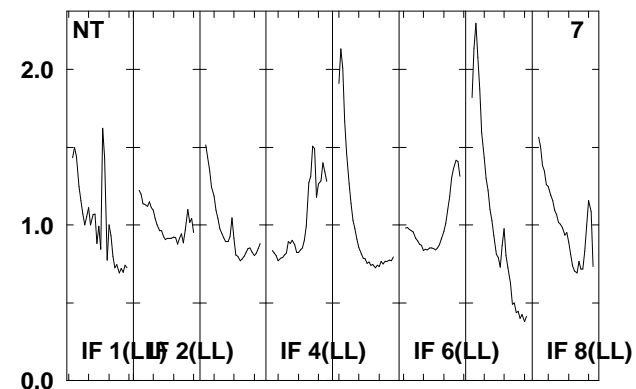
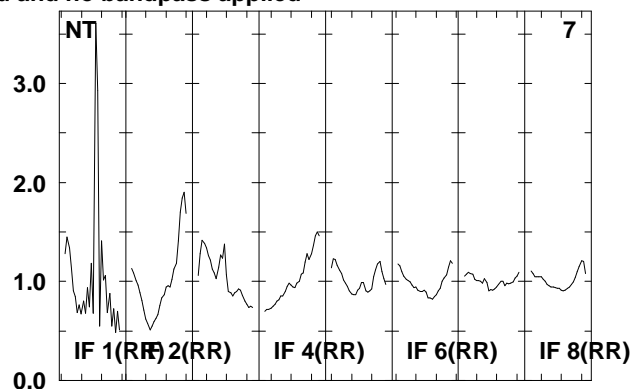
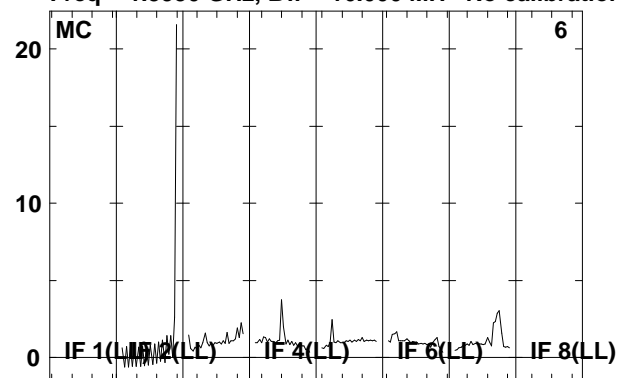

Lower frame: Real Jy

Total-power spectrum Antenna: *

Timerange: 00/09:09:32 to 00/09:12:58

Plot file version 67 created 18-APR-2008 18:27:42

J2333+39 EP061A.UVDATA.1

Freq = 1.5950 GHz, Bw = 16.000 MH No calibration applied and no bandpass applied

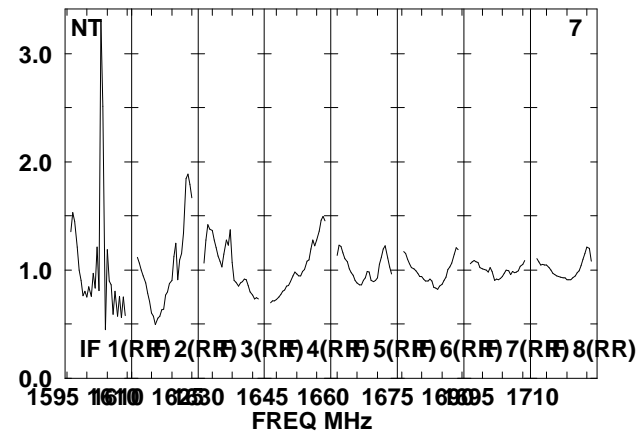
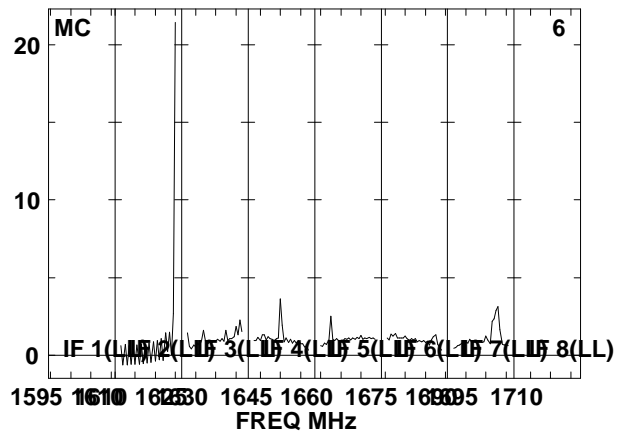
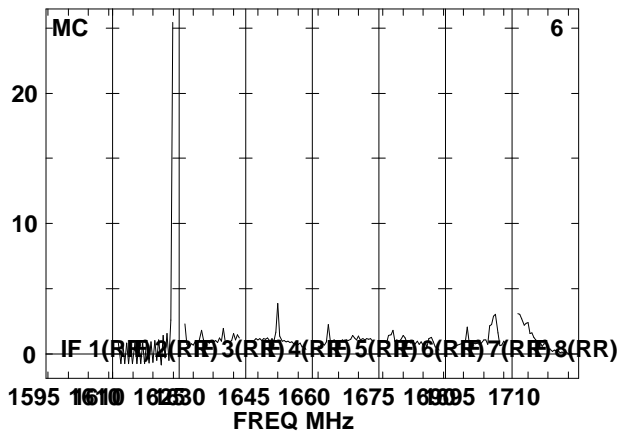
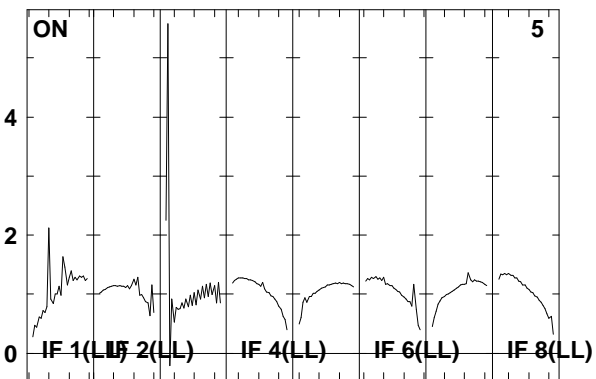
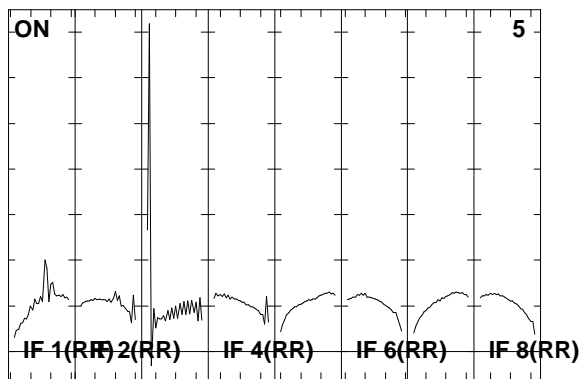
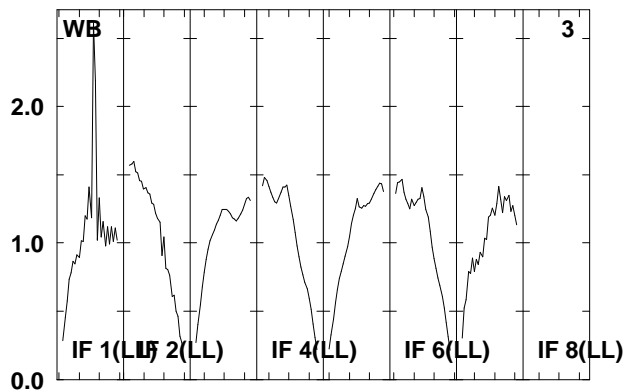
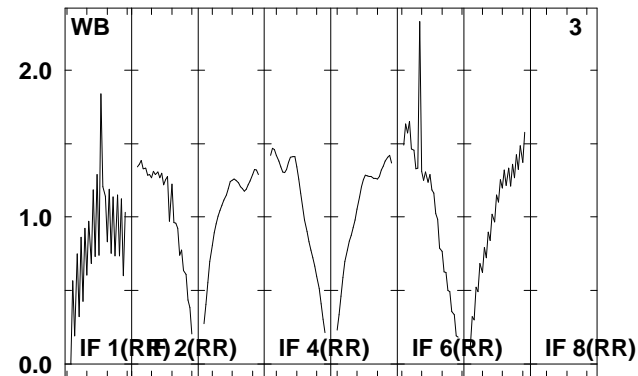
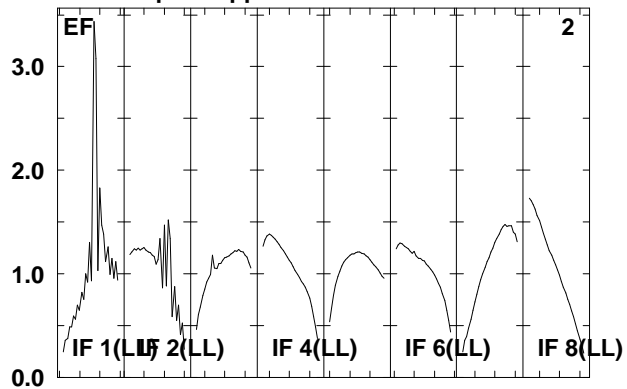
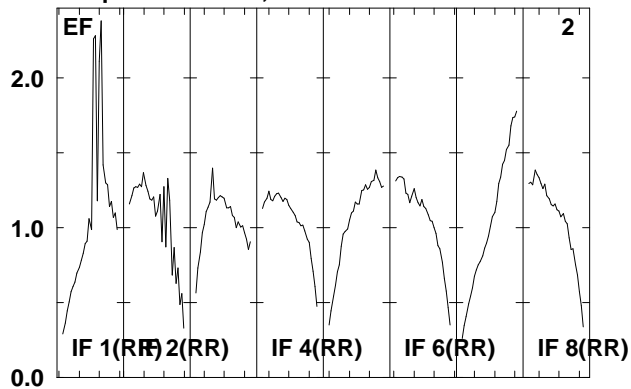

Lower frame: Real Jy
Total-power spectrum Antenna: *
Timerange: 00/09:14:02 to 00/09:15:28

Plot file version 68 created 18-APR-2008 18:27:42

J2333+39 EP061A.UVDATA.1

Freq = 1.5950 GHz, Bw = 16.000 MH No calibration applied and no bandpass applied

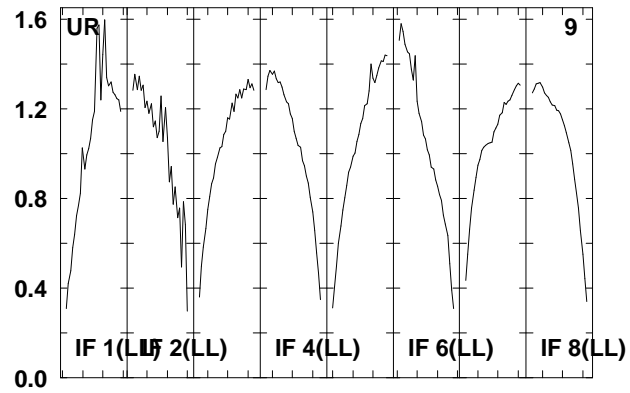
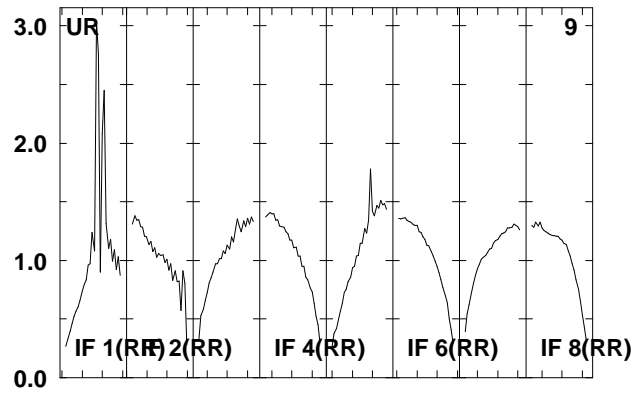
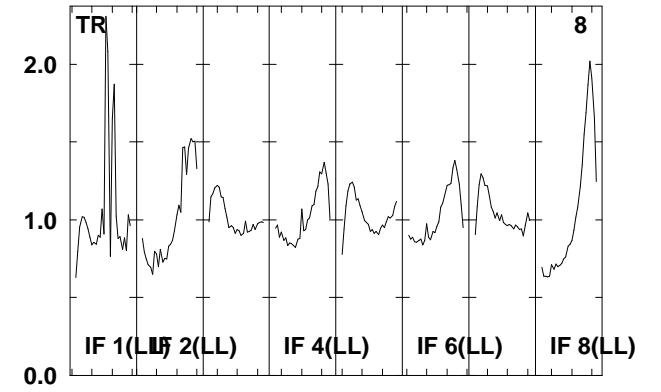
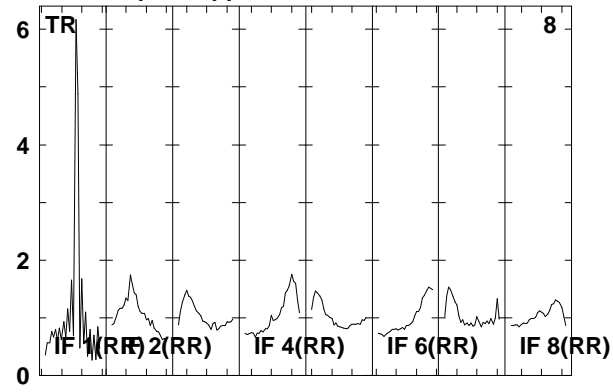
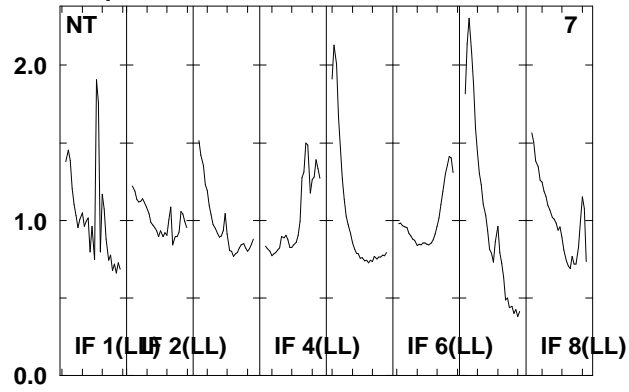

Lower frame: Real Jy
Total-power spectrum Antenna: *
Timerange: 00/09:14:02 to 00/09:15:28

Plot file version 69 created 18-APR-2008 18:27:42

IRAS2336 EP061A.UVDATA.1

Freq = 1.5950 GHz, Bw = 16.000 MH No calibration applied and no bandpass applied

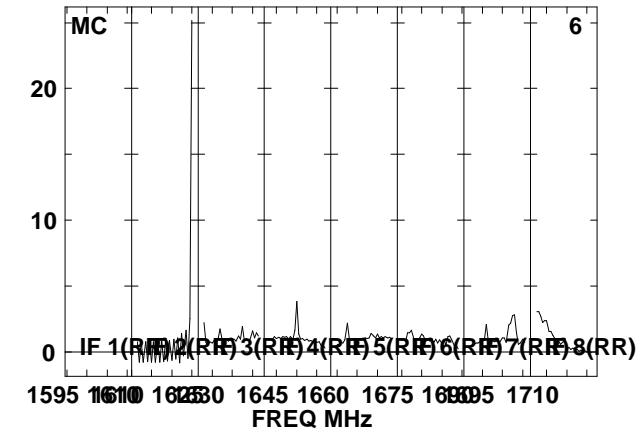
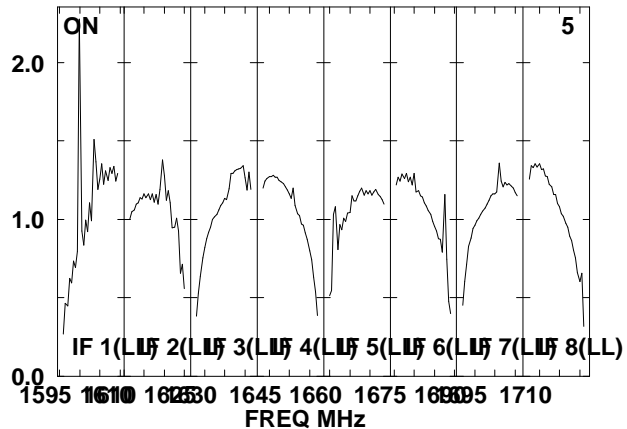
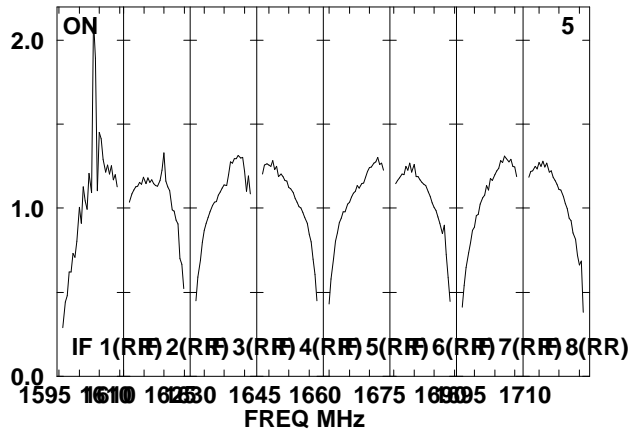
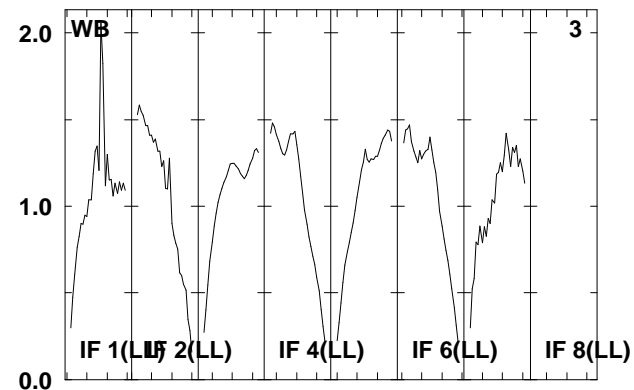
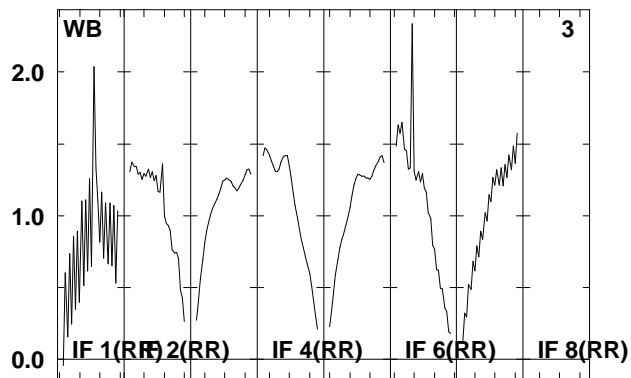
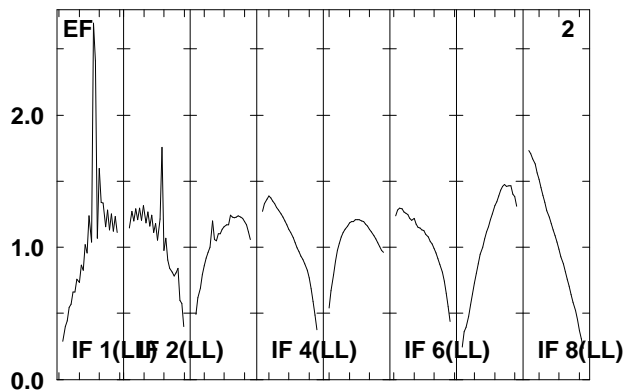
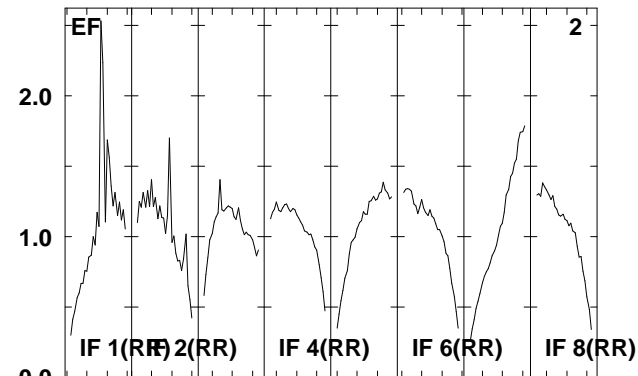
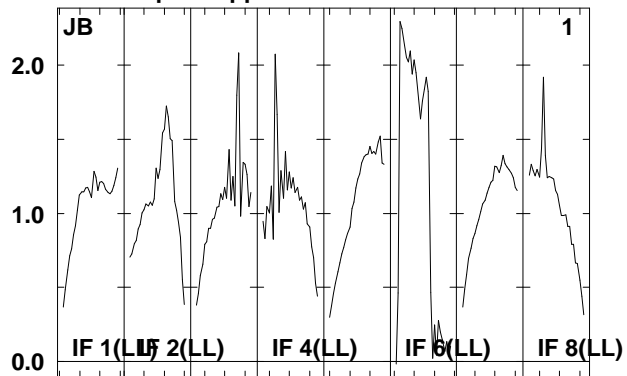
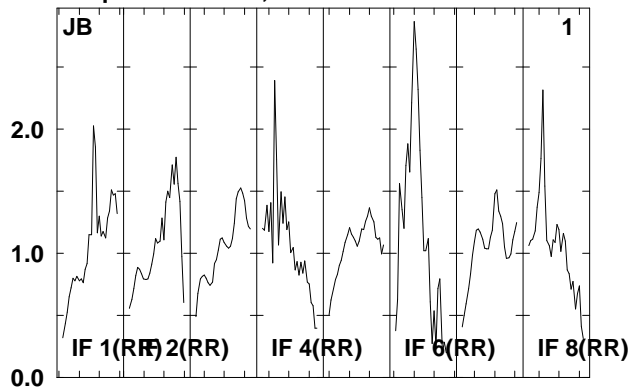

Lower frame: Real Jy
Total-power spectrum Antenna: *
Timerange: 00/09:15:30 to 00/09:18:56

Plot file version 70 created 18-APR-2008 18:27:43

IRAS2336 EP061A.UVDATA.1

Freq = 1.5950 GHz, Bw = 16.000 MH No calibration applied and no bandpass applied

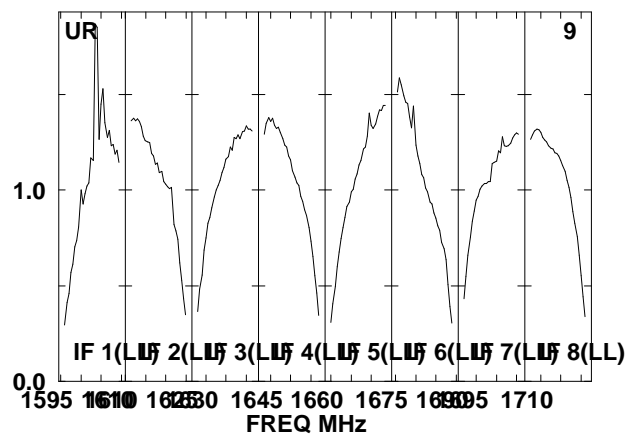
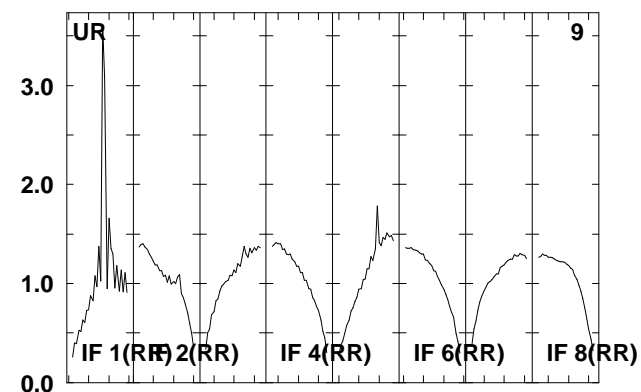
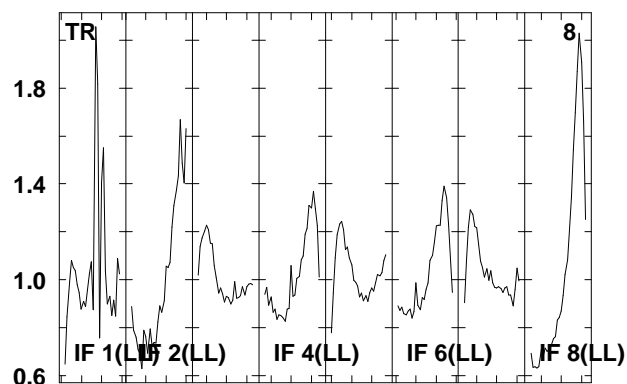
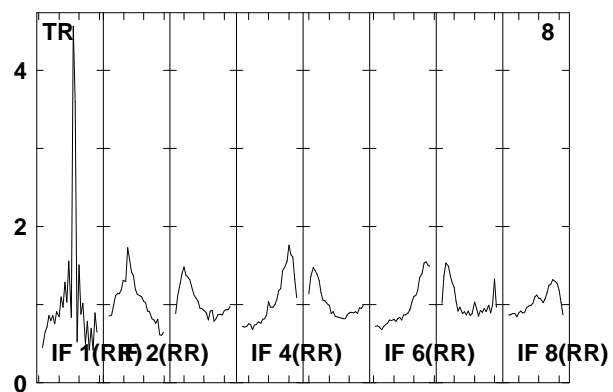
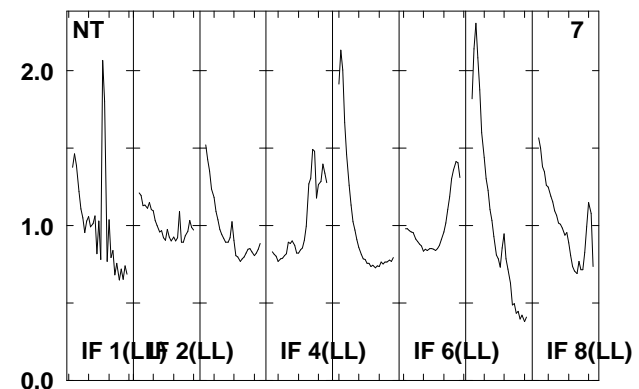
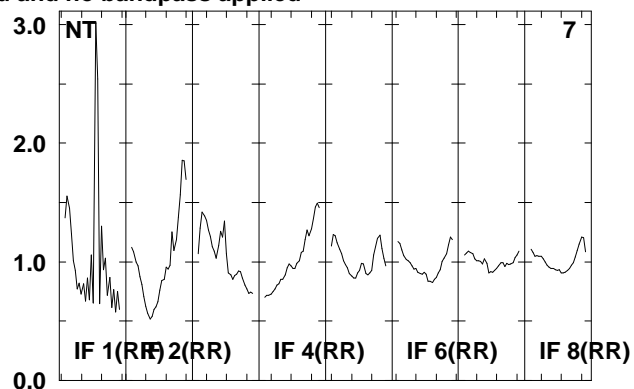
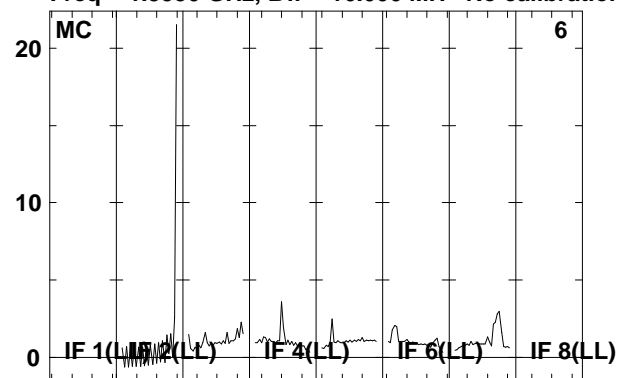

Lower frame: Real Jy

Total-power spectrum Antenna: *

Timerange: 00/09:15:30 to 00/09:18:56

Plot file version 71 created 18-APR-2008 18:27:44

J2333+39 EP061A.UVDATA.1

Freq = 1.5950 GHz, Bw = 16.000 MH No calibration applied and no bandpass applied

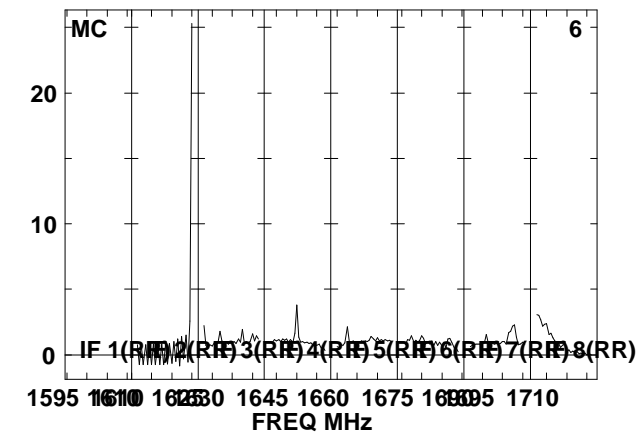
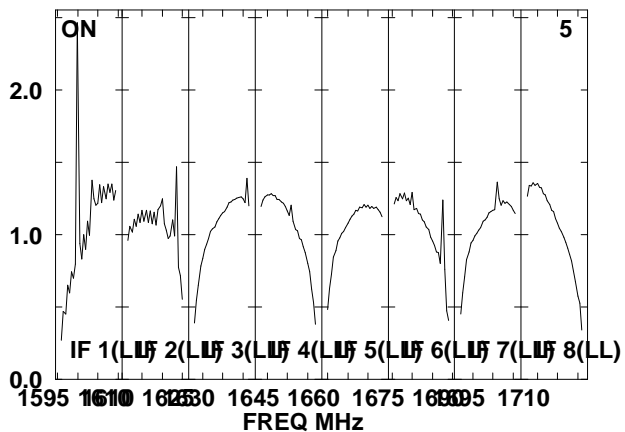
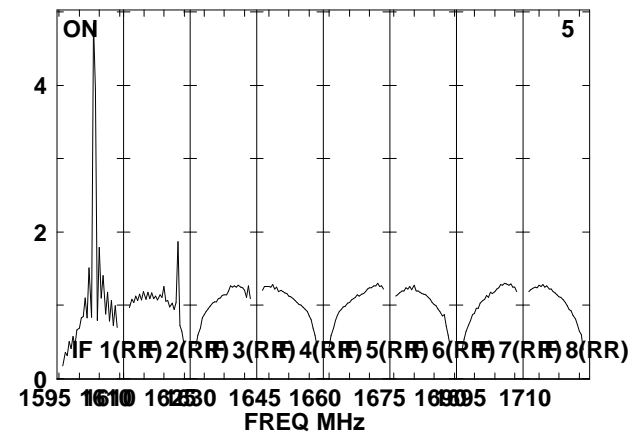
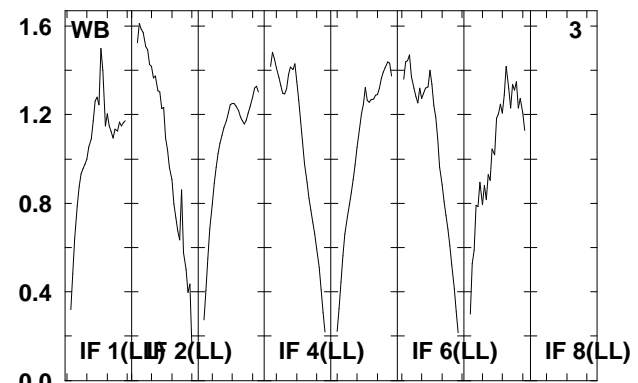
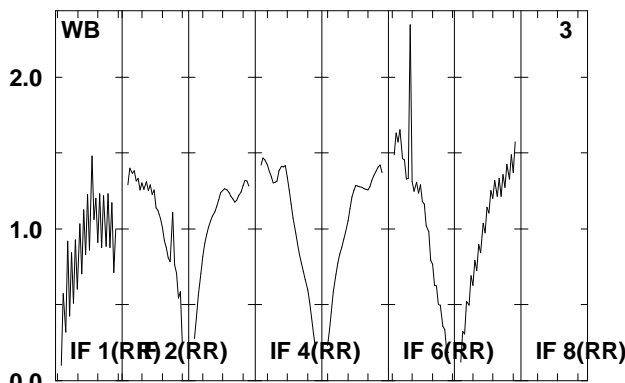
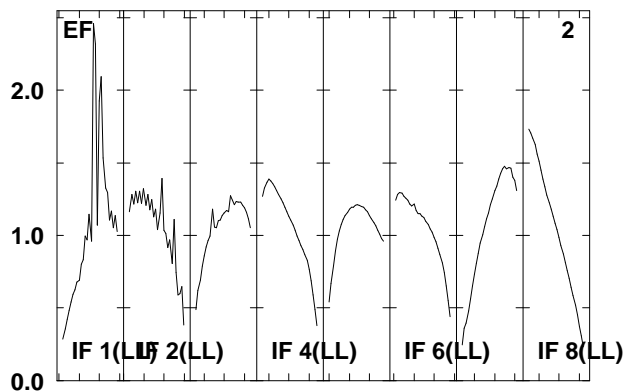
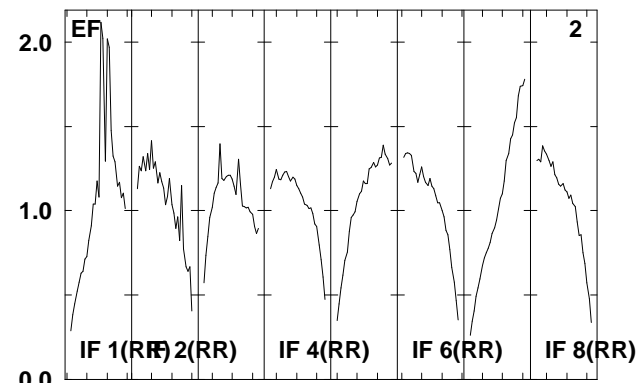
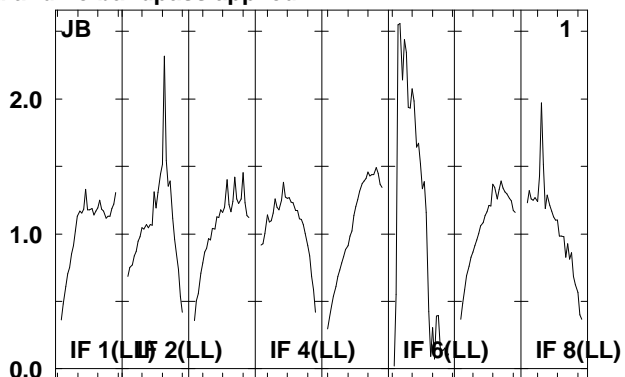
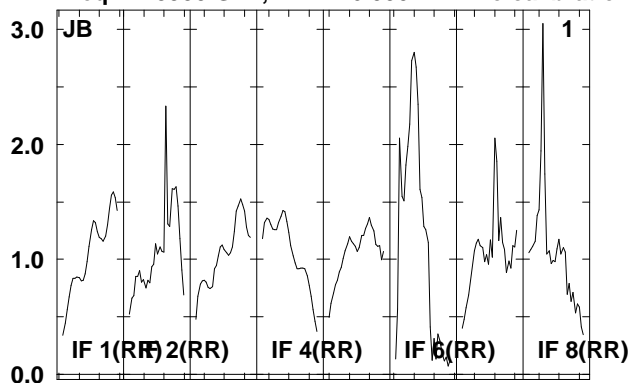

Lower frame: Real Jy
Total-power spectrum Antenna: *
Timerange: 00/09:19:08 to 00/09:20:30

Plot file version 72 created 18-APR-2008 18:27:44

J2333+39 EP061A.UVDATA.1

Freq = 1.5950 GHz, Bw = 16.000 MH No calibration applied and no bandpass applied

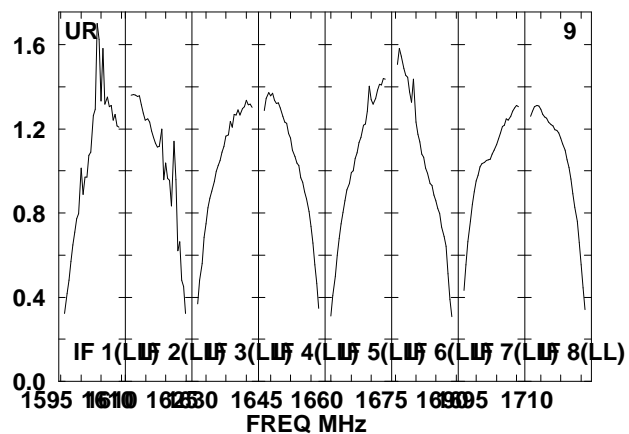
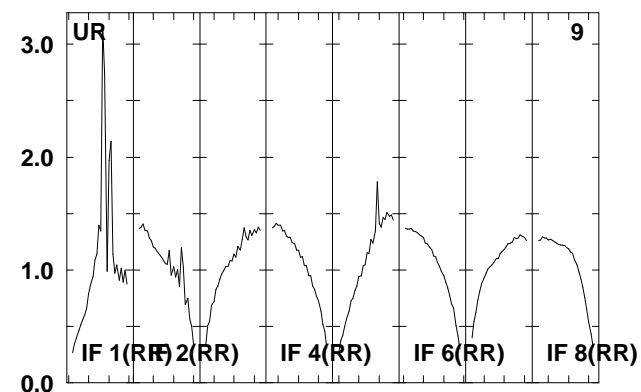
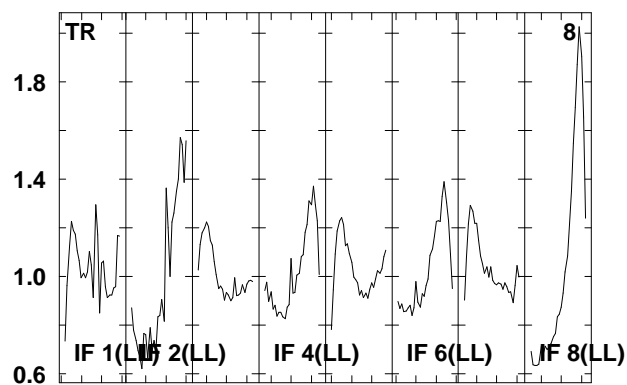
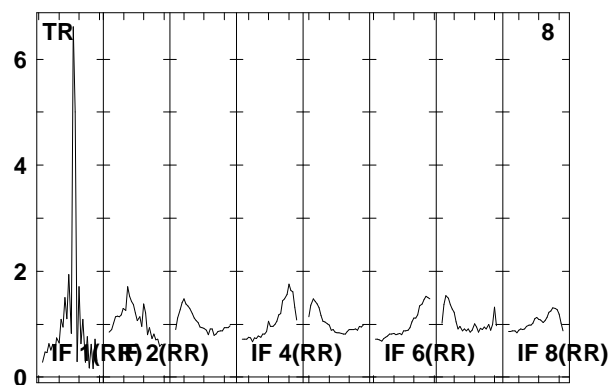
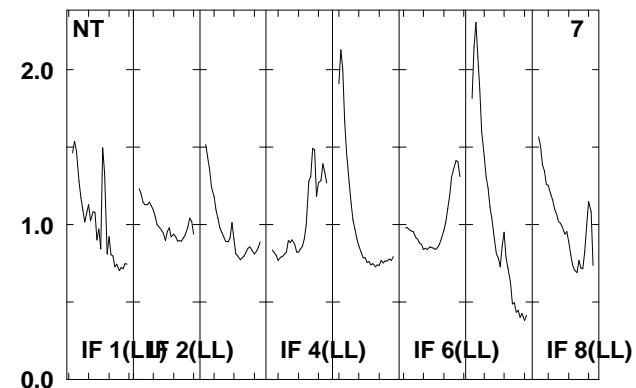
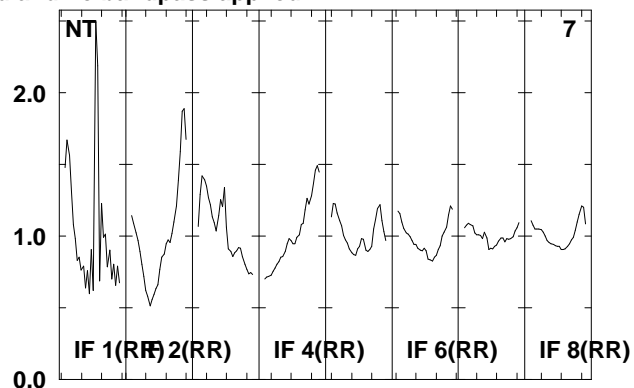
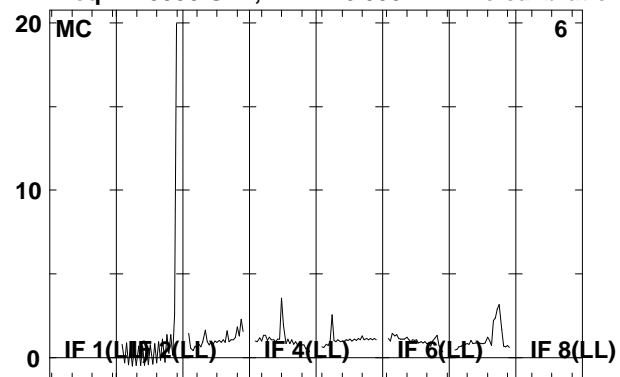

Lower frame: Real Jy

Total-power spectrum Antenna: *

Timerange: 00/09:19:08 to 00/09:20:30

Plot file version 73 created 18-APR-2008 18:27:45

IRAS2336 EP061A.UVDATA.1

Freq = 1.5950 GHz, Bw = 16.000 MH No calibration applied and no bandpass applied

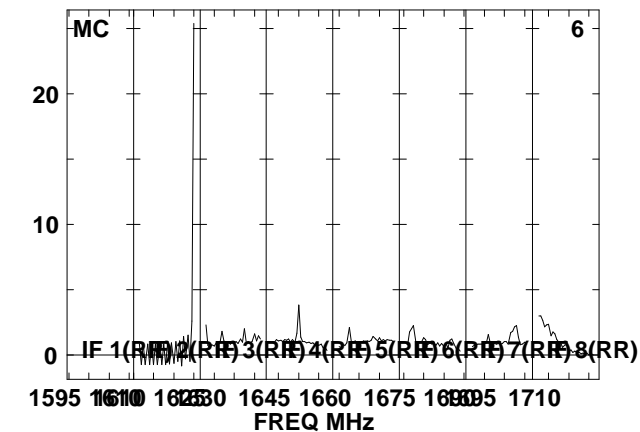
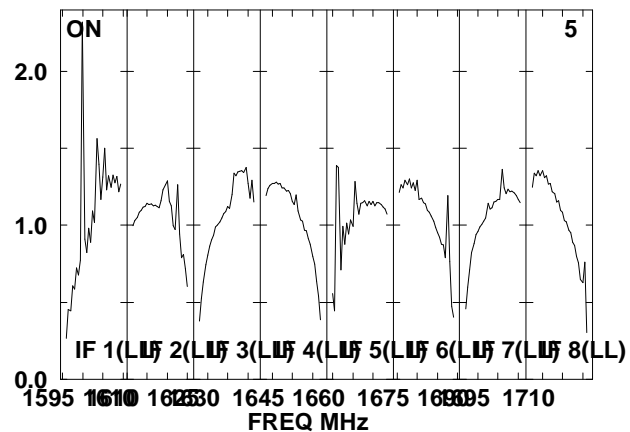
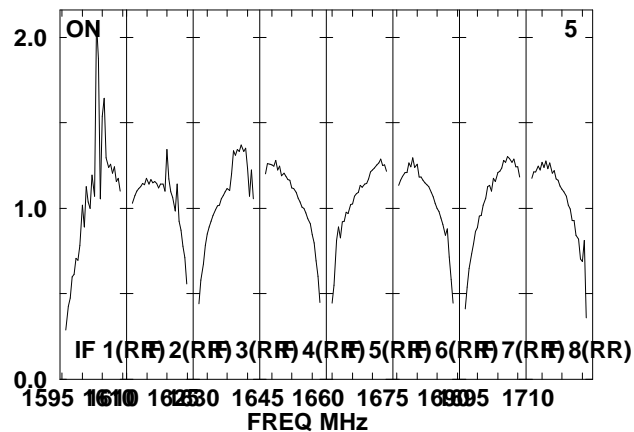
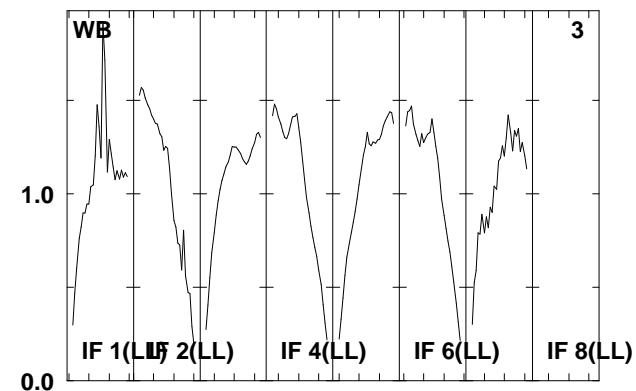
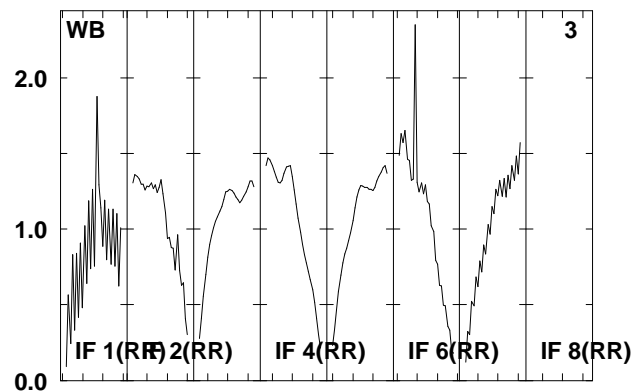
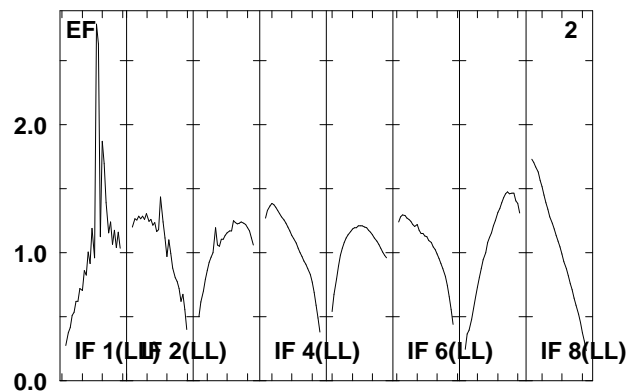
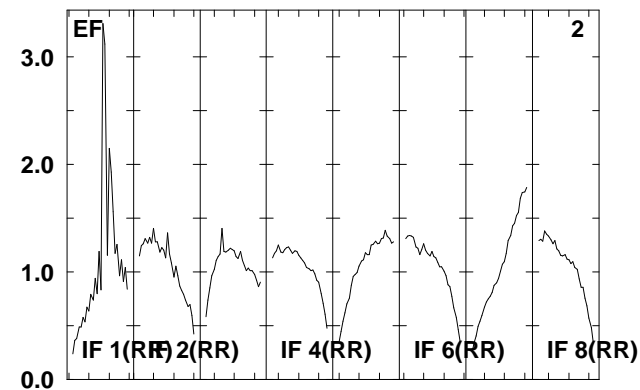
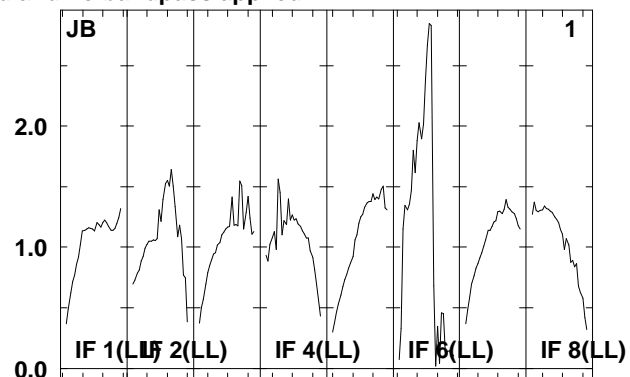
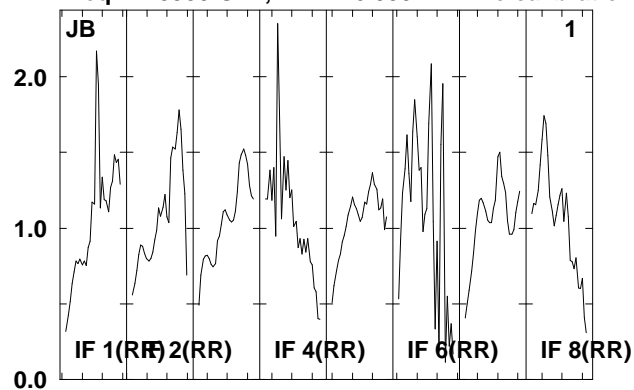

Lower frame: Real Jy
Total-power spectrum Antenna: *
Timerange: 00/09:20:32 to 00/09:24:00

Plot file version 74 created 18-APR-2008 18:27:46

IRAS2336 EP061A.UVDATA.1

Freq = 1.5950 GHz, Bw = 16.000 MH No calibration applied and no bandpass applied

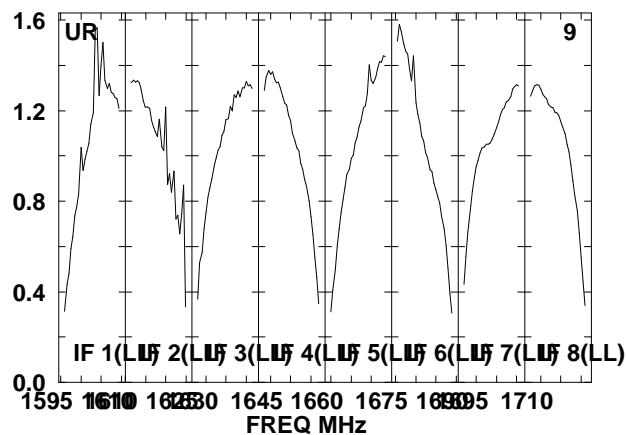
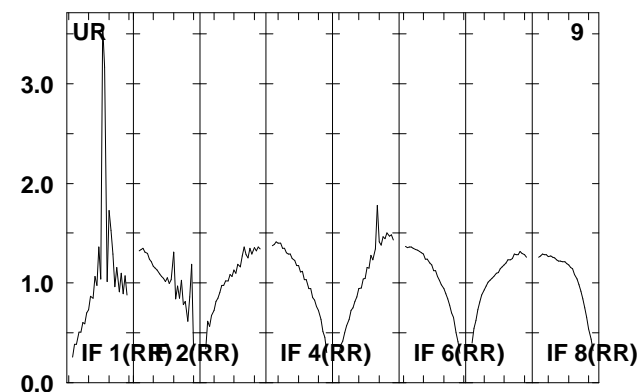
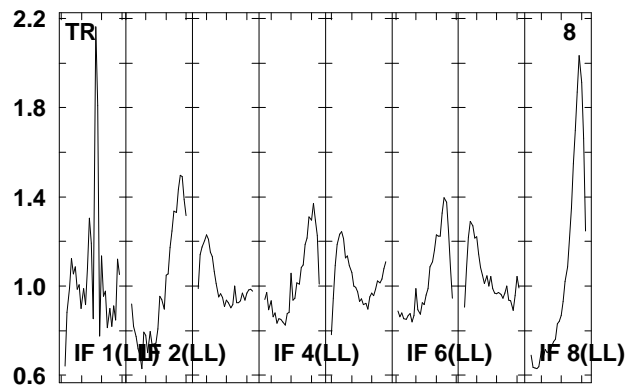
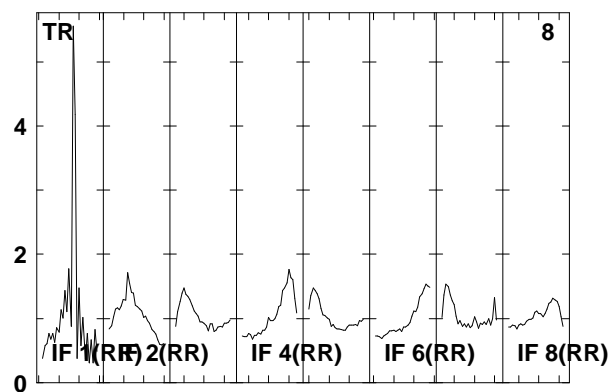
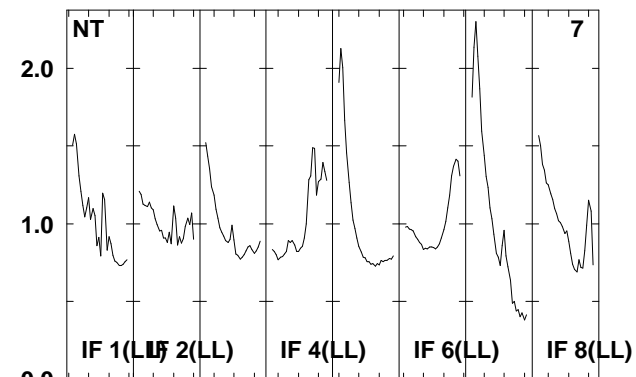
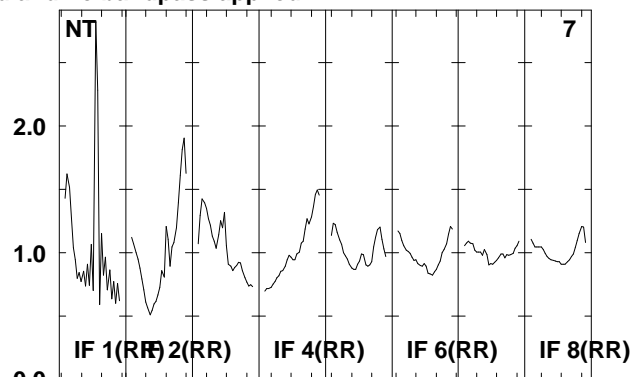
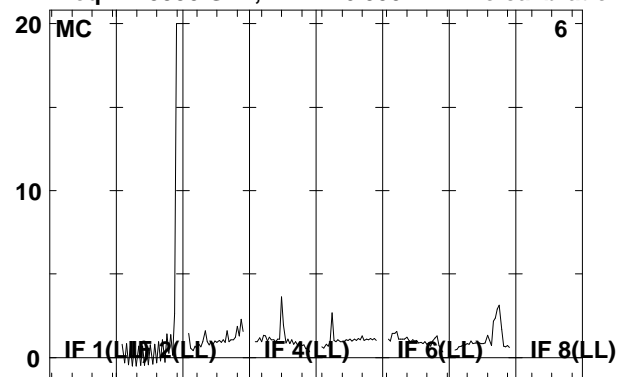

Lower frame: Real Jy

Total-power spectrum Antenna: *

Timerange: 00/09:20:32 to 00/09:24:00

Plot file version 75 created 18-APR-2008 18:27:47

J2333+39 EP061A.UVDATA.1

Freq = 1.5950 GHz, Bw = 16.000 MH No calibration applied and no bandpass applied

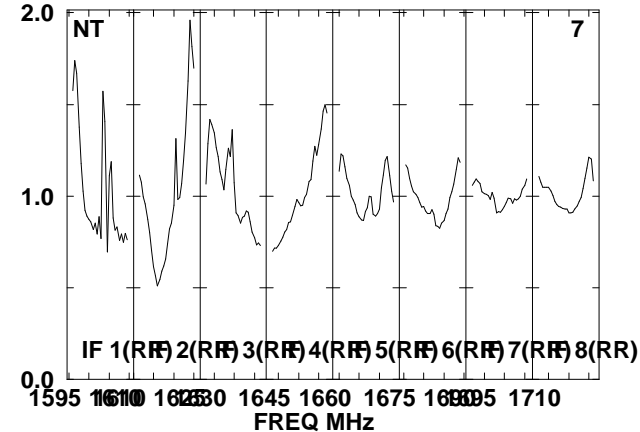
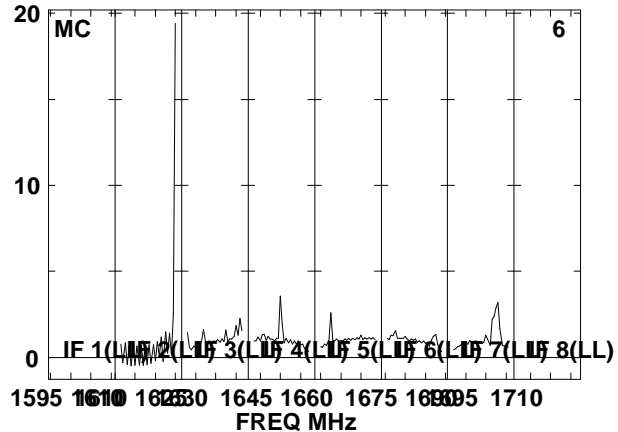
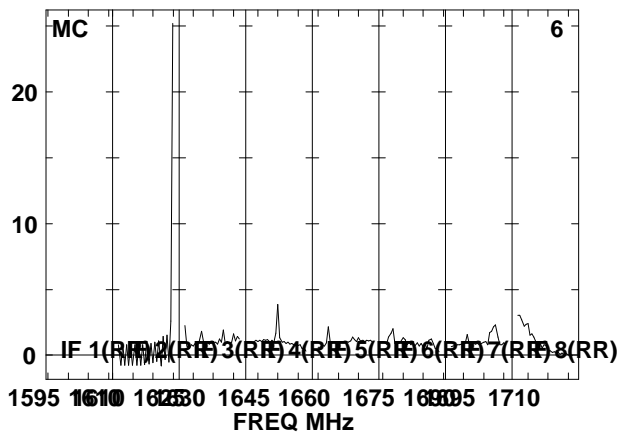
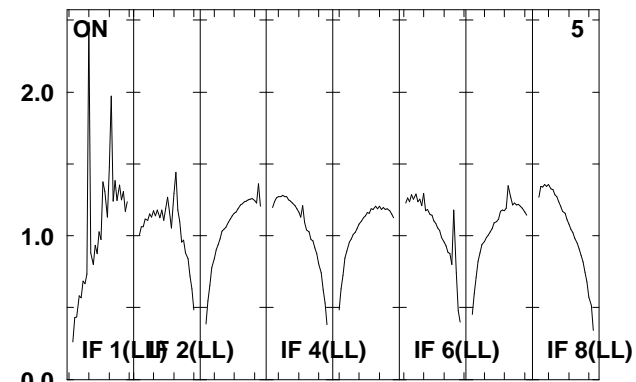
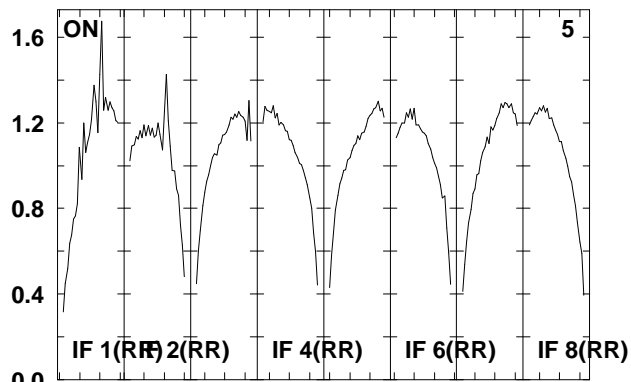
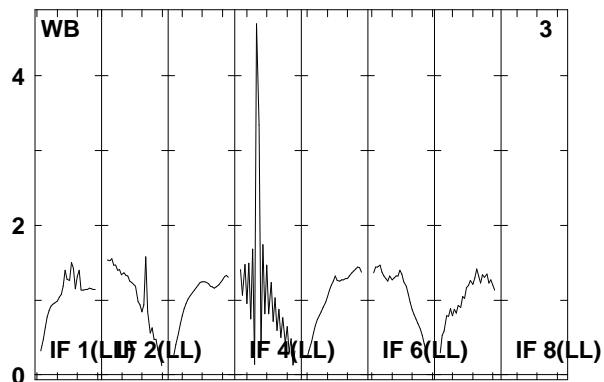
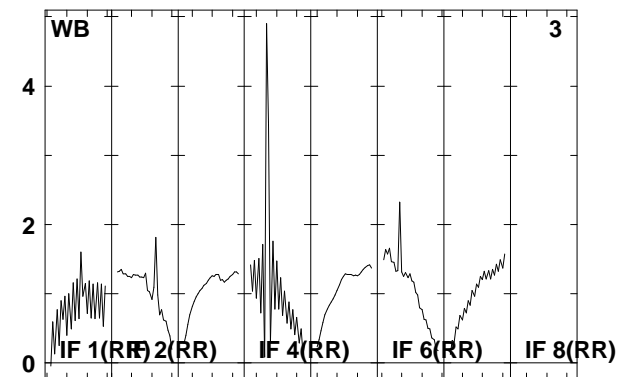
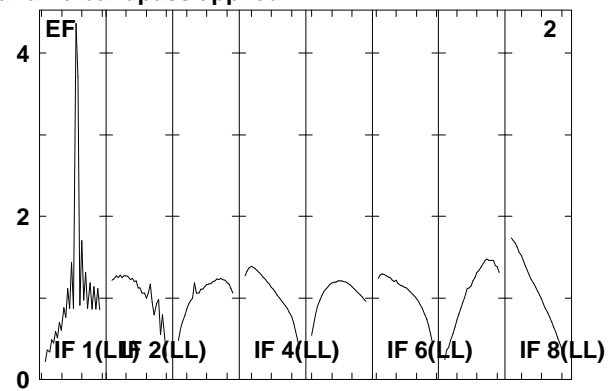
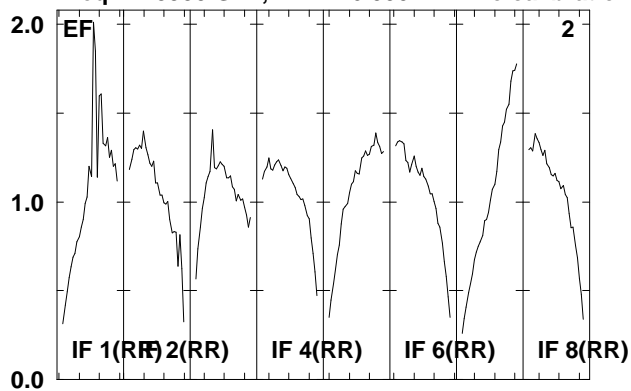

Lower frame: Real Jy
Total-power spectrum Antenna: *
Timerange: 00/09:24:02 to 00/09:25:28

Plot file version 76 created 18-APR-2008 18:27:47

J2333+39 EP061A.UVDATA.1

Freq = 1.5950 GHz, Bw = 16.000 MH No calibration applied and no bandpass applied

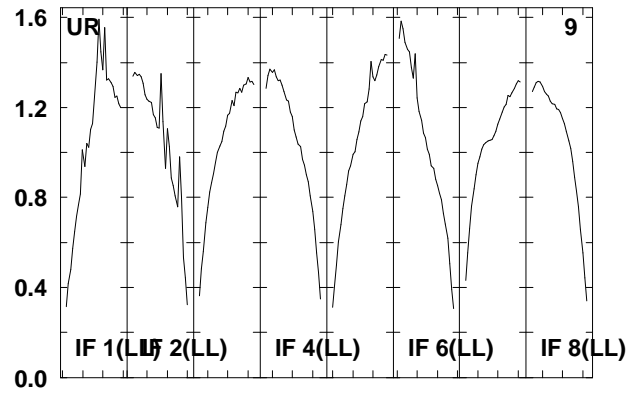
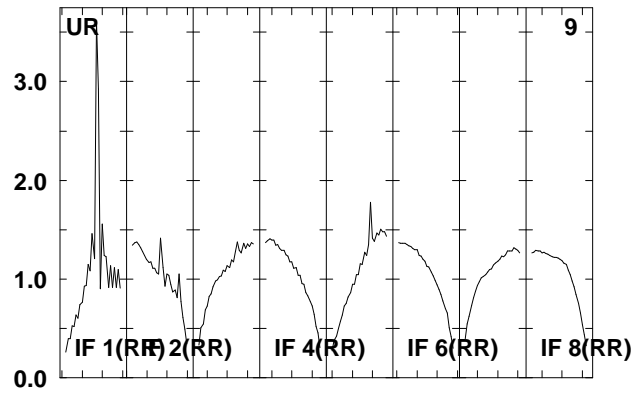
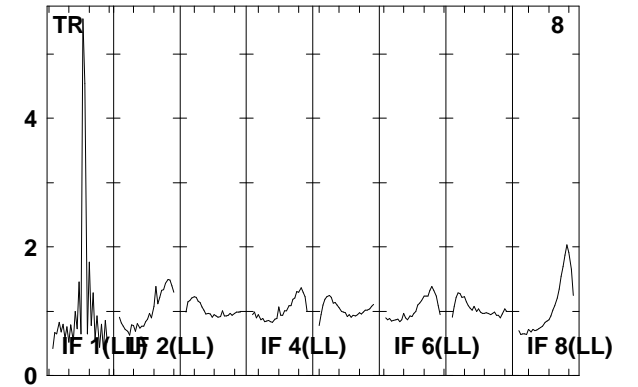
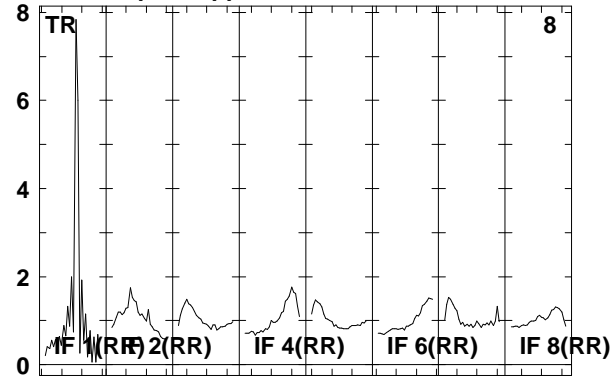
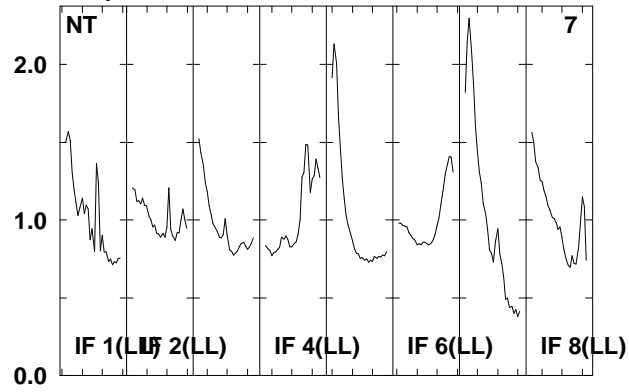

Lower frame: Real Jy
Total-power spectrum Antenna: *
Timerange: 00/09:24:02 to 00/09:25:28

Plot file version 77 created 18-APR-2008 18:27:48

IRAS2336 EP061A.UVDATA.1

Freq = 1.5950 GHz, Bw = 16.000 MH No calibration applied and no bandpass applied

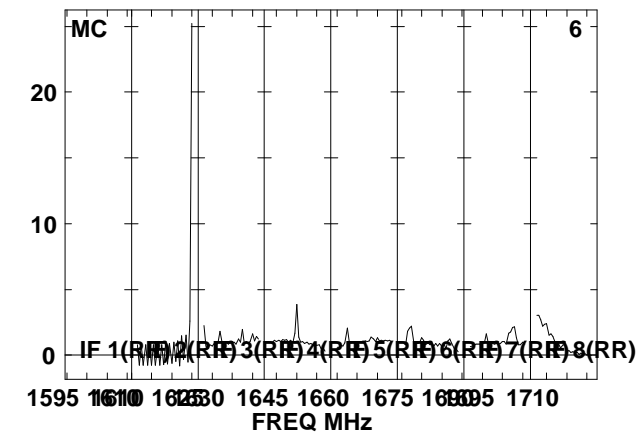
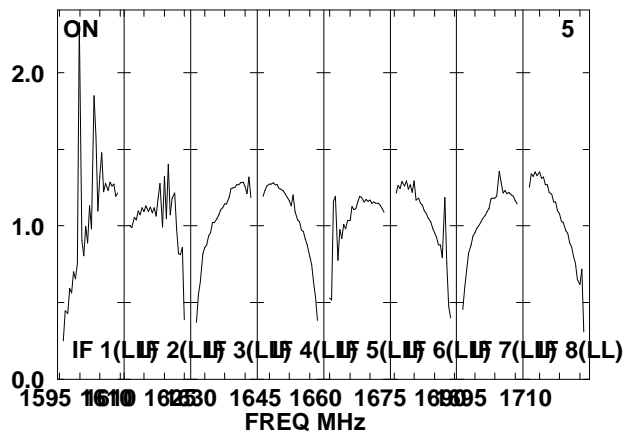
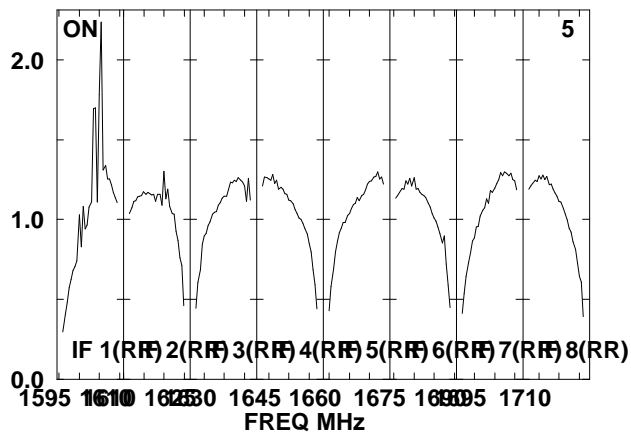
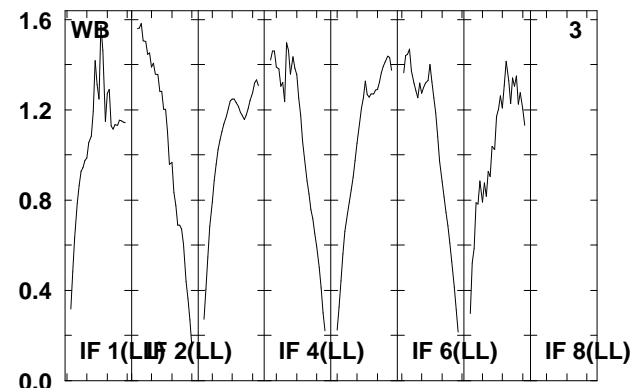
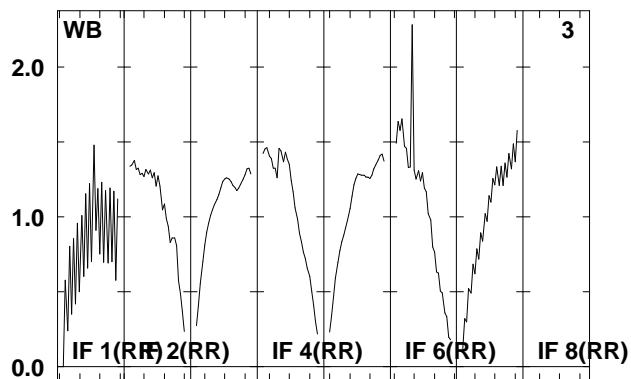
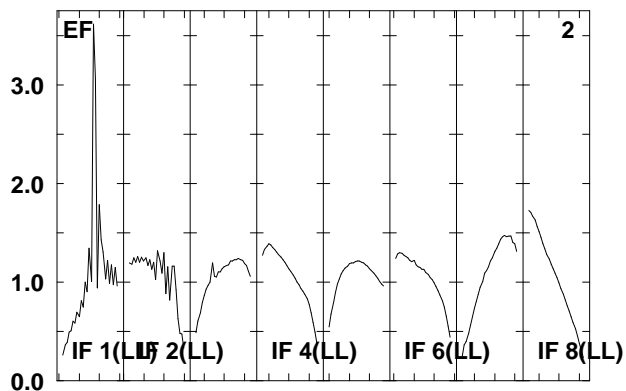
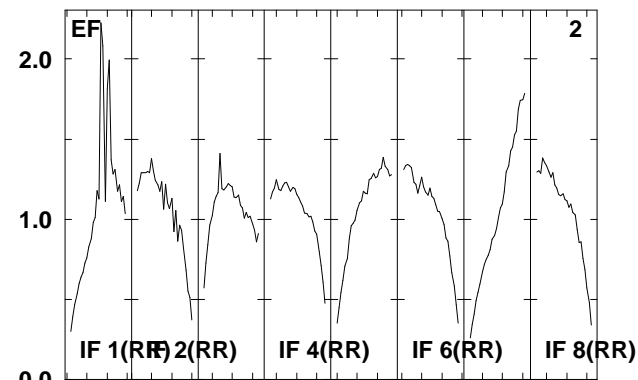
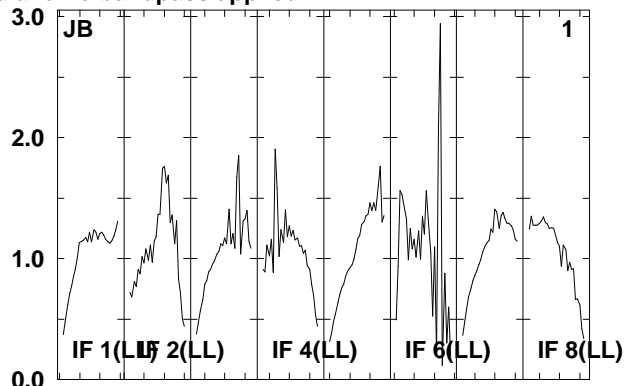
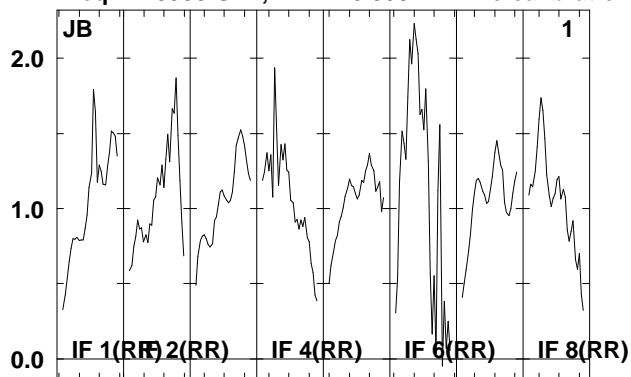

Lower frame: Real Jy

Total-power spectrum Antenna: *

Timerange: 00/09:25:30 to 00/09:28:58

Plot file version 78 created 18-APR-2008 18:27:48

IRAS2336 EP061A.UVDATA.1

Freq = 1.5950 GHz, Bw = 16.000 MH No calibration applied and no bandpass applied

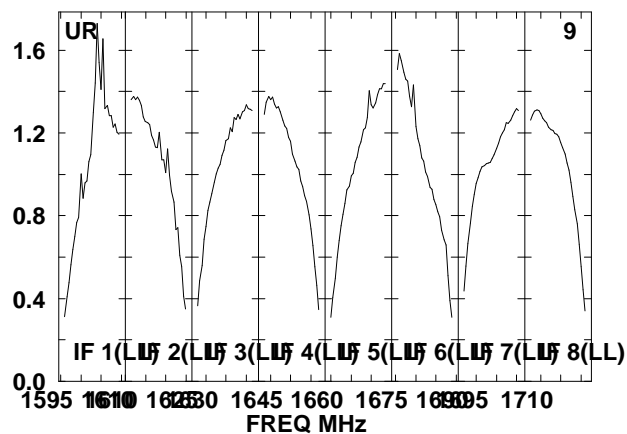
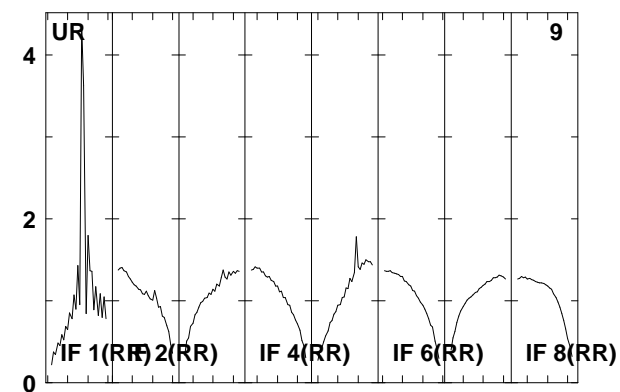
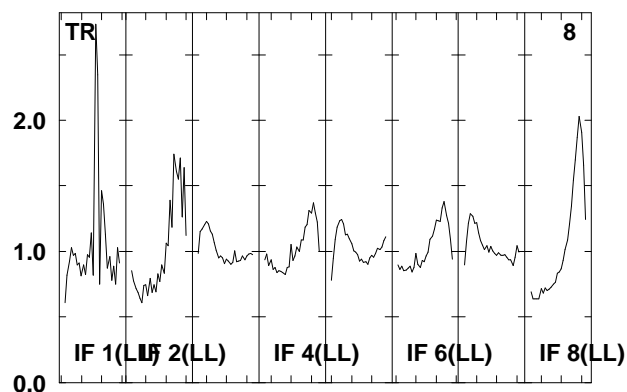
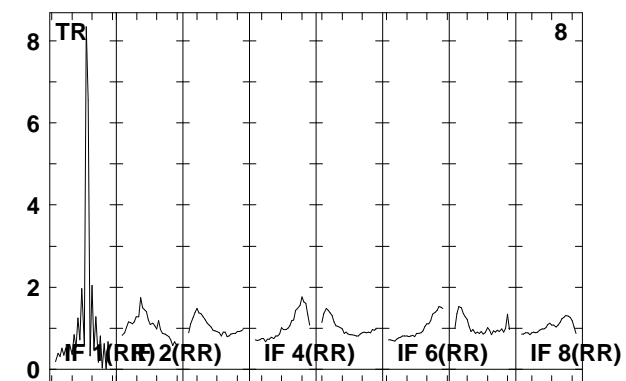
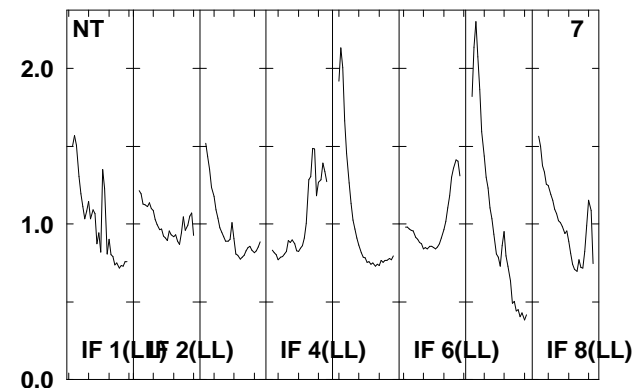
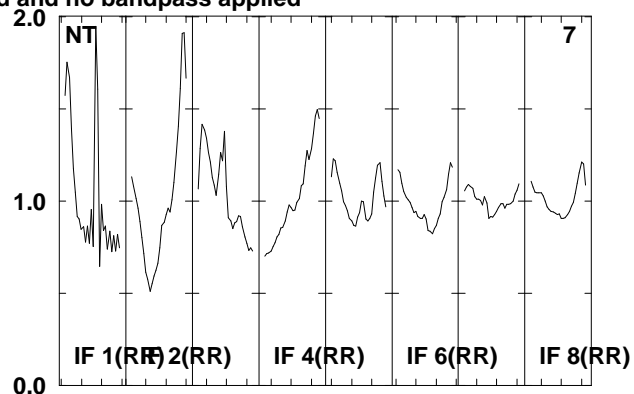
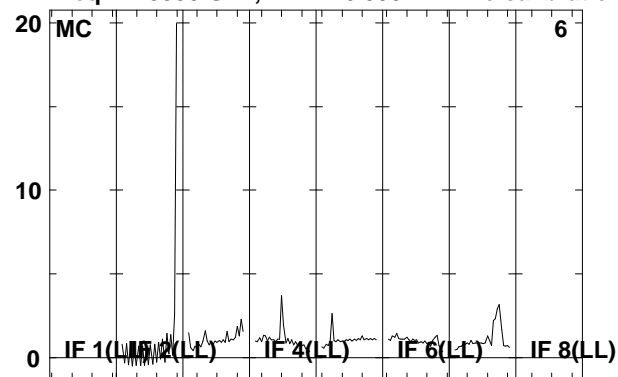

Lower frame: Real Jy

Total-power spectrum Antenna: *

Timerange: 00/09:25:30 to 00/09:28:58

Plot file version 79 created 18-APR-2008 18:27:49

J2333+39 EP061A.UVDATA.1

Freq = 1.5950 GHz, Bw = 16.000 MH No calibration applied and no bandpass applied

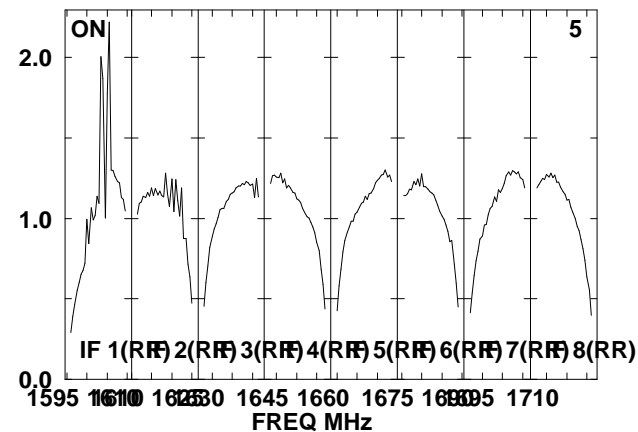
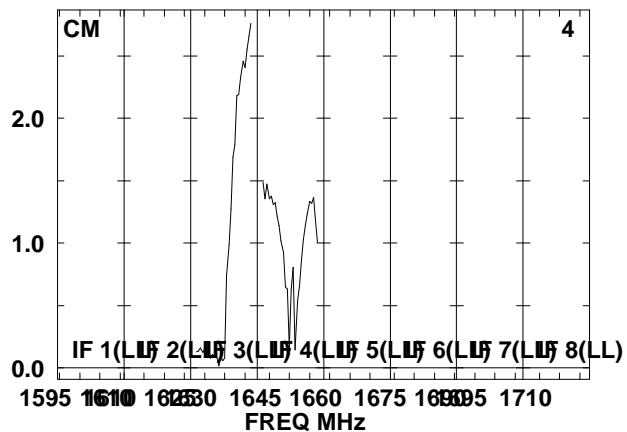
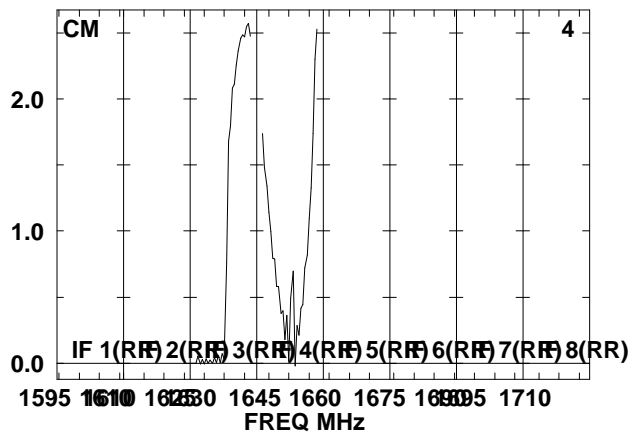
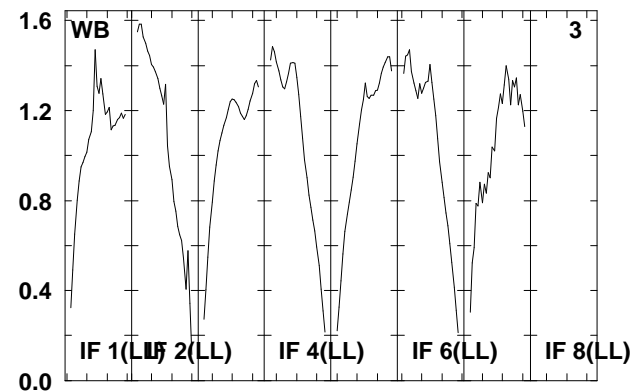
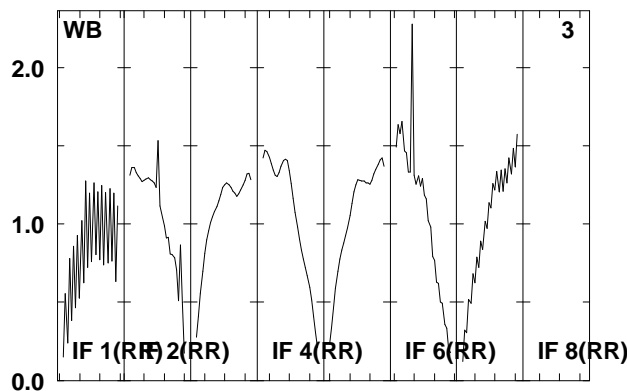
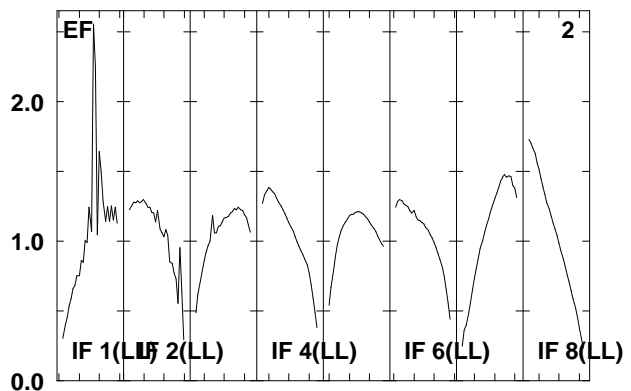
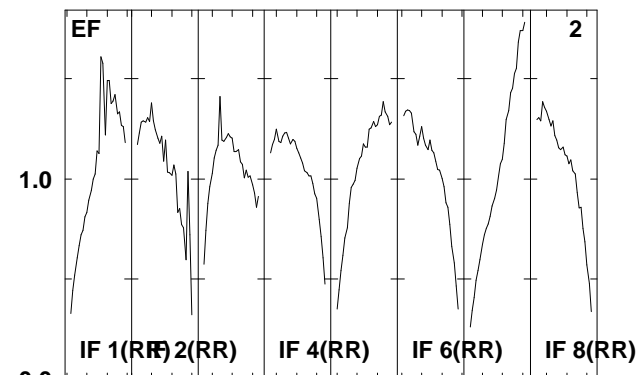
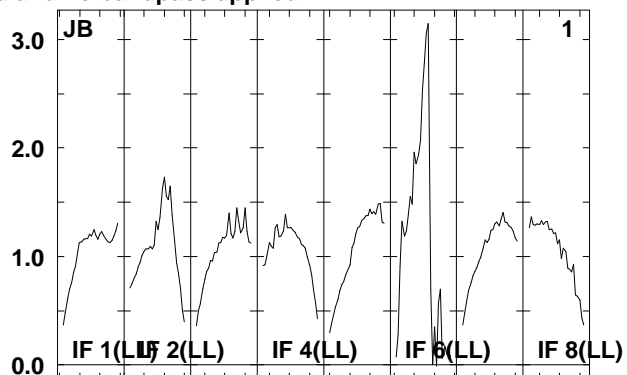
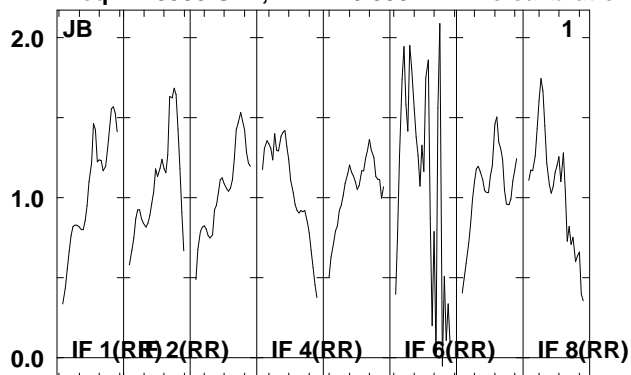

Lower frame: Real Jy
Total-power spectrum Antenna: *
Timerange: 00/09:30:02 to 00/09:31:30

Plot file version 80 created 18-APR-2008 18:27:50

J2333+39 EP061A.UVDATA.1

Freq = 1.5950 GHz, Bw = 16.000 MH No calibration applied and no bandpass applied

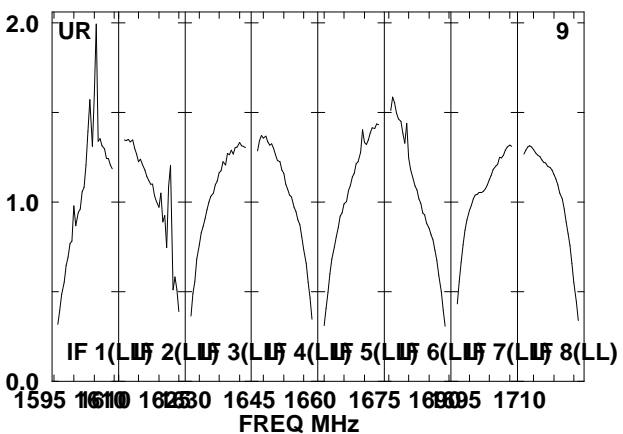
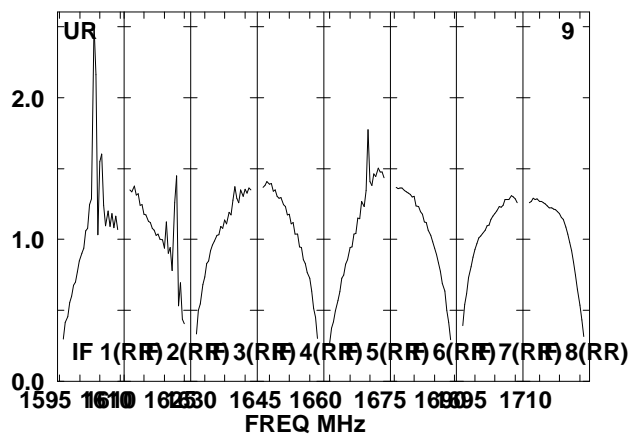
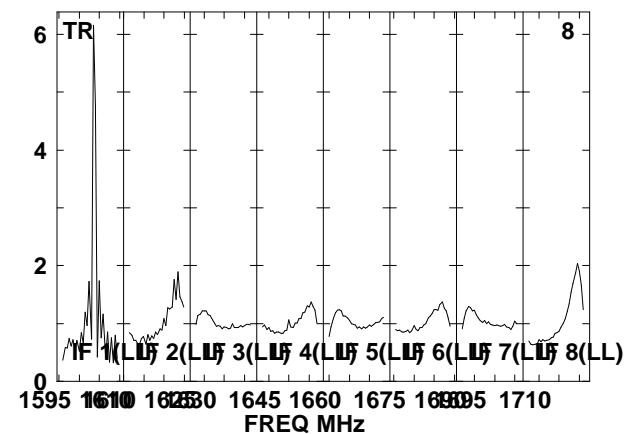
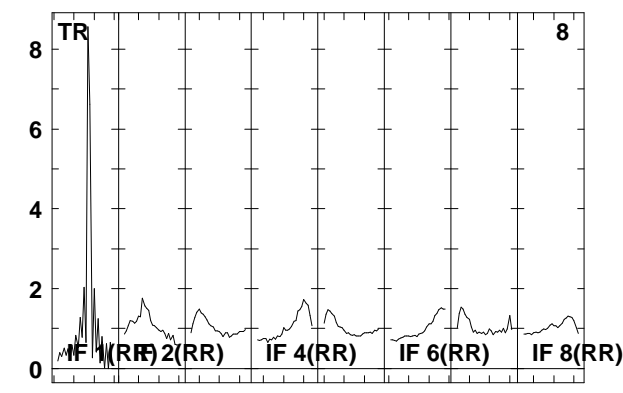
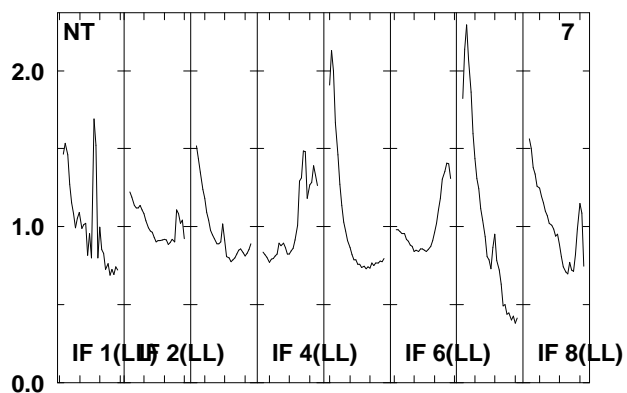
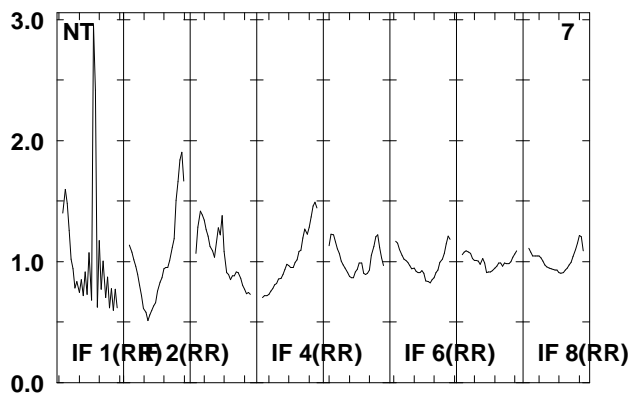
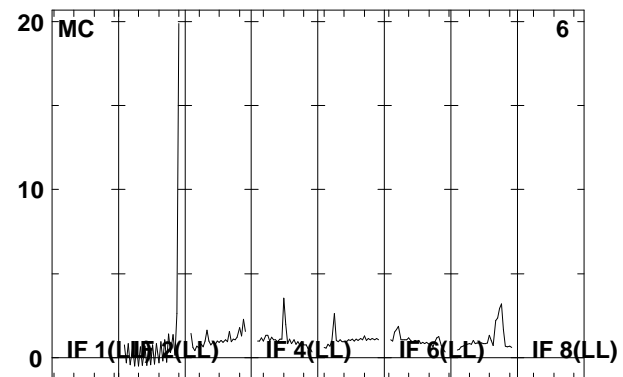
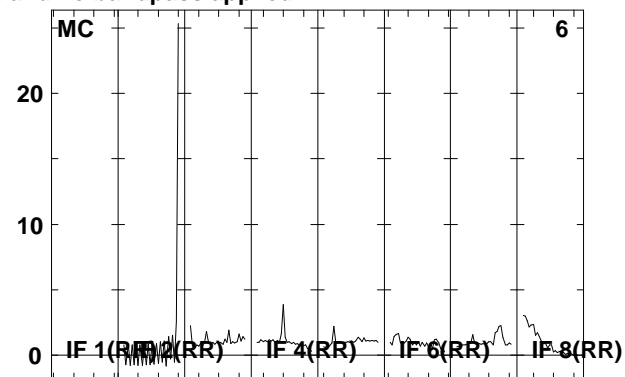
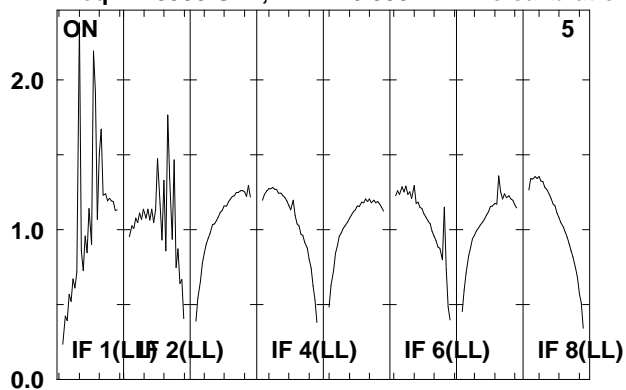

Lower frame: Real Jy
Total-power spectrum Antenna: *
Timerange: 00/09:30:02 to 00/09:31:30

Plot file version 81 created 18-APR-2008 18:27:50

IRAS2336 EP061A.UVDATA.1

Freq = 1.5950 GHz, Bw = 16.000 MH No calibration applied and no bandpass applied

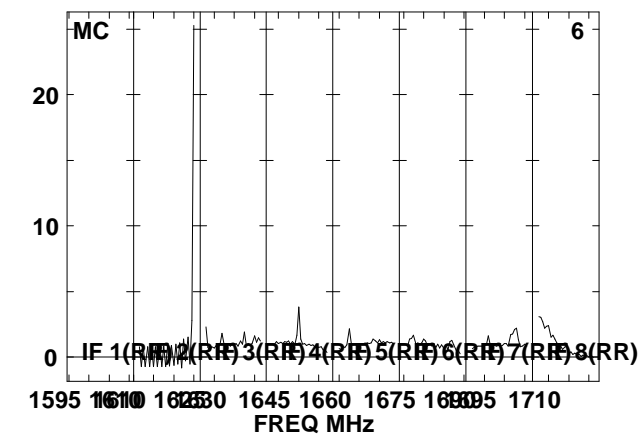
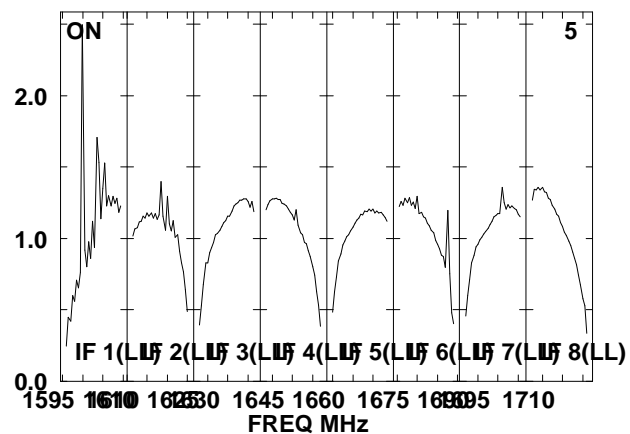
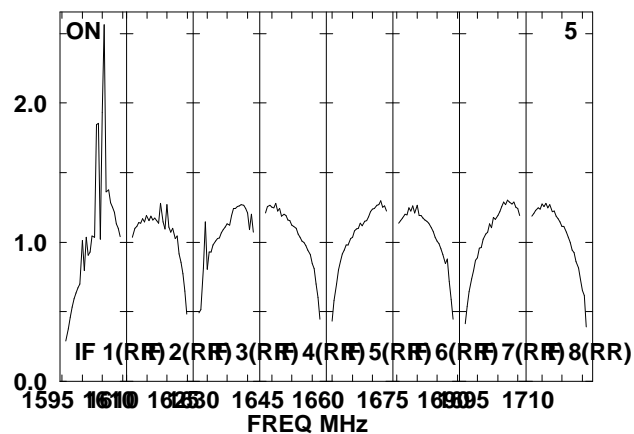
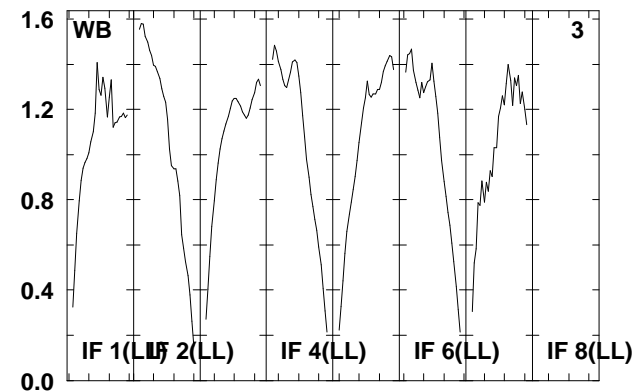
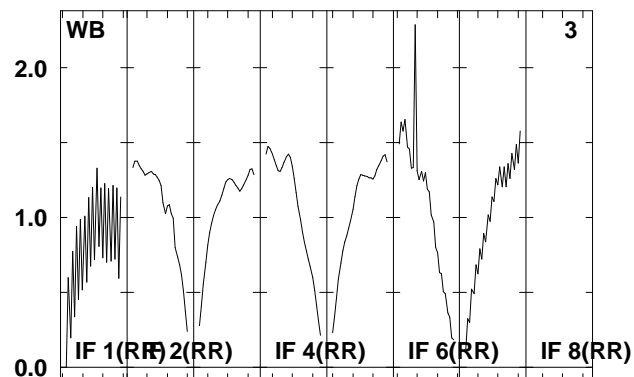
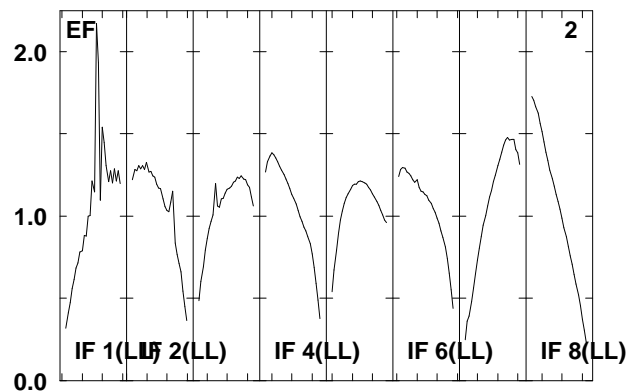
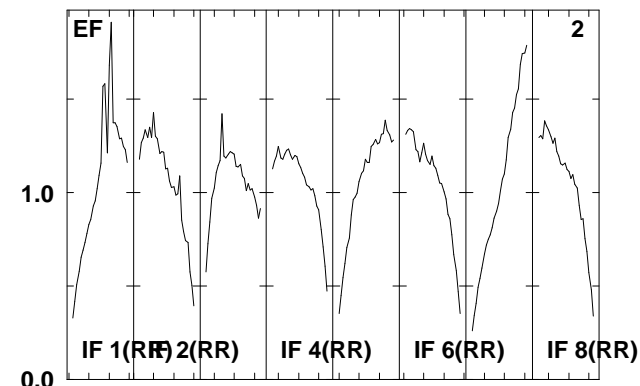
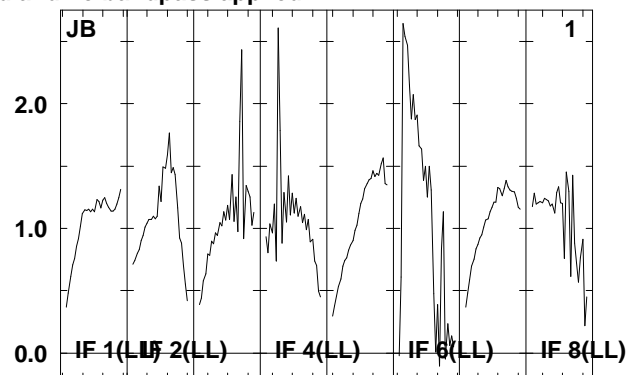
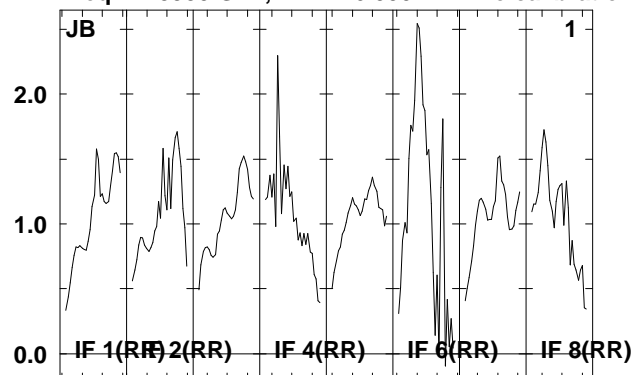

Lower frame: Real Jy
Total-power spectrum Antenna: *
Timerange: 00/09:31:32 to 00/09:35:00

Plot file version 82 created 18-APR-2008 18:27:51

IRAS2336 EP061A.UVDATA.1

Freq = 1.5950 GHz, Bw = 16.000 MH No calibration applied and no bandpass applied

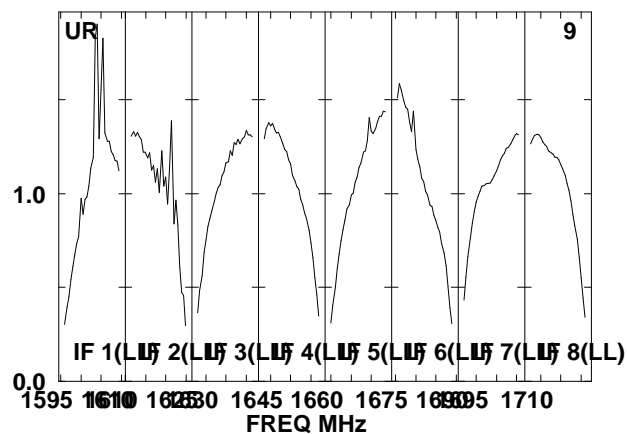
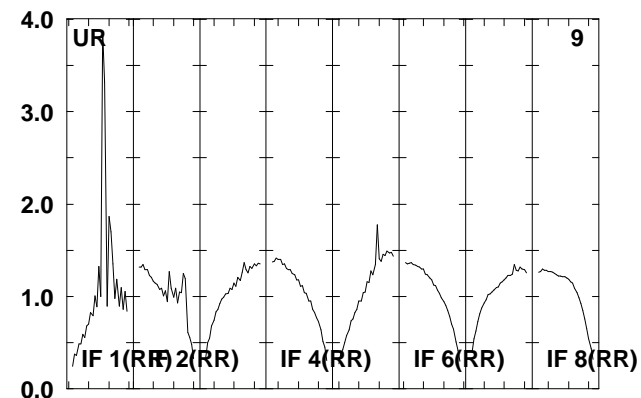
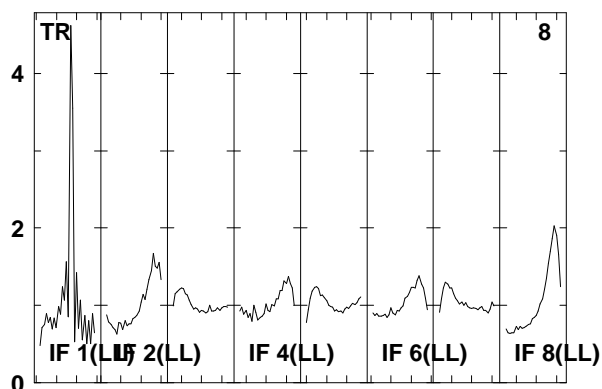
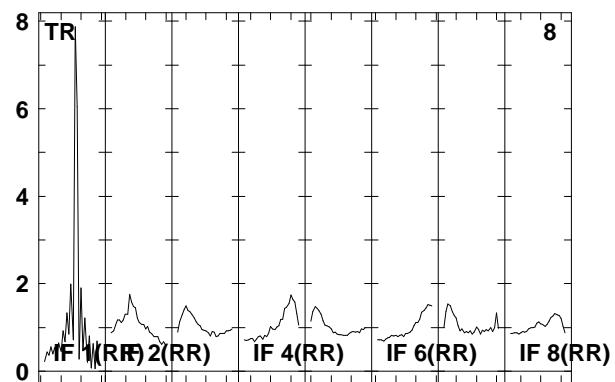
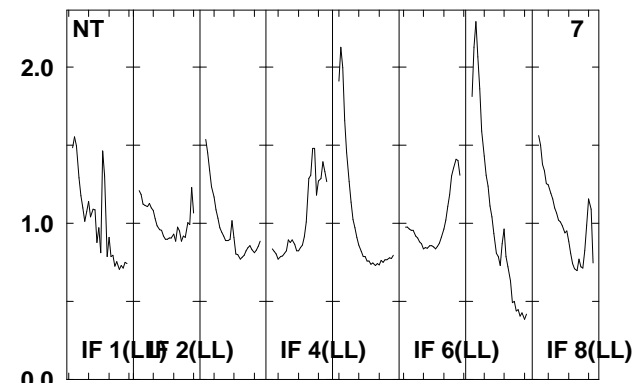
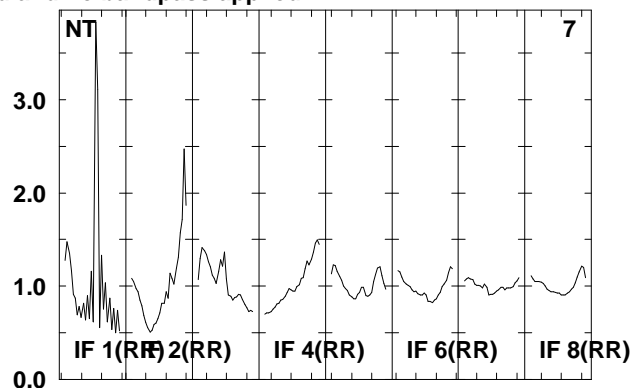
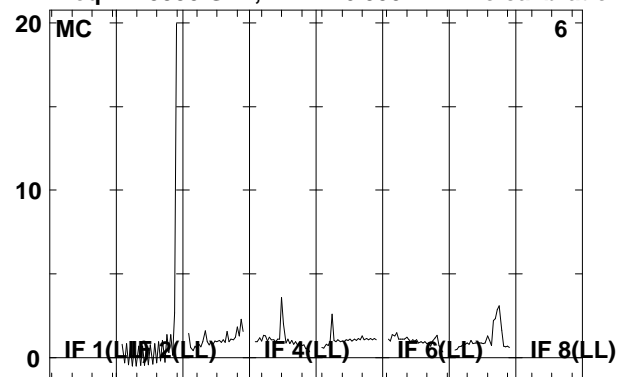

Lower frame: Real Jy

Total-power spectrum Antenna: *

Timerange: 00/09:31:32 to 00/09:35:00

Plot file version 83 created 18-APR-2008 18:27:52

J2333+39 EP061A.UVDATA.1

Freq = 1.5950 GHz, Bw = 16.000 MH No calibration applied and no bandpass applied

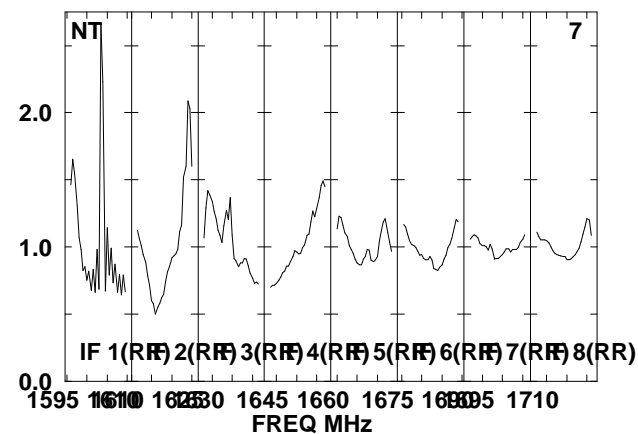
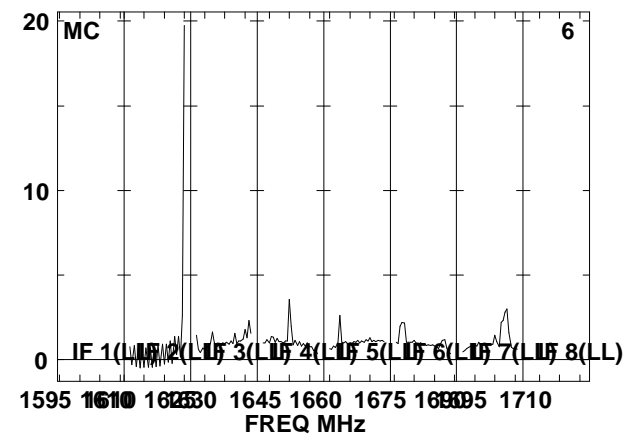
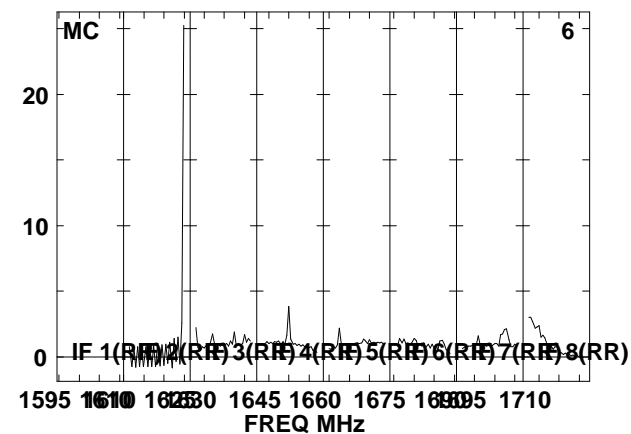
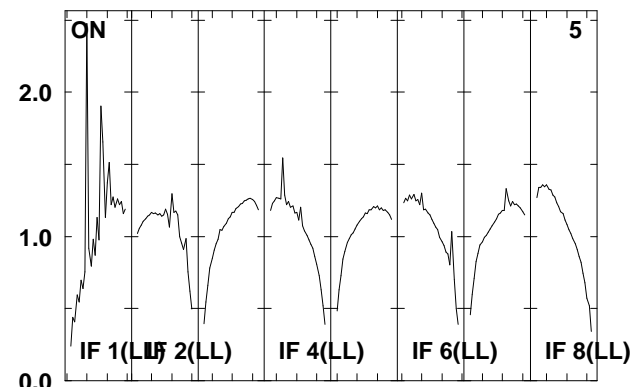
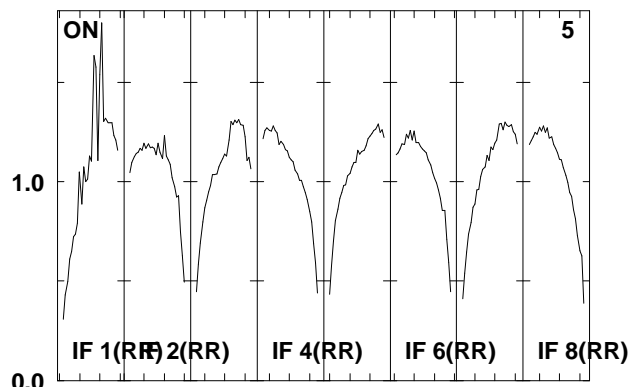
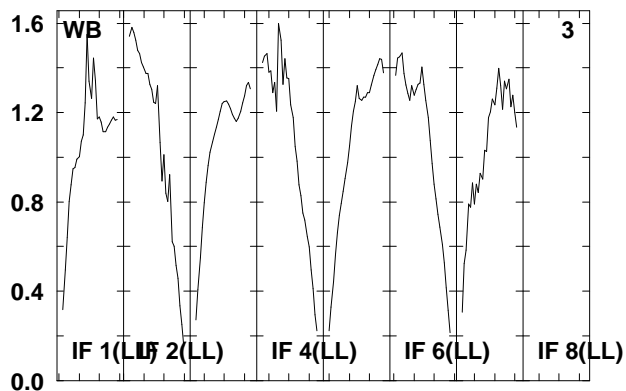
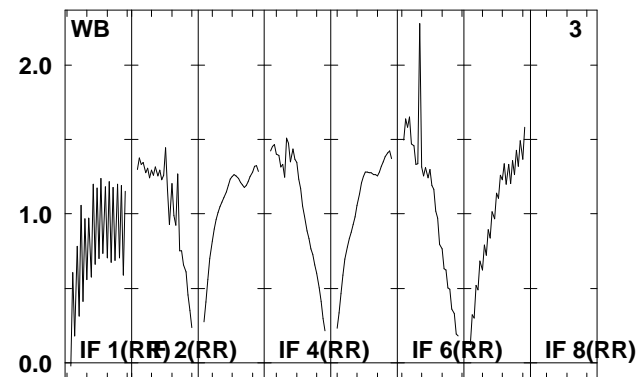
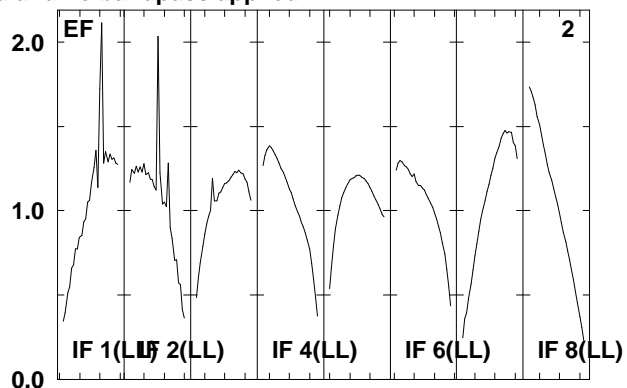
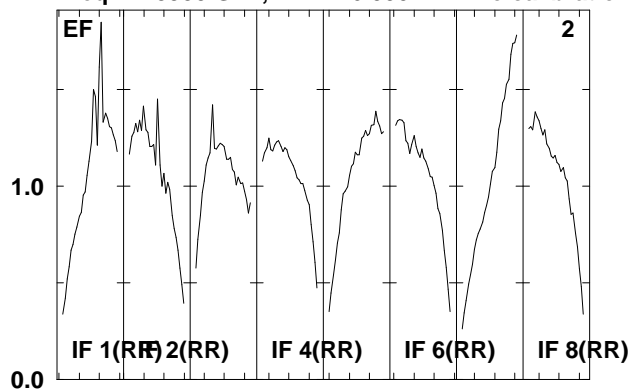

Lower frame: Real Jy
Total-power spectrum Antenna: *
Timerange: 00/09:35:02 to 00/09:36:28

Plot file version 84 created 18-APR-2008 18:27:53

J2333+39 EP061A.UVDATA.1

Freq = 1.5950 GHz, Bw = 16.000 MH No calibration applied and no bandpass applied

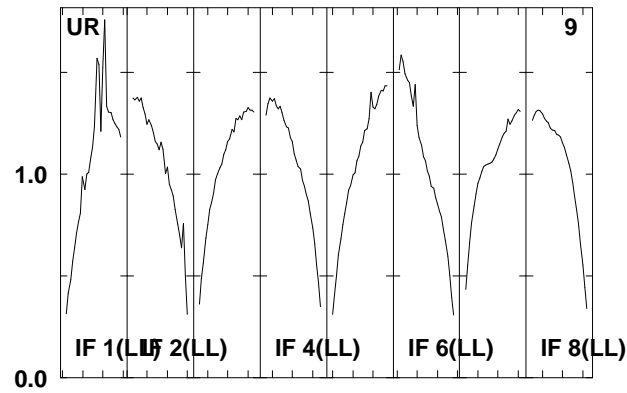
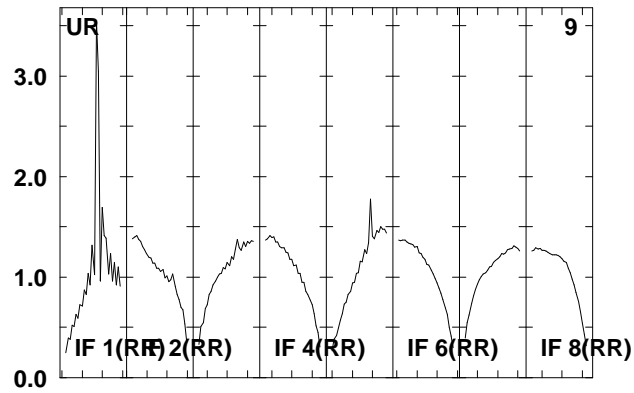
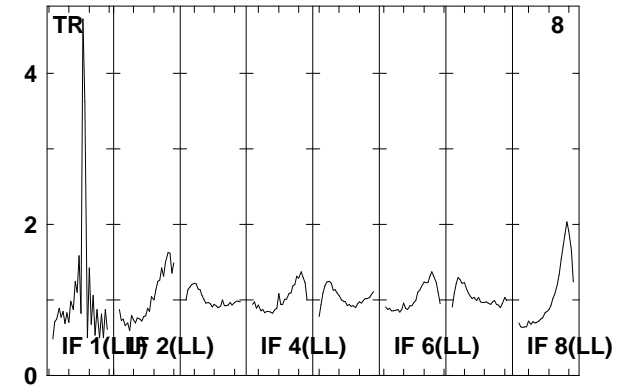
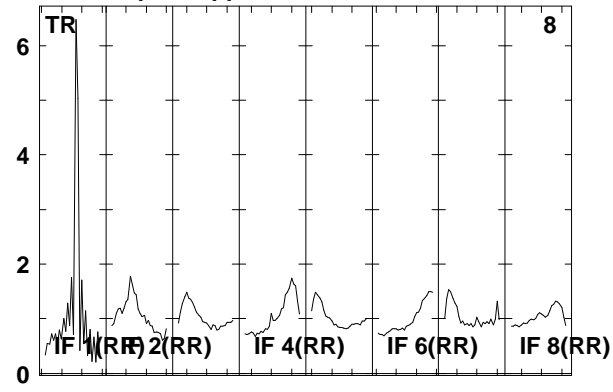
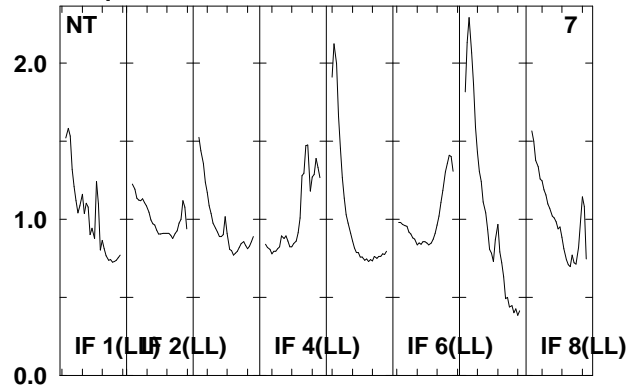

Lower frame: Real Jy
Total-power spectrum Antenna: *
Timerange: 00/09:35:02 to 00/09:36:28

Plot file version 85 created 18-APR-2008 18:27:53
 IRAS2336 EP061A.UVDATA.1
 Freq = 1.5950 GHz, Bw = 16.000 MH No calibration applied and no bandpass applied

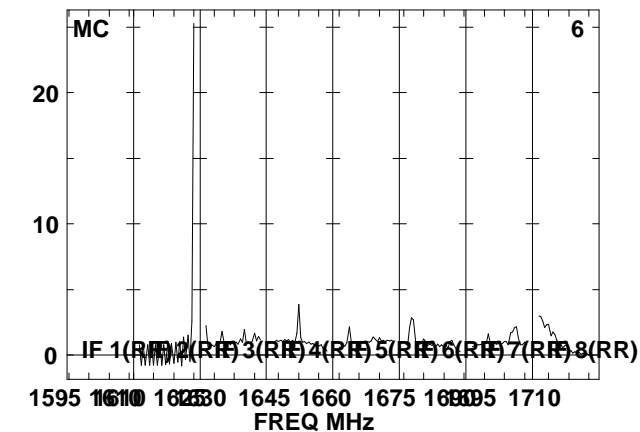
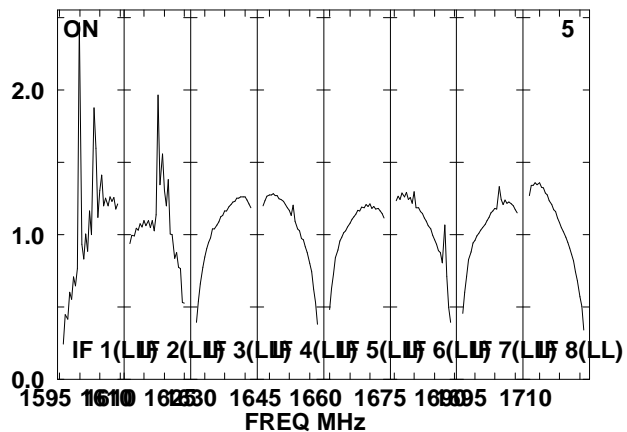
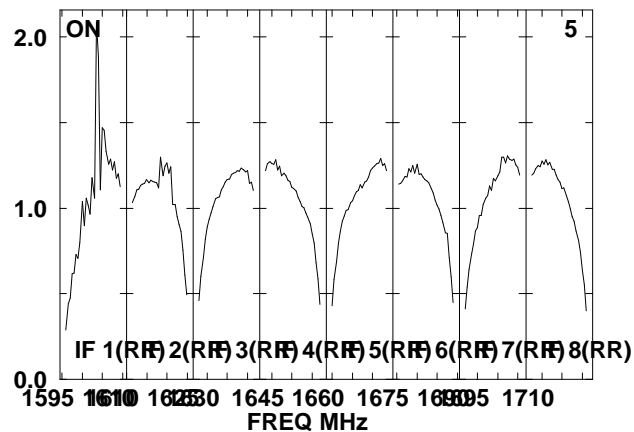
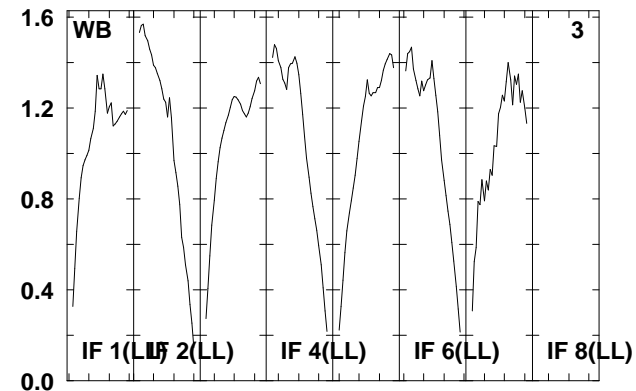
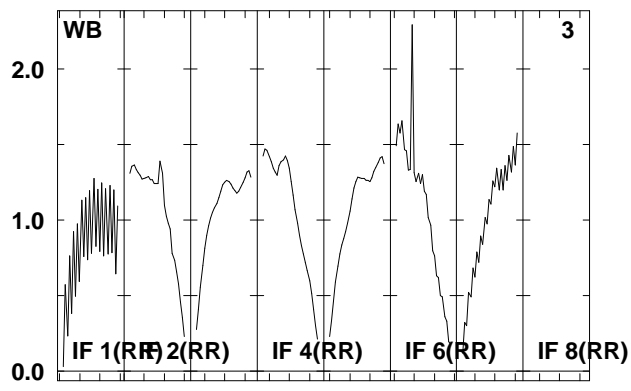
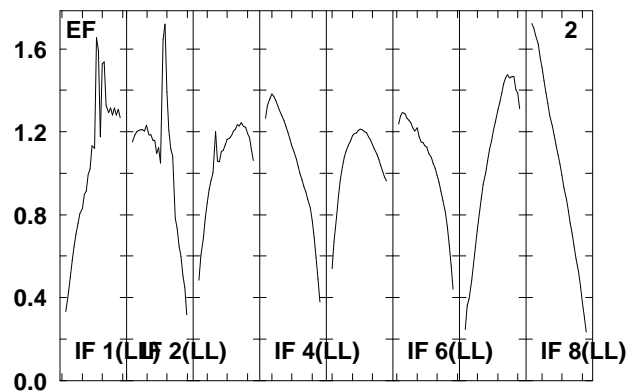
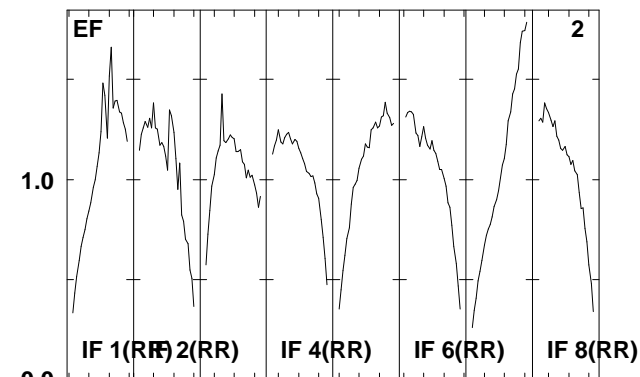
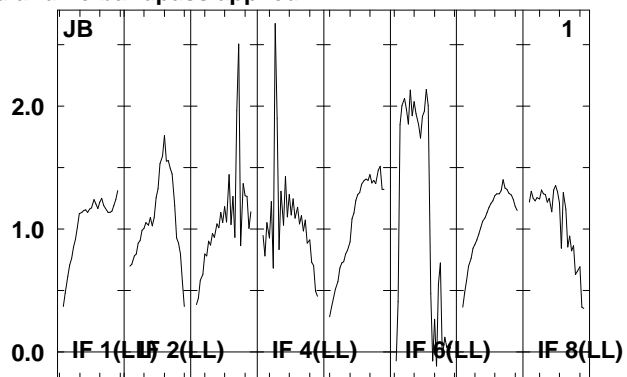
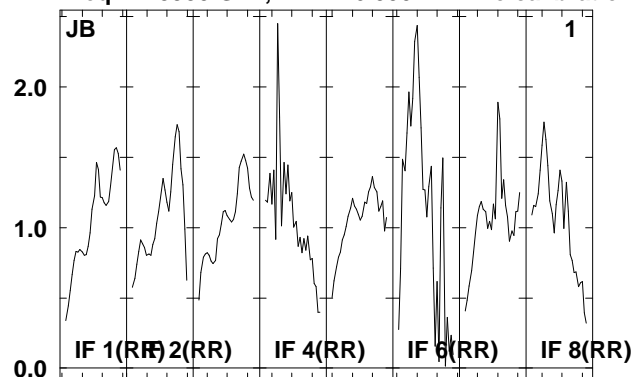

Lower frame: Real Jy
 Total-power spectrum Antenna: *
 Timerange: 00/09:36:30 to 00/09:40:00

Plot file version 86 created 18-APR-2008 18:27:54

IRAS2336 EP061A.UVDATA.1

Freq = 1.5950 GHz, Bw = 16.000 MH No calibration applied and no bandpass applied

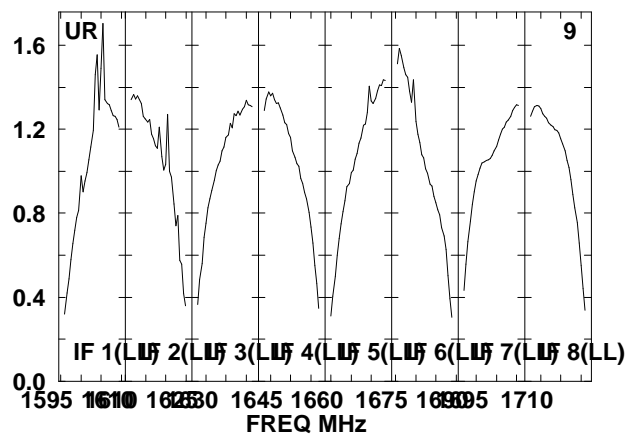
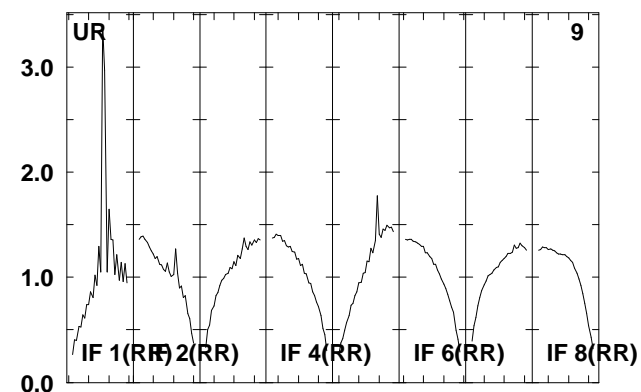
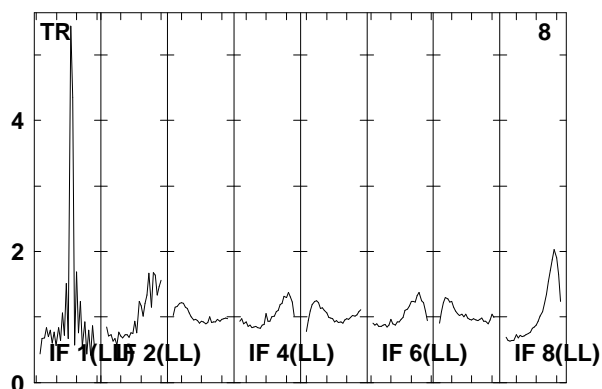
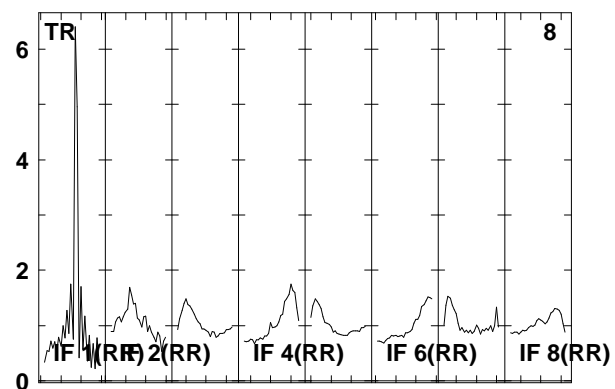
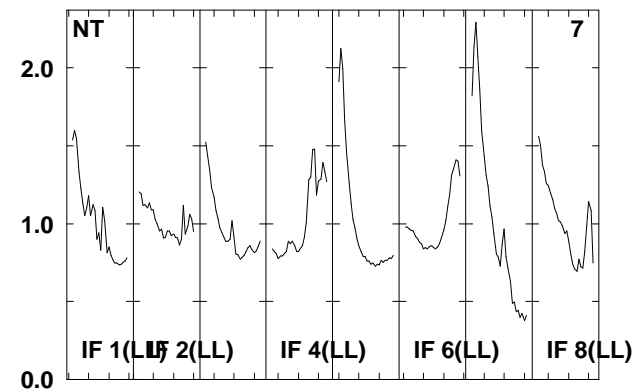
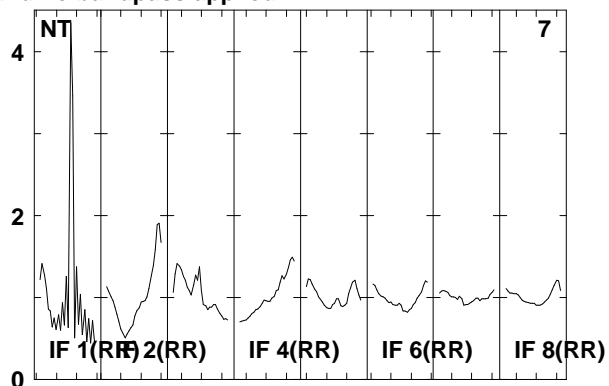
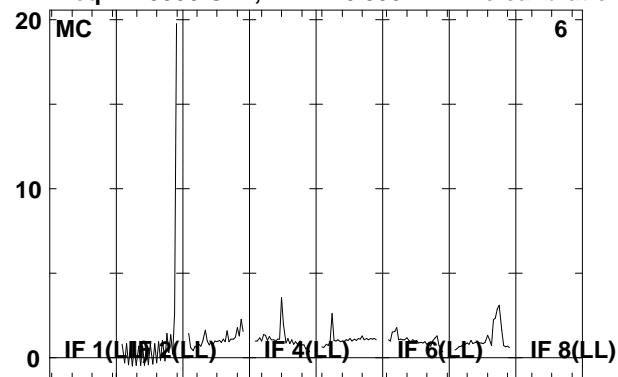

Lower frame: Real Jy

Total-power spectrum Antenna: *

Timerange: 00/09:36:30 to 00/09:40:00

Plot file version 87 created 18-APR-2008 18:27:55

J2333+39 EP061A.UVDATA.1

Freq = 1.5950 GHz, Bw = 16.000 MH No calibration applied and no bandpass applied

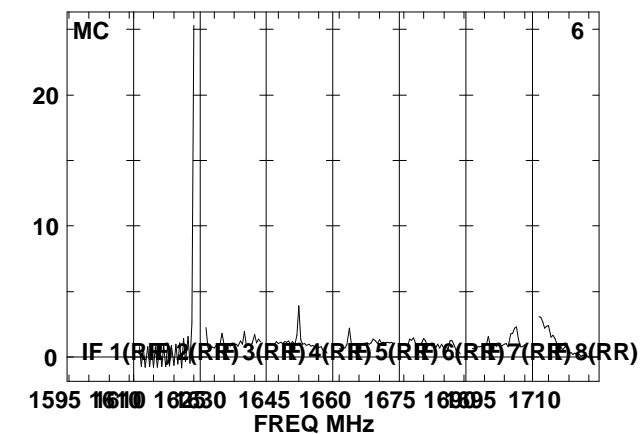
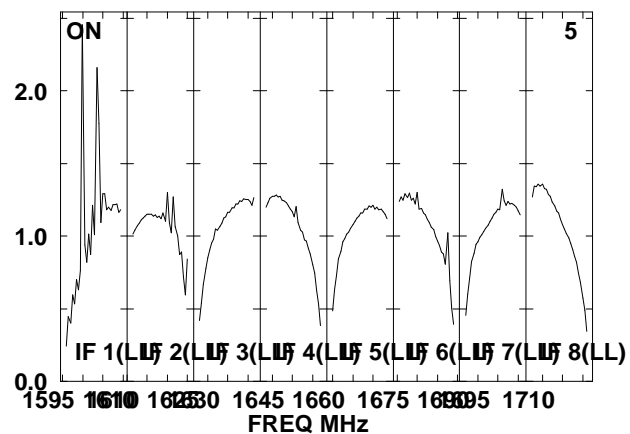
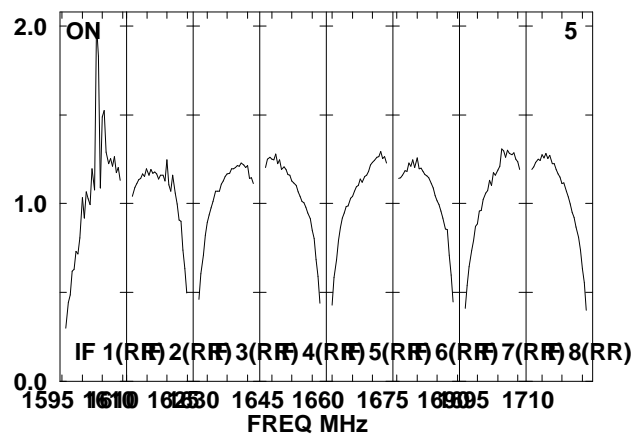
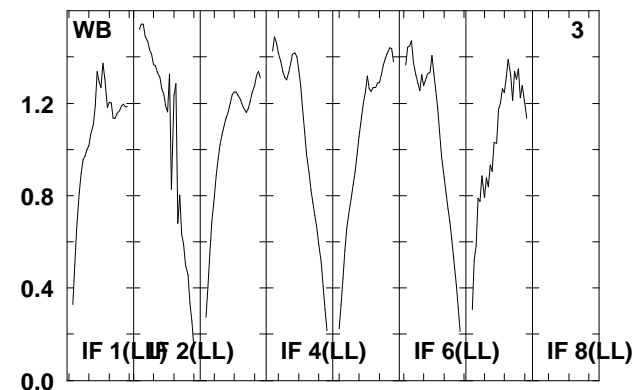
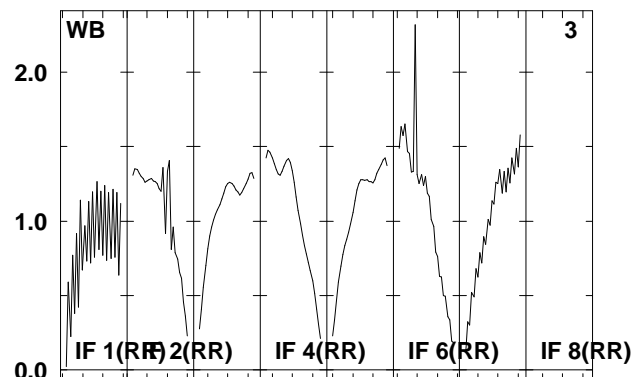
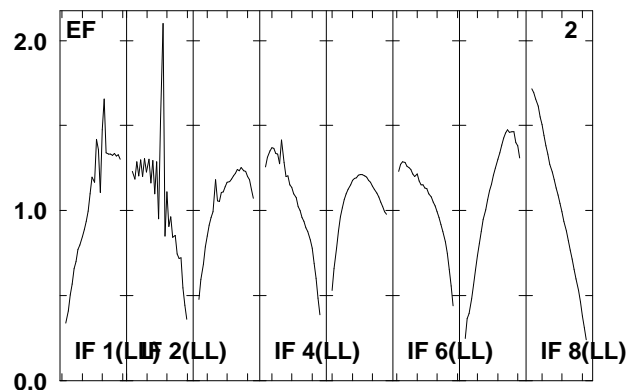
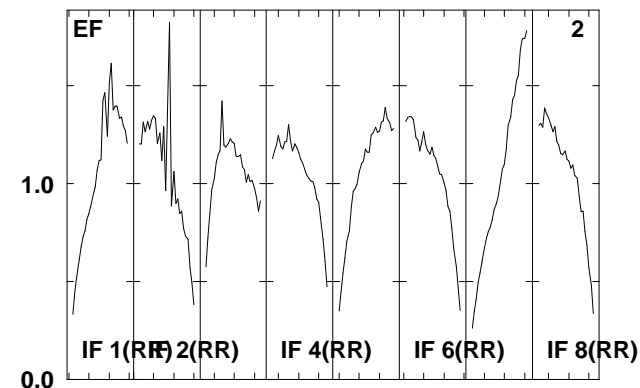
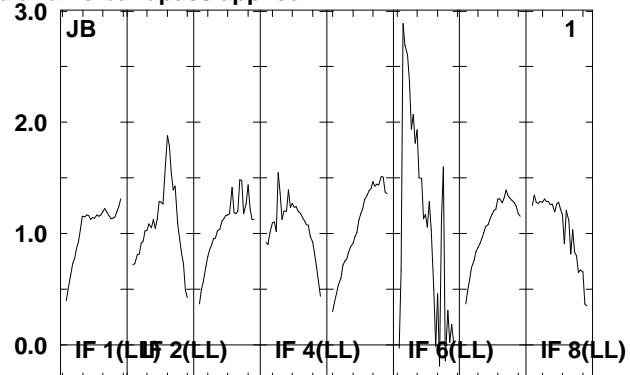
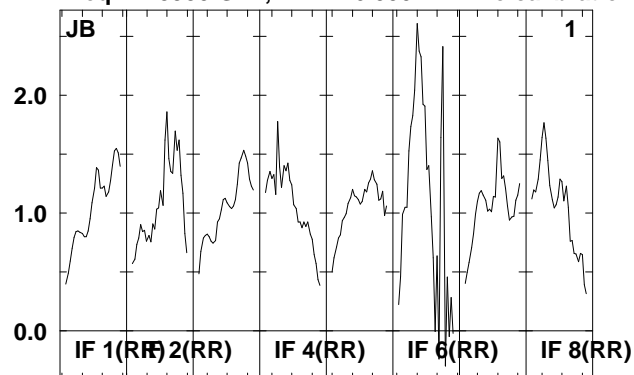

Lower frame: Real Jy
Total-power spectrum Antenna: *
Timerange: 00/09:40:02 to 00/09:41:30

Plot file version 88 created 18-APR-2008 18:27:56

J2333+39 EP061A.UVDATA.1

Freq = 1.5950 GHz, Bw = 16.000 MH No calibration applied and no bandpass applied

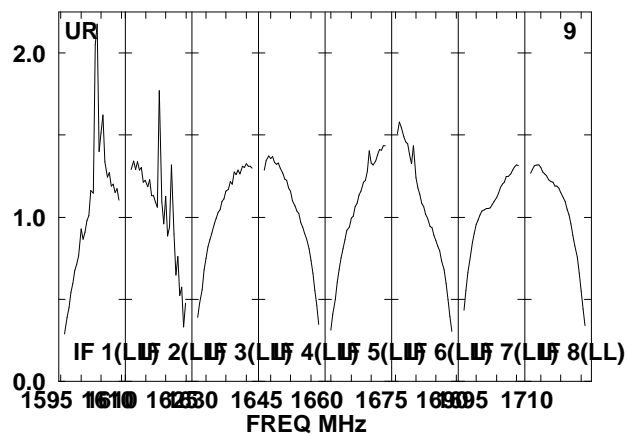
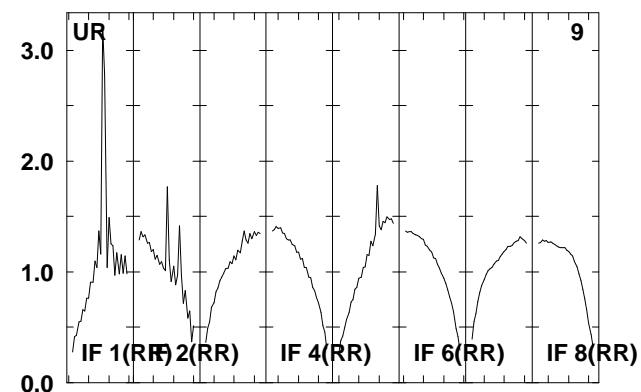
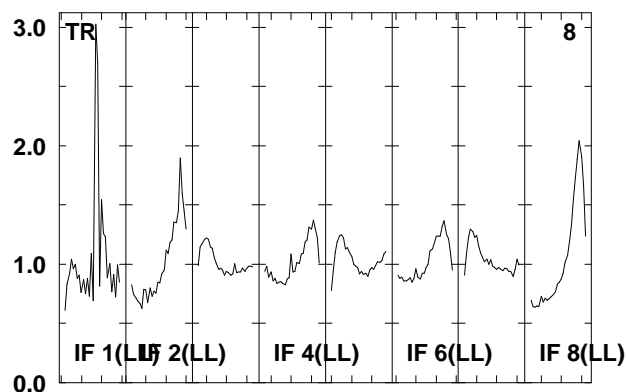
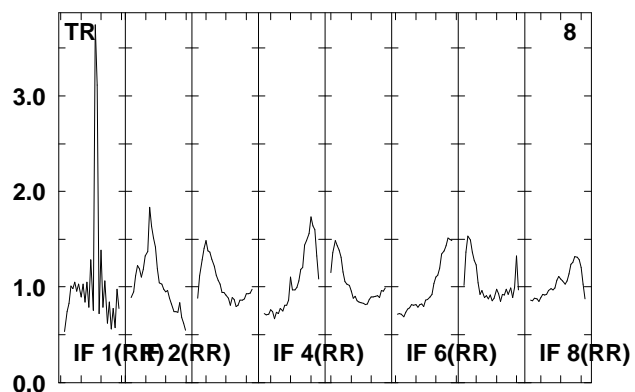
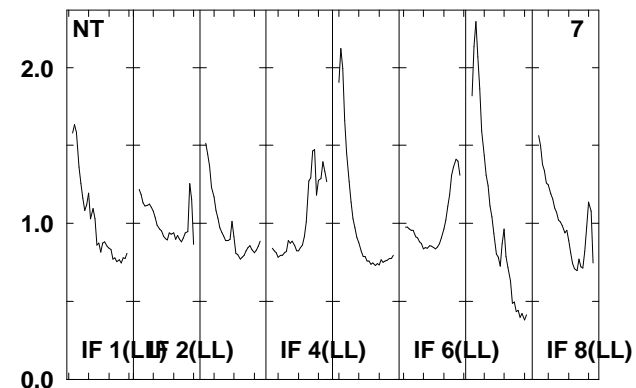
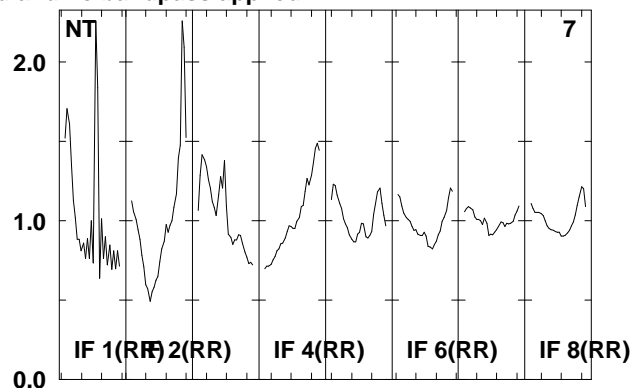
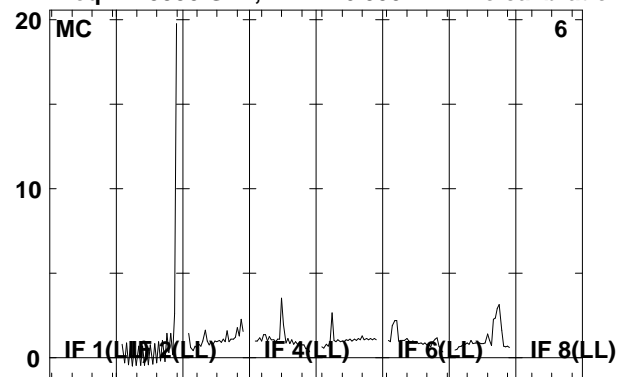

Lower frame: Real Jy

Total-power spectrum Antenna: *

Timerange: 00/09:40:02 to 00/09:41:30

Plot file version 89 created 18-APR-2008 18:27:56

IRAS2336 EP061A.UVDATA.1

Freq = 1.5950 GHz, Bw = 16.000 MH No calibration applied and no bandpass applied

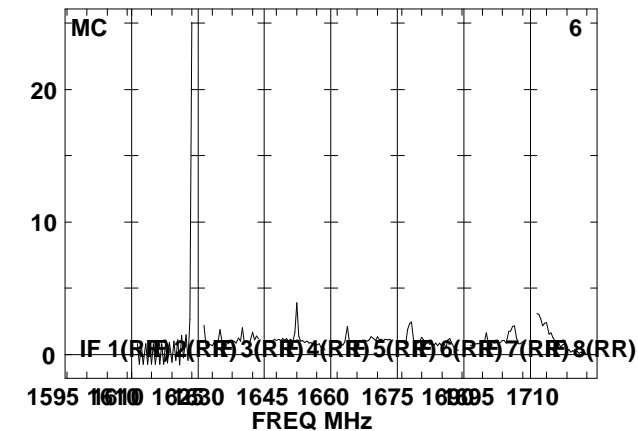
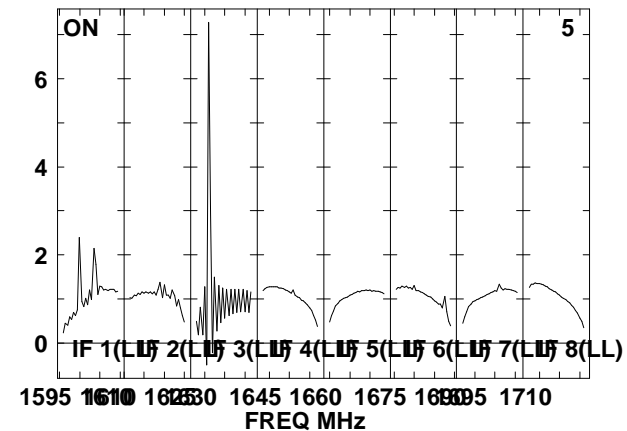
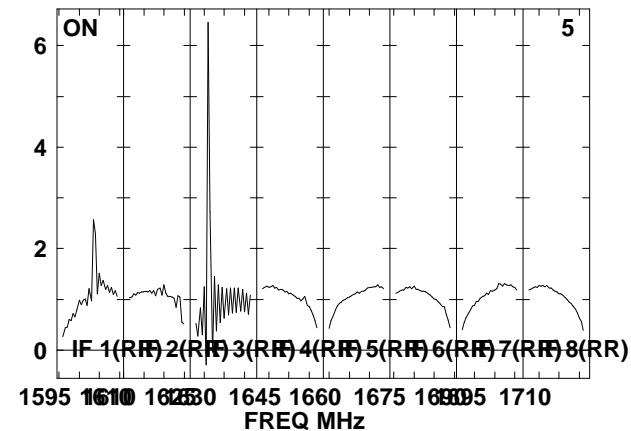
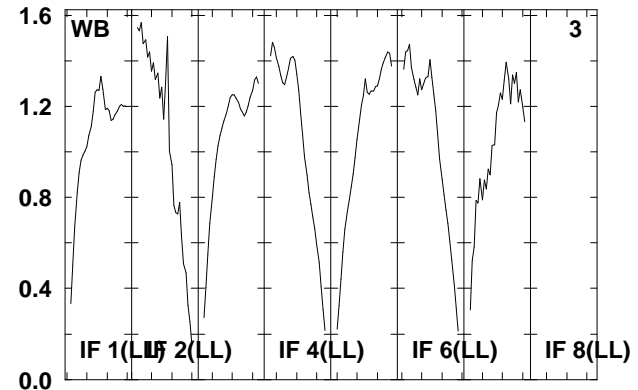
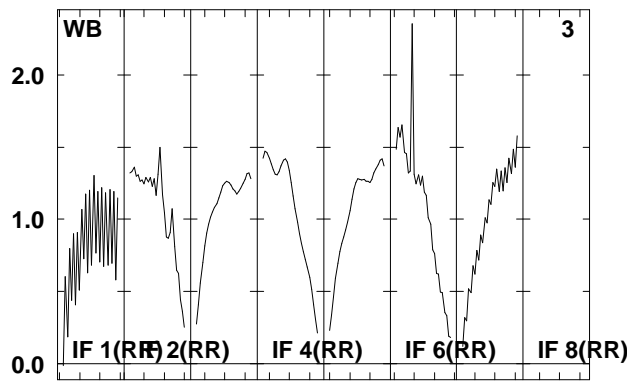
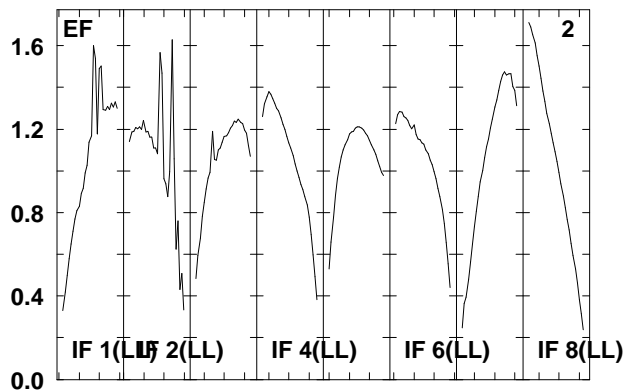
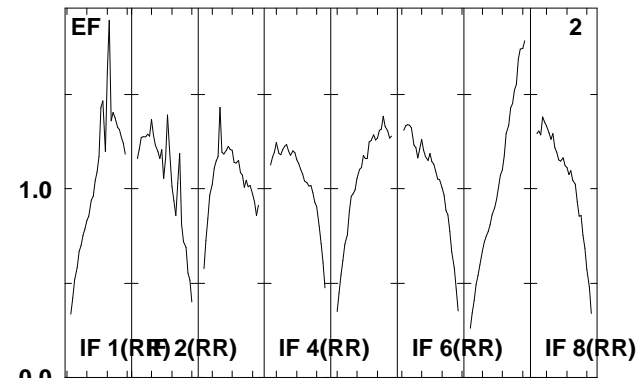
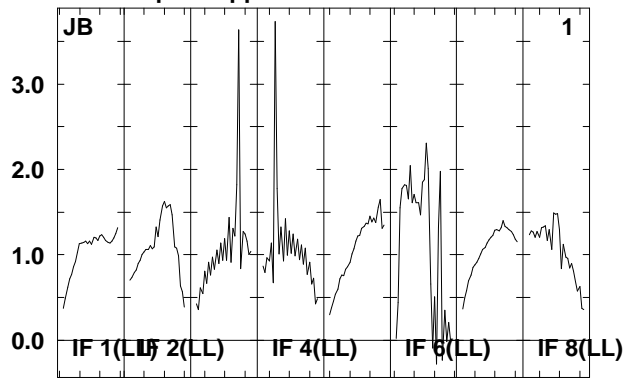
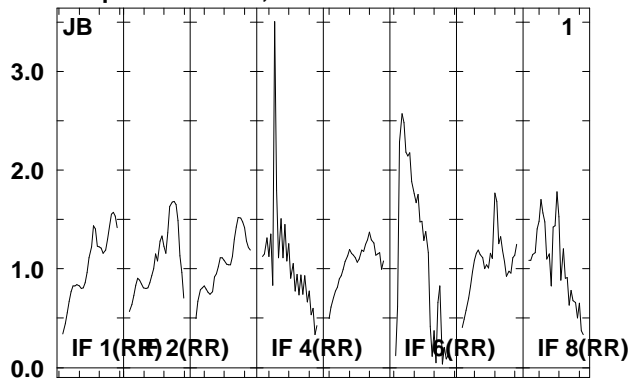

Lower frame: Real Jy
Total-power spectrum Antenna: *
Timerange: 00/09:41:32 to 00/09:44:56

Plot file version 90 created 18-APR-2008 18:27:57

IRAS2336 EP061A.UVDATA.1

Freq = 1.5950 GHz, Bw = 16.000 MH No calibration applied and no bandpass applied

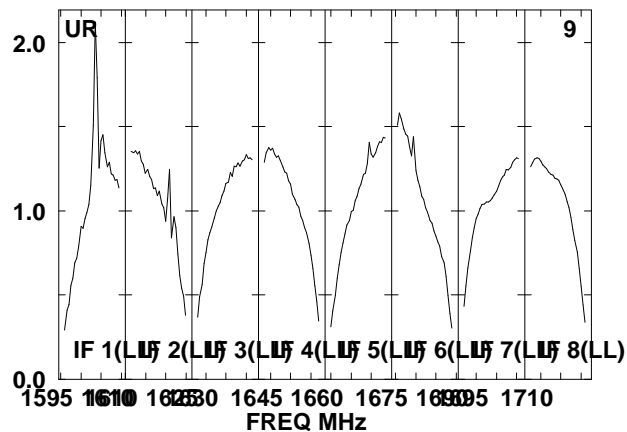
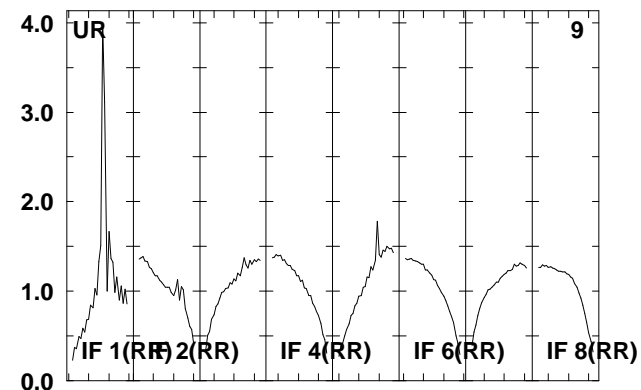
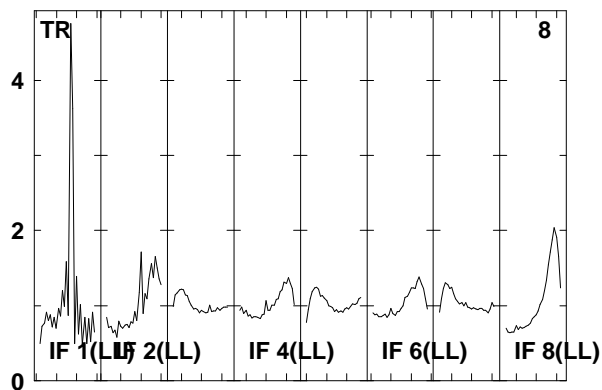
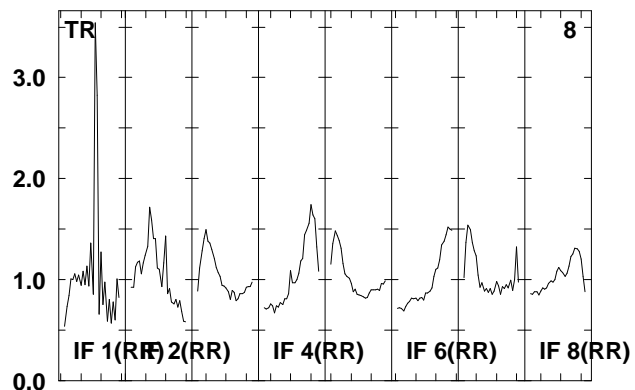
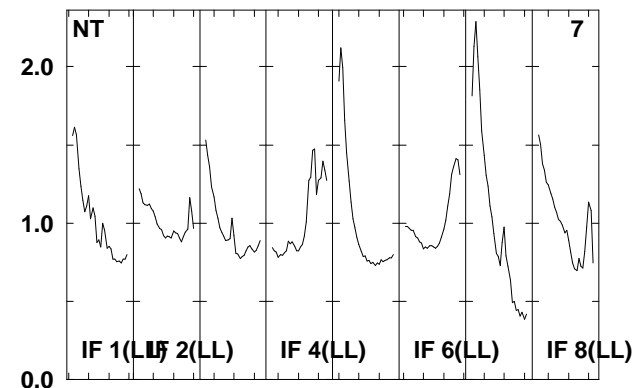
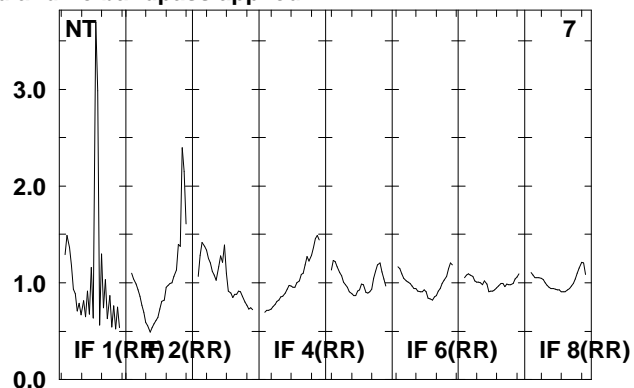
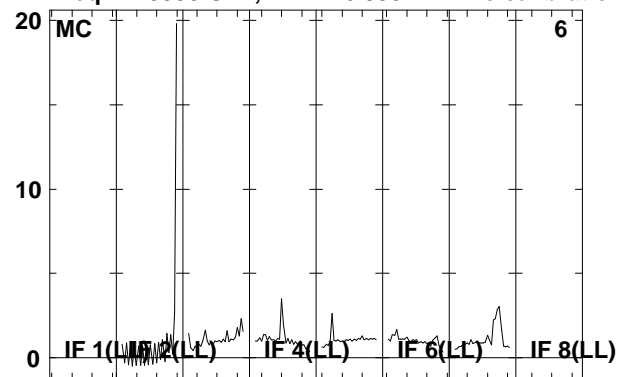

Lower frame: Real Jy

Total-power spectrum Antenna: *

Timerange: 00/09:41:32 to 00/09:44:56

Plot file version 91 created 18-APR-2008 18:27:58

J2333+39 EP061A.UVDATA.1

Freq = 1.5950 GHz, Bw = 16.000 MH No calibration applied and no bandpass applied

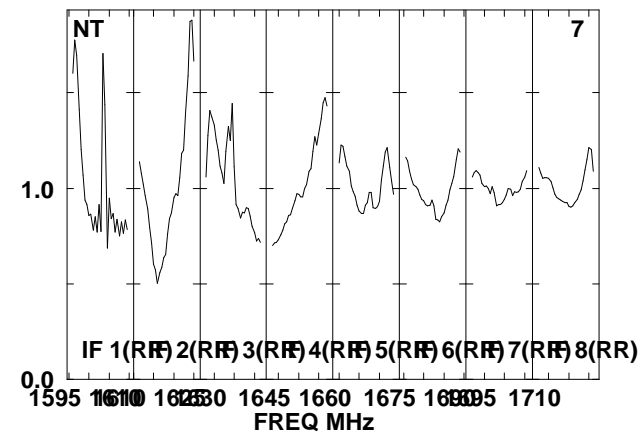
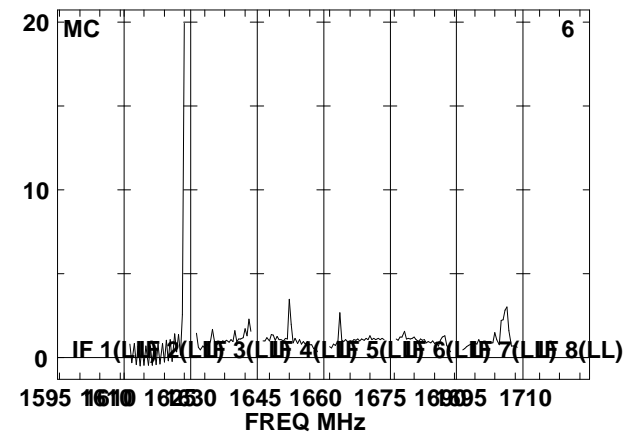
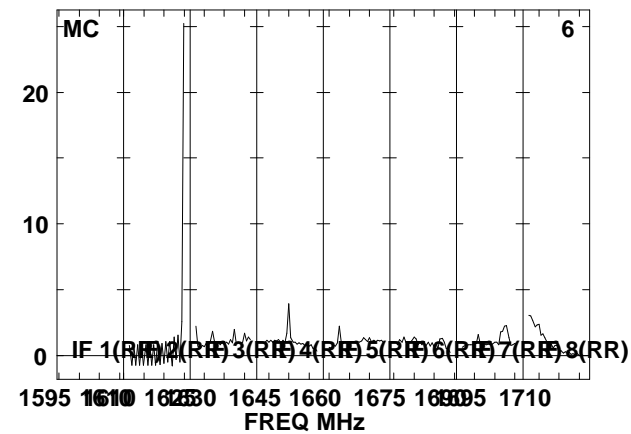
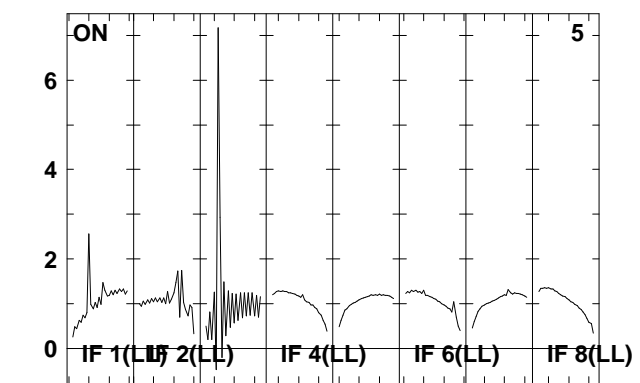
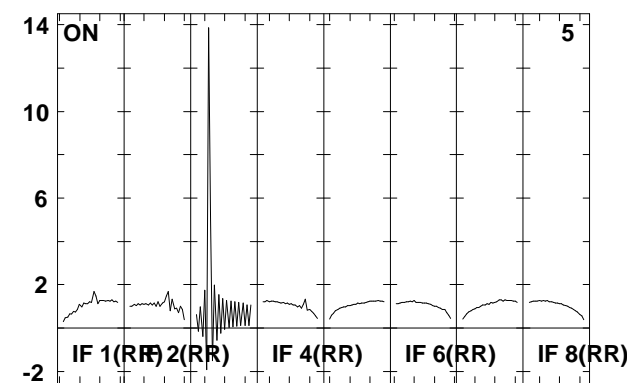
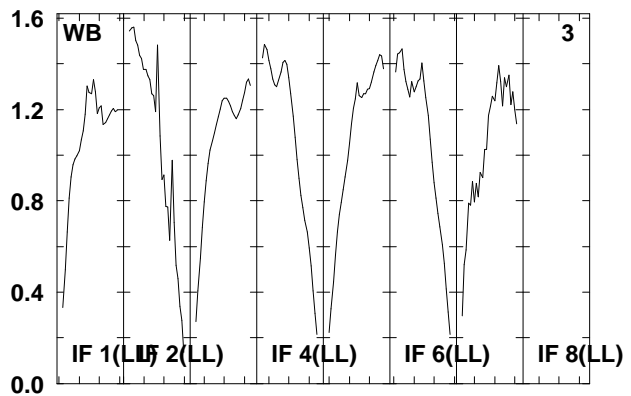
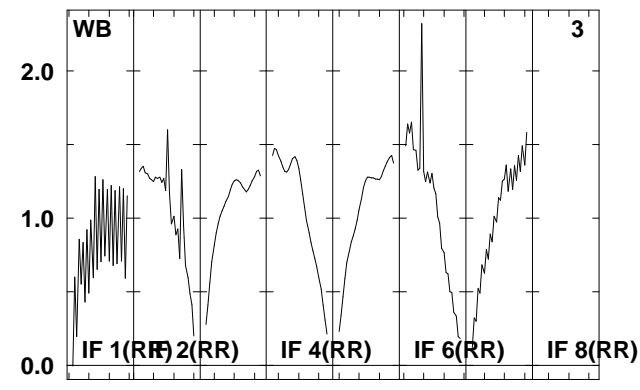
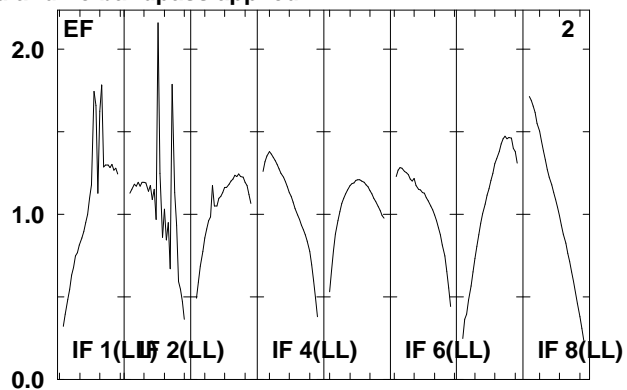
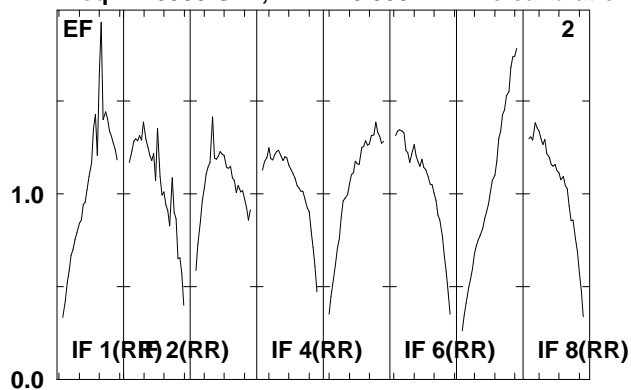

Lower frame: Real Jy
Total-power spectrum Antenna: *
Timerange: 00/09:46:02 to 00/09:47:26

Plot file version 92 created 18-APR-2008 18:27:59

J2333+39 EP061A.UVDATA.1

Freq = 1.5950 GHz, Bw = 16.000 MH No calibration applied and no bandpass applied

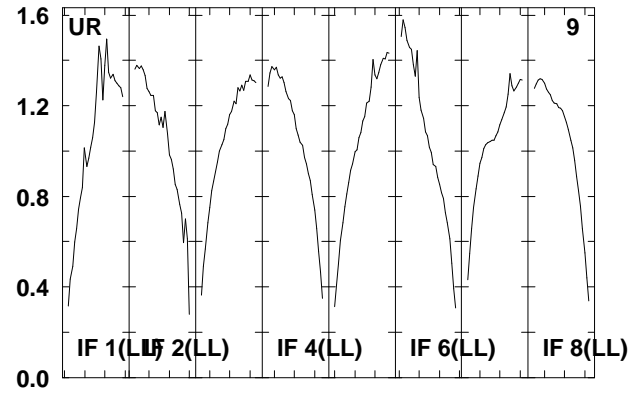
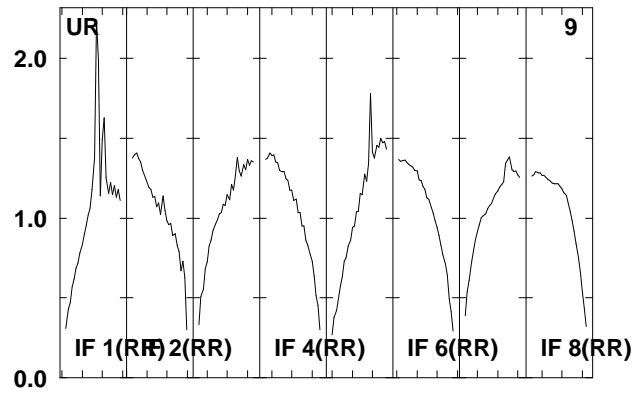
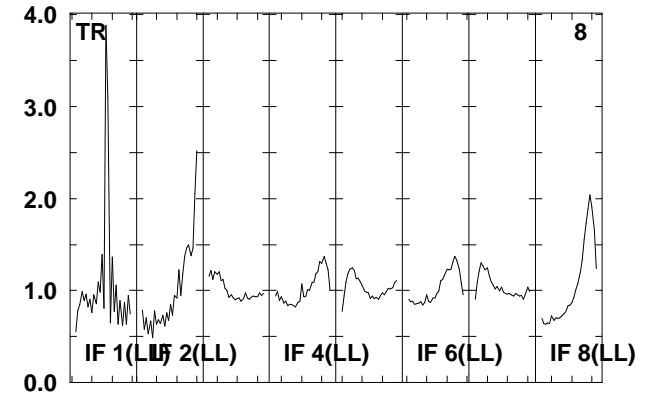
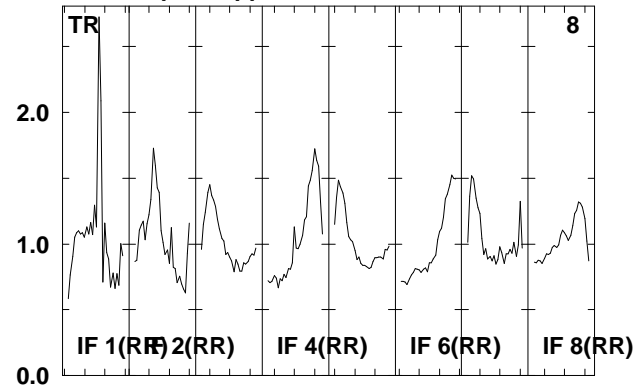
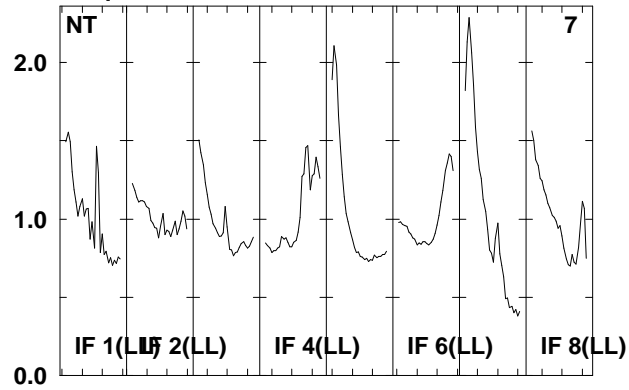

Lower frame: Real Jy
Total-power spectrum Antenna: *
Timerange: 00/09:46:02 to 00/09:47:26

Plot file version 93 created 18-APR-2008 18:27:59

IRAS2336 EP061A.UVDATA.1

Freq = 1.5950 GHz, Bw = 16.000 MH No calibration applied and no bandpass applied

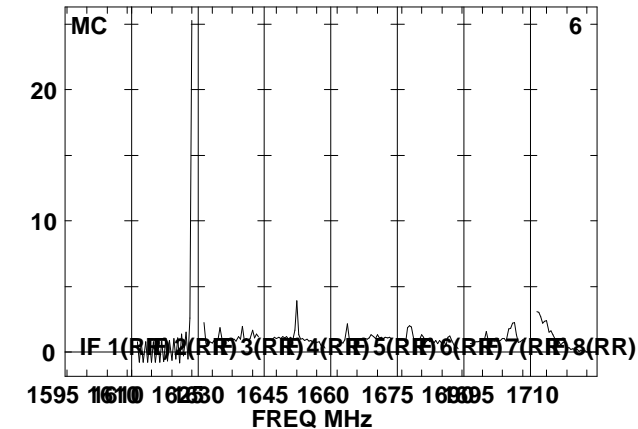
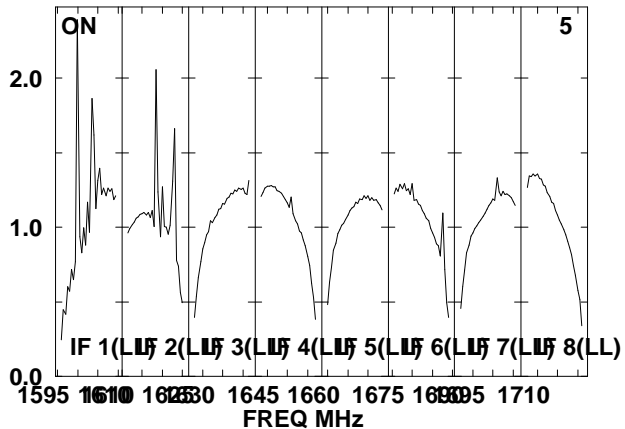
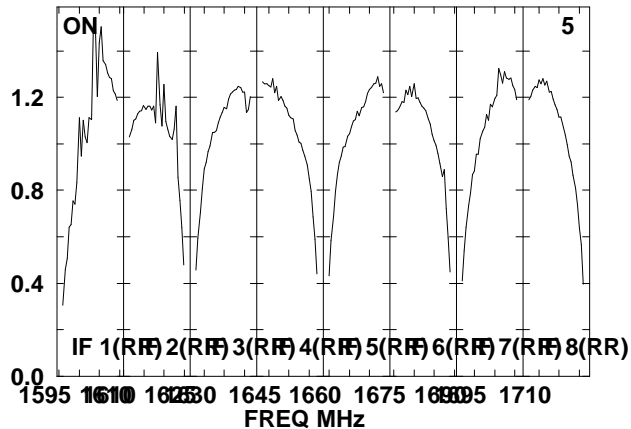
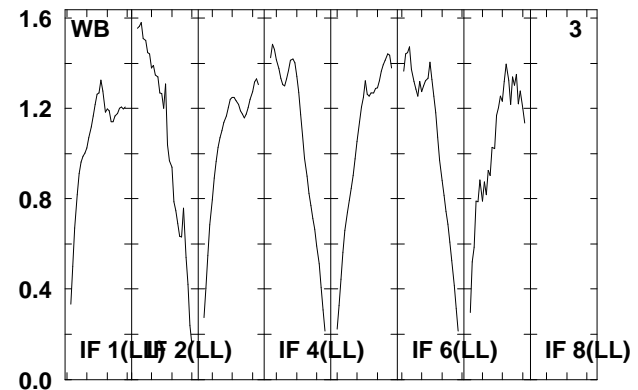
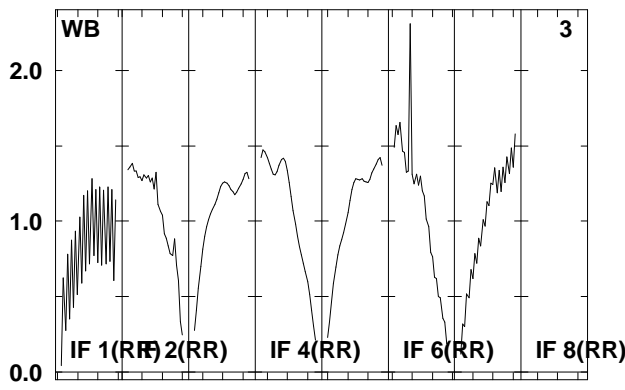
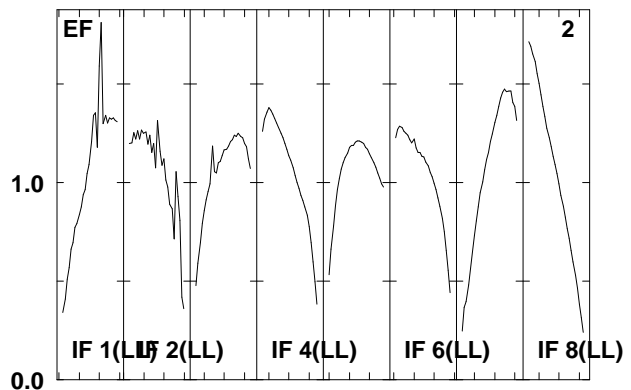
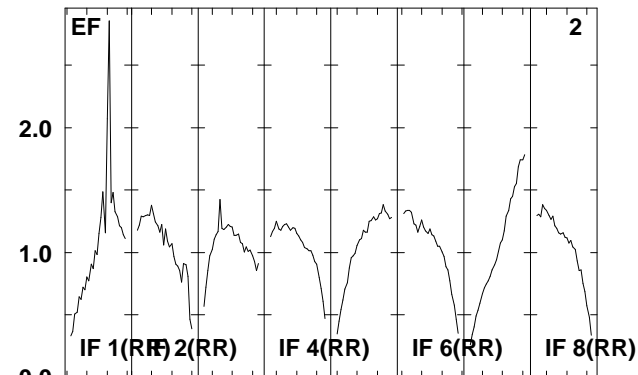
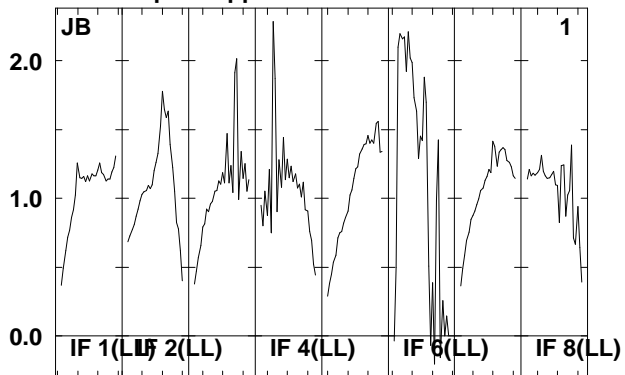
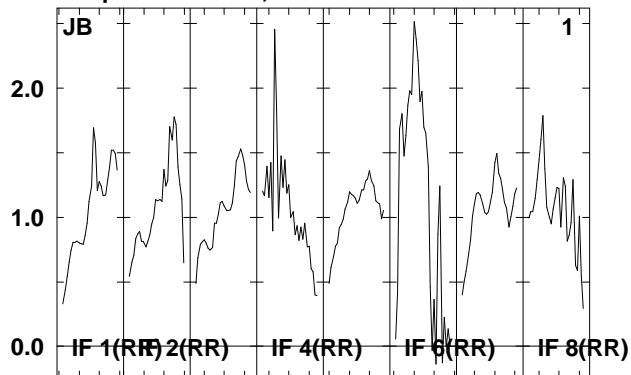

Lower frame: Real Jy
Total-power spectrum Antenna: *
Timerange: 00/09:47:32 to 00/09:51:00

Plot file version 94 created 18-APR-2008 18:28:00
 IRAS2336 EP061A.UVDATA.1
 Freq = 1.5950 GHz, Bw = 16.000 MH No calibration applied and no bandpass applied

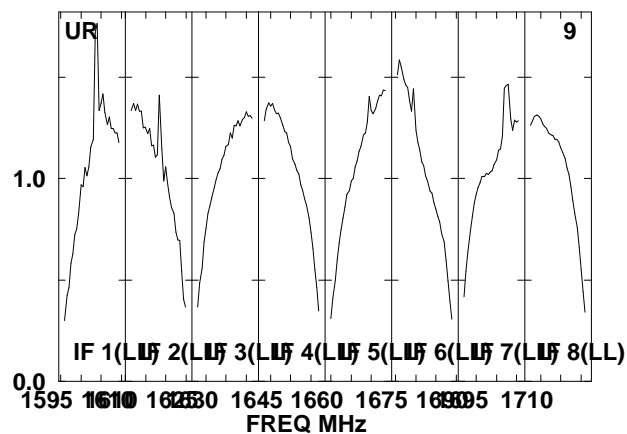
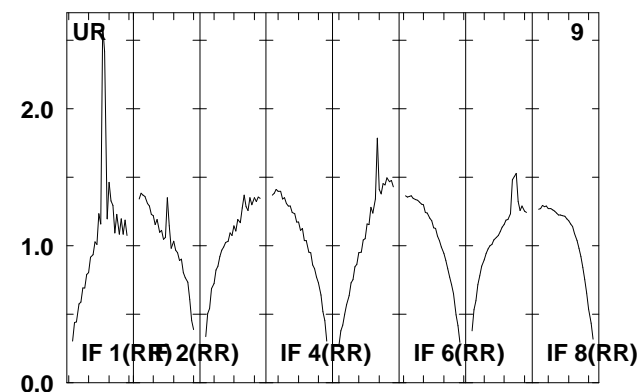
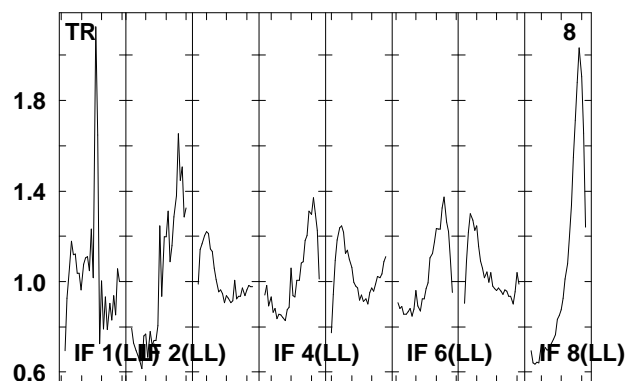
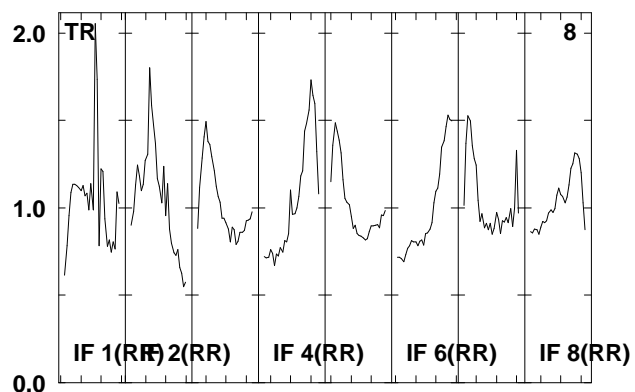
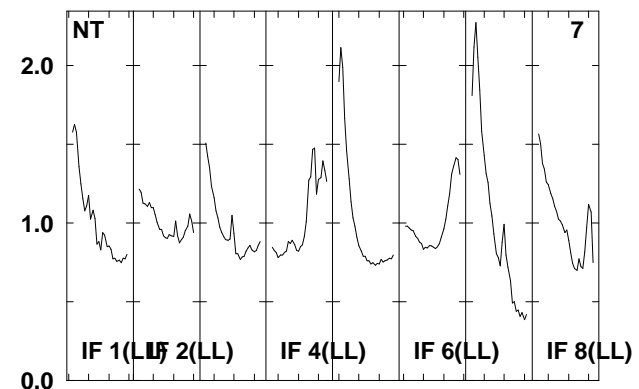
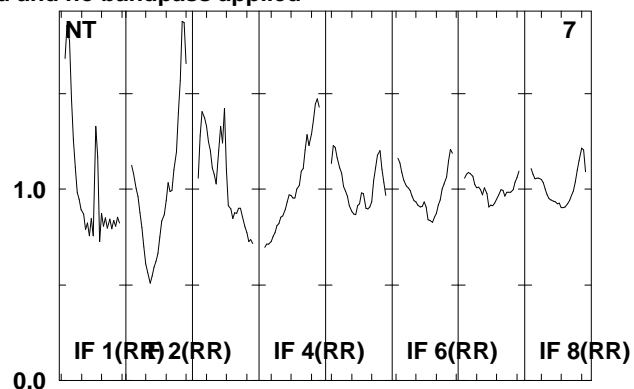
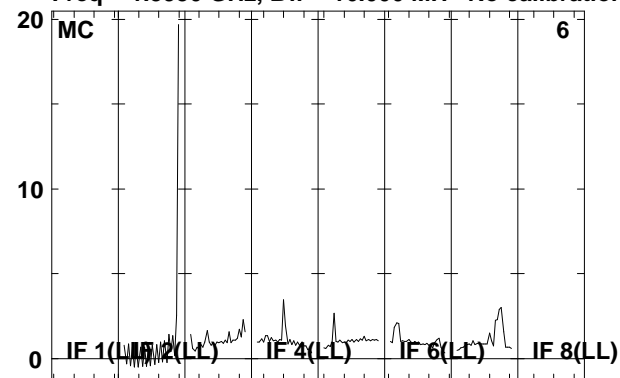

Lower frame: Real Jy
 Total-power spectrum Antenna: *
 Timerange: 00/09:47:32 to 00/09:51:00

Plot file version 95 created 18-APR-2008 18:28:01

J2333+39 EP061A.UVDATA.1

Freq = 1.5950 GHz, Bw = 16.000 MH No calibration applied and no bandpass applied

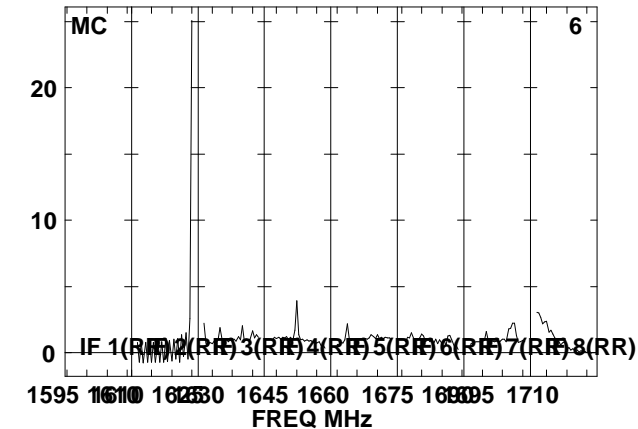
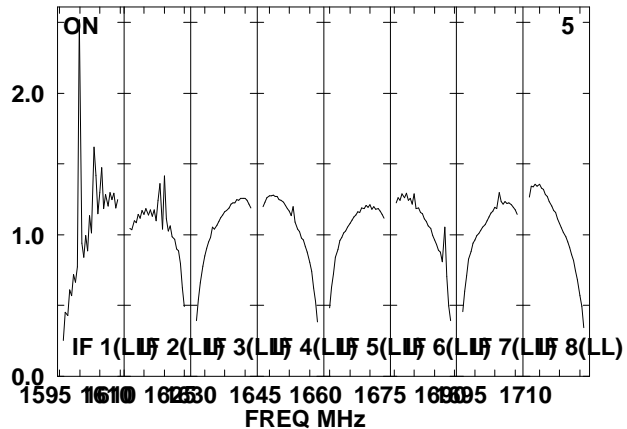
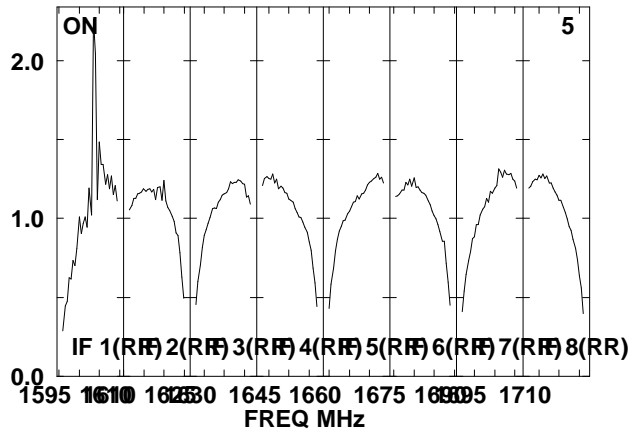
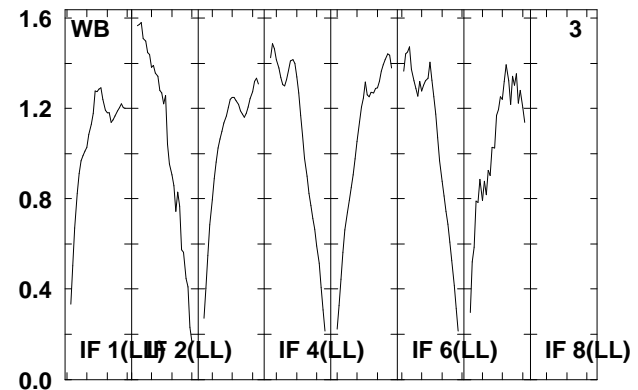
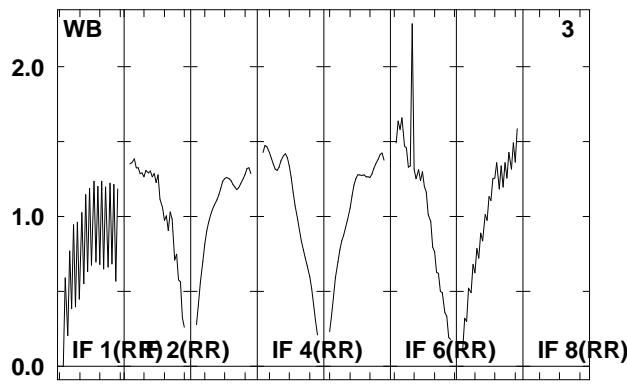
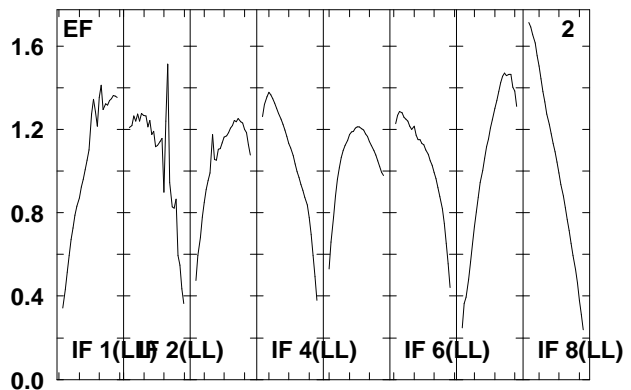
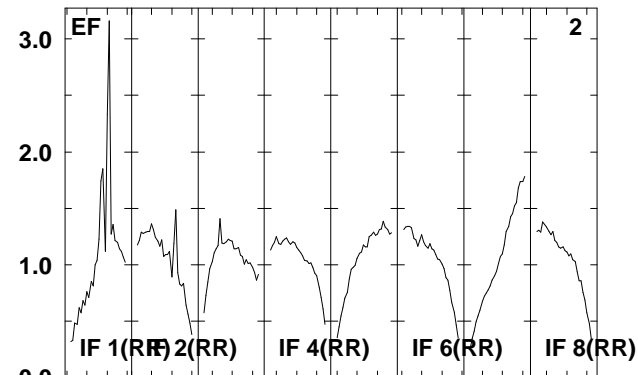
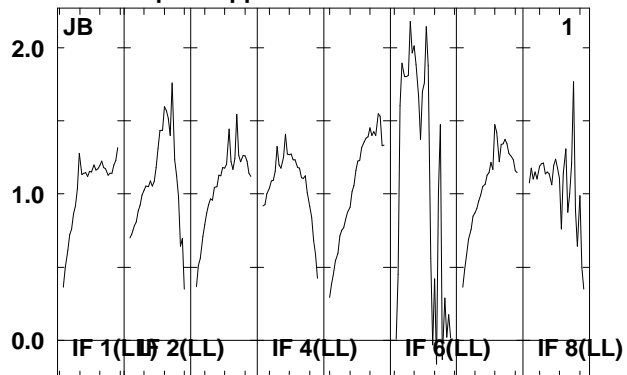
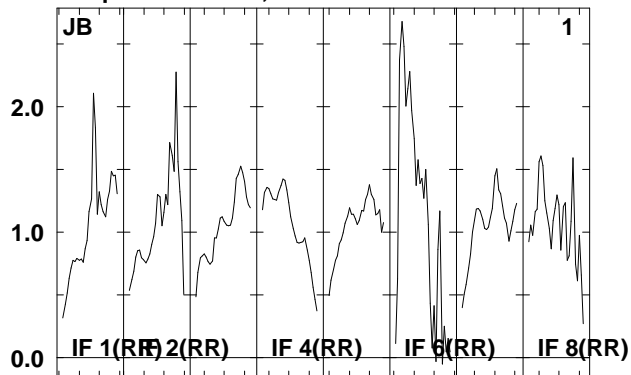

Lower frame: Real Jy
Total-power spectrum Antenna: *
Timerange: 00/09:51:02 to 00/09:52:30

Plot file version 96 created 18-APR-2008 18:28:01
 J2333+39 EP061A.UVDATA.1
 Freq = 1.5950 GHz, Bw = 16.000 MH No calibration applied and no bandpass applied

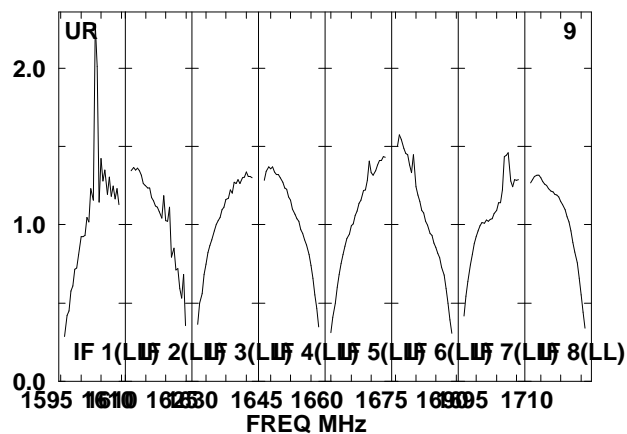
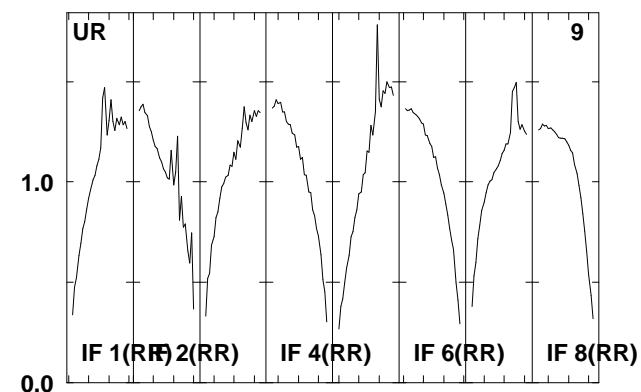
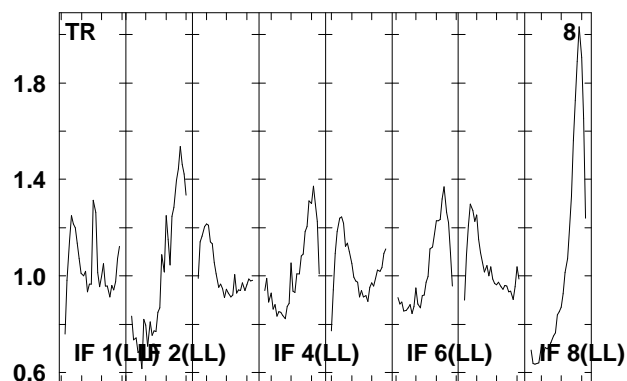
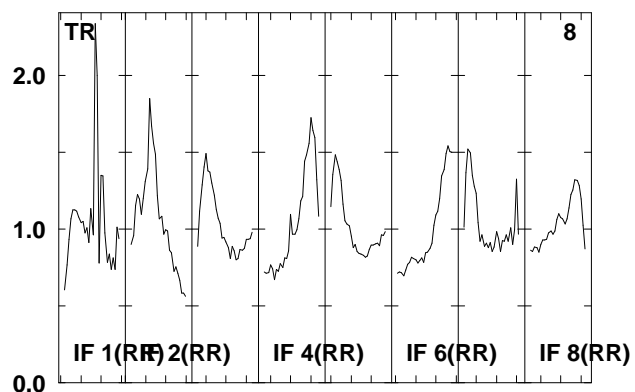
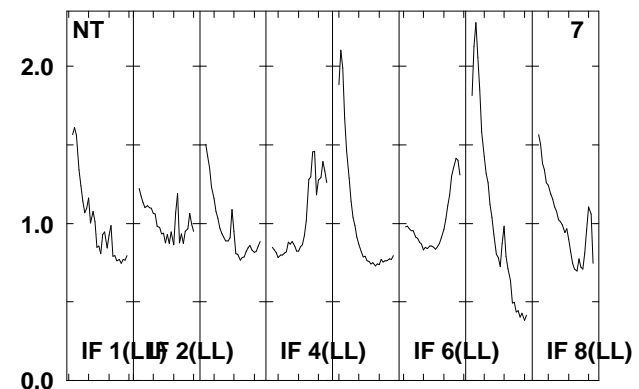
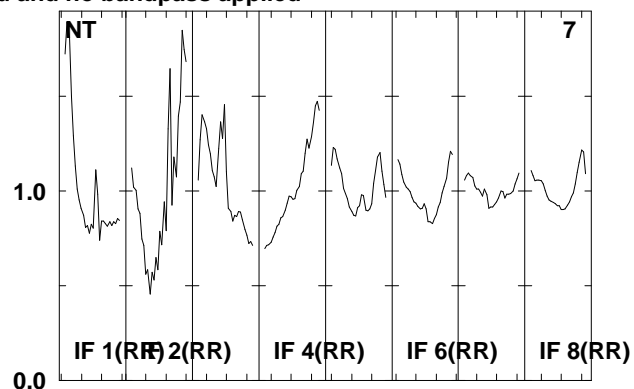
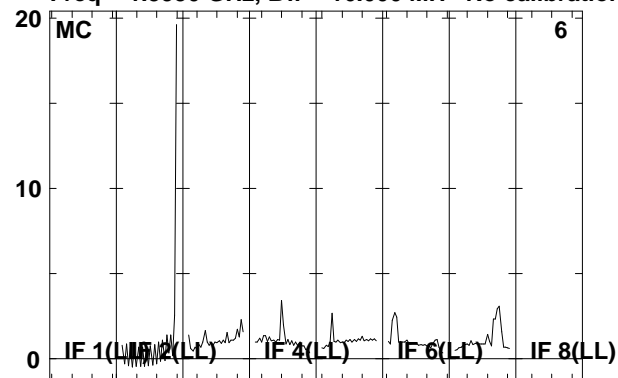

Lower frame: Real Jy
 Total-power spectrum Antenna: *
 Timerange: 00/09:51:02 to 00/09:52:30

Plot file version 97 created 18-APR-2008 18:28:02
 IRAS2336 EP061A.UVDATA.1
 Freq = 1.5950 GHz, Bw = 16.000 MH No calibration applied and no bandpass applied

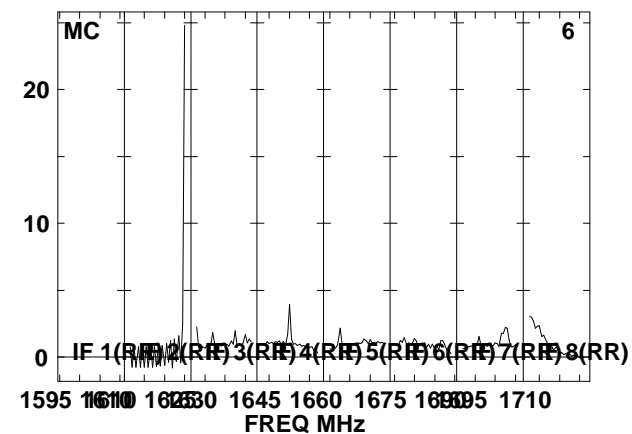
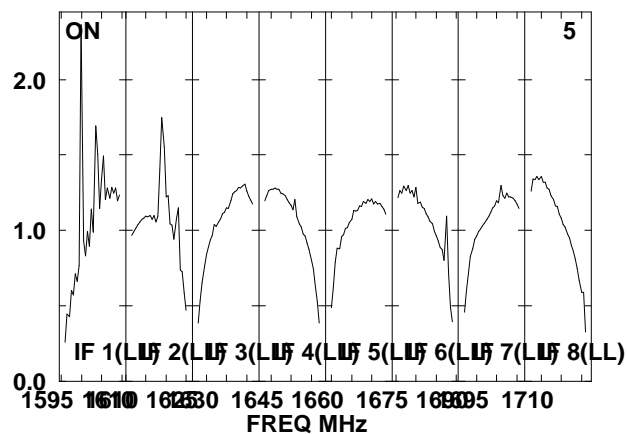
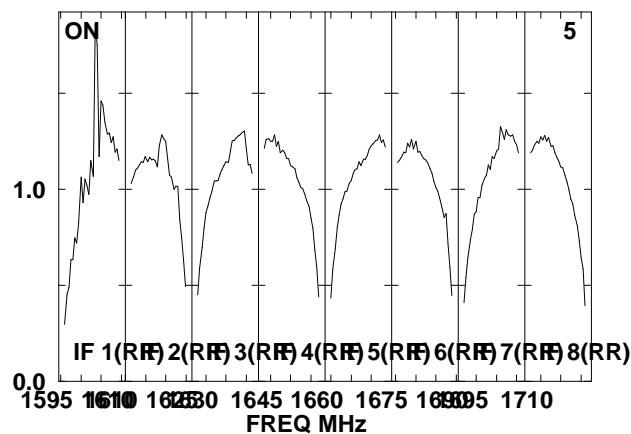
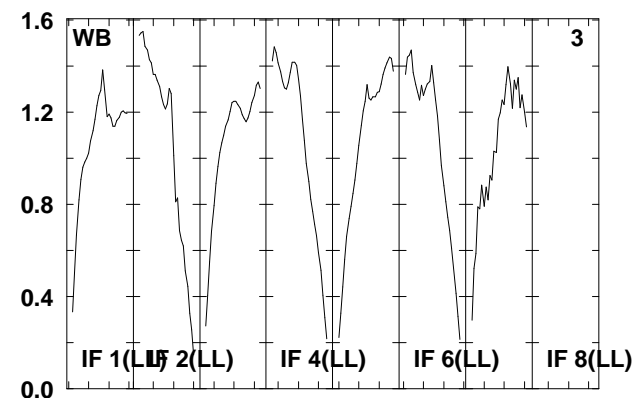
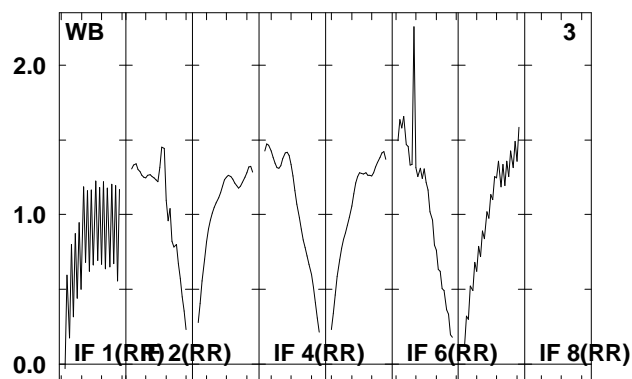
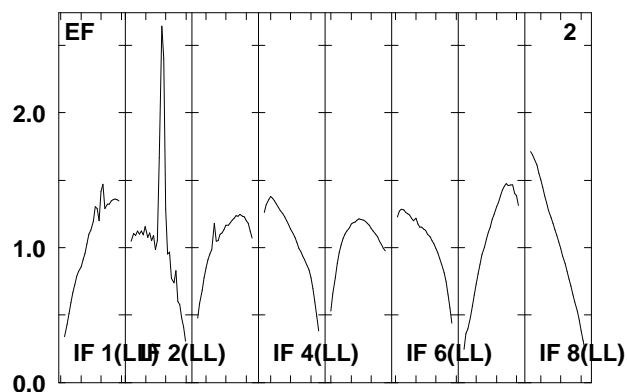
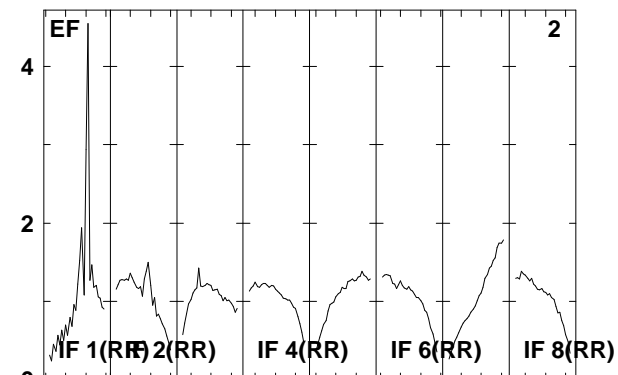
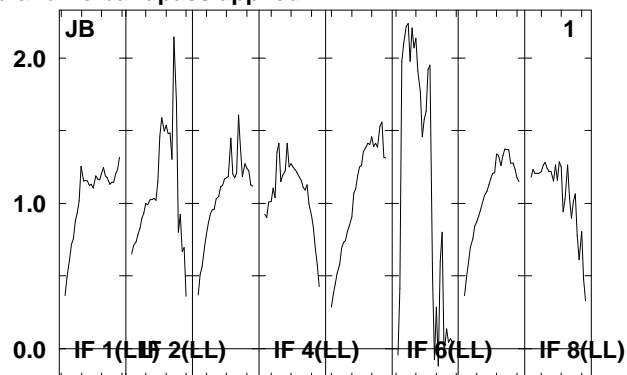
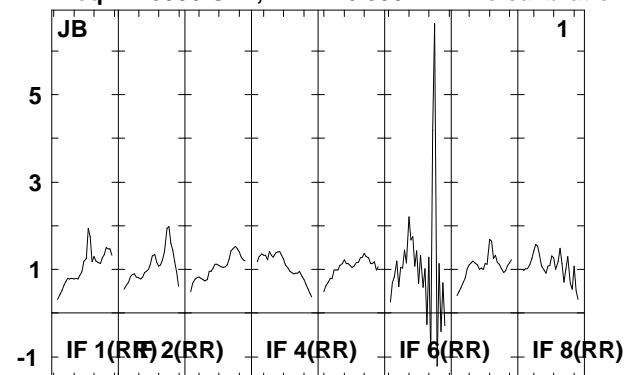

Lower frame: Real Jy
 Total-power spectrum Antenna: *
 Timerange: 00/09:52:32 to 00/09:56:00

Plot file version 98 created 18-APR-2008 18:28:03

IRAS2336 EP061A.UVDATA.1

Freq = 1.5950 GHz, Bw = 16.000 MH No calibration applied and no bandpass applied

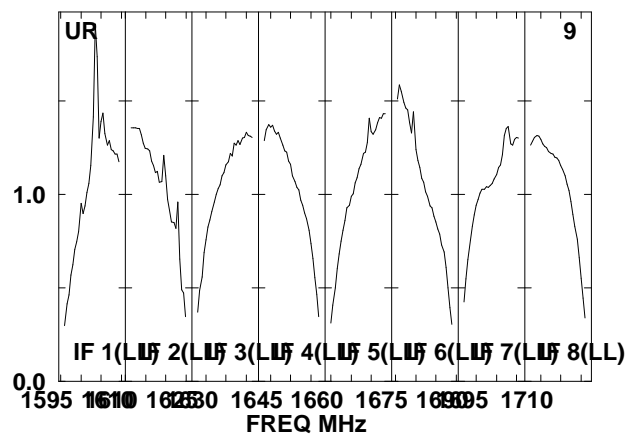
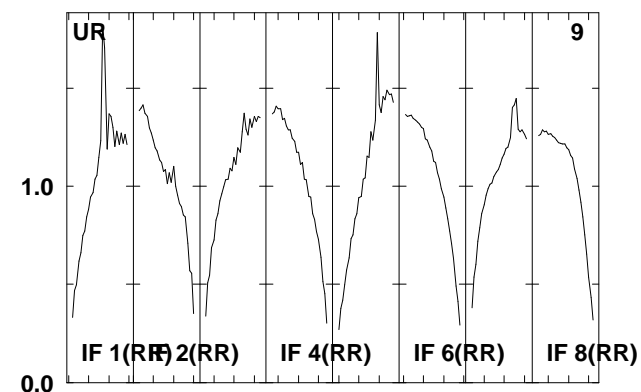
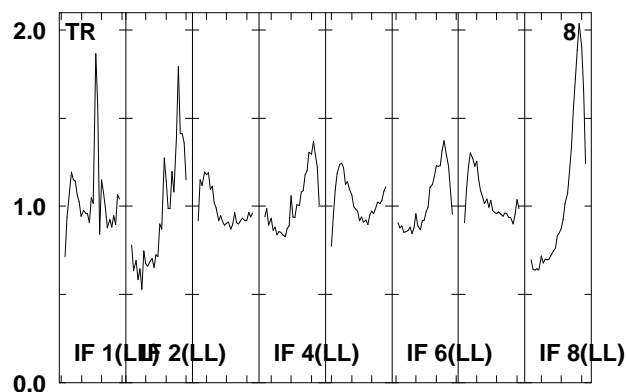
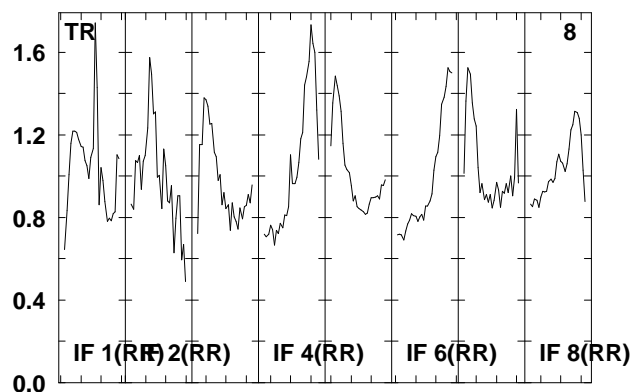
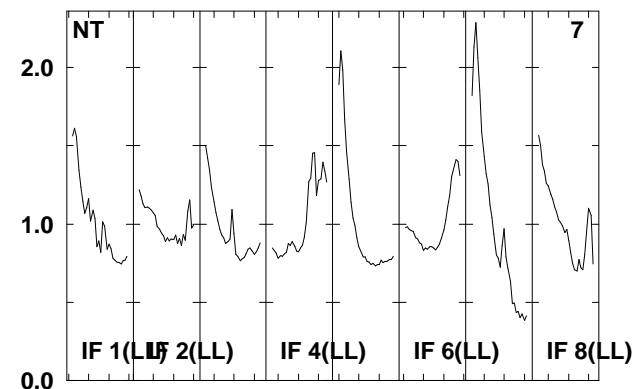
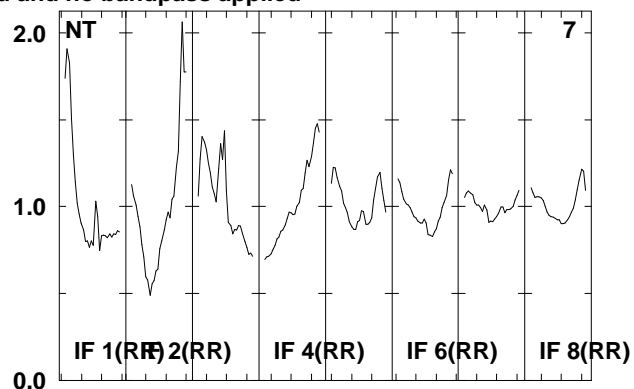
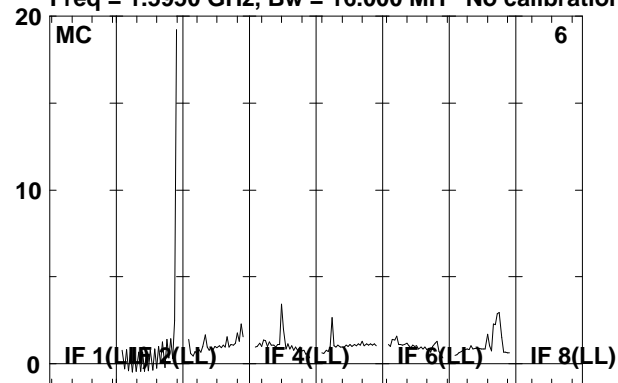

Lower frame: Real Jy

Total-power spectrum Antenna: *

Timerange: 00/09:52:32 to 00/09:56:00

Plot file version 99 created 18-APR-2008 18:28:04

J2333+39 EP061A.UVDATA.1

Freq = 1.5950 GHz, Bw = 16.000 MH No calibration applied and no bandpass applied

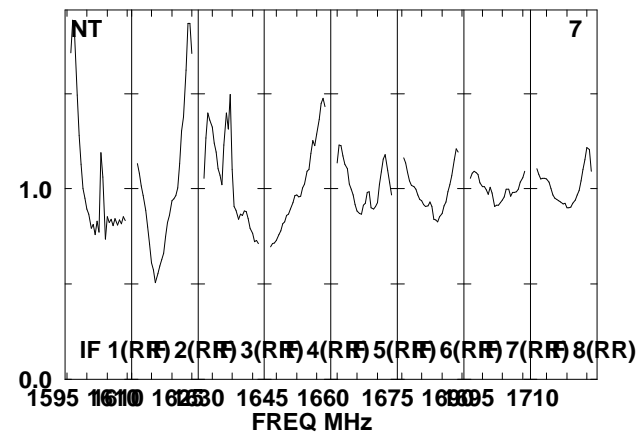
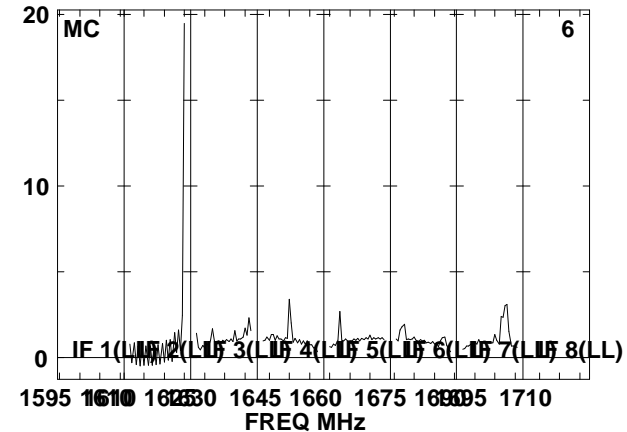
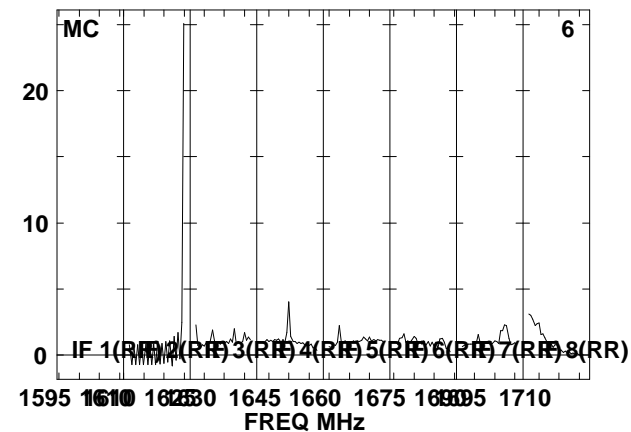
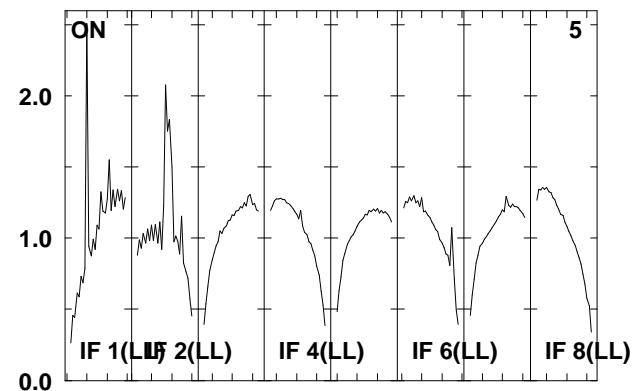
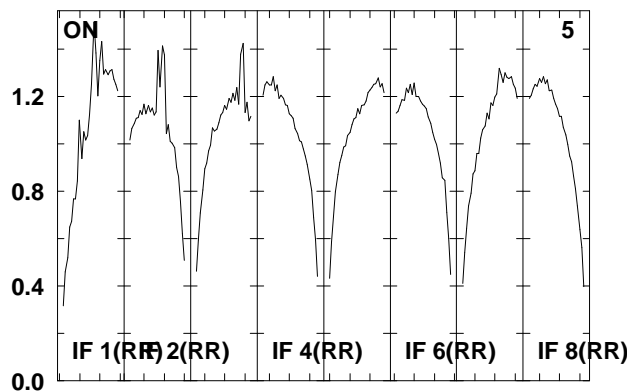
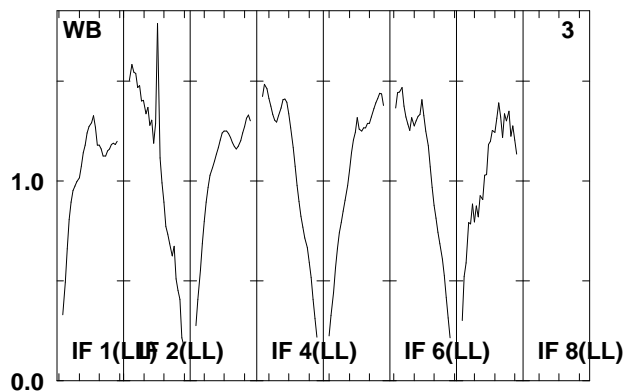
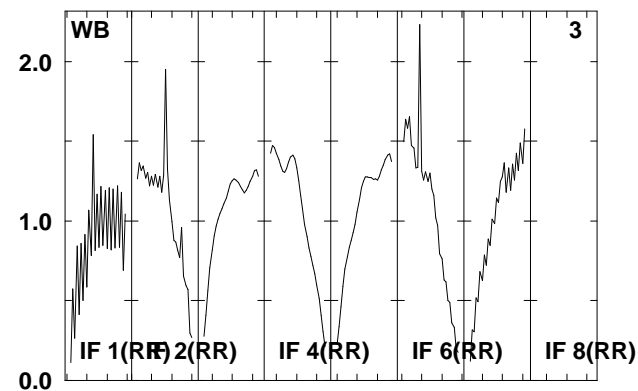
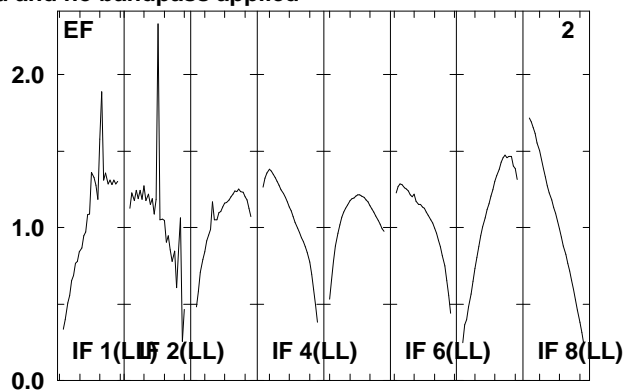
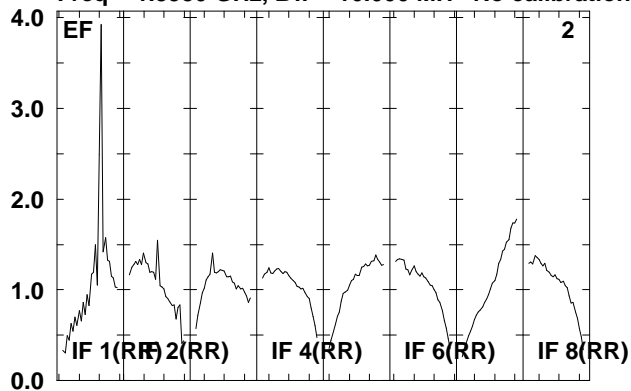

Lower frame: Real Jy
Total-power spectrum Antenna: *
Timerange: 00/09:56:02 to 00/09:57:28

Plot file version 100 created 18-APR-2008 18:28:04

J2333+39 EP061A.UVDATA.1

Freq = 1.5950 GHz, Bw = 16.000 MH No calibration applied and no bandpass applied

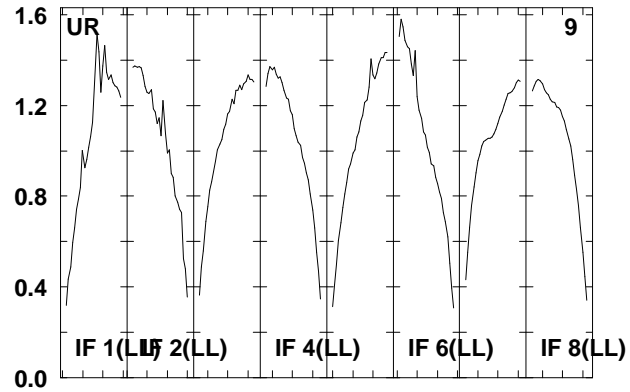
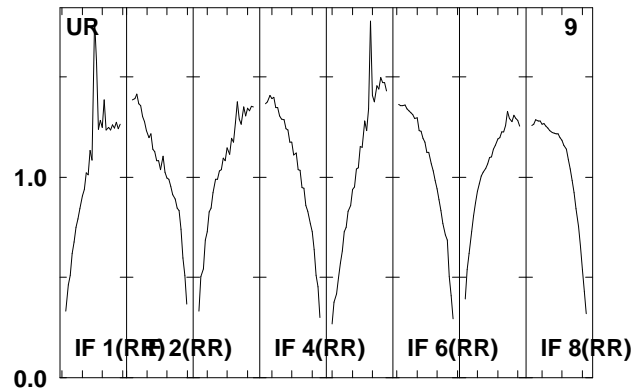
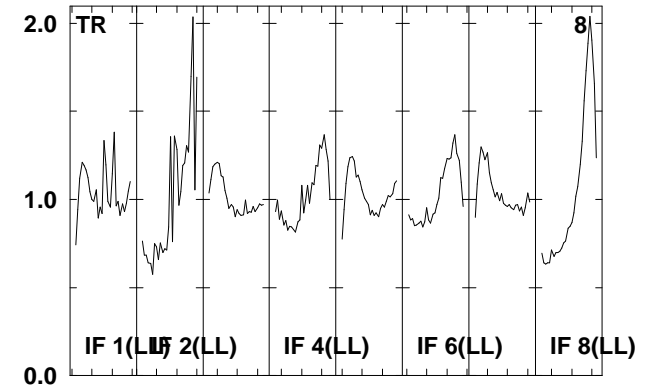
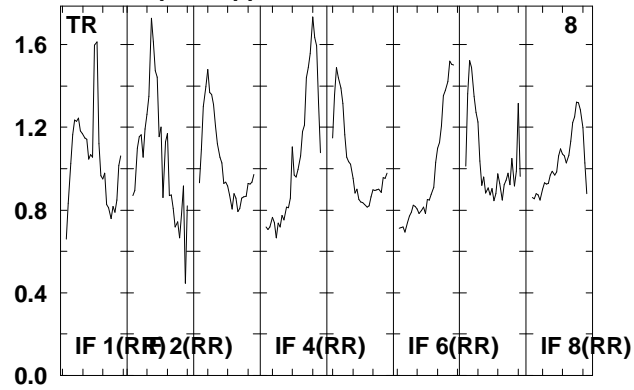
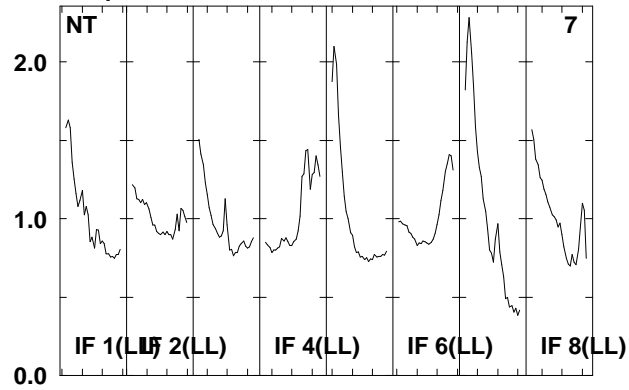

Lower frame: Real Jy
Total-power spectrum Antenna: *
Timerange: 00/09:56:02 to 00/09:57:28

Plot file version 101 created 18-APR-2008 18:28:05

IRAS2336 EP061A.UVDATA.1

Freq = 1.5950 GHz, Bw = 16.000 MH No calibration applied and no bandpass applied

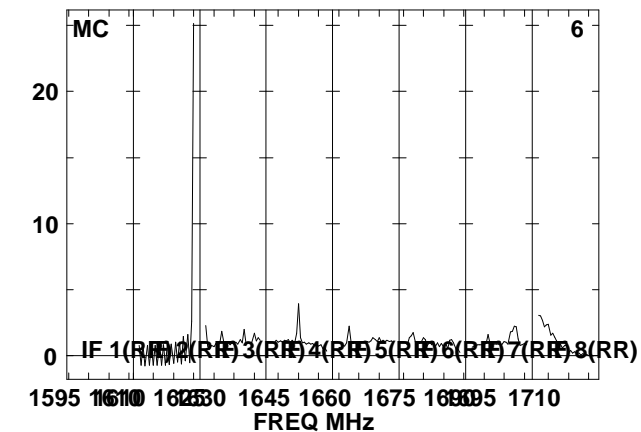
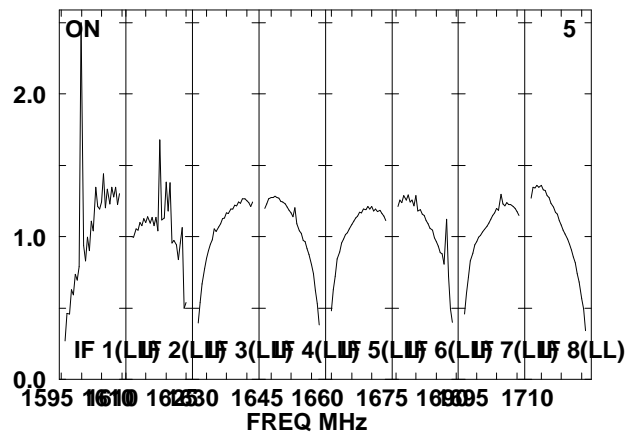
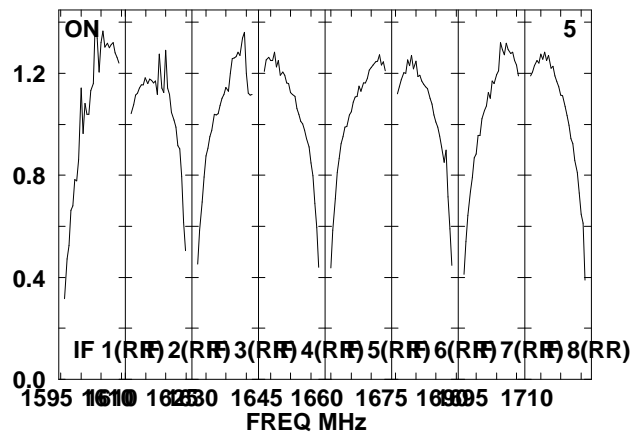
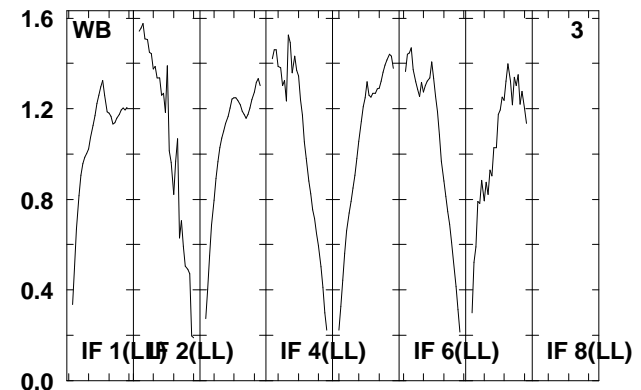
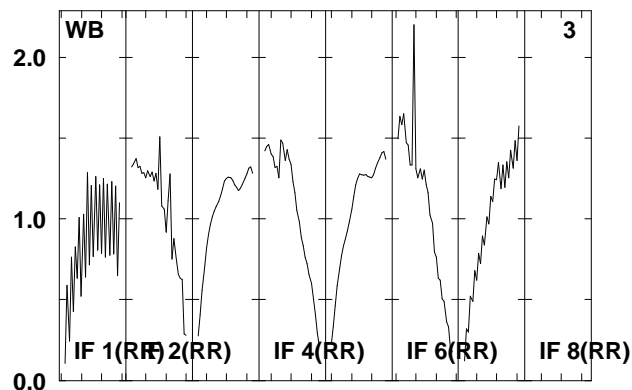
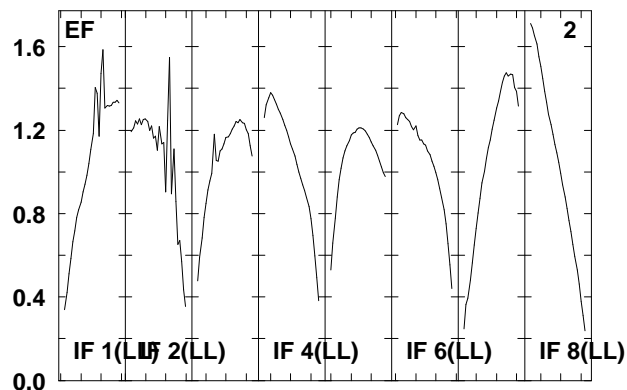
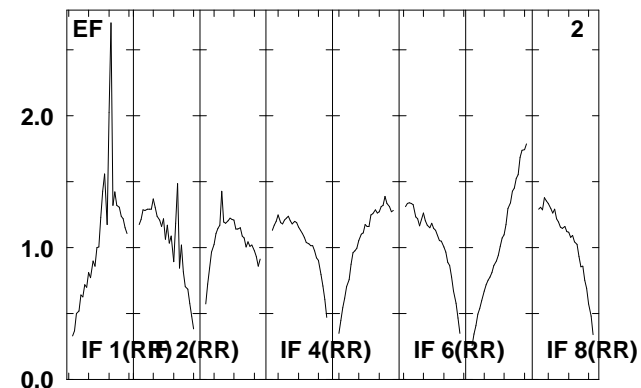
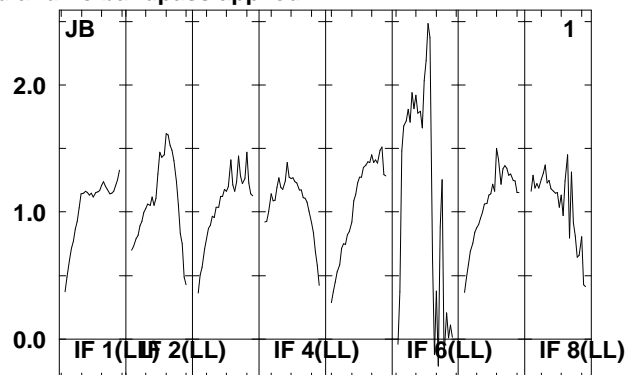
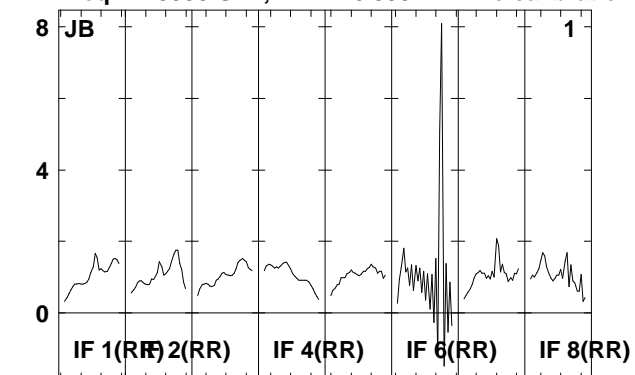

Lower frame: Real Jy
Total-power spectrum Antenna: *
Timerange: 00/09:57:30 to 00/10:00:58

Plot file version 102 created 18-APR-2008 18:28:06

IRAS2336 EP061A.UVDATA.1

Freq = 1.5950 GHz, Bw = 16.000 MH No calibration applied and no bandpass applied

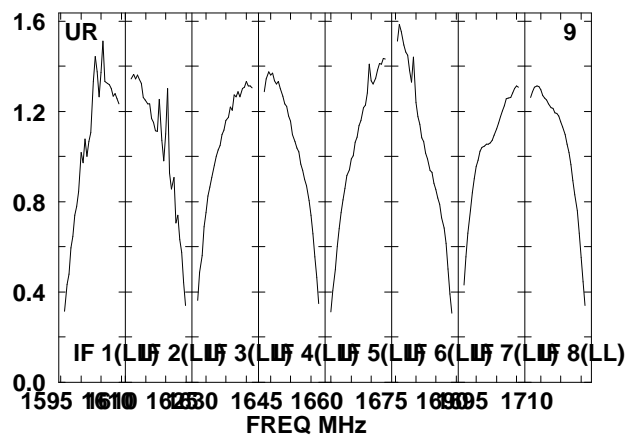
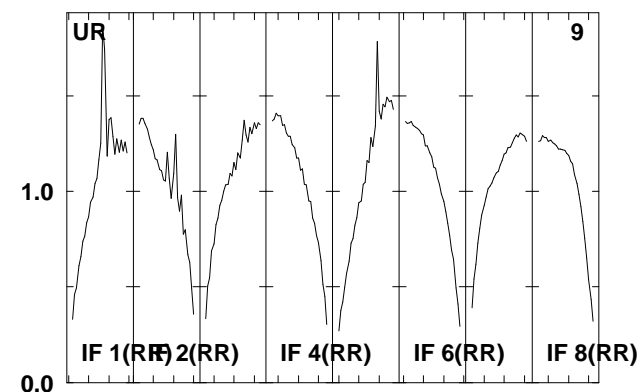
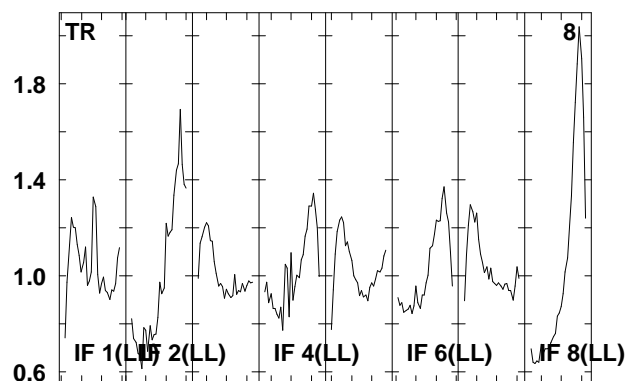
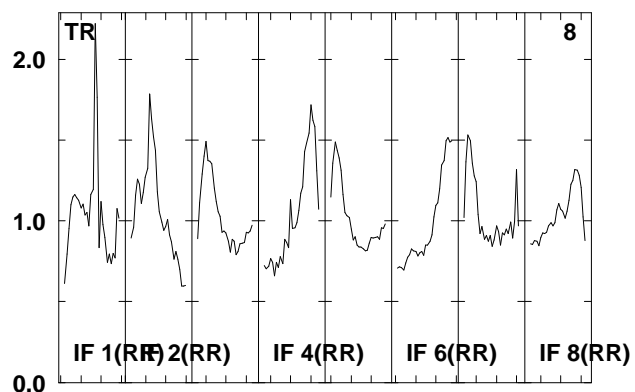
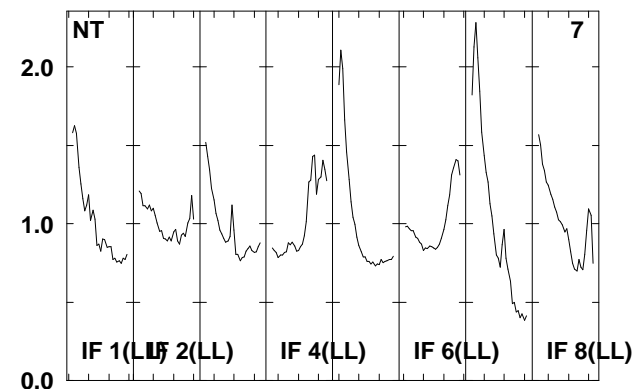
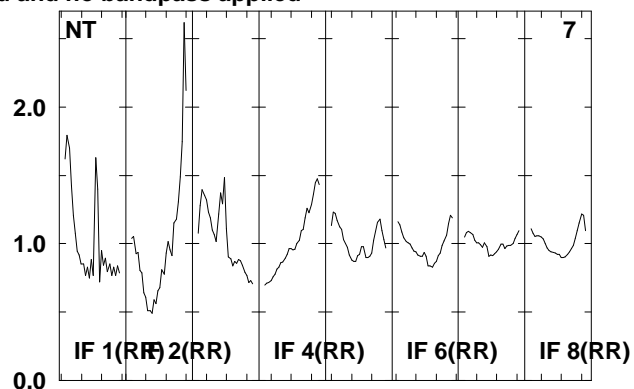
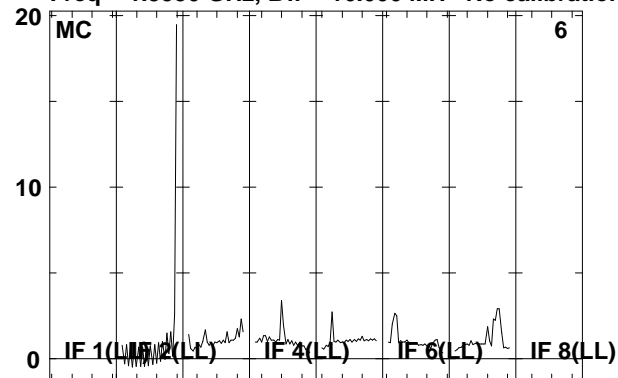

Lower frame: Real Jy

Total-power spectrum Antenna: *

Timerange: 00/09:57:30 to 00/10:00:58

Plot file version 103 created 18-APR-2008 18:28:06

J2333+39 EP061A.UVDATA.1

Freq = 1.5950 GHz, Bw = 16.000 MH No calibration applied and no bandpass applied

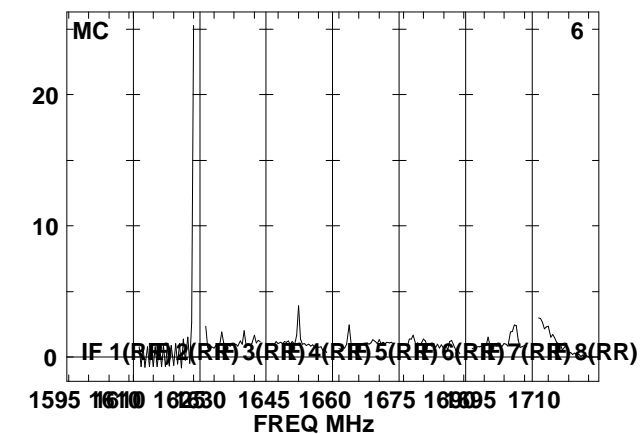
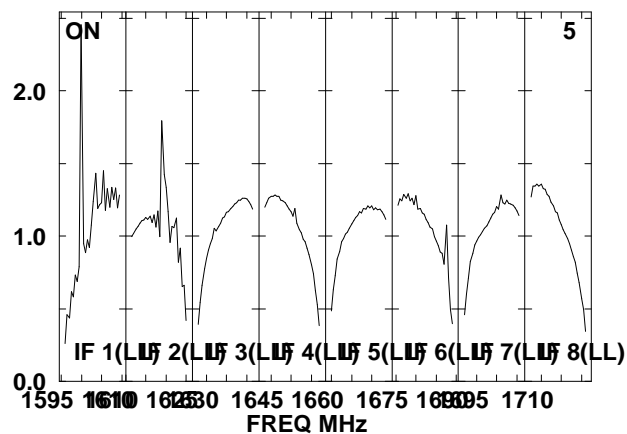
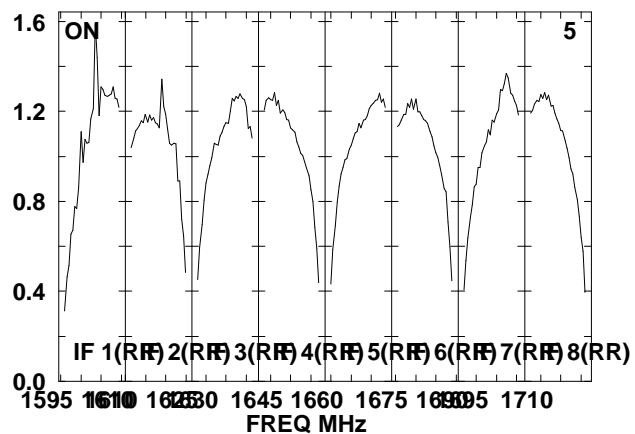
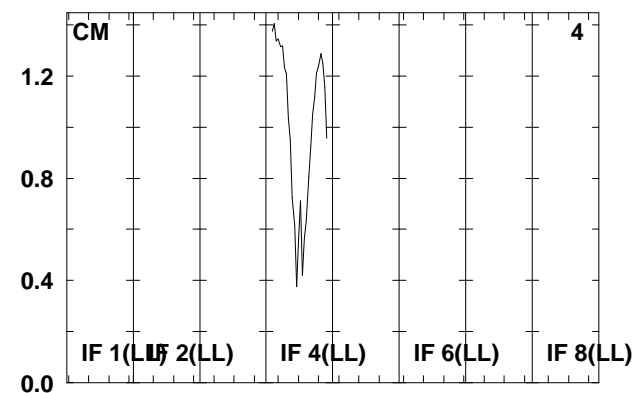
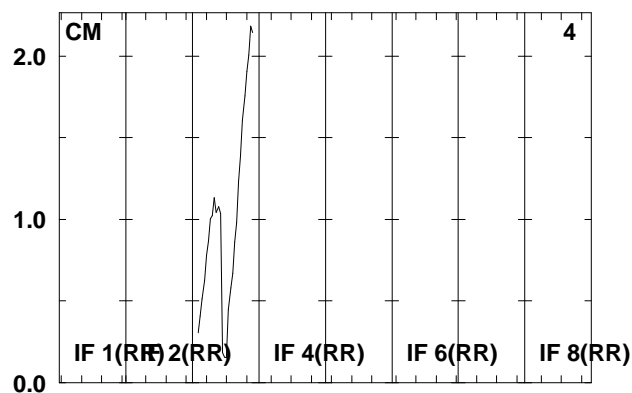
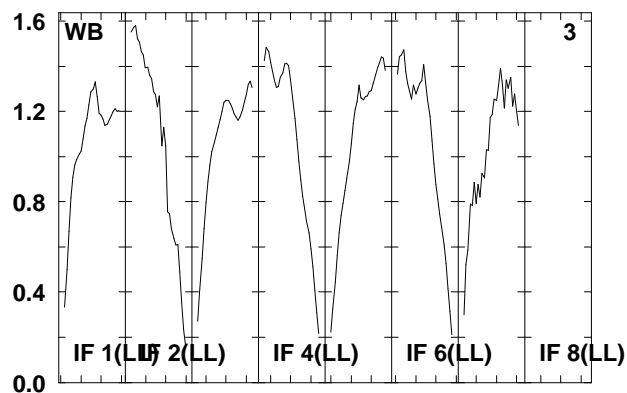
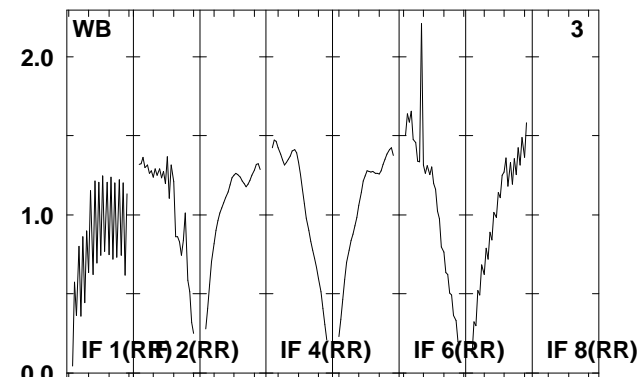
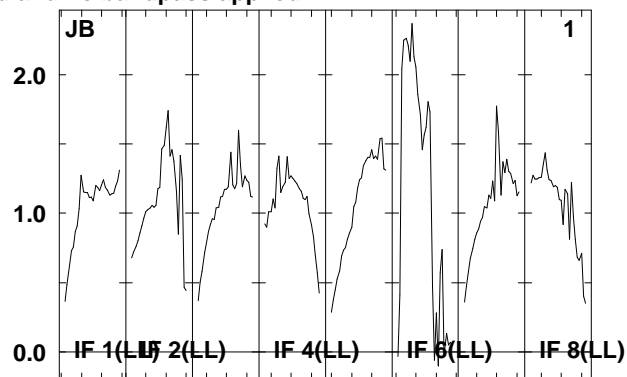
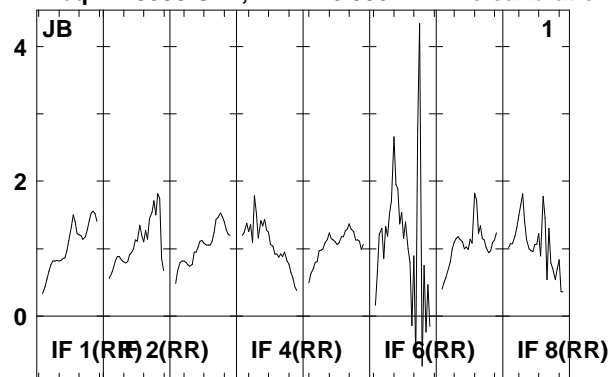

Lower frame: Real Jy
Total-power spectrum Antenna: *
Timerange: 00/10:02:02 to 00/10:03:30

Plot file version 104 created 18-APR-2008 18:28:07

J2333+39 EP061A.UVDATA.1

Freq = 1.5950 GHz, Bw = 16.000 MH No calibration applied and no bandpass applied

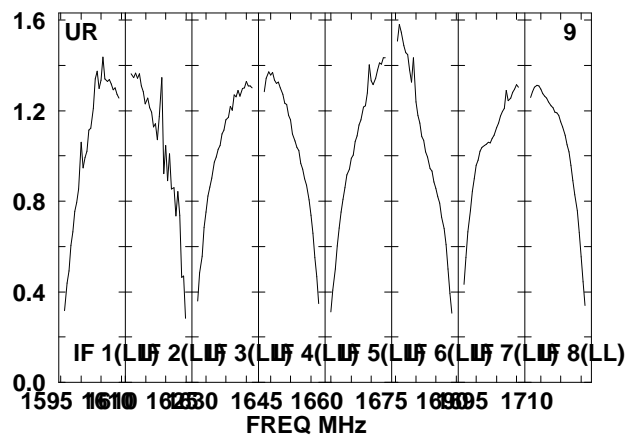
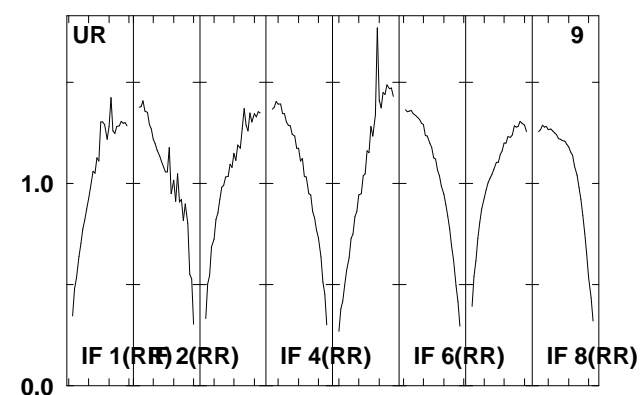
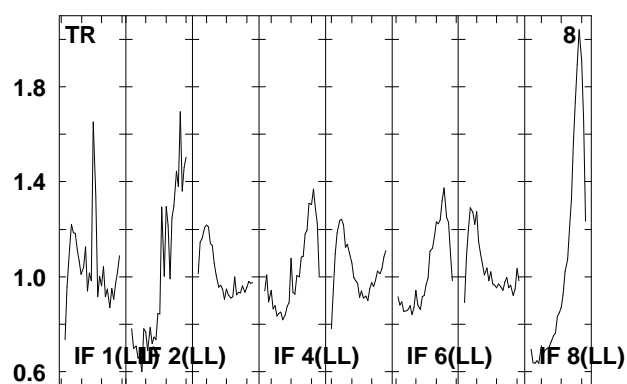
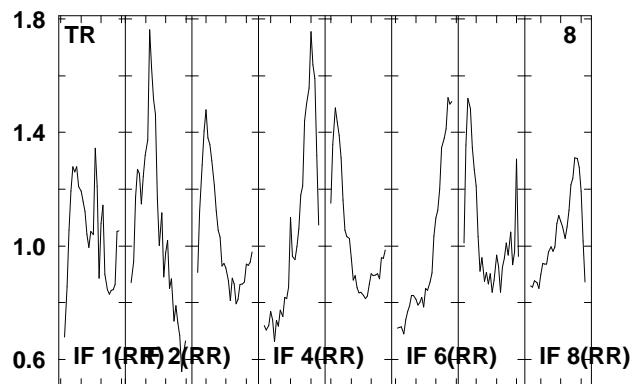
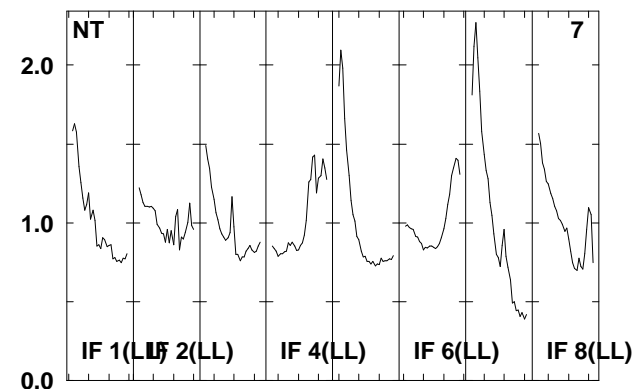
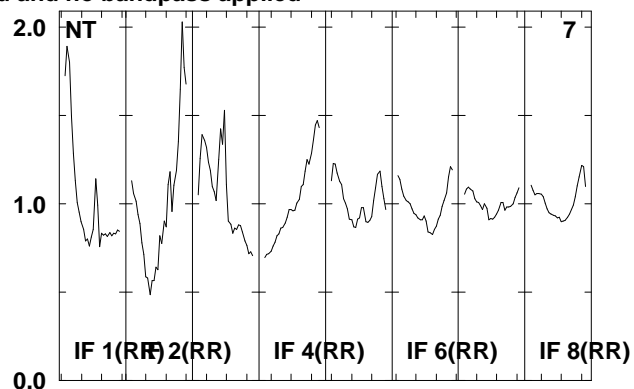
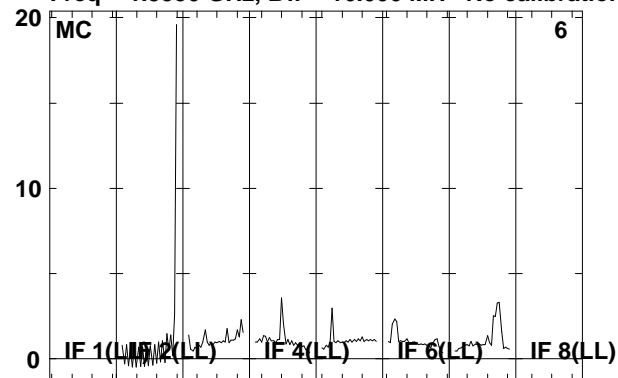

1595 1610 1625 1640 1655 1670 1685 1700 1710
FREQ MHz

Lower frame: Real Jy

Total-power spectrum Antenna: *

Timerange: 00/10:02:02 to 00/10:03:30

Plot file version 105 created 18-APR-2008 18:28:07

IRAS2336 EP061A.UVDATA.1

Freq = 1.5950 GHz, Bw = 16.000 MH No calibration applied and no bandpass applied

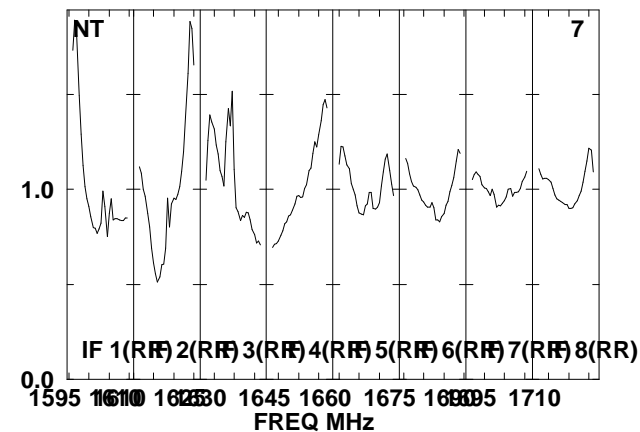
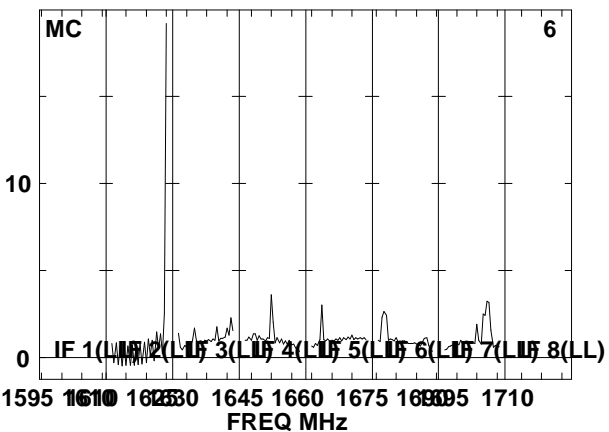
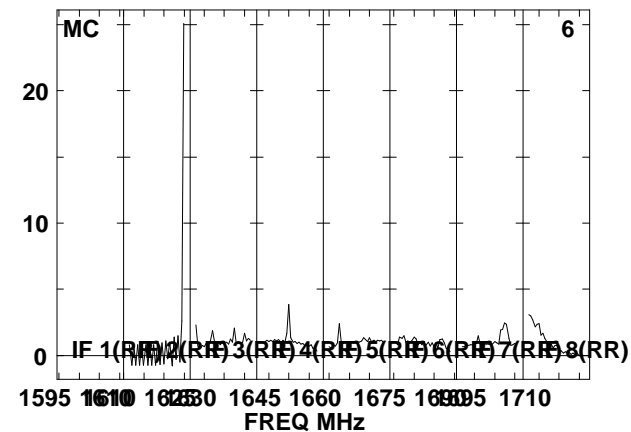
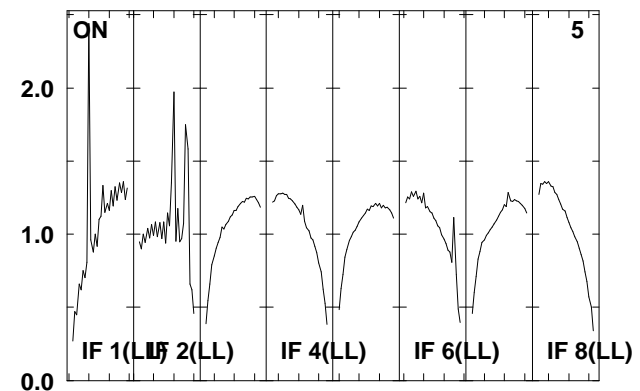
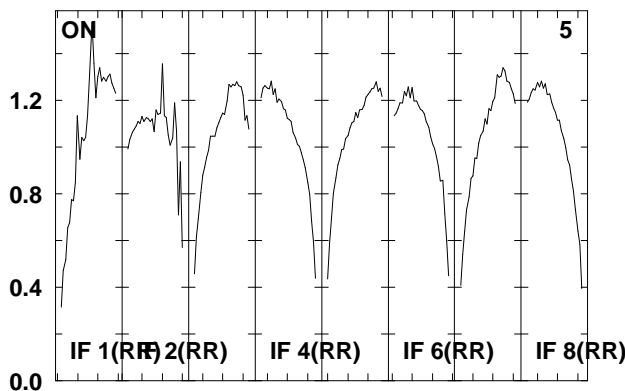
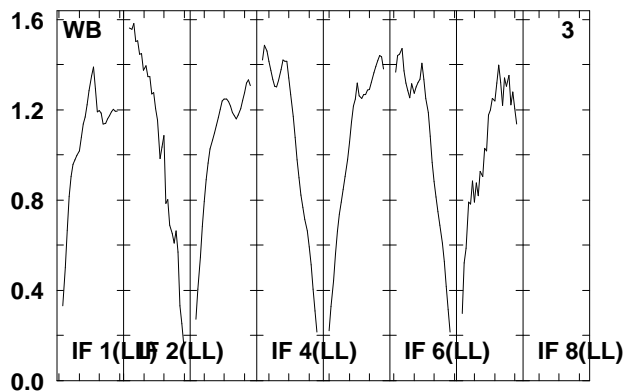
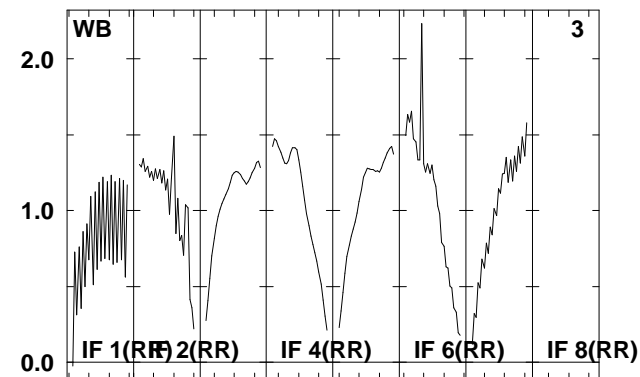
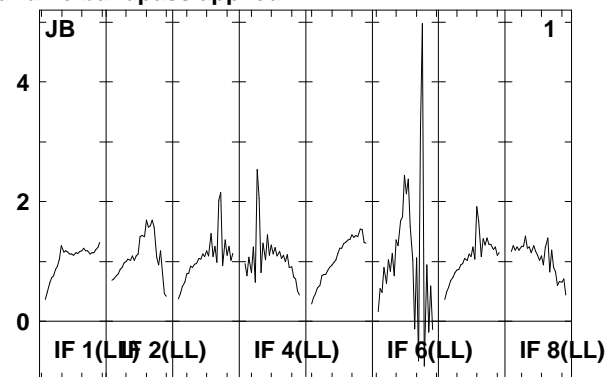
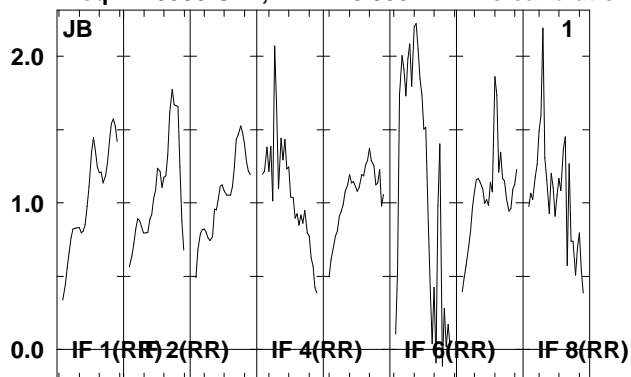

Lower frame: Real Jy
Total-power spectrum Antenna: *
Timerange: 00/10:03:32 to 00/10:05:44

Plot file version 106 created 18-APR-2008 18:28:08

IRAS2336 EP061A.UVDATA.1

Freq = 1.5950 GHz, Bw = 16.000 MH No calibration applied and no bandpass applied

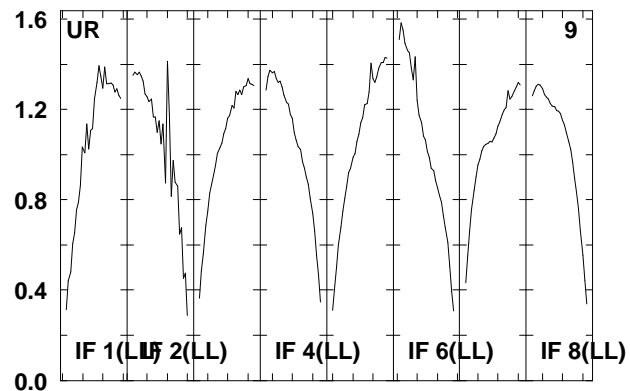
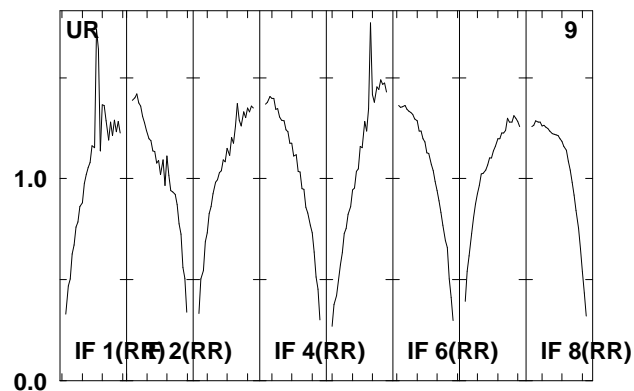
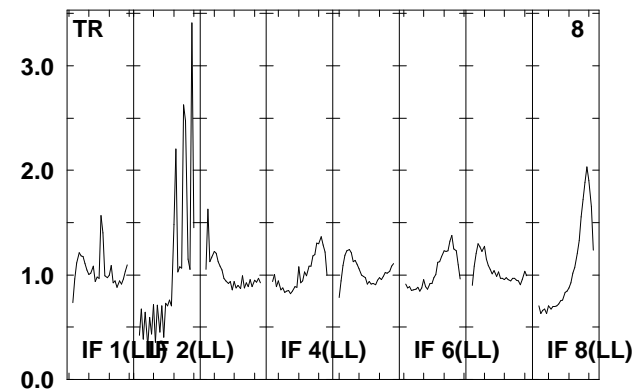
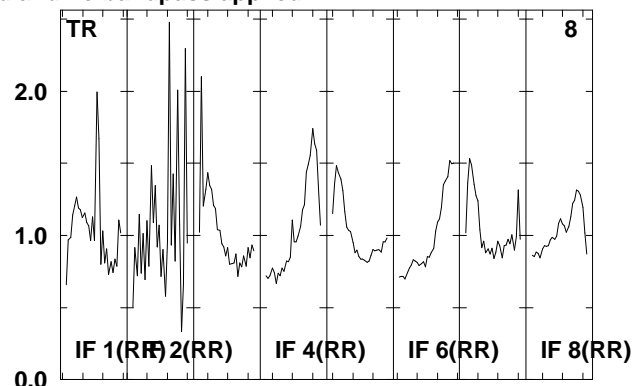
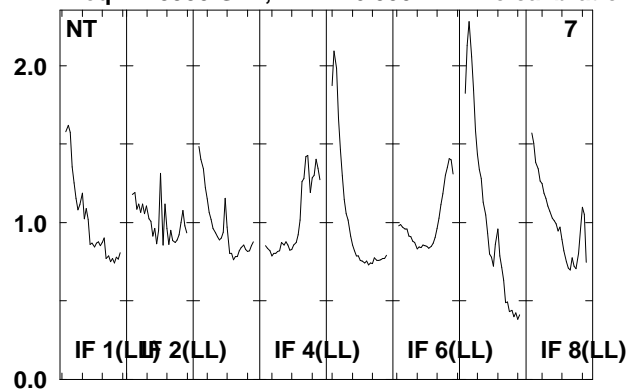

Lower frame: Real Jy
Total-power spectrum Antenna: *
Timerange: 00/10:03:32 to 00/10:05:44

Plot file version 107 created 18-APR-2008 18:28:09

J2333+39 EP061A.UVDATA.1

Freq = 1.5950 GHz, Bw = 16.000 MH No calibration applied and no bandpass applied

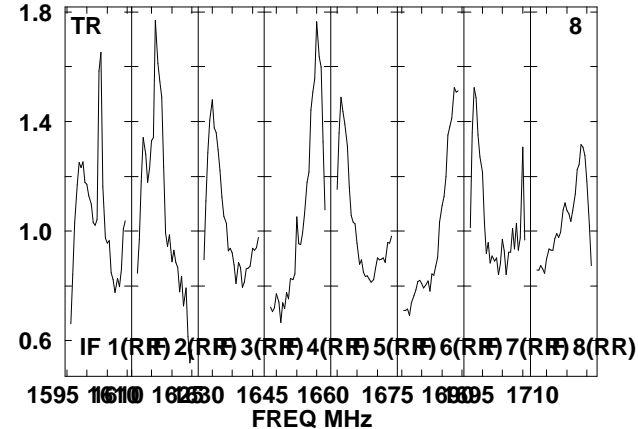
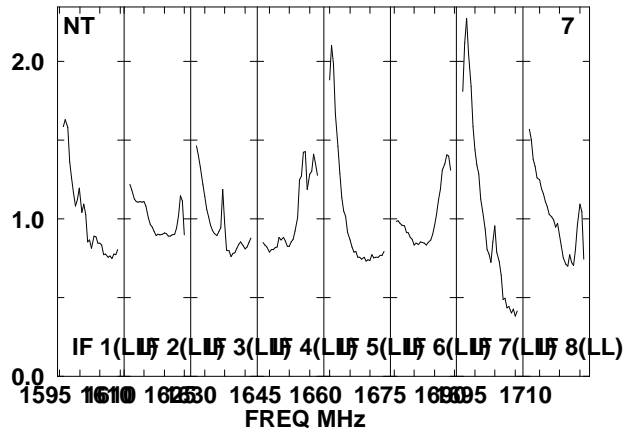
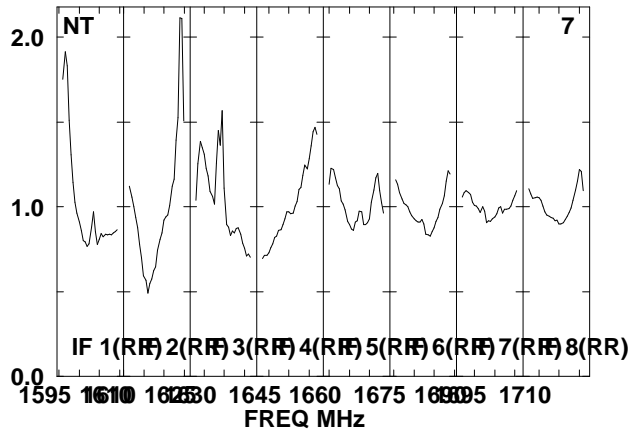
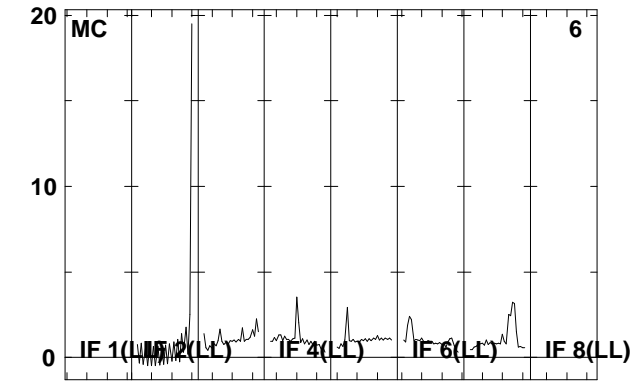
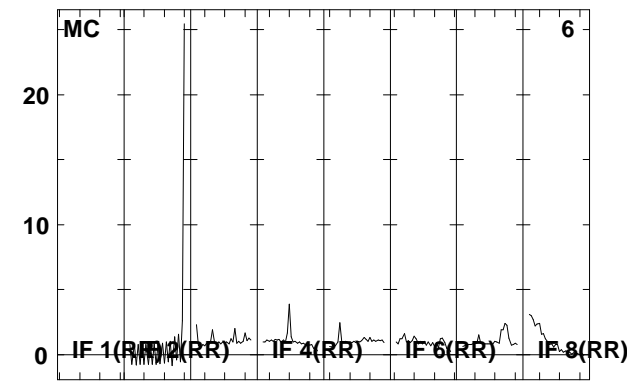
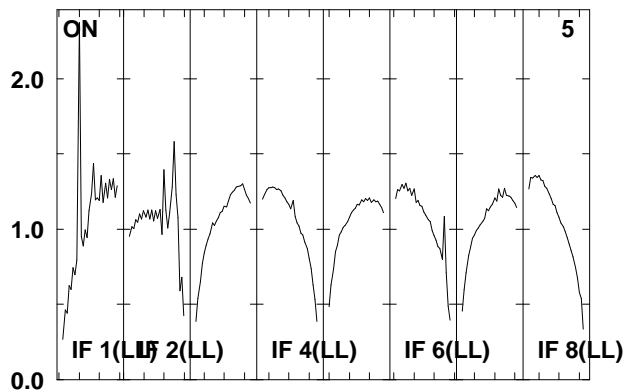
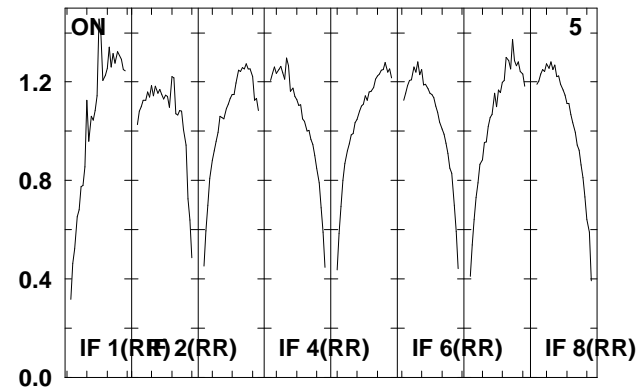
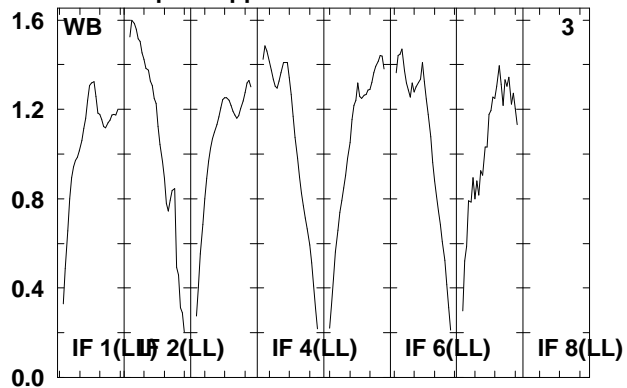
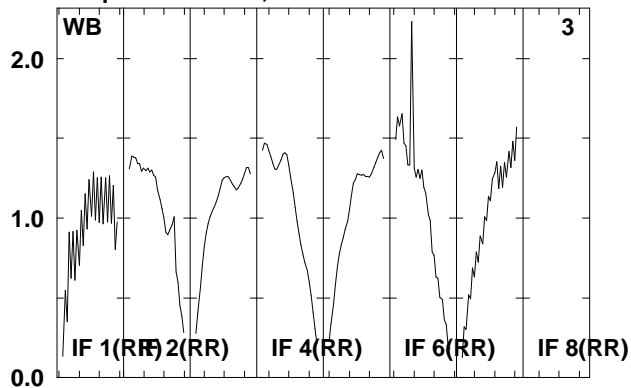

Lower frame: Real Jy
Total-power spectrum Antenna: *
Timerange: 00/10:07:10 to 00/10:08:26

Plot file version 108 created 18-APR-2008 18:28:09

J2333+39 EP061A.UVDATA.1

Freq = 1.5950 GHz, Bw = 16.000 MH No calibration applied and no bandpass applied

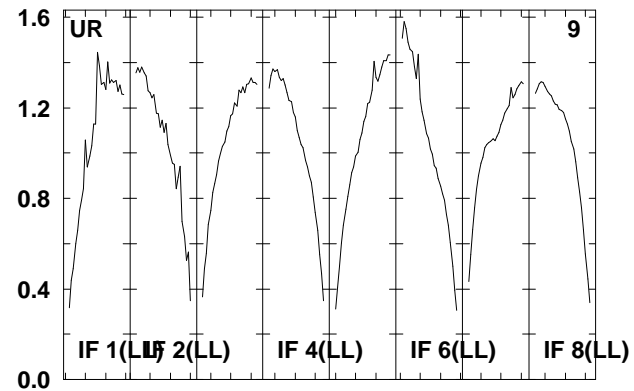
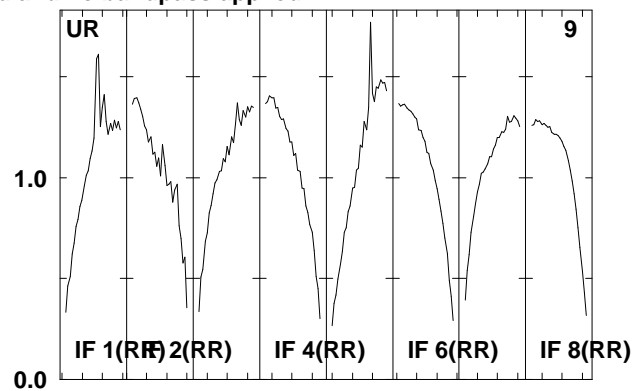
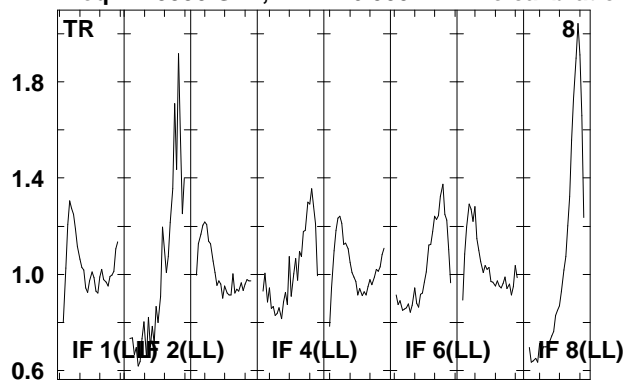

Lower frame: Real Jy
Total-power spectrum Antenna: *
Timerange: 00/10:07:10 to 00/10:08:26

Plot file version 109 created 18-APR-2008 18:28:09

IRAS2336 EP061A.UVDATA.1

Freq = 1.5950 GHz, Bw = 16.000 MH No calibration applied and no bandpass applied

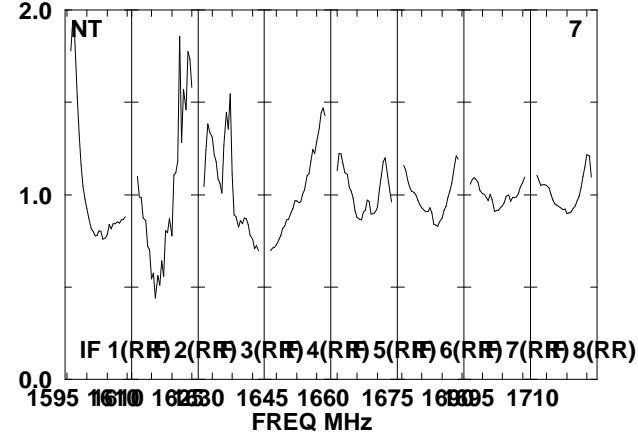
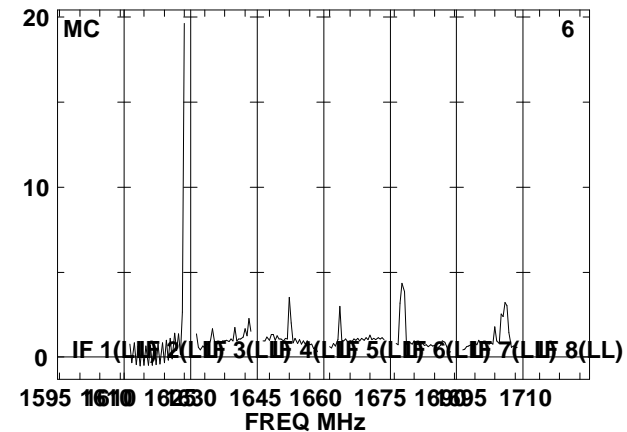
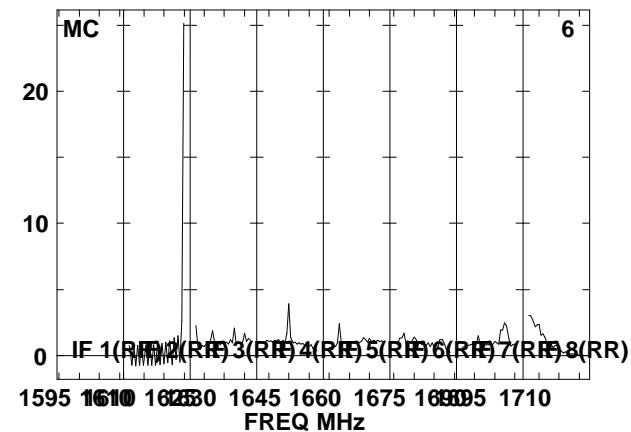
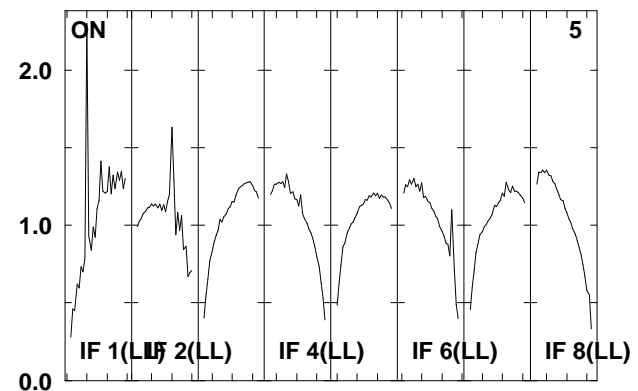
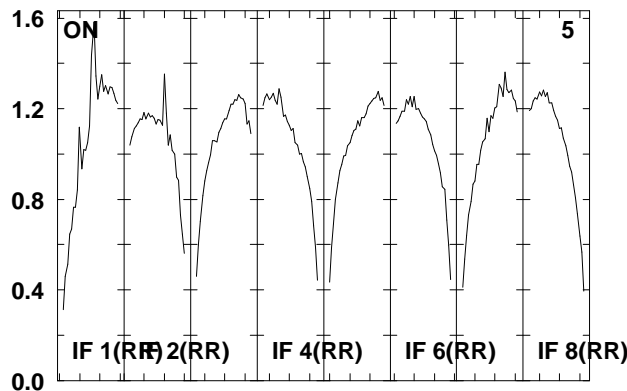
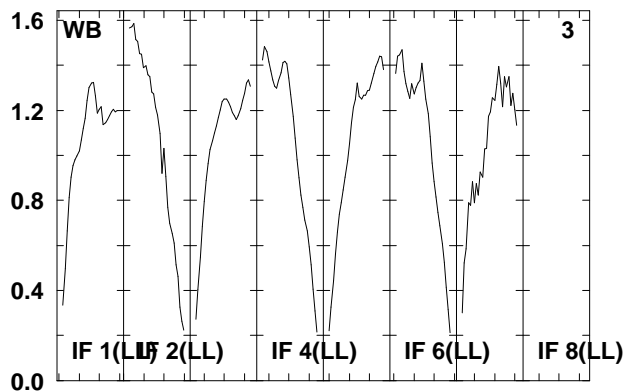
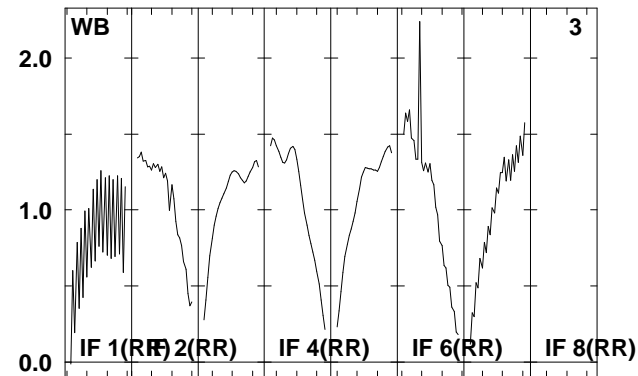
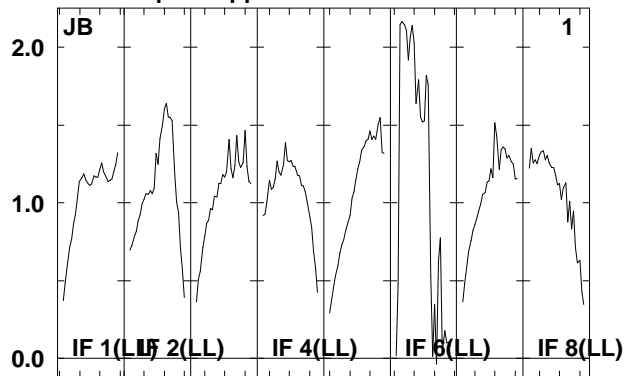
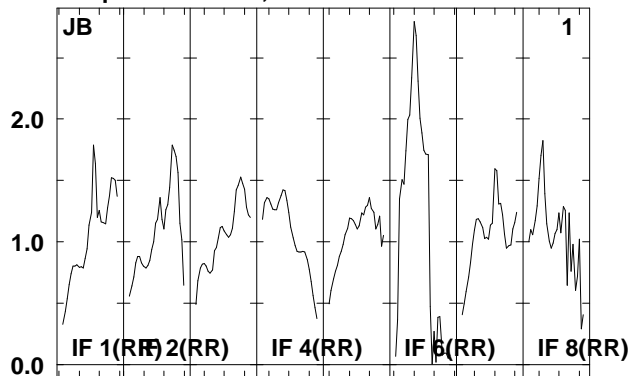

Lower frame: Real Jy
Total-power spectrum Antenna: *
Timerange: 00/10:08:32 to 00/10:12:00

Plot file version 110 created 18-APR-2008 18:28:10

IRAS2336 EP061A.UVDATA.1

Freq = 1.5950 GHz, Bw = 16.000 MH No calibration applied and no bandpass applied

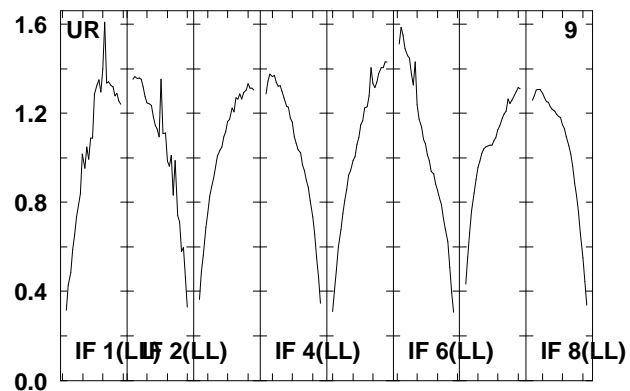
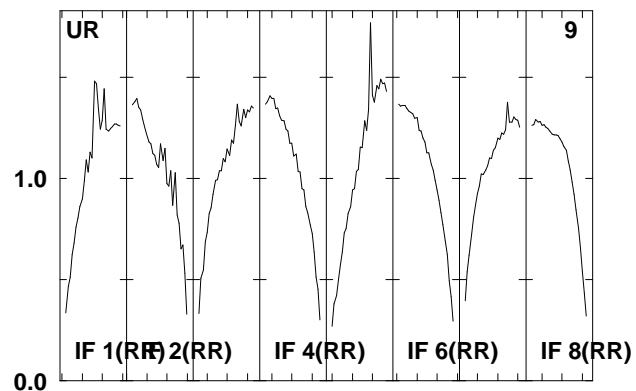
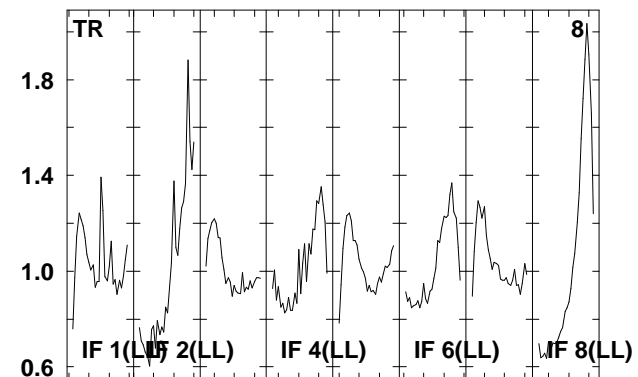
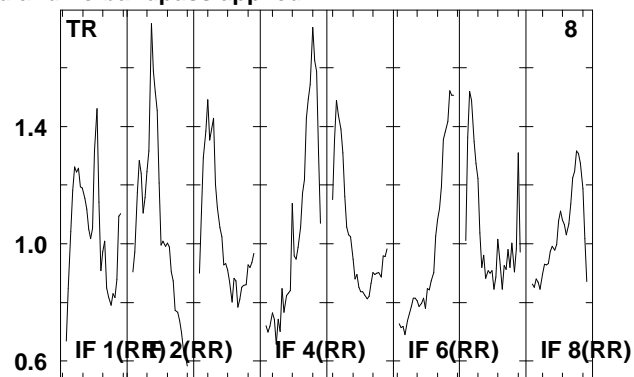
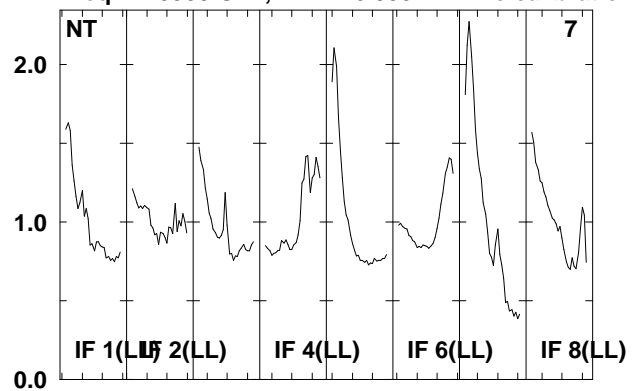

Lower frame: Real Jy
Total-power spectrum Antenna: *
Timerange: 00/10:08:32 to 00/10:12:00

Plot file version 111 created 18-APR-2008 18:28:11

J2333+39 EP061A.UVDATA.1

Freq = 1.5950 GHz, Bw = 16.000 MH No calibration applied and no bandpass applied

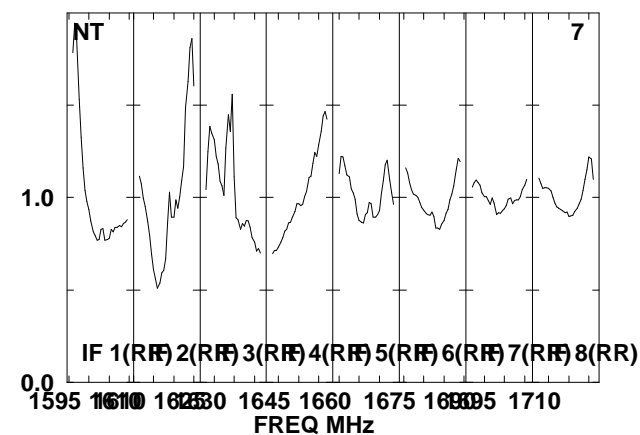
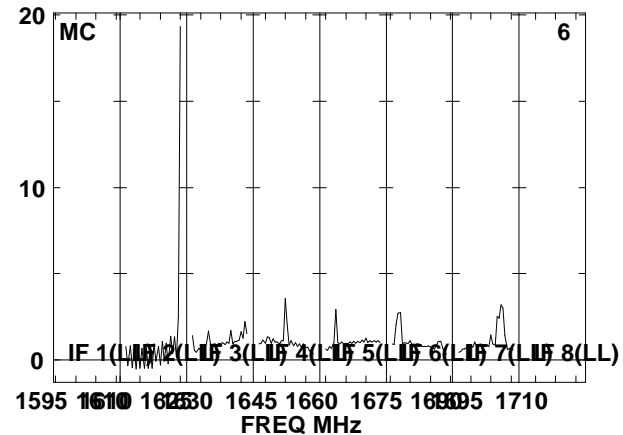
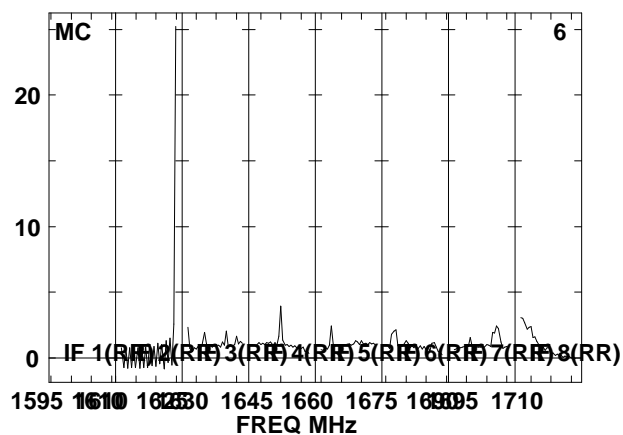
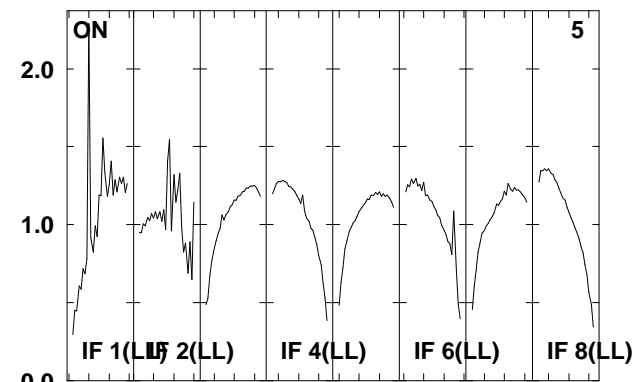
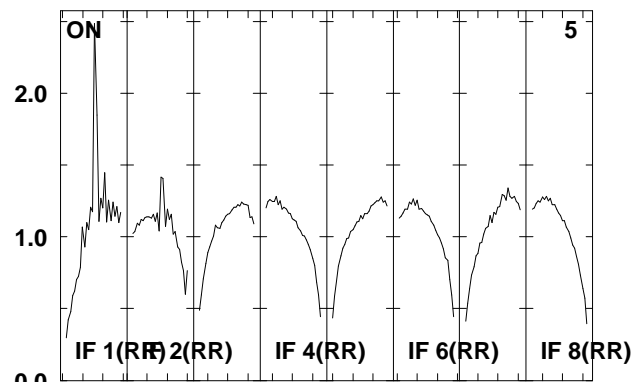
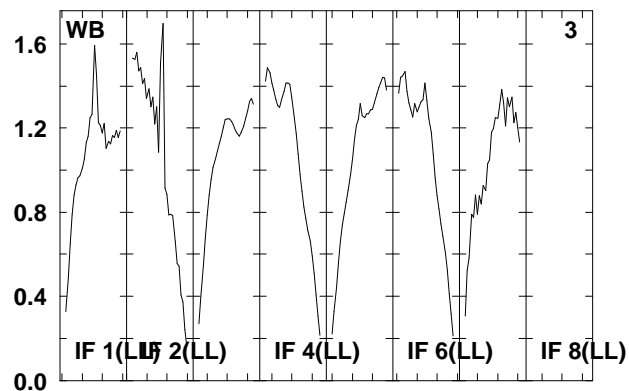
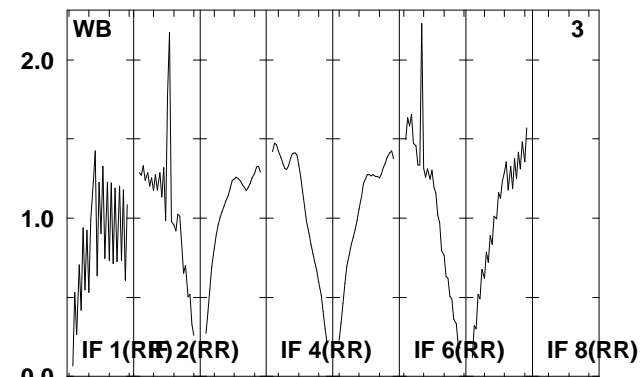
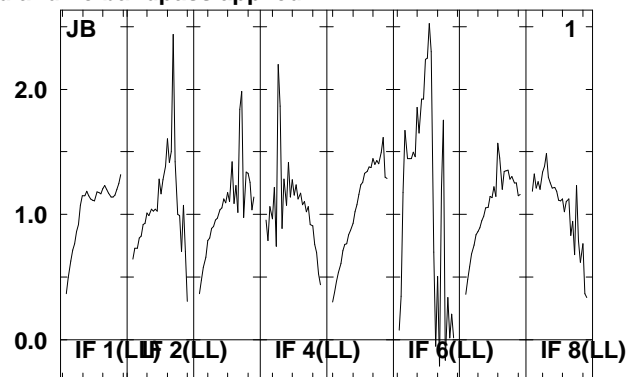
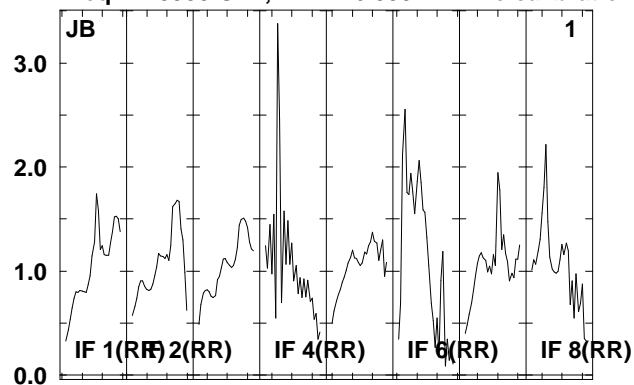

Lower frame: Real Jy
Total-power spectrum Antenna: *
Timerange: 00/10:12:02 to 00/10:13:30

Plot file version 112 created 18-APR-2008 18:28:11

J2333+39 EP061A.UVDATA.1

Freq = 1.5950 GHz, Bw = 16.000 MH No calibration applied and no bandpass applied

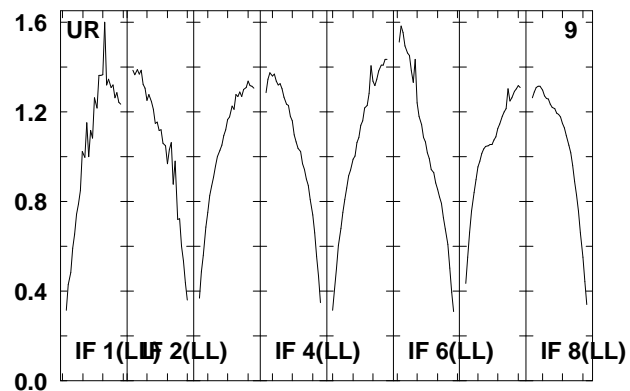
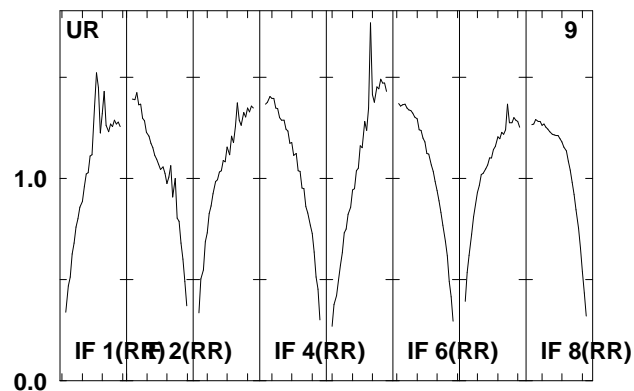
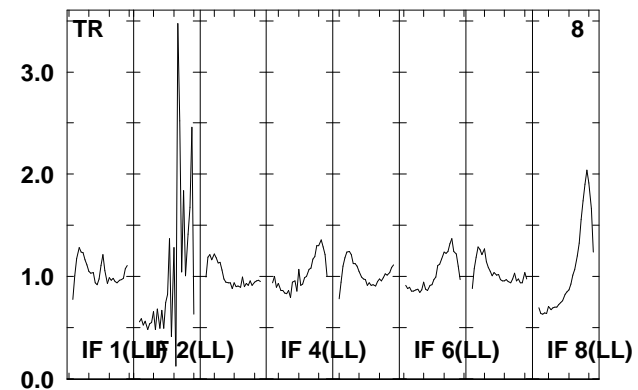
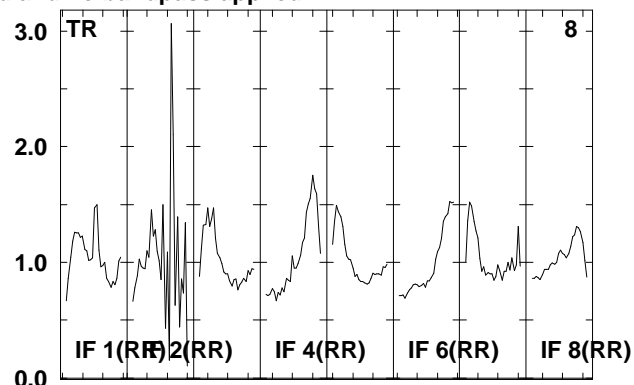
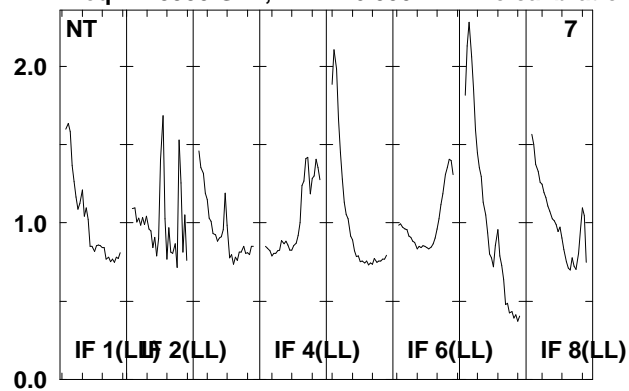

Lower frame: Real Jy
Total-power spectrum Antenna: *
Timerange: 00/10:12:02 to 00/10:13:30

Plot file version 113 created 18-APR-2008 18:28:11

IRAS2336 EP061A.UVDATA.1

Freq = 1.5950 GHz, Bw = 16.000 MH No calibration applied and no bandpass applied

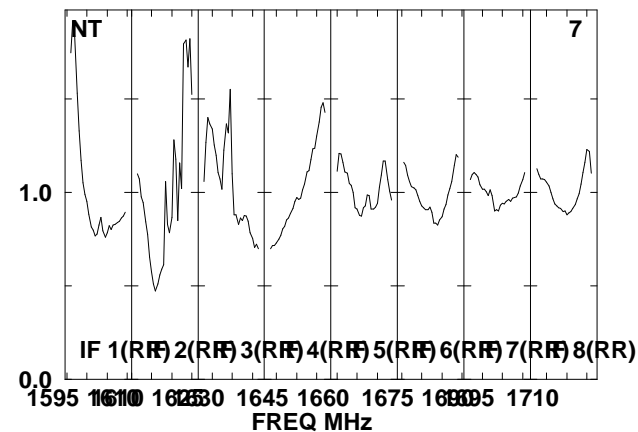
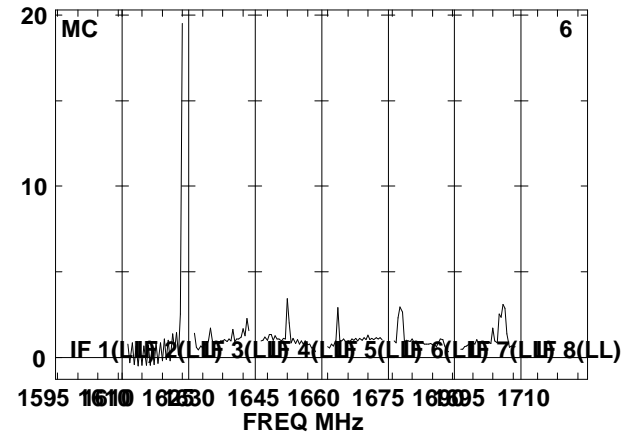
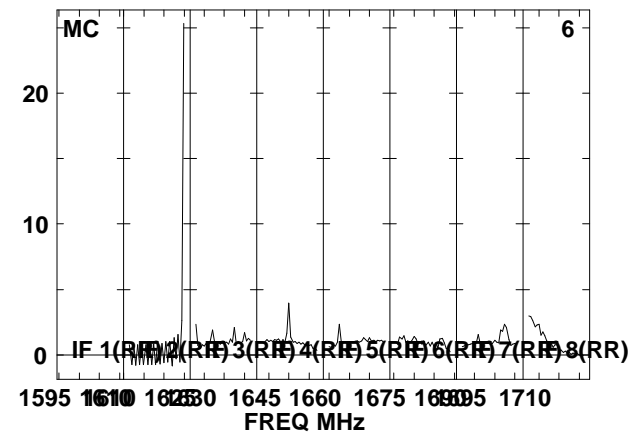
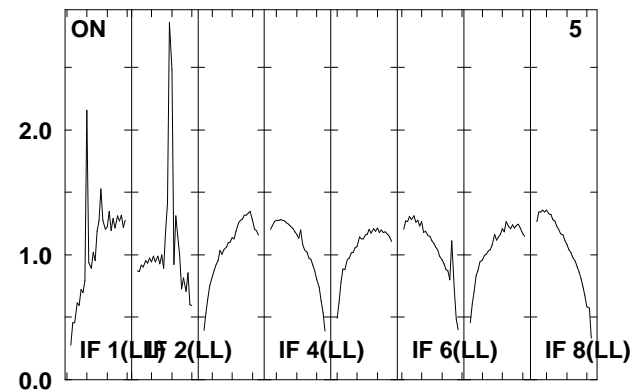
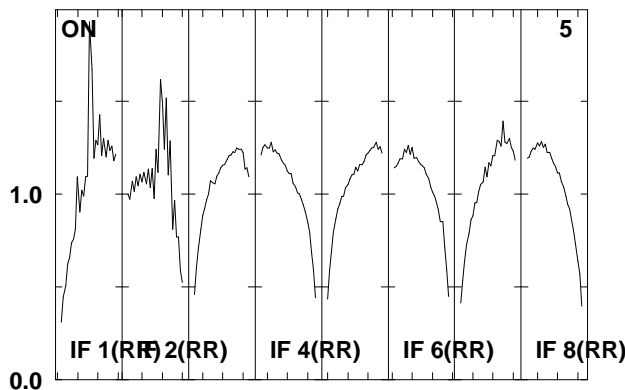
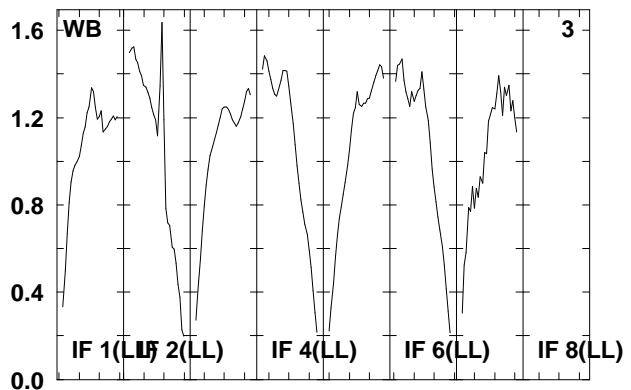
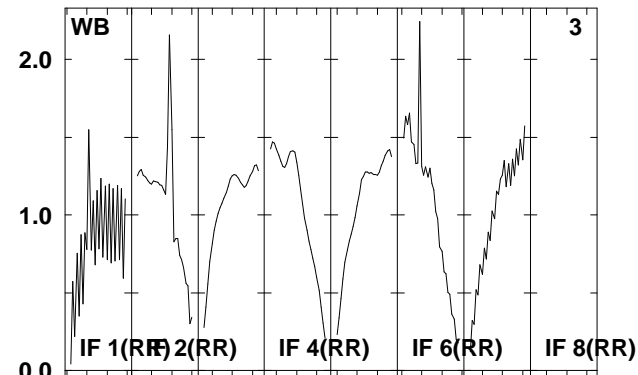
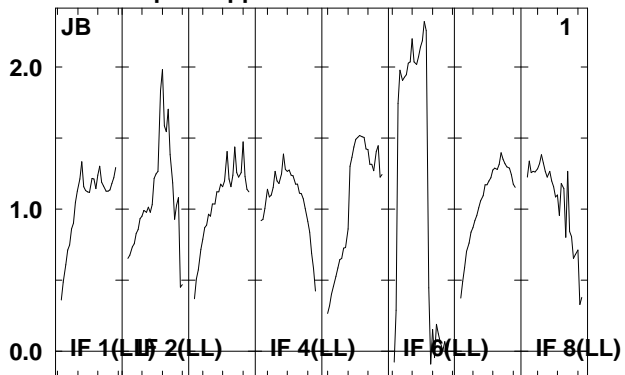
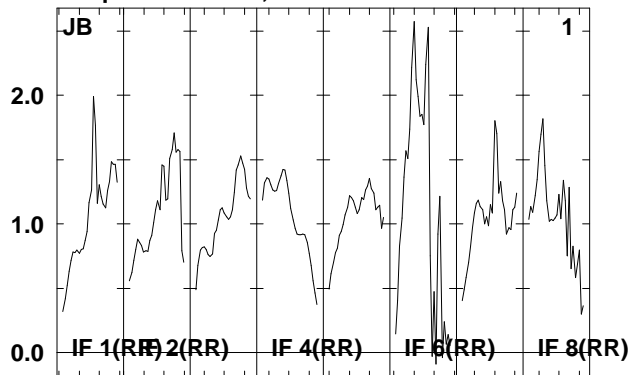

Lower frame: Real Jy
Total-power spectrum Antenna: *
Timerange: 00/10:13:32 to 00/10:16:56

Plot file version 114 created 18-APR-2008 18:28:12

IRAS2336 EP061A.UVDATA.1

Freq = 1.5950 GHz, Bw = 16.000 MH No calibration applied and no bandpass applied

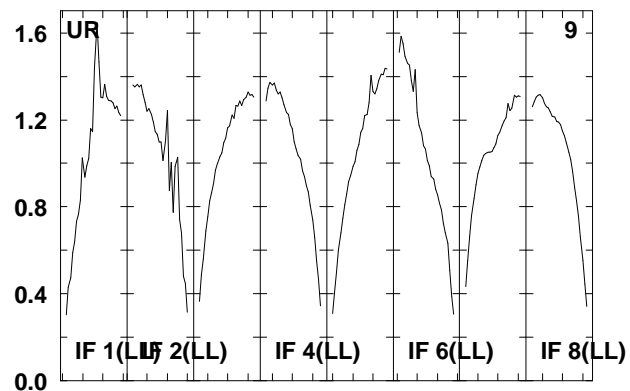
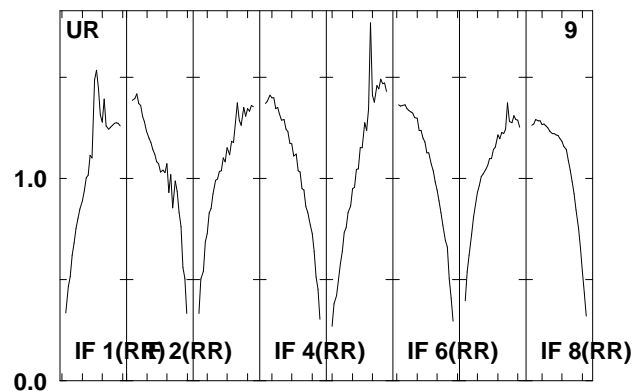
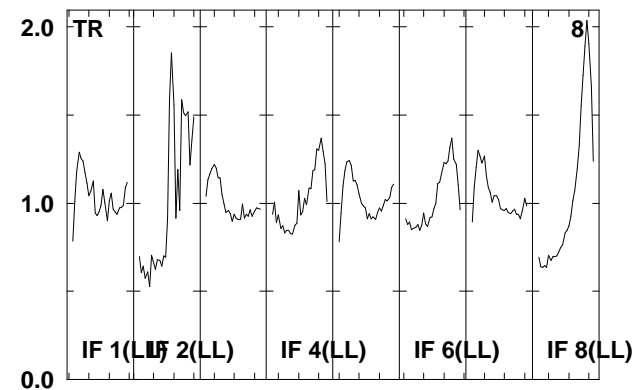
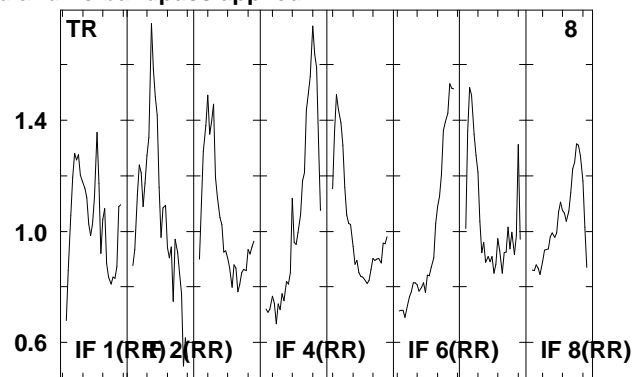
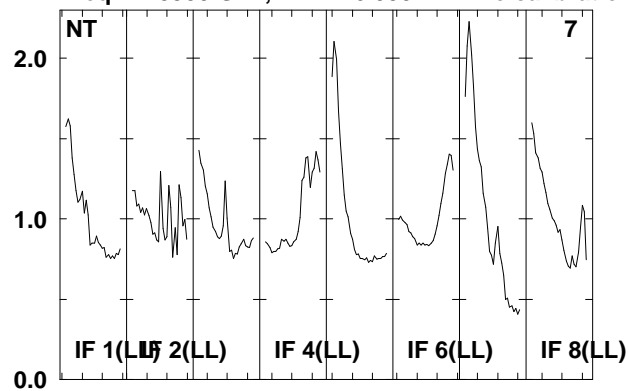

Lower frame: Real Jy
Total-power spectrum Antenna: *
Timerange: 00/10:13:32 to 00/10:16:56

Plot file version 115 created 18-APR-2008 18:28:14

J2333+39 EP061A.UVDATA.1

Freq = 1.5950 GHz, Bw = 16.000 MH No calibration applied and no bandpass applied

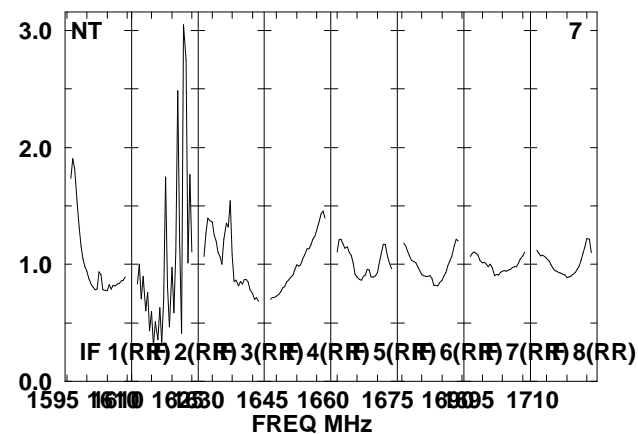
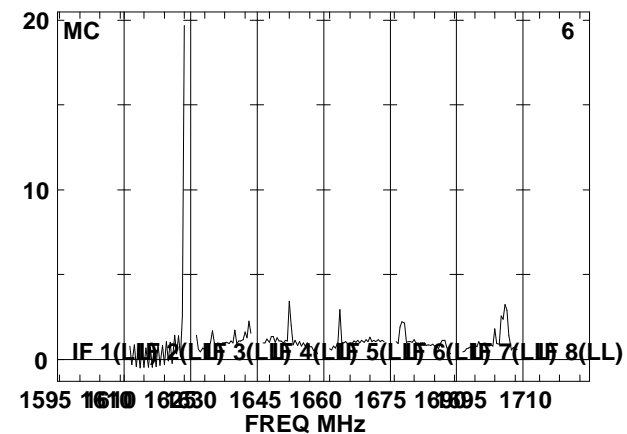
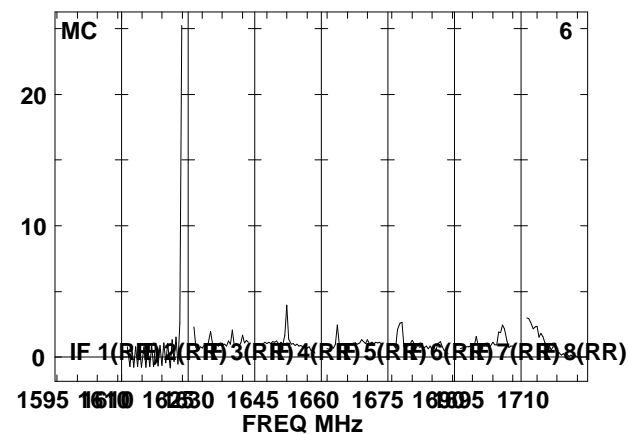
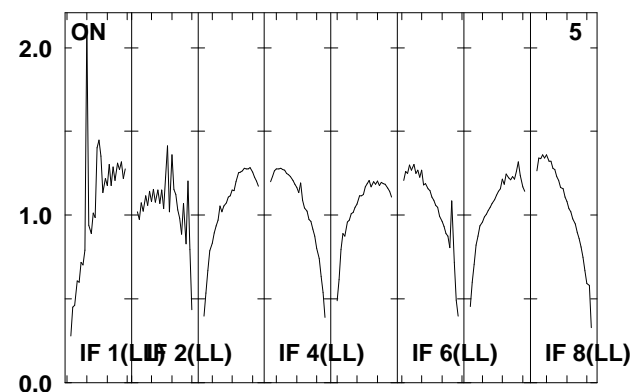
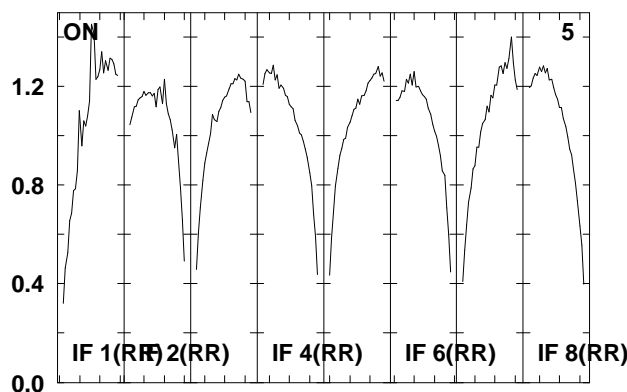
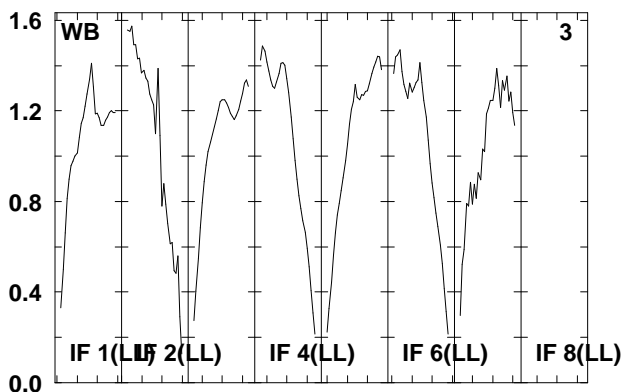
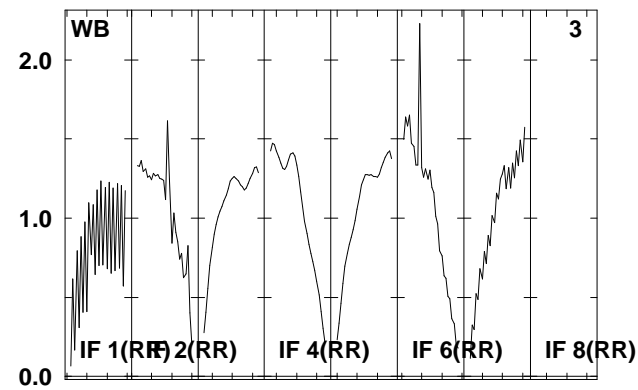
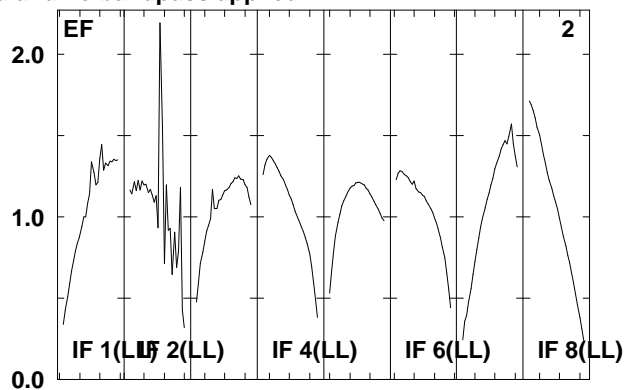
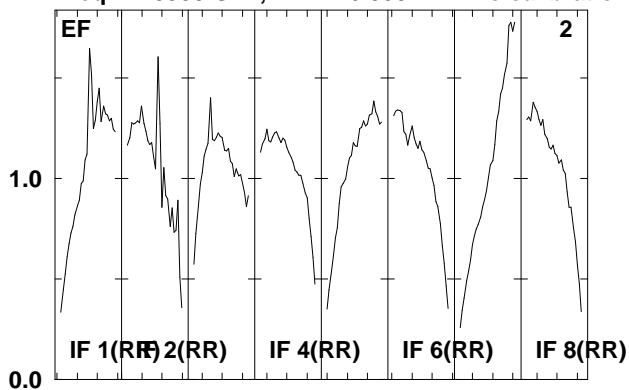

Lower frame: Real Jy
Total-power spectrum Antenna: *
Timerange: 00/10:18:02 to 00/10:19:26

Plot file version 116 created 18-APR-2008 18:28:14

J2333+39 EP061A.UVDATA.1

Freq = 1.5950 GHz, Bw = 16.000 MH No calibration applied and no bandpass applied

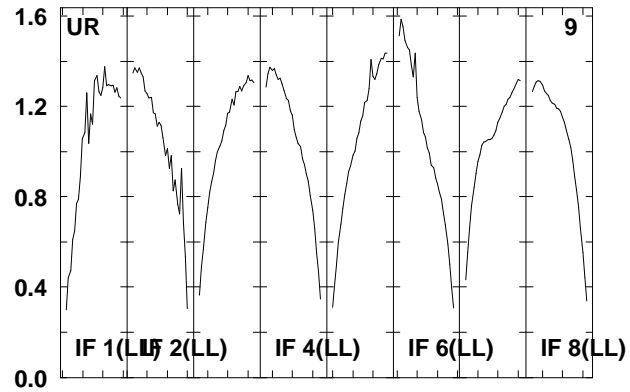
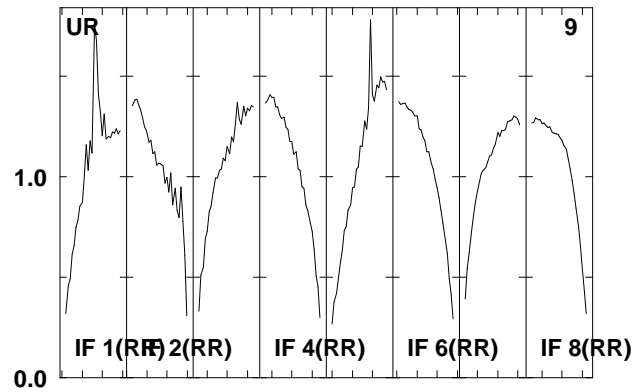
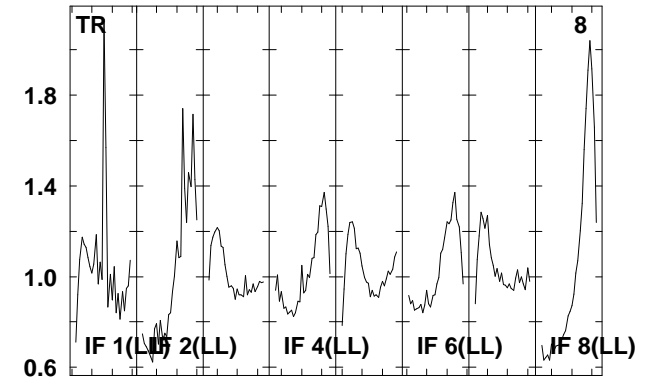
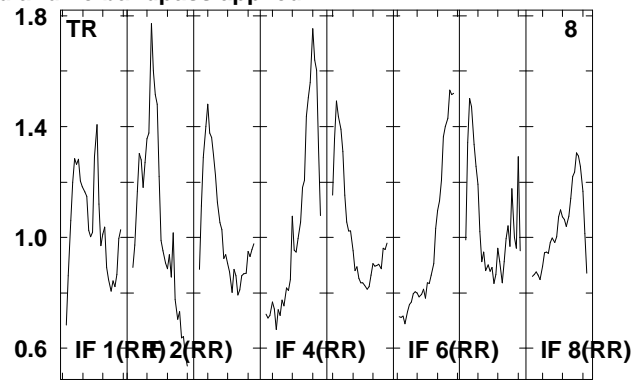
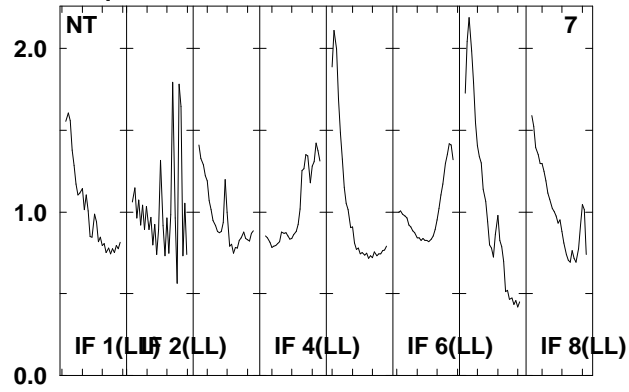

Lower frame: Real Jy
Total-power spectrum Antenna: *
Timerange: 00/10:18:02 to 00/10:19:26

Plot file version 117 created 18-APR-2008 18:28:15

IRAS2336 EP061A.UVDATA.1

Freq = 1.5950 GHz, Bw = 16.000 MH No calibration applied and no bandpass applied

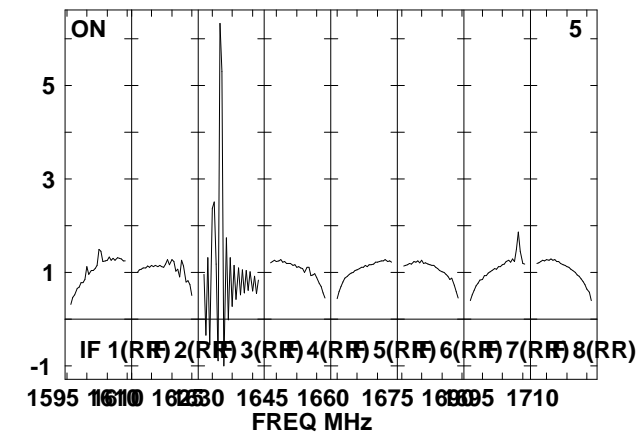
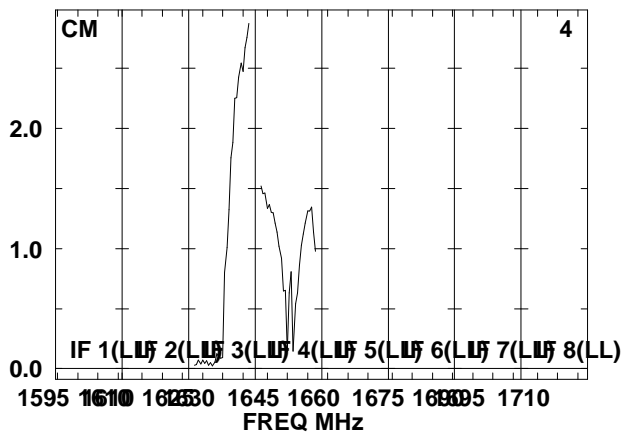
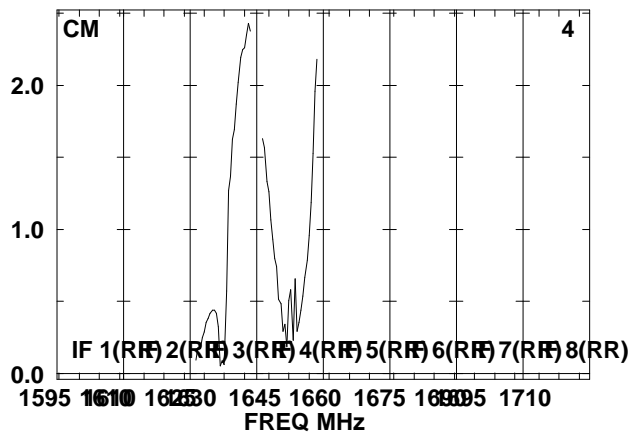
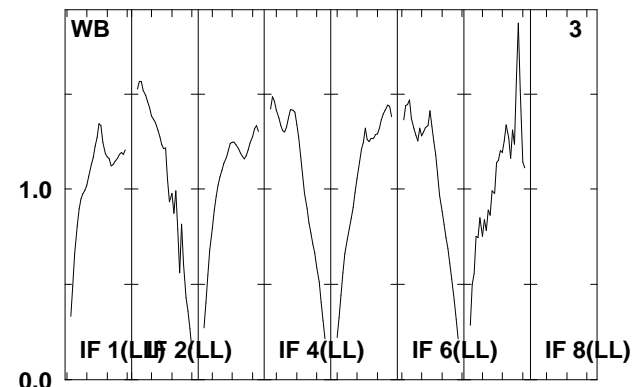
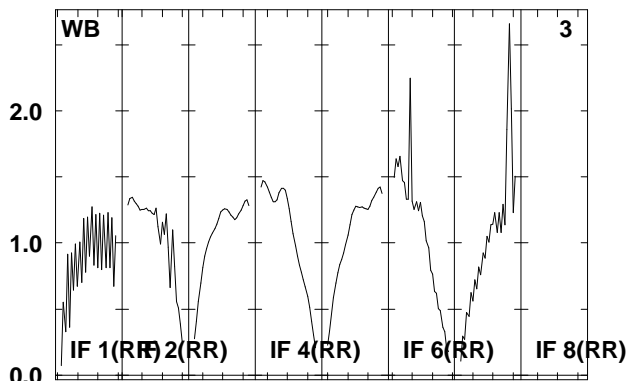
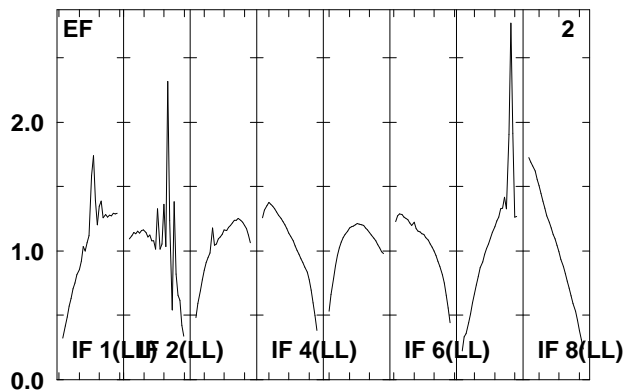
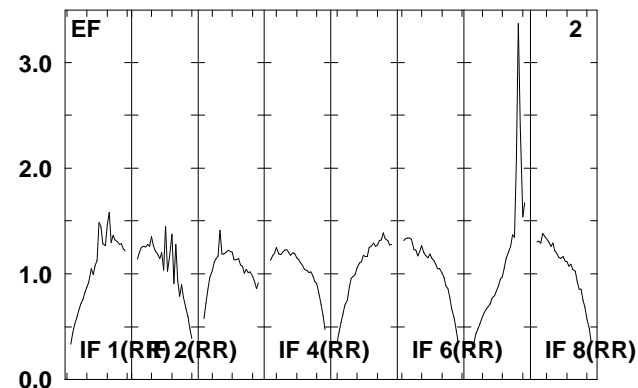
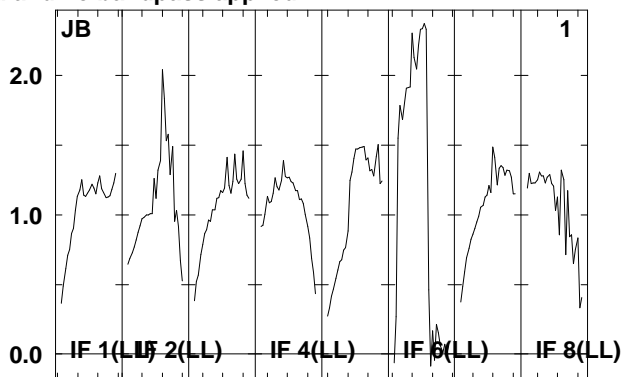
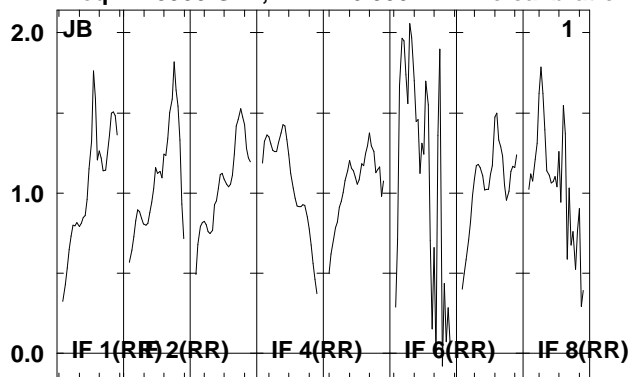

Lower frame: Real Jy
Total-power spectrum Antenna: *
Timerange: 00/10:19:32 to 00/10:23:00

Plot file version 118 created 18-APR-2008 18:28:15

IRAS2336 EP061A.UVDATA.1

Freq = 1.5950 GHz, Bw = 16.000 MH No calibration applied and no bandpass applied

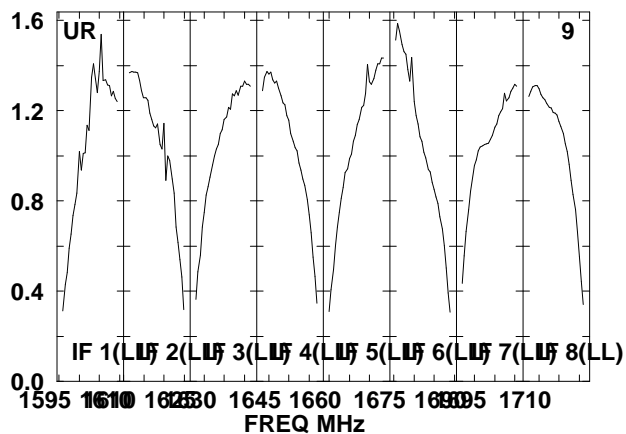
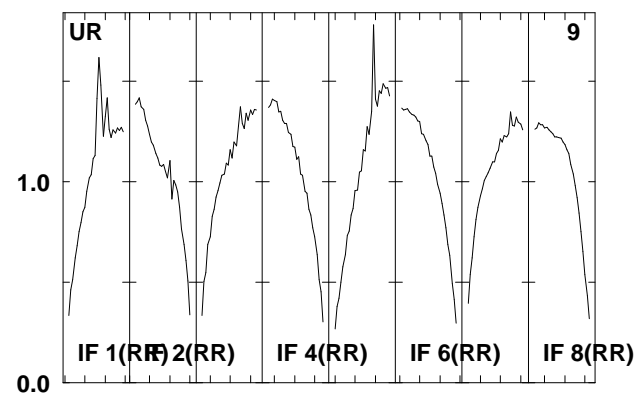
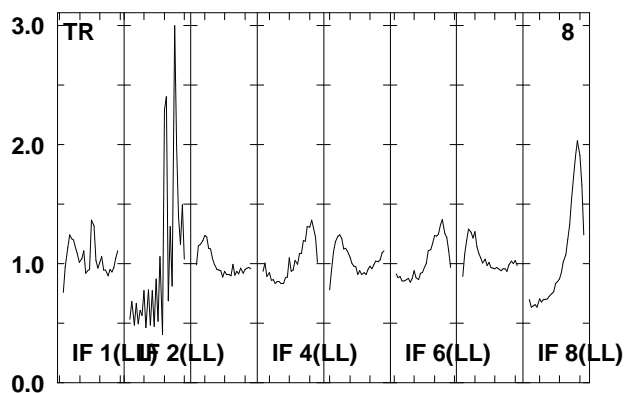
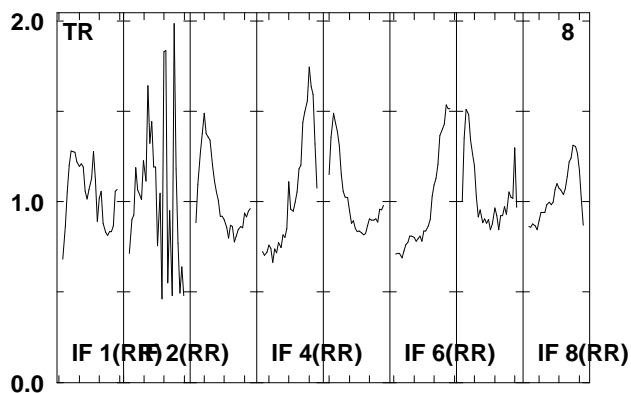
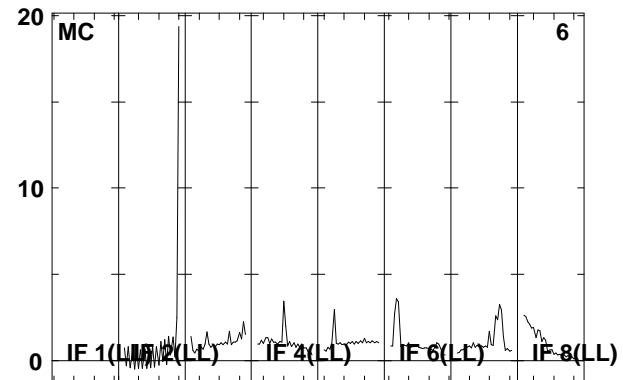
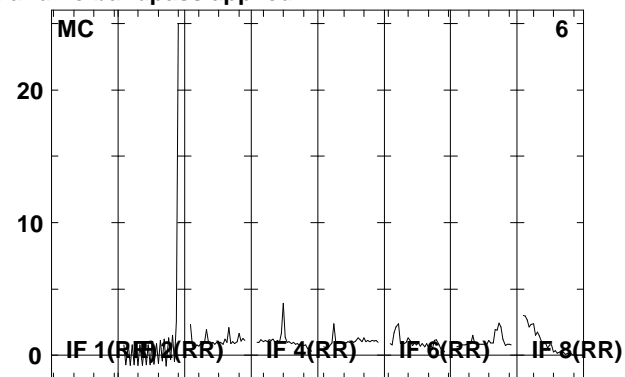
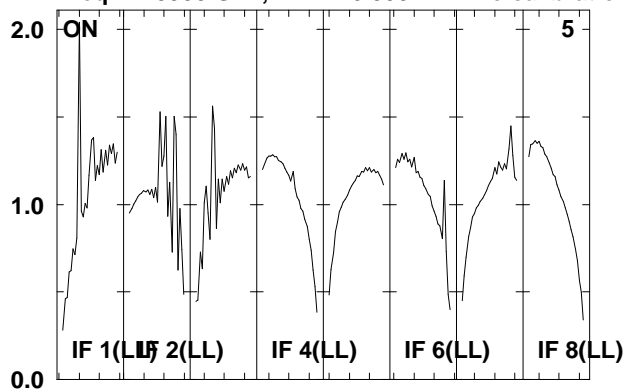

Lower frame: Real Jy

Total-power spectrum Antenna: *

Timerange: 00/10:19:32 to 00/10:23:00

Plot file version 119 created 18-APR-2008 18:28:16

J2333+39 EP061A.UVDATA.1

Freq = 1.5950 GHz, Bw = 16.000 MH No calibration applied and no bandpass applied

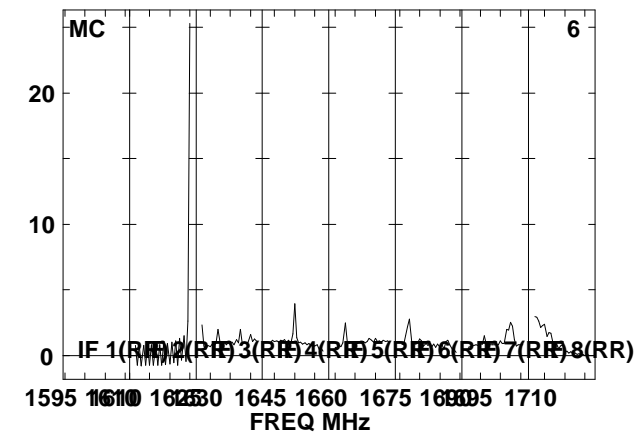
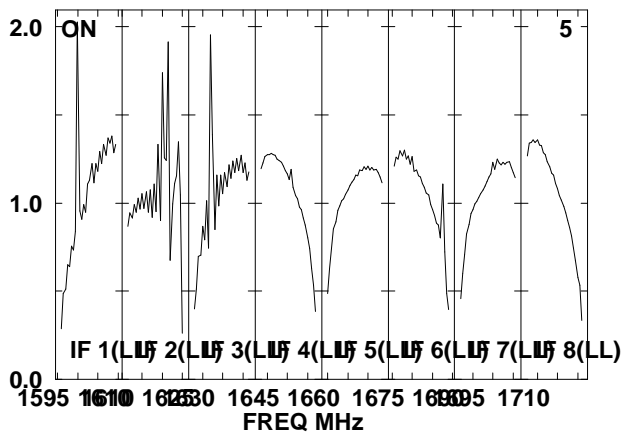
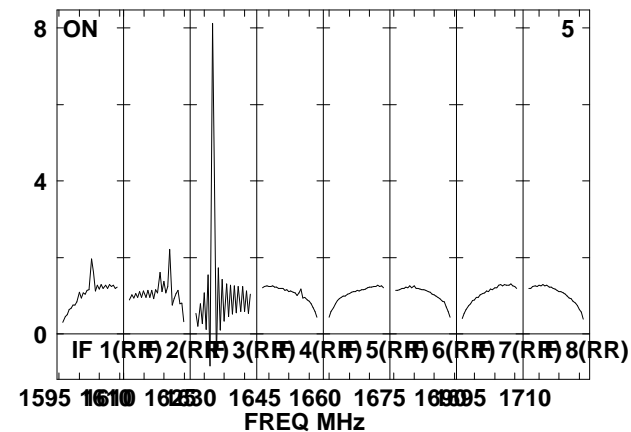
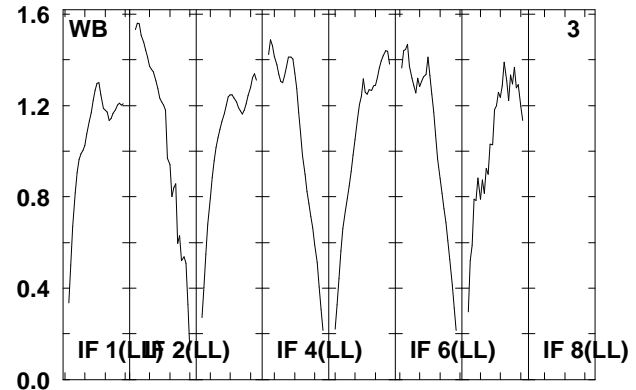
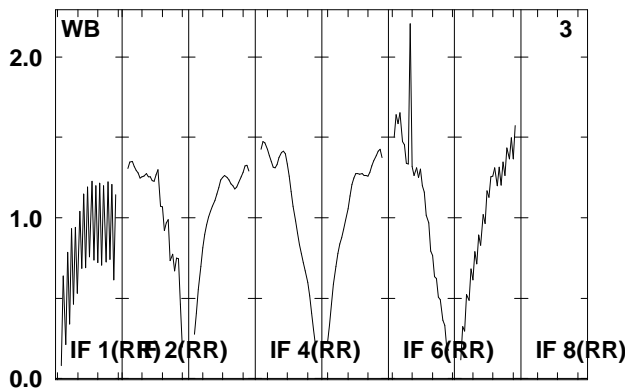
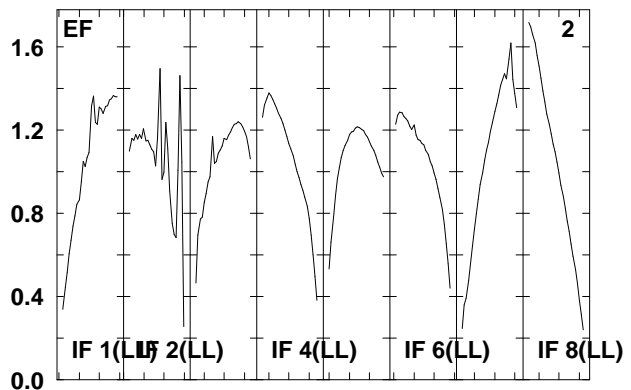
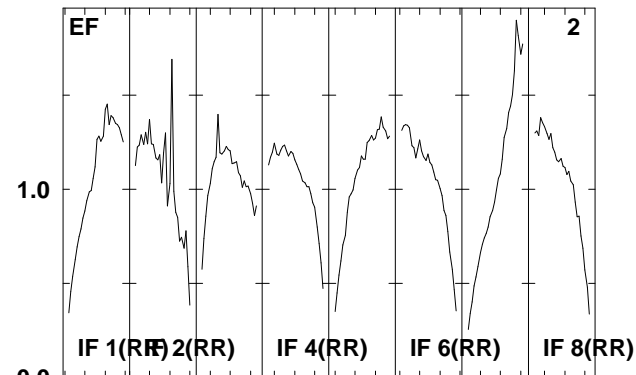
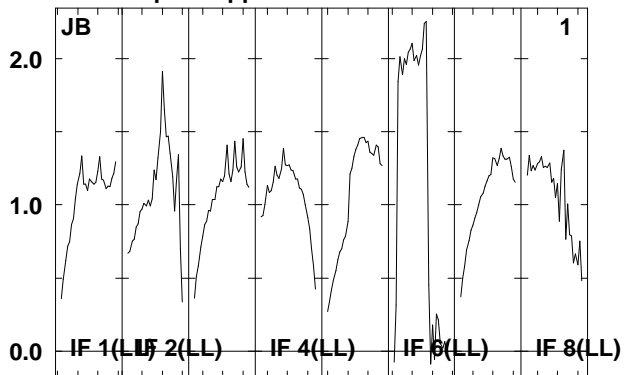
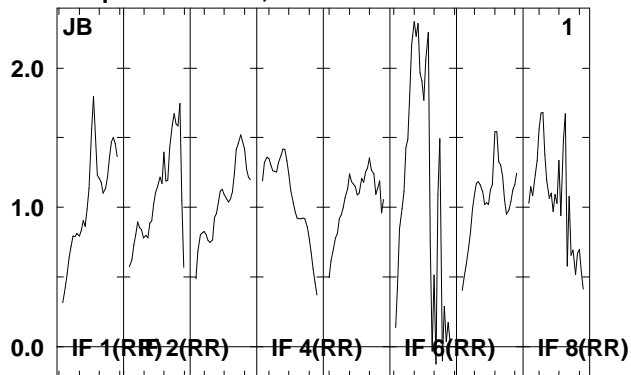

Lower frame: Real Jy
Total-power spectrum Antenna: *
Timerange: 00/10:23:02 to 00/10:24:30

Plot file version 120 created 18-APR-2008 18:28:17

J2333+39 EP061A.UVDATA.1

Freq = 1.5950 GHz, Bw = 16.000 MH No calibration applied and no bandpass applied

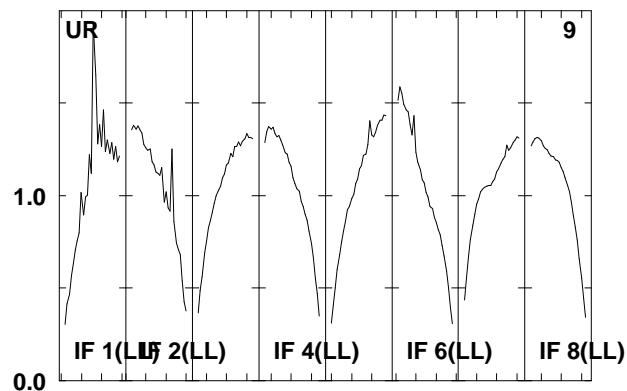
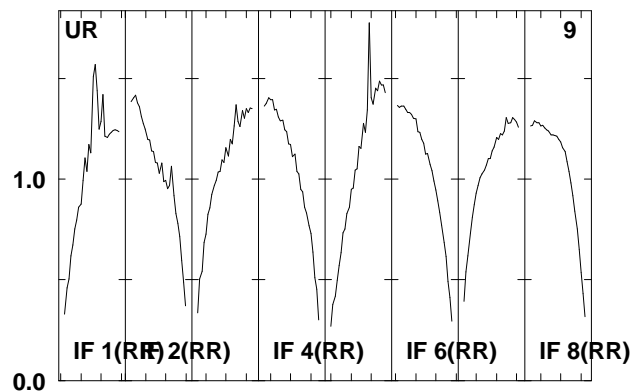
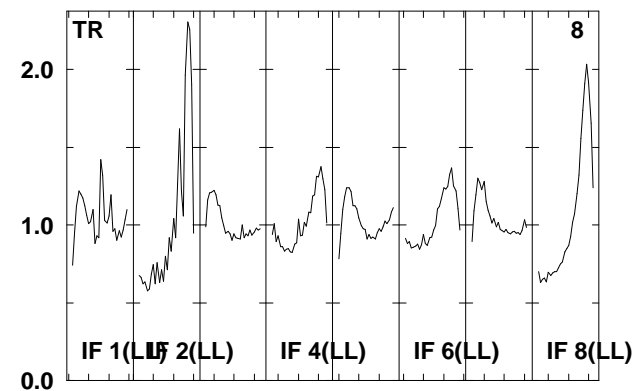
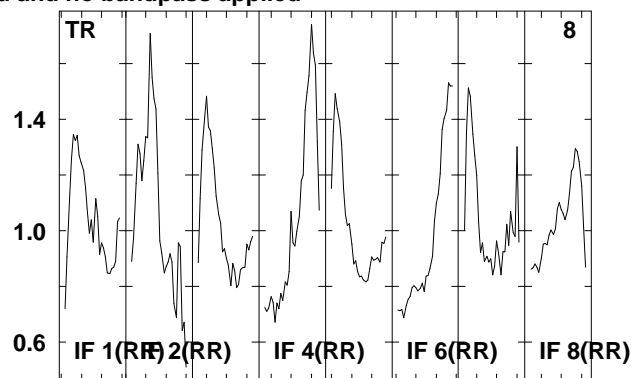
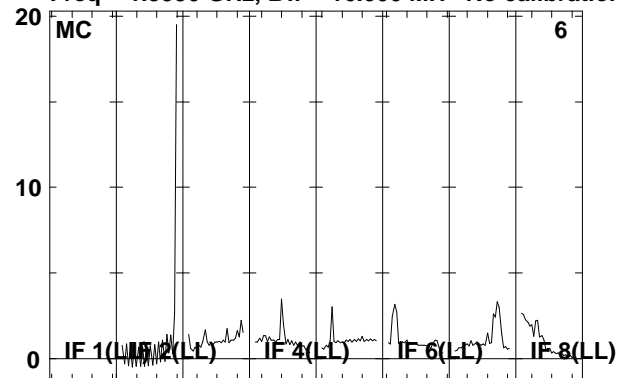

Lower frame: Real Jy
Total-power spectrum Antenna: *
Timerange: 00/10:23:02 to 00/10:24:30

Plot file version 121 created 18-APR-2008 18:28:17

IRAS2336 EP061A.UVDATA.1

Freq = 1.5950 GHz, Bw = 16.000 MH No calibration applied and no bandpass applied

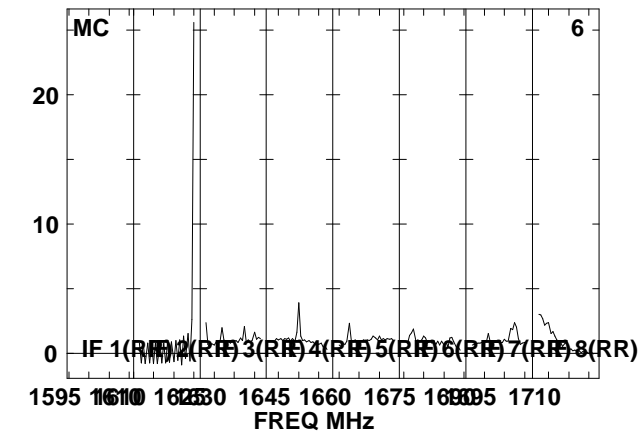
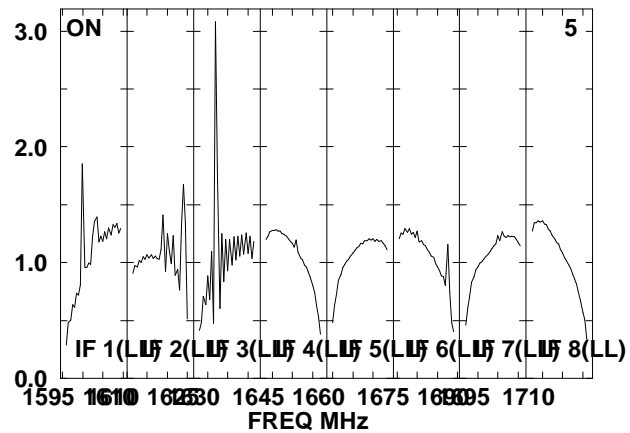
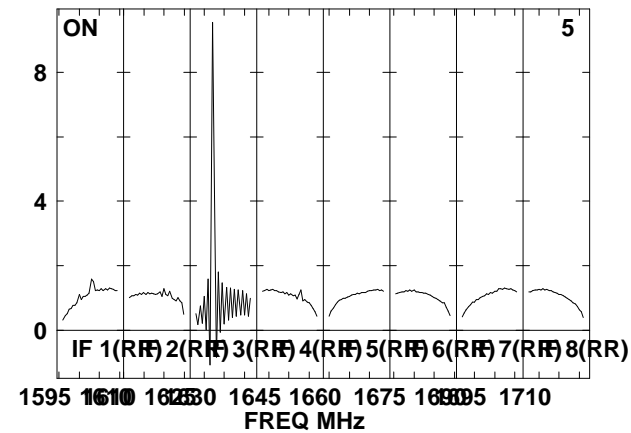
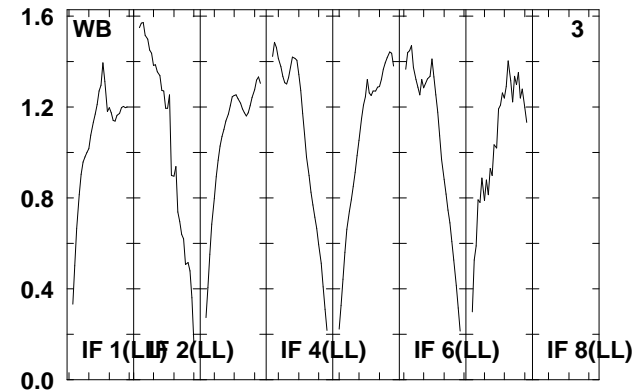
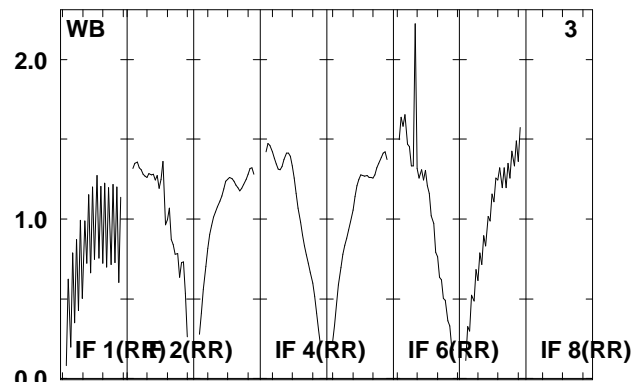
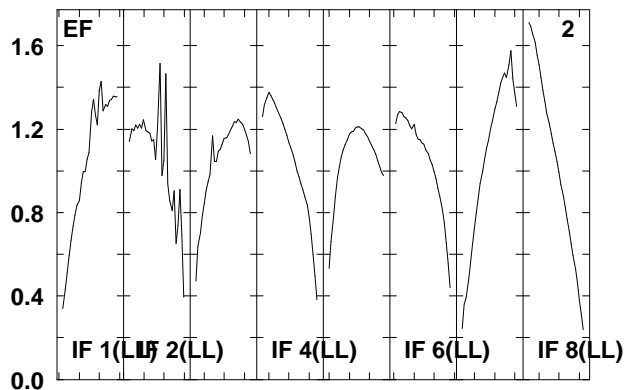
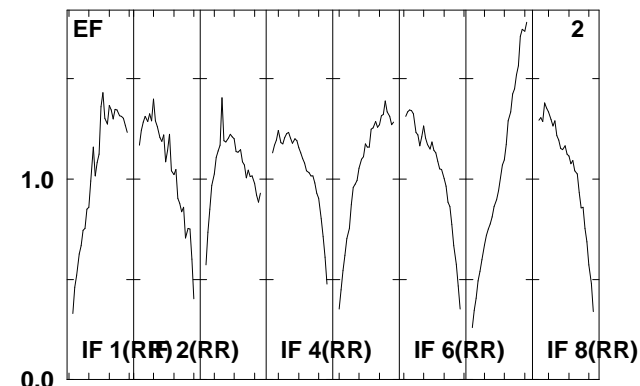
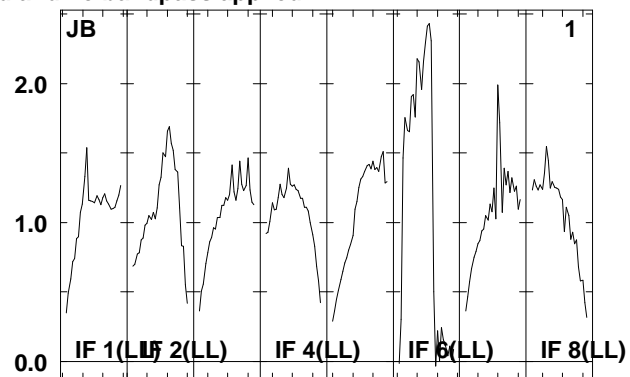
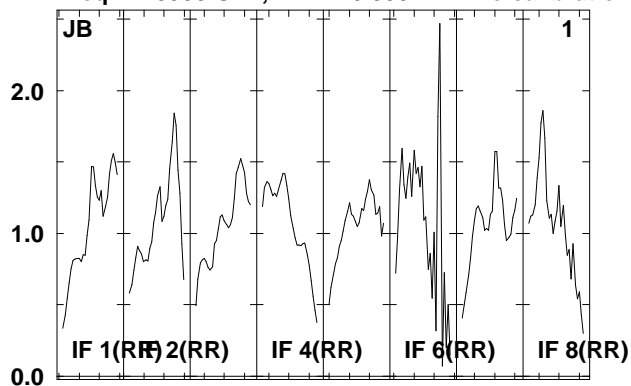

Lower frame: Real Jy
Total-power spectrum Antenna: *
Timerange: 00/10:24:32 to 00/10:28:00

Plot file version 122 created 18-APR-2008 18:28:18

IRAS2336 EP061A.UVDATA.1

Freq = 1.5950 GHz, Bw = 16.000 MH No calibration applied and no bandpass applied

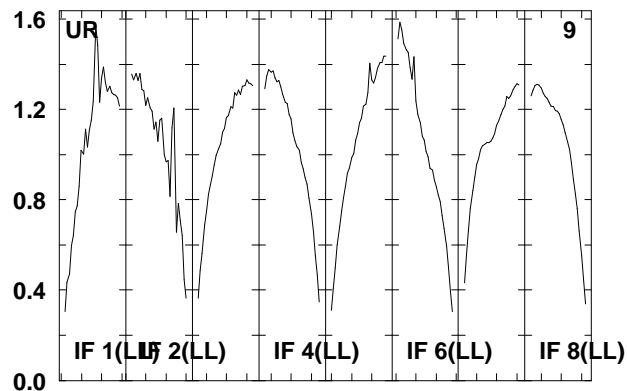
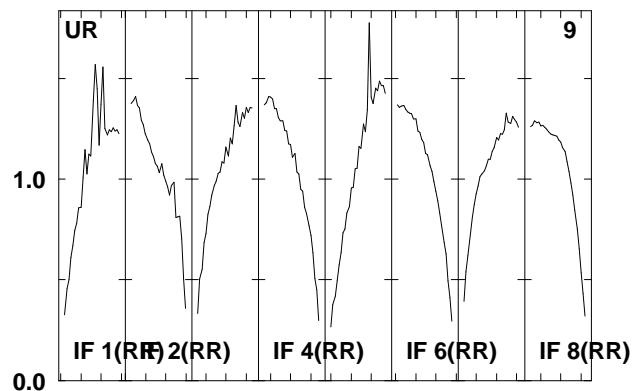
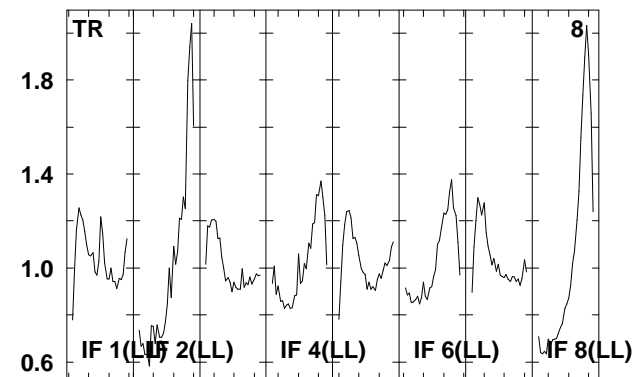
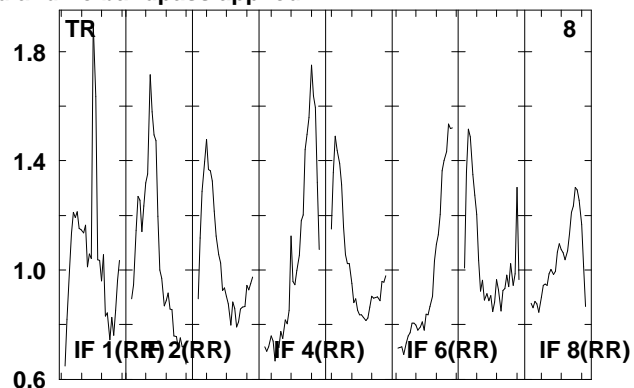
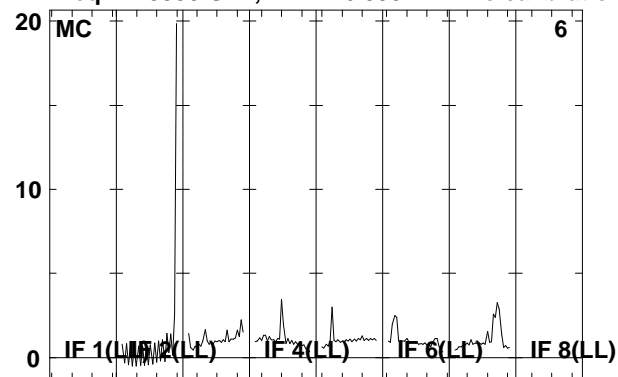

Lower frame: Real Jy
Total-power spectrum Antenna: *
Timerange: 00/10:24:32 to 00/10:28:00

Plot file version 123 created 18-APR-2008 18:28:19

J2333+39 EP061A.UVDATA.1

Freq = 1.5950 GHz, Bw = 16.000 MH No calibration applied and no bandpass applied

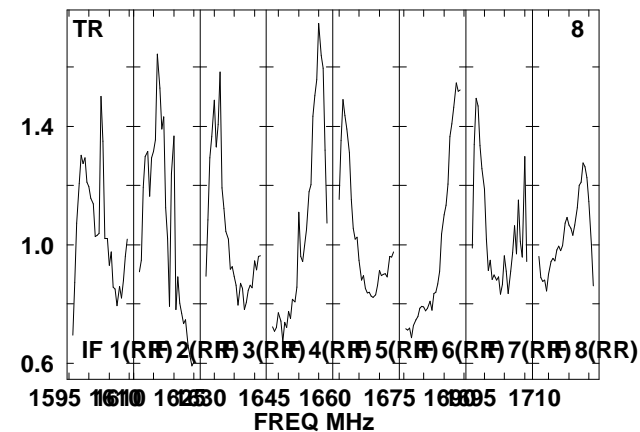
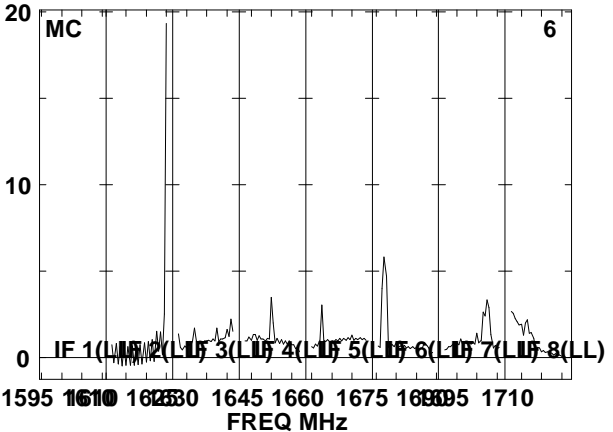
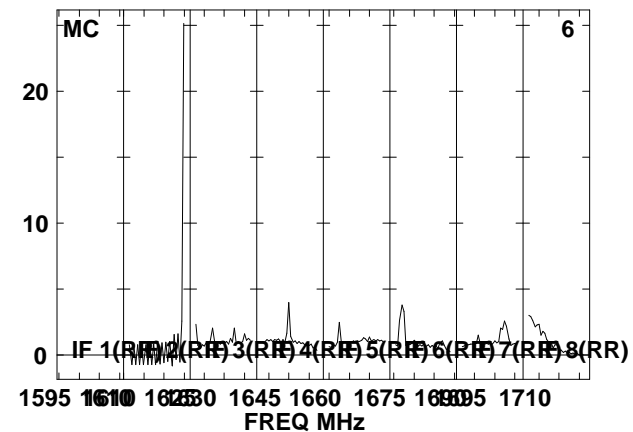
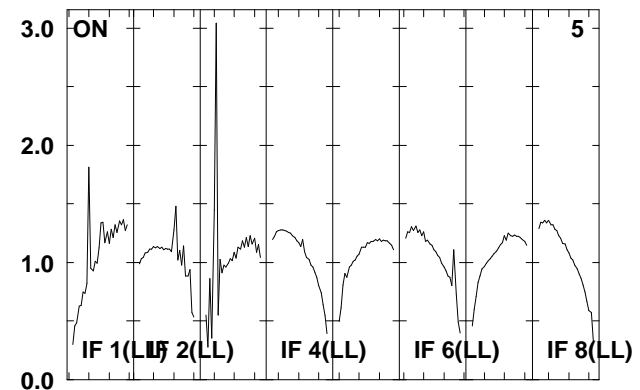
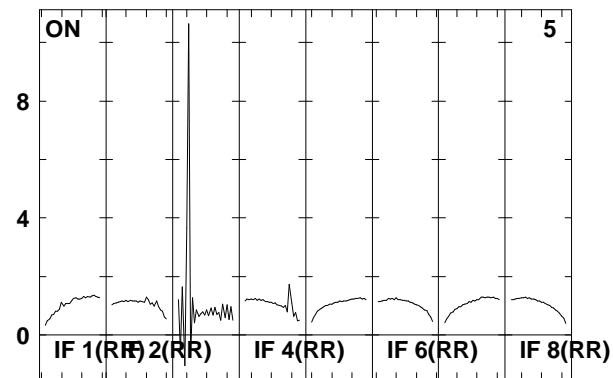
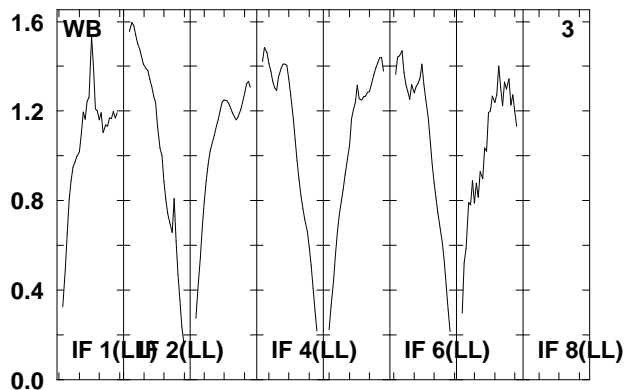
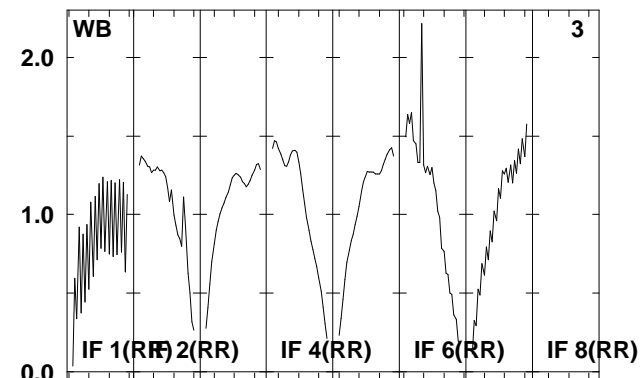
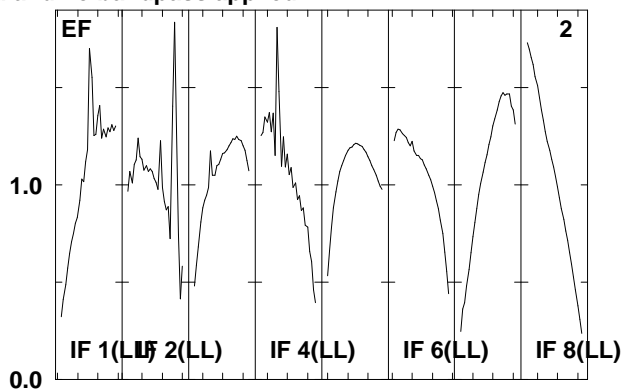
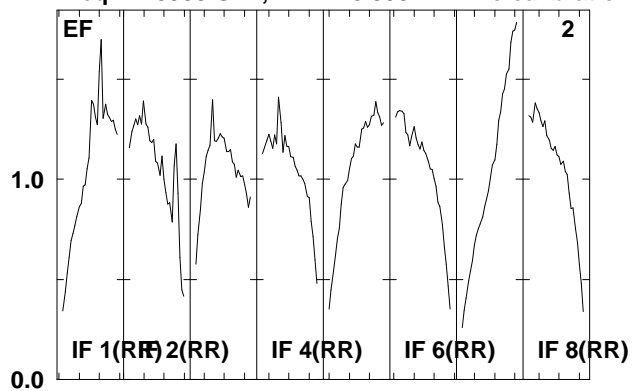

Lower frame: Real Jy
Total-power spectrum Antenna: *
Timerange: 00/10:28:10 to 00/10:29:26

Plot file version 124 created 18-APR-2008 18:28:19

J2333+39 EP061A.UVDATA.1

Freq = 1.5950 GHz, Bw = 16.000 MH No calibration applied and no bandpass applied

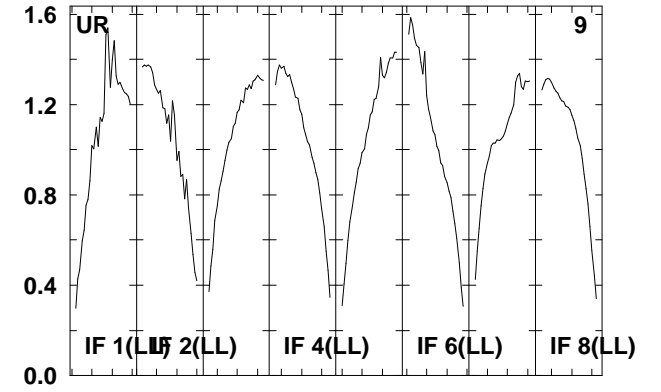
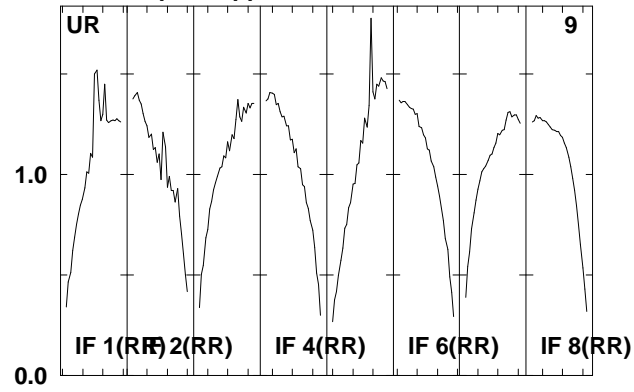
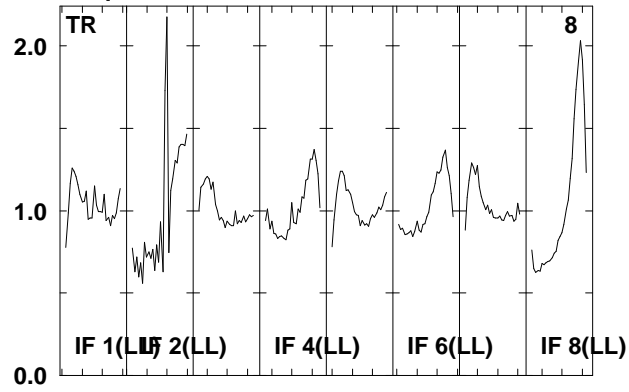

Lower frame: Real Jy
Total-power spectrum Antenna: *
Timerange: 00/10:28:10 to 00/10:29:26

Plot file version 125 created 18-APR-2008 18:28:20

IRAS2336 EP061A.UVDATA.1

Freq = 1.5950 GHz, Bw = 16.000 MH No calibration applied and no bandpass applied

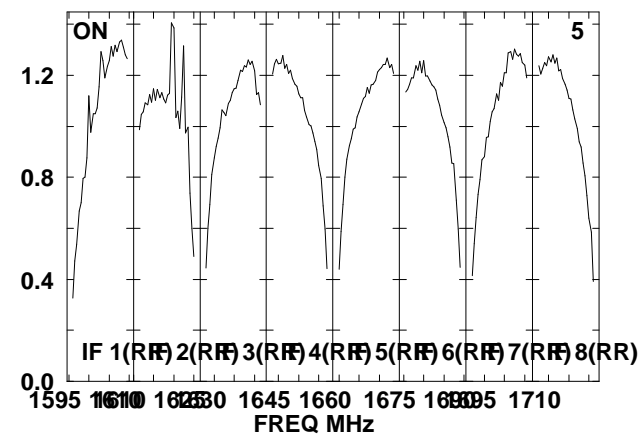
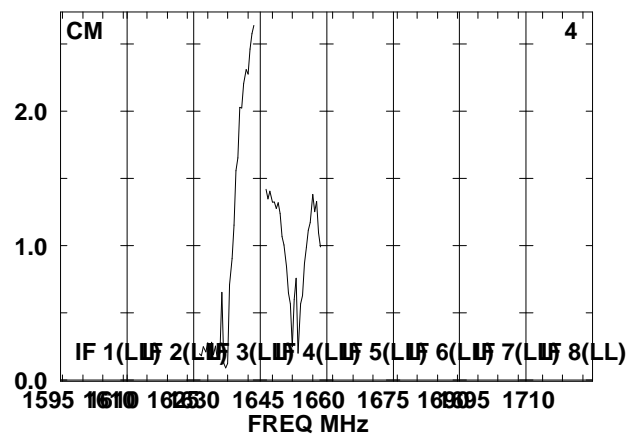
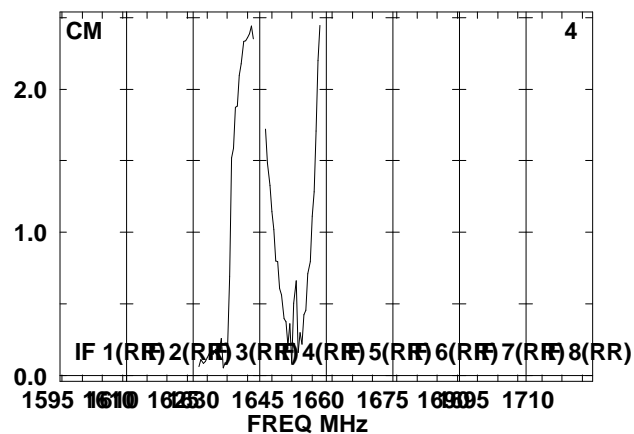
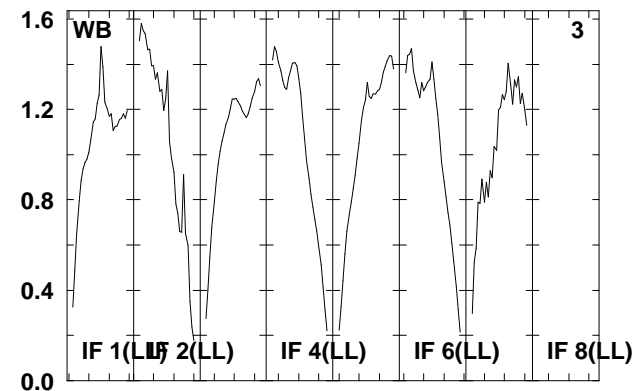
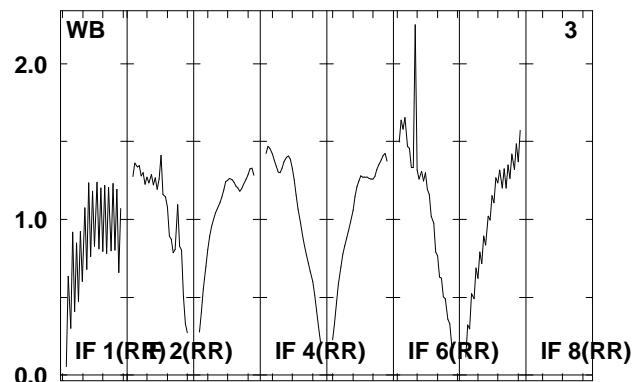
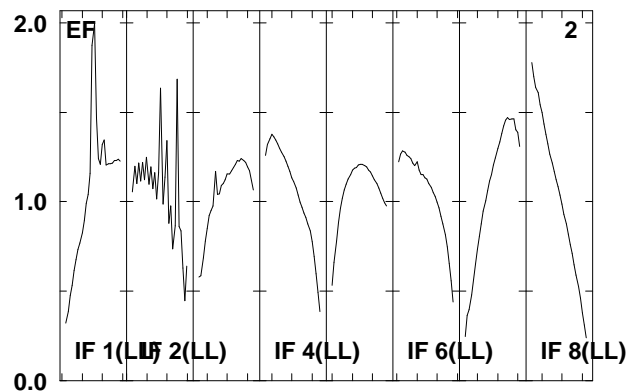
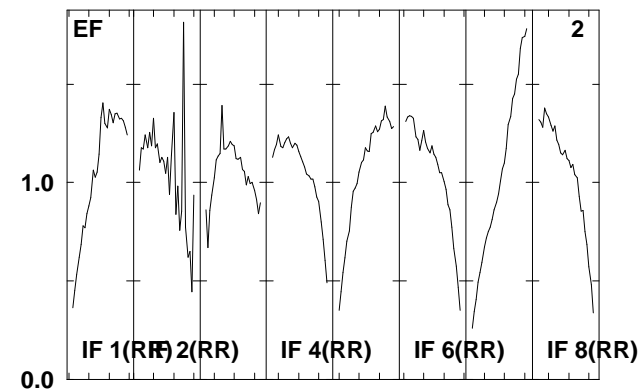
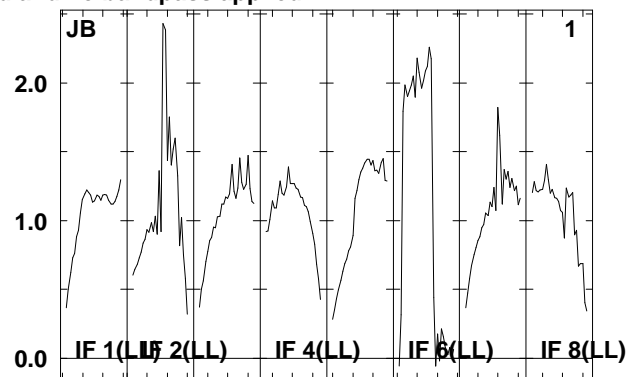
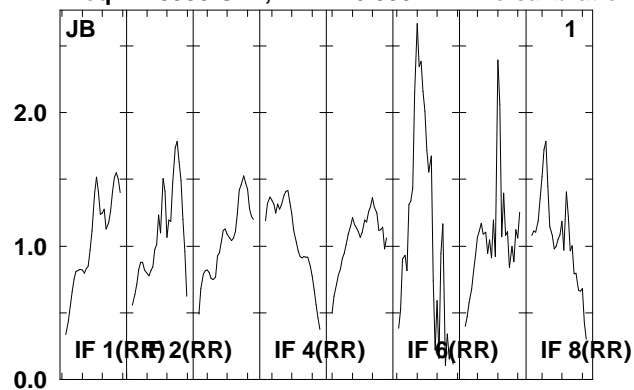

Lower frame: Real Jy
Total-power spectrum Antenna: *
Timerange: 00/10:29:32 to 00/10:32:56

Plot file version 126 created 18-APR-2008 18:28:20

IRAS2336 EP061A.UVDATA.1

Freq = 1.5950 GHz, Bw = 16.000 MH No calibration applied and no bandpass applied

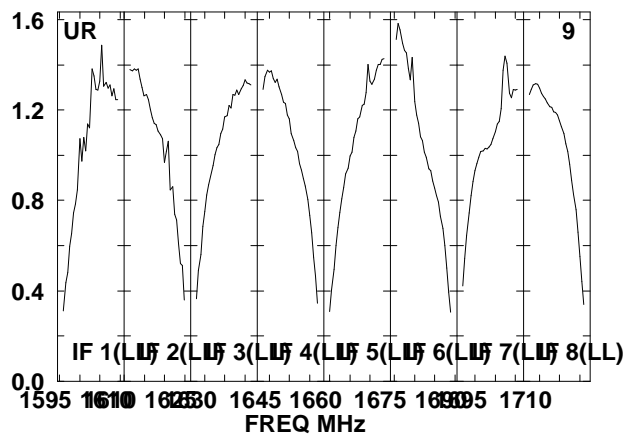
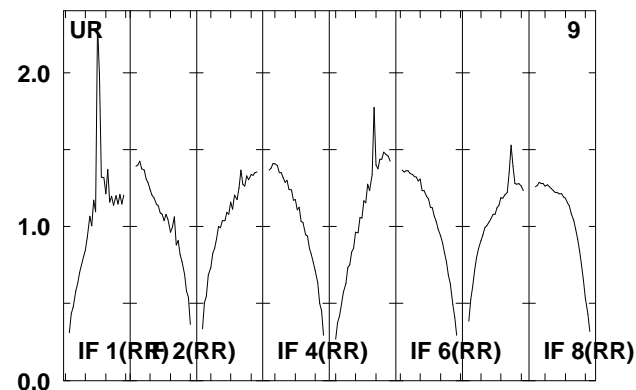
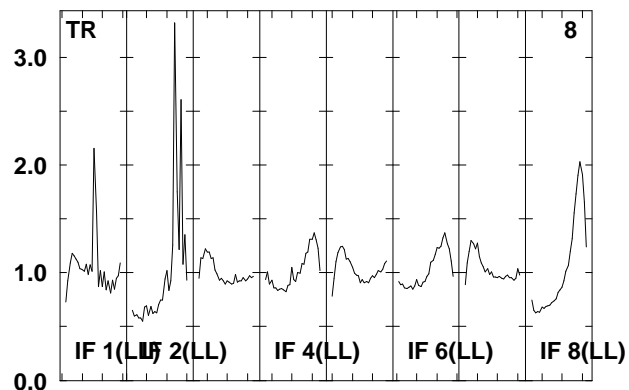
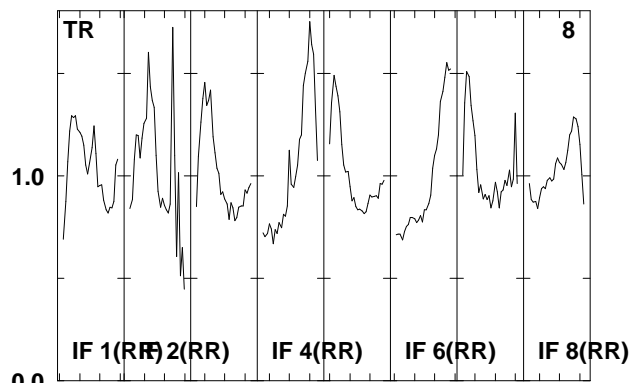
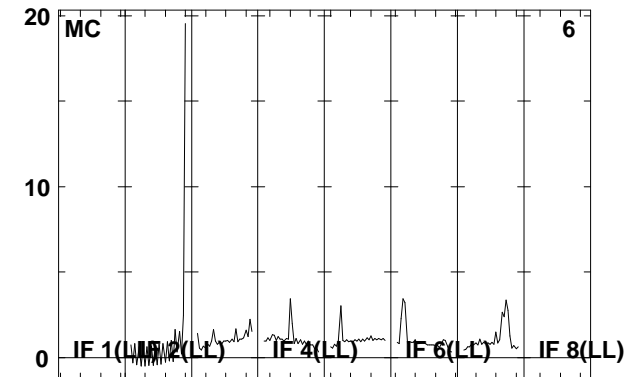
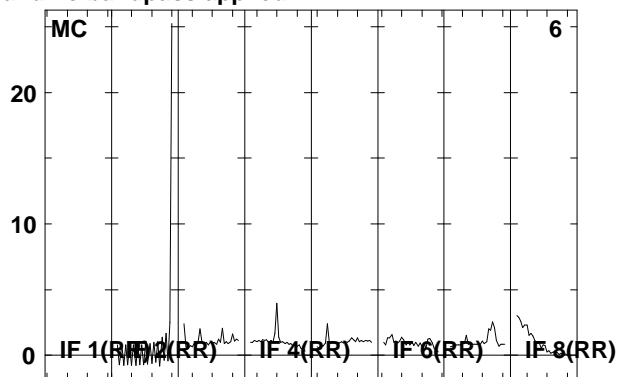
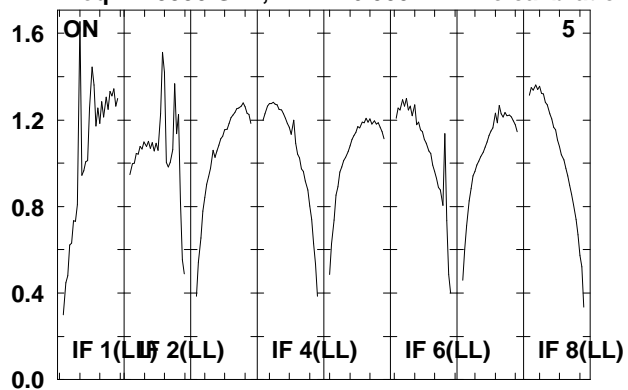

Lower frame: Real Jy

Total-power spectrum Antenna: *

Timerange: 00/10:29:32 to 00/10:32:56

Plot file version 127 created 18-APR-2008 18:28:21

J2333+39 EP061A.UVDATA.1

Freq = 1.5950 GHz, Bw = 16.000 MH No calibration applied and no bandpass applied

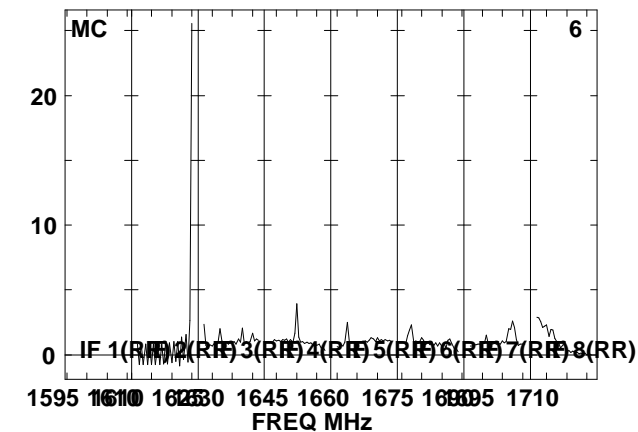
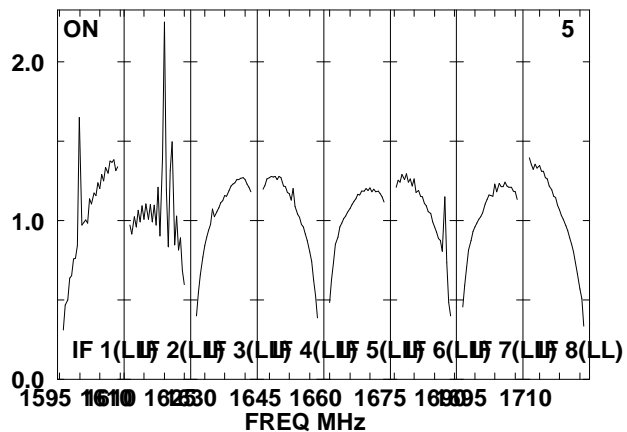
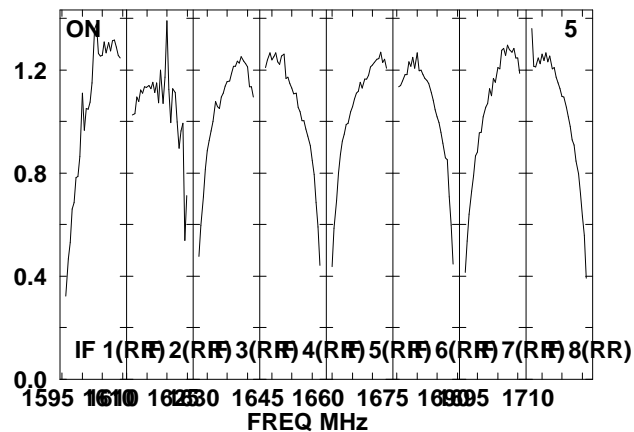
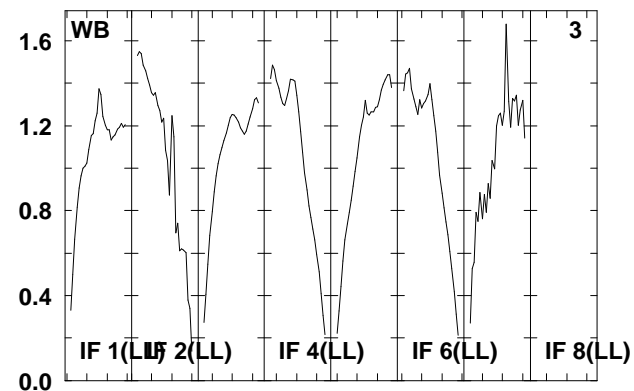
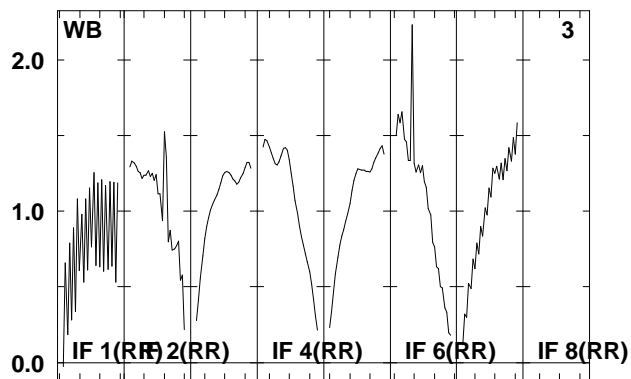
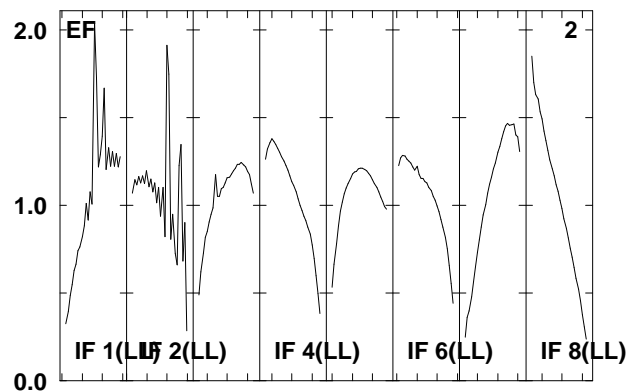
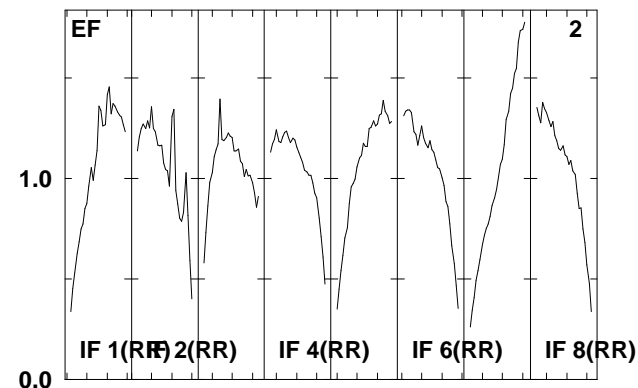
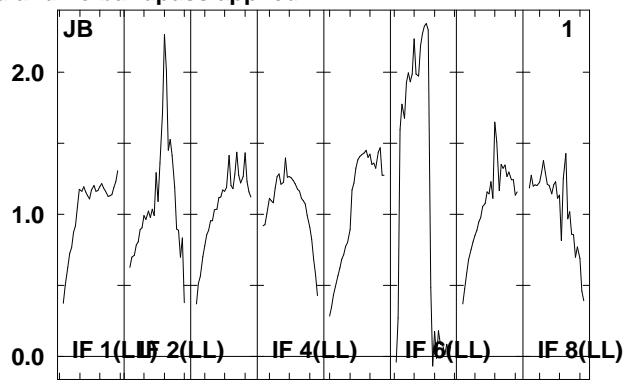
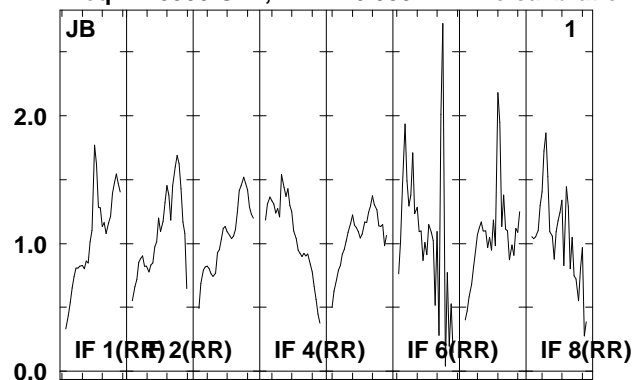

Lower frame: Real Jy
Total-power spectrum Antenna: *
Timerange: 00/10:34:02 to 00/10:35:30

Plot file version 128 created 18-APR-2008 18:28:22

J2333+39 EP061A.UVDATA.1

Freq = 1.5950 GHz, Bw = 16.000 MH No calibration applied and no bandpass applied

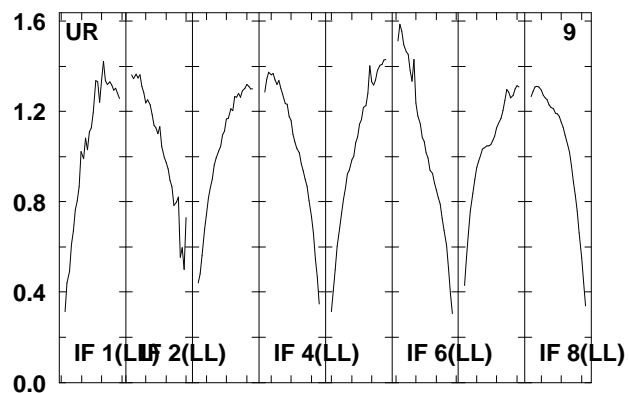
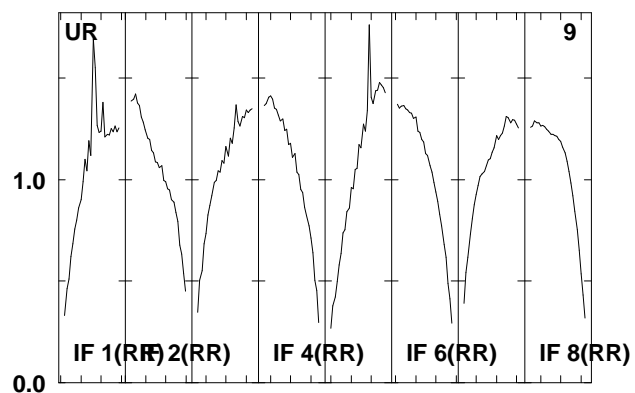
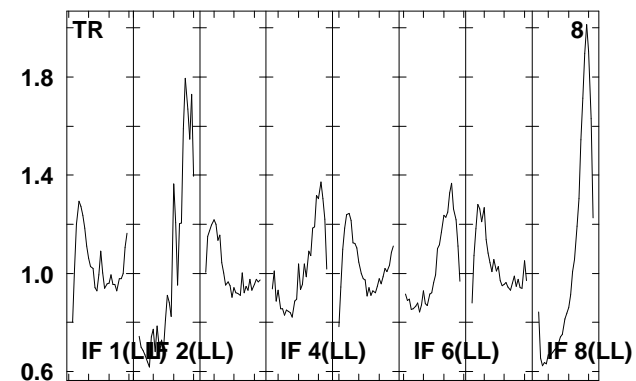
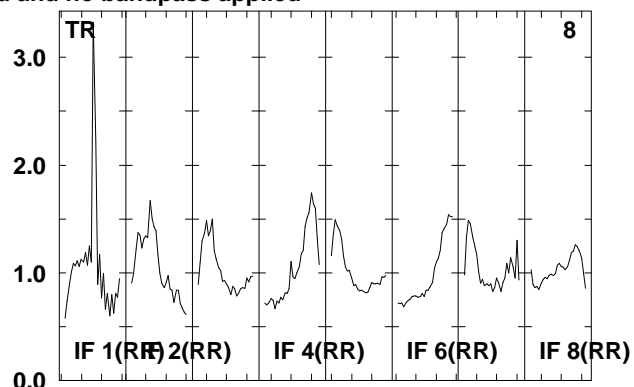
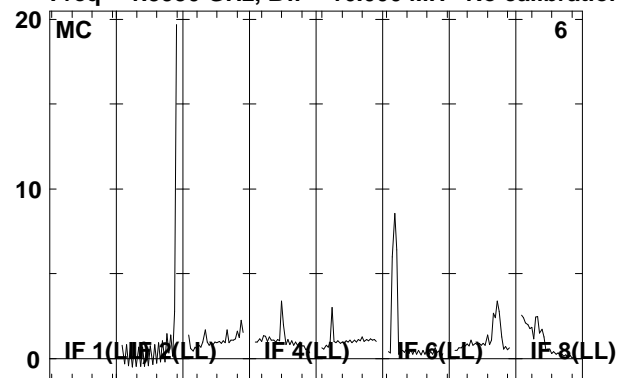

Lower frame: Real Jy
Total-power spectrum Antenna: *
Timerange: 00/10:34:02 to 00/10:35:30

Plot file version 129 created 18-APR-2008 18:28:23

IRAS2336 EP061A.UVDATA.1

Freq = 1.5950 GHz, Bw = 16.000 MH No calibration applied and no bandpass applied

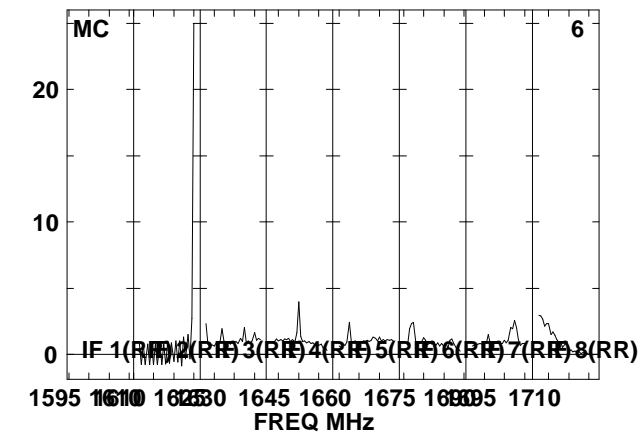
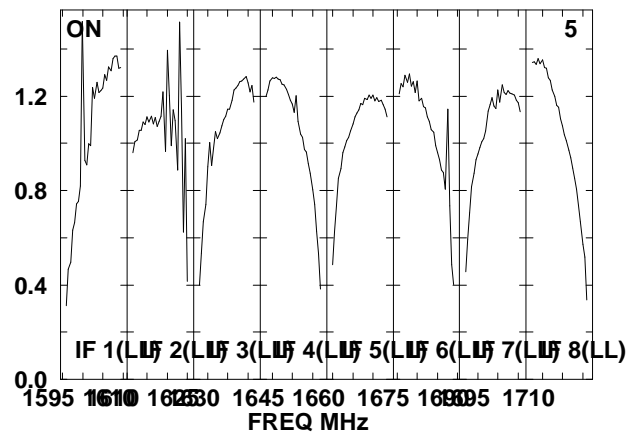
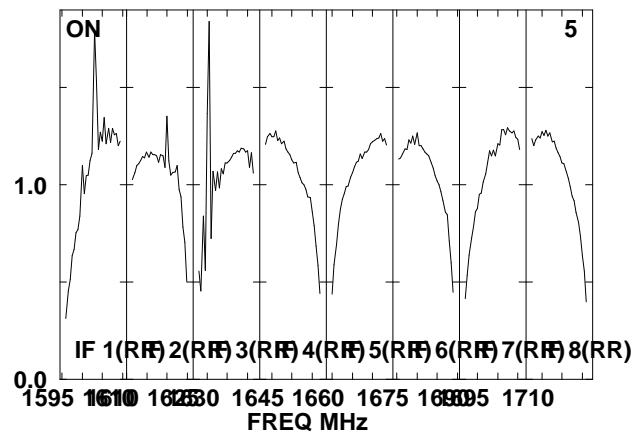
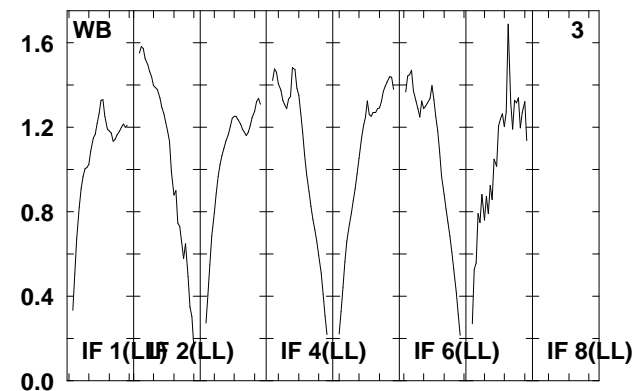
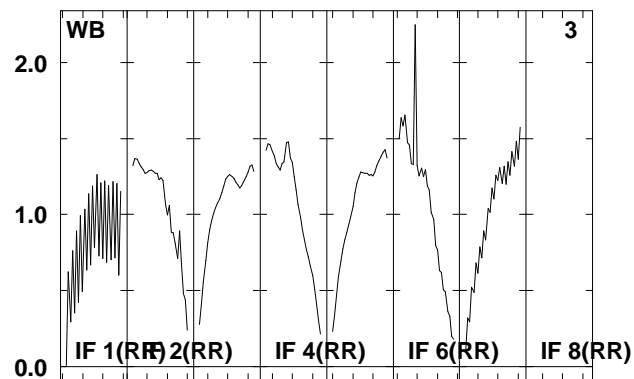
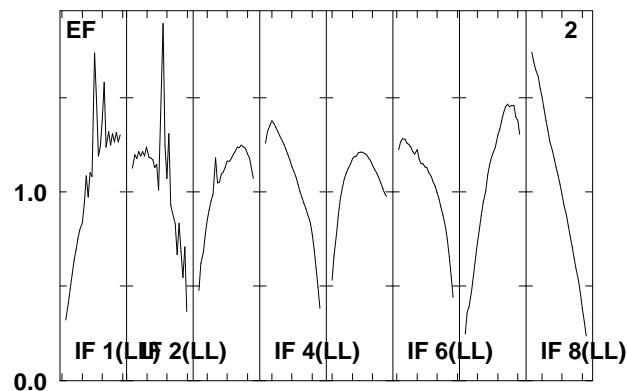
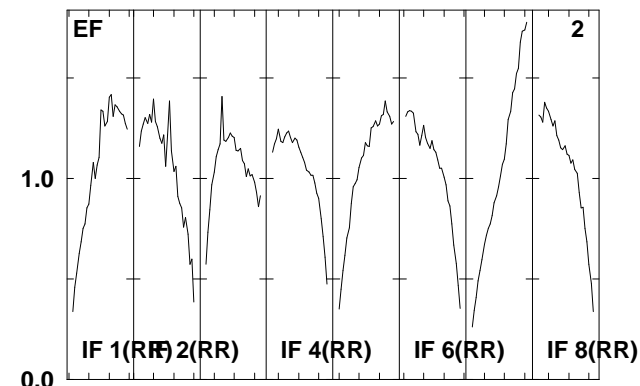
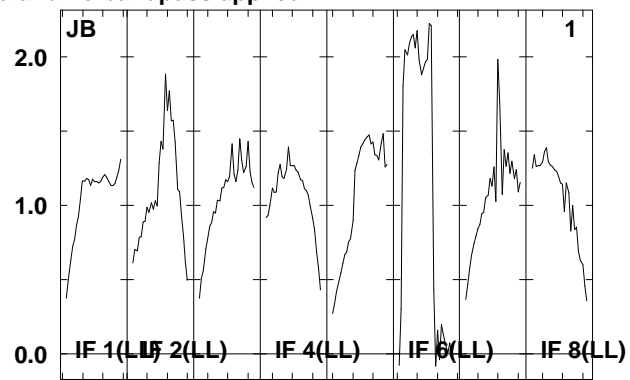
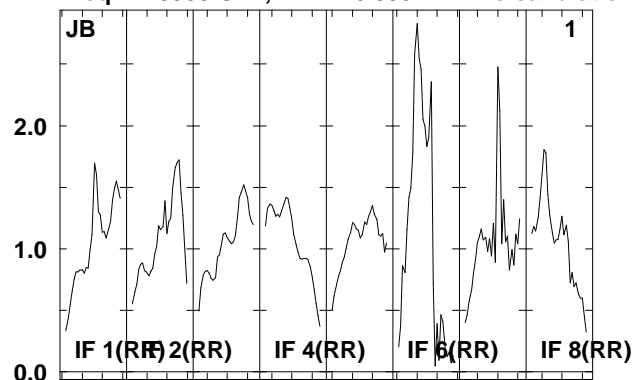

Lower frame: Real Jy

Total-power spectrum Antenna: *

Timerange: 00/10:35:32 to 00/10:39:00

Plot file version 130 created 18-APR-2008 18:28:23

IRAS2336 EP061A.UVDATA.1

Freq = 1.5950 GHz, Bw = 16.000 MH No calibration applied and no bandpass applied

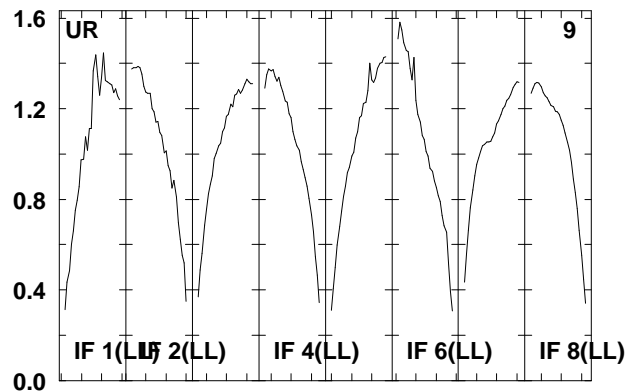
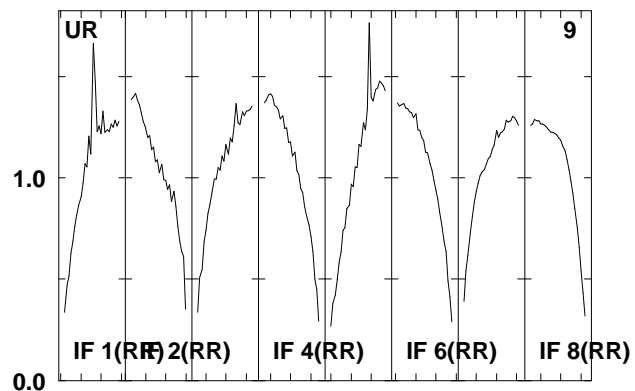
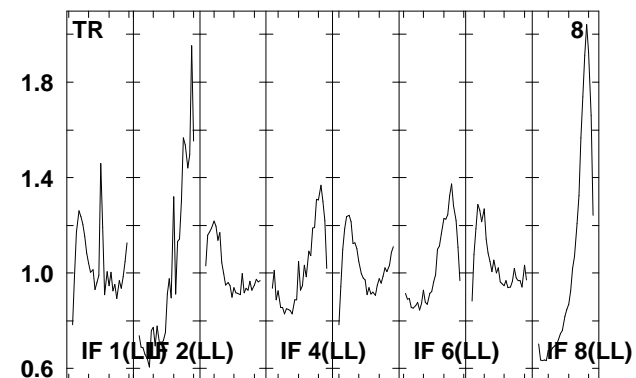
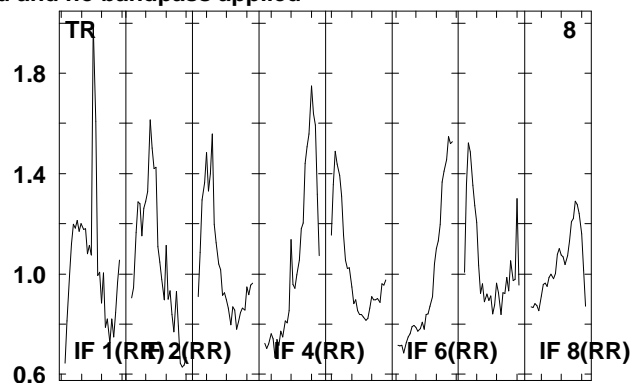
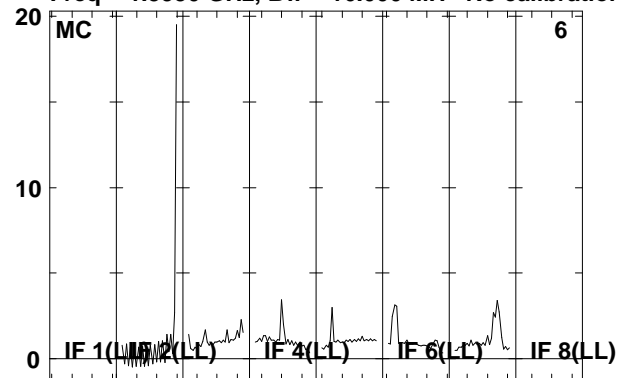

Lower frame: Real Jy
Total-power spectrum Antenna: *
Timerange: 00/10:35:32 to 00/10:39:00

Plot file version 131 created 18-APR-2008 18:28:24

J2333+39 EP061A.UVDATA.1

Freq = 1.5950 GHz, Bw = 16.000 MH No calibration applied and no bandpass applied

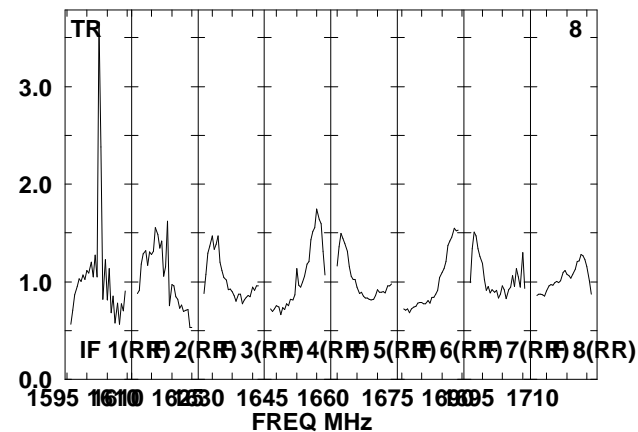
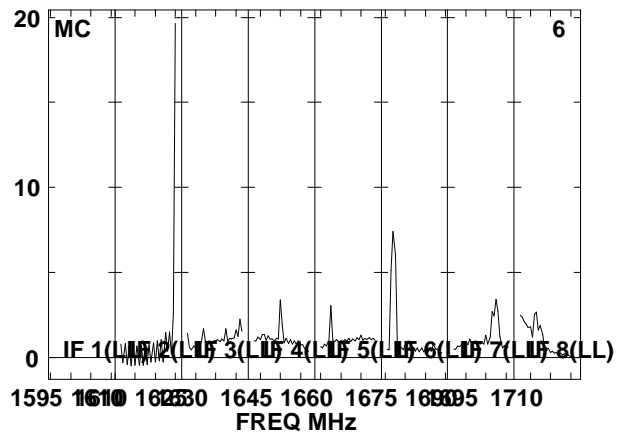
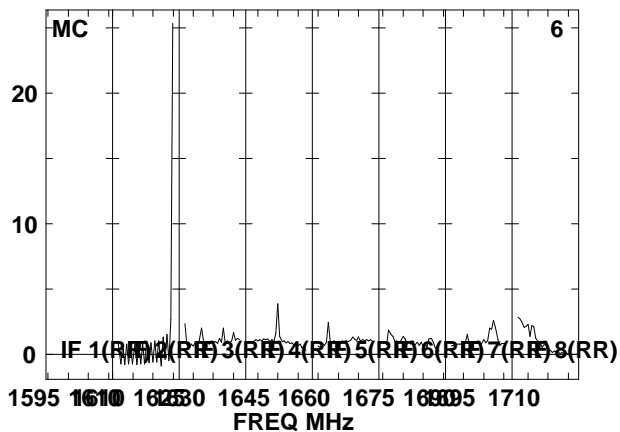
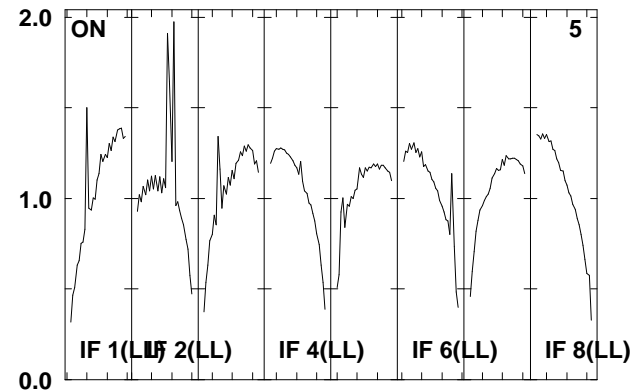
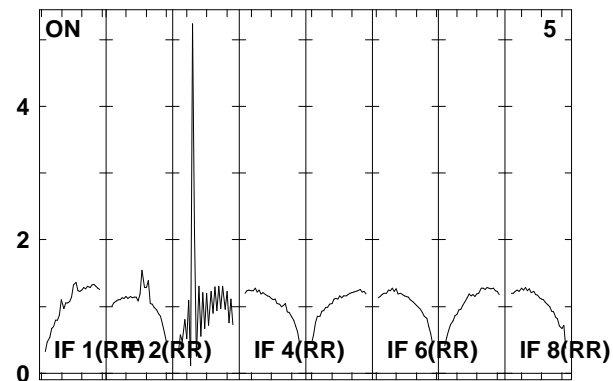
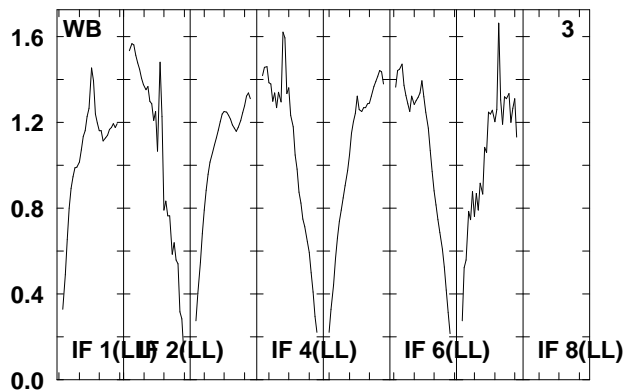
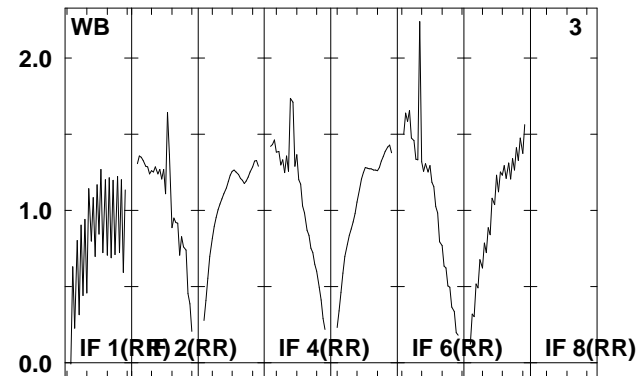
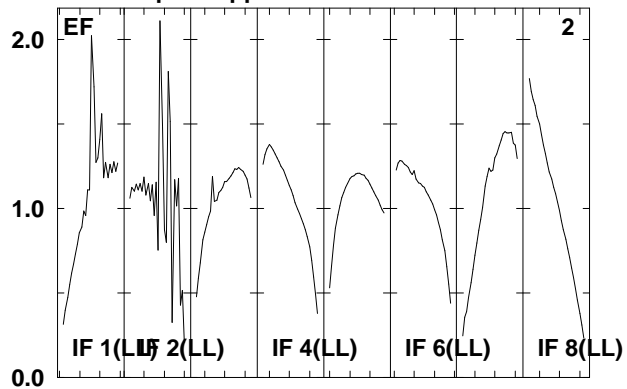
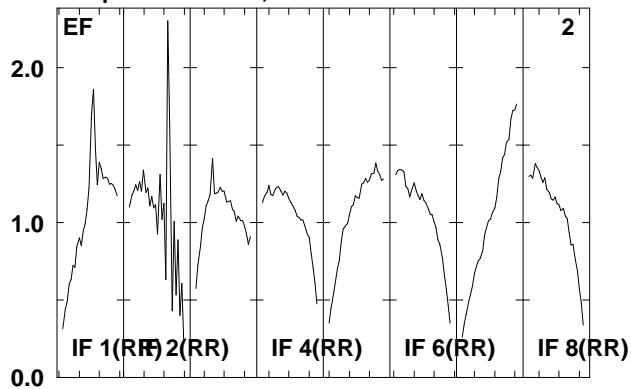

Lower frame: Real Jy

Total-power spectrum Antenna: *

Timerange: 00/10:39:02 to 00/10:40:28

Plot file version 132 created 18-APR-2008 18:28:25

J2333+39 EP061A.UVDATA.1

Freq = 1.5950 GHz, Bw = 16.000 MH No calibration applied and no bandpass applied

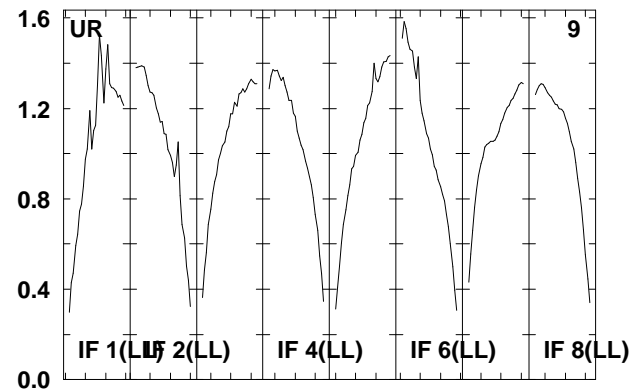
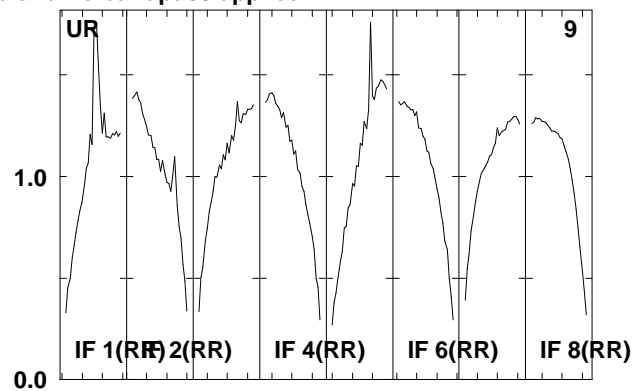
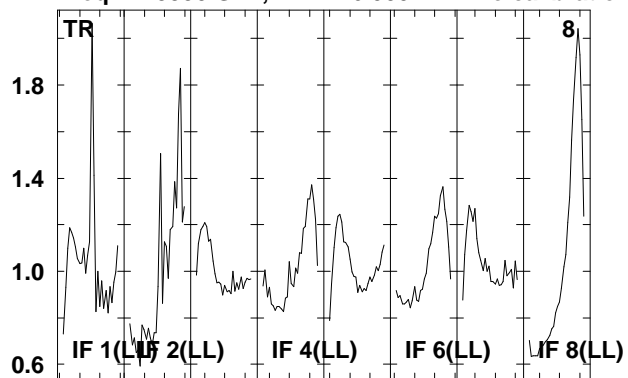

Lower frame: Real Jy
Total-power spectrum Antenna: *
Timerange: 00/10:39:02 to 00/10:40:28

Plot file version 133 created 18-APR-2008 18:28:25

IRAS2336 EP061A.UVDATA.1

Freq = 1.5950 GHz, Bw = 16.000 MH No calibration applied and no bandpass applied

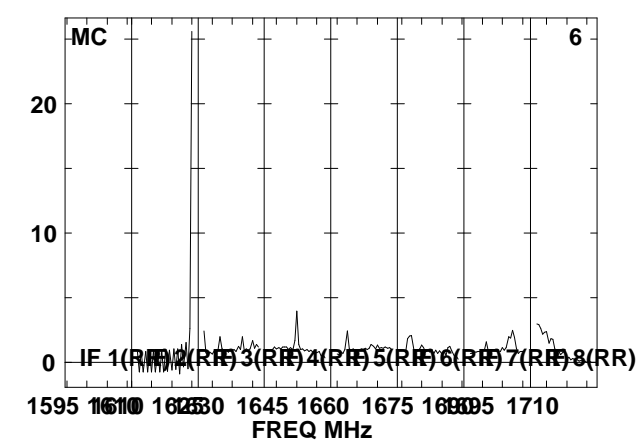
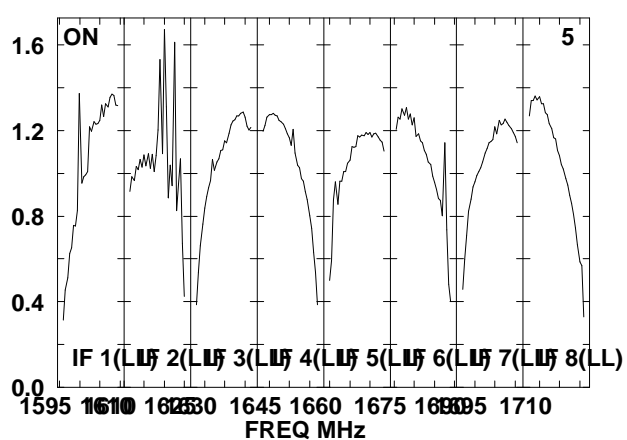
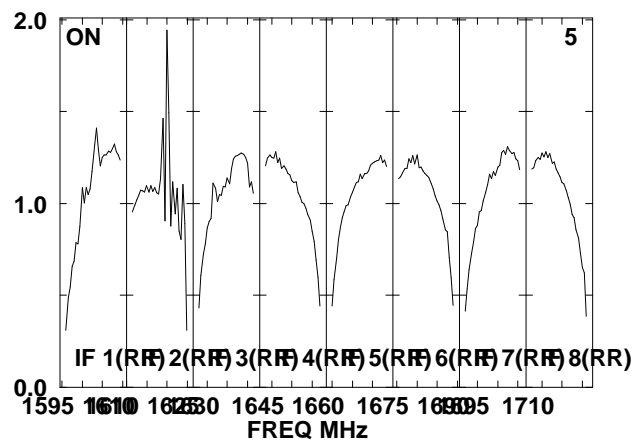
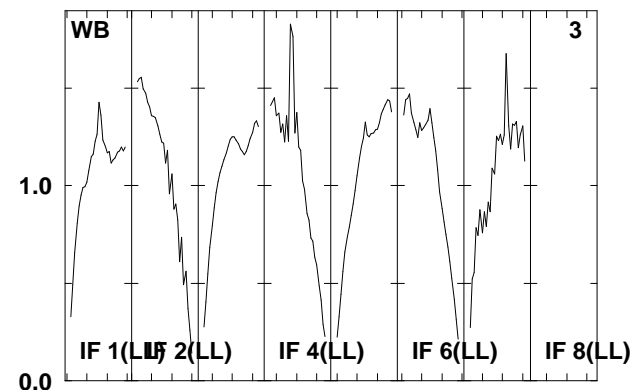
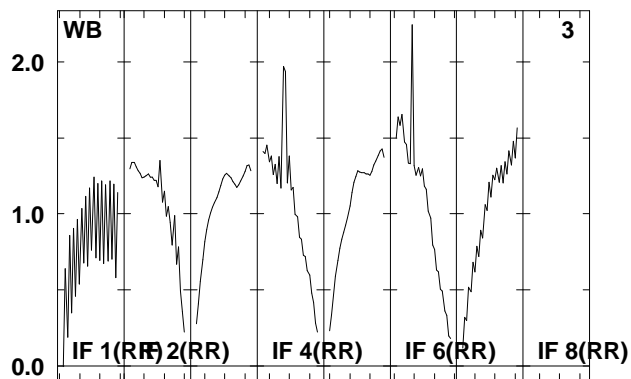
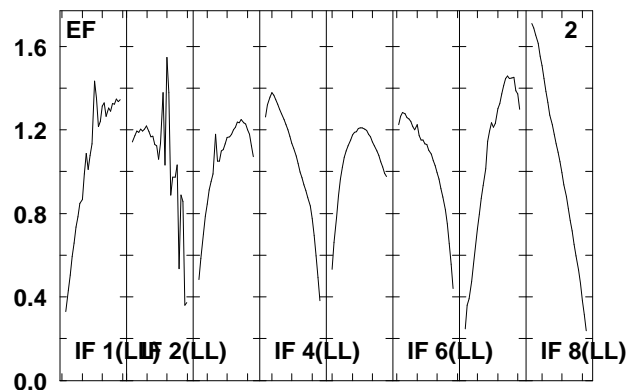
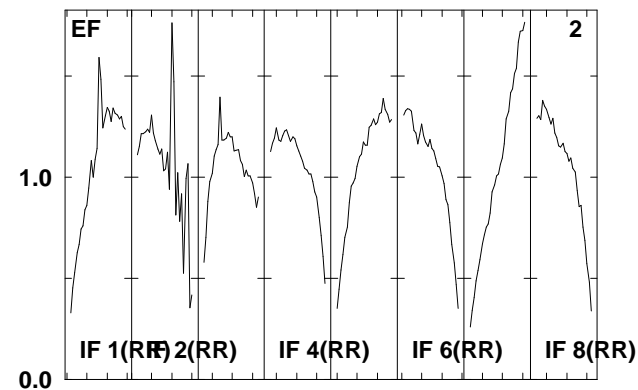
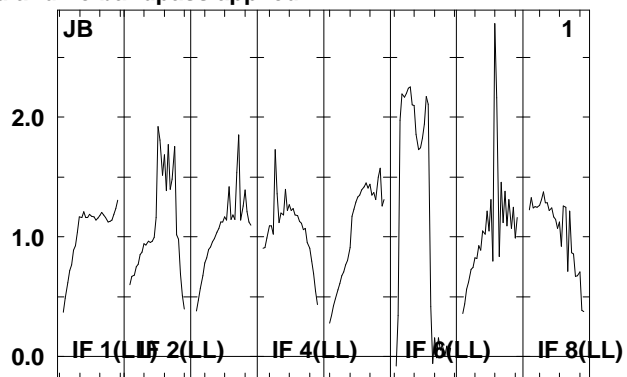
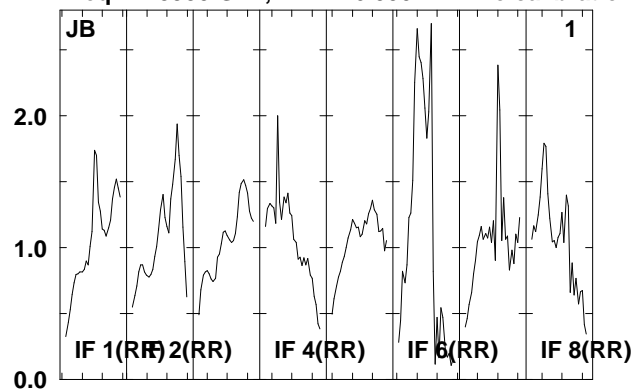

Lower frame: Real Jy
Total-power spectrum Antenna: *
Timerange: 00/10:40:30 to 00/10:43:56

Plot file version 134 created 18-APR-2008 18:28:26

IRAS2336 EP061A.UVDATA.1

Freq = 1.5950 GHz, Bw = 16.000 MH No calibration applied and no bandpass applied

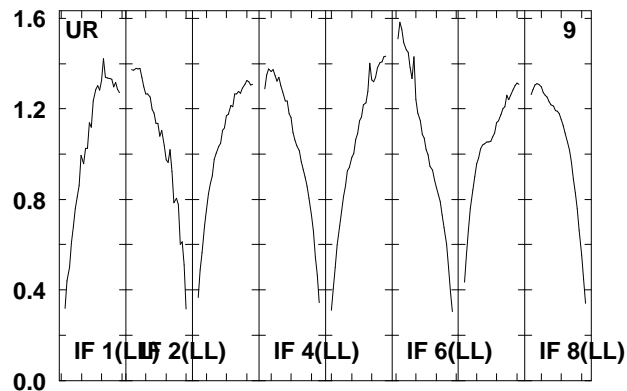
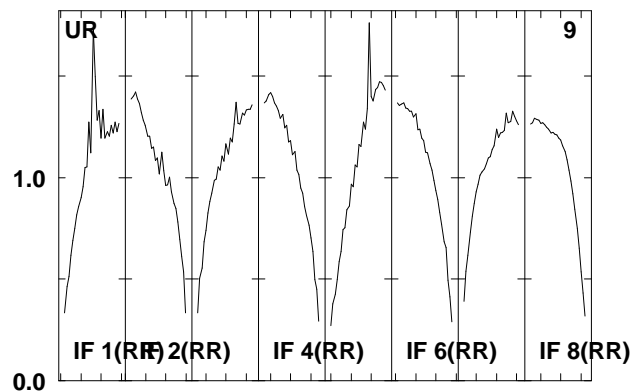
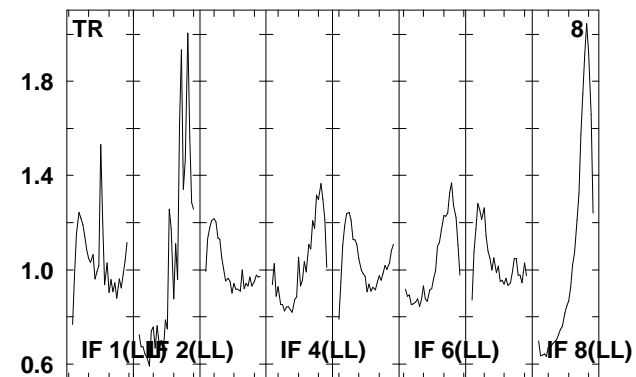
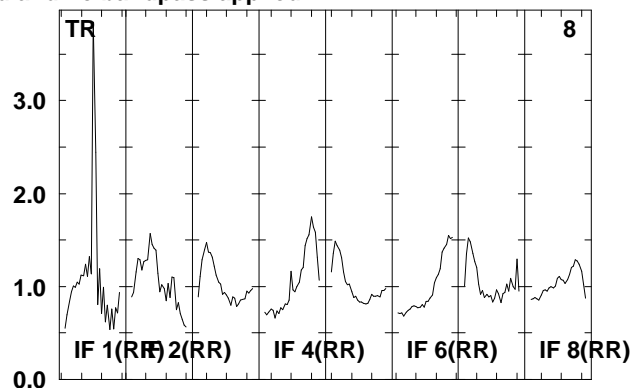
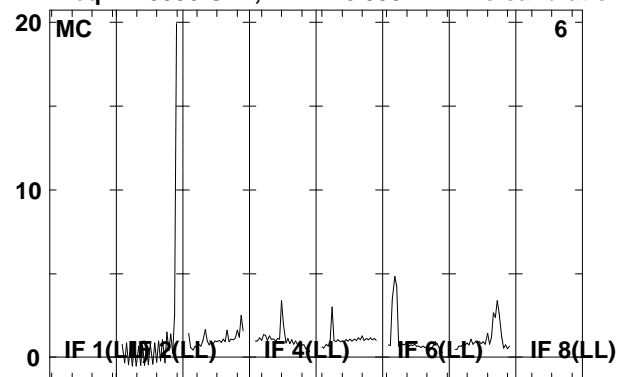

Lower frame: Real Jy
Total-power spectrum Antenna: *
Timerange: 00/10:40:30 to 00/10:43:56

Plot file version 135 created 18-APR-2008 18:28:27

J2333+39 EP061A.UVDATA.1

Freq = 1.5950 GHz, Bw = 16.000 MH No calibration applied and no bandpass applied

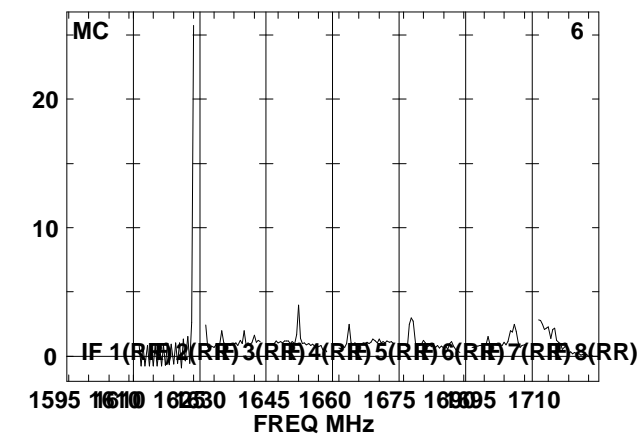
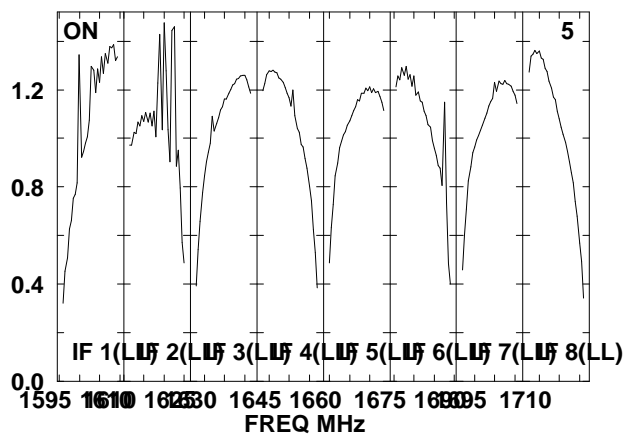
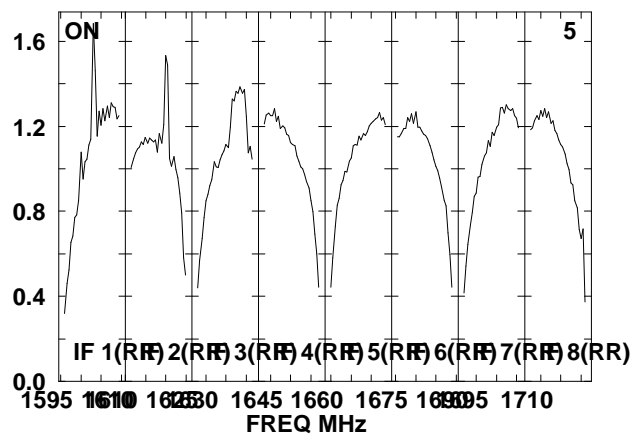
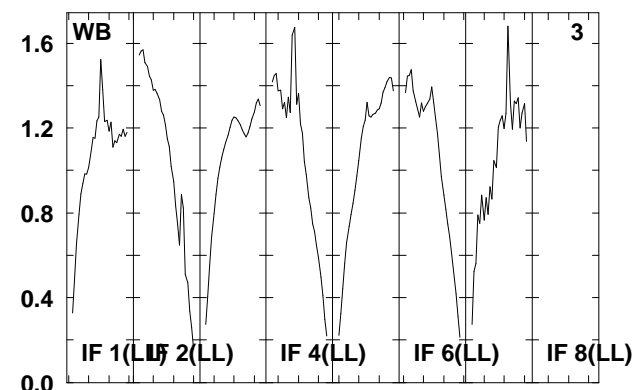
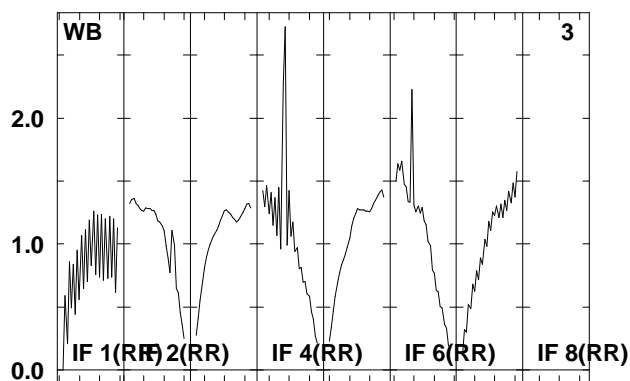
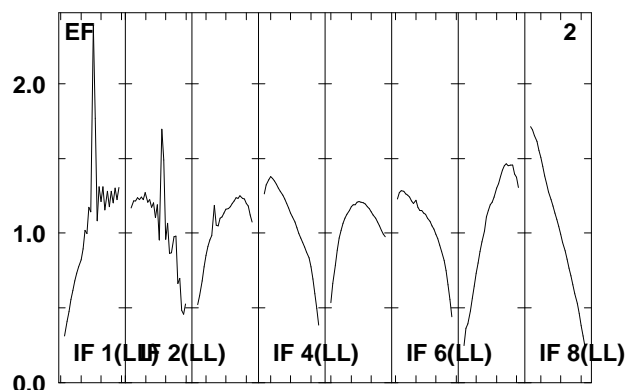
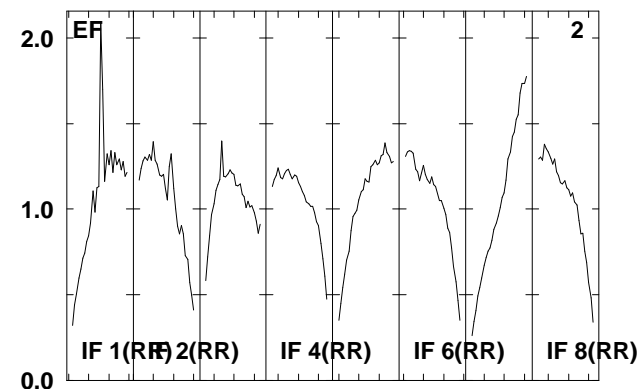
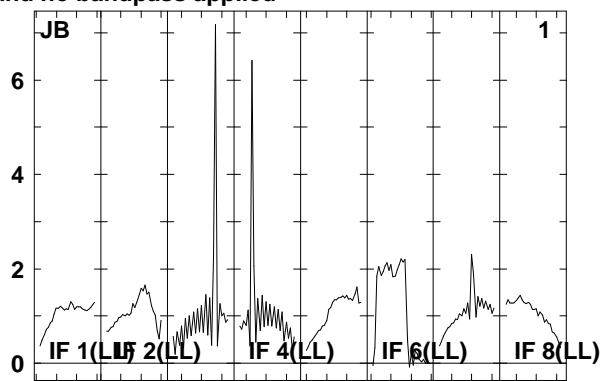
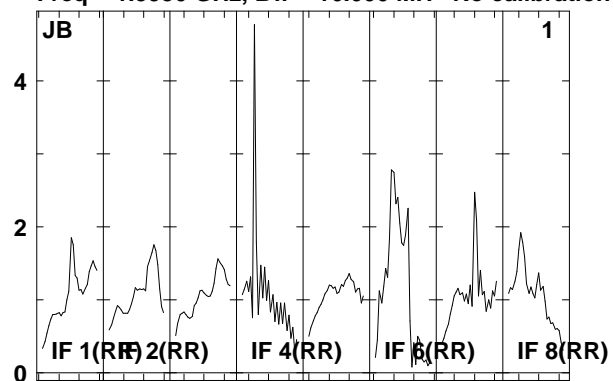

Lower frame: Real Jy
Total-power spectrum Antenna: *
Timerange: 00/10:44:10 to 00/10:45:30

Plot file version 136 created 18-APR-2008 18:28:28

J2333+39 EP061A.UVDATA.1

Freq = 1.5950 GHz, Bw = 16.000 MH No calibration applied and no bandpass applied

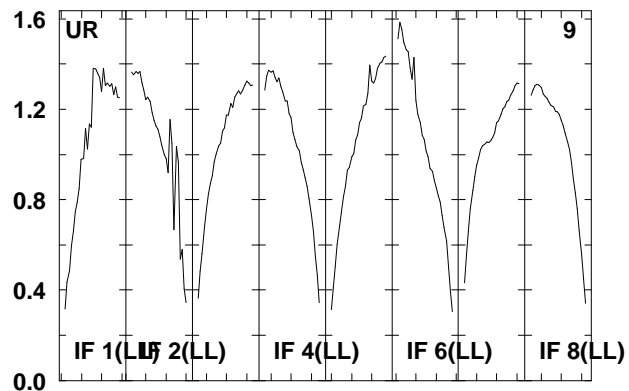
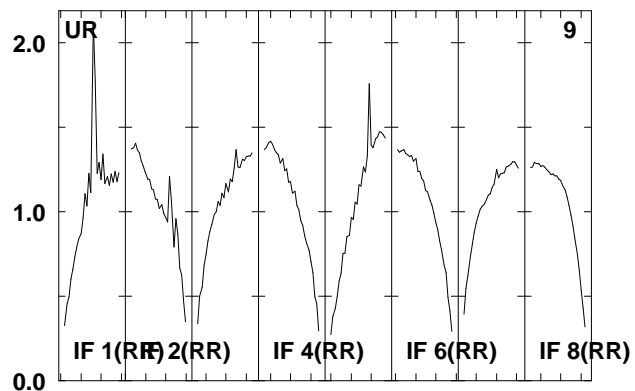
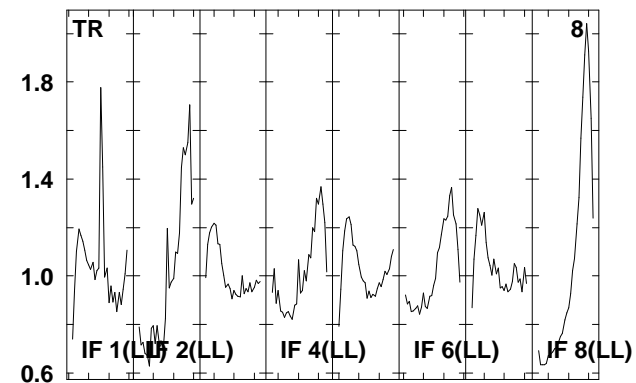
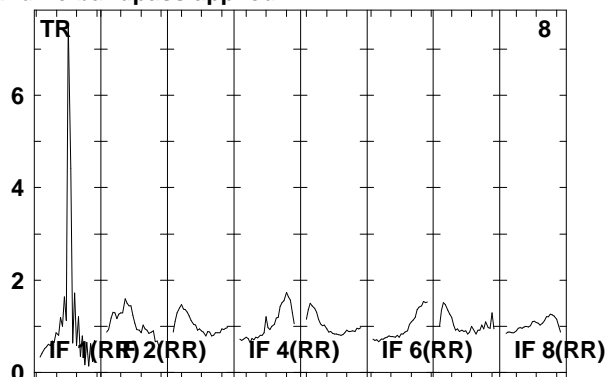
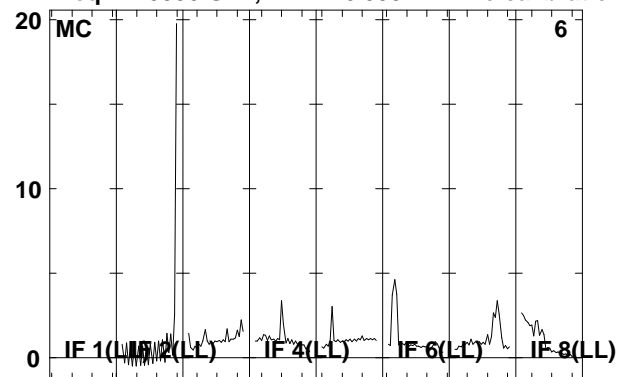

Lower frame: Real Jy
Total-power spectrum Antenna: *
Timerange: 00/10:44:10 to 00/10:45:30

Plot file version 137 created 18-APR-2008 18:28:28

IRAS2336 EP061A.UVDATA.1

Freq = 1.5950 GHz, Bw = 16.000 MH No calibration applied and no bandpass applied

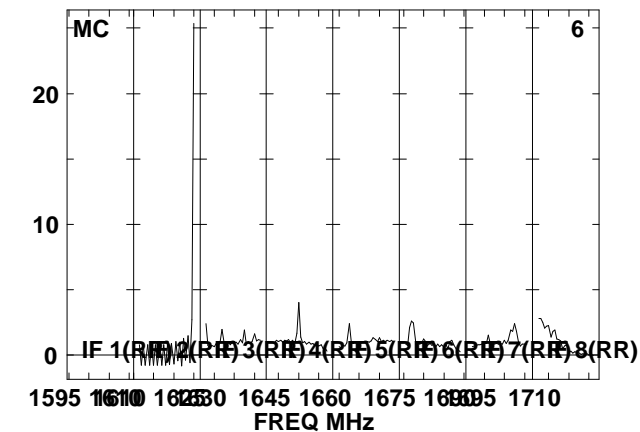
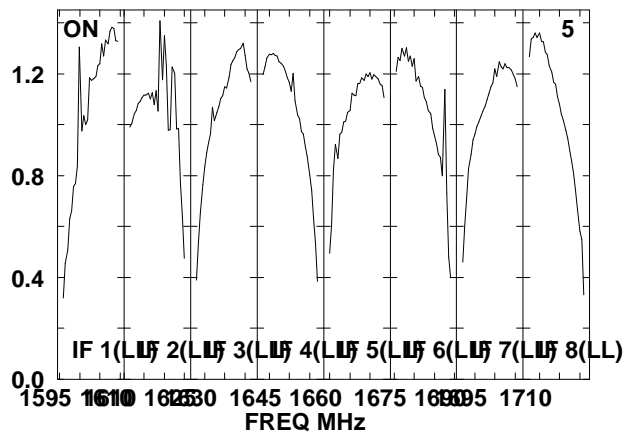
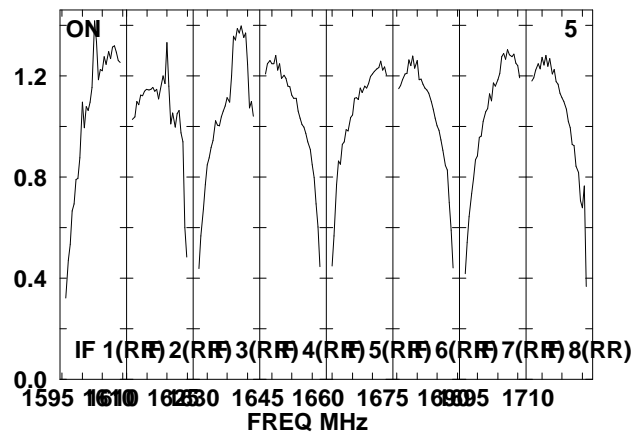
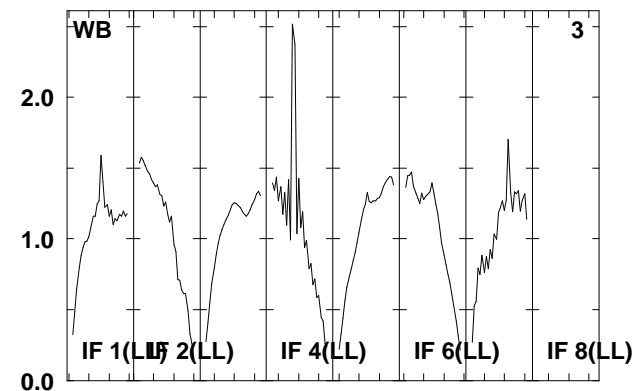
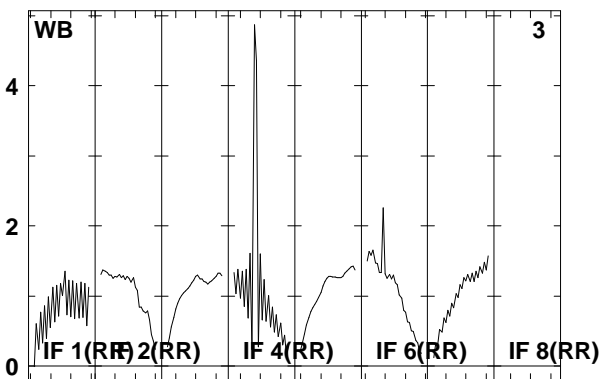
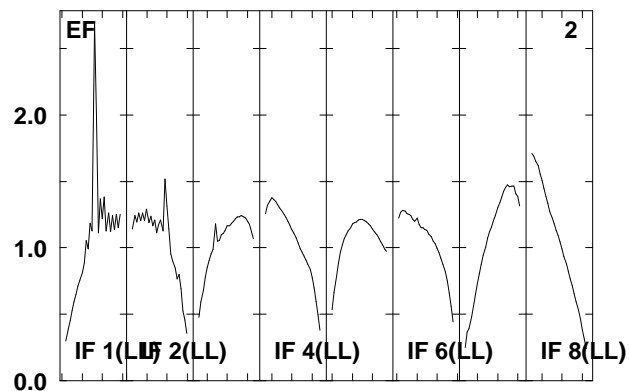
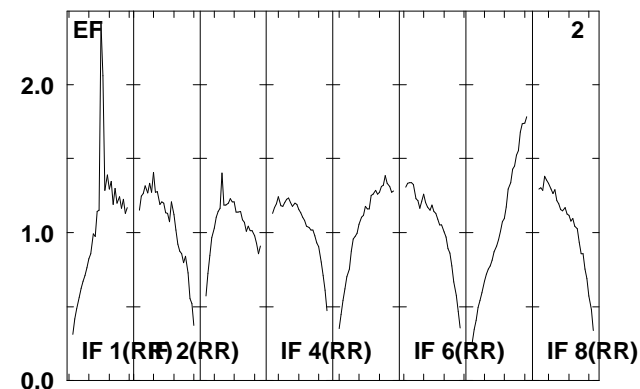
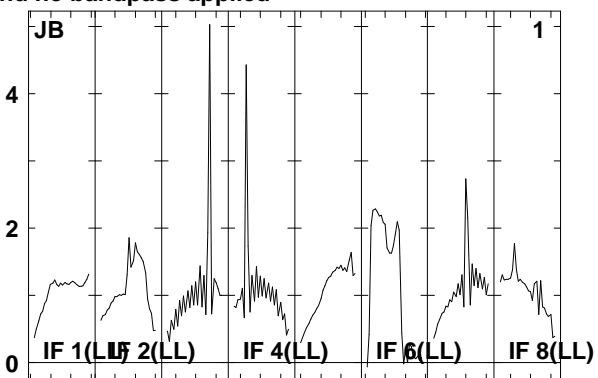
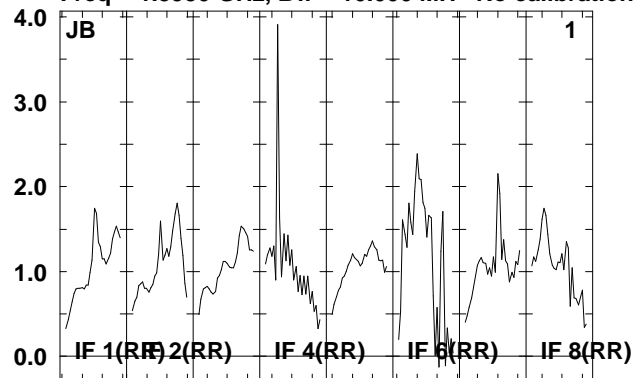

Lower frame: Real Jy
Total-power spectrum Antenna: *
Timerange: 00/10:45:32 to 00/10:48:56

Plot file version 138 created 18-APR-2008 18:28:29

IRAS2336 EP061A.UVDATA.1

Freq = 1.5950 GHz, Bw = 16.000 MH No calibration applied and no bandpass applied

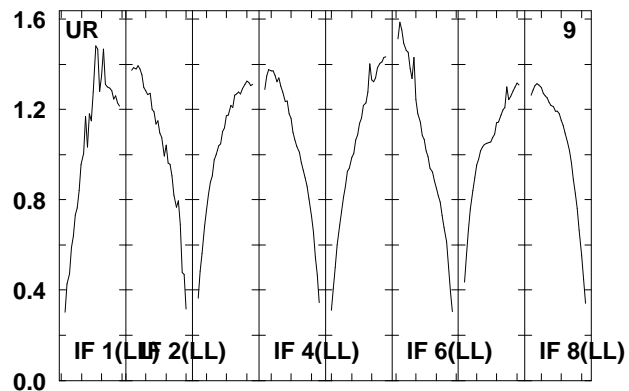
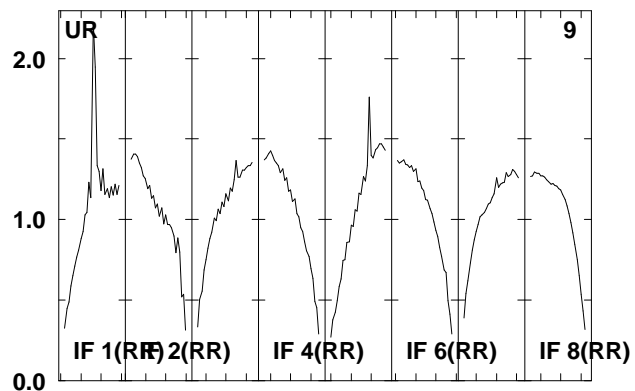
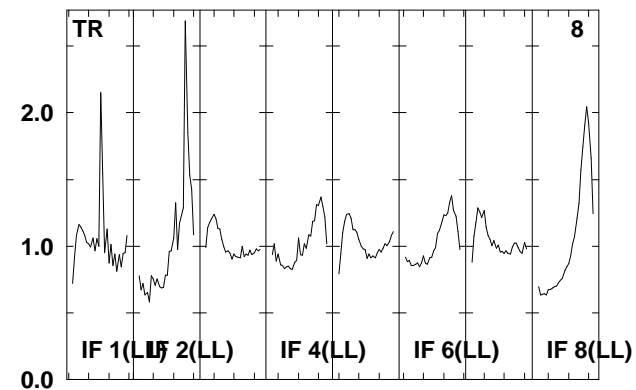
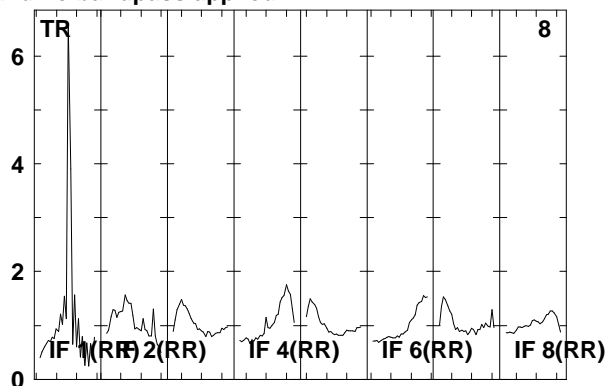
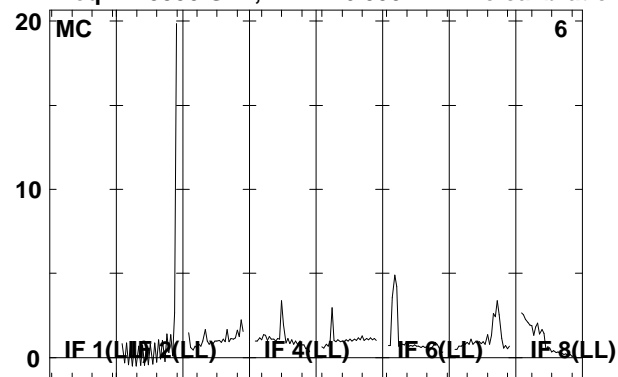

Lower frame: Real Jy
Total-power spectrum Antenna: *
Timerange: 00/10:45:32 to 00/10:48:56

Plot file version 139 created 18-APR-2008 18:28:30

J2333+39 EP061A.UVDATA.1

Freq = 1.5950 GHz, Bw = 16.000 MH No calibration applied and no bandpass applied

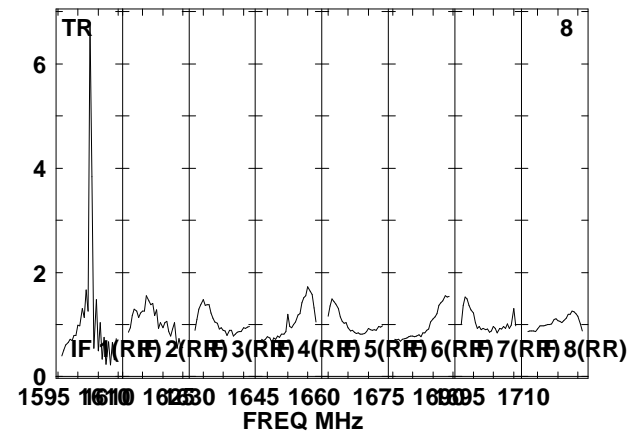
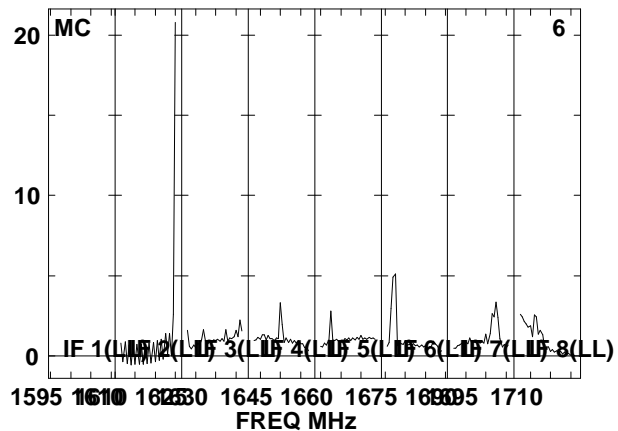
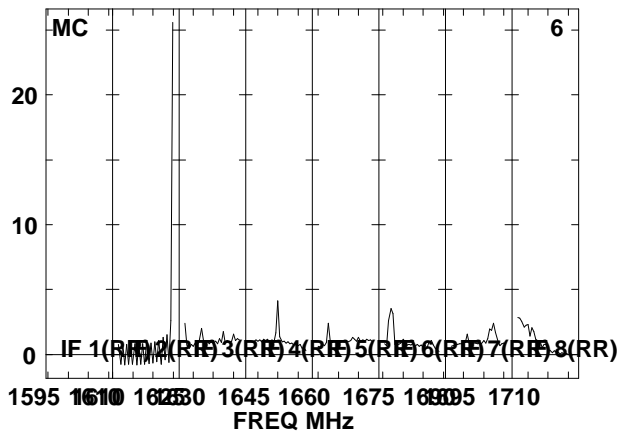
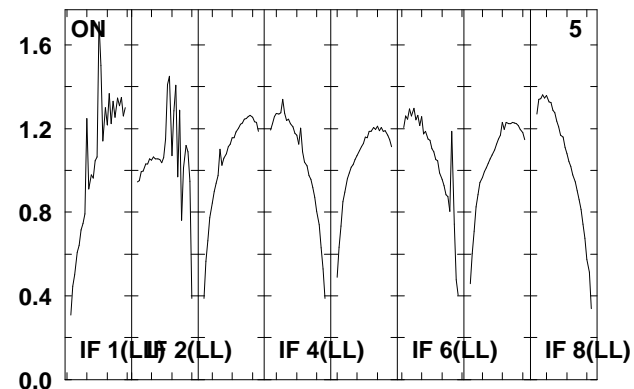
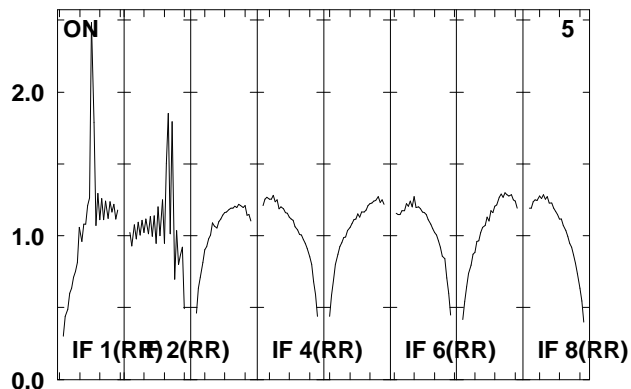
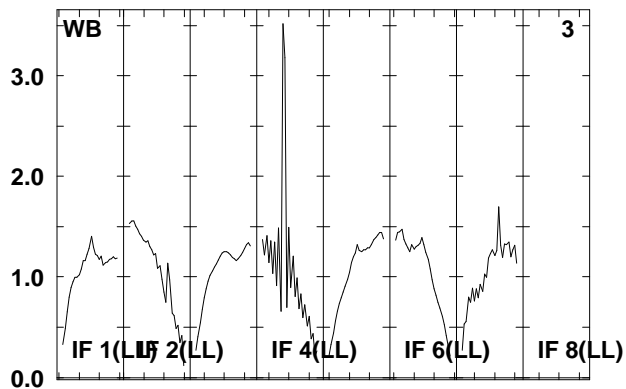
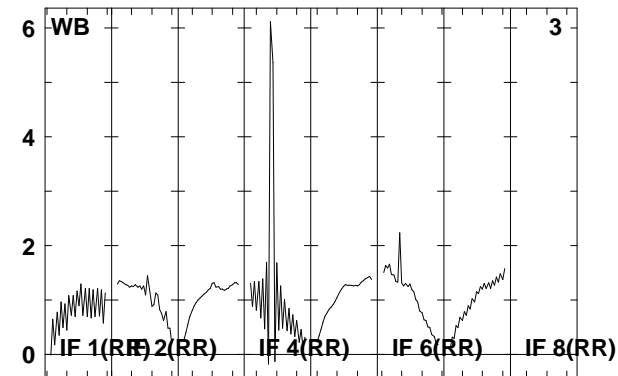
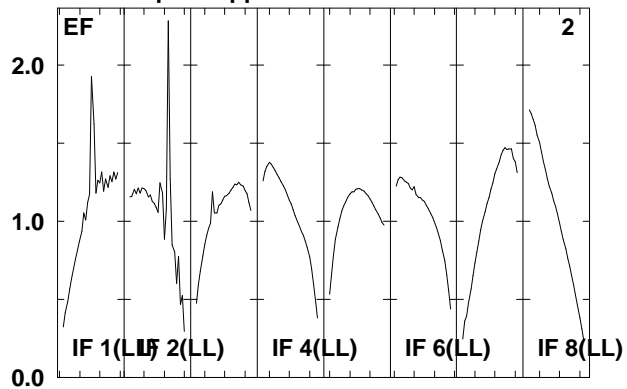
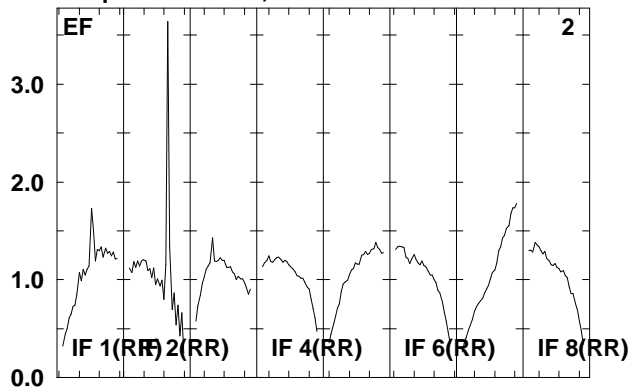

Lower frame: Real Jy
Total-power spectrum Antenna: *
Timerange: 00/10:50:02 to 00/10:51:28

Plot file version 140 created 18-APR-2008 18:28:31

J2333+39 EP061A.UVDATA.1

Freq = 1.5950 GHz, Bw = 16.000 MH No calibration applied and no bandpass applied

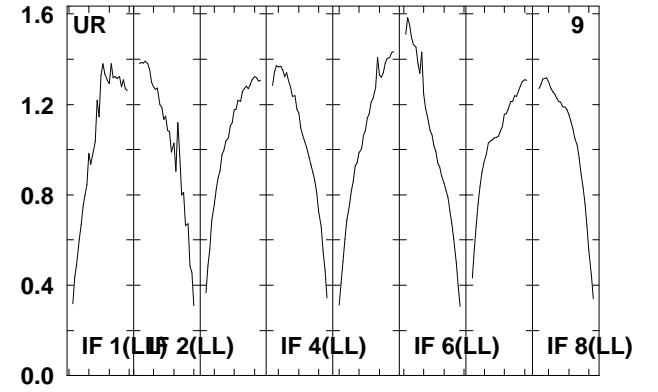
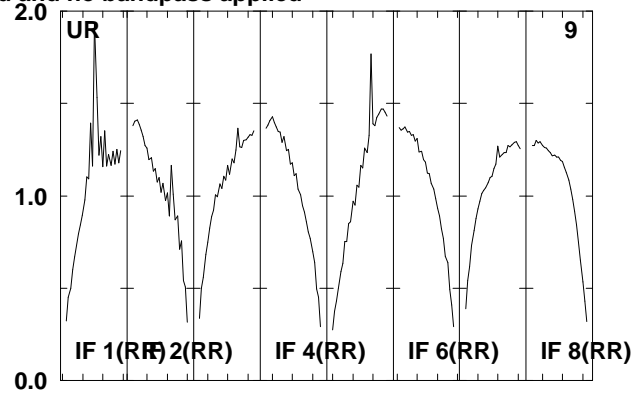
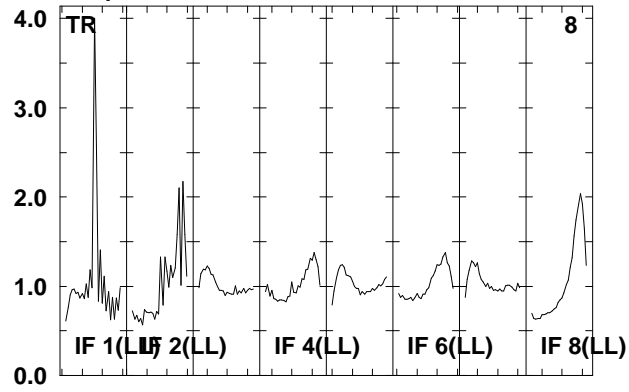

Lower frame: Real Jy
Total-power spectrum Antenna: *
Timerange: 00/10:50:02 to 00/10:51:28

Plot file version 141 created 18-APR-2008 18:28:31

IRAS2336 EP061A.UVDATA.1

Freq = 1.5950 GHz, Bw = 16.000 MH No calibration applied and no bandpass applied

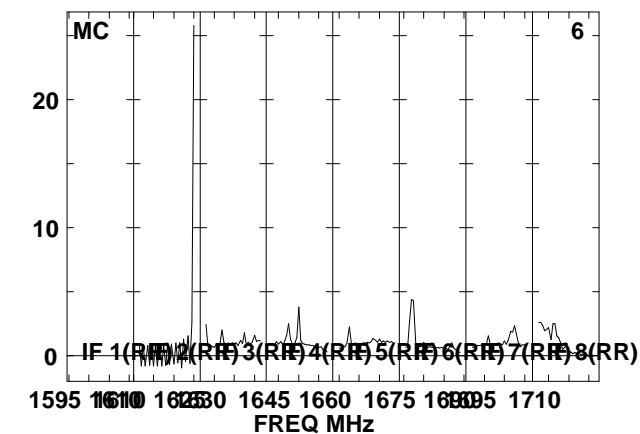
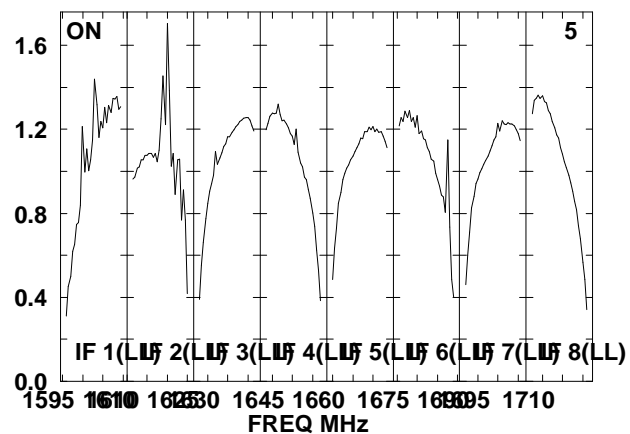
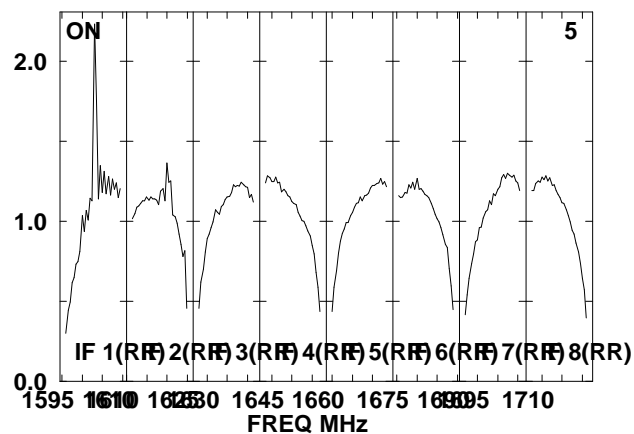
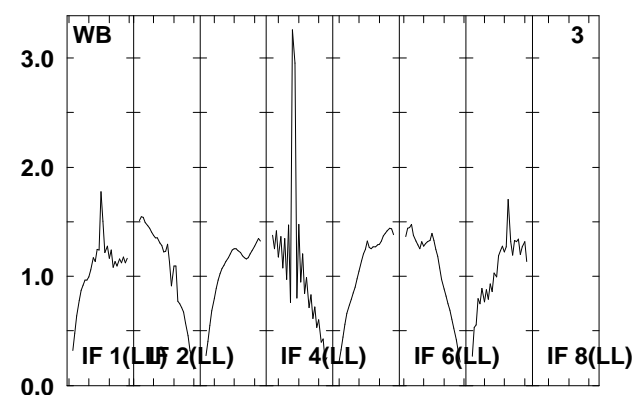
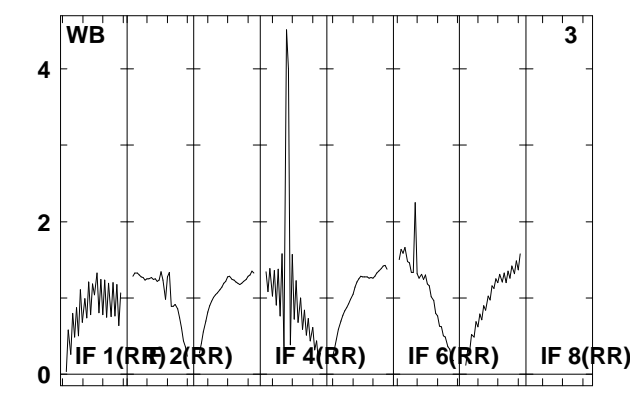
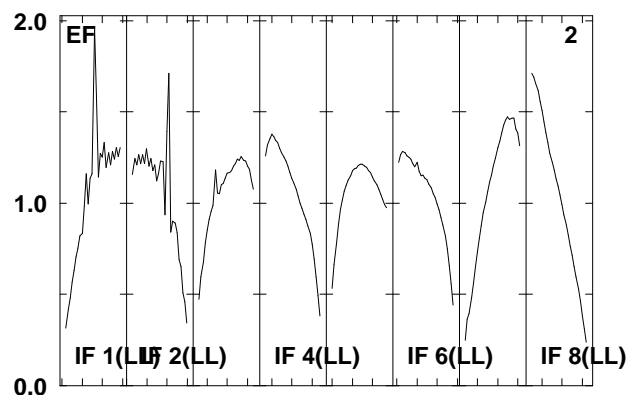
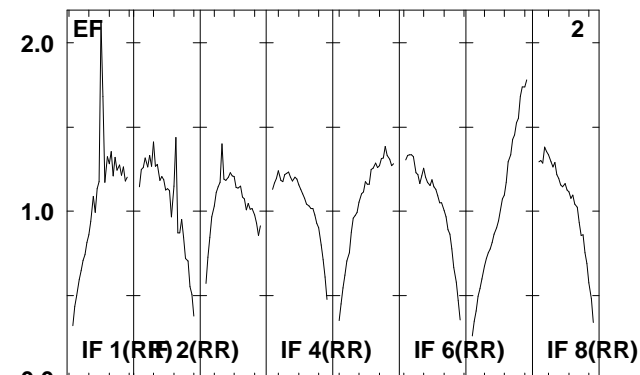
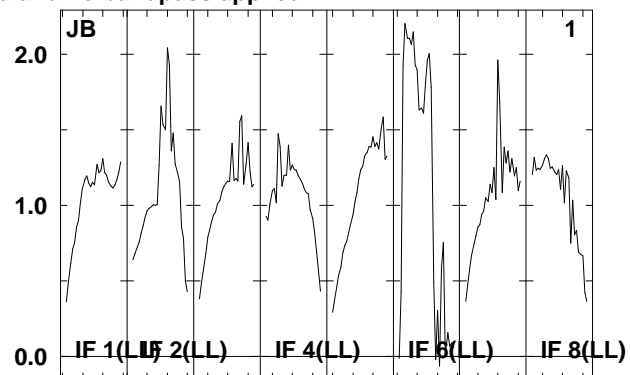
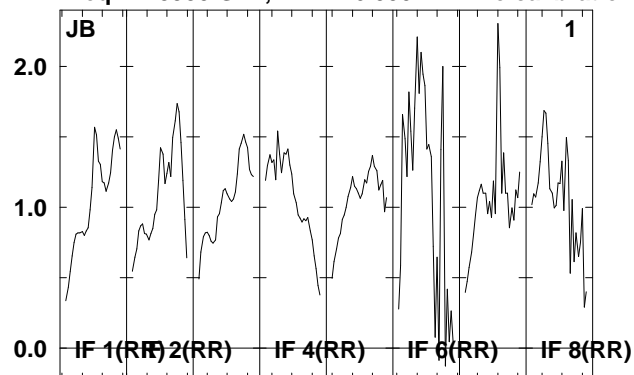

Lower frame: Real Jy
Total-power spectrum Antenna: *
Timerange: 00/10:51:30 to 00/10:55:00

Plot file version 142 created 18-APR-2008 18:28:32

IRAS2336 EP061A.UVDATA.1

Freq = 1.5950 GHz, Bw = 16.000 MH No calibration applied and no bandpass applied

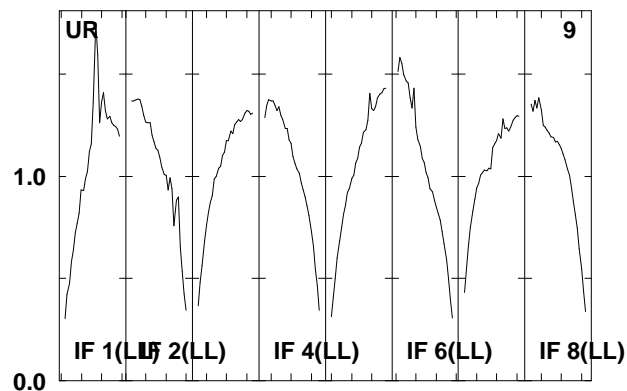
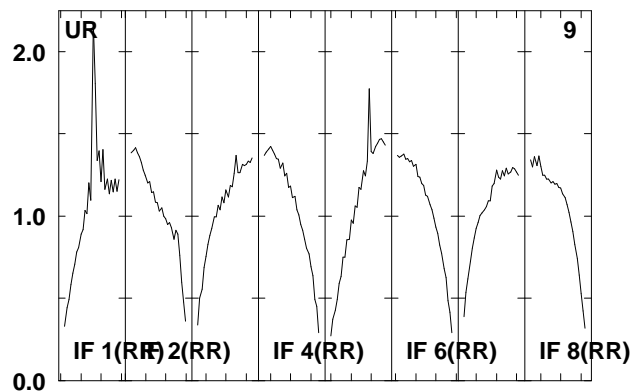
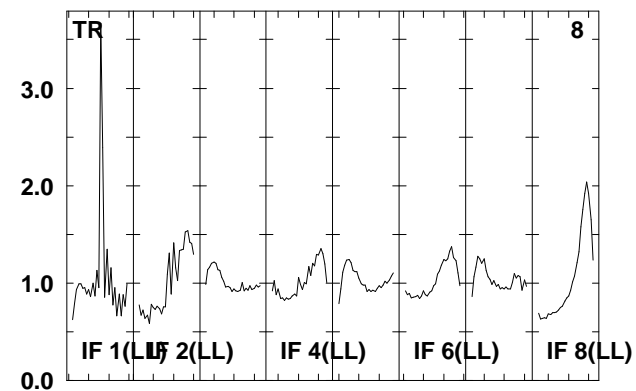
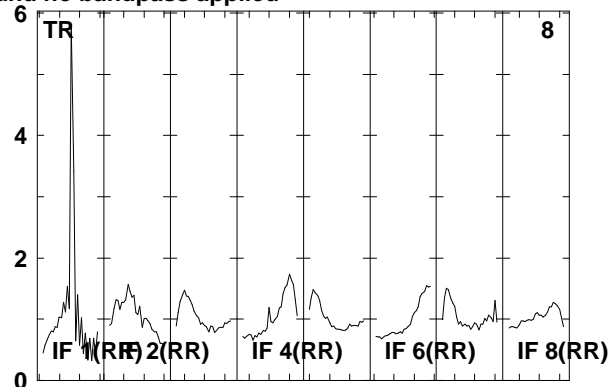
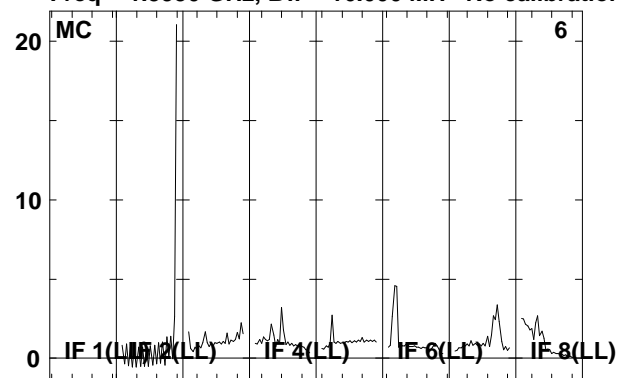

Lower frame: Real Jy
Total-power spectrum Antenna: *
Timerange: 00/10:51:30 to 00/10:55:00

Plot file version 143 created 18-APR-2008 18:28:33

J2333+39 EP061A.UVDATA.1

Freq = 1.5950 GHz, Bw = 16.000 MH No calibration applied and no bandpass applied

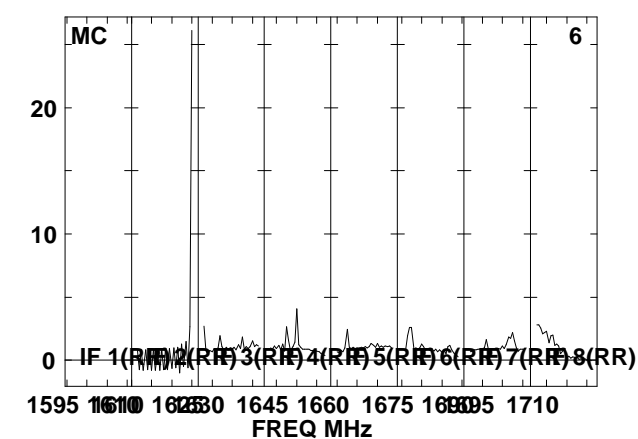
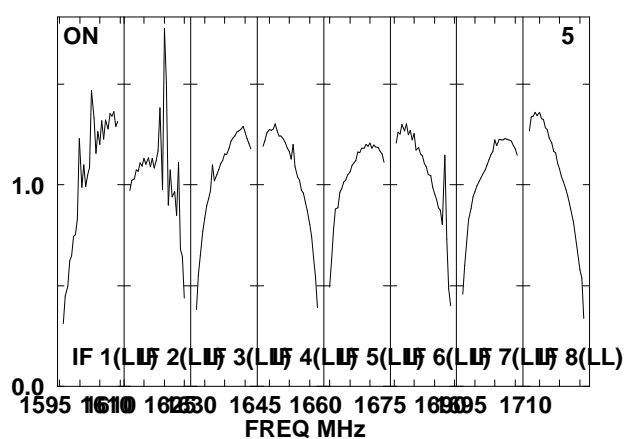
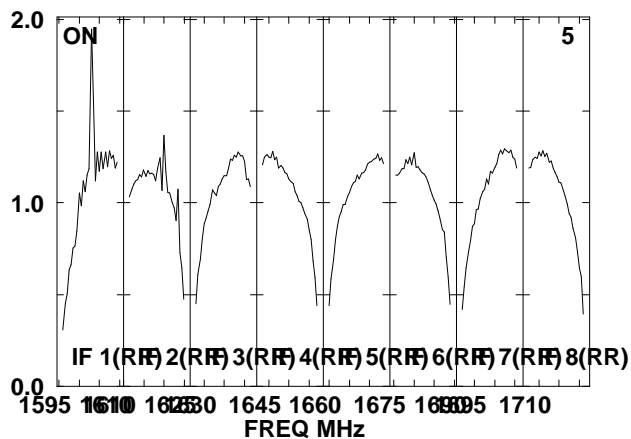
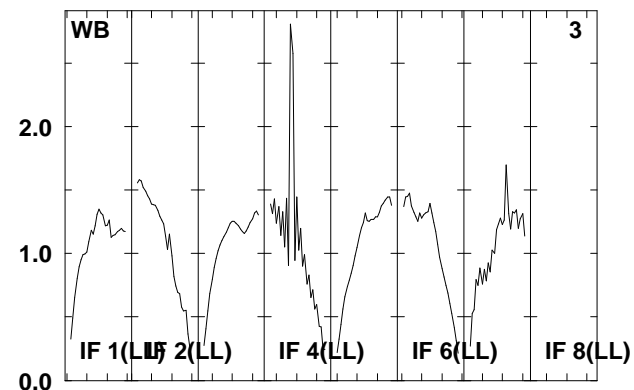
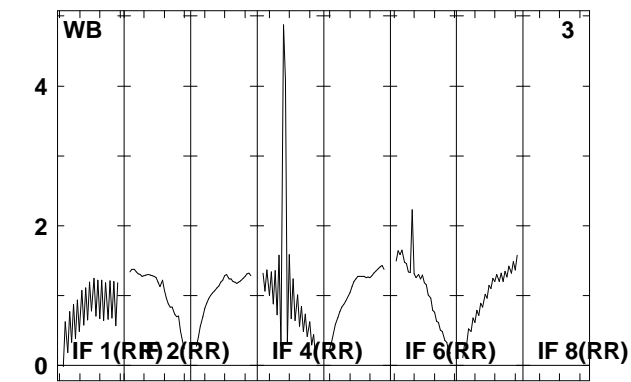
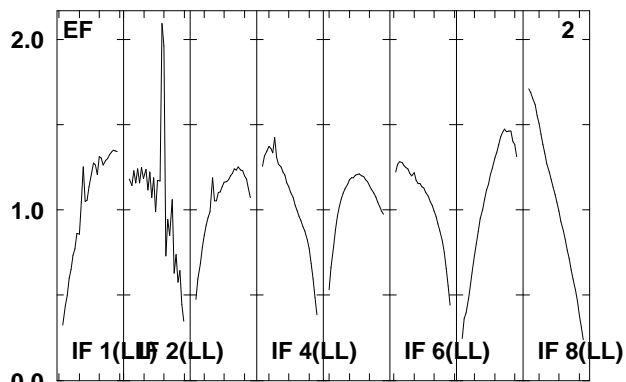
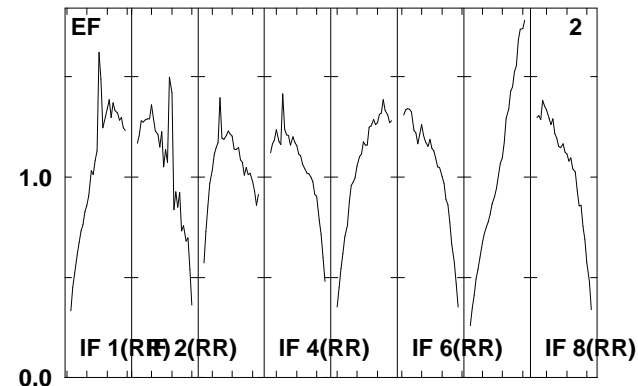
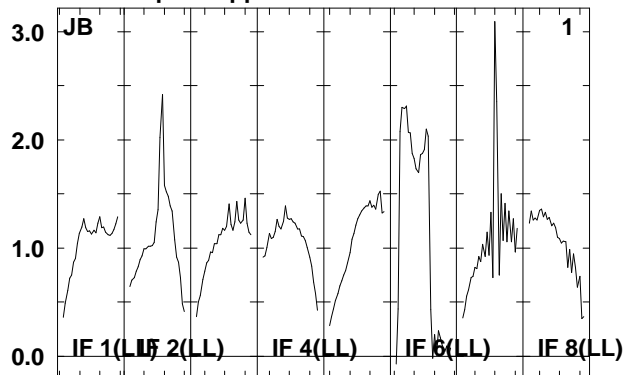
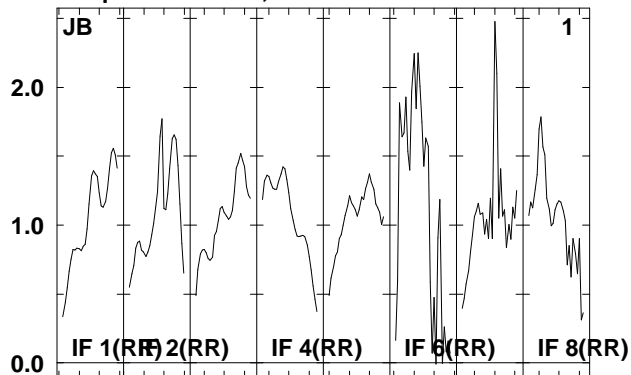

Lower frame: Real Jy
Total-power spectrum Antenna: *
Timerange: 00/10:55:02 to 00/10:56:30

Plot file version 144 created 18-APR-2008 18:28:33

J2333+39 EP061A.UVDATA.1

Freq = 1.5950 GHz, Bw = 16.000 MH No calibration applied and no bandpass applied

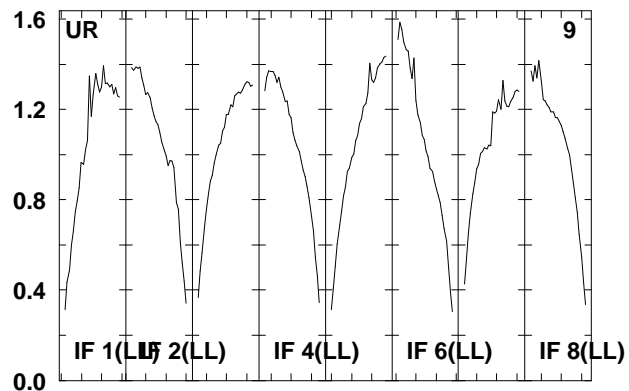
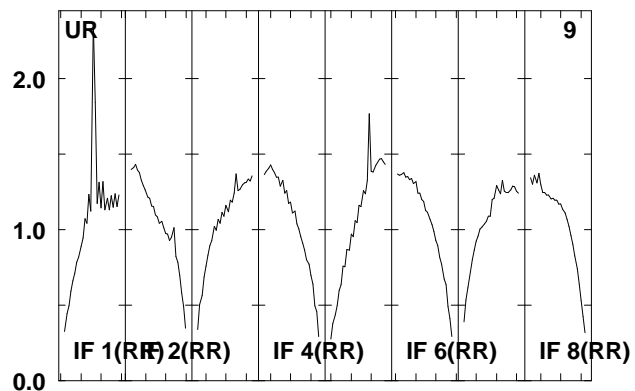
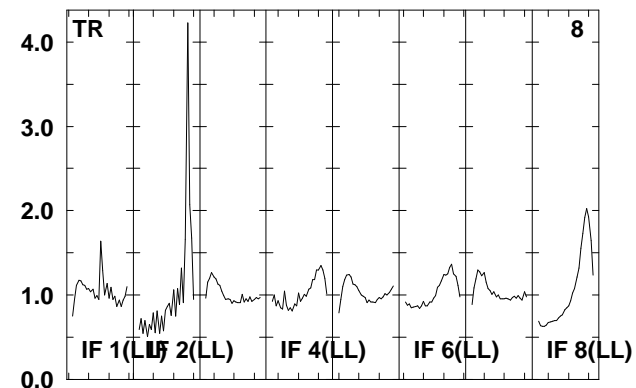
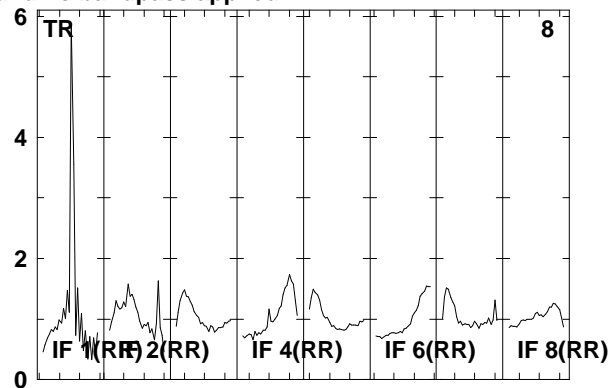
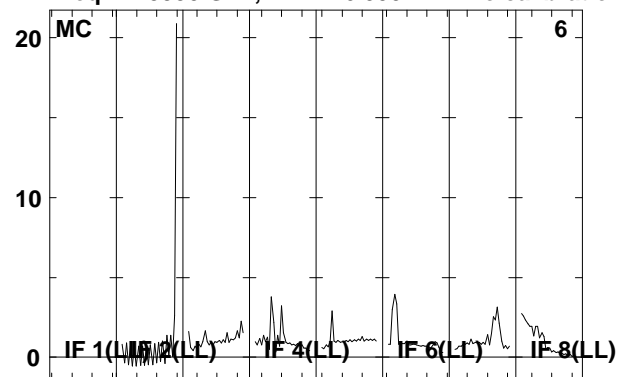

Lower frame: Real Jy
Total-power spectrum Antenna: *
Timerange: 00/10:55:02 to 00/10:56:30

Plot file version 145 created 18-APR-2008 18:28:34

IRAS2336 EP061A.UVDATA.1

Freq = 1.5950 GHz, Bw = 16.000 MH No calibration applied and no bandpass applied

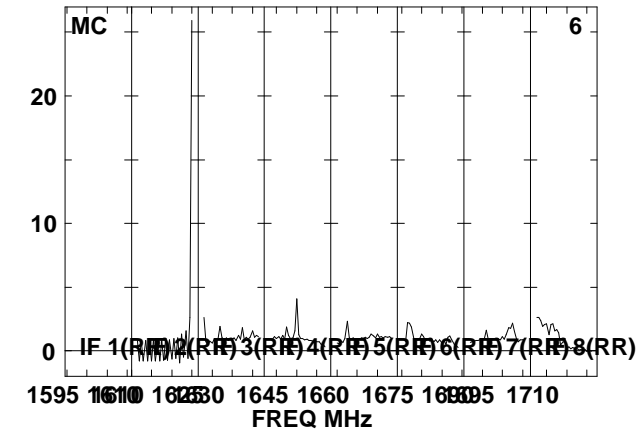
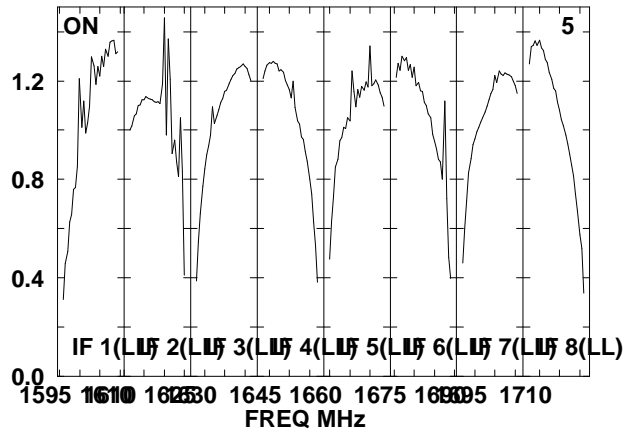
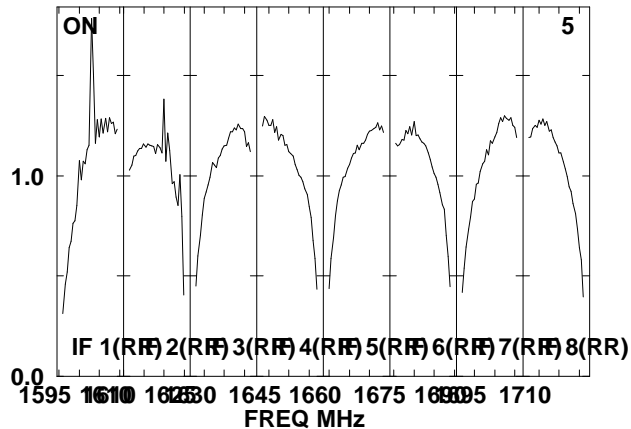
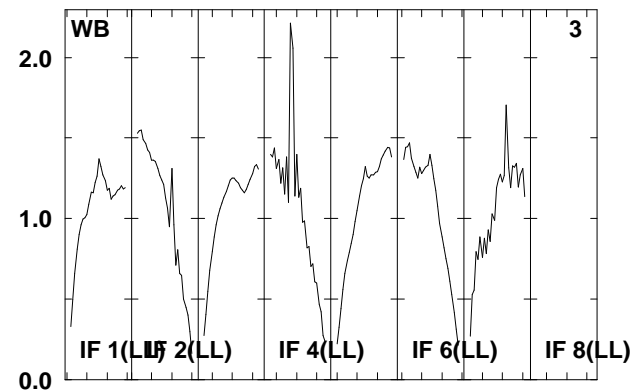
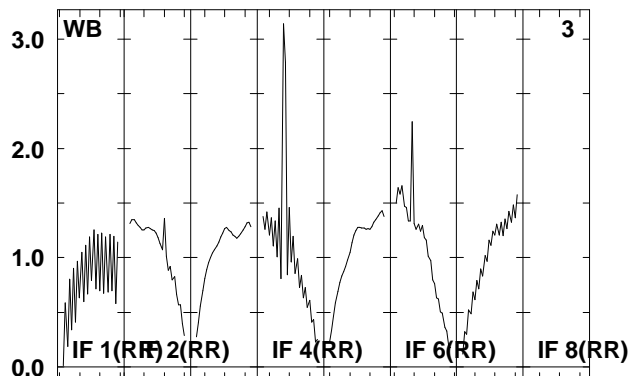
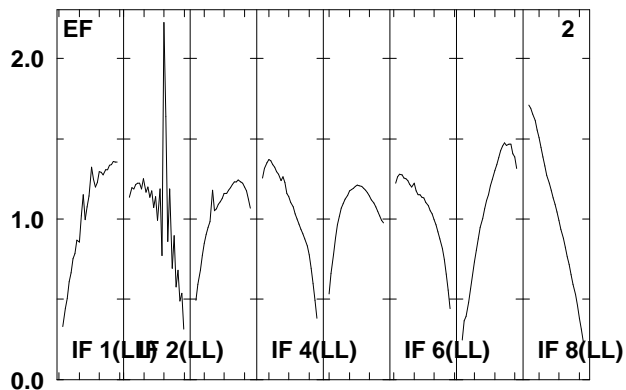
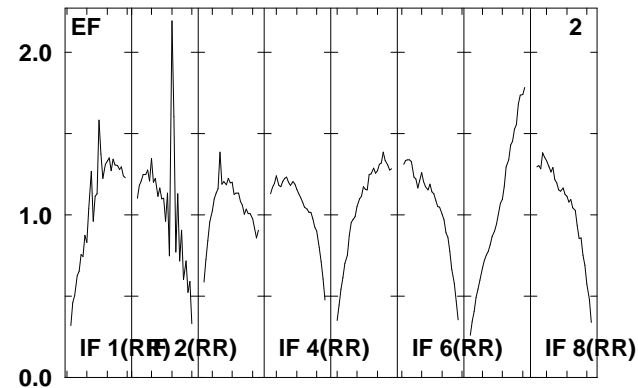
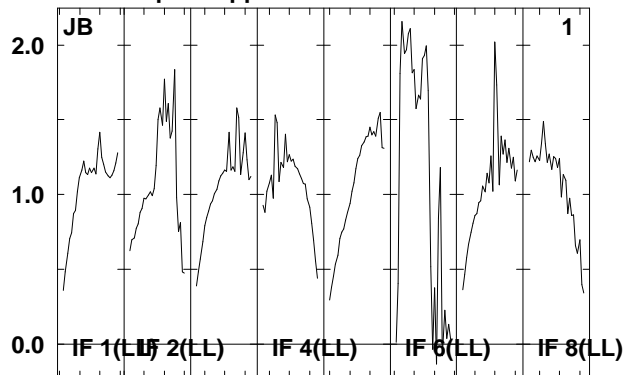
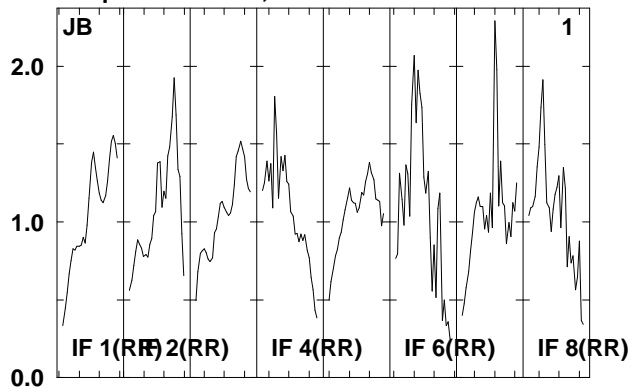

Lower frame: Real Jy

Total-power spectrum Antenna: *

Timerange: 00/10:56:32 to 00/10:59:56

Plot file version 146 created 18-APR-2008 18:28:35

IRAS2336 EP061A.UVDATA.1

Freq = 1.5950 GHz, Bw = 16.000 MH No calibration applied and no bandpass applied

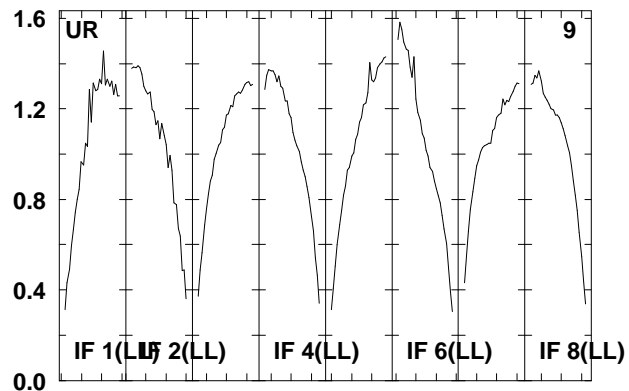
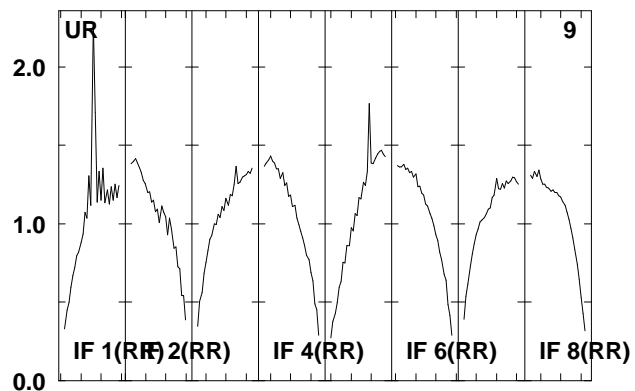
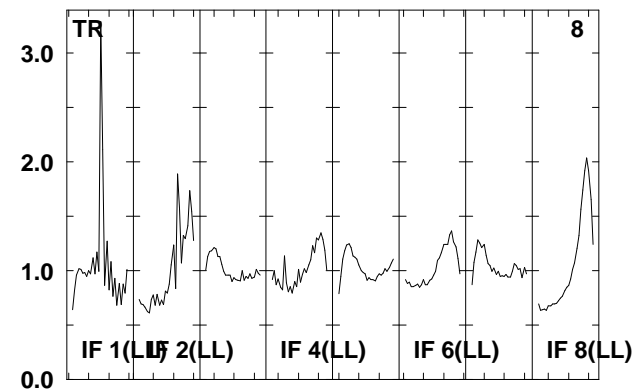
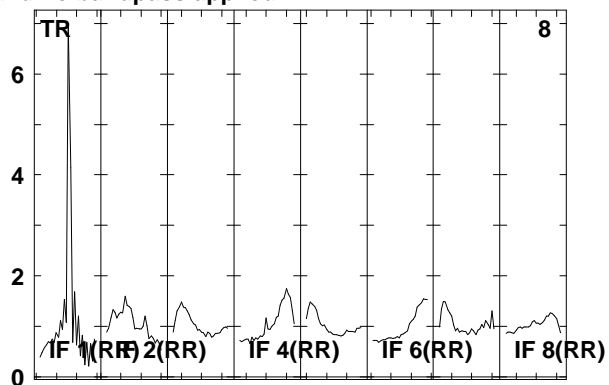
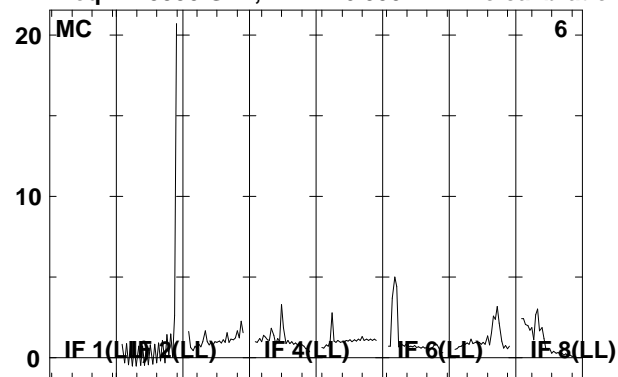

Lower frame: Real Jy
Total-power spectrum Antenna: *
Timerange: 00/10:56:32 to 00/10:59:56

Plot file version 147 created 18-APR-2008 18:28:38

J2333+39 EP061A.UVDATA.1

Freq = 1.5950 GHz, Bw = 16.000 MH No calibration applied and no bandpass applied

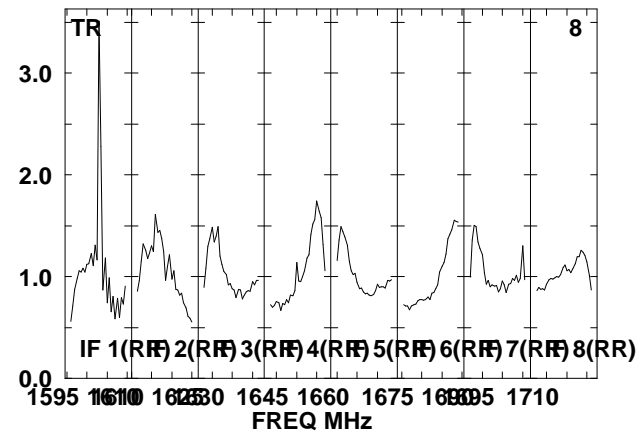
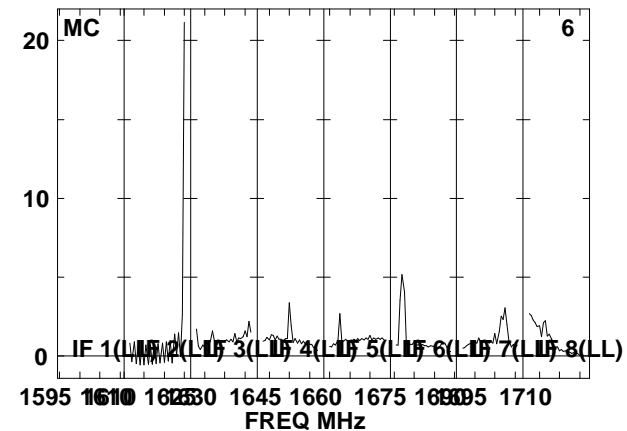
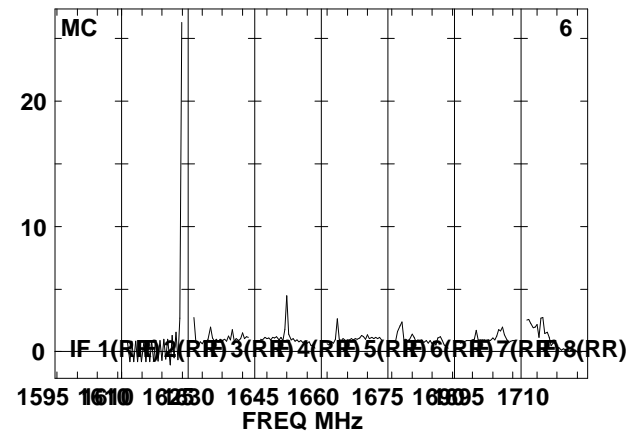
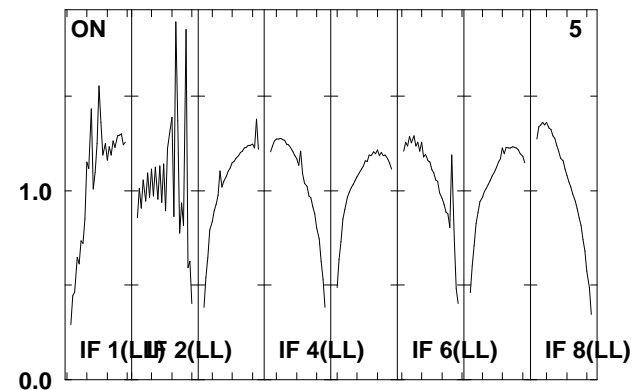
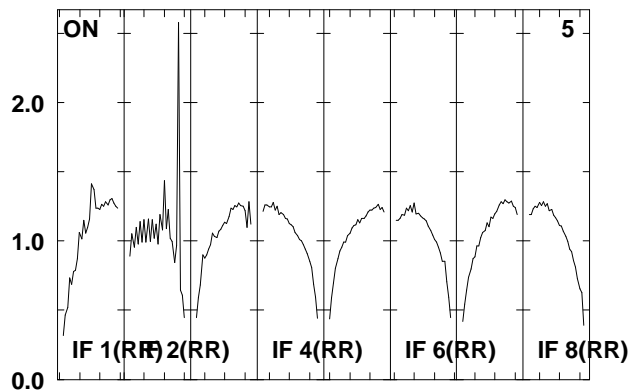
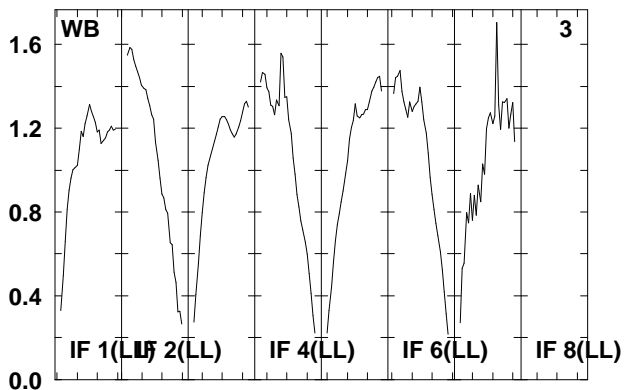
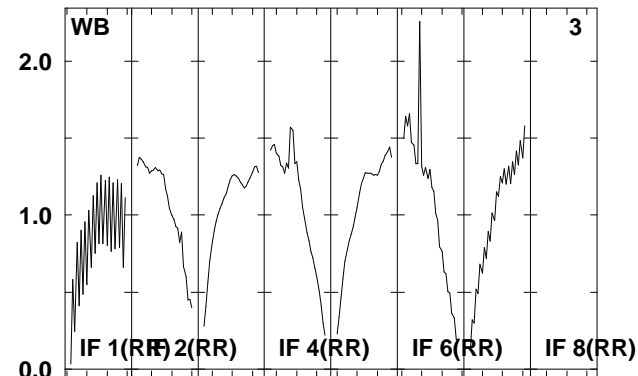
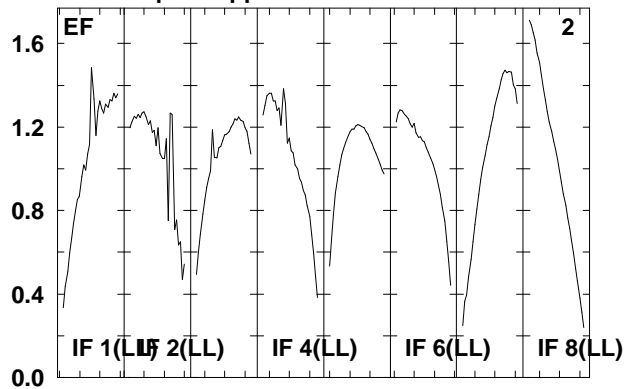
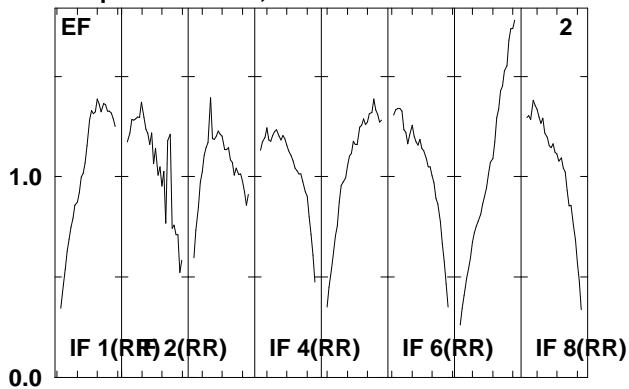

Lower frame: Real Jy

Total-power spectrum Antenna: *

Timerange: 00/11:00:10 to 00/11:01:26

Plot file version 148 created 18-APR-2008 18:28:38

J2333+39 EP061A.UVDATA.1

Freq = 1.5950 GHz, Bw = 16.000 MH No calibration applied and no bandpass applied

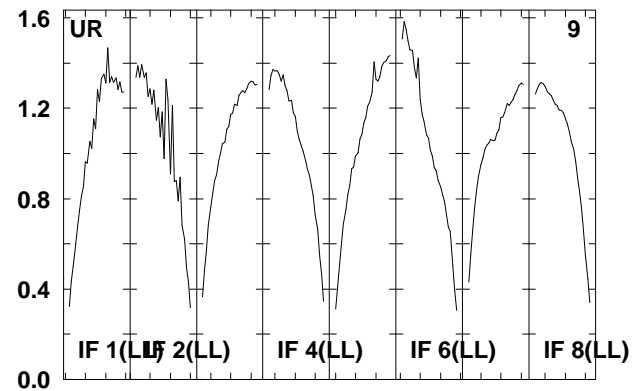
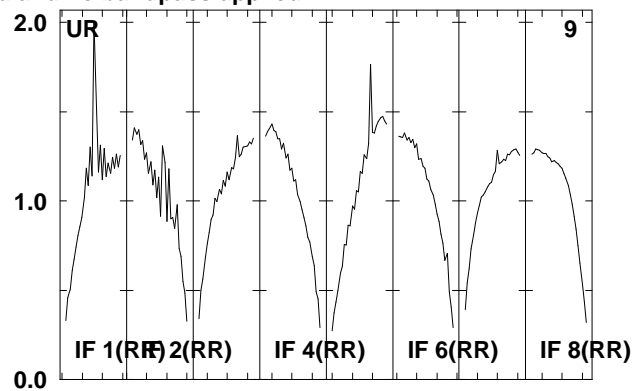
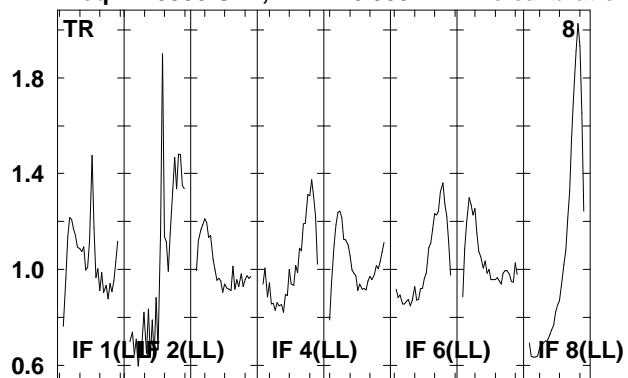

Lower frame: Real Jy
Total-power spectrum Antenna: *
Timerange: 00/11:00:10 to 00/11:01:26

Plot file version 149 created 18-APR-2008 18:28:39

IRAS2336 EP061A.UVDATA.1

Freq = 1.5950 GHz, Bw = 16.000 MH No calibration applied and no bandpass applied

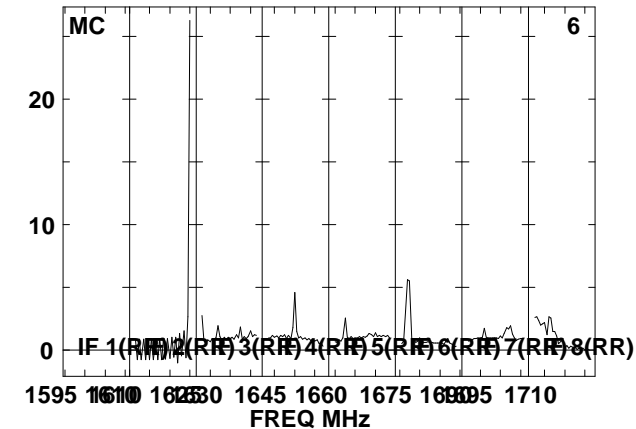
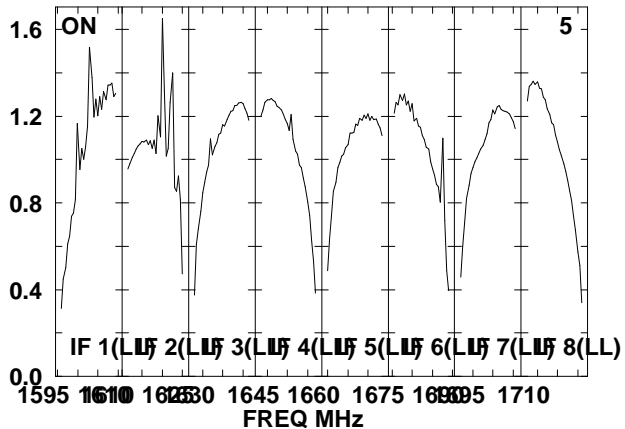
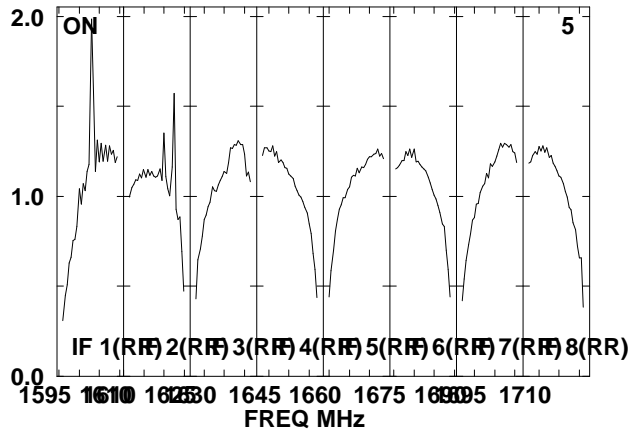
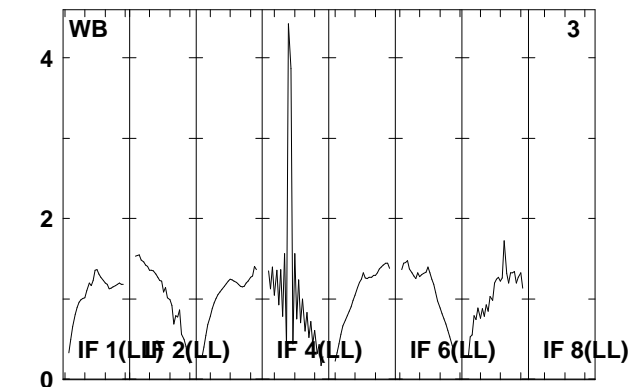
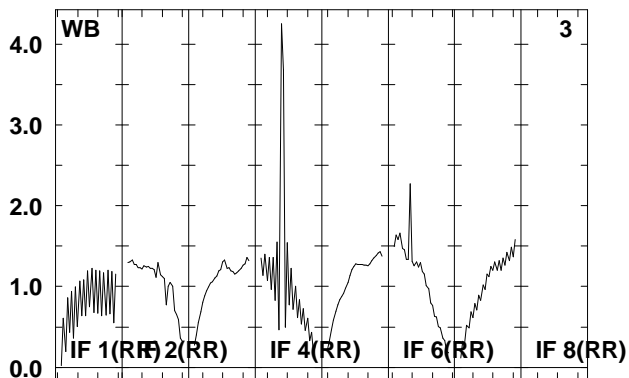
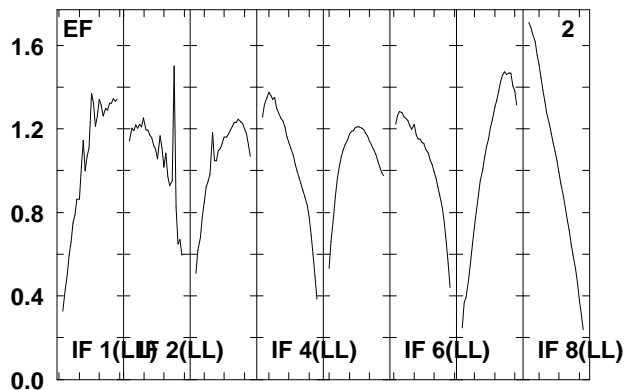
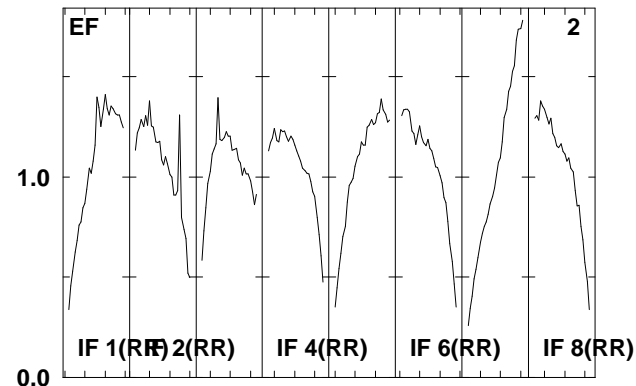
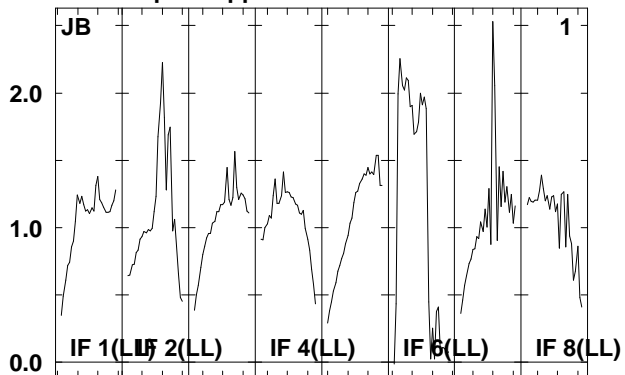
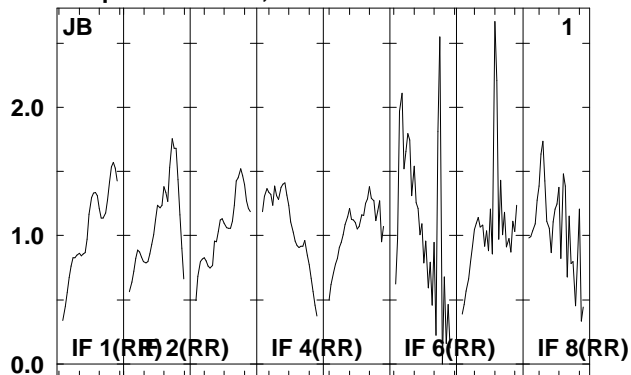

Lower frame: Real Jy
Total-power spectrum Antenna: *
Timerange: 00/11:01:32 to 00/11:04:58

Plot file version 150 created 18-APR-2008 18:28:40

IRAS2336 EP061A.UVDATA.1

Freq = 1.5950 GHz, Bw = 16.000 MH No calibration applied and no bandpass applied

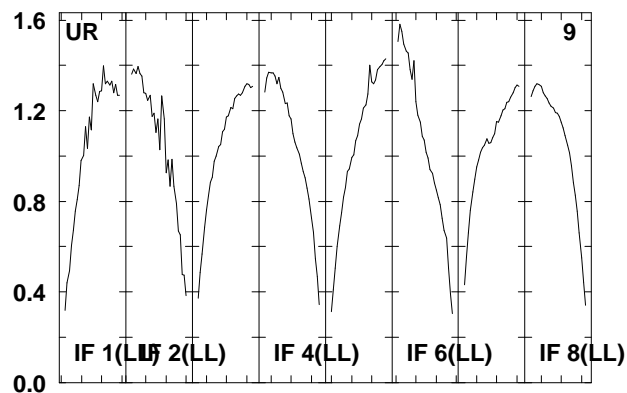
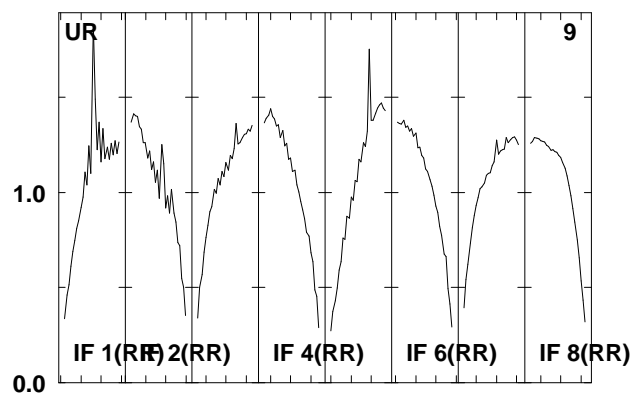
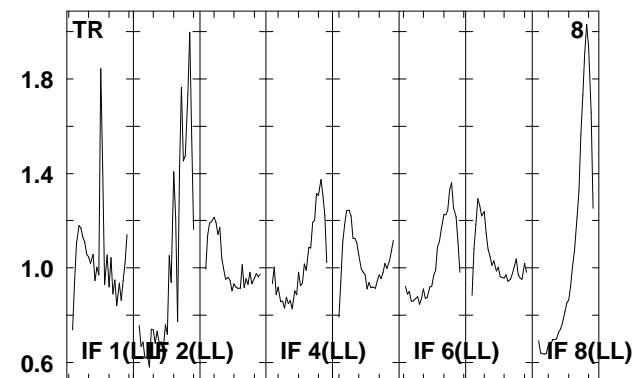
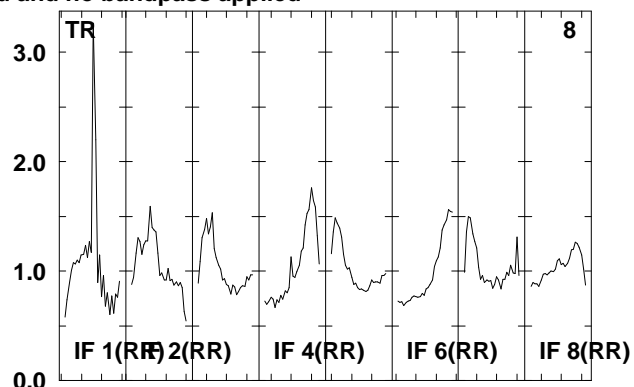
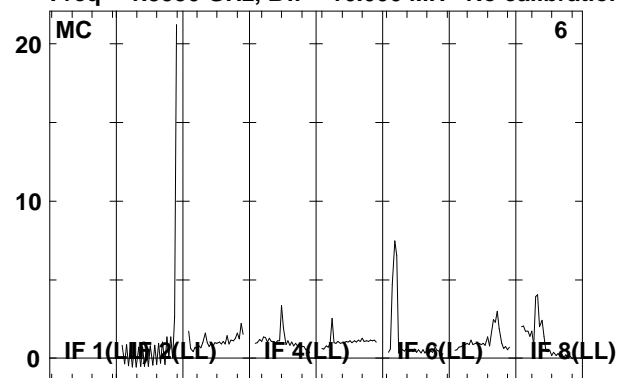

Lower frame: Real Jy
Total-power spectrum Antenna: *
Timerange: 00/11:01:32 to 00/11:04:58

Plot file version 151 created 18-APR-2008 18:28:41

J2333+39 EP061A.UVDATA.1

Freq = 1.5950 GHz, Bw = 16.000 MH No calibration applied and no bandpass applied

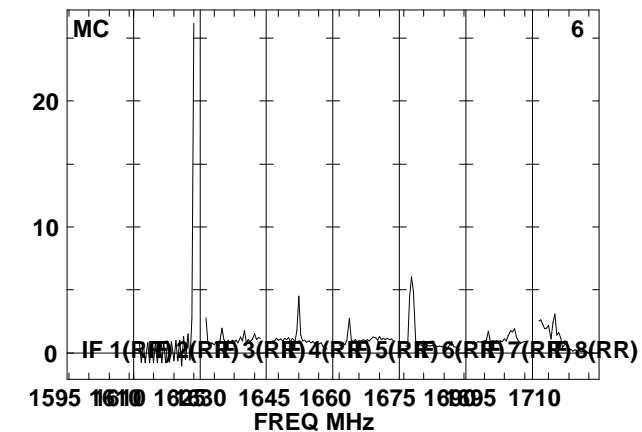
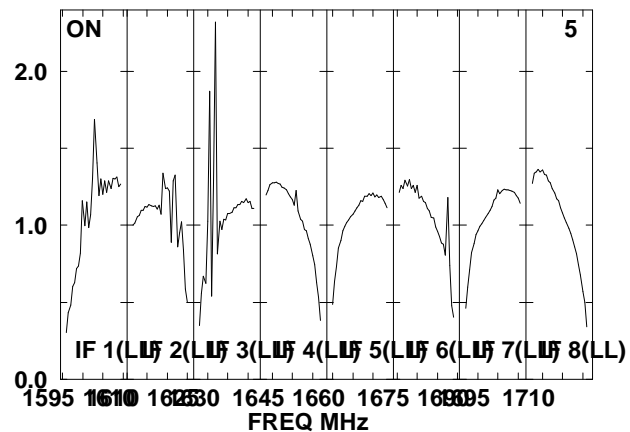
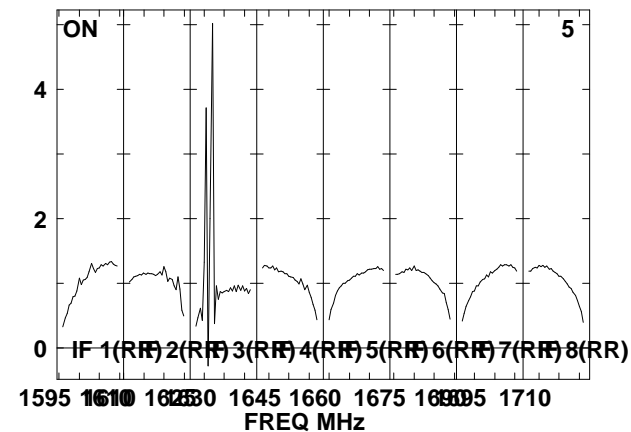
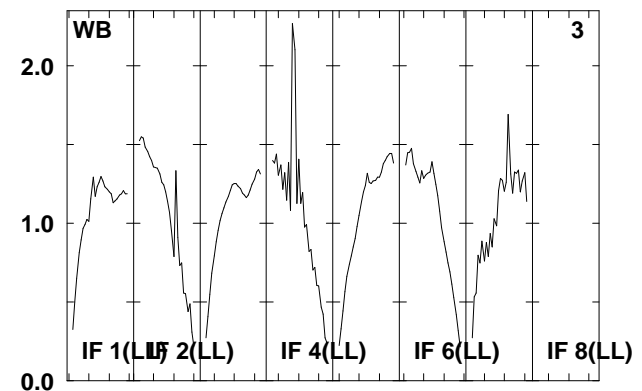
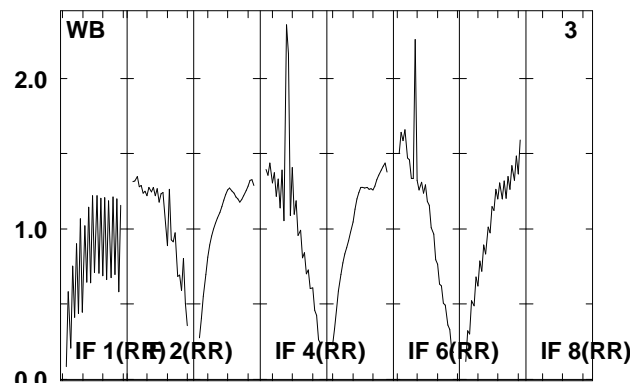
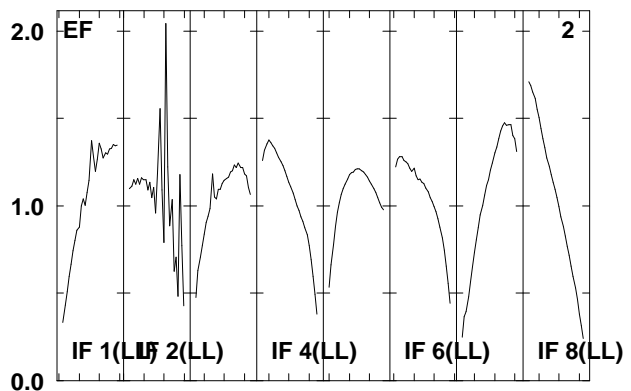
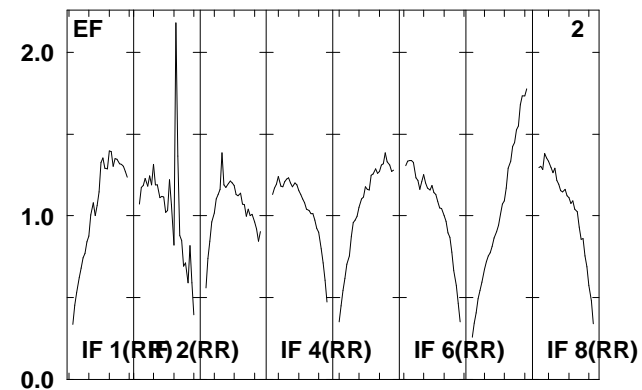
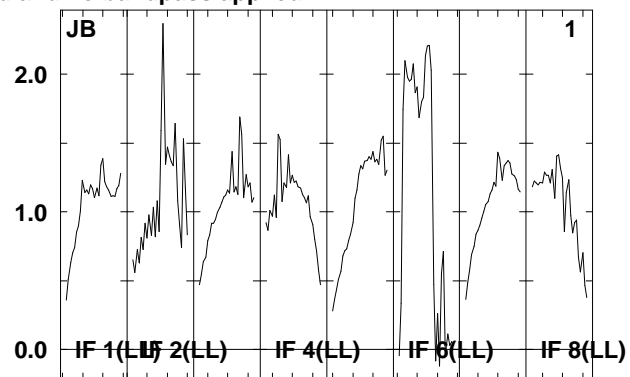
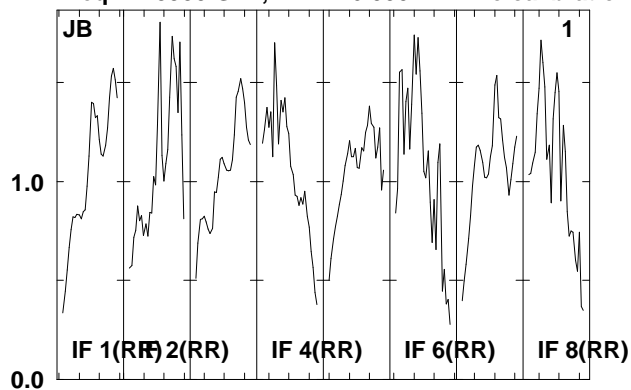

1595 1610 1625 1645 1660 1675 1695 1710
FREQ MHz

Lower frame: Real Jy
Total-power spectrum Antenna: *
Timerange: 00/11:06:02 to 00/11:07:30

Plot file version 152 created 18-APR-2008 18:28:41

J2333+39 EP061A.UVDATA.1

Freq = 1.5950 GHz, Bw = 16.000 MH No calibration applied and no bandpass applied

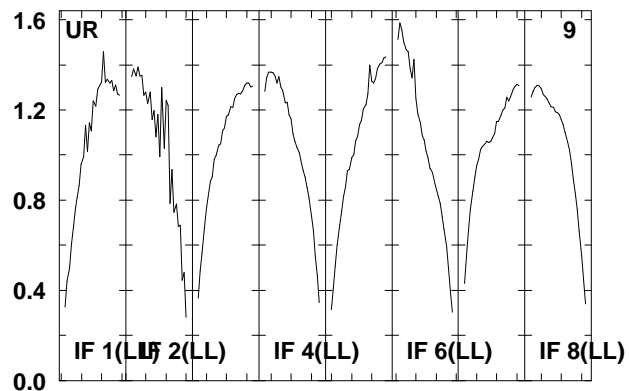
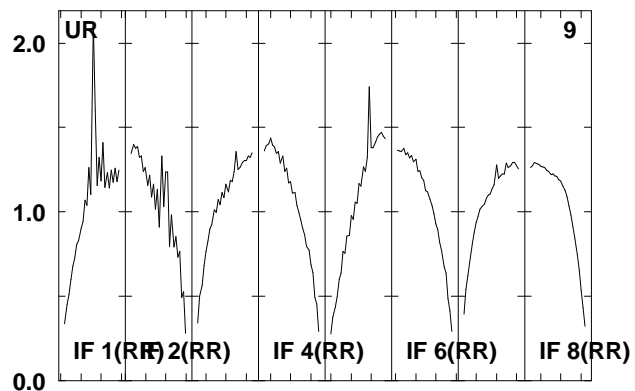
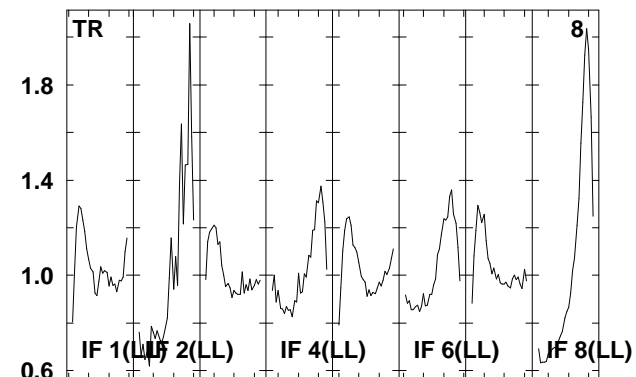
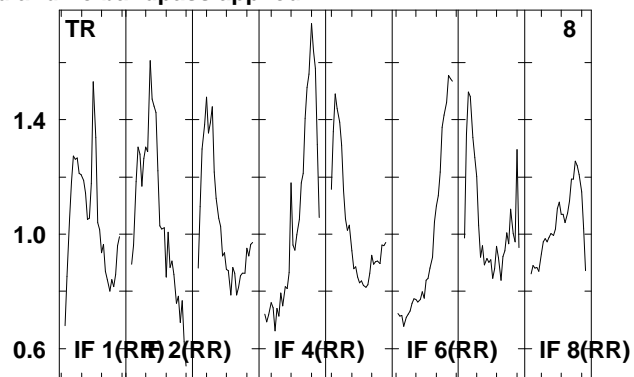
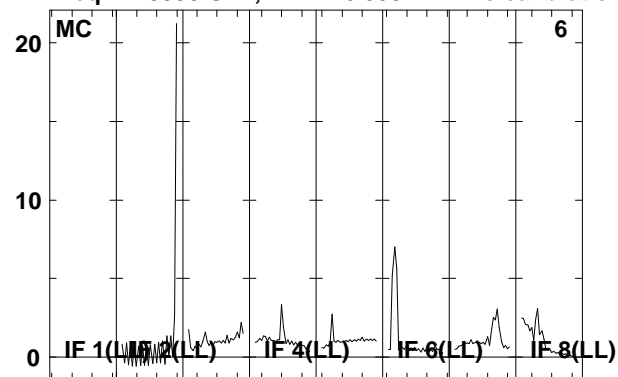

Lower frame: Real Jy
Total-power spectrum Antenna: *
Timerange: 00/11:06:02 to 00/11:07:30

Plot file version 153 created 18-APR-2008 18:28:42

IRAS2336 EP061A.UVDATA.1

Freq = 1.5950 GHz, Bw = 16.000 MH No calibration applied and no bandpass applied

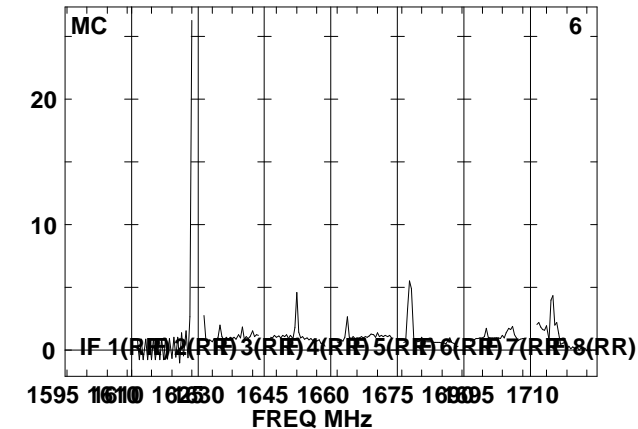
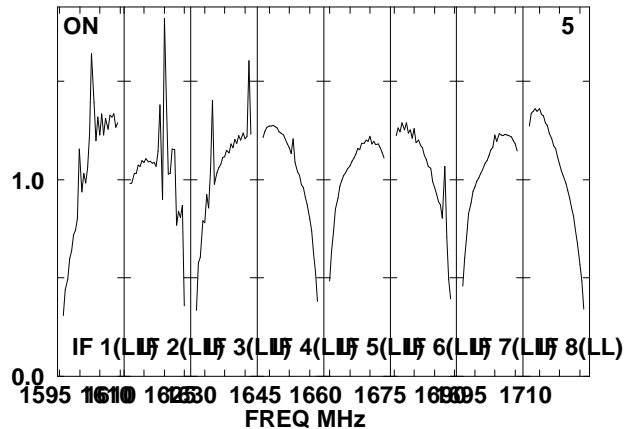
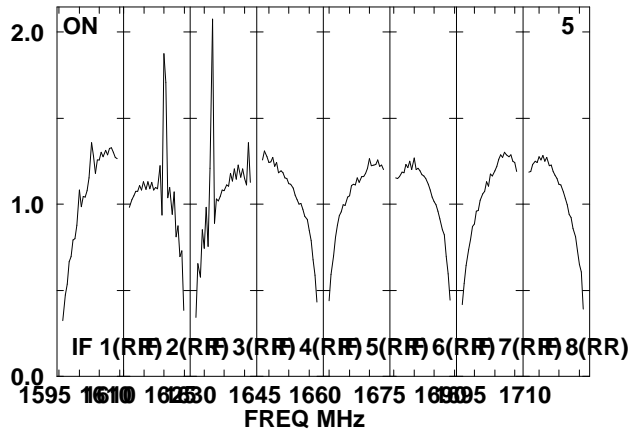
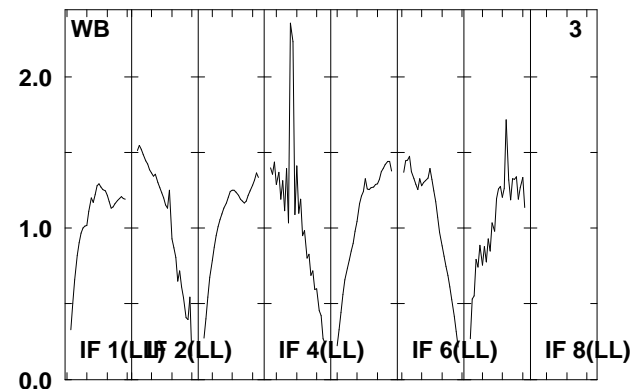
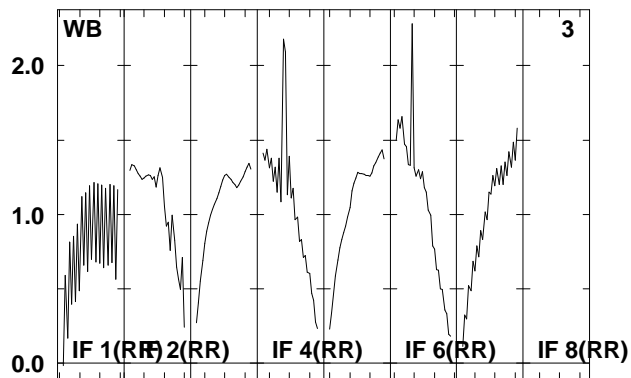
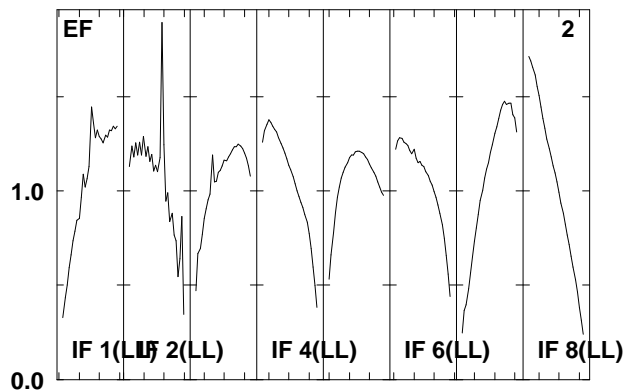
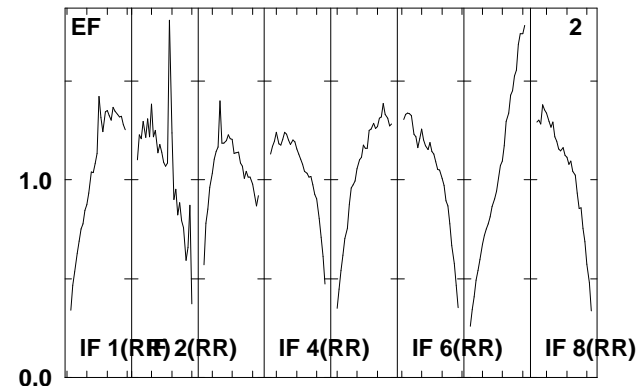
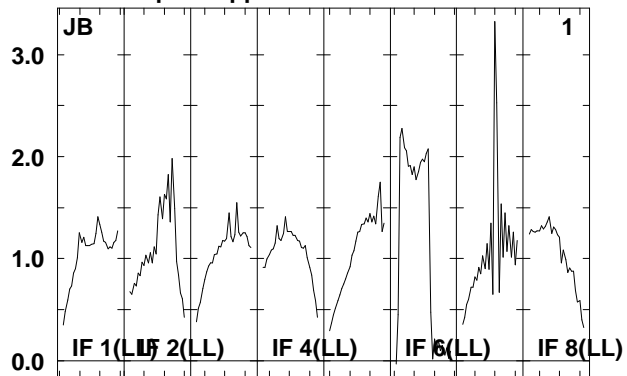
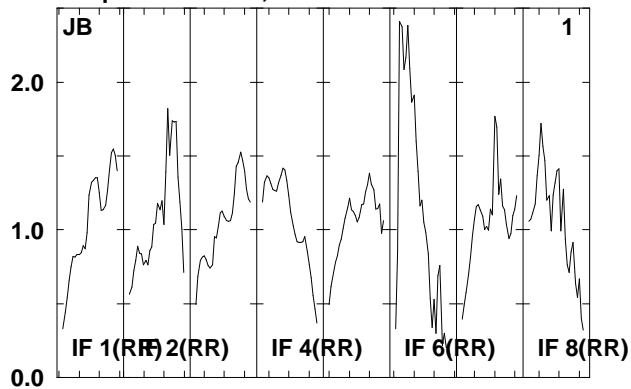

Lower frame: Real Jy
Total-power spectrum Antenna: *
Timerange: 00/11:07:32 to 00/11:11:00

Plot file version 154 created 18-APR-2008 18:28:43

IRAS2336 EP061A.UVDATA.1

Freq = 1.5950 GHz, Bw = 16.000 MH No calibration applied and no bandpass applied

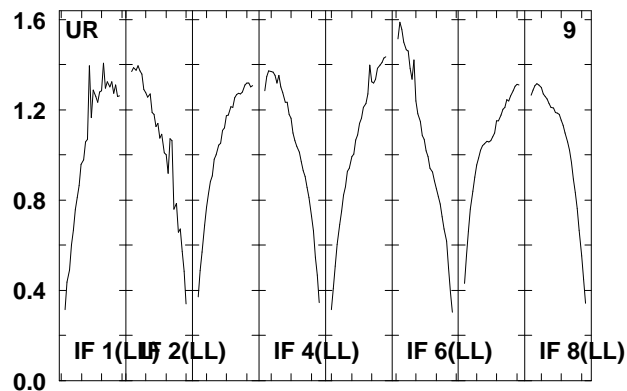
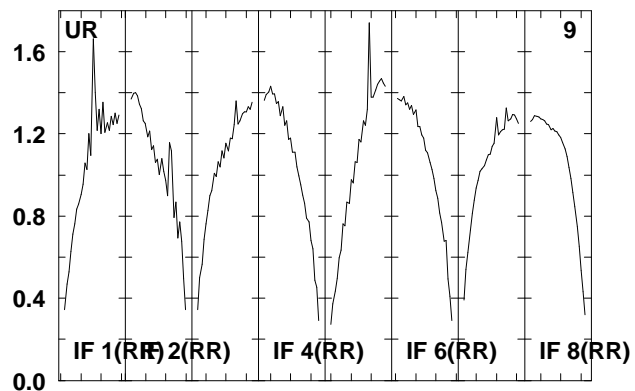
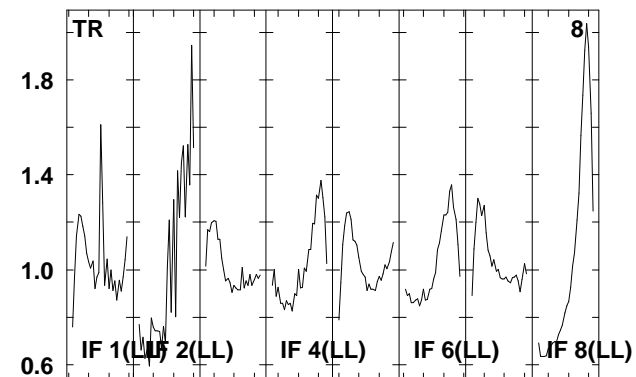
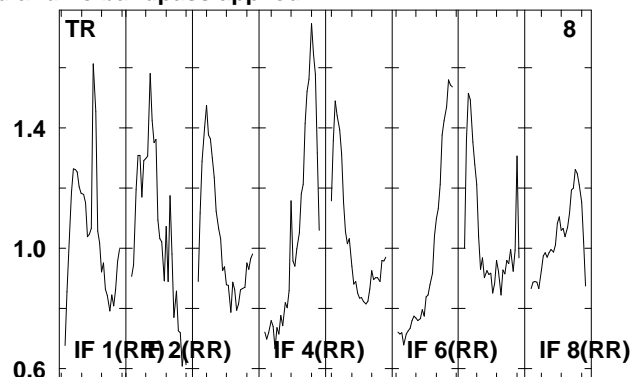
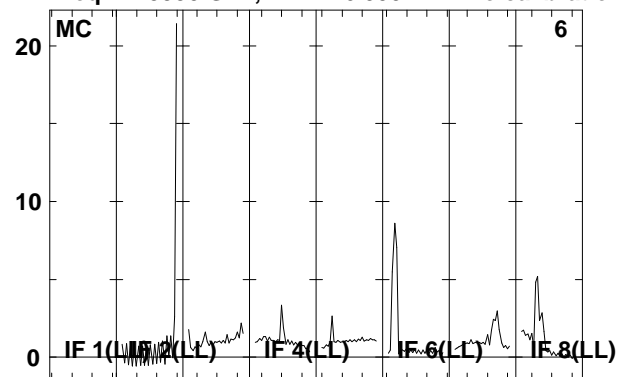

Lower frame: Real Jy
Total-power spectrum Antenna: *
Timerange: 00/11:07:32 to 00/11:11:00

Plot file version 155 created 18-APR-2008 18:28:44

J2333+39 EP061A.UVDATA.1

Freq = 1.5950 GHz, Bw = 16.000 MH No calibration applied and no bandpass applied

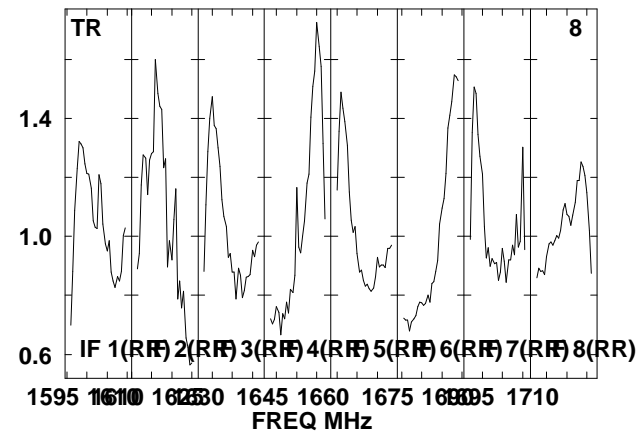
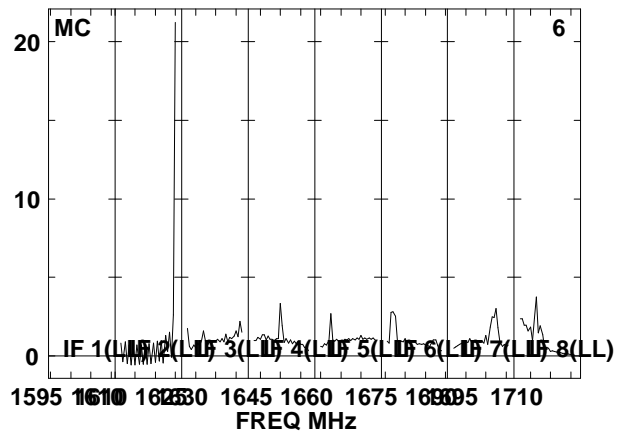
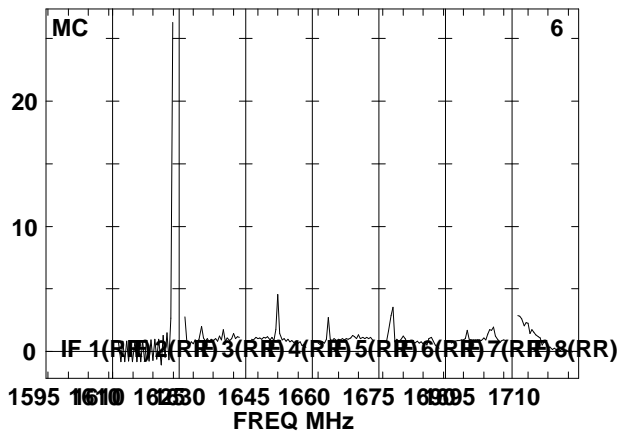
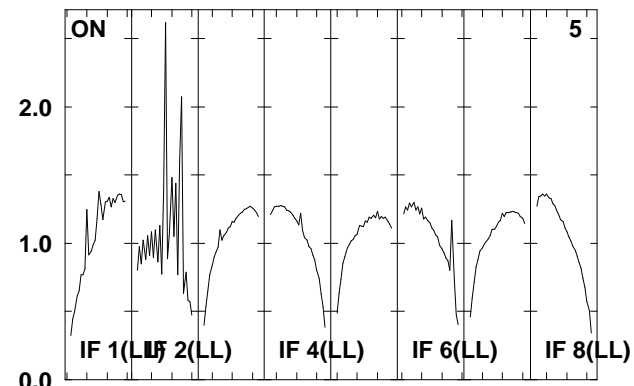
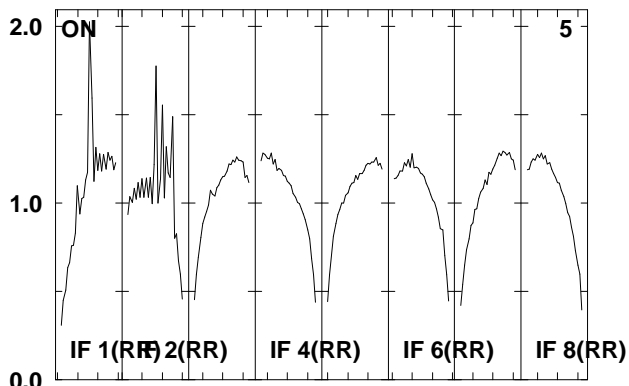
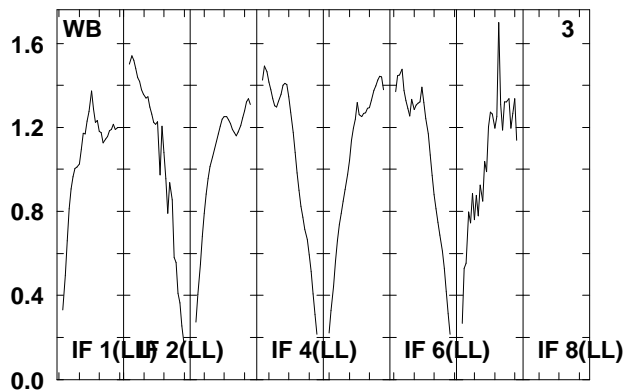
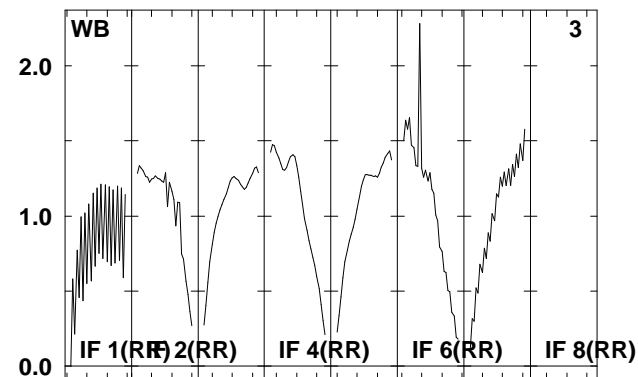
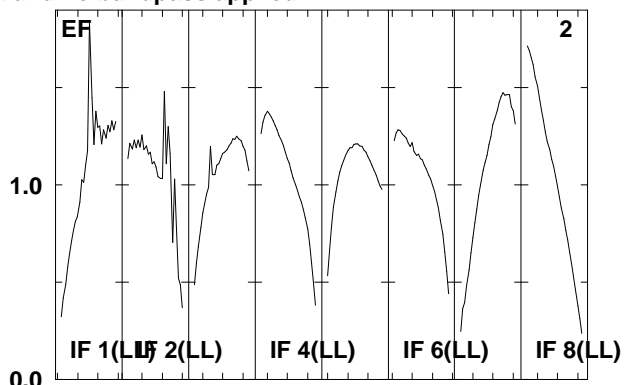
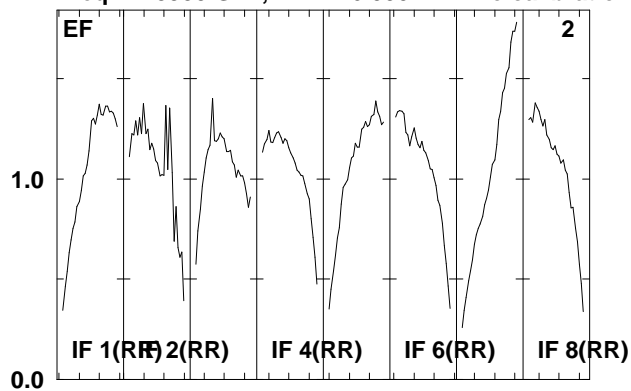

Lower frame: Real Jy
Total-power spectrum Antenna: *
Timerange: 00/11:11:02 to 00/11:12:28

Plot file version 156 created 18-APR-2008 18:28:45

J2333+39 EP061A.UVDATA.1

Freq = 1.5950 GHz, Bw = 16.000 MH No calibration applied and no bandpass applied

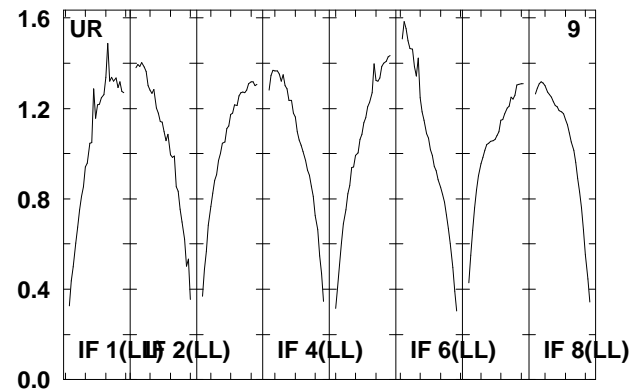
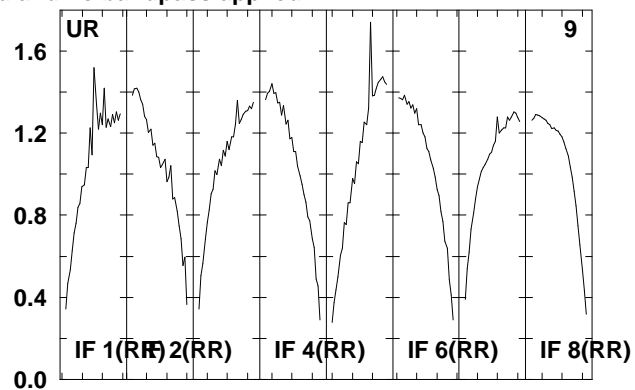
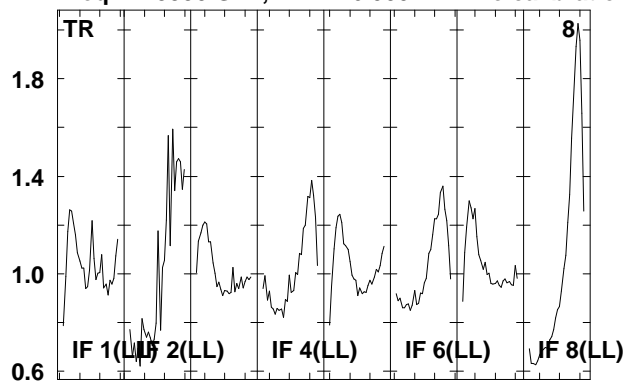

Lower frame: Real Jy
Total-power spectrum Antenna: *
Timerange: 00/11:11:02 to 00/11:12:28

Plot file version 157 created 18-APR-2008 18:28:45

IRAS2336 EP061A.UVDATA.1

Freq = 1.5950 GHz, Bw = 16.000 MH No calibration applied and no bandpass applied

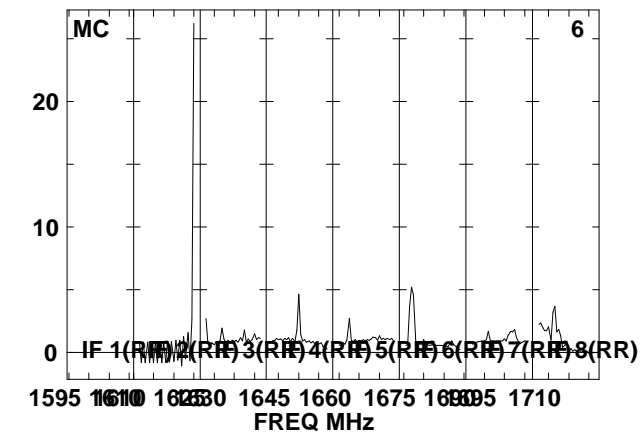
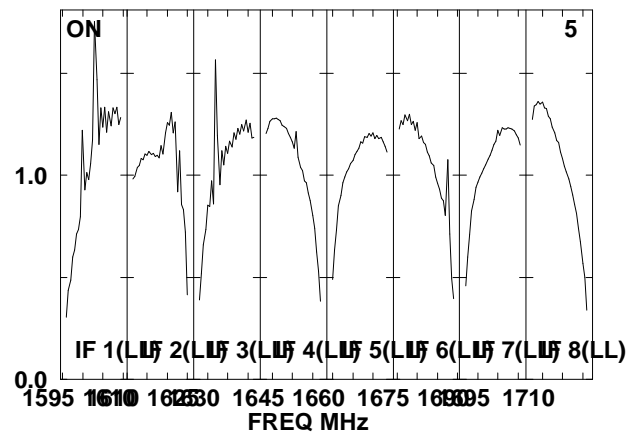
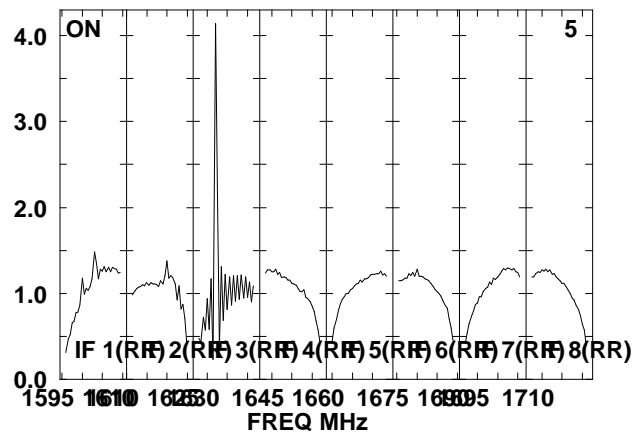
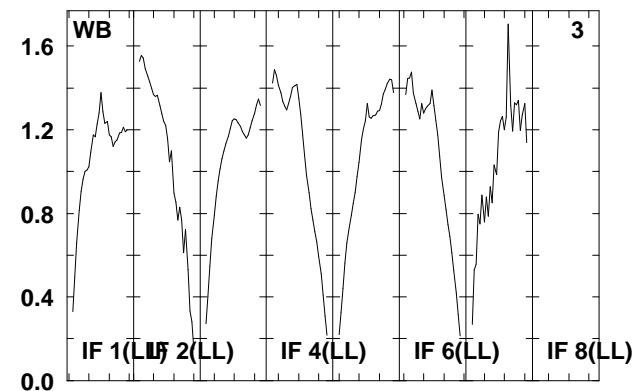
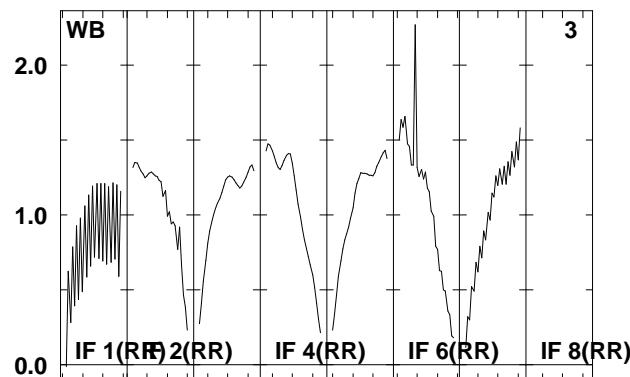
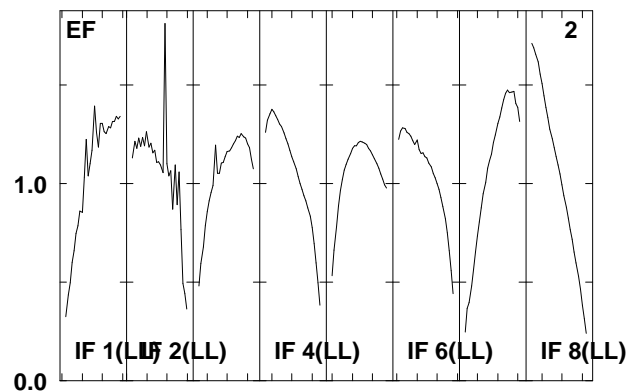
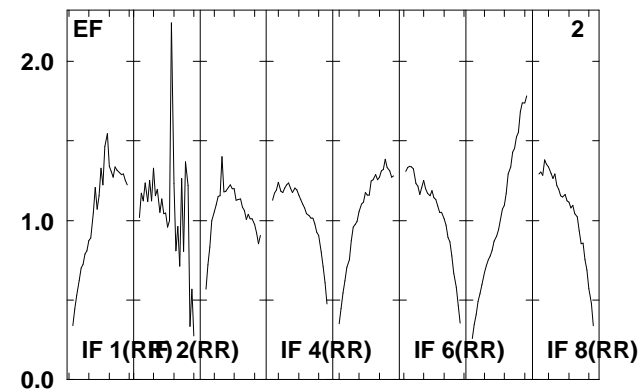
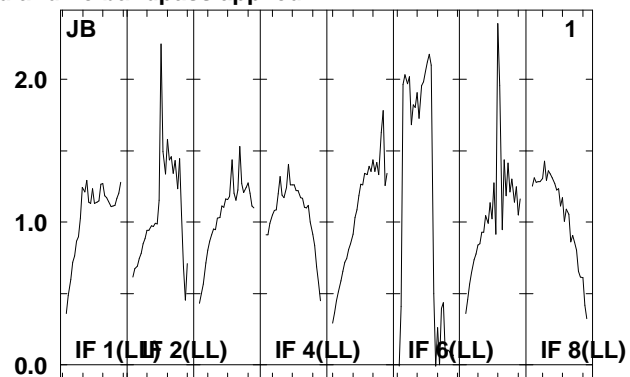
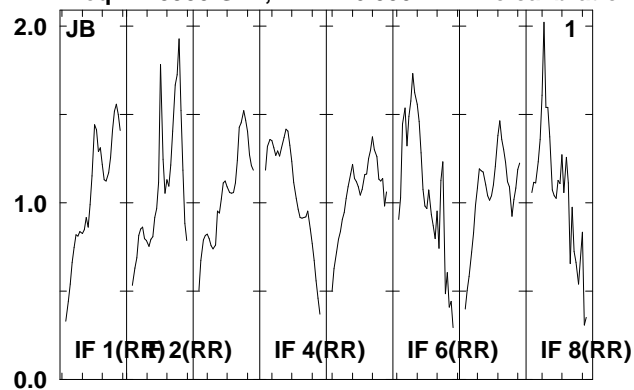

Lower frame: Real Jy
Total-power spectrum Antenna: *
Timerange: 00/11:12:30 to 00/11:16:00

Plot file version 158 created 18-APR-2008 18:28:46

IRAS2336 EP061A.UVDATA.1

Freq = 1.5950 GHz, Bw = 16.000 MH No calibration applied and no bandpass applied

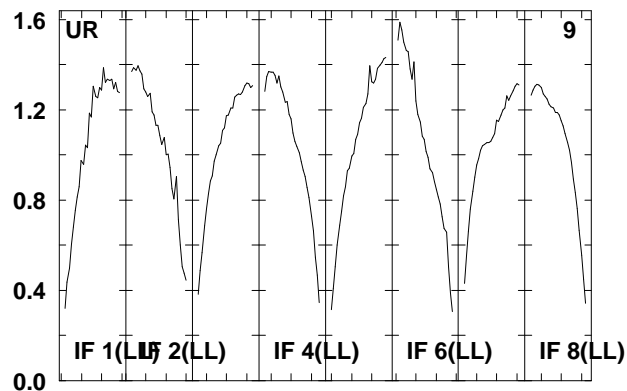
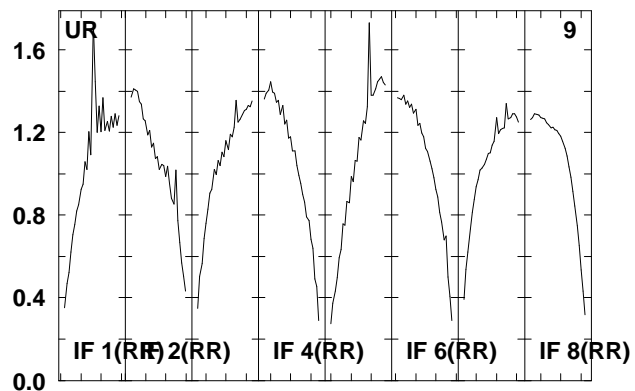
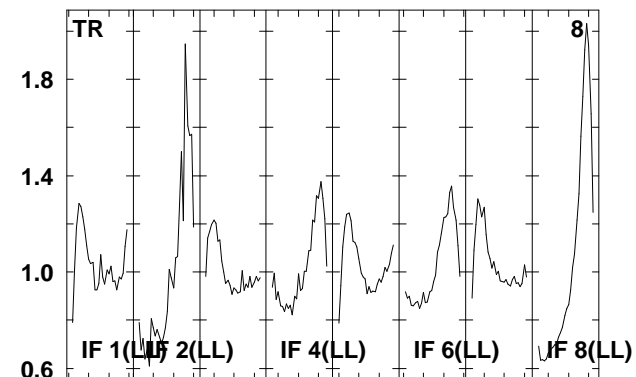
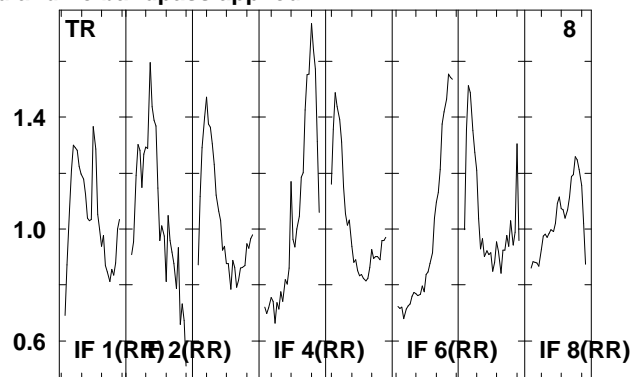
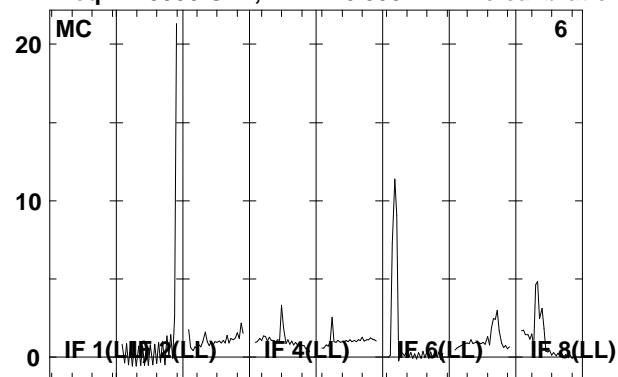

Lower frame: Real Jy
Total-power spectrum Antenna: *
Timerange: 00/11:12:30 to 00/11:16:00

Plot file version 159 created 18-APR-2008 18:28:47

J2333+39 EP061A.UVDATA.1

Freq = 1.5950 GHz, Bw = 16.000 MH No calibration applied and no bandpass applied

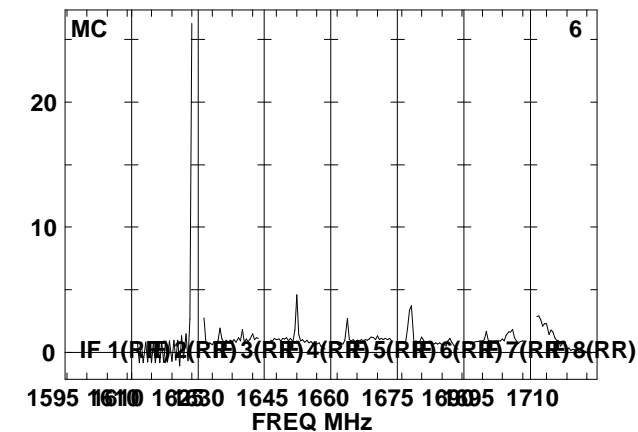
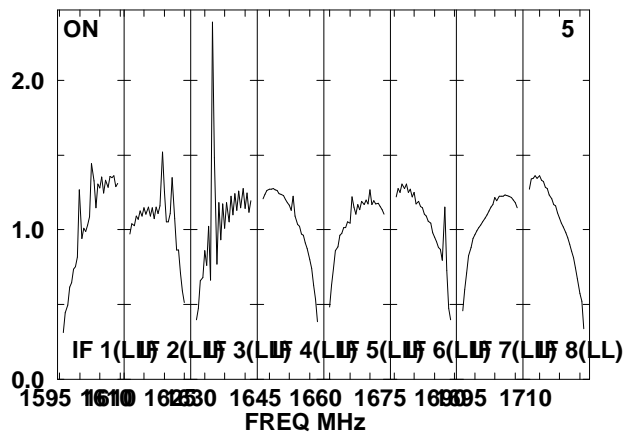
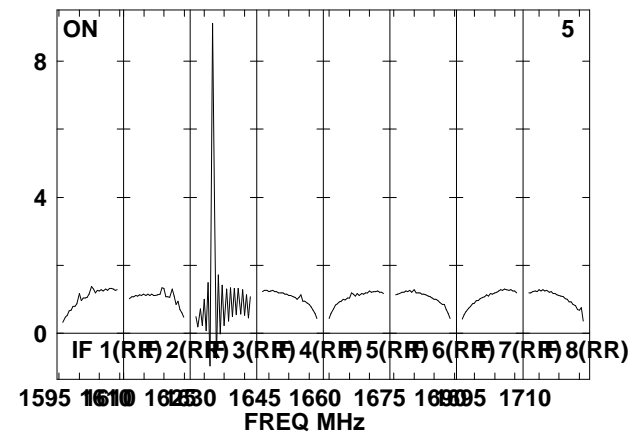
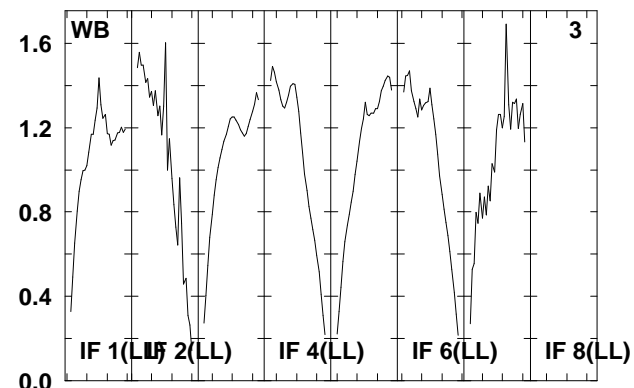
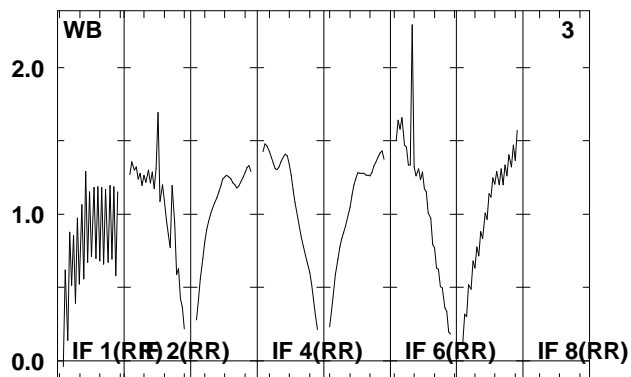
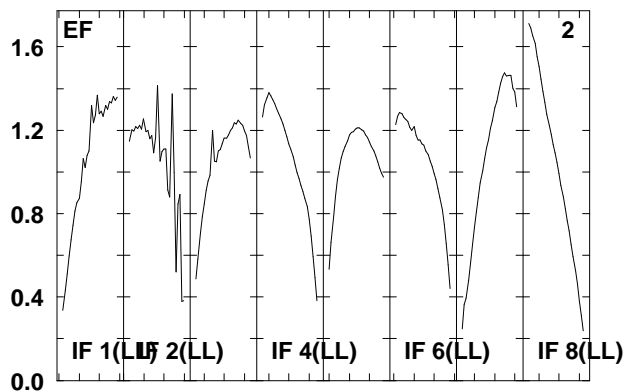
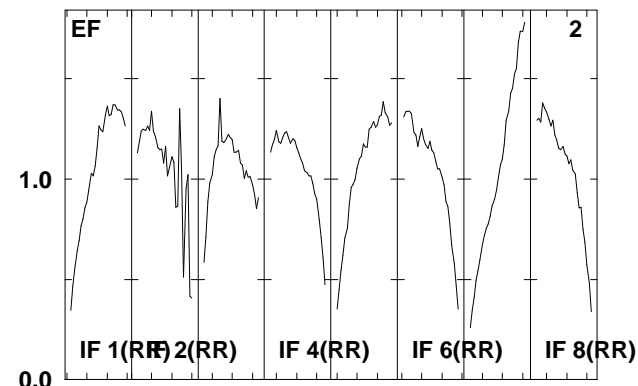
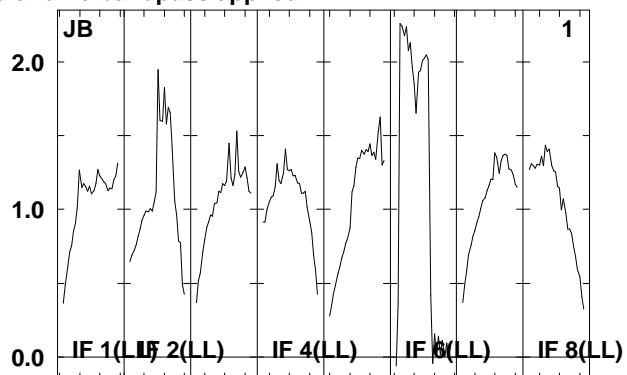
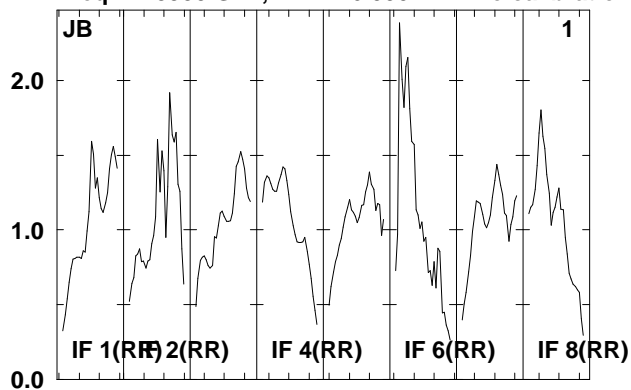

Lower frame: Real Jy
Total-power spectrum Antenna: *
Timerange: 00/11:16:02 to 00/11:17:30

Plot file version 160 created 18-APR-2008 18:28:48

J2333+39 EP061A.UVDATA.1

Freq = 1.5950 GHz, Bw = 16.000 MH No calibration applied and no bandpass applied

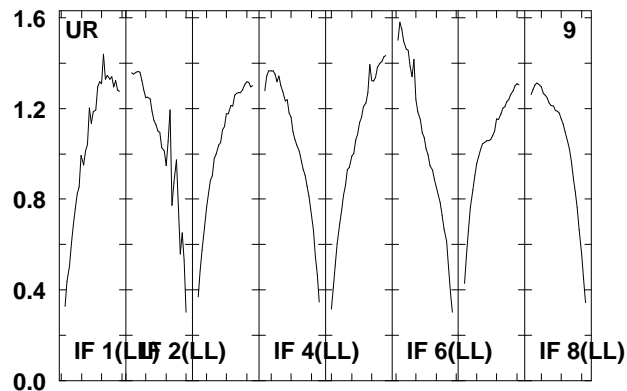
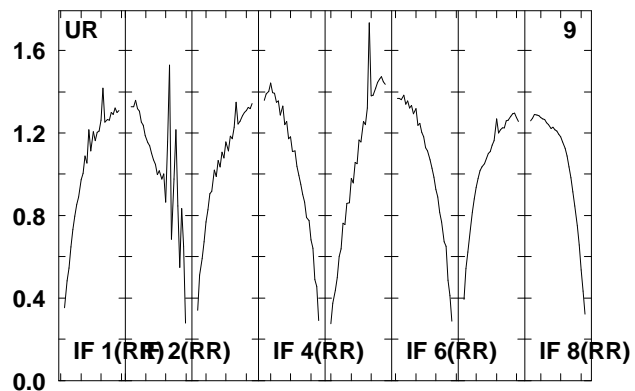
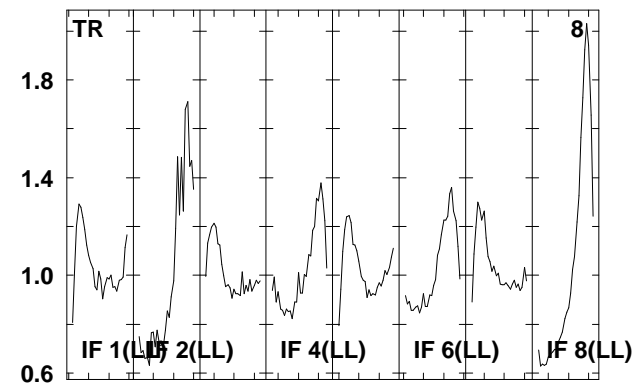
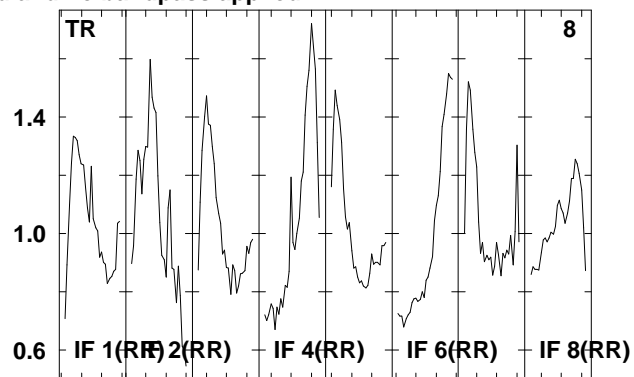
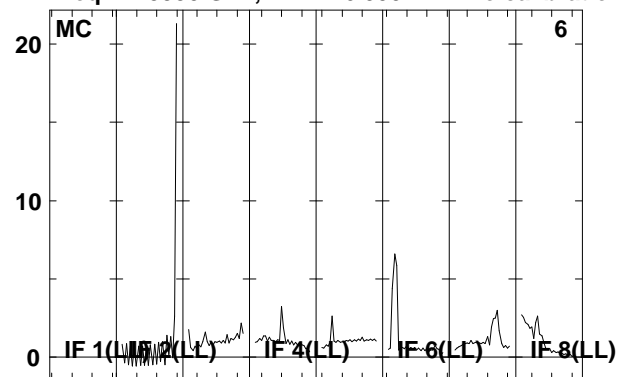

Lower frame: Real Jy
Total-power spectrum Antenna: *
Timerange: 00/11:16:02 to 00/11:17:30

Plot file version 161 created 18-APR-2008 18:28:49

IRAS2336 EP061A.UVDATA.1

Freq = 1.5950 GHz, Bw = 16.000 MH No calibration applied and no bandpass applied

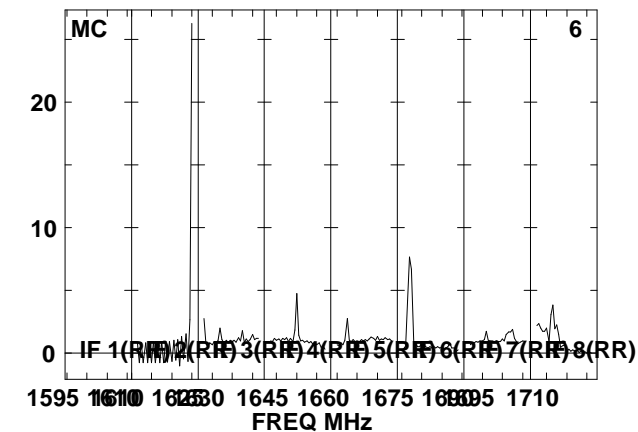
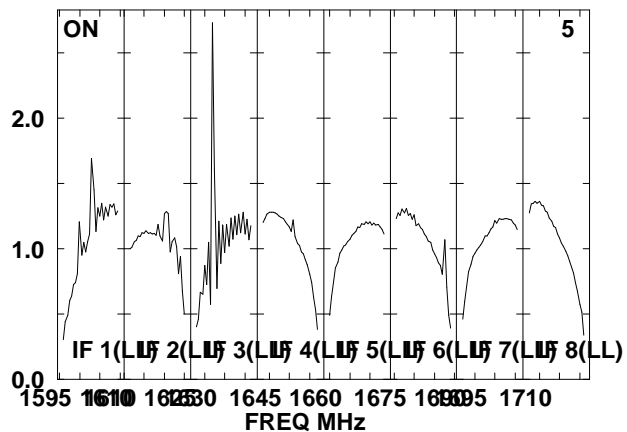
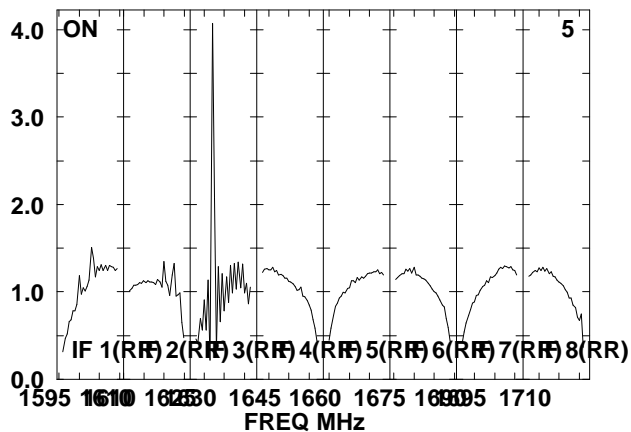
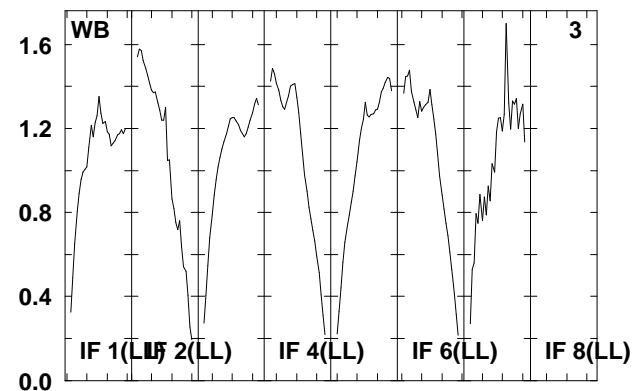
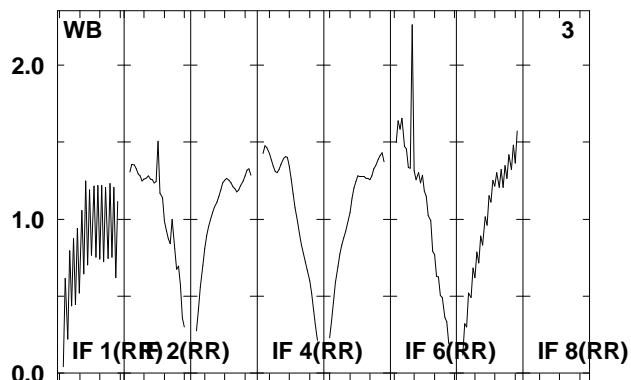
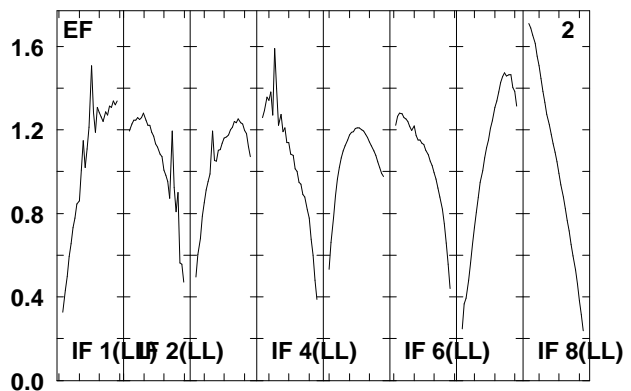
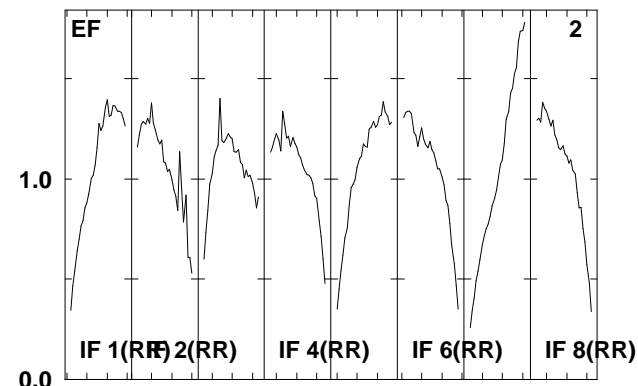
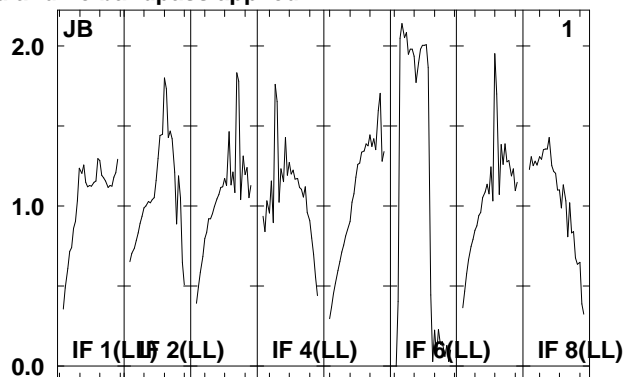
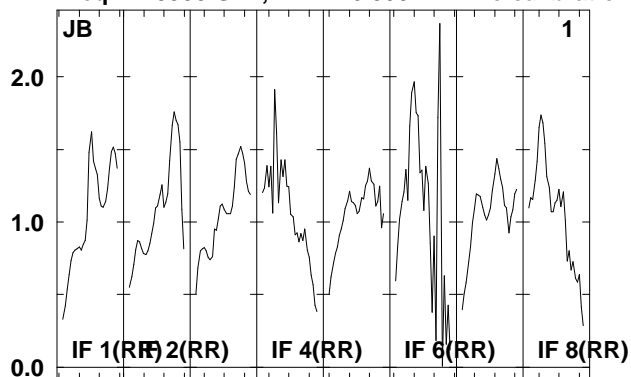

Lower frame: Real Jy
Total-power spectrum Antenna: *
Timerange: 00/11:17:32 to 00/11:20:58

Plot file version 162 created 18-APR-2008 18:28:50

IRAS2336 EP061A.UVDATA.1

Freq = 1.5950 GHz, Bw = 16.000 MH No calibration applied and no bandpass applied

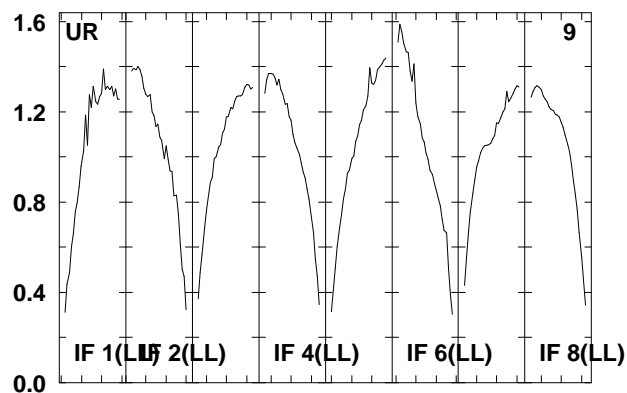
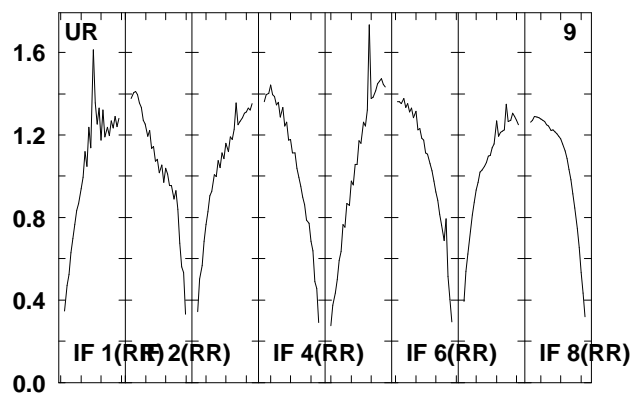
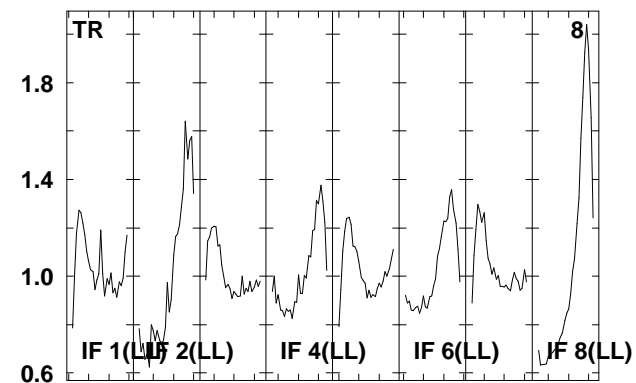
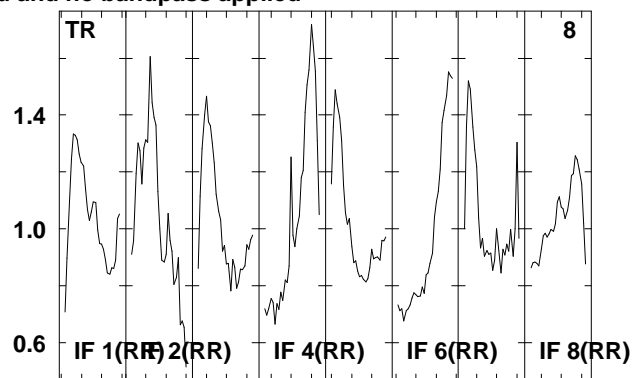
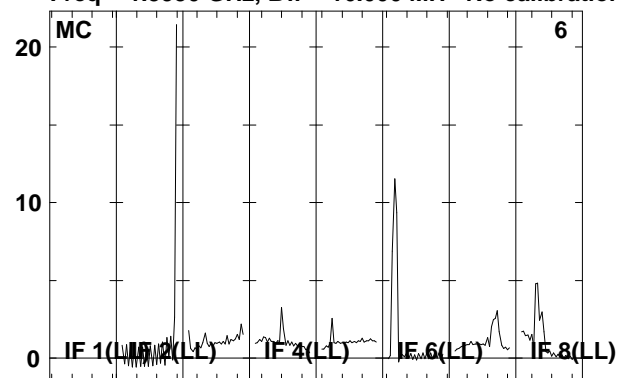

Lower frame: Real Jy
Total-power spectrum Antenna: *
Timerange: 00/11:17:32 to 00/11:20:58

Plot file version 163 created 18-APR-2008 18:28:51

J2333+39 EP061A.UVDATA.1

Freq = 1.5950 GHz, Bw = 16.000 MH No calibration applied and no bandpass applied

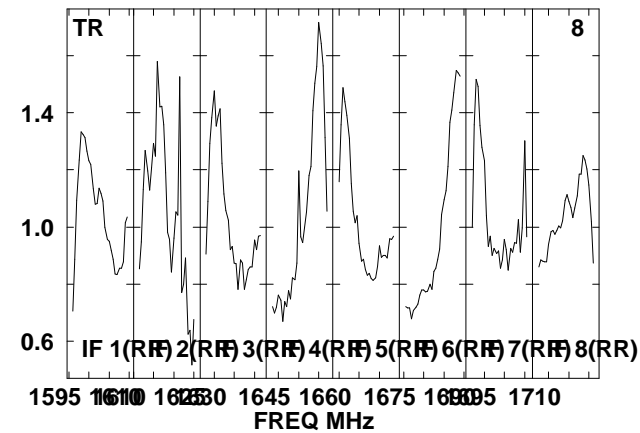
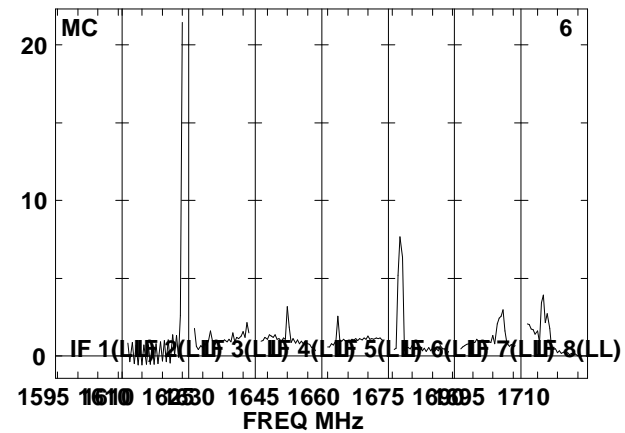
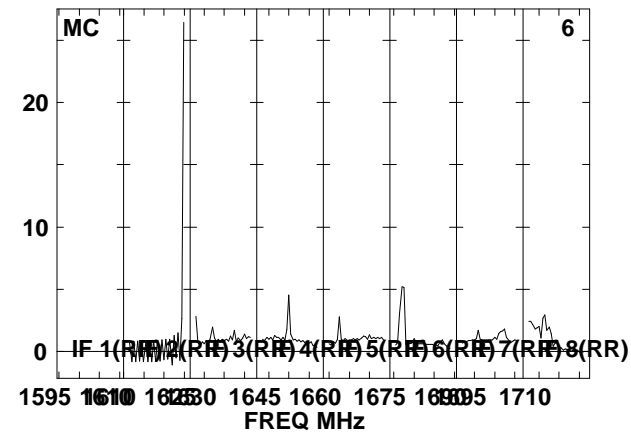
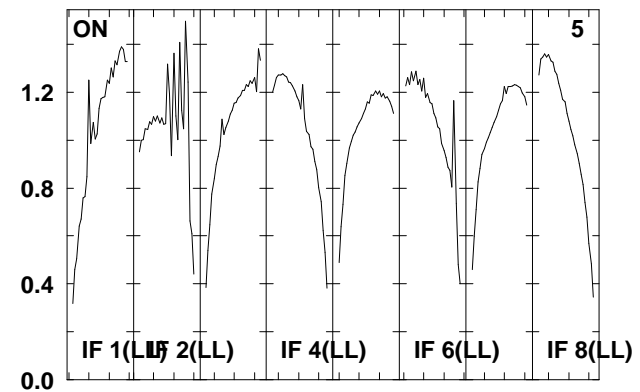
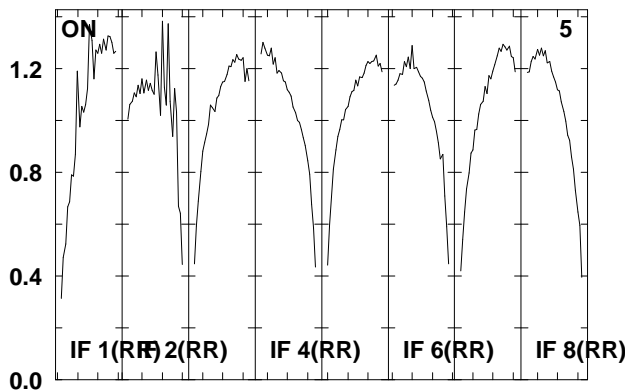
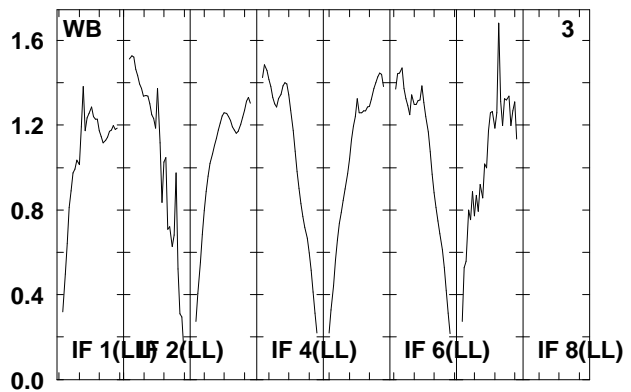
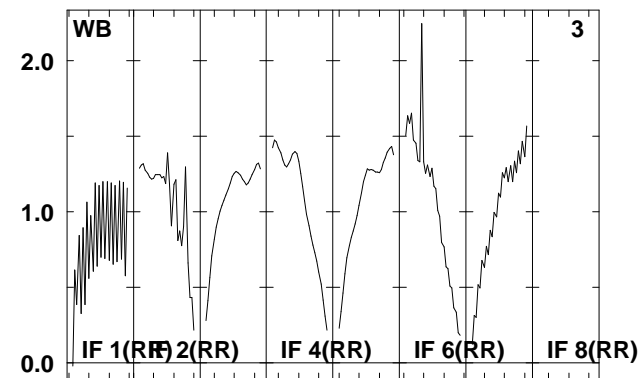
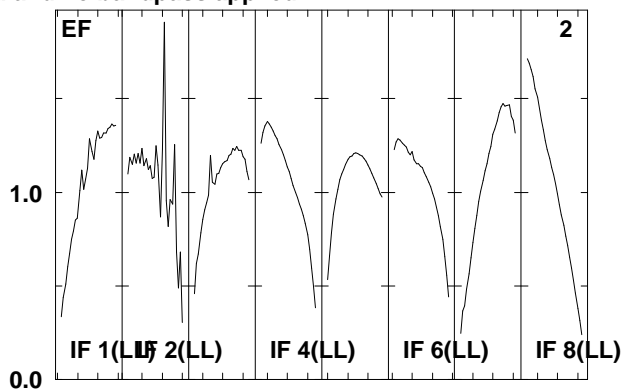
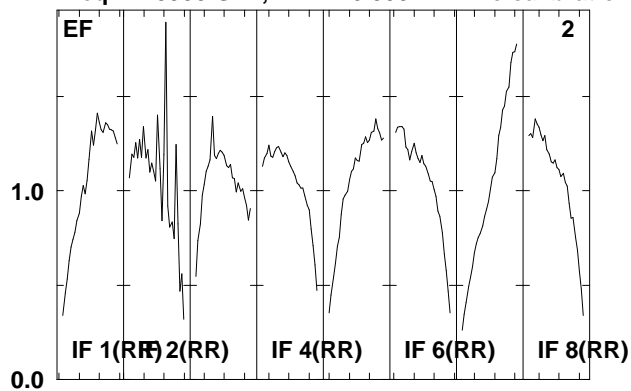

Lower frame: Real Jy
Total-power spectrum Antenna: *
Timerange: 00/11:22:02 to 00/11:23:28

Plot file version 164 created 18-APR-2008 18:28:51

J2333+39 EP061A.UVDATA.1

Freq = 1.5950 GHz, Bw = 16.000 MH No calibration applied and no bandpass applied

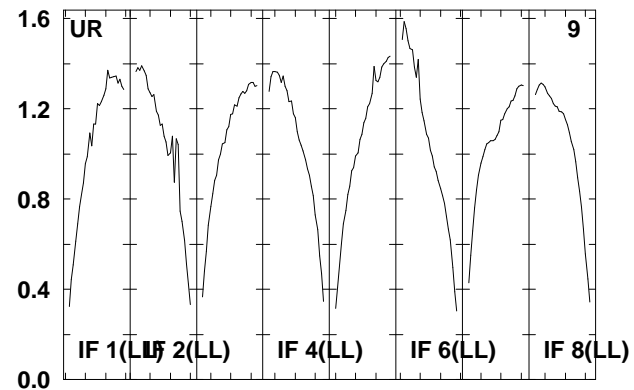
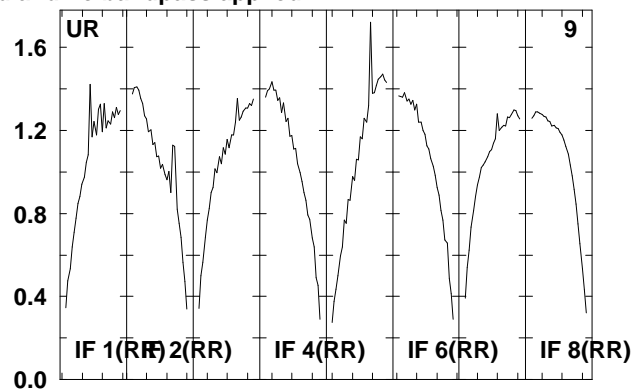
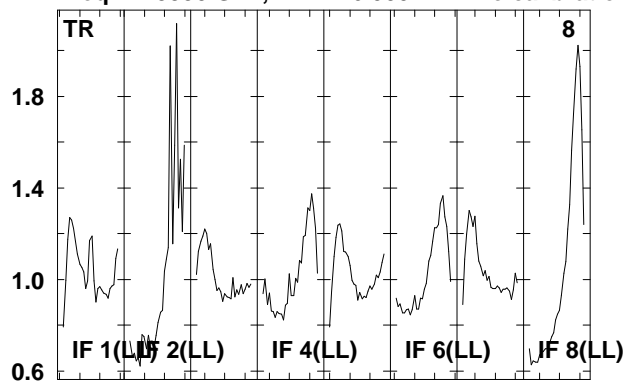

Lower frame: Real Jy
Total-power spectrum Antenna: *
Timerange: 00/11:22:02 to 00/11:23:28

Plot file version 165 created 18-APR-2008 18:28:52

IRAS2336 EP061A.UVDATA.1

Freq = 1.5950 GHz, Bw = 16.000 MH No calibration applied and no bandpass applied

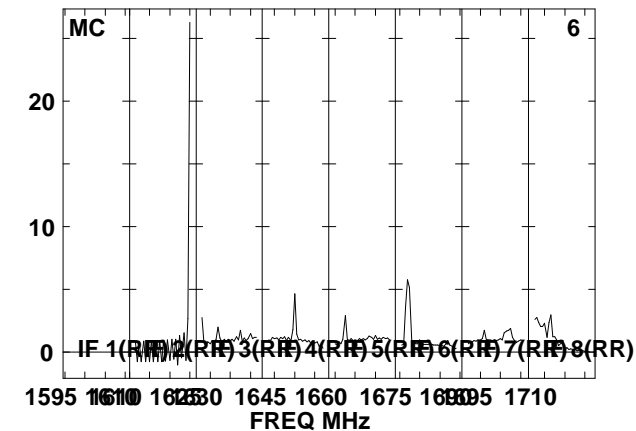
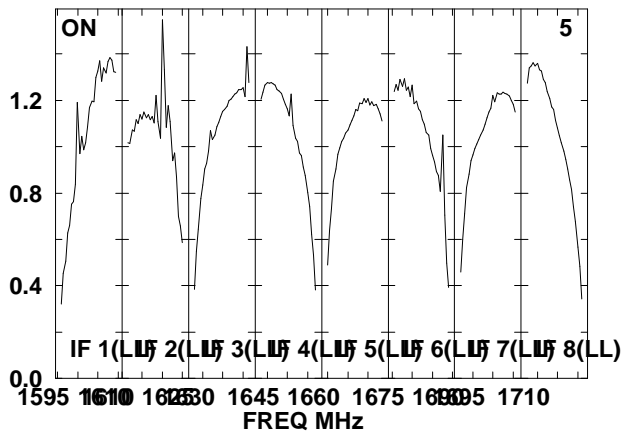
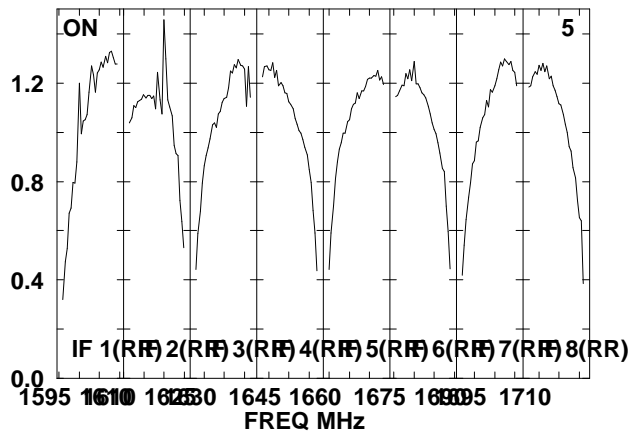
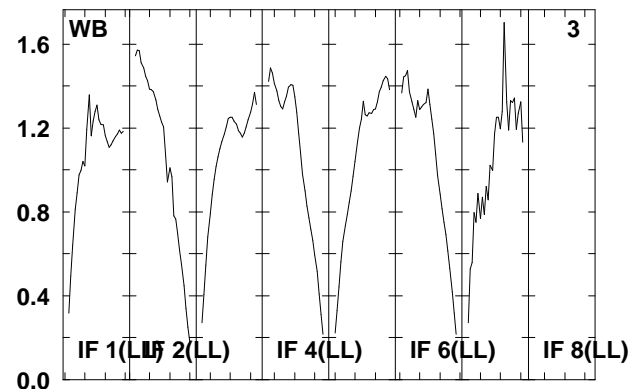
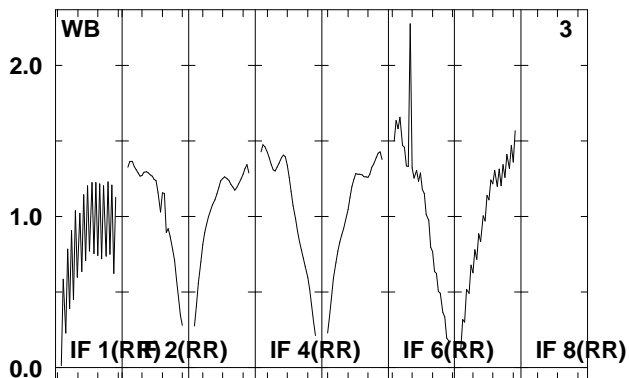
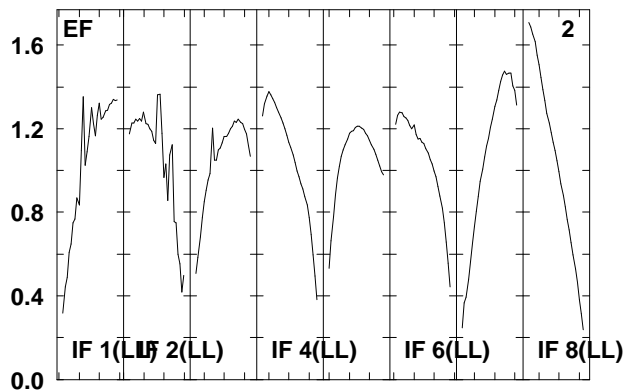
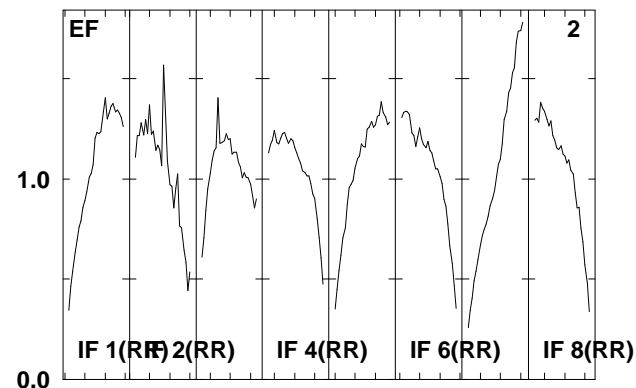
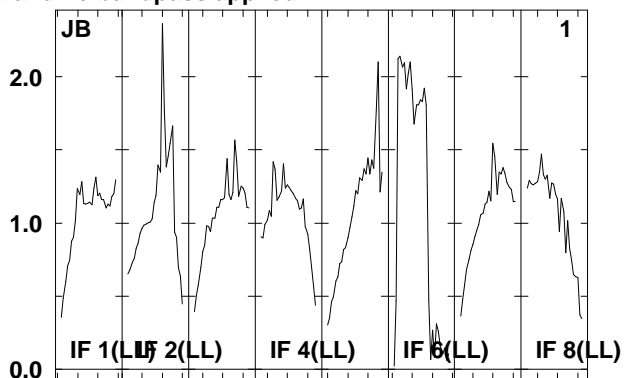
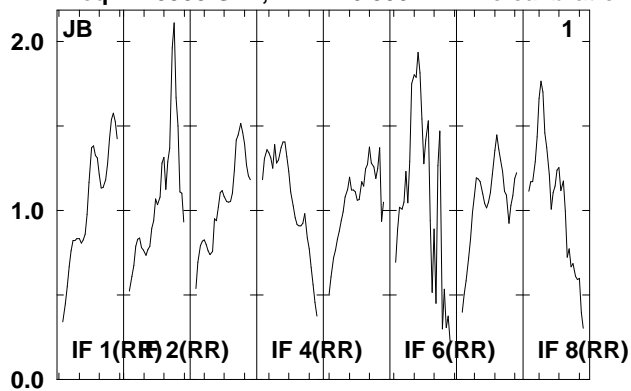

Lower frame: Real Jy
Total-power spectrum Antenna: *
Timerange: 00/11:23:30 to 00/11:27:00

Plot file version 166 created 18-APR-2008 18:28:53

IRAS2336 EP061A.UVDATA.1

Freq = 1.5950 GHz, Bw = 16.000 MH No calibration applied and no bandpass applied

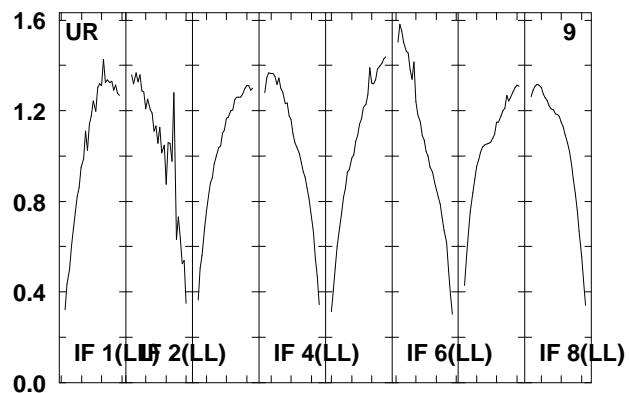
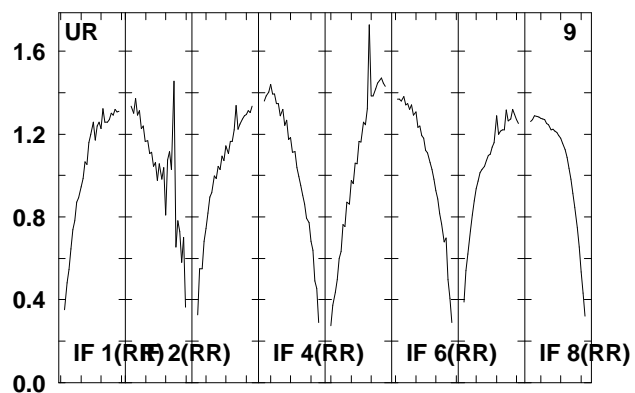
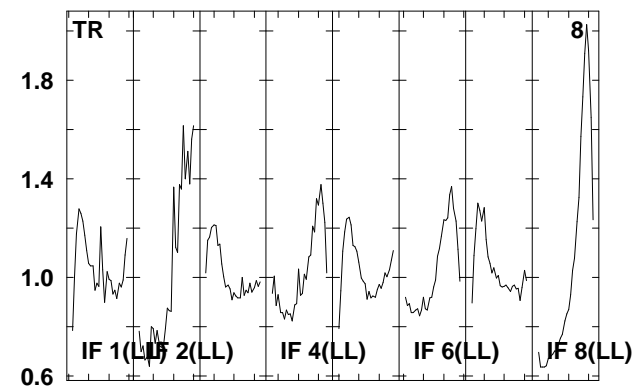
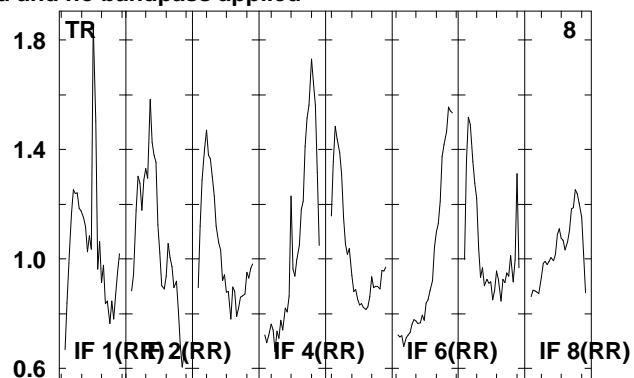
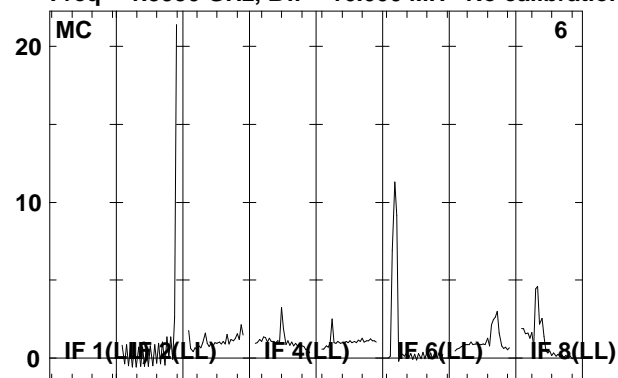

Lower frame: Real Jy
Total-power spectrum Antenna: *
Timerange: 00/11:23:30 to 00/11:27:00

Plot file version 167 created 18-APR-2008 18:28:54

J2333+39 EP061A.UVDATA.1

Freq = 1.5950 GHz, Bw = 16.000 MH No calibration applied and no bandpass applied

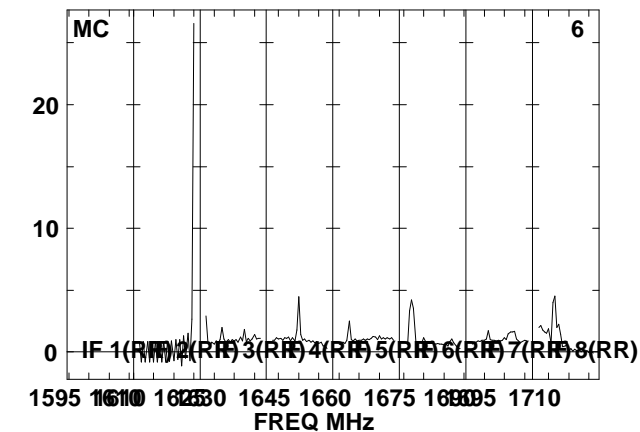
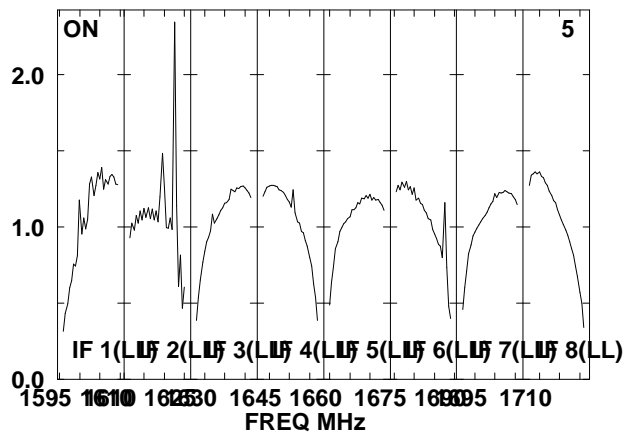
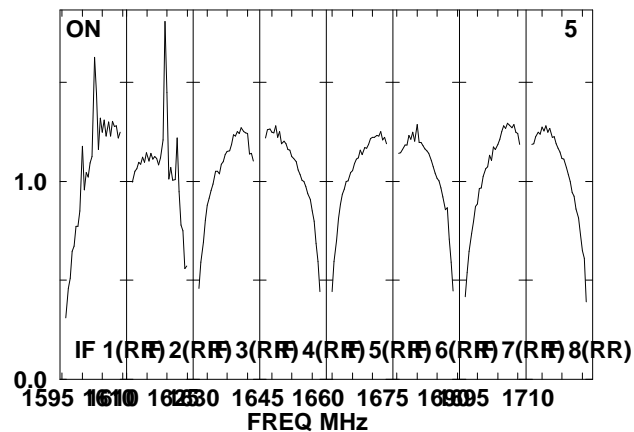
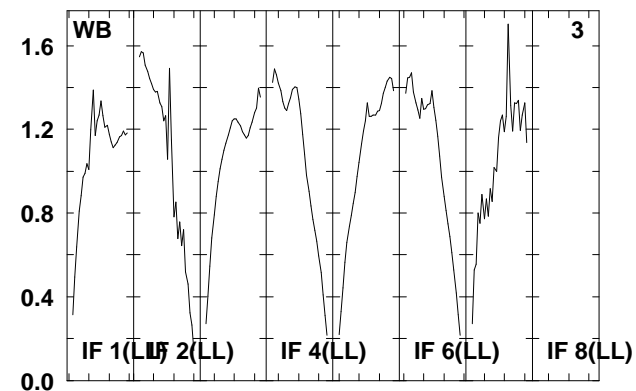
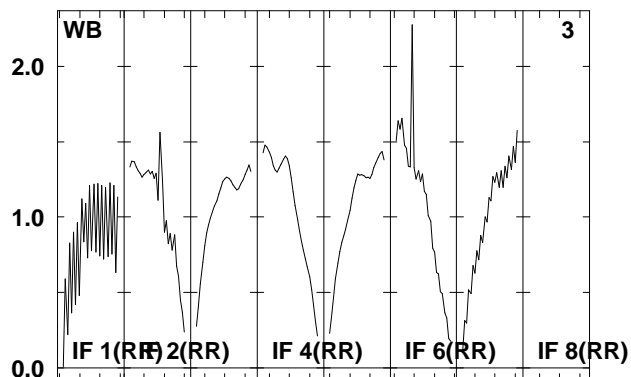
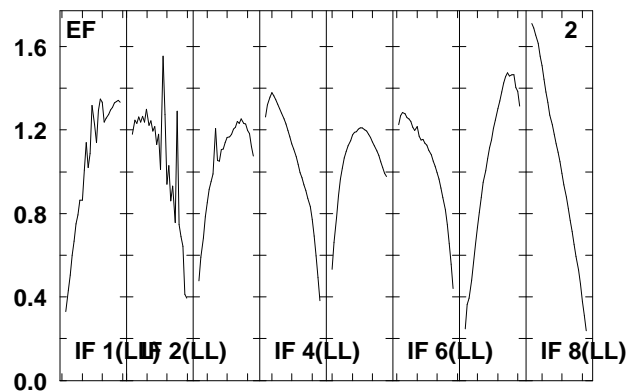
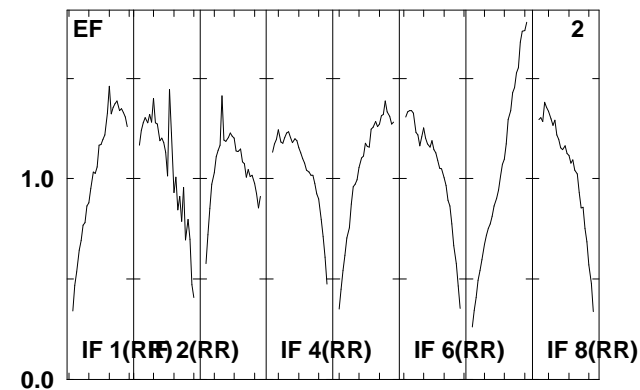
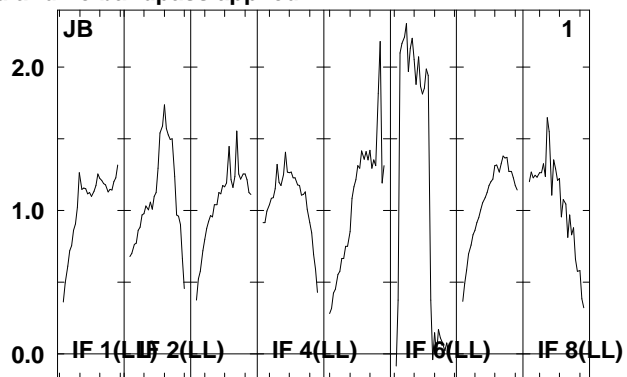
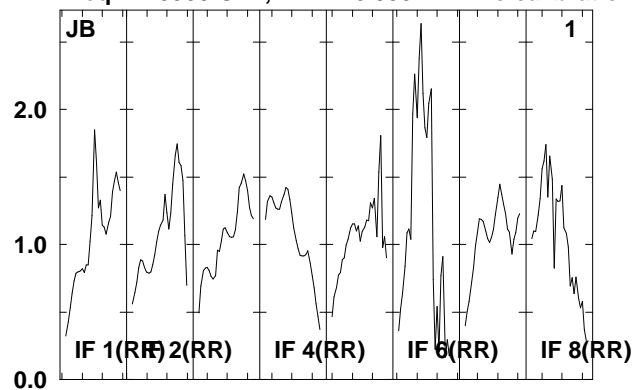

Lower frame: Real Jy

Total-power spectrum Antenna: *

Timerange: 00/11:27:02 to 00/11:28:26

Plot file version 168 created 18-APR-2008 18:28:54

J2333+39 EP061A.UVDATA.1

Freq = 1.5950 GHz, Bw = 16.000 MH No calibration applied and no bandpass applied

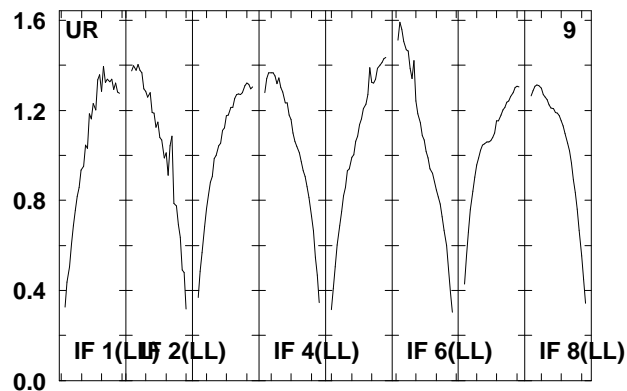
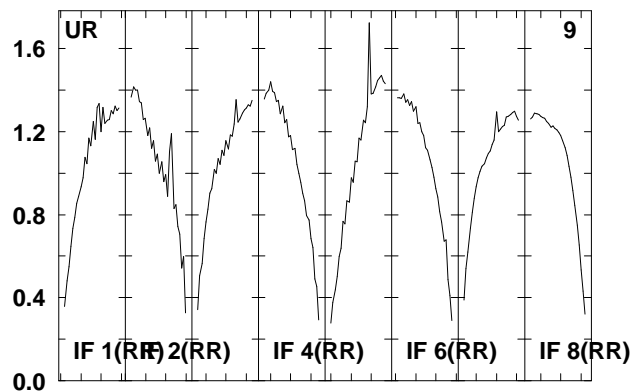
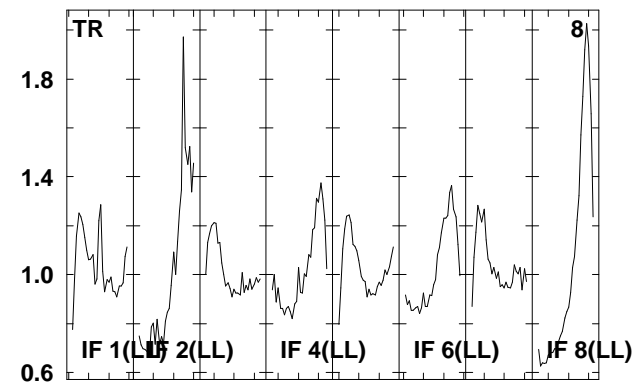
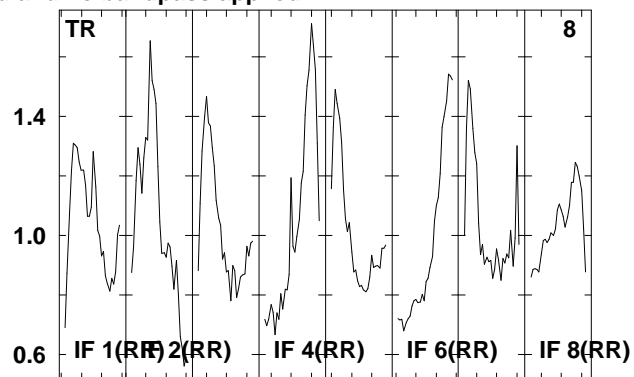
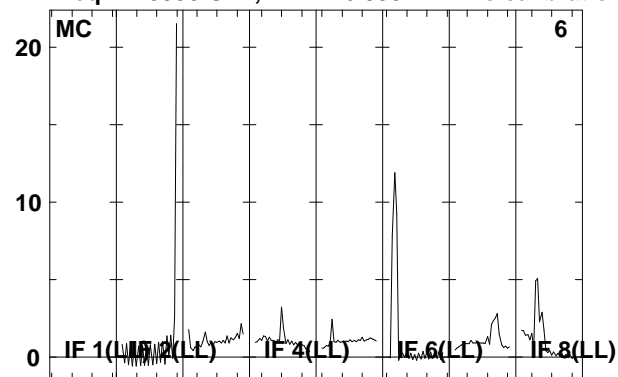

Lower frame: Real Jy
Total-power spectrum Antenna: *
Timerange: 00/11:27:02 to 00/11:28:26

Plot file version 169 created 18-APR-2008 18:28:55

IRAS2336 EP061A.UVDATA.1

Freq = 1.5950 GHz, Bw = 16.000 MH No calibration applied and no bandpass applied

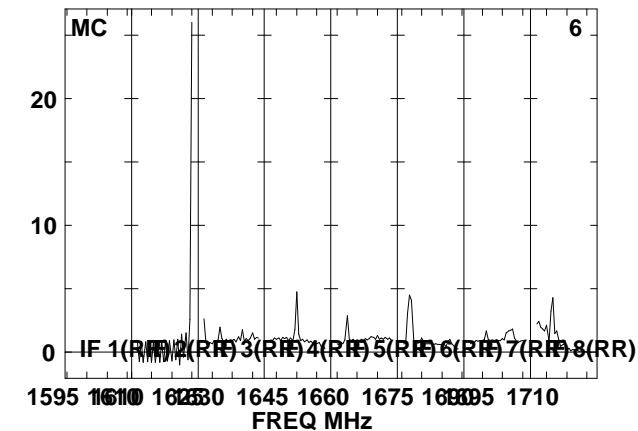
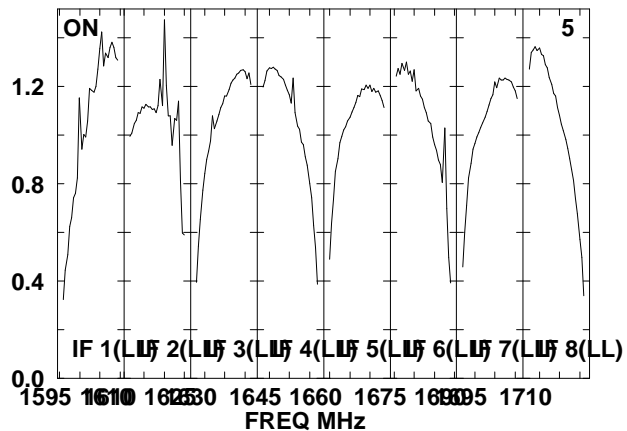
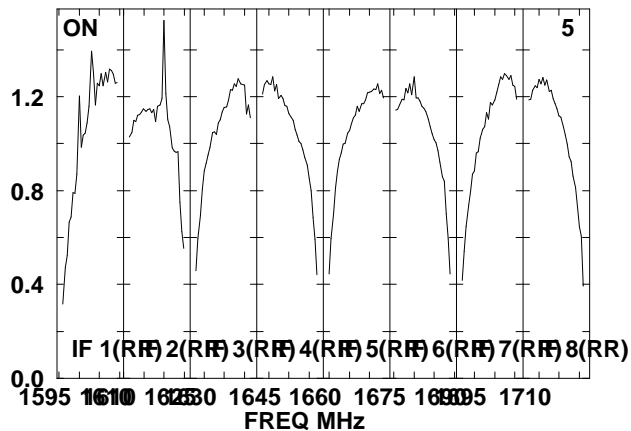
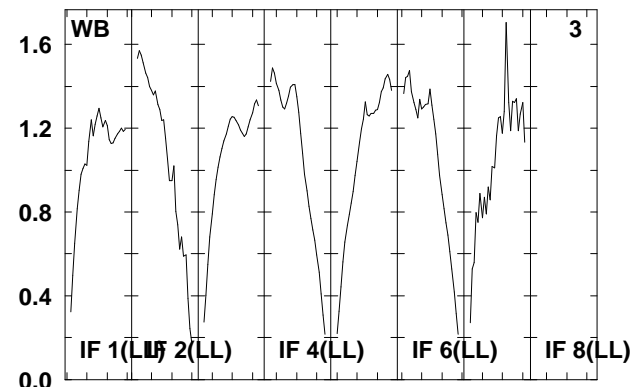
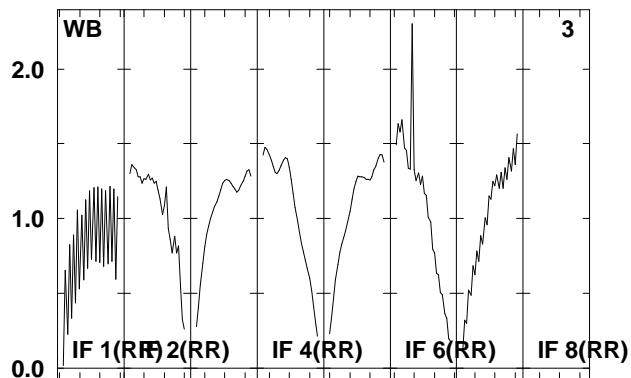
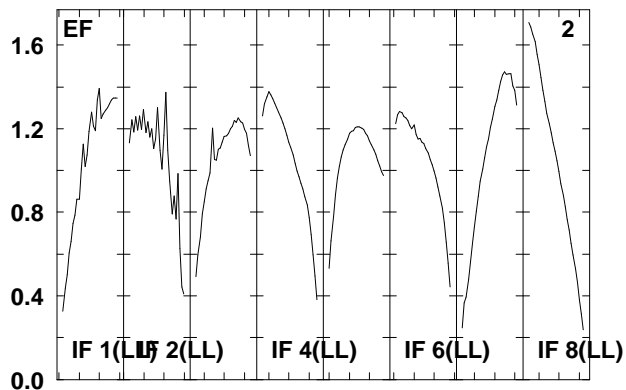
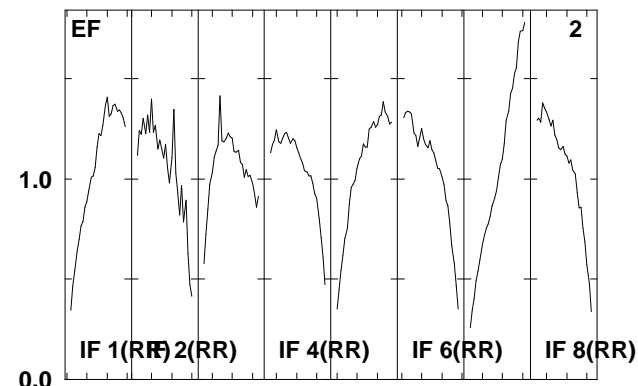
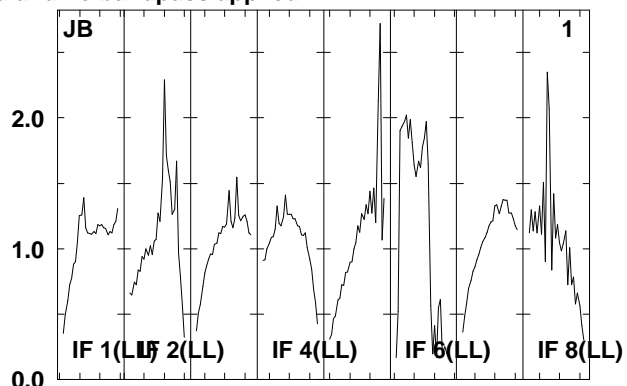
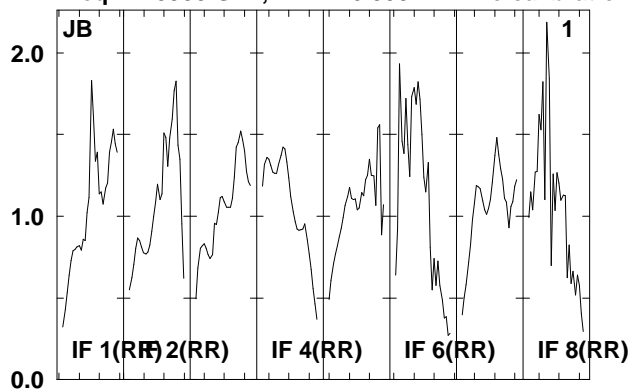

Lower frame: Real Jy
Total-power spectrum Antenna: *
Timerange: 00/11:28:40 to 00/11:32:00

Plot file version 170 created 18-APR-2008 18:28:55

IRAS2336 EP061A.UVDATA.1

Freq = 1.5950 GHz, Bw = 16.000 MH No calibration applied and no bandpass applied

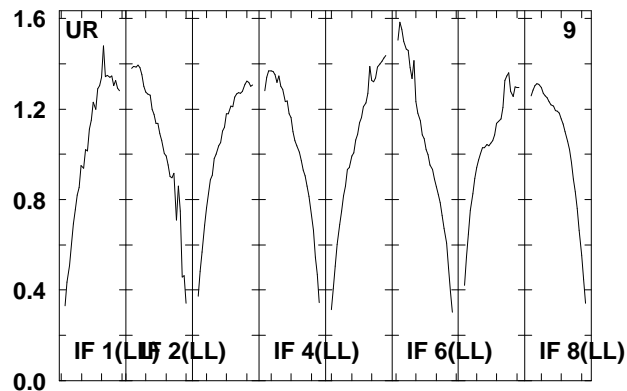
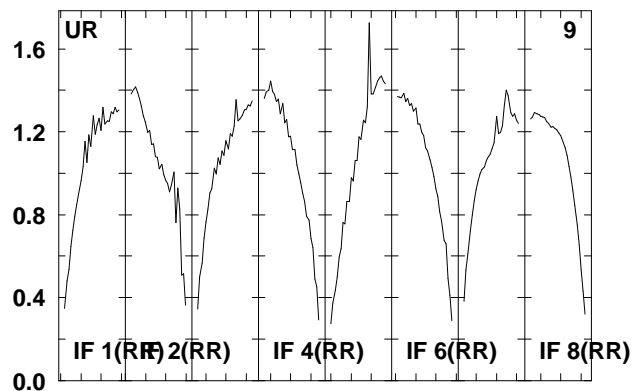
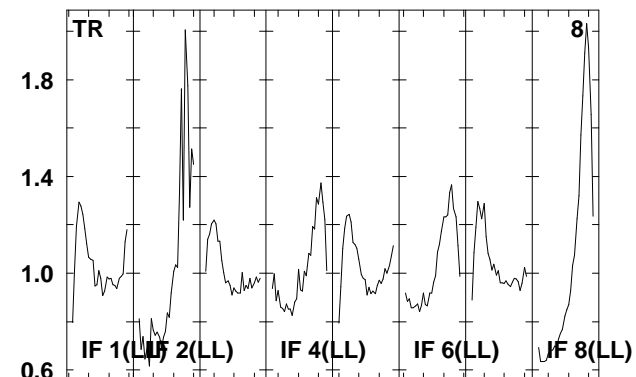
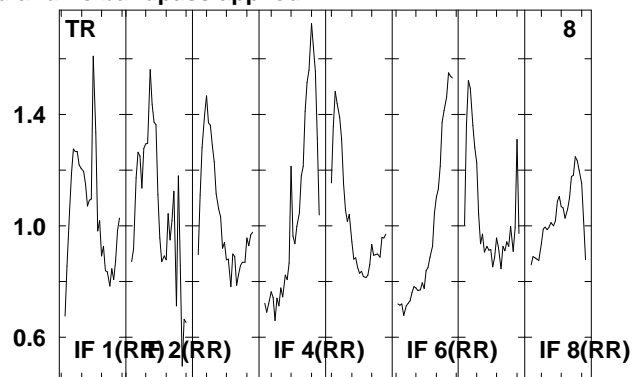
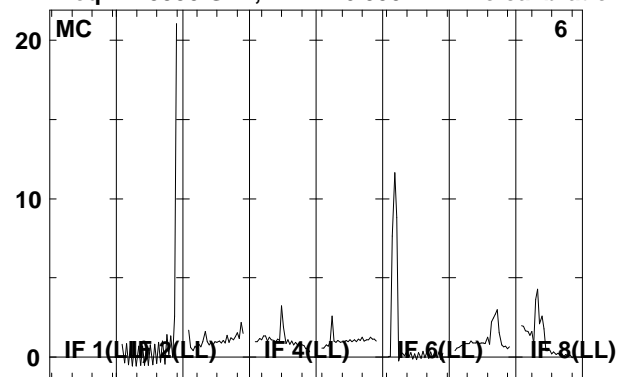

Lower frame: Real Jy
Total-power spectrum Antenna: *
Timerange: 00/11:28:40 to 00/11:32:00

Plot file version 171 created 18-APR-2008 18:28:56

J2333+39 EP061A.UVDATA.1

Freq = 1.5950 GHz, Bw = 16.000 MH No calibration applied and no bandpass applied

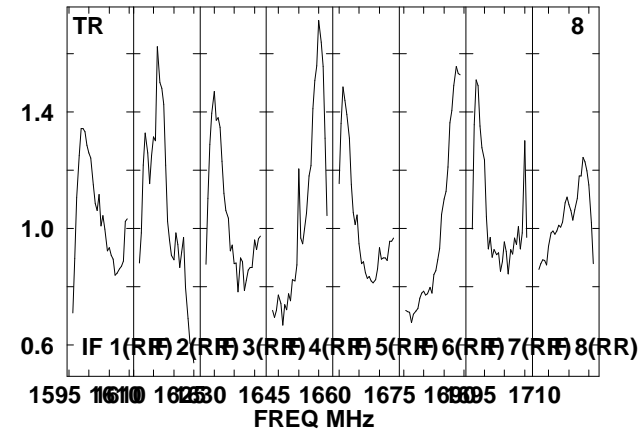
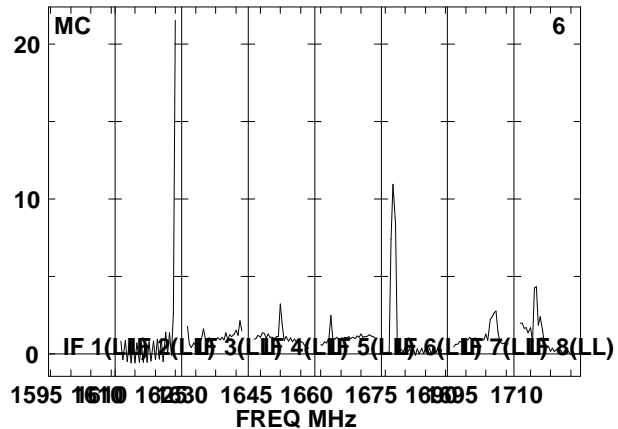
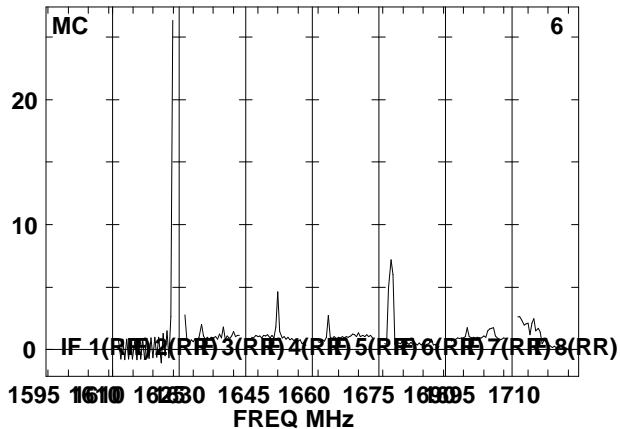
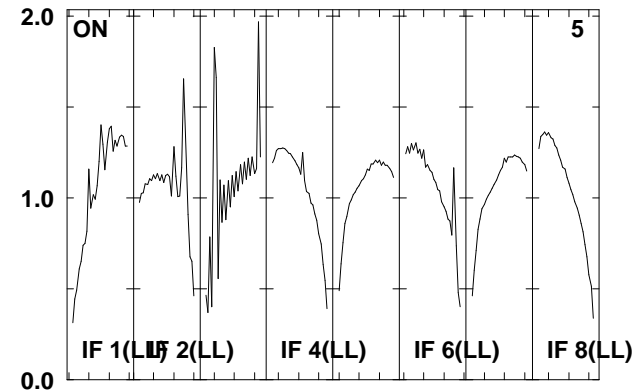
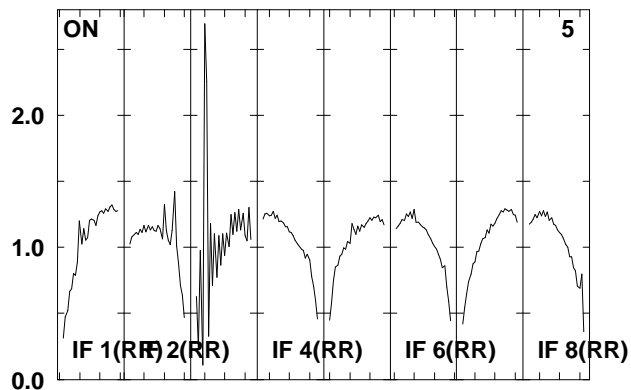
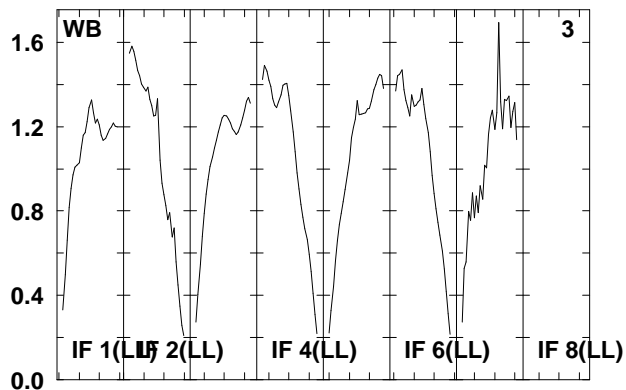
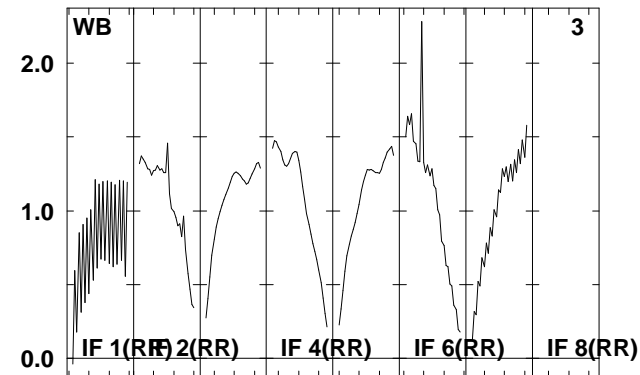
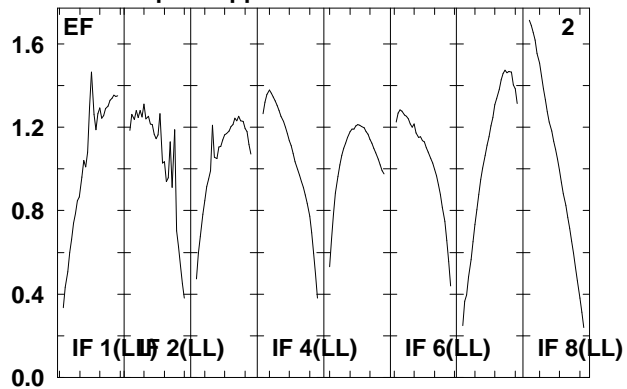
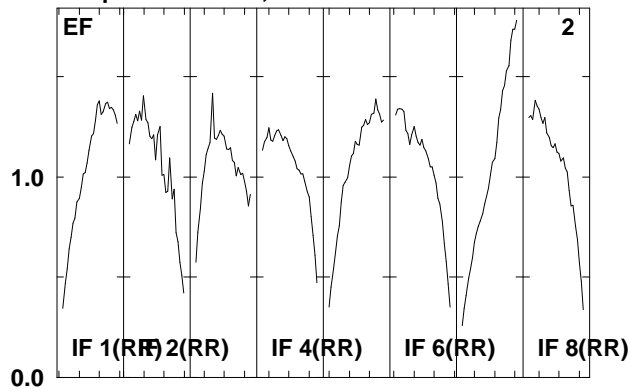

Lower frame: Real Jy

Total-power spectrum Antenna: *

Timerange: 00/11:32:02 to 00/11:33:28

Plot file version 172 created 18-APR-2008 18:28:57

J2333+39 EP061A.UVDATA.1

Freq = 1.5950 GHz, Bw = 16.000 MH No calibration applied and no bandpass applied

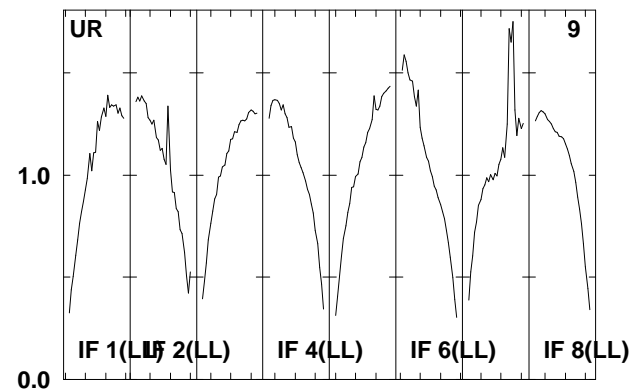
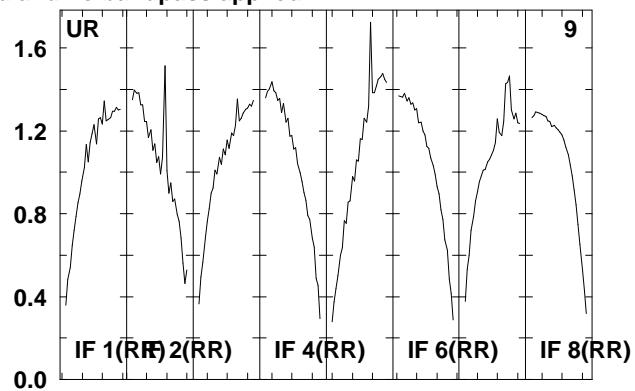
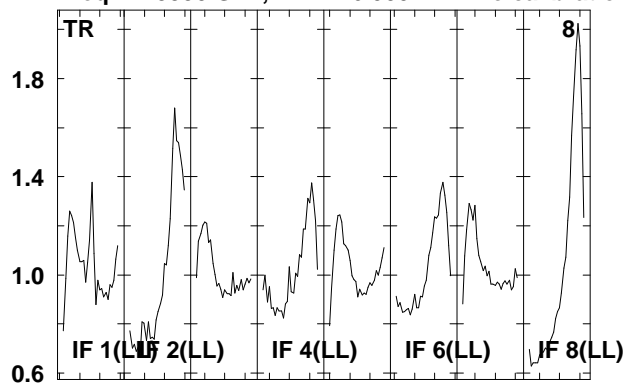

Lower frame: Real Jy
Total-power spectrum Antenna: *
Timerange: 00/11:32:02 to 00/11:33:28

Plot file version 173 created 18-APR-2008 18:28:57

IRAS2336 EP061A.UVDATA.1

Freq = 1.5950 GHz, Bw = 16.000 MH No calibration applied and no bandpass applied

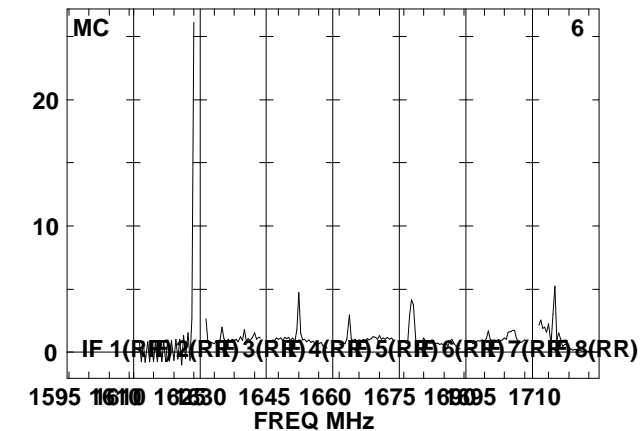
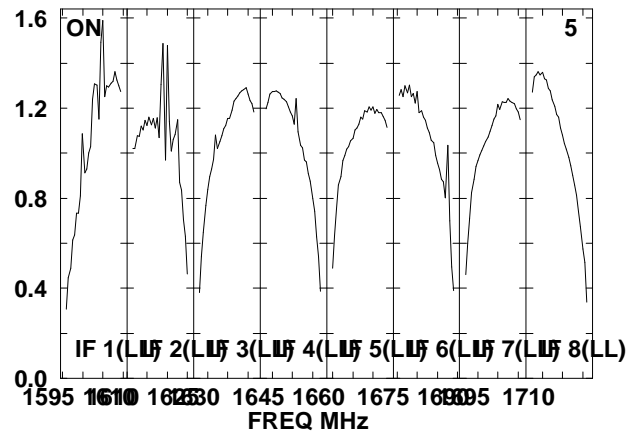
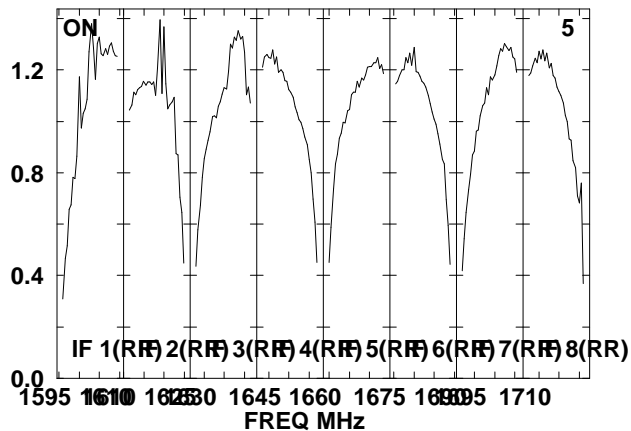
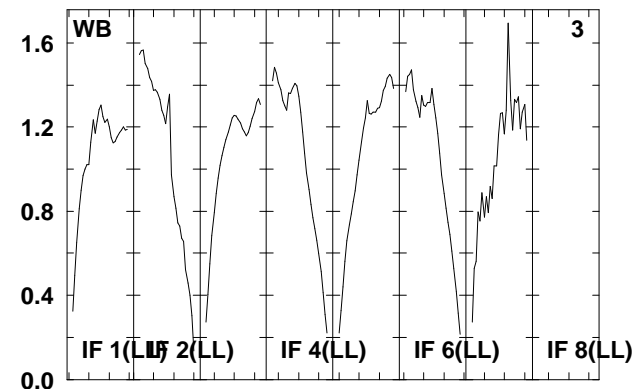
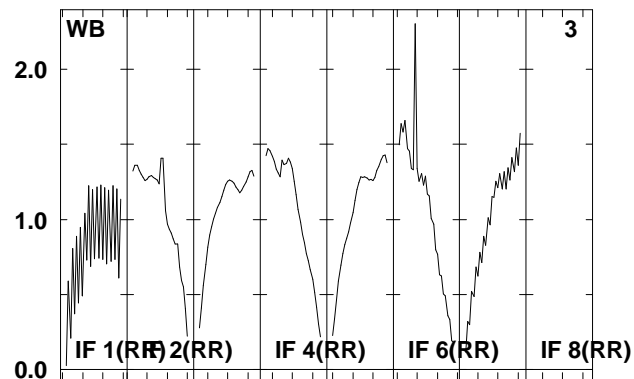
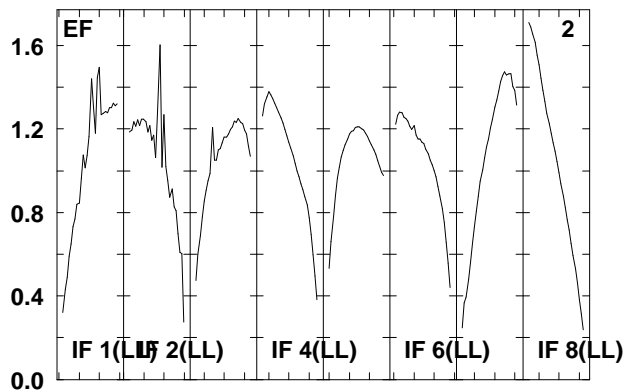
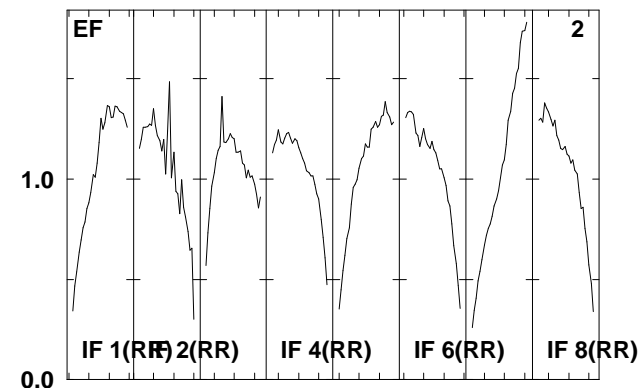
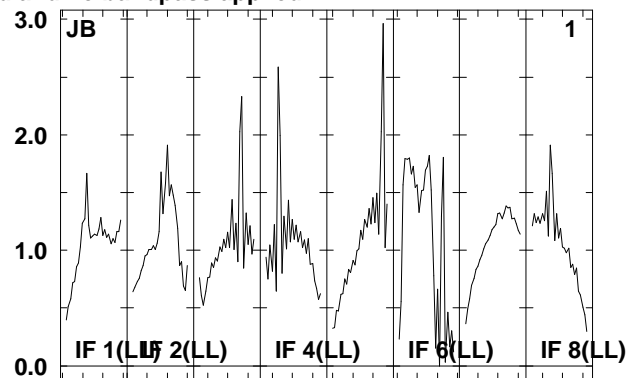
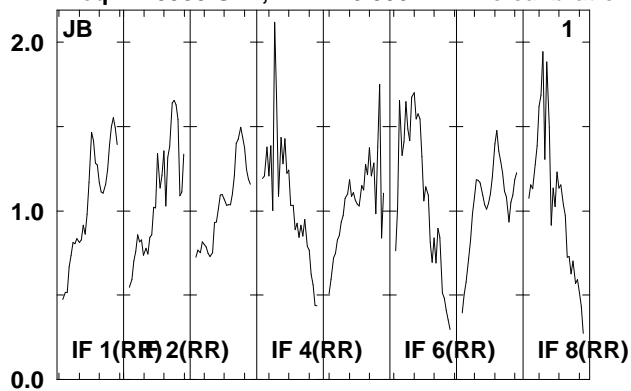

Lower frame: Real Jy
Total-power spectrum Antenna: *
Timerange: 00/11:33:30 to 00/11:36:58

Plot file version 174 created 18-APR-2008 18:28:58

IRAS2336 EP061A.UVDATA.1

Freq = 1.5950 GHz, Bw = 16.000 MH No calibration applied and no bandpass applied

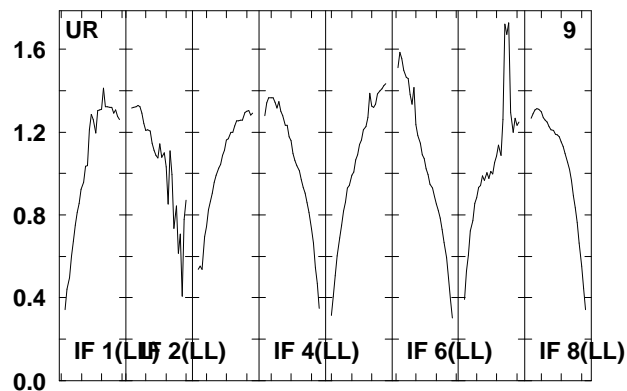
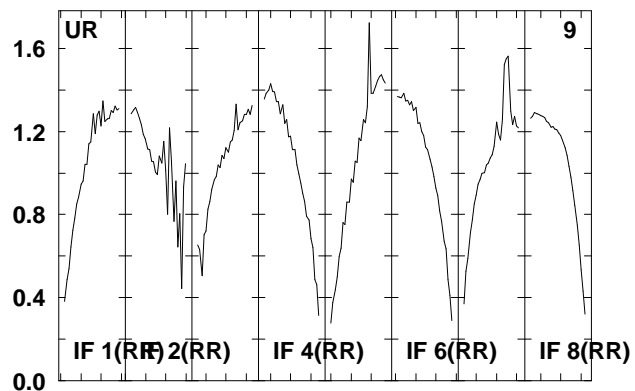
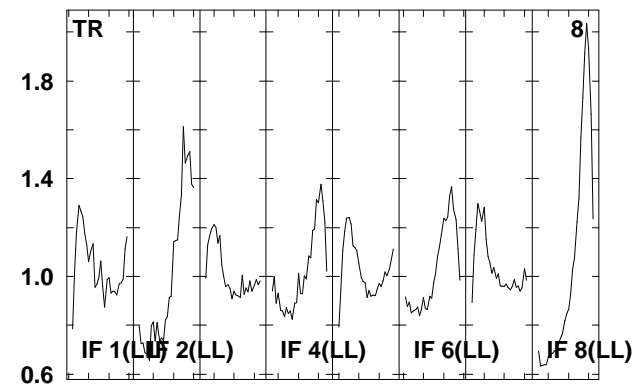
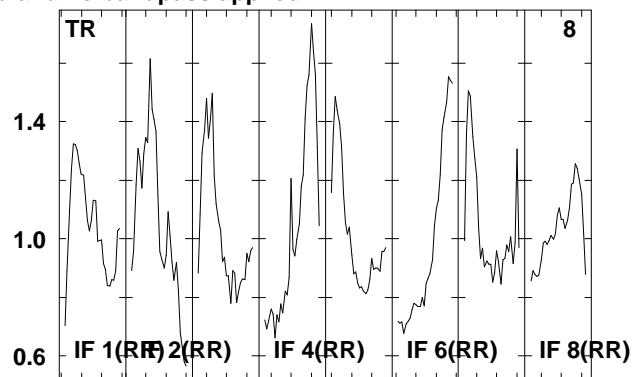
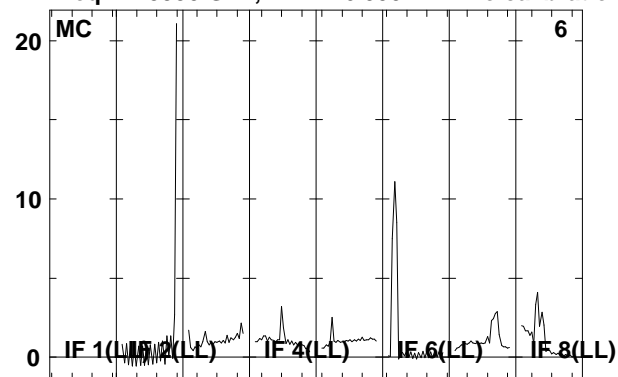

Lower frame: Real Jy
Total-power spectrum Antenna: *
Timerange: 00/11:33:30 to 00/11:36:58

Plot file version 175 created 18-APR-2008 18:28:59

J2333+39 EP061A.UVDATA.1

Freq = 1.5950 GHz, Bw = 16.000 MH No calibration applied and no bandpass applied

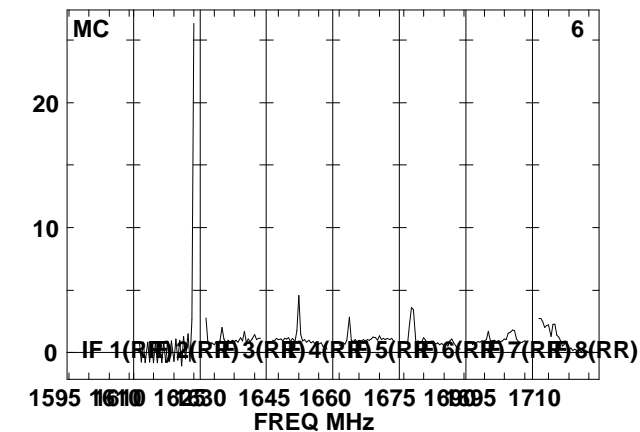
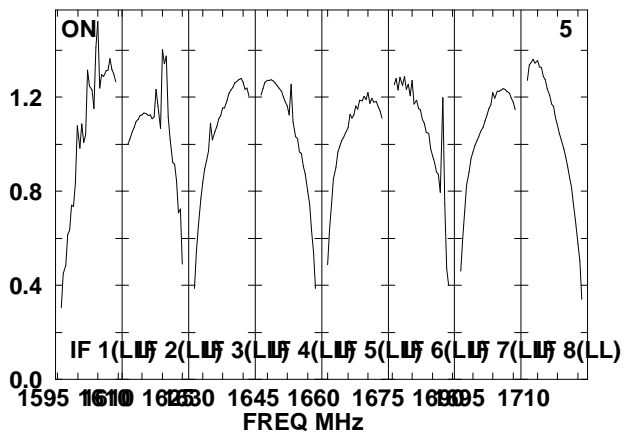
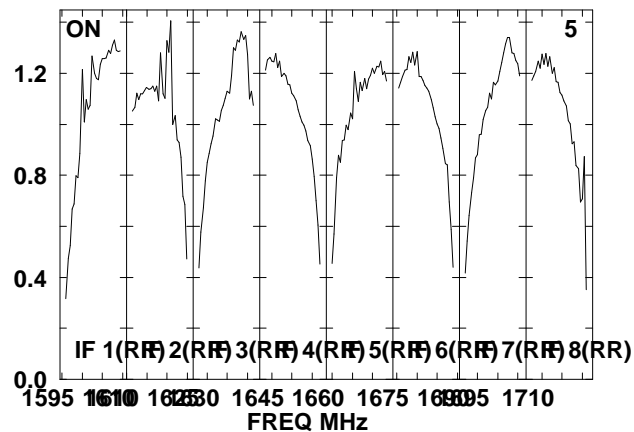
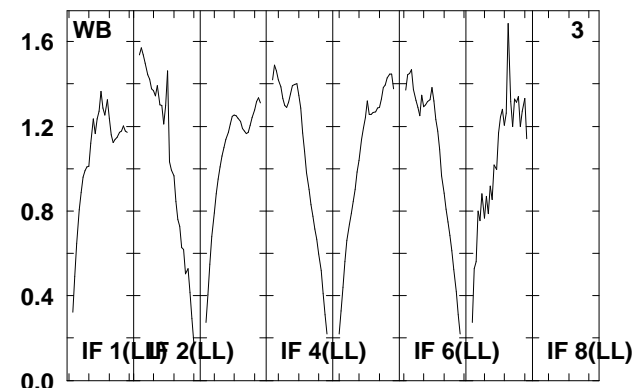
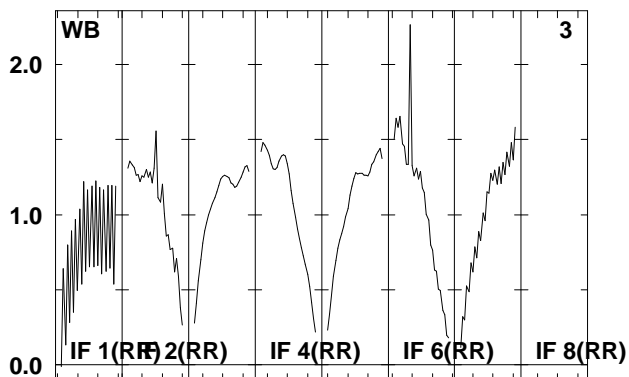
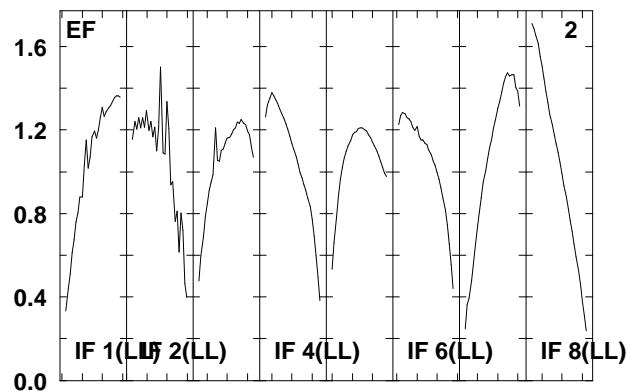
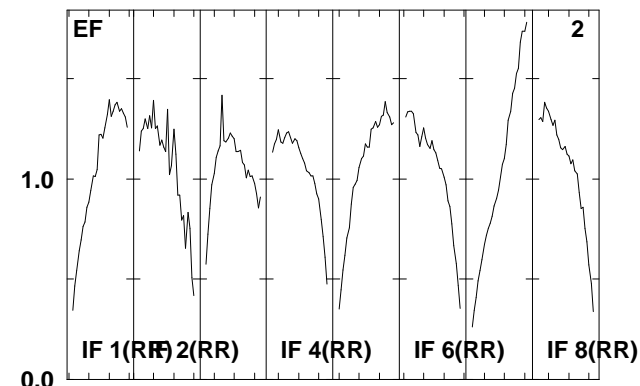
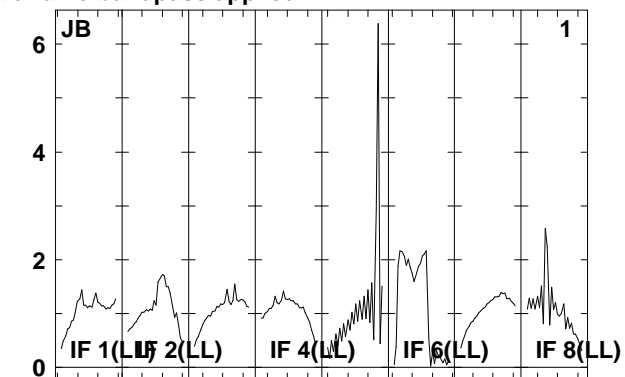
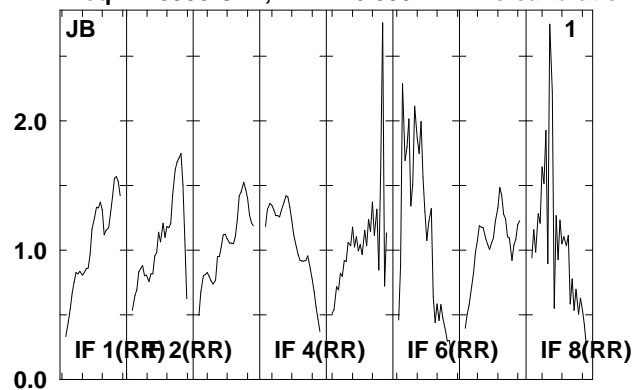

Lower frame: Real Jy
Total-power spectrum Antenna: *
Timerange: 00/11:38:02 to 00/11:39:30

Plot file version 176 created 18-APR-2008 18:28:59

J2333+39 EP061A.UVDATA.1

Freq = 1.5950 GHz, Bw = 16.000 MH No calibration applied and no bandpass applied

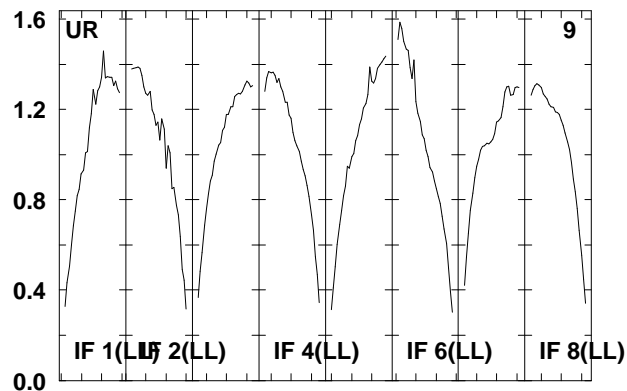
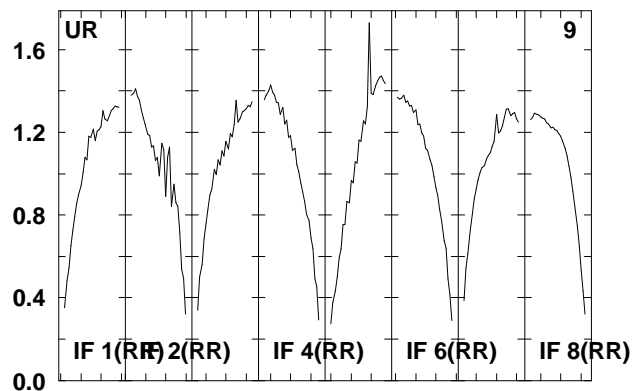
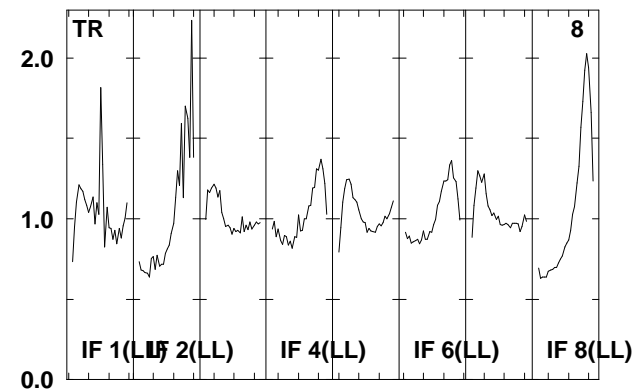
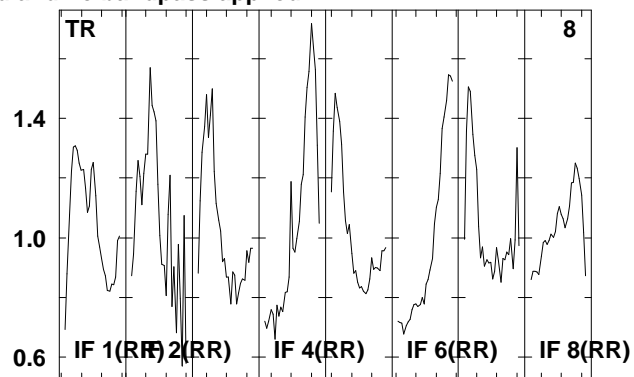
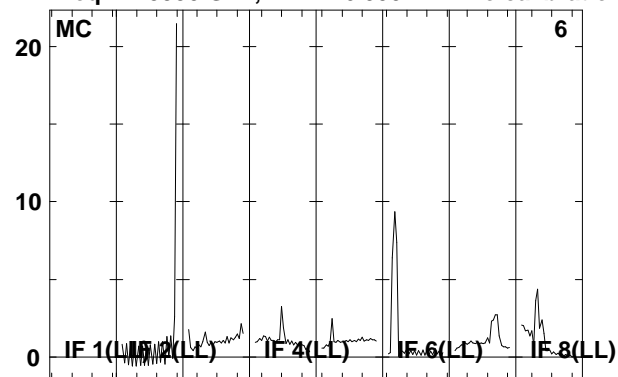

Lower frame: Real Jy
Total-power spectrum Antenna: *
Timerange: 00/11:38:02 to 00/11:39:30

Plot file version 177 created 18-APR-2008 18:29:00

IRAS2336 EP061A.UVDATA.1

Freq = 1.5950 GHz, Bw = 16.000 MH No calibration applied and no bandpass applied

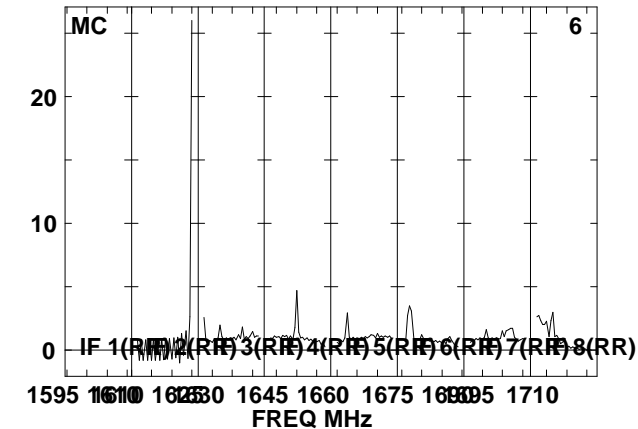
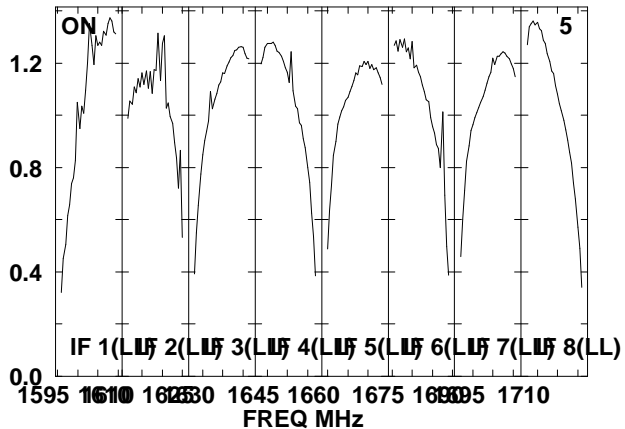
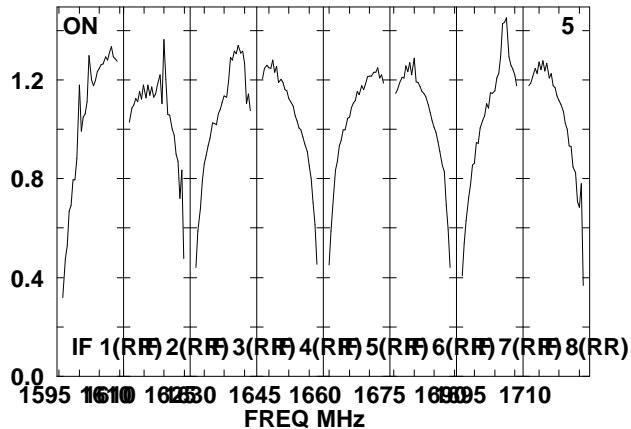
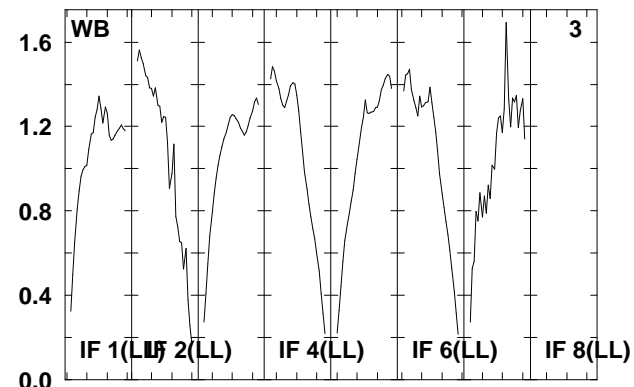
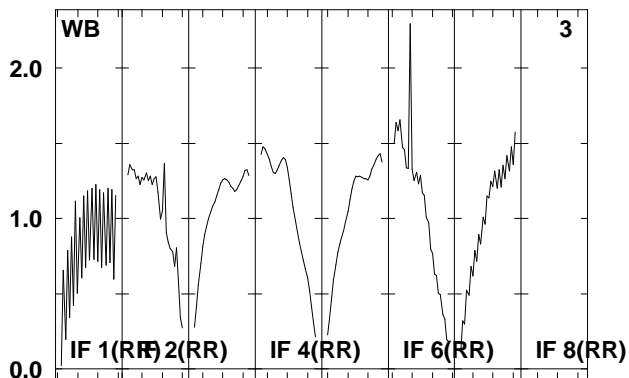
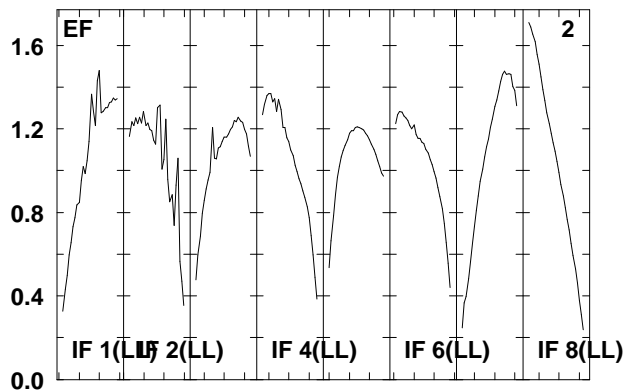
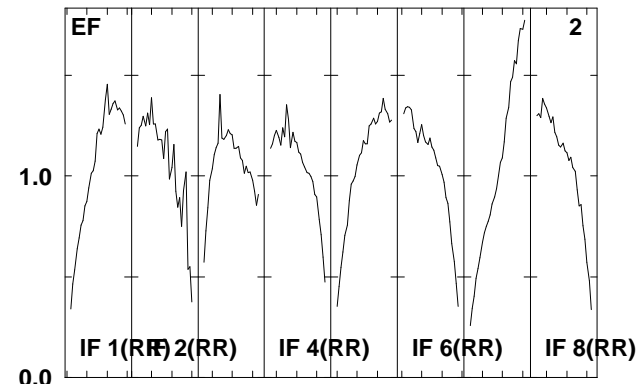
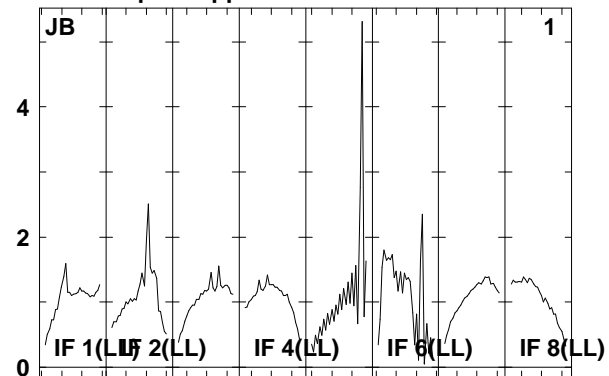
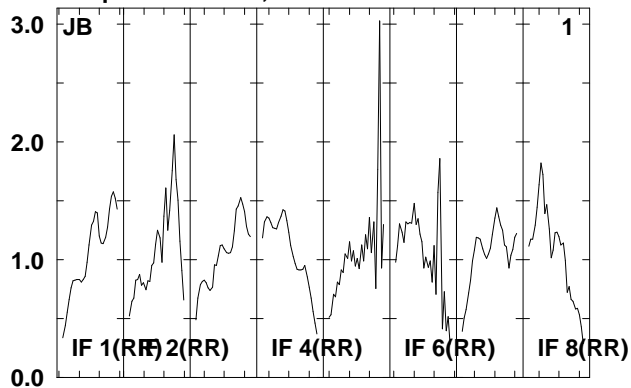

Lower frame: Real Jy
Total-power spectrum Antenna: *
Timerange: 00/11:39:32 to 00/11:42:56

Plot file version 178 created 18-APR-2008 18:29:01

IRAS2336 EP061A.UVDATA.1

Freq = 1.5950 GHz, Bw = 16.000 MH No calibration applied and no bandpass applied

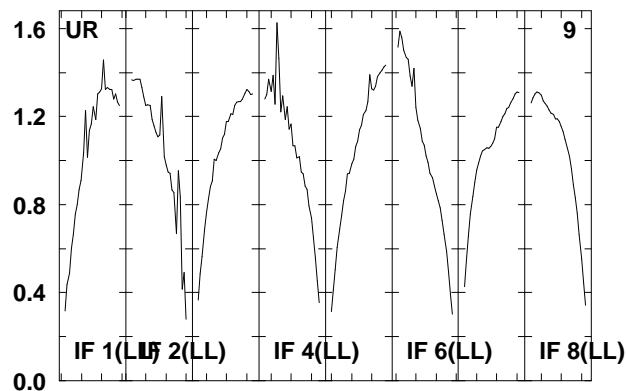
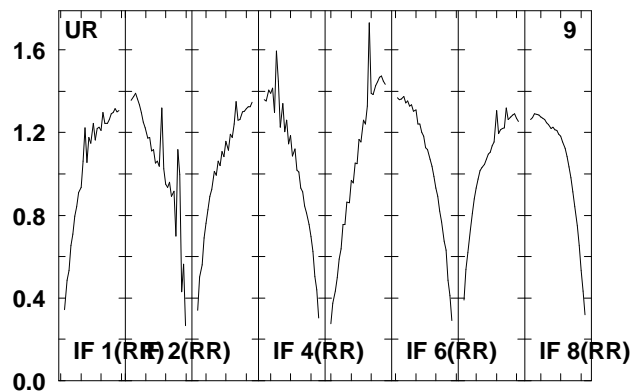
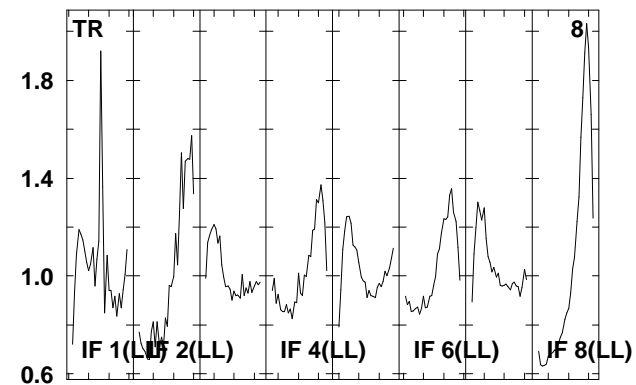
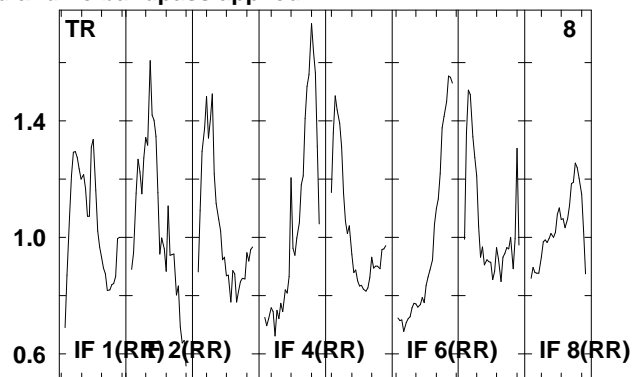
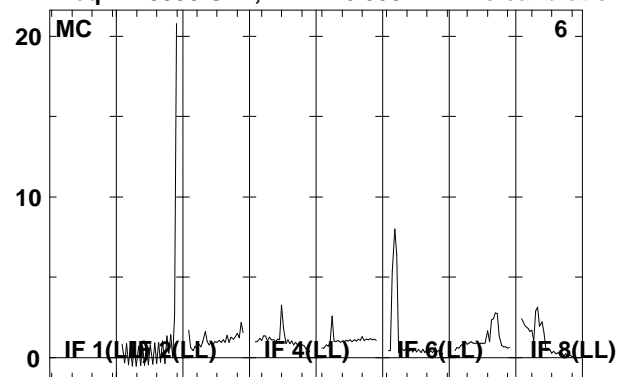

Lower frame: Real Jy
Total-power spectrum Antenna: *
Timerange: 00/11:39:32 to 00/11:42:56

Plot file version 179 created 18-APR-2008 18:29:02

J2333+39 EP061A.UVDATA.1

Freq = 1.5950 GHz, Bw = 16.000 MH No calibration applied and no bandpass applied

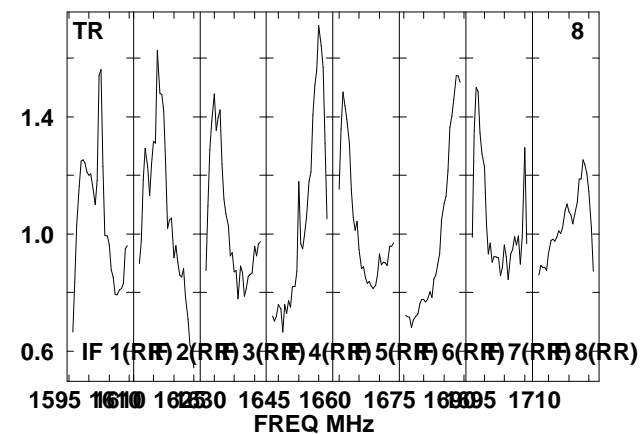
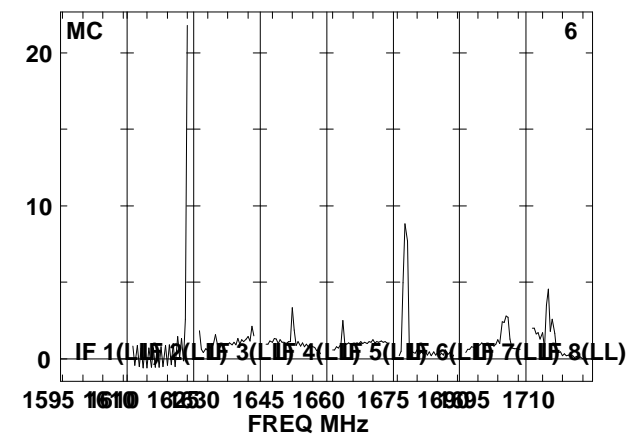
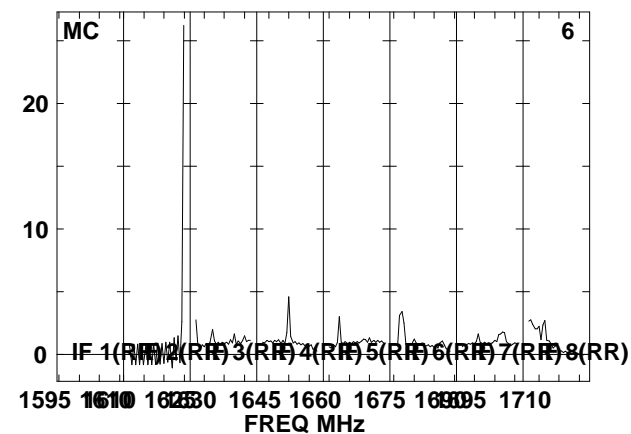
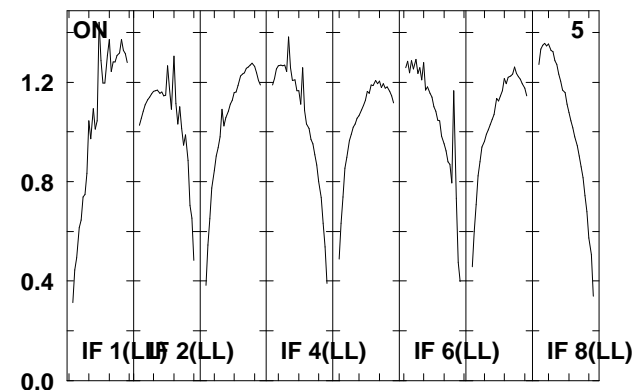
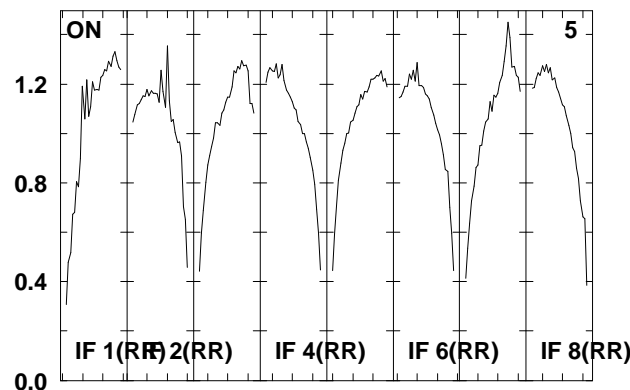
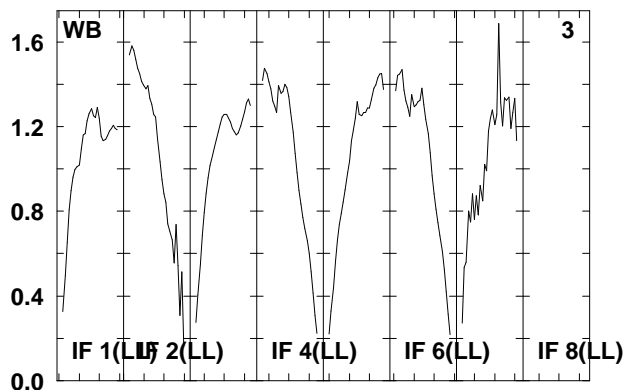
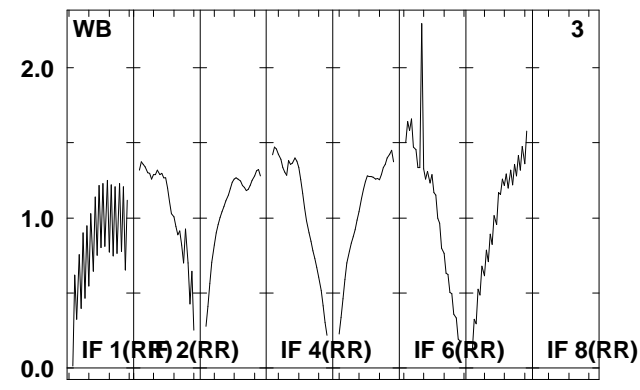
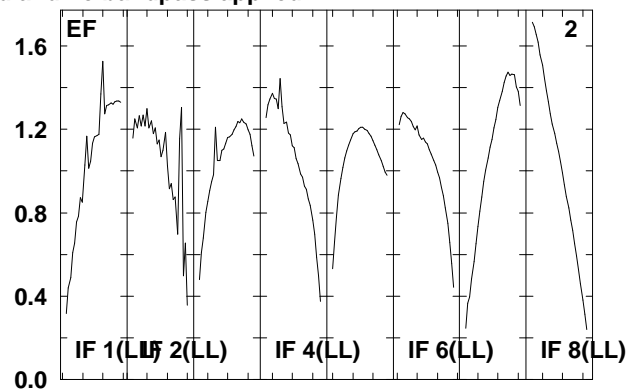
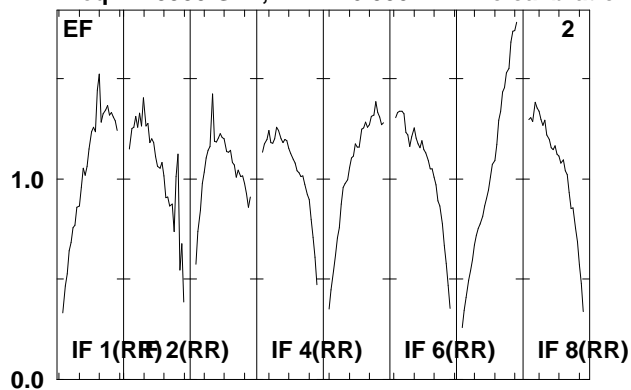

Lower frame: Real Jy
Total-power spectrum Antenna: *
Timerange: 00/11:43:10 to 00/11:44:26

Plot file version 180 created 18-APR-2008 18:29:02

J2333+39 EP061A.UVDATA.1

Freq = 1.5950 GHz, Bw = 16.000 MH No calibration applied and no bandpass applied

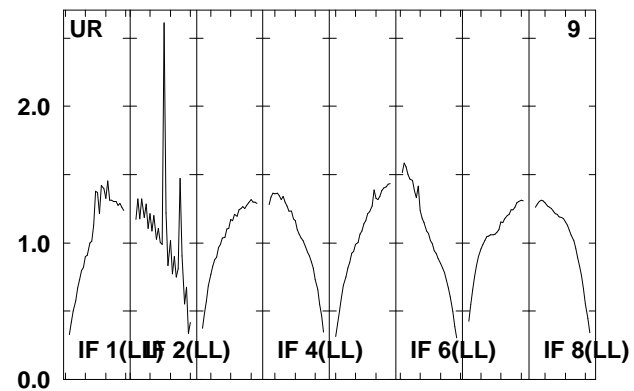
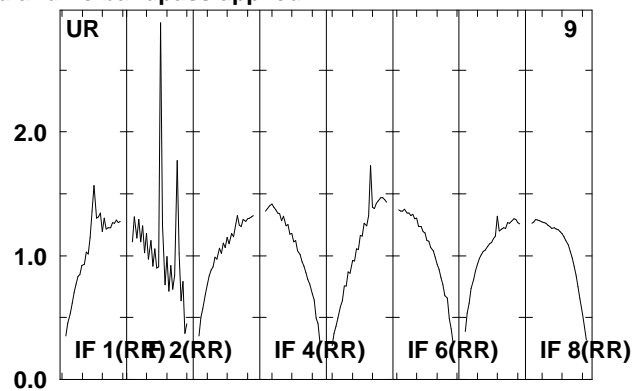
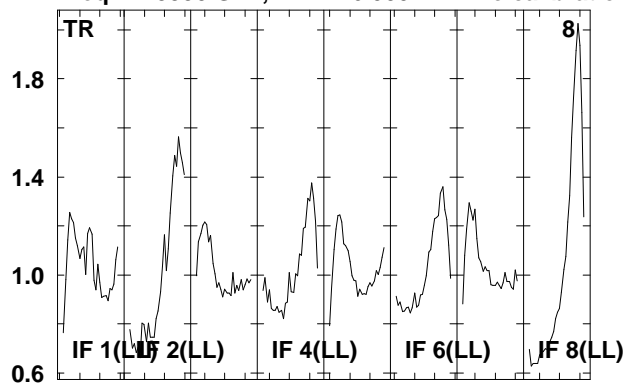

Lower frame: Real Jy
Total-power spectrum Antenna: *
Timerange: 00/11:43:10 to 00/11:44:26

Plot file version 181 created 18-APR-2008 18:29:02

IRAS2336 EP061A.UVDATA.1

Freq = 1.5950 GHz, Bw = 16.000 MH No calibration applied and no bandpass applied

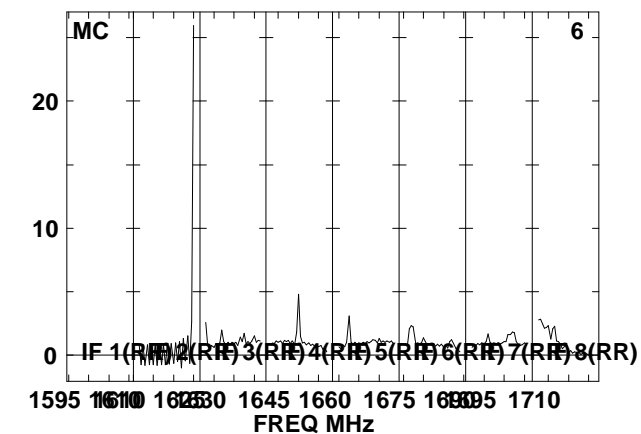
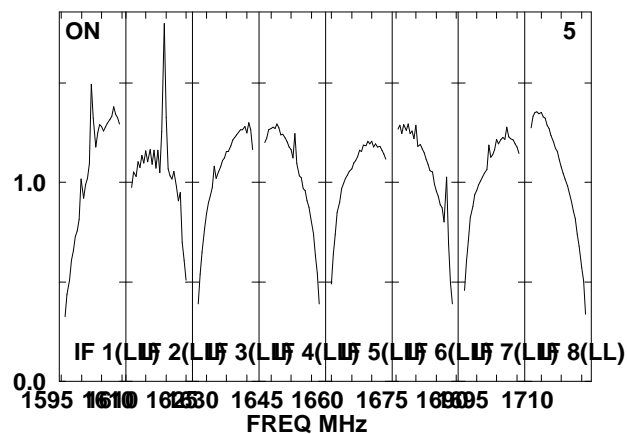
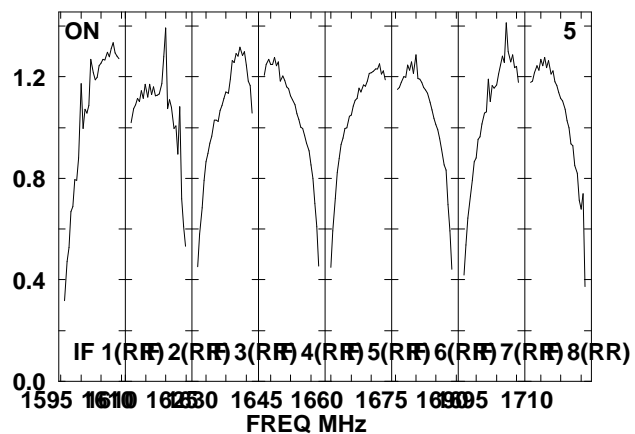
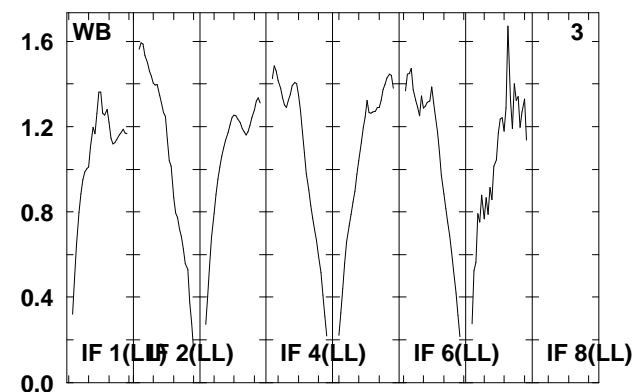
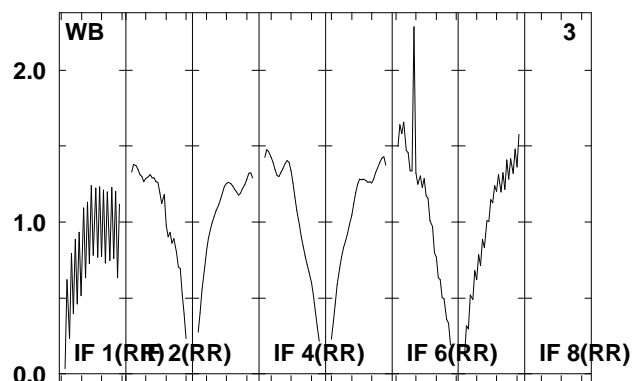
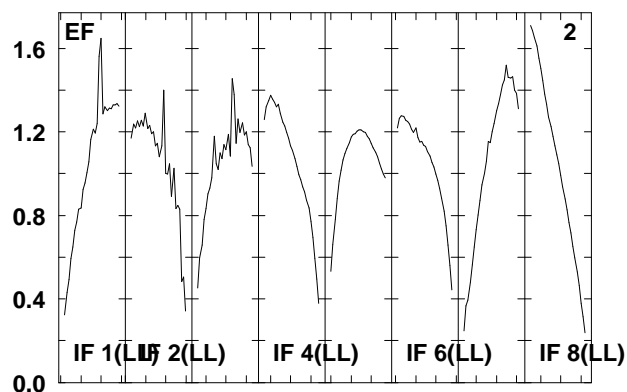
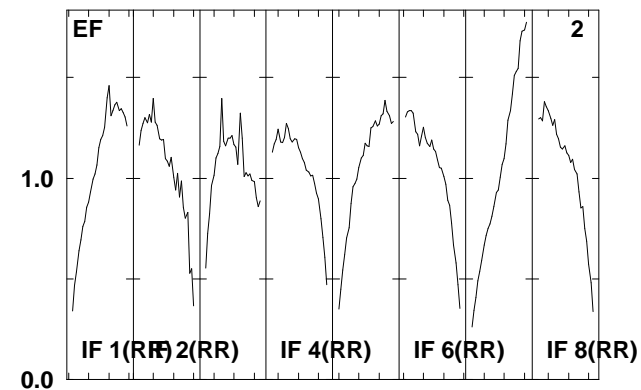
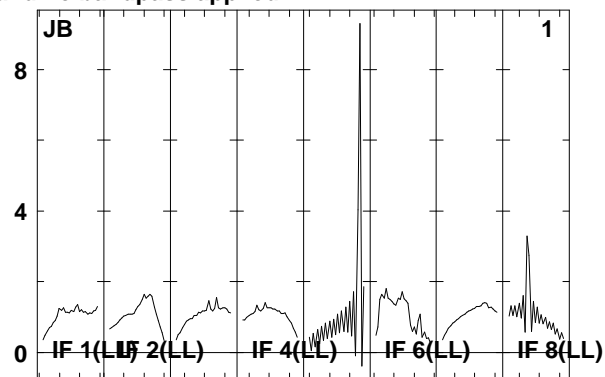
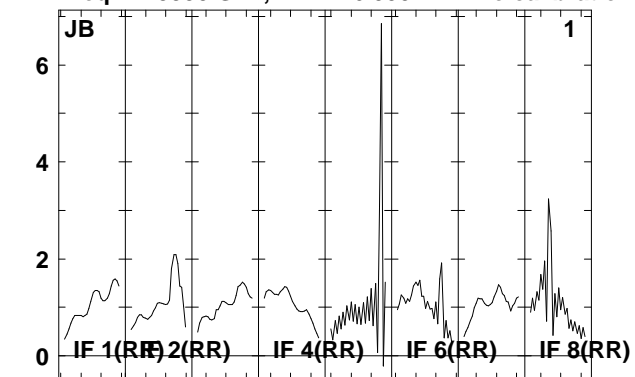

Lower frame: Real Jy
Total-power spectrum Antenna: *
Timerange: 00/11:44:32 to 00/11:48:00

Plot file version 182 created 18-APR-2008 18:29:03

IRAS2336 EP061A.UVDATA.1

Freq = 1.5950 GHz, Bw = 16.000 MH No calibration applied and no bandpass applied

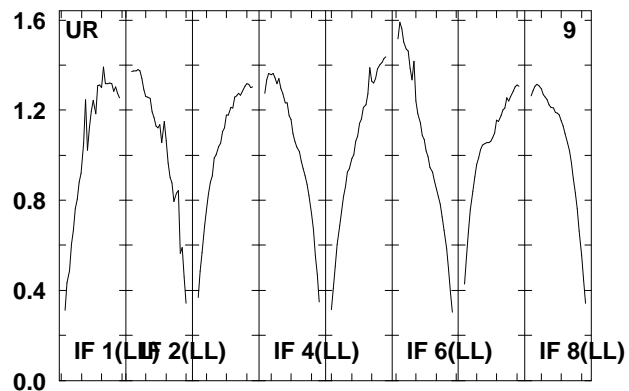
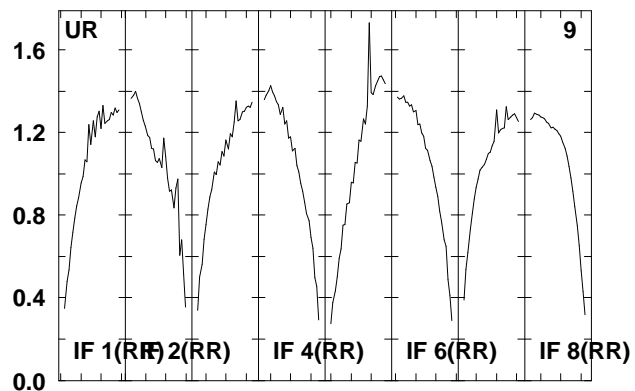
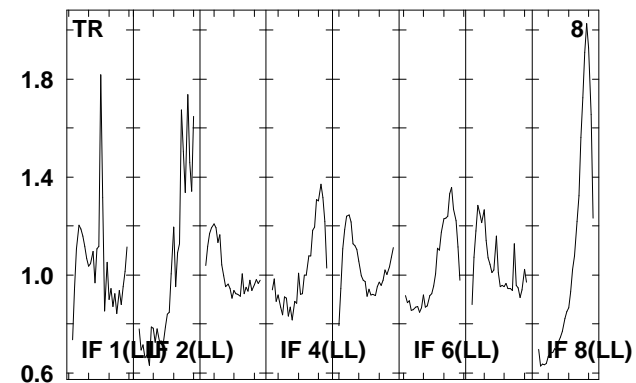
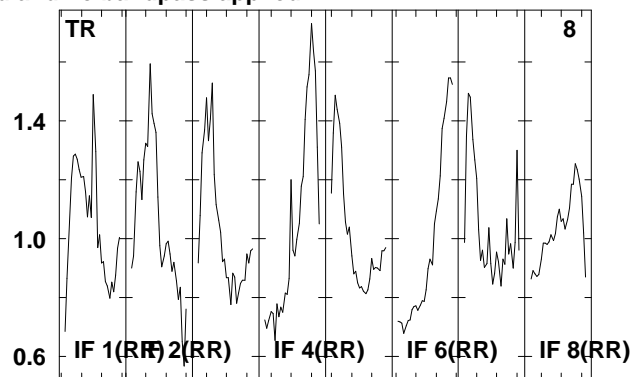
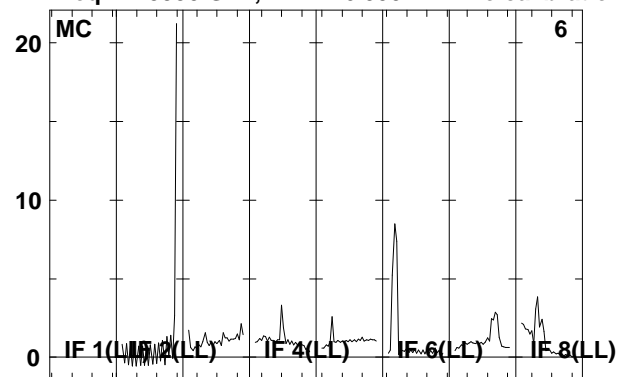

Lower frame: Real Jy
Total-power spectrum Antenna: *
Timerange: 00/11:44:32 to 00/11:48:00

Plot file version 183 created 18-APR-2008 18:29:04

J2333+39 EP061A.UVDATA.1

Freq = 1.5950 GHz, Bw = 16.000 MH No calibration applied and no bandpass applied

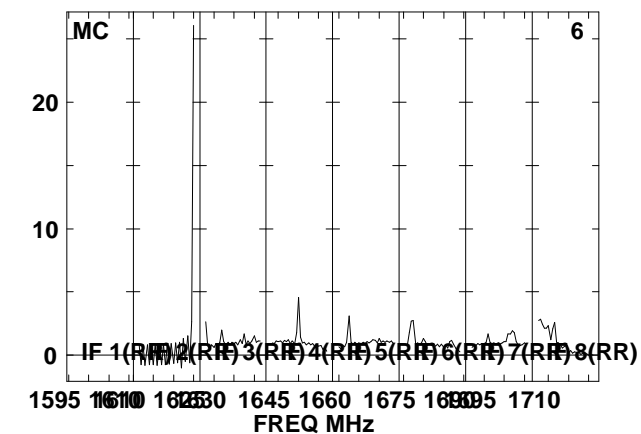
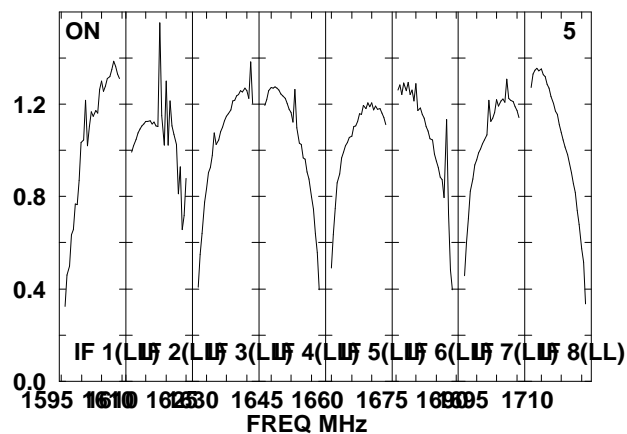
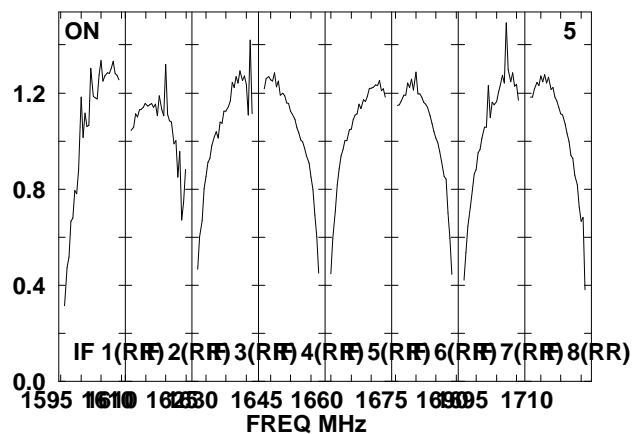
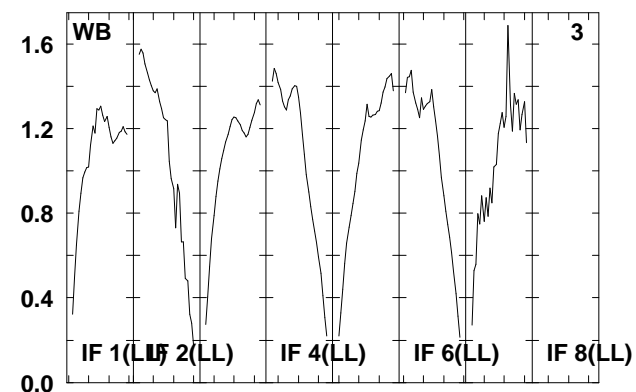
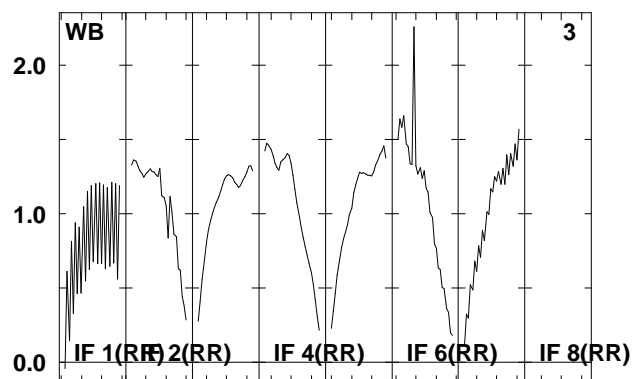
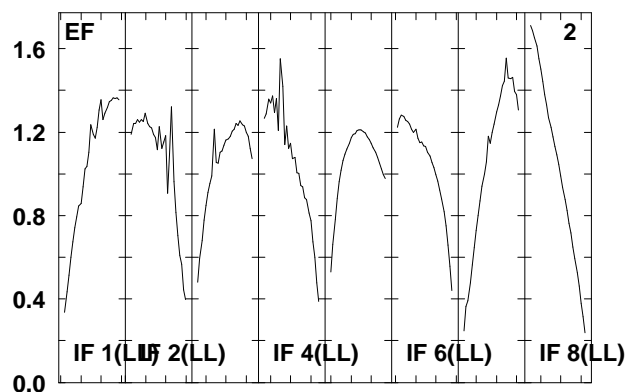
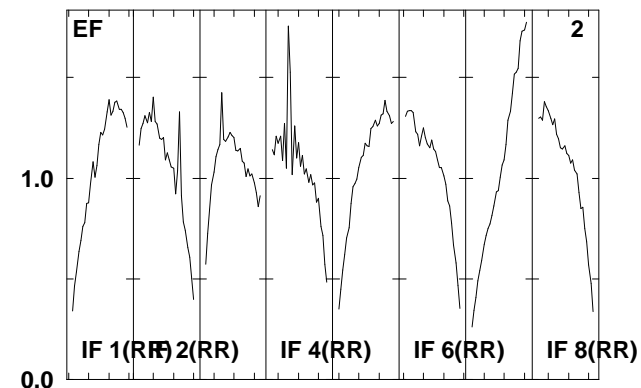
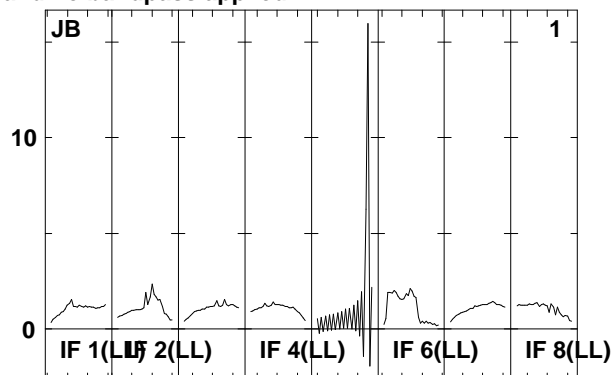
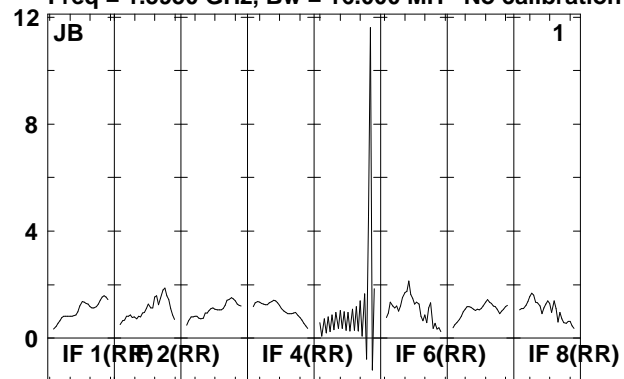

Lower frame: Real Jy
Total-power spectrum Antenna: *
Timerange: 00/11:48:02 to 00/11:49:30

Plot file version 184 created 18-APR-2008 18:29:04

J2333+39 EP061A.UVDATA.1

Freq = 1.5950 GHz, Bw = 16.000 MH No calibration applied and no bandpass applied

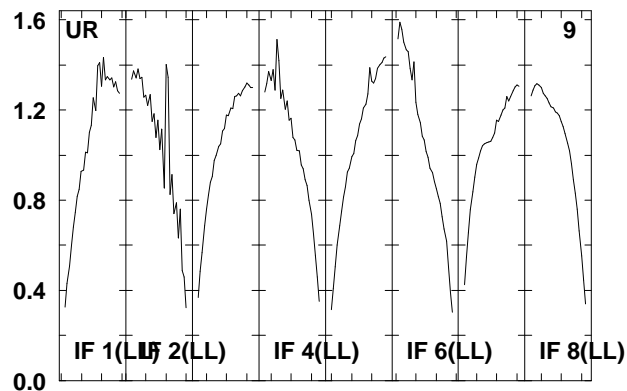
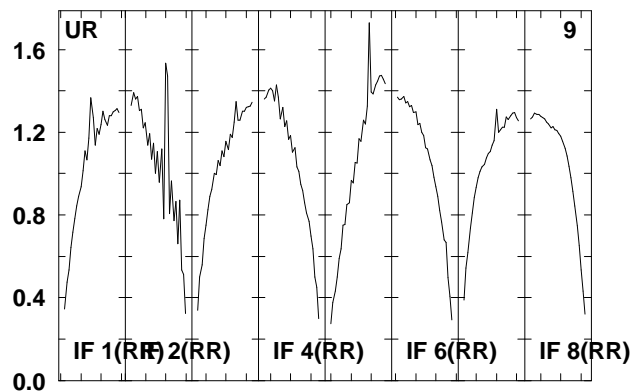
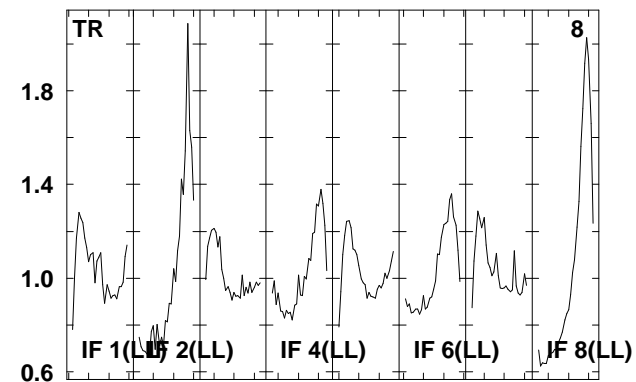
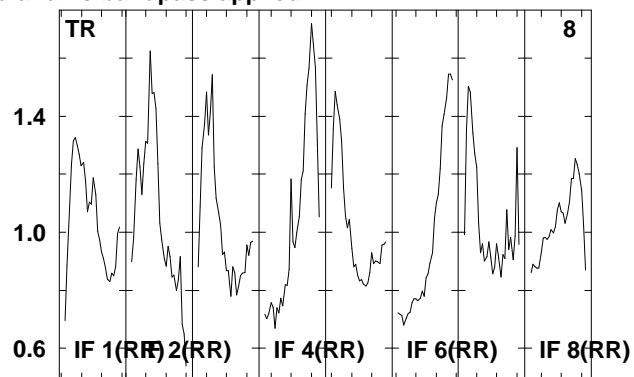
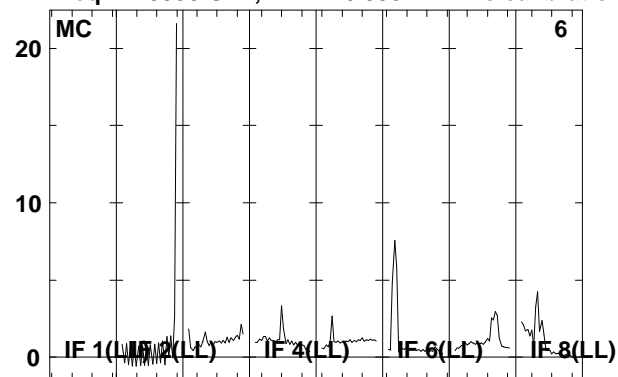

Lower frame: Real Jy
Total-power spectrum Antenna: *
Timerange: 00/11:48:02 to 00/11:49:30

Plot file version 185 created 18-APR-2008 18:29:05

IRAS2336 EP061A.UVDATA.1

Freq = 1.5950 GHz, Bw = 16.000 MH No calibration applied and no bandpass applied

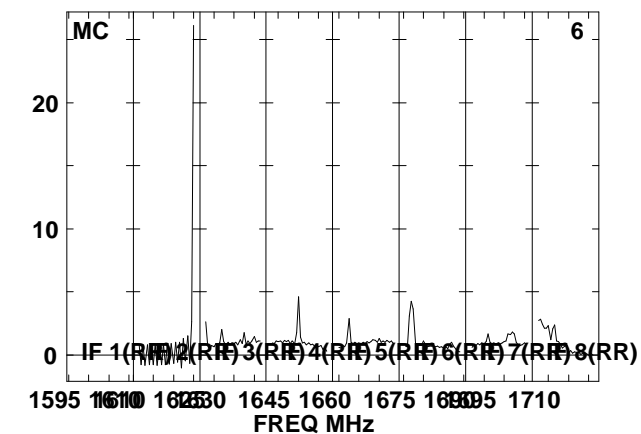
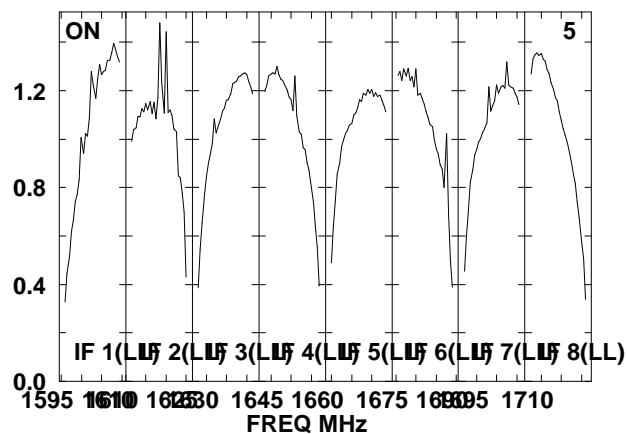
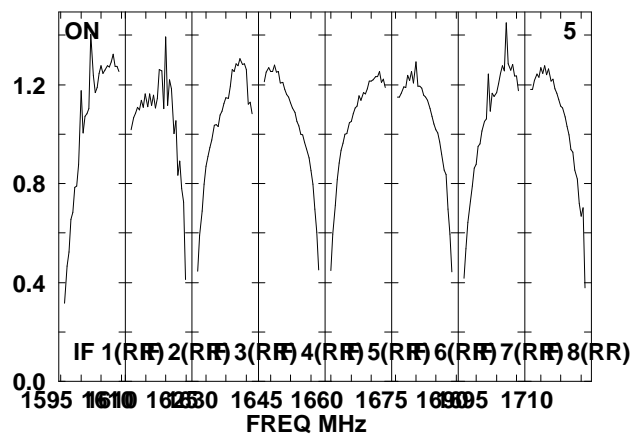
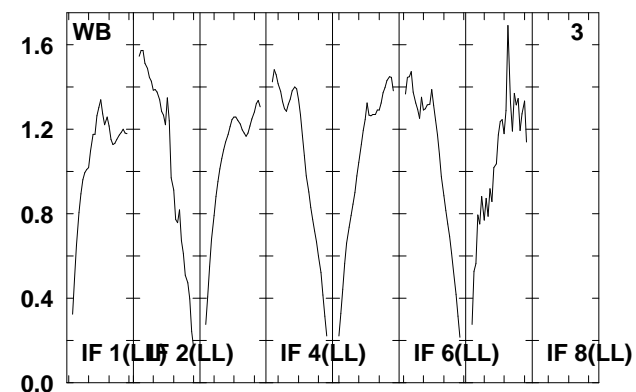
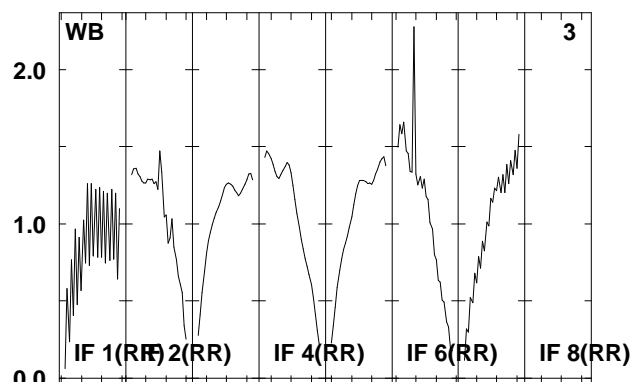
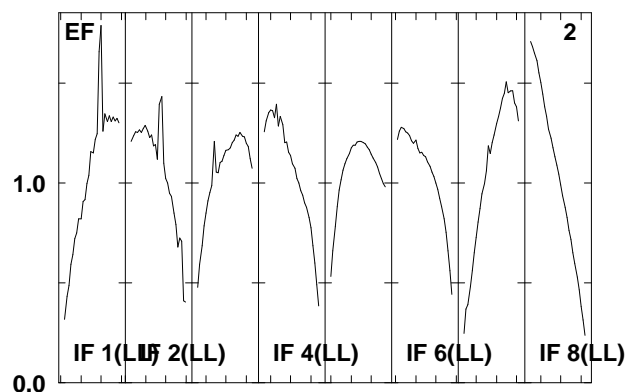
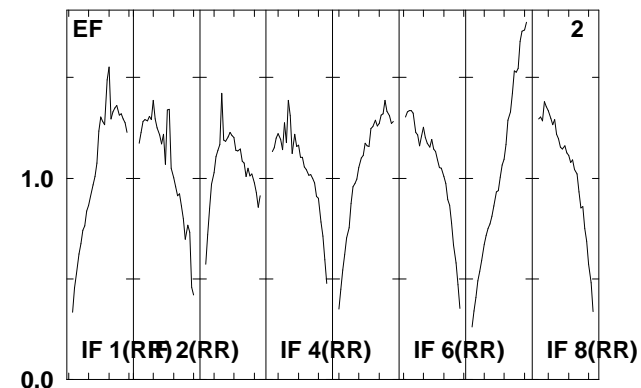
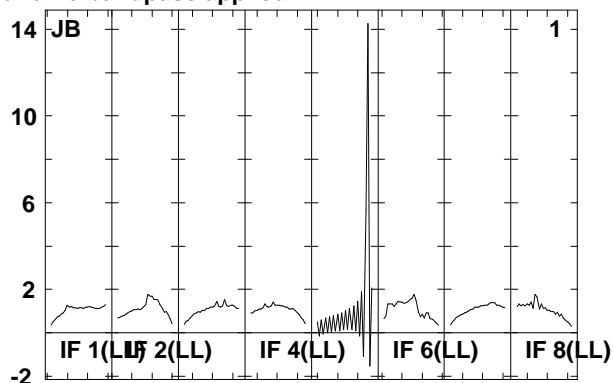
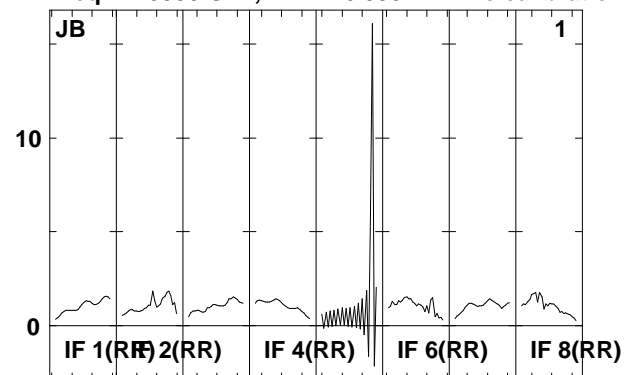

Lower frame: Real Jy
Total-power spectrum Antenna: *
Timerange: 00/11:49:32 to 00/11:52:56

Plot file version 186 created 18-APR-2008 18:29:06

IRAS2336 EP061A.UVDATA.1

Freq = 1.5950 GHz, Bw = 16.000 MH No calibration applied and no bandpass applied

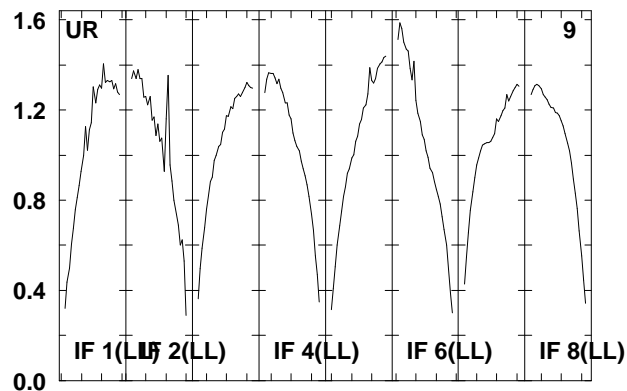
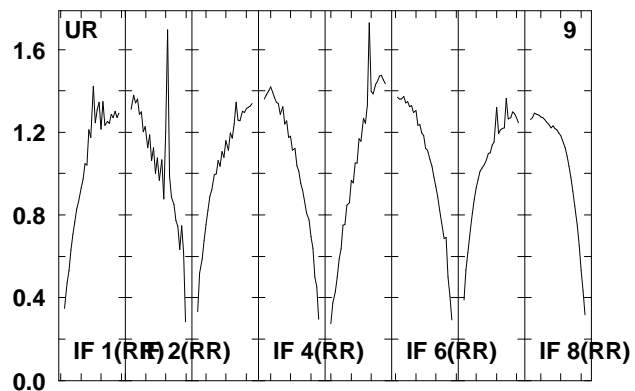
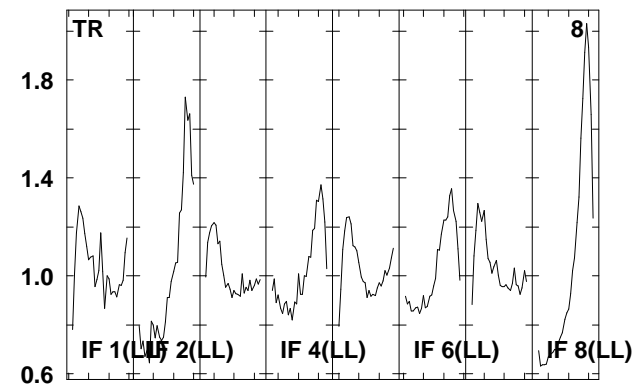
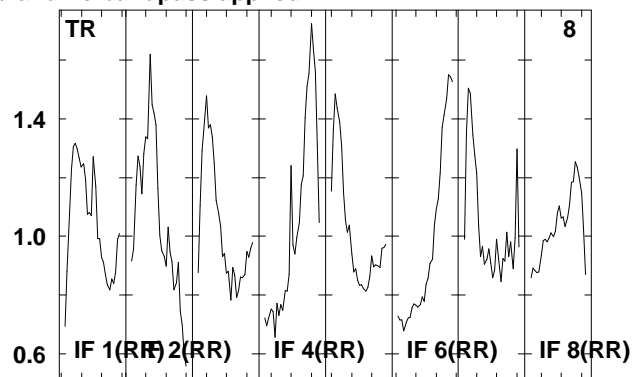
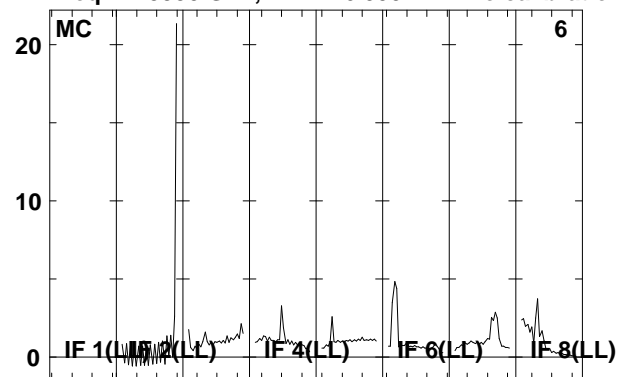

Lower frame: Real Jy
Total-power spectrum Antenna: *
Timerange: 00/11:49:32 to 00/11:52:56

Plot file version 187 created 18-APR-2008 18:29:06

J2333+39 EP061A.UVDATA.1

Freq = 1.5950 GHz, Bw = 16.000 MH No calibration applied and no bandpass applied

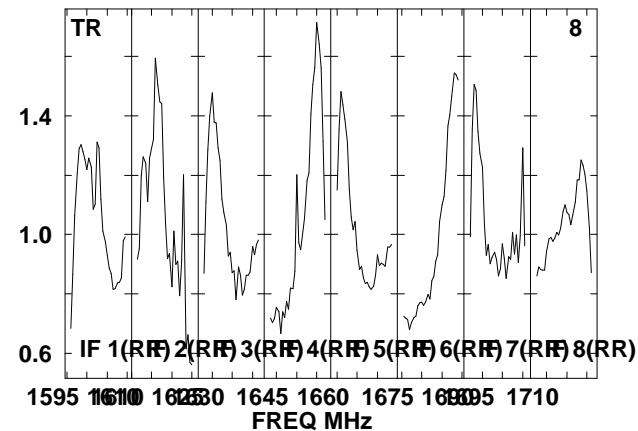
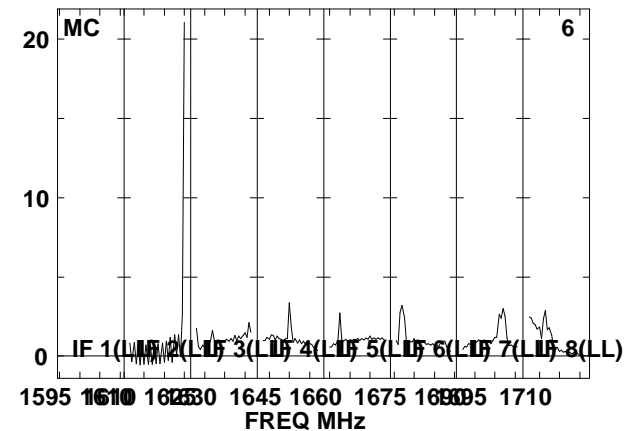
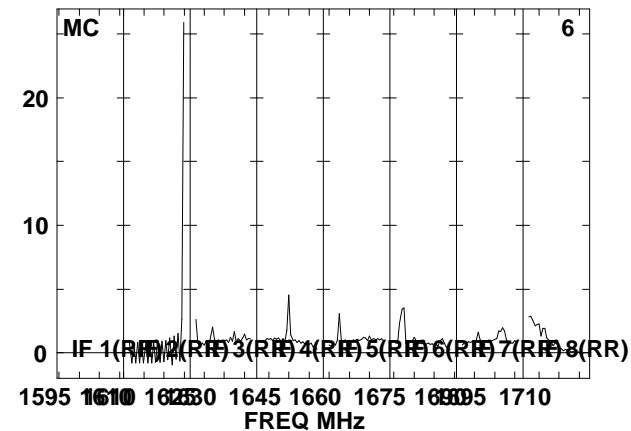
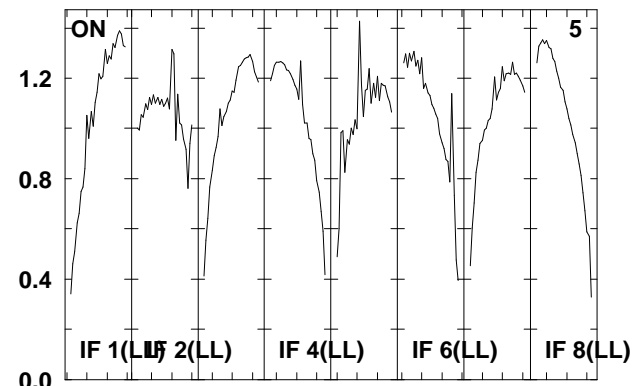
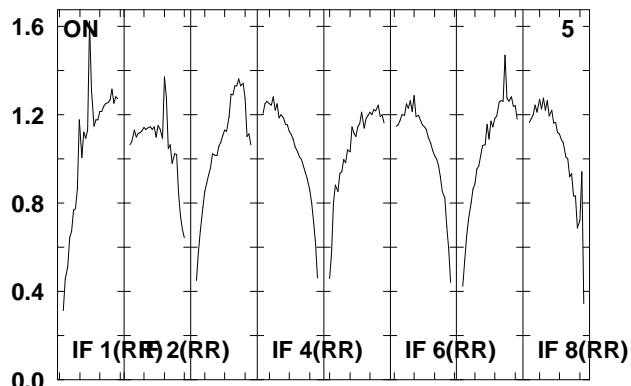
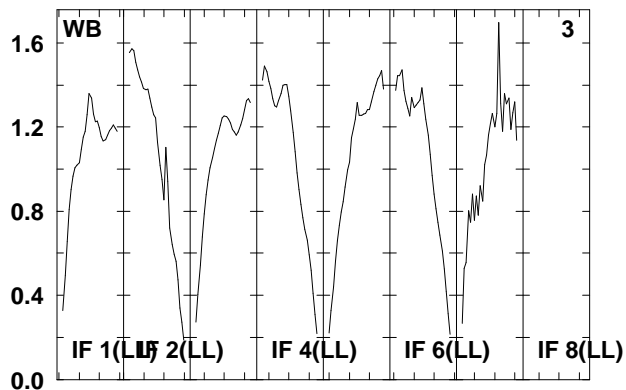
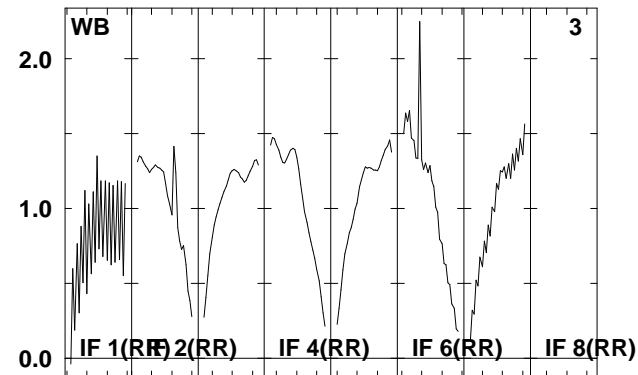
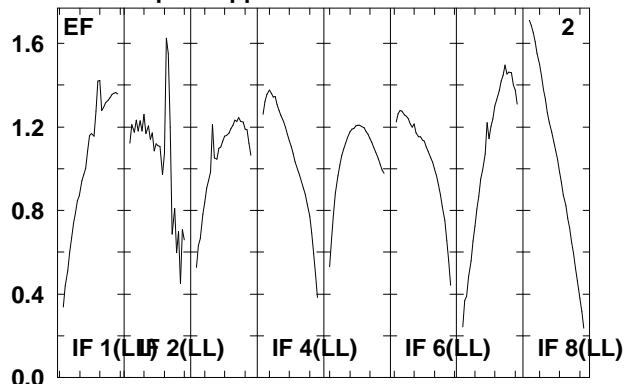
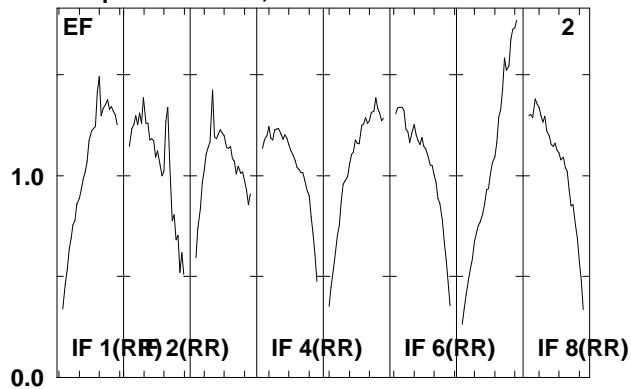

Lower frame: Real Jy
Total-power spectrum Antenna: *
Timerange: 00/11:54:02 to 00/11:55:26

Plot file version 188 created 18-APR-2008 18:29:07

J2333+39 EP061A.UVDATA.1

Freq = 1.5950 GHz, Bw = 16.000 MH No calibration applied and no bandpass applied

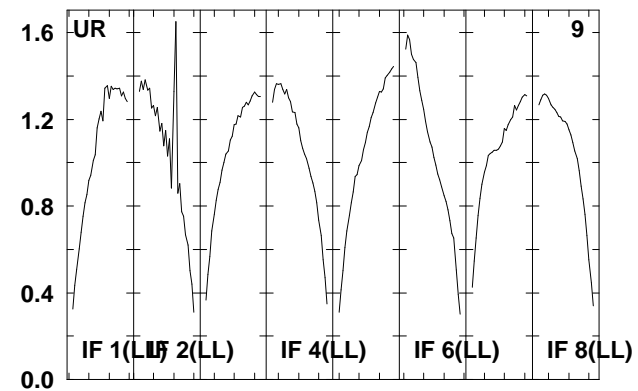
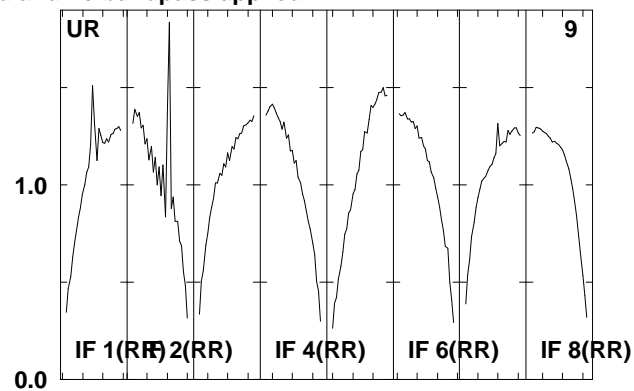
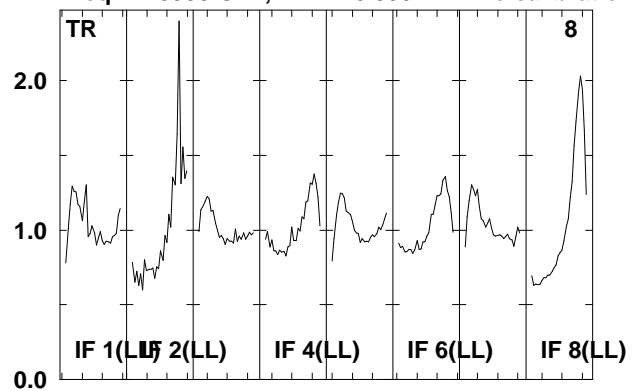

Lower frame: Real Jy
Total-power spectrum Antenna: *
Timerange: 00/11:54:02 to 00/11:55:26

Plot file version 189 created 18-APR-2008 18:29:07

IRAS2336 EP061A.UVDATA.1

Freq = 1.5950 GHz, Bw = 16.000 MH No calibration applied and no bandpass applied

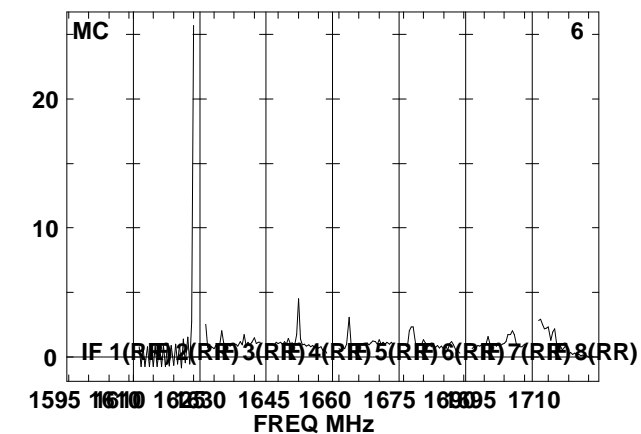
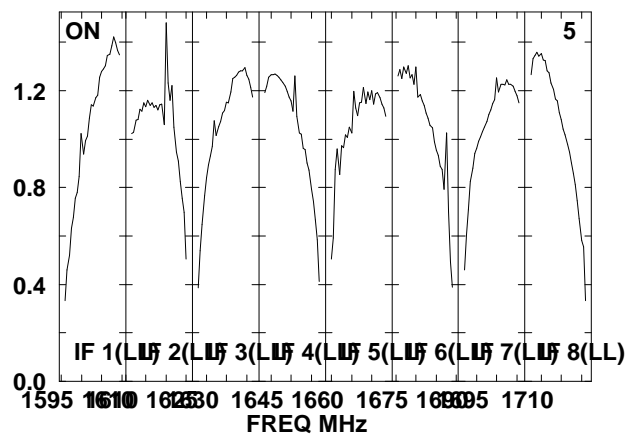
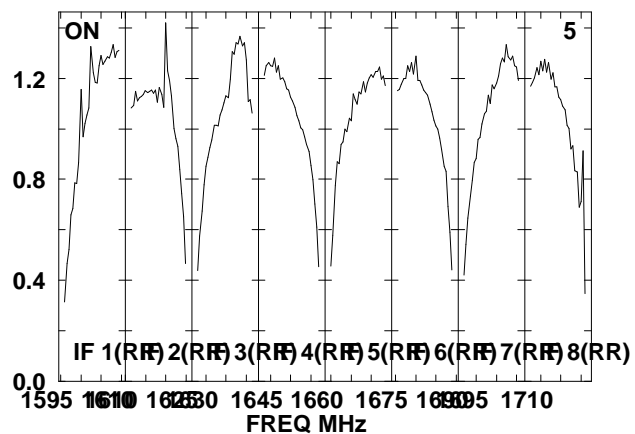
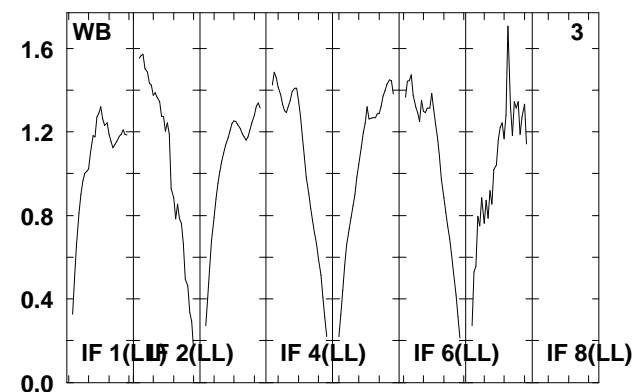
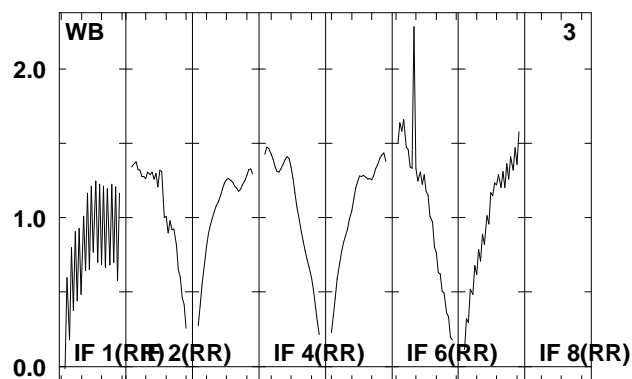
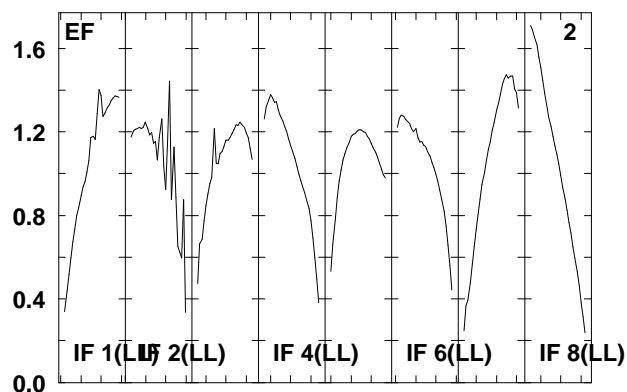
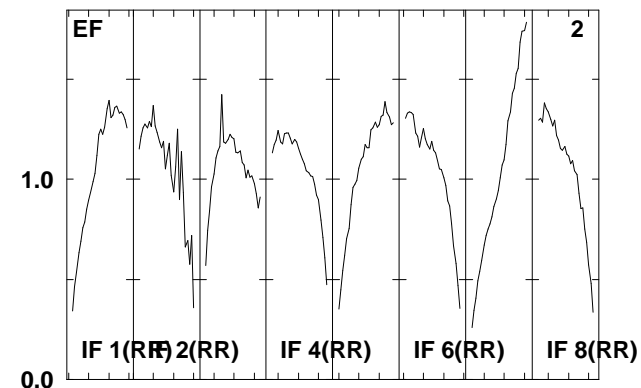
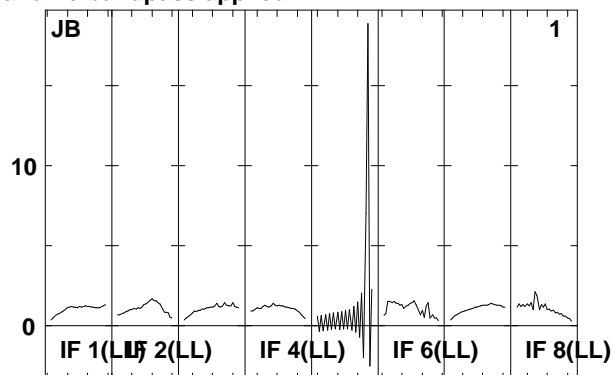
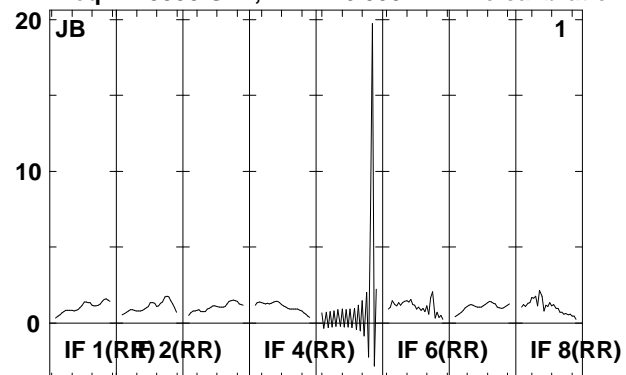

Lower frame: Real Jy
Total-power spectrum Antenna: *
Timerange: 00/11:55:32 to 00/11:59:00

Plot file version 190 created 18-APR-2008 18:29:08

IRAS2336 EP061A.UVDATA.1

Freq = 1.5950 GHz, Bw = 16.000 MH No calibration applied and no bandpass applied

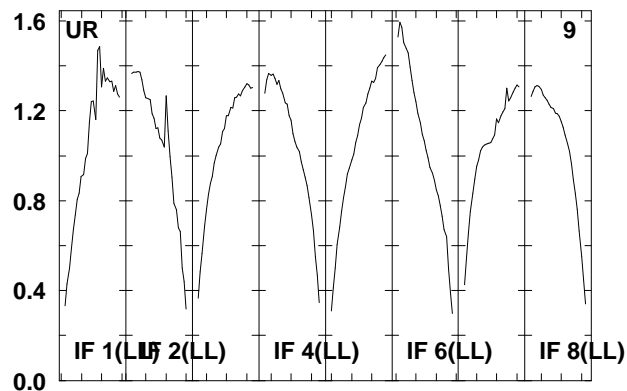
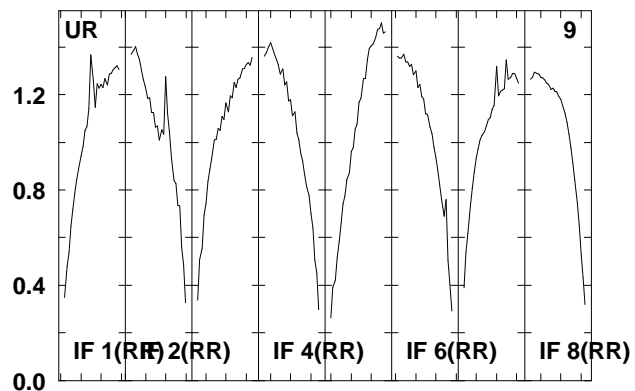
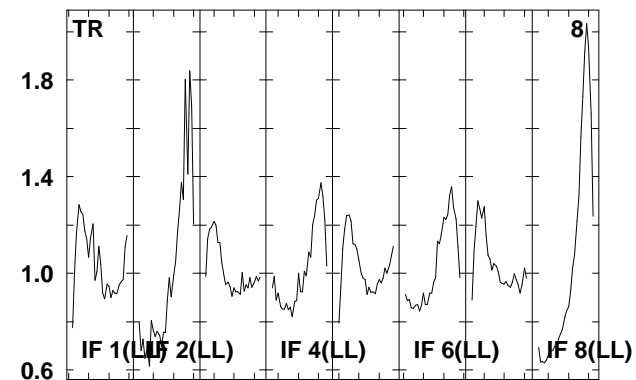
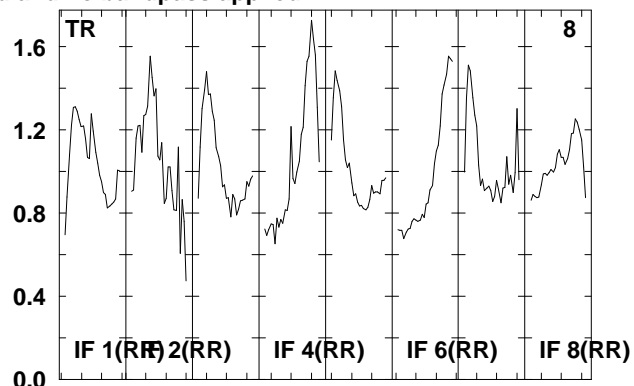
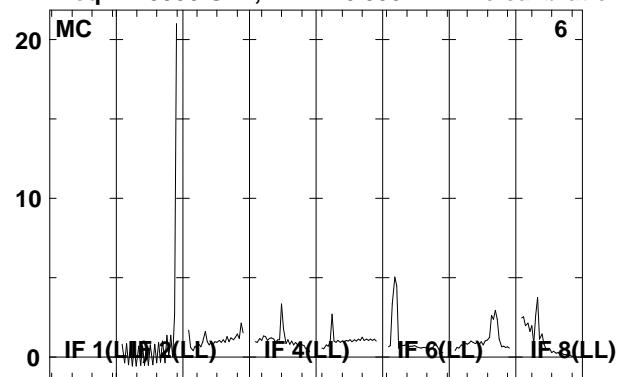

Lower frame: Real Jy
Total-power spectrum Antenna: *
Timerange: 00/11:55:32 to 00/11:59:00

Plot file version 191 created 18-APR-2008 18:29:09

J2333+39 EP061A.UVDATA.1

Freq = 1.5950 GHz, Bw = 16.000 MH No calibration applied and no bandpass applied

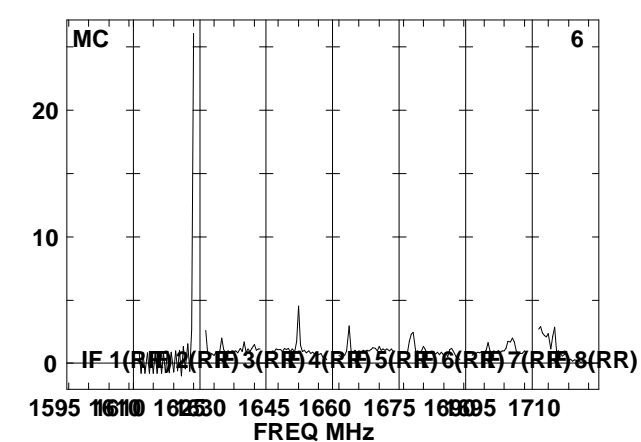
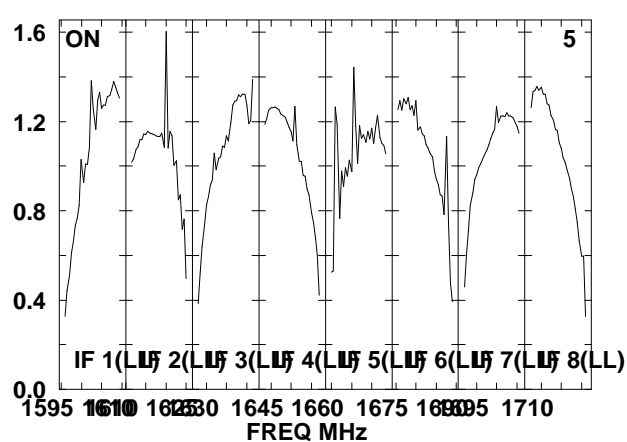
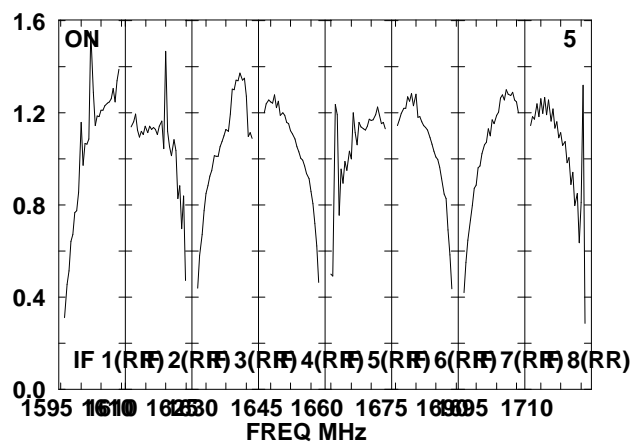
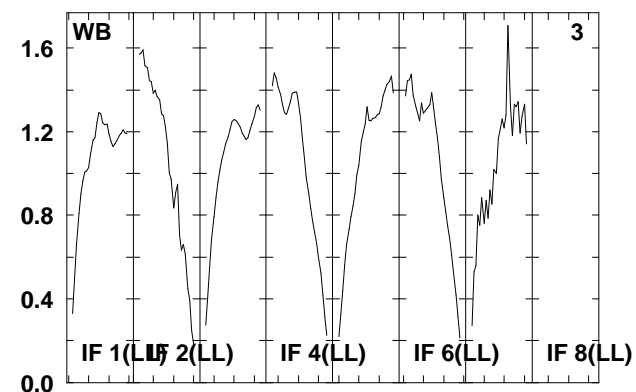
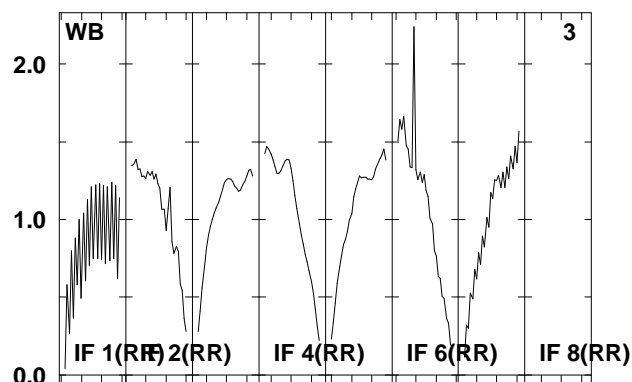
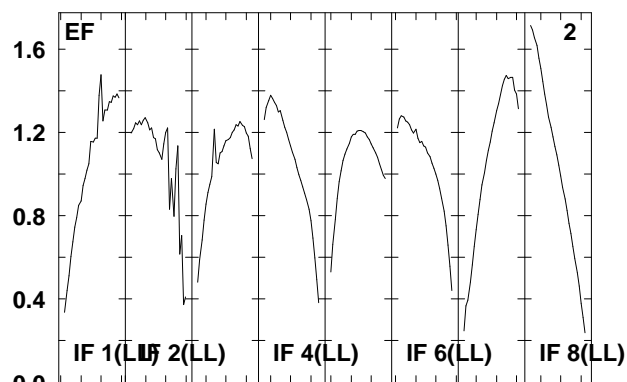
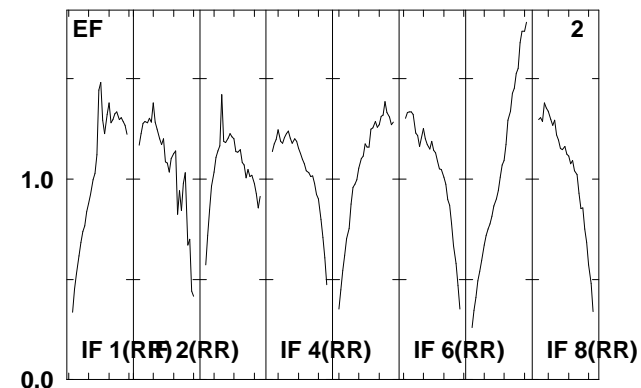
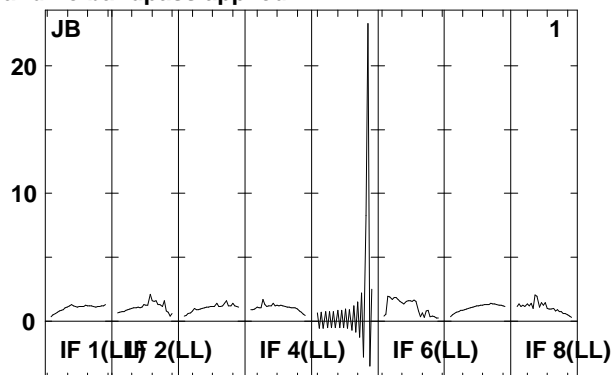
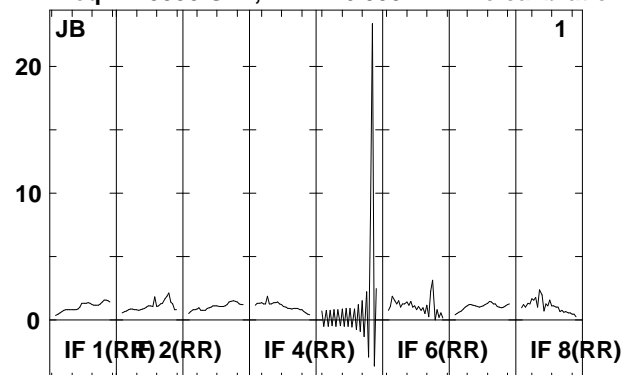

Lower frame: Real Jy
Total-power spectrum Antenna: *
Timerange: 00/11:59:02 to 00/12:00:30

Plot file version 192 created 18-APR-2008 18:29:09

J2333+39 EP061A.UVDATA.1

Freq = 1.5950 GHz, Bw = 16.000 MH No calibration applied and no bandpass applied

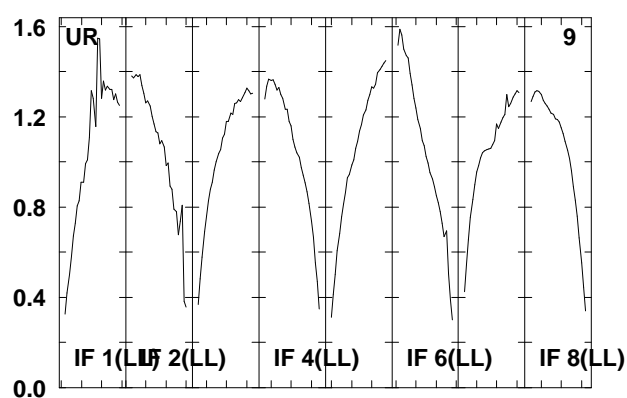
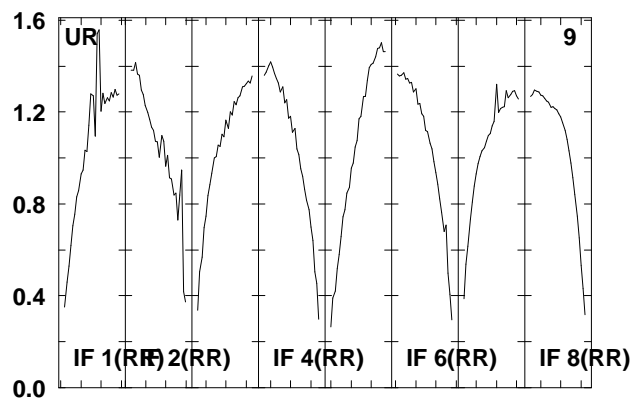
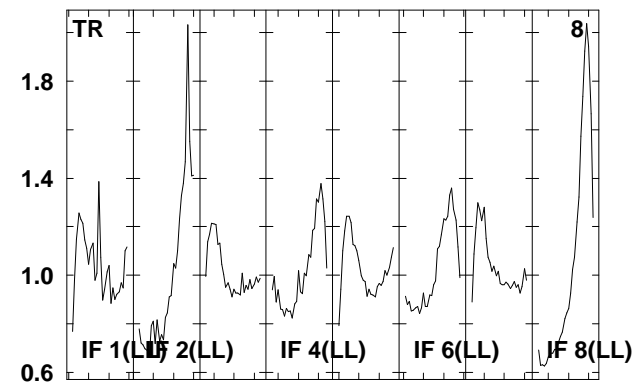
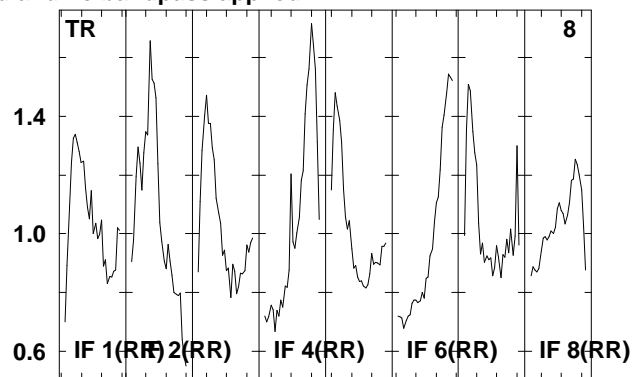
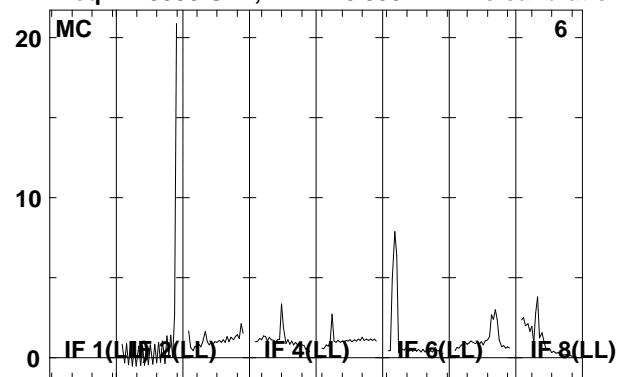

Lower frame: Real Jy
Total-power spectrum Antenna: *
Timerange: 00/11:59:02 to 00/12:00:30

Plot file version 193 created 18-APR-2008 18:29:10

IRAS2336 EP061A.UVDATA.1

Freq = 1.5950 GHz, Bw = 16.000 MH No calibration applied and no bandpass applied

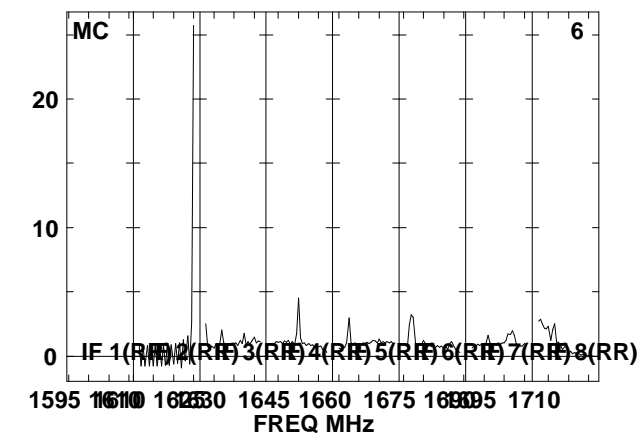
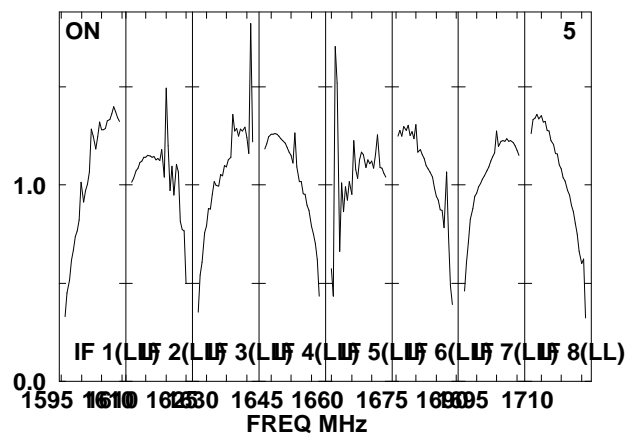
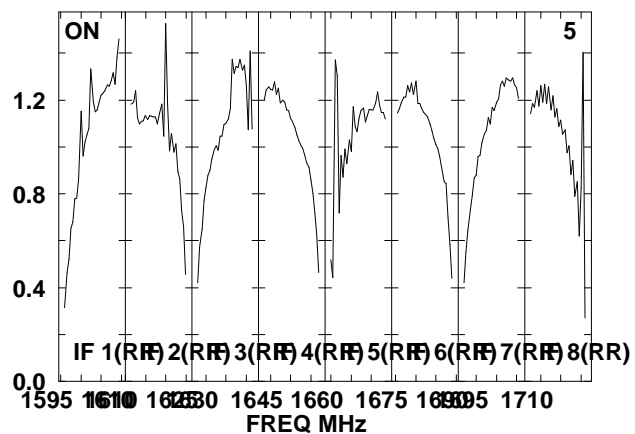
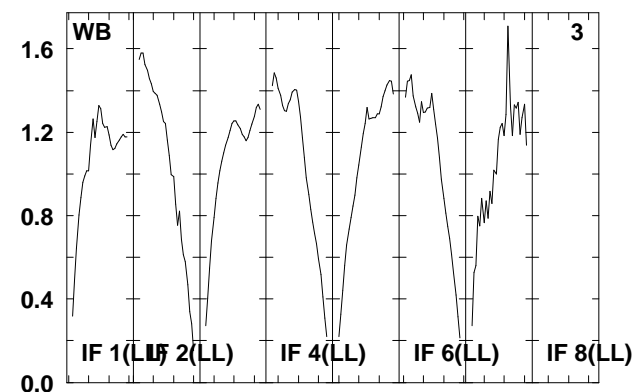
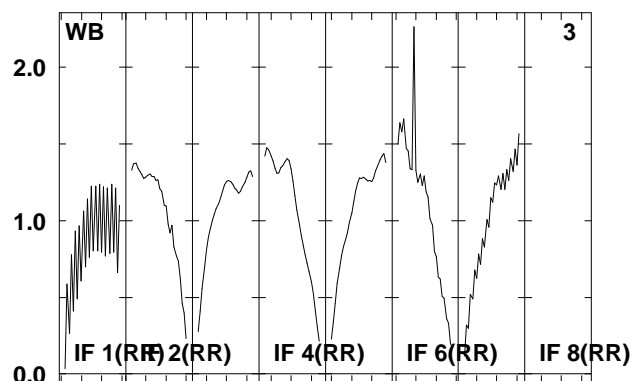
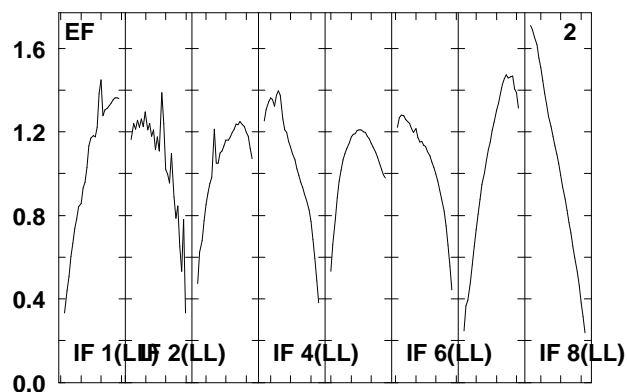
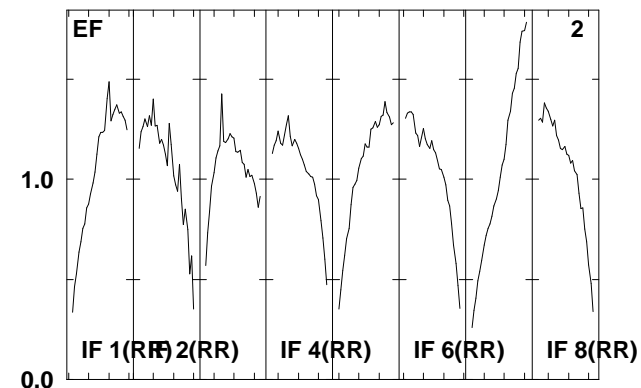
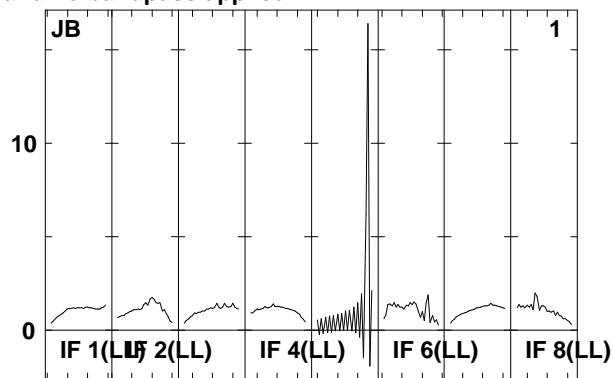
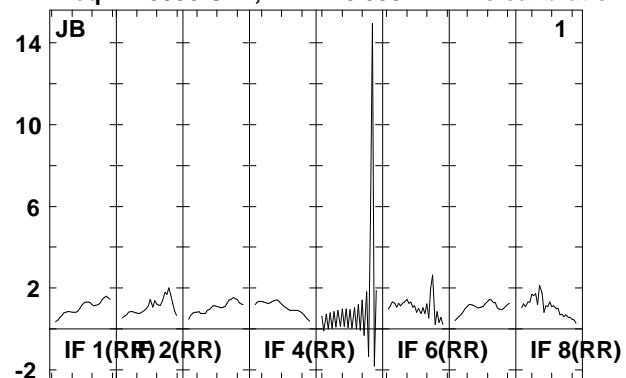

Lower frame: Real Jy
Total-power spectrum Antenna: *
Timerange: 00:12:00:32 to 00:12:03:56

Plot file version 194 created 18-APR-2008 18:29:11

IRAS2336 EP061A.UVDATA.1

Freq = 1.5950 GHz, Bw = 16.000 MH No calibration applied and no bandpass applied

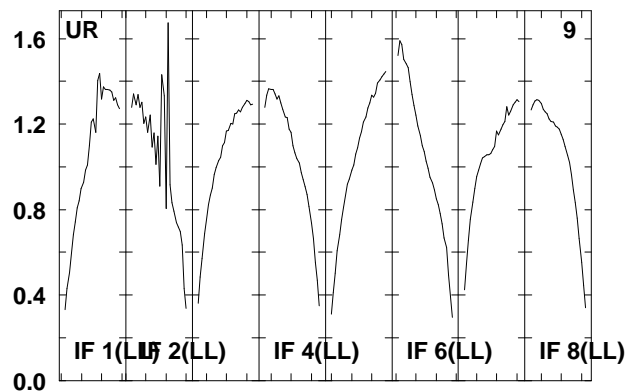
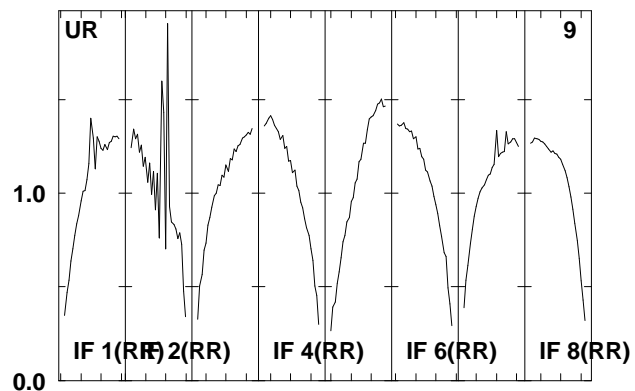
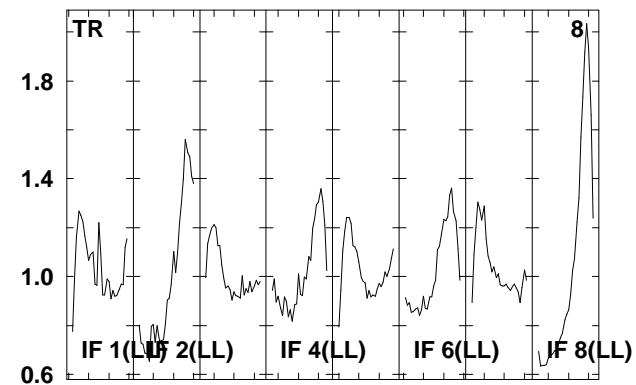
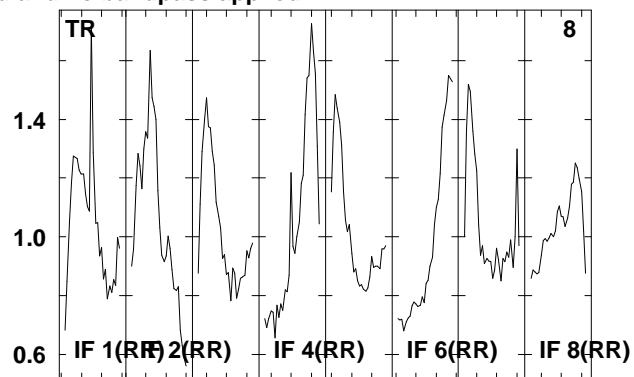
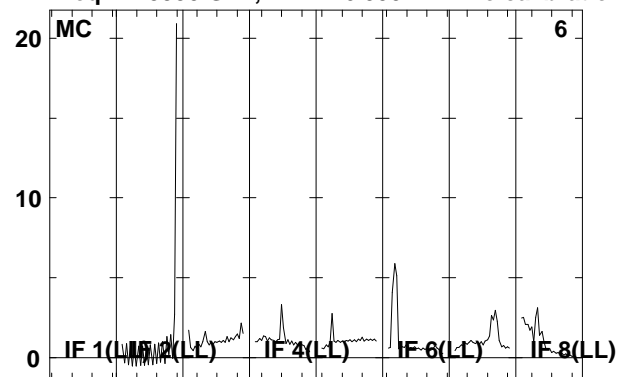

Lower frame: Real Jy
Total-power spectrum Antenna: *
Timerange: 00/12:00:32 to 00/12:03:56

Plot file version 195 created 18-APR-2008 18:29:12

J2333+39 EP061A.UVDATA.1

Freq = 1.5950 GHz, Bw = 16.000 MH No calibration applied and no bandpass applied

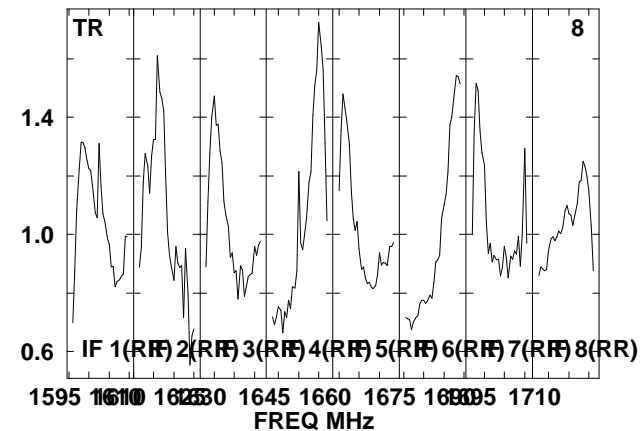
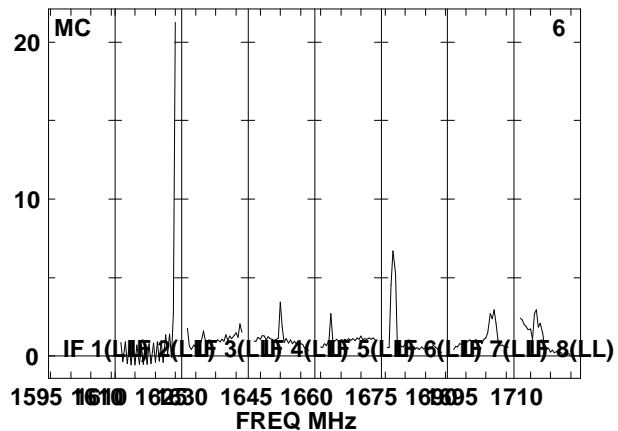
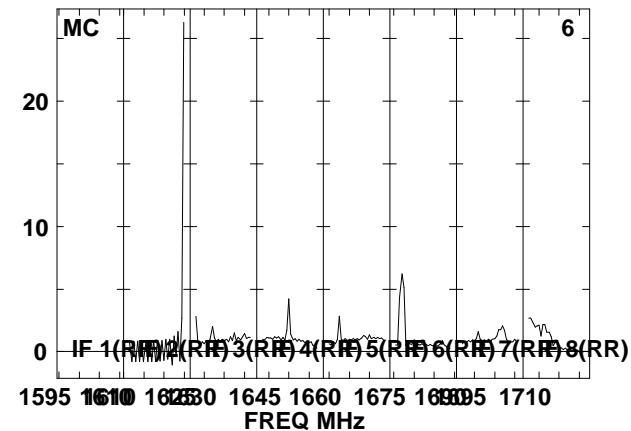
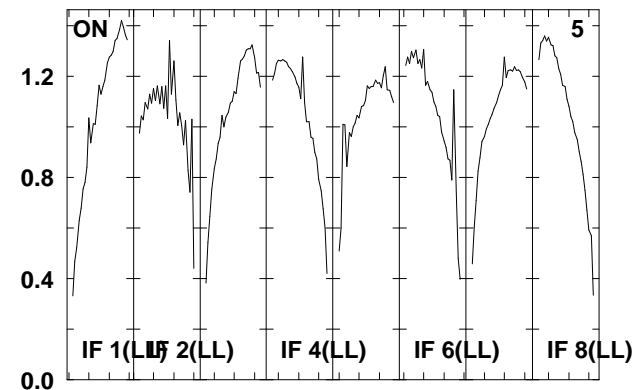
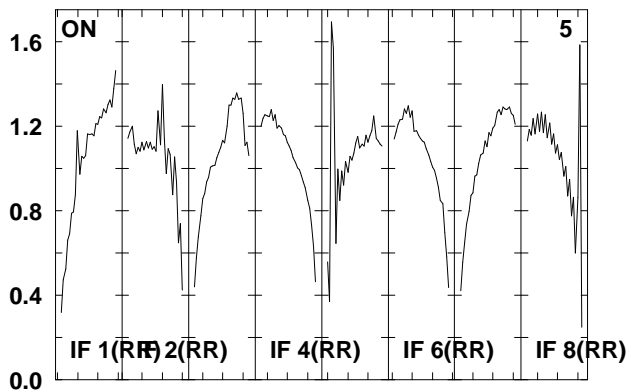
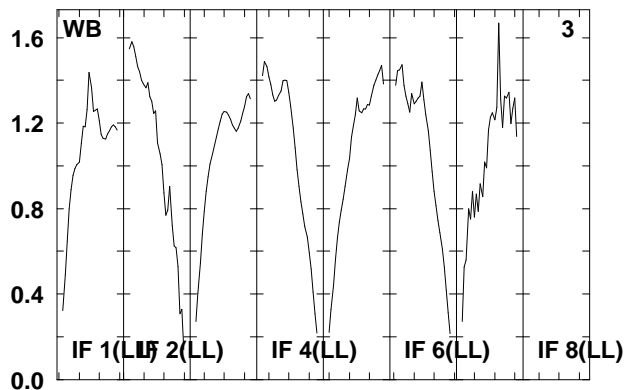
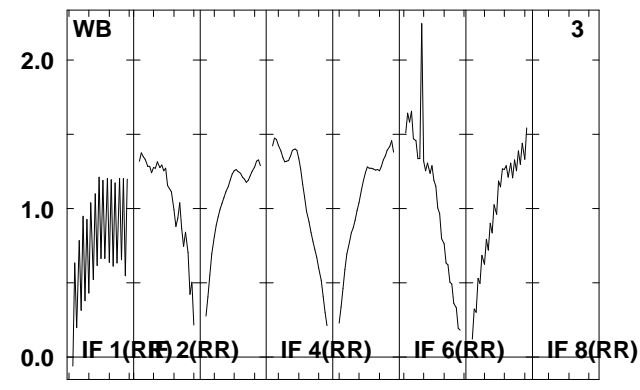
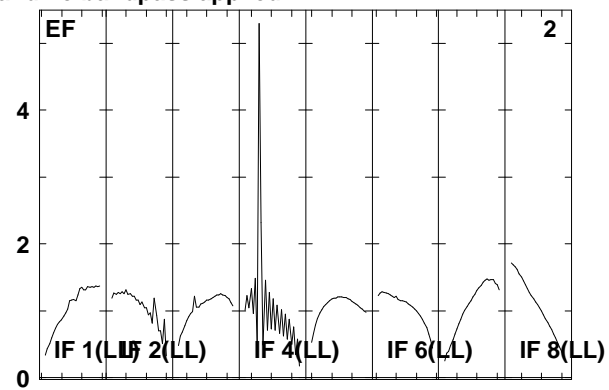
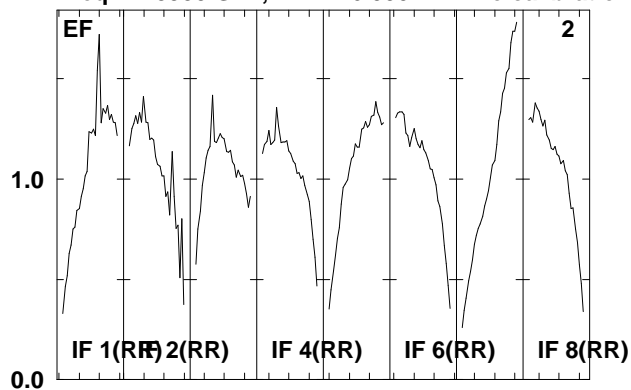

Lower frame: Real Jy
Total-power spectrum Antenna: *
Timerange: 00/12:04:10 to 00/12:05:26

Plot file version 196 created 18-APR-2008 18:29:12

J2333+39 EP061A.UVDATA.1

Freq = 1.5950 GHz, Bw = 16.000 MH No calibration applied and no bandpass applied

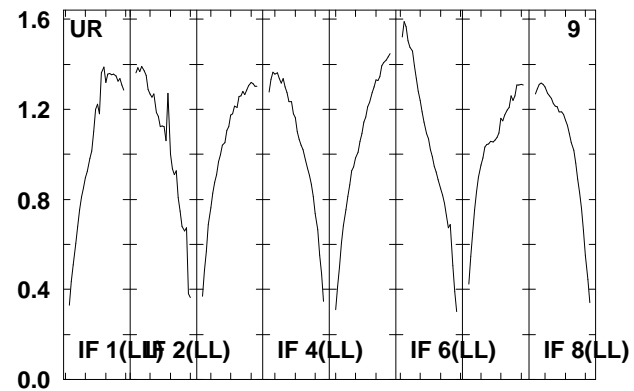
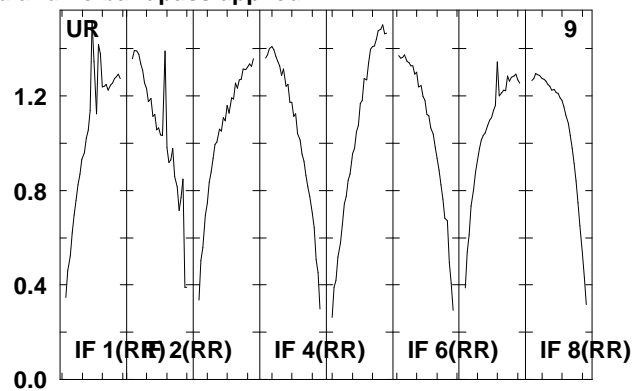
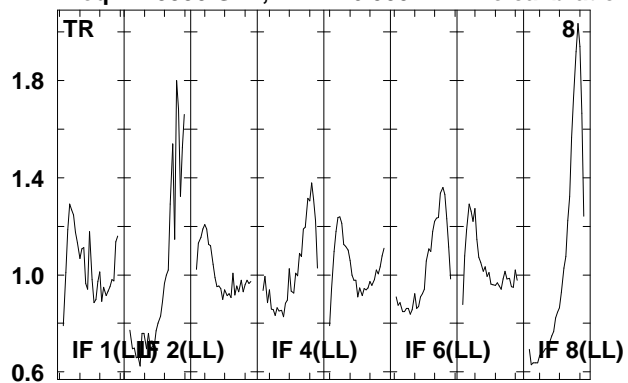

Lower frame: Real Jy
Total-power spectrum Antenna: *
Timerange: 00/12:04:10 to 00/12:05:26

Plot file version 197 created 18-APR-2008 18:29:12

IRAS2336 EP061A.UVDATA.1

Freq = 1.5950 GHz, Bw = 16.000 MH No calibration applied and no bandpass applied

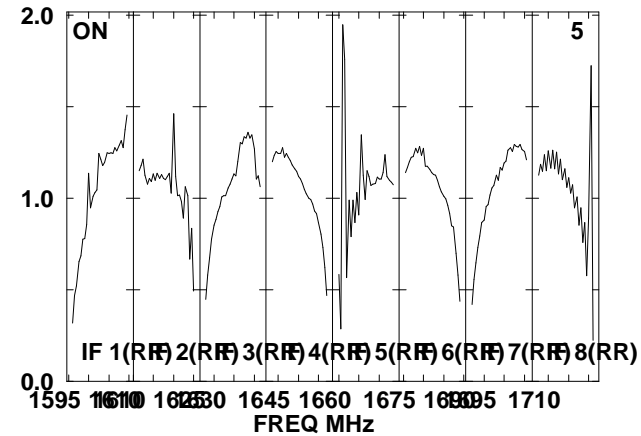
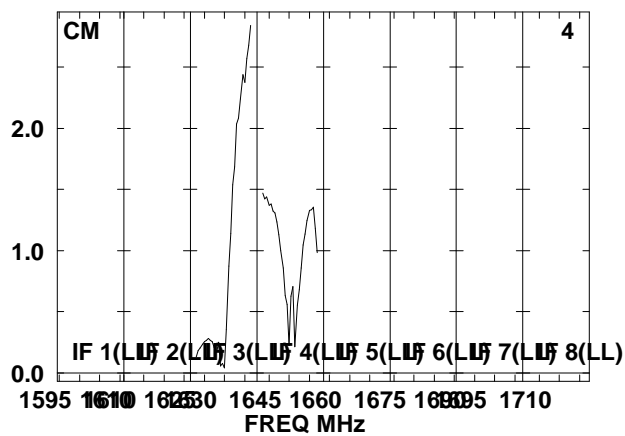
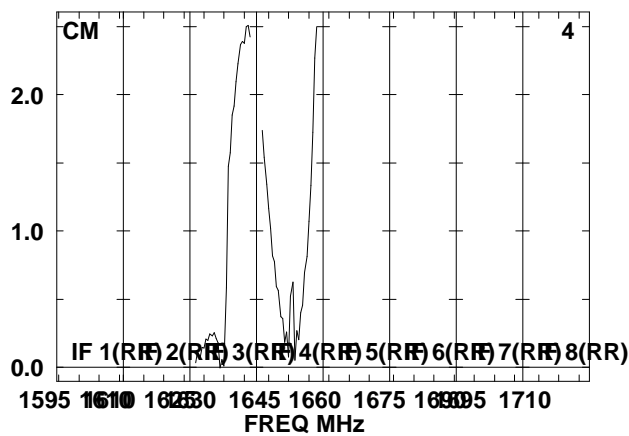
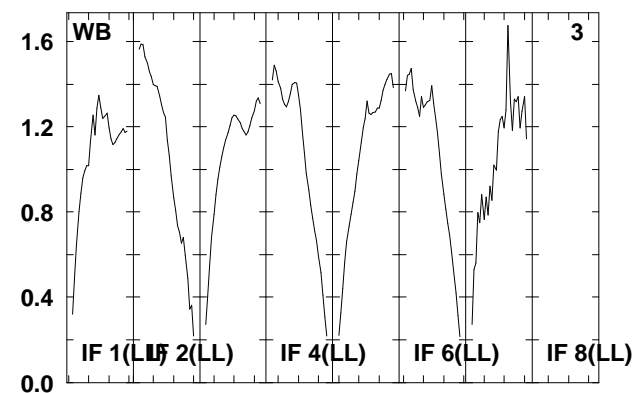
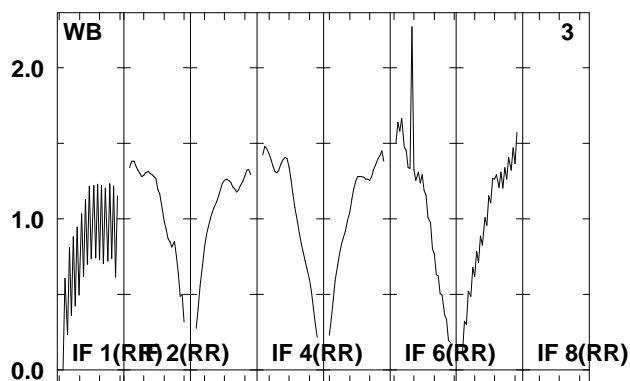
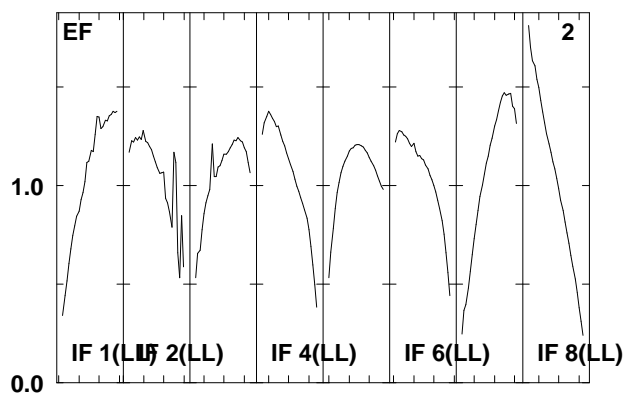
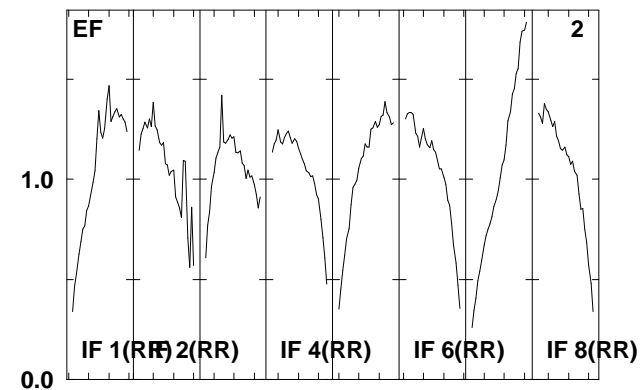
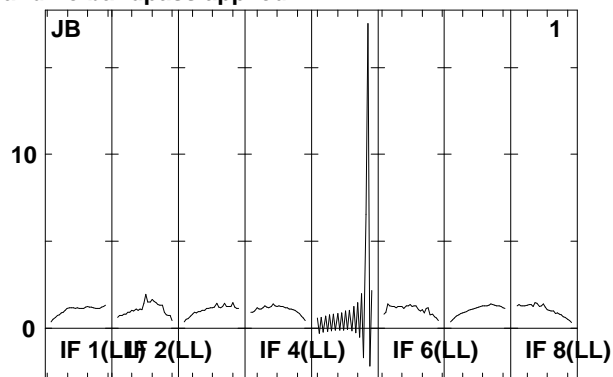
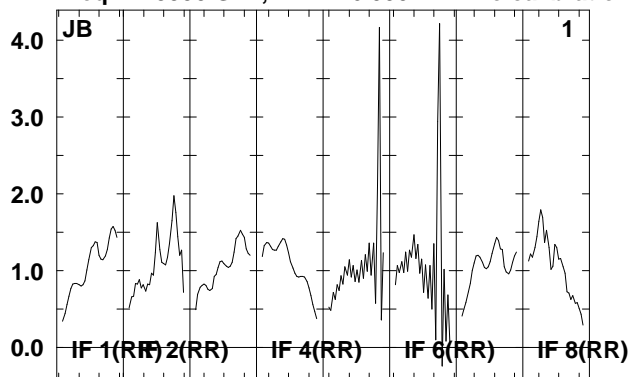

Lower frame: Real Jy
Total-power spectrum Antenna: *
Timerange: 00:12:05:32 to 00:12:08:58

Plot file version 198 created 18-APR-2008 18:29:13

IRAS2336 EP061A.UVDATA.1

Freq = 1.5950 GHz, Bw = 16.000 MH No calibration applied and no bandpass applied

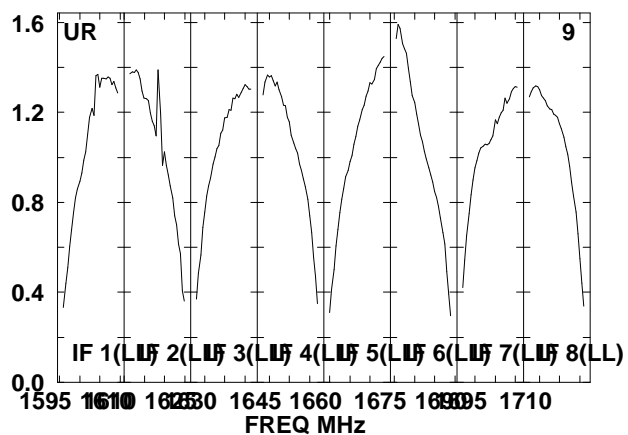
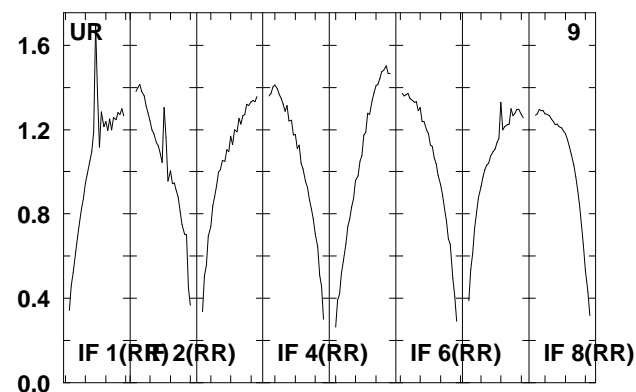
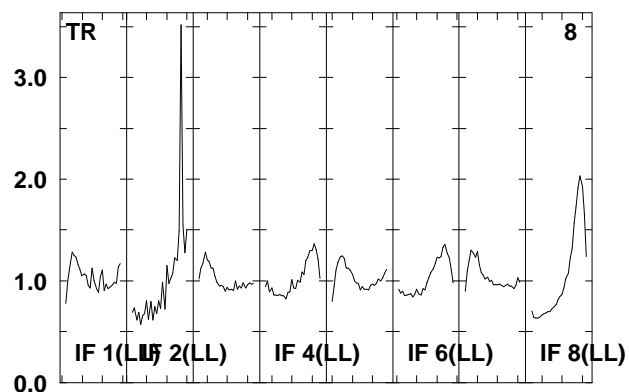
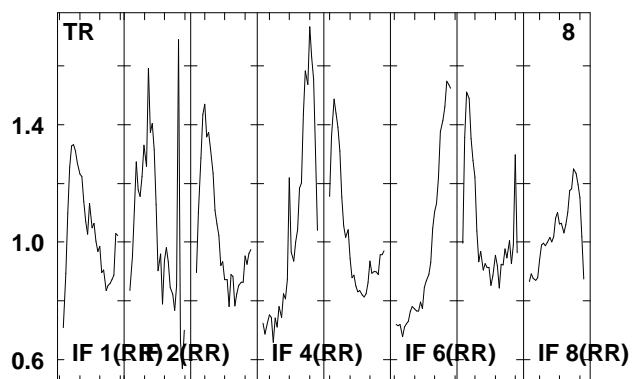
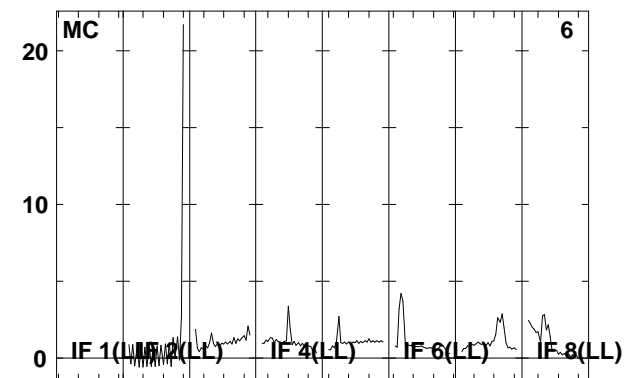
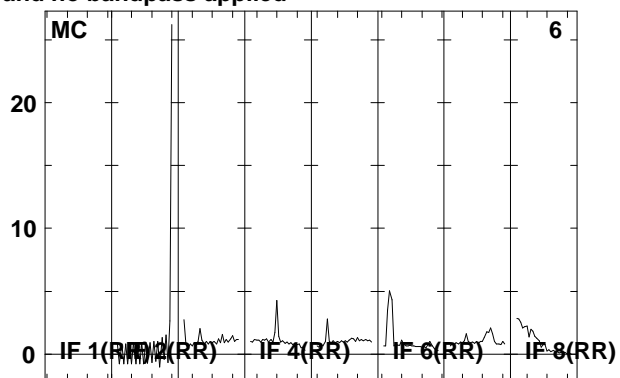
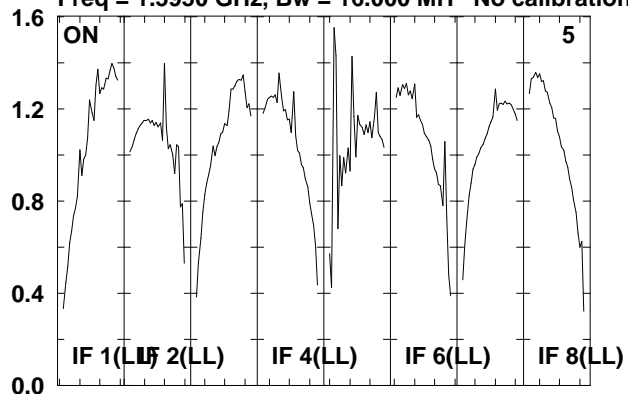

Lower frame: Real Jy

Total-power spectrum Antenna: *

Timerange: 00/12:05:32 to 00/12:08:58

Plot file version 199 created 18-APR-2008 18:29:13

J2333+39 EP061A.UVDATA.1

Freq = 1.5950 GHz, Bw = 16.000 MH No calibration applied and no bandpass applied

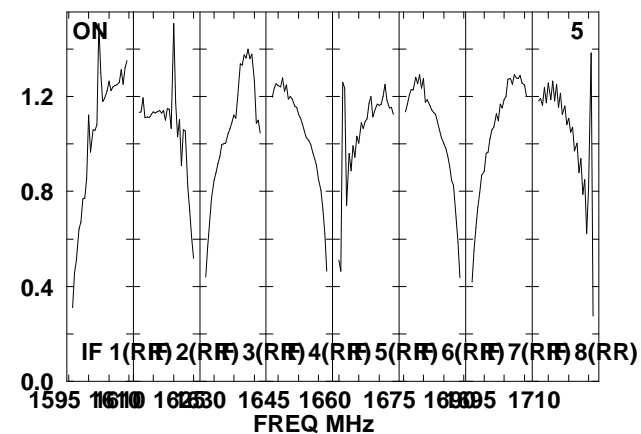
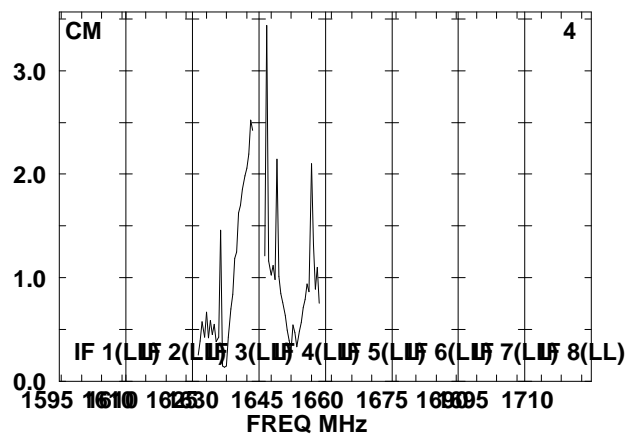
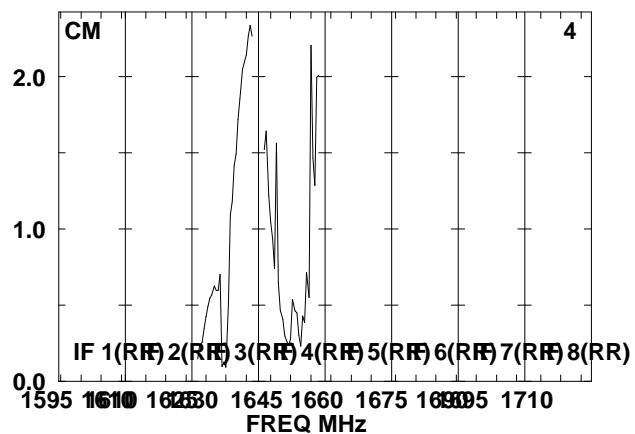
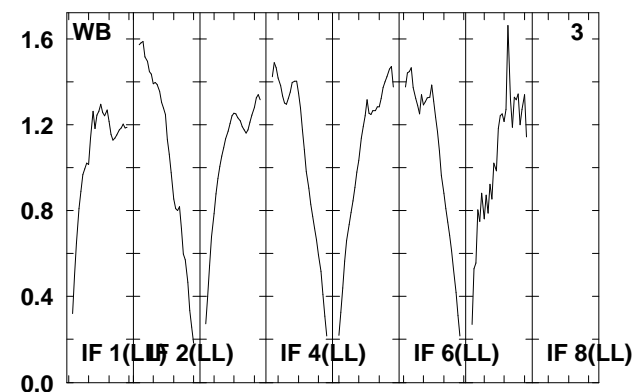
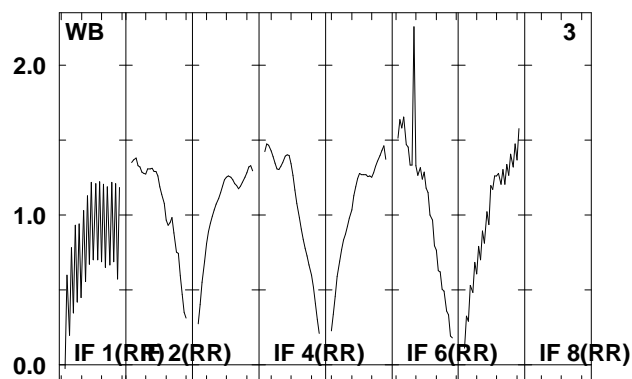
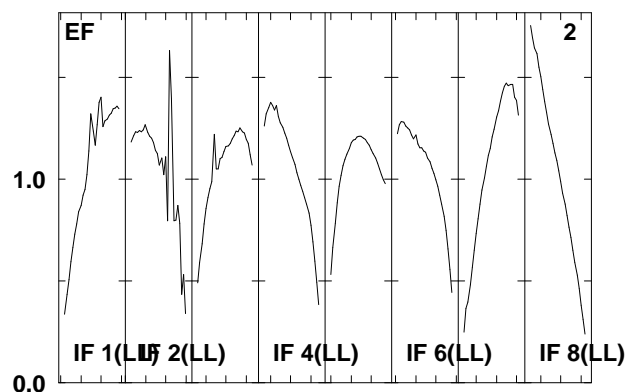
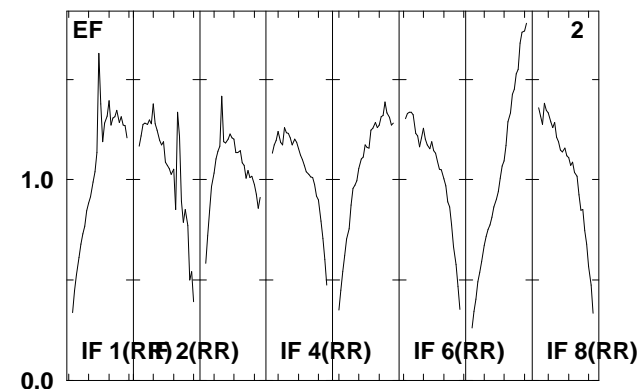
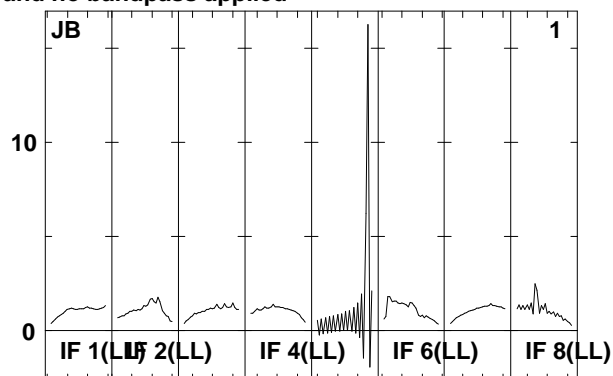
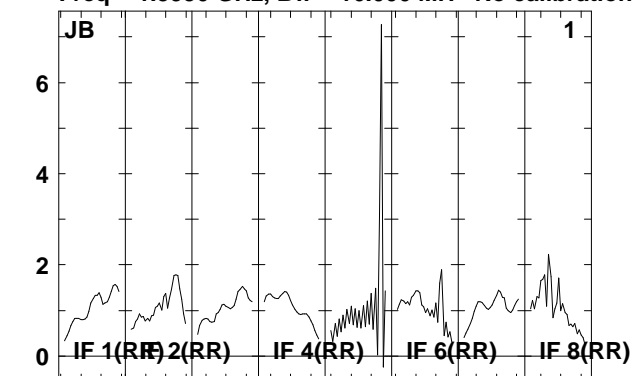

Lower frame: Real Jy
Total-power spectrum Antenna: *
Timerange: 00/12:10:02 to 00/12:11:30

Plot file version 200 created 18-APR-2008 18:29:14

J2333+39 EP061A.UVDATA.1

Freq = 1.5950 GHz, Bw = 16.000 MH No calibration applied and no bandpass applied

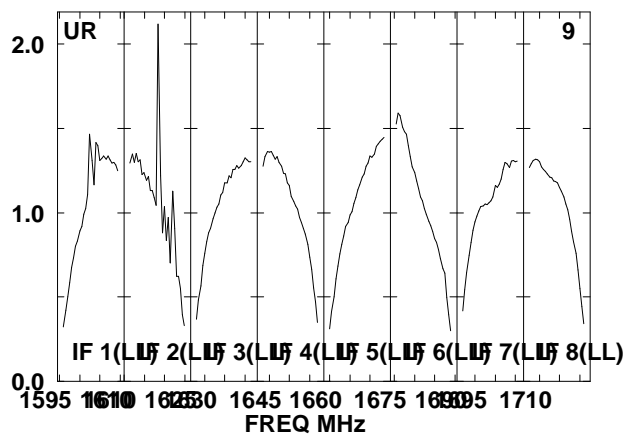
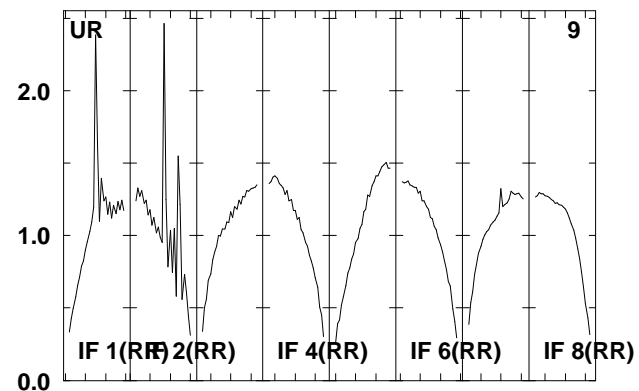
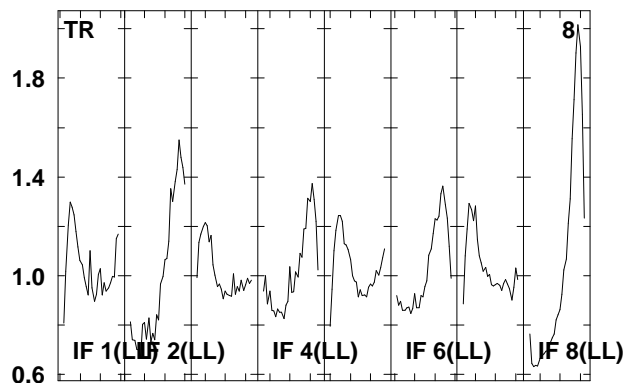
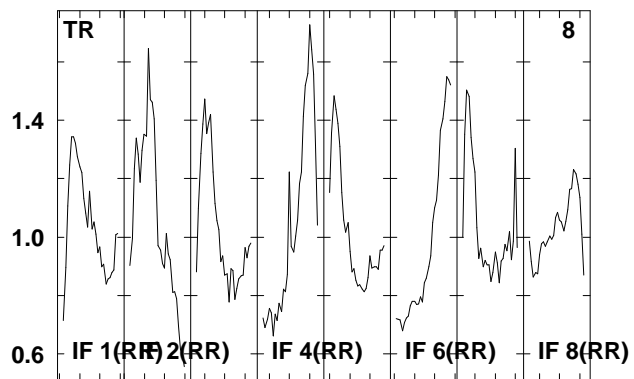
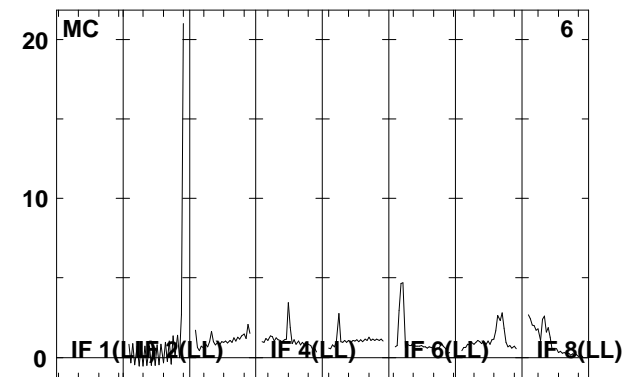
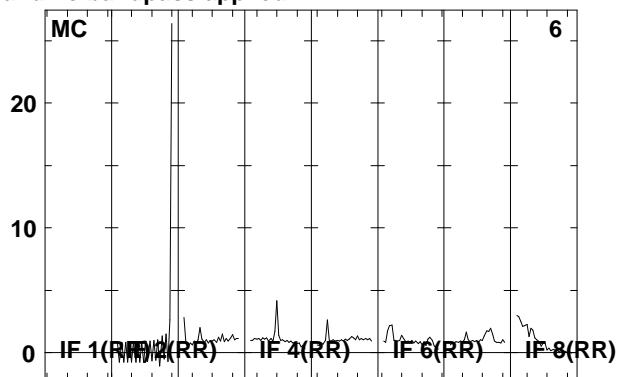
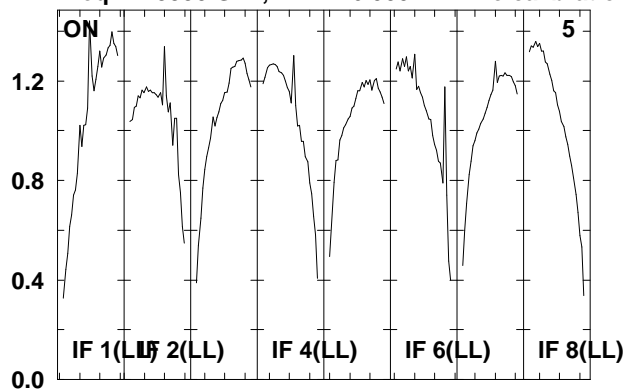

Lower frame: Real Jy

Total-power spectrum Antenna: *

Timerange: 00/12:10:02 to 00/12:11:30

Plot file version 201 created 18-APR-2008 18:29:14

IRAS2336 EP061A.UVDATA.1

Freq = 1.5950 GHz, Bw = 16.000 MH No calibration applied and no bandpass applied

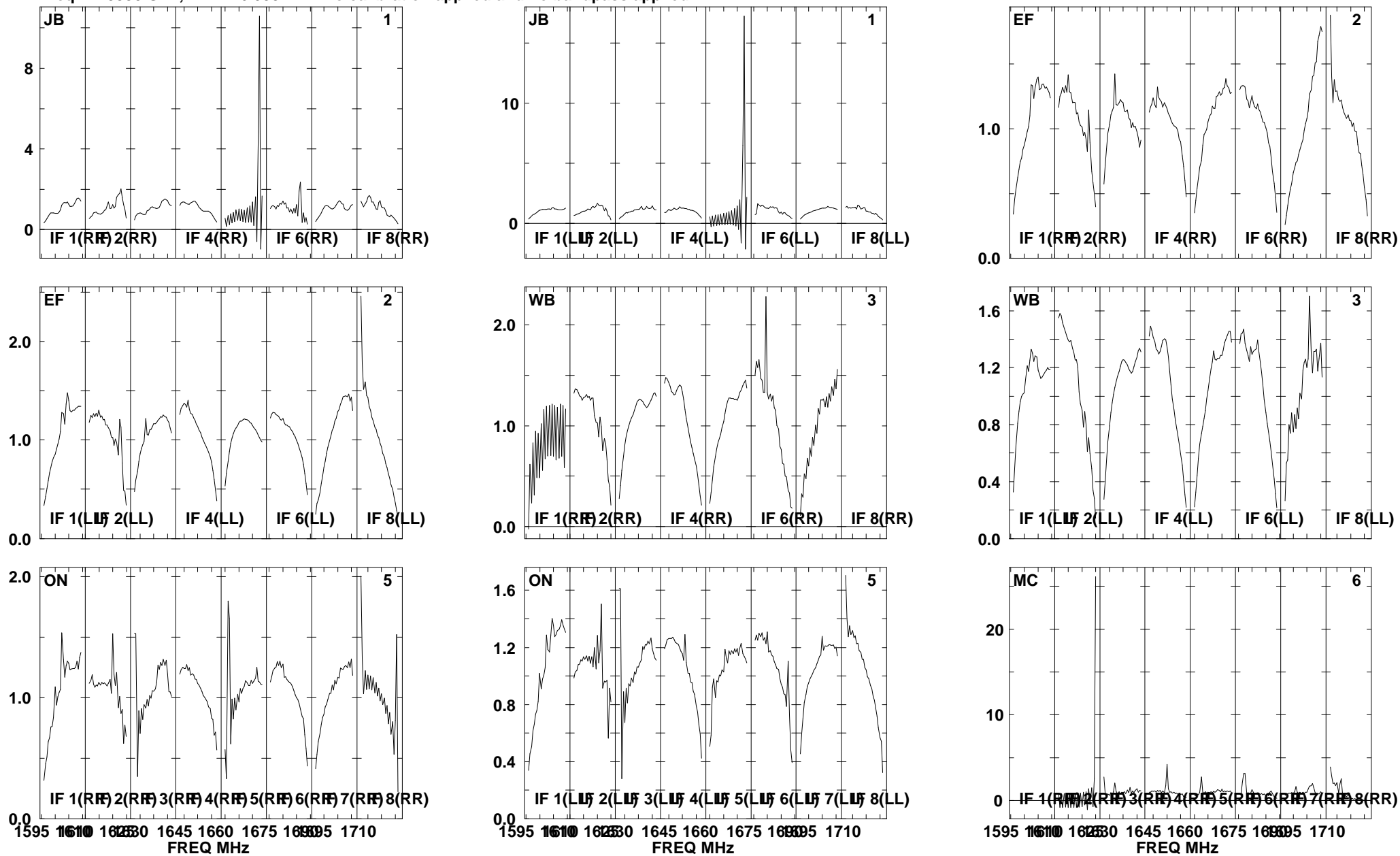

Lower frame: Real Jy
Total-power spectrum Antenna: *
Timerange: 00/12:11:32 to 00/12:15:00

Plot file version 202 created 18-APR-2008 18:29:15

IRAS2336 EP061A.UVDATA.1

Freq = 1.5950 GHz, Bw = 16.000 MH No calibration applied and no bandpass applied

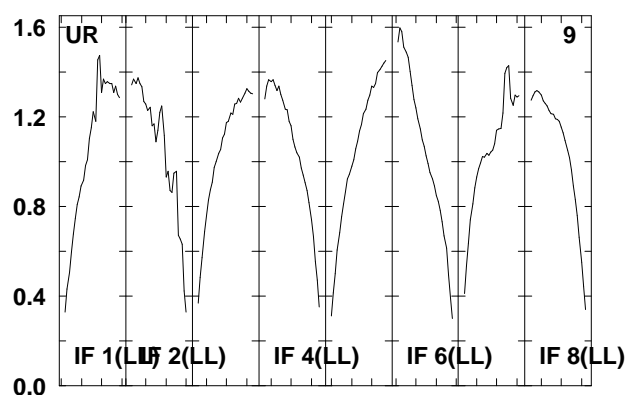
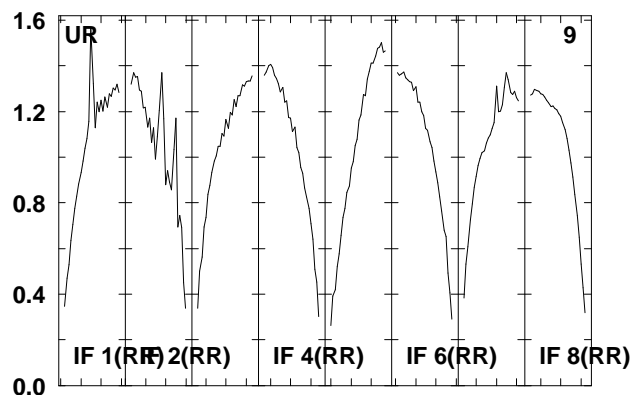
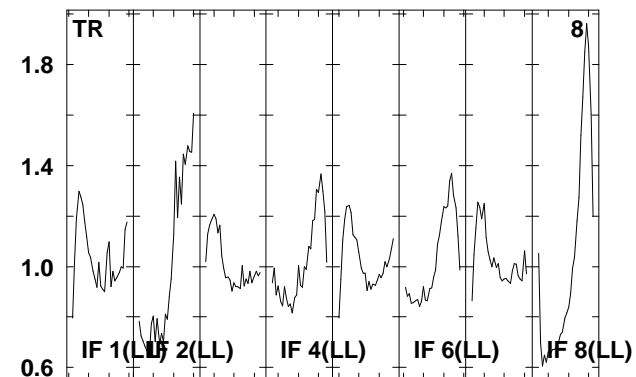
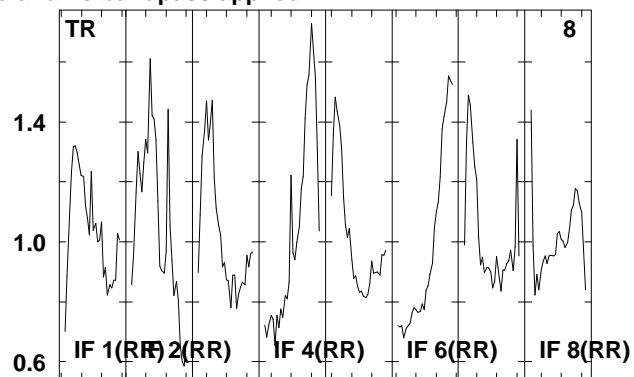
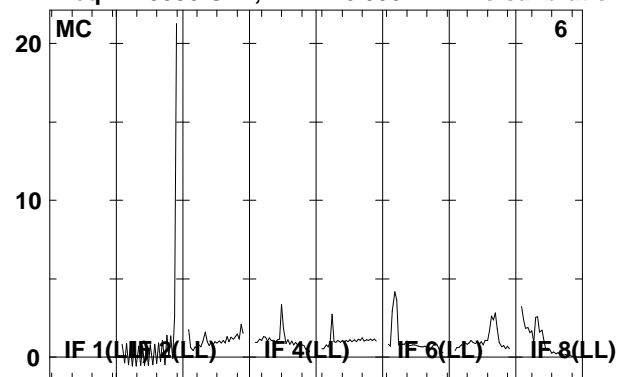

Lower frame: Real Jy
Total-power spectrum Antenna: *
Timerange: 00/12:11:32 to 00/12:15:00

Plot file version 203 created 18-APR-2008 18:29:16

J2333+39 EP061A.UVDATA.1

Freq = 1.5950 GHz, Bw = 16.000 MH No calibration applied and no bandpass applied

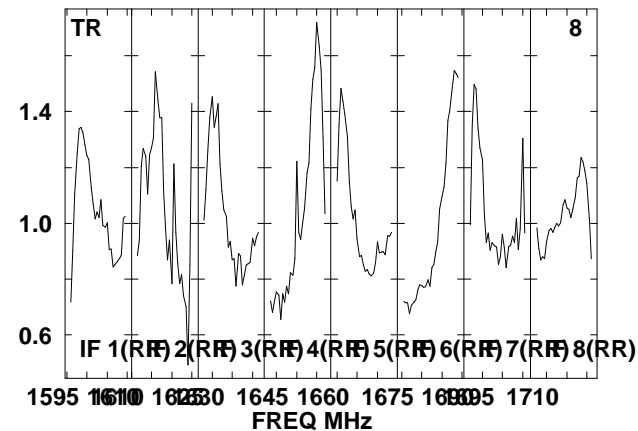
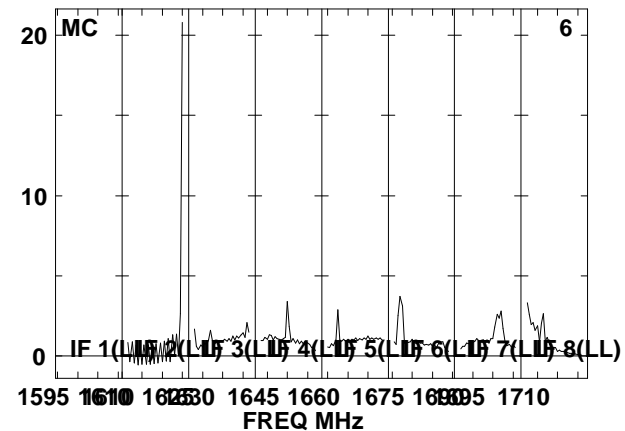
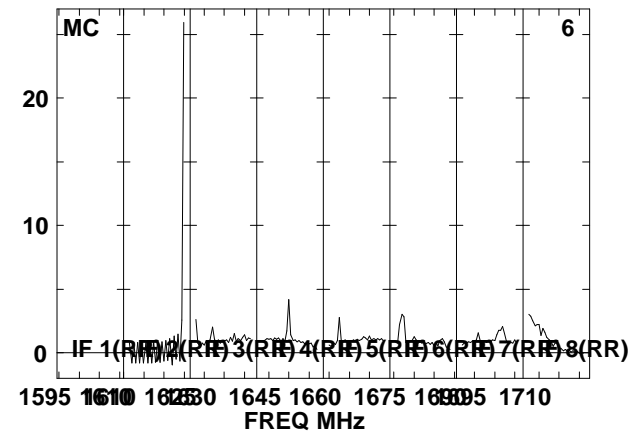
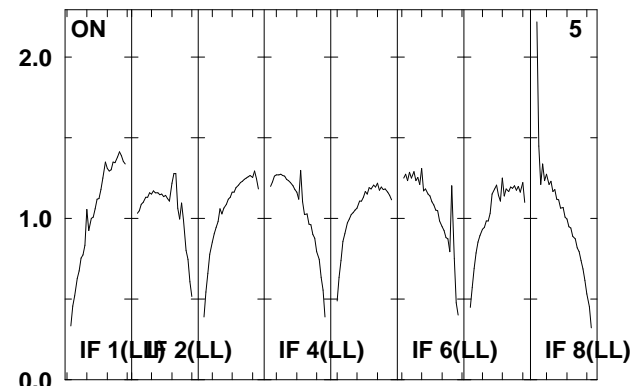
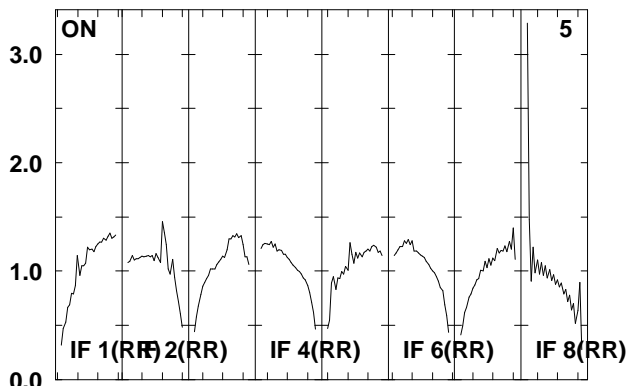
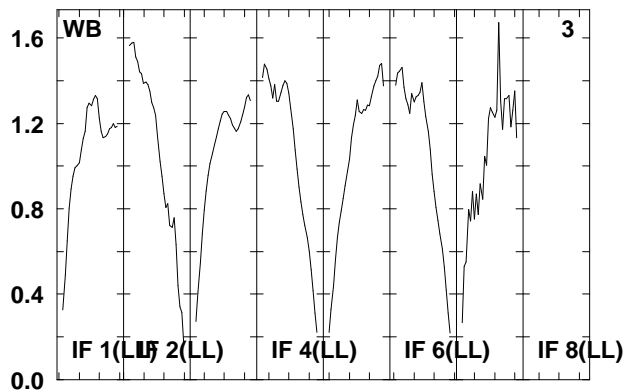
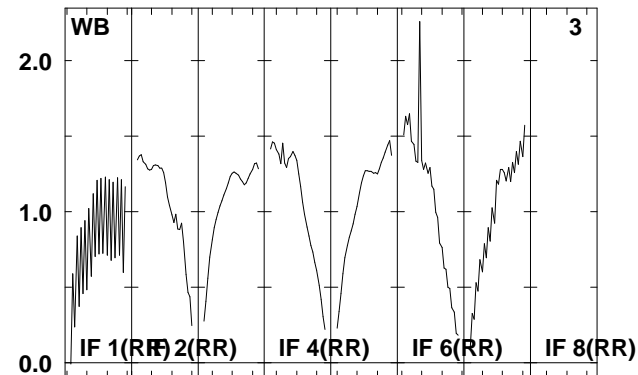
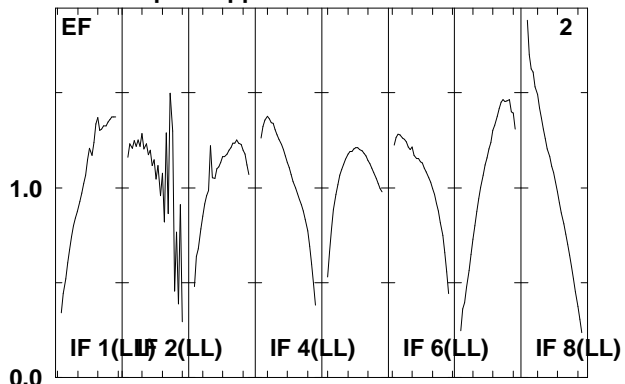
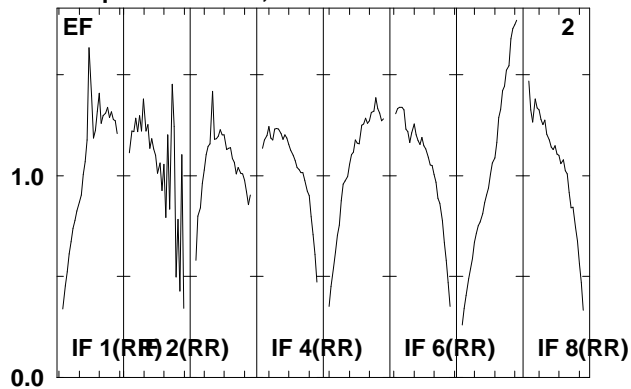

Lower frame: Real Jy

Total-power spectrum Antenna: *

Timerange: 00/12:15:02 to 00/12:16:28

Plot file version 204 created 18-APR-2008 18:29:17

J2333+39 EP061A.UVDATA.1

Freq = 1.5950 GHz, Bw = 16.000 MH No calibration applied and no bandpass applied

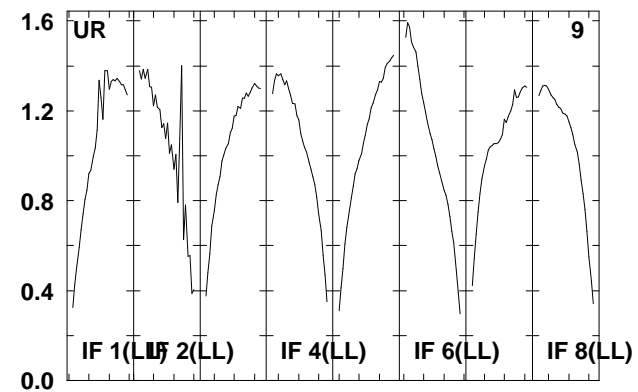
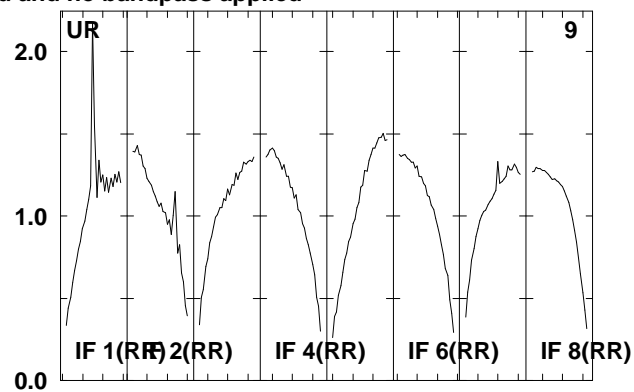
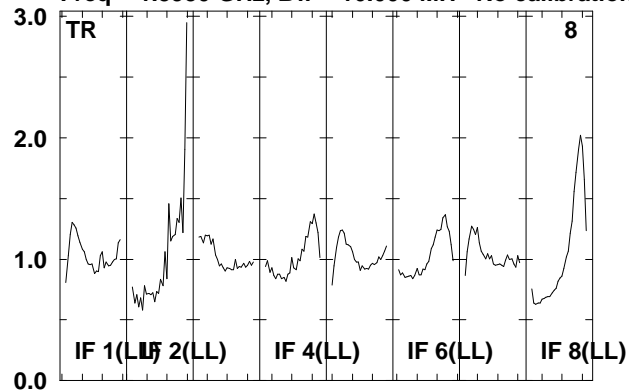

Lower frame: Real Jy
Total-power spectrum Antenna: *
Timerange: 00/12:15:02 to 00/12:16:28

Plot file version 205 created 18-APR-2008 18:29:17

IRAS2336 EP061A.UVDATA.1

Freq = 1.5950 GHz, Bw = 16.000 MH No calibration applied and no bandpass applied

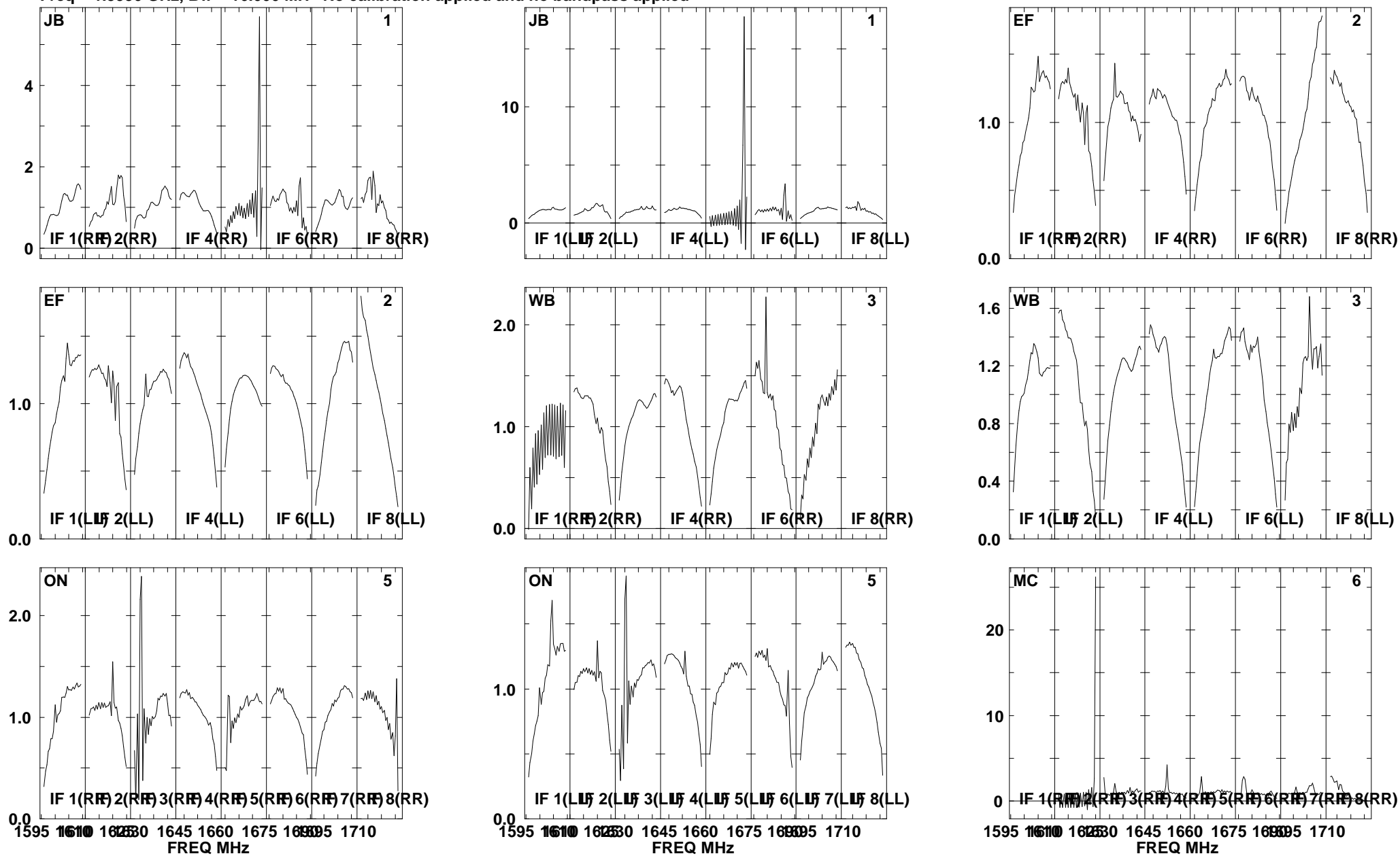

Lower frame: Real Jy
Total-power spectrum Antenna: *
Timerange: 00/12:16:30 to 00/12:20:00

Plot file version 206 created 18-APR-2008 18:29:18

IRAS2336 EP061A.UVDATA.1

Freq = 1.5950 GHz, Bw = 16.000 MH No calibration applied and no bandpass applied

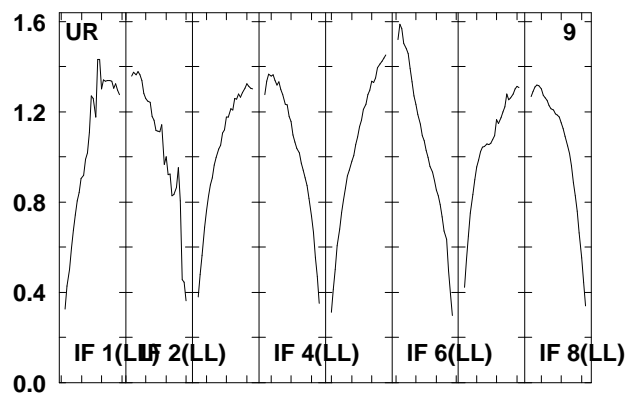
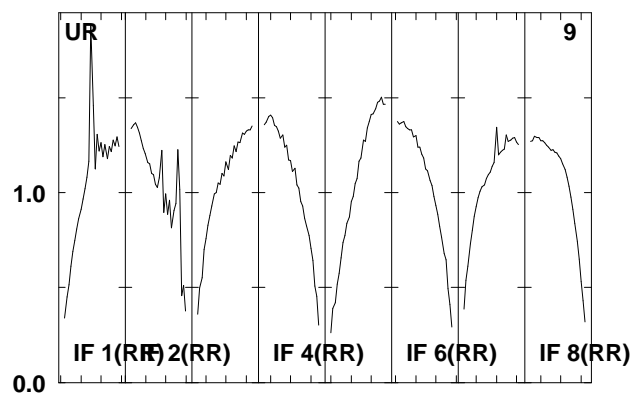
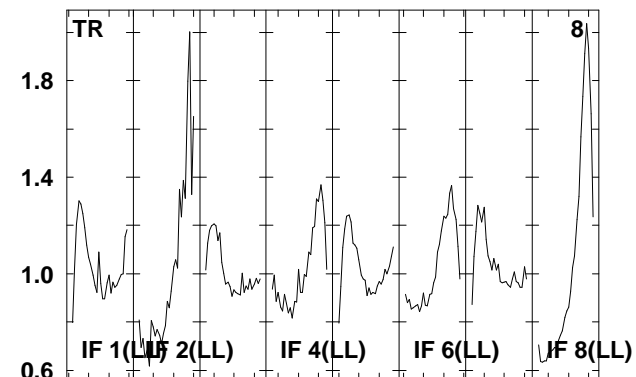
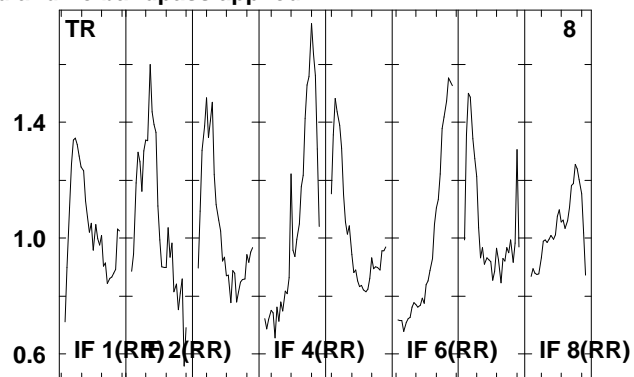
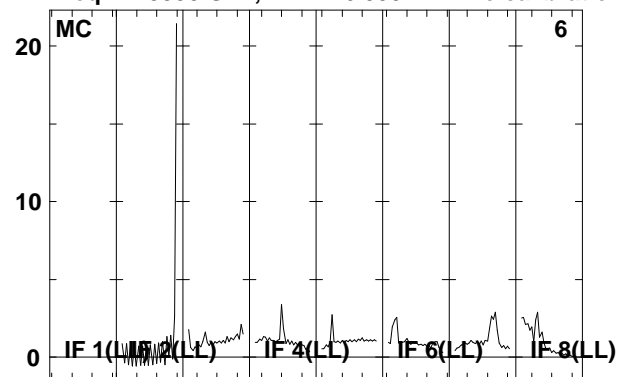

Lower frame: Real Jy
Total-power spectrum Antenna: *
Timerange: 00/12:16:30 to 00/12:20:00

Plot file version 207 created 18-APR-2008 18:29:19

J2333+39 EP061A.UVDATA.1

Freq = 1.5950 GHz, Bw = 16.000 MH No calibration applied and no bandpass applied

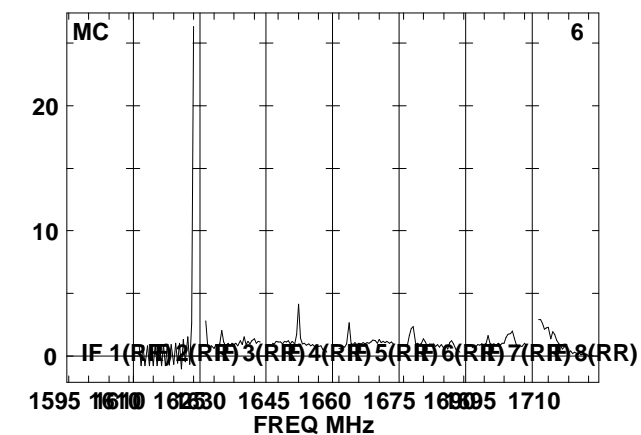
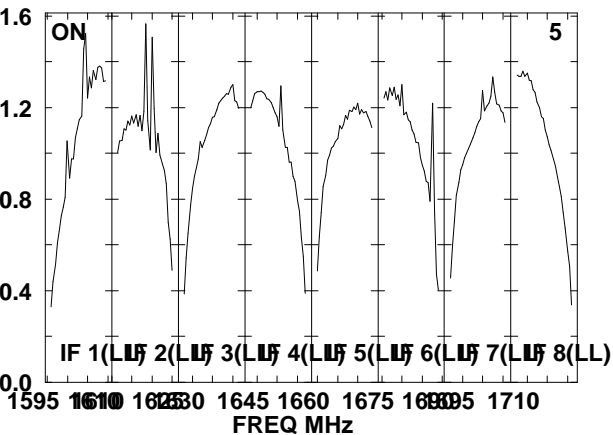
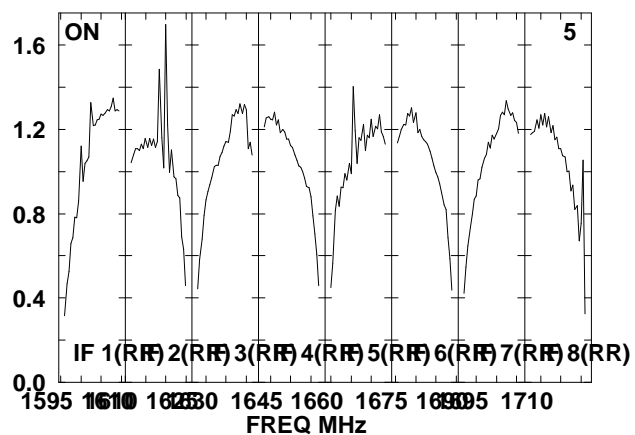
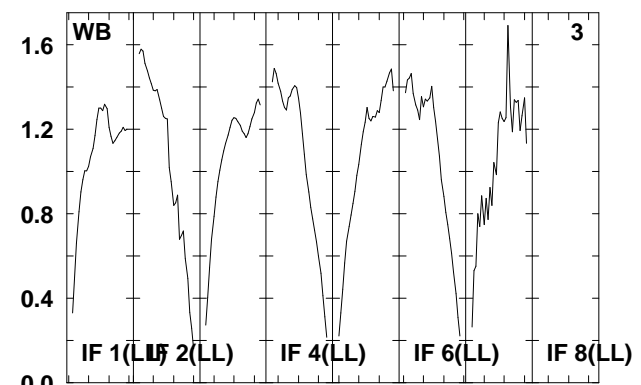
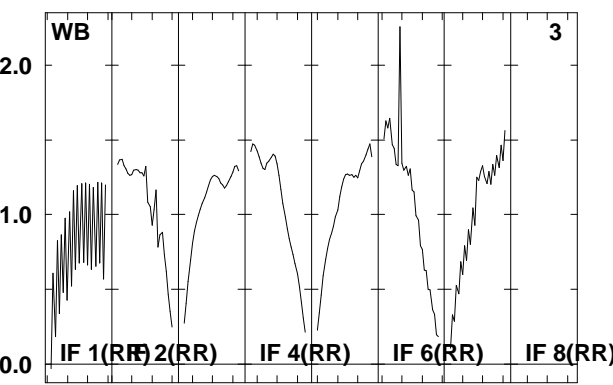
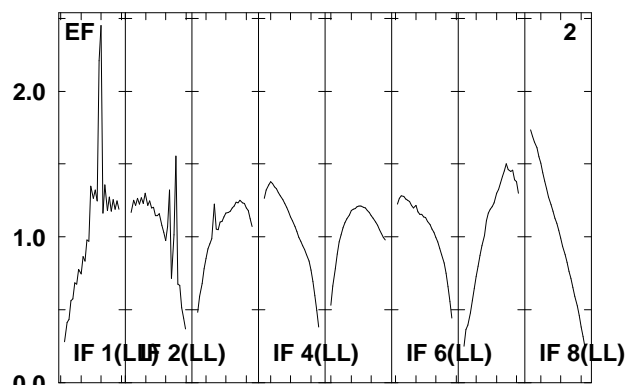
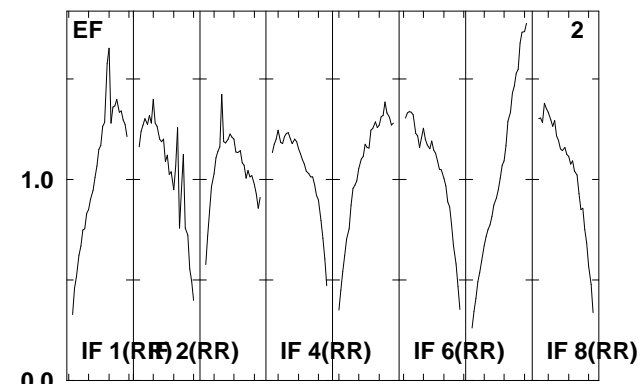
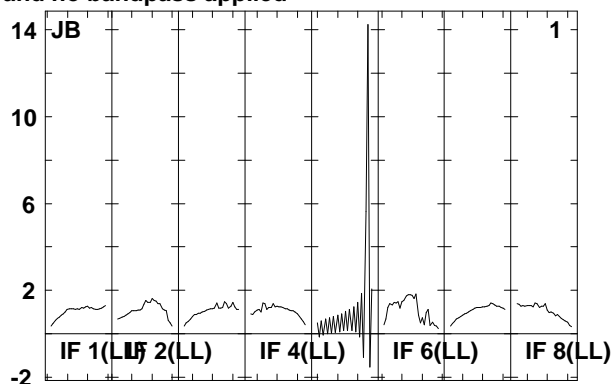
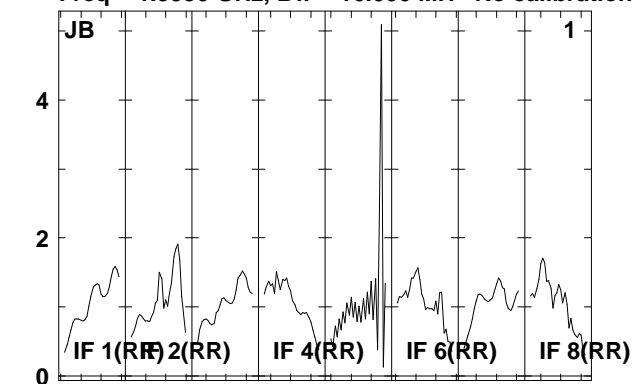

Lower frame: Real Jy
Total-power spectrum Antenna: *
Timerange: 00/12:20:02 to 00/12:21:30

Plot file version 208 created 18-APR-2008 18:29:20

J2333+39 EP061A.UVDATA.1

Freq = 1.5950 GHz, Bw = 16.000 MH No calibration applied and no bandpass applied

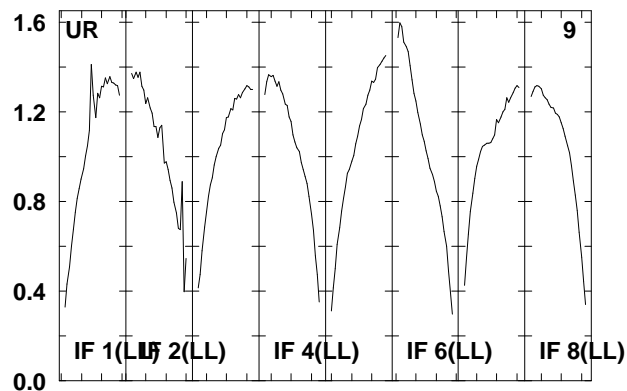
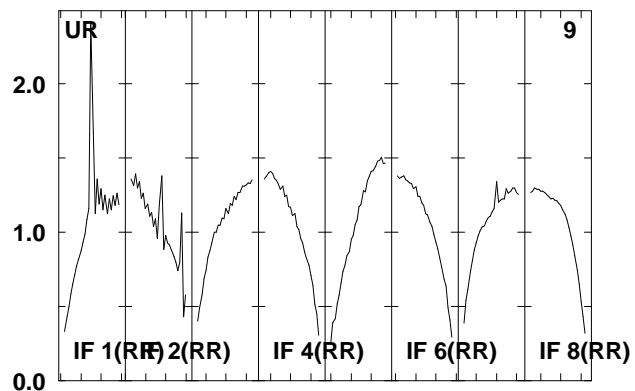
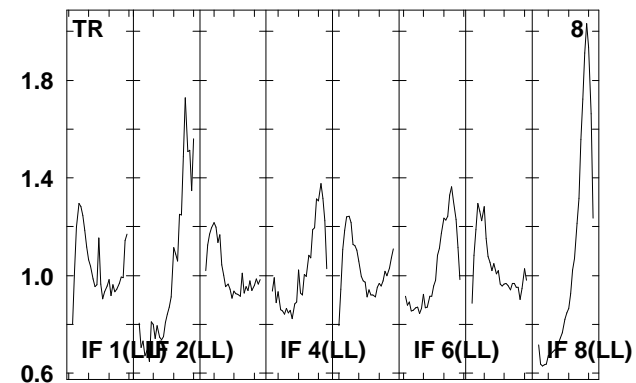
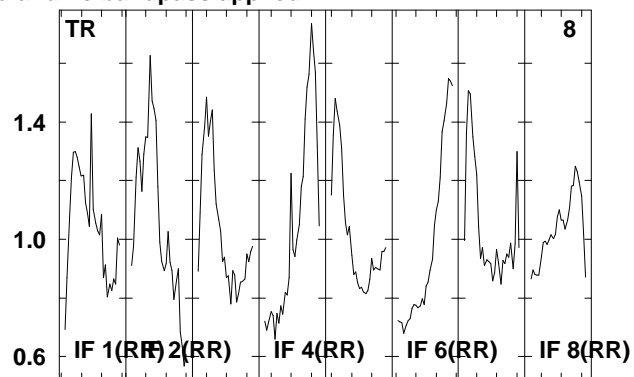
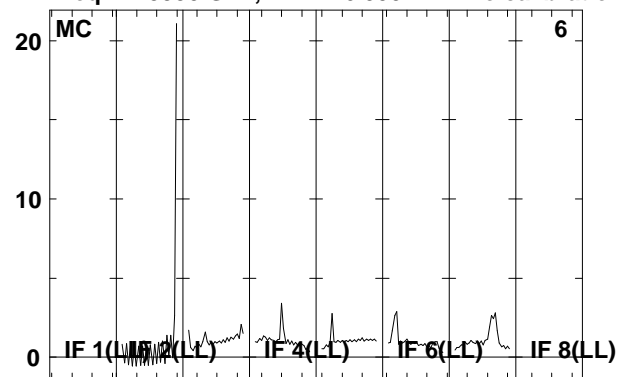

Lower frame: Real Jy
Total-power spectrum Antenna: *
Timerange: 00/12:20:02 to 00/12:21:30

Plot file version 209 created 18-APR-2008 18:29:20

IRAS2336 EP061A.UVDATA.1

Freq = 1.5950 GHz, Bw = 16.000 MH No calibration applied and no bandpass applied

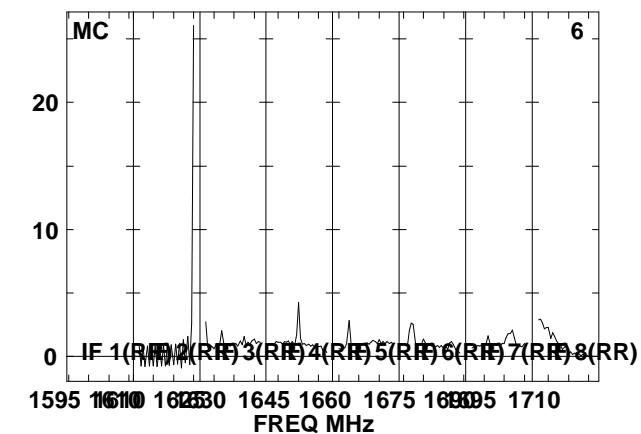
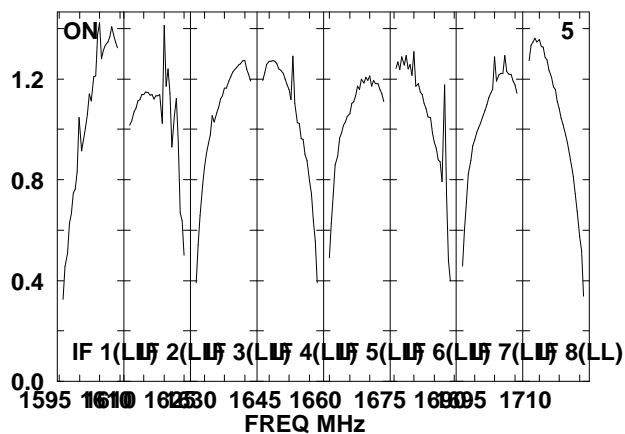
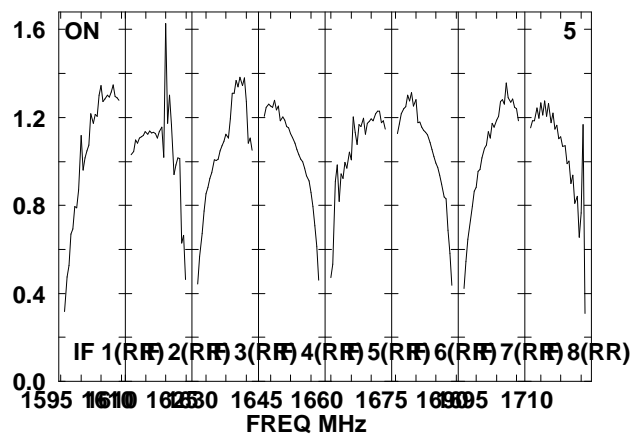
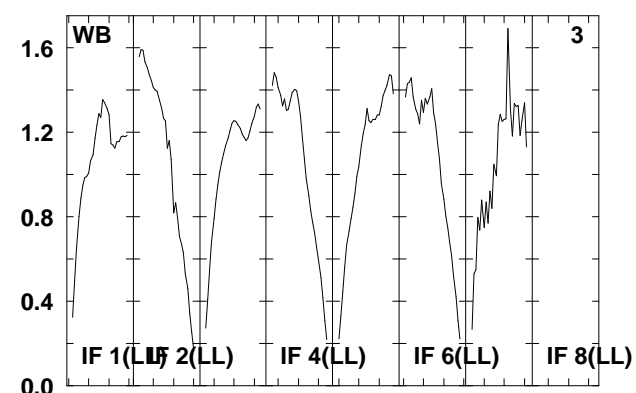
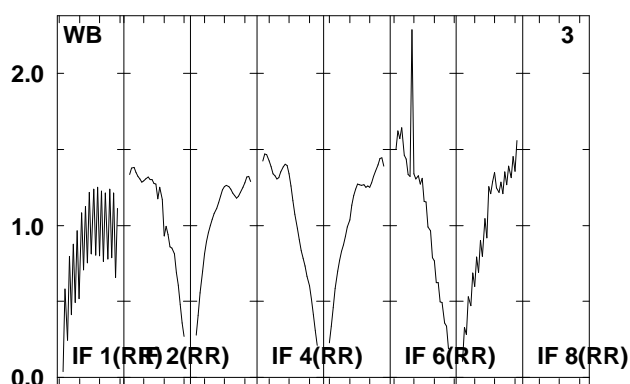
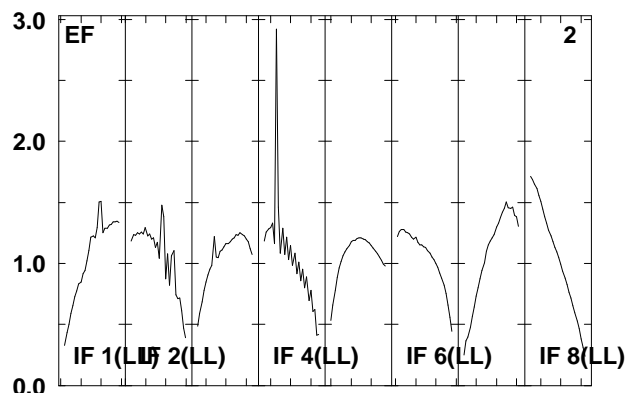
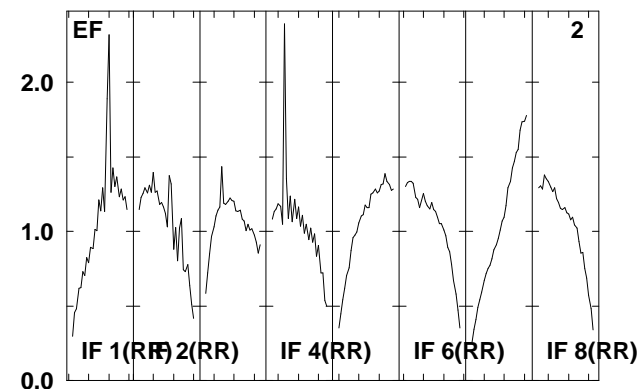
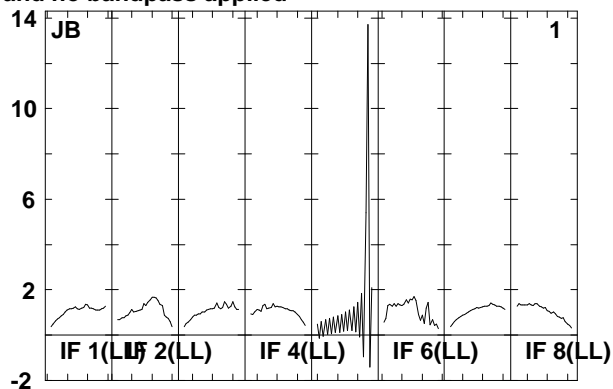
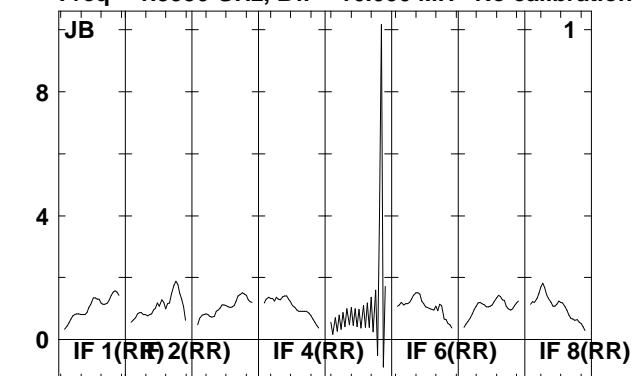

Lower frame: Real Jy

Total-power spectrum Antenna: *

Timerange: 00/12:21:32 to 00/12:24:56

Plot file version 210 created 18-APR-2008 18:29:21

IRAS2336 EP061A.UVDATA.1

Freq = 1.5950 GHz, Bw = 16.000 MH No calibration applied and no bandpass applied

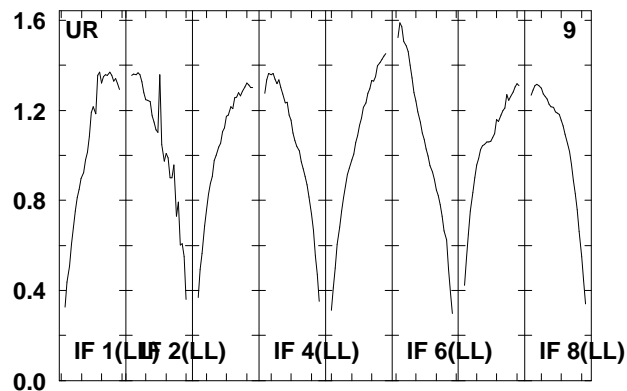
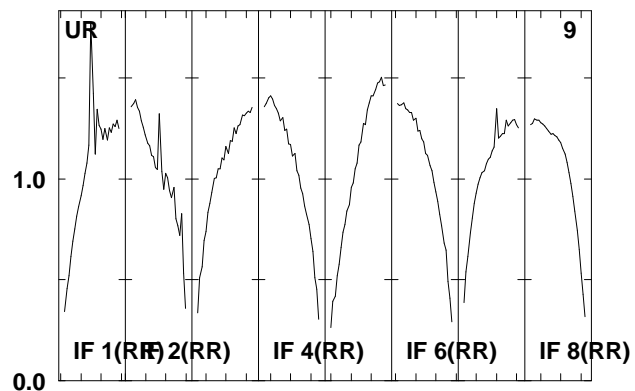
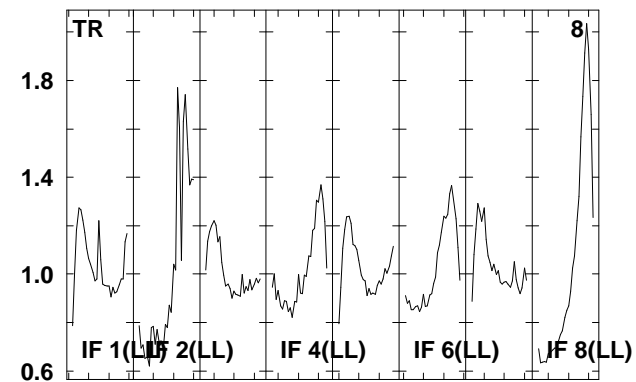
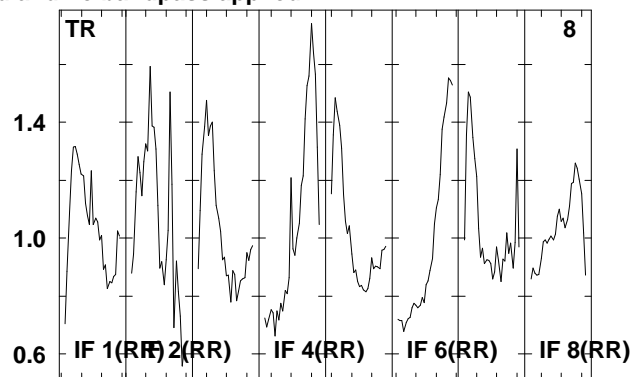
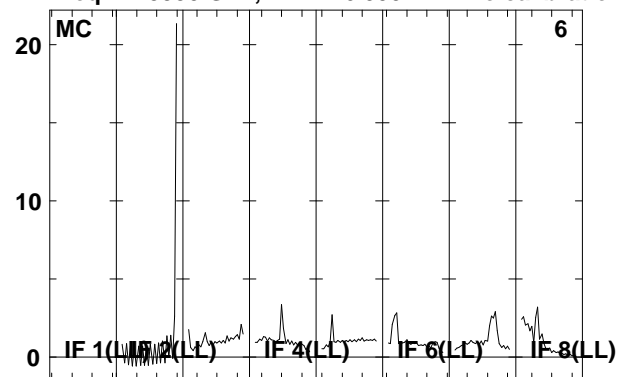

Lower frame: Real Jy
Total-power spectrum Antenna: *
Timerange: 00/12:21:32 to 00/12:24:56

Plot file version 211 created 18-APR-2008 18:29:22

J2333+39 EP061A.UVDATA.1

Freq = 1.5950 GHz, Bw = 16.000 MH No calibration applied and no bandpass applied

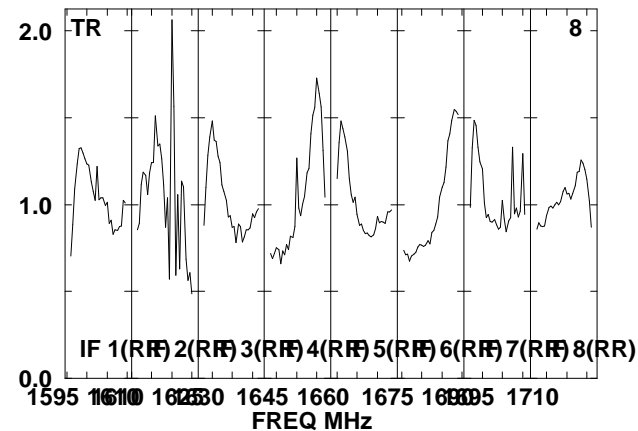
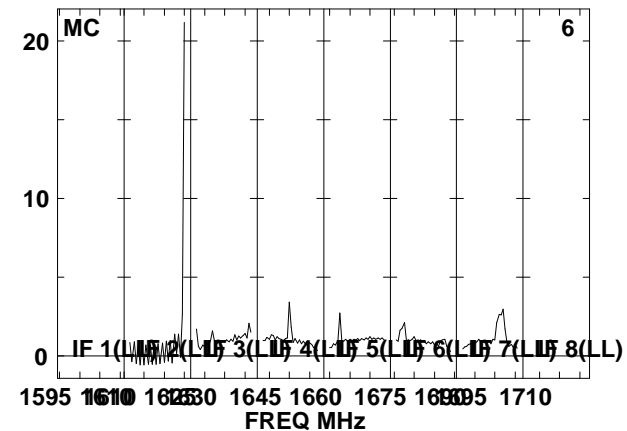
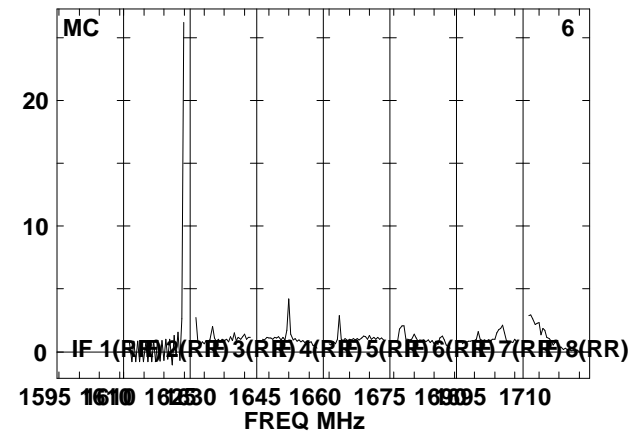
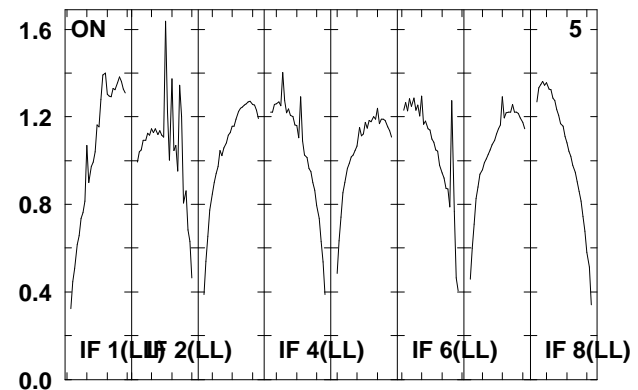
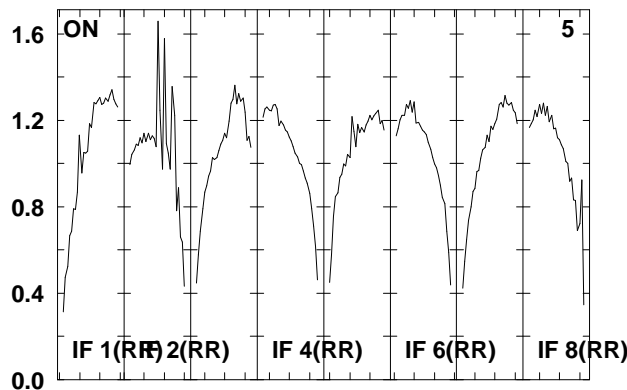
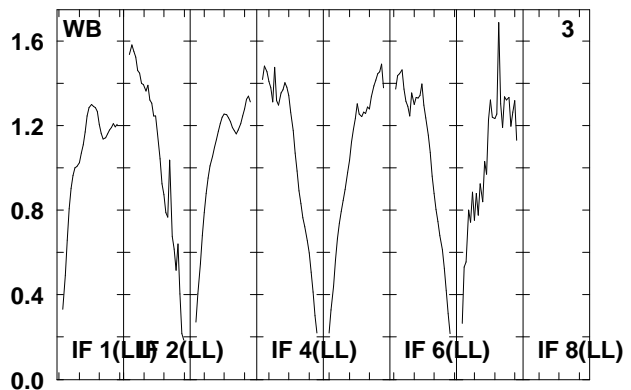
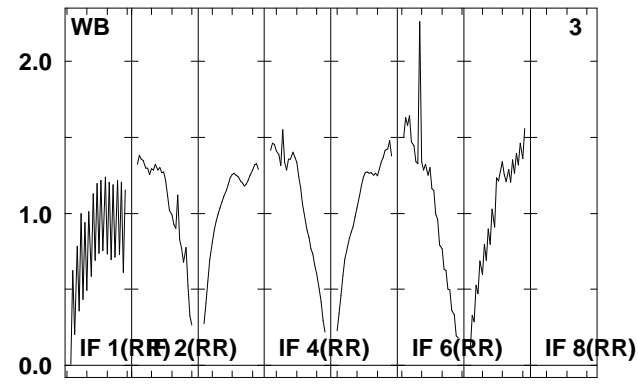
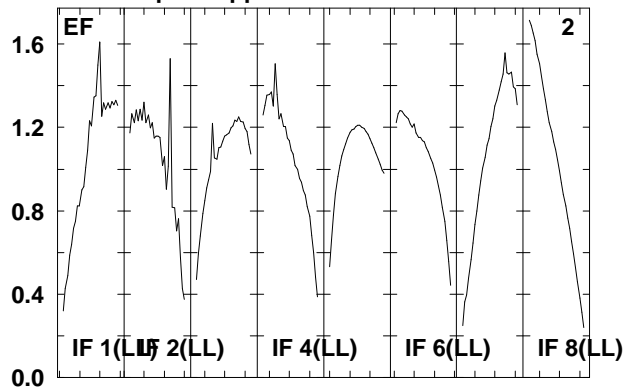
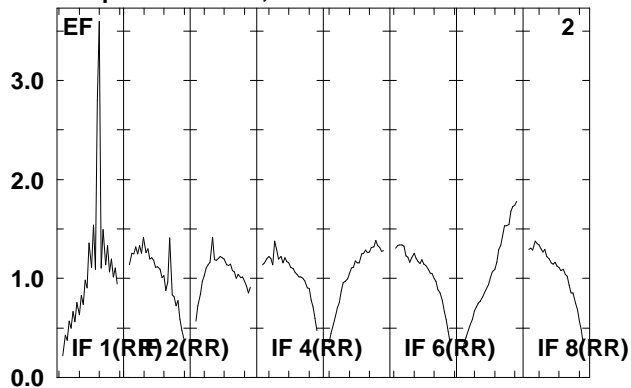

Lower frame: Real Jy

Total-power spectrum Antenna: *

Timerange: 00/12:26:02 to 00/12:27:26

Plot file version 212 created 18-APR-2008 18:29:22

J2333+39 EP061A.UVDATA.1

Freq = 1.5950 GHz, Bw = 16.000 MH No calibration applied and no bandpass applied

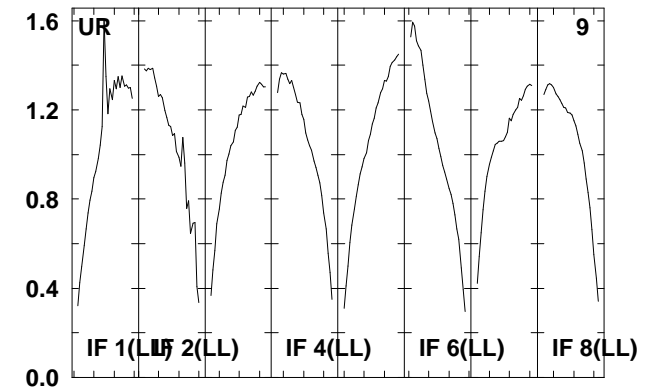
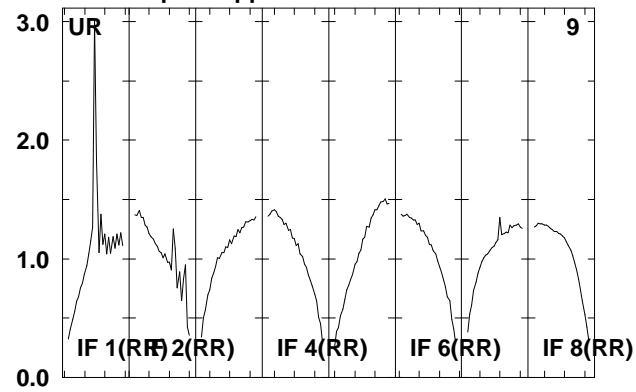
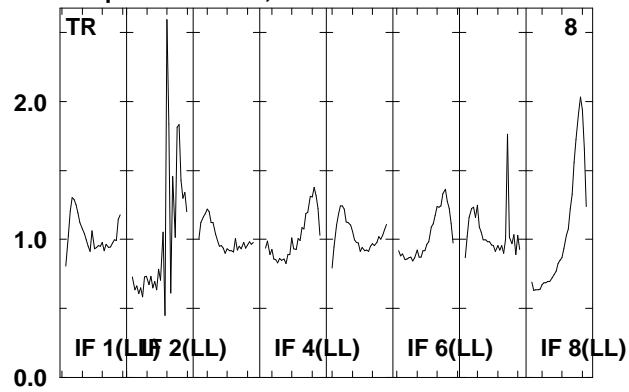

Lower frame: Real Jy
Total-power spectrum Antenna: *
Timerange: 00/12:26:02 to 00/12:27:26

Plot file version 213 created 18-APR-2008 18:29:23

IRAS2336 EP061A.UVDATA.1

Freq = 1.5950 GHz, Bw = 16.000 MH No calibration applied and no bandpass applied

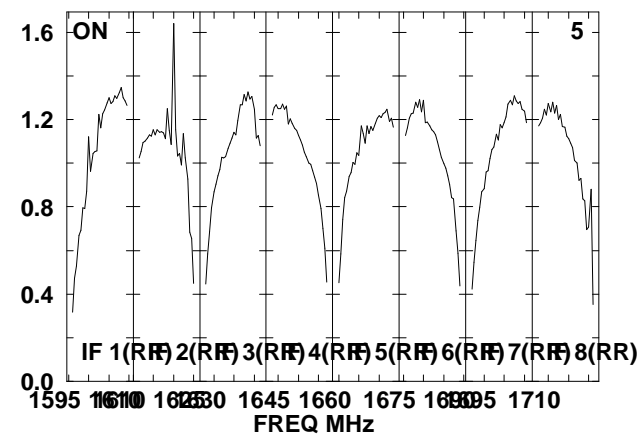
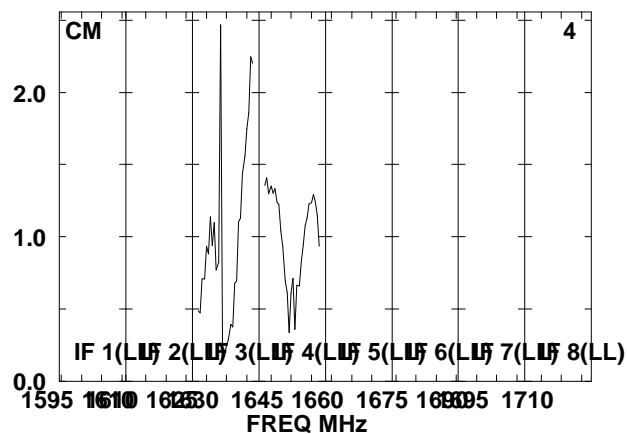
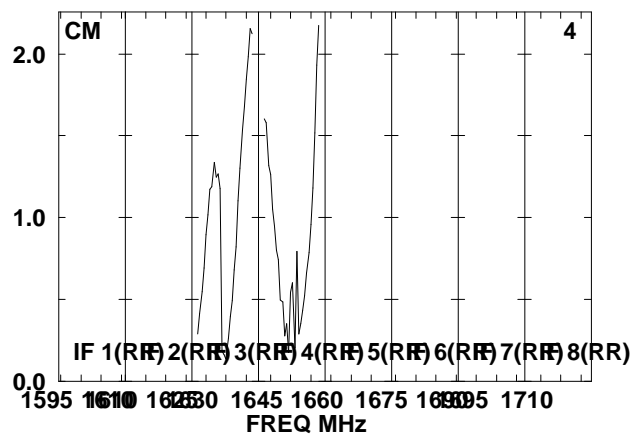
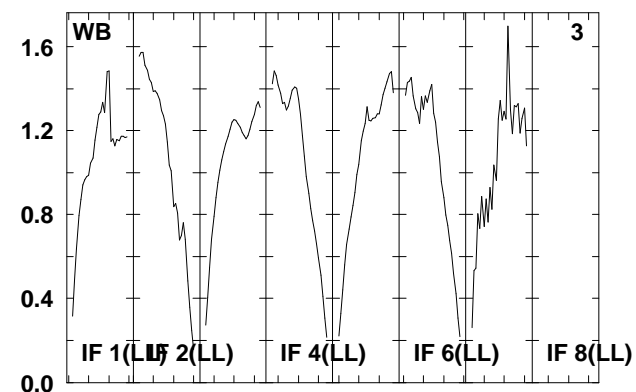
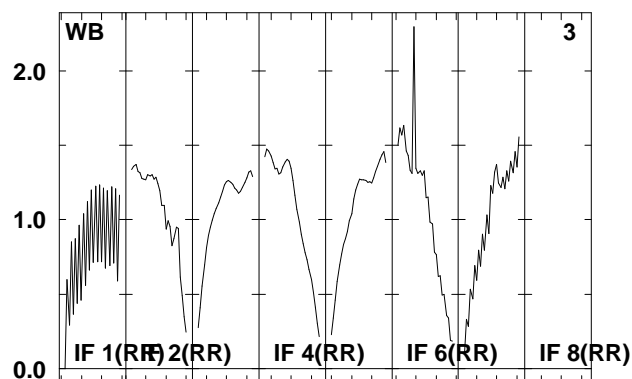
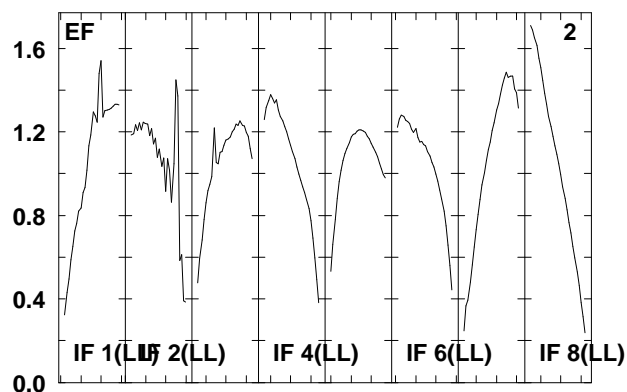
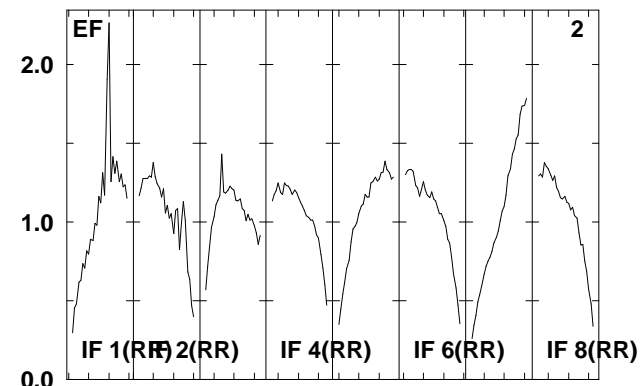
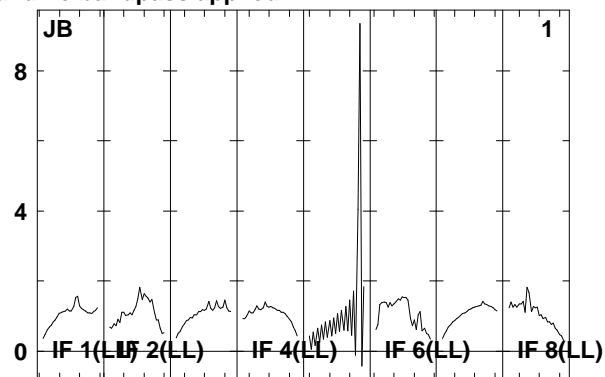
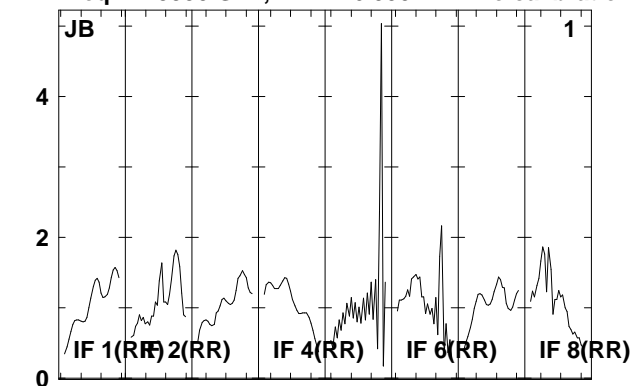

Lower frame: Real Jy
Total-power spectrum Antenna: *
Timerange: 00/12:27:32 to 00/12:30:56

Plot file version 214 created 18-APR-2008 18:29:23

IRAS2336 EP061A.UVDATA.1

Freq = 1.5950 GHz, Bw = 16.000 MH No calibration applied and no bandpass applied

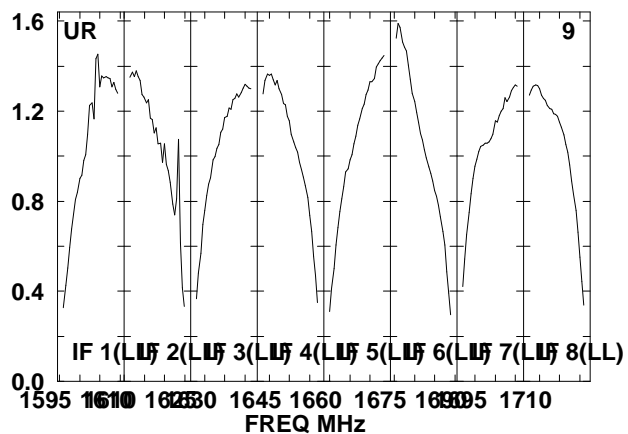
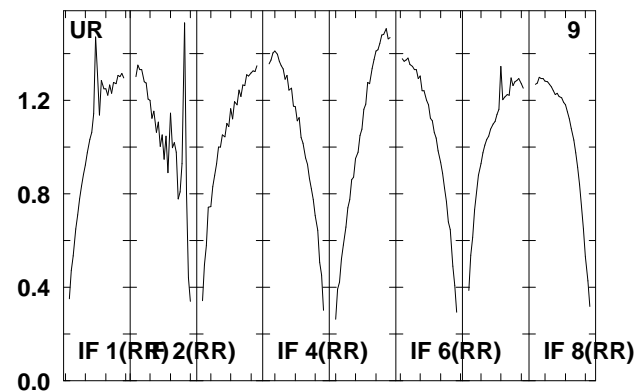
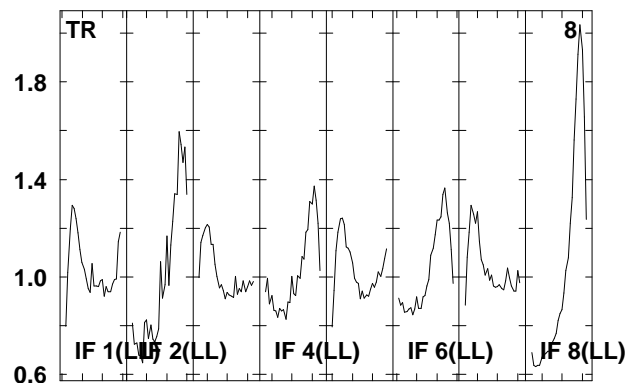
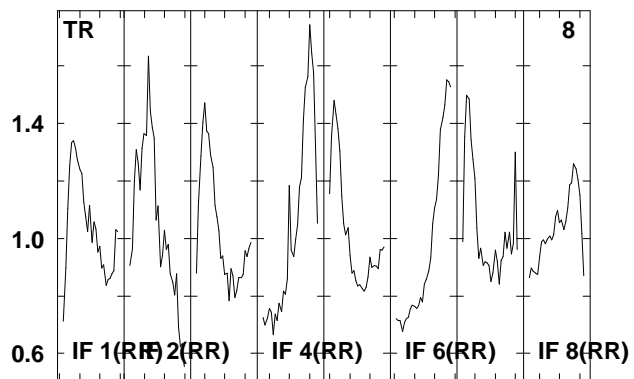
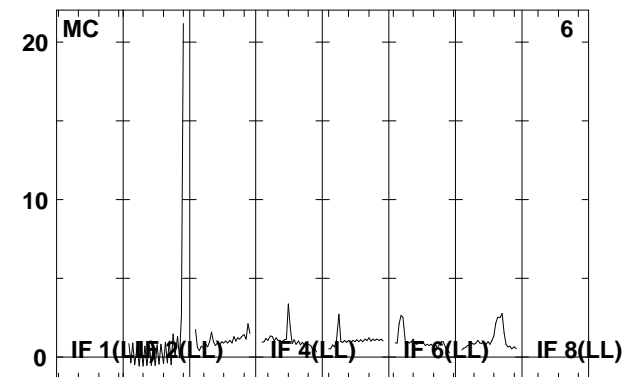
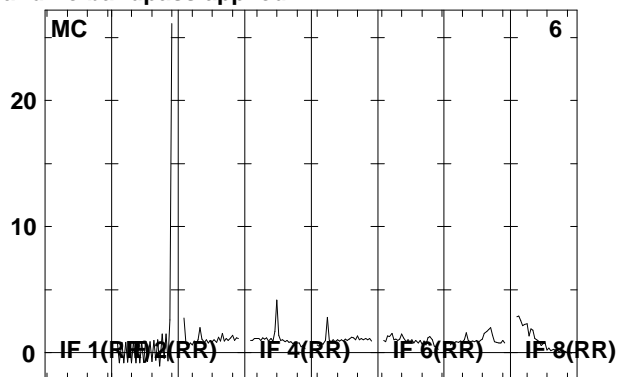
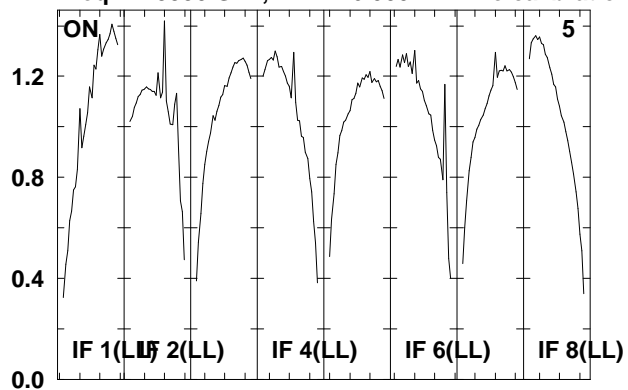

Lower frame: Real Jy

Total-power spectrum Antenna: *

Timerange: 00/12:27:32 to 00/12:30:56

Plot file version 215 created 18-APR-2008 18:29:24

J2333+39 EP061A.UVDATA.1

Freq = 1.5950 GHz, Bw = 16.000 MH No calibration applied and no bandpass applied

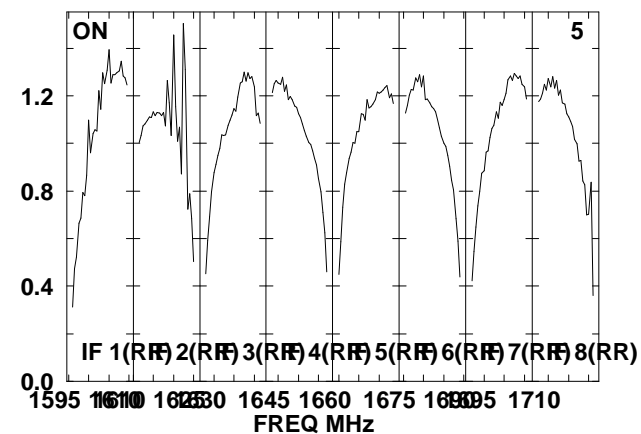
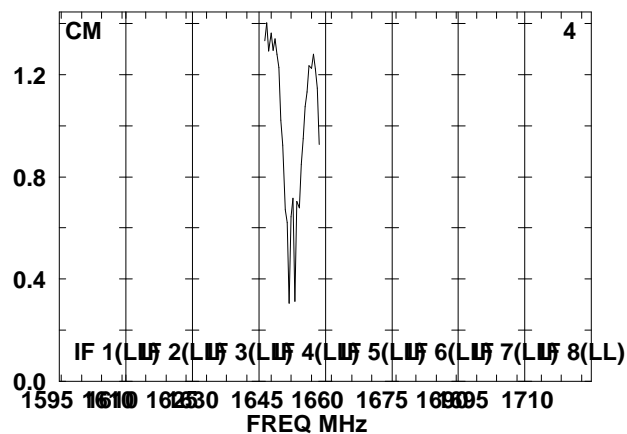
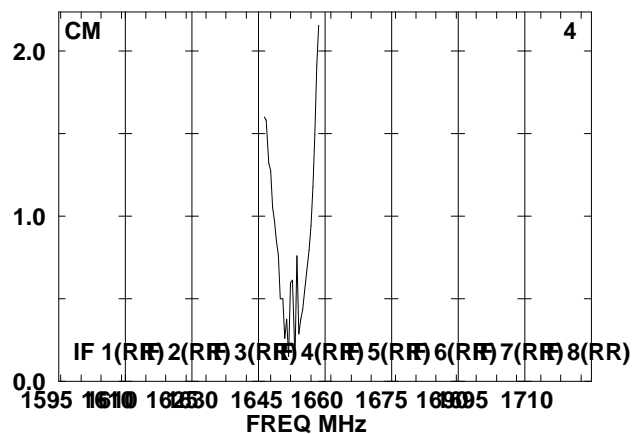
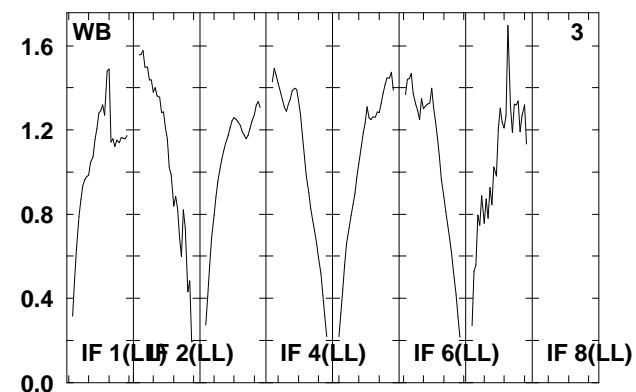
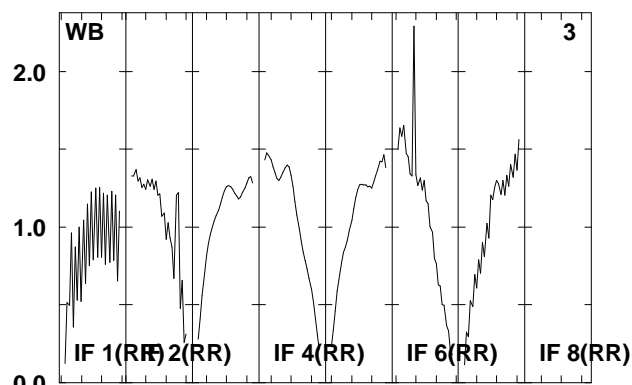
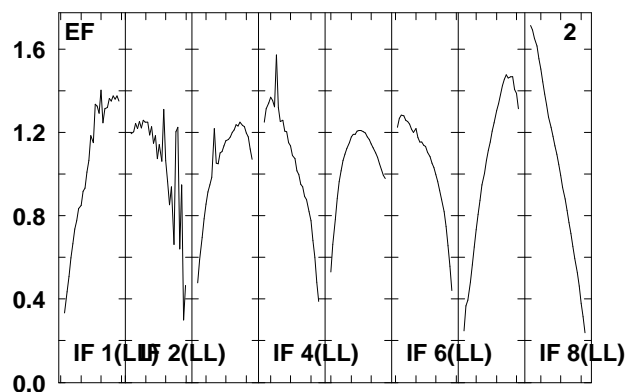
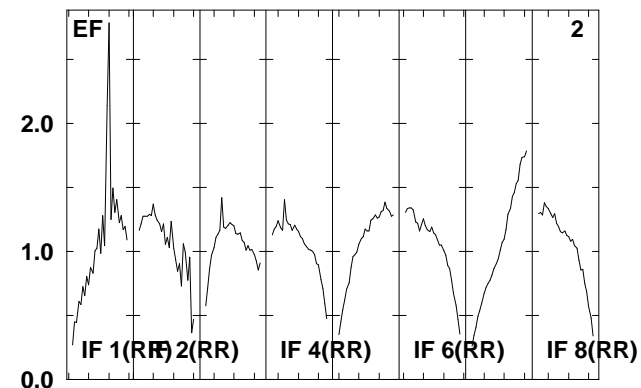
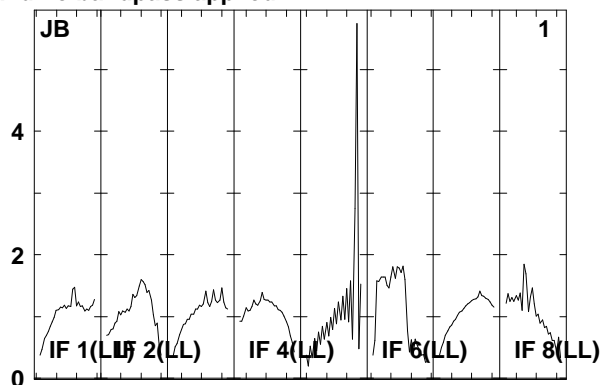
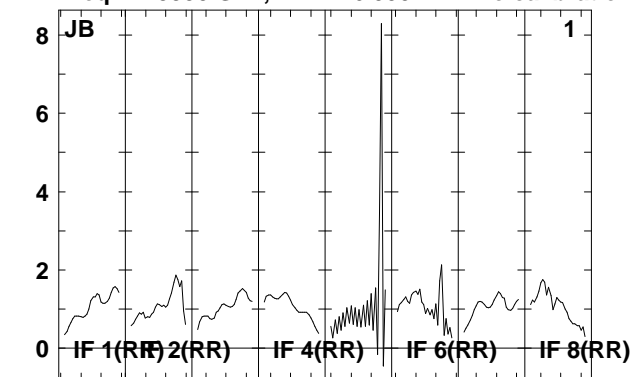

Lower frame: Real Jy
Total-power spectrum Antenna: *
Timerange: 00/12:31:10 to 00/12:32:30

Plot file version 216 created 18-APR-2008 18:29:24

J2333+39 EP061A.UVDATA.1

Freq = 1.5950 GHz, Bw = 16.000 MH No calibration applied and no bandpass applied

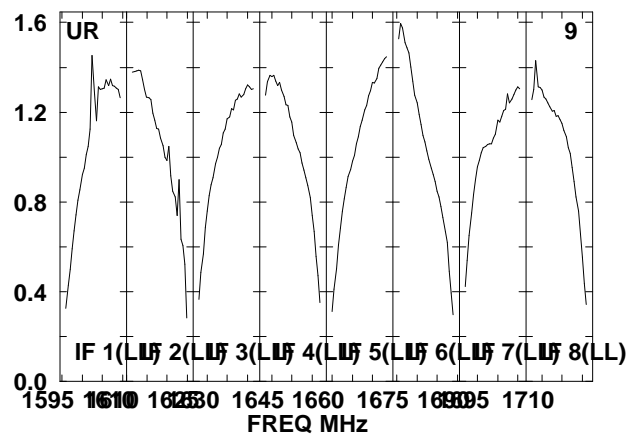
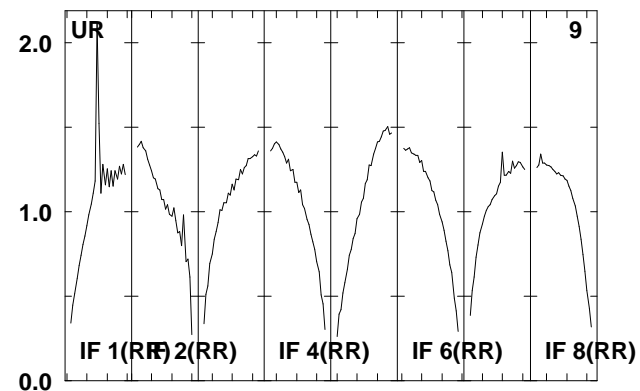
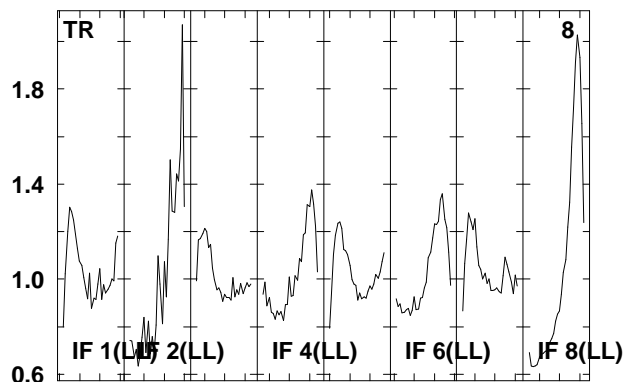
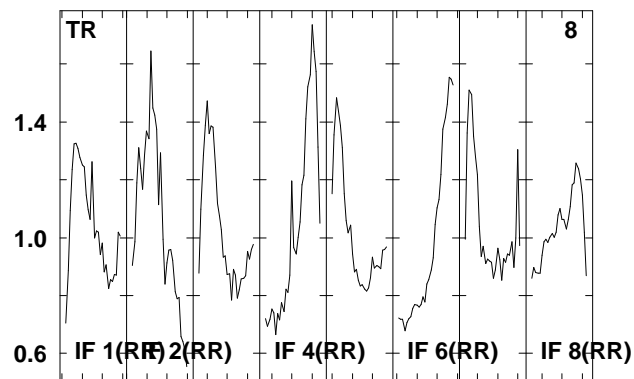
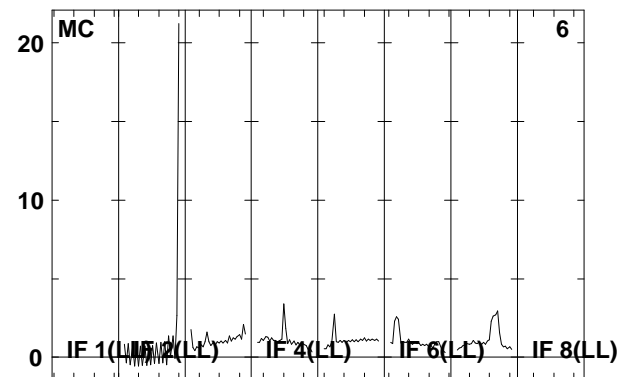
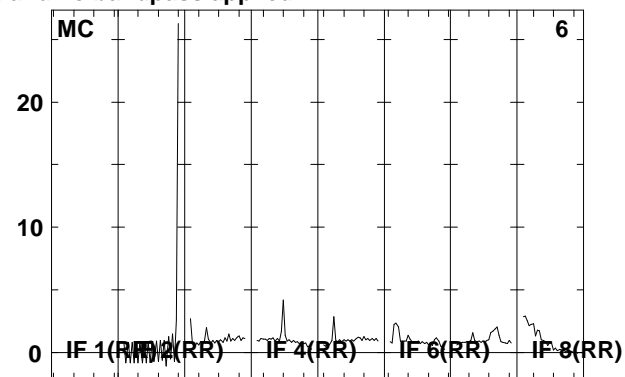
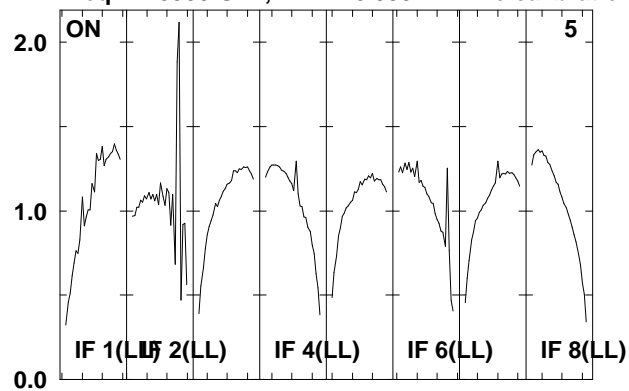

Lower frame: Real Jy

Total-power spectrum Antenna: *

Timerange: 00/12:31:10 to 00/12:32:30

Plot file version 217 created 18-APR-2008 18:29:25

IRAS2336 EP061A.UVDATA.1

Freq = 1.5950 GHz, Bw = 16.000 MH No calibration applied and no bandpass applied

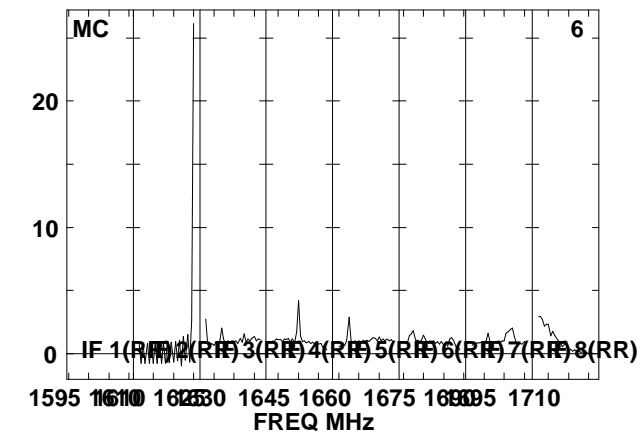
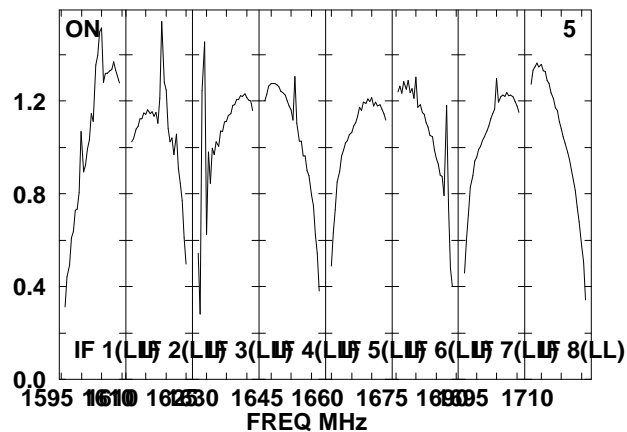
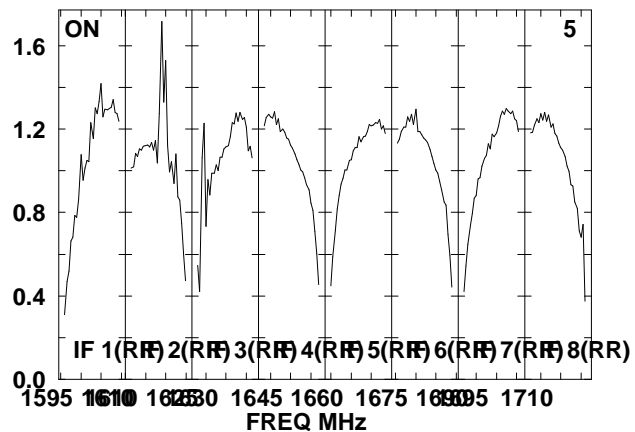
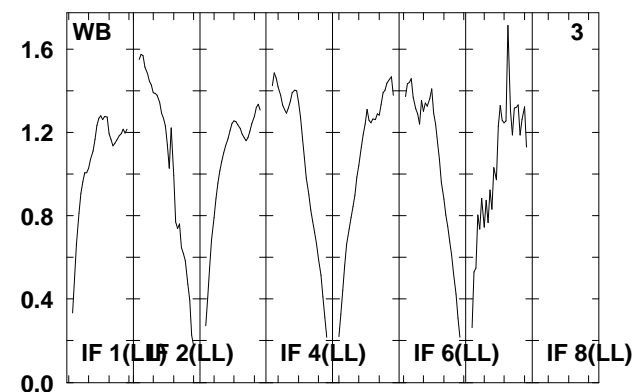
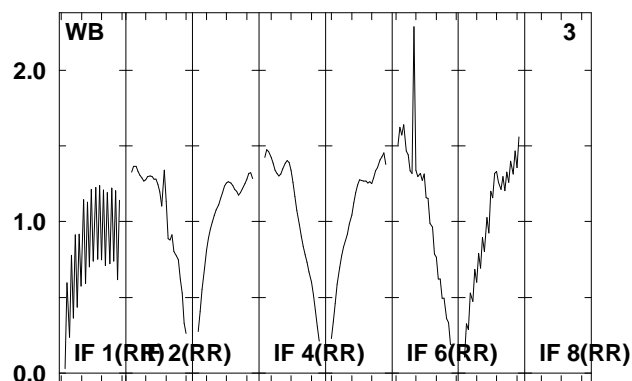
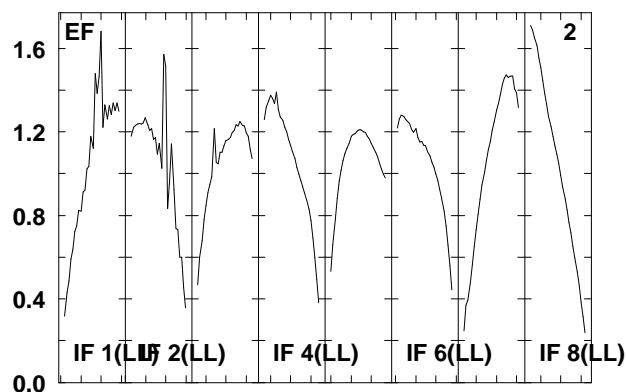
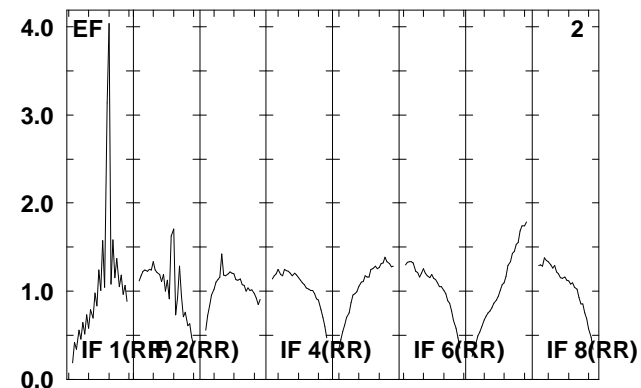
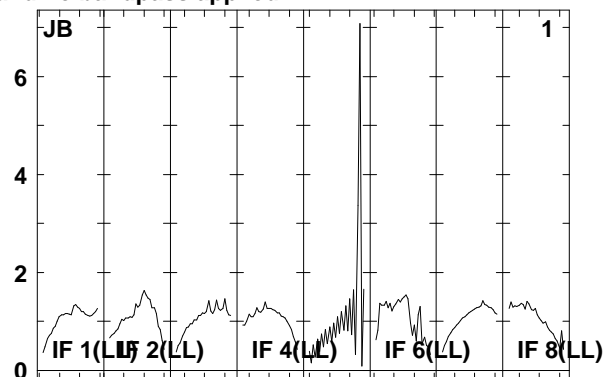
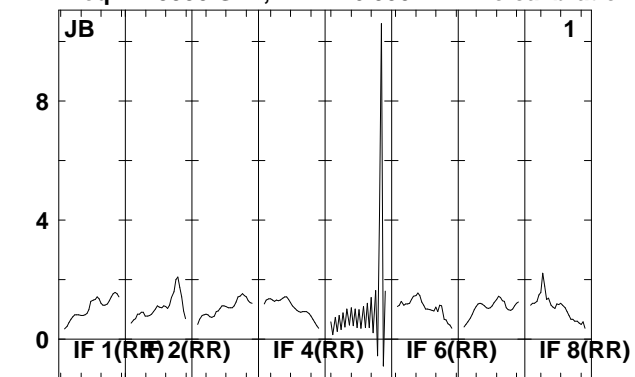

Lower frame: Real Jy
Total-power spectrum Antenna: *
Timerange: 00/12:32:32 to 00/12:36:00

Plot file version 218 created 18-APR-2008 18:29:26

IRAS2336 EP061A.UVDATA.1

Freq = 1.5950 GHz, Bw = 16.000 MH No calibration applied and no bandpass applied

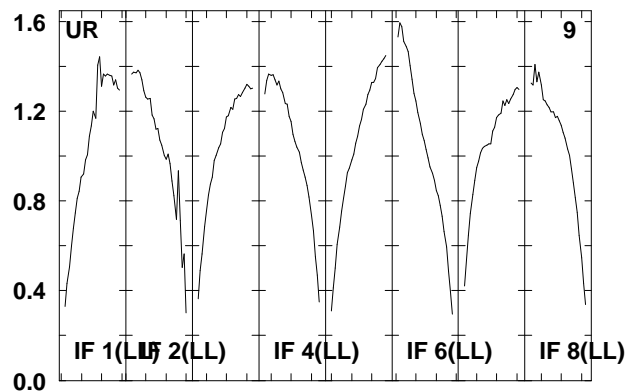
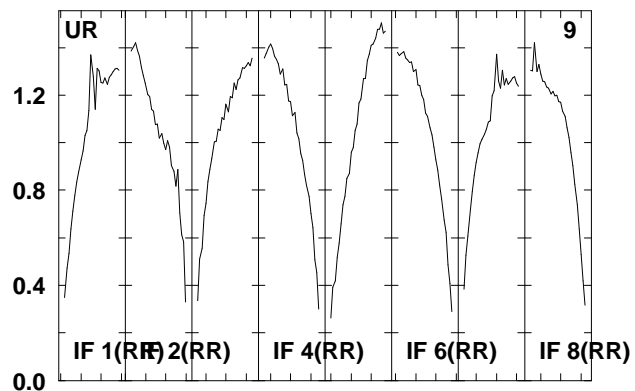
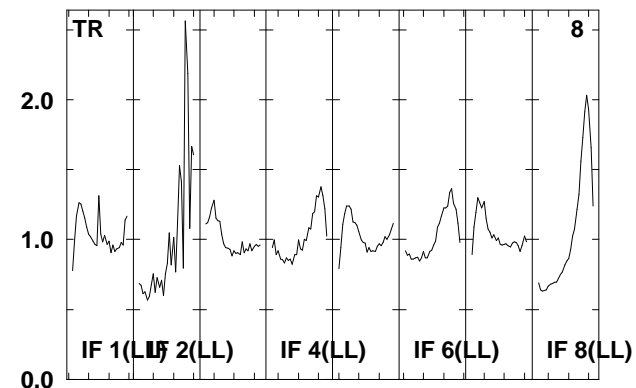
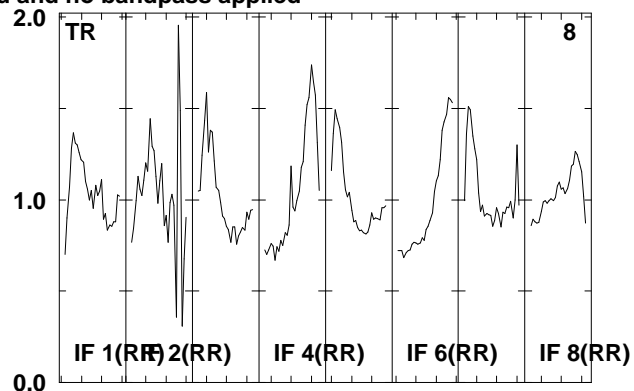
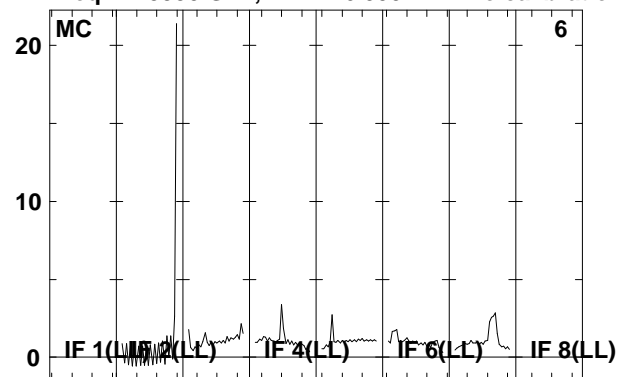

Lower frame: Real Jy
Total-power spectrum Antenna: *
Timerange: 00/12:32:32 to 00/12:36:00

Plot file version 219 created 18-APR-2008 18:29:27

J2333+39 EP061A.UVDATA.1

Freq = 1.5950 GHz, Bw = 16.000 MH No calibration applied and no bandpass applied

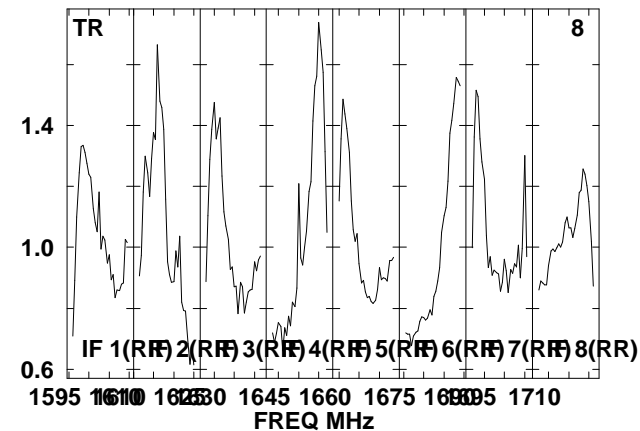
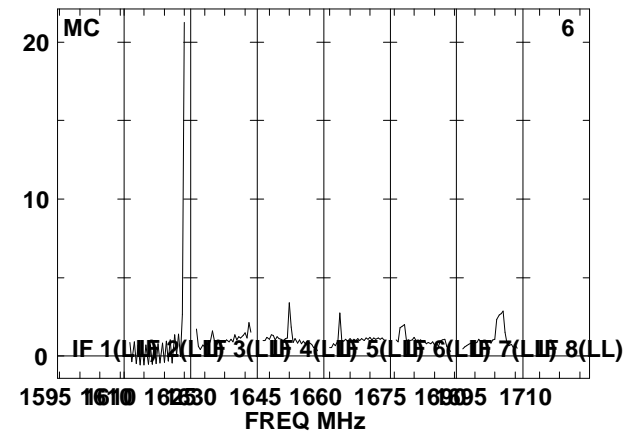
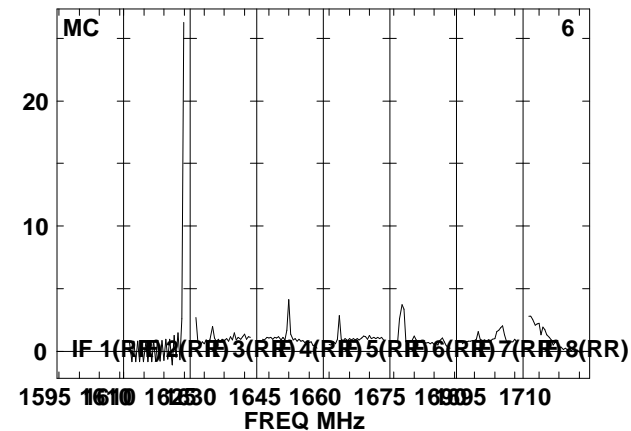
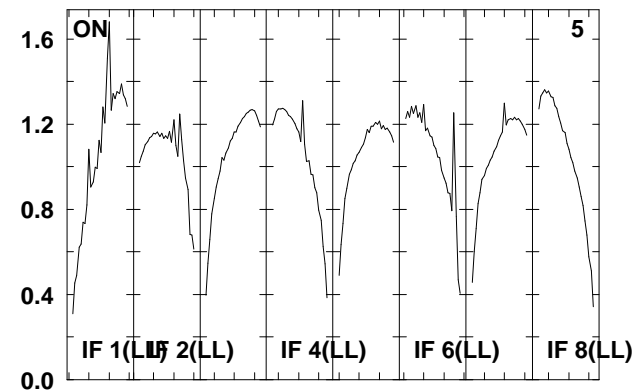
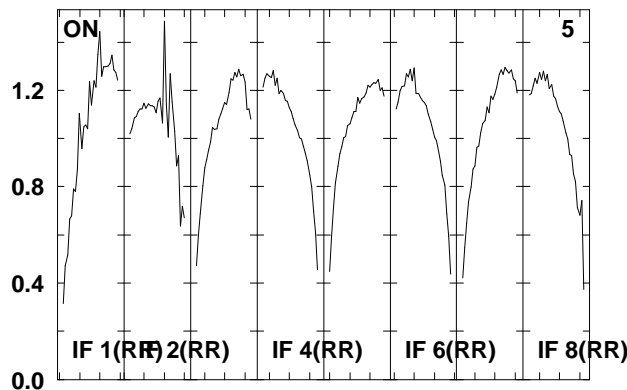
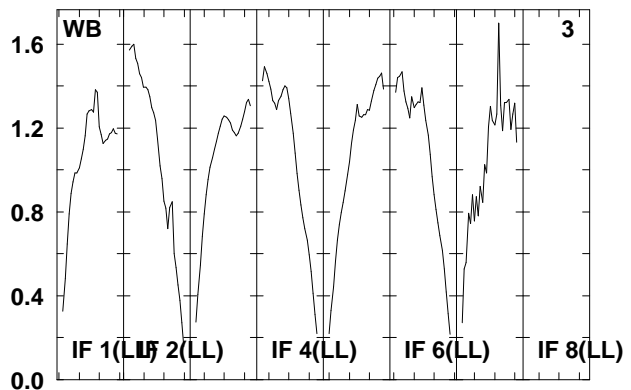
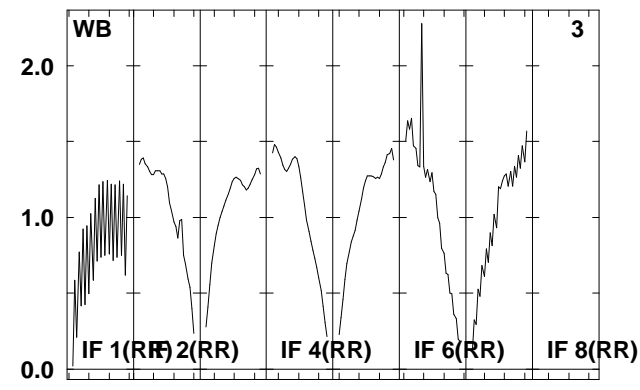
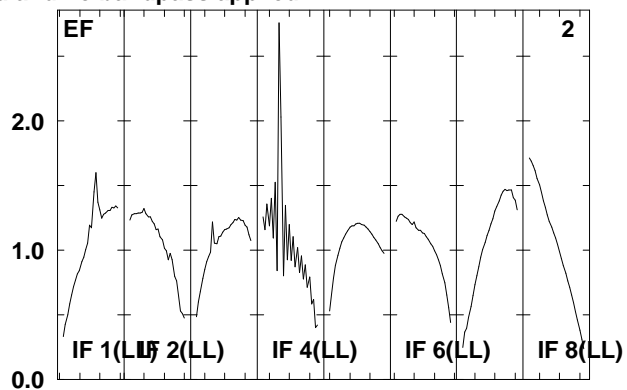
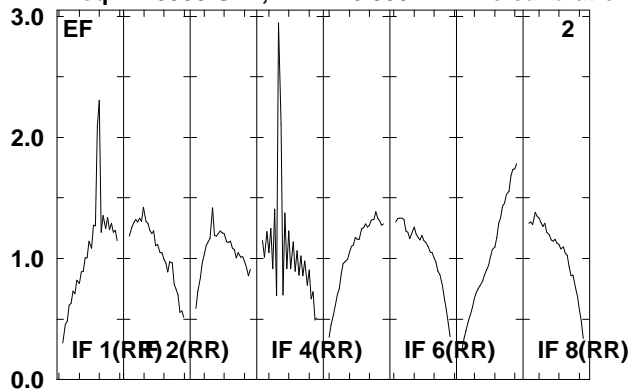

Lower frame: Real Jy

Total-power spectrum Antenna: *

Timerange: 00/12:36:02 to 00/12:37:28

Plot file version 220 created 18-APR-2008 18:29:27

J2333+39 EP061A.UVDATA.1

Freq = 1.5950 GHz, Bw = 16.000 MH No calibration applied and no bandpass applied

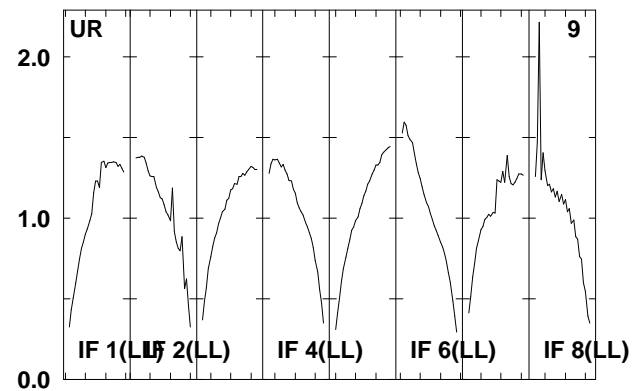
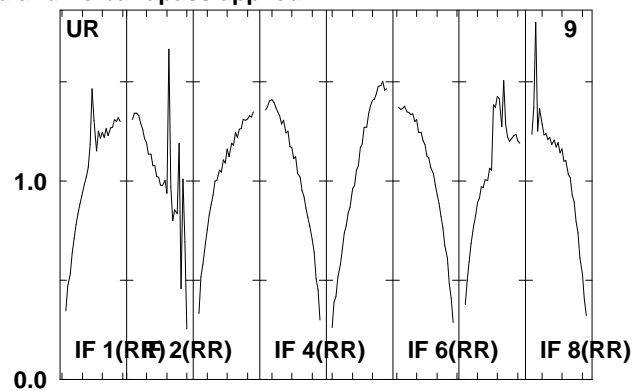
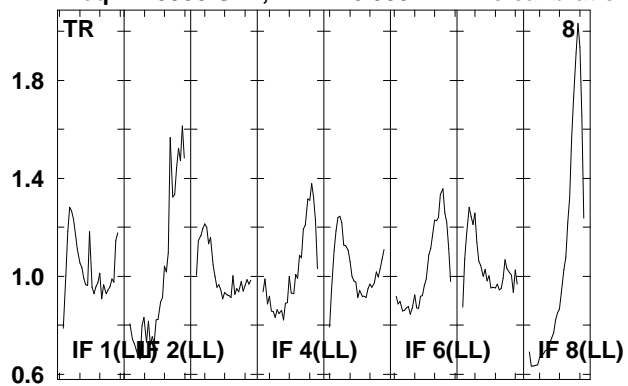

Lower frame: Real Jy
Total-power spectrum Antenna: *
Timerange: 00/12:36:02 to 00/12:37:28

Plot file version 221 created 18-APR-2008 18:29:27

IRAS2336 EP061A.UVDATA.1

Freq = 1.5950 GHz, Bw = 16.000 MH No calibration applied and no bandpass applied

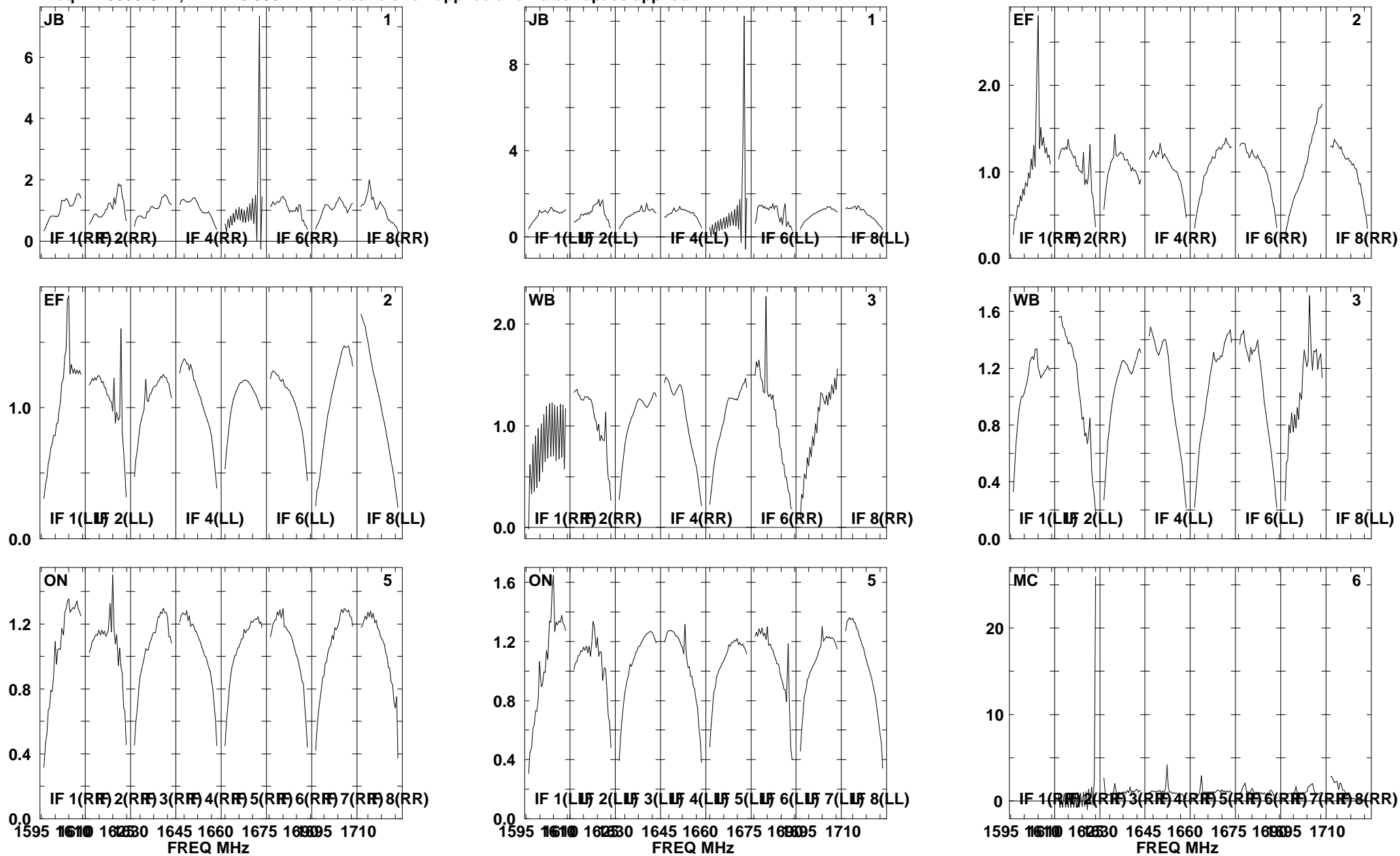

Lower frame: Real Jy
Total-power spectrum Antenna: *
Timerange: 00/12:37:30 to 00/12:40:58

Plot file version 222 created 18-APR-2008 18:29:28

IRAS2336 EP061A.UVDATA.1

Freq = 1.5950 GHz, Bw = 16.000 MH No calibration applied and no bandpass applied

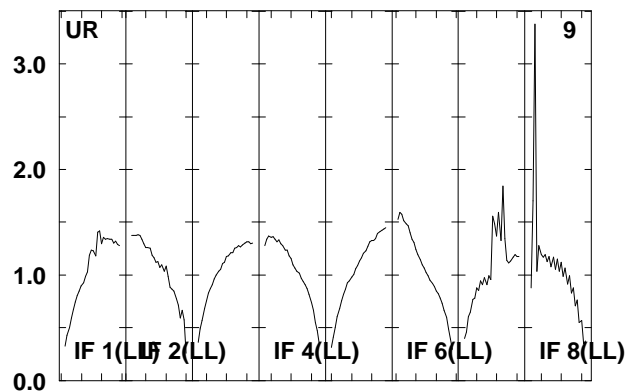
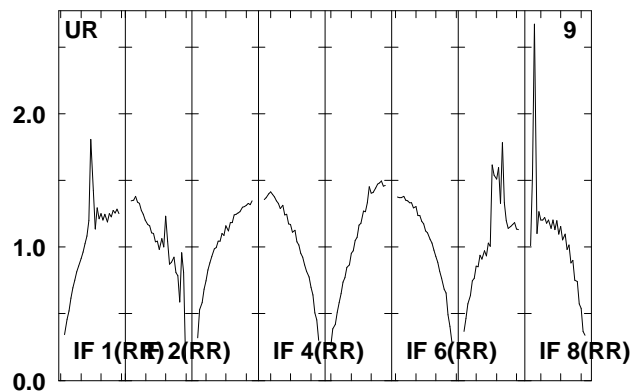
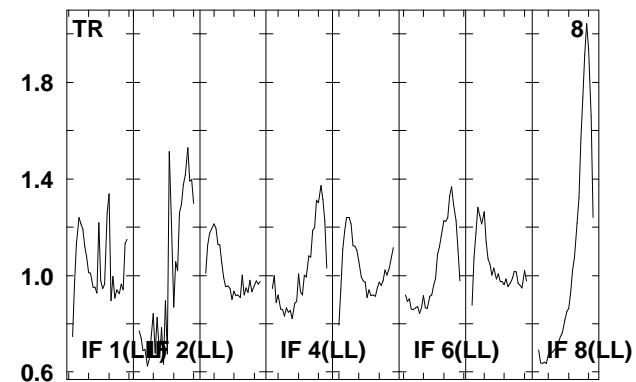
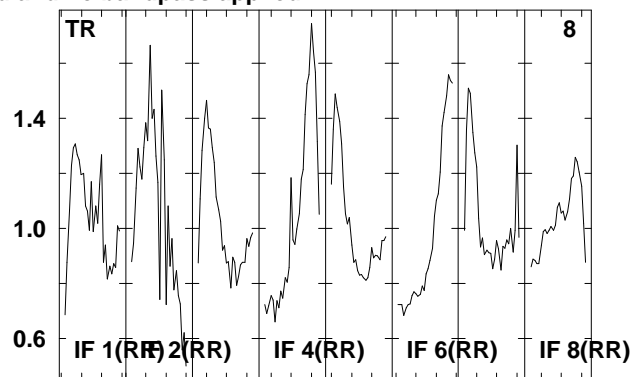
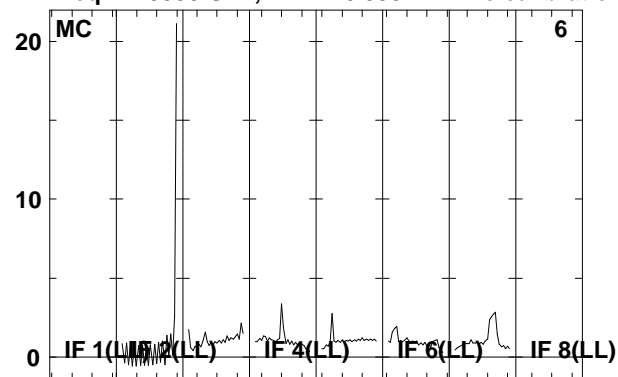

Lower frame: Real Jy
Total-power spectrum Antenna: *
Timerange: 00/12:37:30 to 00/12:40:58

Plot file version 223 created 18-APR-2008 18:29:29

J2333+39 EP061A.UVDATA.1

Freq = 1.5950 GHz, Bw = 16.000 MH No calibration applied and no bandpass applied

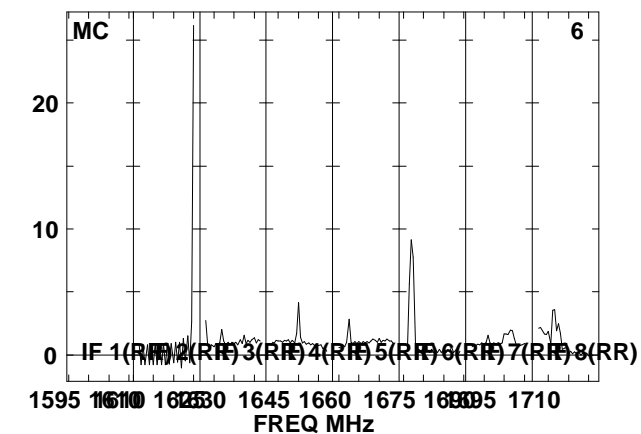
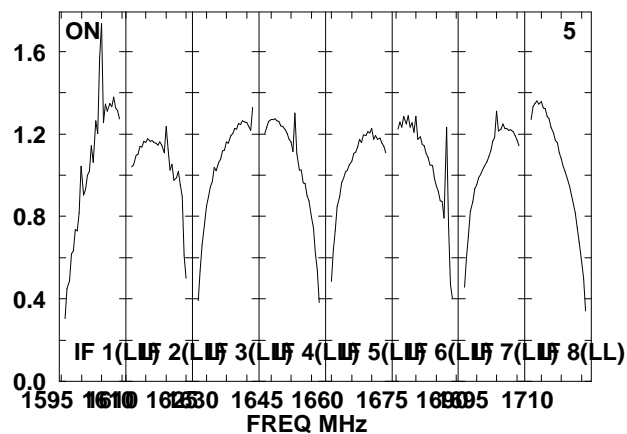
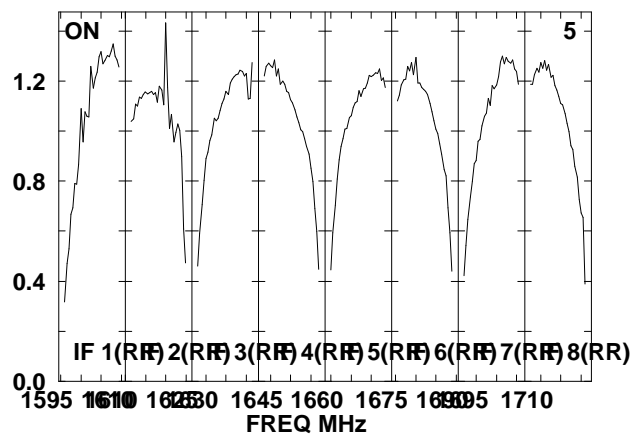
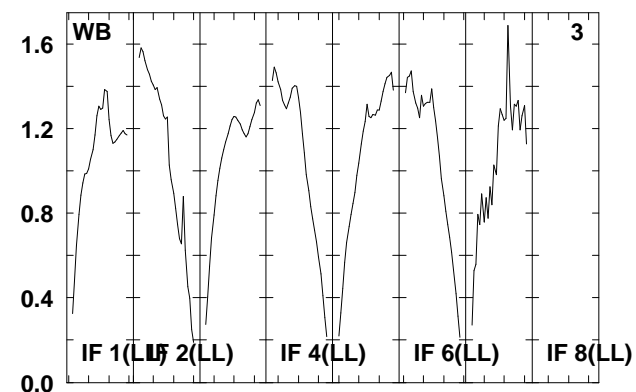
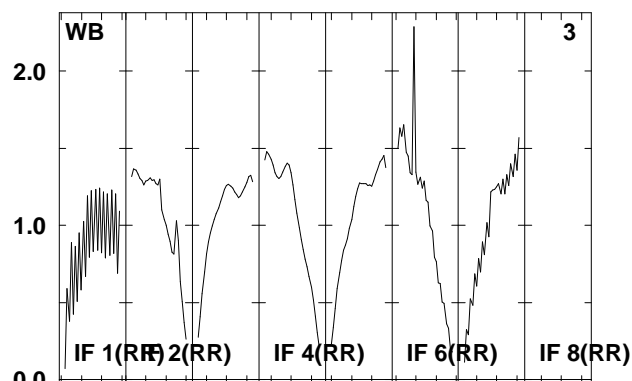
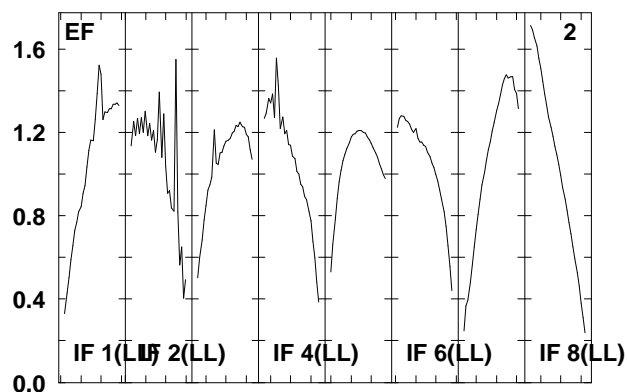
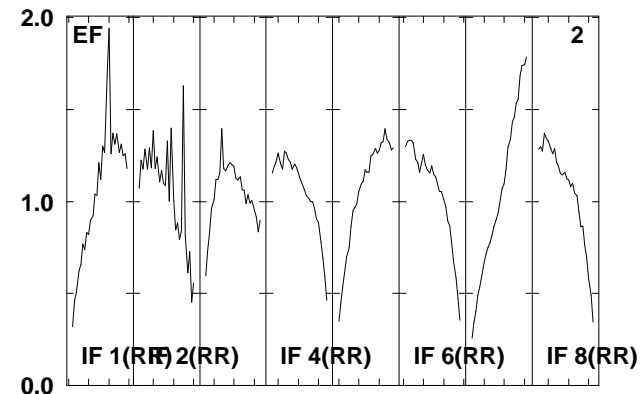
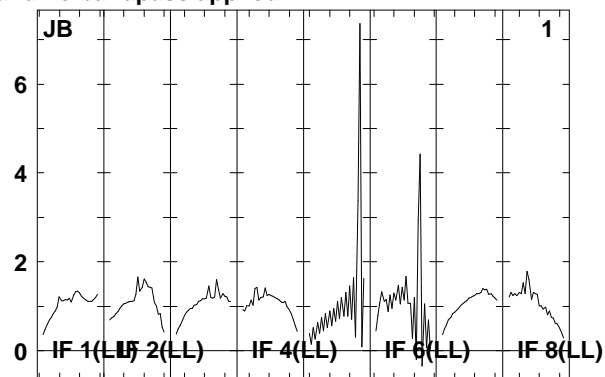
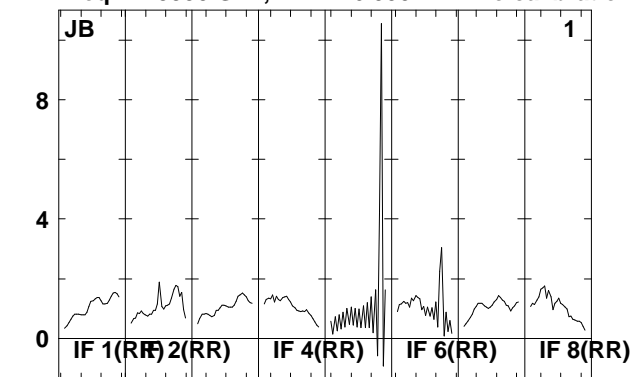

Lower frame: Real Jy
Total-power spectrum Antenna: *
Timerange: 00/12:42:02 to 00/12:43:30

Plot file version 224 created 18-APR-2008 18:29:30

J2333+39 EP061A.UVDATA.1

Freq = 1.5950 GHz, Bw = 16.000 MH No calibration applied and no bandpass applied

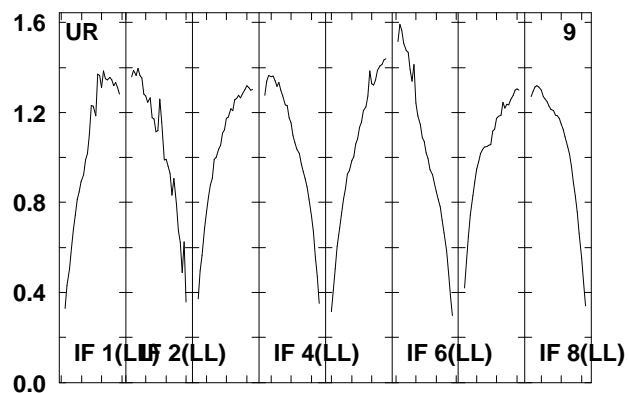
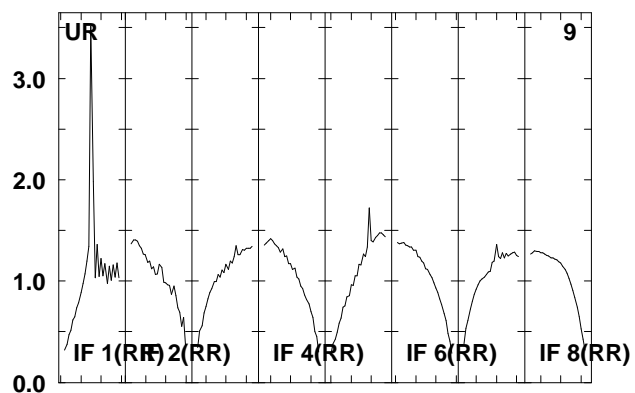
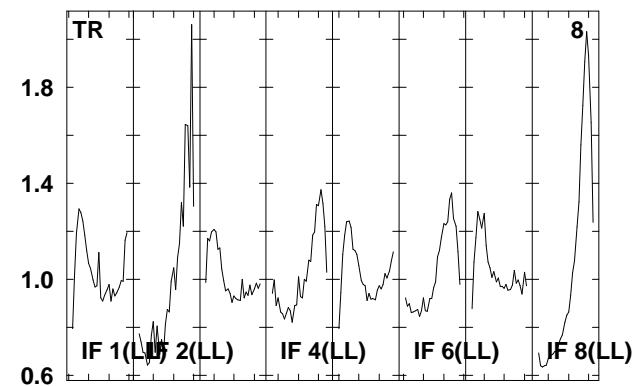
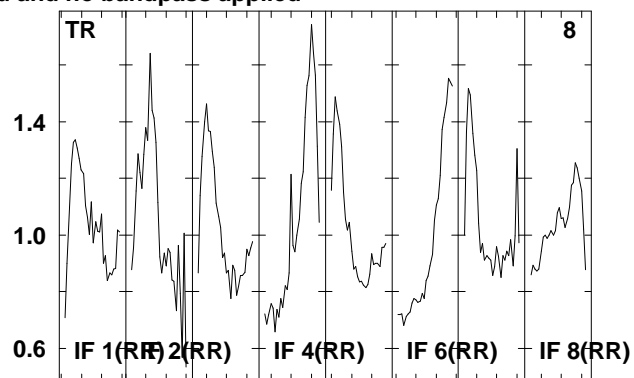
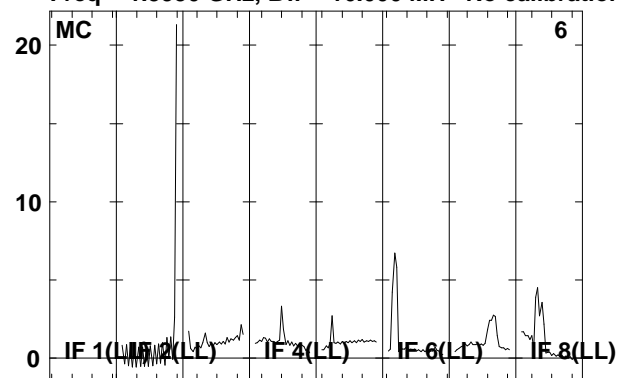

Lower frame: Real Jy
Total-power spectrum Antenna: *
Timerange: 00/12:42:02 to 00/12:43:30

Plot file version 225 created 18-APR-2008 18:29:30

IRAS2336 EP061A.UVDATA.1

Freq = 1.5950 GHz, Bw = 16.000 MH No calibration applied and no bandpass applied

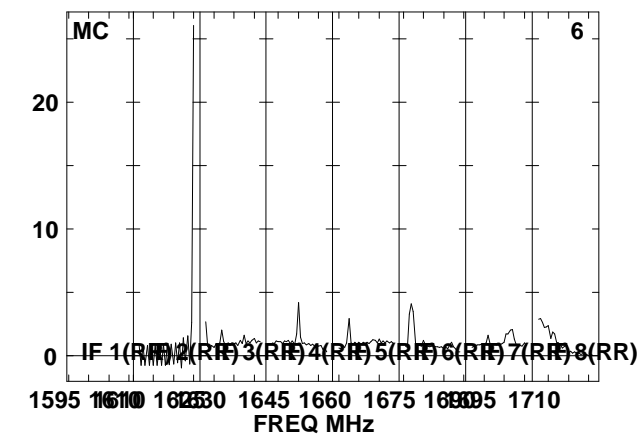
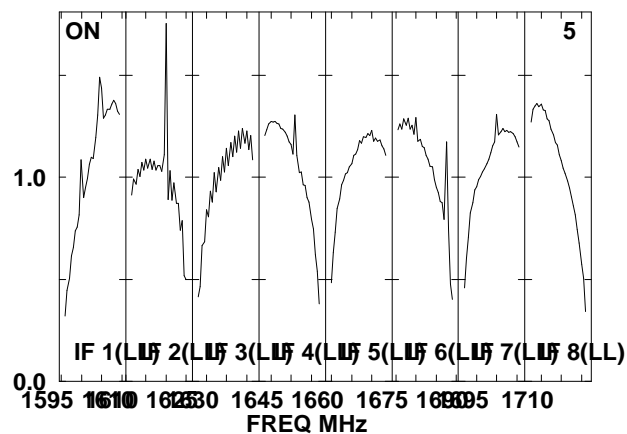
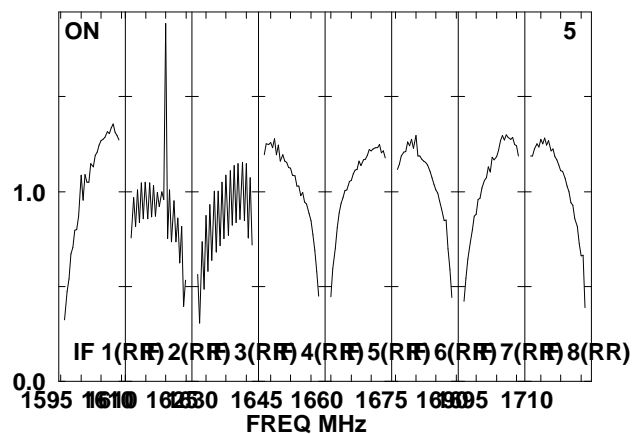
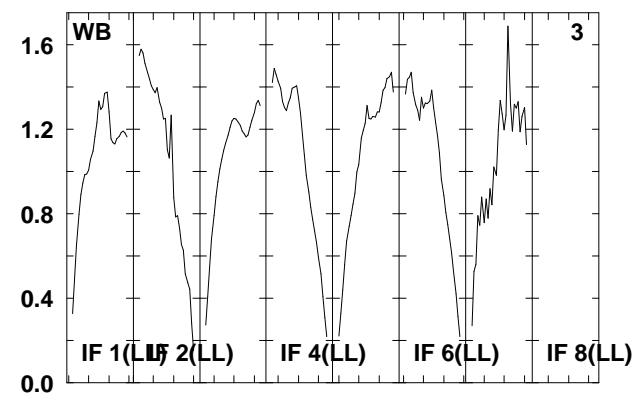
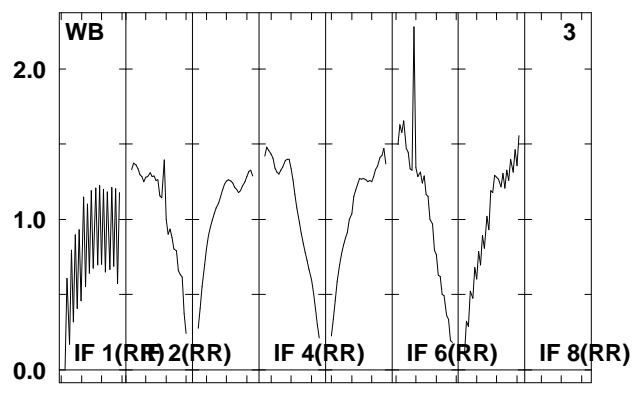
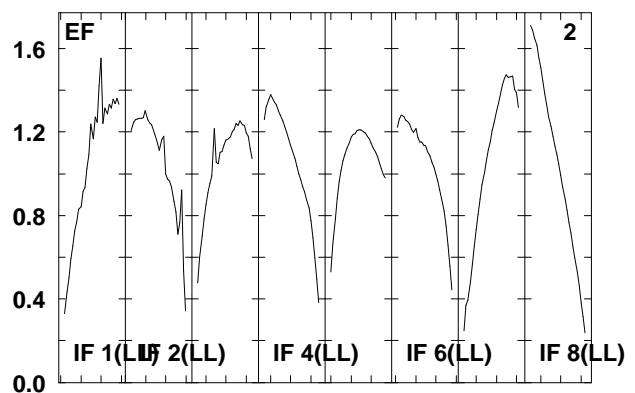
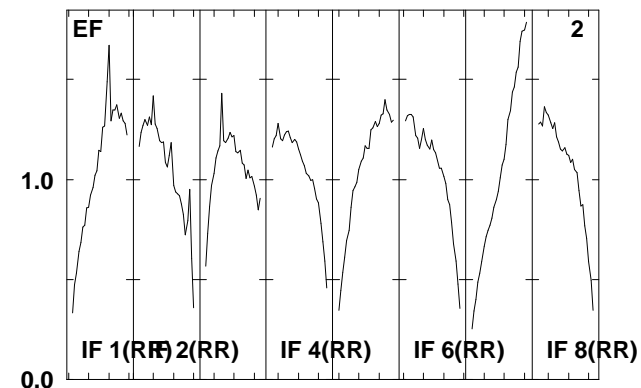
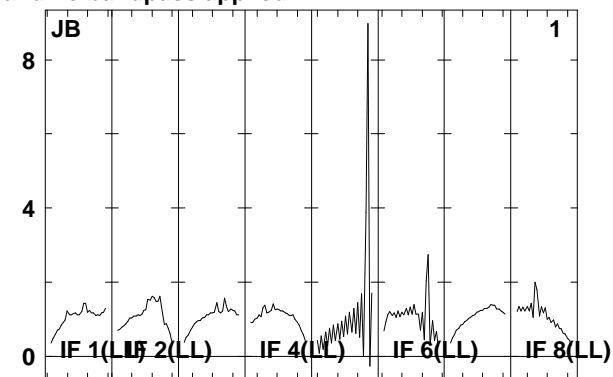
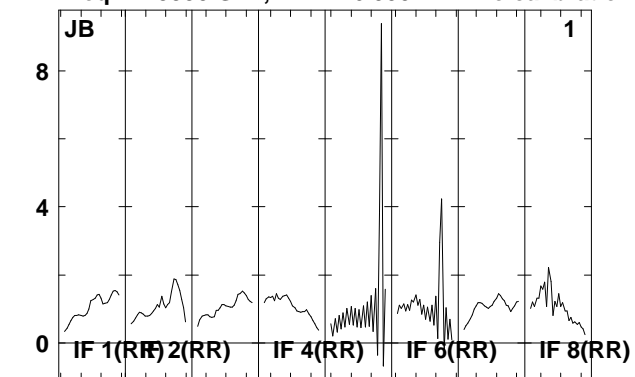

Lower frame: Real Jy

Total-power spectrum Antenna: *

Timerange: 00/12:43:32 to 00/12:47:00

Plot file version 226 created 18-APR-2008 18:29:31

IRAS2336 EP061A.UVDATA.1

Freq = 1.5950 GHz, Bw = 16.000 MH No calibration applied and no bandpass applied

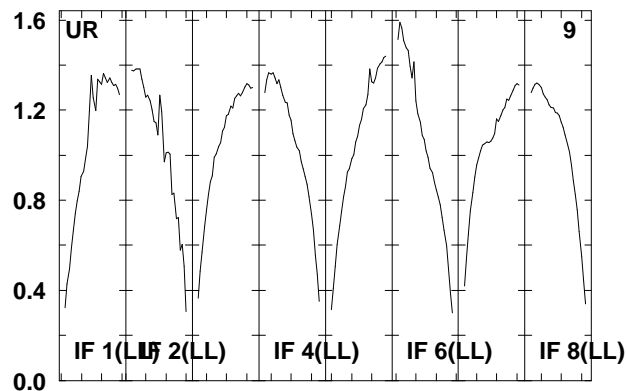
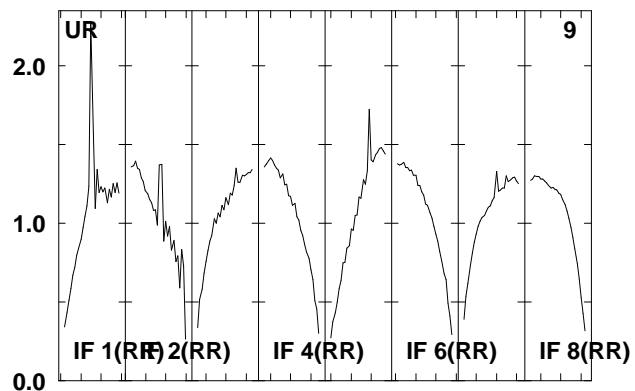
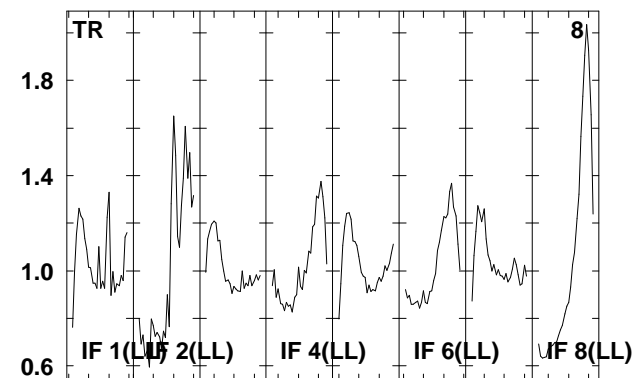
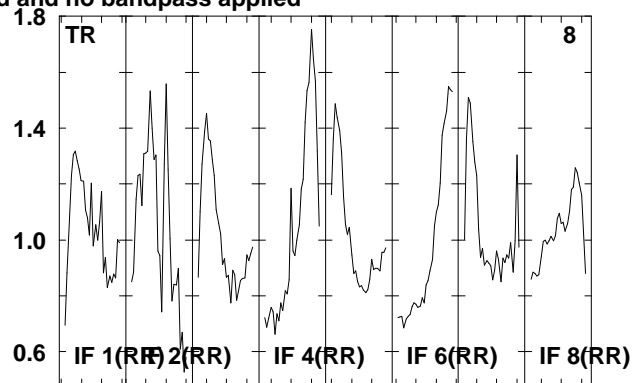
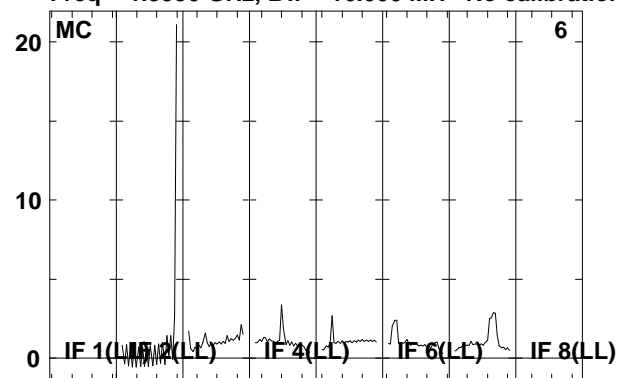

Lower frame: Real Jy
Total-power spectrum Antenna: *
Timerange: 00/12:43:32 to 00/12:47:00

Plot file version 227 created 18-APR-2008 18:29:32

J2333+39 EP061A.UVDATA.1

Freq = 1.5950 GHz, Bw = 16.000 MH No calibration applied and no bandpass applied

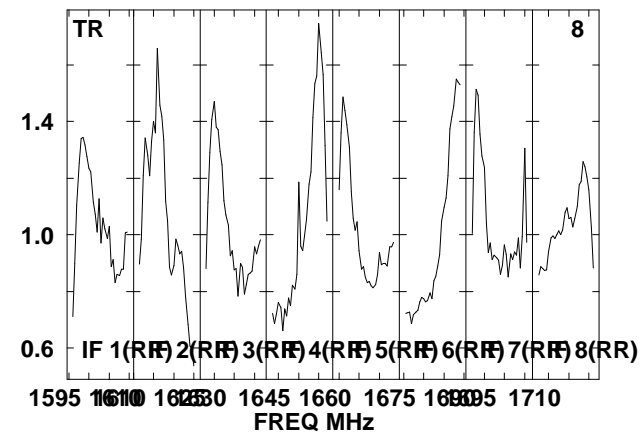
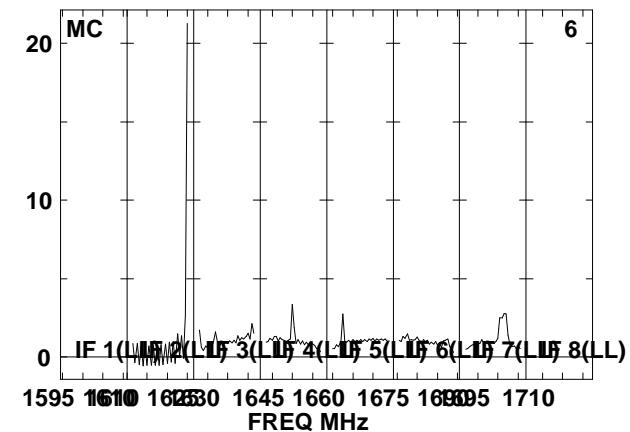
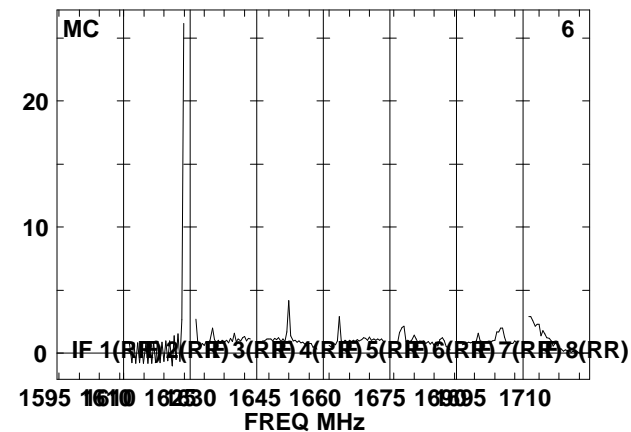
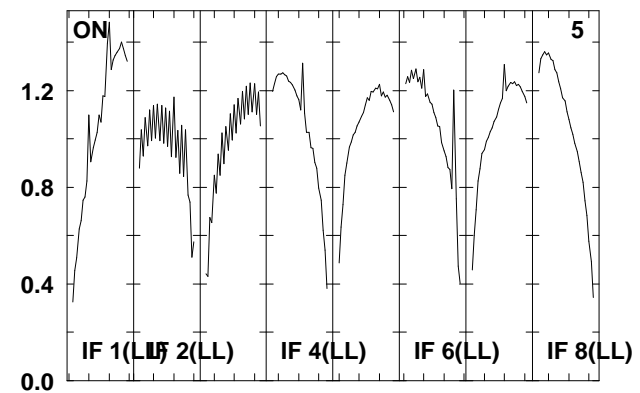
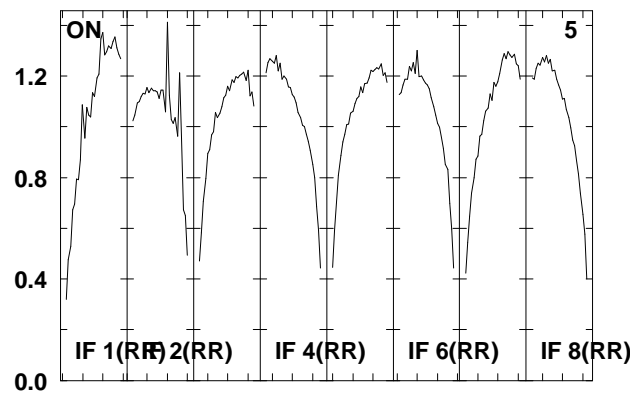
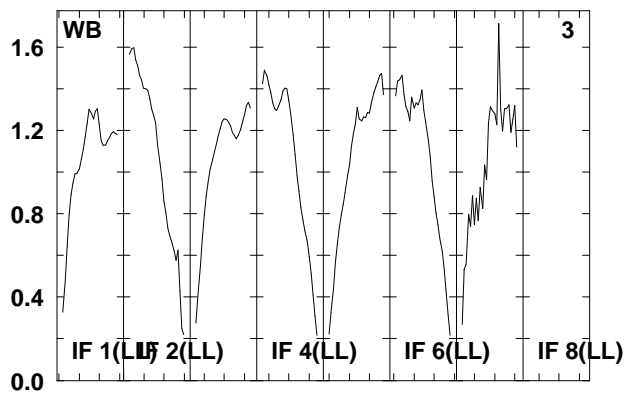
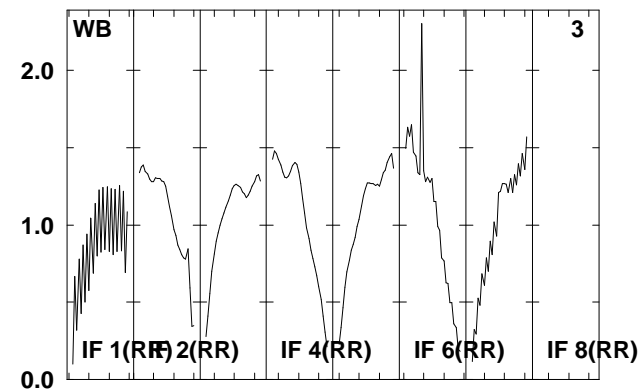
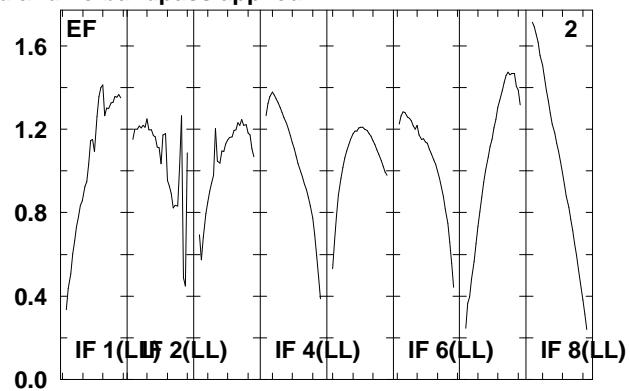
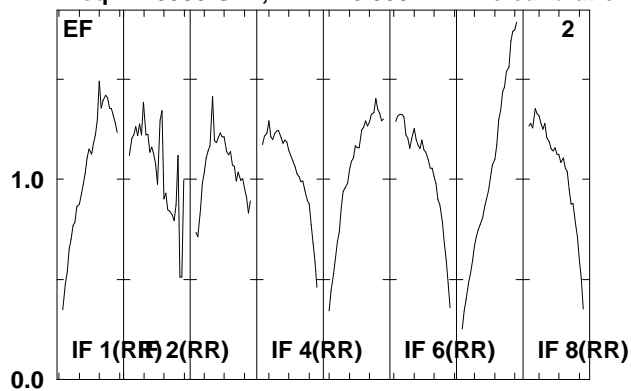

Lower frame: Real Jy
Total-power spectrum Antenna: *
Timerange: 00/12:47:02 to 00/12:48:28

Plot file version 228 created 18-APR-2008 18:29:32

J2333+39 EP061A.UVDATA.1

Freq = 1.5950 GHz, Bw = 16.000 MH No calibration applied and no bandpass applied

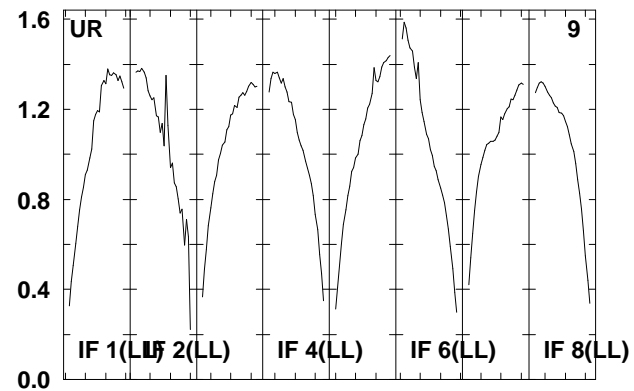
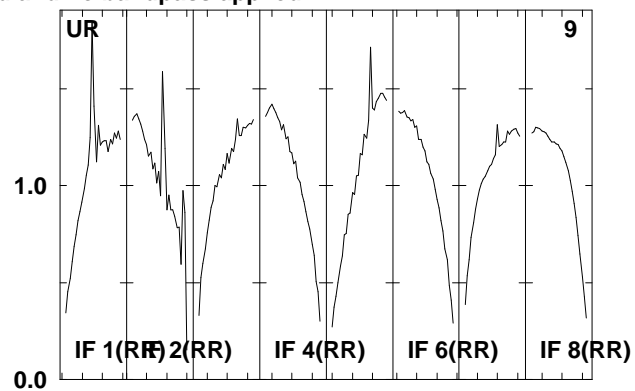
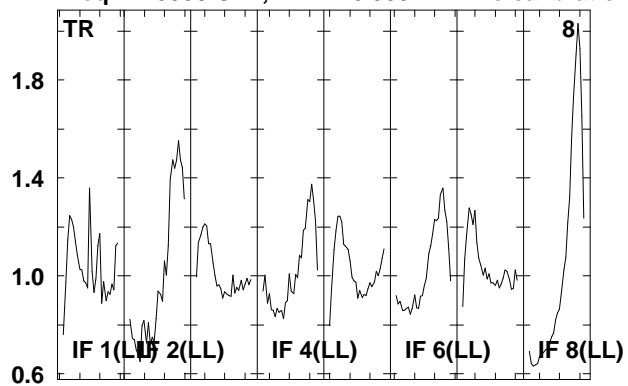

Lower frame: Real Jy
Total-power spectrum Antenna: *
Timerange: 00/12:47:02 to 00/12:48:28

Plot file version 229 created 18-APR-2008 18:29:33

IRAS2336 EP061A.UVDATA.1

Freq = 1.5950 GHz, Bw = 16.000 MH No calibration applied and no bandpass applied

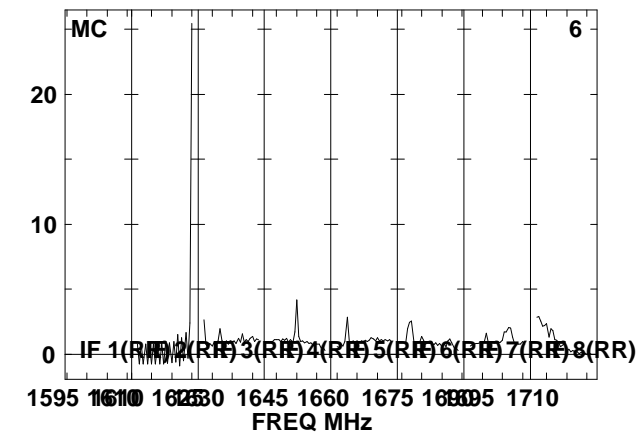
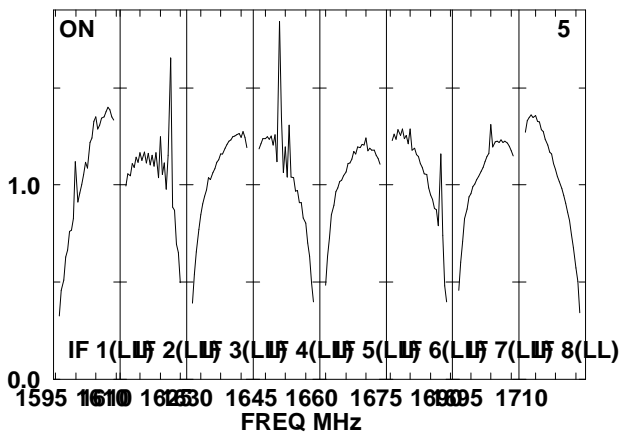
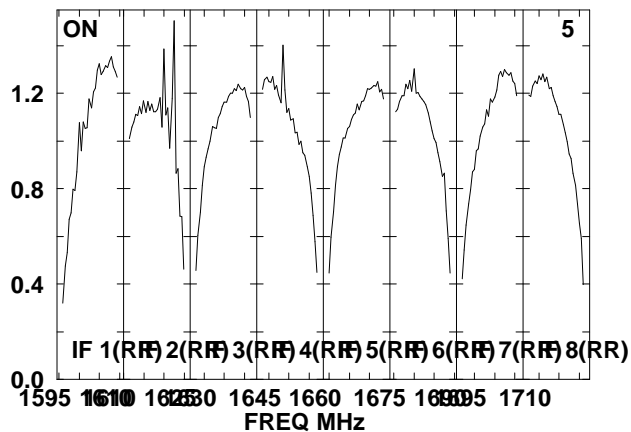
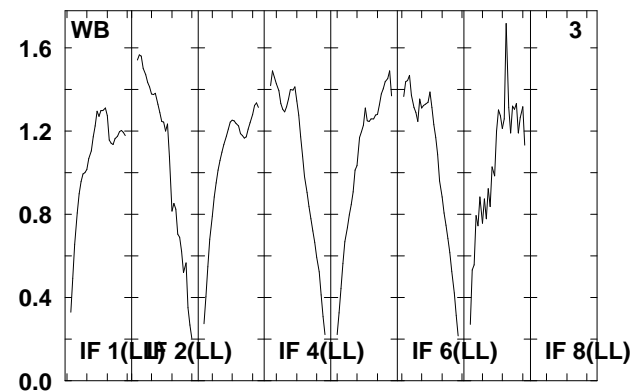
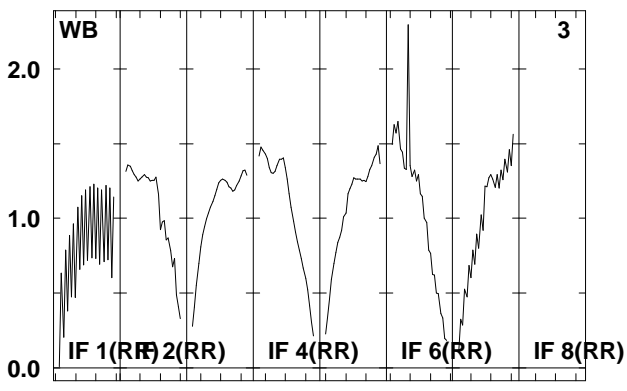
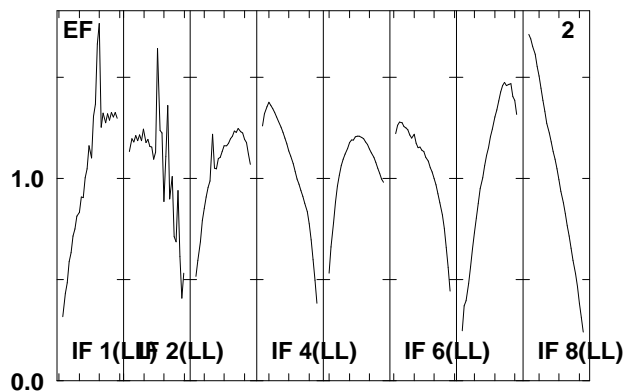
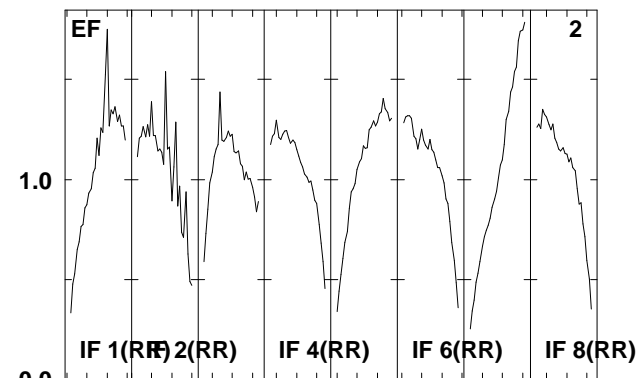
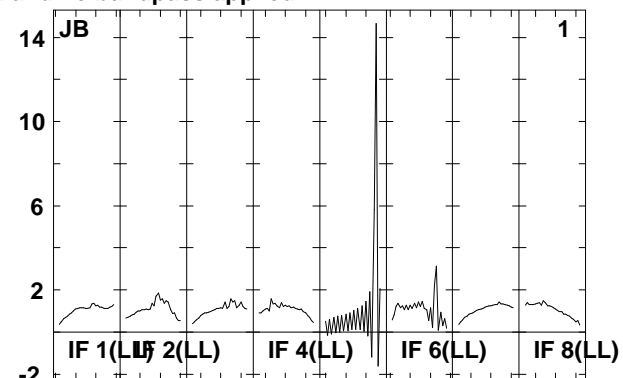
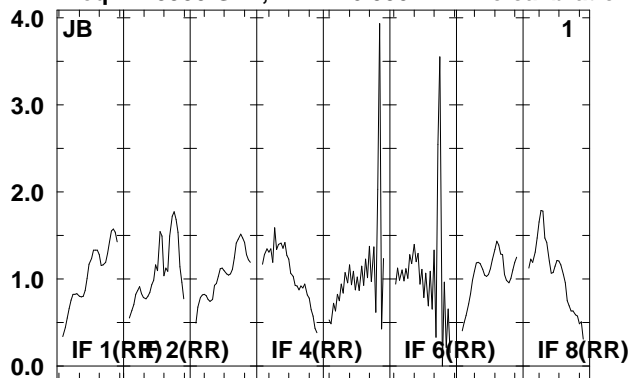

Lower frame: Real Jy
Total-power spectrum Antenna: *
Timerange: 00/12:48:30 to 00/12:52:00

Plot file version 230 created 18-APR-2008 18:29:34

IRAS2336 EP061A.UVDATA.1

Freq = 1.5950 GHz, Bw = 16.000 MH No calibration applied and no bandpass applied

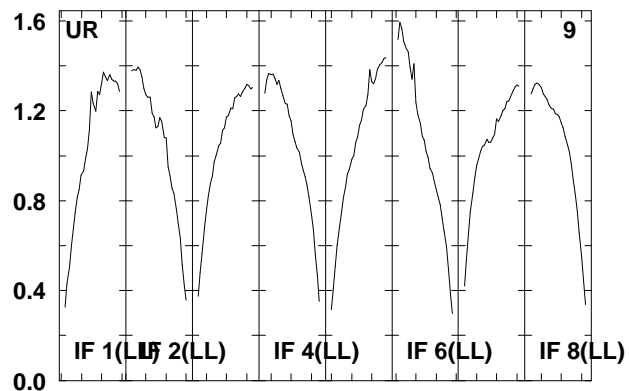
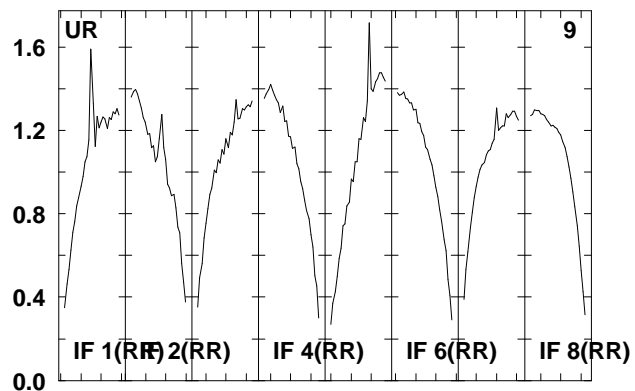
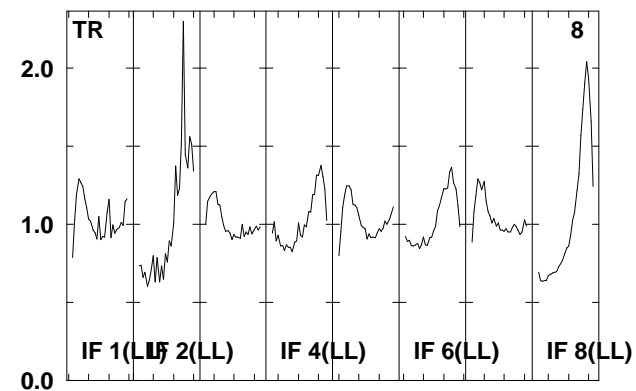
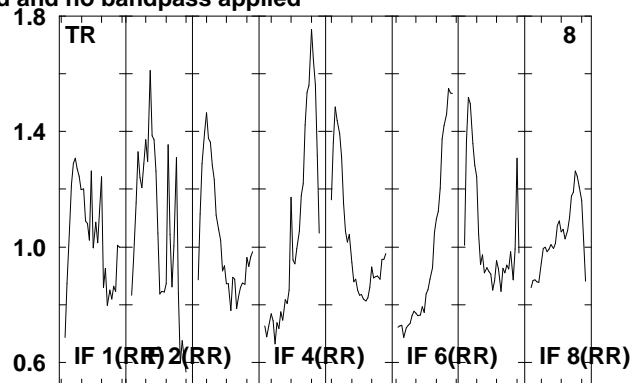
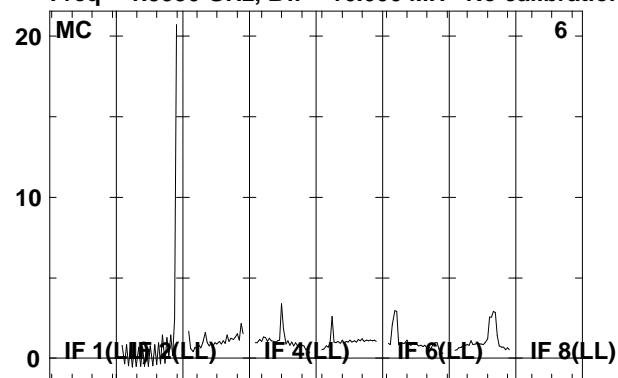

Lower frame: Real Jy
Total-power spectrum Antenna: *
Timerange: 00/12:48:30 to 00/12:52:00

Plot file version 231 created 18-APR-2008 18:29:36

J2333+39 EP061A.UVDATA.1

Freq = 1.5950 GHz, Bw = 16.000 MH No calibration applied and no bandpass applied

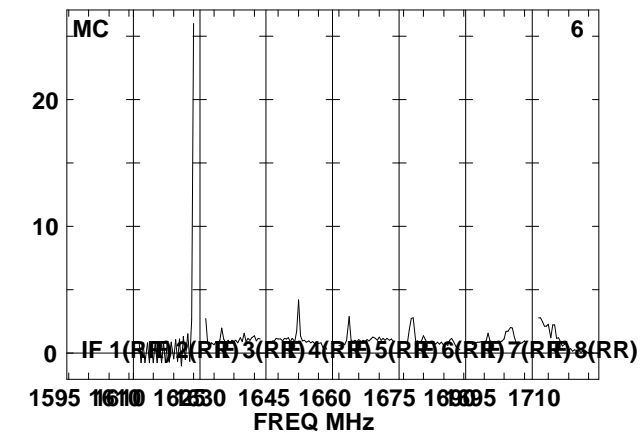
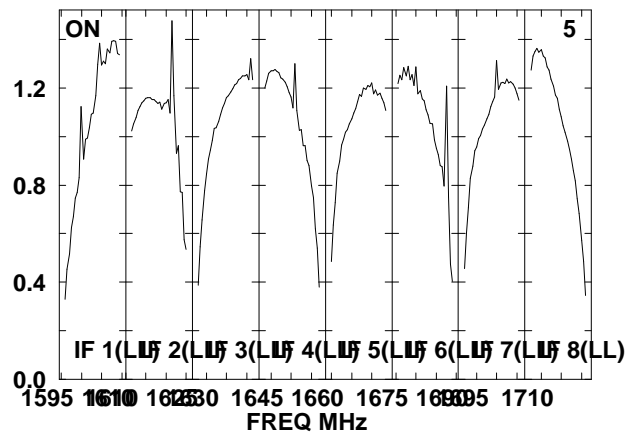
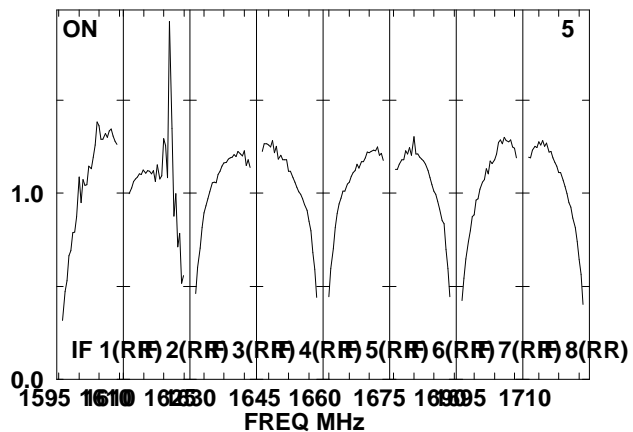
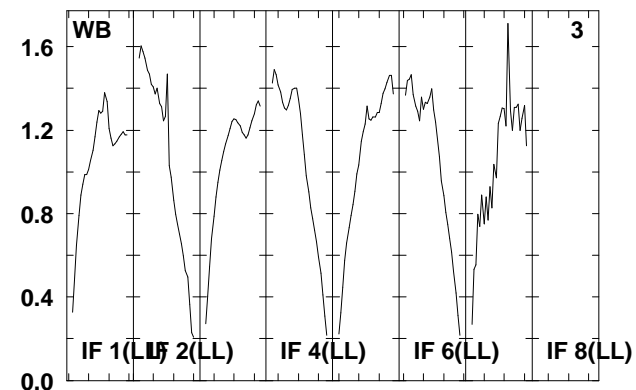
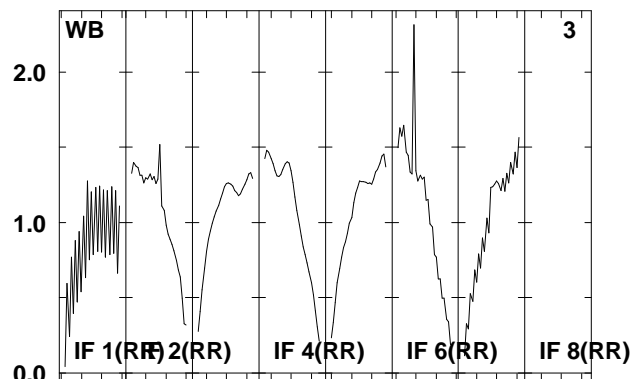
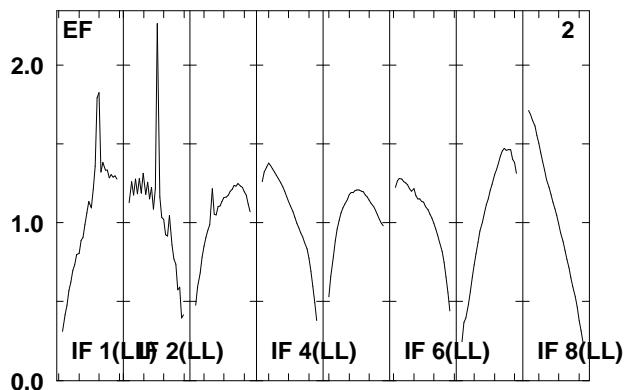
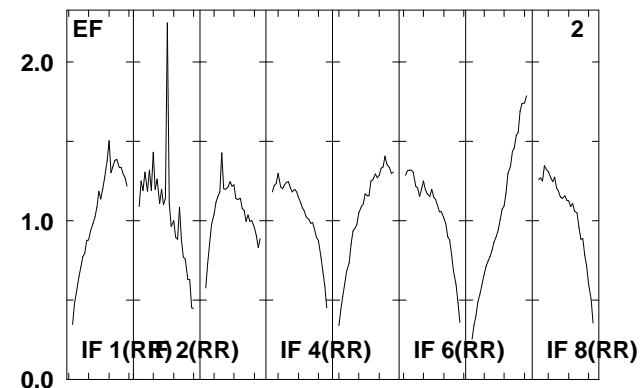
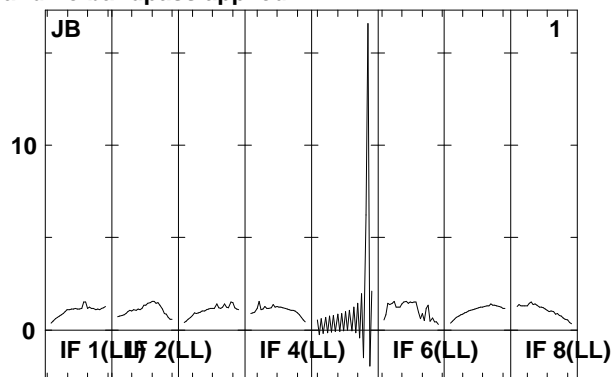
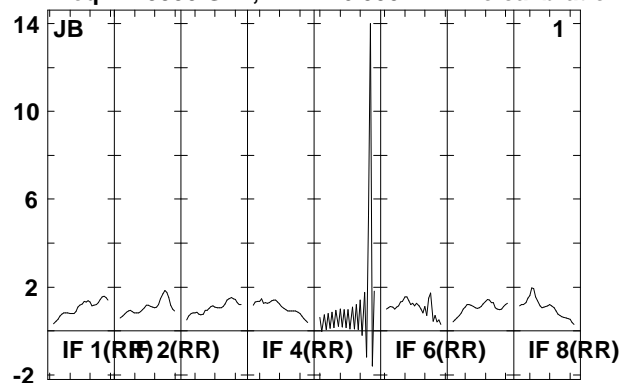

Lower frame: Real Jy

Total-power spectrum Antenna: *

Timerange: 00:12:52:02 to 00:12:53:30

Plot file version 232 created 18-APR-2008 18:29:36

J2333+39 EP061A.UVDATA.1

Freq = 1.5950 GHz, Bw = 16.000 MH No calibration applied and no bandpass applied

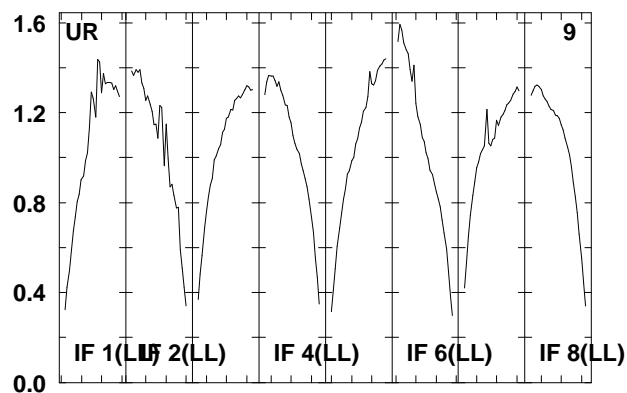
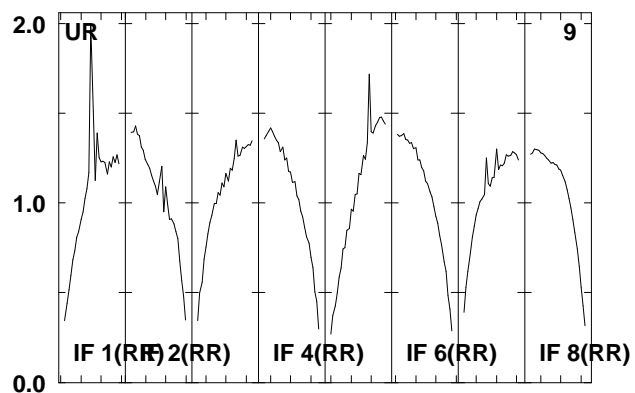
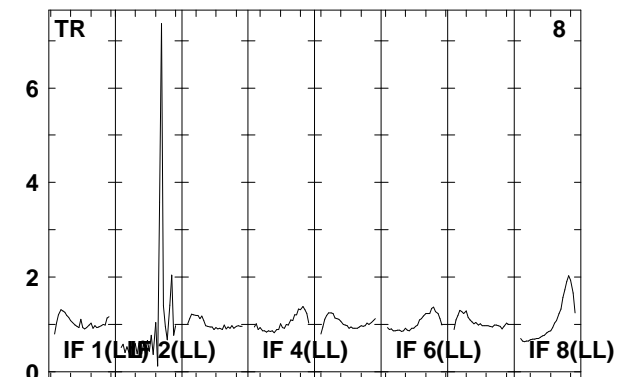
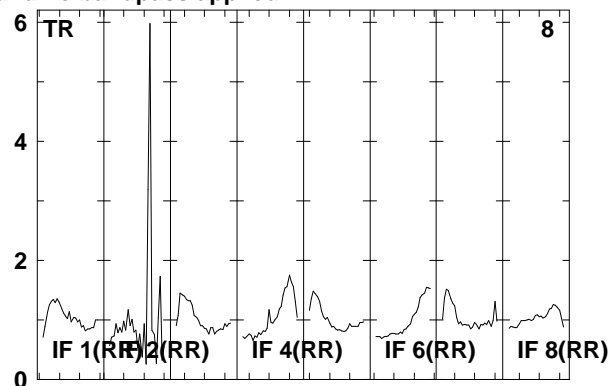
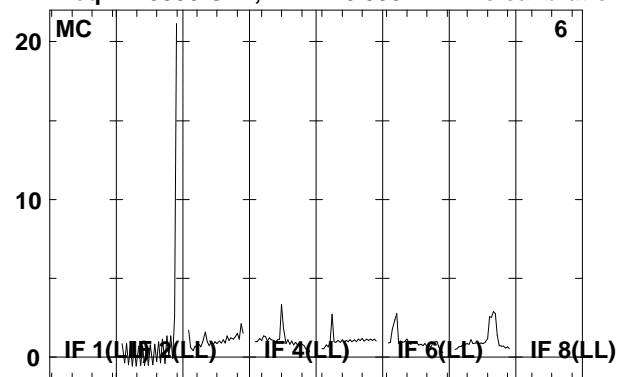

Lower frame: Real Jy
Total-power spectrum Antenna: *
Timerange: 00/12:52:02 to 00/12:53:30

Plot file version 233 created 18-APR-2008 18:29:37

IRAS2336 EP061A.UVDATA.1

Freq = 1.5950 GHz, Bw = 16.000 MH No calibration applied and no bandpass applied

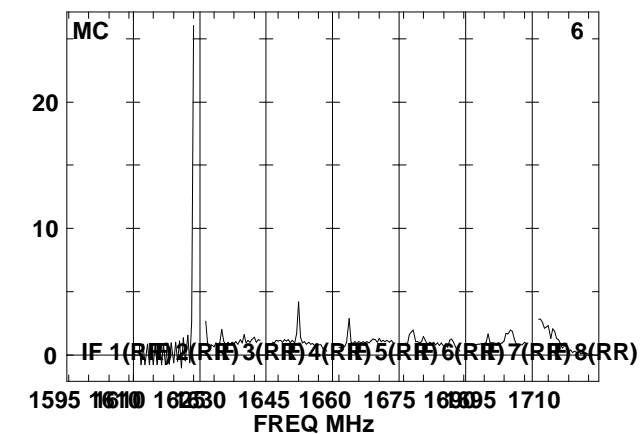
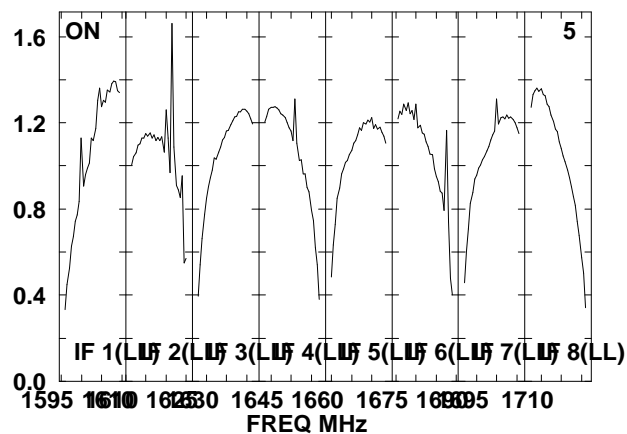
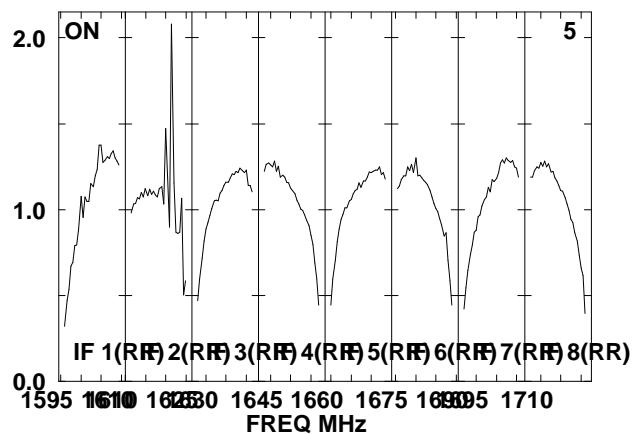
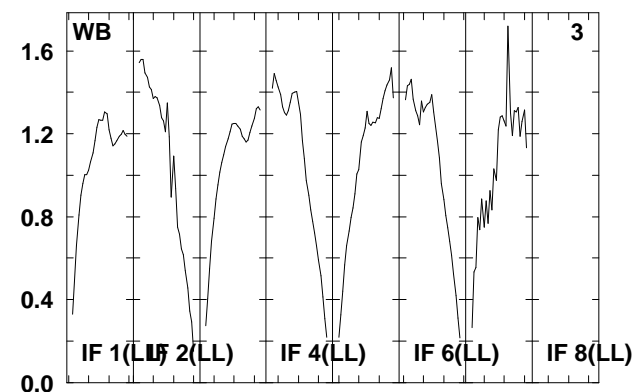
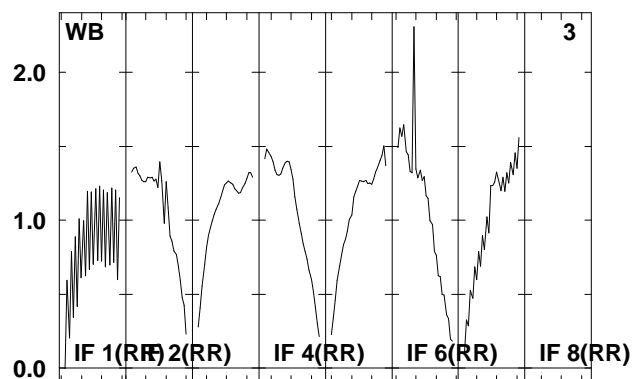
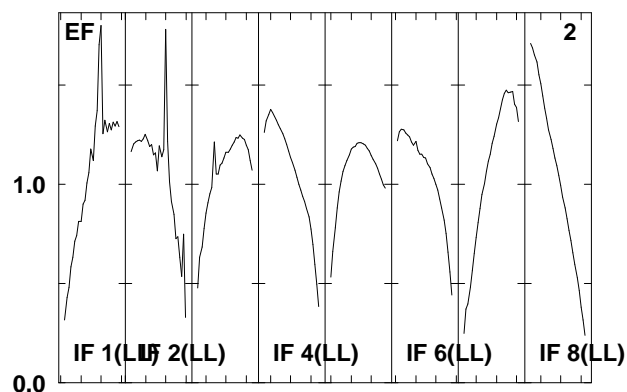
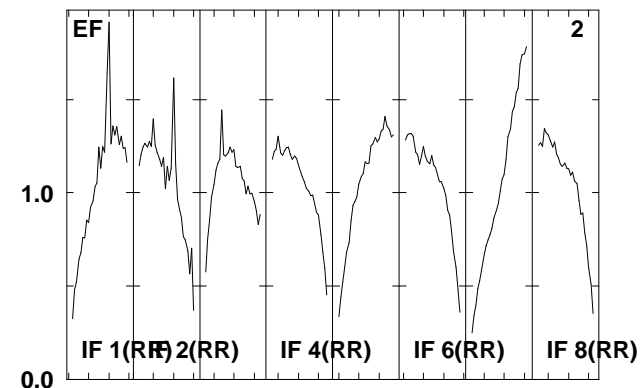
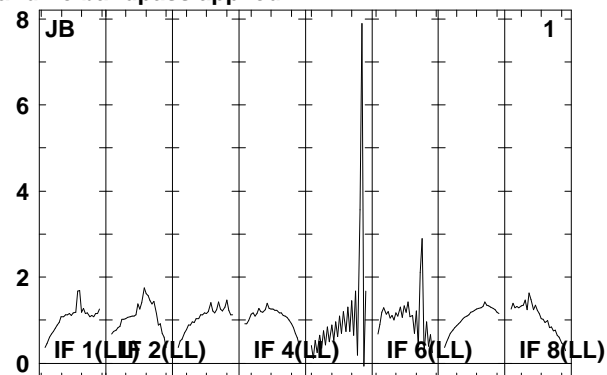
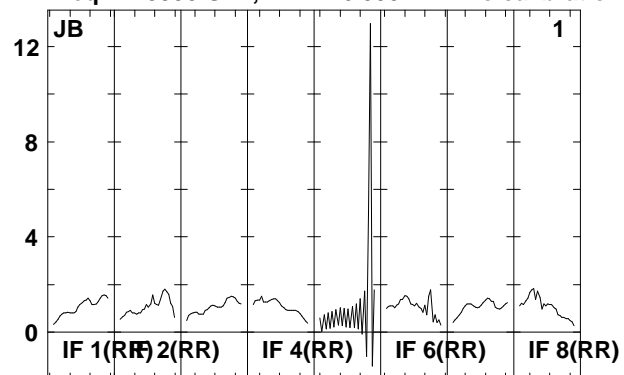

Lower frame: Real Jy

Total-power spectrum Antenna: *

Timerange: 00/12:53:32 to 00/12:56:56

Plot file version 234 created 18-APR-2008 18:29:38

IRAS2336 EP061A.UVDATA.1

Freq = 1.5950 GHz, Bw = 16.000 MH No calibration applied and no bandpass applied

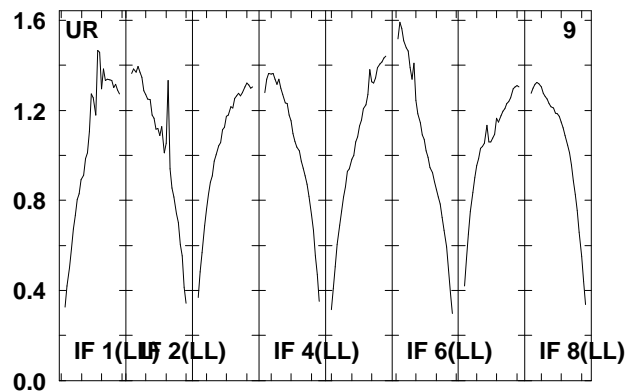
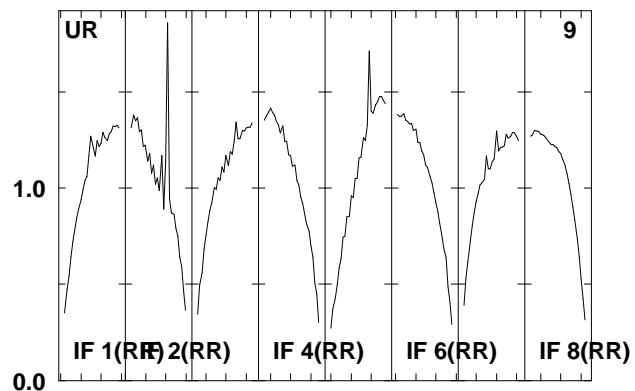
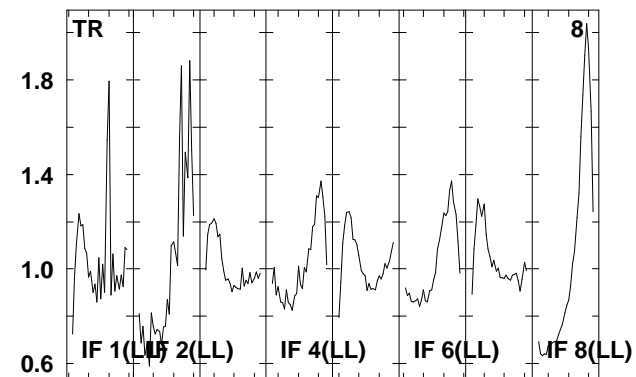
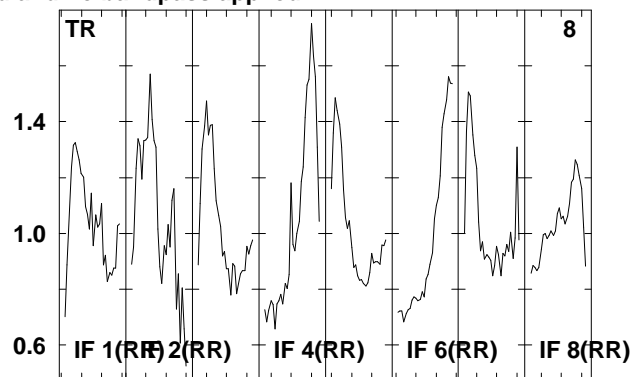
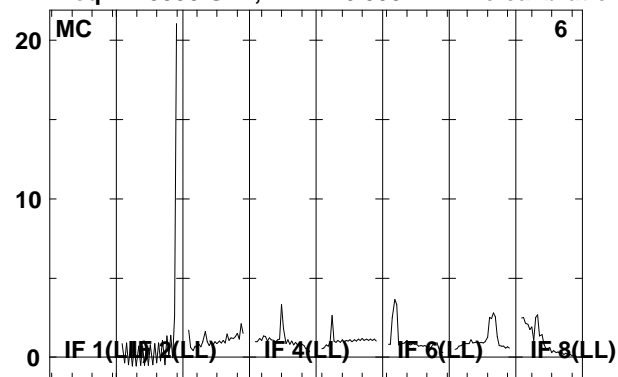

Lower frame: Real Jy
Total-power spectrum Antenna: *
Timerange: 00/12:53:32 to 00/12:56:56

Plot file version 235 created 18-APR-2008 18:29:39

J2333+39 EP061A.UVDATA.1

Freq = 1.5950 GHz, Bw = 16.000 MH No calibration applied and no bandpass applied

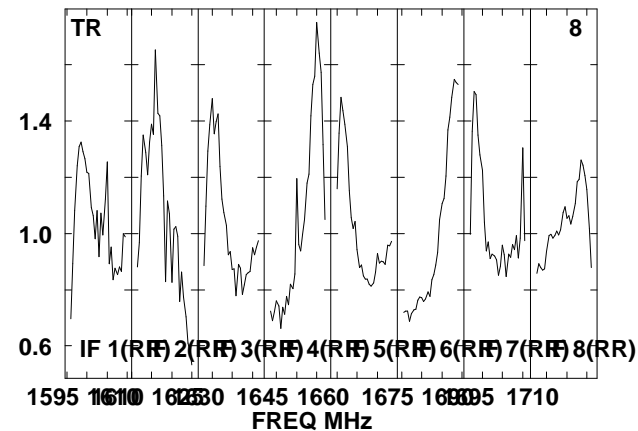
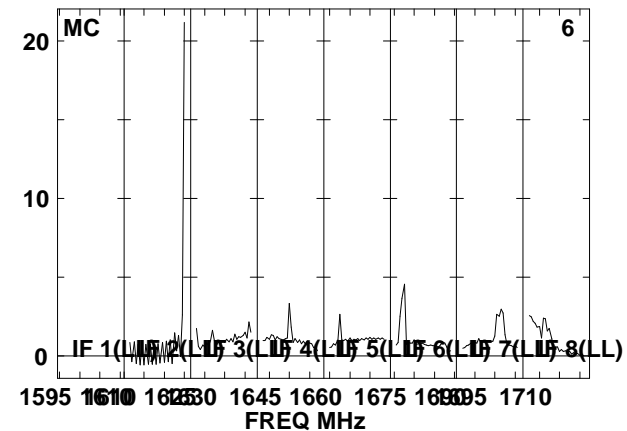
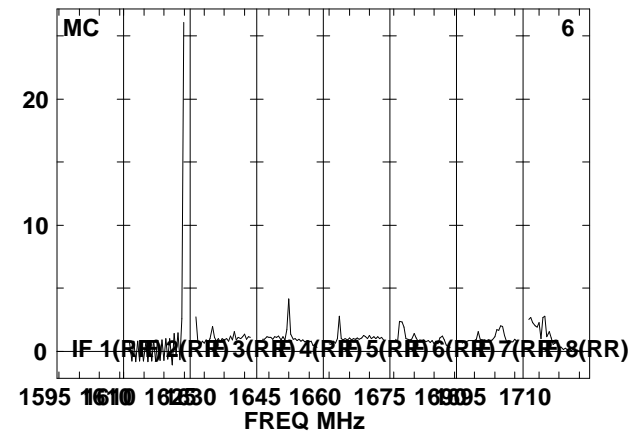
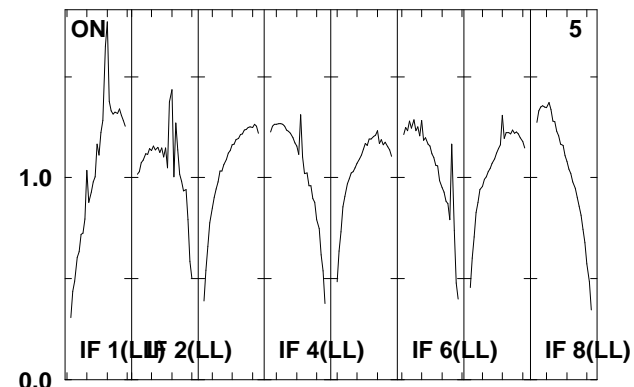
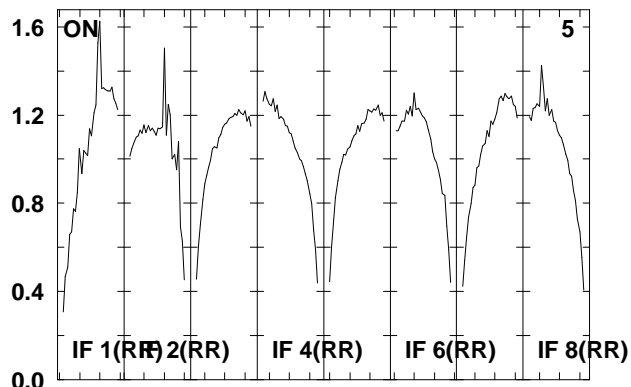
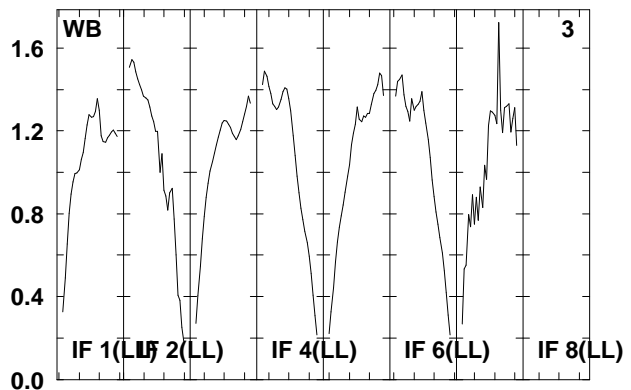
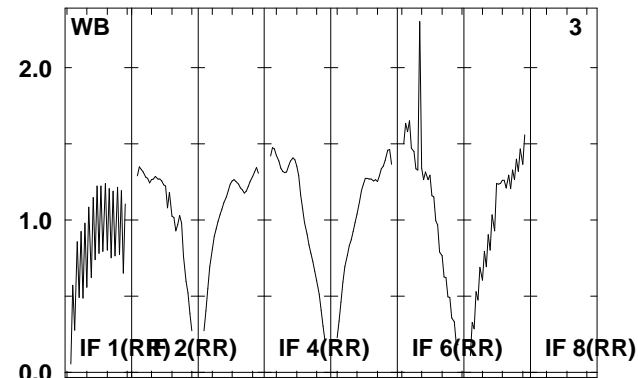
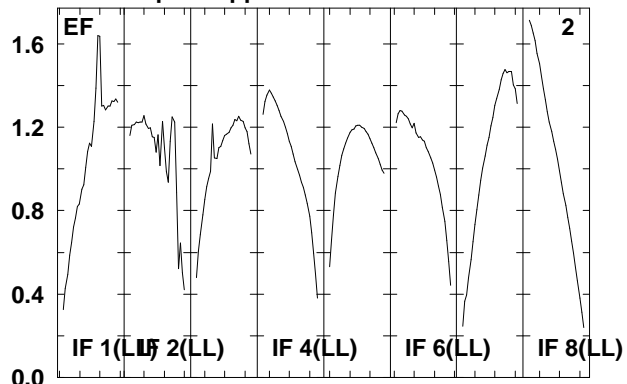
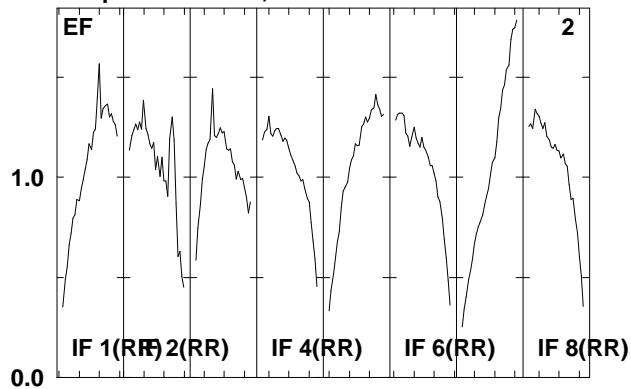

Lower frame: Real Jy

Total-power spectrum Antenna: *

Timerange: 00/12:58:02 to 00/12:59:26

Plot file version 236 created 18-APR-2008 18:29:39

J2333+39 EP061A.UVDATA.1

Freq = 1.5950 GHz, Bw = 16.000 MH No calibration applied and no bandpass applied

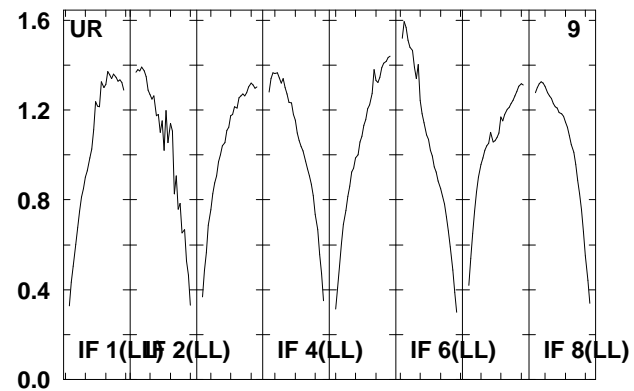
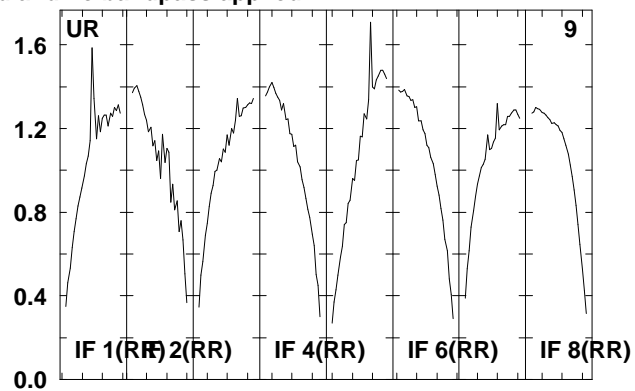
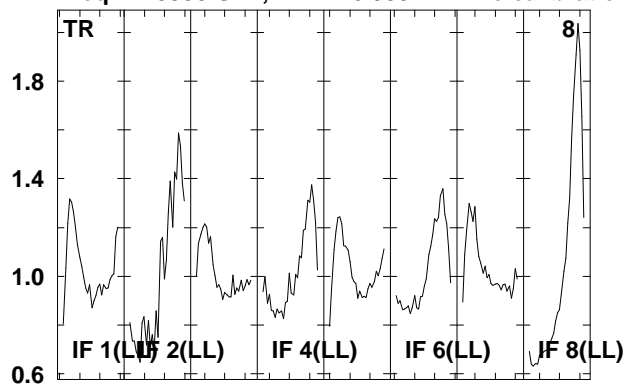

Lower frame: Real Jy
Total-power spectrum Antenna: *
Timerange: 00/12:58:02 to 00/12:59:26

Plot file version 237 created 18-APR-2008 18:29:39

IRAS2336 EP061A.UVDATA.1

Freq = 1.5950 GHz, Bw = 16.000 MH No calibration applied and no bandpass applied

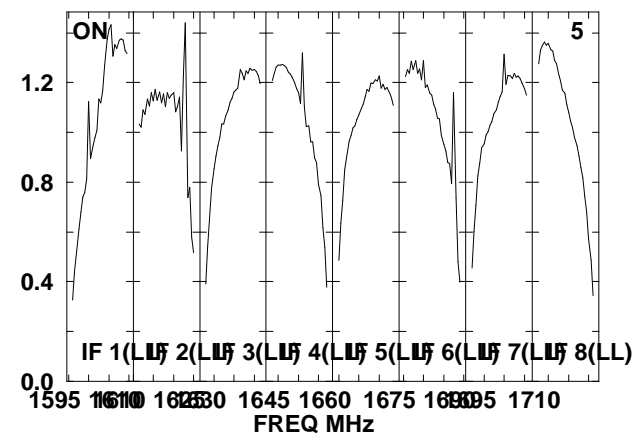
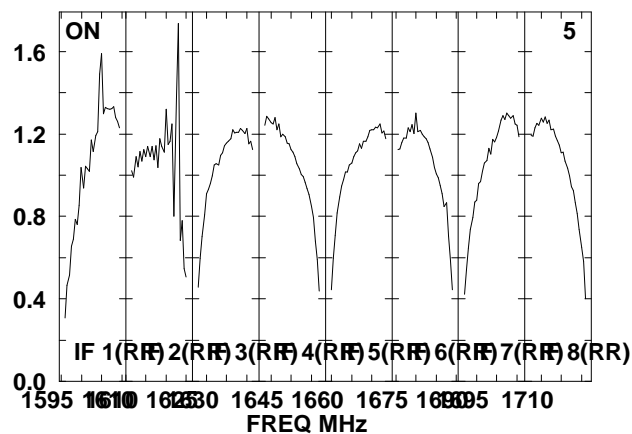
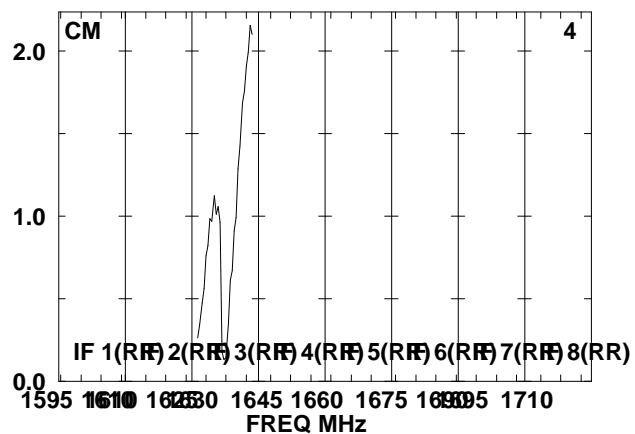
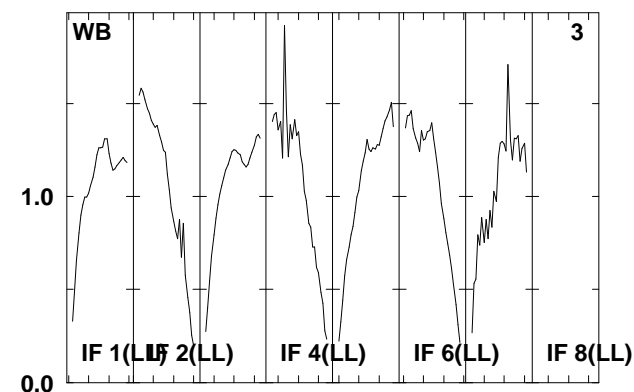
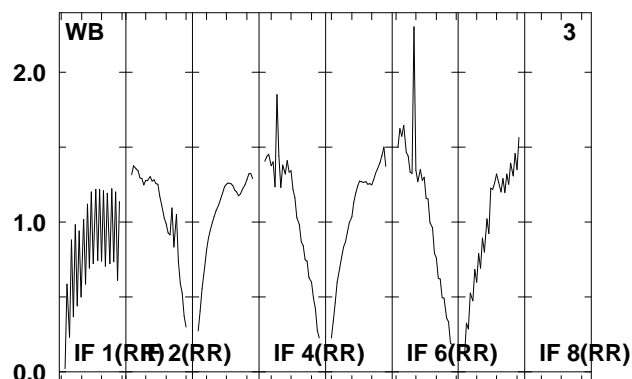
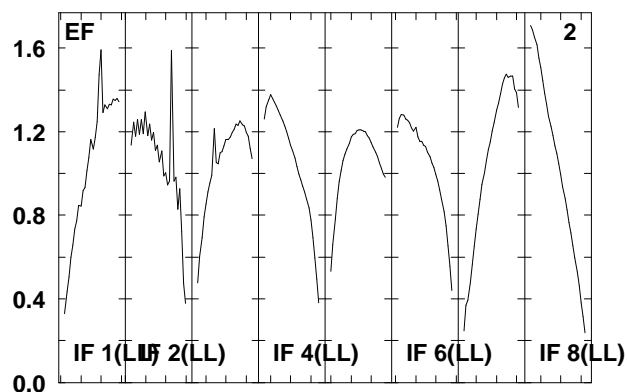
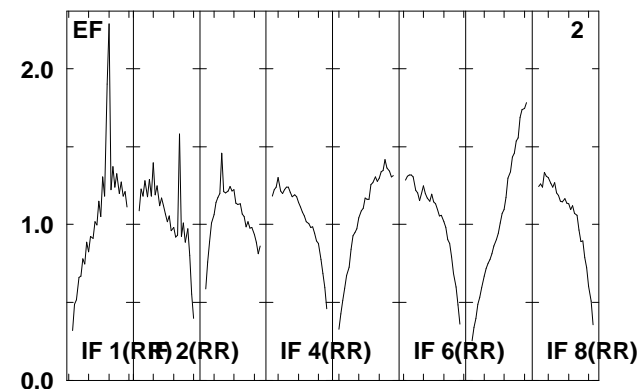
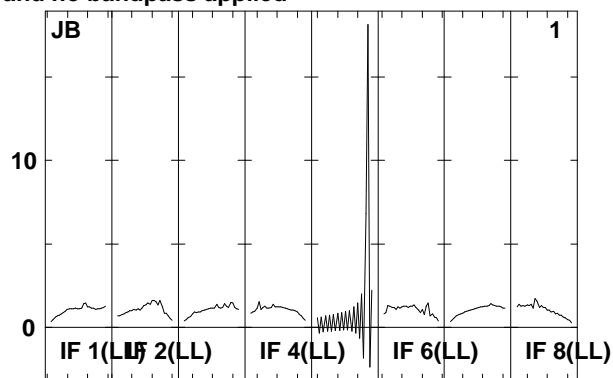
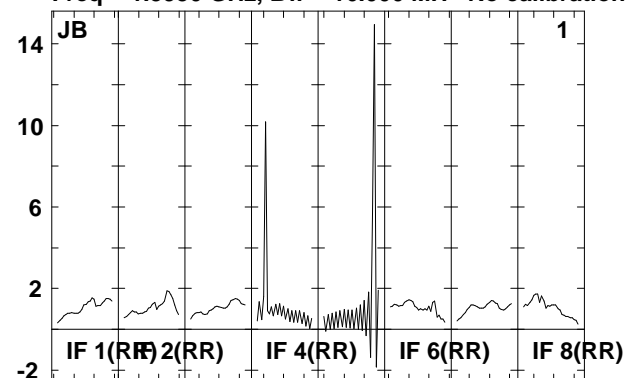

Lower frame: Real Jy
Total-power spectrum Antenna: *
Timerange: 00/12:59:32 to 00/13:03:00

Plot file version 238 created 18-APR-2008 18:29:40

IRAS2336 EP061A.UVDATA.1

Freq = 1.5950 GHz, Bw = 16.000 MH No calibration applied and no bandpass applied

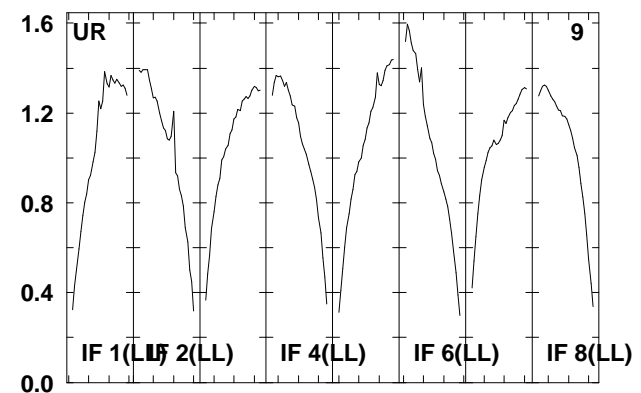
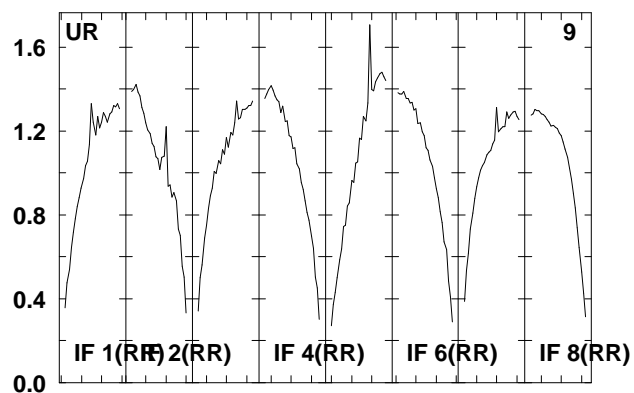
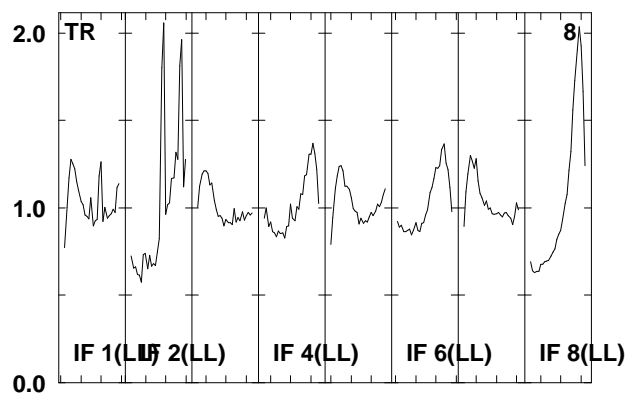
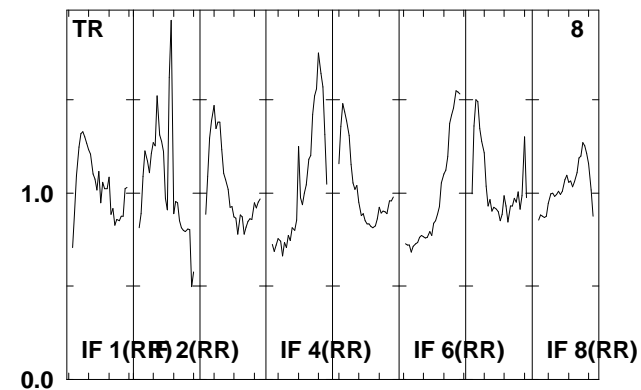
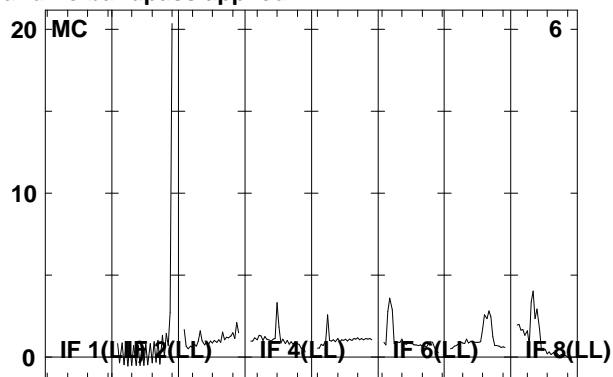
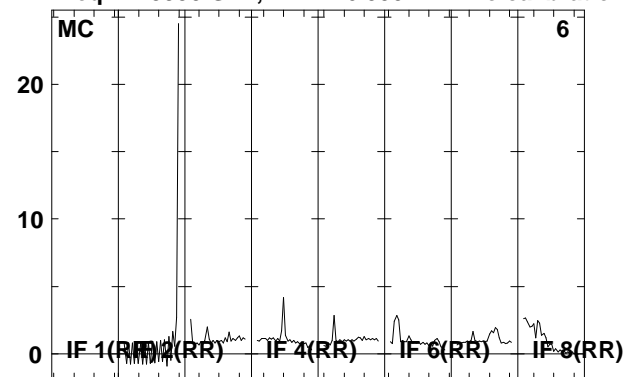

Lower frame: Real Jy
Total-power spectrum Antenna: *
Timerange: 00/12:59:32 to 00/13:03:00

Plot file version 239 created 18-APR-2008 18:29:41

J2333+39 EP061A.UVDATA.1

Freq = 1.5950 GHz, Bw = 16.000 MH No calibration applied and no bandpass applied

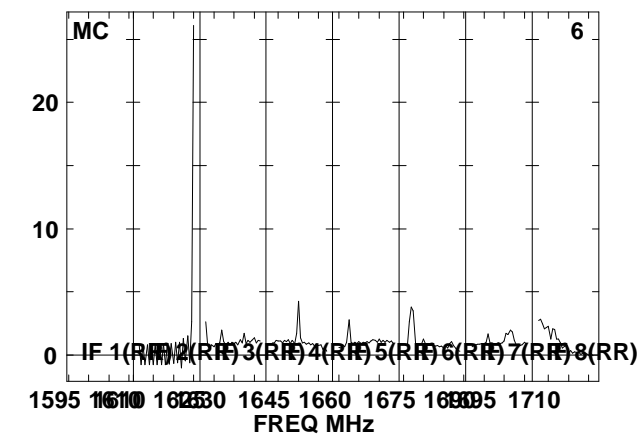
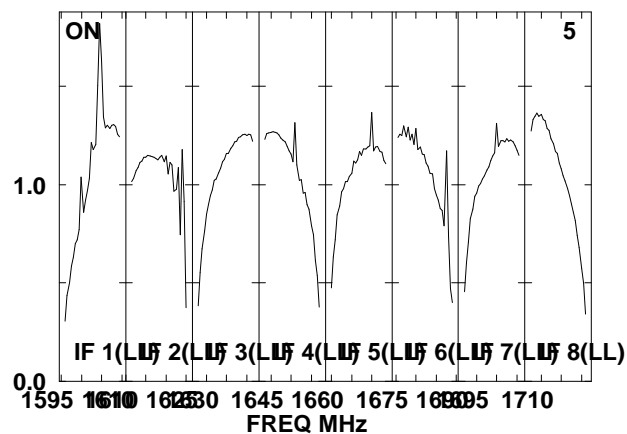
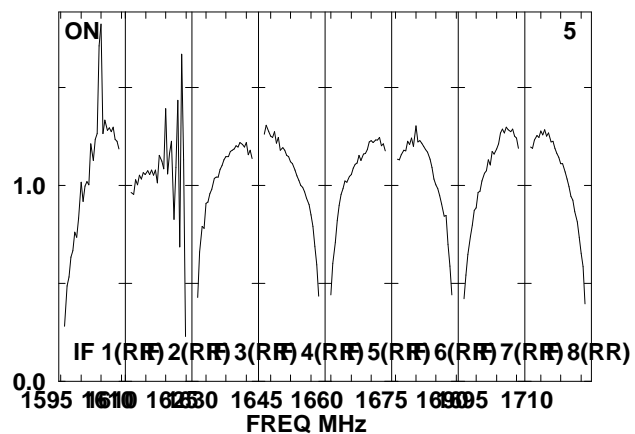
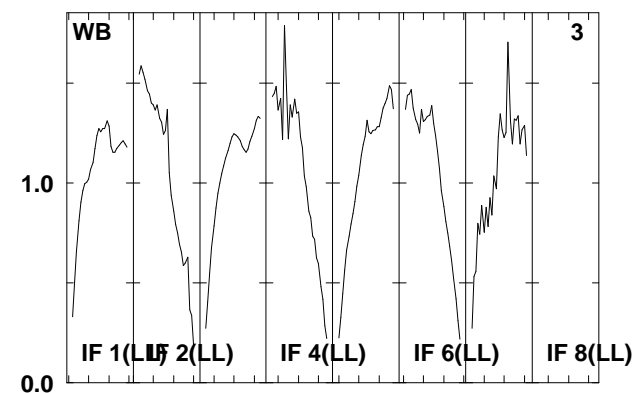
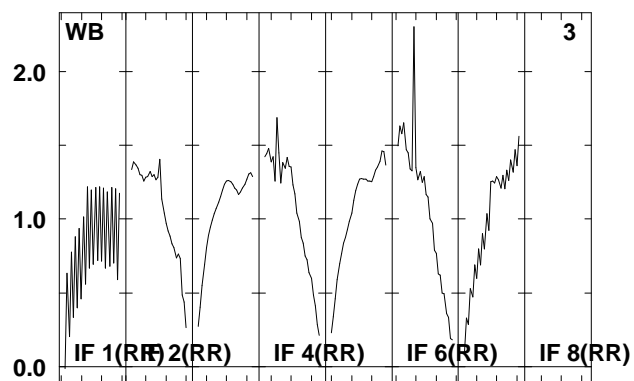
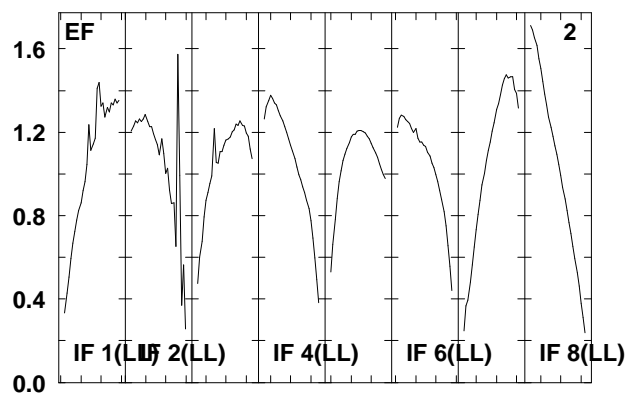
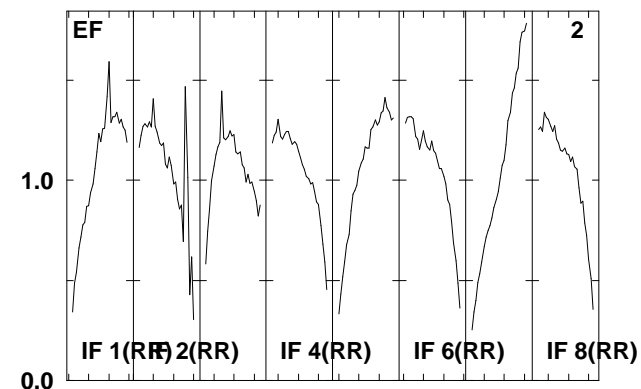
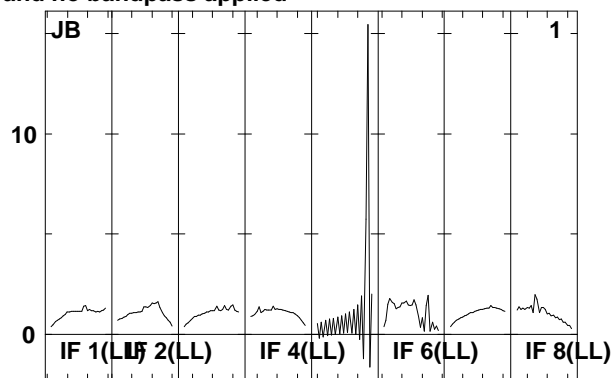
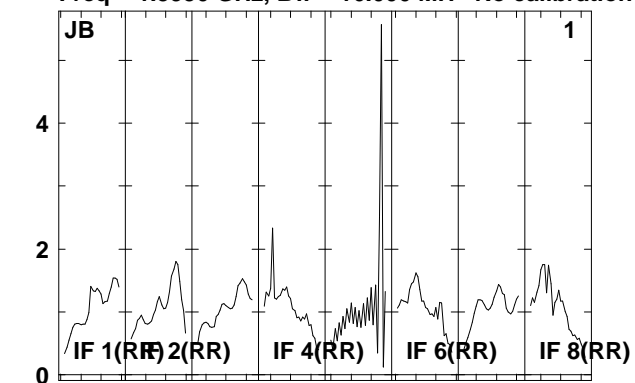

Lower frame: Real Jy
Total-power spectrum Antenna: *
Timerange: 00/13:03:02 to 00/13:04:30

Plot file version 240 created 18-APR-2008 18:29:41

J2333+39 EP061A.UVDATA.1

Freq = 1.5950 GHz, Bw = 16.000 MH No calibration applied and no bandpass applied

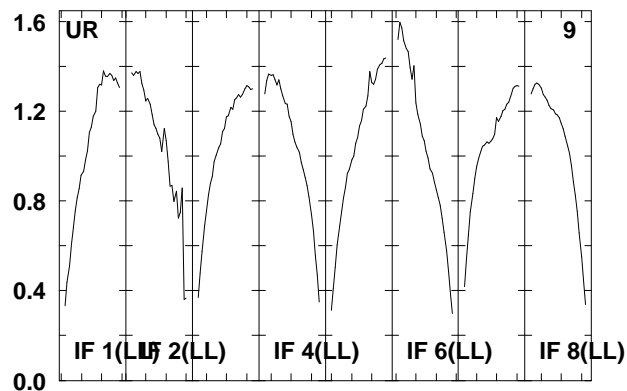
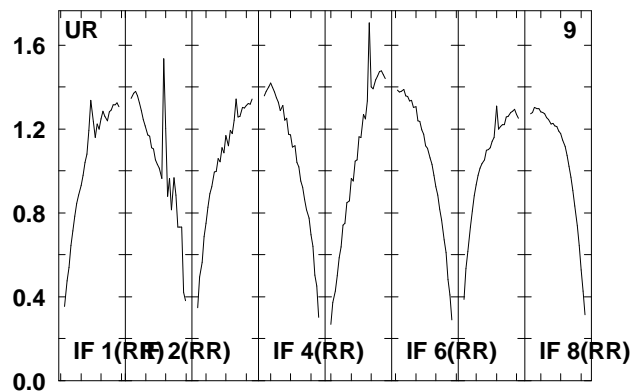
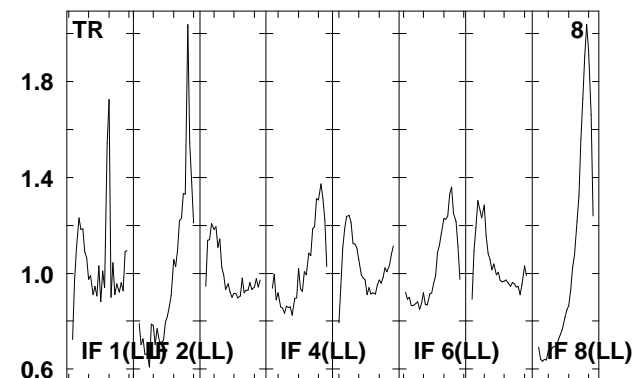
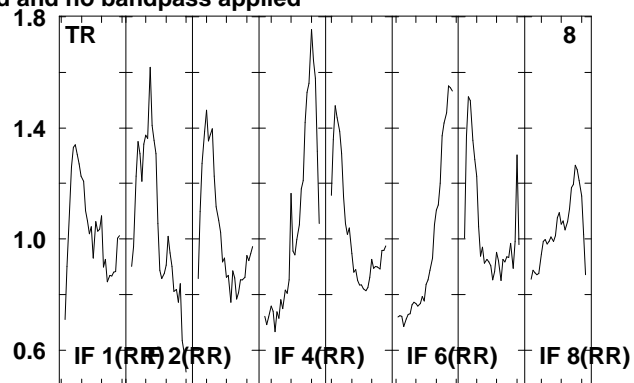
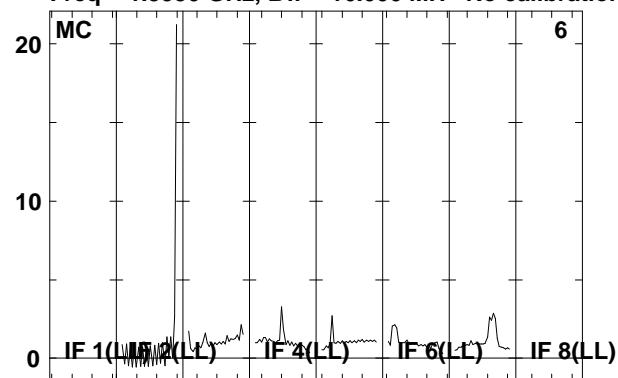

Lower frame: Real Jy
Total-power spectrum Antenna: *
Timerange: 00/13:03:02 to 00/13:04:30

Plot file version 241 created 18-APR-2008 18:29:42

IRAS2336 EP061A.UVDATA.1

Freq = 1.5950 GHz, Bw = 16.000 MH No calibration applied and no bandpass applied

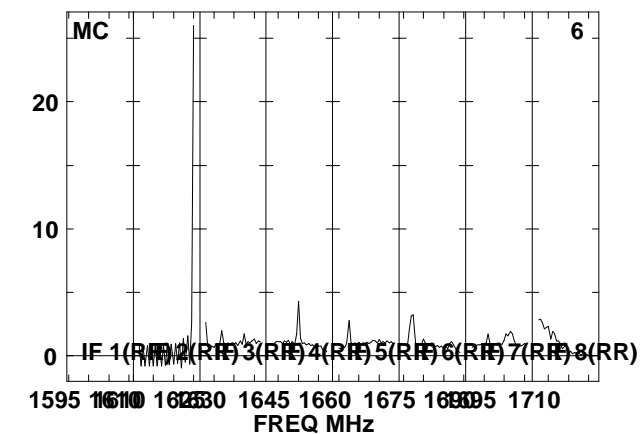
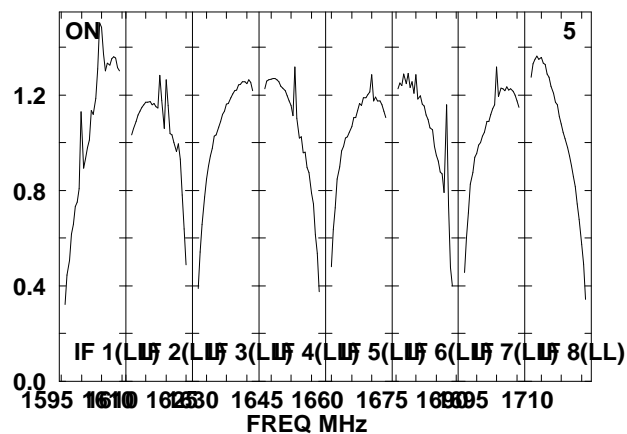
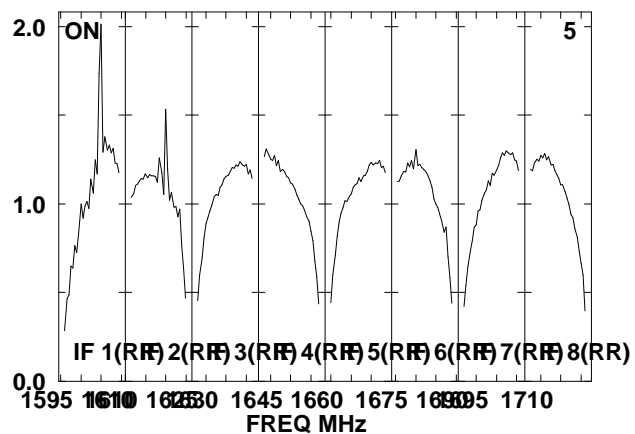
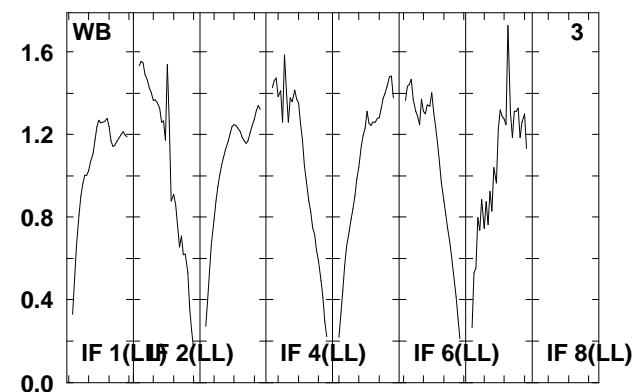
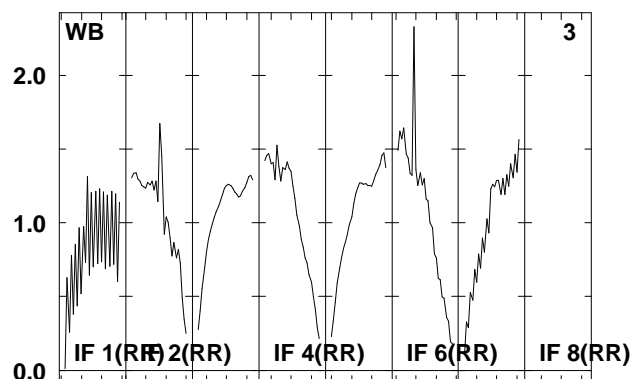
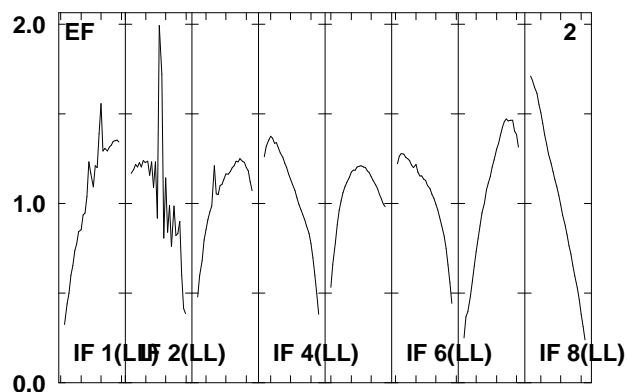
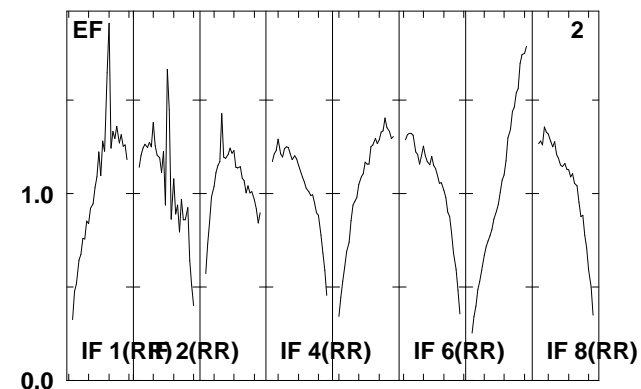
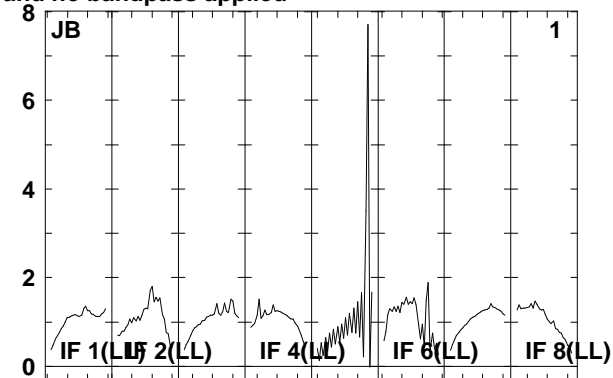
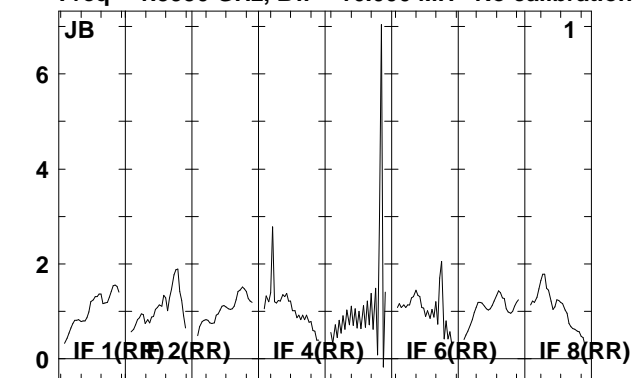

Lower frame: Real Jy
Total-power spectrum Antenna: *
Timerange: 00/13:04:32 to 00/13:08:00

Plot file version 242 created 18-APR-2008 18:29:43

IRAS2336 EP061A.UVDATA.1

Freq = 1.5950 GHz, Bw = 16.000 MH No calibration applied and no bandpass applied

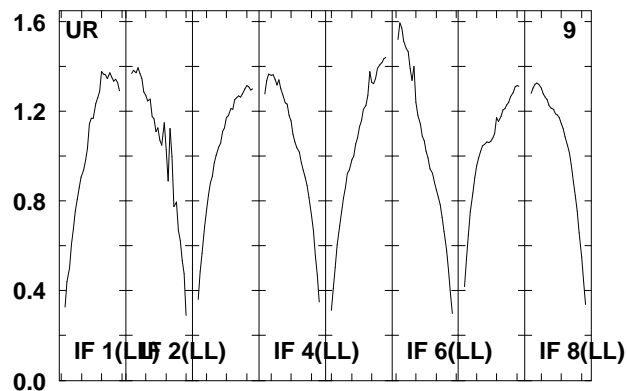
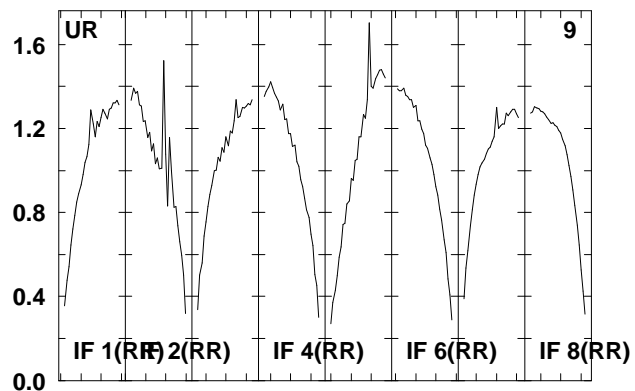
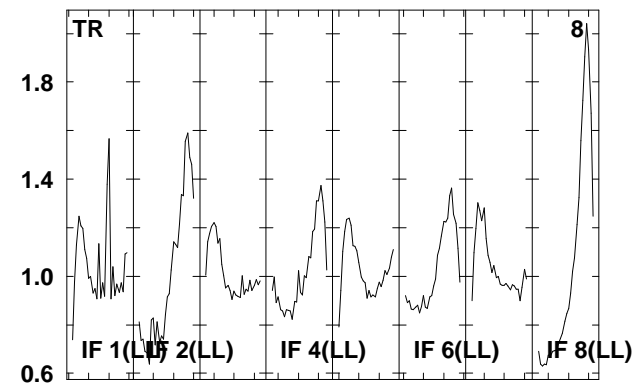
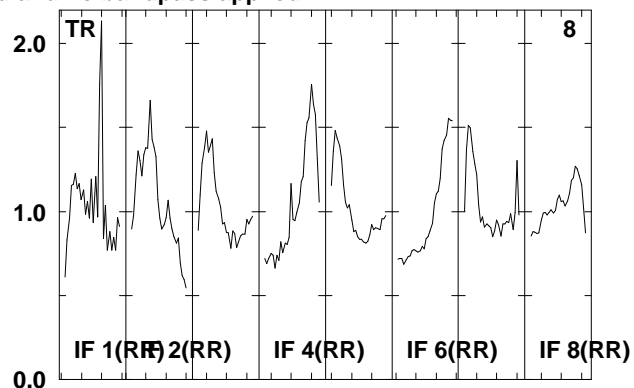
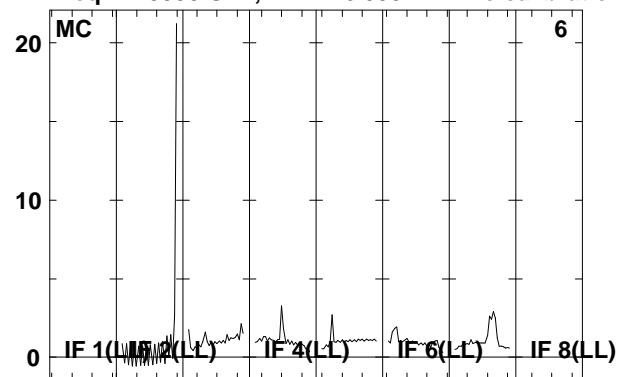

Lower frame: Real Jy
Total-power spectrum Antenna: *
Timerange: 00/13:04:32 to 00/13:08:00

Plot file version 243 created 18-APR-2008 18:29:44

J2333+39 EP061A.UVDATA.1

Freq = 1.5950 GHz, Bw = 16.000 MH No calibration applied and no bandpass applied

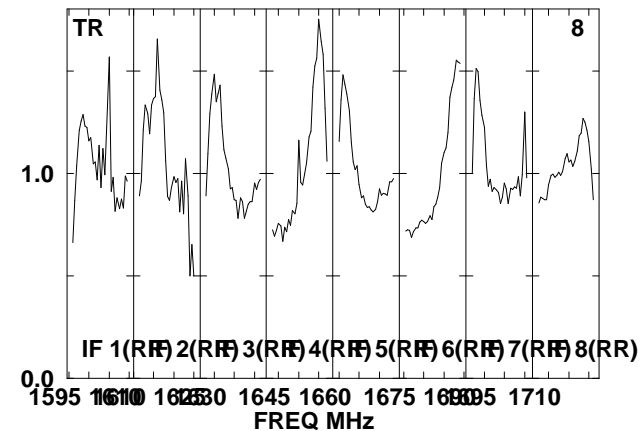
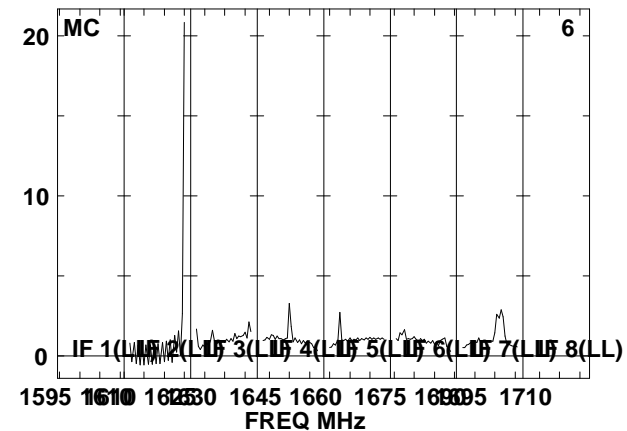
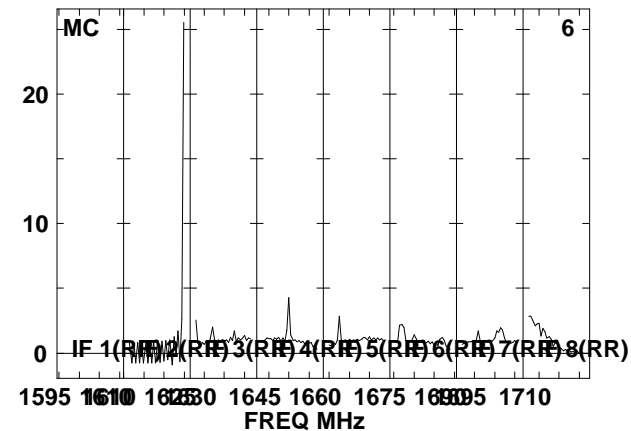
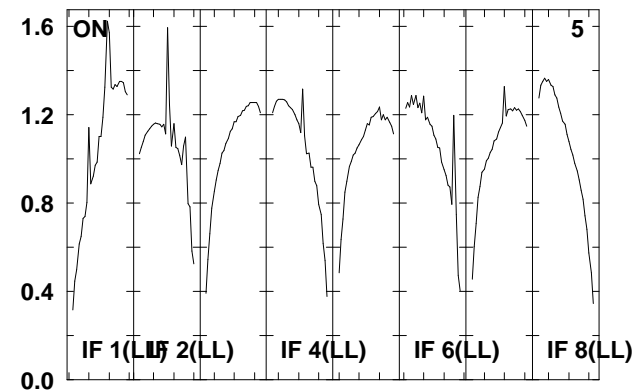
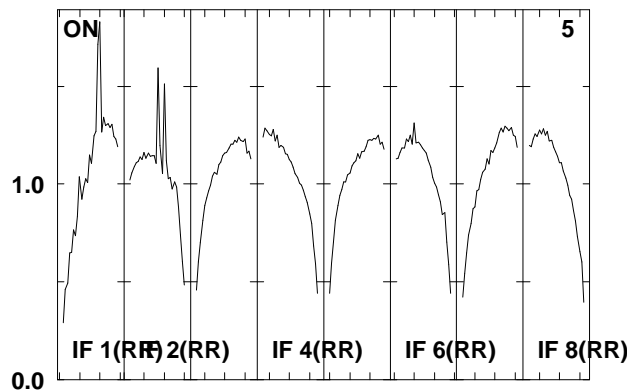
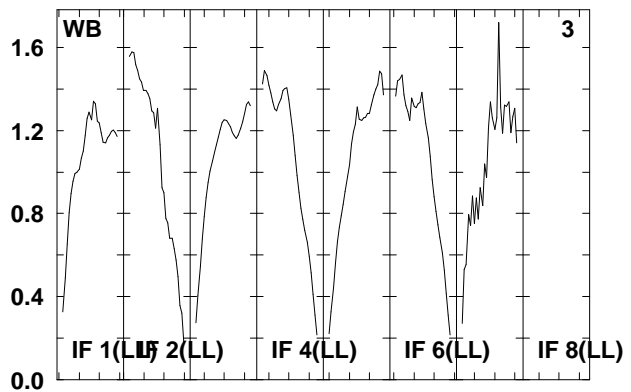
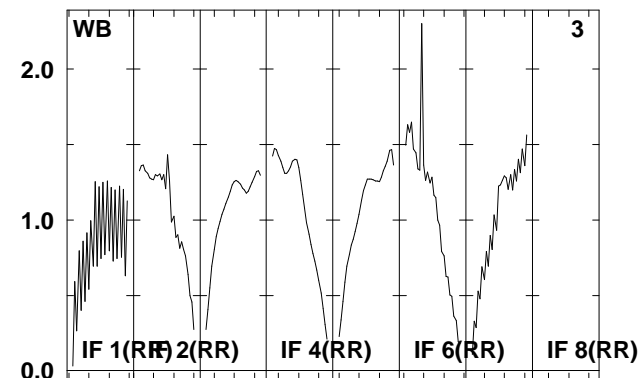
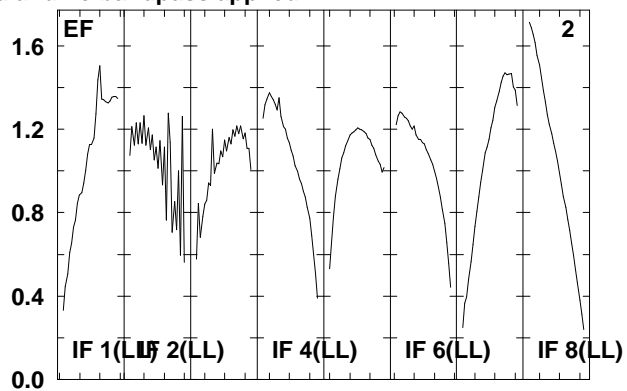
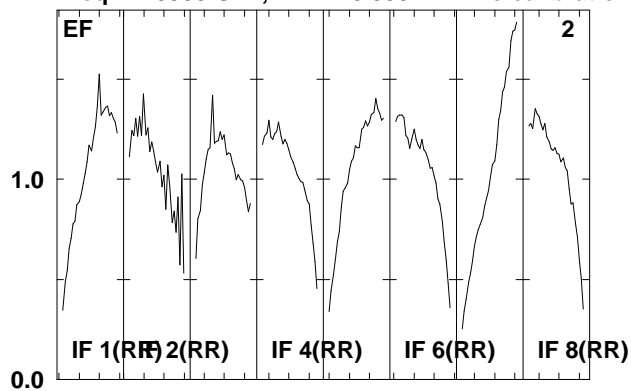

Lower frame: Real Jy
Total-power spectrum Antenna: *
Timerange: 00/13:08:02 to 00/13:09:28

Plot file version 244 created 18-APR-2008 18:29:44

J2333+39 EP061A.UVDATA.1

Freq = 1.5950 GHz, Bw = 16.000 MH No calibration applied and no bandpass applied

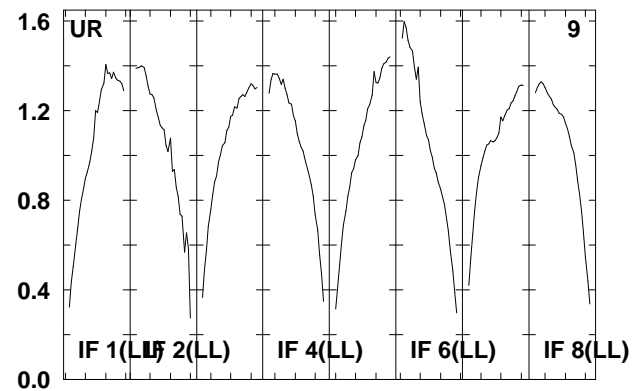
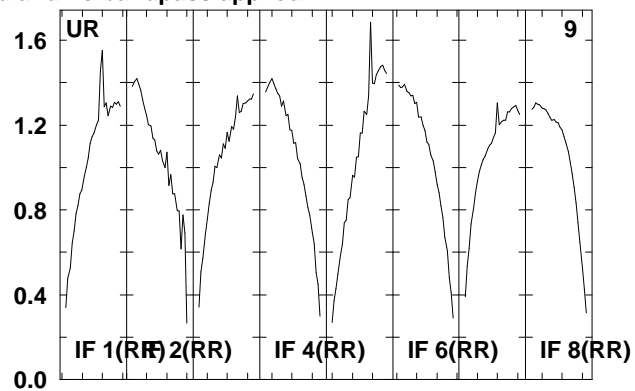
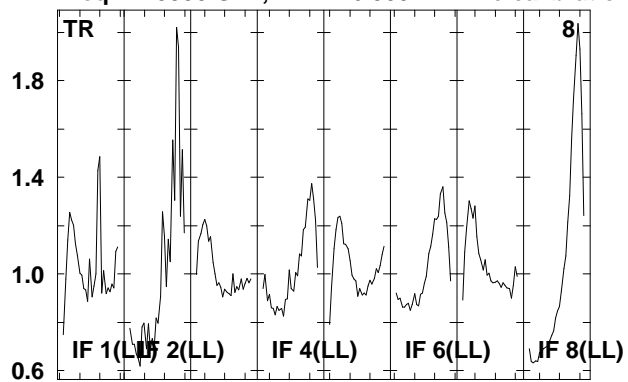

Lower frame: Real Jy
Total-power spectrum Antenna: *
Timerange: 00/13:08:02 to 00/13:09:28

Plot file version 245 created 18-APR-2008 18:29:44

IRAS2336 EP061A.UVDATA.1

Freq = 1.5950 GHz, Bw = 16.000 MH No calibration applied and no bandpass applied

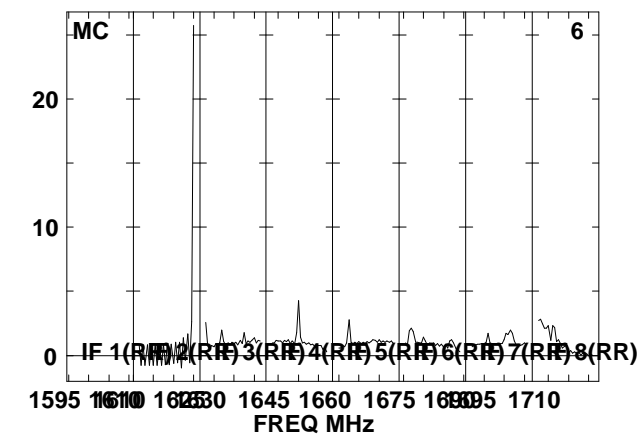
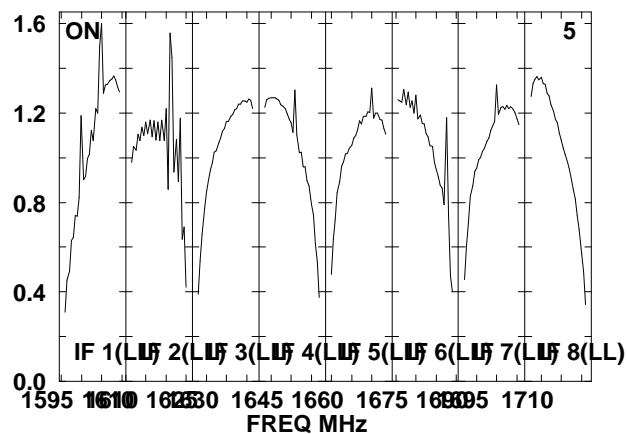
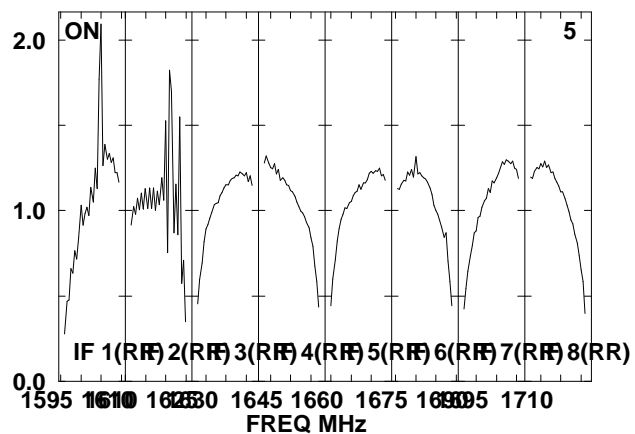
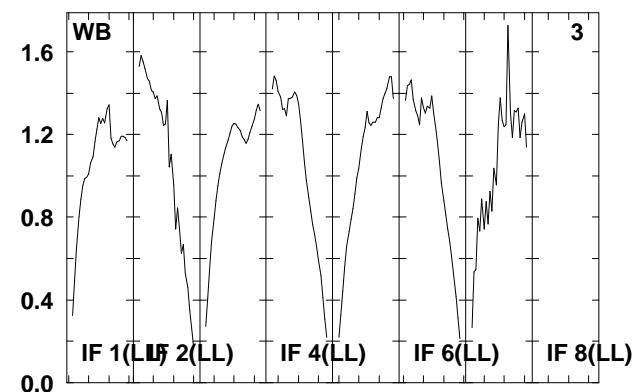
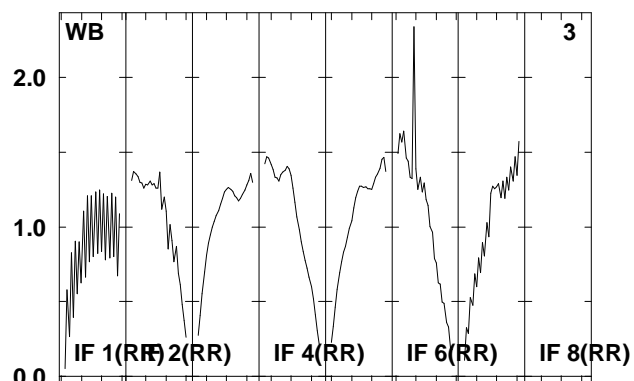
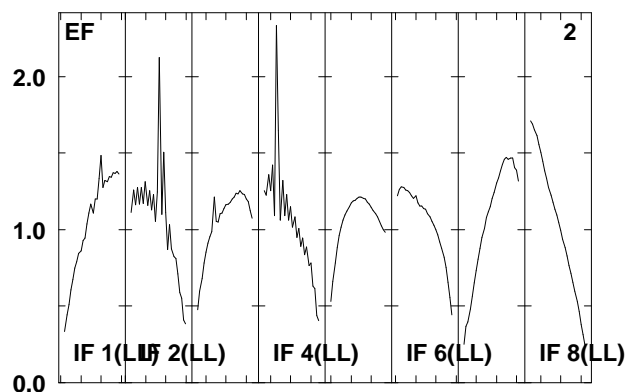
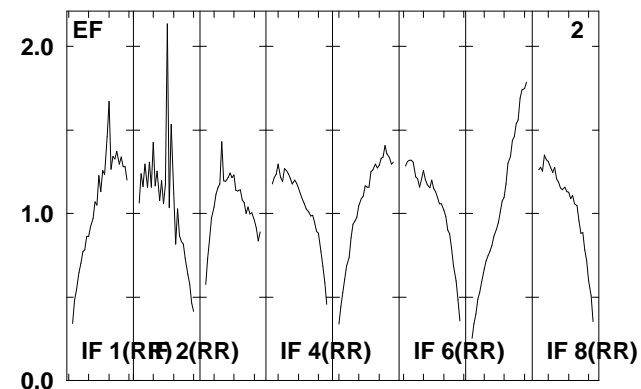
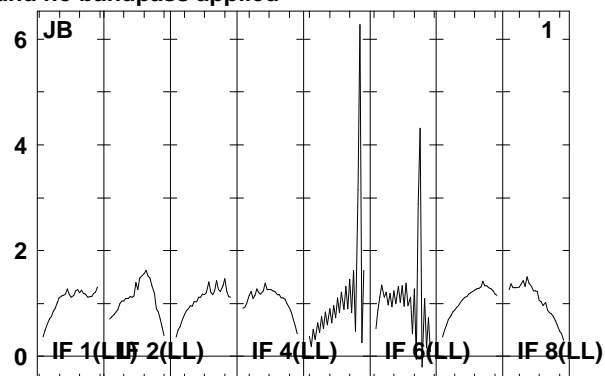
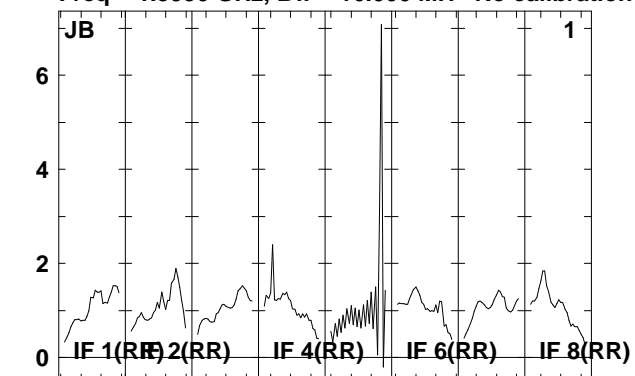

Lower frame: Real Jy

Total-power spectrum Antenna: *

Timerange: 00/13:09:30 to 00/13:12:58

Plot file version 246 created 18-APR-2008 18:29:45

IRAS2336 EP061A.UVDATA.1

Freq = 1.5950 GHz, Bw = 16.000 MH No calibration applied and no bandpass applied

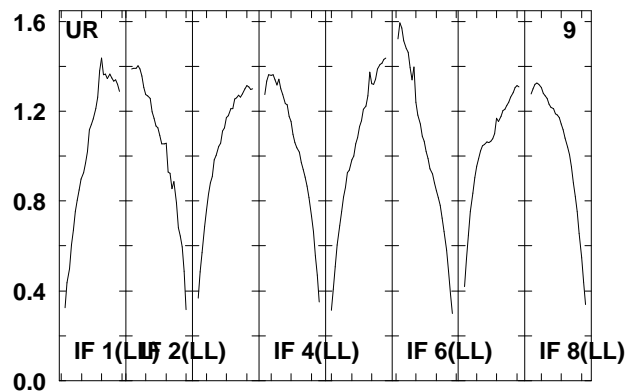
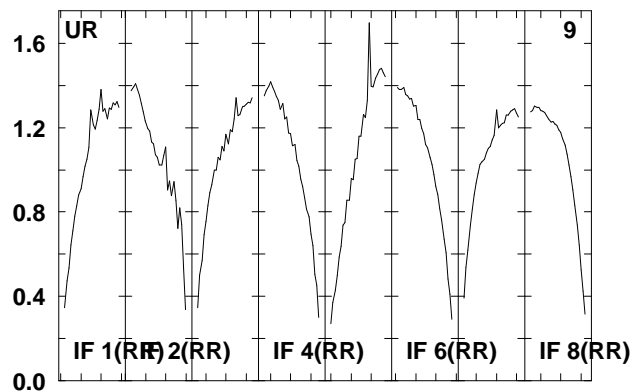
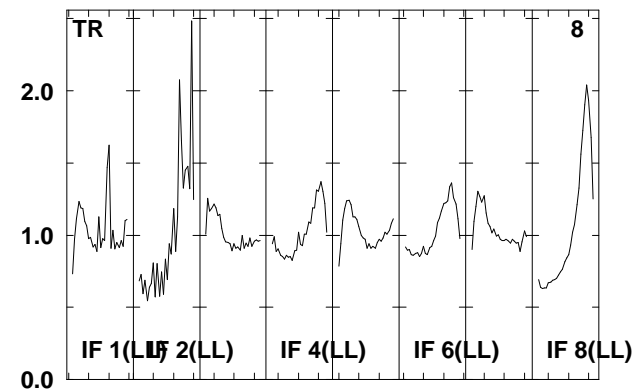
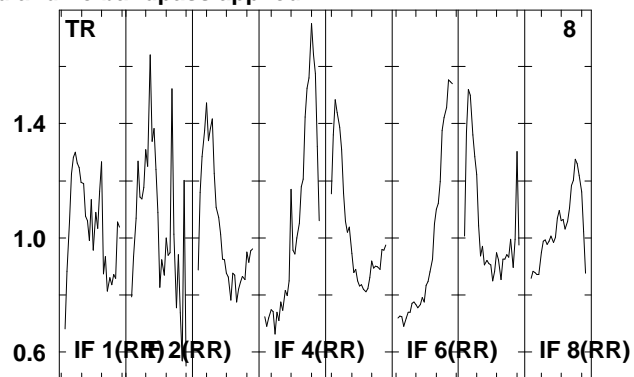
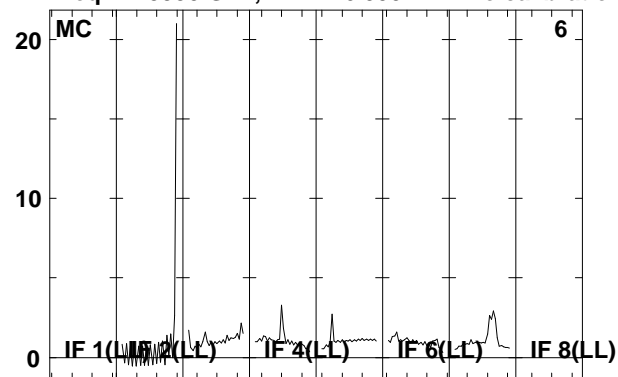

Lower frame: Real Jy
Total-power spectrum Antenna: *
Timerange: 00/13:09:30 to 00/13:12:58

Plot file version 247 created 18-APR-2008 18:29:46

J2333+39 EP061A.UVDATA.1

Freq = 1.5950 GHz, Bw = 16.000 MH No calibration applied and no bandpass applied

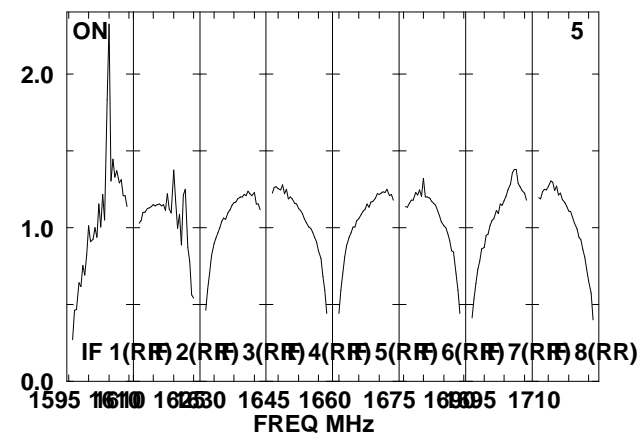
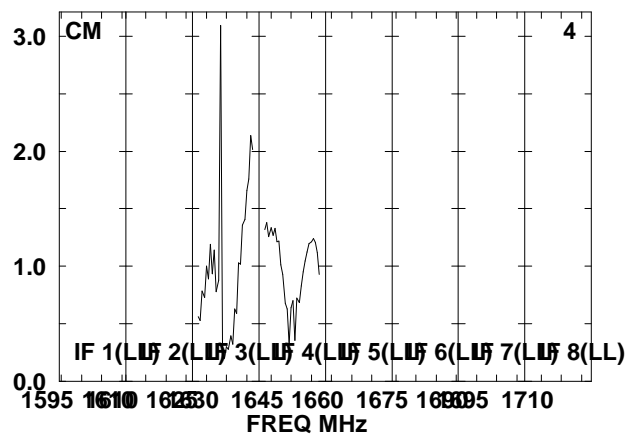
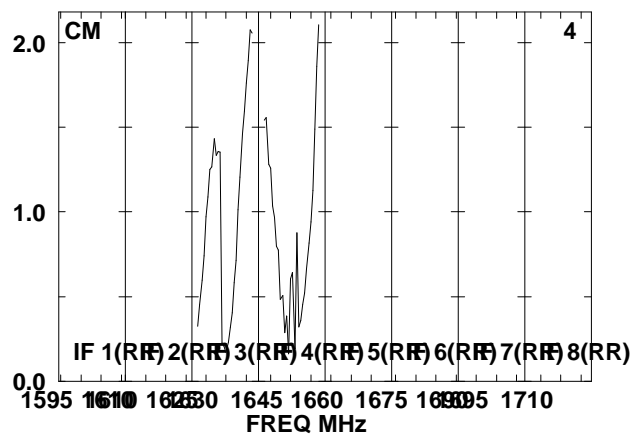
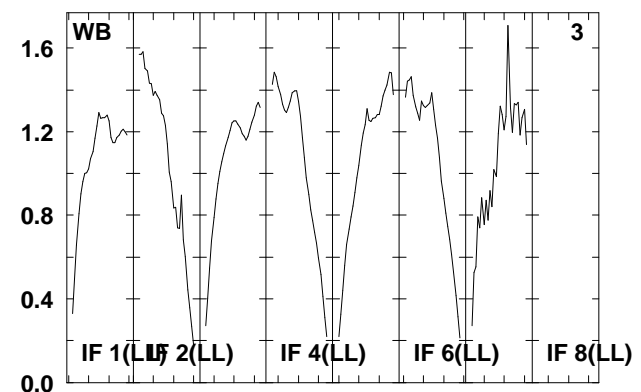
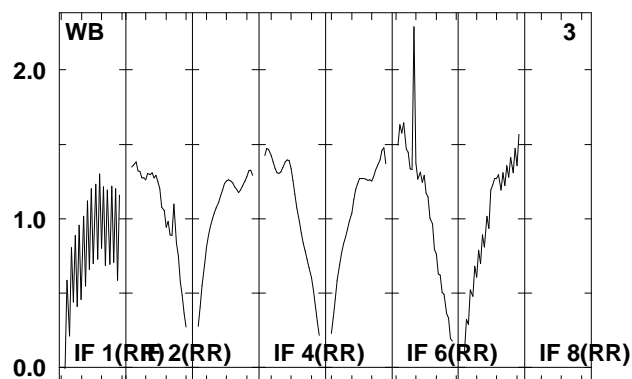
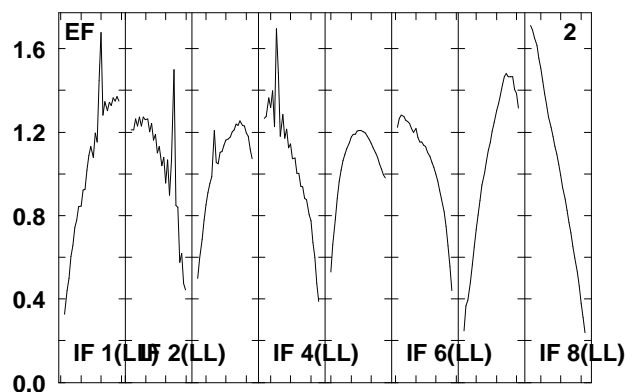
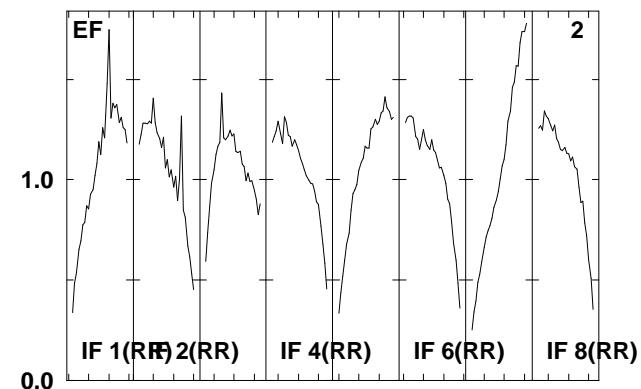
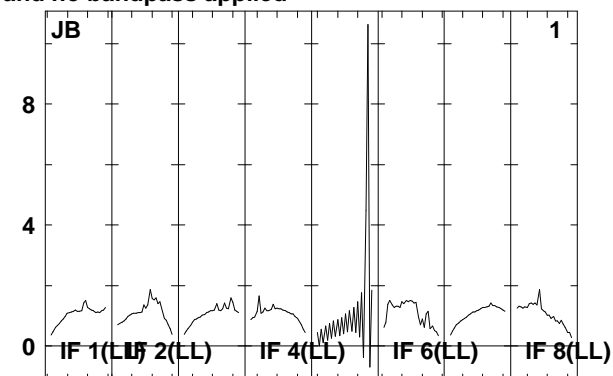
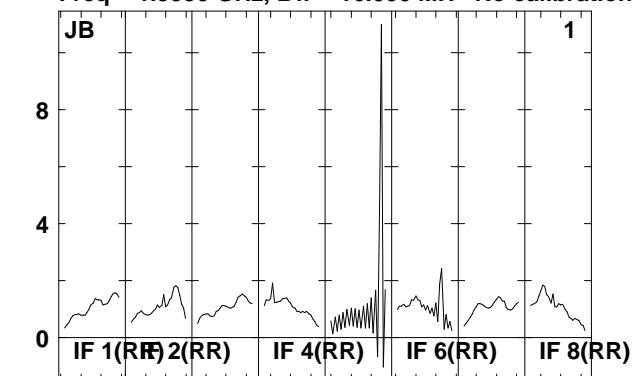

Lower frame: Real Jy
Total-power spectrum Antenna: *
Timerange: 00/13:14:02 to 00/13:15:30

Plot file version 248 created 18-APR-2008 18:29:47

J2333+39 EP061A.UVDATA.1

Freq = 1.5950 GHz, Bw = 16.000 MH No calibration applied and no bandpass applied

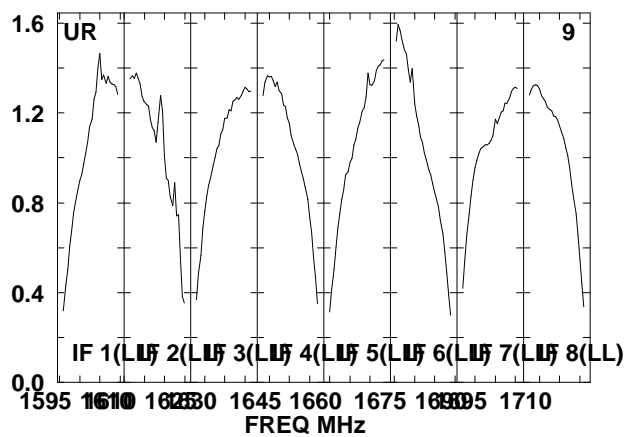
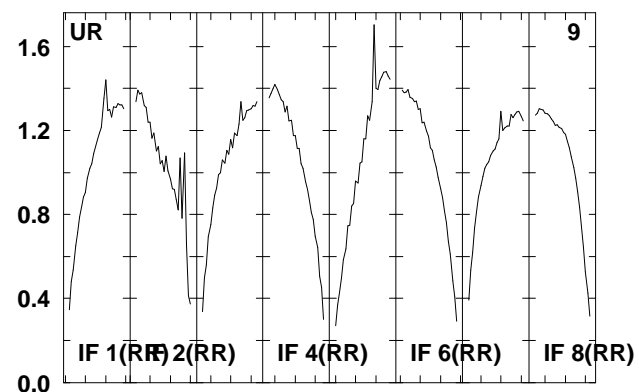
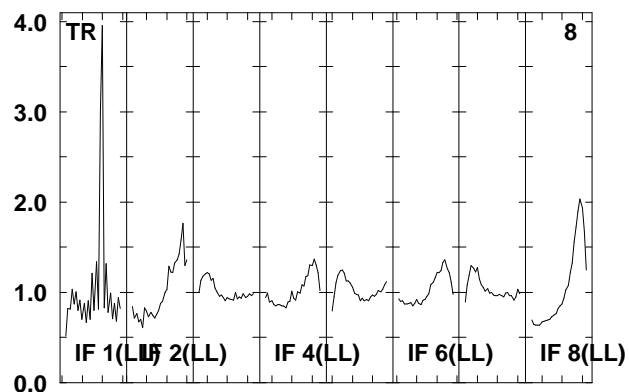
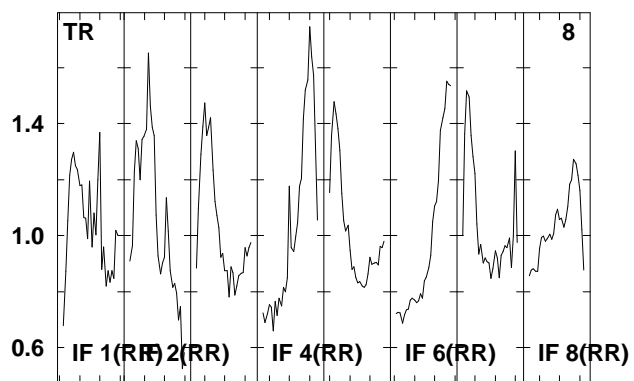
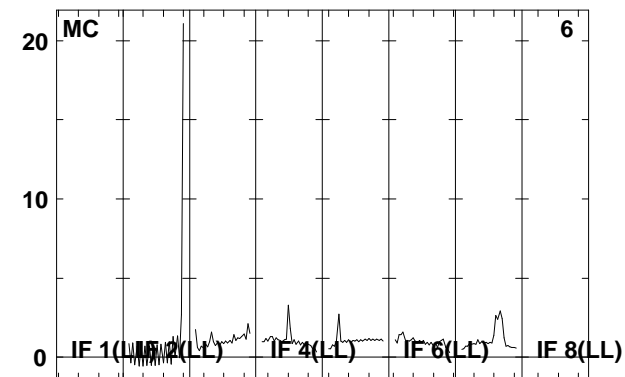
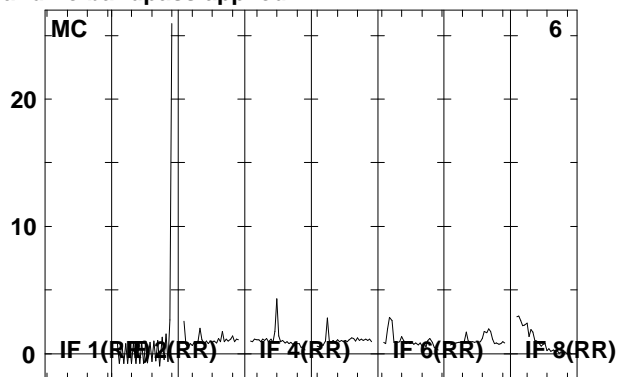
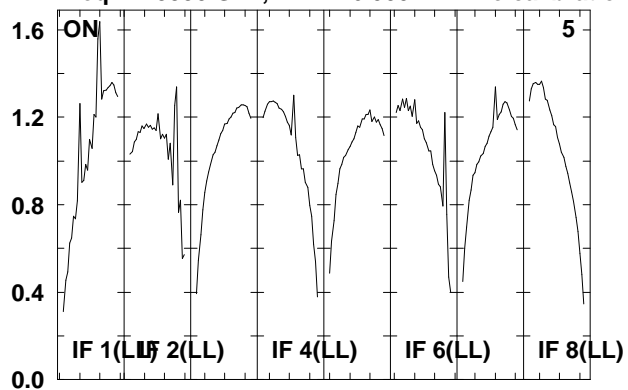

Lower frame: Real Jy

Total-power spectrum Antenna: *

Timerange: 00/13:14:02 to 00/13:15:30

Plot file version 249 created 18-APR-2008 18:29:47

IRAS2336 EP061A.UVDATA.1

Freq = 1.5950 GHz, Bw = 16.000 MH No calibration applied and no bandpass applied

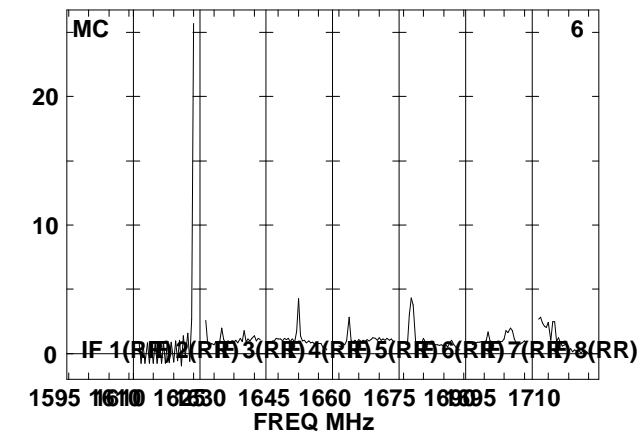
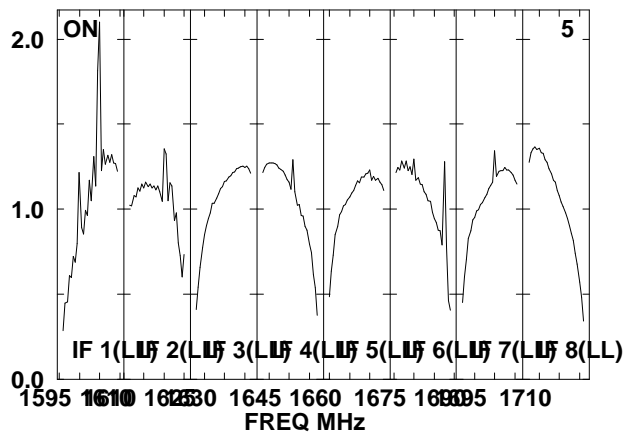
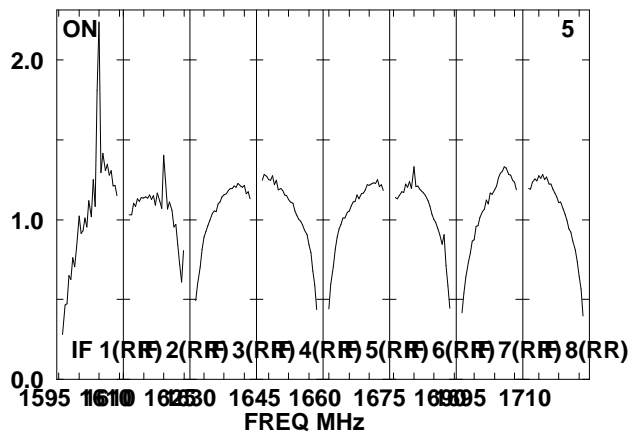
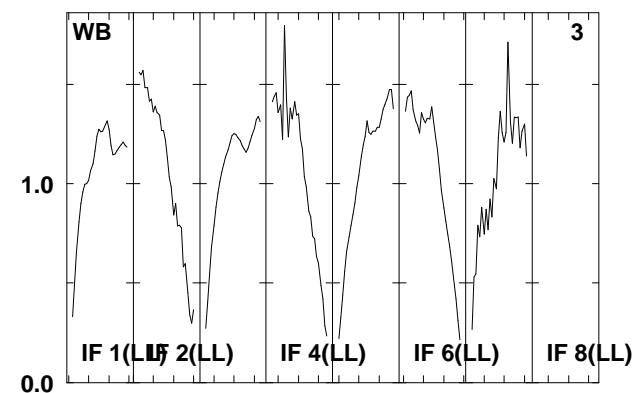
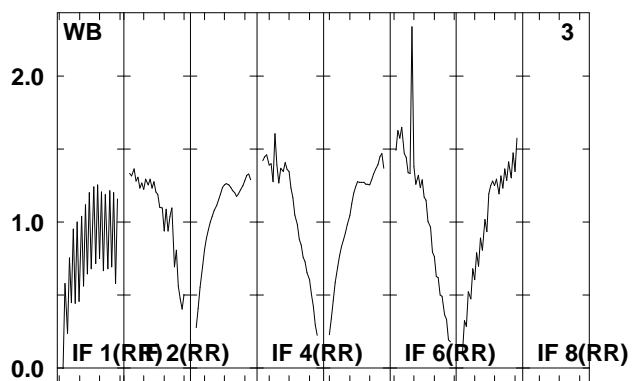
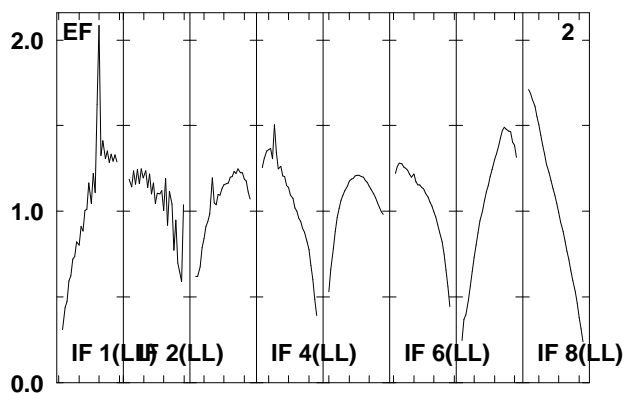
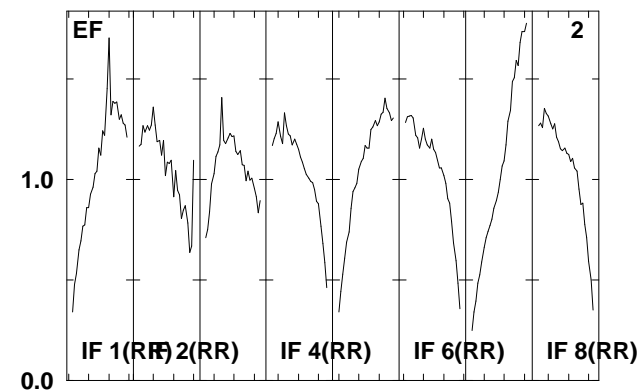
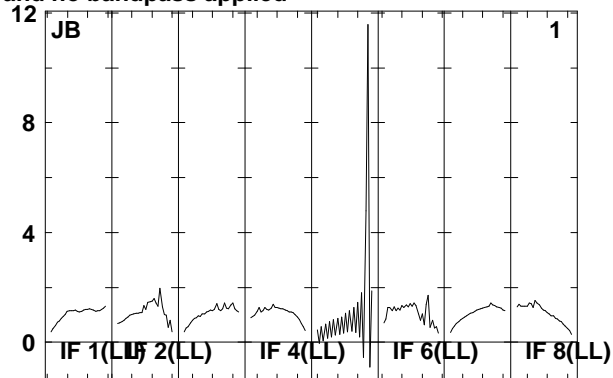
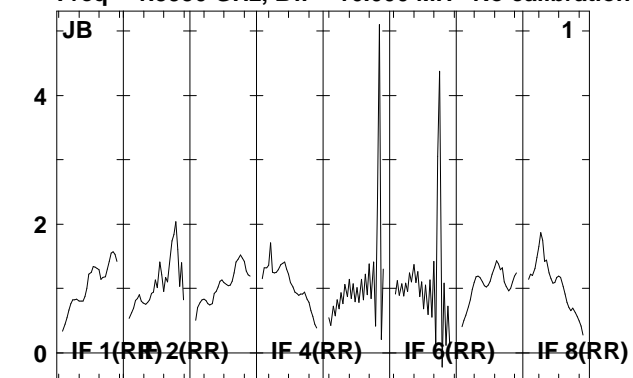

Lower frame: Real Jy
Total-power spectrum Antenna: *
Timerange: 00/13:15:32 to 00/13:19:00

Plot file version 250 created 18-APR-2008 18:29:48

IRAS2336 EP061A.UVDATA.1

Freq = 1.5950 GHz, Bw = 16.000 MH No calibration applied and no bandpass applied

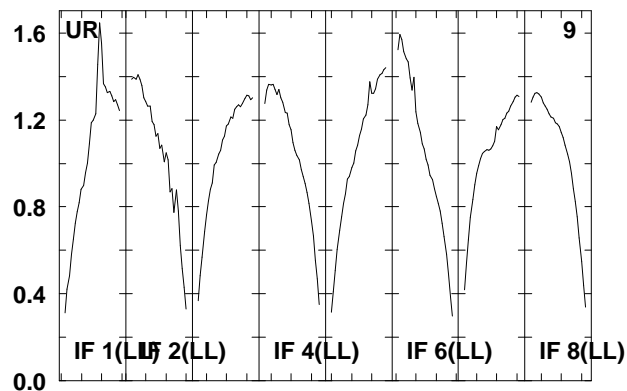
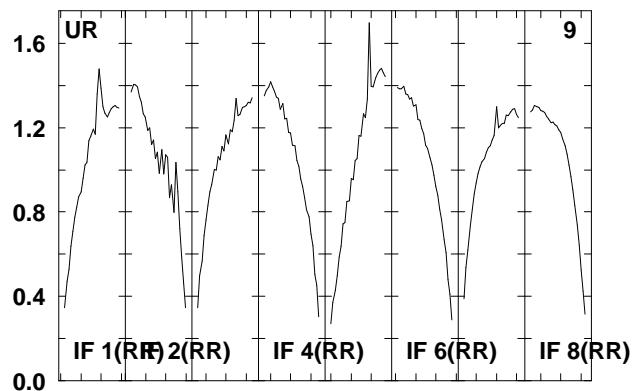
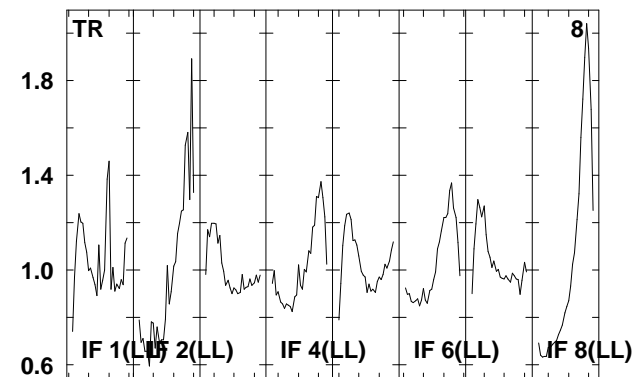
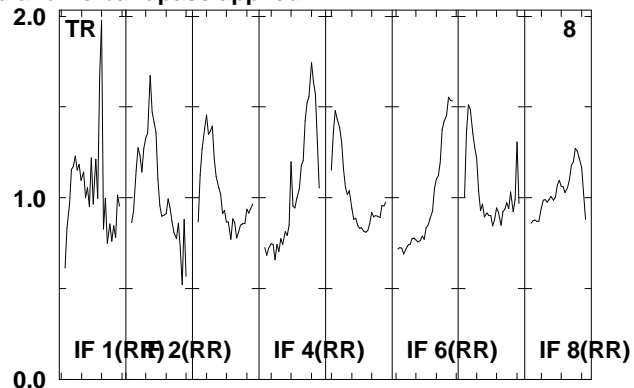
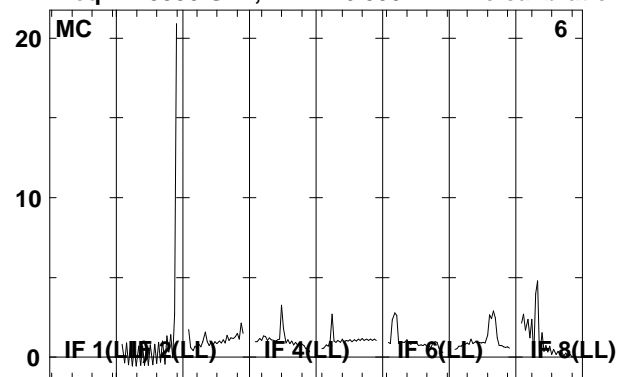

Lower frame: Real Jy
Total-power spectrum Antenna: *
Timerange: 00/13:15:32 to 00/13:19:00

Plot file version 251 created 18-APR-2008 18:29:50

J2333+39 EP061A.UVDATA.1

Freq = 1.5950 GHz, Bw = 16.000 MH No calibration applied and no bandpass applied

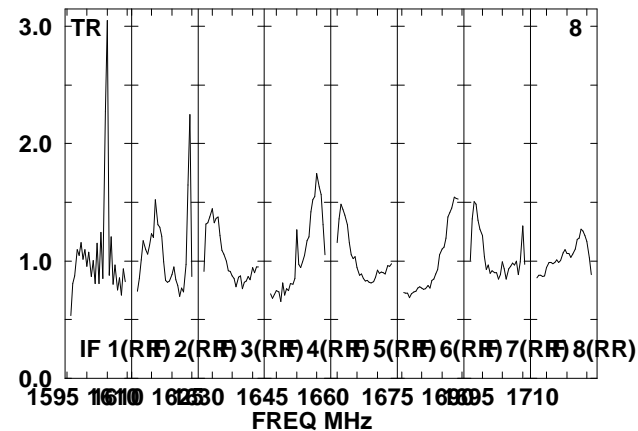
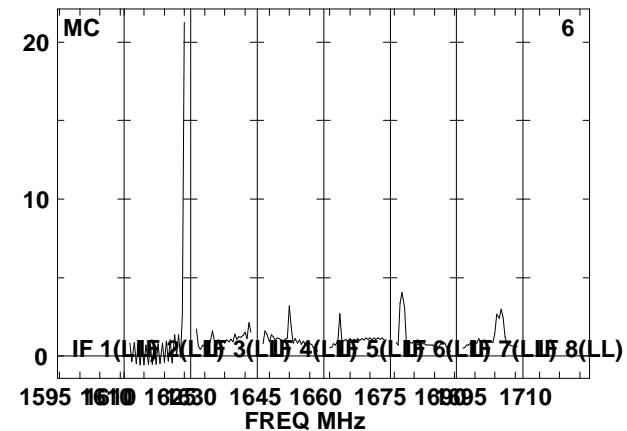
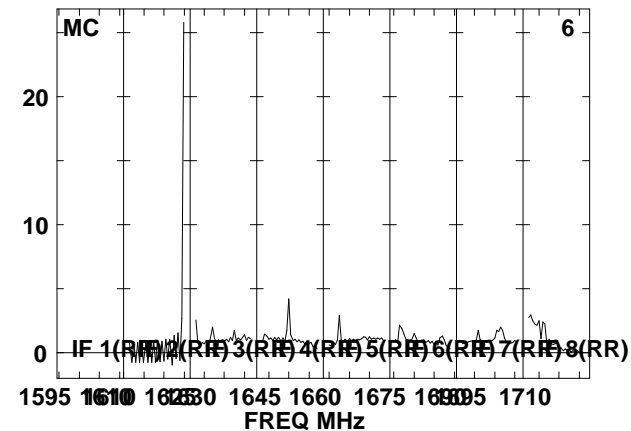
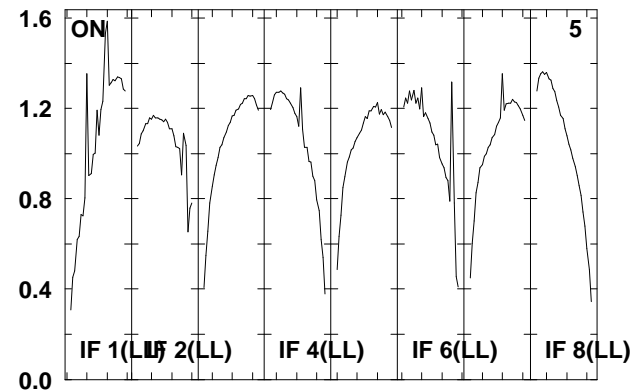
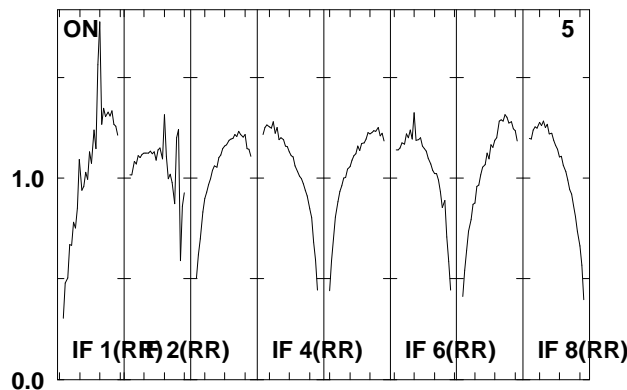
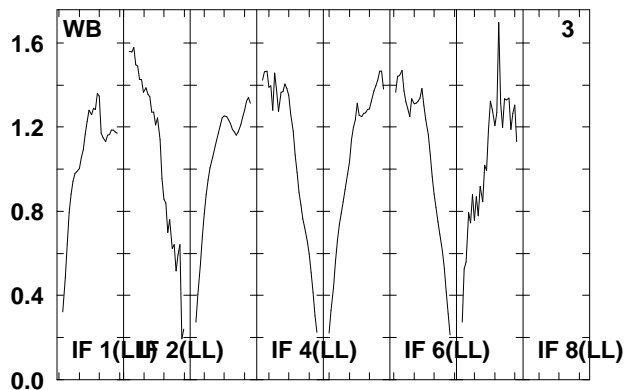
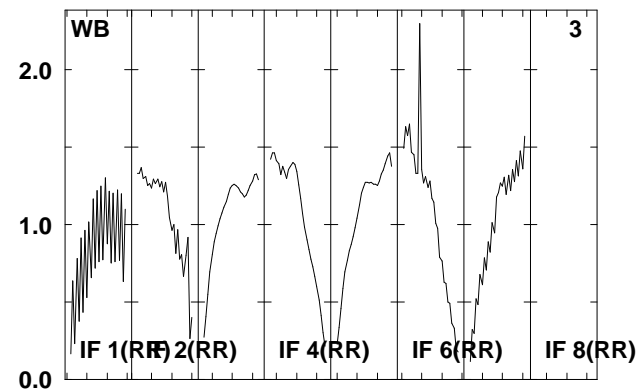
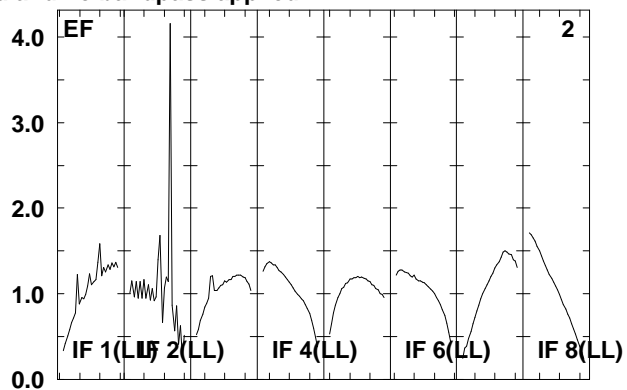
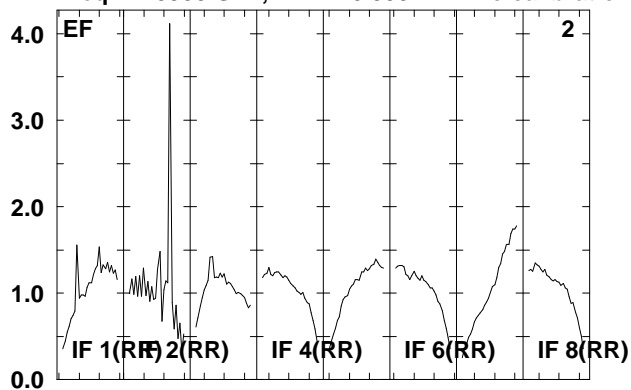

Lower frame: Real Jy
Total-power spectrum Antenna: *
Timerange: 00/13:19:02 to 00/13:20:28

Plot file version 252 created 18-APR-2008 18:29:50

J2333+39 EP061A.UVDATA.1

Freq = 1.5950 GHz, Bw = 16.000 MH No calibration applied and no bandpass applied

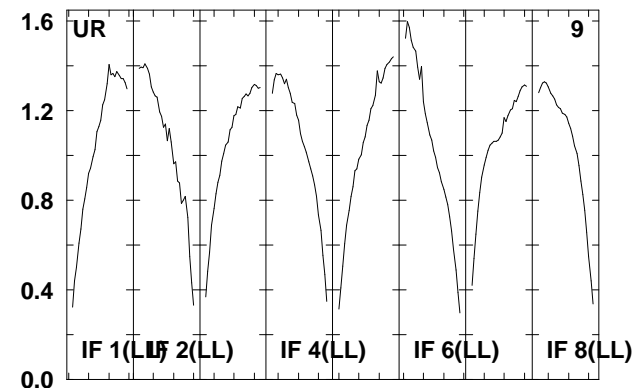
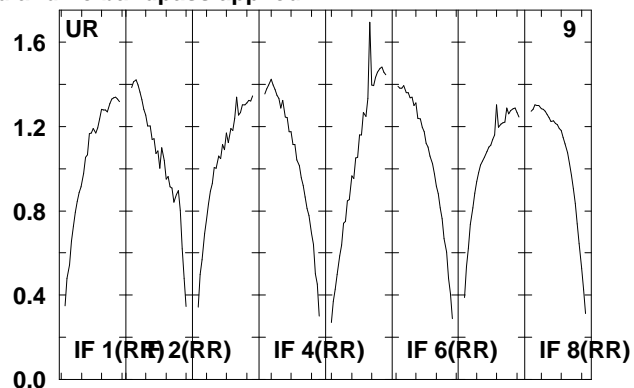
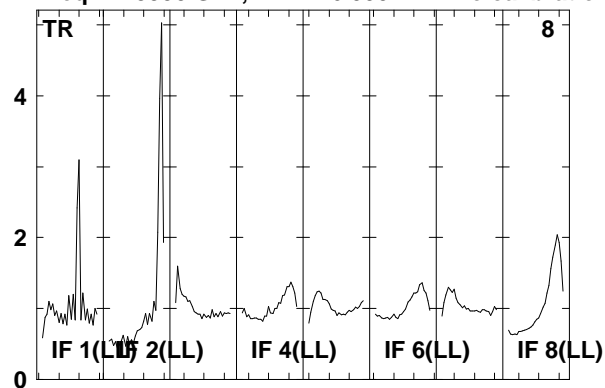

Lower frame: Real Jy
Total-power spectrum Antenna: *
Timerange: 00/13:19:02 to 00/13:20:28

Plot file version 253 created 18-APR-2008 18:29:51

IRAS2336 EP061A.UVDATA.1

Freq = 1.5950 GHz, Bw = 16.000 MH No calibration applied and no bandpass applied

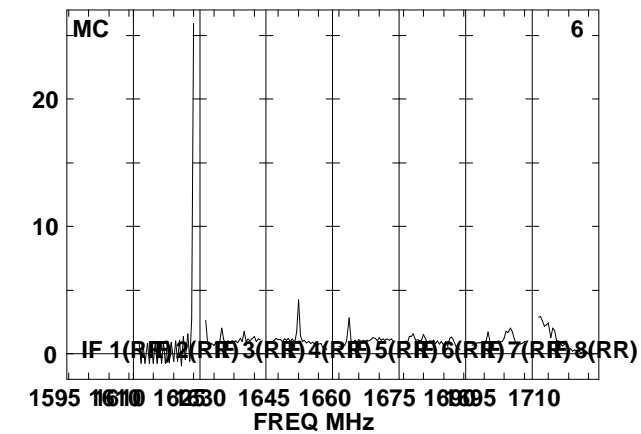
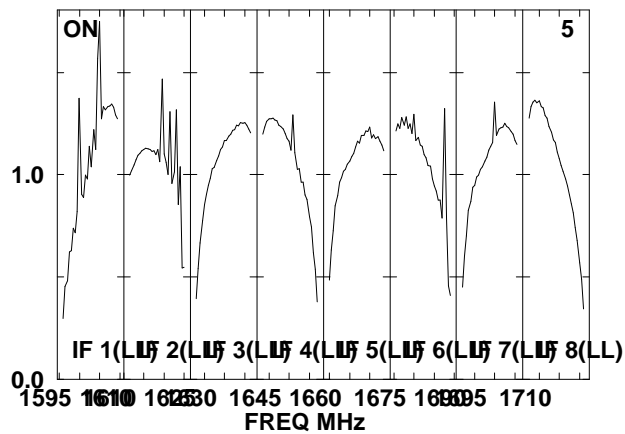
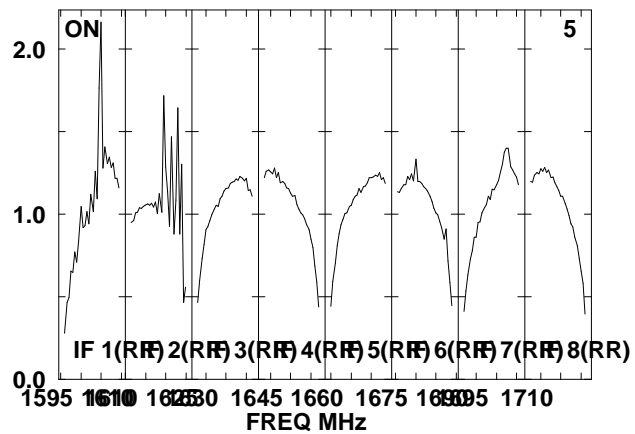
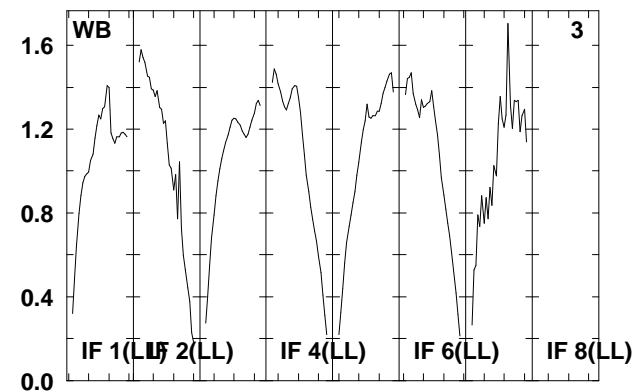
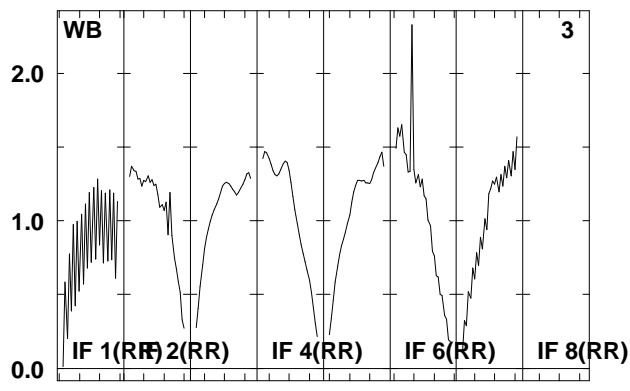
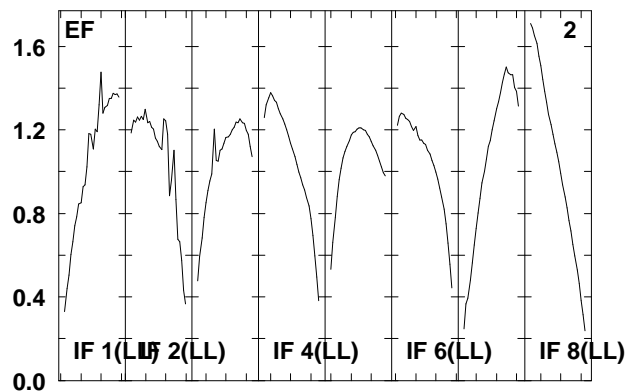
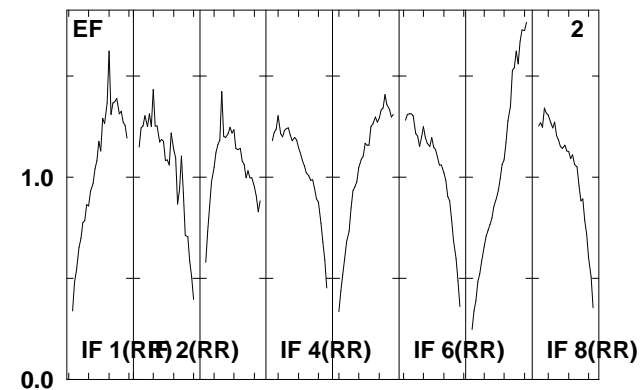
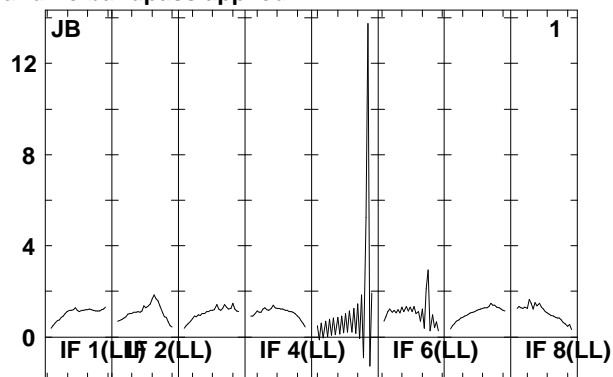
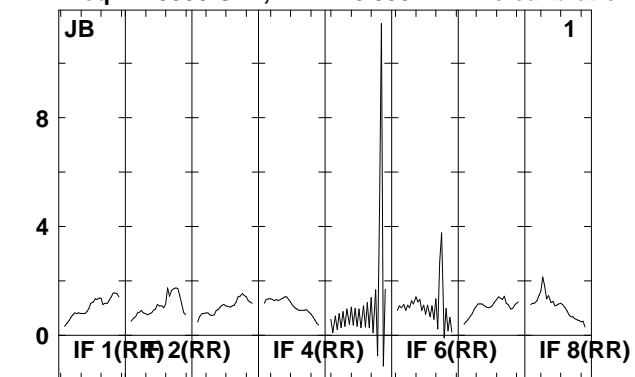

Lower frame: Real Jy
Total-power spectrum Antenna: *
Timerange: 00/13:20:30 to 00/13:24:00

Plot file version 254 created 18-APR-2008 18:29:52

IRAS2336 EP061A.UVDATA.1

Freq = 1.5950 GHz, Bw = 16.000 MH No calibration applied and no bandpass applied

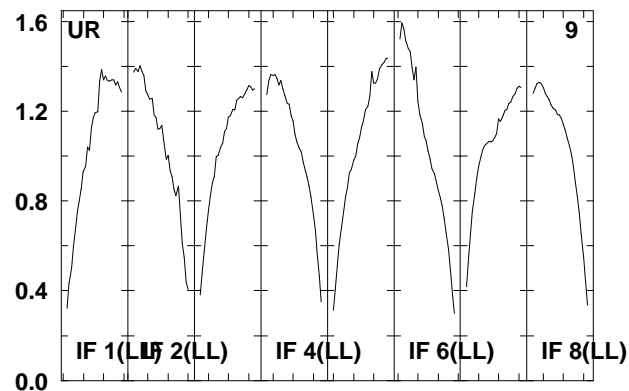
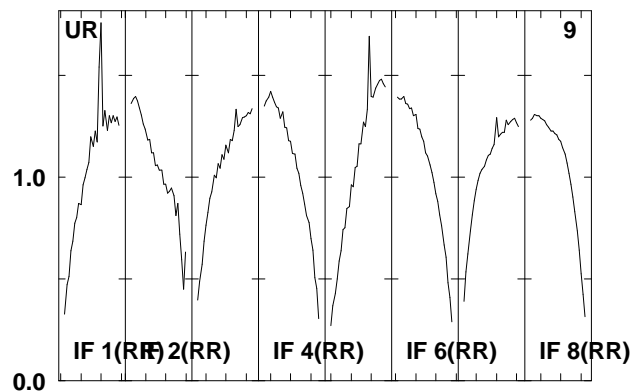
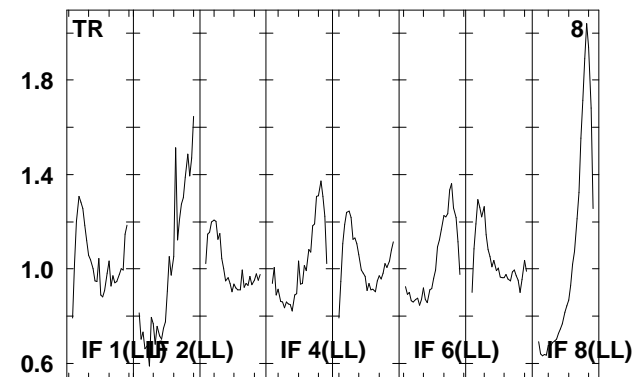
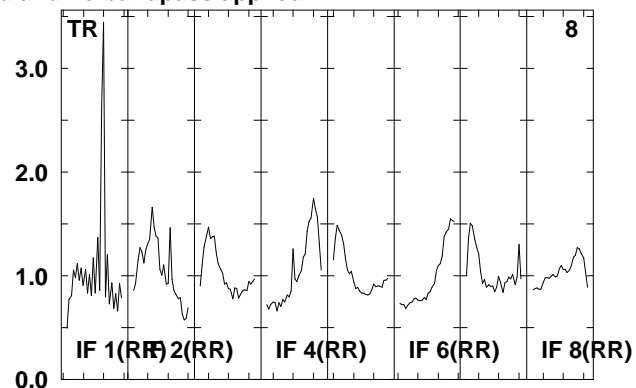
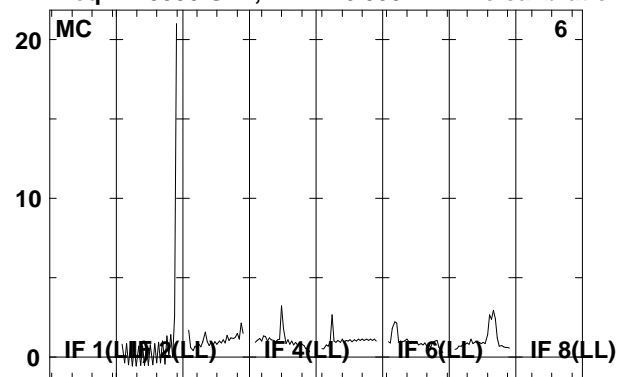

Lower frame: Real Jy
Total-power spectrum Antenna: *
Timerange: 00/13:20:30 to 00/13:24:00

Plot file version 255 created 18-APR-2008 18:29:52

J2333+39 EP061A.UVDATA.1

Freq = 1.5950 GHz, Bw = 16.000 MH No calibration applied and no bandpass applied

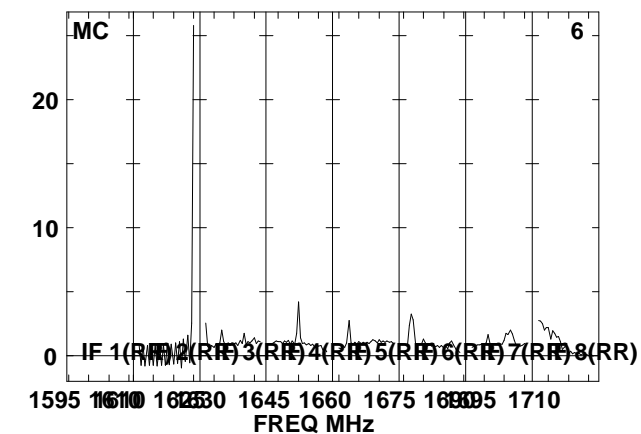
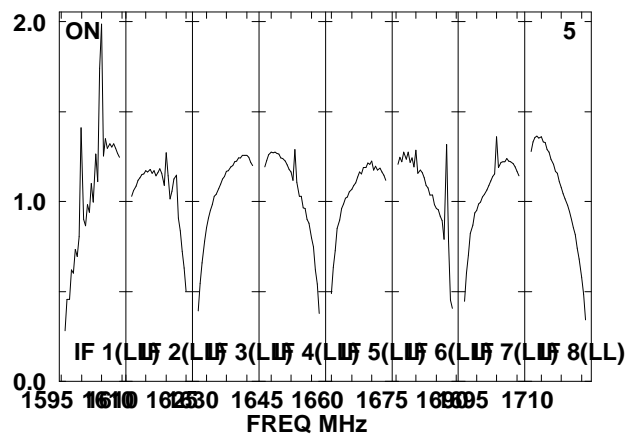
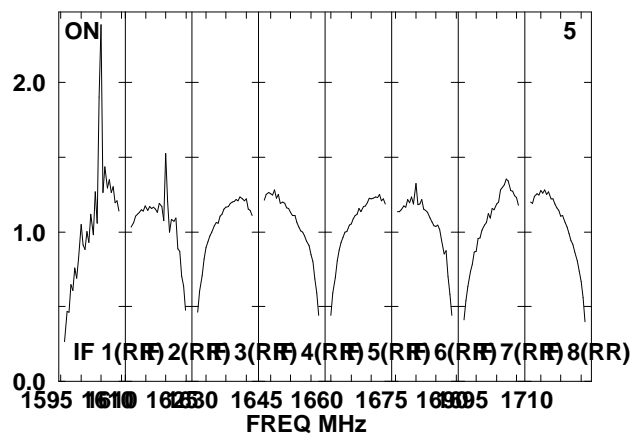
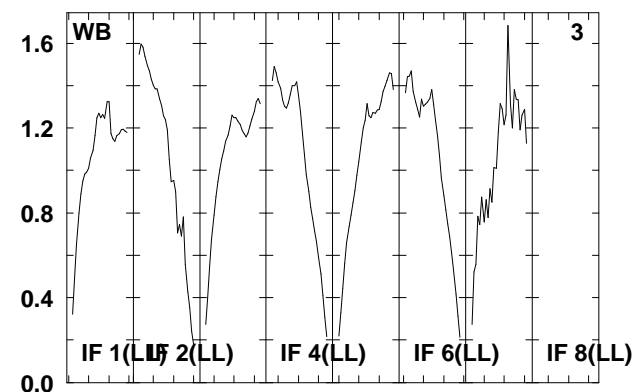
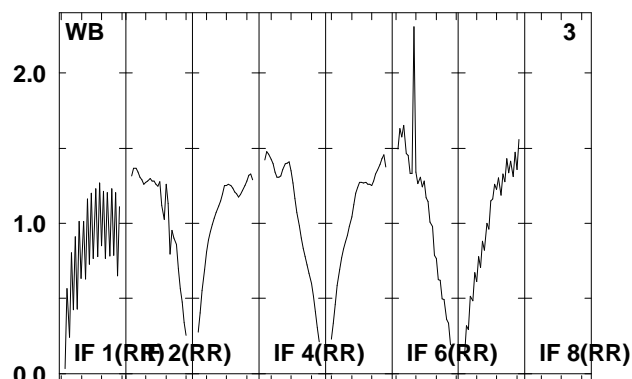
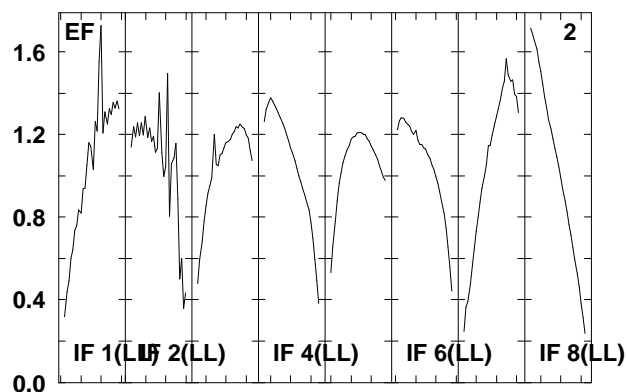
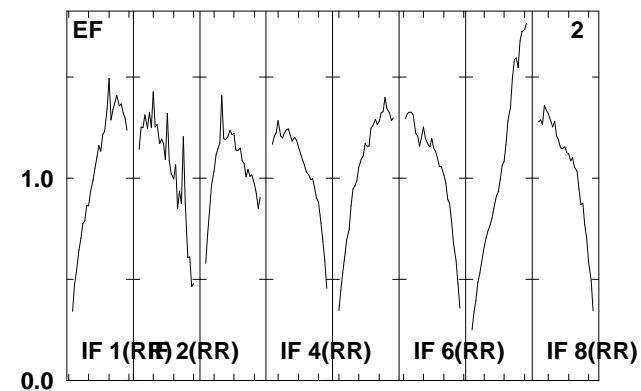
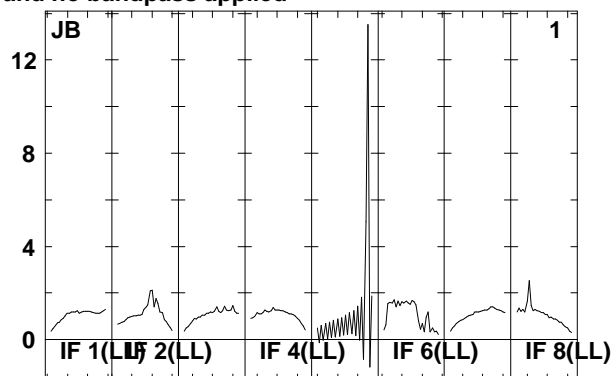
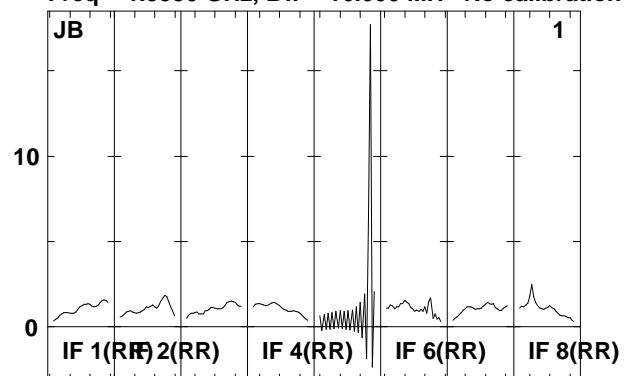

Lower frame: Real Jy
Total-power spectrum Antenna: *
Timerange: 00/13:24:02 to 00/13:25:26

Plot file version 256 created 18-APR-2008 18:29:53

J2333+39 EP061A.UVDATA.1

Freq = 1.5950 GHz, Bw = 16.000 MH No calibration applied and no bandpass applied

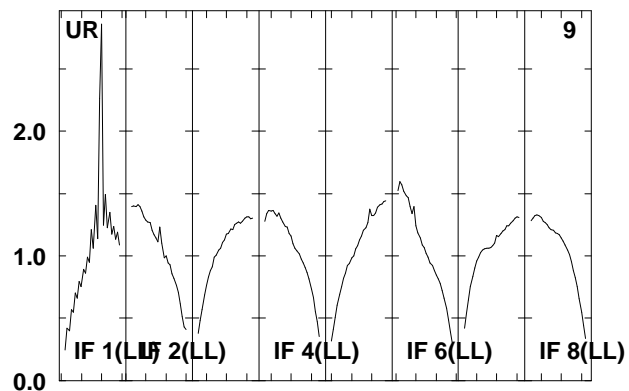
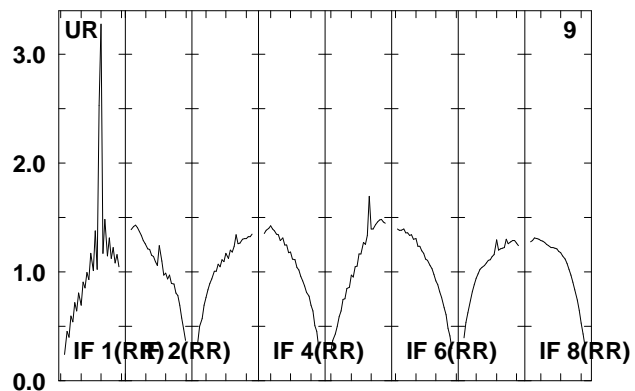
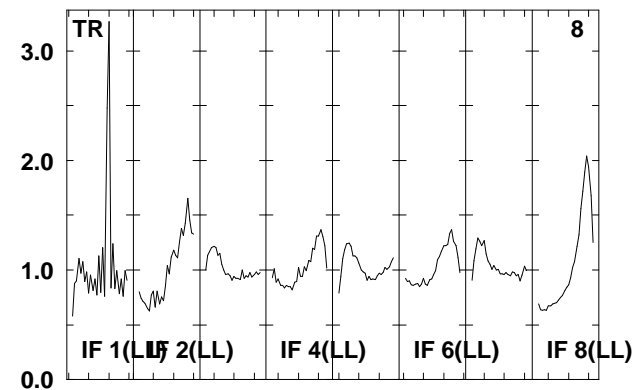
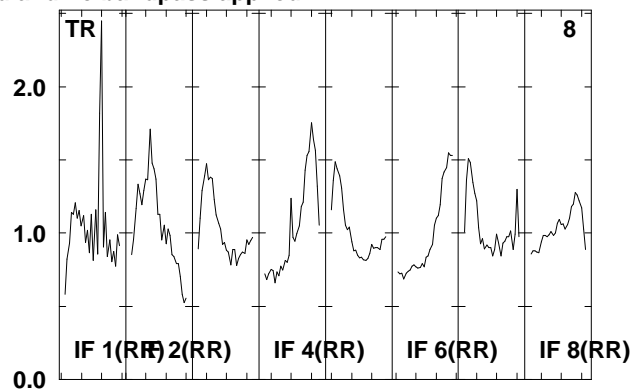
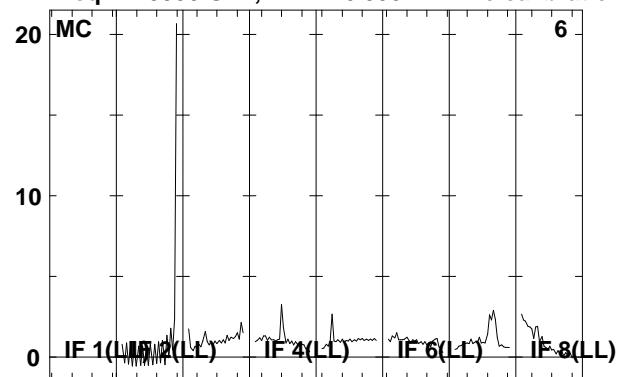

Lower frame: Real Jy
Total-power spectrum Antenna: *
Timerange: 00/13:24:02 to 00/13:25:26

Plot file version 257 created 18-APR-2008 18:29:53

IRAS2336 EP061A.UVDATA.1

Freq = 1.5950 GHz, Bw = 16.000 MH No calibration applied and no bandpass applied

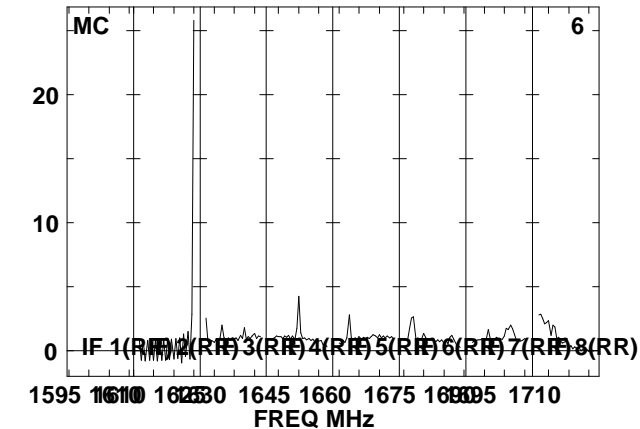
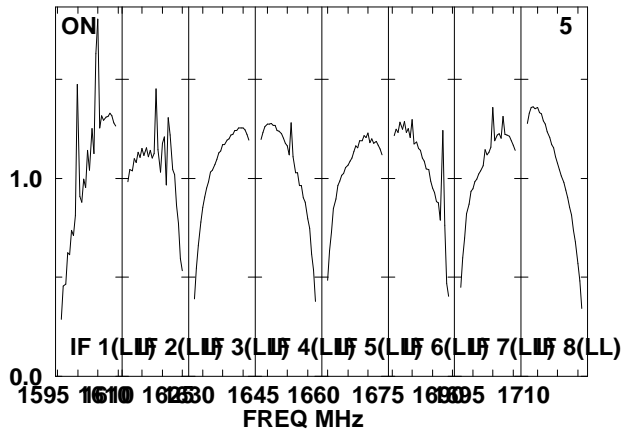
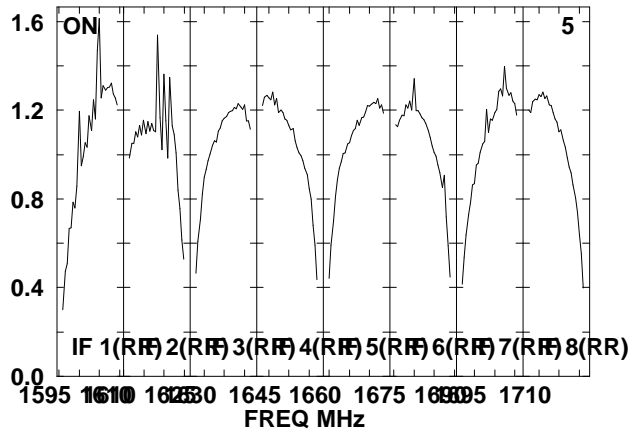
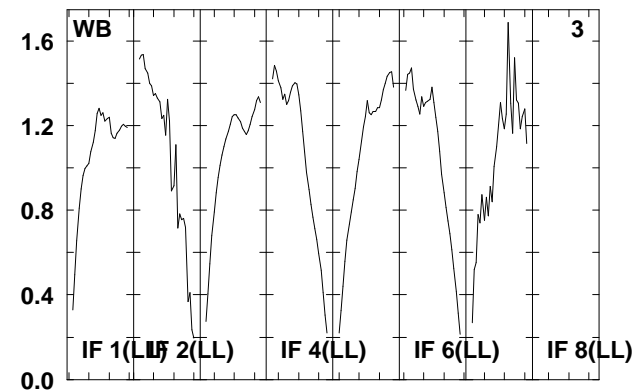
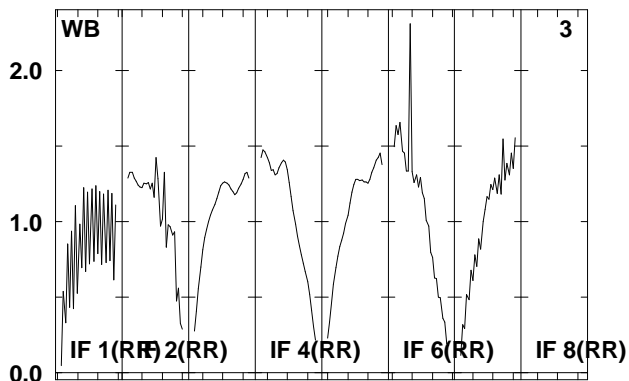
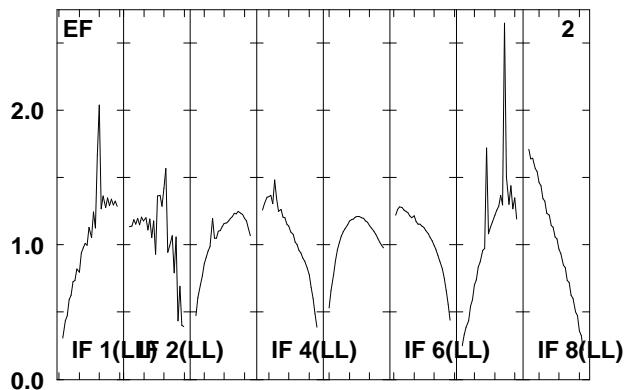
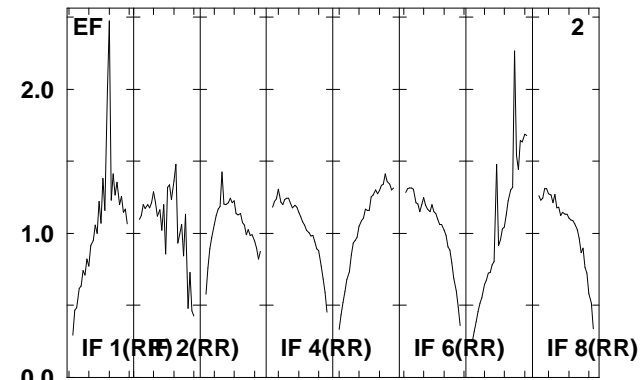
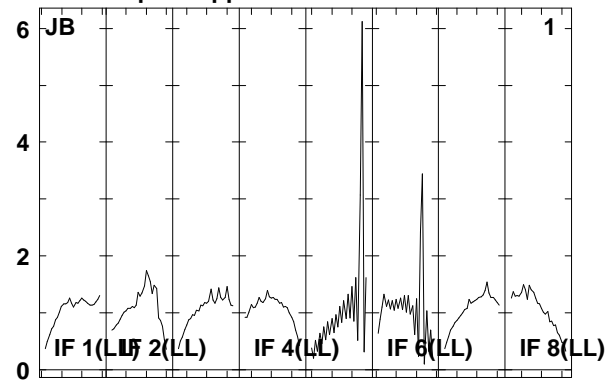
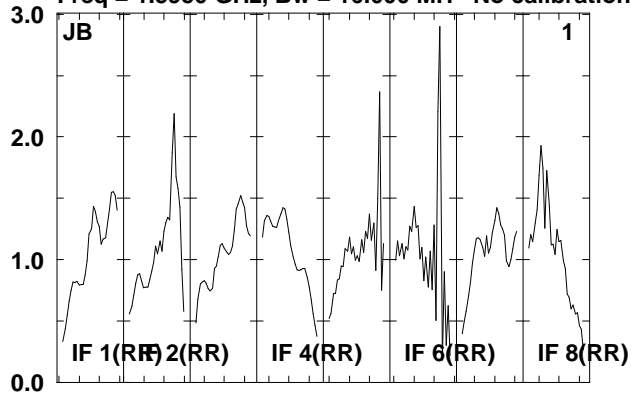

Lower frame: Real Jy
Total-power spectrum Antenna: *
Timerange: 00/13:25:38 to 00/13:29:56

Plot file version 258 created 18-APR-2008 18:29:54

IRAS2336 EP061A.UVDATA.1

Freq = 1.5950 GHz, Bw = 16.000 MH No calibration applied and no bandpass applied

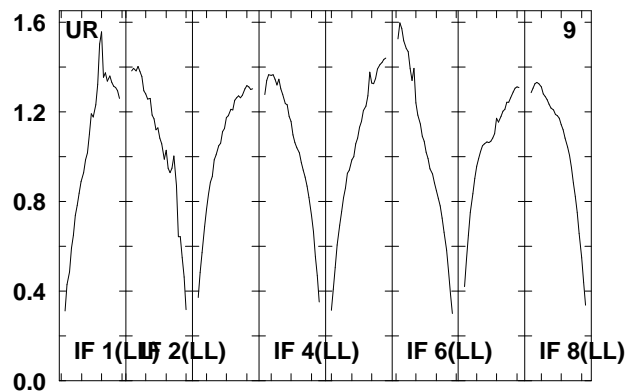
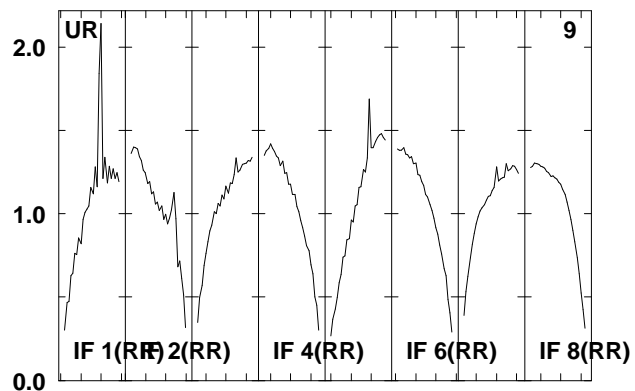
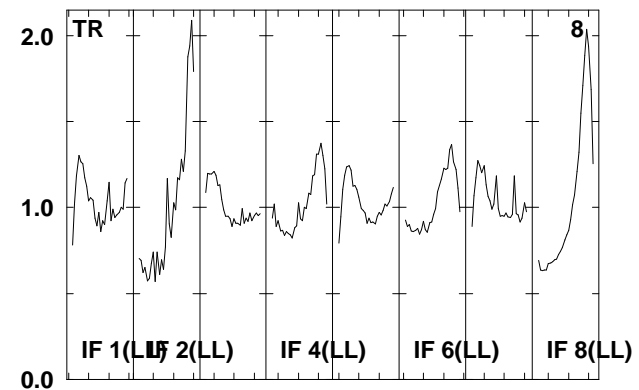
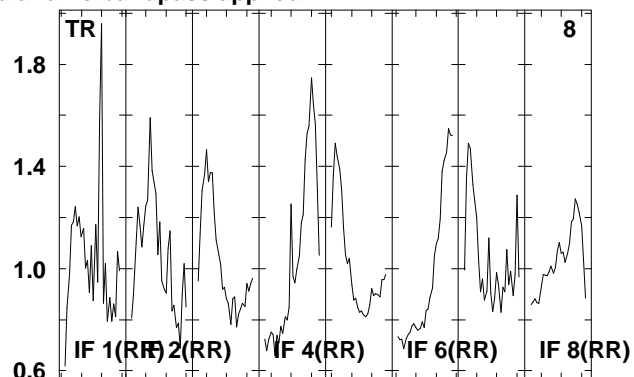
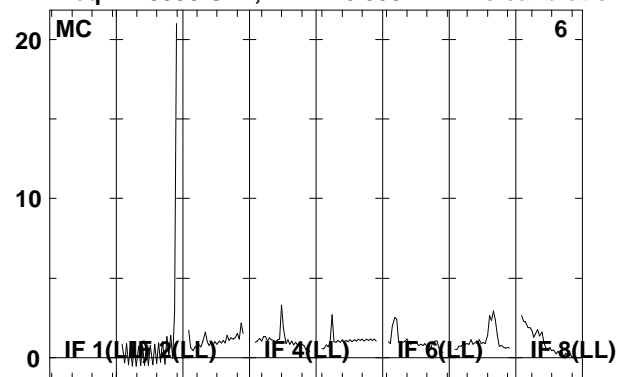

Lower frame: Real Jy
Total-power spectrum Antenna: *
Timerange: 00/13:25:38 to 00/13:29:56