

Plot file version 1 created 22-APR-2008 12:25:06

J0730-02 EP061B.UVDATA.1

Freq = 1.5950 GHz, Bw = 16.000 MH No calibration applied and no bandpass applied

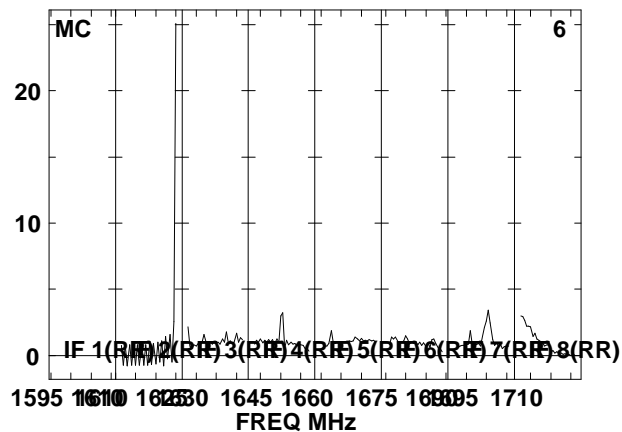
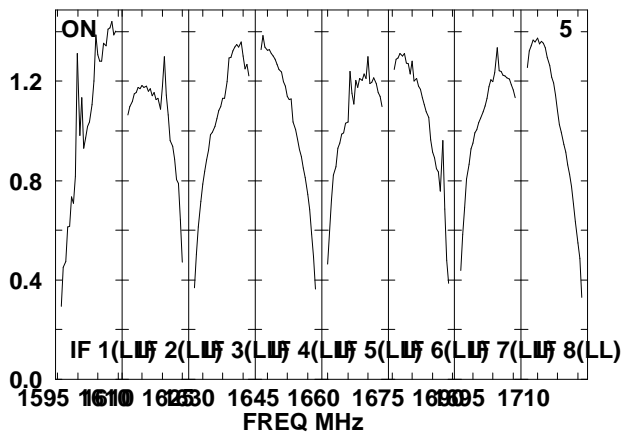
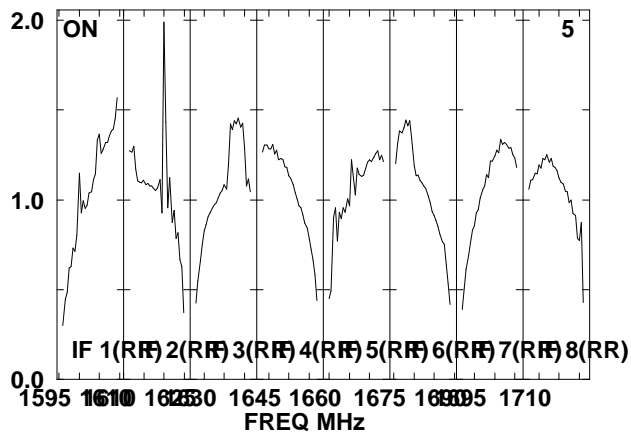
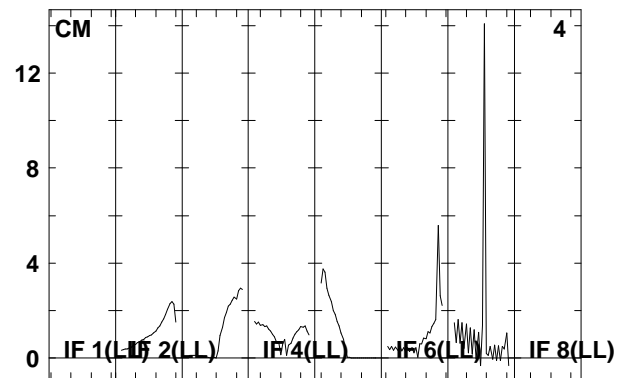
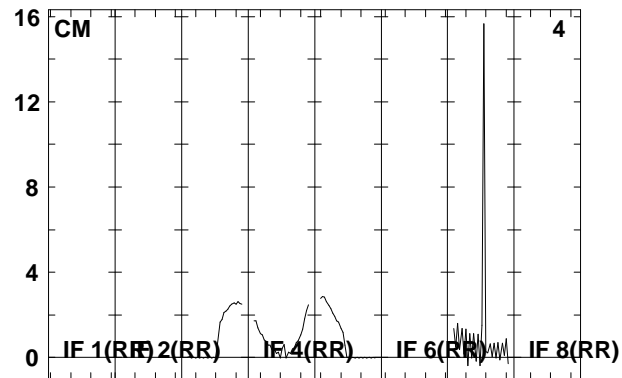
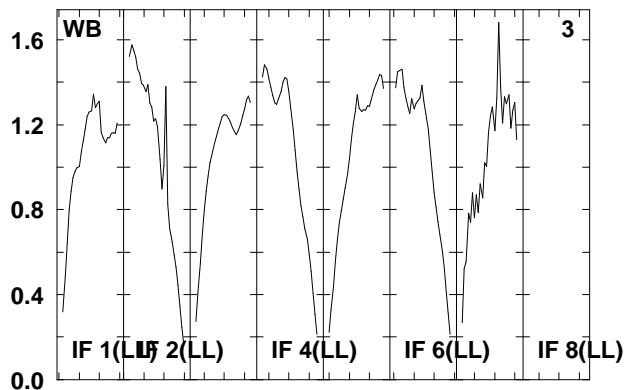
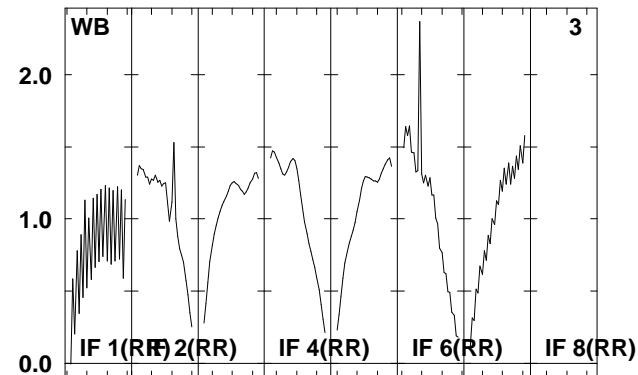
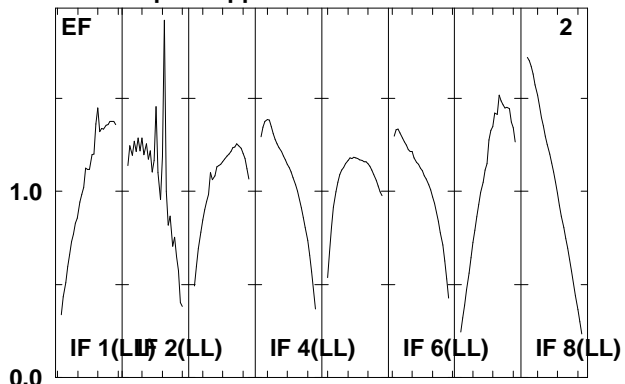
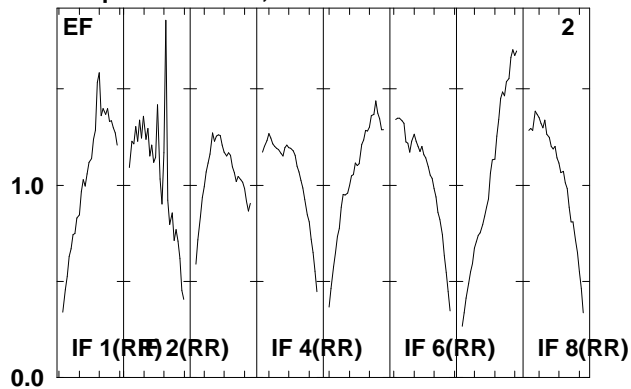

Lower frame: Real Jy

Total-power spectrum Antenna: *

Timerange: 00/16:00:02 to 00/16:01:30

Plot file version 2 created 22-APR-2008 12:25:07

J0730-02 EP061B.UVDATA.1

Freq = 1.5950 GHz, Bw = 16.000 MH No calibration applied and no bandpass applied

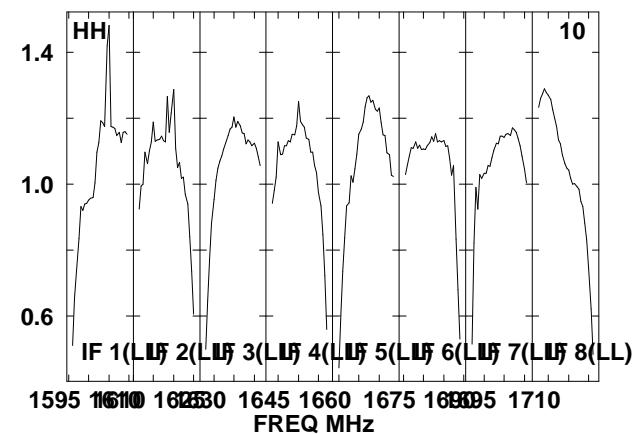
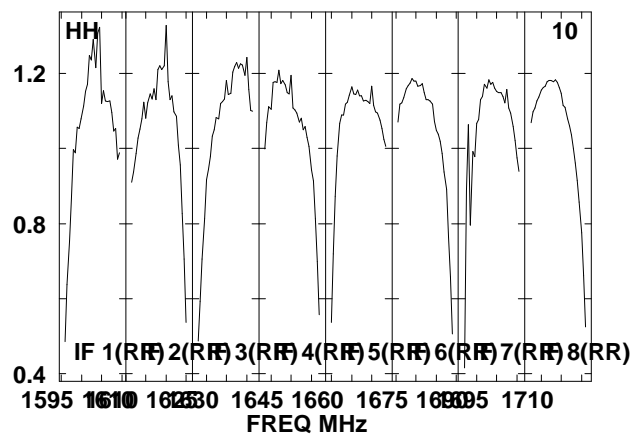
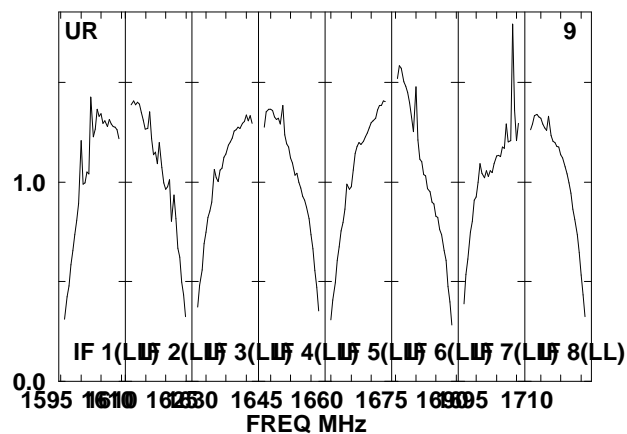
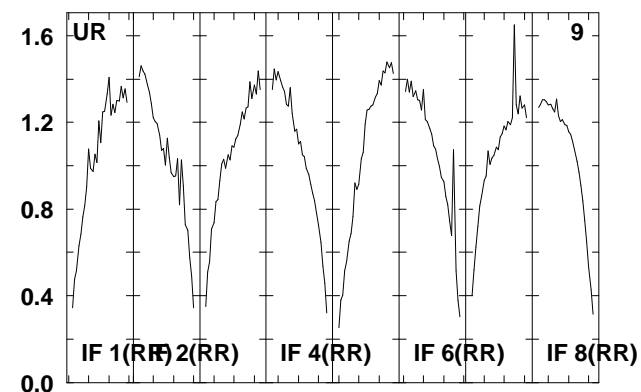
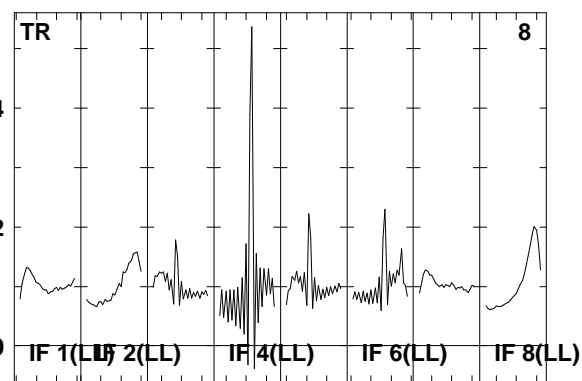
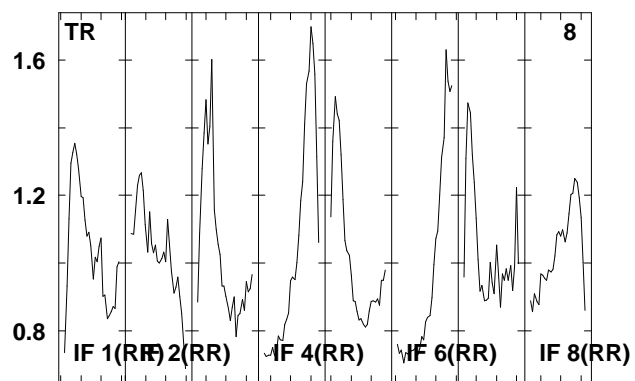
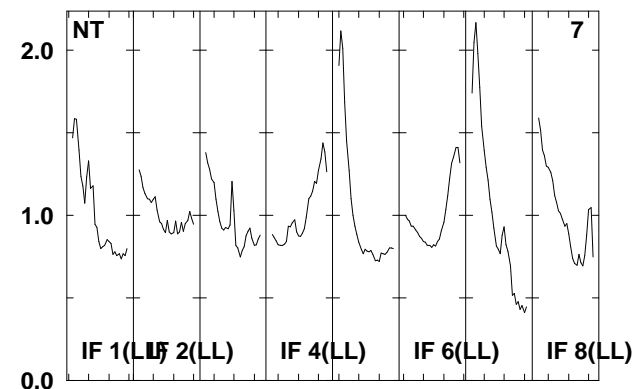
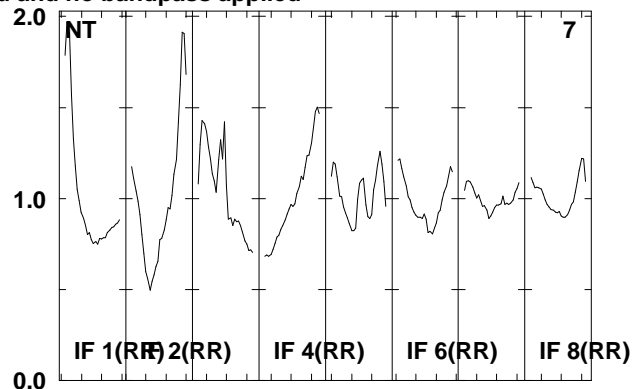
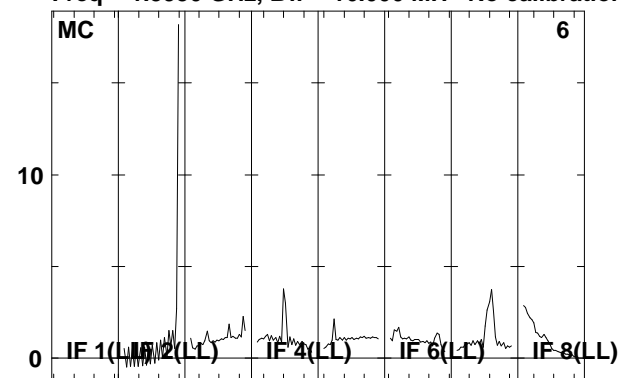

Lower frame: Real Jy

Total-power spectrum Antenna: *

Timerange: 00/16:00:02 to 00/16:01:30

Plot file version 3 created 22-APR-2008 12:25:08
 IRAS0725 EP061B.UVDATA.1
 Freq = 1.5950 GHz, Bw = 16.000 MH No calibration applied and no bandpass applied

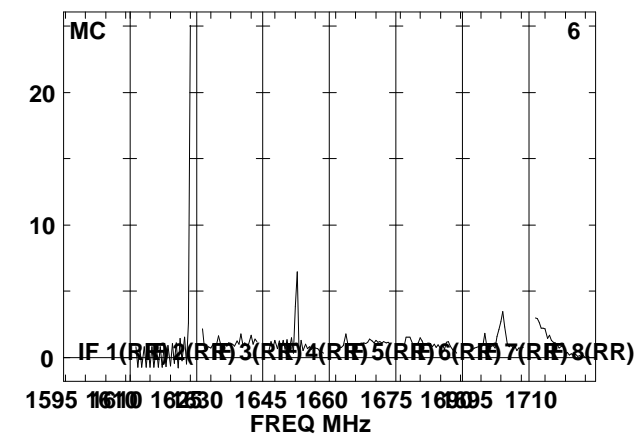
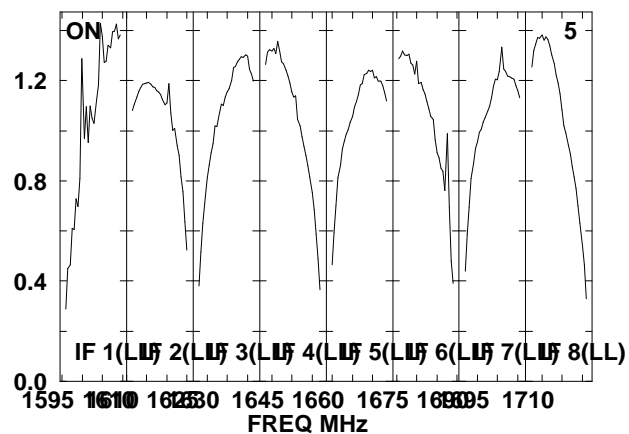
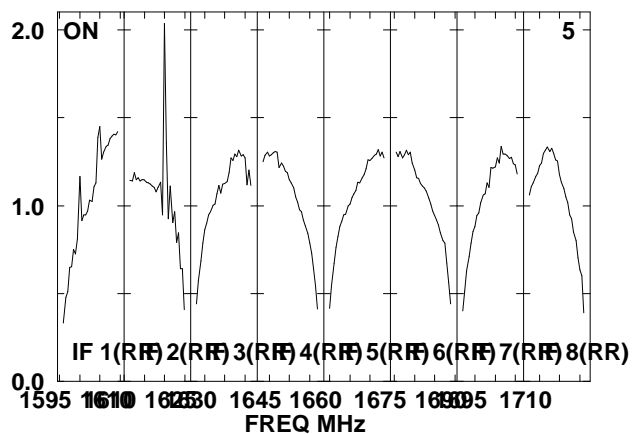
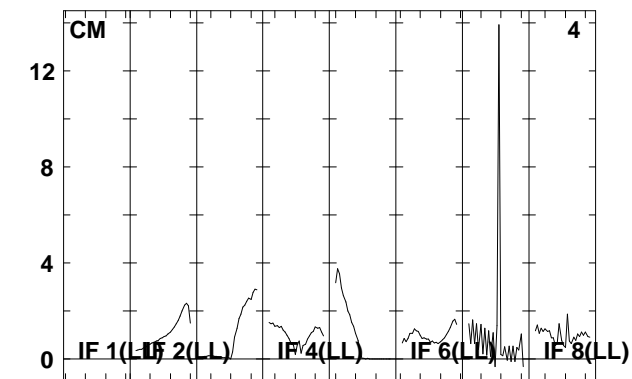
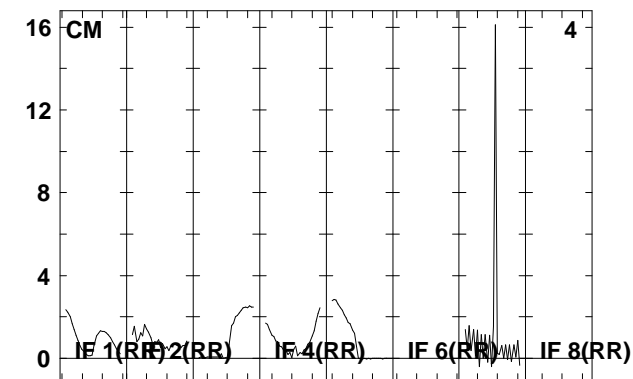
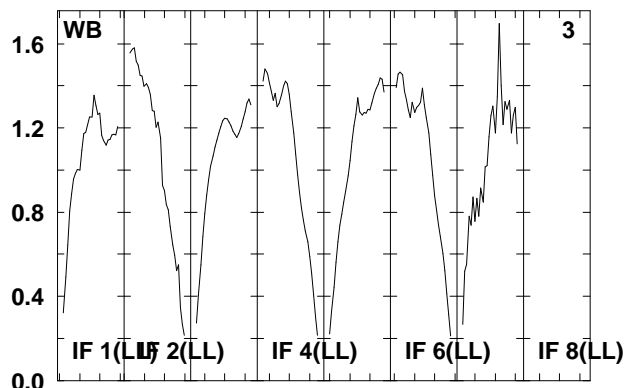
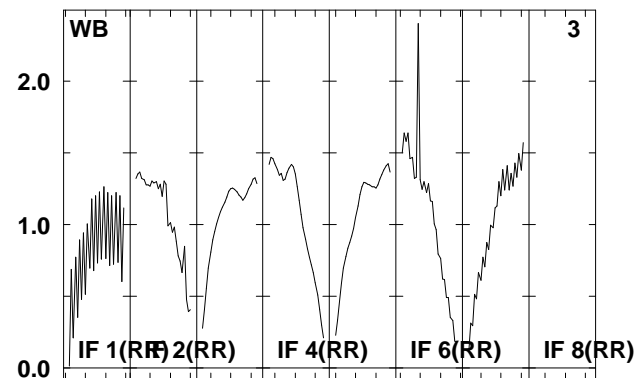
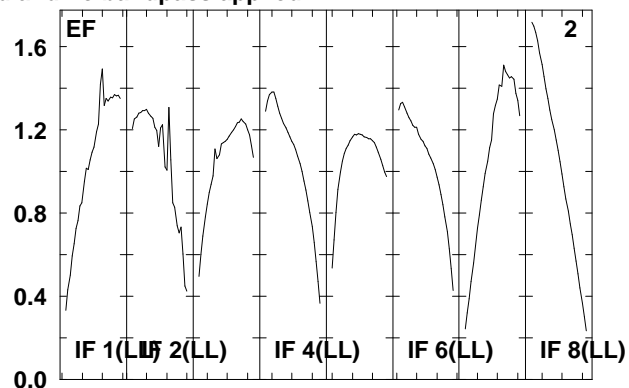
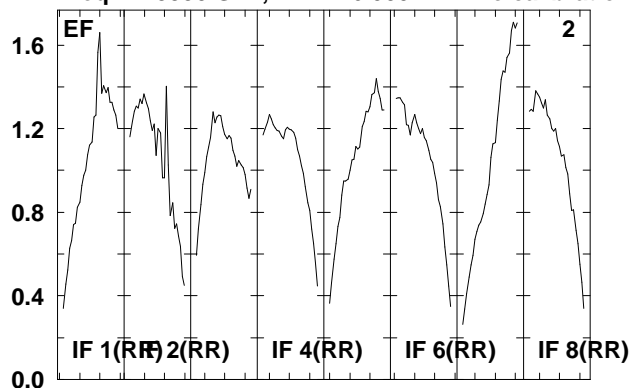

Lower frame: Real Jy
 Total-power spectrum Antenna: *
 Timerange: 00/16:01:32 to 00/16:05:00

Plot file version 4 created 22-APR-2008 12:25:08

IRAS0725 EP061B.UVDATA.1

Freq = 1.5950 GHz, Bw = 16.000 MH No calibration applied and no bandpass applied

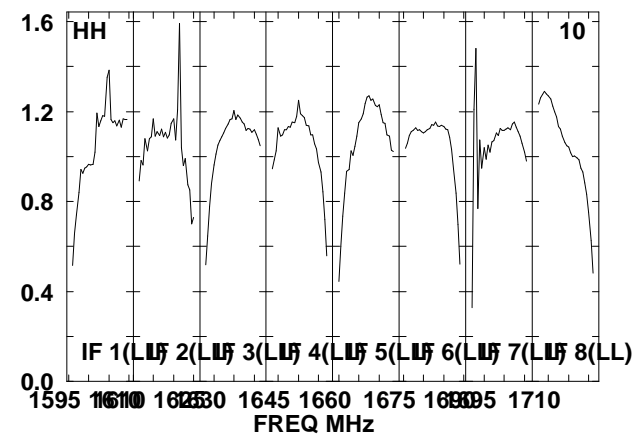
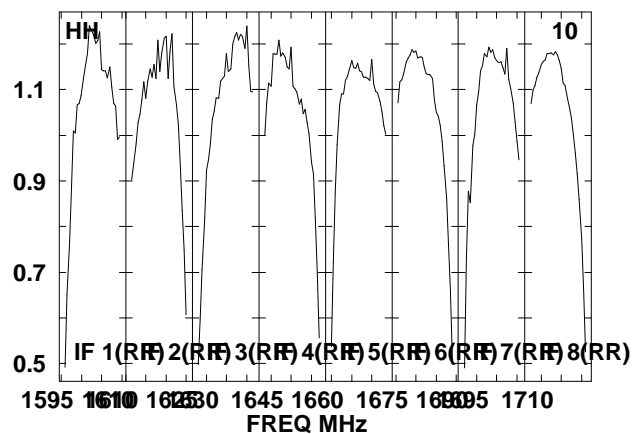
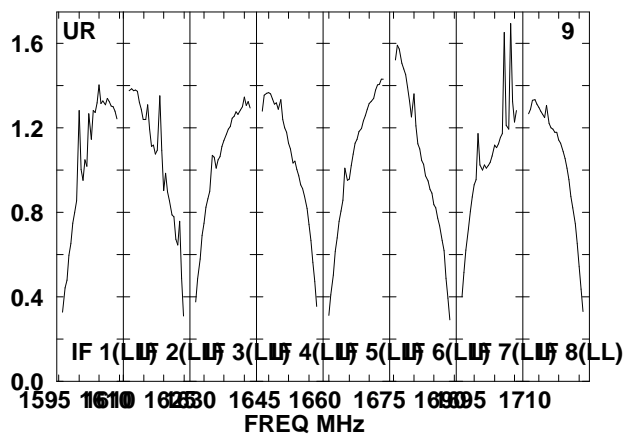
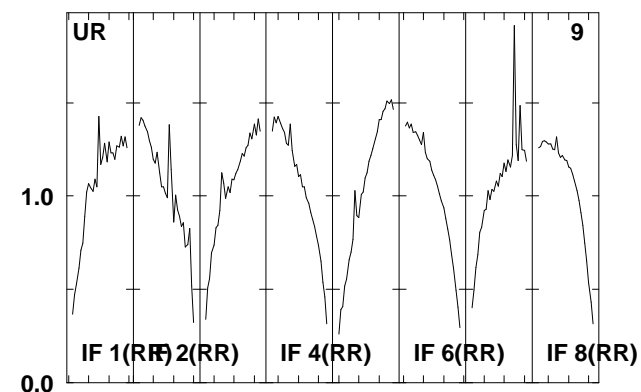
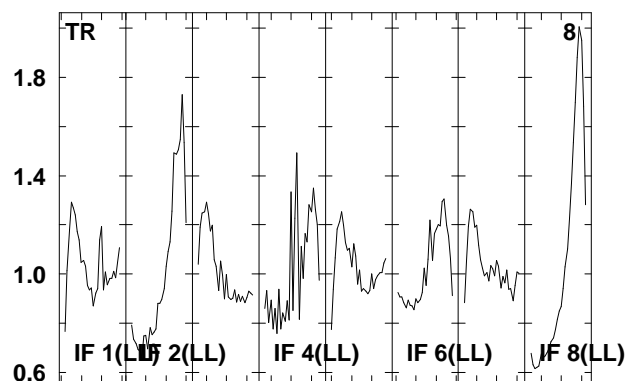
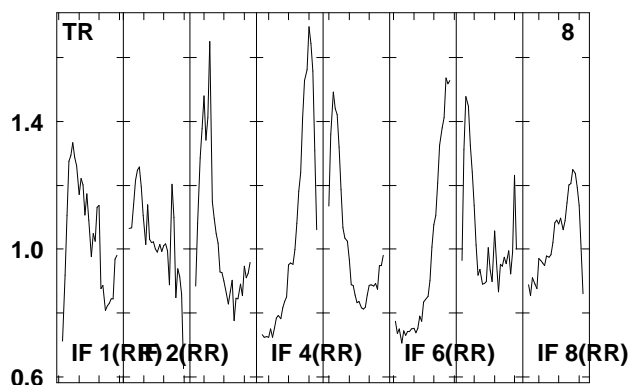
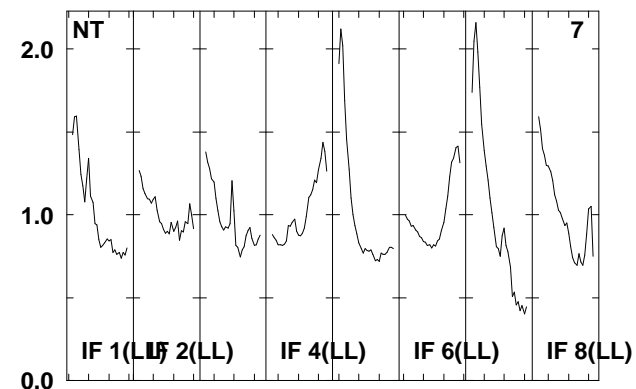
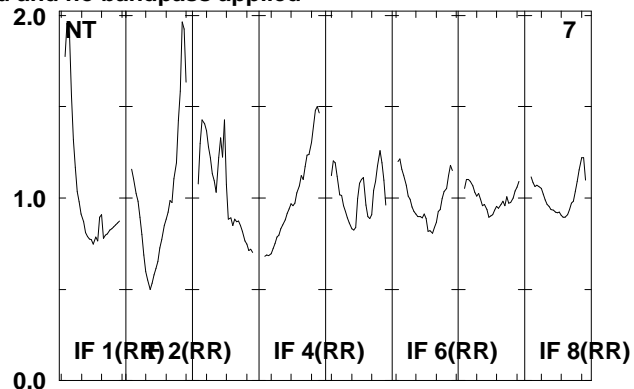
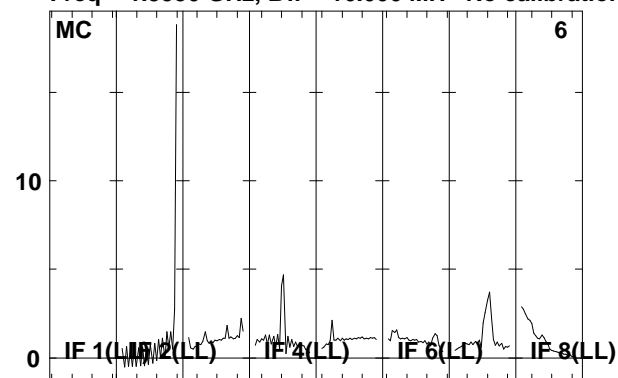

Lower frame: Real Jy

Total-power spectrum Antenna: *

Timerange: 00/16:01:32 to 00/16:05:00

Plot file version 5 created 22-APR-2008 12:25:10

J0730-02 EP061B.UVDATA.1

Freq = 1.5950 GHz, Bw = 16.000 MH No calibration applied and no bandpass applied

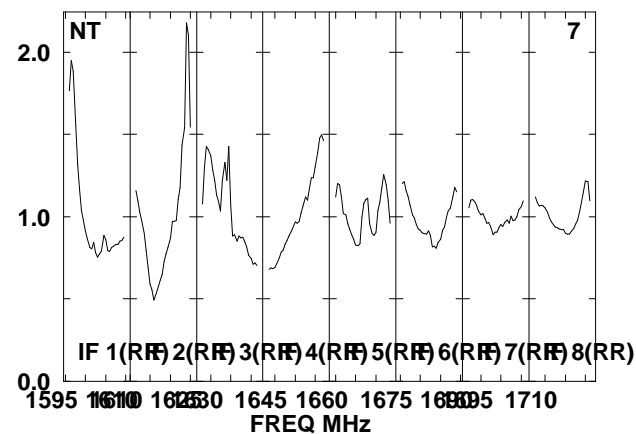
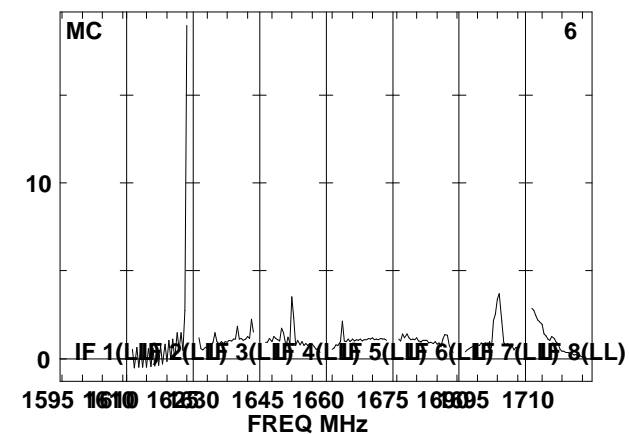
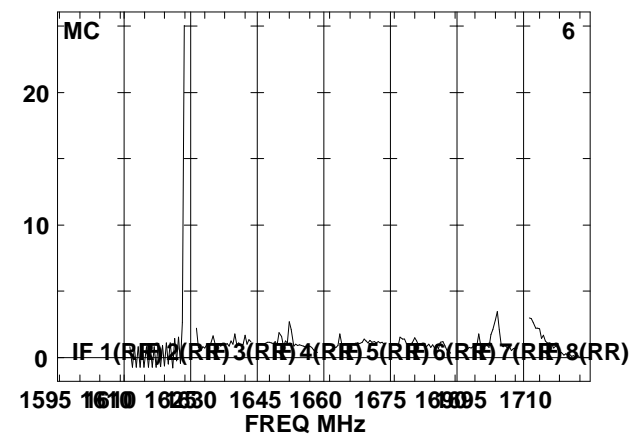
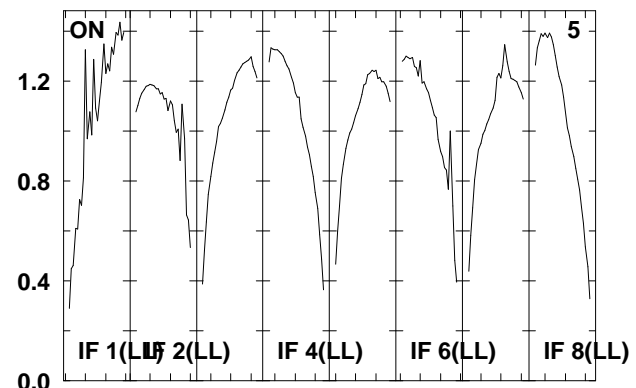
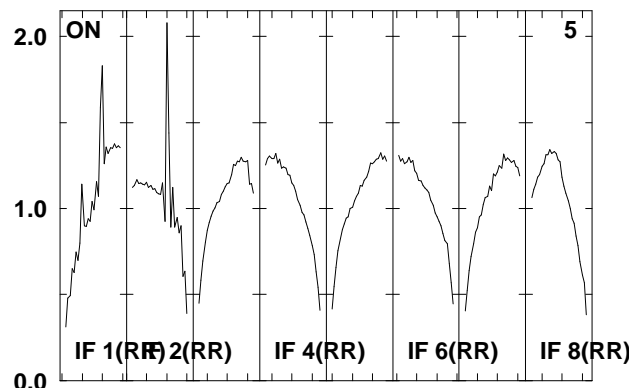
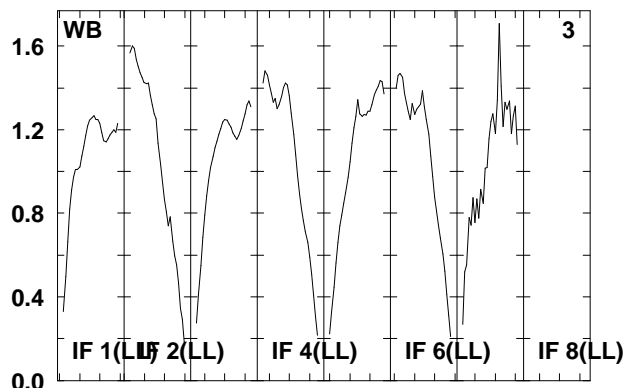
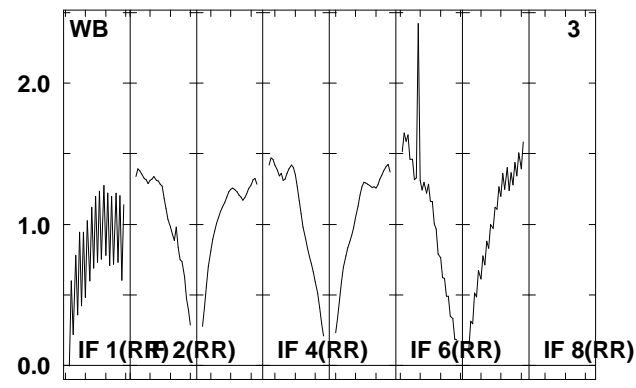
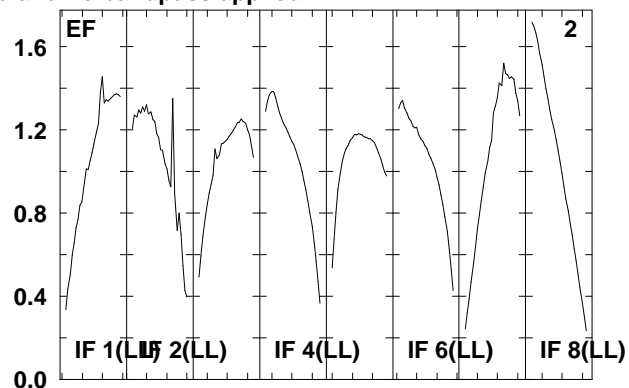
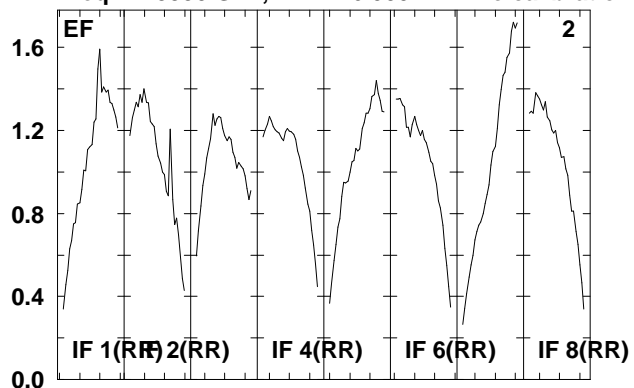

Lower frame: Real Jy
Total-power spectrum Antenna: *
Timerange: 00/16:05:02 to 00/16:06:30

Plot file version 6 created 22-APR-2008 12:25:10

J0730-02 EP061B.UVDATA.1

Freq = 1.5950 GHz, Bw = 16.000 MH No calibration applied and no bandpass applied

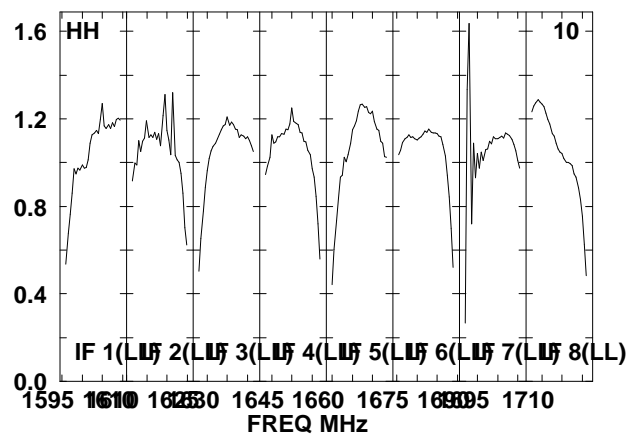
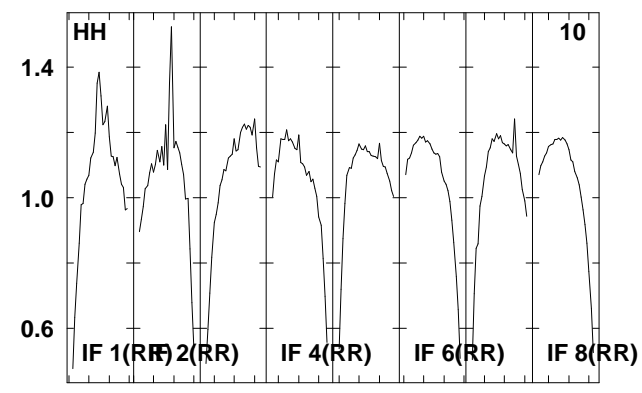
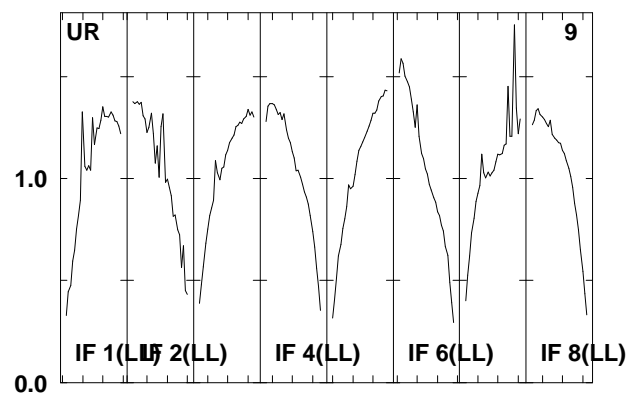
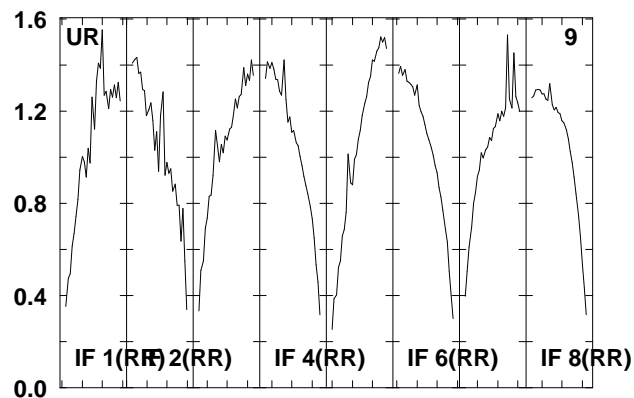
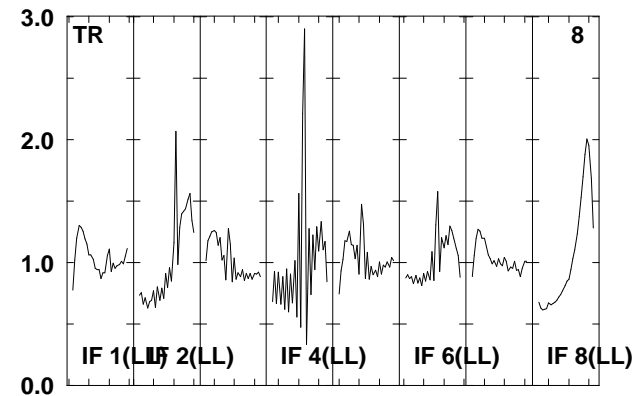
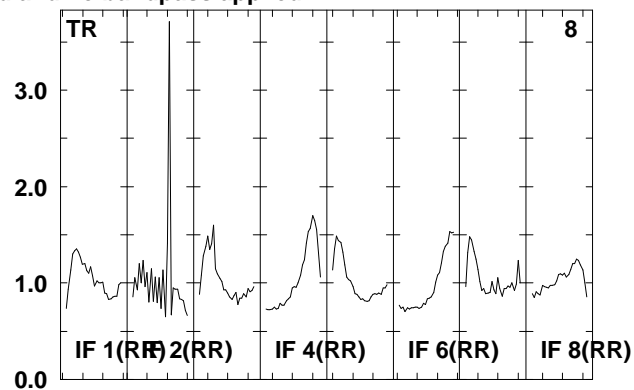
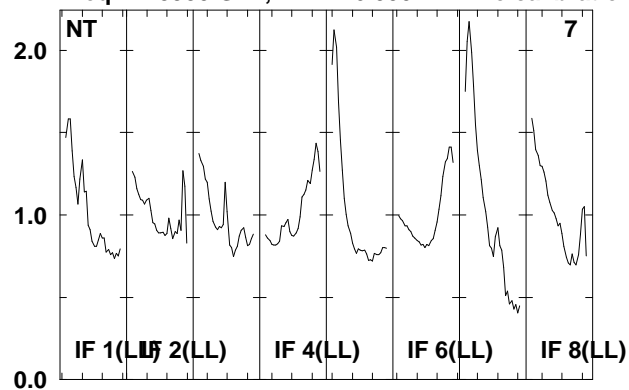

Lower frame: Real Jy

Total-power spectrum Antenna: *

Timerange: 00/16:05:02 to 00/16:06:30

Plot file version 7 created 22-APR-2008 12:25:11

IRAS0725 EP061B.UVDATA.1

Freq = 1.5950 GHz, Bw = 16.000 MH No calibration applied and no bandpass applied

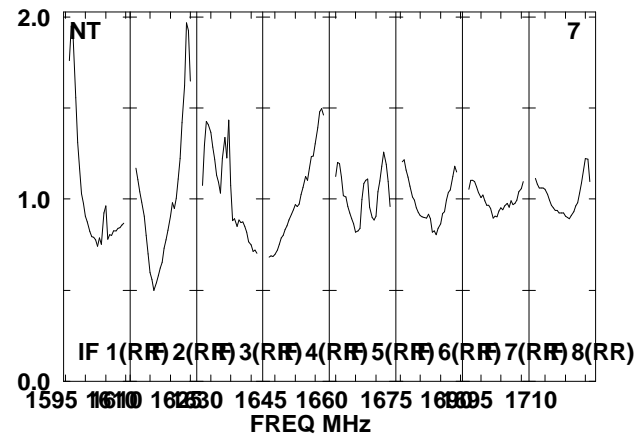
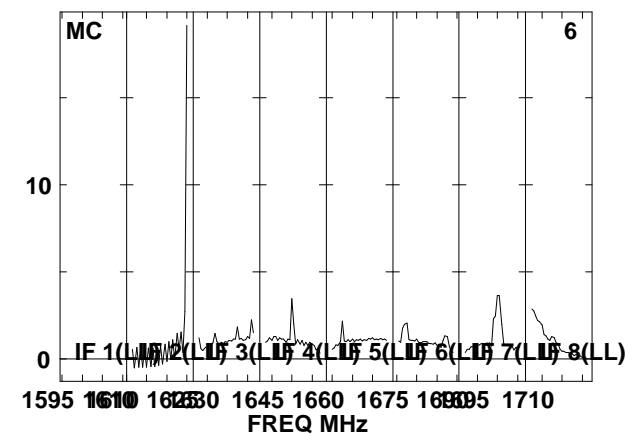
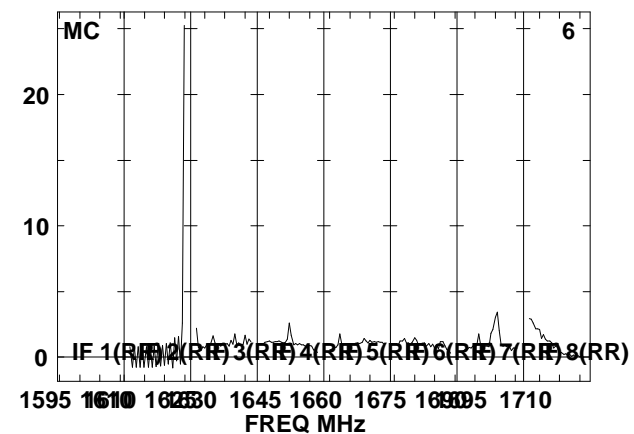
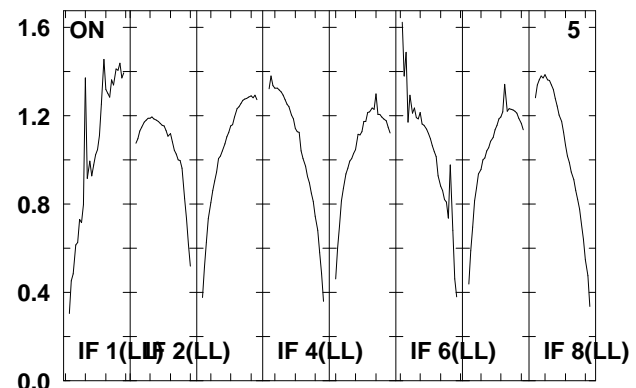
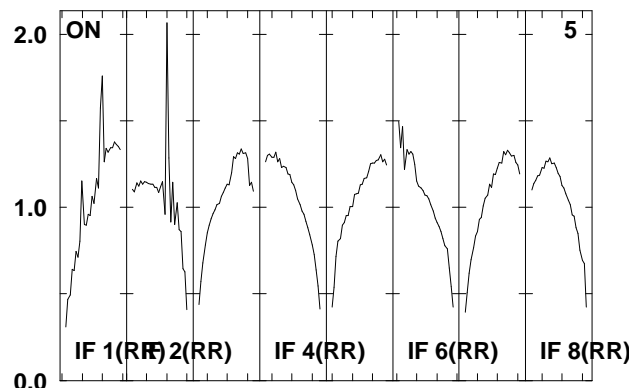
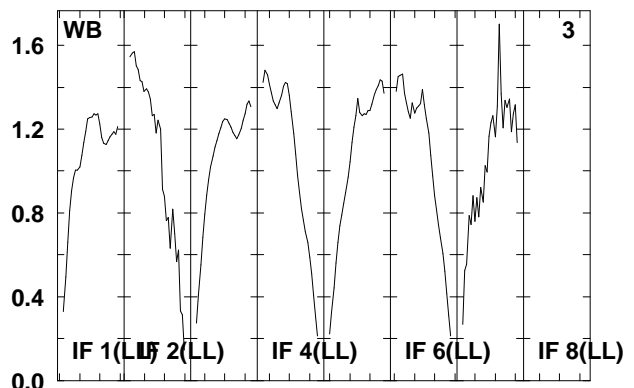
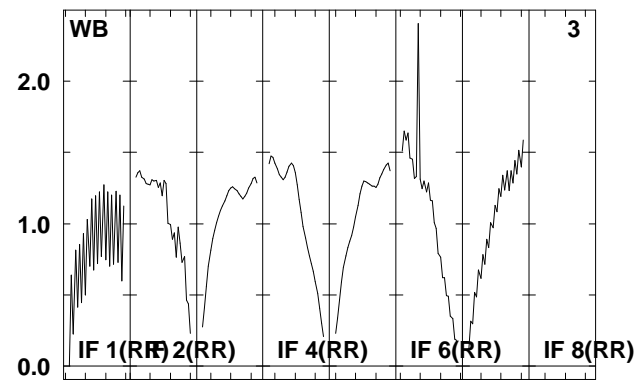
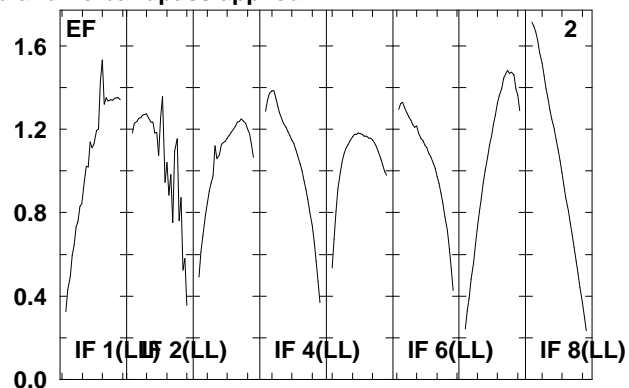
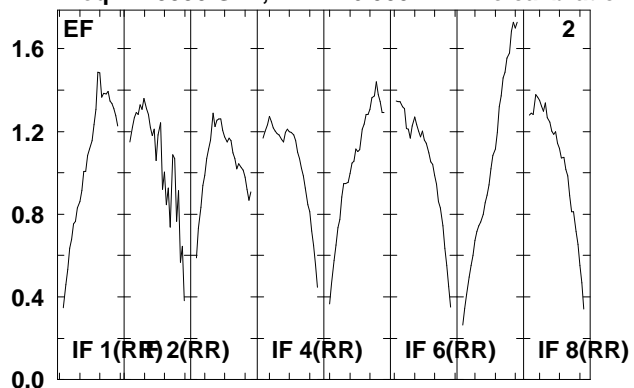

Lower frame: Real Jy
Total-power spectrum Antenna: *
Timerange: 00/16:06:32 to 00/16:10:00

Plot file version 8 created 22-APR-2008 12:25:12

IRAS0725 EP061B.UVDATA.1

Freq = 1.5950 GHz, Bw = 16.000 MH No calibration applied and no bandpass applied

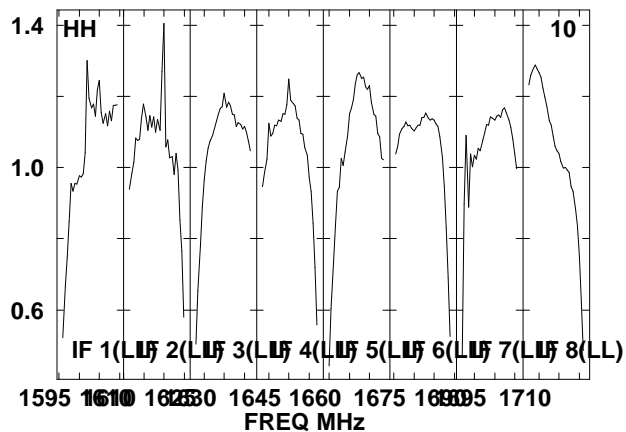
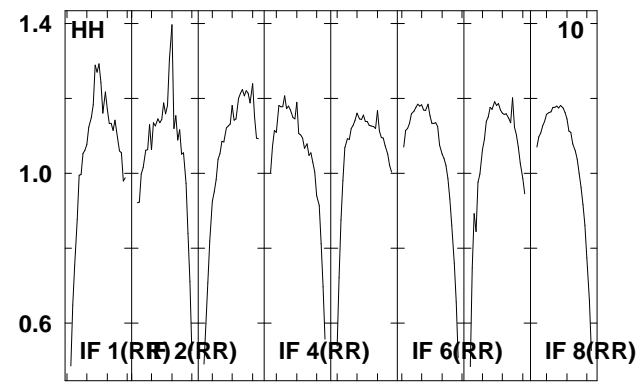
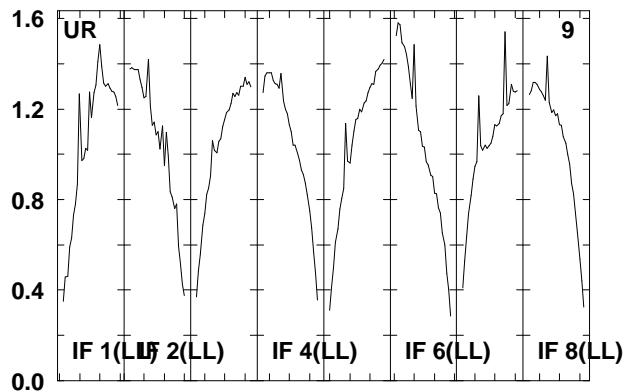
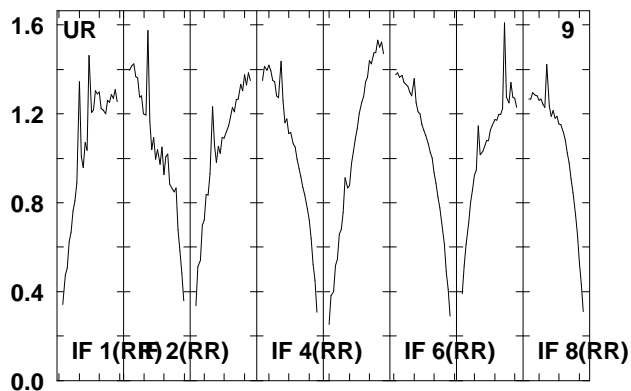
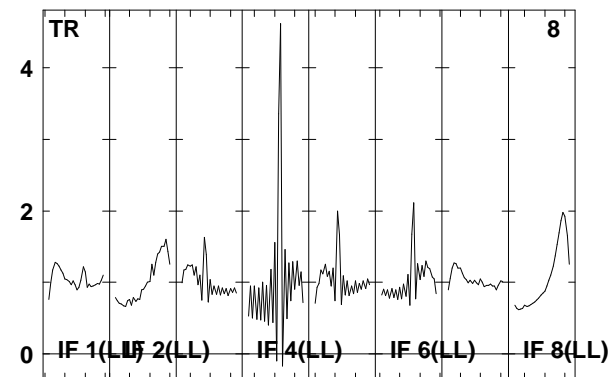
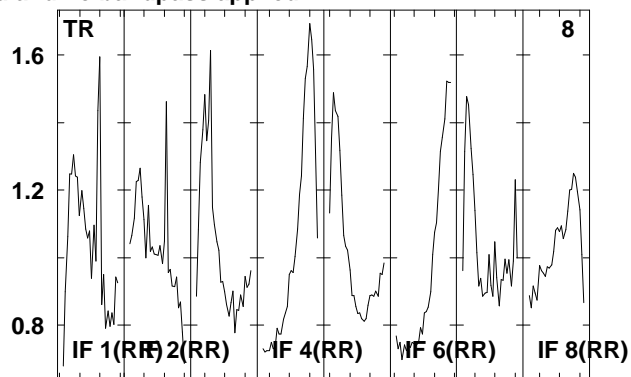
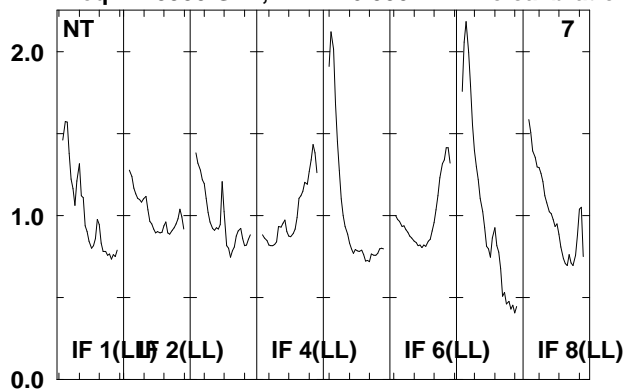

Lower frame: Real Jy

Total-power spectrum Antenna: *

Timerange: 00/16:06:32 to 00/16:10:00

Plot file version 9 created 22-APR-2008 12:25:13

J0730-02 EP061B.UVDATA.1

Freq = 1.5950 GHz, Bw = 16.000 MH No calibration applied and no bandpass applied

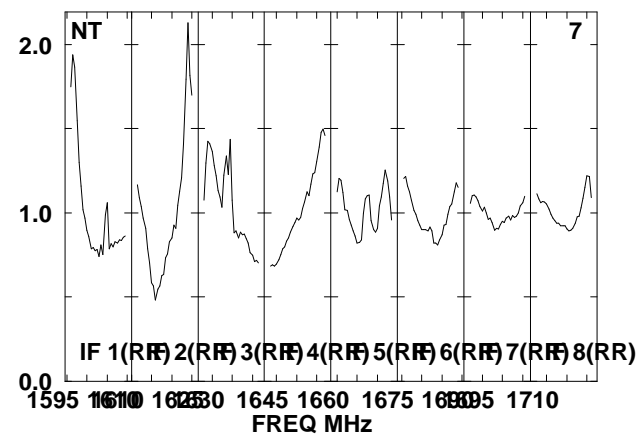
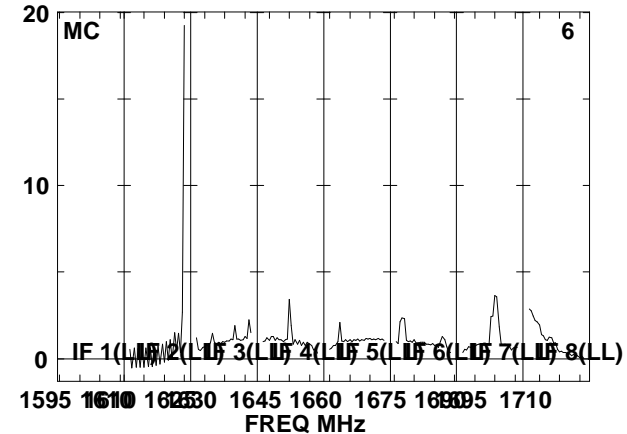
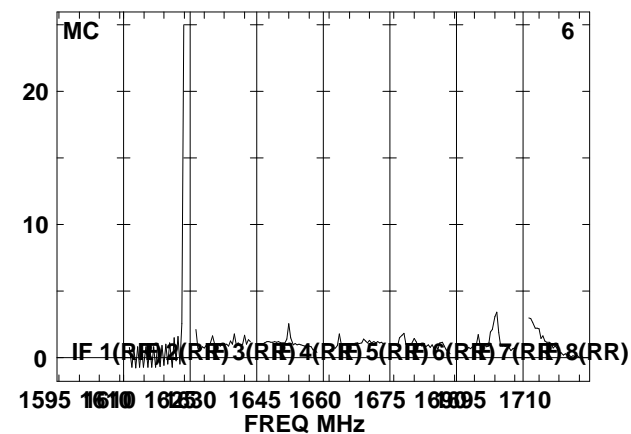
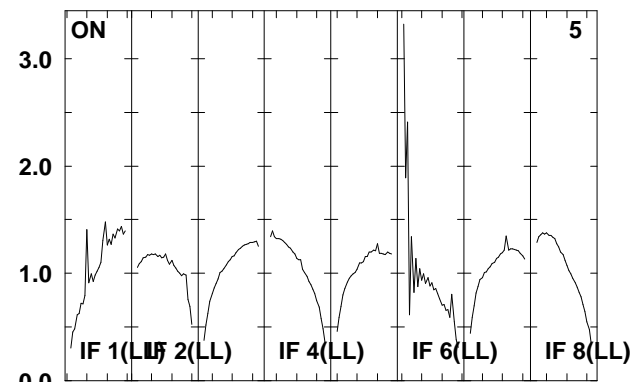
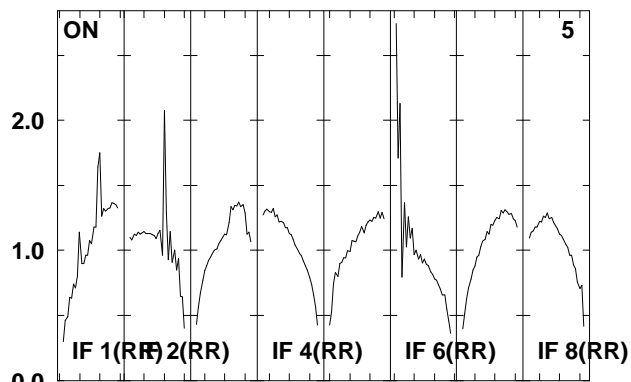
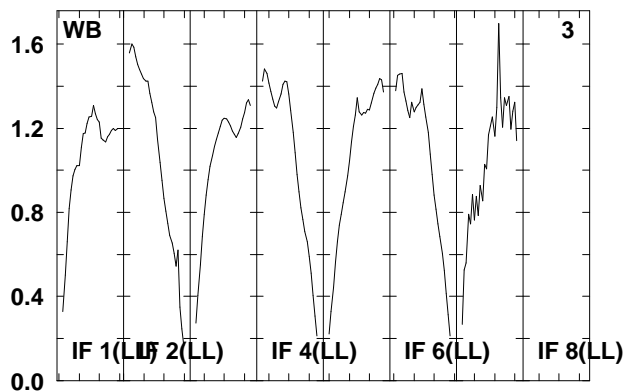
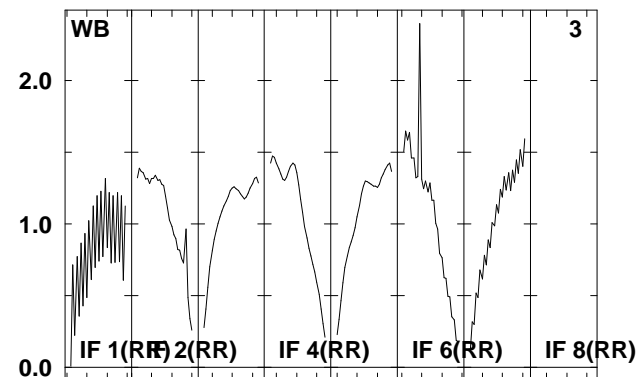
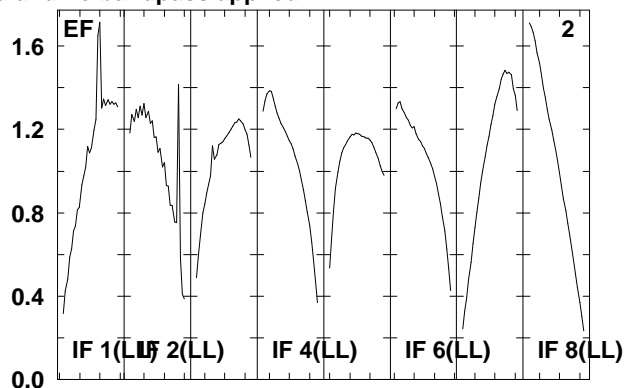
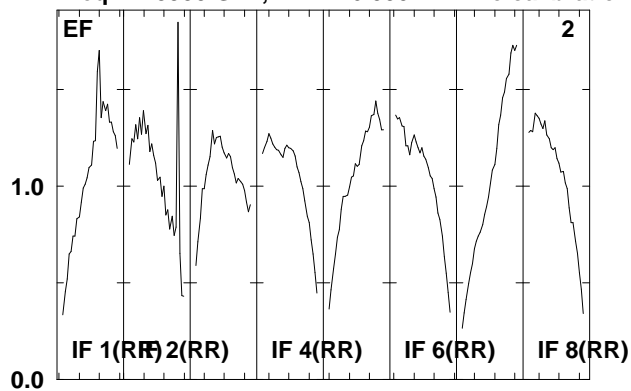

Lower frame: Real Jy
Total-power spectrum Antenna: *
Timerange: 00/16:10:02 to 00/16:11:30

Plot file version 10 created 22-APR-2008 12:25:13

J0730-02 EP061B.UVDATA.1

Freq = 1.5950 GHz, Bw = 16.000 MH No calibration applied and no bandpass applied

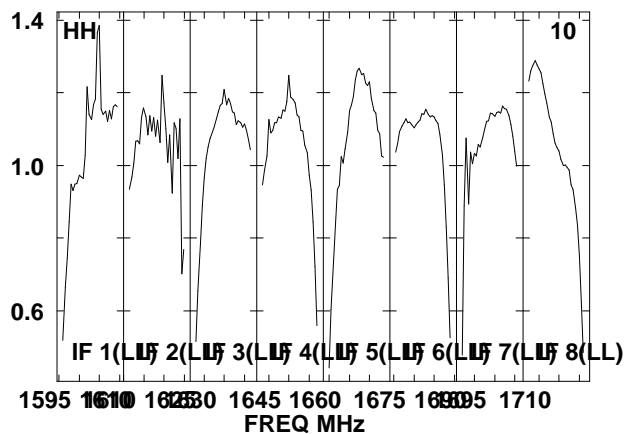
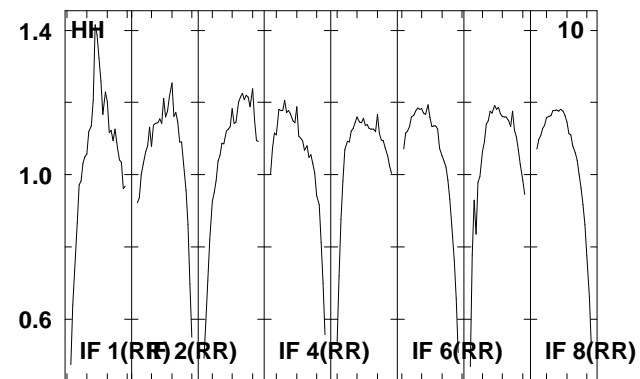
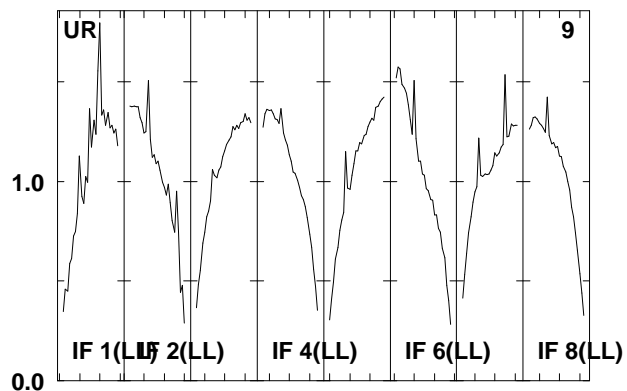
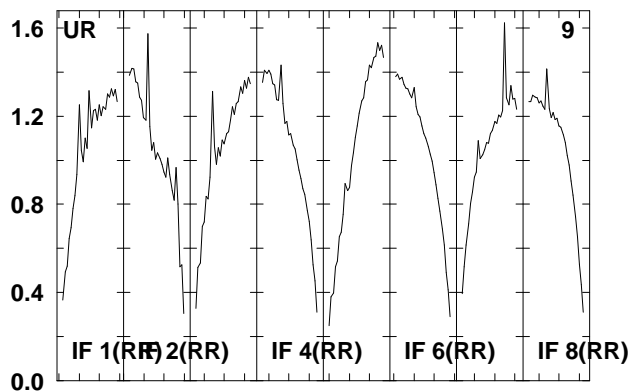
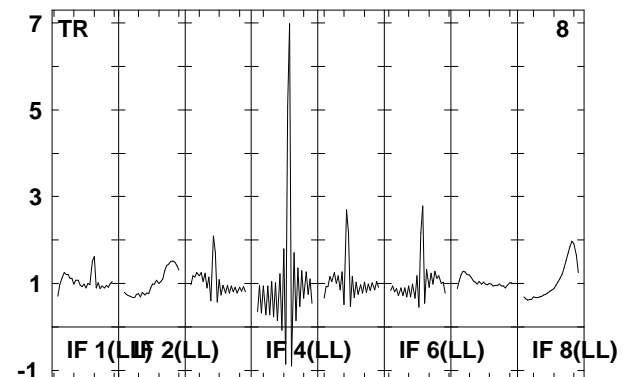
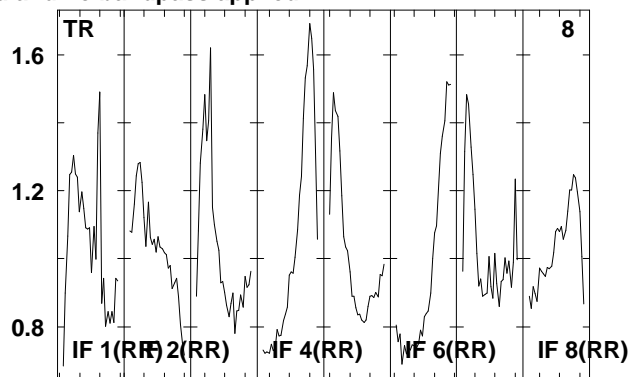
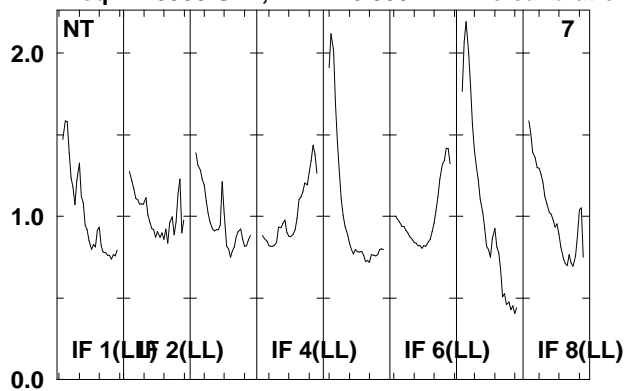

Lower frame: Real Jy

Total-power spectrum Antenna: *

Timerange: 00/16:10:02 to 00/16:11:30

Plot file version 11 created 22-APR-2008 12:25:14

IRAS0725 EP061B.UVDATA.1

Freq = 1.5950 GHz, Bw = 16.000 MH No calibration applied and no bandpass applied

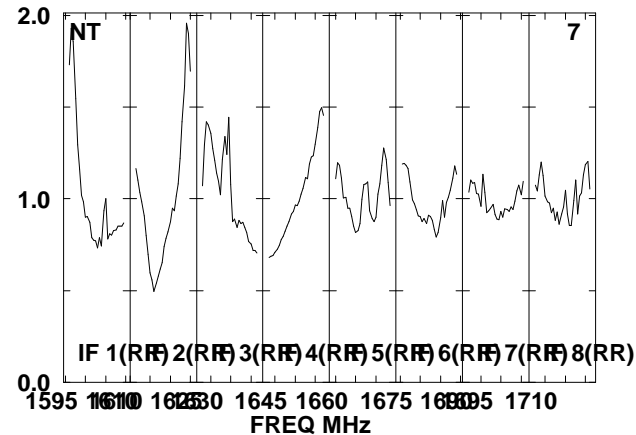
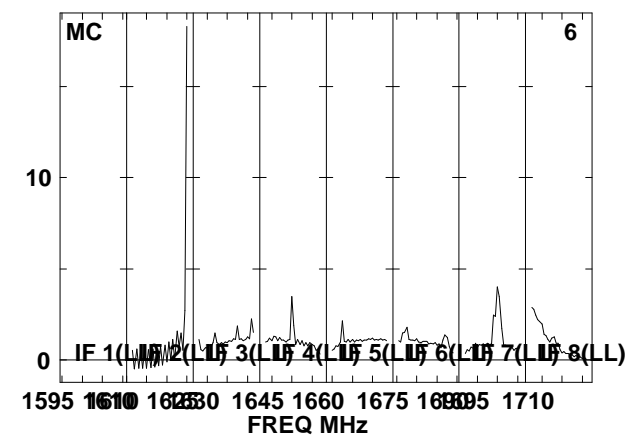
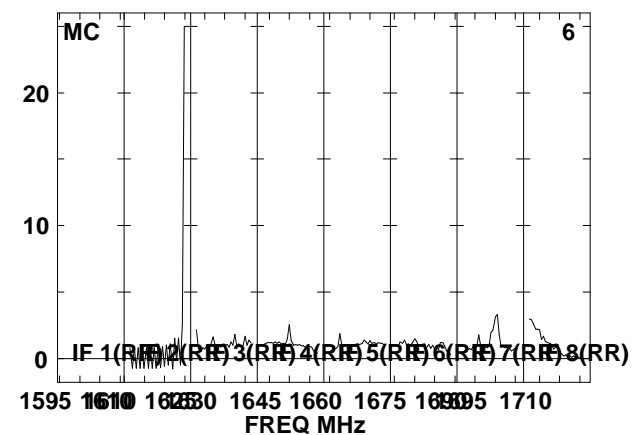
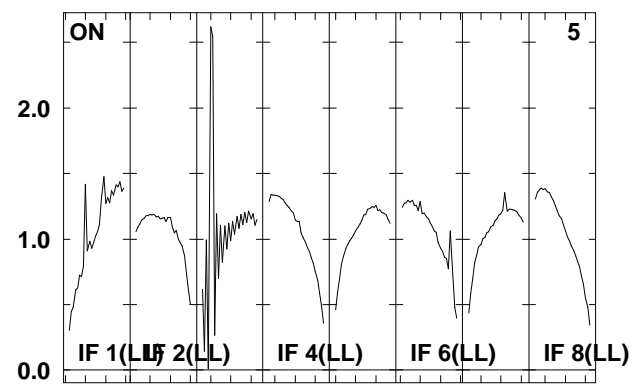
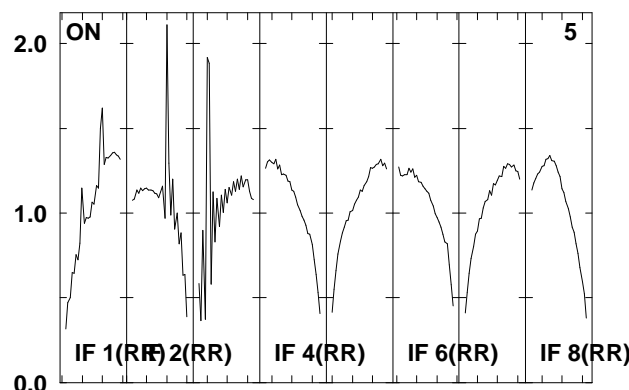
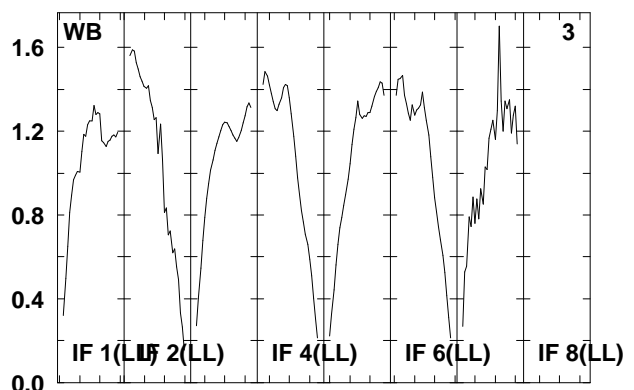
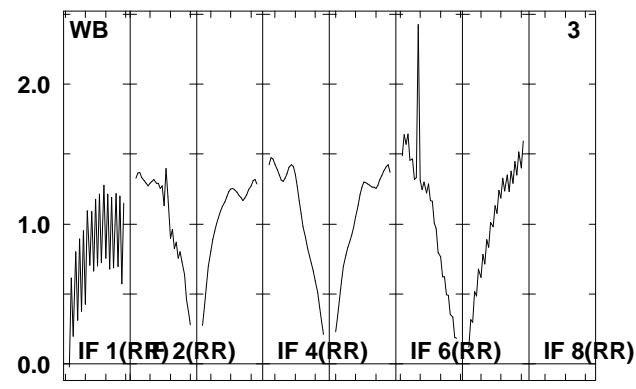
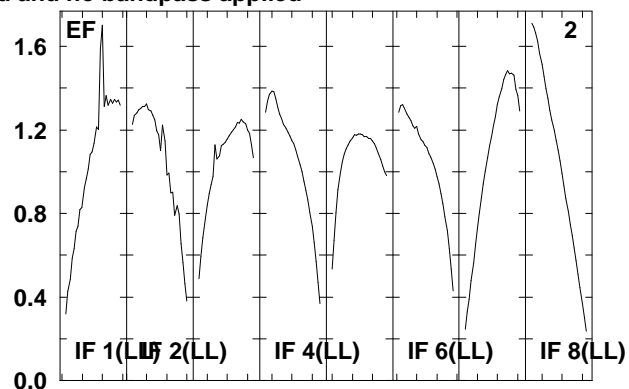
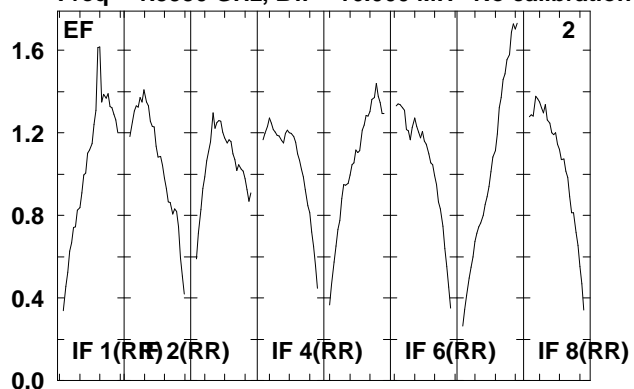

Lower frame: Real Jy
Total-power spectrum Antenna: *
Timerange: 00/16:11:32 to 00/16:14:58

Plot file version 12 created 22-APR-2008 12:25:15

IRAS0725 EP061B.UVDATA.1

Freq = 1.5950 GHz, Bw = 16.000 MH No calibration applied and no bandpass applied

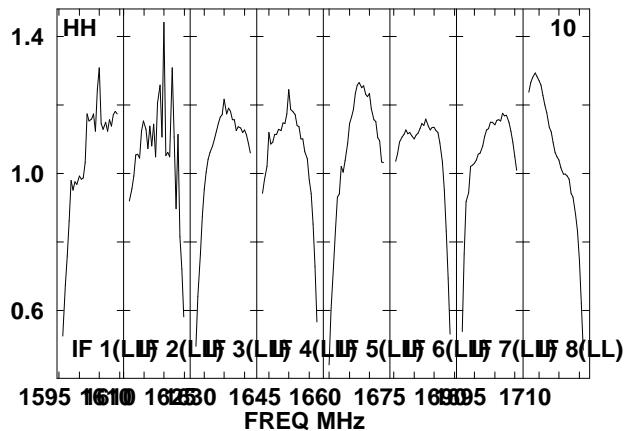
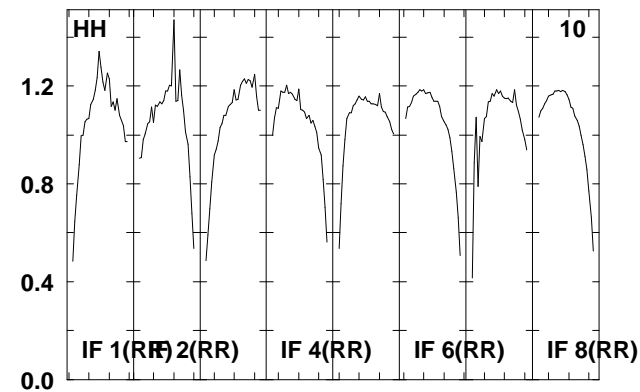
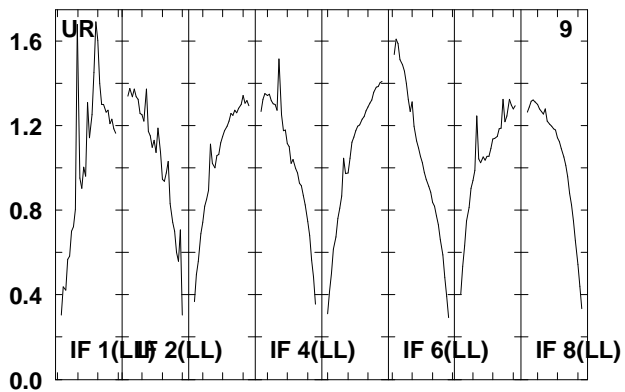
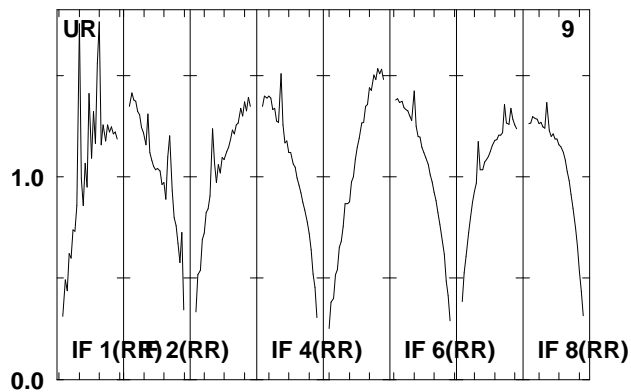
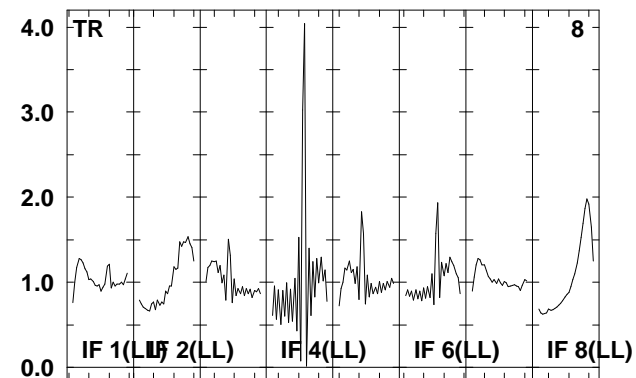
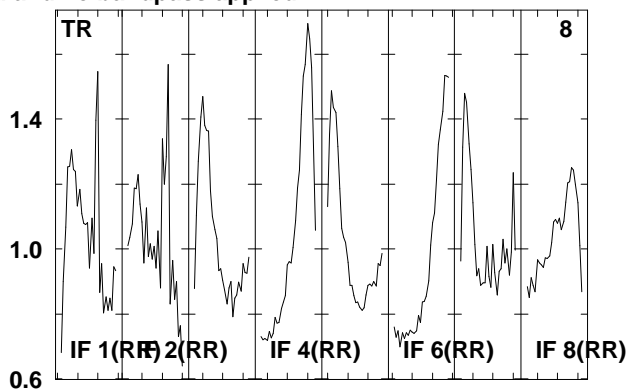
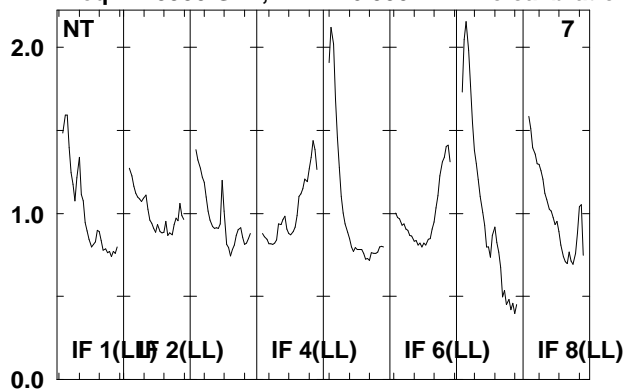

Lower frame: Real Jy

Total-power spectrum Antenna: *

Timerange: 00/16:11:32 to 00/16:14:58

Plot file version 13 created 22-APR-2008 12:25:16

J0730-02 EP061B.UVDATA.1

Freq = 1.5950 GHz, Bw = 16.000 MH No calibration applied and no bandpass applied

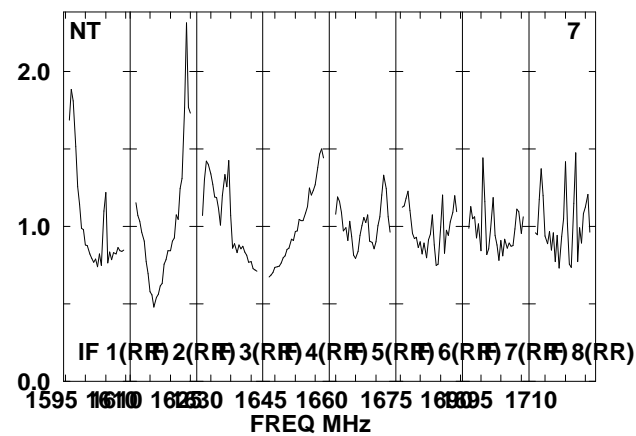
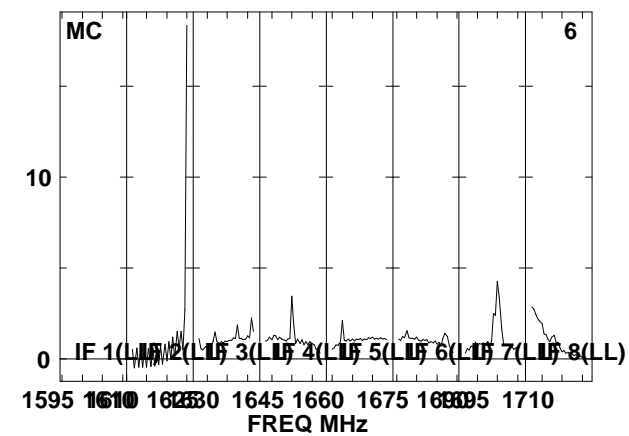
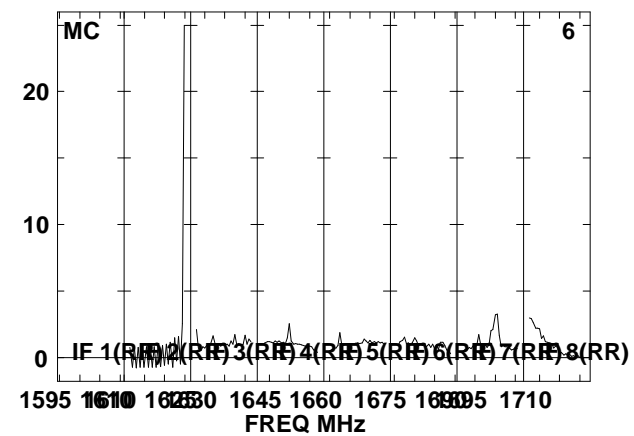
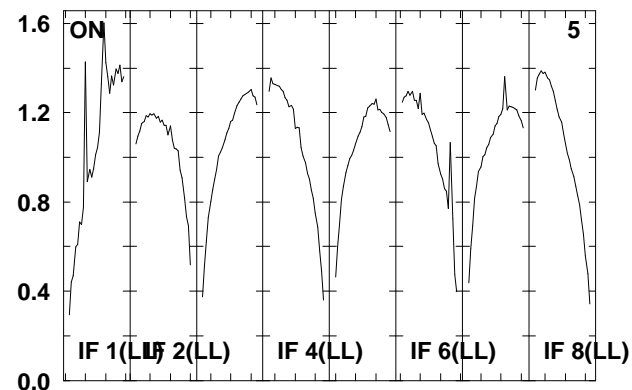
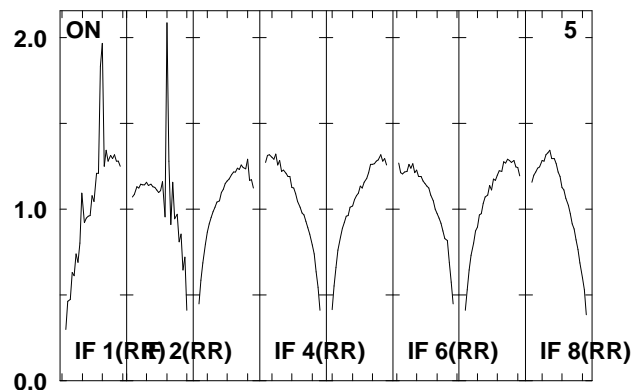
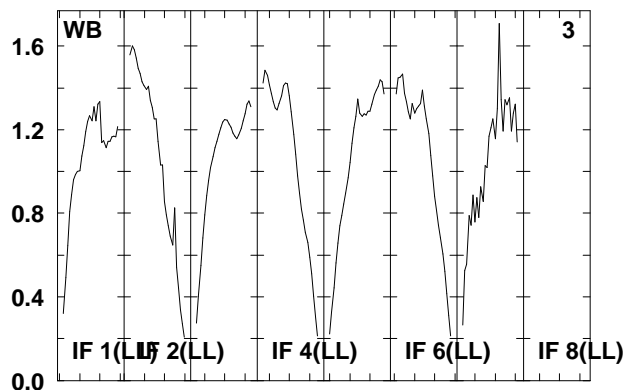
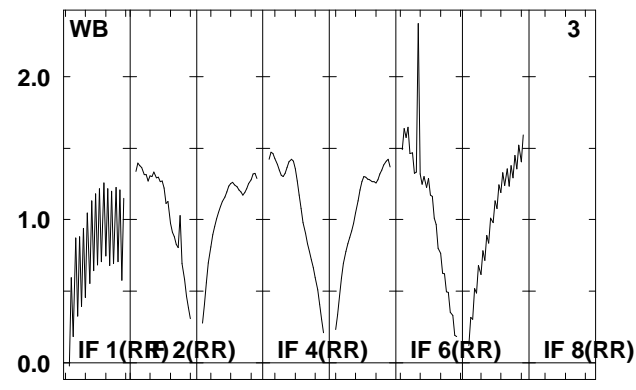
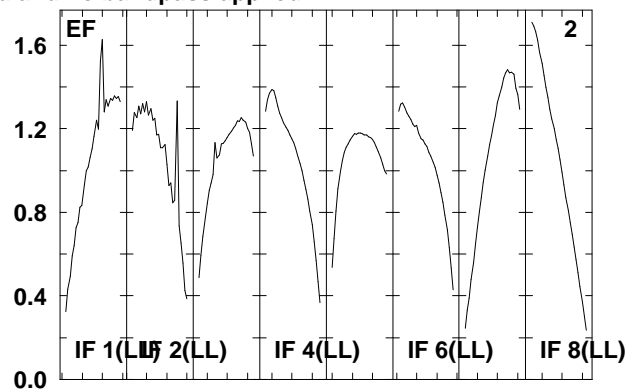
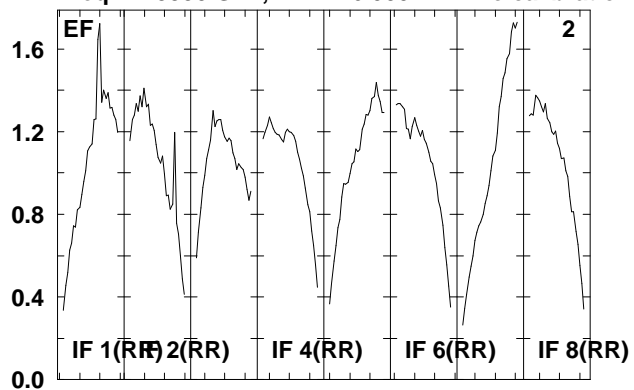

Lower frame: Real Jy
Total-power spectrum Antenna: *
Timerange: 00/16:16:02 to 00/16:17:30

Plot file version 14 created 22-APR-2008 12:25:17

J0730-02 EP061B.UVDATA.1

Freq = 1.5950 GHz, Bw = 16.000 MH No calibration applied and no bandpass applied

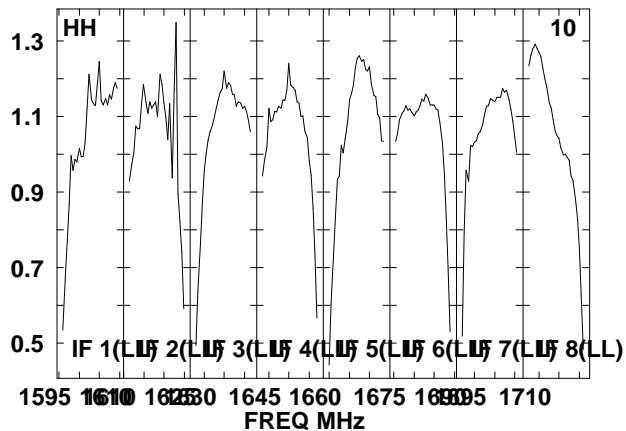
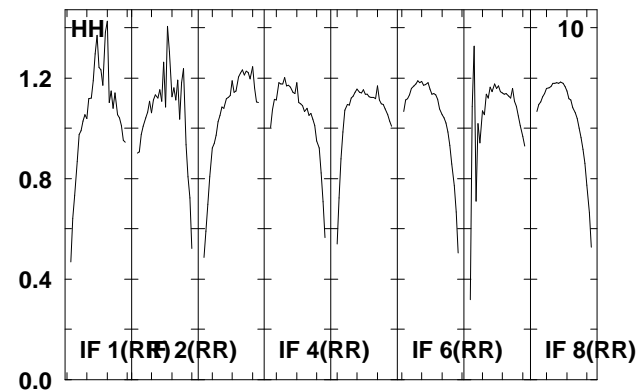
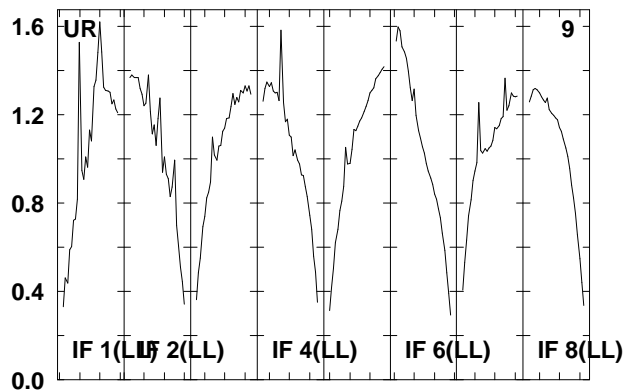
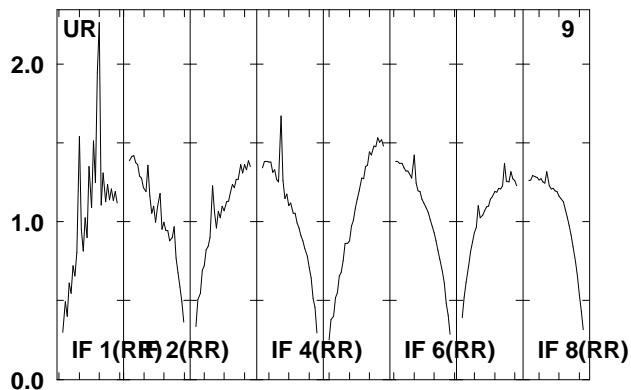
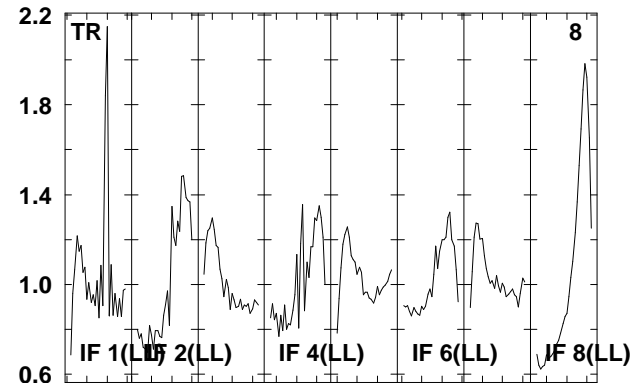
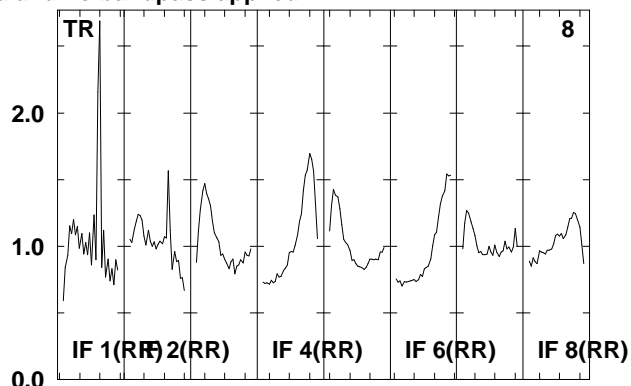
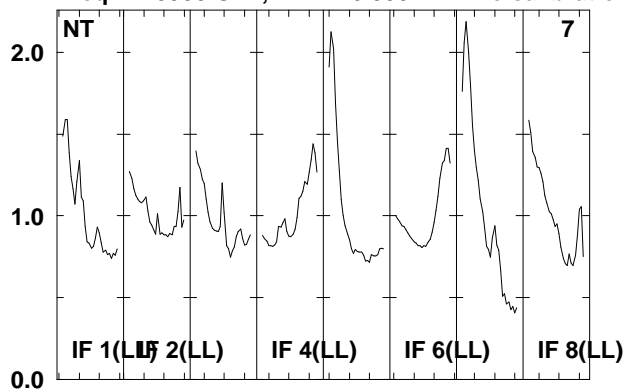

Lower frame: Real Jy

Total-power spectrum Antenna: *

Timerange: 00/16:16:02 to 00/16:17:30

Plot file version 15 created 22-APR-2008 12:25:18

IRAS0725 EP061B.UVDATA.1

Freq = 1.5950 GHz, Bw = 16.000 MH No calibration applied and no bandpass applied

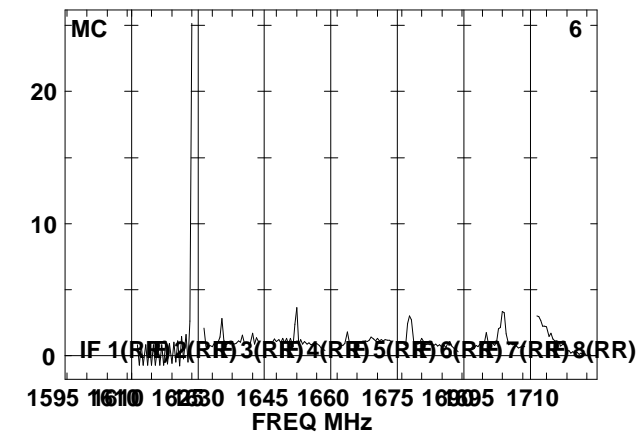
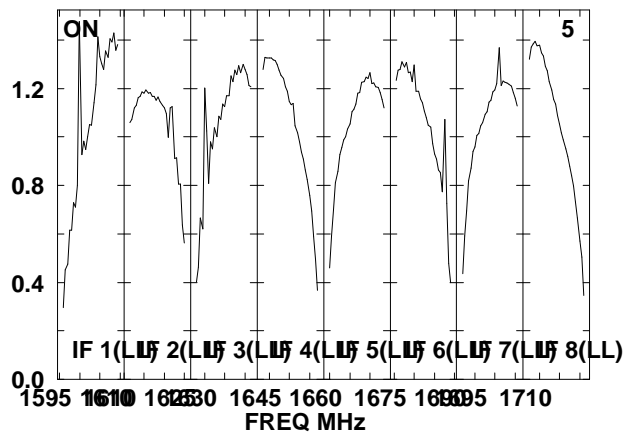
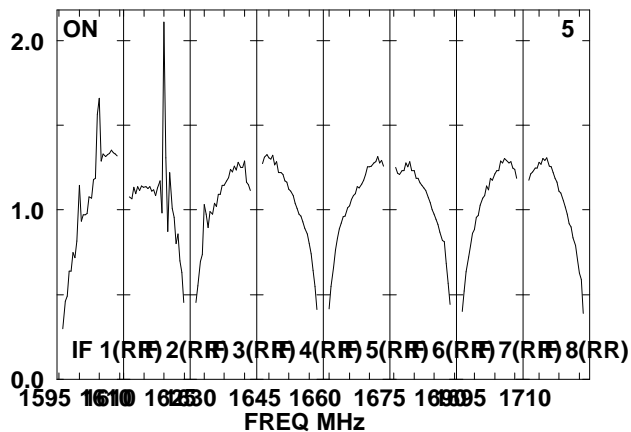
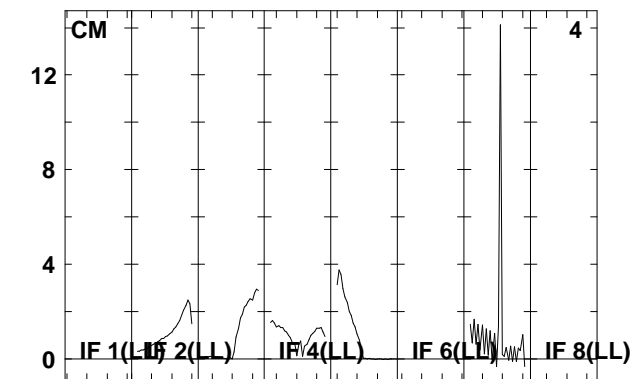
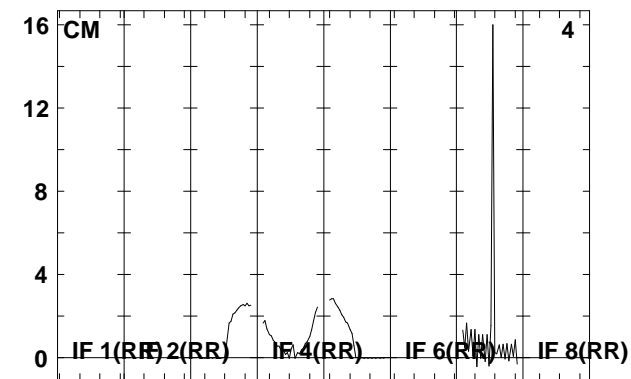
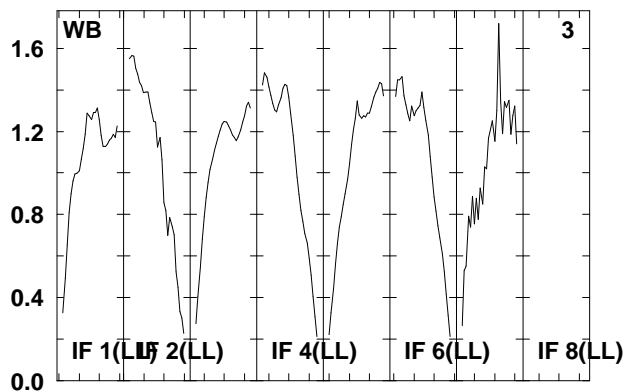
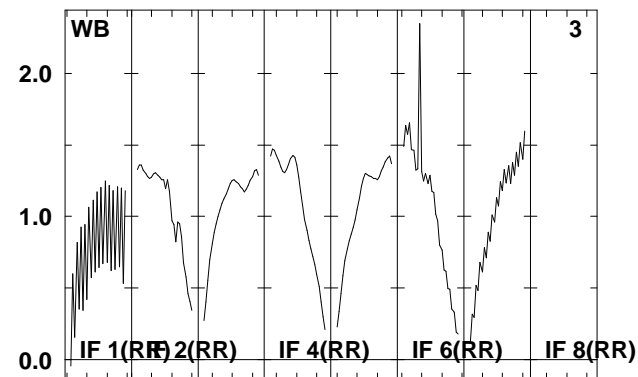
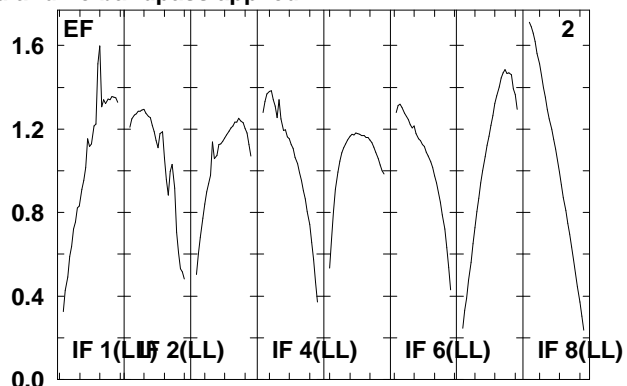
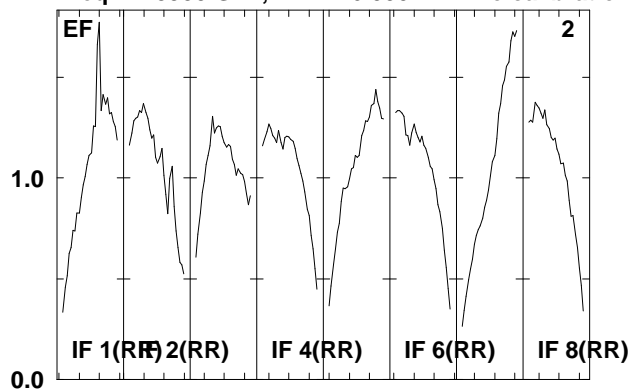

Lower frame: Real Jy

Total-power spectrum Antenna: *

Timerange: 00/16:17:32 to 00/16:21:00

Plot file version 16 created 22-APR-2008 12:25:19

IRAS0725 EP061B.UVDATA.1

Freq = 1.5950 GHz, Bw = 16.000 MH No calibration applied and no bandpass applied

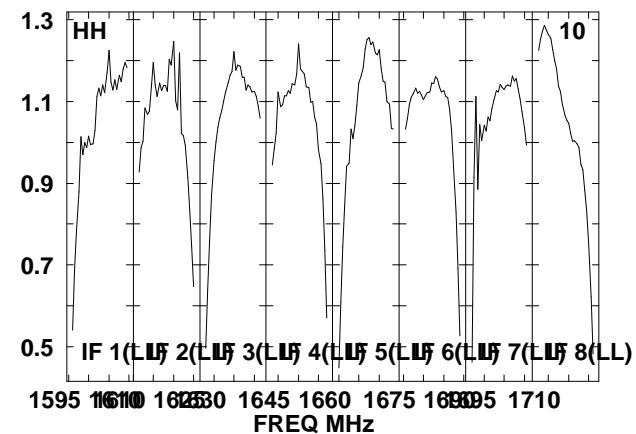
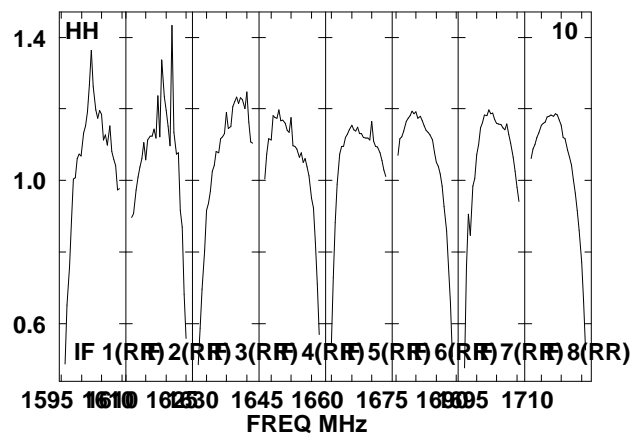
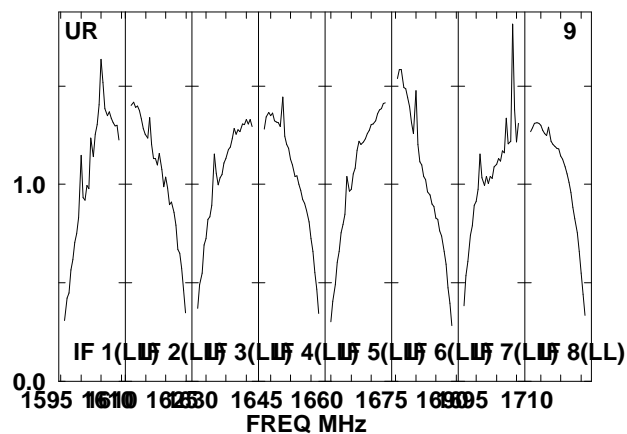
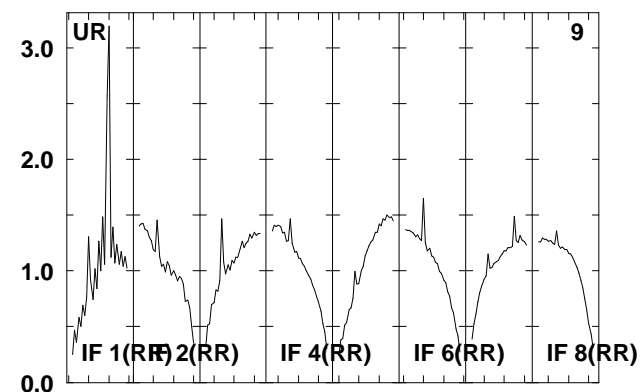
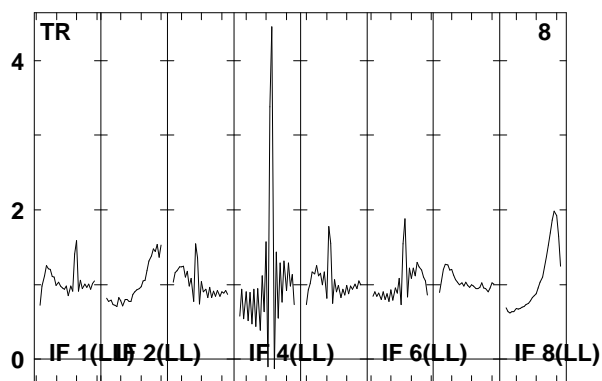
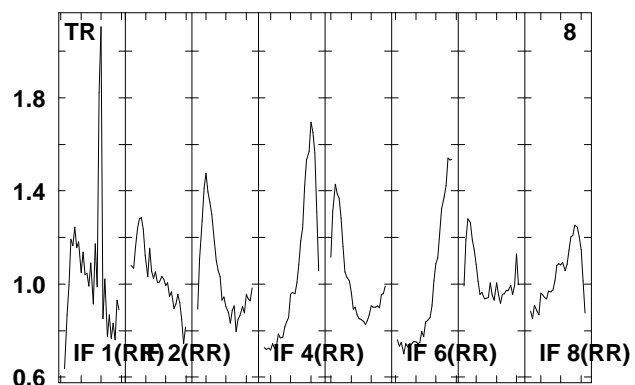
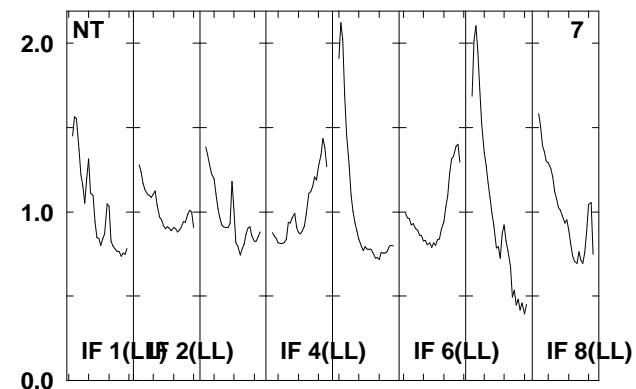
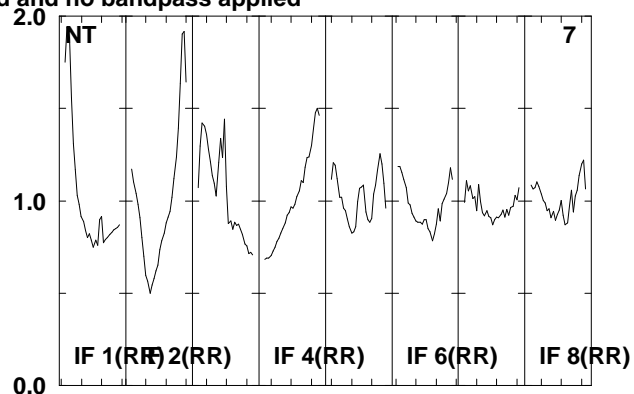
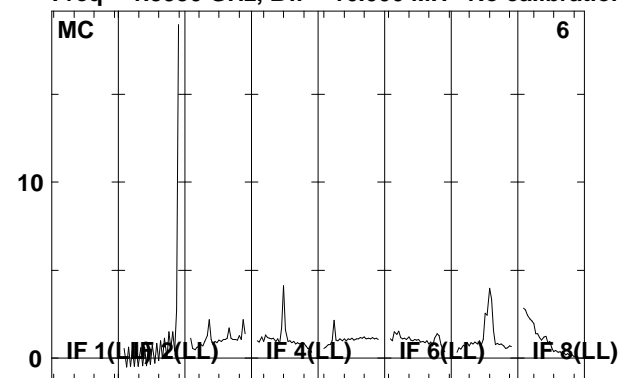

Lower frame: Real Jy

Total-power spectrum Antenna: *

Timerange: 00/16:17:32 to 00/16:21:00

Plot file version 17 created 22-APR-2008 12:25:20

J0730-02 EP061B.UVDATA.1

Freq = 1.5950 GHz, Bw = 16.000 MH No calibration applied and no bandpass applied

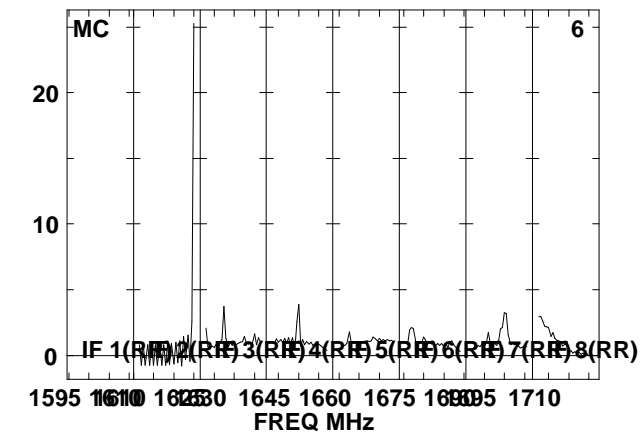
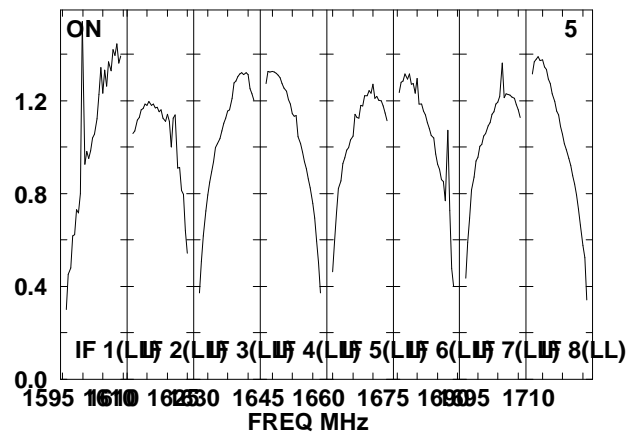
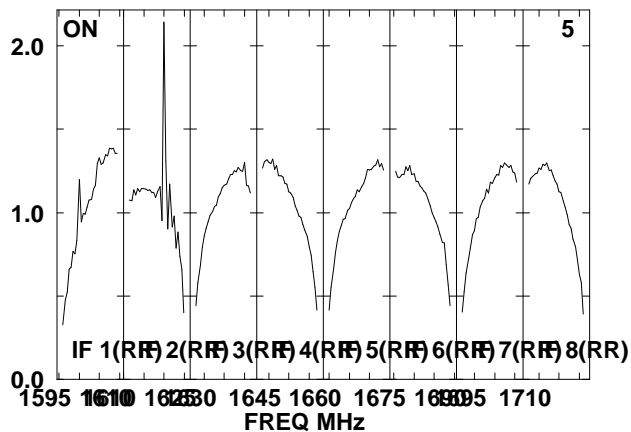
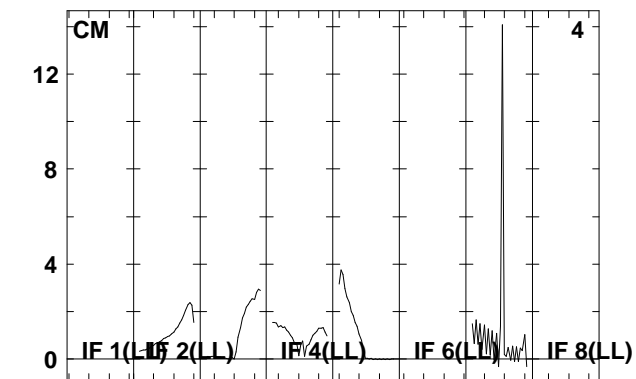
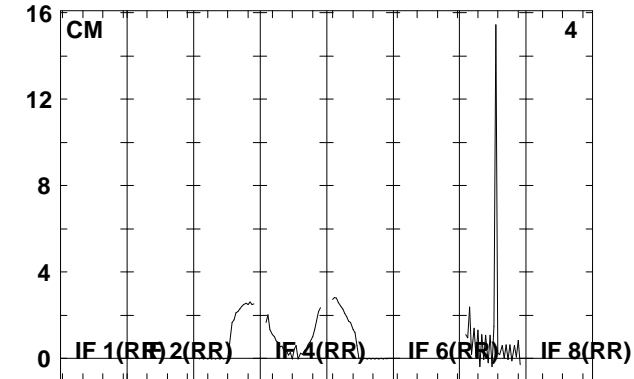
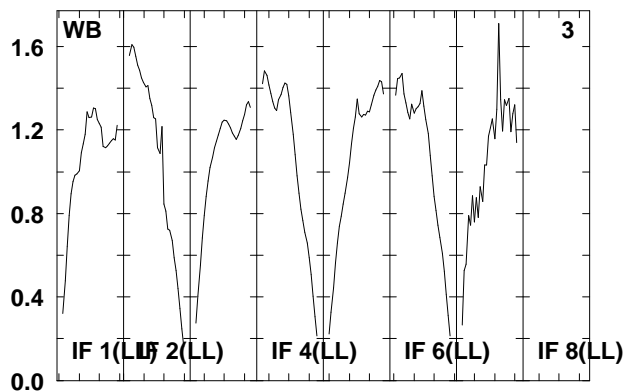
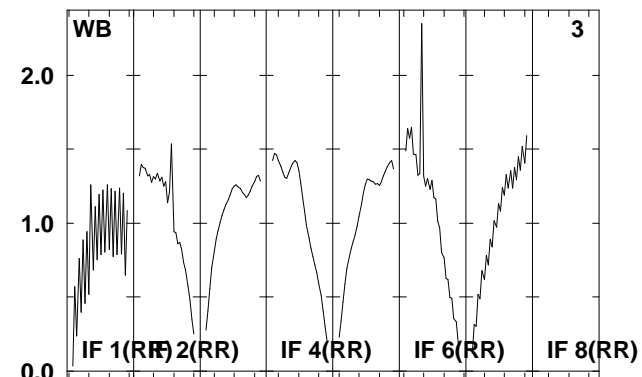
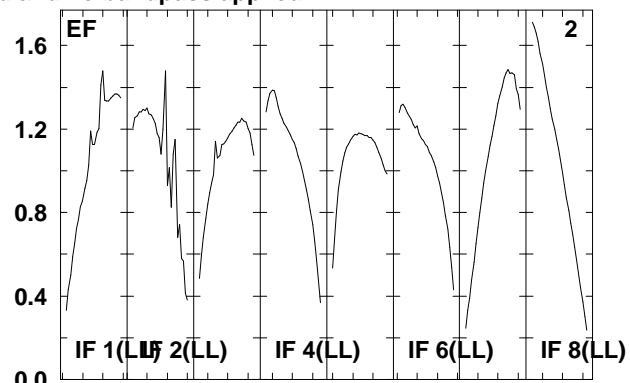
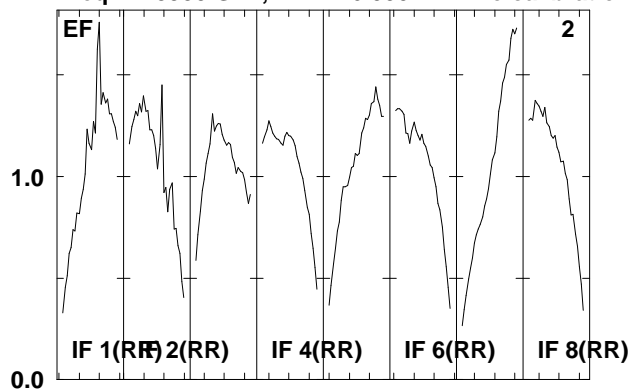

Lower frame: Real Jy
Total-power spectrum Antenna: *
Timerange: 00/16:21:02 to 00/16:22:30

Plot file version 18 created 22-APR-2008 12:25:20

J0730-02 EP061B.UVDATA.1

Freq = 1.5950 GHz, Bw = 16.000 MH No calibration applied and no bandpass applied

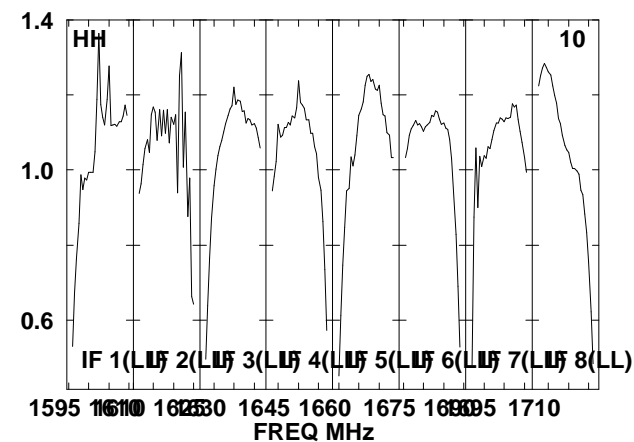
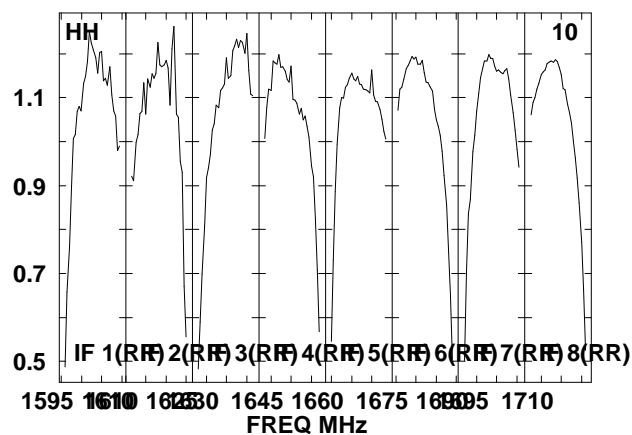
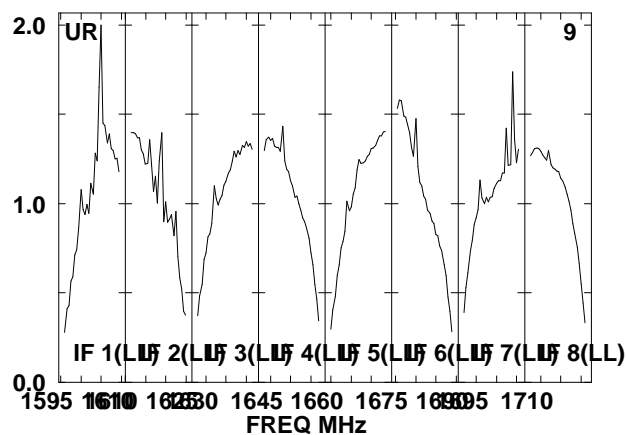
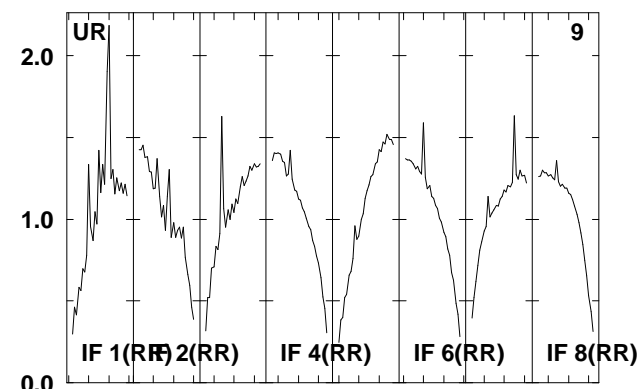
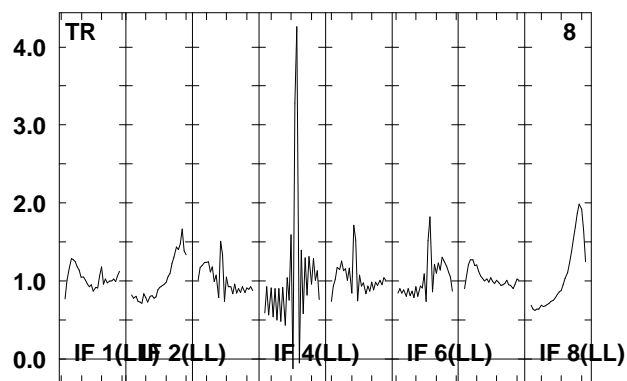
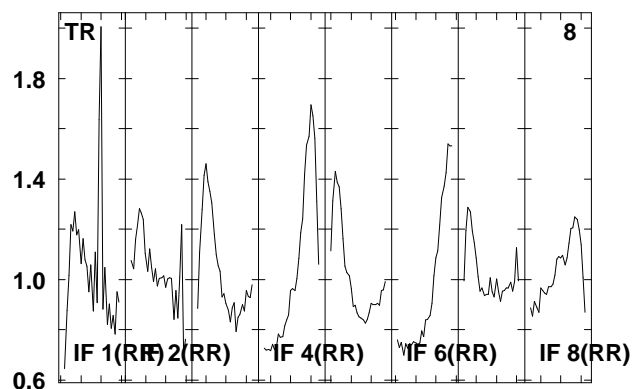
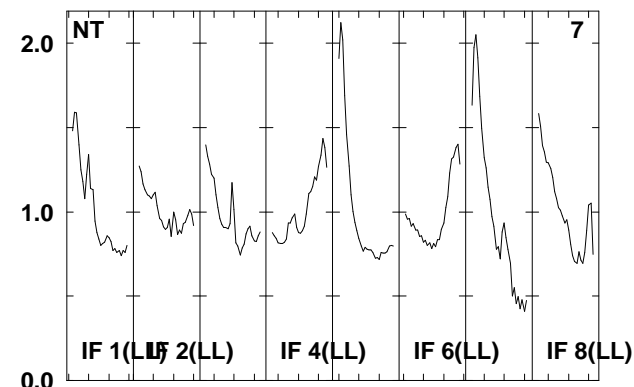
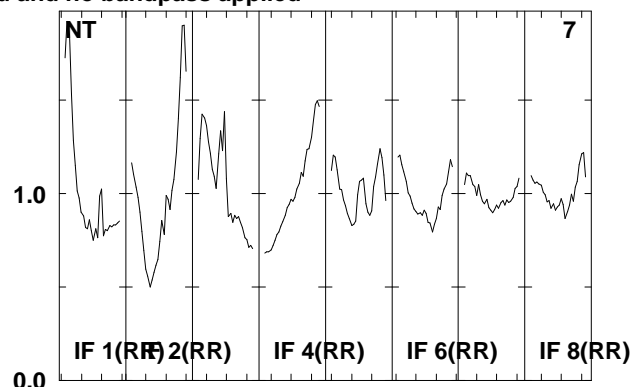
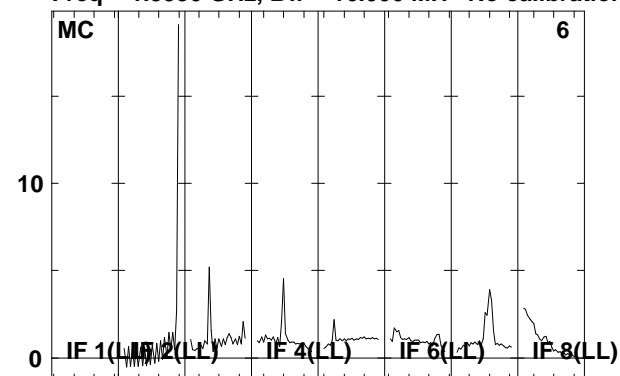

Lower frame: Real Jy

Total-power spectrum Antenna: *

Timerange: 00/16:21:02 to 00/16:22:30

Plot file version 19 created 22-APR-2008 12:25:21
 IRAS0725 EP061B.UVDATA.1
 Freq = 1.5950 GHz, Bw = 16.000 MH No calibration applied and no bandpass applied

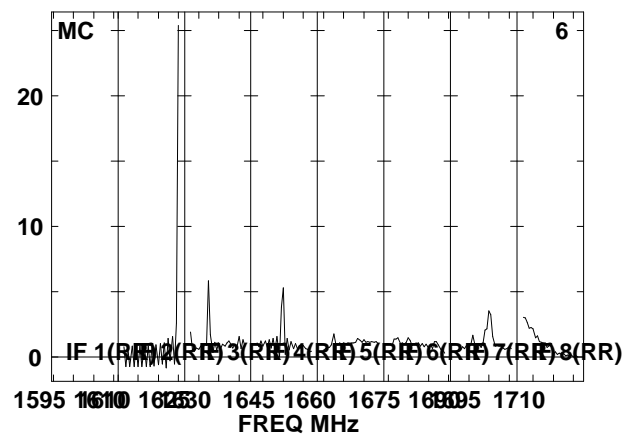
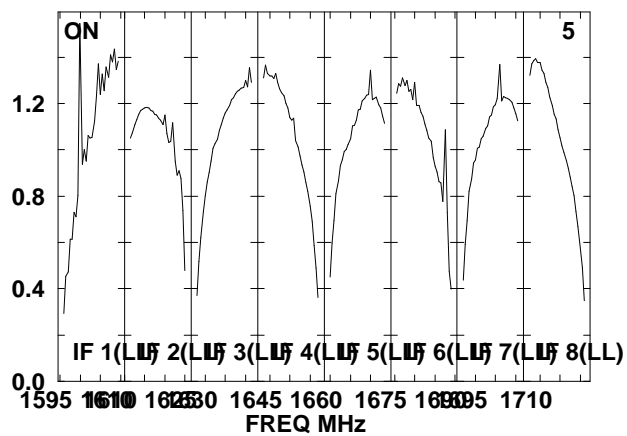
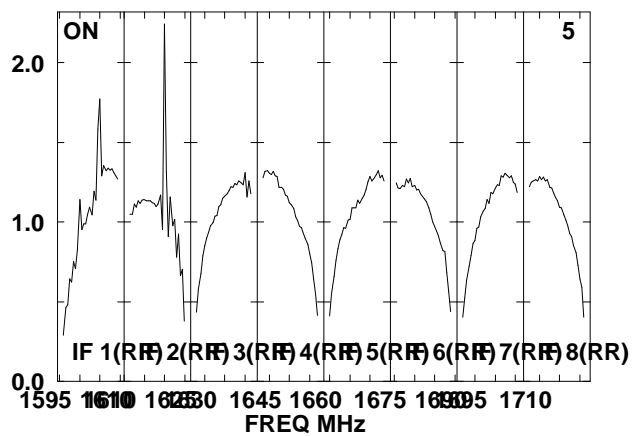
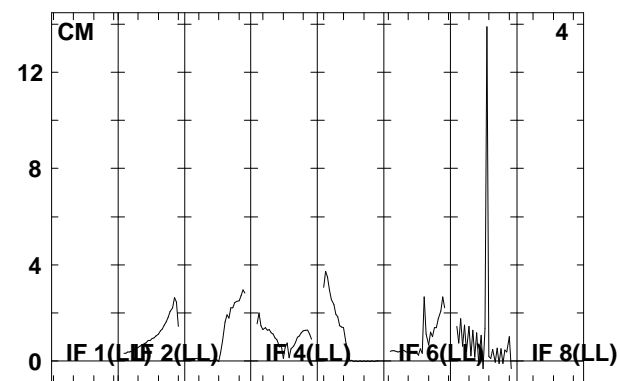
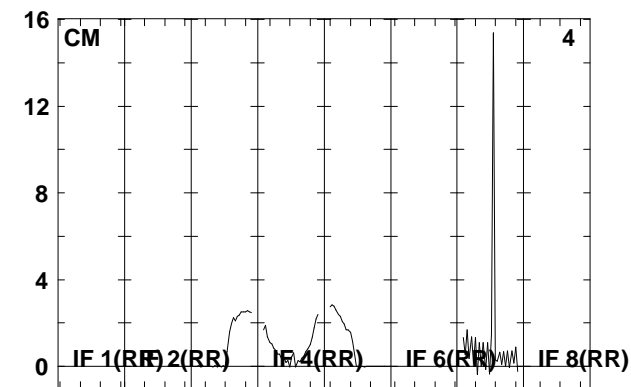
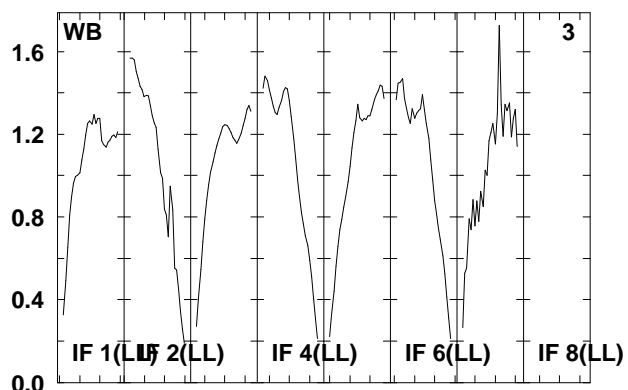
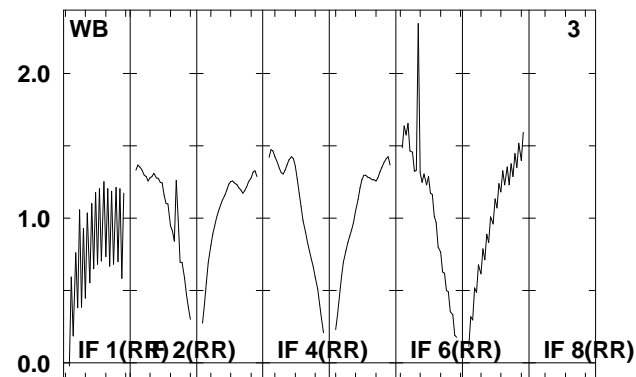
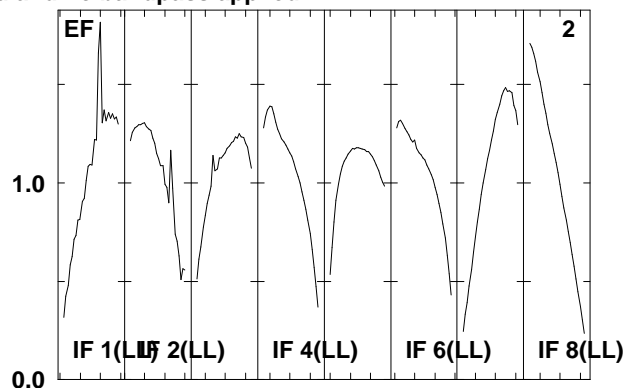
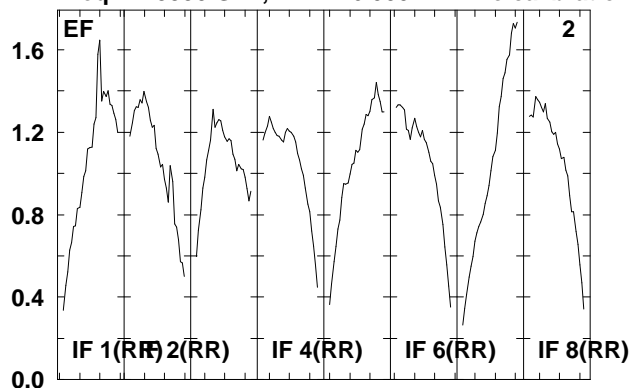

Lower frame: Real Jy
 Total-power spectrum Antenna: *
 Timerange: 00/16:22:32 to 00/16:26:00

Plot file version 20 created 22-APR-2008 12:25:22

IRAS0725 EP061B.UVDATA.1

Freq = 1.5950 GHz, Bw = 16.000 MH No calibration applied and no bandpass applied

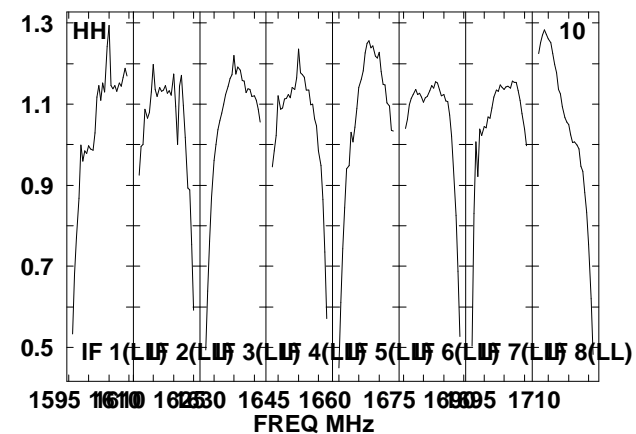
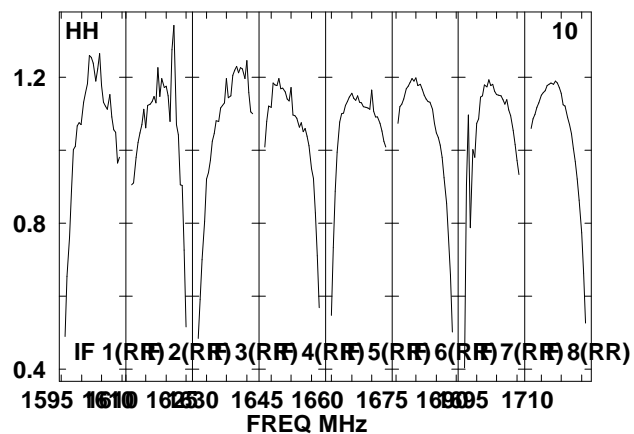
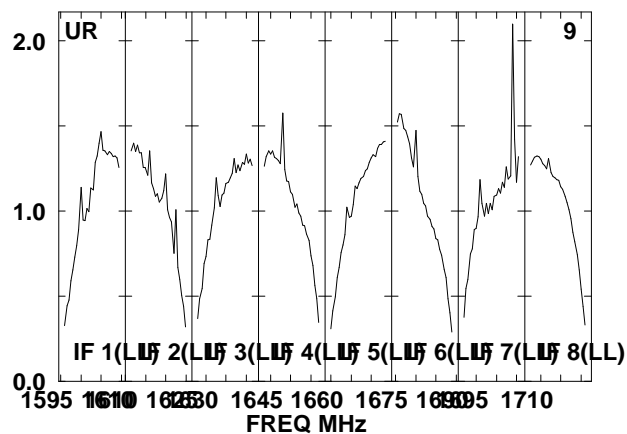
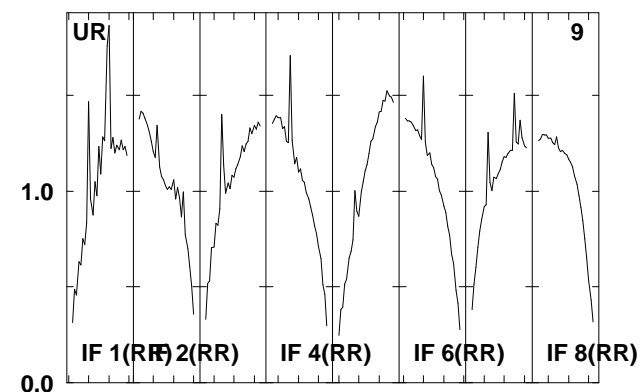
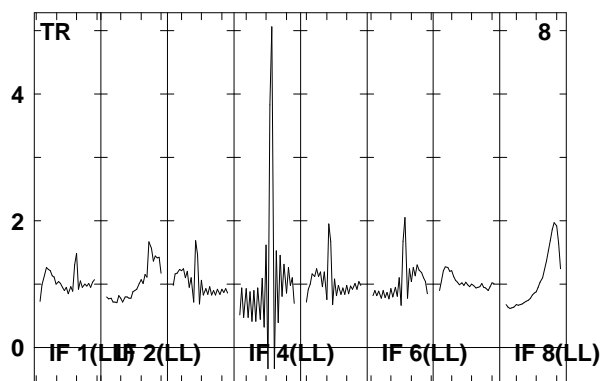
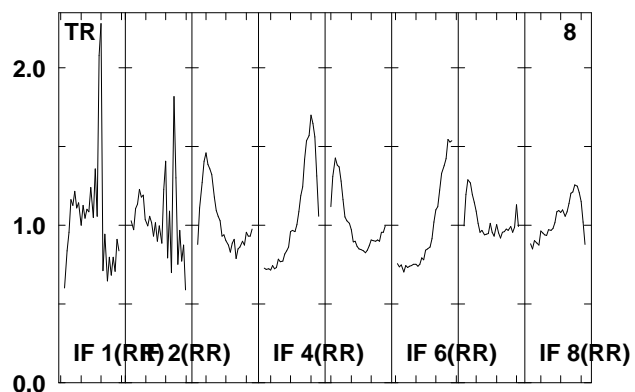
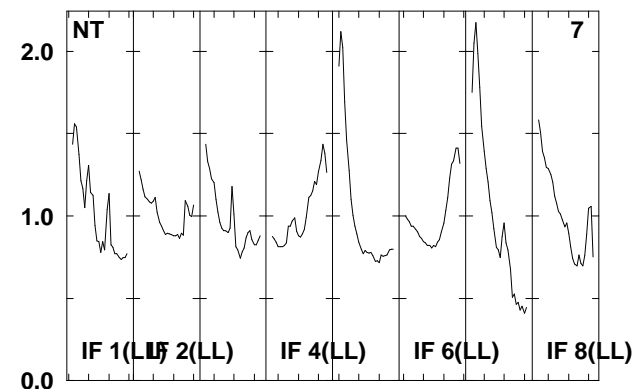
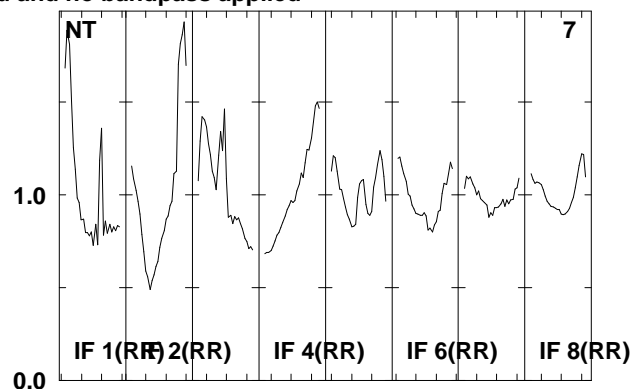
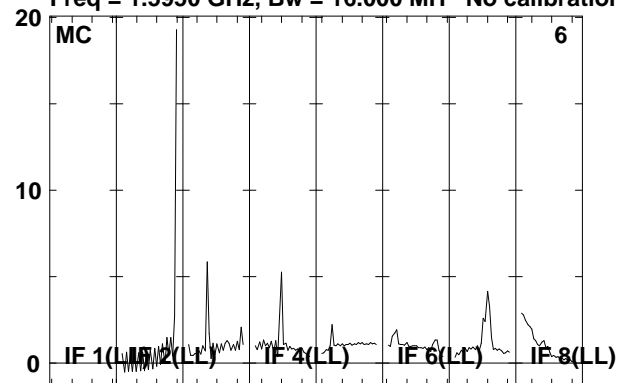

Lower frame: Real Jy

Total-power spectrum Antenna: *

Timerange: 00/16:22:32 to 00/16:26:00

Plot file version 21 created 22-APR-2008 12:25:23

J0730-02 EP061B.UVDATA.1

Freq = 1.5950 GHz, Bw = 16.000 MH No calibration applied and no bandpass applied

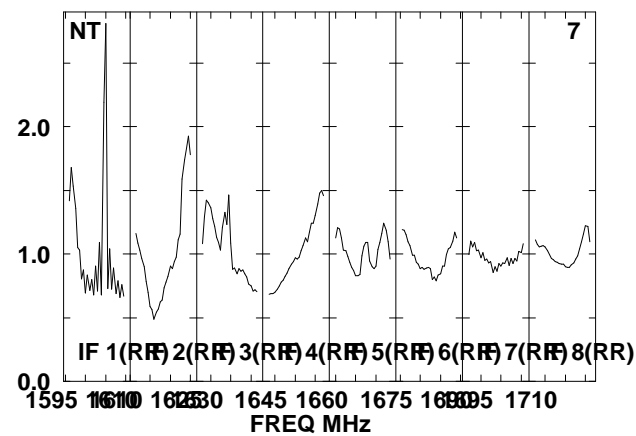
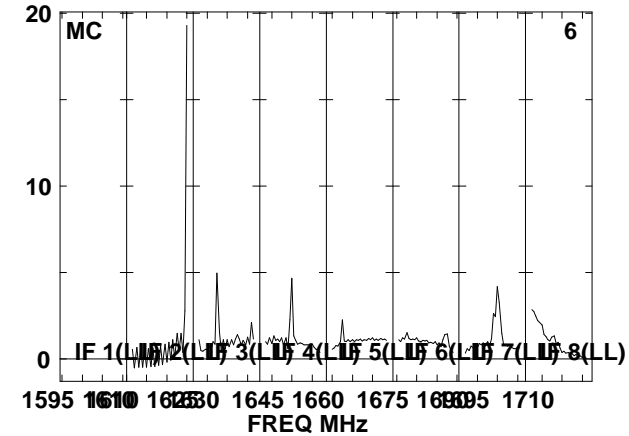
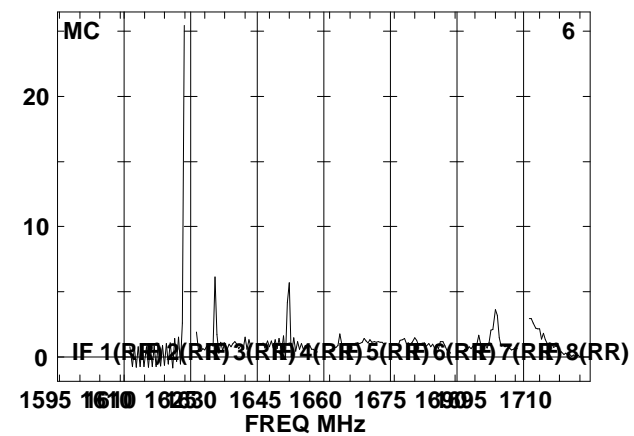
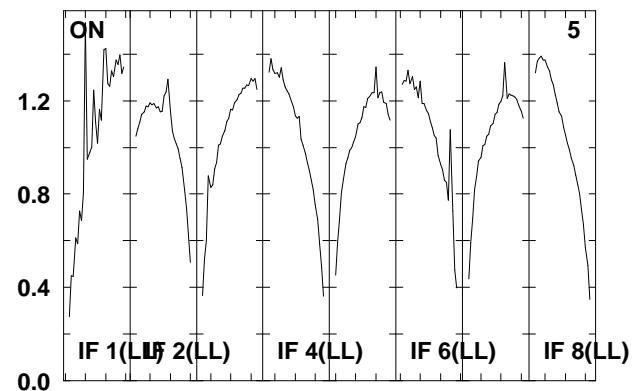
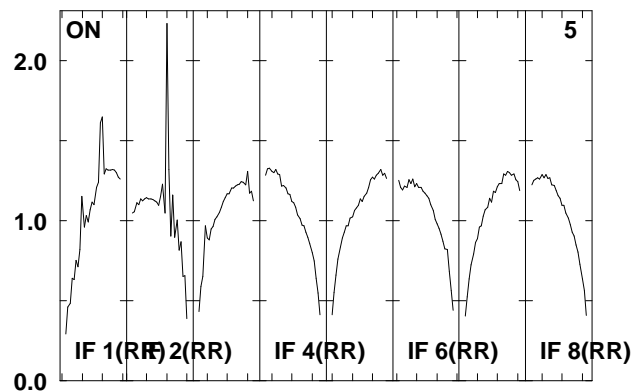
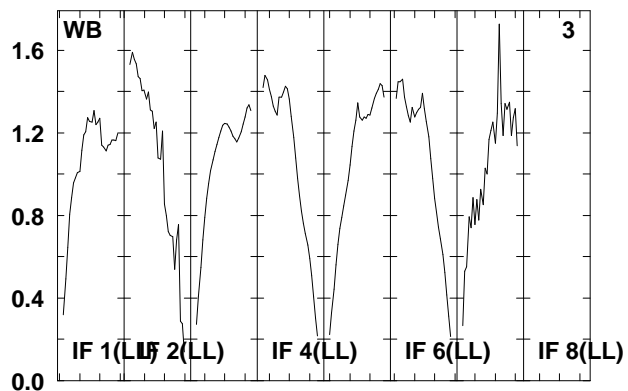
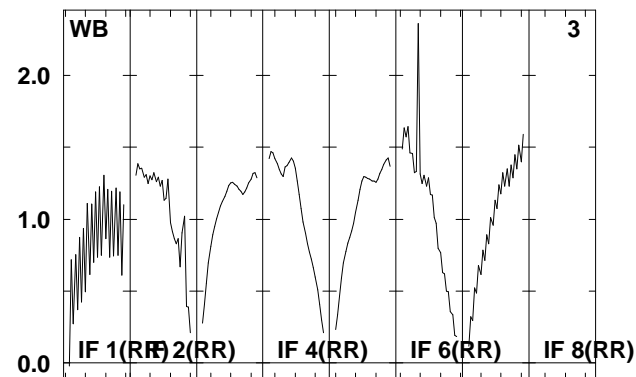
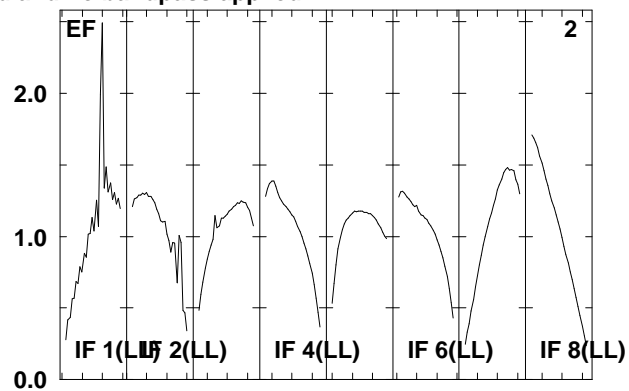
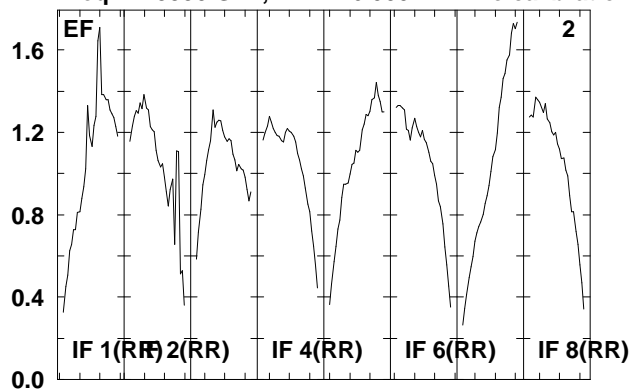

Lower frame: Real Jy
Total-power spectrum Antenna: *
Timerange: 00/16:26:02 to 00/16:27:30

Plot file version 22 created 22-APR-2008 12:25:24

J0730-02 EP061B.UVDATA.1

Freq = 1.5950 GHz, Bw = 16.000 MH No calibration applied and no bandpass applied

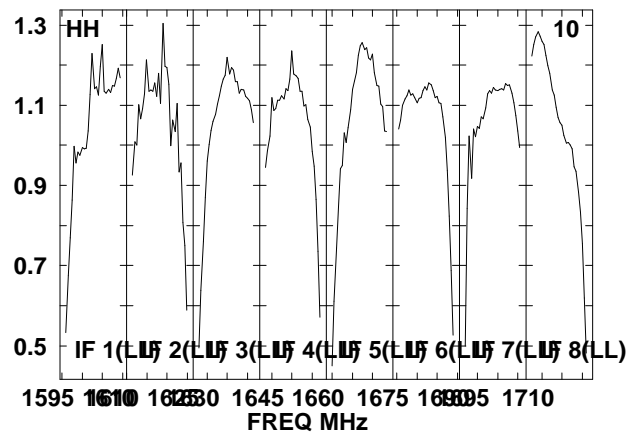
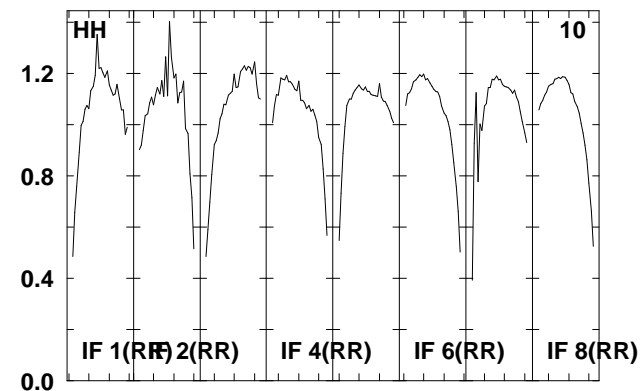
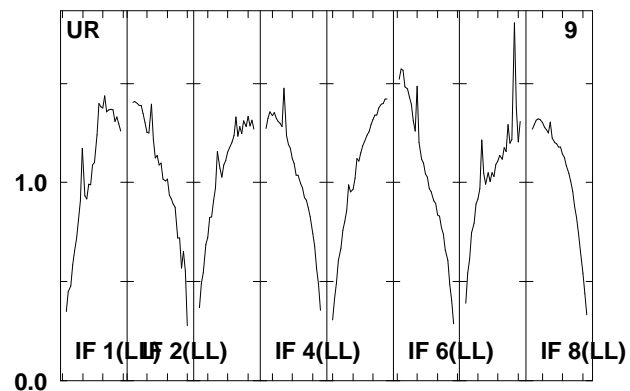
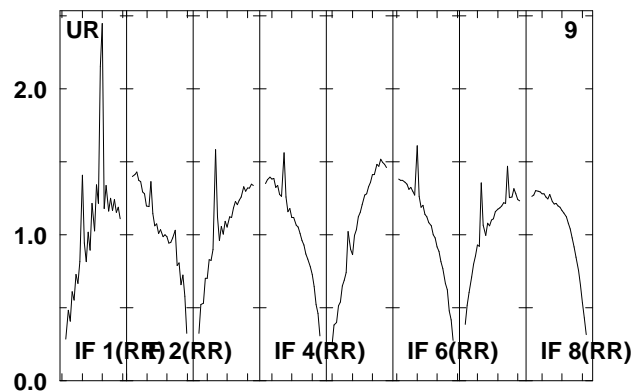
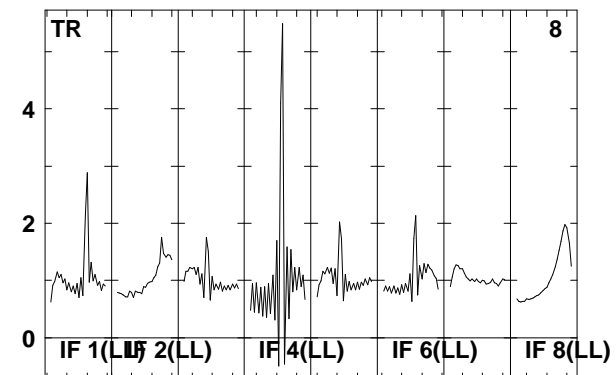
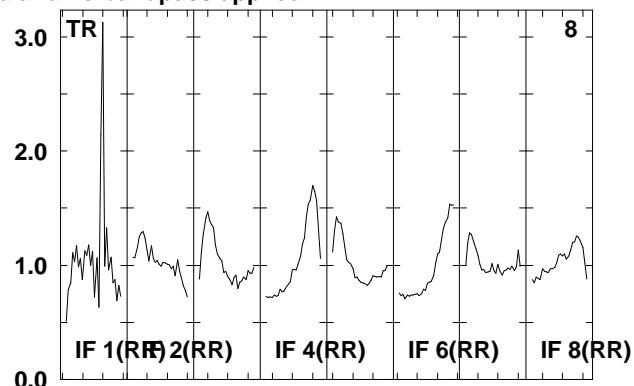
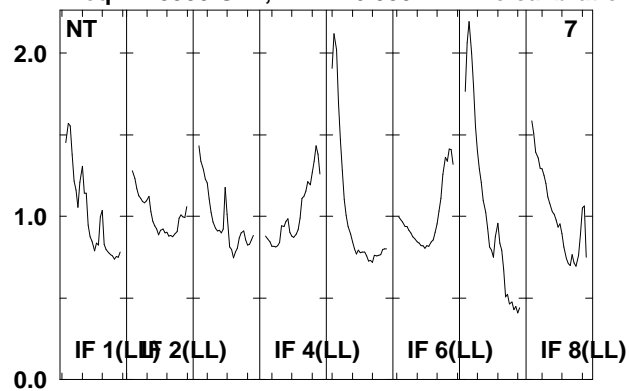

Lower frame: Real Jy

Total-power spectrum Antenna: *

Timerange: 00/16:26:02 to 00/16:27:30

Plot file version 23 created 22-APR-2008 12:25:25

IRAS0725 EP061B.UVDATA.1

Freq = 1.5950 GHz, Bw = 16.000 MH No calibration applied and no bandpass applied

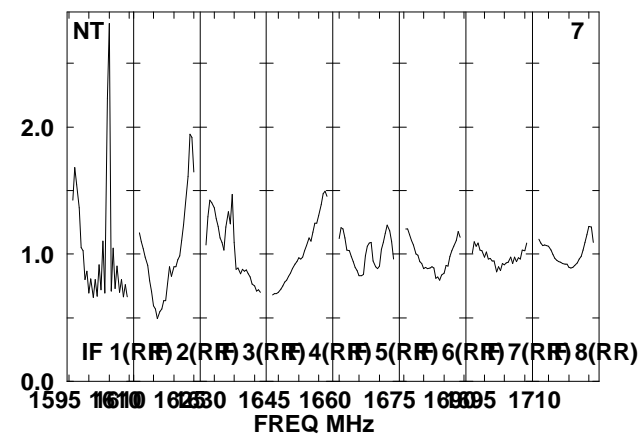
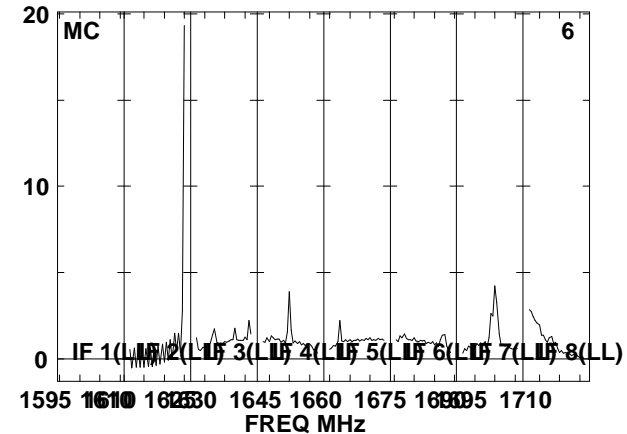
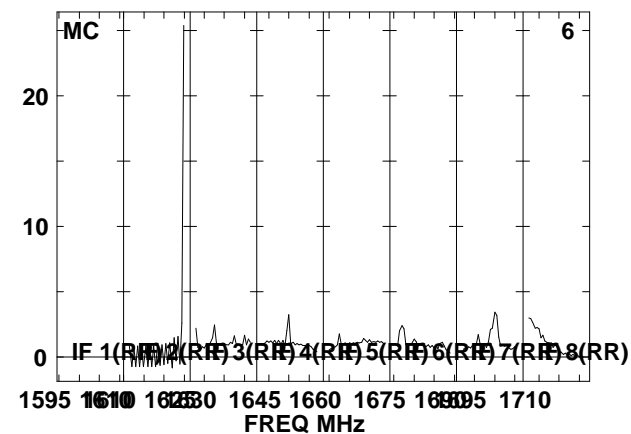
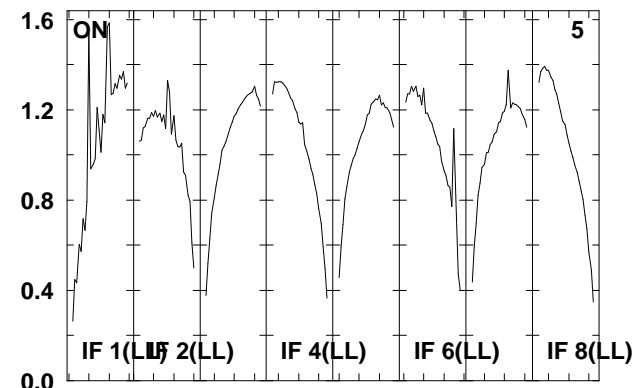
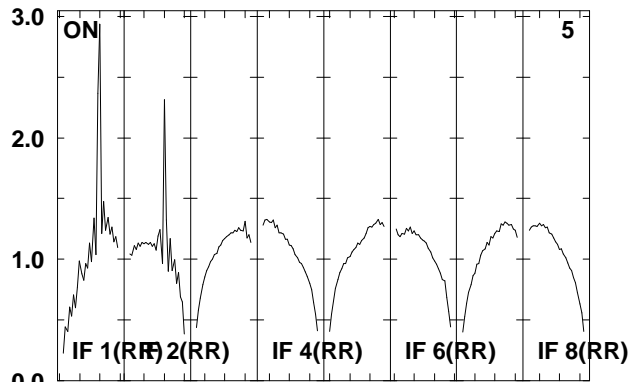
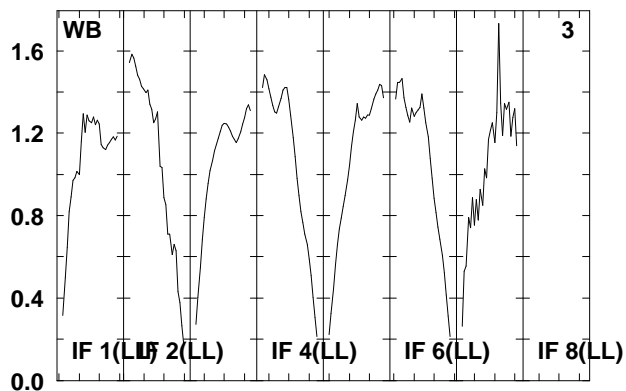
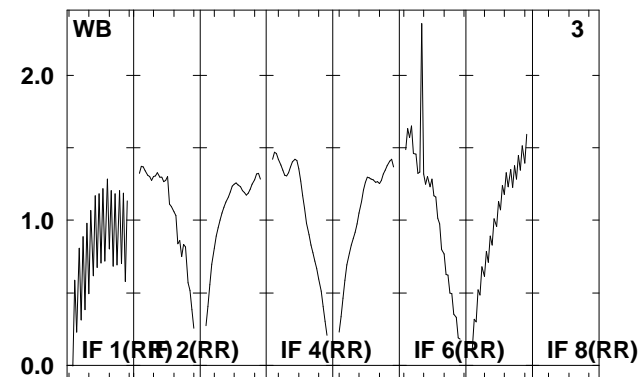
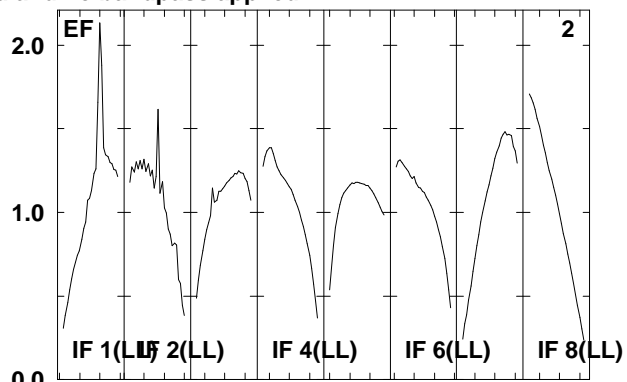
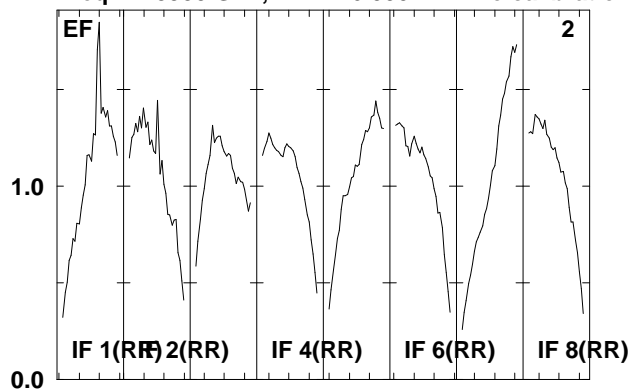

Lower frame: Real Jy
Total-power spectrum Antenna: *
Timerange: 00/16:27:32 to 00/16:30:58

Plot file version 24 created 22-APR-2008 12:25:26

IRAS0725 EP061B.UVDATA.1

Freq = 1.5950 GHz, Bw = 16.000 MH No calibration applied and no bandpass applied

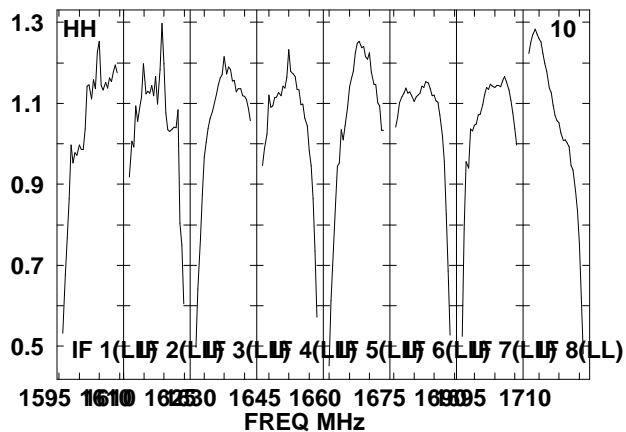
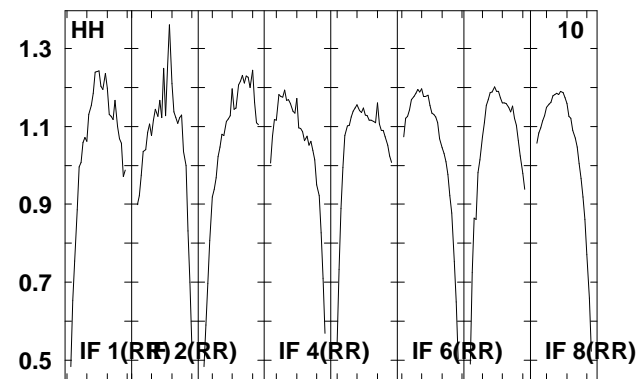
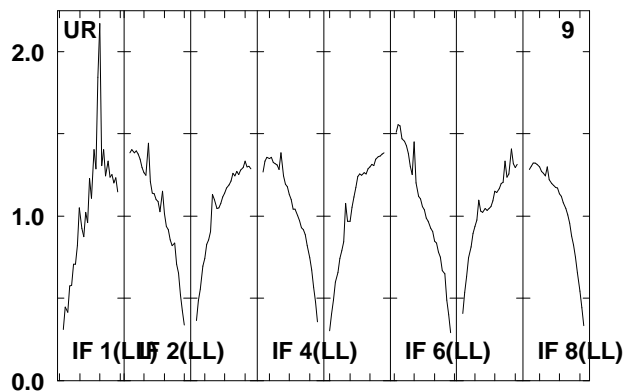
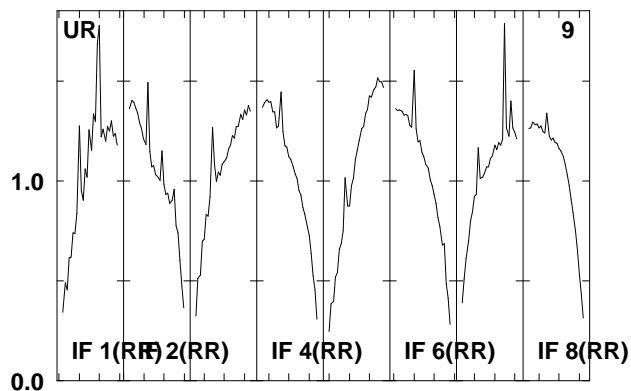
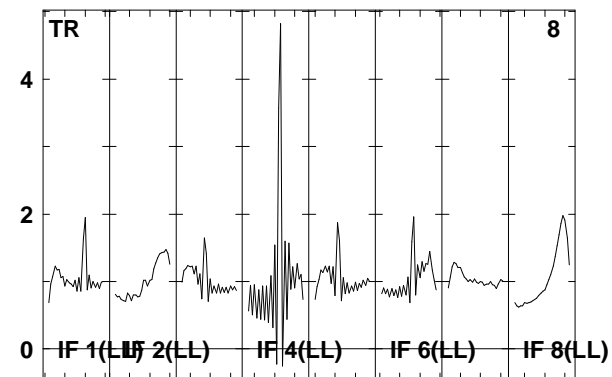
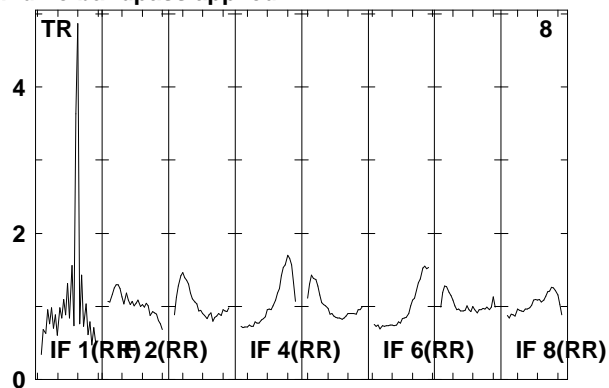
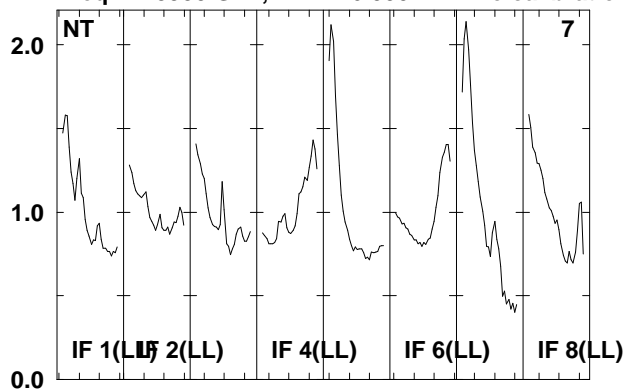

Lower frame: Real Jy

Total-power spectrum Antenna: *

Timerange: 00/16:27:32 to 00/16:30:58

Plot file version 25 created 22-APR-2008 12:25:27

J0730-02 EP061B.UVDATA.1

Freq = 1.5950 GHz, Bw = 16.000 MH No calibration applied and no bandpass applied

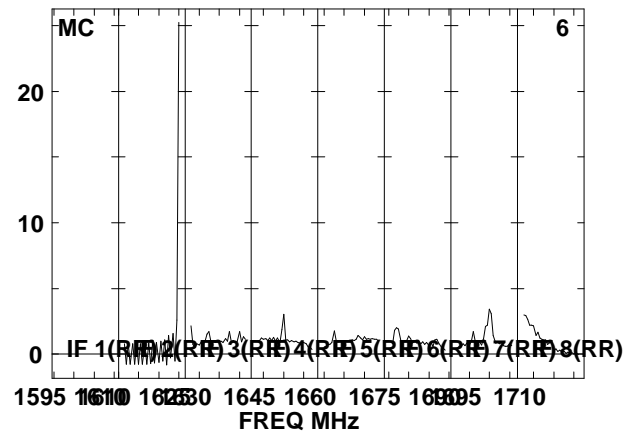
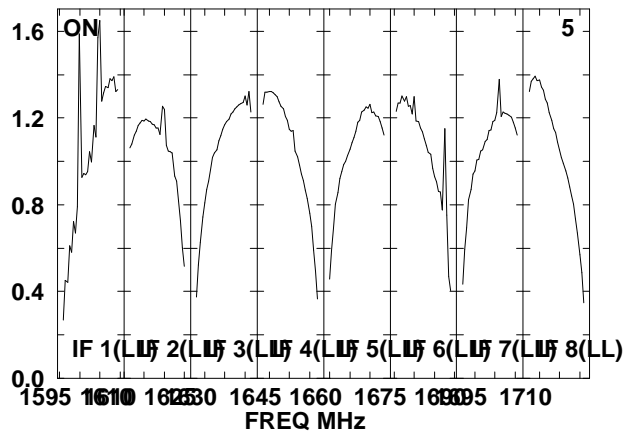
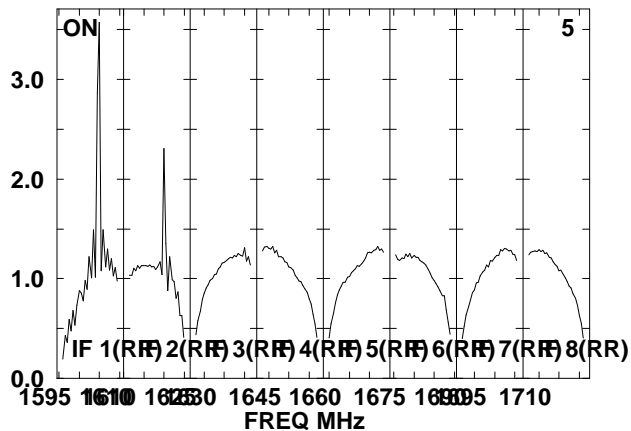
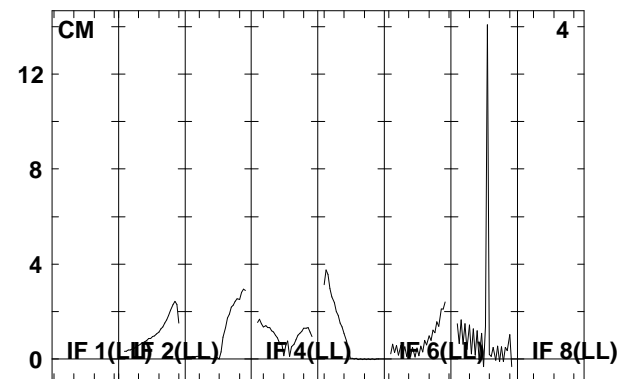
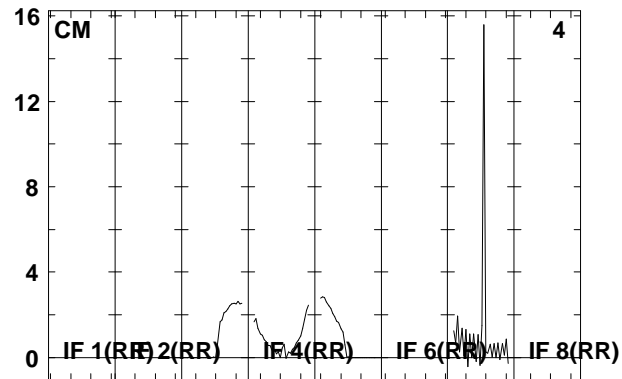
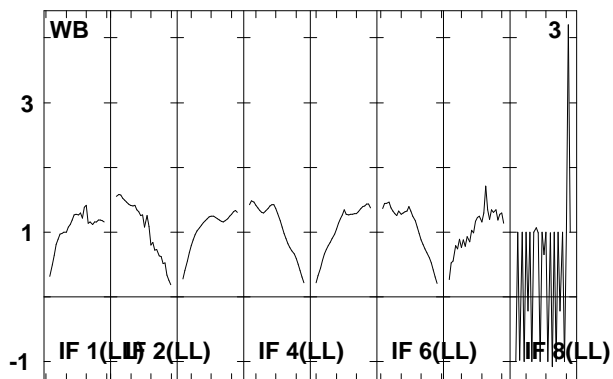
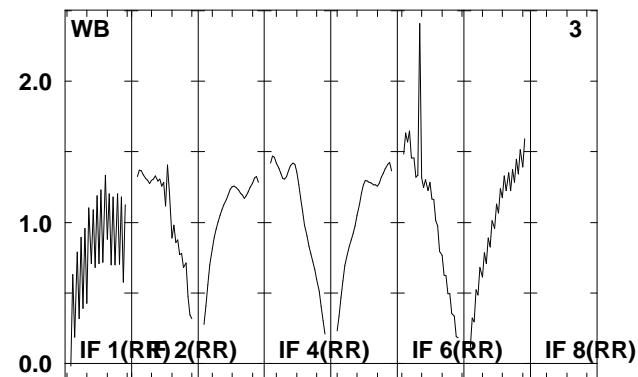
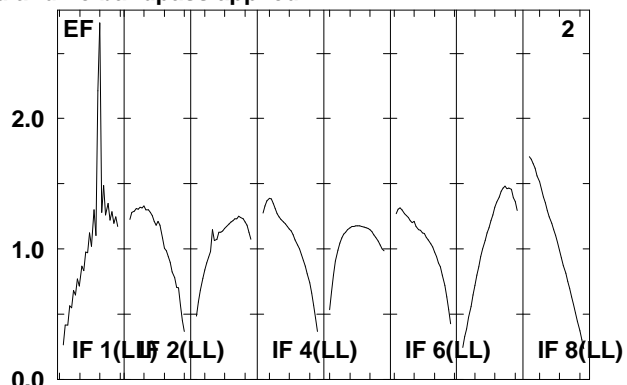
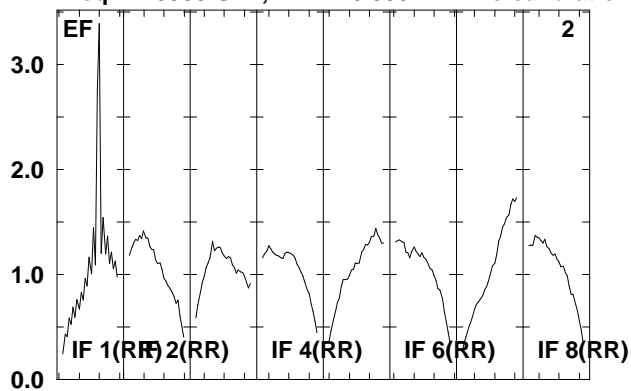

Lower frame: Real Jy
Total-power spectrum Antenna: *
Timerange: 00/16:32:02 to 00/16:33:30

Plot file version 26 created 22-APR-2008 12:25:27

J0730-02 EP061B.UVDATA.1

Freq = 1.5950 GHz, Bw = 16.000 MH No calibration applied and no bandpass applied

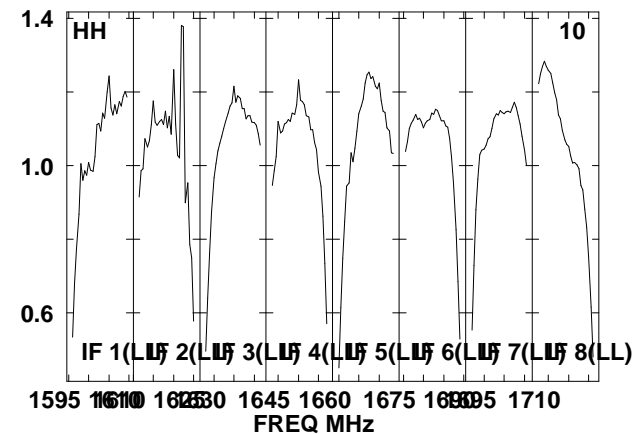
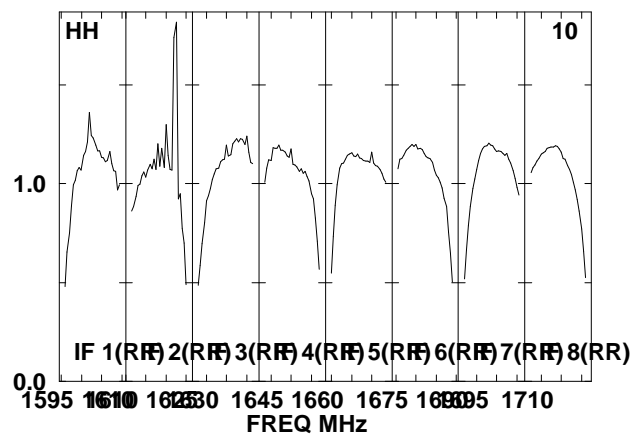
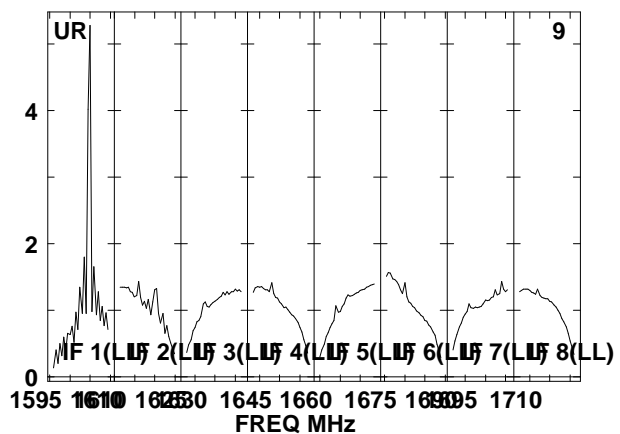
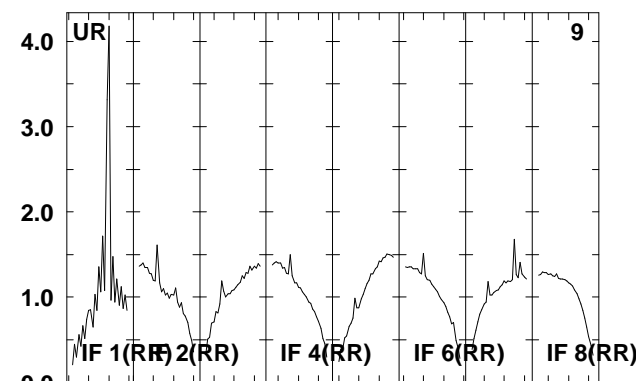
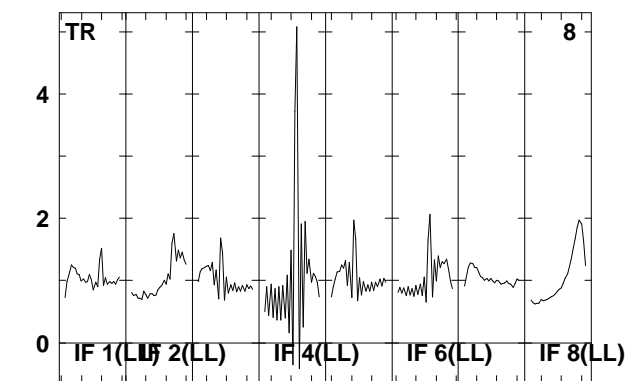
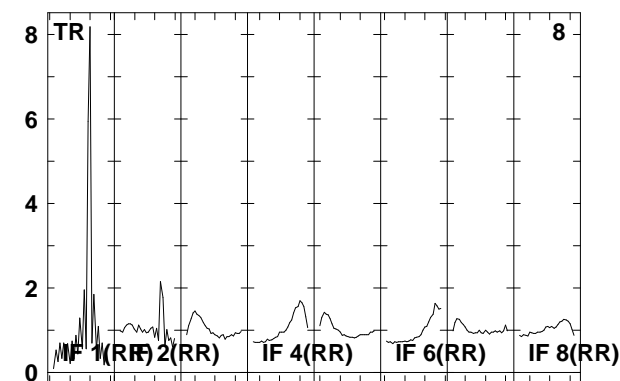
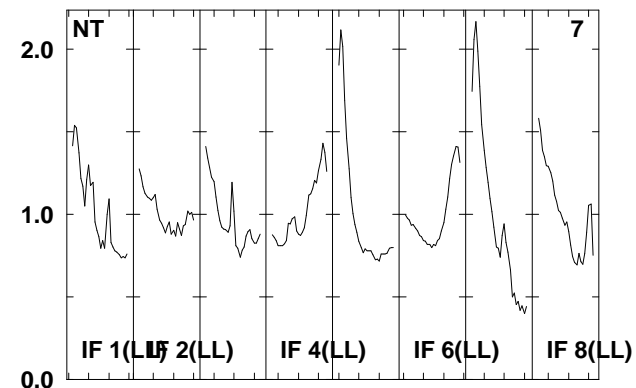
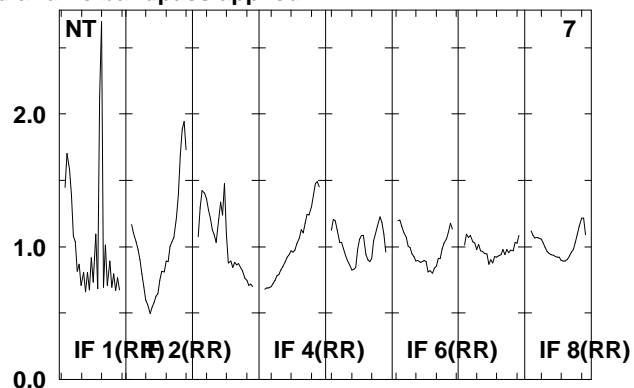
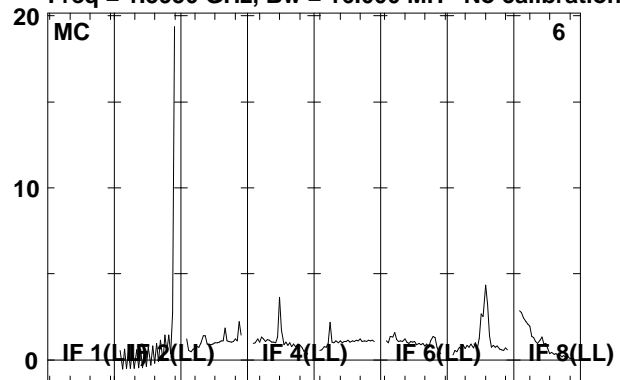

Lower frame: Real Jy

Total-power spectrum Antenna: *

Timerange: 00/16:32:02 to 00/16:33:30

Plot file version 27 created 22-APR-2008 12:25:28

IRAS0725 EP061B.UVDATA.1

Freq = 1.5950 GHz, Bw = 16.000 MH No calibration applied and no bandpass applied

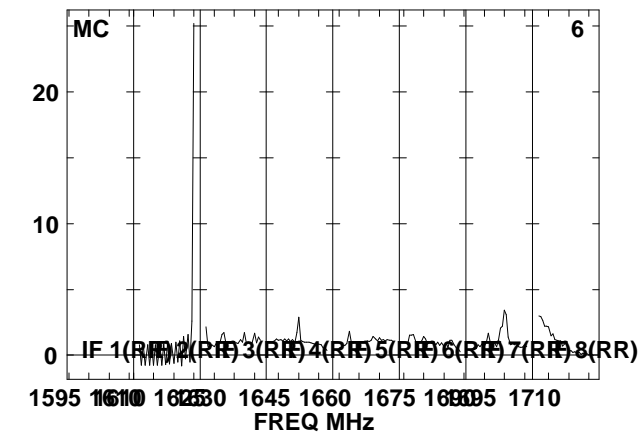
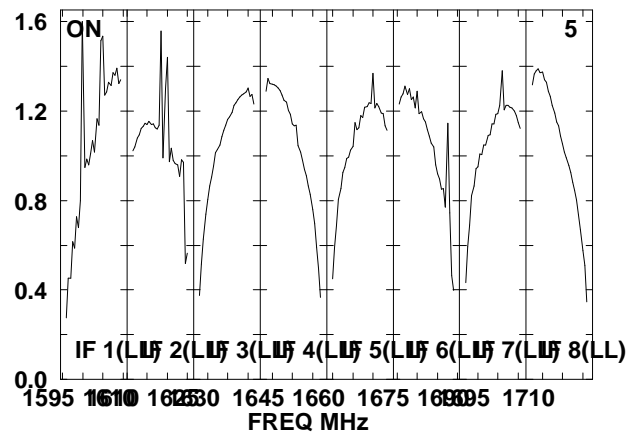
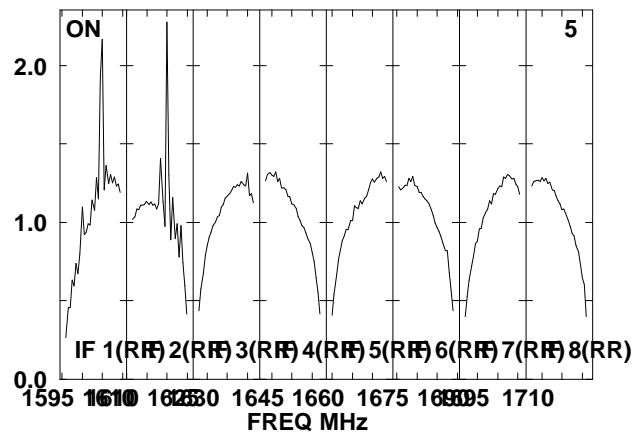
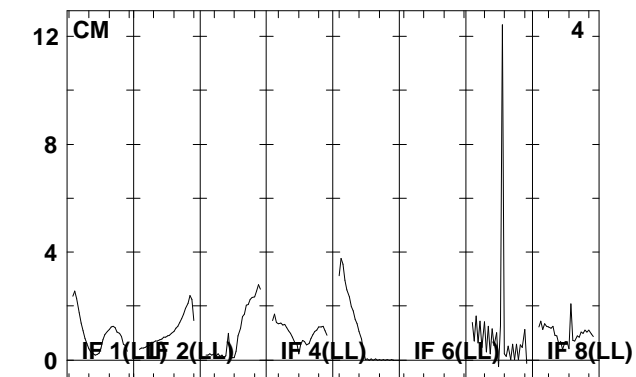
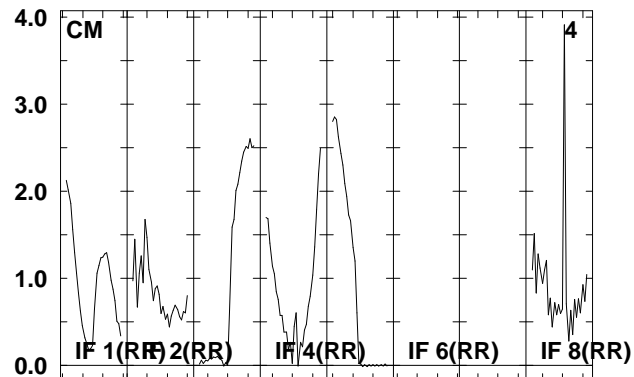
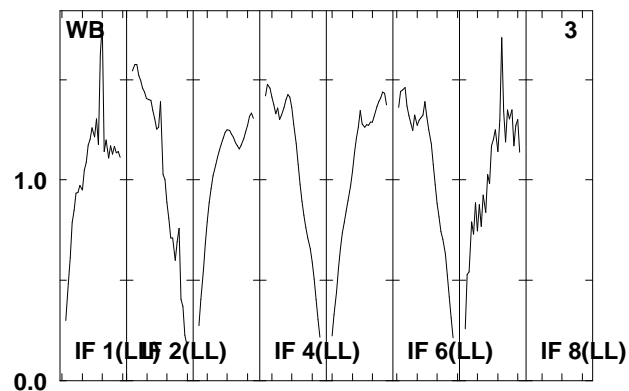
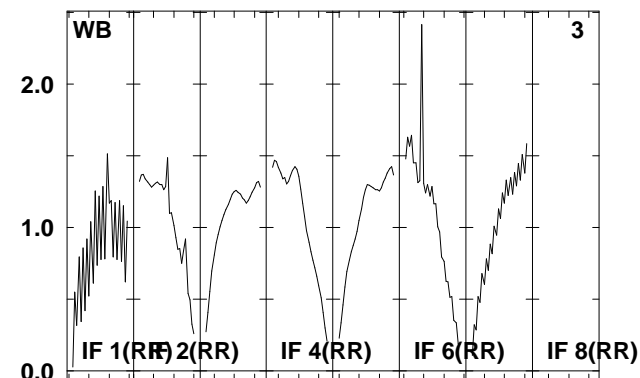
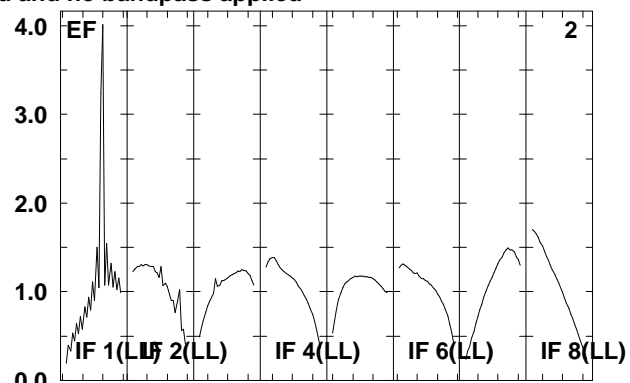
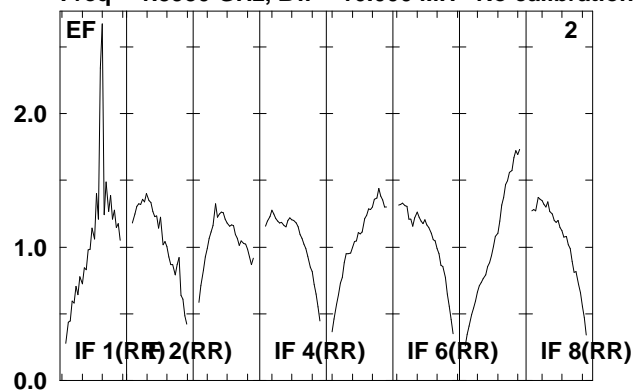

Lower frame: Real Jy
Total-power spectrum Antenna: *
Timerange: 00/16:33:32 to 00/16:37:00

Plot file version 28 created 22-APR-2008 12:25:29

IRAS0725 EP061B.UVDATA.1

Freq = 1.5950 GHz, Bw = 16.000 MH No calibration applied and no bandpass applied

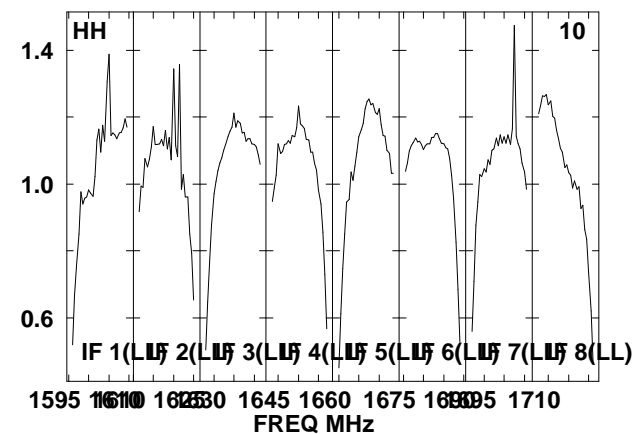
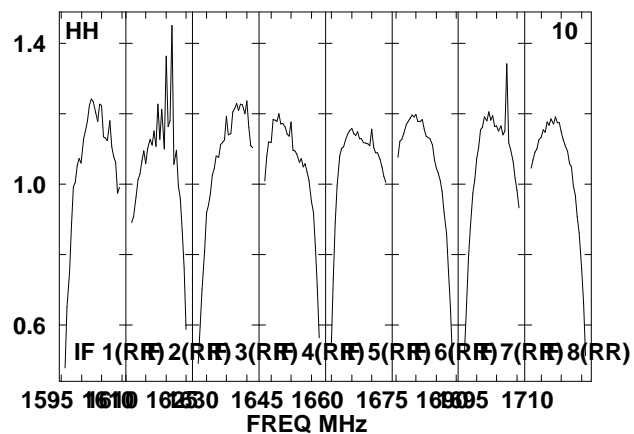
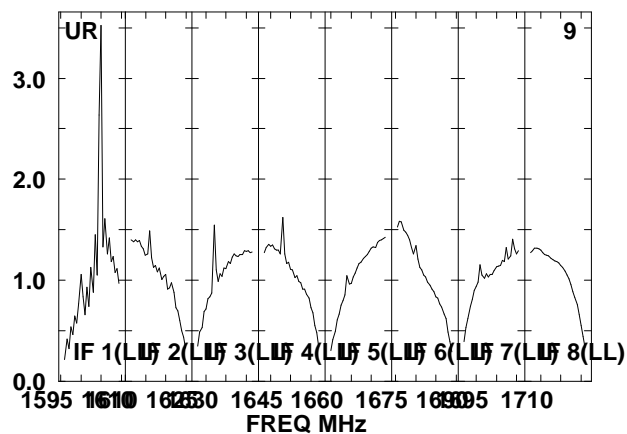
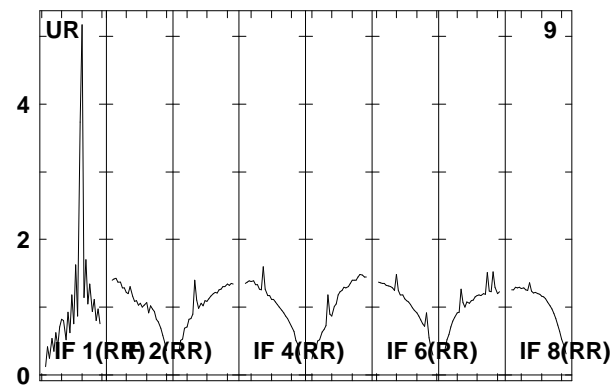
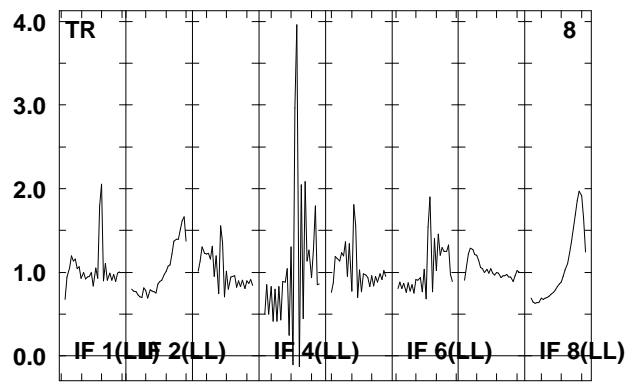
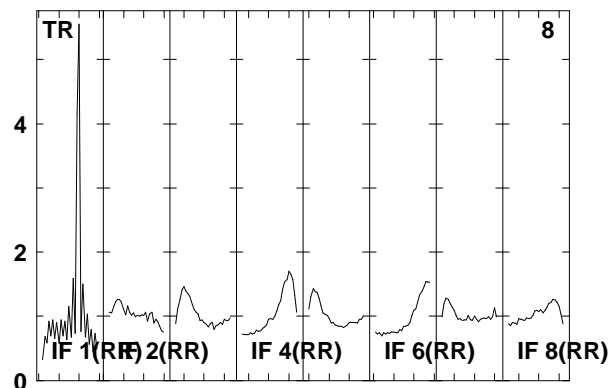
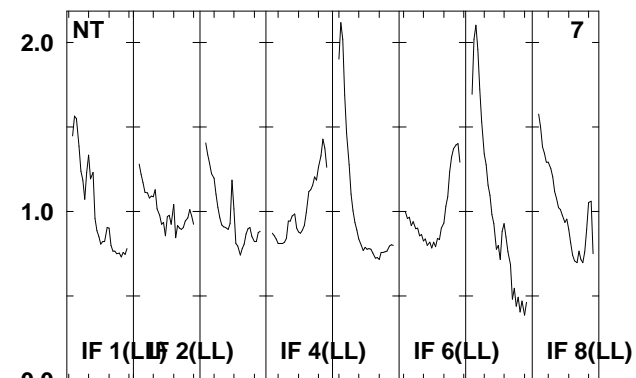
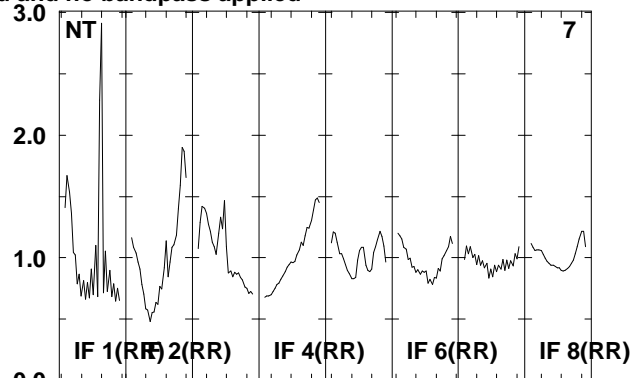
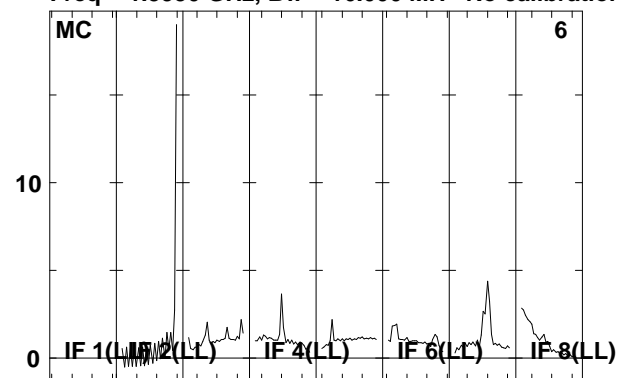

Lower frame: Real Jy
Total-power spectrum Antenna: *
Timerange: 00/16:33:32 to 00/16:37:00

Plot file version 29 created 22-APR-2008 12:25:31

J0730-02 EP061B.UVDATA.1

Freq = 1.5950 GHz, Bw = 16.000 MH No calibration applied and no bandpass applied

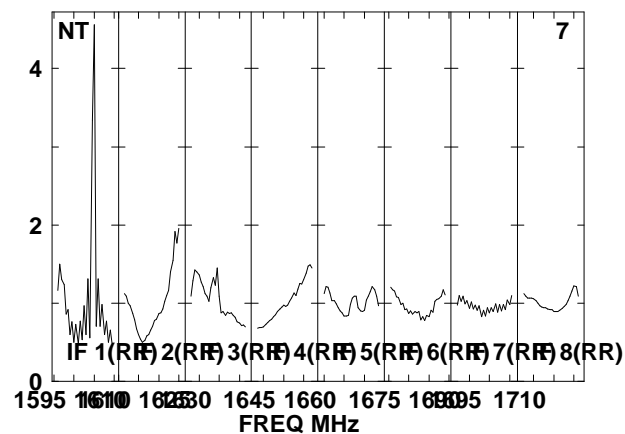
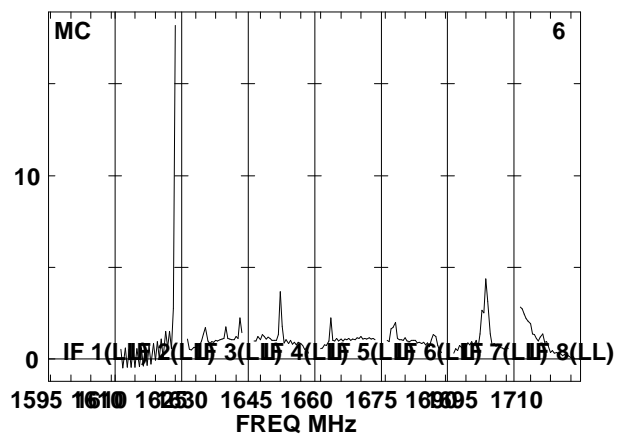
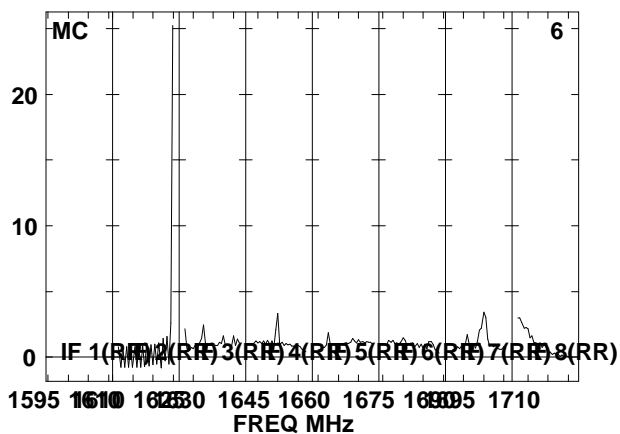
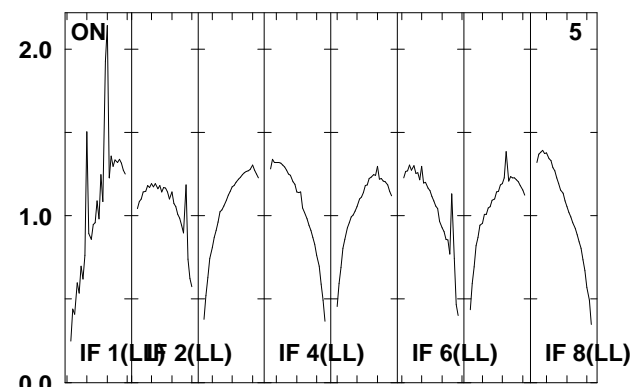
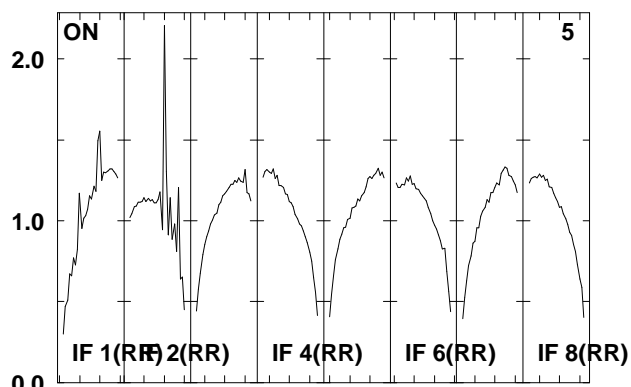
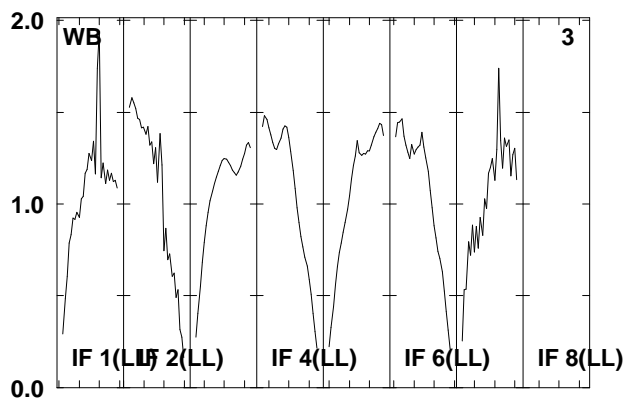
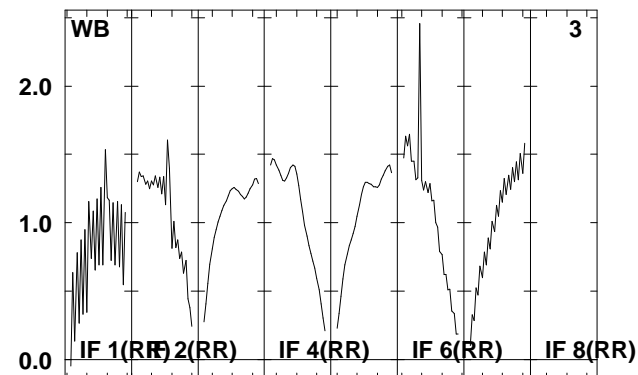
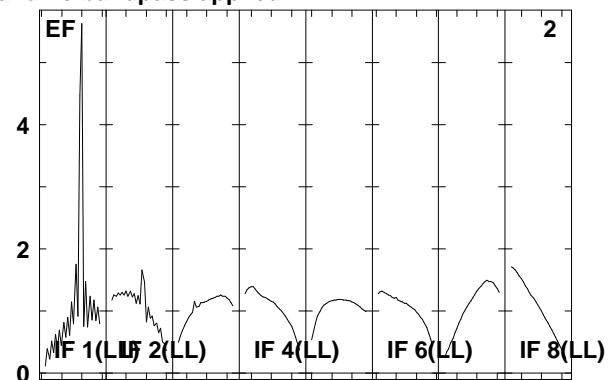
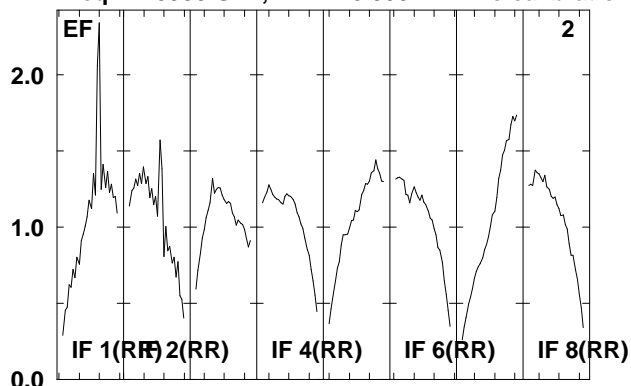

Lower frame: Real Jy
Total-power spectrum Antenna: *
Timerange: 00/16:37:02 to 00/16:38:30

Plot file version 30 created 22-APR-2008 12:25:32

J0730-02 EP061B.UVDATA.1

Freq = 1.5950 GHz, Bw = 16.000 MH No calibration applied and no bandpass applied

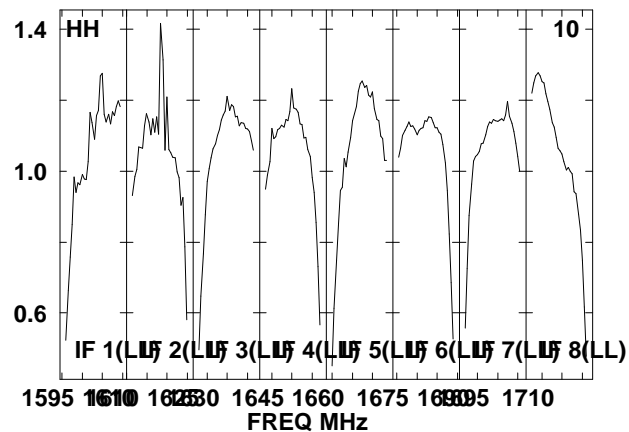
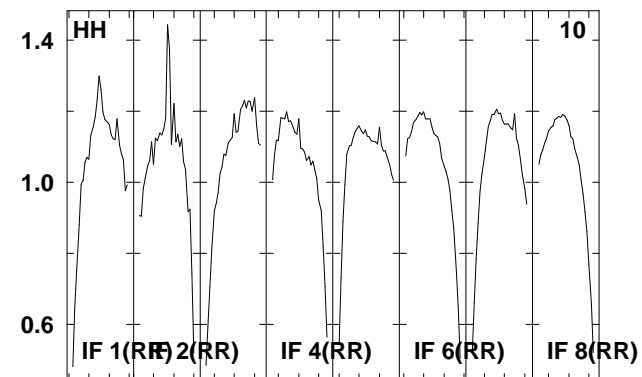
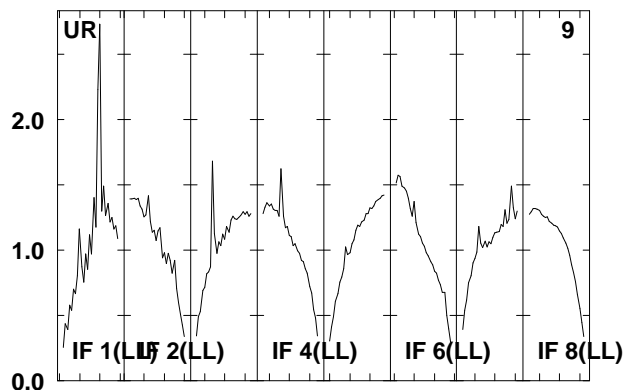
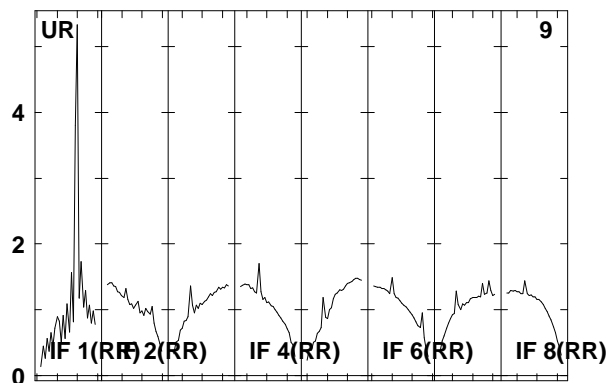
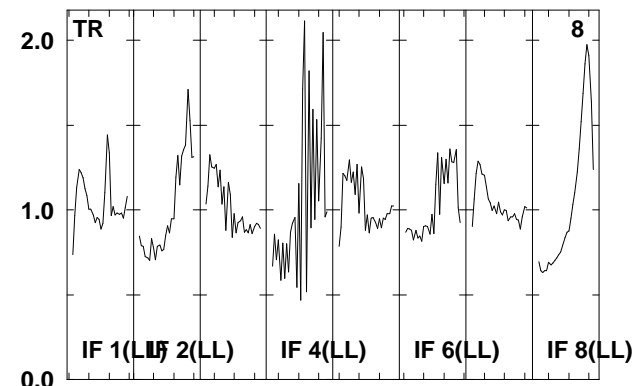
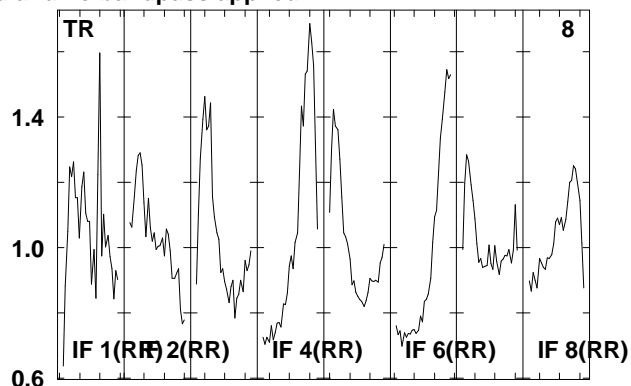
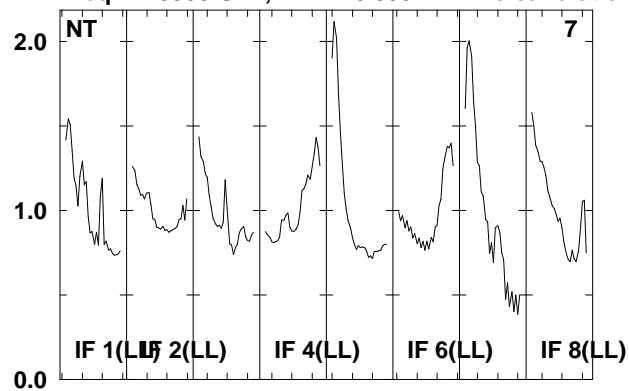

Lower frame: Real Jy

Total-power spectrum Antenna: *

Timerange: 00/16:37:02 to 00/16:38:30

Plot file version 31 created 22-APR-2008 12:25:33

IRAS0725 EP061B.UVDATA.1

Freq = 1.5950 GHz, Bw = 16.000 MH No calibration applied and no bandpass applied

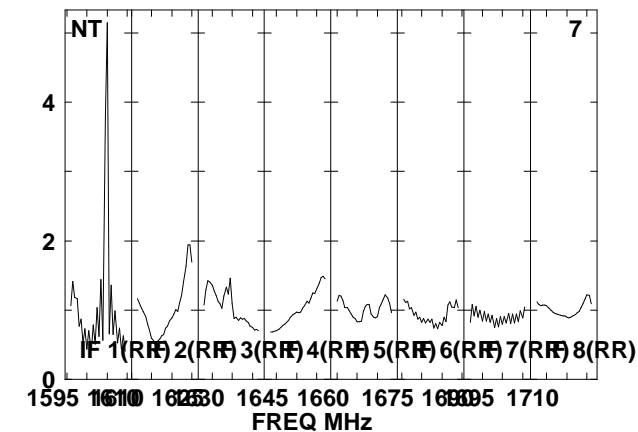
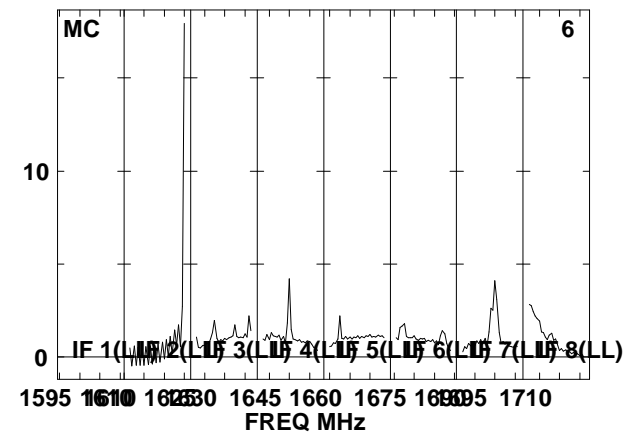
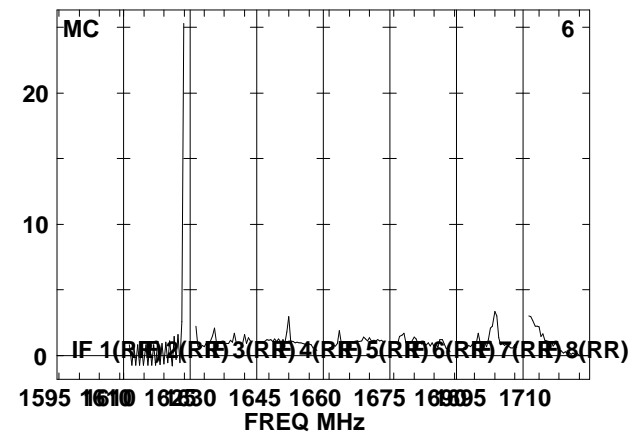
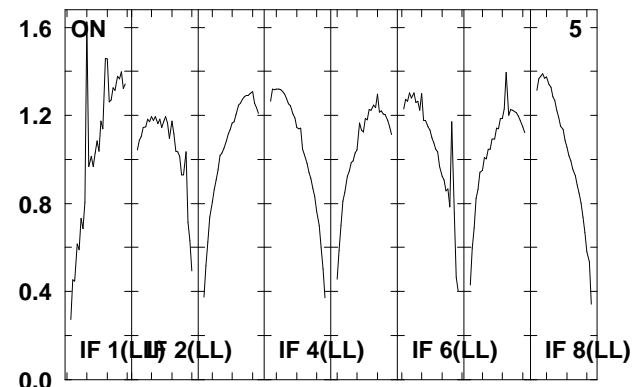
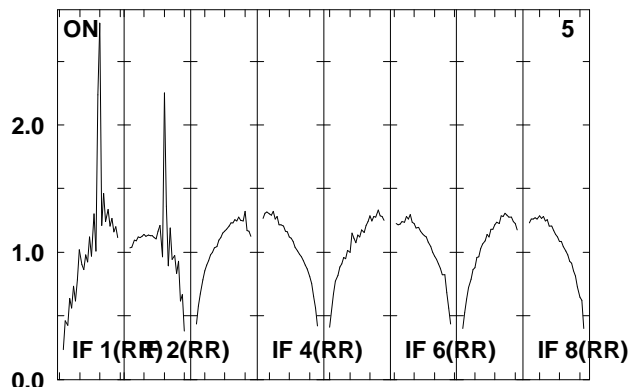
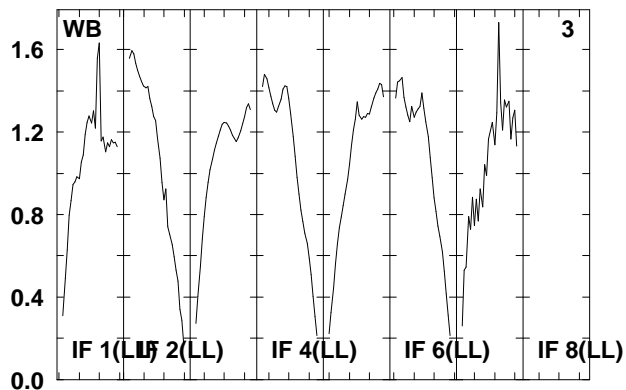
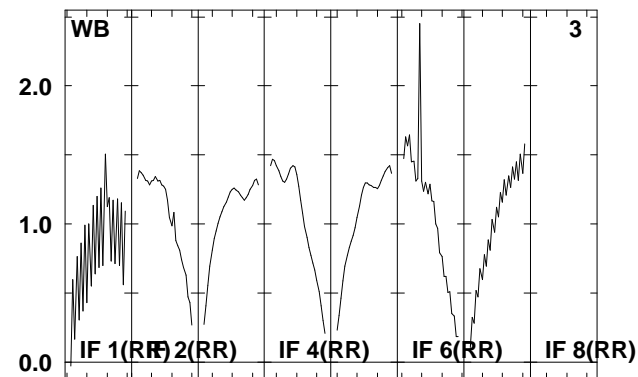
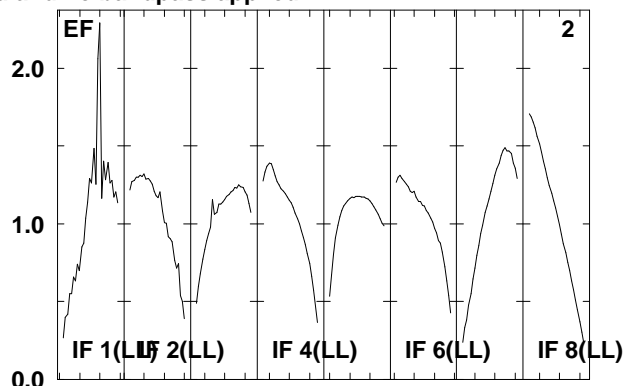
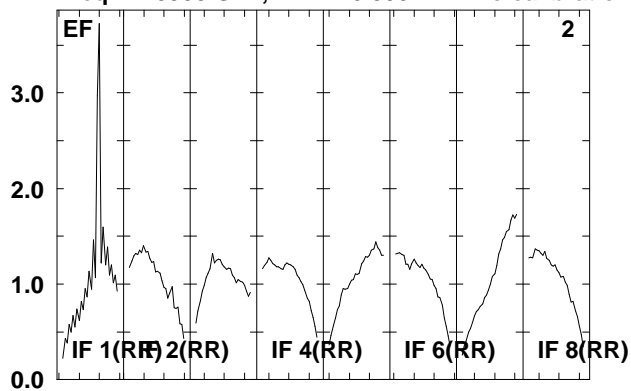

Lower frame: Real Jy
Total-power spectrum Antenna: *
Timerange: 00/16:38:32 to 00/16:42:00

Plot file version 32 created 22-APR-2008 12:25:34

IRAS0725 EP061B.UVDATA.1

Freq = 1.5950 GHz, Bw = 16.000 MH No calibration applied and no bandpass applied

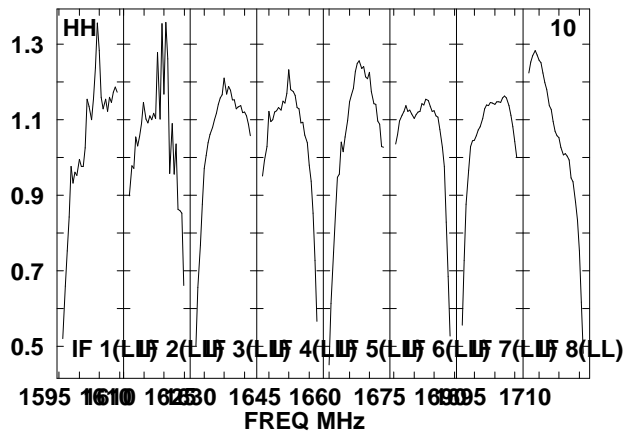
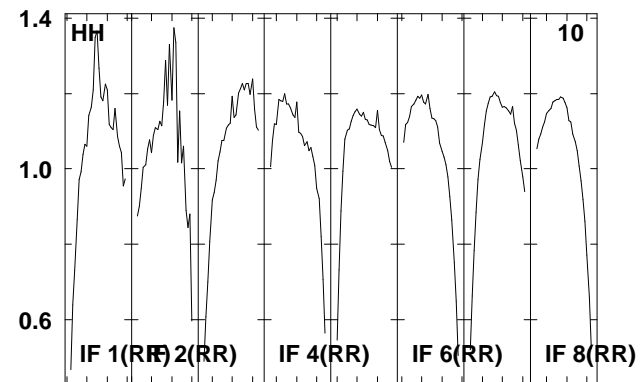
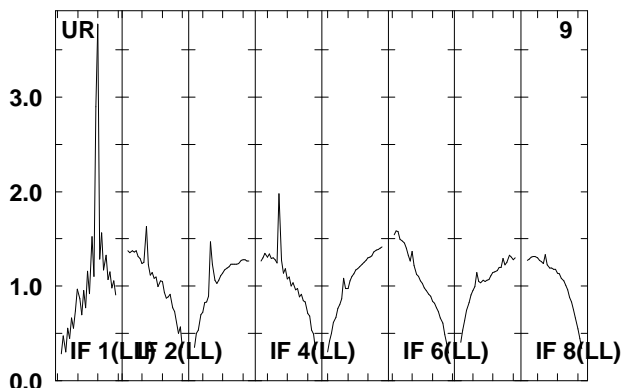
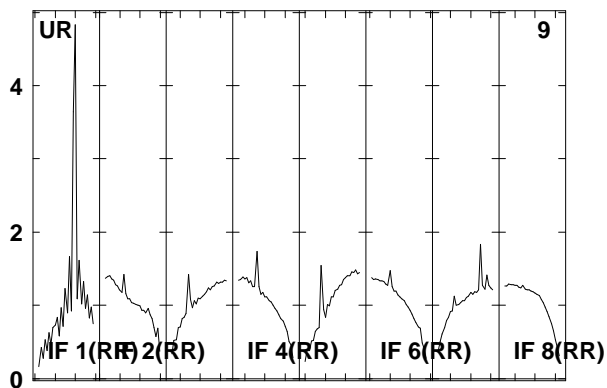
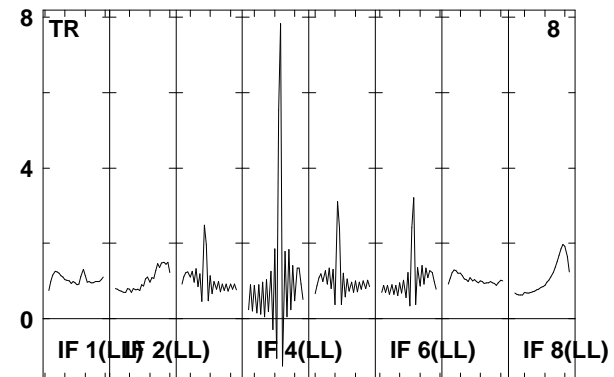
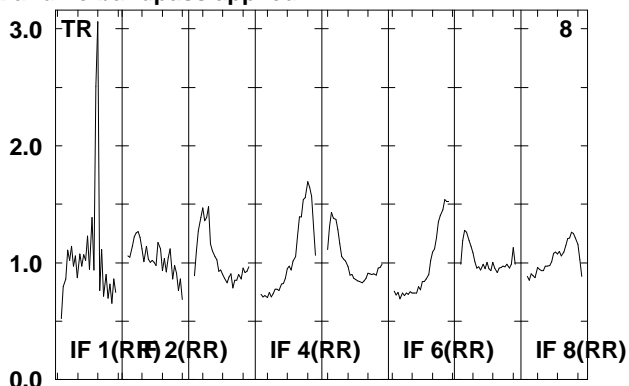
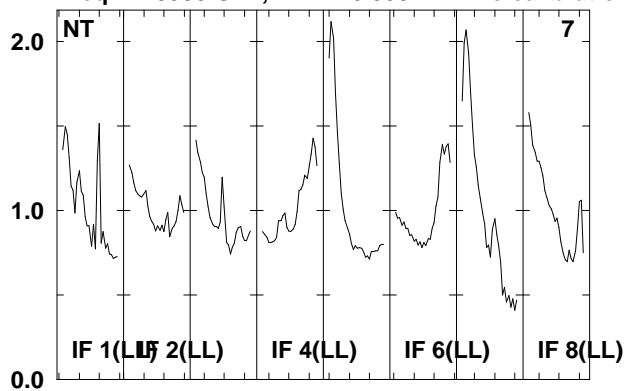

Lower frame: Real Jy

Total-power spectrum Antenna: *

Timerange: 00/16:38:32 to 00/16:42:00

Plot file version 33 created 22-APR-2008 12:25:34

J0730-02 EP061B.UVDATA.1

Freq = 1.5950 GHz, Bw = 16.000 MH No calibration applied and no bandpass applied

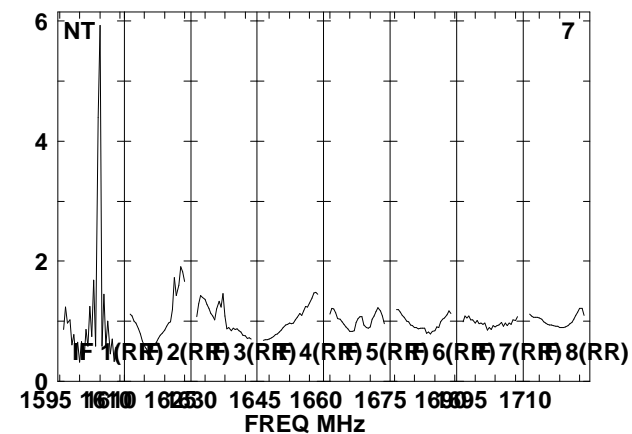
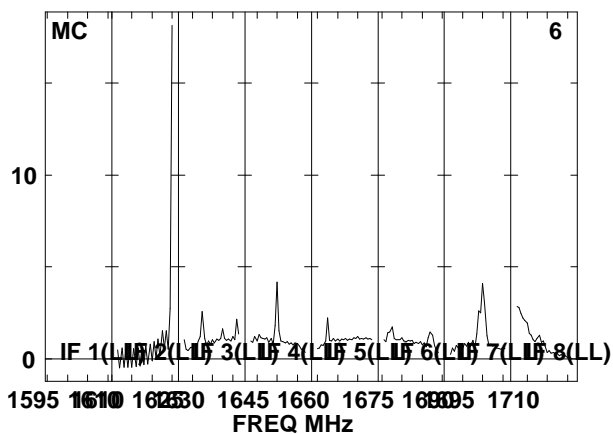
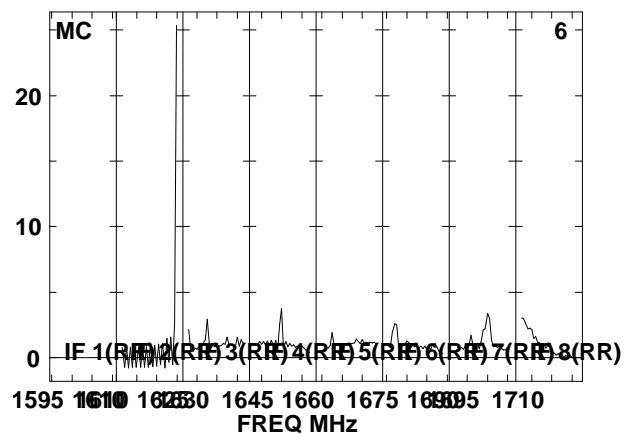
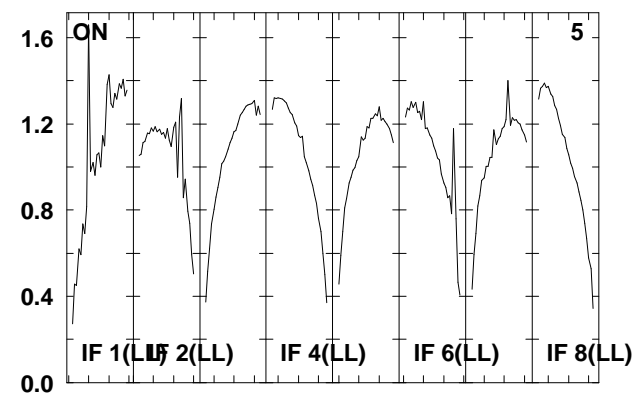
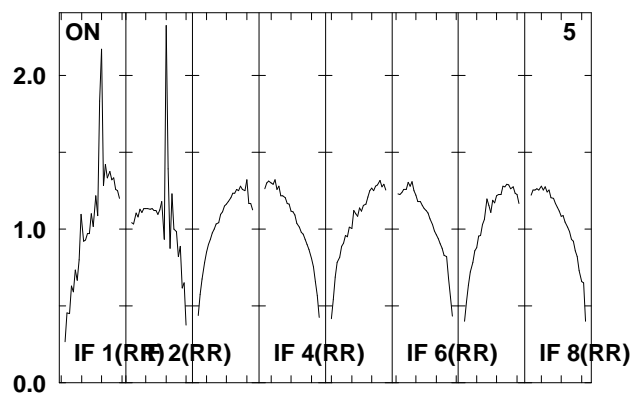
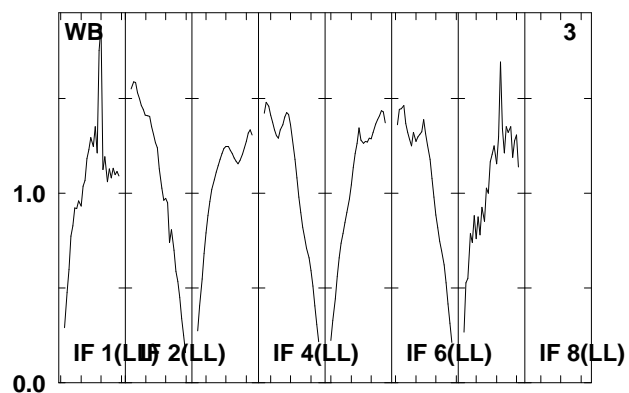
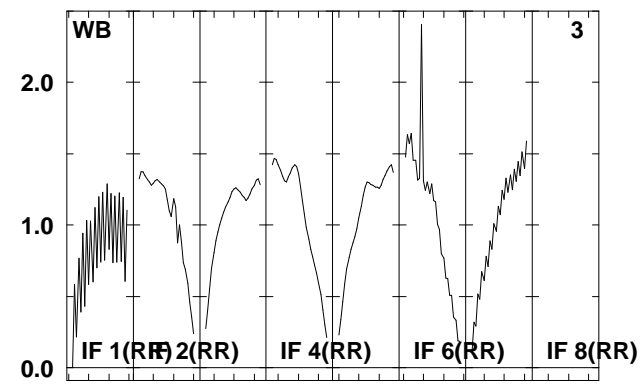
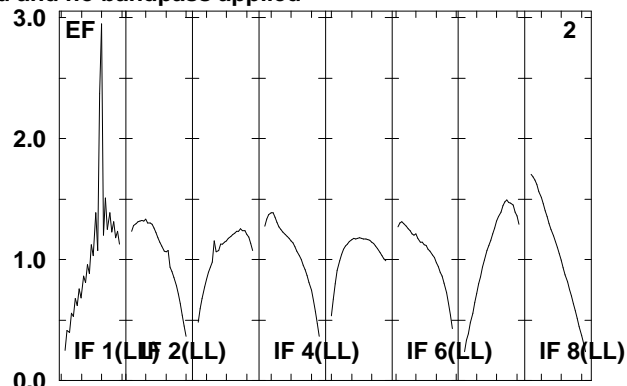
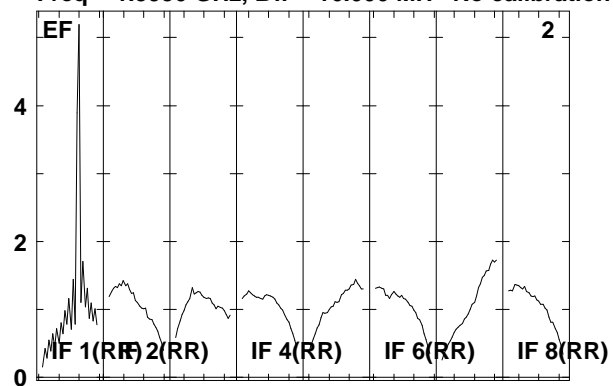

Lower frame: Real Jy

Total-power spectrum Antenna: *

Timerange: 00/16:42:02 to 00/16:43:30

Plot file version 34 created 22-APR-2008 12:25:35

J0730-02 EP061B.UVDATA.1

Freq = 1.5950 GHz, Bw = 16.000 MH No calibration applied and no bandpass applied

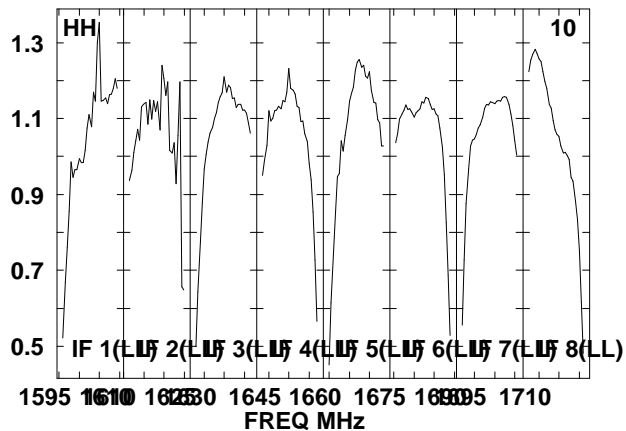
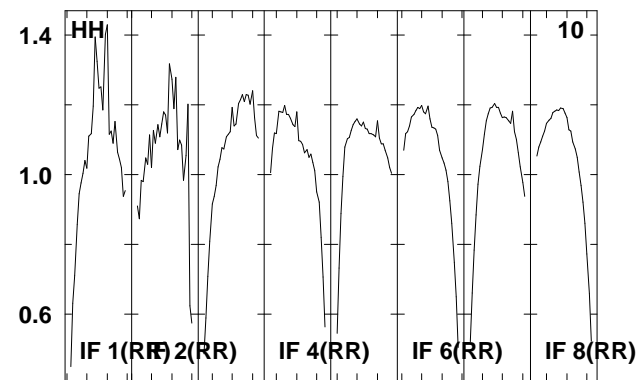
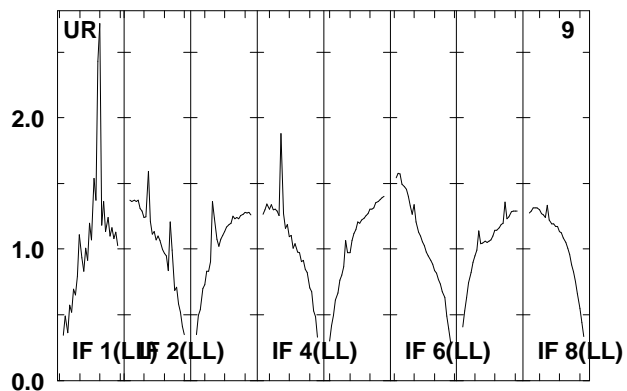
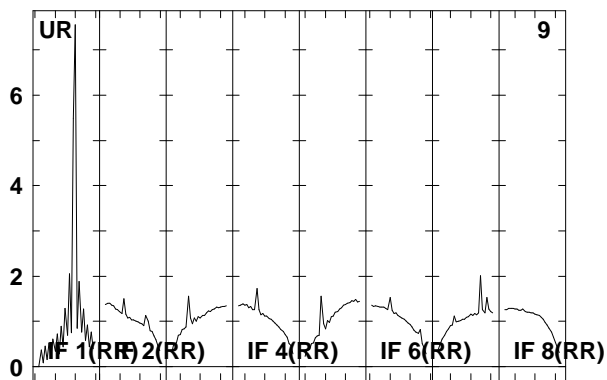
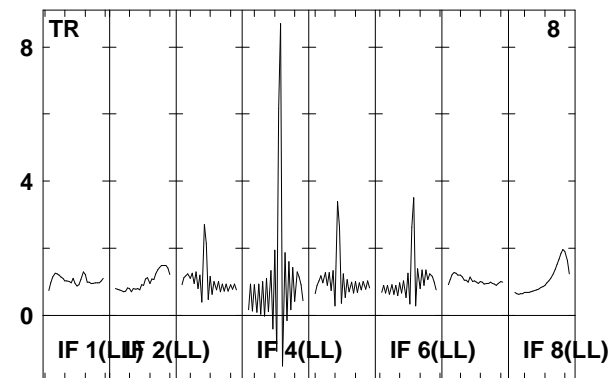
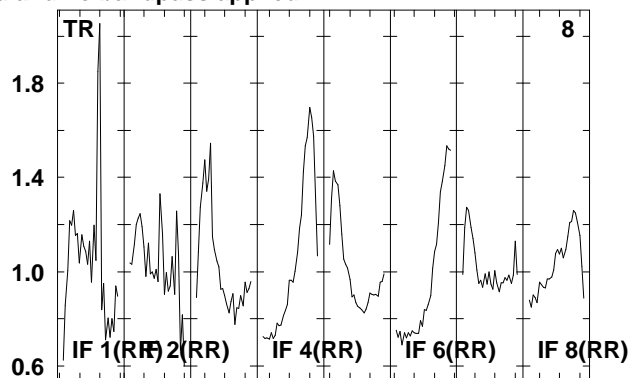
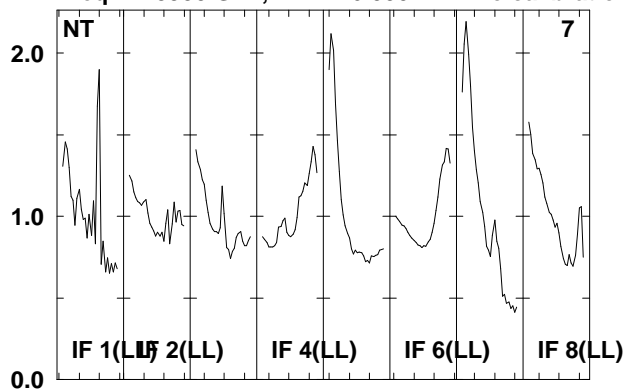

Lower frame: Real Jy

Total-power spectrum Antenna: *

Timerange: 00/16:42:02 to 00/16:43:30

Plot file version 35 created 22-APR-2008 12:25:35

IRAS0725 EP061B.UVDATA.1

Freq = 1.5950 GHz, Bw = 16.000 MH No calibration applied and no bandpass applied

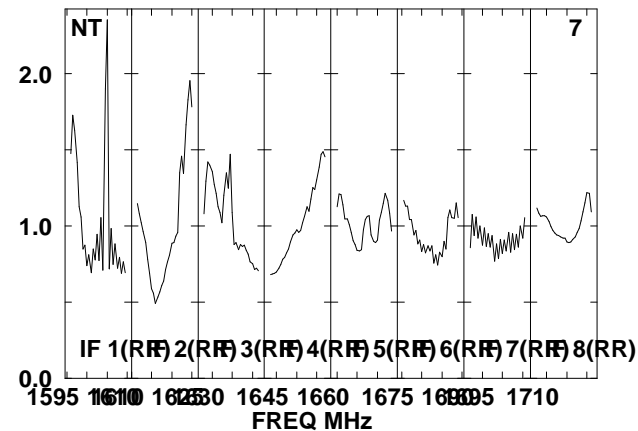
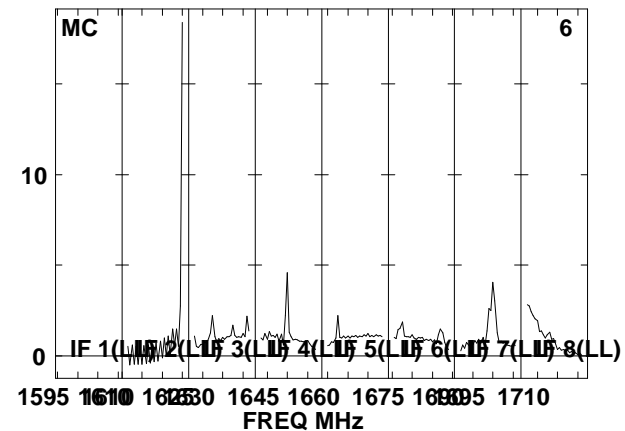
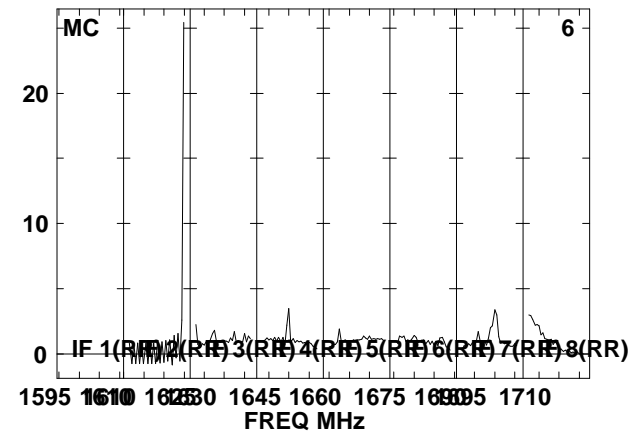
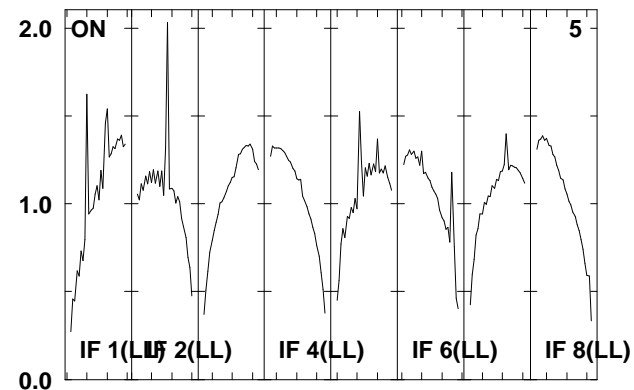
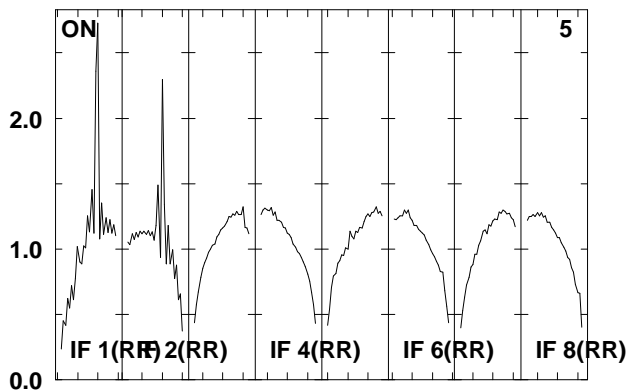
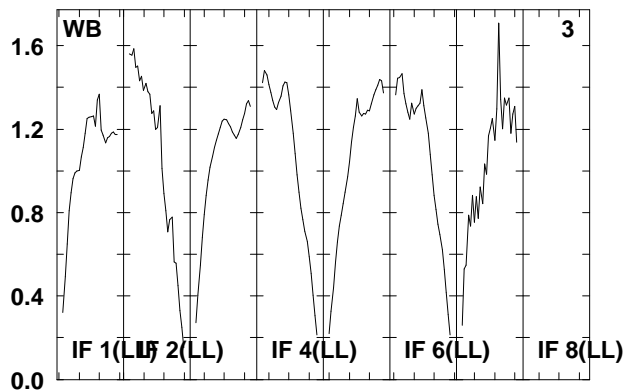
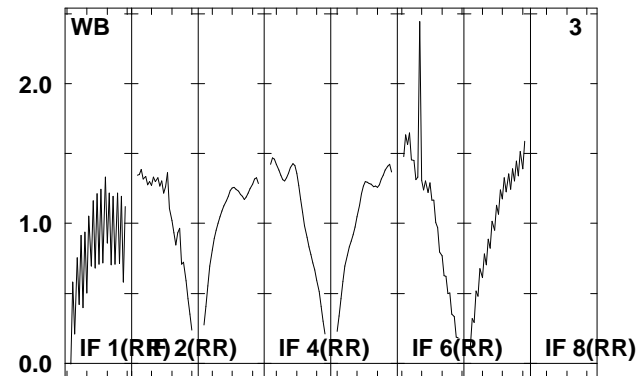
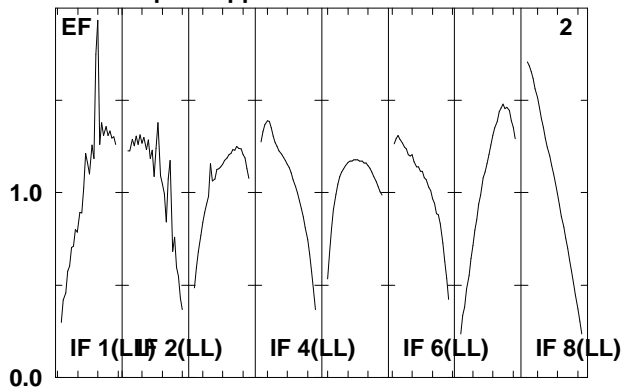
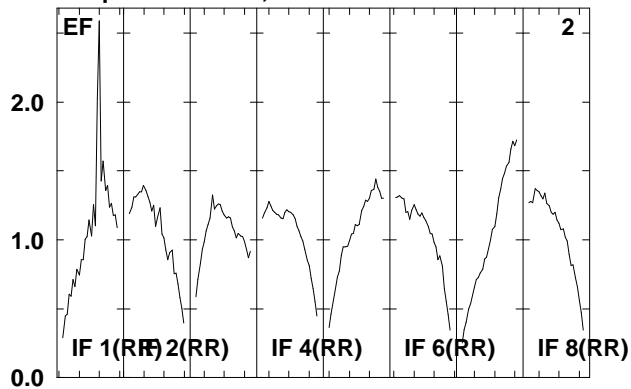

Lower frame: Real Jy
Total-power spectrum Antenna: *
Timerange: 00/16:43:32 to 00/16:46:58

Plot file version 36 created 22-APR-2008 12:25:36

IRAS0725 EP061B.UVDATA.1

Freq = 1.5950 GHz, Bw = 16.000 MH No calibration applied and no bandpass applied

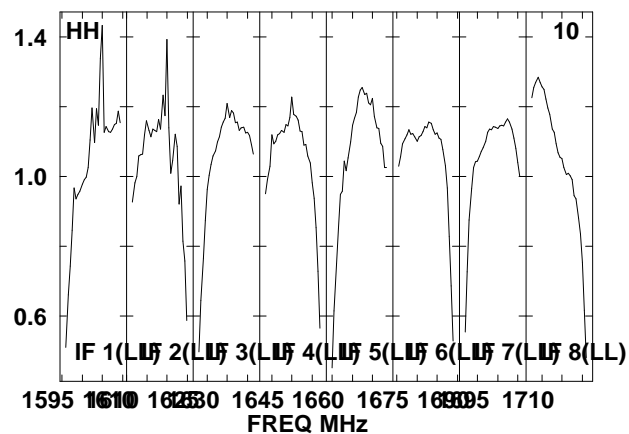
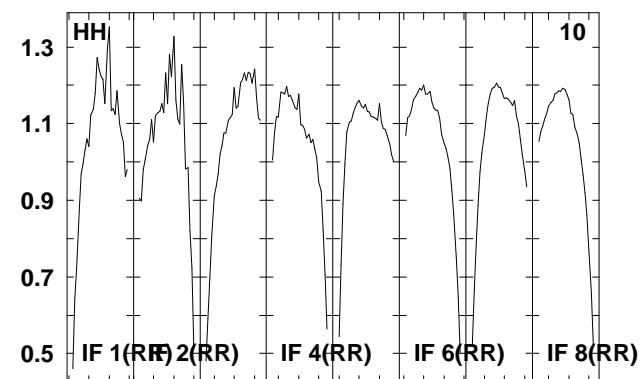
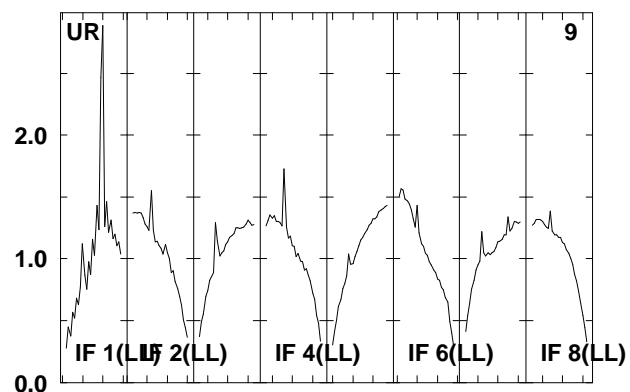
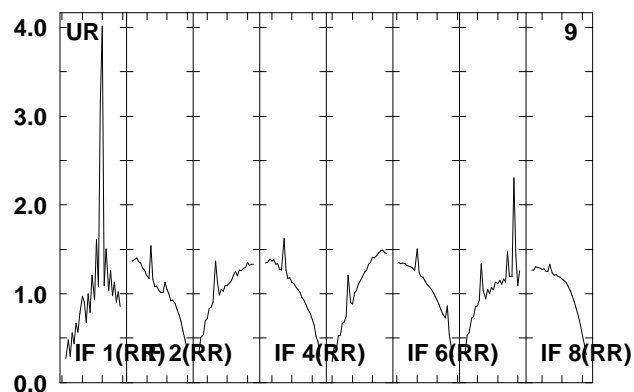
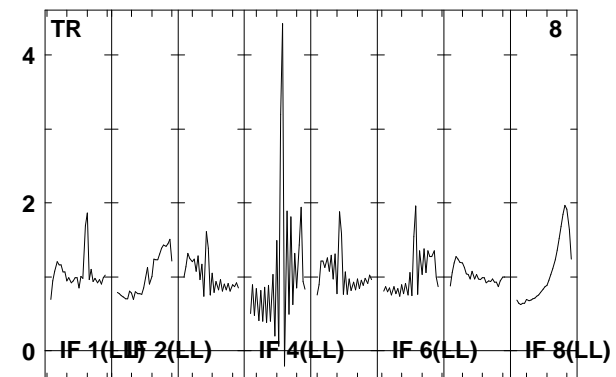
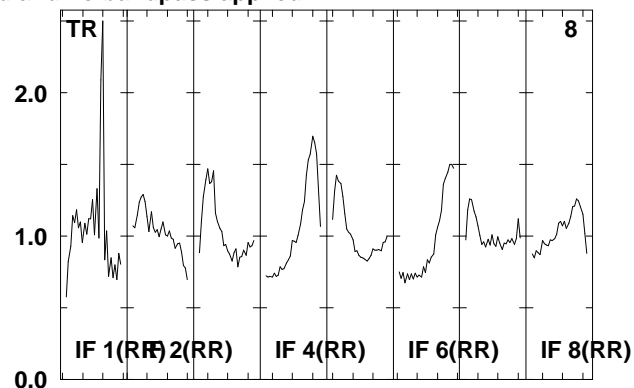
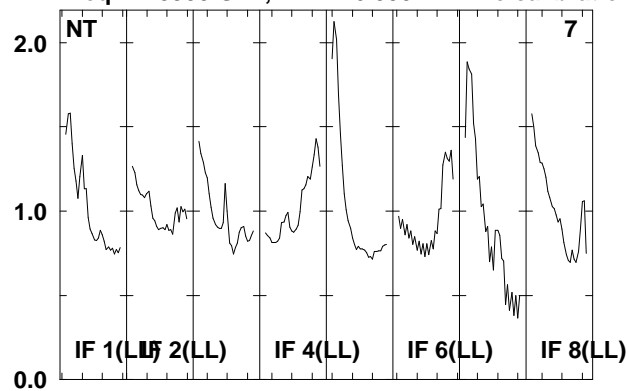

Lower frame: Real Jy

Total-power spectrum Antenna: *

Timerange: 00/16:43:32 to 00/16:46:58

Plot file version 37 created 22-APR-2008 12:25:37

J0730-02 EP061B.UVDATA.1

Freq = 1.5950 GHz, Bw = 16.000 MH No calibration applied and no bandpass applied

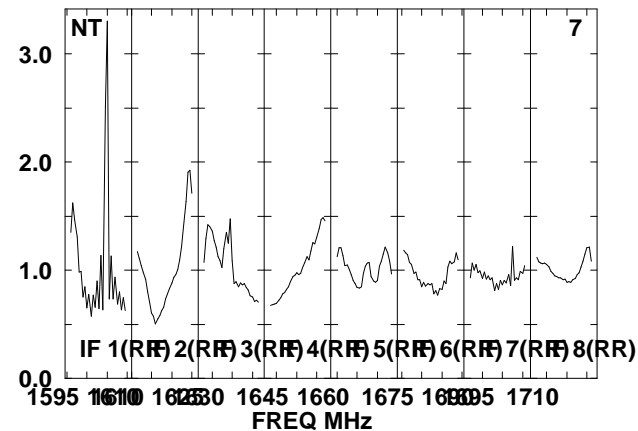
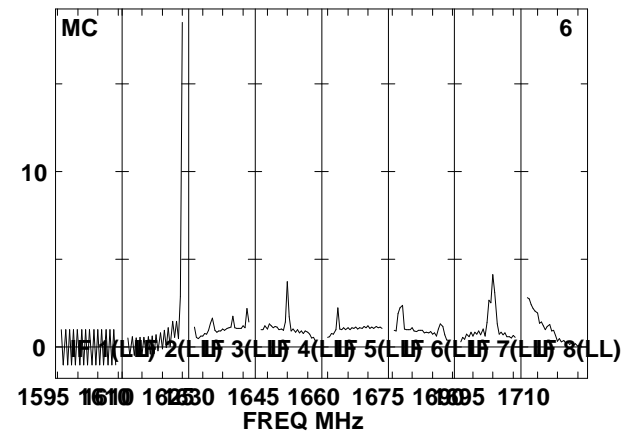
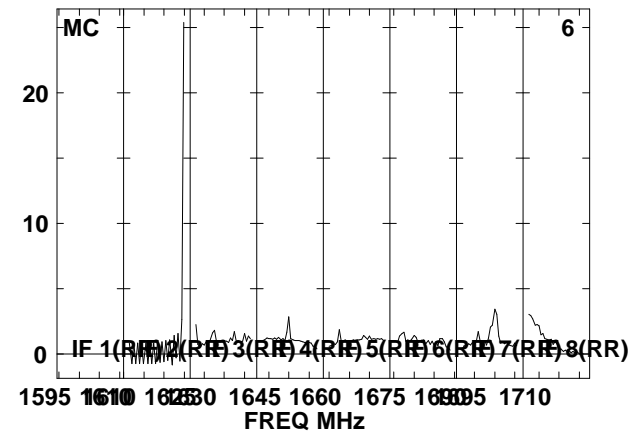
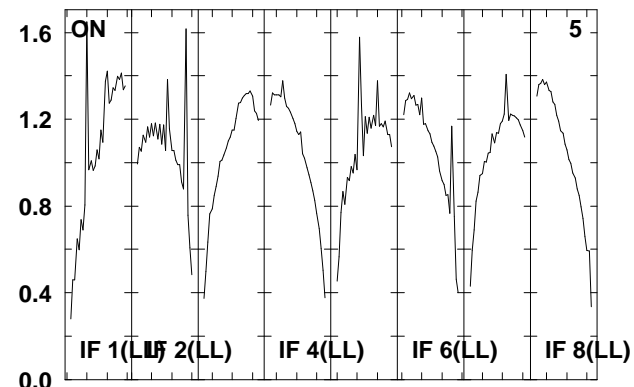
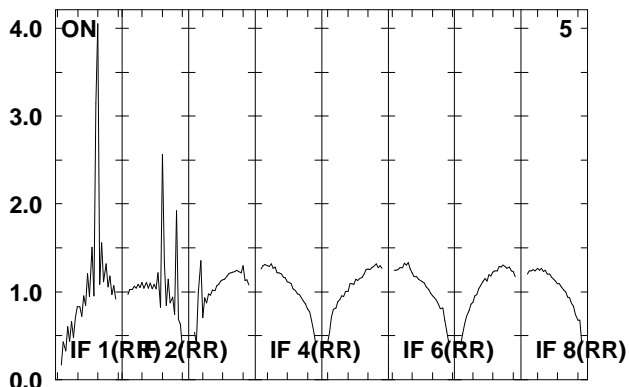
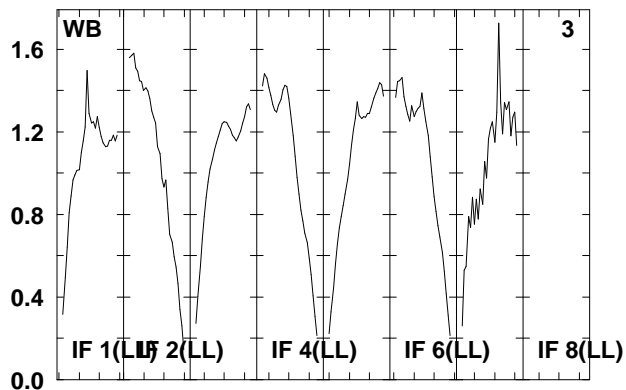
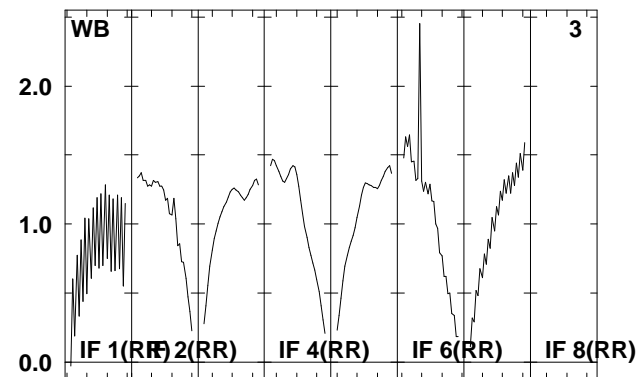
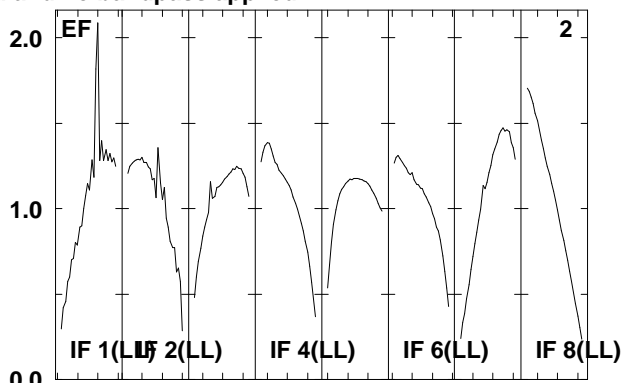
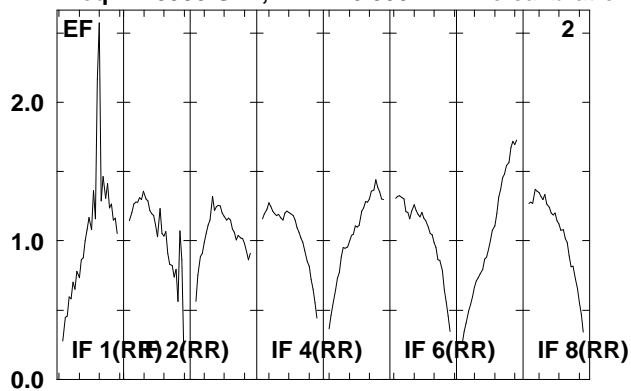

Lower frame: Real Jy
Total-power spectrum Antenna: *
Timerange: 00/16:48:02 to 00/16:49:30

Plot file version 38 created 22-APR-2008 12:25:38

J0730-02 EP061B.UVDATA.1

Freq = 1.5950 GHz, Bw = 16.000 MH No calibration applied and no bandpass applied

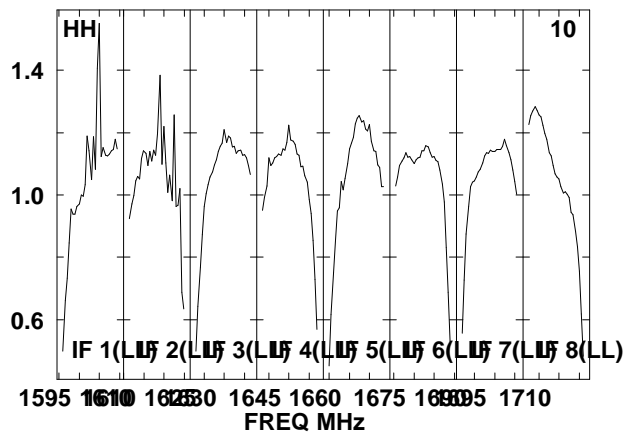
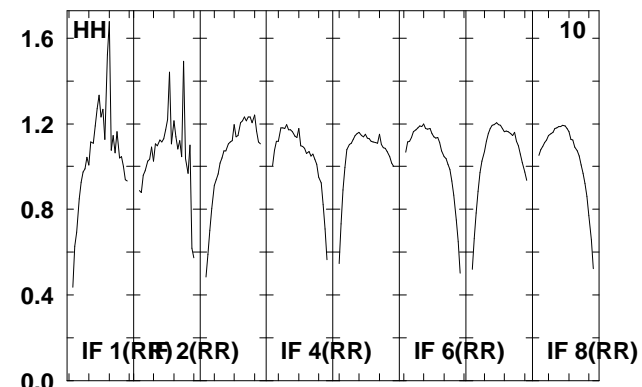
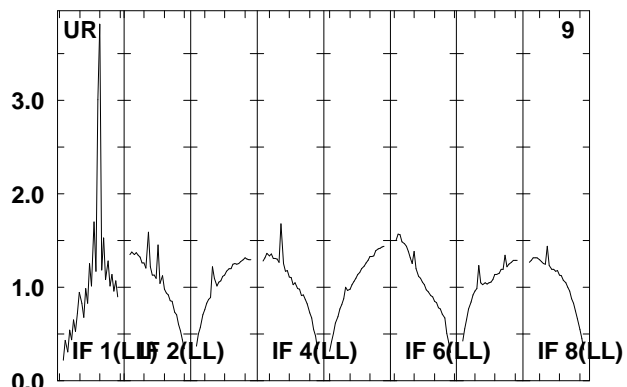
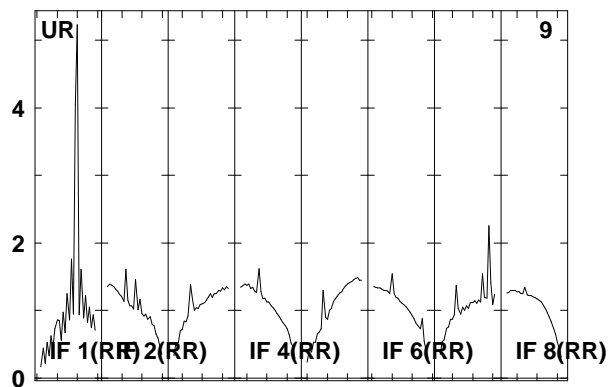
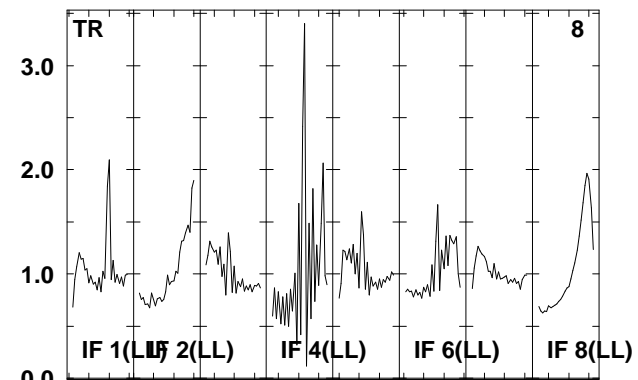
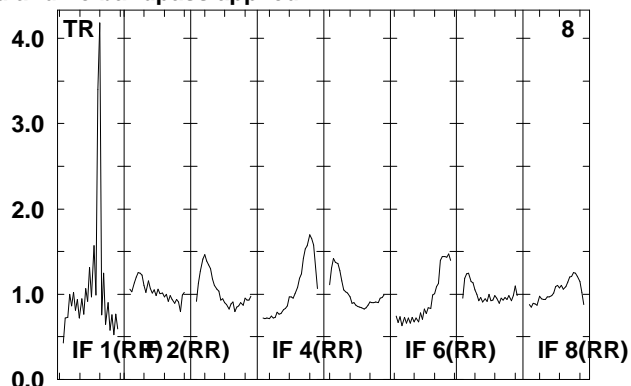
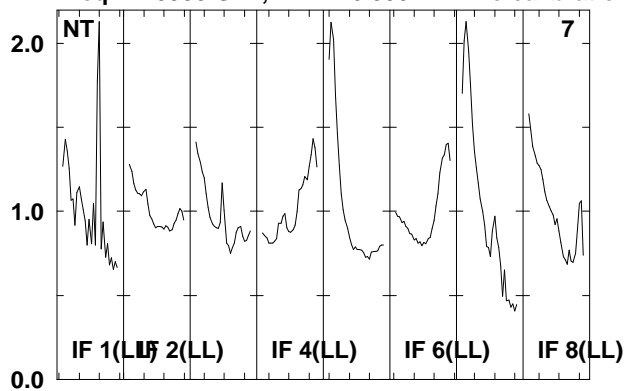

Lower frame: Real Jy

Total-power spectrum Antenna: *

Timerange: 00/16:48:02 to 00/16:49:30

Plot file version 39 created 22-APR-2008 12:25:39

IRAS0725 EP061B.UVDATA.1

Freq = 1.5950 GHz, Bw = 16.000 MH No calibration applied and no bandpass applied

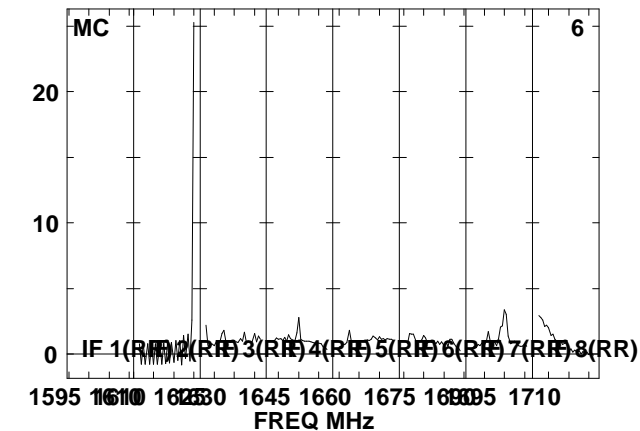
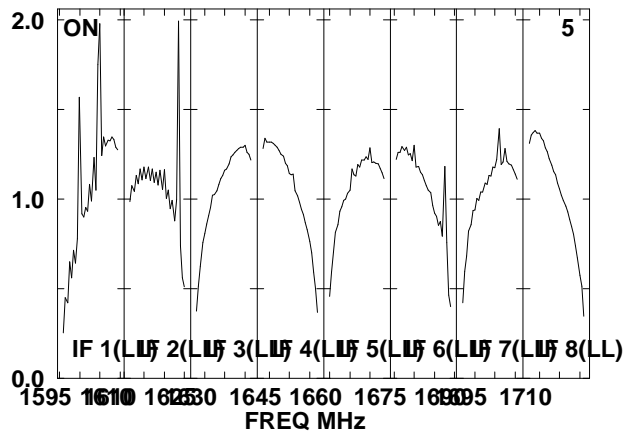
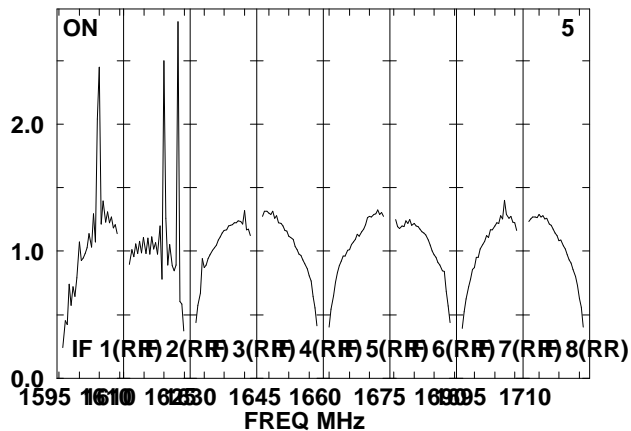
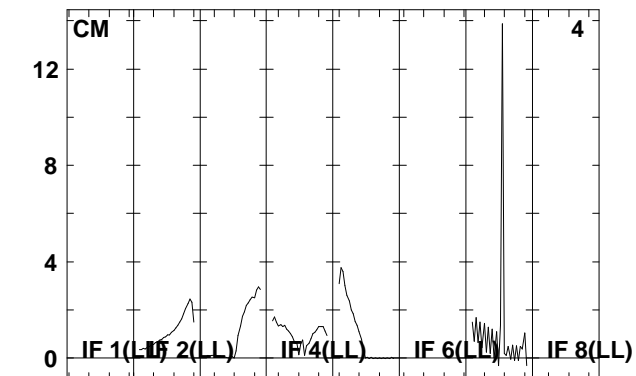
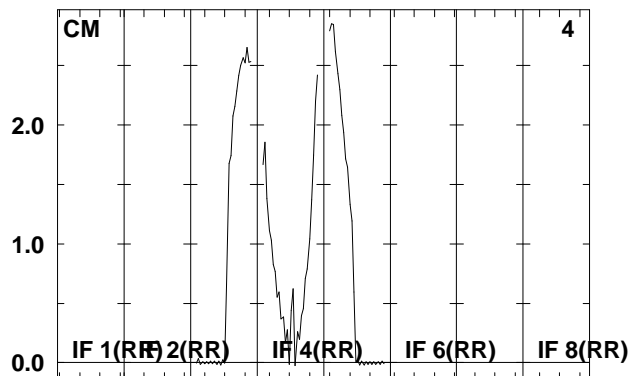
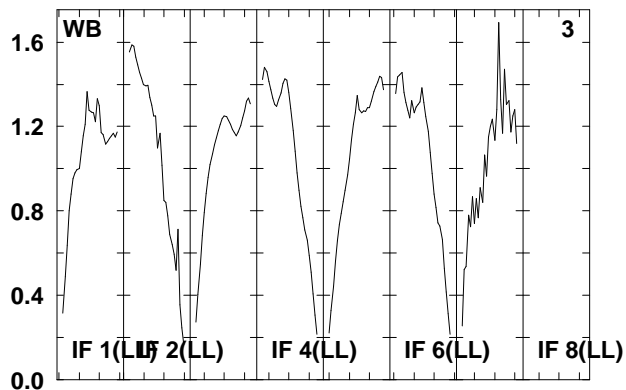
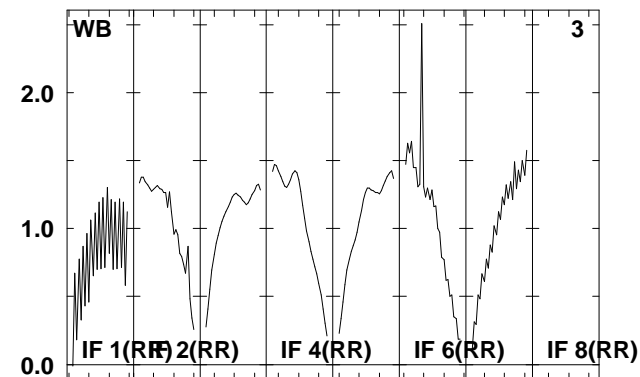
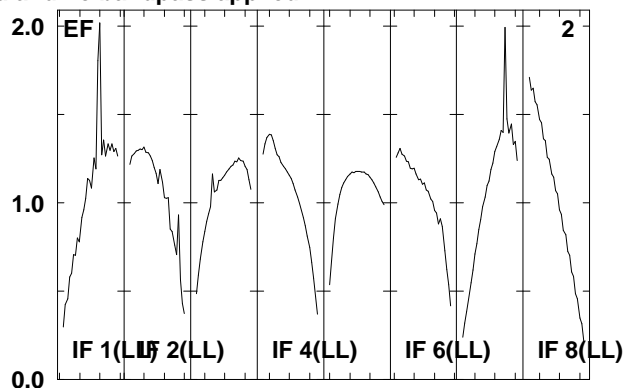
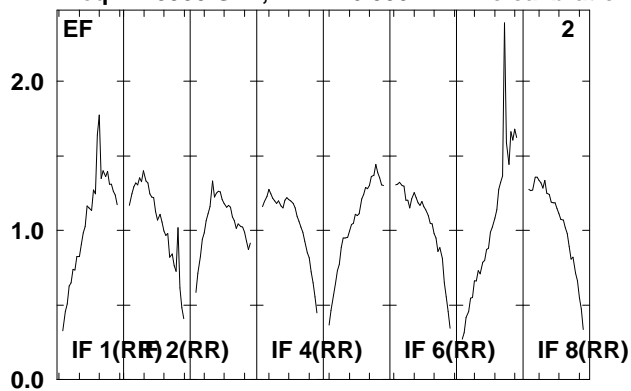

Lower frame: Real Jy
Total-power spectrum Antenna: *
Timerange: 00/16:49:32 to 00/16:53:00

Plot file version 40 created 22-APR-2008 12:25:40

IRAS0725 EP061B.UVDATA.1

Freq = 1.5950 GHz, Bw = 16.000 MH No calibration applied and no bandpass applied

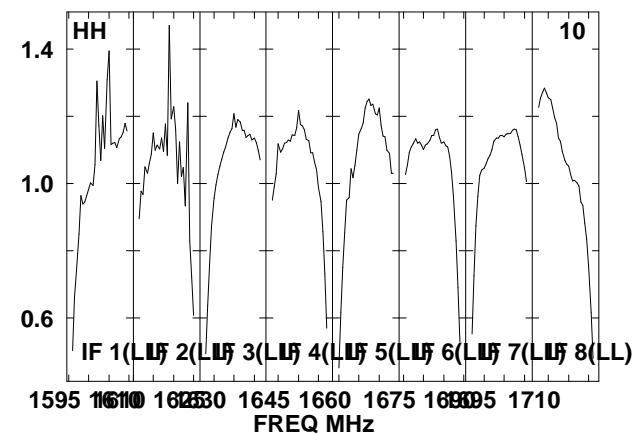
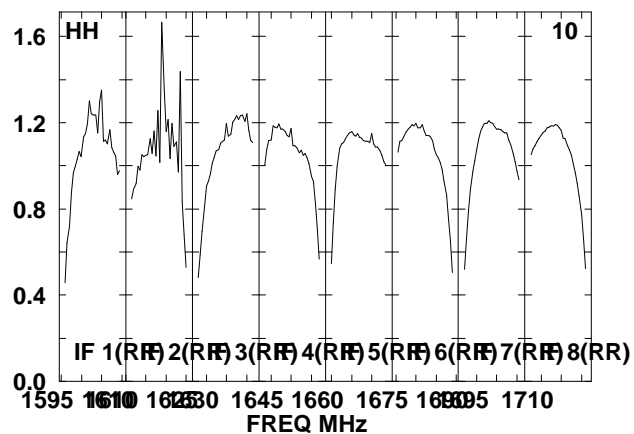
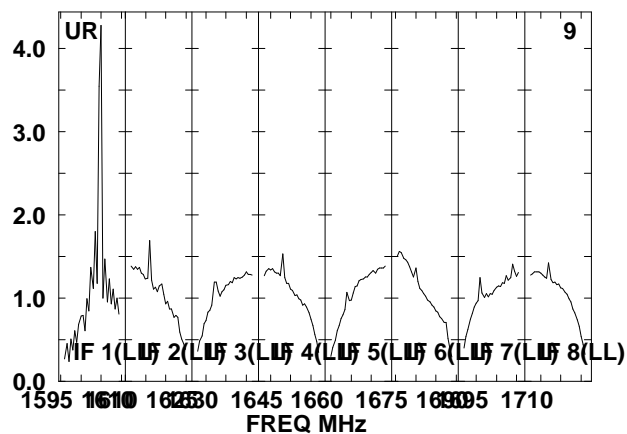
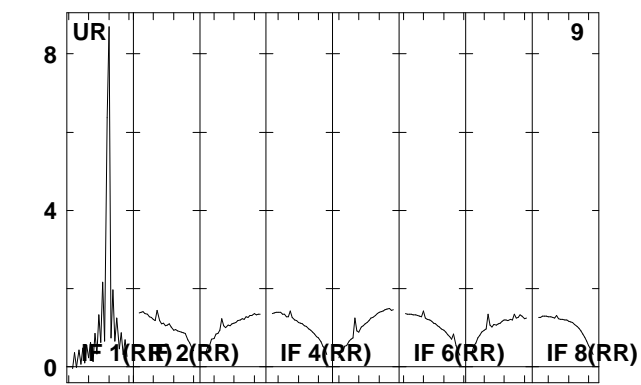
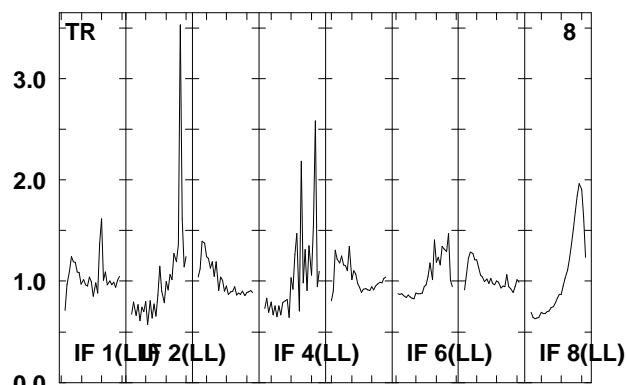
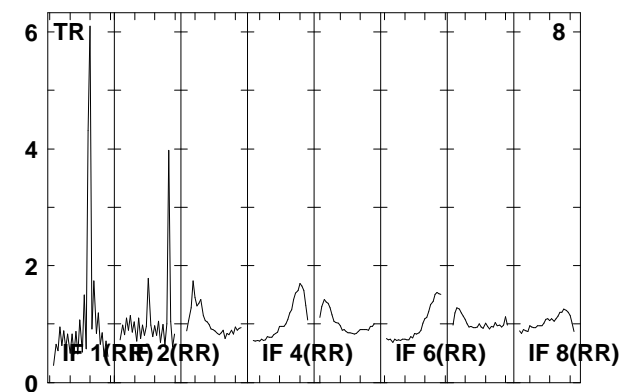
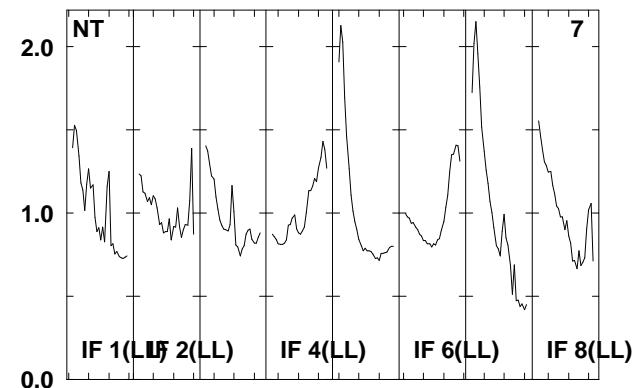
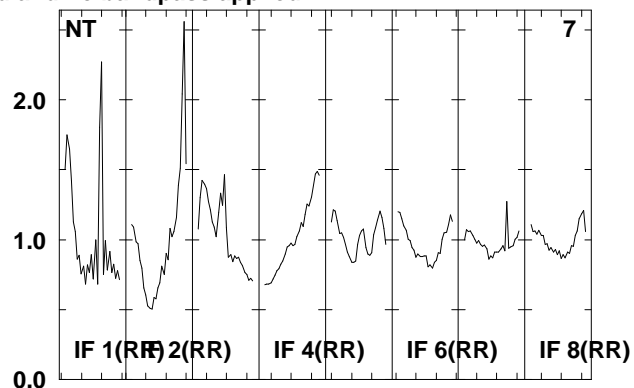
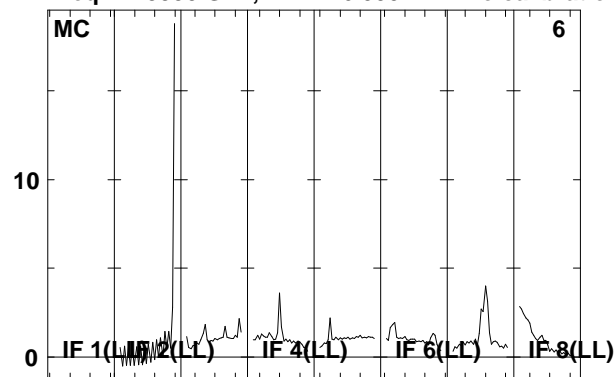

Lower frame: Real Jy

Total-power spectrum Antenna: *

Timerange: 00/16:49:32 to 00/16:53:00

Plot file version 41 created 22-APR-2008 12:25:41

J0730-02 EP061B.UVDATA.1

Freq = 1.5950 GHz, Bw = 16.000 MH No calibration applied and no bandpass applied

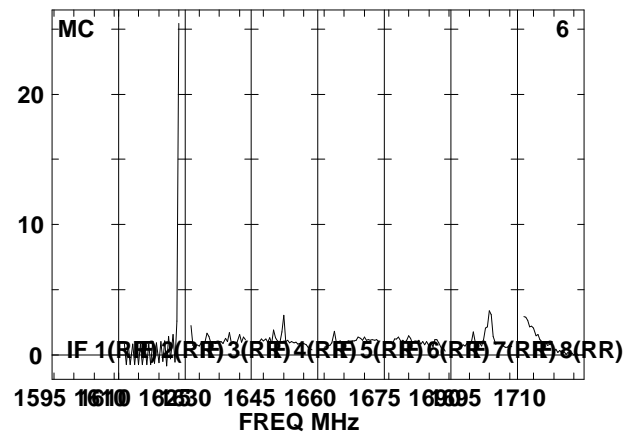
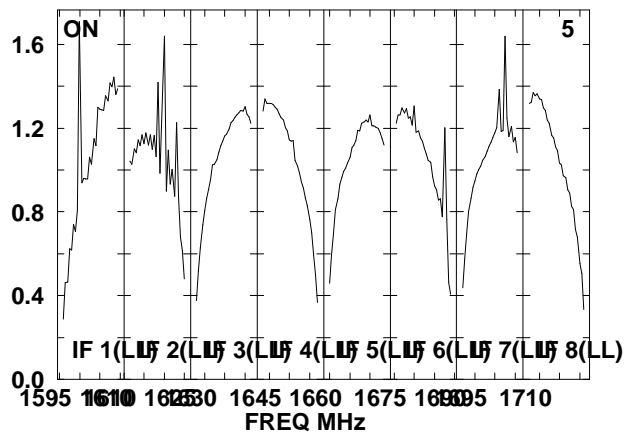
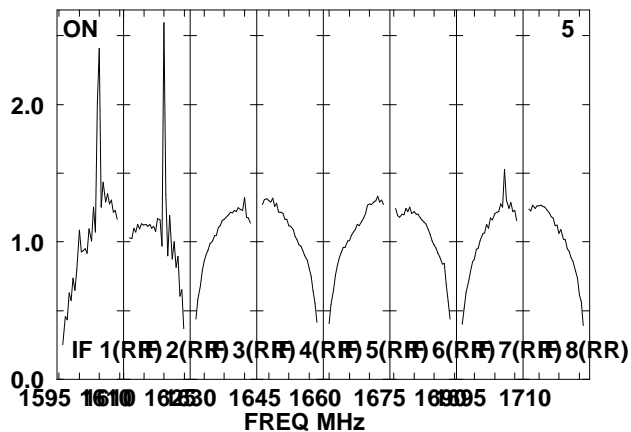
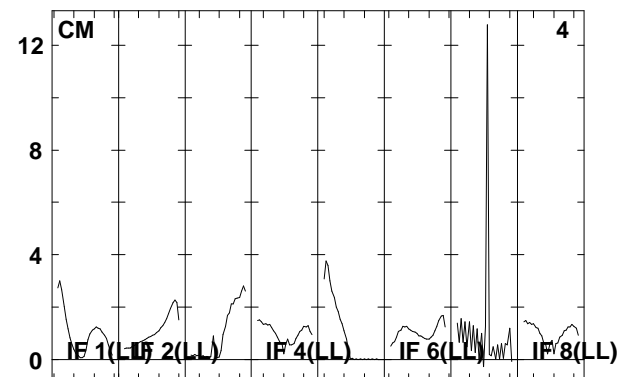
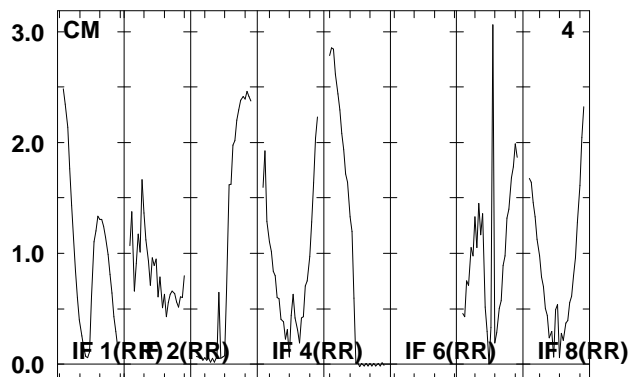
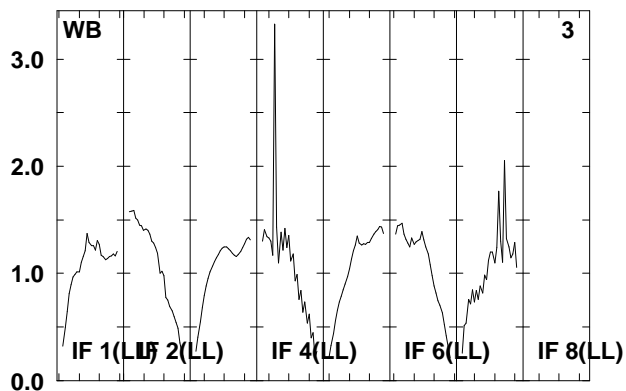
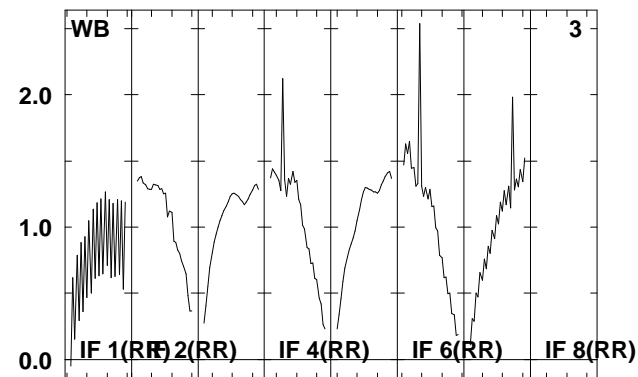
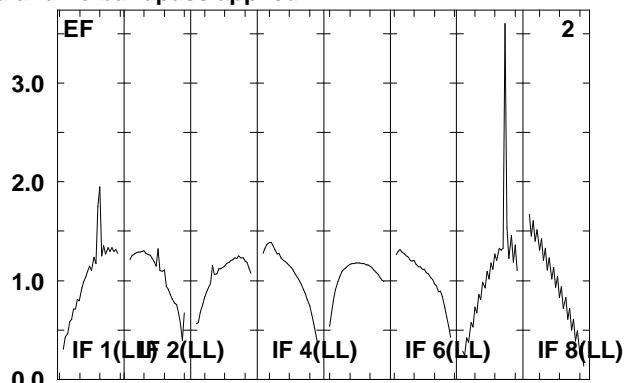
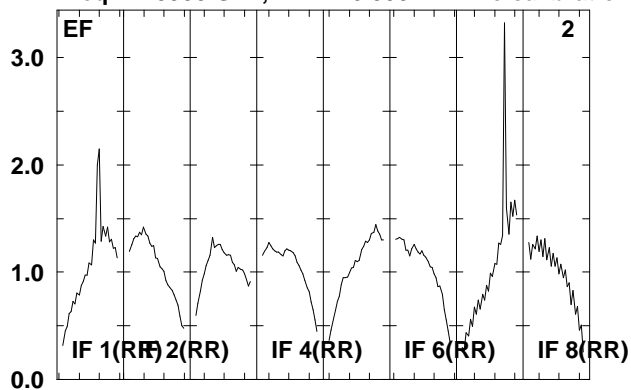

Lower frame: Real Jy
Total-power spectrum Antenna: *
Timerange: 00/16:53:02 to 00/16:54:30

Plot file version 42 created 22-APR-2008 12:25:42

J0730-02 EP061B.UVDATA.1

Freq = 1.5950 GHz, Bw = 16.000 MH No calibration applied and no bandpass applied

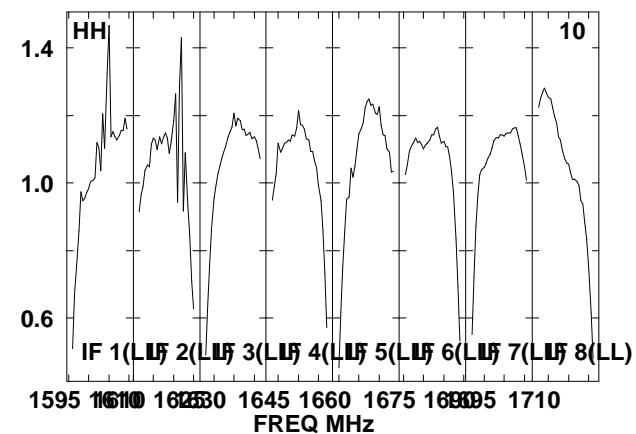
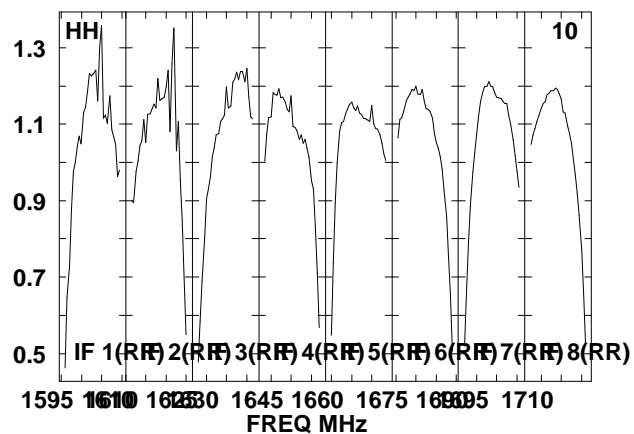
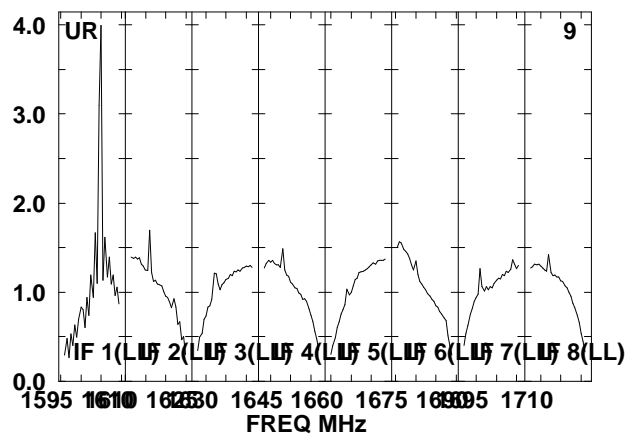
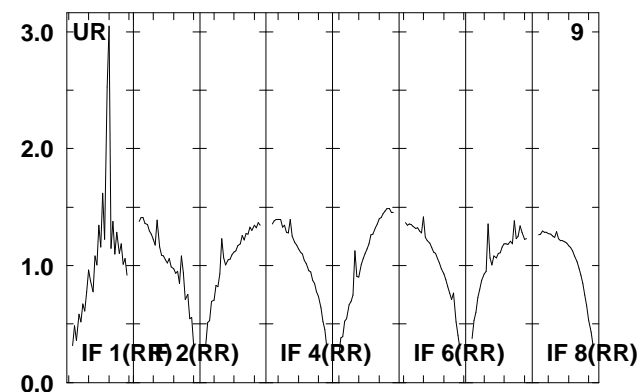
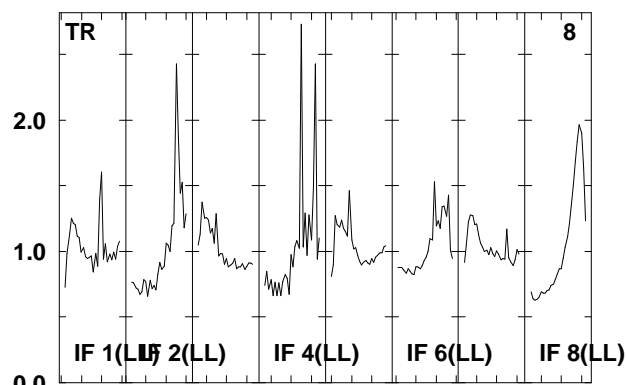
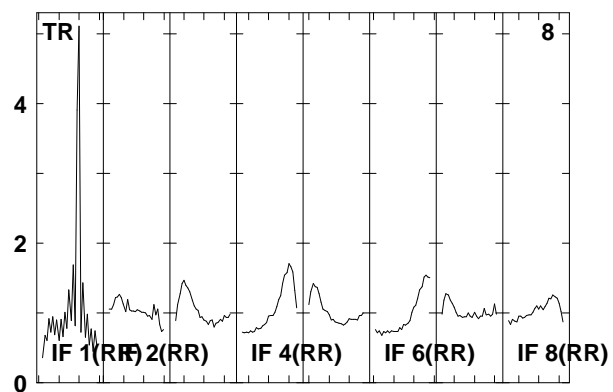
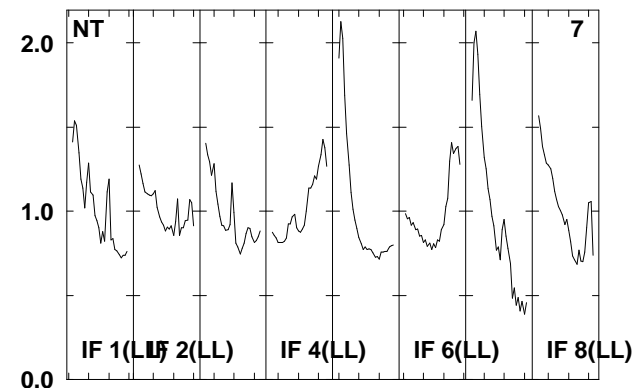
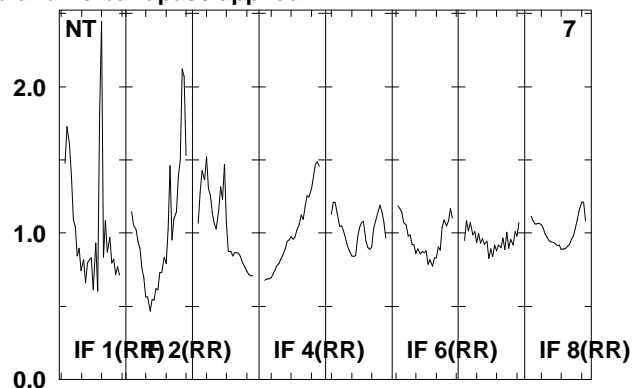
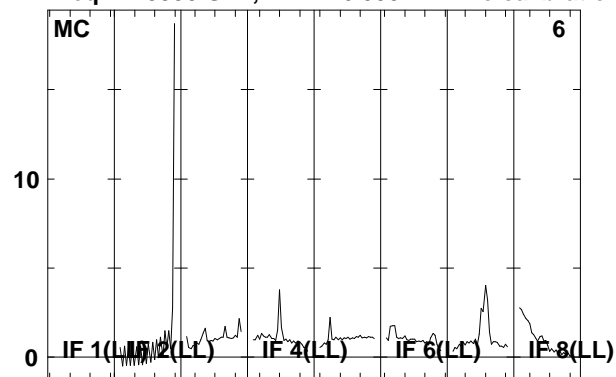

Lower frame: Real Jy
Total-power spectrum Antenna: *
Timerange: 00/16:53:02 to 00/16:54:30

Plot file version 43 created 22-APR-2008 12:25:43

IRAS0725 EP061B.UVDATA.1

Freq = 1.5950 GHz, Bw = 16.000 MH No calibration applied and no bandpass applied

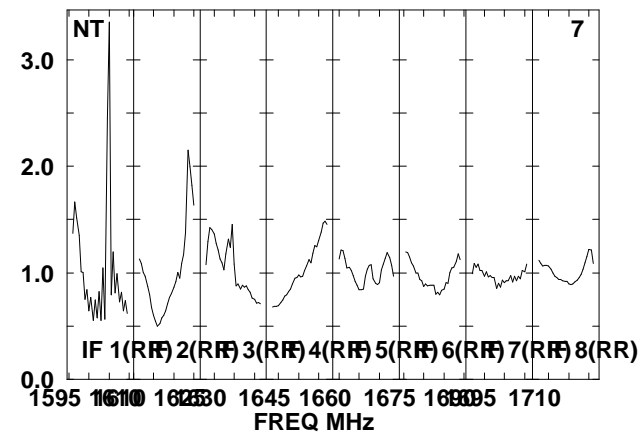
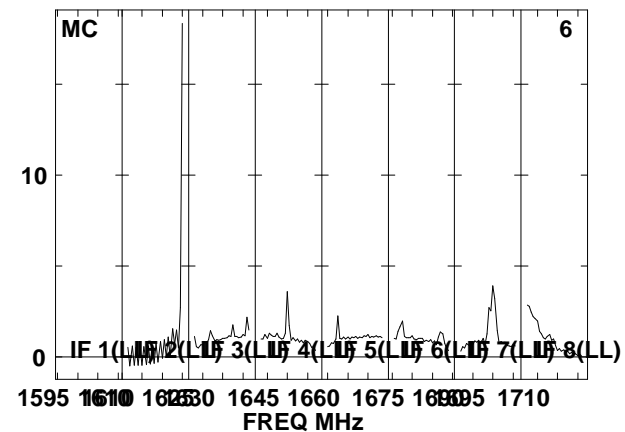
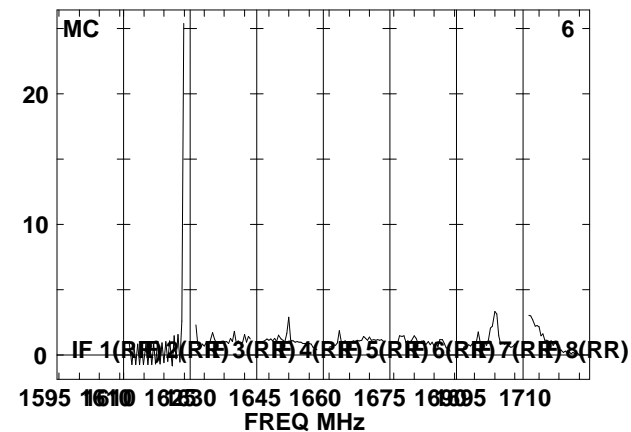
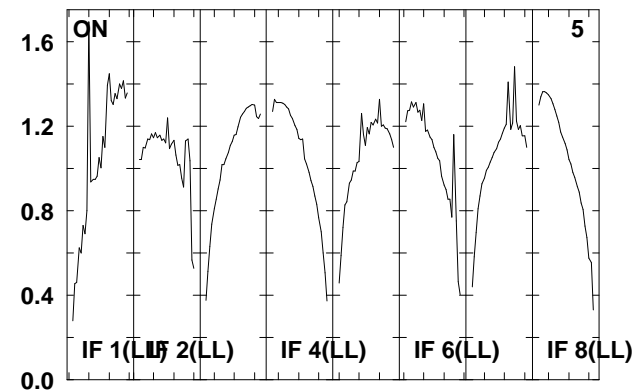
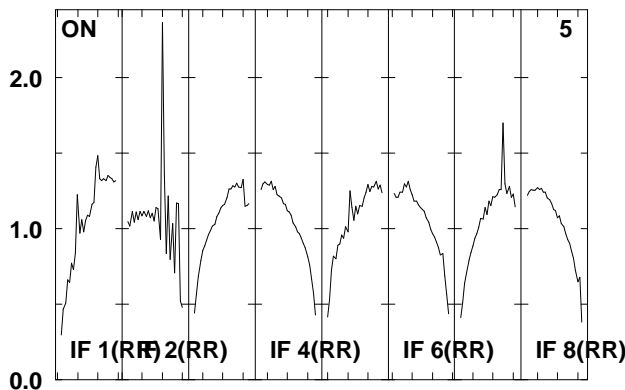
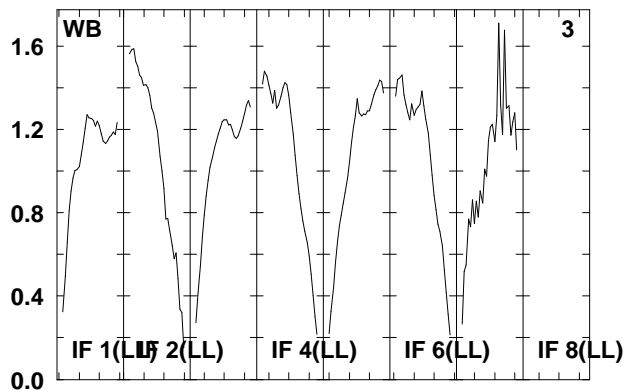
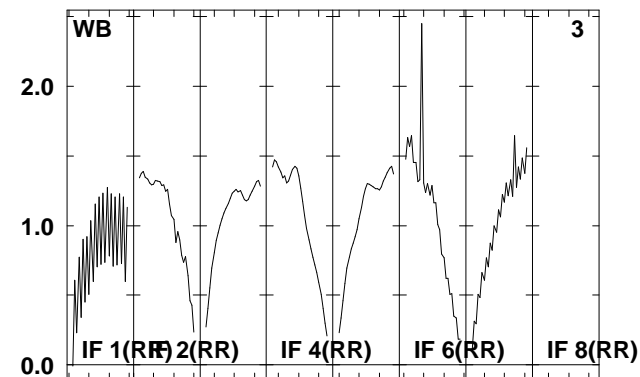
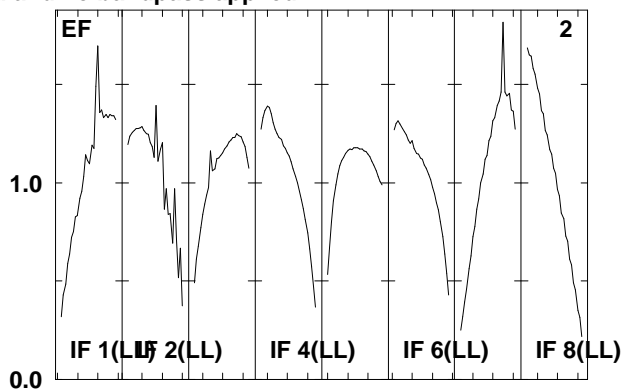
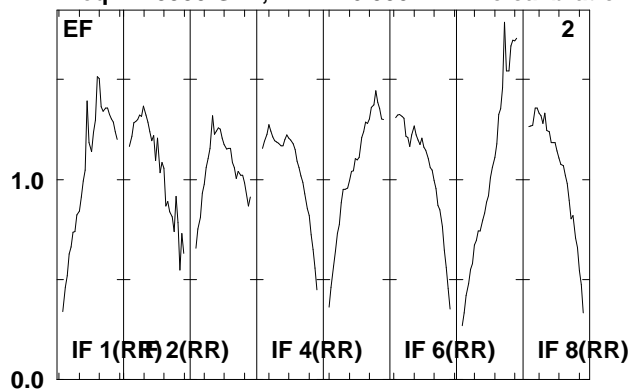

Lower frame: Real Jy
Total-power spectrum Antenna: *
Timerange: 00/16:54:32 to 00/16:58:00

Plot file version 44 created 22-APR-2008 12:25:44

IRAS0725 EP061B.UVDATA.1

Freq = 1.5950 GHz, Bw = 16.000 MH No calibration applied and no bandpass applied

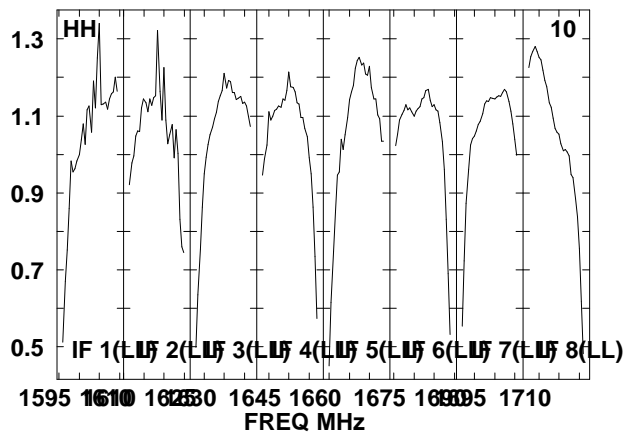
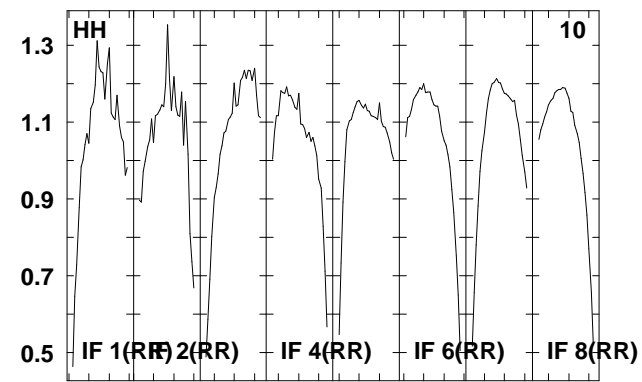
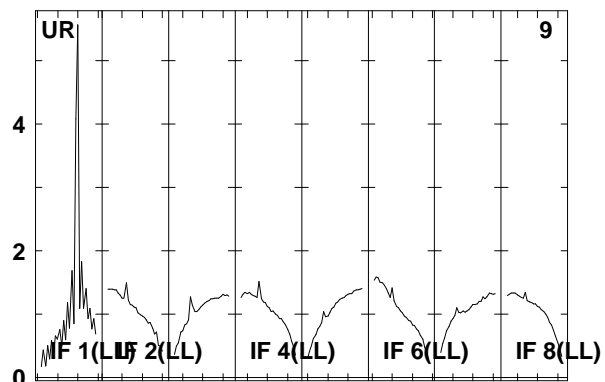
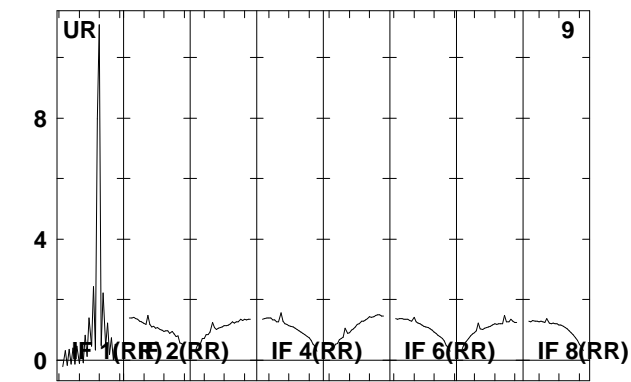
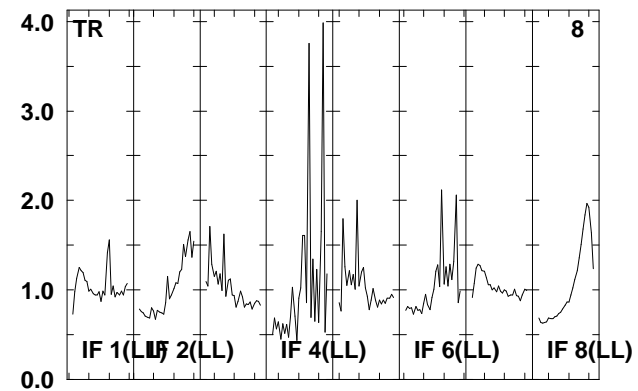
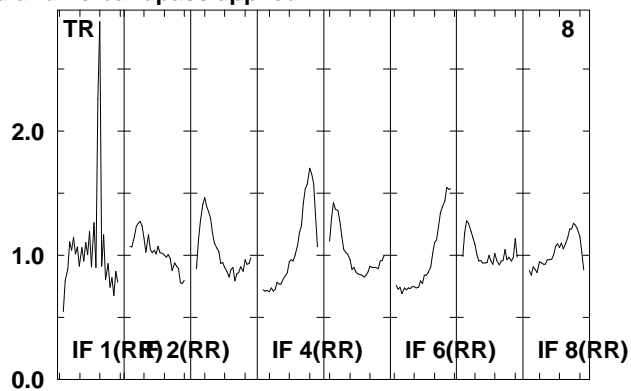
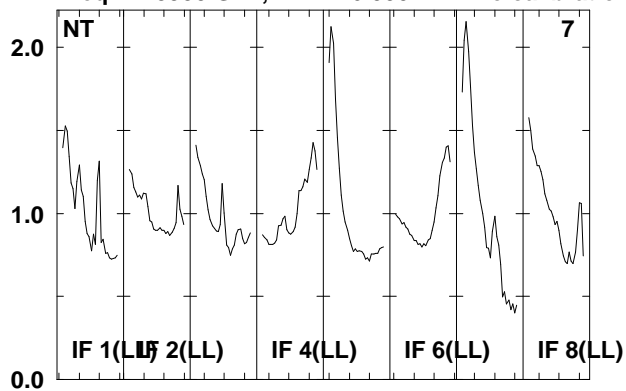

Lower frame: Real Jy

Total-power spectrum Antenna: *

Timerange: 00/16:54:32 to 00/16:58:00

Plot file version 45 created 22-APR-2008 12:25:45

J0730-02 EP061B.UVDATA.1

Freq = 1.5950 GHz, Bw = 16.000 MH No calibration applied and no bandpass applied

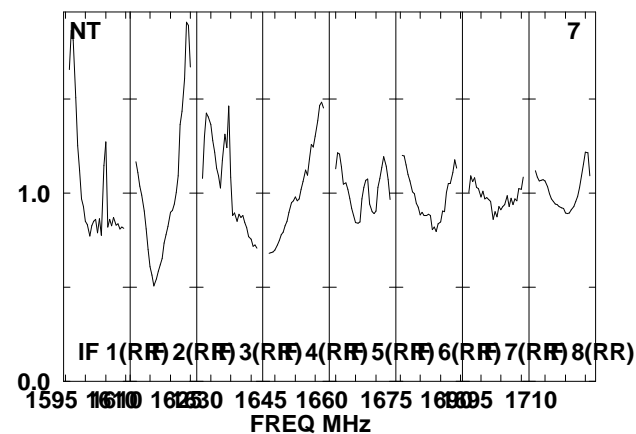
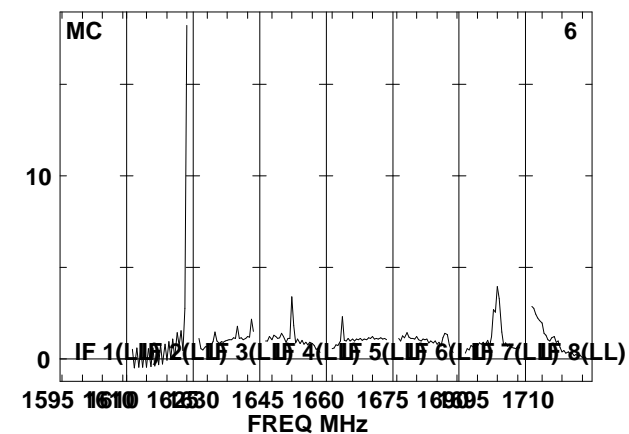
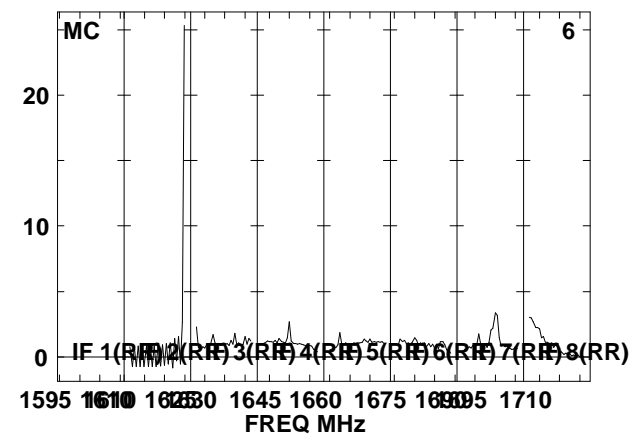
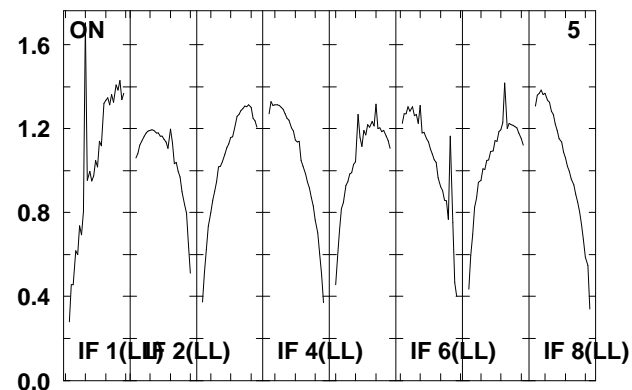
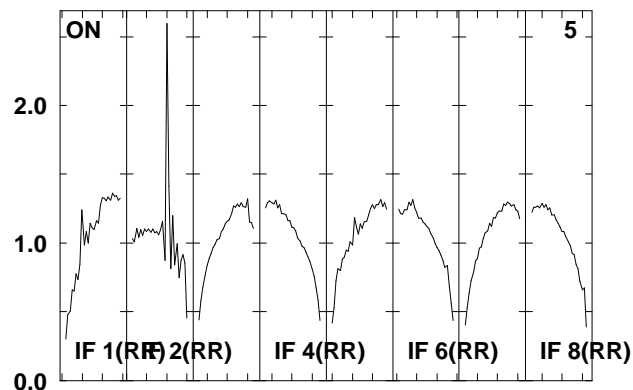
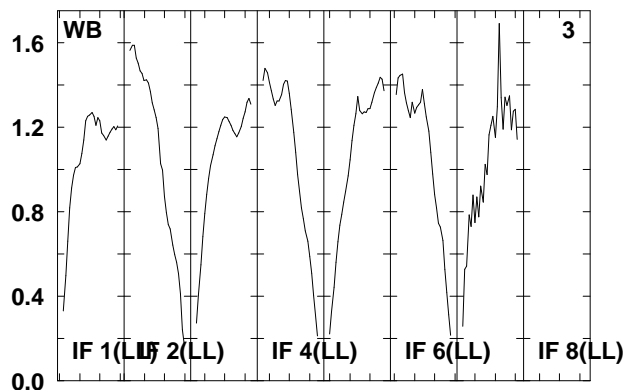
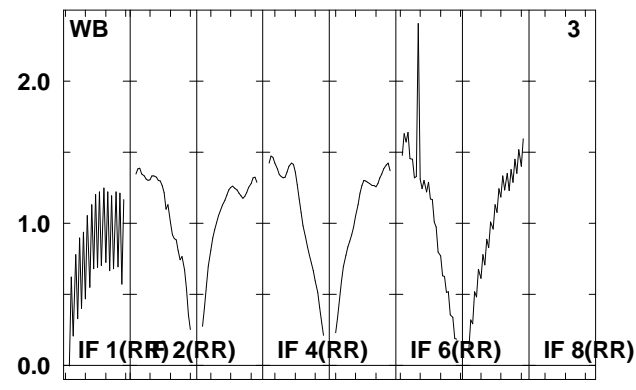
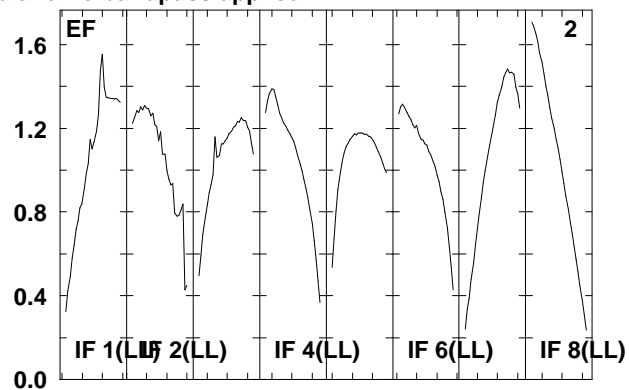
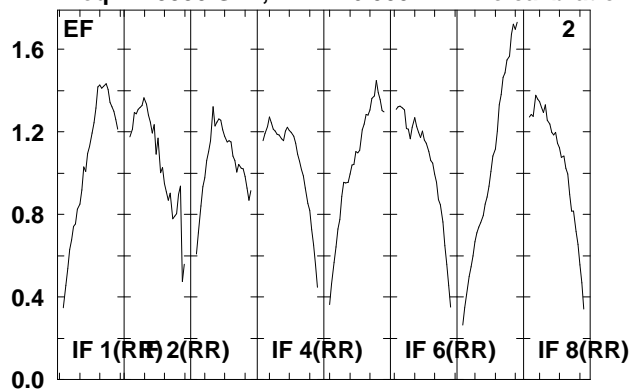

Lower frame: Real Jy
Total-power spectrum Antenna: *
Timerange: 00/16:58:02 to 00/16:59:30

Plot file version 46 created 22-APR-2008 12:25:46

J0730-02 EP061B.UVDATA.1

Freq = 1.5950 GHz, Bw = 16.000 MH No calibration applied and no bandpass applied

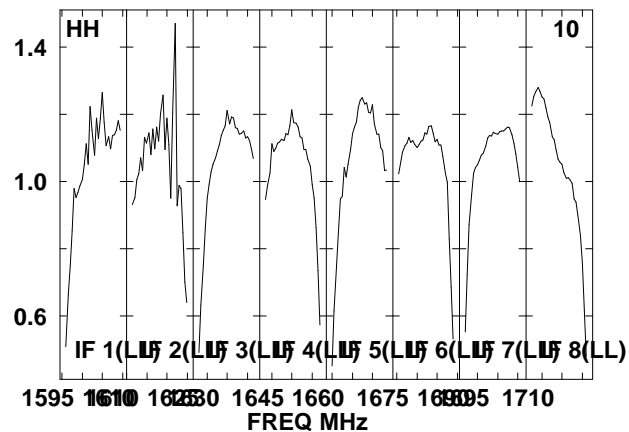
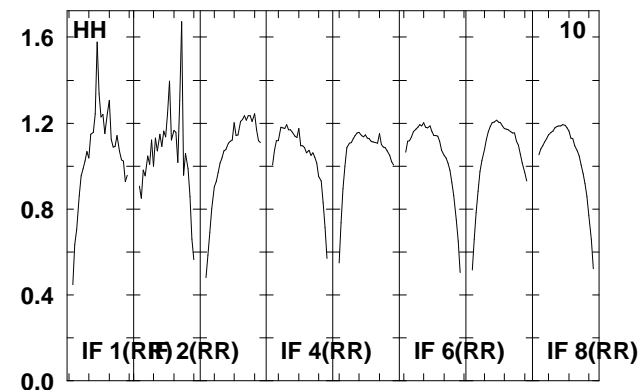
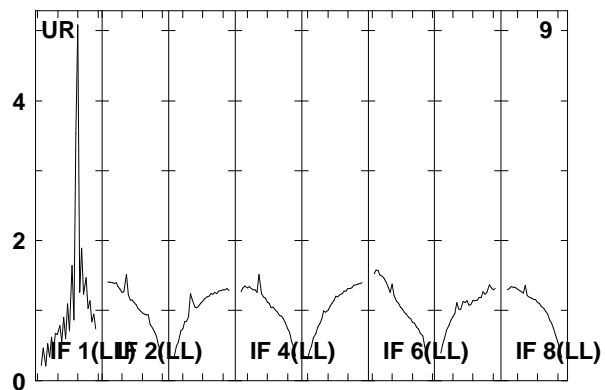
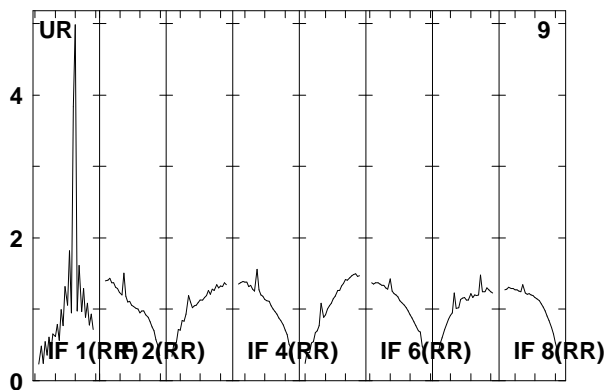
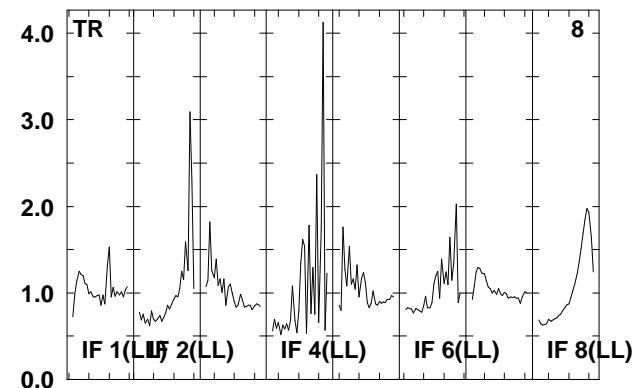
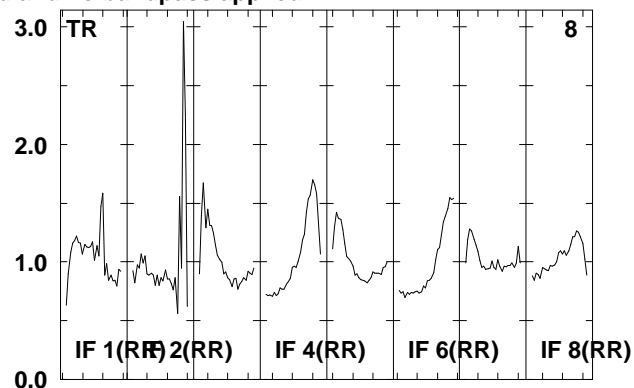
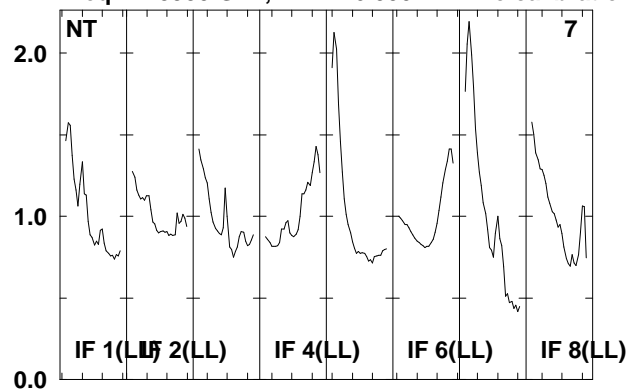

Lower frame: Real Jy

Total-power spectrum Antenna: *

Timerange: 00/16:58:02 to 00/16:59:30

Plot file version 47 created 22-APR-2008 12:25:46

IRAS0725 EP061B.UVDATA.1

Freq = 1.5950 GHz, Bw = 16.000 MH No calibration applied and no bandpass applied

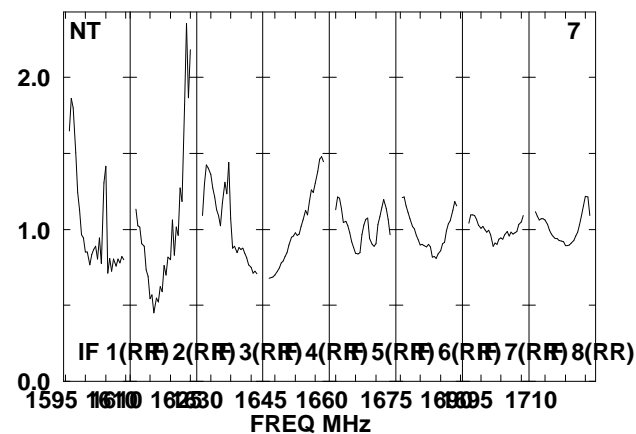
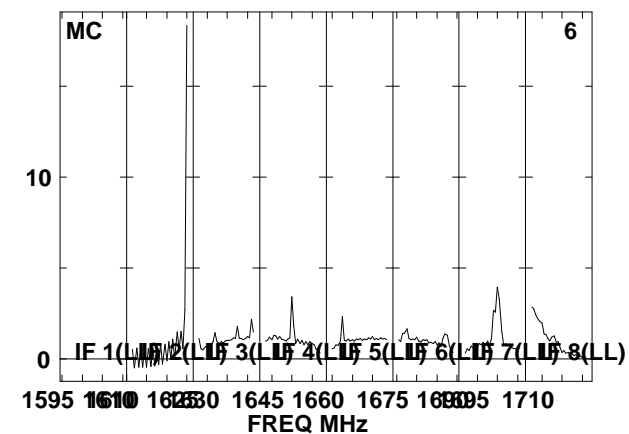
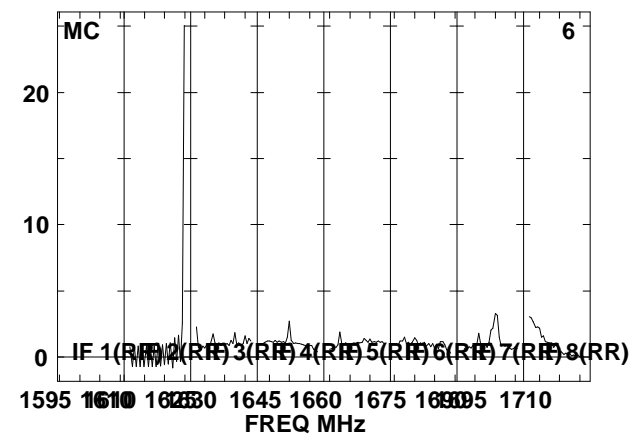
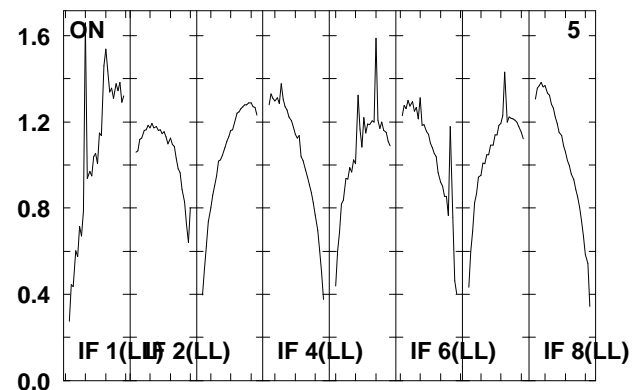
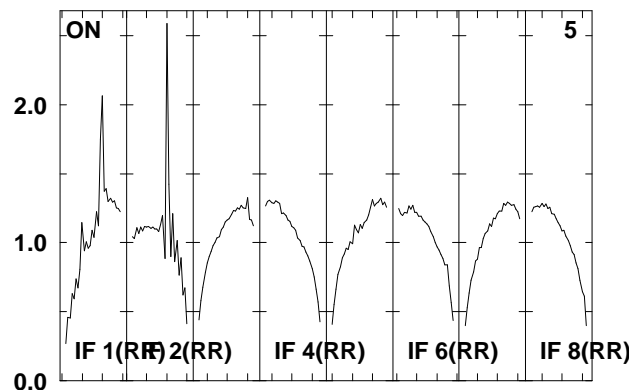
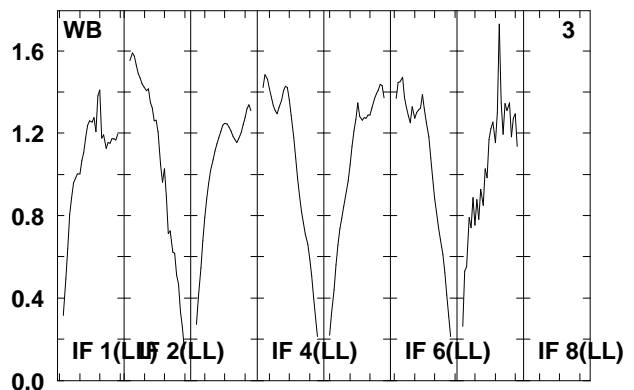
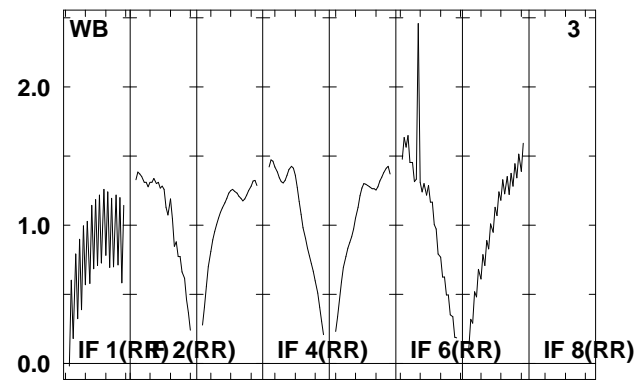
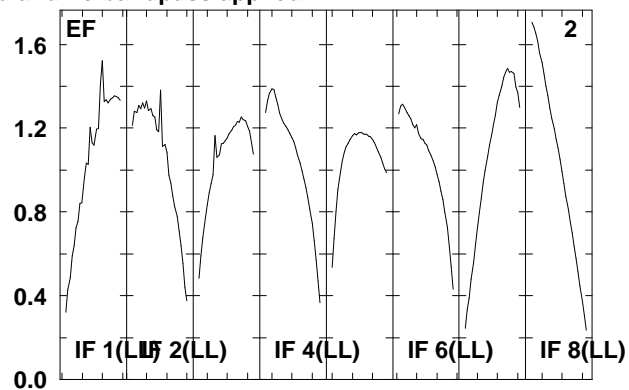
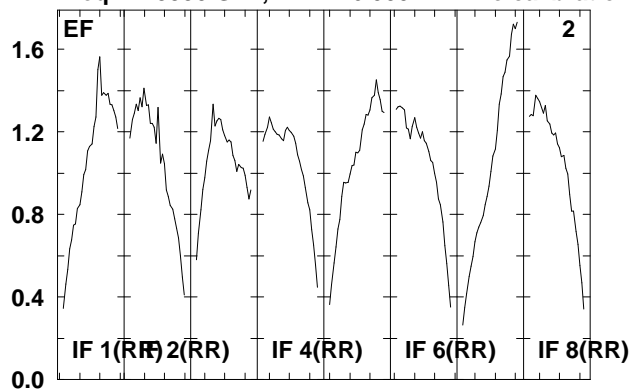

Lower frame: Real Jy
Total-power spectrum Antenna: *
Timerange: 00/16:59:32 to 00/17:02:56

Plot file version 48 created 22-APR-2008 12:25:47

IRAS0725 EP061B.UVDATA.1

Freq = 1.5950 GHz, Bw = 16.000 MH No calibration applied and no bandpass applied

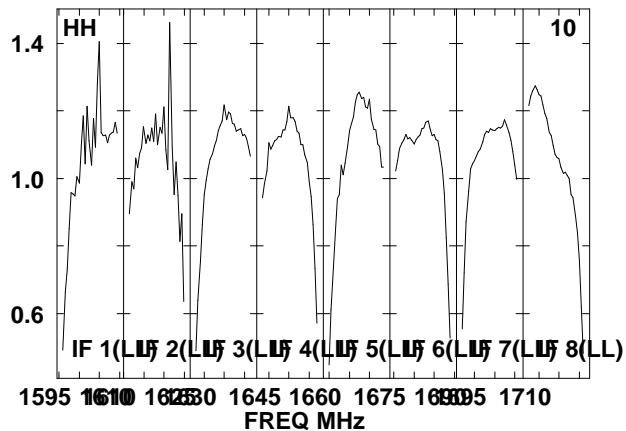
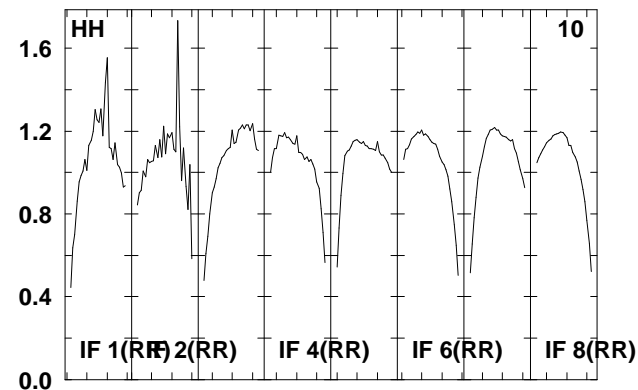
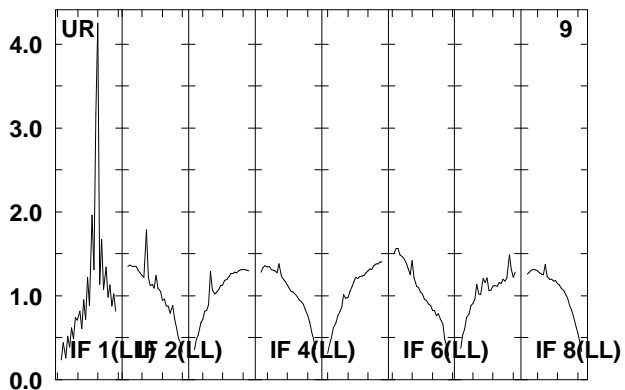
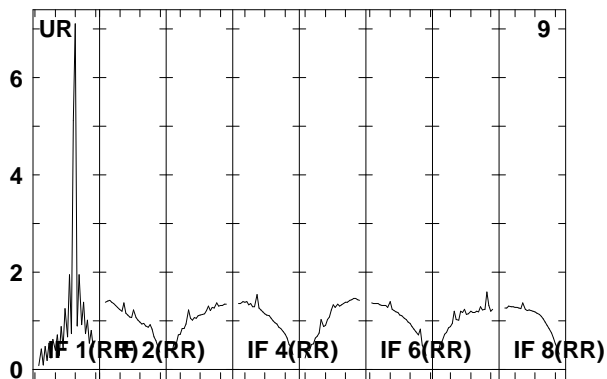
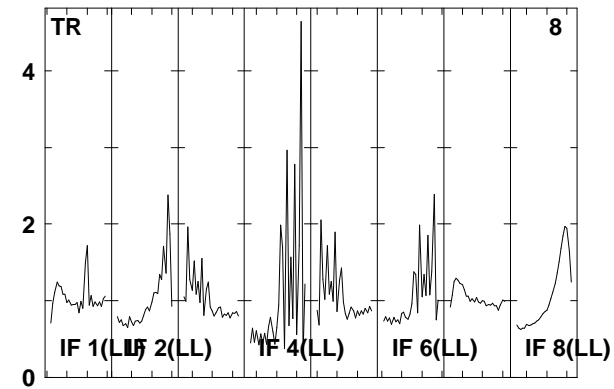
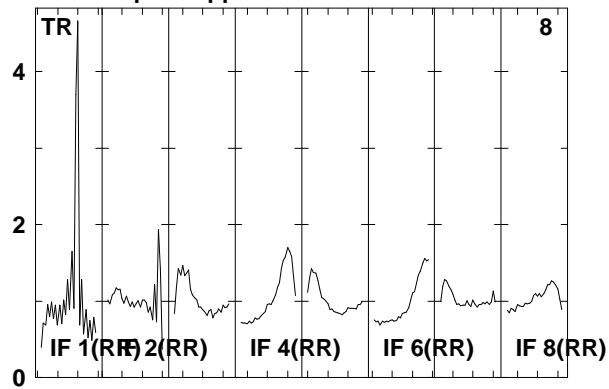
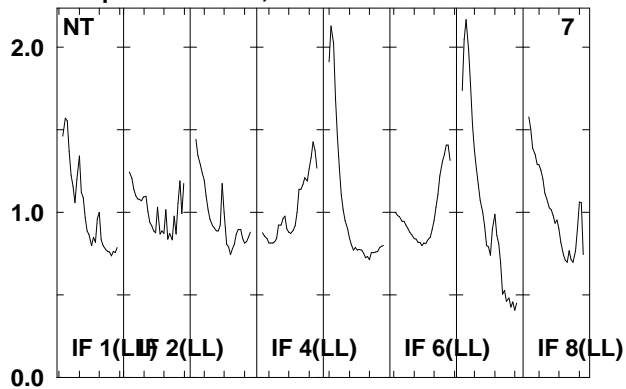

Lower frame: Real Jy

Total-power spectrum Antenna: *

Timerange: 00/16:59:32 to 00/17:02:56

Plot file version 49 created 22-APR-2008 12:25:48

J0730-02 EP061B.UVDATA.1

Freq = 1.5950 GHz, Bw = 16.000 MH No calibration applied and no bandpass applied

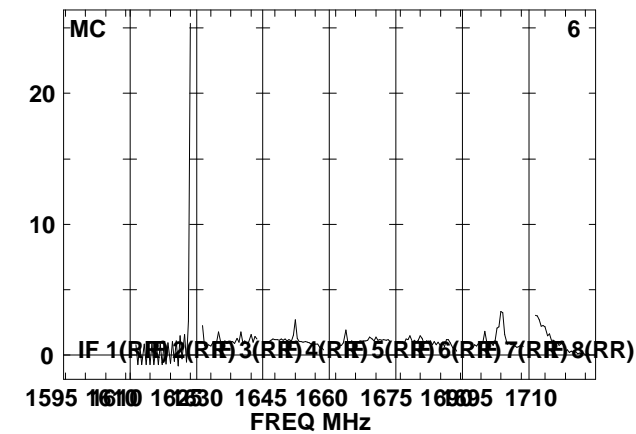
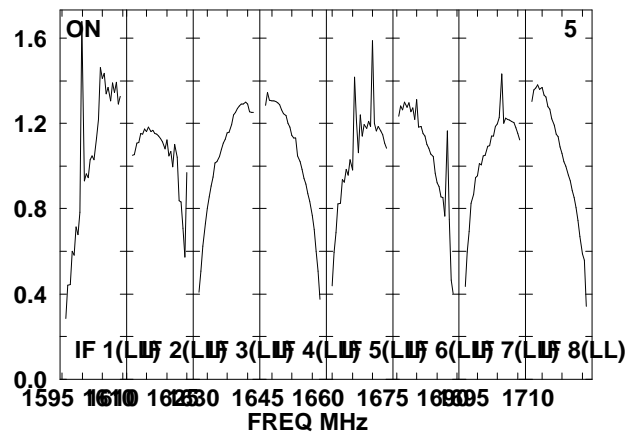
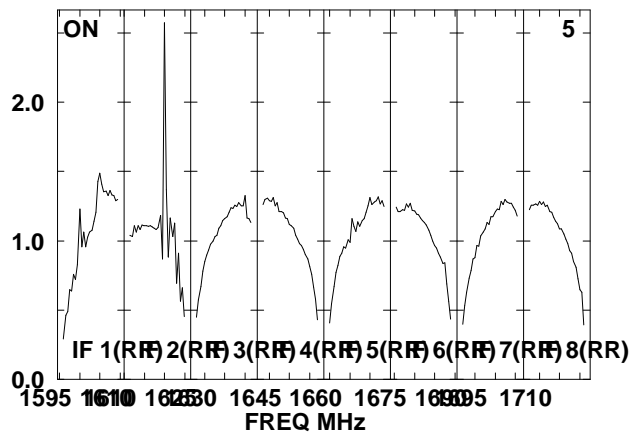
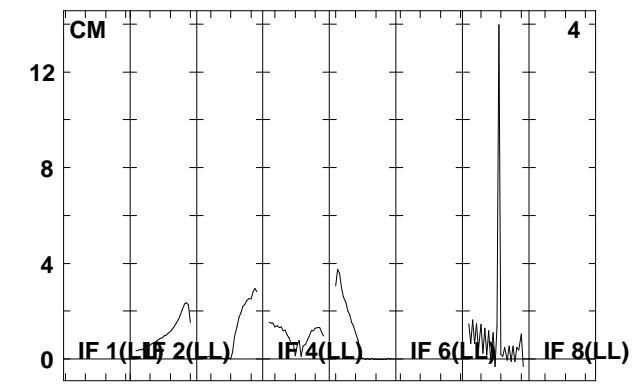
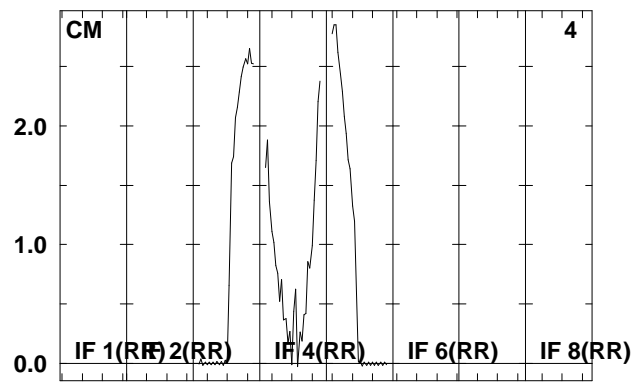
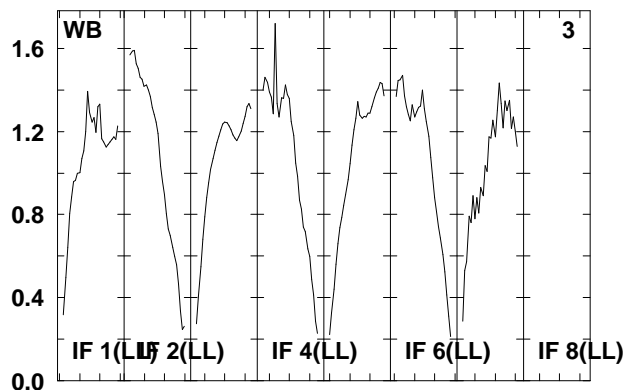
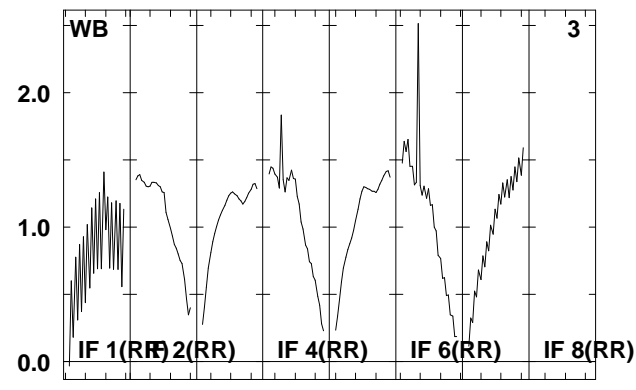
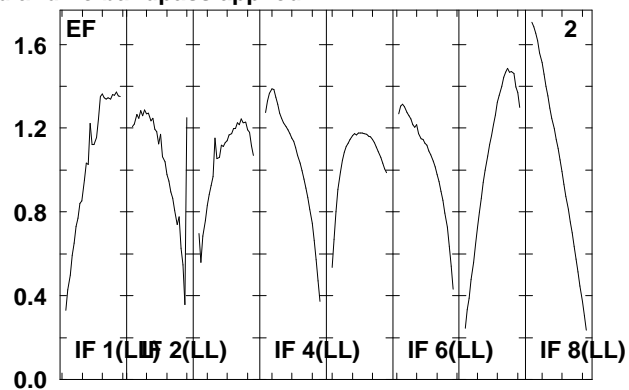
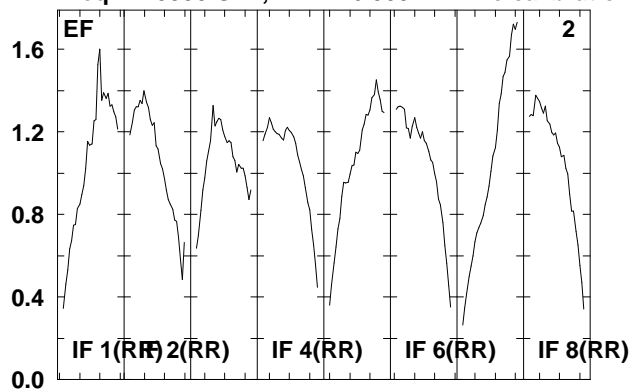

Lower frame: Real Jy
Total-power spectrum Antenna: *
Timerange: 00/17:04:02 to 00/17:05:30

Plot file version 50 created 22-APR-2008 12:25:48

J0730-02 EP061B.UVDATA.1

Freq = 1.5950 GHz, Bw = 16.000 MH No calibration applied and no bandpass applied

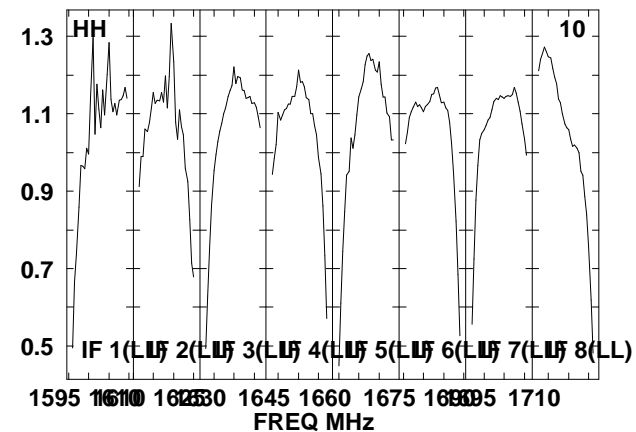
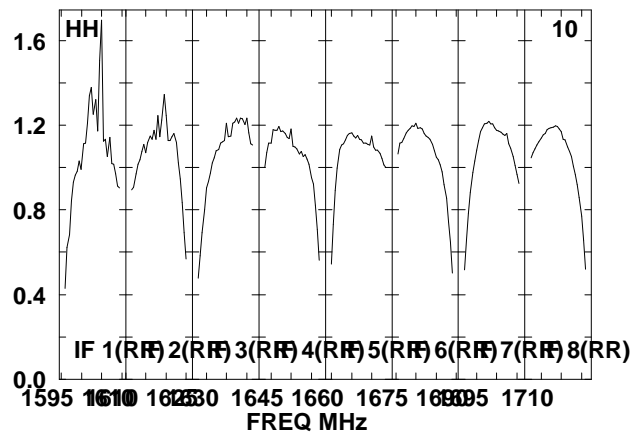
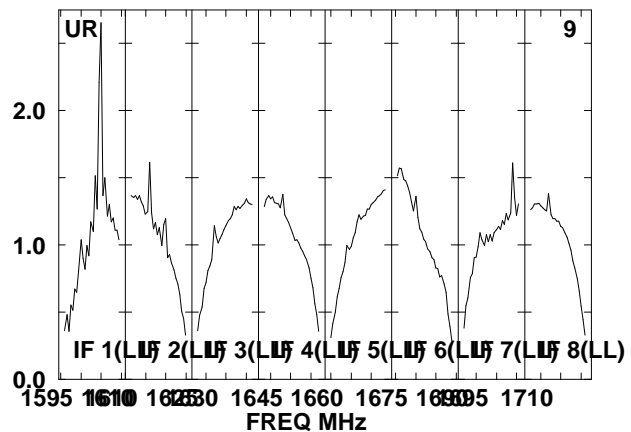
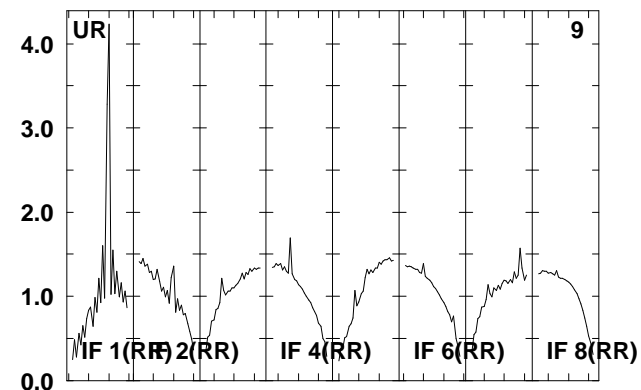
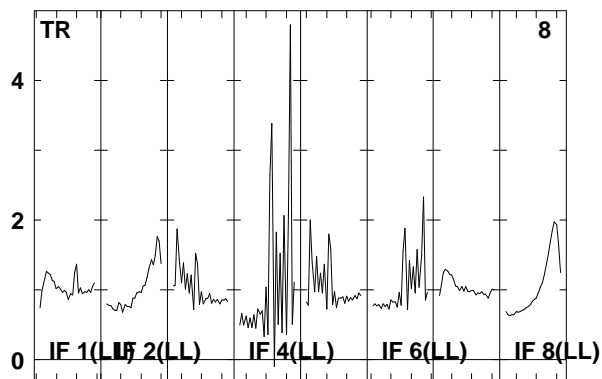
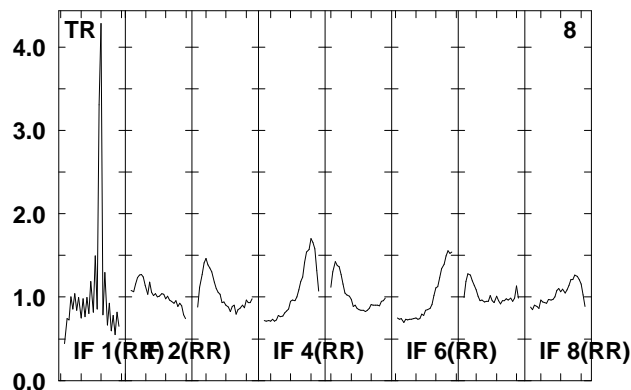
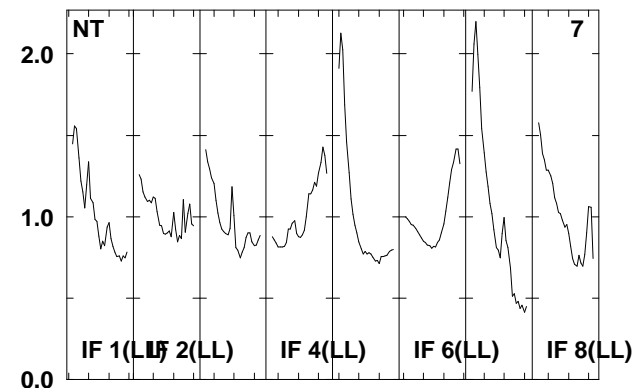
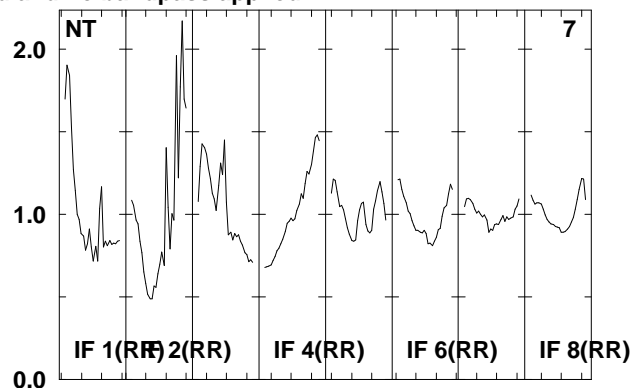
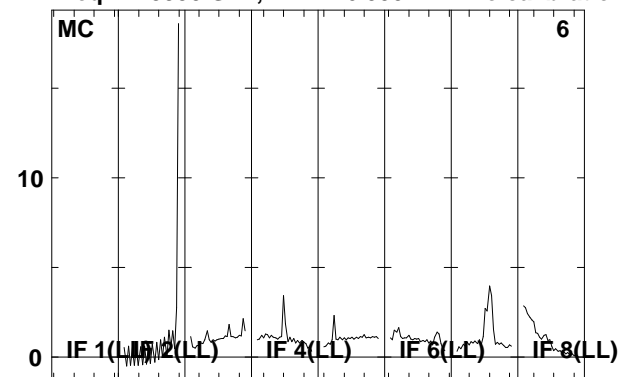

Lower frame: Real Jy
Total-power spectrum Antenna: *
Timerange: 00/17:04:02 to 00/17:05:30

Plot file version 51 created 22-APR-2008 12:25:50

IRAS0725 EP061B.UVDATA.1

Freq = 1.5950 GHz, Bw = 16.000 MH No calibration applied and no bandpass applied

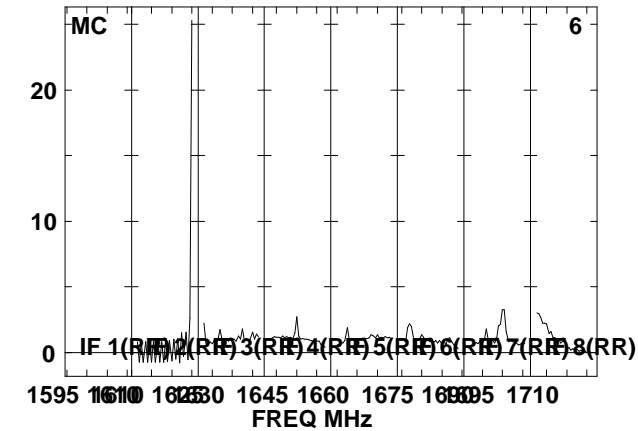
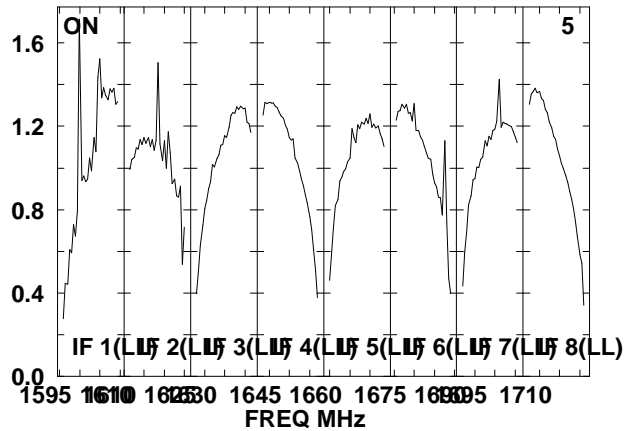
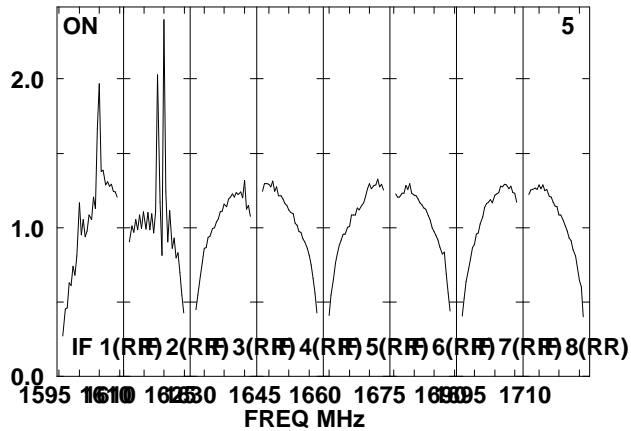
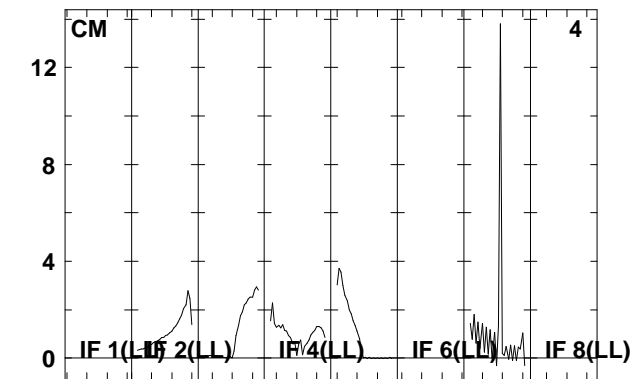
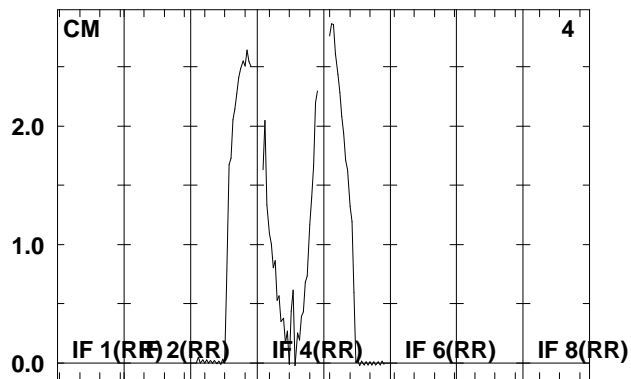
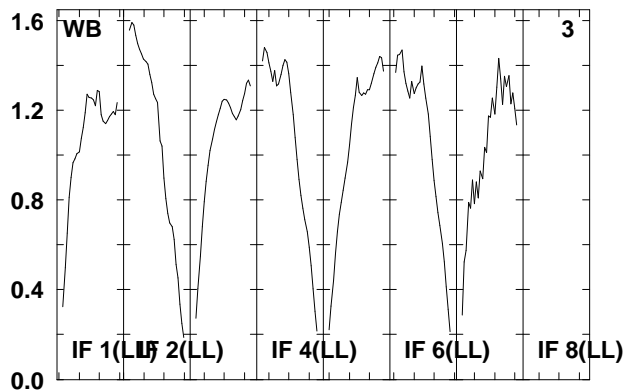
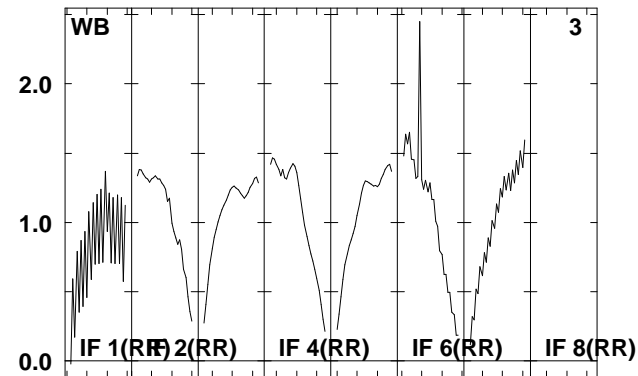
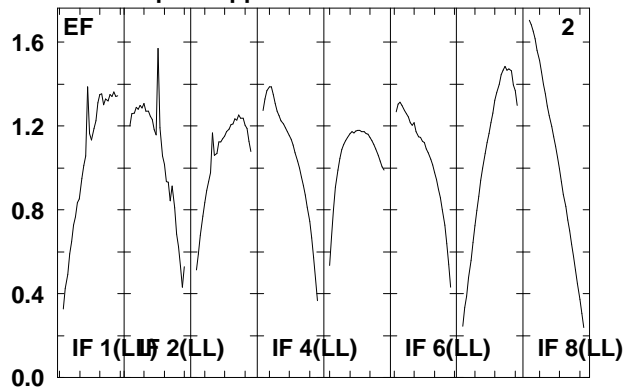
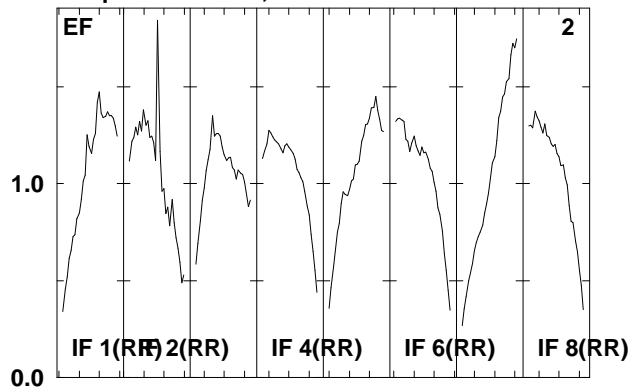

Lower frame: Real Jy
Total-power spectrum Antenna: *
Timerange: 00/17:05:32 to 00/17:09:00

Plot file version 52 created 22-APR-2008 12:25:50

IRAS0725 EP061B.UVDATA.1

Freq = 1.5950 GHz, Bw = 16.000 MH No calibration applied and no bandpass applied

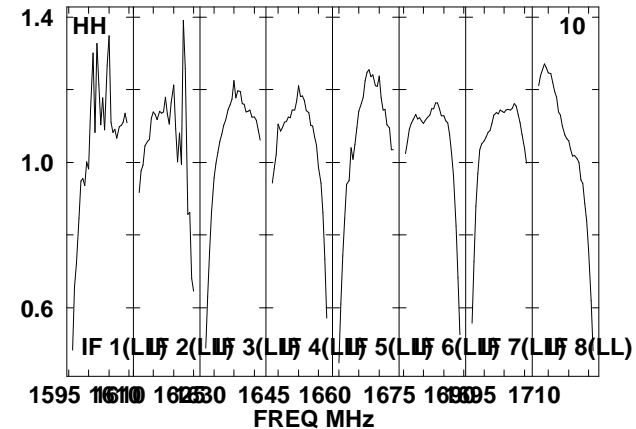
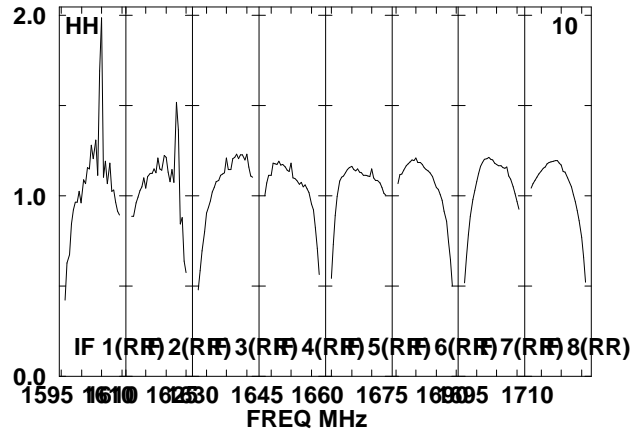
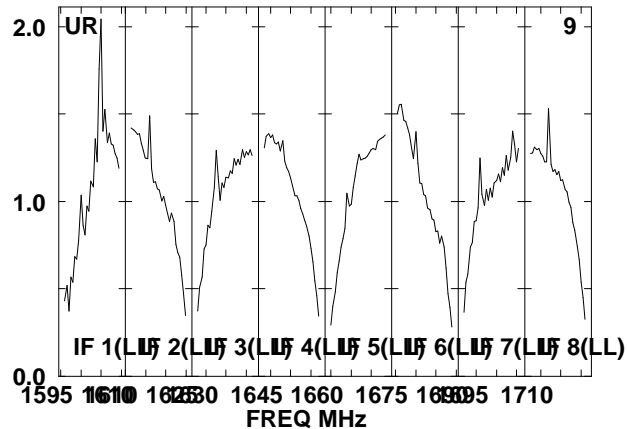
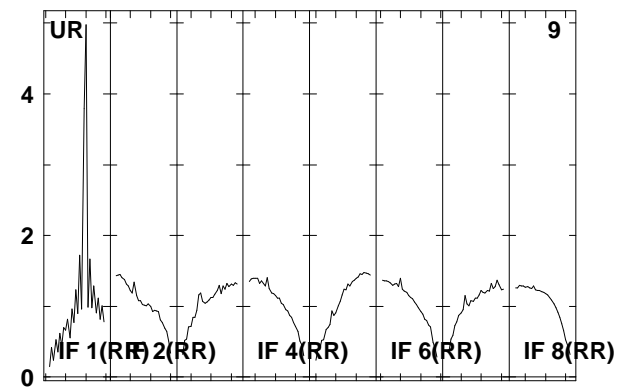
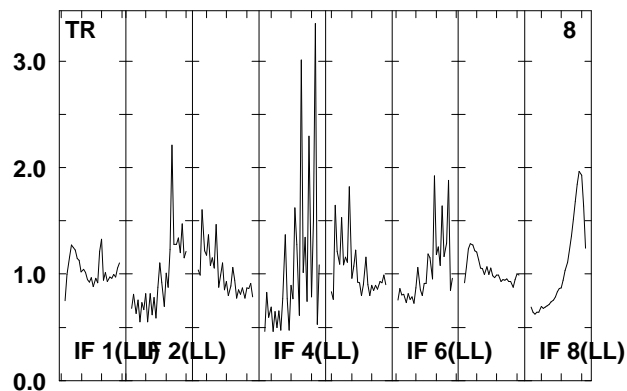
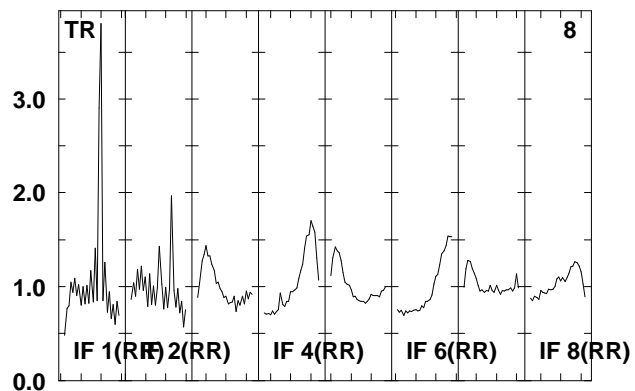
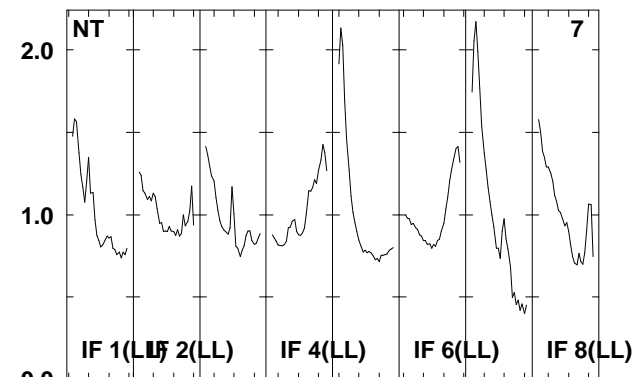
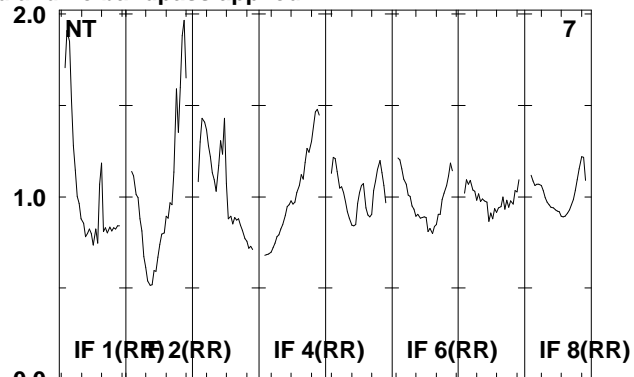
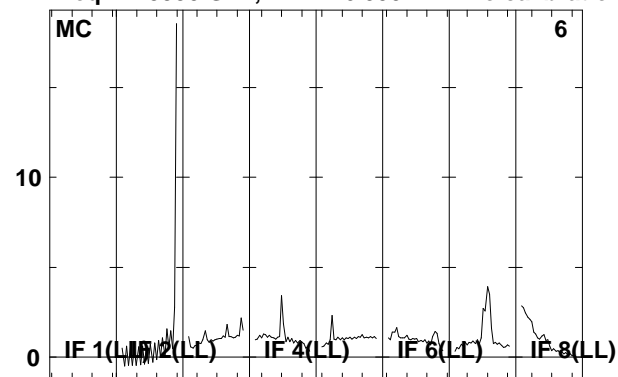

Lower frame: Real Jy
Total-power spectrum Antenna: *
Timerange: 00/17:05:32 to 00/17:09:00

Plot file version 53 created 22-APR-2008 12:25:51

J0730-02 EP061B.UVDATA.1

Freq = 1.5950 GHz, Bw = 16.000 MH No calibration applied and no bandpass applied

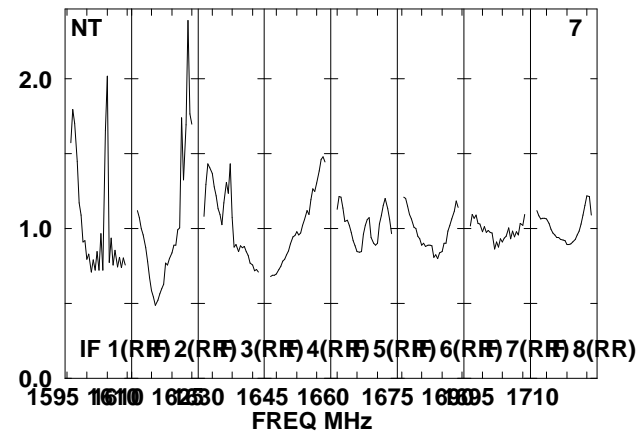
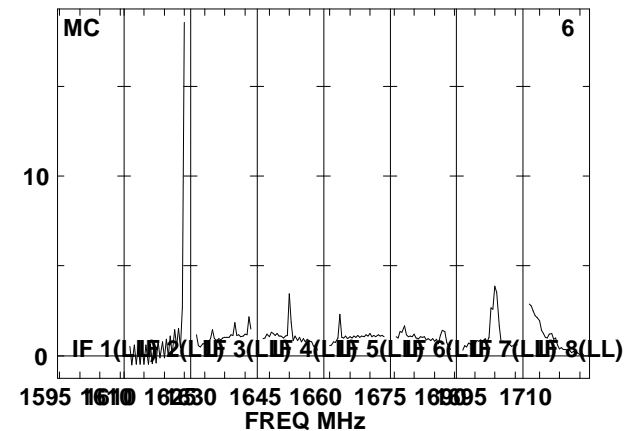
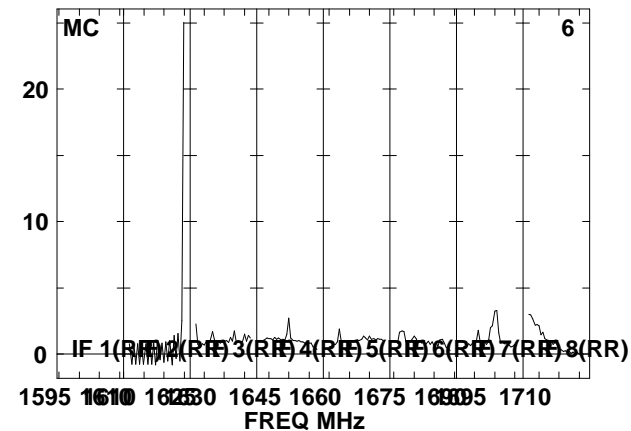
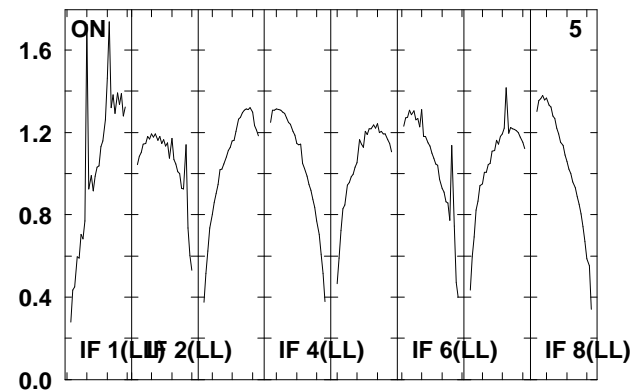
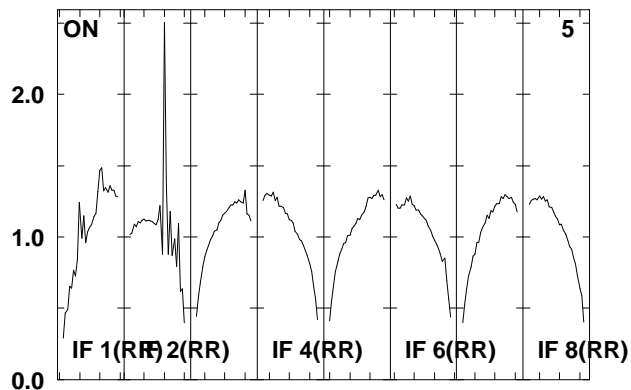
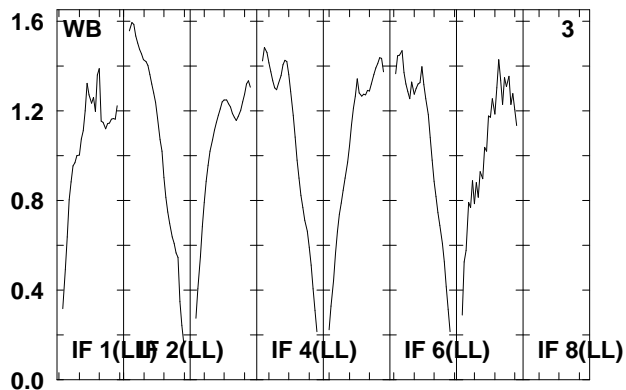
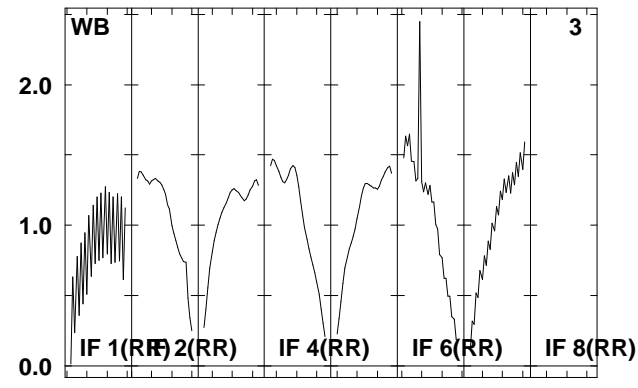
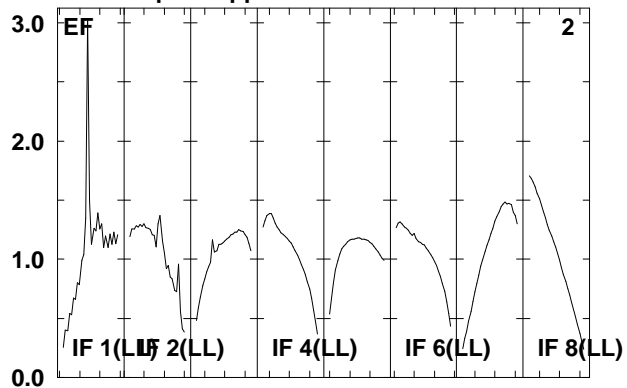
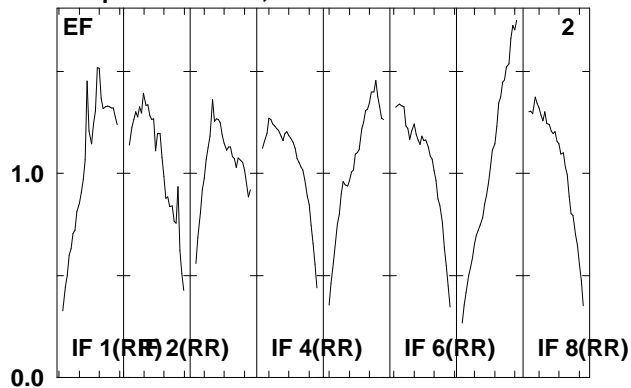

Lower frame: Real Jy

Total-power spectrum Antenna: *

Timerange: 00/17:09:02 to 00/17:10:30

Plot file version 54 created 22-APR-2008 12:25:52

J0730-02 EP061B.UVDATA.1

Freq = 1.5950 GHz, Bw = 16.000 MH No calibration applied and no bandpass applied

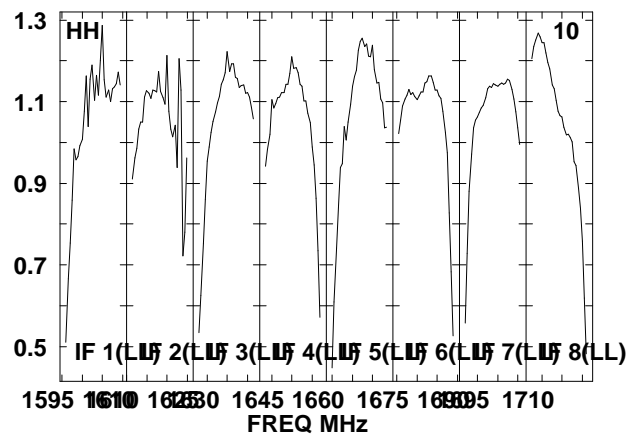
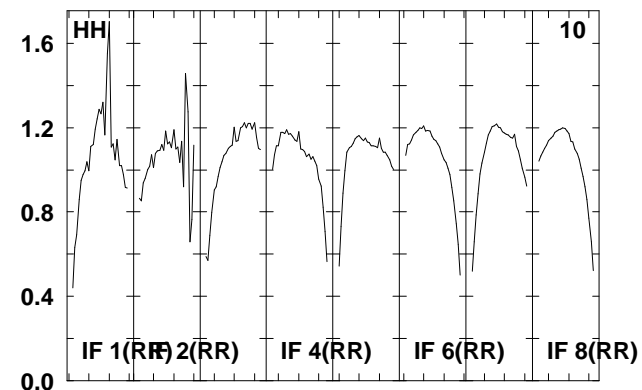
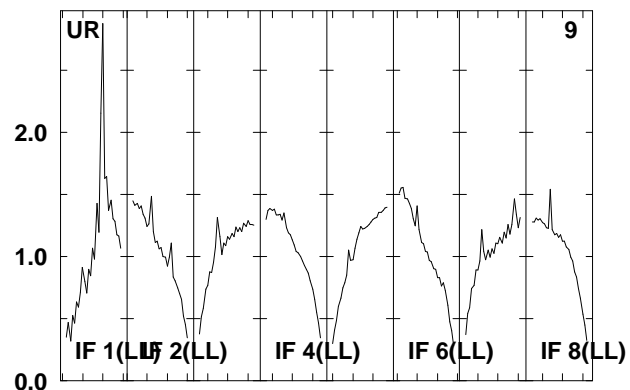
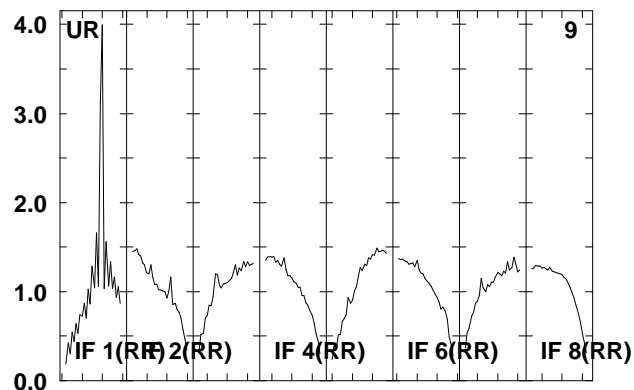
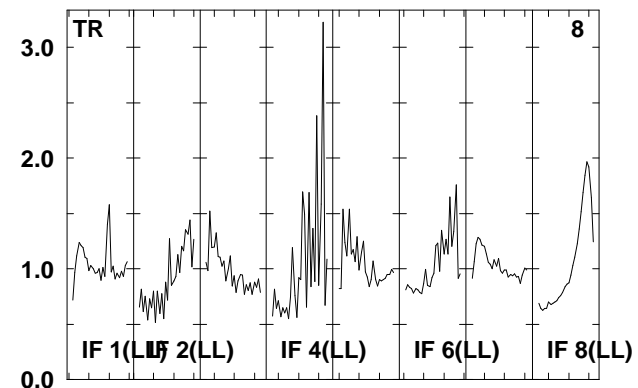
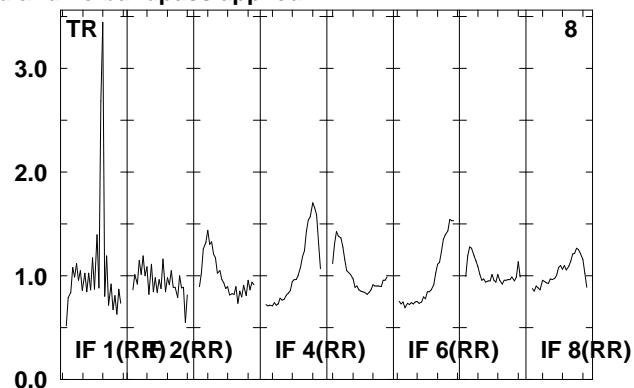
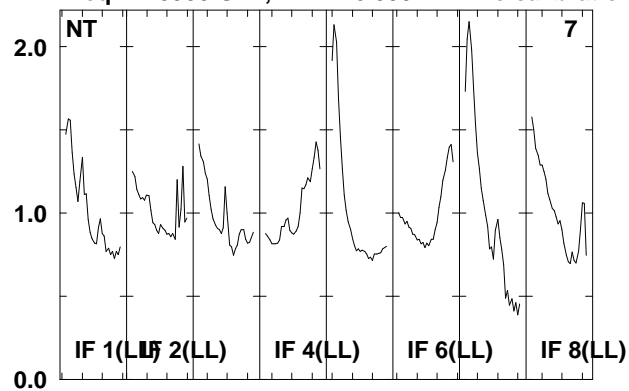

Lower frame: Real Jy

Total-power spectrum Antenna: *

Timerange: 00/17:09:02 to 00/17:10:30

Plot file version 55 created 22-APR-2008 12:25:52

IRAS0725 EP061B.UVDATA.1

Freq = 1.5950 GHz, Bw = 16.000 MH No calibration applied and no bandpass applied

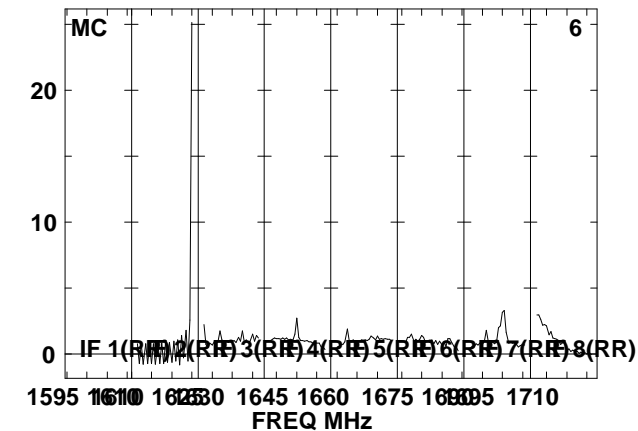
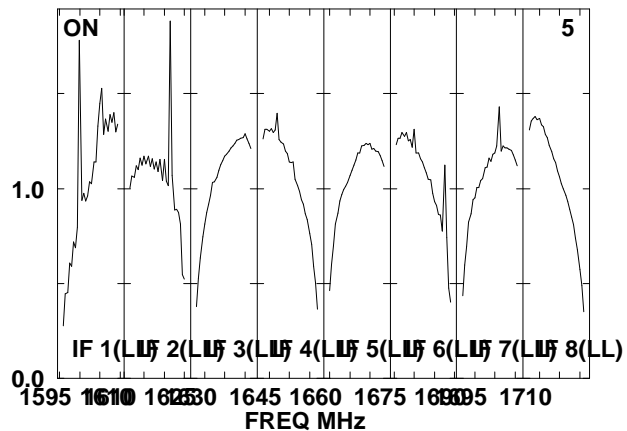
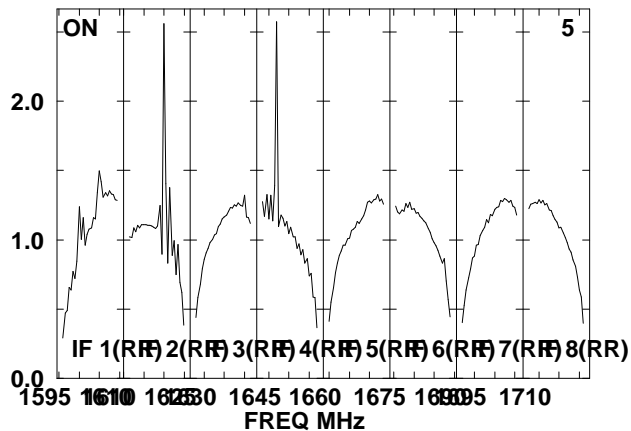
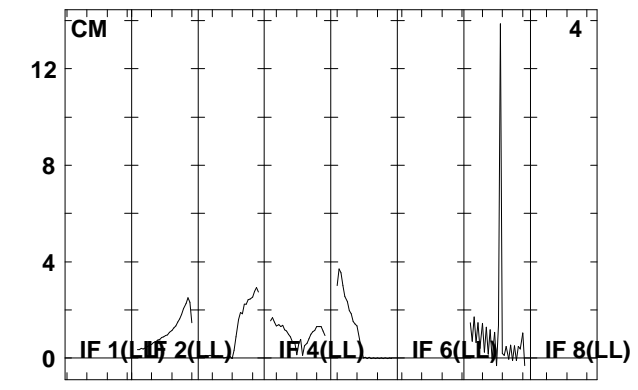
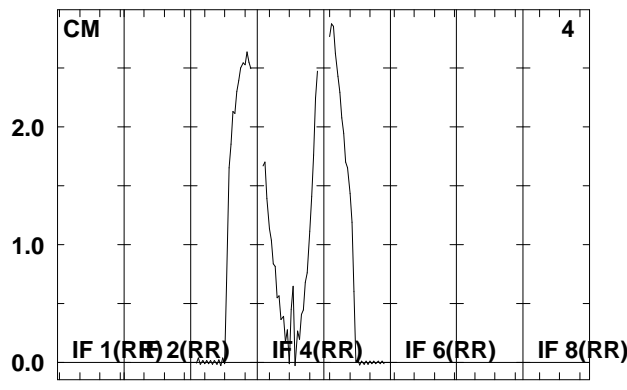
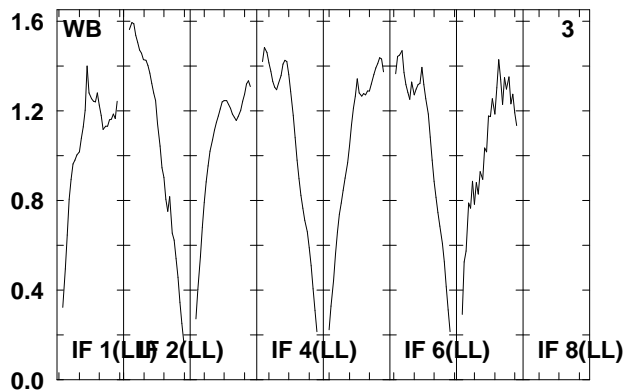
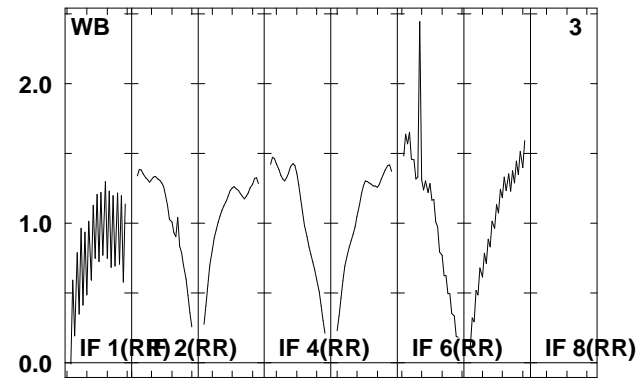
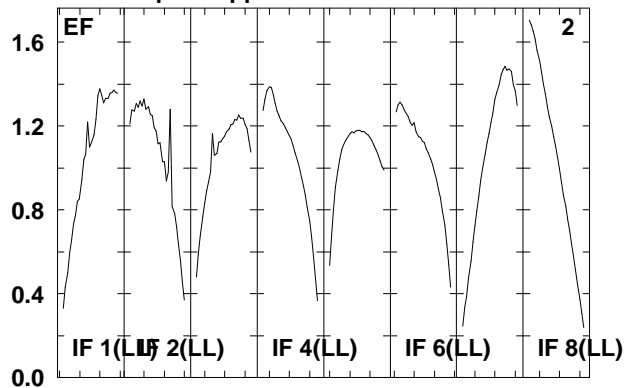
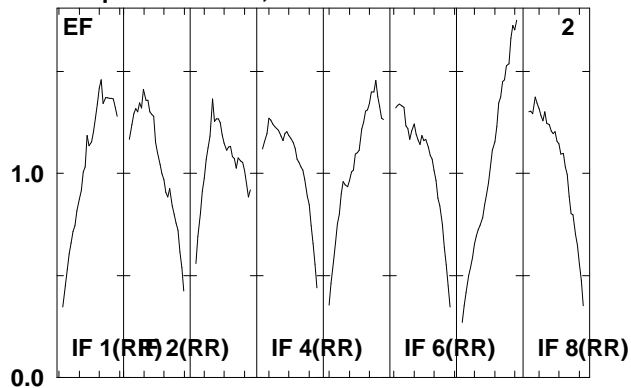

Lower frame: Real Jy
Total-power spectrum Antenna: *
Timerange: 00/17:10:32 to 00/17:14:00

Plot file version 56 created 22-APR-2008 12:25:53

IRAS0725 EP061B.UVDATA.1

Freq = 1.5950 GHz, Bw = 16.000 MH No calibration applied and no bandpass applied

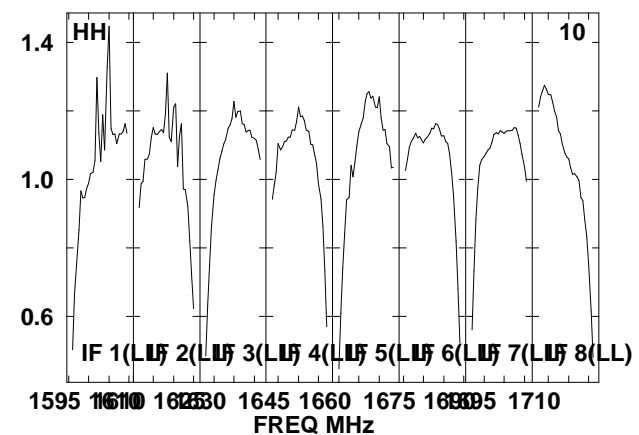
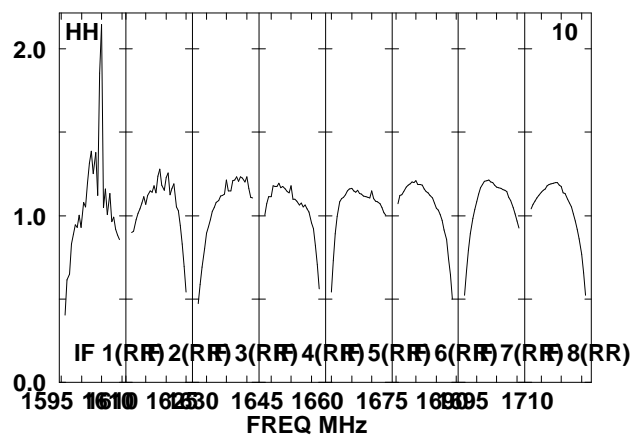
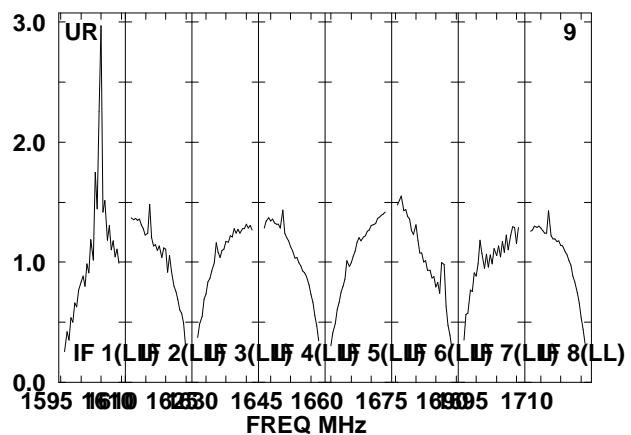
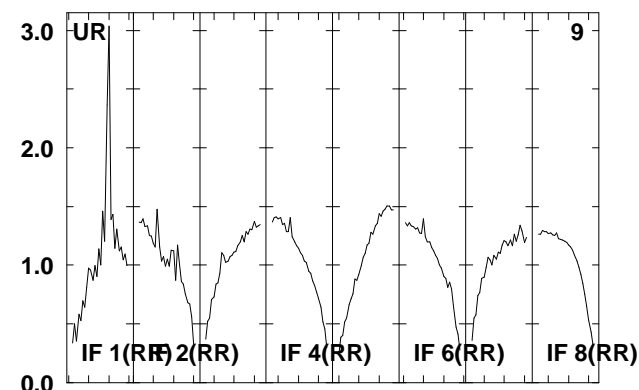
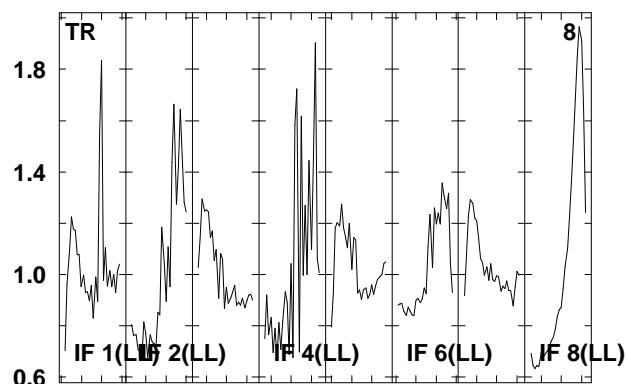
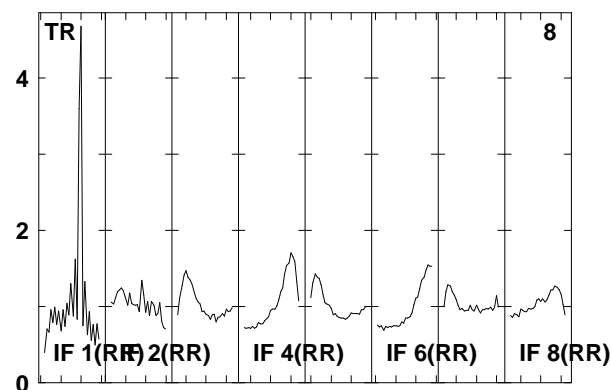
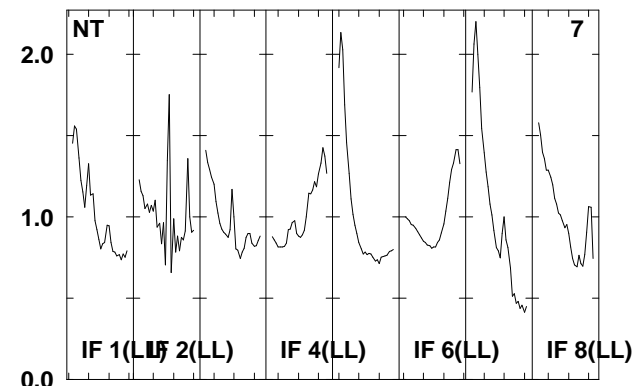
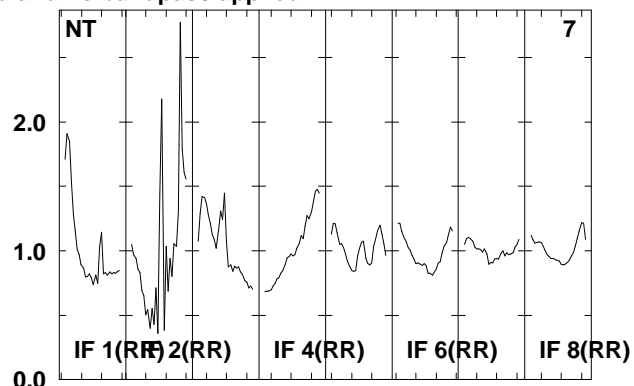
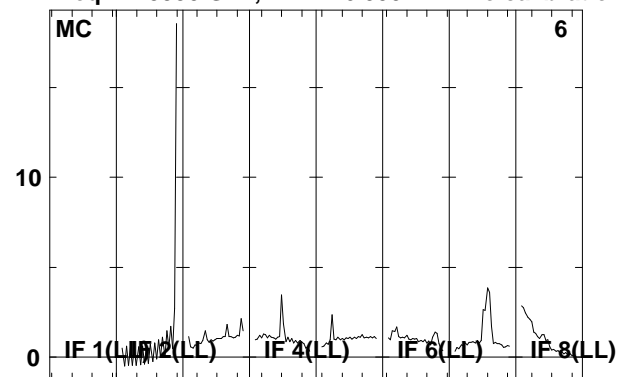

Lower frame: Real Jy

Total-power spectrum Antenna: *

Timerange: 00/17:10:32 to 00/17:14:00

Plot file version 57 created 22-APR-2008 12:25:55

J0730-02 EP061B.UVDATA.1

Freq = 1.5950 GHz, Bw = 16.000 MH No calibration applied and no bandpass applied

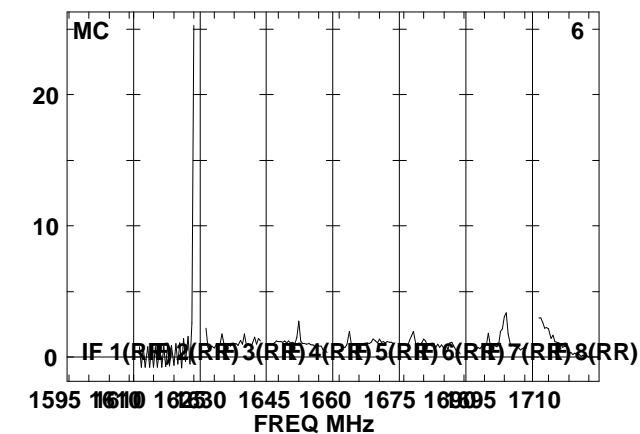
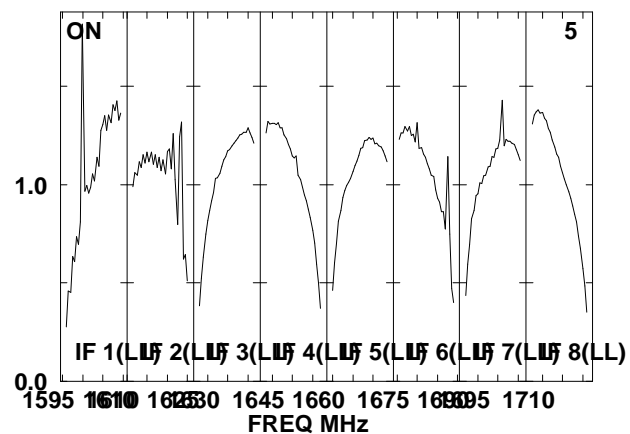
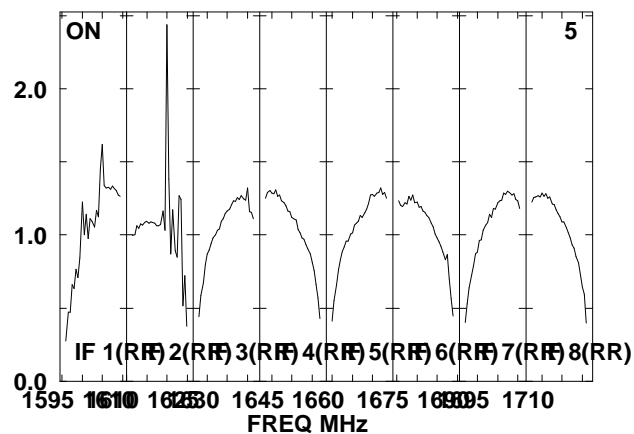
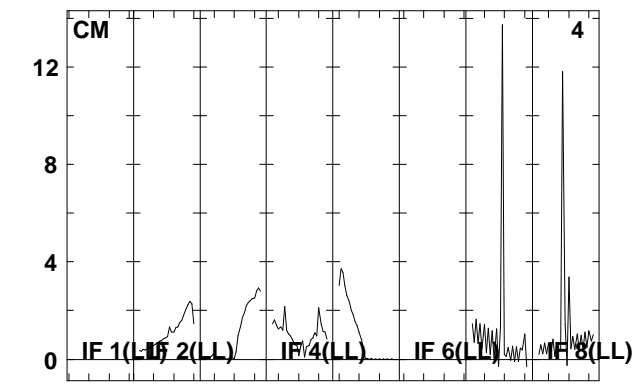
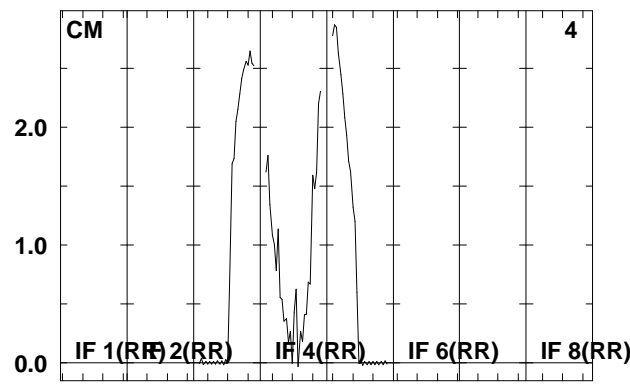
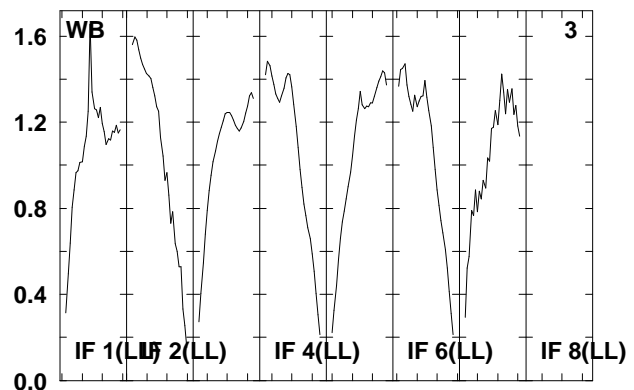
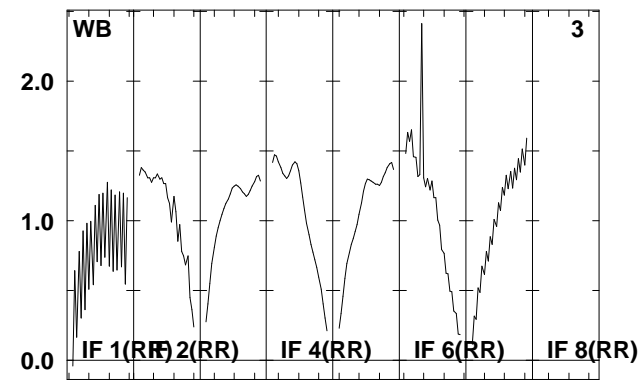
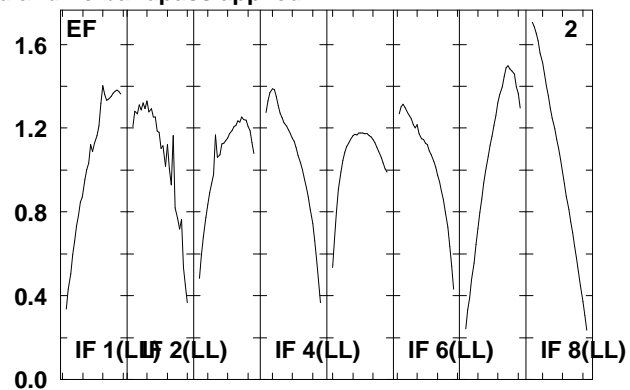
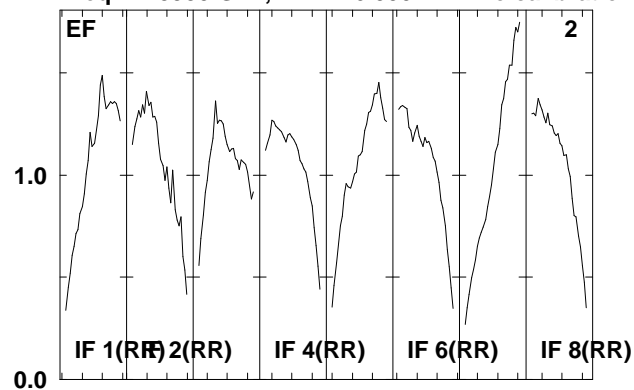

Lower frame: Real Jy
Total-power spectrum Antenna: *
Timerange: 00/17:14:02 to 00/17:15:30

Plot file version 58 created 22-APR-2008 12:25:55

J0730-02 EP061B.UVDATA.1

Freq = 1.5950 GHz, Bw = 16.000 MH No calibration applied and no bandpass applied

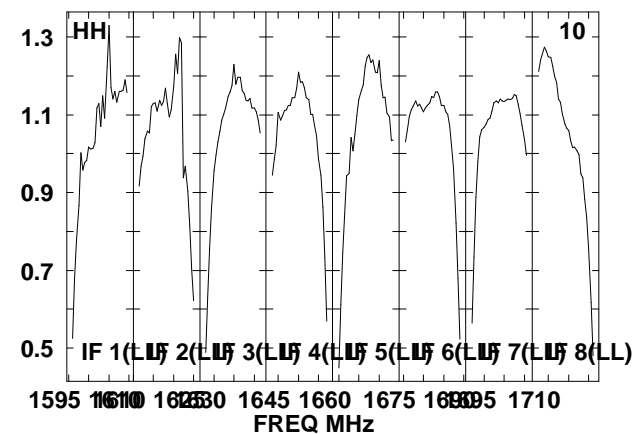
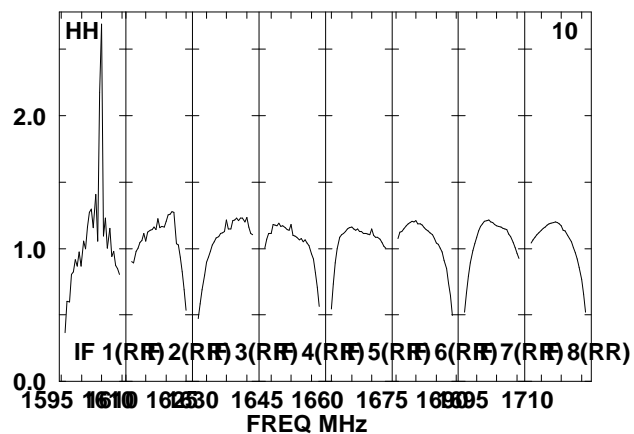
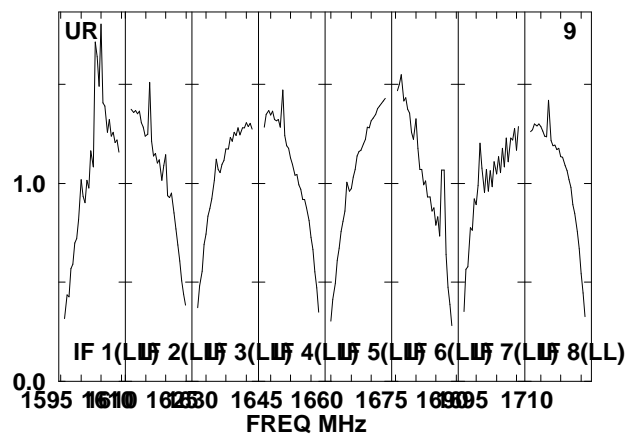
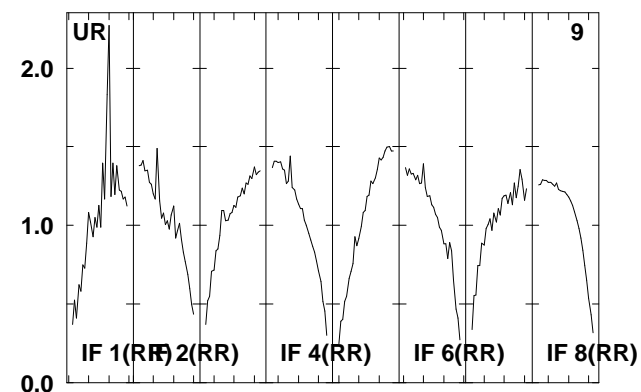
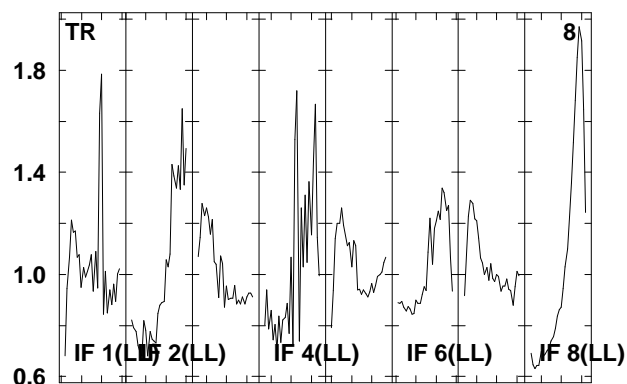
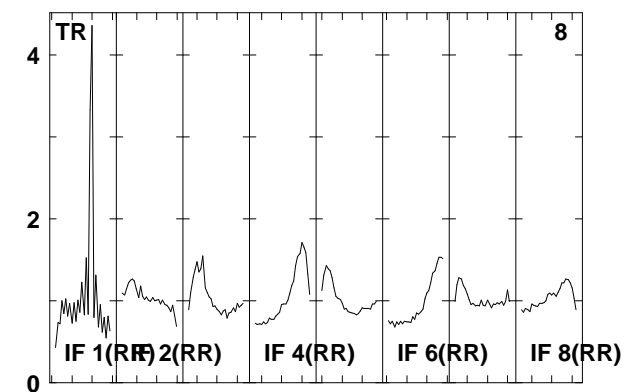
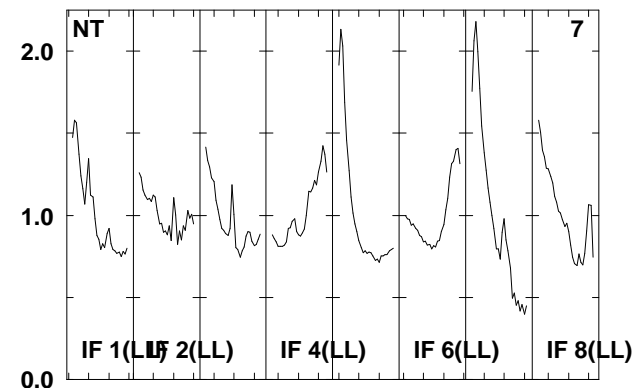
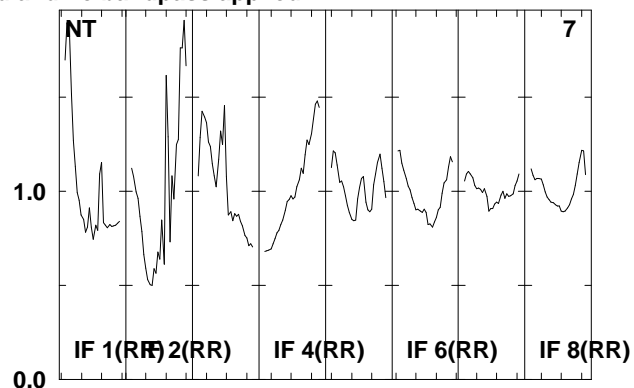
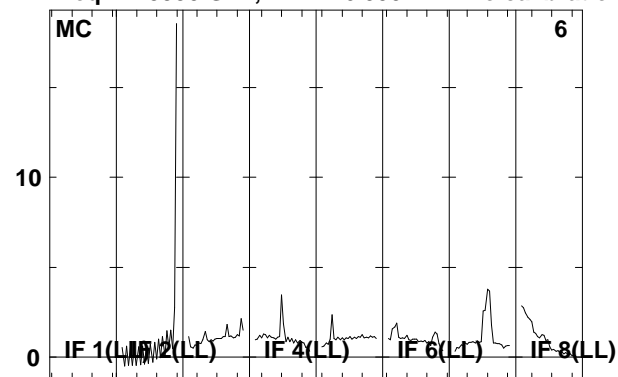

Lower frame: Real Jy
Total-power spectrum Antenna: *
Timerange: 00/17:14:02 to 00/17:15:30

Plot file version 59 created 22-APR-2008 12:25:56

IRAS0725 EP061B.UVDATA.1

Freq = 1.5950 GHz, Bw = 16.000 MH No calibration applied and no bandpass applied

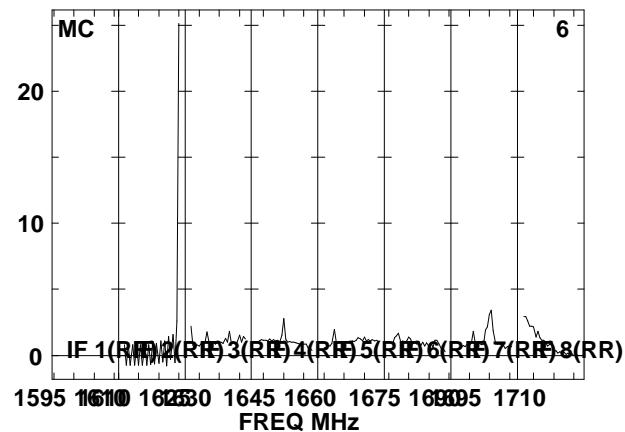
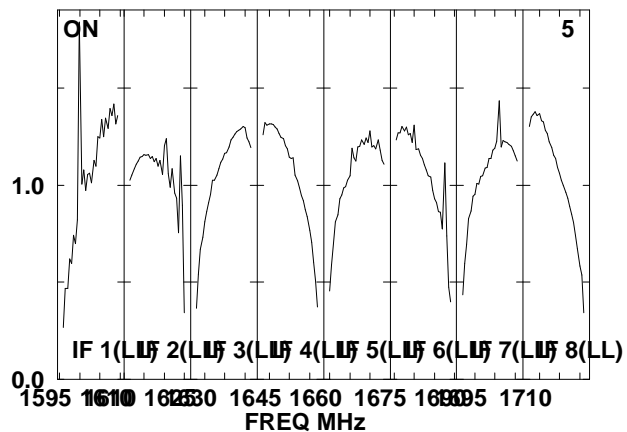
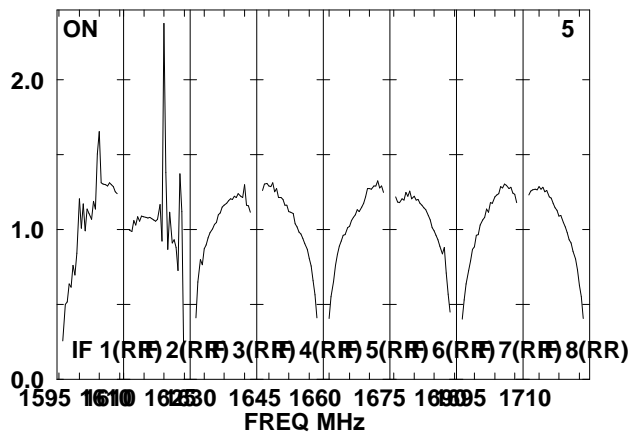
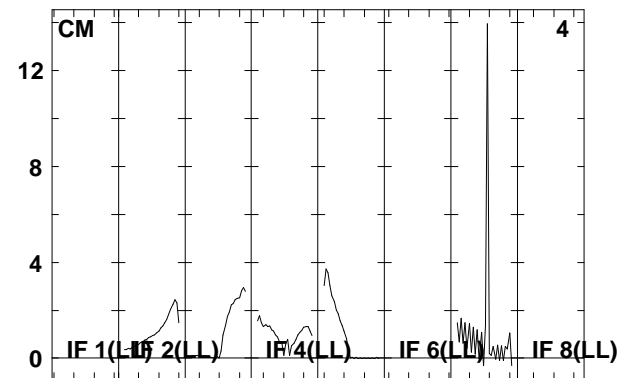
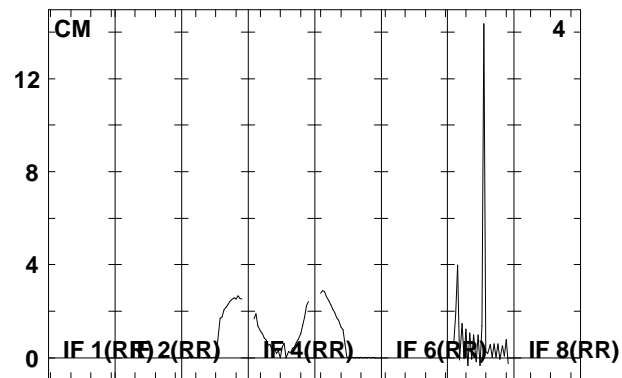
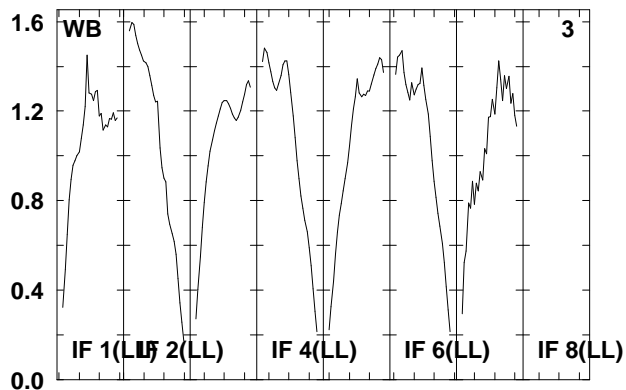
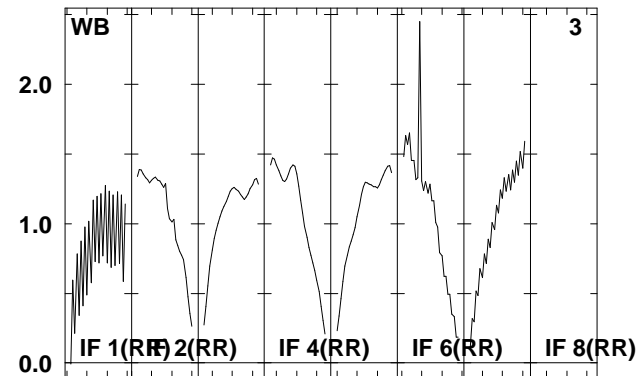
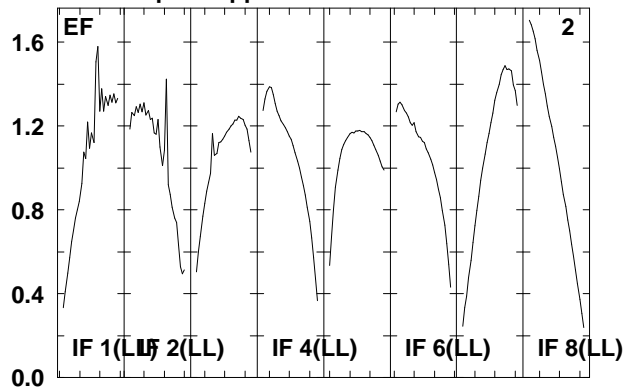
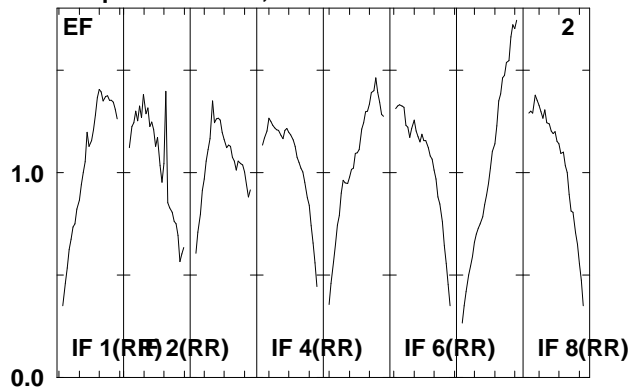

Lower frame: Real Jy
Total-power spectrum Antenna: *
Timerange: 00/17:15:32 to 00/17:18:56

Plot file version 60 created 22-APR-2008 12:25:56

IRAS0725 EP061B.UVDATA.1

Freq = 1.5950 GHz, Bw = 16.000 MH No calibration applied and no bandpass applied

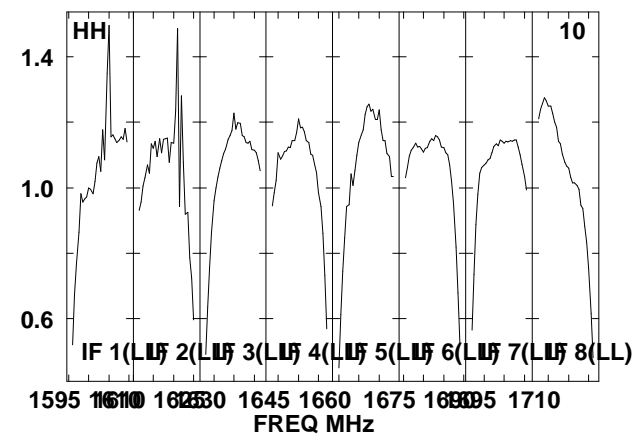
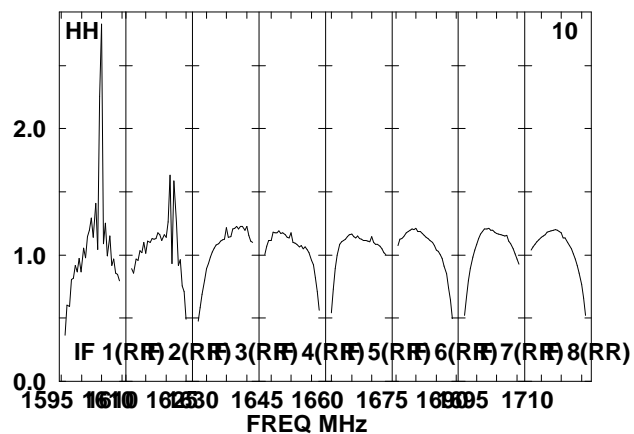
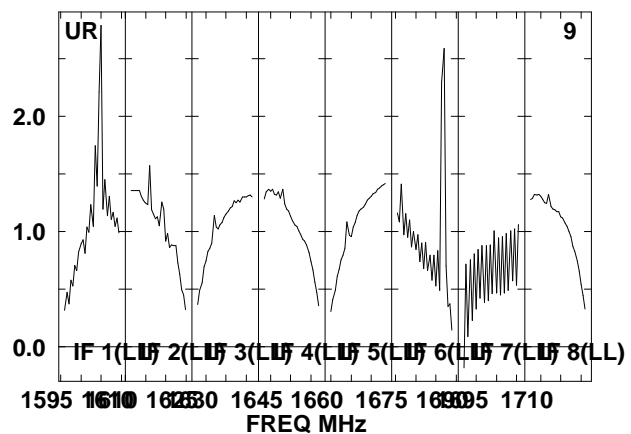
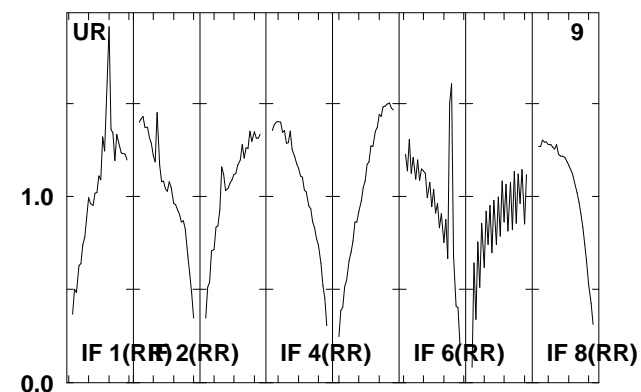
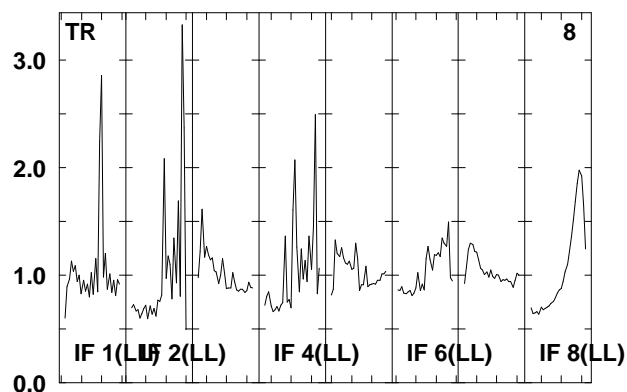
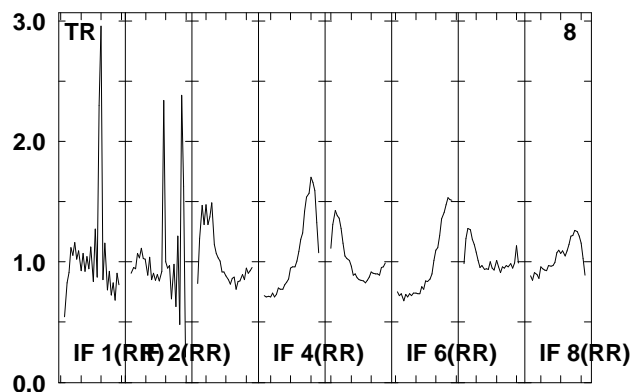
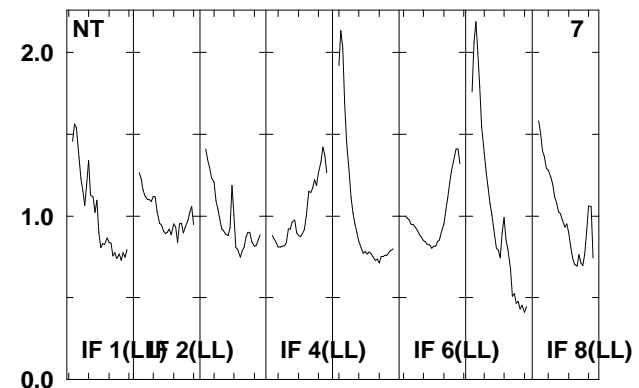
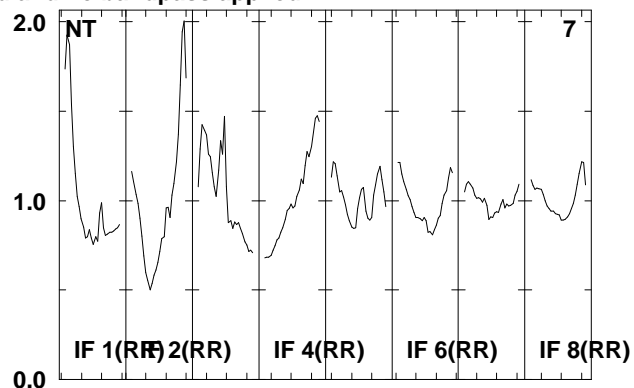
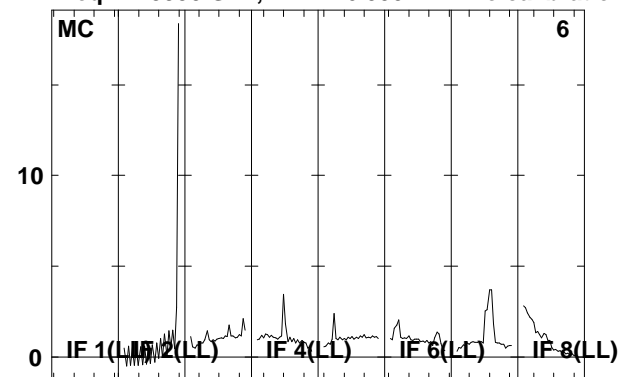

Lower frame: Real Jy

Total-power spectrum Antenna: *

Timerange: 00/17:15:32 to 00/17:18:56

Plot file version 61 created 22-APR-2008 12:25:57

J0730-02 EP061B.UVDATA.1

Freq = 1.5950 GHz, Bw = 16.000 MH No calibration applied and no bandpass applied

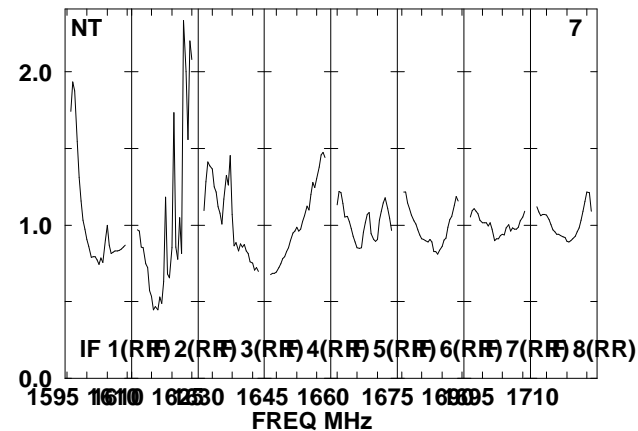
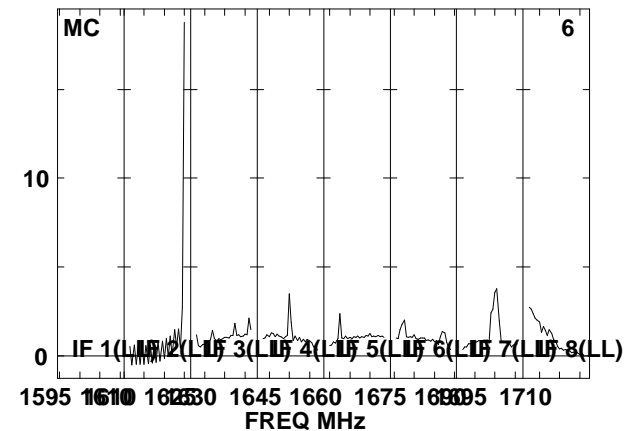
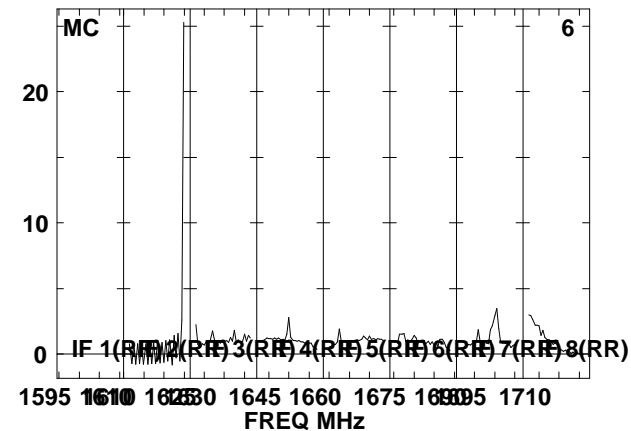
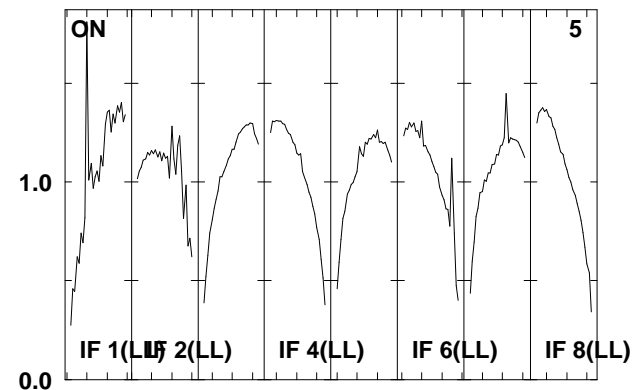
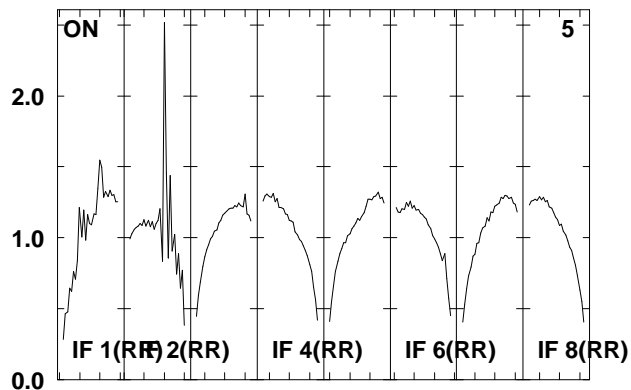
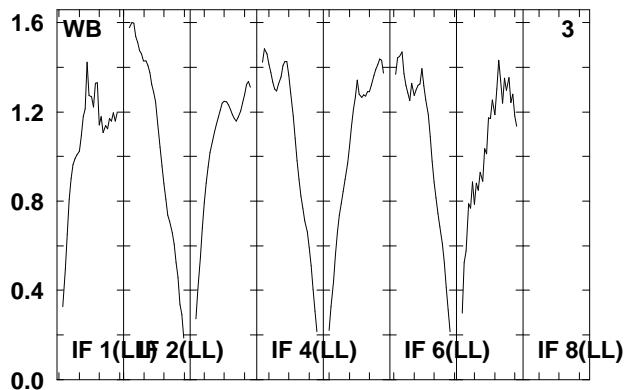
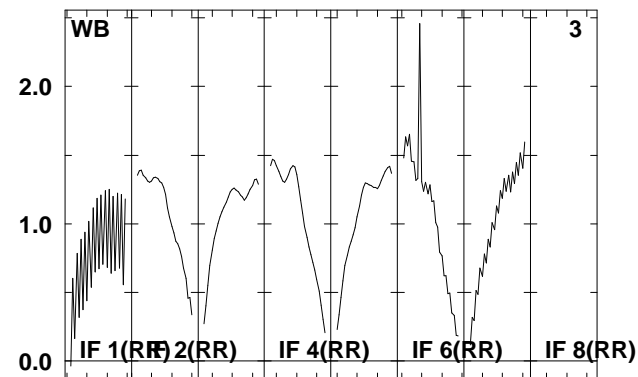
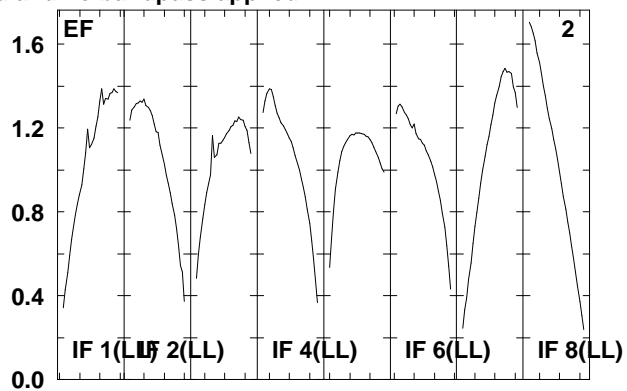
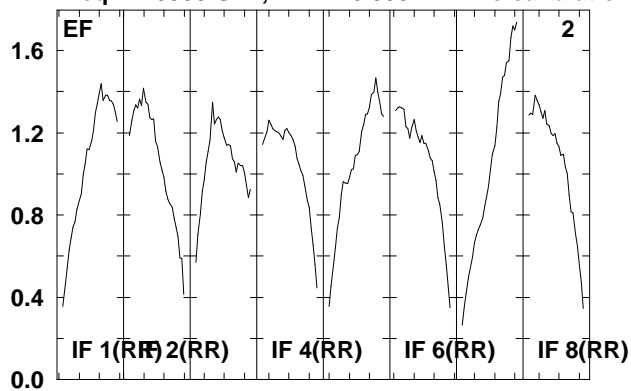

Lower frame: Real Jy
Total-power spectrum Antenna: *
Timerange: 00/17:20:02 to 00/17:21:26

Plot file version 62 created 22-APR-2008 12:25:58

J0730-02 EP061B.UVDATA.1

Freq = 1.5950 GHz, Bw = 16.000 MH No calibration applied and no bandpass applied

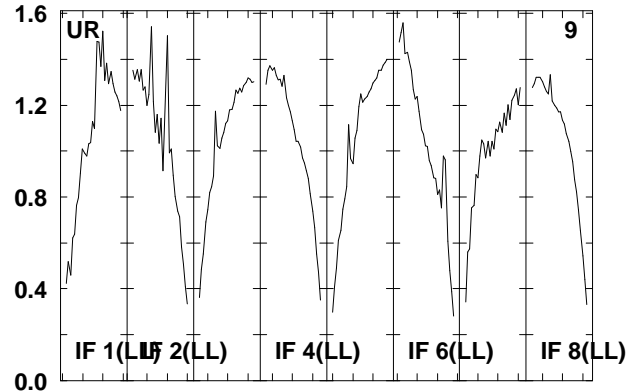
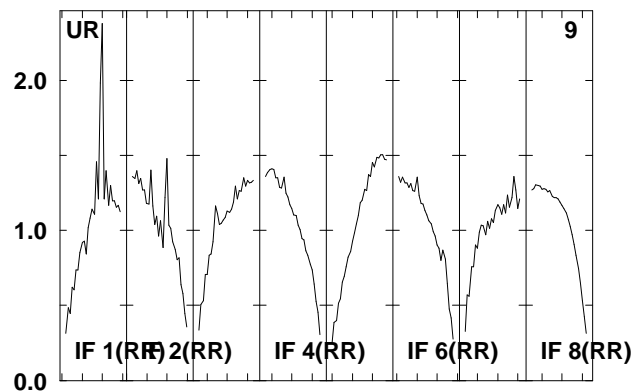
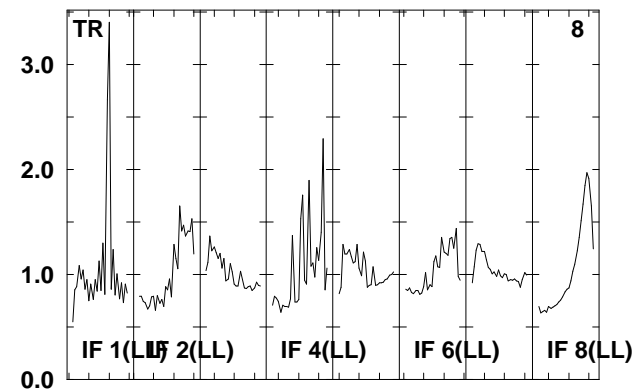
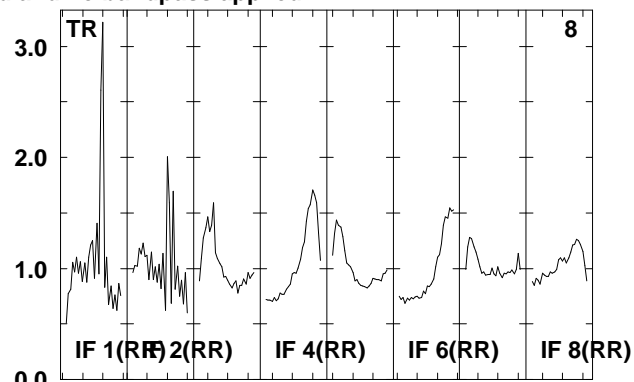
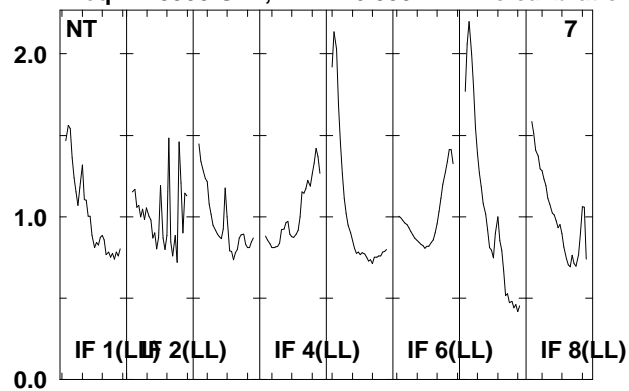

Lower frame: Real Jy
Total-power spectrum Antenna: *
Timerange: 00/17:20:02 to 00/17:21:26

Plot file version 63 created 22-APR-2008 12:25:58

IRAS0725 EP061B.UVDATA.1

Freq = 1.5950 GHz, Bw = 16.000 MH No calibration applied and no bandpass applied

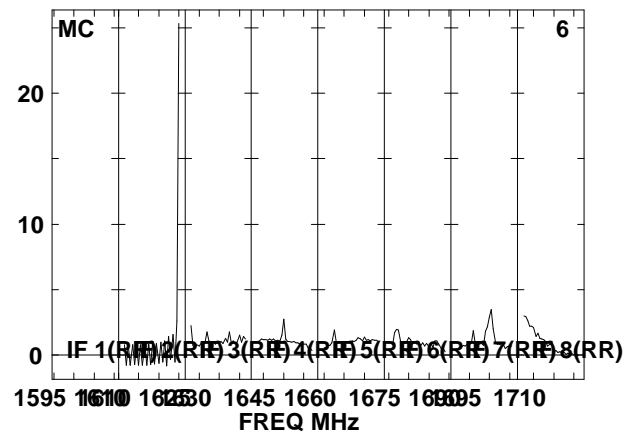
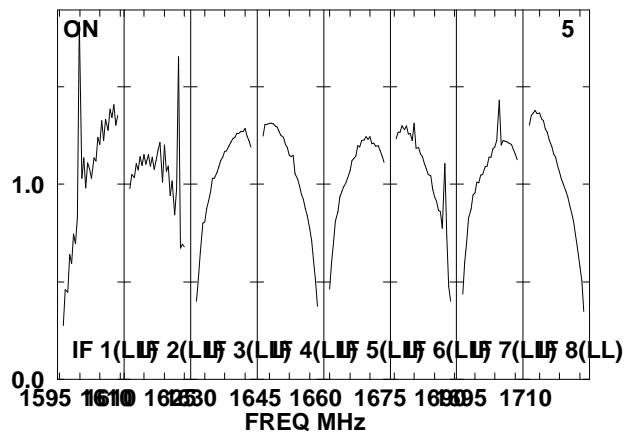
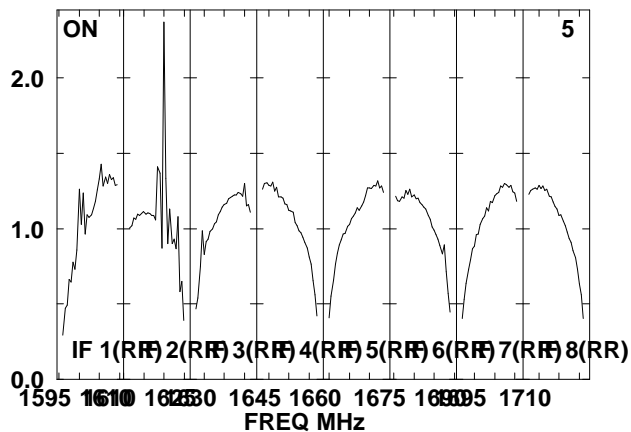
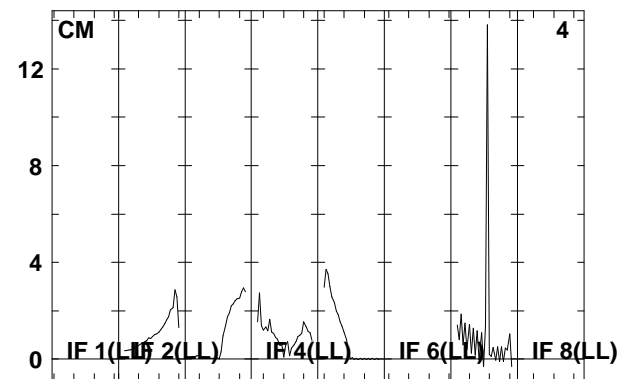
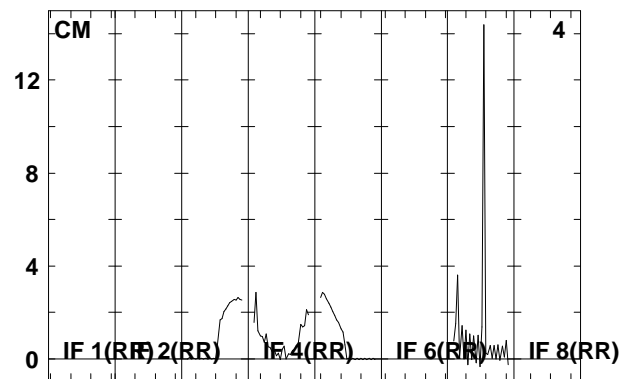
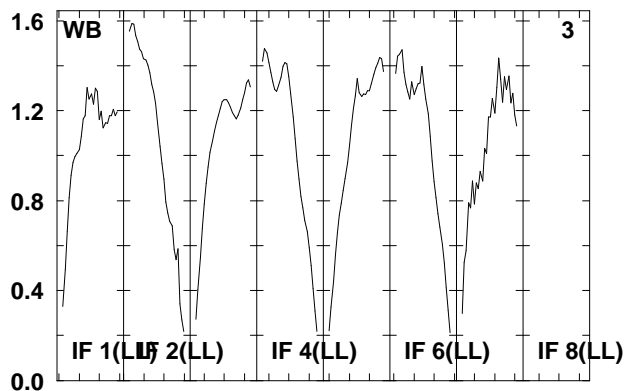
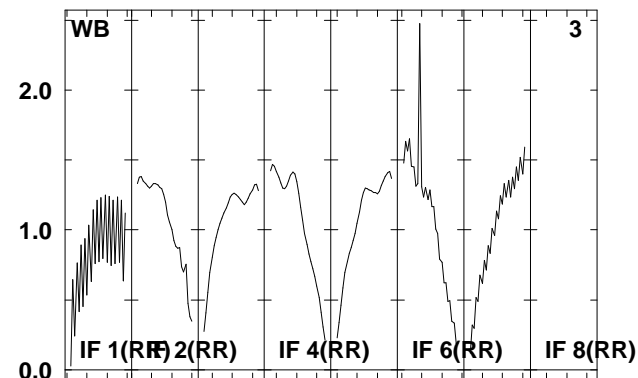
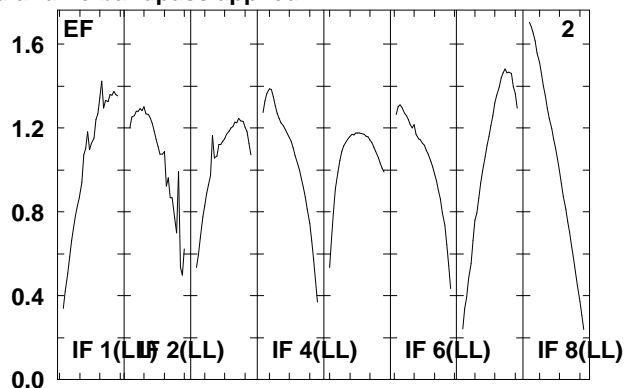
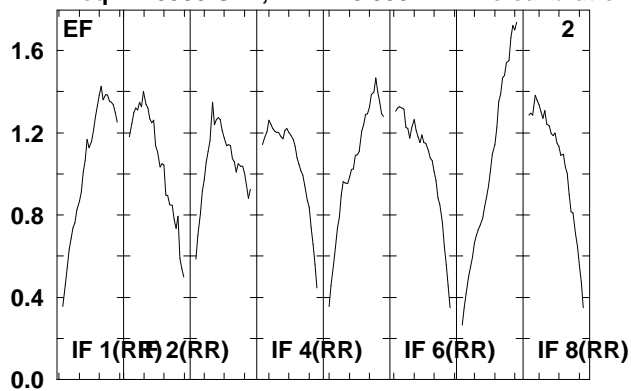

Lower frame: Real Jy
Total-power spectrum Antenna: *
Timerange: 00/17:21:34 to 00/17:25:00

Plot file version 64 created 22-APR-2008 12:25:59

IRAS0725 EP061B.UVDATA.1

Freq = 1.5950 GHz, Bw = 16.000 MH No calibration applied and no bandpass applied

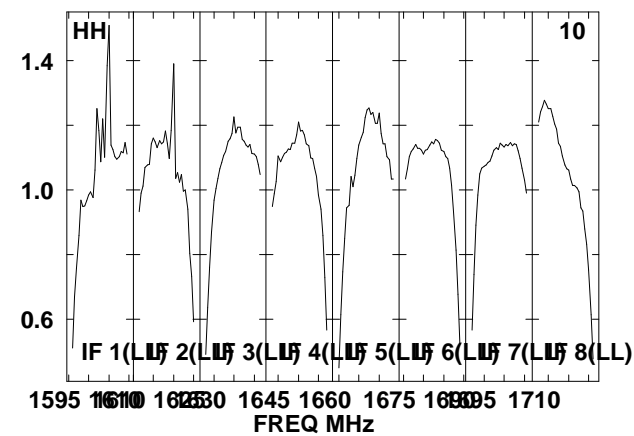
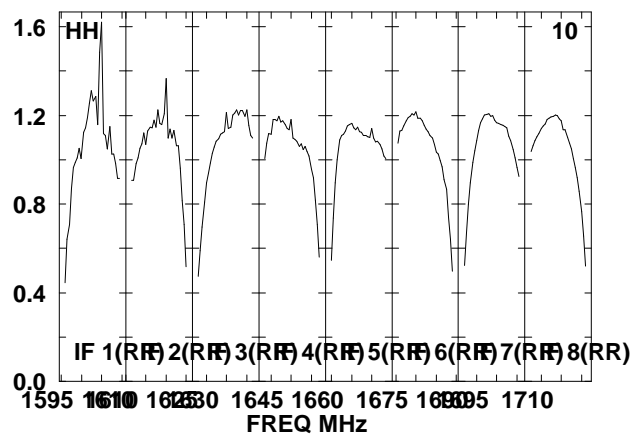
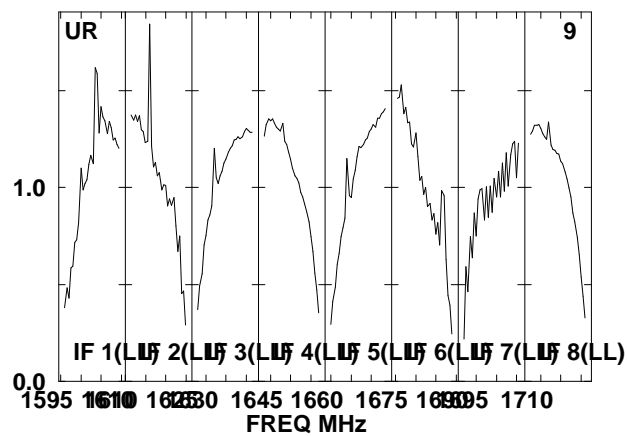
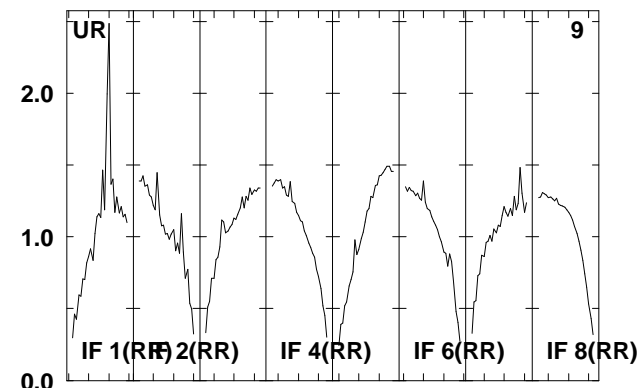
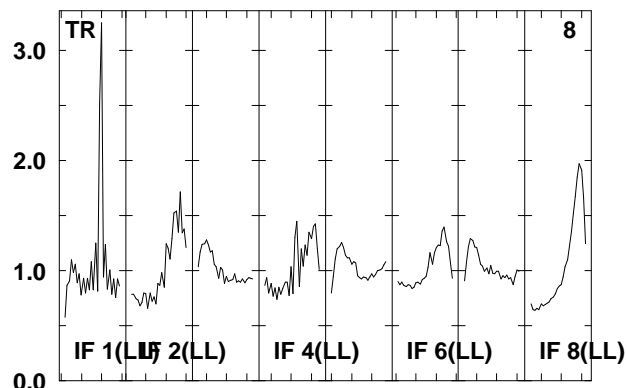
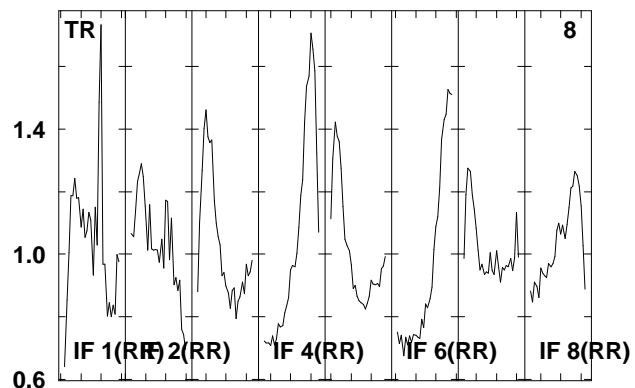
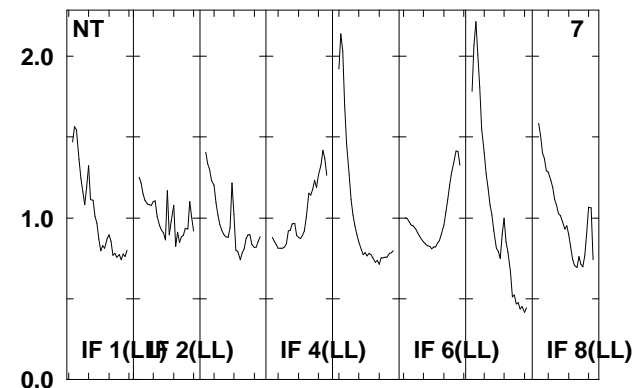
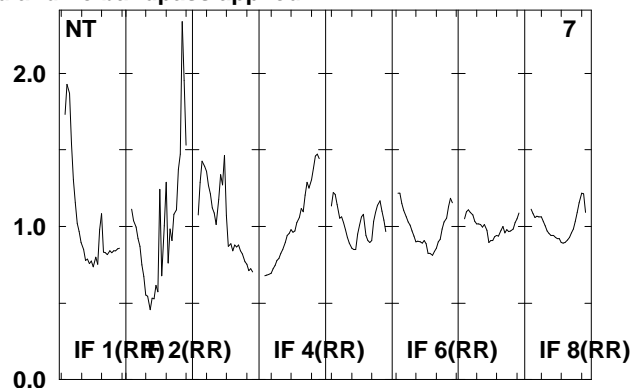
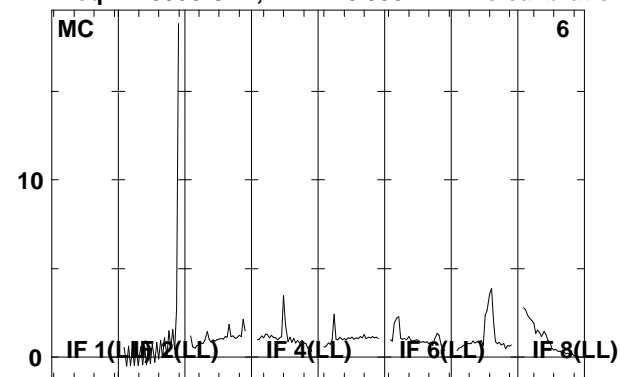

Lower frame: Real Jy
Total-power spectrum Antenna: *
Timerange: 00/17:21:34 to 00/17:25:00

Plot file version 65 created 22-APR-2008 12:26:00
 J0730-02 EP061B.UVDATA.1
 Freq = 1.5950 GHz, Bw = 16.000 MH No calibration applied and no bandpass applied

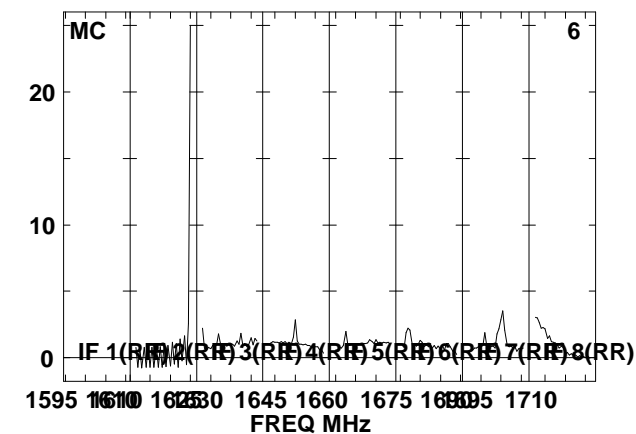
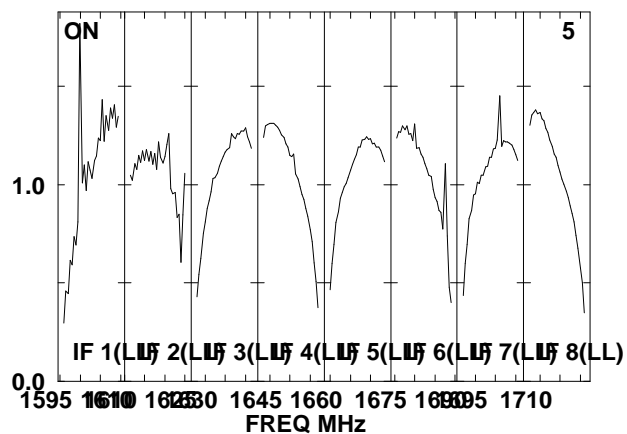
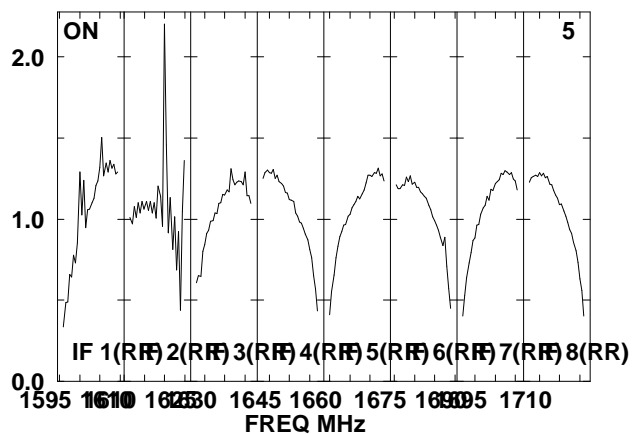
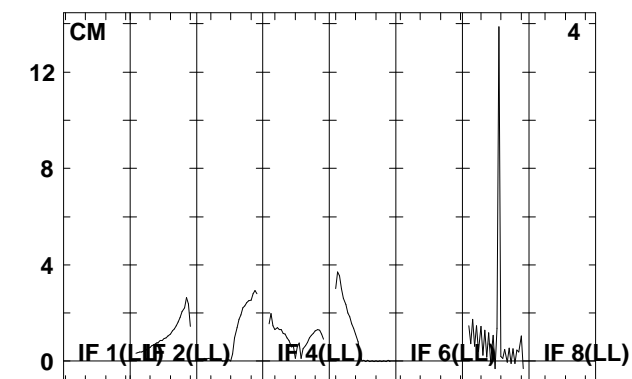
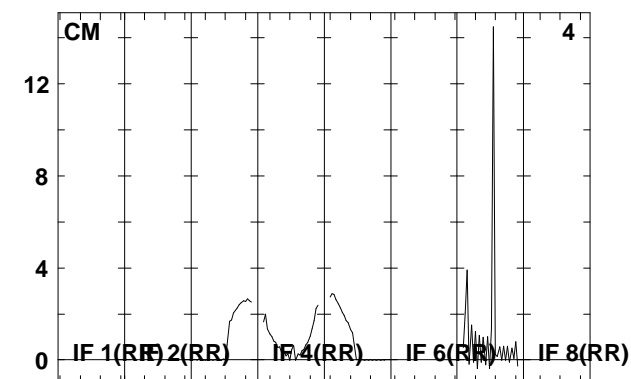
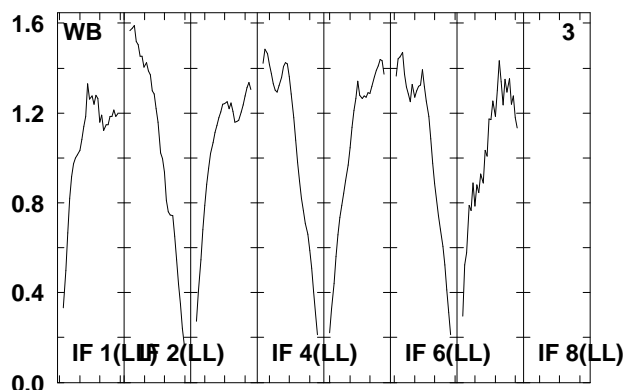
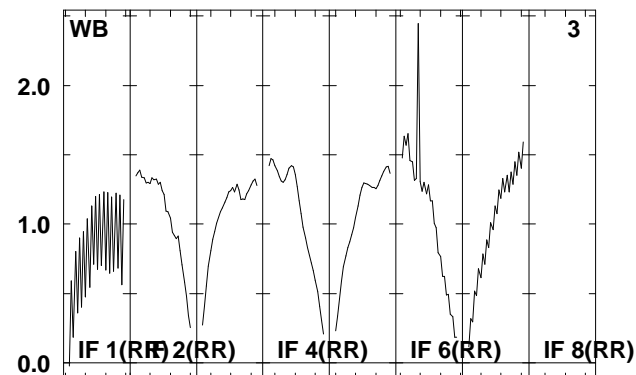
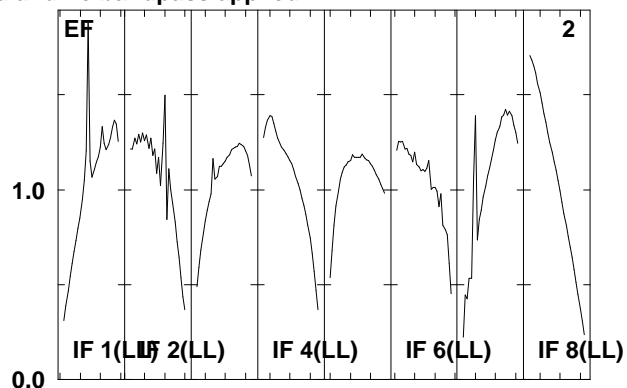
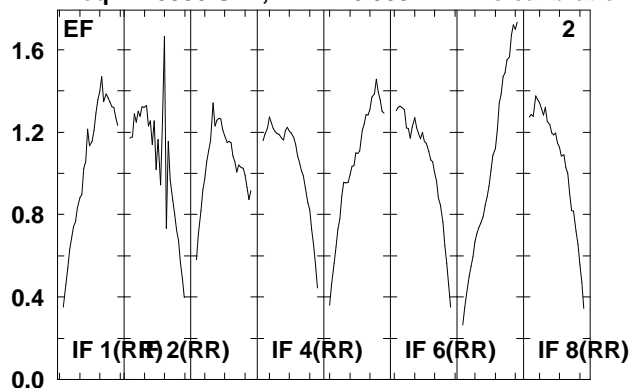

Lower frame: Real Jy
 Total-power spectrum Antenna: *
 Timerange: 00/17:25:02 to 00/17:26:30

Plot file version 66 created 22-APR-2008 12:26:01

J0730-02 EP061B.UVDATA.1

Freq = 1.5950 GHz, Bw = 16.000 MH No calibration applied and no bandpass applied

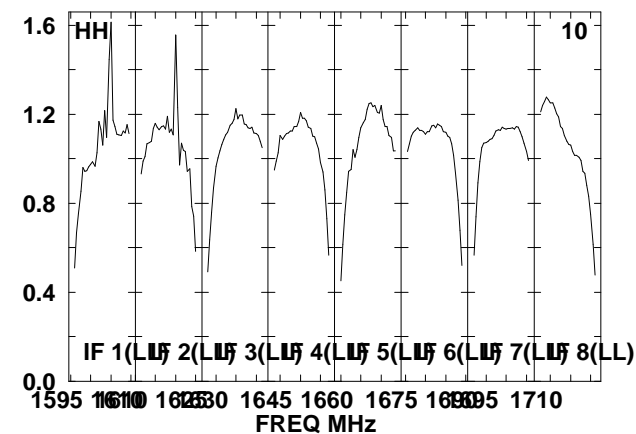
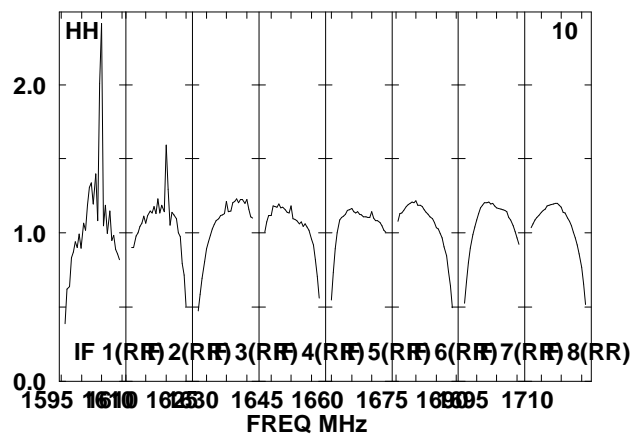
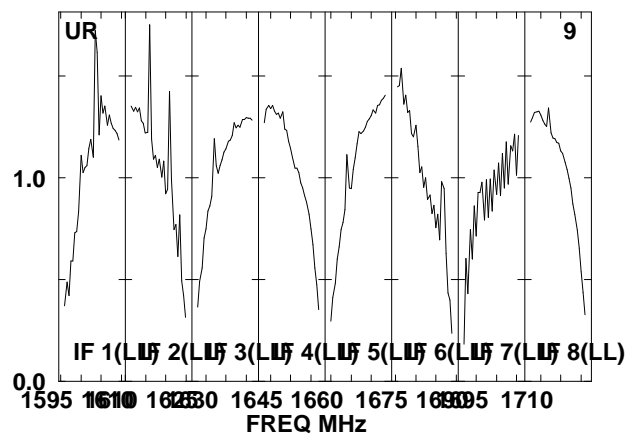
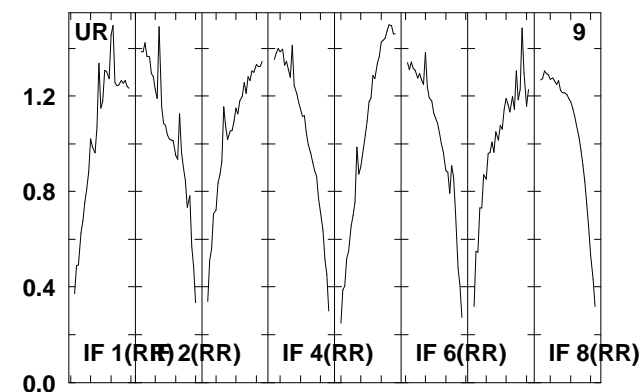
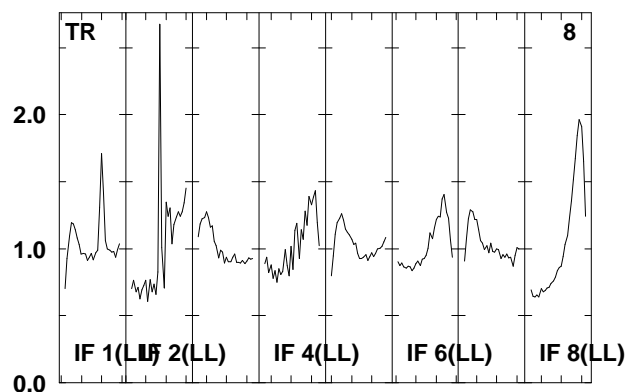
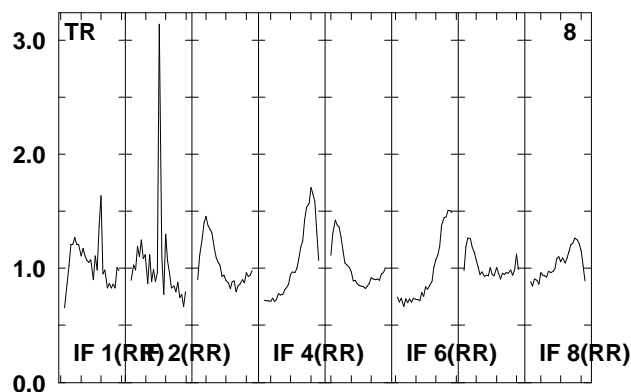
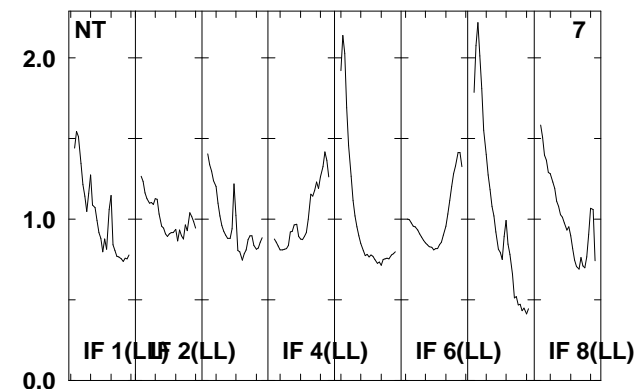
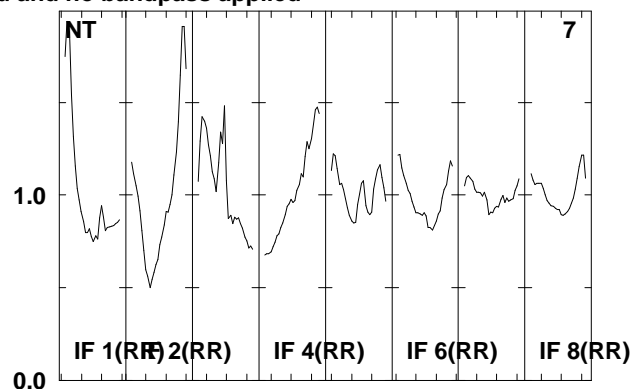
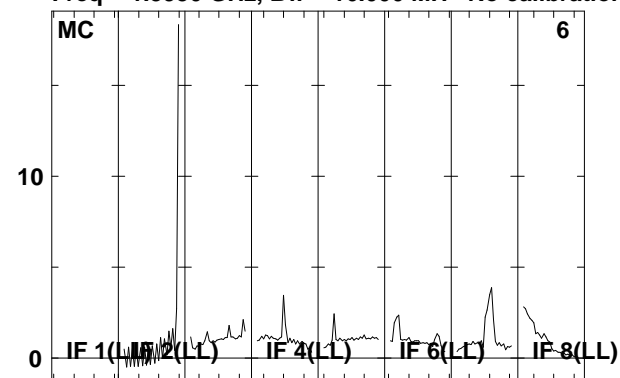

Lower frame: Real Jy

Total-power spectrum Antenna: *

Timerange: 00/17:25:02 to 00/17:26:30

Plot file version 67 created 22-APR-2008 12:26:02

IRAS0725 EP061B.UVDATA.1

Freq = 1.5950 GHz, Bw = 16.000 MH No calibration applied and no bandpass applied

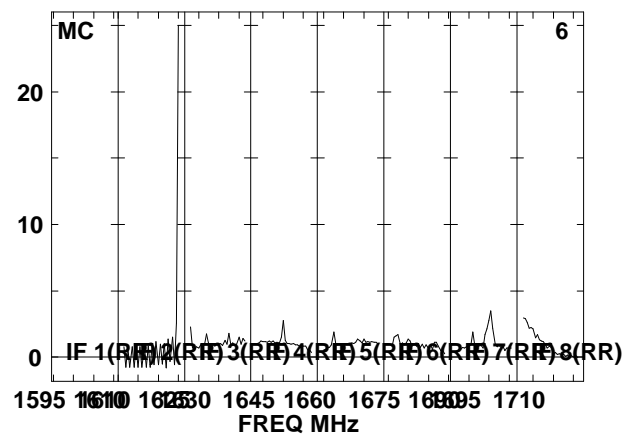
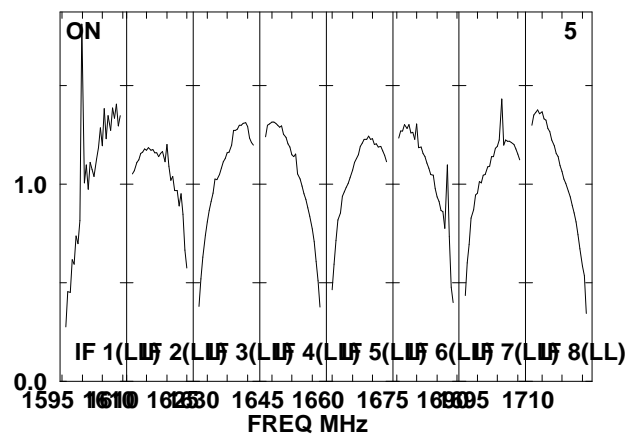
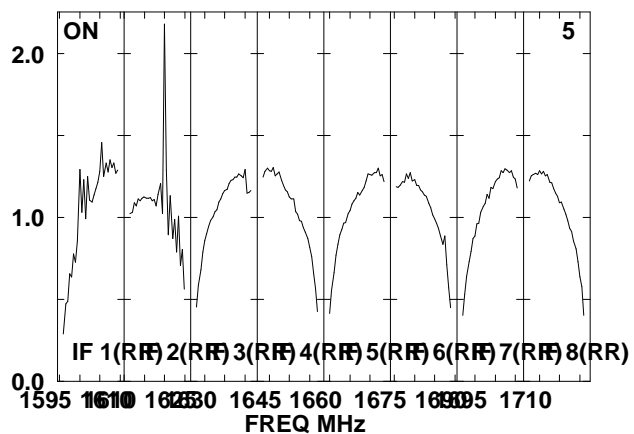
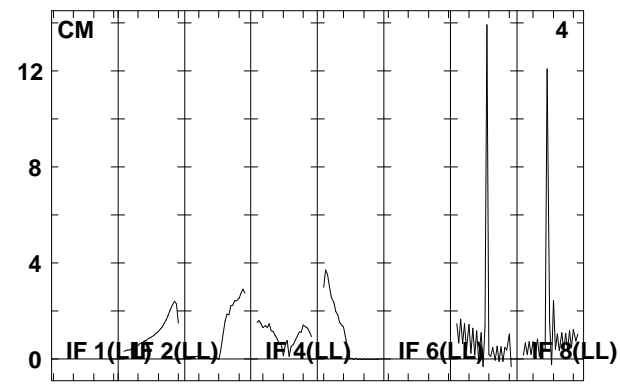
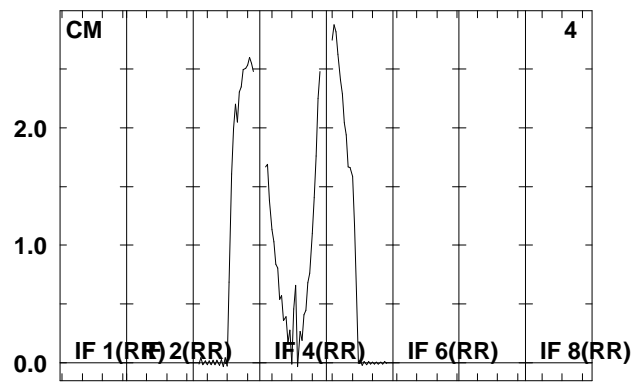
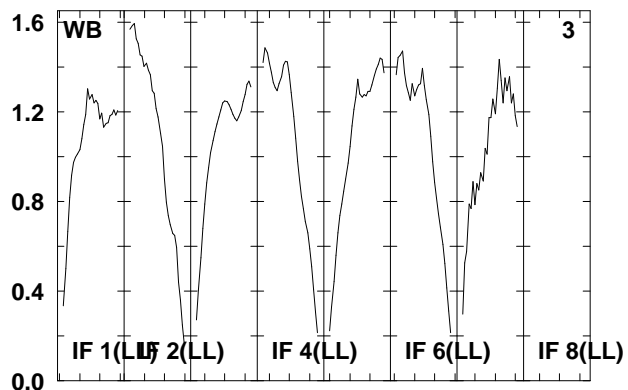
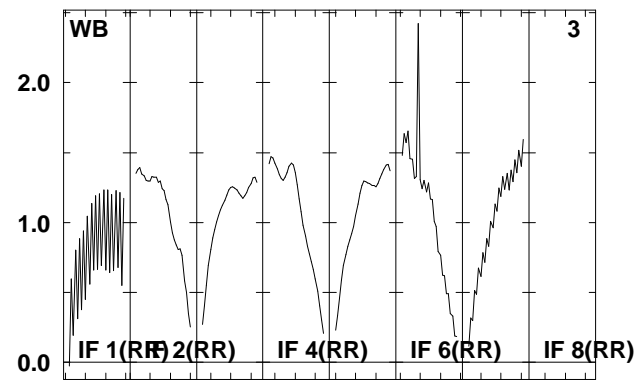
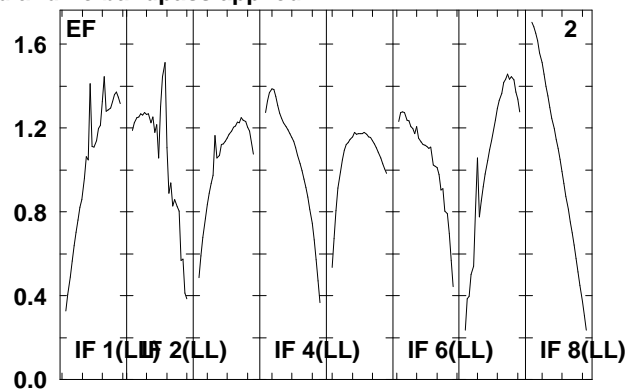
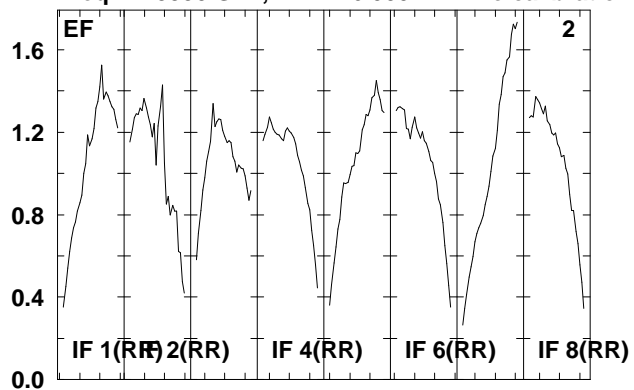

Lower frame: Real Jy
Total-power spectrum Antenna: *
Timerange: 00/17:26:32 to 00/17:30:00

Plot file version 68 created 22-APR-2008 12:26:03

IRAS0725 EP061B.UVDATA.1

Freq = 1.5950 GHz, Bw = 16.000 MH No calibration applied and no bandpass applied

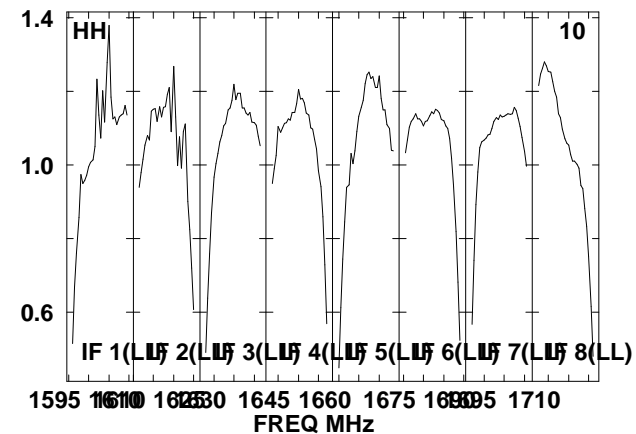
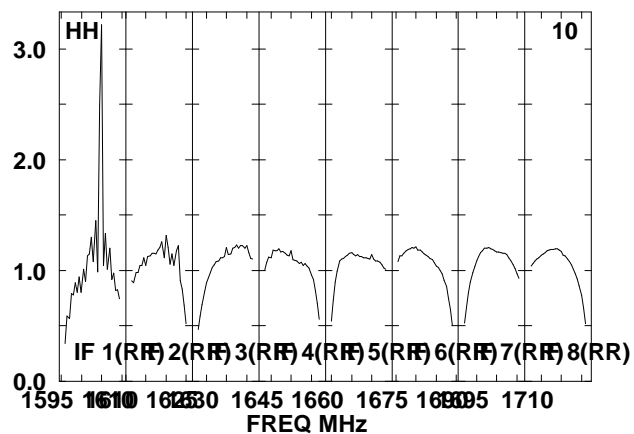
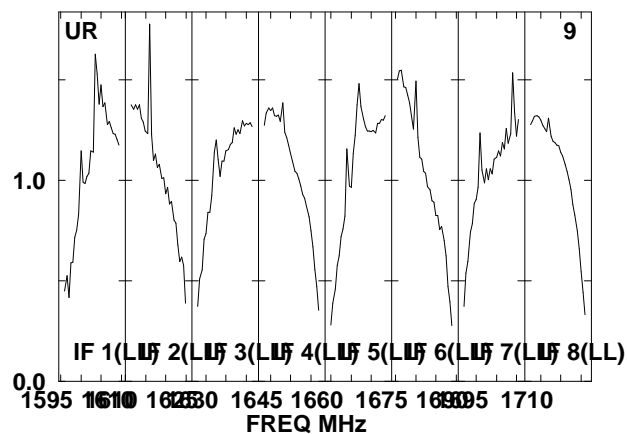
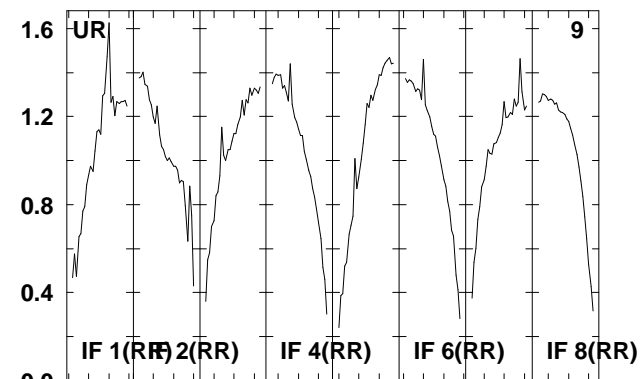
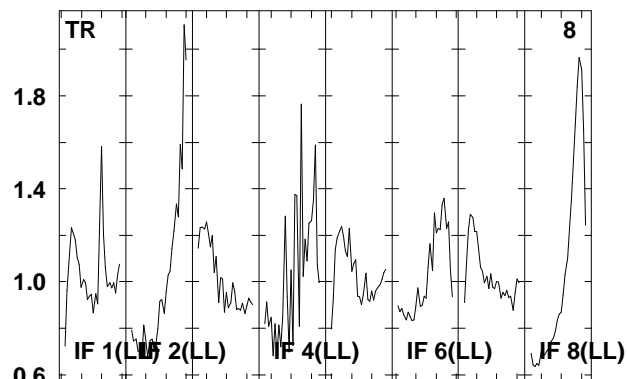
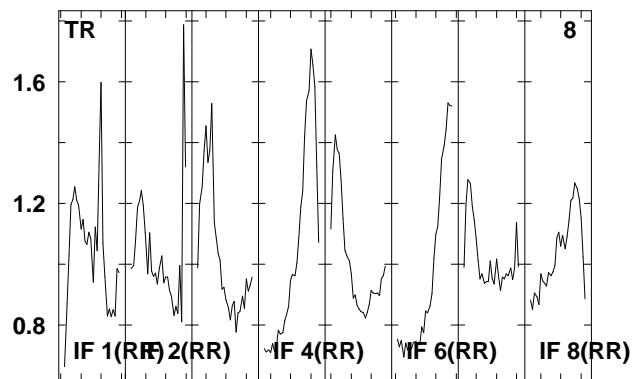
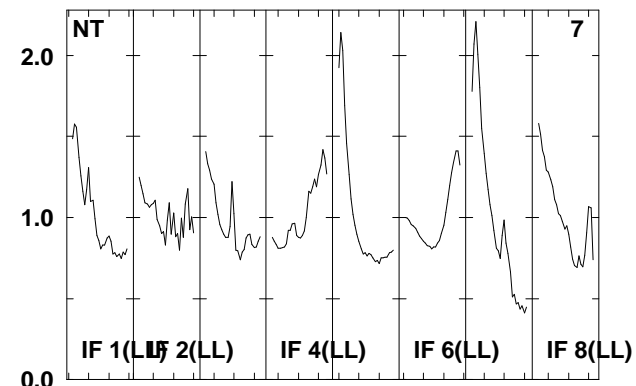
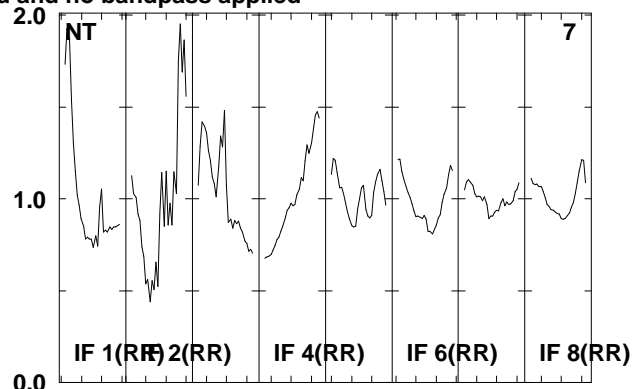
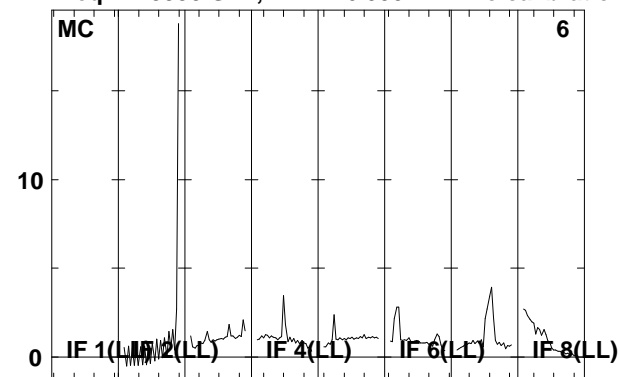

Lower frame: Real Jy

Total-power spectrum Antenna: *

Timerange: 00/17:26:32 to 00/17:30:00

Plot file version 69 created 22-APR-2008 12:26:04

J0730-02 EP061B.UVDATA.1

Freq = 1.5950 GHz, Bw = 16.000 MH No calibration applied and no bandpass applied

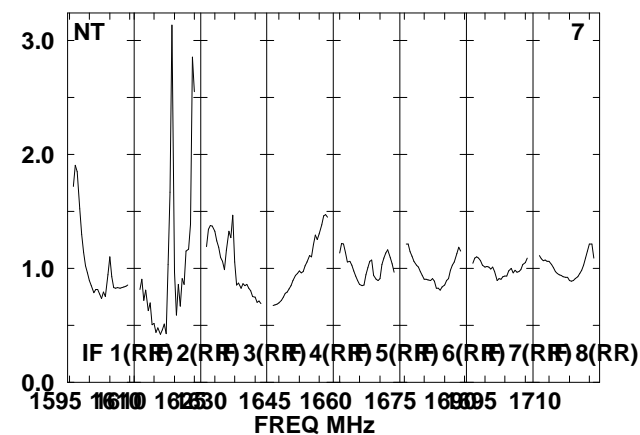
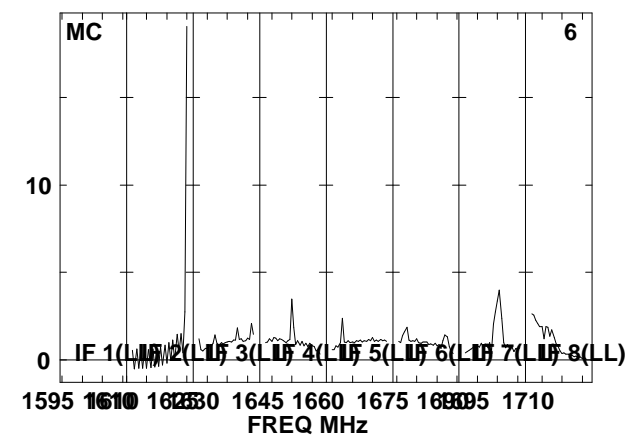
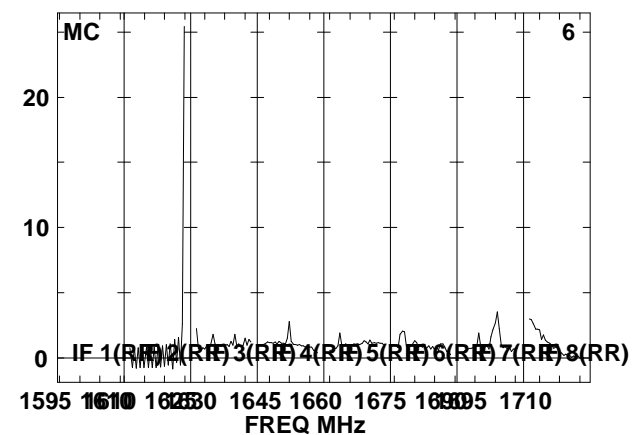
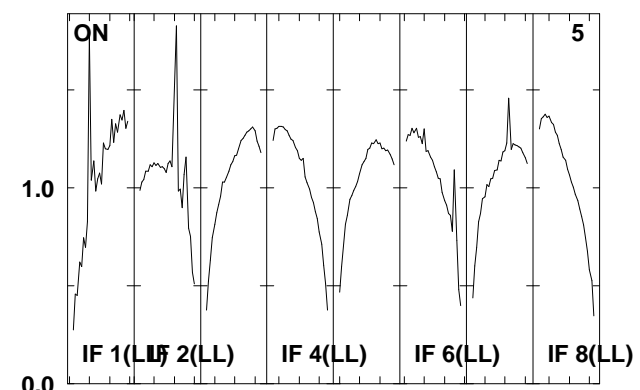
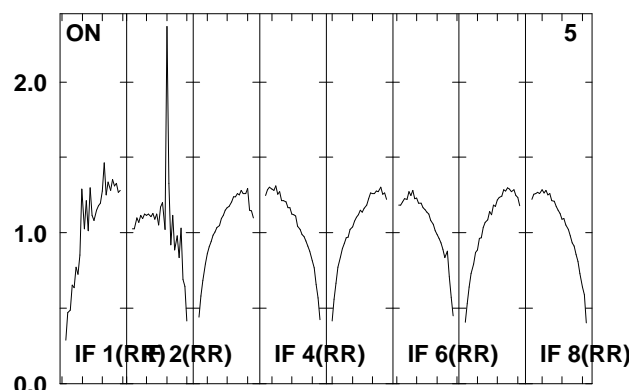
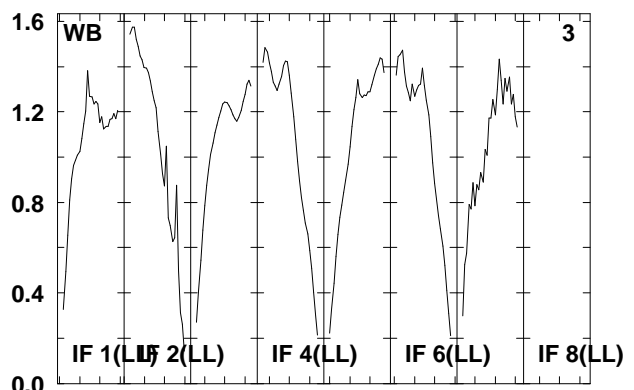
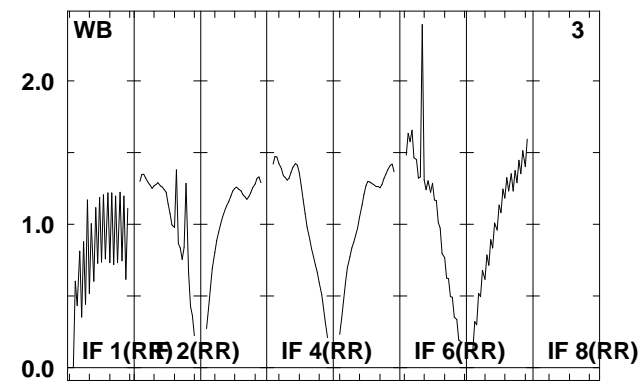
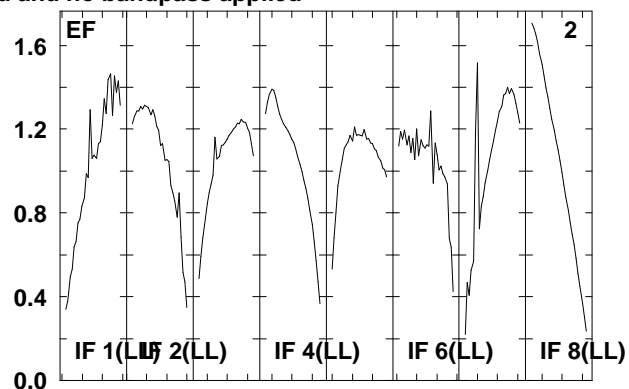
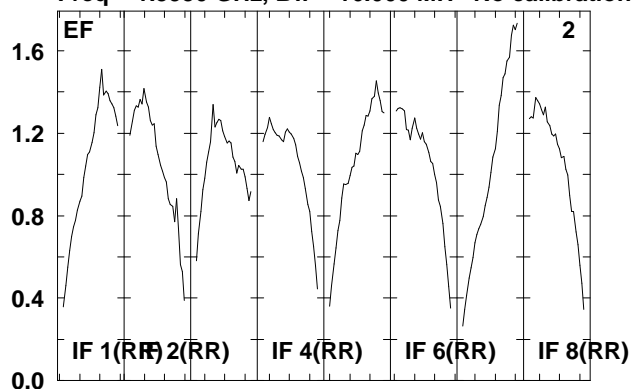

Lower frame: Real Jy
Total-power spectrum Antenna: *
Timerange: 00/17:30:02 to 00/17:31:30

Plot file version 70 created 22-APR-2008 12:26:05

J0730-02 EP061B.UVDATA.1

Freq = 1.5950 GHz, Bw = 16.000 MH No calibration applied and no bandpass applied

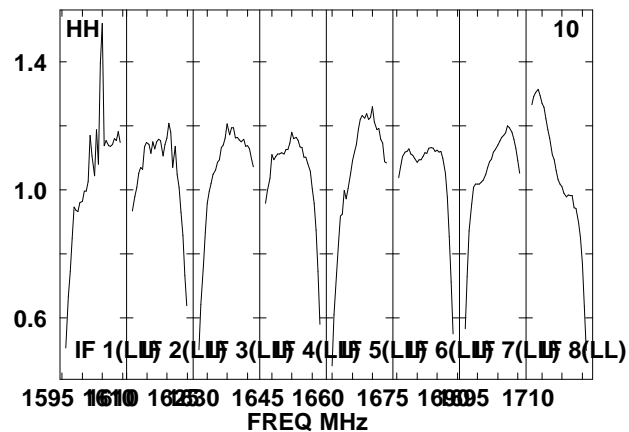
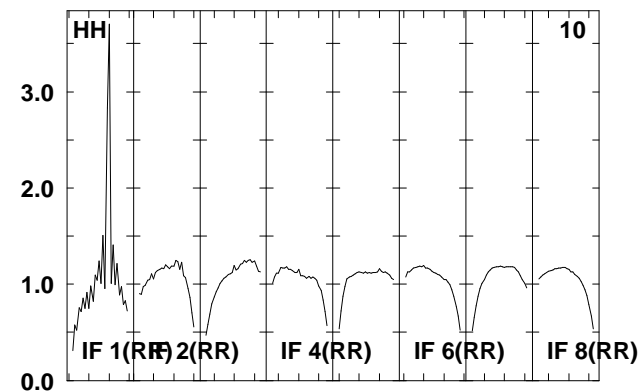
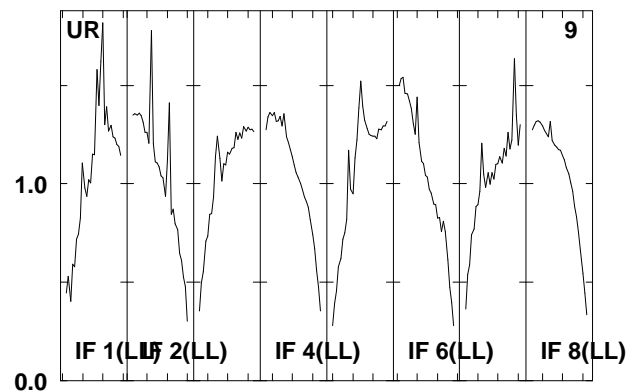
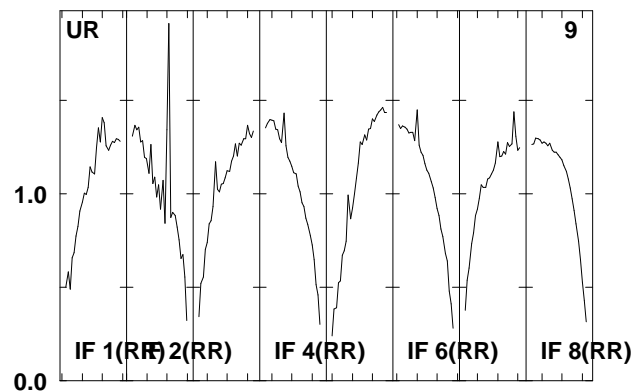
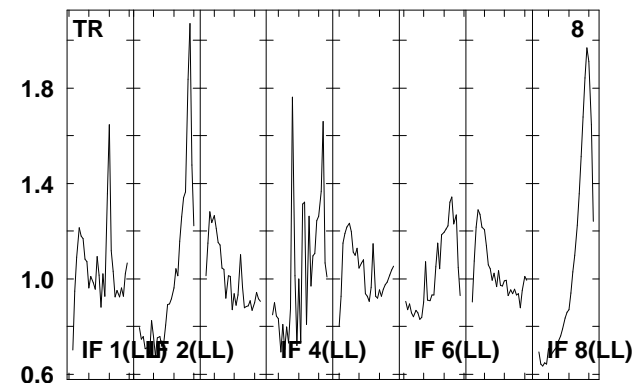
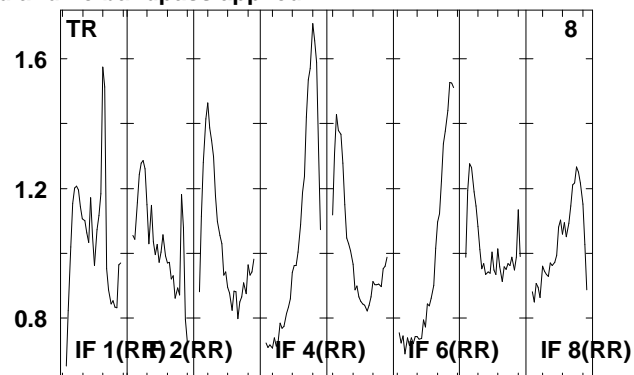
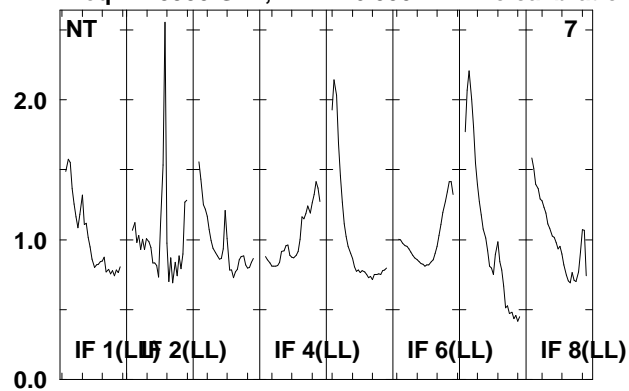

Lower frame: Real Jy

Total-power spectrum Antenna: *

Timerange: 00/17:30:02 to 00/17:31:30

Plot file version 71 created 22-APR-2008 12:26:05

IRAS0725 EP061B.UVDATA.1

Freq = 1.5950 GHz, Bw = 16.000 MH No calibration applied and no bandpass applied

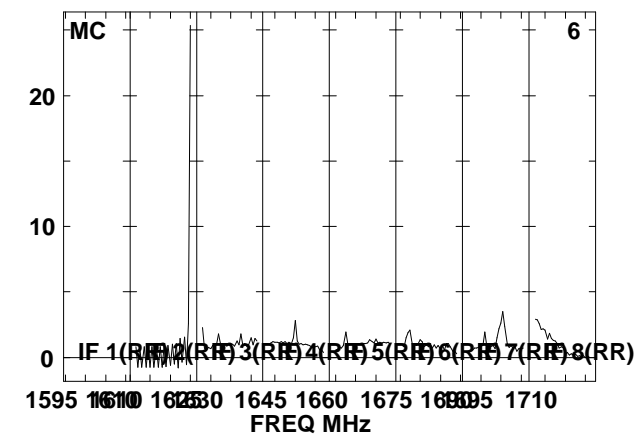
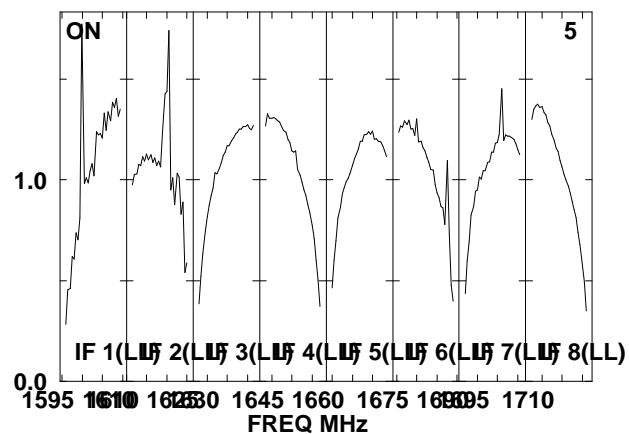
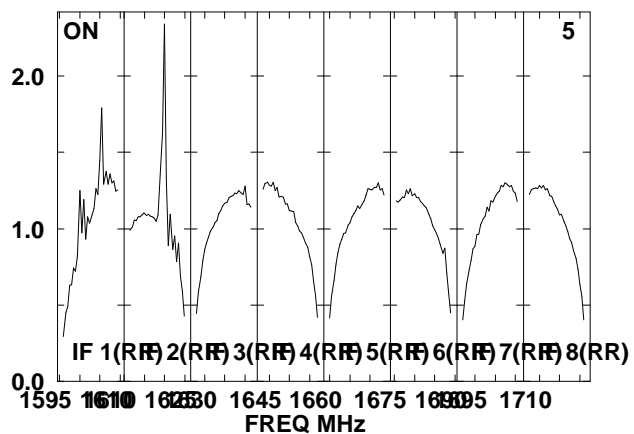
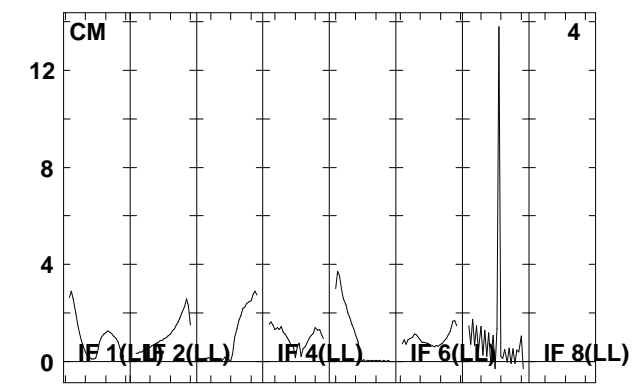
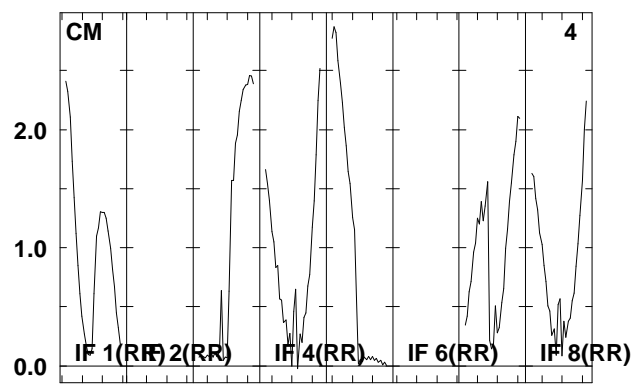
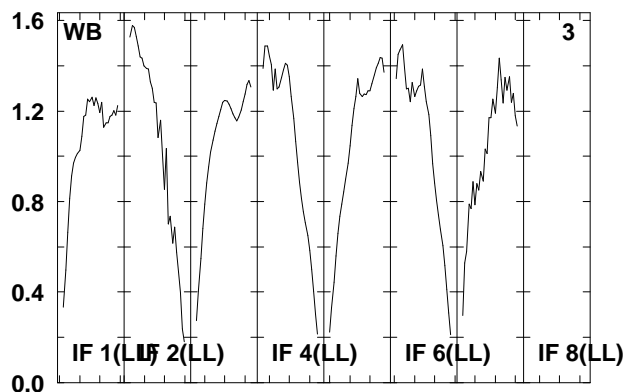
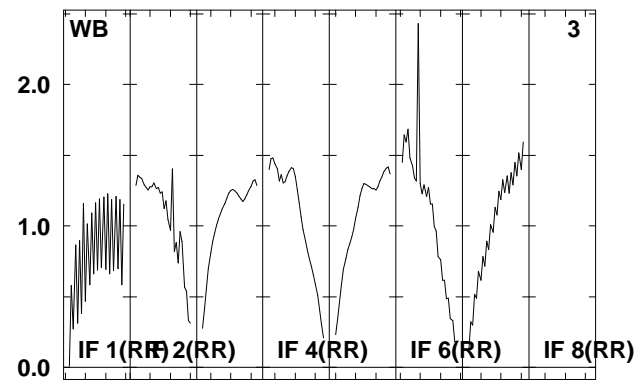
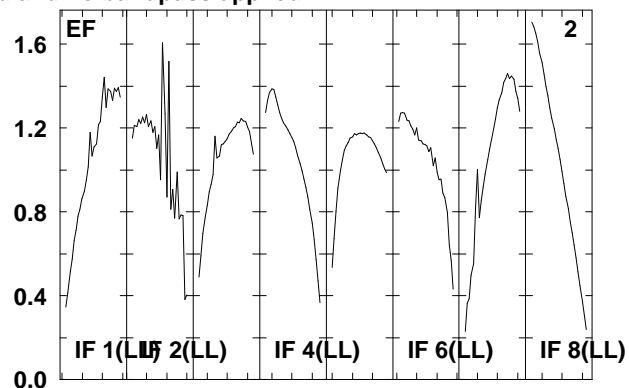
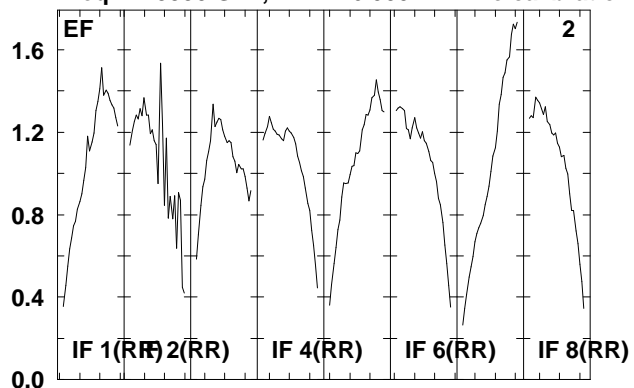

Lower frame: Real Jy
Total-power spectrum Antenna: *
Timerange: 00/17:31:32 to 00/17:34:56

Plot file version 72 created 22-APR-2008 12:26:06

IRAS0725 EP061B.UVDATA.1

Freq = 1.5950 GHz, Bw = 16.000 MH No calibration applied and no bandpass applied

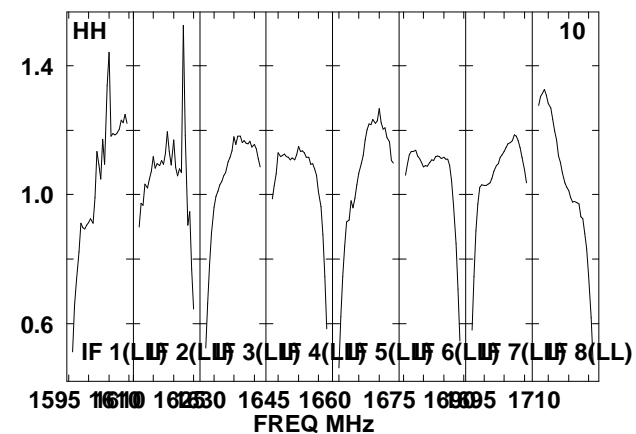
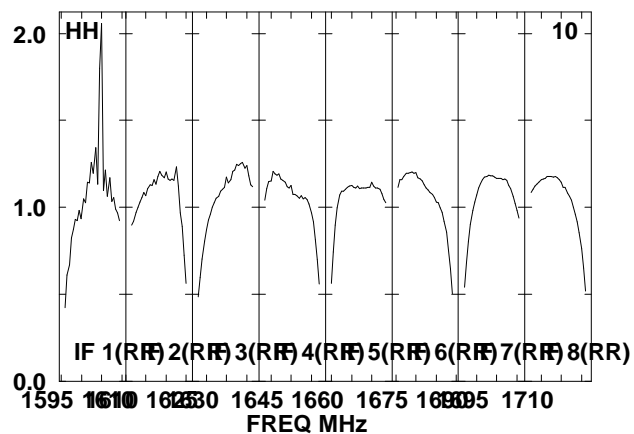
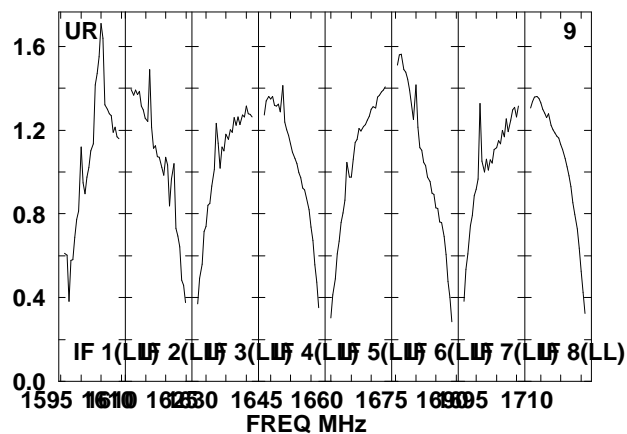
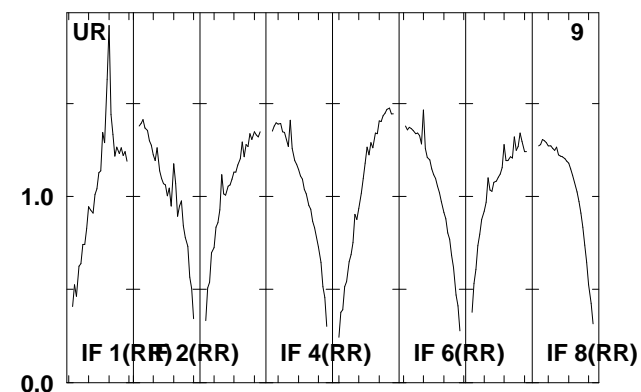
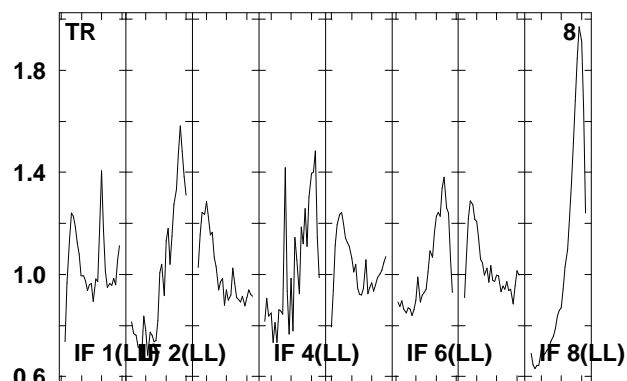
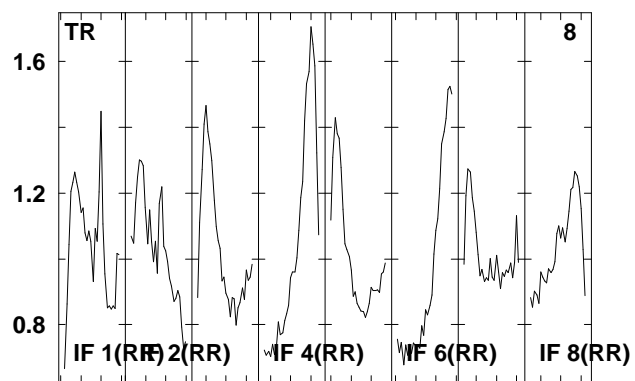
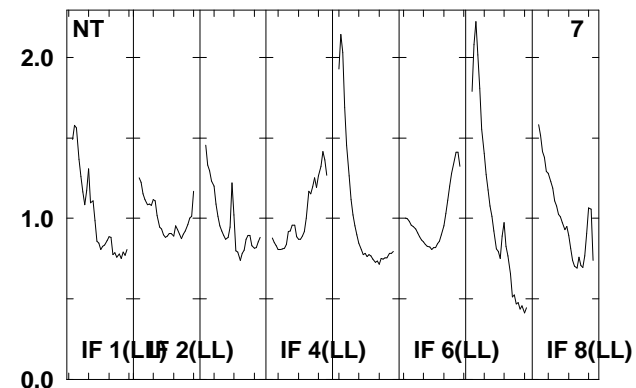
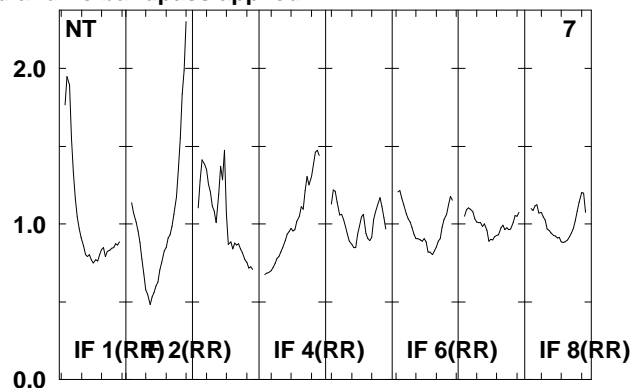
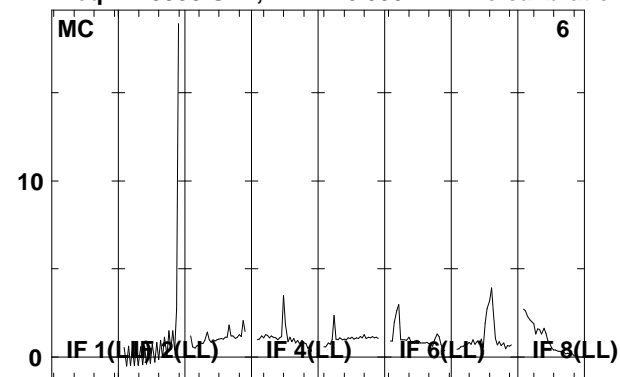

Lower frame: Real Jy

Total-power spectrum Antenna: *

Timerange: 00/17:31:32 to 00/17:34:56

Plot file version 73 created 22-APR-2008 12:26:08
 J0730-02 EP061B.UVDATA.1
 Freq = 1.5950 GHz, Bw = 16.000 MH No calibration applied and no bandpass applied

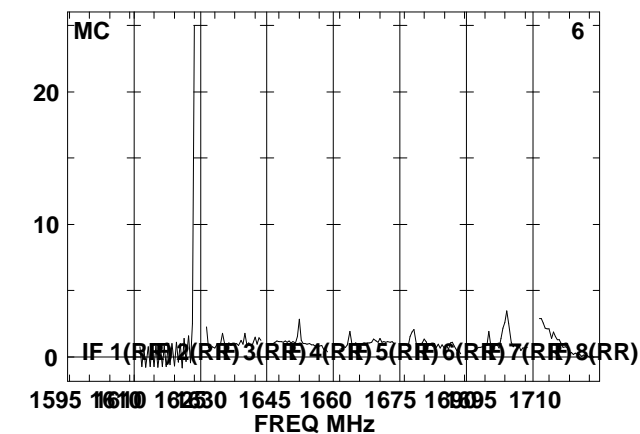
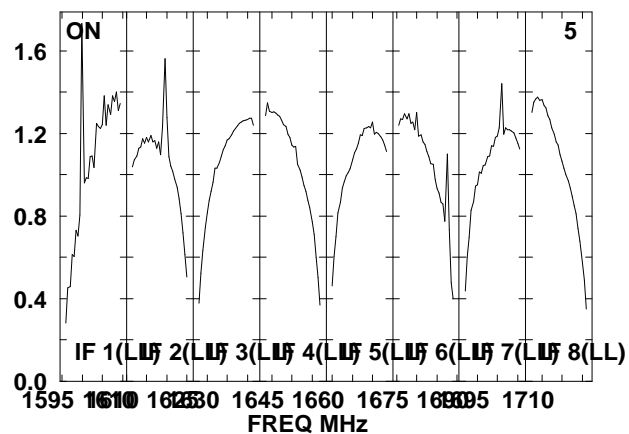
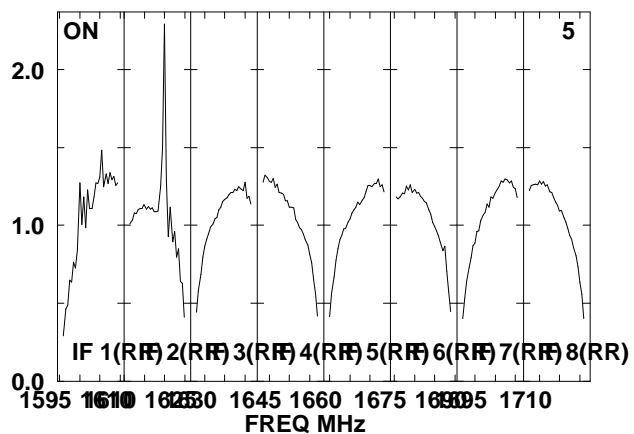
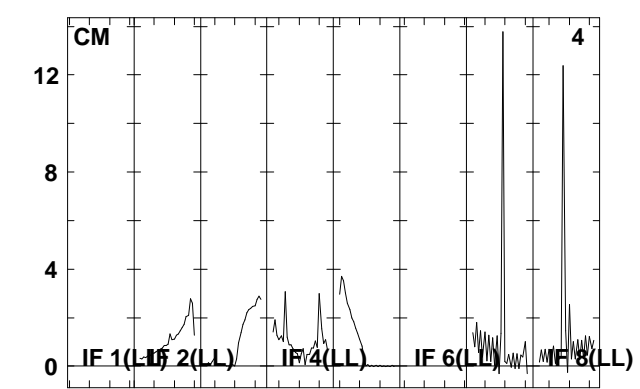
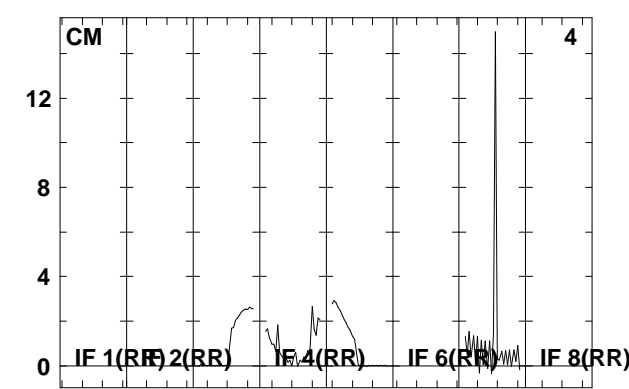
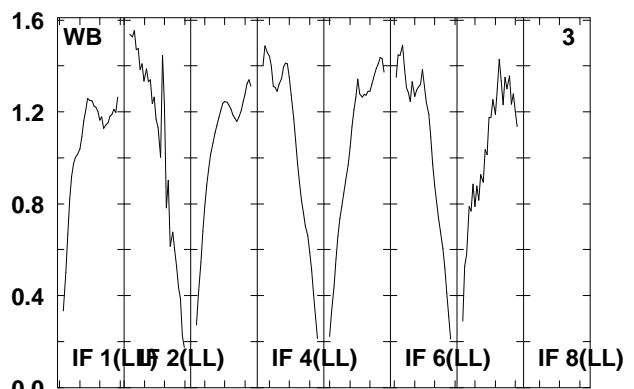
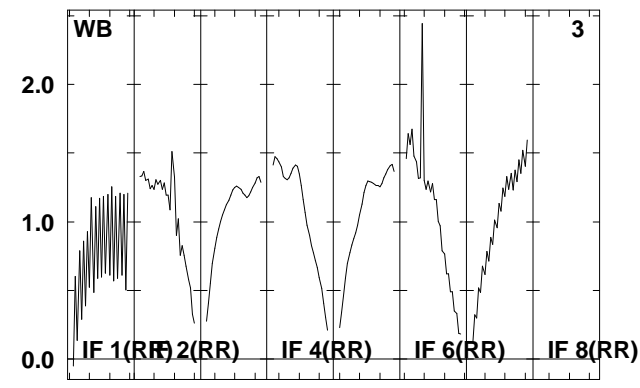
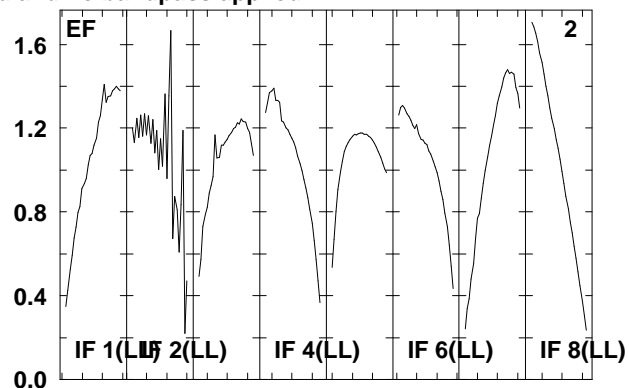
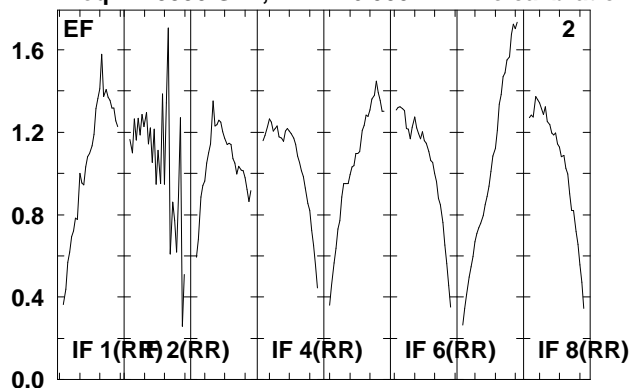

Lower frame: Real Jy
 Total-power spectrum Antenna: *
 Timerange: 00/17:36:02 to 00/17:37:30

Plot file version 74 created 22-APR-2008 12:26:09

J0730-02 EP061B.UVDATA.1

Freq = 1.5950 GHz, Bw = 16.000 MH No calibration applied and no bandpass applied

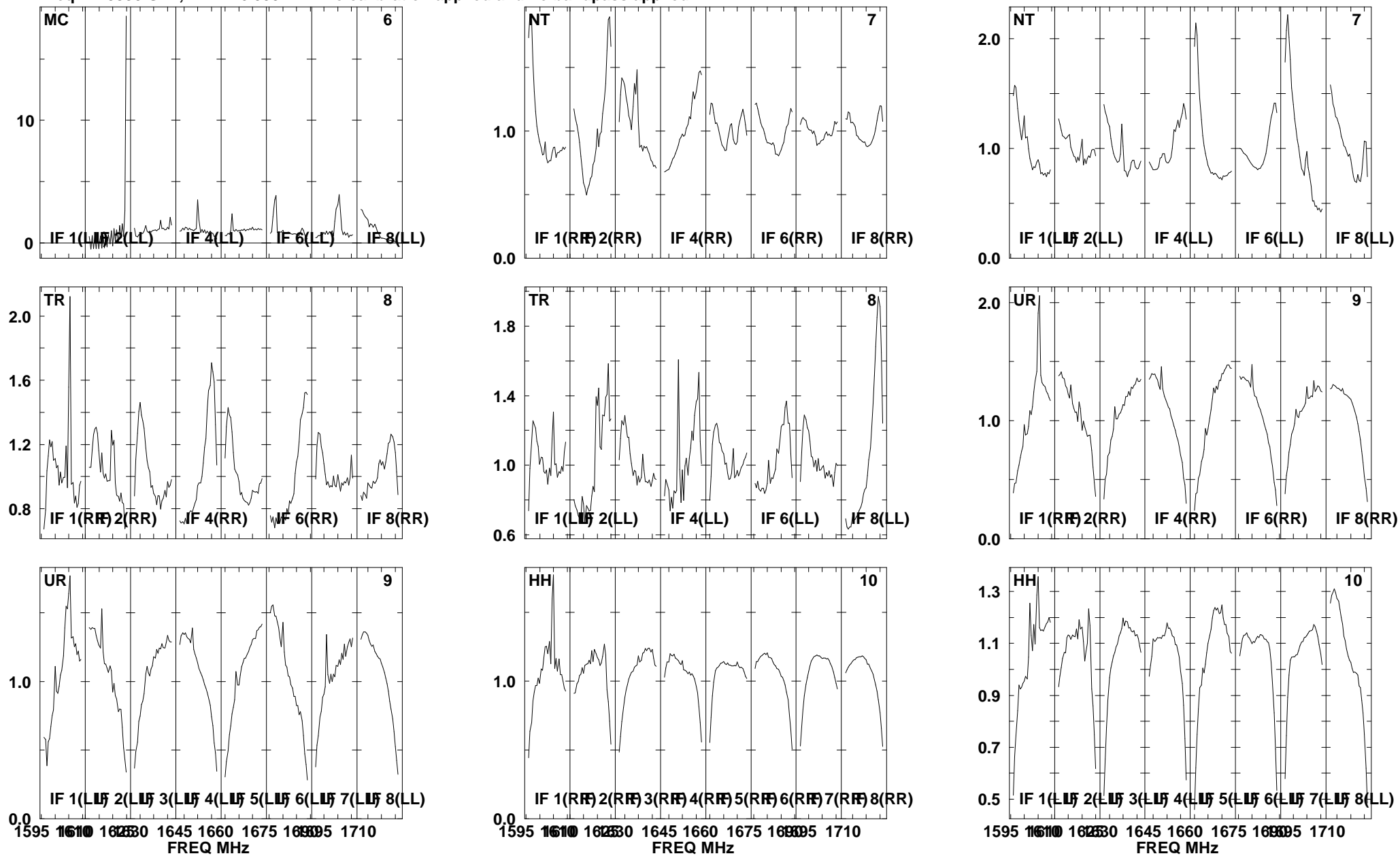

Lower frame: Real Jy
Total-power spectrum Antenna: *
Timerange: 00/17:36:02 to 00/17:37:30

Plot file version 75 created 22-APR-2008 12:26:10

IRAS0725 EP061B.UVDATA.1

Freq = 1.5950 GHz, Bw = 16.000 MH No calibration applied and no bandpass applied

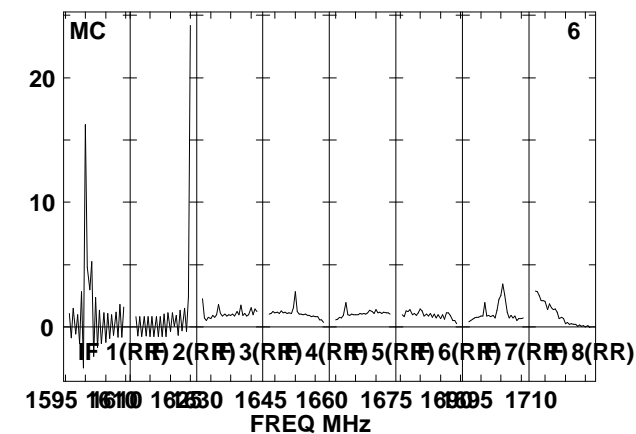
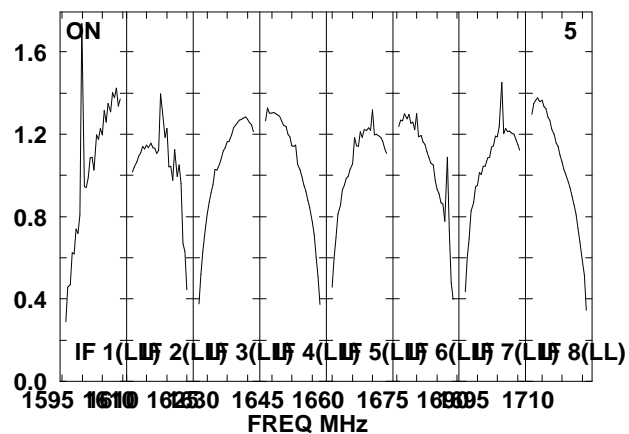
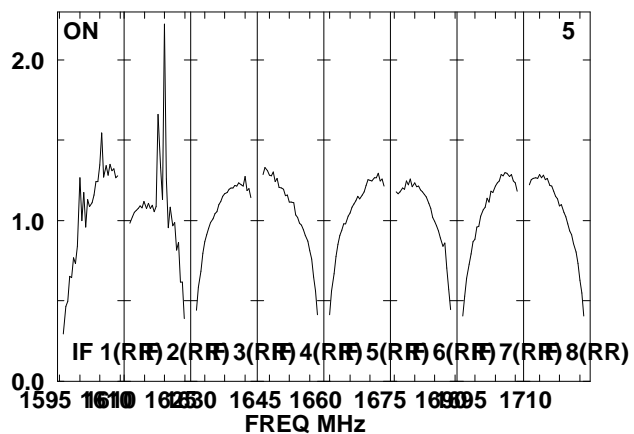
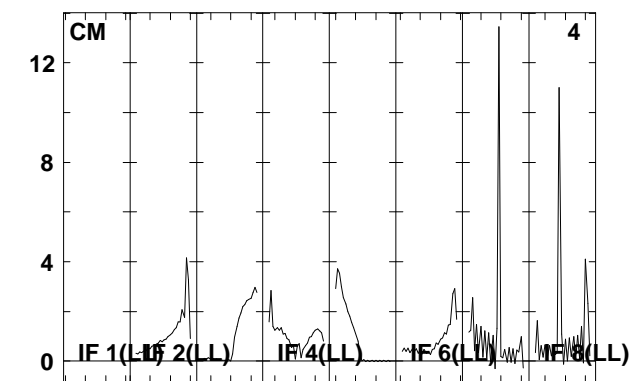
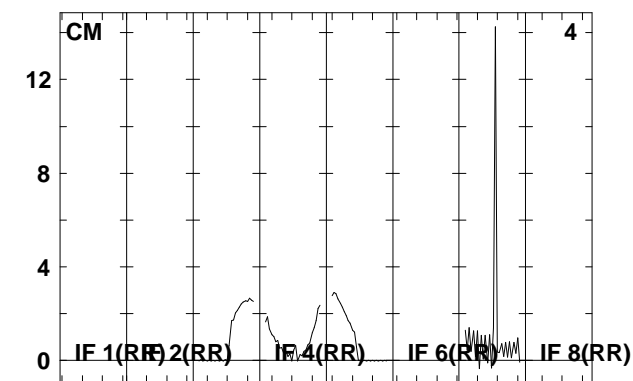
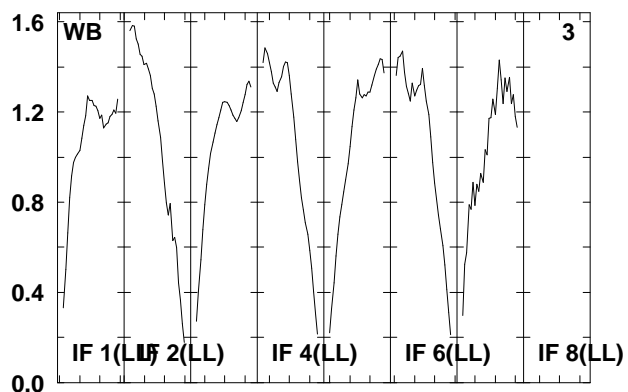
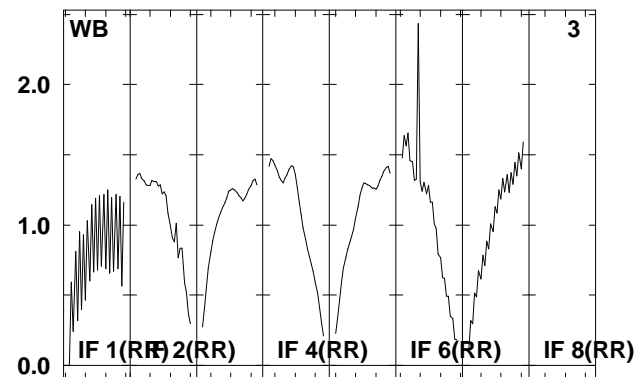
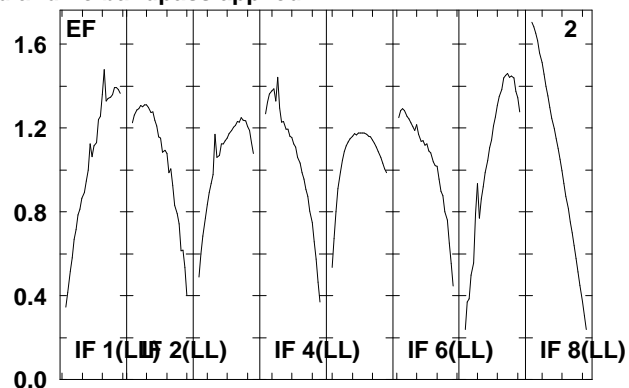
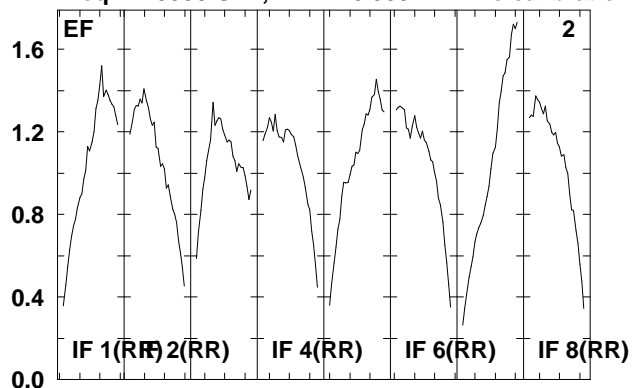

Lower frame: Real Jy
Total-power spectrum Antenna: *
Timerange: 00/17:37:32 to 00/17:41:00

Plot file version 76 created 22-APR-2008 12:26:11

IRAS0725 EP061B.UVDATA.1

Freq = 1.5950 GHz, Bw = 16.000 MH No calibration applied and no bandpass applied

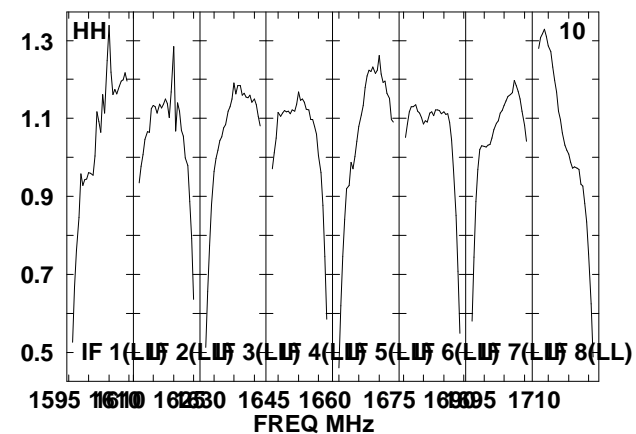
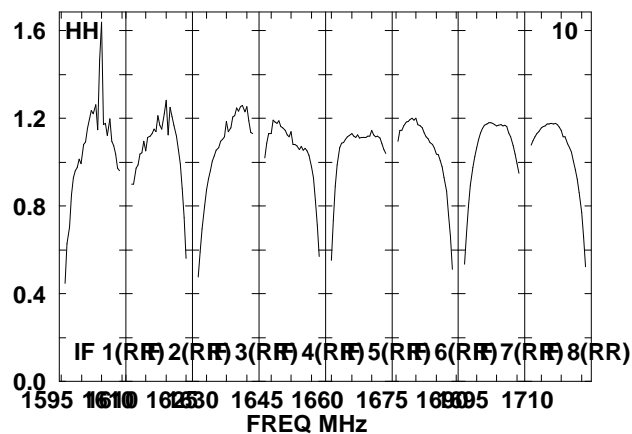
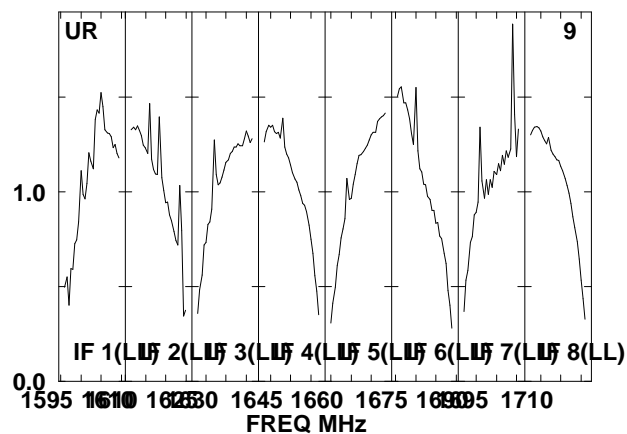
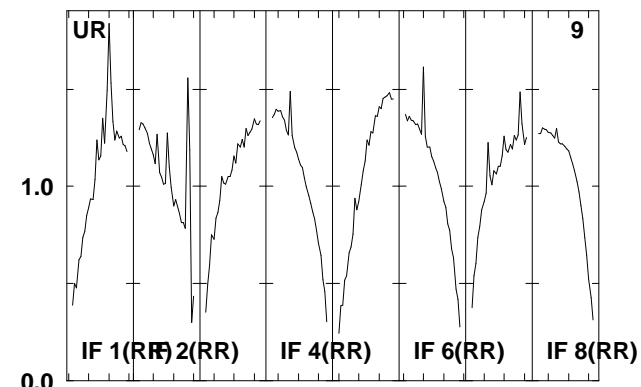
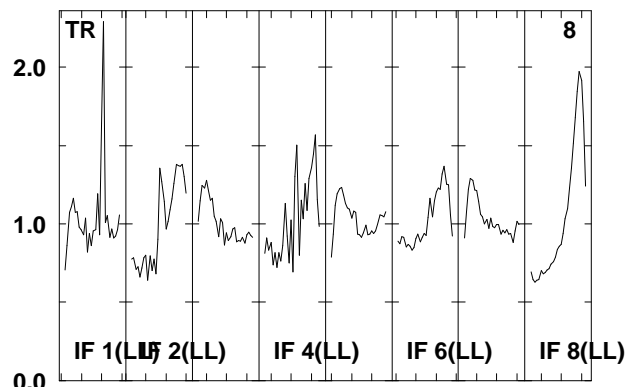
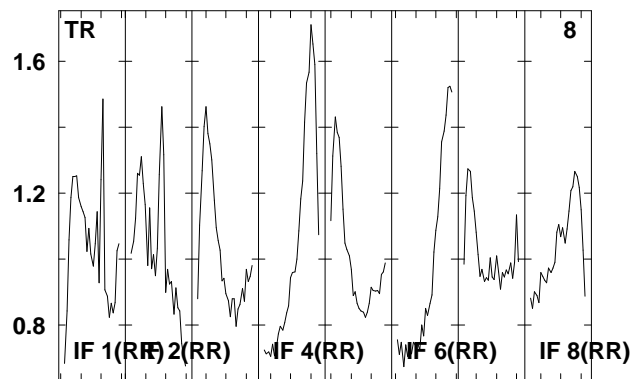
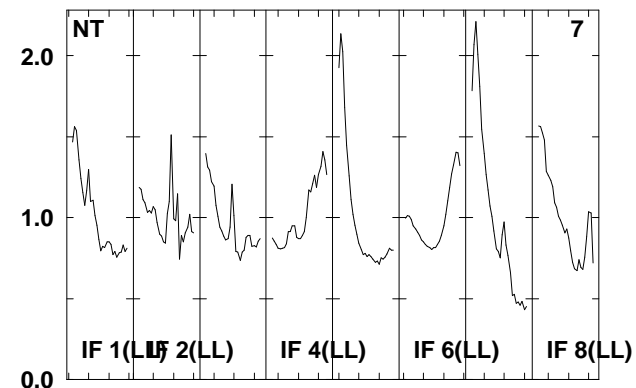
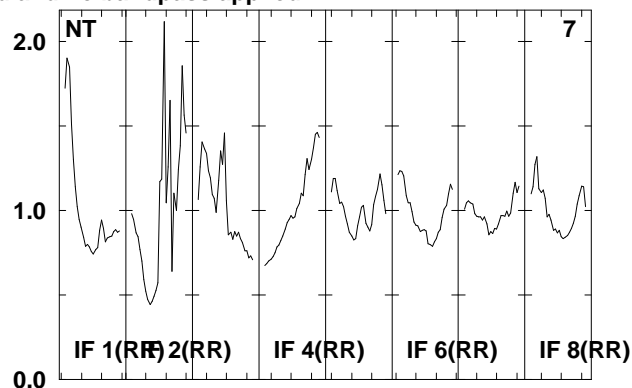
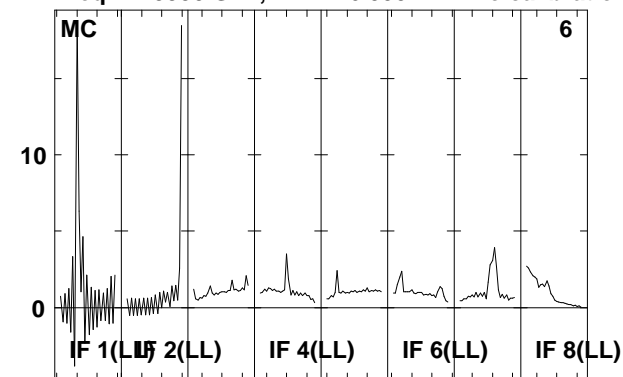

Lower frame: Real Jy
Total-power spectrum Antenna: *
Timerange: 00/17:37:32 to 00/17:41:00

Plot file version 77 created 22-APR-2008 12:26:12

J0730-02 EP061B.UVDATA.1

Freq = 1.5950 GHz, Bw = 16.000 MH No calibration applied and no bandpass applied

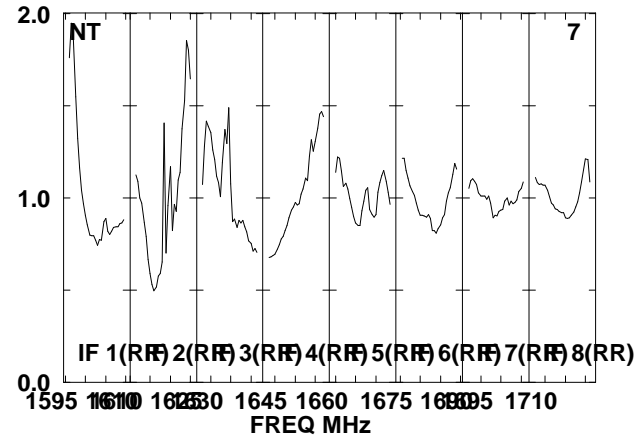
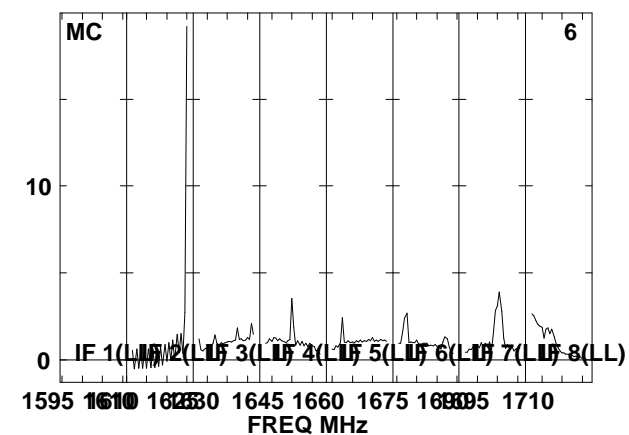
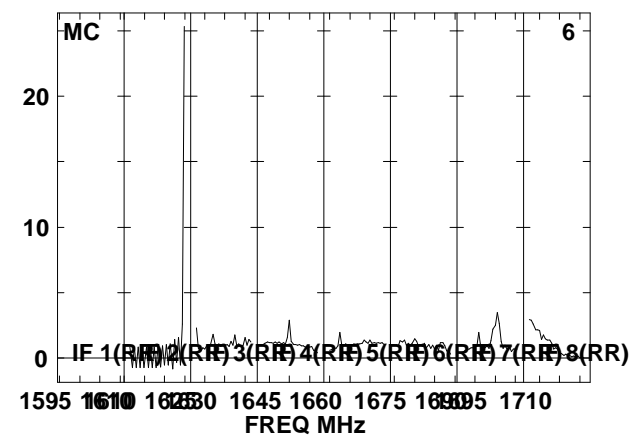
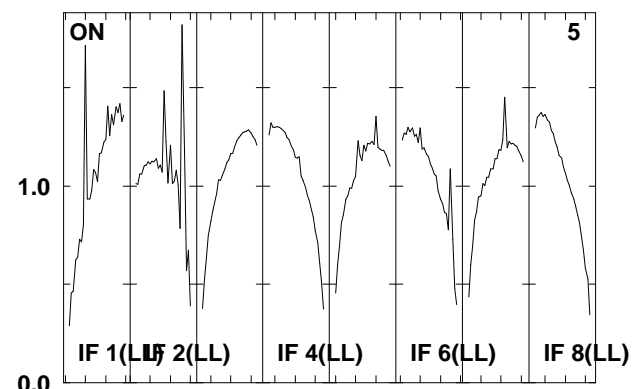
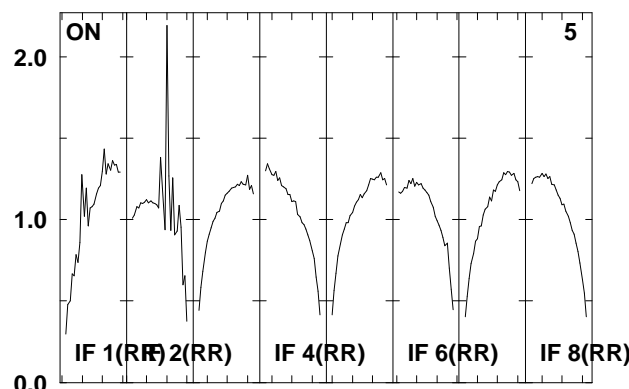
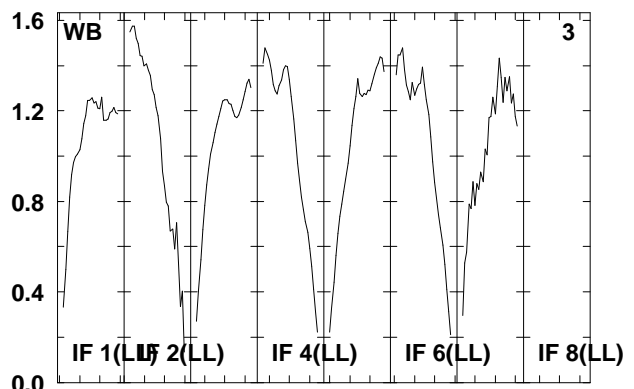
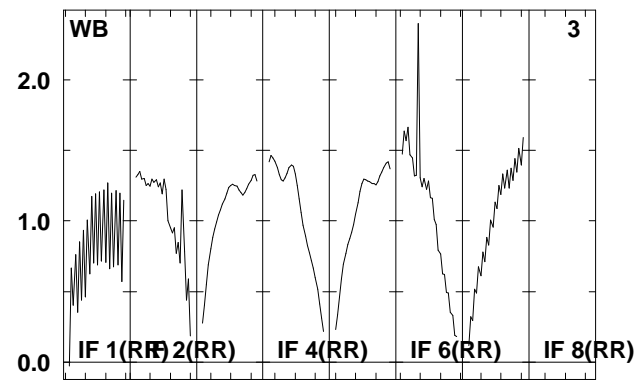
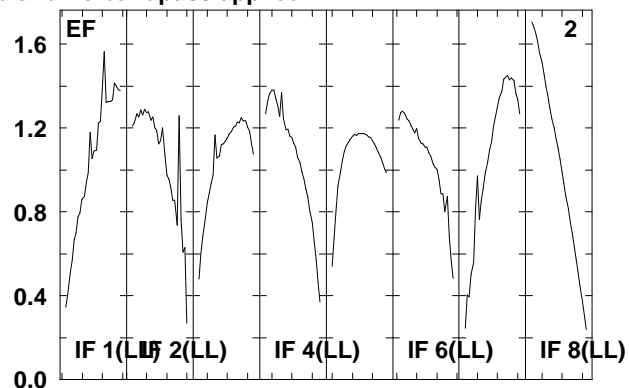
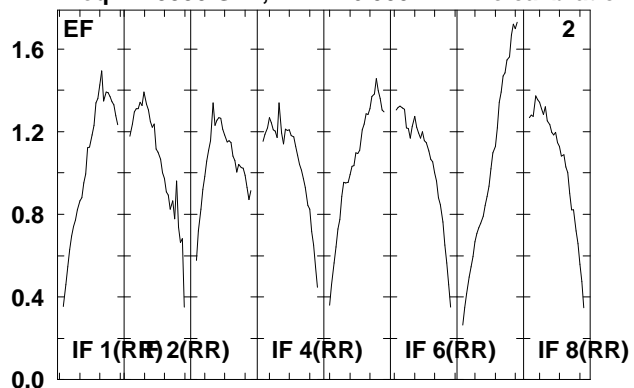

Lower frame: Real Jy
Total-power spectrum Antenna: *
Timerange: 00/17:41:02 to 00/17:42:30

Plot file version 78 created 22-APR-2008 12:26:13

J0730-02 EP061B.UVDATA.1

Freq = 1.5950 GHz, Bw = 16.000 MH No calibration applied and no bandpass applied

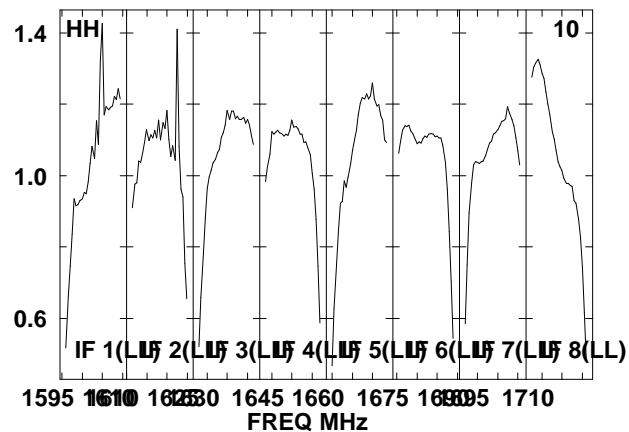
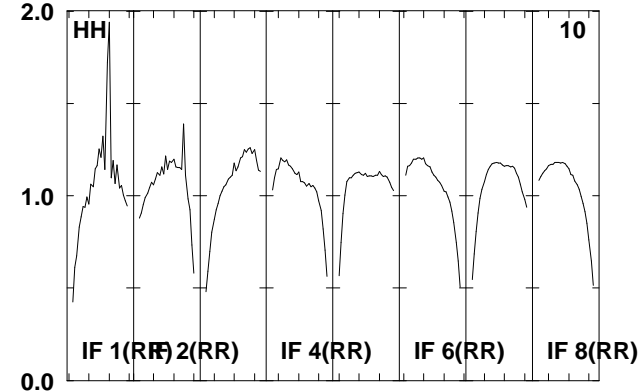
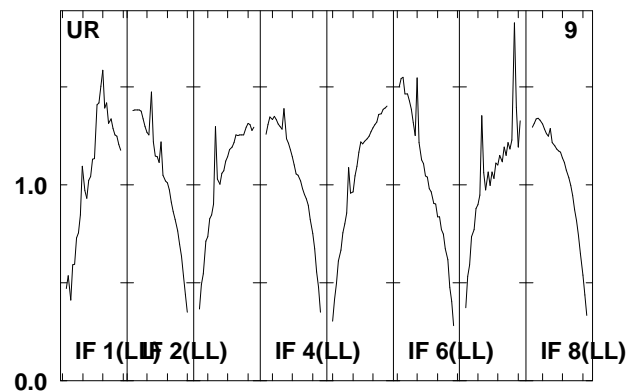
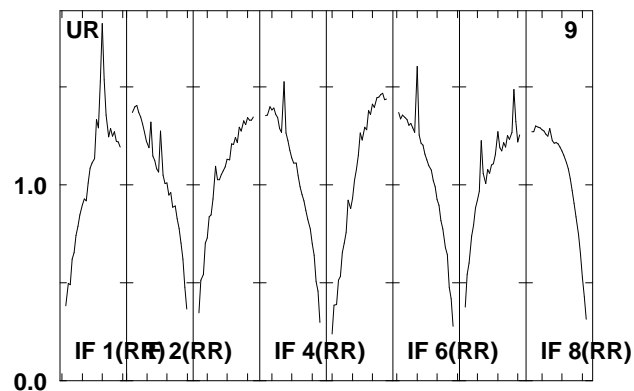
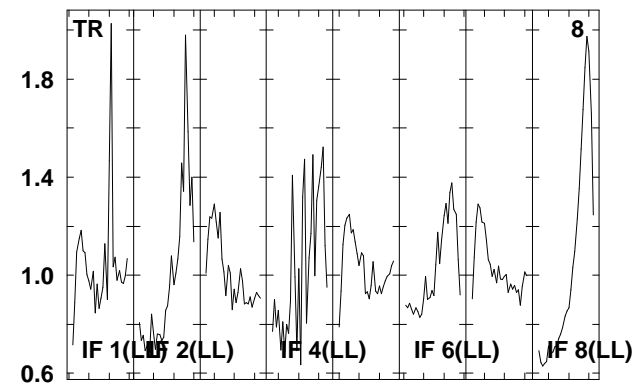
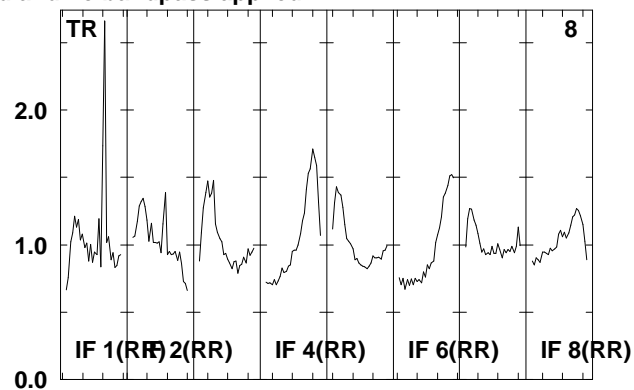
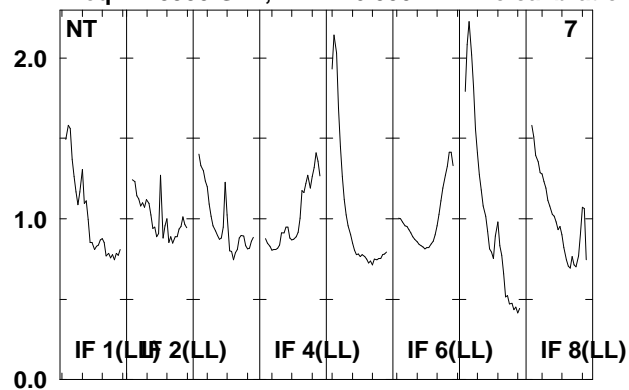

Lower frame: Real Jy

Total-power spectrum Antenna: *

Timerange: 00/17:41:02 to 00/17:42:30

Plot file version 79 created 22-APR-2008 12:26:14

IRAS0725 EP061B.UVDATA.1

Freq = 1.5950 GHz, Bw = 16.000 MH No calibration applied and no bandpass applied

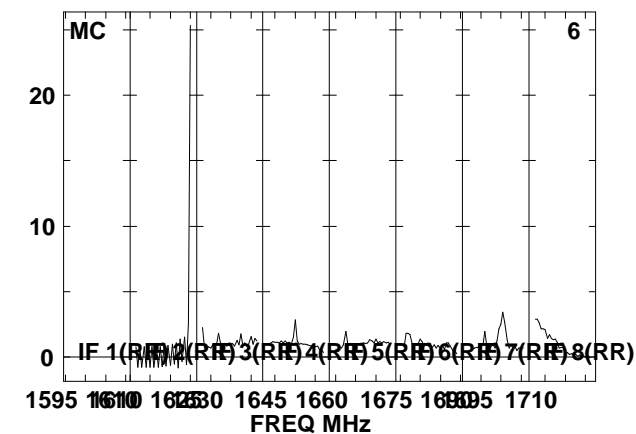
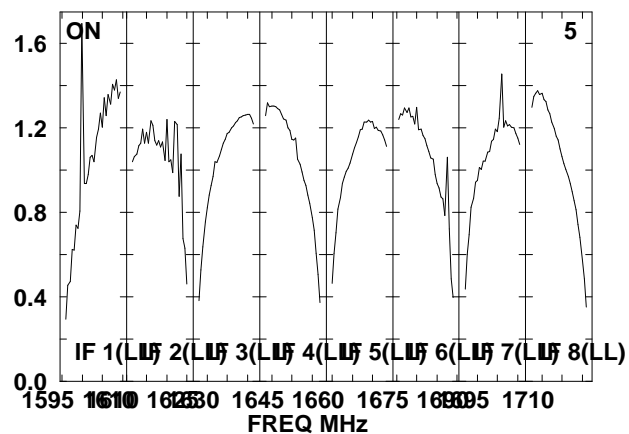
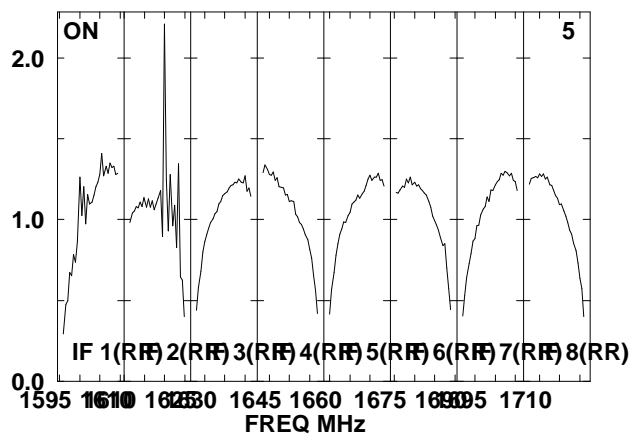
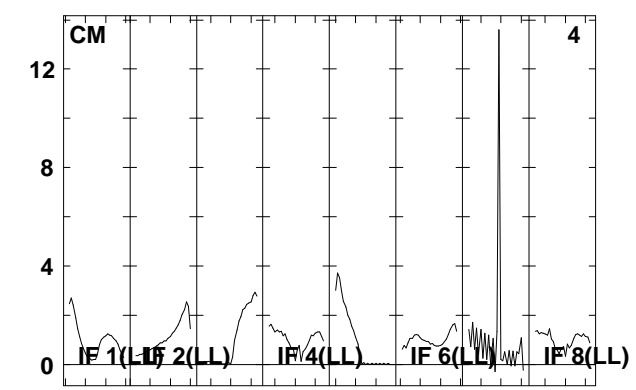
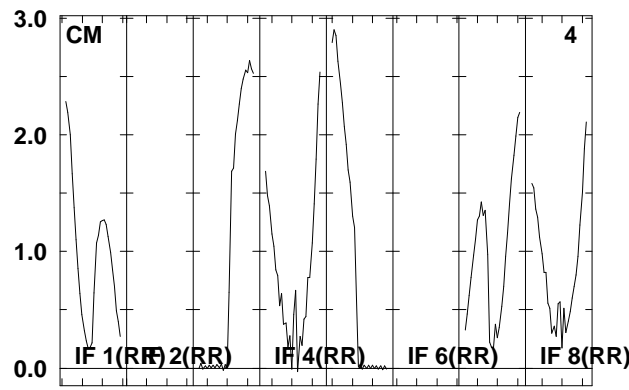
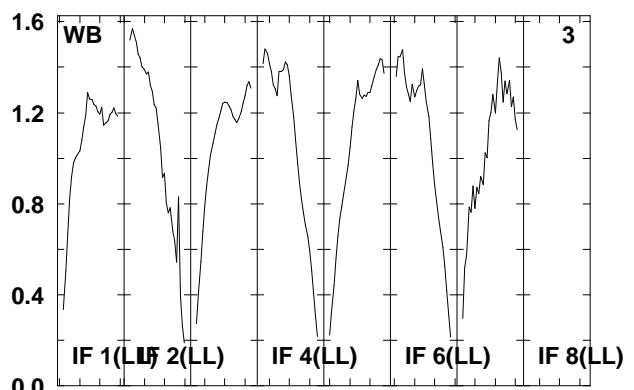
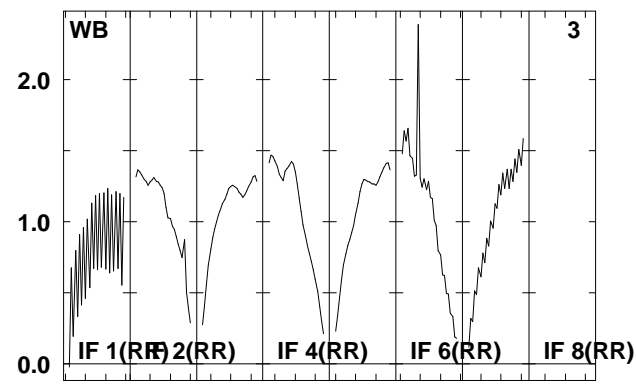
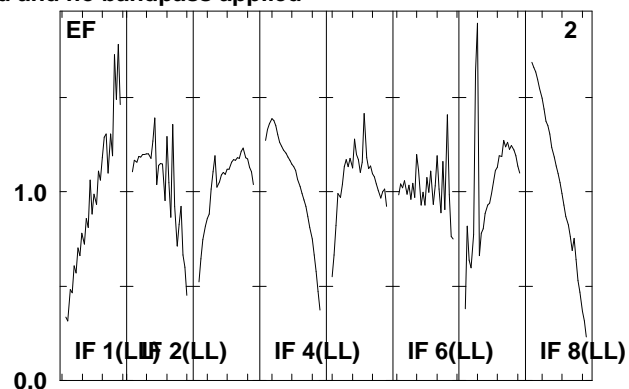
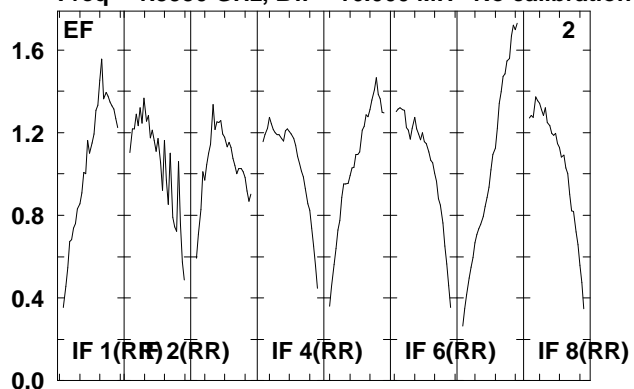

Lower frame: Real Jy
Total-power spectrum Antenna: *
Timerange: 00/17:42:32 to 00/17:46:00

Plot file version 80 created 22-APR-2008 12:26:14

IRAS0725 EP061B.UVDATA.1

Freq = 1.5950 GHz, Bw = 16.000 MH No calibration applied and no bandpass applied

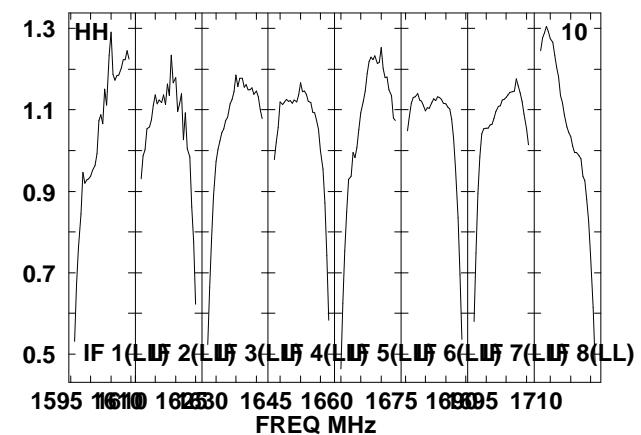
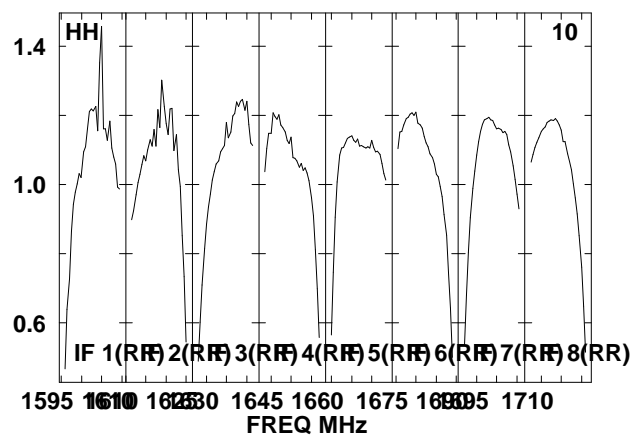
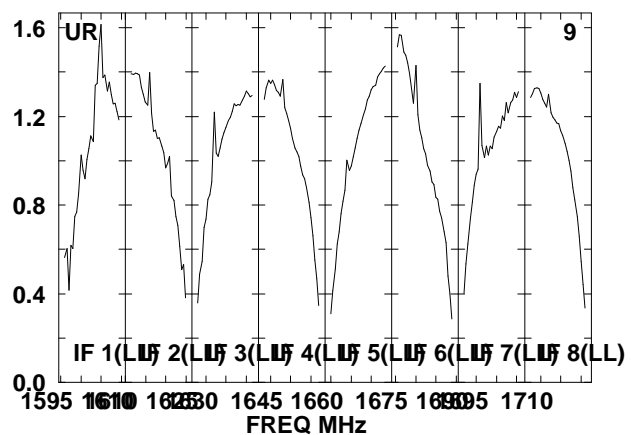
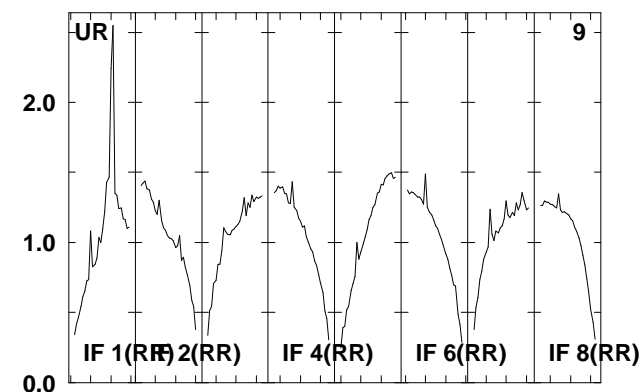
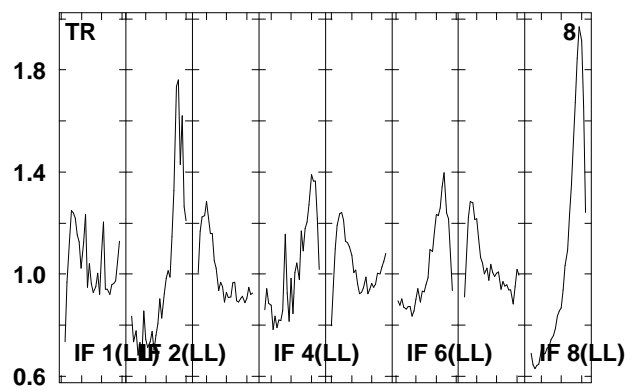
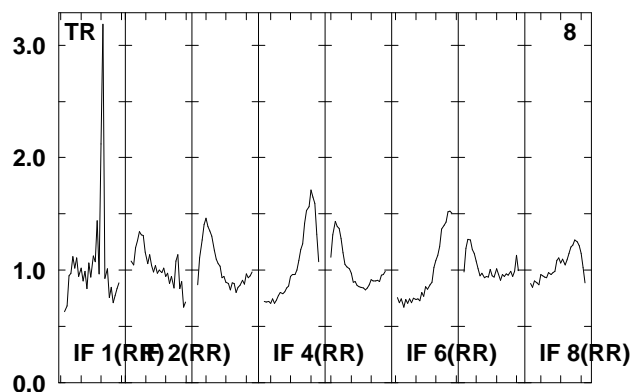
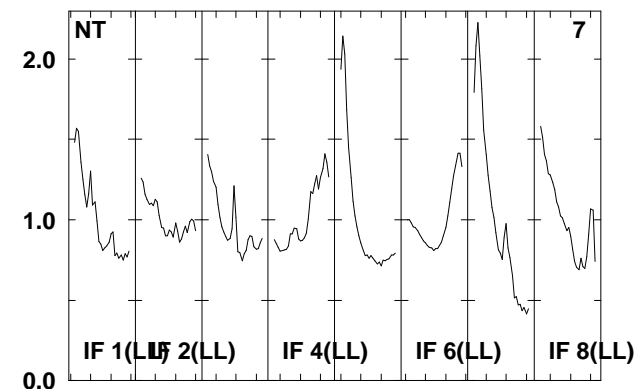
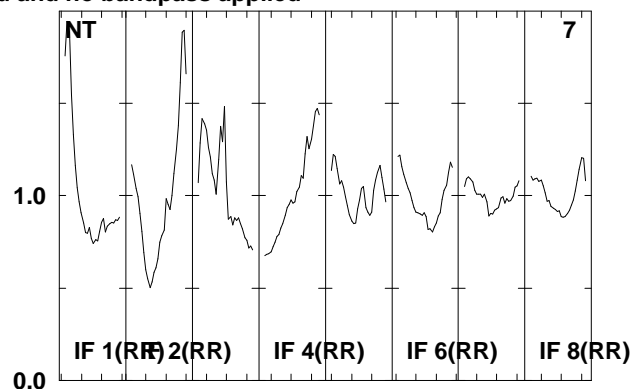
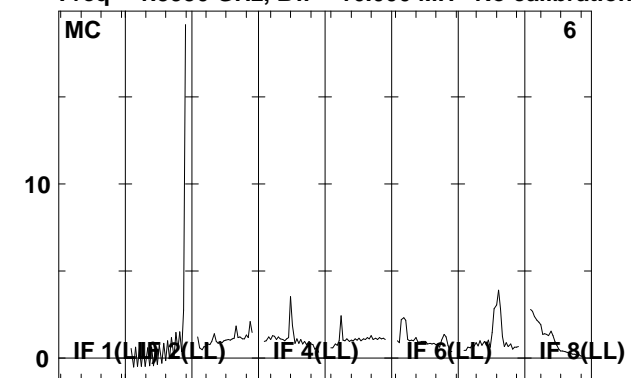

Lower frame: Real Jy

Total-power spectrum Antenna: *

Timerange: 00/17:42:32 to 00/17:46:00

Plot file version 81 created 22-APR-2008 12:26:16

J0730-02 EP061B.UVDATA.1

Freq = 1.5950 GHz, Bw = 16.000 MH No calibration applied and no bandpass applied

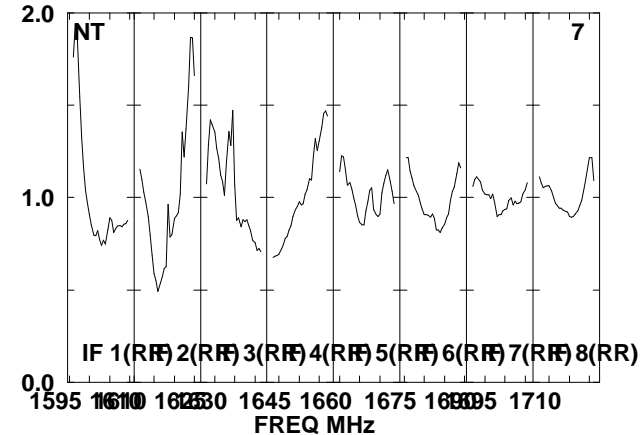
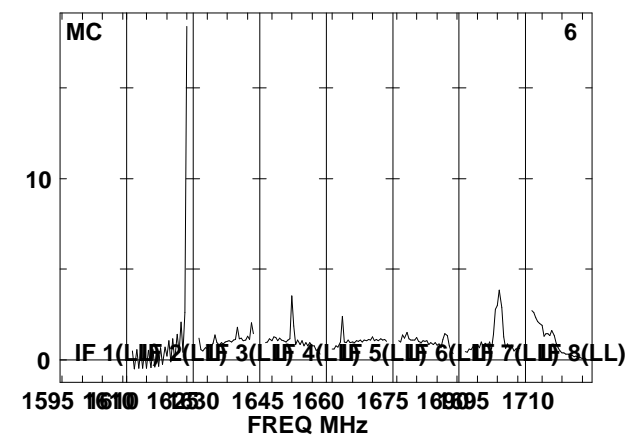
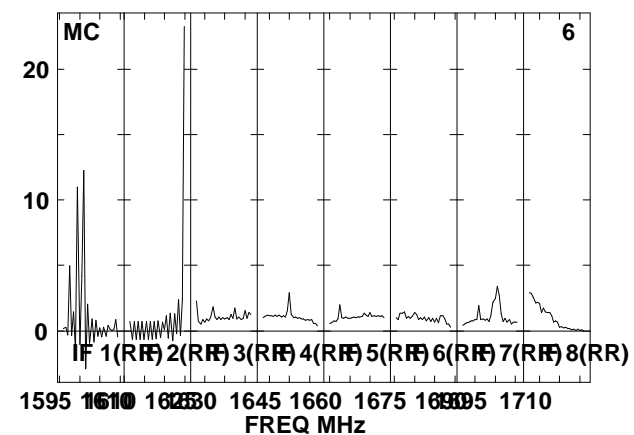
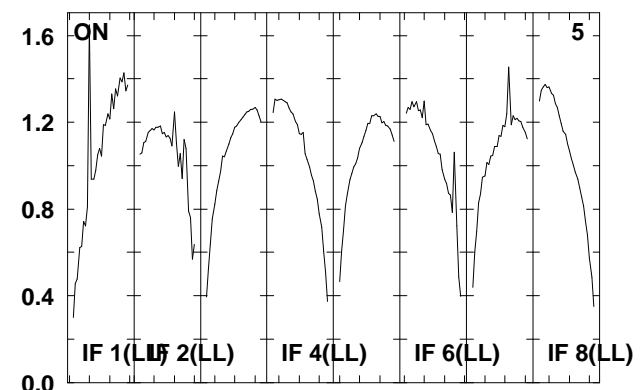
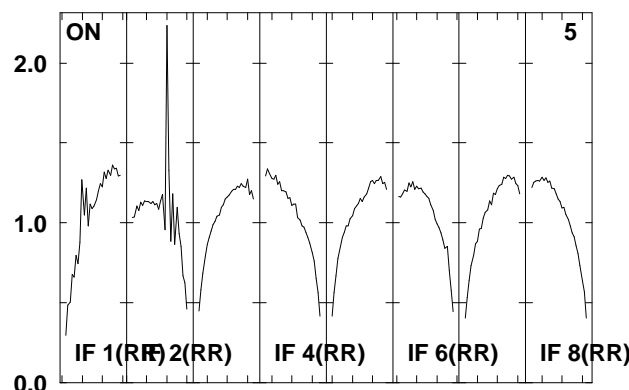
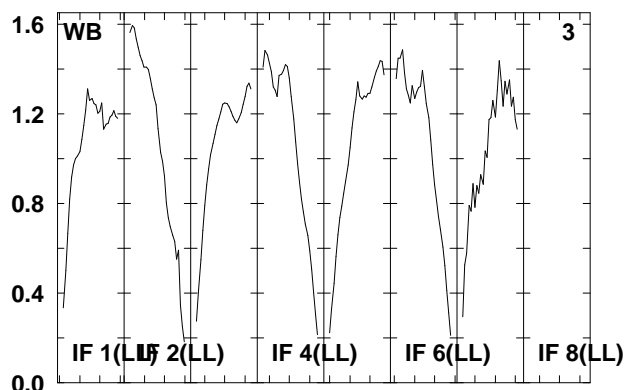
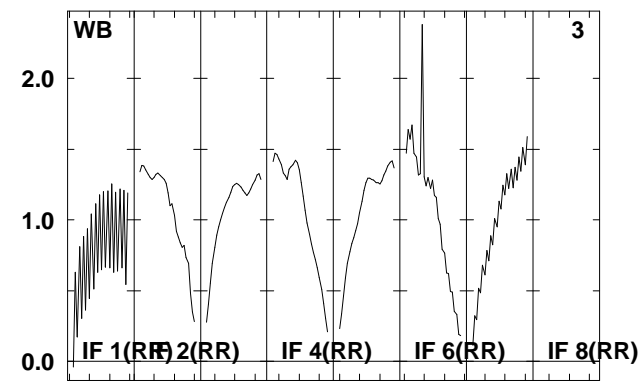
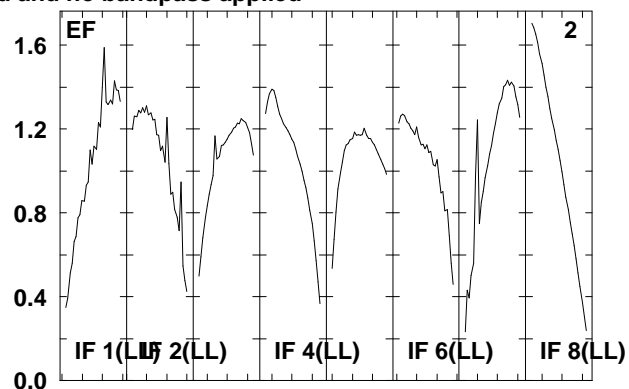
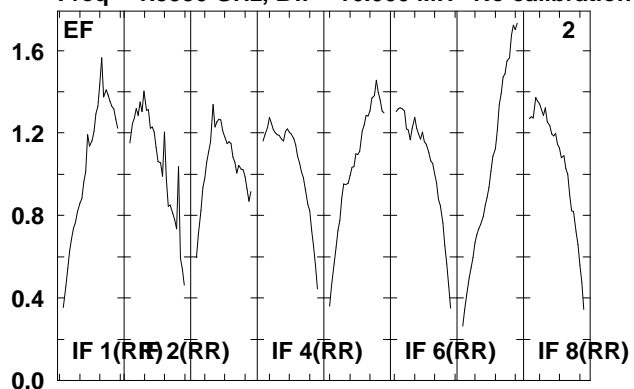

Lower frame: Real Jy
Total-power spectrum Antenna: *
Timerange: 00/17:46:02 to 00/17:47:30

Plot file version 82 created 22-APR-2008 12:26:16

J0730-02 EP061B.UVDATA.1

Freq = 1.5950 GHz, Bw = 16.000 MH No calibration applied and no bandpass applied

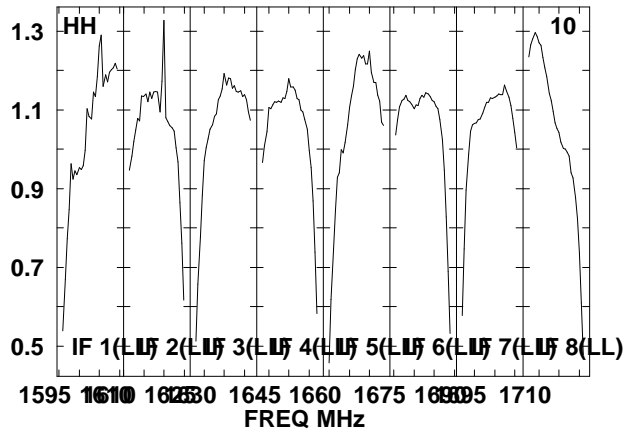
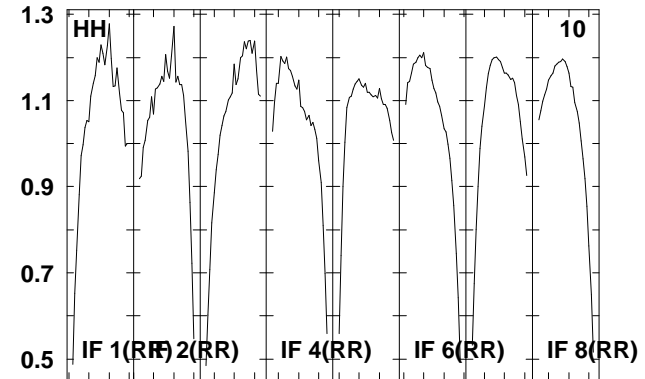
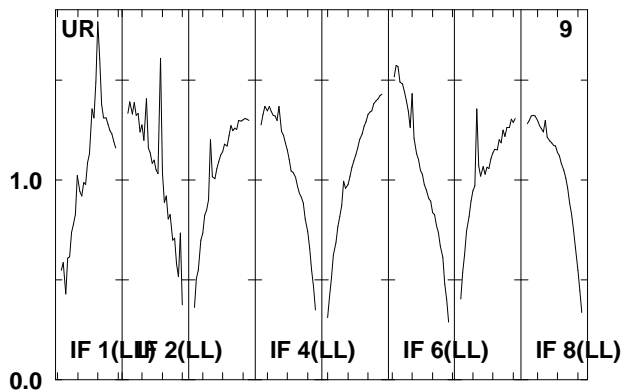
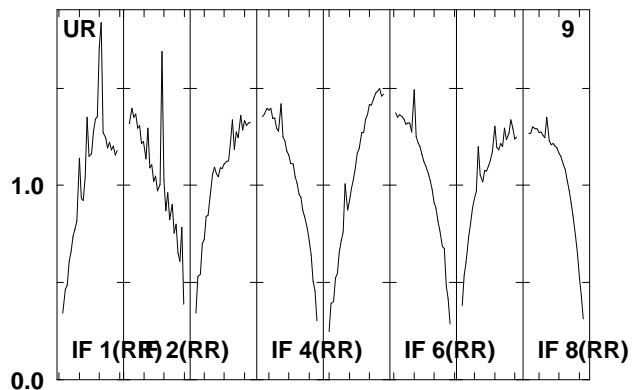
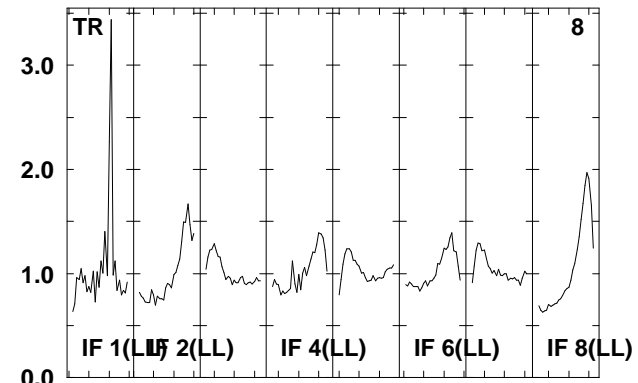
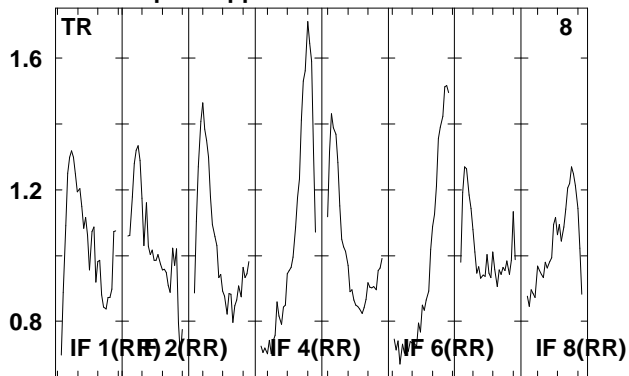
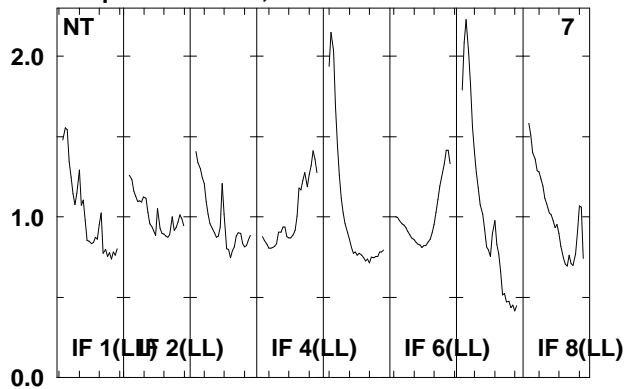

Lower frame: Real Jy

Total-power spectrum Antenna: *

Timerange: 00/17:46:02 to 00/17:47:30

Plot file version 83 created 22-APR-2008 12:26:17

IRAS0725 EP061B.UVDATA.1

Freq = 1.5950 GHz, Bw = 16.000 MH No calibration applied and no bandpass applied

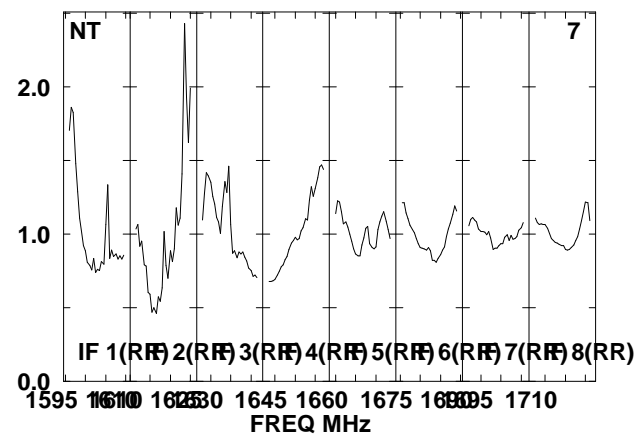
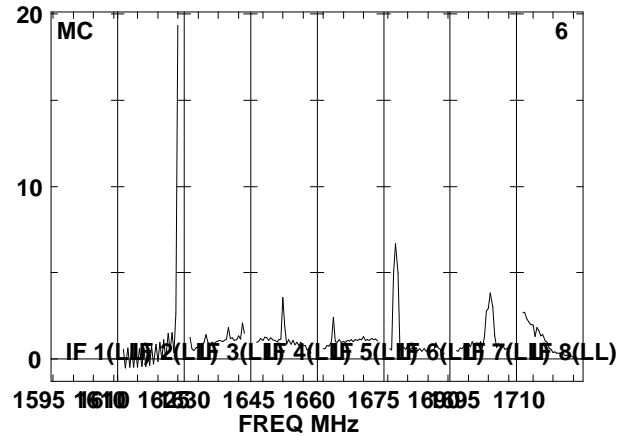
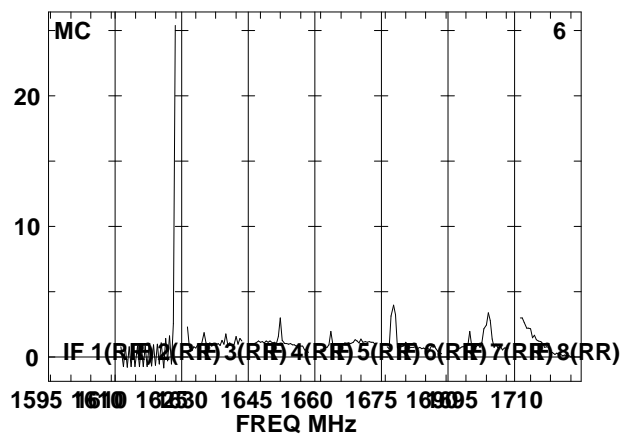
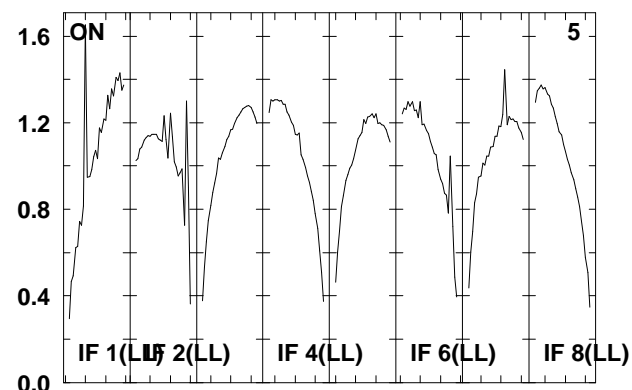
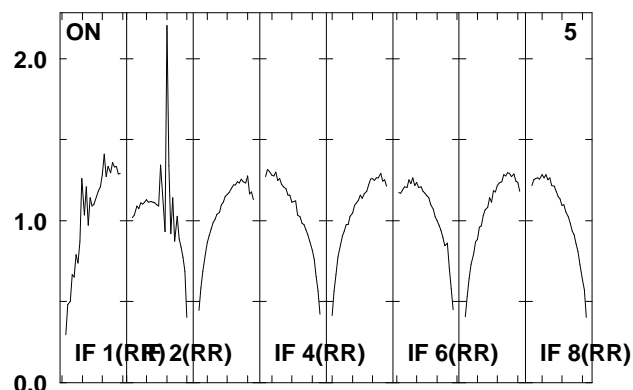
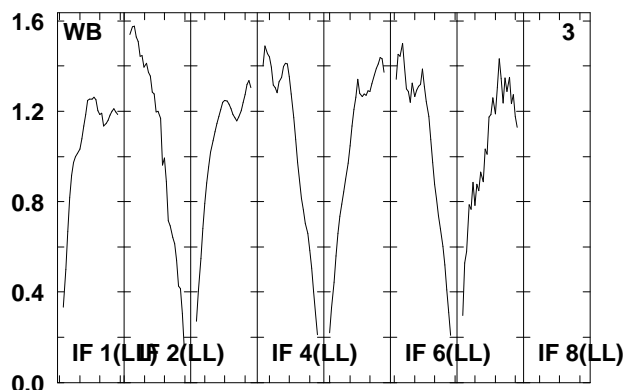
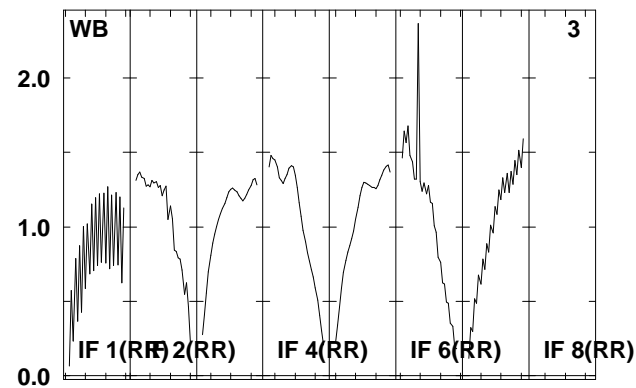
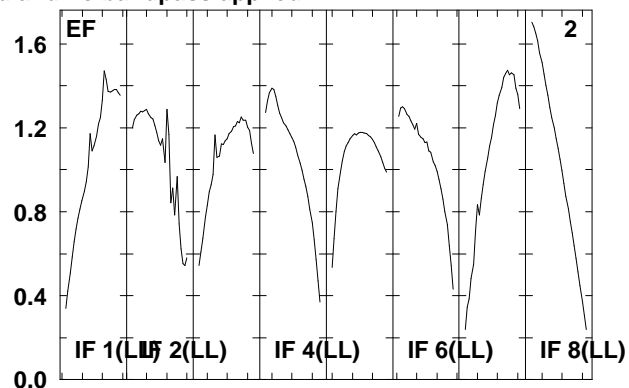
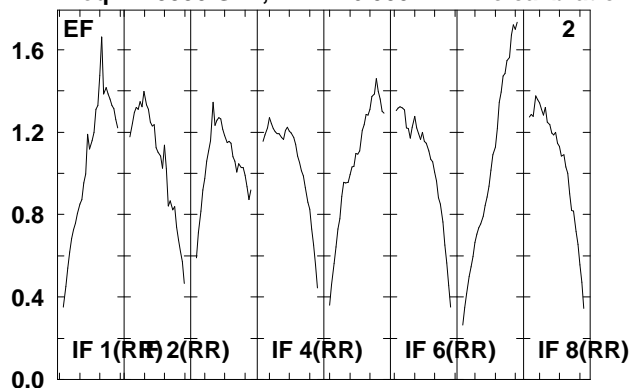

Lower frame: Real Jy
Total-power spectrum Antenna: *
Timerange: 00/17:47:32 to 00/17:50:58

Plot file version 84 created 22-APR-2008 12:26:18

IRAS0725 EP061B.UVDATA.1

Freq = 1.5950 GHz, Bw = 16.000 MH No calibration applied and no bandpass applied

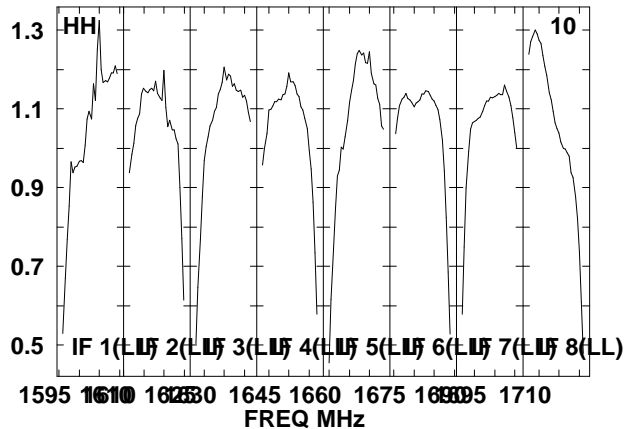
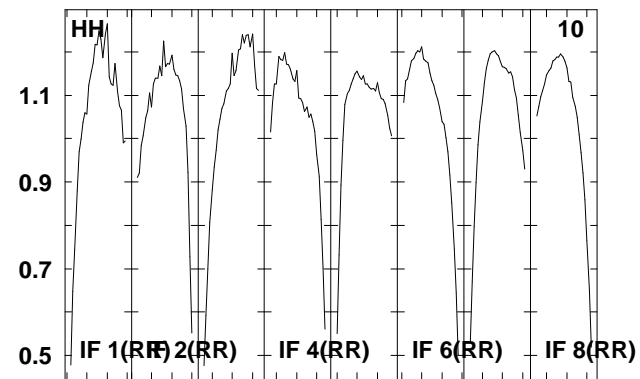
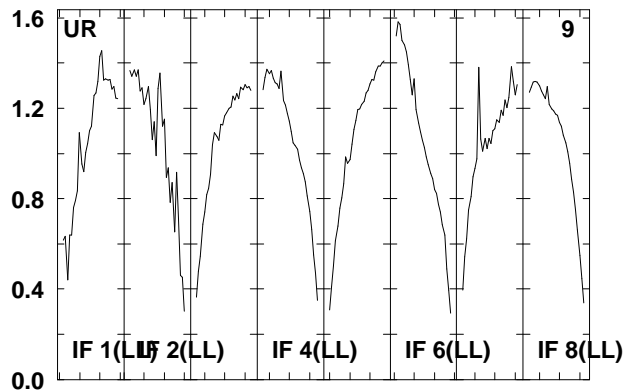
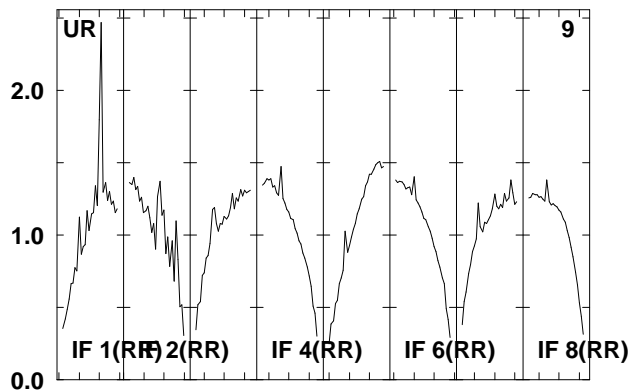
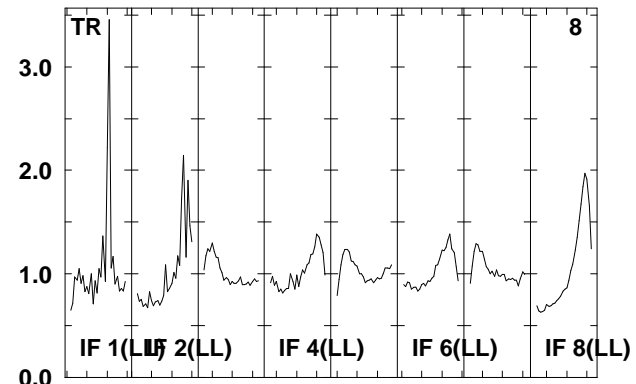
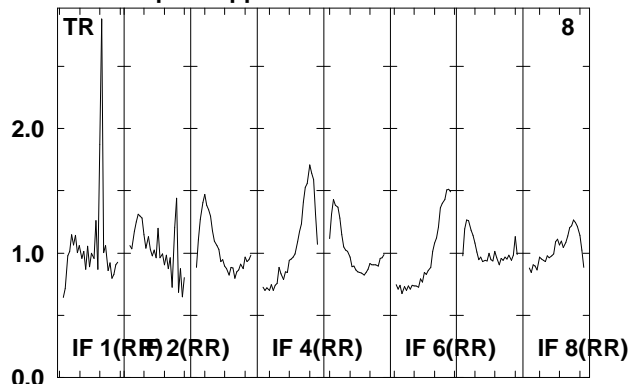
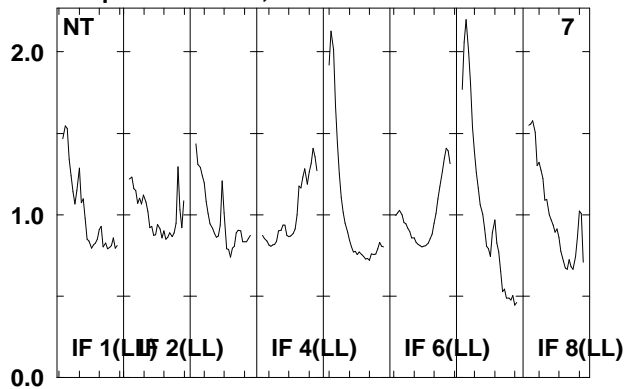

Lower frame: Real Jy

Total-power spectrum Antenna: *

Timerange: 00/17:47:32 to 00/17:50:58

Plot file version 85 created 22-APR-2008 12:26:19

J0730-02 EP061B.UVDATA.1

Freq = 1.5950 GHz, Bw = 16.000 MH No calibration applied and no bandpass applied

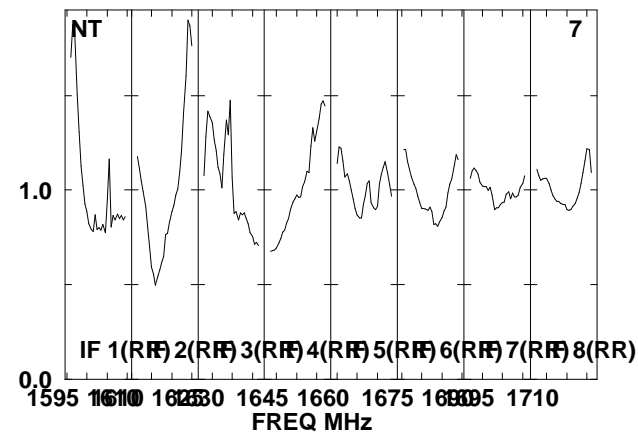
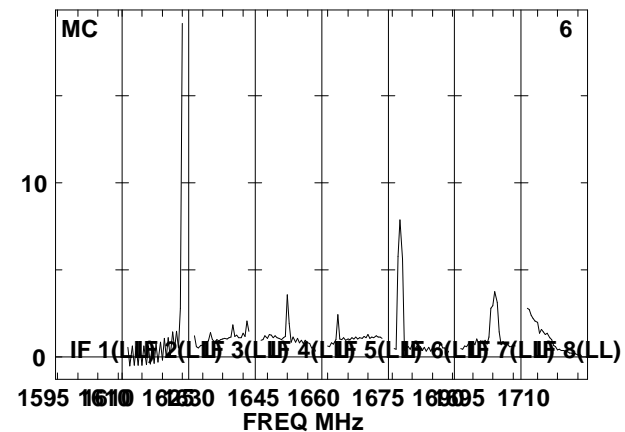
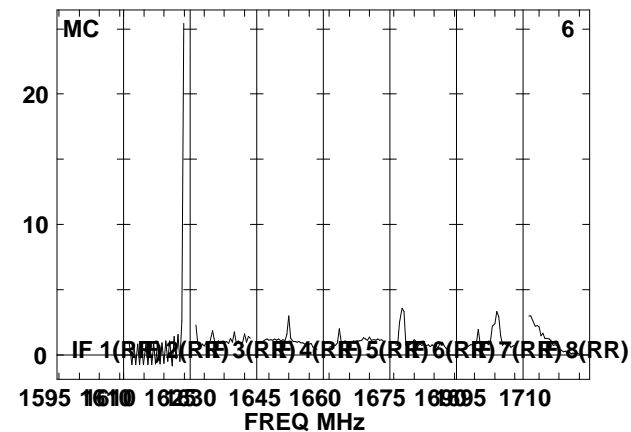
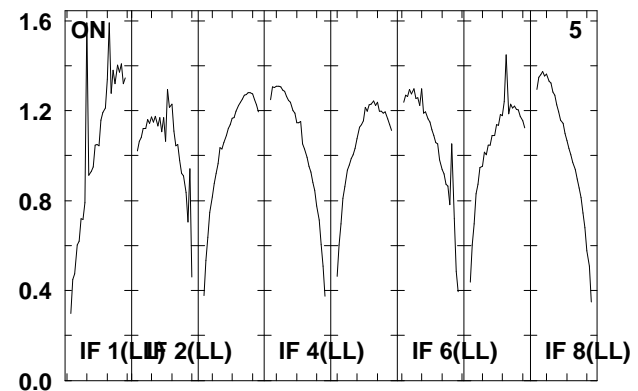
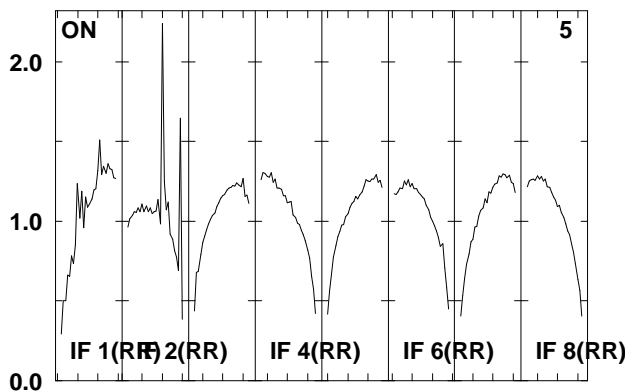
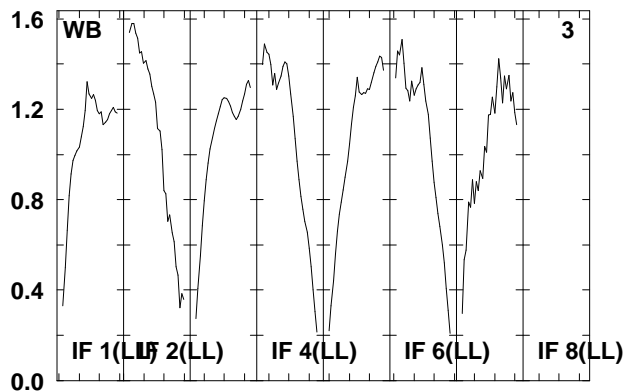
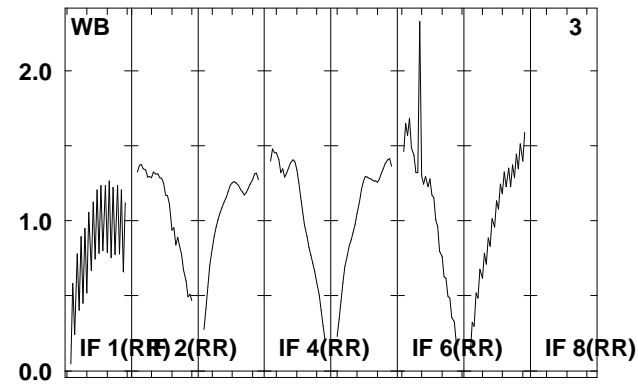
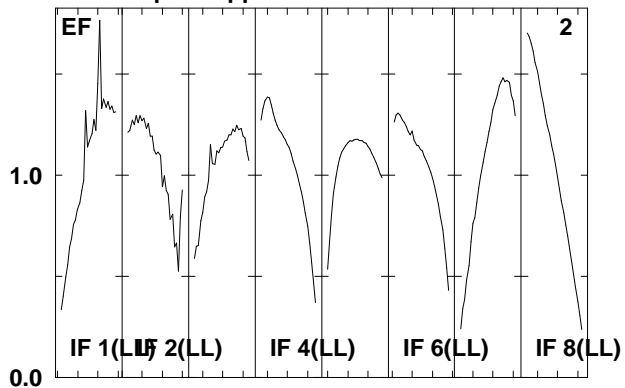
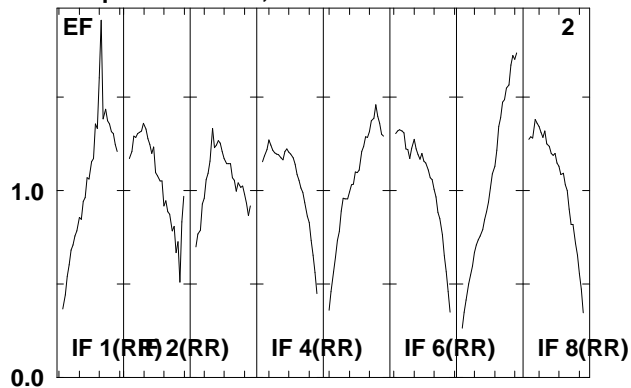

Lower frame: Real Jy
Total-power spectrum Antenna: *
Timerange: 00/17:52:02 to 00/17:53:30

Plot file version 86 created 22-APR-2008 12:26:20

J0730-02 EP061B.UVDATA.1

Freq = 1.5950 GHz, Bw = 16.000 MH No calibration applied and no bandpass applied

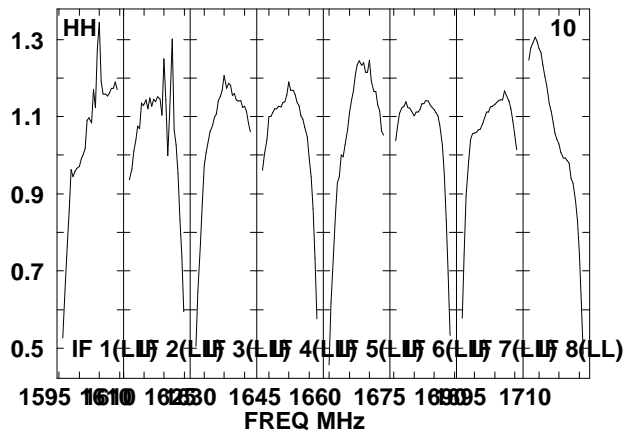
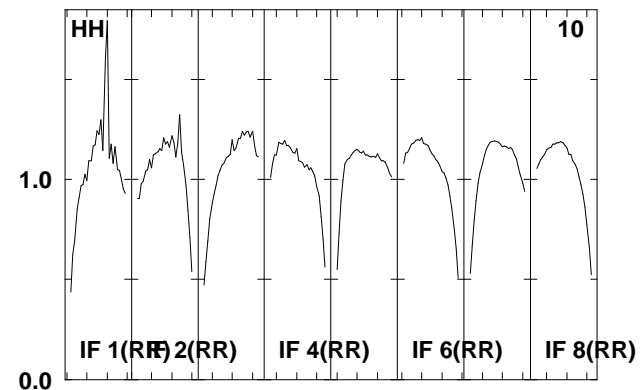
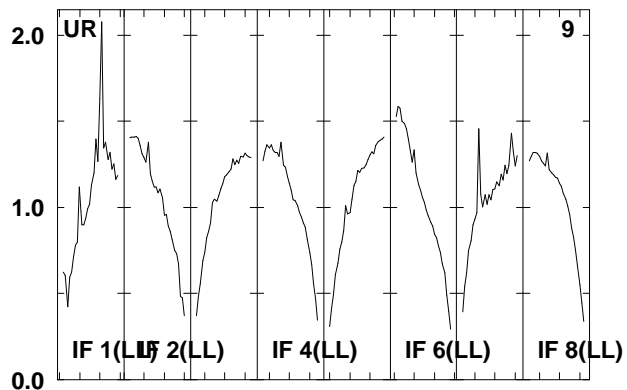
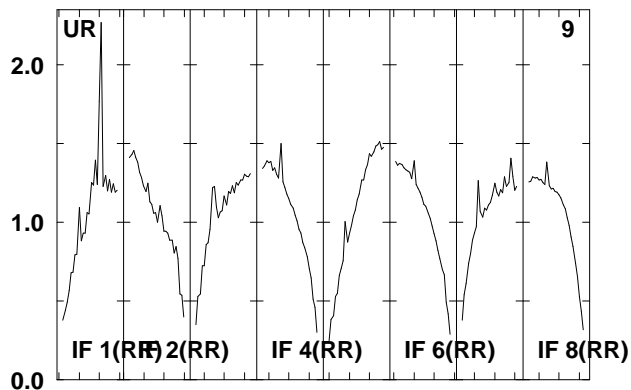
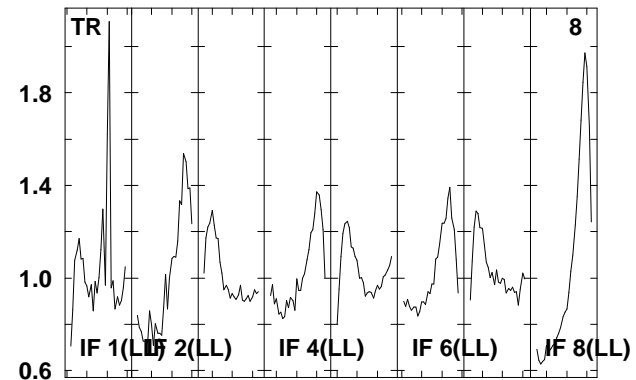
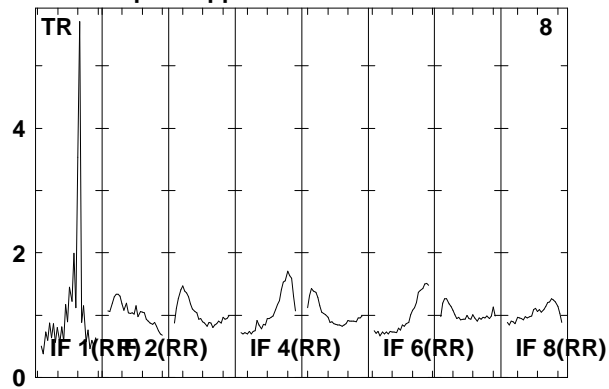
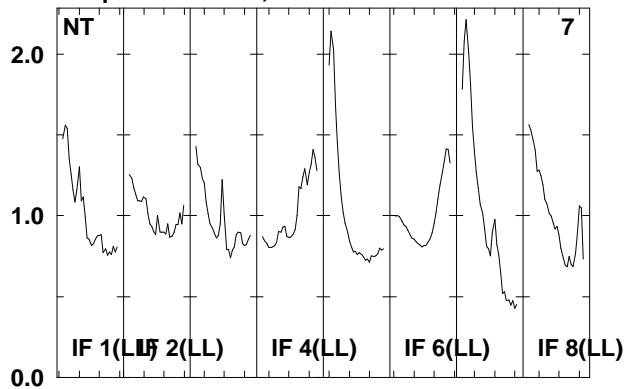

Lower frame: Real Jy

Total-power spectrum Antenna: *

Timerange: 00/17:52:02 to 00/17:53:30

Plot file version 87 created 22-APR-2008 12:26:21

IRAS0725 EP061B.UVDATA.1

Freq = 1.5950 GHz, Bw = 16.000 MH No calibration applied and no bandpass applied

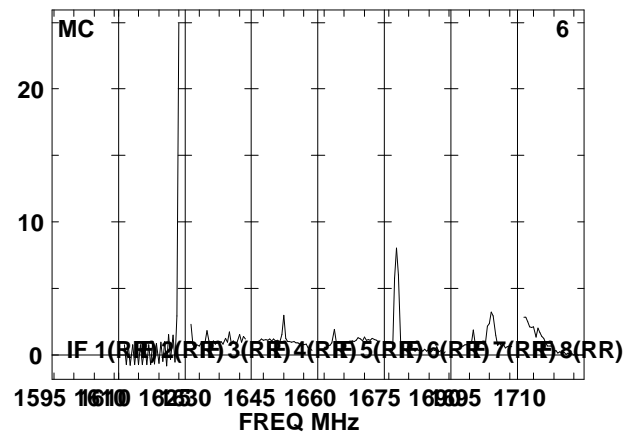
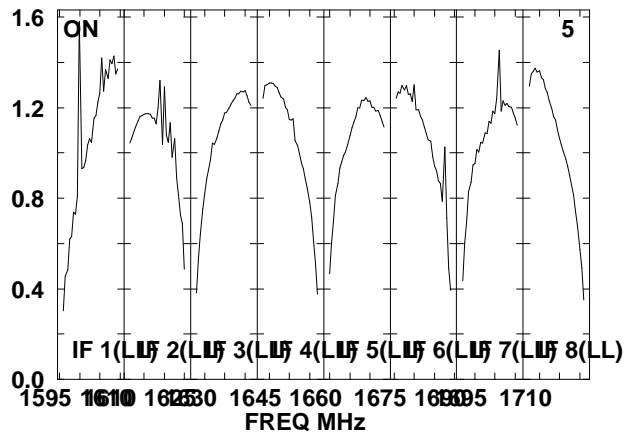
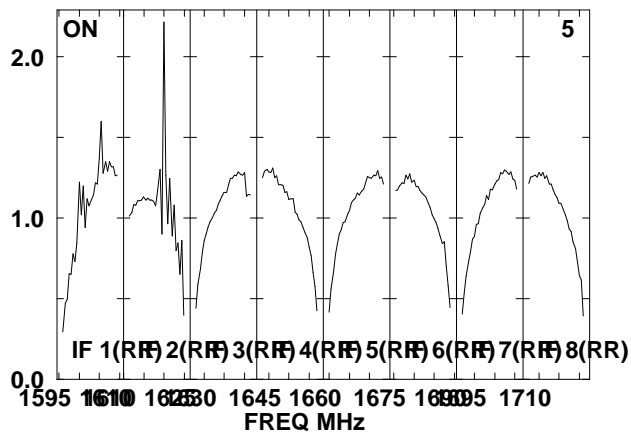
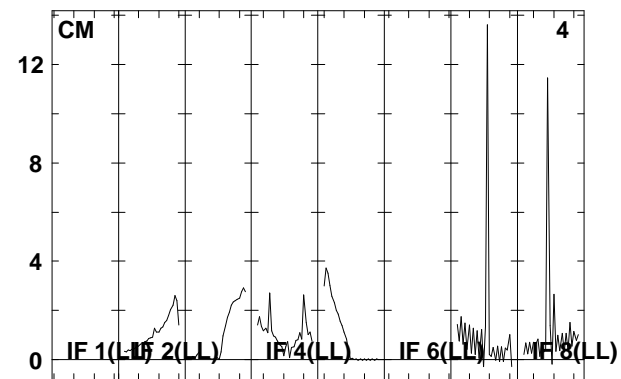
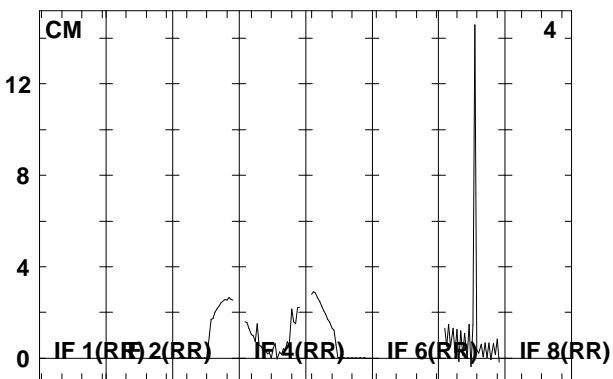
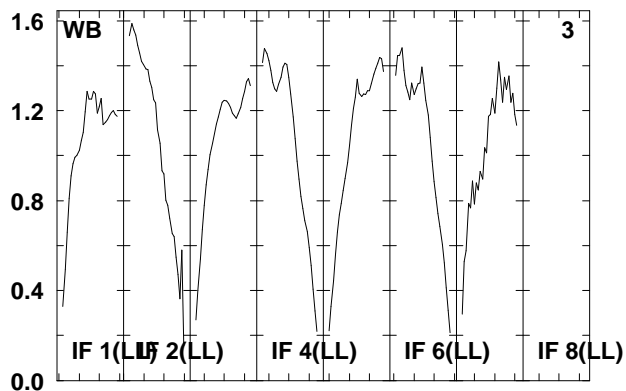
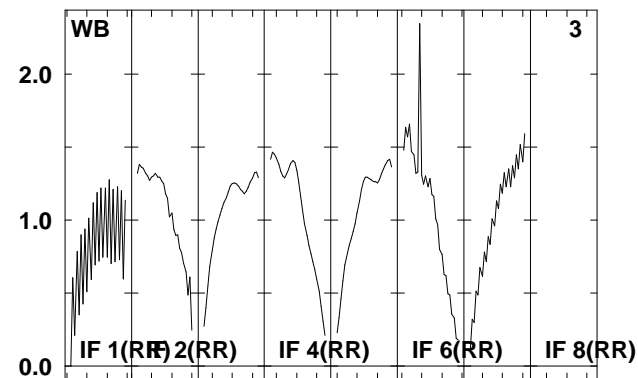
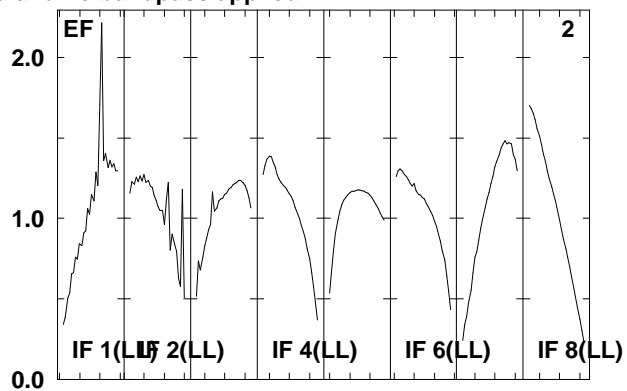
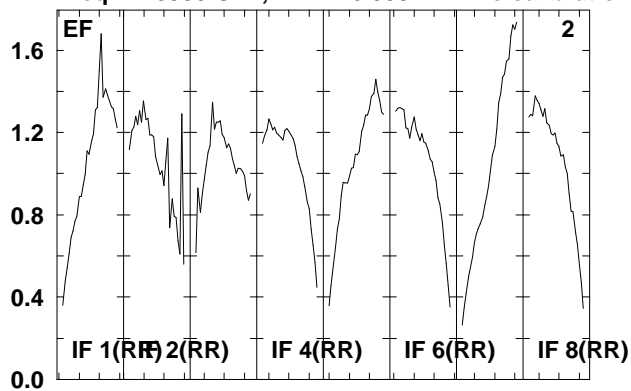

Lower frame: Real Jy
Total-power spectrum Antenna: *
Timerange: 00/17:53:32 to 00/17:57:00

Plot file version 88 created 22-APR-2008 12:26:22

IRAS0725 EP061B.UVDATA.1

Freq = 1.5950 GHz, Bw = 16.000 MH No calibration applied and no bandpass applied

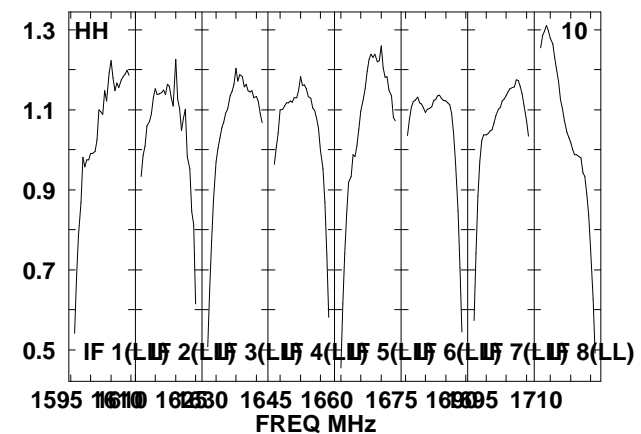
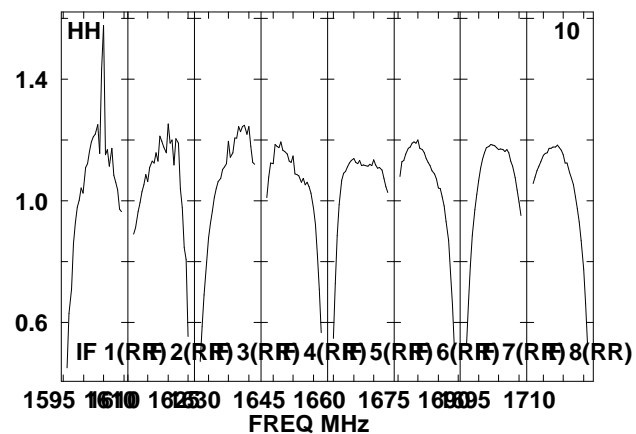
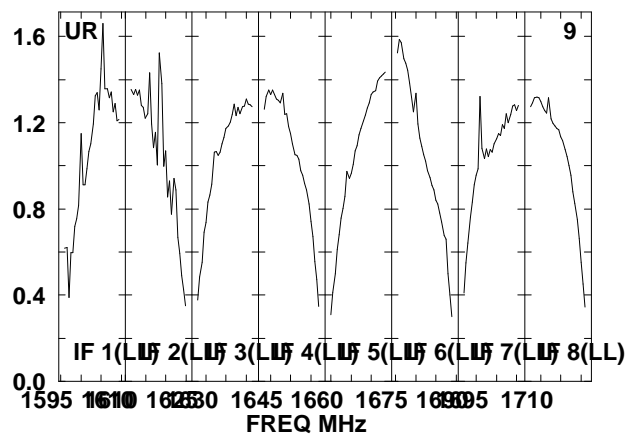
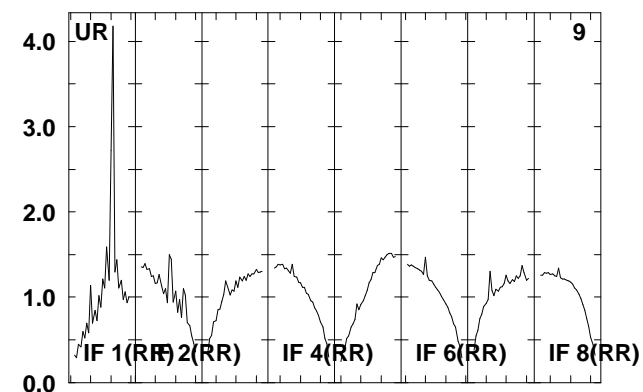
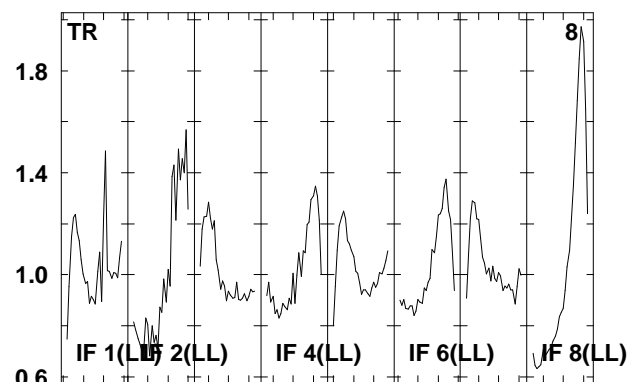
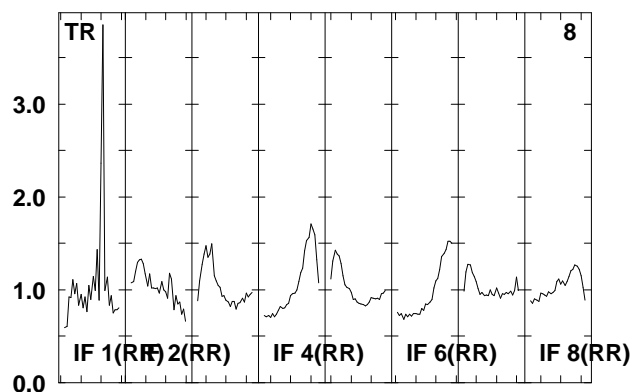
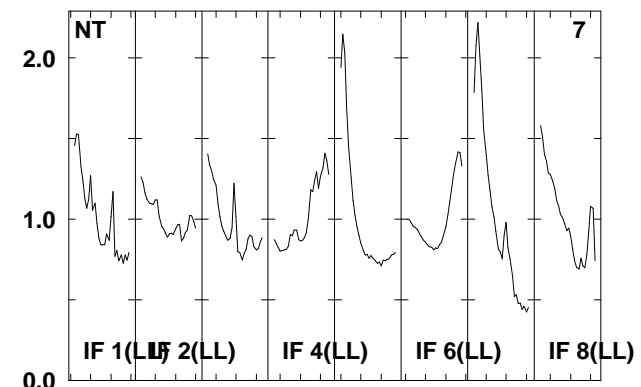
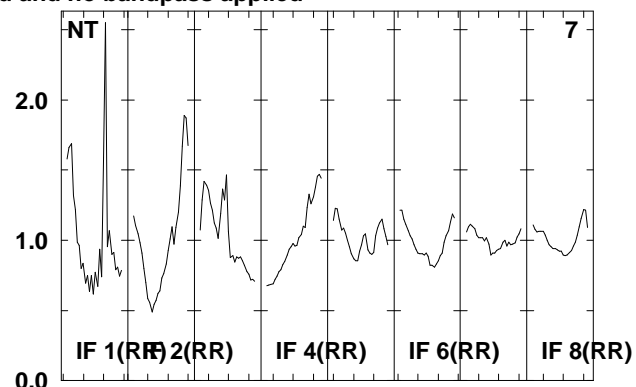
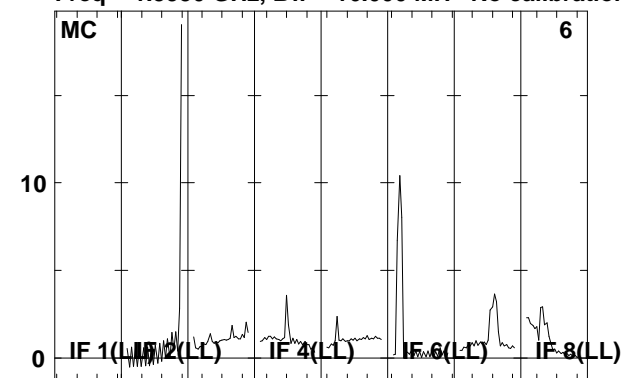

Lower frame: Real Jy

Total-power spectrum Antenna: *

Timerange: 00/17:53:32 to 00/17:57:00

Plot file version 89 created 22-APR-2008 12:26:23

J0730-02 EP061B.UVDATA.1

Freq = 1.5950 GHz, Bw = 16.000 MH No calibration applied and no bandpass applied

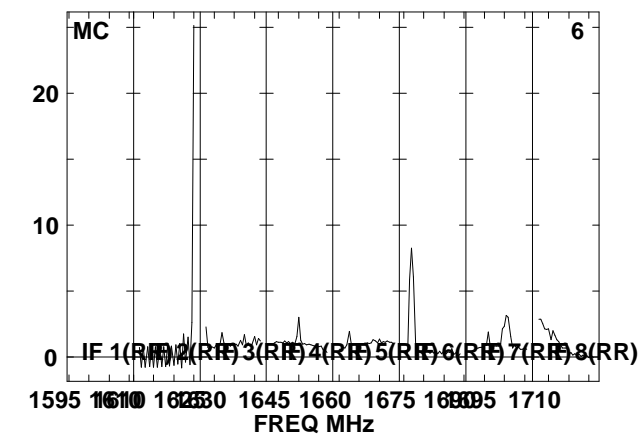
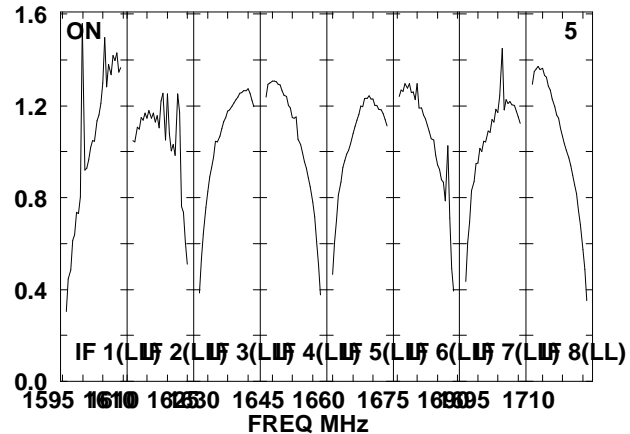
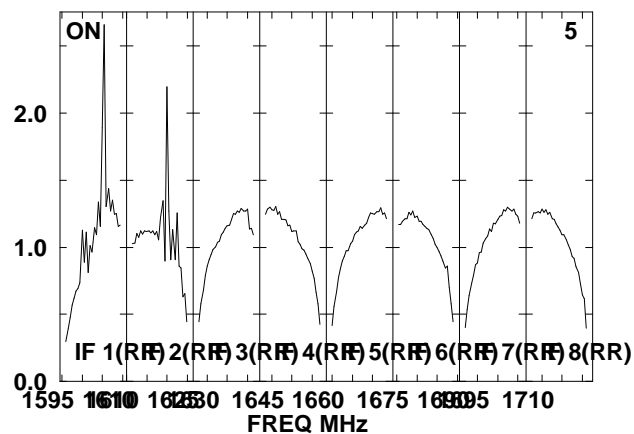
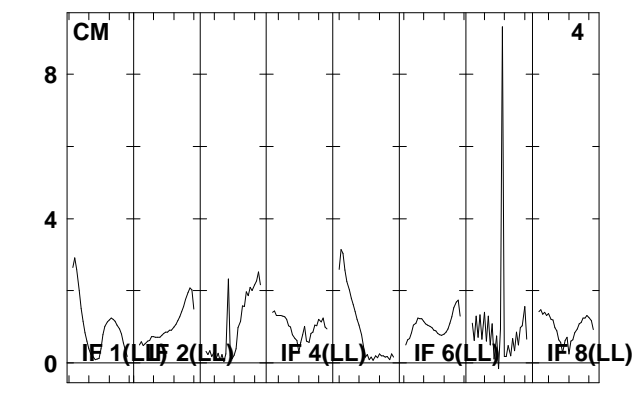
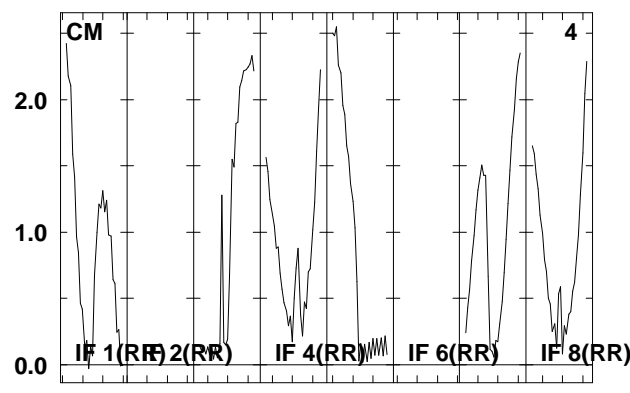
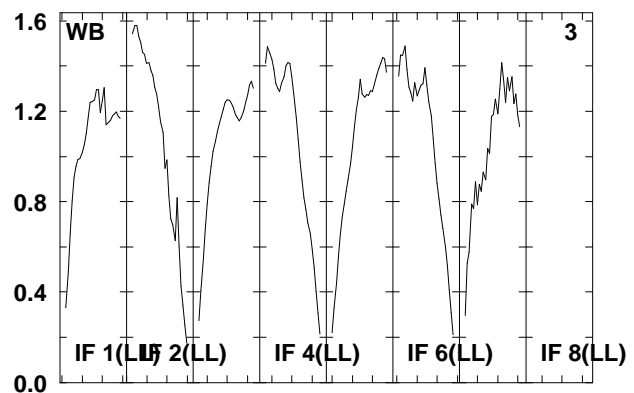
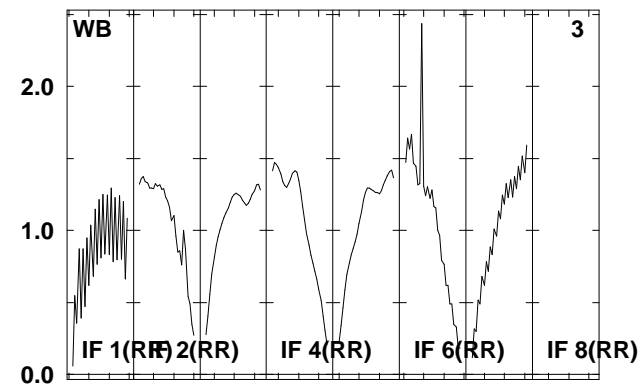
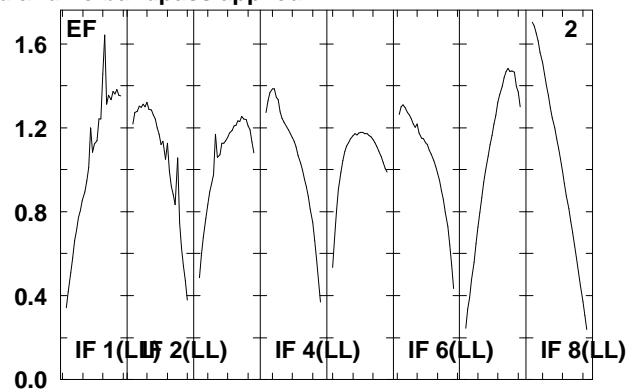
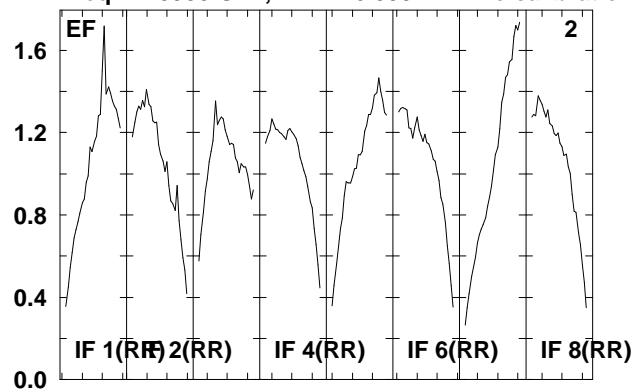

Lower frame: Real Jy
Total-power spectrum Antenna: *
Timerange: 00/17:57:02 to 00/17:58:26

Plot file version 90 created 22-APR-2008 12:26:23

J0730-02 EP061B.UVDATA.1

Freq = 1.5950 GHz, Bw = 16.000 MH No calibration applied and no bandpass applied

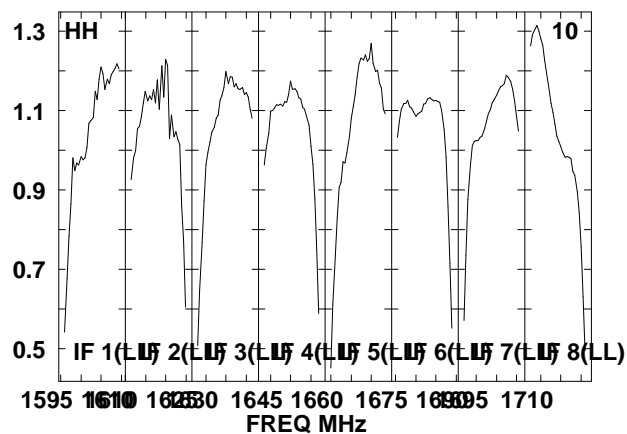
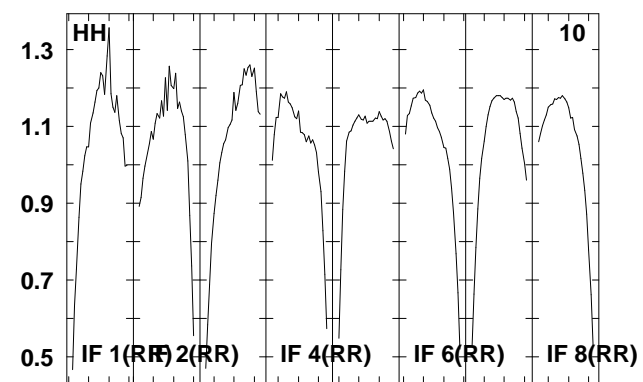
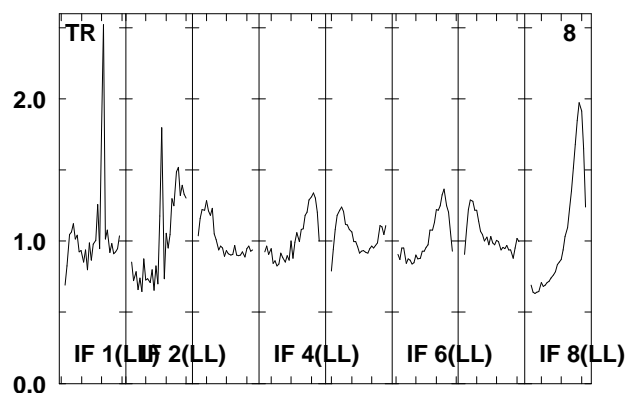
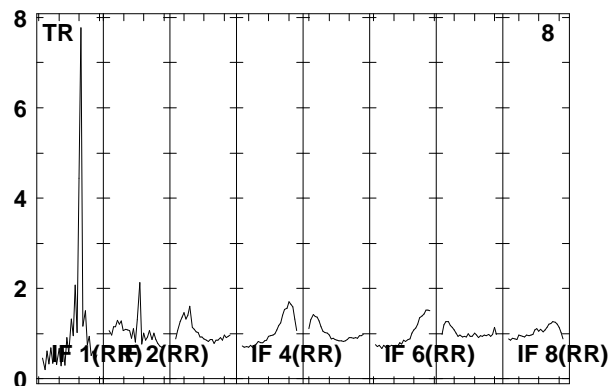
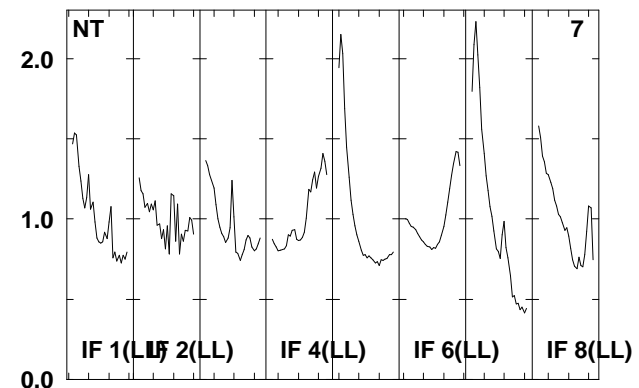
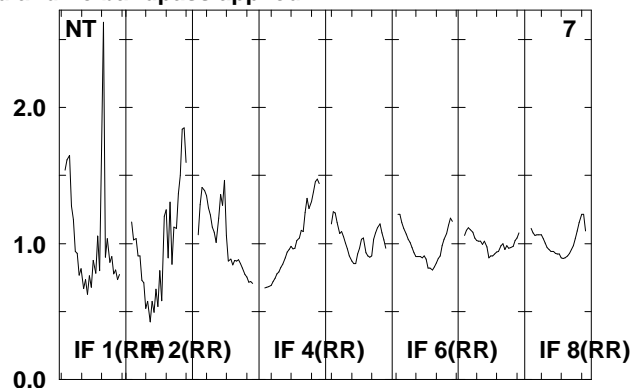
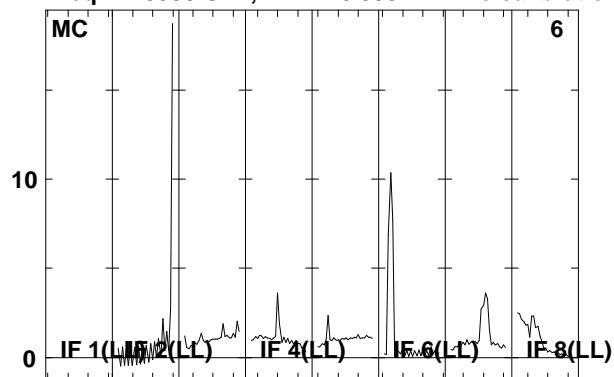

Lower frame: Real Jy

Total-power spectrum Antenna: *

Timerange: 00/17:57:02 to 00/17:58:26

Plot file version 91 created 22-APR-2008 12:26:24

IRAS0725 EP061B.UVDATA.1

Freq = 1.5950 GHz, Bw = 16.000 MH No calibration applied and no bandpass applied

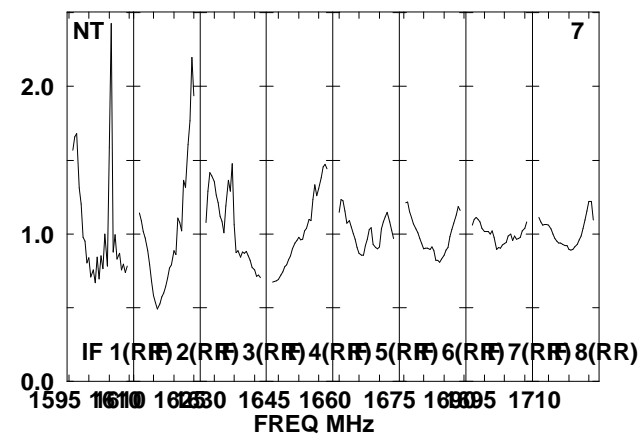
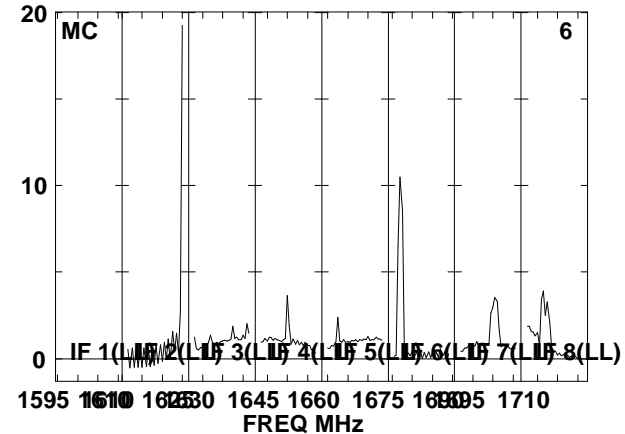
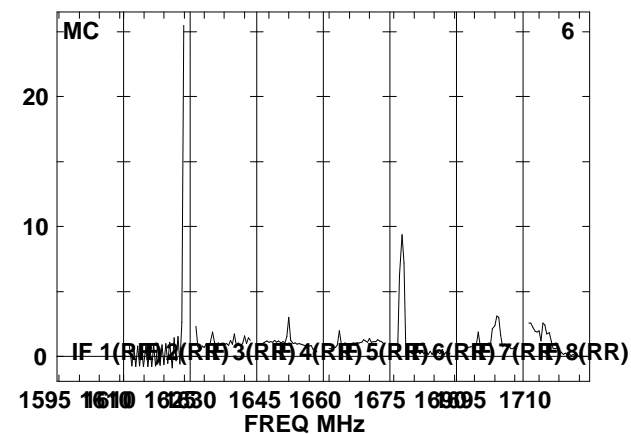
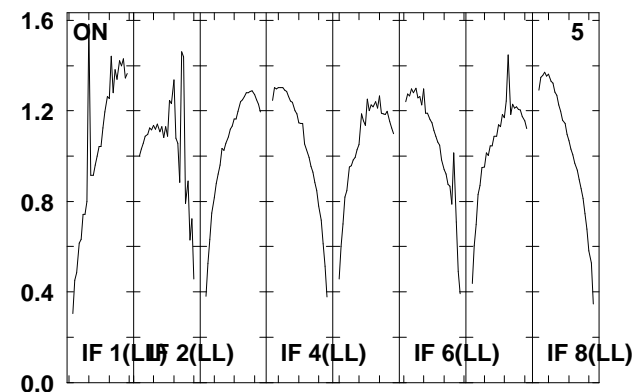
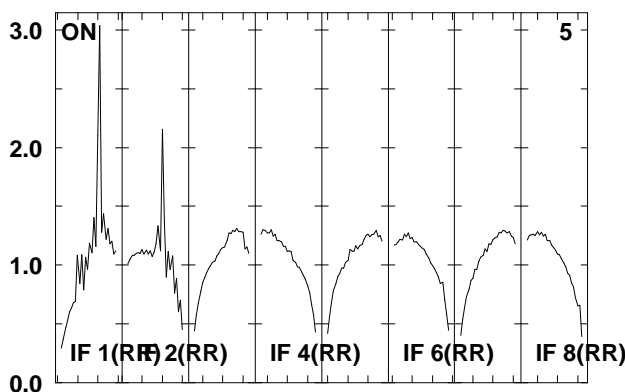
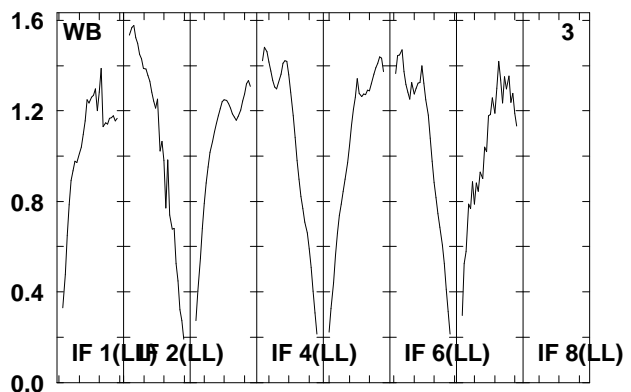
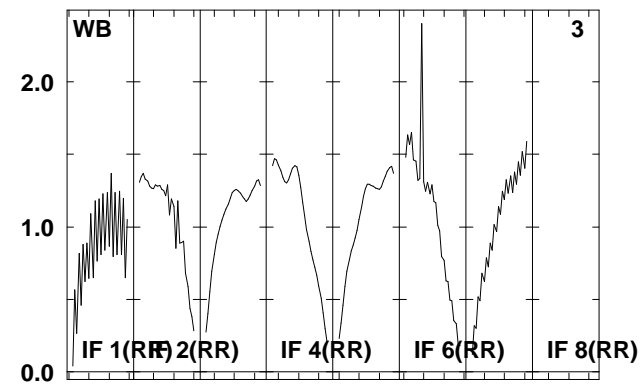
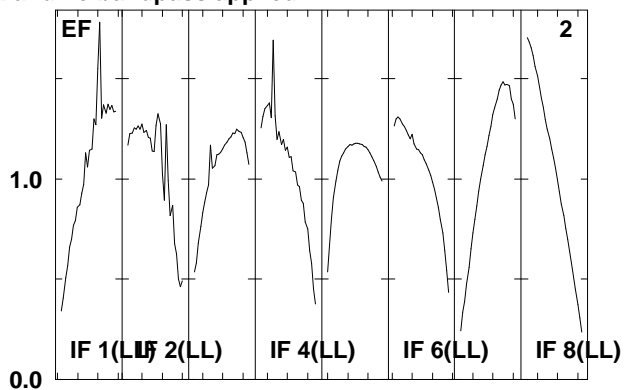
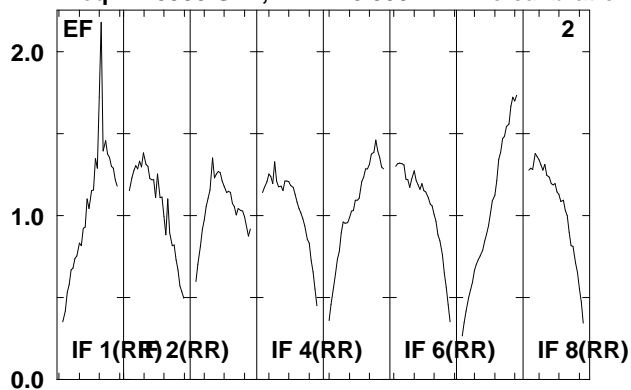

Lower frame: Real Jy
Total-power spectrum Antenna: *
Timerange: 00/17:58:34 to 00/18:02:00

Plot file version 92 created 22-APR-2008 12:26:25

IRAS0725 EP061B.UVDATA.1

Freq = 1.5950 GHz, Bw = 16.000 MH No calibration applied and no bandpass applied

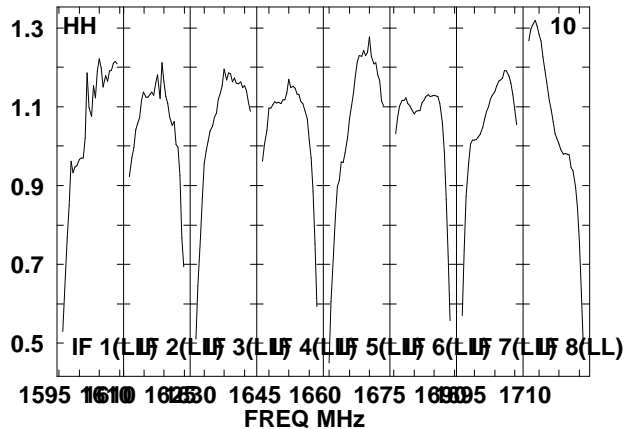
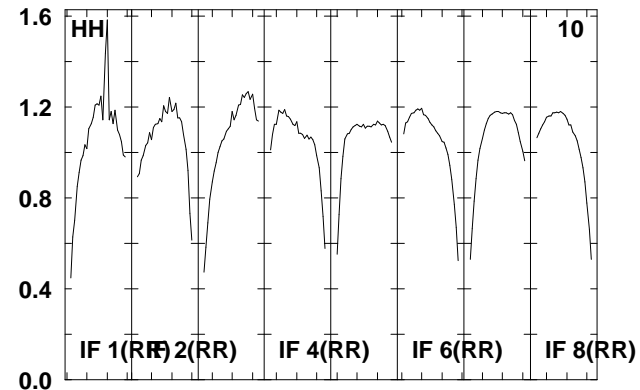
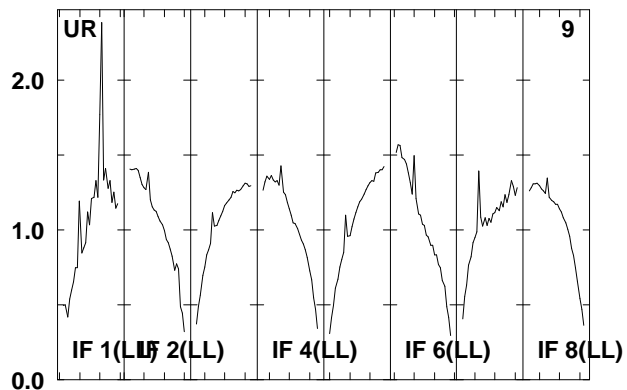
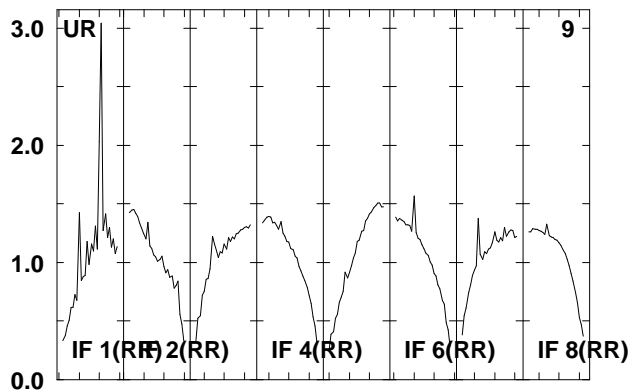
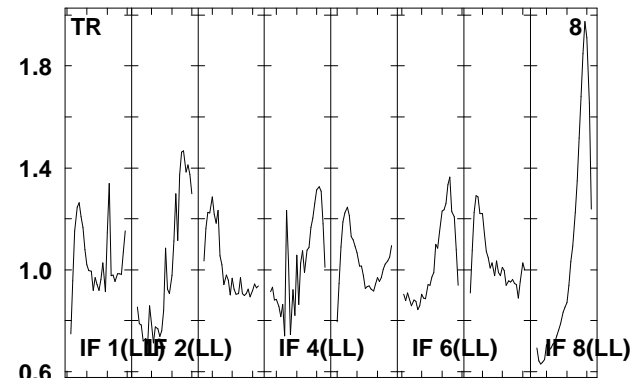
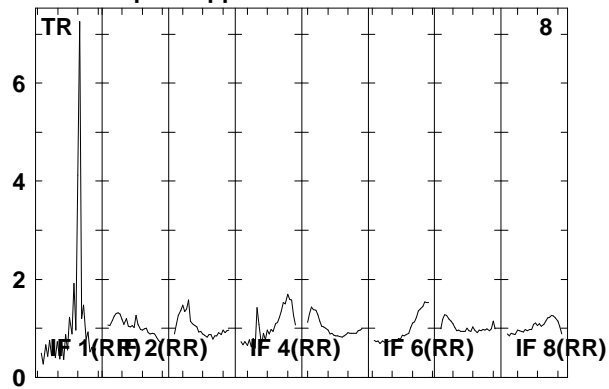
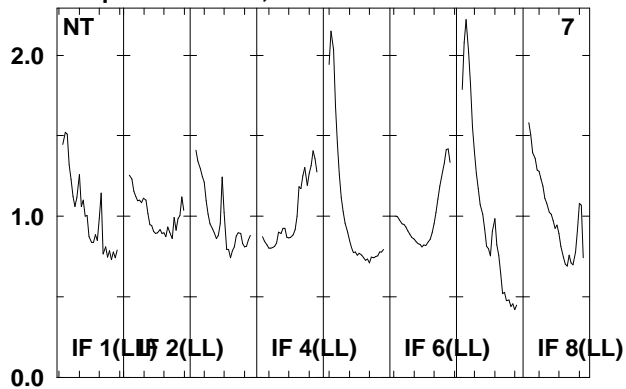

Lower frame: Real Jy

Total-power spectrum Antenna: *

Timerange: 00/17:58:34 to 00/18:02:00

Plot file version 93 created 22-APR-2008 12:26:26

J0730-02 EP061B.UVDATA.1

Freq = 1.5950 GHz, Bw = 16.000 MH No calibration applied and no bandpass applied

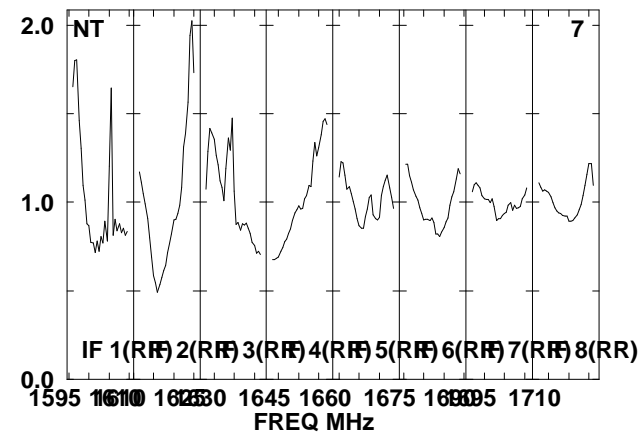
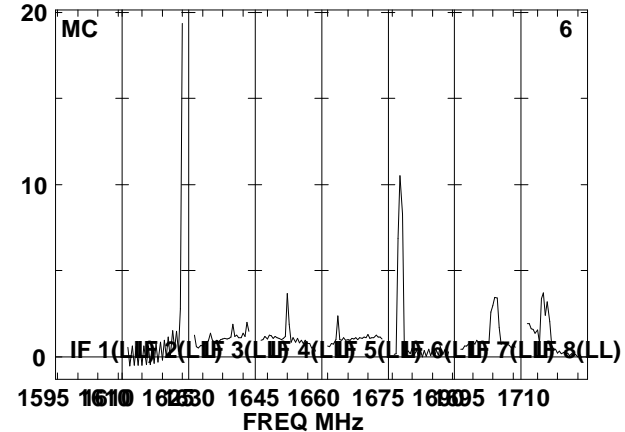
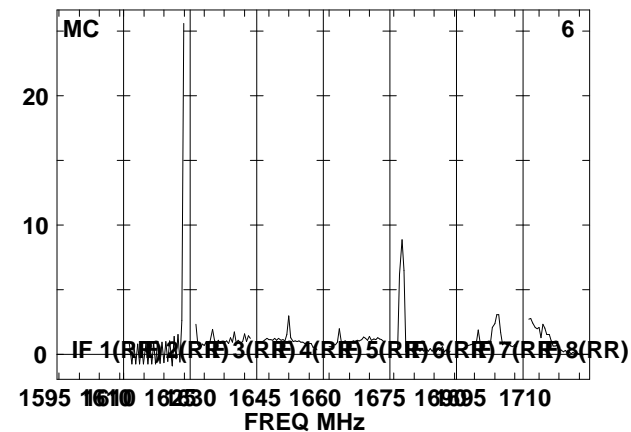
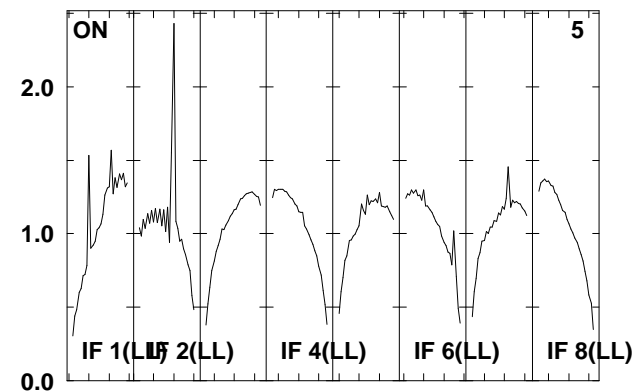
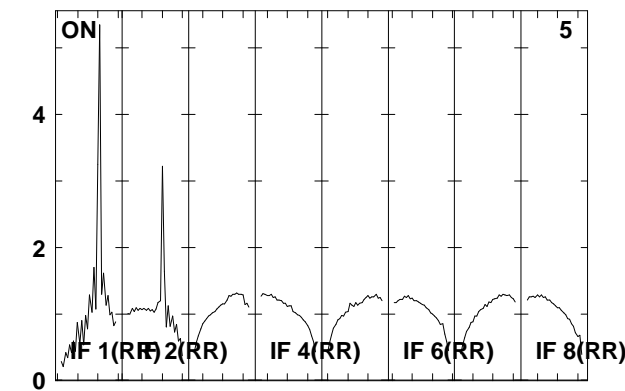
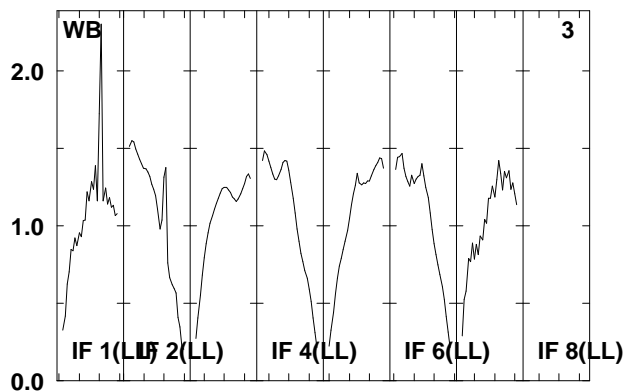
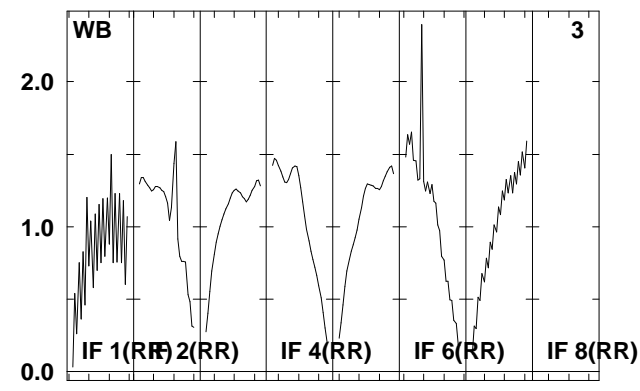
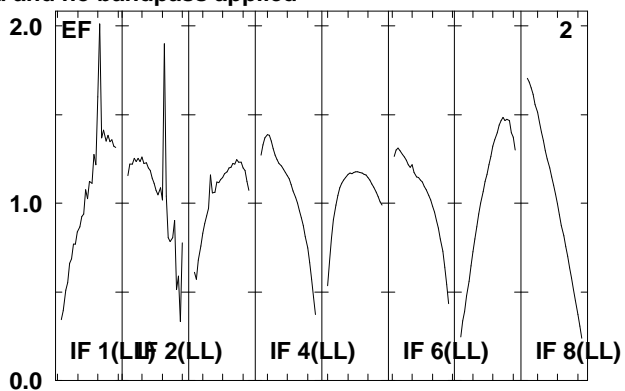
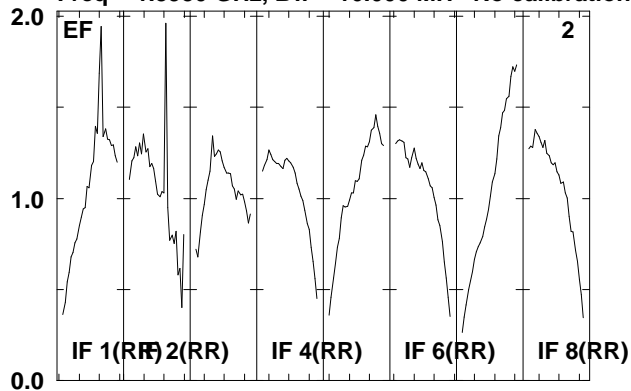

Lower frame: Real Jy
Total-power spectrum Antenna: *
Timerange: 00/18:02:02 to 00/18:03:30

Plot file version 94 created 22-APR-2008 12:26:27

J0730-02 EP061B.UVDATA.1

Freq = 1.5950 GHz, Bw = 16.000 MH No calibration applied and no bandpass applied

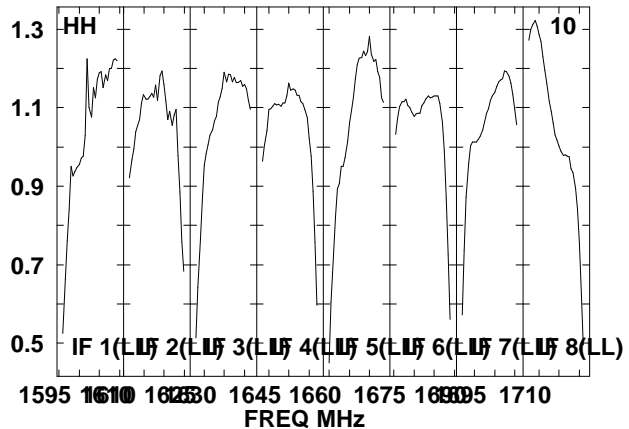
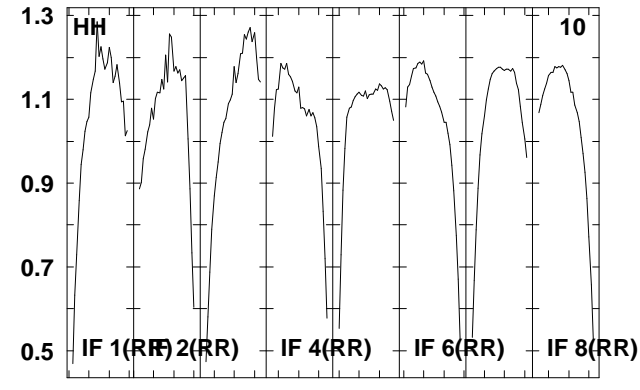
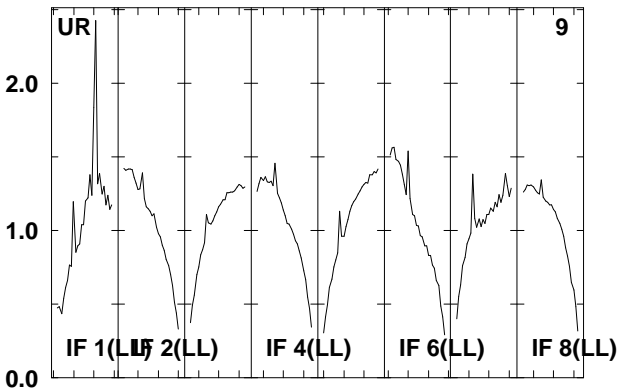
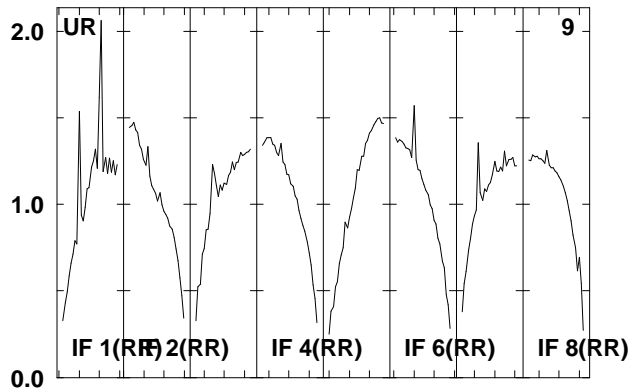
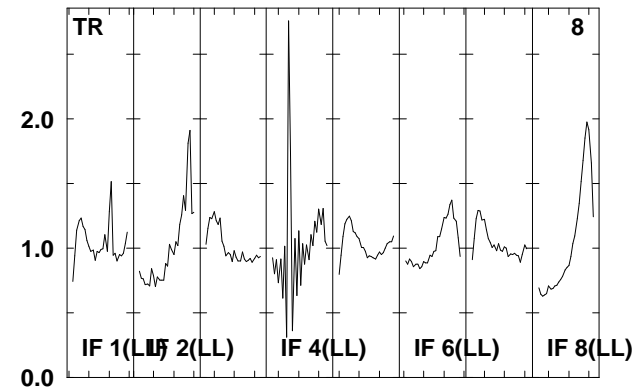
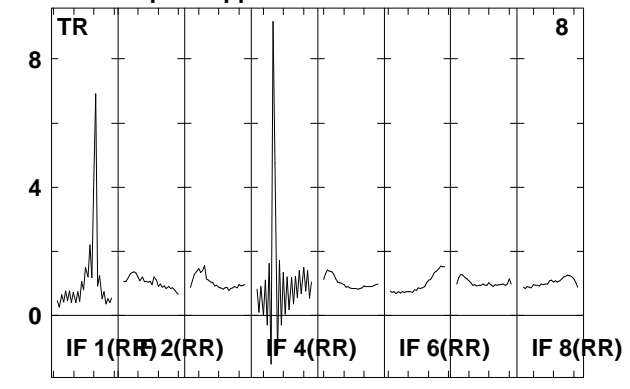
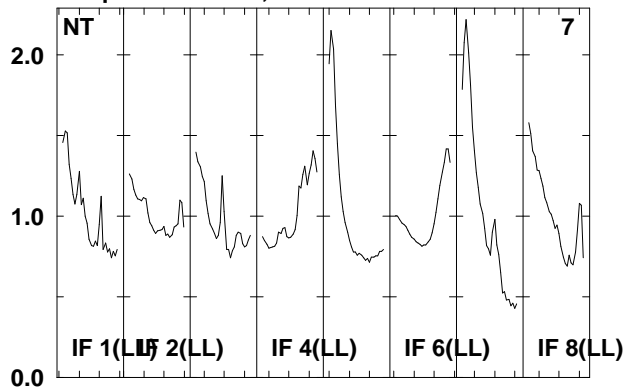

Lower frame: Real Jy
Total-power spectrum Antenna: *
Timerange: 00/18:02:02 to 00/18:03:30

Plot file version 95 created 22-APR-2008 12:26:28

IRAS0725 EP061B.UVDATA.1

Freq = 1.5950 GHz, Bw = 16.000 MH No calibration applied and no bandpass applied

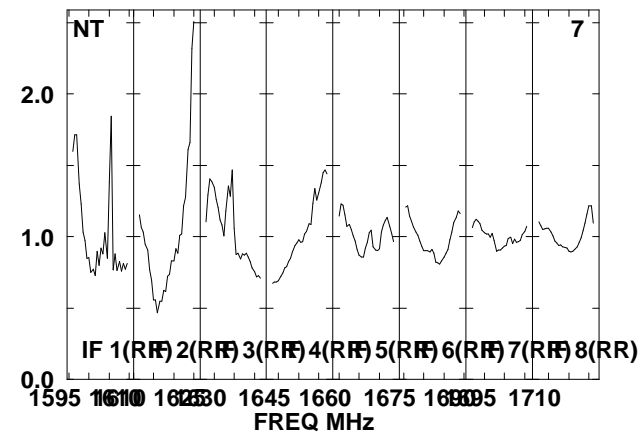
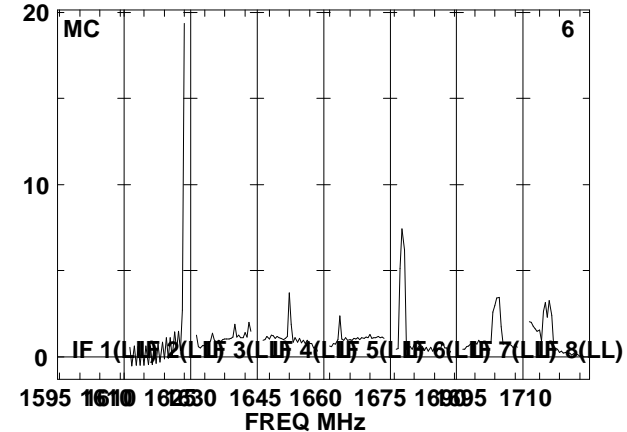
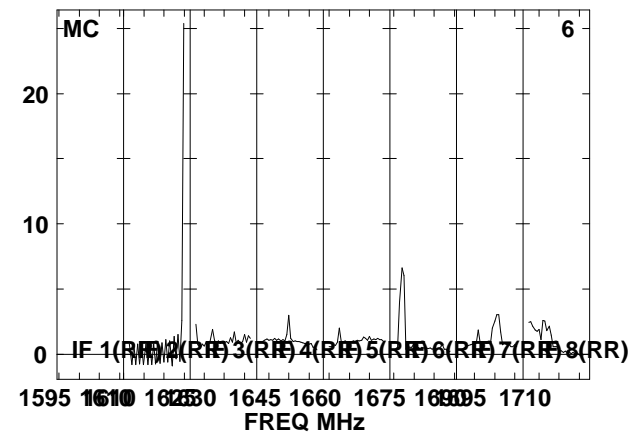
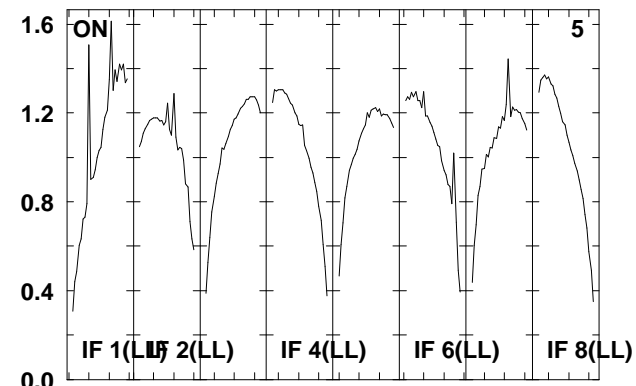
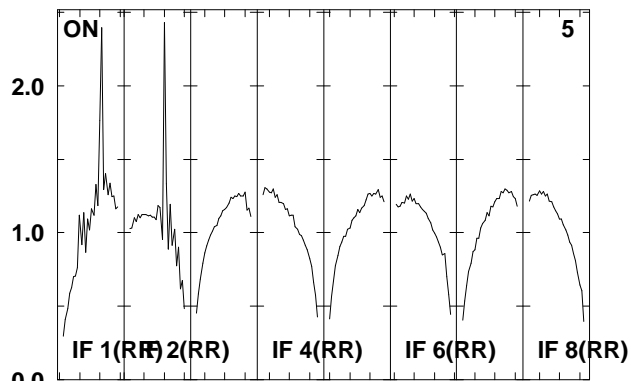
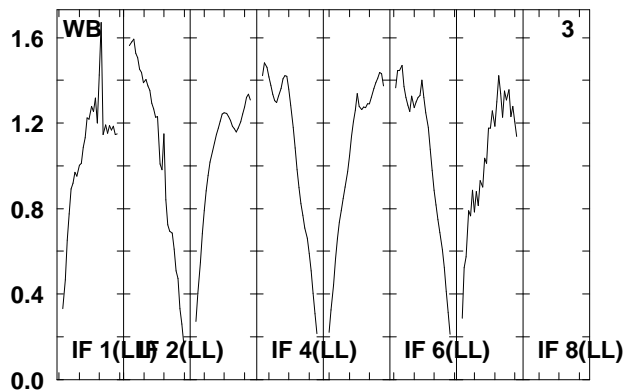
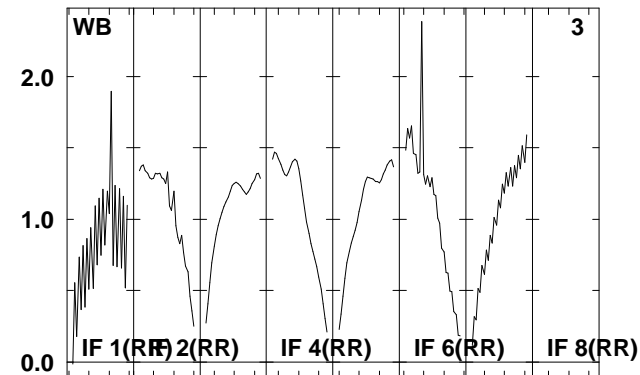
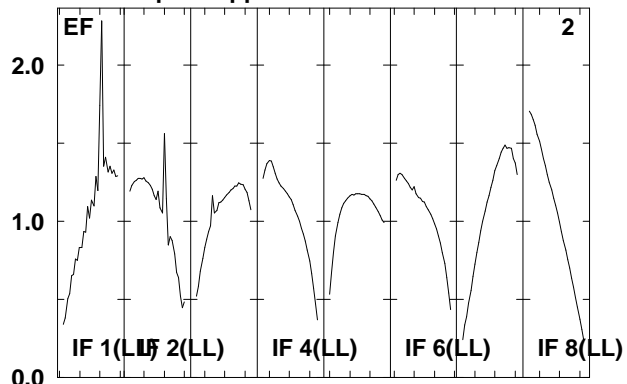
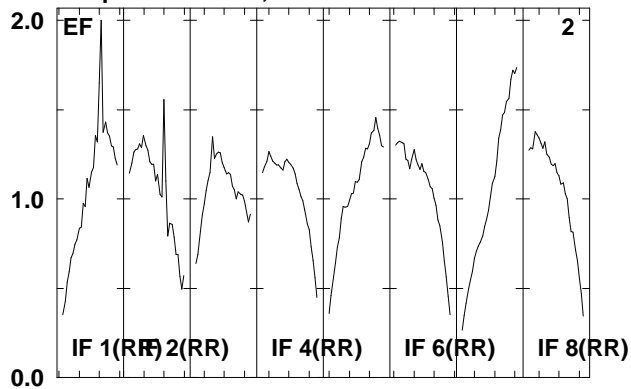

Lower frame: Real Jy
Total-power spectrum Antenna: *
Timerange: 00/18:03:32 to 00/18:06:56

Plot file version 96 created 22-APR-2008 12:26:28
 IRAS0725 EP061B.UVDATA.1
 Freq = 1.5950 GHz, Bw = 16.000 MH No calibration applied and no bandpass applied

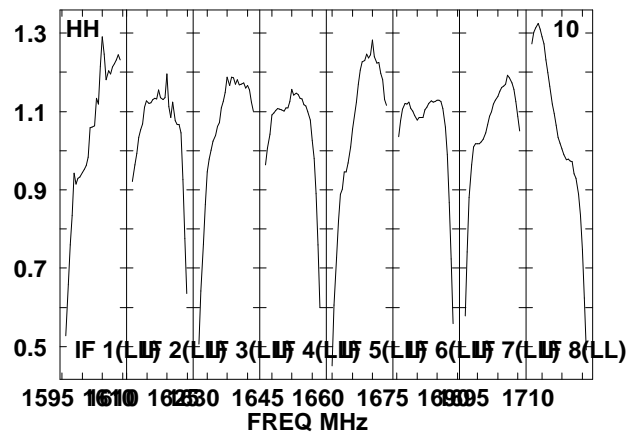
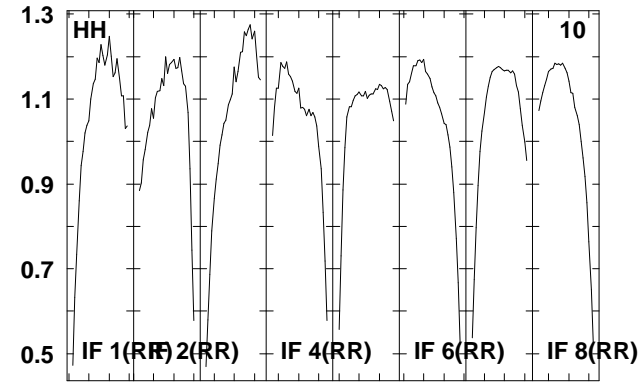
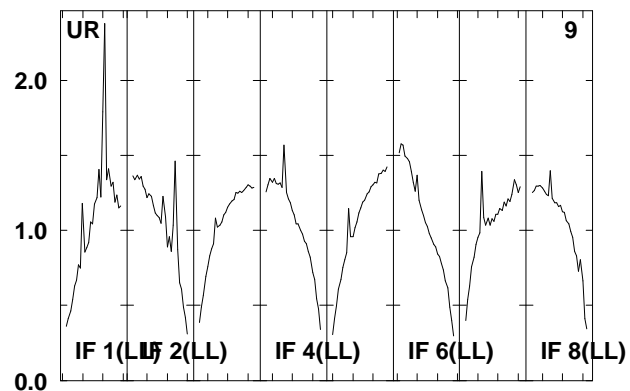
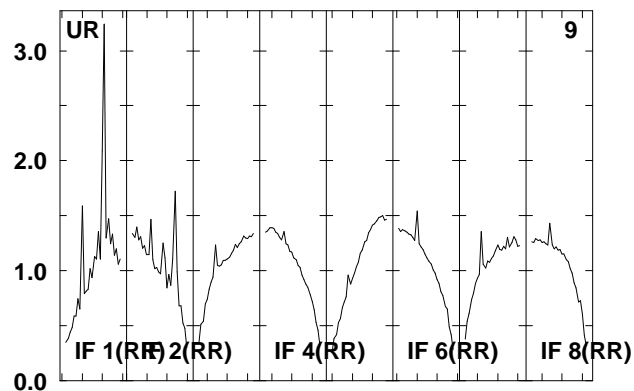
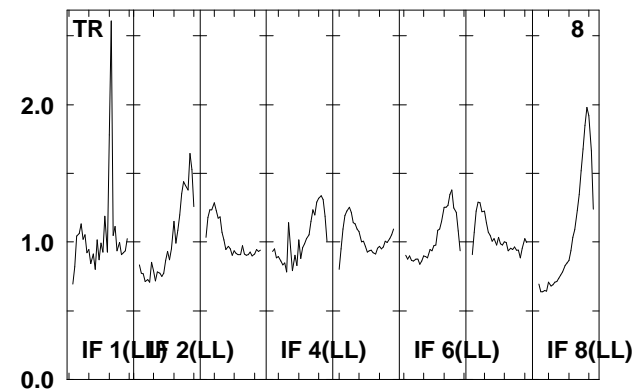
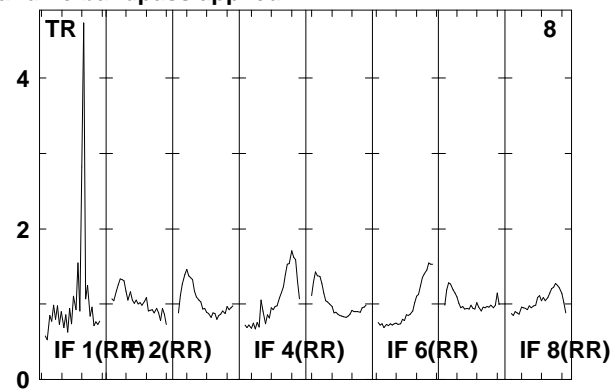
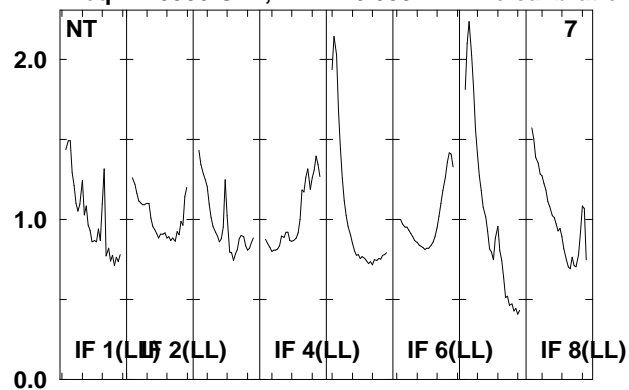

Lower frame: Real Jy
 Total-power spectrum Antenna: *
 Timerange: 00/18:03:32 to 00/18:06:56

Plot file version 97 created 22-APR-2008 12:26:30

J0730-02 EP061B.UVDATA.1

Freq = 1.5950 GHz, Bw = 16.000 MH No calibration applied and no bandpass applied

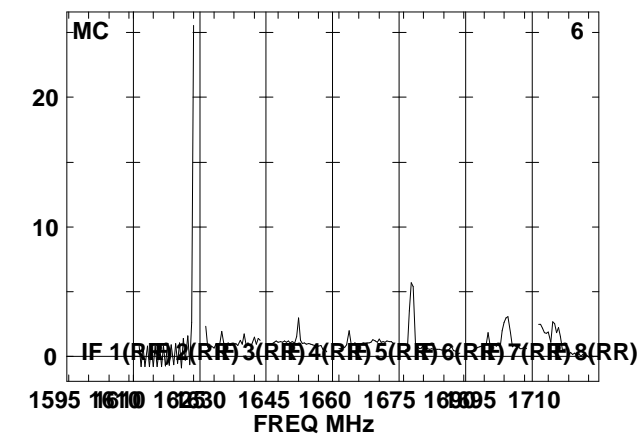
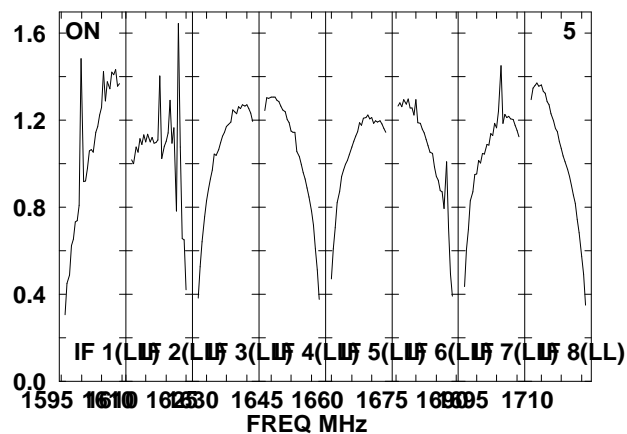
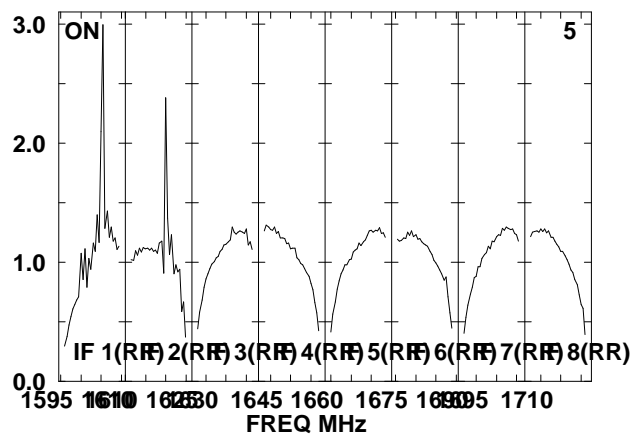
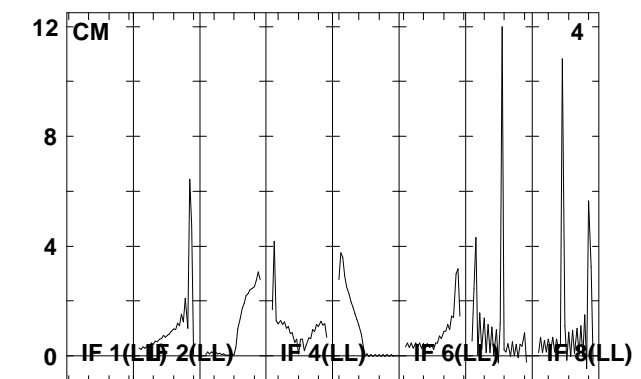
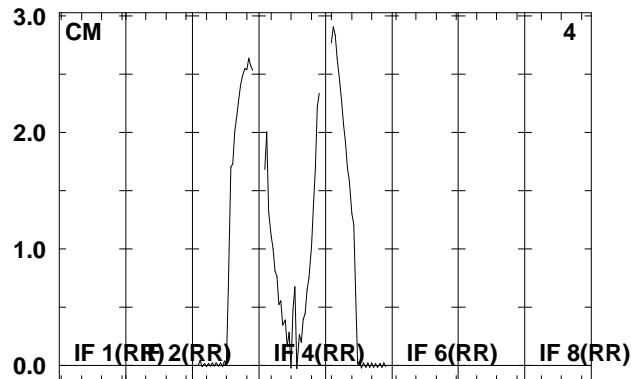
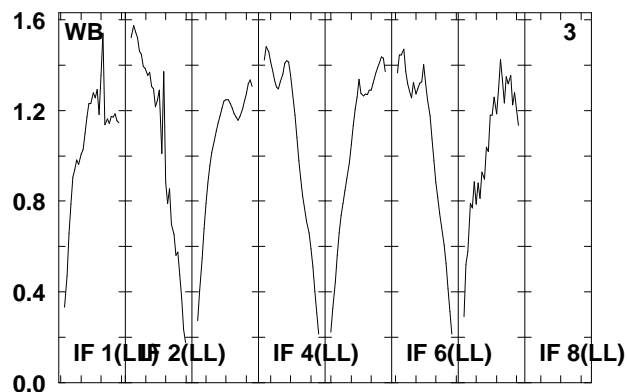
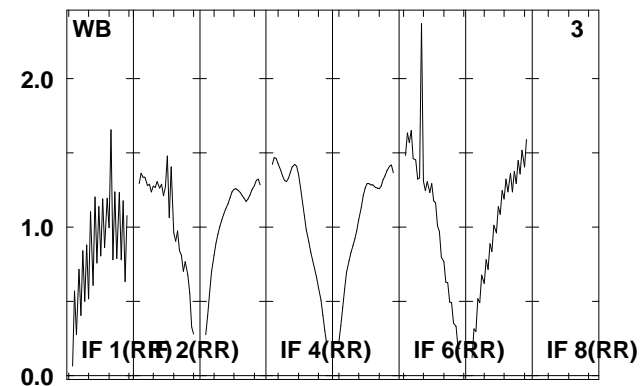
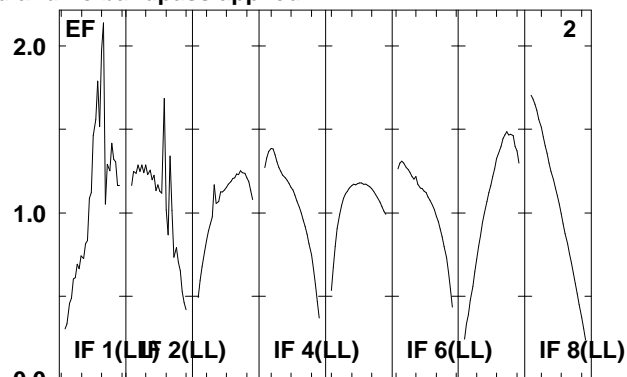
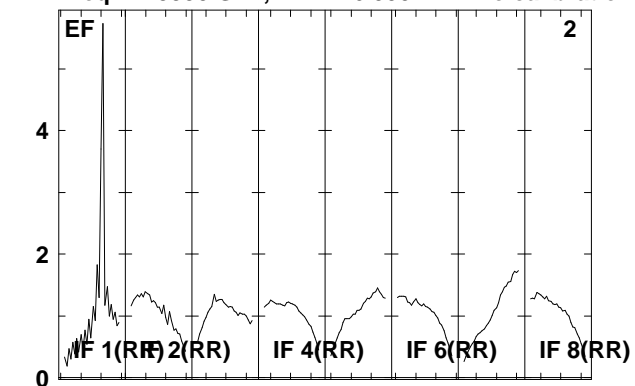

Lower frame: Real Jy
Total-power spectrum Antenna: *
Timerange: 00/18:08:02 to 00/18:09:30

Plot file version 98 created 22-APR-2008 12:26:30
 J0730-02 EP061B.UVDATA.1
 Freq = 1.5950 GHz, Bw = 16.000 MH No calibration applied and no bandpass applied

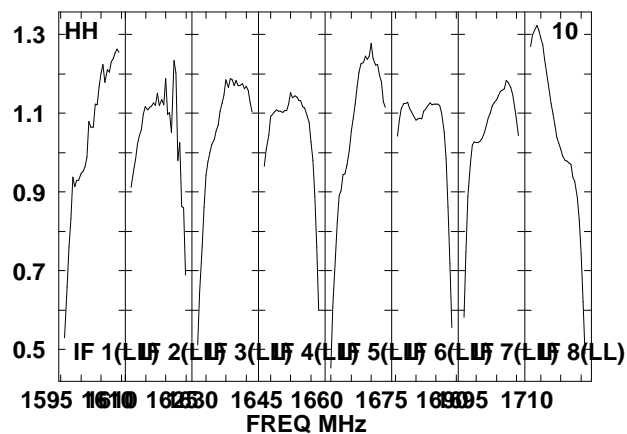
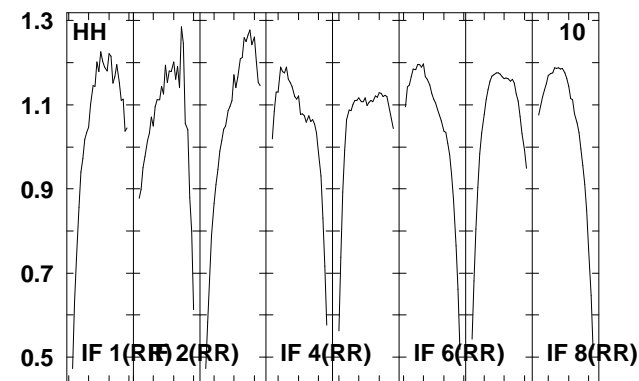
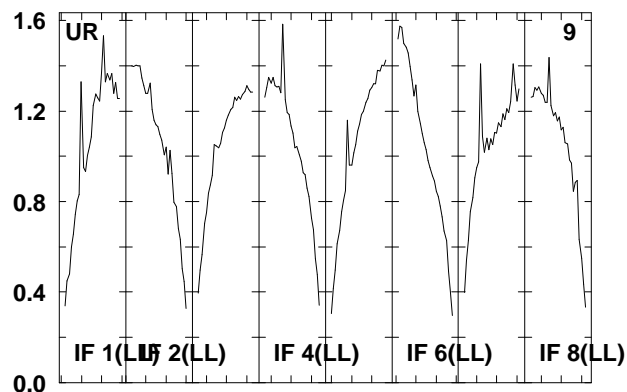
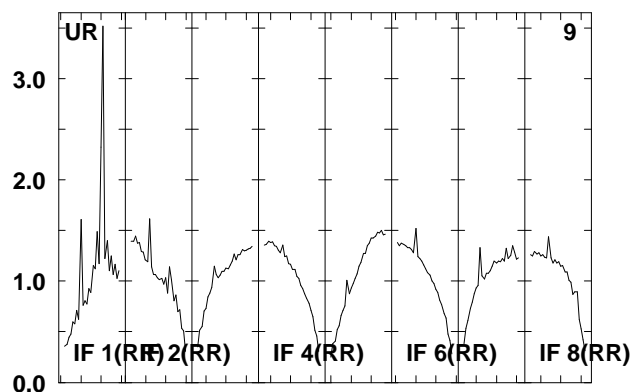
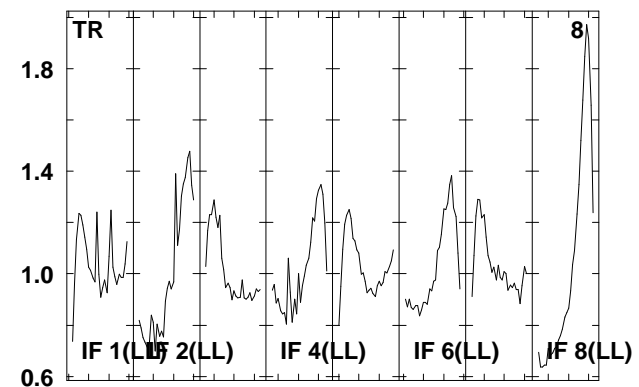
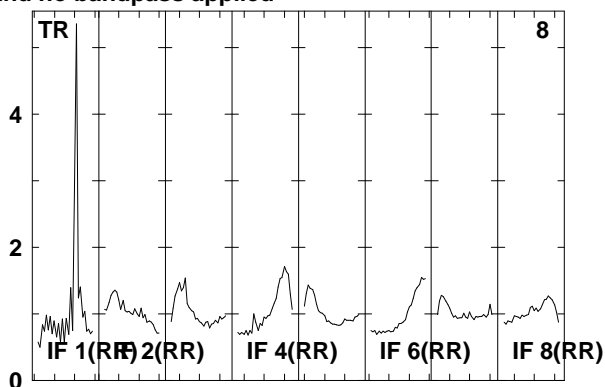
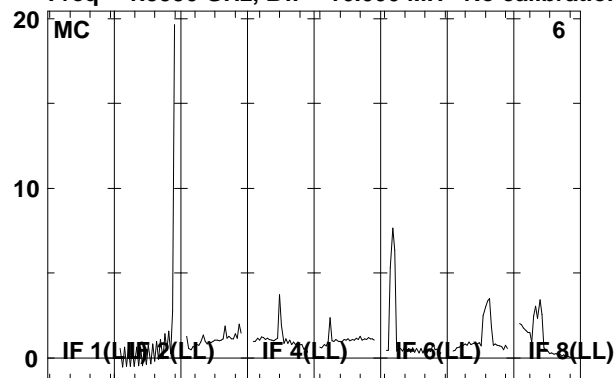

Lower frame: Real Jy
 Total-power spectrum Antenna: *
 Timerange: 00/18:08:02 to 00/18:09:30

Plot file version 99 created 22-APR-2008 12:26:31

IRAS0725 EP061B.UVDATA.1

Freq = 1.5950 GHz, Bw = 16.000 MH No calibration applied and no bandpass applied

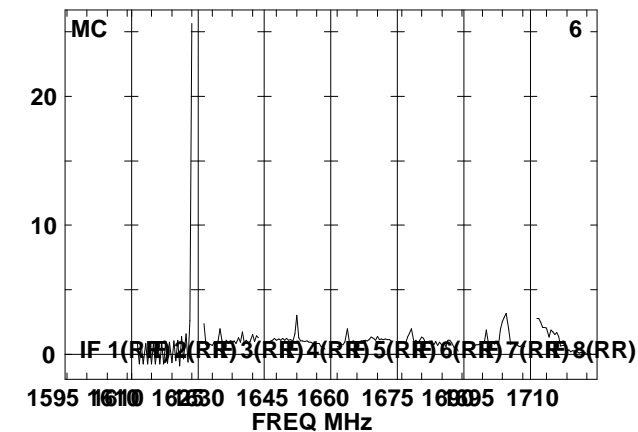
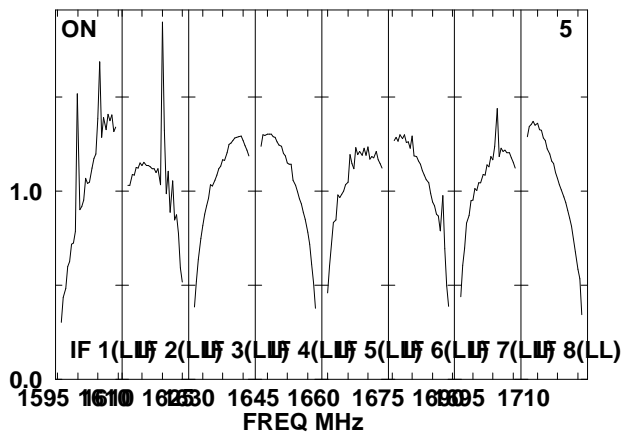
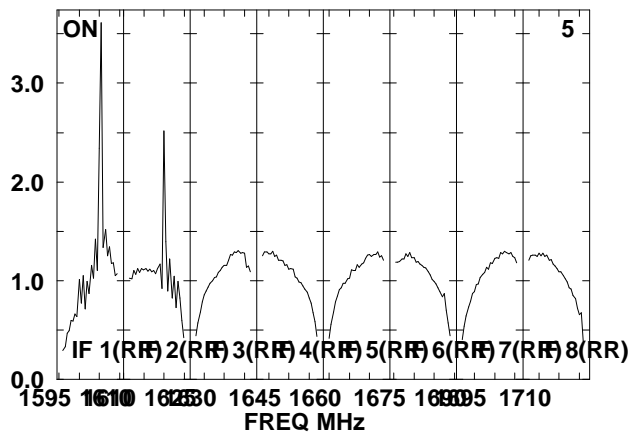
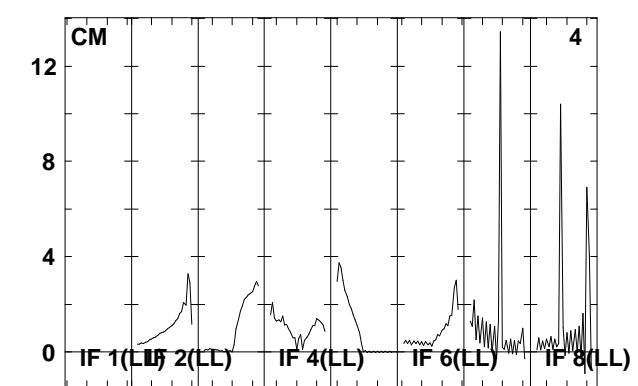
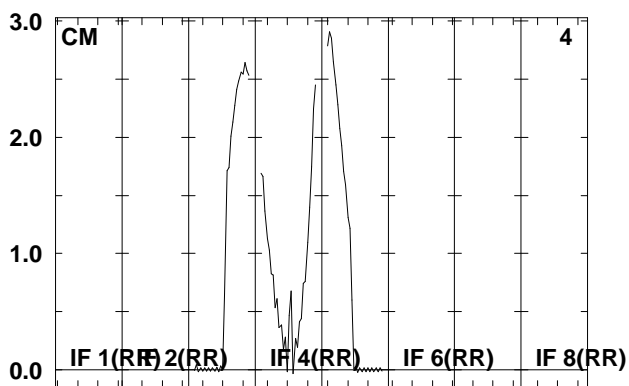
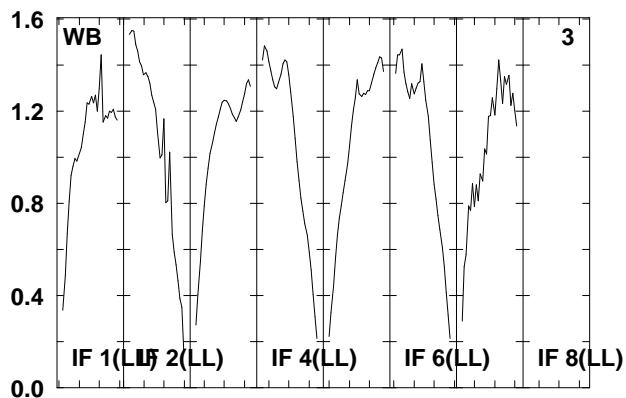
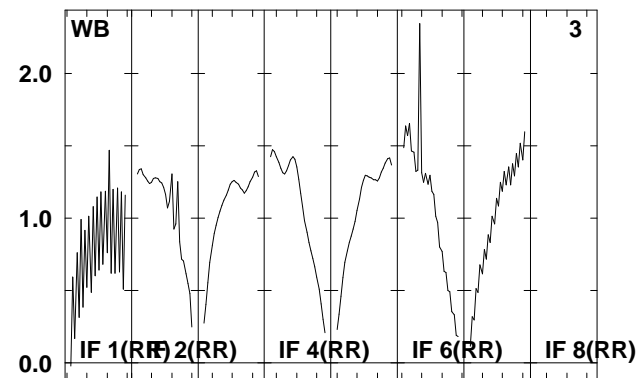
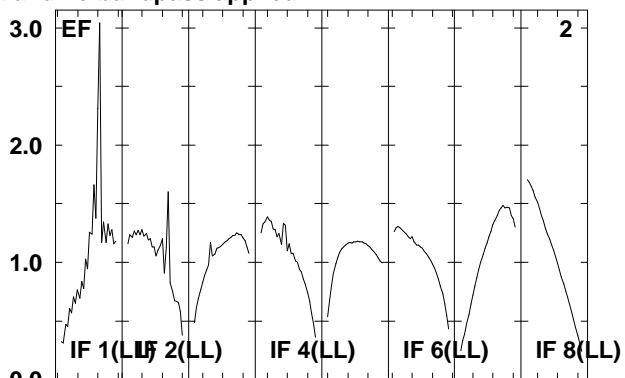
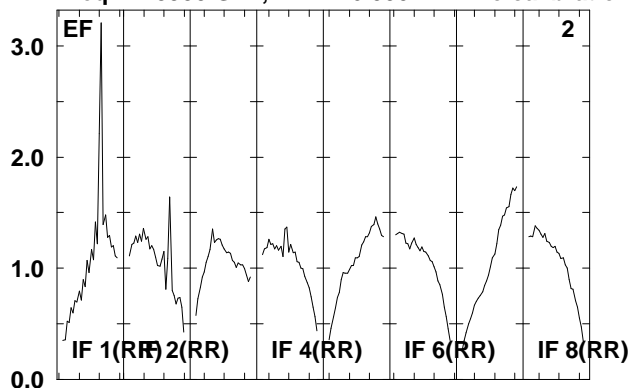

Lower frame: Real Jy
Total-power spectrum Antenna: *
Timerange: 00/18:09:32 to 00/18:13:00

Plot file version 100 created 22-APR-2008 12:26:32

IRAS0725 EP061B.UVDATA.1

Freq = 1.5950 GHz, Bw = 16.000 MH No calibration applied and no bandpass applied

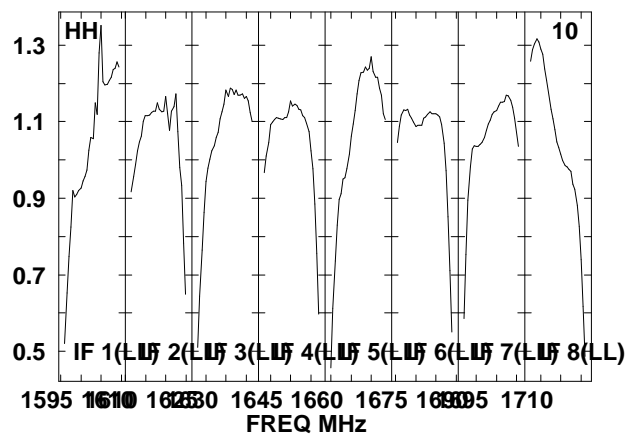
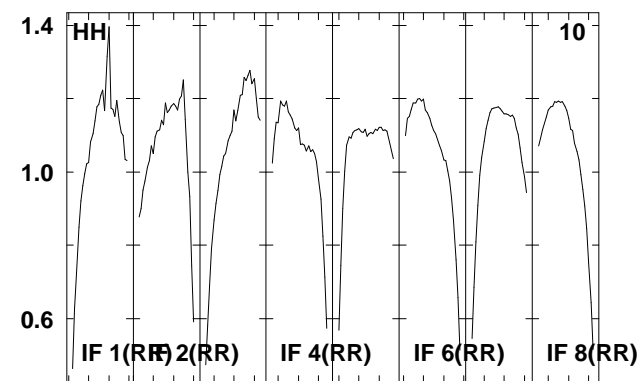
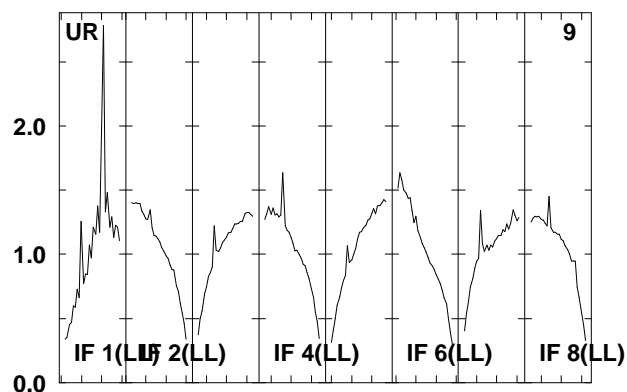
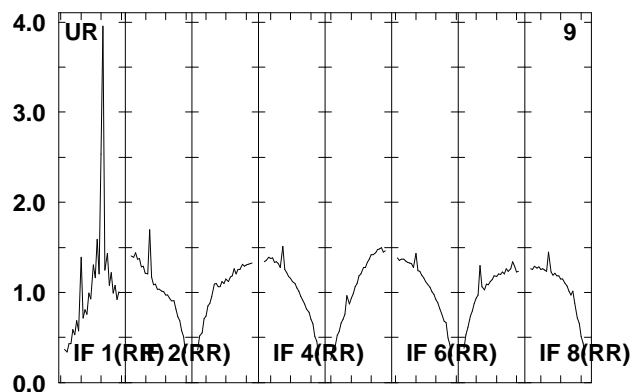
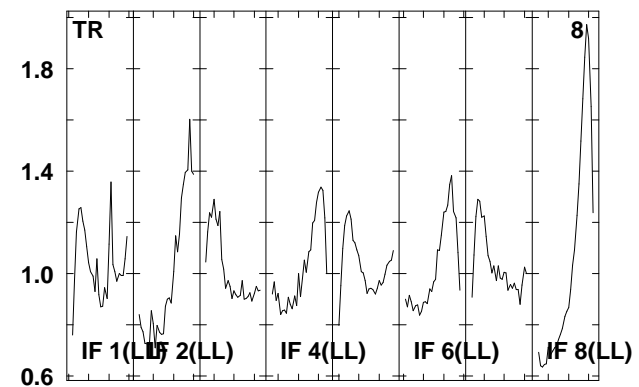
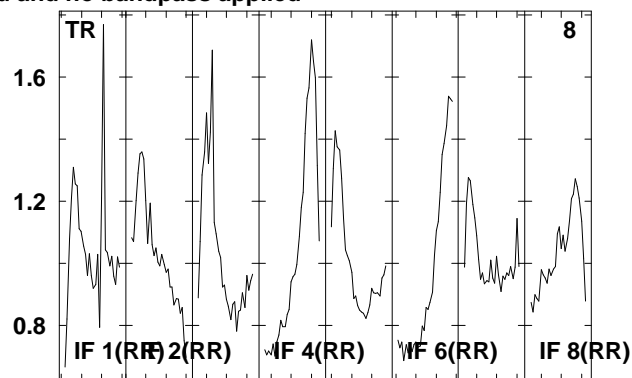
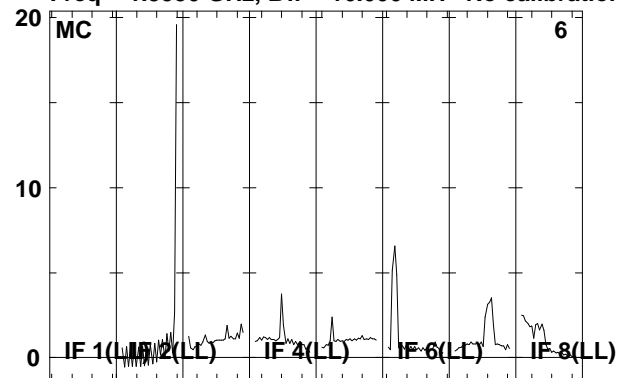

Lower frame: Real Jy

Total-power spectrum Antenna: *

Timerange: 00/18:09:32 to 00/18:13:00

Plot file version 101 created 22-APR-2008 12:26:33

J0730-02 EP061B.UVDATA.1

Freq = 1.5950 GHz, Bw = 16.000 MH No calibration applied and no bandpass applied

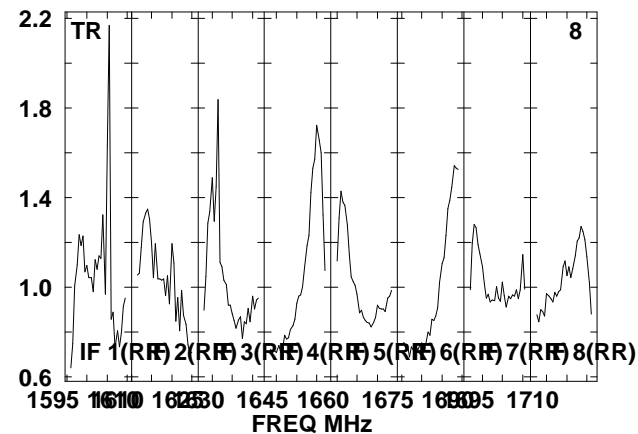
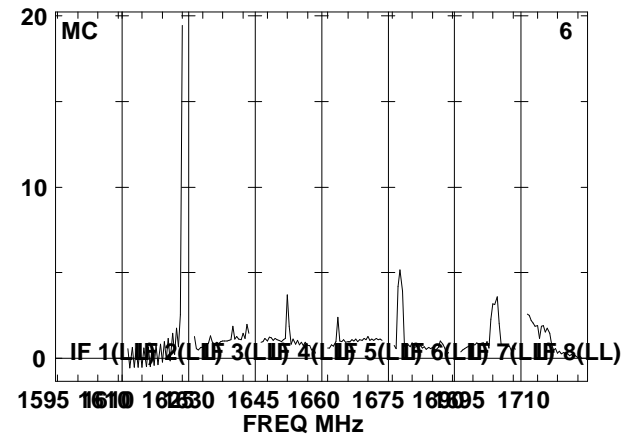
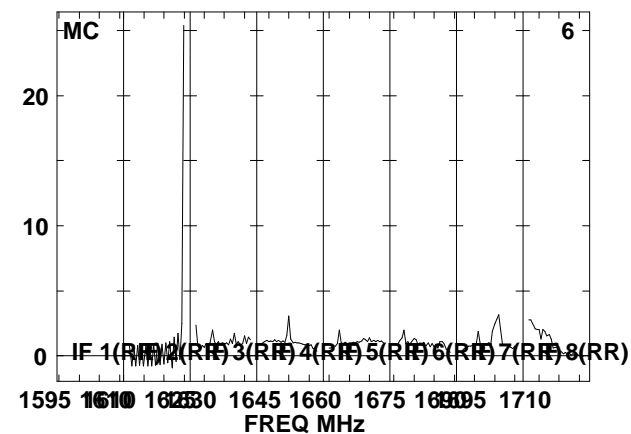
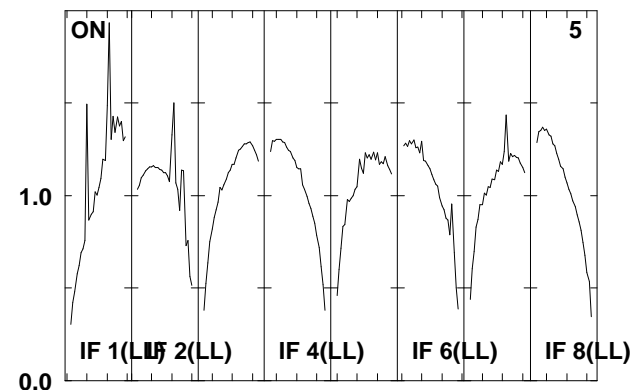
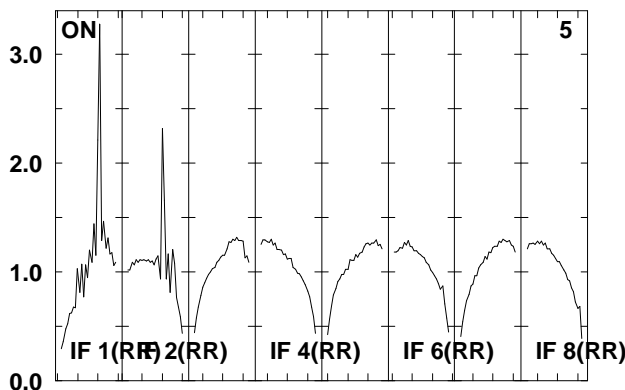
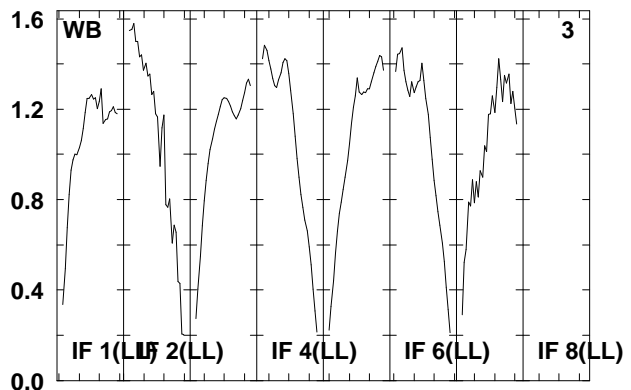
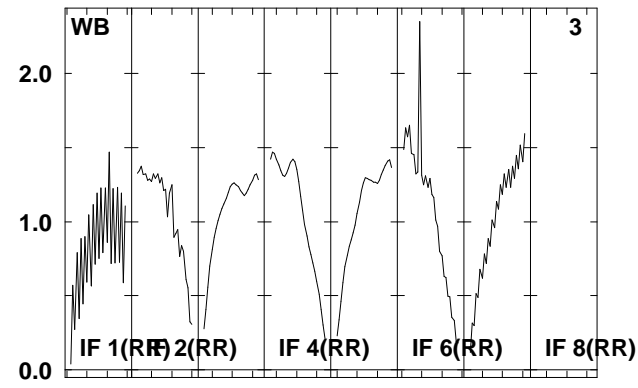
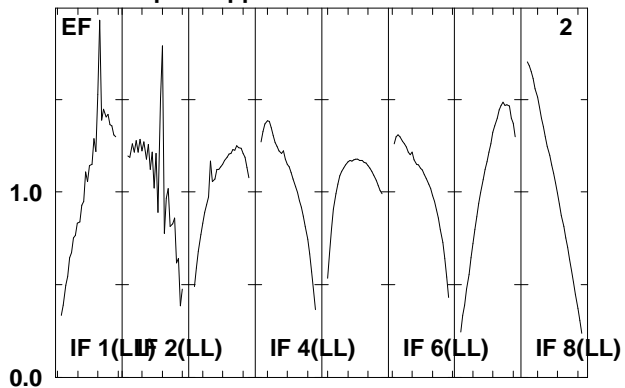
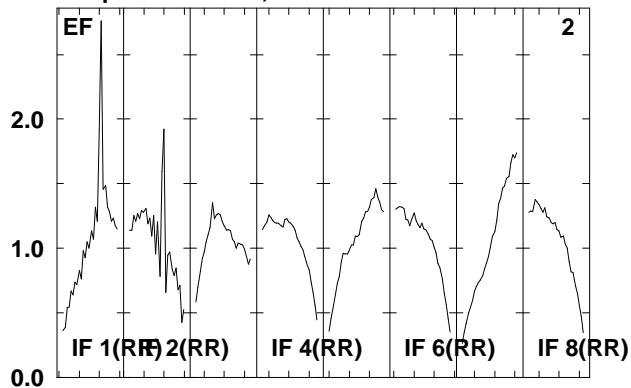

Lower frame: Real Jy
Total-power spectrum Antenna: *
Timerange: 00/18:13:02 to 00/18:14:30

Plot file version 102 created 22-APR-2008 12:26:34

J0730-02 EP061B.UVDATA.1

Freq = 1.5950 GHz, Bw = 16.000 MH No calibration applied and no bandpass applied

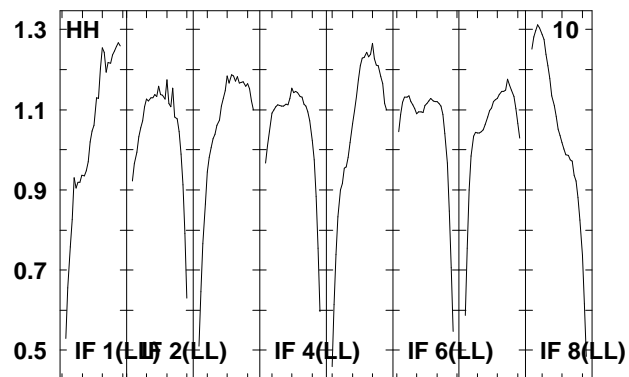
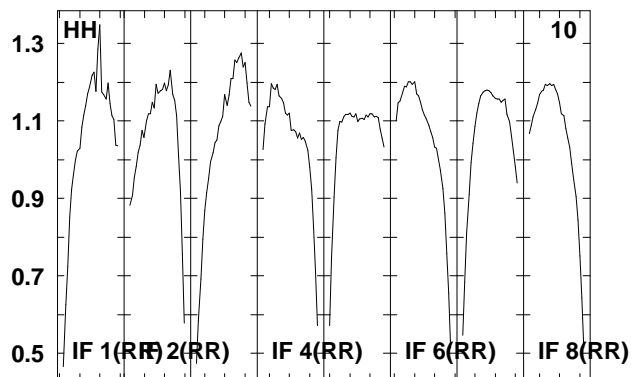
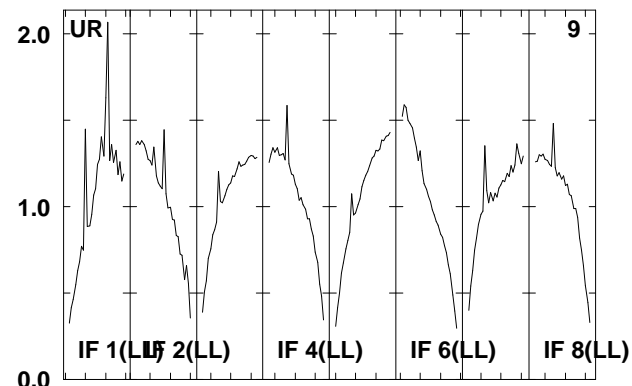
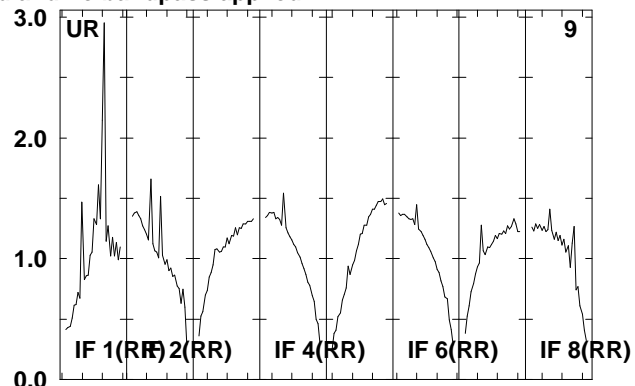
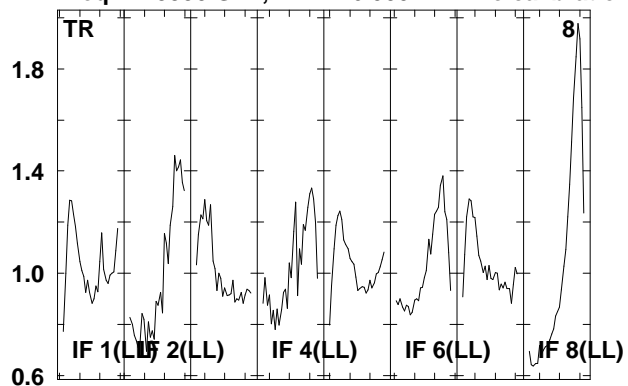

Lower frame: Real Jy
Total-power spectrum Antenna: *
Timerange: 00/18:13:02 to 00/18:14:30

Plot file version 103 created 22-APR-2008 12:26:34

IRAS0725 EP061B.UVDATA.1

Freq = 1.5950 GHz, Bw = 16.000 MH No calibration applied and no bandpass applied

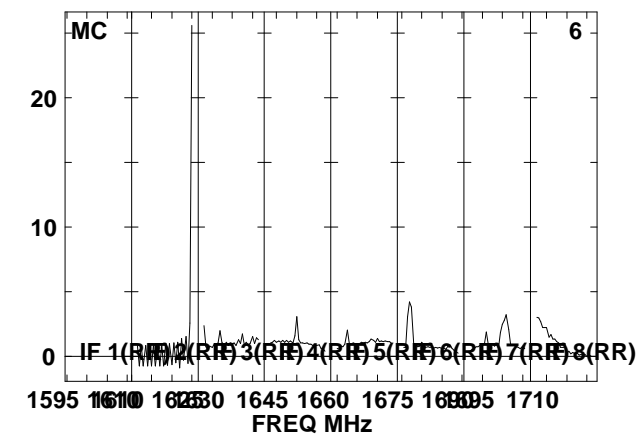
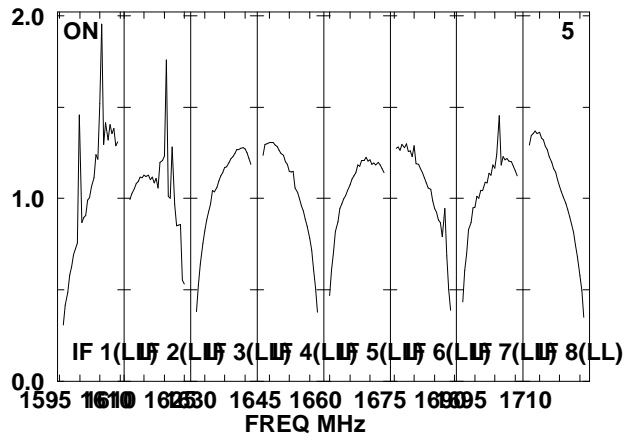
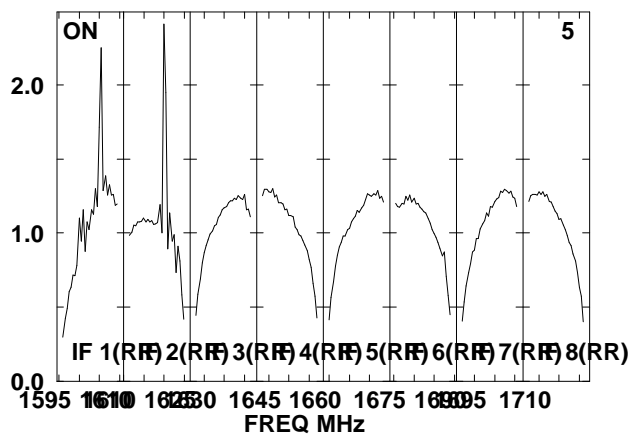
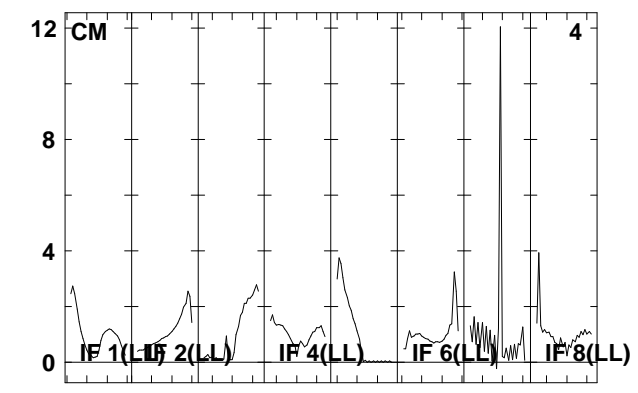
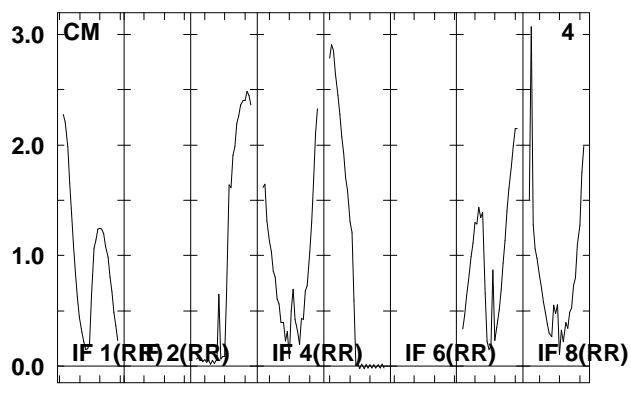
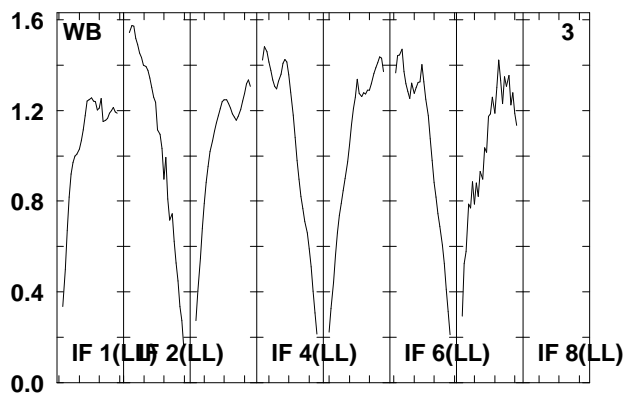
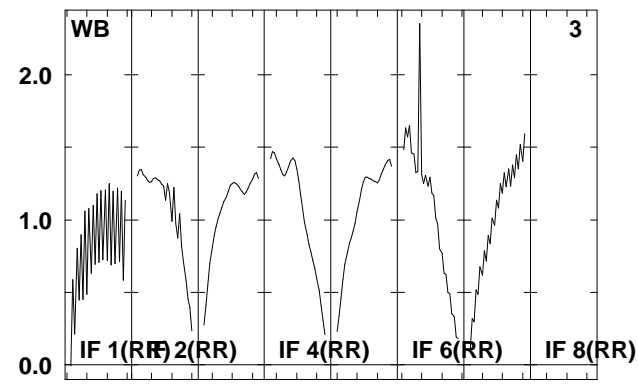
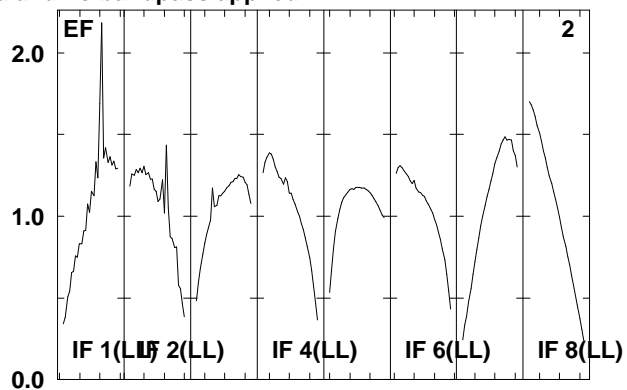
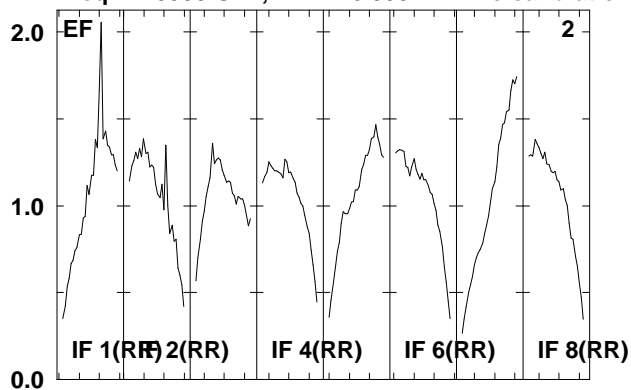

Lower frame: Real Jy

Total-power spectrum Antenna: *

Timerange: 00/18:14:32 to 00/18:18:00

Plot file version 104 created 22-APR-2008 12:26:35

IRAS0725 EP061B.UVDATA.1

Freq = 1.5950 GHz, Bw = 16.000 MH No calibration applied and no bandpass applied

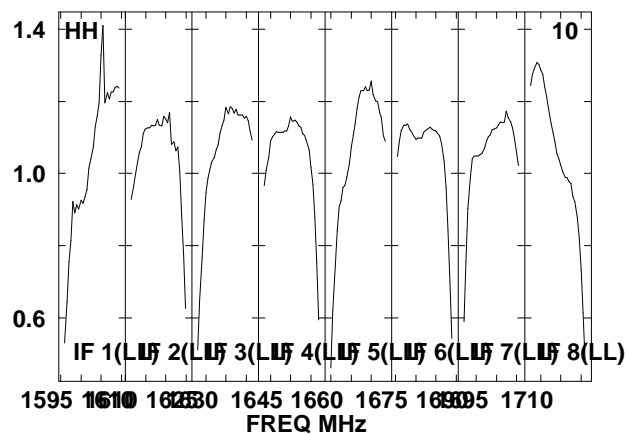
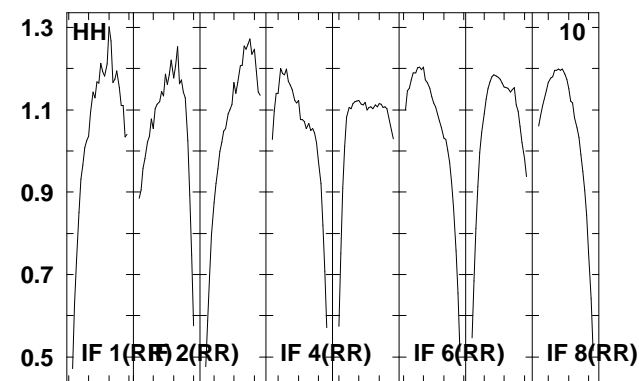
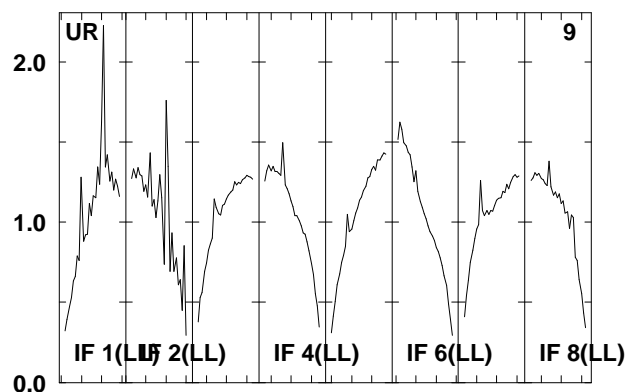
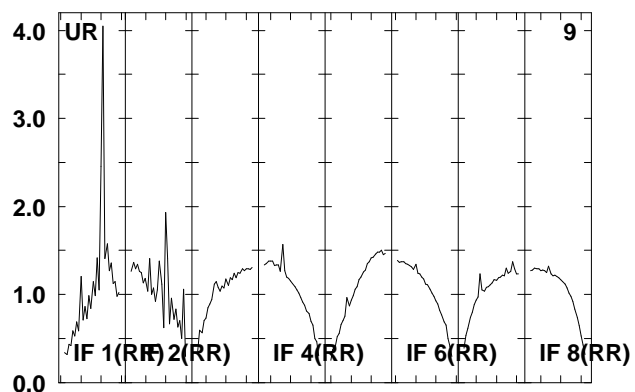
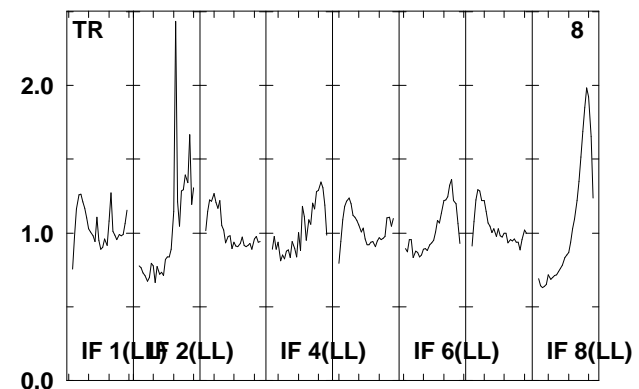
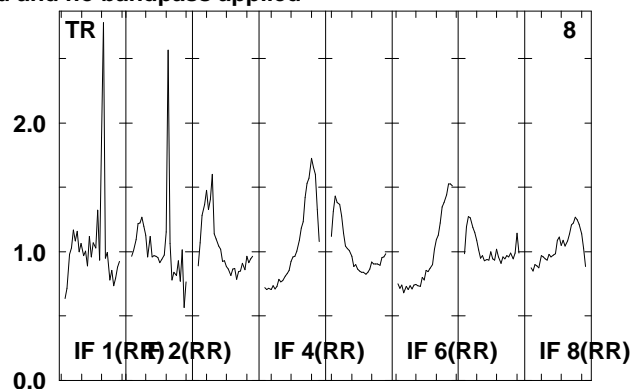
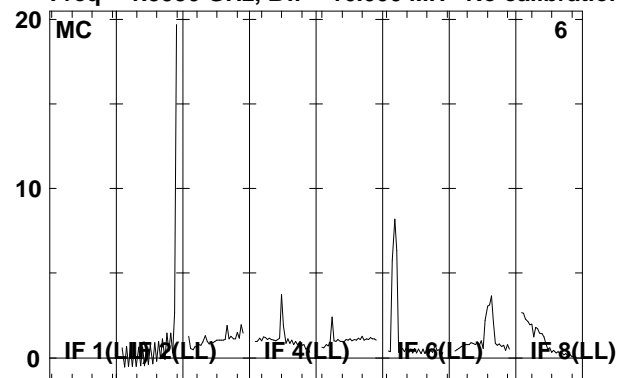

Lower frame: Real Jy

Total-power spectrum Antenna: *

Timerange: 00/18:14:32 to 00/18:18:00

Plot file version 105 created 22-APR-2008 12:26:36

J0730-02 EP061B.UVDATA.1

Freq = 1.5950 GHz, Bw = 16.000 MH No calibration applied and no bandpass applied

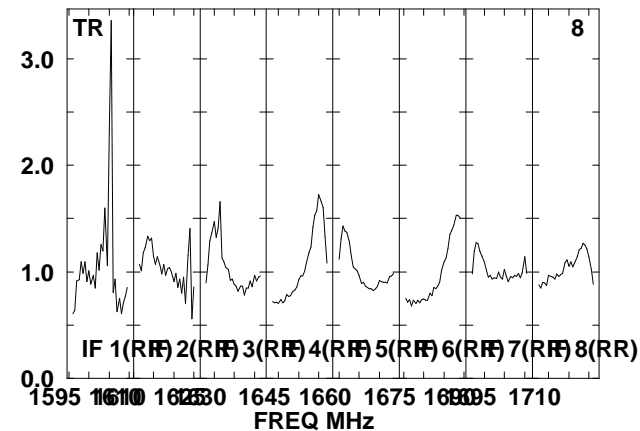
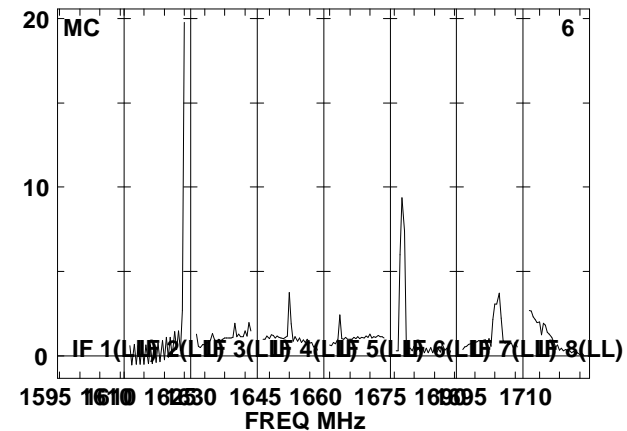
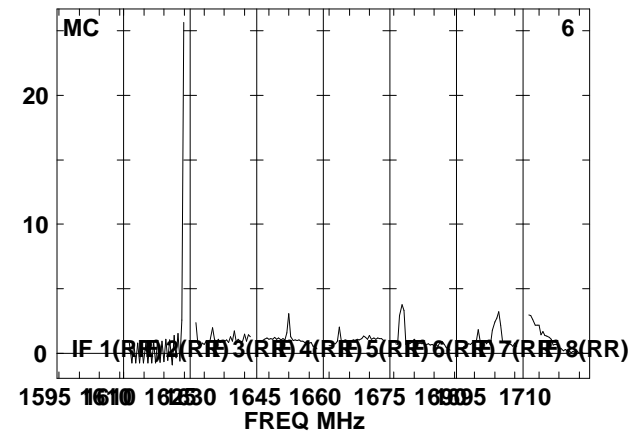
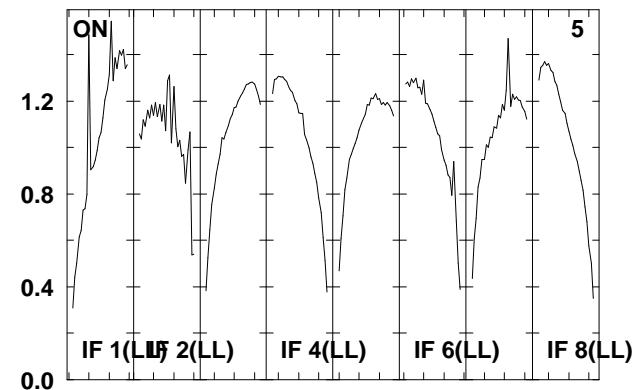
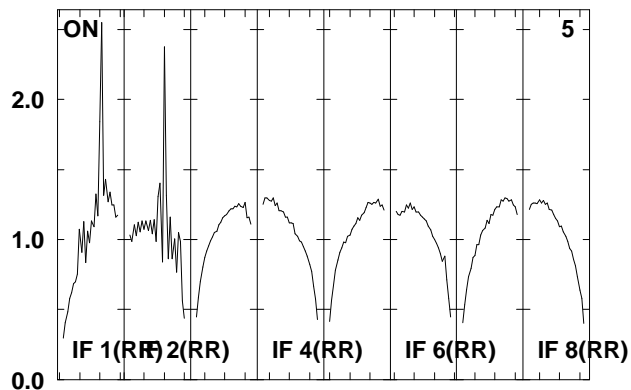
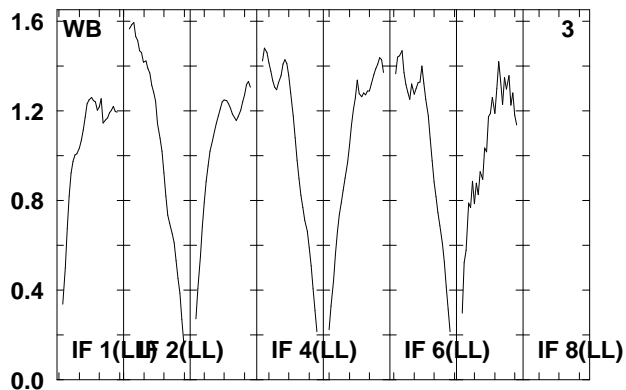
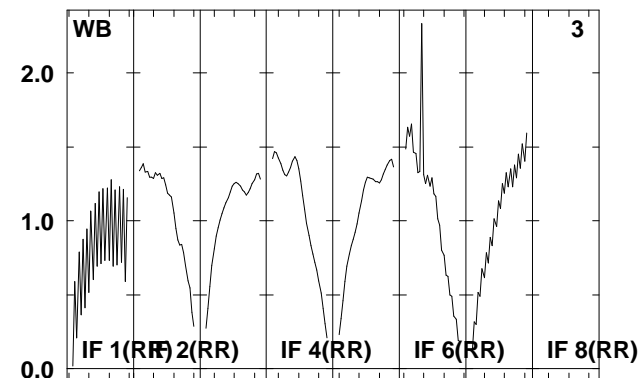
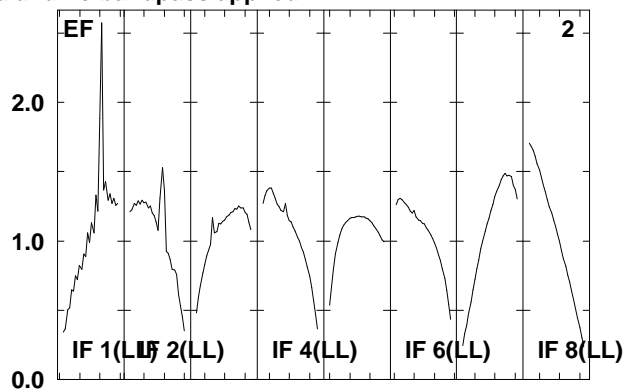
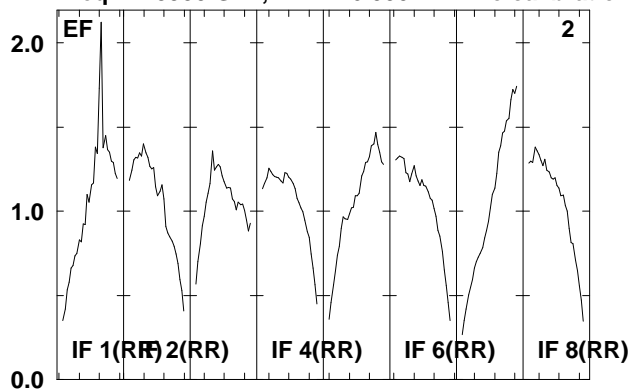

Lower frame: Real Jy

Total-power spectrum Antenna: *

Timerange: 00/18:18:02 to 00/18:19:30

Plot file version 106 created 22-APR-2008 12:26:37

J0730-02 EP061B.UVDATA.1

Freq = 1.5950 GHz, Bw = 16.000 MH No calibration applied and no bandpass applied

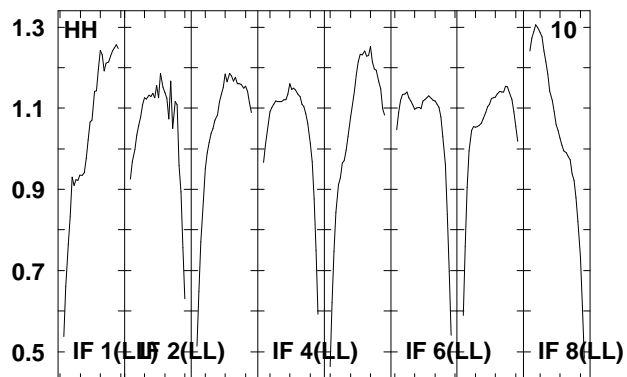
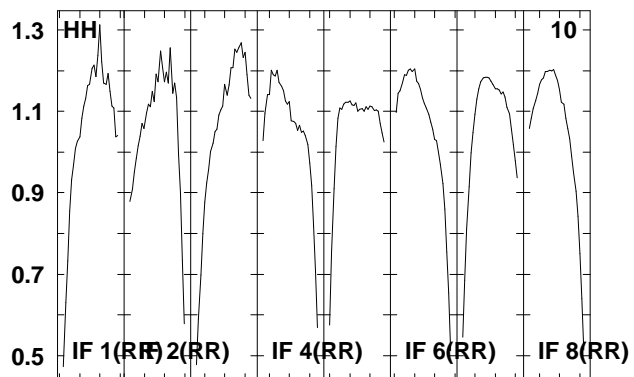
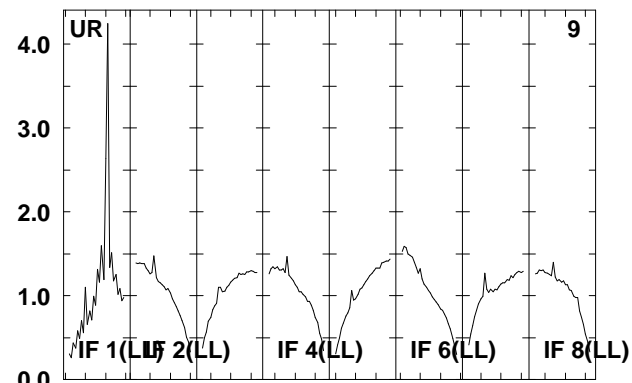
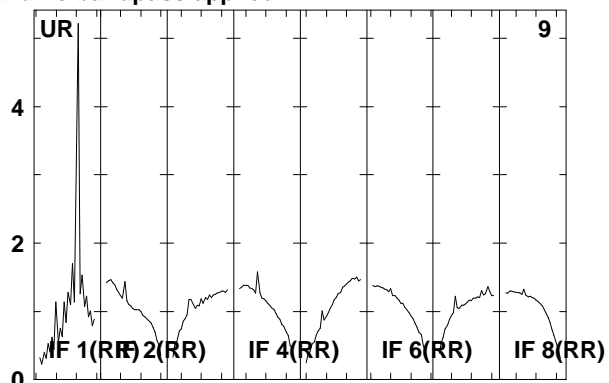
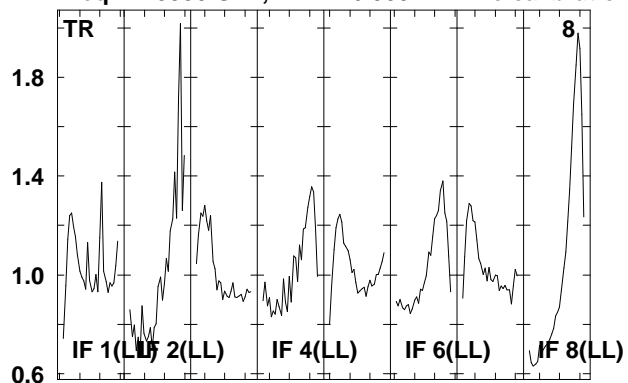

Lower frame: Real Jy
Total-power spectrum Antenna: *
Timerange: 00/18:18:02 to 00/18:19:30

Plot file version 107 created 22-APR-2008 12:26:38

IRAS0725 EP061B.UVDATA.1

Freq = 1.5950 GHz, Bw = 16.000 MH No calibration applied and no bandpass applied

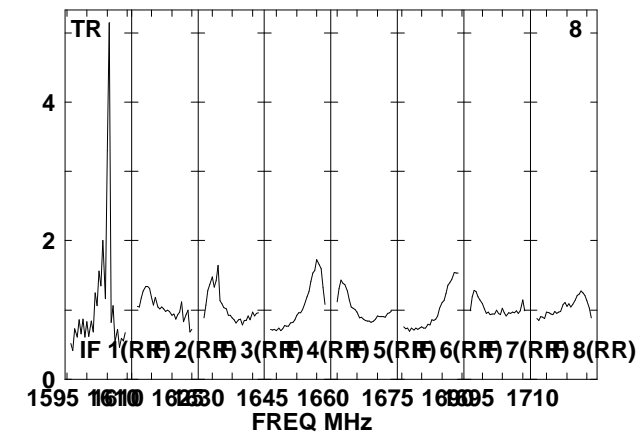
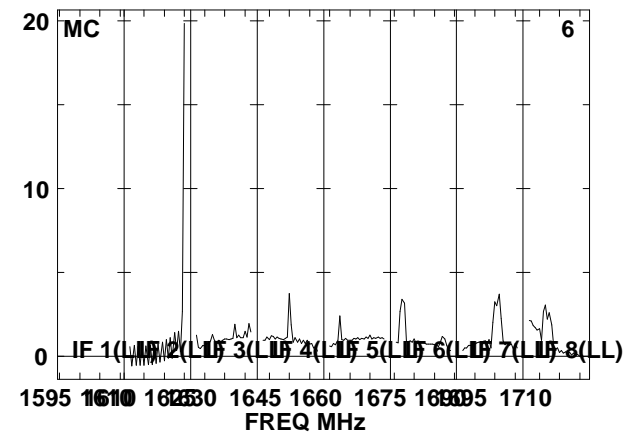
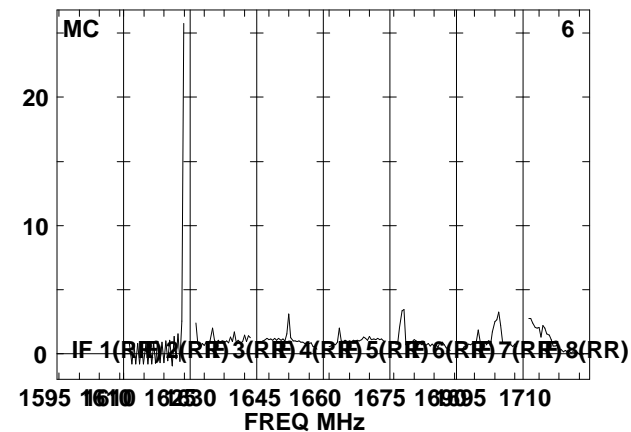
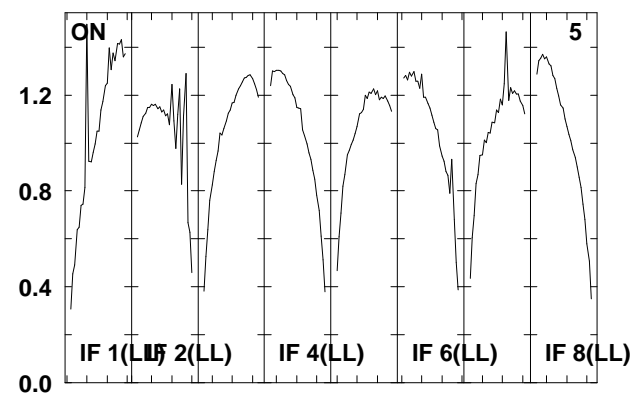
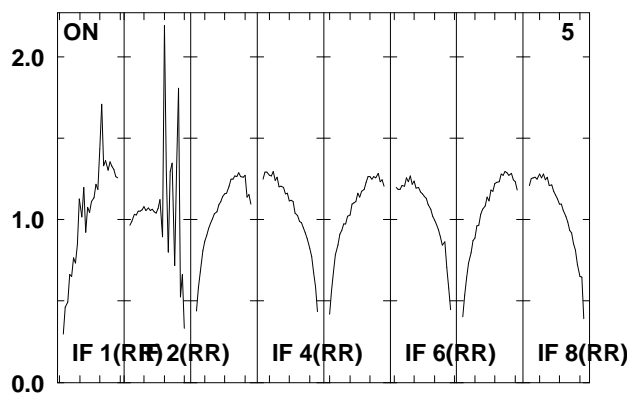
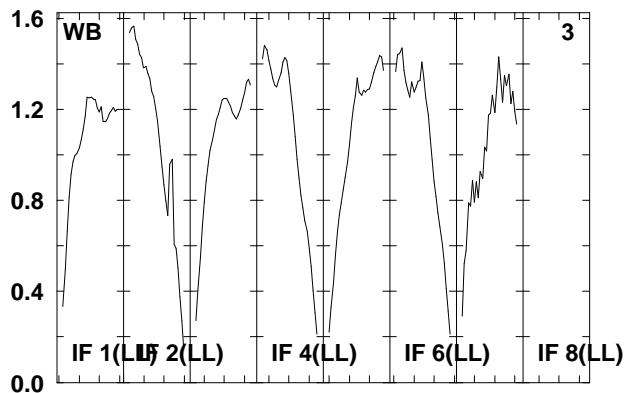
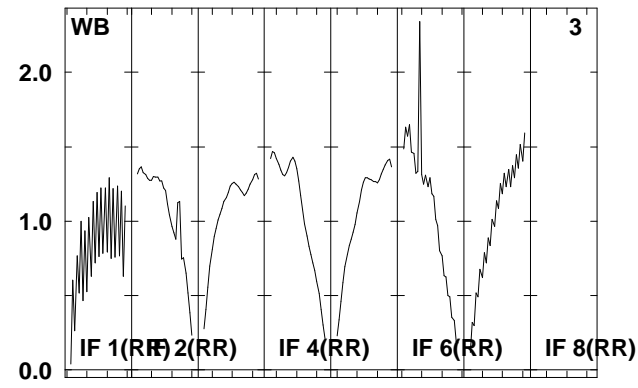
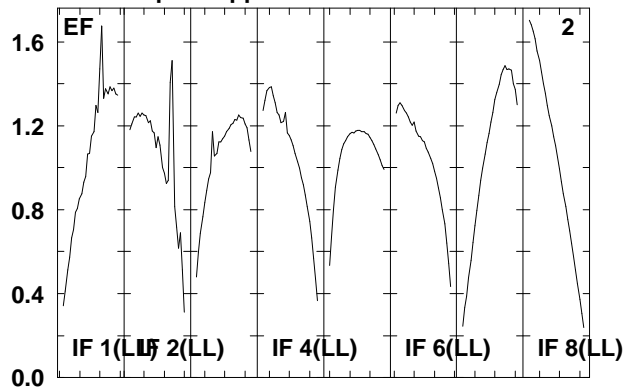
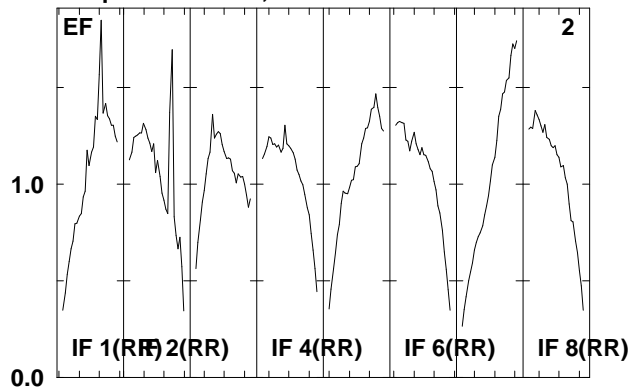

Lower frame: Real Jy

Total-power spectrum Antenna: *

Timerange: 00/18:19:32 to 00/18:22:58

Plot file version 108 created 22-APR-2008 12:26:39

IRAS0725 EP061B.UVDATA.1

Freq = 1.5950 GHz, Bw = 16.000 MH No calibration applied and no bandpass applied

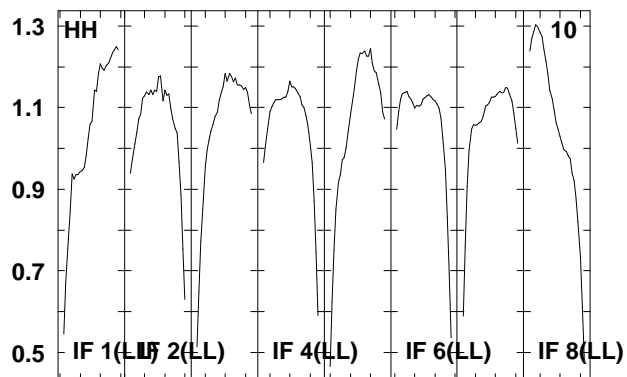
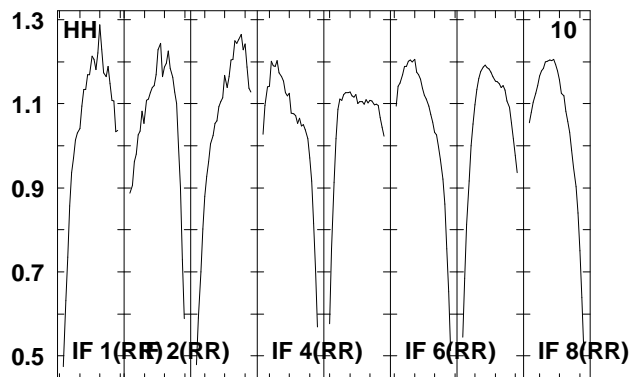
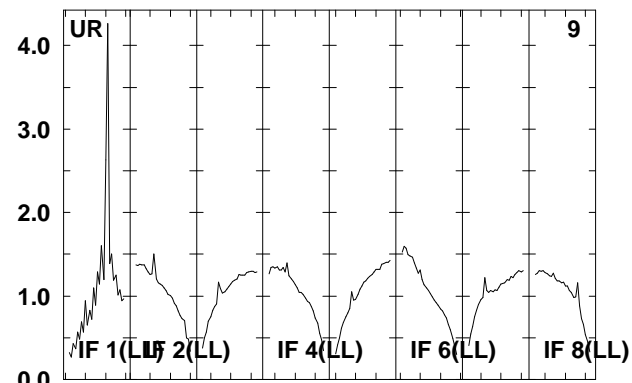
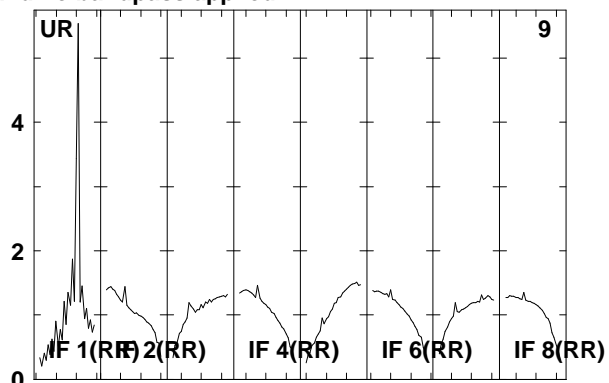
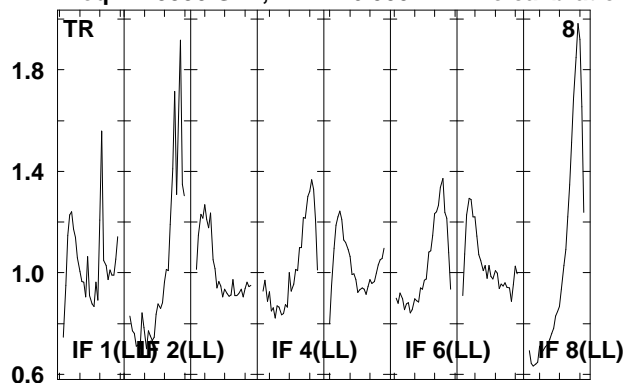

Lower frame: Real Jy
Total-power spectrum Antenna: *
Timerange: 00/18:19:32 to 00/18:22:58

Plot file version 109 created 22-APR-2008 12:26:40

J0730-02 EP061B.UVDATA.1

Freq = 1.5950 GHz, Bw = 16.000 MH No calibration applied and no bandpass applied

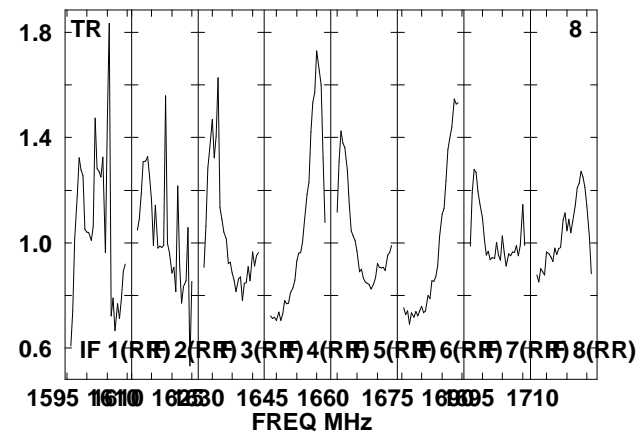
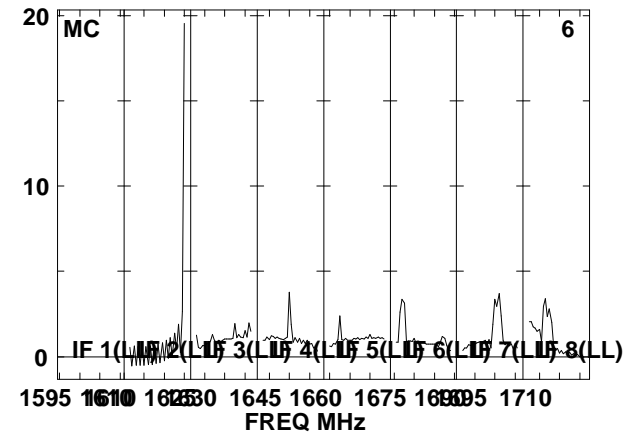
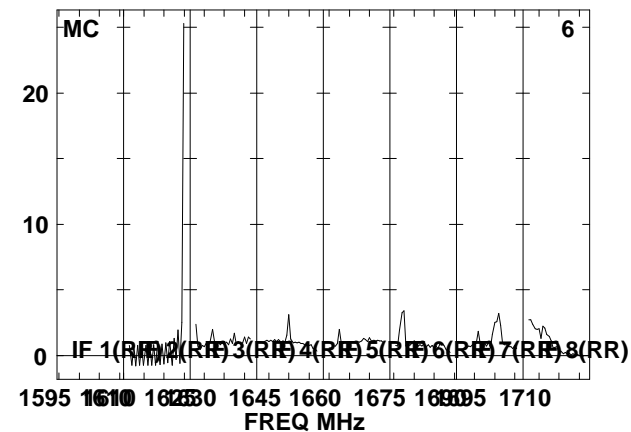
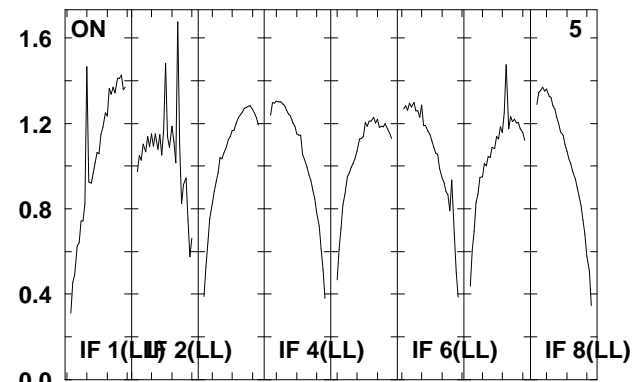
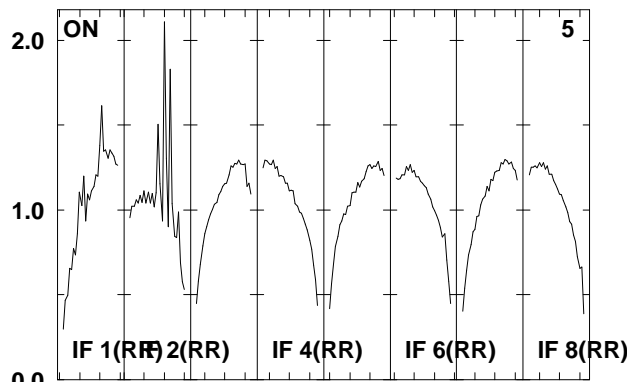
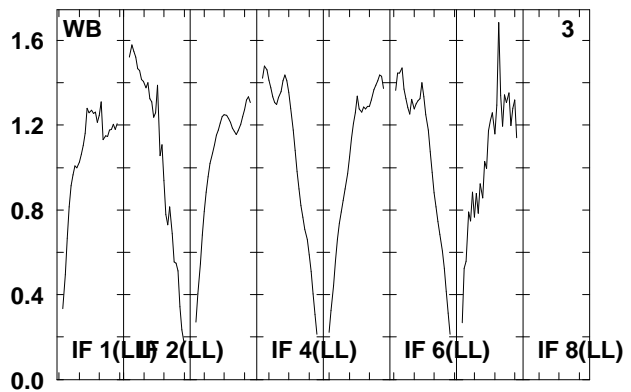
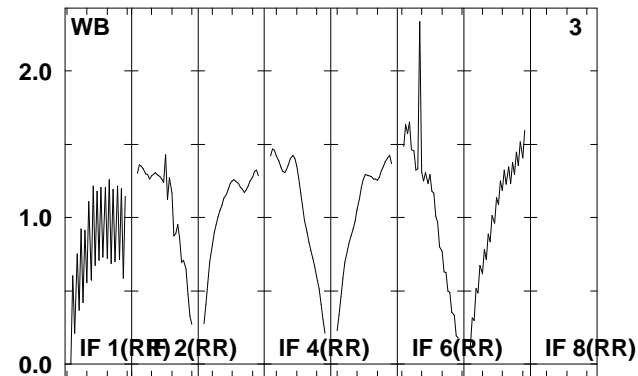
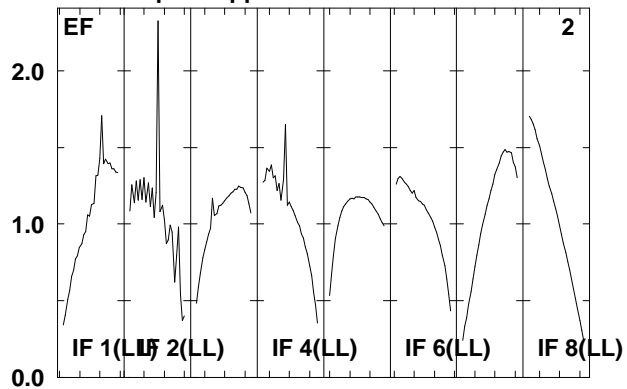
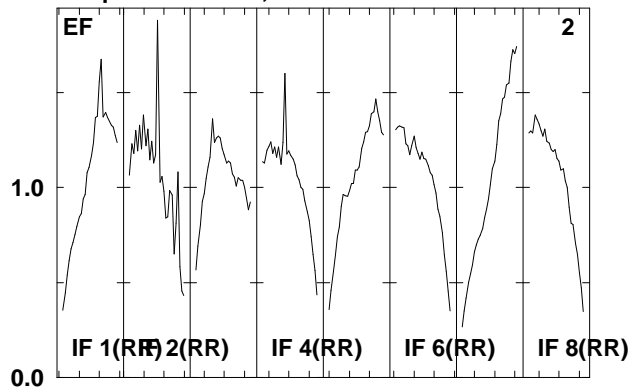

Lower frame: Real Jy
Total-power spectrum Antenna: *
Timerange: 00/18:24:02 to 00/18:25:30

Plot file version 110 created 22-APR-2008 12:26:40

J0730-02 EP061B.UVDATA.1

Freq = 1.5950 GHz, Bw = 16.000 MH No calibration applied and no bandpass applied

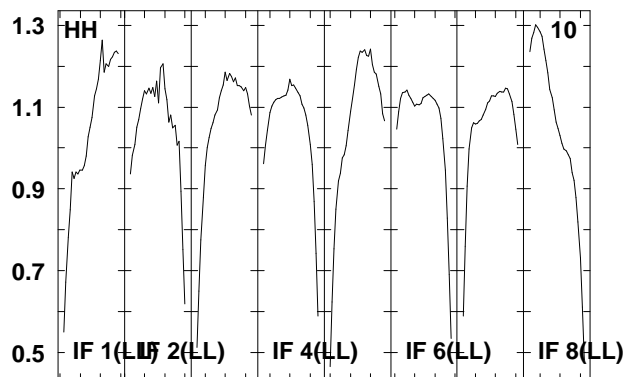
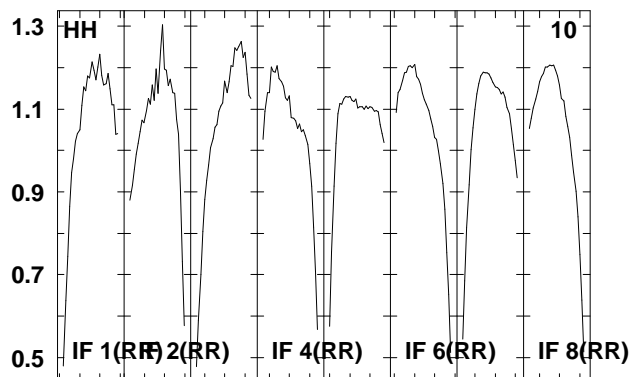
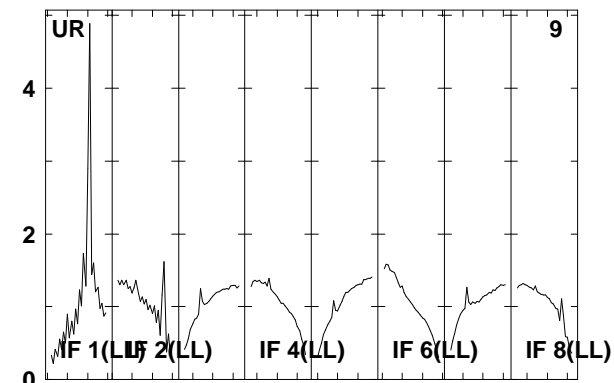
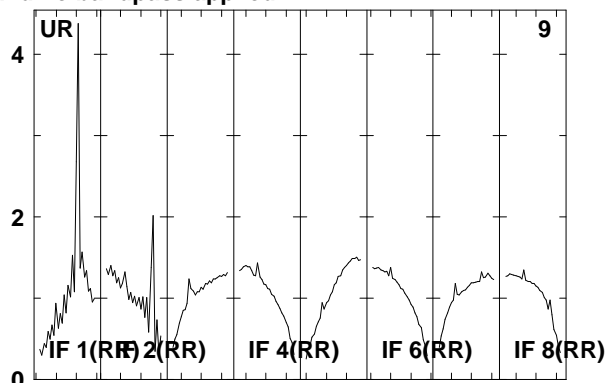
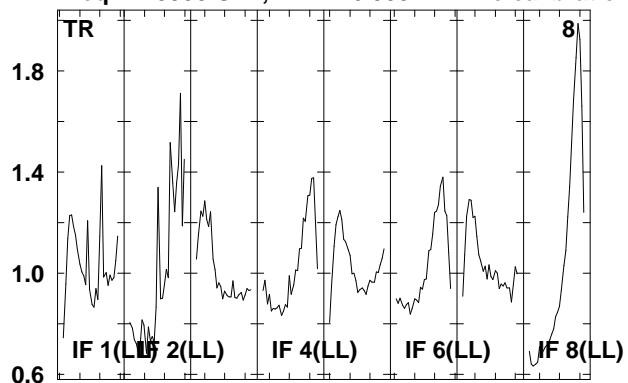

Lower frame: Real Jy
Total-power spectrum Antenna: *
Timerange: 00/18:24:02 to 00/18:25:30

Plot file version 111 created 22-APR-2008 12:26:41

IRAS0725 EP061B.UVDATA.1

Freq = 1.5950 GHz, Bw = 16.000 MH No calibration applied and no bandpass applied

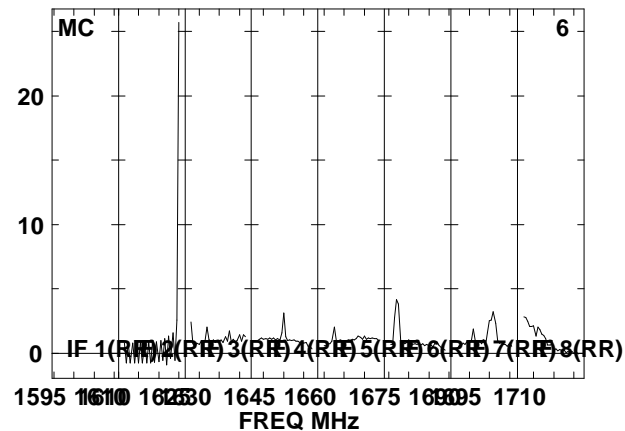
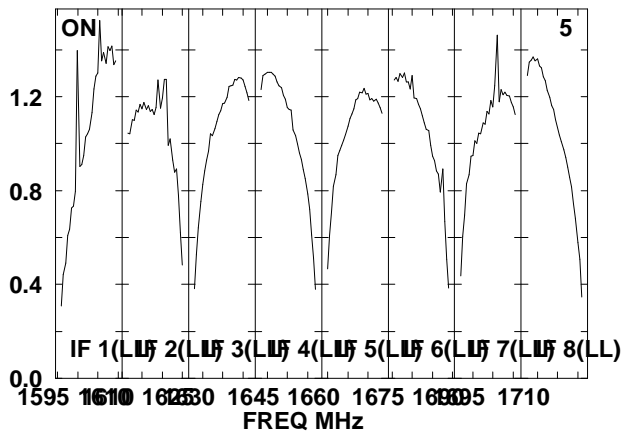
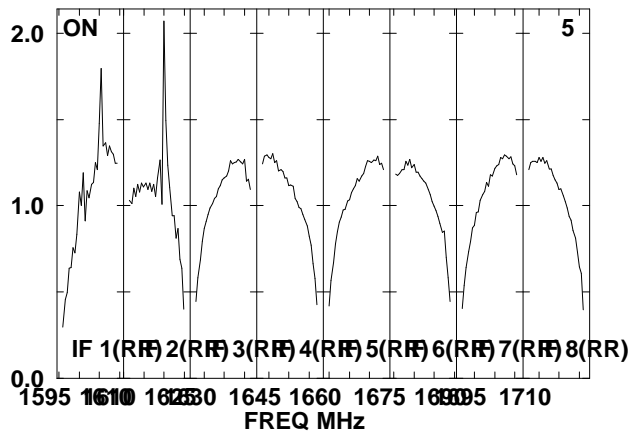
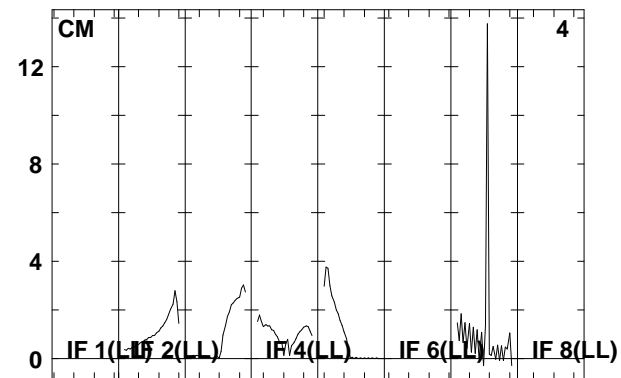
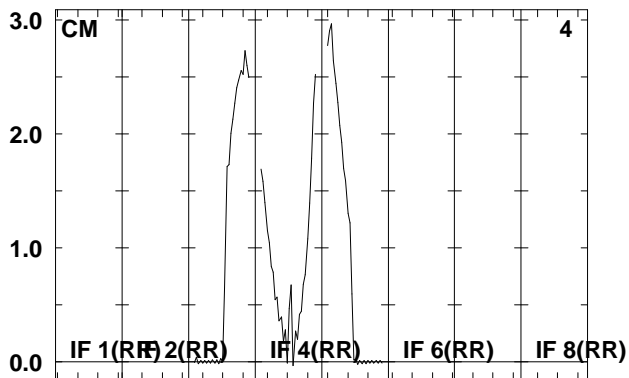
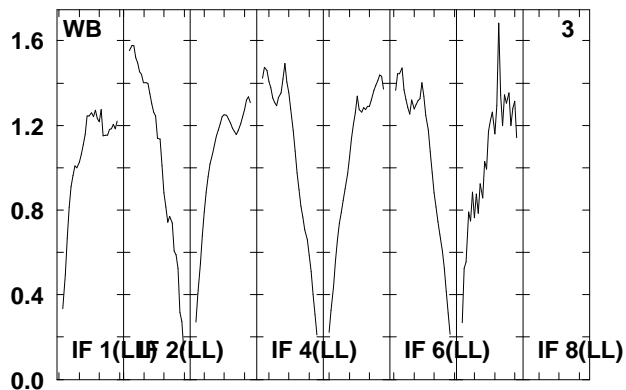
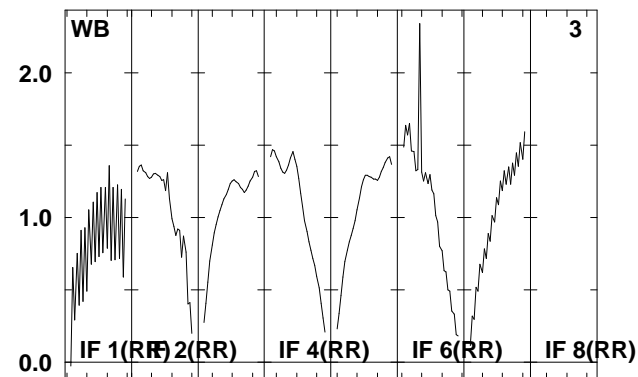
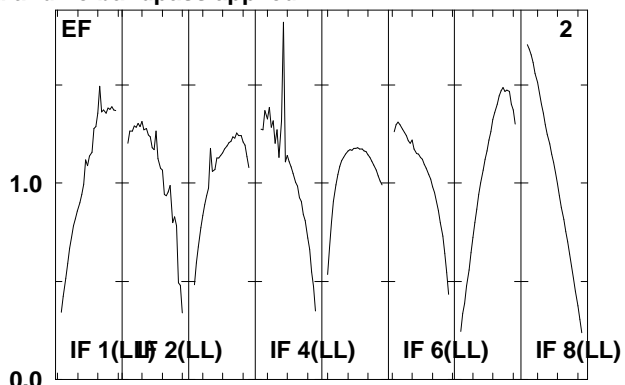
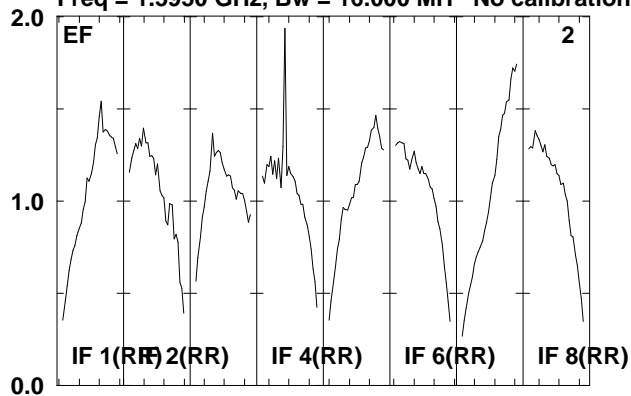

Lower frame: Real Jy

Total-power spectrum Antenna: *

Timerange: 00/18:25:32 to 00/18:29:00

Plot file version 112 created 22-APR-2008 12:26:42

IRAS0725 EP061B.UVDATA.1

Freq = 1.5950 GHz, Bw = 16.000 MH No calibration applied and no bandpass applied

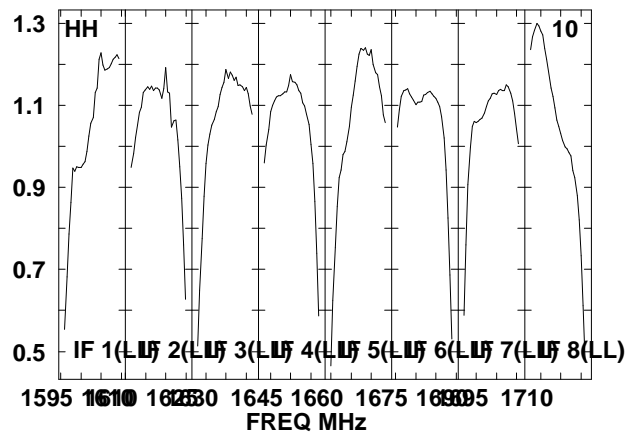
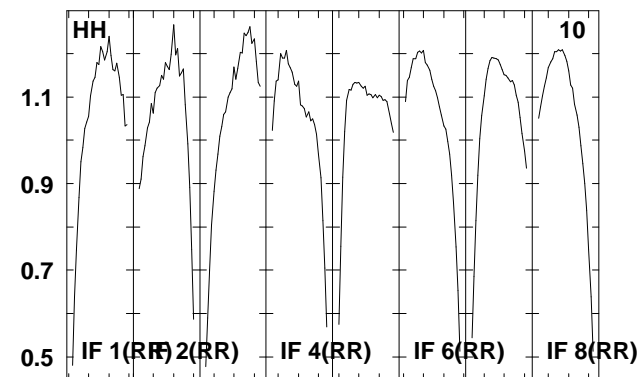
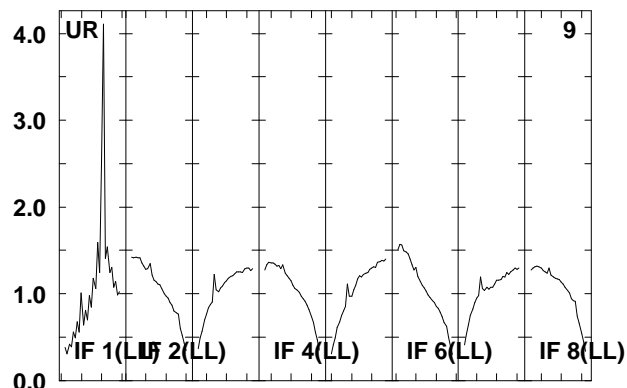
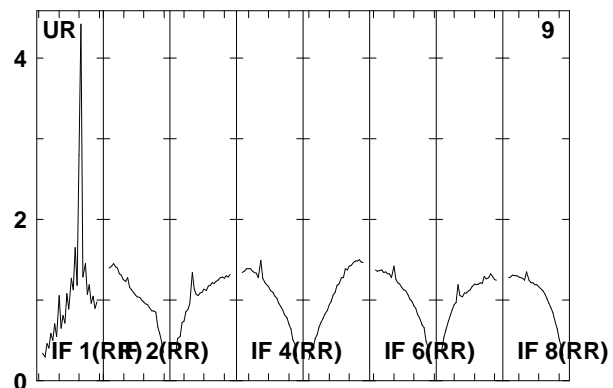
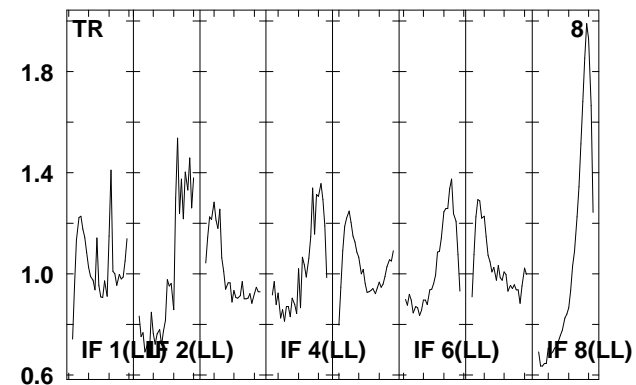
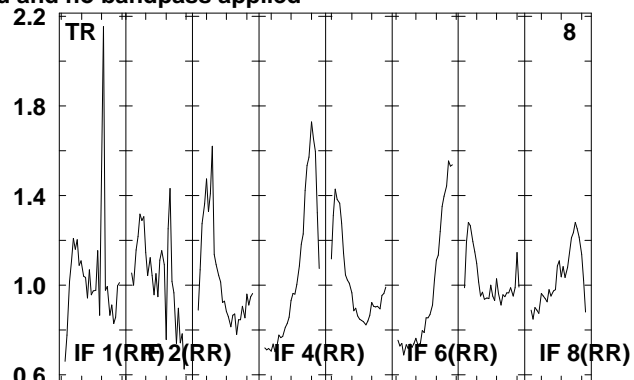
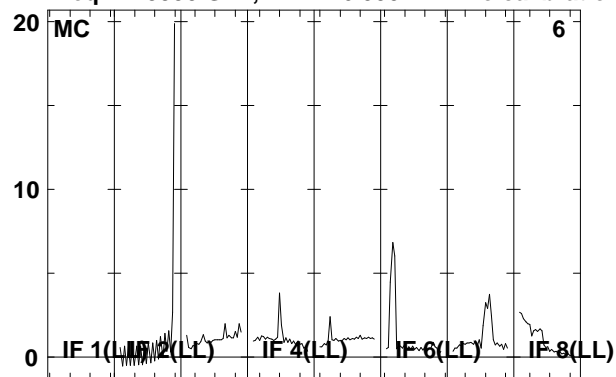

Lower frame: Real Jy

Total-power spectrum Antenna: *

Timerange: 00/18:25:32 to 00/18:29:00

Plot file version 113 created 22-APR-2008 12:26:43

J0730-02 EP061B.UVDATA.1

Freq = 1.5950 GHz, Bw = 16.000 MH No calibration applied and no bandpass applied

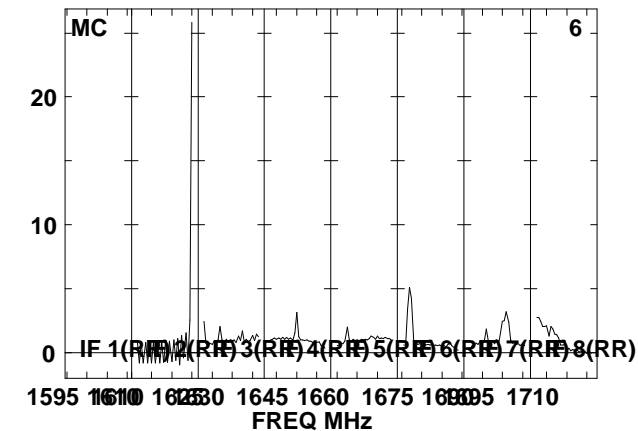
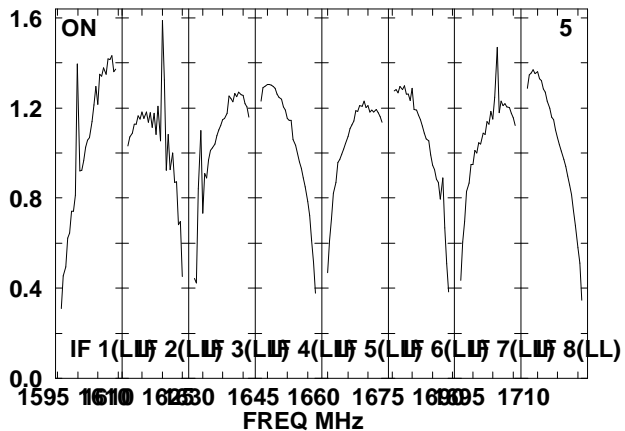
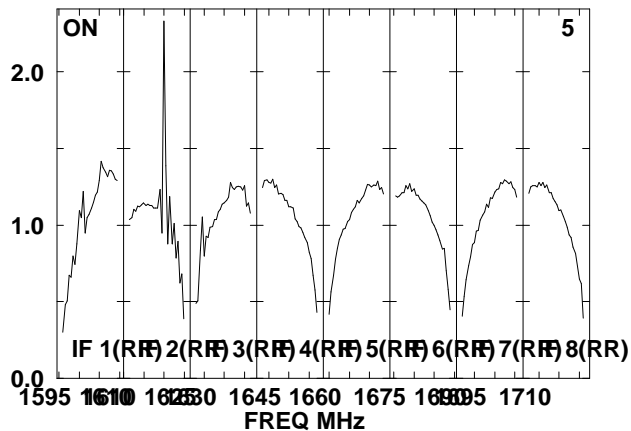
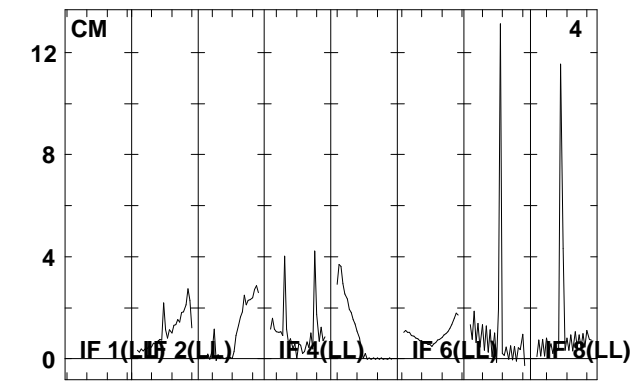
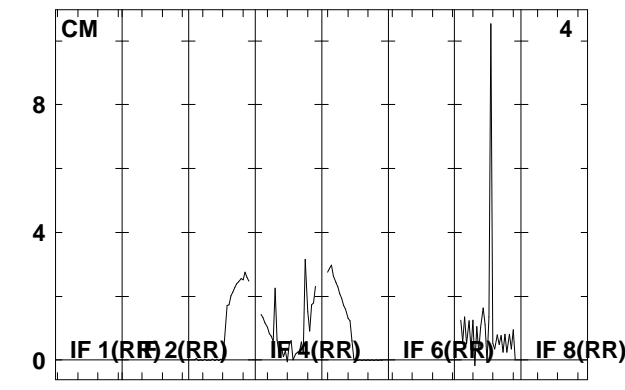
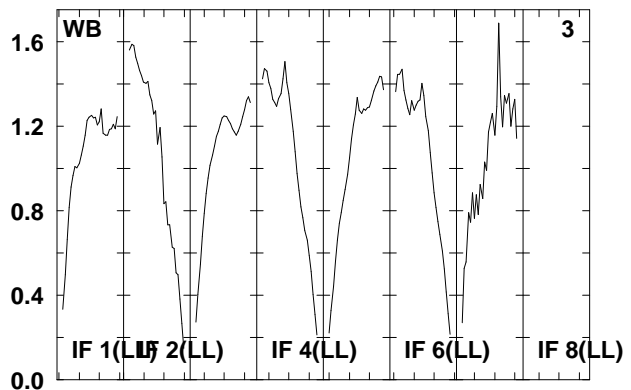
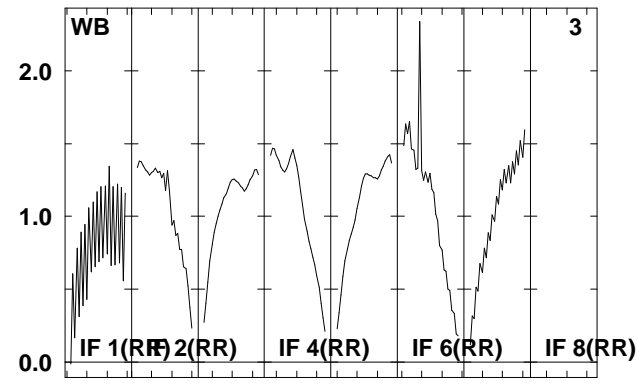
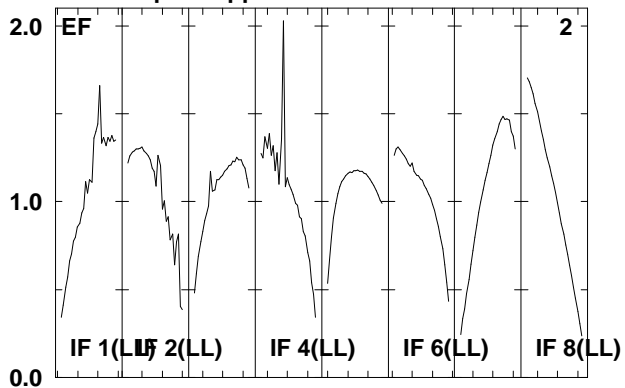
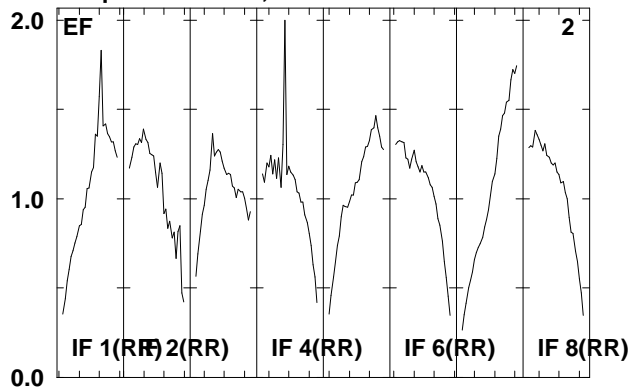

Lower frame: Real Jy
Total-power spectrum Antenna: *
Timerange: 00/18:29:02 to 00/18:30:30

Plot file version 114 created 22-APR-2008 12:26:43

J0730-02 EP061B.UVDATA.1

Freq = 1.5950 GHz, Bw = 16.000 MH No calibration applied and no bandpass applied

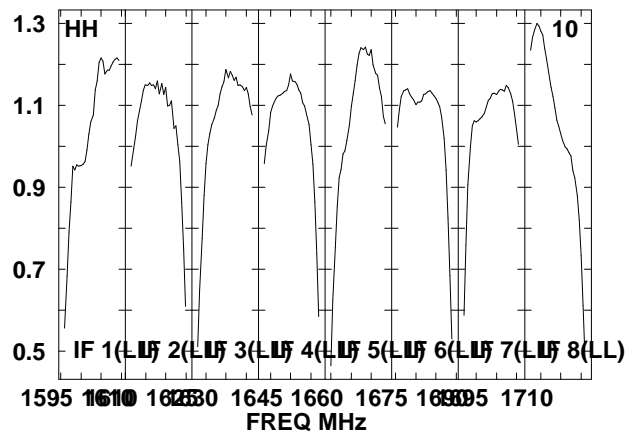
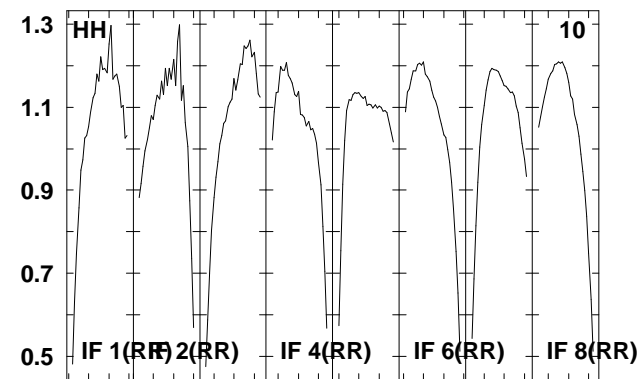
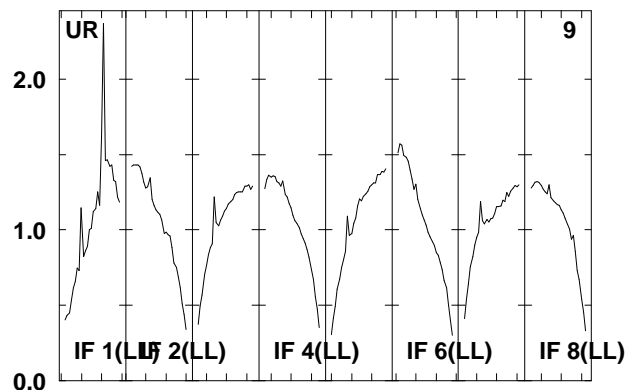
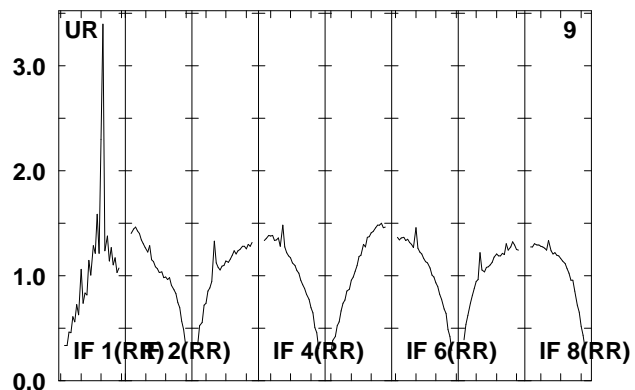
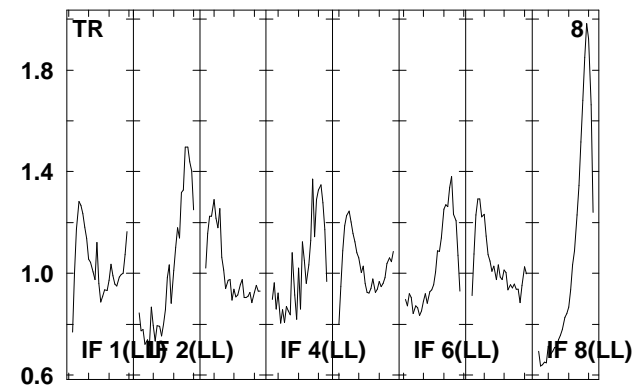
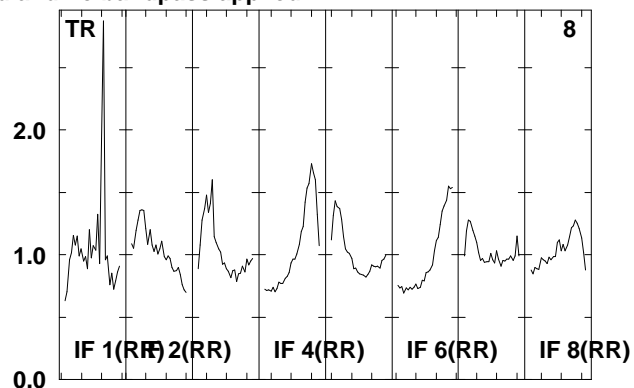
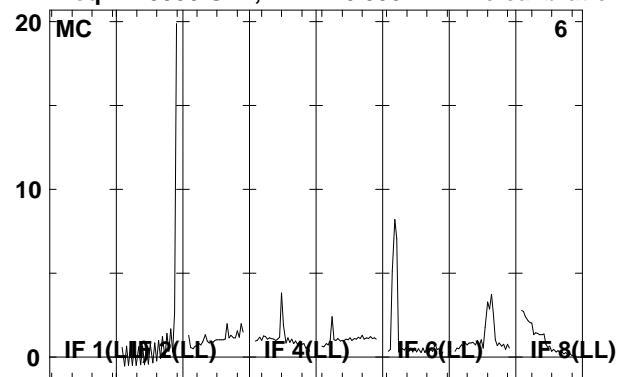

Lower frame: Real Jy

Total-power spectrum Antenna: *

Timerange: 00/18:29:02 to 00/18:30:30

Plot file version 115 created 22-APR-2008 12:26:44

IRAS0725 EP061B.UVDATA.1

Freq = 1.5950 GHz, Bw = 16.000 MH No calibration applied and no bandpass applied

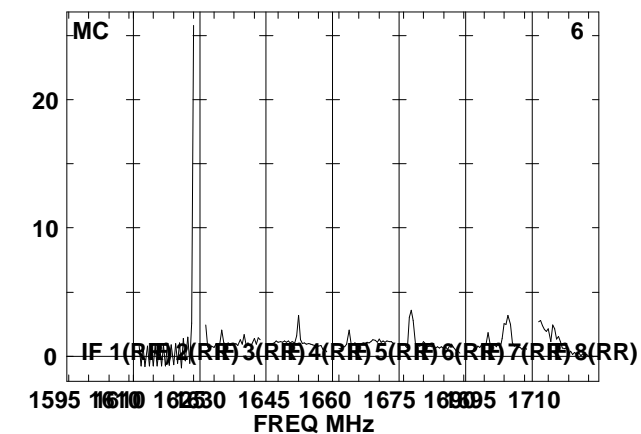
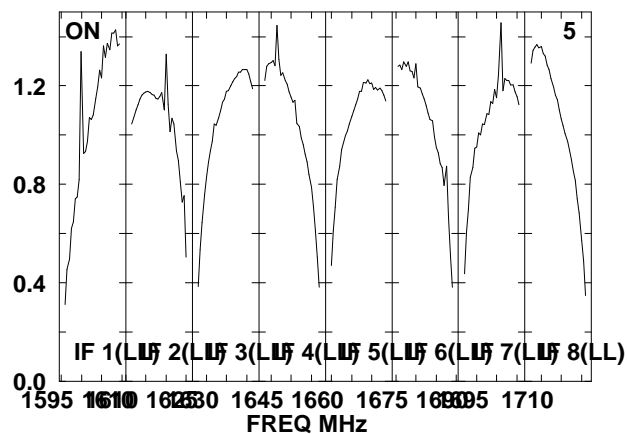
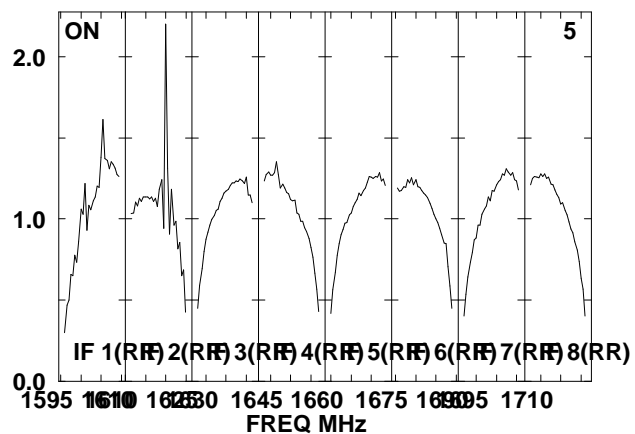
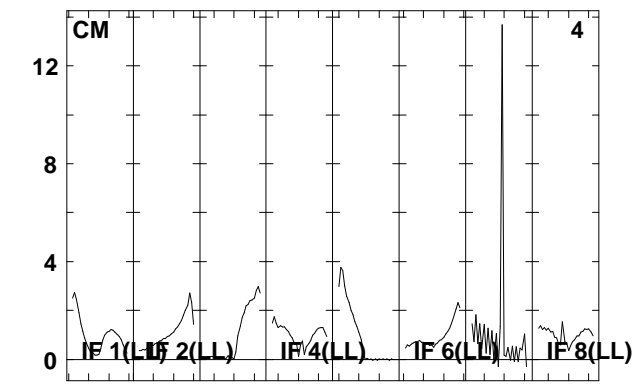
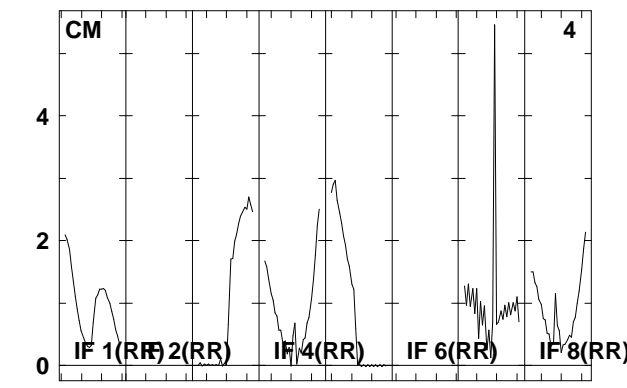
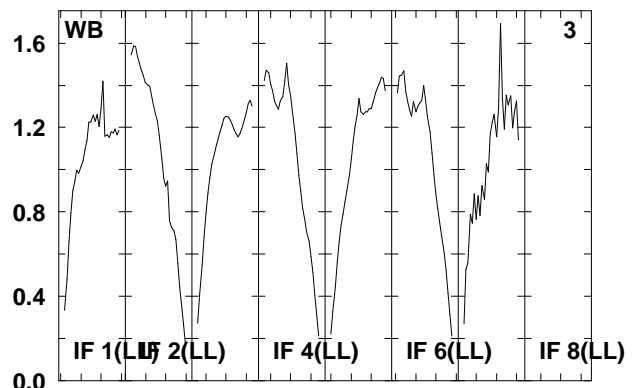
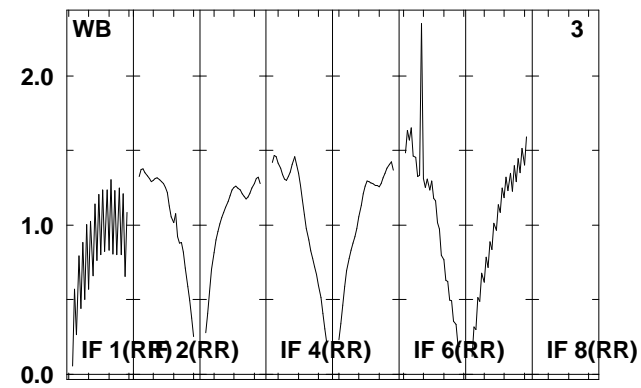
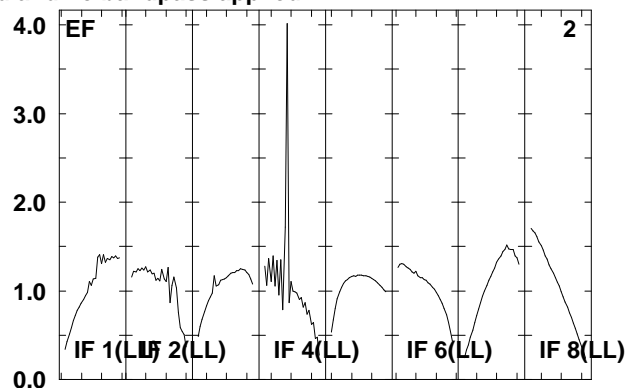
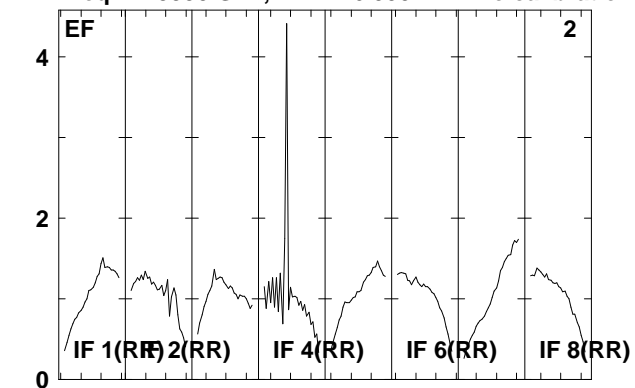

Lower frame: Real Jy
Total-power spectrum Antenna: *
Timerange: 00/18:30:32 to 00/18:34:00

Plot file version 116 created 22-APR-2008 12:26:45

IRAS0725 EP061B.UVDATA.1

Freq = 1.5950 GHz, Bw = 16.000 MH No calibration applied and no bandpass applied

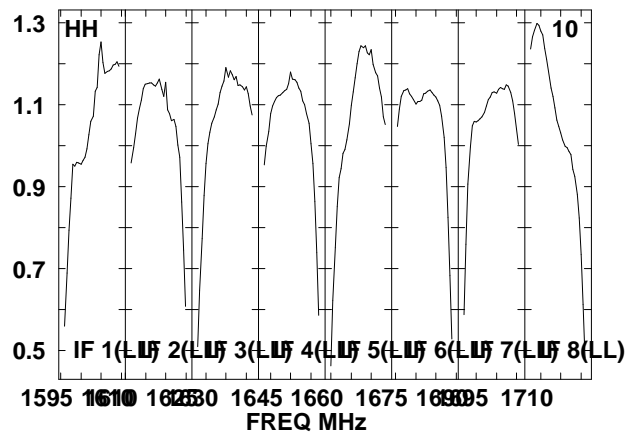
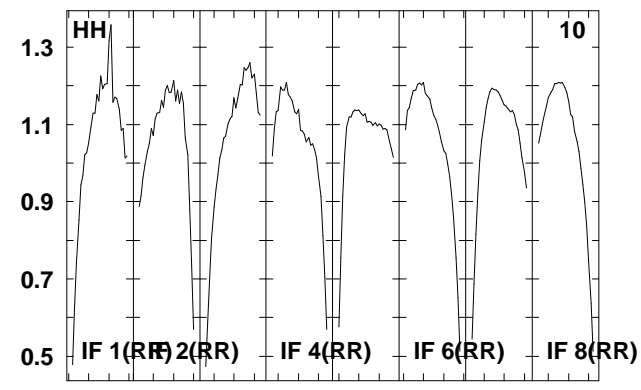
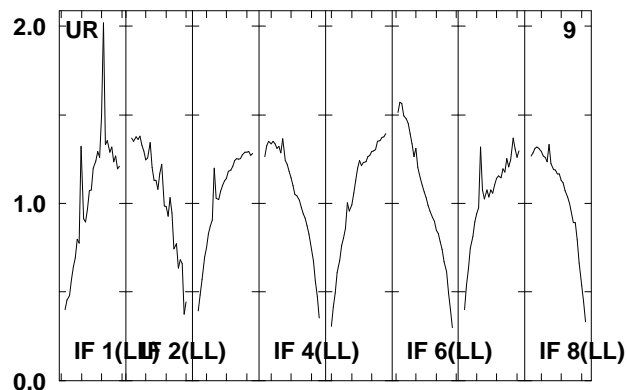
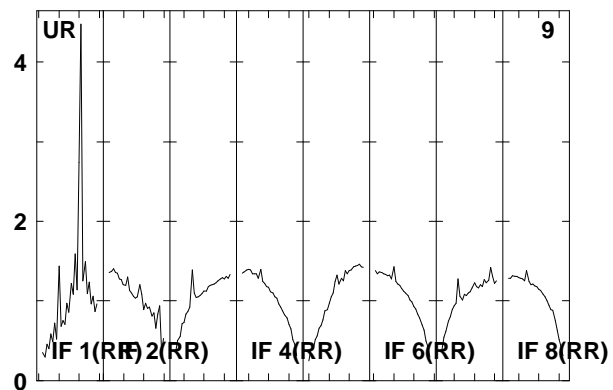
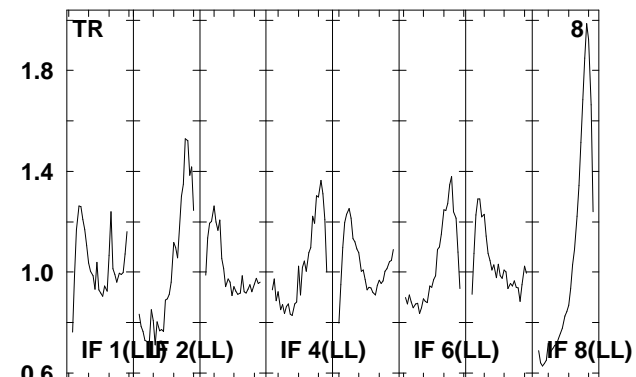
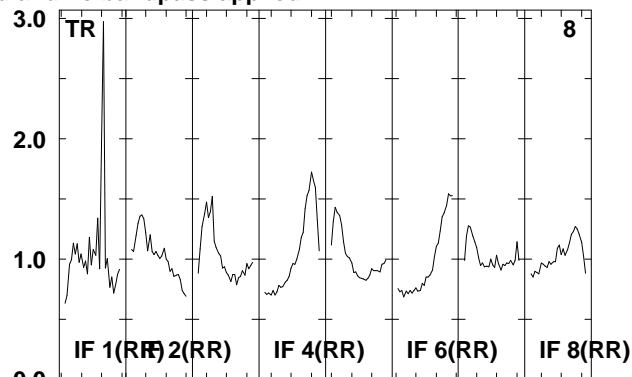
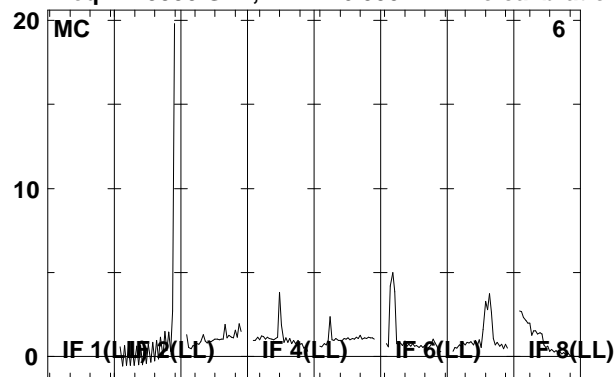

Lower frame: Real Jy

Total-power spectrum Antenna: *

Timerange: 00/18:30:32 to 00/18:34:00

Plot file version 117 created 22-APR-2008 12:26:46

J0730-02 EP061B.UVDATA.1

Freq = 1.5950 GHz, Bw = 16.000 MH No calibration applied and no bandpass applied

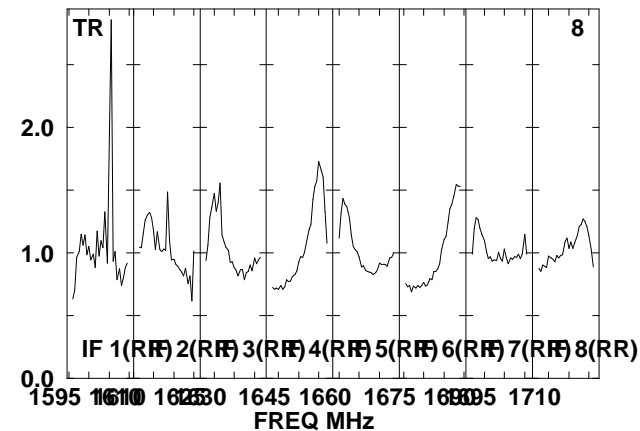
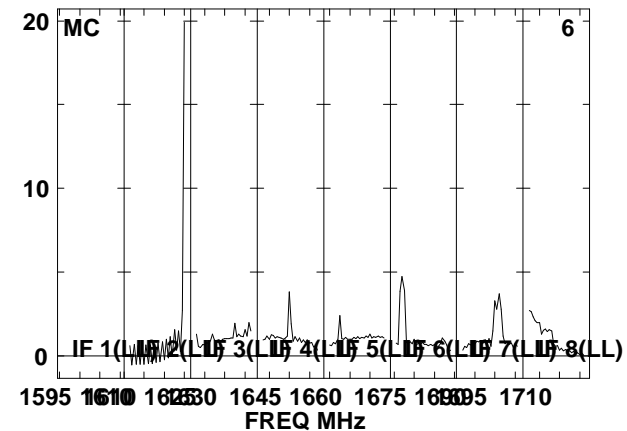
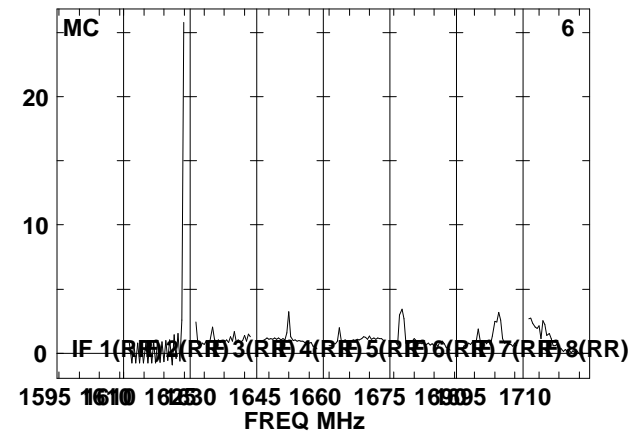
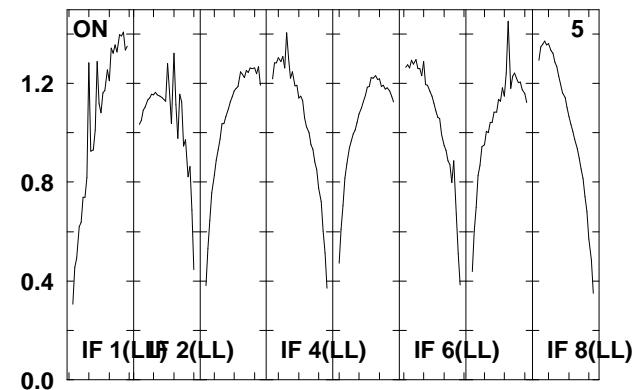
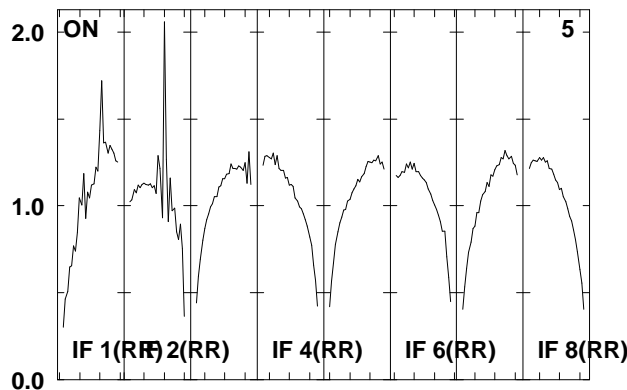
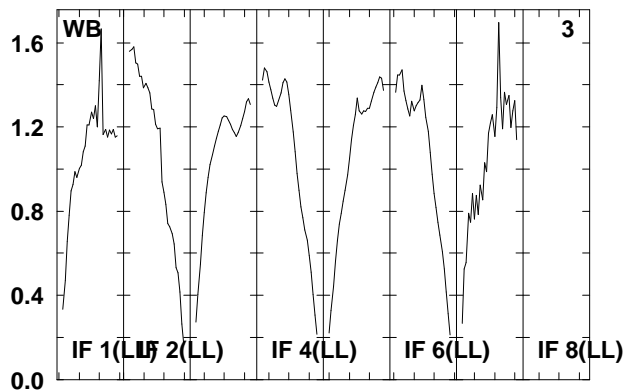
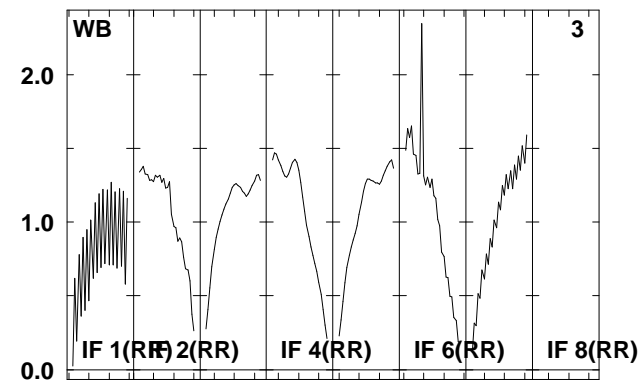
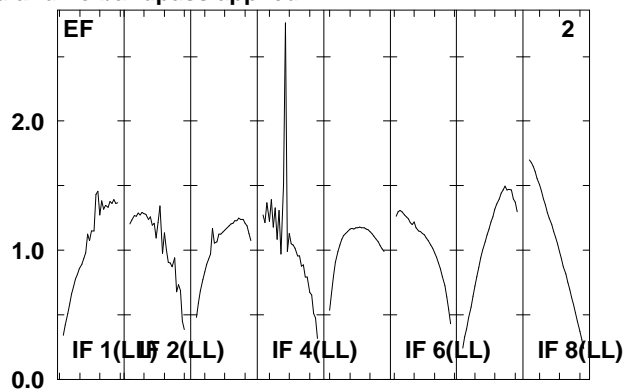
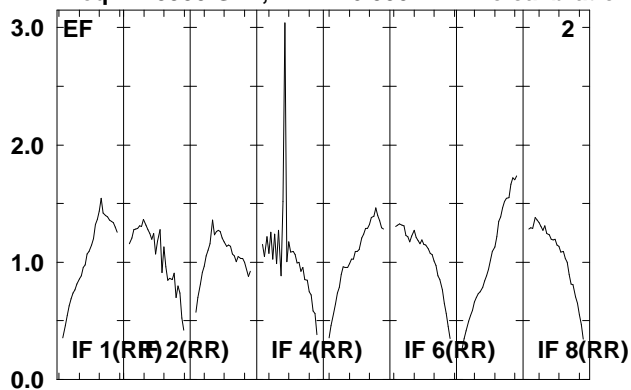

Lower frame: Real Jy
Total-power spectrum Antenna: *
Timerange: 00/18:34:02 to 00/18:35:30

Plot file version 118 created 22-APR-2008 12:26:46

J0730-02 EP061B.UVDATA.1

Freq = 1.5950 GHz, Bw = 16.000 MH No calibration applied and no bandpass applied

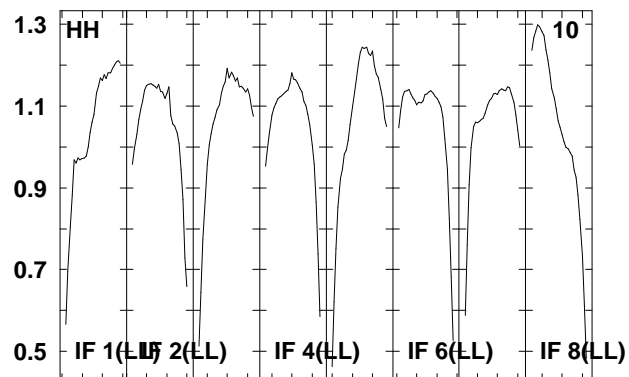
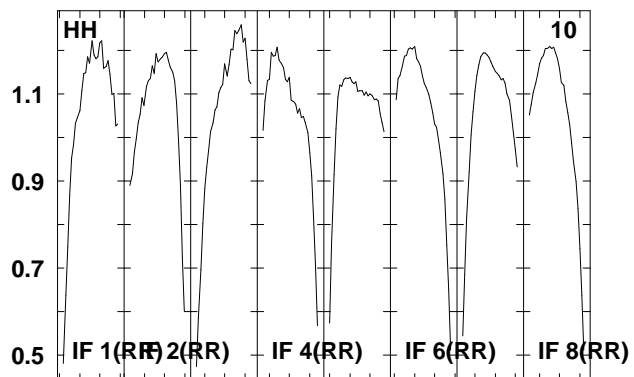
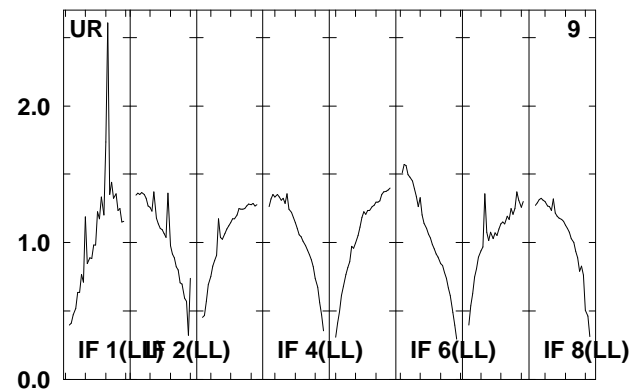
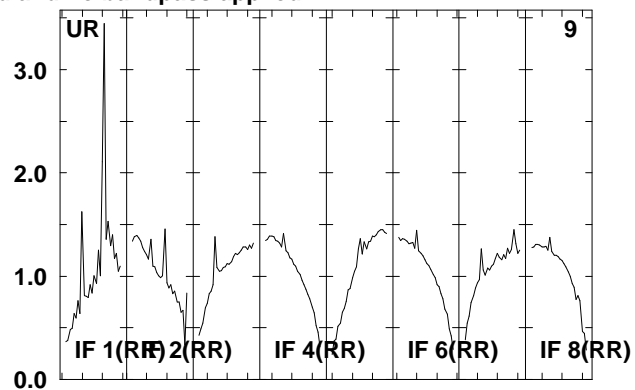
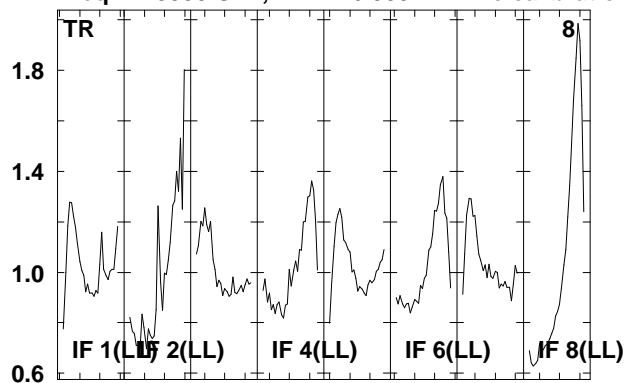

Lower frame: Real Jy
Total-power spectrum Antenna: *
Timerange: 00/18:34:02 to 00/18:35:30

Plot file version 119 created 22-APR-2008 12:26:47

IRAS0725 EP061B.UVDATA.1

Freq = 1.5950 GHz, Bw = 16.000 MH No calibration applied and no bandpass applied

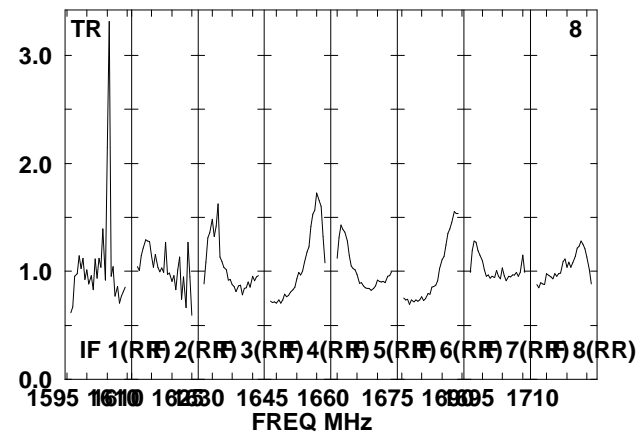
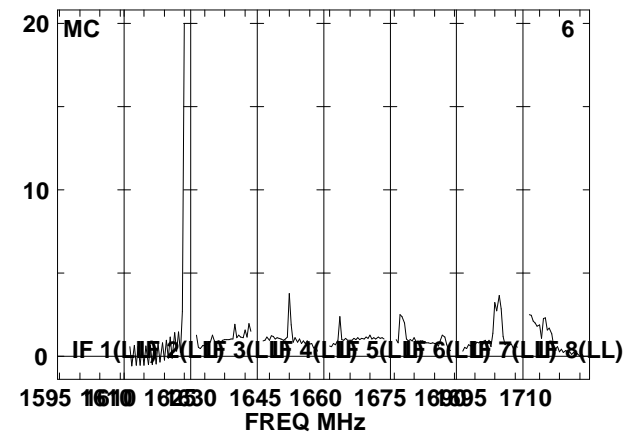
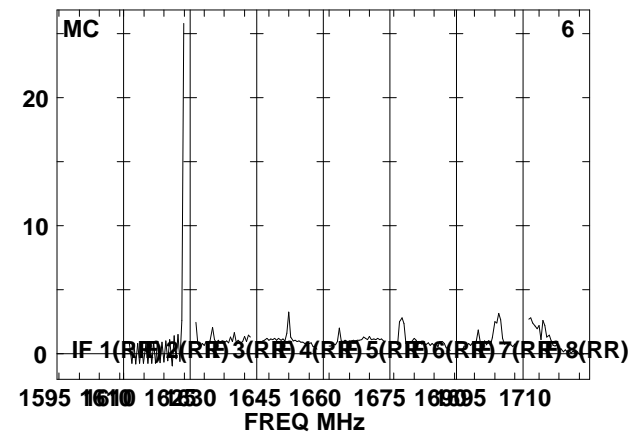
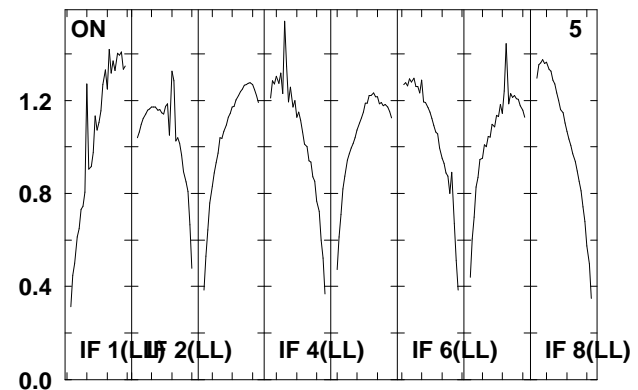
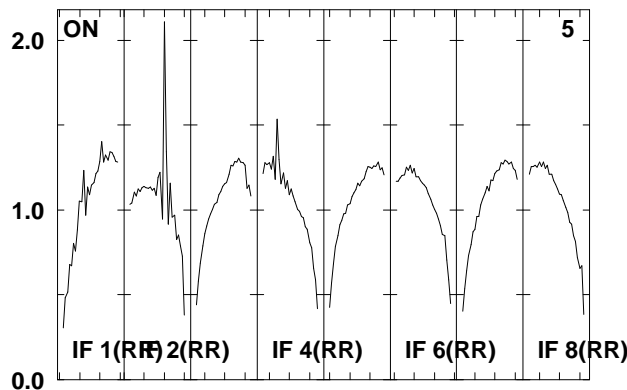
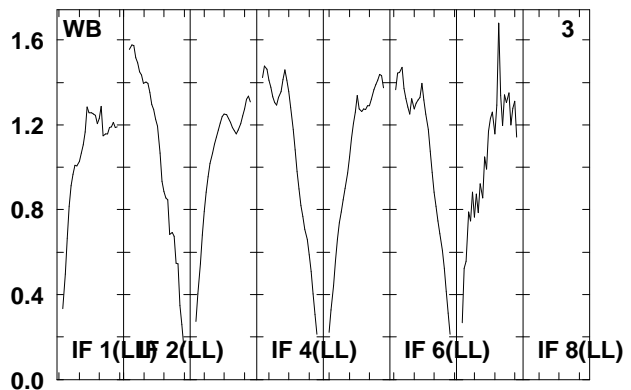
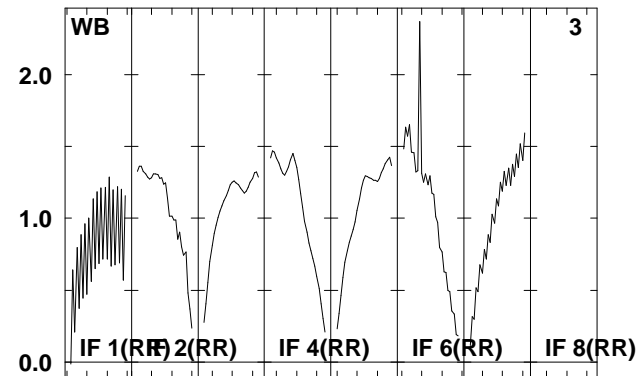
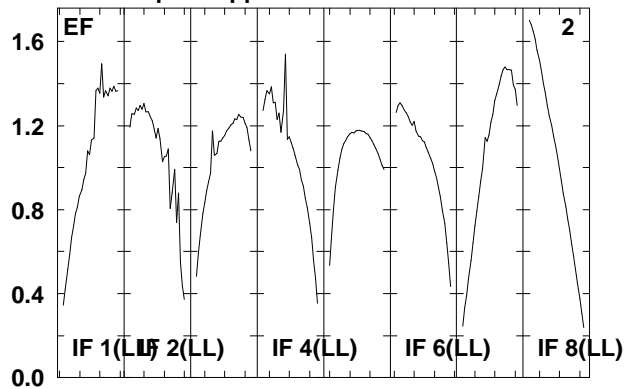
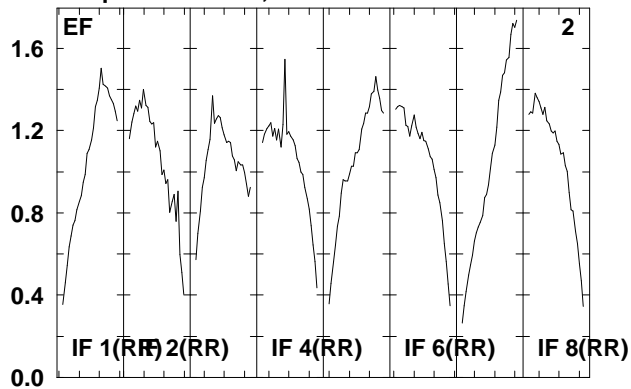

Lower frame: Real Jy
Total-power spectrum Antenna: *
Timerange: 00/18:35:32 to 00/18:39:00

Plot file version 120 created 22-APR-2008 12:26:49

IRAS0725 EP061B.UVDATA.1

Freq = 1.5950 GHz, Bw = 16.000 MH No calibration applied and no bandpass applied

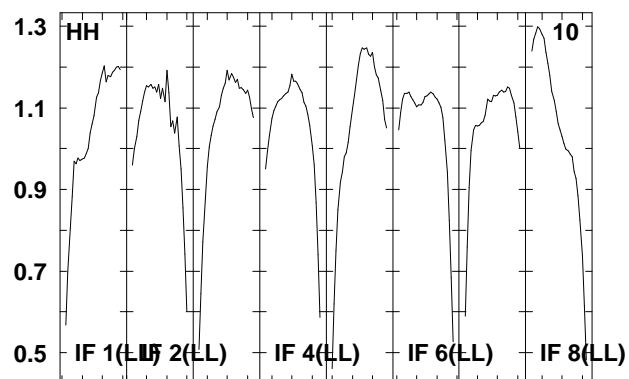
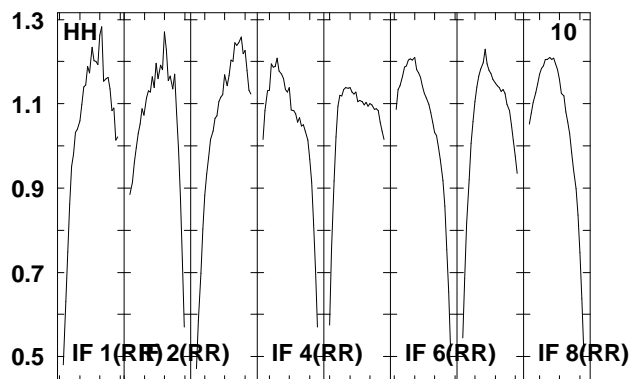
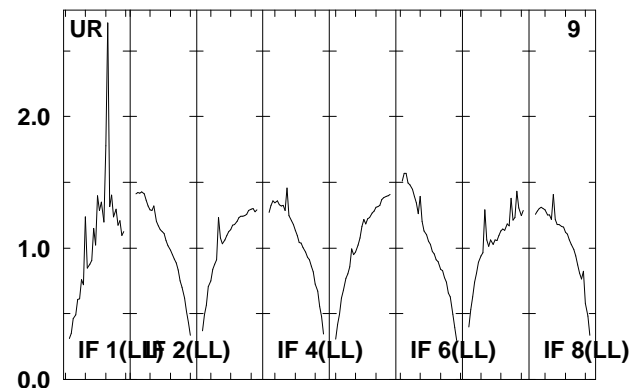
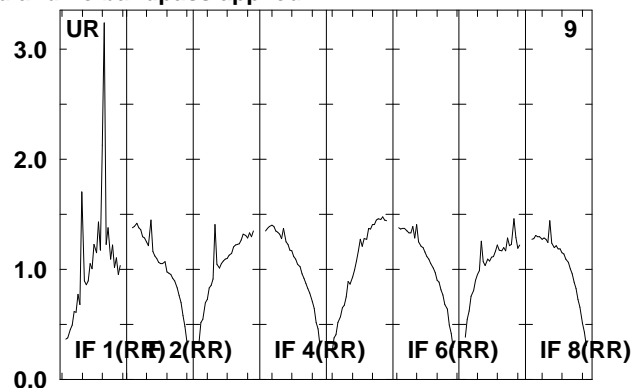
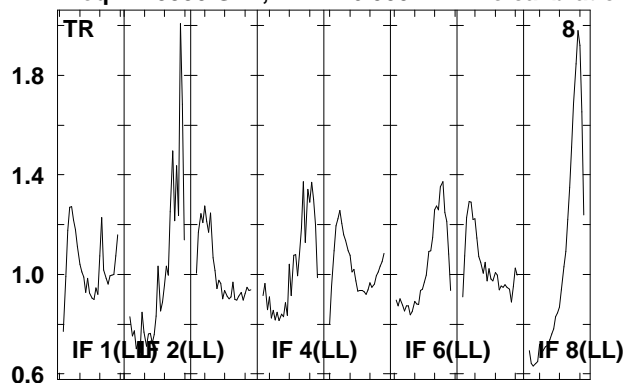

Lower frame: Real Jy
Total-power spectrum Antenna: *
Timerange: 00/18:35:32 to 00/18:39:00

Plot file version 121 created 22-APR-2008 12:26:50

4C39.25 EP061B.UVDATA.1

Freq = 1.5950 GHz, Bw = 16.000 MH No calibration applied and no bandpass applied

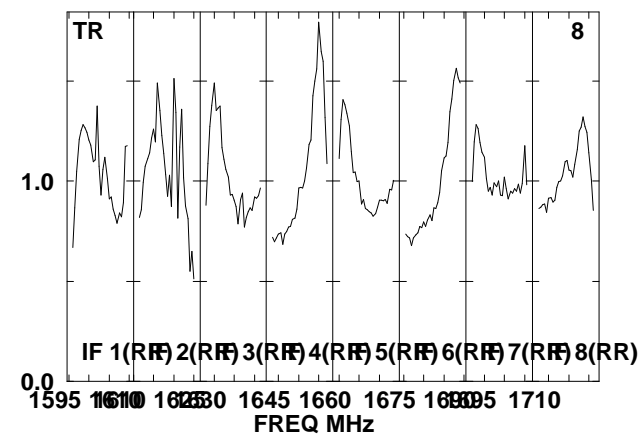
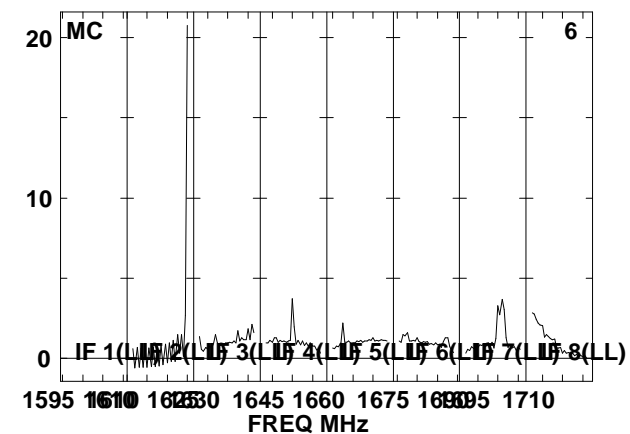
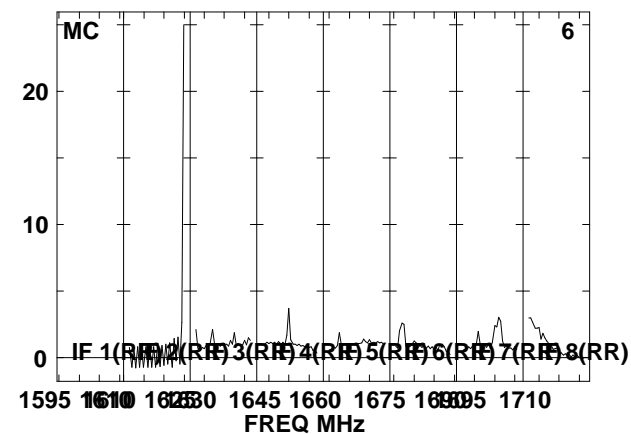
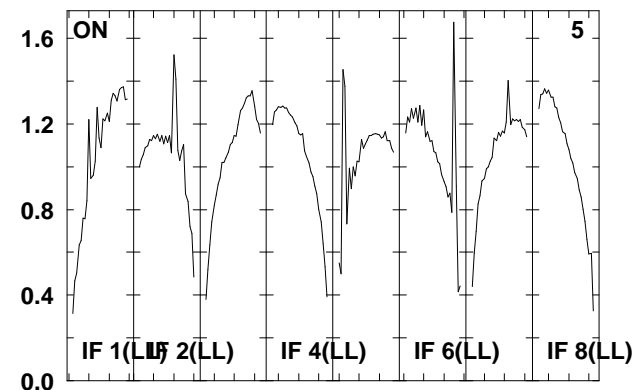
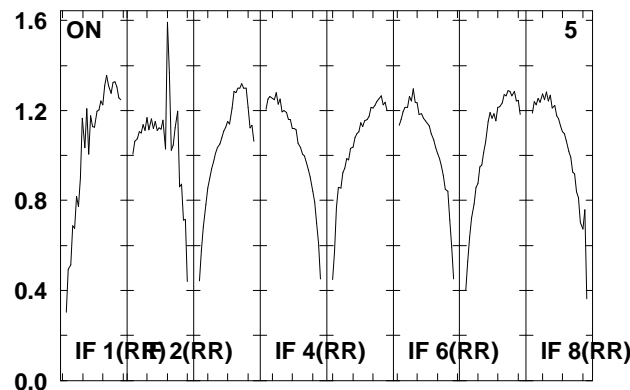
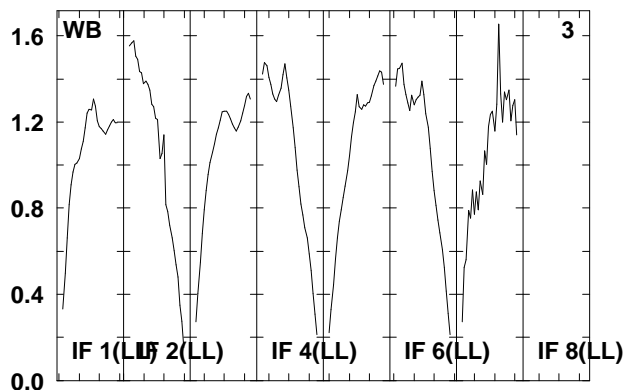
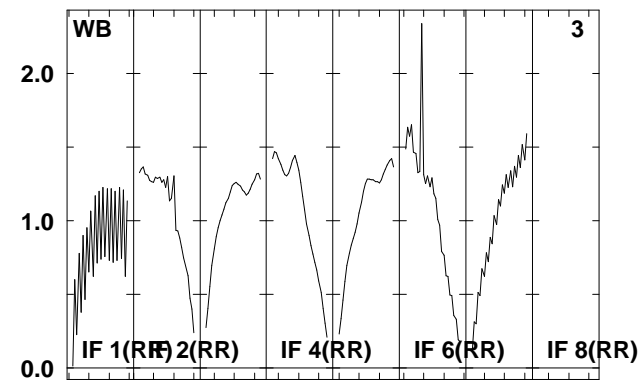
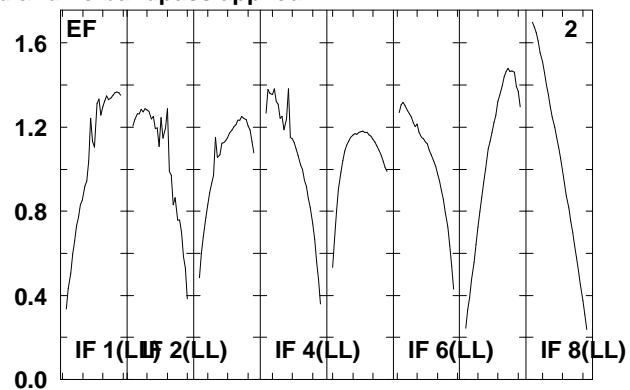
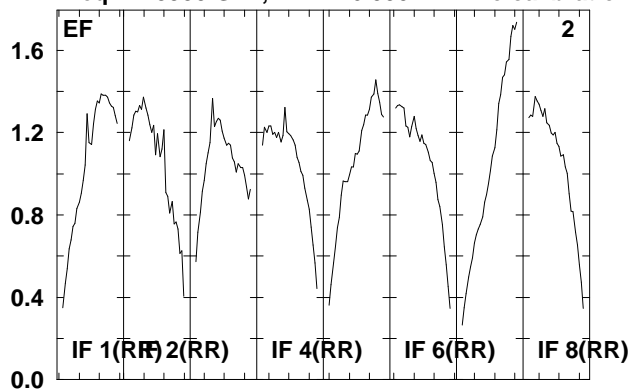

Lower frame: Real Jy
Total-power spectrum Antenna: *
Timerange: 00/18:39:02 to 00/18:46:56

Plot file version 122 created 22-APR-2008 12:26:51

4C39.25 EP061B.UVDATA.1

Freq = 1.5950 GHz, Bw = 16.000 MH No calibration applied and no bandpass applied

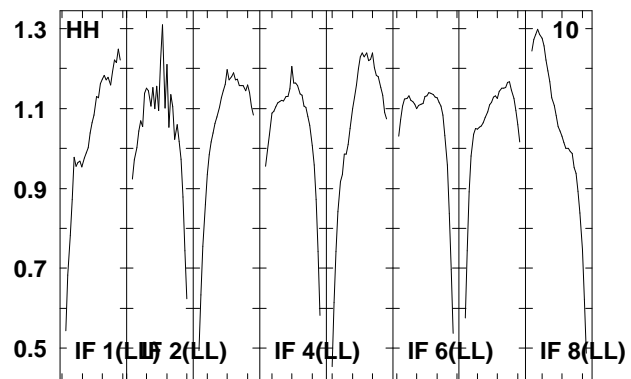
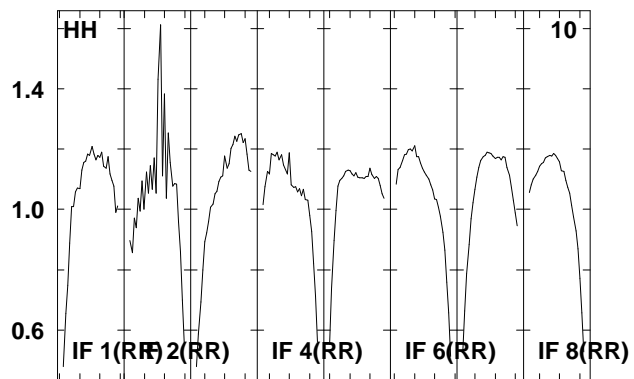
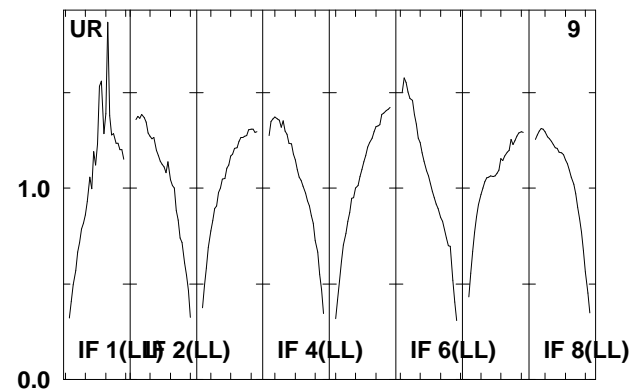
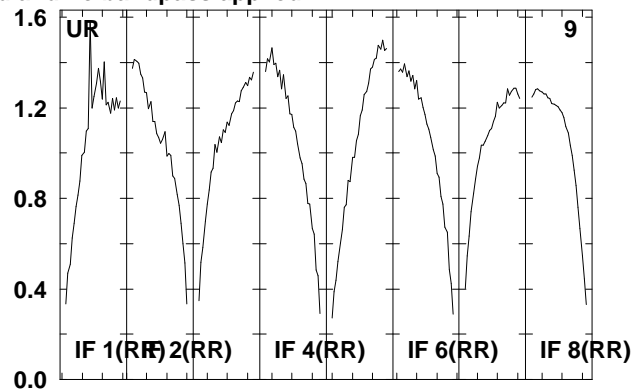
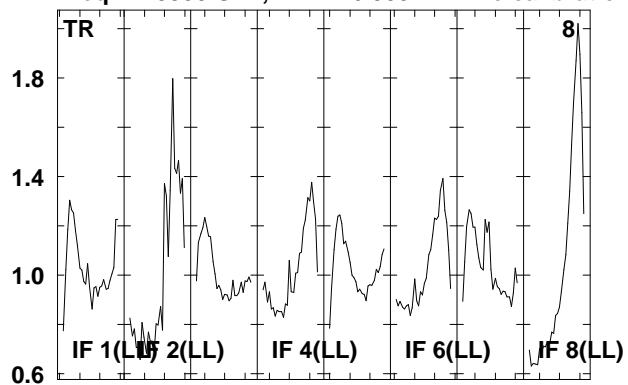

Lower frame: Real Jy
Total-power spectrum Antenna: *
Timerange: 00/18:39:02 to 00/18:46:56

Plot file version 123 created 22-APR-2008 12:26:52

J0730-02 EP061B.UVDATA.1

Freq = 1.5950 GHz, Bw = 16.000 MH No calibration applied and no bandpass applied

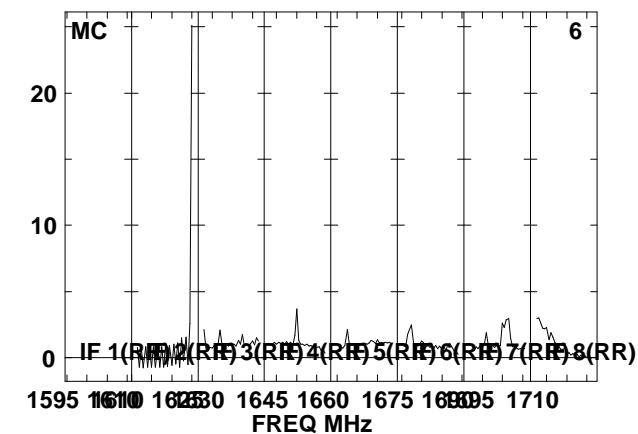
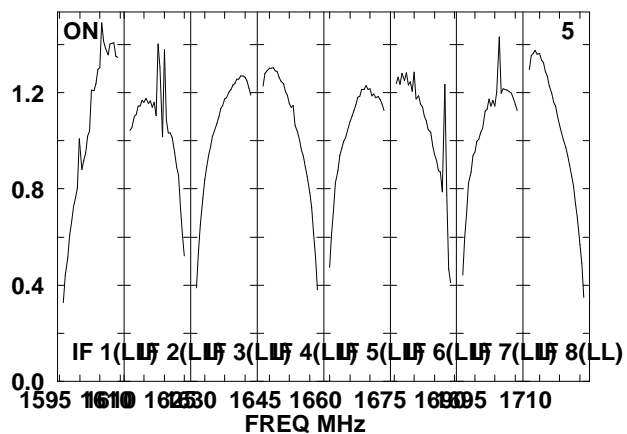
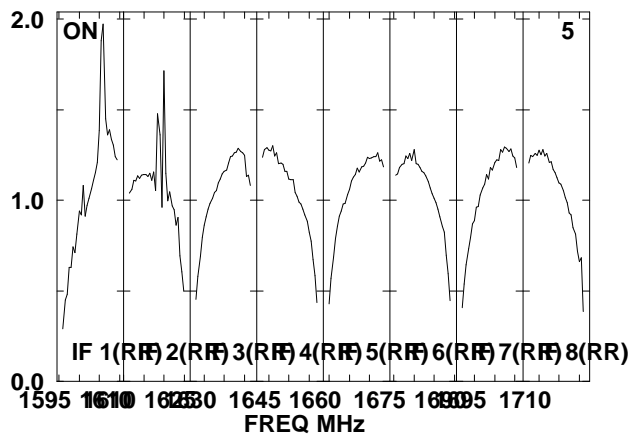
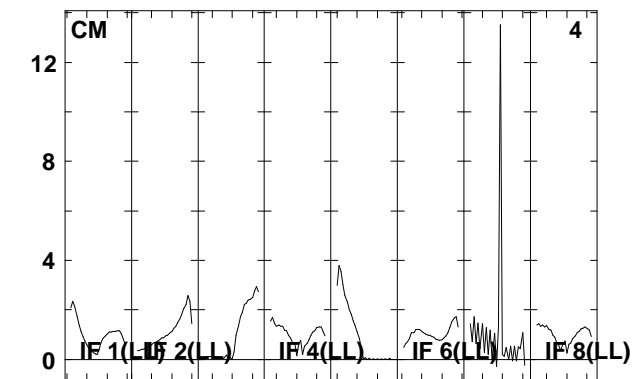
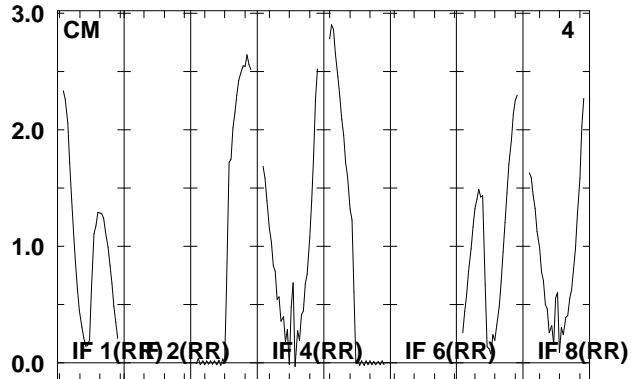
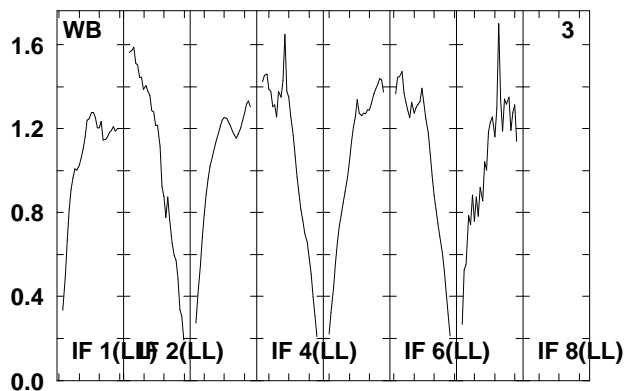
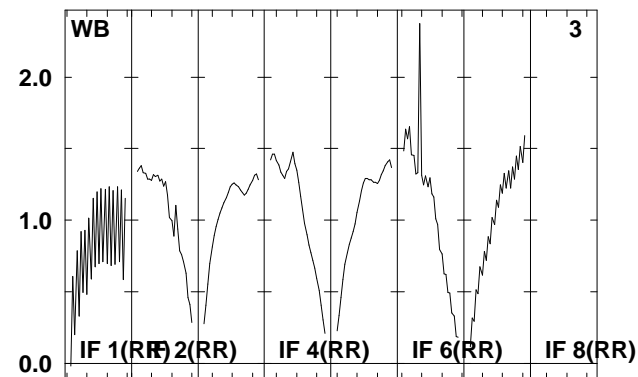
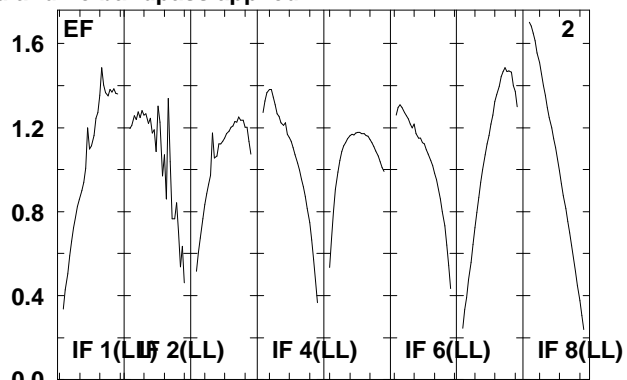
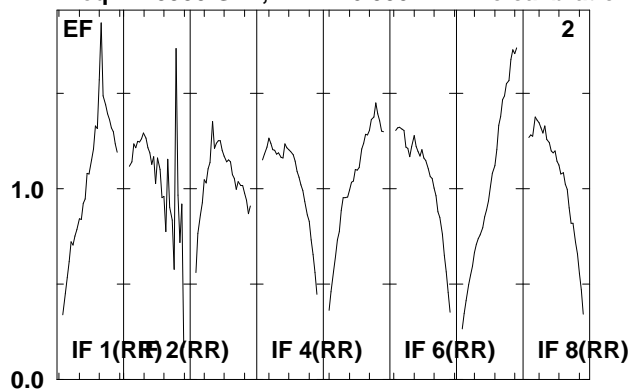

Lower frame: Real Jy

Total-power spectrum Antenna: *

Timerange: 00/18:49:02 to 00/18:53:00

Plot file version 124 created 22-APR-2008 12:26:52

J0730-02 EP061B.UVDATA.1

Freq = 1.5950 GHz, Bw = 16.000 MH No calibration applied and no bandpass applied

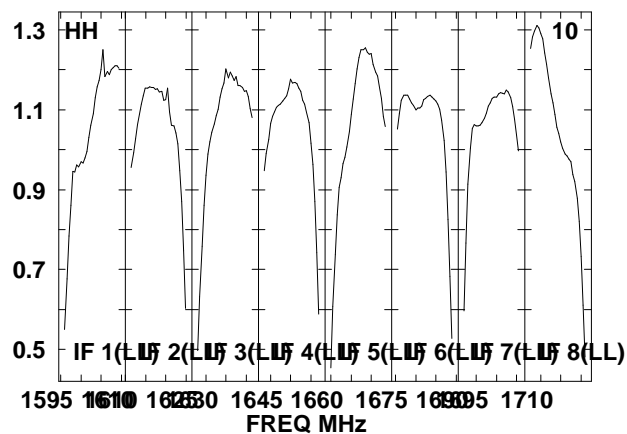
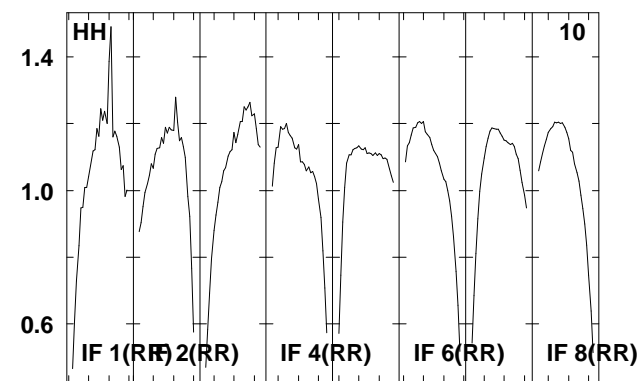
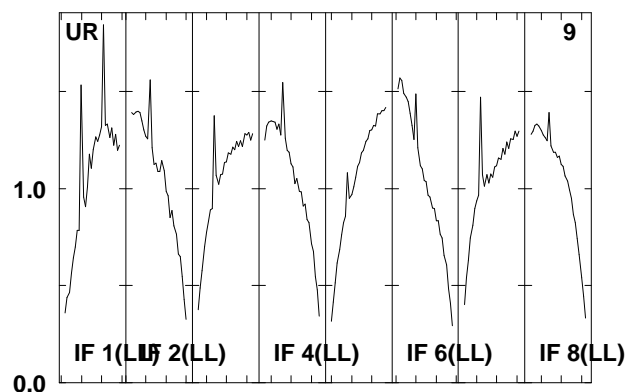
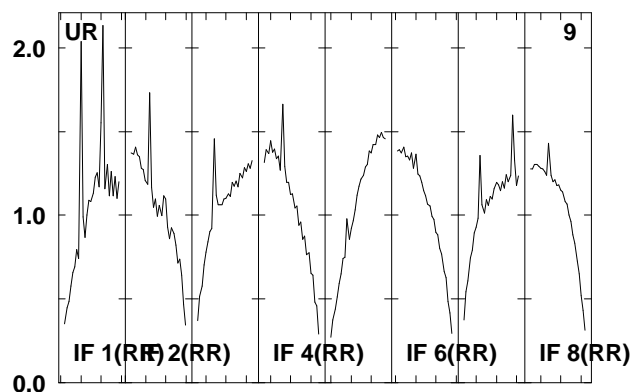
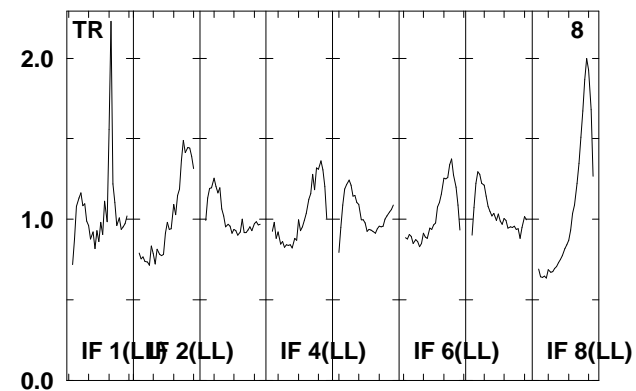
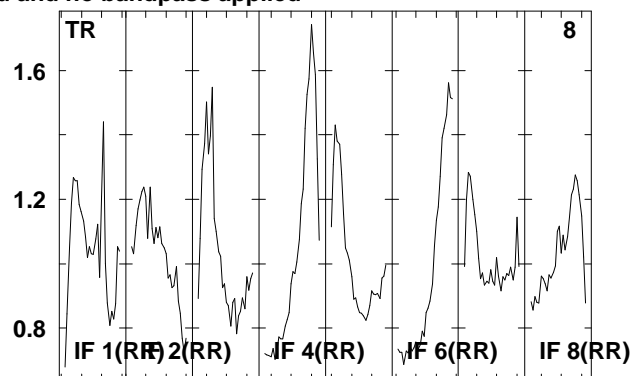
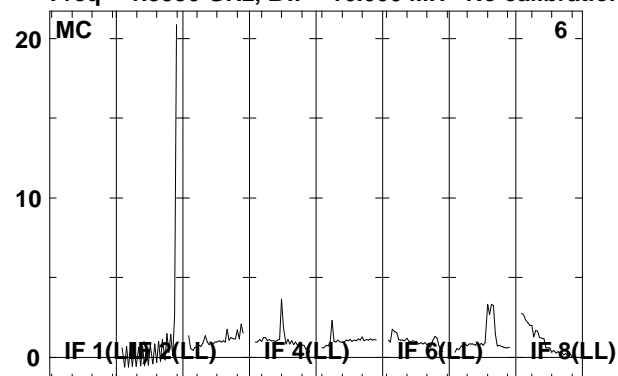

Lower frame: Real Jy

Total-power spectrum Antenna: *

Timerange: 00/18:49:02 to 00/18:53:00

Plot file version 125 created 22-APR-2008 12:26:53

IRAS0725 EP061B.UVDATA.1

Freq = 1.5950 GHz, Bw = 16.000 MH No calibration applied and no bandpass applied

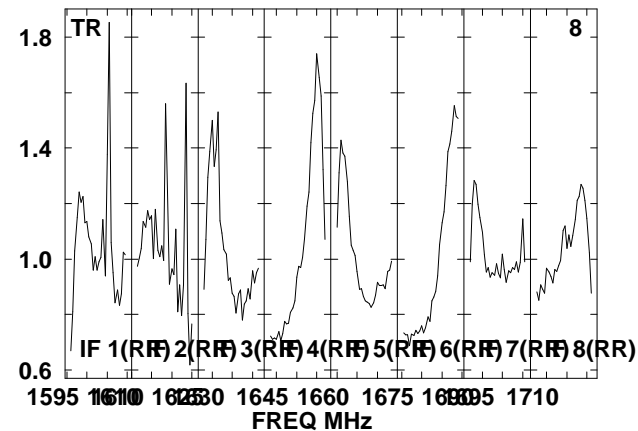
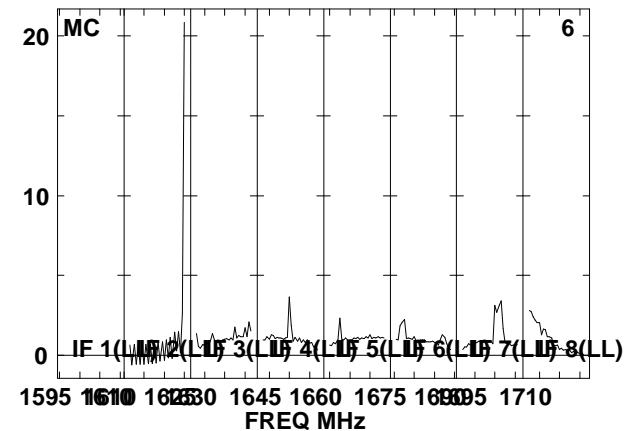
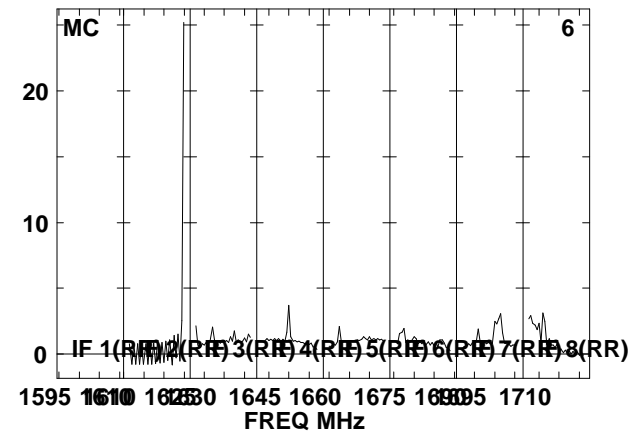
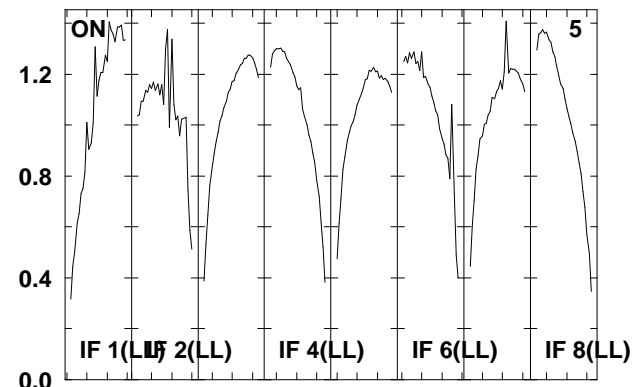
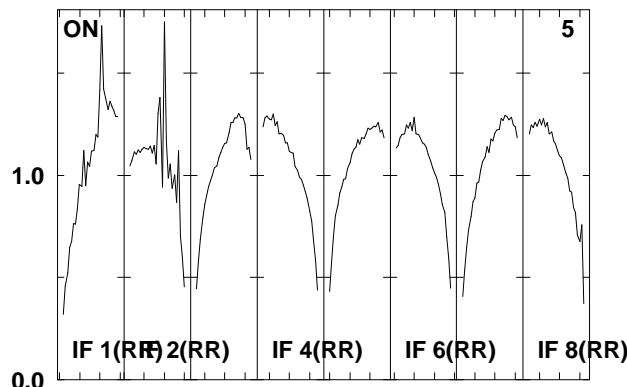
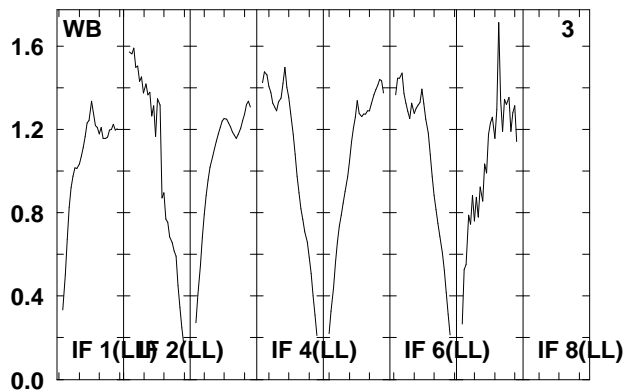
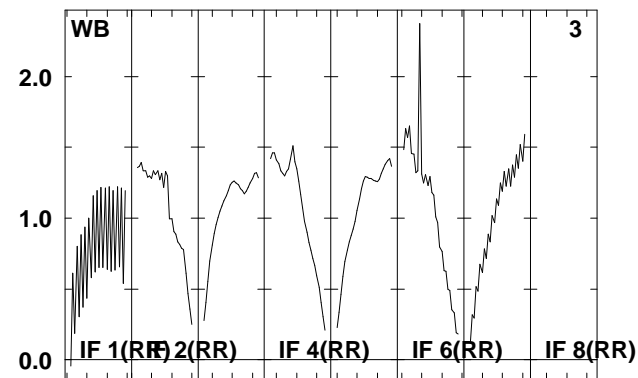
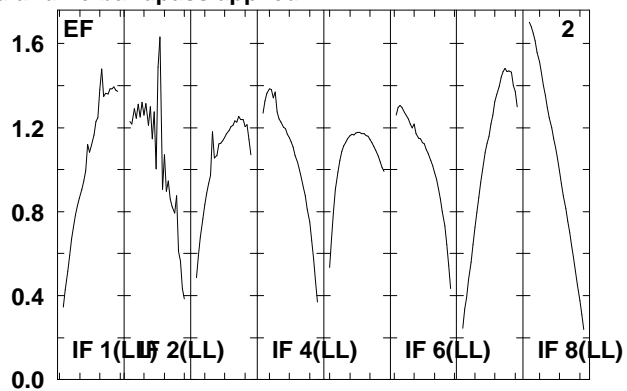
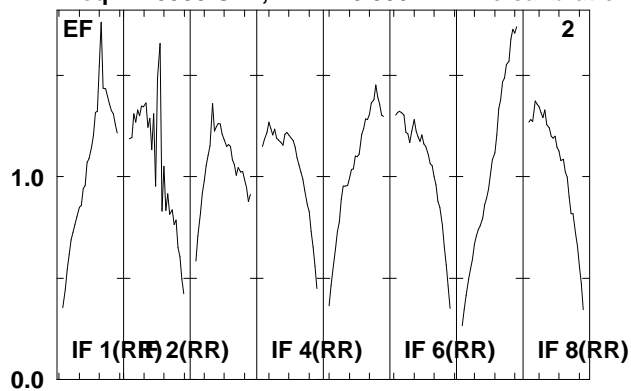

Lower frame: Real Jy
Total-power spectrum Antenna: *
Timerange: 00/18:53:02 to 00/18:56:30

Plot file version 126 created 22-APR-2008 12:26:54

IRAS0725 EP061B.UVDATA.1

Freq = 1.5950 GHz, Bw = 16.000 MH No calibration applied and no bandpass applied

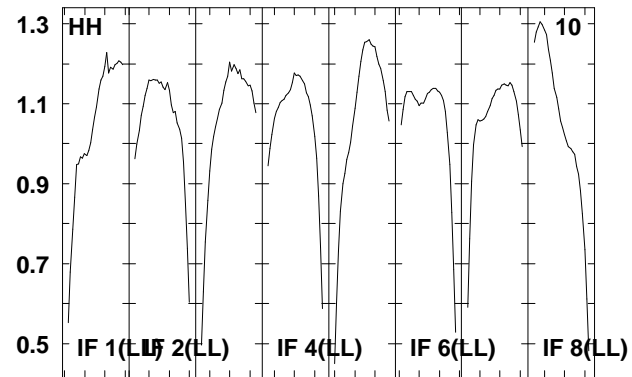
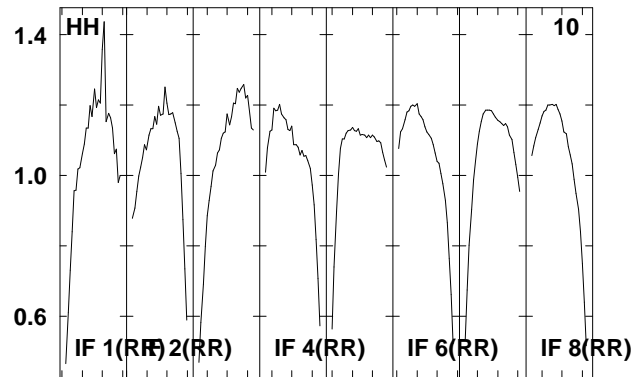
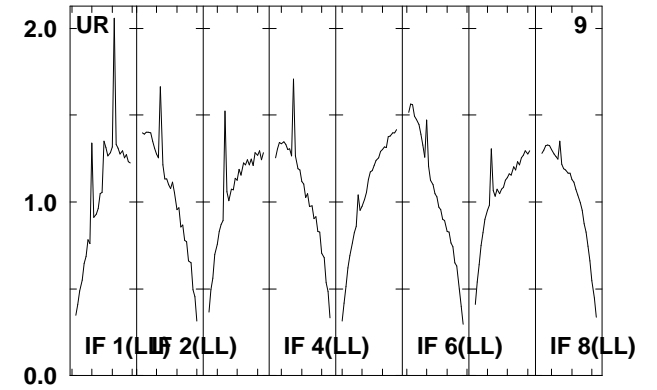
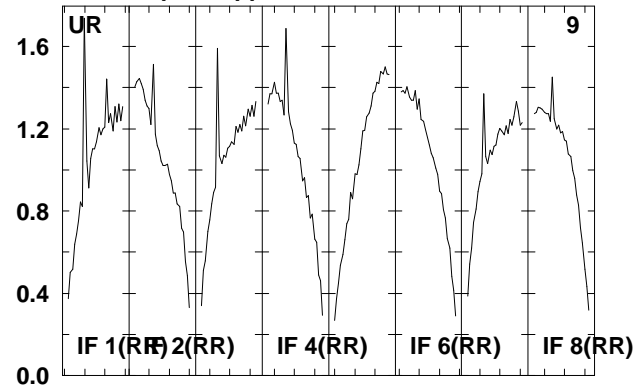
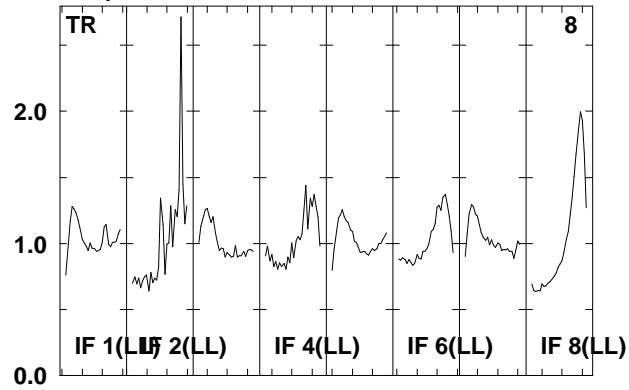

Lower frame: Real Jy
Total-power spectrum Antenna: *
Timerange: 00/18:53:02 to 00/18:56:30

Plot file version 127 created 22-APR-2008 12:26:54

J0730-02 EP061B.UVDATA.1

Freq = 1.5950 GHz, Bw = 16.000 MH No calibration applied and no bandpass applied

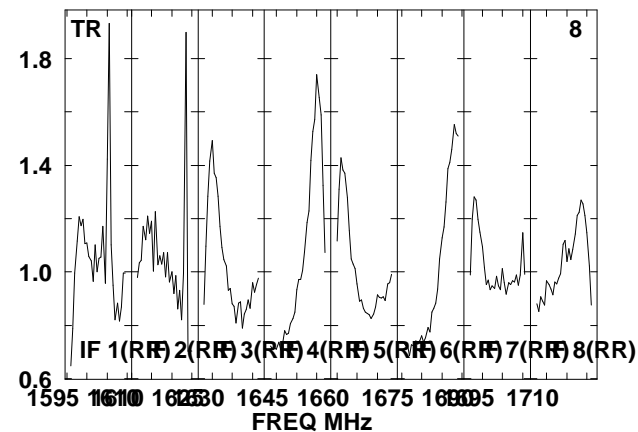
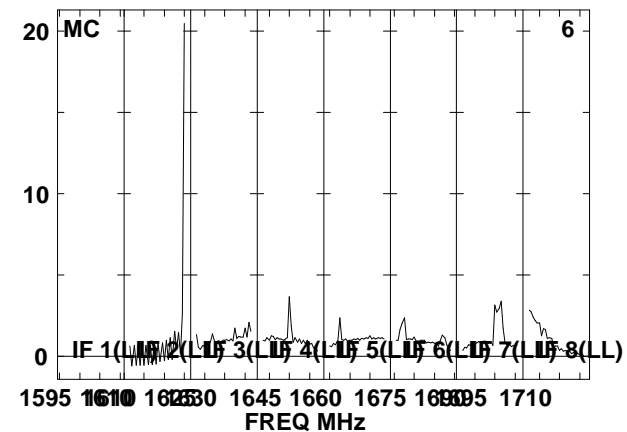
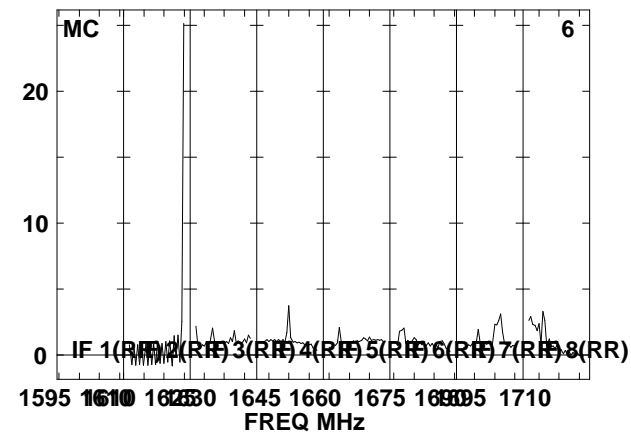
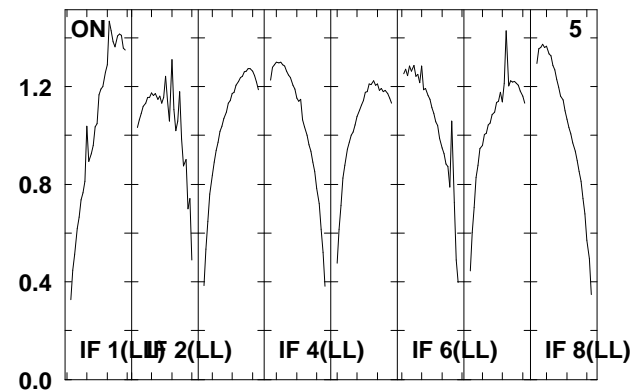
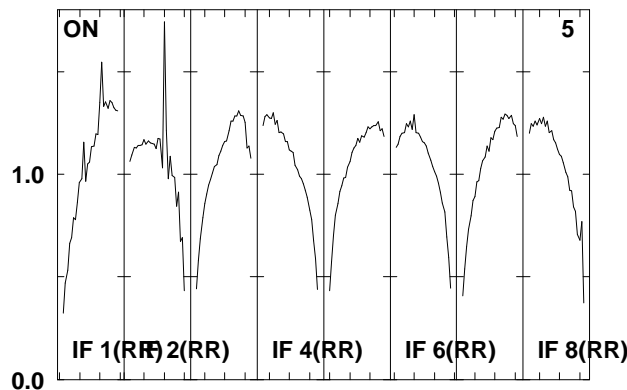
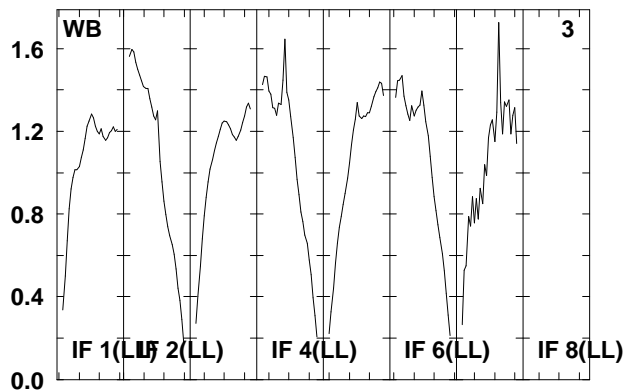
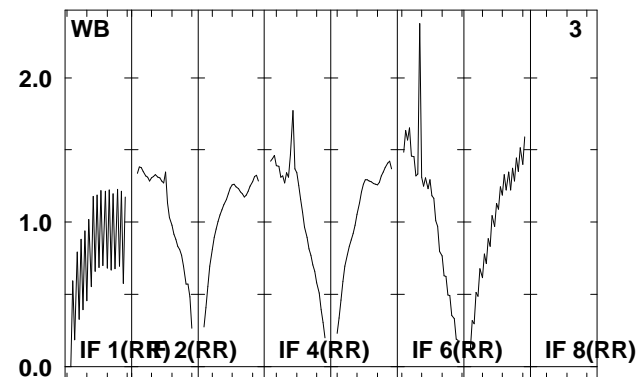
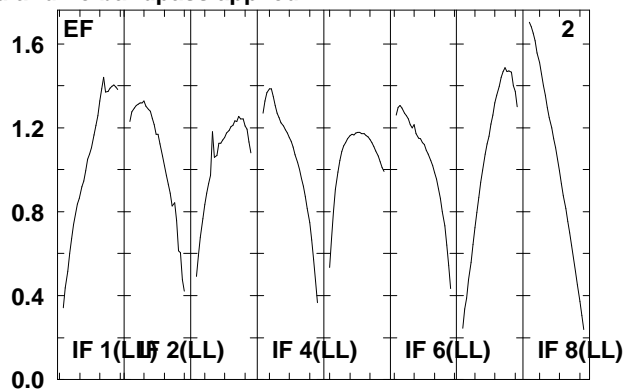
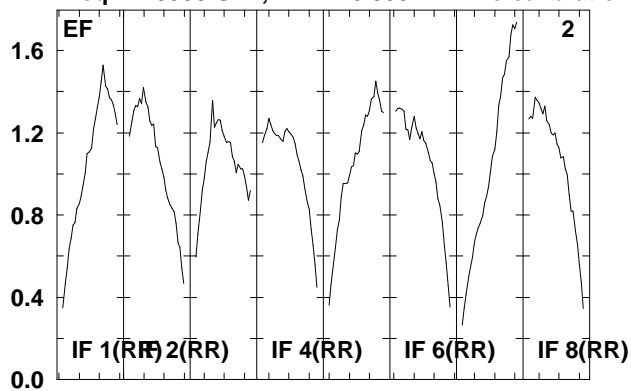

Lower frame: Real Jy
Total-power spectrum Antenna: *
Timerange: 00/18:56:32 to 00/18:58:00

Plot file version 128 created 22-APR-2008 12:26:55

J0730-02 EP061B.UVDATA.1

Freq = 1.5950 GHz, Bw = 16.000 MH No calibration applied and no bandpass applied

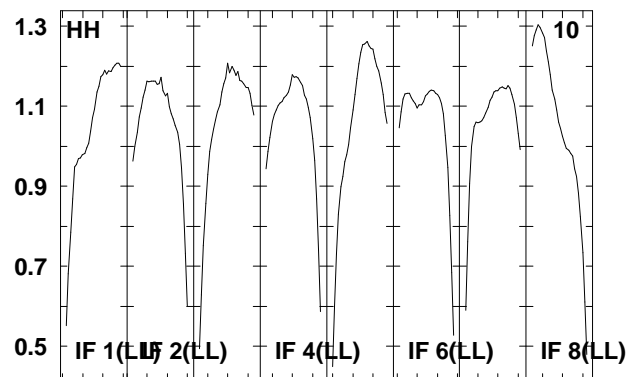
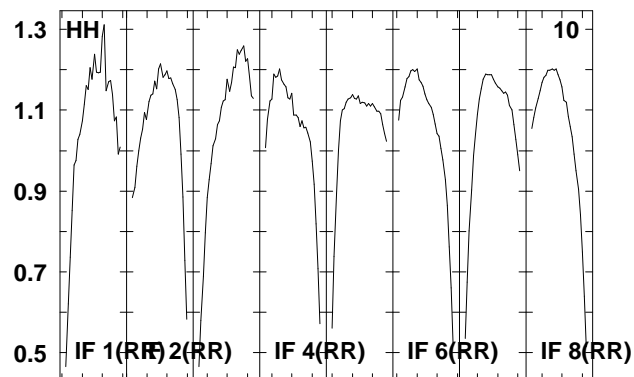
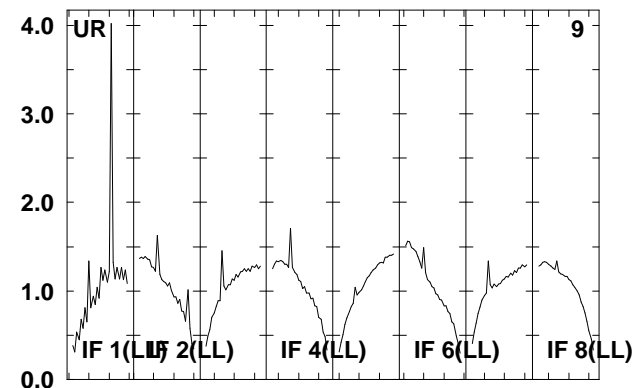
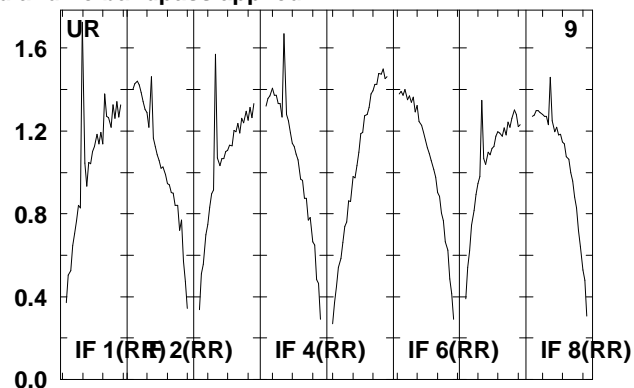
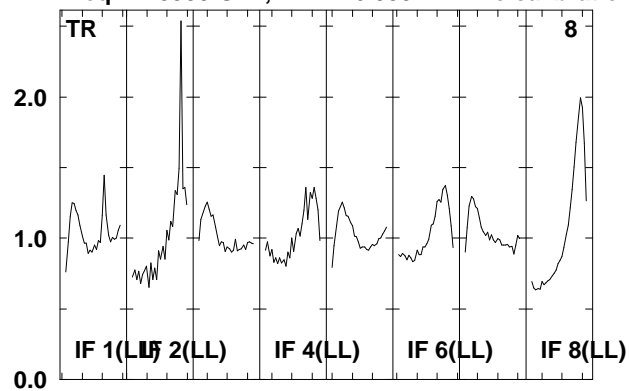

Lower frame: Real Jy
Total-power spectrum Antenna: *
Timerange: 00/18:56:32 to 00/18:58:00

Plot file version 129 created 22-APR-2008 12:26:55

IRAS0725 EP061B.UVDATA.1

Freq = 1.5950 GHz, Bw = 16.000 MH No calibration applied and no bandpass applied

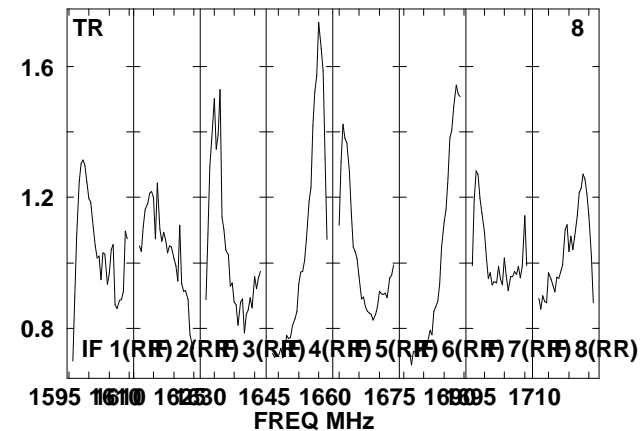
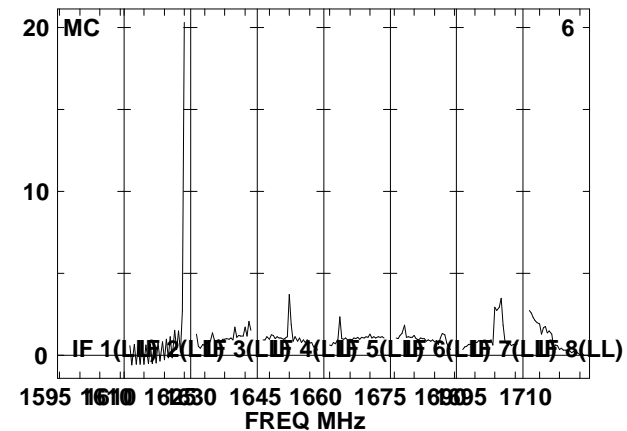
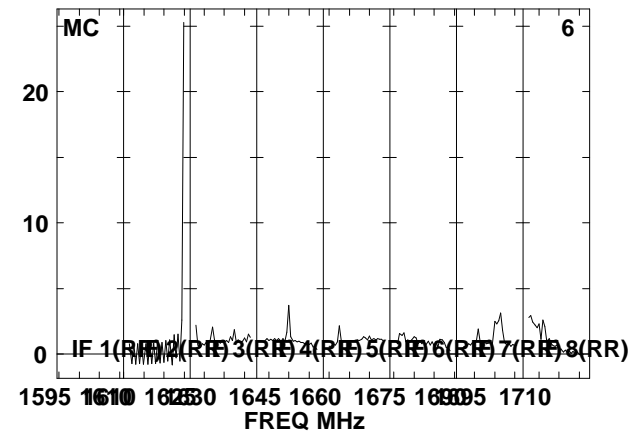
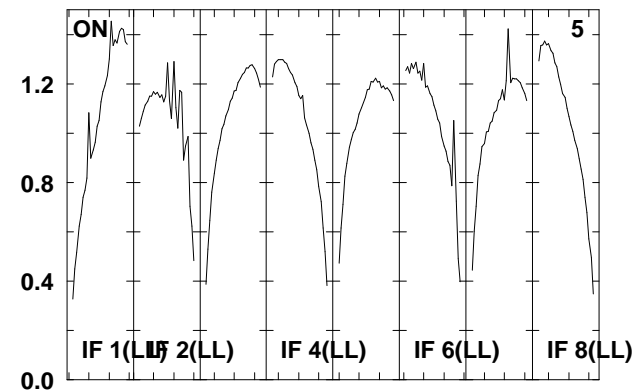
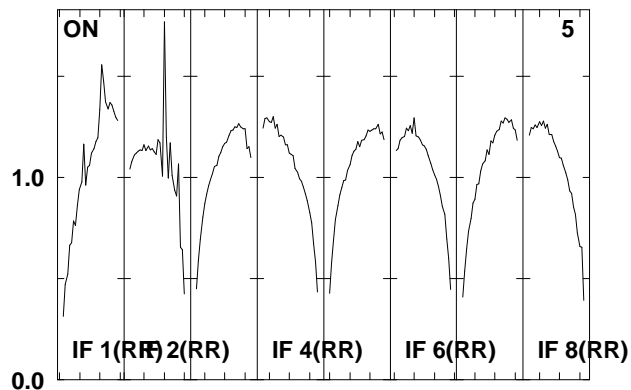
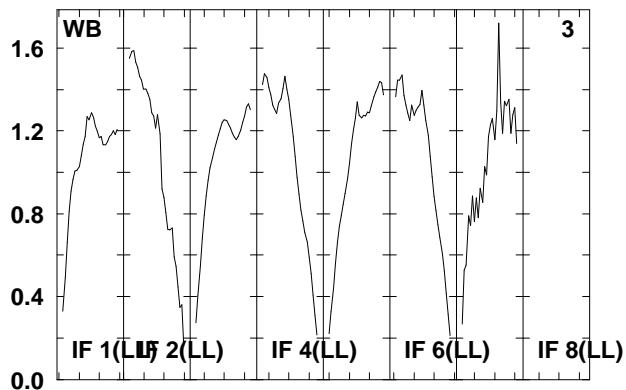
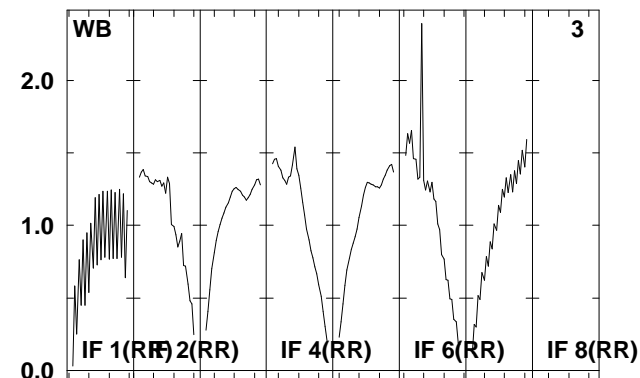
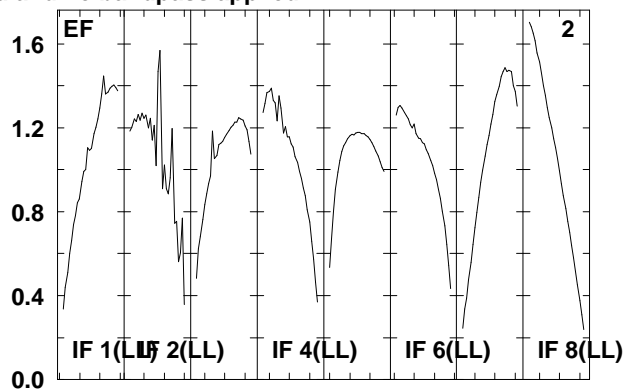
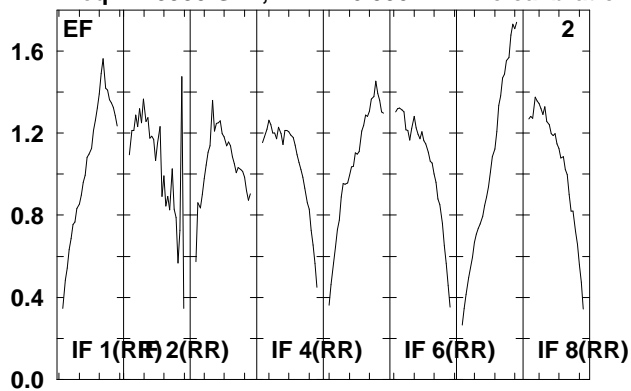

Lower frame: Real Jy

Total-power spectrum Antenna: *

Timerange: 00/18:58:02 to 00/19:01:30

Plot file version 130 created 22-APR-2008 12:26:56

IRAS0725 EP061B.UVDATA.1

Freq = 1.5950 GHz, Bw = 16.000 MH No calibration applied and no bandpass applied

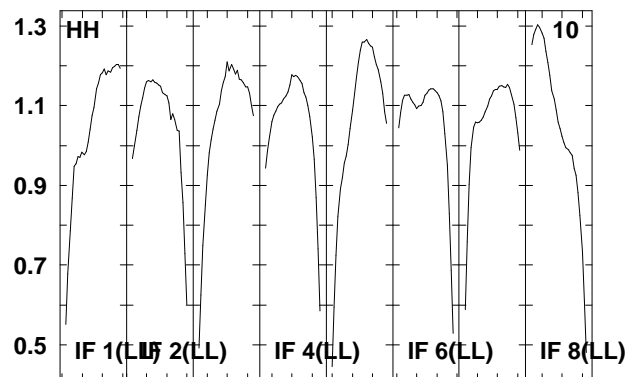
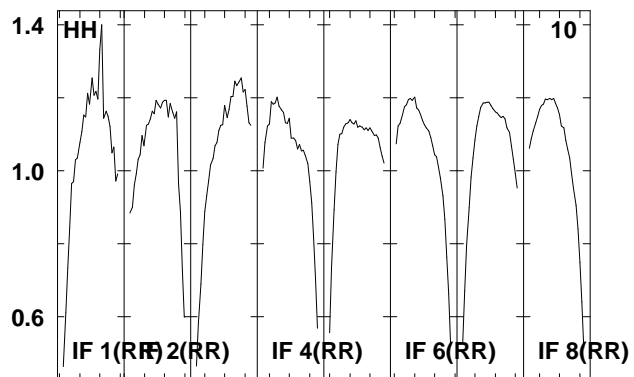
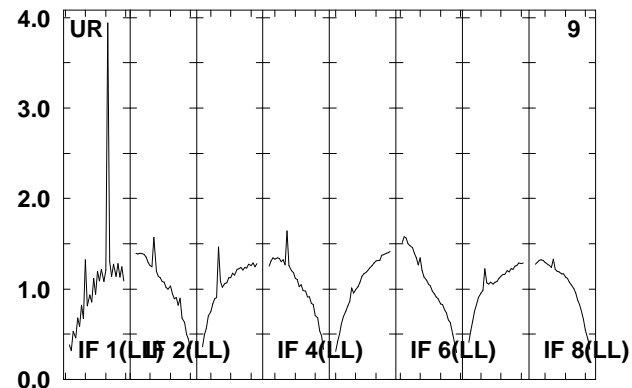
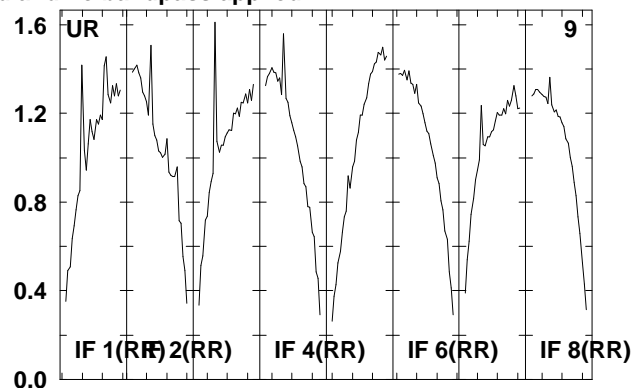
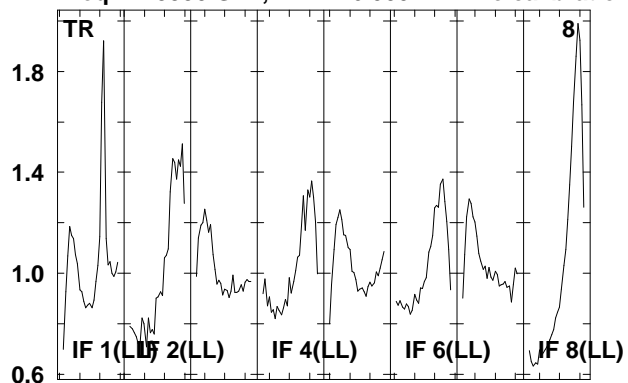

Lower frame: Real Jy
Total-power spectrum Antenna: *
Timerange: 00/18:58:02 to 00/19:01:30

Plot file version 131 created 22-APR-2008 12:26:57

J0730-02 EP061B.UVDATA.1

Freq = 1.5950 GHz, Bw = 16.000 MH No calibration applied and no bandpass applied

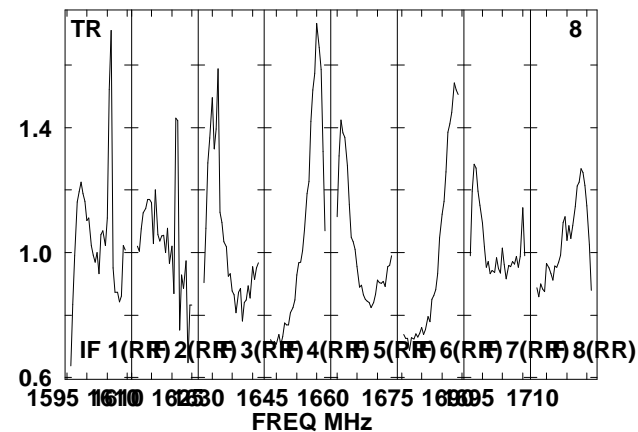
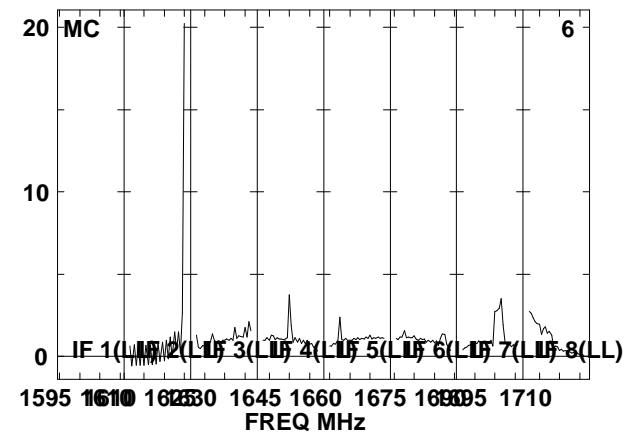
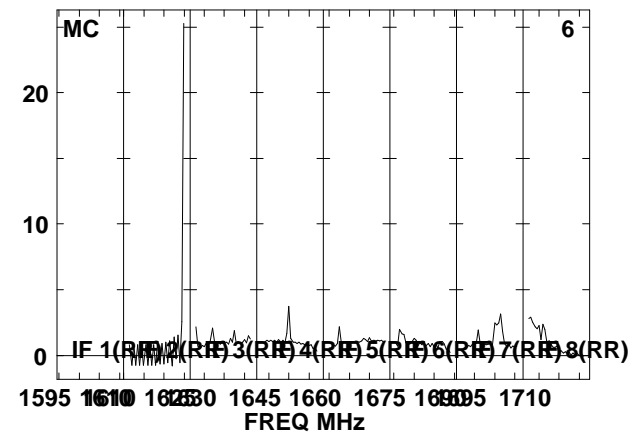
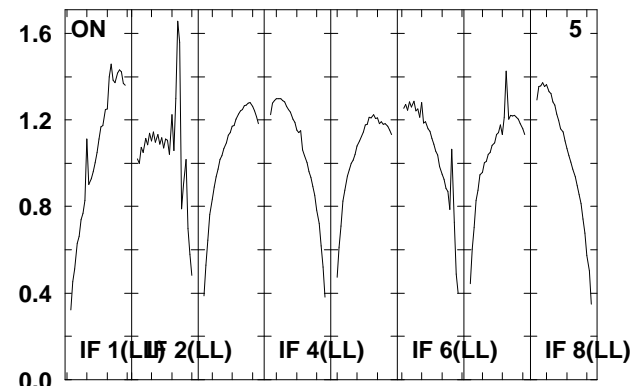
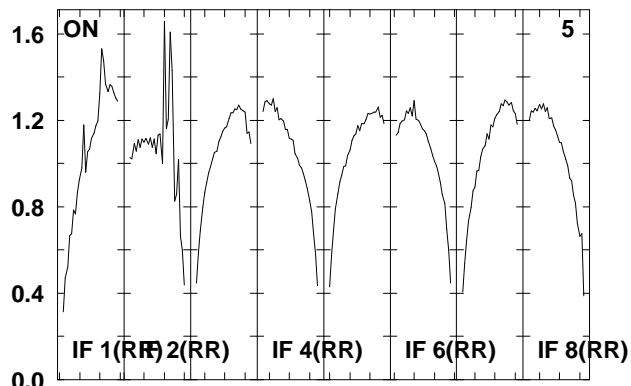
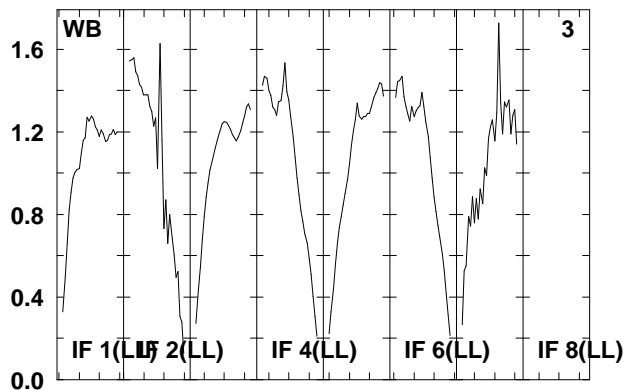
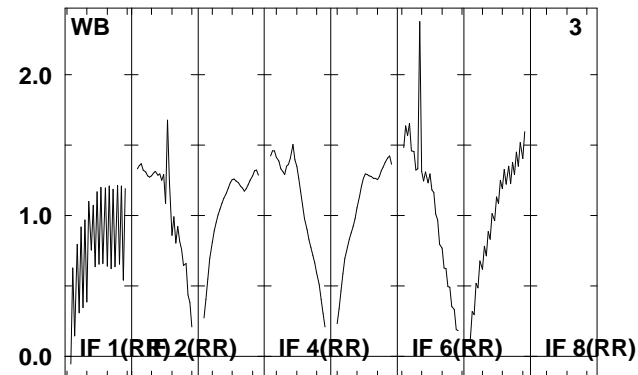
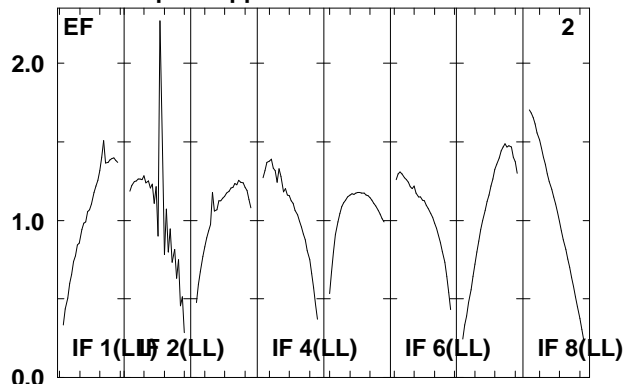
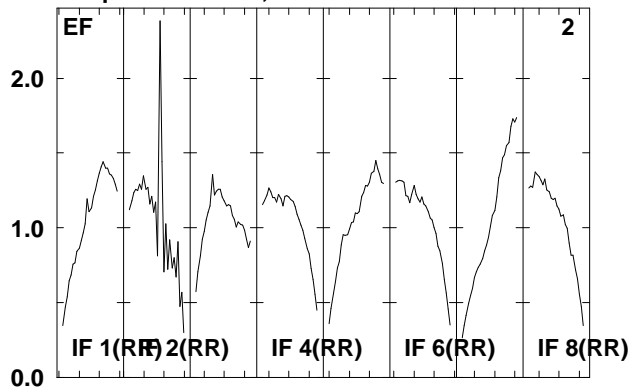

Lower frame: Real Jy

Total-power spectrum Antenna: *

Timerange: 00/19:01:32 to 00/19:03:00

Plot file version 132 created 22-APR-2008 12:26:57

J0730-02 EP061B.UVDATA.1

Freq = 1.5950 GHz, Bw = 16.000 MH No calibration applied and no bandpass applied

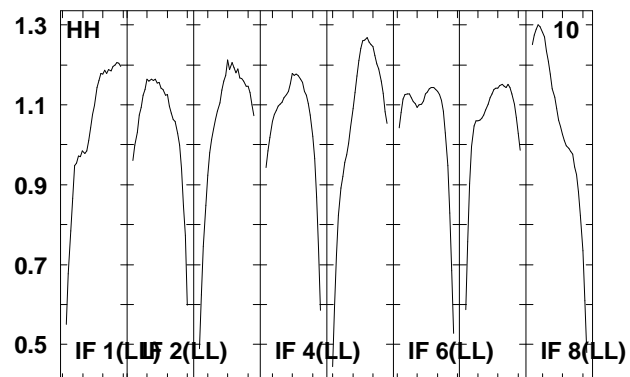
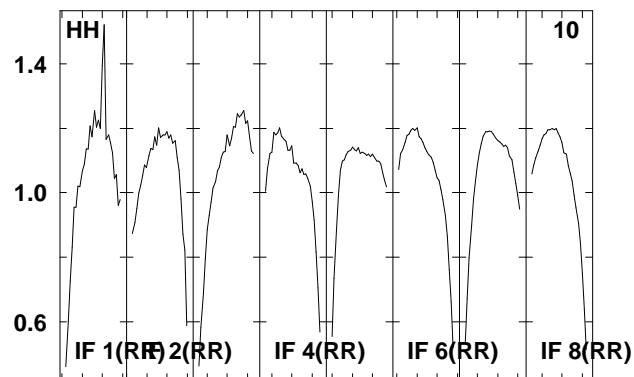
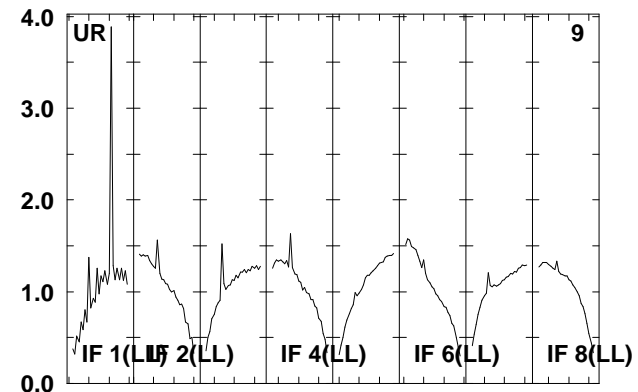
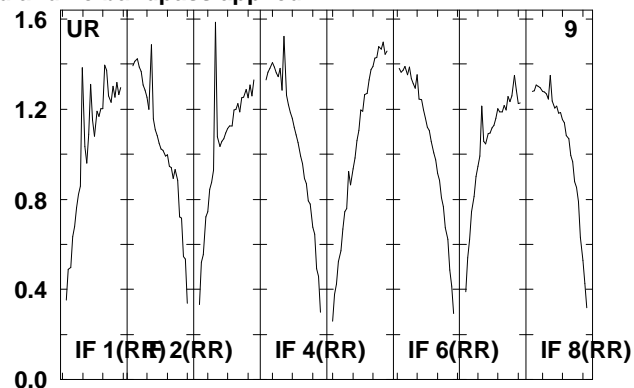
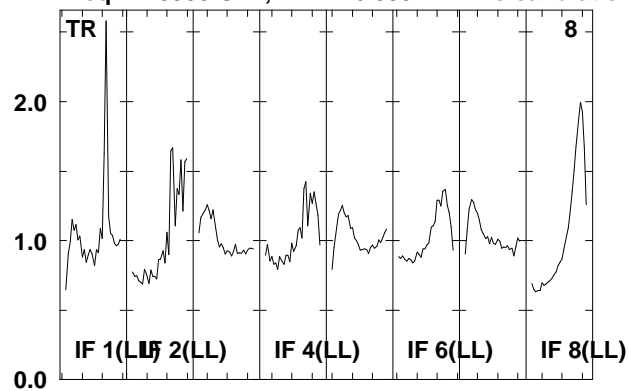

Lower frame: Real Jy
Total-power spectrum Antenna: *
Timerange: 00/19:01:32 to 00/19:03:00

Plot file version 133 created 22-APR-2008 12:26:58

IRAS0725 EP061B.UVDATA.1

Freq = 1.5950 GHz, Bw = 16.000 MH No calibration applied and no bandpass applied

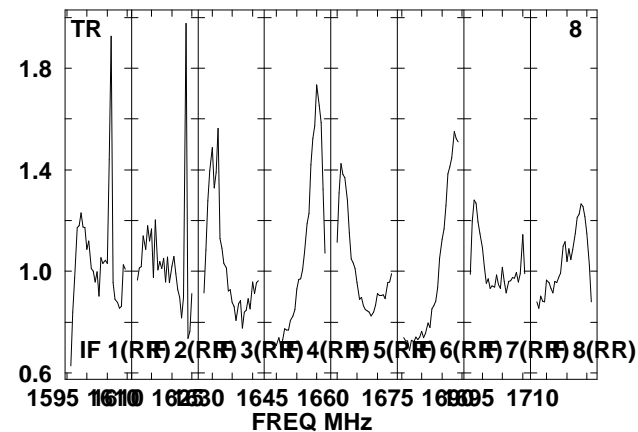
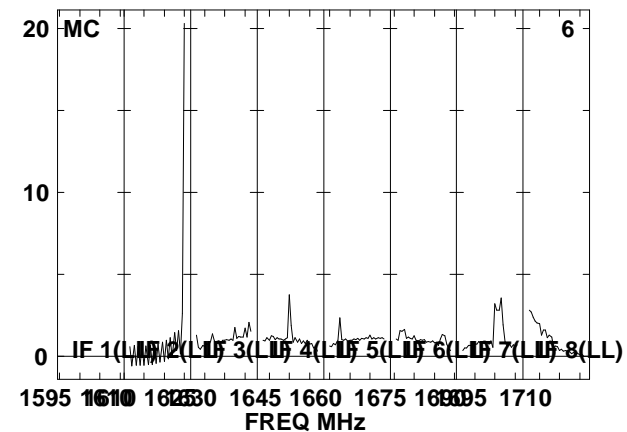
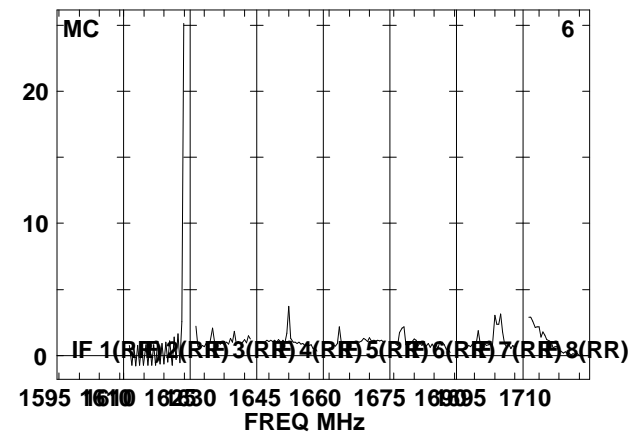
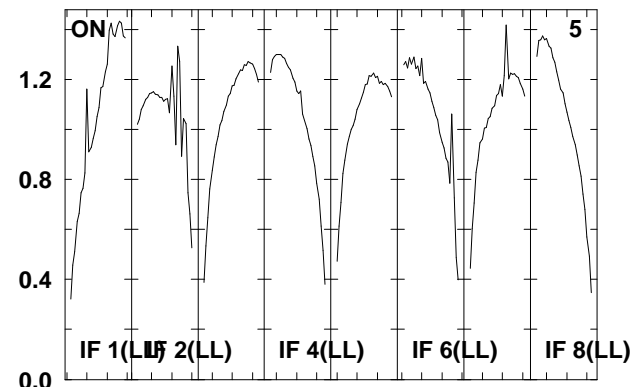
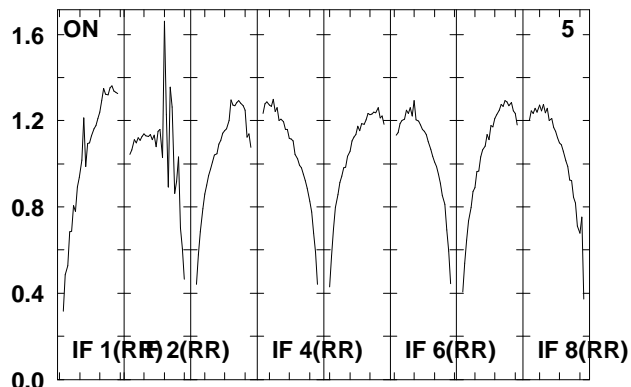
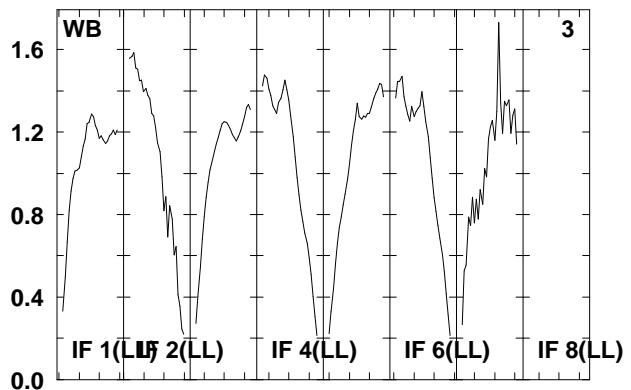
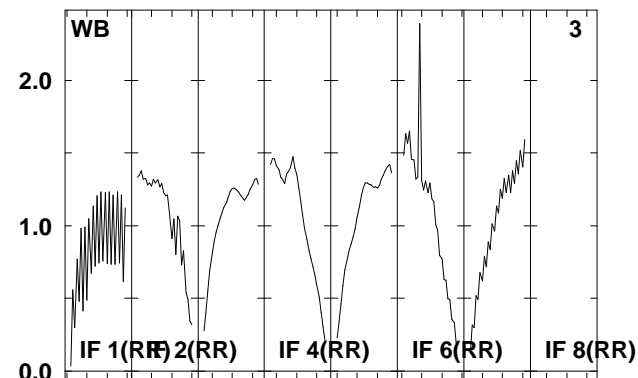
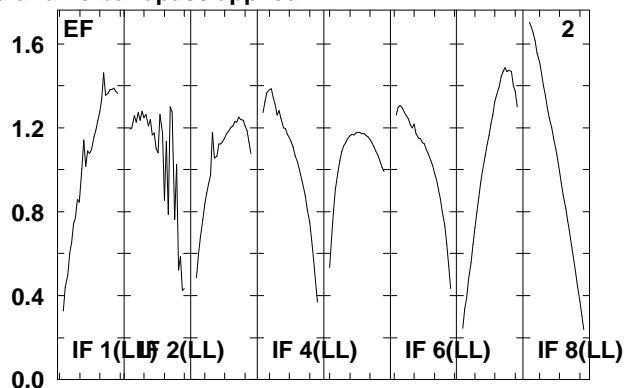
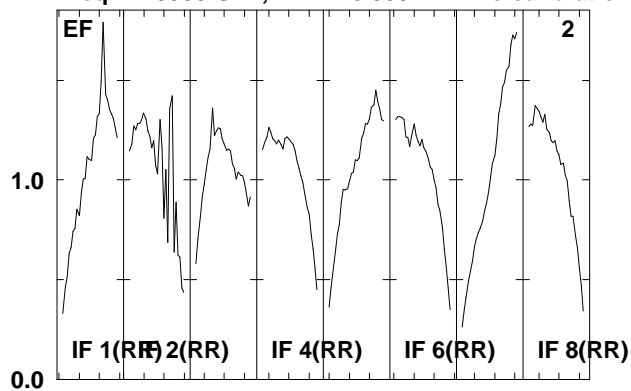

Lower frame: Real Jy

Total-power spectrum Antenna: *

Timerange: 00/19:03:02 to 00/19:06:28

Plot file version 134 created 22-APR-2008 12:26:59

IRAS0725 EP061B.UVDATA.1

Freq = 1.5950 GHz, Bw = 16.000 MH No calibration applied and no bandpass applied

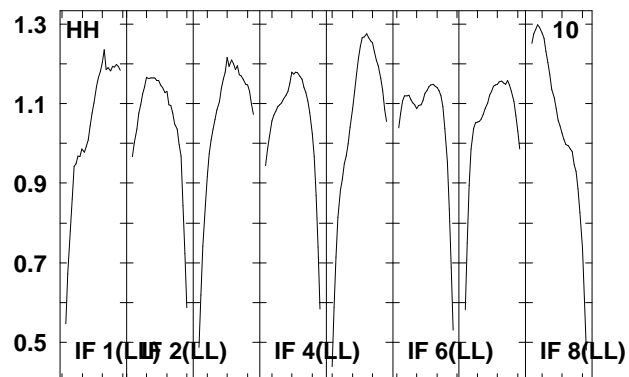
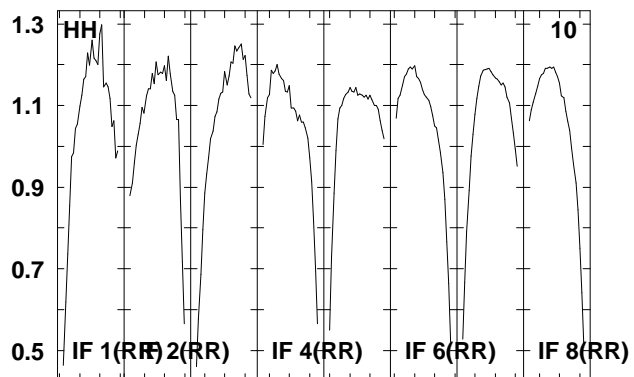
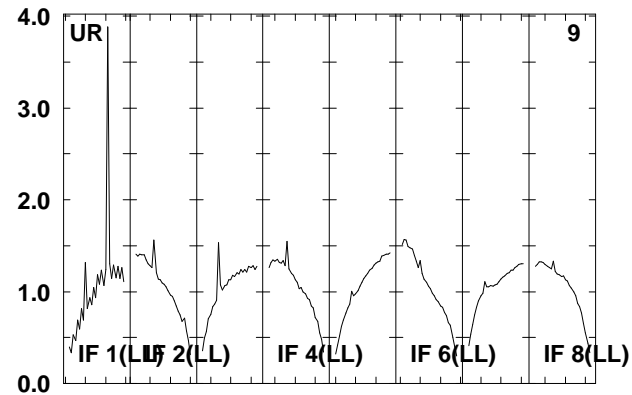
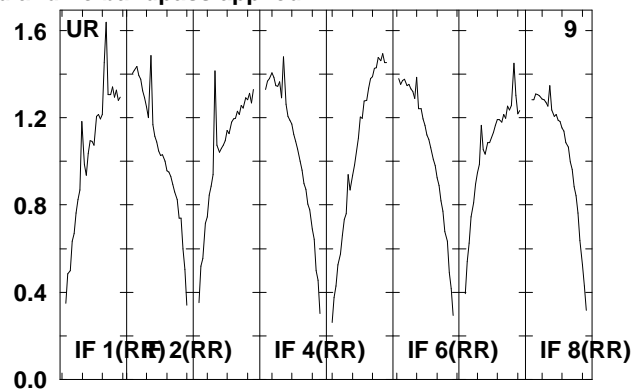
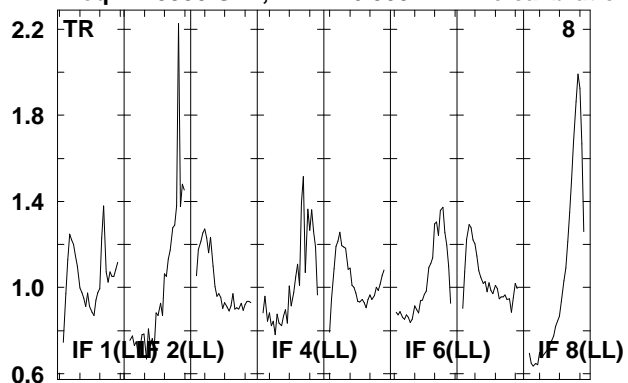

Lower frame: Real Jy
Total-power spectrum Antenna: *
Timerange: 00/19:03:02 to 00/19:06:28

Plot file version 135 created 22-APR-2008 12:26:59

J0730-02 EP061B.UVDATA.1

Freq = 1.5950 GHz, Bw = 16.000 MH No calibration applied and no bandpass applied

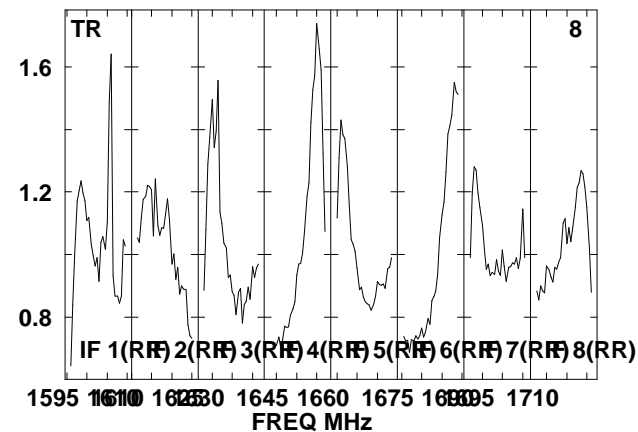
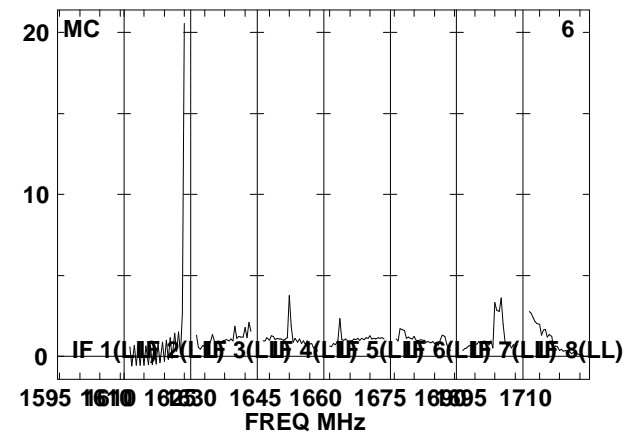
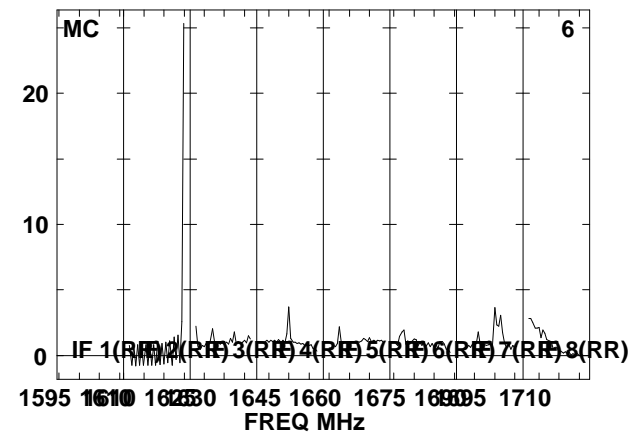
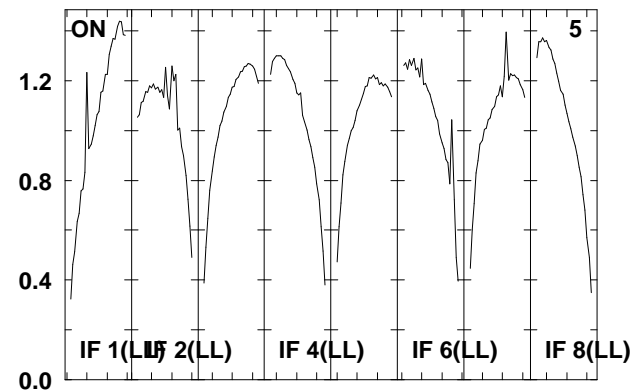
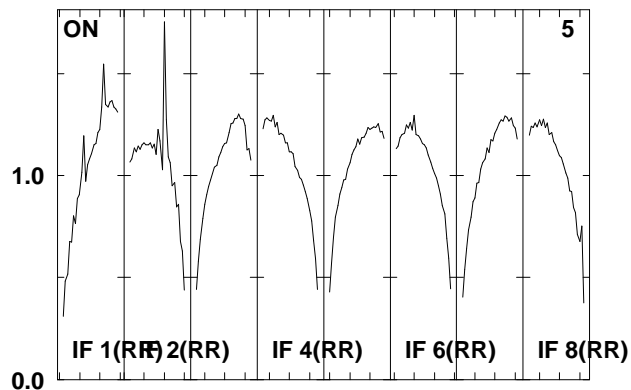
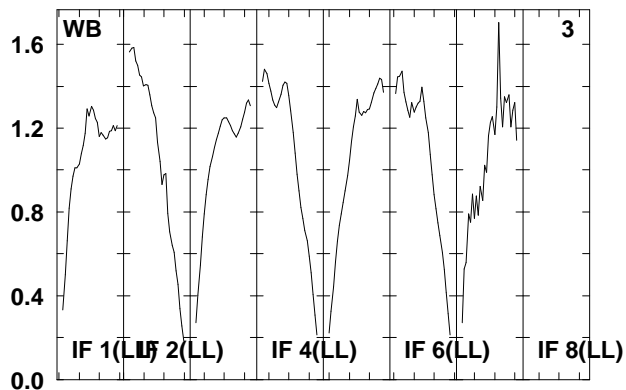
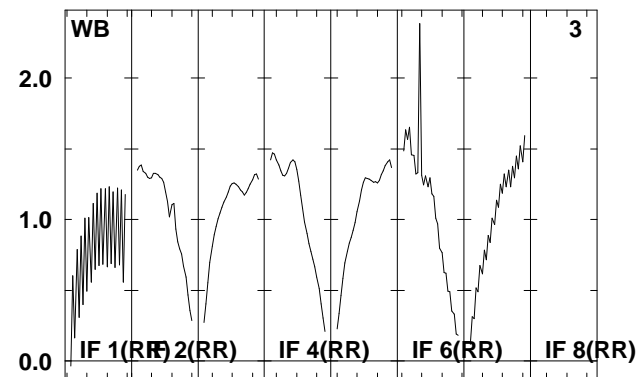
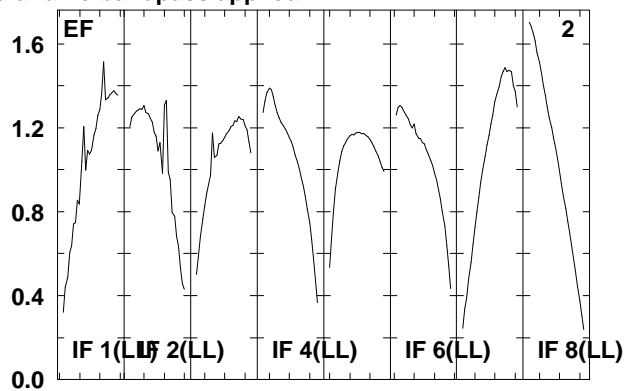
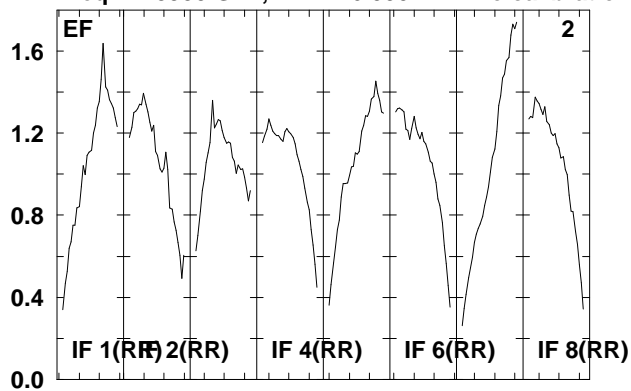

Lower frame: Real Jy

Total-power spectrum Antenna: *

Timerange: 00/19:07:32 to 00/19:09:00

Plot file version 136 created 22-APR-2008 12:27:00

J0730-02 EP061B.UVDATA.1

Freq = 1.5950 GHz, Bw = 16.000 MH No calibration applied and no bandpass applied

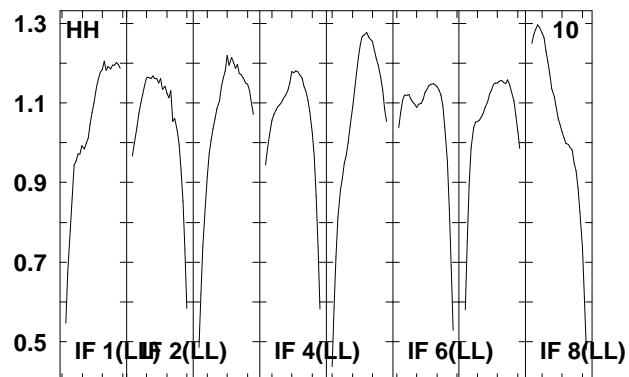
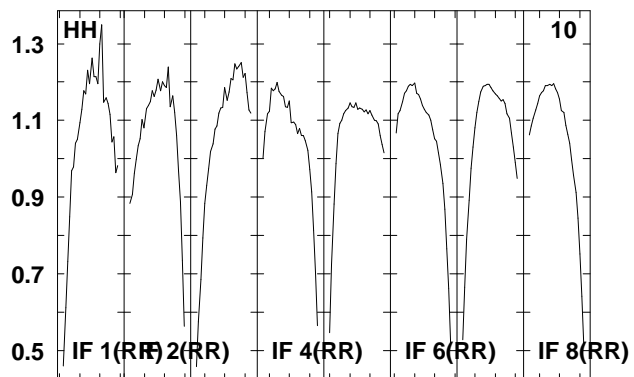
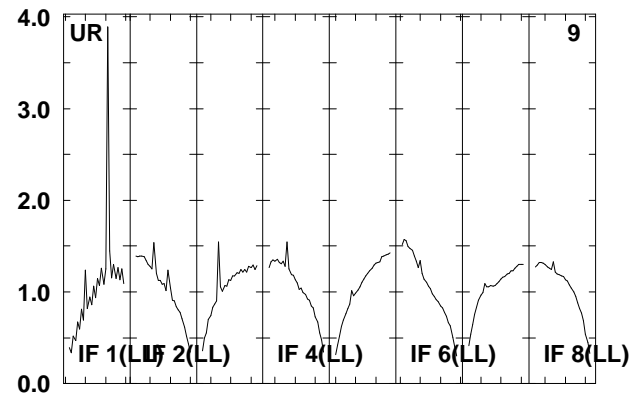
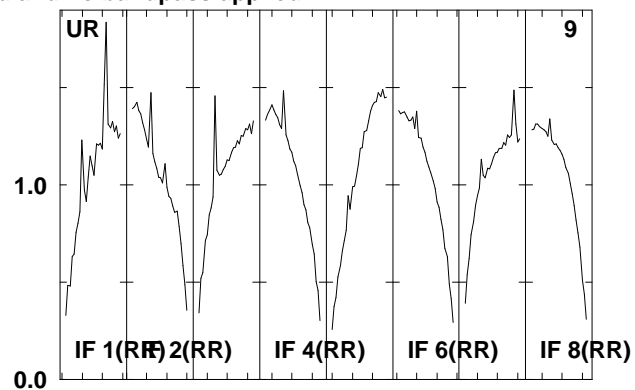
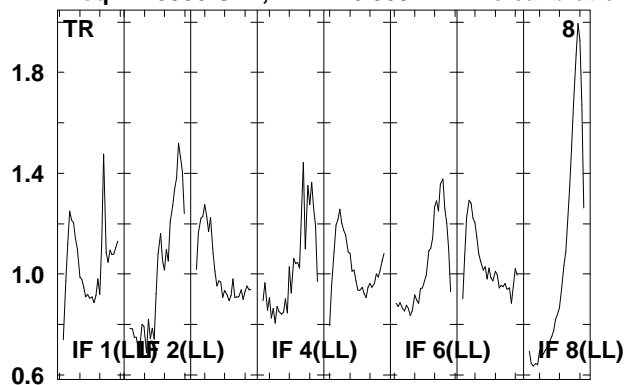

Lower frame: Real Jy
Total-power spectrum Antenna: *
Timerange: 00/19:07:32 to 00/19:09:00

Plot file version 137 created 22-APR-2008 12:27:01

IRAS0725 EP061B.UVDATA.1

Freq = 1.5950 GHz, Bw = 16.000 MH No calibration applied and no bandpass applied

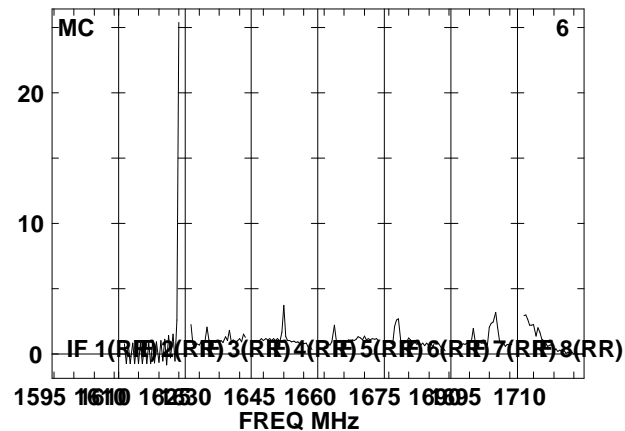
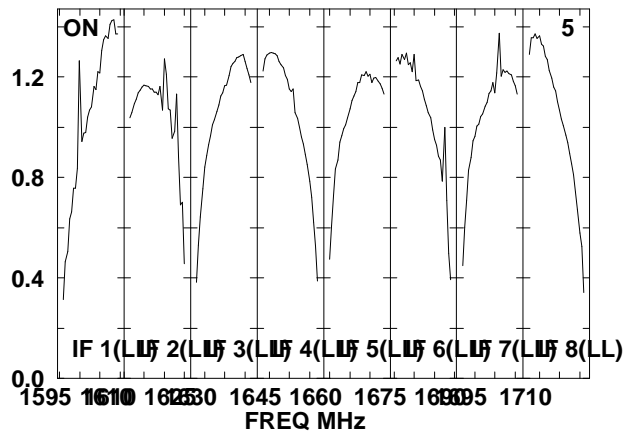
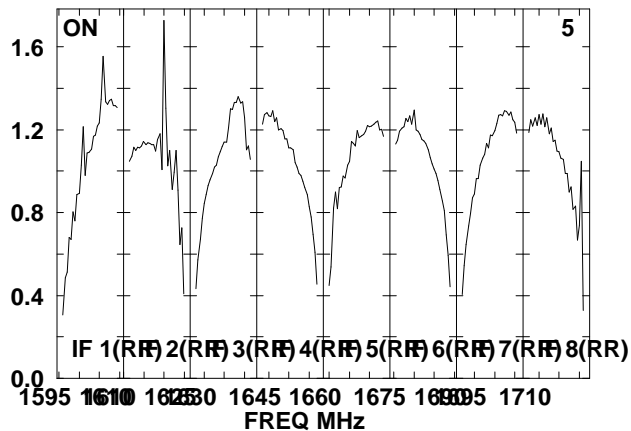
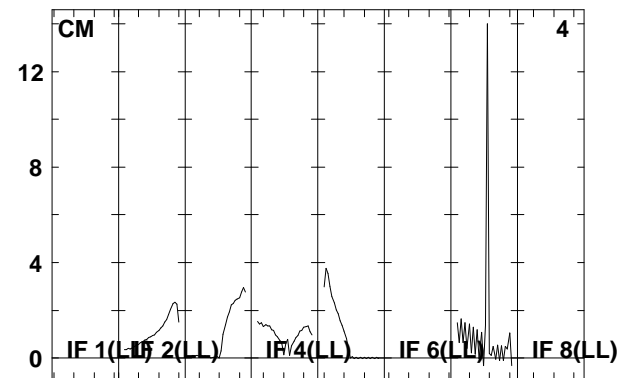
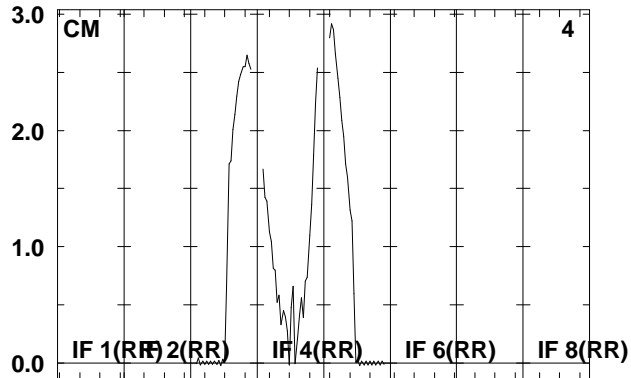
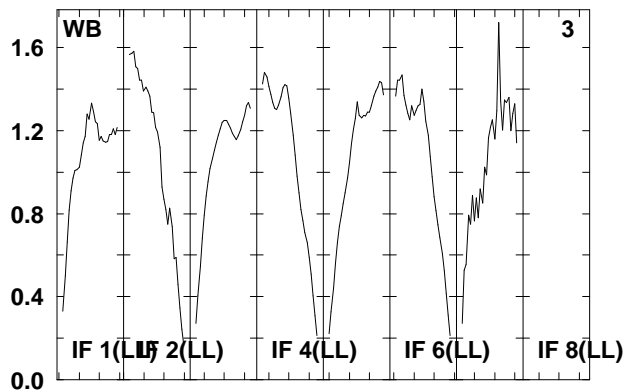
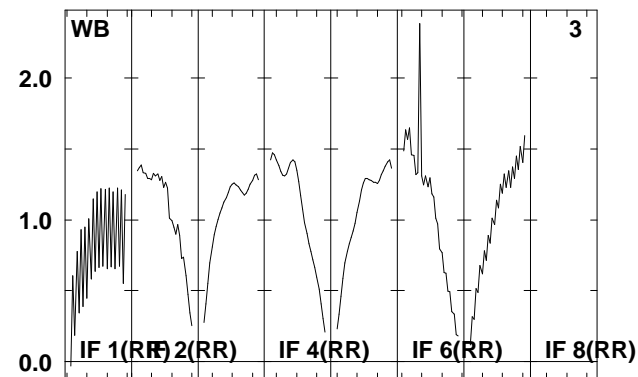
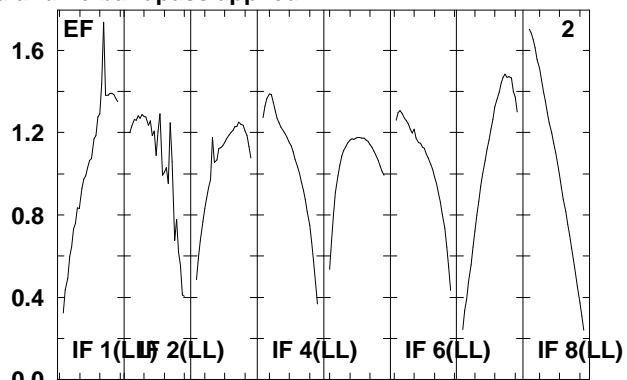
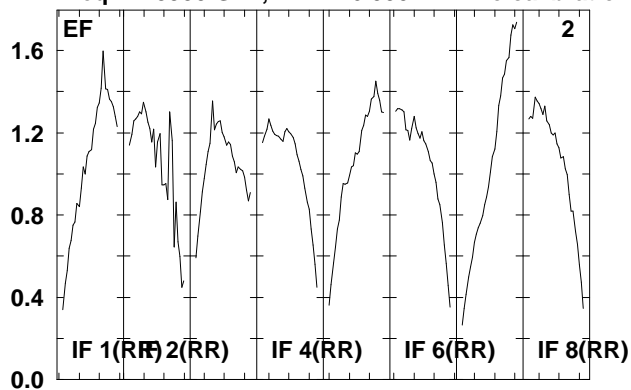

Lower frame: Real Jy

Total-power spectrum Antenna: *

Timerange: 00/19:09:02 to 00/19:12:30

Plot file version 138 created 22-APR-2008 12:27:02

IRAS0725 EP061B.UVDATA.1

Freq = 1.5950 GHz, Bw = 16.000 MH No calibration applied and no bandpass applied

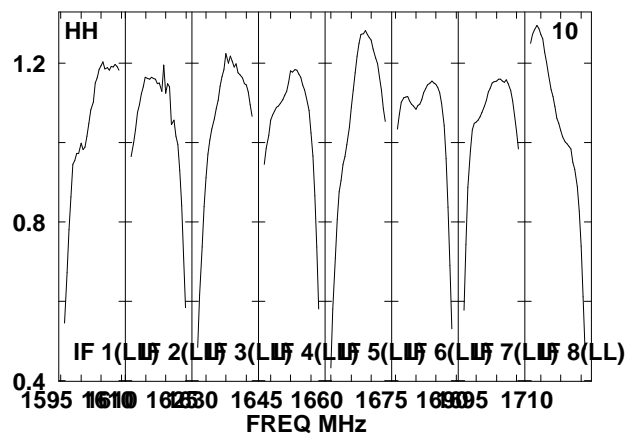
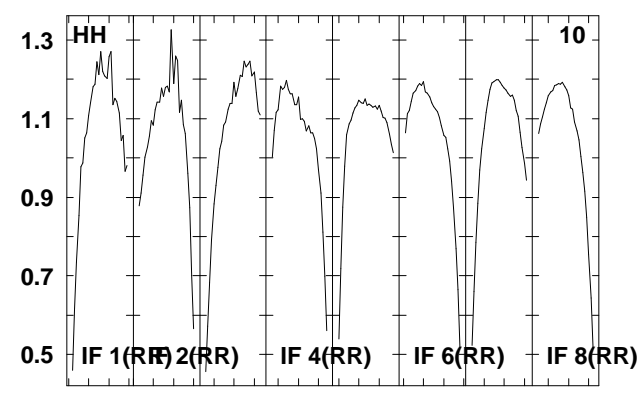
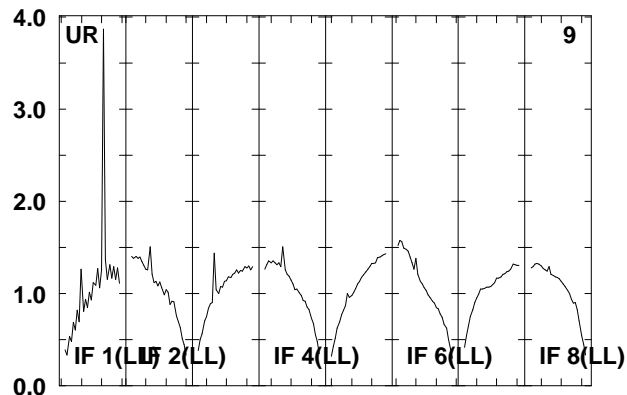
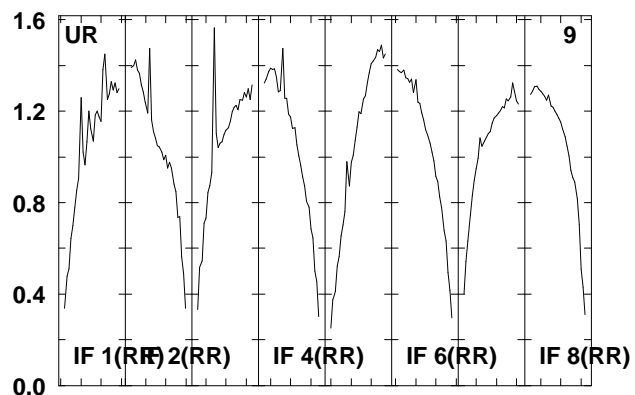
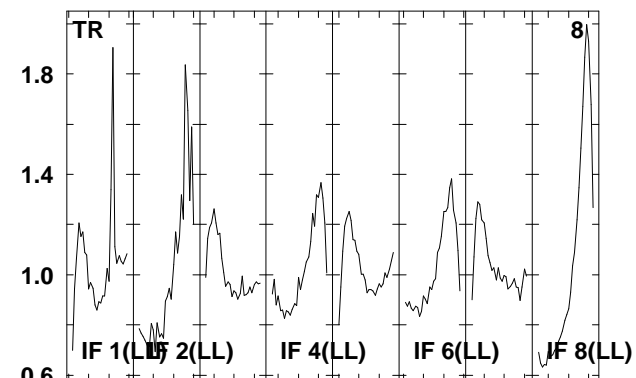
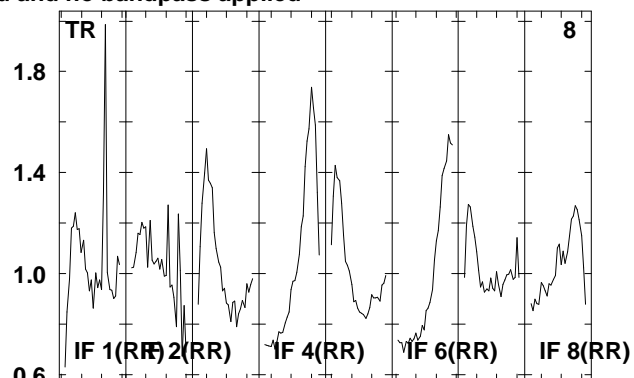
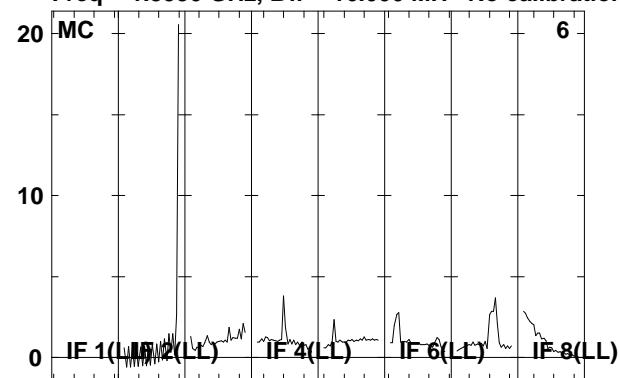

Lower frame: Real Jy

Total-power spectrum Antenna: *

Timerange: 00/19:09:02 to 00/19:12:30

Plot file version 139 created 22-APR-2008 12:27:03

J0730-02 EP061B.UVDATA.1

Freq = 1.5950 GHz, Bw = 16.000 MH No calibration applied and no bandpass applied

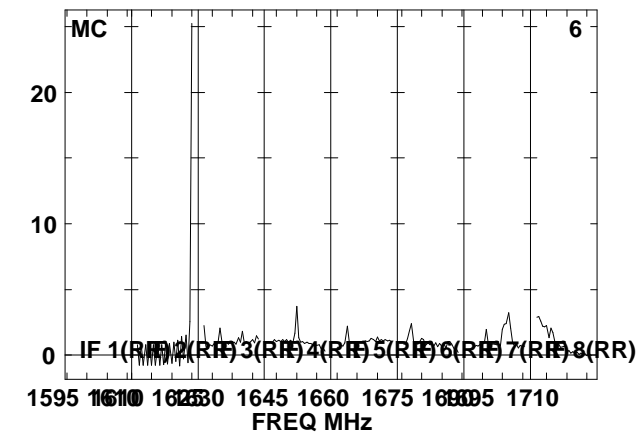
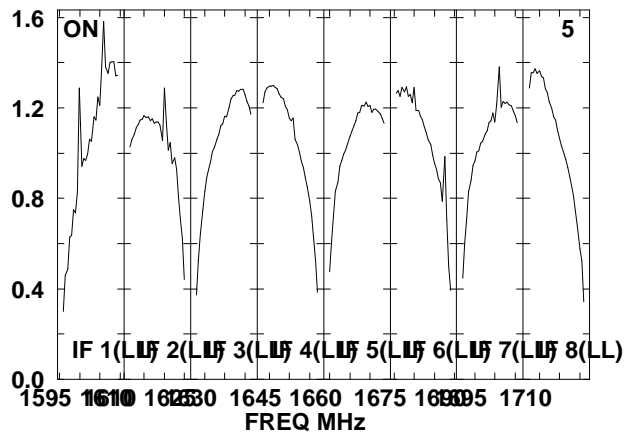
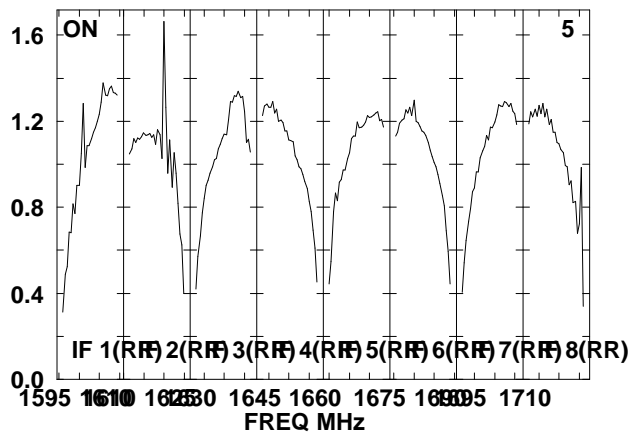
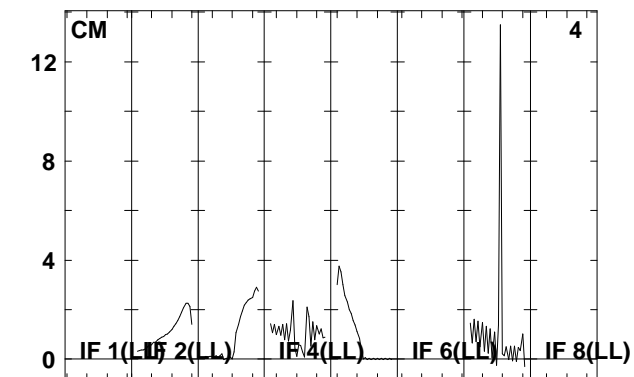
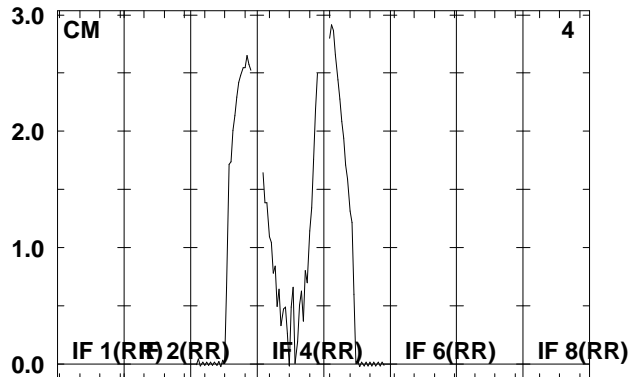
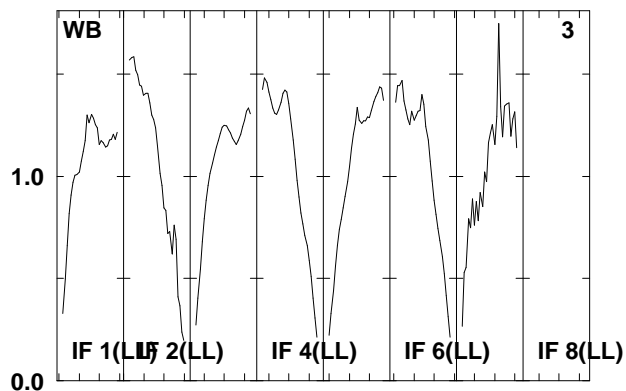
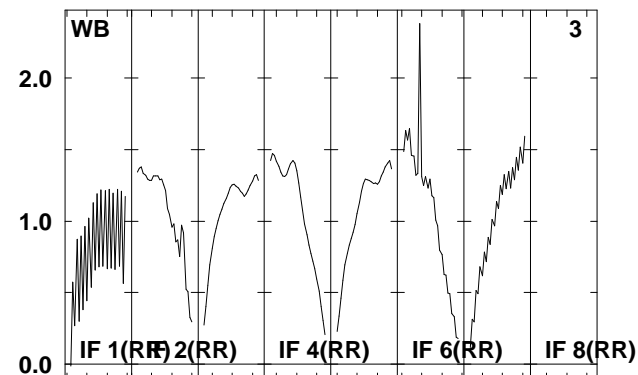
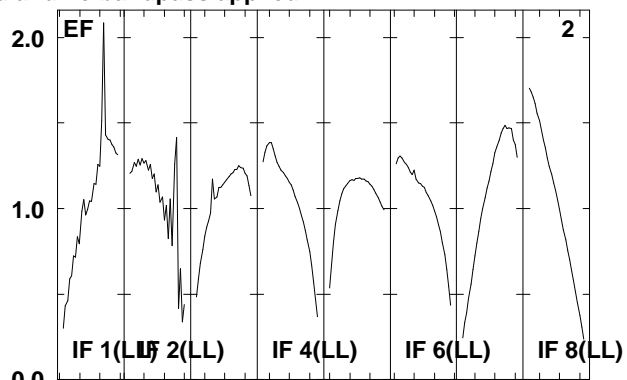
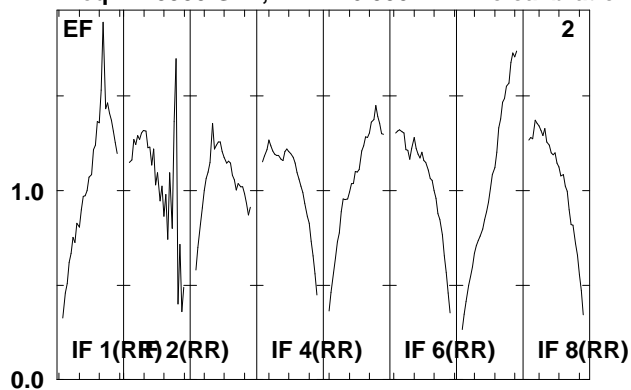

Lower frame: Real Jy
Total-power spectrum Antenna: *
Timerange: 00/19:12:32 to 00/19:14:00

Plot file version 140 created 22-APR-2008 12:27:03

J0730-02 EP061B.UVDATA.1

Freq = 1.5950 GHz, Bw = 16.000 MH No calibration applied and no bandpass applied

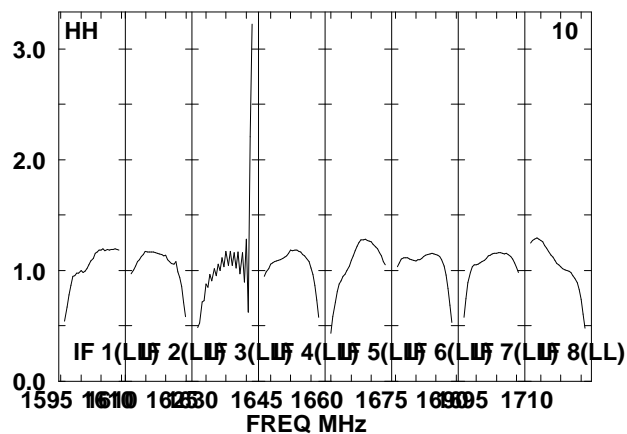
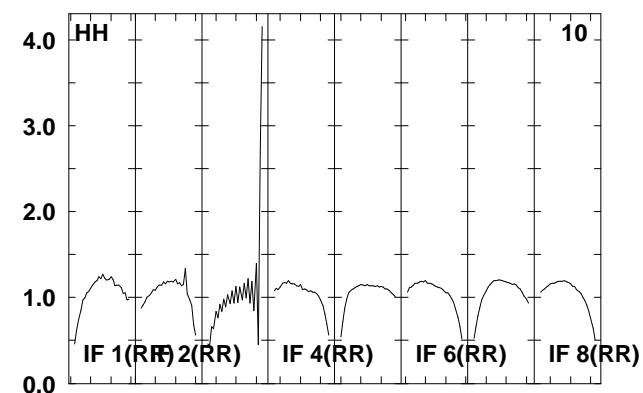
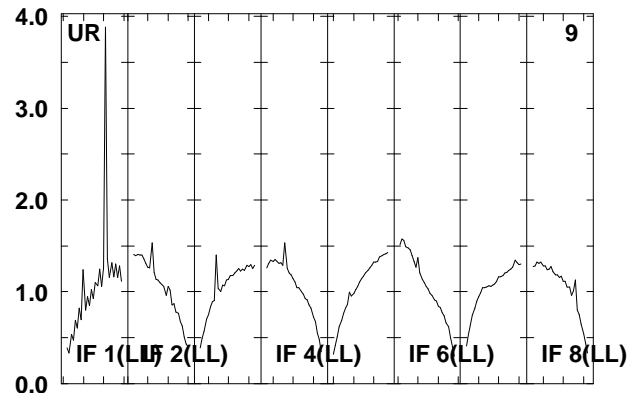
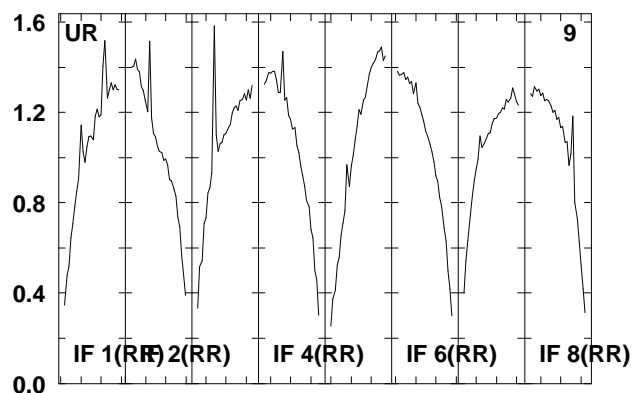
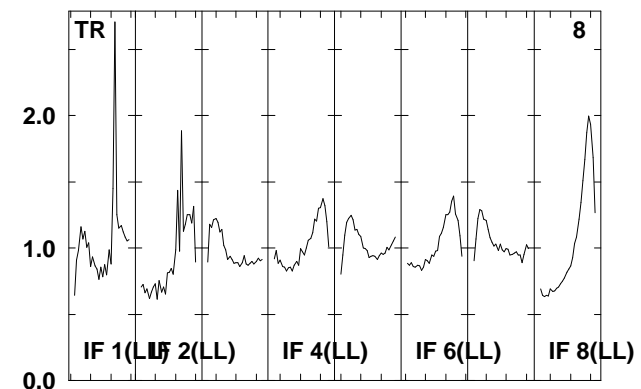
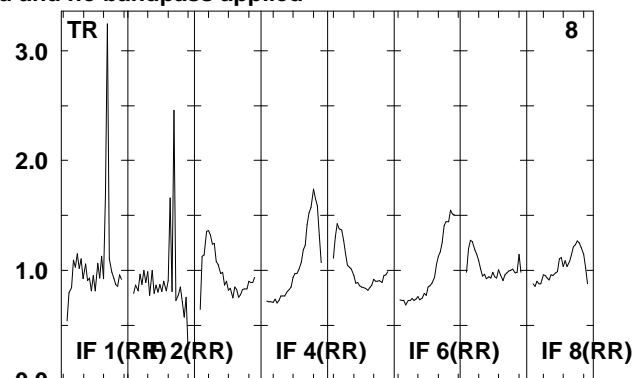
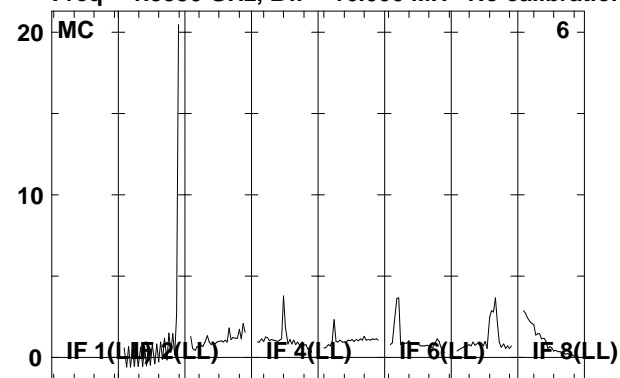

Lower frame: Real Jy

Total-power spectrum Antenna: *

Timerange: 00/19:12:32 to 00/19:14:00

Plot file version 141 created 22-APR-2008 12:27:04

IRAS0725 EP061B.UVDATA.1

Freq = 1.5950 GHz, Bw = 16.000 MH No calibration applied and no bandpass applied

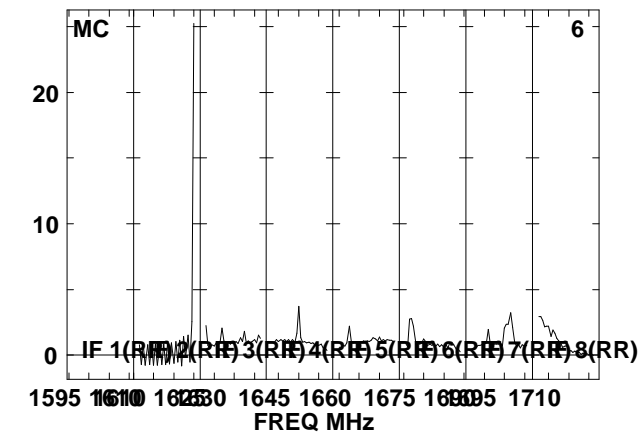
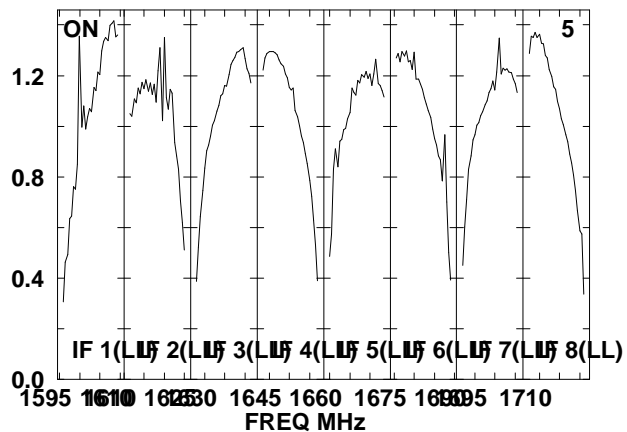
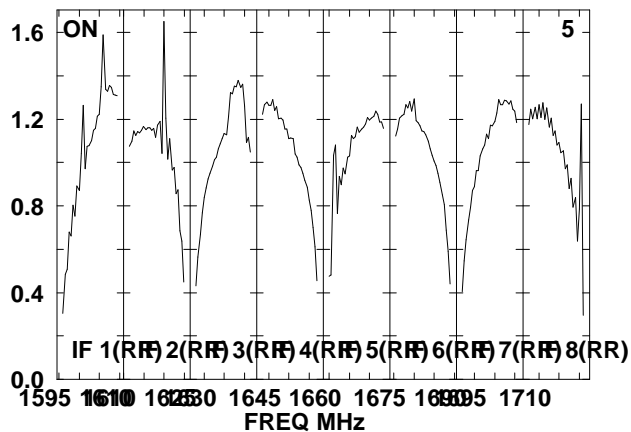
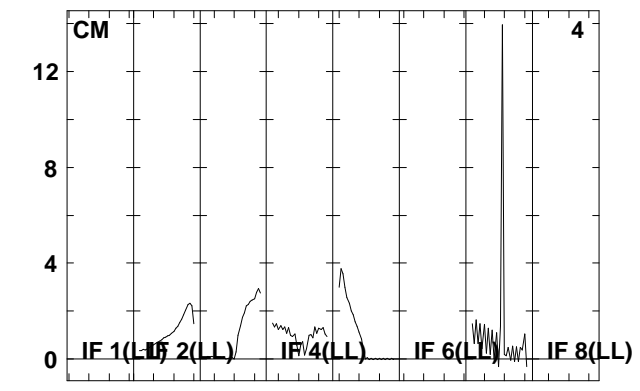
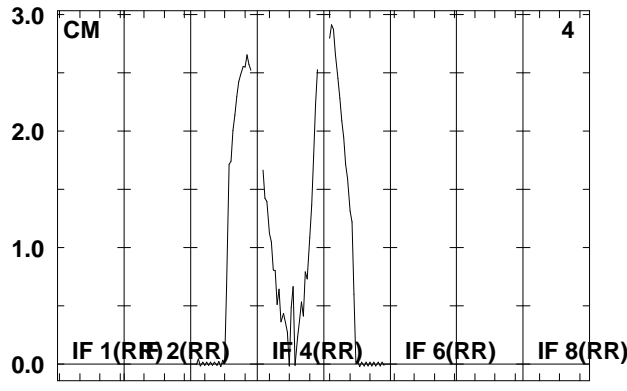
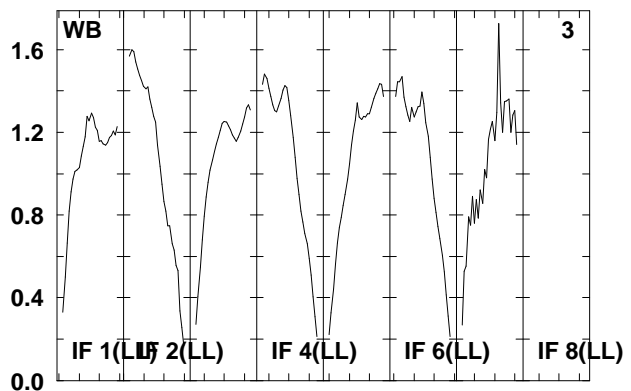
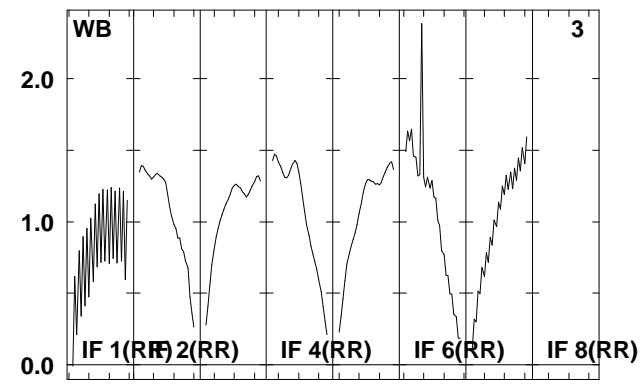
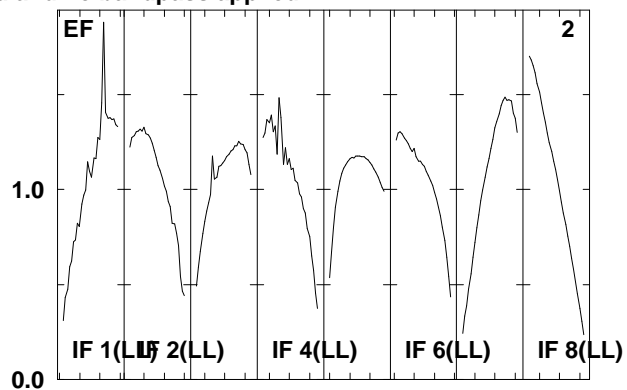
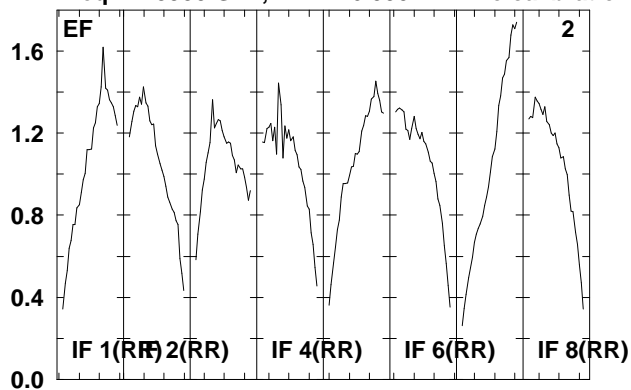

Lower frame: Real Jy
Total-power spectrum Antenna: *
Timerange: 00/19:14:02 to 00/19:17:30

Plot file version 142 created 22-APR-2008 12:27:05

IRAS0725 EP061B.UVDATA.1

Freq = 1.5950 GHz, Bw = 16.000 MH No calibration applied and no bandpass applied

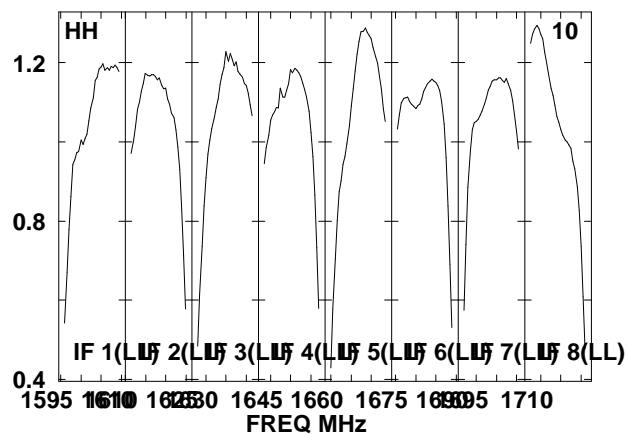
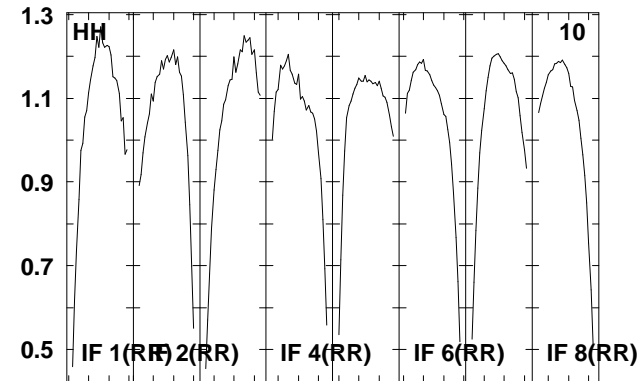
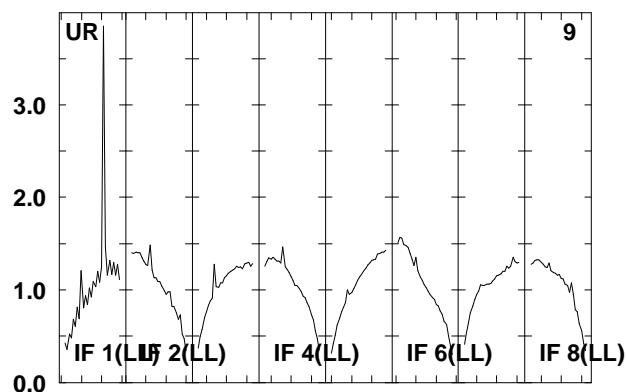
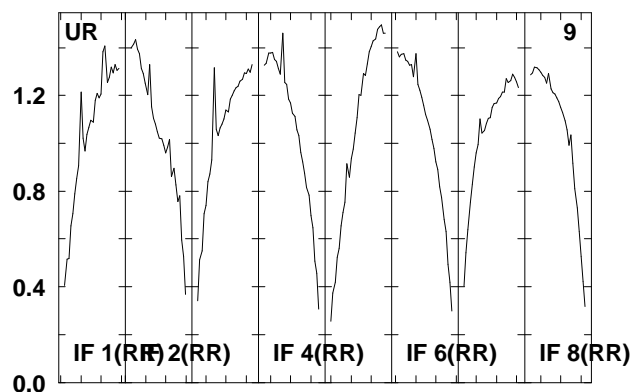
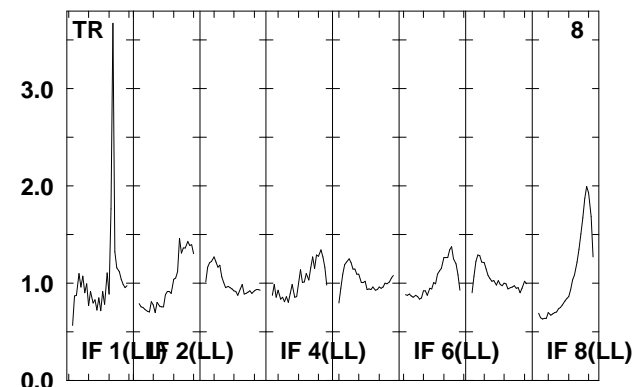
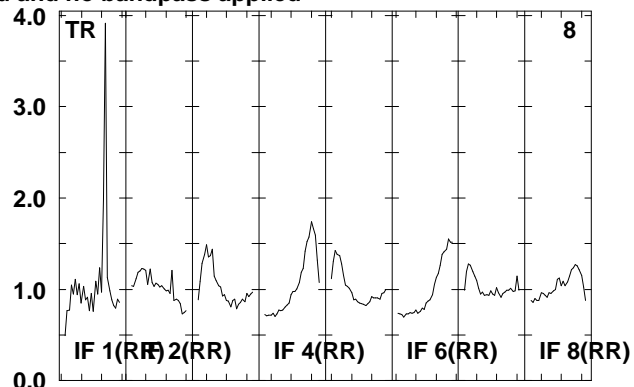
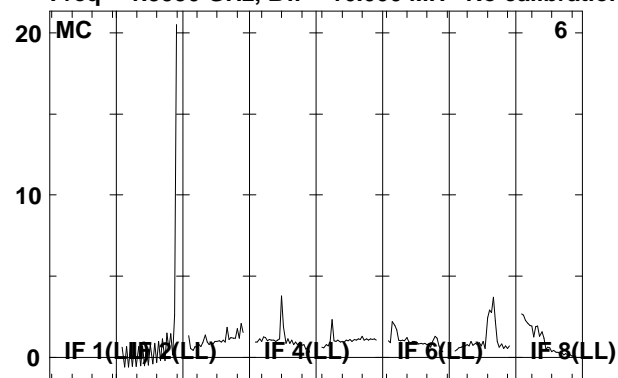

Lower frame: Real Jy

Total-power spectrum Antenna: *

Timerange: 00/19:14:02 to 00/19:17:30

Plot file version 143 created 22-APR-2008 12:27:06

J0730-02 EP061B.UVDATA.1

Freq = 1.5950 GHz, Bw = 16.000 MH No calibration applied and no bandpass applied

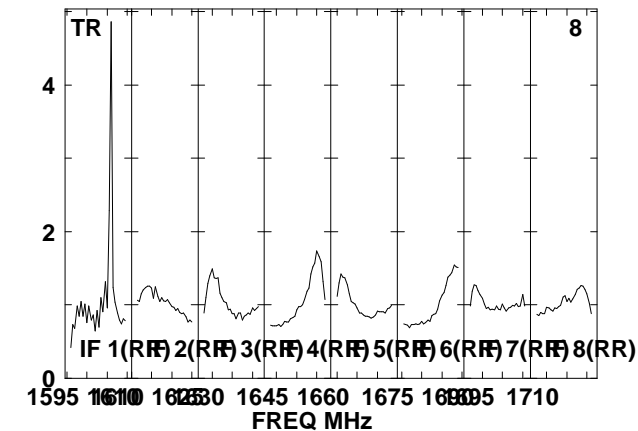
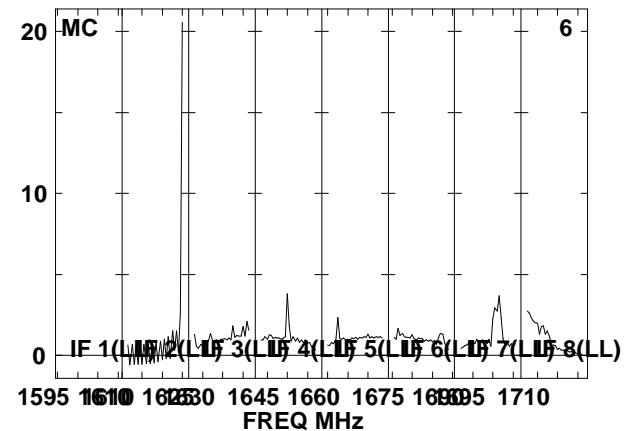
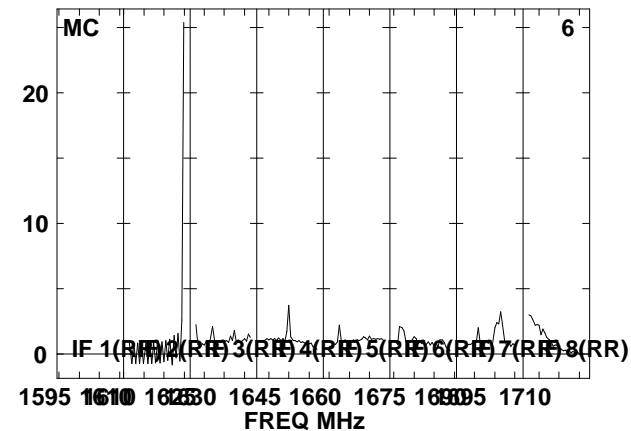
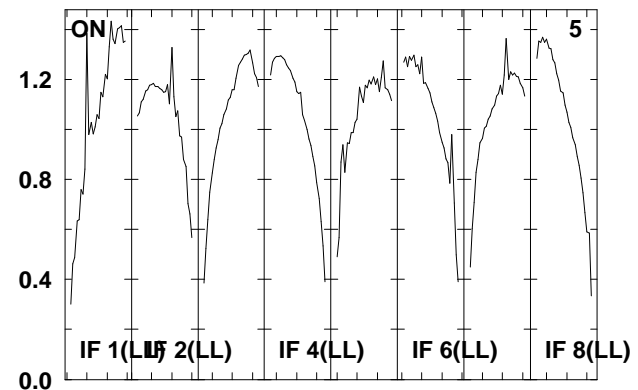
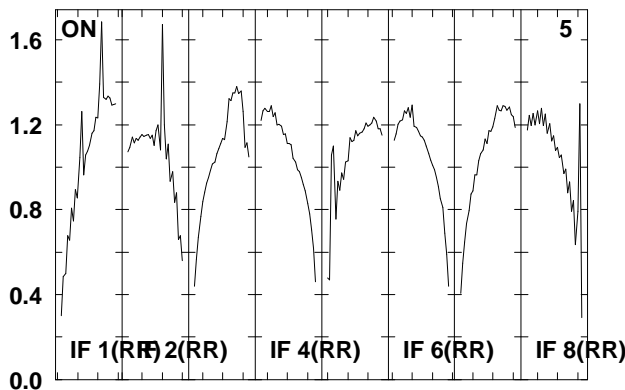
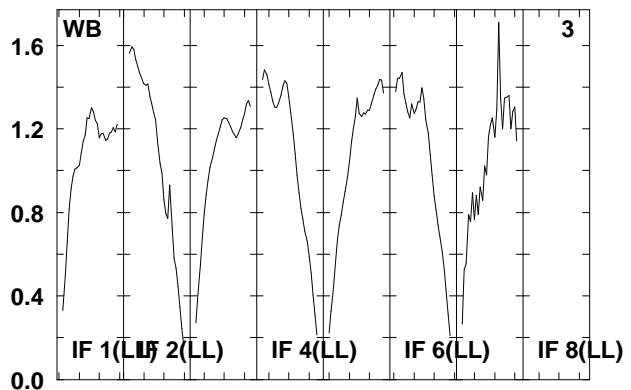
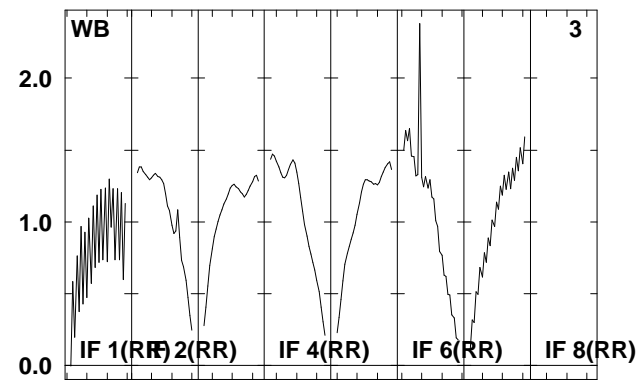
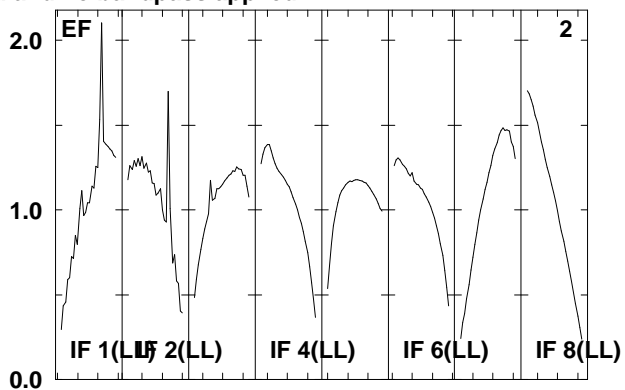
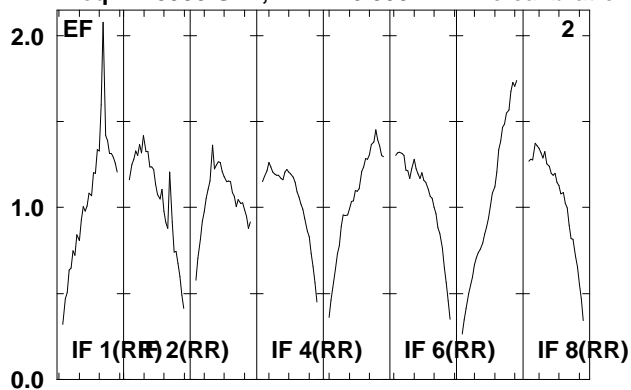

Lower frame: Real Jy

Total-power spectrum Antenna: *

Timerange: 00/19:17:32 to 00/19:19:00

Plot file version 144 created 22-APR-2008 12:27:07

J0730-02 EP061B.UVDATA.1

Freq = 1.5950 GHz, Bw = 16.000 MH No calibration applied and no bandpass applied

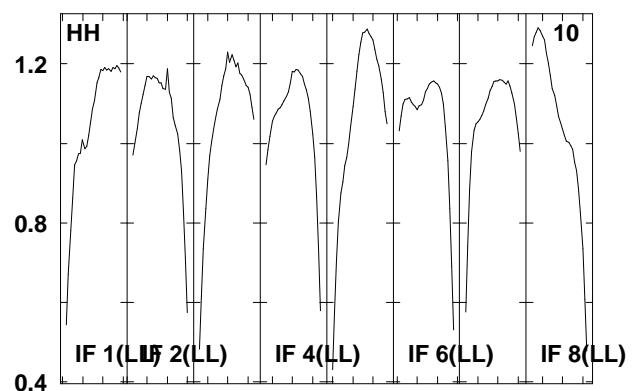
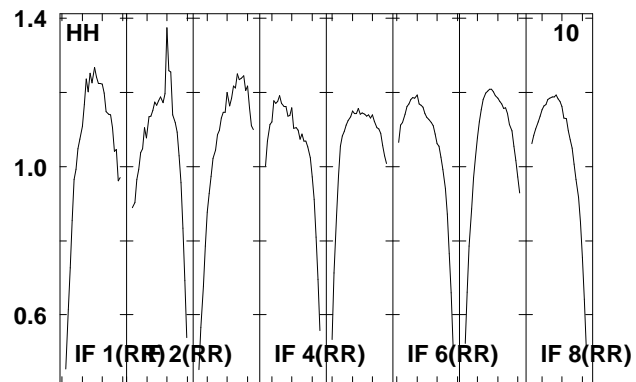
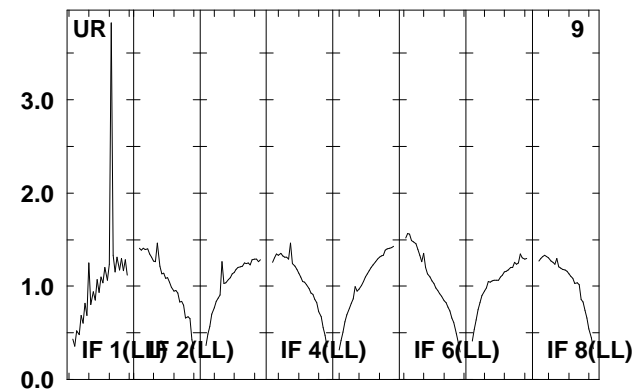
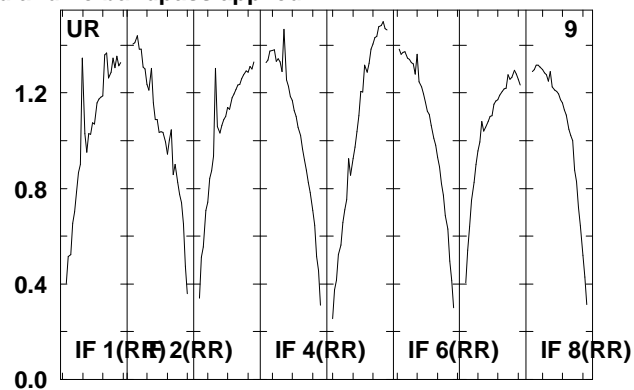
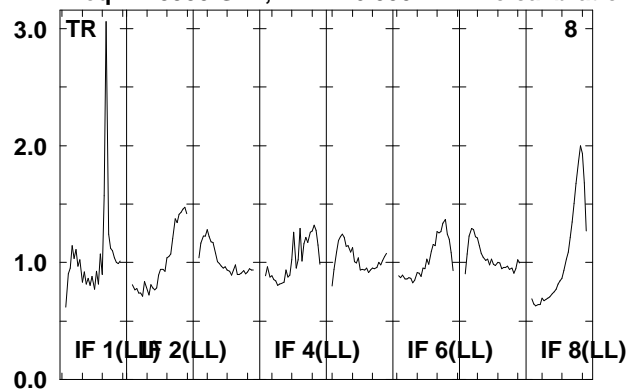

Lower frame: Real Jy
Total-power spectrum Antenna: *
Timerange: 00/19:17:32 to 00/19:19:00

Plot file version 145 created 22-APR-2008 12:27:08

IRAS0725 EP061B.UVDATA.1

Freq = 1.5950 GHz, Bw = 16.000 MH No calibration applied and no bandpass applied

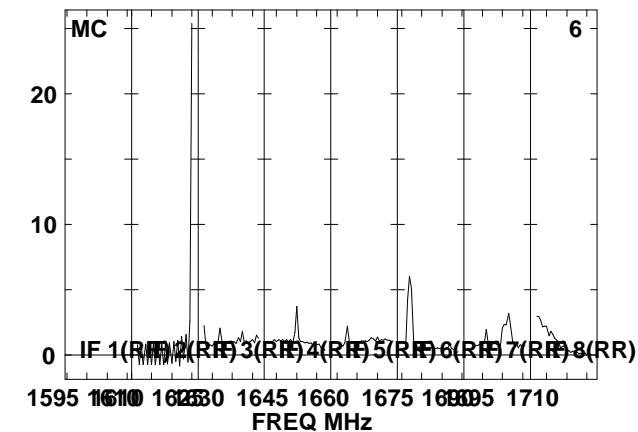
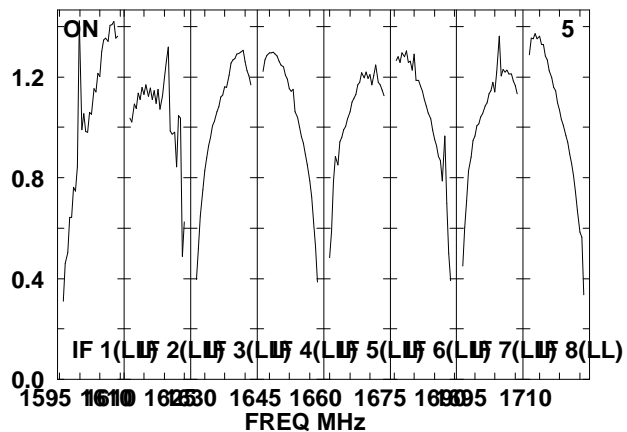
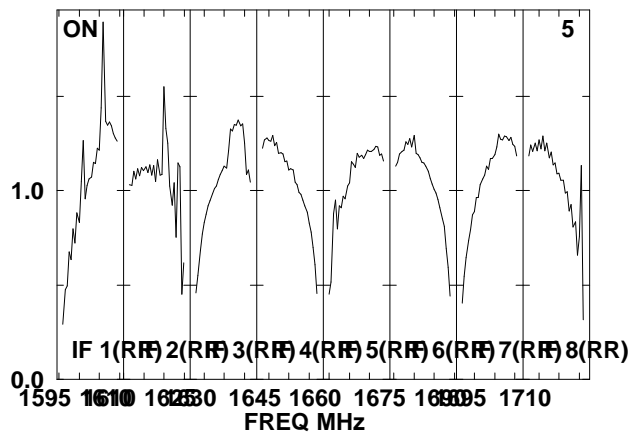
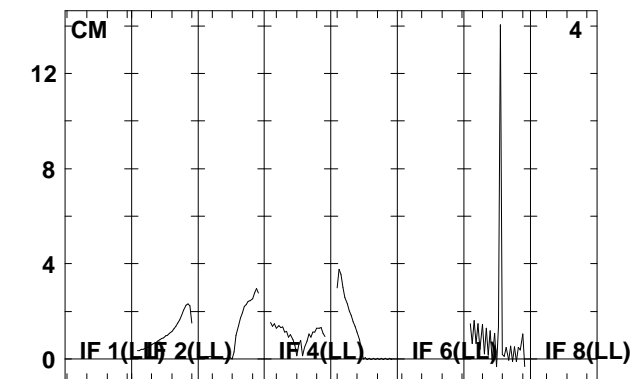
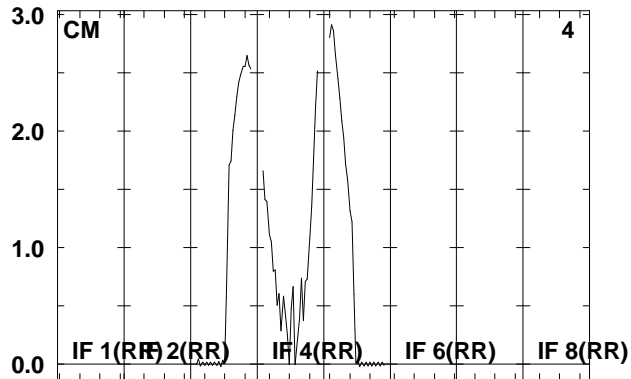
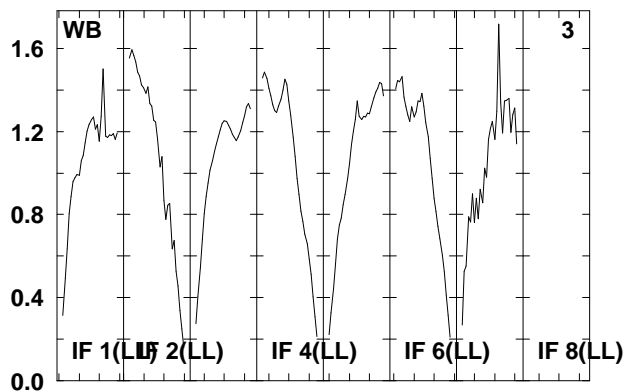
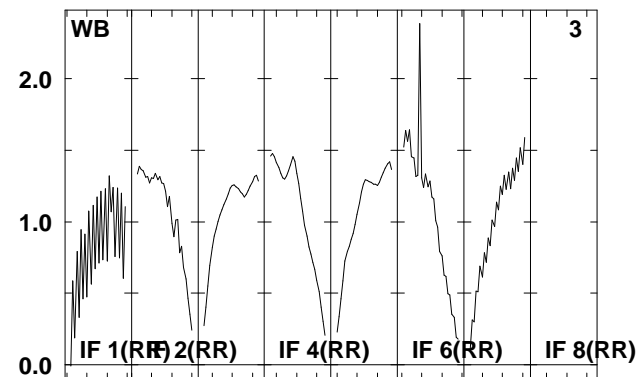
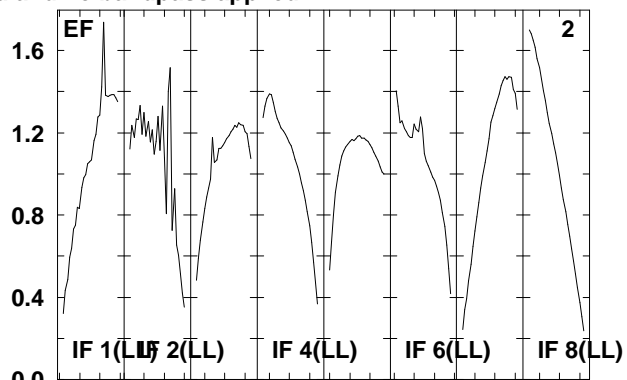
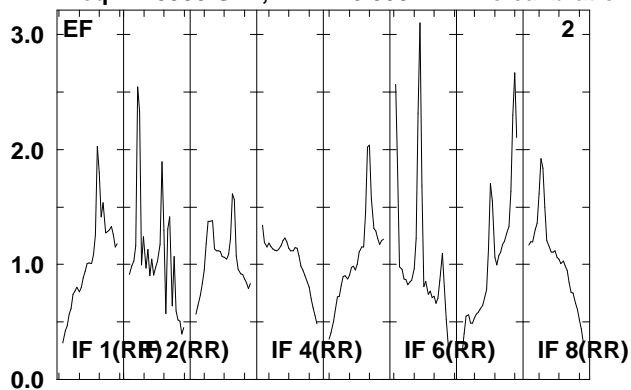

Lower frame: Real Jy

Total-power spectrum Antenna: *

Timerange: 00/19:19:02 to 00/19:22:28

Plot file version 146 created 22-APR-2008 12:27:09

IRAS0725 EP061B.UVDATA.1

Freq = 1.5950 GHz, Bw = 16.000 MH No calibration applied and no bandpass applied

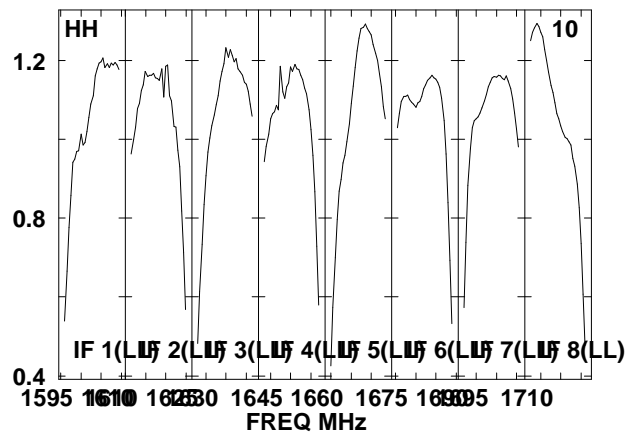
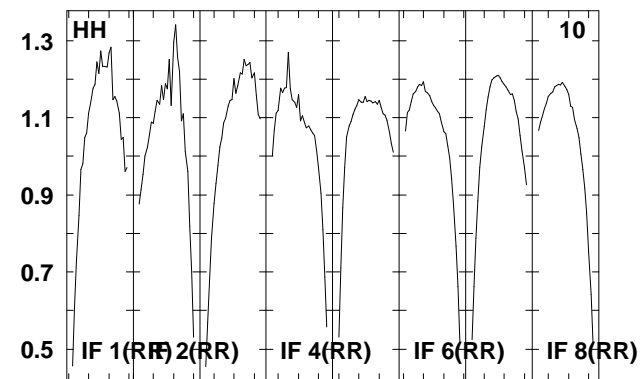
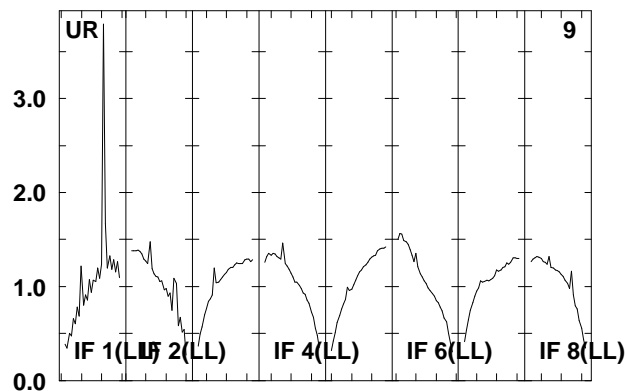
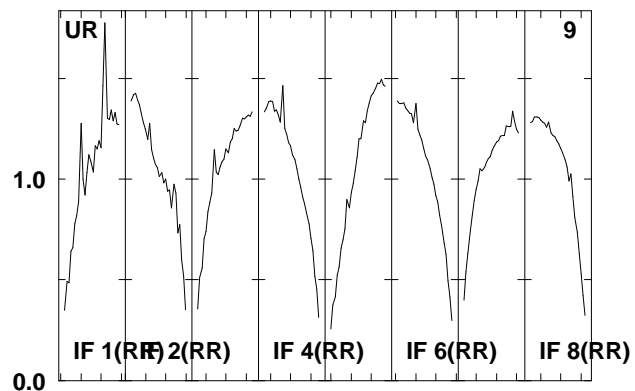
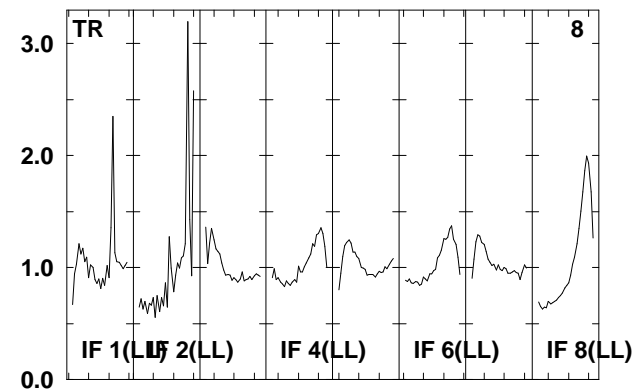
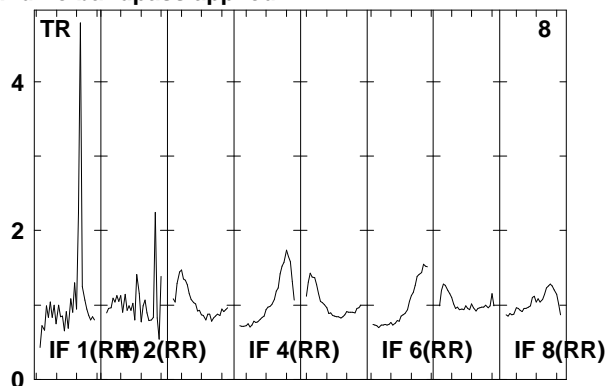
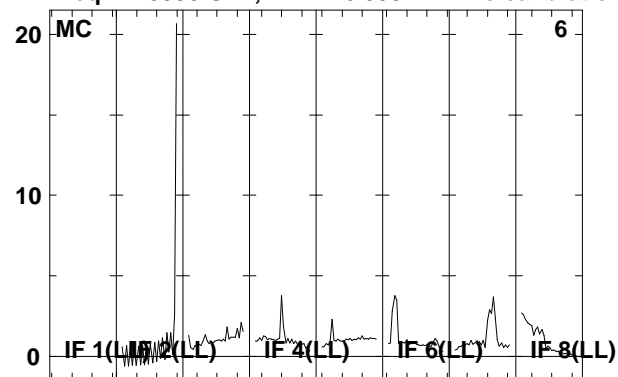

Lower frame: Real Jy

Total-power spectrum Antenna: *

Timerange: 00/19:19:02 to 00/19:22:28

Plot file version 147 created 22-APR-2008 12:27:10

J0730-02 EP061B.UVDATA.1

Freq = 1.5950 GHz, Bw = 16.000 MH No calibration applied and no bandpass applied

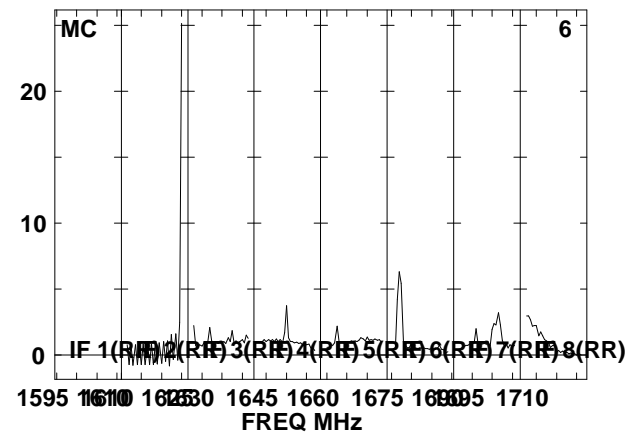
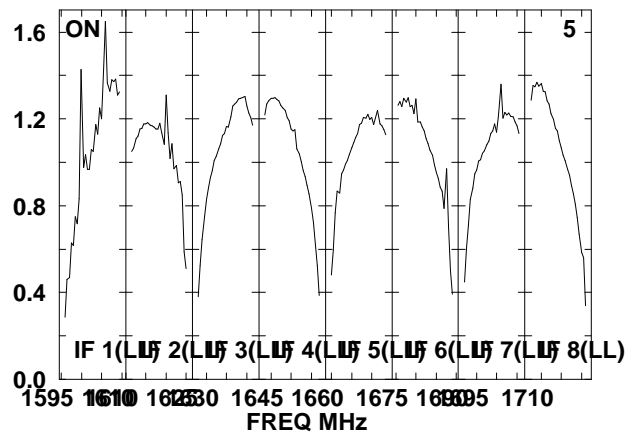
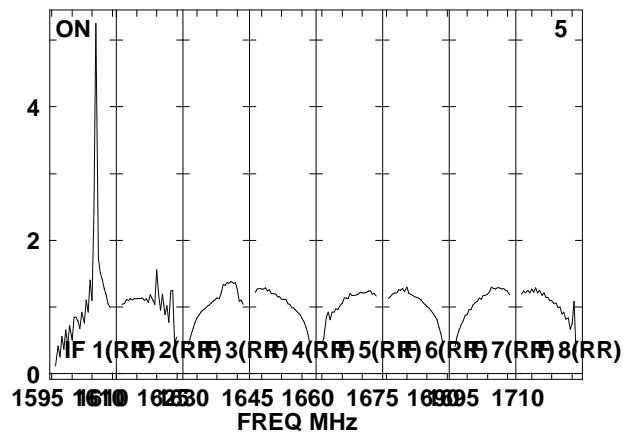
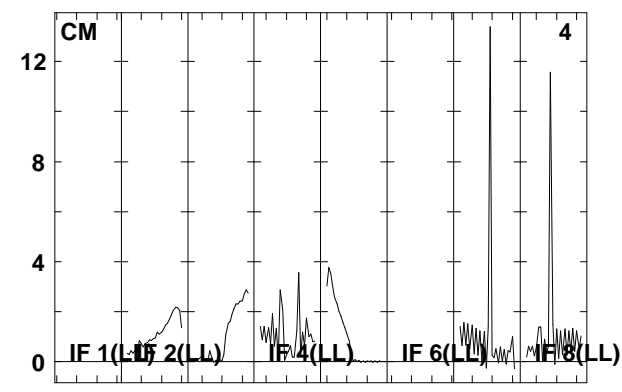
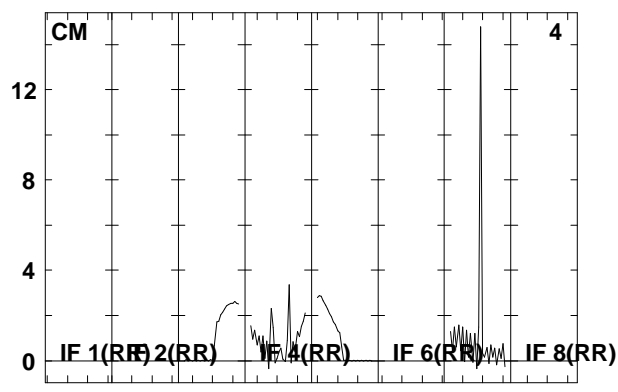
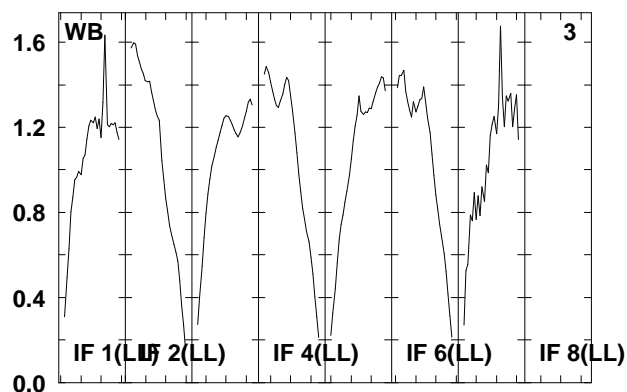
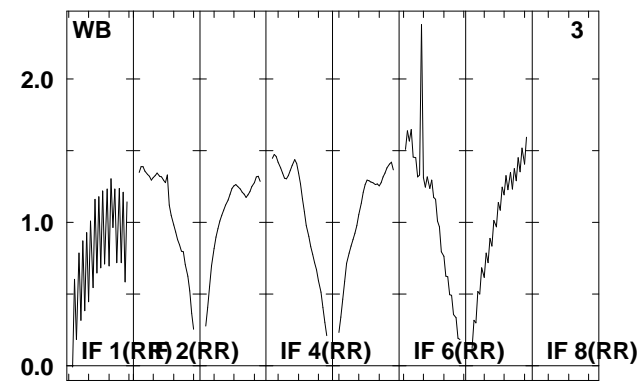
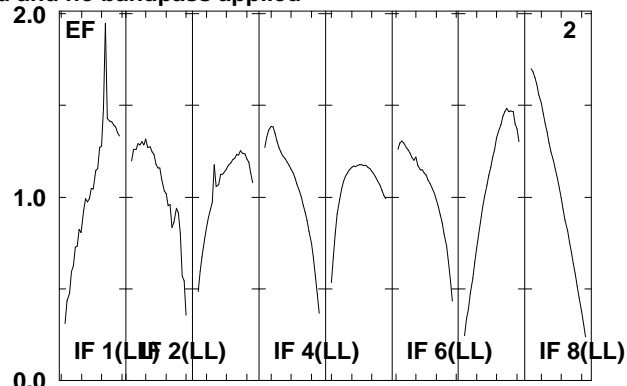
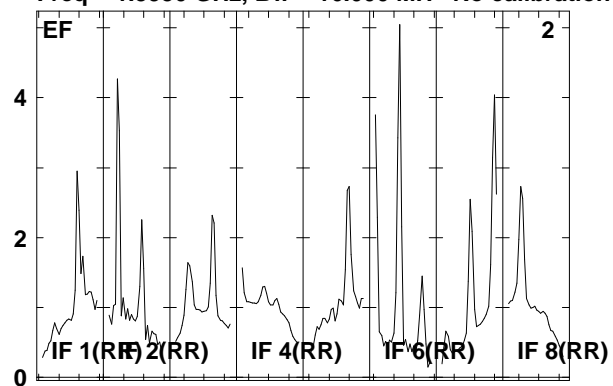

Lower frame: Real Jy
Total-power spectrum Antenna: *
Timerange: 00/19:23:32 to 00/19:25:00

Plot file version 148 created 22-APR-2008 12:27:11

J0730-02 EP061B.UVDATA.1

Freq = 1.5950 GHz, Bw = 16.000 MH No calibration applied and no bandpass applied

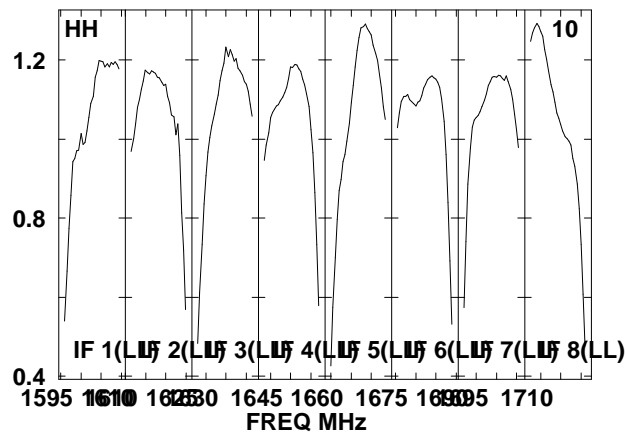
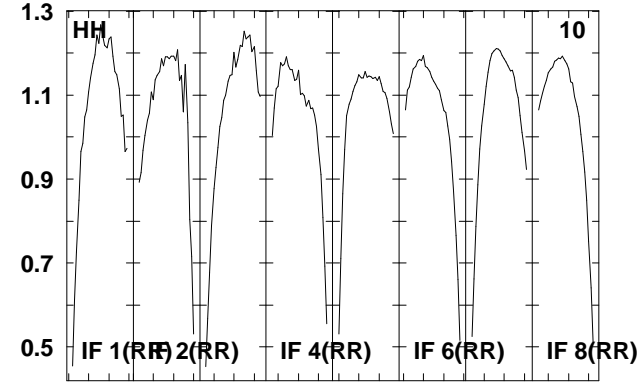
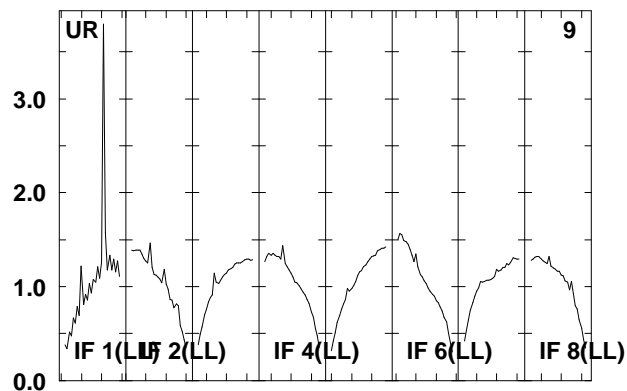
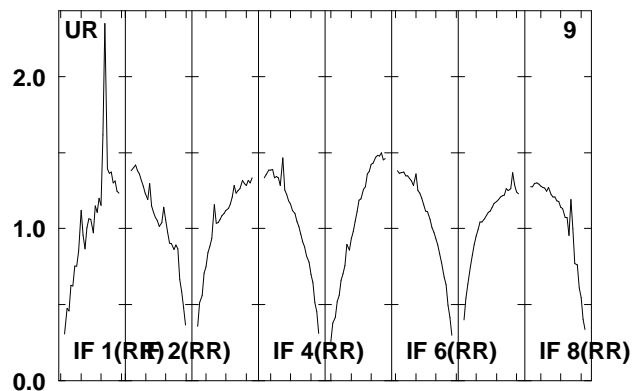
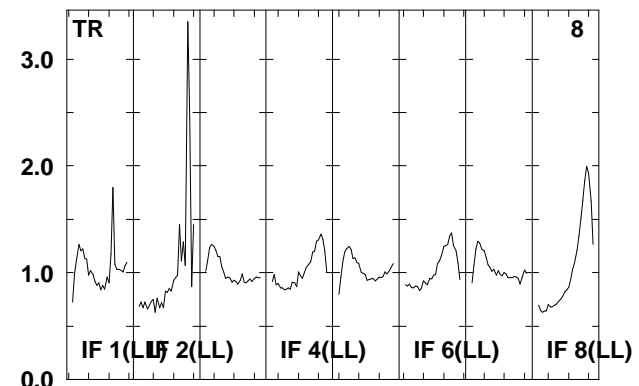
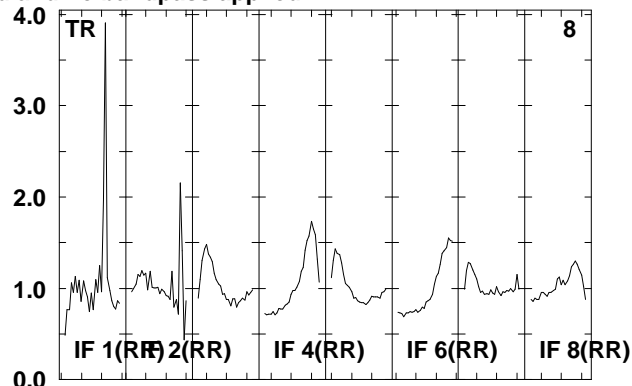
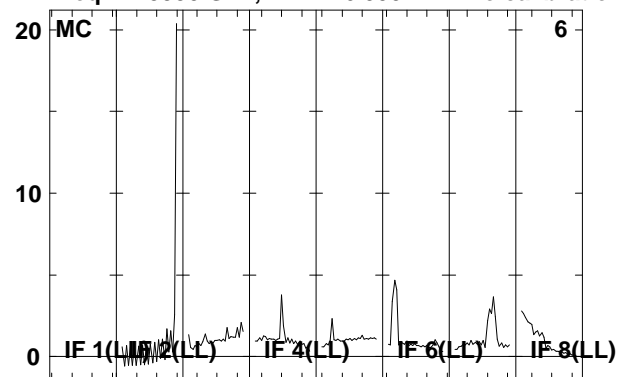

Lower frame: Real Jy

Total-power spectrum Antenna: *

Timerange: 00/19:23:32 to 00/19:25:00

Plot file version 149 created 22-APR-2008 12:27:11

IRAS0725 EP061B.UVDATA.1

Freq = 1.5950 GHz, Bw = 16.000 MH No calibration applied and no bandpass applied

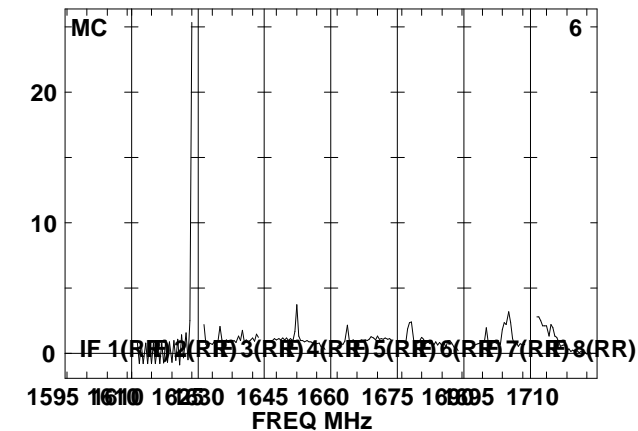
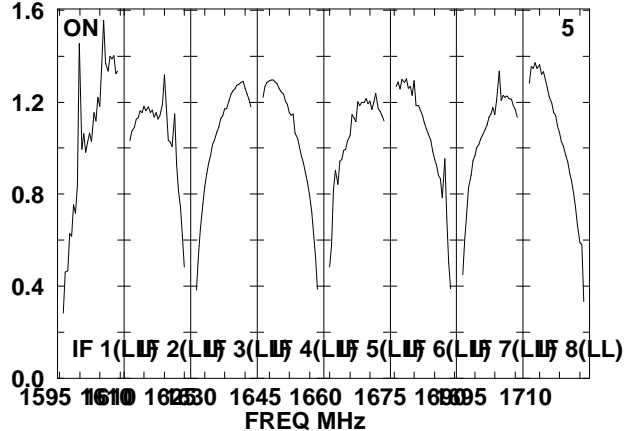
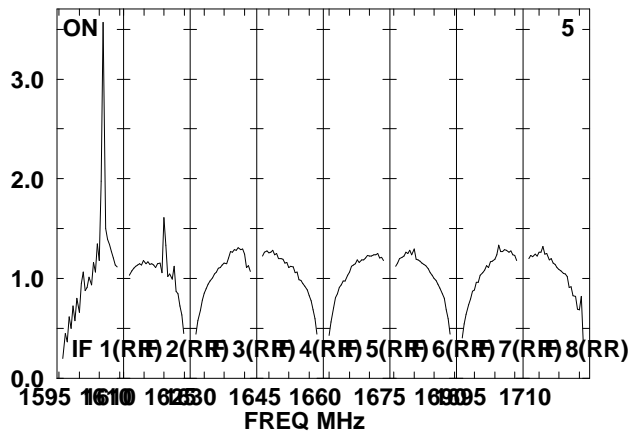
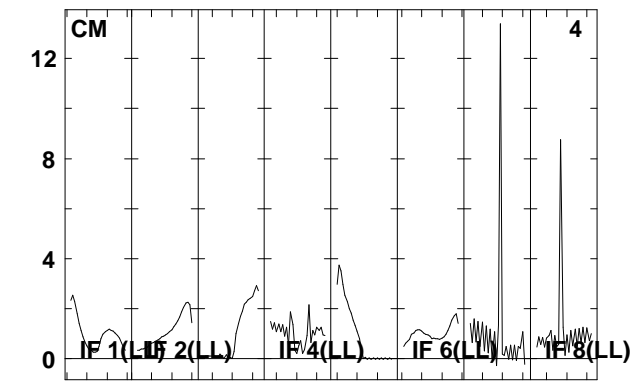
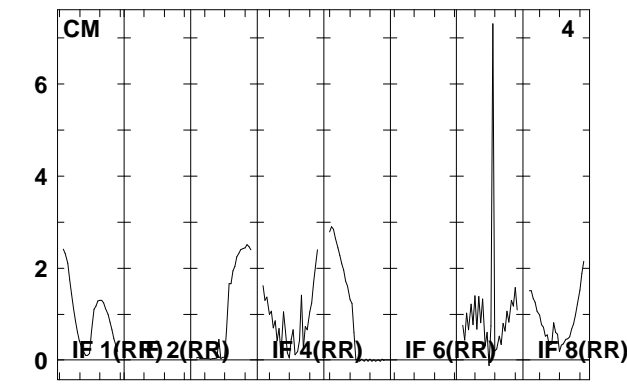
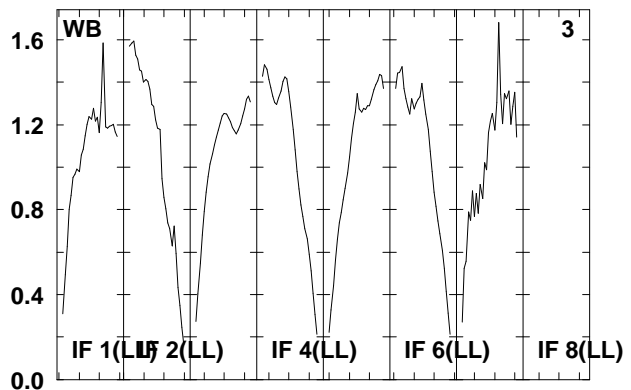
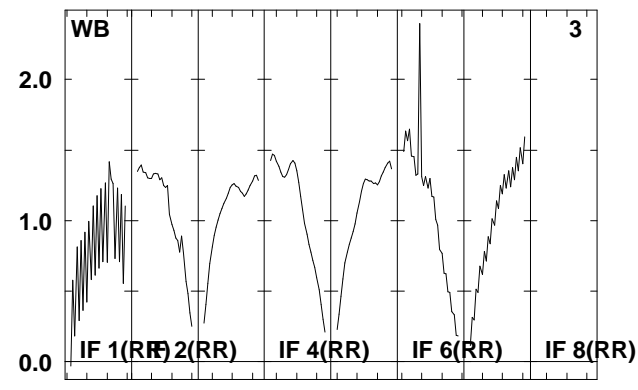
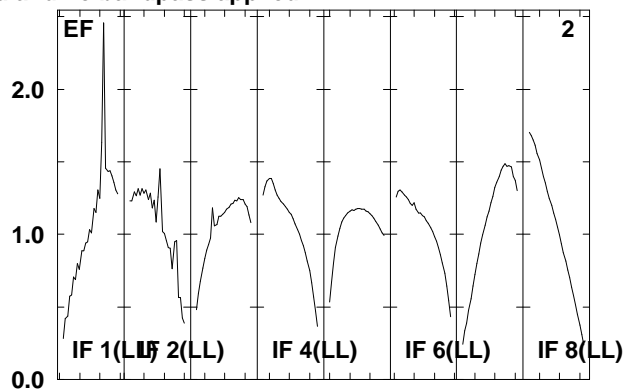
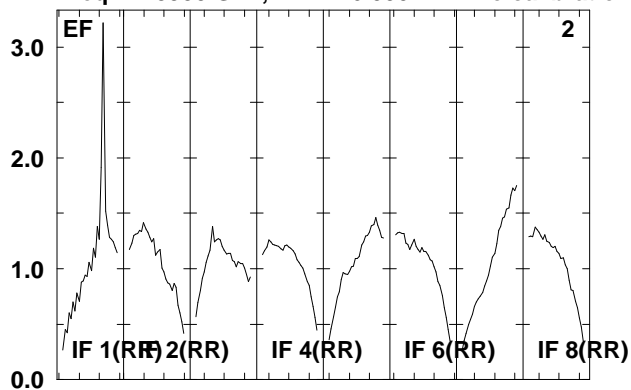

Lower frame: Real Jy
Total-power spectrum Antenna: *
Timerange: 00/19:25:02 to 00/19:28:30

Plot file version 150 created 22-APR-2008 12:27:12

IRAS0725 EP061B.UVDATA.1

Freq = 1.5950 GHz, Bw = 16.000 MH No calibration applied and no bandpass applied

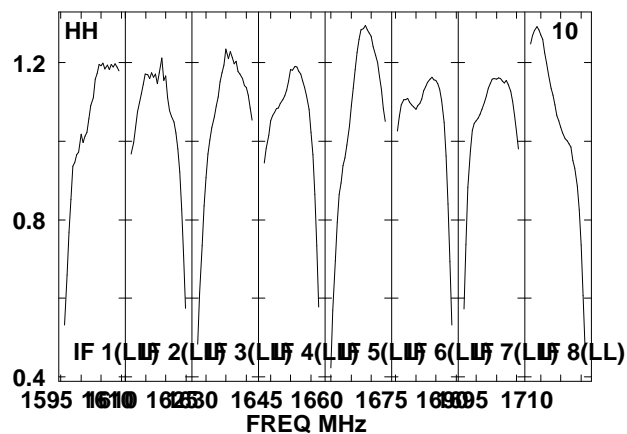
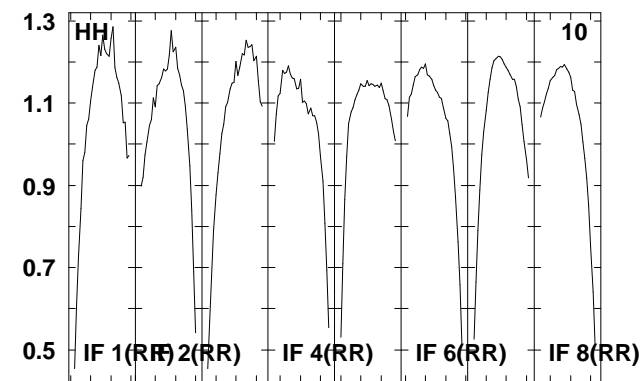
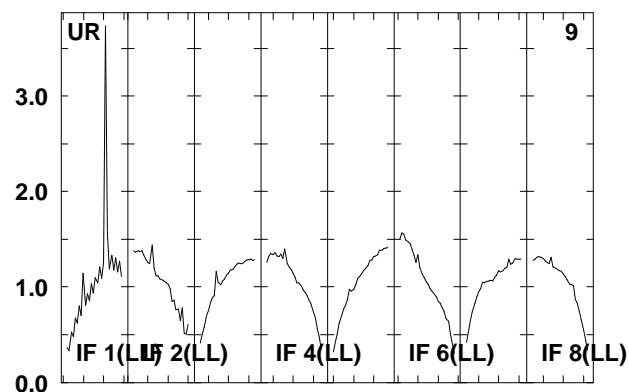
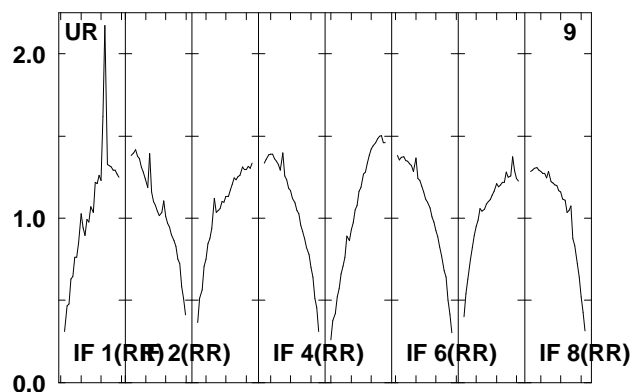
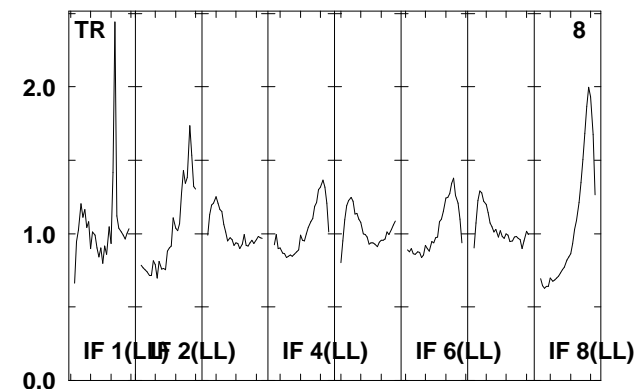
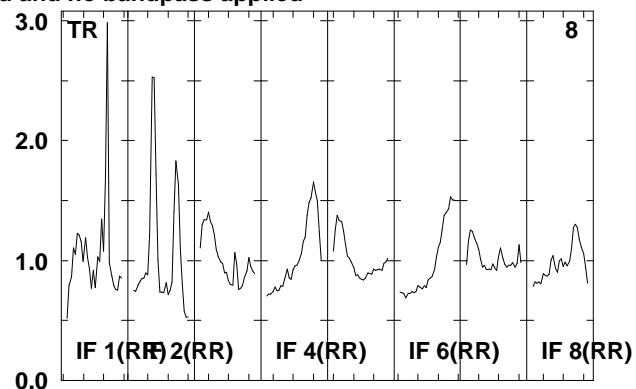
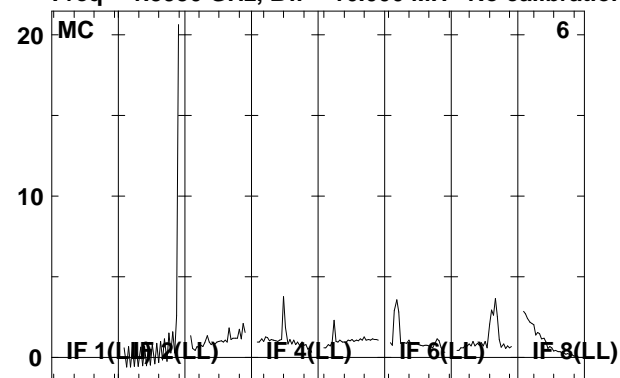

Lower frame: Real Jy

Total-power spectrum Antenna: *

Timerange: 00/19:25:02 to 00/19:28:30

Plot file version 151 created 22-APR-2008 12:27:13

J0730-02 EP061B.UVDATA.1

Freq = 1.5950 GHz, Bw = 16.000 MH No calibration applied and no bandpass applied

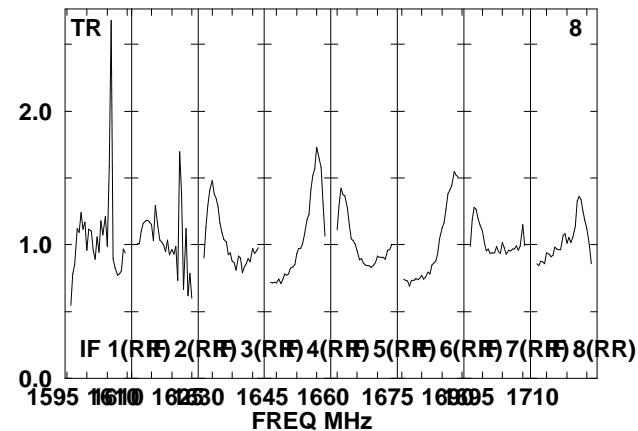
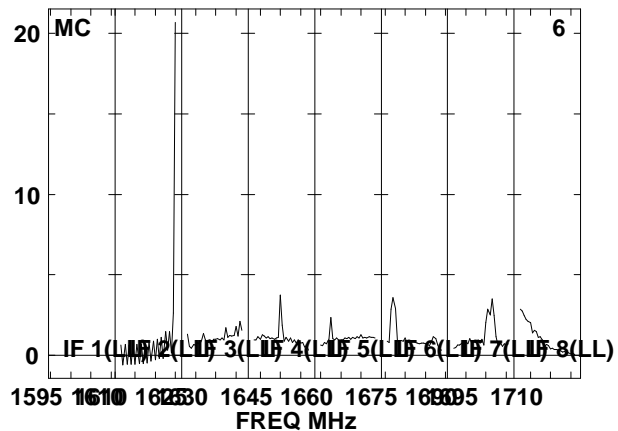
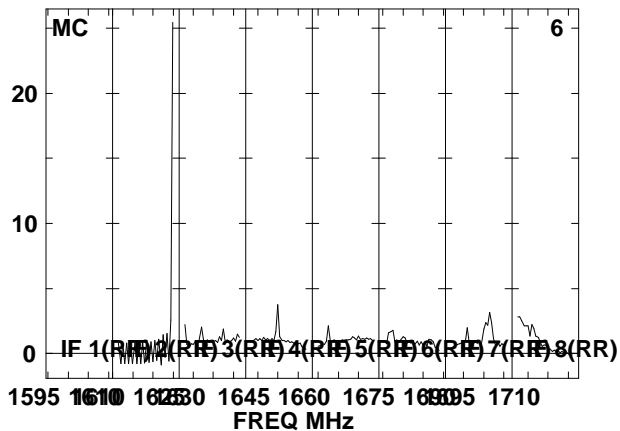
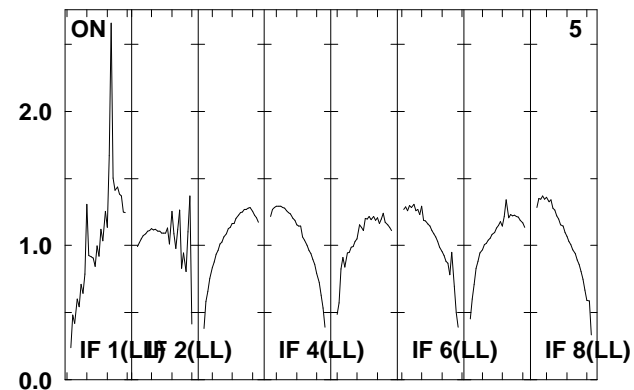
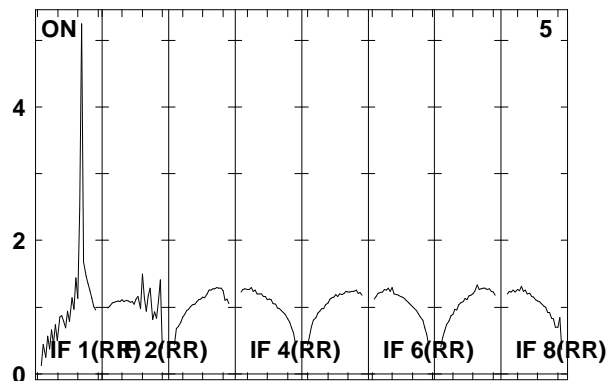
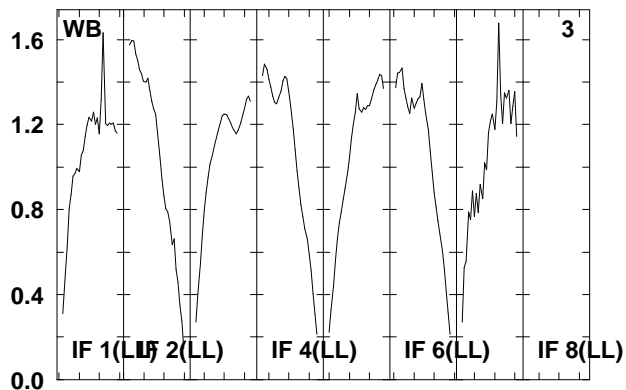
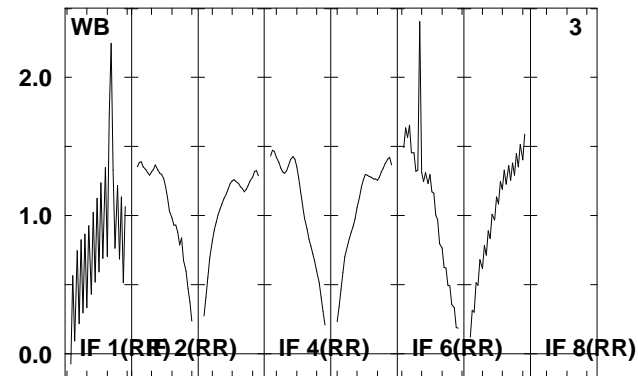
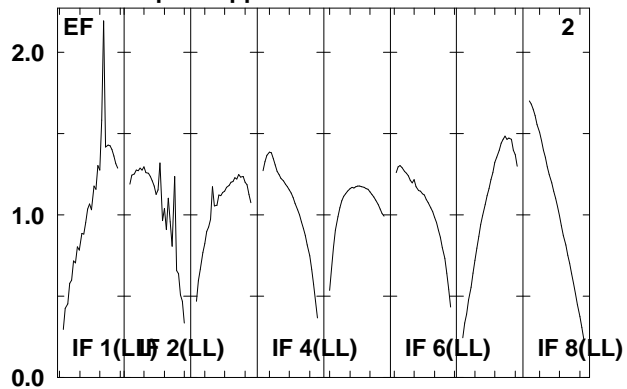
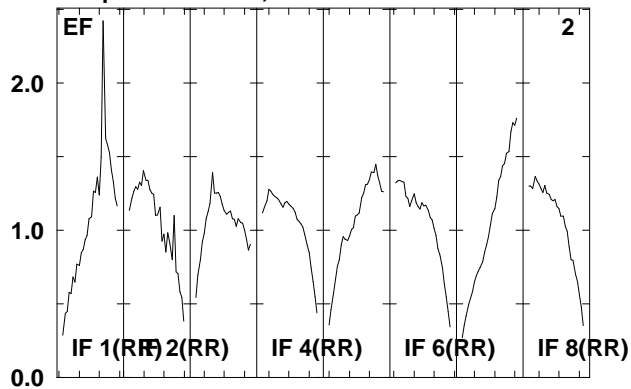

Lower frame: Real Jy
Total-power spectrum Antenna: *
Timerange: 00/19:28:32 to 00/19:30:00

Plot file version 152 created 22-APR-2008 12:27:13

J0730-02 EP061B.UVDATA.1

Freq = 1.5950 GHz, Bw = 16.000 MH No calibration applied and no bandpass applied

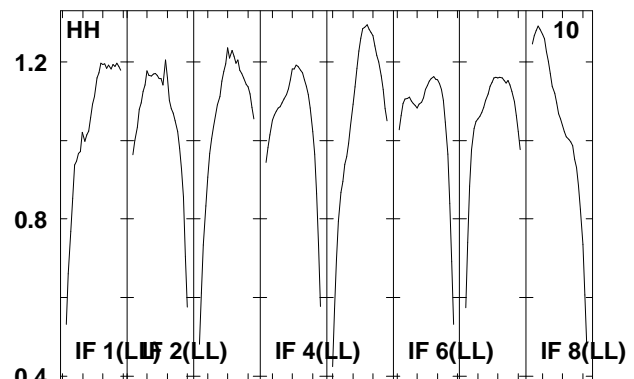
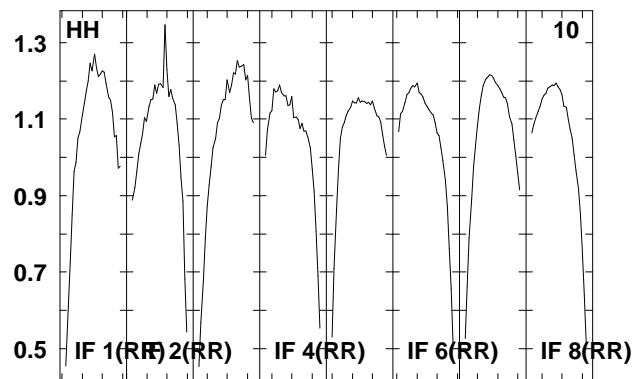
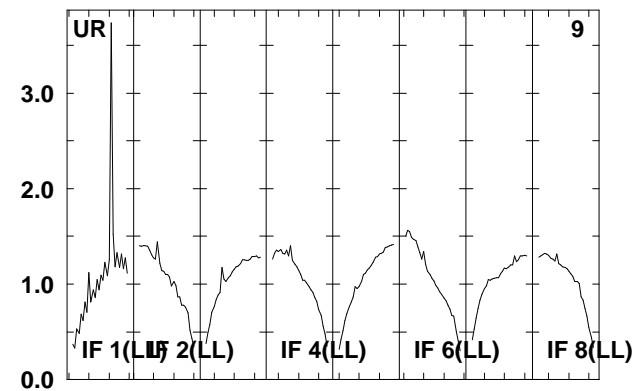
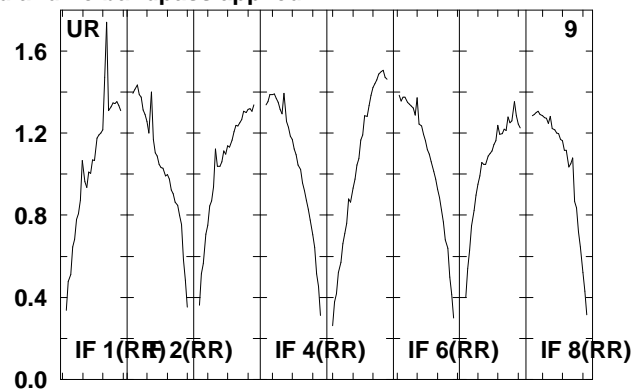
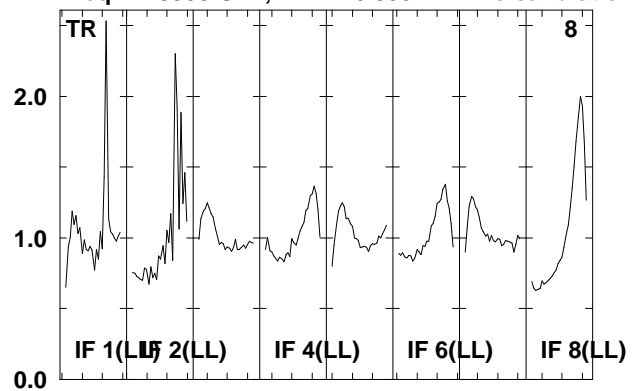

Lower frame: Real Jy
Total-power spectrum Antenna: *
Timerange: 00/19:28:32 to 00/19:30:00

Plot file version 153 created 22-APR-2008 12:27:14

IRAS0725 EP061B.UVDATA.1

Freq = 1.5950 GHz, Bw = 16.000 MH No calibration applied and no bandpass applied

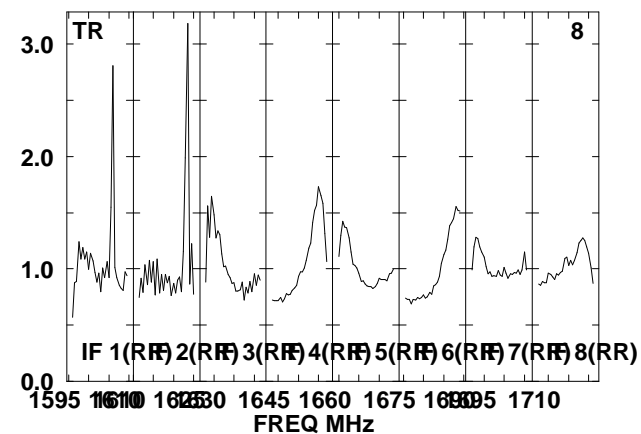
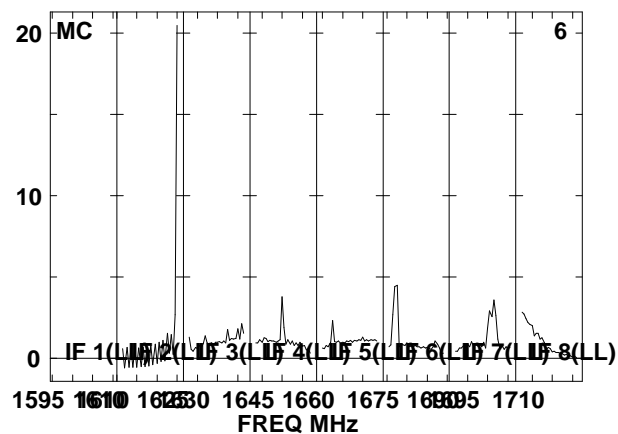
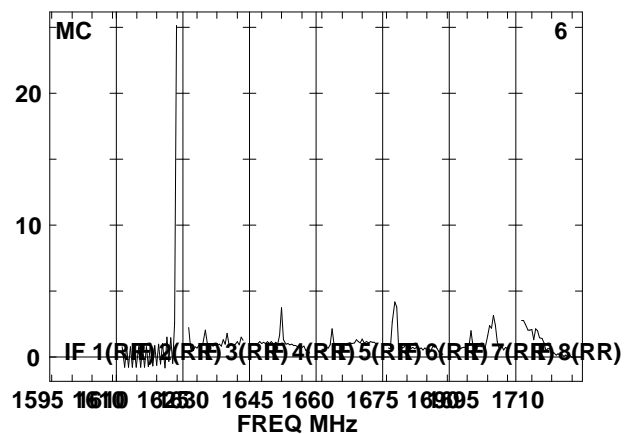
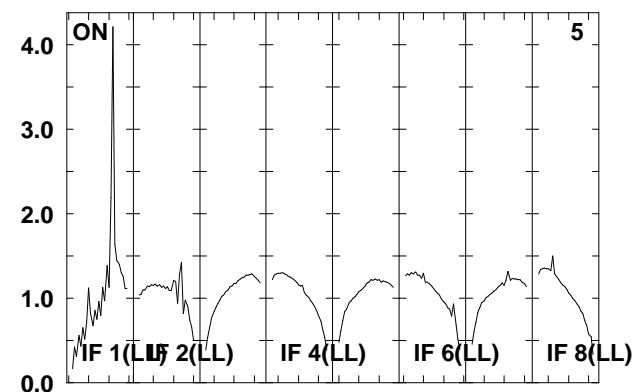
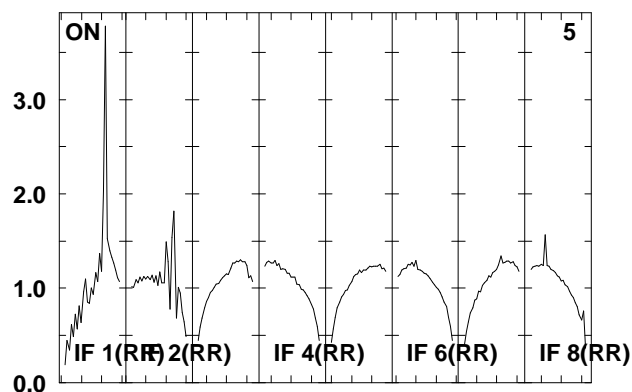
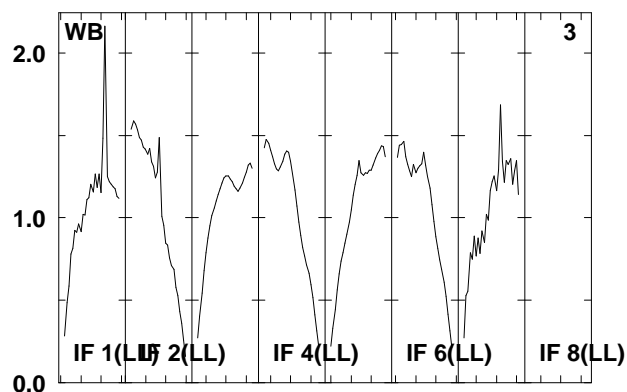
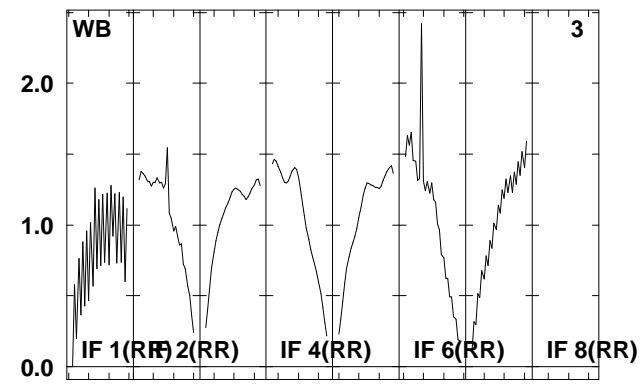
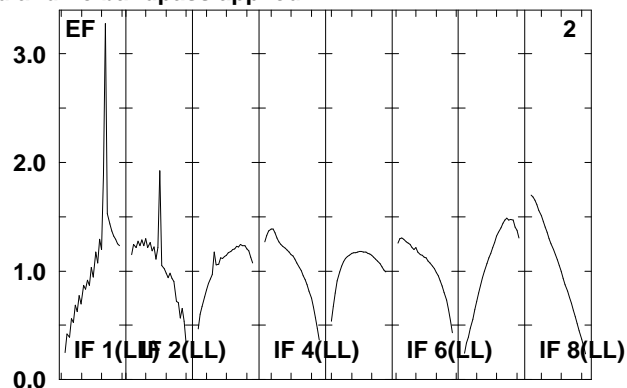
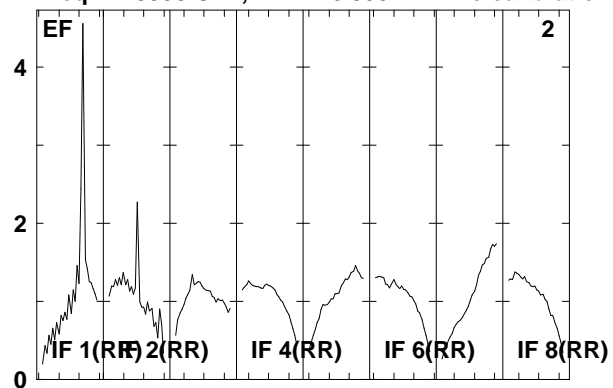

Lower frame: Real Jy

Total-power spectrum Antenna: *

Timerange: 00/19:30:02 to 00/19:33:30

Plot file version 154 created 22-APR-2008 12:27:15

IRAS0725 EP061B.UVDATA.1

Freq = 1.5950 GHz, Bw = 16.000 MH No calibration applied and no bandpass applied

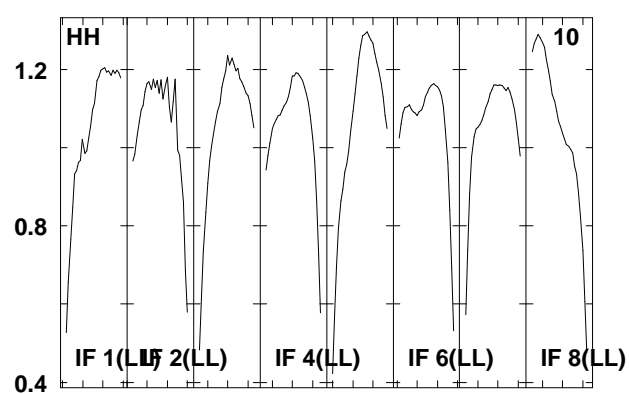
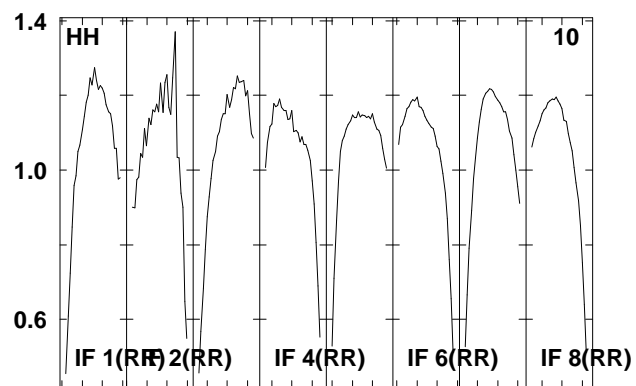
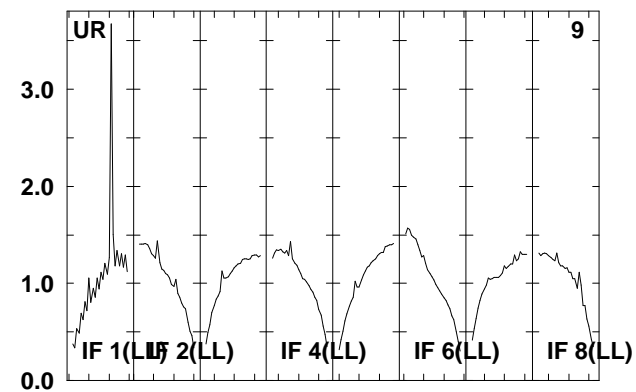
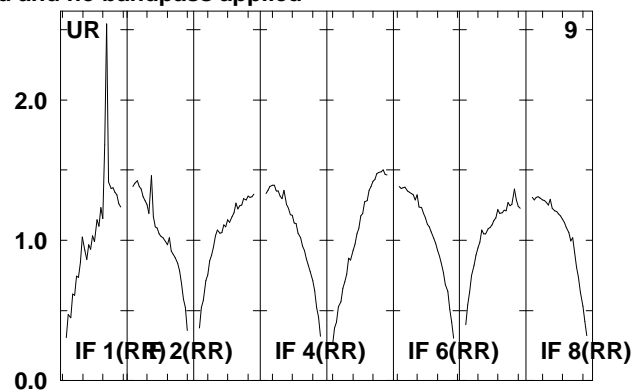
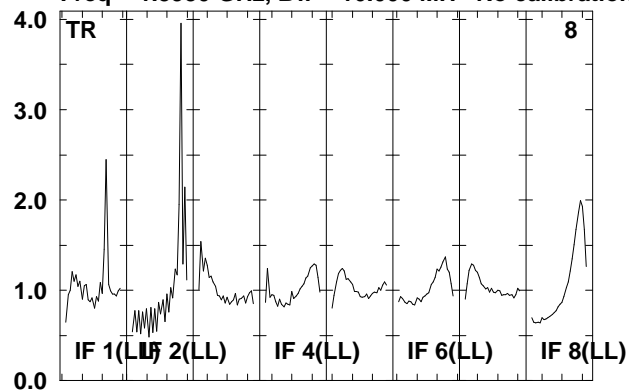

Lower frame: Real Jy
Total-power spectrum Antenna: *
Timerange: 00/19:30:02 to 00/19:33:30

Plot file version 155 created 22-APR-2008 12:27:15

J0730-02 EP061B.UVDATA.1

Freq = 1.5950 GHz, Bw = 16.000 MH No calibration applied and no bandpass applied

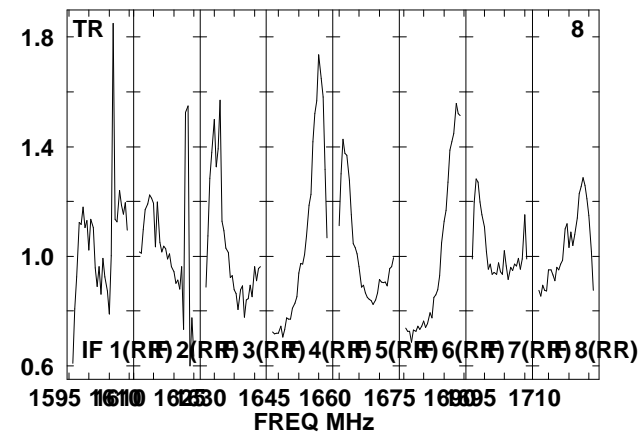
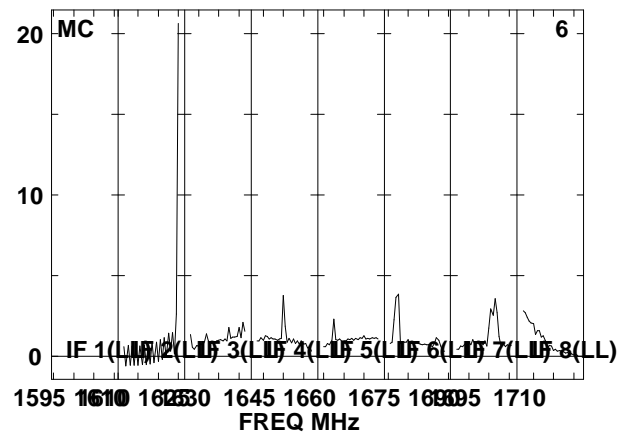
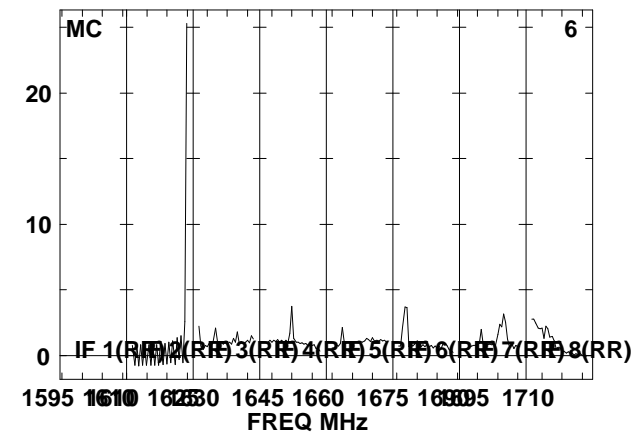
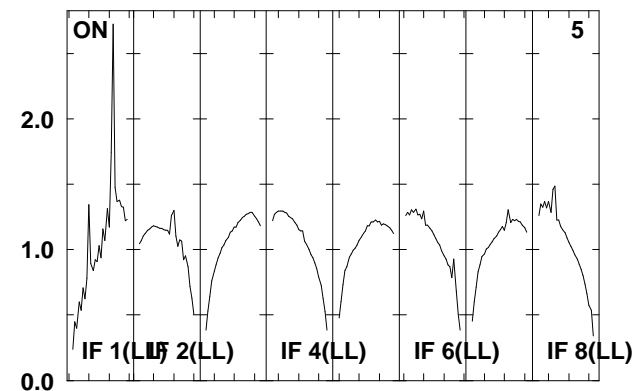
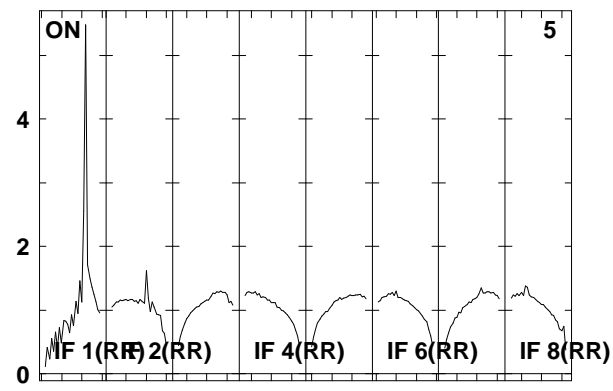
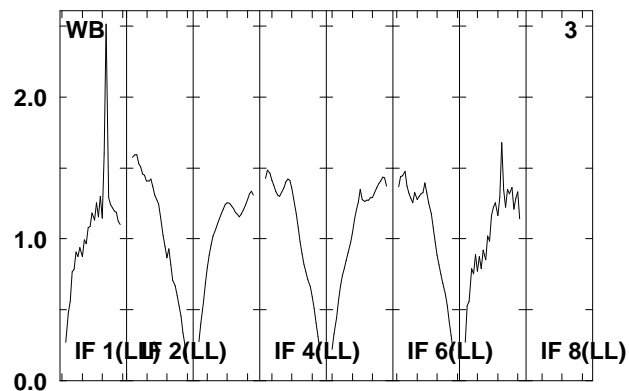
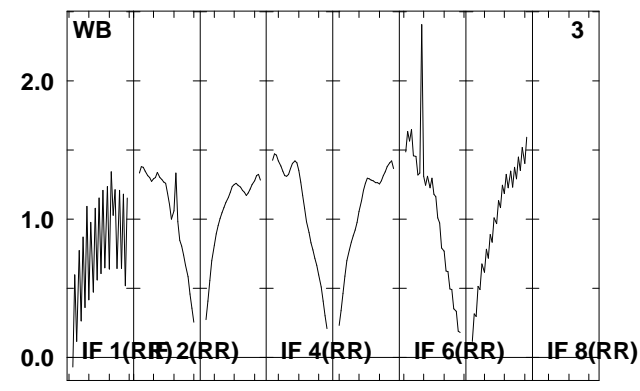
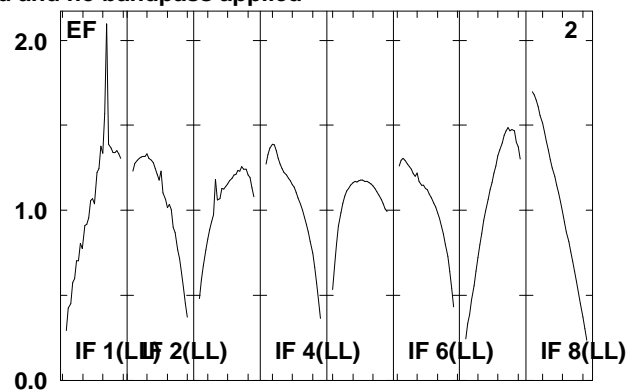
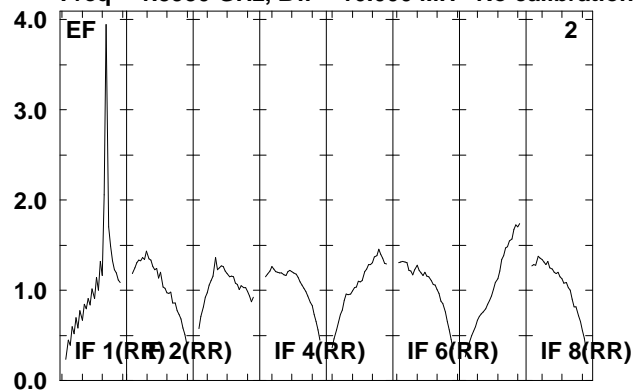

Lower frame: Real Jy
Total-power spectrum Antenna: *
Timerange: 00/19:33:32 to 00/19:35:00

Plot file version 156 created 22-APR-2008 12:27:16

J0730-02 EP061B.UVDATA.1

Freq = 1.5950 GHz, Bw = 16.000 MH No calibration applied and no bandpass applied

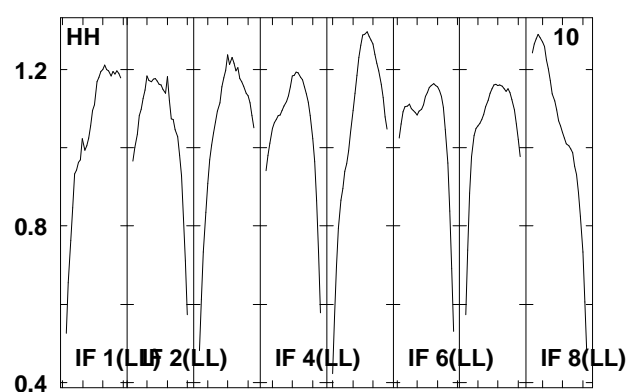
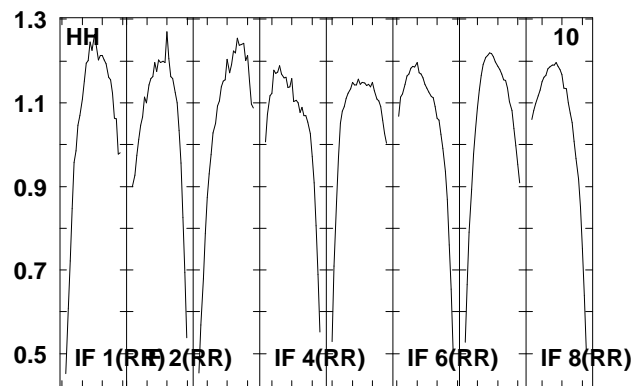
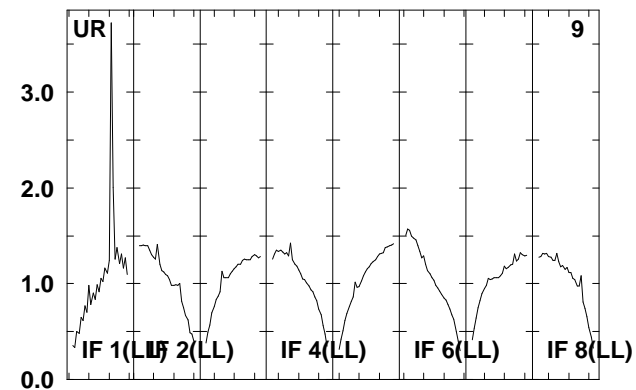
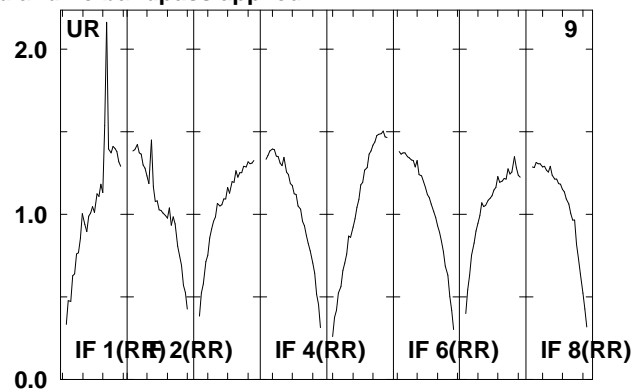
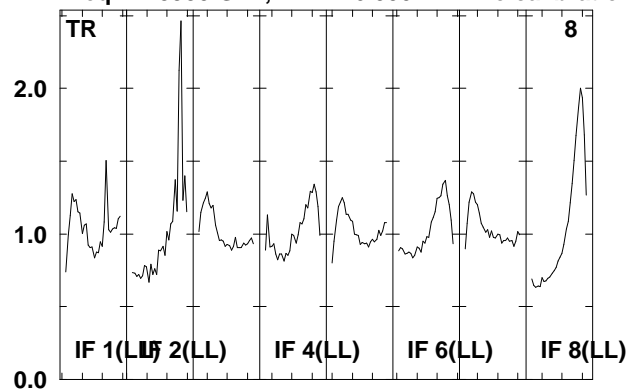

Lower frame: Real Jy
Total-power spectrum Antenna: *
Timerange: 00/19:33:32 to 00/19:35:00

Plot file version 157 created 22-APR-2008 12:27:16

IRAS0725 EP061B.UVDATA.1

Freq = 1.5950 GHz, Bw = 16.000 MH No calibration applied and no bandpass applied

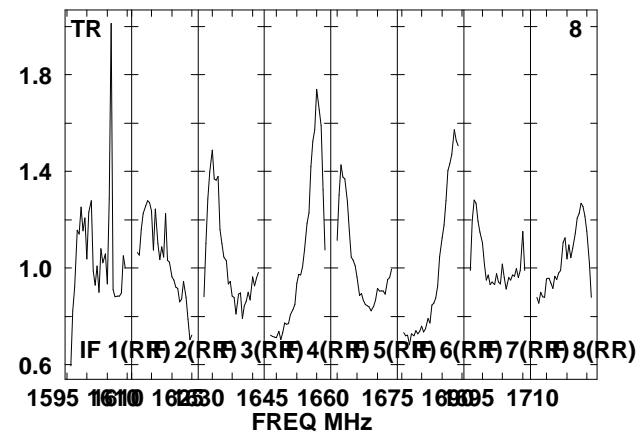
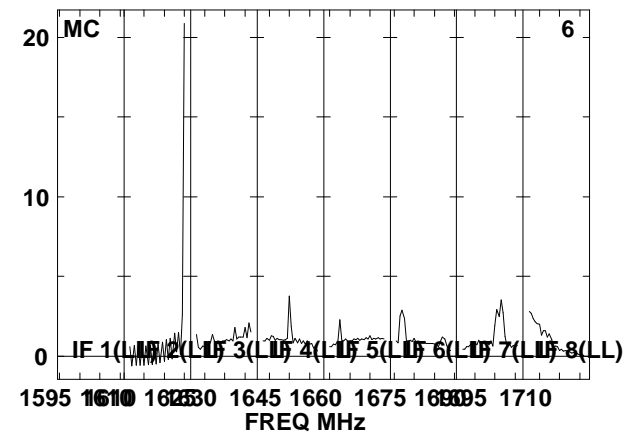
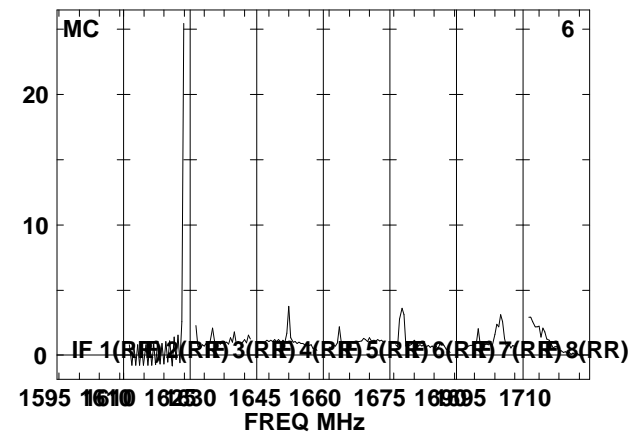
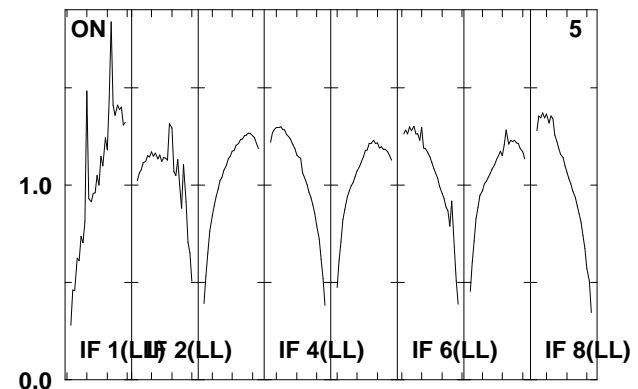
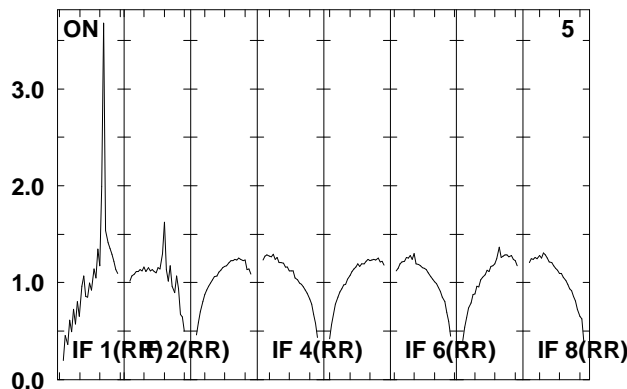
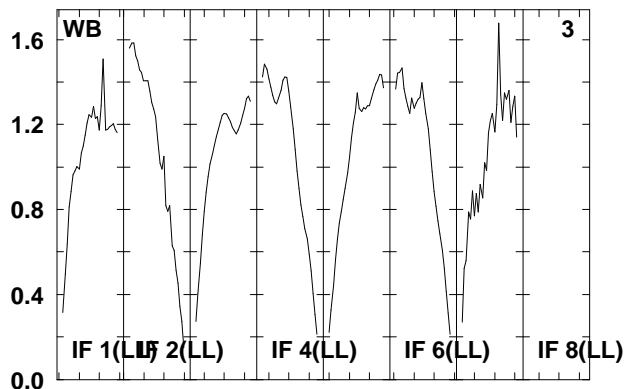
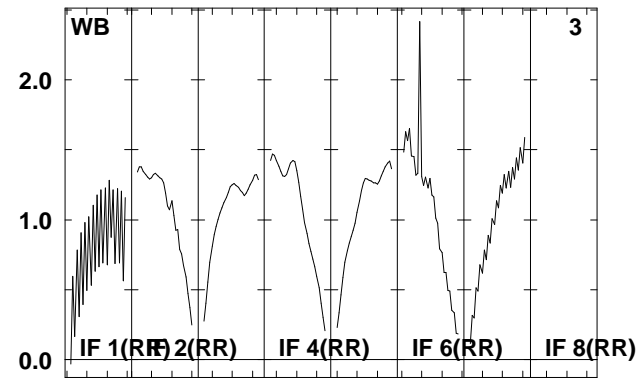
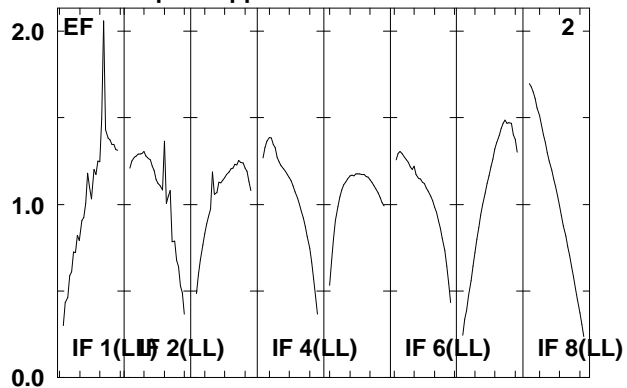
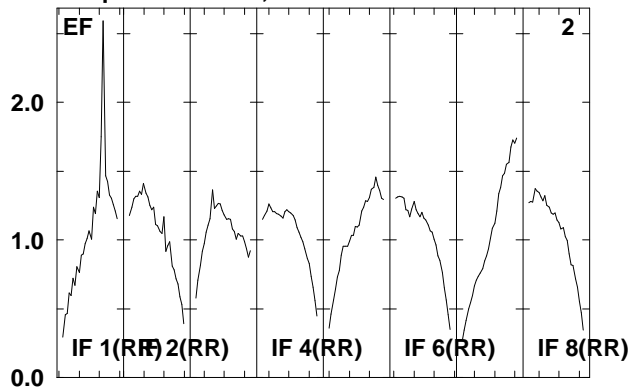

Lower frame: Real Jy
Total-power spectrum Antenna: *
Timerange: 00/19:35:02 to 00/19:38:28

Plot file version 158 created 22-APR-2008 12:27:17

IRAS0725 EP061B.UVDATA.1

Freq = 1.5950 GHz, Bw = 16.000 MH No calibration applied and no bandpass applied

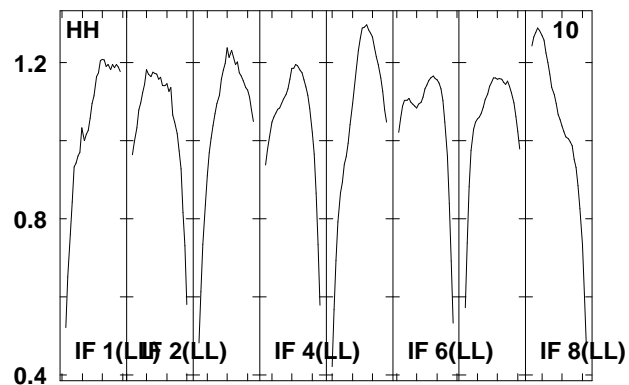
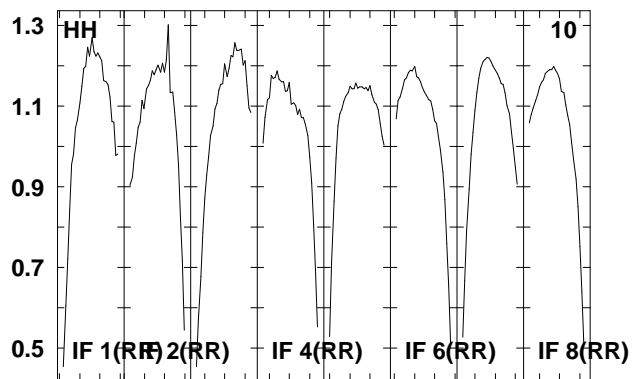
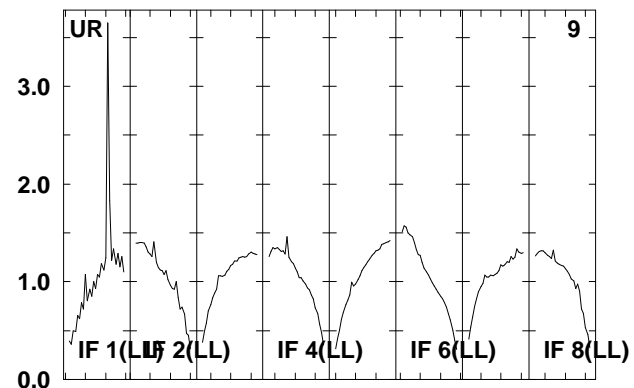
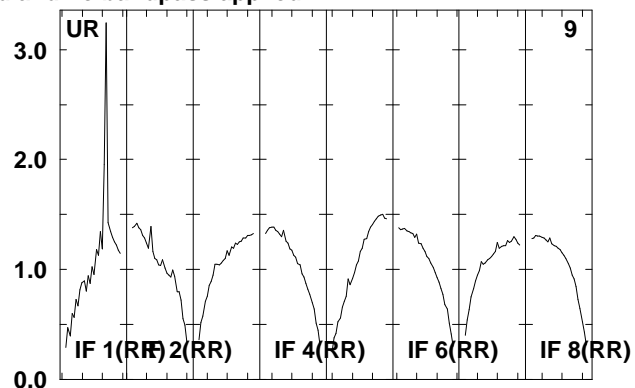
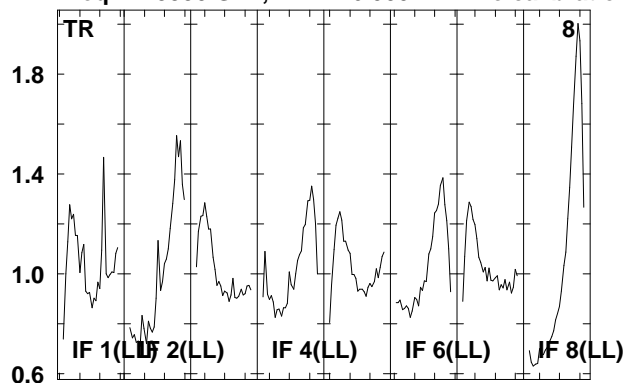

Lower frame: Real Jy
Total-power spectrum Antenna: *
Timerange: 00/19:35:02 to 00/19:38:28

Plot file version 159 created 22-APR-2008 12:27:19

J0730-02 EP061B.UVDATA.1

Freq = 1.5950 GHz, Bw = 16.000 MH No calibration applied and no bandpass applied

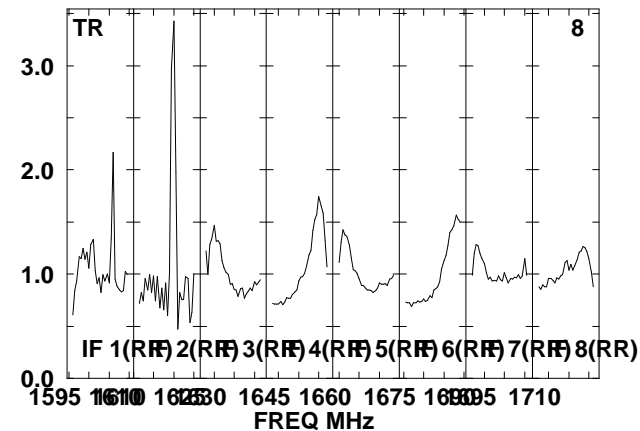
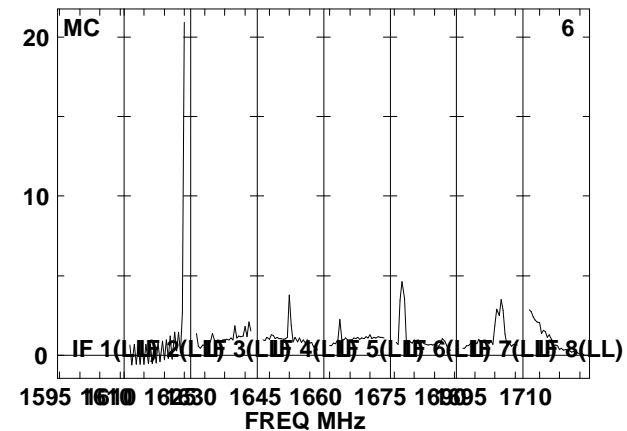
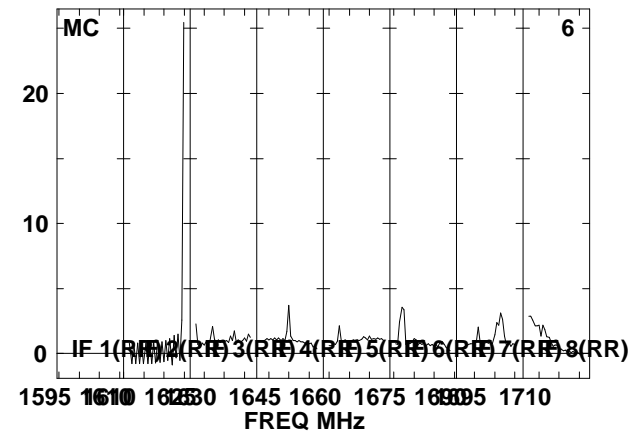
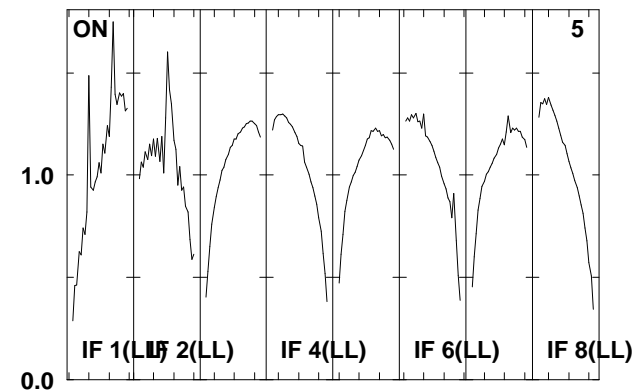
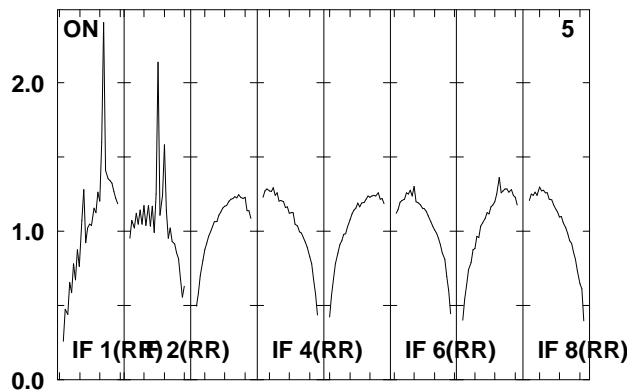
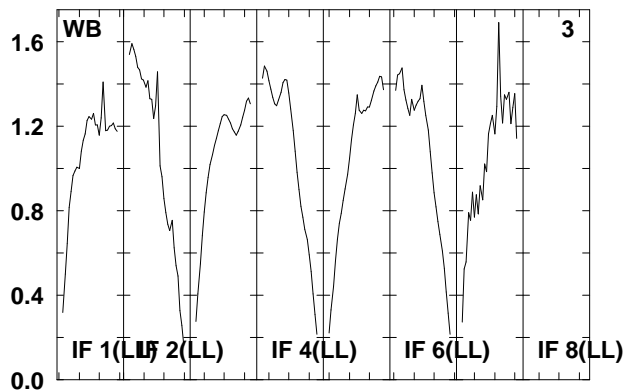
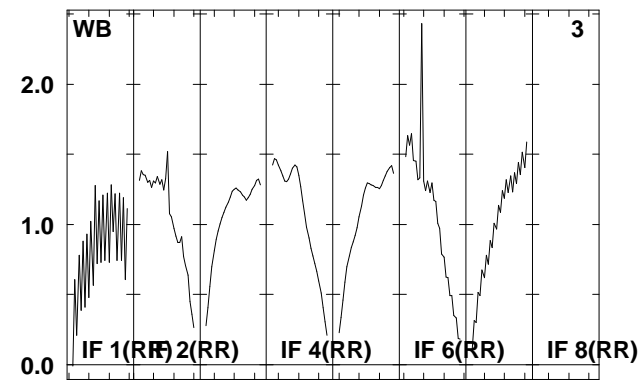
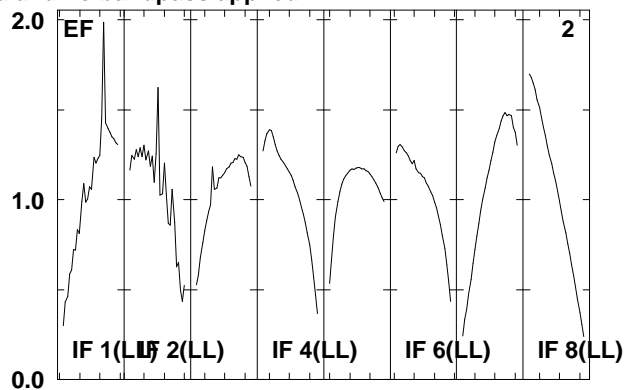
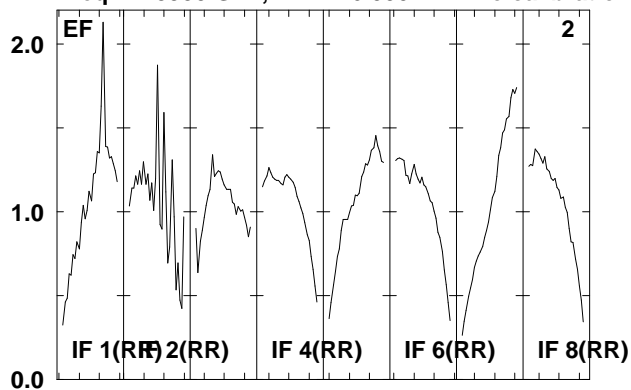

Lower frame: Real Jy
Total-power spectrum Antenna: *
Timerange: 00/19:39:32 to 00/19:41:00

Plot file version 160 created 22-APR-2008 12:27:19

J0730-02 EP061B.UVDATA.1

Freq = 1.5950 GHz, Bw = 16.000 MH No calibration applied and no bandpass applied

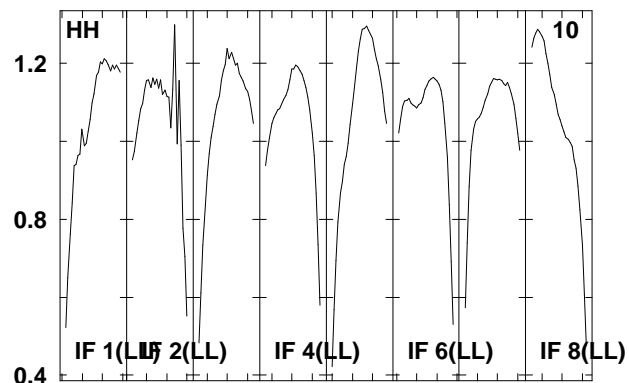
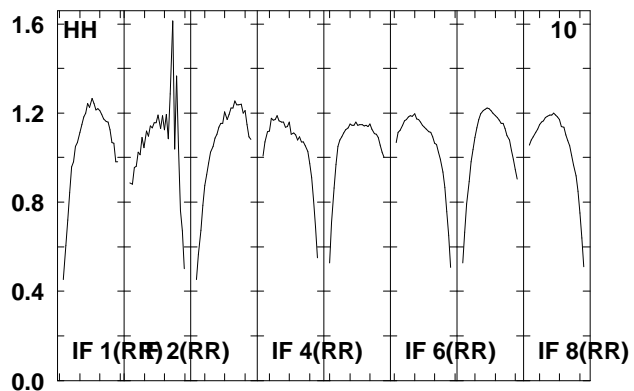
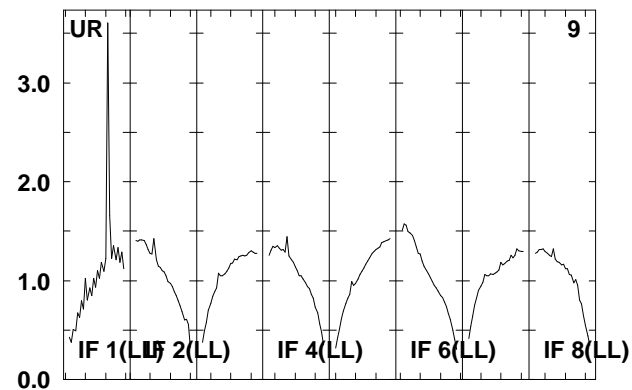
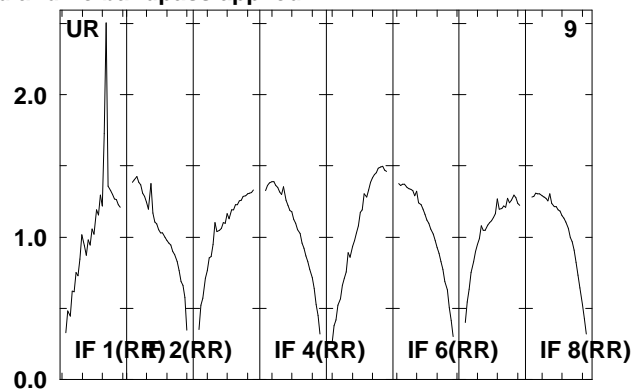
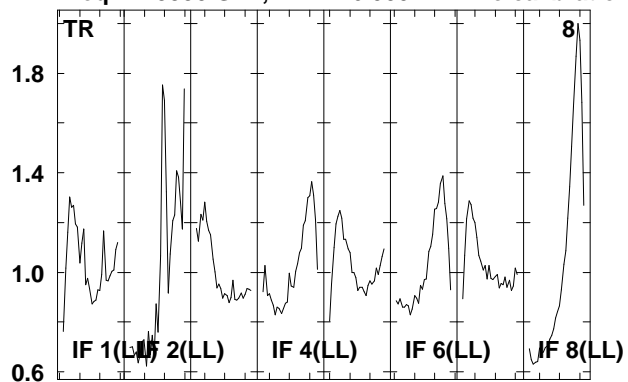

Lower frame: Real Jy
Total-power spectrum Antenna: *
Timerange: 00/19:39:32 to 00/19:41:00

Plot file version 161 created 22-APR-2008 12:27:20

IRAS0725 EP061B.UVDATA.1

Freq = 1.5950 GHz, Bw = 16.000 MH No calibration applied and no bandpass applied

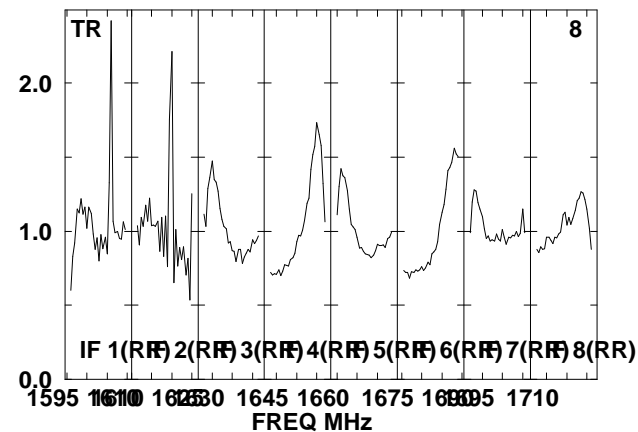
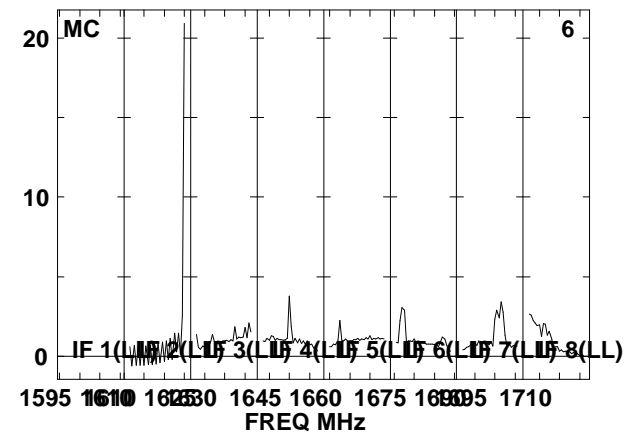
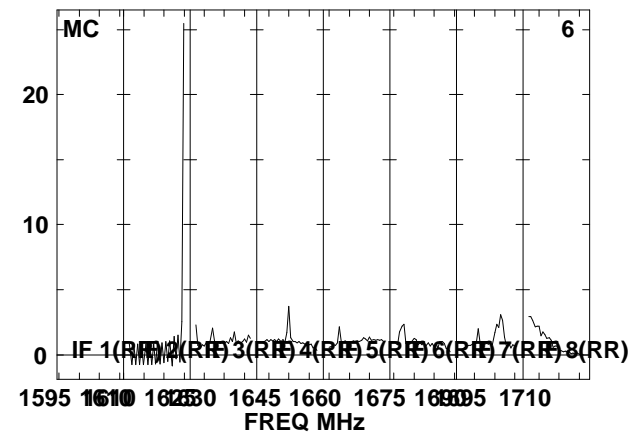
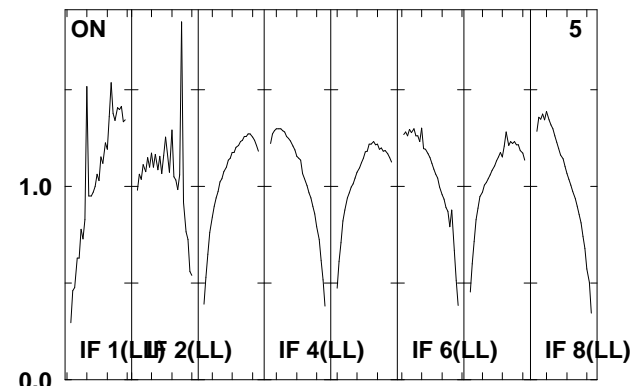
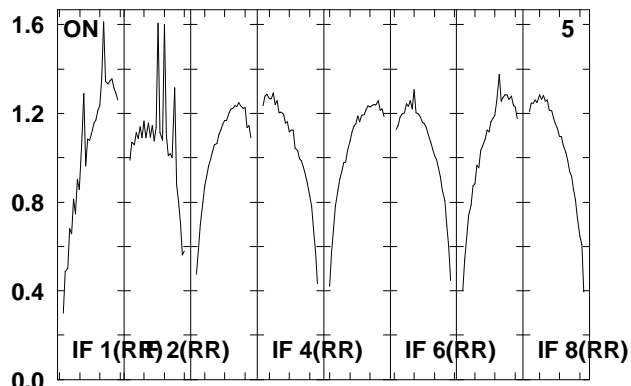
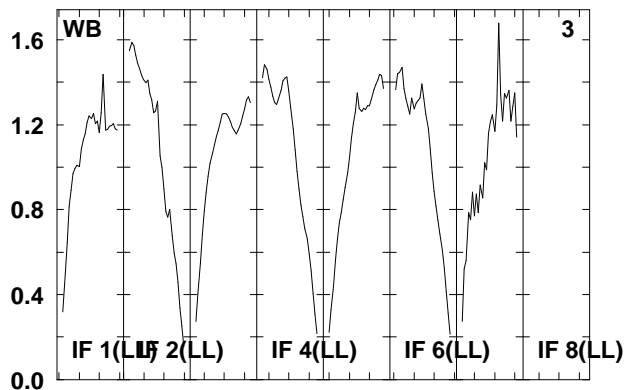
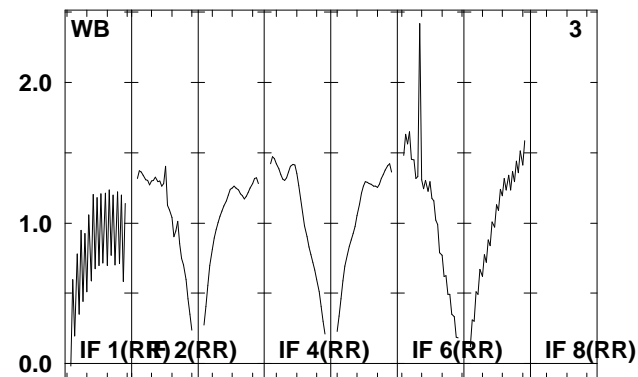
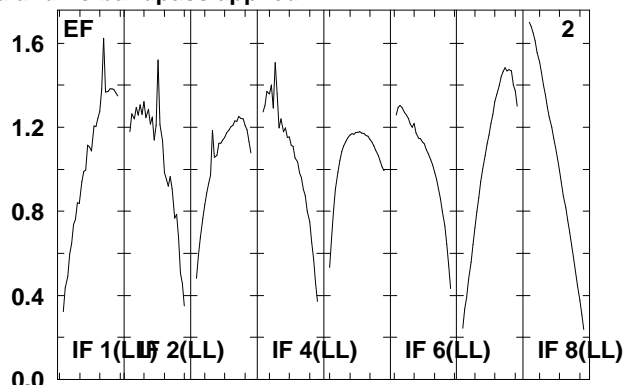
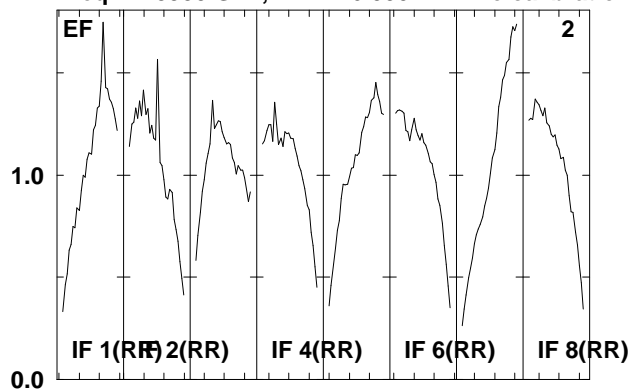

Lower frame: Real Jy
Total-power spectrum Antenna: *
Timerange: 00/19:41:02 to 00/19:44:30

Plot file version 162 created 22-APR-2008 12:27:21

IRAS0725 EP061B.UVDATA.1

Freq = 1.5950 GHz, Bw = 16.000 MH No calibration applied and no bandpass applied

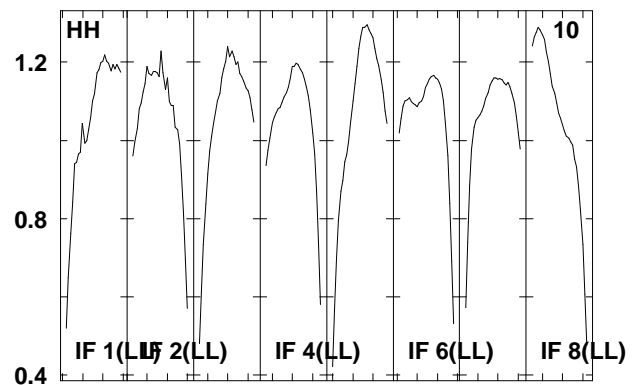
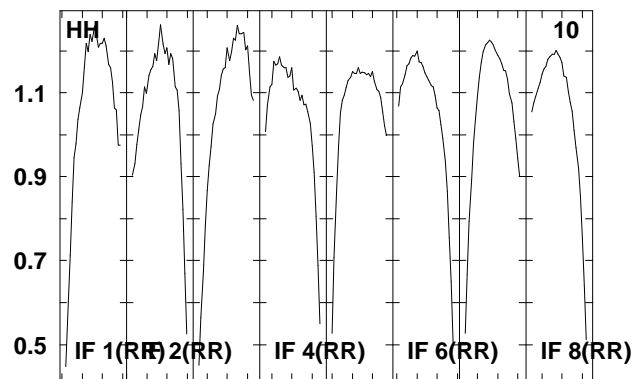
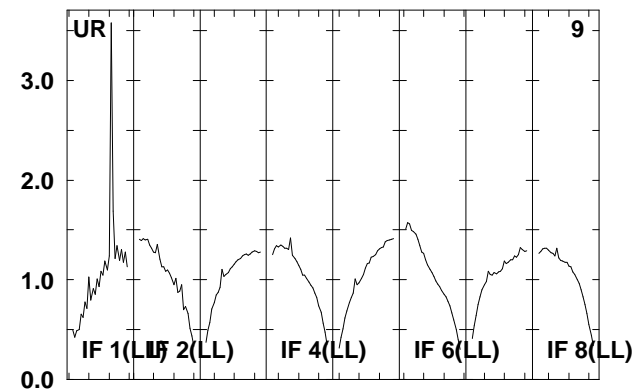
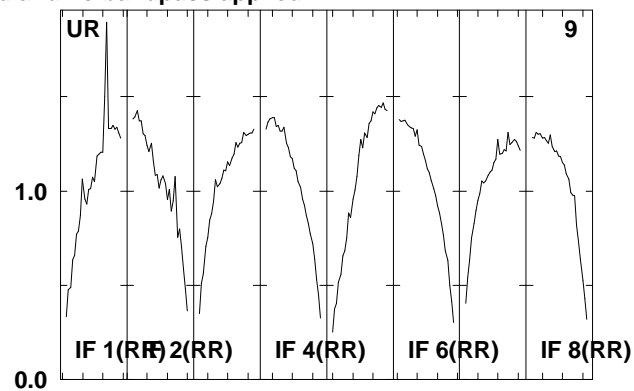
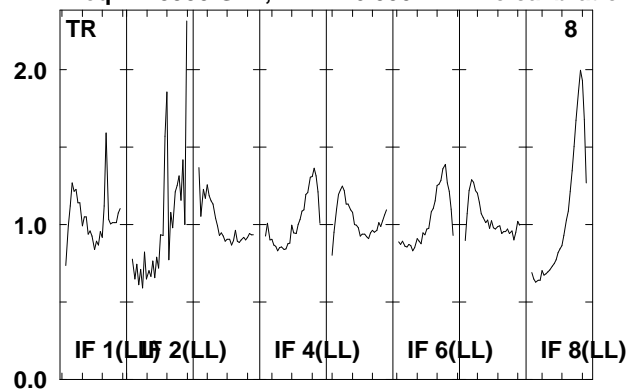

Lower frame: Real Jy
Total-power spectrum Antenna: *
Timerange: 00/19:41:02 to 00/19:44:30

Plot file version 163 created 22-APR-2008 12:27:22

J0730-02 EP061B.UVDATA.1

Freq = 1.5950 GHz, Bw = 16.000 MH No calibration applied and no bandpass applied

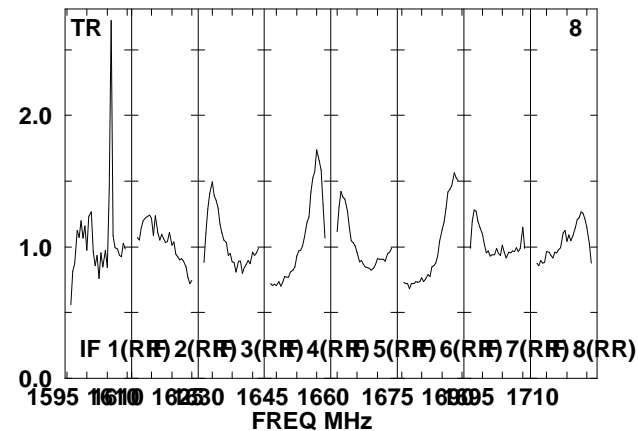
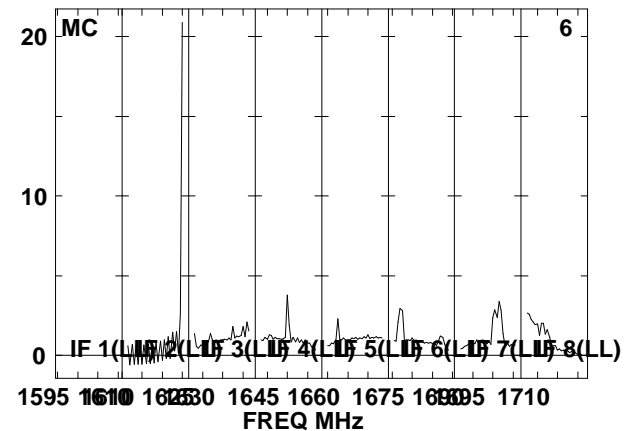
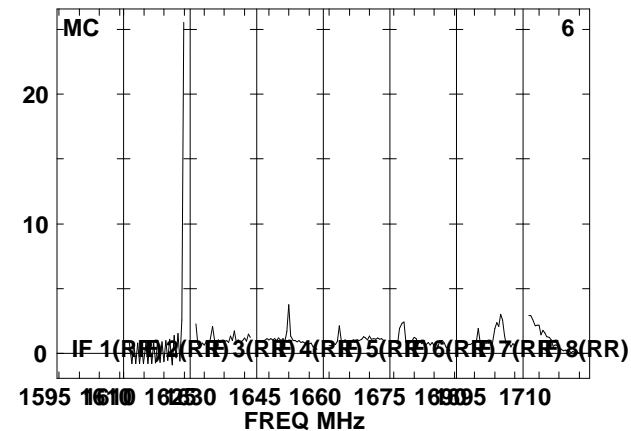
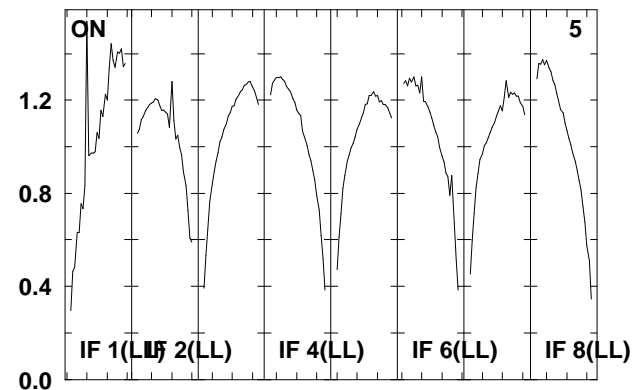
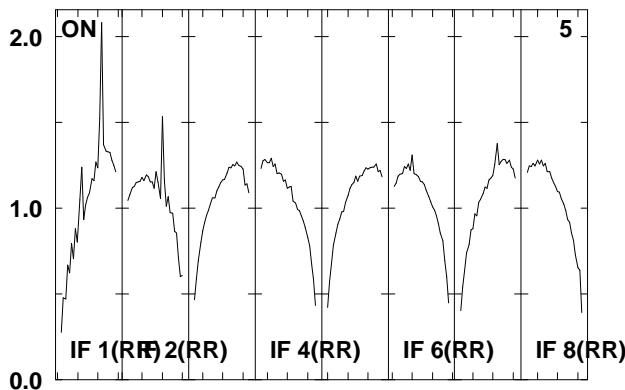
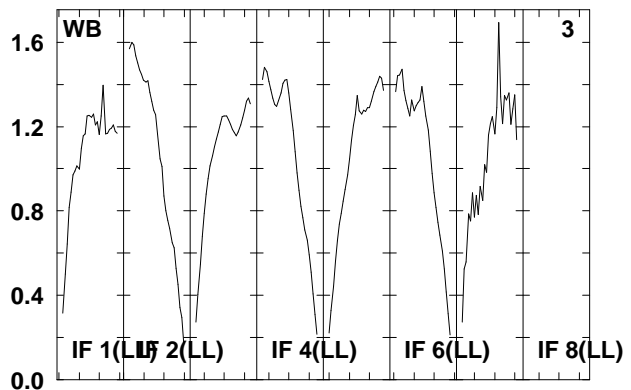
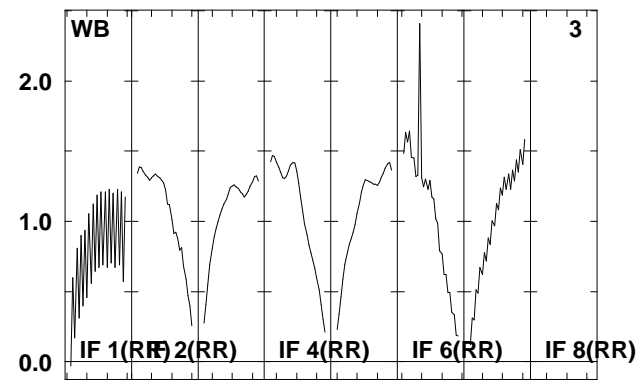
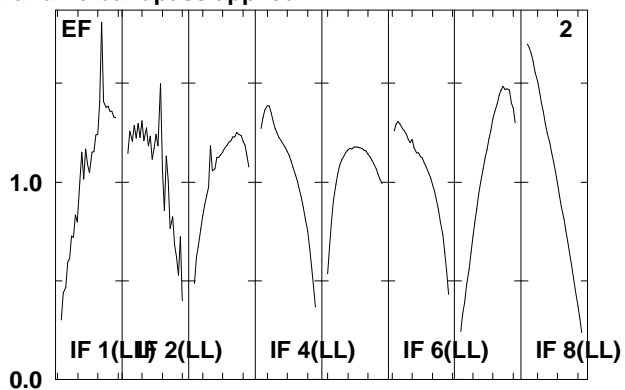
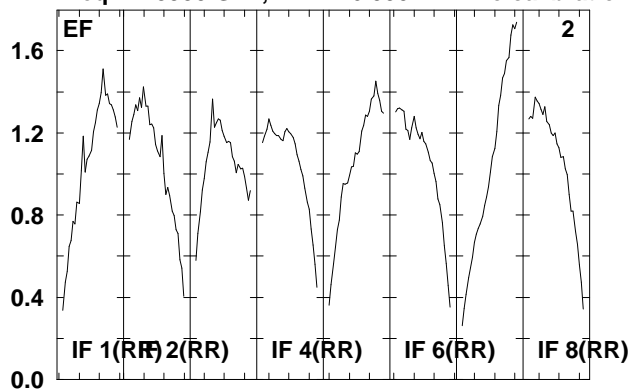

Lower frame: Real Jy
Total-power spectrum Antenna: *
Timerange: 00/19:44:32 to 00/19:46:00

Plot file version 164 created 22-APR-2008 12:27:22

J0730-02 EP061B.UVDATA.1

Freq = 1.5950 GHz, Bw = 16.000 MH No calibration applied and no bandpass applied

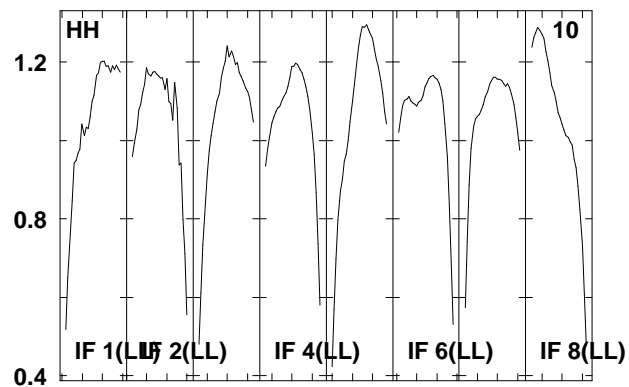
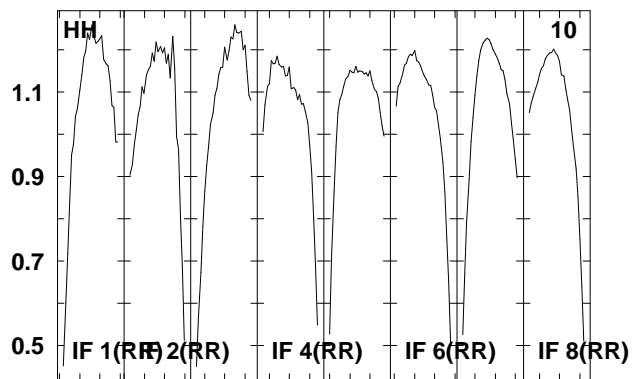
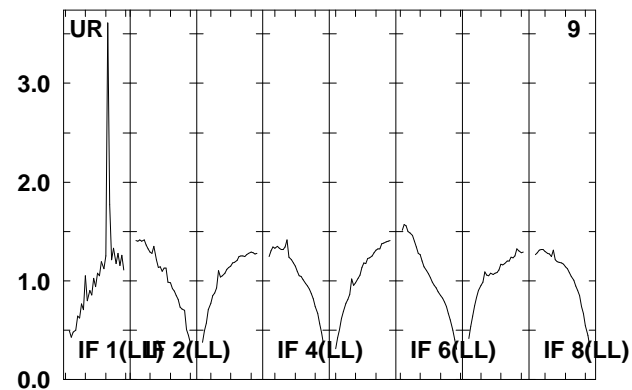
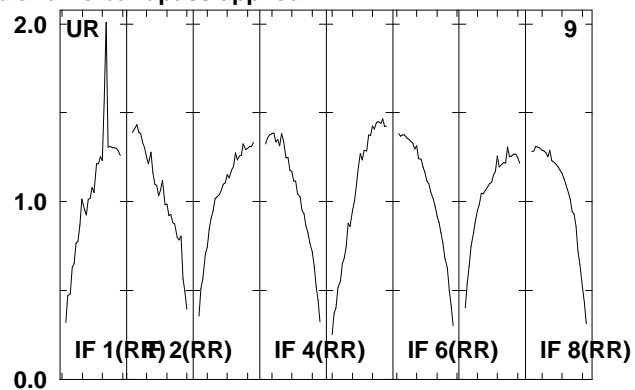
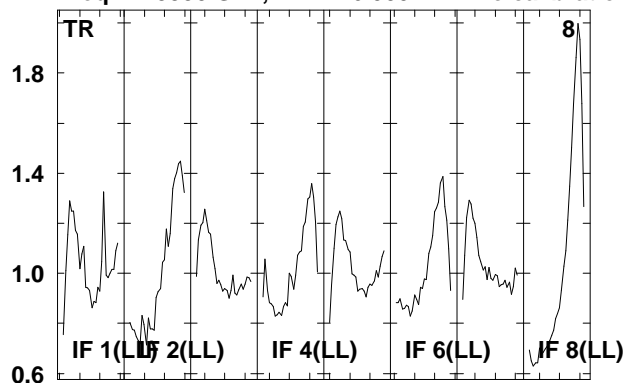

Lower frame: Real Jy
Total-power spectrum Antenna: *
Timerange: 00/19:44:32 to 00/19:46:00

Plot file version 165 created 22-APR-2008 12:27:23

IRAS0725 EP061B.UVDATA.1

Freq = 1.5950 GHz, Bw = 16.000 MH No calibration applied and no bandpass applied

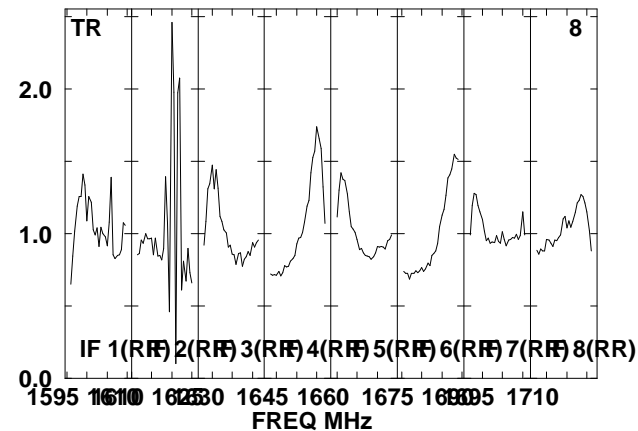
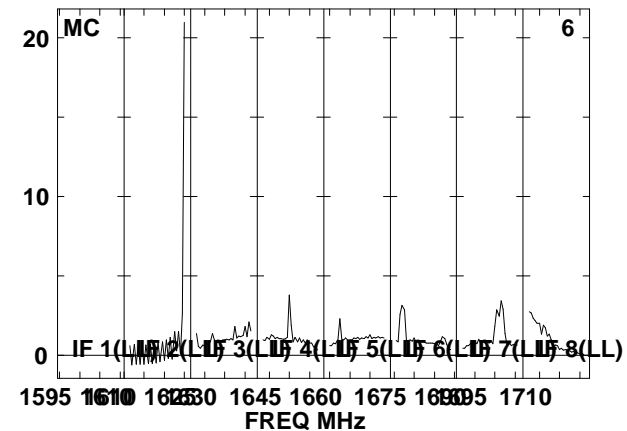
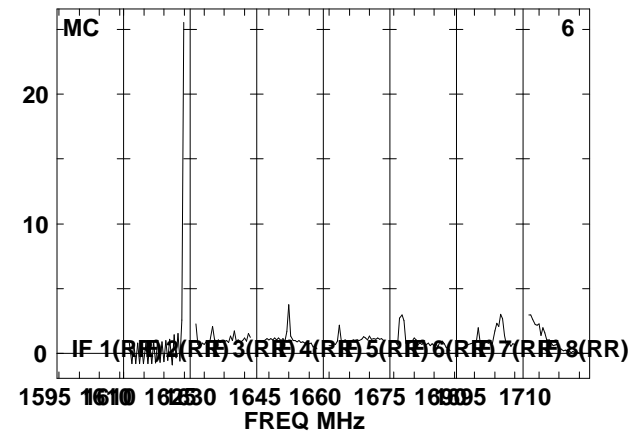
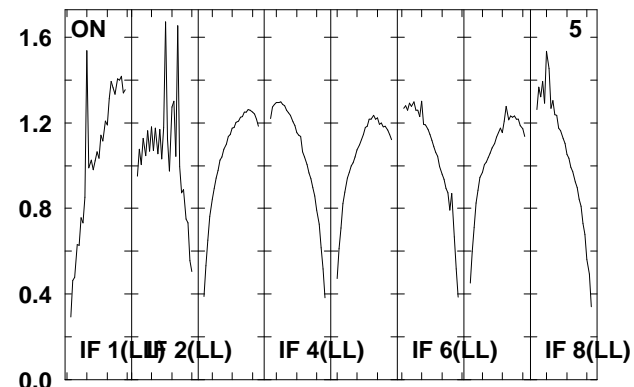
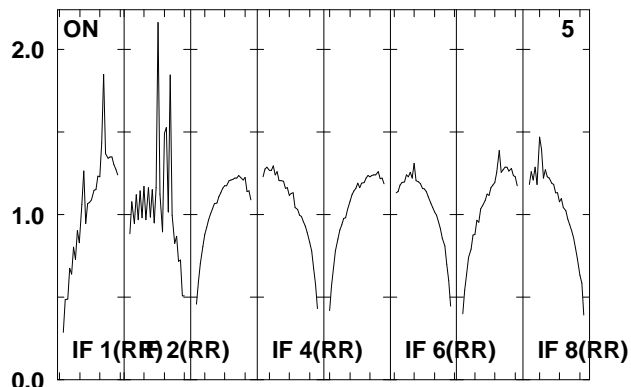
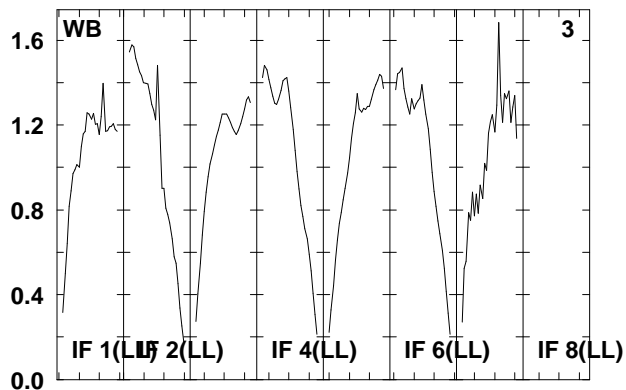
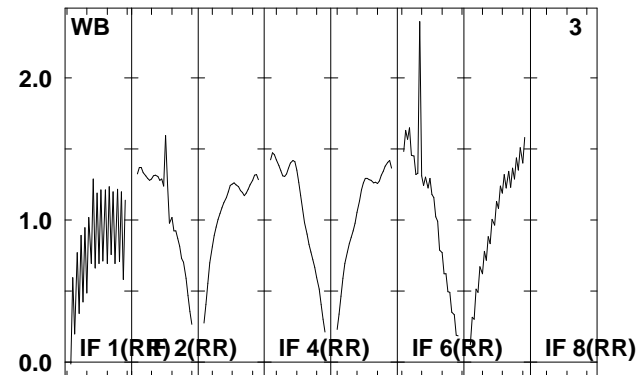
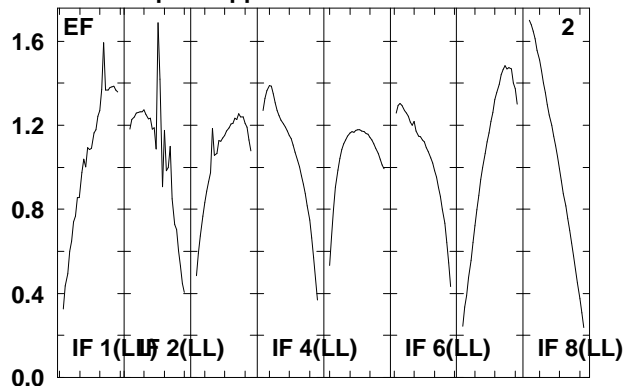
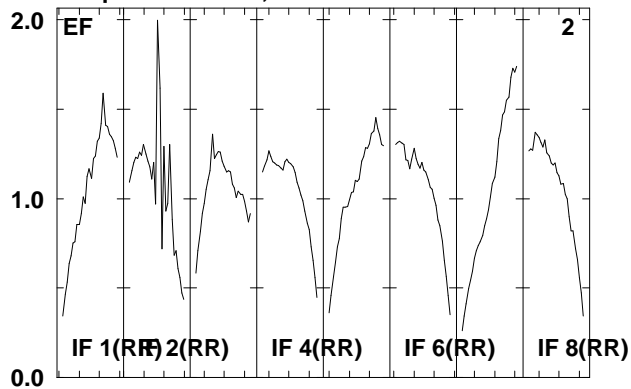

Lower frame: Real Jy
Total-power spectrum Antenna: *
Timerange: 00/19:46:02 to 00/19:49:30

Plot file version 166 created 22-APR-2008 12:27:23

IRAS0725 EP061B.UVDATA.1

Freq = 1.5950 GHz, Bw = 16.000 MH No calibration applied and no bandpass applied

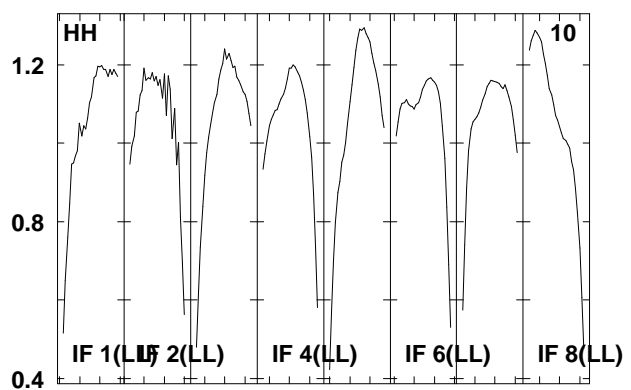
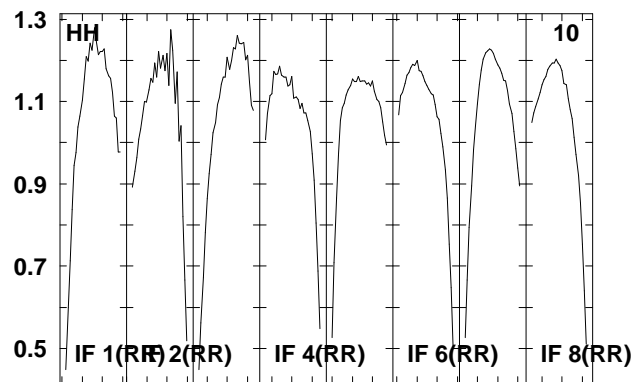
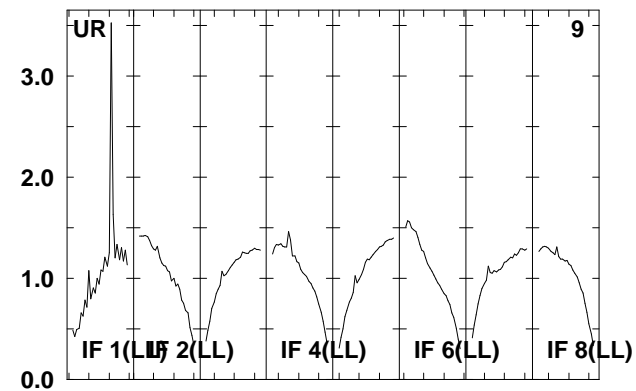
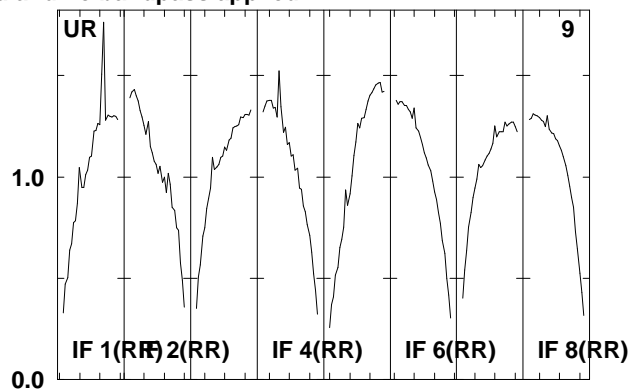
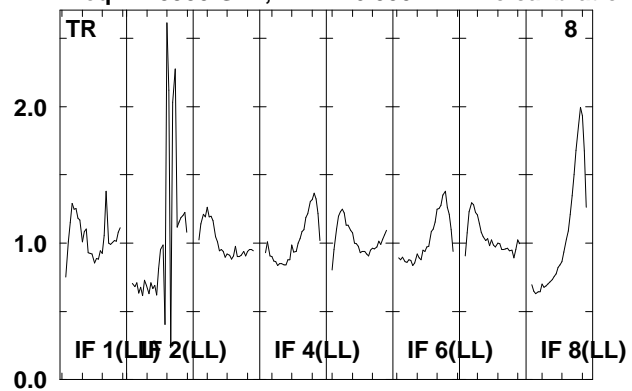

Lower frame: Real Jy
Total-power spectrum Antenna: *
Timerange: 00/19:46:02 to 00/19:49:30

Plot file version 167 created 22-APR-2008 12:27:24

J0730-02 EP061B.UVDATA.1

Freq = 1.5950 GHz, Bw = 16.000 MH No calibration applied and no bandpass applied

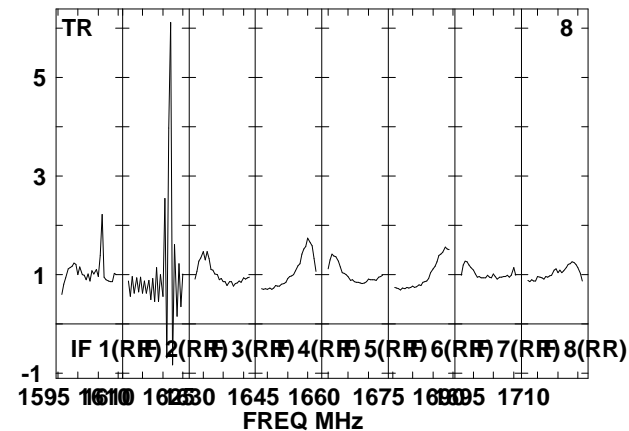
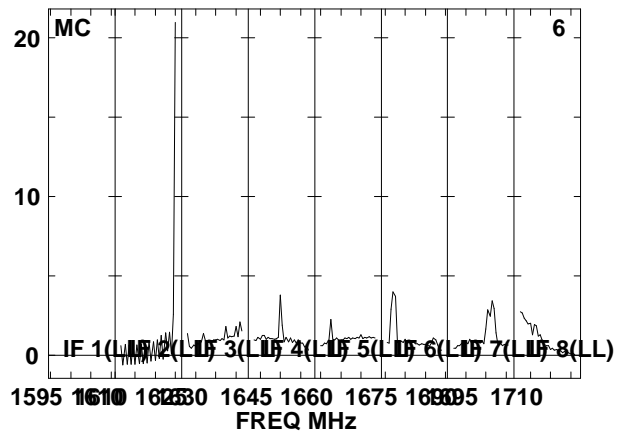
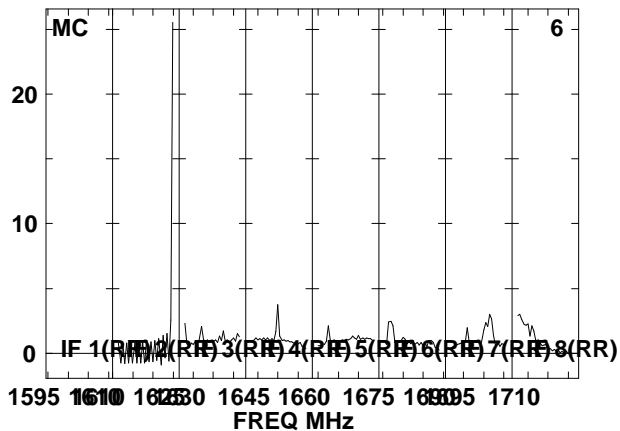
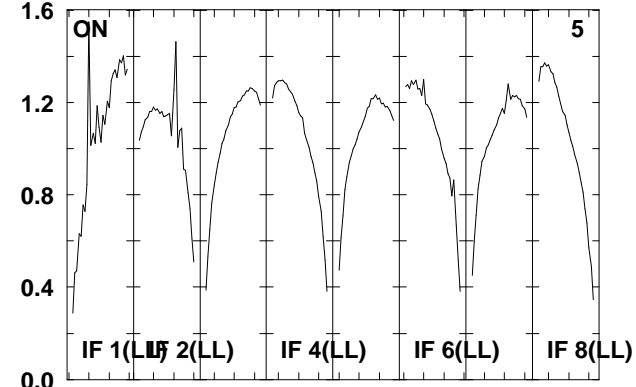
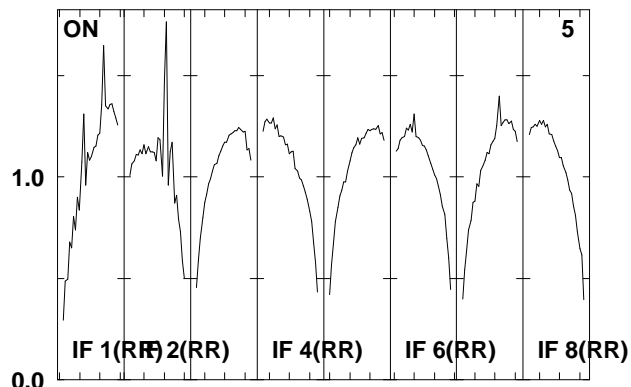
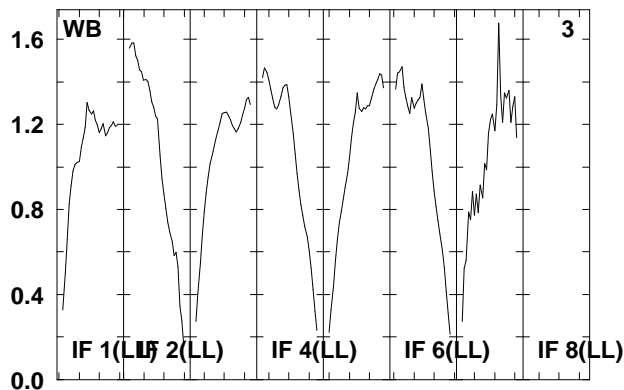
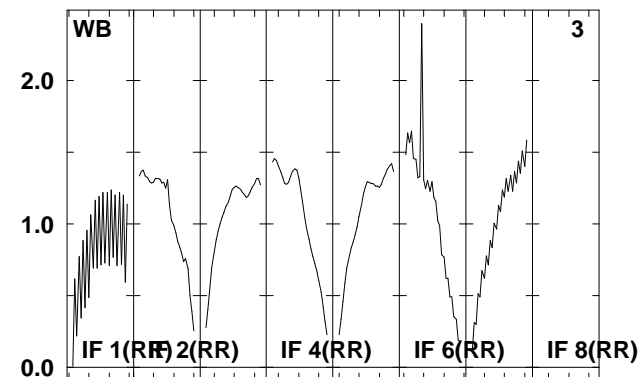
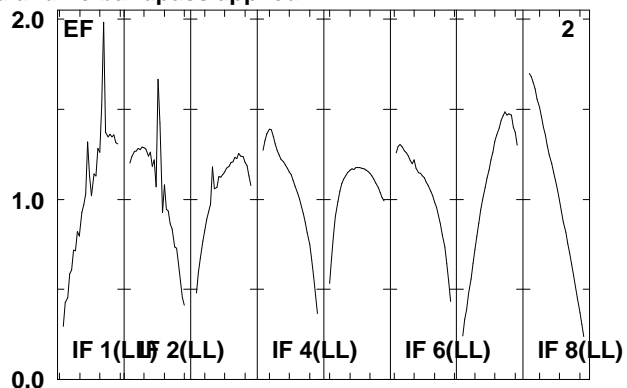
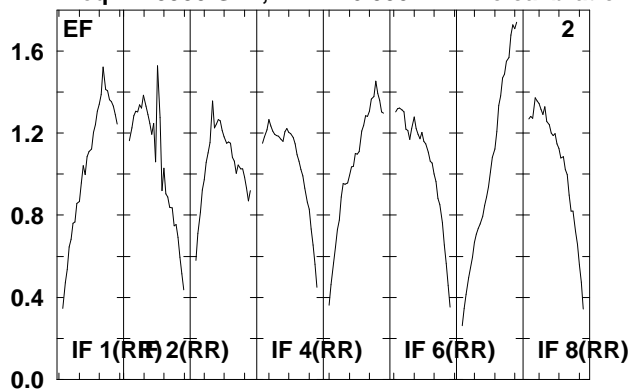

Lower frame: Real Jy
Total-power spectrum Antenna: *
Timerange: 00/19:49:32 to 00/19:51:00

Plot file version 168 created 22-APR-2008 12:27:24

J0730-02 EP061B.UVDATA.1

Freq = 1.5950 GHz, Bw = 16.000 MH No calibration applied and no bandpass applied

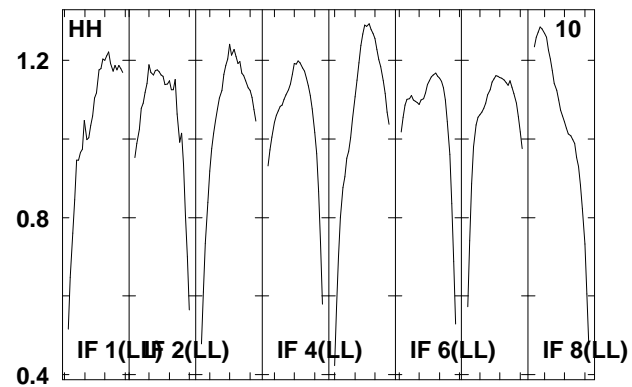
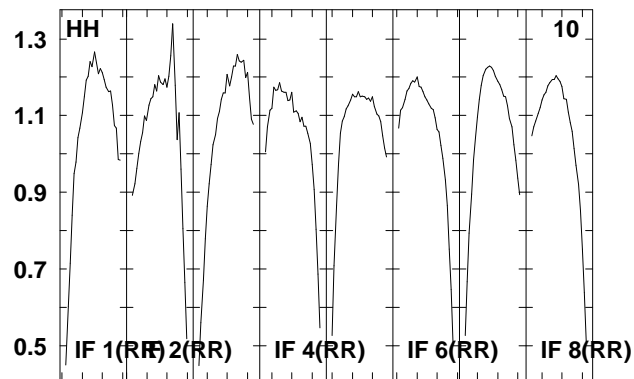
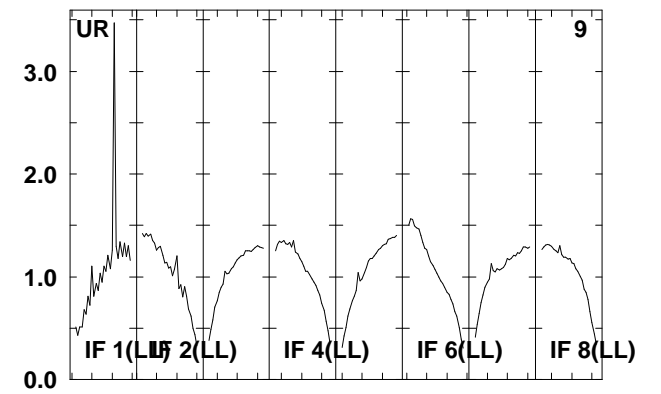
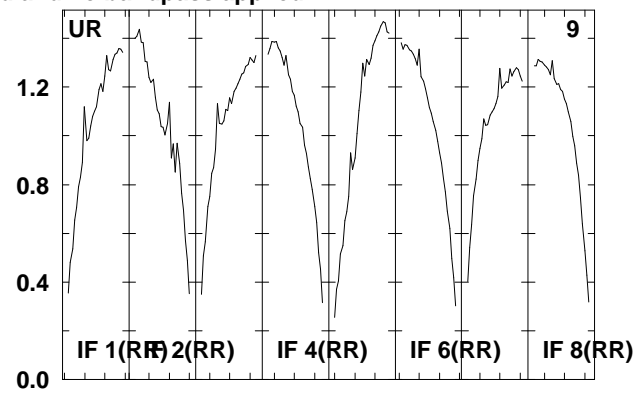
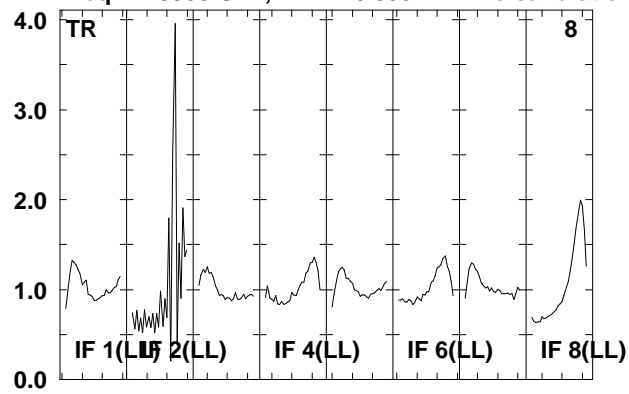

Lower frame: Real Jy
Total-power spectrum Antenna: *
Timerange: 00/19:49:32 to 00/19:51:00

Plot file version 169 created 22-APR-2008 12:27:25

IRAS0725 EP061B.UVDATA.1

Freq = 1.5950 GHz, Bw = 16.000 MH No calibration applied and no bandpass applied

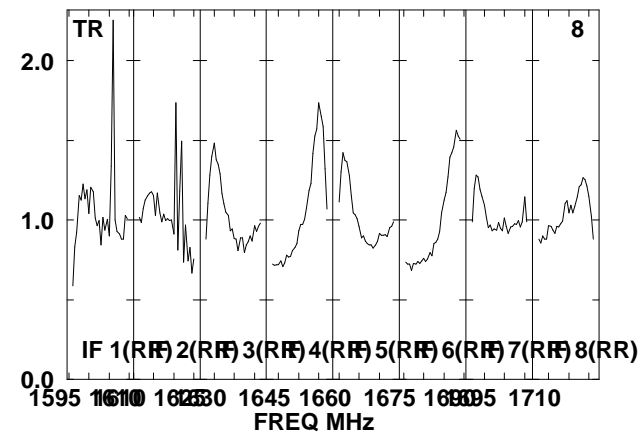
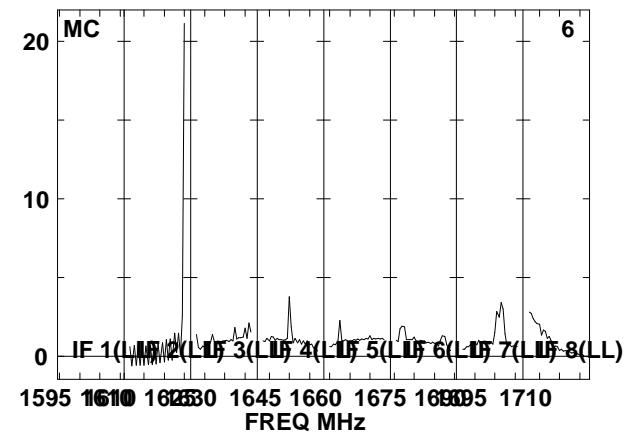
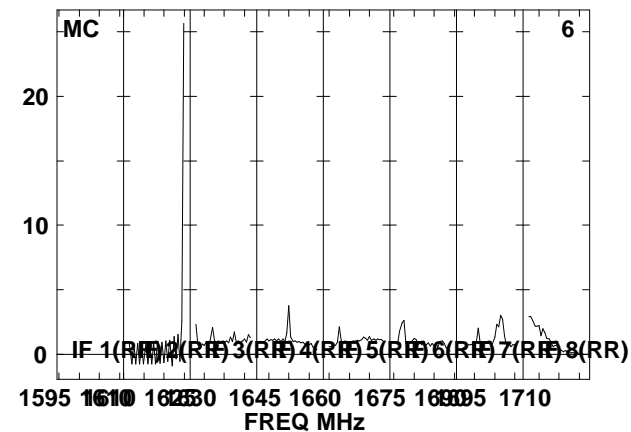
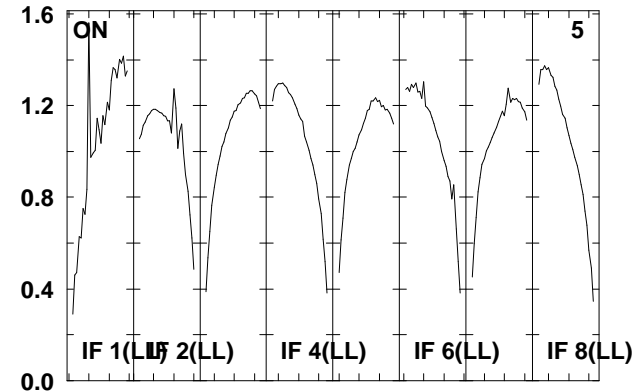
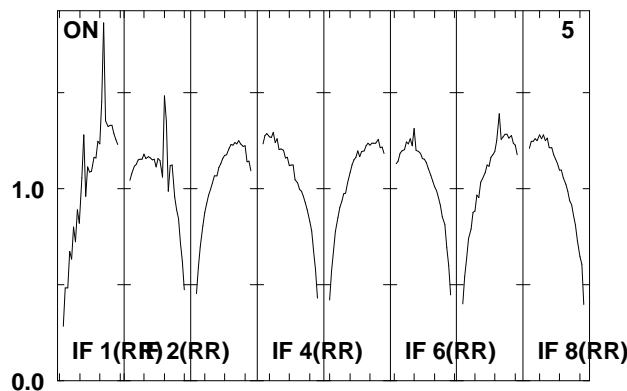
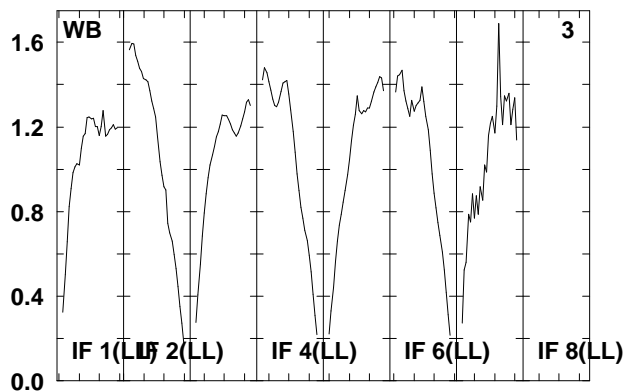
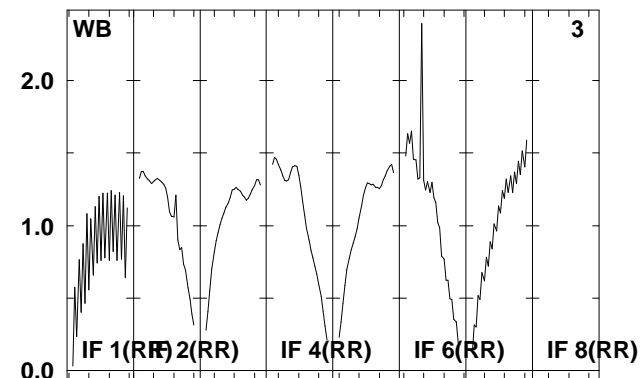
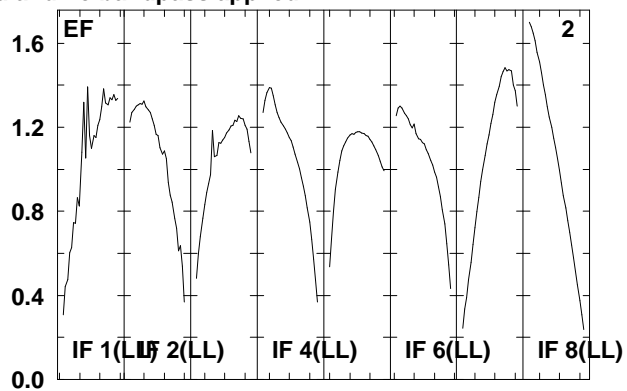
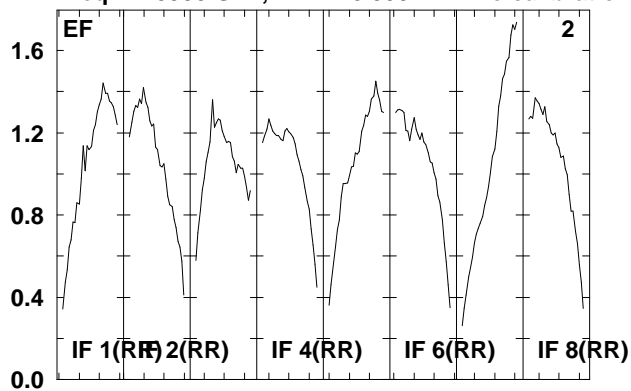

Lower frame: Real Jy

Total-power spectrum Antenna: *

Timerange: 00/19:51:02 to 00/19:54:26

Plot file version 170 created 22-APR-2008 12:27:26

IRAS0725 EP061B.UVDATA.1

Freq = 1.5950 GHz, Bw = 16.000 MH No calibration applied and no bandpass applied

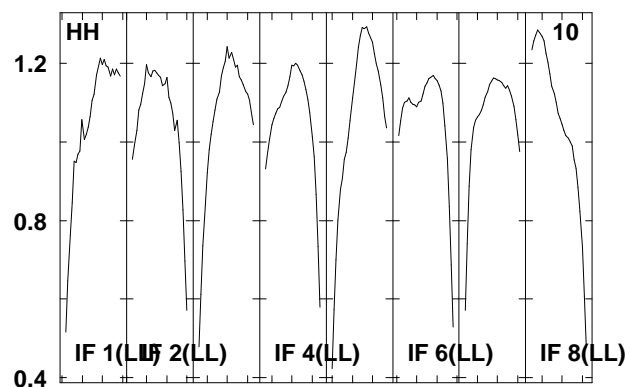
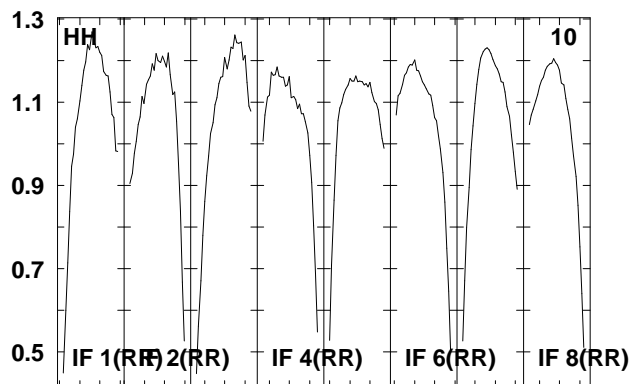
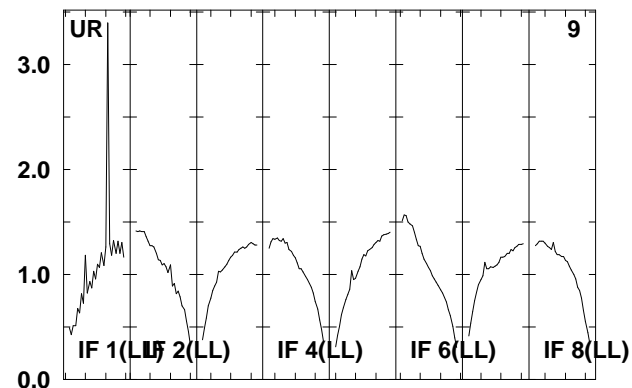
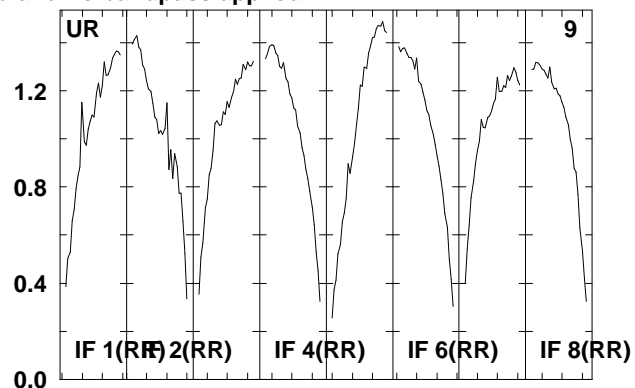
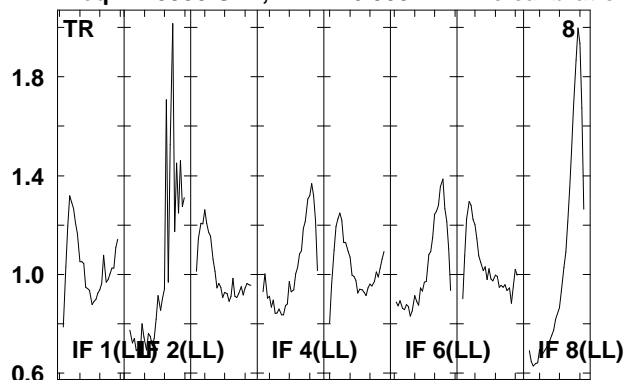

Lower frame: Real Jy
Total-power spectrum Antenna: *
Timerange: 00/19:51:02 to 00/19:54:26

Plot file version 171 created 22-APR-2008 12:27:27

J0730-02 EP061B.UVDATA.1

Freq = 1.5950 GHz, Bw = 16.000 MH No calibration applied and no bandpass applied

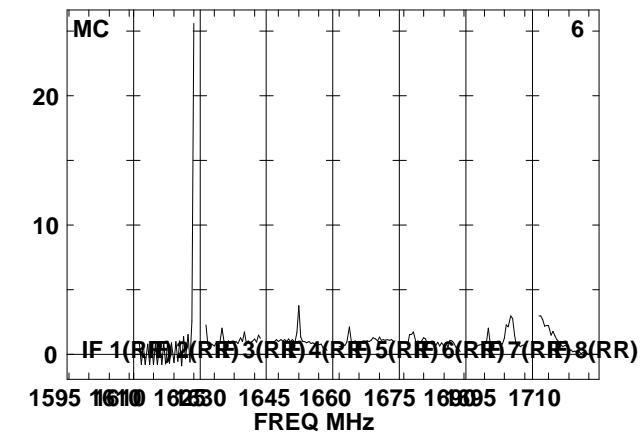
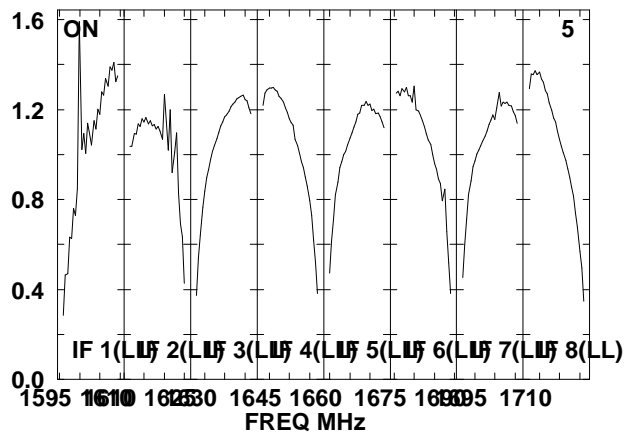
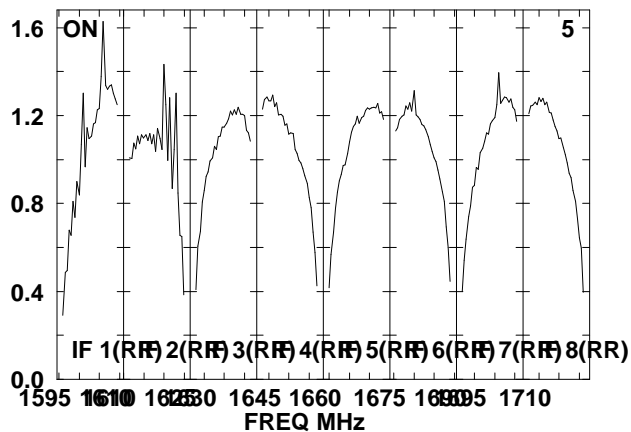
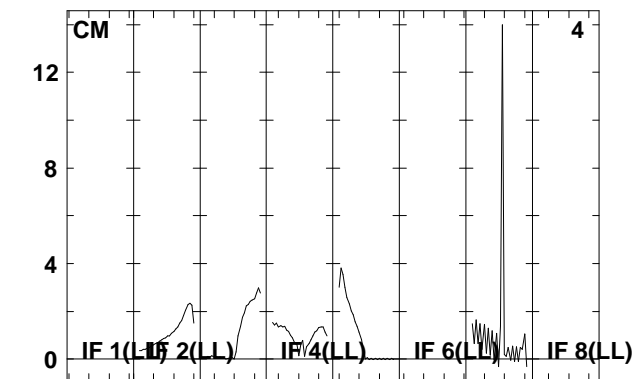
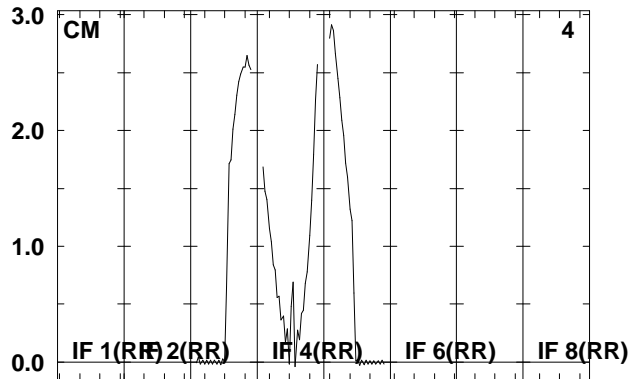
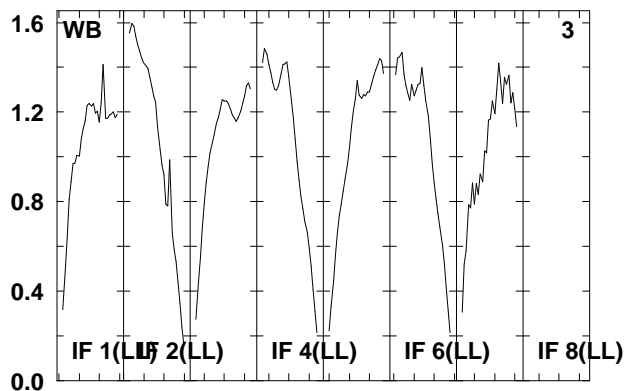
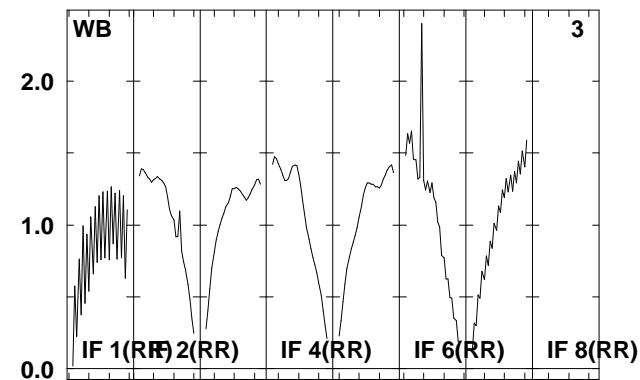
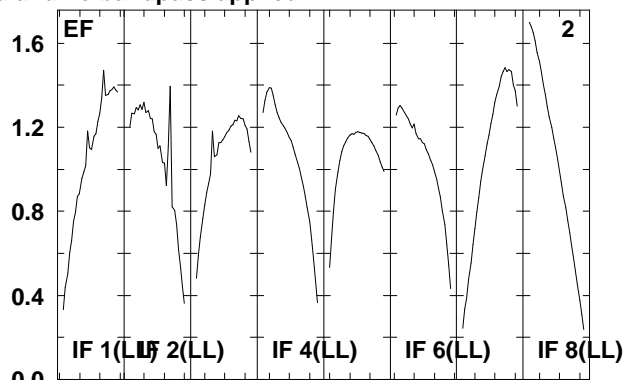
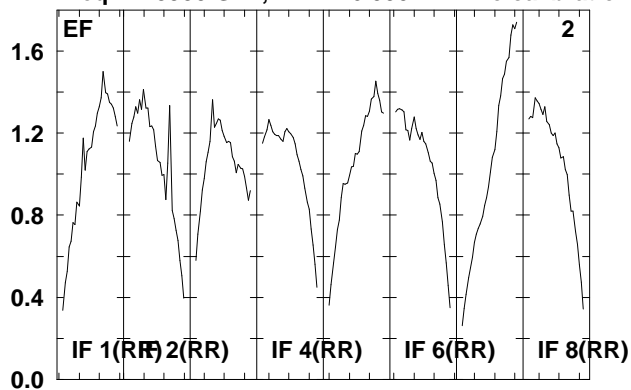

Lower frame: Real Jy
Total-power spectrum Antenna: *
Timerange: 00/19:55:32 to 00/19:57:00

Plot file version 172 created 22-APR-2008 12:27:27

J0730-02 EP061B.UVDATA.1

Freq = 1.5950 GHz, Bw = 16.000 MH No calibration applied and no bandpass applied

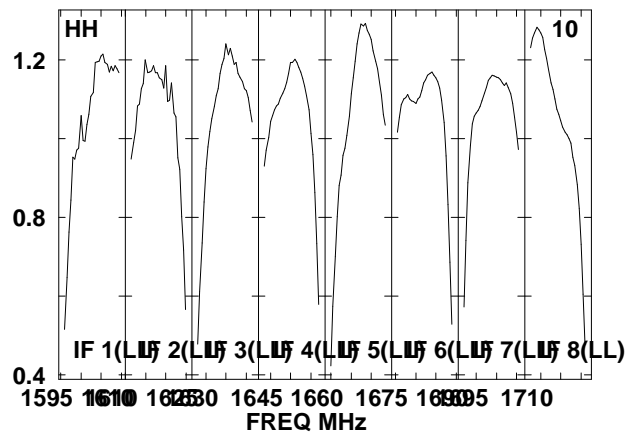
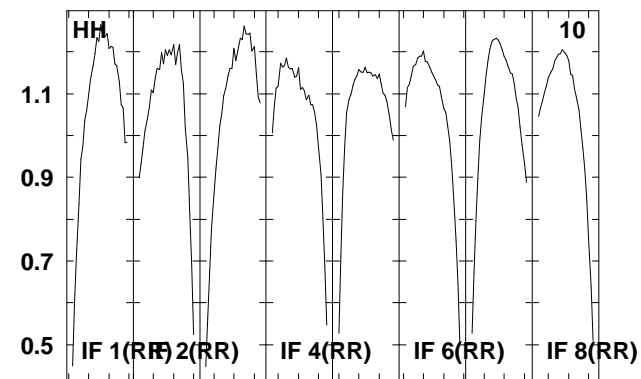
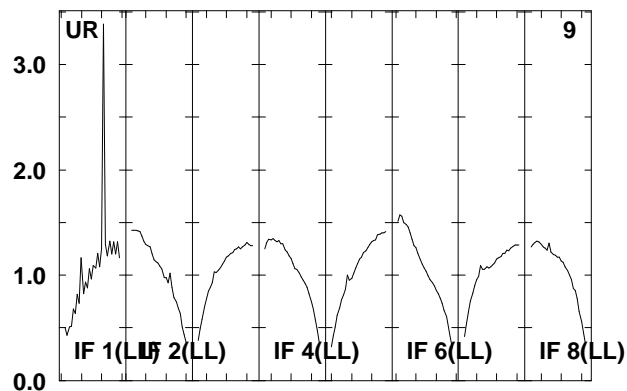
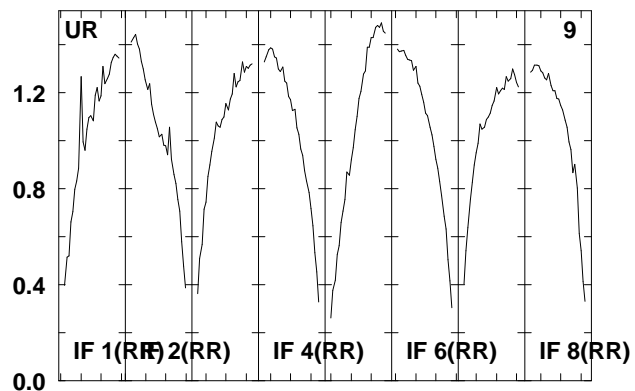
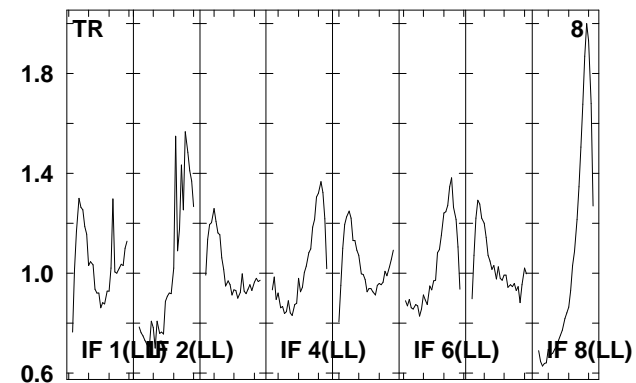
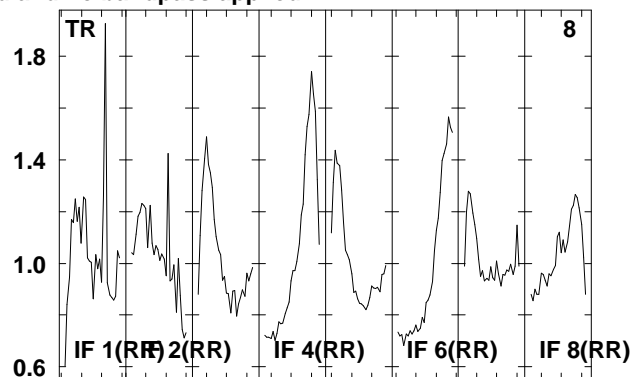
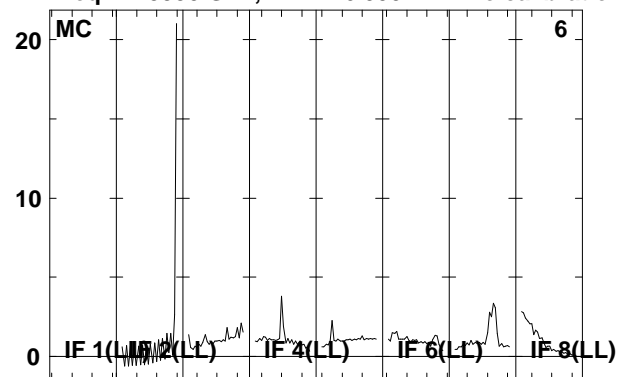

Lower frame: Real Jy

Total-power spectrum Antenna: *

Timerange: 00/19:55:32 to 00/19:57:00

Plot file version 173 created 22-APR-2008 12:27:28

IRAS0725 EP061B.UVDATA.1

Freq = 1.5950 GHz, Bw = 16.000 MH No calibration applied and no bandpass applied

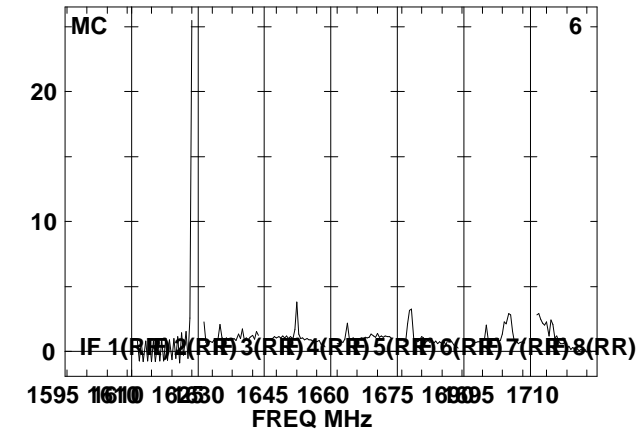
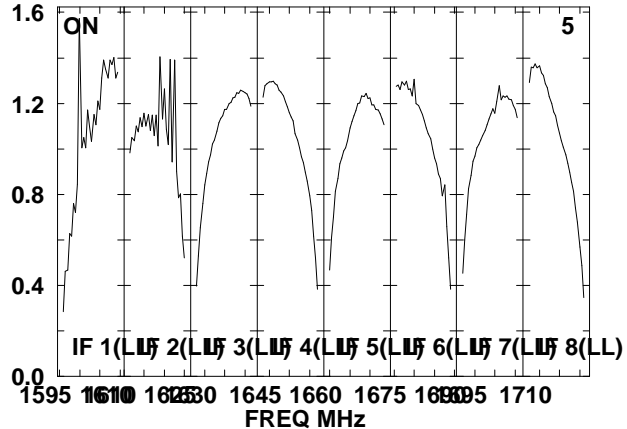
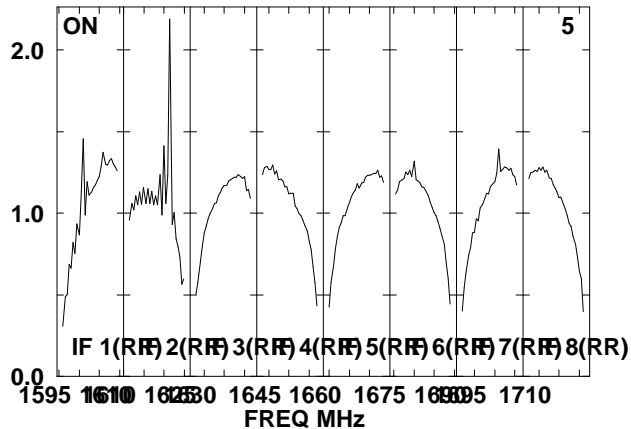
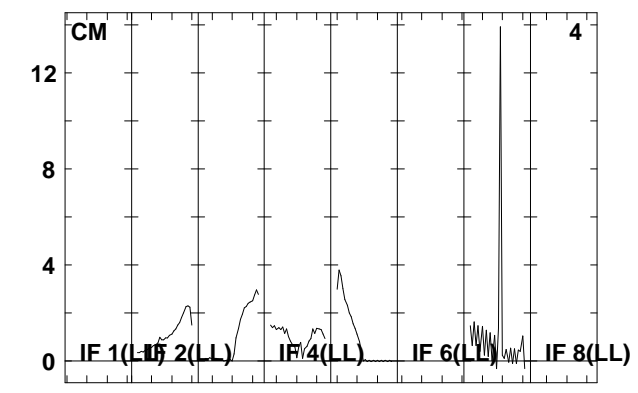
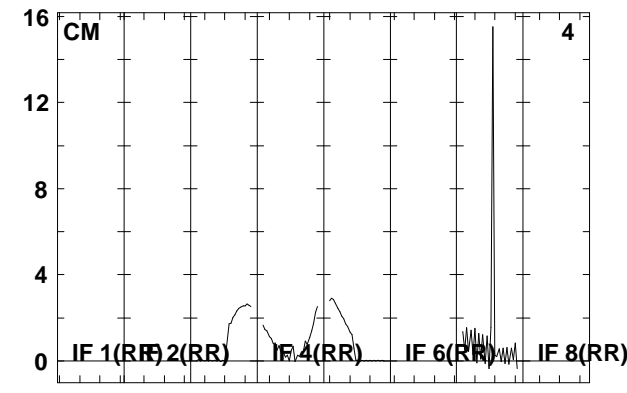
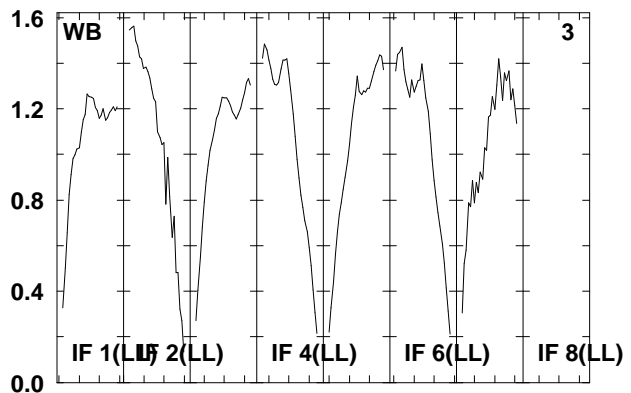
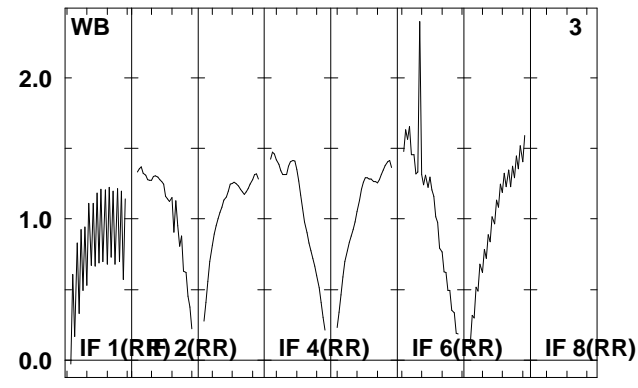
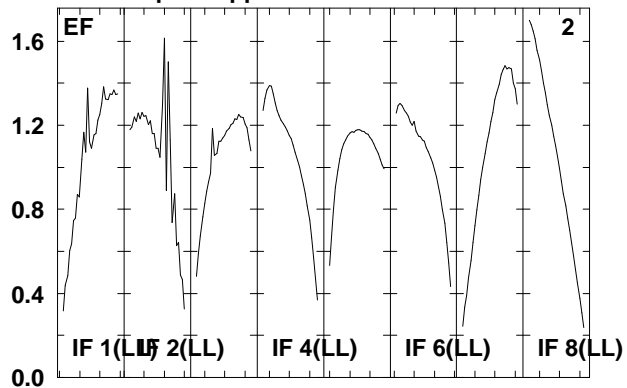
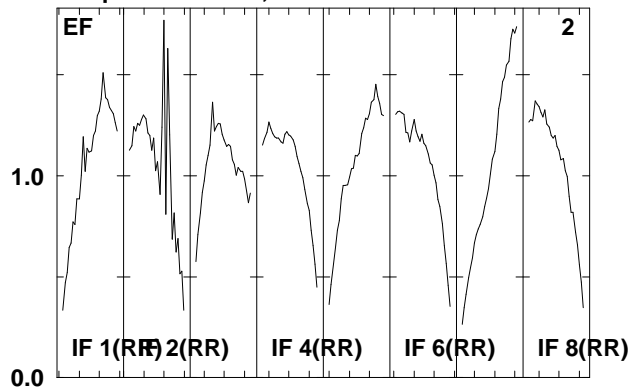

Lower frame: Real Jy

Total-power spectrum Antenna: *

Timerange: 00/19:57:02 to 00/20:00:30

Plot file version 174 created 22-APR-2008 12:27:28

IRAS0725 EP061B.UVDATA.1

Freq = 1.5950 GHz, Bw = 16.000 MH No calibration applied and no bandpass applied

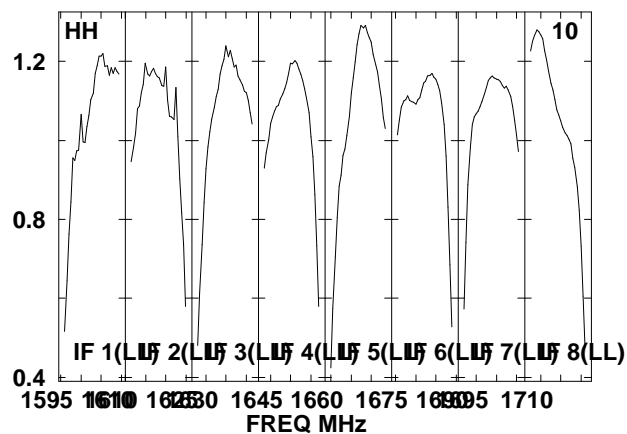
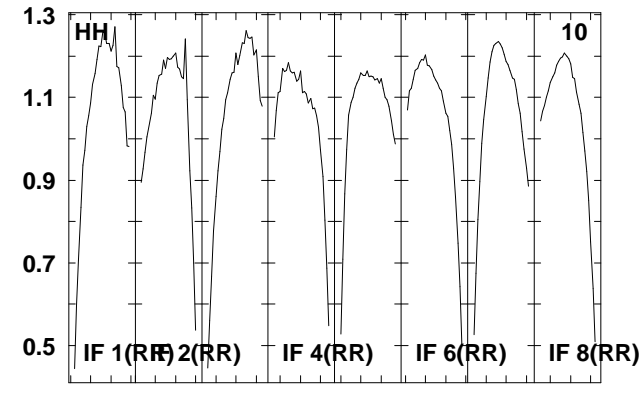
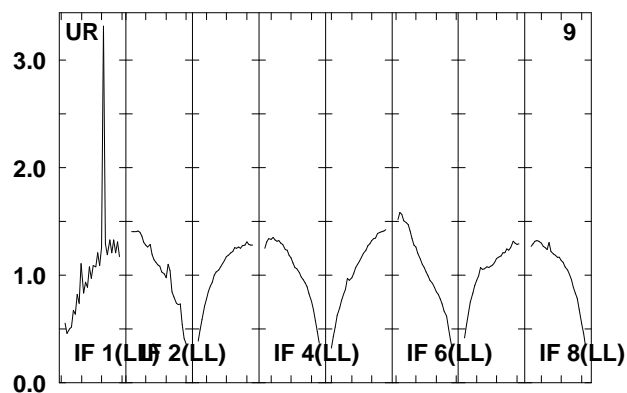
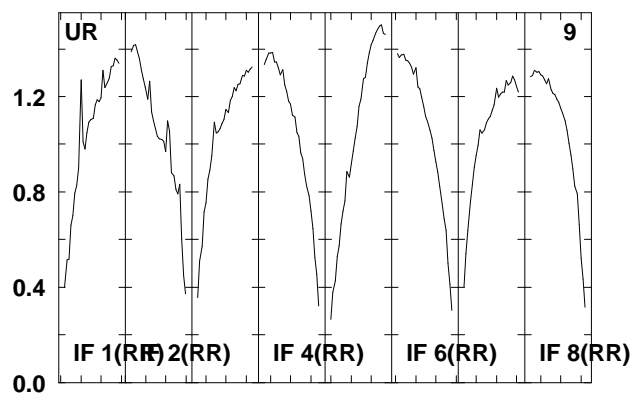
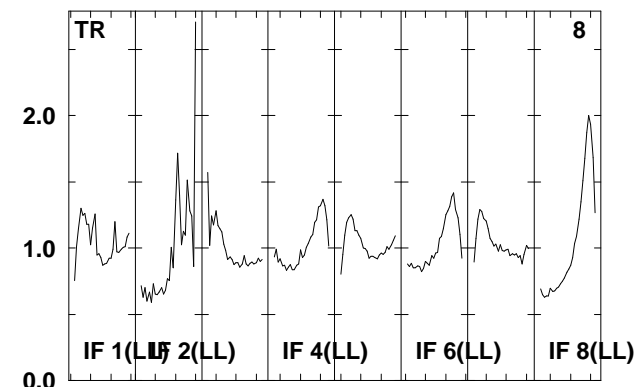
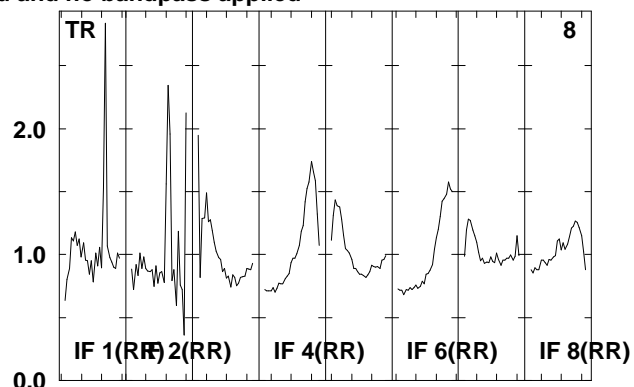
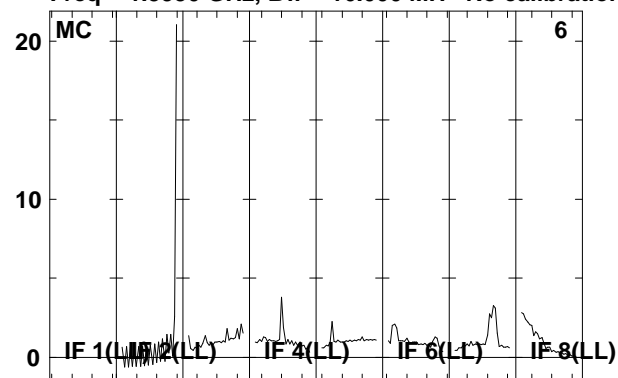

Lower frame: Real Jy

Total-power spectrum Antenna: *

Timerange: 00/19:57:02 to 00/20:00:30

Plot file version 175 created 22-APR-2008 12:27:30

J0730-02 EP061B.UVDATA.1

Freq = 1.5950 GHz, Bw = 16.000 MH No calibration applied and no bandpass applied

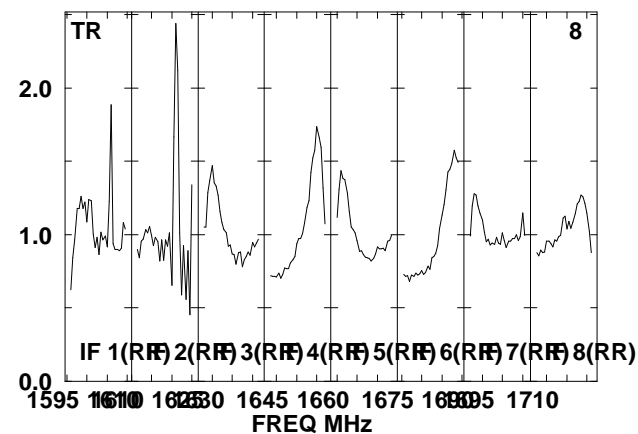
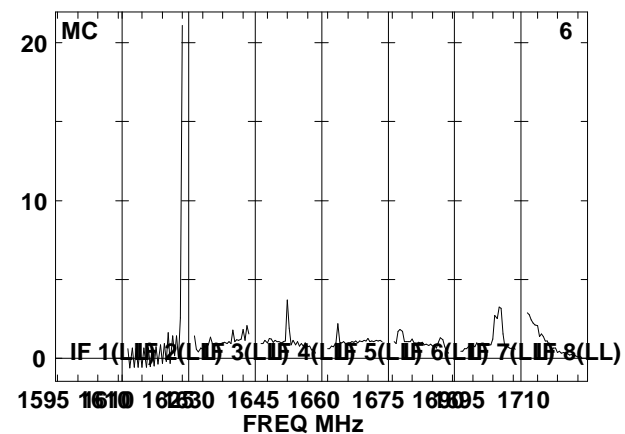
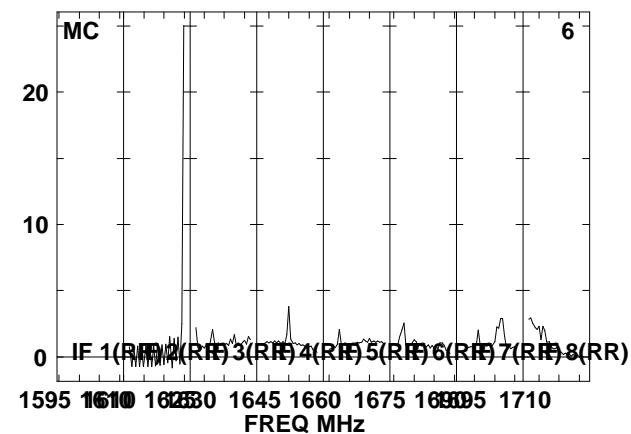
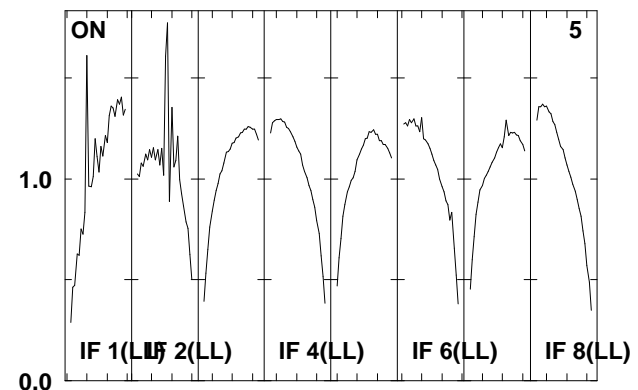
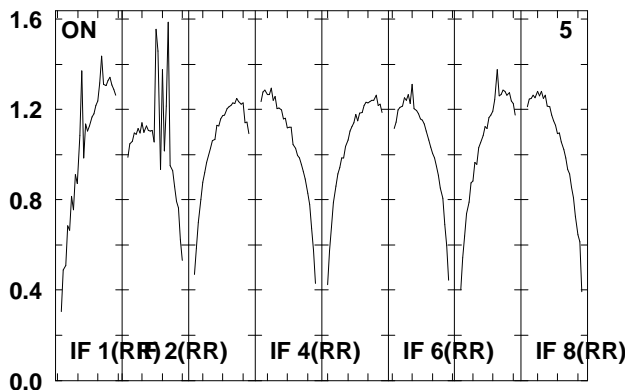
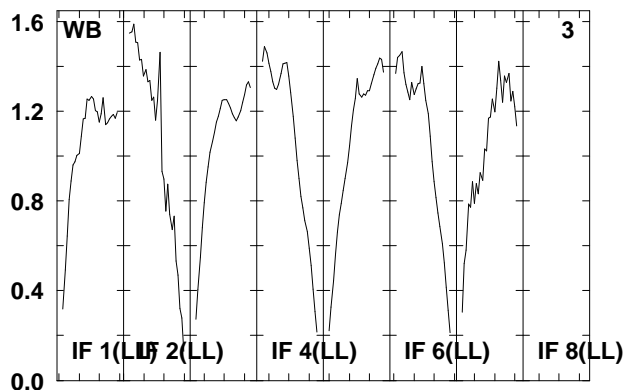
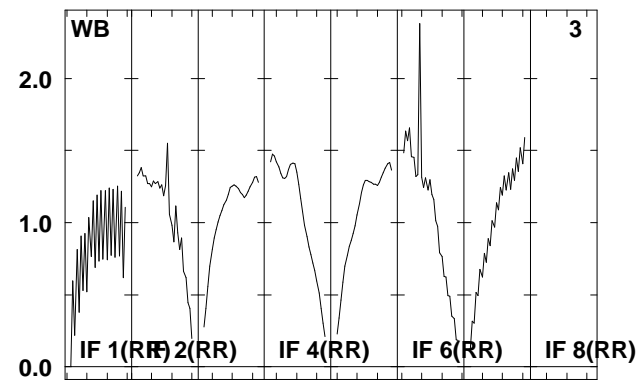
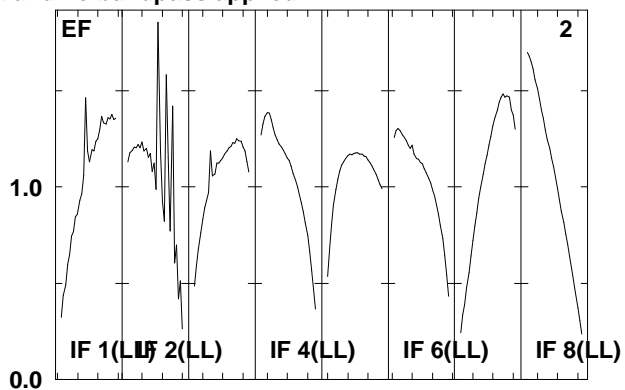
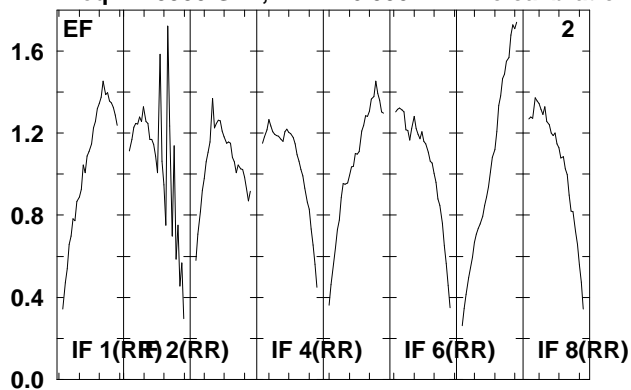

Lower frame: Real Jy
Total-power spectrum Antenna: *
Timerange: 00/20:00:32 to 00/20:02:00

Plot file version 176 created 22-APR-2008 12:27:30

J0730-02 EP061B.UVDATA.1

Freq = 1.5950 GHz, Bw = 16.000 MH No calibration applied and no bandpass applied

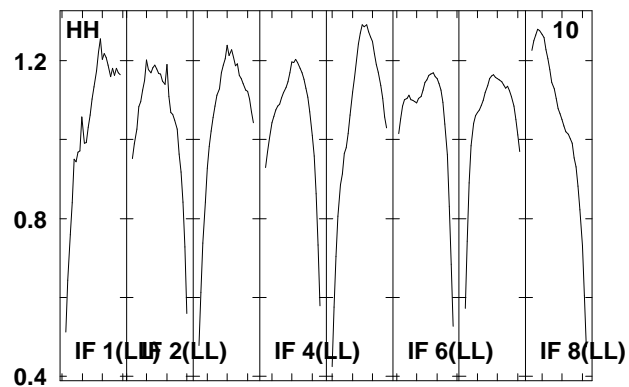
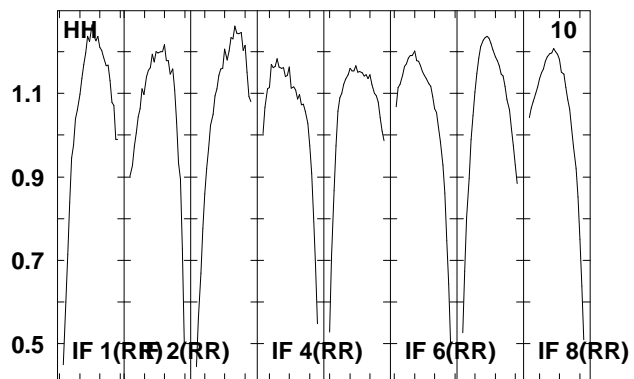
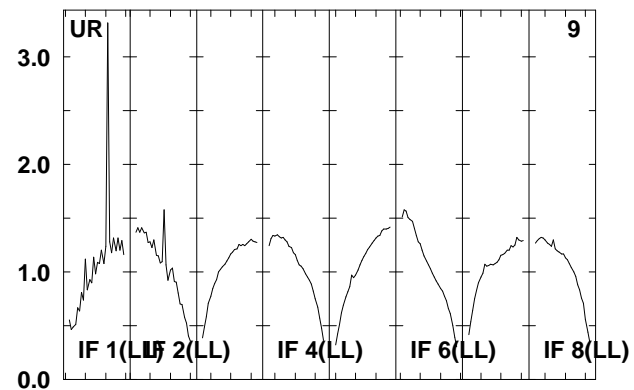
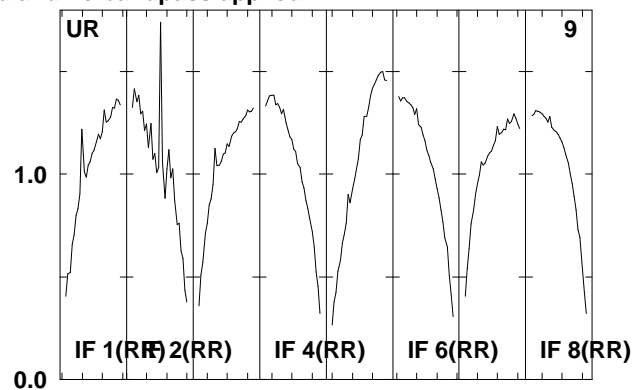
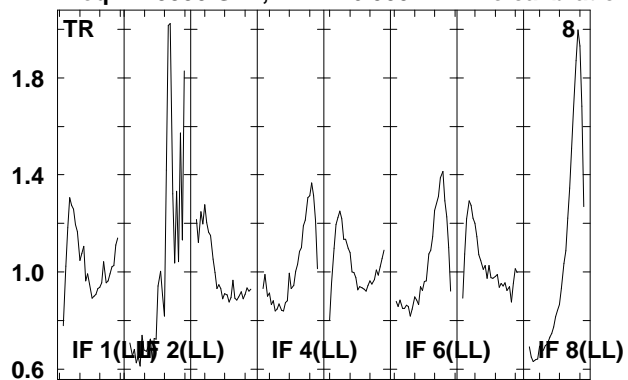

Lower frame: Real Jy
Total-power spectrum Antenna: *
Timerange: 00/20:00:32 to 00/20:02:00

Plot file version 177 created 22-APR-2008 12:27:31

IRAS0725 EP061B.UVDATA.1

Freq = 1.5950 GHz, Bw = 16.000 MH No calibration applied and no bandpass applied

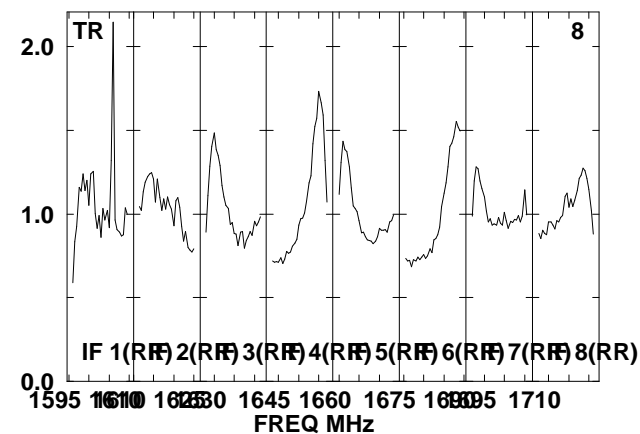
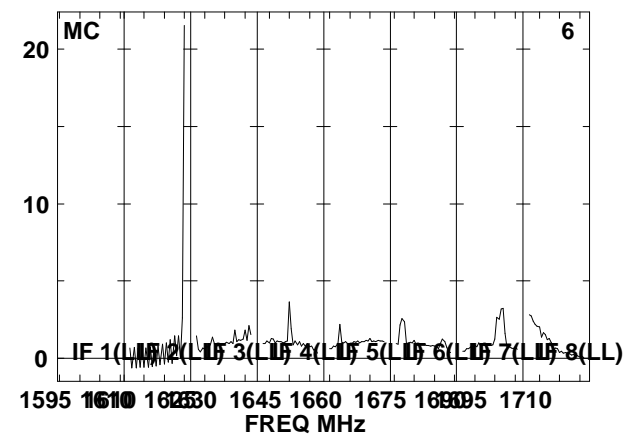
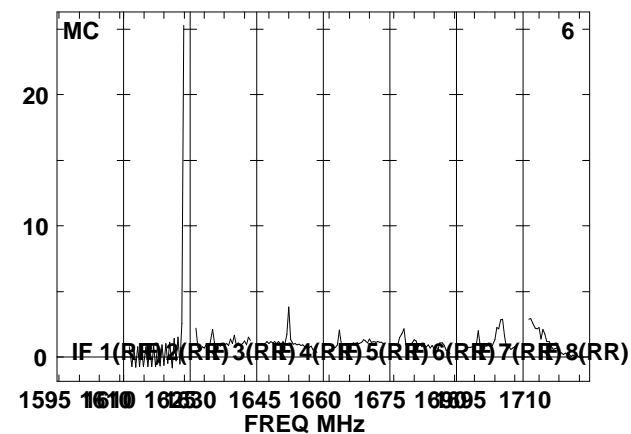
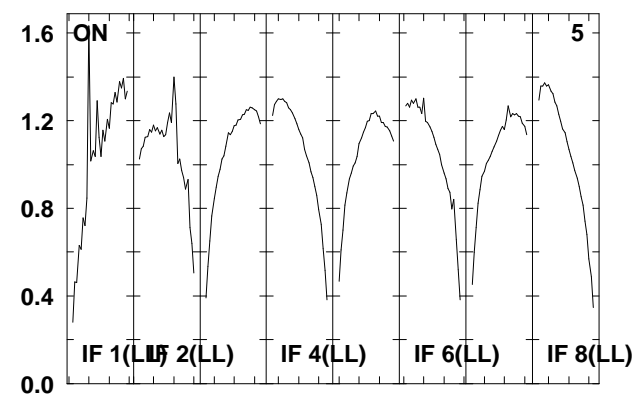
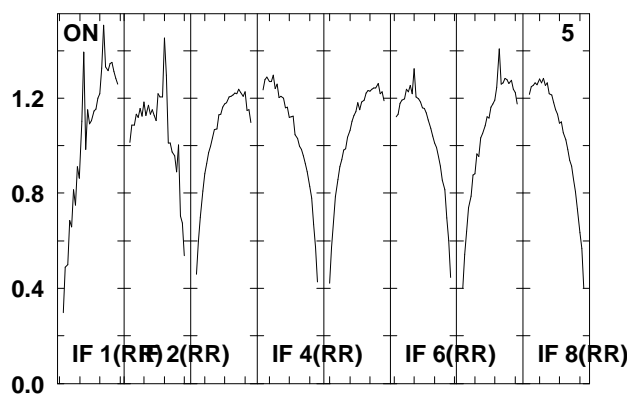
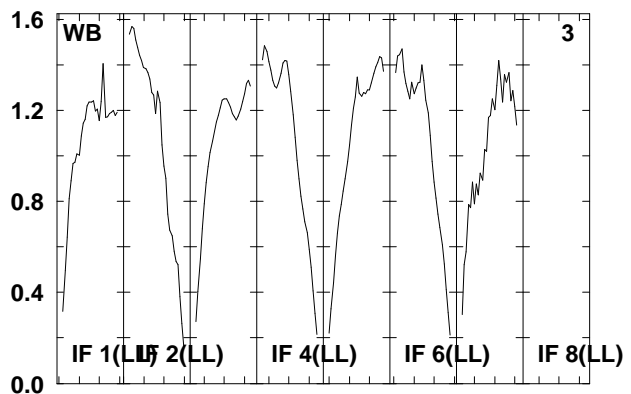
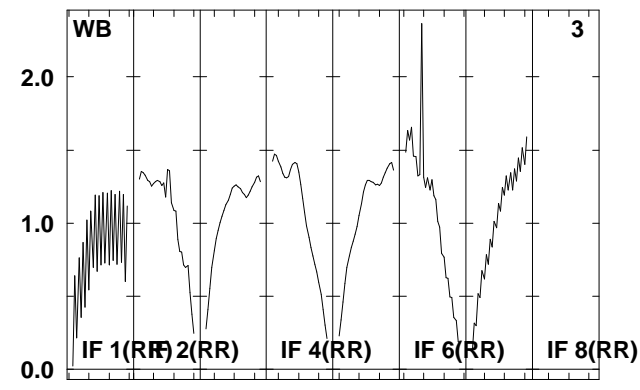
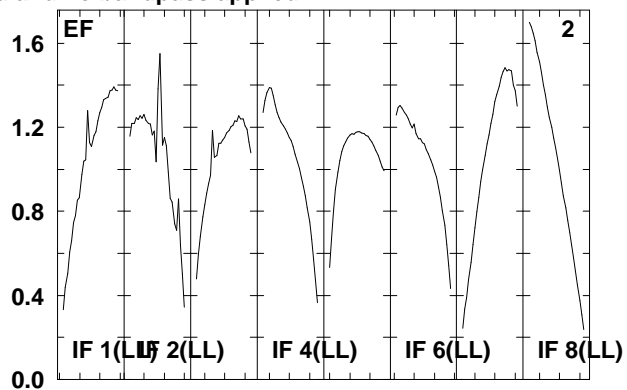
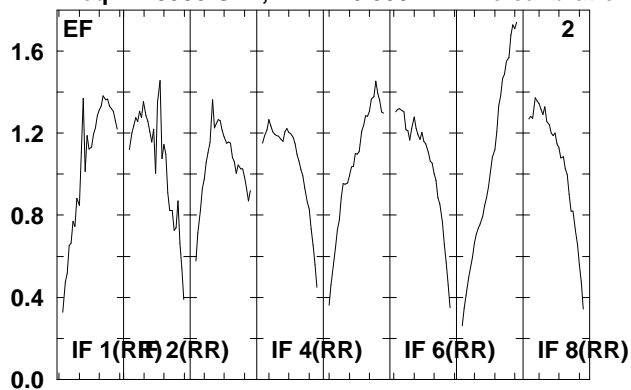

Lower frame: Real Jy
Total-power spectrum Antenna: *
Timerange: 00/20:02:02 to 00/20:05:30

Plot file version 178 created 22-APR-2008 12:27:32

IRAS0725 EP061B.UVDATA.1

Freq = 1.5950 GHz, Bw = 16.000 MH No calibration applied and no bandpass applied

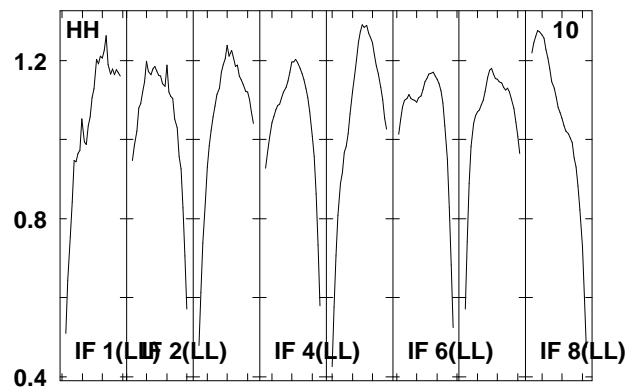
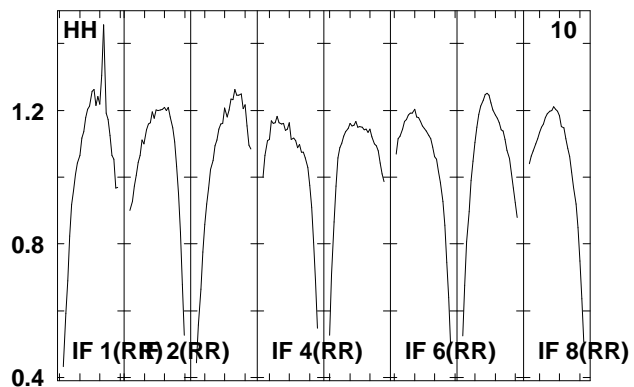
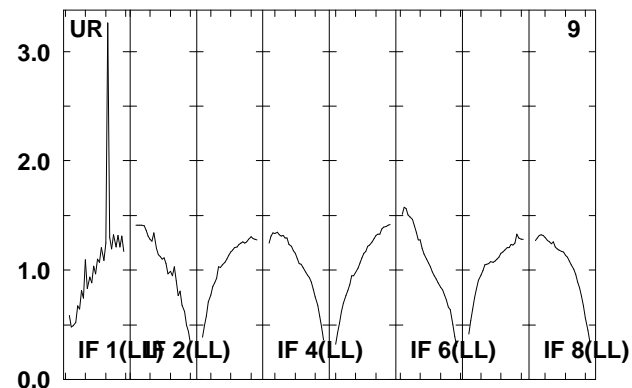
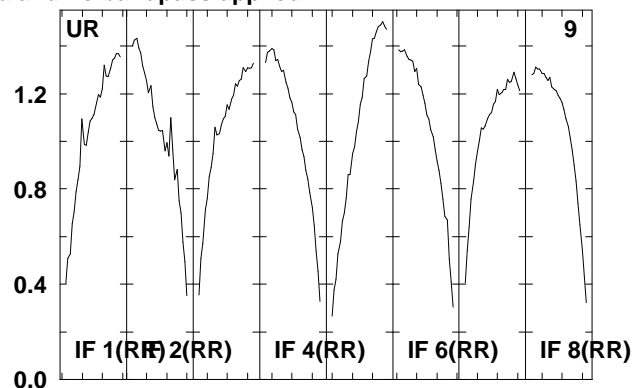
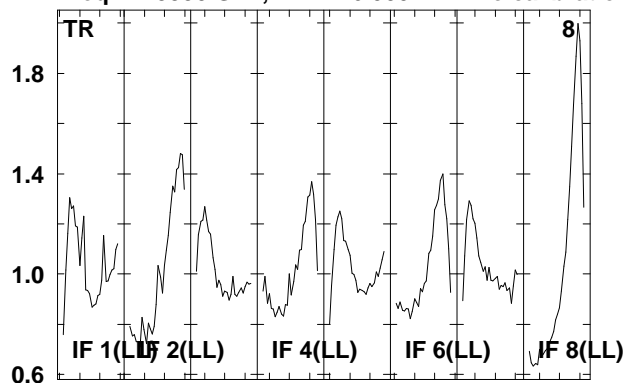

Lower frame: Real Jy
Total-power spectrum Antenna: *
Timerange: 00/20:02:02 to 00/20:05:30

Plot file version 179 created 22-APR-2008 12:27:32

J0730-02 EP061B.UVDATA.1

Freq = 1.5950 GHz, Bw = 16.000 MH No calibration applied and no bandpass applied

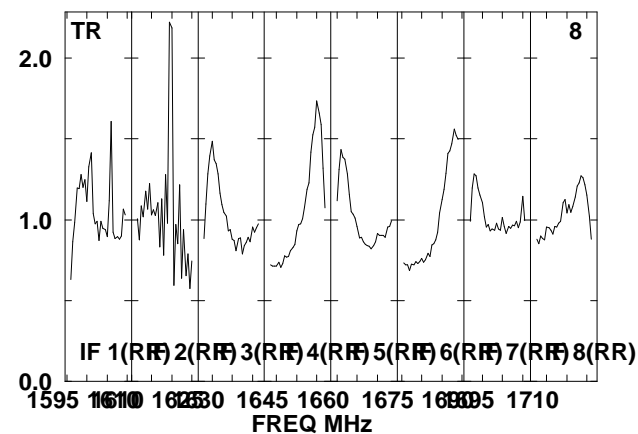
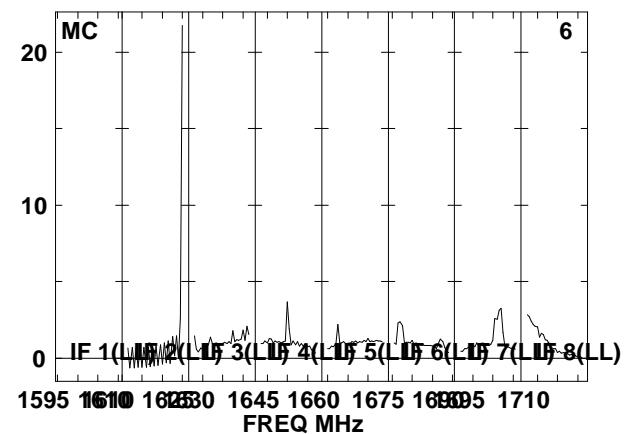
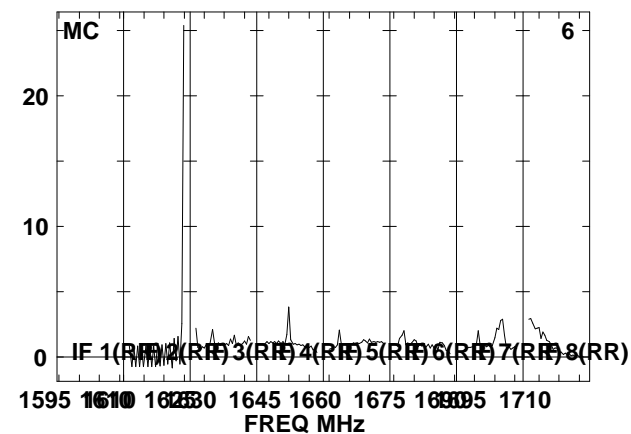
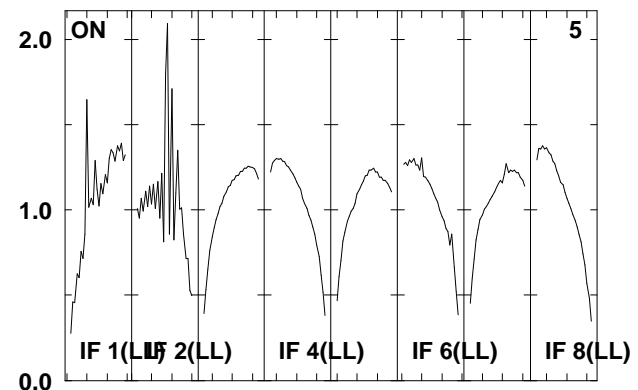
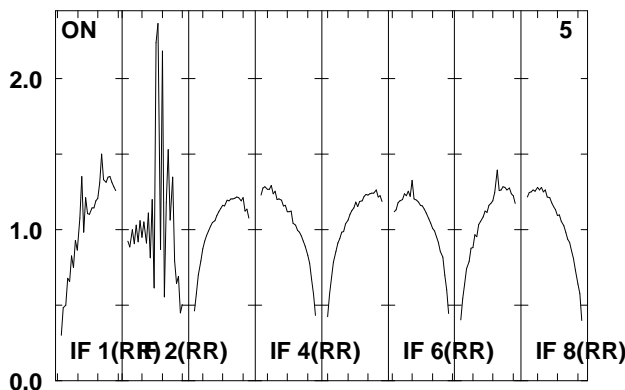
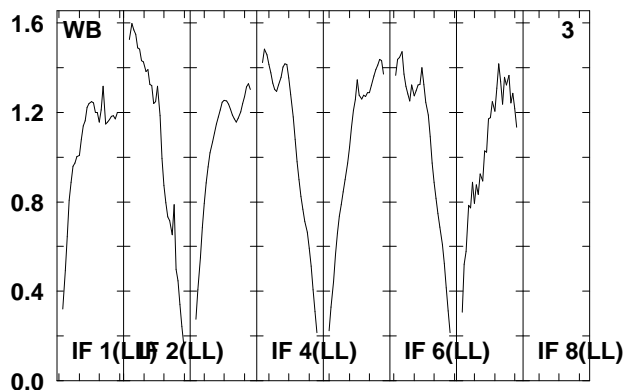
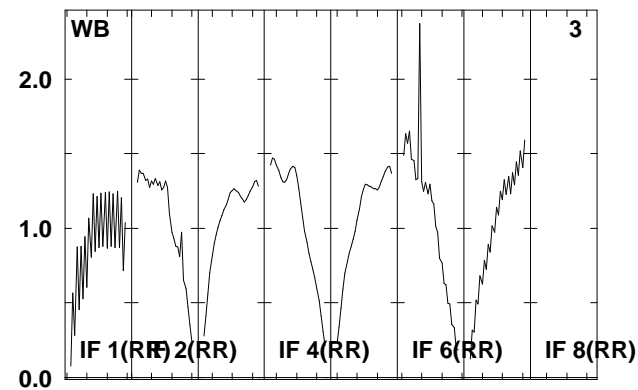
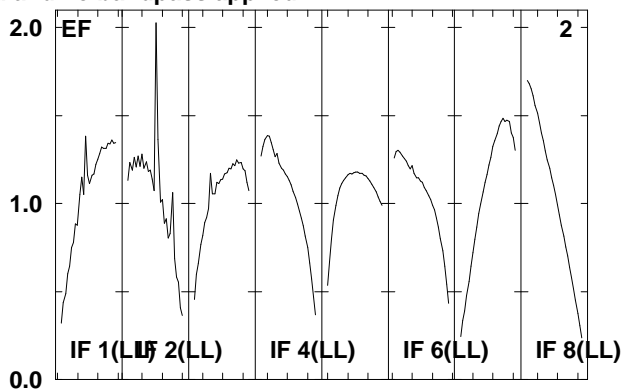
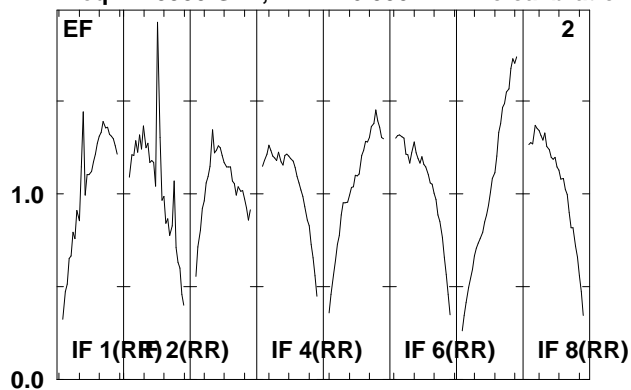

Lower frame: Real Jy
Total-power spectrum Antenna: *
Timerange: 00/20:05:32 to 00/20:07:00

Plot file version 180 created 22-APR-2008 12:27:33

J0730-02 EP061B.UVDATA.1

Freq = 1.5950 GHz, Bw = 16.000 MH No calibration applied and no bandpass applied

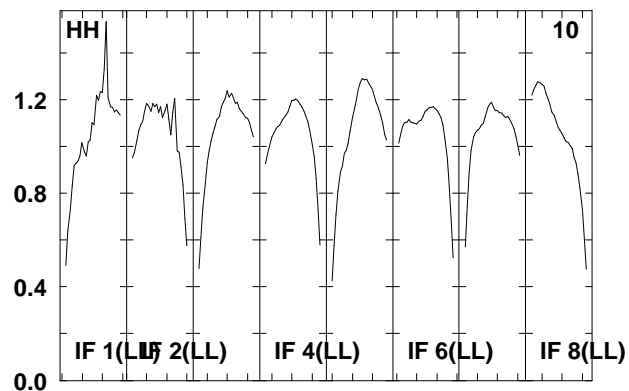
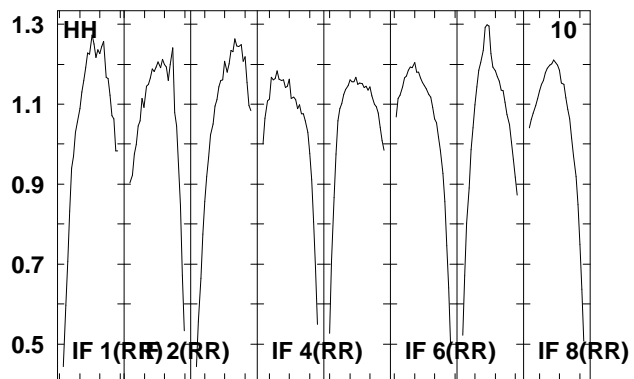
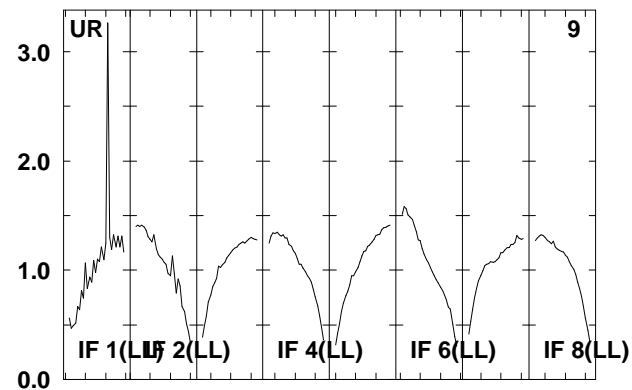
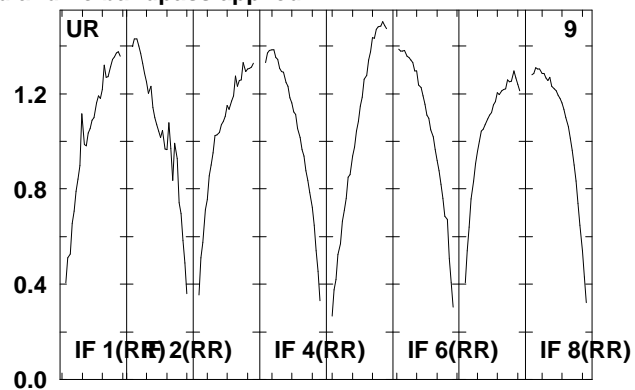
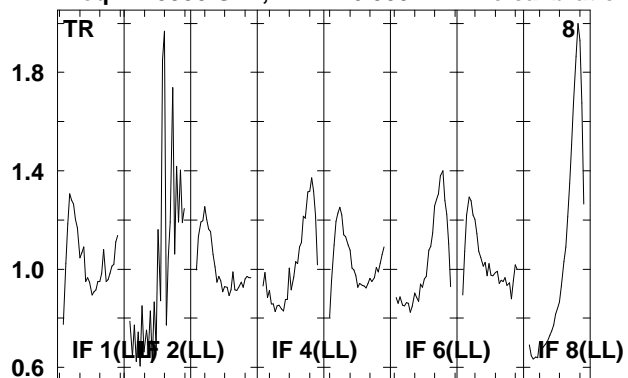

Lower frame: Real Jy
Total-power spectrum Antenna: *
Timerange: 00/20:05:32 to 00/20:07:00

Plot file version 181 created 22-APR-2008 12:27:33

IRAS0725 EP061B.UVDATA.1

Freq = 1.5950 GHz, Bw = 16.000 MH No calibration applied and no bandpass applied

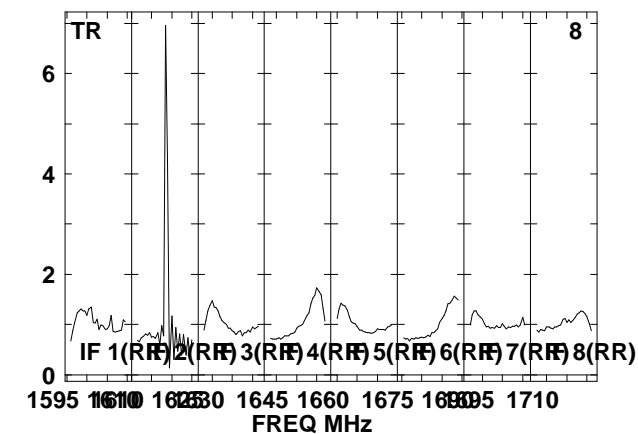
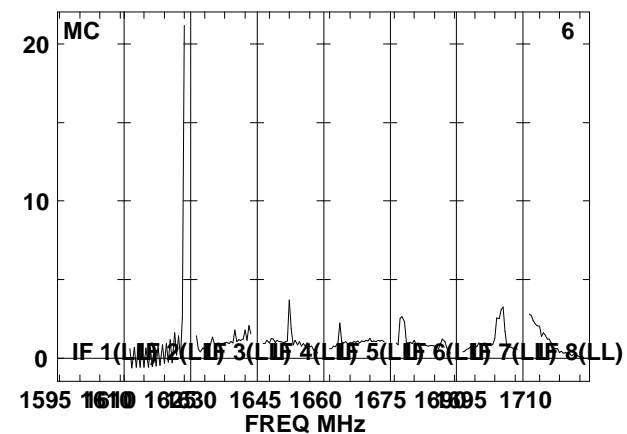
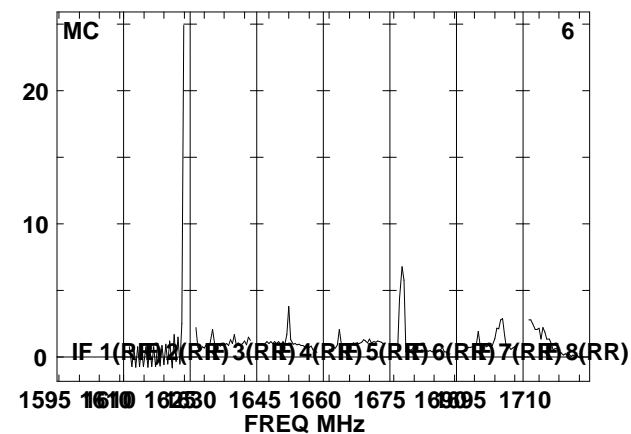
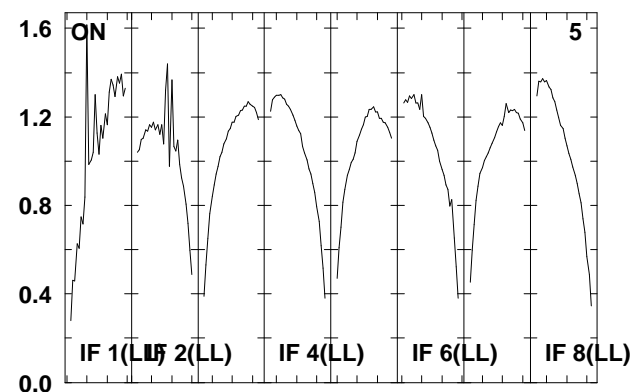
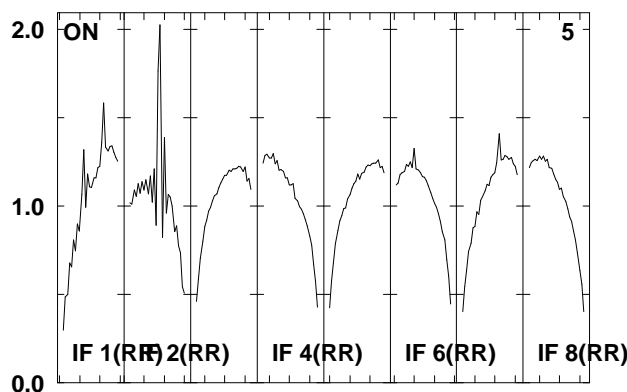
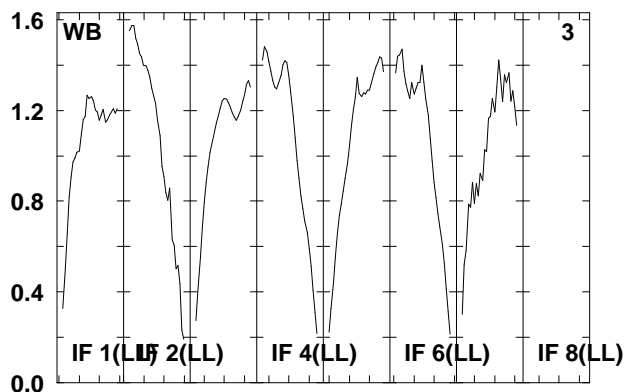
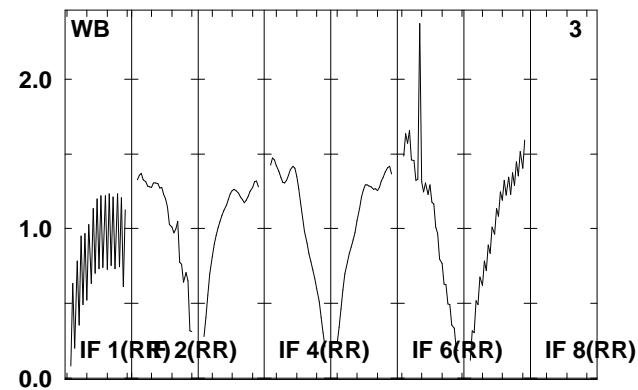
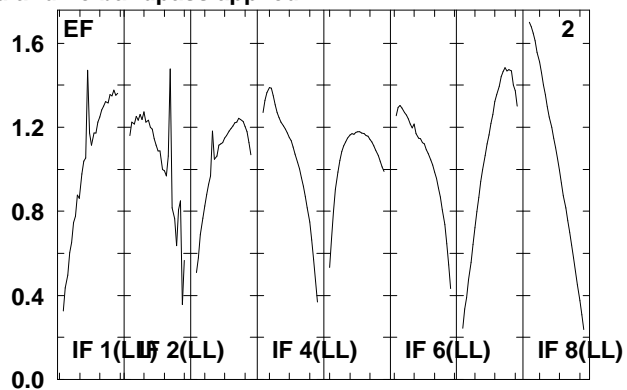
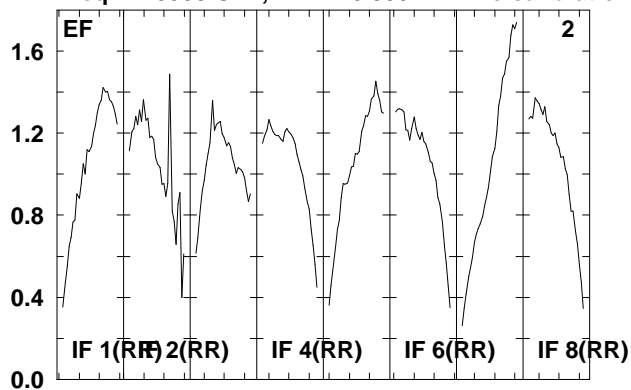

Lower frame: Real Jy
Total-power spectrum Antenna: *
Timerange: 00/20:07:02 to 00/20:10:28

Plot file version 182 created 22-APR-2008 12:27:34

IRAS0725 EP061B.UVDATA.1

Freq = 1.5950 GHz, Bw = 16.000 MH No calibration applied and no bandpass applied

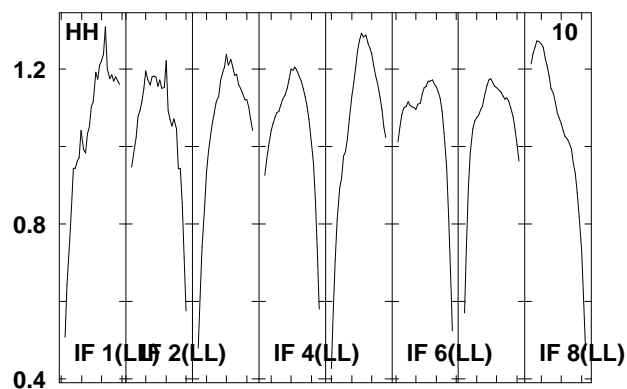
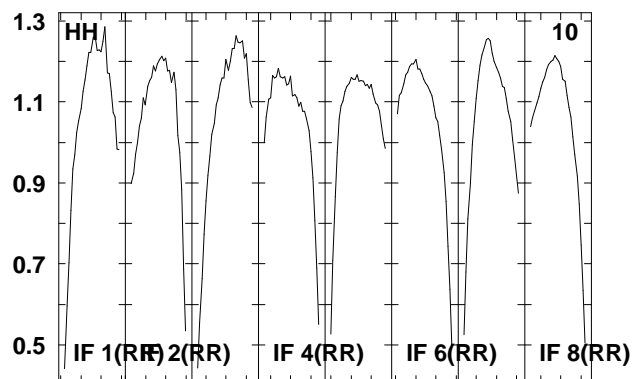
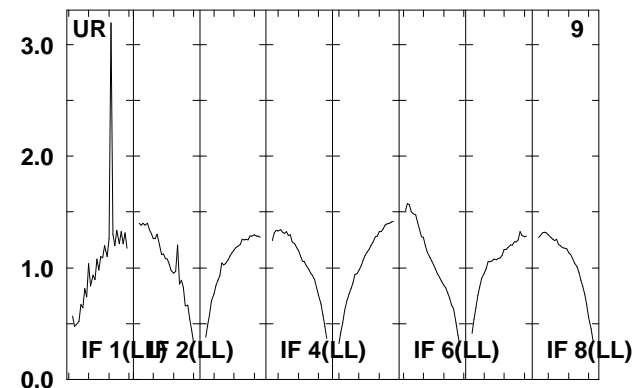
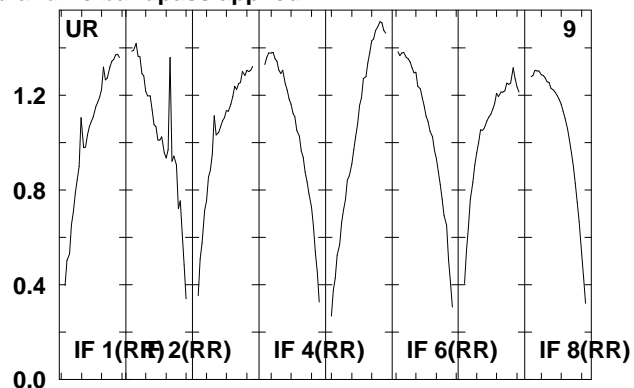
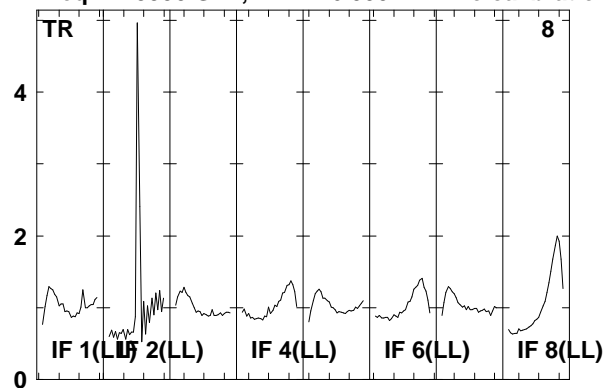

Lower frame: Real Jy
Total-power spectrum Antenna: *
Timerange: 00/20:07:02 to 00/20:10:28

Plot file version 183 created 22-APR-2008 12:27:35

J0730-02 EP061B.UVDATA.1

Freq = 1.5950 GHz, Bw = 16.000 MH No calibration applied and no bandpass applied

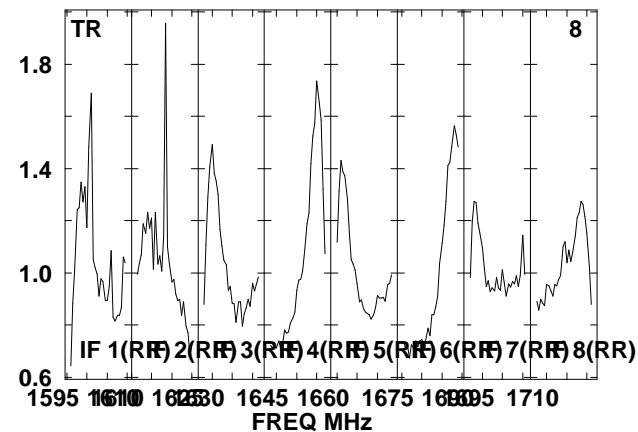
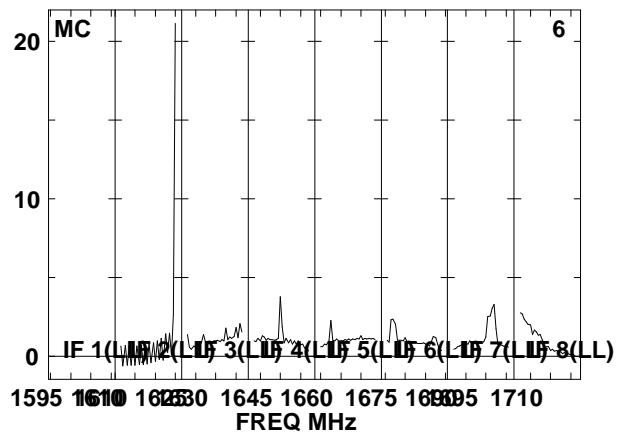
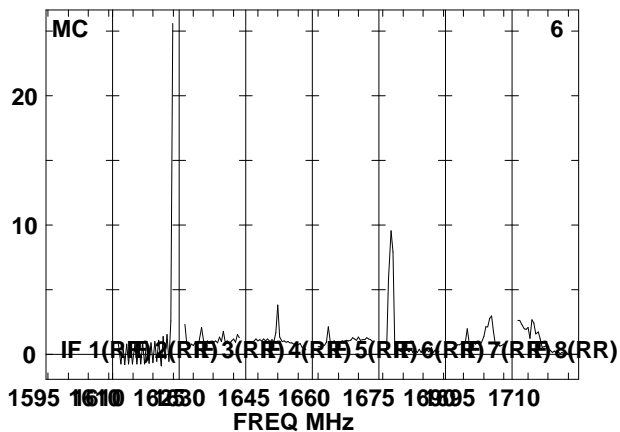
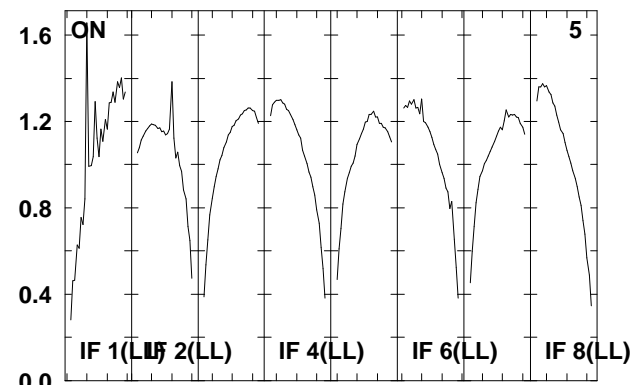
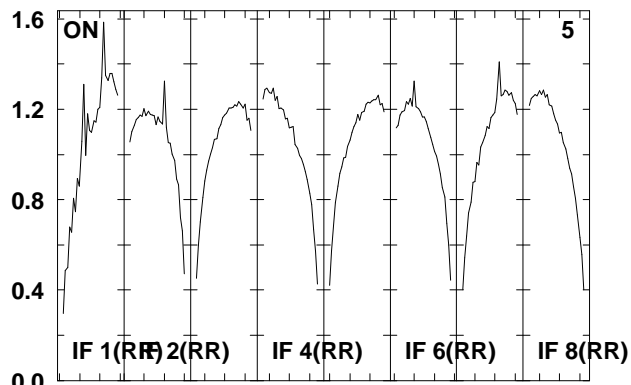
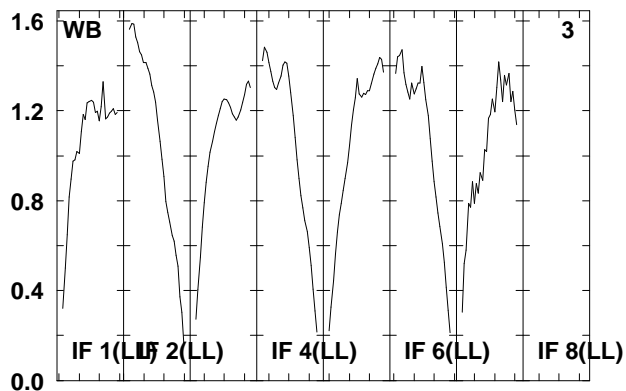
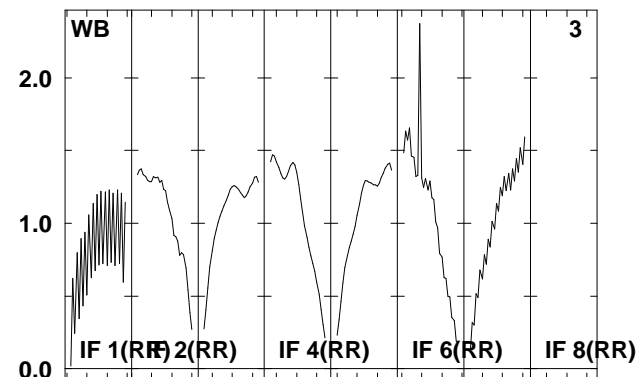
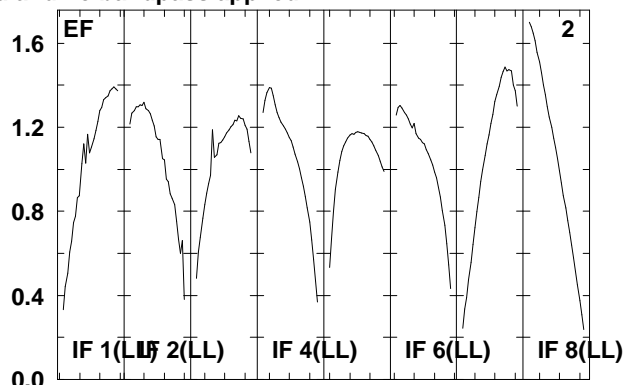
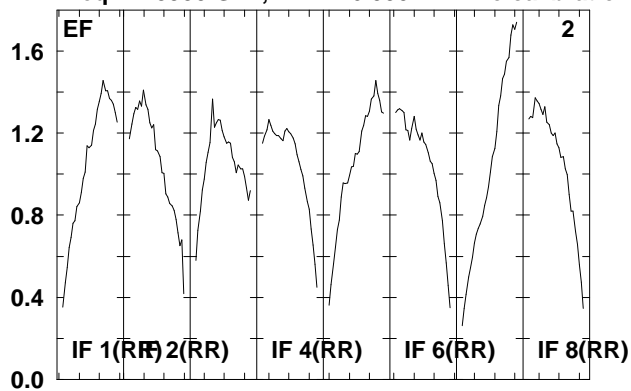

Lower frame: Real Jy
Total-power spectrum Antenna: *
Timerange: 00/20:11:32 to 00/20:13:00

Plot file version 184 created 22-APR-2008 12:27:36

J0730-02 EP061B.UVDATA.1

Freq = 1.5950 GHz, Bw = 16.000 MH No calibration applied and no bandpass applied

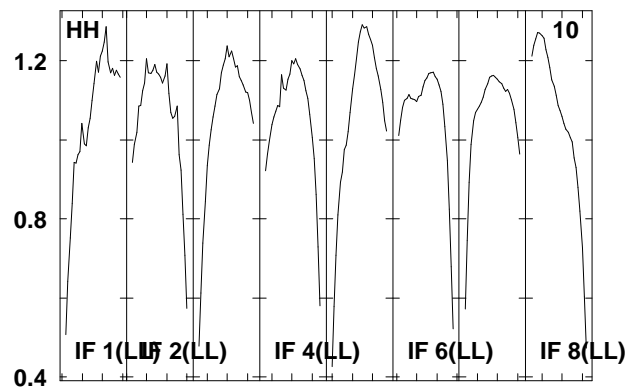
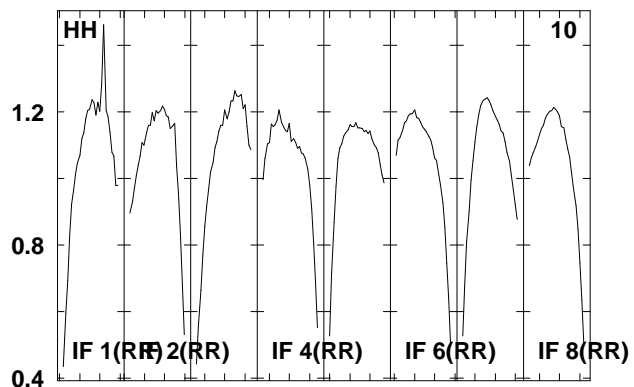
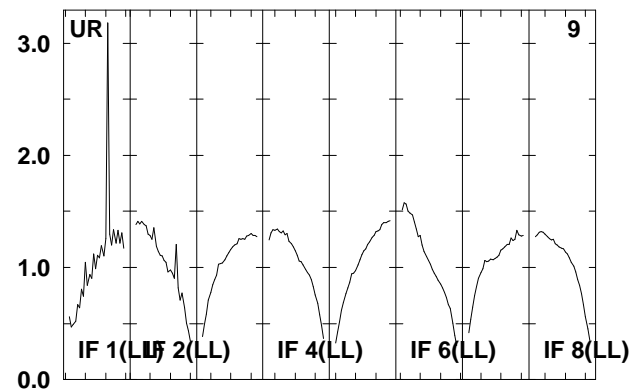
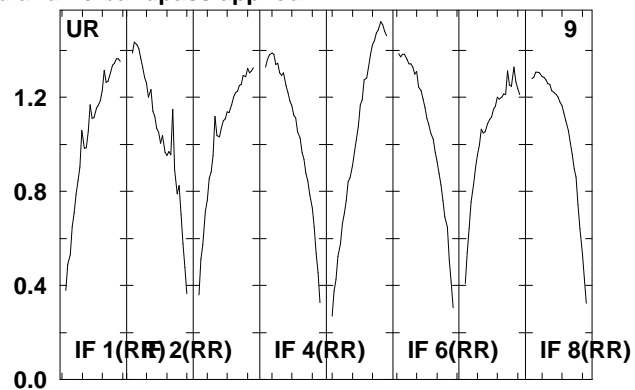
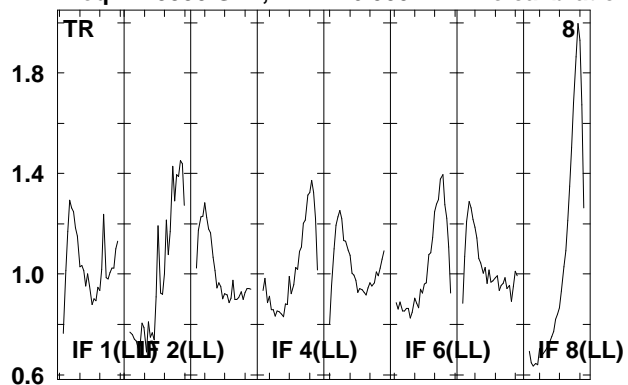

Lower frame: Real Jy
Total-power spectrum Antenna: *
Timerange: 00/20:11:32 to 00/20:13:00

Plot file version 185 created 22-APR-2008 12:27:36

IRAS0725 EP061B.UVDATA.1

Freq = 1.5950 GHz, Bw = 16.000 MH No calibration applied and no bandpass applied

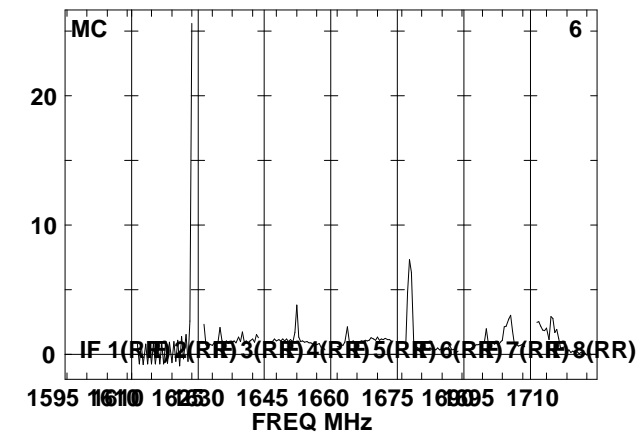
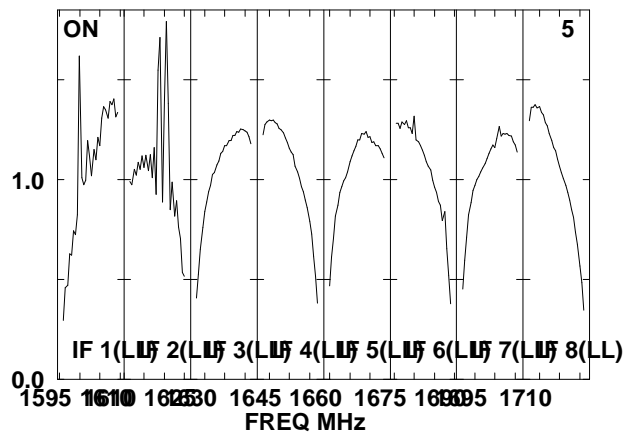
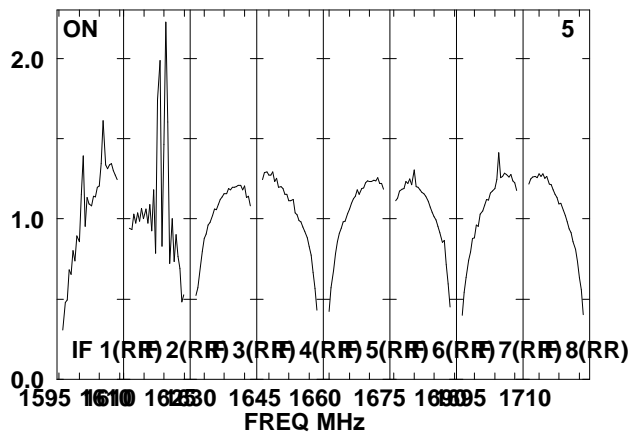
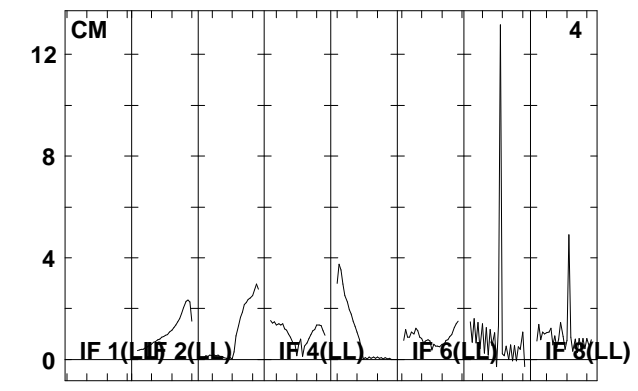
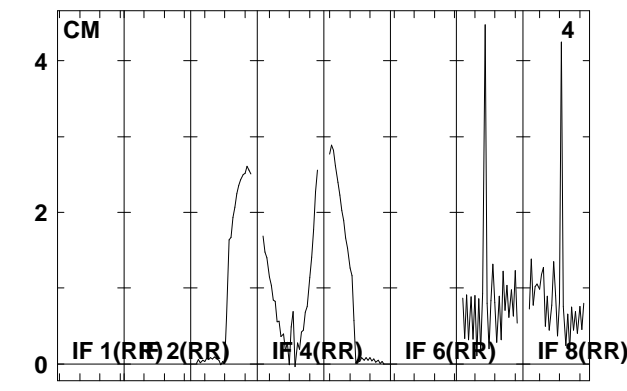
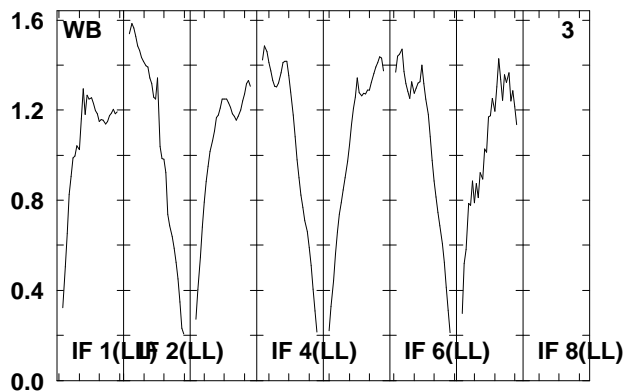
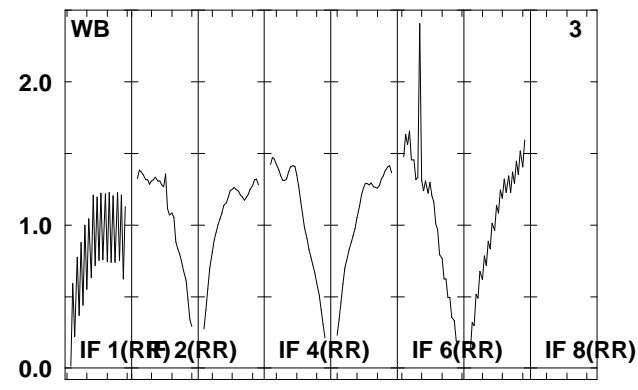
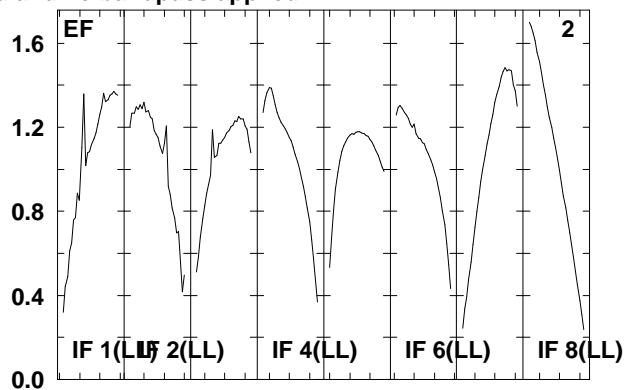
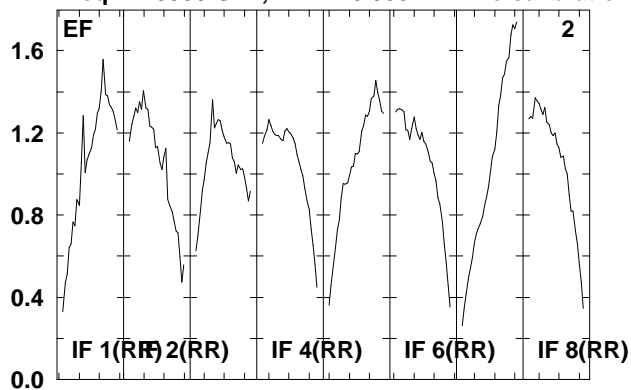

Lower frame: Real Jy

Total-power spectrum Antenna: *

Timerange: 00/20:13:02 to 00/20:16:30

Plot file version 186 created 22-APR-2008 12:27:37

IRAS0725 EP061B.UVDATA.1

Freq = 1.5950 GHz, Bw = 16.000 MH No calibration applied and no bandpass applied

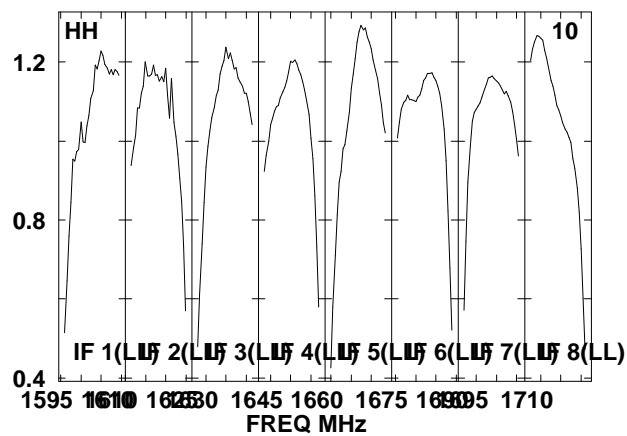
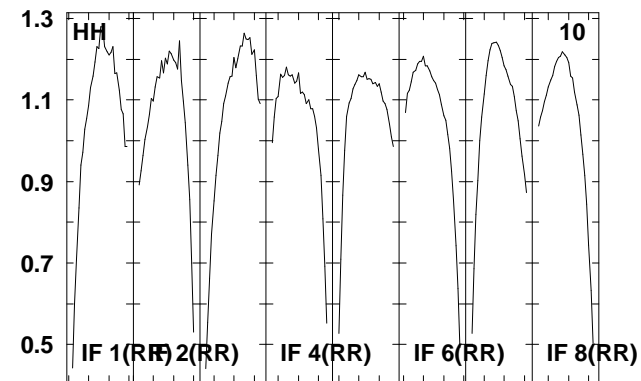
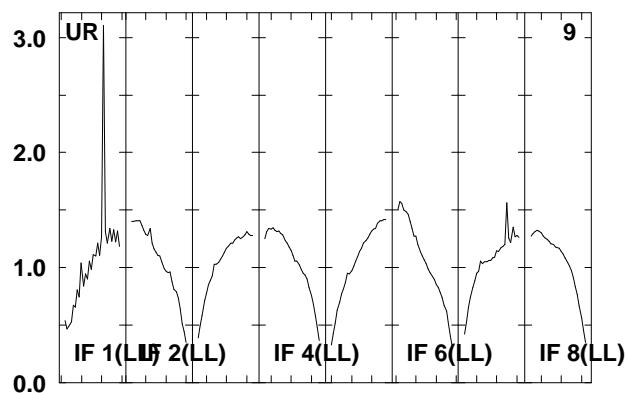
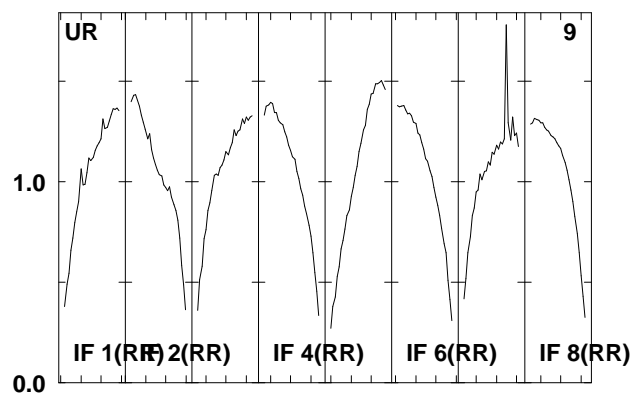
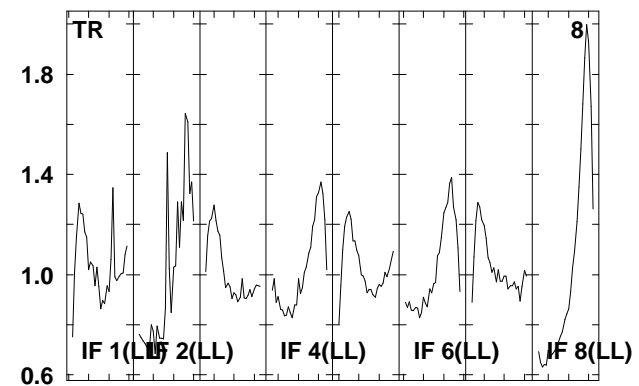
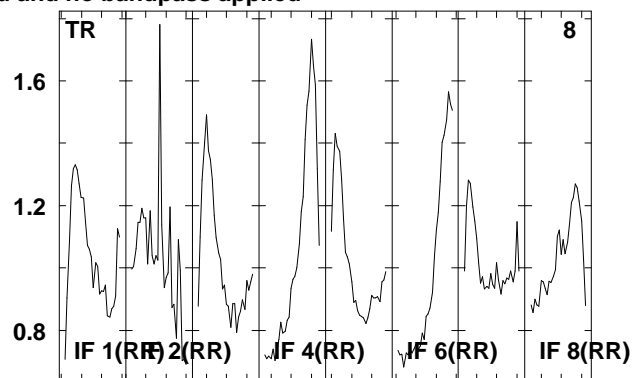
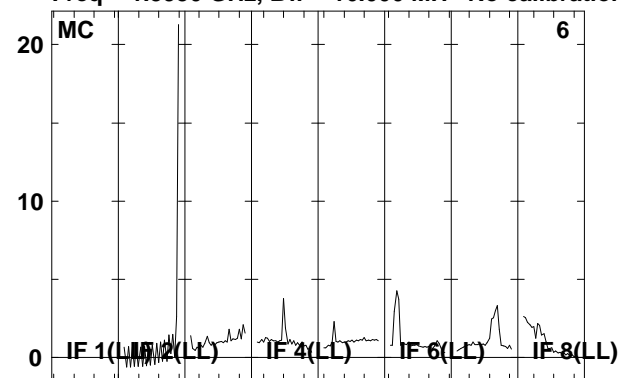

Lower frame: Real Jy

Total-power spectrum Antenna: *

Timerange: 00/20:13:02 to 00/20:16:30

Plot file version 187 created 22-APR-2008 12:27:38

J0730-02 EP061B.UVDATA.1

Freq = 1.5950 GHz, Bw = 16.000 MH No calibration applied and no bandpass applied

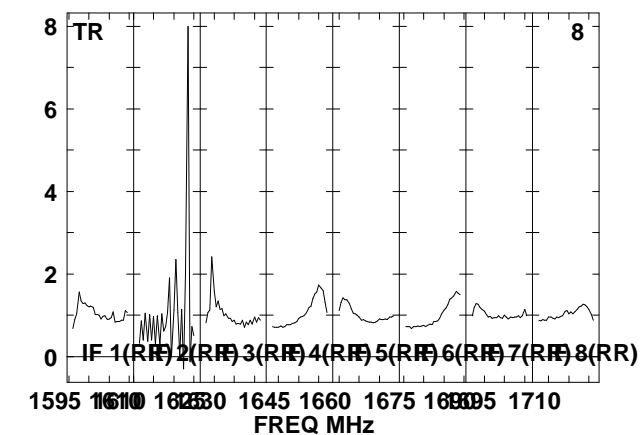
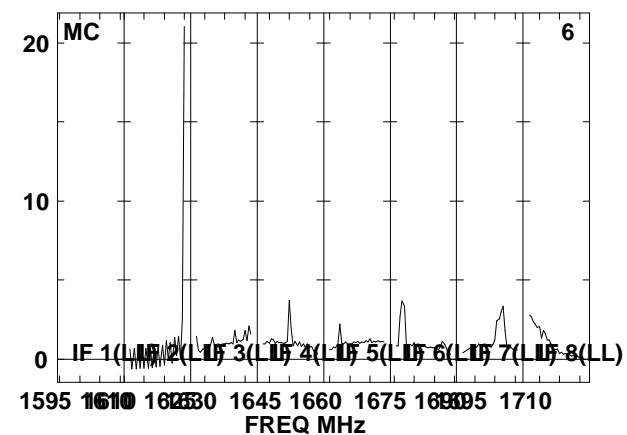
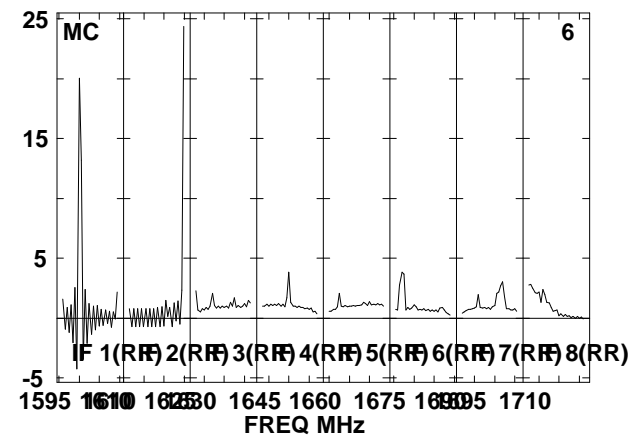
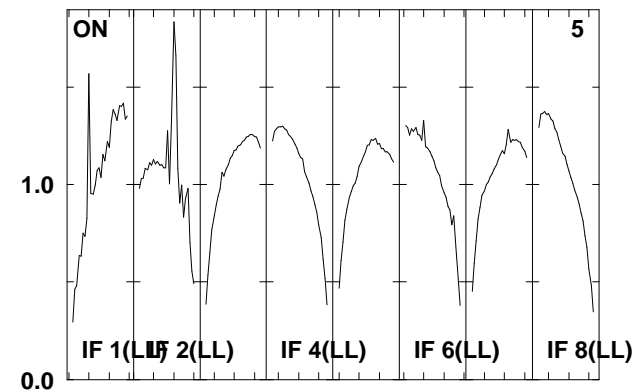
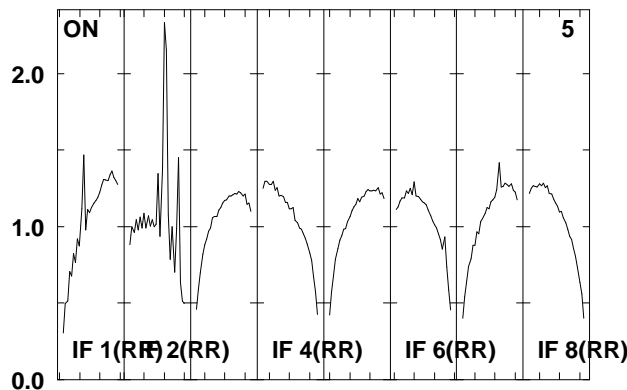
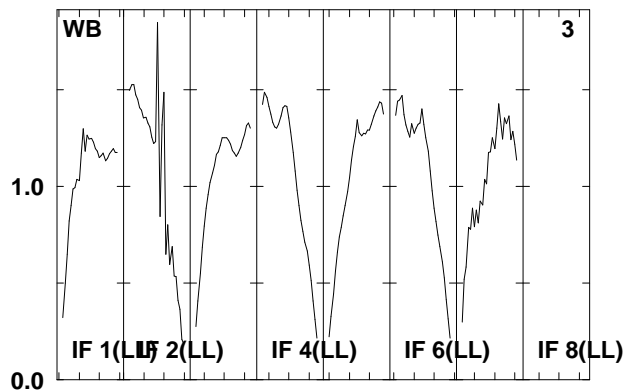
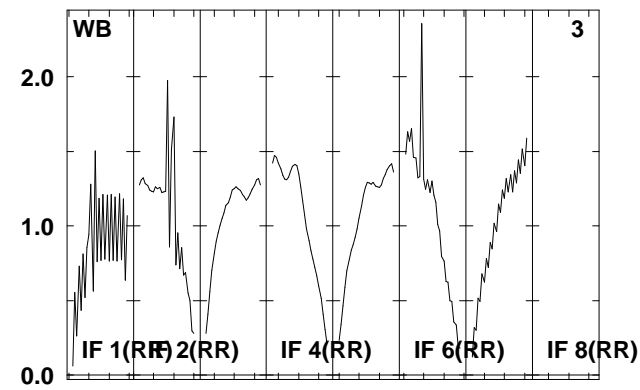
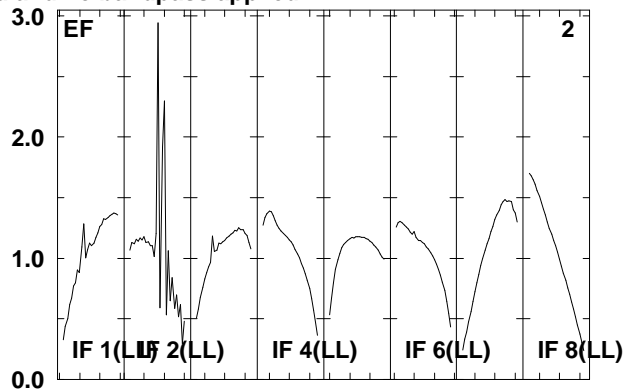
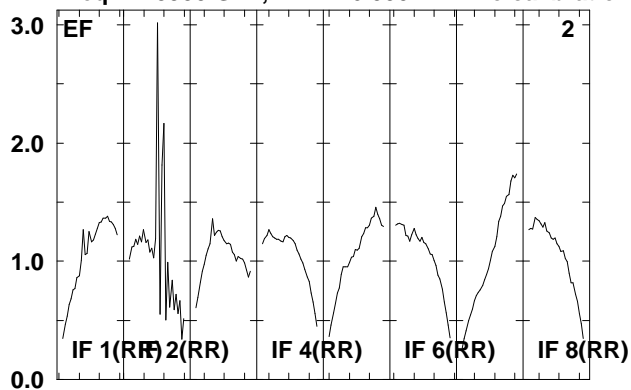

Lower frame: Real Jy
Total-power spectrum Antenna: *
Timerange: 00/20:16:32 to 00/20:18:00

Plot file version 188 created 22-APR-2008 12:27:39

J0730-02 EP061B.UVDATA.1

Freq = 1.5950 GHz, Bw = 16.000 MH No calibration applied and no bandpass applied

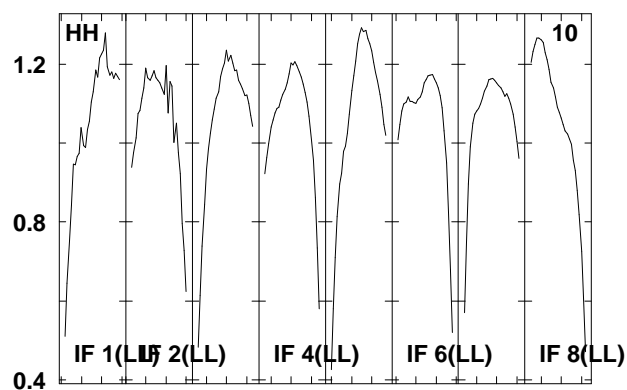
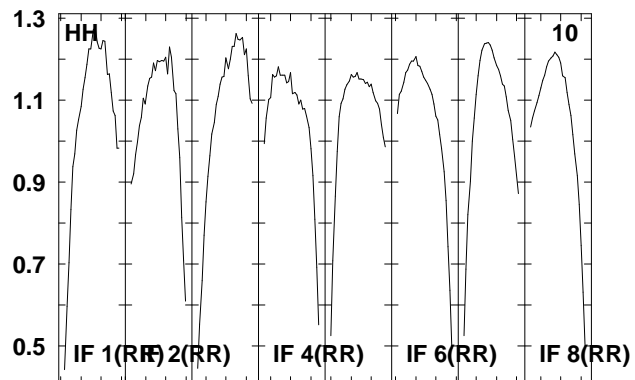
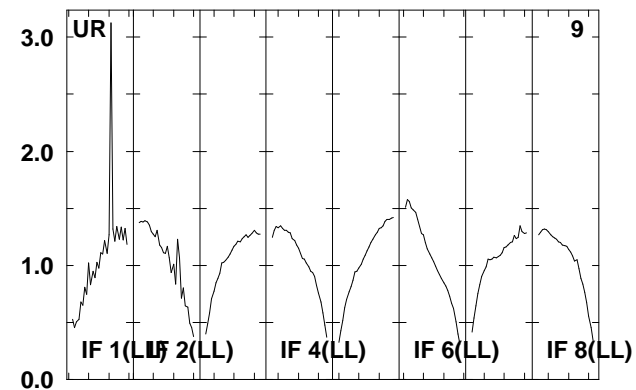
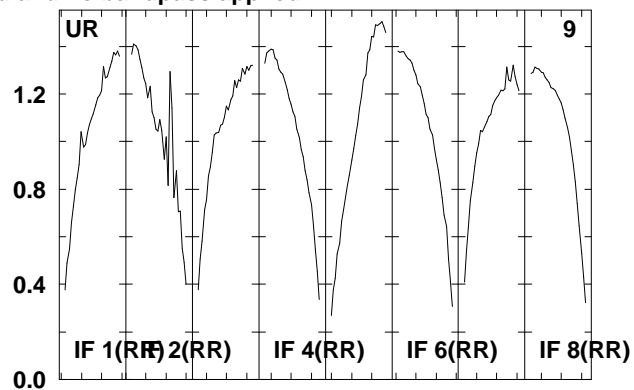
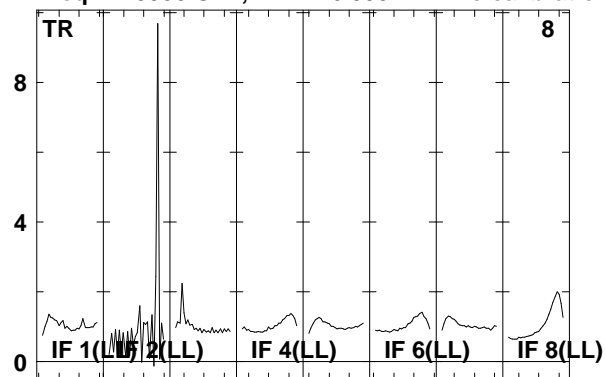

Lower frame: Real Jy
Total-power spectrum Antenna: *
Timerange: 00/20:16:32 to 00/20:18:00

Plot file version 189 created 22-APR-2008 12:27:40

IRAS0725 EP061B.UVDATA.1

Freq = 1.5950 GHz, Bw = 16.000 MH No calibration applied and no bandpass applied

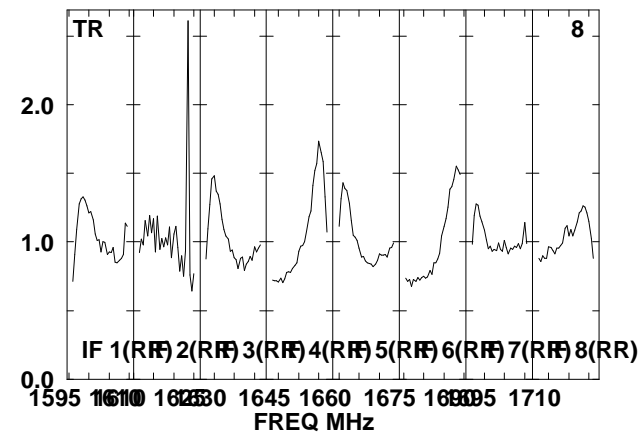
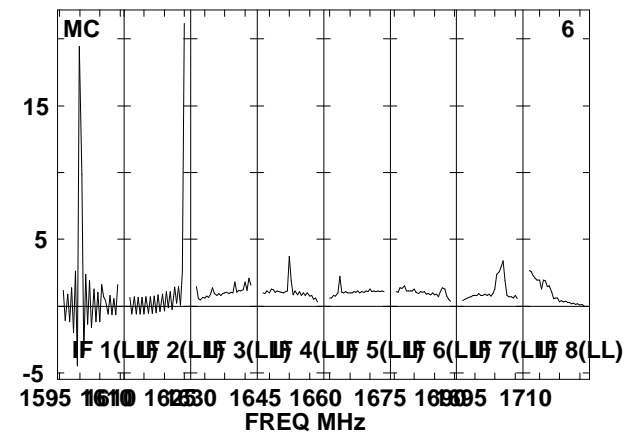
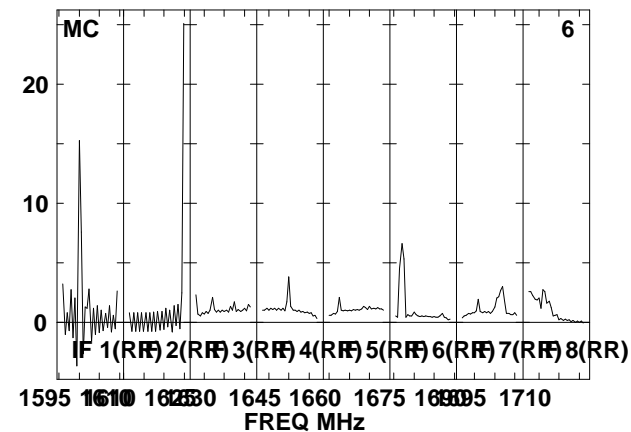
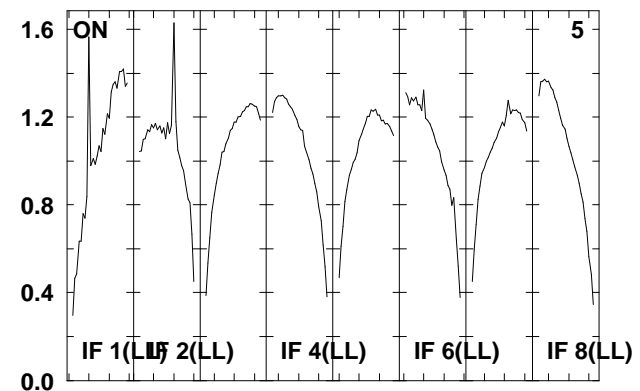
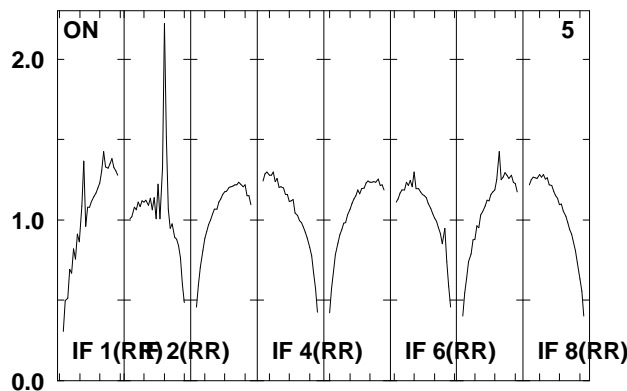
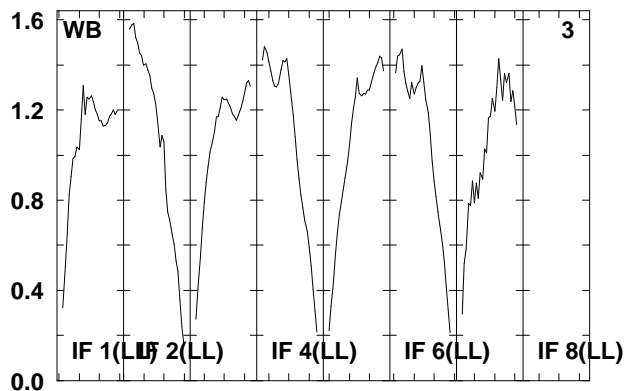
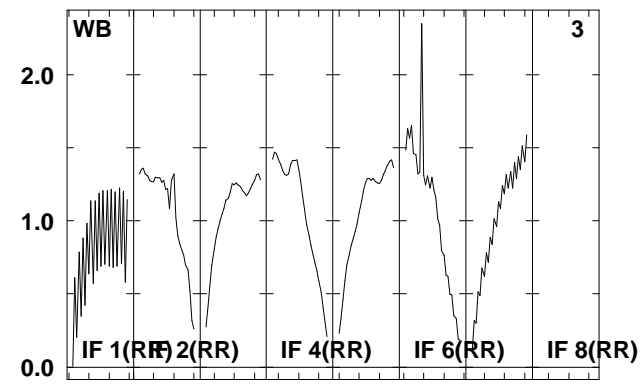
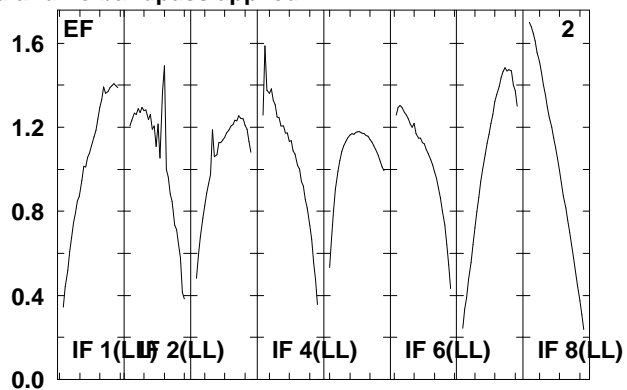
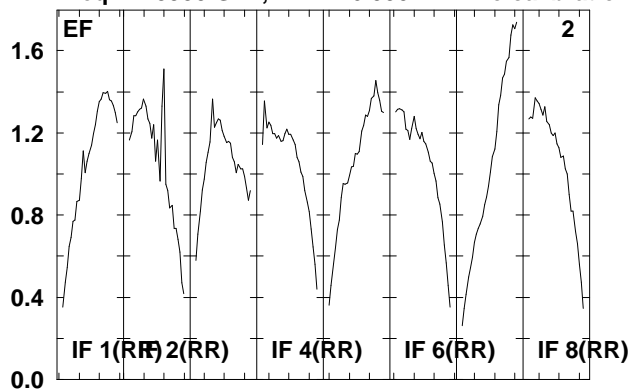

Lower frame: Real Jy
Total-power spectrum Antenna: *
Timerange: 00/20:18:02 to 00/20:21:30

Plot file version 190 created 22-APR-2008 12:27:41

IRAS0725 EP061B.UVDATA.1

Freq = 1.5950 GHz, Bw = 16.000 MH No calibration applied and no bandpass applied

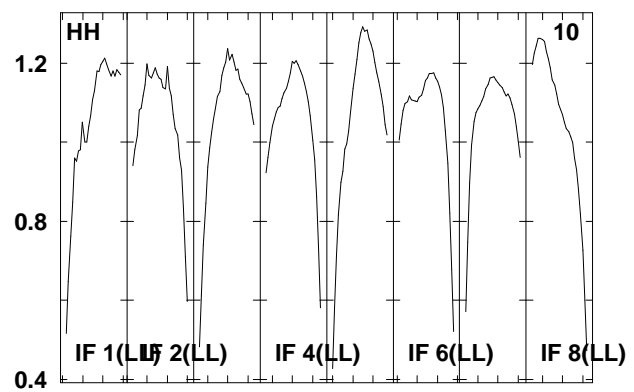
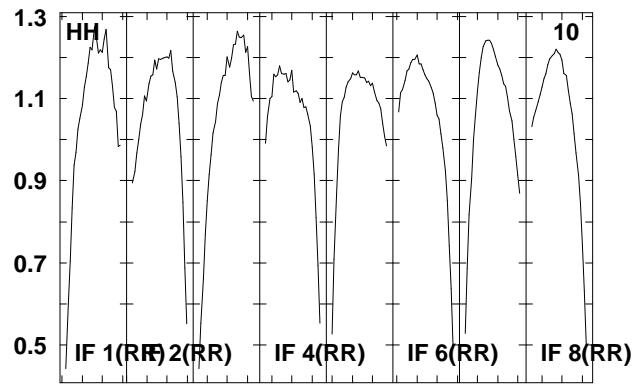
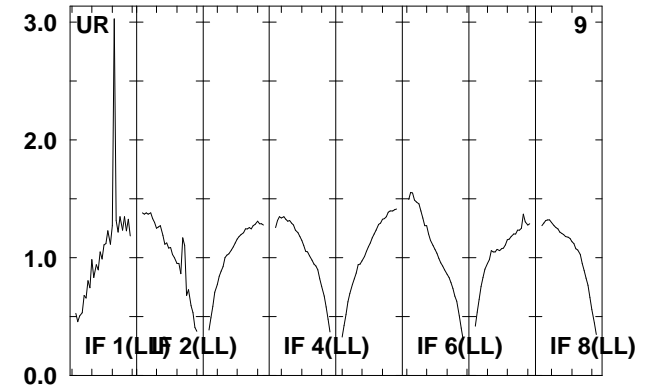
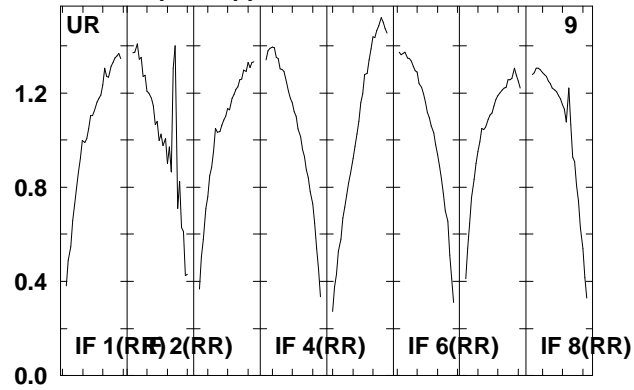
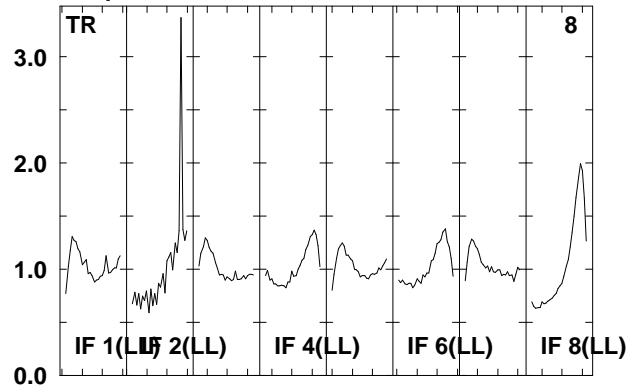

Lower frame: Real Jy
Total-power spectrum Antenna: *
Timerange: 00/20:18:02 to 00/20:21:30

Plot file version 191 created 22-APR-2008 12:27:41

J0730-02 EP061B.UVDATA.1

Freq = 1.5950 GHz, Bw = 16.000 MH No calibration applied and no bandpass applied

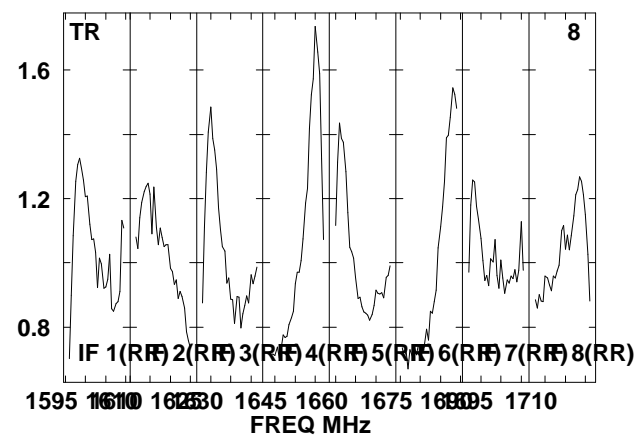
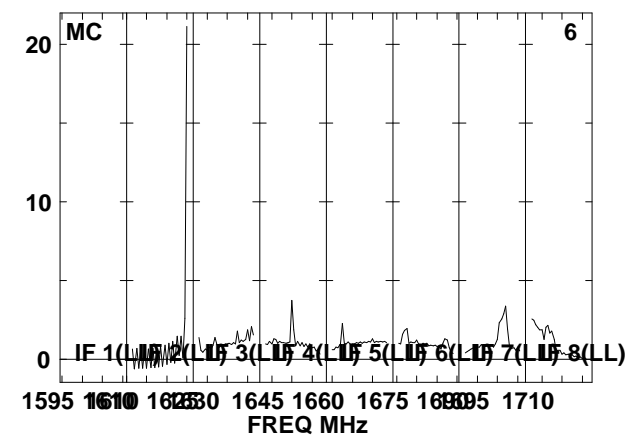
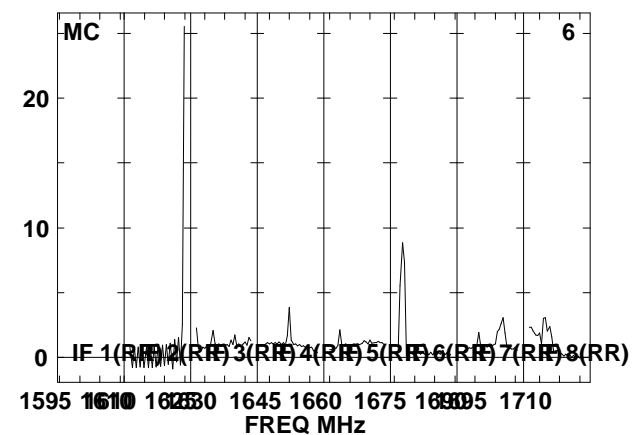
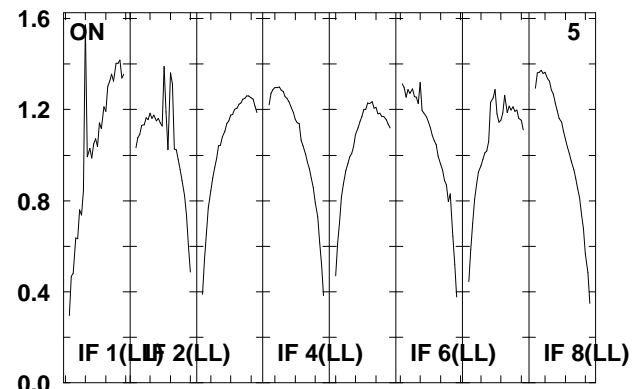
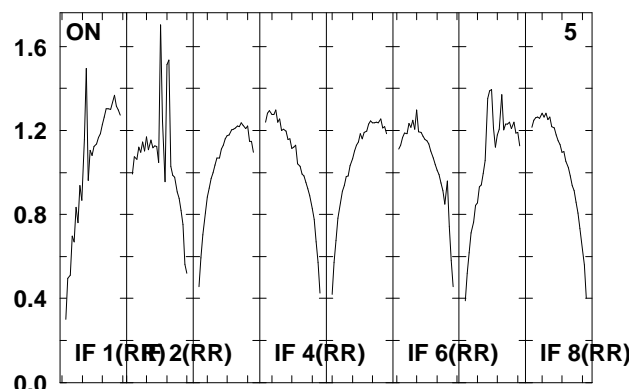
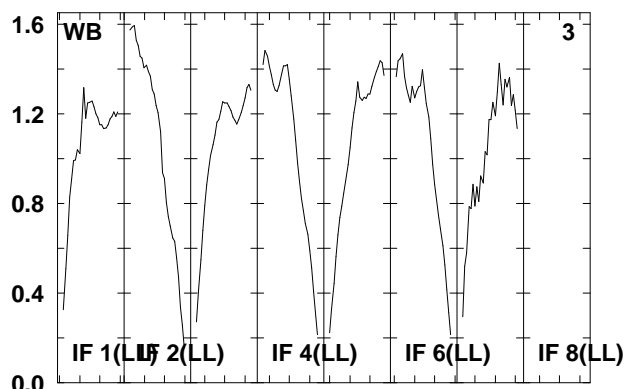
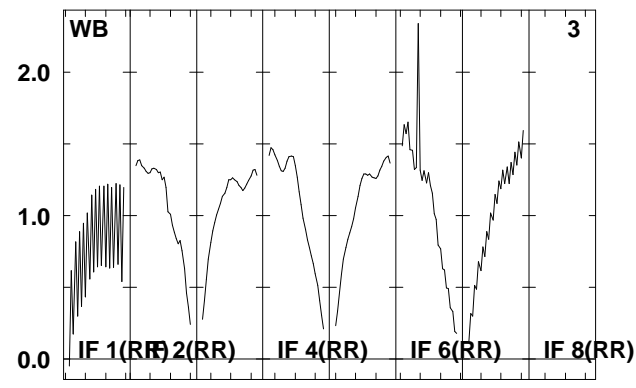
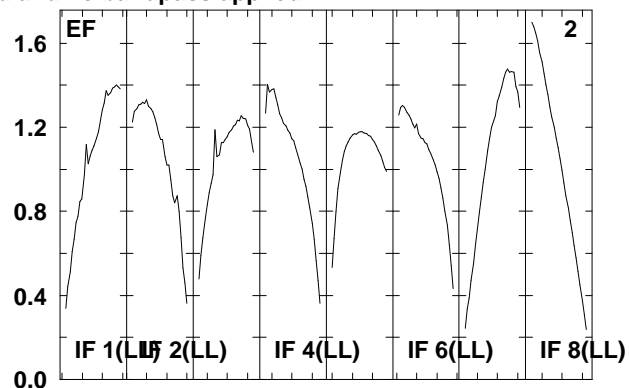
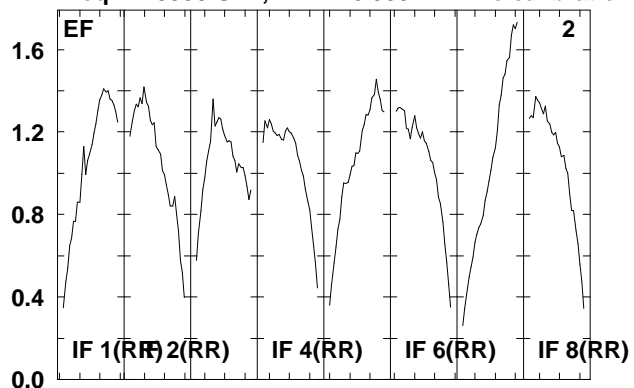

Lower frame: Real Jy
Total-power spectrum Antenna: *
Timerange: 00/20:21:32 to 00/20:23:00

Plot file version 192 created 22-APR-2008 12:27:42

J0730-02 EP061B.UVDATA.1

Freq = 1.5950 GHz, Bw = 16.000 MH No calibration applied and no bandpass applied

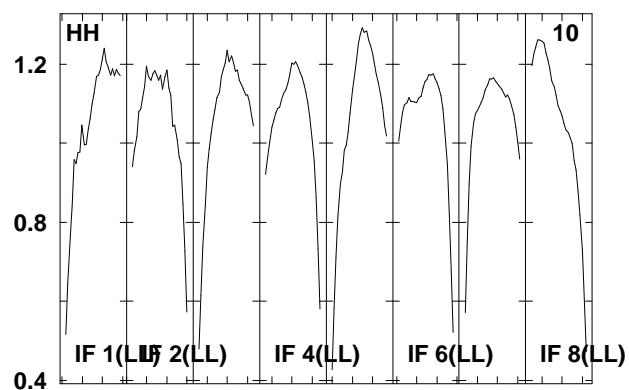
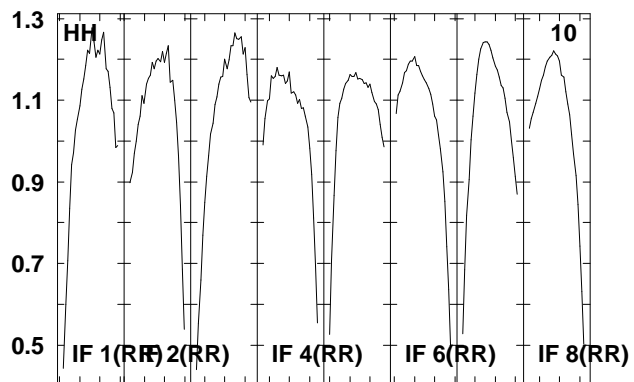
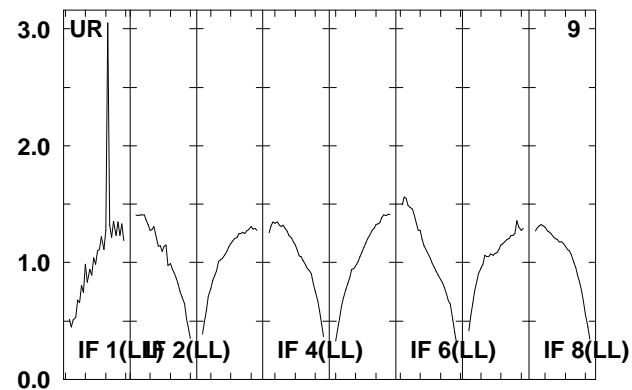
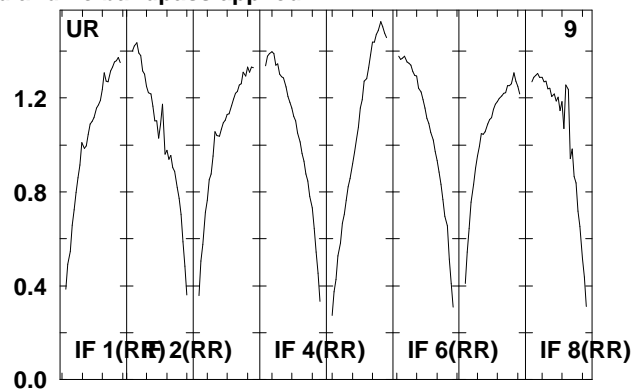
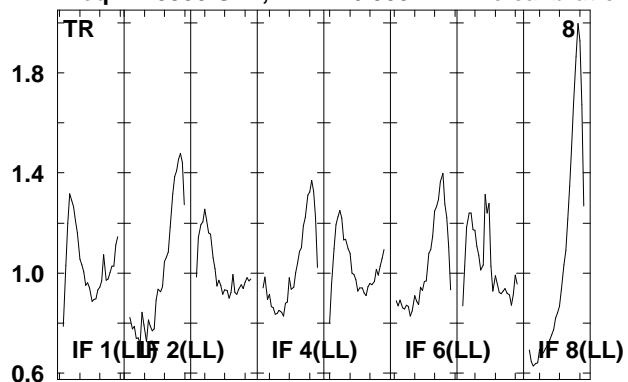

Lower frame: Real Jy
Total-power spectrum Antenna: *
Timerange: 00/20:21:32 to 00/20:23:00

Plot file version 193 created 22-APR-2008 12:27:42

IRAS0725 EP061B.UVDATA.1

Freq = 1.5950 GHz, Bw = 16.000 MH No calibration applied and no bandpass applied

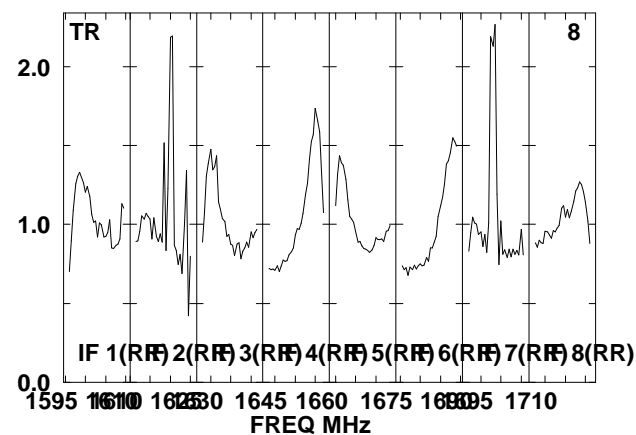
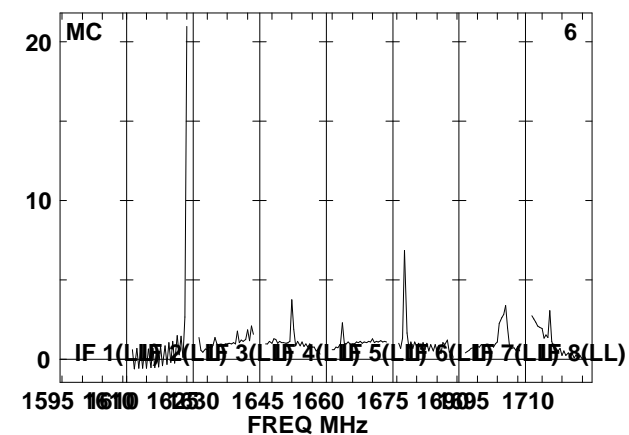
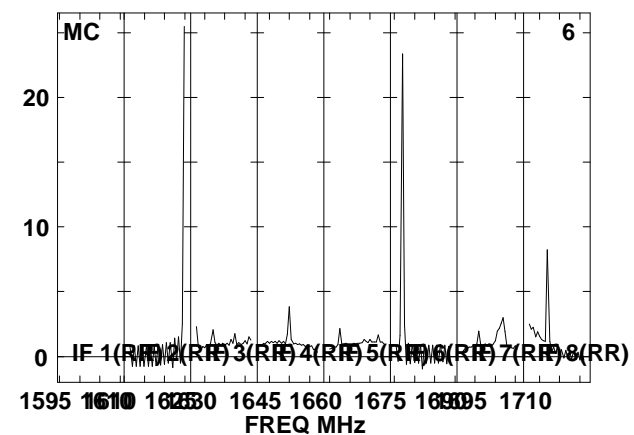
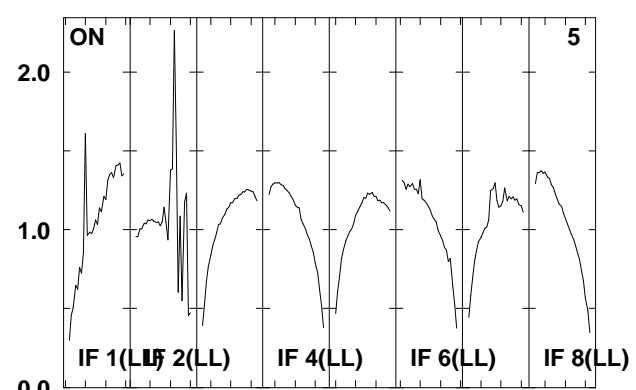
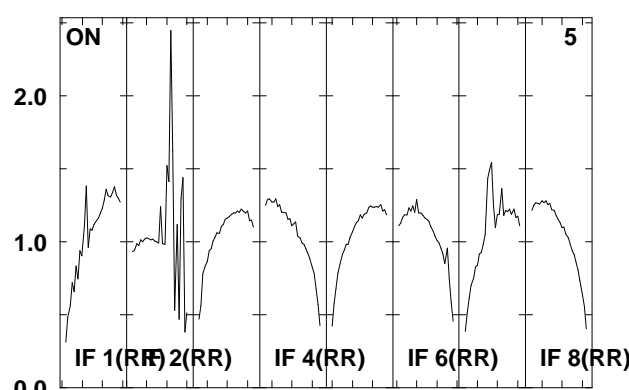
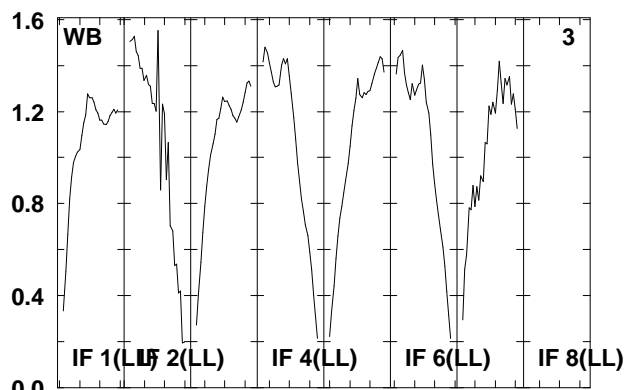
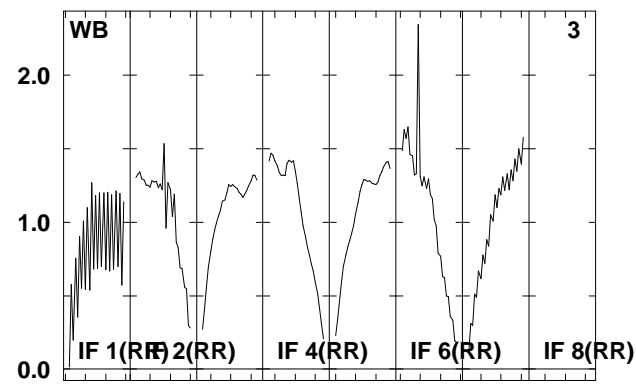
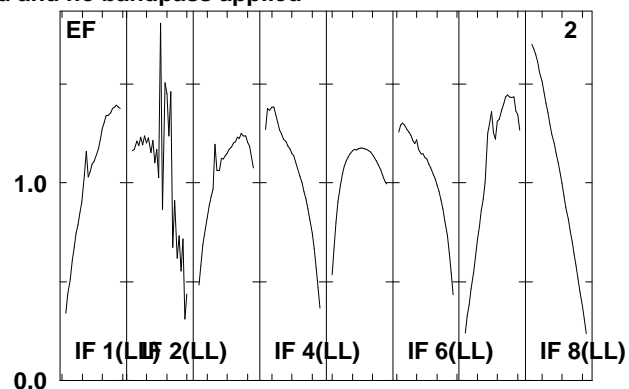
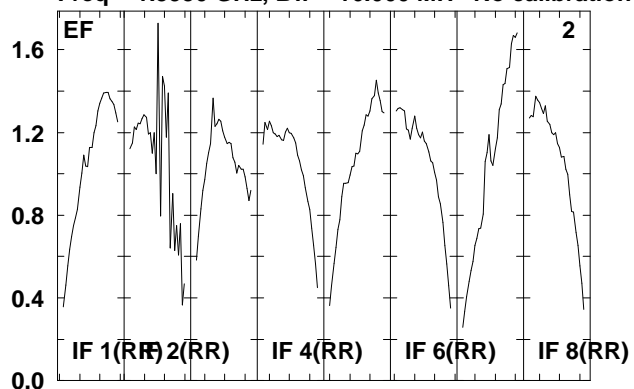

Lower frame: Real Jy
Total-power spectrum Antenna: *
Timerange: 00/20:23:02 to 00/20:26:26

Plot file version 194 created 22-APR-2008 12:27:44

IRAS0725 EP061B.UVDATA.1

Freq = 1.5950 GHz, Bw = 16.000 MH No calibration applied and no bandpass applied

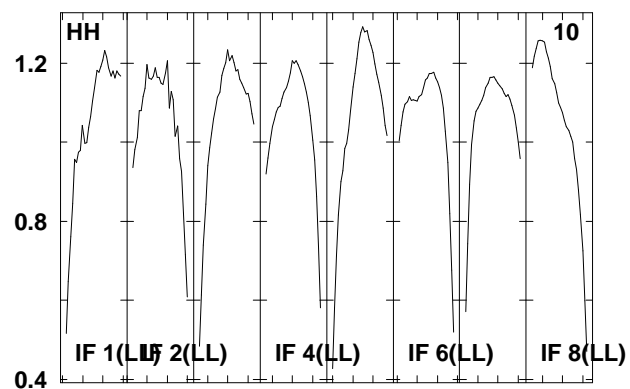
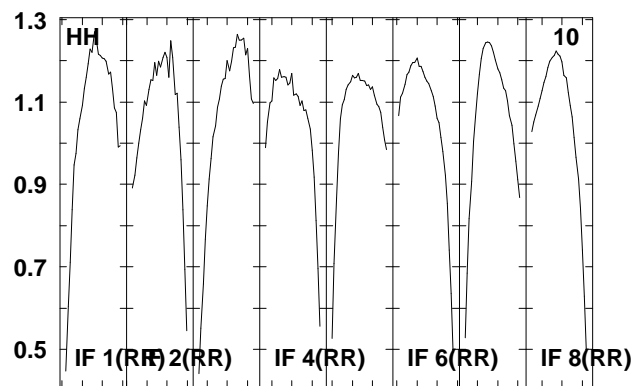
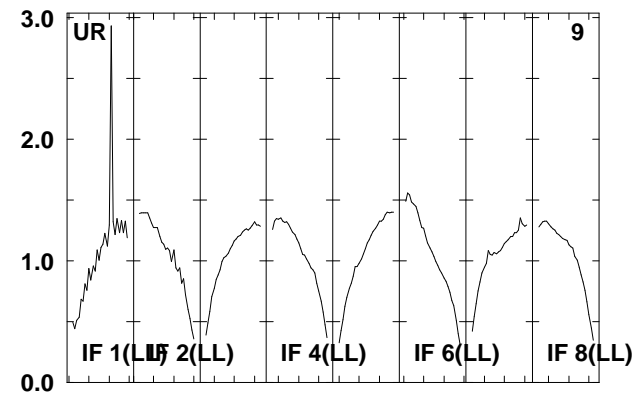
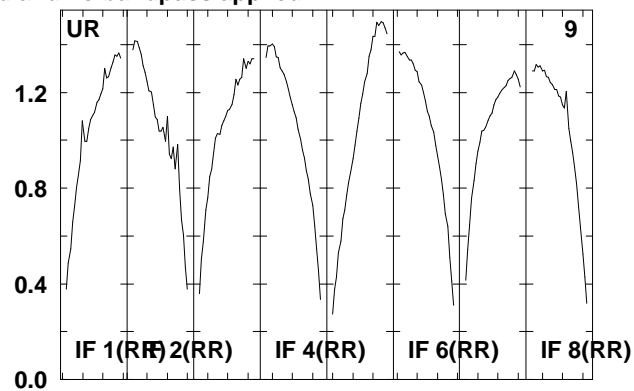
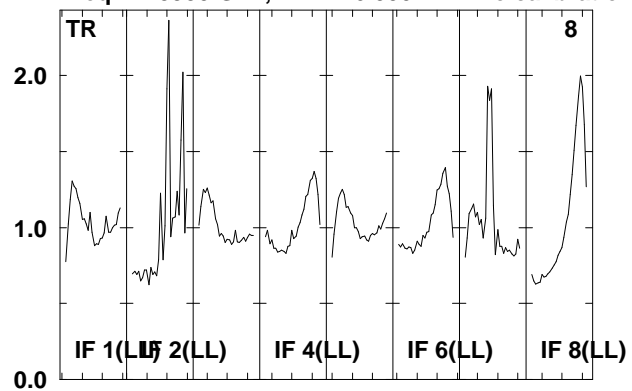

Lower frame: Real Jy
Total-power spectrum Antenna: *
Timerange: 00/20:23:02 to 00/20:26:26

Plot file version 195 created 22-APR-2008 12:27:44

J0730-02 EP061B.UVDATA.1

Freq = 1.5950 GHz, Bw = 16.000 MH No calibration applied and no bandpass applied

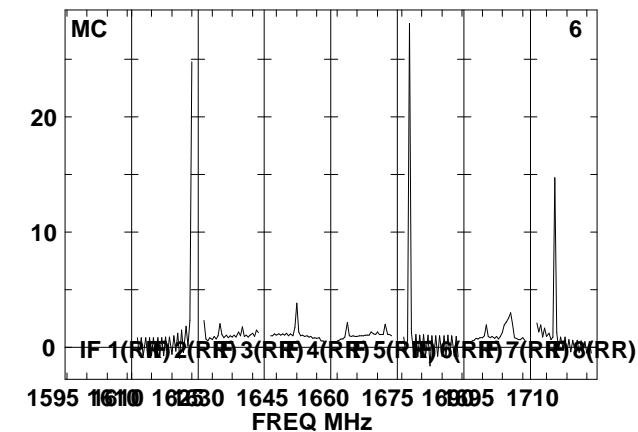
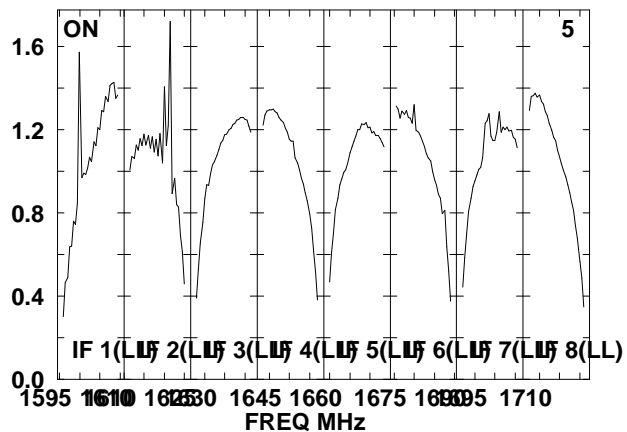
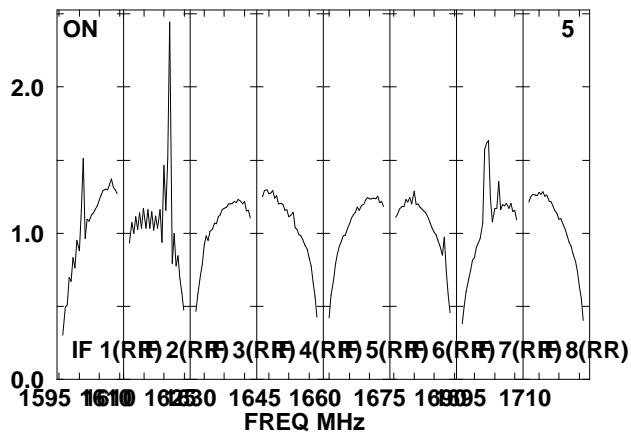
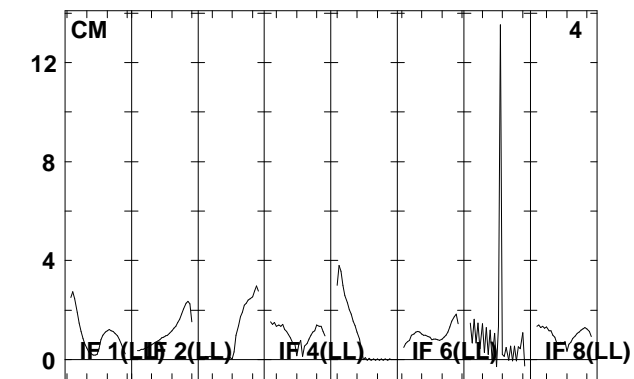
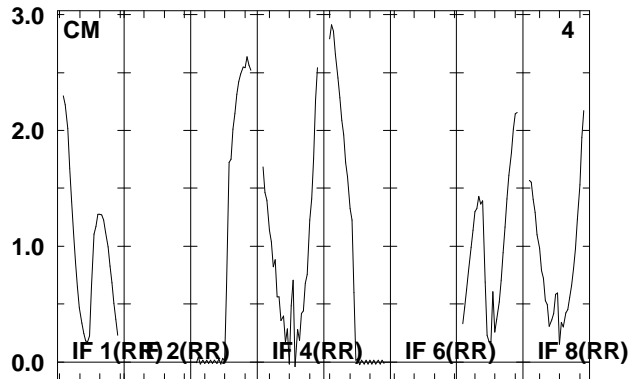
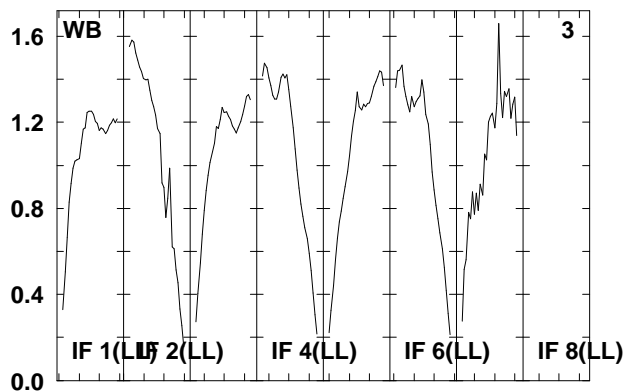
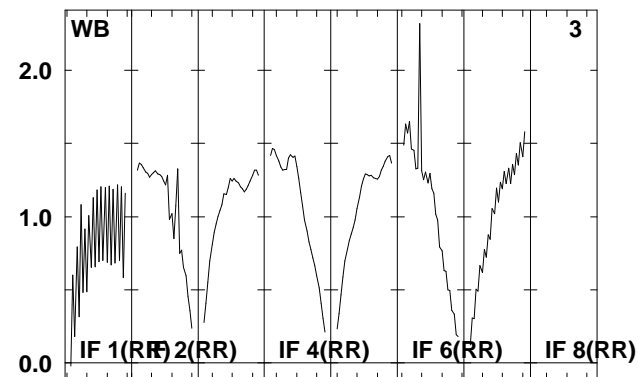
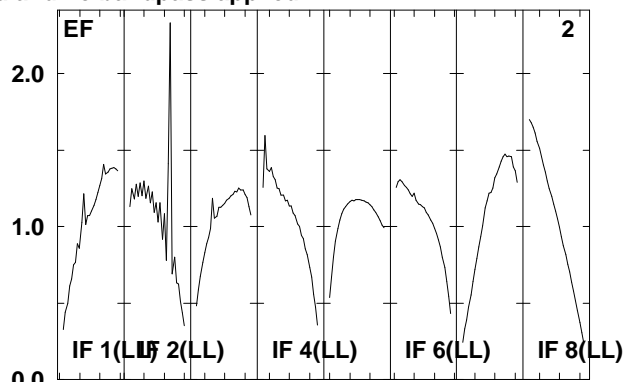
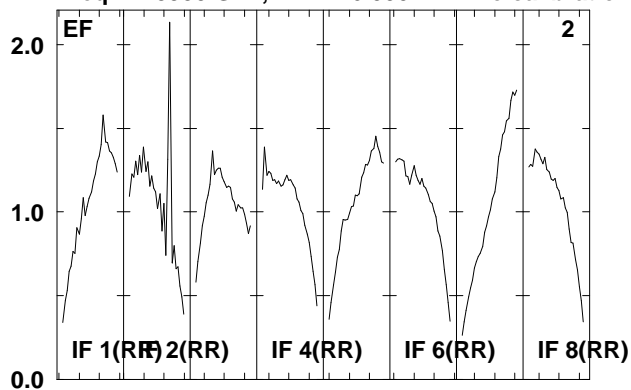

Lower frame: Real Jy
Total-power spectrum Antenna: *
Timerange: 00/20:27:32 to 00/20:28:56

Plot file version 196 created 22-APR-2008 12:27:45

J0730-02 EP061B.UVDATA.1

Freq = 1.5950 GHz, Bw = 16.000 MH No calibration applied and no bandpass applied

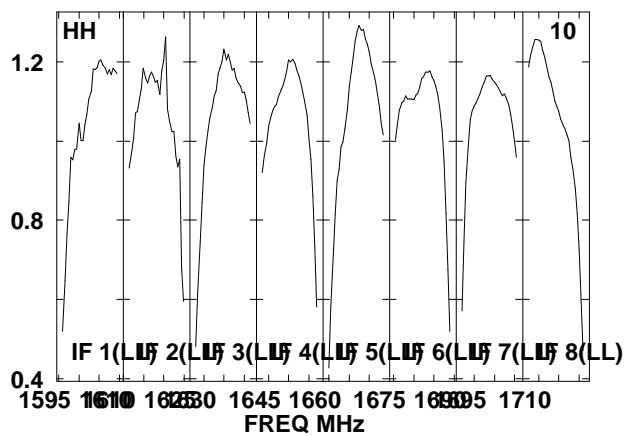
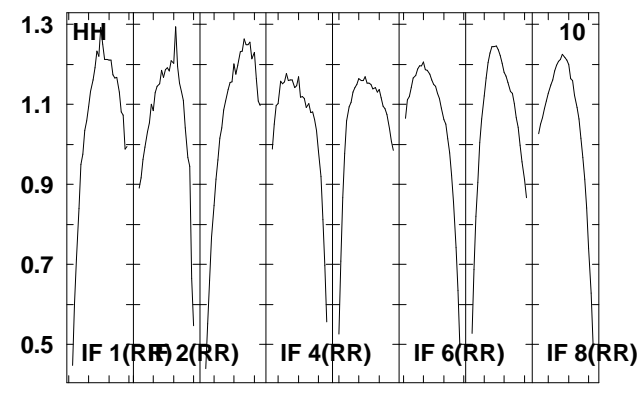
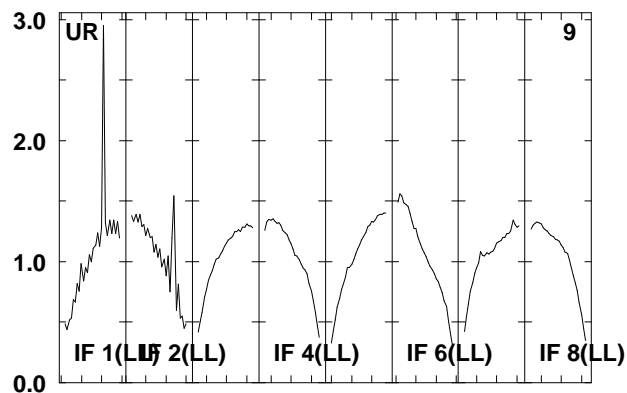
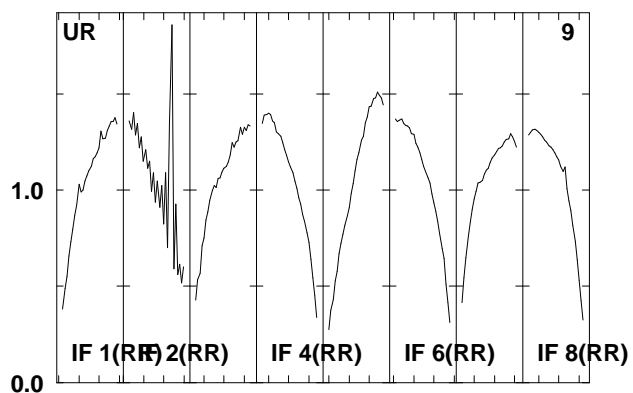
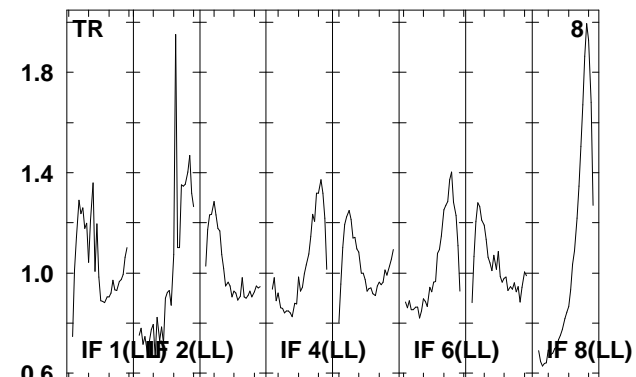
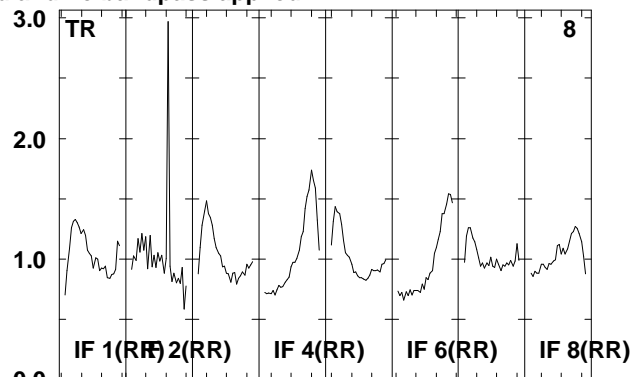
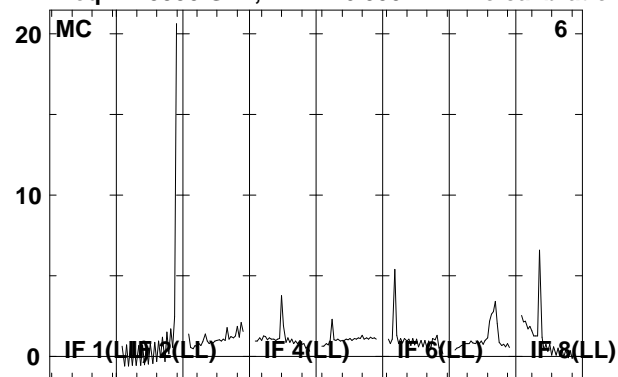

Lower frame: Real Jy

Total-power spectrum Antenna: *

Timerange: 00/20:27:32 to 00/20:28:56

Plot file version 197 created 22-APR-2008 12:27:46

IRAS0725 EP061B.UVDATA.1

Freq = 1.5950 GHz, Bw = 16.000 MH No calibration applied and no bandpass applied

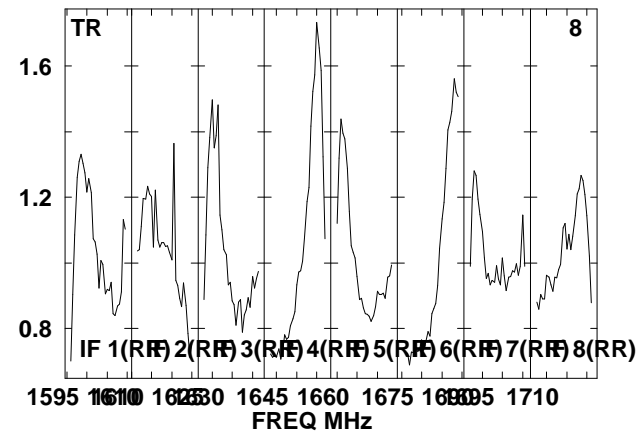
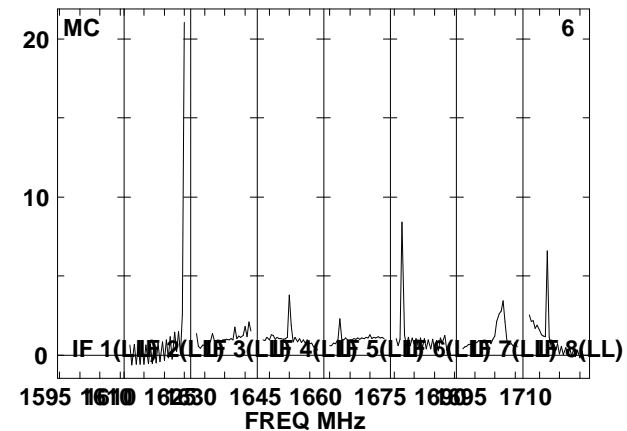
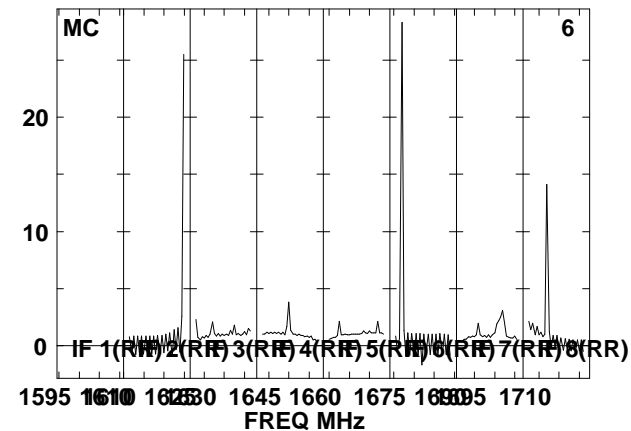
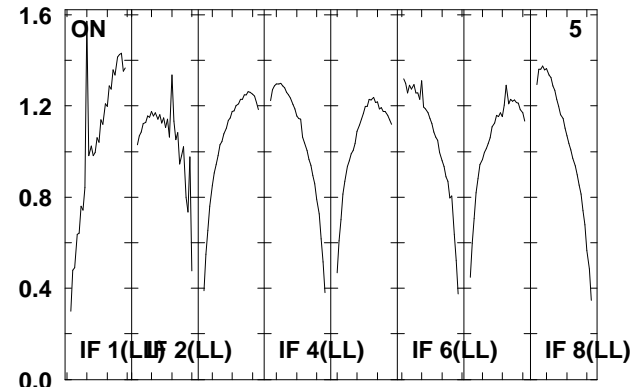
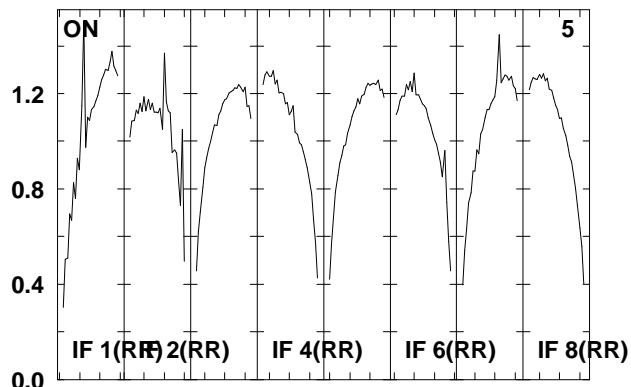
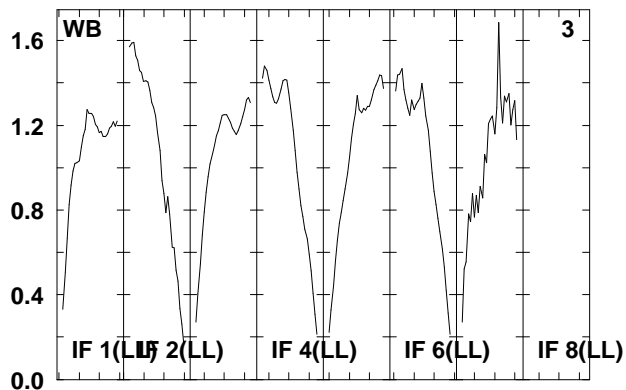
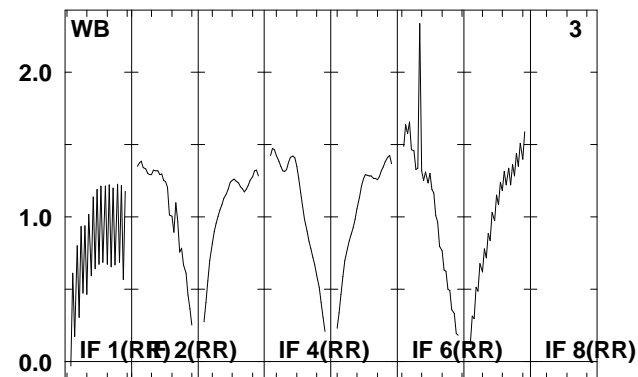
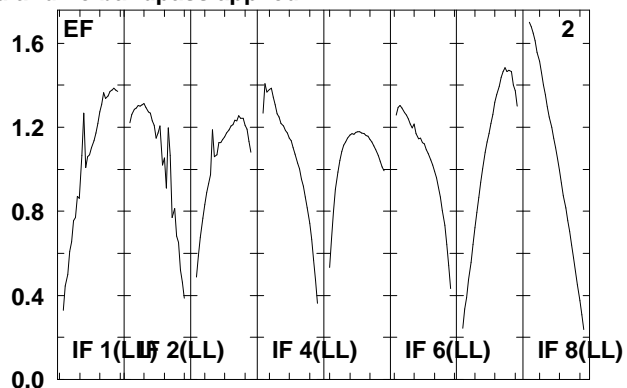
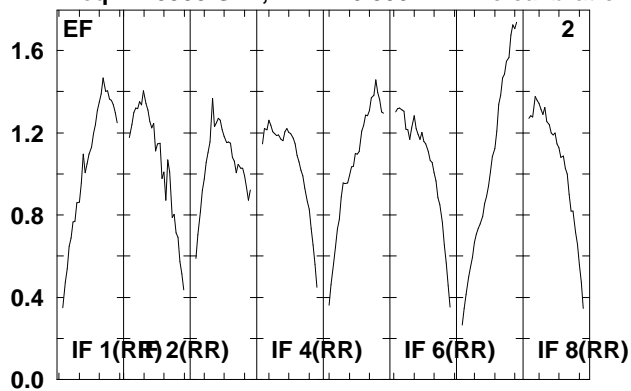

Lower frame: Real Jy
Total-power spectrum Antenna: *
Timerange: 00/20:29:04 to 00/20:32:30

Plot file version 198 created 22-APR-2008 12:27:46

IRAS0725 EP061B.UVDATA.1

Freq = 1.5950 GHz, Bw = 16.000 MH No calibration applied and no bandpass applied

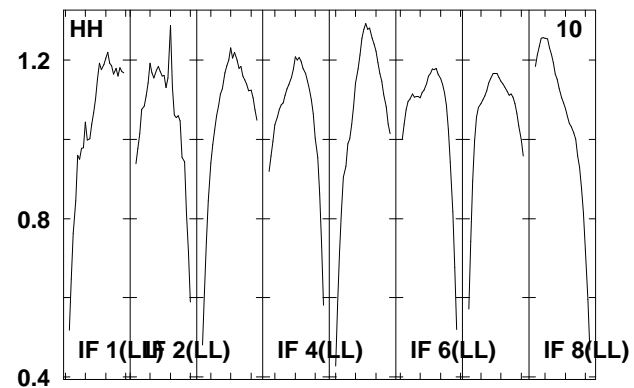
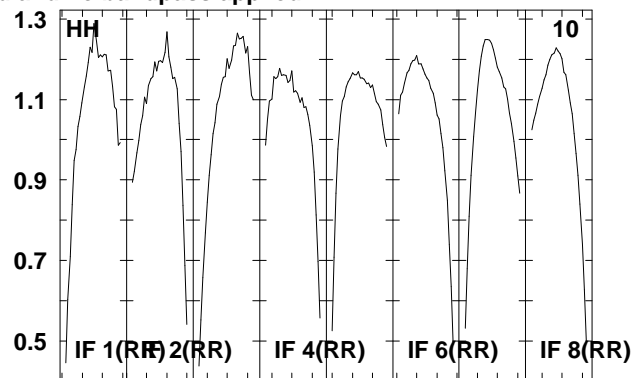
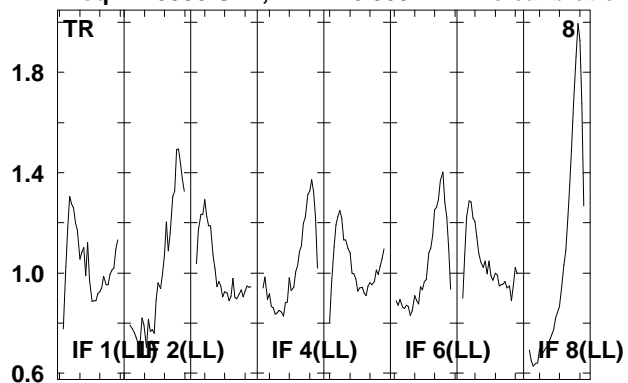

Lower frame: Real Jy
Total-power spectrum Antenna: *
Timerange: 00/20:29:04 to 00/20:32:30

Plot file version 199 created 22-APR-2008 12:27:47

J0730-02 EP061B.UVDATA.1

Freq = 1.5950 GHz, Bw = 16.000 MH No calibration applied and no bandpass applied

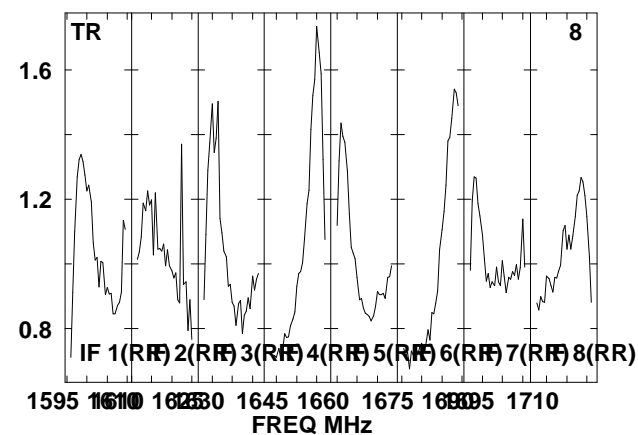
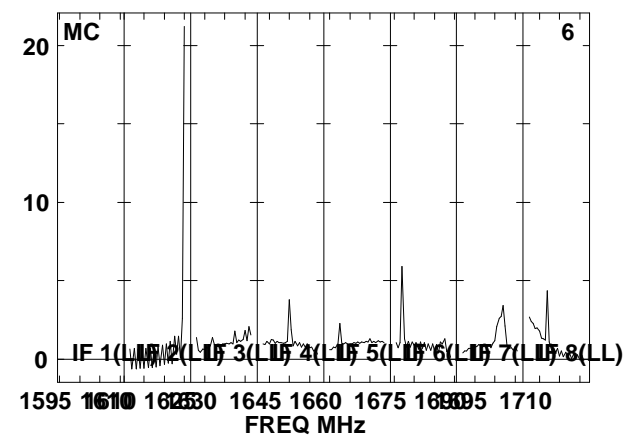
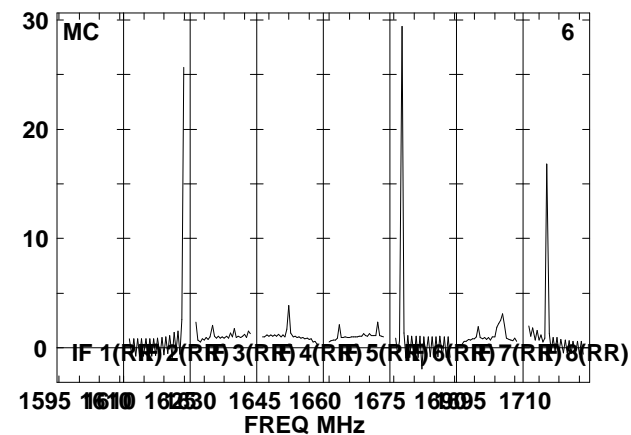
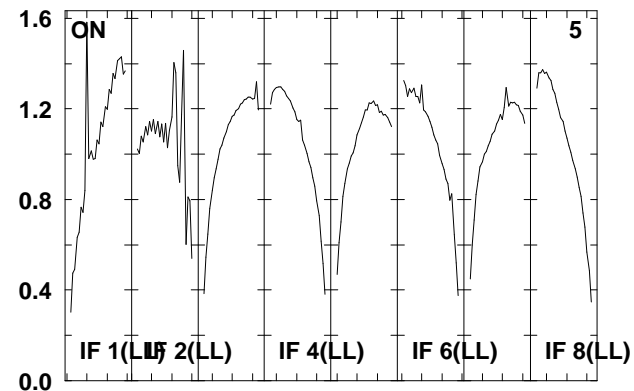
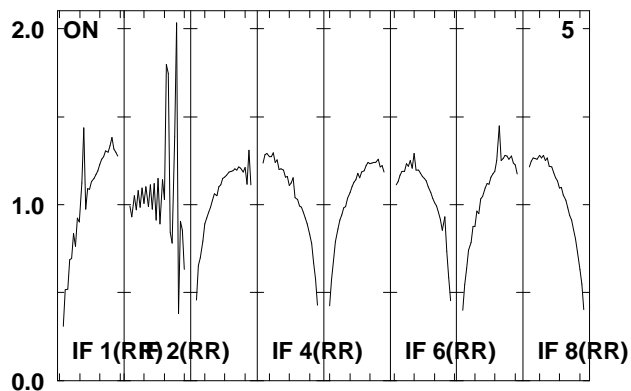
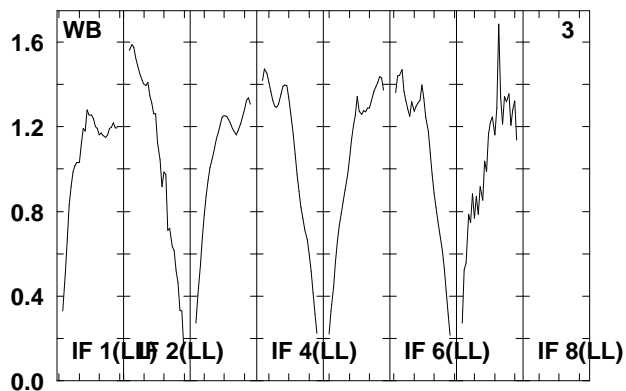
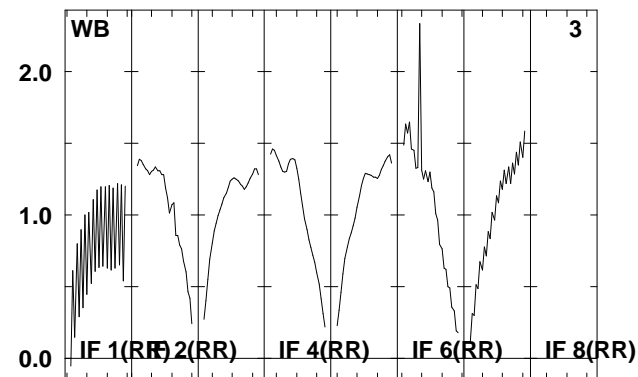
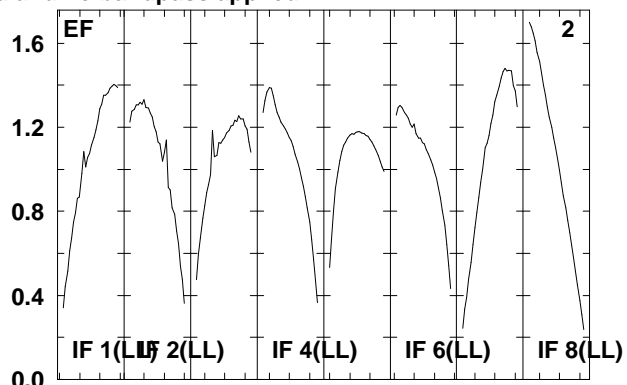
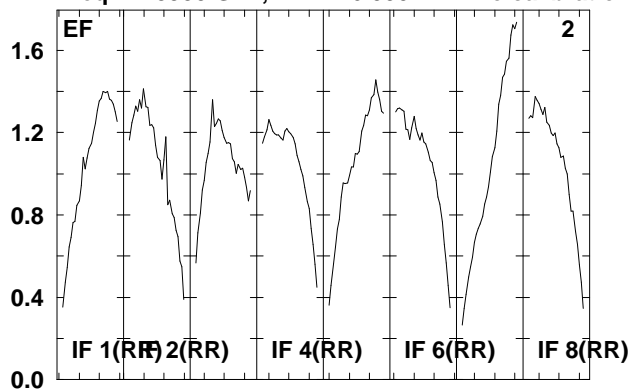

Lower frame: Real Jy
Total-power spectrum Antenna: *
Timerange: 00/20:32:32 to 00/20:34:00

Plot file version 200 created 22-APR-2008 12:27:47

J0730-02 EP061B.UVDATA.1

Freq = 1.5950 GHz, Bw = 16.000 MH No calibration applied and no bandpass applied

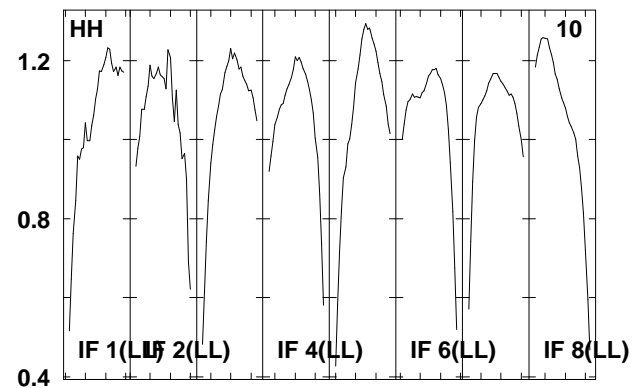
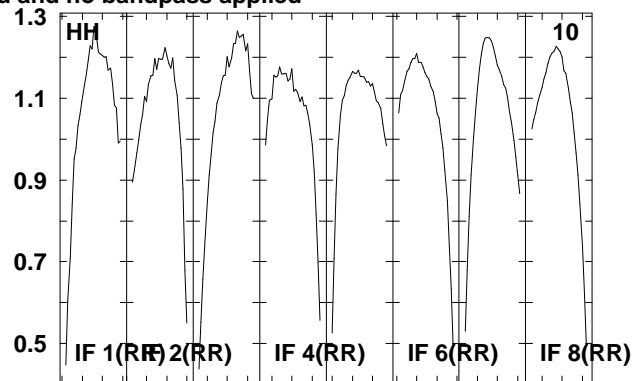
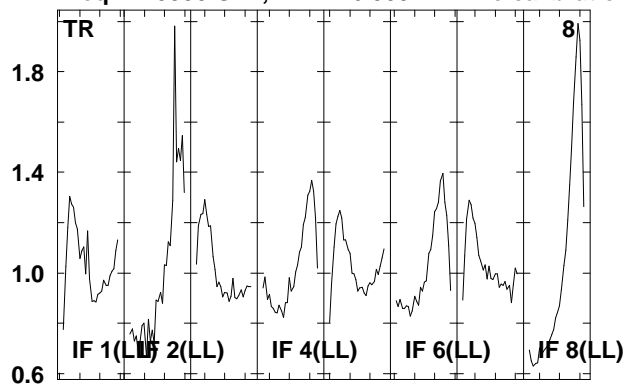

Lower frame: Real Jy
Total-power spectrum Antenna: *
Timerange: 00/20:32:32 to 00/20:34:00

Plot file version 201 created 22-APR-2008 12:27:48

IRAS0725 EP061B.UVDATA.1

Freq = 1.5950 GHz, Bw = 16.000 MH No calibration applied and no bandpass applied

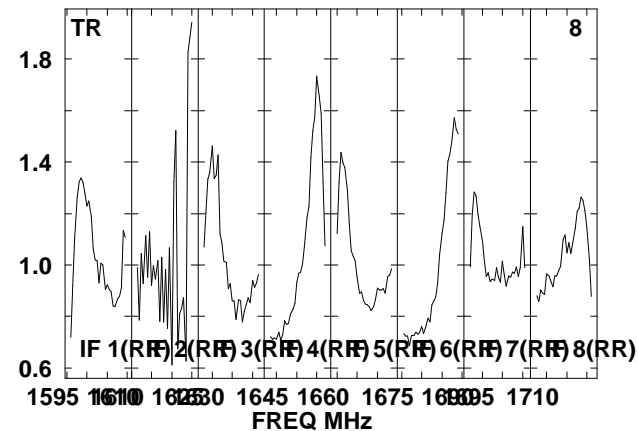
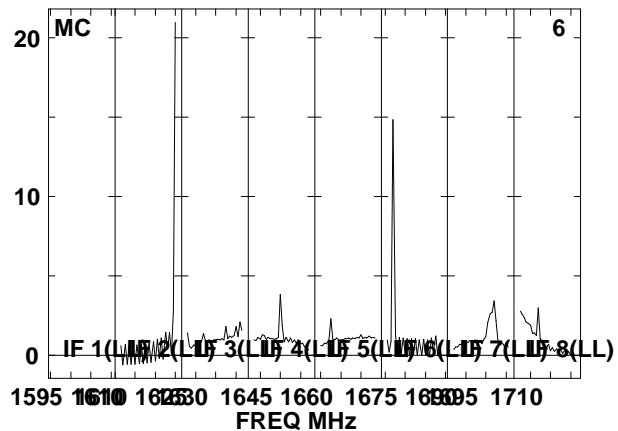
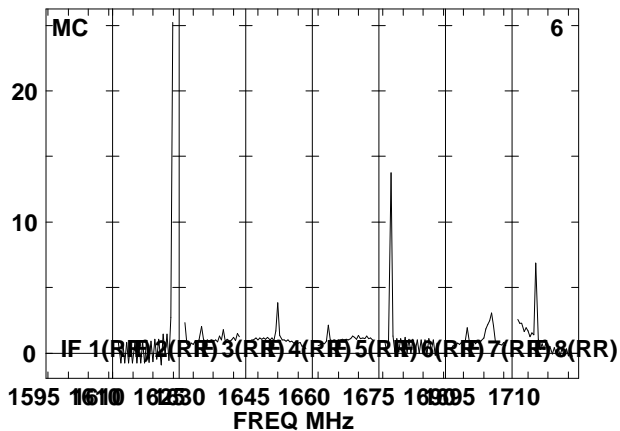
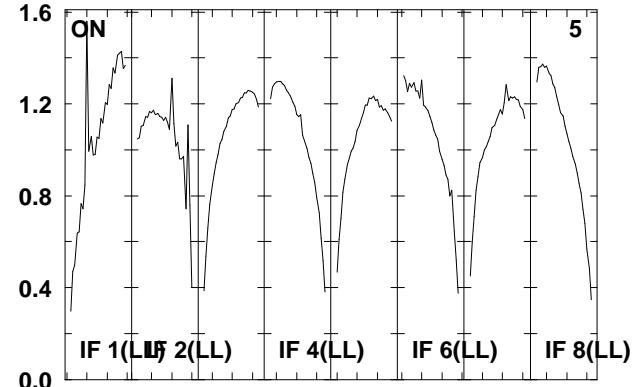
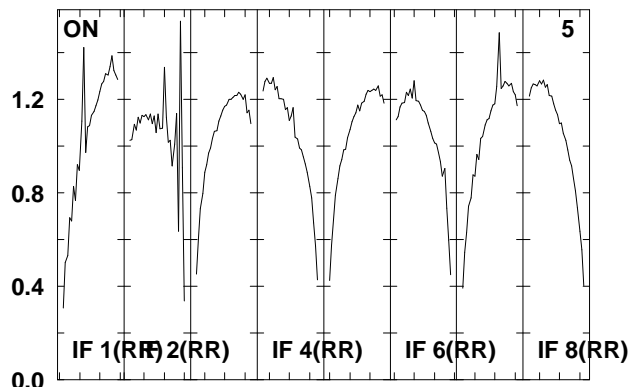
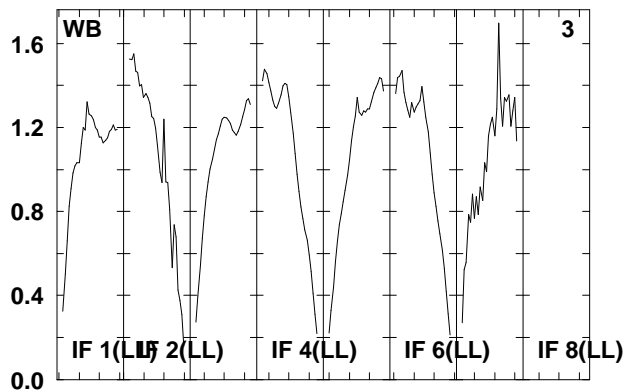
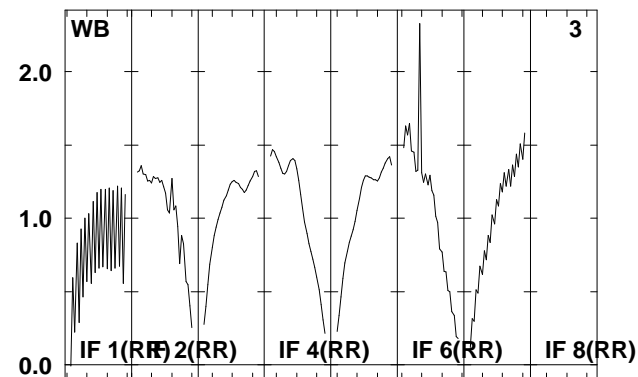
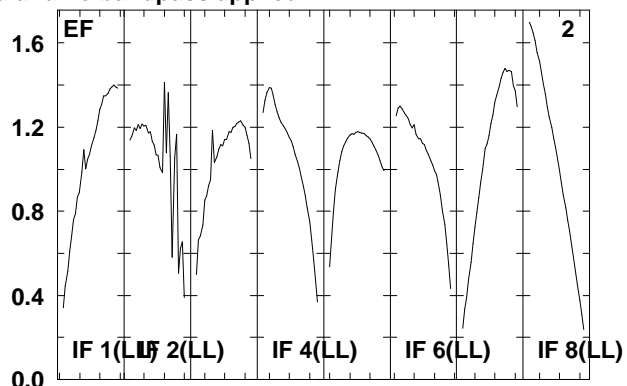
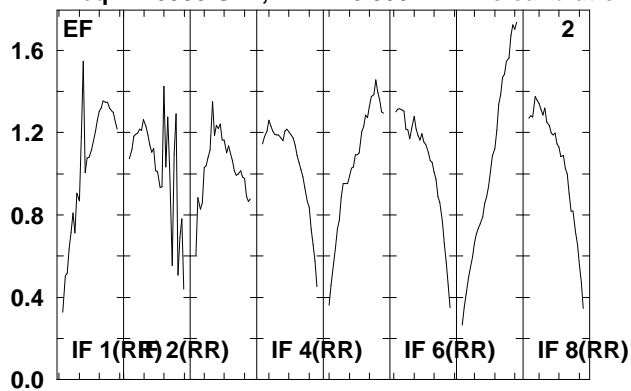

Lower frame: Real Jy
Total-power spectrum Antenna: *
Timerange: 00/20:34:02 to 00/20:37:30

Plot file version 202 created 22-APR-2008 12:27:48

IRAS0725 EP061B.UVDATA.1

Freq = 1.5950 GHz, Bw = 16.000 MH No calibration applied and no bandpass applied

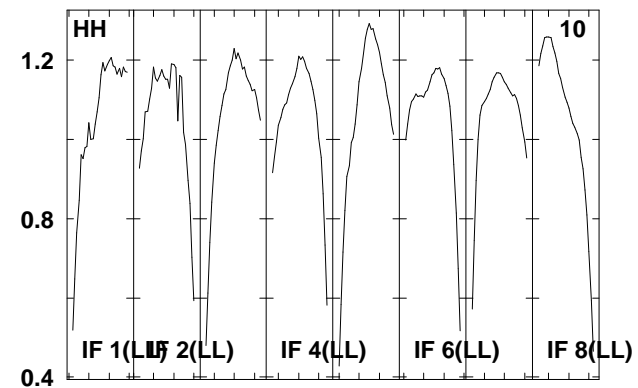
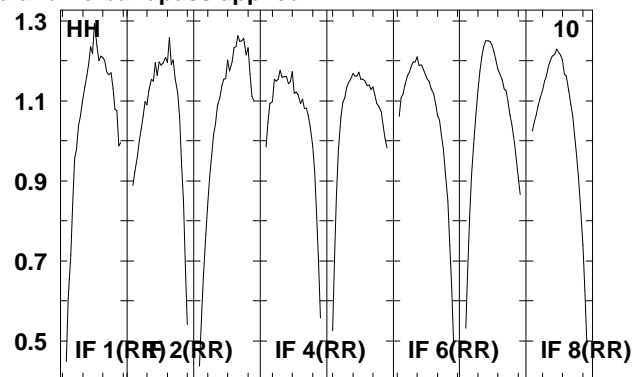
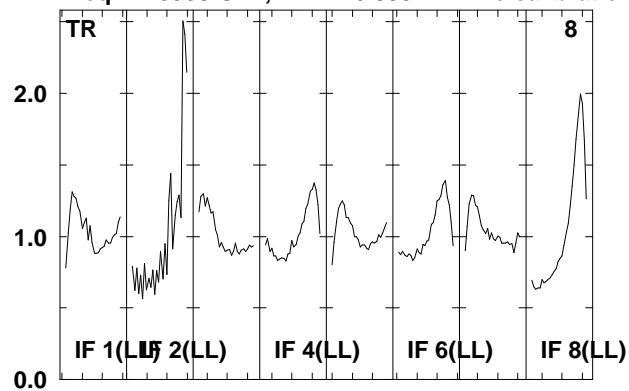

Lower frame: Real Jy
Total-power spectrum Antenna: *
Timerange: 00/20:34:02 to 00/20:37:30

Plot file version 203 created 22-APR-2008 12:27:49

J0730-02 EP061B.UVDATA.1

Freq = 1.5950 GHz, Bw = 16.000 MH No calibration applied and no bandpass applied

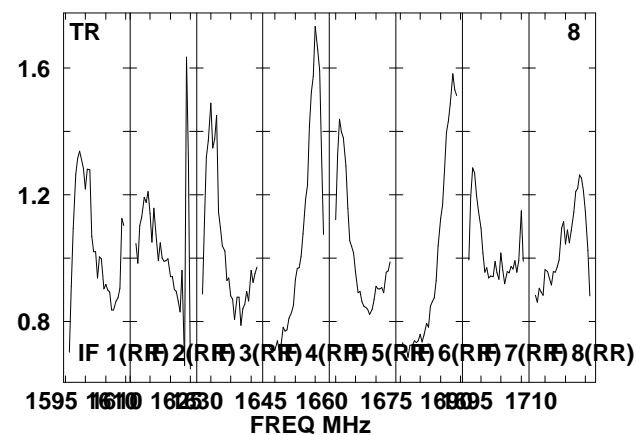
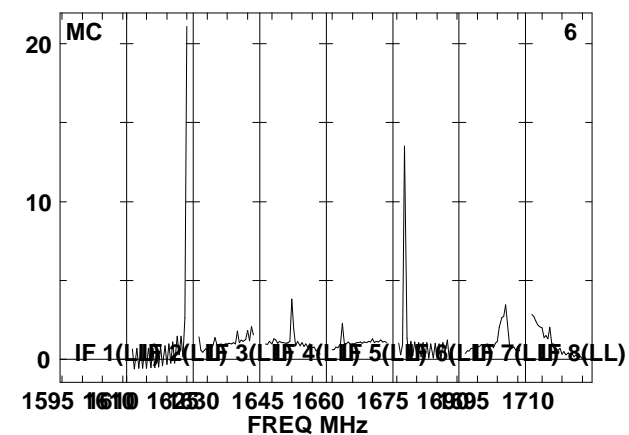
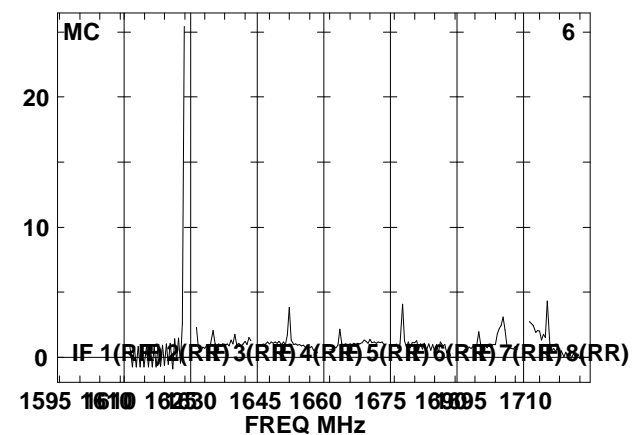
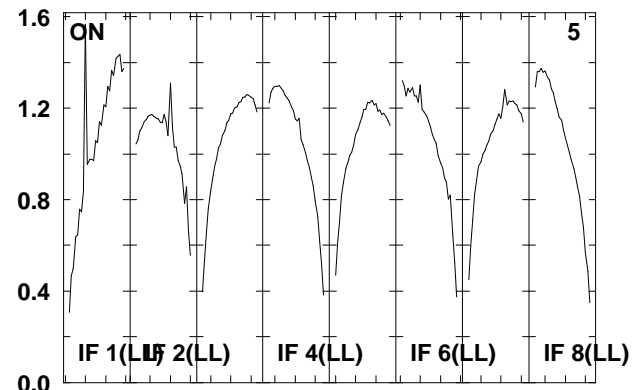
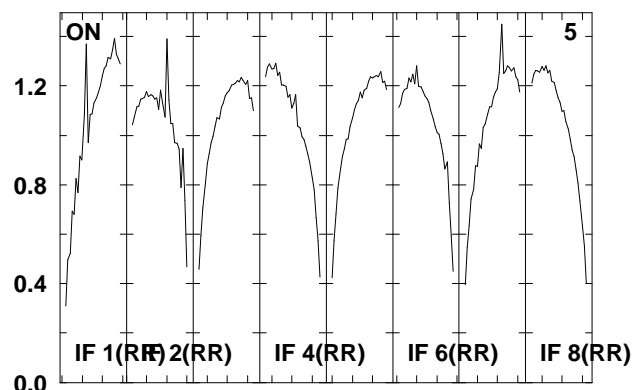
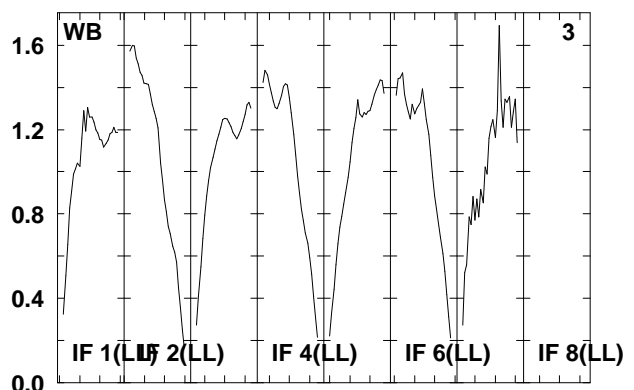
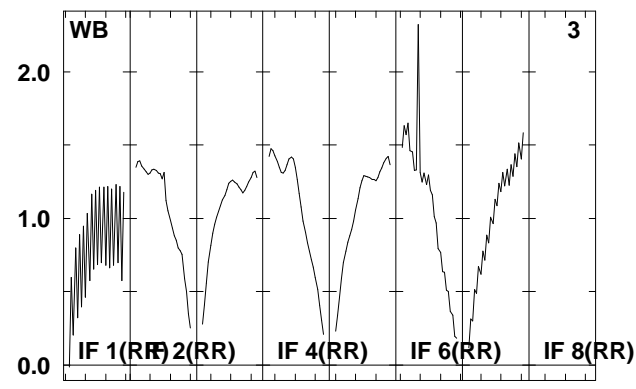
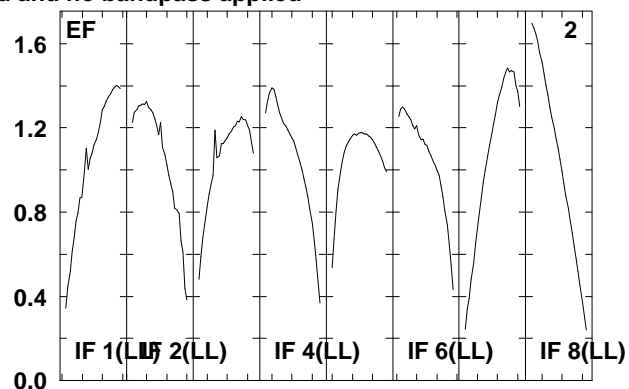
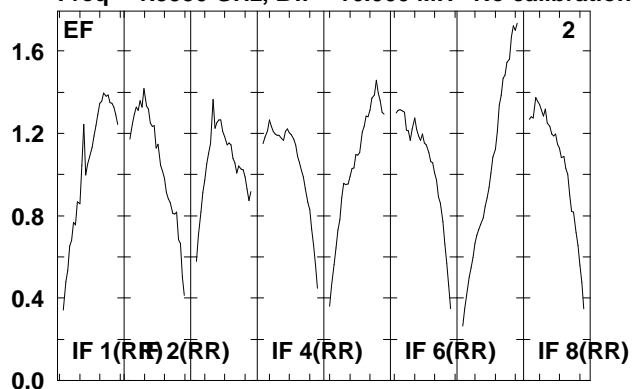

Lower frame: Real Jy
Total-power spectrum Antenna: *
Timerange: 00/20:37:32 to 00/20:39:00

Plot file version 204 created 22-APR-2008 12:27:50

J0730-02 EP061B.UVDATA.1

Freq = 1.5950 GHz, Bw = 16.000 MH No calibration applied and no bandpass applied

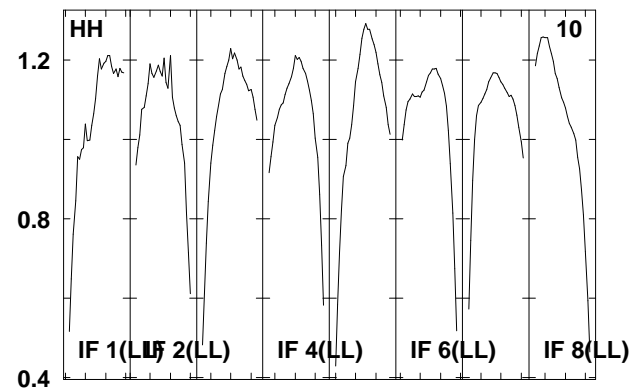
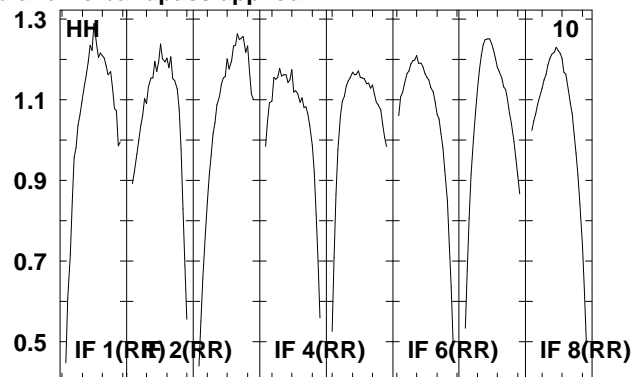
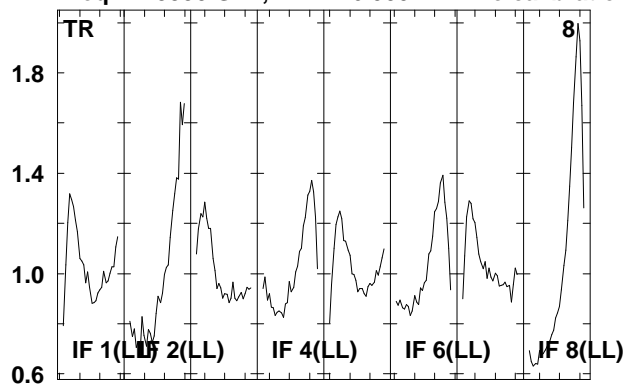

Lower frame: Real Jy
Total-power spectrum Antenna: *
Timerange: 00/20:37:32 to 00/20:39:00

Plot file version 205 created 22-APR-2008 12:27:50

IRAS0725 EP061B.UVDATA.1

Freq = 1.5950 GHz, Bw = 16.000 MH No calibration applied and no bandpass applied

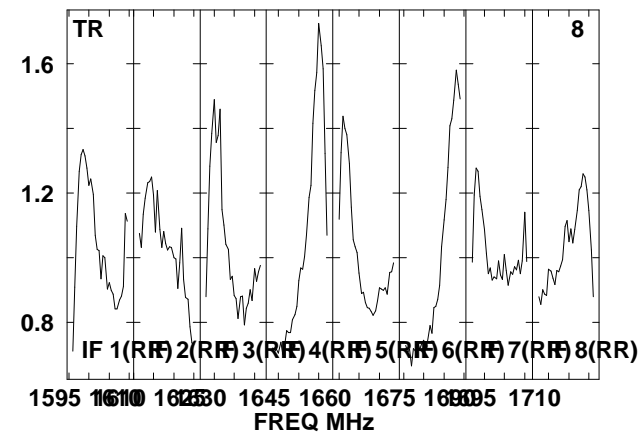
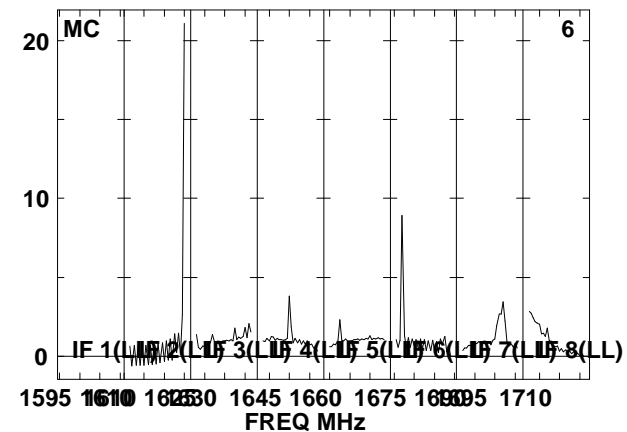
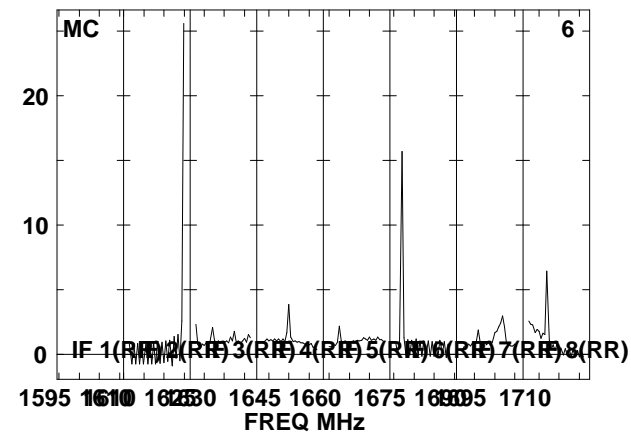
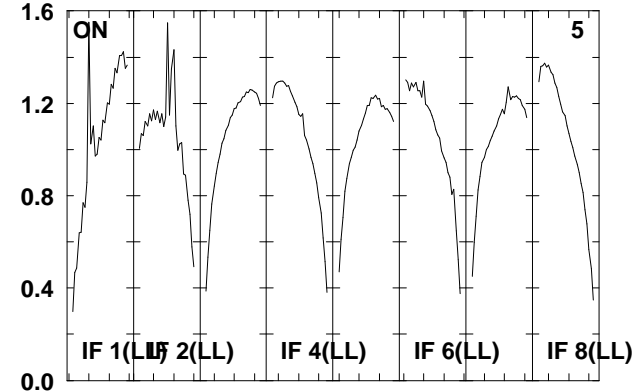
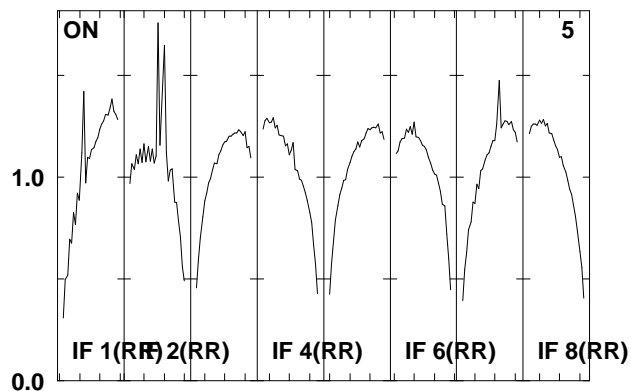
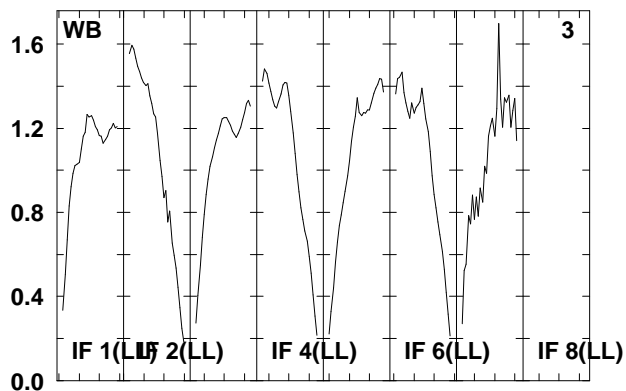
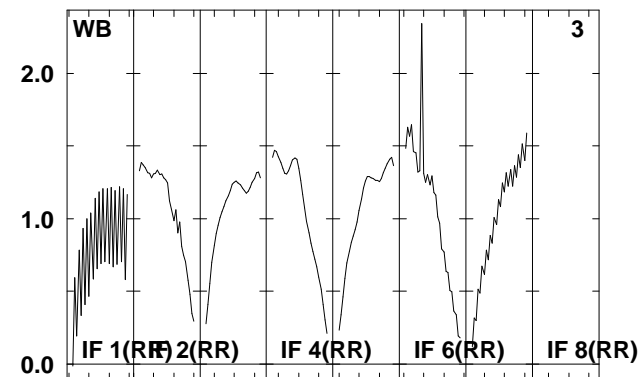
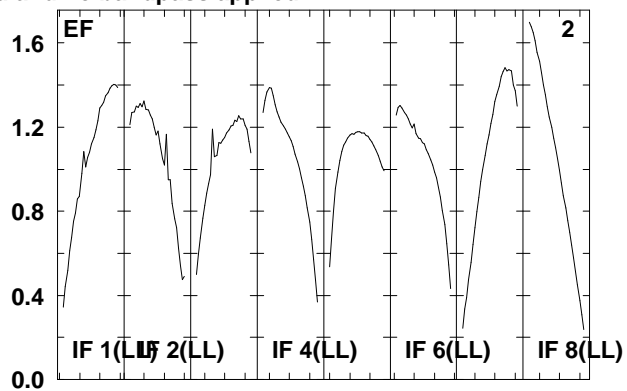
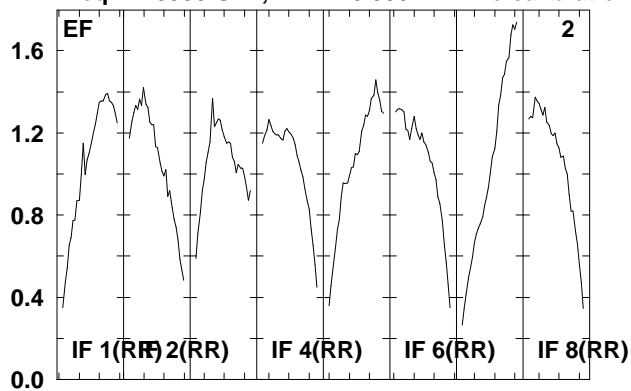

Lower frame: Real Jy

Total-power spectrum Antenna: *

Timerange: 00/20:39:02 to 00/20:42:30

Plot file version 206 created 22-APR-2008 12:27:51

IRAS0725 EP061B.UVDATA.1

Freq = 1.5950 GHz, Bw = 16.000 MH No calibration applied and no bandpass applied

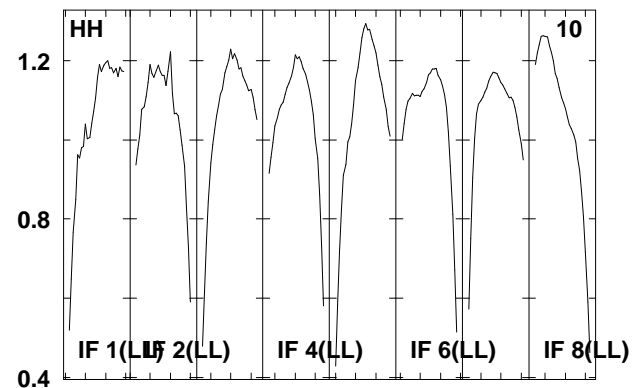
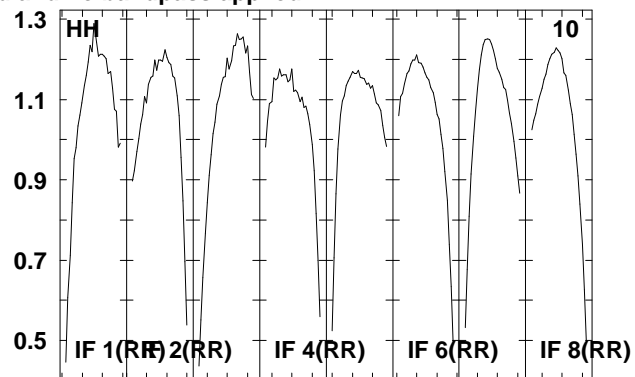
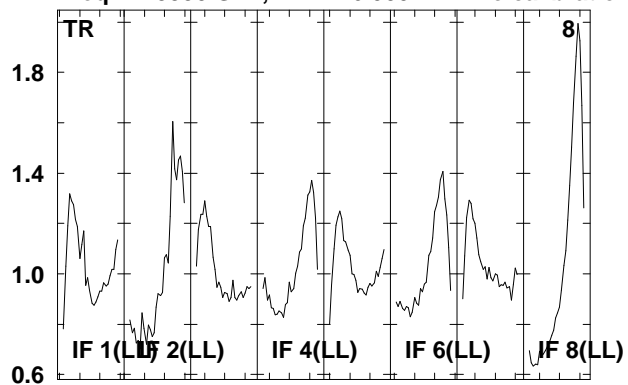

Lower frame: Real Jy
Total-power spectrum Antenna: *
Timerange: 00/20:39:02 to 00/20:42:30

Plot file version 207 created 22-APR-2008 12:27:52

J0730-02 EP061B.UVDATA.1

Freq = 1.5950 GHz, Bw = 16.000 MH No calibration applied and no bandpass applied

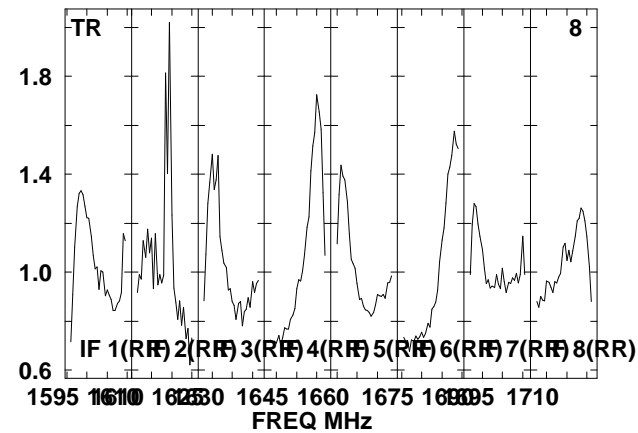
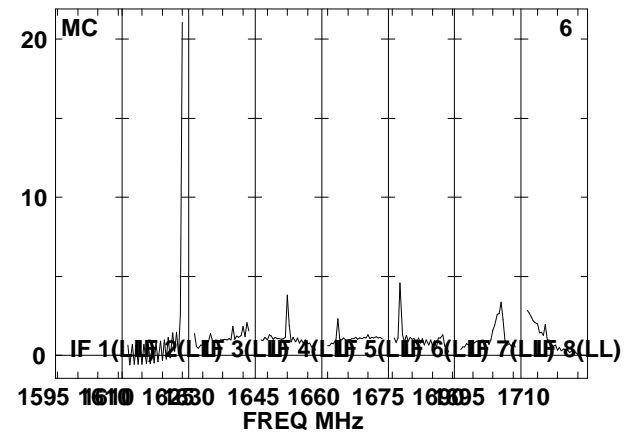
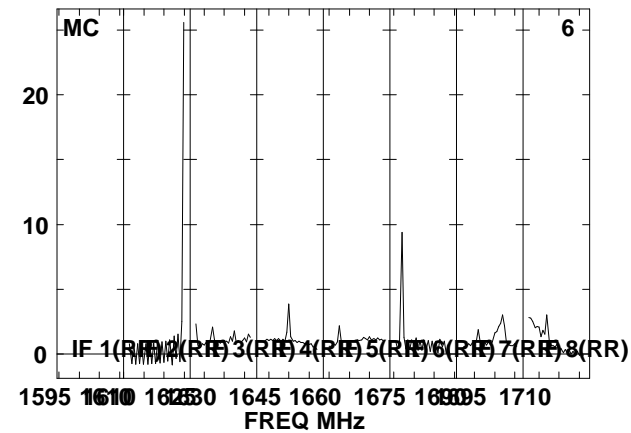
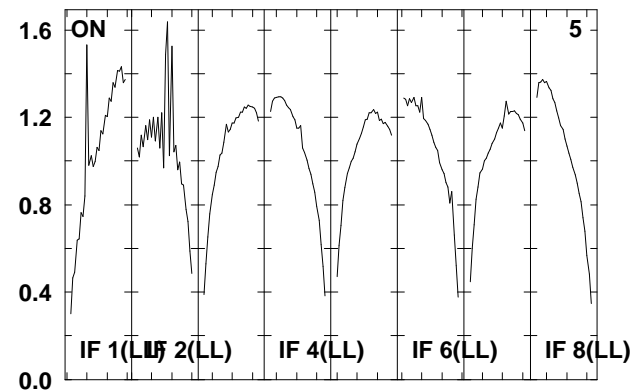
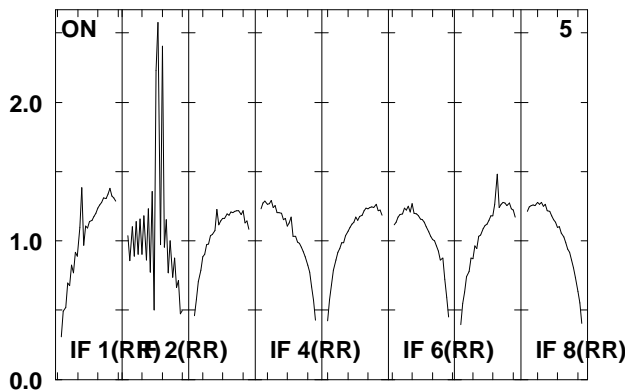
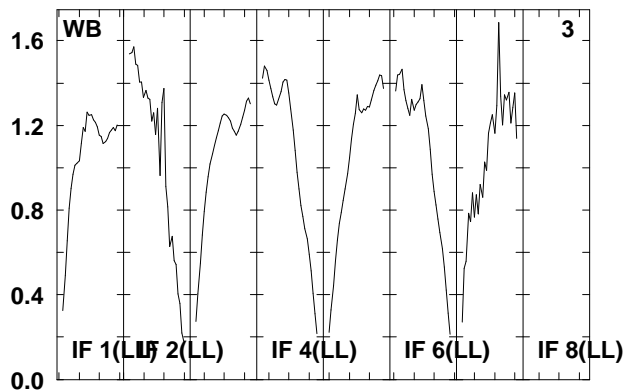
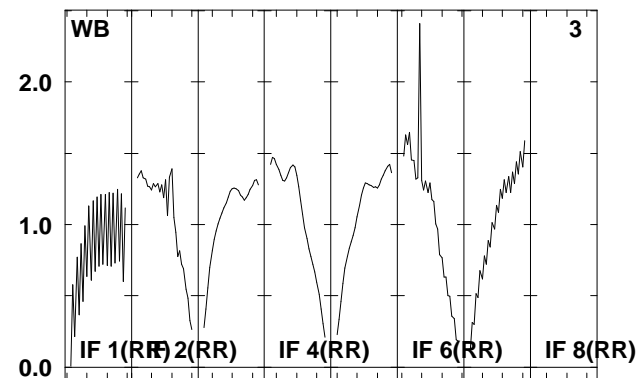
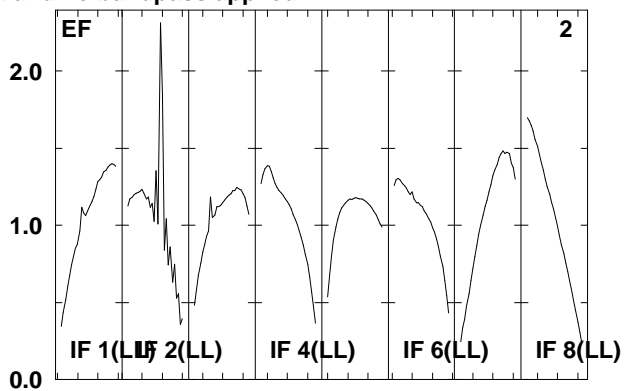
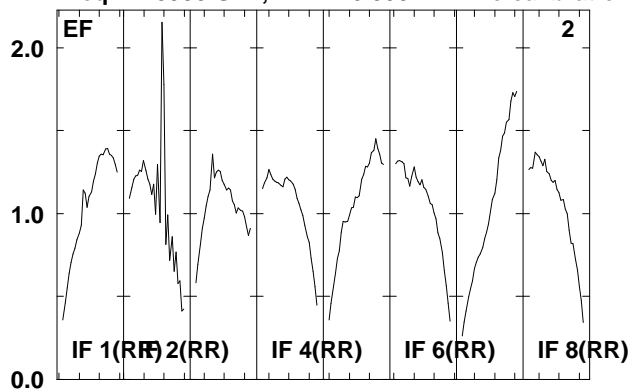

Lower frame: Real Jy
Total-power spectrum Antenna: *
Timerange: 00/20:43:32 to 00/20:45:00

Plot file version 208 created 22-APR-2008 12:27:52

J0730-02 EP061B.UVDATA.1

Freq = 1.5950 GHz, Bw = 16.000 MH No calibration applied and no bandpass applied

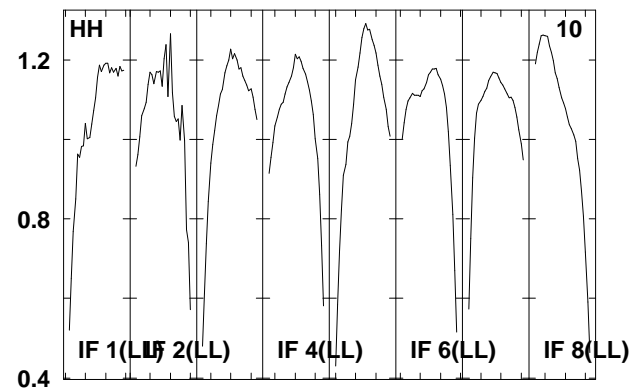
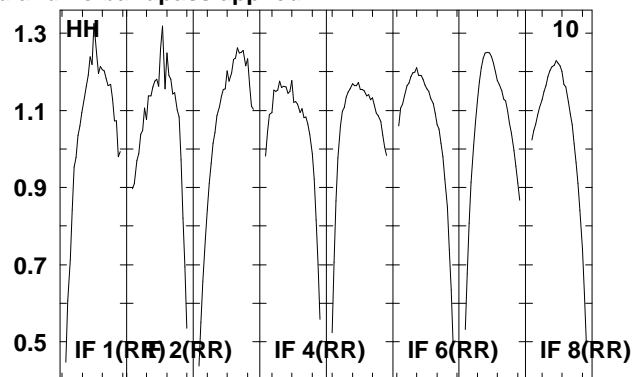
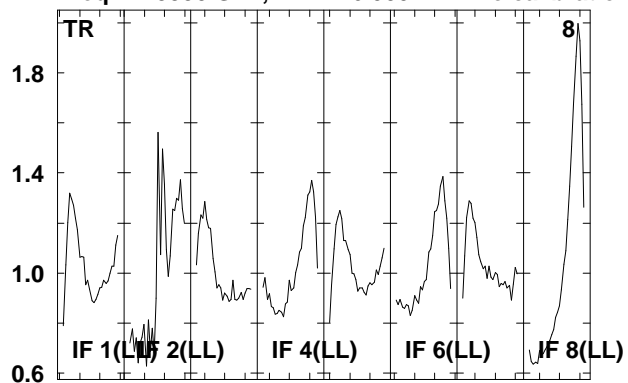

Lower frame: Real Jy
Total-power spectrum Antenna: *
Timerange: 00/20:43:32 to 00/20:45:00

Plot file version 209 created 22-APR-2008 12:27:53

IRAS0725 EP061B.UVDATA.1

Freq = 1.5950 GHz, Bw = 16.000 MH No calibration applied and no bandpass applied

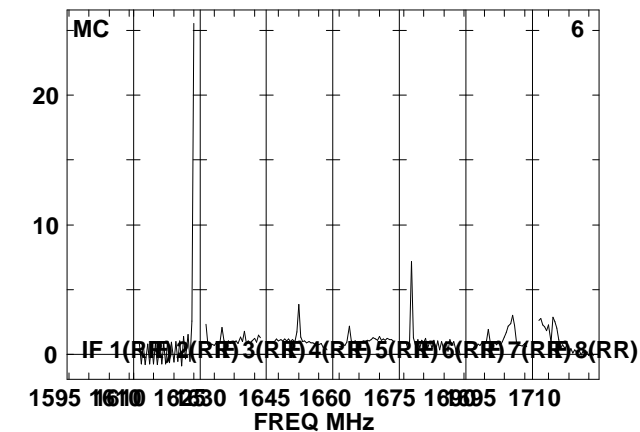
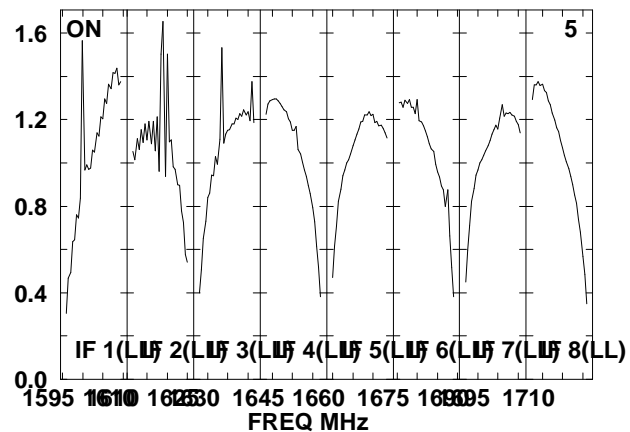
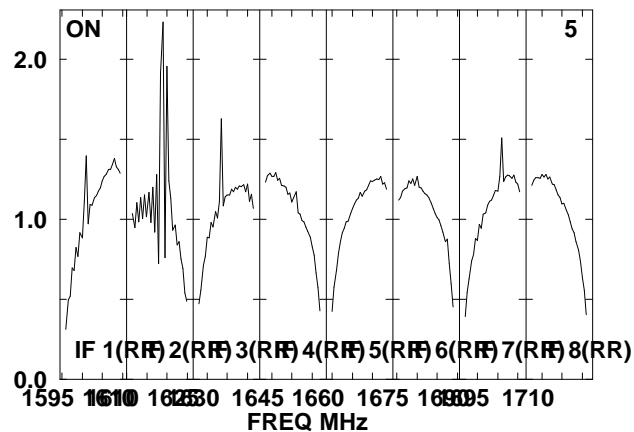
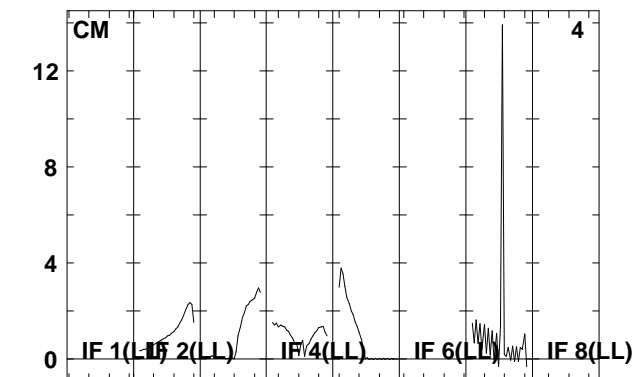
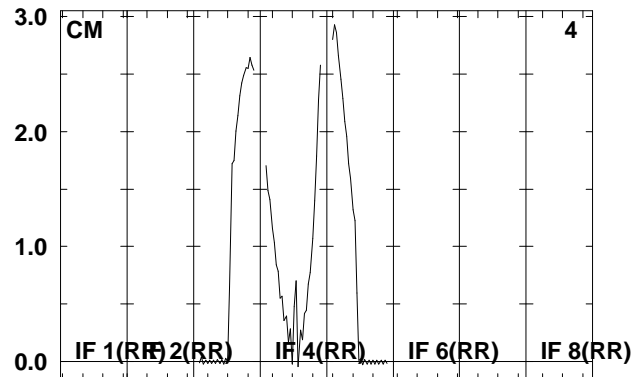
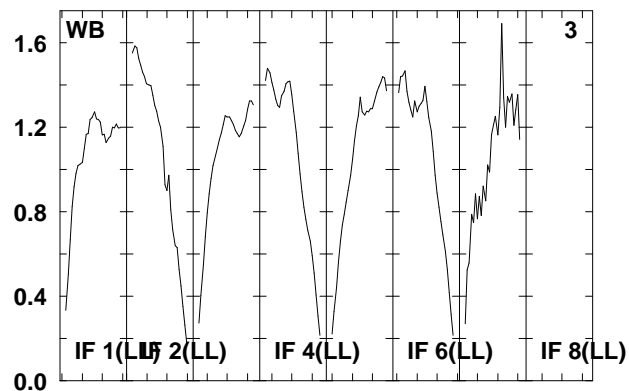
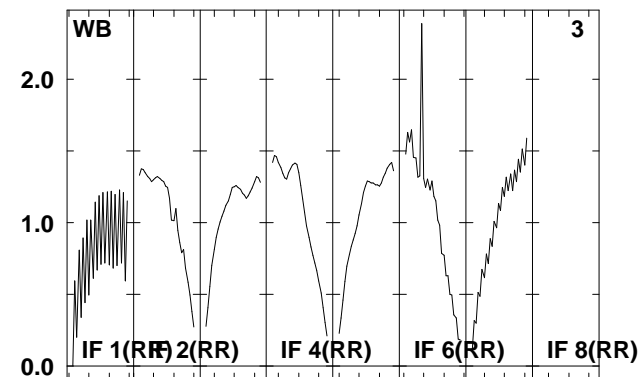
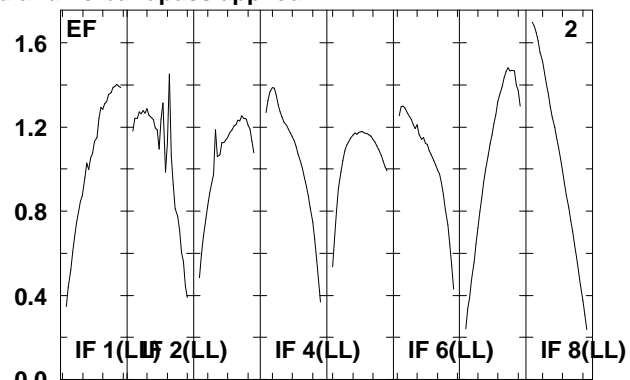
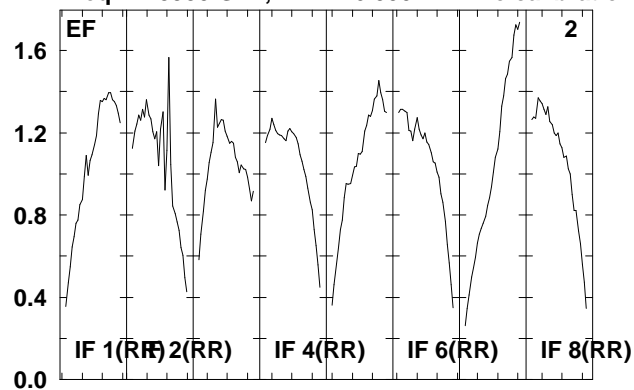

Lower frame: Real Jy
Total-power spectrum Antenna: *
Timerange: 00/20:45:02 to 00/20:48:30

Plot file version 210 created 22-APR-2008 12:27:54

IRAS0725 EP061B.UVDATA.1

Freq = 1.5950 GHz, Bw = 16.000 MH No calibration applied and no bandpass applied

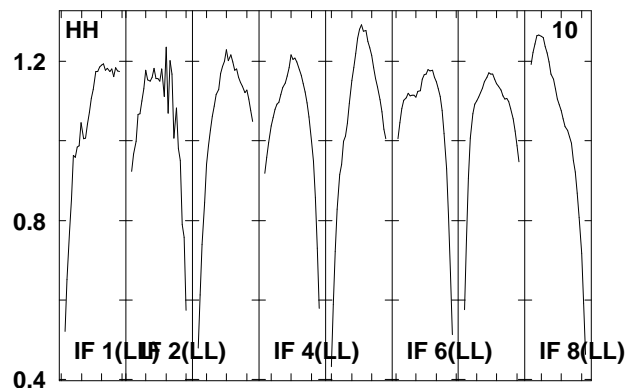
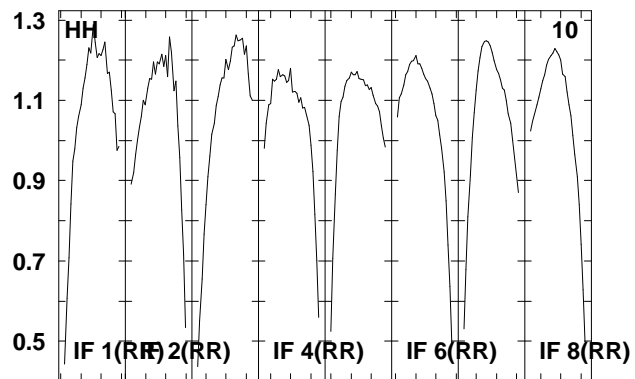
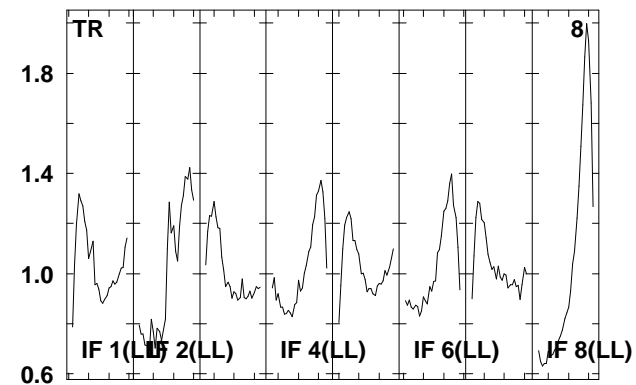
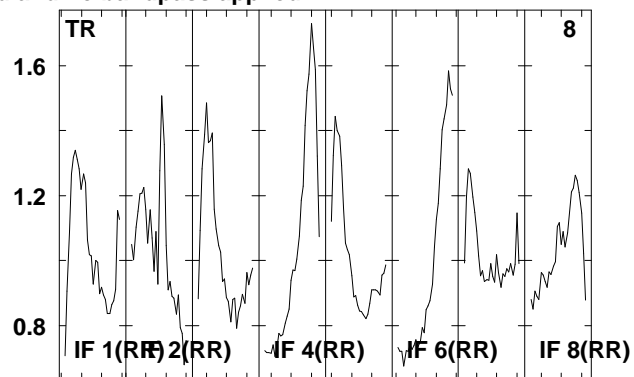
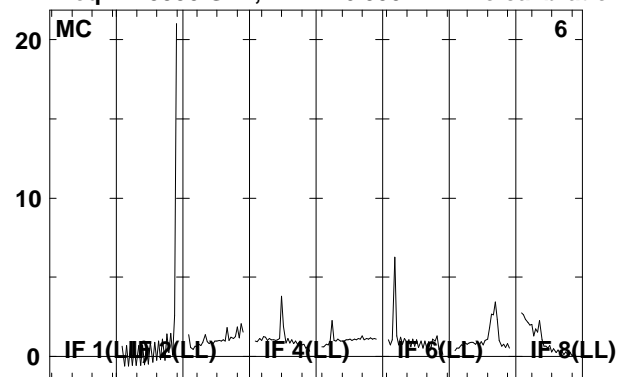

Lower frame: Real Jy
Total-power spectrum Antenna: *
Timerange: 00/20:45:02 to 00/20:48:30

Plot file version 211 created 22-APR-2008 12:27:55

J0730-02 EP061B.UVDATA.1

Freq = 1.5950 GHz, Bw = 16.000 MH No calibration applied and no bandpass applied

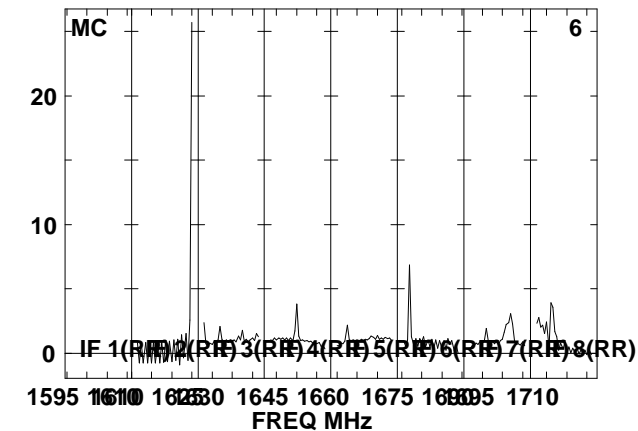
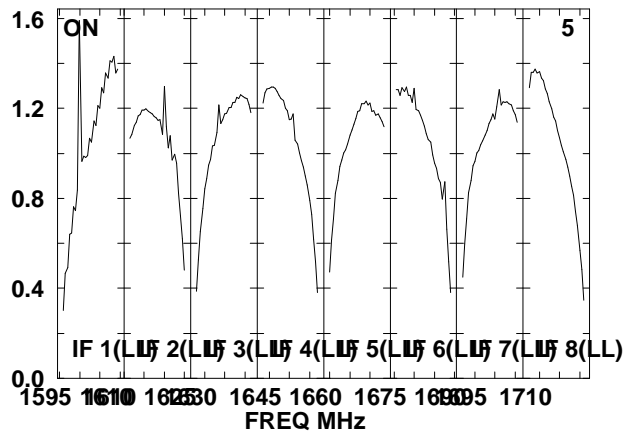
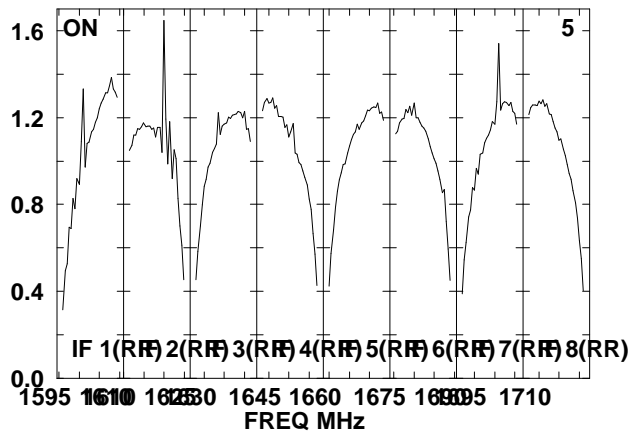
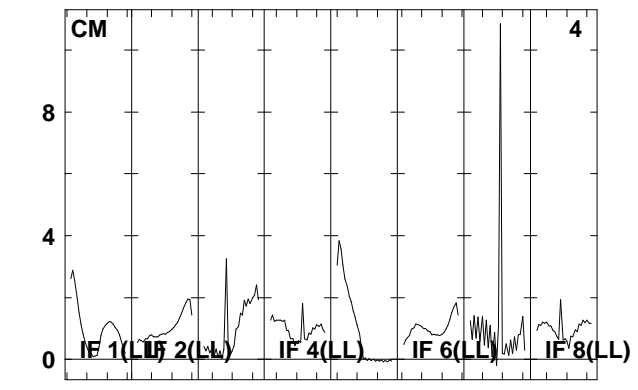
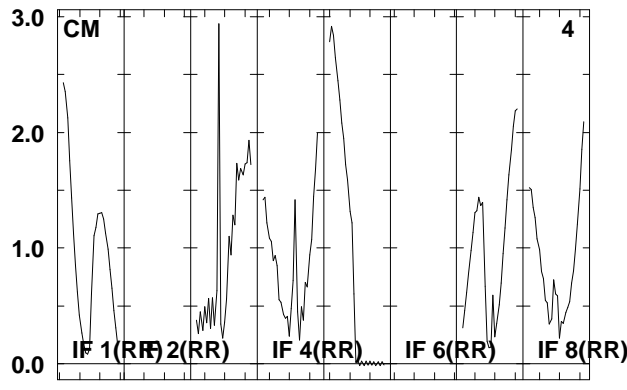
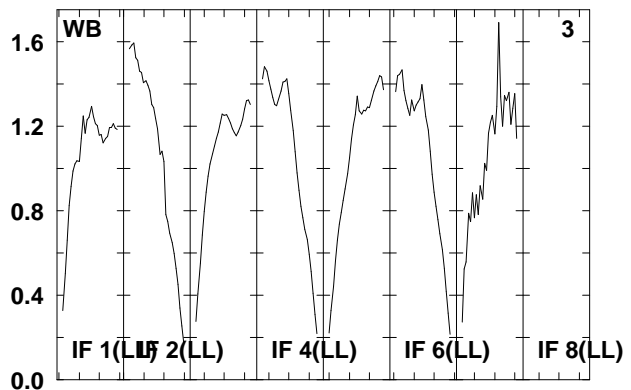
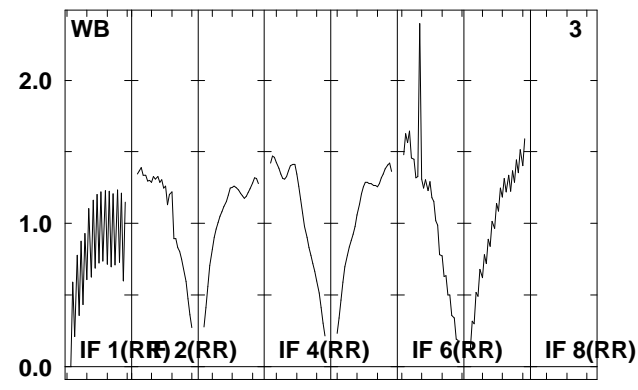
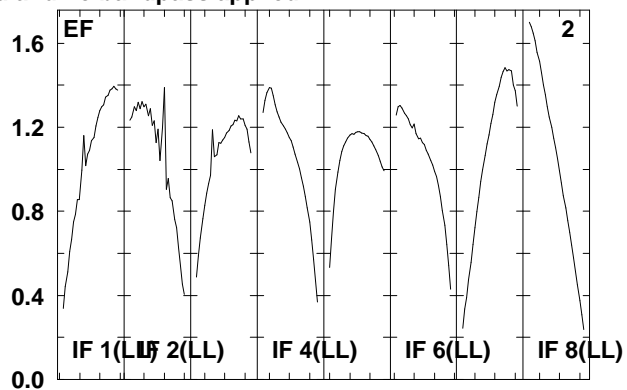
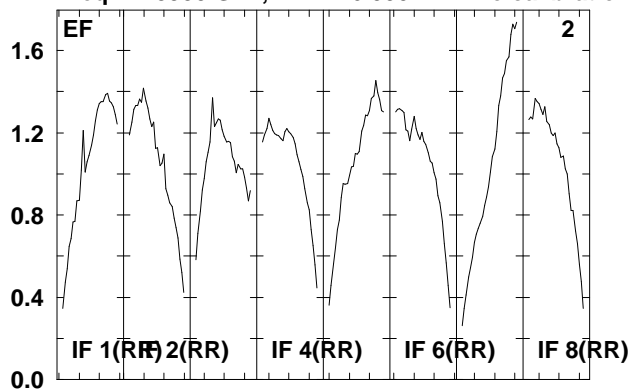

Lower frame: Real Jy

Total-power spectrum Antenna: *

Timerange: 00/20:48:32 to 00/20:50:00

Plot file version 212 created 22-APR-2008 12:27:55

J0730-02 EP061B.UVDATA.1

Freq = 1.5950 GHz, Bw = 16.000 MH No calibration applied and no bandpass applied

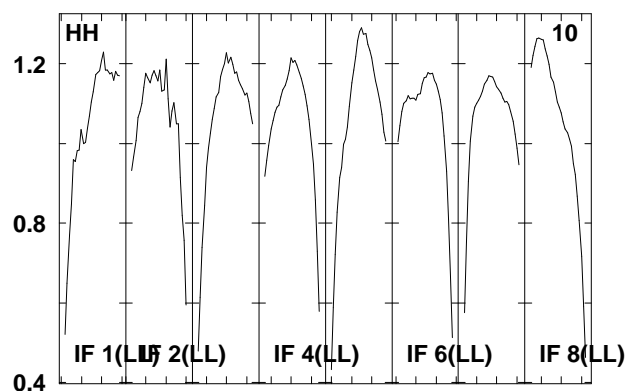
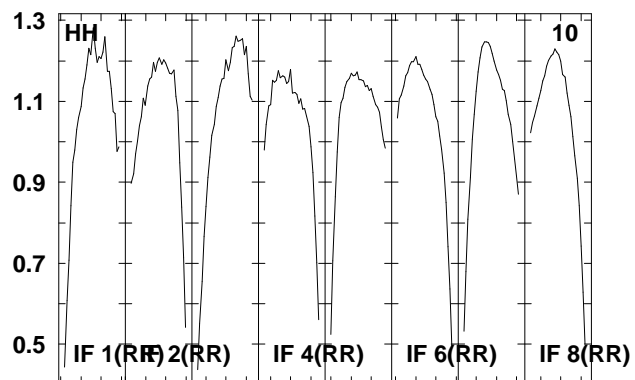
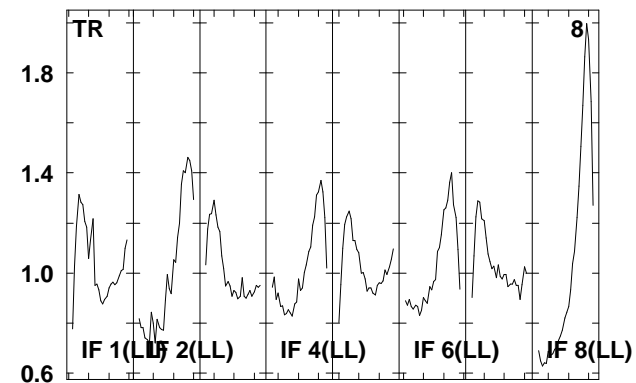
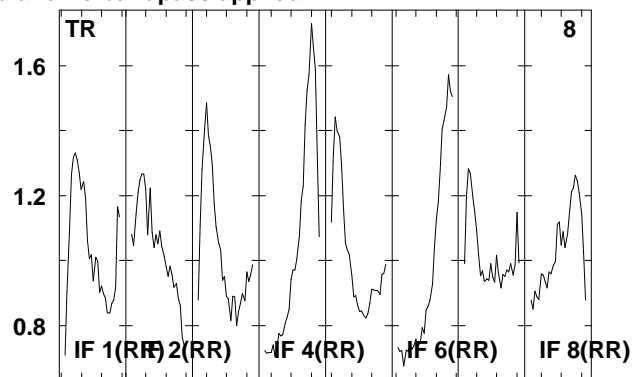
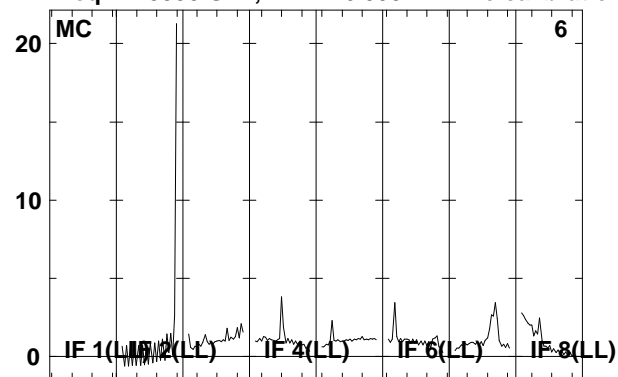

Lower frame: Real Jy
Total-power spectrum Antenna: *
Timerange: 00/20:48:32 to 00/20:50:00

Plot file version 213 created 22-APR-2008 12:27:56

IRAS0725 EP061B.UVDATA.1

Freq = 1.5950 GHz, Bw = 16.000 MH No calibration applied and no bandpass applied

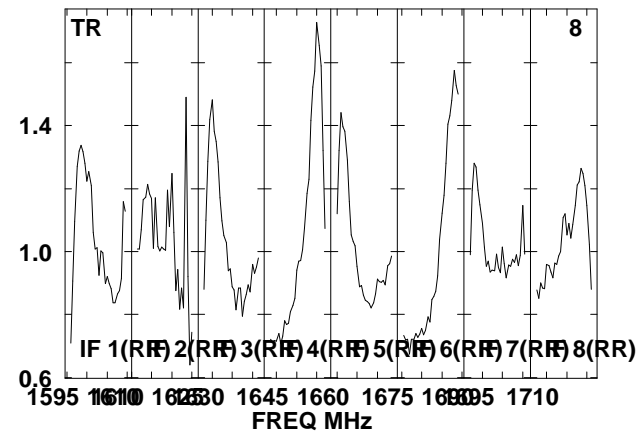
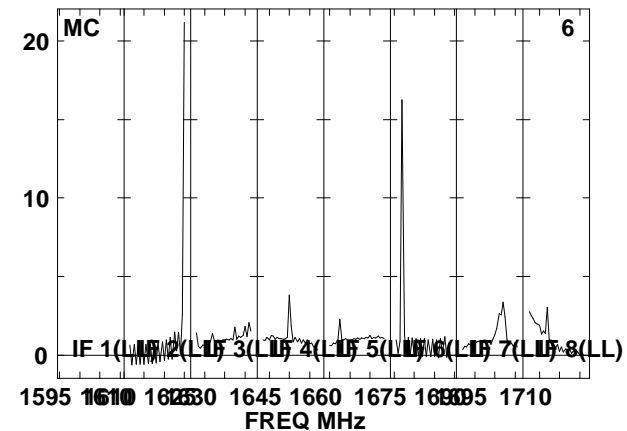
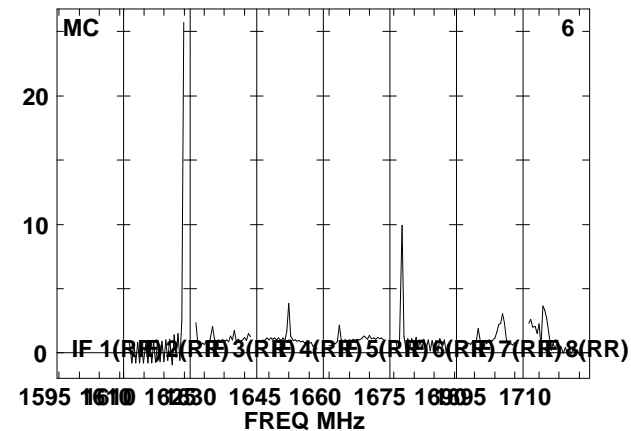
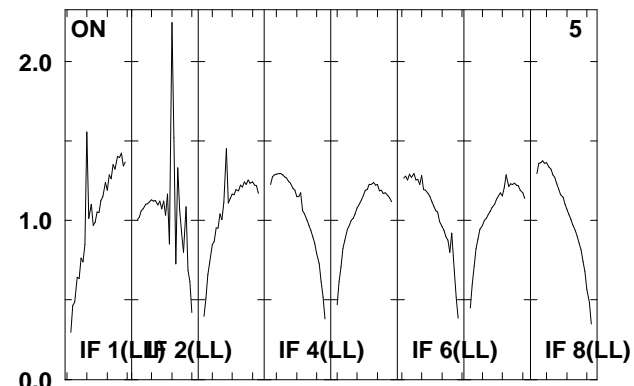
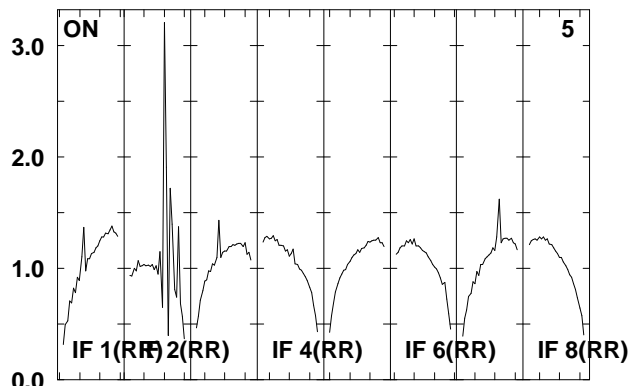
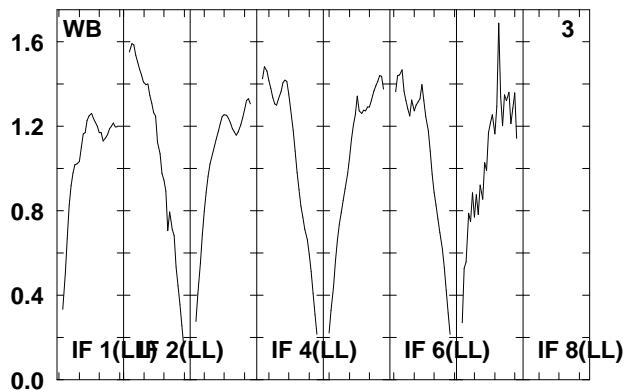
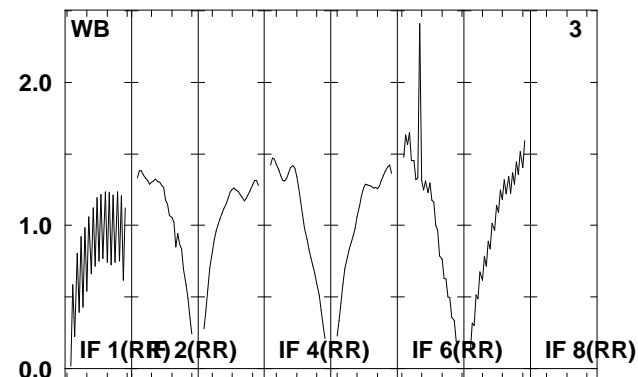
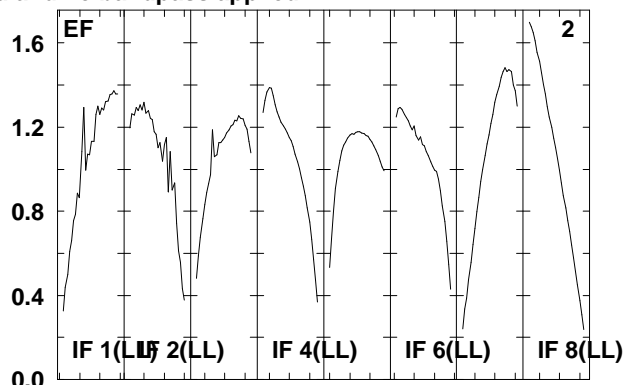
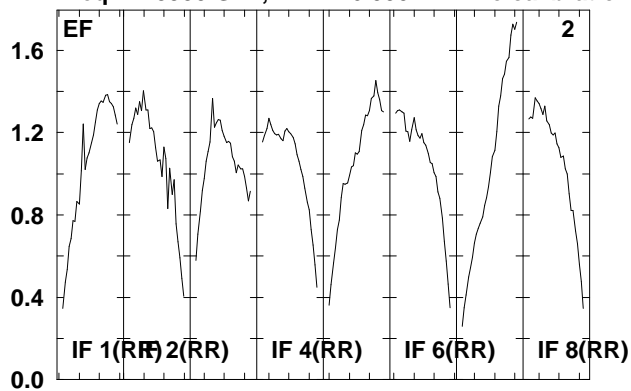

Lower frame: Real Jy

Total-power spectrum Antenna: *

Timerange: 00/20:50:02 to 00/20:53:30

Plot file version 214 created 22-APR-2008 12:27:57

IRAS0725 EP061B.UVDATA.1

Freq = 1.5950 GHz, Bw = 16.000 MH No calibration applied and no bandpass applied

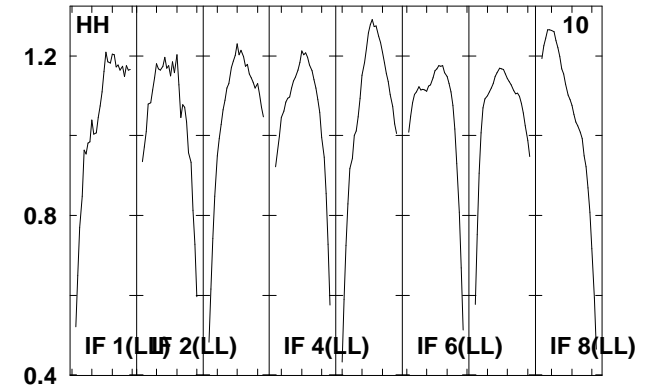
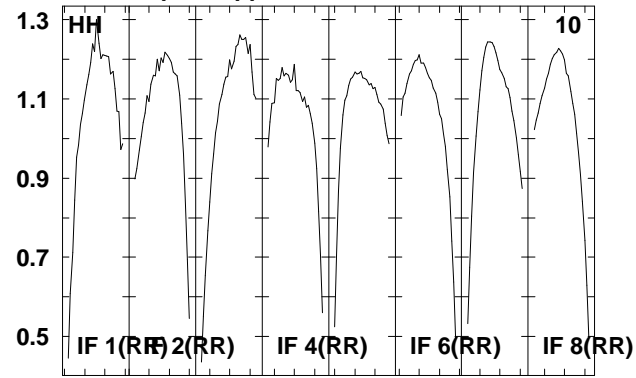
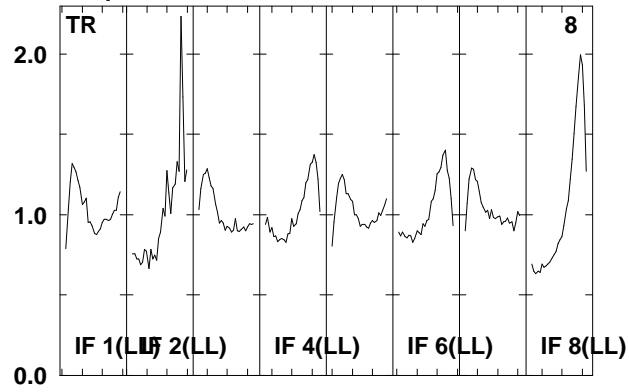

Lower frame: Real Jy
Total-power spectrum Antenna: *
Timerange: 00/20:50:02 to 00/20:53:30

Plot file version 215 created 22-APR-2008 12:27:57

J0730-02 EP061B.UVDATA.1

Freq = 1.5950 GHz, Bw = 16.000 MH No calibration applied and no bandpass applied

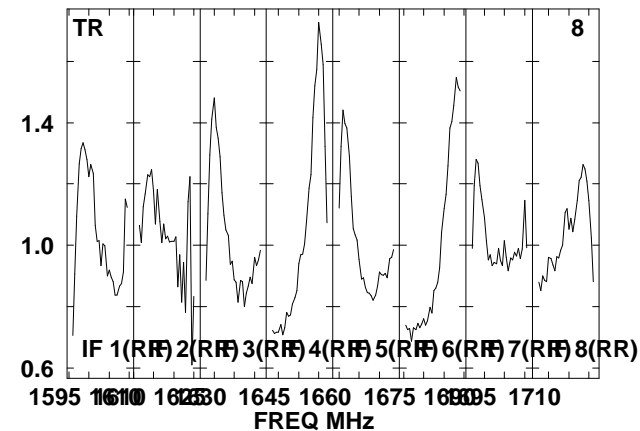
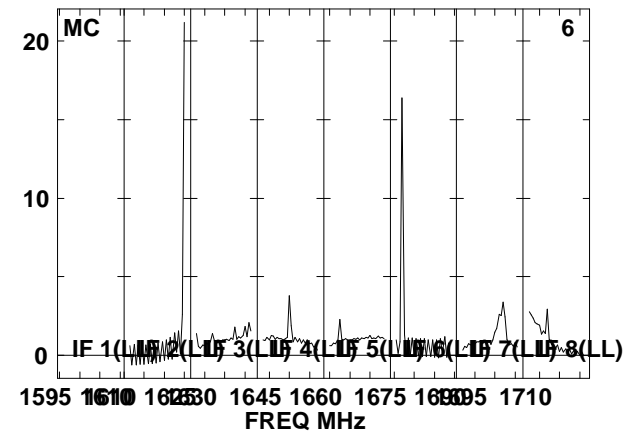
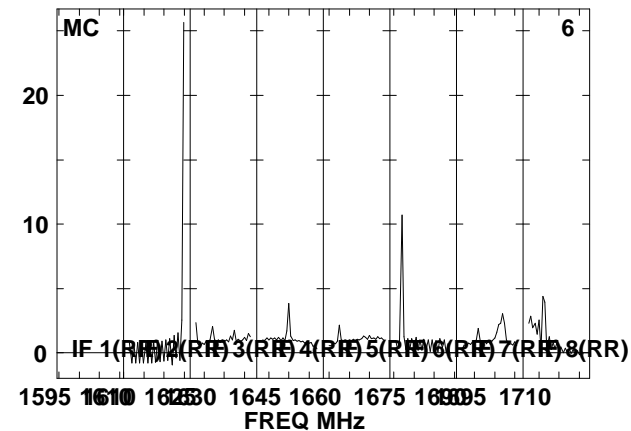
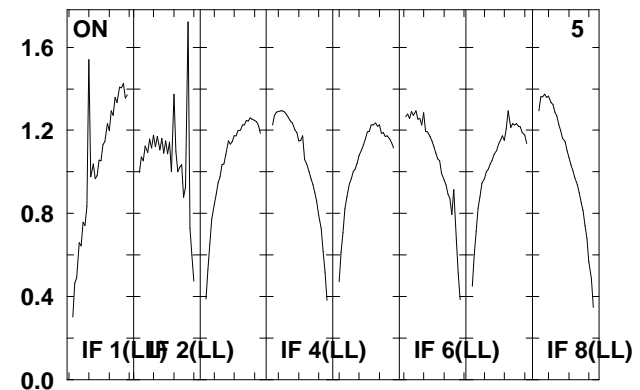
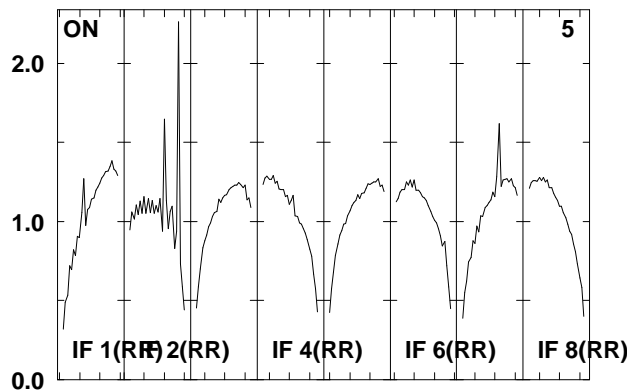
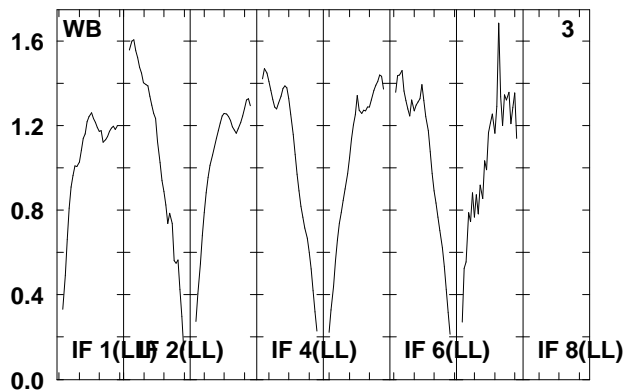
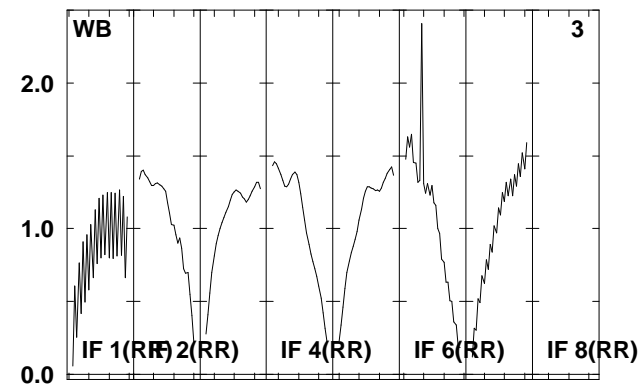
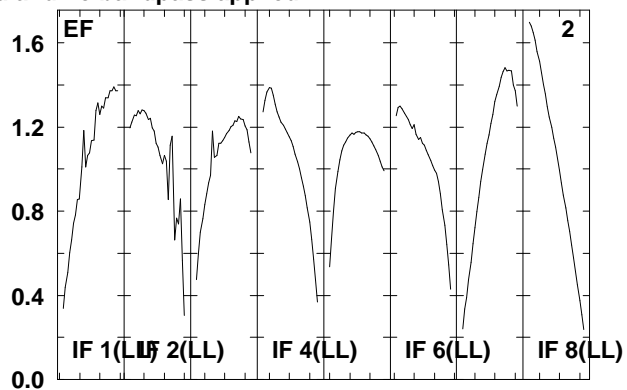
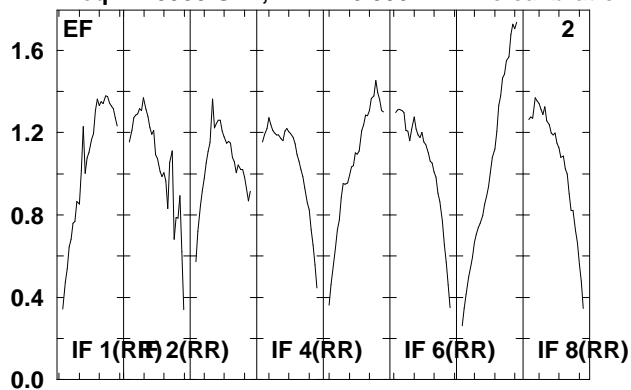

Lower frame: Real Jy

Total-power spectrum Antenna: *

Timerange: 00/20:53:32 to 00/20:55:00

Plot file version 216 created 22-APR-2008 12:27:58

J0730-02 EP061B.UVDATA.1

Freq = 1.5950 GHz, Bw = 16.000 MH No calibration applied and no bandpass applied

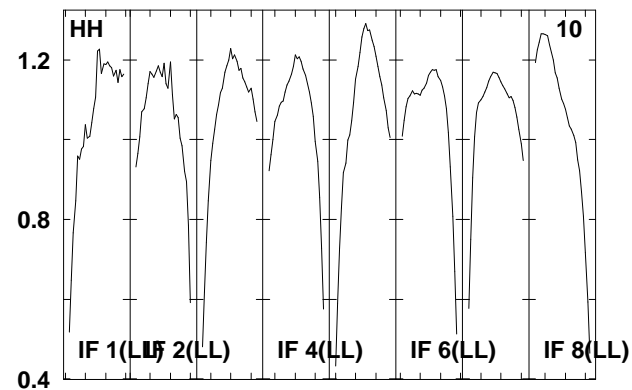
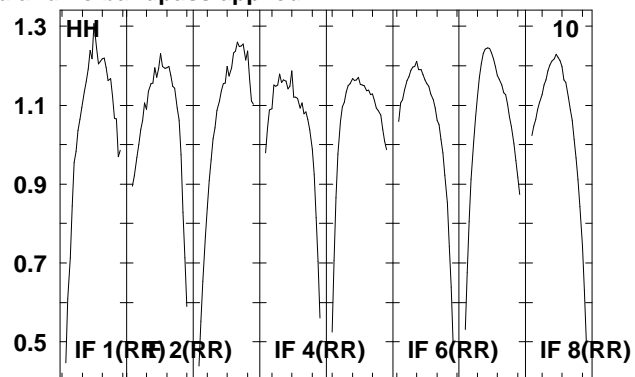
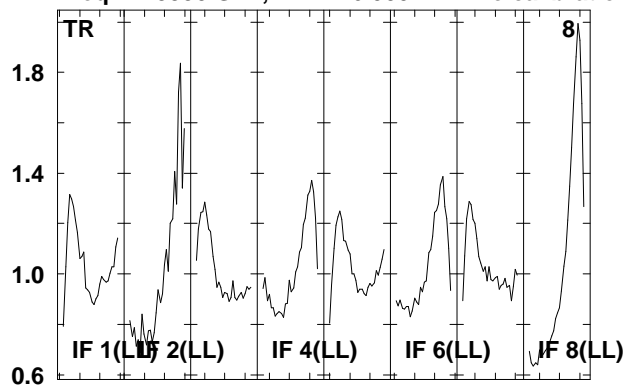

Lower frame: Real Jy
Total-power spectrum Antenna: *
Timerange: 00/20:53:32 to 00/20:55:00

Plot file version 217 created 22-APR-2008 12:27:58

IRAS0725 EP061B.UVDATA.1

Freq = 1.5950 GHz, Bw = 16.000 MH No calibration applied and no bandpass applied

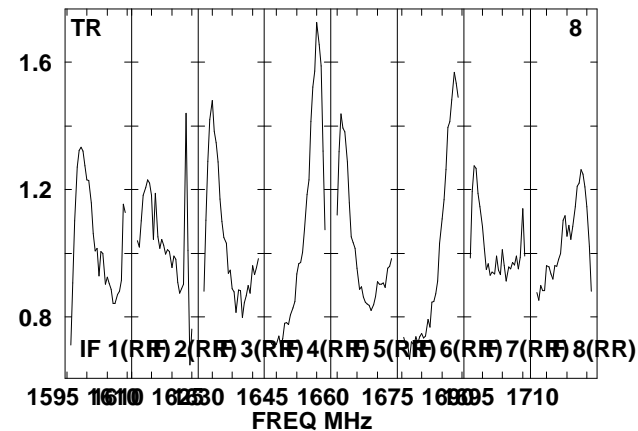
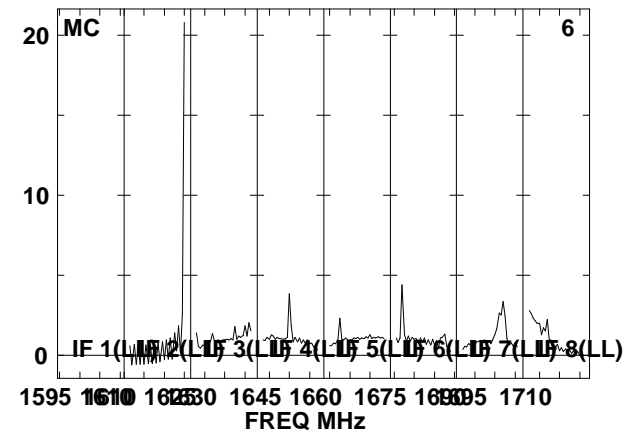
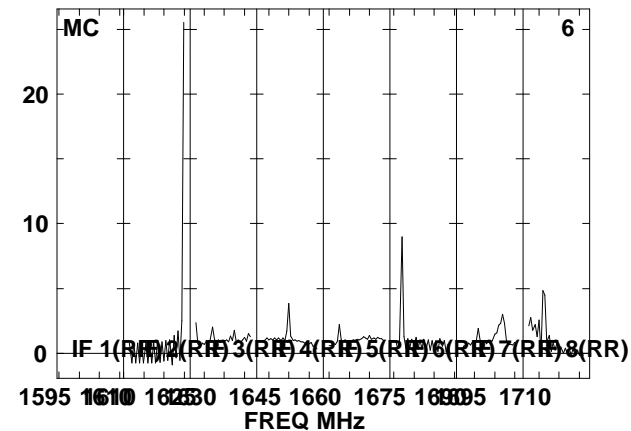
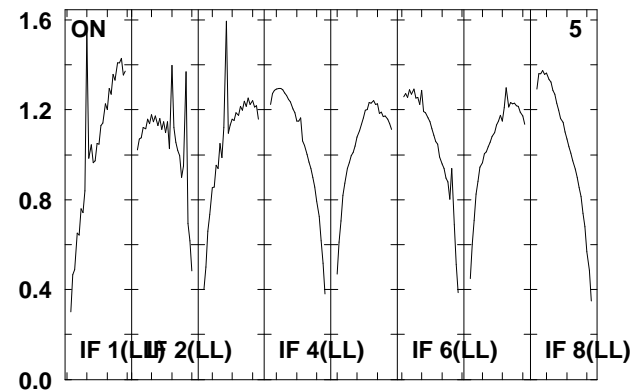
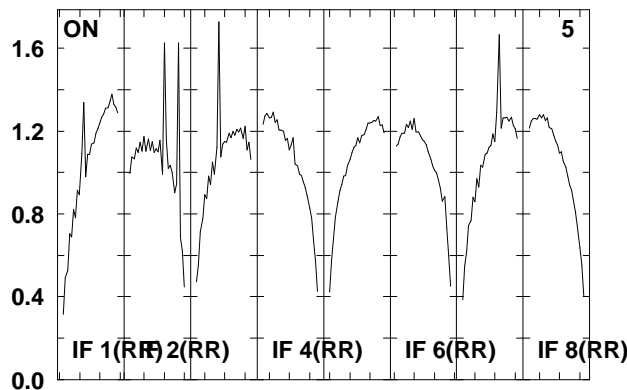
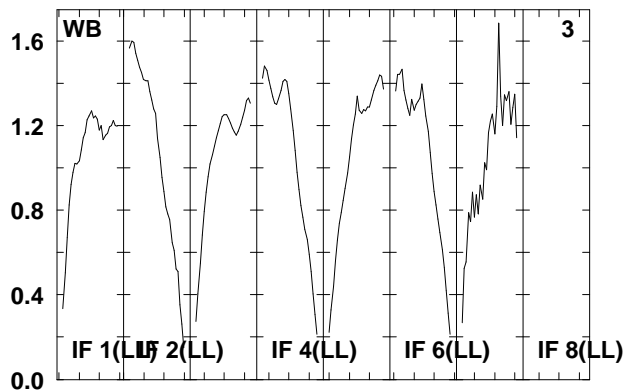
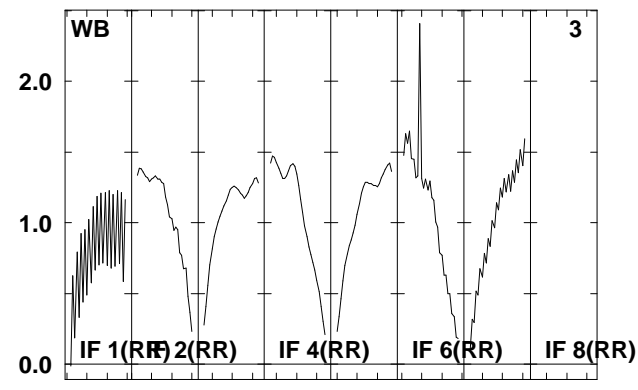
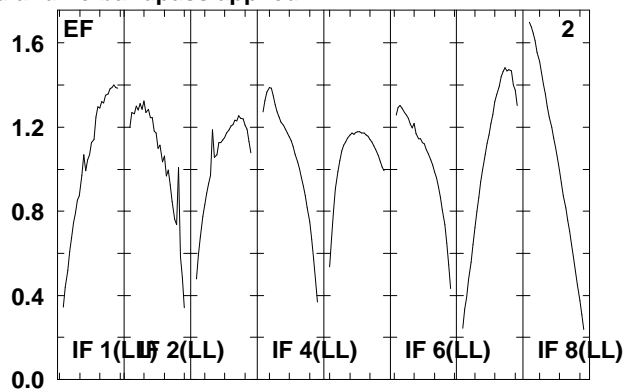
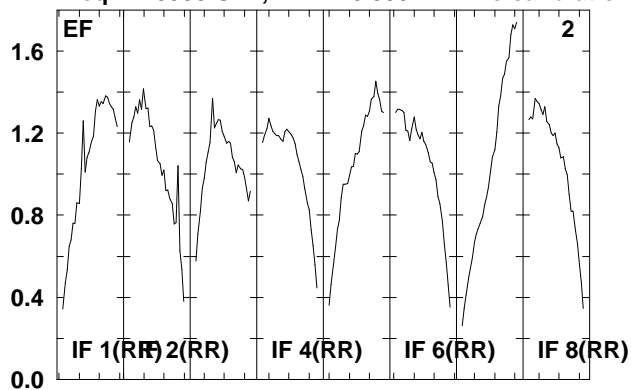

Lower frame: Real Jy
Total-power spectrum Antenna: *
Timerange: 00/20:55:02 to 00/20:58:30

Plot file version 218 created 22-APR-2008 12:27:59

IRAS0725 EP061B.UVDATA.1

Freq = 1.5950 GHz, Bw = 16.000 MH No calibration applied and no bandpass applied

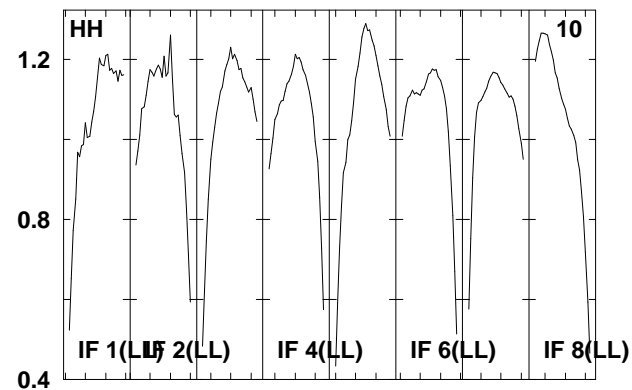
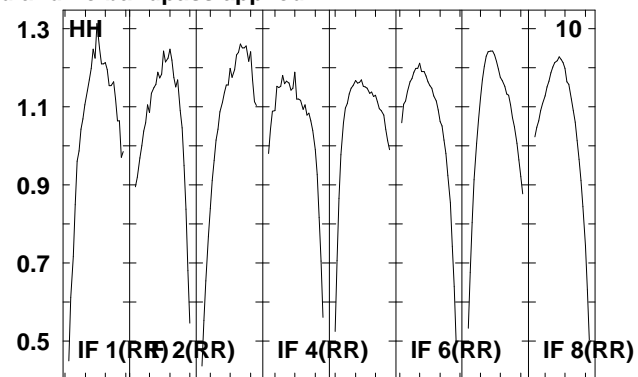
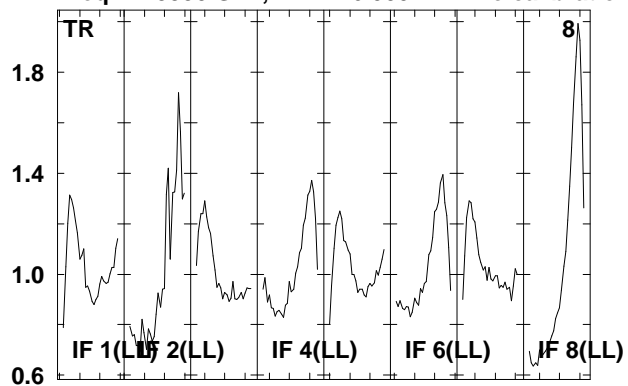

Lower frame: Real Jy
Total-power spectrum Antenna: *
Timerange: 00/20:55:02 to 00/20:58:30

Plot file version 219 created 22-APR-2008 12:28:00

J0730-02 EP061B.UVDATA.1

Freq = 1.5950 GHz, Bw = 16.000 MH No calibration applied and no bandpass applied

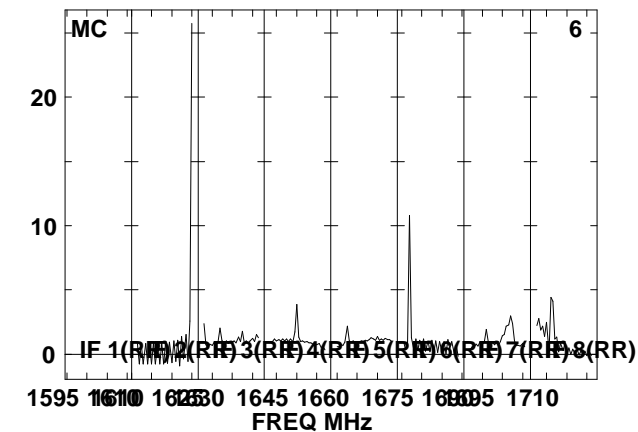
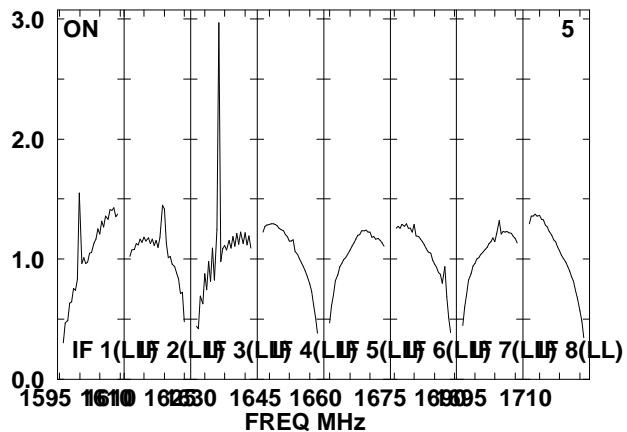
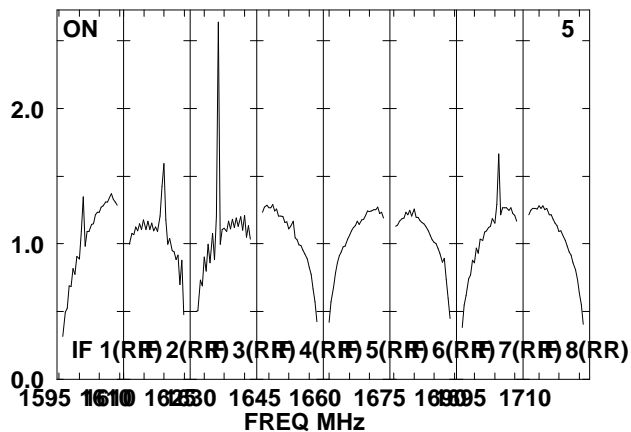
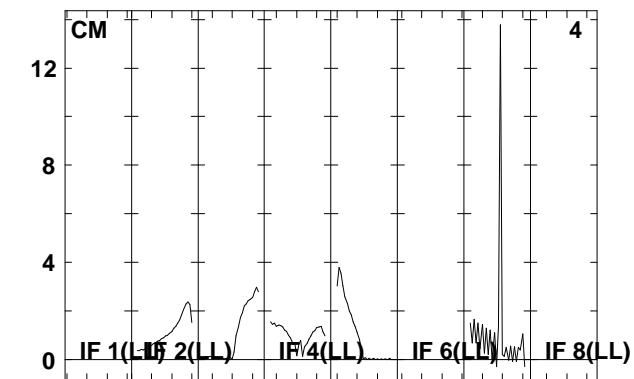
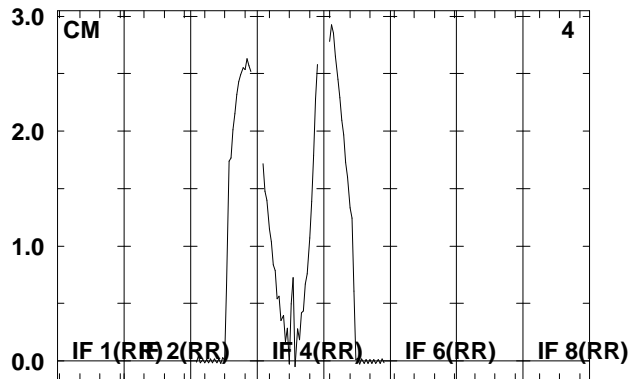
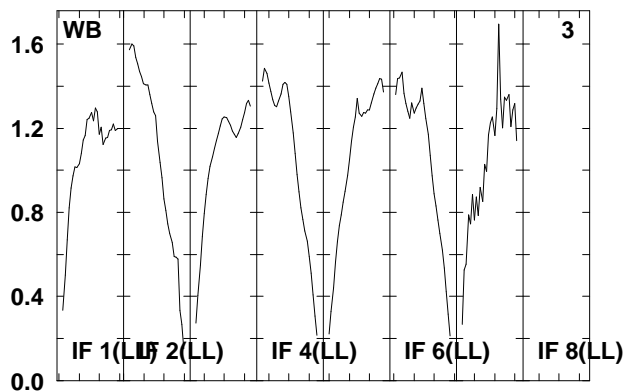
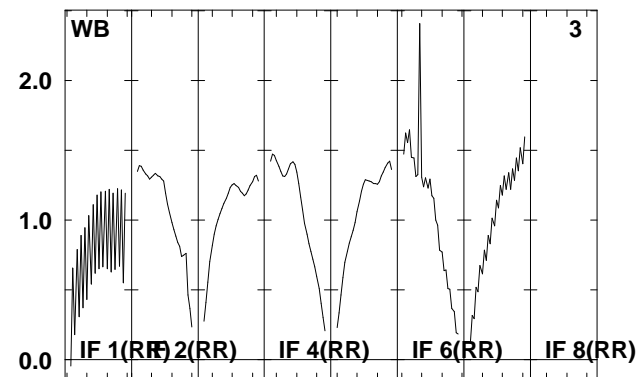
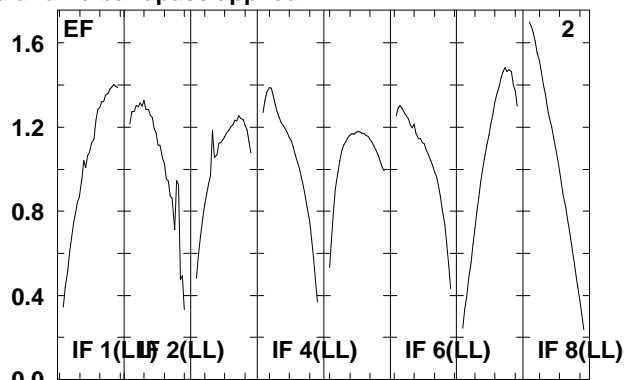
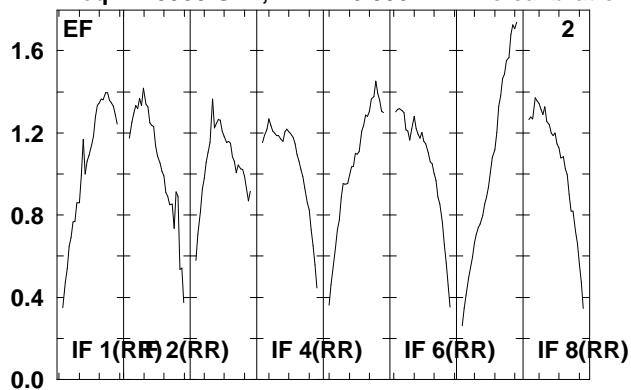

Lower frame: Real Jy
Total-power spectrum Antenna: *
Timerange: 00/20:59:32 to 00/21:01:00

Plot file version 220 created 22-APR-2008 12:28:00

J0730-02 EP061B.UVDATA.1

Freq = 1.5950 GHz, Bw = 16.000 MH No calibration applied and no bandpass applied

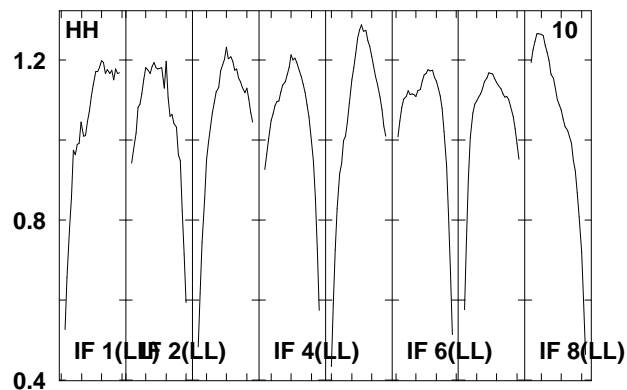
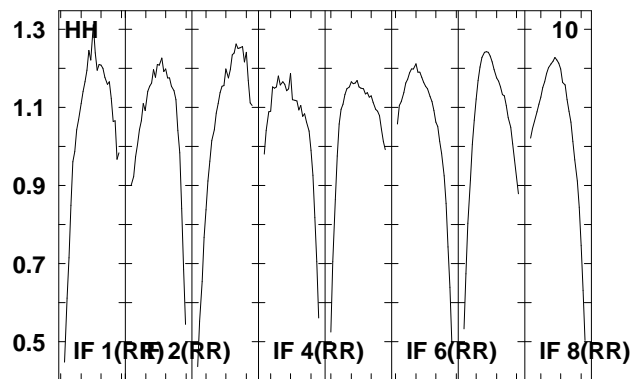
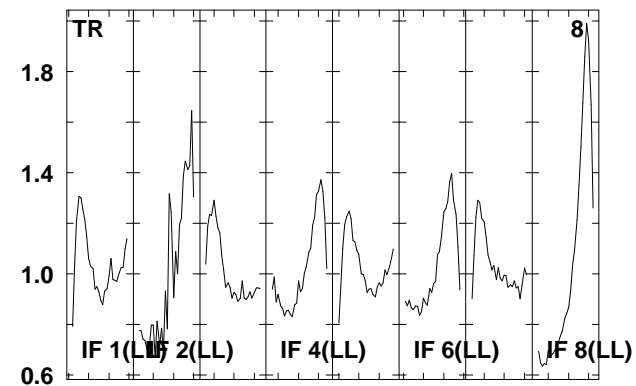
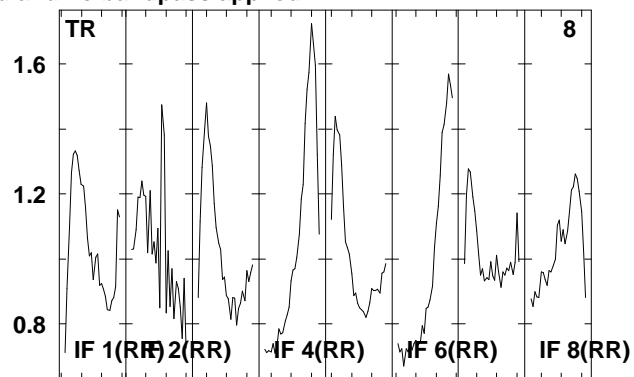
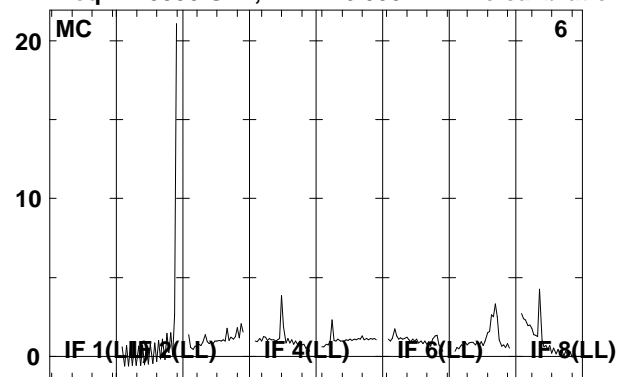

Lower frame: Real Jy
Total-power spectrum Antenna: *
Timerange: 00/20:59:32 to 00/21:01:00

Plot file version 221 created 22-APR-2008 12:28:01

IRAS0725 EP061B.UVDATA.1

Freq = 1.5950 GHz, Bw = 16.000 MH No calibration applied and no bandpass applied

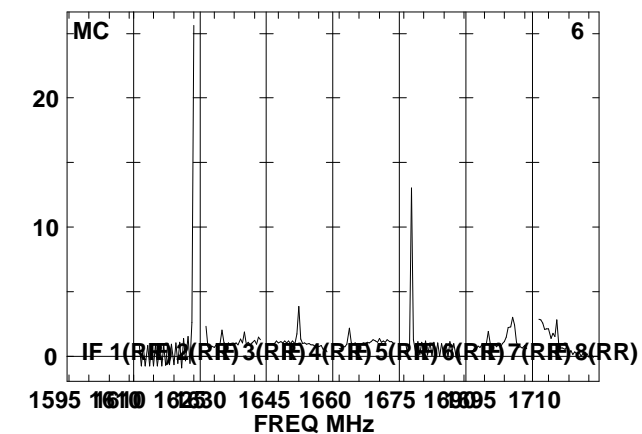
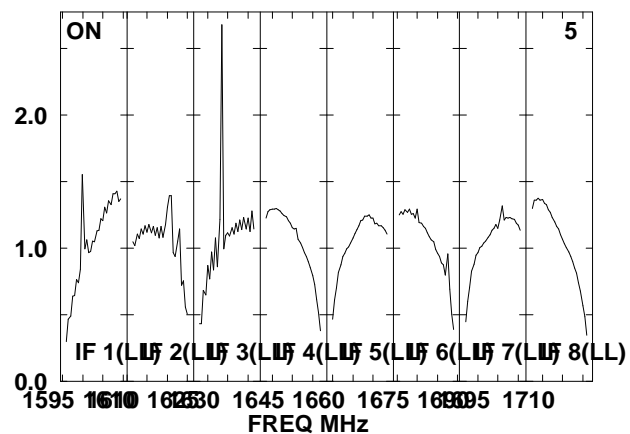
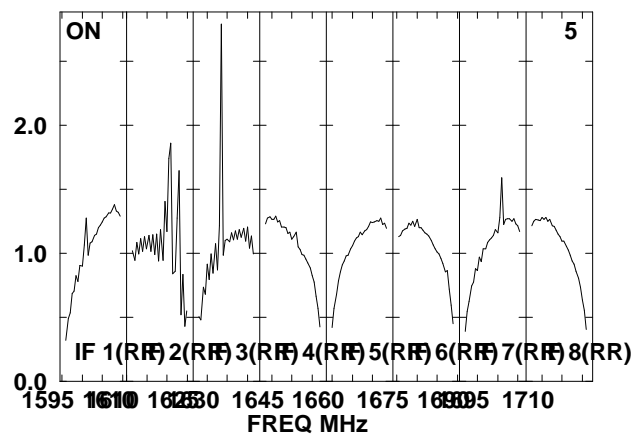
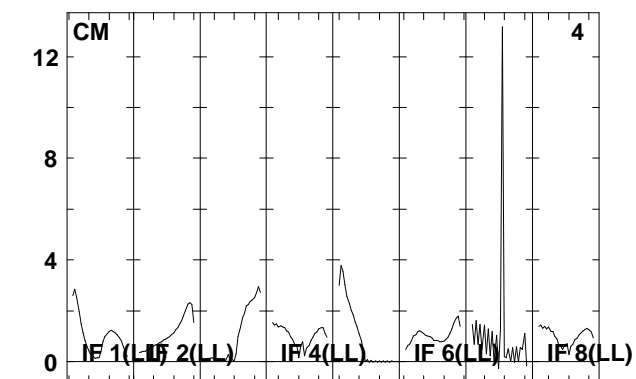
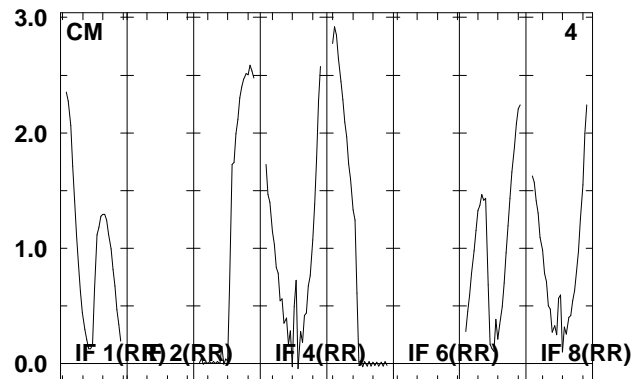
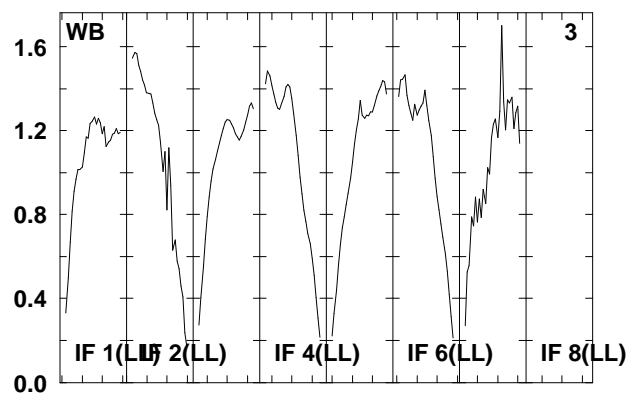
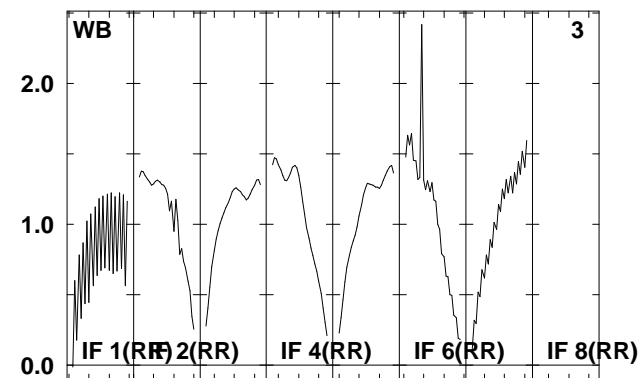
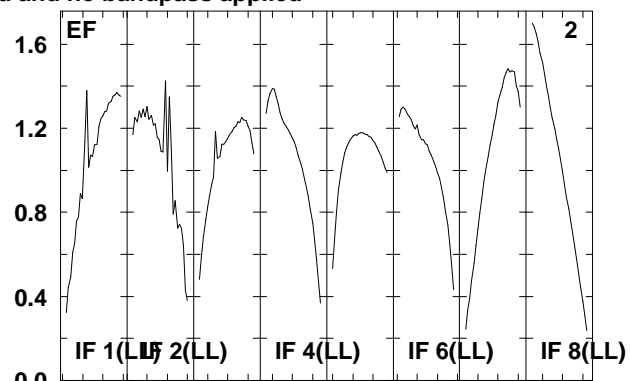
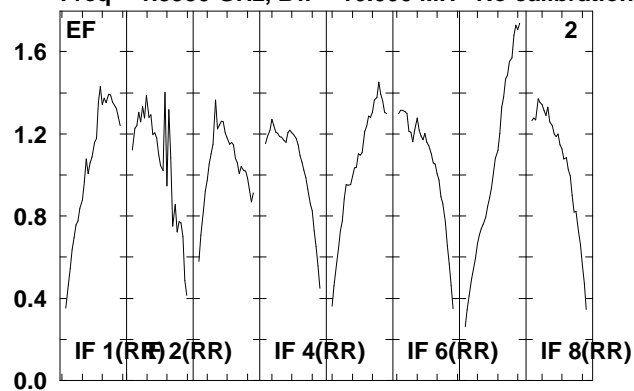

Lower frame: Real Jy
Total-power spectrum Antenna: *
Timerange: 00/21:01:04 to 00/21:04:30

Plot file version 222 created 22-APR-2008 12:28:01

IRAS0725 EP061B.UVDATA.1

Freq = 1.5950 GHz, Bw = 16.000 MH No calibration applied and no bandpass applied

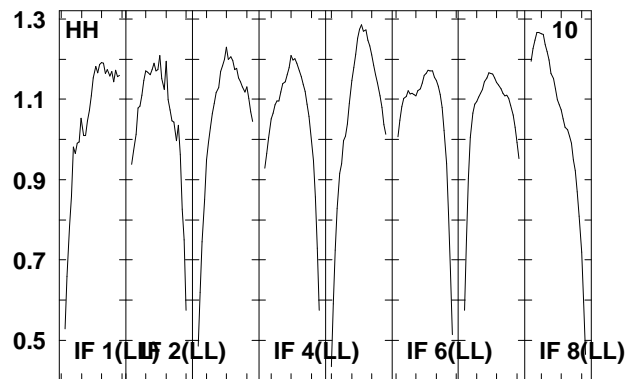
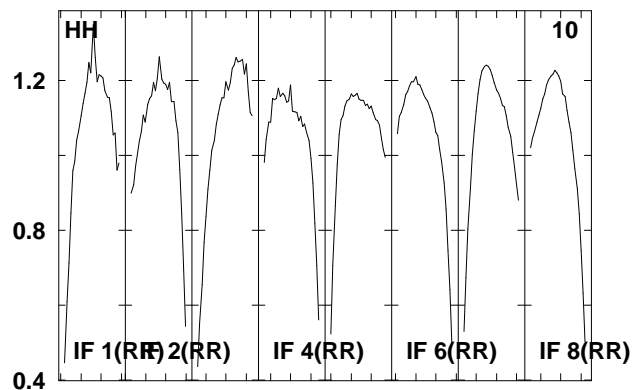
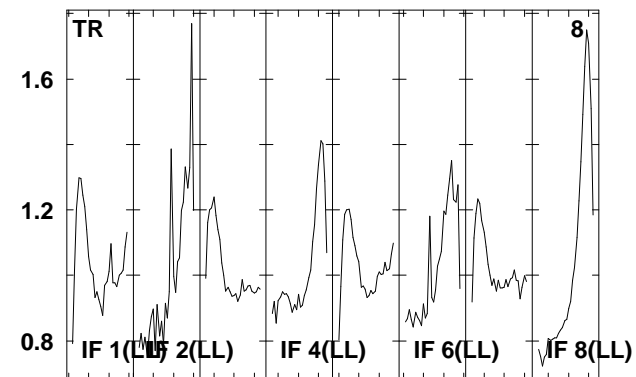
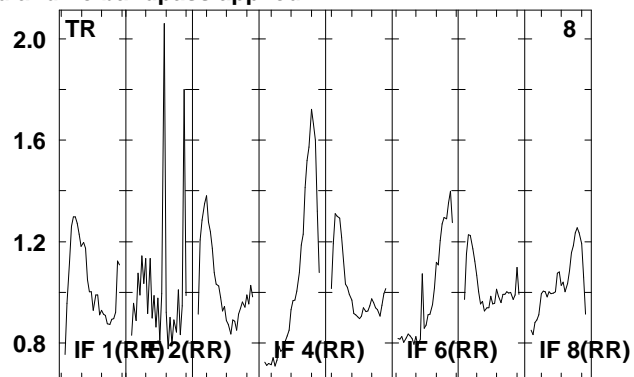
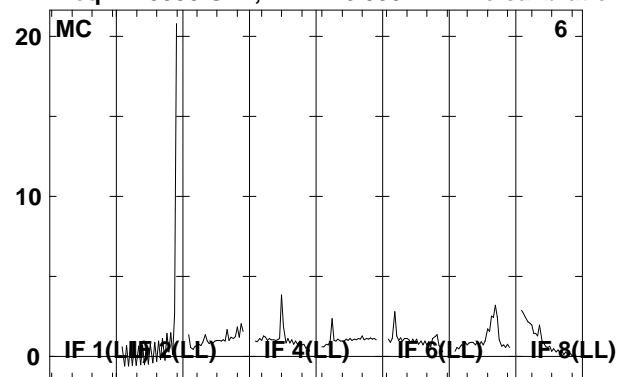

Lower frame: Real Jy
Total-power spectrum Antenna: *
Timerange: 00/21:01:04 to 00/21:04:30

Plot file version 223 created 22-APR-2008 12:28:02

J0730-02 EP061B.UVDATA.1

Freq = 1.5950 GHz, Bw = 16.000 MH No calibration applied and no bandpass applied

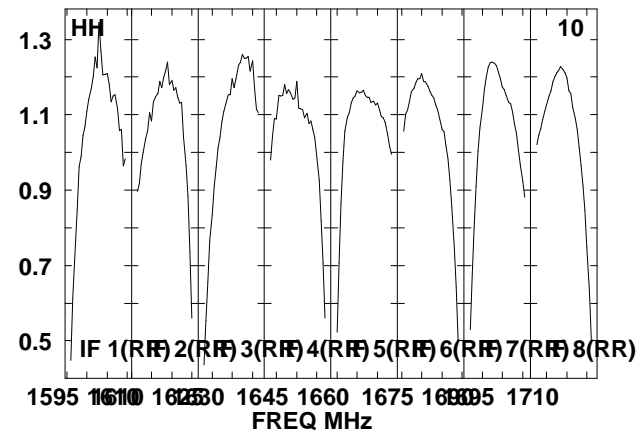
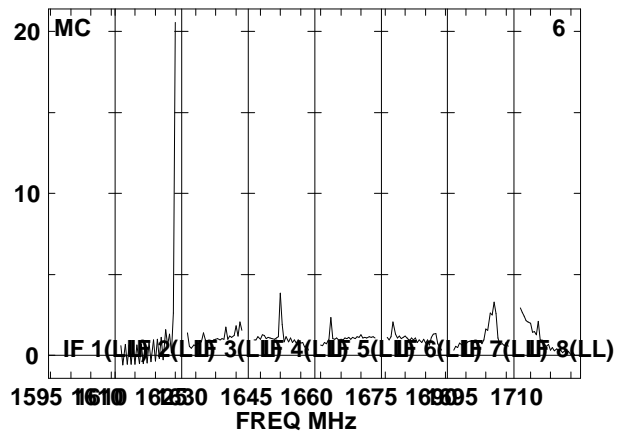
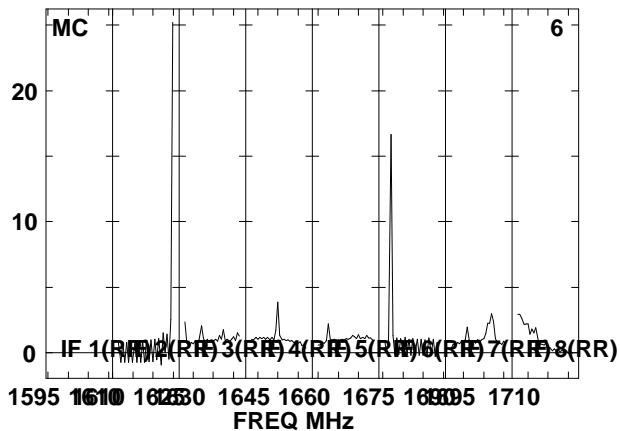
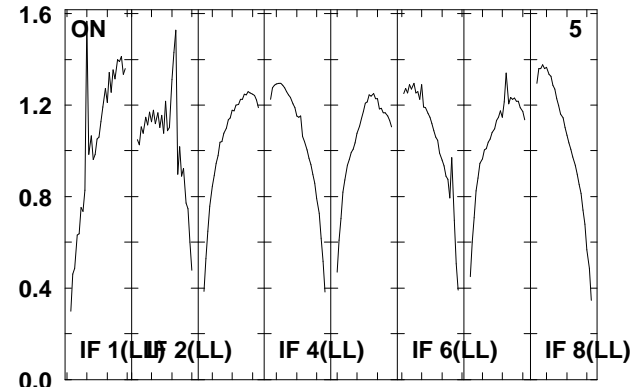
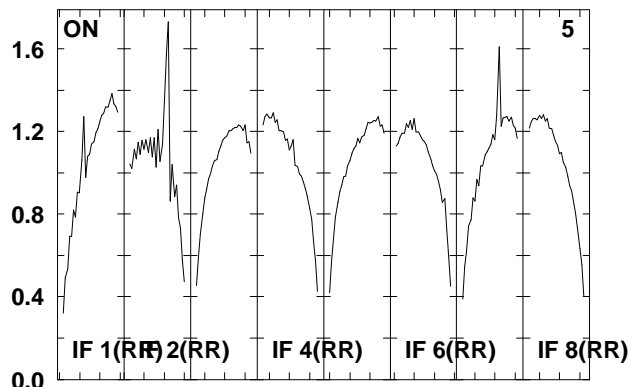
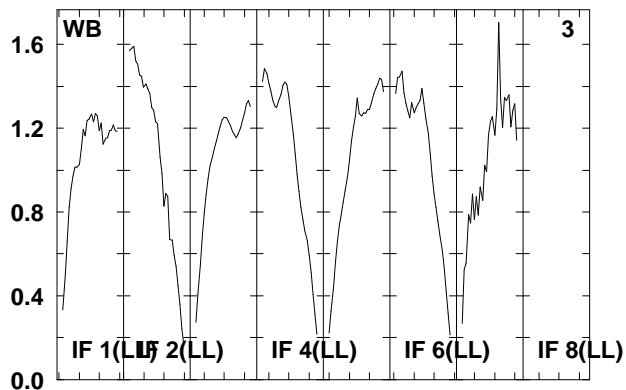
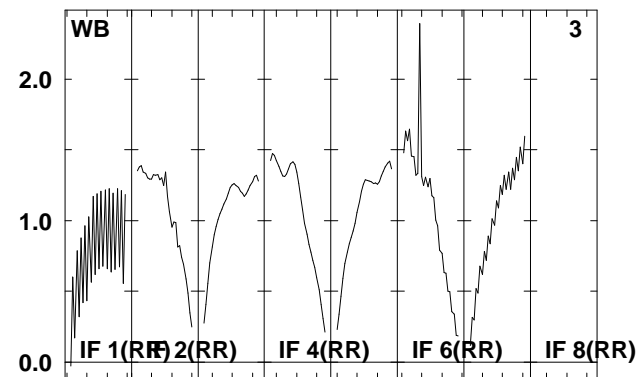
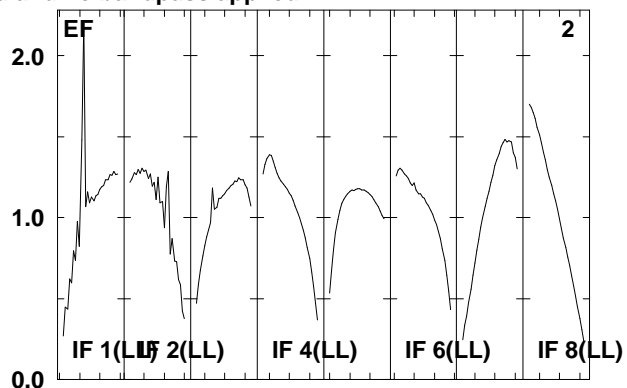
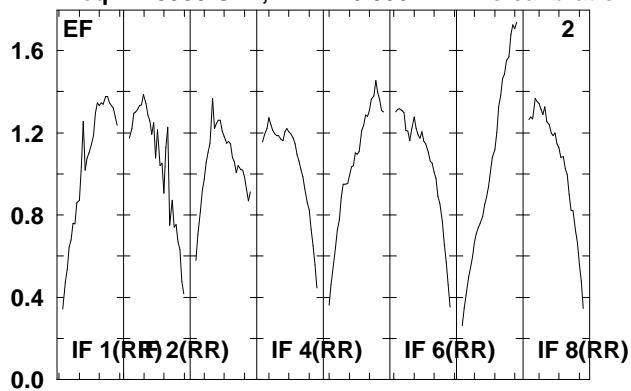

Lower frame: Real Jy
Total-power spectrum Antenna: *
Timerange: 00/21:04:32 to 00/21:06:00

Plot file version 224 created 22-APR-2008 12:28:02

J0730-02 EP061B.UVDATA.1

Freq = 1.5950 GHz, Bw = 16.000 MH No calibration applied and no bandpass applied

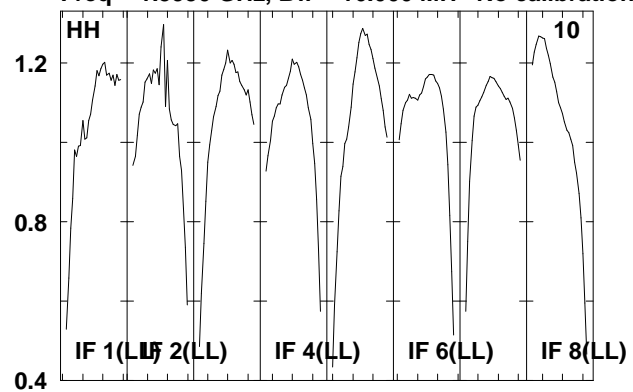

Lower frame: Real Jy
Total-power spectrum Antenna: *
Timerange: 00/21:04:32 to 00/21:06:00

Plot file version 225 created 22-APR-2008 12:28:02

IRAS0725 EP061B.UVDATA.1

Freq = 1.5950 GHz, Bw = 16.000 MH No calibration applied and no bandpass applied

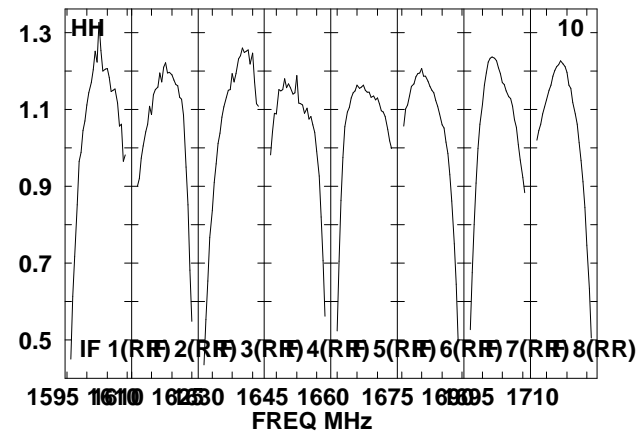
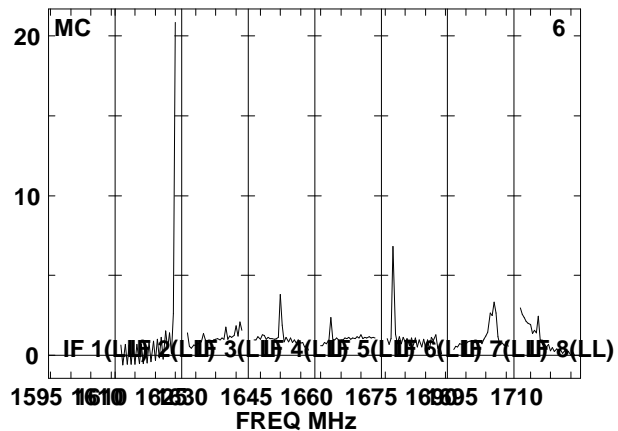
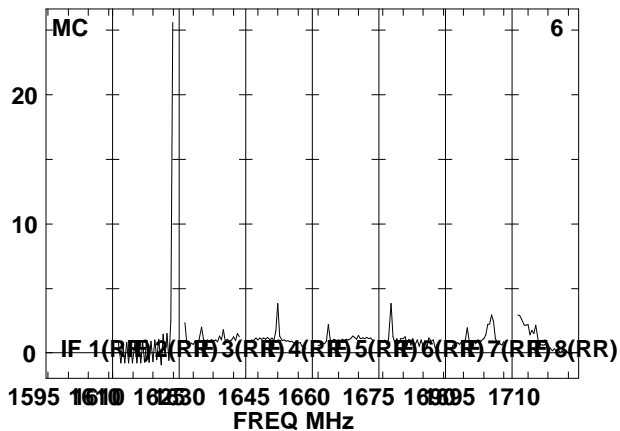
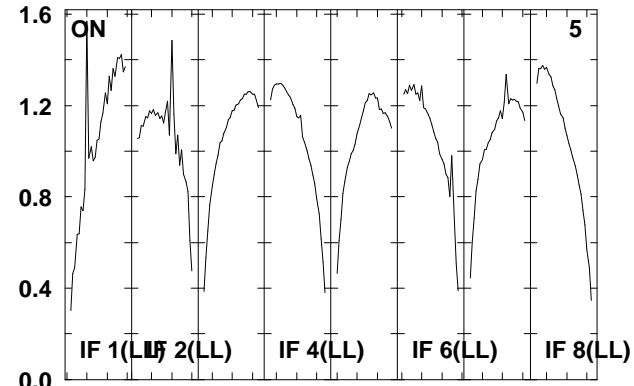
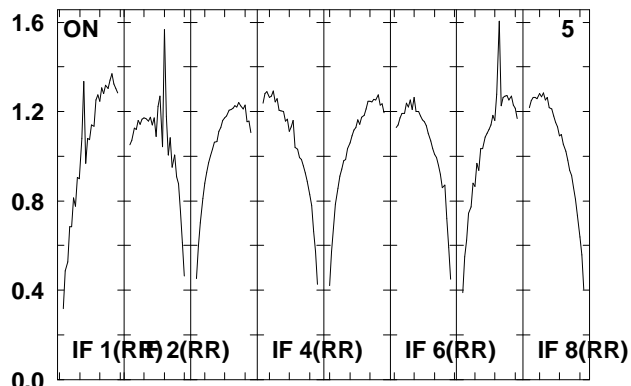
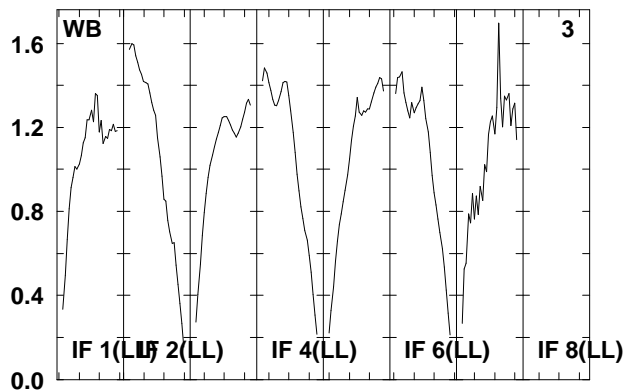
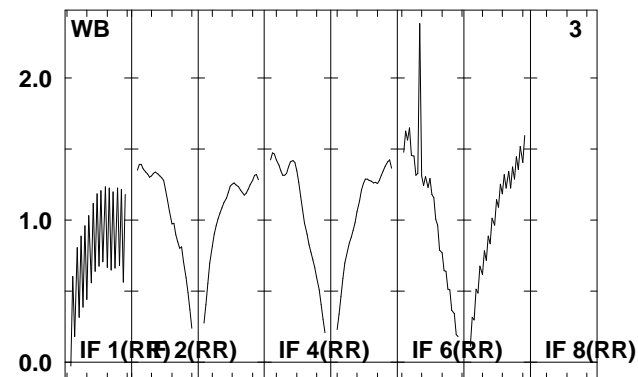
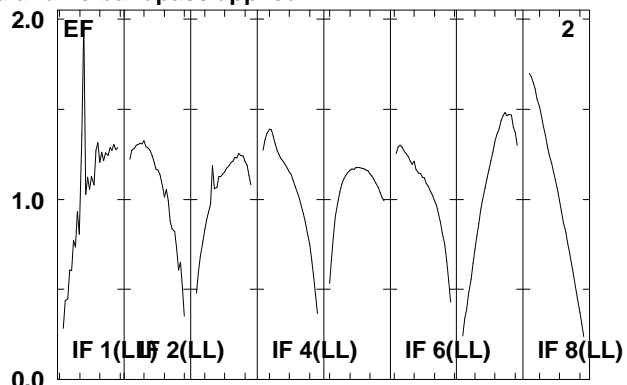
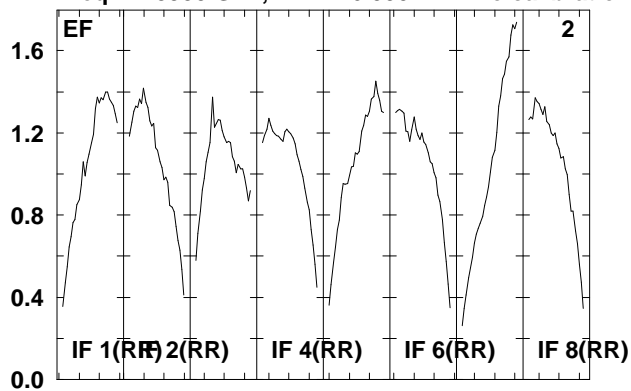

Lower frame: Real Jy
Total-power spectrum Antenna: *
Timerange: 00/21:06:02 to 00/21:09:30

Plot file version 226 created 22-APR-2008 12:28:04

IRAS0725 EP061B.UVDATA.1

Freq = 1.5950 GHz, Bw = 16.000 MH No calibration applied and no bandpass applied

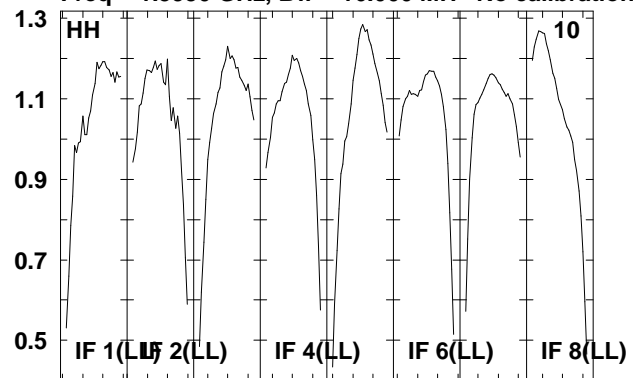

Lower frame: Real Jy
Total-power spectrum Antenna: *
Timerange: 00/21:06:02 to 00/21:09:30

Plot file version 227 created 22-APR-2008 12:28:04

J0730-02 EP061B.UVDATA.1

Freq = 1.5950 GHz, Bw = 16.000 MH No calibration applied and no bandpass applied

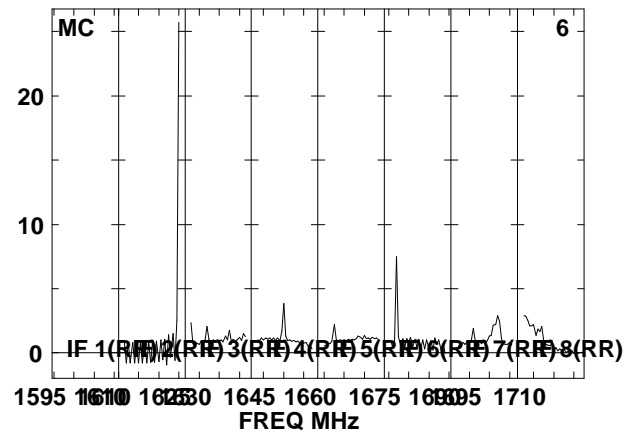
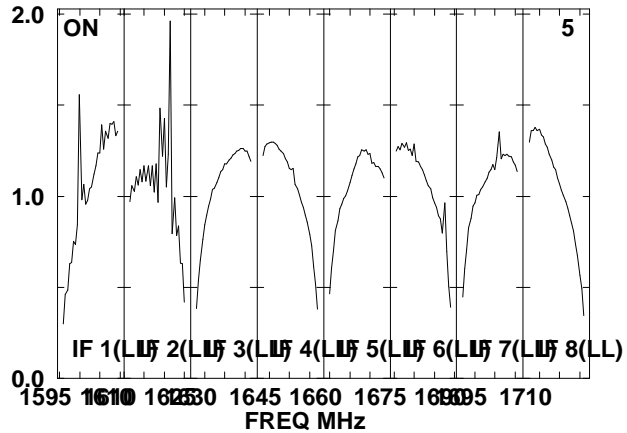
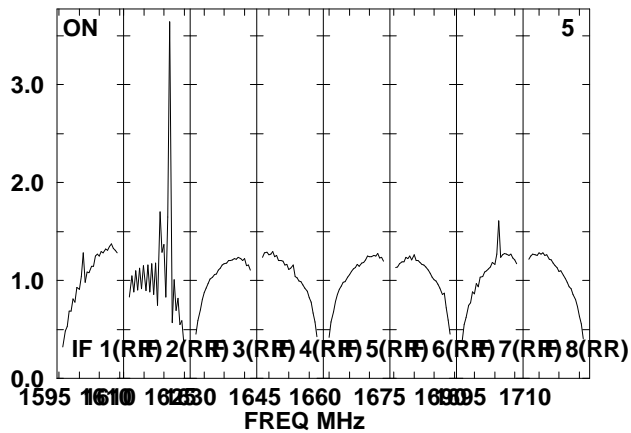
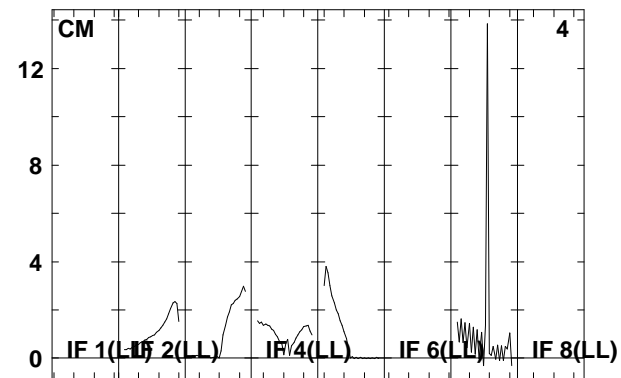
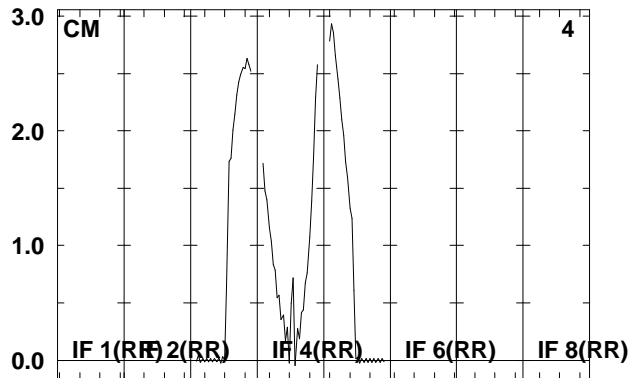
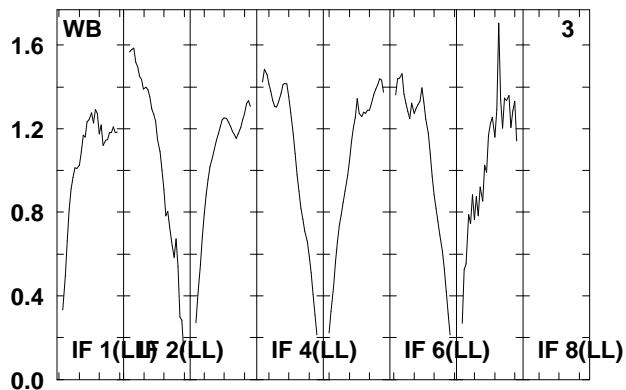
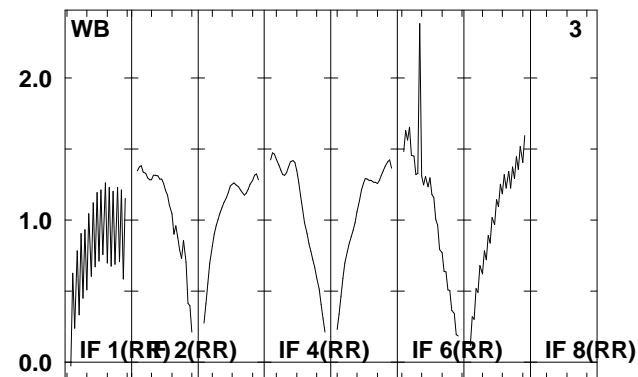
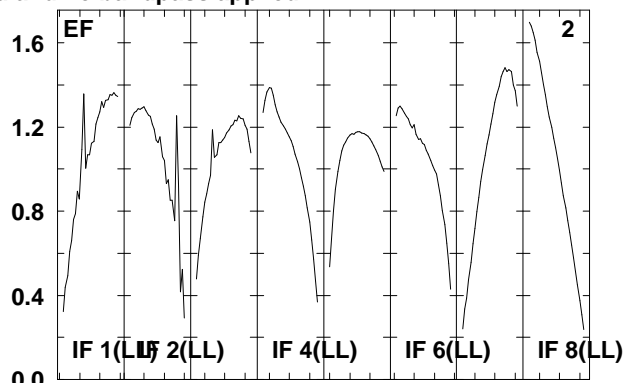
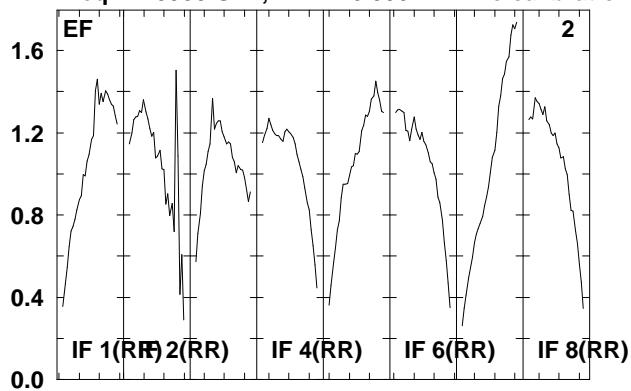

Lower frame: Real Jy
Total-power spectrum Antenna: *
Timerange: 00/21:09:34 to 00/21:11:00

Plot file version 228 created 22-APR-2008 12:28:04

J0730-02 EP061B.UVDATA.1

Freq = 1.5950 GHz, Bw = 16.000 MH No calibration applied and no bandpass applied

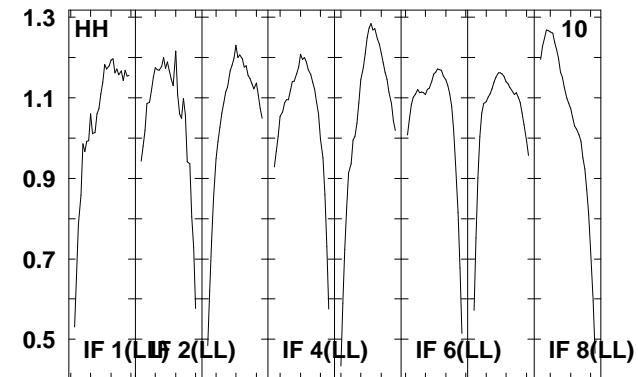
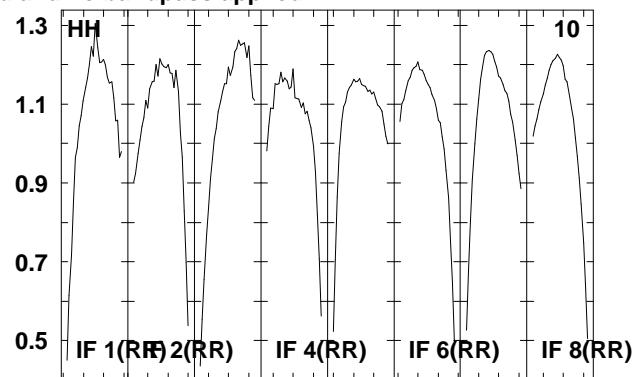
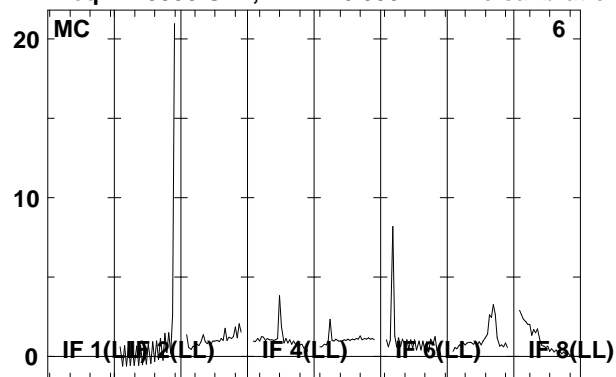

Lower frame: Real Jy
Total-power spectrum Antenna: *
Timerange: 00/21:09:34 to 00/21:11:00

Plot file version 229 created 22-APR-2008 12:28:05

IRAS0725 EP061B.UVDATA.1

Freq = 1.5950 GHz, Bw = 16.000 MH No calibration applied and no bandpass applied

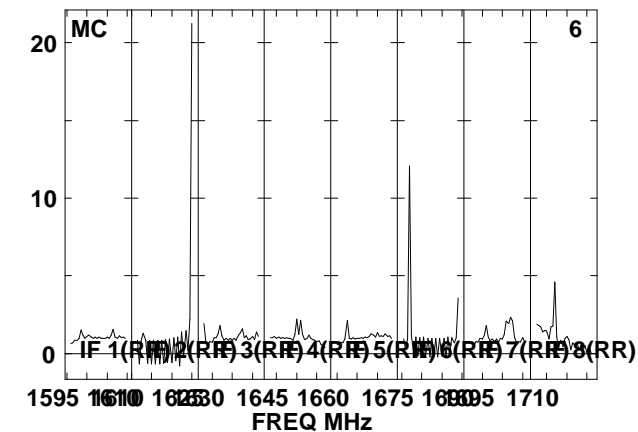
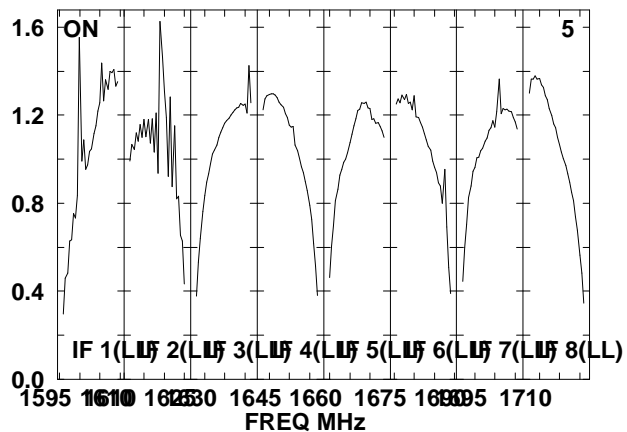
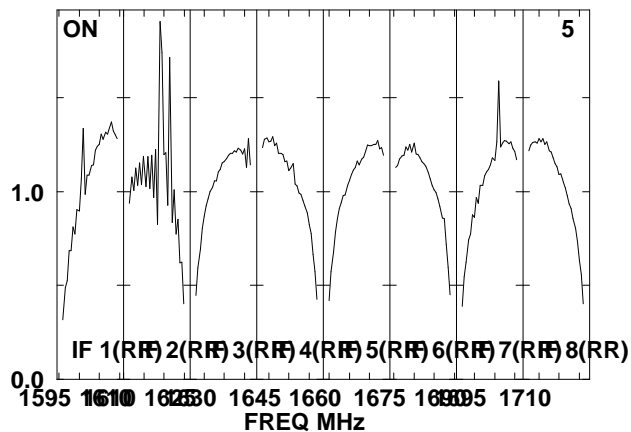
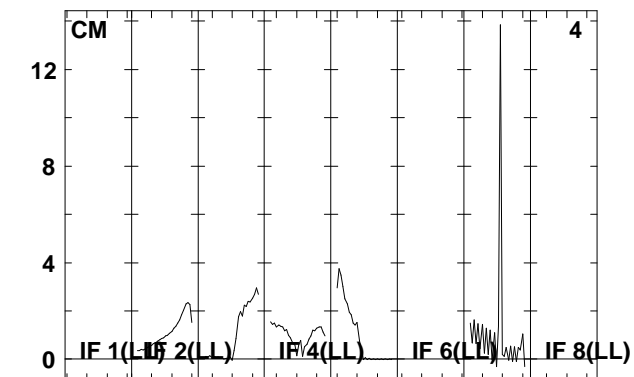
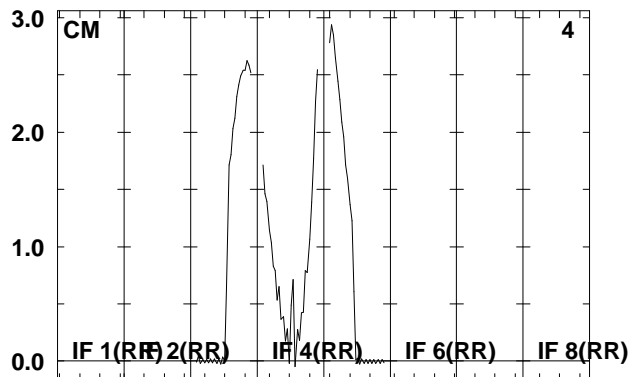
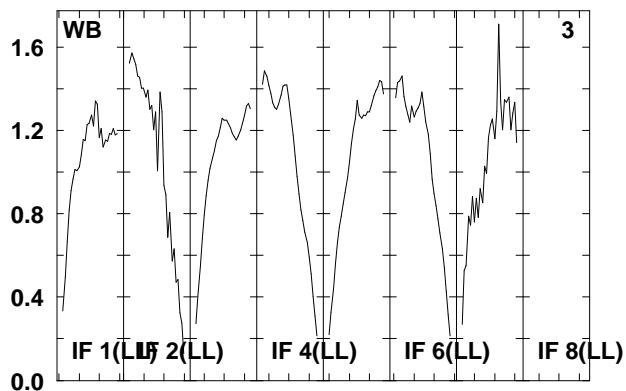
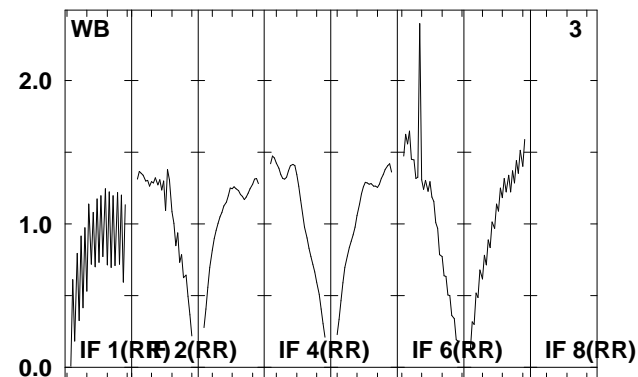
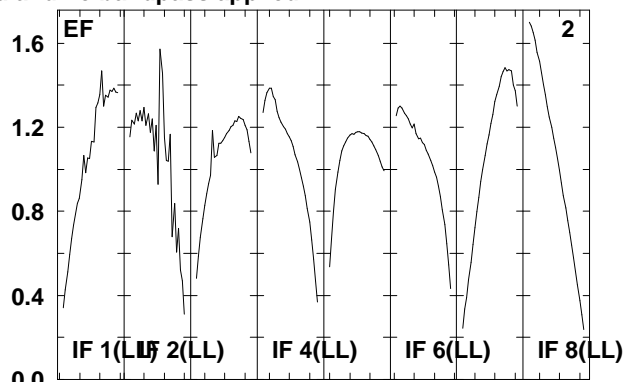
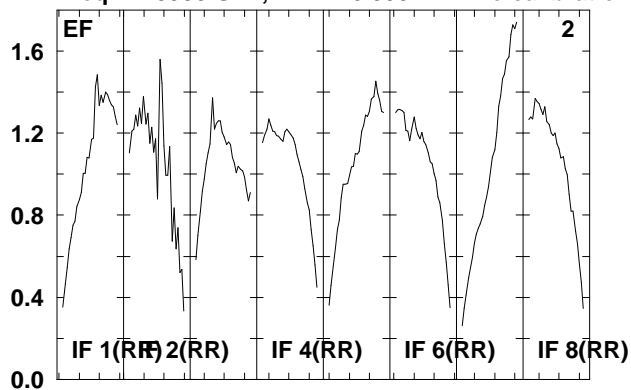

Lower frame: Real Jy
Total-power spectrum Antenna: *
Timerange: 00/21:11:04 to 00/21:14:30

Plot file version 230 created 22-APR-2008 12:28:05

IRAS0725 EP061B.UVDATA.1

Freq = 1.5950 GHz, Bw = 16.000 MH No calibration applied and no bandpass applied

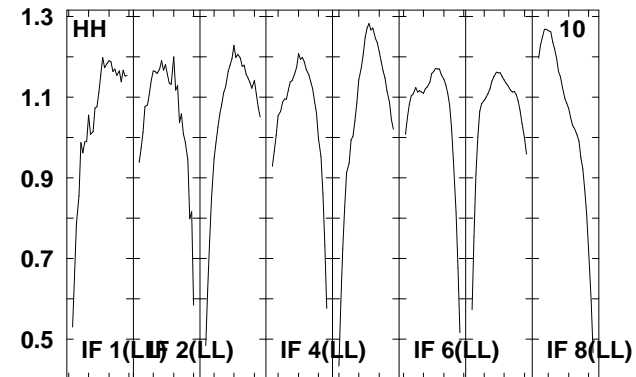
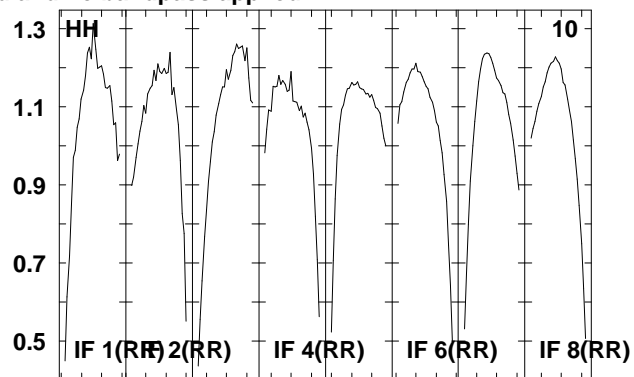
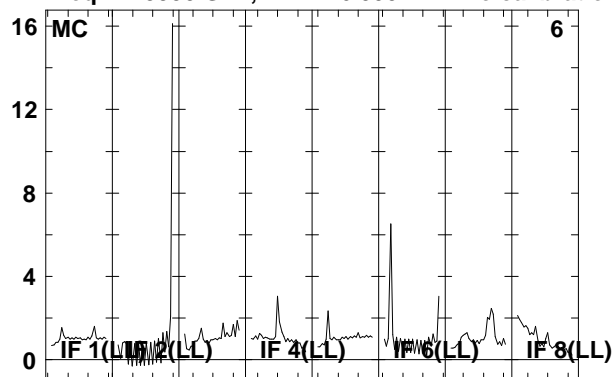

Lower frame: Real Jy
Total-power spectrum Antenna: *
Timerange: 00/21:11:04 to 00/21:14:30

Plot file version 231 created 22-APR-2008 12:28:06

J0730-02 EP061B.UVDATA.1

Freq = 1.5950 GHz, Bw = 16.000 MH No calibration applied and no bandpass applied

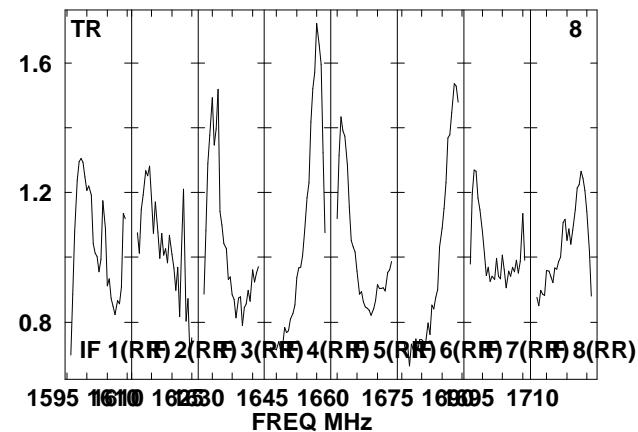
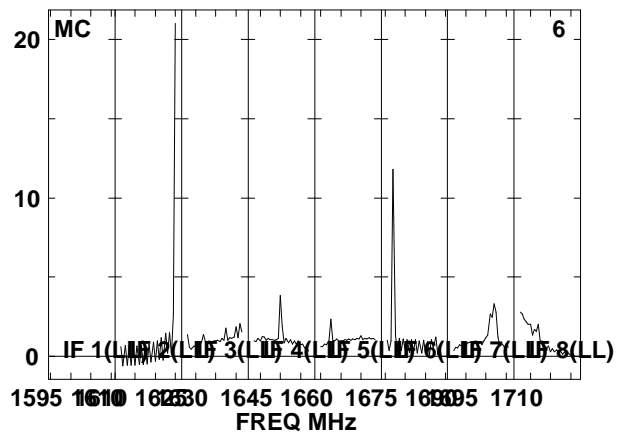
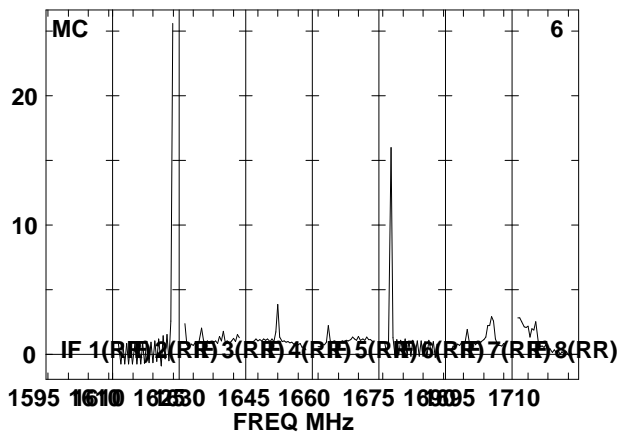
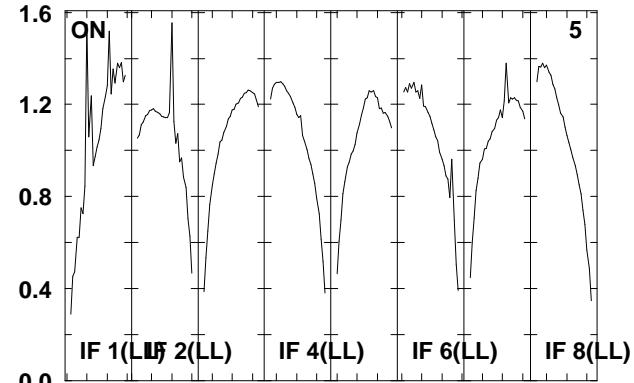
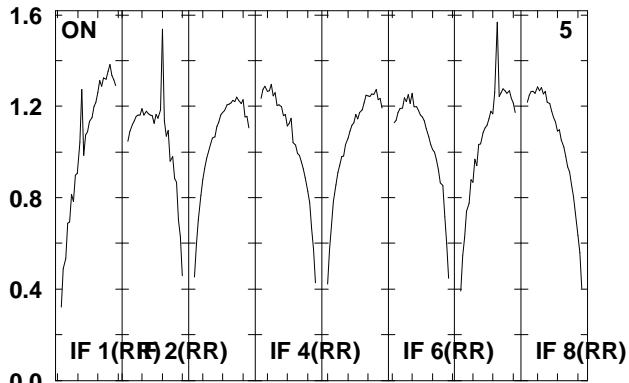
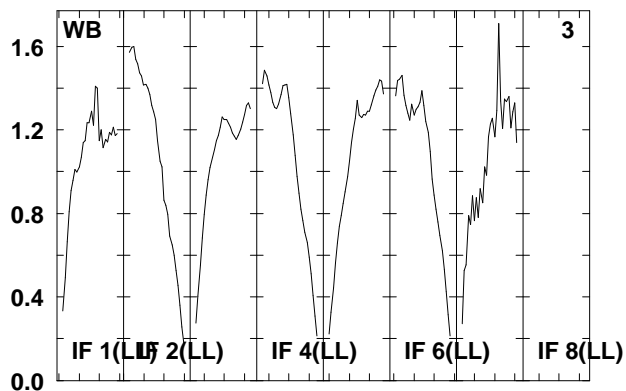
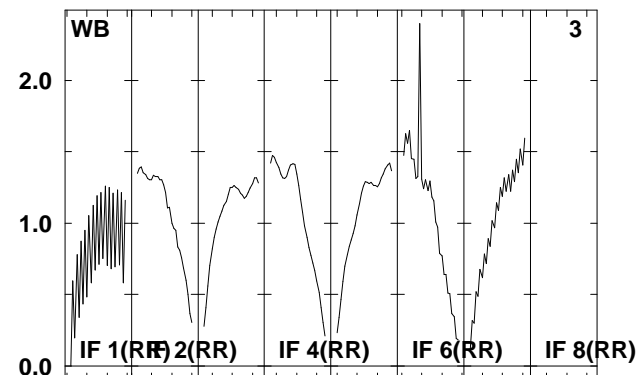
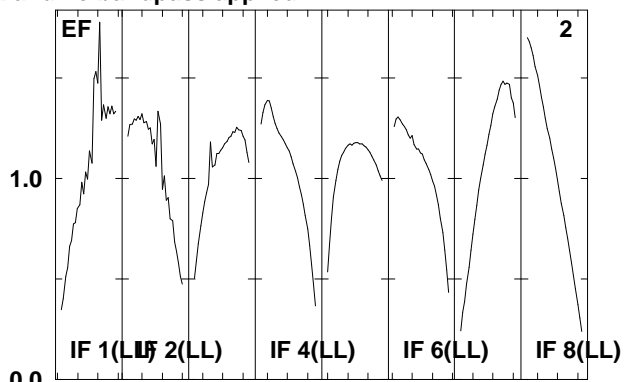
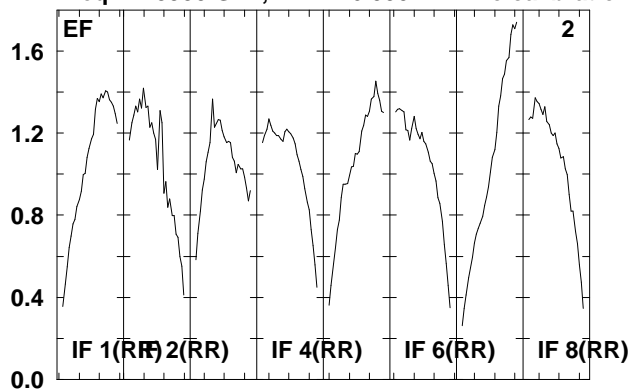

Lower frame: Real Jy
Total-power spectrum Antenna: *
Timerange: 00/21:15:32 to 00/21:17:00

Plot file version 232 created 22-APR-2008 12:28:06

J0730-02 EP061B.UVDATA.1

Freq = 1.5950 GHz, Bw = 16.000 MH No calibration applied and no bandpass applied

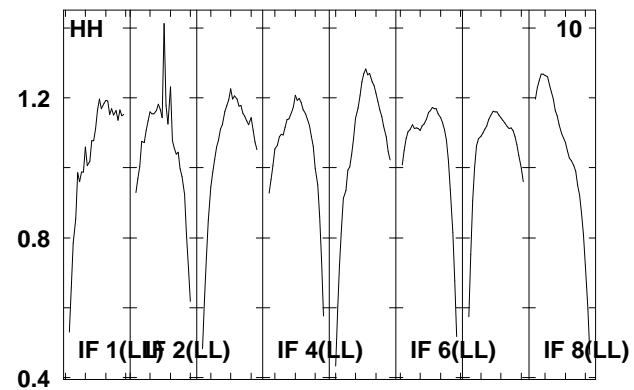
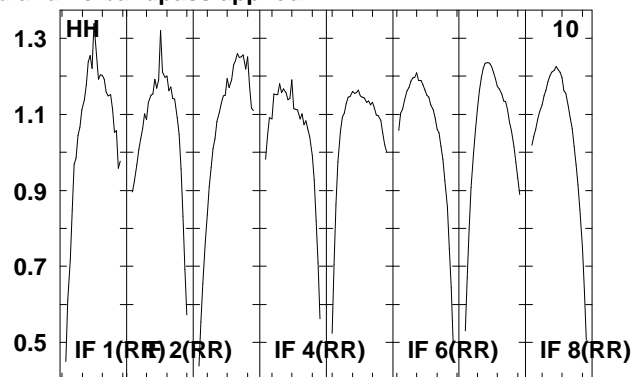
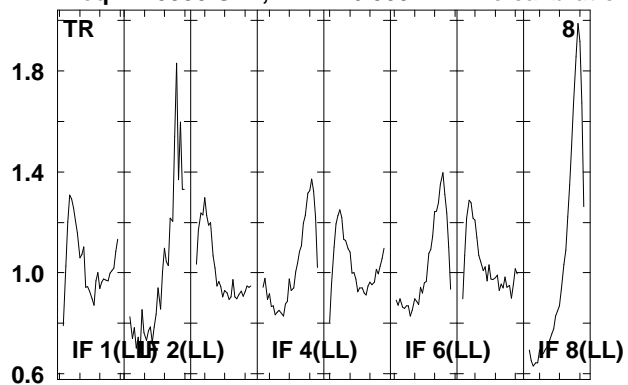

Lower frame: Real Jy
Total-power spectrum Antenna: *
Timerange: 00/21:15:32 to 00/21:17:00

Plot file version 233 created 22-APR-2008 12:28:06

IRAS0725 EP061B.UVDATA.1

Freq = 1.5950 GHz, Bw = 16.000 MH No calibration applied and no bandpass applied

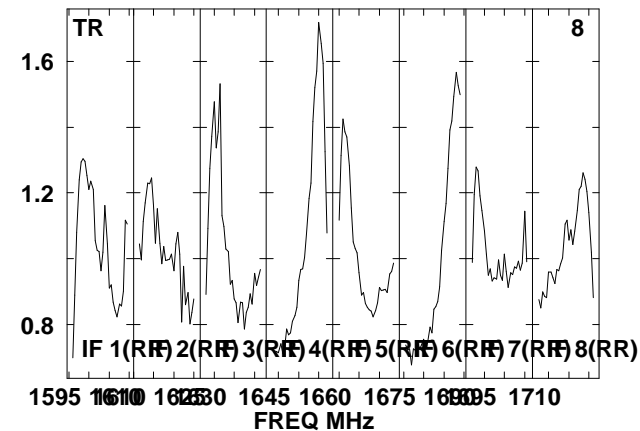
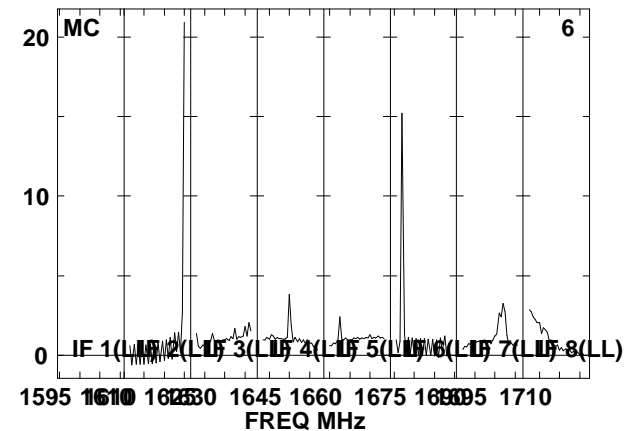
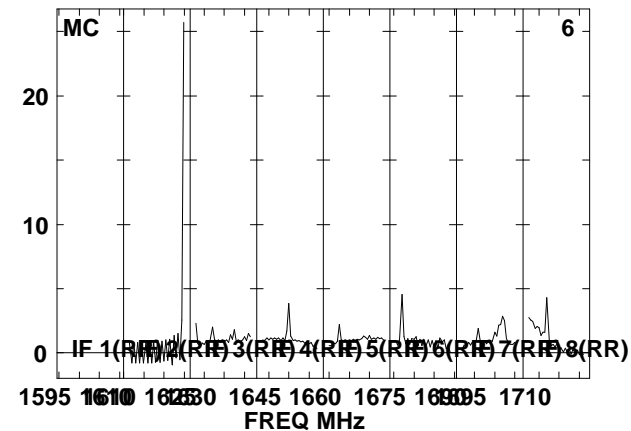
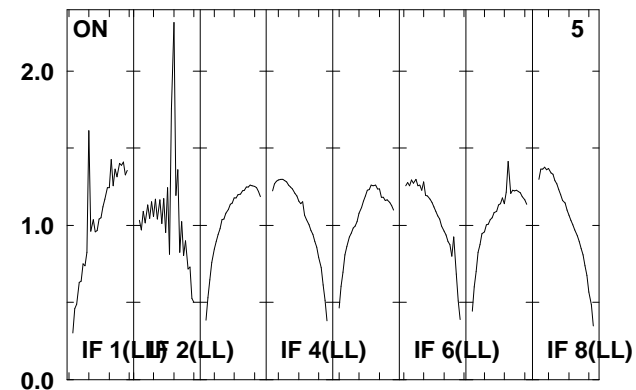
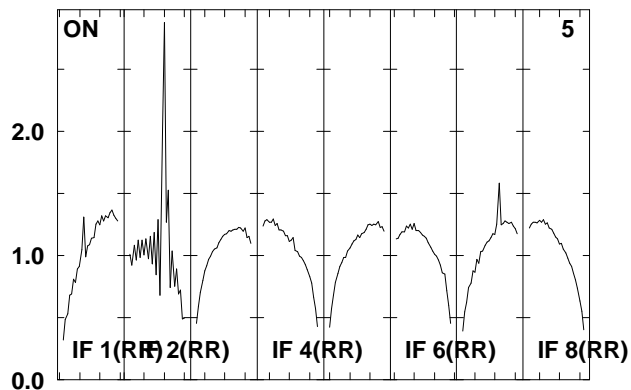
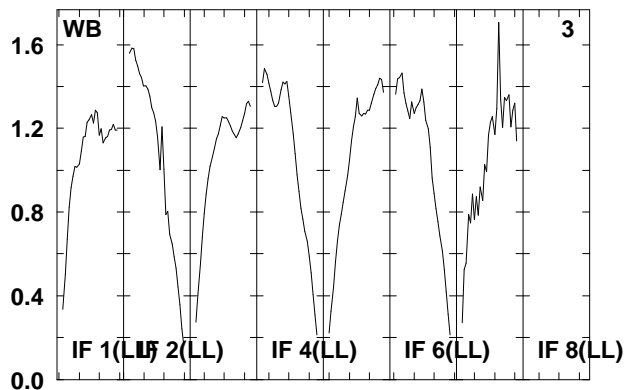
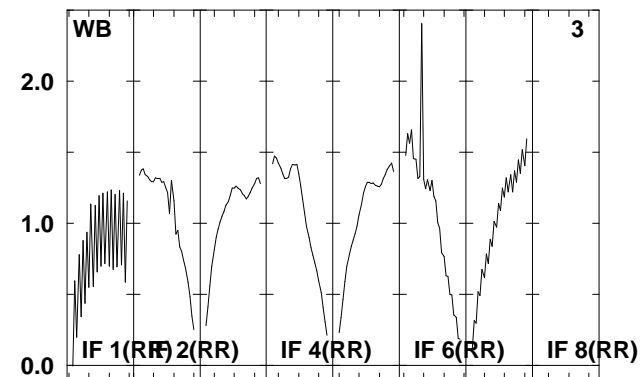
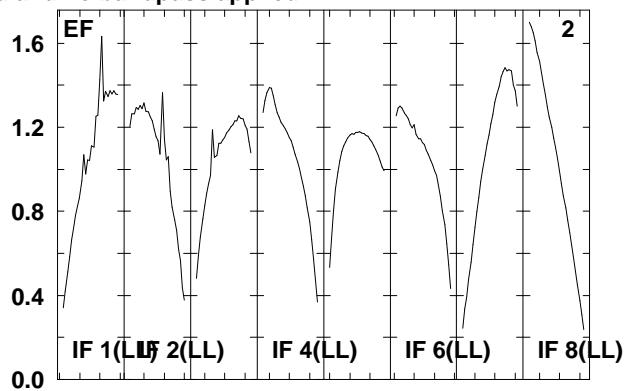
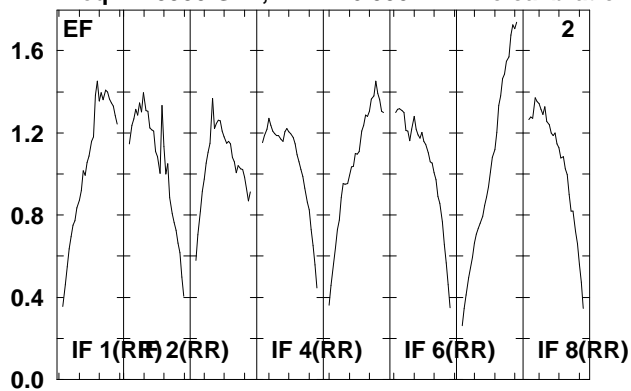

Lower frame: Real Jy

Total-power spectrum Antenna: *

Timerange: 00/21:17:02 to 00/21:20:30

Plot file version 234 created 22-APR-2008 12:28:07

IRAS0725 EP061B.UVDATA.1

Freq = 1.5950 GHz, Bw = 16.000 MH No calibration applied and no bandpass applied

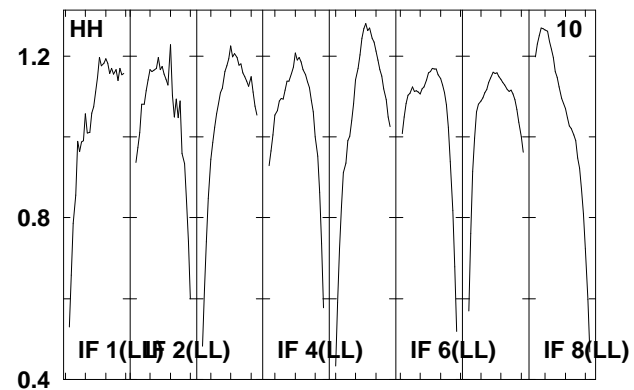
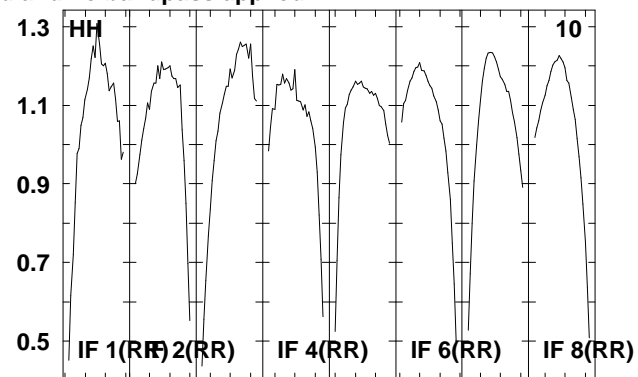
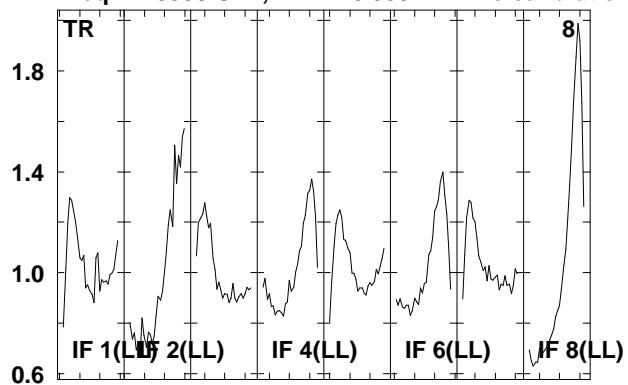

Lower frame: Real Jy
Total-power spectrum Antenna: *
Timerange: 00/21:17:02 to 00/21:20:30

Plot file version 235 created 22-APR-2008 12:28:08

J0730-02 EP061B.UVDATA.1

Freq = 1.5950 GHz, Bw = 16.000 MH No calibration applied and no bandpass applied

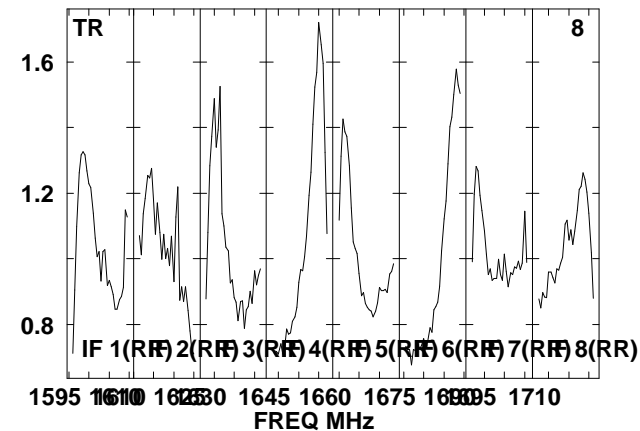
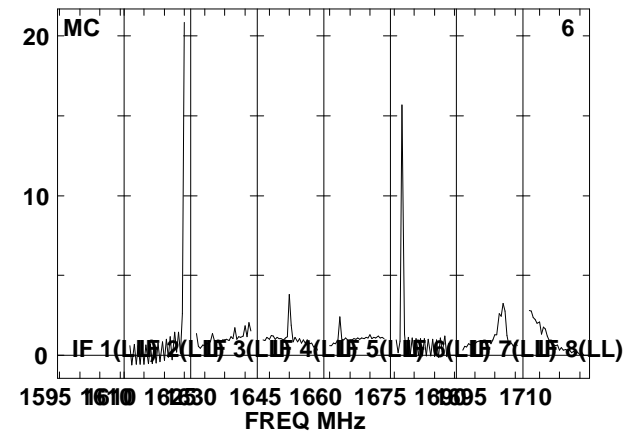
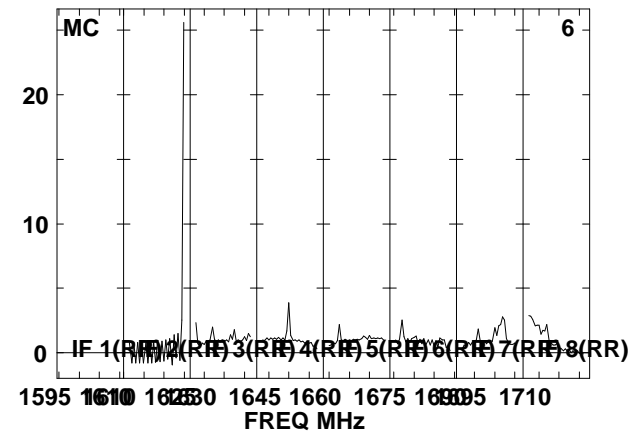
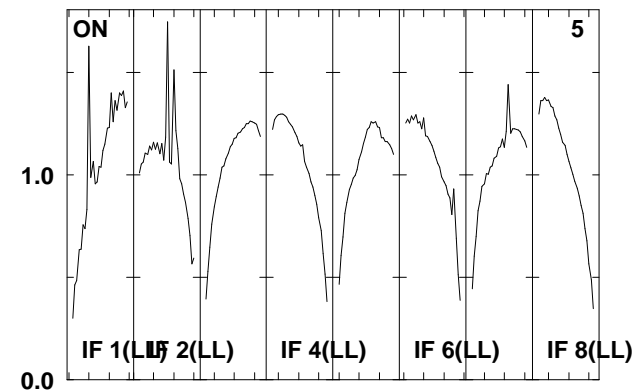
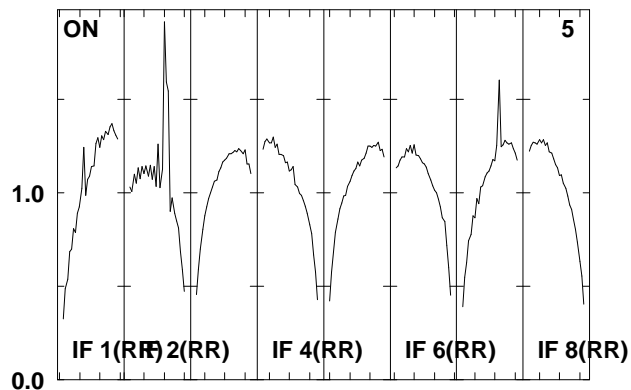
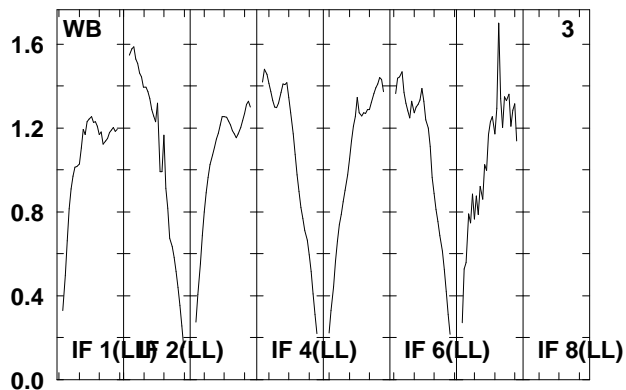
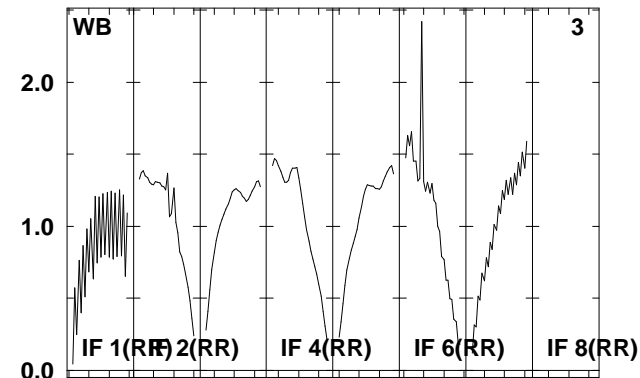
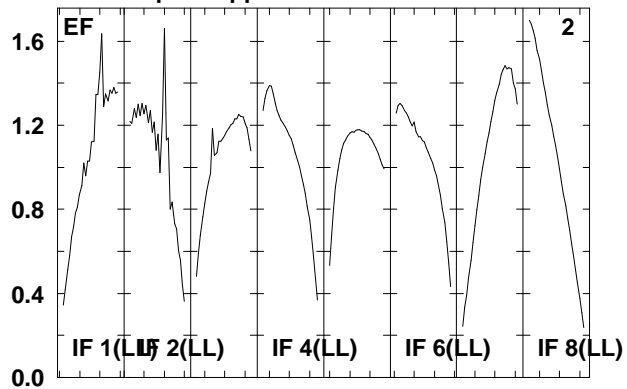
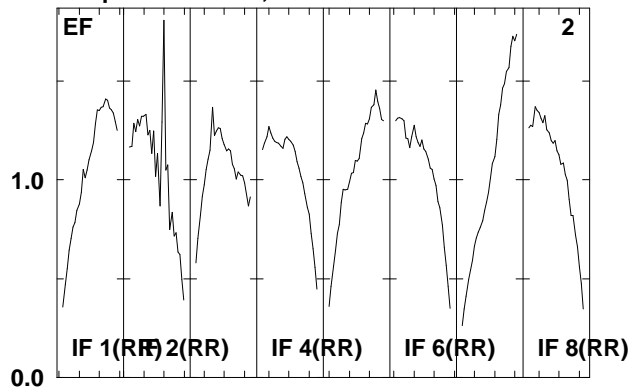

Lower frame: Real Jy
Total-power spectrum Antenna: *
Timerange: 00/21:20:32 to 00/21:22:00

Plot file version 236 created 22-APR-2008 12:28:09

J0730-02 EP061B.UVDATA.1

Freq = 1.5950 GHz, Bw = 16.000 MH No calibration applied and no bandpass applied

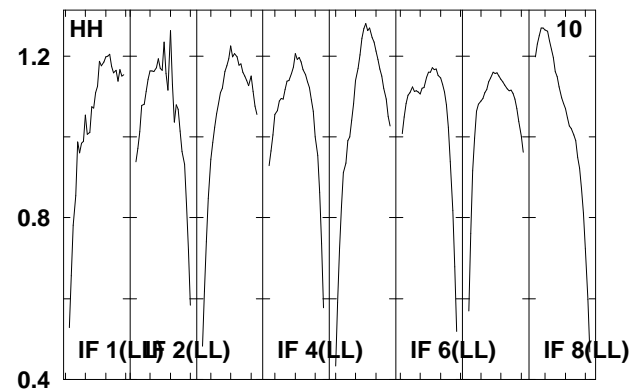
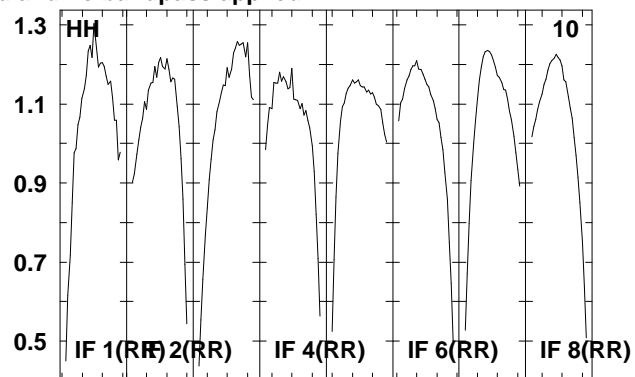
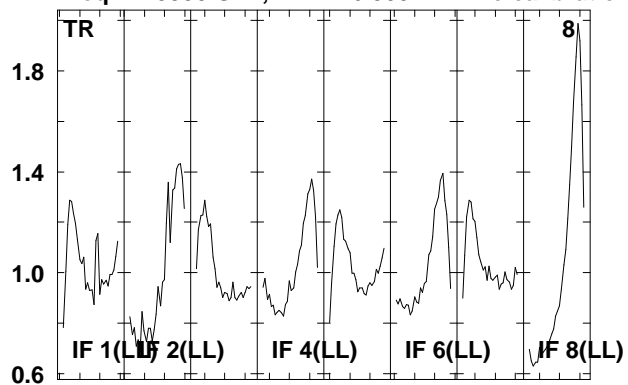

Lower frame: Real Jy
Total-power spectrum Antenna: *
Timerange: 00/21:20:32 to 00/21:22:00

Plot file version 237 created 22-APR-2008 12:28:09

IRAS0725 EP061B.UVDATA.1

Freq = 1.5950 GHz, Bw = 16.000 MH No calibration applied and no bandpass applied

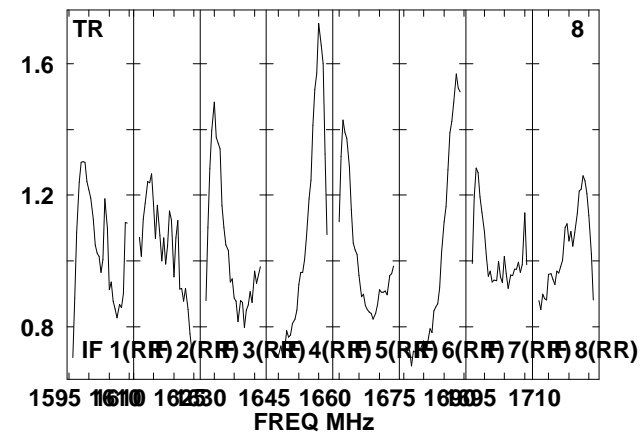
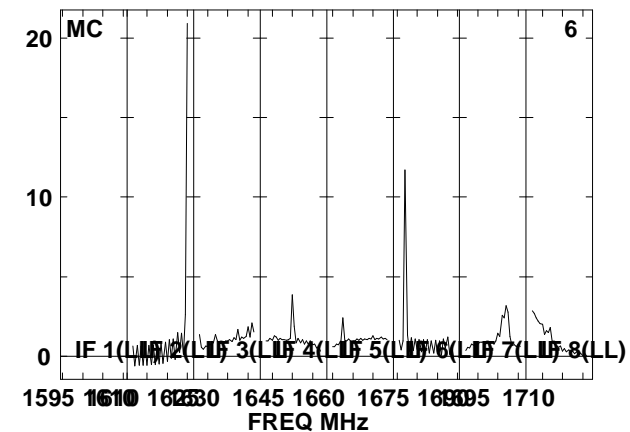
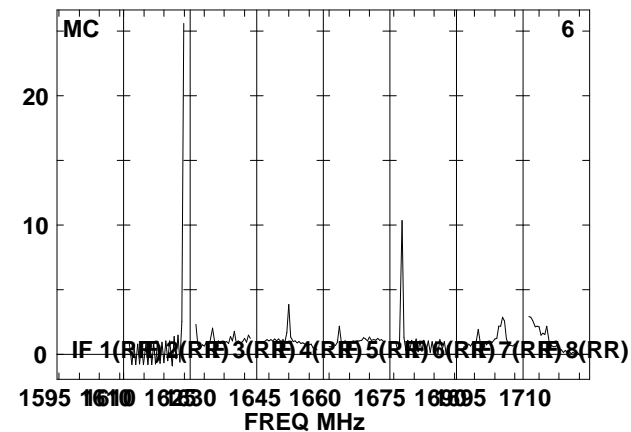
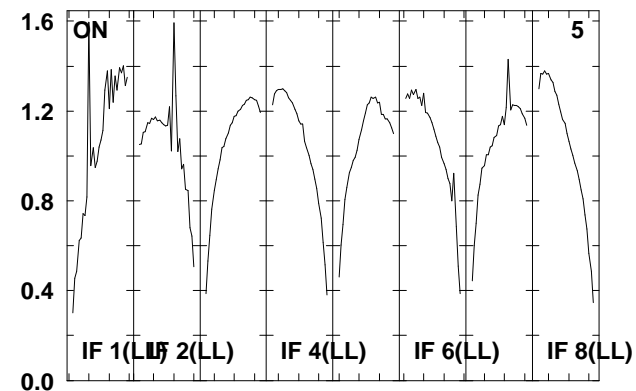
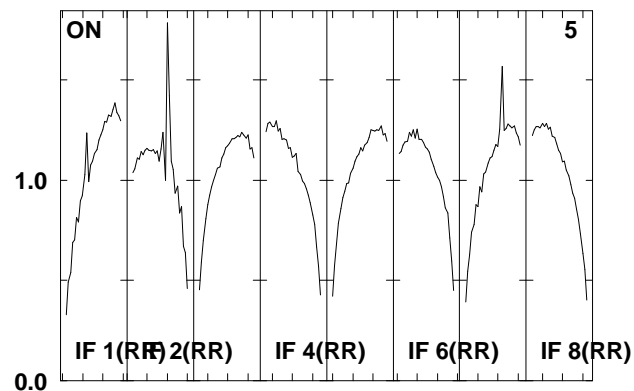
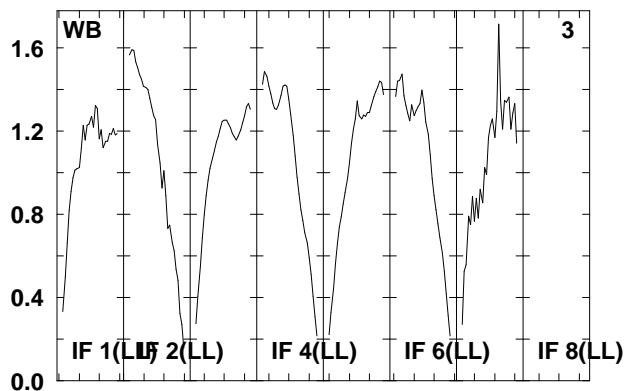
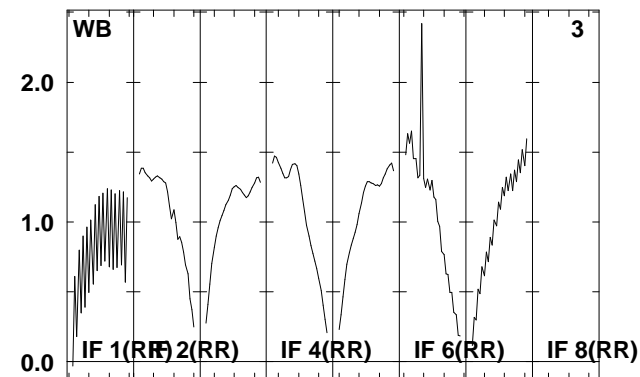
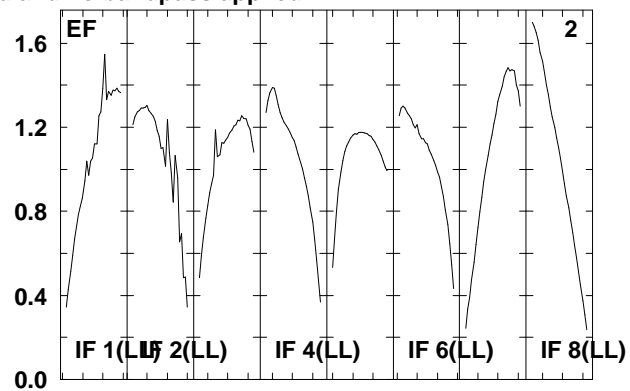
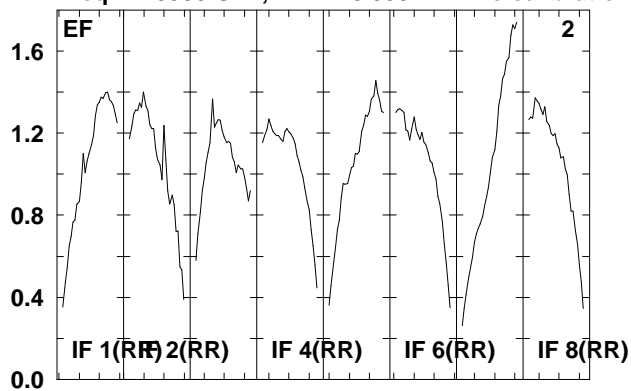

Lower frame: Real Jy

Total-power spectrum Antenna: *

Timerange: 00/21:22:02 to 00/21:25:30

Plot file version 238 created 22-APR-2008 12:28:10

IRAS0725 EP061B.UVDATA.1

Freq = 1.5950 GHz, Bw = 16.000 MH No calibration applied and no bandpass applied

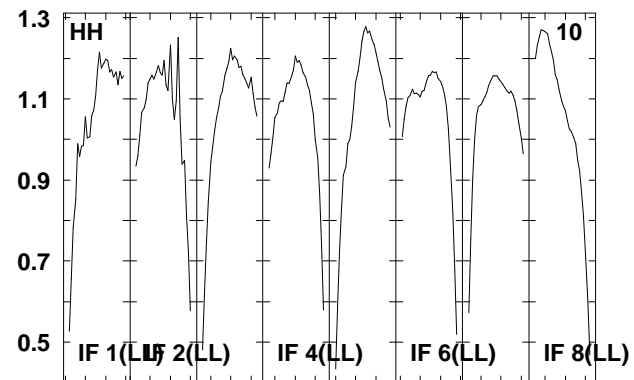
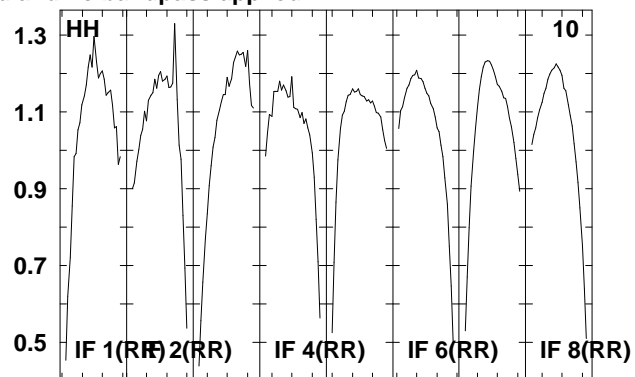
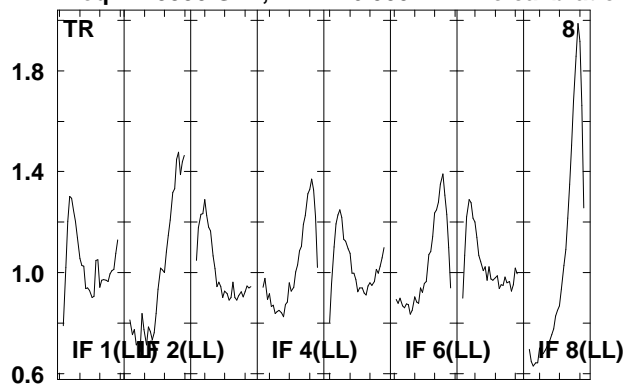

Lower frame: Real Jy
Total-power spectrum Antenna: *
Timerange: 00/21:22:02 to 00/21:25:30

Plot file version 239 created 22-APR-2008 12:28:11

J0730-02 EP061B.UVDATA.1

Freq = 1.5950 GHz, Bw = 16.000 MH No calibration applied and no bandpass applied

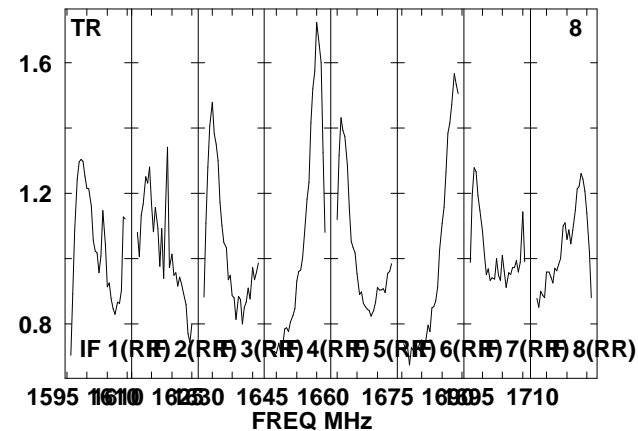
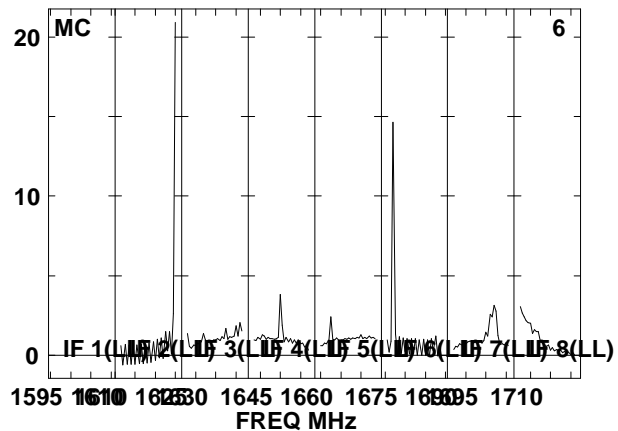
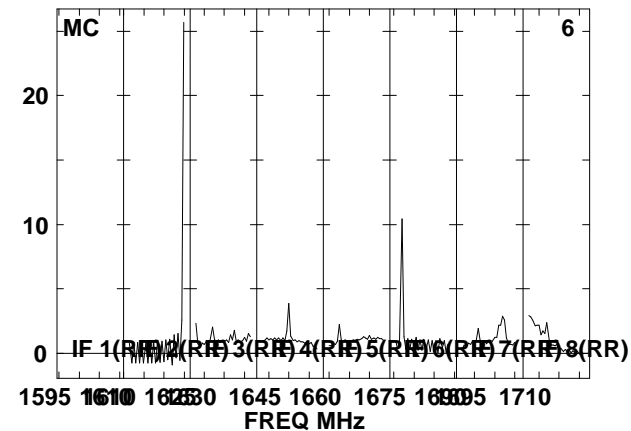
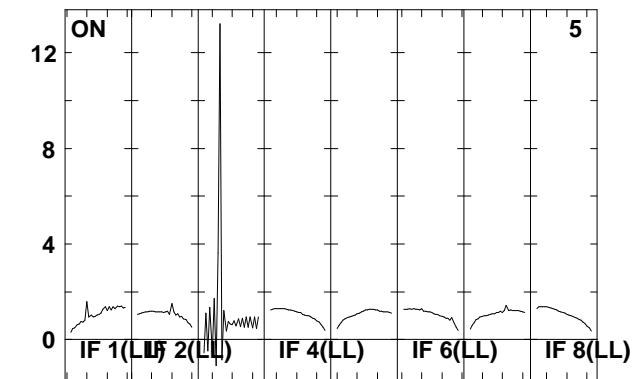
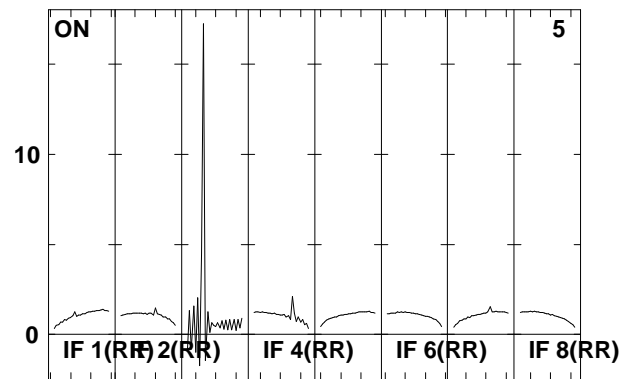
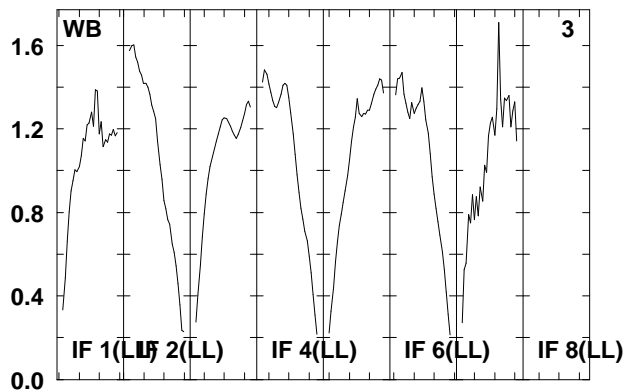
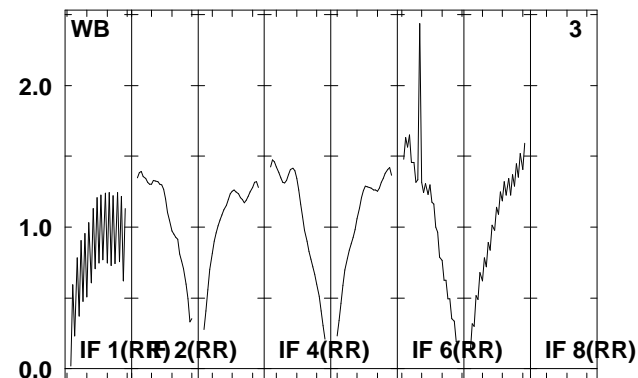
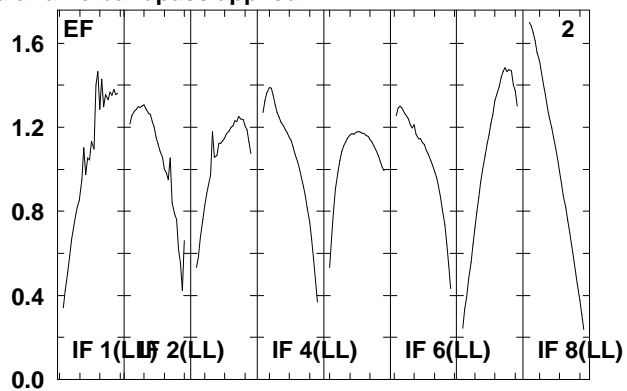
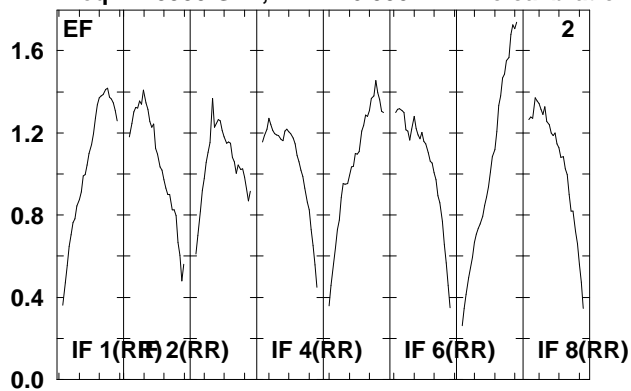

Lower frame: Real Jy
Total-power spectrum Antenna: *
Timerange: 00/21:25:32 to 00/21:27:00

Plot file version 240 created 22-APR-2008 12:28:11

J0730-02 EP061B.UVDATA.1

Freq = 1.5950 GHz, Bw = 16.000 MH No calibration applied and no bandpass applied

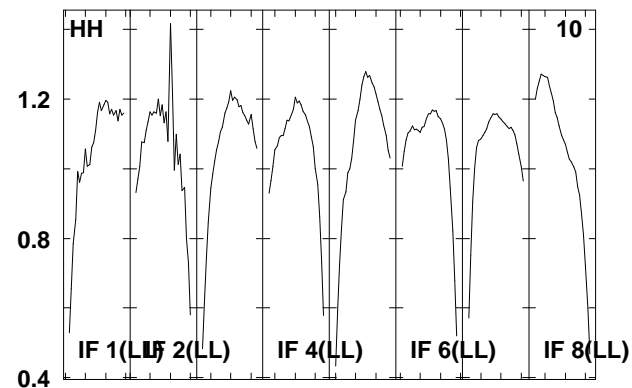
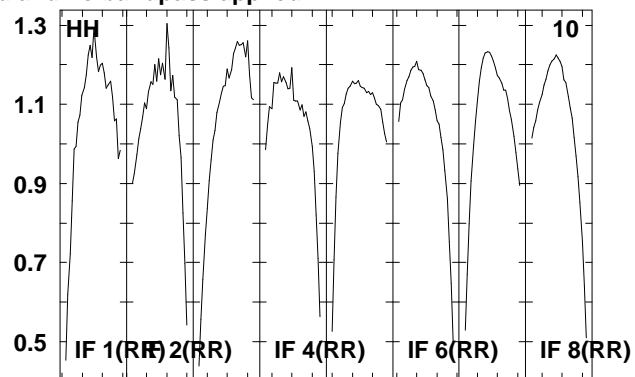
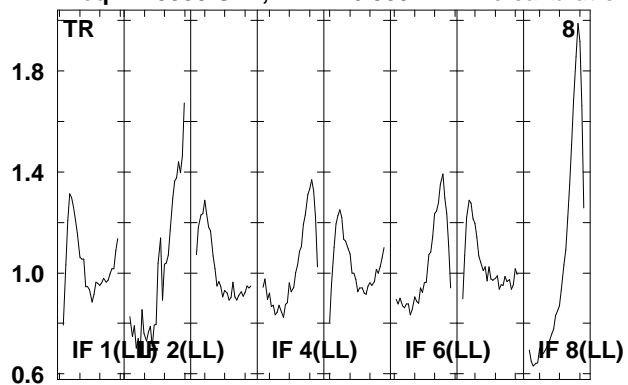

Lower frame: Real Jy
Total-power spectrum Antenna: *
Timerange: 00/21:25:32 to 00/21:27:00

Plot file version 241 created 22-APR-2008 12:28:12

IRAS0725 EP061B.UVDATA.1

Freq = 1.5950 GHz, Bw = 16.000 MH No calibration applied and no bandpass applied

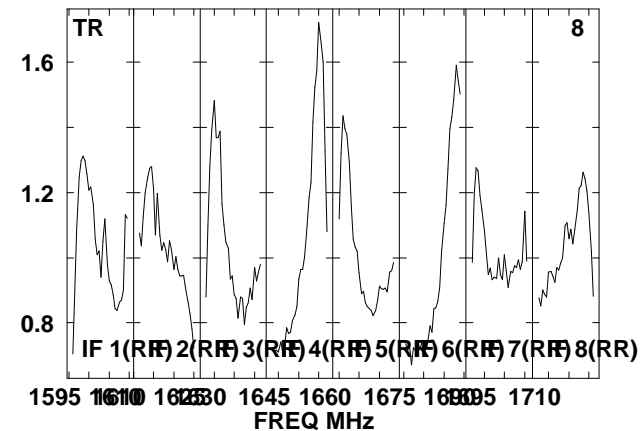
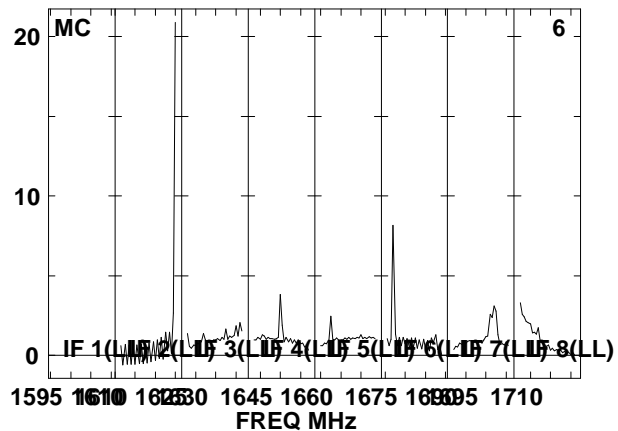
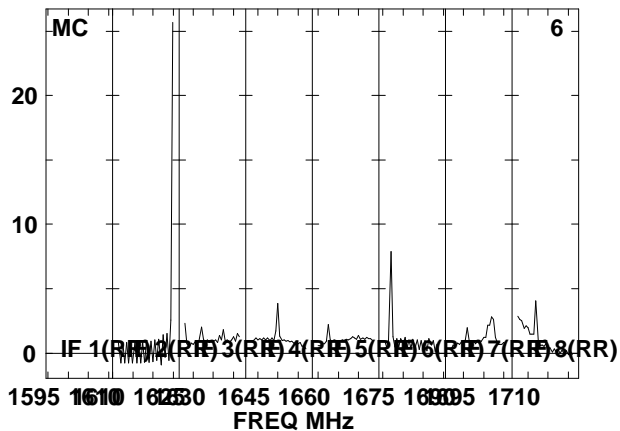
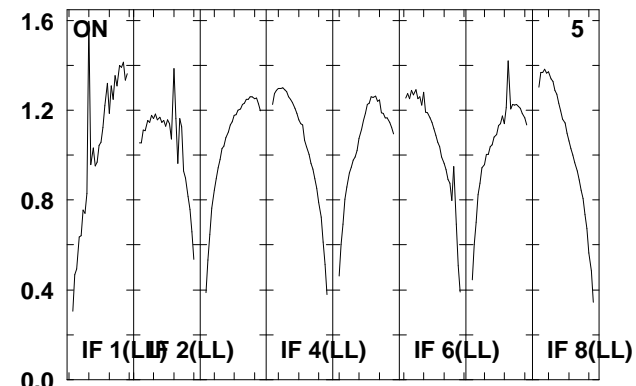
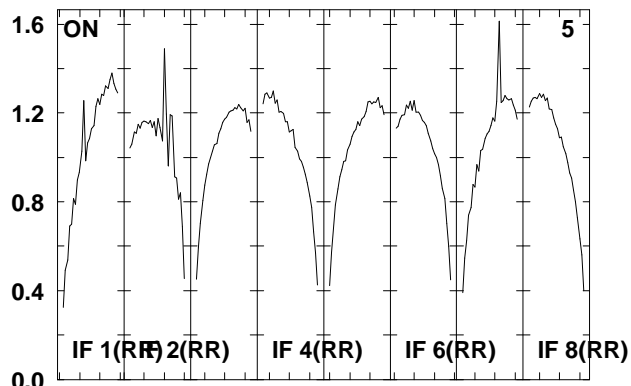
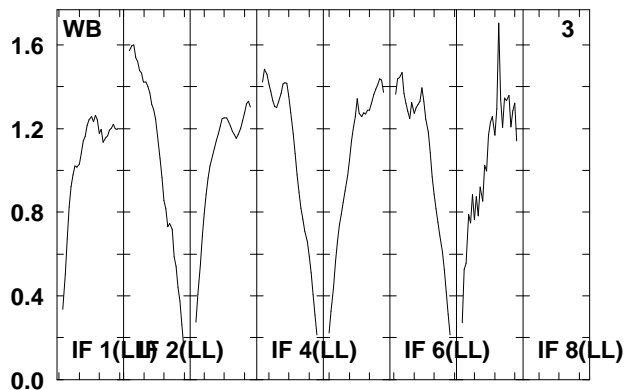
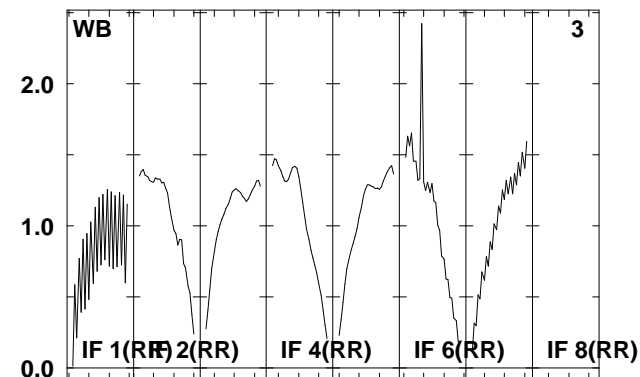
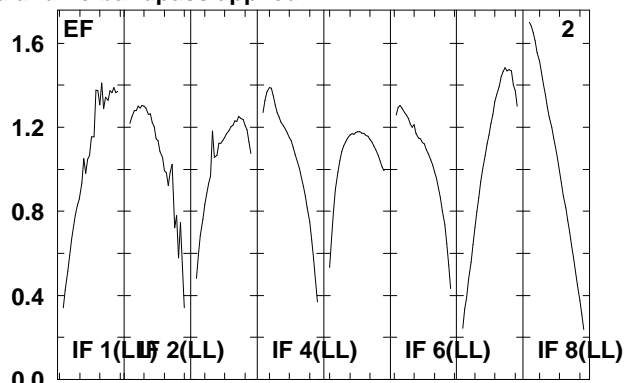
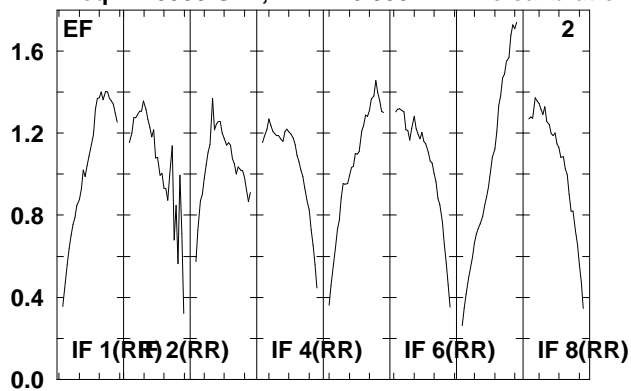

Lower frame: Real Jy
Total-power spectrum Antenna: *
Timerange: 00/21:27:02 to 00/21:30:26

Plot file version 242 created 22-APR-2008 12:28:13

IRAS0725 EP061B.UVDATA.1

Freq = 1.5950 GHz, Bw = 16.000 MH No calibration applied and no bandpass applied

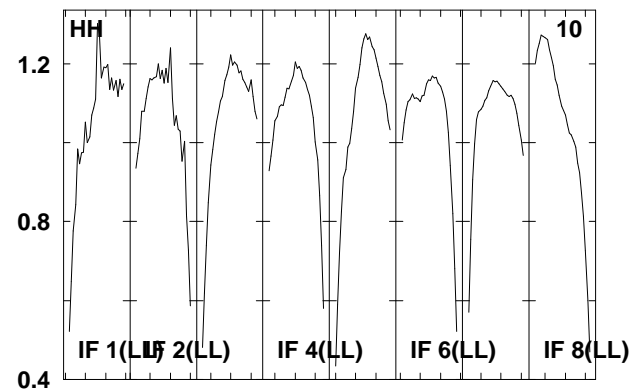
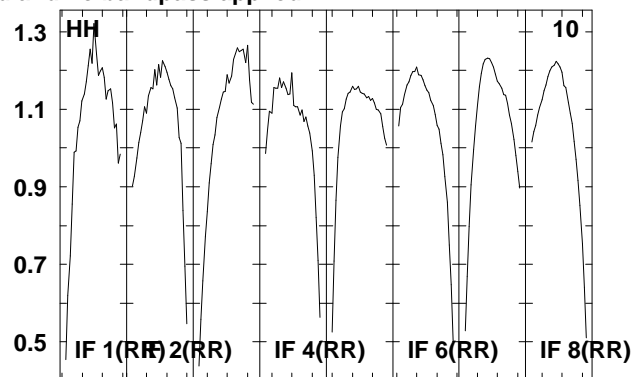
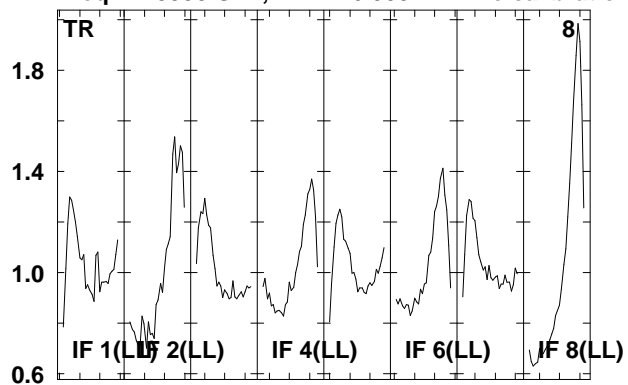

Lower frame: Real Jy
Total-power spectrum Antenna: *
Timerange: 00/21:27:02 to 00/21:30:26

Plot file version 243 created 22-APR-2008 12:28:13

J0730-02 EP061B.UVDATA.1

Freq = 1.5950 GHz, Bw = 16.000 MH No calibration applied and no bandpass applied

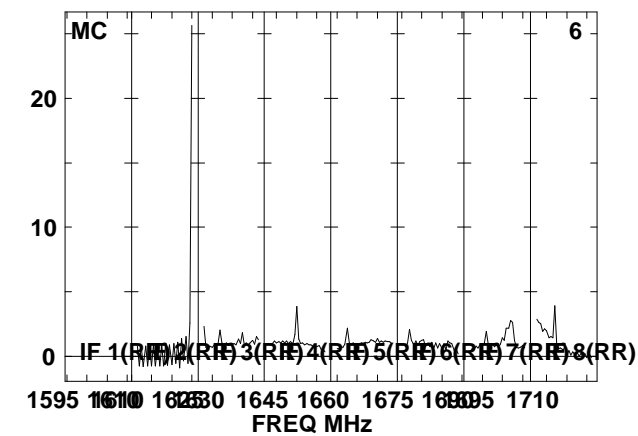
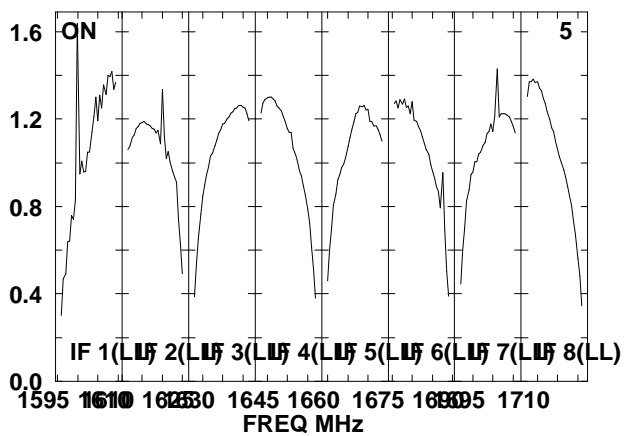
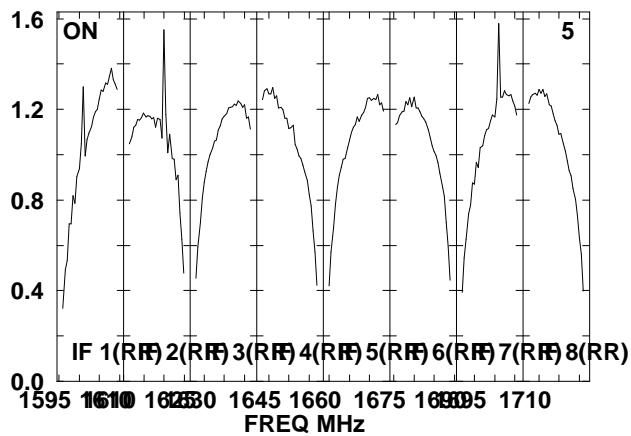
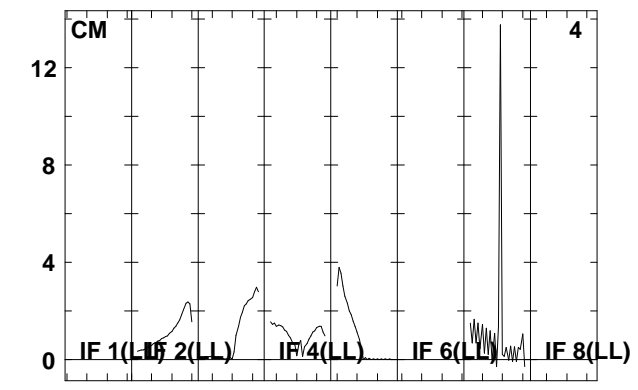
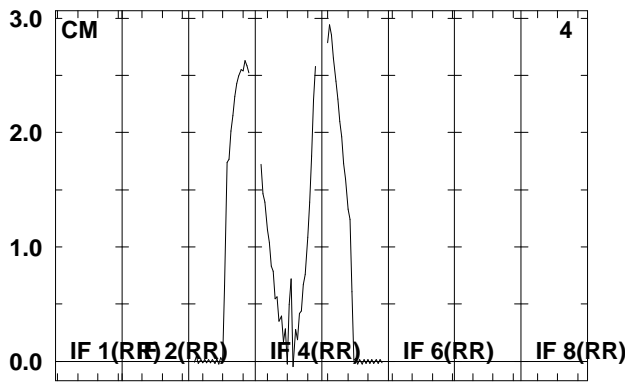
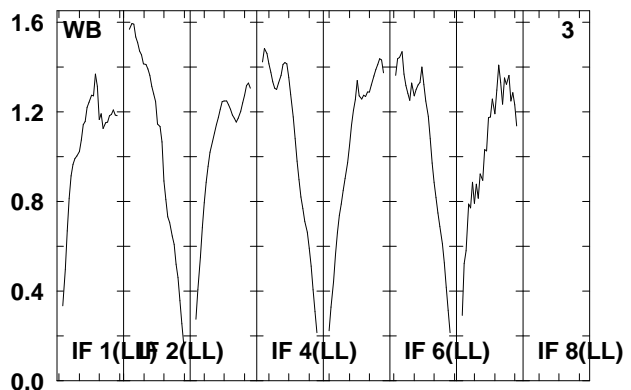
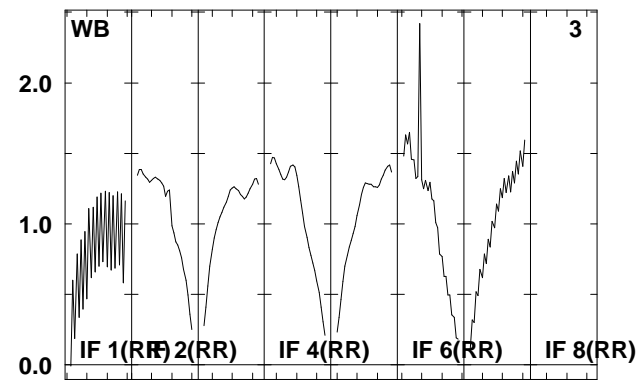
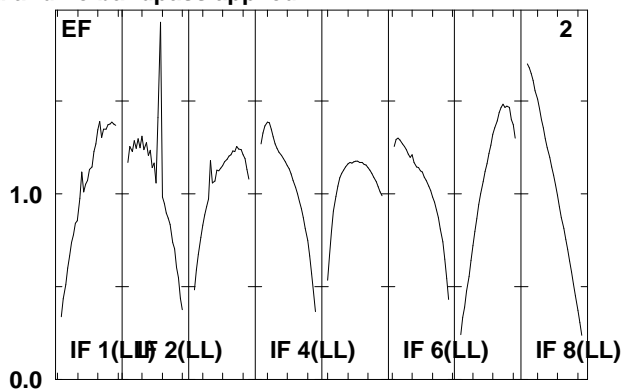
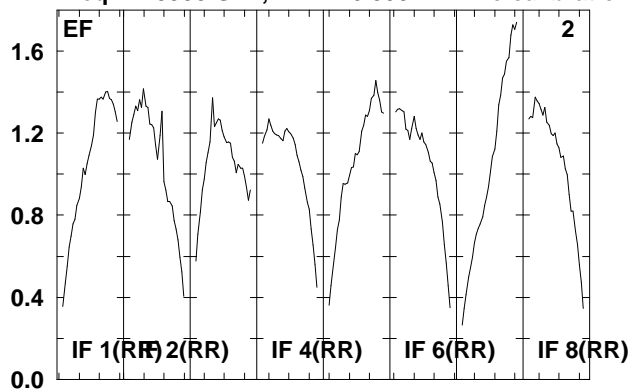

Lower frame: Real Jy
Total-power spectrum Antenna: *
Timerange: 00/21:31:32 to 00/21:33:00

Plot file version 244 created 22-APR-2008 12:28:14

J0730-02 EP061B.UVDATA.1

Freq = 1.5950 GHz, Bw = 16.000 MH No calibration applied and no bandpass applied

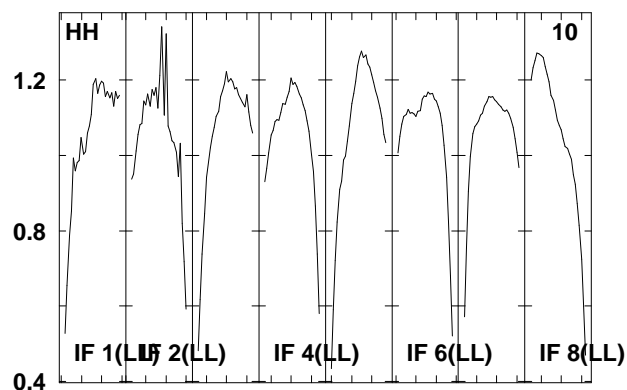
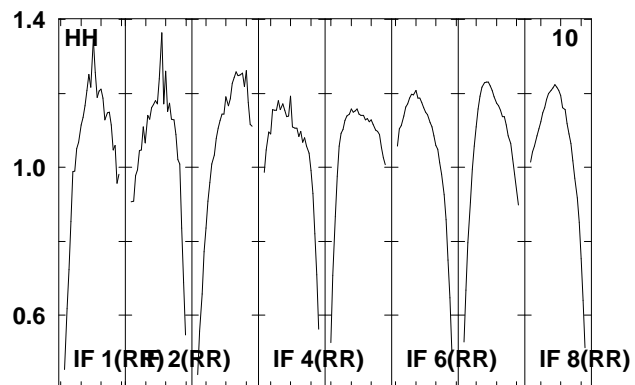
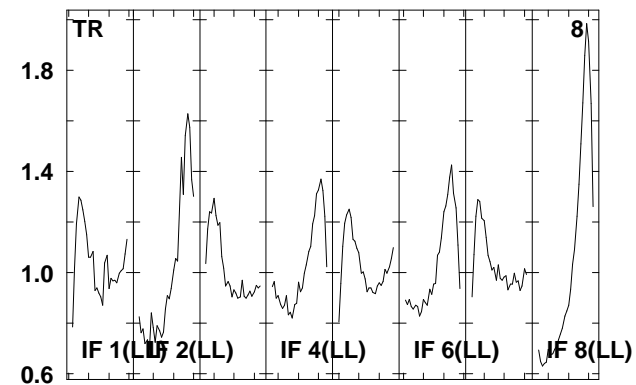
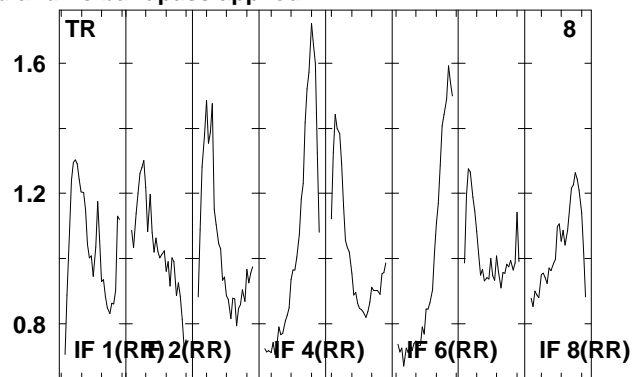
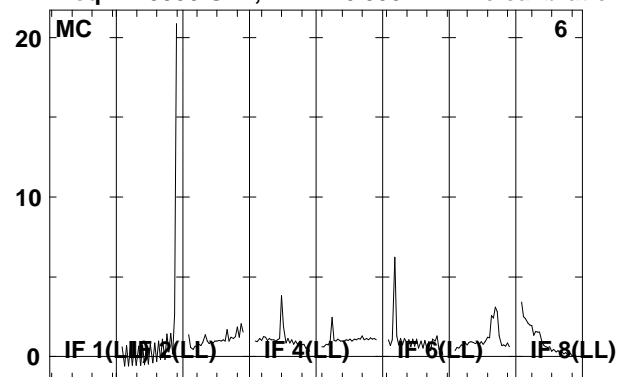

Lower frame: Real Jy
Total-power spectrum Antenna: *
Timerange: 00/21:31:32 to 00/21:33:00

Plot file version 245 created 22-APR-2008 12:28:14

IRAS0725 EP061B.UVDATA.1

Freq = 1.5950 GHz, Bw = 16.000 MH No calibration applied and no bandpass applied

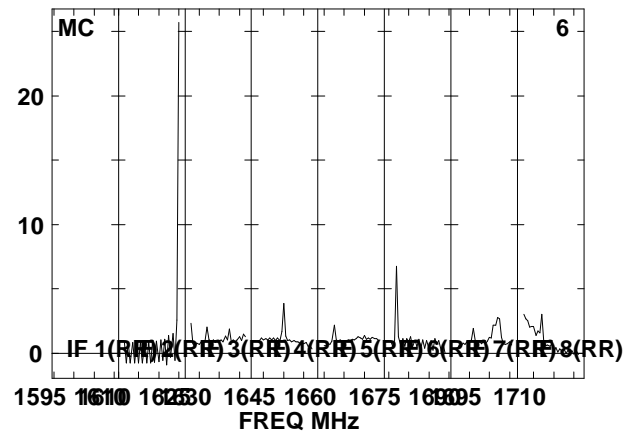
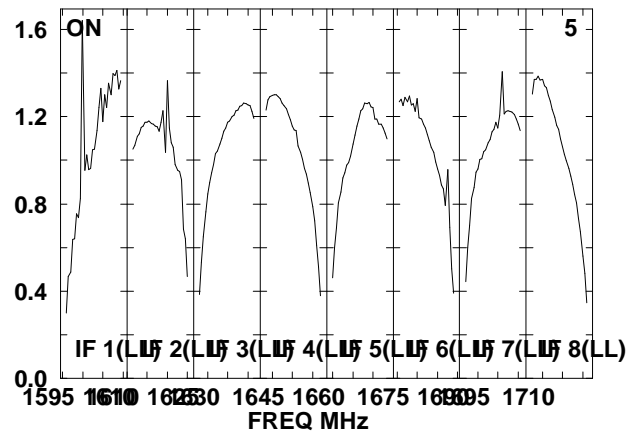
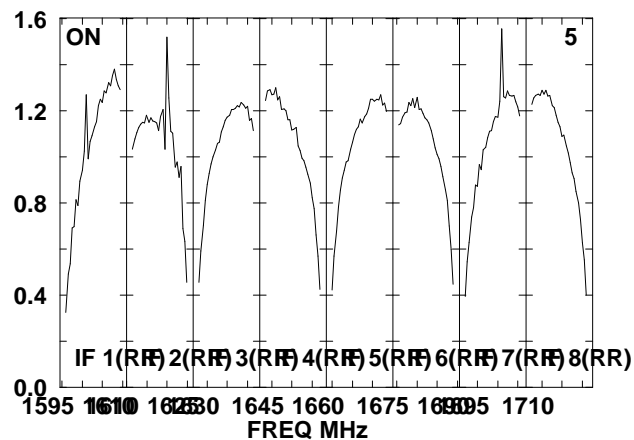
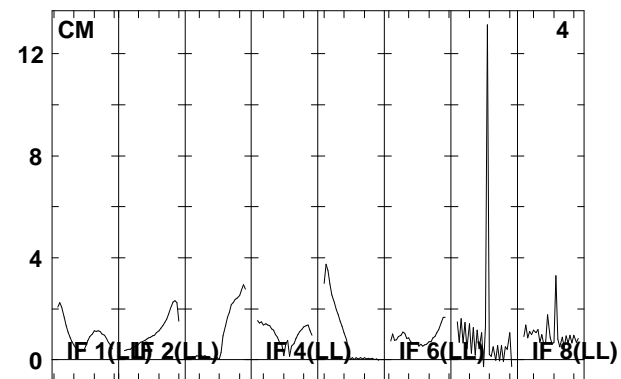
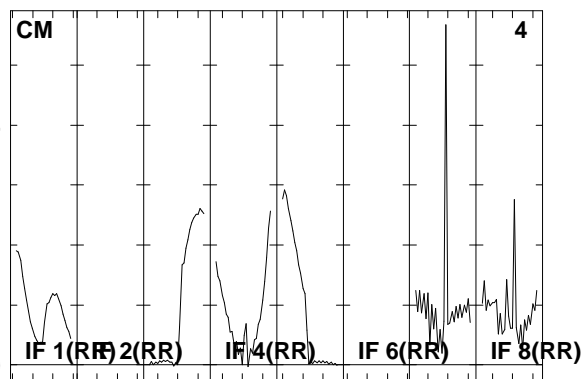
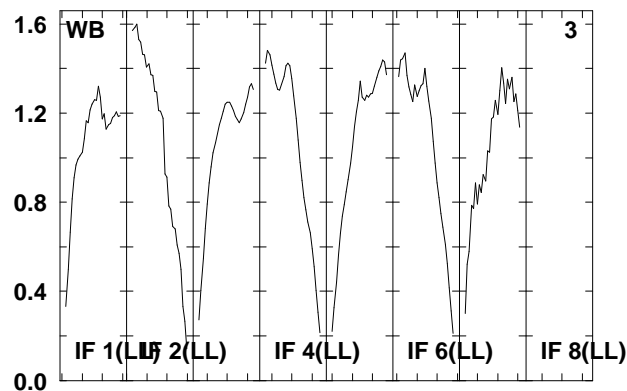
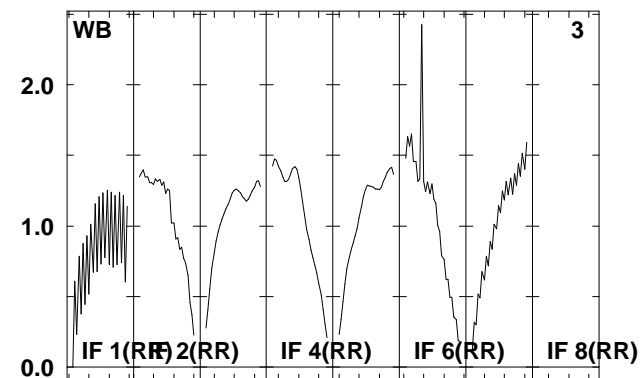
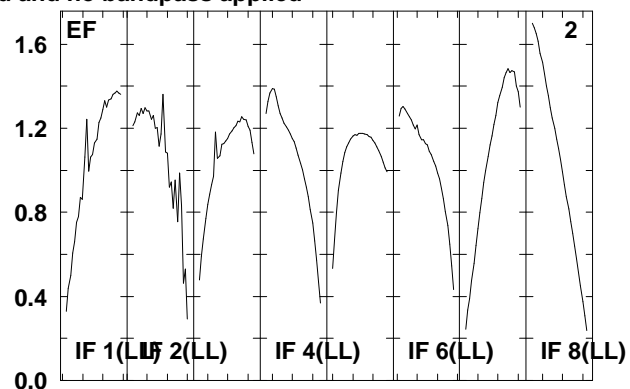
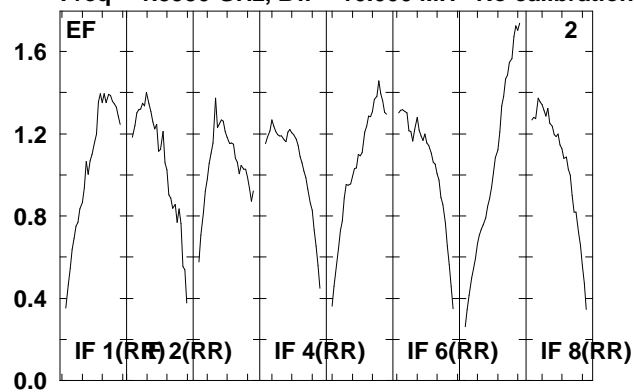

Lower frame: Real Jy
Total-power spectrum Antenna: *
Timerange: 00/21:33:02 to 00/21:36:30

Plot file version 246 created 22-APR-2008 12:28:15

IRAS0725 EP061B.UVDATA.1

Freq = 1.5950 GHz, Bw = 16.000 MH No calibration applied and no bandpass applied

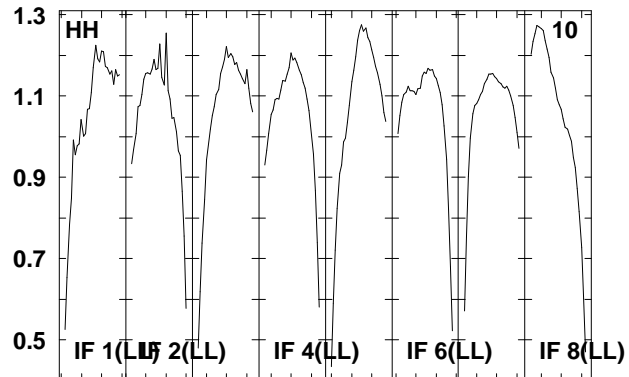
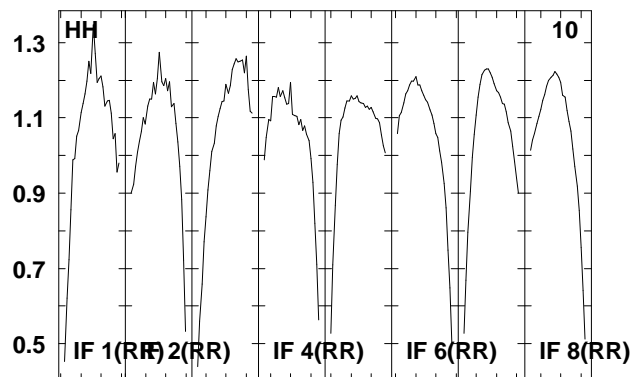
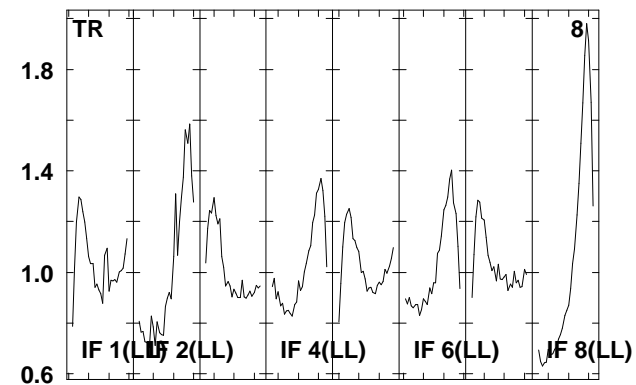
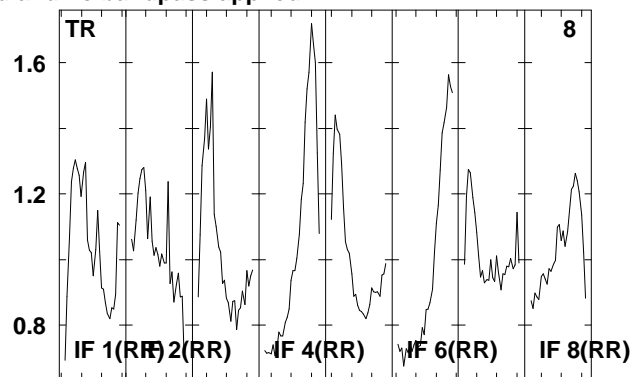
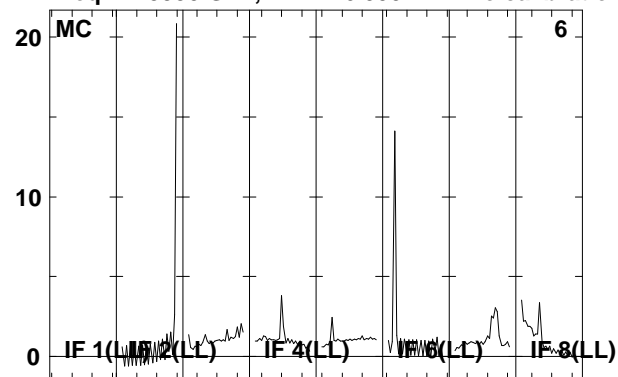

Lower frame: Real Jy
Total-power spectrum Antenna: *
Timerange: 00/21:33:02 to 00/21:36:30

Plot file version 247 created 22-APR-2008 12:28:16

J0730-02 EP061B.UVDATA.1

Freq = 1.5950 GHz, Bw = 16.000 MH No calibration applied and no bandpass applied

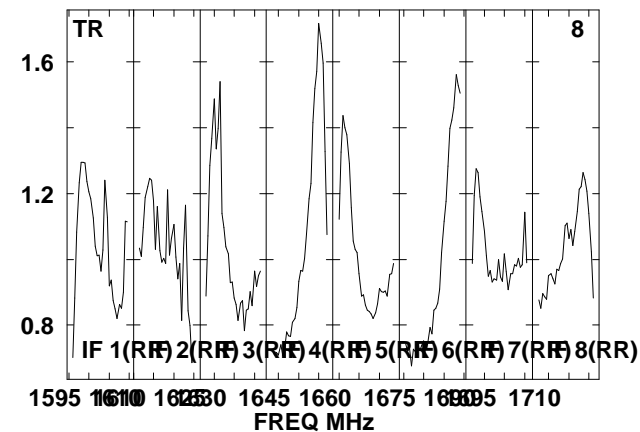
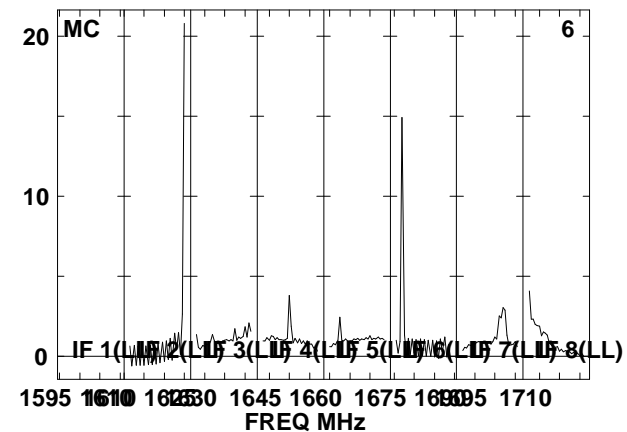
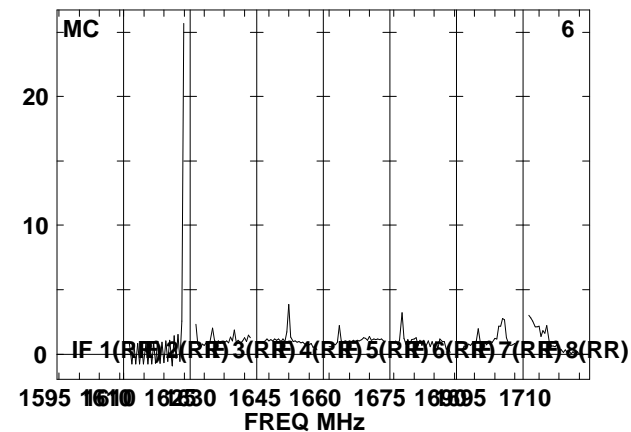
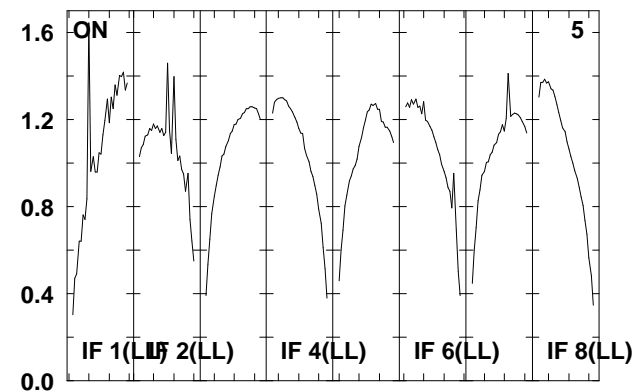
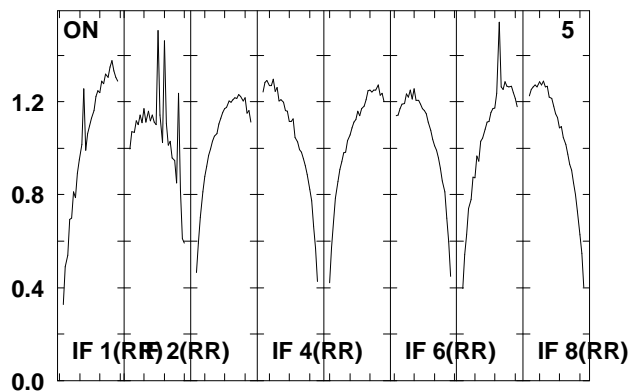
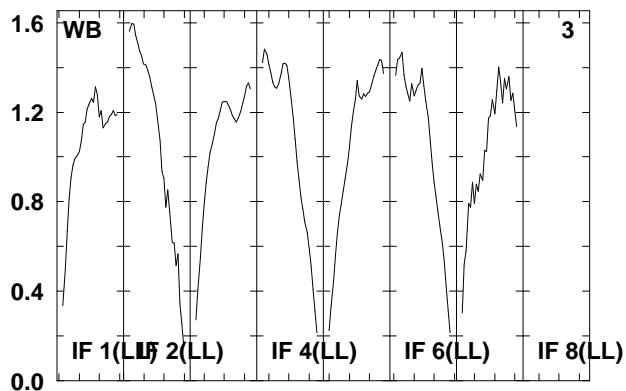
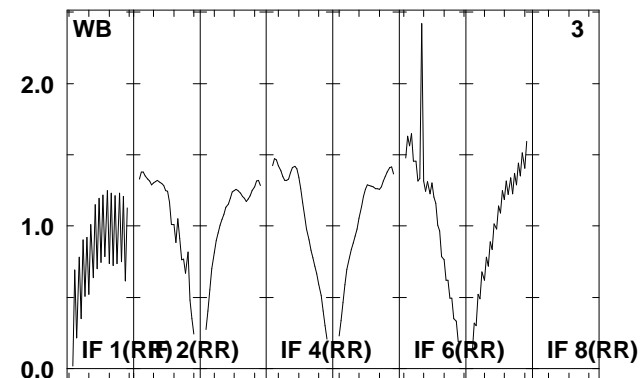
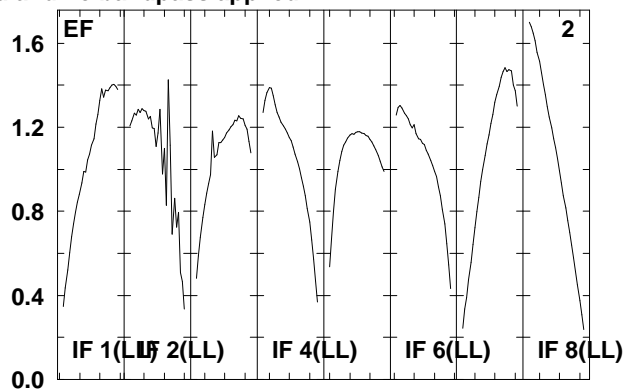
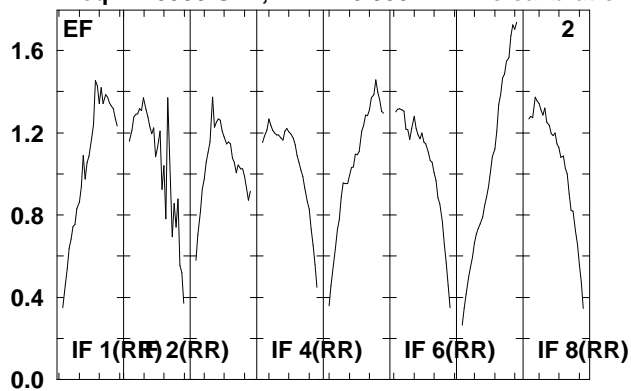

Lower frame: Real Jy
Total-power spectrum Antenna: *
Timerange: 00/21:36:32 to 00/21:38:00

Plot file version 248 created 22-APR-2008 12:28:16

J0730-02 EP061B.UVDATA.1

Freq = 1.5950 GHz, Bw = 16.000 MH No calibration applied and no bandpass applied

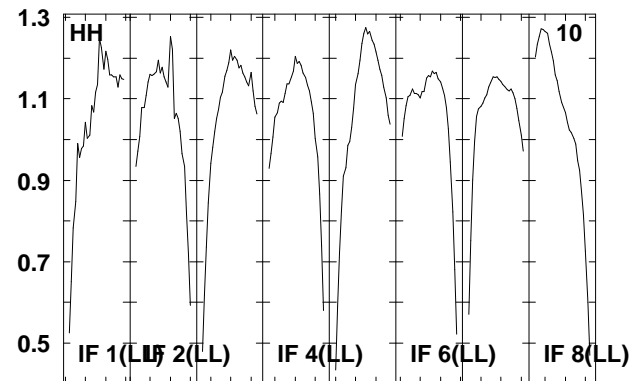
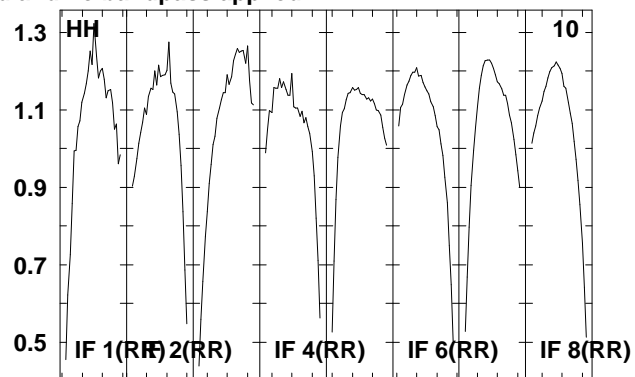
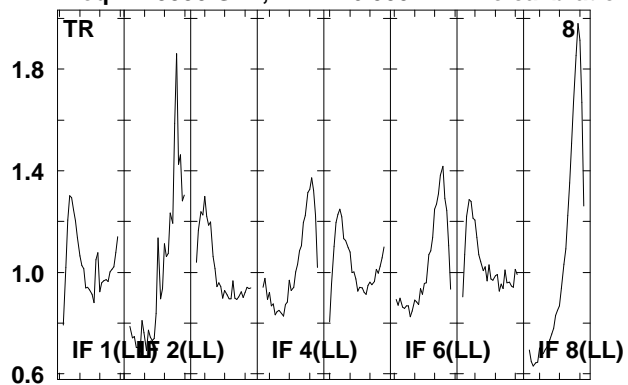

Lower frame: Real Jy
Total-power spectrum Antenna: *
Timerange: 00/21:36:32 to 00/21:38:00

Plot file version 249 created 22-APR-2008 12:28:17

IRAS0725 EP061B.UVDATA.1

Freq = 1.5950 GHz, Bw = 16.000 MH No calibration applied and no bandpass applied

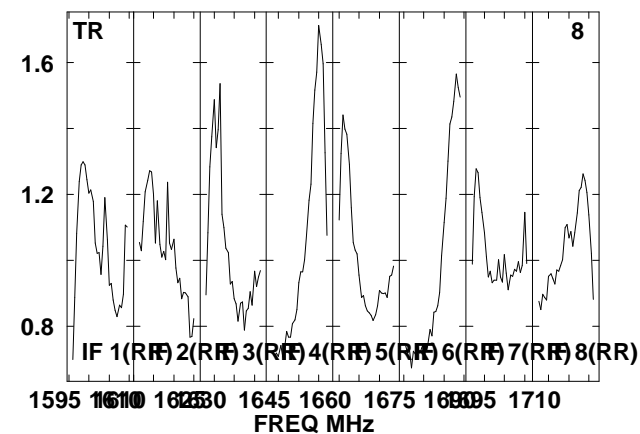
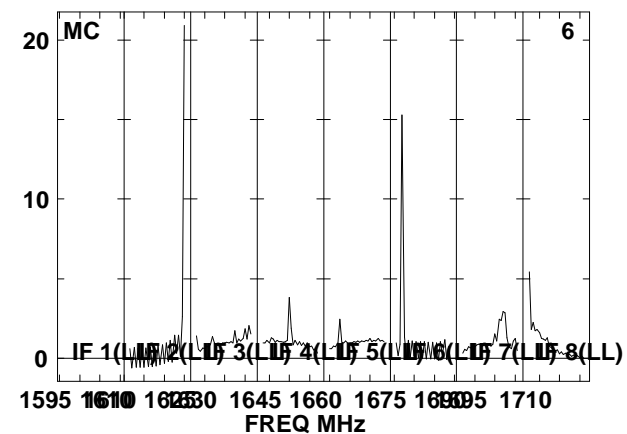
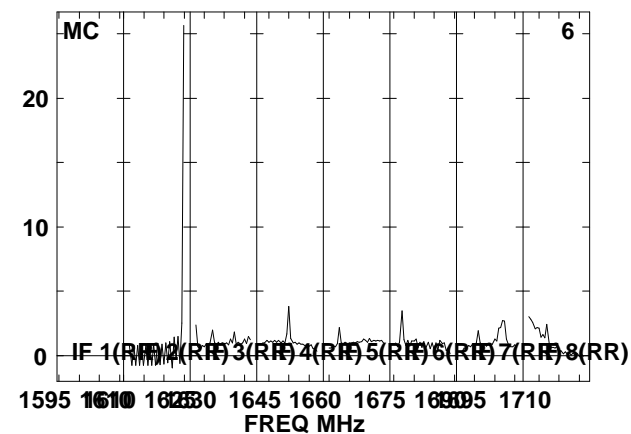
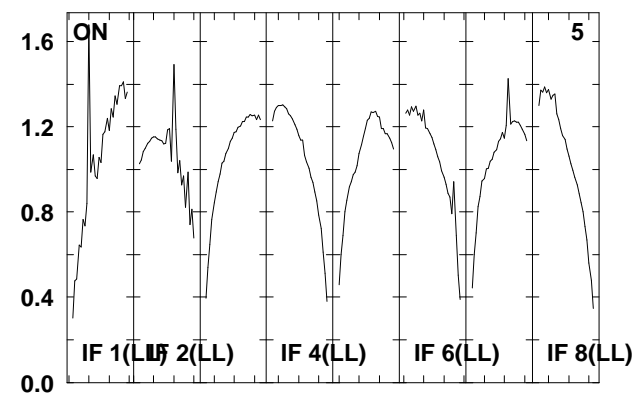
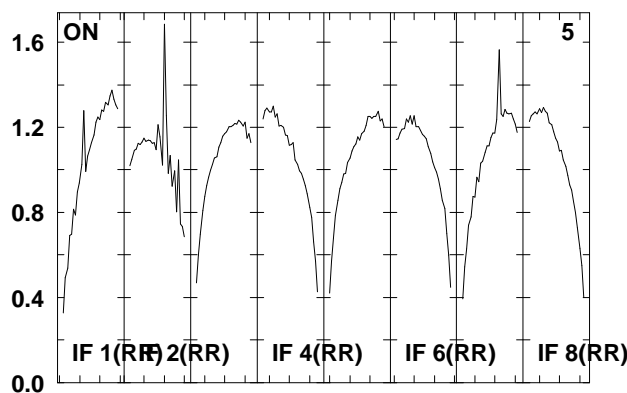
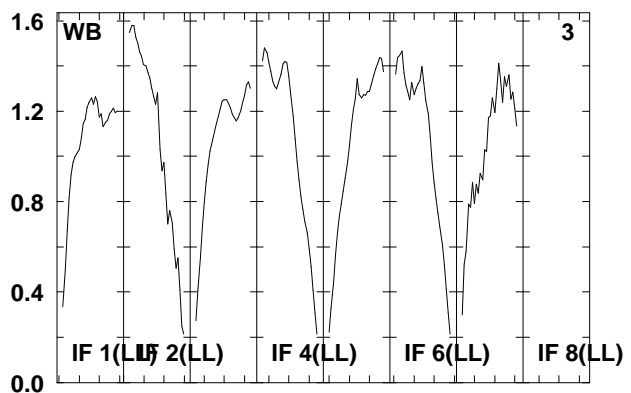
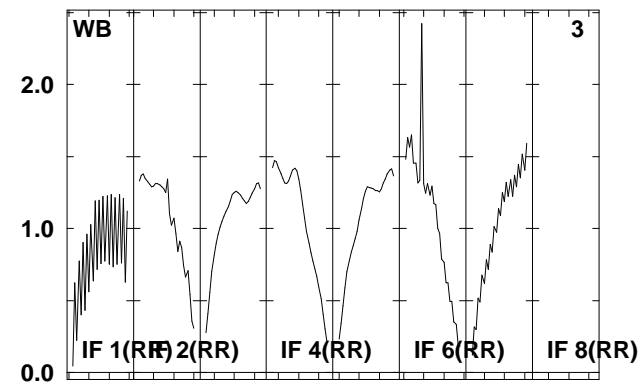
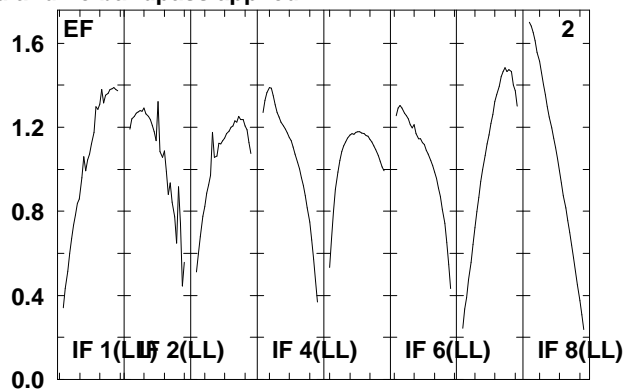
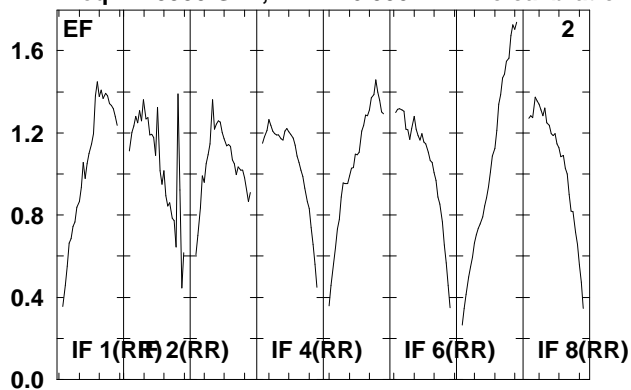

Lower frame: Real Jy
Total-power spectrum Antenna: *
Timerange: 00/21:38:02 to 00/21:41:30

Plot file version 250 created 22-APR-2008 12:28:18

IRAS0725 EP061B.UVDATA.1

Freq = 1.5950 GHz, Bw = 16.000 MH No calibration applied and no bandpass applied

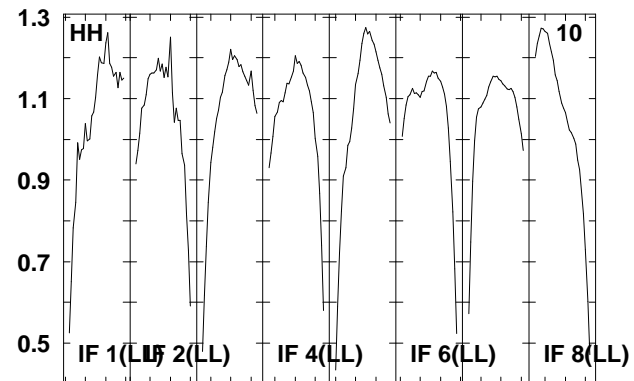
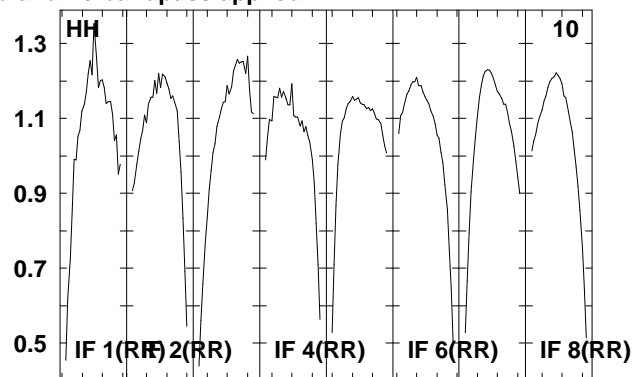
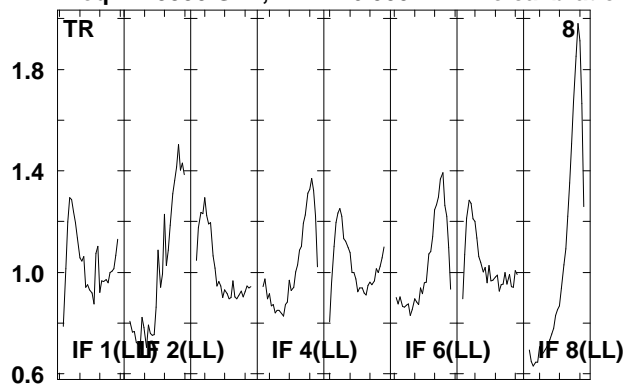

Lower frame: Real Jy
Total-power spectrum Antenna: *
Timerange: 00/21:38:02 to 00/21:41:30

Plot file version 251 created 22-APR-2008 12:28:18

J0730-02 EP061B.UVDATA.1

Freq = 1.5950 GHz, Bw = 16.000 MH No calibration applied and no bandpass applied

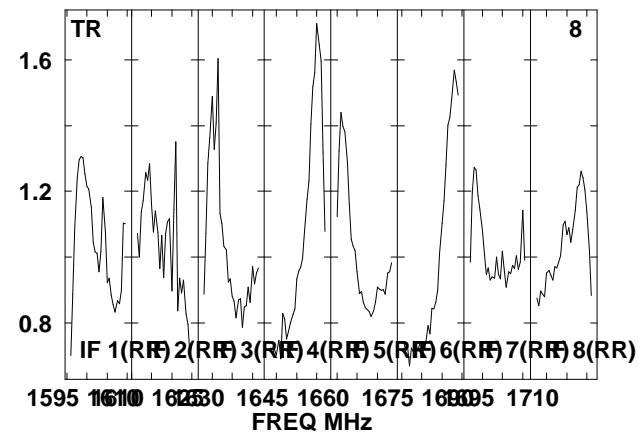
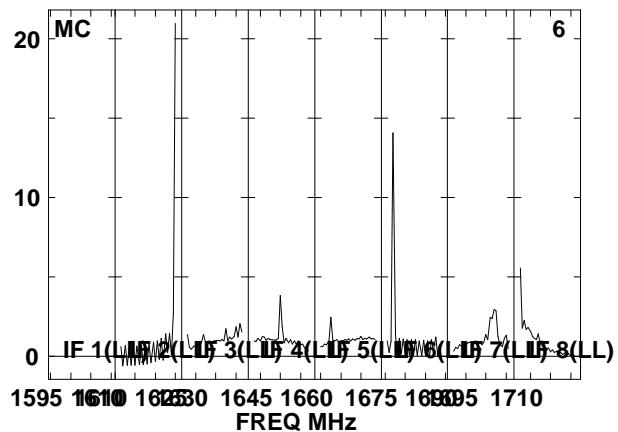
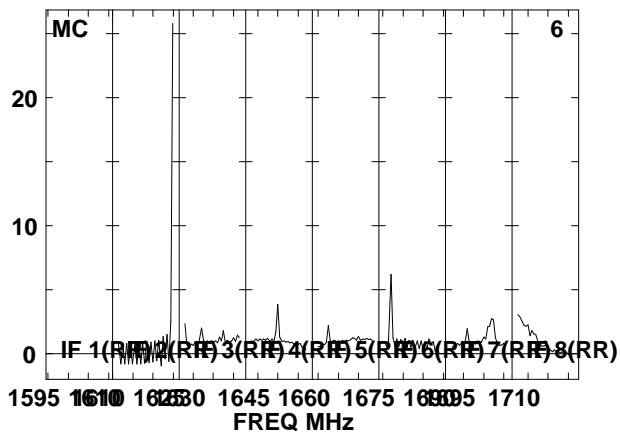
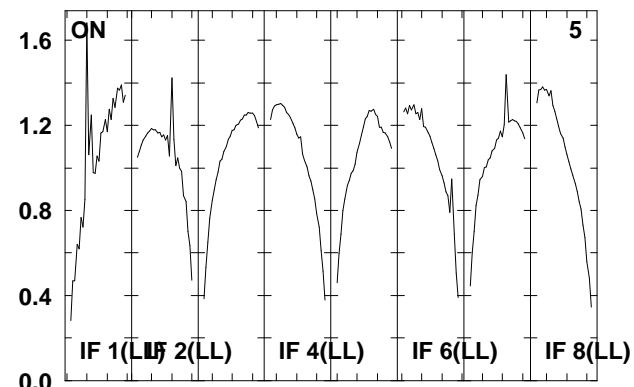
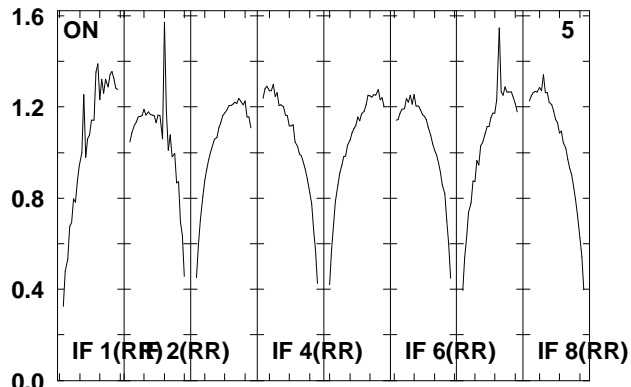
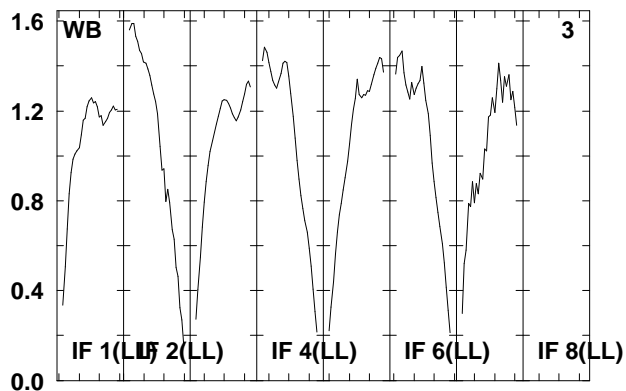
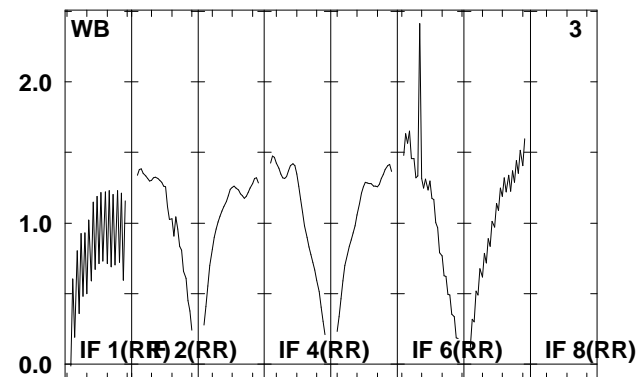
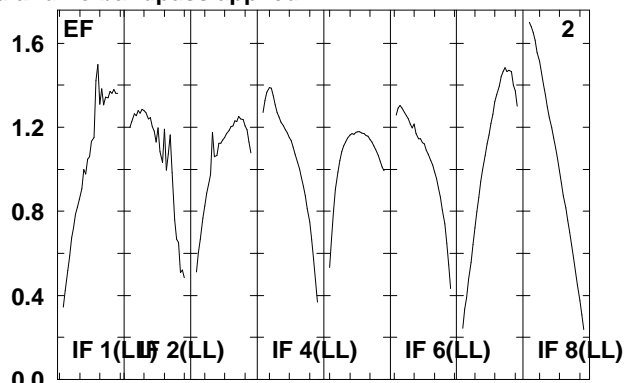
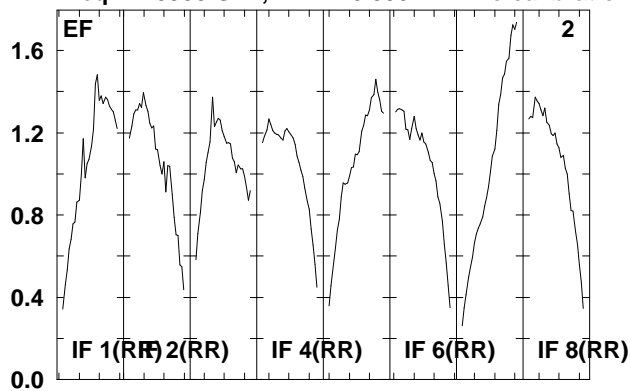

Lower frame: Real Jy

Total-power spectrum Antenna: *

Timerange: 00/21:41:32 to 00/21:43:00

Plot file version 252 created 22-APR-2008 12:28:19

J0730-02 EP061B.UVDATA.1

Freq = 1.5950 GHz, Bw = 16.000 MH No calibration applied and no bandpass applied

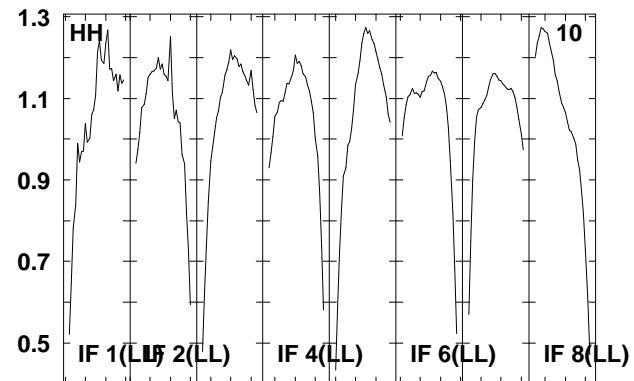
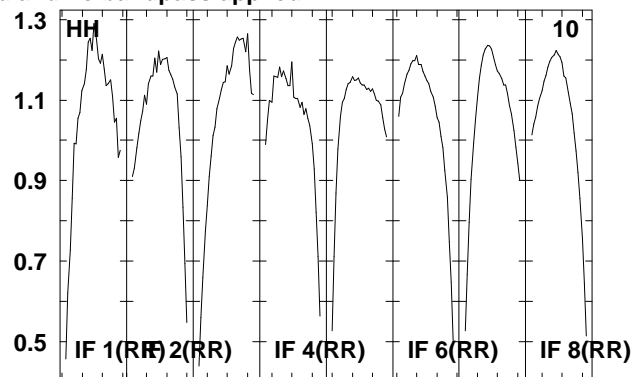
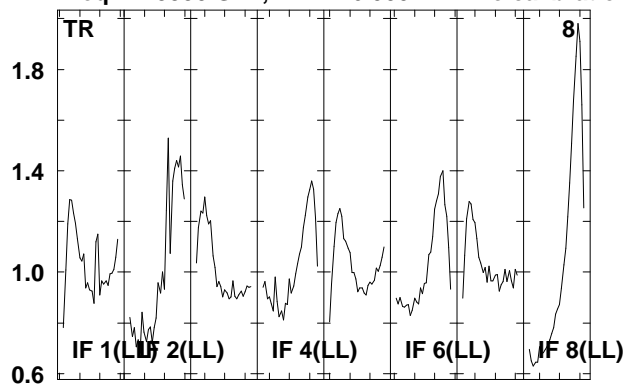

Lower frame: Real Jy
Total-power spectrum Antenna: *
Timerange: 00/21:41:32 to 00/21:43:00

Plot file version 253 created 22-APR-2008 12:28:20

IRAS0725 EP061B.UVDATA.1

Freq = 1.5950 GHz, Bw = 16.000 MH No calibration applied and no bandpass applied

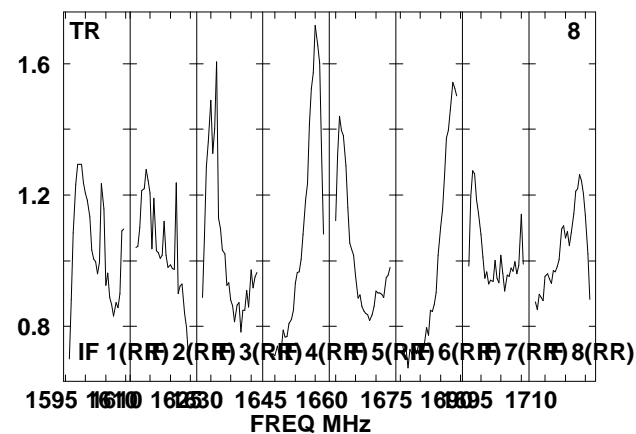
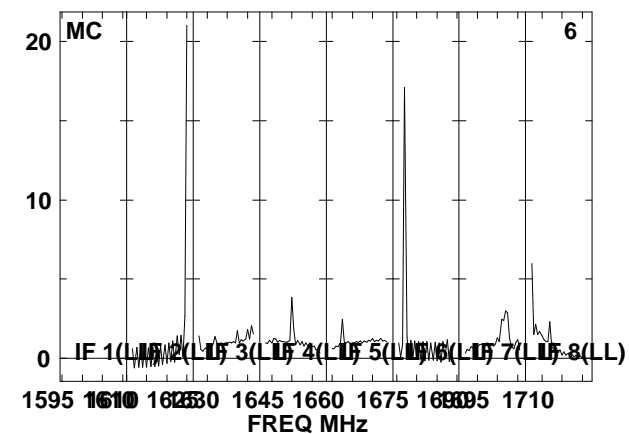
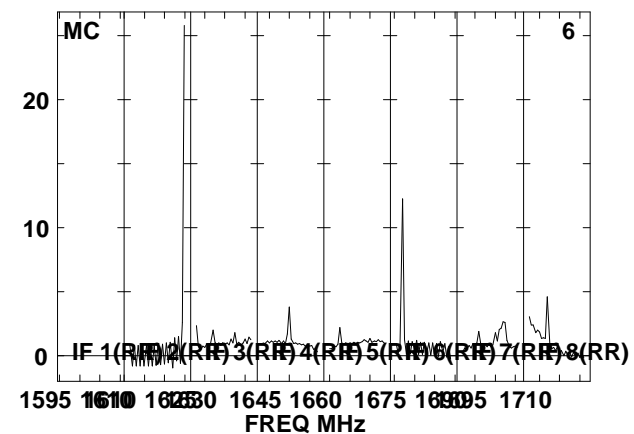
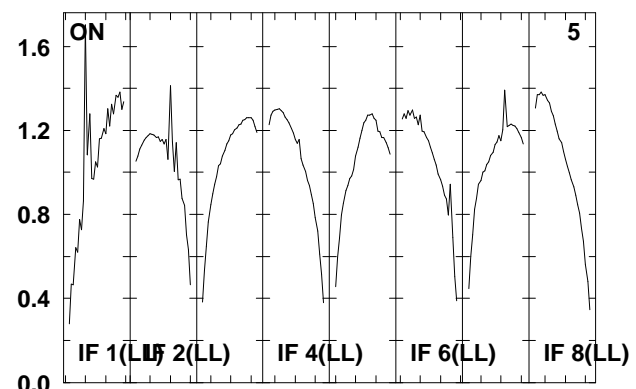
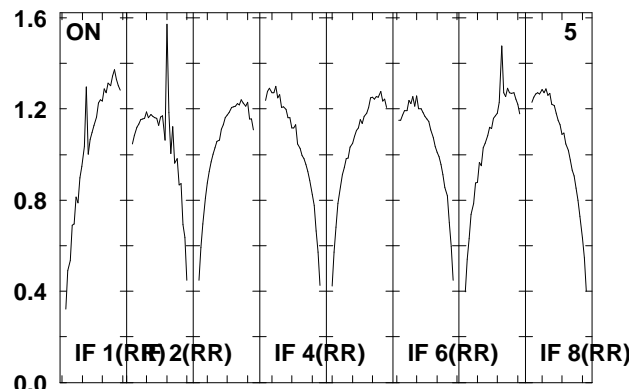
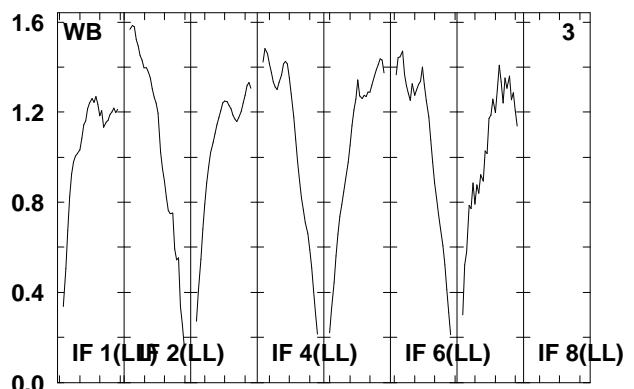
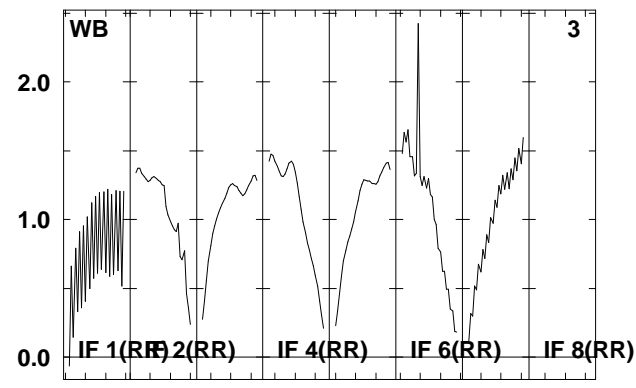
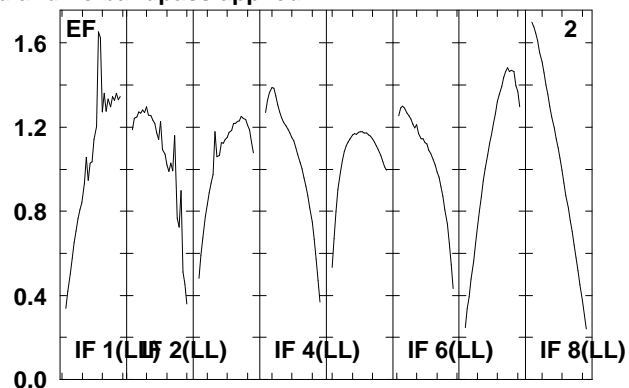
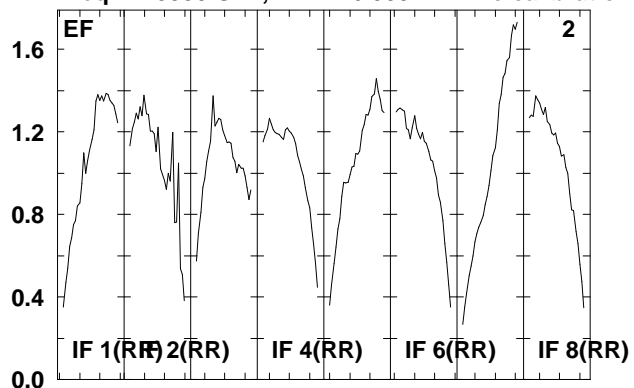

Lower frame: Real Jy
Total-power spectrum Antenna: *
Timerange: 00/21:43:02 to 00/21:44:56

Plot file version 254 created 22-APR-2008 12:28:20

IRAS0725 EP061B.UVDATA.1

Freq = 1.5950 GHz, Bw = 16.000 MH No calibration applied and no bandpass applied

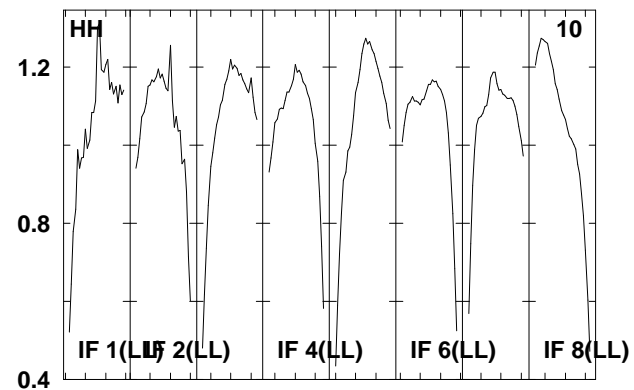
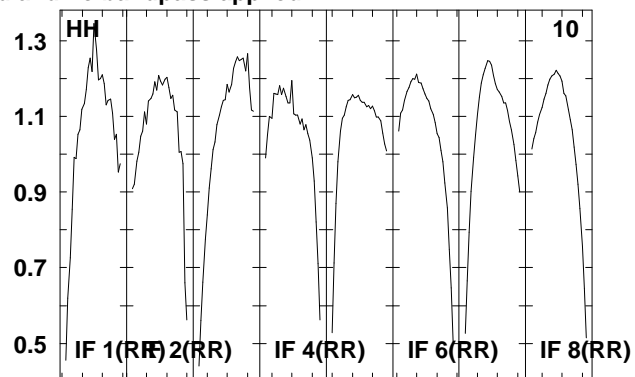
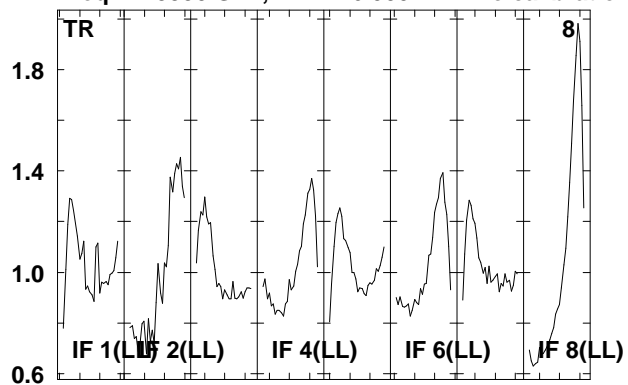

Lower frame: Real Jy
Total-power spectrum Antenna: *
Timerange: 00/21:43:02 to 00/21:44:56

Plot file version 255 created 22-APR-2008 12:28:22

3C286 EP061B.UVDATA.1

Freq = 1.5950 GHz, Bw = 16.000 MH No calibration applied and no bandpass applied

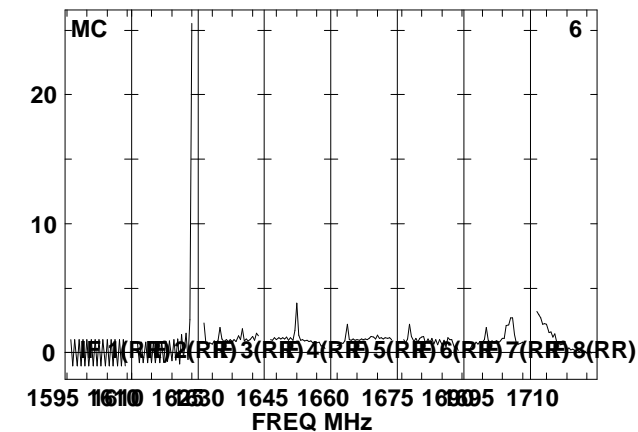
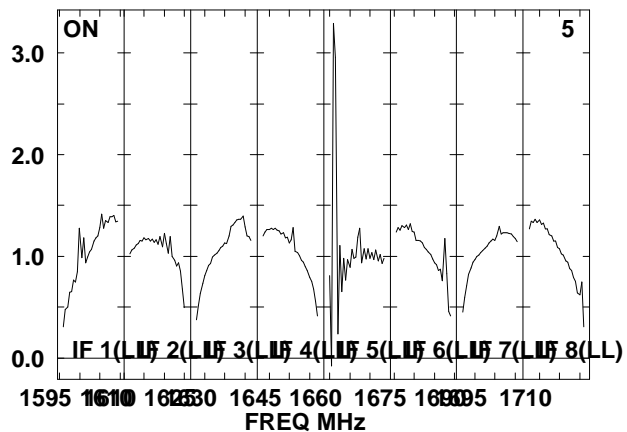
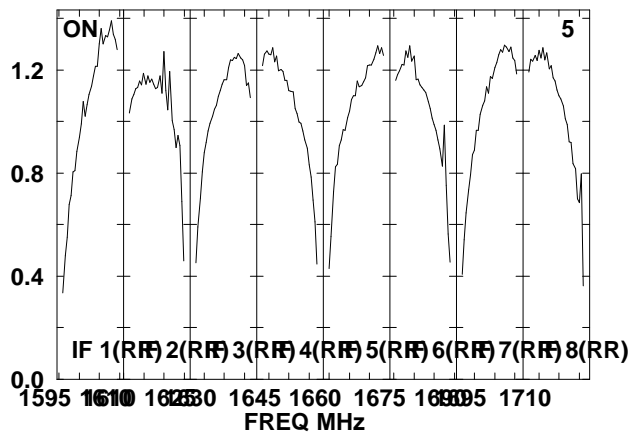
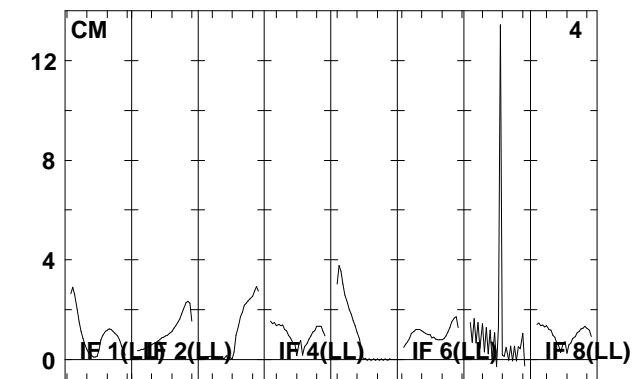
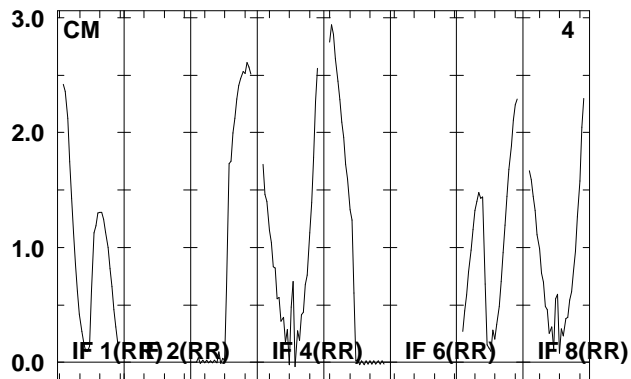
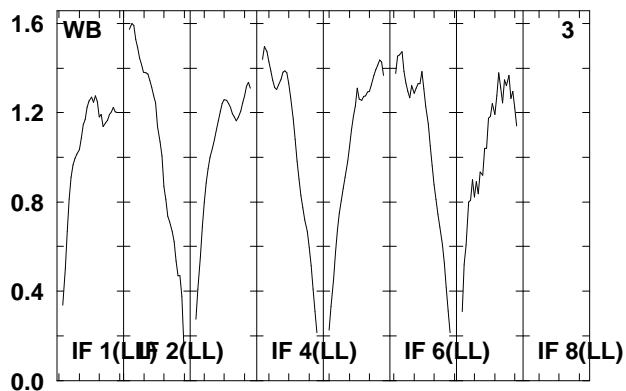
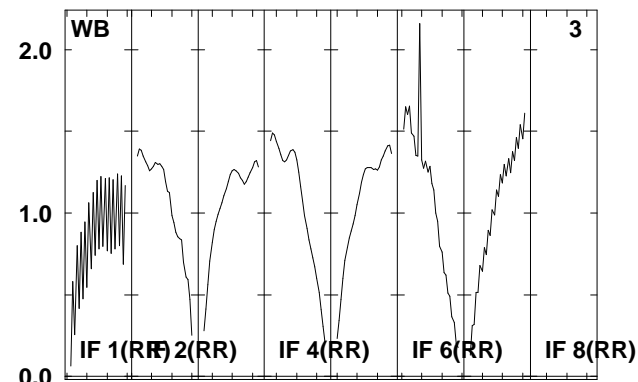
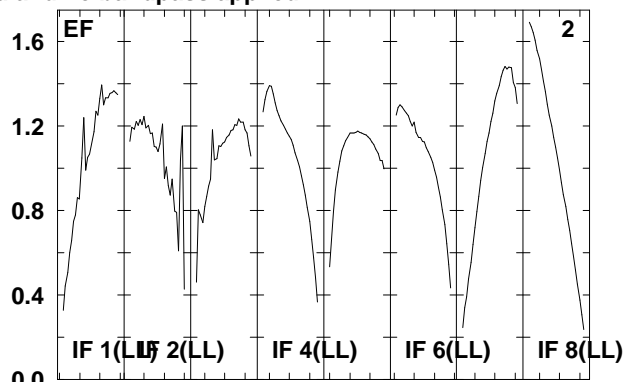
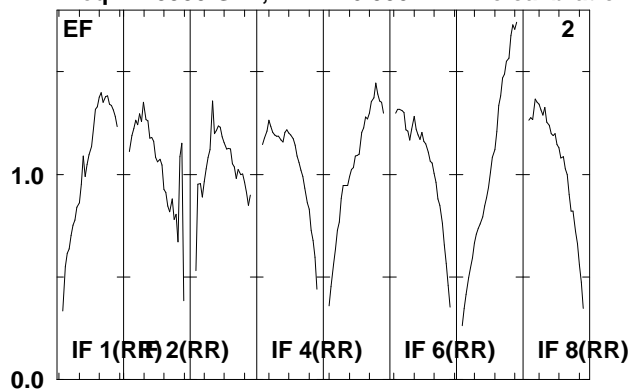

Lower frame: Real Jy
Total-power spectrum Antenna: *
Timerange: 00/21:46:02 to 00/21:55:00

Plot file version 256 created 22-APR-2008 12:28:23

3C286 EP061B.UVDATA.1

Freq = 1.5950 GHz, Bw = 16.000 MH No calibration applied and no bandpass applied

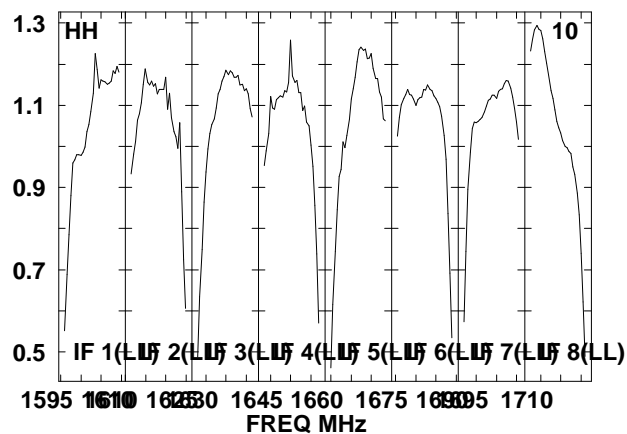
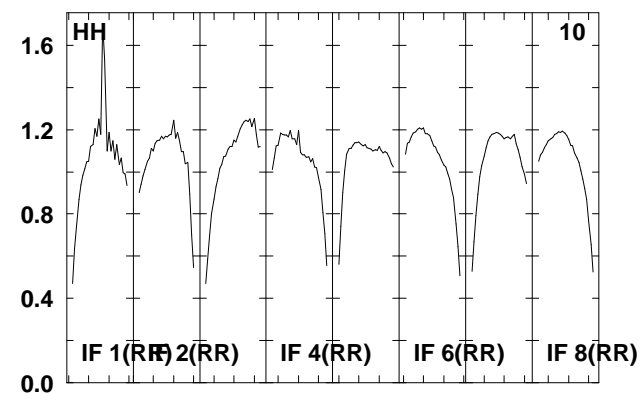
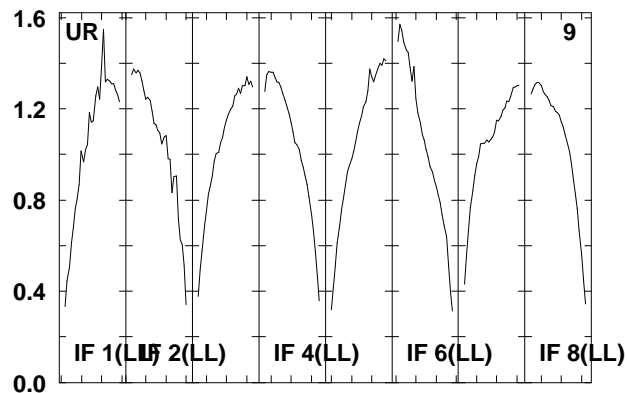
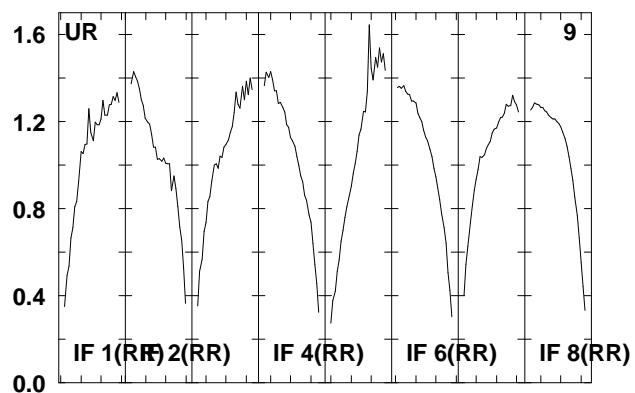
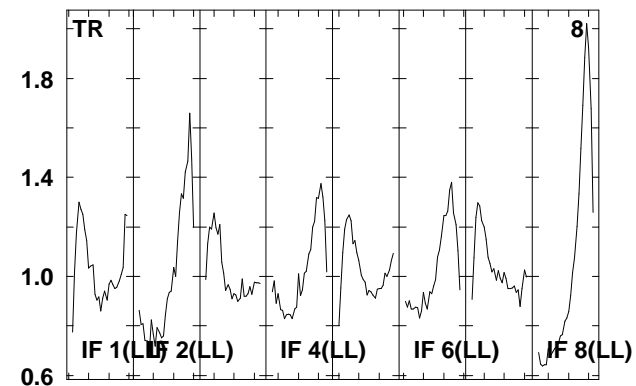
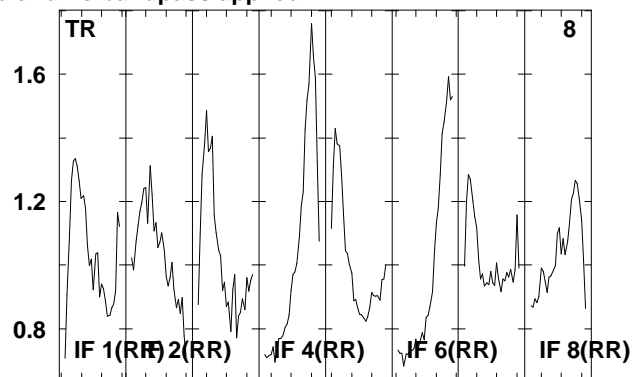
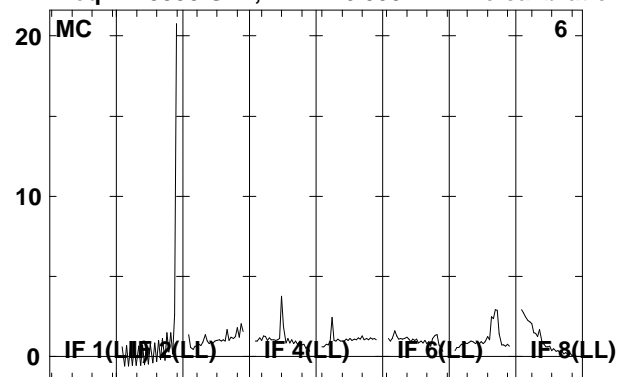

1595 1610 1625 1640 1655 1670 1685 1700 1715
FREQ MHz

Lower frame: Real Jy

Total-power spectrum Antenna: *

Timerange: 00/21:46:02 to 00/21:55:00

Plot file version 257 created 22-APR-2008 12:28:24

3C273 EP061B.UVDATA.1

Freq = 1.5950 GHz, Bw = 16.000 MH No calibration applied and no bandpass applied

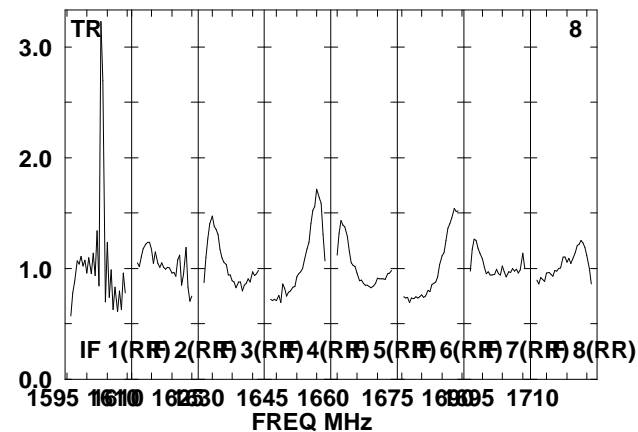
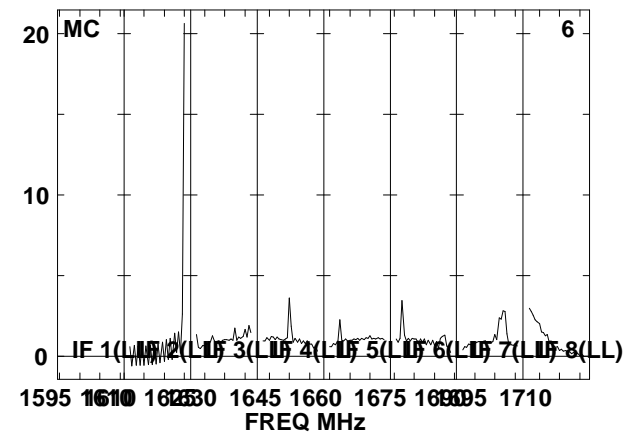
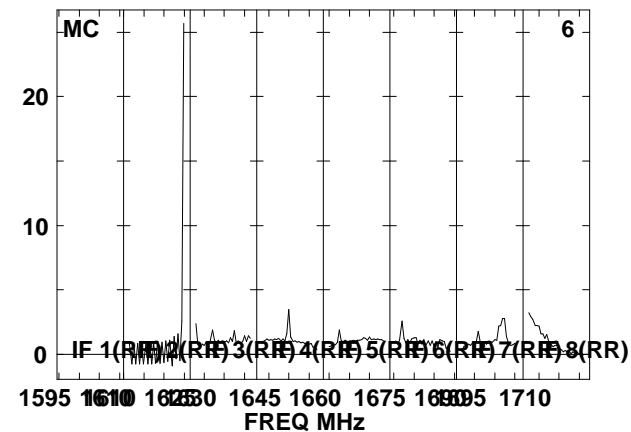
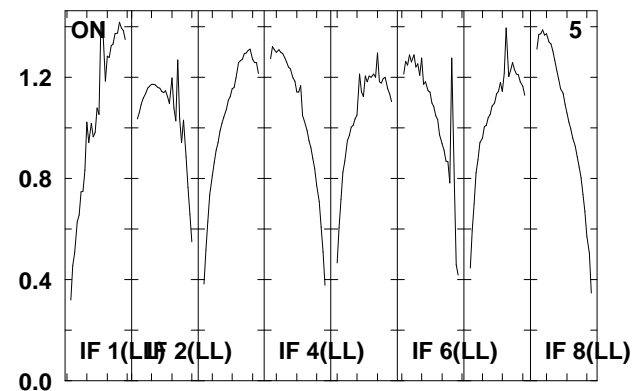
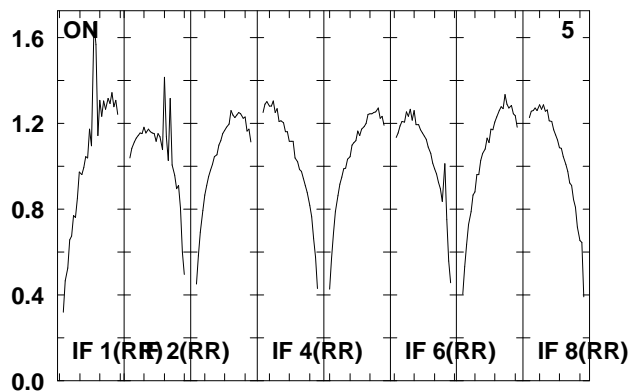
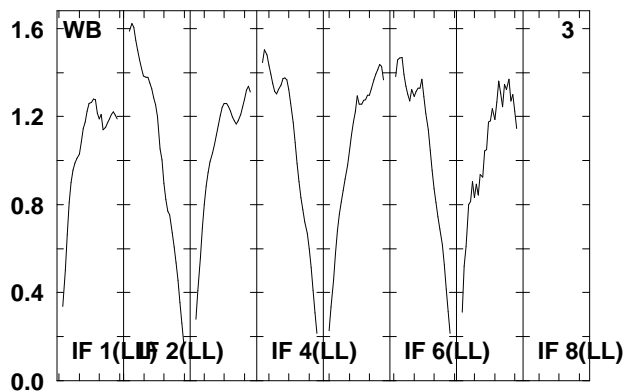
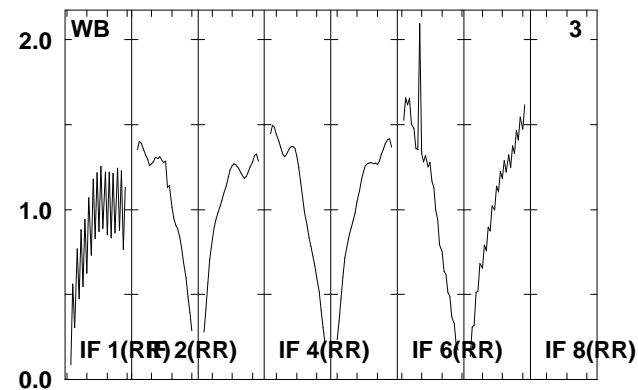
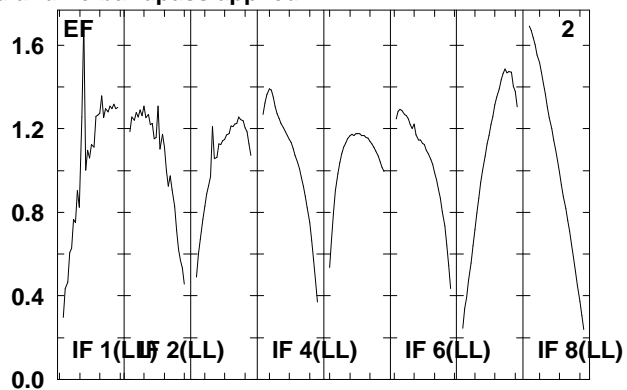
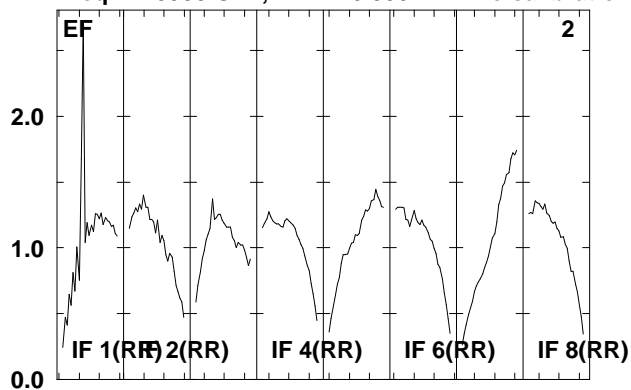

Lower frame: Real Jy
Total-power spectrum Antenna: *
Timerange: 00/21:55:02 to 00/21:59:56

Plot file version 258 created 22-APR-2008 12:28:25

3C273 EP061B.UVDATA.1

Freq = 1.5950 GHz, Bw = 16.000 MH No calibration applied and no bandpass applied

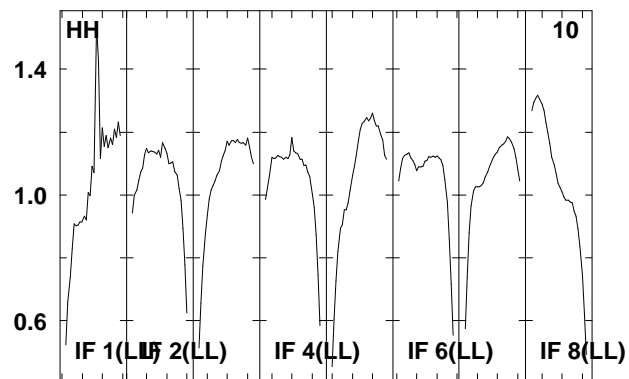
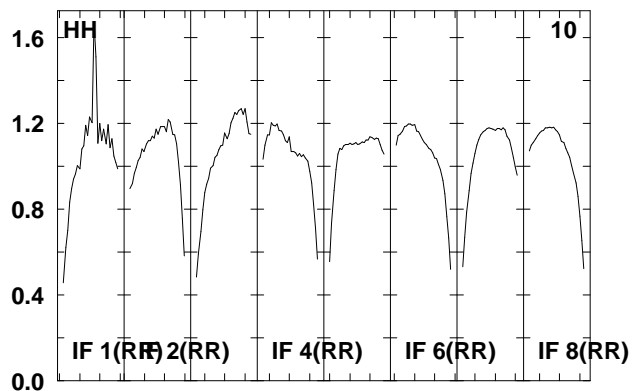
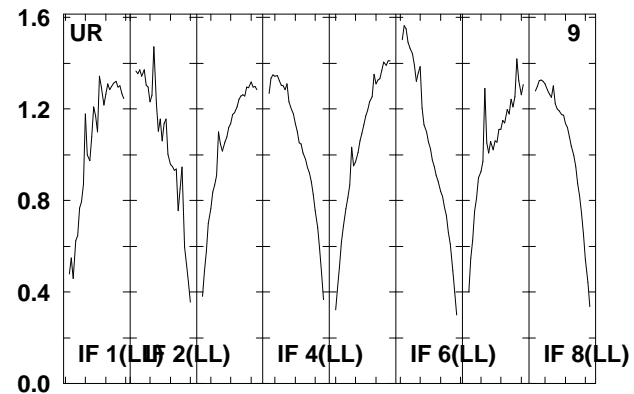
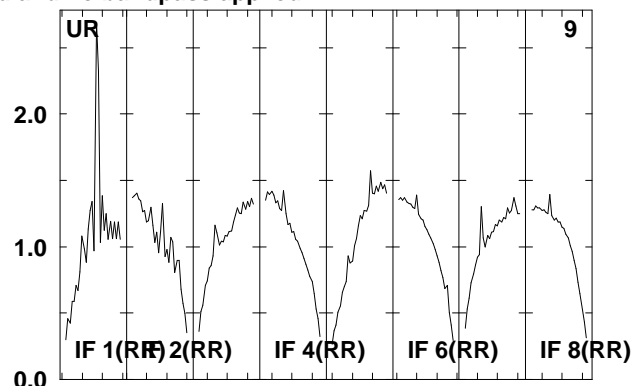
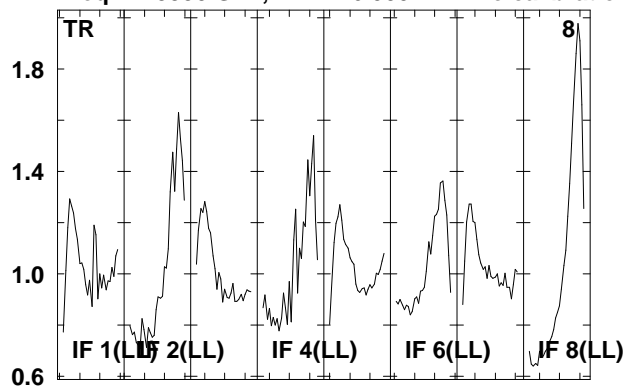

Lower frame: Real Jy
Total-power spectrum Antenna: *
Timerange: 00/21:55:02 to 00/21:59:56