

Plot file version 1 created 29-APR-2009 14:26:18

2134+004 EP064D.UVDATA.1

Freq = 1.5950 GHz, Bw = 16.000 MH Calibrated with CL # 3 and BP # 1 (BP mode 1)

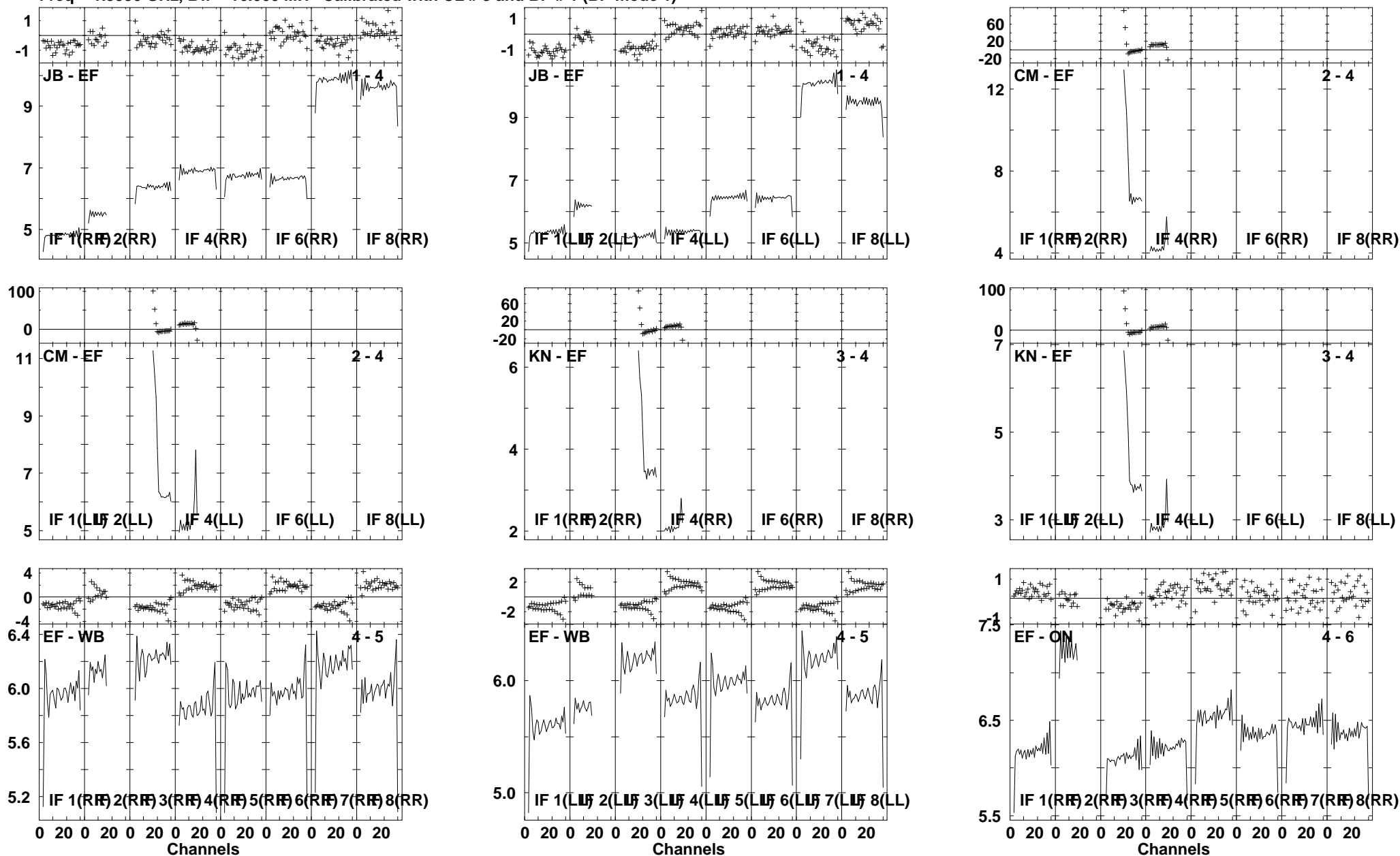

Lower frame: Ampl Jy Top frame: Phas deg
Vector averaged cross-power spectrum Several baselines displayed
Timerange: 00/12:00:01 to 00/12:06:27

Plot file version 2 created 29-APR-2009 14:26:22

2134+004 EP064D.UVDATA.1

Freq = 1.5950 GHz, Bw = 16.000 MH Calibrated with CL # 3 and BP # 1 (BP mode 1)

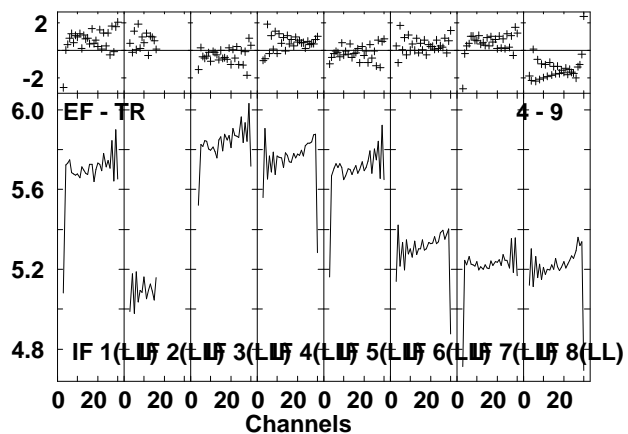
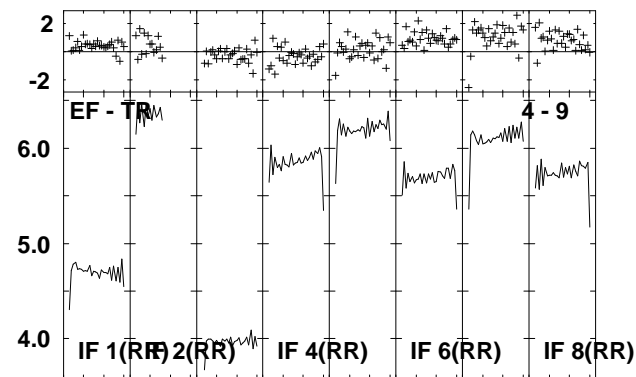
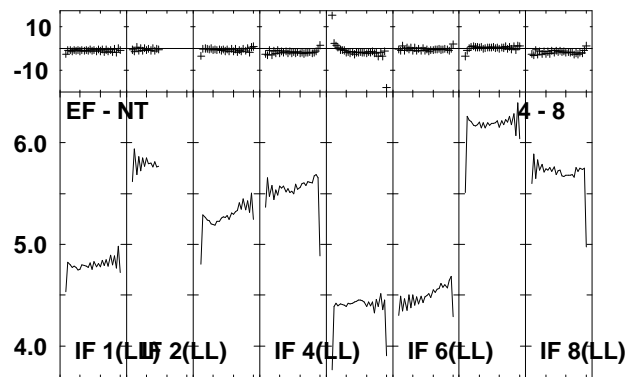
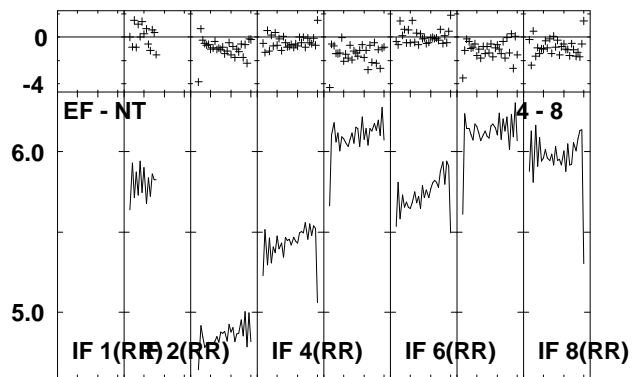
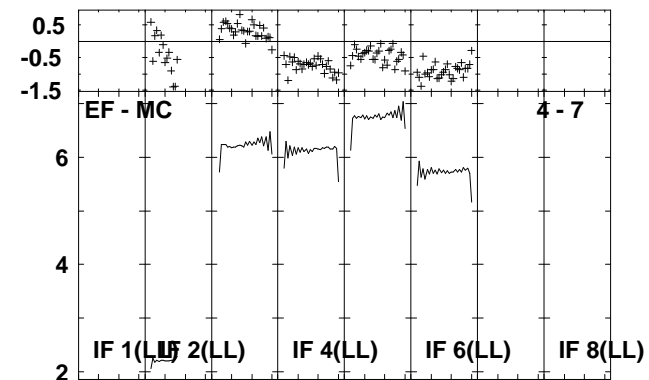
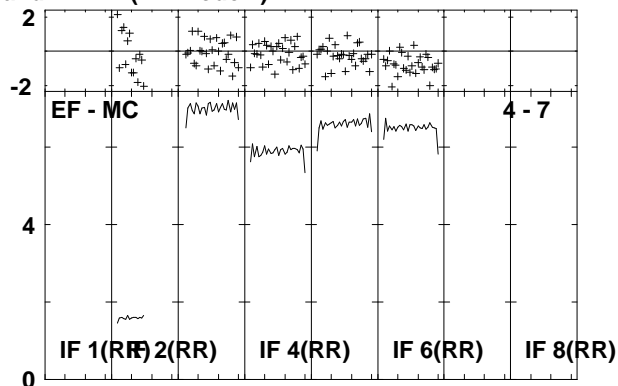
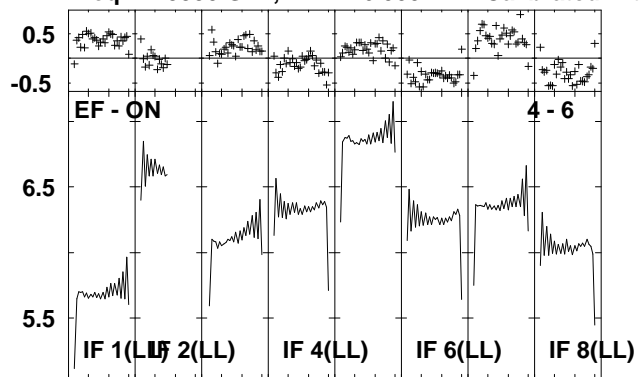

Lower frame: Ampl Jy Top frame: Phas deg
Vector averaged cross-power spectrum Several baselines displayed
Timerange: 00/12:00:01 to 00/12:06:27

Plot file version 3 created 29-APR-2009 14:26:28

3C454.3 EP064D.UVDATA.1

Freq = 1.5950 GHz, Bw = 16.000 MH Calibrated with CL # 3 and BP # 1 (BP mode 1)

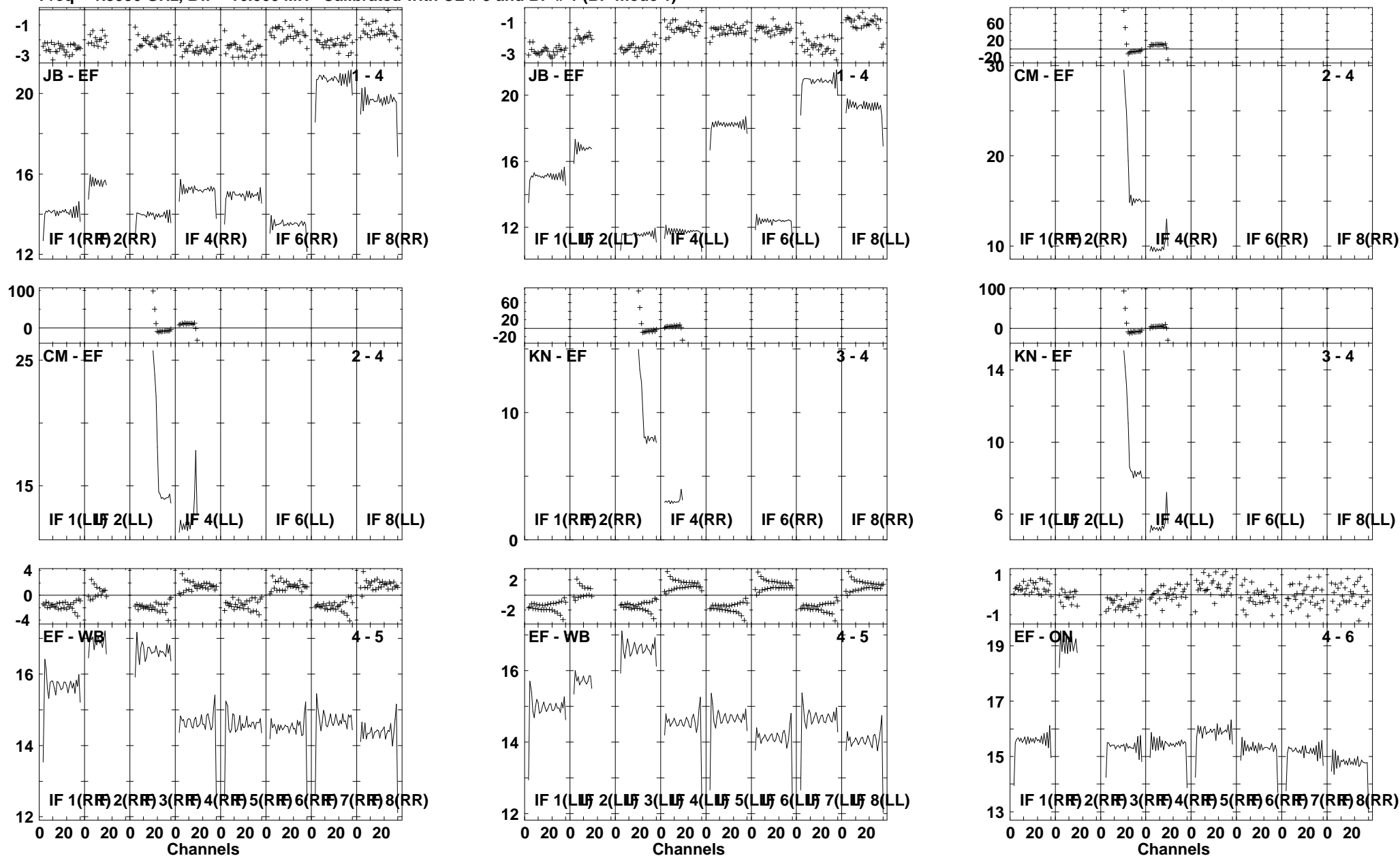

Lower frame: Ampl Jy Top frame: Phas deg
Vector averaged cross-power spectrum Several baselines displayed
Timerange: 00/12:06:31 to 00/12:12:59

Plot file version 4 created 29-APR-2009 14:26:32

3C454.3 EP064D.UVDATA.1

Freq = 1.5950 GHz, Bw = 16.000 MH Calibrated with CL # 3 and BP # 1 (BP mode 1)

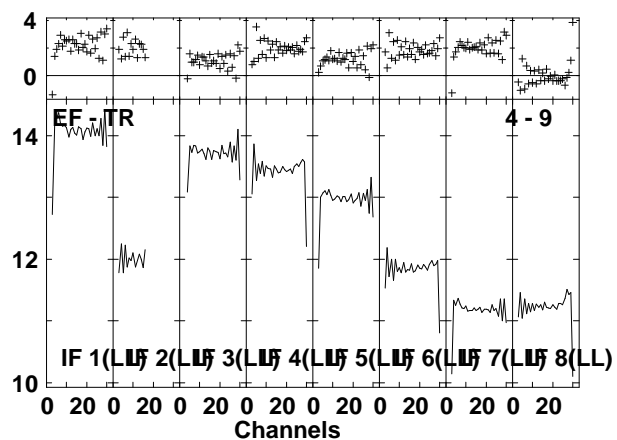
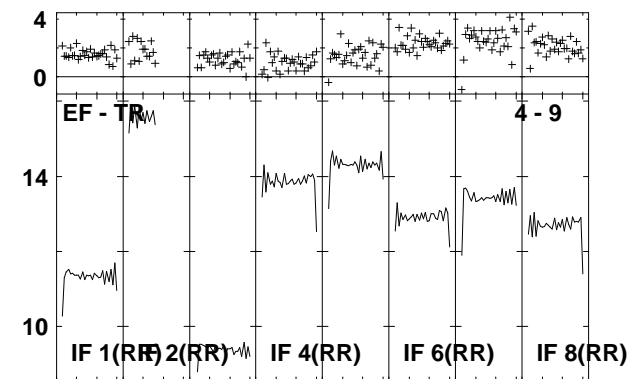
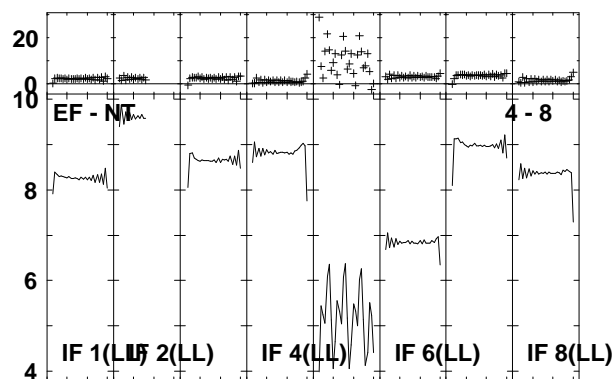
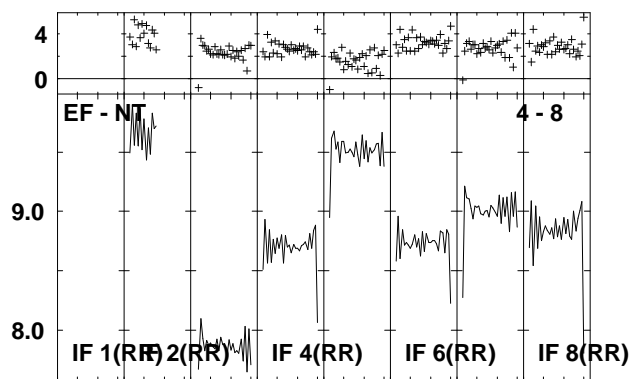
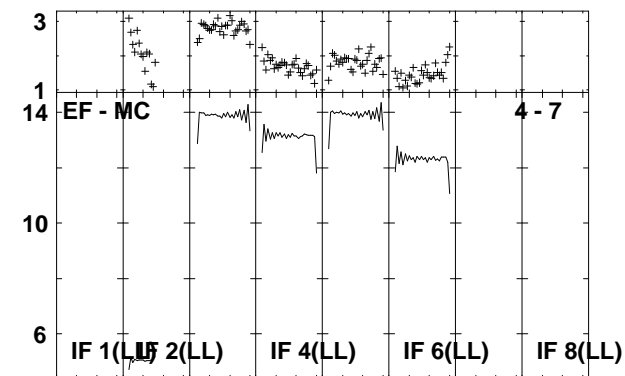
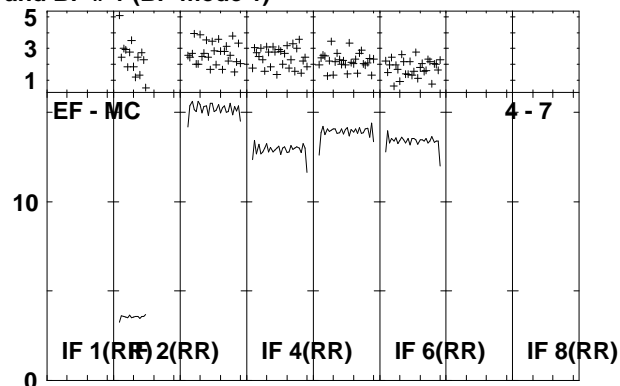
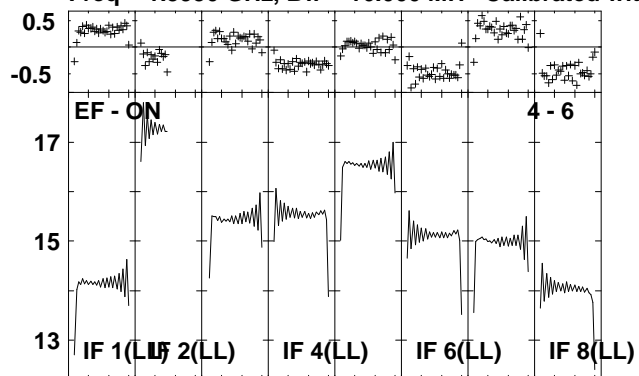

Lower frame: Ampl Jy Top frame: Phas deg
Vector averaged cross-power spectrum Several baselines displayed
Timerange: 00/12:06:31 to 00/12:12:59

Plot file version 5 created 29-APR-2009 14:26:36
 J2333+39 EP064D.UVDATA.1
 Freq = 1.5950 GHz, Bw = 16.000 MH Calibrated with CL # 3 and BP # 1 (BP mode 1)

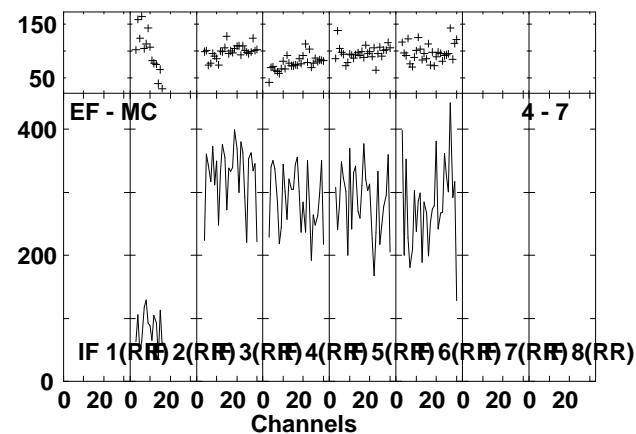
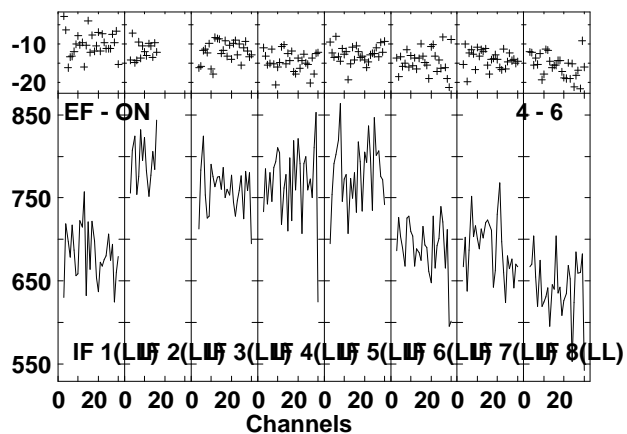
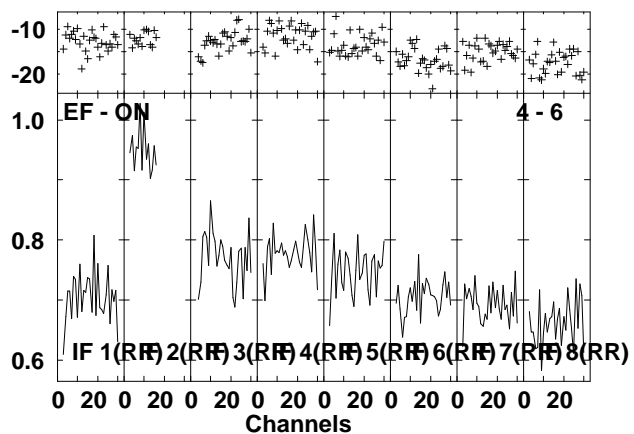
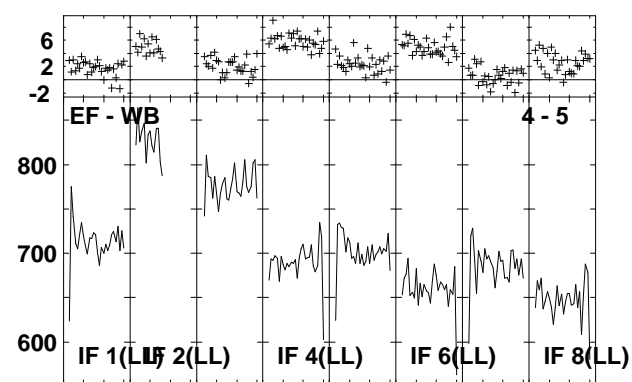
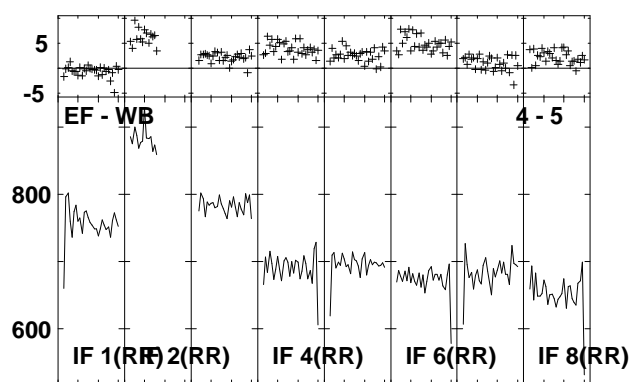
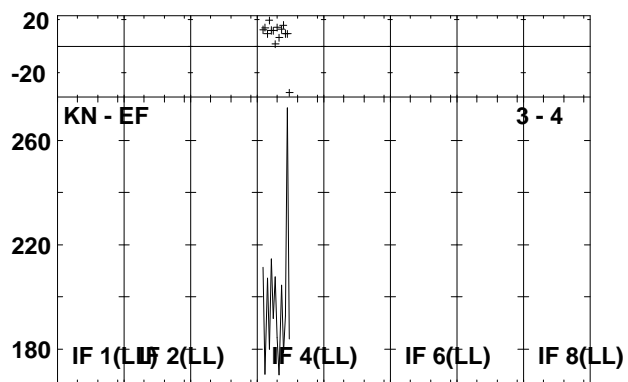
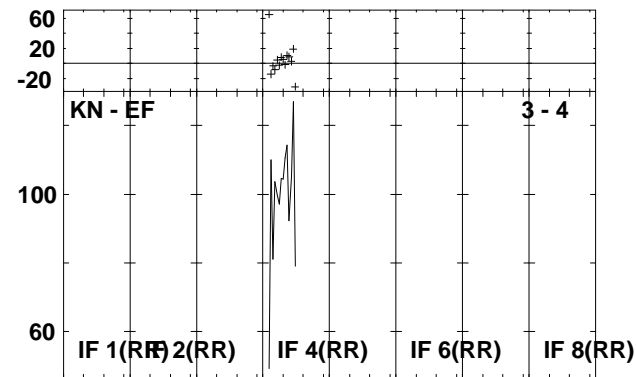
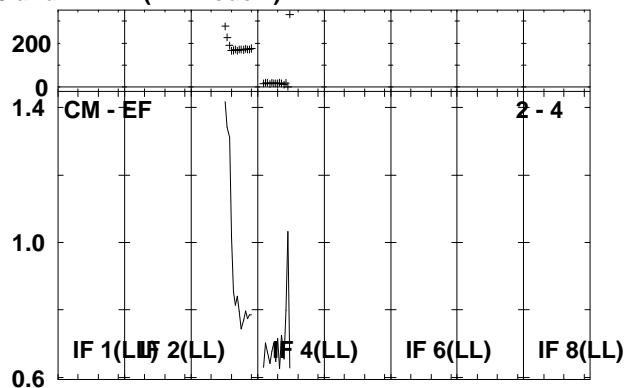
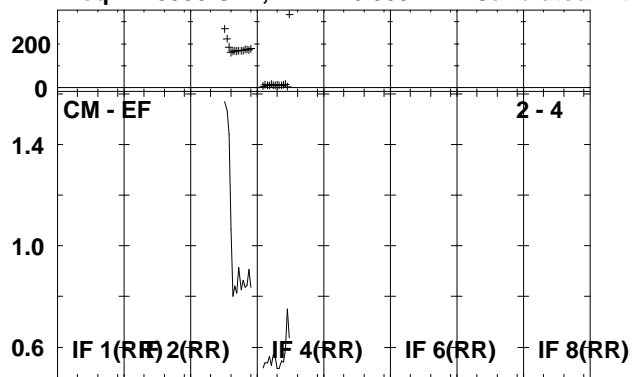

Lower frame: Ampl Jy Top frame: Phas deg
 Vector averaged cross-power spectrum Several baselines displayed
 Timerange: 00/12:14:03 to 00/12:15:27

Plot file version 6 created 29-APR-2009 14:26:37
 J2333+39 EP064D.UVDATA.1
 Freq = 1.5950 GHz, Bw = 16.000 MH Calibrated with CL # 3 and BP # 1 (BP mode 1)

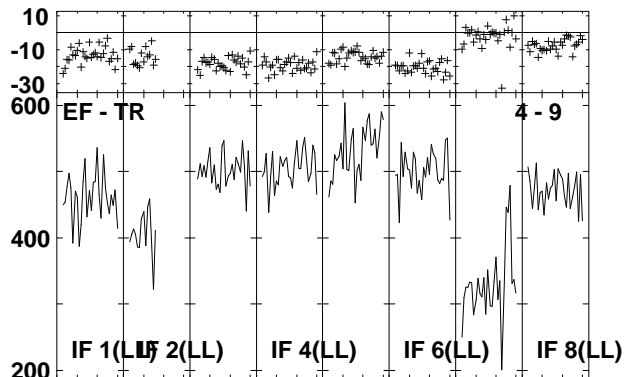
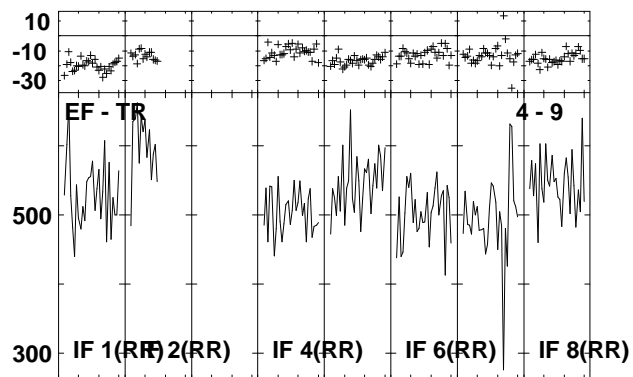
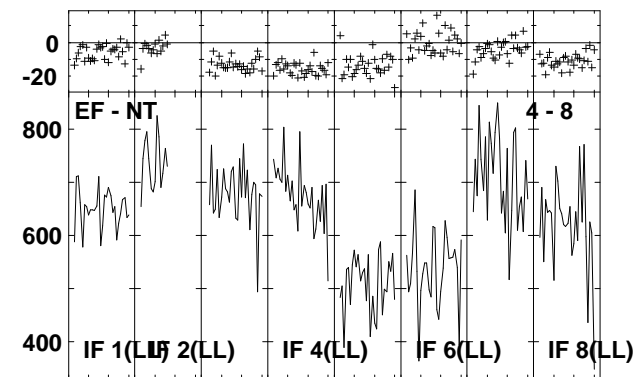
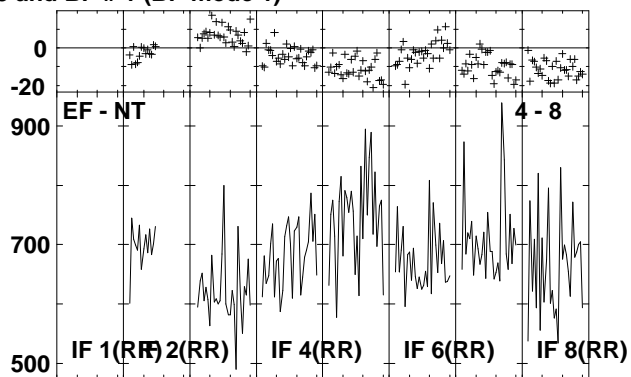
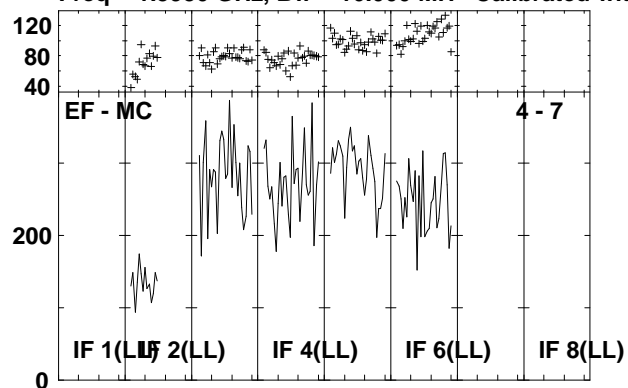

Lower frame: Milli Ampl Jy Top frame: Phas deg
 Vector averaged cross-power spectrum Several baselines displayed
 Timerange: 00:12:14:03 to 00:12:15:27

Plot file version 7 created 29-APR-2009 14:26:38

IRAS2336 EP064D.UVDATA.1

Freq = 1.5950 GHz, Bw = 16.000 MH Calibrated with CL # 3 and BP # 1 (BP mode 1)

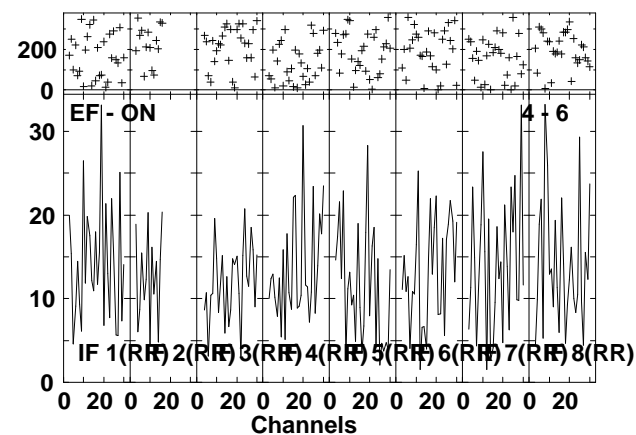
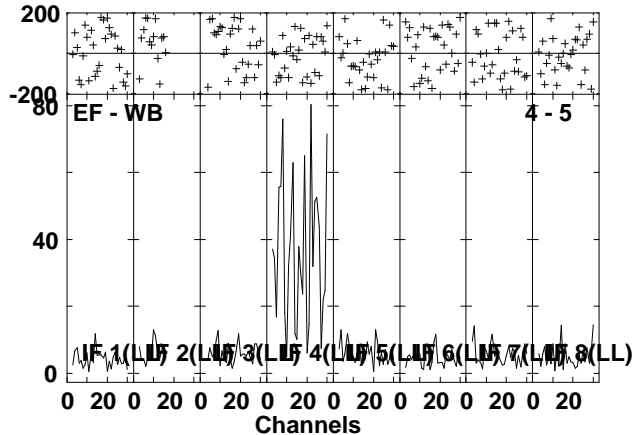
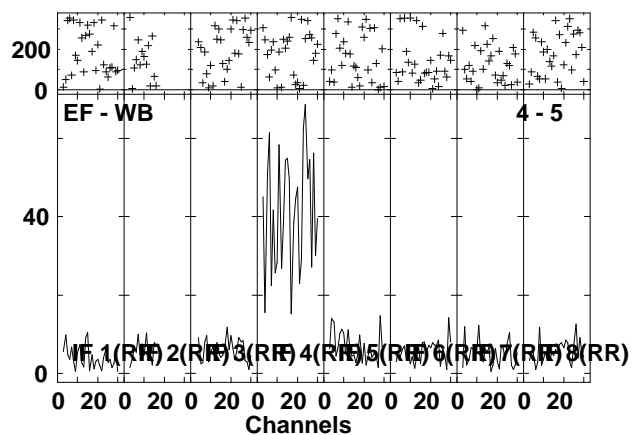
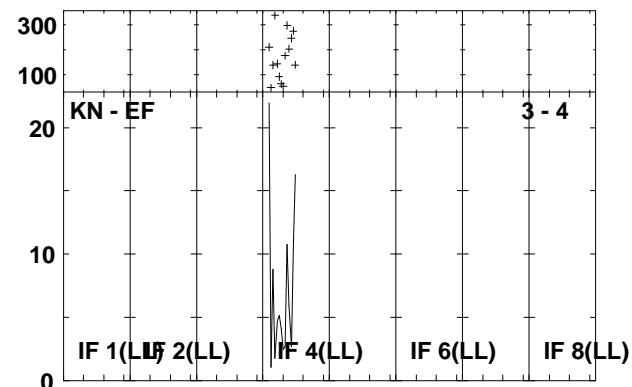
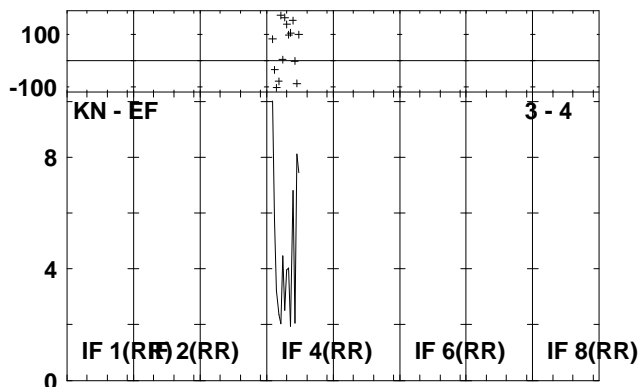
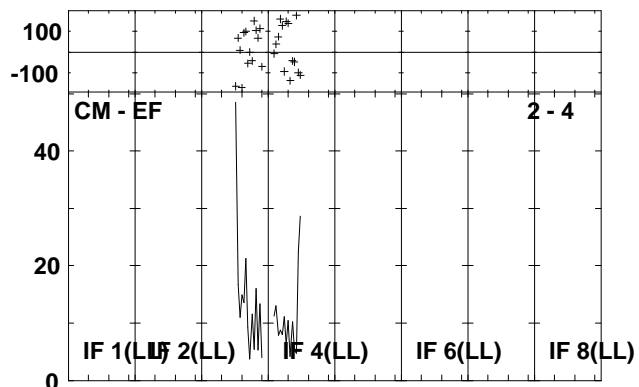
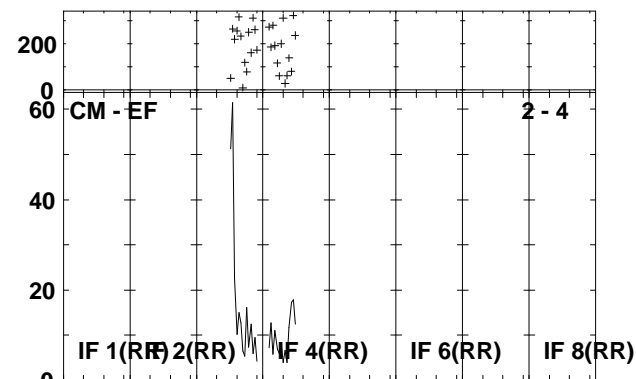
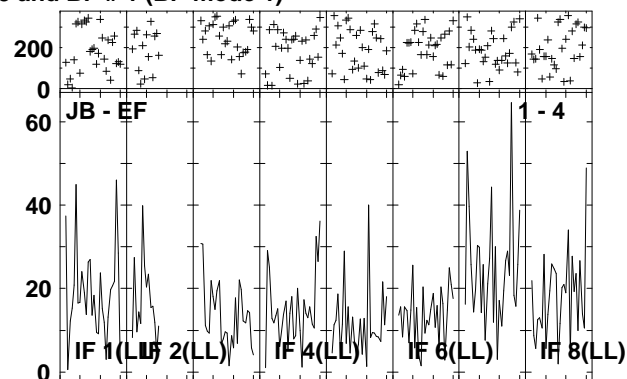
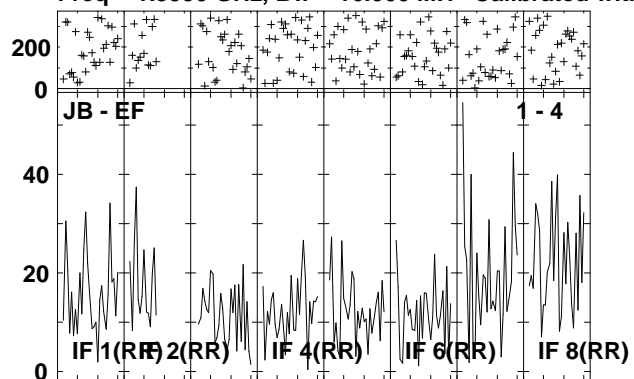

Lower frame: Milli Ampl Jy Top frame: Phas deg
Vector averaged cross-power spectrum Several baselines displayed
Timerange: 00/12:15:39 to 00/12:18:59

Plot file version 8 created 29-APR-2009 14:26:40

IRAS2336 EP064D.UVDATA.1

Freq = 1.5950 GHz, Bw = 16.000 MH Calibrated with CL # 3 and BP # 1 (BP mode 1)

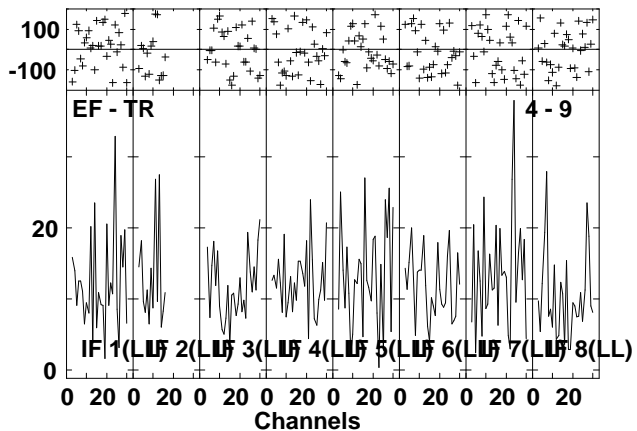
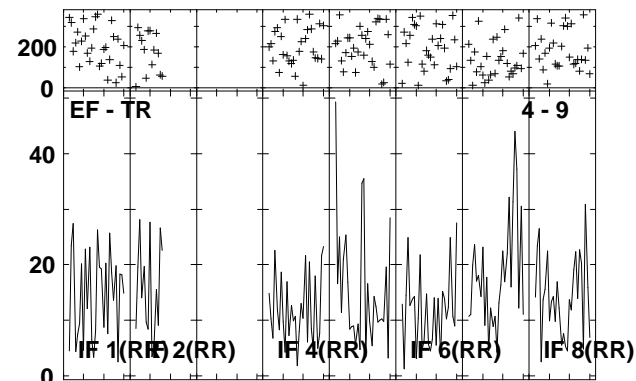
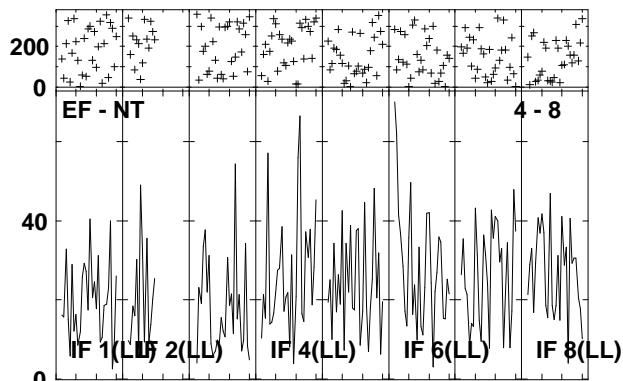
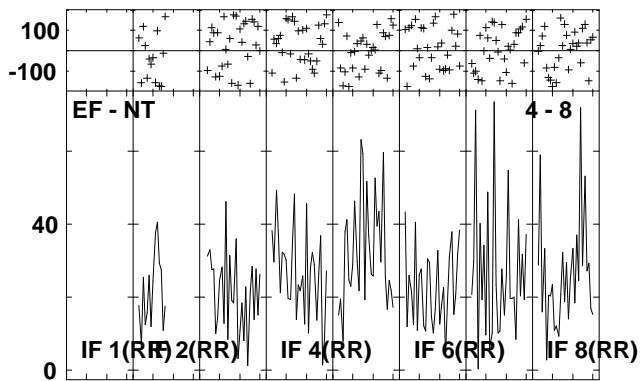
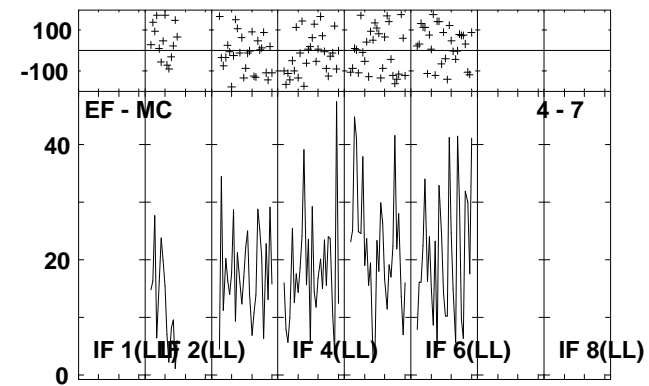
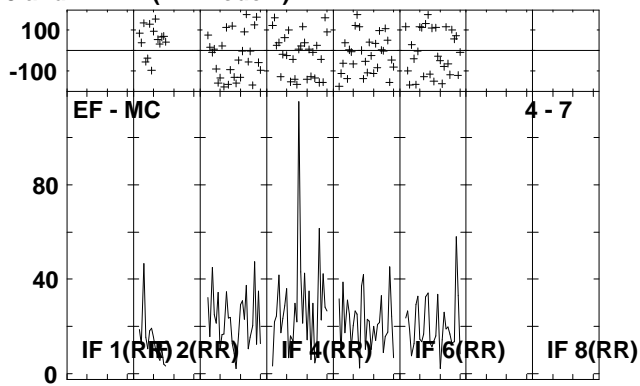
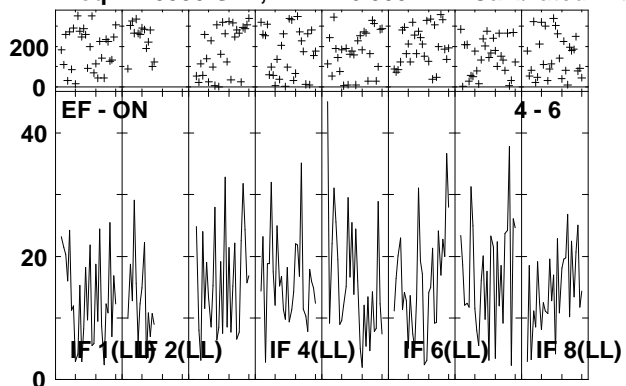

Lower frame: Milli Ampl Jy Top frame: Phas deg
Vector averaged cross-power spectrum Several baselines displayed
Timerange: 00/12:15:39 to 00/12:18:59

Plot file version 9 created 29-APR-2009 14:26:44

J2333+39 EP064D.UVDATA.1

Freq = 1.5950 GHz, Bw = 16.000 MH Calibrated with CL # 3 and BP # 1 (BP mode 1)

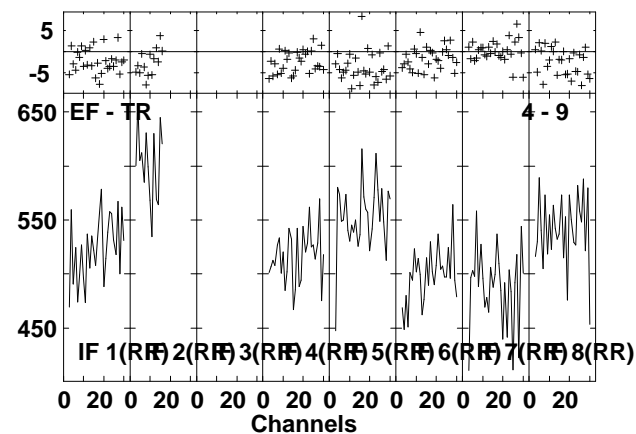
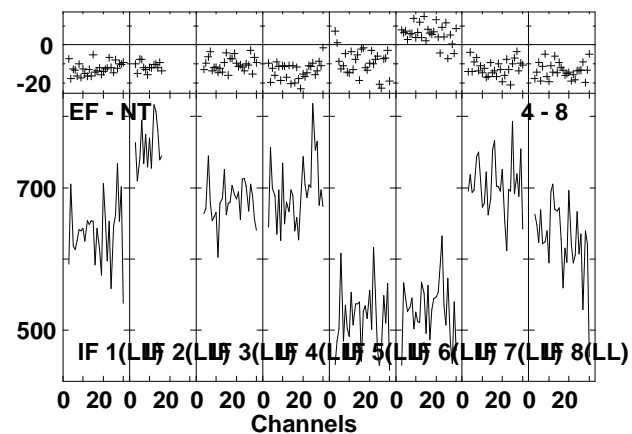
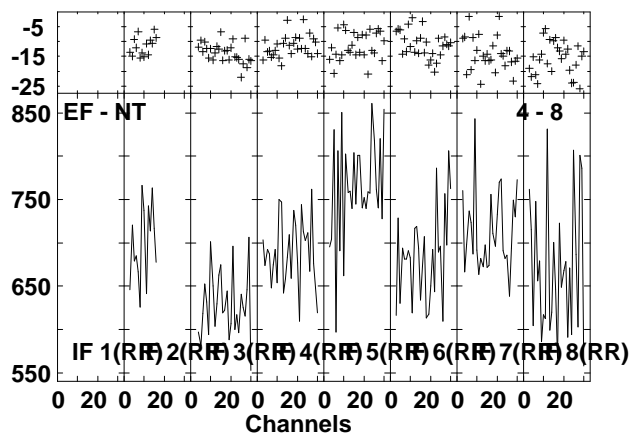
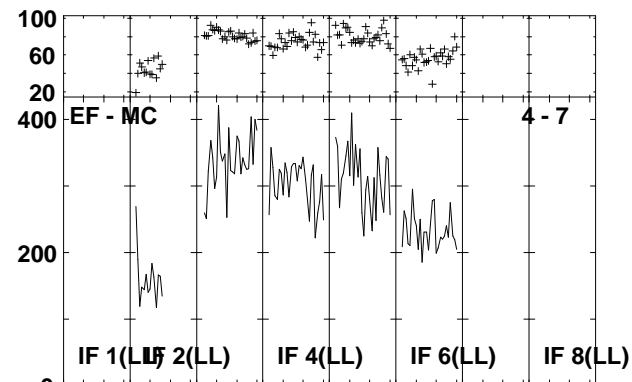
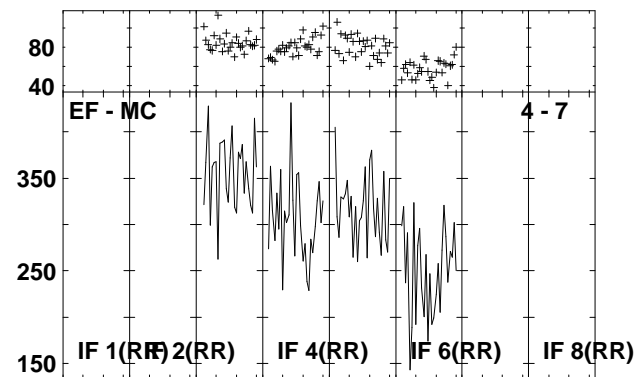
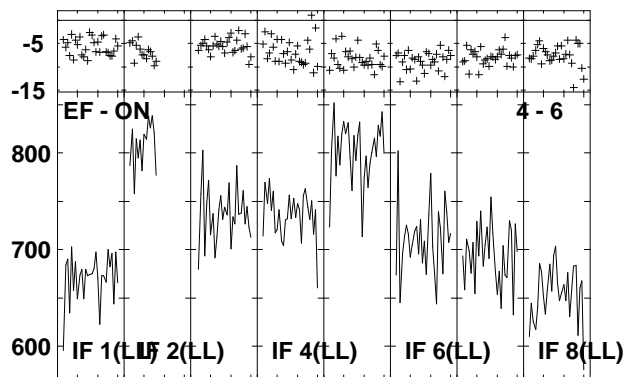
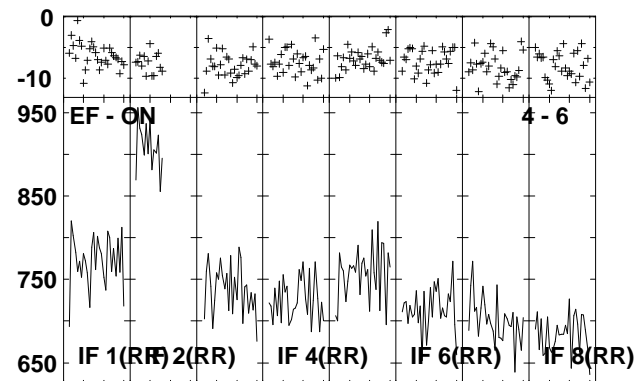
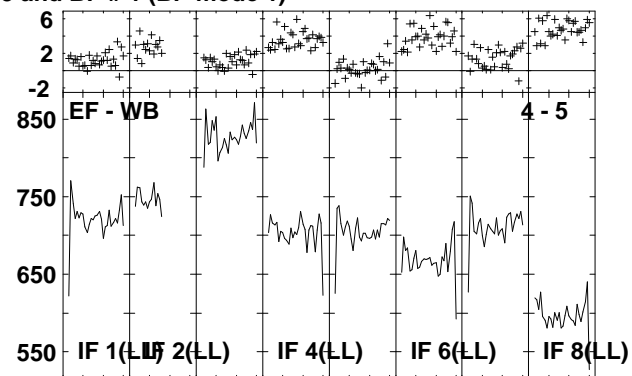
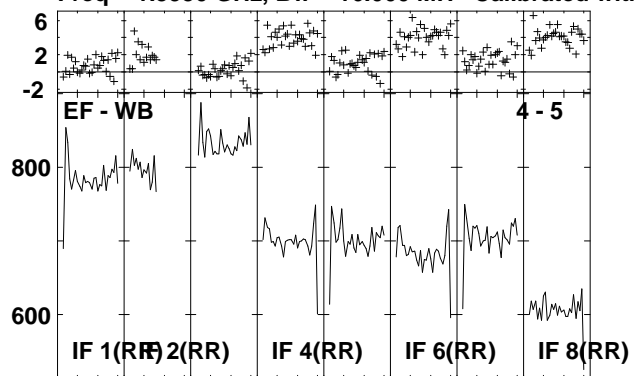

Lower frame: Milli Ampl Jy Top frame: Phas deg
Vector averaged cross-power spectrum Several baselines displayed
Timerange: 00/12:19:01 to 00/12:20:27

Plot file version 10 created 29-APR-2009 14:26:45

J2333+39 EP064D.UVDATA.1

Freq = 1.5950 GHz, Bw = 16.000 MH Calibrated with CL # 3 and BP # 1 (BP mode 1)

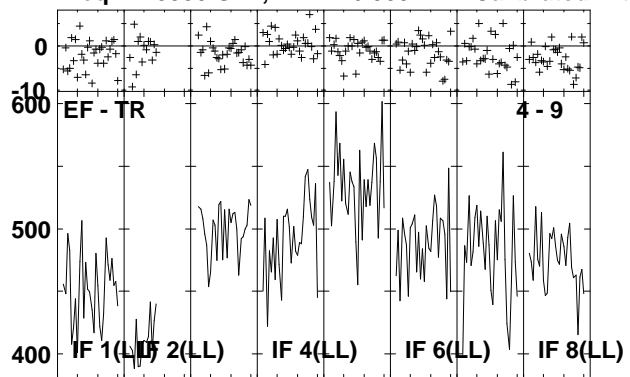

Lower frame: Milli Ampl Jy Top frame: Phas deg
Vector averaged cross-power spectrum Several baselines displayed
Timerange: 00/12:19:01 to 00/12:20:27

Plot file version 11 created 29-APR-2009 14:26:46

IRAS2336 EP064D.UVDATA.1

Freq = 1.5950 GHz, Bw = 16.000 MH Calibrated with CL # 3 and BP # 1 (BP mode 1)

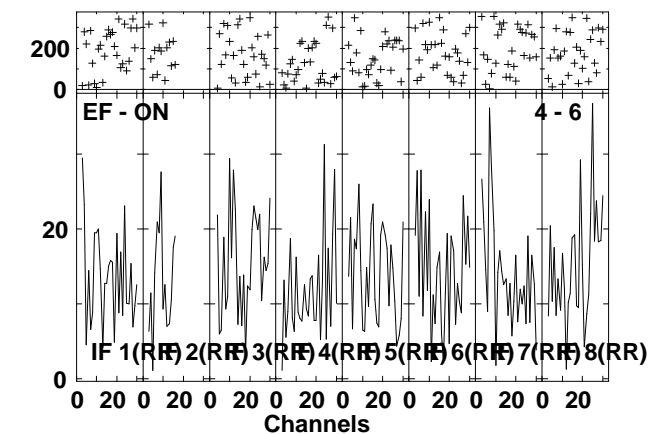
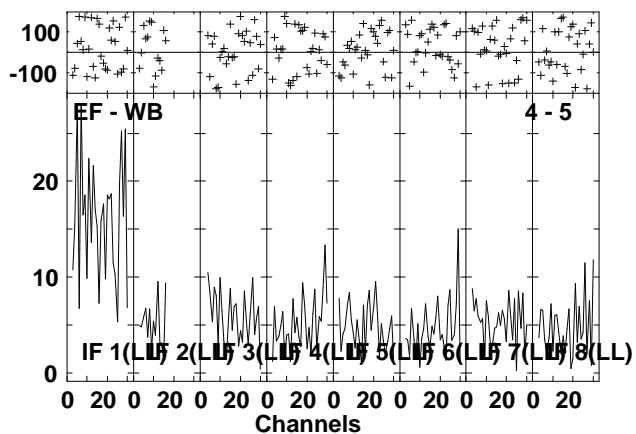
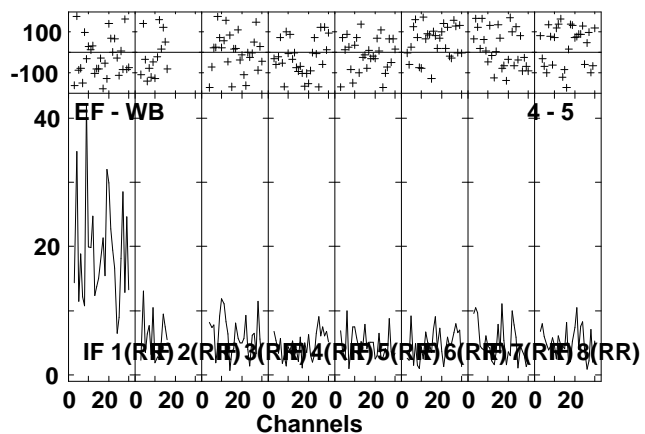
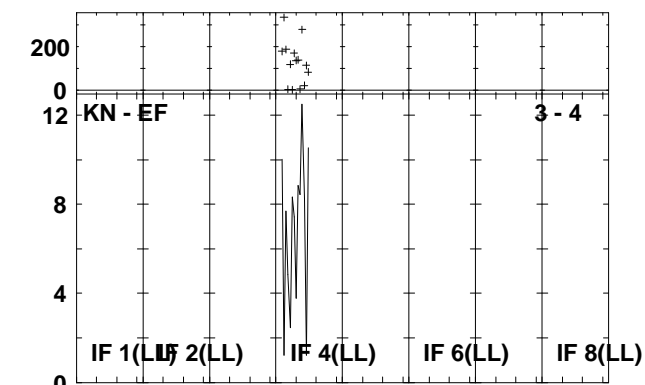
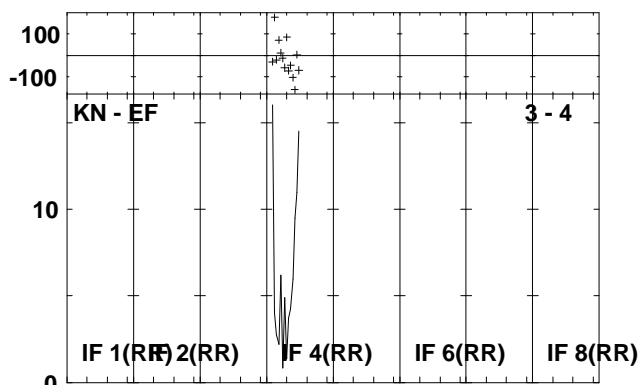
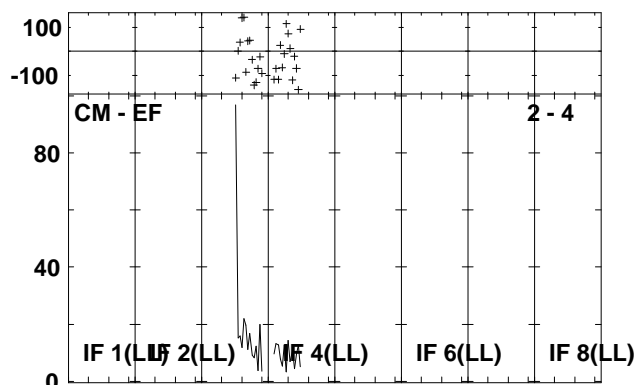
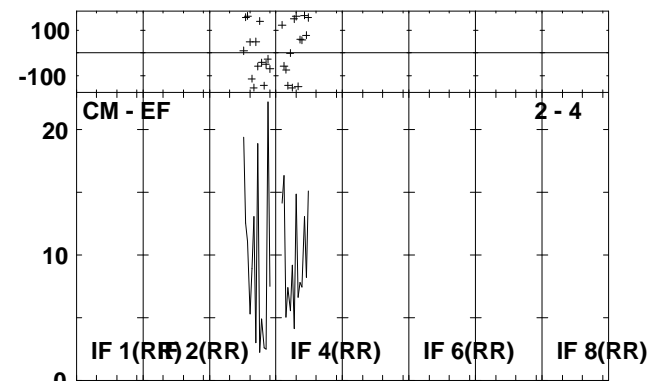
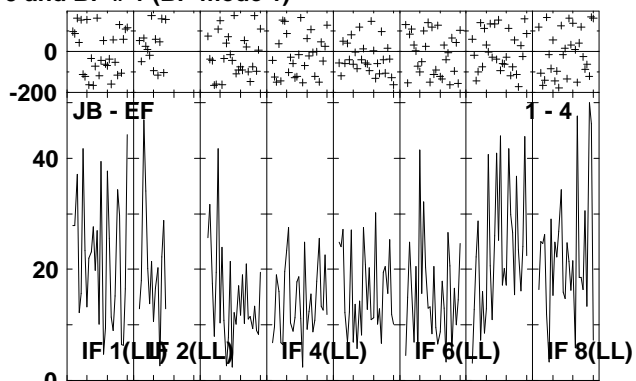
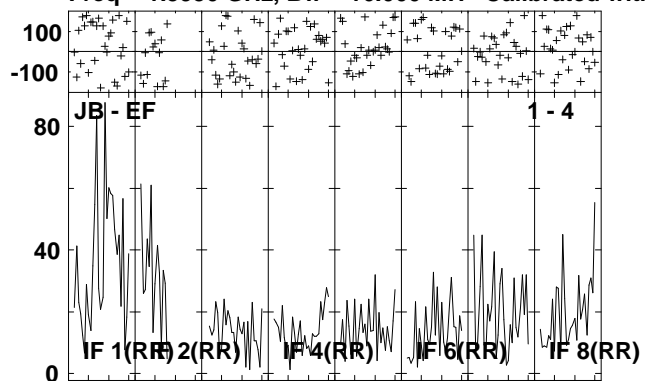

Lower frame: Milli Ampl Jy Top frame: Phas deg
Vector averaged cross-power spectrum Several baselines displayed
Timerange: 00/12:20:29 to 00/12:23:59

Plot file version 12 created 29-APR-2009 14:26:48

IRAS2336 EP064D.UVDATA.1

Freq = 1.5950 GHz, Bw = 16.000 MH Calibrated with CL # 3 and BP # 1 (BP mode 1)

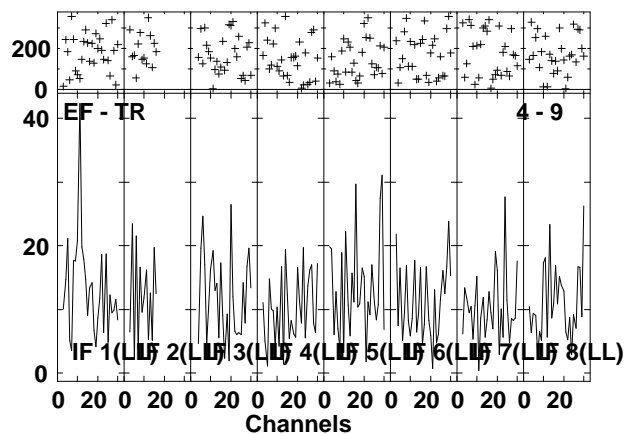
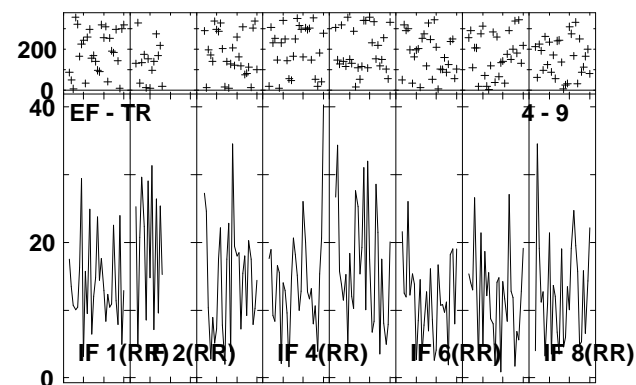
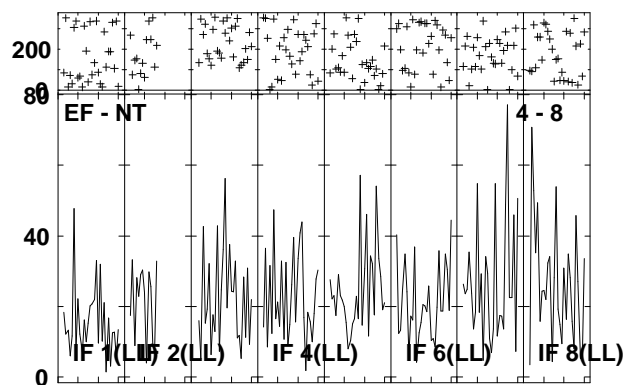
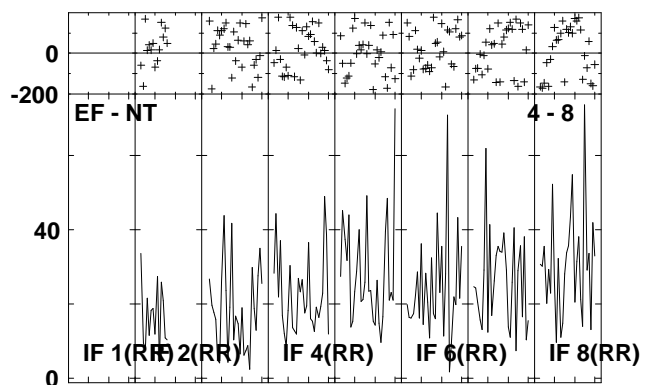
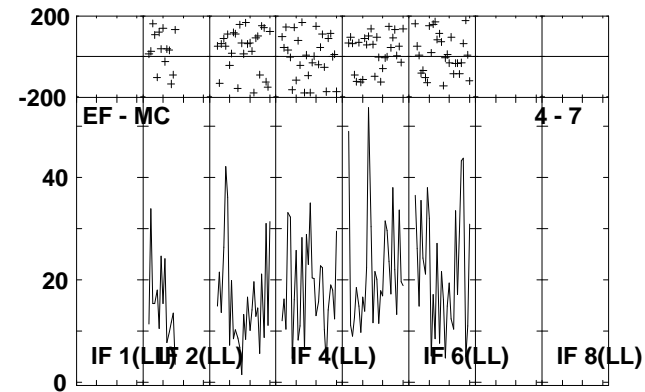
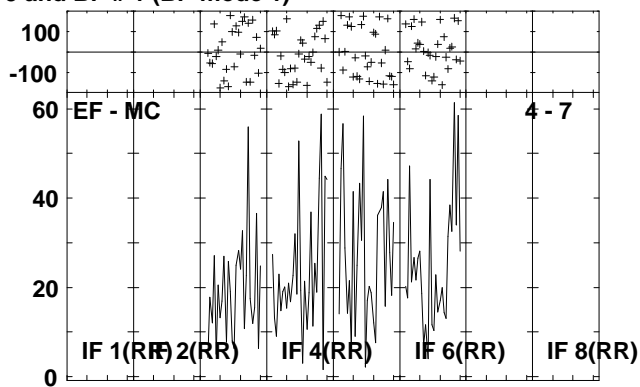
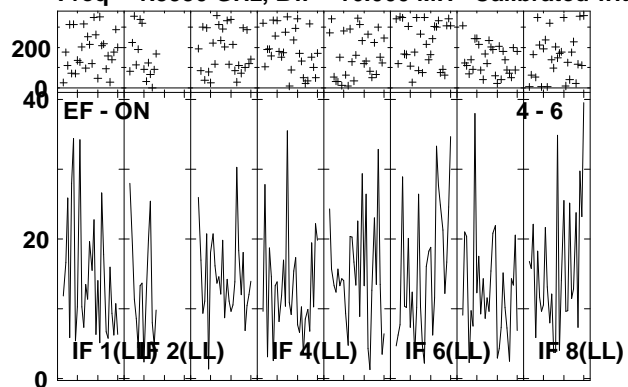

Lower frame: Milli Ampl Jy Top frame: Phas deg
Vector averaged cross-power spectrum Several baselines displayed
Timerange: 00/12:20:29 to 00/12:23:59

Plot file version 13 created 29-APR-2009 14:26:52

J2333+39 EP064D.UVDATA.1

Freq = 1.5950 GHz, Bw = 16.000 MH Calibrated with CL # 3 and BP # 1 (BP mode 1)

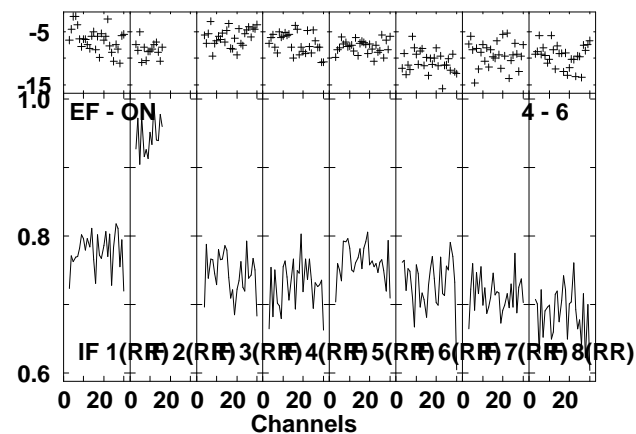
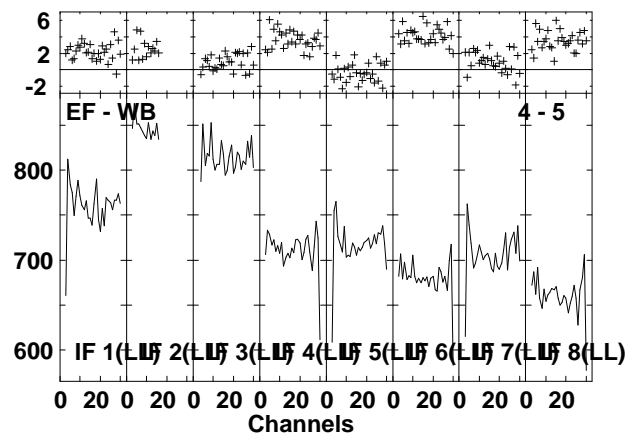
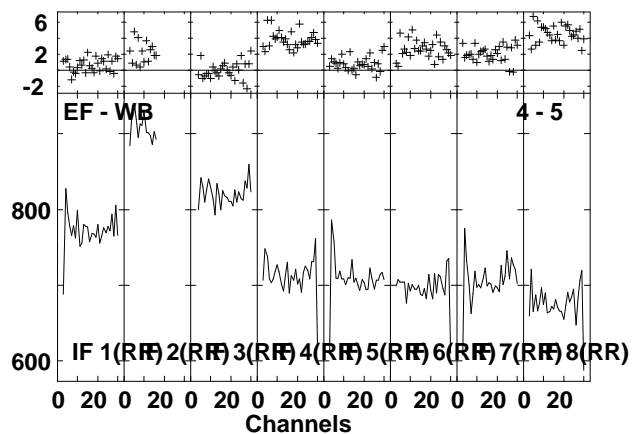
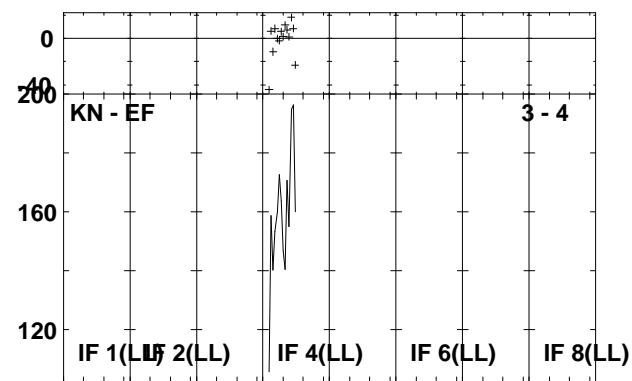
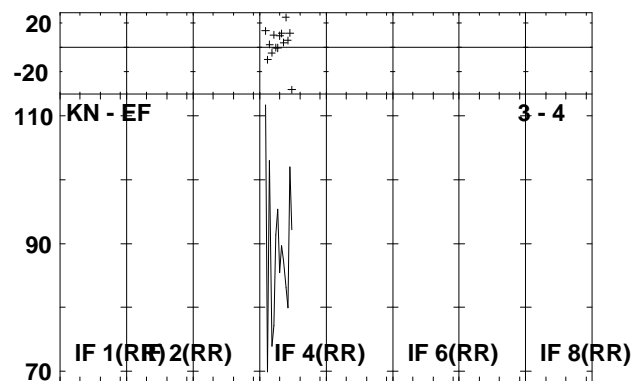
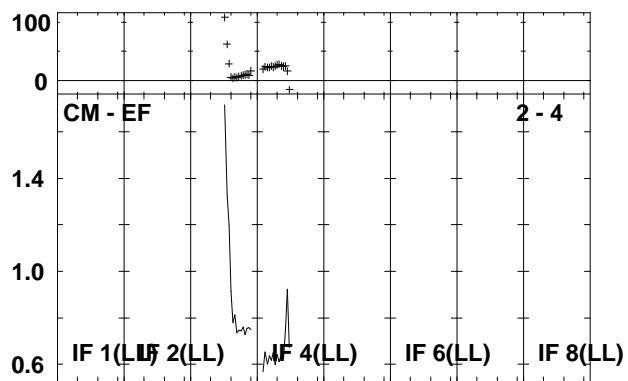
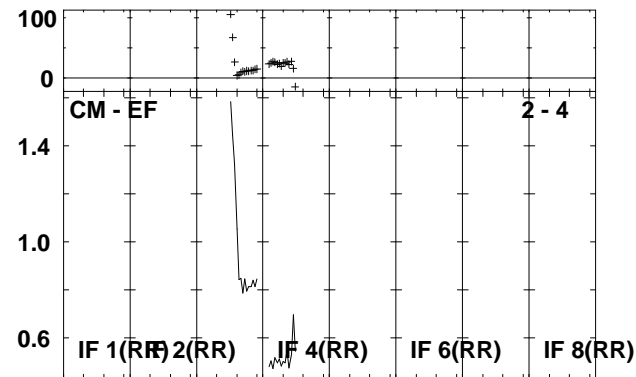
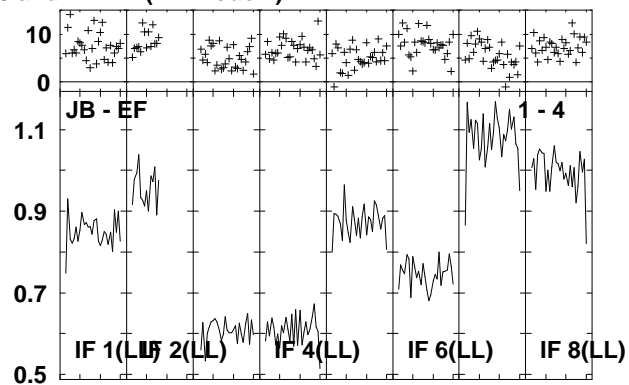
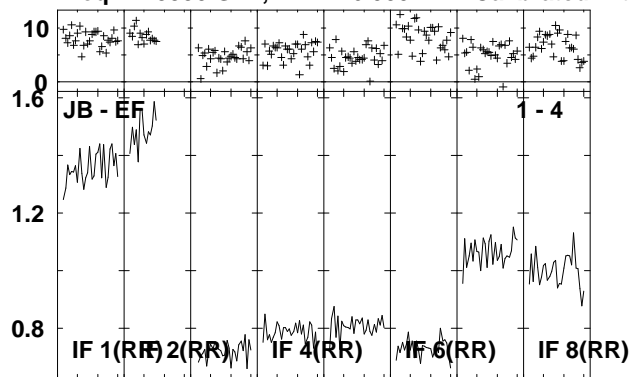

Lower frame: Ampl Jy Top frame: Phas deg
Vector averaged cross-power spectrum Several baselines displayed
Timerange: 00/12:24:01 to 00/12:25:31

Plot file version 14 created 29-APR-2009 14:26:53

J2333+39 EP064D.UVDATA.1

Freq = 1.5950 GHz, Bw = 16.000 MH Calibrated with CL # 3 and BP # 1 (BP mode 1)

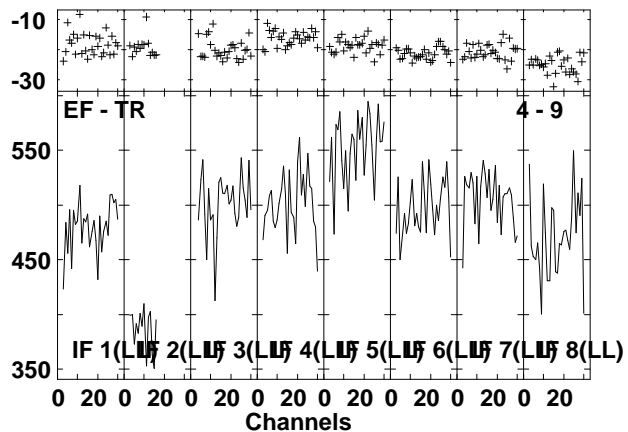
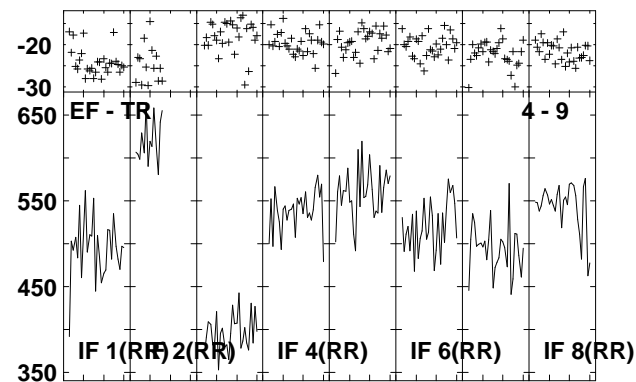
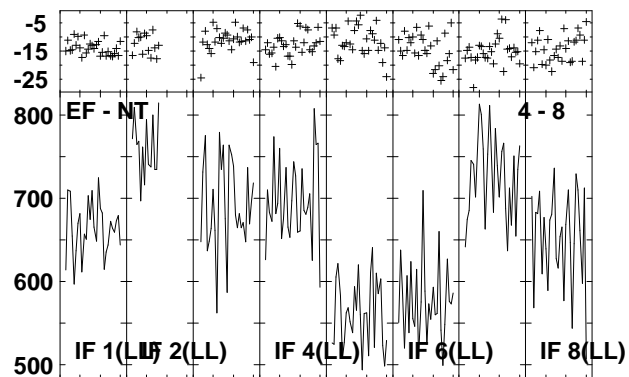
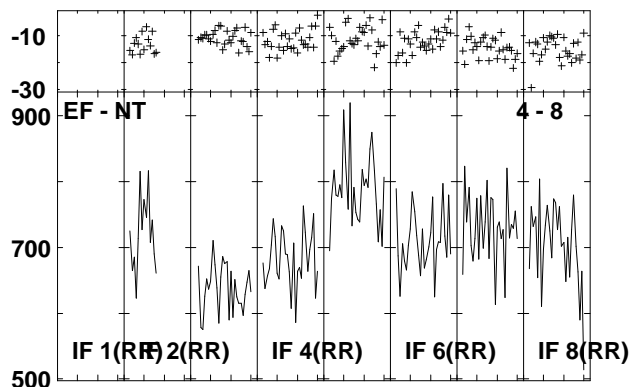
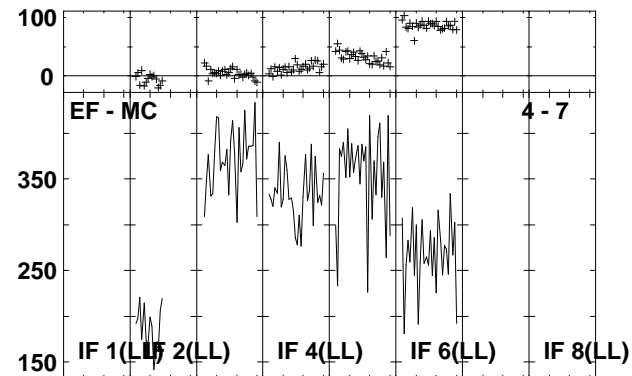
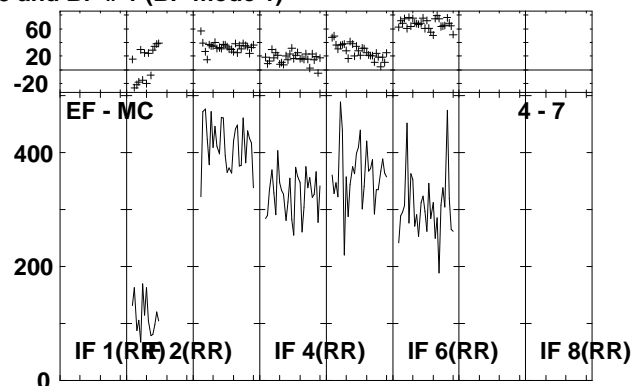
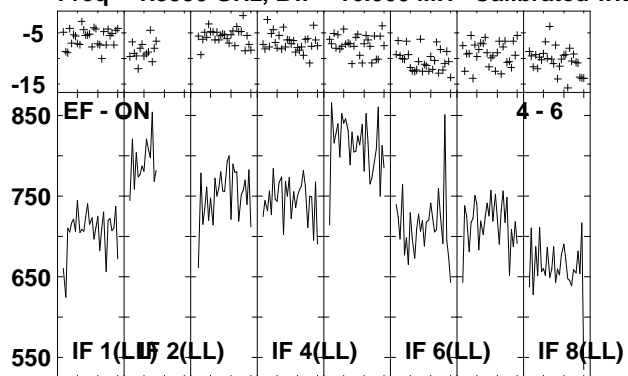

Lower frame: Milli Ampl Jy Top frame: Phas deg
Vector averaged cross-power spectrum Several baselines displayed
Timerange: 00/12:24:01 to 00/12:25:31

Plot file version 15 created 29-APR-2009 14:26:55

IRAS2336 EP064D.UVDATA.1

Freq = 1.5950 GHz, Bw = 16.000 MH Calibrated with CL # 3 and BP # 1 (BP mode 1)

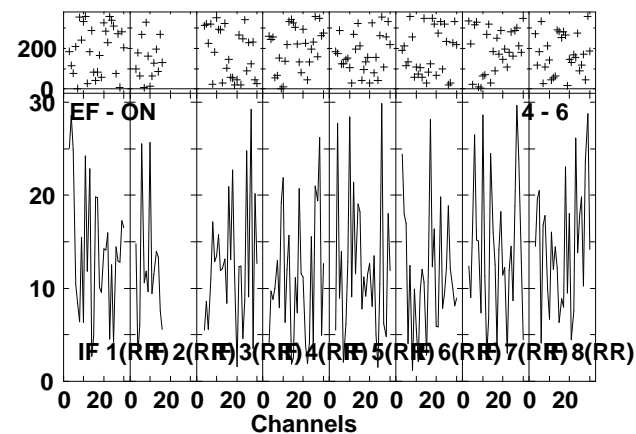
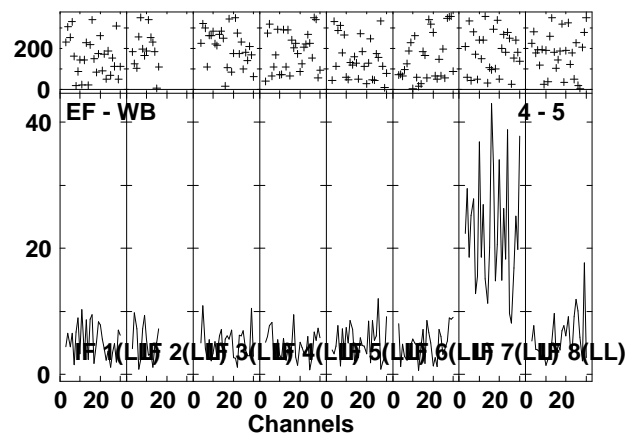
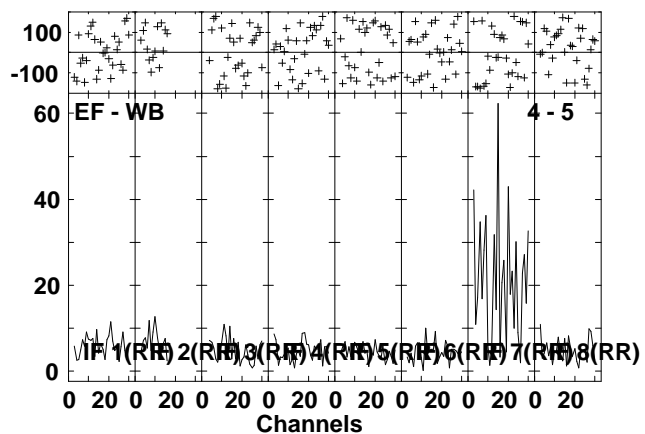
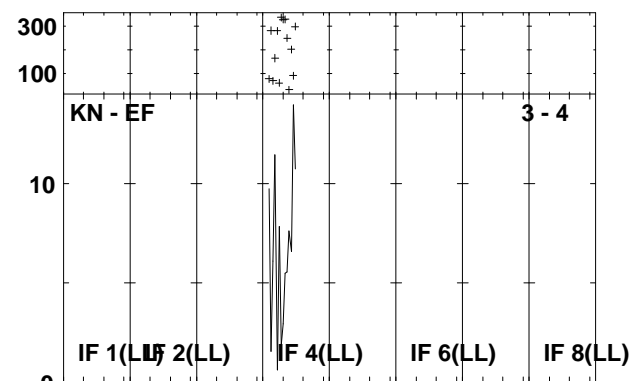
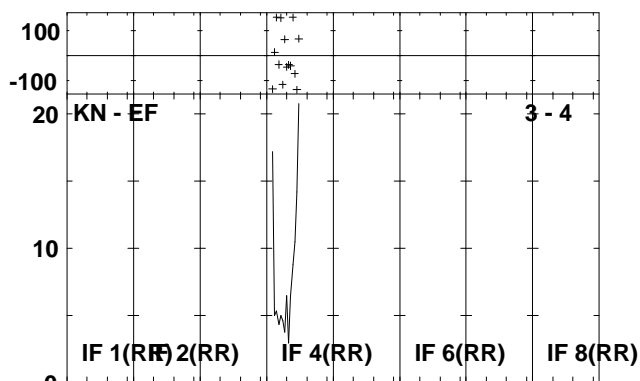
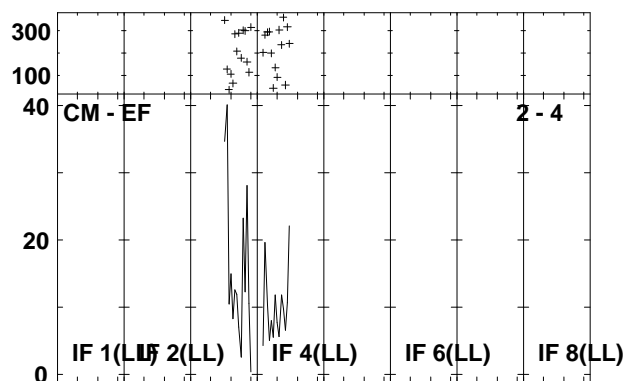
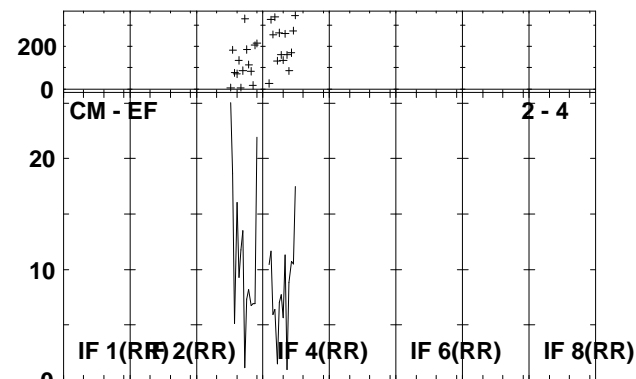
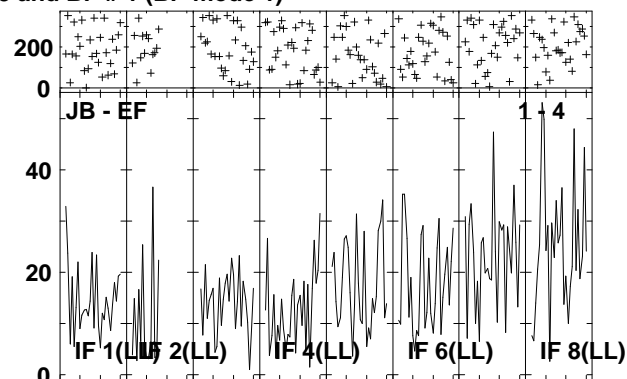
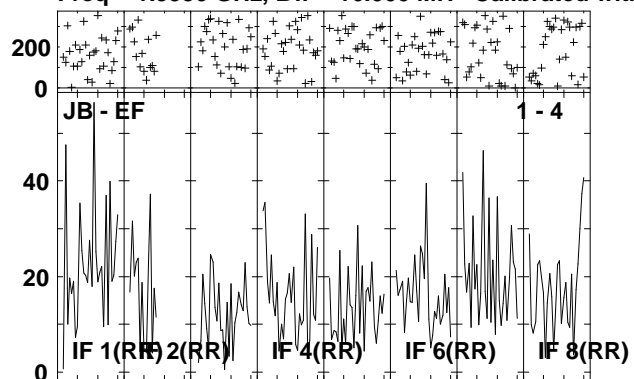

Lower frame: Milli Ampl Jy Top frame: Phas deg
Vector averaged cross-power spectrum Several baselines displayed
Timerange: 00/12:25:33 to 00/12:28:59

Plot file version 16 created 29-APR-2009 14:26:57

IRAS2336 EP064D.UVDATA.1

Freq = 1.5950 GHz, Bw = 16.000 MH Calibrated with CL # 3 and BP # 1 (BP mode 1)

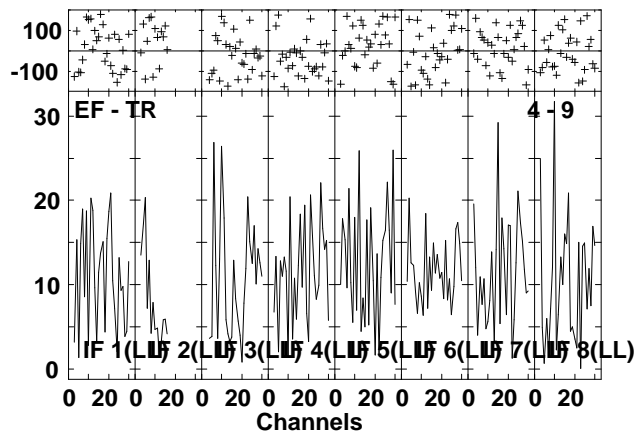
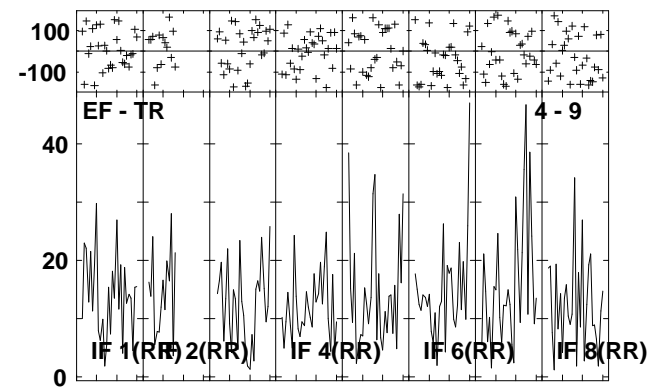
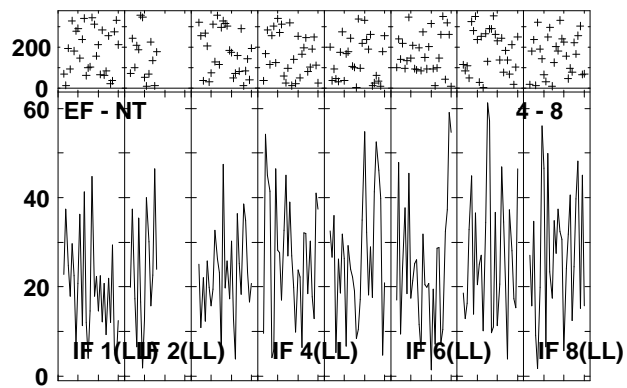
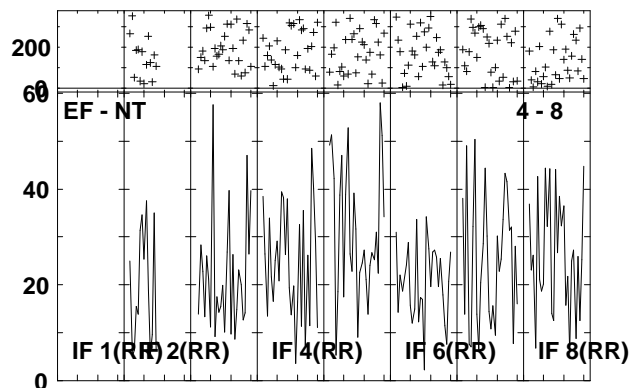
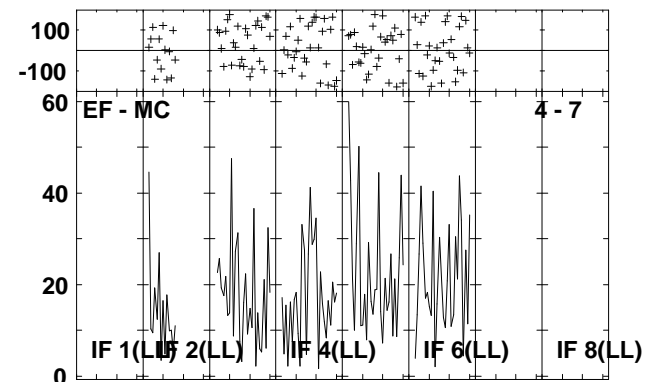
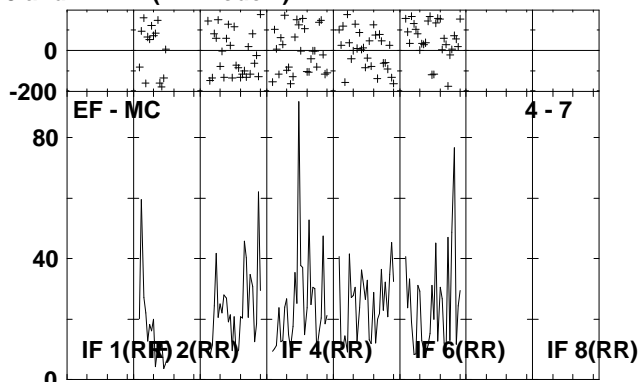
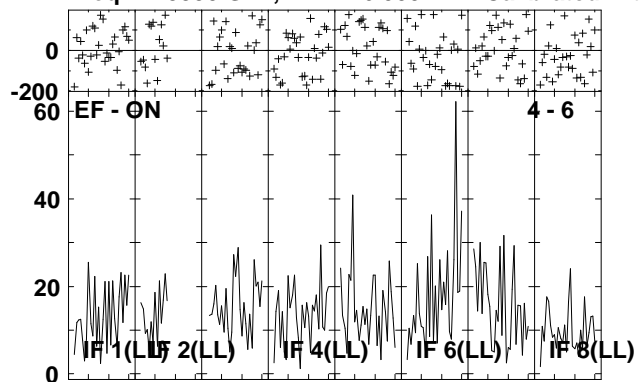

Lower frame: Milli Ampl Jy Top frame: Phas deg
Vector averaged cross-power spectrum Several baselines displayed
Timerange: 00/12:25:33 to 00/12:28:59

Plot file version 17 created 29-APR-2009 14:27:00

J2333+39 EP064D.UVDATA.1

Freq = 1.5950 GHz, Bw = 16.000 MH Calibrated with CL # 3 and BP # 1 (BP mode 1)

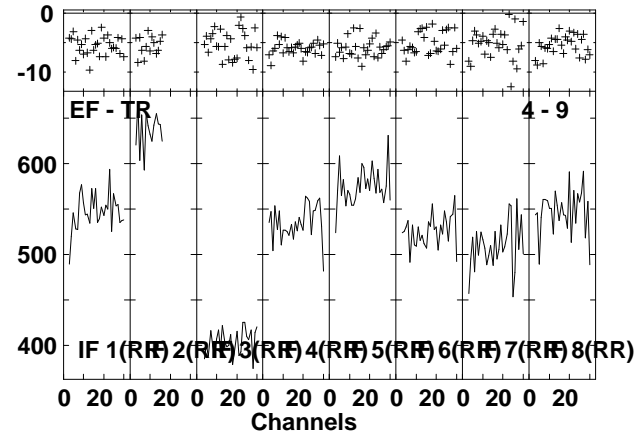
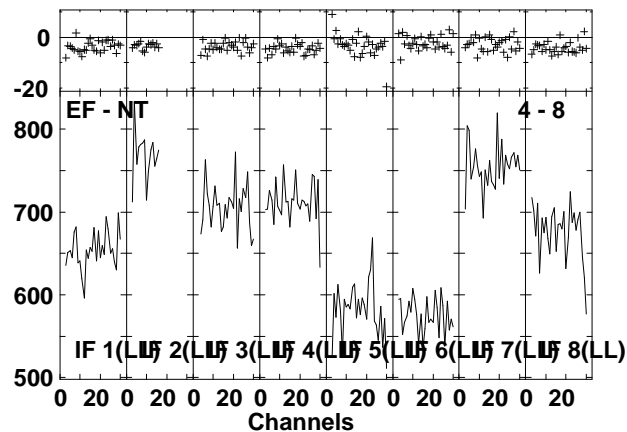
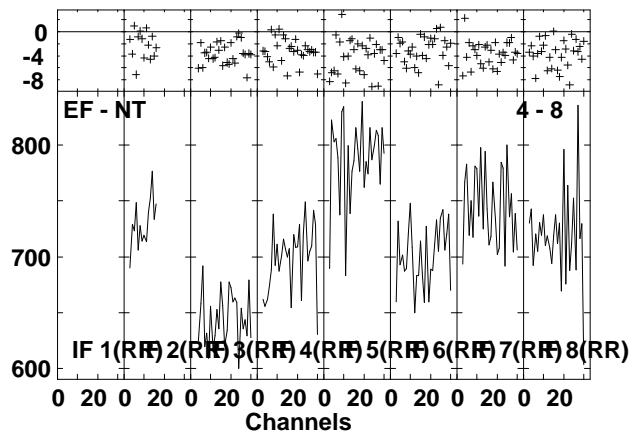
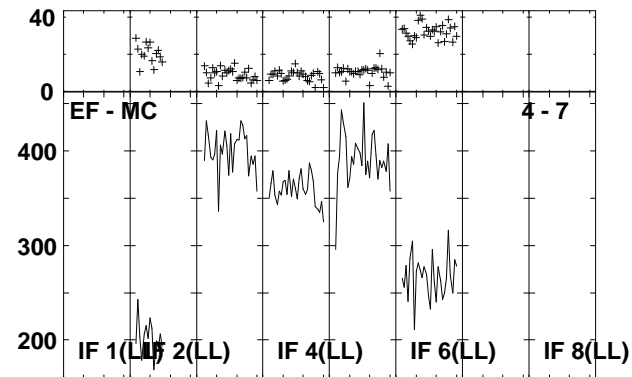
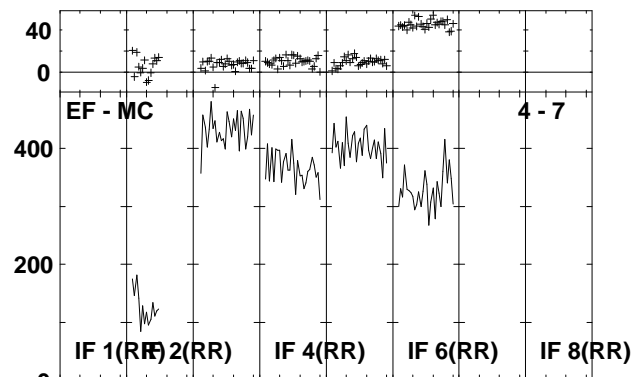
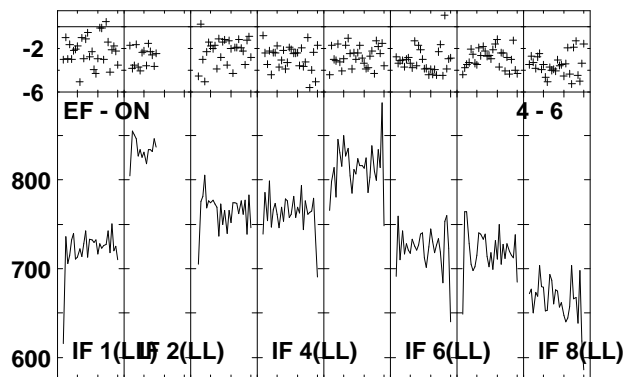
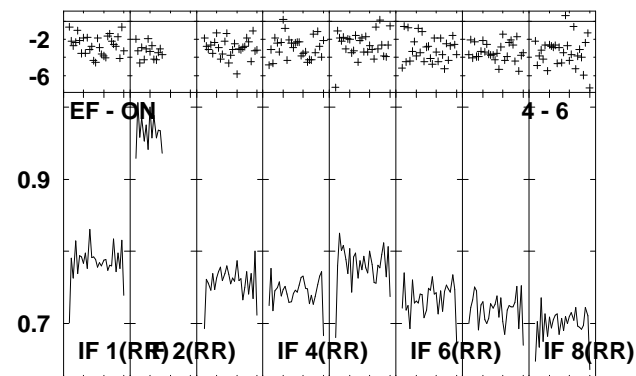
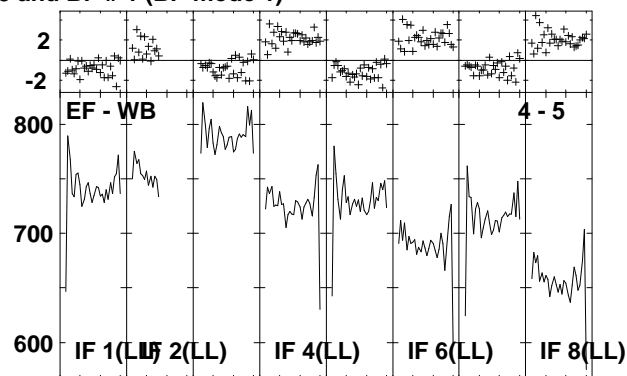
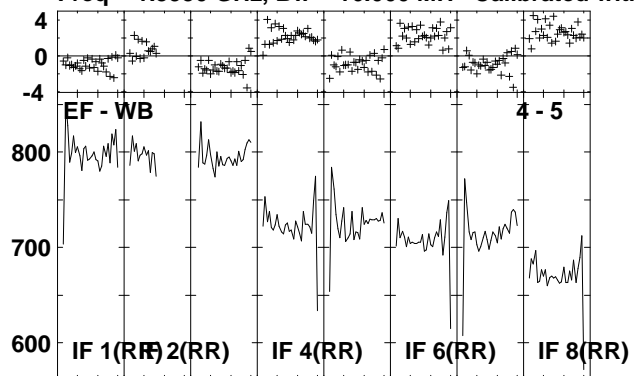

Lower frame: Milli Ampl Jy Top frame: Phas deg
Vector averaged cross-power spectrum Several baselines displayed
Timerange: 00/12:30:01 to 00/12:31:27

Plot file version 18 created 29-APR-2009 14:27:01

J2333+39 EP064D.UVDATA.1

Freq = 1.5950 GHz, Bw = 16.000 MH Calibrated with CL # 3 and BP # 1 (BP mode 1)

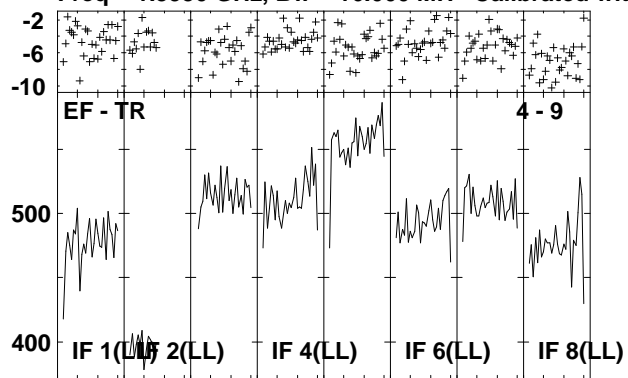

Lower frame: Milli Ampl Jy Top frame: Phas deg
Vector averaged cross-power spectrum Several baselines displayed
Timerange: 00/12:30:01 to 00/12:31:27

Plot file version 19 created 29-APR-2009 14:27:02

IRAS2336 EP064D.UVDATA.1

Freq = 1.5950 GHz, Bw = 16.000 MH Calibrated with CL # 3 and BP # 1 (BP mode 1)

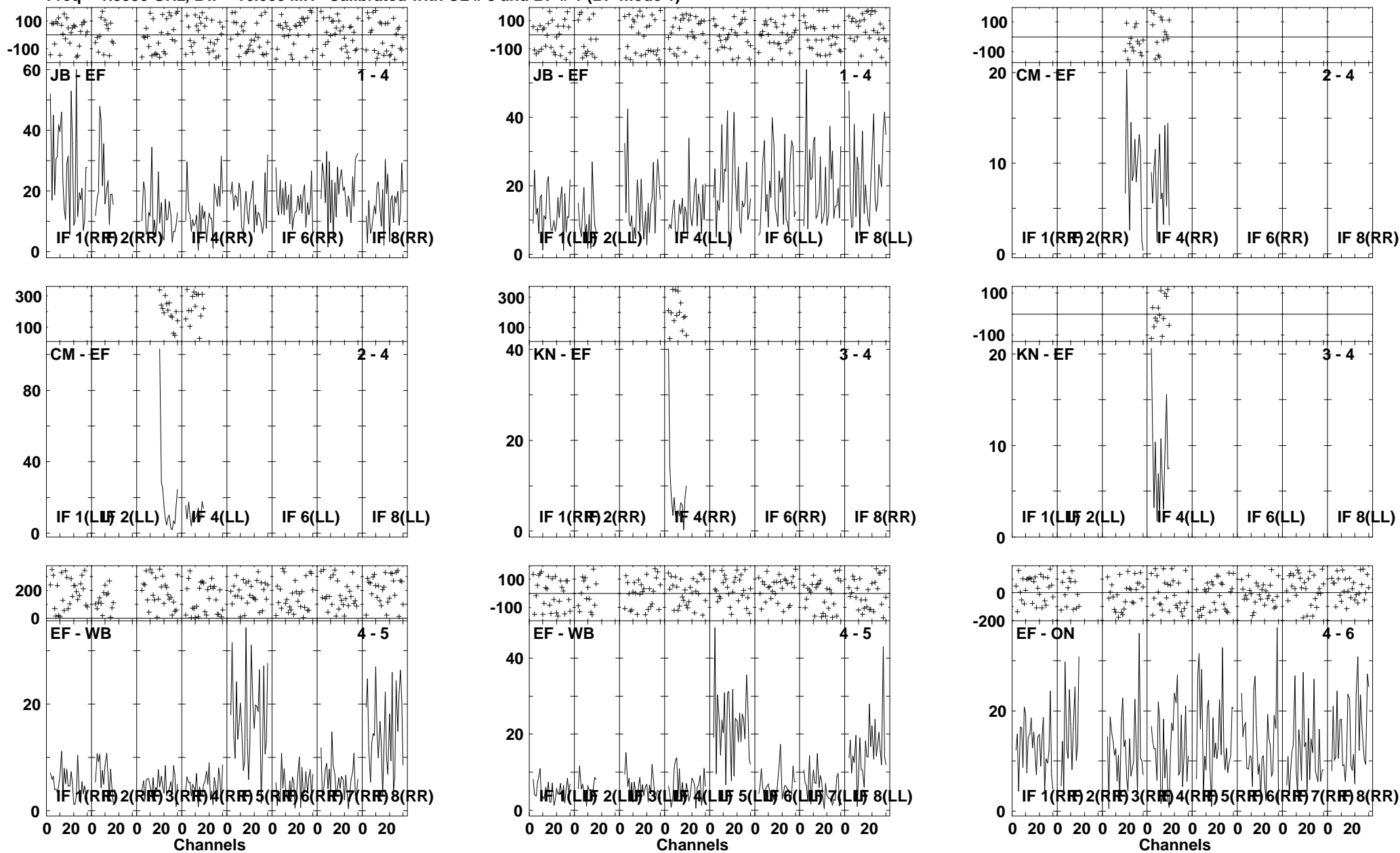

Lower frame: Milli Ampl Jy Top frame: Phas deg
Vector averaged cross-power spectrum Several baselines displayed
Timerange: 00:12:31:29 to 00:12:34:59

Plot file version 20 created 29-APR-2009 14:27:04

IRAS2336 EP064D.UVDATA.1

Freq = 1.5950 GHz, Bw = 16.000 MH Calibrated with CL # 3 and BP # 1 (BP mode 1)

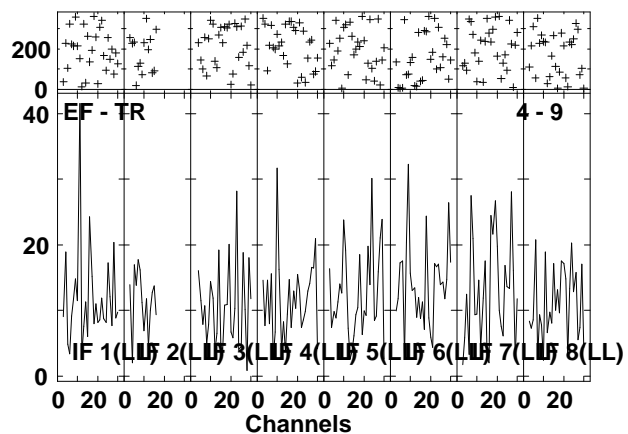
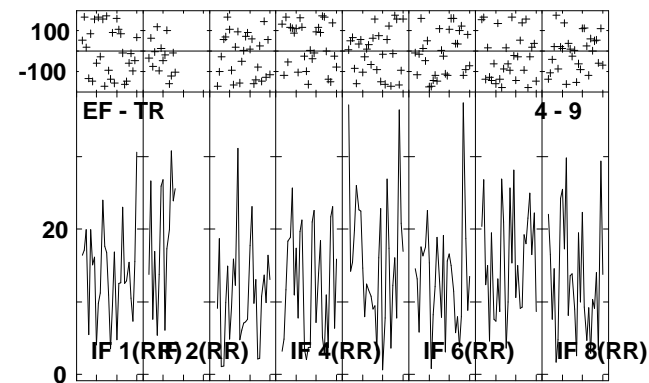
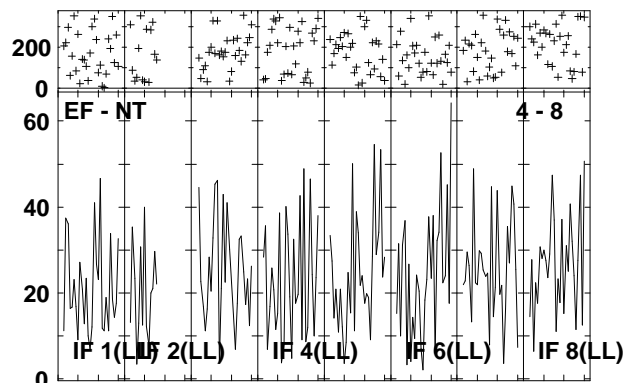
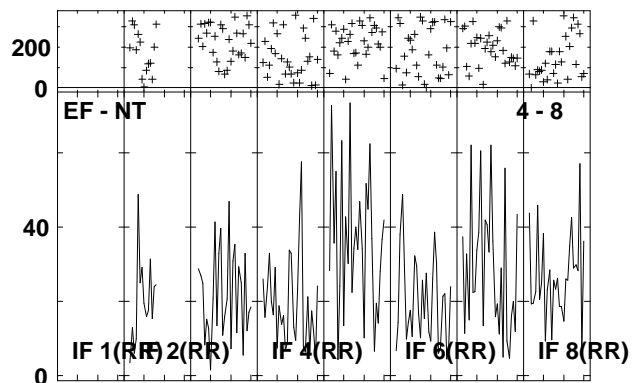
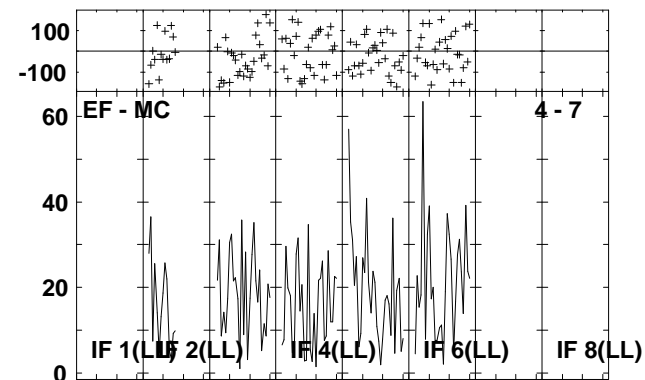
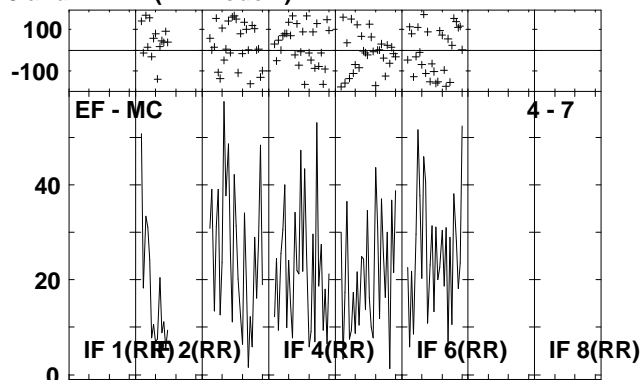
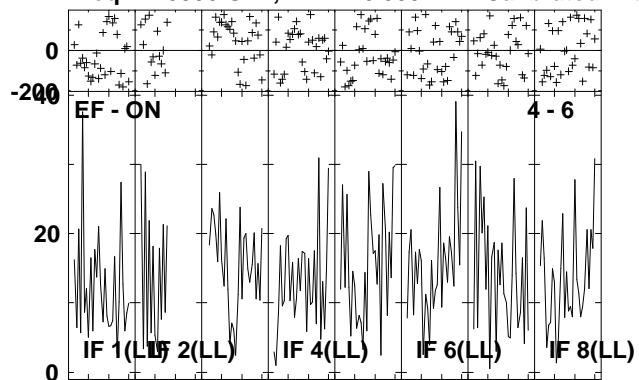

Lower frame: Milli Ampl Jy Top frame: Phas deg
Vector averaged cross-power spectrum Several baselines displayed
Timerange: 00/12:31:29 to 00/12:34:59

Plot file version 21 created 29-APR-2009 14:27:08

J2333+39 EP064D.UVDATA.1

Freq = 1.5950 GHz, Bw = 16.000 MH Calibrated with CL # 3 and BP # 1 (BP mode 1)

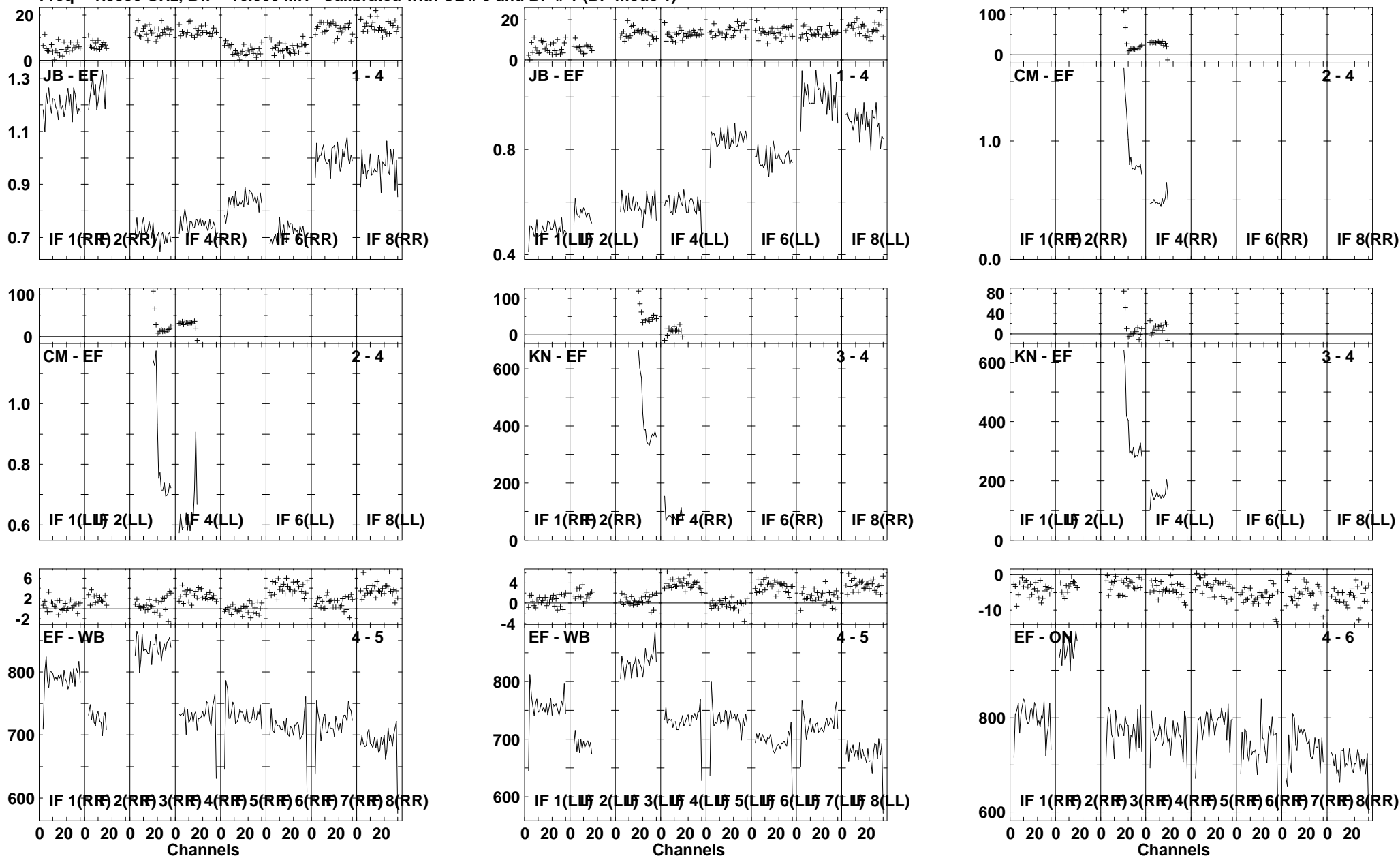

Lower frame: Ampl Jy Top frame: Phas deg
Vector averaged cross-power spectrum Several baselines displayed
Timerange: 00/12:35:01 to 00/12:36:29

Plot file version 22 created 29-APR-2009 14:27:09

J2333+39 EP064D.UVDATA.1

Freq = 1.5950 GHz, Bw = 16.000 MH Calibrated with CL # 3 and BP # 1 (BP mode 1)

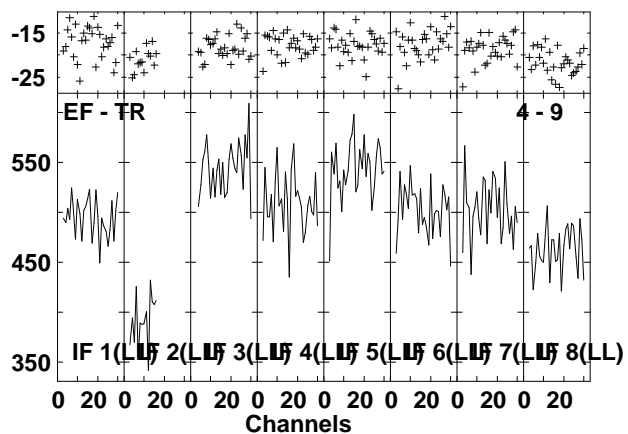
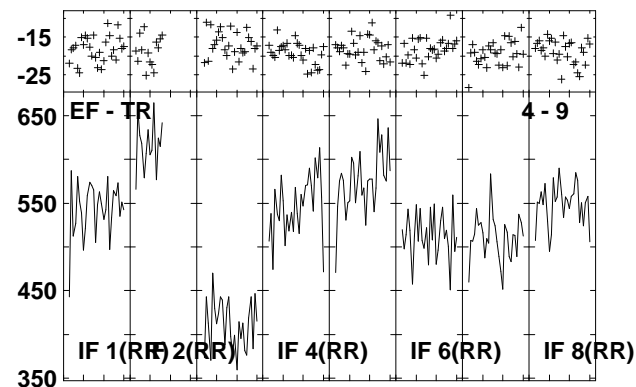
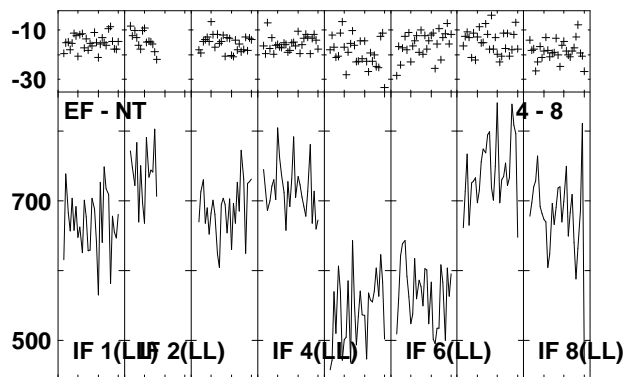
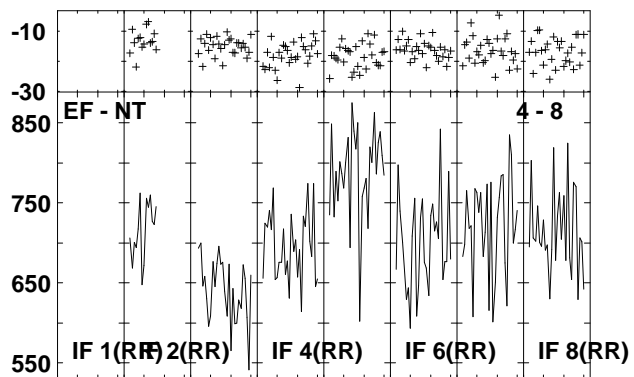
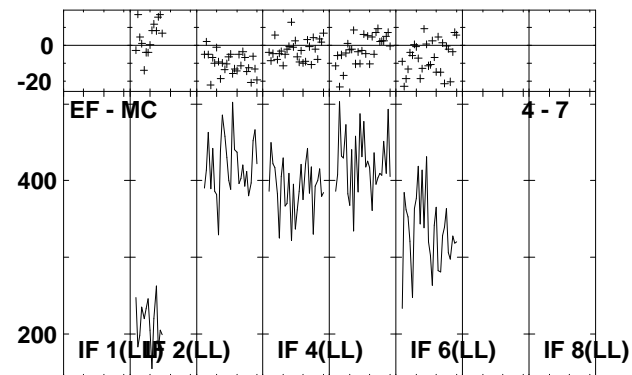
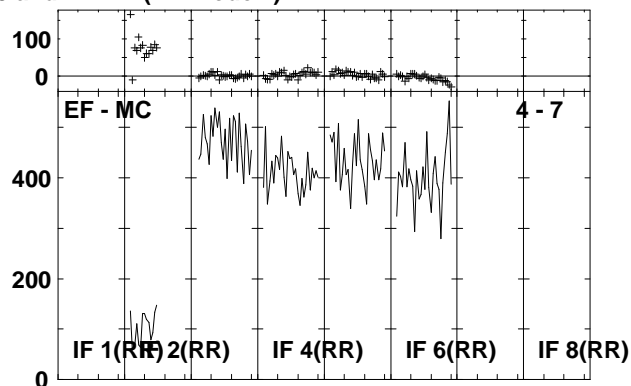
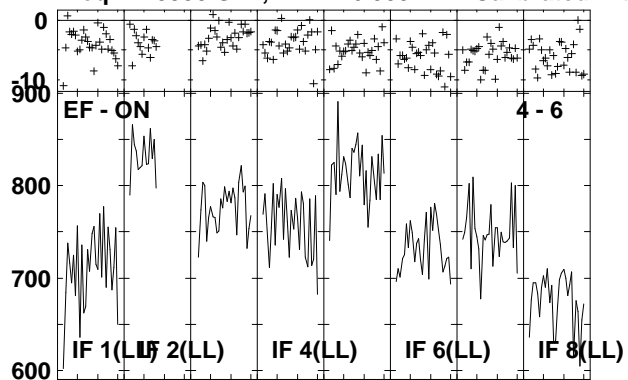

Lower frame: Milli Ampl Jy Top frame: Phas deg
Vector averaged cross-power spectrum Several baselines displayed
Timerange: 00/12:35:01 to 00/12:36:29

Plot file version 23 created 29-APR-2009 14:27:10

IRAS2336 EP064D.UVDATA.1

Freq = 1.5950 GHz, Bw = 16.000 MH Calibrated with CL # 3 and BP # 1 (BP mode 1)

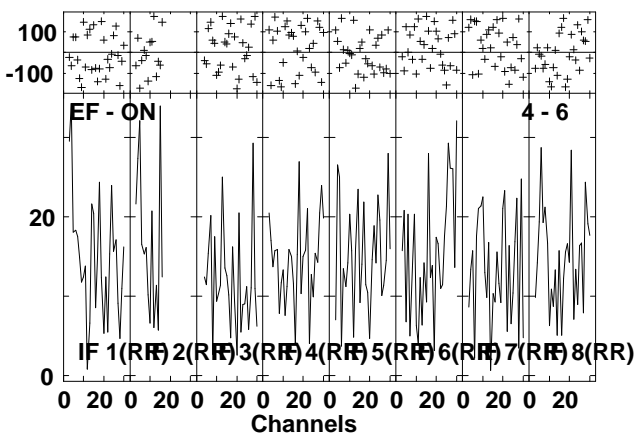
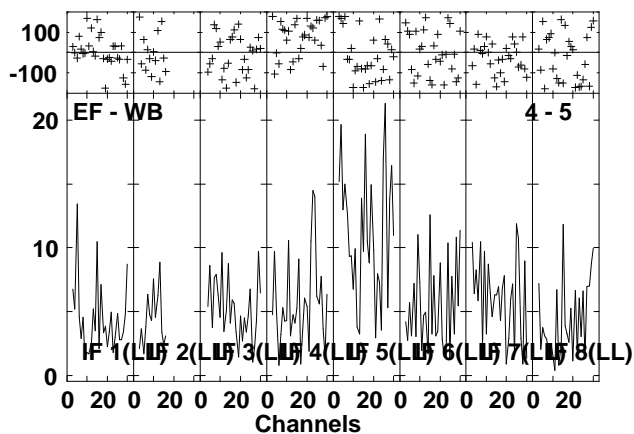
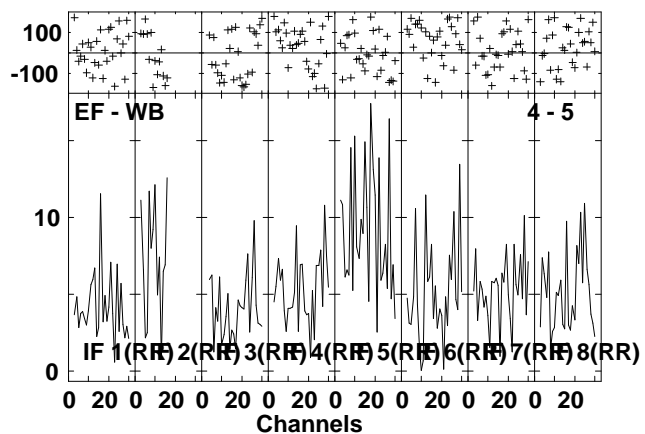
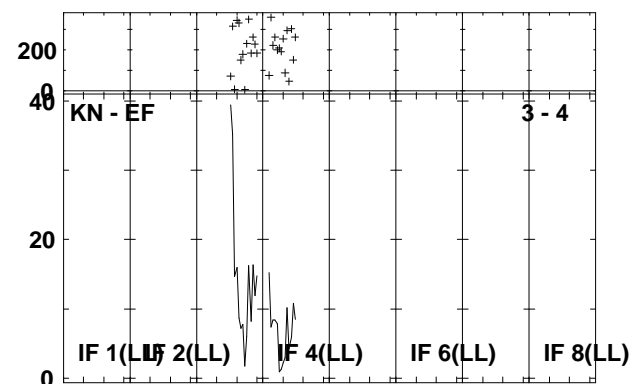
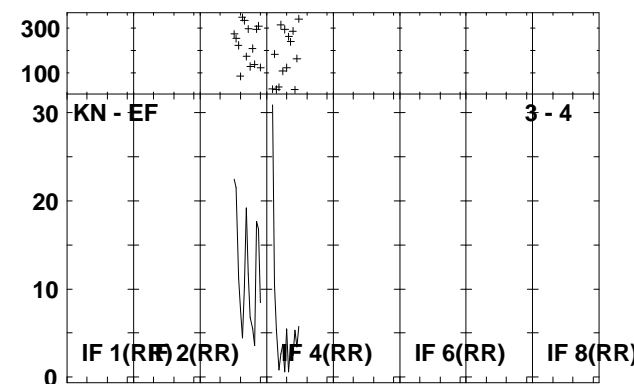
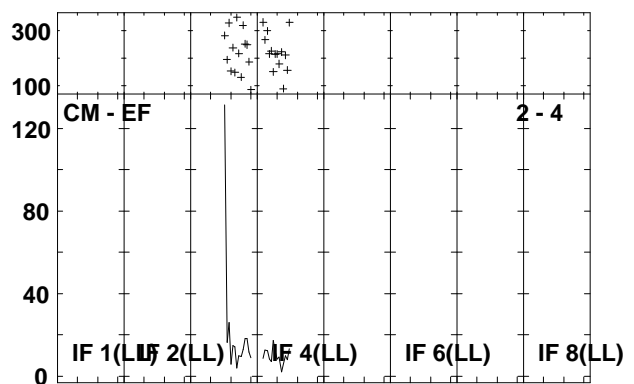
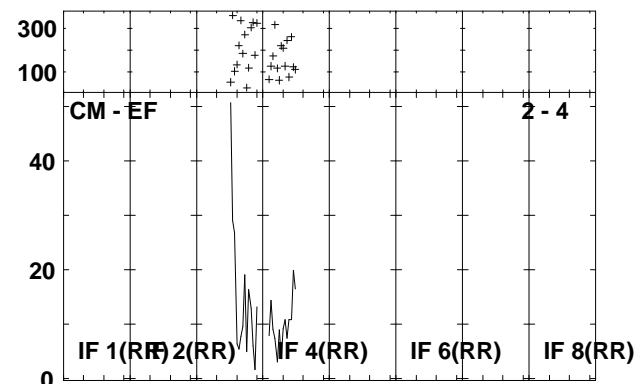
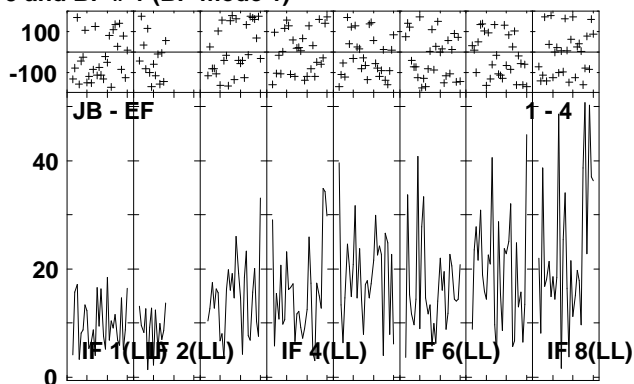
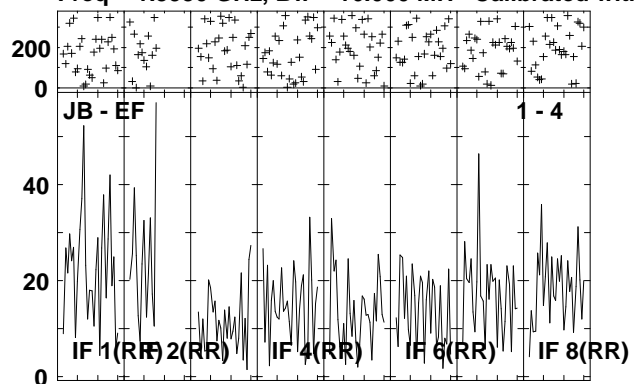

Lower frame: Milli Ampl Jy Top frame: Phas deg
Vector averaged cross-power spectrum Several baselines displayed
Timerange: 00/12:36:31 to 00/12:39:59

Plot file version 24 created 29-APR-2009 14:27:13

IRAS2336 EP064D.UVDATA.1

Freq = 1.5950 GHz, Bw = 16.000 MH Calibrated with CL # 3 and BP # 1 (BP mode 1)

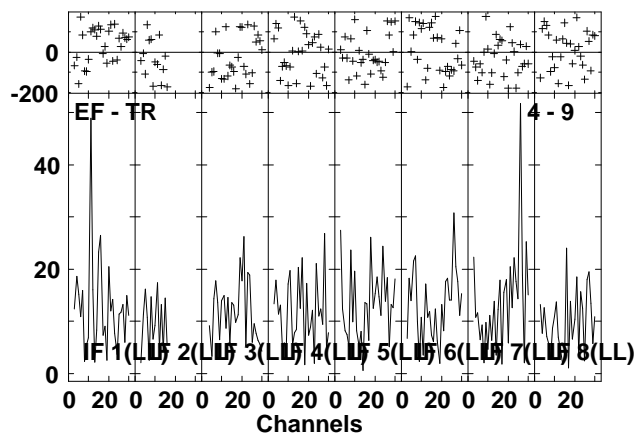
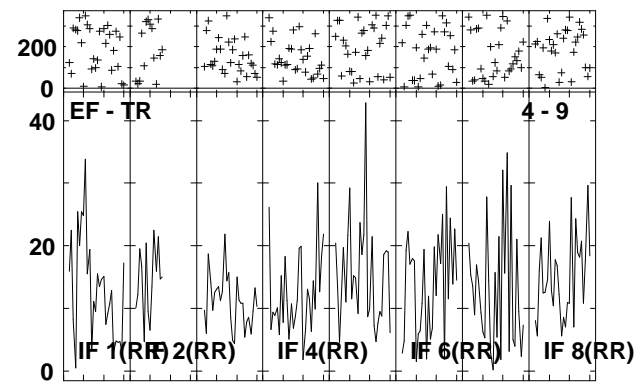
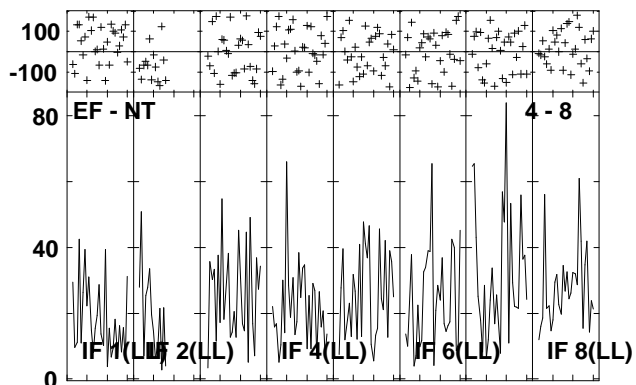
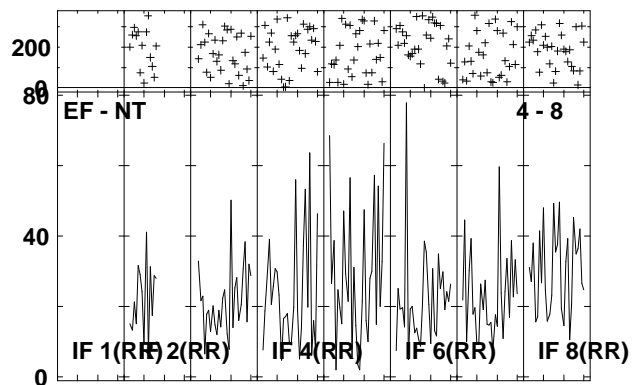
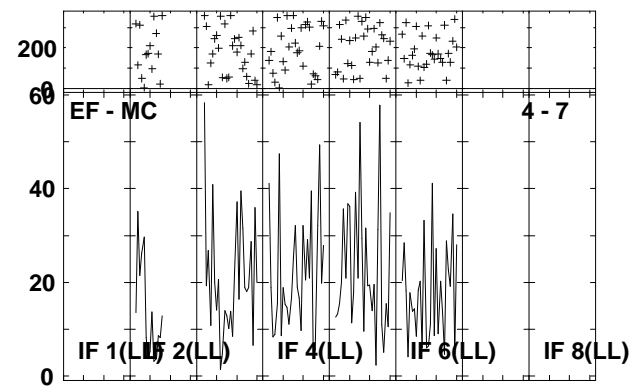
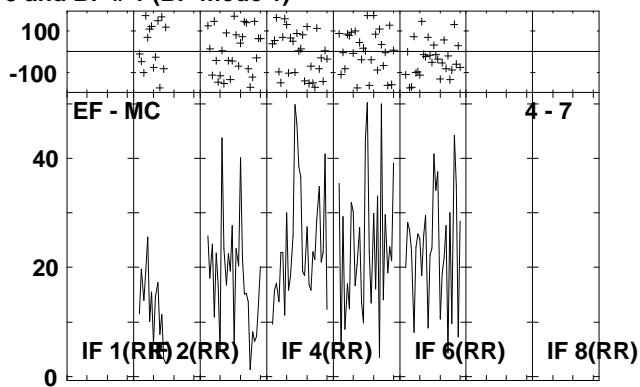
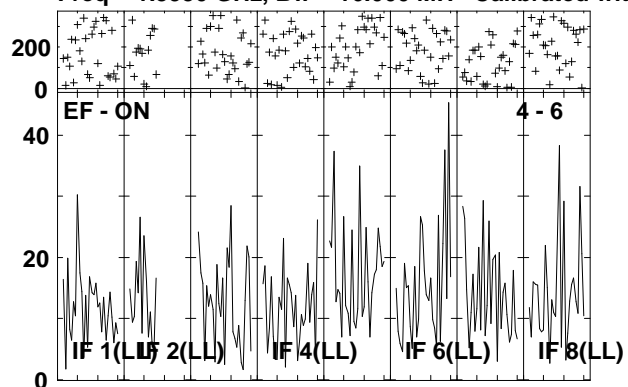

Lower frame: Milli Ampl Jy Top frame: Phas deg
Vector averaged cross-power spectrum Several baselines displayed
Timerange: 00/12:36:31 to 00/12:39:59

Plot file version 25 created 29-APR-2009 14:27:16

J2333+39 EP064D.UVDATA.1

Freq = 1.5950 GHz, Bw = 16.000 MH Calibrated with CL # 3 and BP # 1 (BP mode 1)

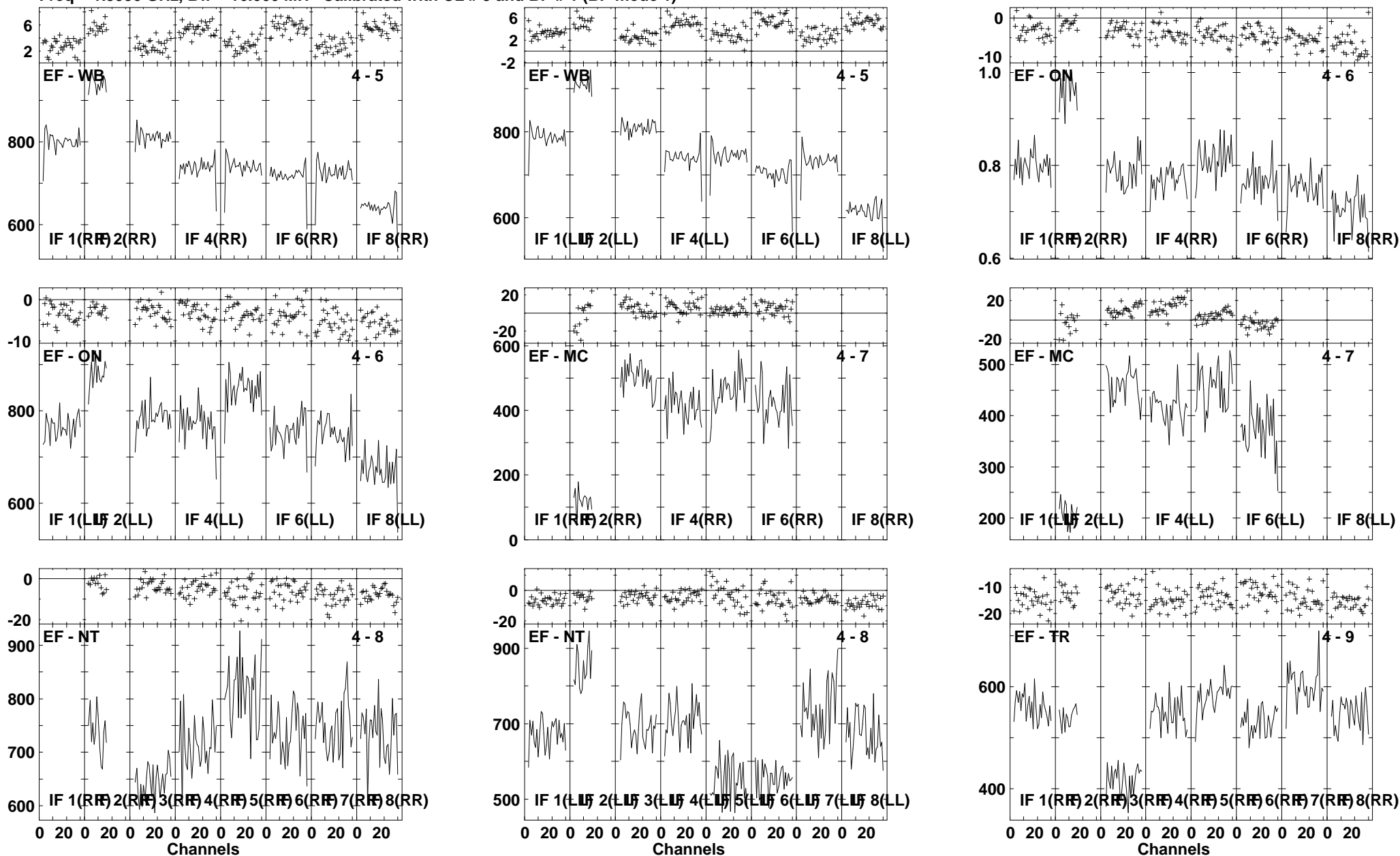

Lower frame: Milli Ampl Jy Top frame: Phas deg
Vector averaged cross-power spectrum Several baselines displayed
Timerange: 00:12:40:01 to 00:12:41:27

Plot file version 26 created 29-APR-2009 14:27:17

J2333+39 EP064D.UVDATA.1

Freq = 1.5950 GHz, Bw = 16.000 MH Calibrated with CL # 3 and BP # 1 (BP mode 1)

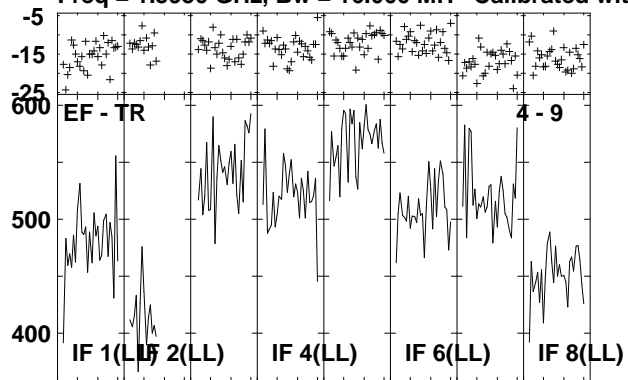

Lower frame: Milli Ampl Jy Top frame: Phas deg
Vector averaged cross-power spectrum Several baselines displayed
Timerange: 00/12:40:01 to 00/12:41:27

Plot file version 27 created 29-APR-2009 14:27:18

IRAS2336 EP064D.UVDATA.1

Freq = 1.5950 GHz, Bw = 16.000 MH Calibrated with CL # 3 and BP # 1 (BP mode 1)

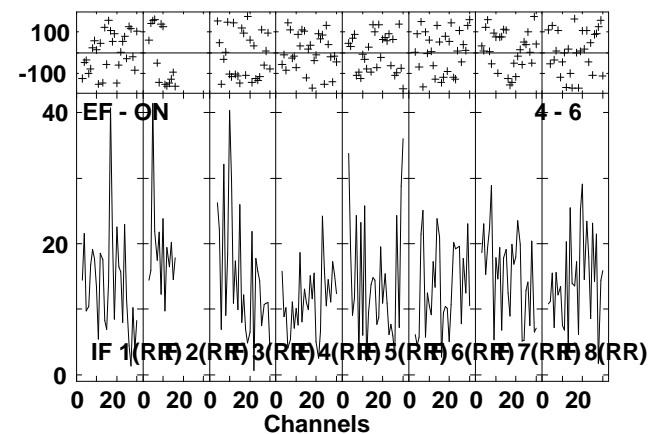
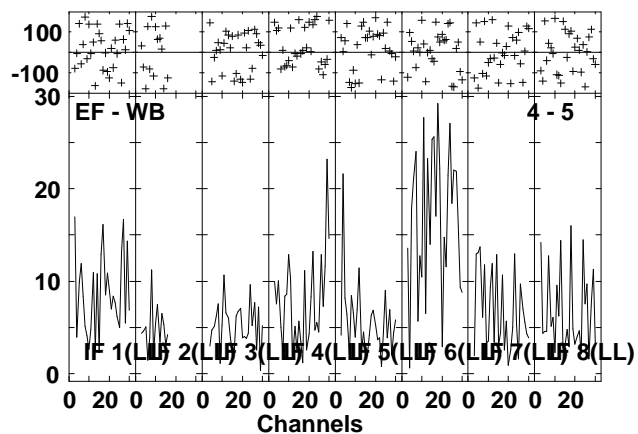
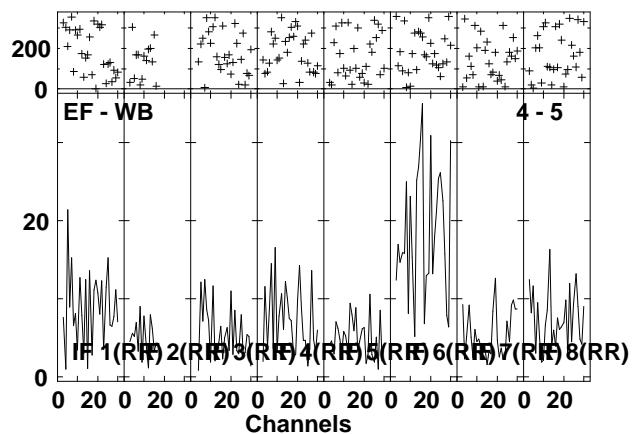
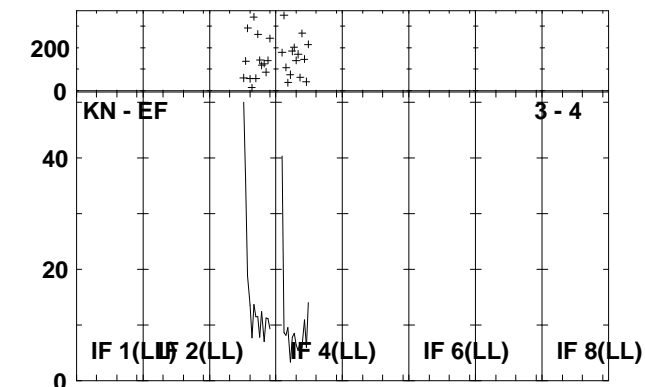
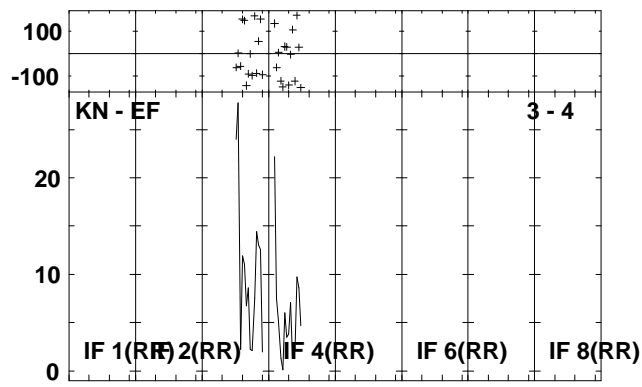
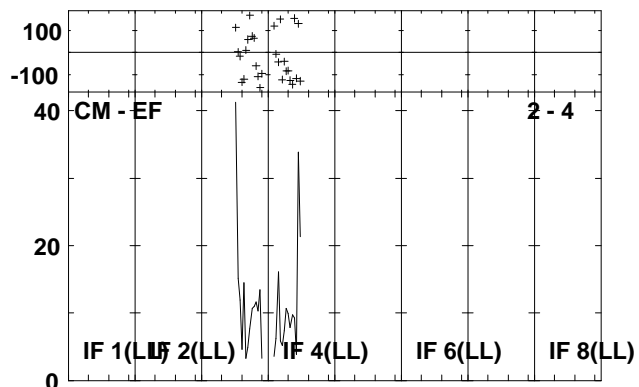
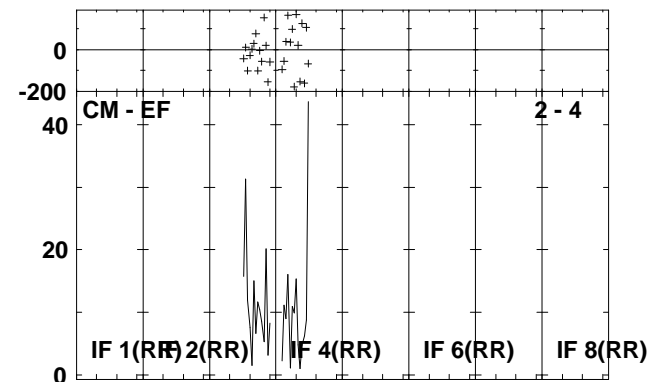
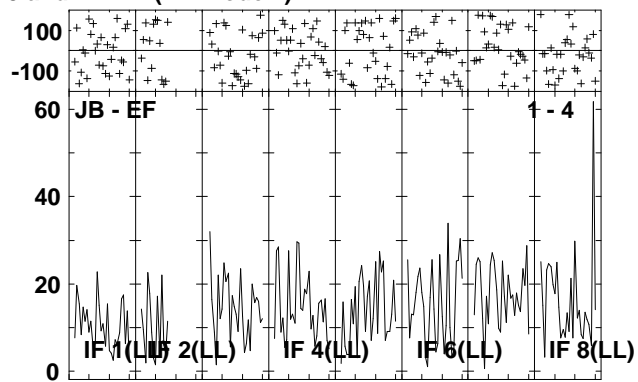
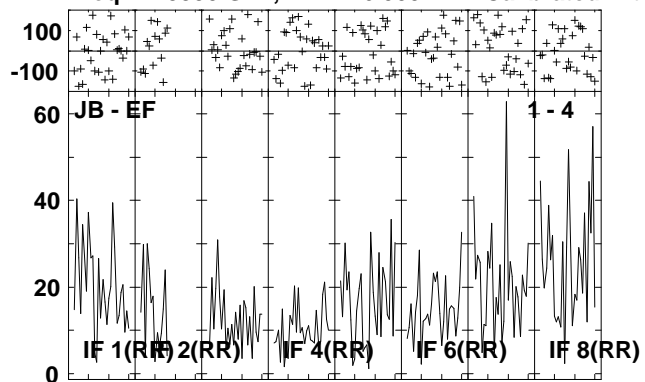

Lower frame: Milli Ampl Jy Top frame: Phas deg
Vector averaged cross-power spectrum Several baselines displayed
Timerange: 00/12:41:29 to 00/12:44:59

Plot file version 28 created 29-APR-2009 14:27:20

IRAS2336 EP064D.UVDATA.1

Freq = 1.5950 GHz, Bw = 16.000 MH Calibrated with CL # 3 and BP # 1 (BP mode 1)

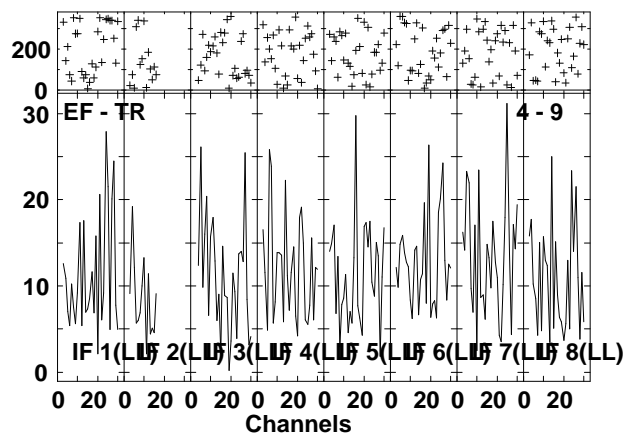
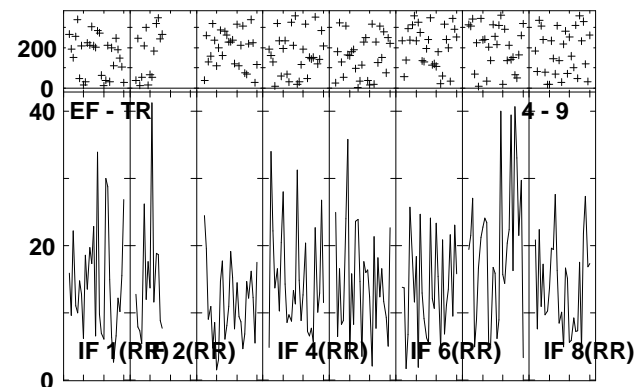
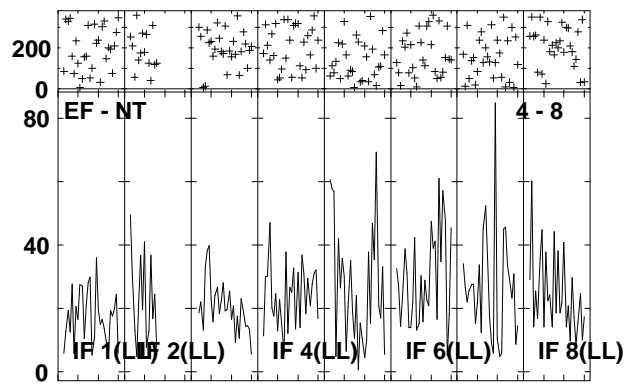
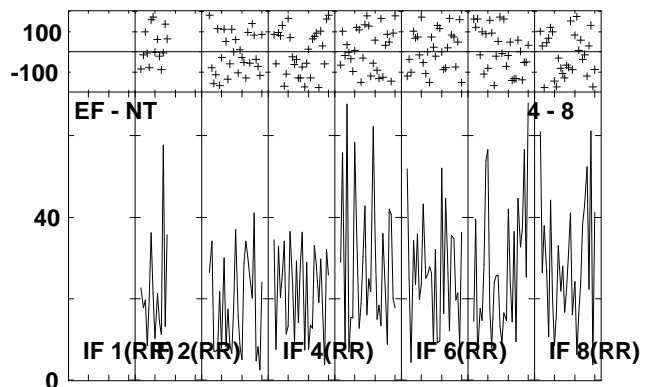
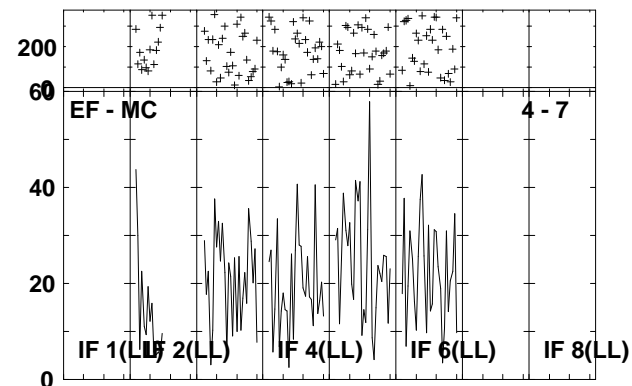
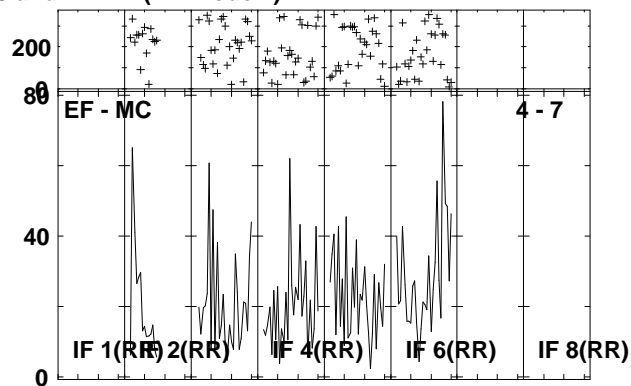
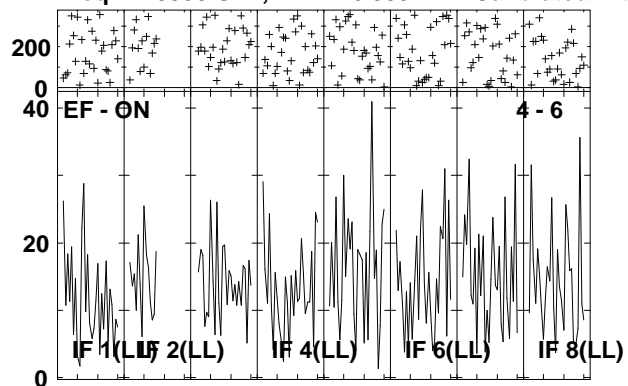

Lower frame: Milli Ampl Jy Top frame: Phas deg
Vector averaged cross-power spectrum Several baselines displayed
Timerange: 00/12:41:29 to 00/12:44:59

Plot file version 29 created 29-APR-2009 14:27:24

J2333+39 EP064D.UVDATA.1

Freq = 1.5950 GHz, Bw = 16.000 MH Calibrated with CL # 3 and BP # 1 (BP mode 1)

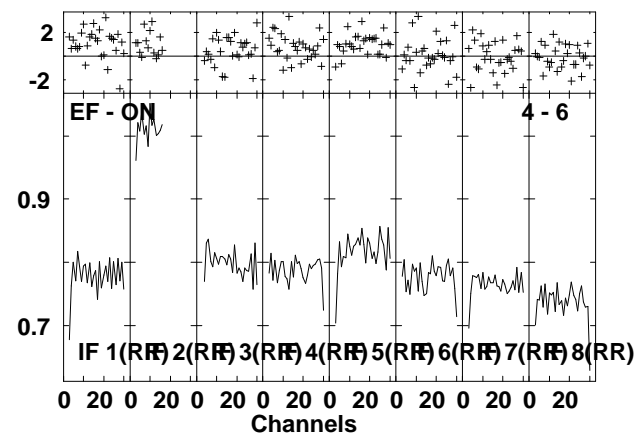
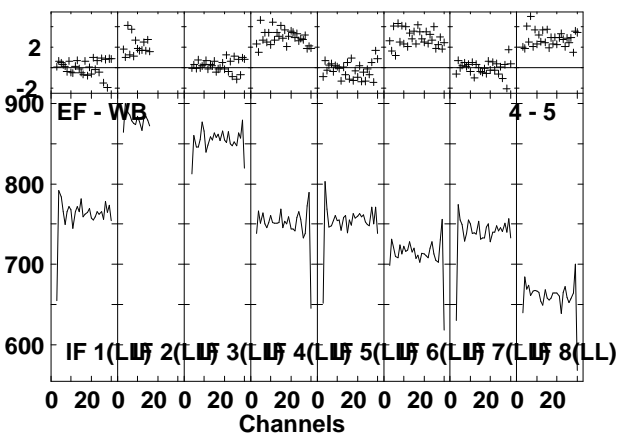
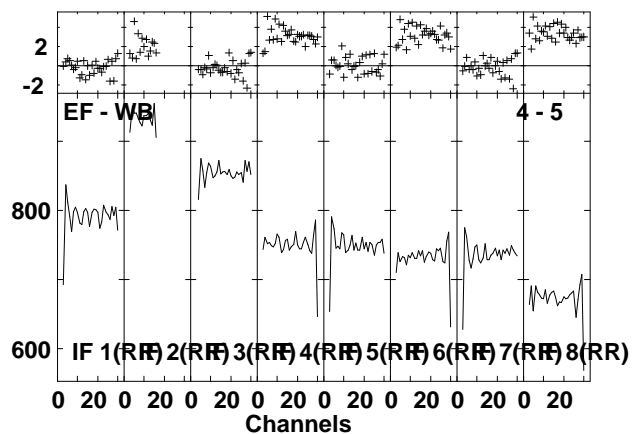
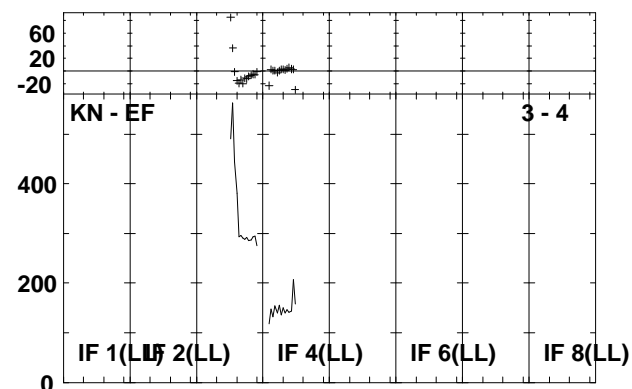
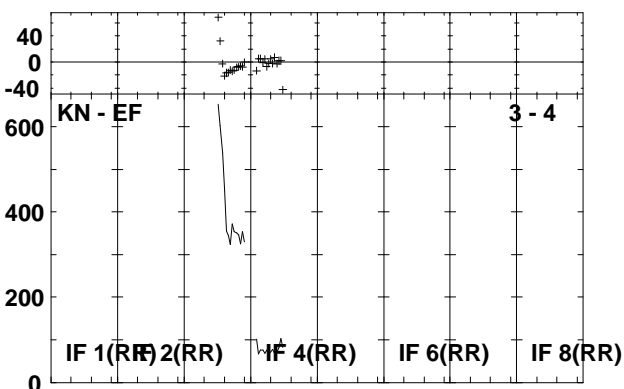
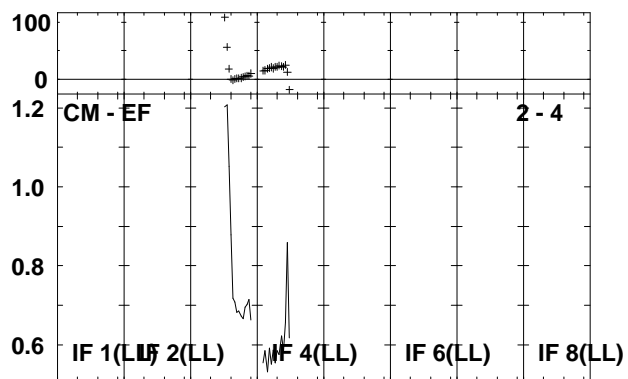
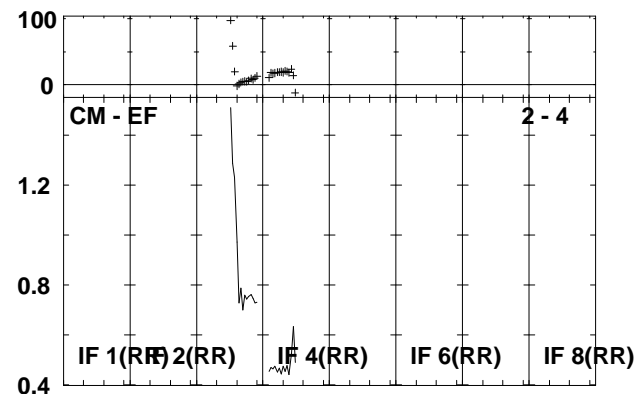
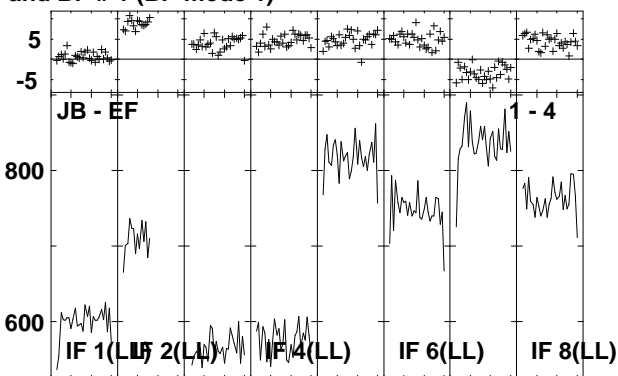
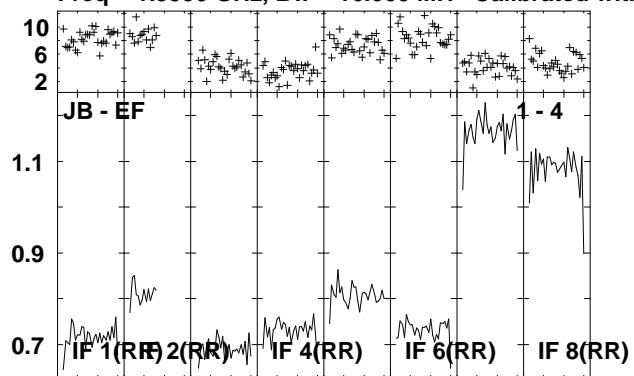

Lower frame: Ampl Jy Top frame: Phas deg
Vector averaged cross-power spectrum Several baselines displayed
Timerange: 00/12:46:01 to 00/12:47:31

Plot file version 30 created 29-APR-2009 14:27:25

J2333+39 EP064D.UVDATA.1

Freq = 1.5950 GHz, Bw = 16.000 MH Calibrated with CL # 3 and BP # 1 (BP mode 1)

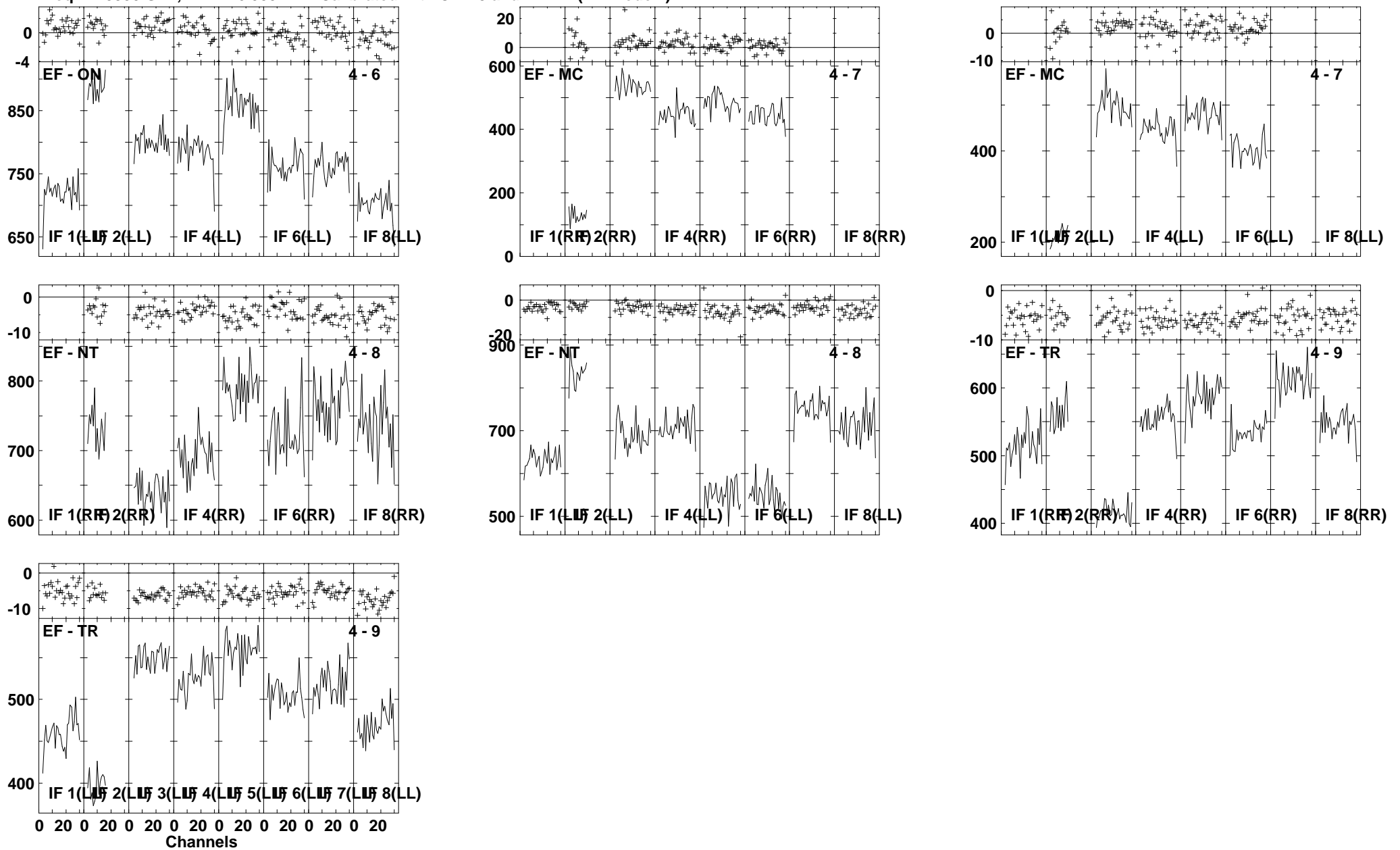

Lower frame: Milli Ampl Jy Top frame: Phas deg
Vector averaged cross-power spectrum Several baselines displayed
Timerange: 00/12:46:01 to 00/12:47:31

Plot file version 31 created 29-APR-2009 14:27:27

IRAS2336 EP064D.UVDATA.1

Freq = 1.5950 GHz, Bw = 16.000 MH Calibrated with CL # 3 and BP # 1 (BP mode 1)

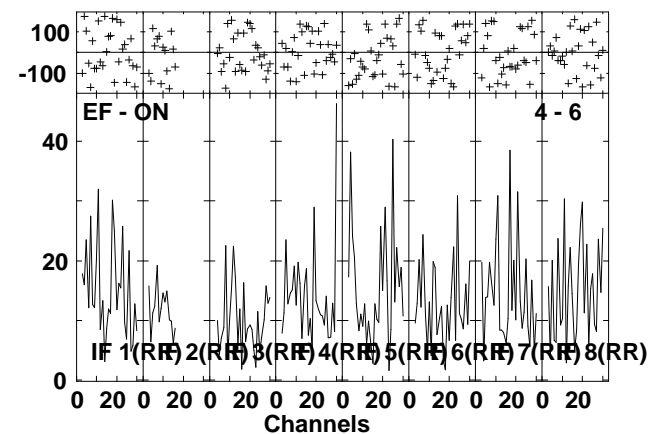
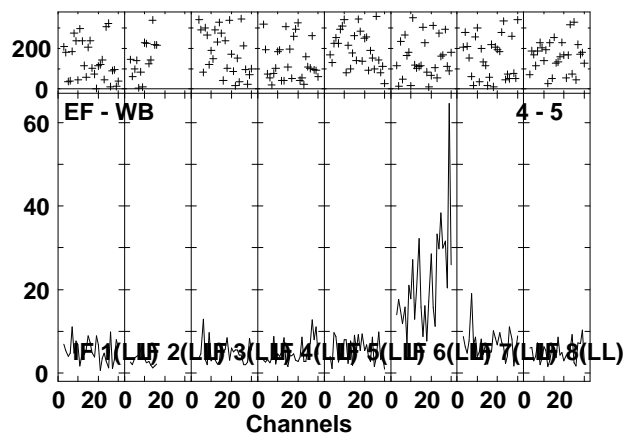
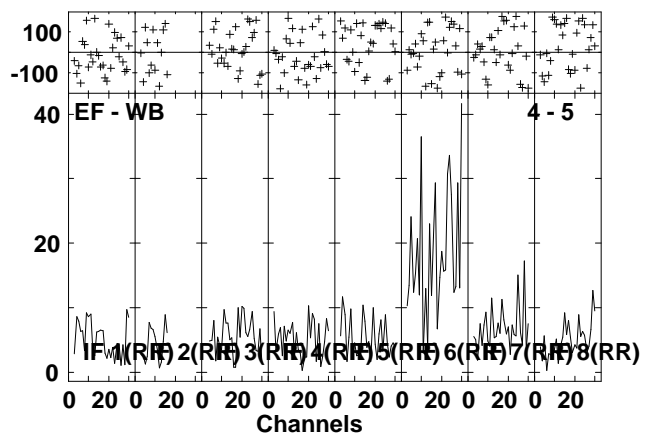
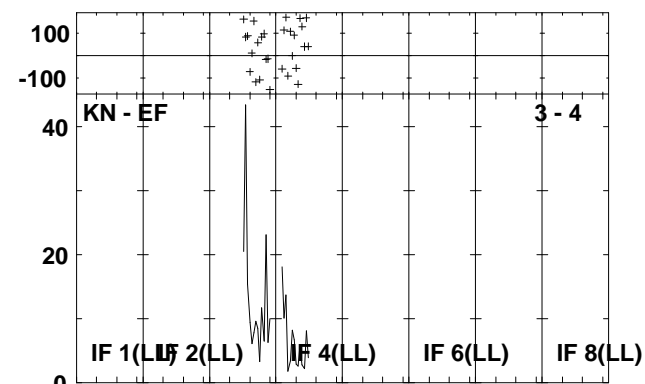
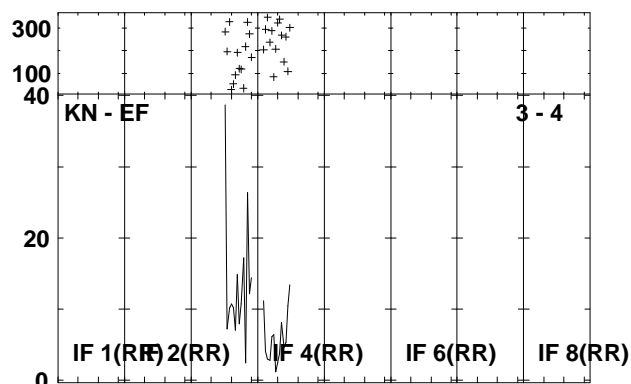
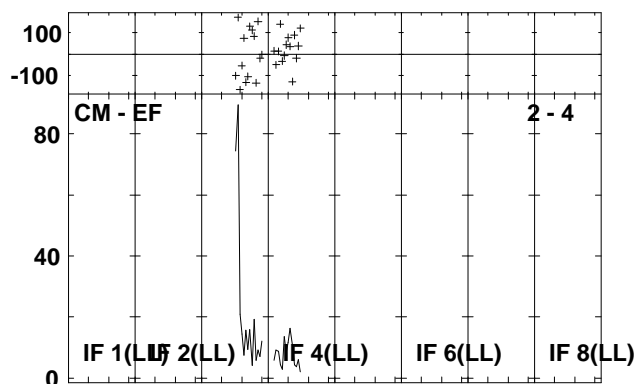
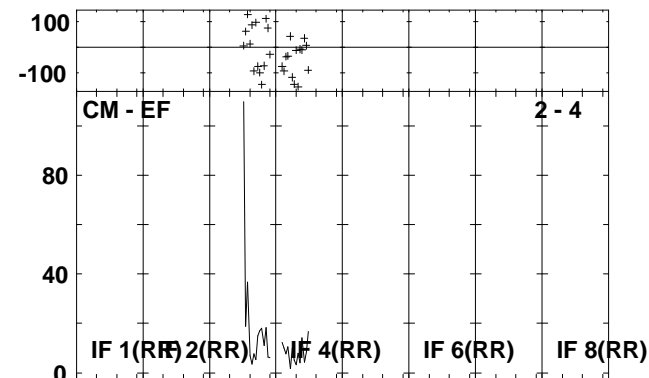
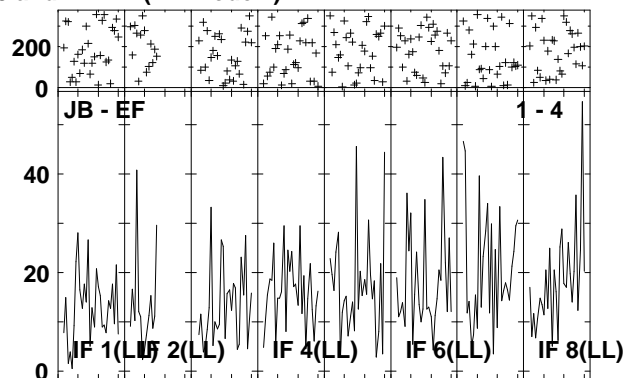
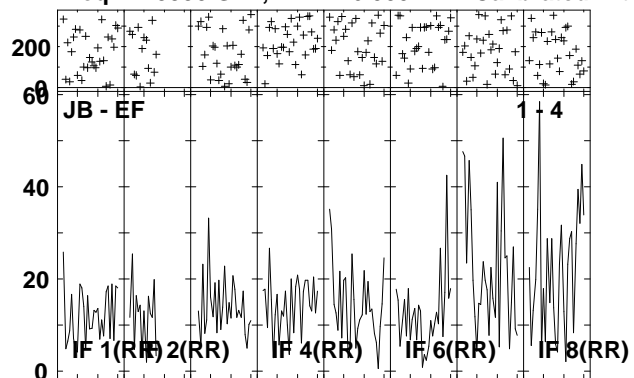

Lower frame: Milli Ampl Jy Top frame: Phas deg
Vector averaged cross-power spectrum Several baselines displayed
Timerange: 00:12:47:33 to 00:12:50:59

Plot file version 32 created 29-APR-2009 14:27:29

IRAS2336 EP064D.UVDATA.1

Freq = 1.5950 GHz, Bw = 16.000 MH Calibrated with CL # 3 and BP # 1 (BP mode 1)

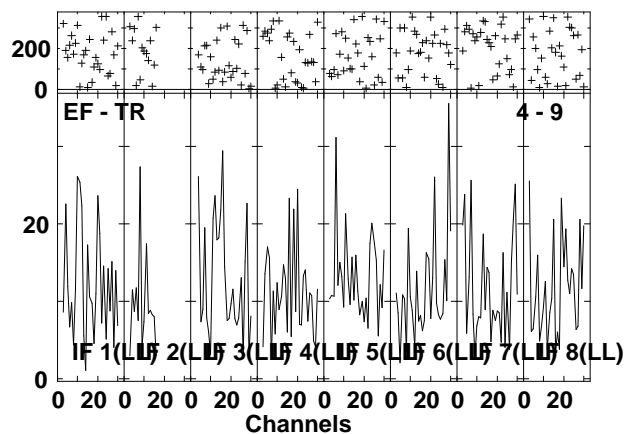
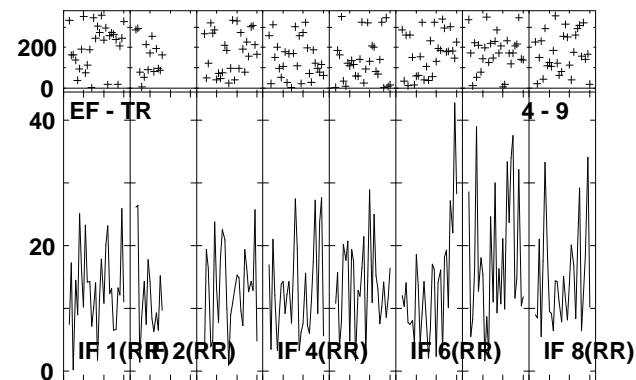
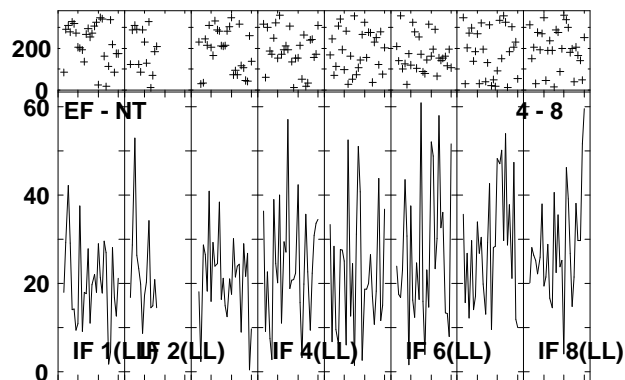
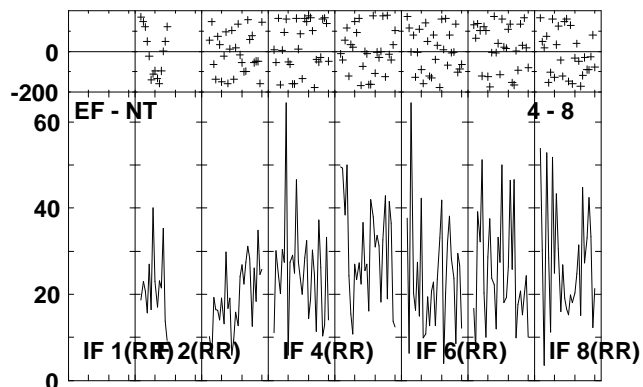
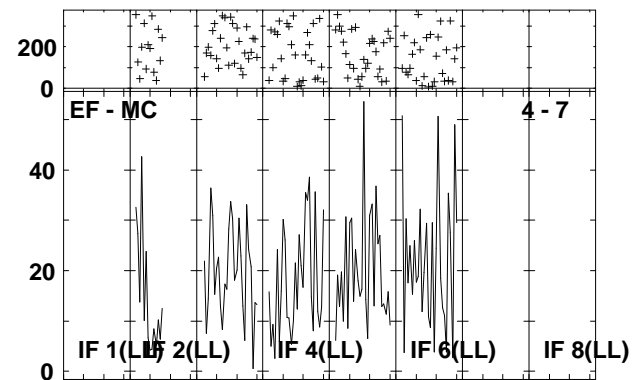
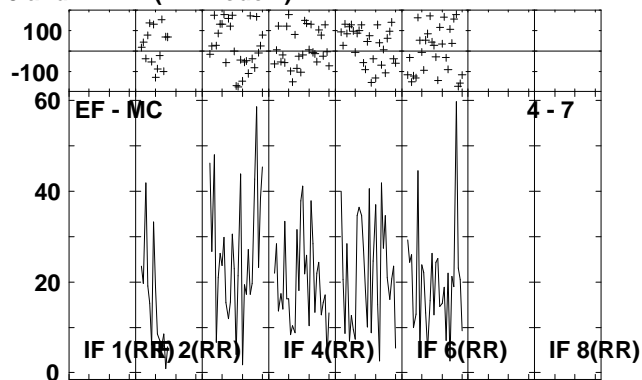
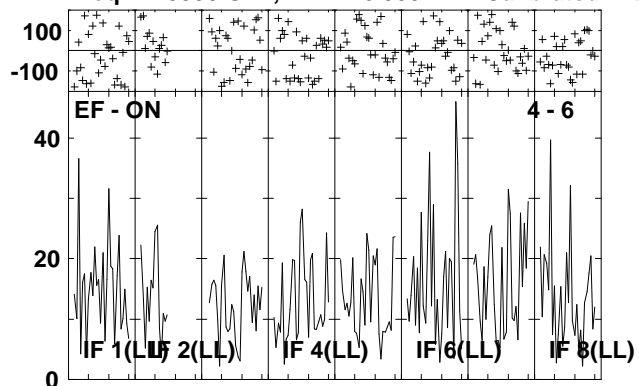

Lower frame: Milli Ampl Jy Top frame: Phas deg
Vector averaged cross-power spectrum Several baselines displayed
Timerange: 00/12:47:33 to 00/12:50:59

Plot file version 33 created 29-APR-2009 14:27:32

J2333+39 EP064D.UVDATA.1

Freq = 1.5950 GHz, Bw = 16.000 MH Calibrated with CL # 3 and BP # 1 (BP mode 1)

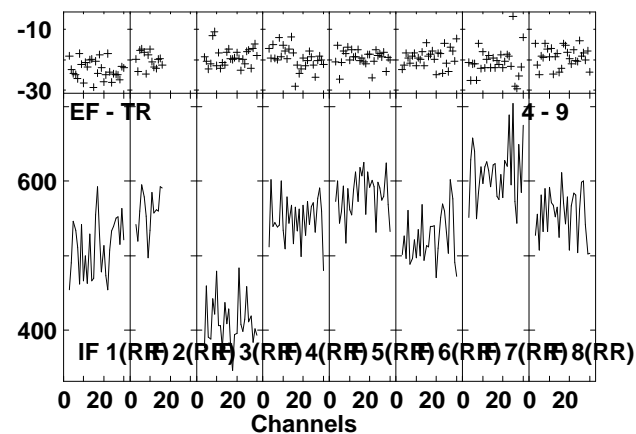
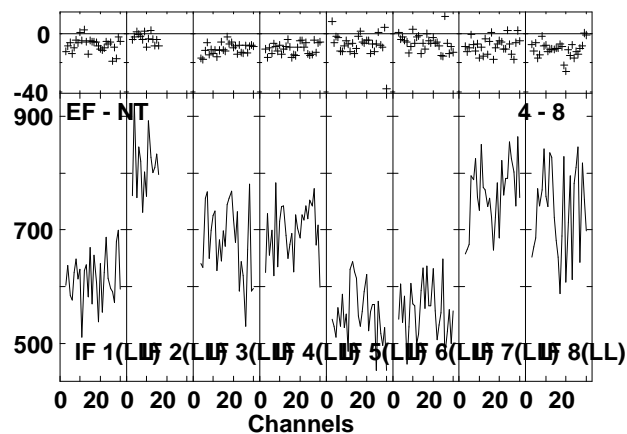
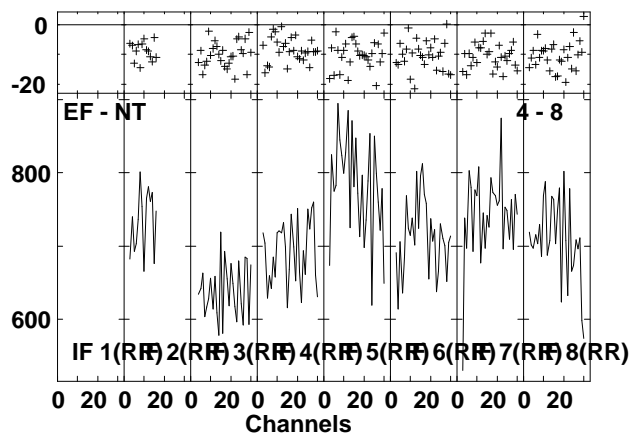
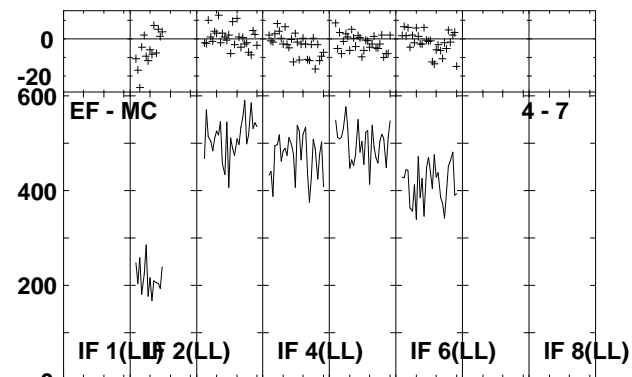
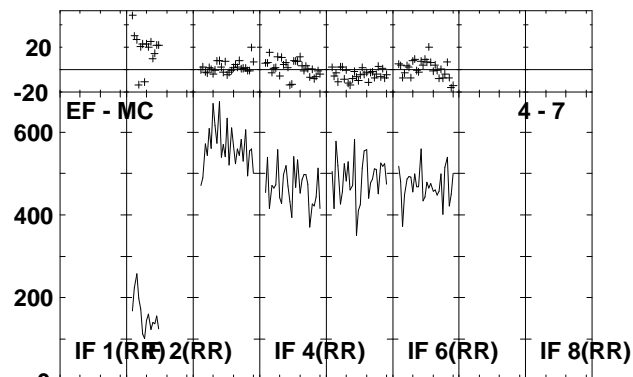
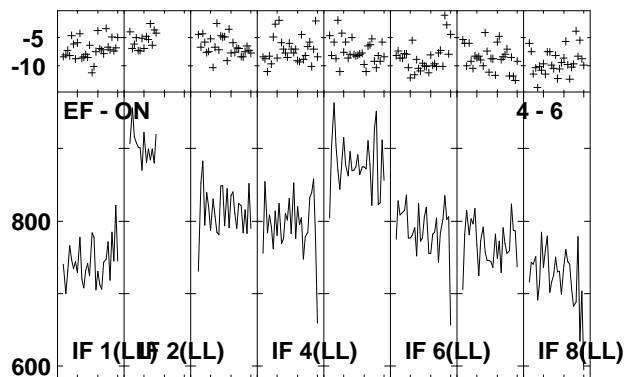
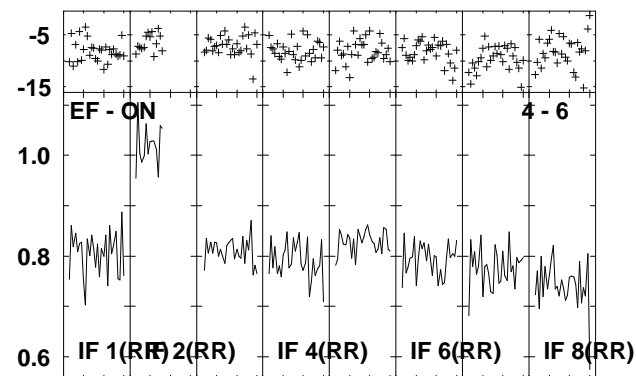
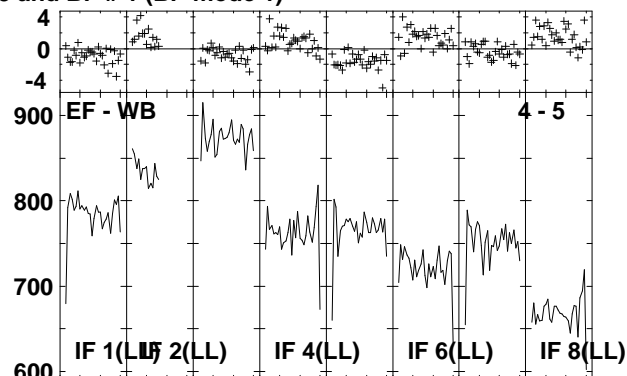
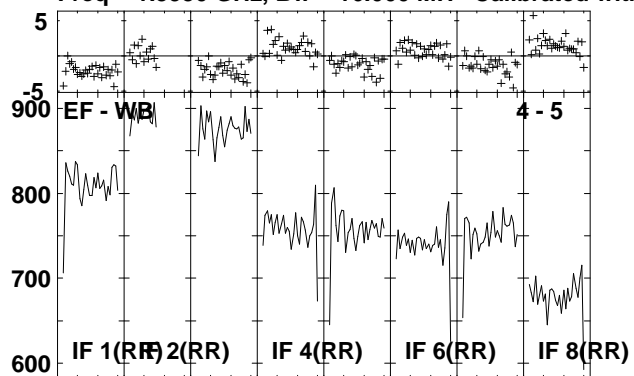

Lower frame: Milli Ampl Jy Top frame: Phas deg
Vector averaged cross-power spectrum Several baselines displayed
Timerange: 00/12:51:01 to 00/12:52:27

Plot file version 34 created 29-APR-2009 14:27:33

J2333+39 EP064D.UVDATA.1

Freq = 1.5950 GHz, Bw = 16.000 MH Calibrated with CL # 3 and BP # 1 (BP mode 1)

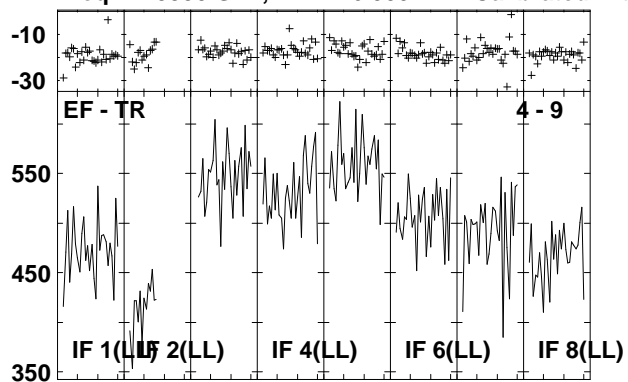

Lower frame: Milli Ampl Jy Top frame: Phas deg
Vector averaged cross-power spectrum Several baselines displayed
Timerange: 00/12:51:01 to 00/12:52:27

Plot file version 35 created 29-APR-2009 14:27:34

IRAS2336 EP064D.UVDATA.1

Freq = 1.5950 GHz, Bw = 16.000 MH Calibrated with CL # 3 and BP # 1 (BP mode 1)

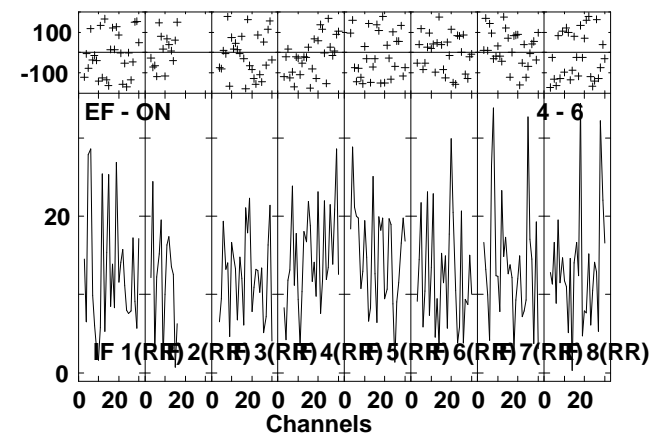
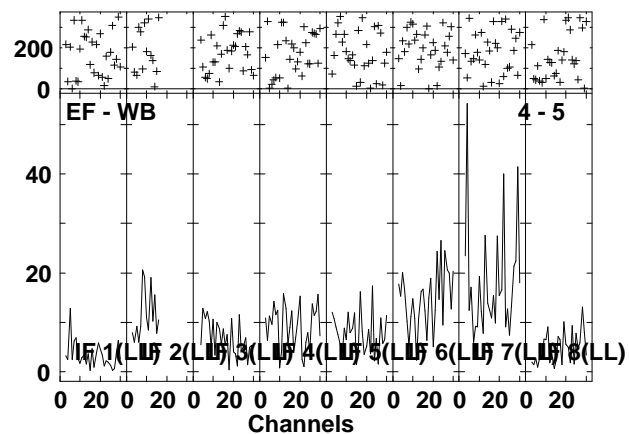
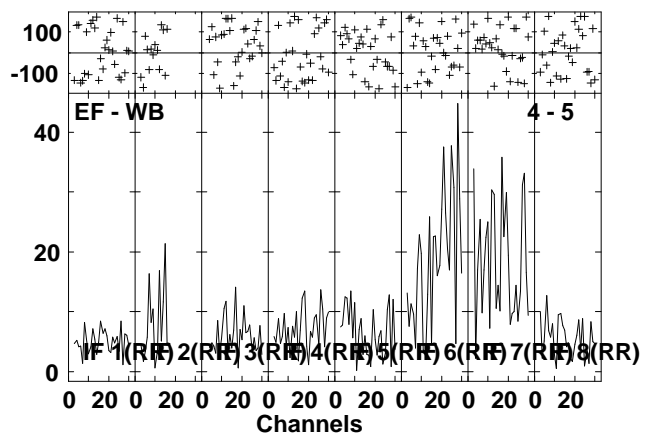
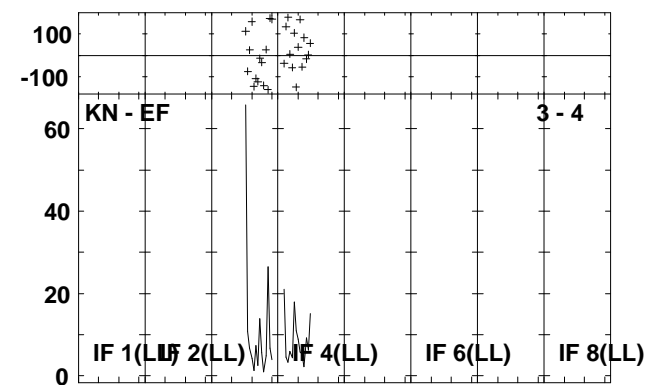
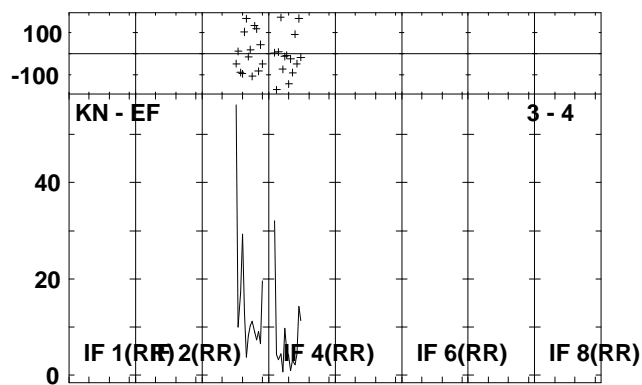
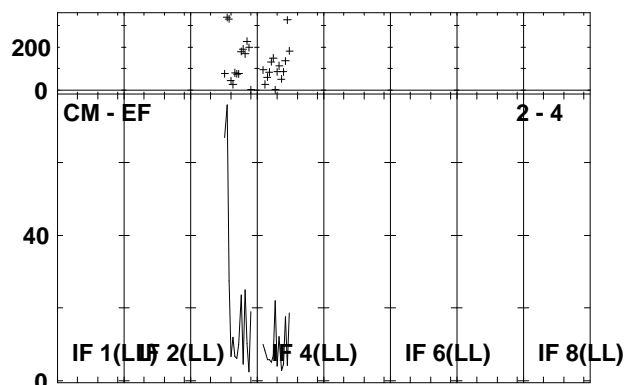
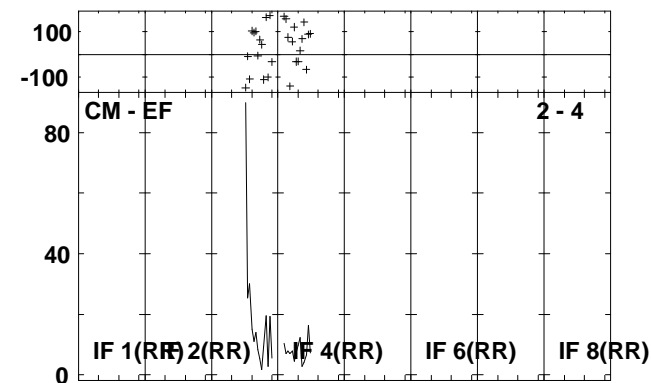
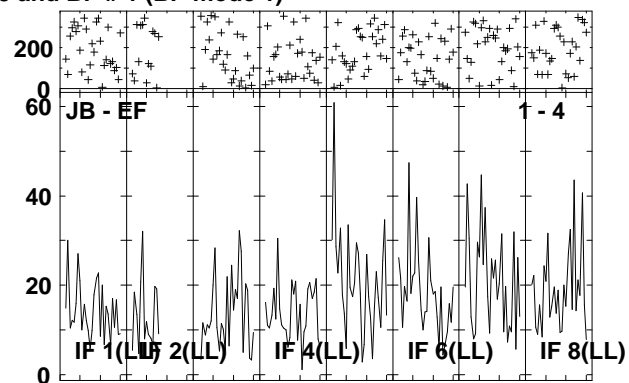
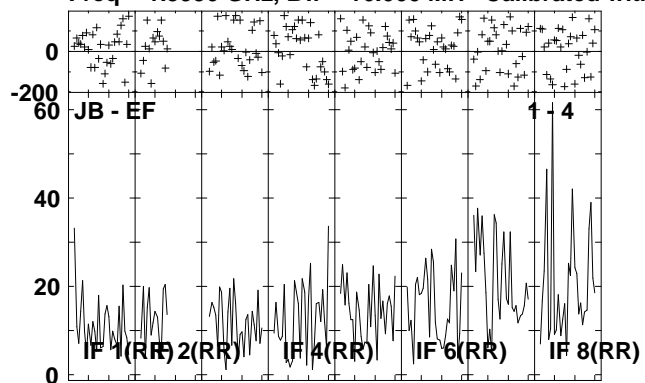

Lower frame: Milli Ampl Jy Top frame: Phas deg
Vector averaged cross-power spectrum Several baselines displayed
Timerange: 00/12:52:29 to 00/12:55:59

Plot file version 36 created 29-APR-2009 14:27:36
 IRAS2336 EP064D.UVDATA.1
 Freq = 1.5950 GHz, Bw = 16.000 MH Calibrated with CL # 3 and BP # 1 (BP mode 1)

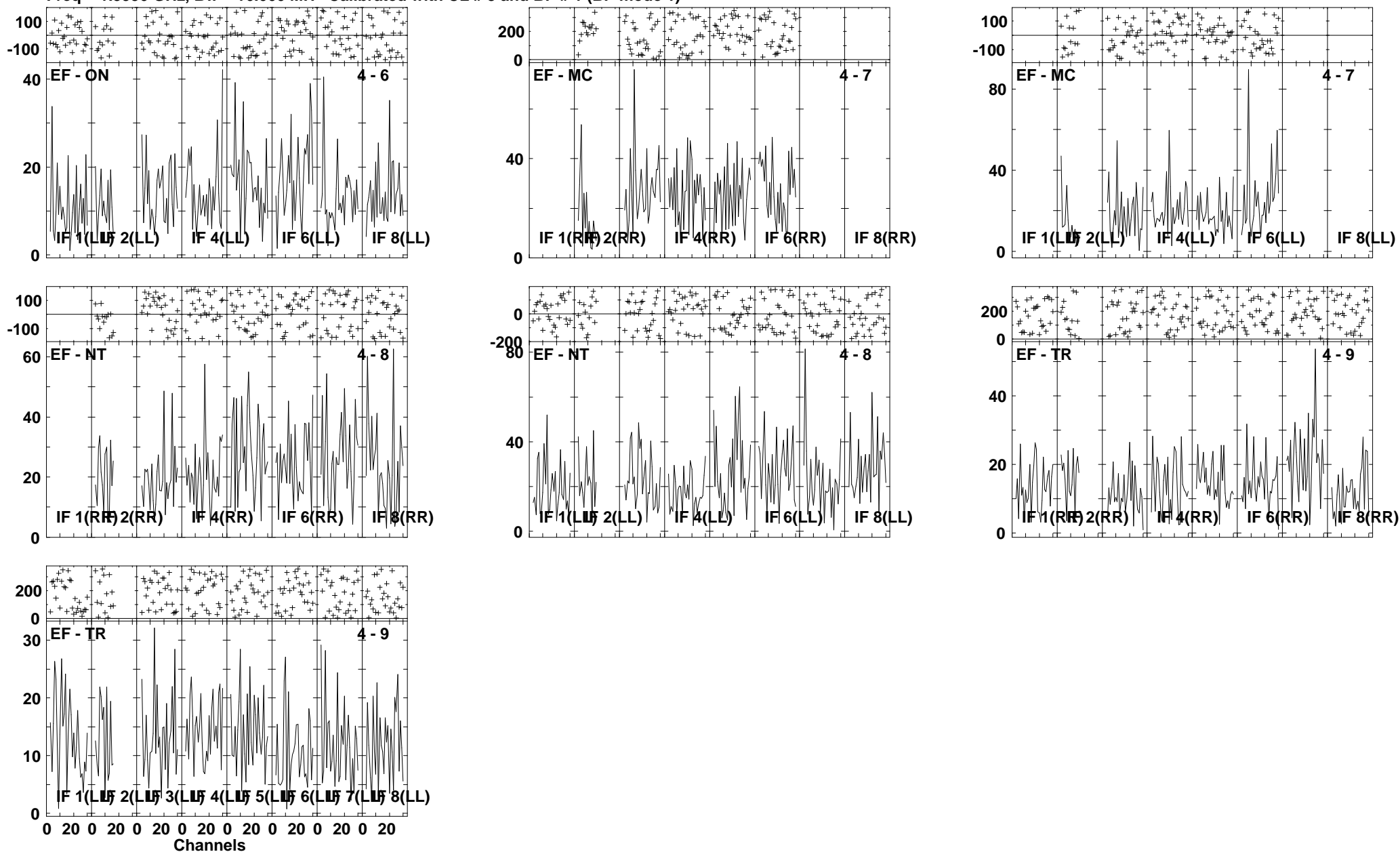

Lower frame: Milli Ampl Jy Top frame: Phas deg
 Vector averaged cross-power spectrum Several baselines displayed
 Timerange: 00/12:52:29 to 00/12:55:29

Plot file version 37 created 29-APR-2009 14:27:39

J2333+39 EP064D.UVDATA.1

Freq = 1.5950 GHz, Bw = 16.000 MH Calibrated with CL # 3 and BP # 1 (BP mode 1)

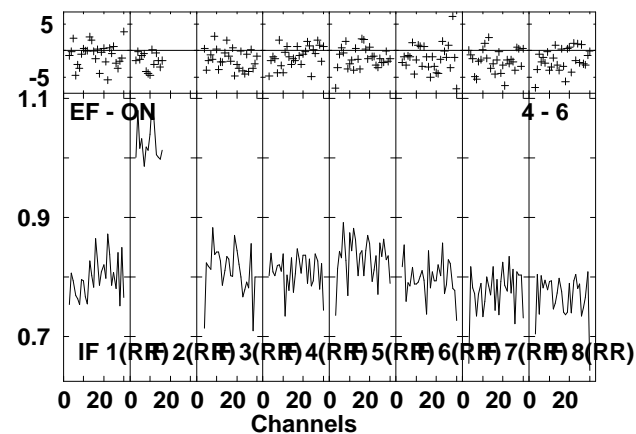
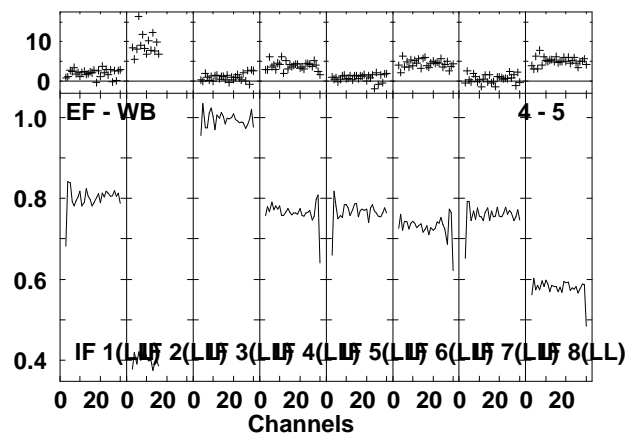
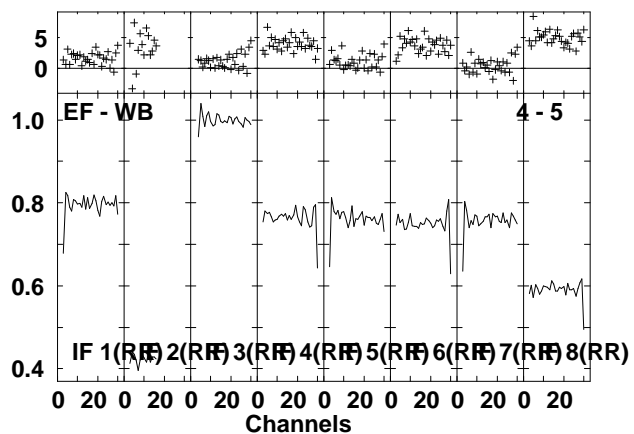
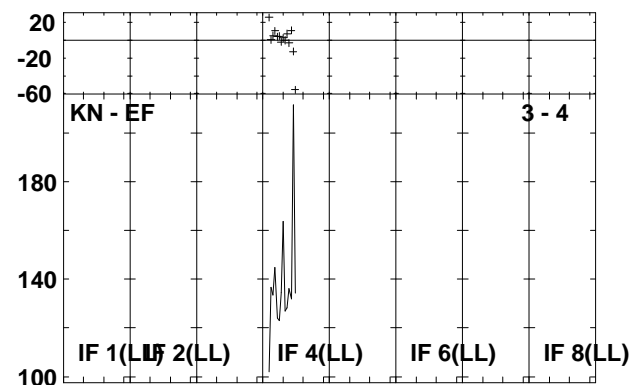
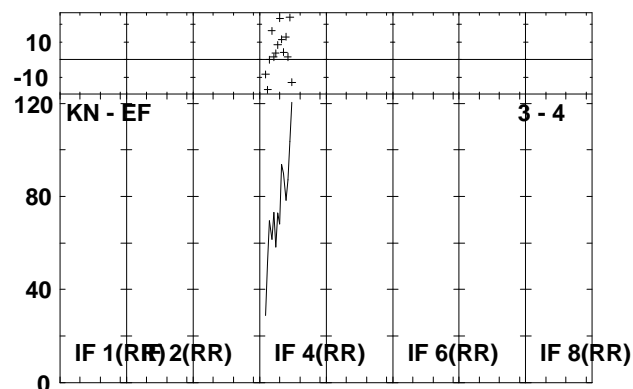
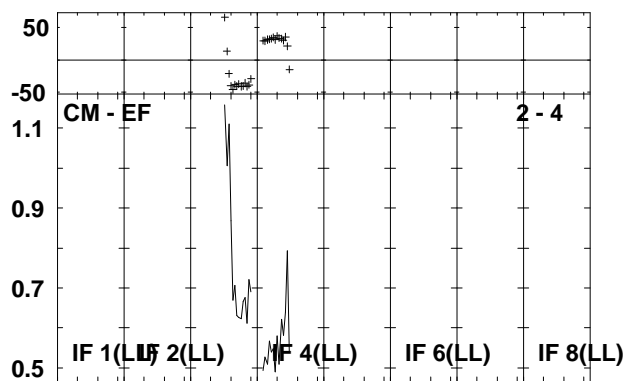
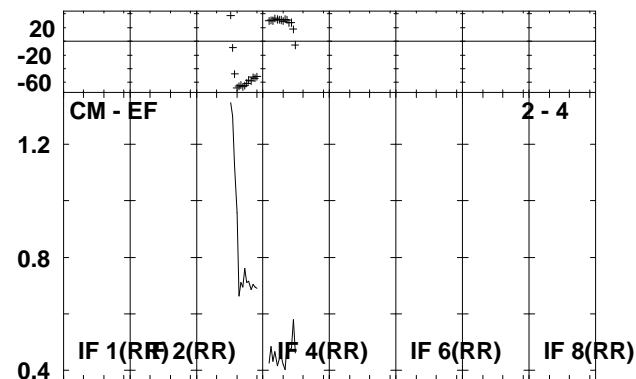
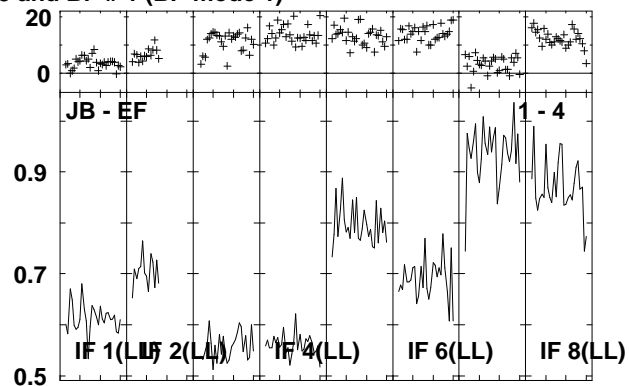
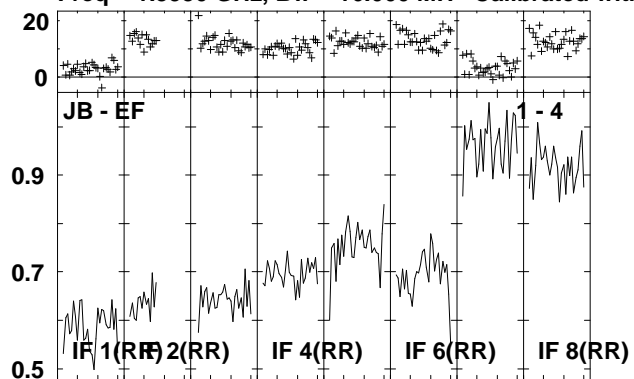

Lower frame: Ampl Jy Top frame: Phas deg
Vector averaged cross-power spectrum Several baselines displayed
Timerange: 00/12:56:01 to 00/12:57:31

Plot file version 38 created 29-APR-2009 14:27:40

J2333+39 EP064D.UVDATA.1

Freq = 1.5950 GHz, Bw = 16.000 MH Calibrated with CL # 3 and BP # 1 (BP mode 1)

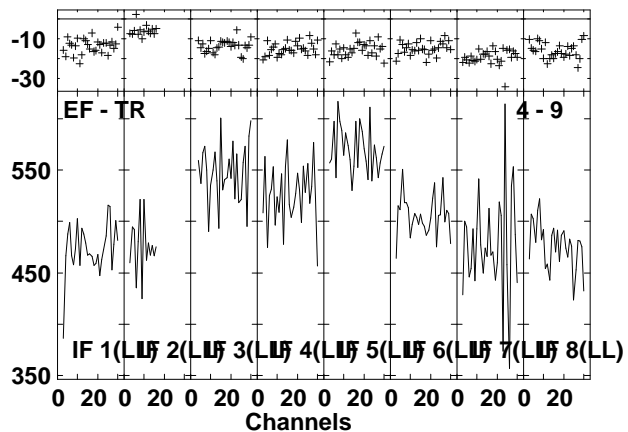
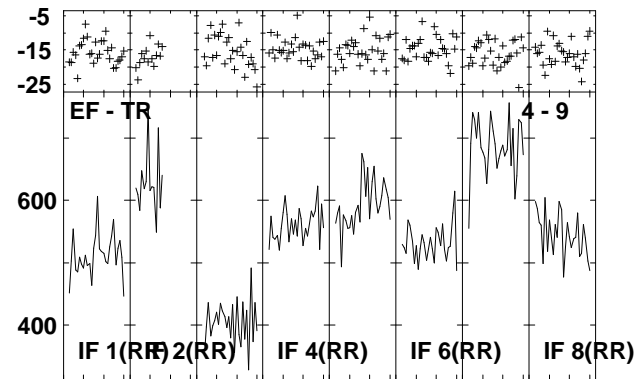
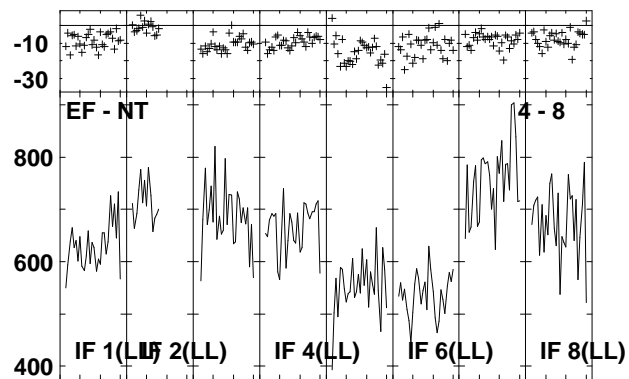
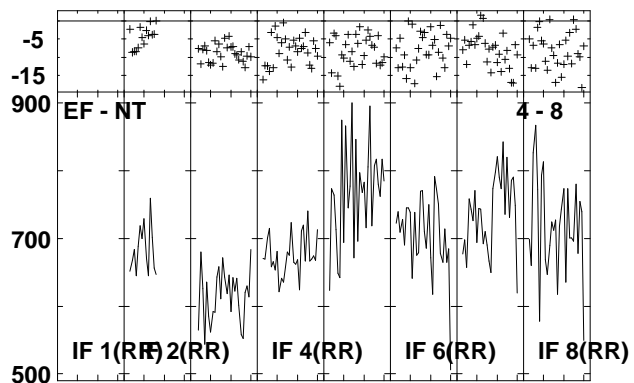
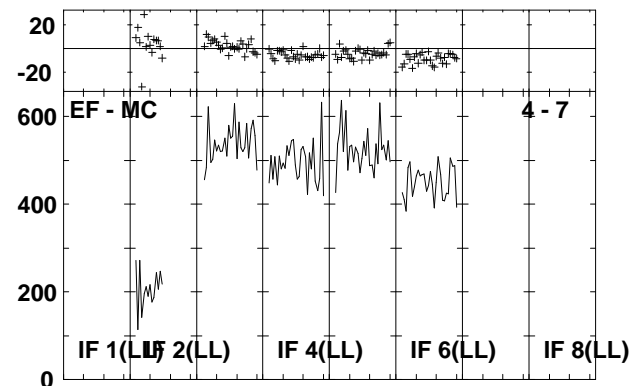
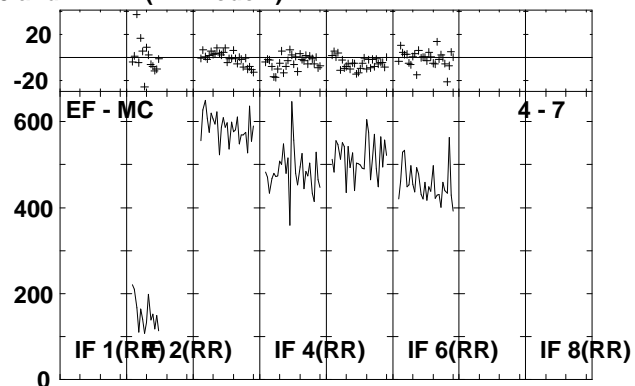
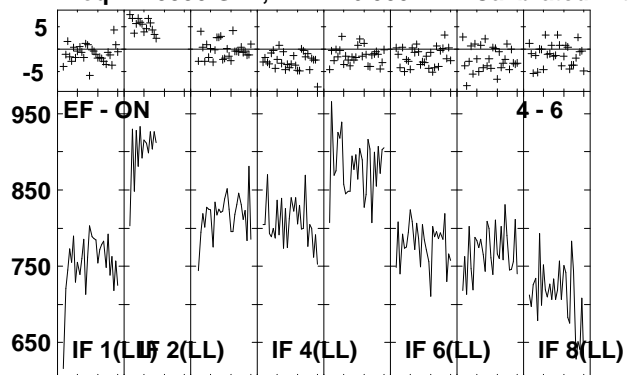

Lower frame: Milli Ampl Jy Top frame: Phas deg
Vector averaged cross-power spectrum Several baselines displayed
Timerange: 00/12:56:01 to 00/12:57:31

Plot file version 39 created 29-APR-2009 14:27:42

IRAS2336 EP064D.UVDATA.1

Freq = 1.5950 GHz, Bw = 16.000 MH Calibrated with CL # 3 and BP # 1 (BP mode 1)

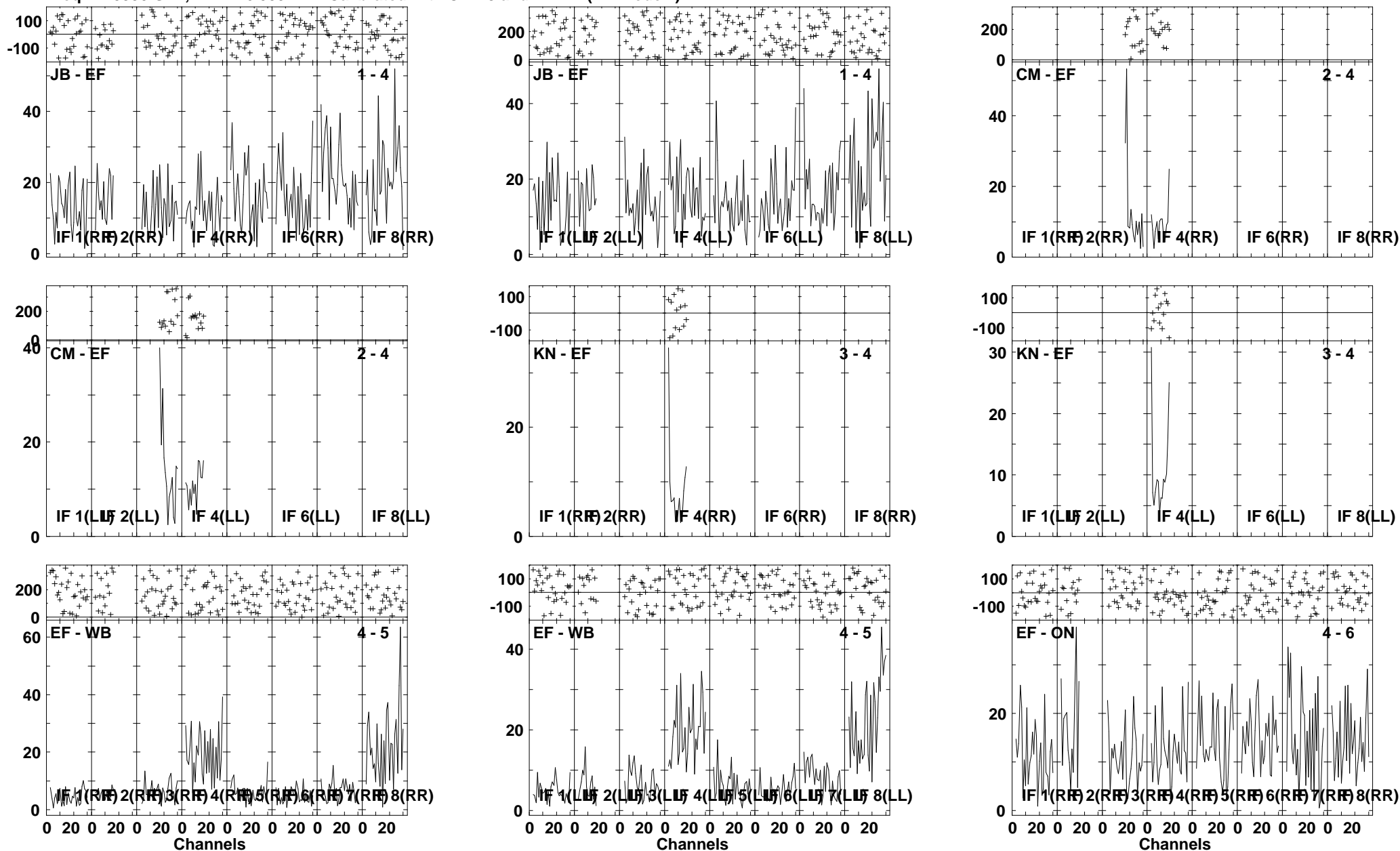

Lower frame: Milli Ampl Jy Top frame: Phas deg
Vector averaged cross-power spectrum Several baselines displayed
Timerange: 00/12:57:33 to 00/13:00:57

Plot file version 40 created 29-APR-2009 14:27:44

IRAS2336 EP064D.UVDATA.1

Freq = 1.5950 GHz, Bw = 16.000 MH Calibrated with CL # 3 and BP # 1 (BP mode 1)

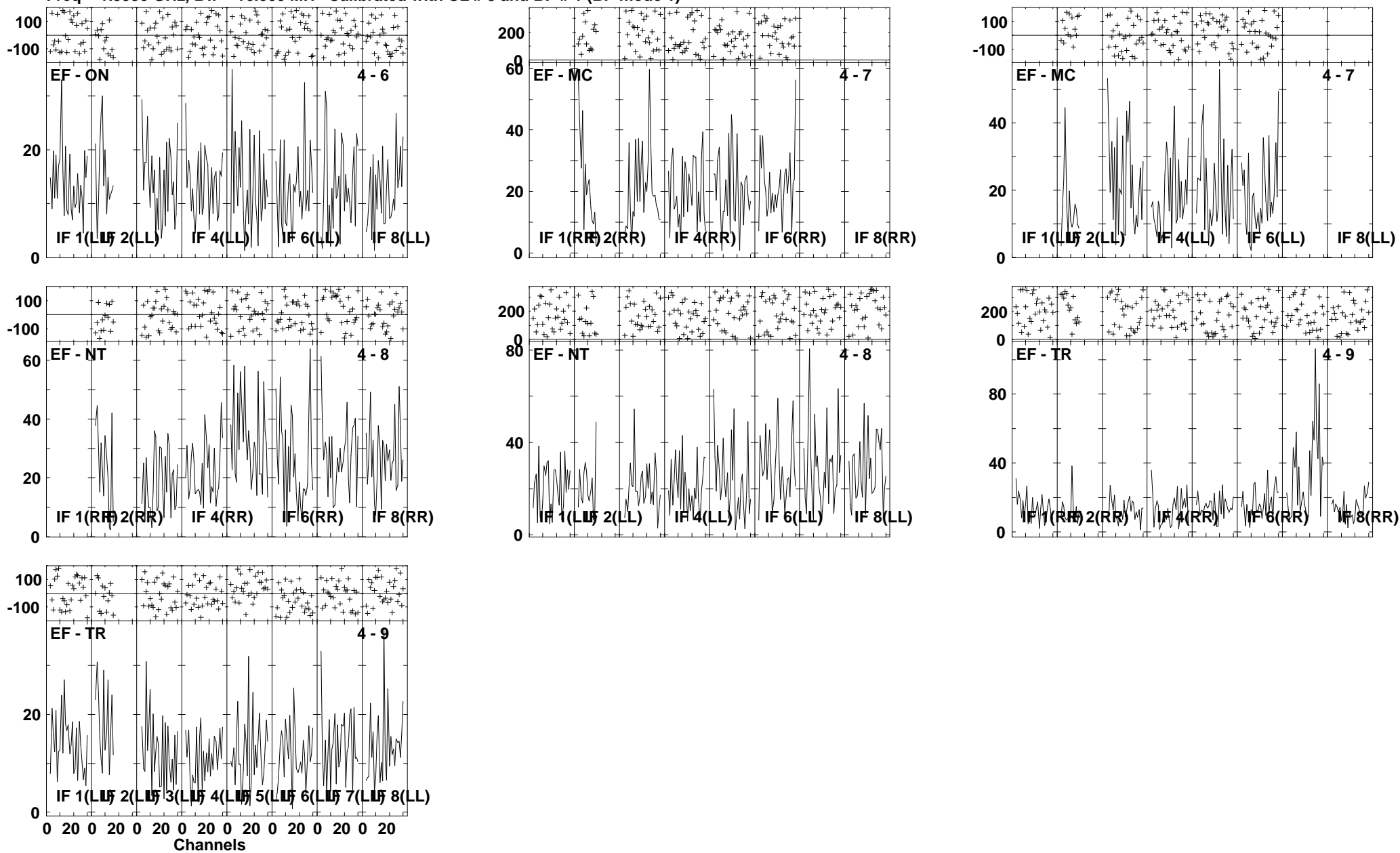

Lower frame: Milli Ampl Jy Top frame: Phas deg
Vector averaged cross-power spectrum Several baselines displayed
Timerange: 00/12:57:33 to 00/13:00:57

Plot file version 41 created 29-APR-2009 14:27:48

J2333+39 EP064D.UVDATA.1

Freq = 1.5950 GHz, Bw = 16.000 MH Calibrated with CL # 3 and BP # 1 (BP mode 1)

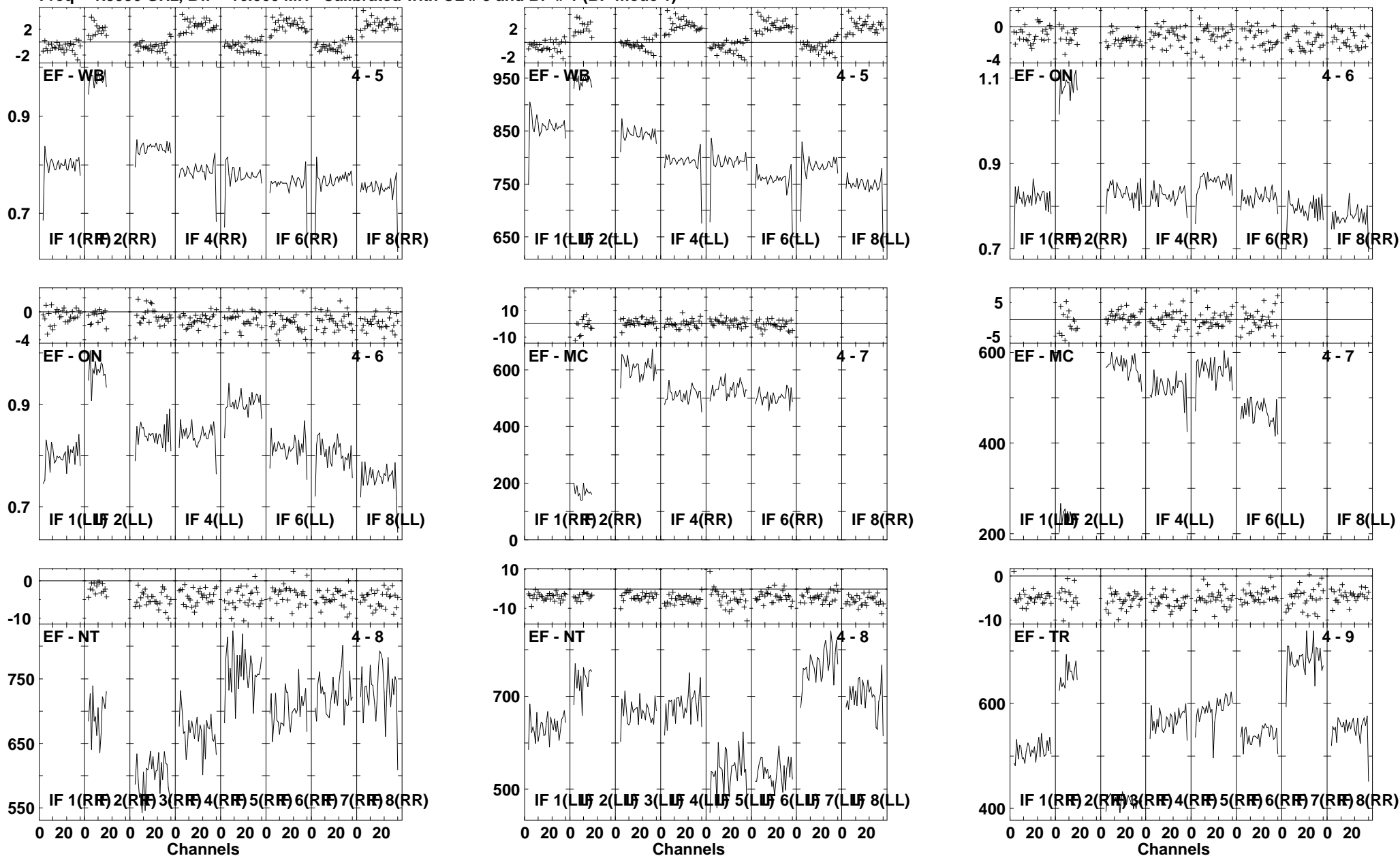

Lower frame: Ampl Jy Top frame: Phas deg
Vector averaged cross-power spectrum Several baselines displayed
Timerange: 00/13:02:02 to 00/13:03:26

Plot file version 42 created 29-APR-2009 14:27:49
J2333+39 EP064D.UVDATA.1
Freq = 1.5950 GHz, Bw = 16.000 MH Calibrated with CL # 3 and BP # 1 (BP mode 1)

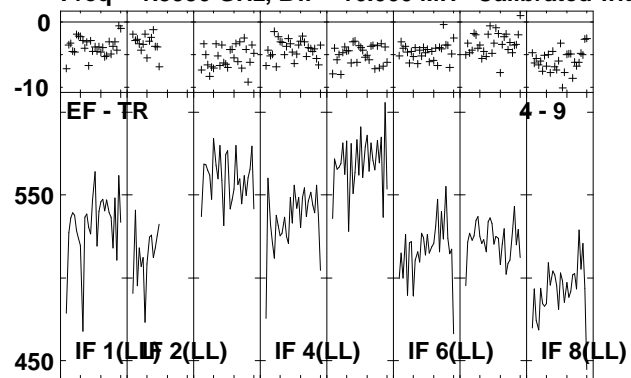

Lower frame: Milli Ampl Jy Top frame: Phas deg
Vector averaged cross-power spectrum Several baselines displayed
Timerange: 00/13:02:02 to 00/13:03:26

Plot file version 43 created 29-APR-2009 14:27:49

IRAS2336 EP064D.UVDATA.1

Freq = 1.5950 GHz, Bw = 16.000 MH Calibrated with CL # 3 and BP # 1 (BP mode 1)

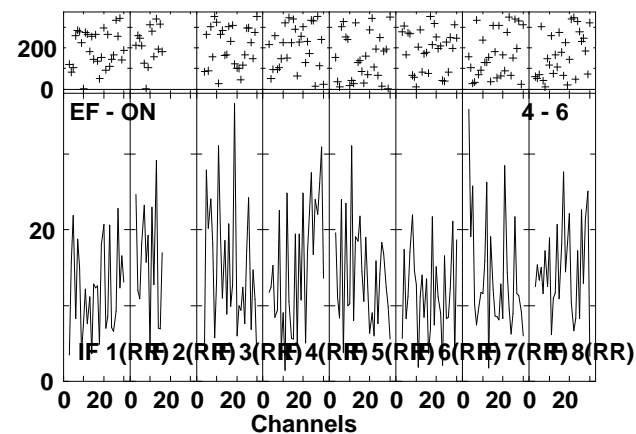
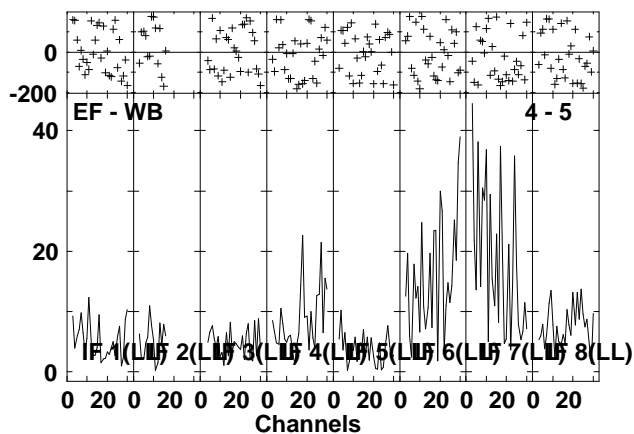
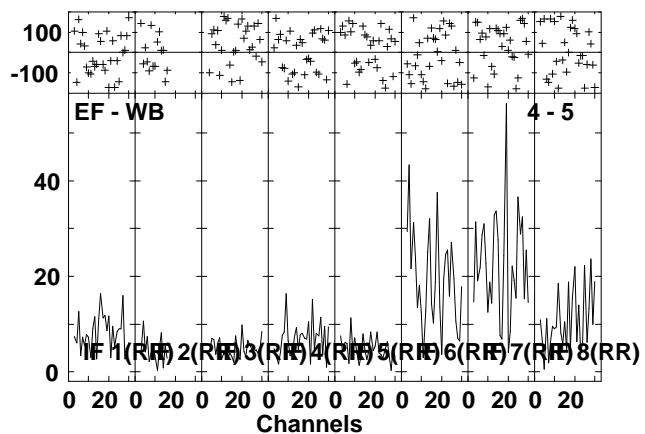
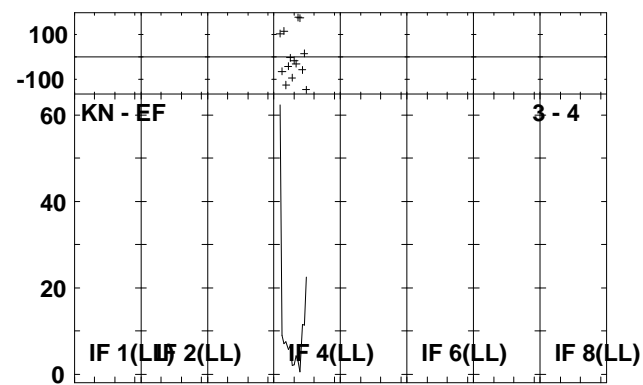
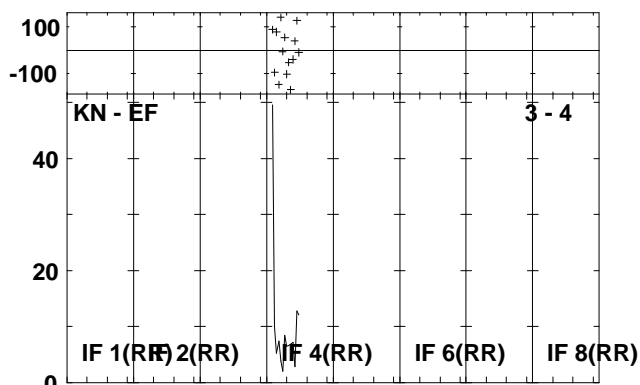
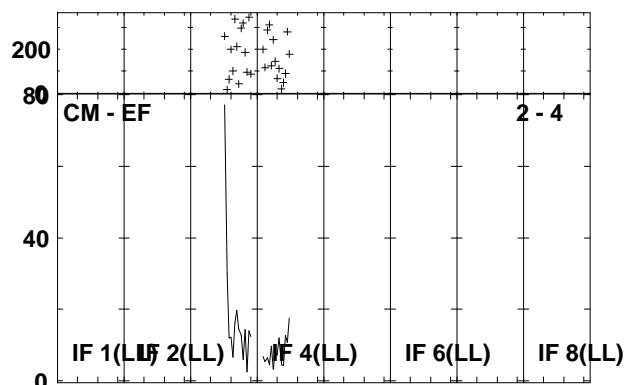
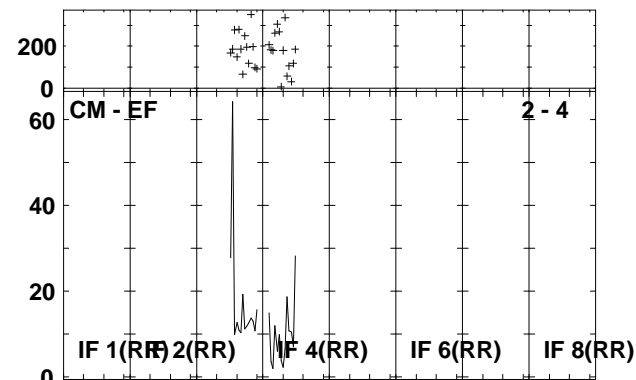
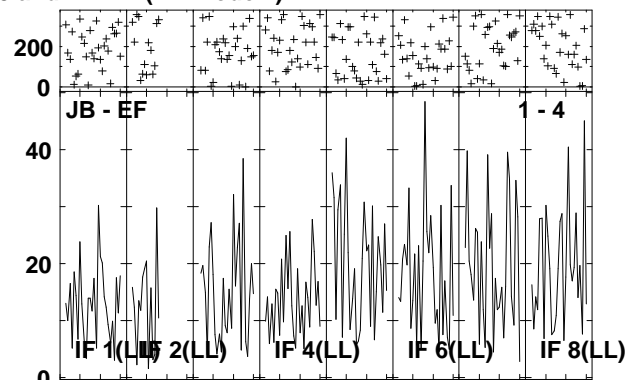
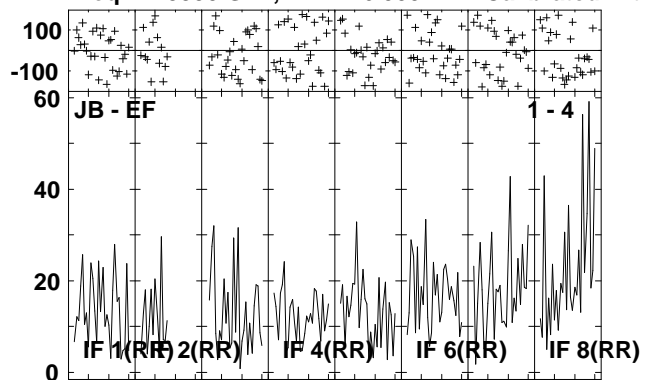

Lower frame: Milli Ampl Jy Top frame: Phas deg
Vector averaged cross-power spectrum Several baselines displayed
Timerange: 00/13:03:32 to 00/13:07:00

Plot file version 44 created 29-APR-2009 14:27:52

IRAS2336 EP064D.UVDATA.1

Freq = 1.5950 GHz, Bw = 16.000 MH Calibrated with CL # 3 and BP # 1 (BP mode 1)

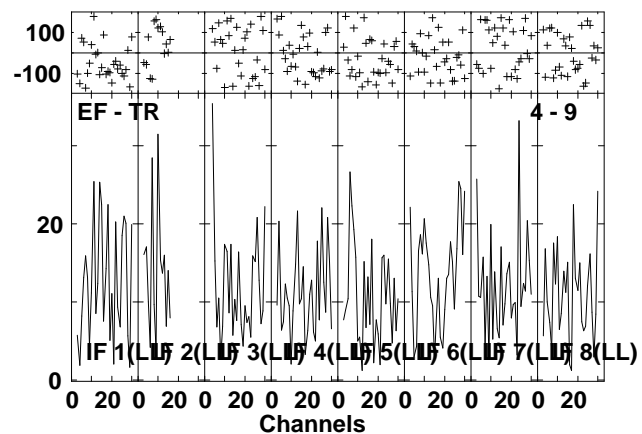
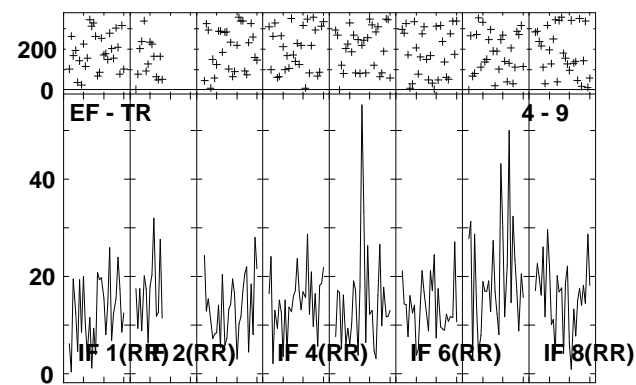
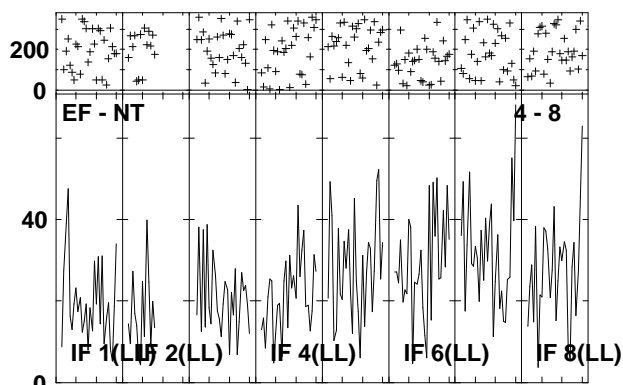
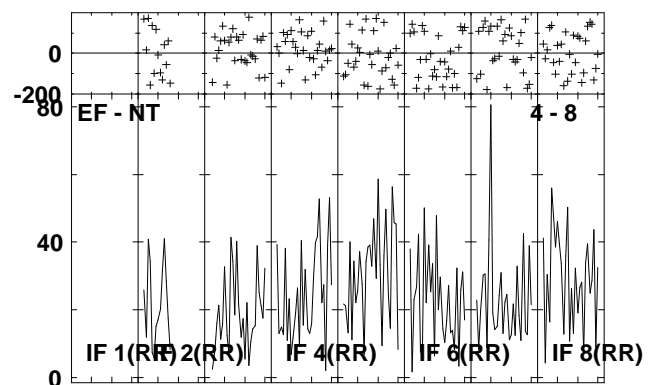
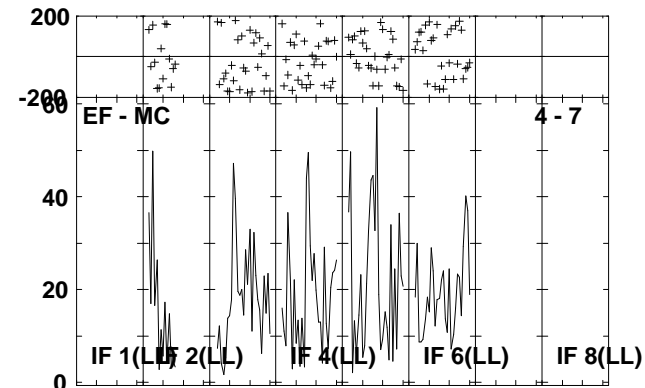
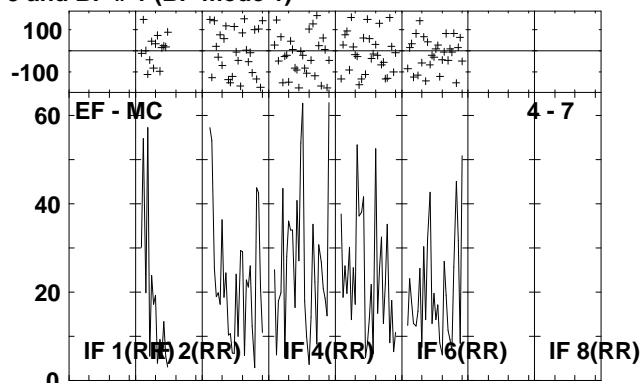
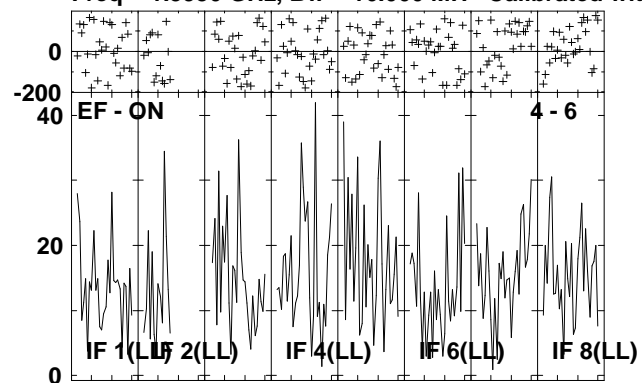

Lower frame: Milli Ampl Jy Top frame: Phas deg
Vector averaged cross-power spectrum Several baselines displayed
Timerange: 00/13:03:32 to 00/13:07:00

Plot file version 45 created 29-APR-2009 14:27:54
 J2333+39 EP064D.UVDATA.1
 Freq = 1.5950 GHz, Bw = 16.000 MH Calibrated with CL # 3 and BP # 1 (BP mode 1)

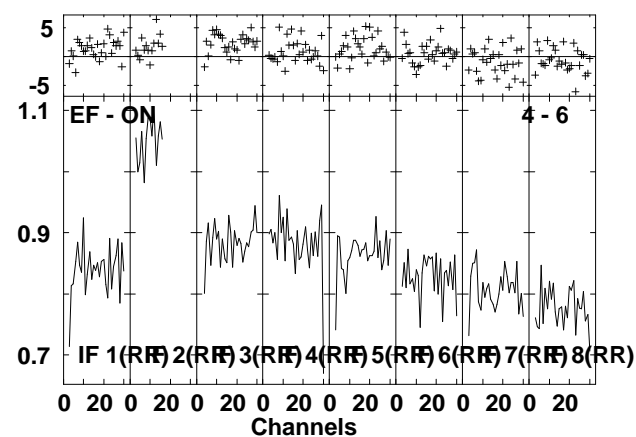
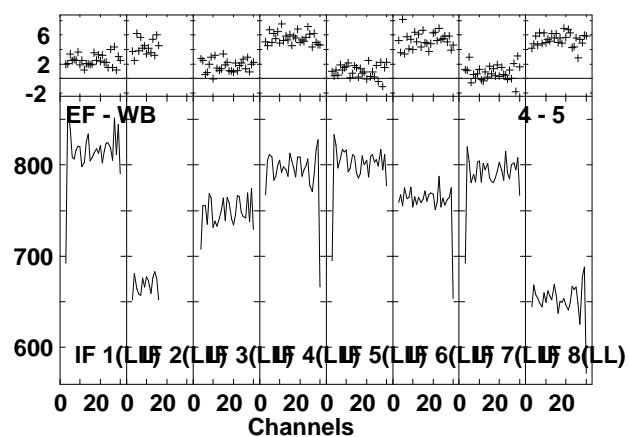
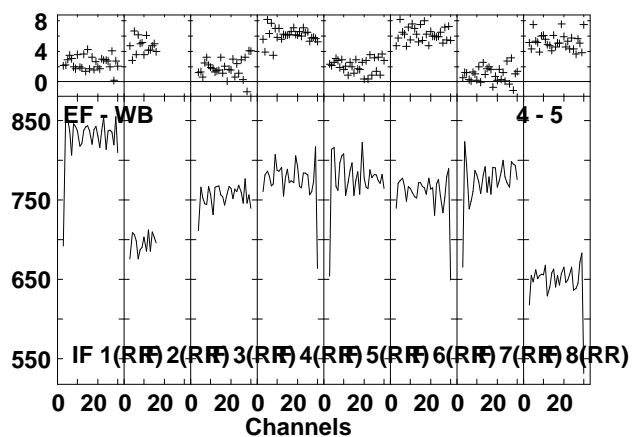
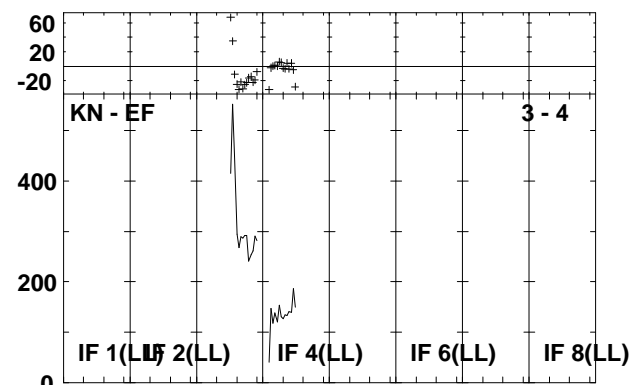
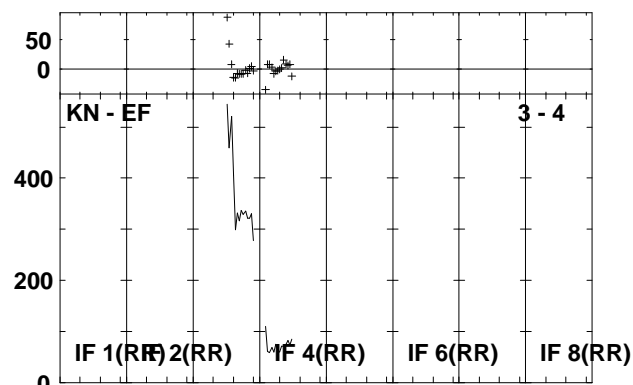
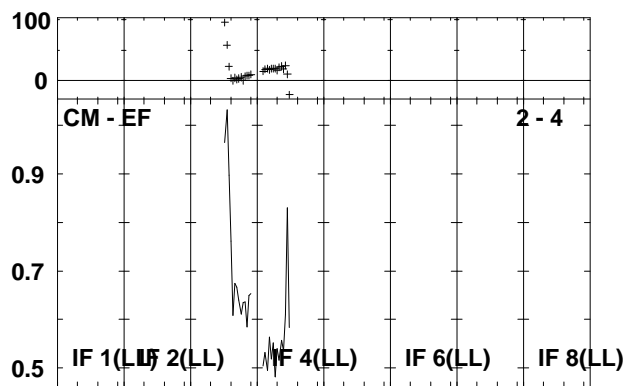
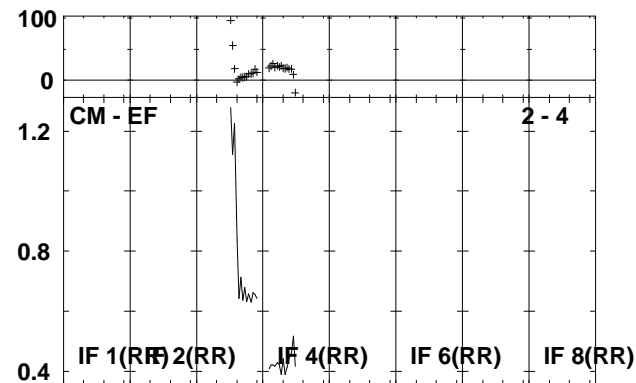
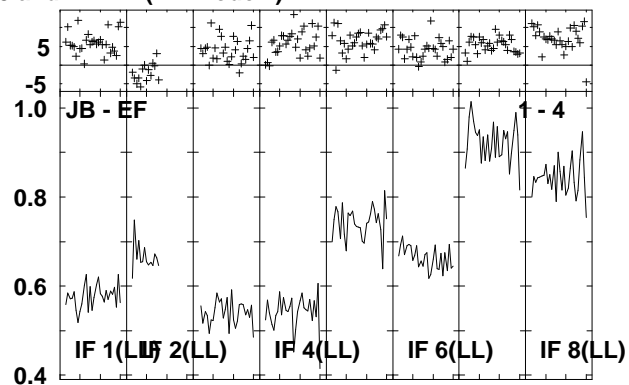
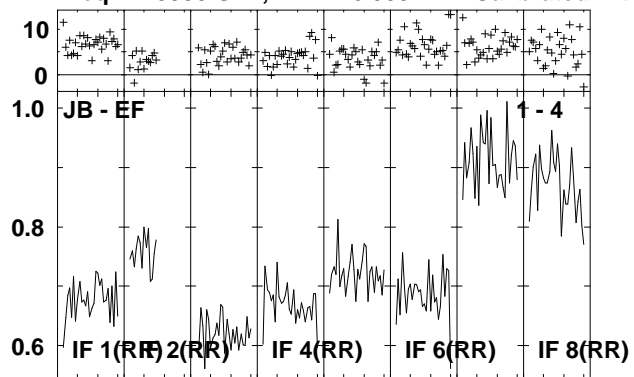

Lower frame: Ampl Jy Top frame: Phas deg
 Vector averaged cross-power spectrum Several baselines displayed
 Timerange: 00/13:07:02 to 00/13:08:30

Plot file version 46 created 29-APR-2009 14:27:55

J2333+39 EP064D.UVDATA.1

Freq = 1.5950 GHz, Bw = 16.000 MH Calibrated with CL # 3 and BP # 1 (BP mode 1)

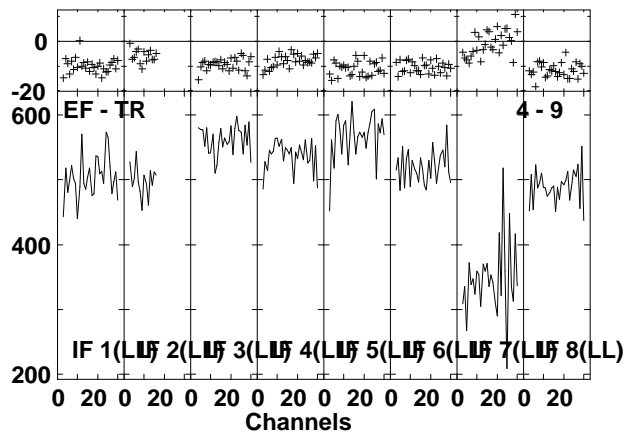
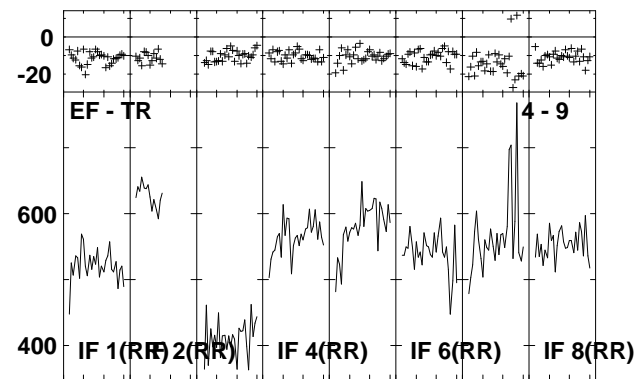
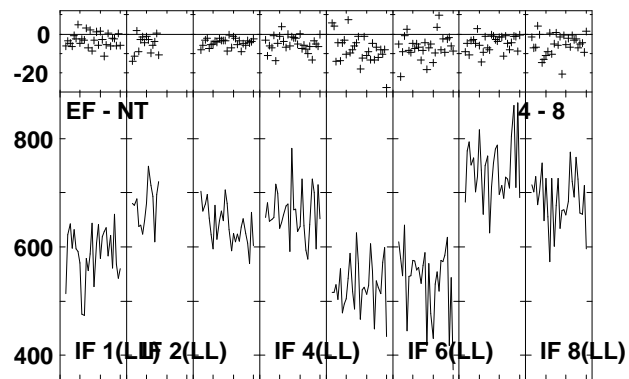
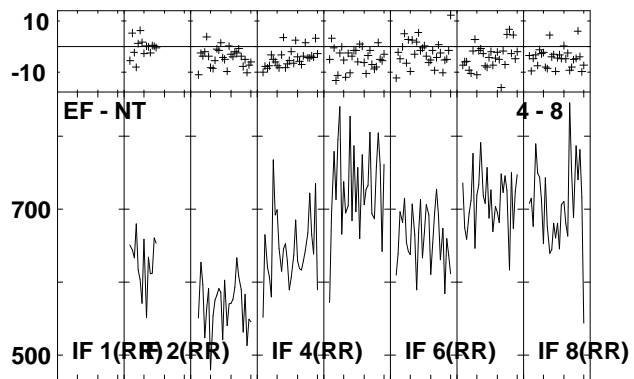
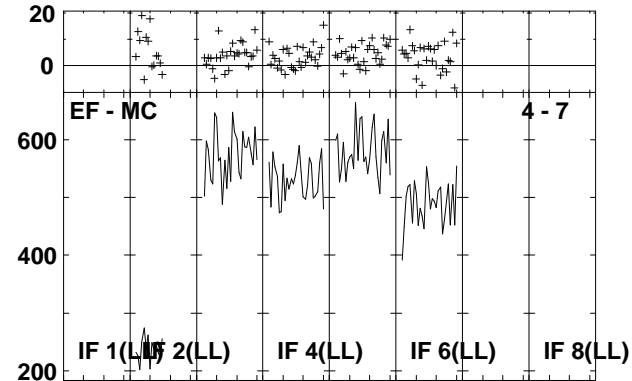
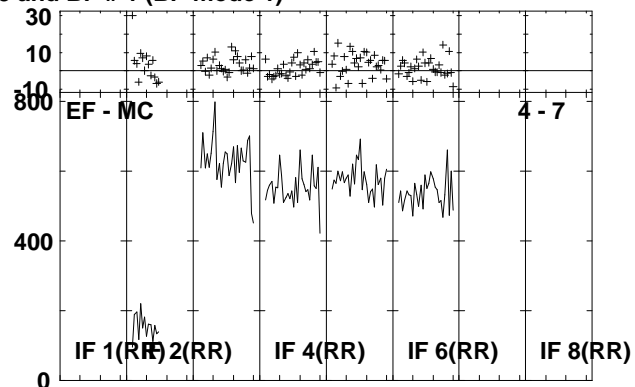
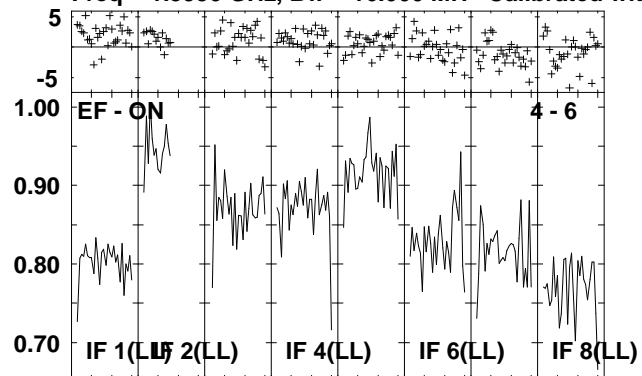

Lower frame: Ampl Jy Top frame: Phas deg
Vector averaged cross-power spectrum Several baselines displayed
Timerange: 00/13:07:02 to 00/13:08:30

Plot file version 47 created 29-APR-2009 14:27:57

IRAS2336 EP064D.UVDATA.1

Freq = 1.5950 GHz, Bw = 16.000 MH Calibrated with CL # 3 and BP # 1 (BP mode 1)

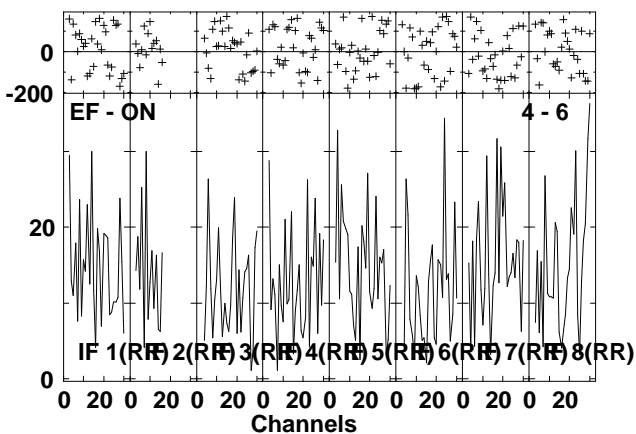
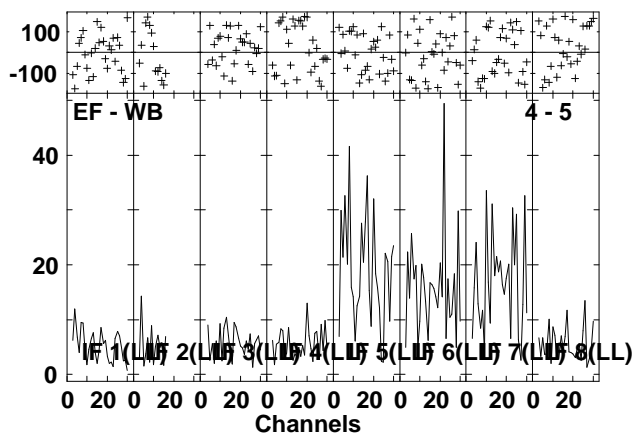
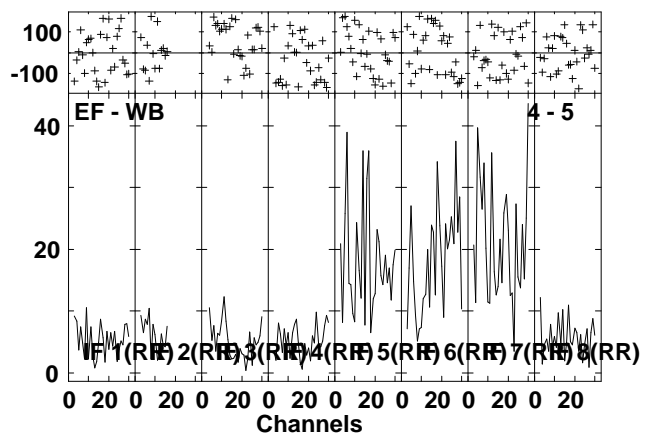
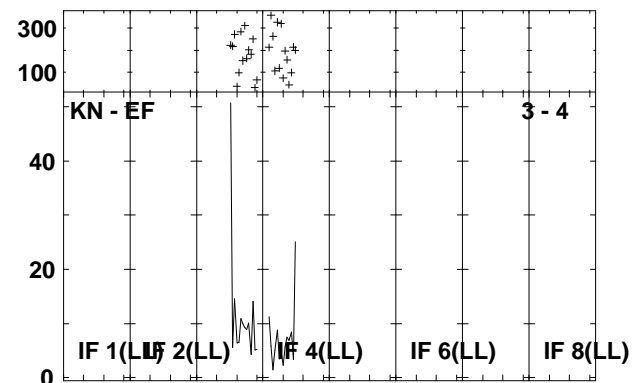
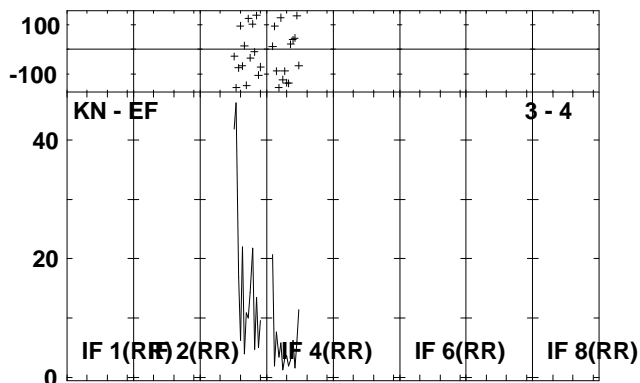
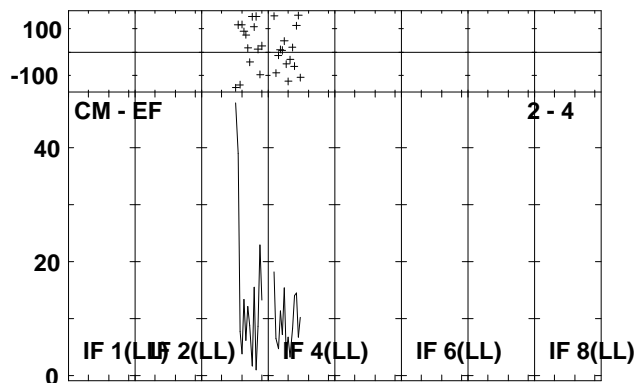
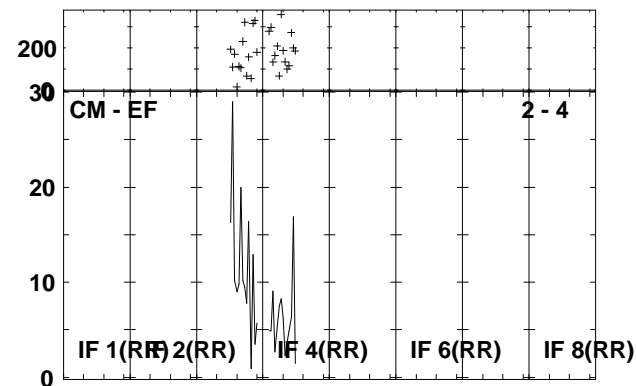
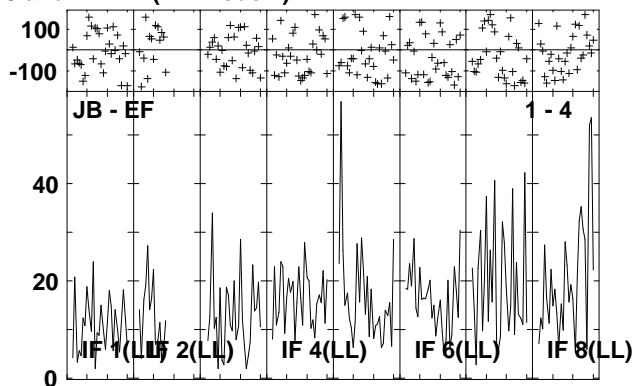
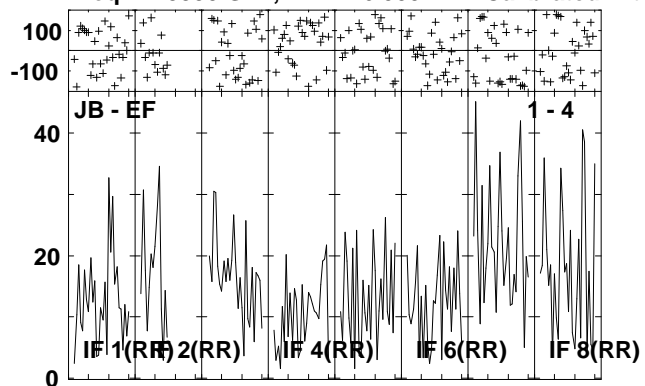

Lower frame: Milli Ampl Jy Top frame: Phas deg
Vector averaged cross-power spectrum Several baselines displayed
Timerange: 00/13:08:32 to 00/13:12:00

Plot file version 48 created 29-APR-2009 14:27:59

IRAS2336 EP064D.UVDATA.1

Freq = 1.5950 GHz, Bw = 16.000 MH Calibrated with CL # 3 and BP # 1 (BP mode 1)

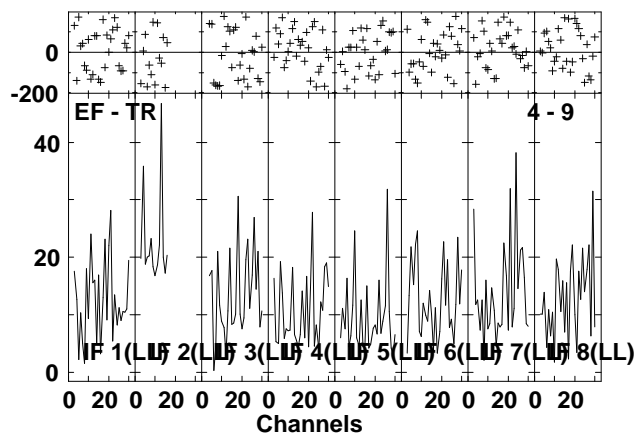
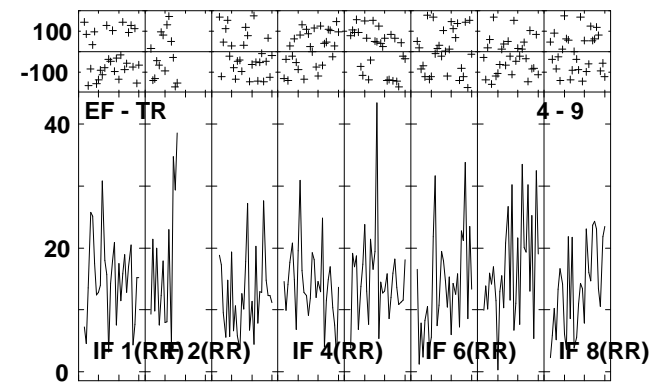
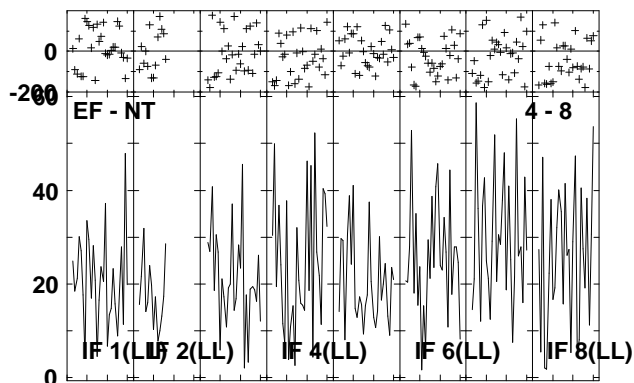
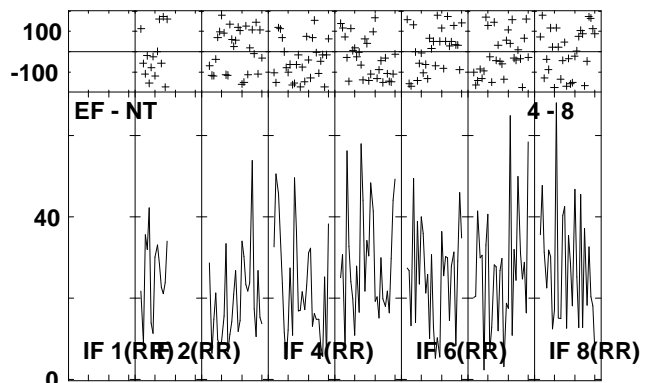
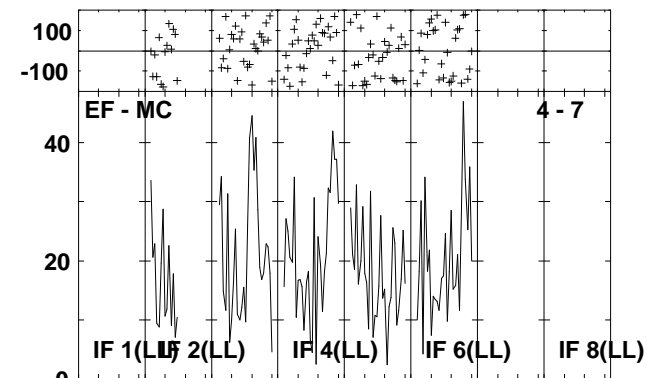
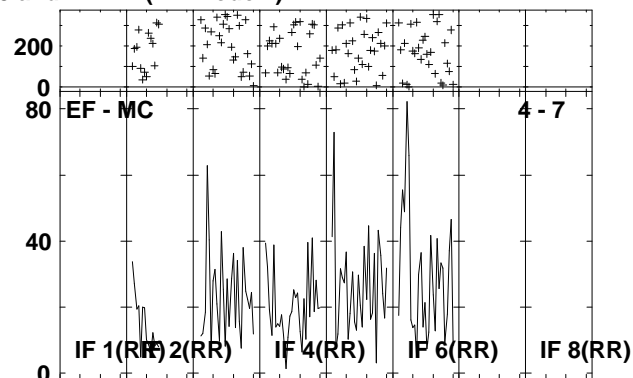
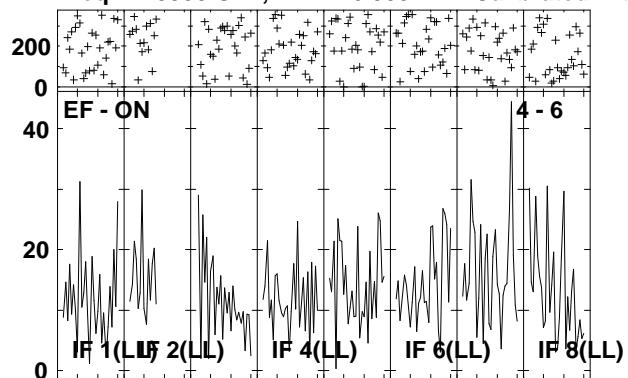

Lower frame: Milli Ampl Jy Top frame: Phas deg
Vector averaged cross-power spectrum Several baselines displayed
Timerange: 00/13:08:32 to 00/13:12:00

Plot file version 49 created 29-APR-2009 14:28:03

J2333+39 EP064D.UVDATA.1

Freq = 1.5950 GHz, Bw = 16.000 MH Calibrated with CL # 3 and BP # 1 (BP mode 1)

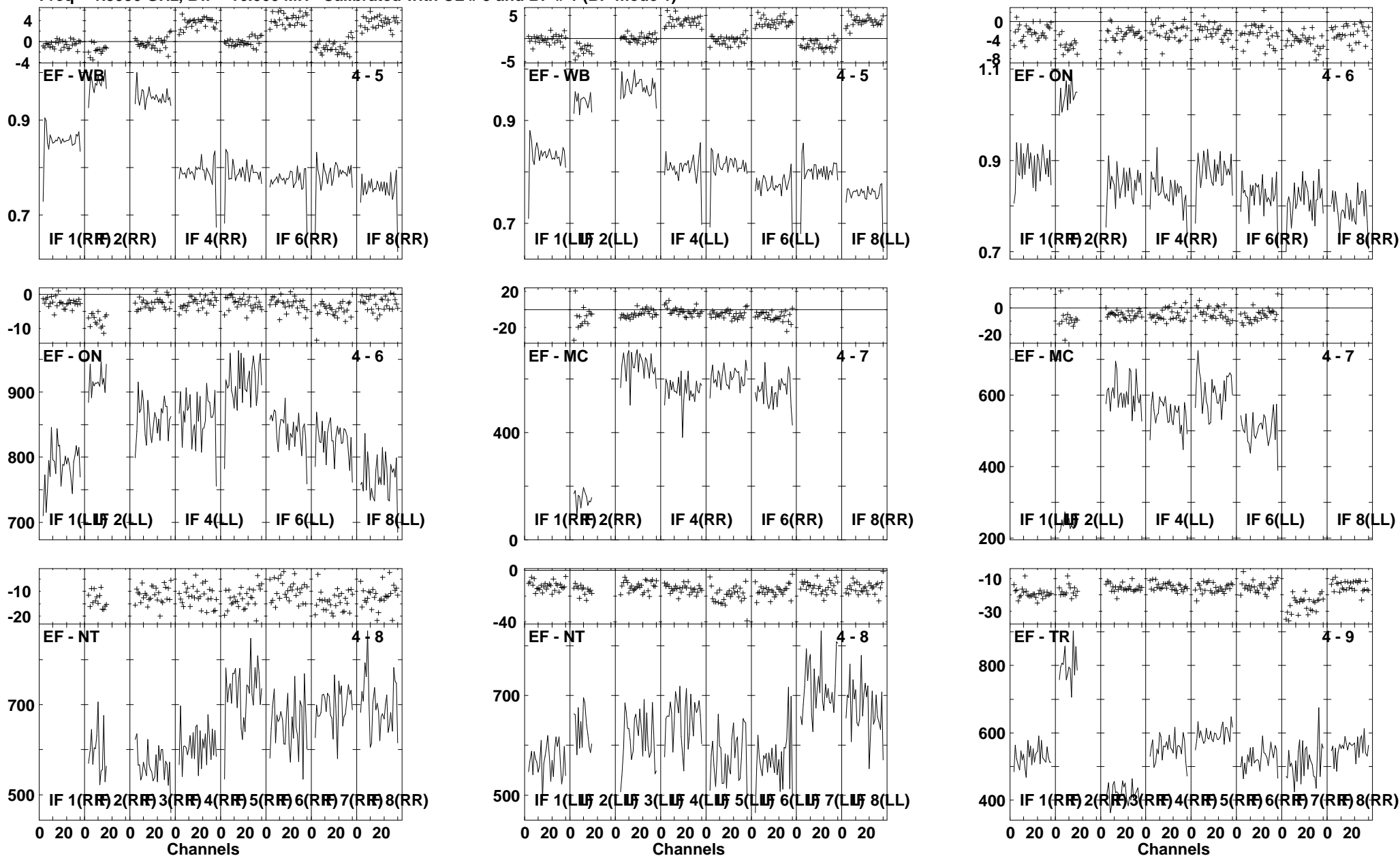

Lower frame: Ampl Jy Top frame: Phas deg
Vector averaged cross-power spectrum Several baselines displayed
Timerange: 00/13:12:02 to 00/13:13:28

Plot file version 50 created 29-APR-2009 14:28:04
J2333+39 EP064D.UVDATA.1
Freq = 1.5950 GHz, Bw = 16.000 MH Calibrated with CL # 3 and BP # 1 (BP mode 1)

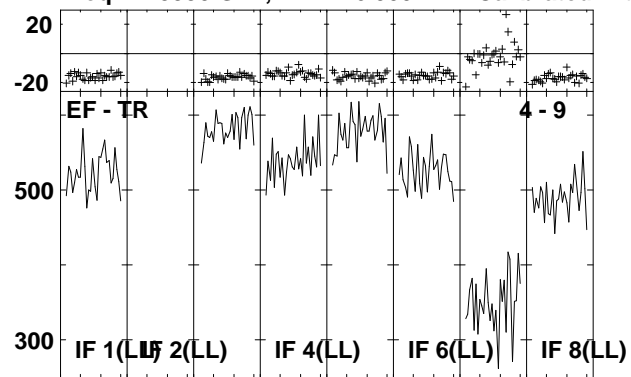

Lower frame: Milli Ampl Jy Top frame: Phas deg
Vector averaged cross-power spectrum Several baselines displayed
Timerange: 00/13:12:02 to 00/13:13:28

Plot file version 51 created 29-APR-2009 14:28:05
 IRAS2336 EP064D.UVDATA.1
 Freq = 1.5950 GHz, Bw = 16.000 MH Calibrated with CL # 3 and BP # 1 (BP mode 1)

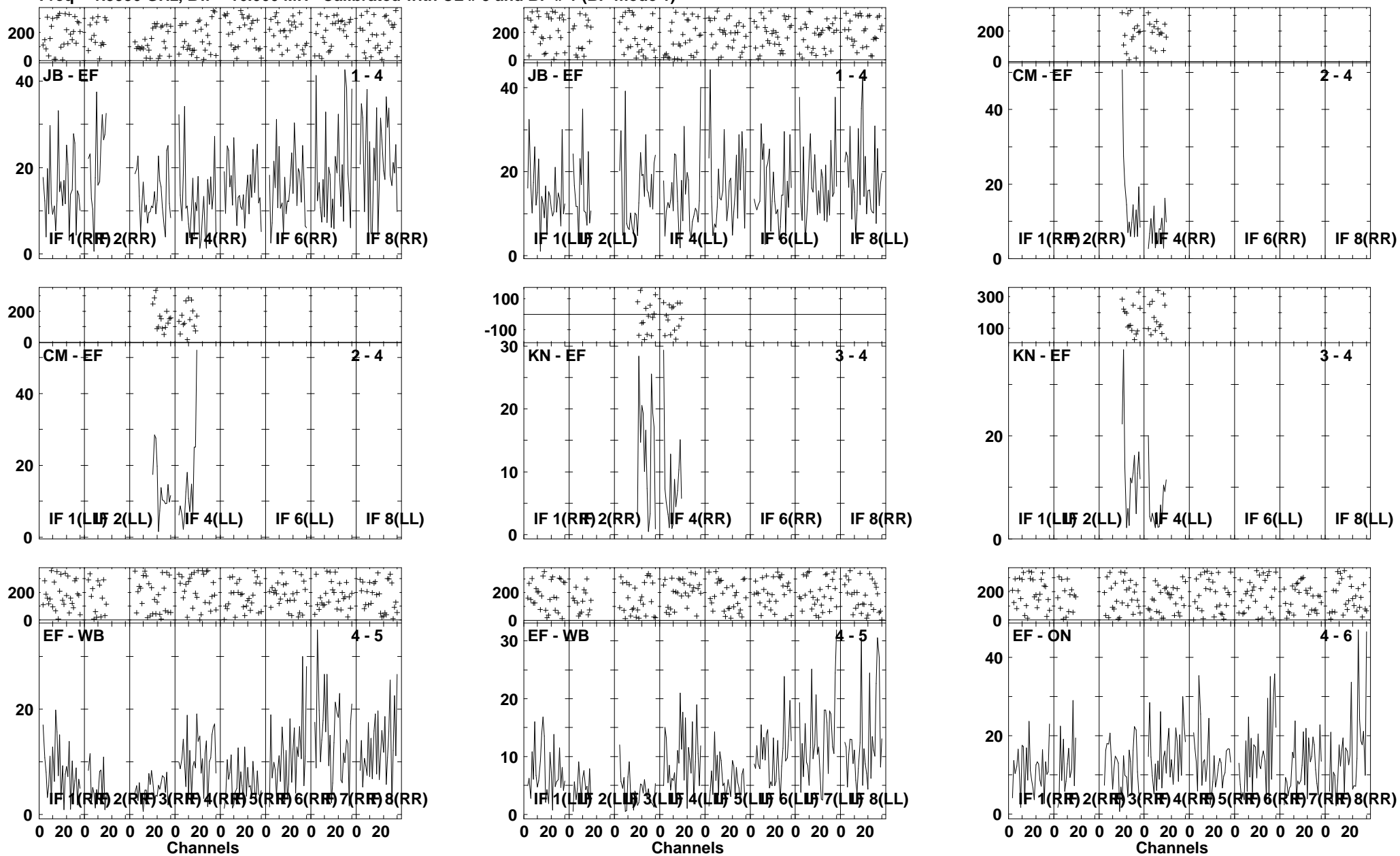

Lower frame: Milli Ampl Jy Top frame: Phas deg
 Vector averaged cross-power spectrum Several baselines displayed
 Timerange: 00/13:13:30 to 00/13:16:58

Plot file version 52 created 29-APR-2009 14:28:07

IRAS2336 EP064D.UVDATA.1

Freq = 1.5950 GHz, Bw = 16.000 MH Calibrated with CL # 3 and BP # 1 (BP mode 1)

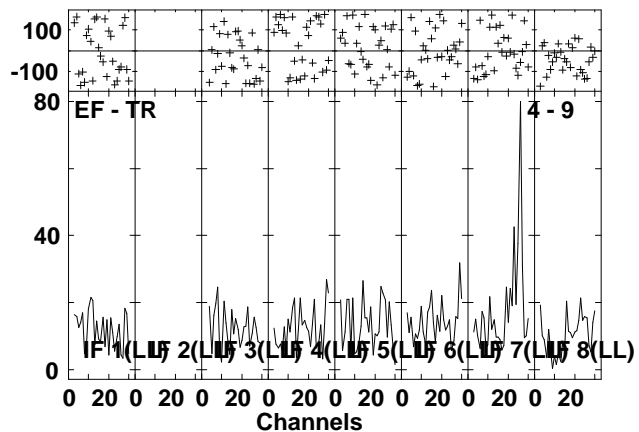
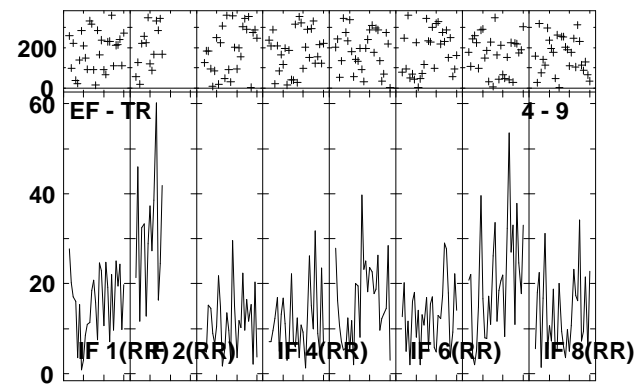
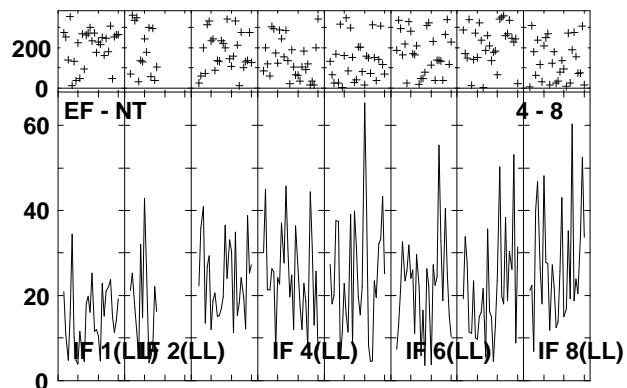
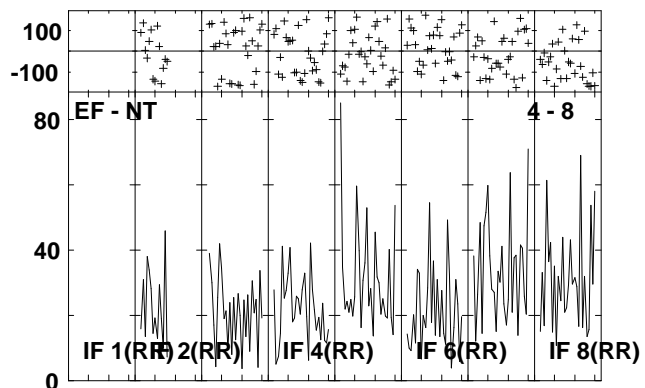
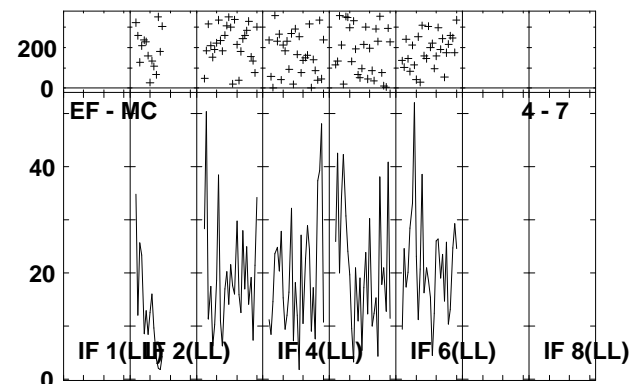
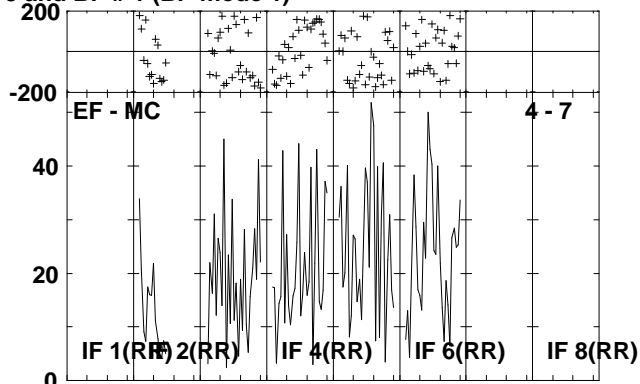
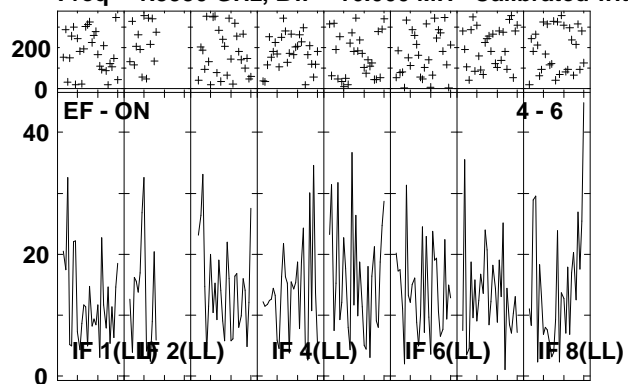

Lower frame: Milli Ampl Jy Top frame: Phas deg
Vector averaged cross-power spectrum Several baselines displayed
Timerange: 00/13:13:30 to 00/13:16:58

Plot file version 53 created 29-APR-2009 14:28:10

J2333+39 EP064D.UVDATA.1

Freq = 1.5950 GHz, Bw = 16.000 MH Calibrated with CL # 3 and BP # 1 (BP mode 1)

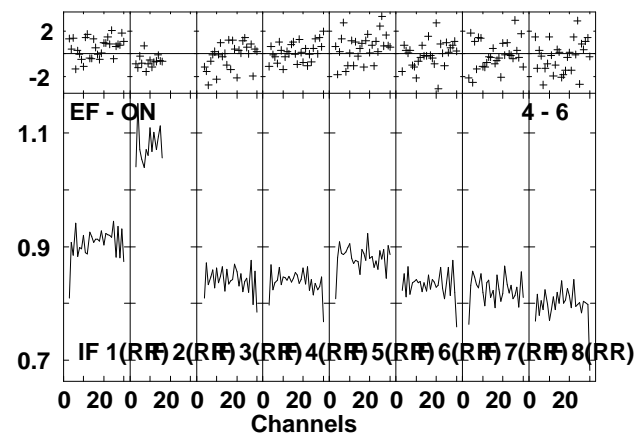
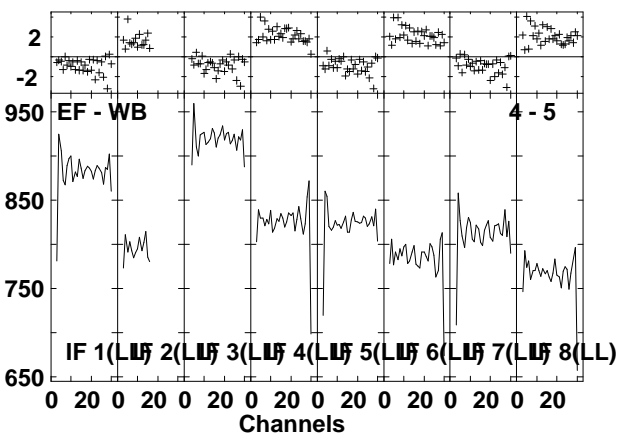
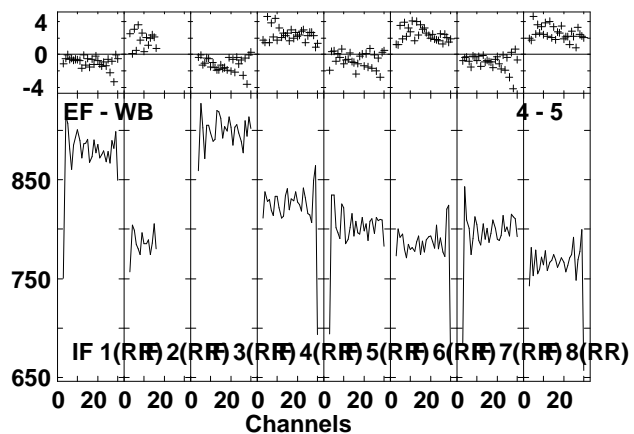
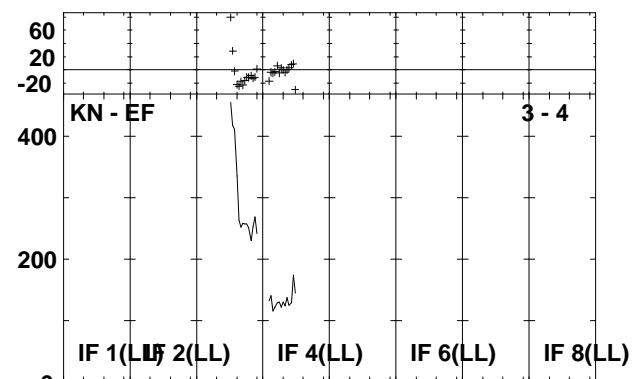
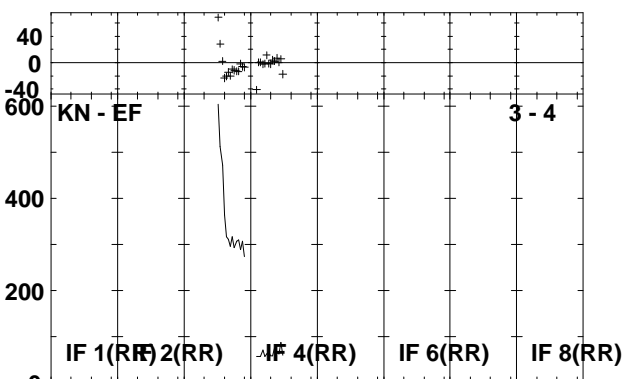
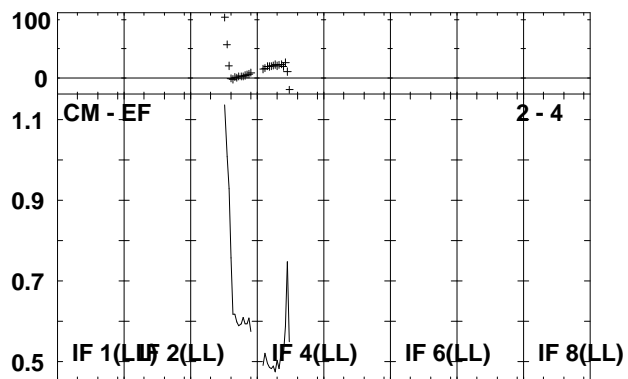
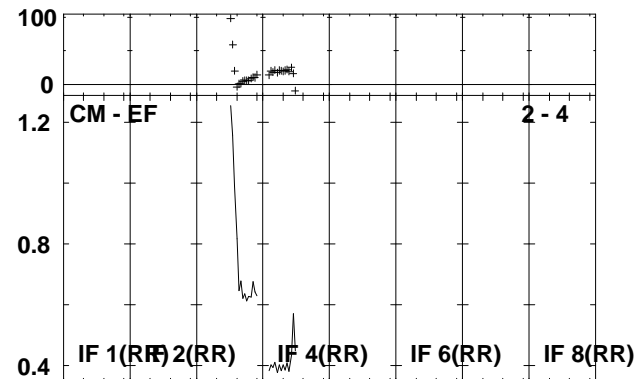
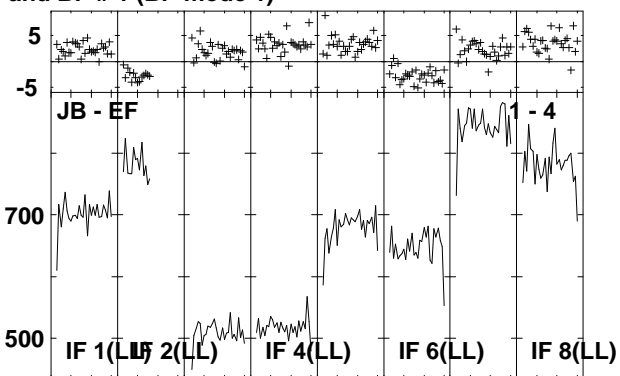
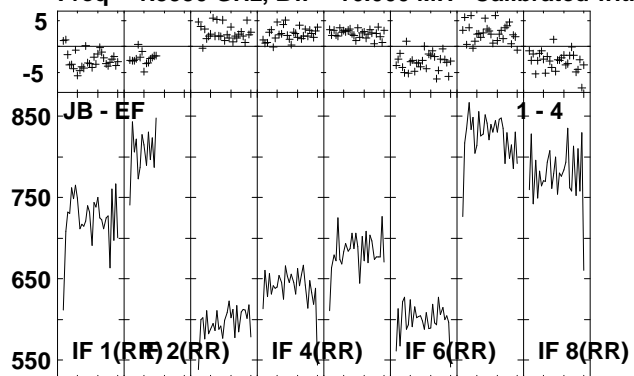

Lower frame: Milli Ampl Jy Top frame: Phas deg
Vector averaged cross-power spectrum Several baselines displayed
Timerange: 00/13:18:00 to 00/13:19:30

Plot file version 54 created 29-APR-2009 14:28:11

J2333+39 EP064D.UVDATA.1

Freq = 1.5950 GHz, Bw = 16.000 MH Calibrated with CL # 3 and BP # 1 (BP mode 1)

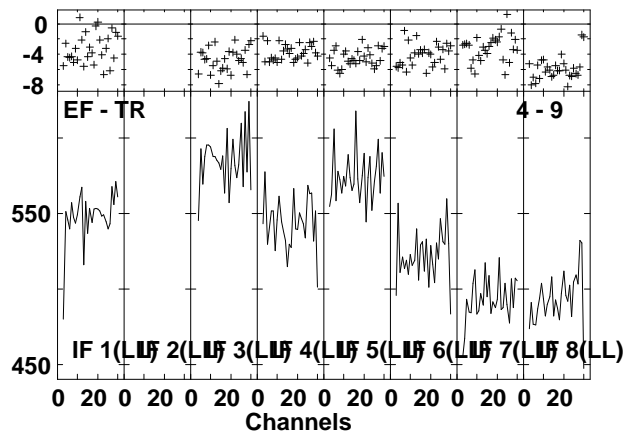
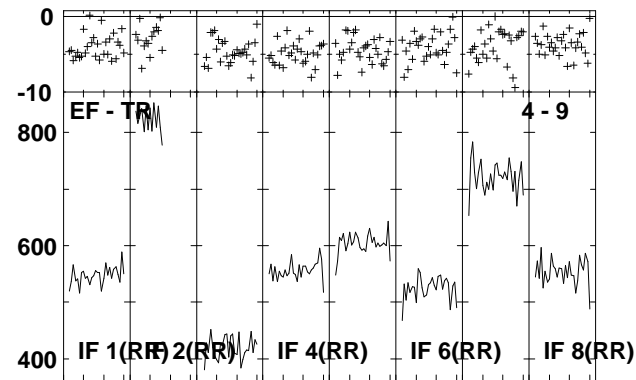
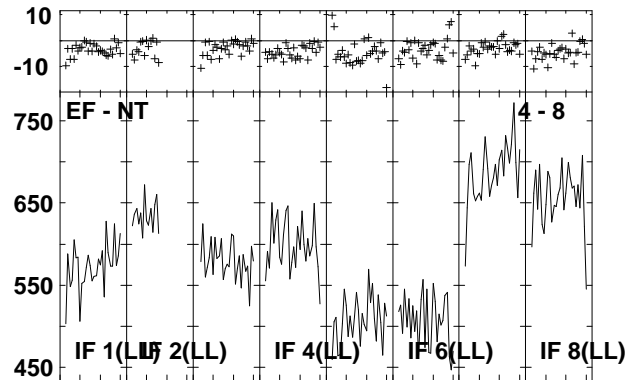
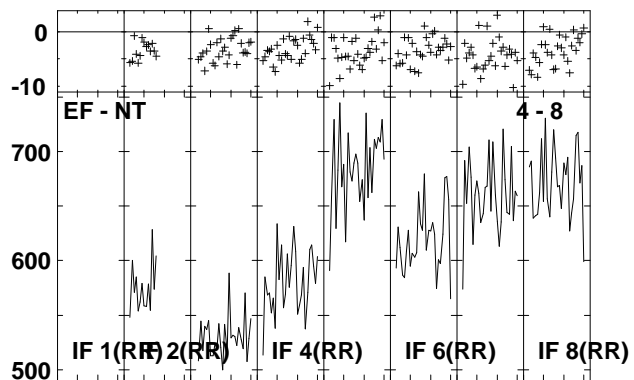
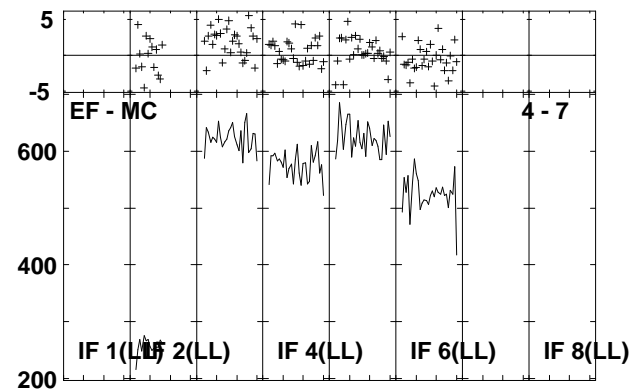
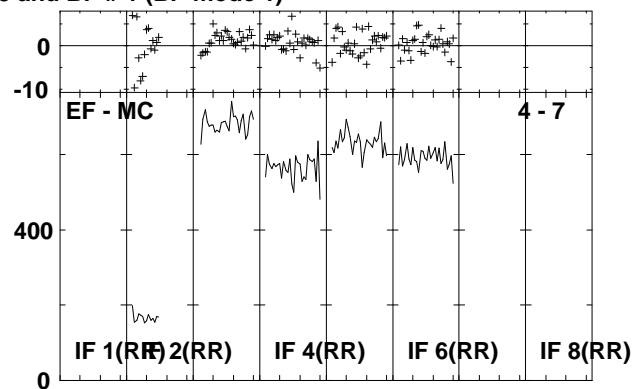
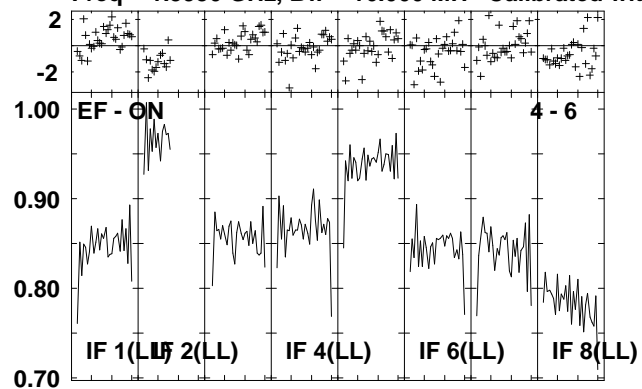

Lower frame: Ampl Jy Top frame: Phas deg
Vector averaged cross-power spectrum Several baselines displayed
Timerange: 00/13:18:00 to 00/13:19:30

Plot file version 55 created 29-APR-2009 14:28:13

IRAS2336 EP064D.UVDATA.1

Freq = 1.5950 GHz, Bw = 16.000 MH Calibrated with CL # 3 and BP # 1 (BP mode 1)

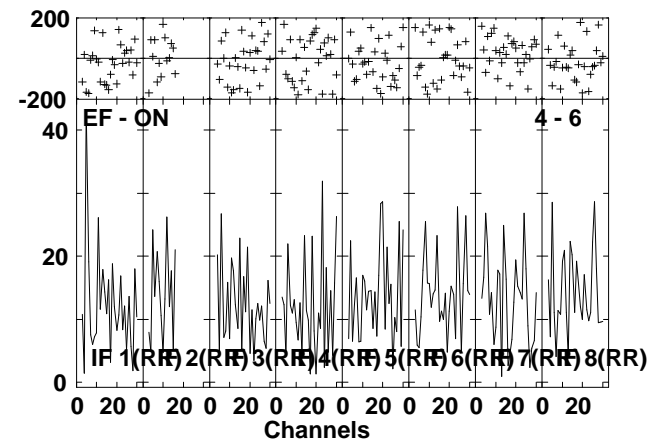
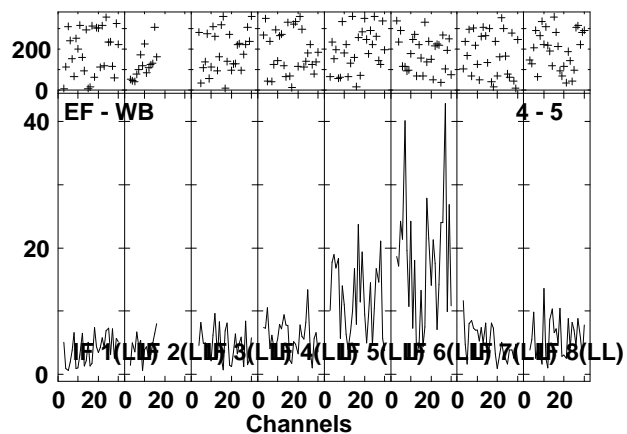
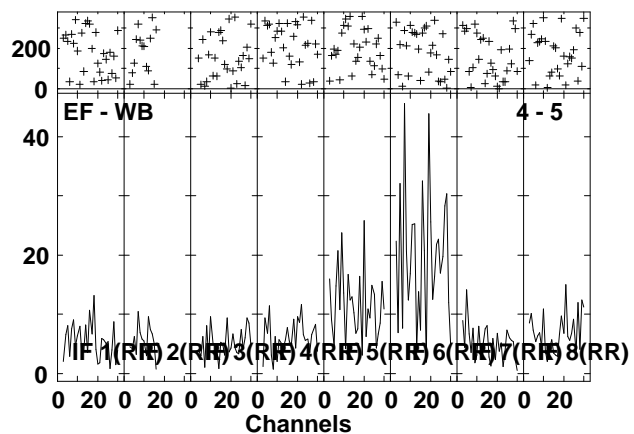
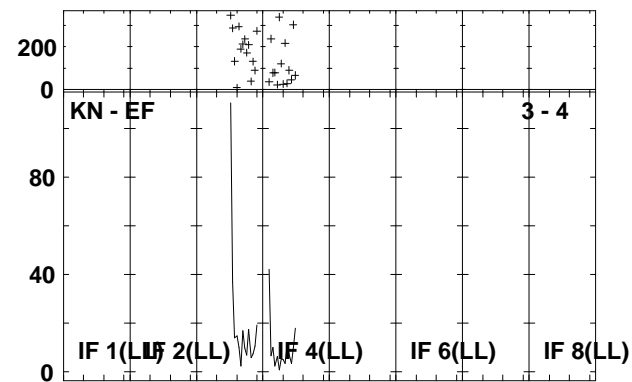
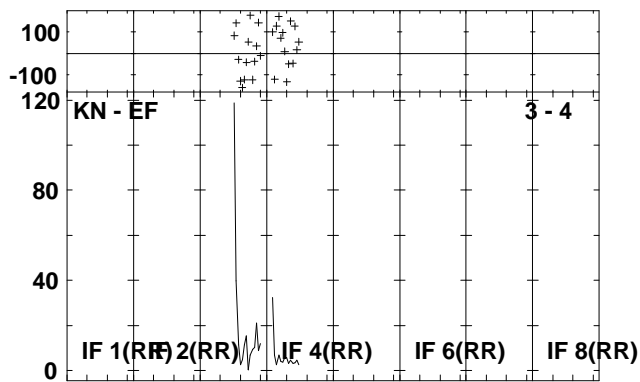
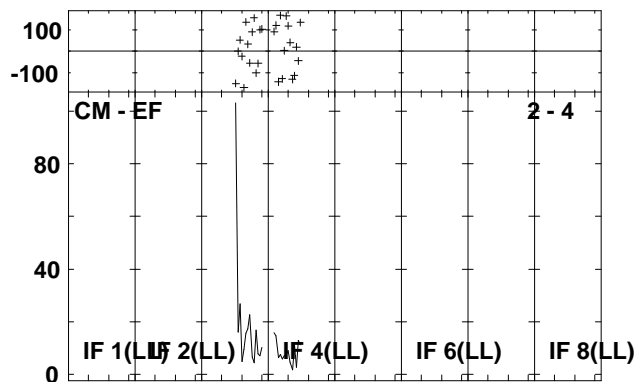
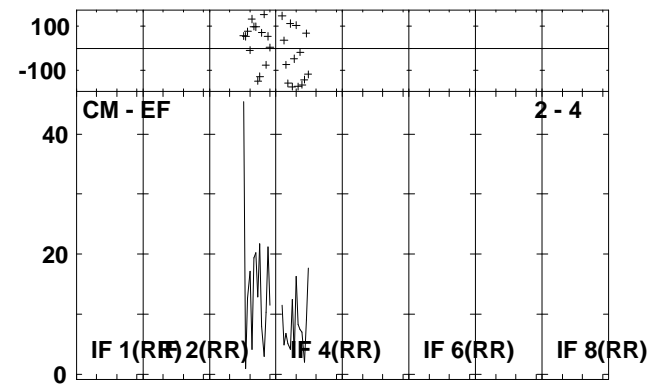
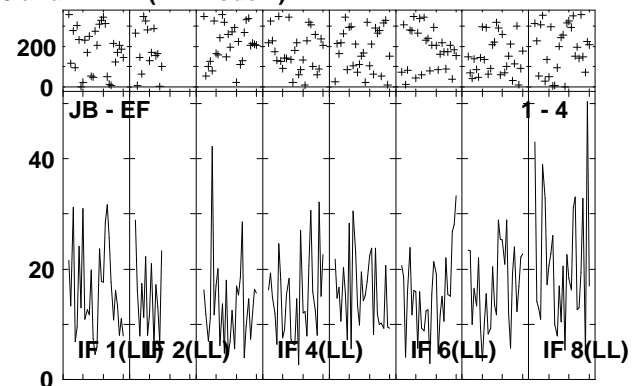
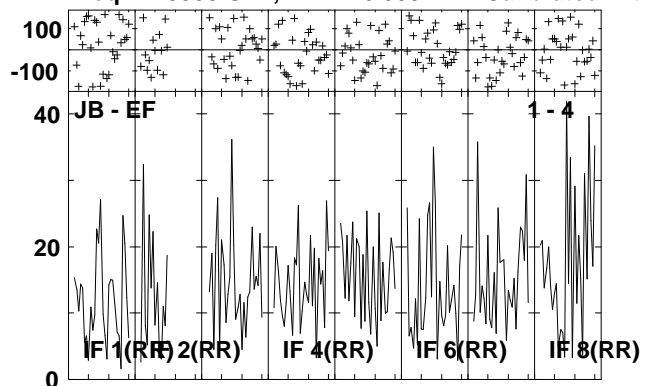

Lower frame: Milli Ampl Jy Top frame: Phas deg
Vector averaged cross-power spectrum Several baselines displayed
Timerange: 00/13:19:32 to 00/13:23:00

Plot file version 56 created 29-APR-2009 14:28:16

IRAS2336 EP064D.UVDATA.1

Freq = 1.5950 GHz, Bw = 16.000 MH Calibrated with CL # 3 and BP # 1 (BP mode 1)

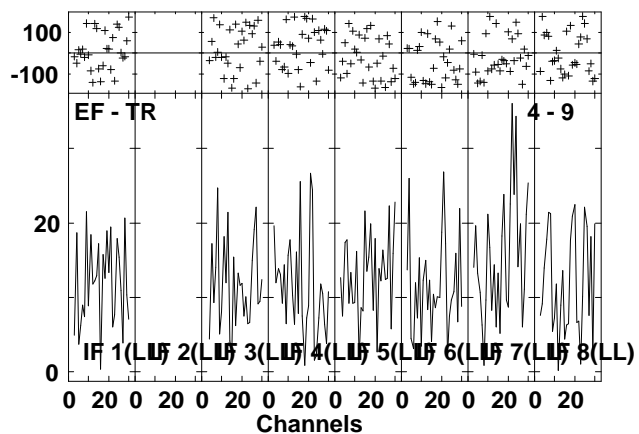
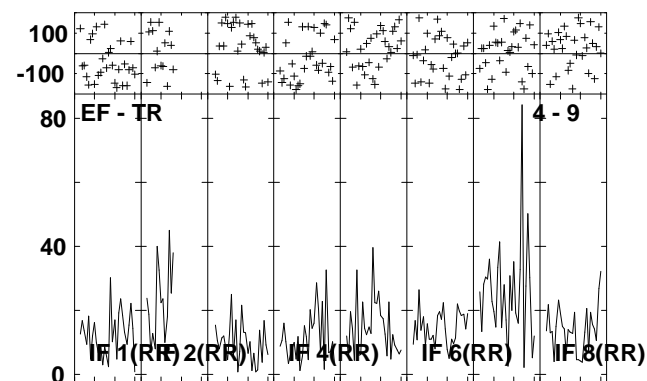
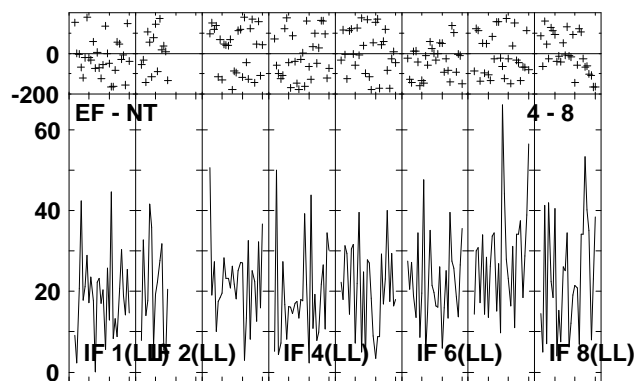
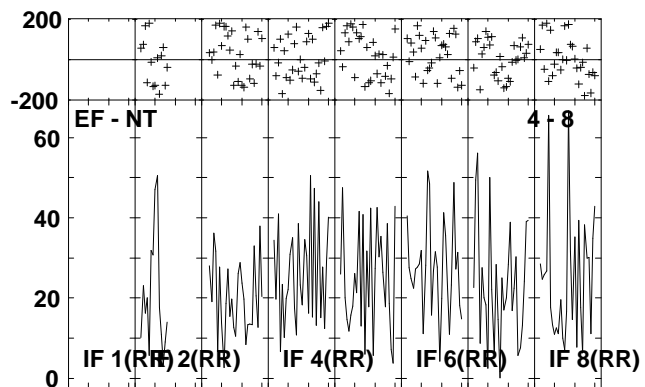
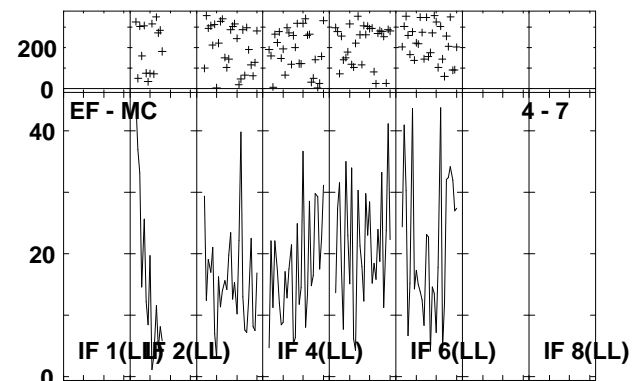
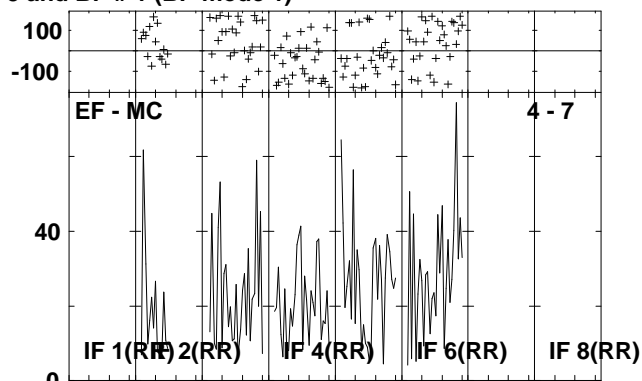
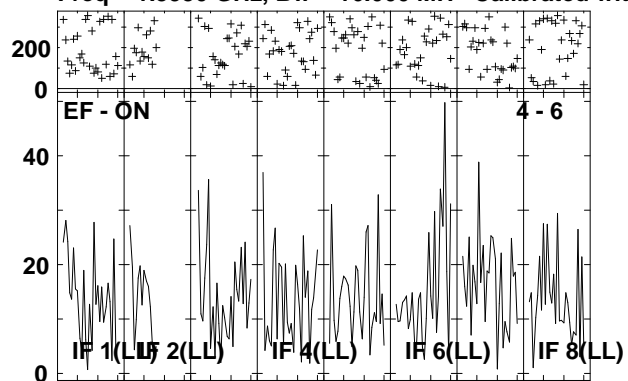

Lower frame: Milli Ampl Jy Top frame: Phas deg
Vector averaged cross-power spectrum Several baselines displayed
Timerange: 00/13:19:32 to 00/13:23:00

Plot file version 57 created 29-APR-2009 14:28:19

J2333+39 EP064D.UVDATA.1

Freq = 1.5950 GHz, Bw = 16.000 MH Calibrated with CL # 3 and BP # 1 (BP mode 1)

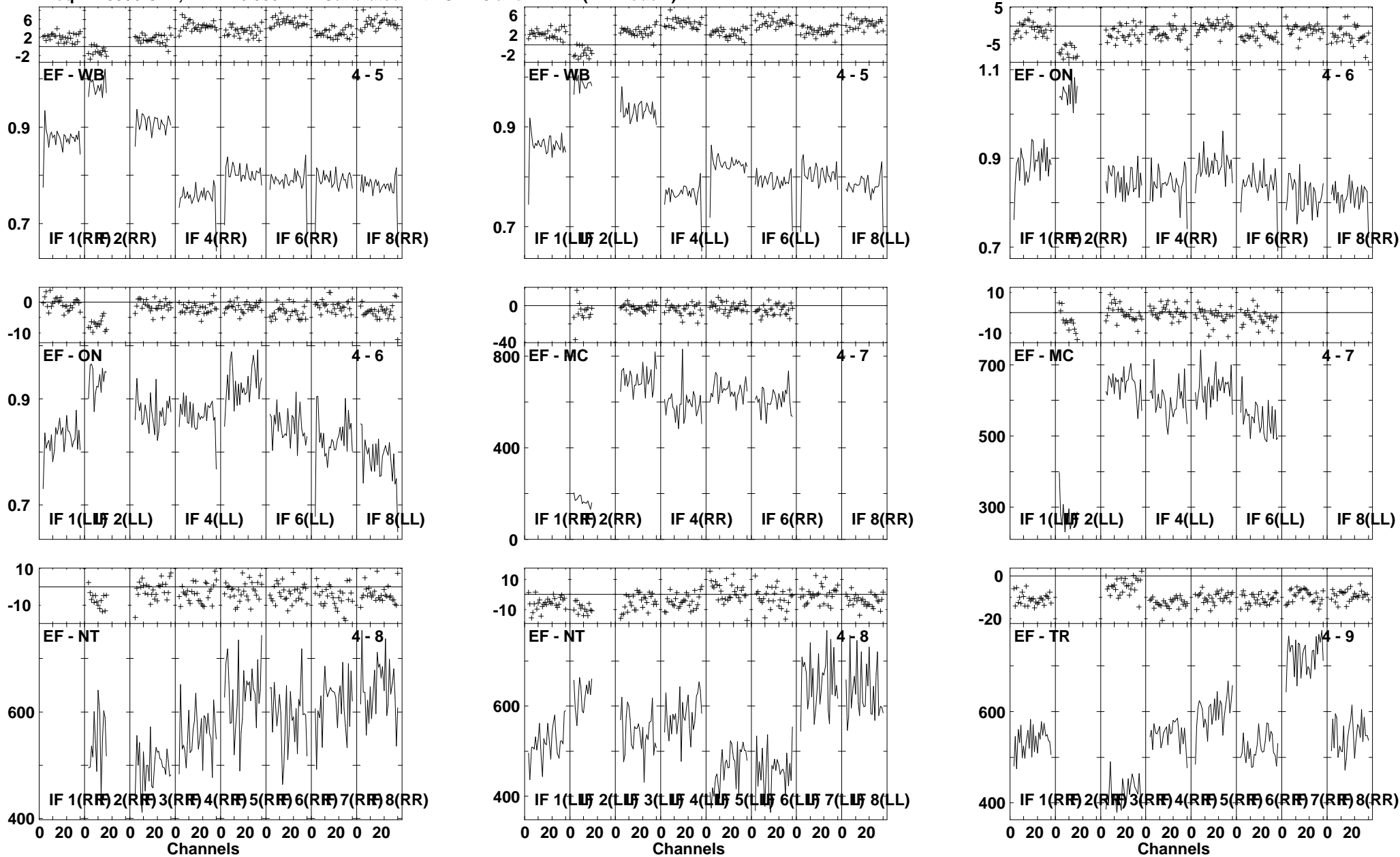

Lower frame: Ampl Jy Top frame: Phas deg
Vector averaged cross-power spectrum Several baselines displayed
Timerange: 00/13:23:02 to 00/13:24:28

Plot file version 58 created 29-APR-2009 14:28:20

J2333+39 EP064D.UVDATA.1

Freq = 1.5950 GHz, Bw = 16.000 MH Calibrated with CL # 3 and BP # 1 (BP mode 1)

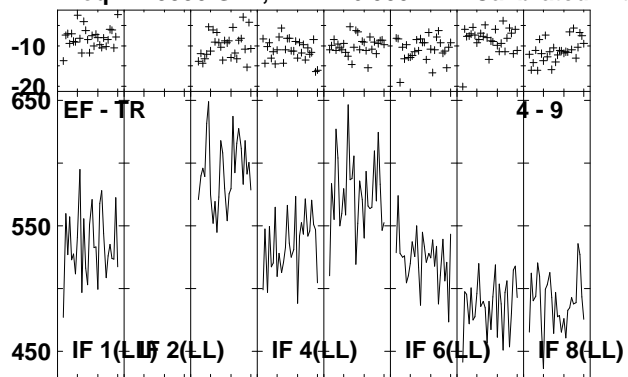

Lower frame: Milli Ampl Jy Top frame: Phas deg
Vector averaged cross-power spectrum Several baselines displayed
Timerange: 00/13:23:02 to 00/13:24:28

Plot file version 59 created 29-APR-2009 14:28:21

IRAS2336 EP064D.UVDATA.1

Freq = 1.5950 GHz, Bw = 16.000 MH Calibrated with CL # 3 and BP # 1 (BP mode 1)

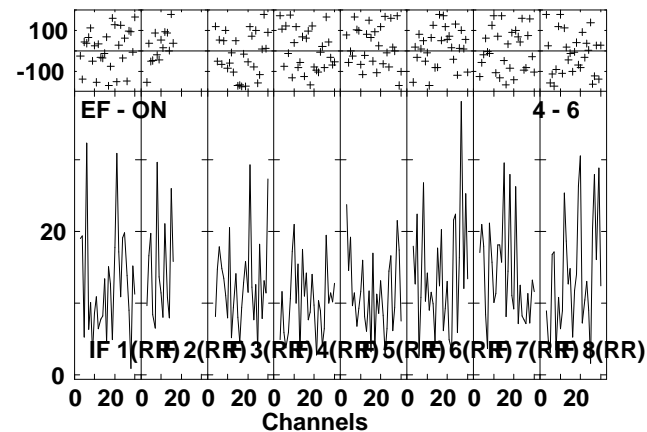
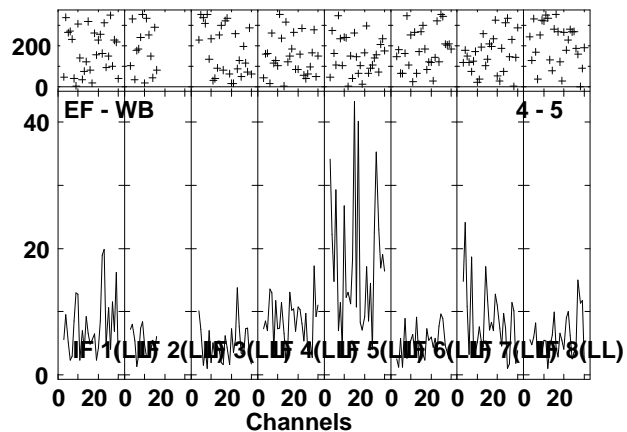
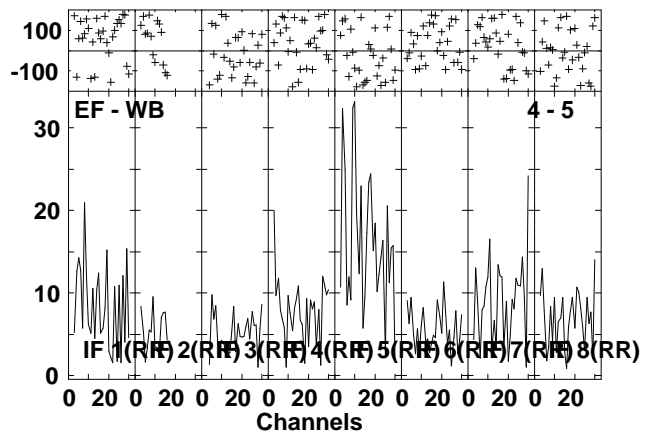
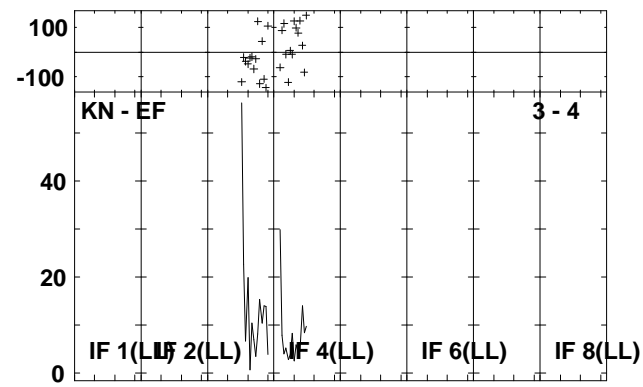
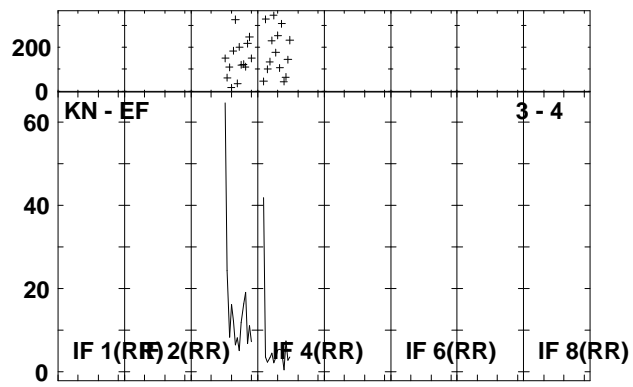
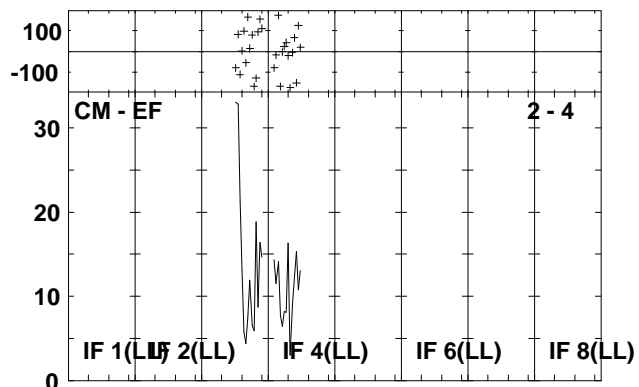
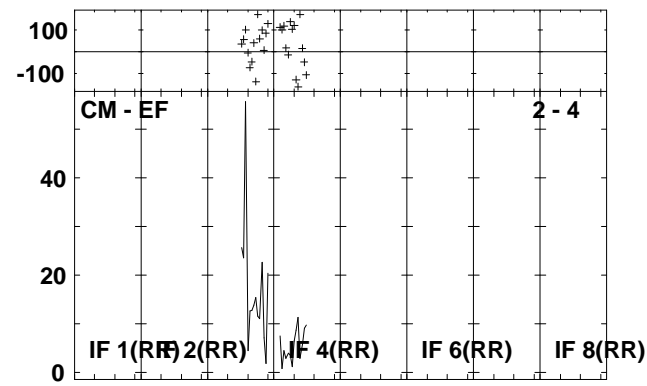
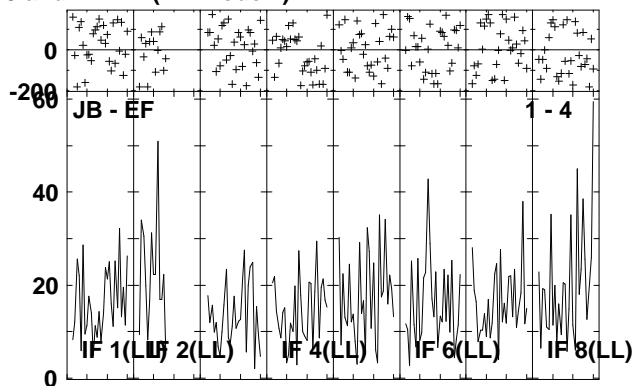
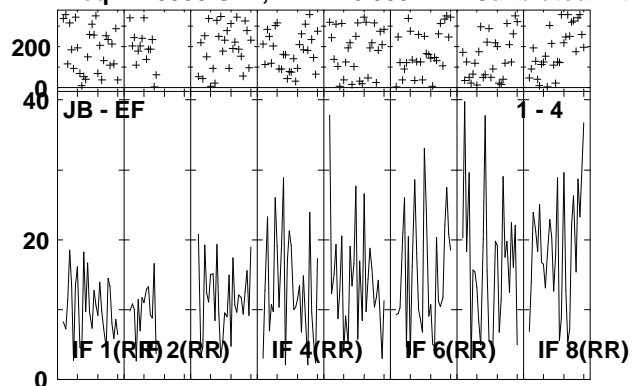

Lower frame: Milli Ampl Jy Top frame: Phas deg
Vector averaged cross-power spectrum Several baselines displayed
Timerange: 00/13:24:30 to 00/13:28:00

Plot file version 60 created 29-APR-2009 14:28:24

IRAS2336 EP064D.UVDATA.1

Freq = 1.5950 GHz, Bw = 16.000 MH Calibrated with CL # 3 and BP # 1 (BP mode 1)

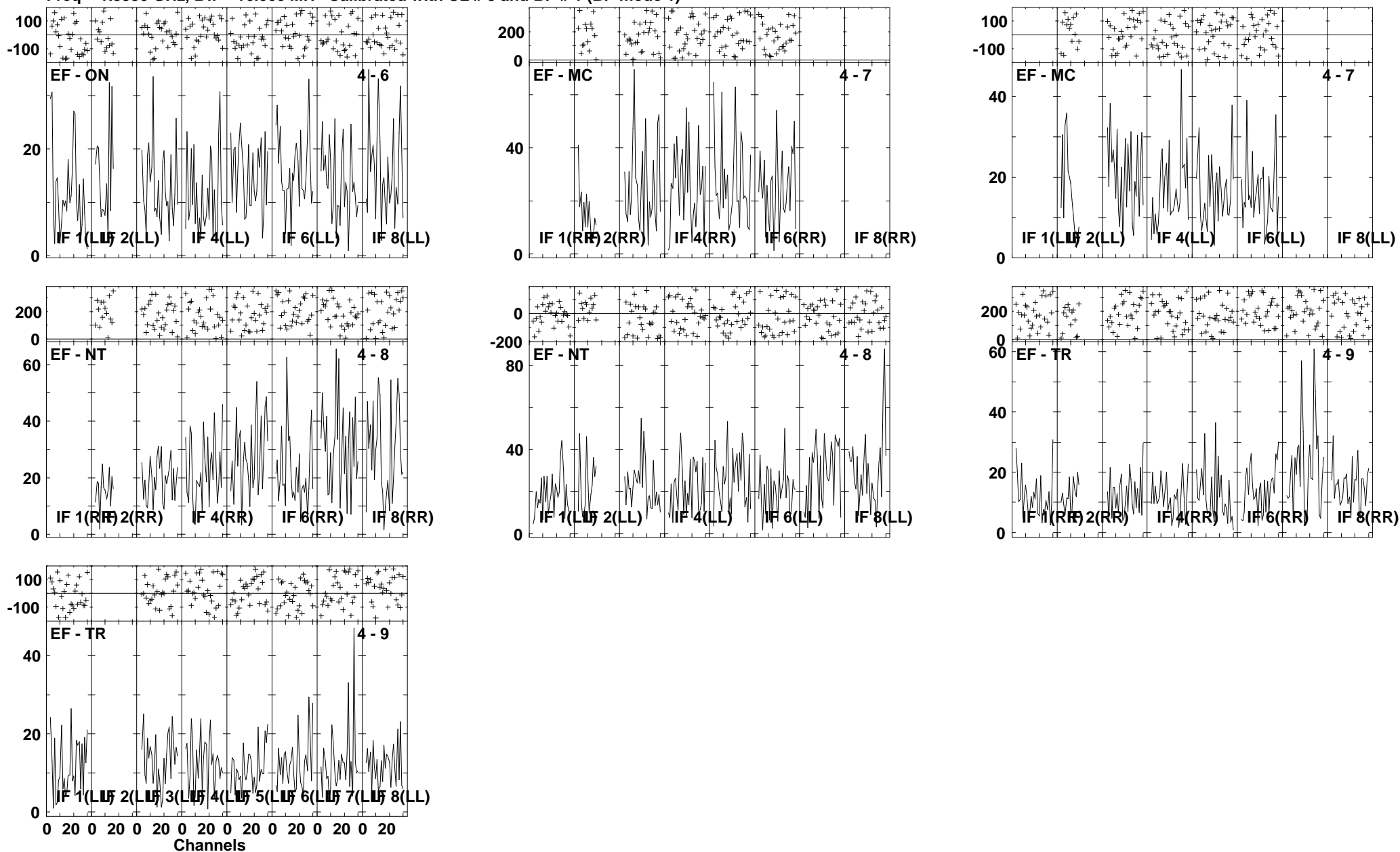

Lower frame: Milli Ampl Jy Top frame: Phas deg
Vector averaged cross-power spectrum Several baselines displayed
Timerange: 00/13:24:30 to 00/13:28:00

Plot file version 61 created 29-APR-2009 14:28:27

J2333+39 EP064D.UVDATA.1

Freq = 1.5950 GHz, Bw = 16.000 MH Calibrated with CL # 3 and BP # 1 (BP mode 1)

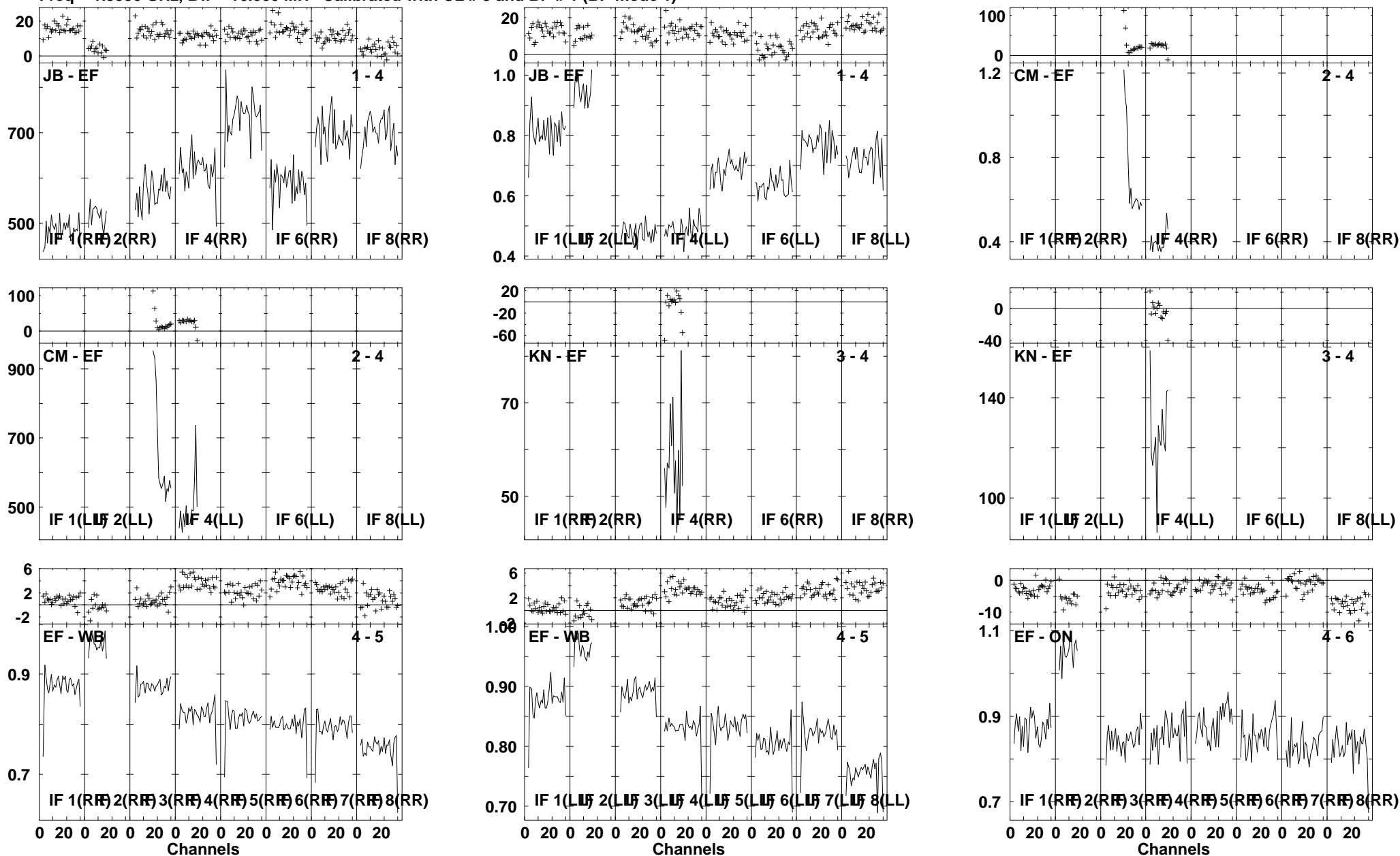

Lower frame: Milli Ampl Jy Top frame: Phas deg
Vector averaged cross-power spectrum Several baselines displayed
Timerange: 00/13:28:02 to 00/13:29:30

Plot file version 62 created 29-APR-2009 14:28:28

J2333+39 EP064D.UVDATA.1

Freq = 1.5950 GHz, Bw = 16.000 MH Calibrated with CL # 3 and BP # 1 (BP mode 1)

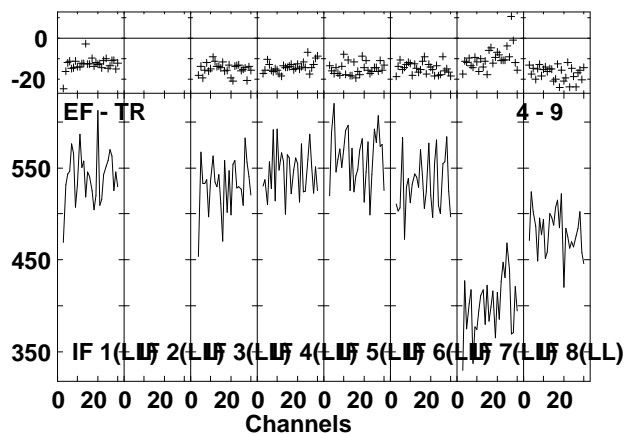
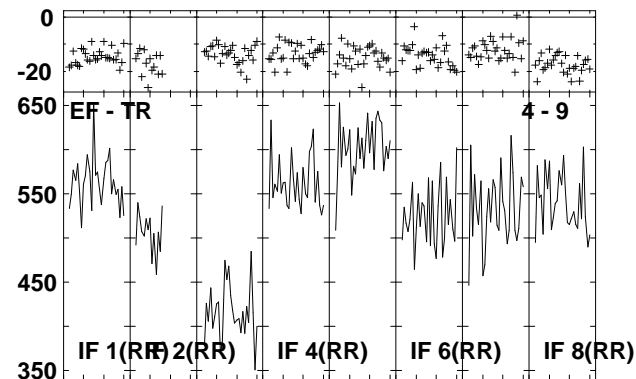
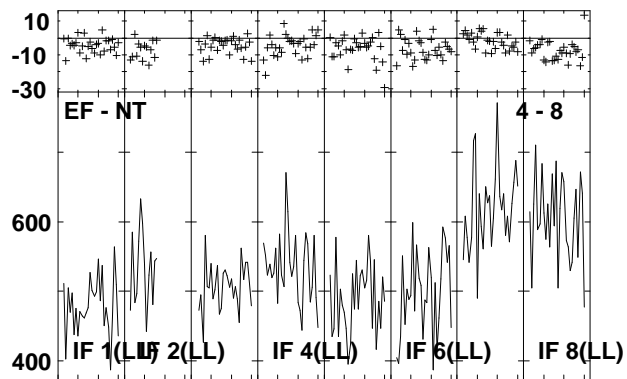
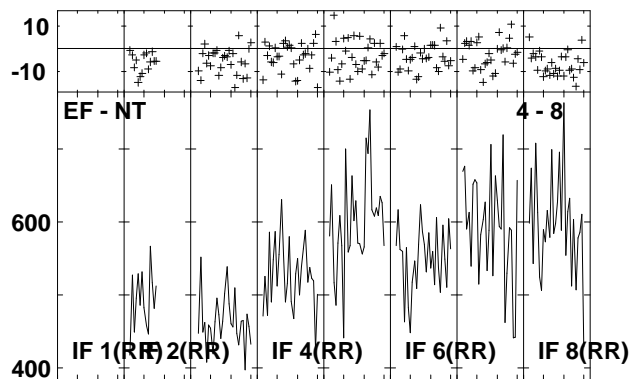
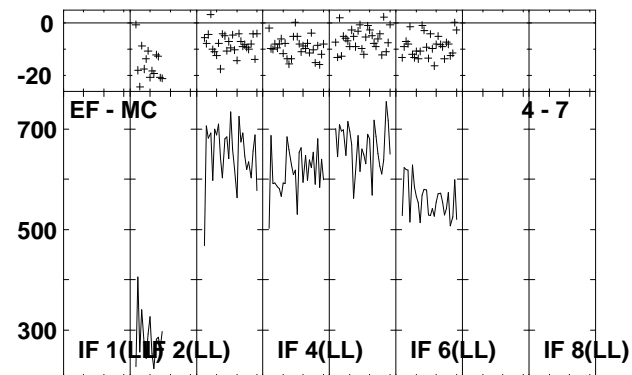
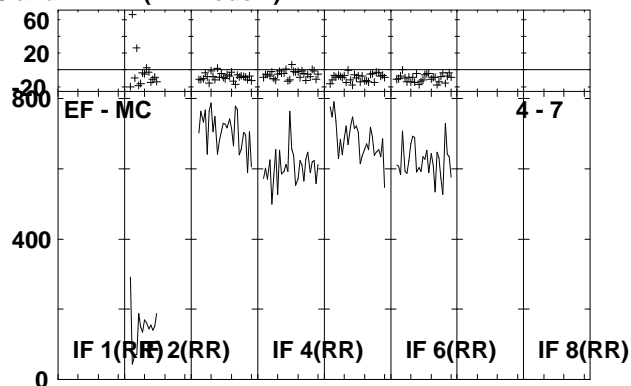
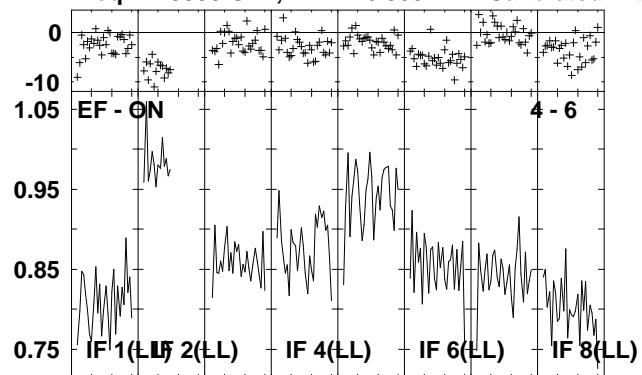

Lower frame: Ampl Jy Top frame: Phas deg
Vector averaged cross-power spectrum Several baselines displayed
Timerange: 00/13:28:02 to 00/13:29:30

Plot file version 63 created 29-APR-2009 14:28:30

IRAS2336 EP064D.UVDATA.1

Freq = 1.5950 GHz, Bw = 16.000 MH Calibrated with CL # 3 and BP # 1 (BP mode 1)

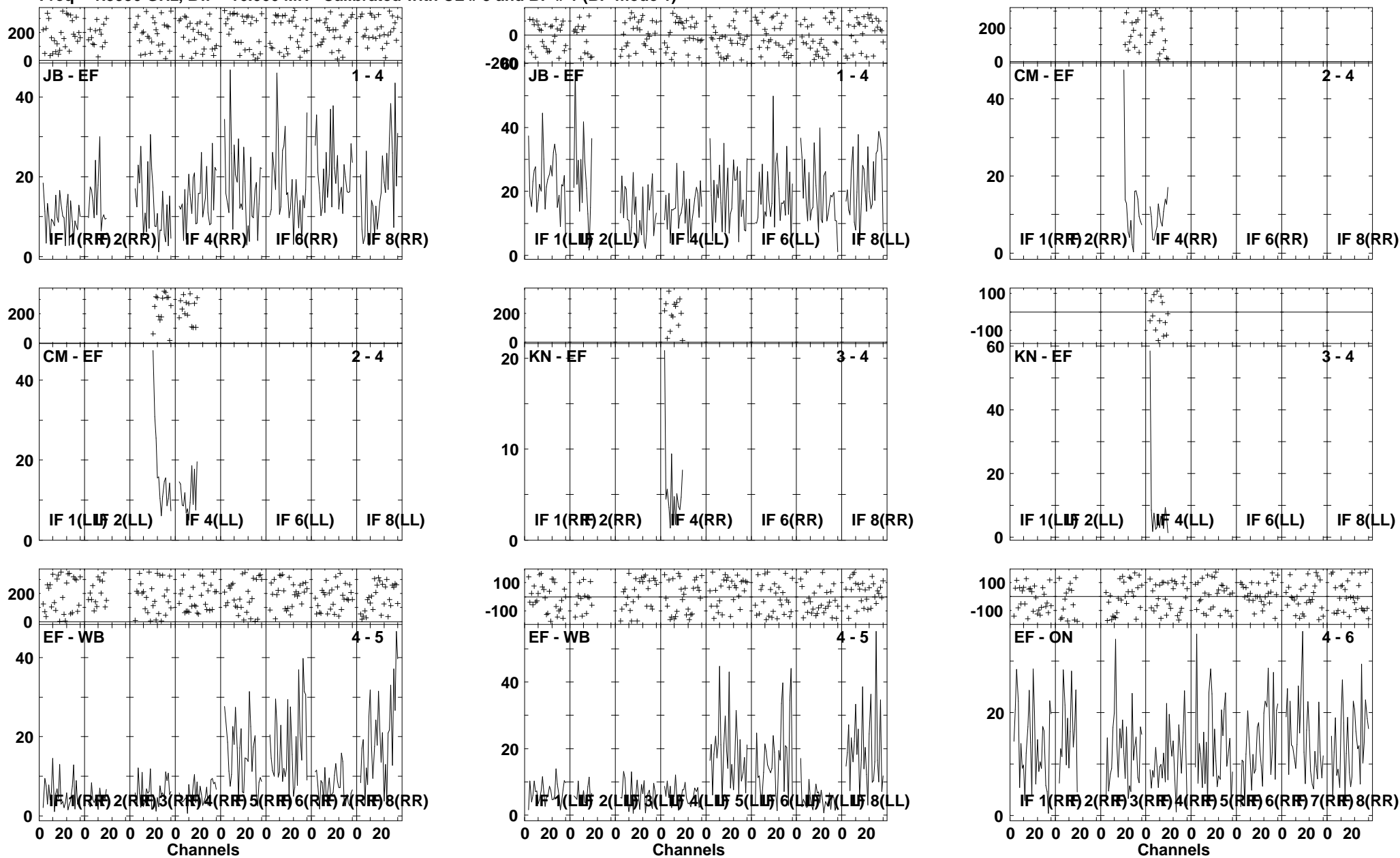

Lower frame: Milli Ampl Jy Top frame: Phas deg
Vector averaged cross-power spectrum Several baselines displayed
Timerange: 00/13:29:32 to 00/13:32:58

Plot file version 64 created 29-APR-2009 14:28:32

IRAS2336 EP064D.UVDATA.1

Freq = 1.5950 GHz, Bw = 16.000 MH Calibrated with CL # 3 and BP # 1 (BP mode 1)

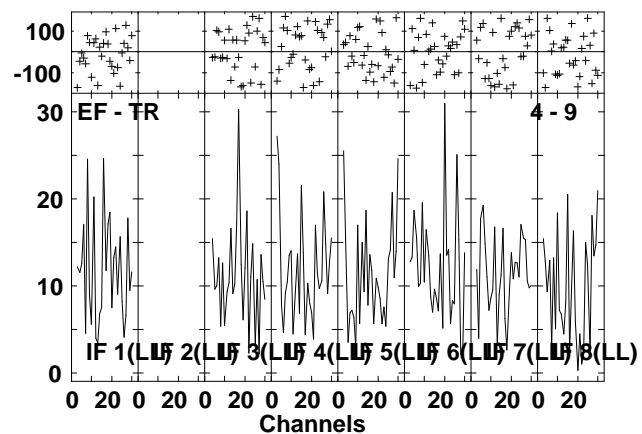
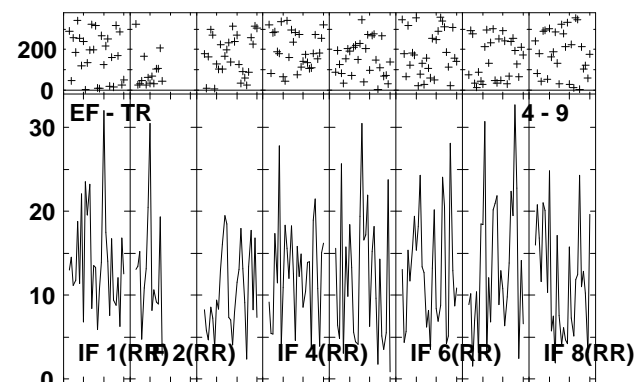
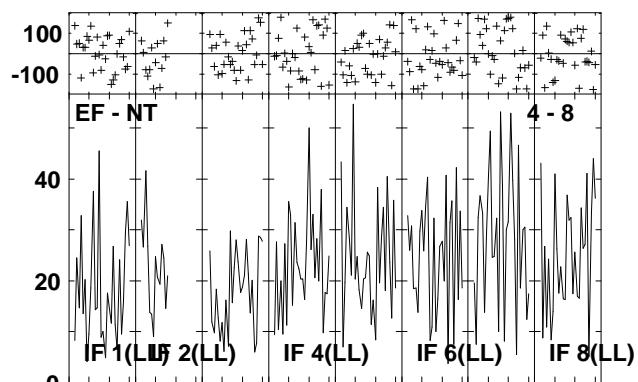
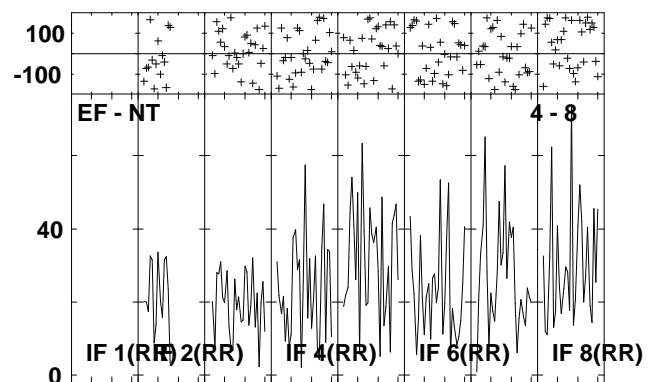
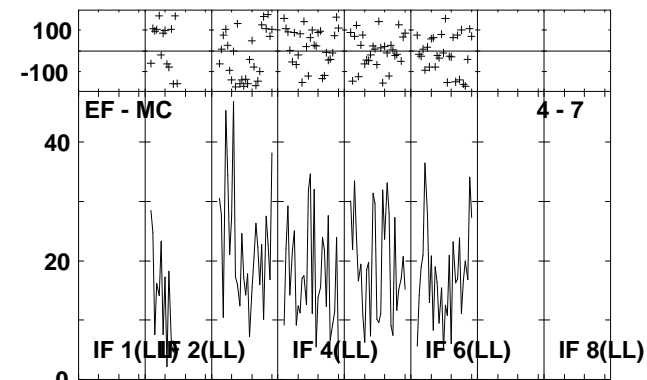
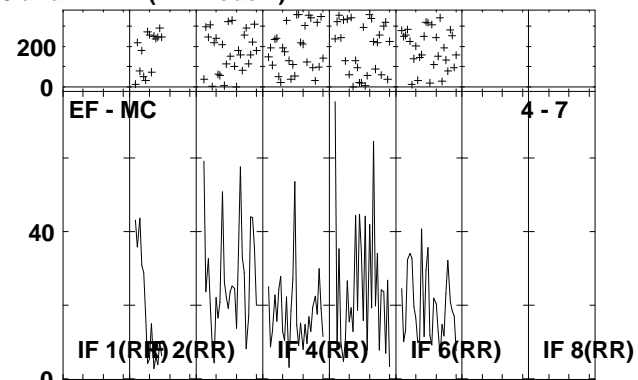
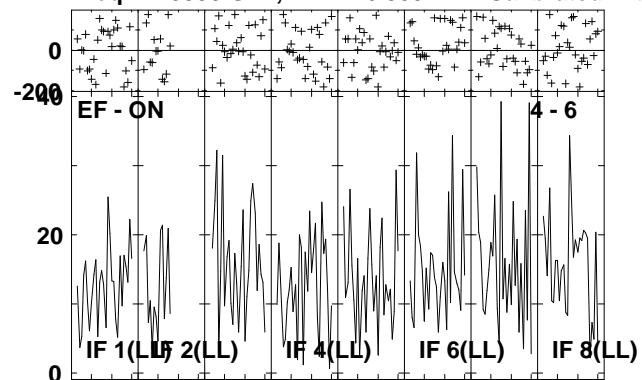

Lower frame: Milli Ampl Jy Top frame: Phas deg
Vector averaged cross-power spectrum Several baselines displayed
Timerange: 00/13:29:32 to 00/13:32:58

Plot file version 65 created 29-APR-2009 14:28:35

J2333+39 EP064D.UVDATA.1

Freq = 1.5950 GHz, Bw = 16.000 MH Calibrated with CL # 3 and BP # 1 (BP mode 1)

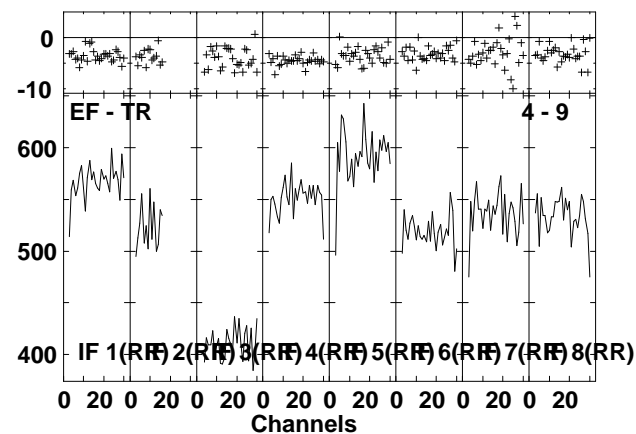
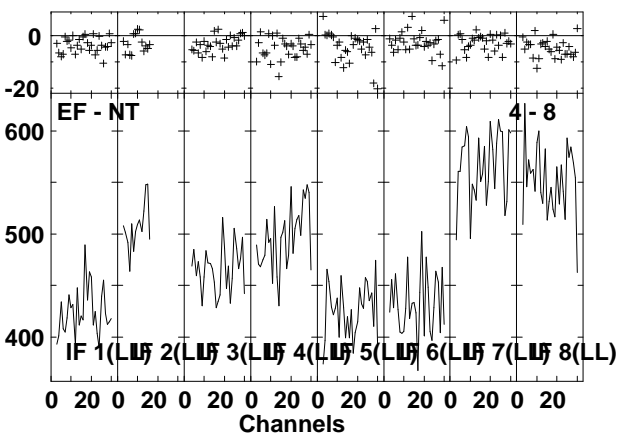
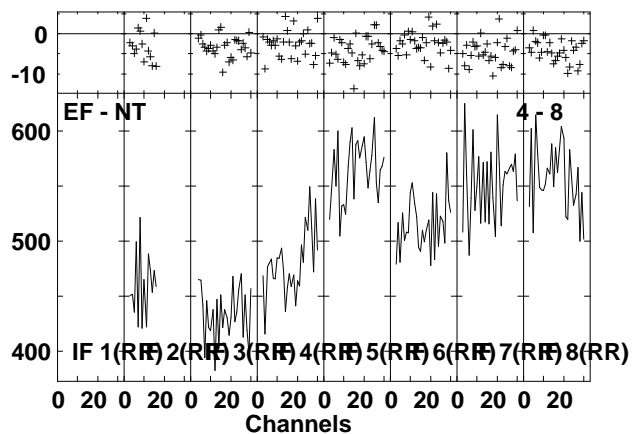
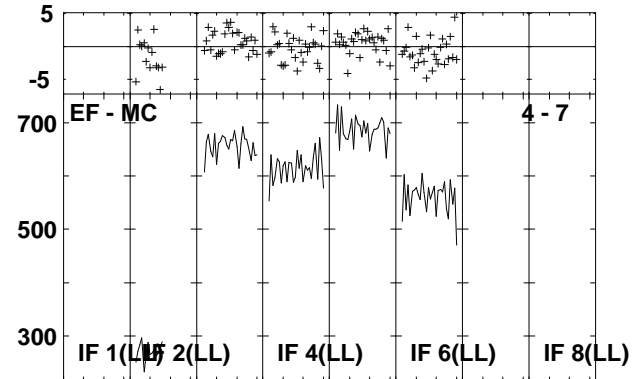
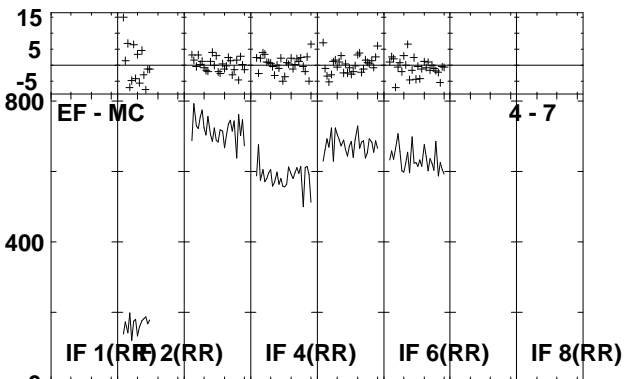
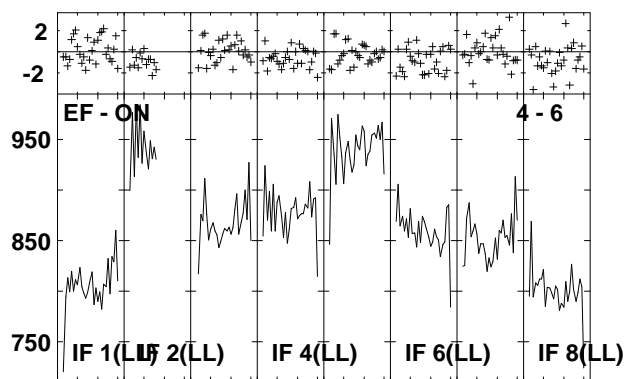
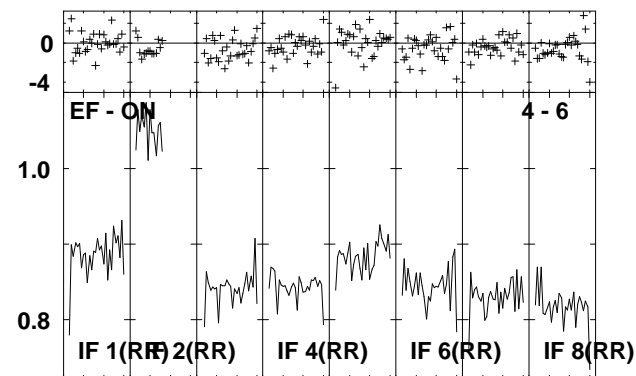
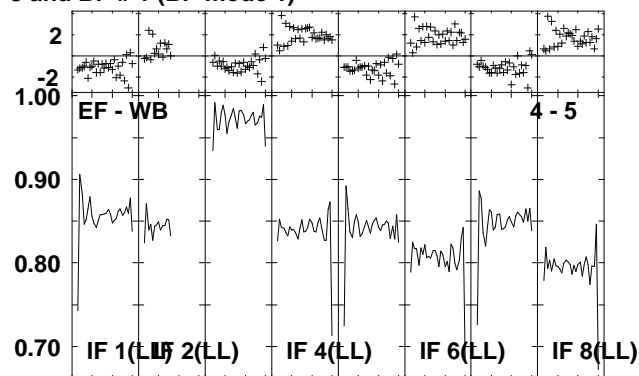
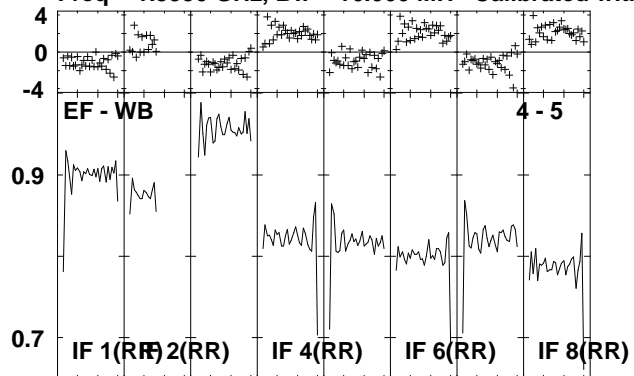

Lower frame: Ampl Jy Top frame: Phas deg
Vector averaged cross-power spectrum Several baselines displayed
Timerange: 00/13:34:00 to 00/13:35:28

Plot file version 66 created 29-APR-2009 14:28:36

J2333+39 EP064D.UVDATA.1

Freq = 1.5950 GHz, Bw = 16.000 MH Calibrated with CL # 3 and BP # 1 (BP mode 1)

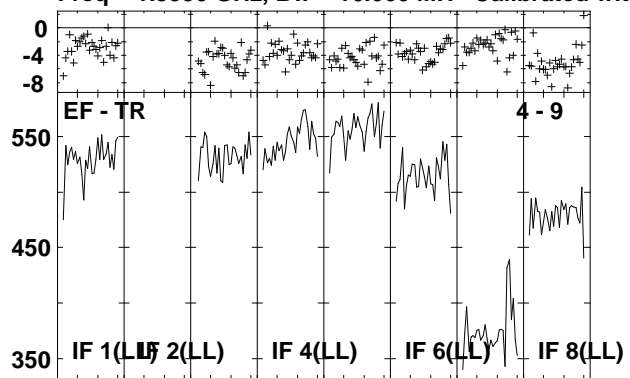

Lower frame: Milli Ampl Jy Top frame: Phas deg
Vector averaged cross-power spectrum Several baselines displayed
Timerange: 00/13:34:00 to 00/13:35:28

Plot file version 67 created 29-APR-2009 14:28:37

IRAS2336 EP064D.UVDATA.1

Freq = 1.5950 GHz, Bw = 16.000 MH Calibrated with CL # 3 and BP # 1 (BP mode 1)

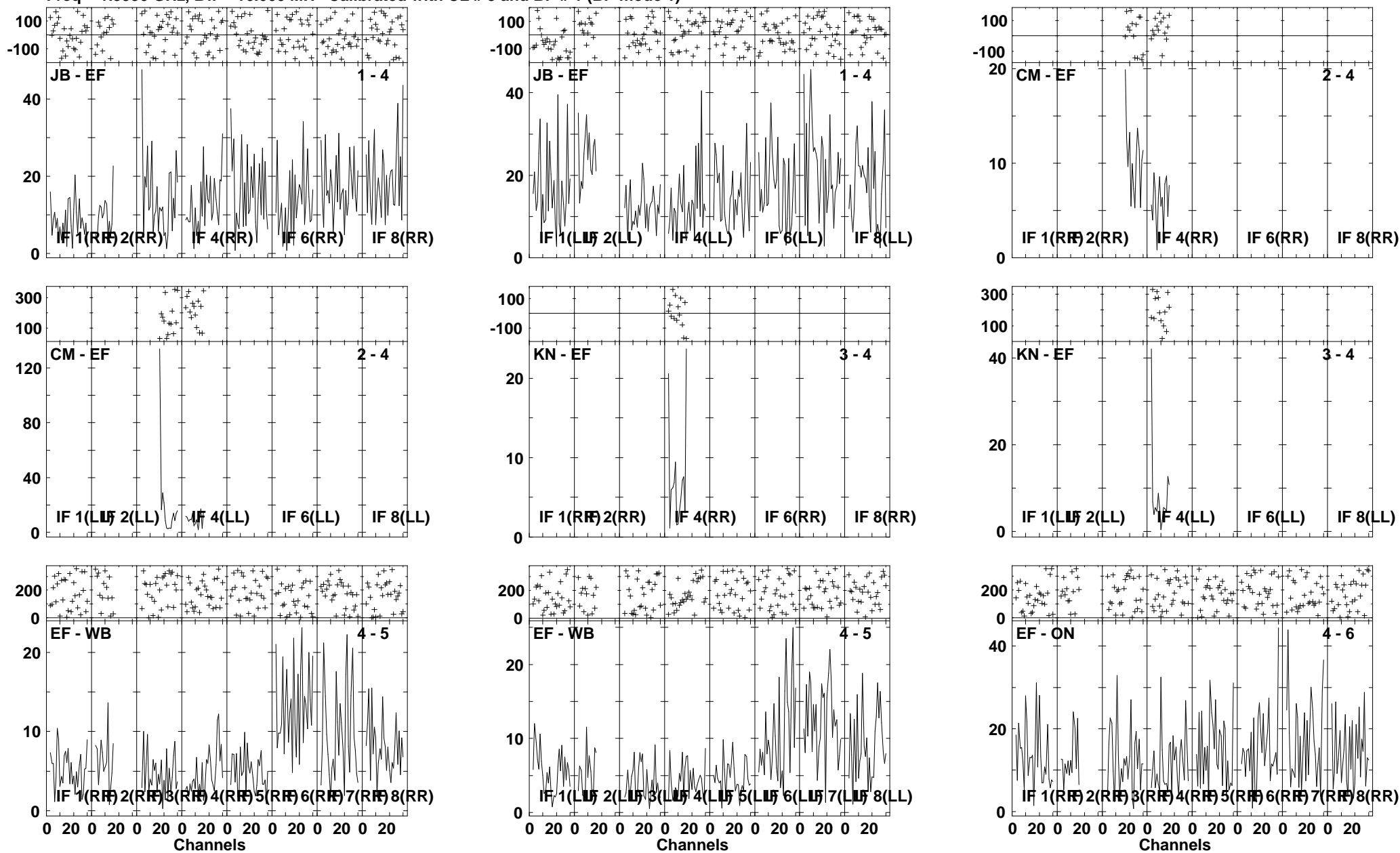

Lower frame: Milli Ampl Jy Top frame: Phas deg
Vector averaged cross-power spectrum Several baselines displayed
Timerange: 00/13:35:30 to 00/13:39:00

Plot file version 68 created 29-APR-2009 14:28:40

IRAS2336 EP064D.UVDATA.1

Freq = 1.5950 GHz, Bw = 16.000 MH Calibrated with CL # 3 and BP # 1 (BP mode 1)

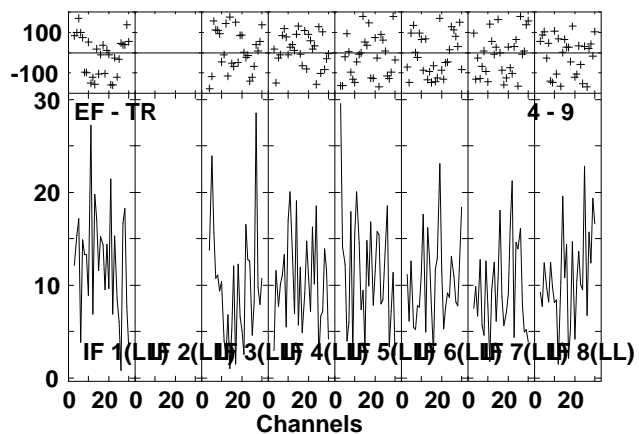
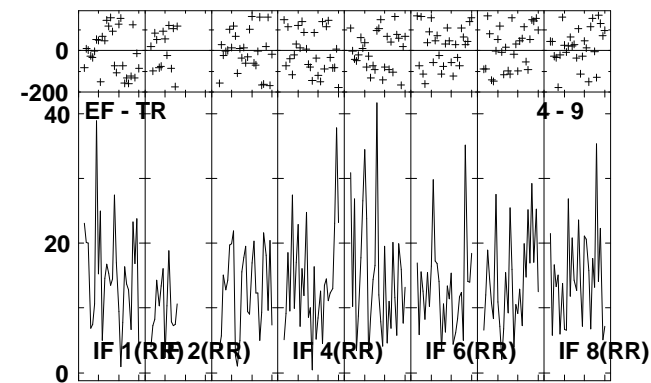
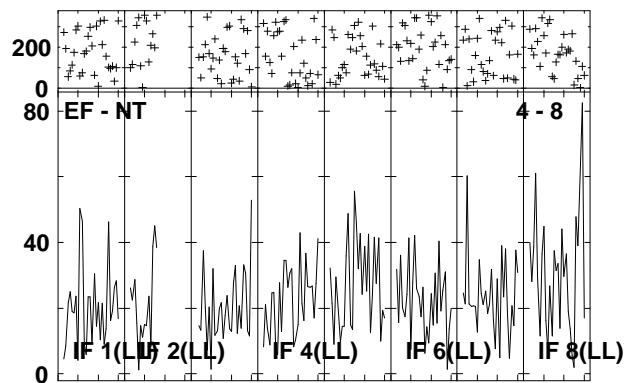
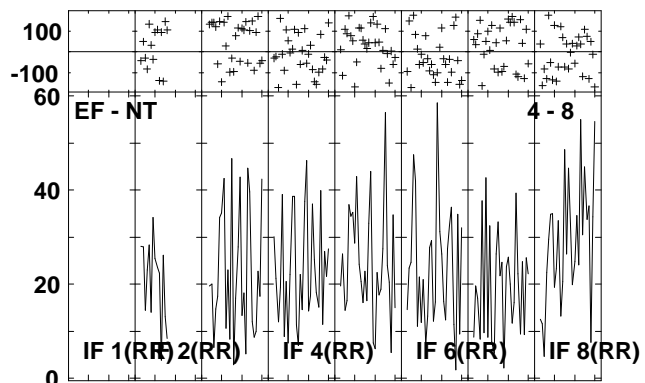
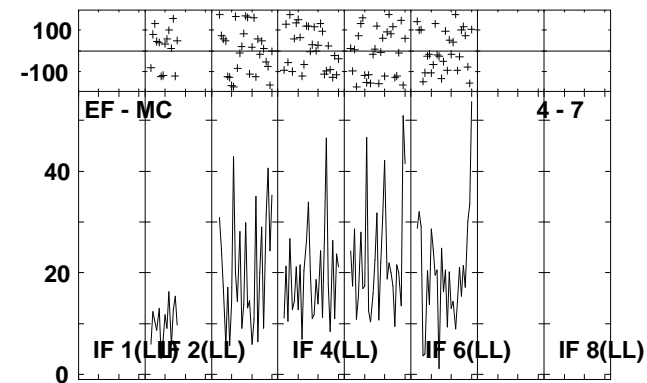
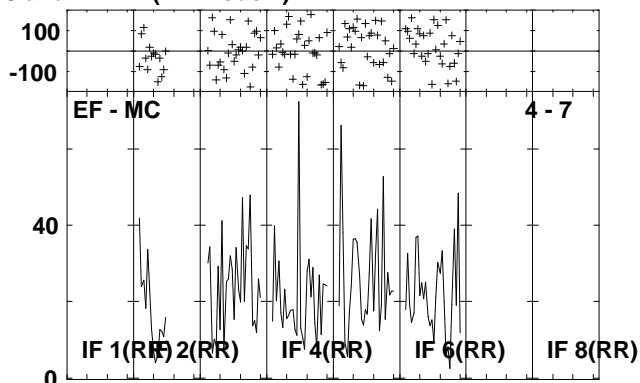
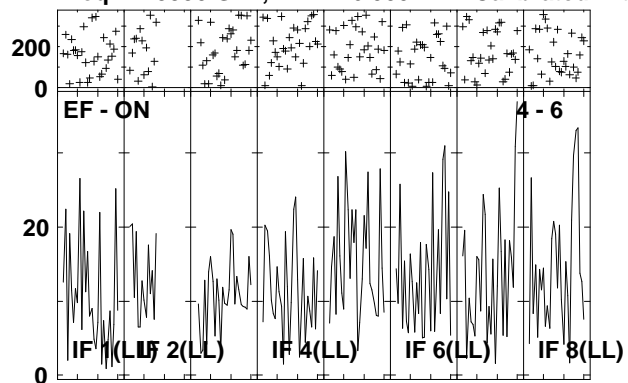

Lower frame: Milli Ampl Jy Top frame: Phas deg
Vector averaged cross-power spectrum Several baselines displayed
Timerange: 00/13:35:30 to 00/13:39:00

Plot file version 69 created 29-APR-2009 14:28:43

J2333+39 EP064D.UVDATA.1

Freq = 1.5950 GHz, Bw = 16.000 MH Calibrated with CL # 3 and BP # 1 (BP mode 1)

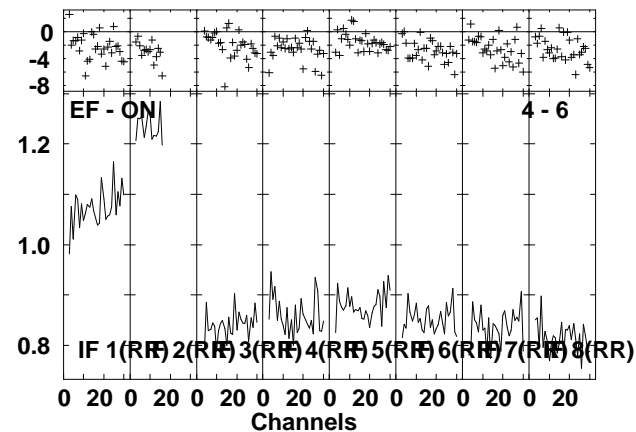
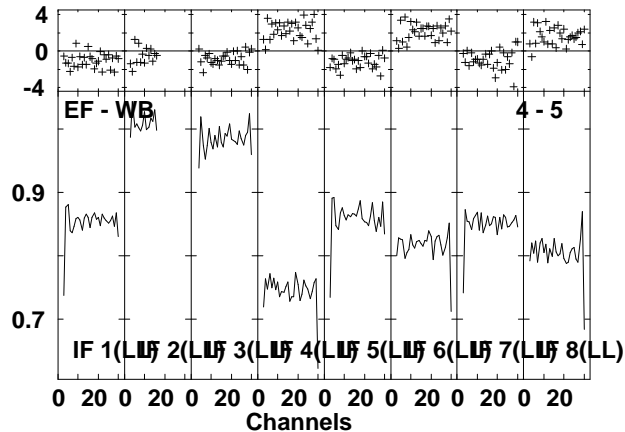
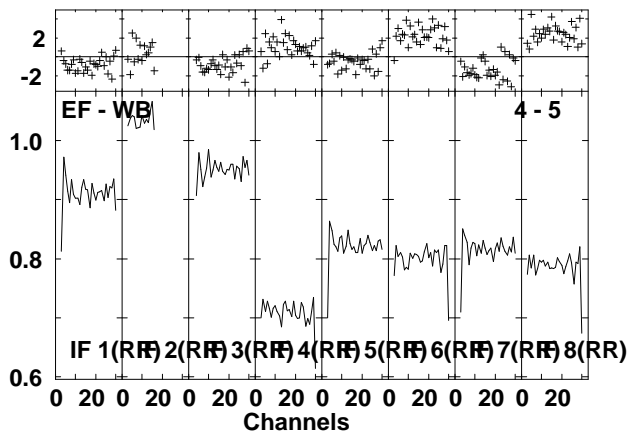
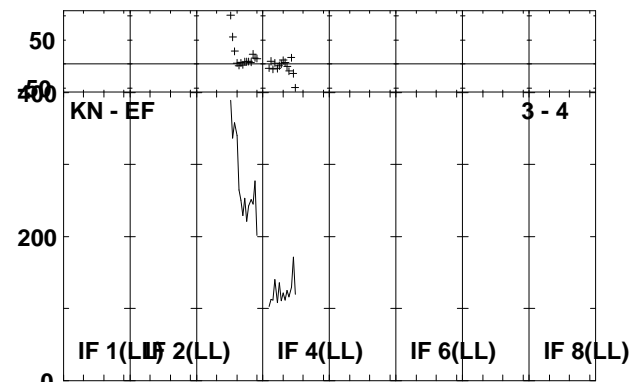
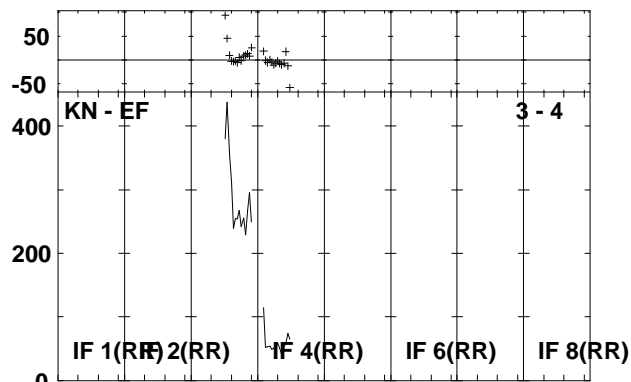
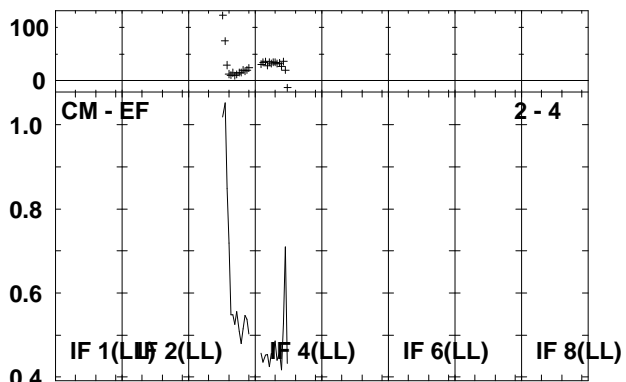
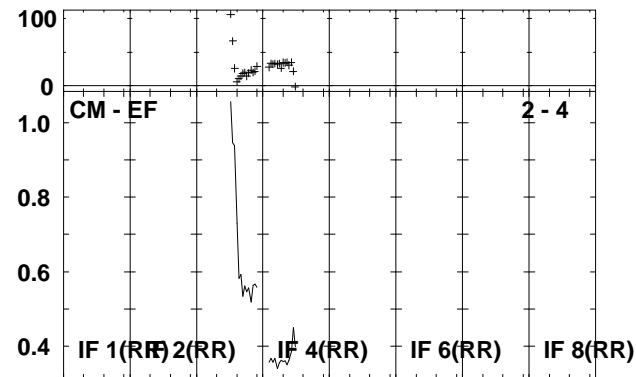
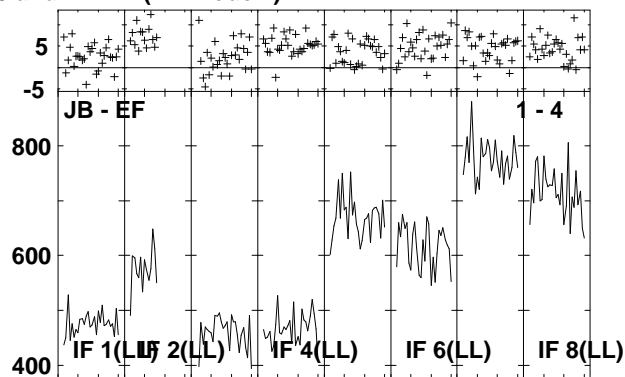
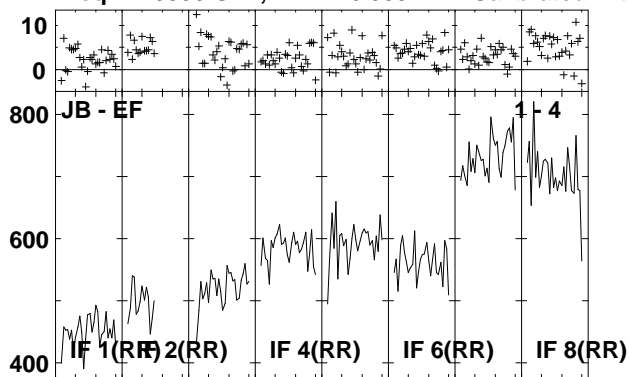

Lower frame: Milli Ampl Jy Top frame: Phas deg
Vector averaged cross-power spectrum Several baselines displayed
Timerange: 00/13:39:02 to 00/13:40:30

Plot file version 70 created 29-APR-2009 14:28:44

J2333+39 EP064D.UVDATA.1

Freq = 1.5950 GHz, Bw = 16.000 MH Calibrated with CL # 3 and BP # 1 (BP mode 1)

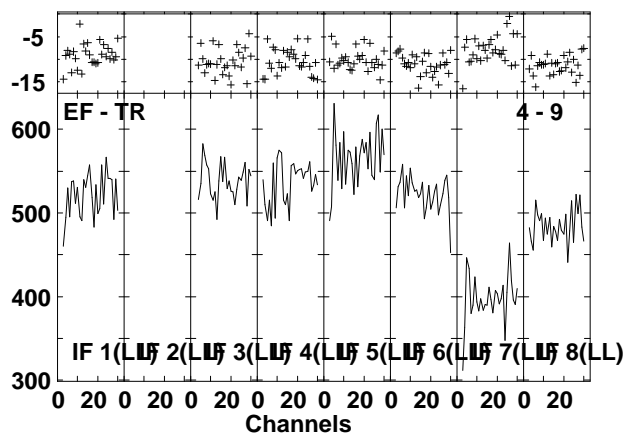
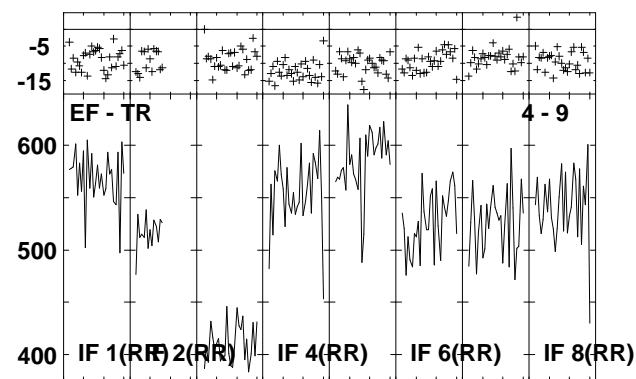
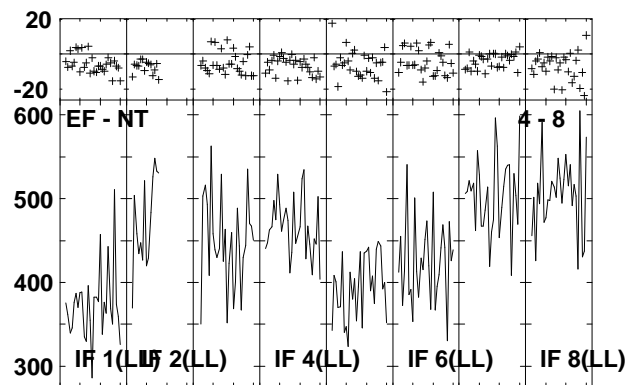
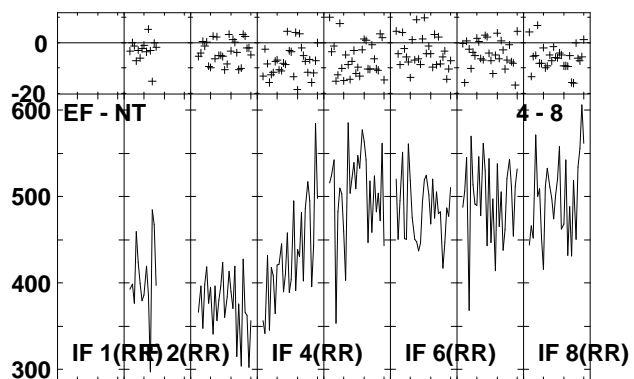
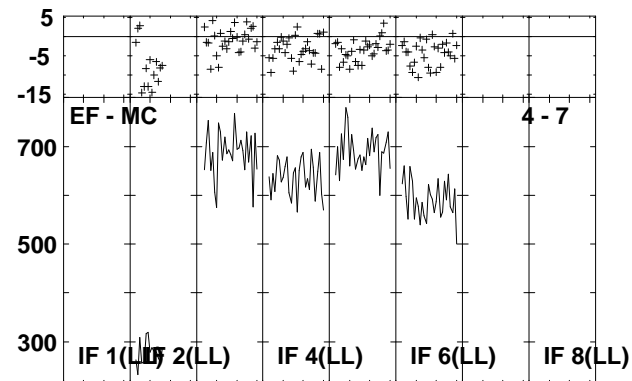
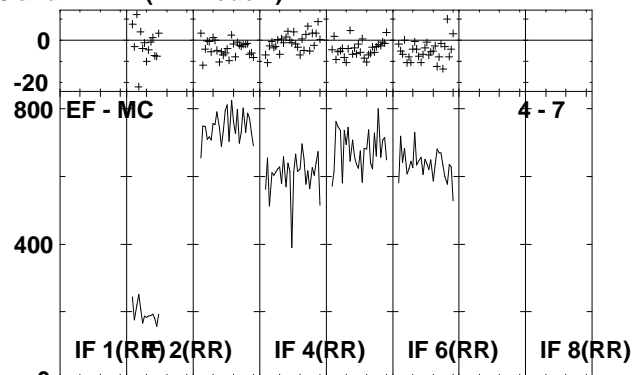
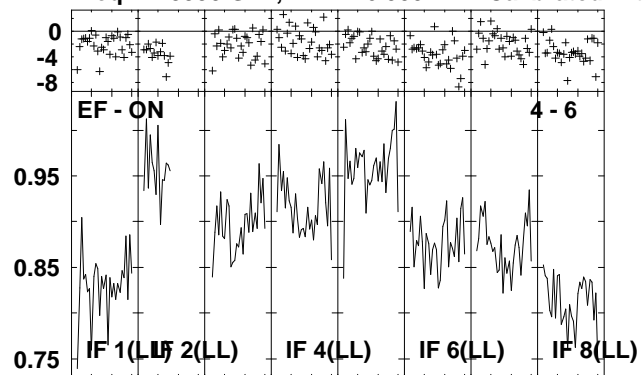

Lower frame: Ampl Jy Top frame: Phas deg
Vector averaged cross-power spectrum Several baselines displayed
Timerange: 00/13:39:02 to 00/13:40:30

Plot file version 71 created 29-APR-2009 14:28:46

IRAS2336 EP064D.UVDATA.1

Freq = 1.5950 GHz, Bw = 16.000 MH Calibrated with CL # 3 and BP # 1 (BP mode 1)

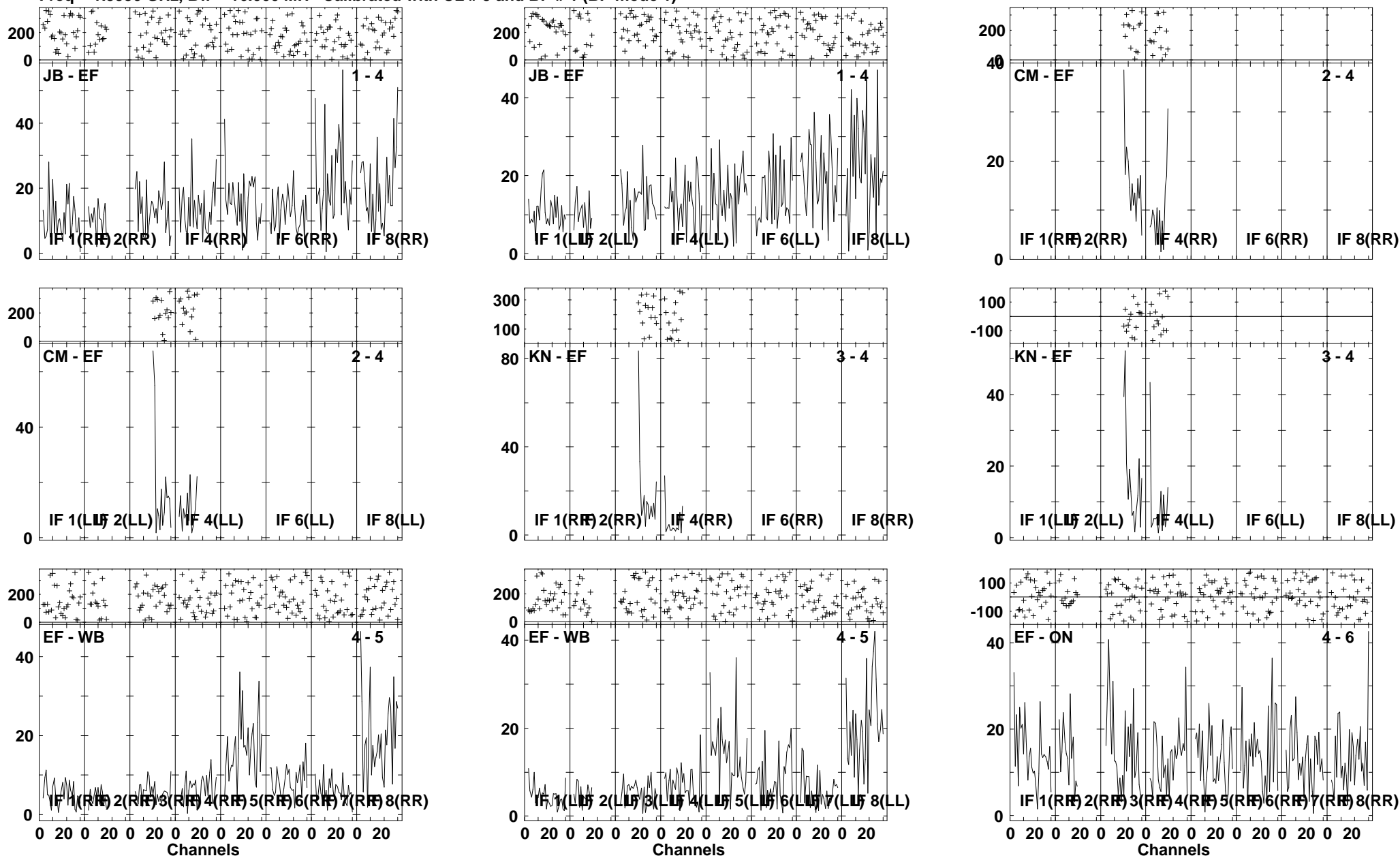

Lower frame: Milli Ampl Jy Top frame: Phas deg
Vector averaged cross-power spectrum Several baselines displayed
Timerange: 00/13:40:32 to 00/13:44:00

Plot file version 72 created 29-APR-2009 14:28:49

IRAS2336 EP064D.UVDATA.1

Freq = 1.5950 GHz, Bw = 16.000 MH Calibrated with CL # 3 and BP # 1 (BP mode 1)

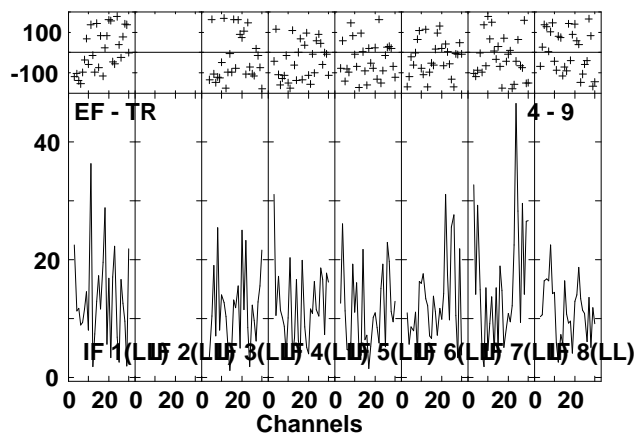
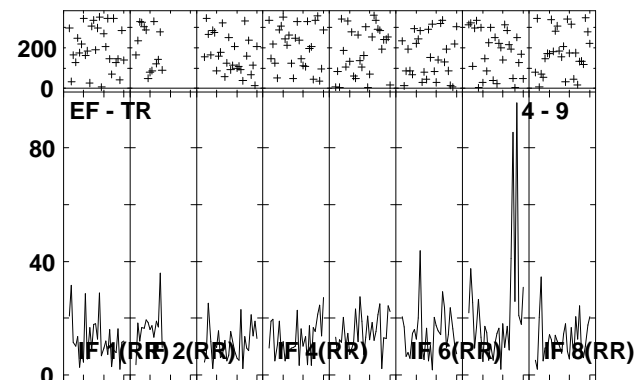
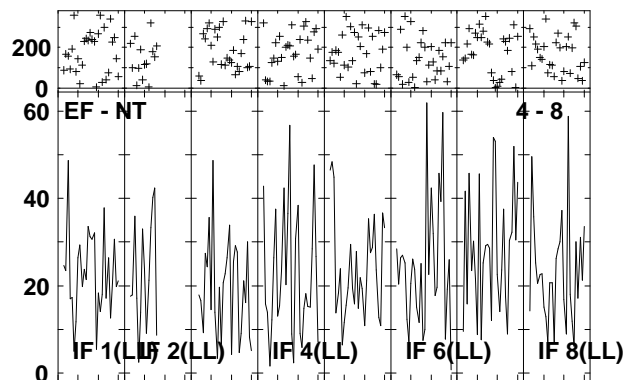
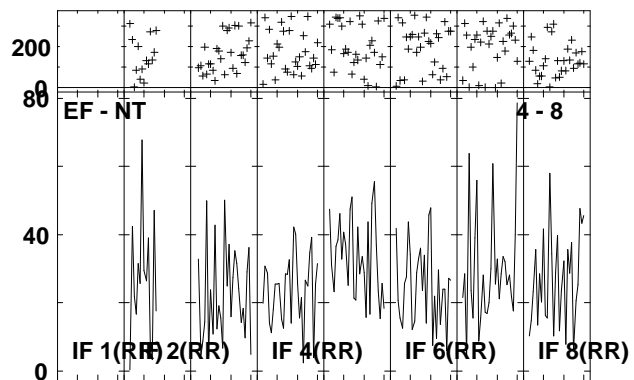
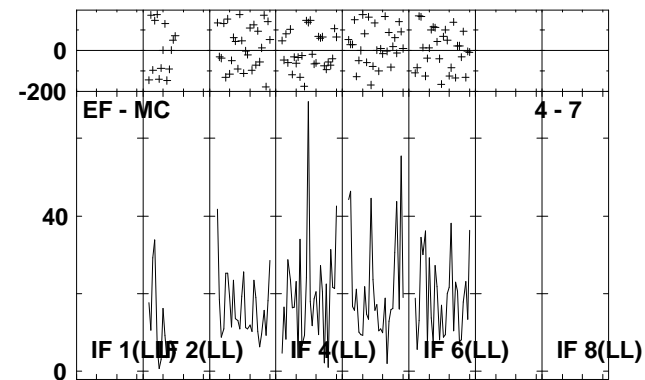
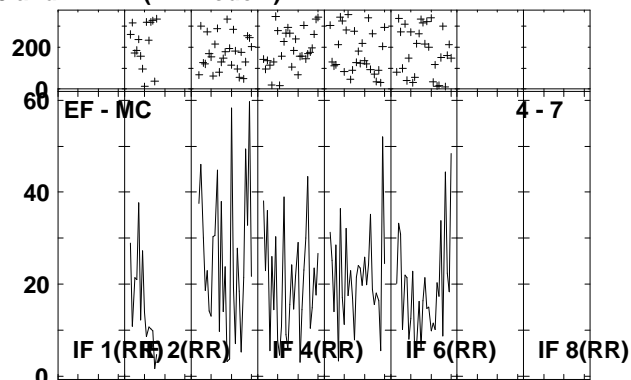
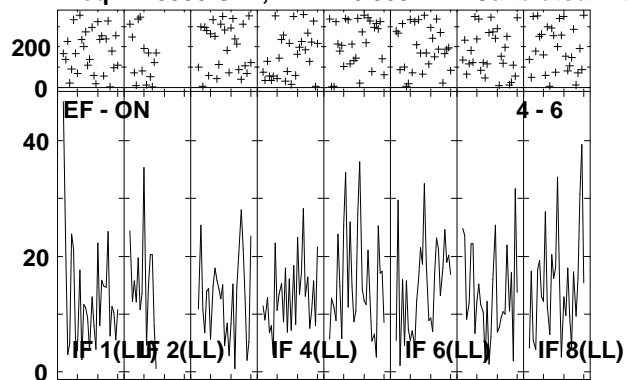

Lower frame: Milli Ampl Jy Top frame: Phas deg
Vector averaged cross-power spectrum Several baselines displayed
Timerange: 00/13:40:32 to 00/13:44:00

Plot file version 73 created 29-APR-2009 14:28:52

J2333+39 EP064D.UVDATA.1

Freq = 1.5950 GHz, Bw = 16.000 MH Calibrated with CL # 3 and BP # 1 (BP mode 1)

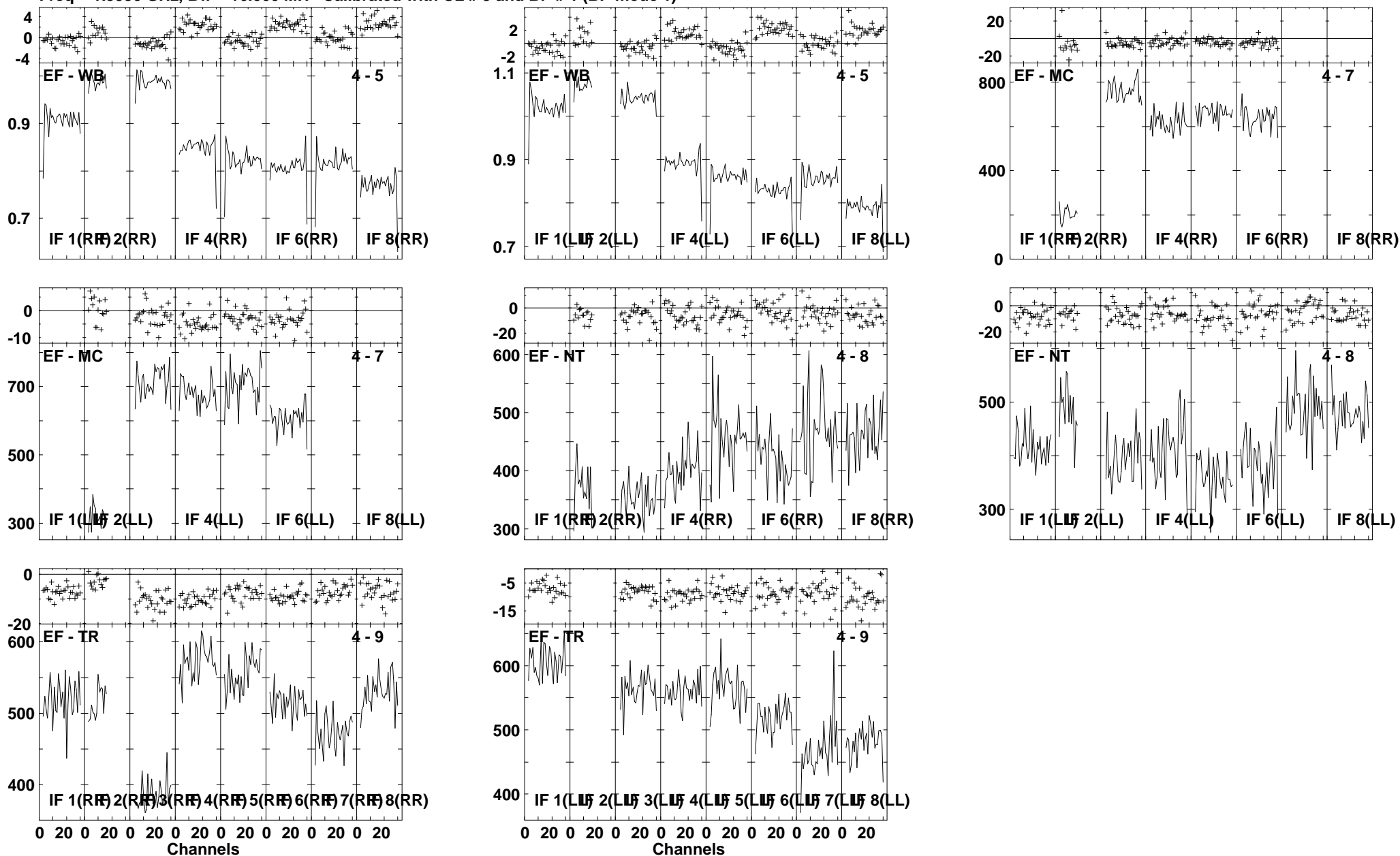

Lower frame: Ampl Jy Top frame: Phas deg
Vector averaged cross-power spectrum Several baselines displayed
Timerange: 00/13:44:02 to 00/13:45:28

Plot file version 74 created 29-APR-2009 14:28:54

IRAS2336 EP064D.UVDATA.1

Freq = 1.5950 GHz, Bw = 16.000 MH Calibrated with CL # 3 and BP # 1 (BP mode 1)

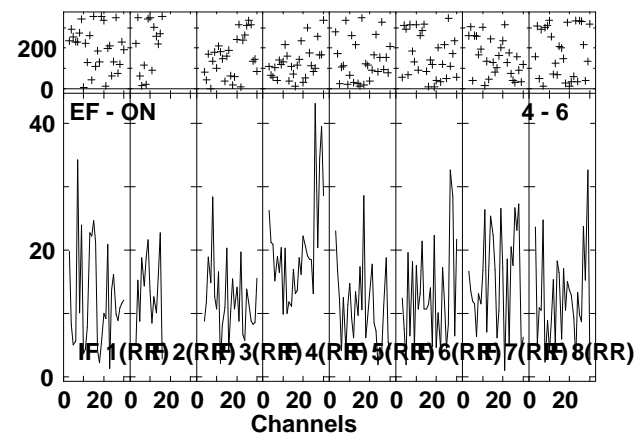
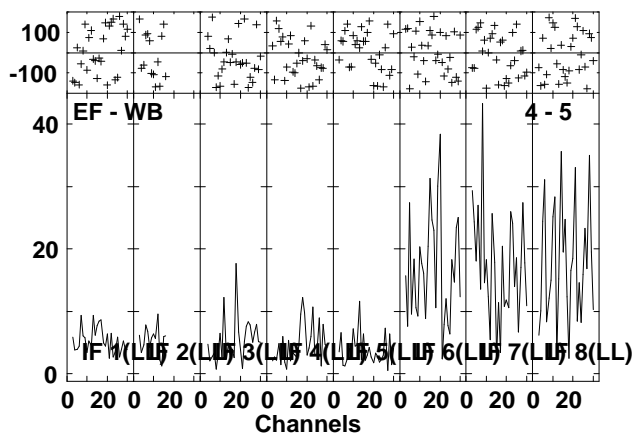
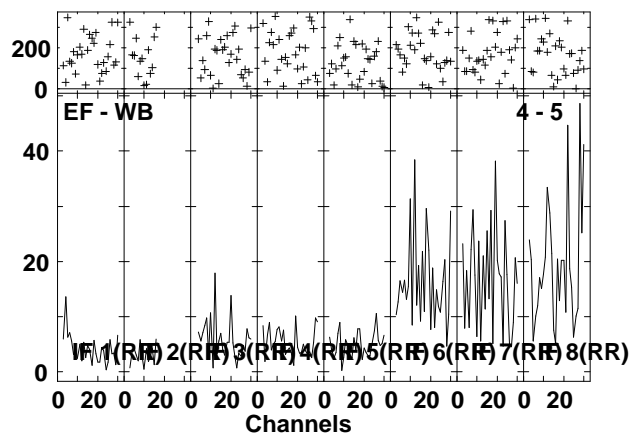
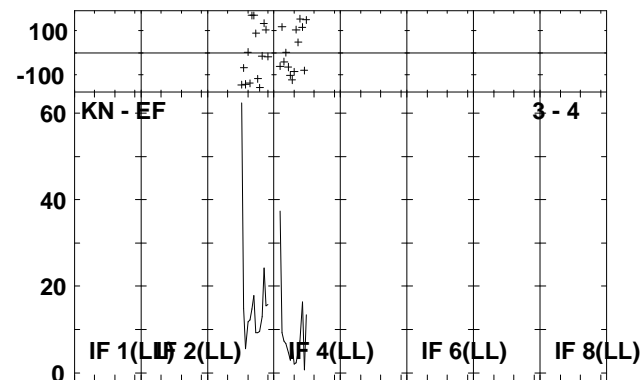
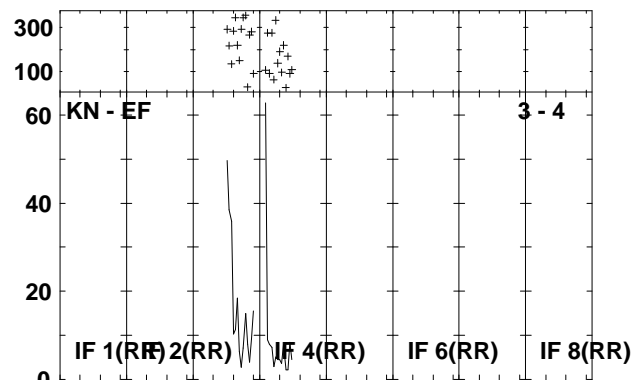
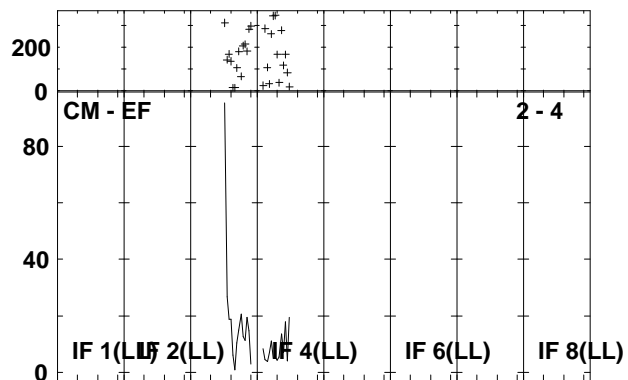
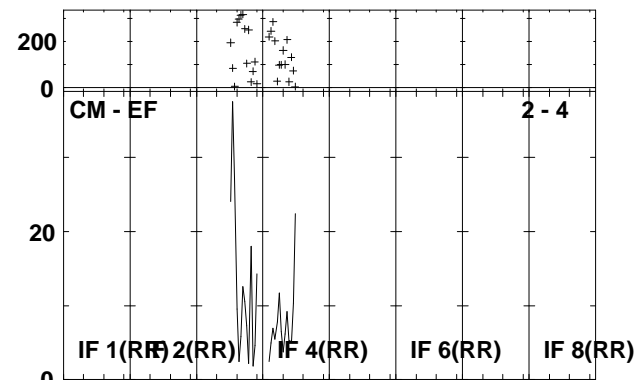
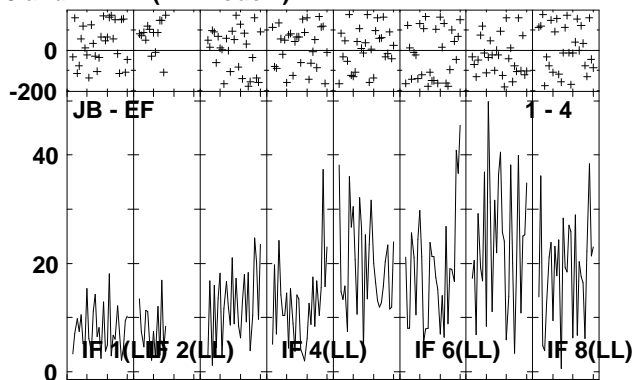
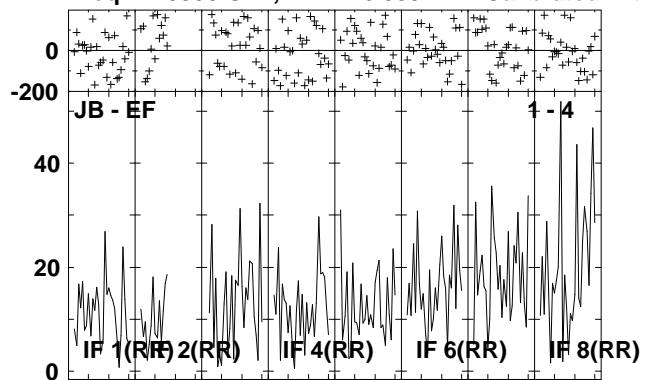

Lower frame: Milli Ampl Jy Top frame: Phas deg
Vector averaged cross-power spectrum Several baselines displayed
Timerange: 00/13:45:30 to 00/13:48:58

Plot file version 75 created 29-APR-2009 14:28:57

IRAS2336 EP064D.UVDATA.1

Freq = 1.5950 GHz, Bw = 16.000 MH Calibrated with CL # 3 and BP # 1 (BP mode 1)

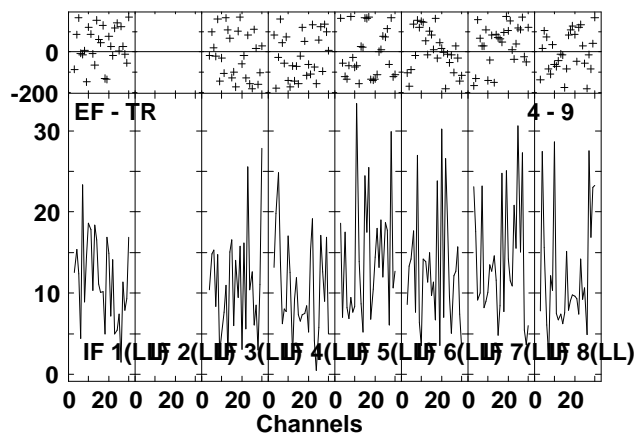
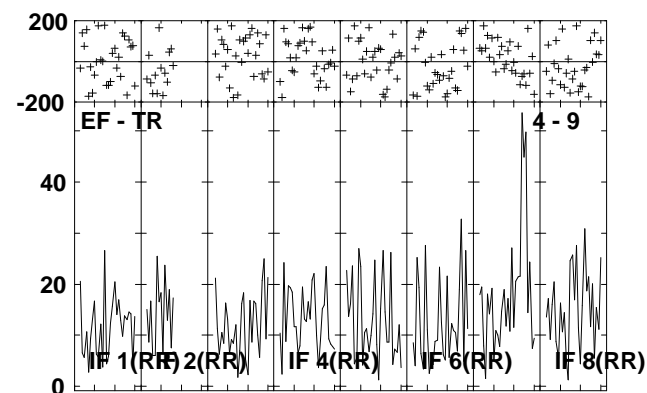
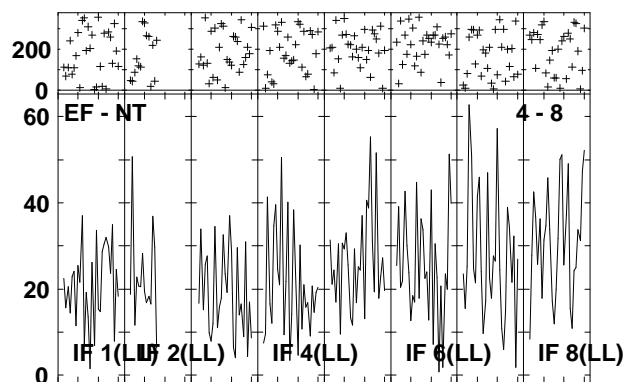
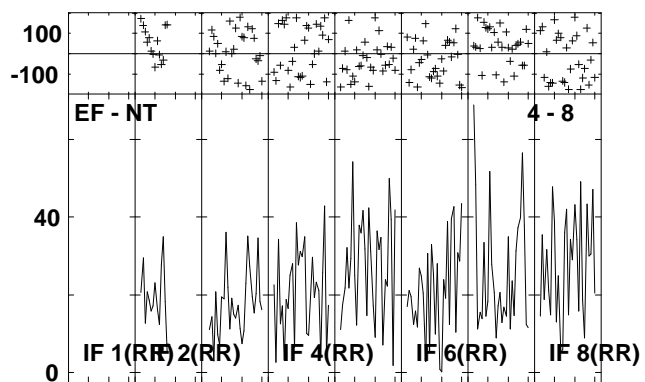
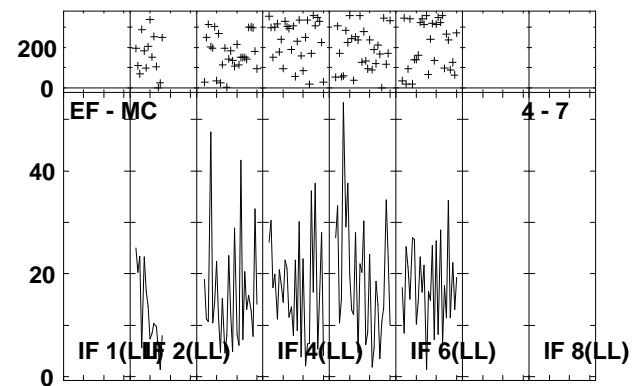
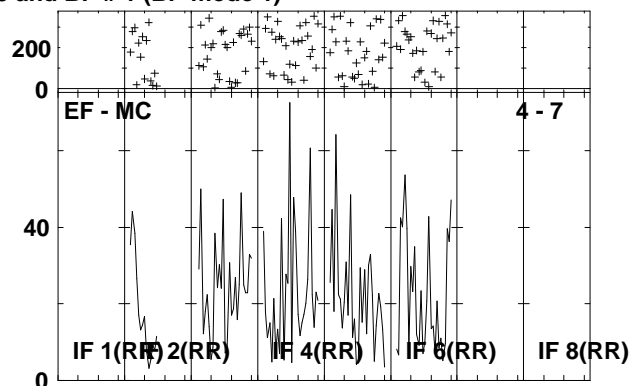
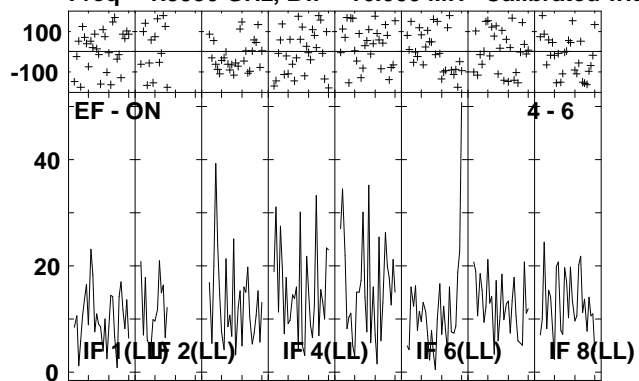

Lower frame: Milli Ampl Jy Top frame: Phas deg
Vector averaged cross-power spectrum Several baselines displayed
Timerange: 00/13:45:30 to 00/13:48:58

Plot file version 76 created 29-APR-2009 14:29:00

J2333+39 EP064D.UVDATA.1

Freq = 1.5950 GHz, Bw = 16.000 MH Calibrated with CL # 3 and BP # 1 (BP mode 1)

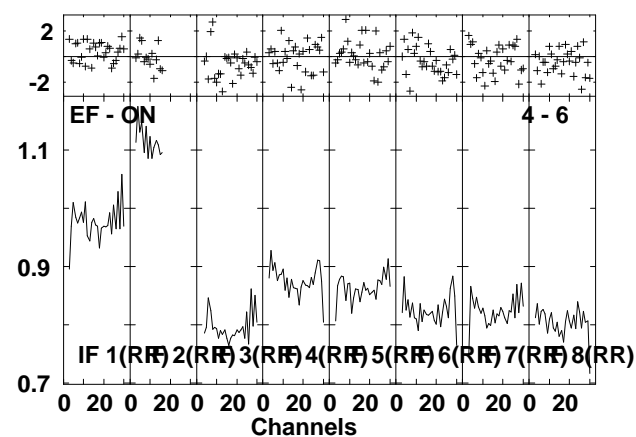
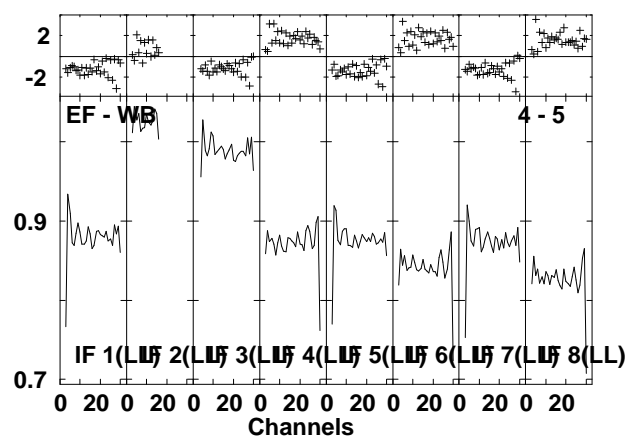
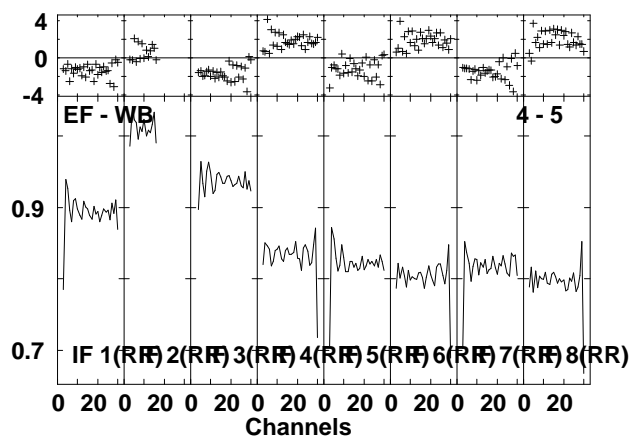
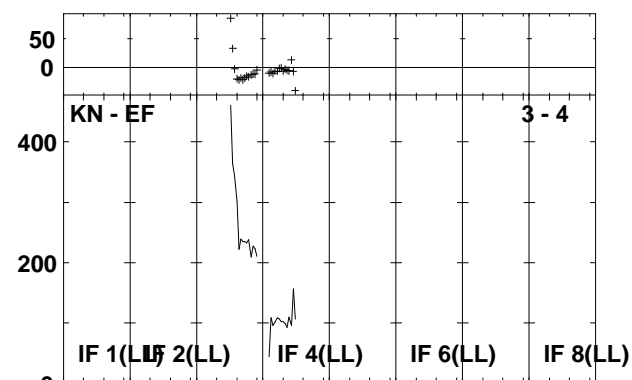
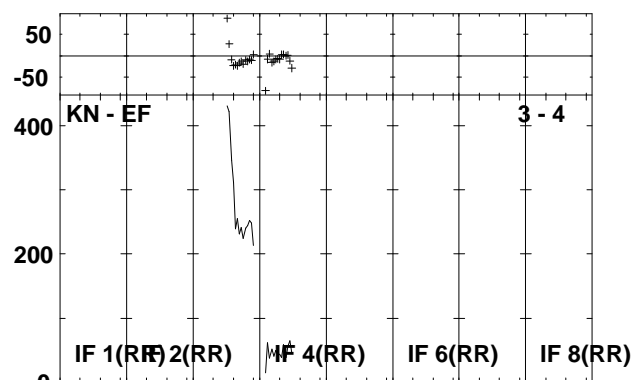
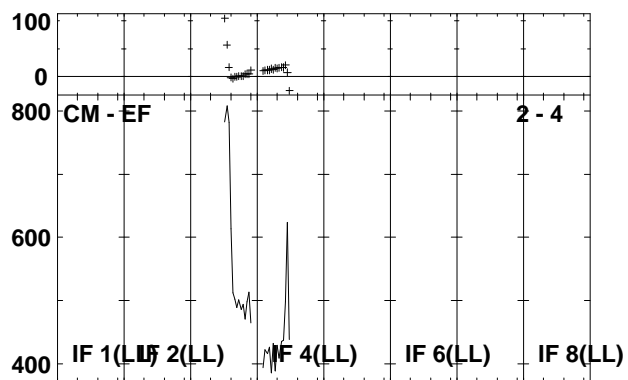
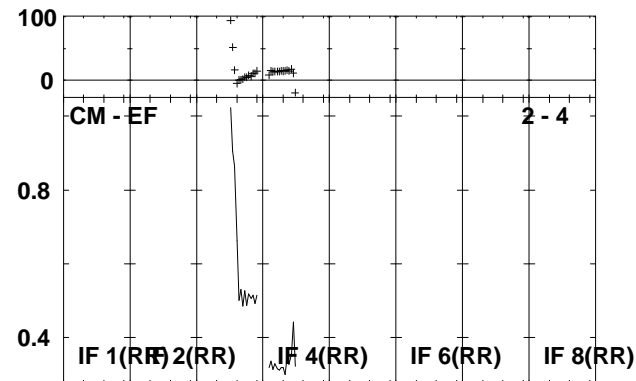
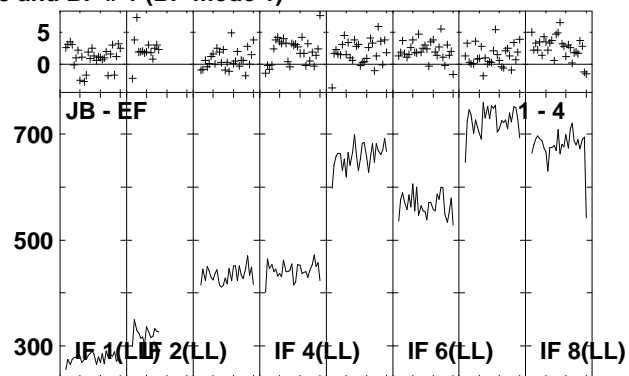
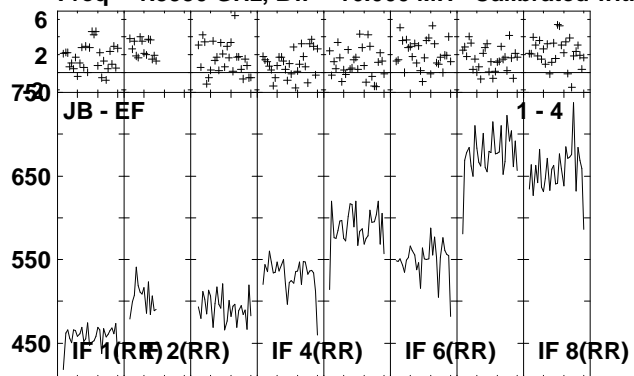

Lower frame: Milli Ampl Jy Top frame: Phas deg
Vector averaged cross-power spectrum Several baselines displayed
Timerange: 00/13:50:02 to 00/13:51:30

Plot file version 77 created 29-APR-2009 14:29:01

J2333+39 EP064D.UVDATA.1

Freq = 1.5950 GHz, Bw = 16.000 MH Calibrated with CL # 3 and BP # 1 (BP mode 1)

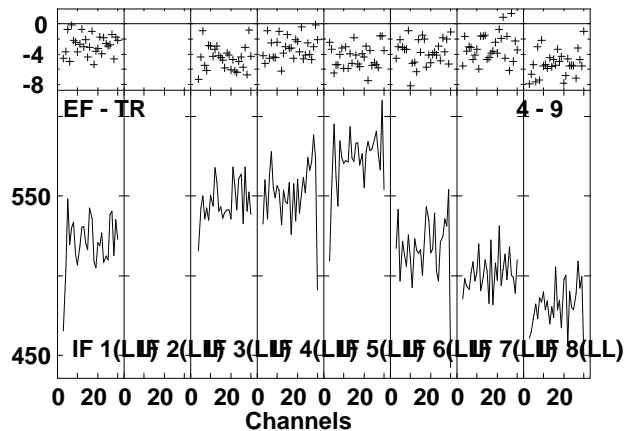
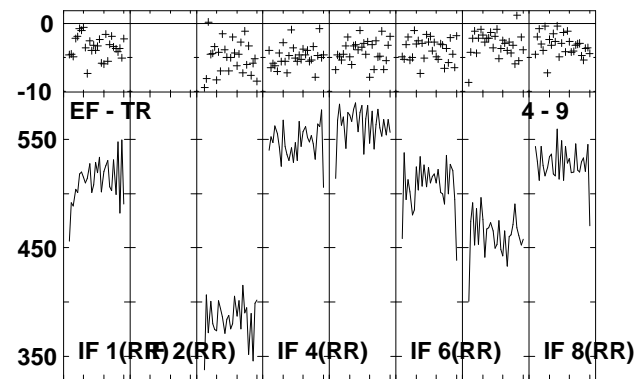
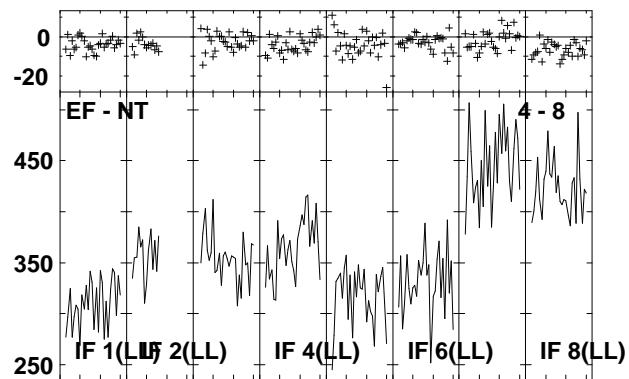
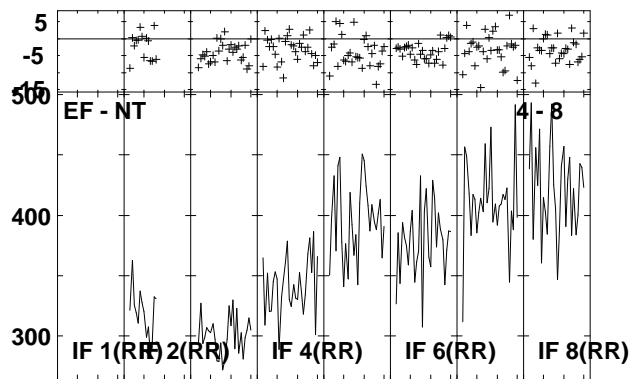
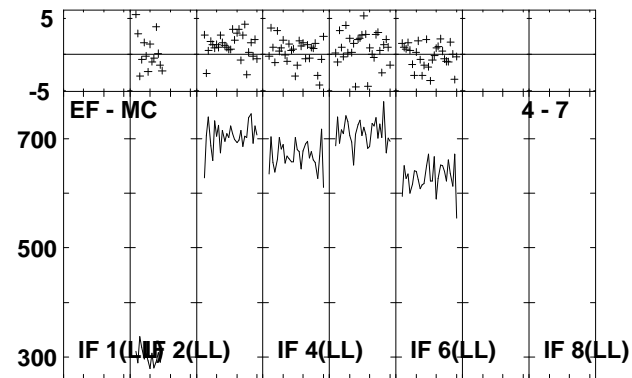
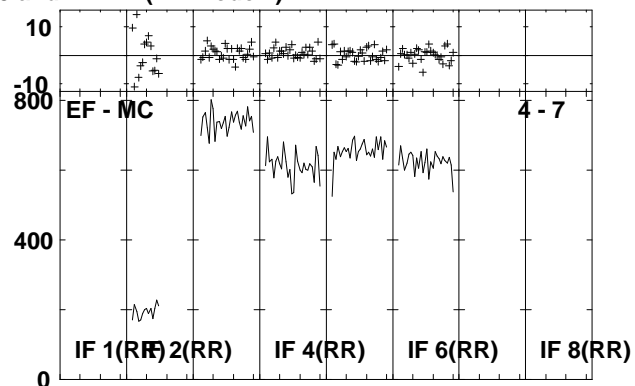
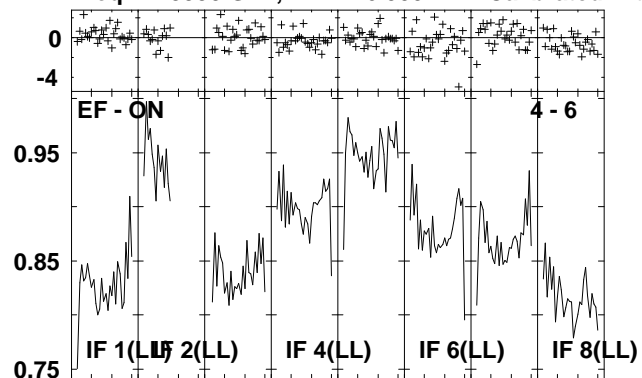

Lower frame: Ampl Jy Top frame: Phas deg
Vector averaged cross-power spectrum Several baselines displayed
Timerange: 00/13:50:02 to 00/13:51:30

Plot file version 78 created 29-APR-2009 14:29:03

IRAS2336 EP064D.UVDATA.1

Freq = 1.5950 GHz, Bw = 16.000 MH Calibrated with CL # 3 and BP # 1 (BP mode 1)

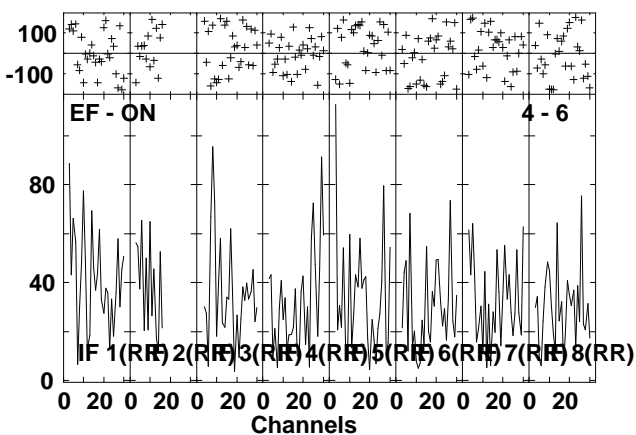
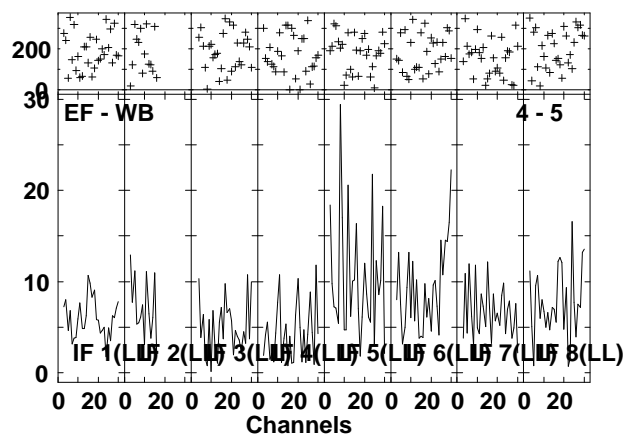
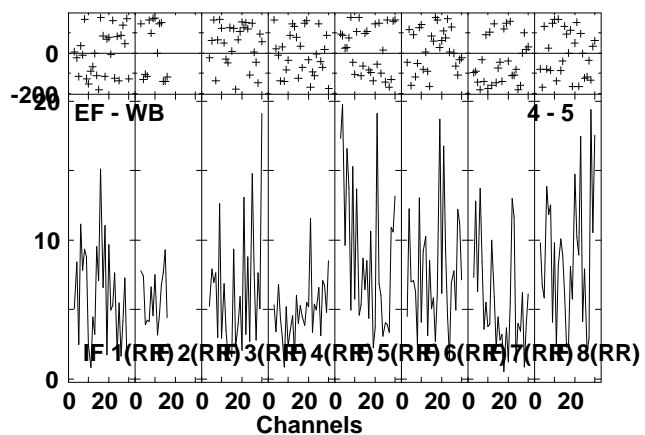
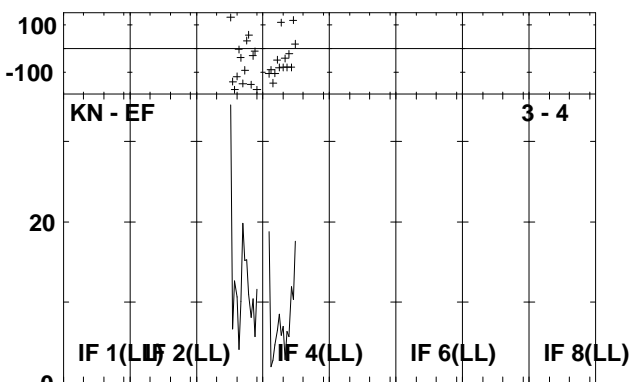
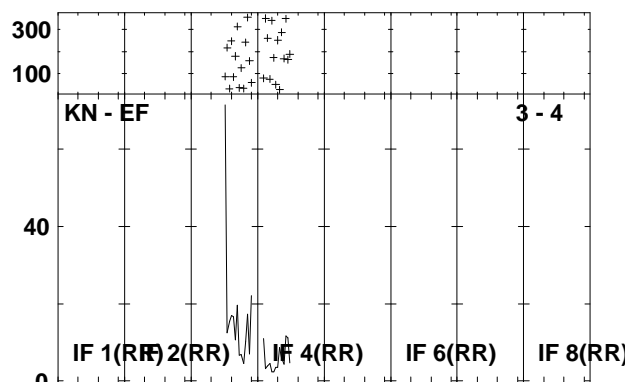
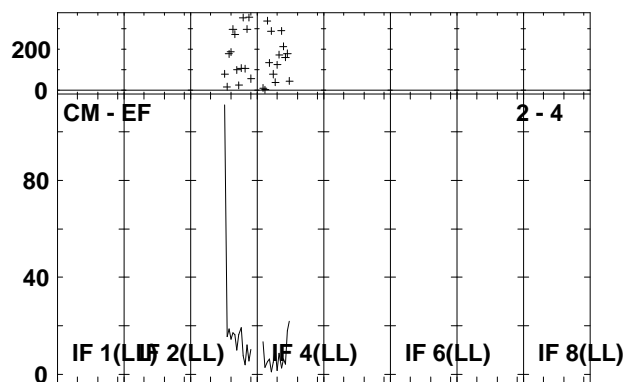
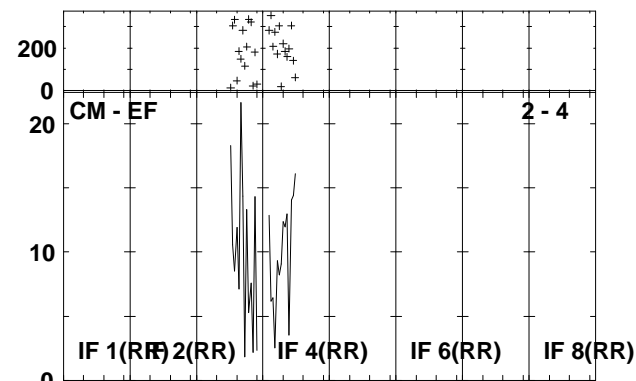
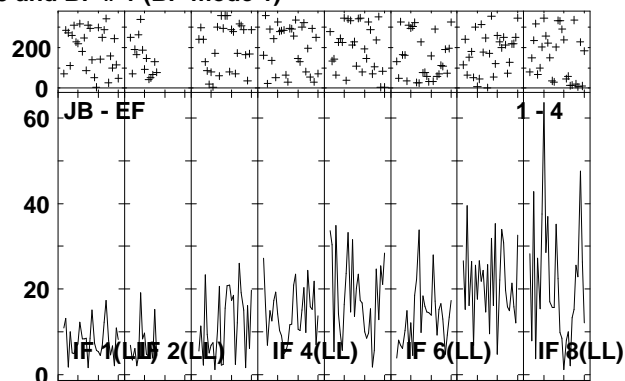
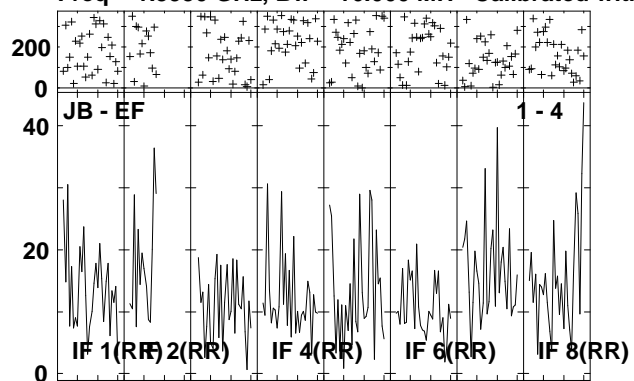

Lower frame: Milli Ampl Jy Top frame: Phas deg
Vector averaged cross-power spectrum Several baselines displayed
Timerange: 00/13:51:41 to 00/13:55:01

Plot file version 79 created 29-APR-2009 14:29:05
 IRAS2336 EP064D.UVDATA.1
 Freq = 1.5950 GHz, Bw = 16.000 MH Calibrated with CL # 3 and BP # 1 (BP mode 1)

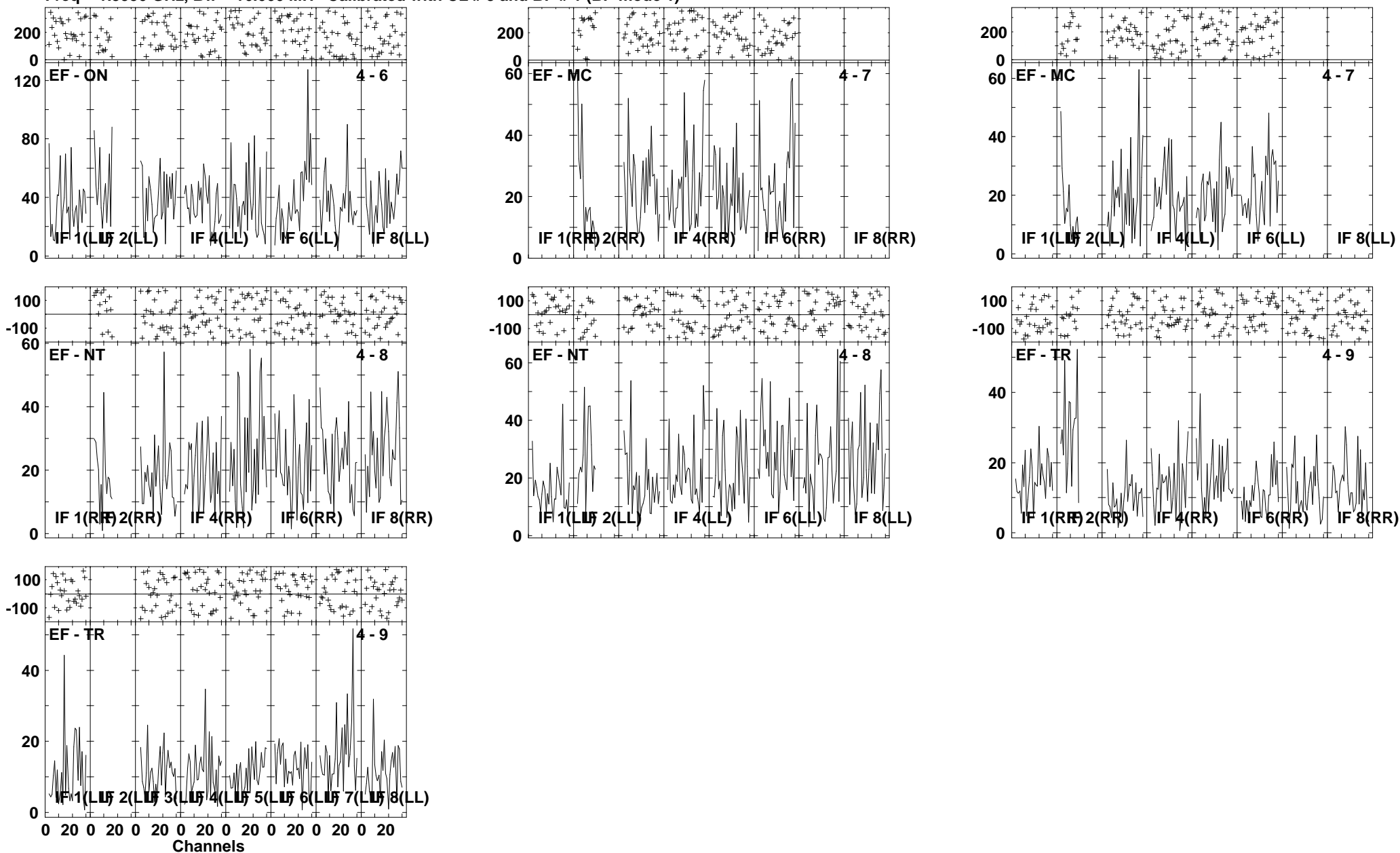

Lower frame: Milli Ampl Jy Top frame: Phas deg
 Vector averaged cross-power spectrum Several baselines displayed
 Timerange: 00/13:51:41 to 00/13:55:01

Plot file version 80 created 29-APR-2009 14:29:08

J2333+39 EP064D.UVDATA.1

Freq = 1.5950 GHz, Bw = 16.000 MH Calibrated with CL # 3 and BP # 1 (BP mode 1)

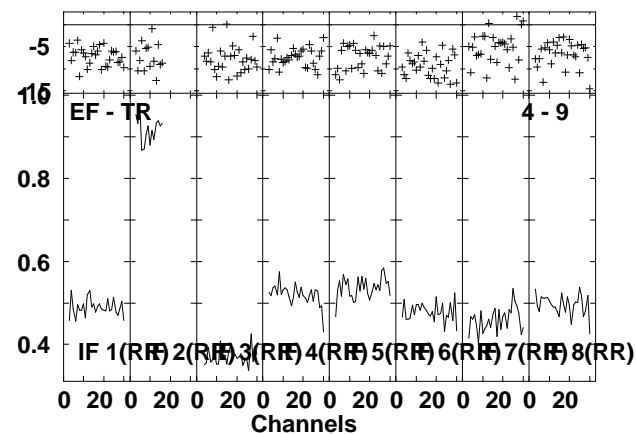
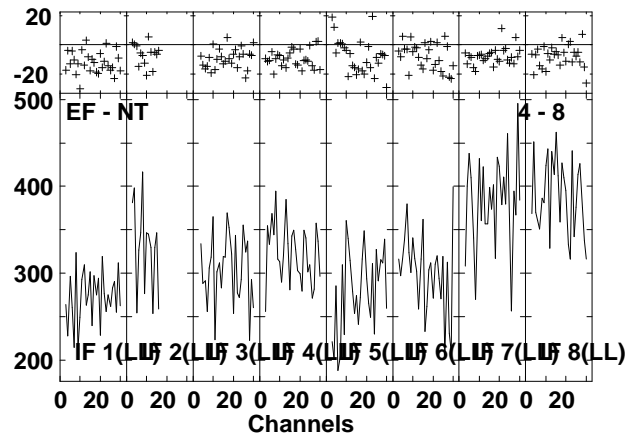
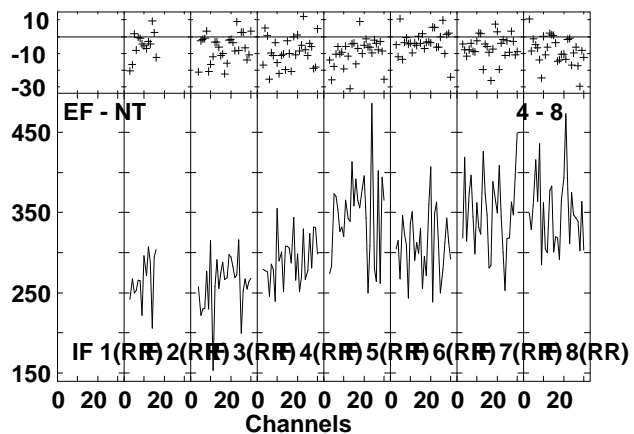
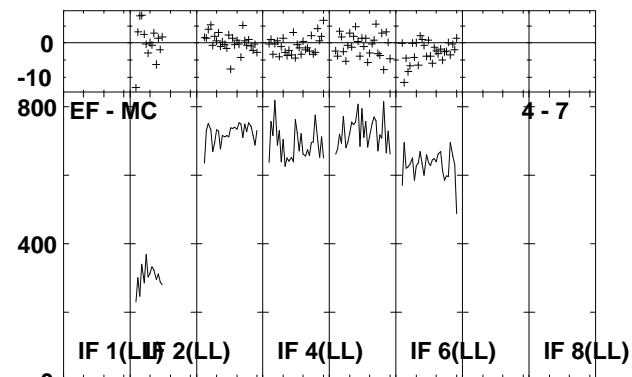
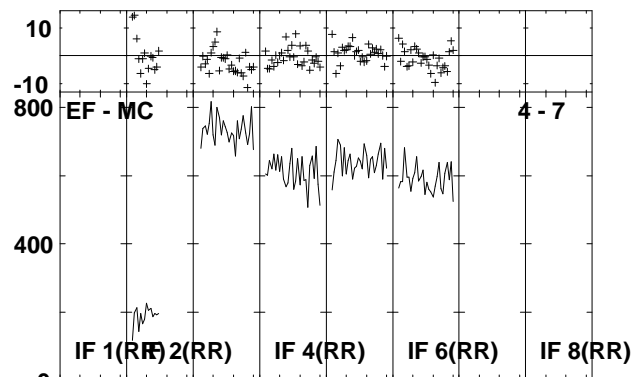
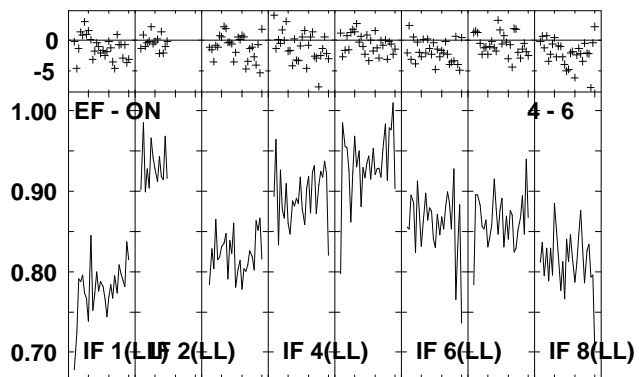
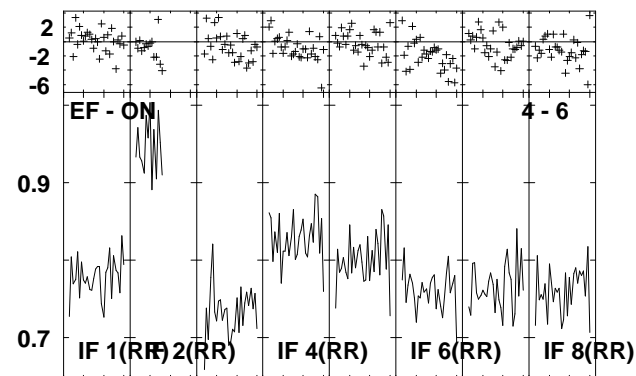
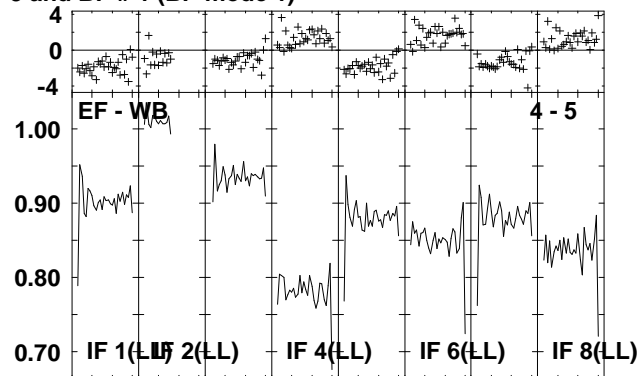
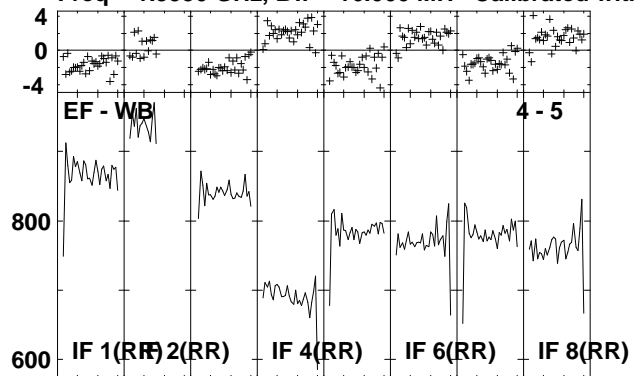

Lower frame: Milli Ampl Jy Top frame: Phas deg
Vector averaged cross-power spectrum Several baselines displayed
Timerange: 00/13:55:03 to 00/13:56:27

Plot file version 81 created 29-APR-2009 14:29:09
J2333+39 EP064D.UVDATA.1
Freq = 1.5950 GHz, Bw = 16.000 MH Calibrated with CL # 3 and BP # 1 (BP mode 1)

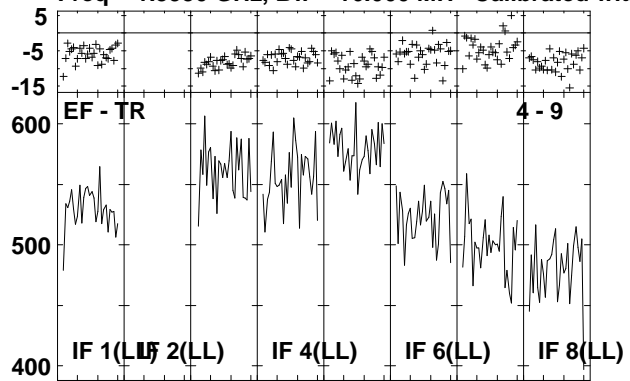

Lower frame: Milli Ampl Jy Top frame: Phas deg
Vector averaged cross-power spectrum Several baselines displayed
Timerange: 00/13:55:03 to 00/13:56:27

Plot file version 82 created 29-APR-2009 14:29:10

IRAS2336 EP064D.UVDATA.1

Freq = 1.5950 GHz, Bw = 16.000 MH Calibrated with CL # 3 and BP # 1 (BP mode 1)

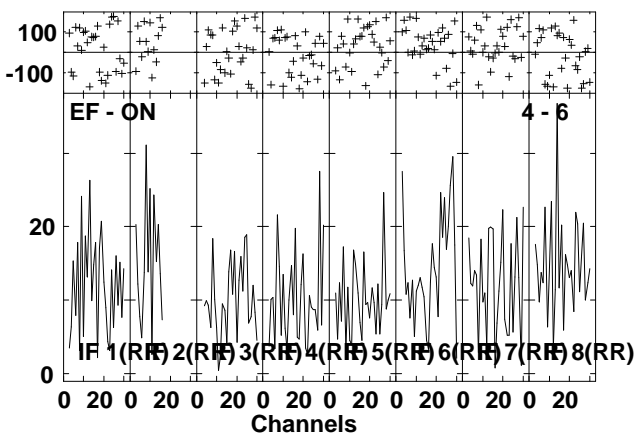
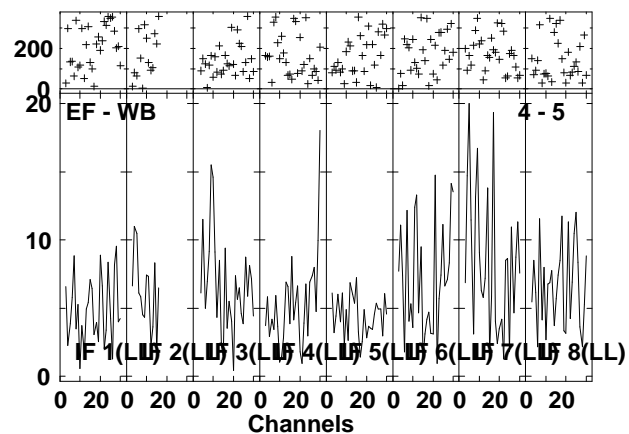
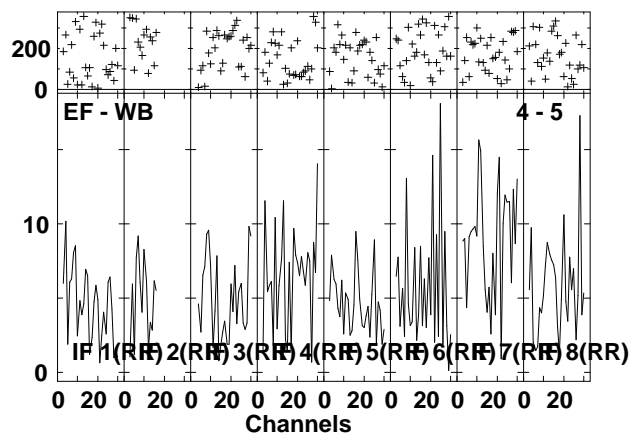
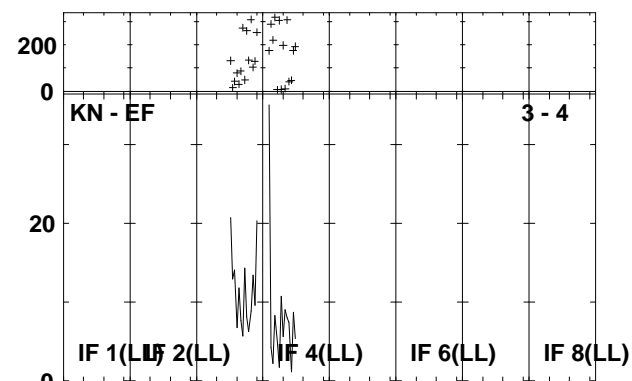
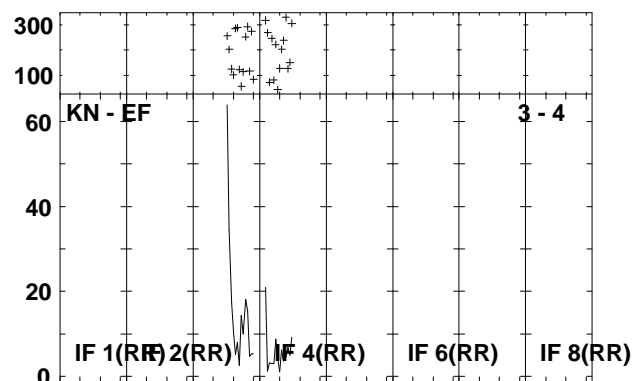
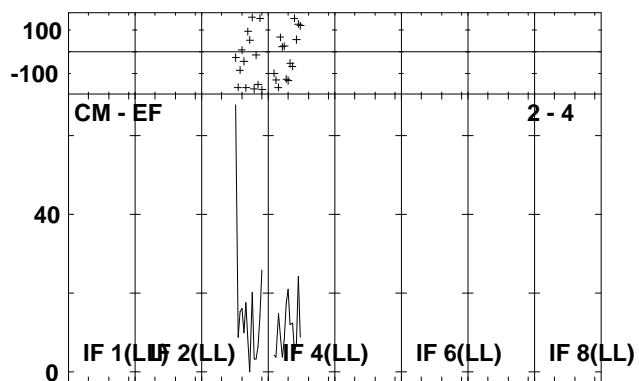
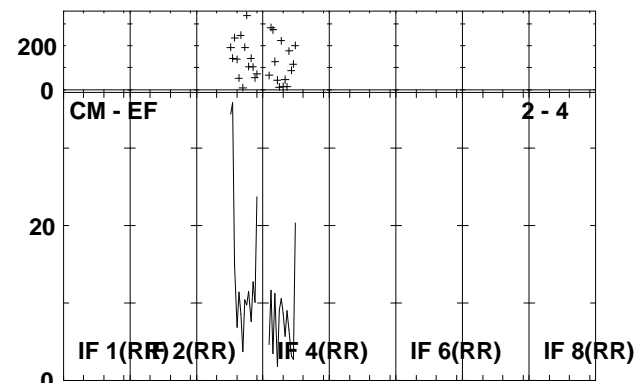
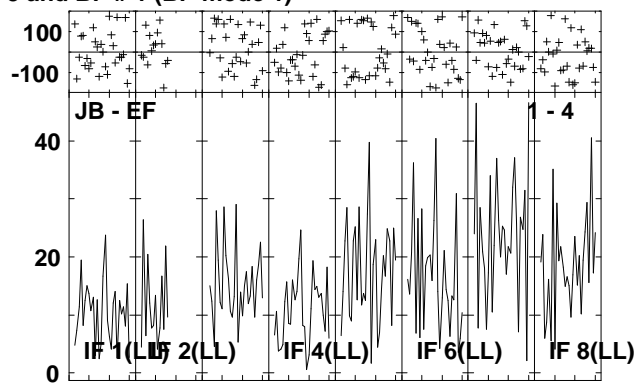
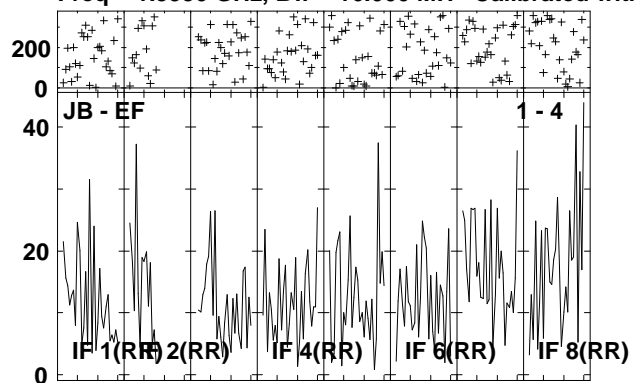

Lower frame: Milli Ampl Jy Top frame: Phas deg
Vector averaged cross-power spectrum Several baselines displayed
Timerange: 00/13:56:29 to 00/13:59:59

Plot file version 83 created 29-APR-2009 14:29:12

IRAS2336 EP064D.UVDATA.1

Freq = 1.5950 GHz, Bw = 16.000 MH Calibrated with CL # 3 and BP # 1 (BP mode 1)

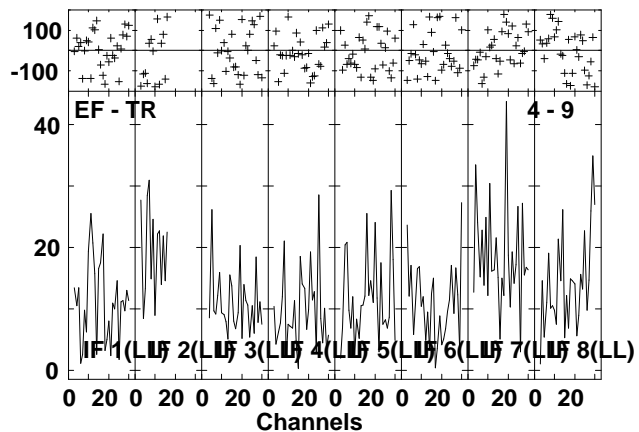
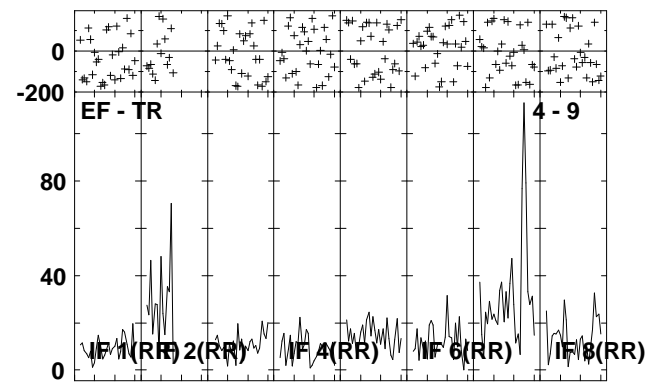
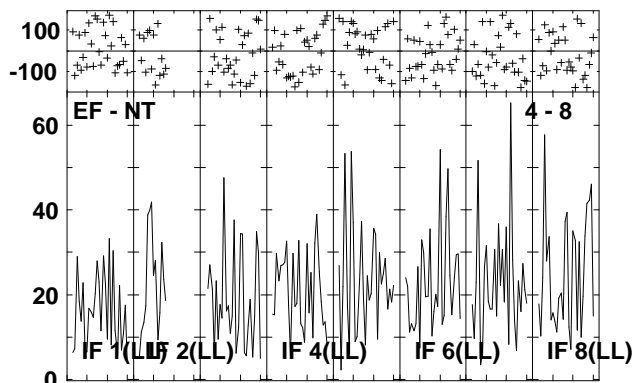
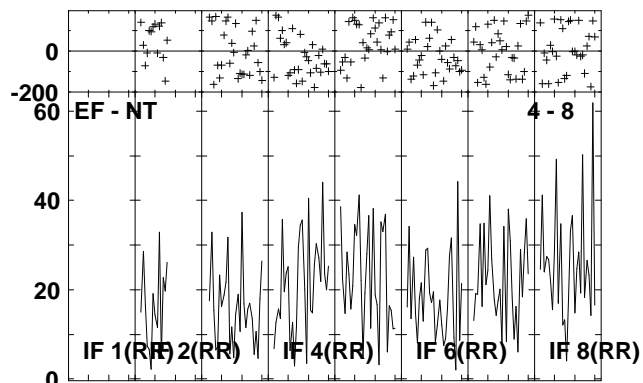
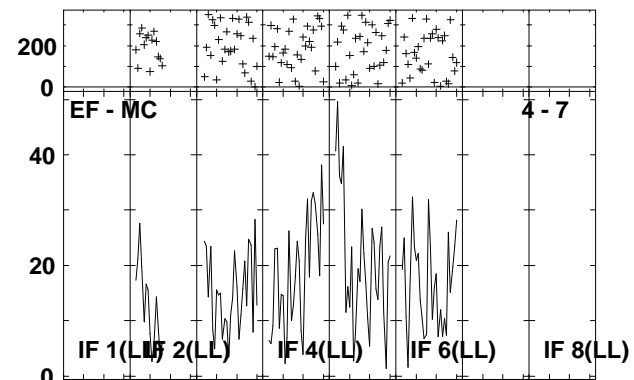
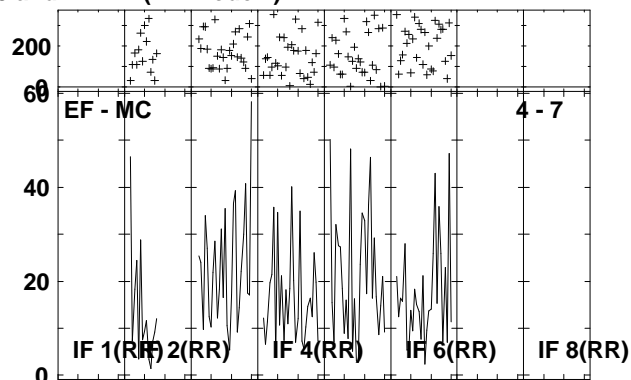
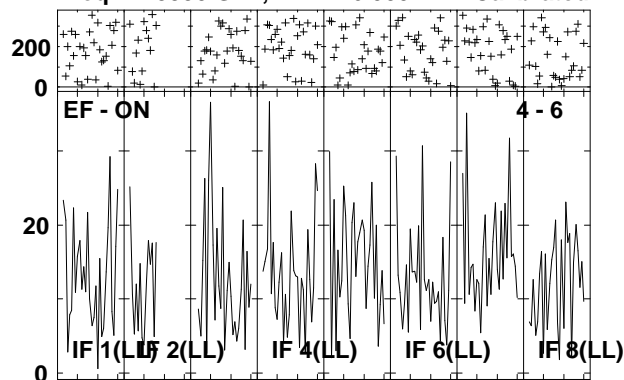

Lower frame: Milli Ampl Jy Top frame: Phas deg
Vector averaged cross-power spectrum Several baselines displayed
Timerange: 00/13:56:29 to 00/13:59:59

Plot file version 84 created 29-APR-2009 14:29:15

J2333+39 EP064D.UVDATA.1

Freq = 1.5950 GHz, Bw = 16.000 MH Calibrated with CL # 3 and BP # 1 (BP mode 1)

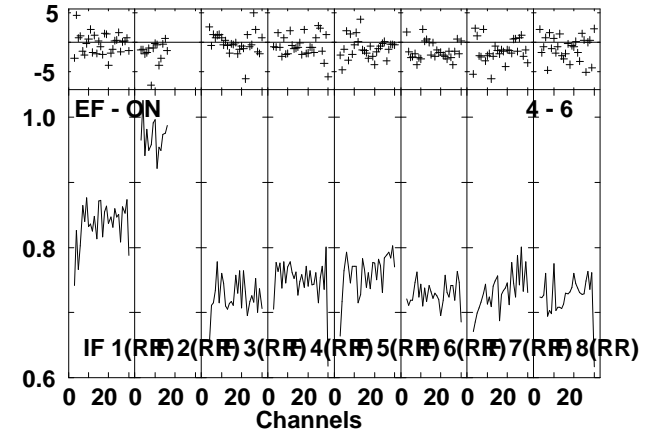
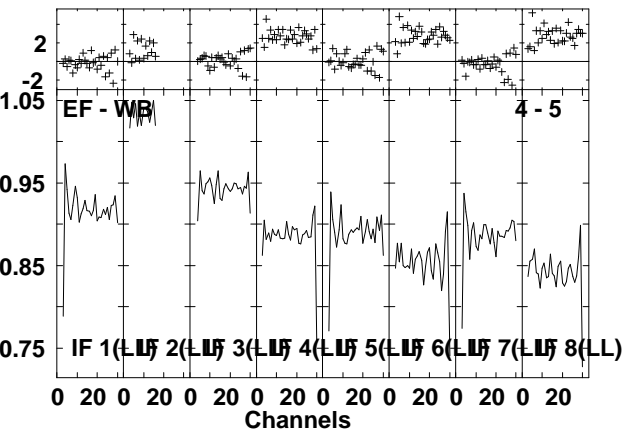
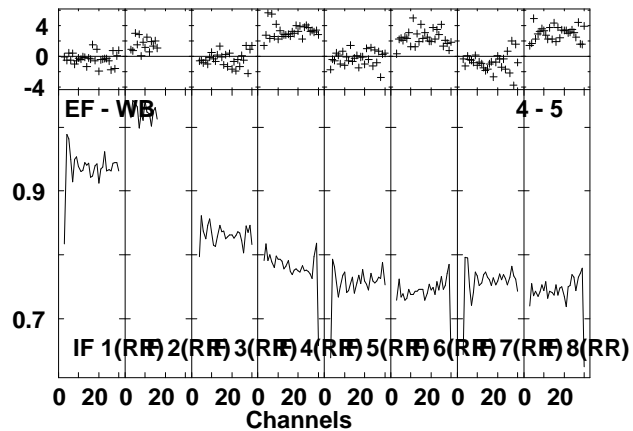
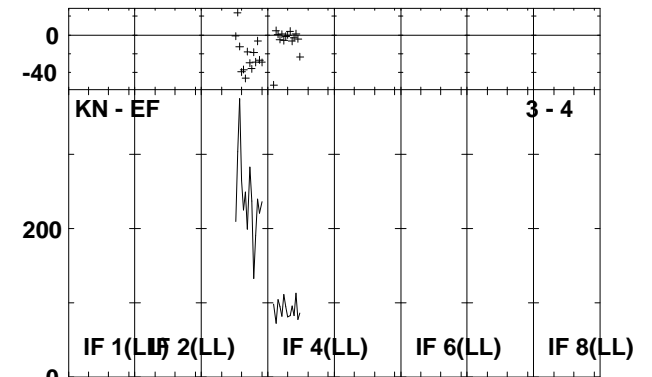
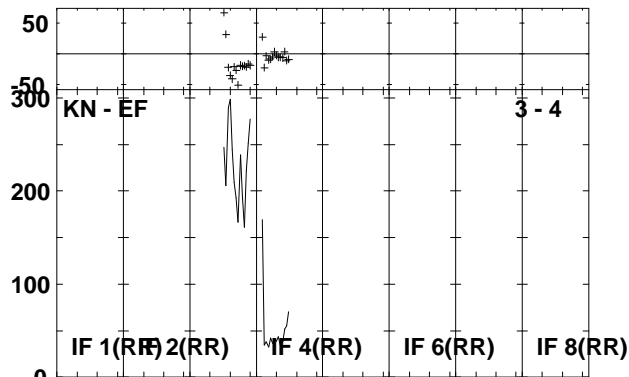
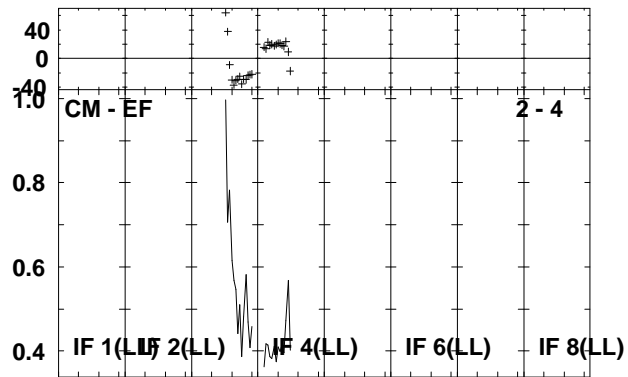
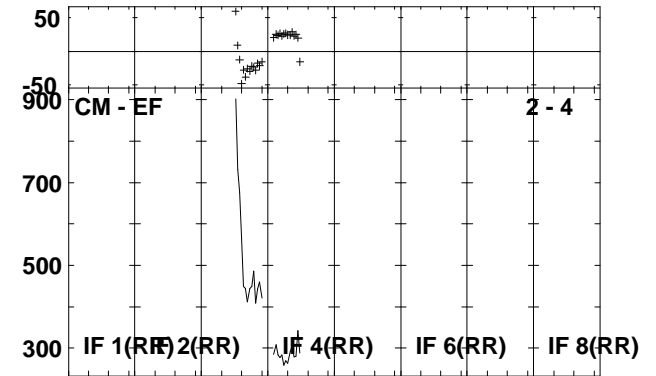
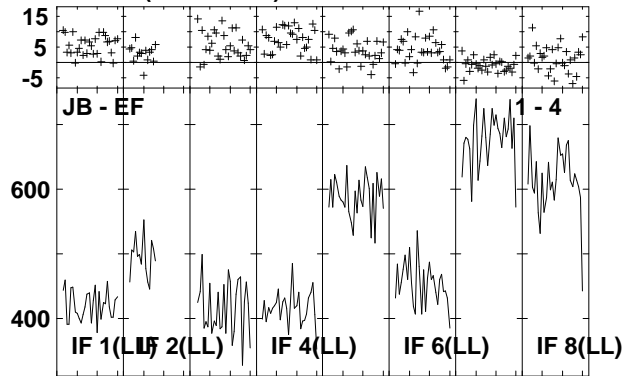
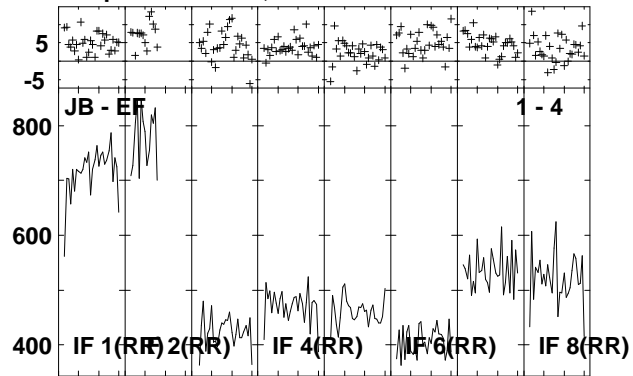

Lower frame: Milli Ampl Jy Top frame: Phas deg
Vector averaged cross-power spectrum Several baselines displayed
Timerange: 00/14:00:01 to 00/14:01:31

Plot file version 85 created 29-APR-2009 14:29:16

J2333+39 EP064D.UVDATA.1

Freq = 1.5950 GHz, Bw = 16.000 MH Calibrated with CL # 3 and BP # 1 (BP mode 1)

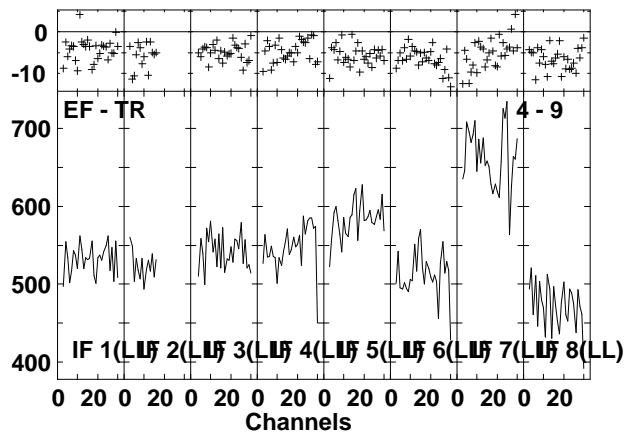
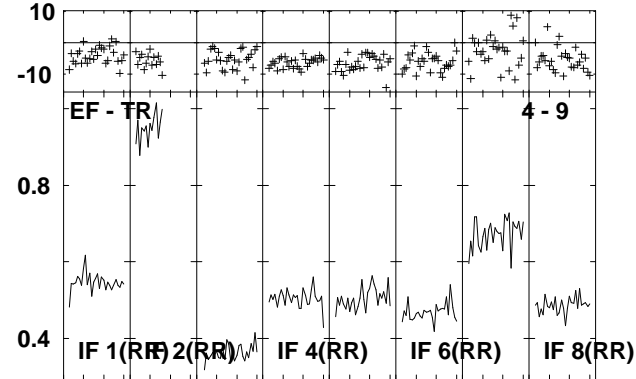
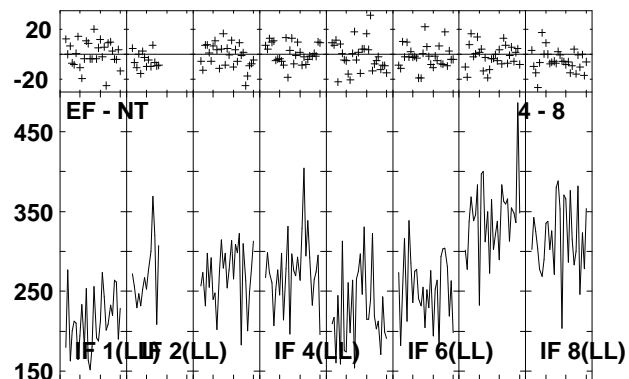
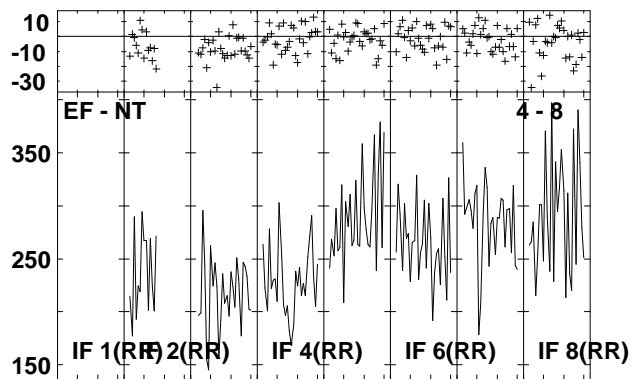
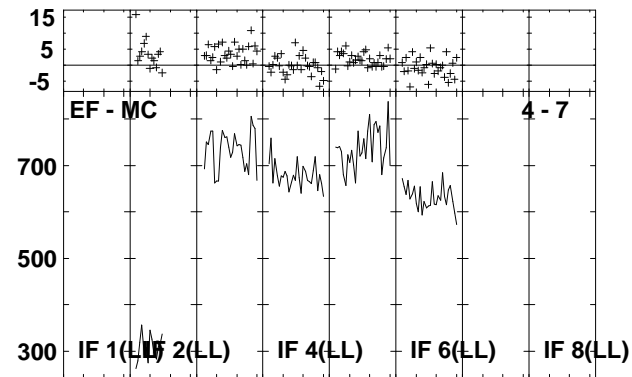
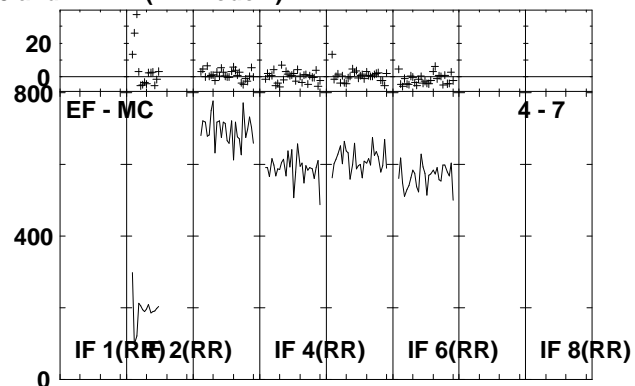
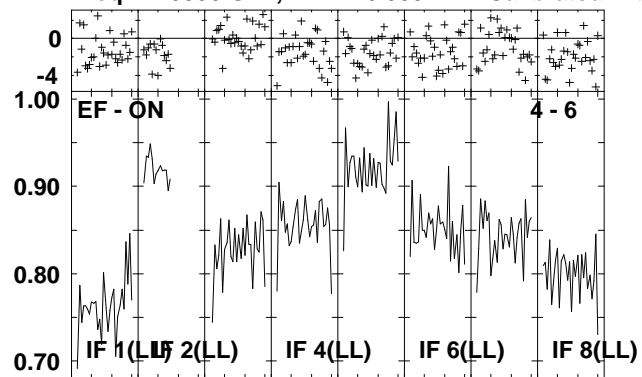

Lower frame: Ampl Jy Top frame: Phas deg
Vector averaged cross-power spectrum Several baselines displayed
Timerange: 00/14:00:01 to 00/14:01:31

Plot file version 86 created 29-APR-2009 14:29:18

IRAS2336 EP064D.UVDATA.1

Freq = 1.5950 GHz, Bw = 16.000 MH Calibrated with CL # 3 and BP # 1 (BP mode 1)

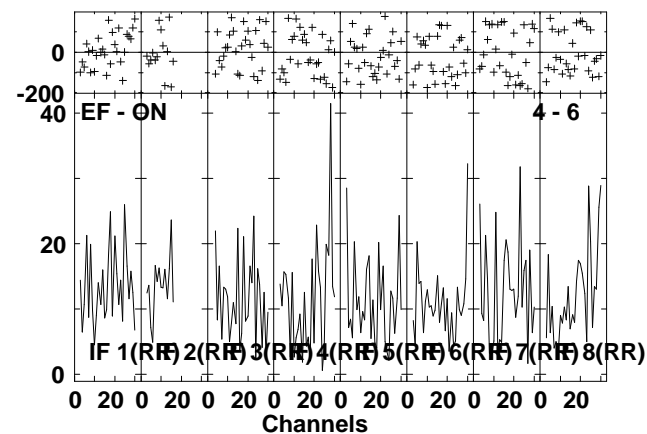
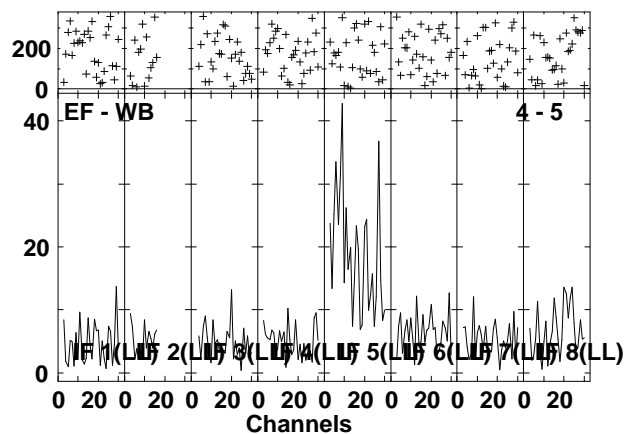
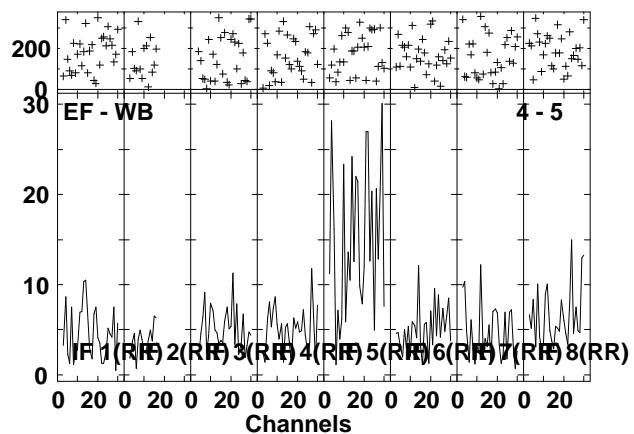
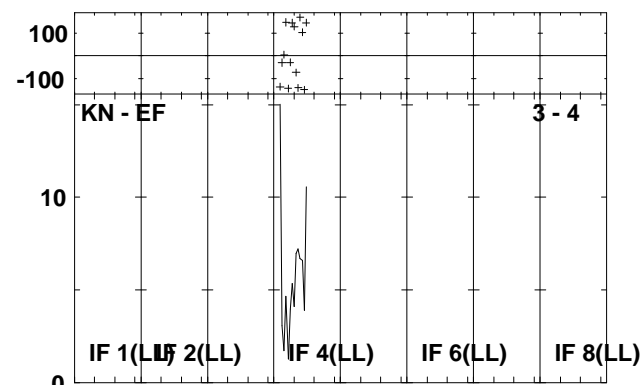
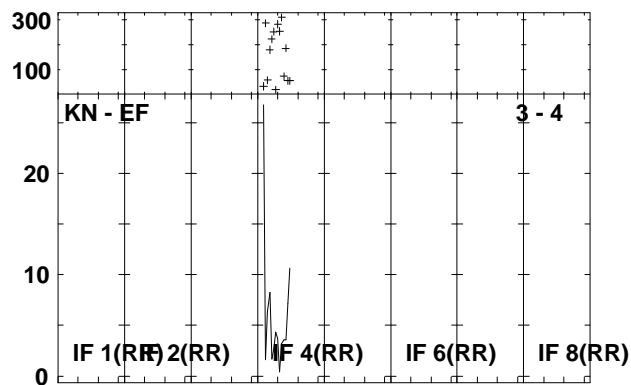
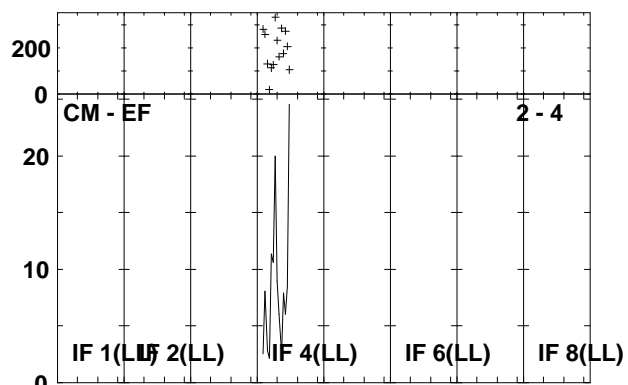
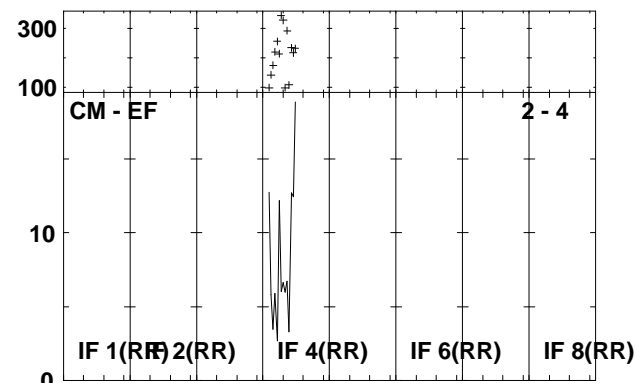
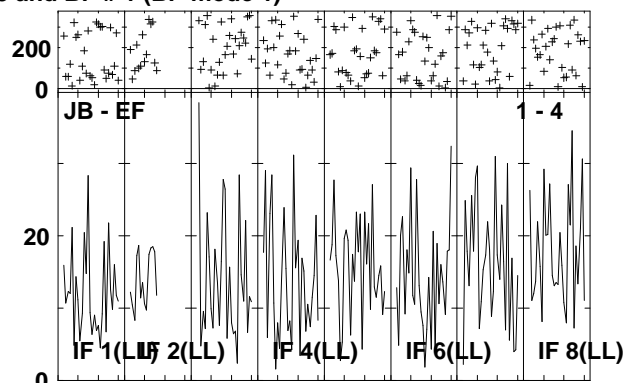
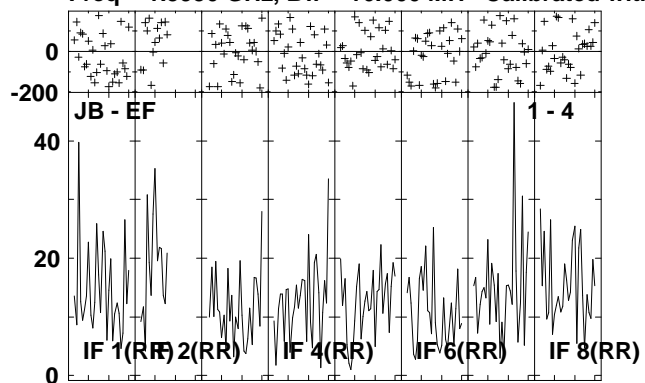

Lower frame: Milli Ampl Jy Top frame: Phas deg
Vector averaged cross-power spectrum Several baselines displayed
Timerange: 00/14:01:33 to 00/14:04:59

Plot file version 87 created 29-APR-2009 14:29:21

IRAS2336 EP064D.UVDATA.1

Freq = 1.5950 GHz, Bw = 16.000 MH Calibrated with CL # 3 and BP # 1 (BP mode 1)

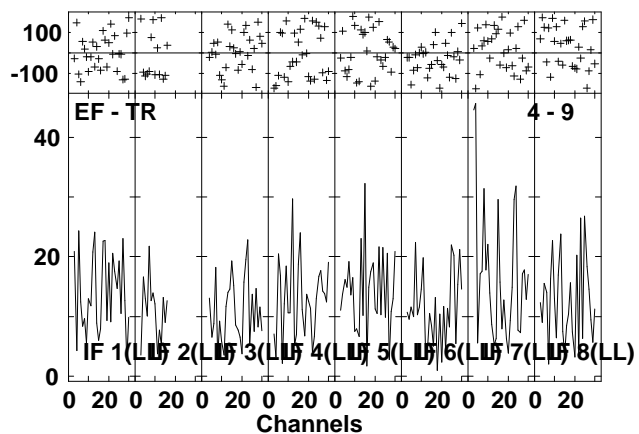
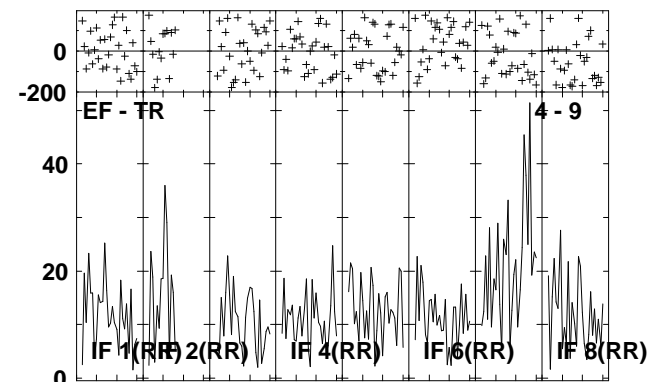
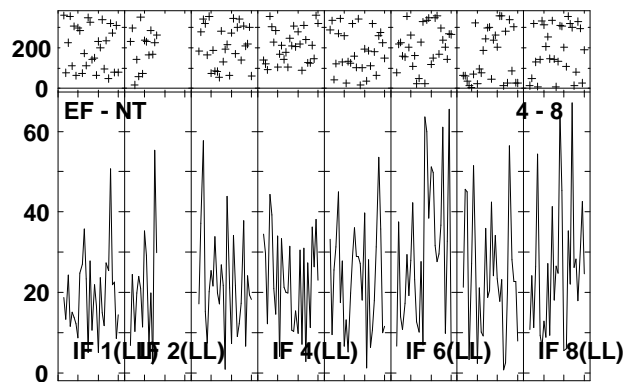
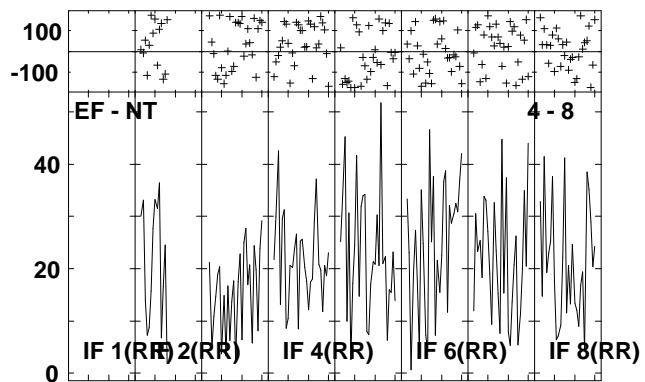
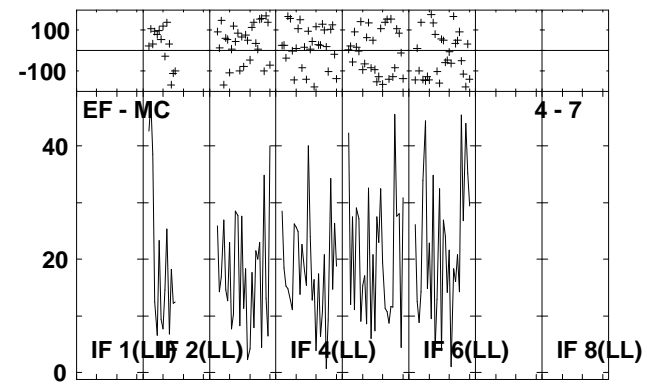
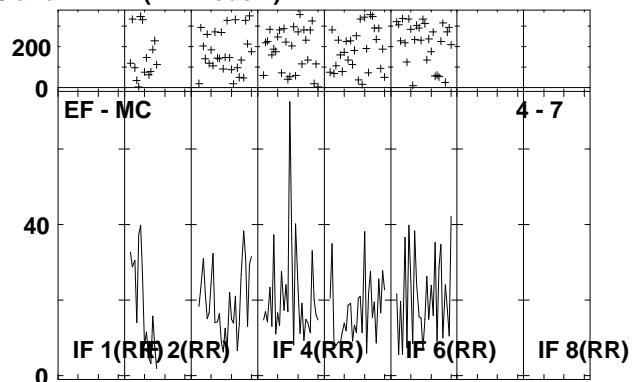
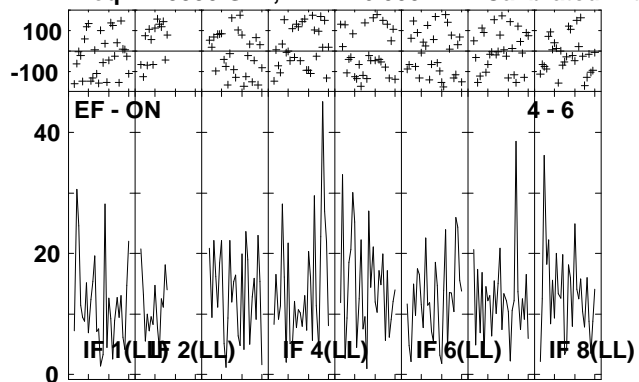

Lower frame: Milli Ampl Jy Top frame: Phas deg
Vector averaged cross-power spectrum Several baselines displayed
Timerange: 00/14:01:33 to 00/14:04:59

Plot file version 88 created 29-APR-2009 14:29:24

J2333+39 EP064D.UVDATA.1

Freq = 1.5950 GHz, Bw = 16.000 MH Calibrated with CL # 3 and BP # 1 (BP mode 1)

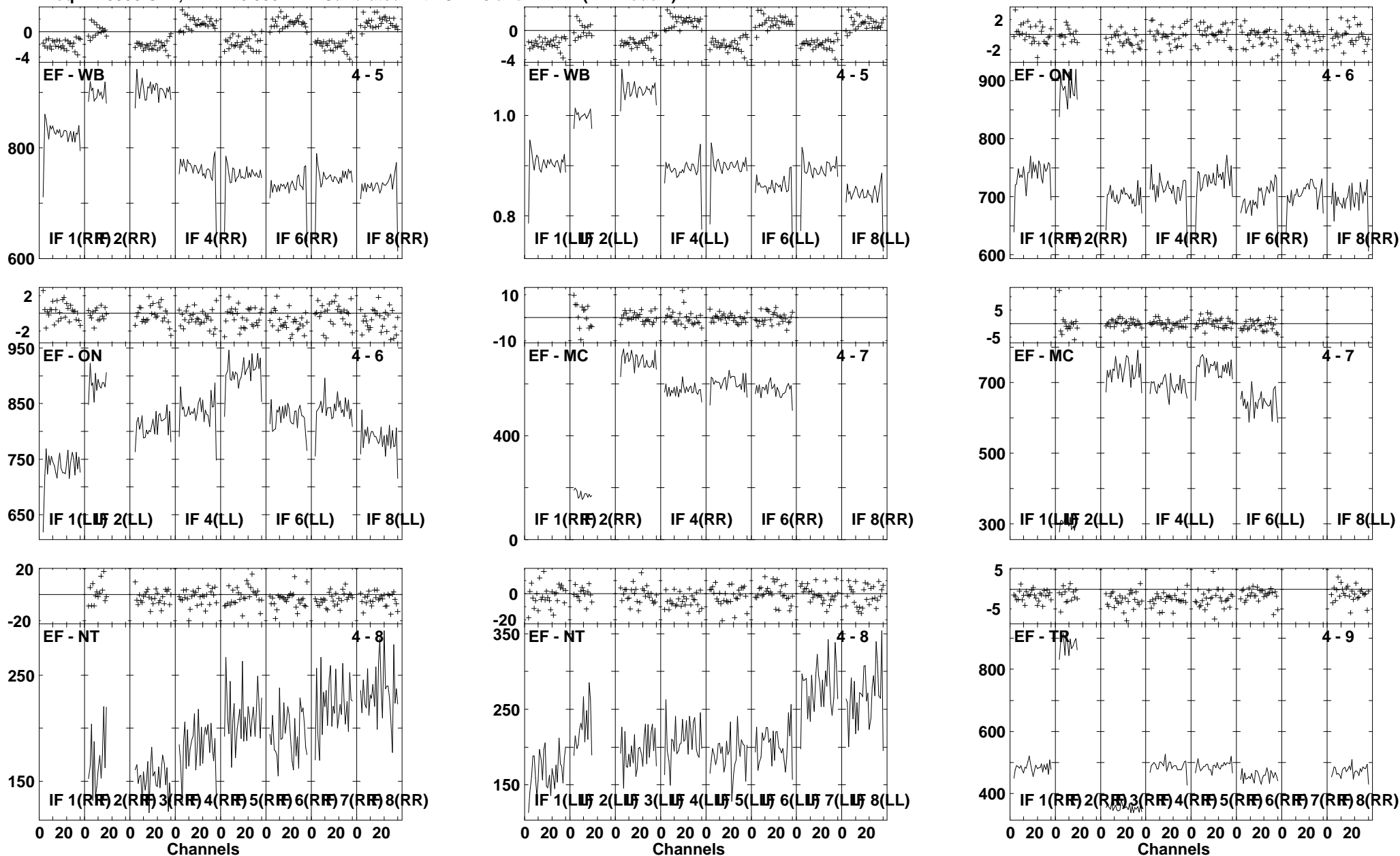

Lower frame: Milli Ampl Jy Top frame: Phas deg
Vector averaged cross-power spectrum Several baselines displayed
Timerange: 00/14:06:01 to 00/14:07:27

Plot file version 89 created 29-APR-2009 14:29:25

J2333+39 EP064D.UVDATA.1

Freq = 1.5950 GHz, Bw = 16.000 MH Calibrated with CL # 3 and BP # 1 (BP mode 1)

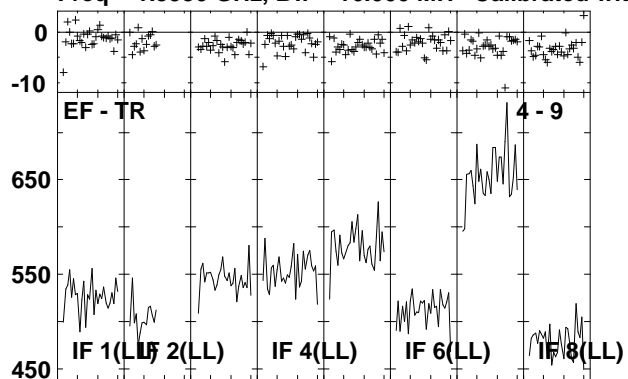

Lower frame: Milli Ampl Jy Top frame: Phas deg
Vector averaged cross-power spectrum Several baselines displayed
Timerange: 00/14:06:01 to 00/14:07:27

Plot file version 90 created 29-APR-2009 14:29:26

IRAS2336 EP064D.UVDATA.1

Freq = 1.5950 GHz, Bw = 16.000 MH Calibrated with CL # 3 and BP # 1 (BP mode 1)

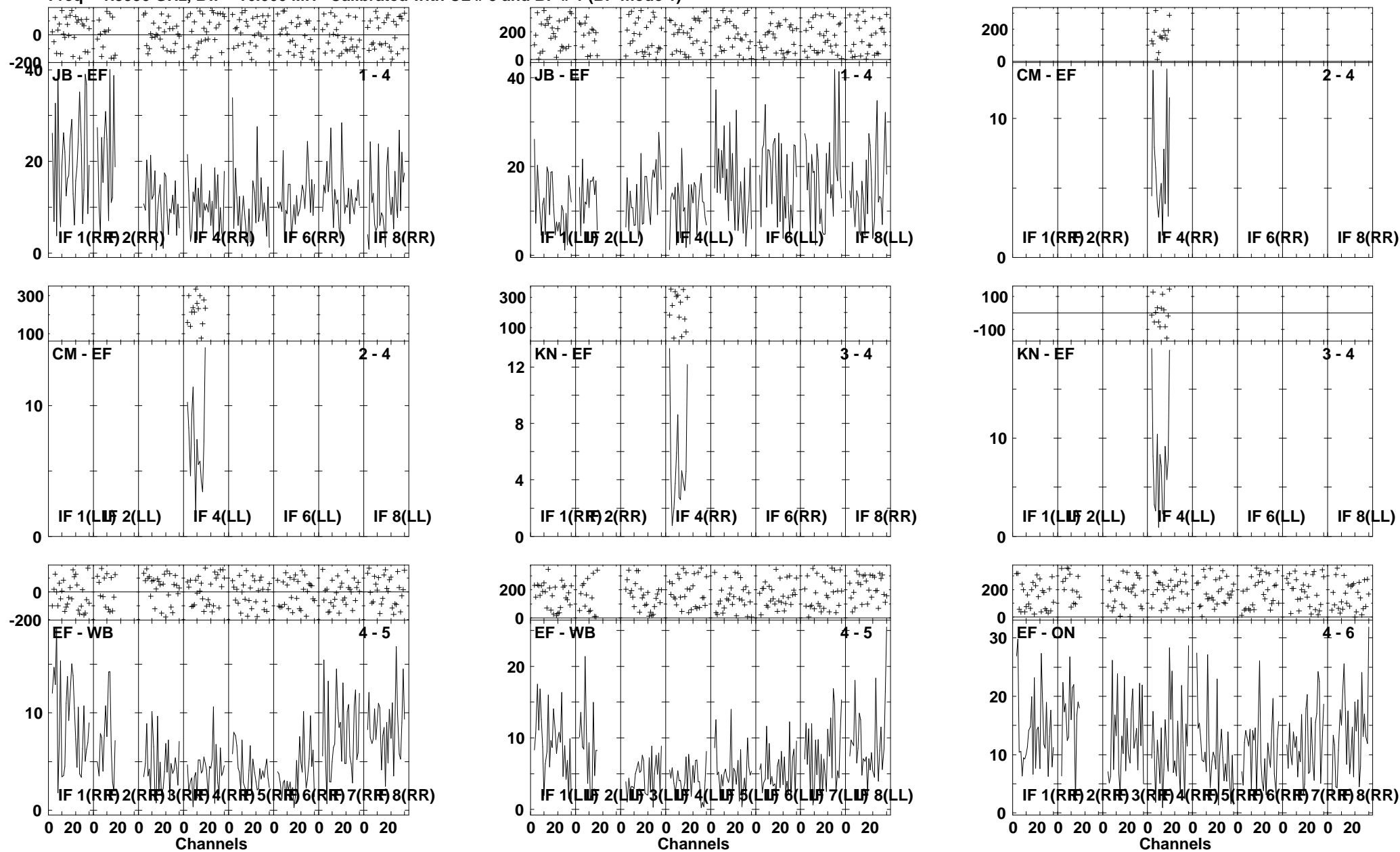

Lower frame: Milli Ampl Jy Top frame: Phas deg
Vector averaged cross-power spectrum Several baselines displayed
Timerange: 00/14:07:29 to 00/14:10:59

Plot file version 91 created 29-APR-2009 14:29:28

IRAS2336 EP064D.UVDATA.1

Freq = 1.5950 GHz, Bw = 16.000 MH Calibrated with CL # 3 and BP # 1 (BP mode 1)

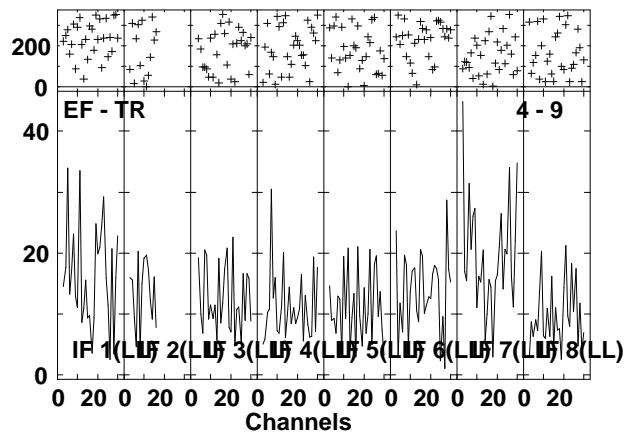
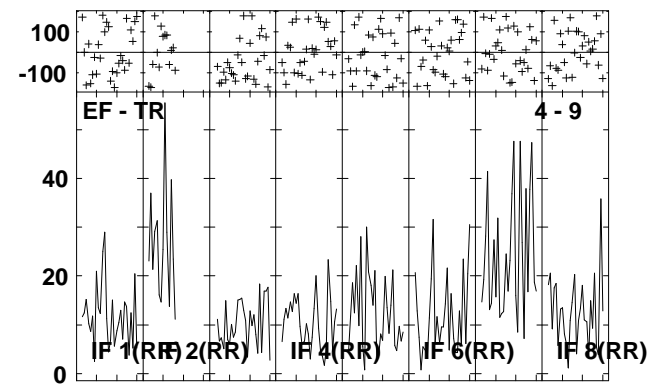
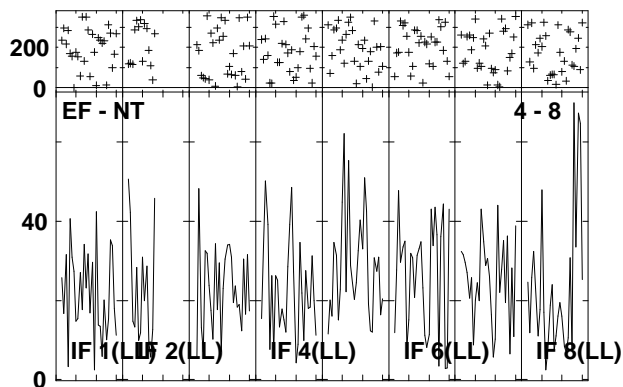
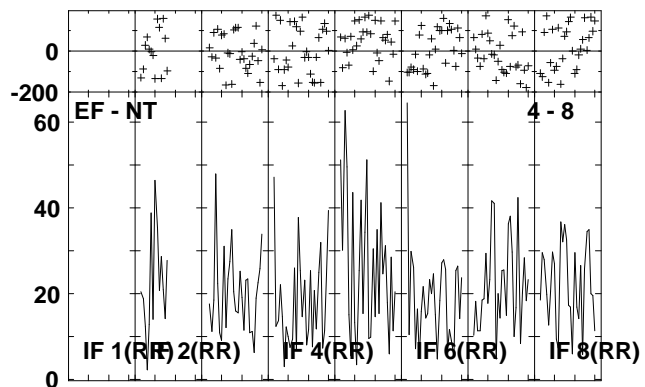
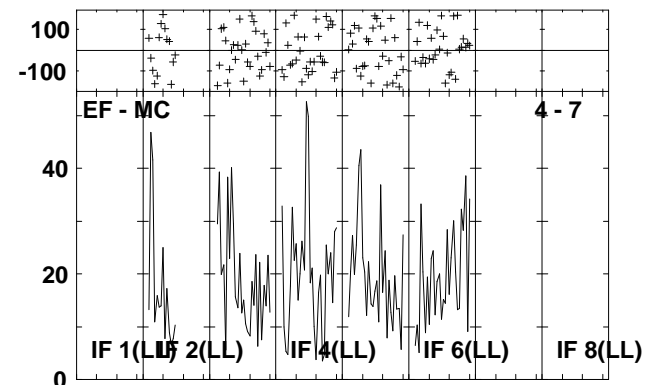
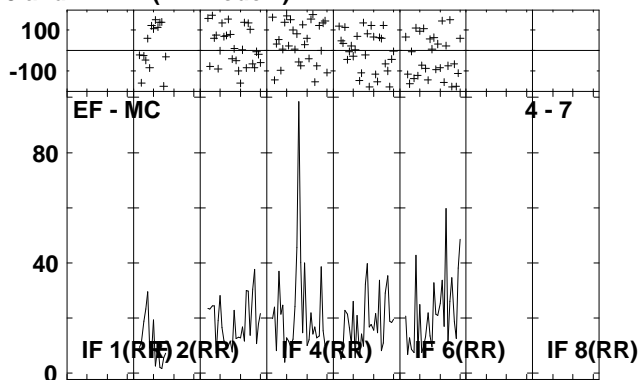
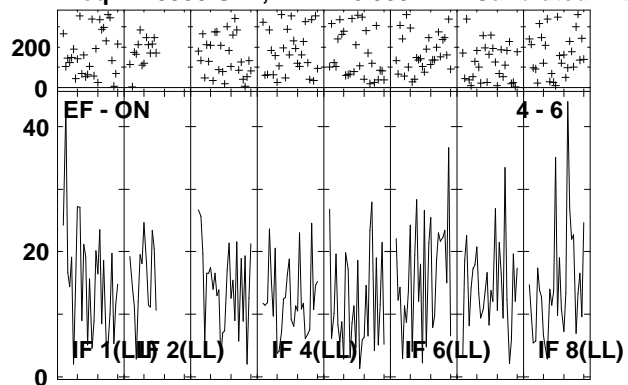

Lower frame: Milli Ampl Jy Top frame: Phas deg
Vector averaged cross-power spectrum Several baselines displayed
Timerange: 00/14:07:29 to 00/14:10:59

Plot file version 92 created 29-APR-2009 14:29:32

J2333+39 EP064D.UVDATA.1

Freq = 1.5950 GHz, Bw = 16.000 MH Calibrated with CL # 3 and BP # 1 (BP mode 1)

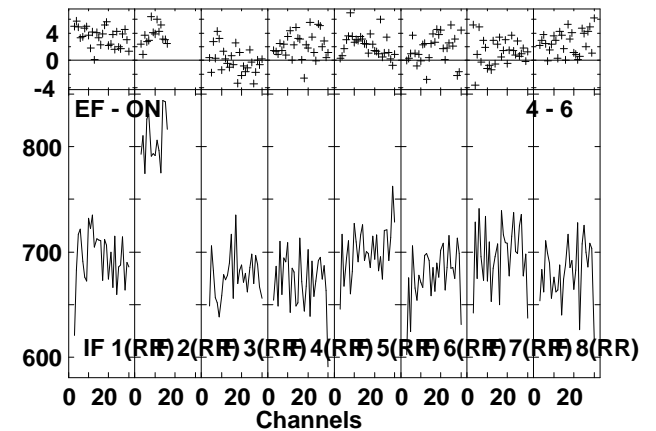
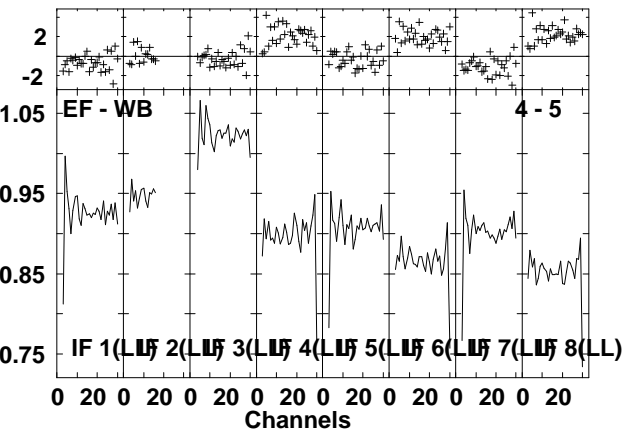
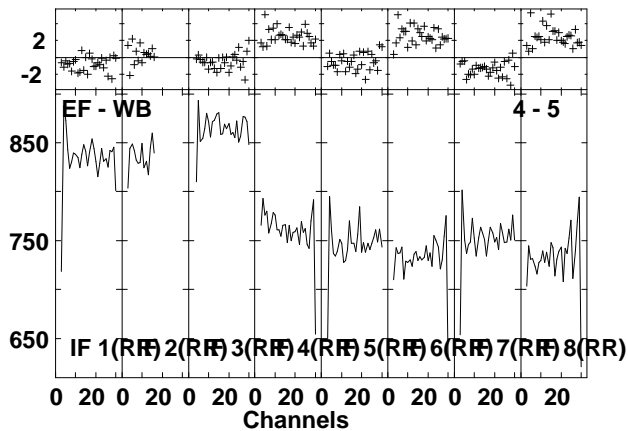
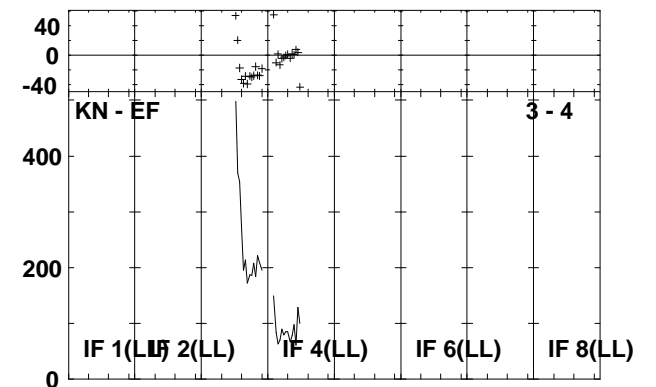
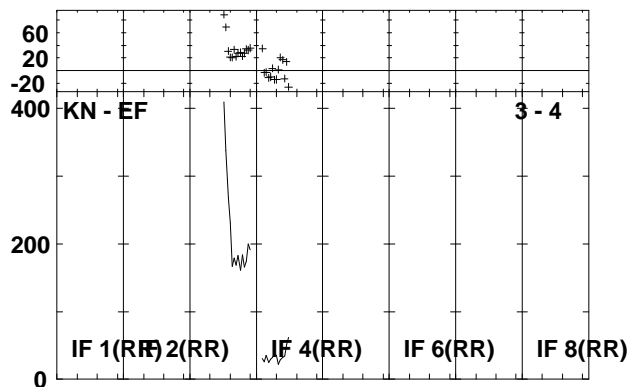
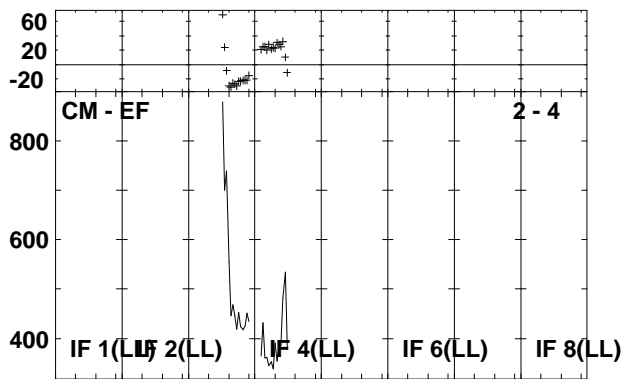
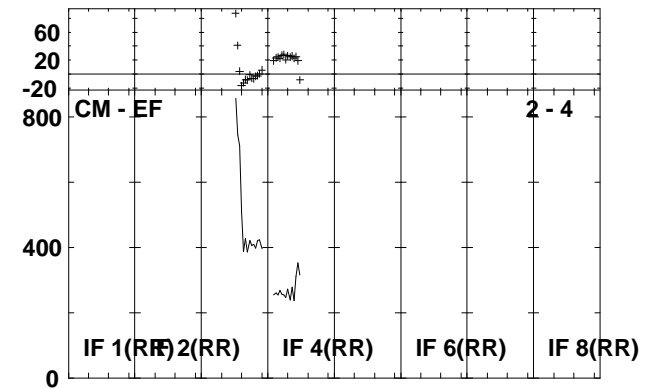
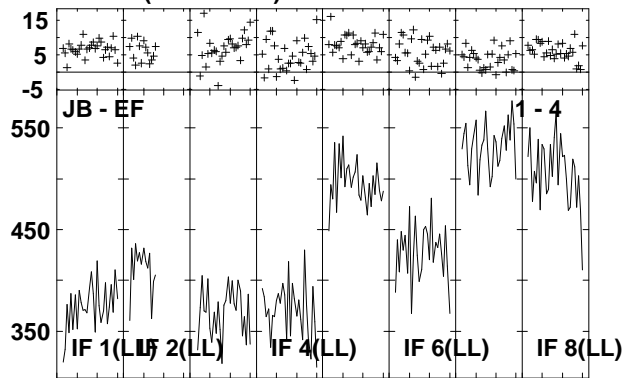
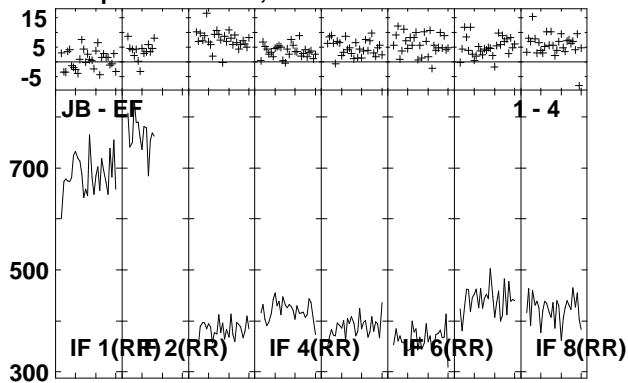

Lower frame: Milli Ampl Jy Top frame: Phas deg
Vector averaged cross-power spectrum Several baselines displayed
Timerange: 00/14:11:01 to 00/14:12:29

Plot file version 93 created 29-APR-2009 14:29:33

J2333+39 EP064D.UVDATA.1

Freq = 1.5950 GHz, Bw = 16.000 MH Calibrated with CL # 3 and BP # 1 (BP mode 1)

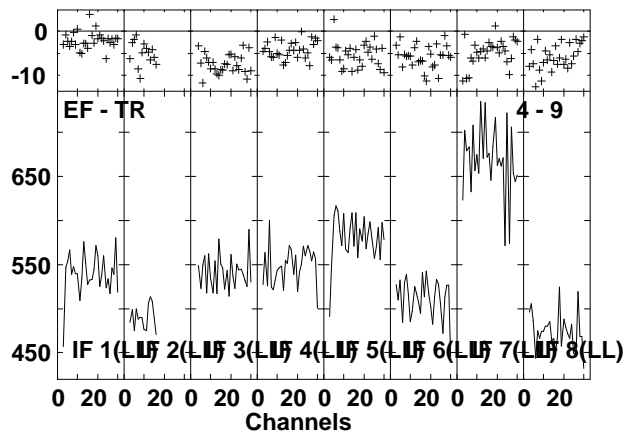
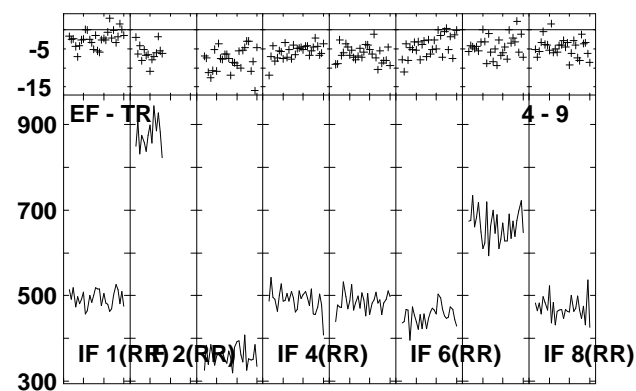
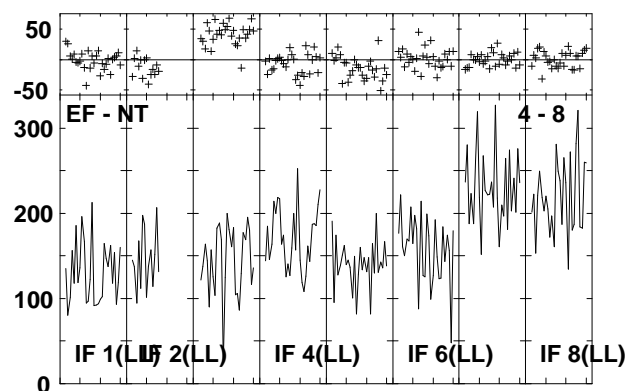
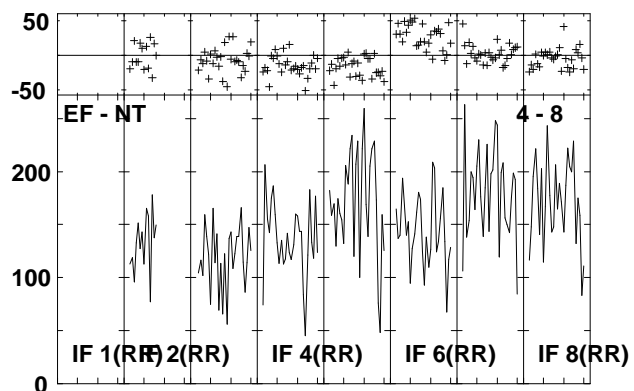
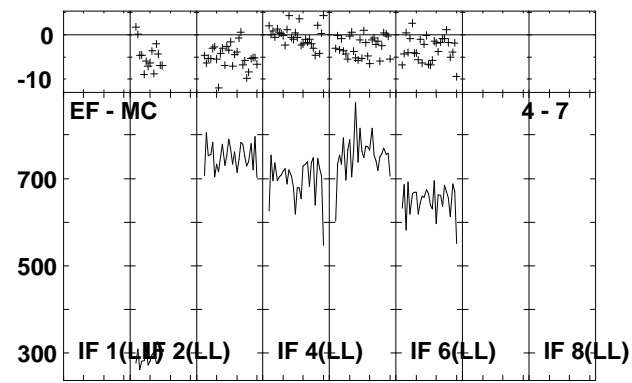
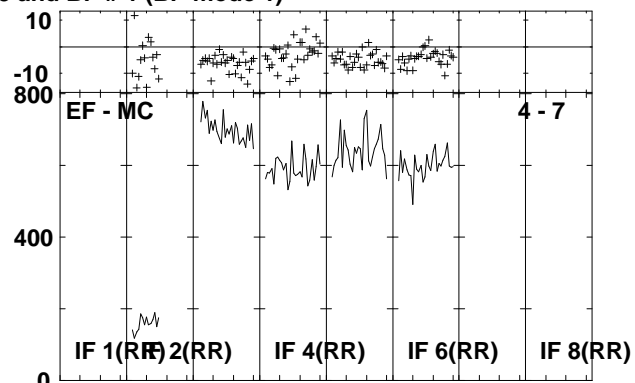
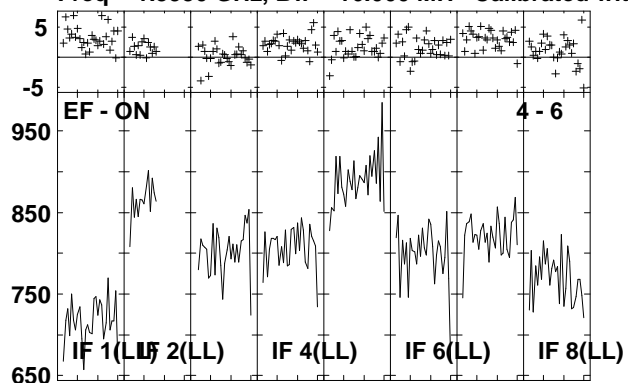

Lower frame: Milli Ampl Jy Top frame: Phas deg
Vector averaged cross-power spectrum Several baselines displayed
Timerange: 00/14:11:01 to 00/14:12:29

Plot file version 94 created 29-APR-2009 14:29:35

IRAS2336 EP064D.UVDATA.1

Freq = 1.5950 GHz, Bw = 16.000 MH Calibrated with CL # 3 and BP # 1 (BP mode 1)

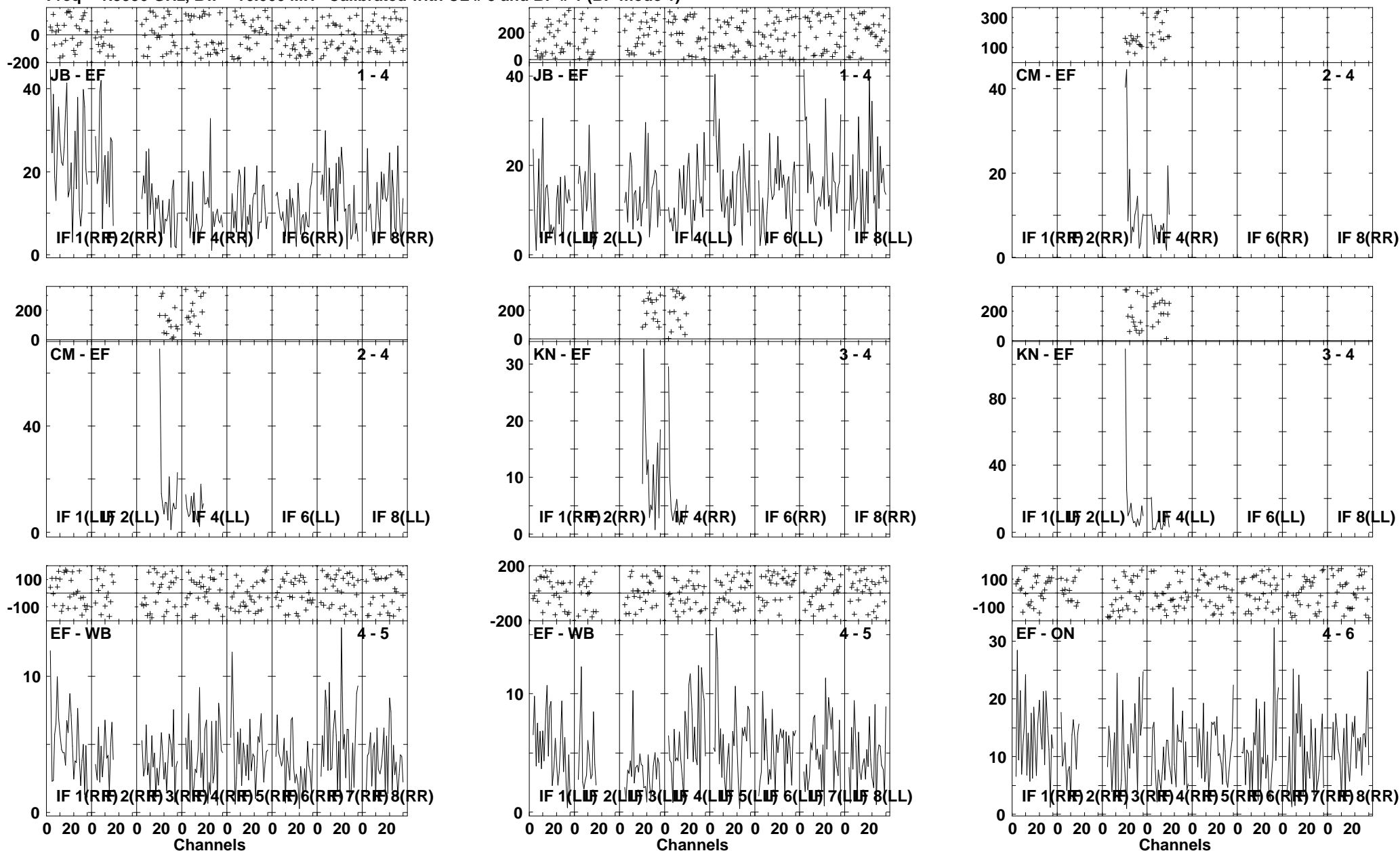

Lower frame: Milli Ampl Jy Top frame: Phas deg
Vector averaged cross-power spectrum Several baselines displayed
Timerange: 00/14:12:31 to 00/14:15:59

Plot file version 95 created 29-APR-2009 14:29:37

IRAS2336 EP064D.UVDATA.1

Freq = 1.5950 GHz, Bw = 16.000 MH Calibrated with CL # 3 and BP # 1 (BP mode 1)

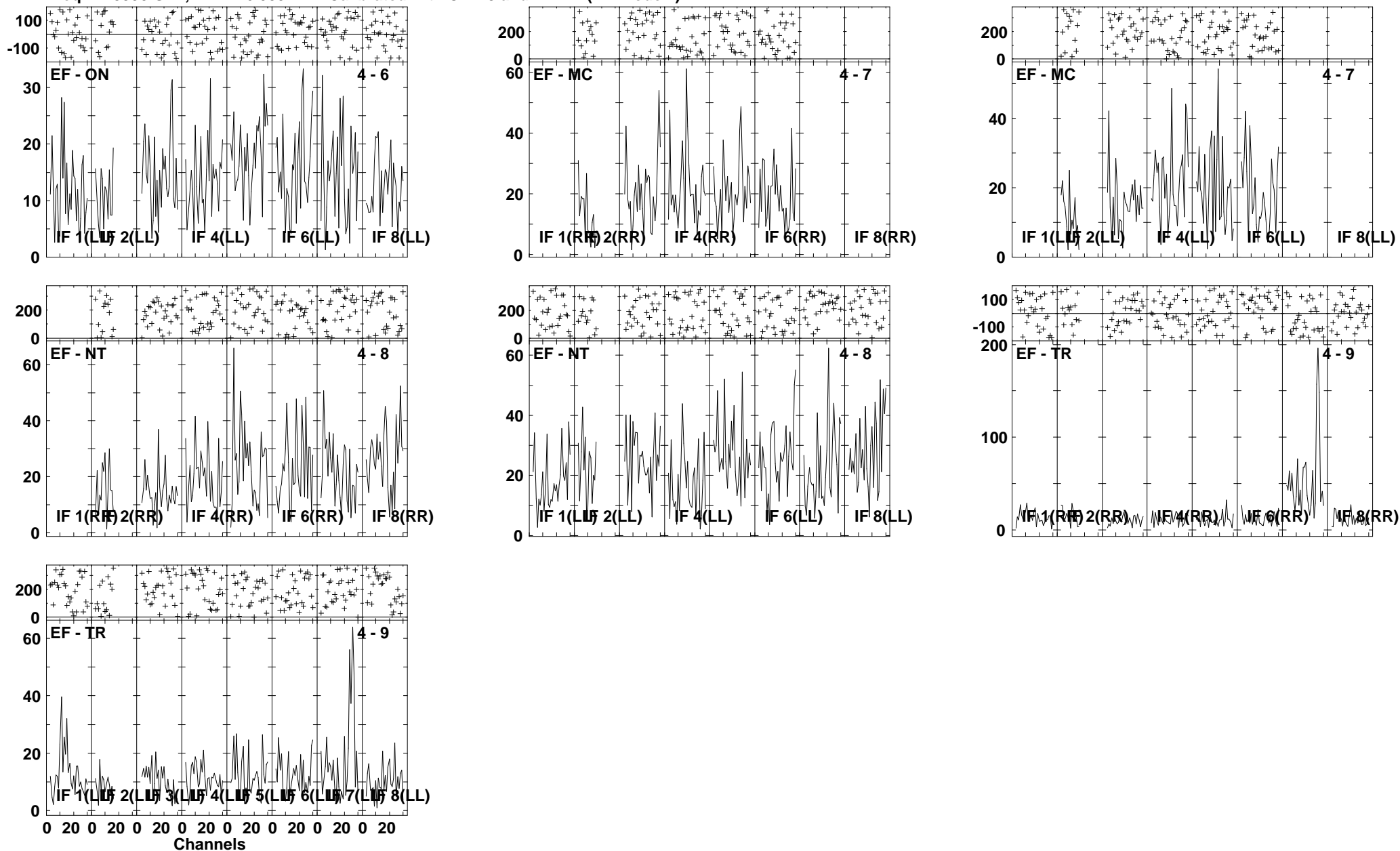

Lower frame: Milli Ampl Jy Top frame: Phas deg
Vector averaged cross-power spectrum Several baselines displayed
Timerange: 00/14:12:31 to 00/14:15:59

Plot file version 96 created 29-APR-2009 14:29:41

J2333+39 EP064D.UVDATA.1

Freq = 1.5950 GHz, Bw = 16.000 MH Calibrated with CL # 3 and BP # 1 (BP mode 1)

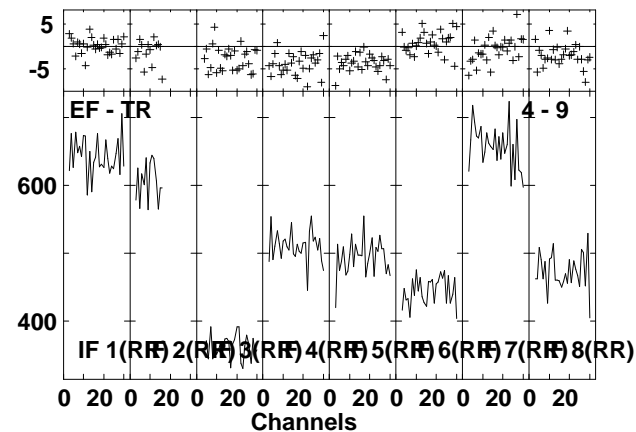
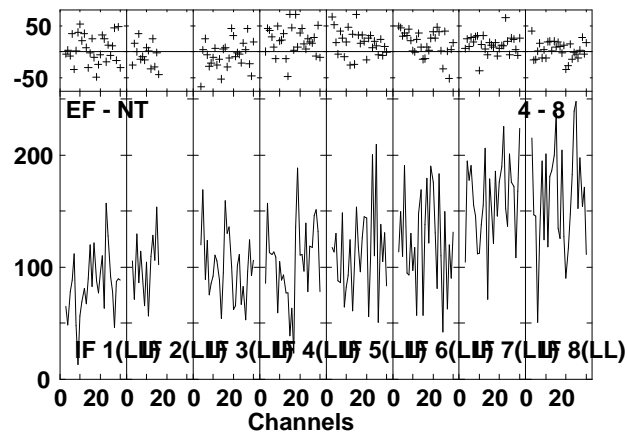
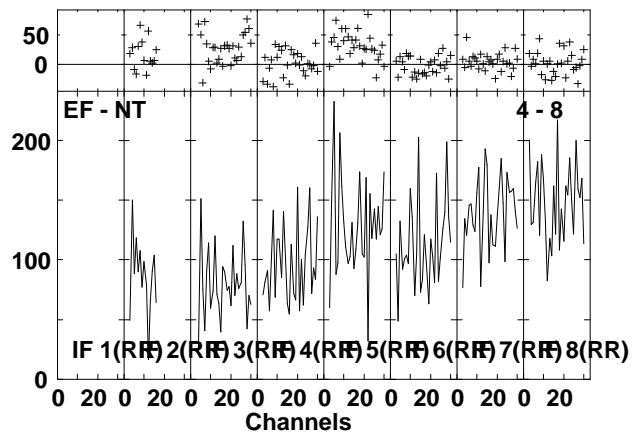
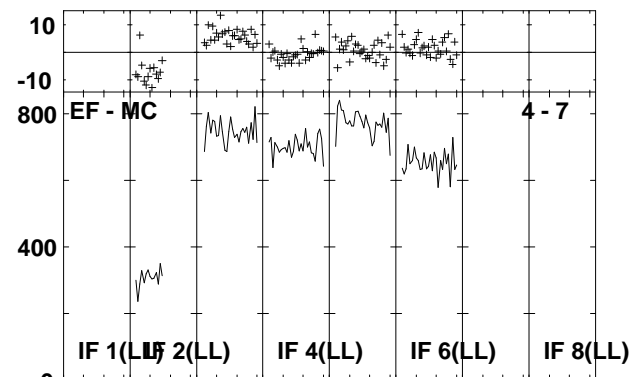
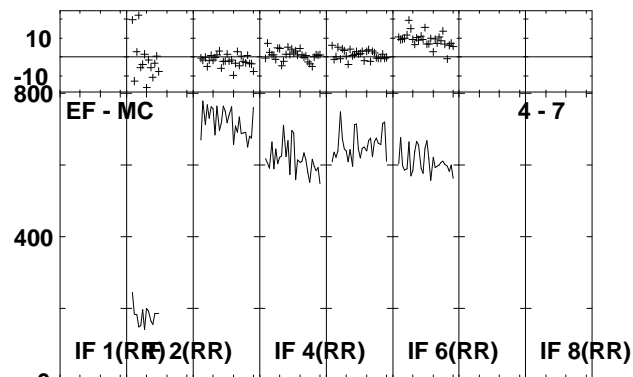
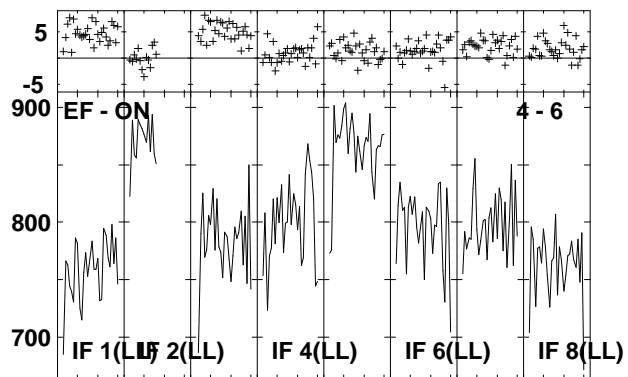
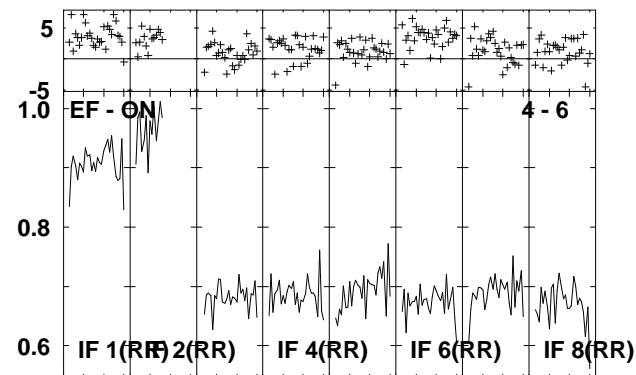
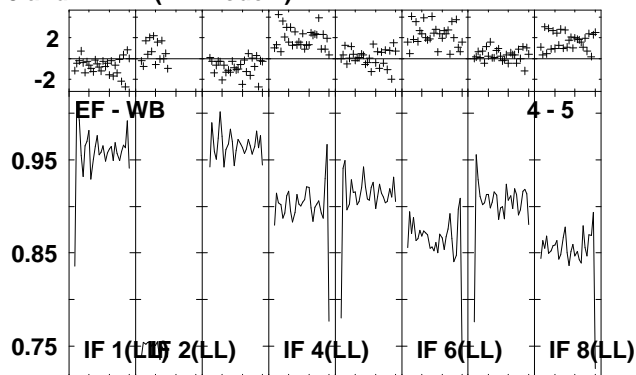
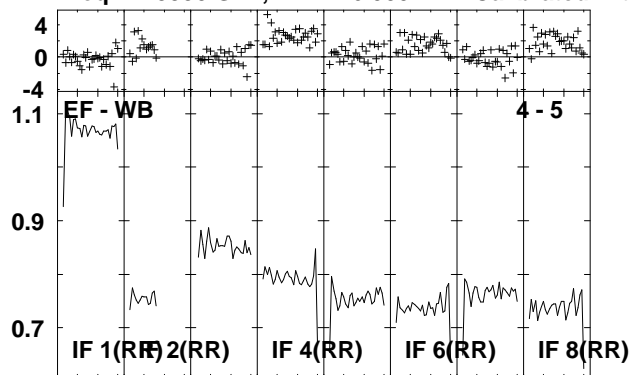

Lower frame: Ampl Jy Top frame: Phas deg
Vector averaged cross-power spectrum Several baselines displayed
Timerange: 00:14:16:01 to 00:14:17:27

Plot file version 97 created 29-APR-2009 14:29:41
J2333+39 EP064D.UVDATA.1
Freq = 1.5950 GHz, Bw = 16.000 MH Calibrated with CL # 3 and BP # 1 (BP mode 1)

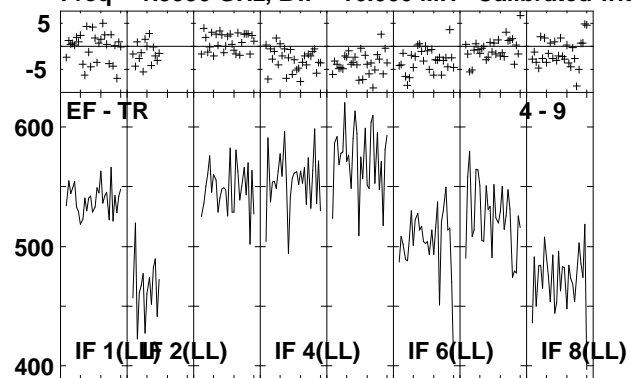

Lower frame: Milli Ampl Jy Top frame: Phas deg
Vector averaged cross-power spectrum Several baselines displayed
Timerange: 00/14:16:01 to 00/14:17:27

Plot file version 98 created 29-APR-2009 14:29:42

IRAS2336 EP064D.UVDATA.1

Freq = 1.5950 GHz, Bw = 16.000 MH Calibrated with CL # 3 and BP # 1 (BP mode 1)

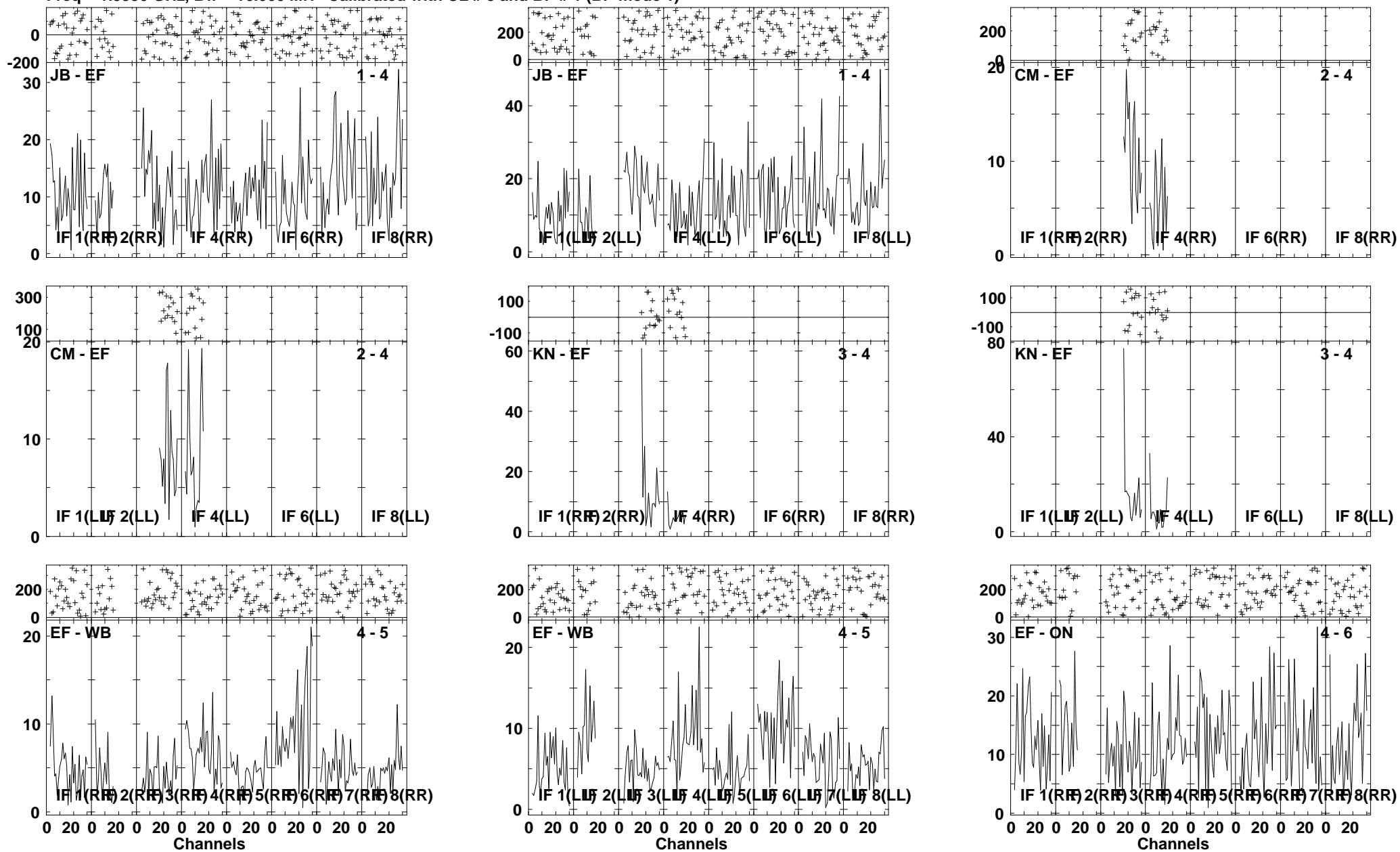

Lower frame: Milli Ampl Jy Top frame: Phas deg
Vector averaged cross-power spectrum Several baselines displayed
Timerange: 00/14:17:29 to 00/14:20:59

Plot file version 99 created 29-APR-2009 14:29:45

IRAS2336 EP064D.UVDATA.1

Freq = 1.5950 GHz, Bw = 16.000 MH Calibrated with CL # 3 and BP # 1 (BP mode 1)

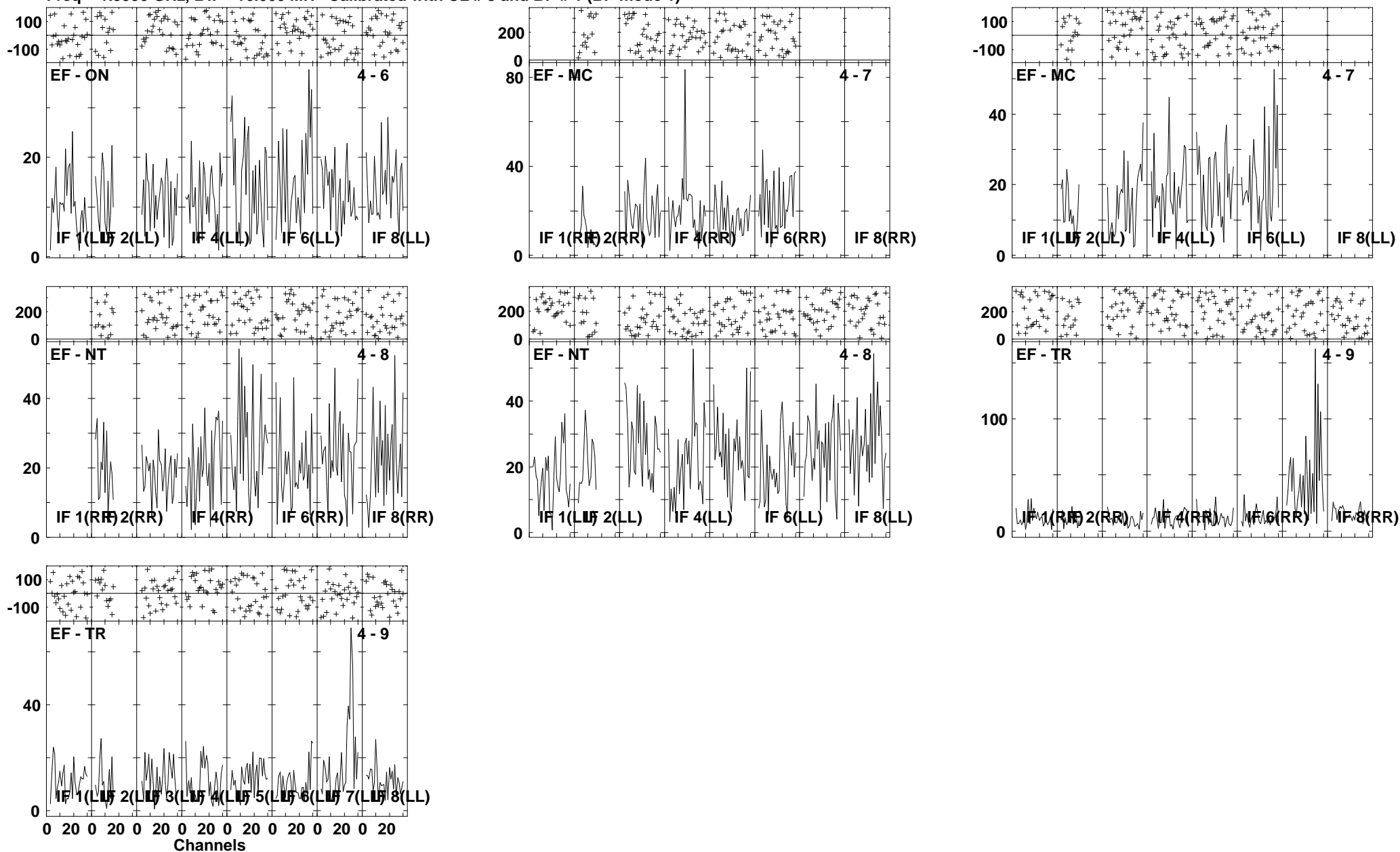

Lower frame: Milli Ampl Jy Top frame: Phas deg
Vector averaged cross-power spectrum Several baselines displayed
Timerange: 00/14:17:29 to 00/14:20:59

Plot file version 100 created 29-APR-2009 14:29:48

J2333+39 EP064D.UVDATA.1

Freq = 1.5950 GHz, Bw = 16.000 MH Calibrated with CL # 3 and BP # 1 (BP mode 1)

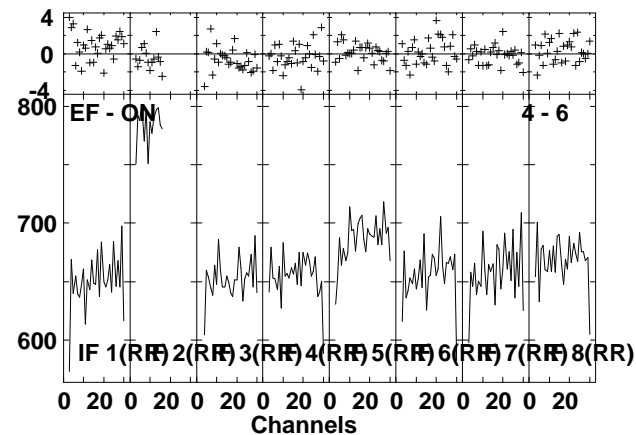
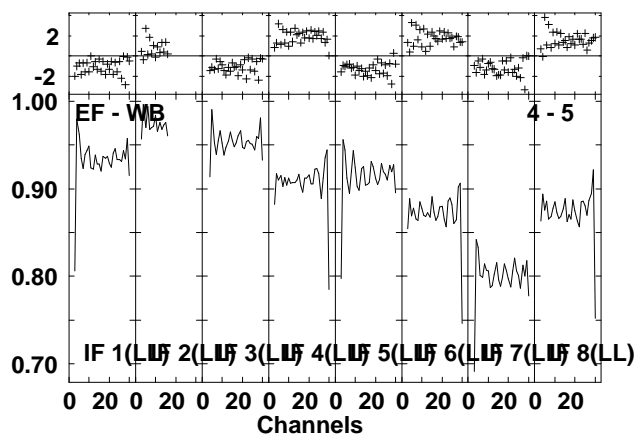
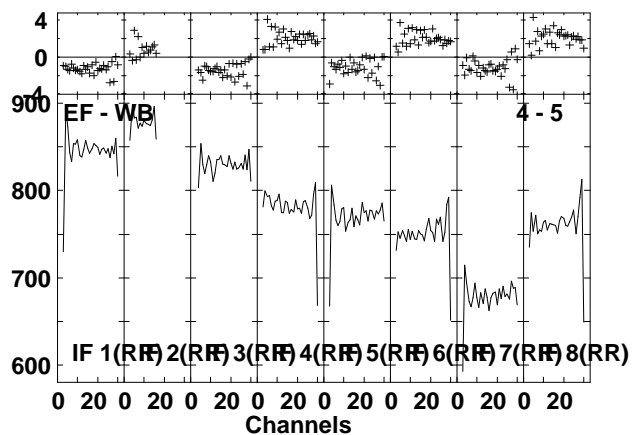
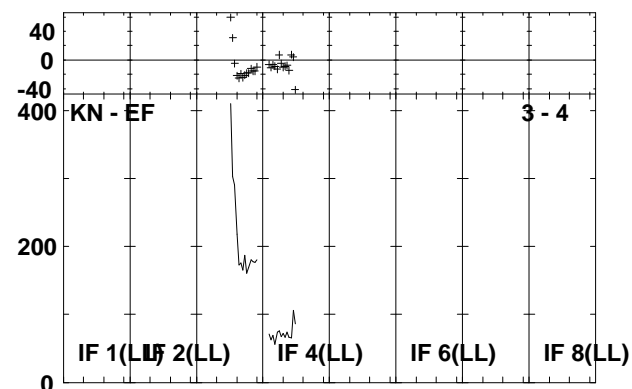
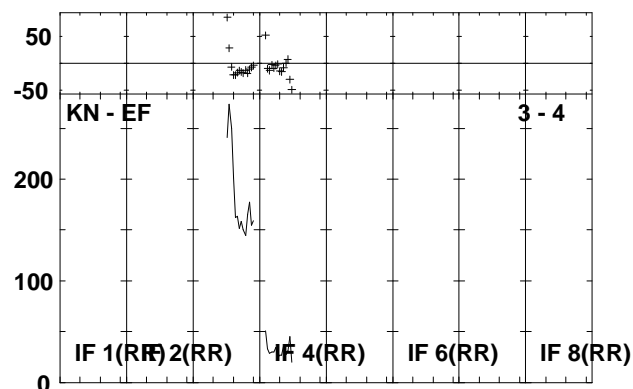
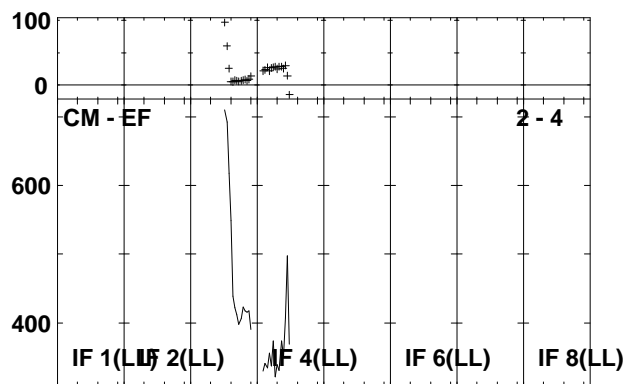
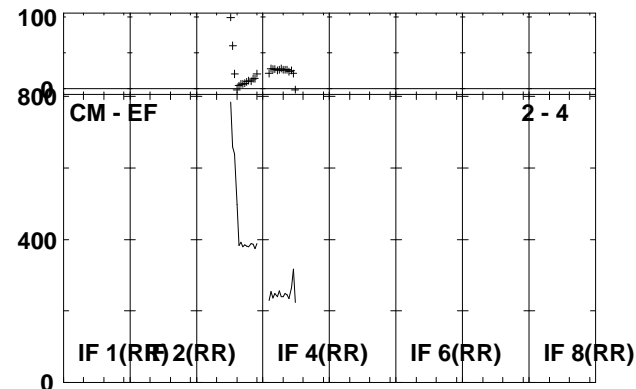
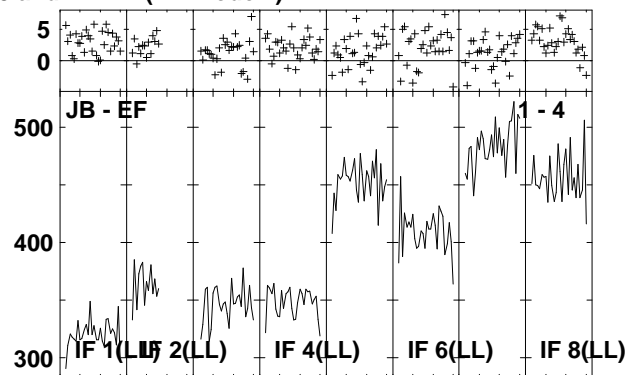
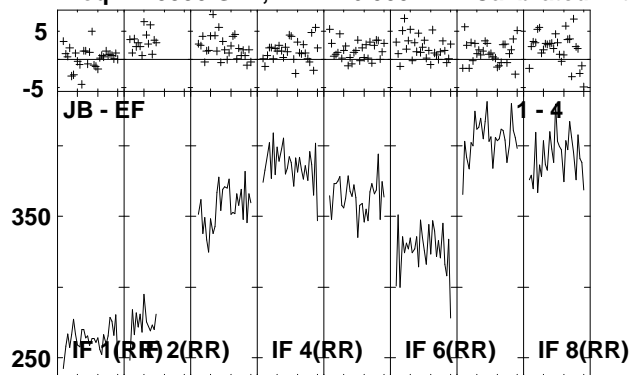

Lower frame: Milli Ampl Jy Top frame: Phas deg
Vector averaged cross-power spectrum Several baselines displayed
Timerange: 00/14:22:01 to 00/14:23:31

Plot file version 101 created 29-APR-2009 14:29:49

J2333+39 EP064D.UVDATA.1

Freq = 1.5950 GHz, Bw = 16.000 MH Calibrated with CL # 3 and BP # 1 (BP mode 1)

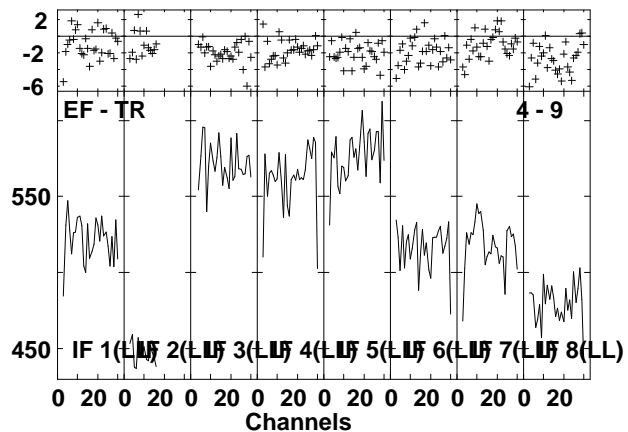
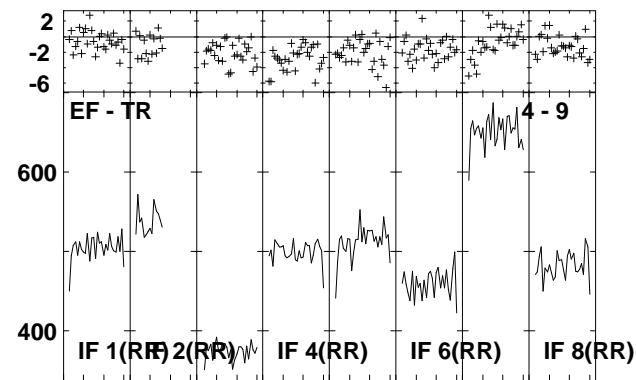
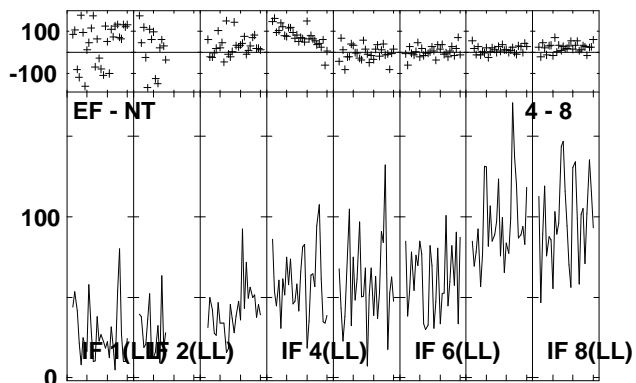
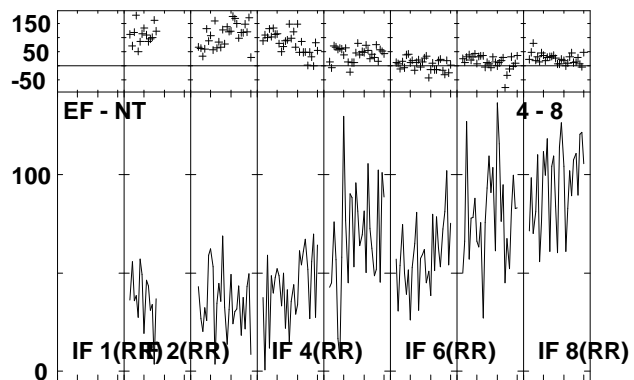
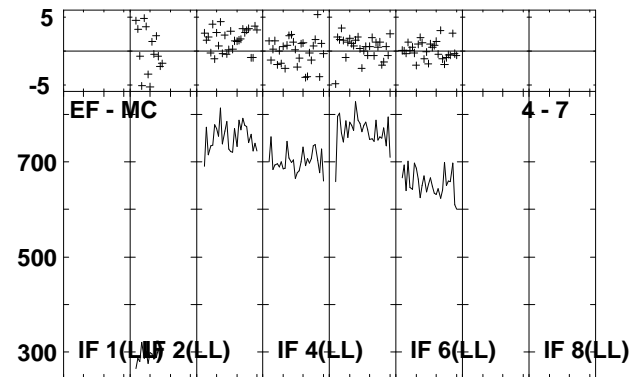
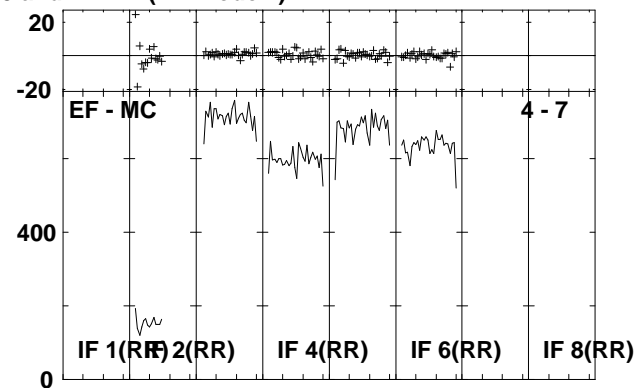
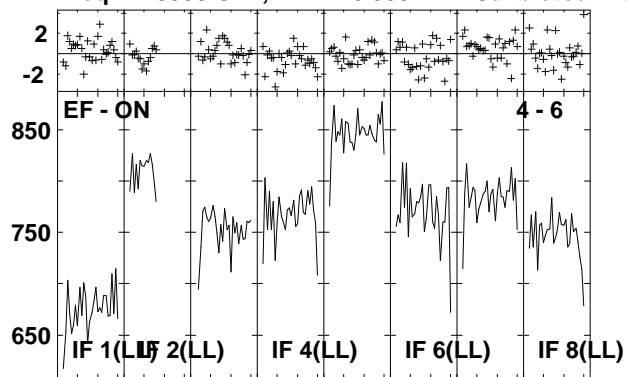

0 20 0 20 0 20 0 20 0 20 0 20 0 20 0 20 0 20 0 20
Channels
Lower frame: Milli Ampl Jy Top frame: Phas deg
Vector averaged cross-power spectrum Several baselines displayed
Timerange: 00/14:22:01 to 00/14:23:31

Plot file version 102 created 29-APR-2009 14:29:51

IRAS2336 EP064D.UVDATA.1

Freq = 1.5950 GHz, Bw = 16.000 MH Calibrated with CL # 3 and BP # 1 (BP mode 1)

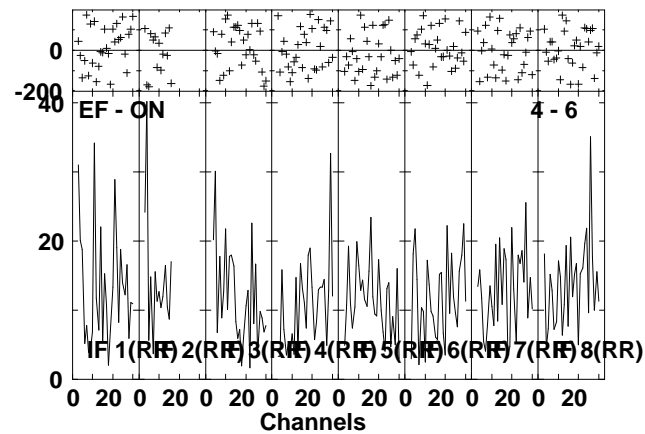
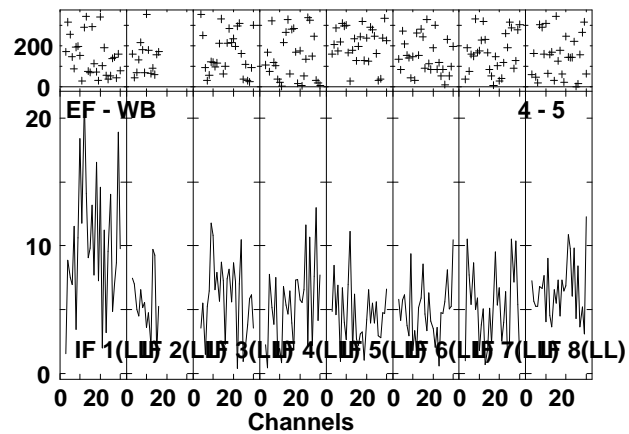
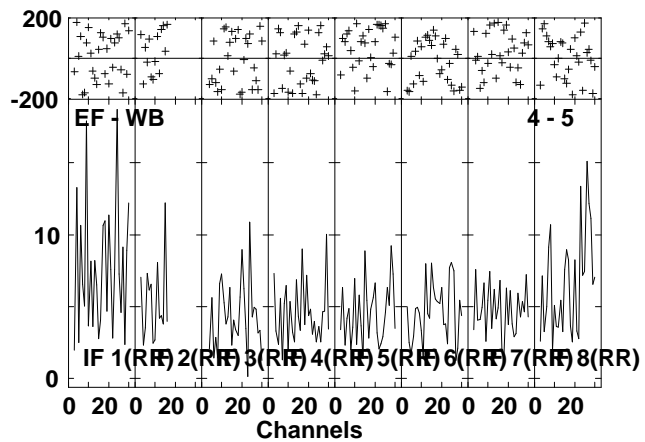
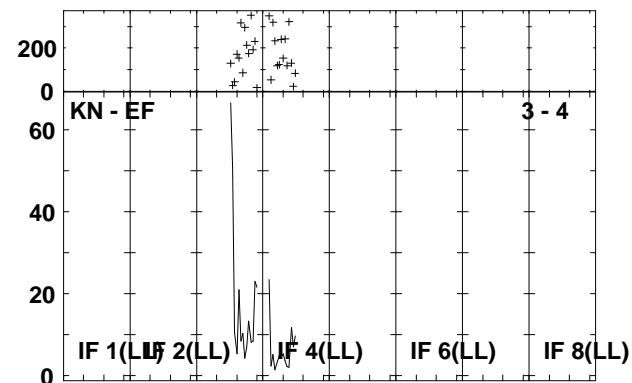
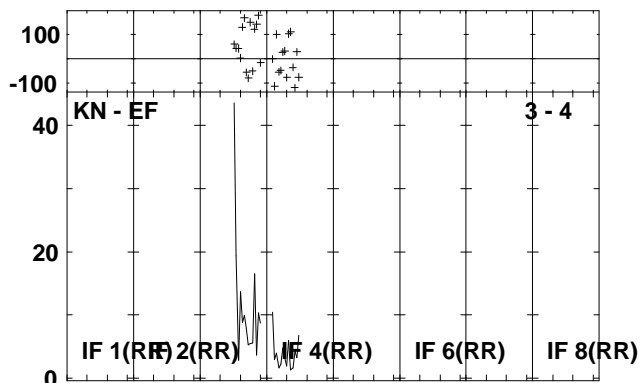
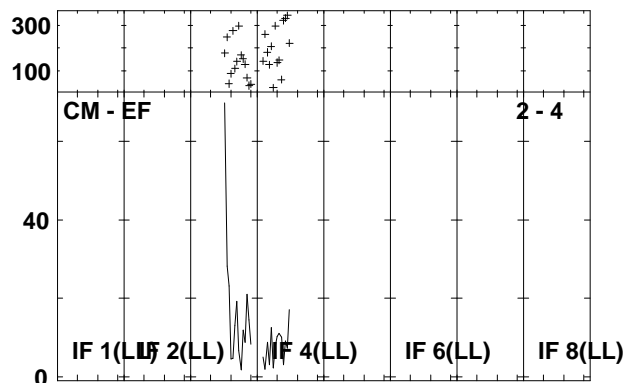
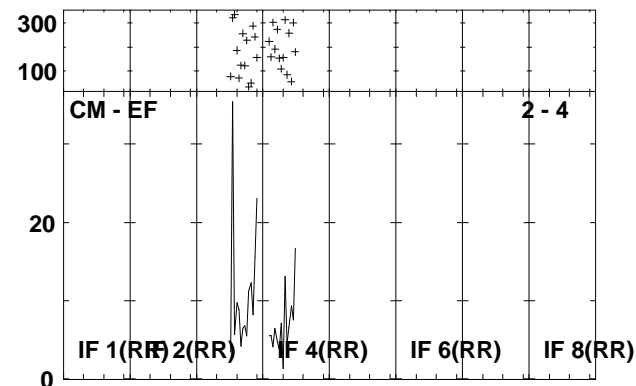
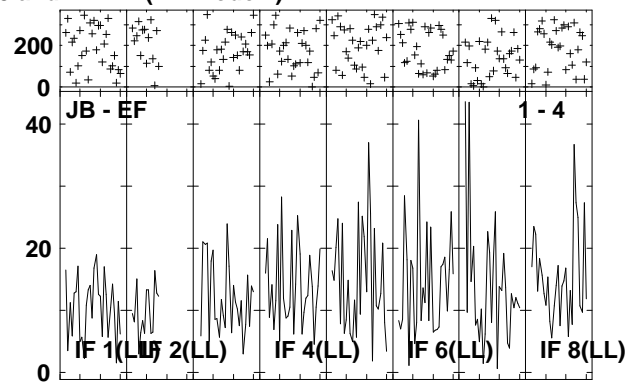
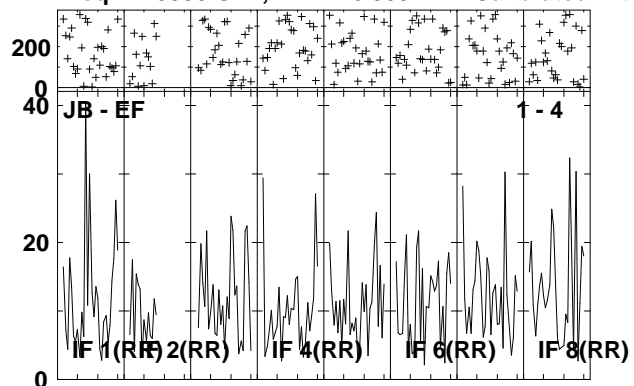

Lower frame: Milli Ampl Jy Top frame: Phas deg
Vector averaged cross-power spectrum Several baselines displayed
Timerange: 00/14:23:33 to 00/14:26:59

Plot file version 103 created 29-APR-2009 14:29:54

IRAS2336 EP064D.UVDATA.1

Freq = 1.5950 GHz, Bw = 16.000 MH Calibrated with CL # 3 and BP # 1 (BP mode 1)

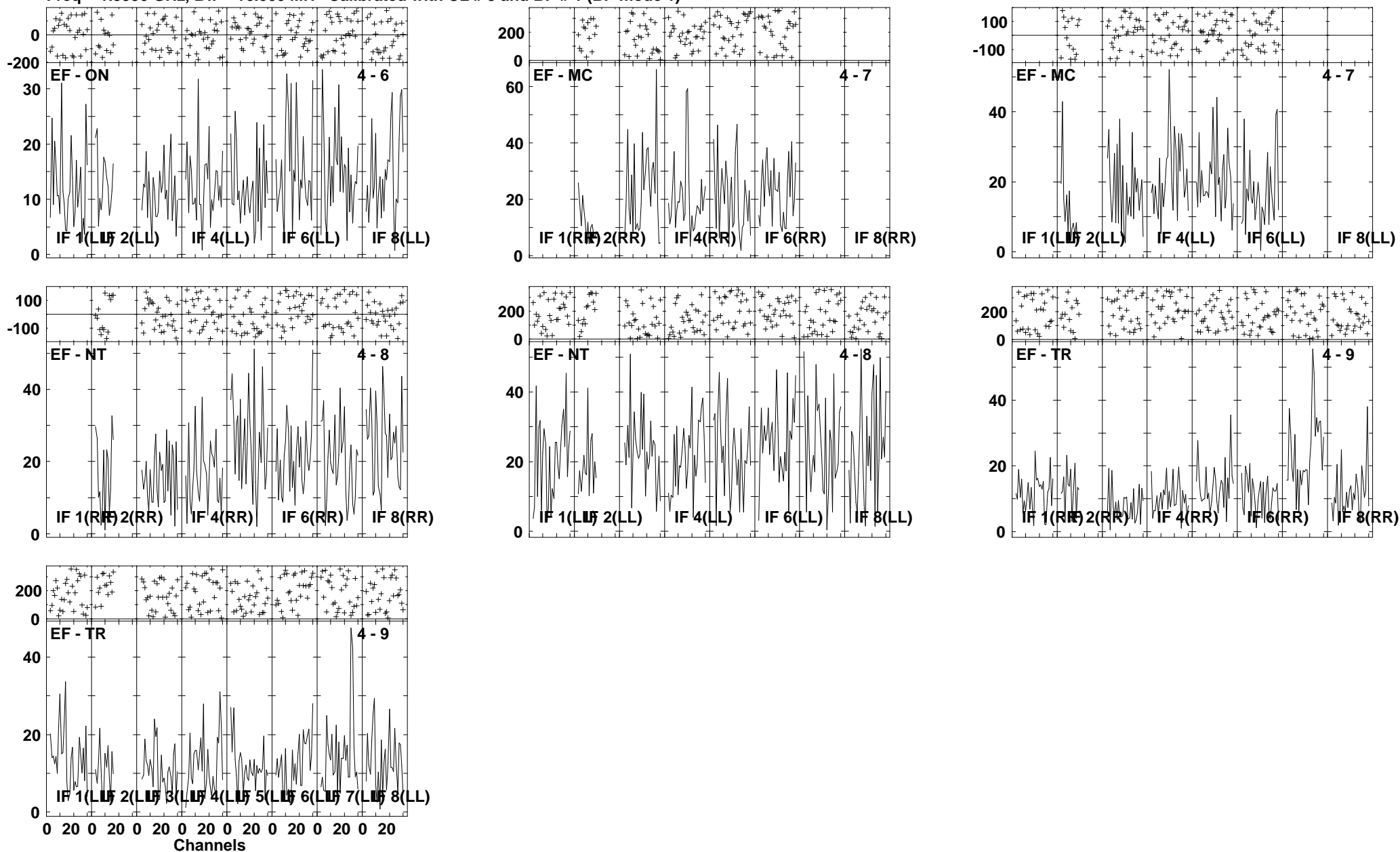

Lower frame: Milli Ampl Jy Top frame: Phas deg
Vector averaged cross-power spectrum Several baselines displayed
Timerange: 00/14:23:33 to 00/14:26:59

Plot file version 104 created 29-APR-2009 14:29:58
 J2333+39 EP064D.UVDATA.1
 Freq = 1.5950 GHz, Bw = 16.000 MH Calibrated with CL # 3 and BP # 1 (BP mode 1)

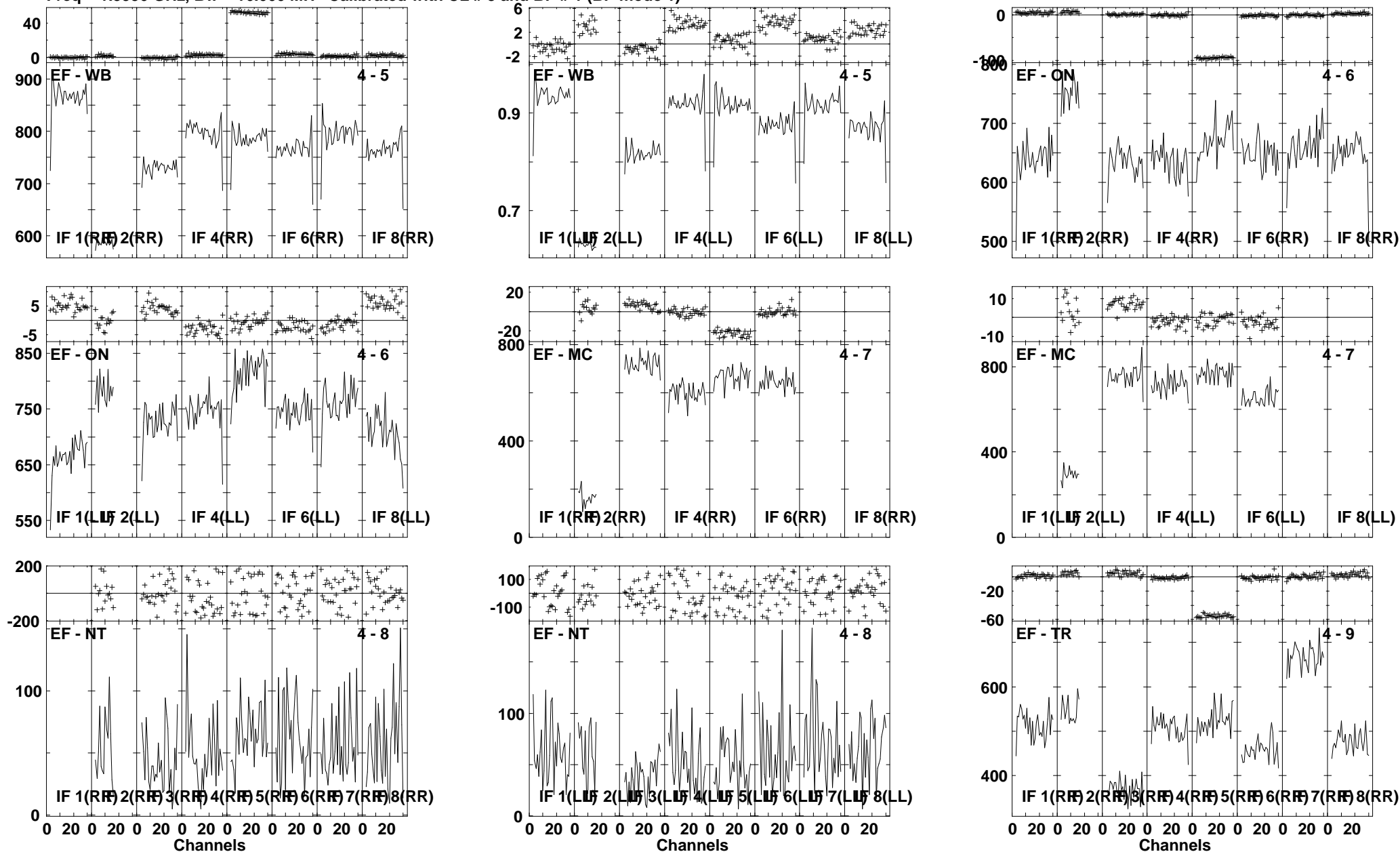

Lower frame: Milli Ampl Jy Top frame: Phas deg
 Vector averaged cross-power spectrum Several baselines displayed
 Timerange: 00/14:27:01 to 00/14:28:27

Plot file version 105 created 29-APR-2009 14:29:58

J2333+39 EP064D.UVDATA.1

Freq = 1.5950 GHz, Bw = 16.000 MH Calibrated with CL # 3 and BP # 1 (BP mode 1)

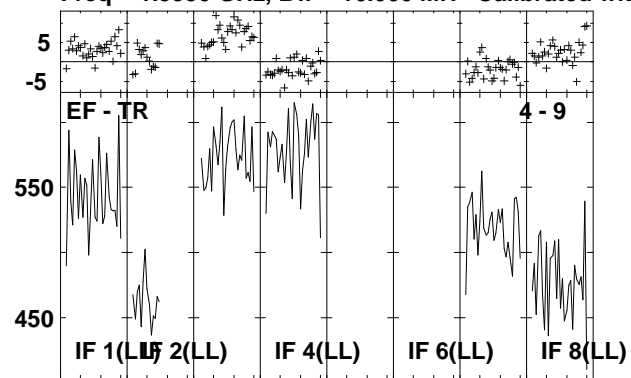

Lower frame: Milli Ampl Jy Top frame: Phas deg
Vector averaged cross-power spectrum Several baselines displayed
Timerange: 00/14:27:01 to 00/14:28:27

Plot file version 106 created 29-APR-2009 14:29:59

IRAS2336 EP064D.UVDATA.1

Freq = 1.5950 GHz, Bw = 16.000 MH Calibrated with CL # 3 and BP # 1 (BP mode 1)

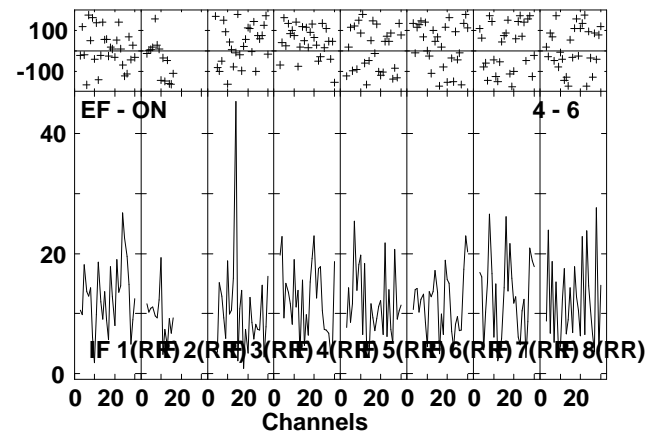
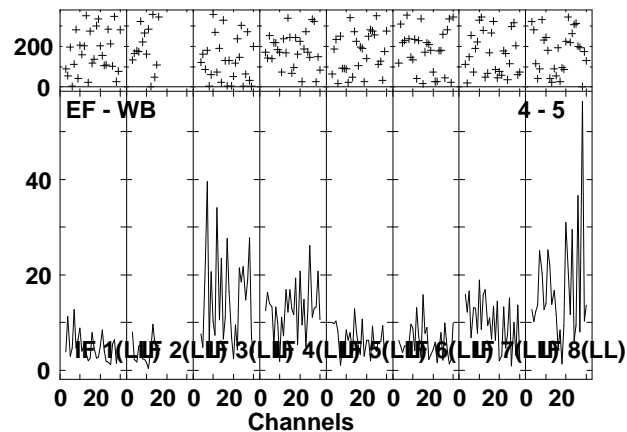
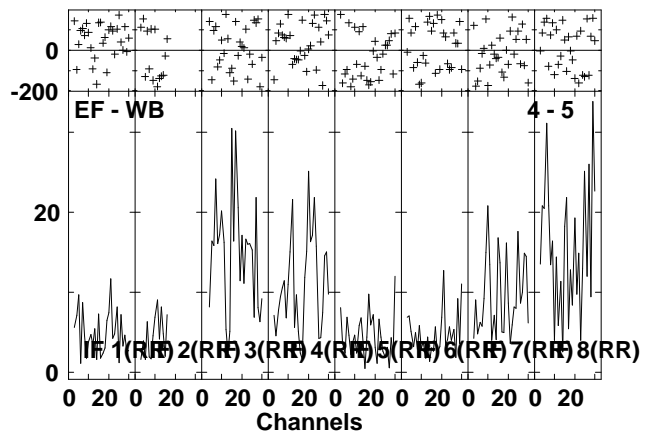
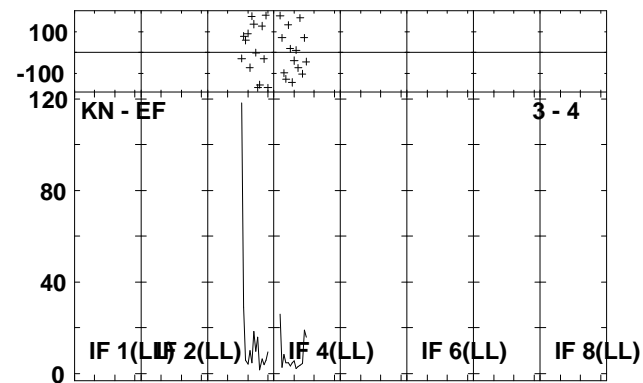
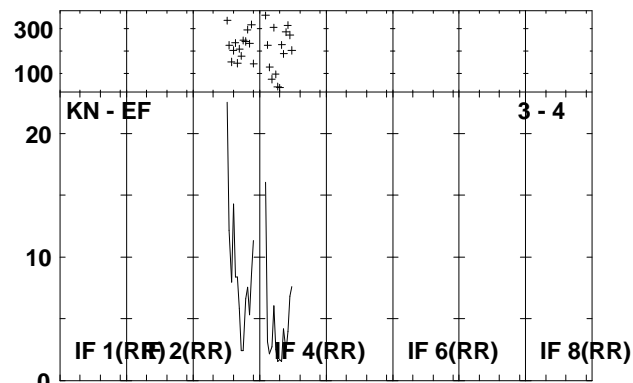
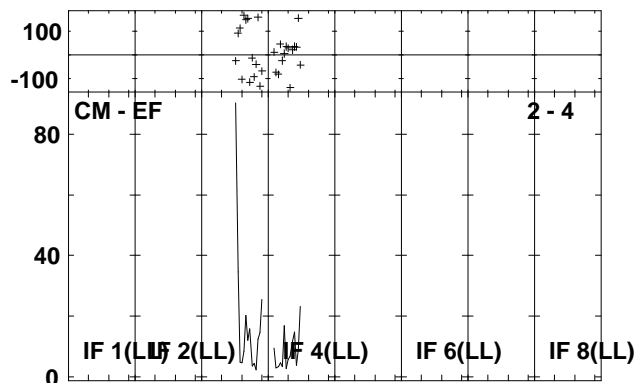
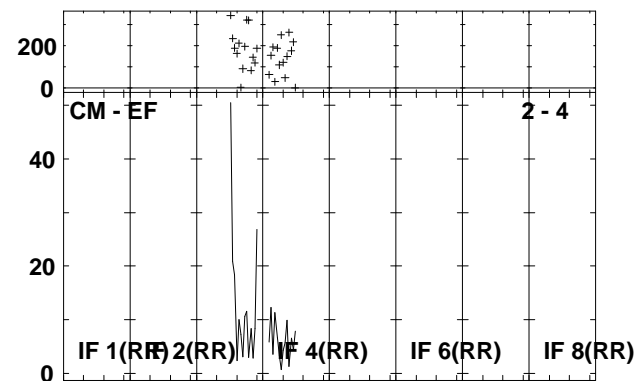
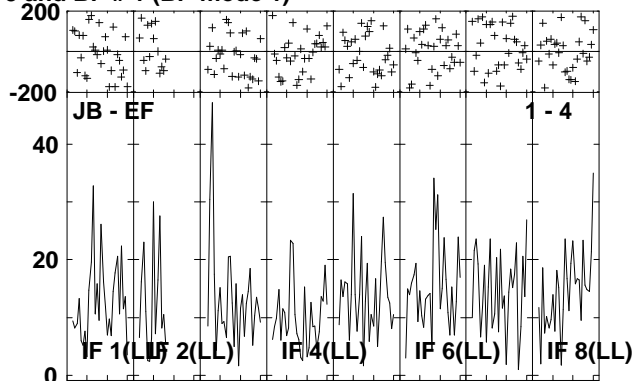
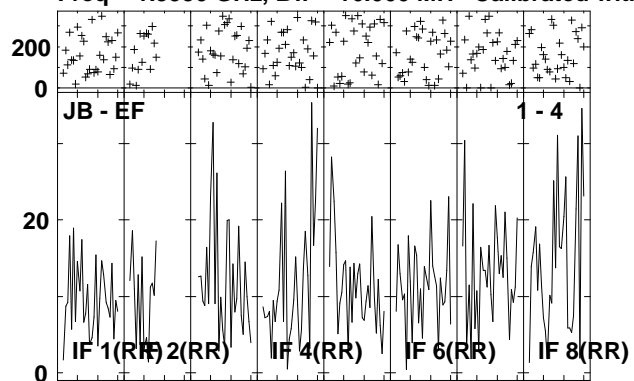

Lower frame: Milli Ampl Jy Top frame: Phas deg
Vector averaged cross-power spectrum Several baselines displayed
Timerange: 00/14:28:29 to 00/14:31:59

Plot file version 107 created 29-APR-2009 14:30:02

IRAS2336 EP064D.UVDATA.1

Freq = 1.5950 GHz, Bw = 16.000 MH Calibrated with CL # 3 and BP # 1 (BP mode 1)

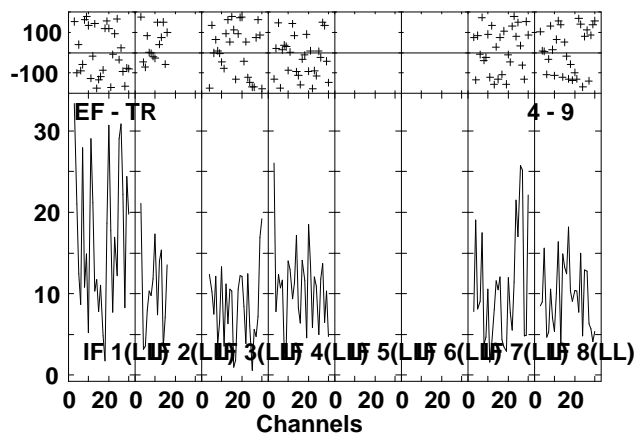
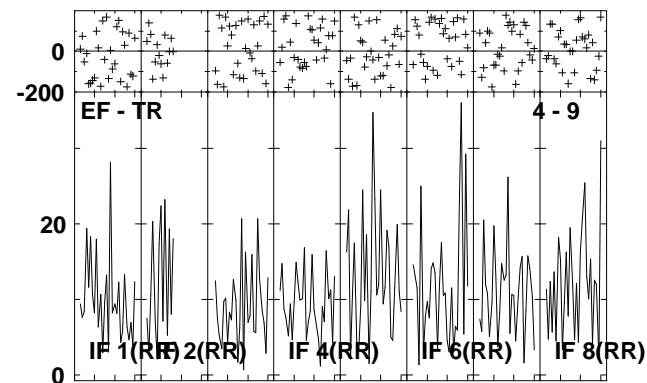
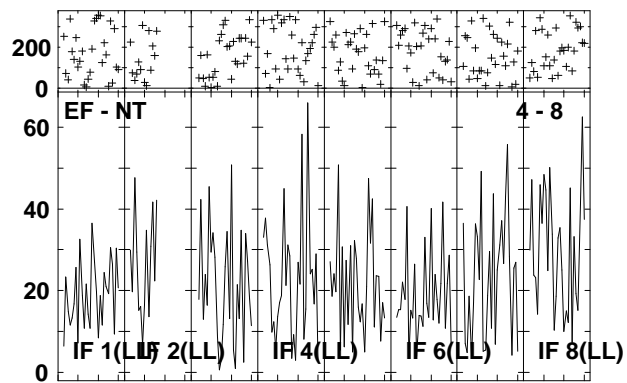
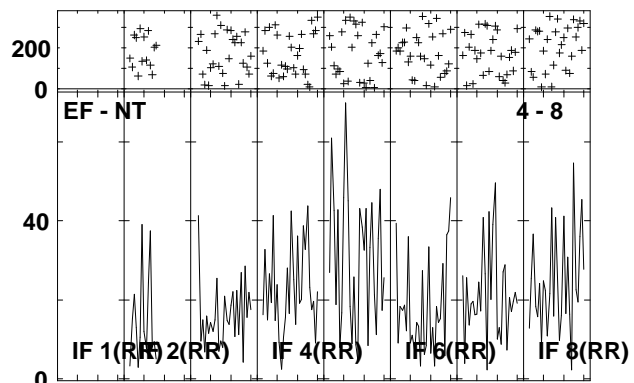
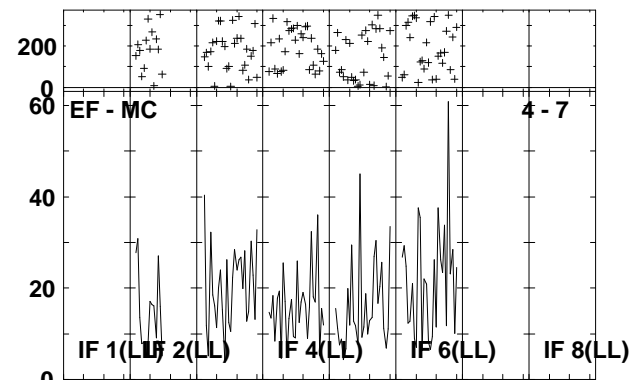
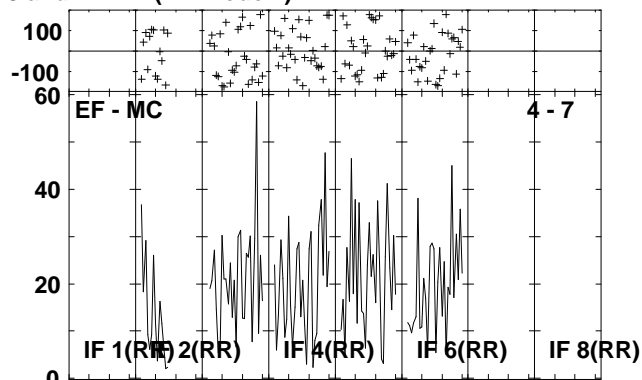
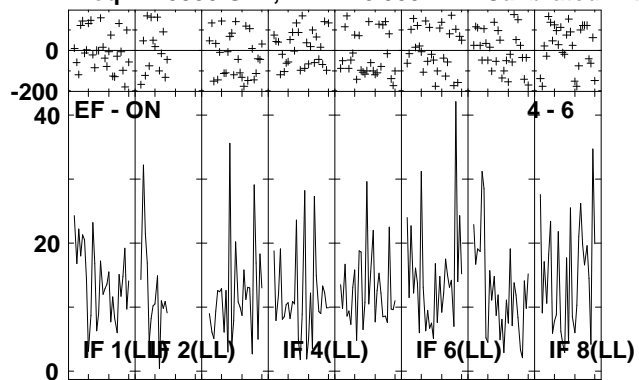

Lower frame: Milli Ampl Jy Top frame: Phas deg
Vector averaged cross-power spectrum Several baselines displayed
Timerange: 00/14:28:29 to 00/14:31:59

Plot file version 108 created 29-APR-2009 14:30:05

J2333+39 EP064D.UVDATA.1

Freq = 1.5950 GHz, Bw = 16.000 MH Calibrated with CL # 3 and BP # 1 (BP mode 1)

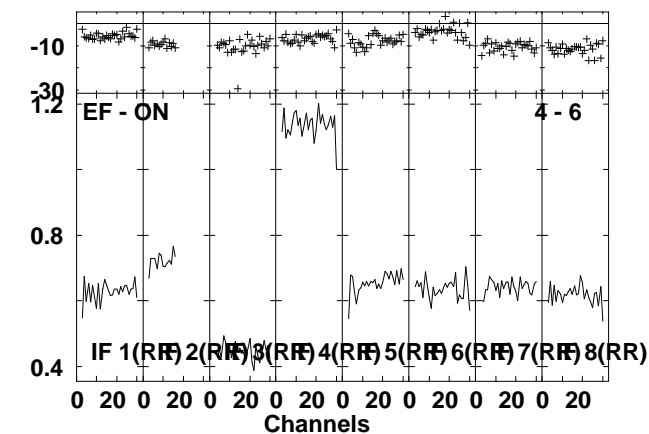
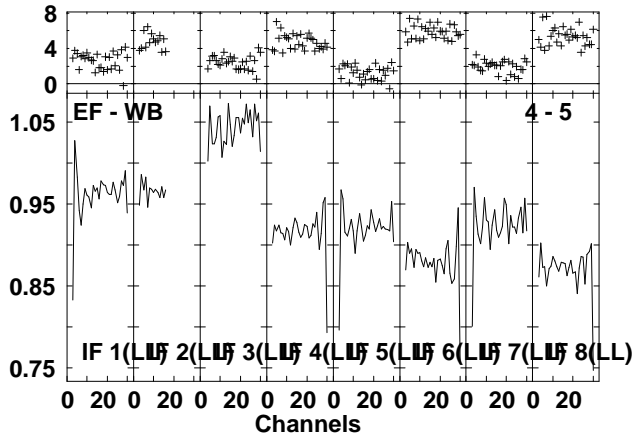
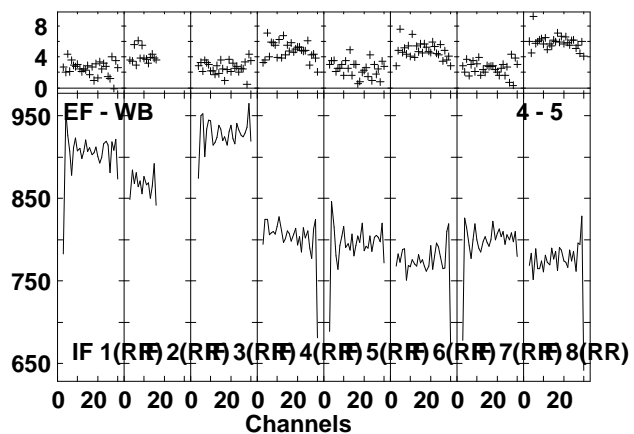
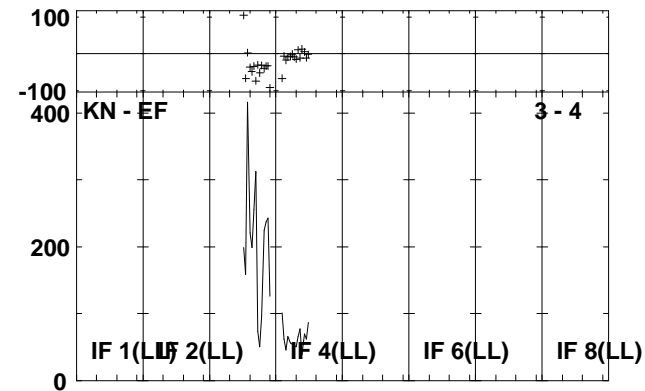
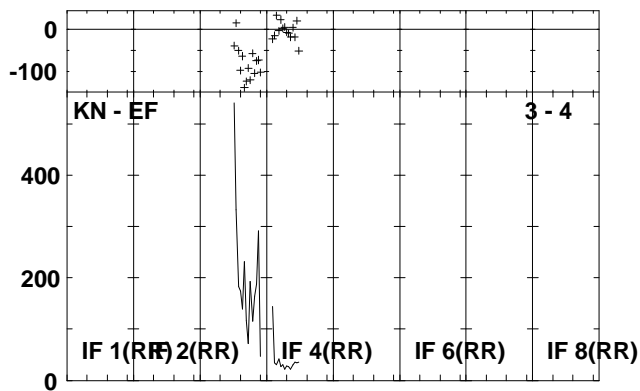
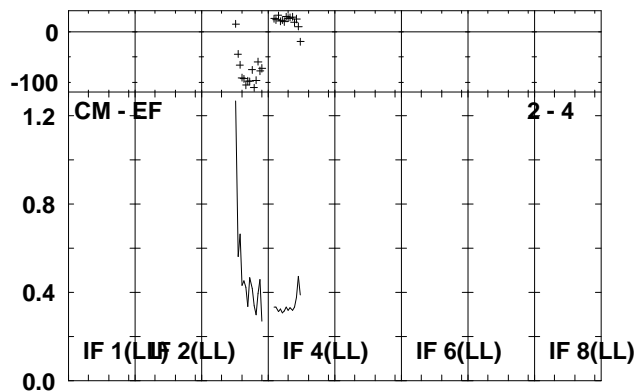
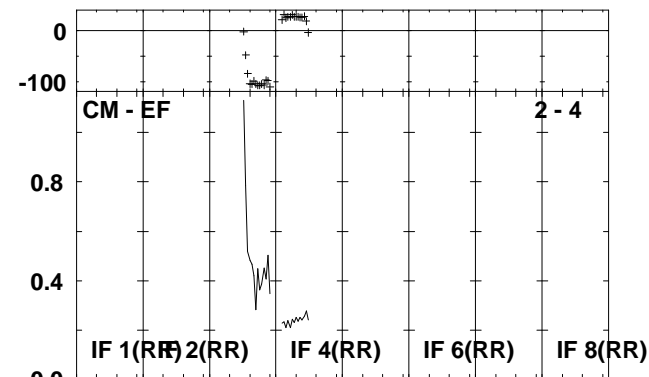
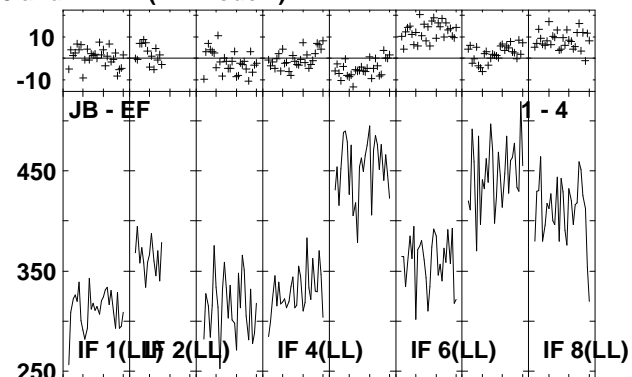
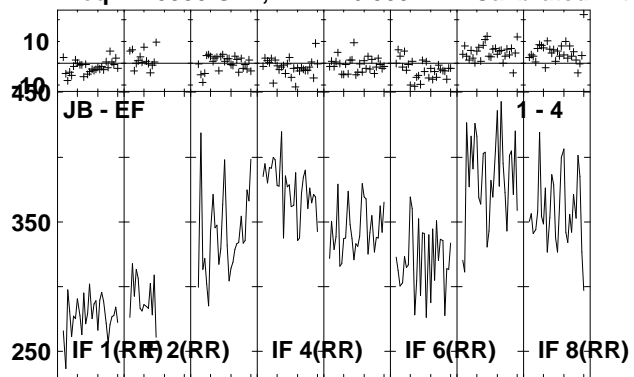

Lower frame: Milli Ampl Jy Top frame: Phas deg
Vector averaged cross-power spectrum Several baselines displayed
Timerange: 00/14:32:01 to 00/14:33:31

Plot file version 109 created 29-APR-2009 14:30:06

J2333+39 EP064D.UVDATA.1

Freq = 1.5950 GHz, Bw = 16.000 MH Calibrated with CL # 3 and BP # 1 (BP mode 1)

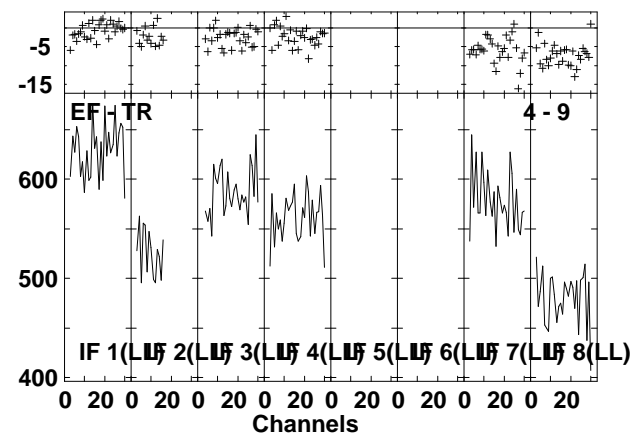
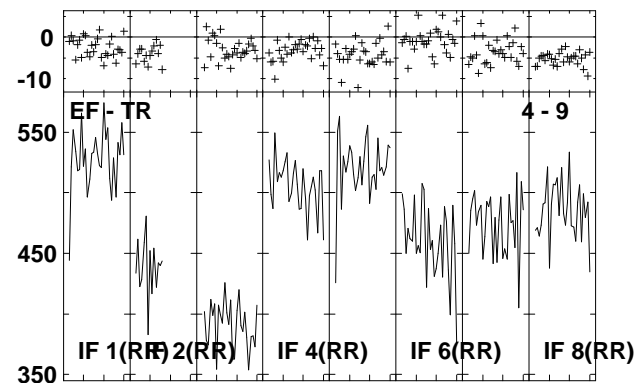
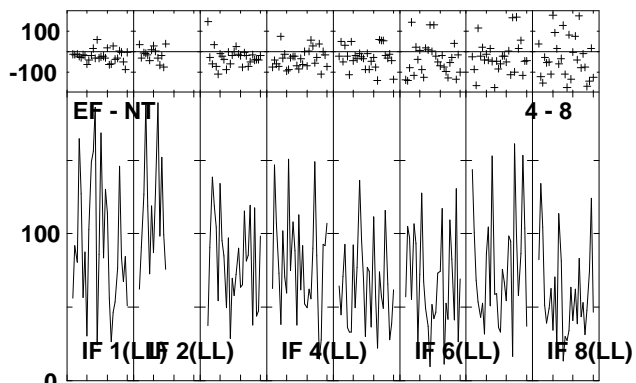
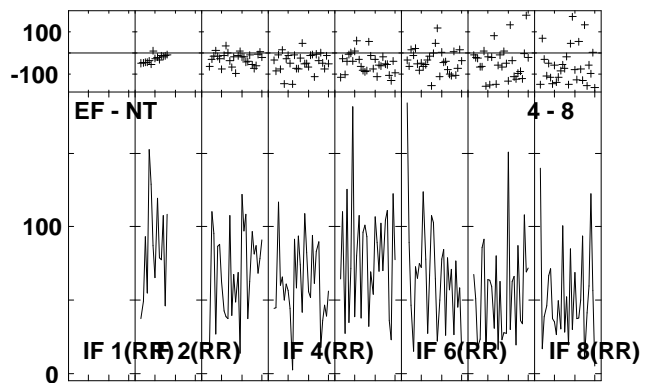
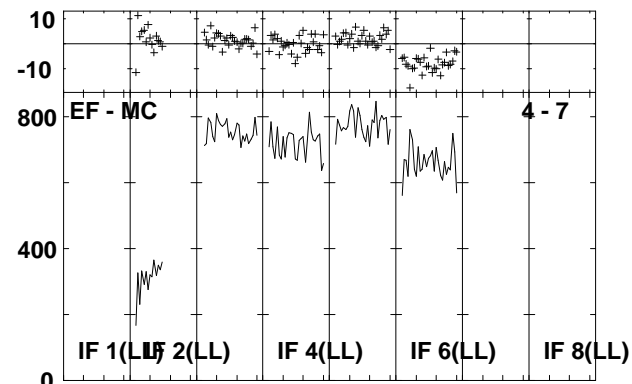
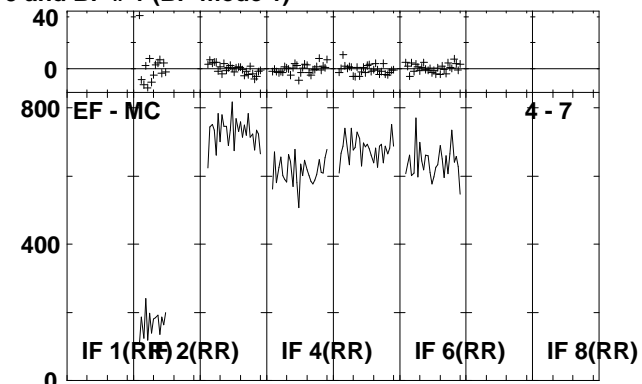
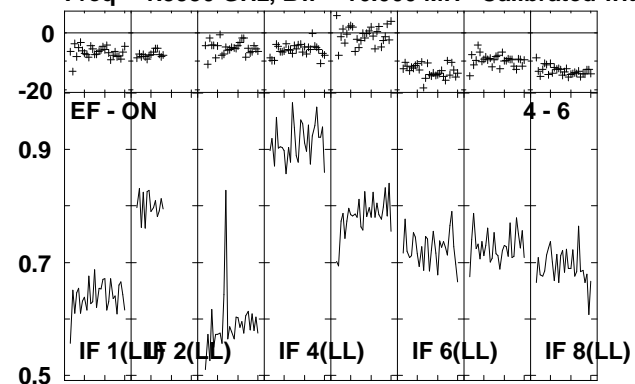

Lower frame: Ampl Jy Top frame: Phas deg
Vector averaged cross-power spectrum Several baselines displayed
Timerange: 00/14:32:01 to 00/14:33:31

Plot file version 110 created 29-APR-2009 14:30:08

IRAS2336 EP064D.UVDATA.1

Freq = 1.5950 GHz, Bw = 16.000 MH Calibrated with CL # 3 and BP # 1 (BP mode 1)

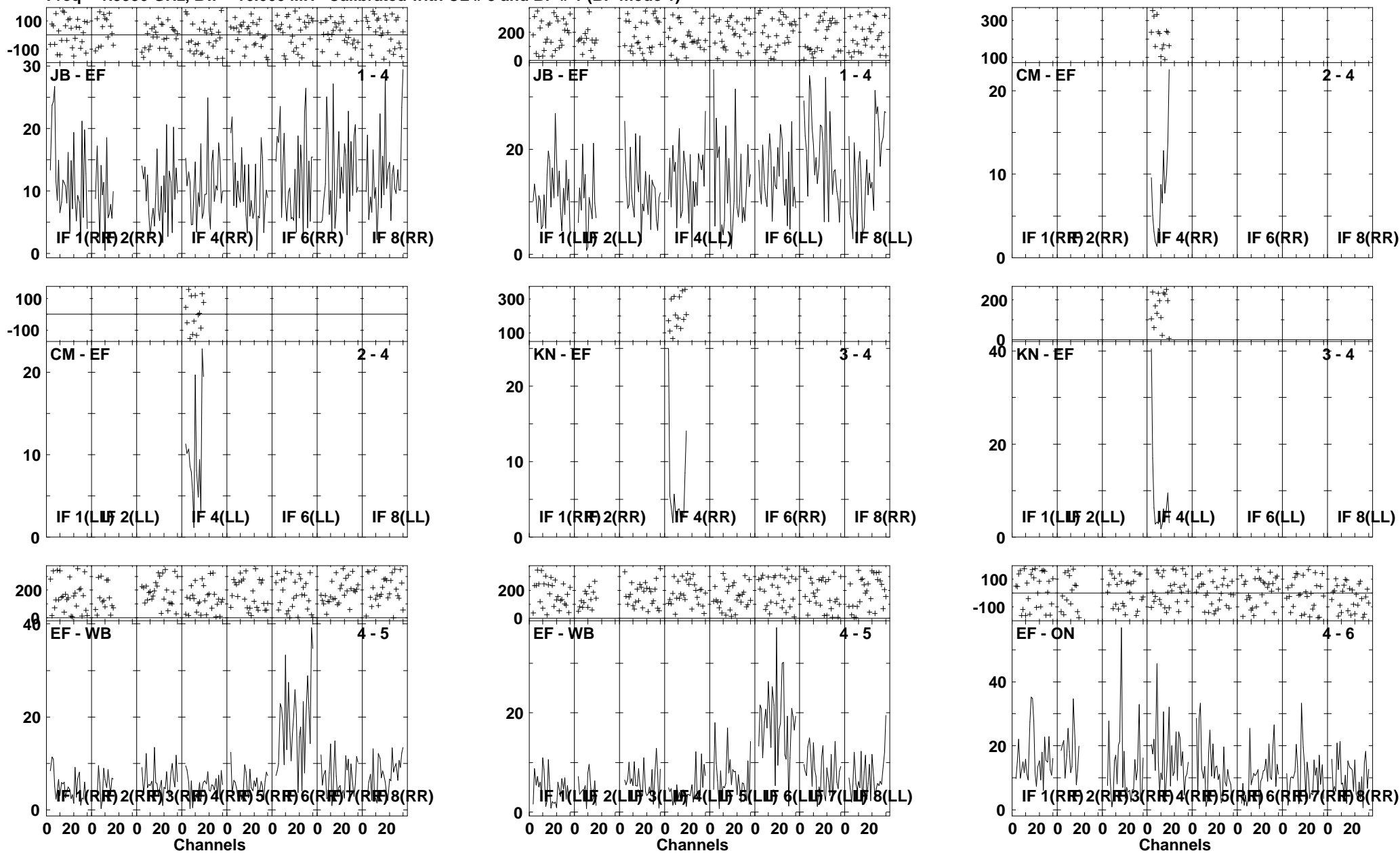

Lower frame: Milli Ampl Jy Top frame: Phas deg
Vector averaged cross-power spectrum Several baselines displayed
Timerange: 00/14:33:33 to 00/14:36:59

Plot file version 111 created 29-APR-2009 14:30:10

IRAS2336 EP064D.UVDATA.1

Freq = 1.5950 GHz, Bw = 16.000 MH Calibrated with CL # 3 and BP # 1 (BP mode 1)

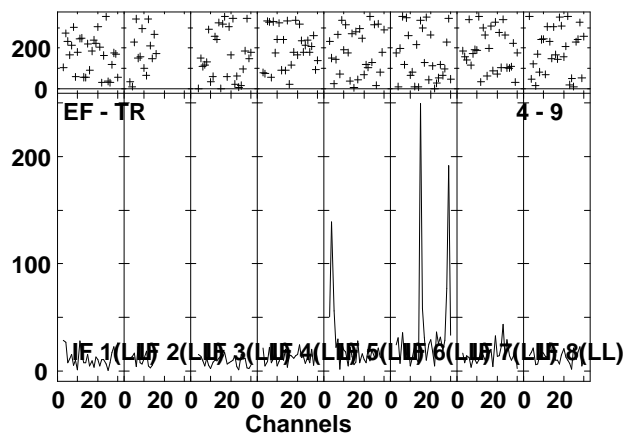
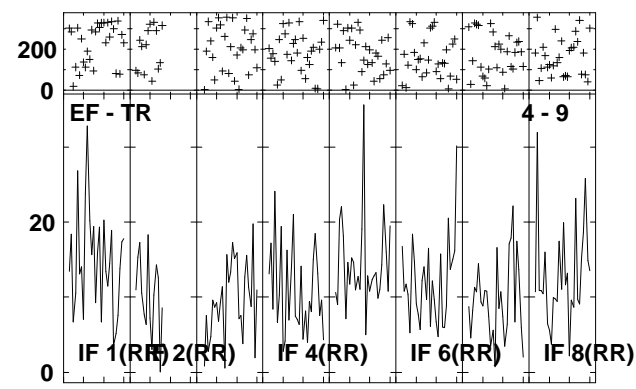
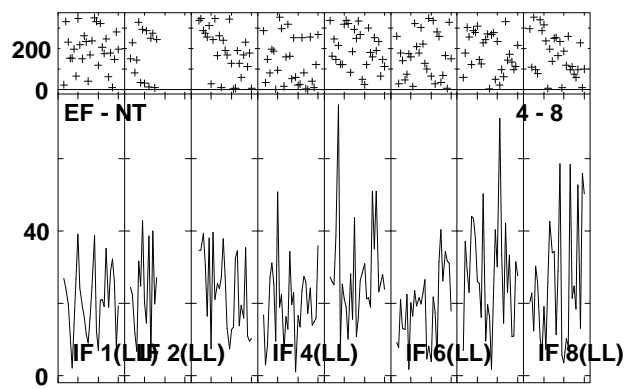
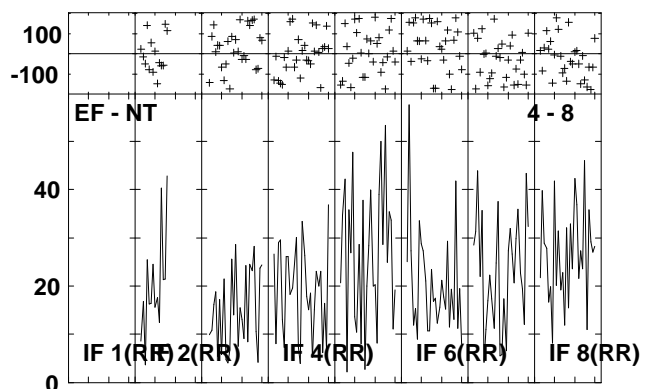
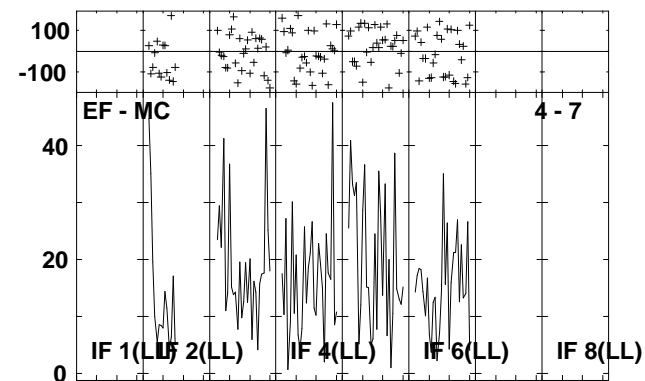
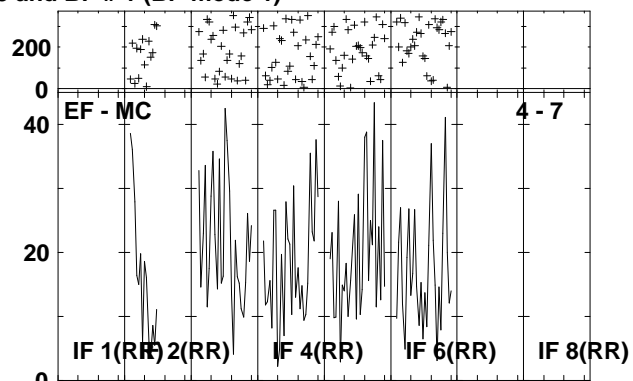
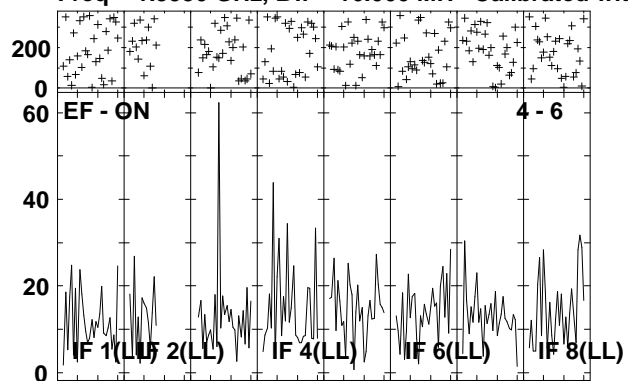

Lower frame: Milli Ampl Jy Top frame: Phas deg
Vector averaged cross-power spectrum Several baselines displayed
Timerange: 00/14:33:33 to 00/14:36:59

Plot file version 112 created 29-APR-2009 14:30:14

J2333+39 EP064D.UVDATA.1

Freq = 1.5950 GHz, Bw = 16.000 MH Calibrated with CL # 3 and BP # 1 (BP mode 1)

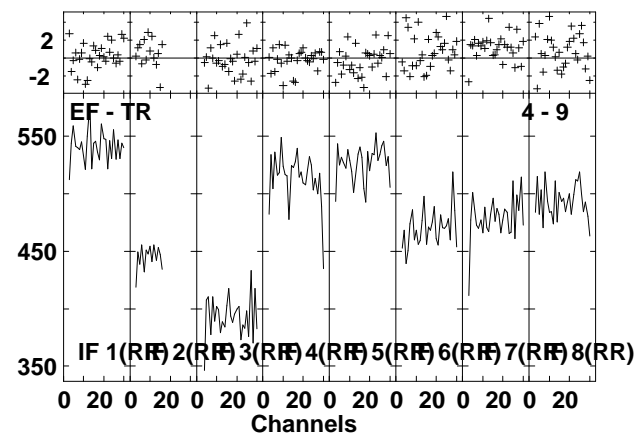
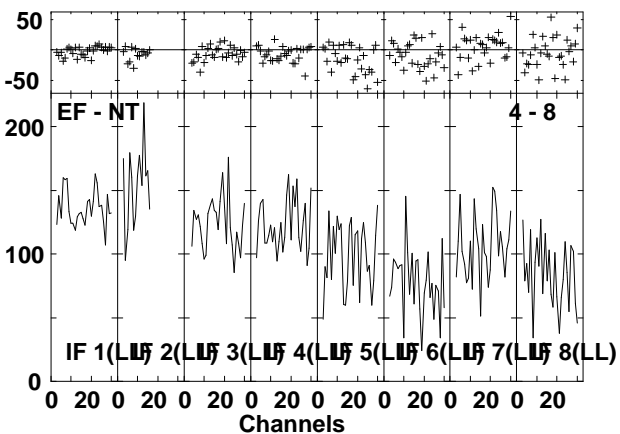
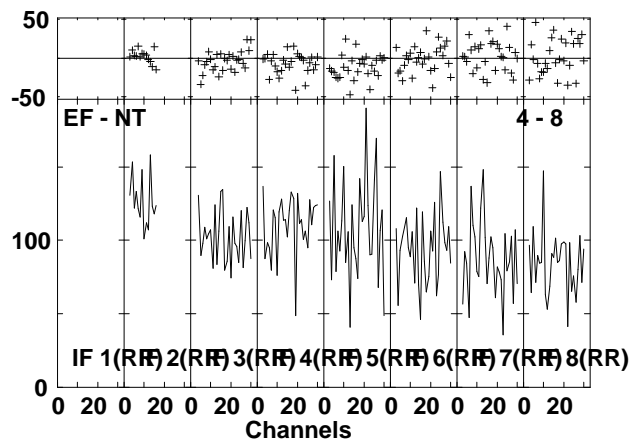
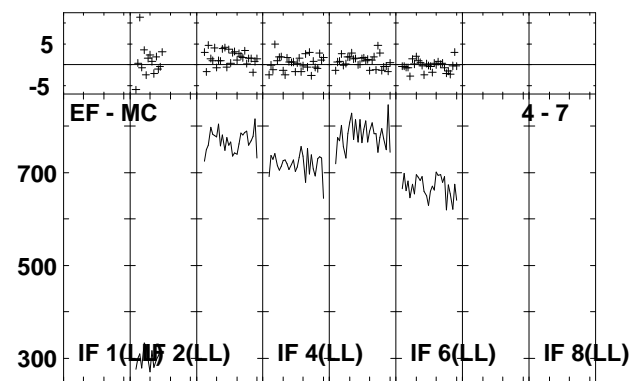
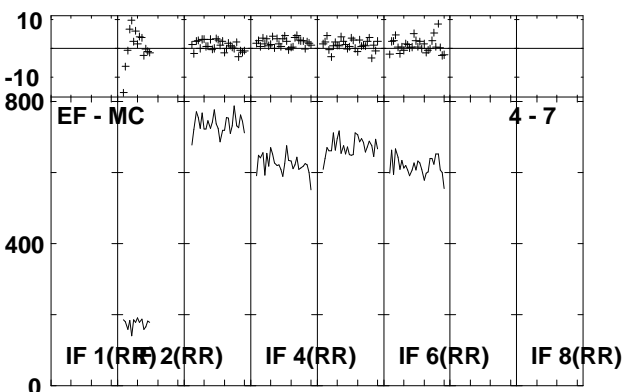
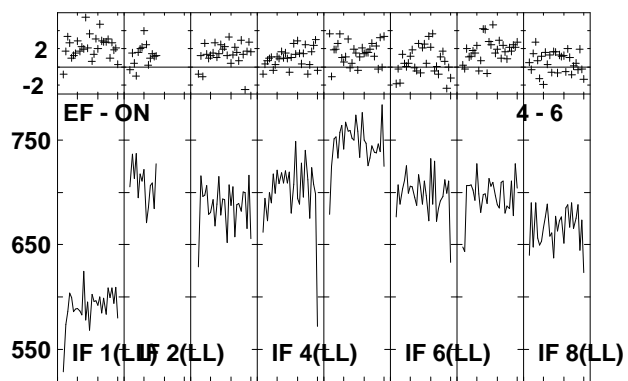
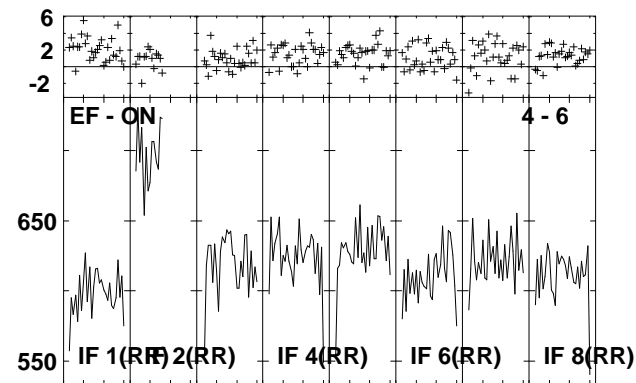
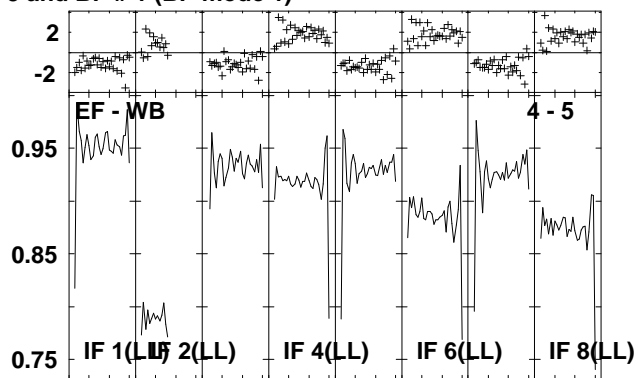
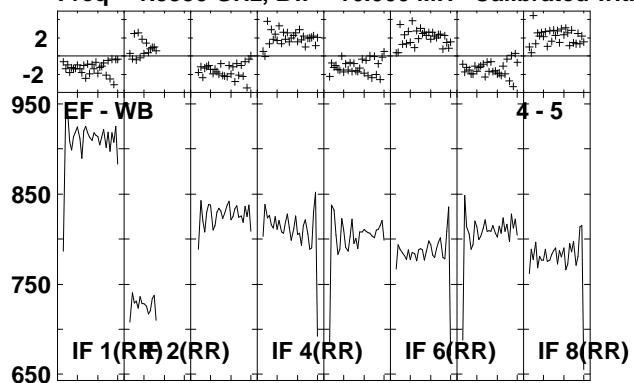

Lower frame: Milli Ampl Jy Top frame: Phas deg
Vector averaged cross-power spectrum Several baselines displayed
Timerange: 00/14:38:01 to 00/14:39:27

Plot file version 113 created 29-APR-2009 14:30:15
J2333+39 EP064D.UVDATA.1
Freq = 1.5950 GHz, Bw = 16.000 MH Calibrated with CL # 3 and BP # 1 (BP mode 1)

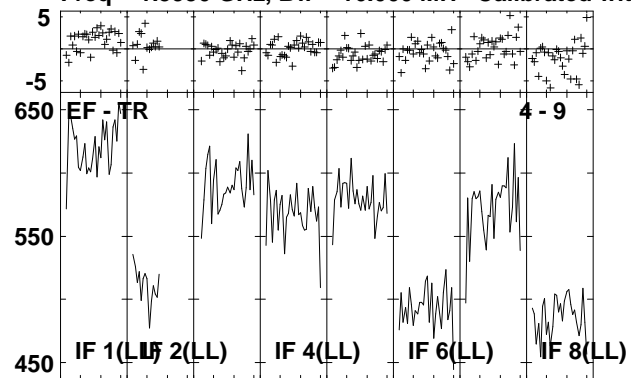

Lower frame: Milli Ampl Jy Top frame: Phas deg
Vector averaged cross-power spectrum Several baselines displayed
Timerange: 00/14:38:01 to 00/14:39:27

Plot file version 114 created 29-APR-2009 14:30:16

IRAS2336 EP064D.UVDATA.1

Freq = 1.5950 GHz, Bw = 16.000 MH Calibrated with CL # 3 and BP # 1 (BP mode 1)

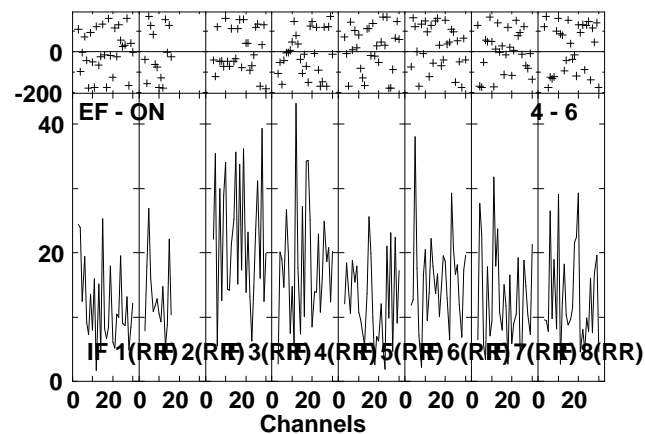
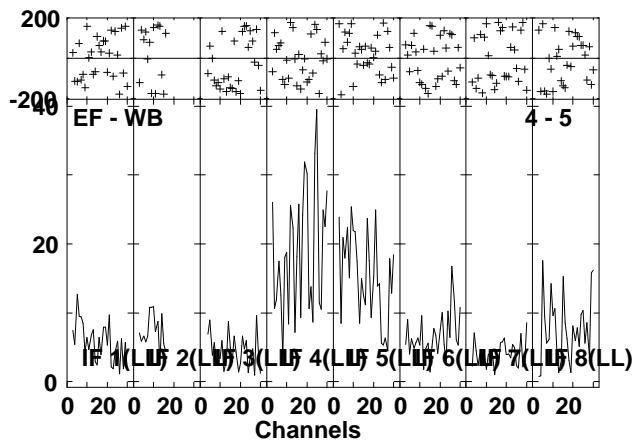
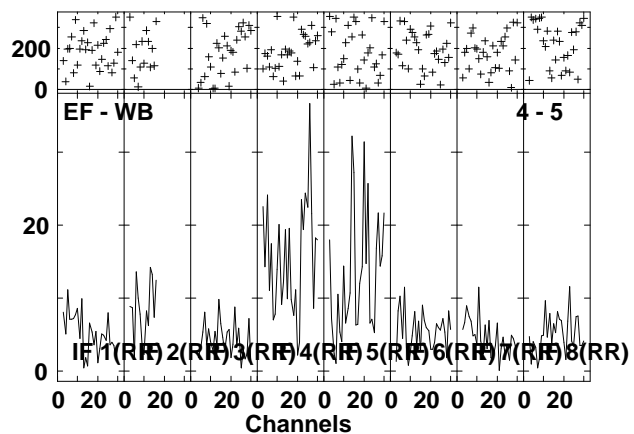
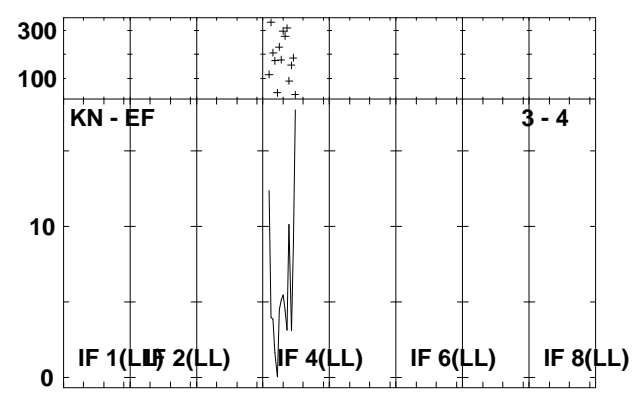
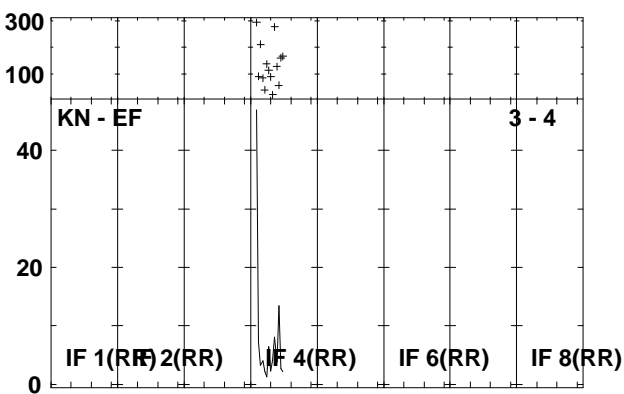
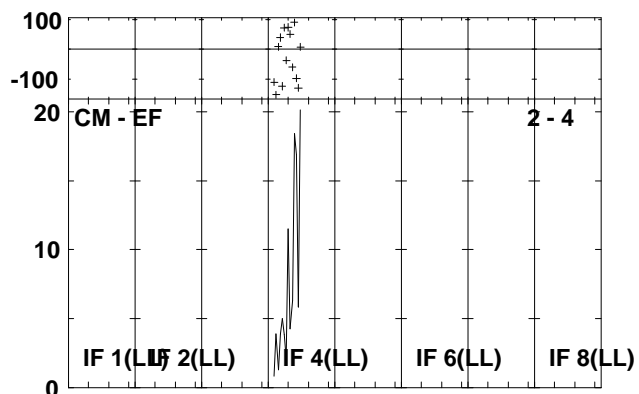
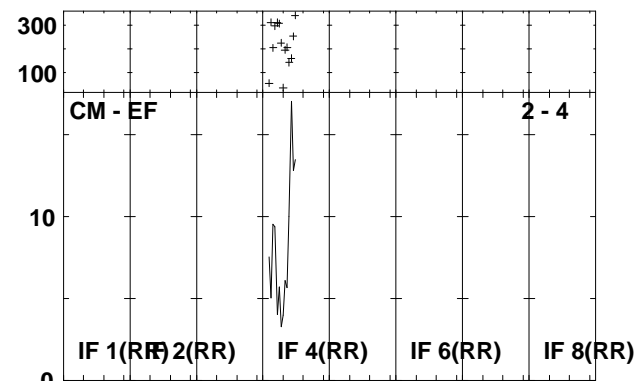
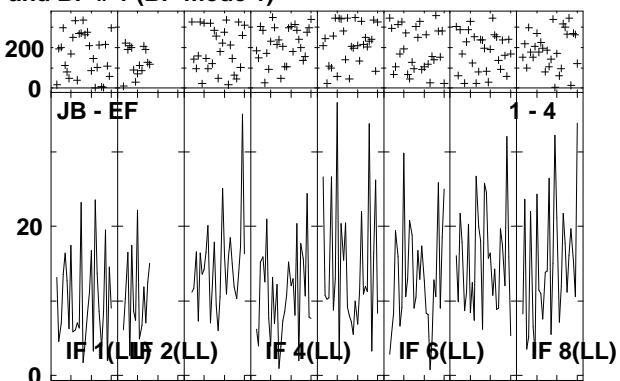
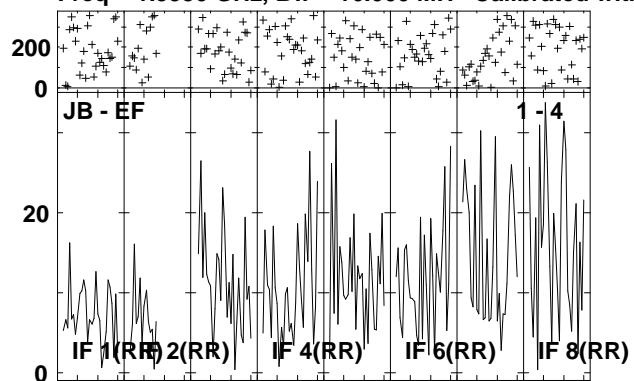

Lower frame: Milli Ampl Jy Top frame: Phas deg
Vector averaged cross-power spectrum Several baselines displayed
Timerange: 00/14:39:29 to 00/14:42:59

Plot file version 115 created 29-APR-2009 14:30:18

IRAS2336 EP064D.UVDATA.1

Freq = 1.5950 GHz, Bw = 16.000 MH Calibrated with CL # 3 and BP # 1 (BP mode 1)

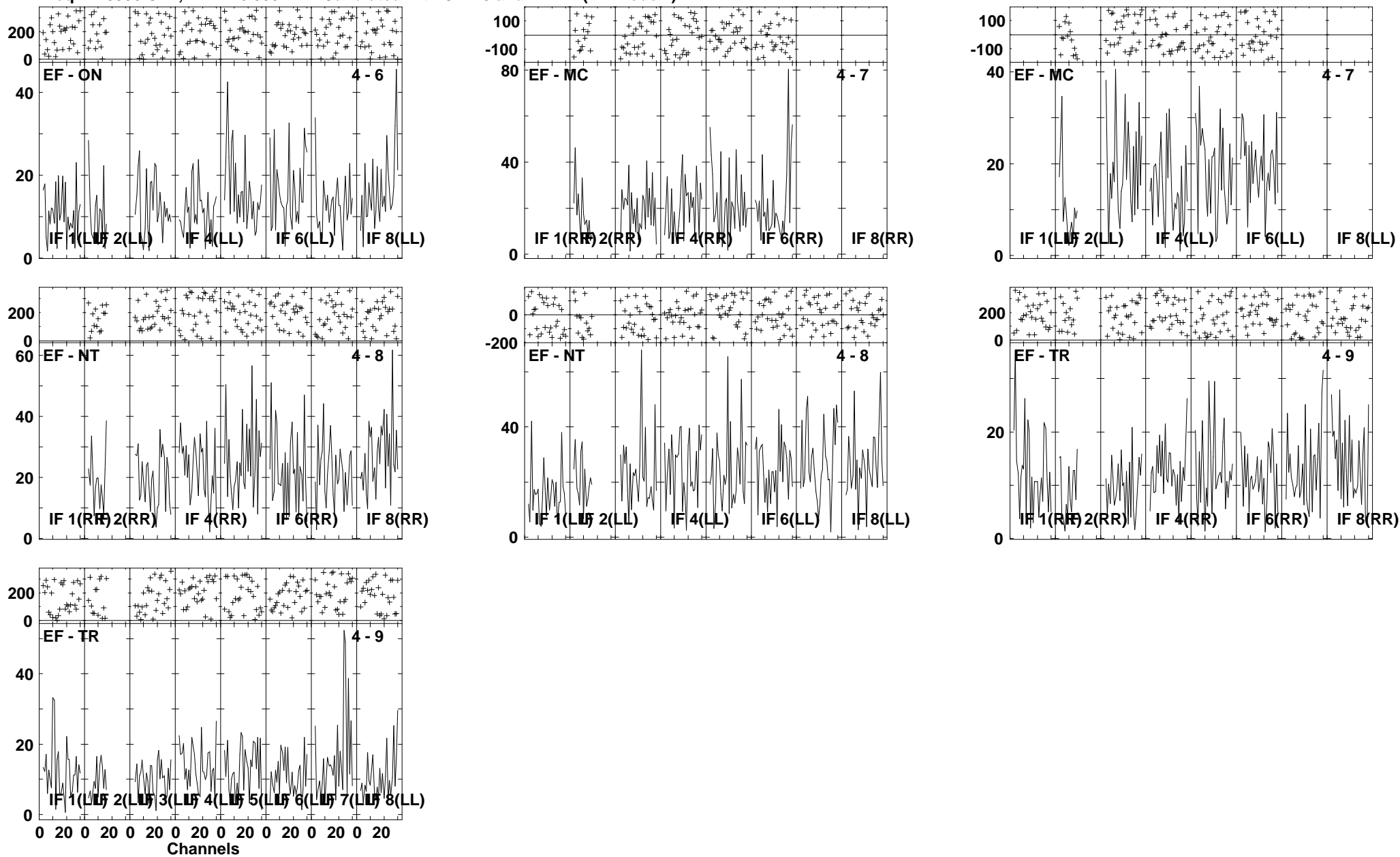

Lower frame: Milli Ampl Jy Top frame: Phas deg
Vector averaged cross-power spectrum Several baselines displayed
Timerange: 00/14:39:29 to 00/14:42:59

Plot file version 116 created 29-APR-2009 14:30:22
 J2333+39 EP064D.UVDATA.1
 Freq = 1.5950 GHz, Bw = 16.000 MH Calibrated with CL # 3 and BP # 1 (BP mode 1)

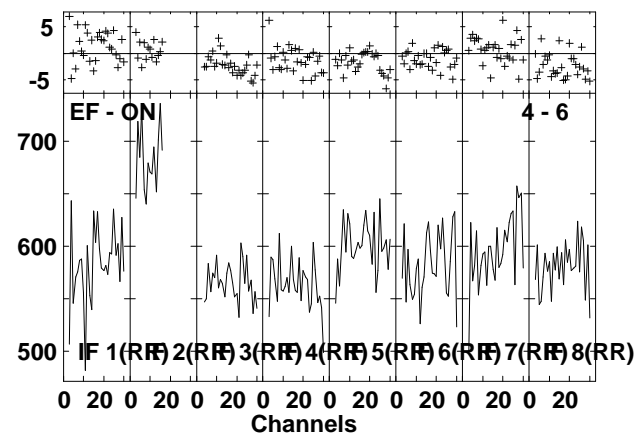
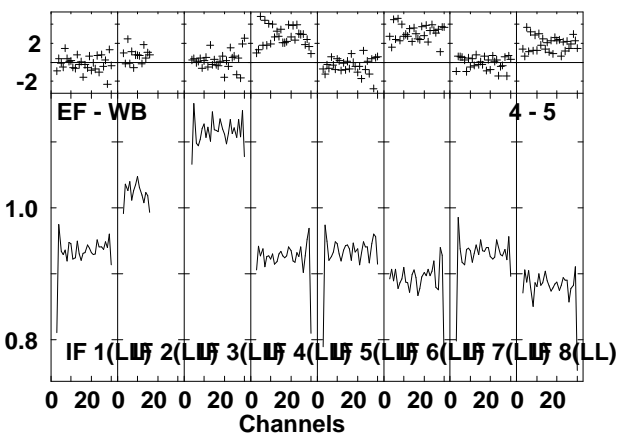
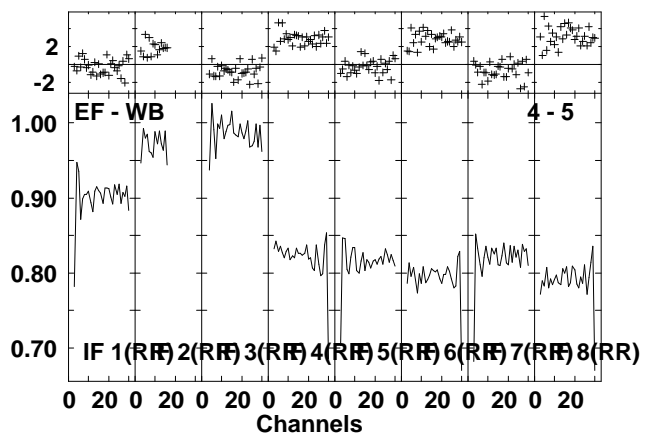
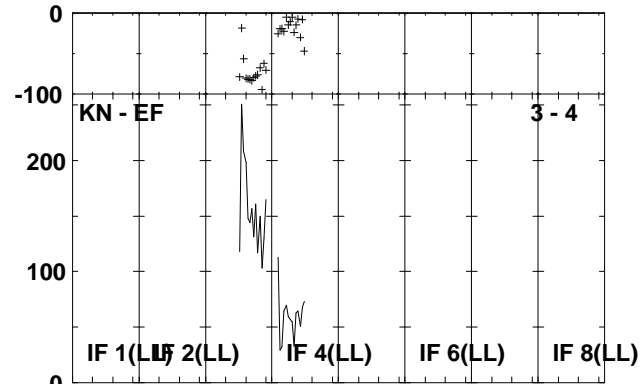
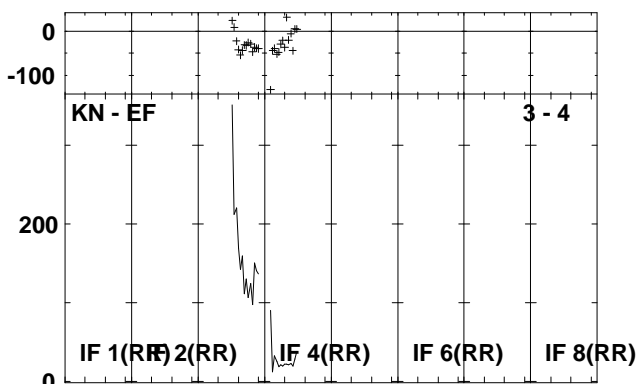
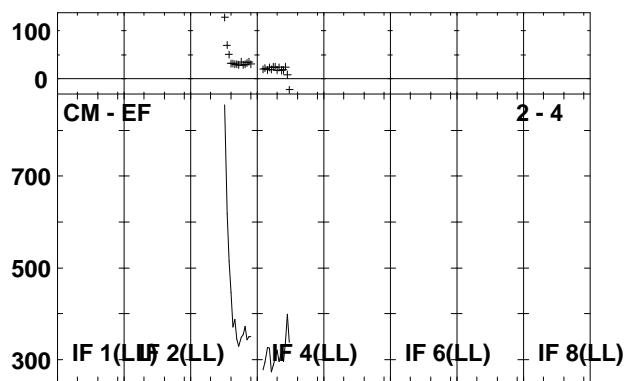
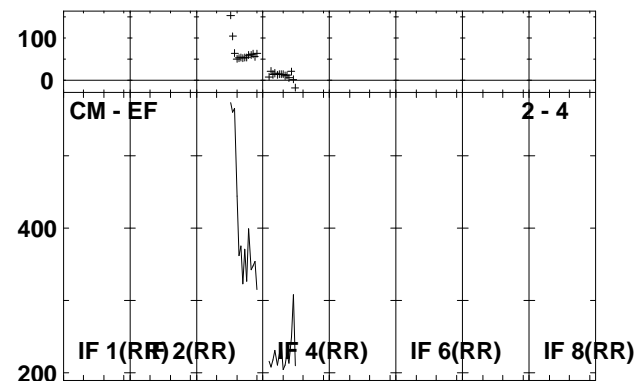
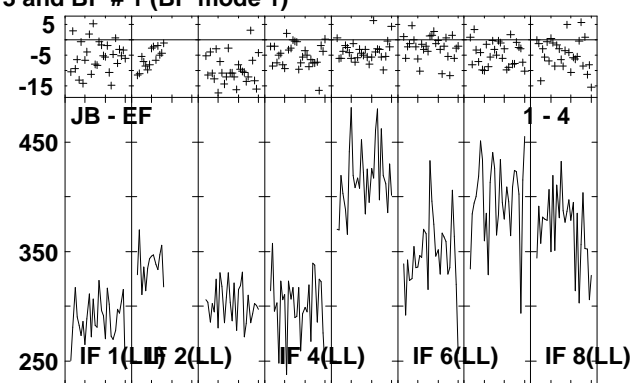
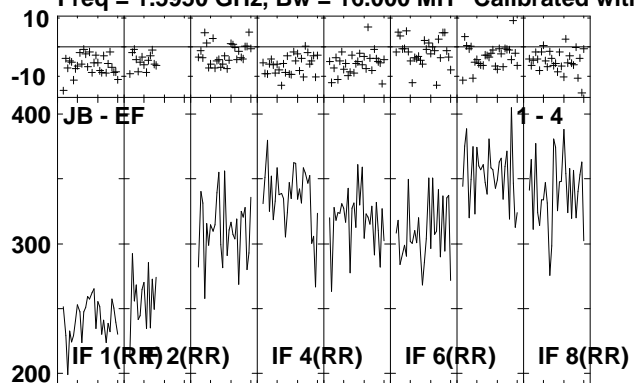

Lower frame: Milli Ampl Jy Top frame: Phas deg
 Vector averaged cross-power spectrum Several baselines displayed
 Timerange: 00/14:43:01 to 00/14:44:29

Plot file version 117 created 29-APR-2009 14:30:23

J2333+39 EP064D.UVDATA.1

Freq = 1.5950 GHz, Bw = 16.000 MH Calibrated with CL # 3 and BP # 1 (BP mode 1)

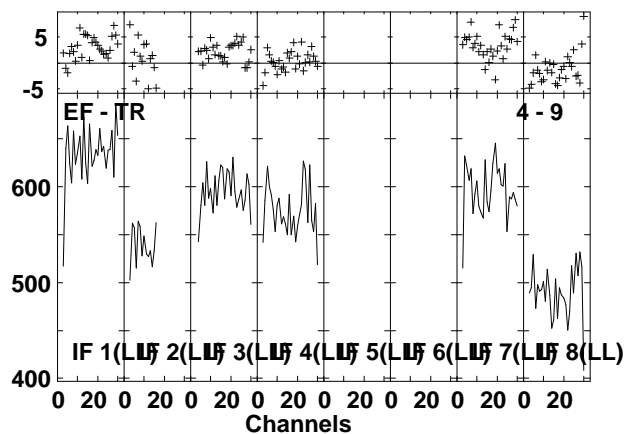
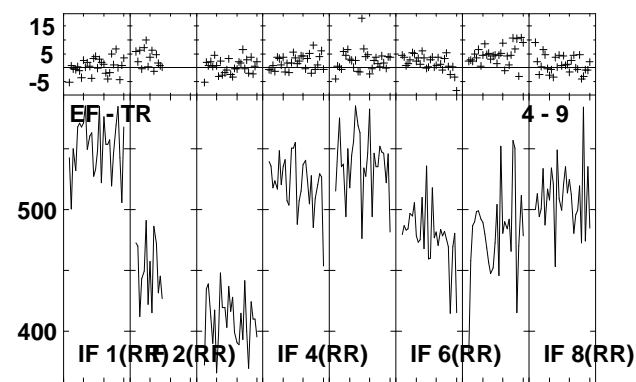
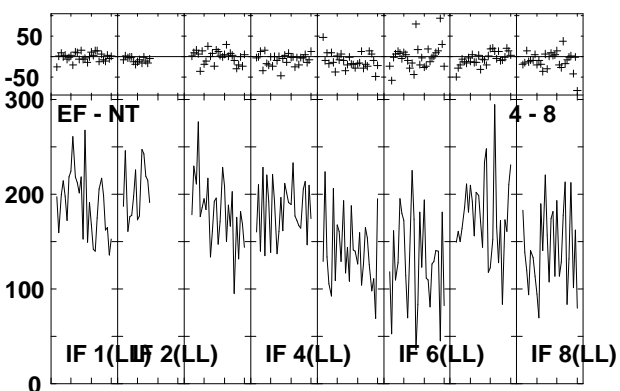
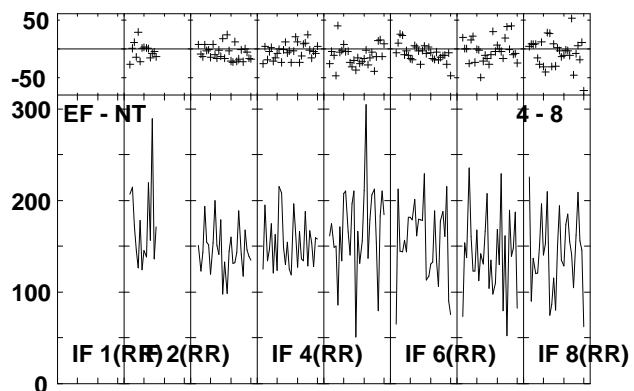
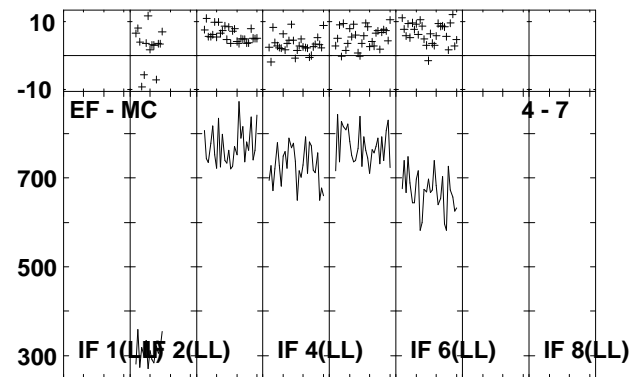
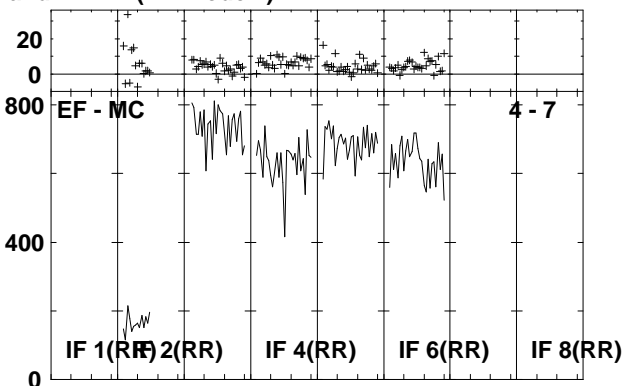
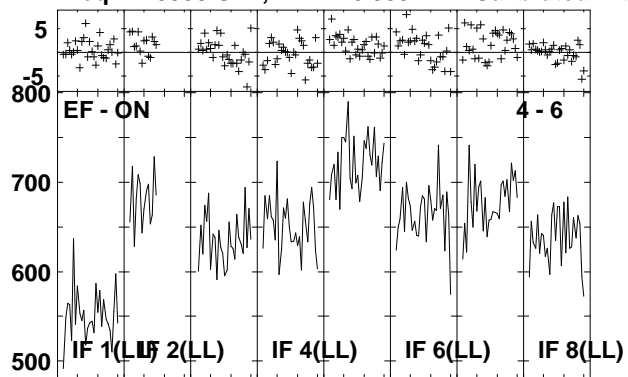

Lower frame: Milli Ampl Jy Top frame: Phas deg
Vector averaged cross-power spectrum Several baselines displayed
Timerange: 00/14:43:01 to 00/14:44:29

Plot file version 118 created 29-APR-2009 14:30:25

IRAS2336 EP064D.UVDATA.1

Freq = 1.5950 GHz, Bw = 16.000 MH Calibrated with CL # 3 and BP # 1 (BP mode 1)

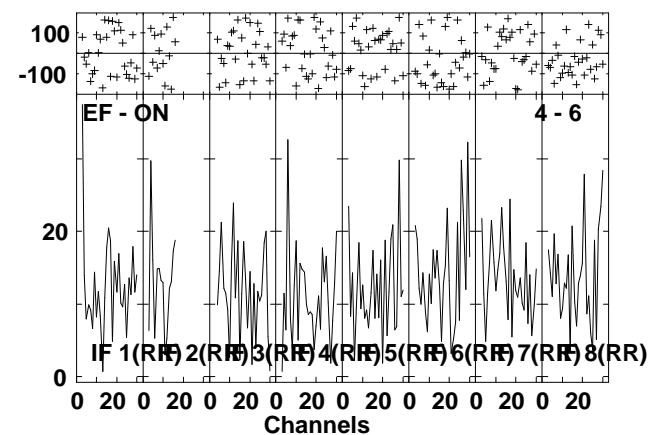
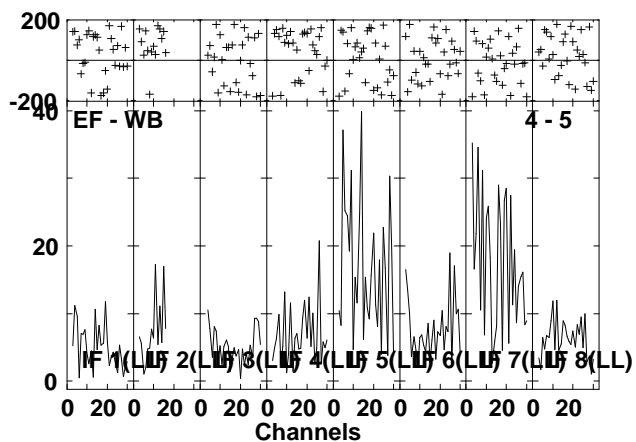
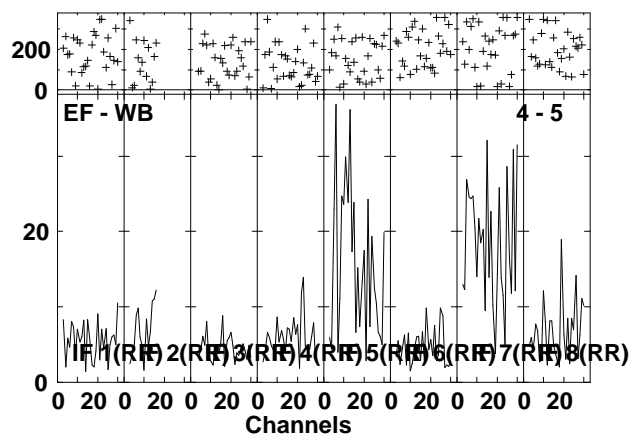
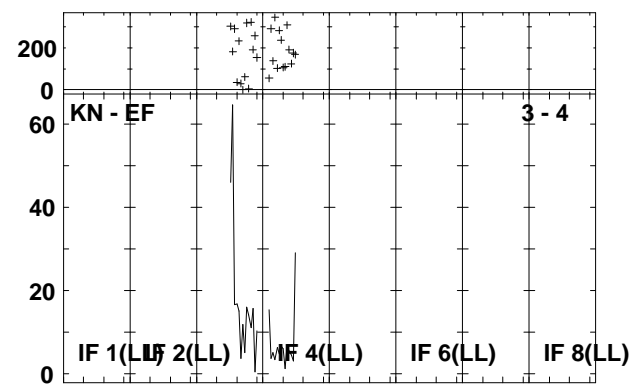
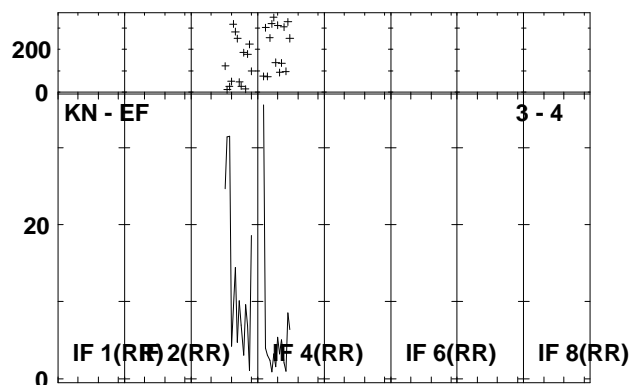
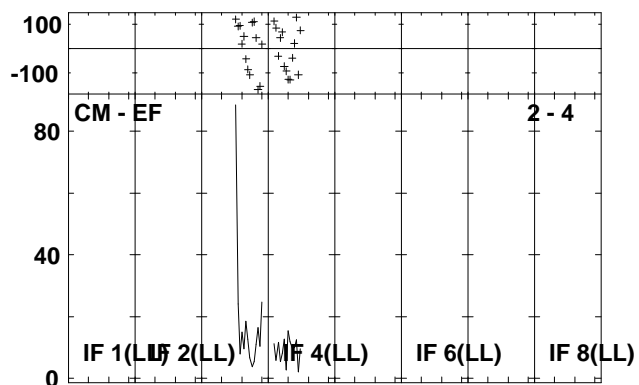
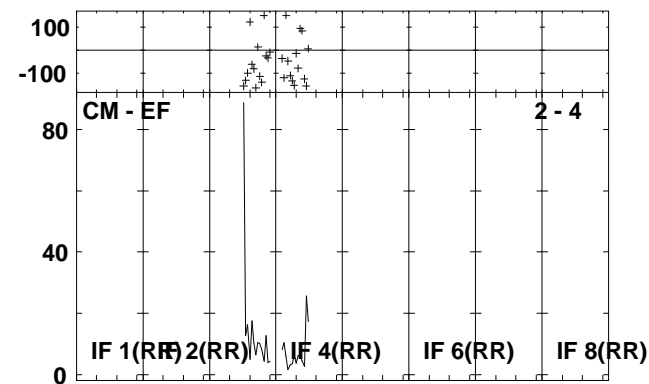
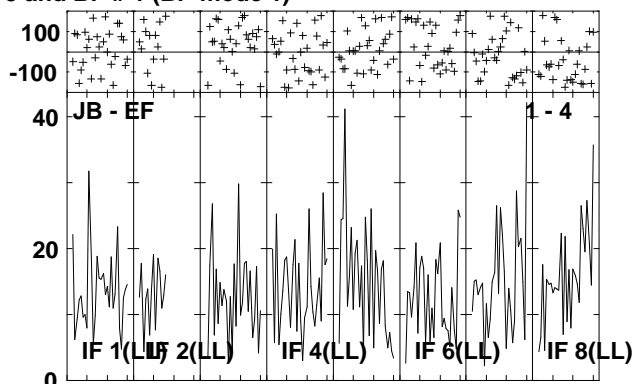
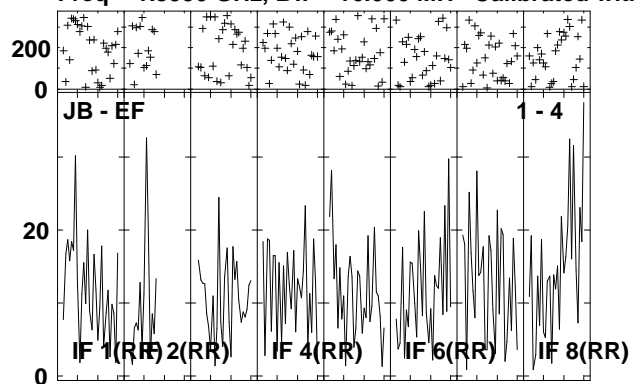

Lower frame: Milli Ampl Jy Top frame: Phas deg
Vector averaged cross-power spectrum Several baselines displayed
Timerange: 00:14:44:31 to 00:14:47:59

Plot file version 119 created 29-APR-2009 14:30:27

IRAS2336 EP064D.UVDATA.1

Freq = 1.5950 GHz, Bw = 16.000 MH Calibrated with CL # 3 and BP # 1 (BP mode 1)

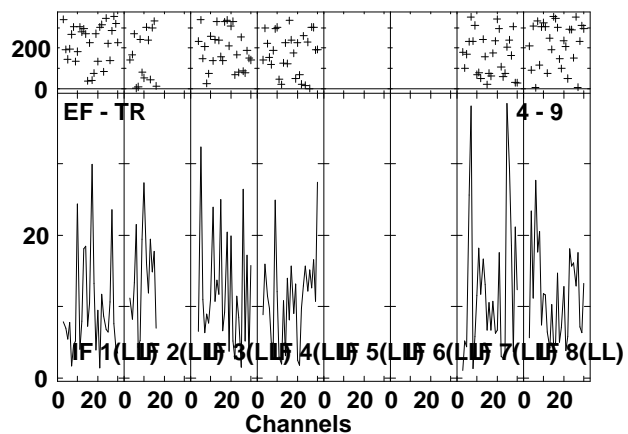
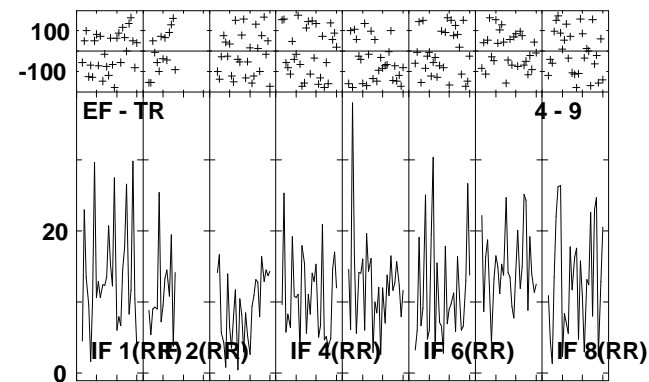
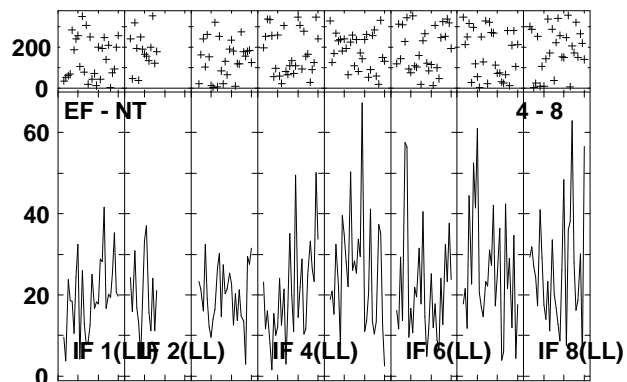
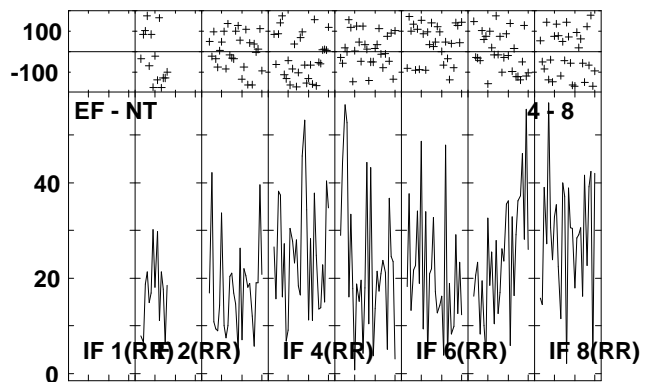
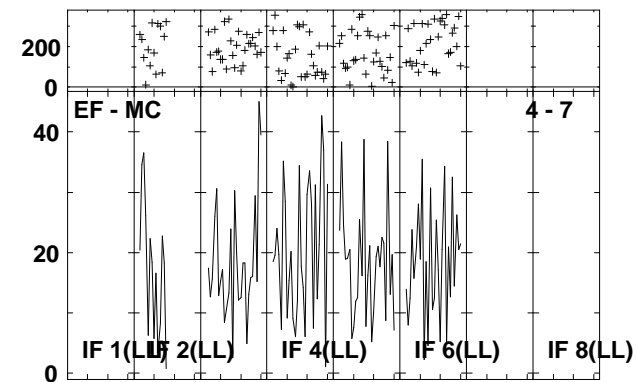
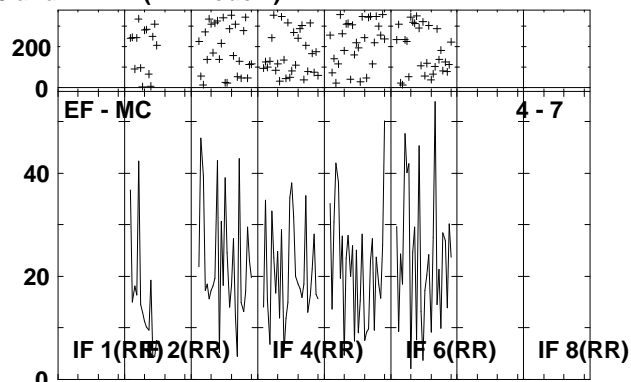
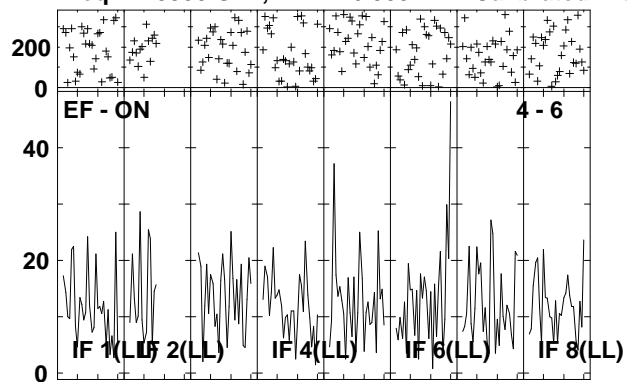

Lower frame: Milli Ampl Jy Top frame: Phas deg
Vector averaged cross-power spectrum Several baselines displayed
Timerange: 00/14:44:31 to 00/14:47:59

Plot file version 120 created 29-APR-2009 14:30:31

J2333+39 EP064D.UVDATA.1

Freq = 1.5950 GHz, Bw = 16.000 MH Calibrated with CL # 3 and BP # 1 (BP mode 1)

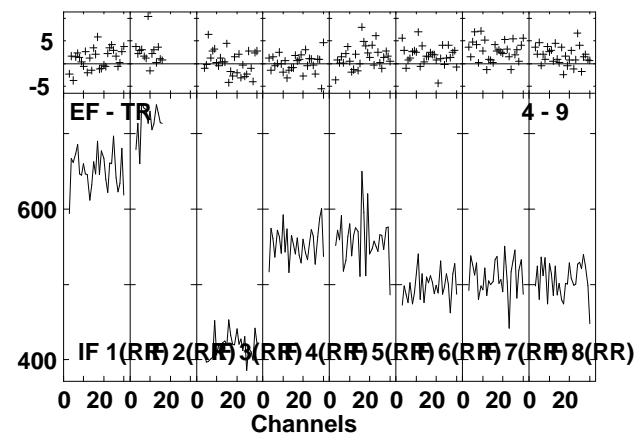
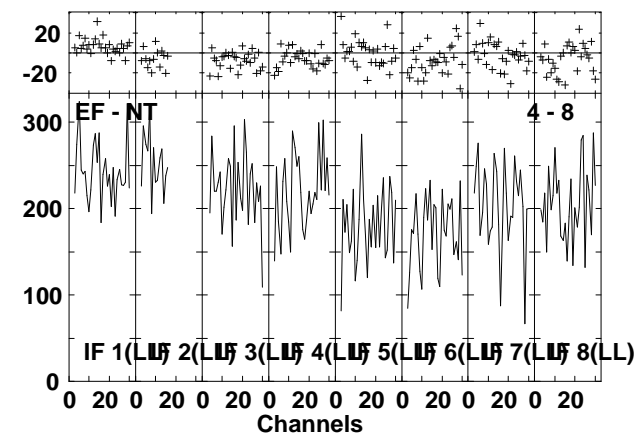
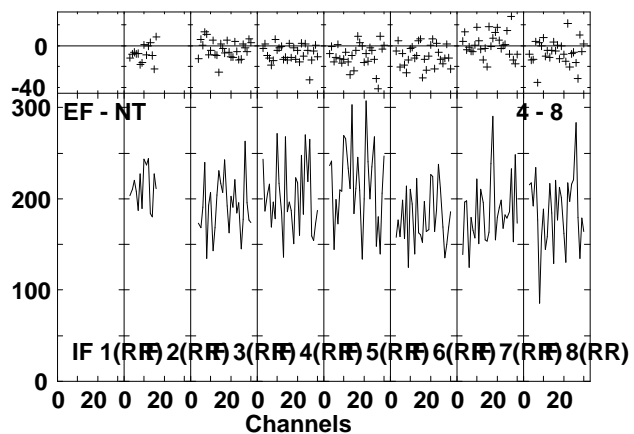
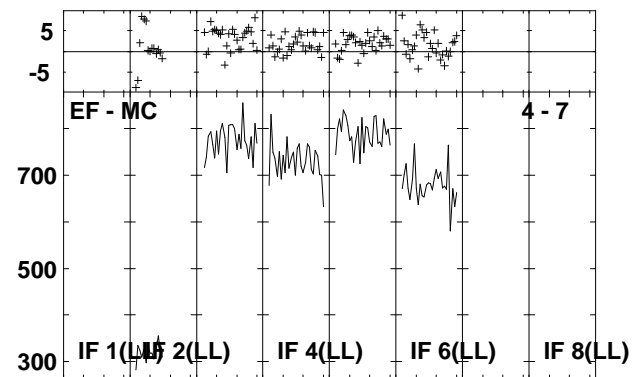
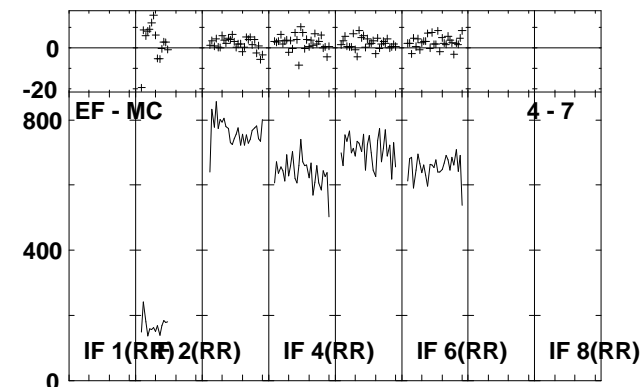
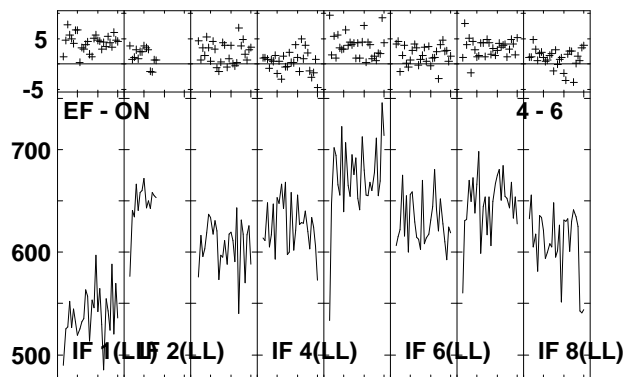
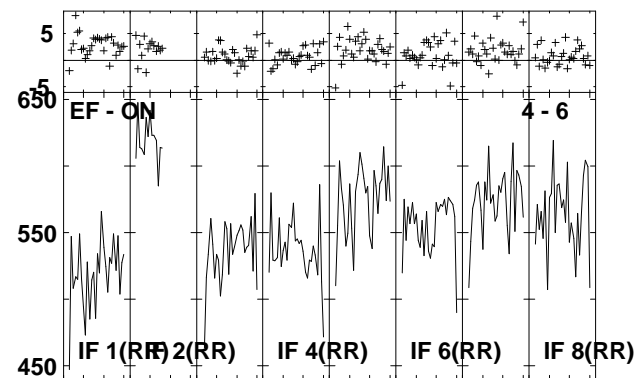
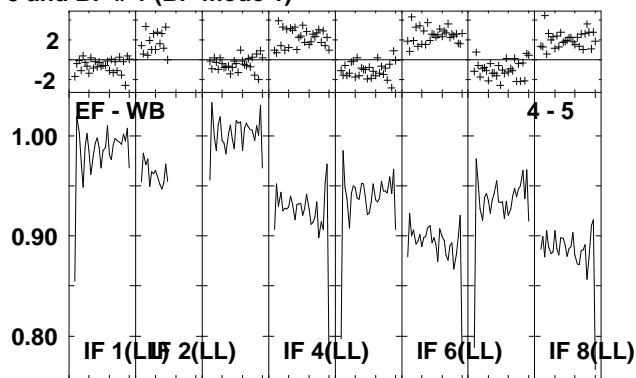
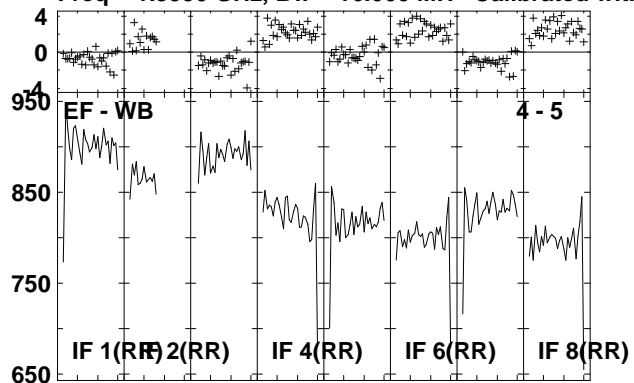

Lower frame: Milli Ampl Jy Top frame: Phas deg
Vector averaged cross-power spectrum Several baselines displayed
Timerange: 00/14:48:01 to 00/14:49:27

Plot file version 121 created 29-APR-2009 14:30:32

J2333+39 EP064D.UVDATA.1

Freq = 1.5950 GHz, Bw = 16.000 MH Calibrated with CL # 3 and BP # 1 (BP mode 1)

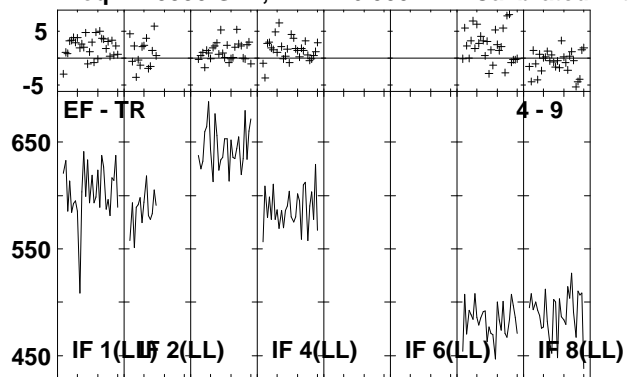

Lower frame: Milli Ampl Jy Top frame: Phas deg
Vector averaged cross-power spectrum Several baselines displayed
Timerange: 00/14:48:01 to 00/14:49:27

Plot file version 122 created 29-APR-2009 14:30:33

IRAS2336 EP064D.UVDATA.1

Freq = 1.5950 GHz, Bw = 16.000 MH Calibrated with CL # 3 and BP # 1 (BP mode 1)

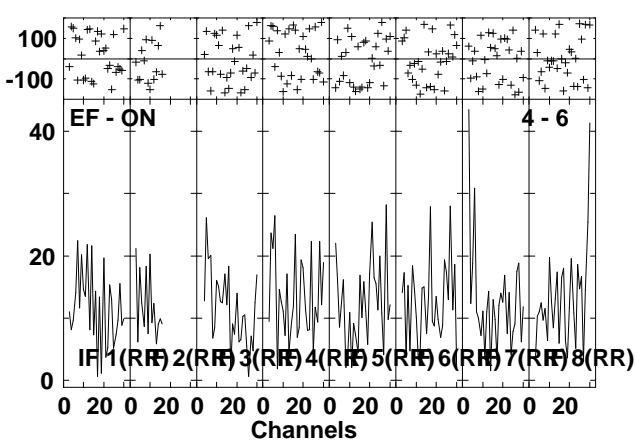
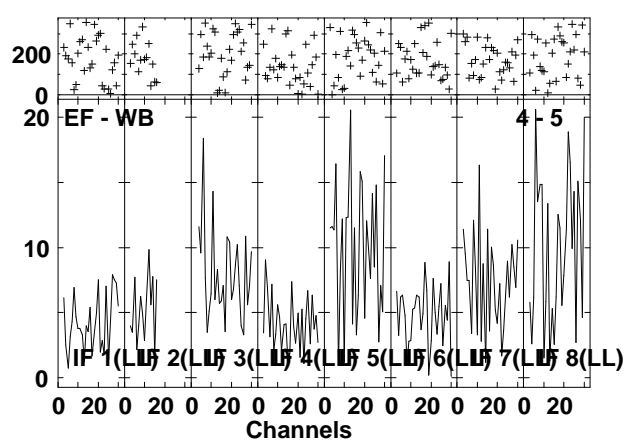
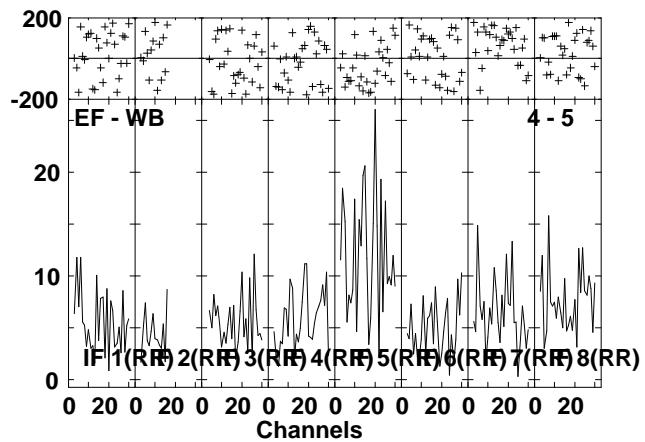
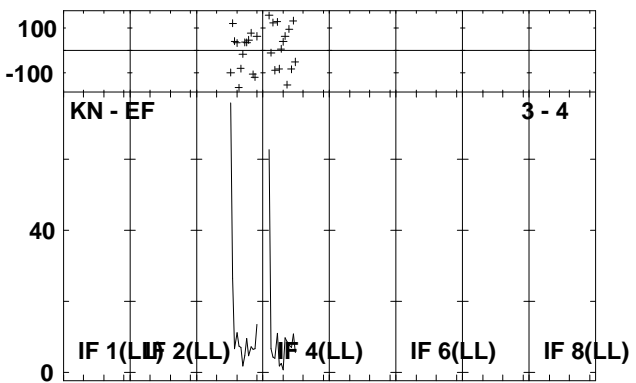
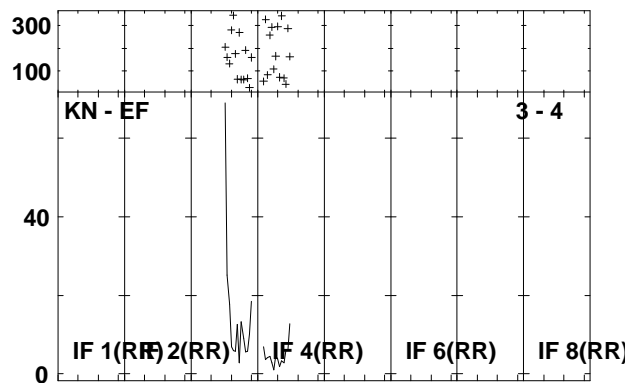
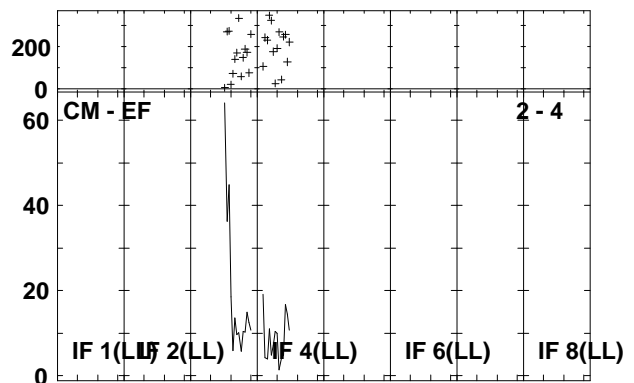
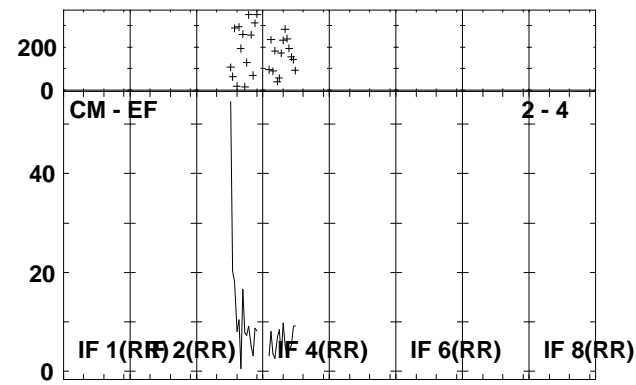
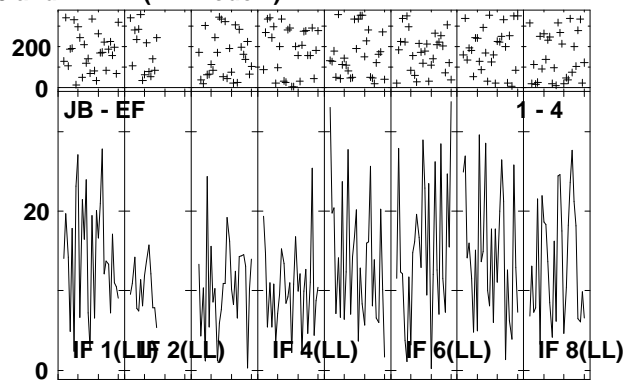
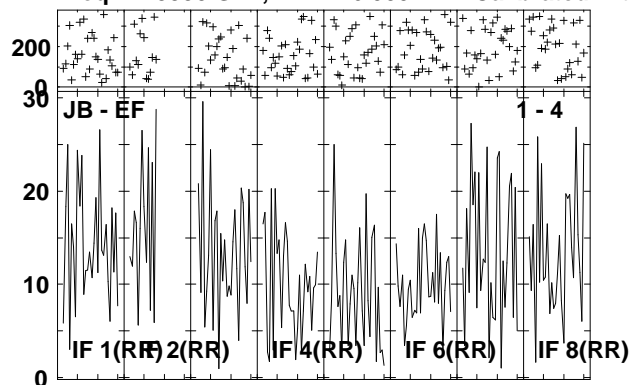

Lower frame: Milli Ampl Jy Top frame: Phas deg
Vector averaged cross-power spectrum Several baselines displayed
Timerange: 00/14:49:29 to 00/14:52:57

Plot file version 123 created 29-APR-2009 14:30:35

IRAS2336 EP064D.UVDATA.1

Freq = 1.5950 GHz, Bw = 16.000 MH Calibrated with CL # 3 and BP # 1 (BP mode 1)

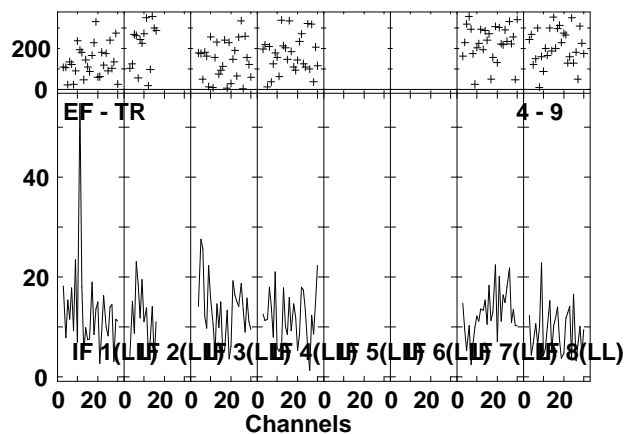
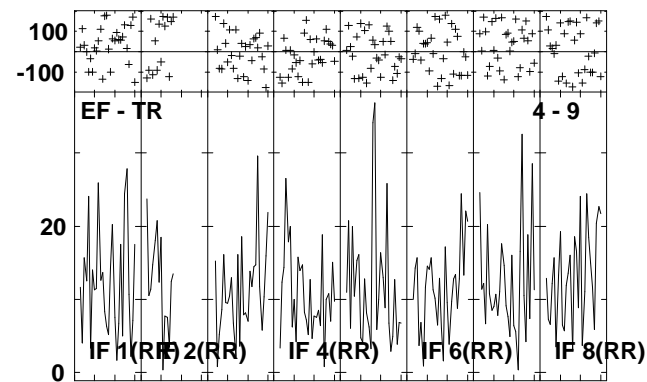
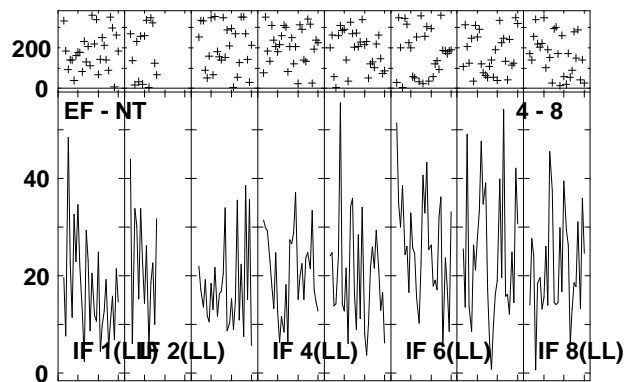
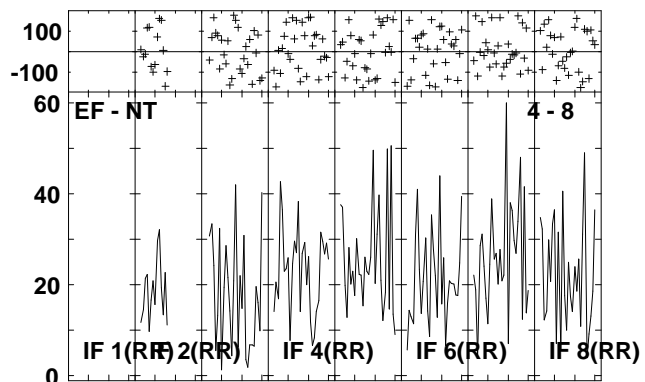
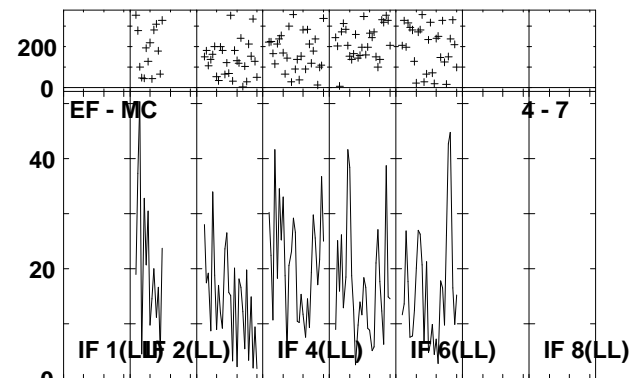
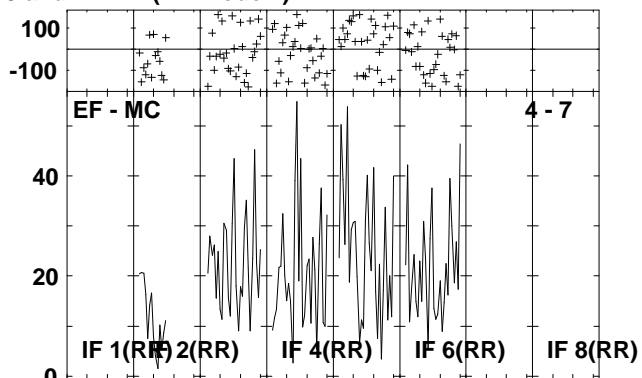
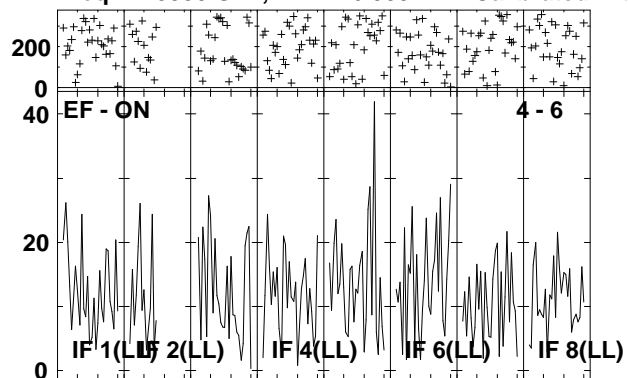

Lower frame: Milli Ampl Jy Top frame: Phas deg
Vector averaged cross-power spectrum Several baselines displayed
Timerange: 00/14:49:29 to 00/14:52:57

Plot file version 124 created 29-APR-2009 14:30:38

J2333+39 EP064D.UVDATA.1

Freq = 1.5950 GHz, Bw = 16.000 MH Calibrated with CL # 3 and BP # 1 (BP mode 1)

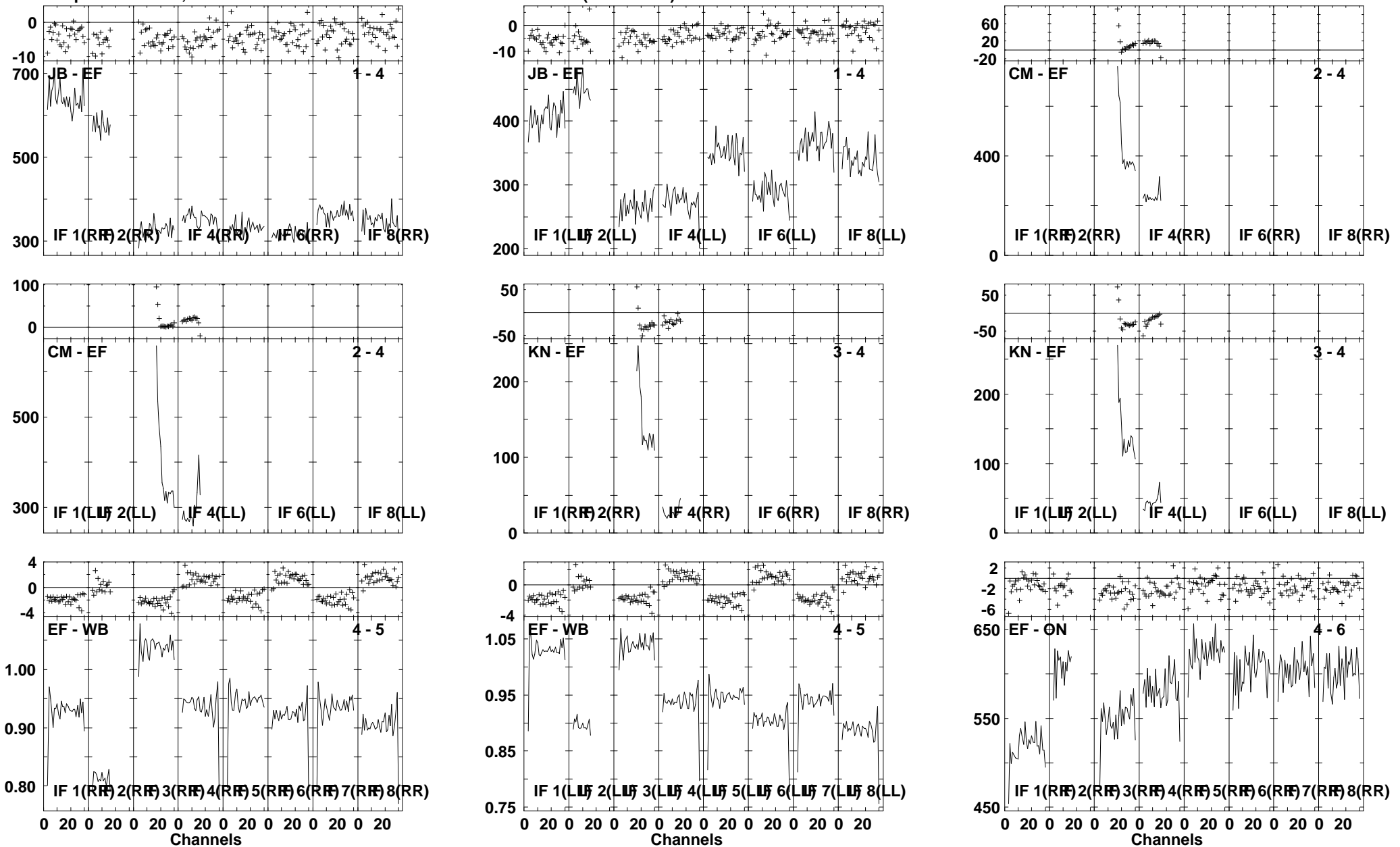

Lower frame: Milli Ampl Jy Top frame: Phas deg
Vector averaged cross-power spectrum Several baselines displayed
Timerange: 00/14:54:02 to 00/14:55:30

Plot file version 125 created 29-APR-2009 14:30:40

J2333+39 EP064D.UVDATA.1

Freq = 1.5950 GHz, Bw = 16.000 MH Calibrated with CL # 3 and BP # 1 (BP mode 1)

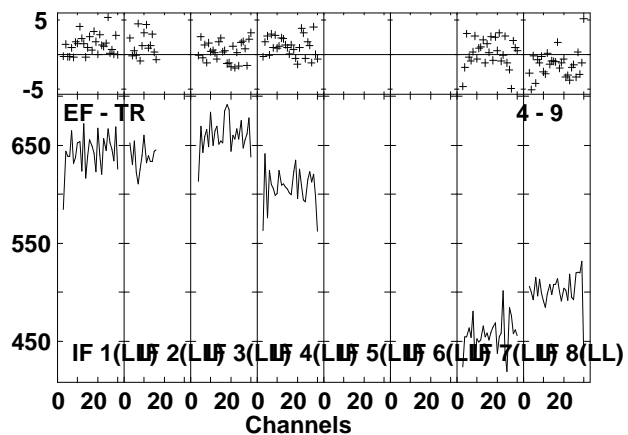
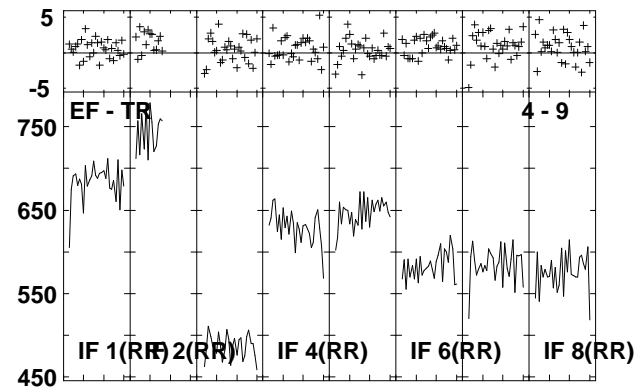
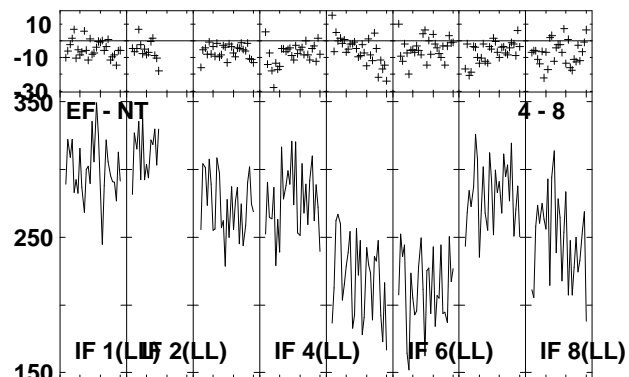
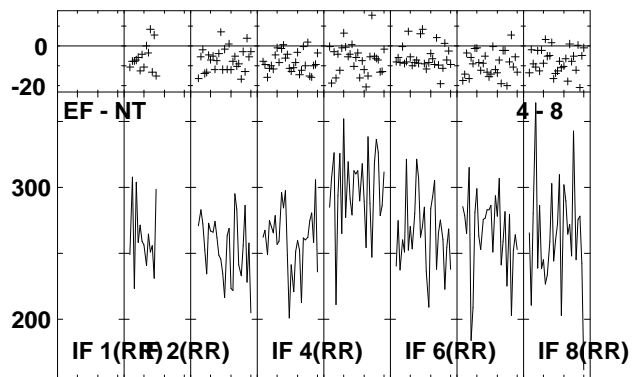
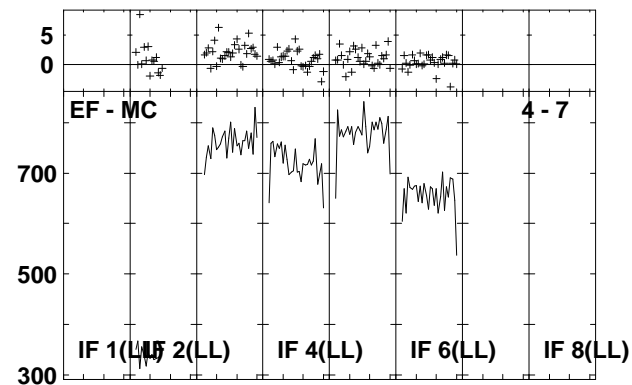
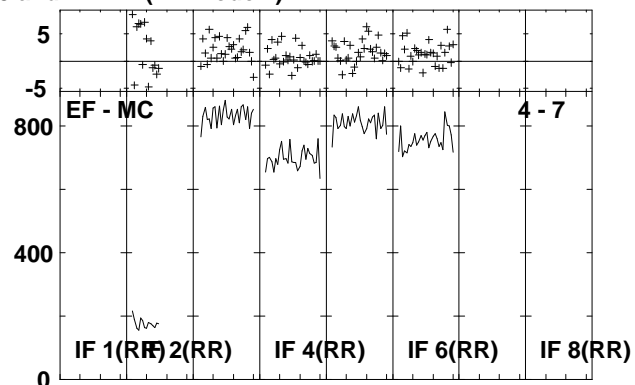
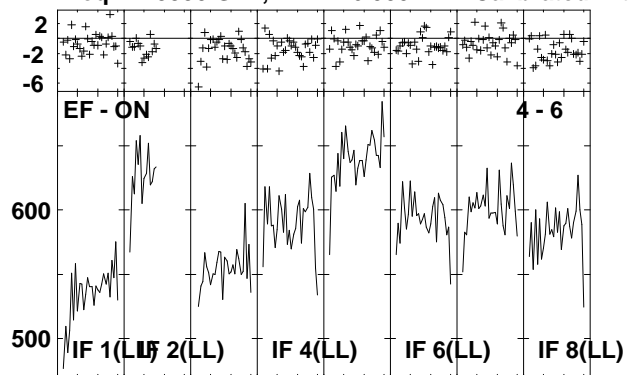

Lower frame: Milli Ampl Jy Top frame: Phas deg
Vector averaged cross-power spectrum Several baselines displayed
Timerange: 00/14:54:02 to 00/14:55:30

Plot file version 126 created 29-APR-2009 14:30:42

IRAS2336 EP064D.UVDATA.1

Freq = 1.5950 GHz, Bw = 16.000 MH Calibrated with CL # 3 and BP # 1 (BP mode 1)

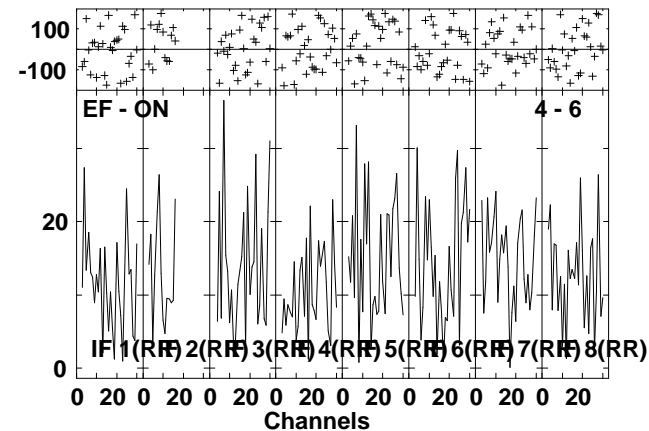
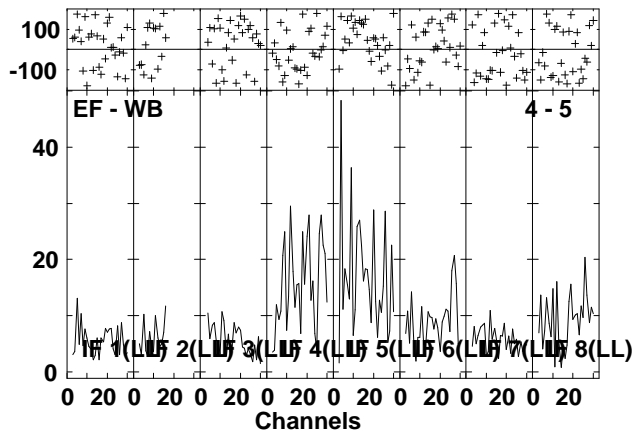
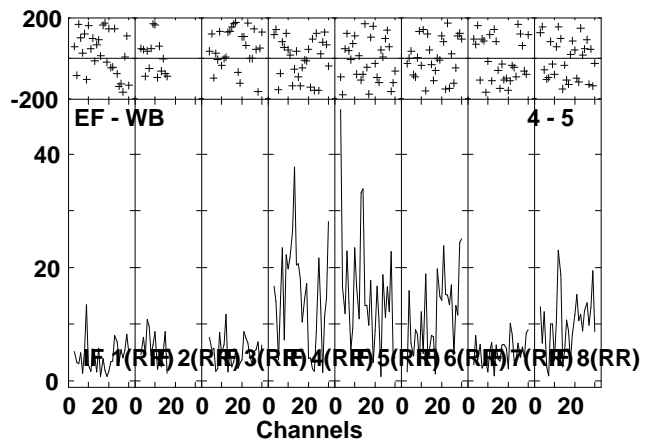
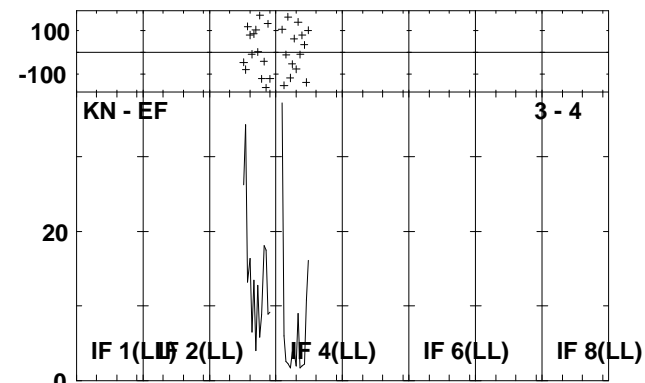
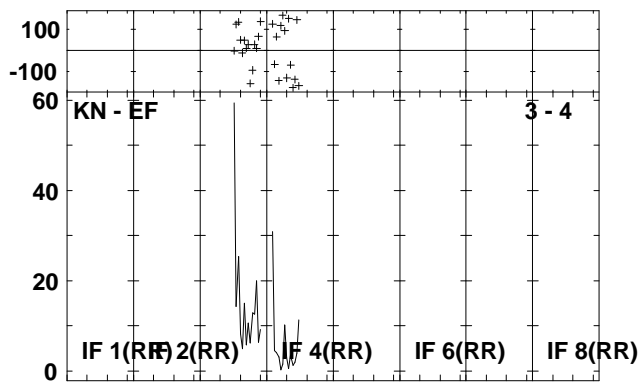
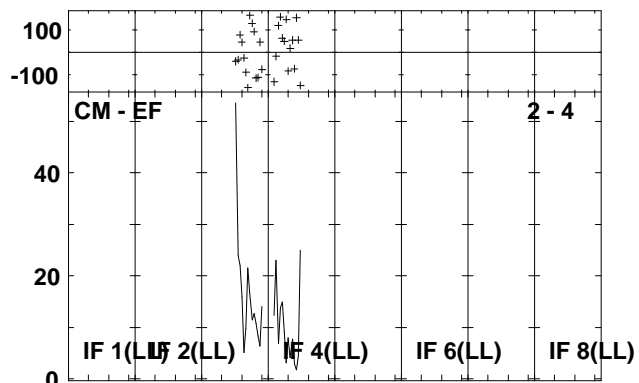
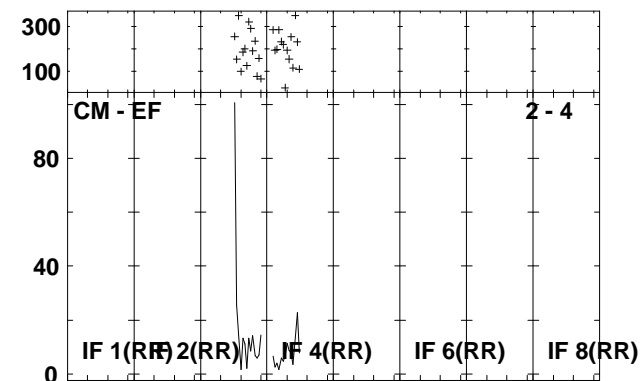
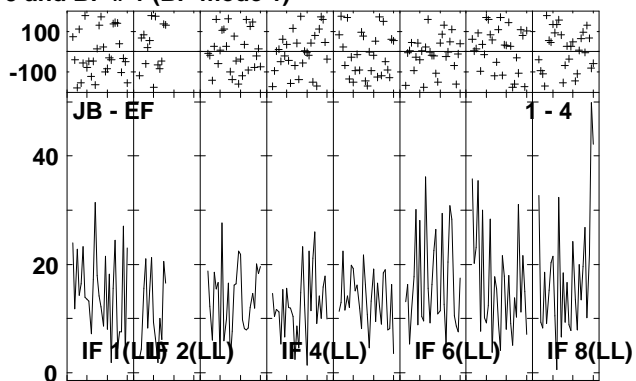
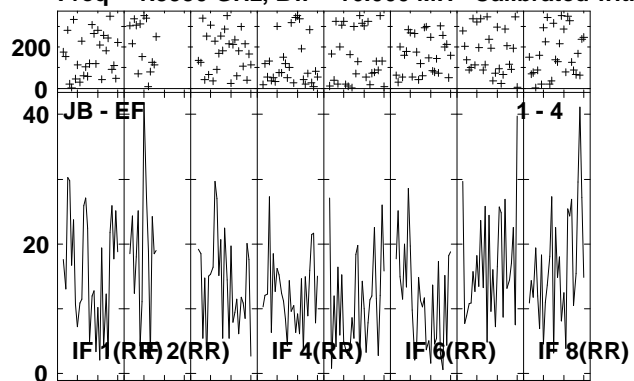

Lower frame: Milli Ampl Jy Top frame: Phas deg
Vector averaged cross-power spectrum Several baselines displayed
Timerange: 00/14:55:32 to 00/14:59:00

Plot file version 127 created 29-APR-2009 14:30:44

IRAS2336 EP064D.UVDATA.1

Freq = 1.5950 GHz, Bw = 16.000 MH Calibrated with CL # 3 and BP # 1 (BP mode 1)

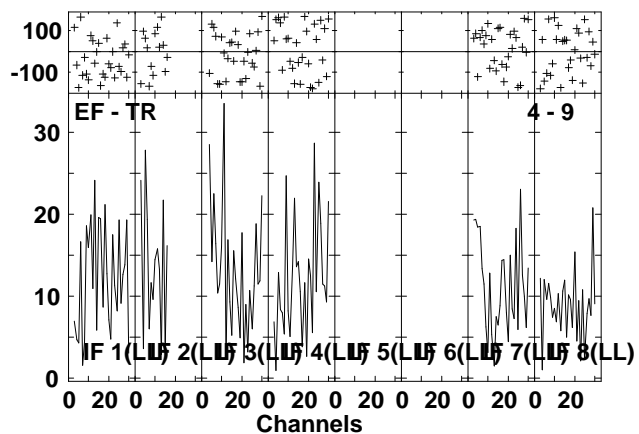
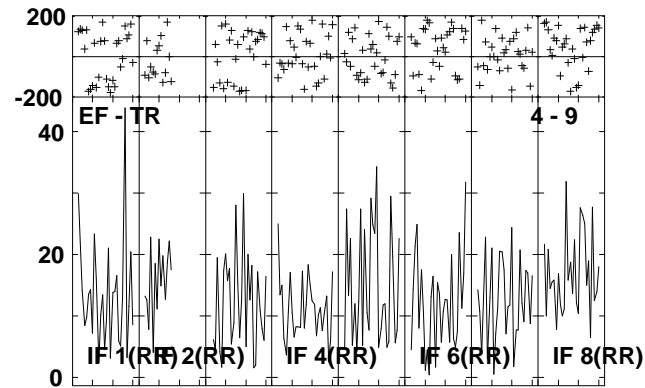
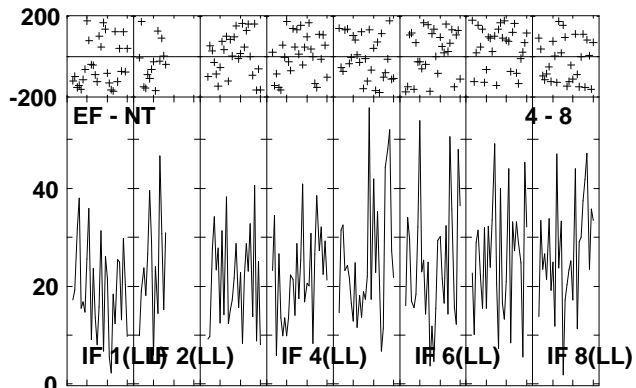
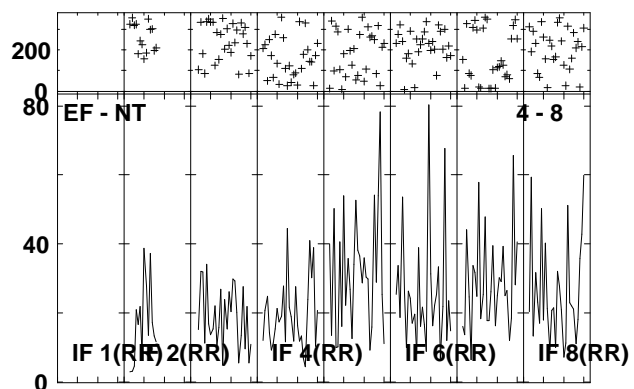
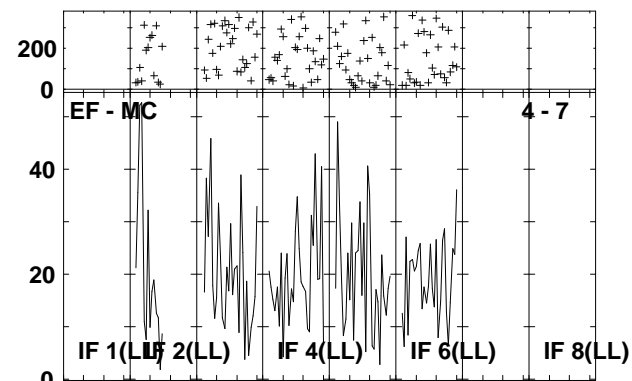
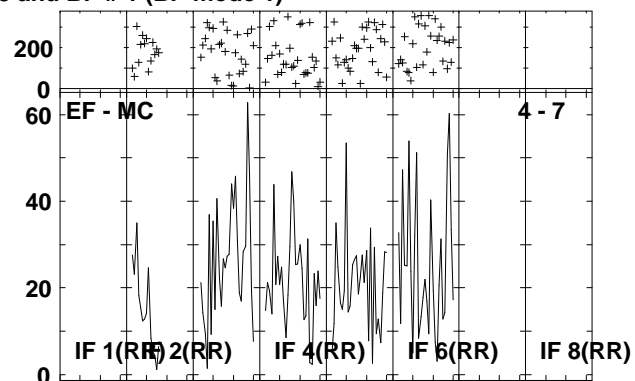
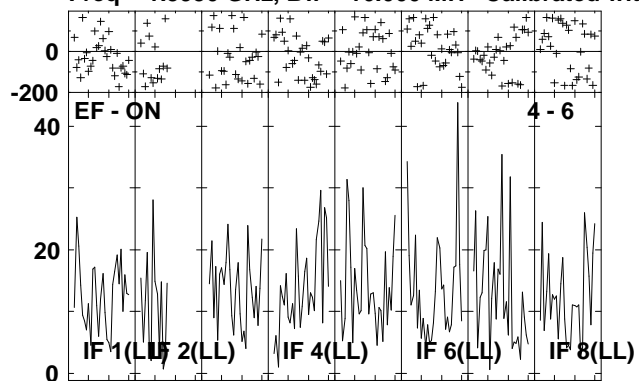

Lower frame: Milli Ampl Jy Top frame: Phas deg
Vector averaged cross-power spectrum Several baselines displayed
Timerange: 00/14:55:32 to 00/14:59:00

Plot file version 128 created 29-APR-2009 14:30:48

J2333+39 EP064D.UVDATA.1

Freq = 1.5950 GHz, Bw = 16.000 MH Calibrated with CL # 3 and BP # 1 (BP mode 1)

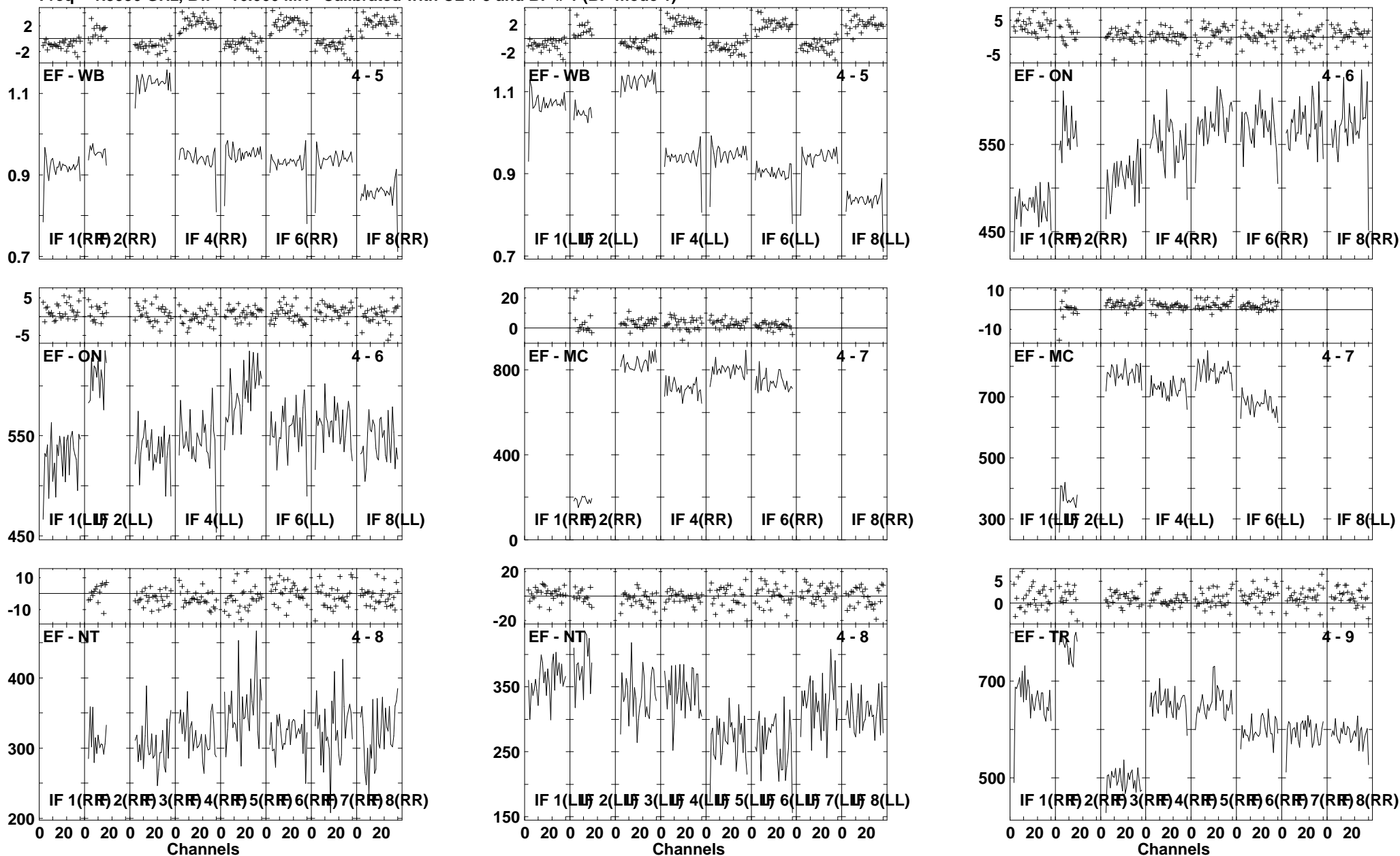

Lower frame: Ampl Jy Top frame: Phas deg
Vector averaged cross-power spectrum Several baselines displayed
Timerange: 00/14:59:02 to 00/15:00:28

Plot file version 129 created 29-APR-2009 14:30:49
J2333+39 EP064D.UVDATA.1
Freq = 1.5950 GHz, Bw = 16.000 MH Calibrated with CL # 3 and BP # 1 (BP mode 1)

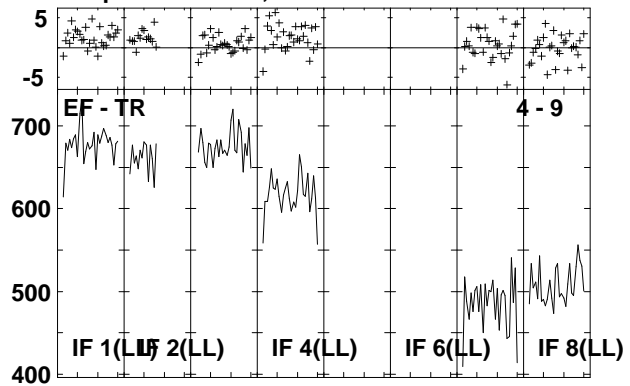

Lower frame: Milli Ampl Jy Top frame: Phas deg
Vector averaged cross-power spectrum Several baselines displayed
Timerange: 00/14:59:02 to 00/15:00:28

Plot file version 130 created 29-APR-2009 14:30:50

IRAS2336 EP064D.UVDATA.1

Freq = 1.5950 GHz, Bw = 16.000 MH Calibrated with CL # 3 and BP # 1 (BP mode 1)

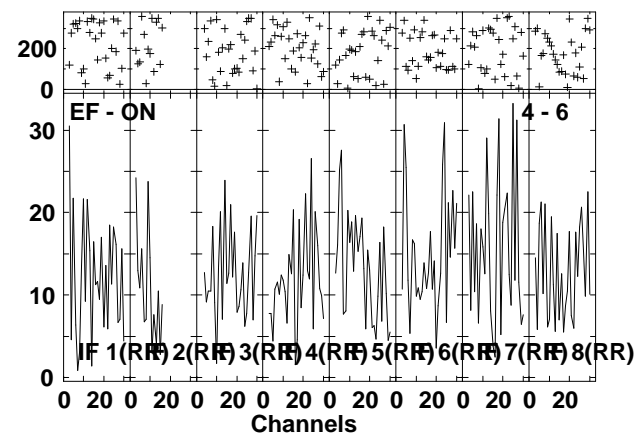
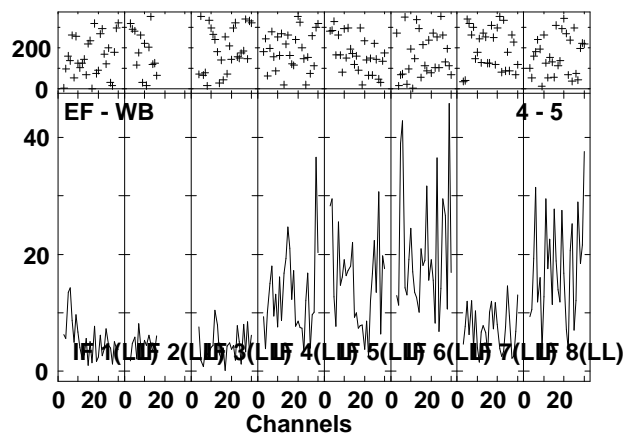
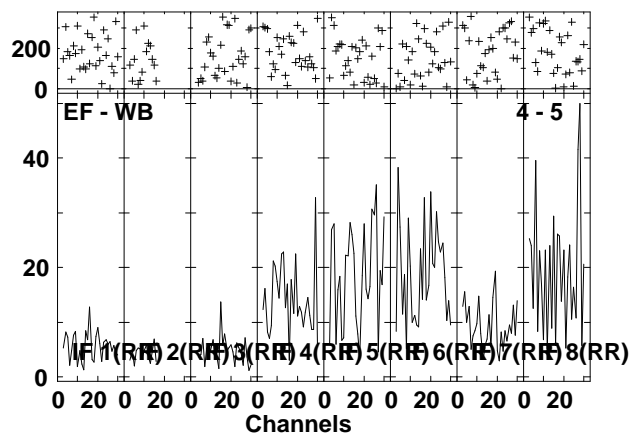
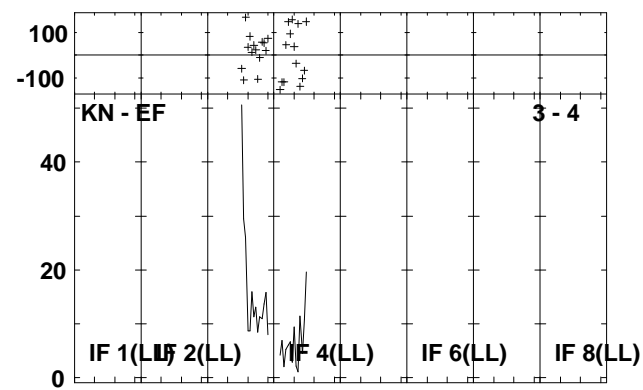
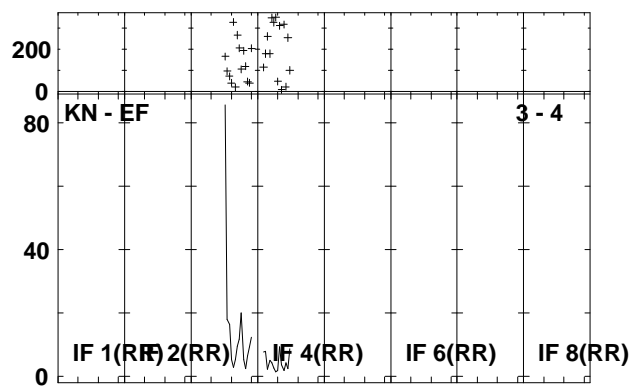
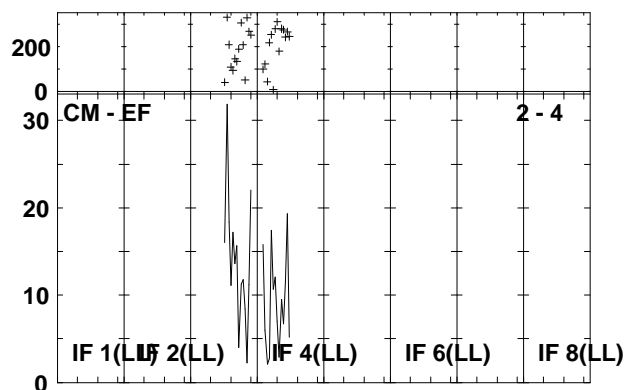
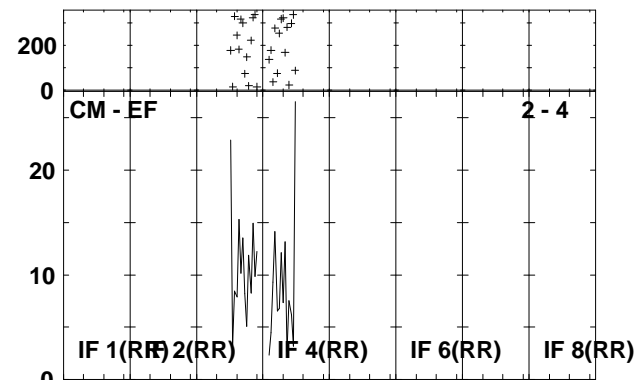
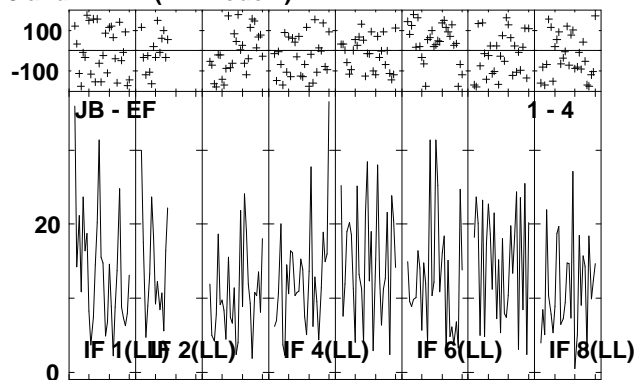
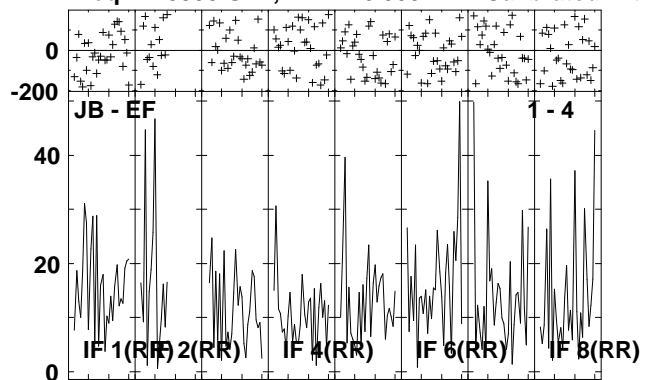

Lower frame: Milli Ampl Jy Top frame: Phas deg
Vector averaged cross-power spectrum Several baselines displayed
Timerange: 00/15:00:30 to 00/15:04:00

Plot file version 131 created 29-APR-2009 14:30:52

IRAS2336 EP064D.UVDATA.1

Freq = 1.5950 GHz, Bw = 16.000 MH Calibrated with CL # 3 and BP # 1 (BP mode 1)

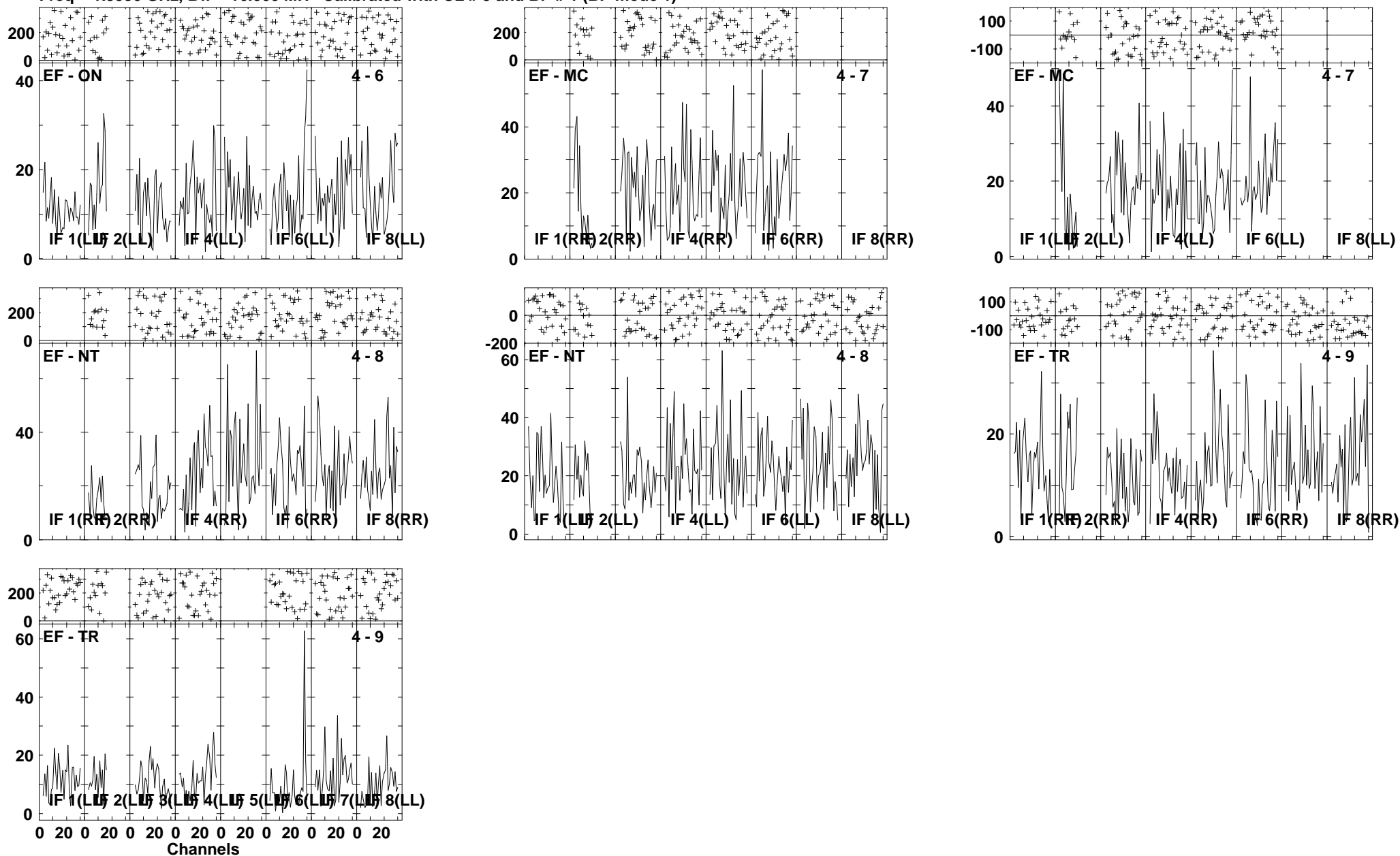

Lower frame: Milli Ampl Jy Top frame: Phas deg
Vector averaged cross-power spectrum Several baselines displayed
Timerange: 00/15:00:30 to 00/15:04:00

Plot file version 132 created 29-APR-2009 14:30:56

J2333+39 EP064D.UVDATA.1

Freq = 1.5950 GHz, Bw = 16.000 MH Calibrated with CL # 3 and BP # 1 (BP mode 1)

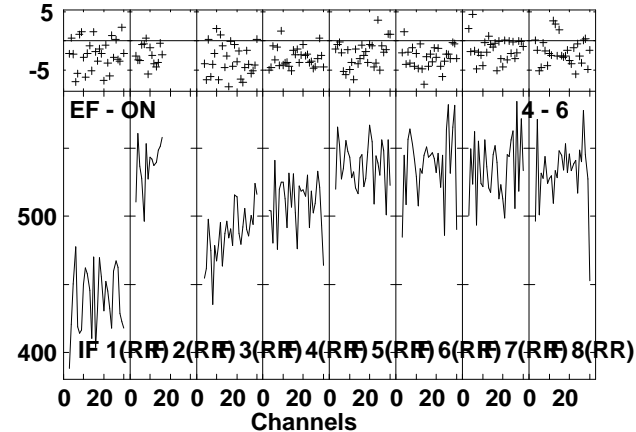
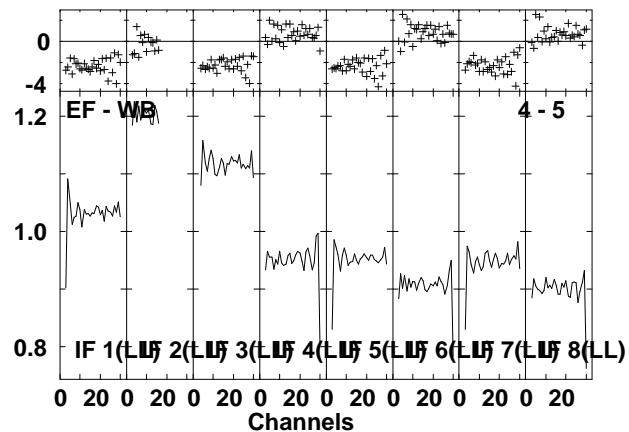
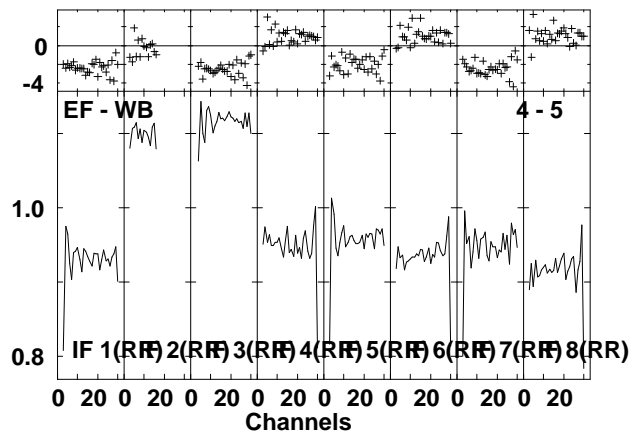
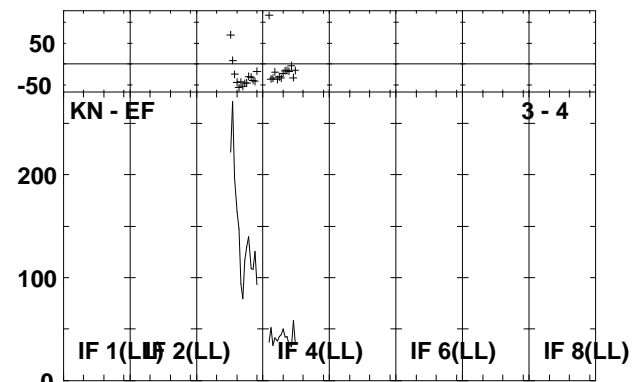
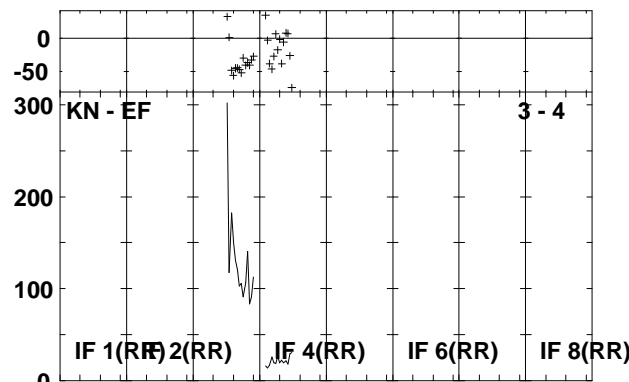
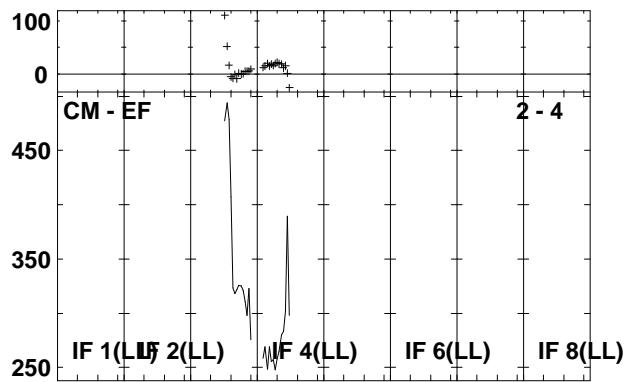
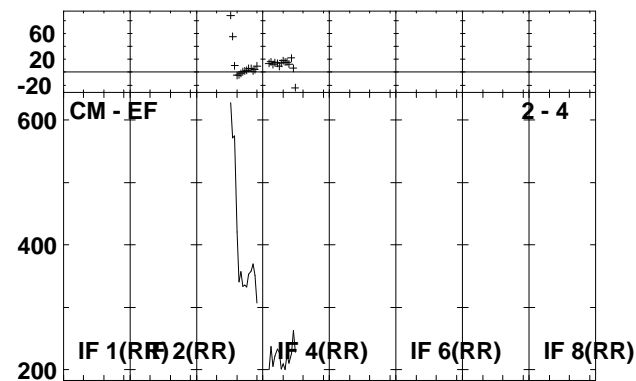
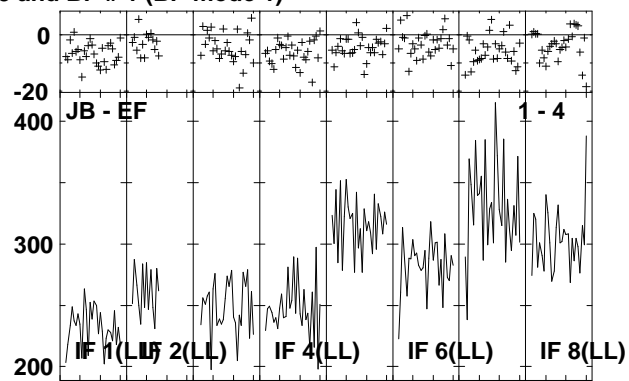
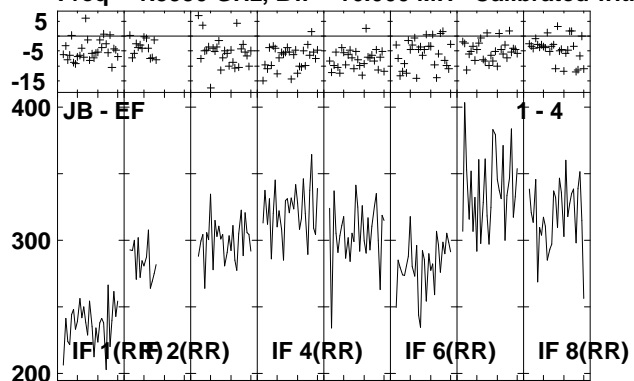

Lower frame: Milli Ampl Jy Top frame: Phas deg
Vector averaged cross-power spectrum Several baselines displayed
Timerange: 00/15:04:02 to 00/15:05:26

Plot file version 133 created 29-APR-2009 14:30:57

J2333+39 EP064D.UVDATA.1

Freq = 1.5950 GHz, Bw = 16.000 MH Calibrated with CL # 3 and BP # 1 (BP mode 1)

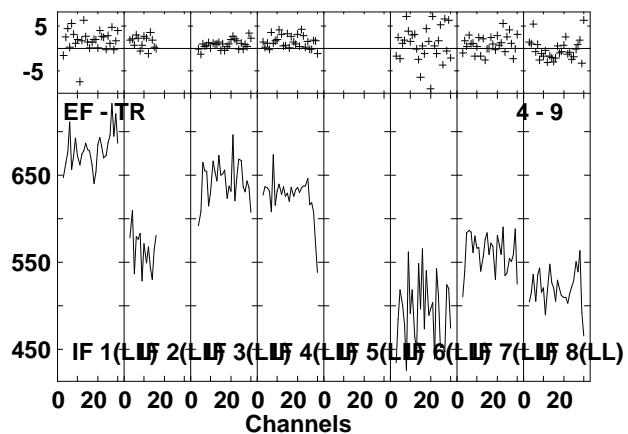
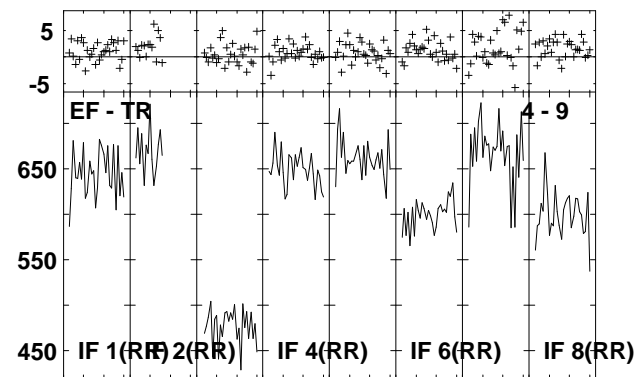
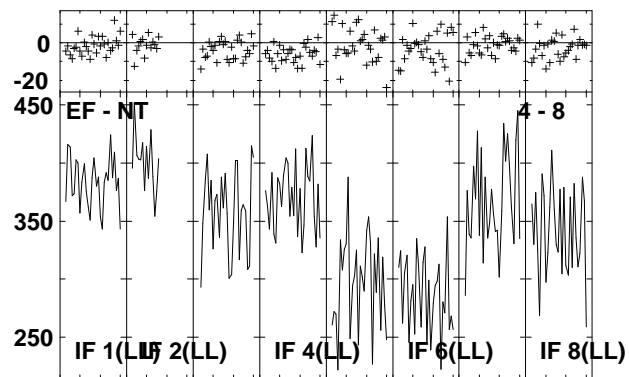
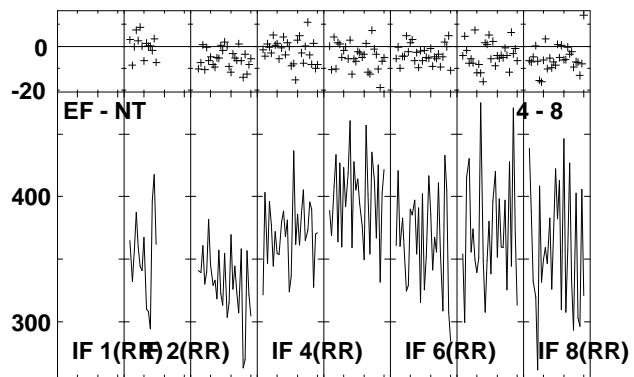
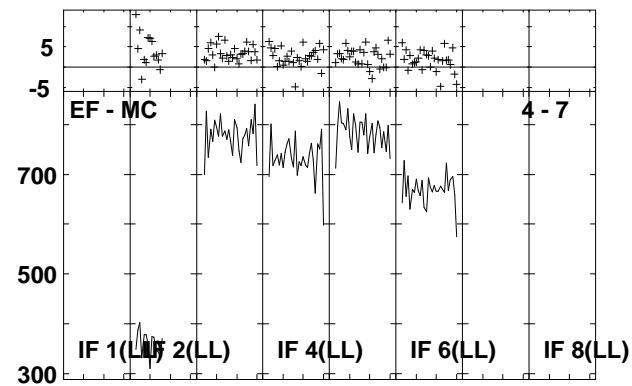
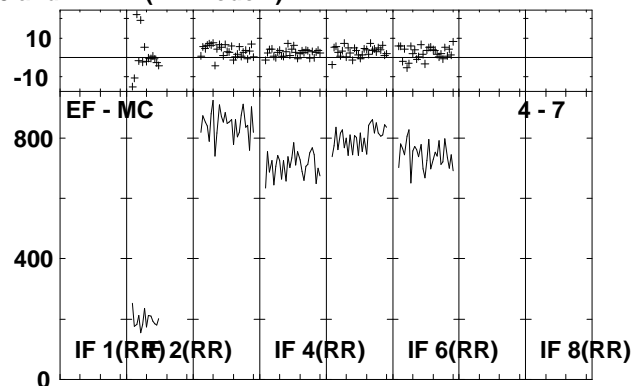
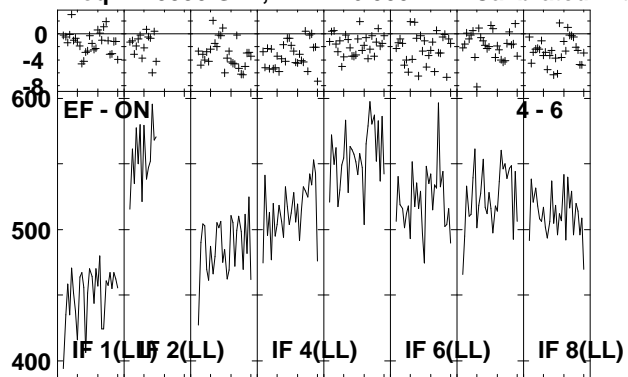

Lower frame: Milli Ampl Jy Top frame: Phas deg
Vector averaged cross-power spectrum Several baselines displayed
Timerange: 00/15:04:02 to 00/15:05:26

Plot file version 134 created 29-APR-2009 14:30:58

IRAS2336 EP064D.UVDATA.1

Freq = 1.5950 GHz, Bw = 16.000 MH Calibrated with CL # 3 and BP # 1 (BP mode 1)

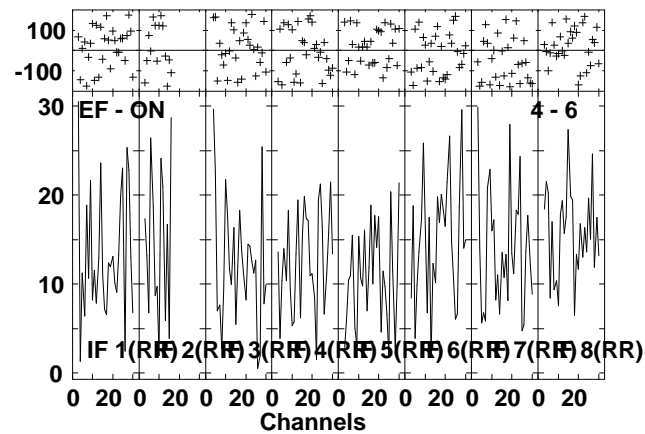
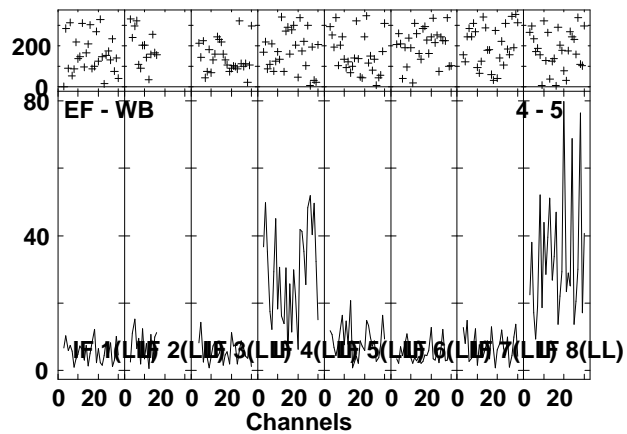
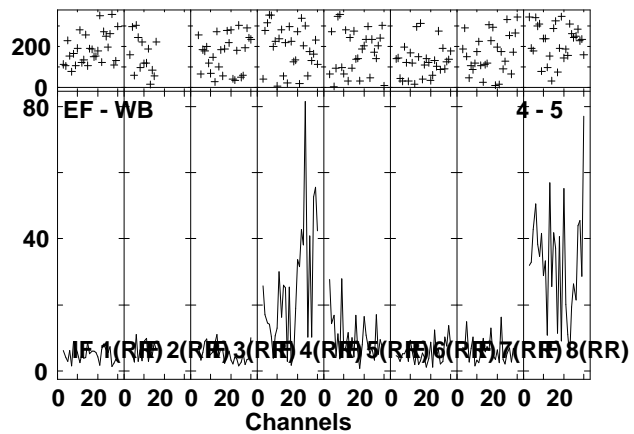
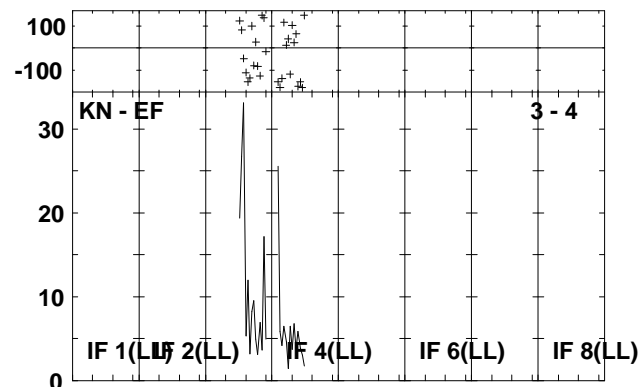
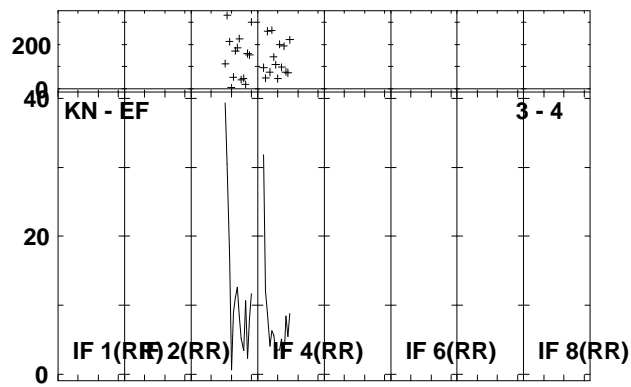
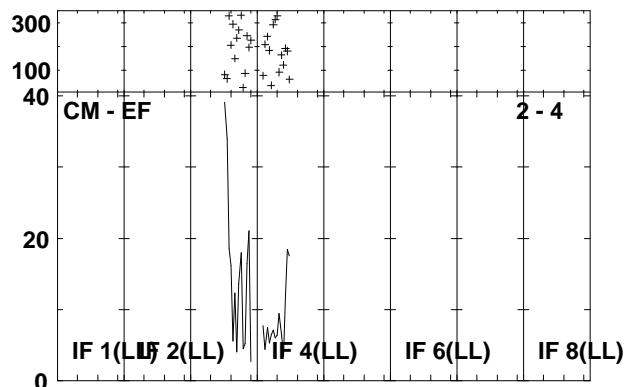
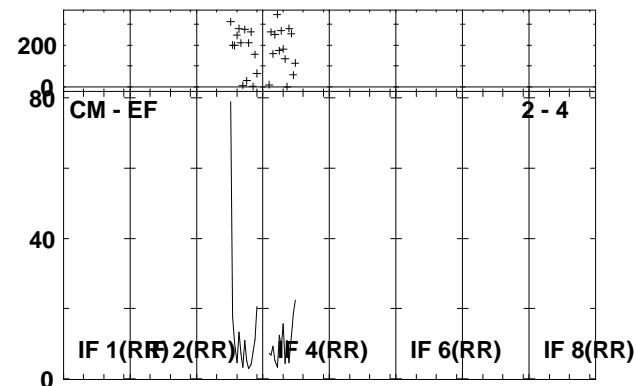
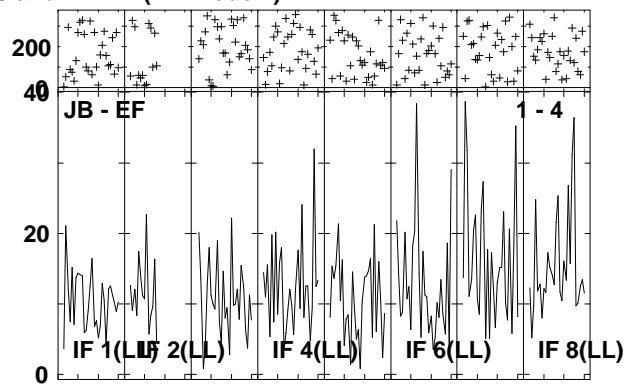
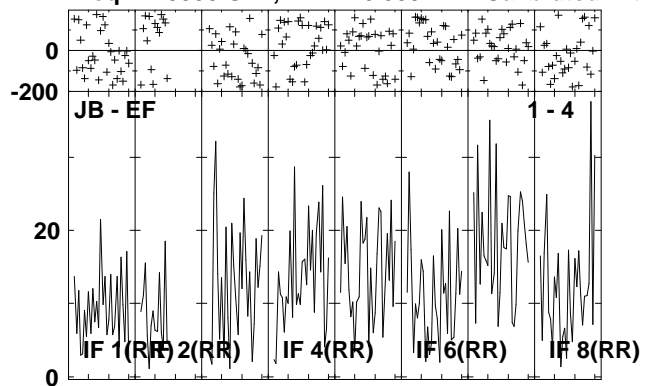

Lower frame: Milli Ampl Jy Top frame: Phas deg
Vector averaged cross-power spectrum Several baselines displayed
Timerange: 00/15:05:38 to 00/15:08:56

Plot file version 135 created 29-APR-2009 14:31:01

IRAS2336 EP064D.UVDATA.1

Freq = 1.5950 GHz, Bw = 16.000 MH Calibrated with CL # 3 and BP # 1 (BP mode 1)

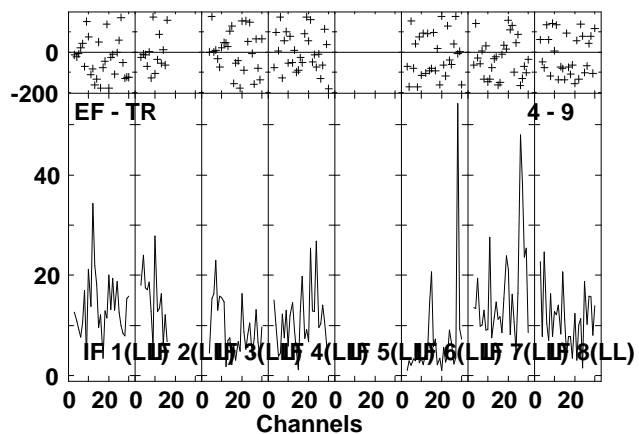
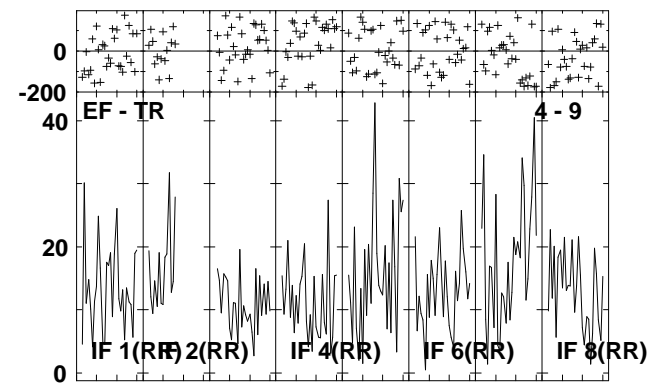
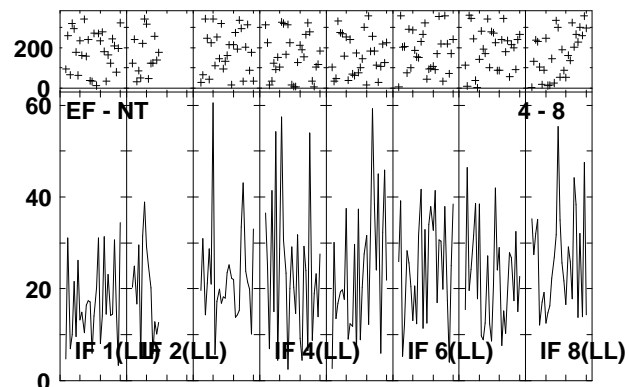
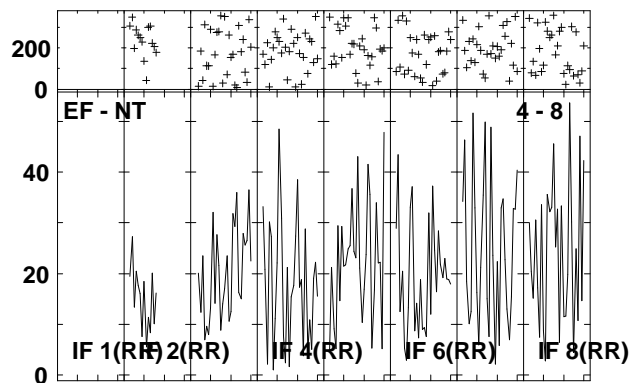
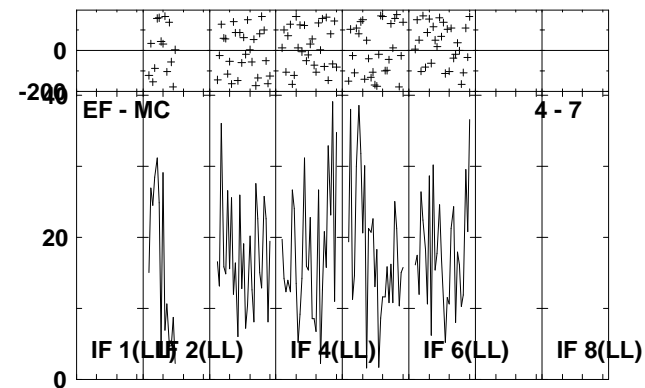
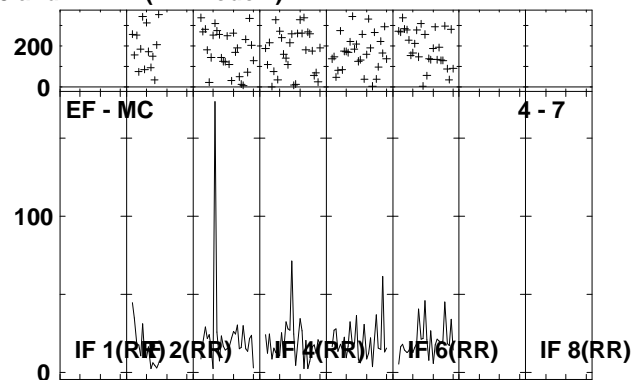
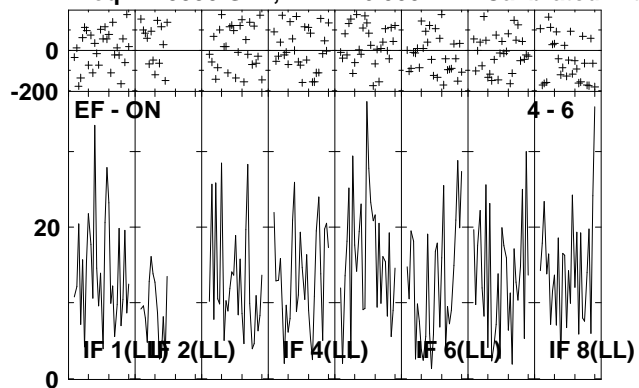

Lower frame: Milli Ampl Jy Top frame: Phas deg
Vector averaged cross-power spectrum Several baselines displayed
Timerange: 00/15:05:38 to 00/15:08:56

Plot file version 136 created 29-APR-2009 14:31:04

J2333+39 EP064D.UVDATA.1

Freq = 1.5950 GHz, Bw = 16.000 MH Calibrated with CL # 3 and BP # 1 (BP mode 1)

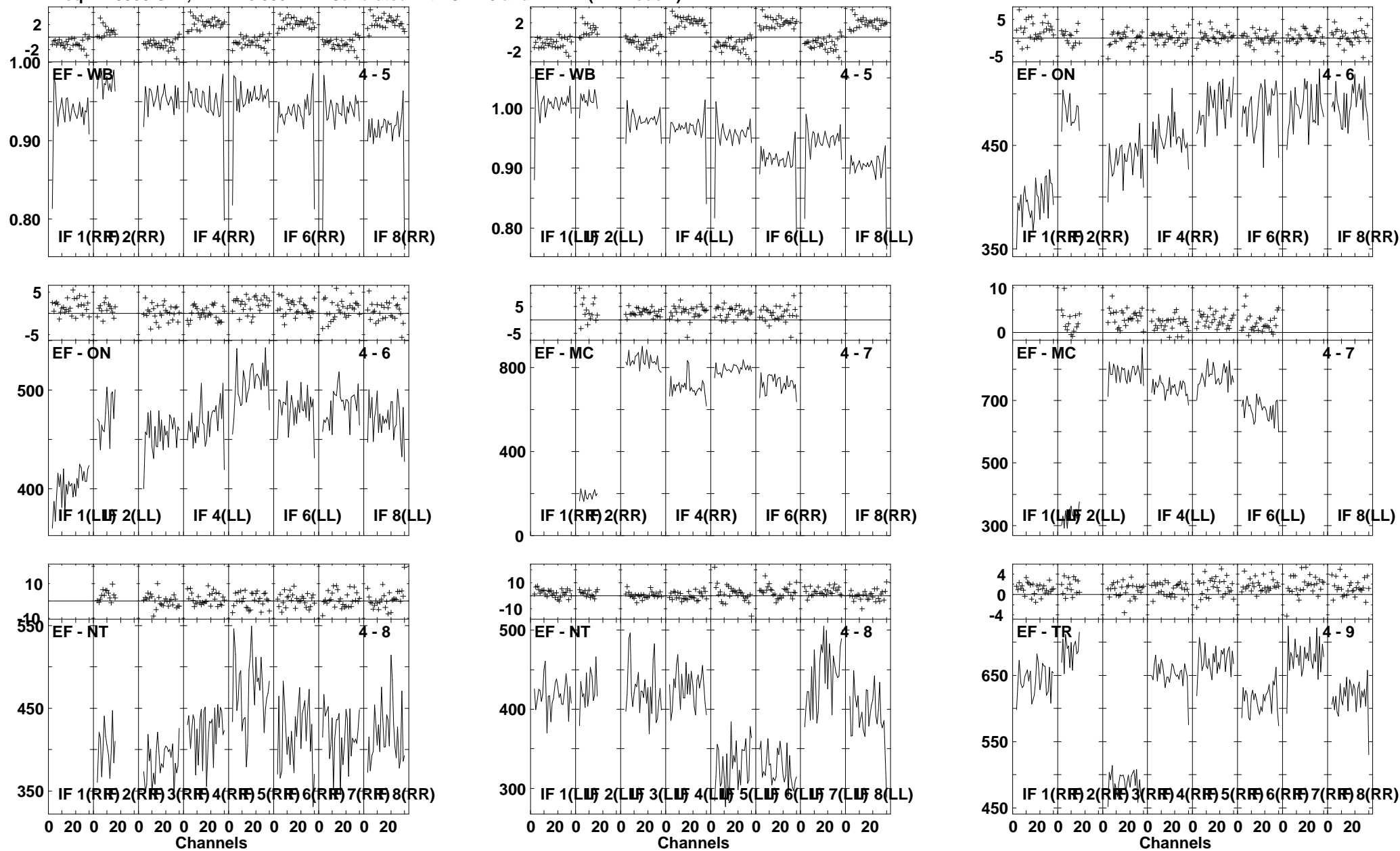

Lower frame: Ampl Jy Top frame: Phas deg
Vector averaged cross-power spectrum Several baselines displayed
Timerange: 00/15:10:01 to 00/15:11:27

Plot file version 137 created 29-APR-2009 14:31:05
J2333+39 EP064D.UVDATA.1
Freq = 1.5950 GHz, Bw = 16.000 MH Calibrated with CL # 3 and BP # 1 (BP mode 1)

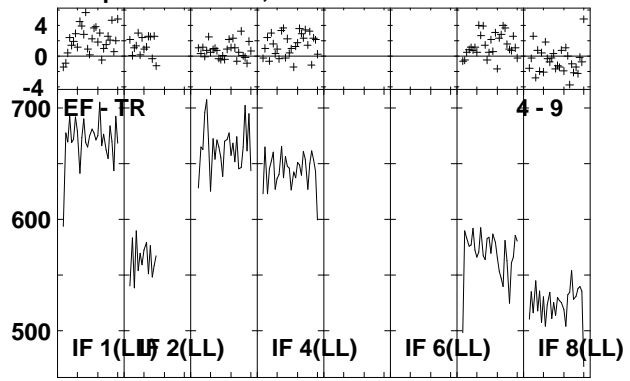

Lower frame: Milli Ampl Jy Top frame: Phas deg
Vector averaged cross-power spectrum Several baselines displayed
Timerange: 00/15:10:01 to 00/15:11:27

Plot file version 138 created 29-APR-2009 14:31:06

IRAS2336 EP064D.UVDATA.1

Freq = 1.5950 GHz, Bw = 16.000 MH Calibrated with CL # 3 and BP # 1 (BP mode 1)

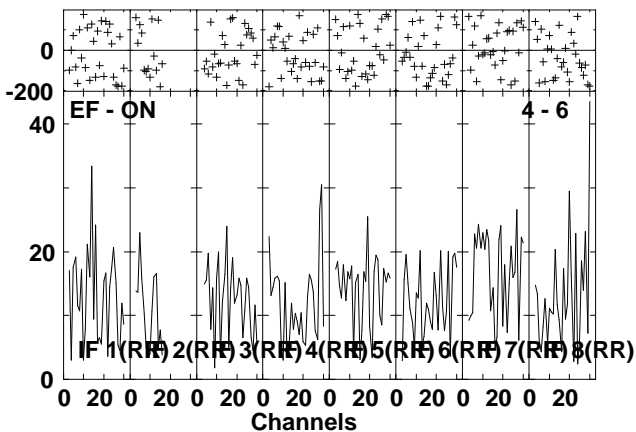
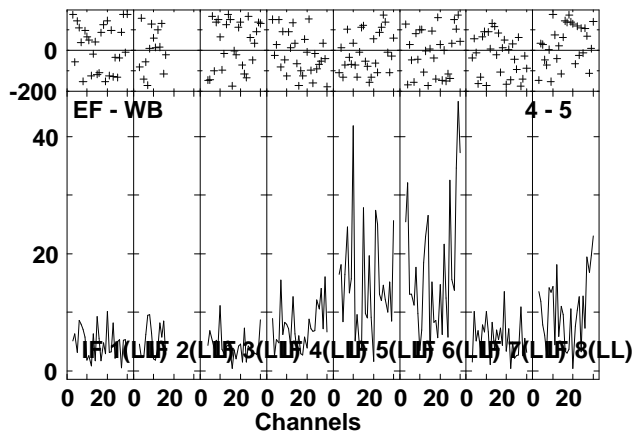
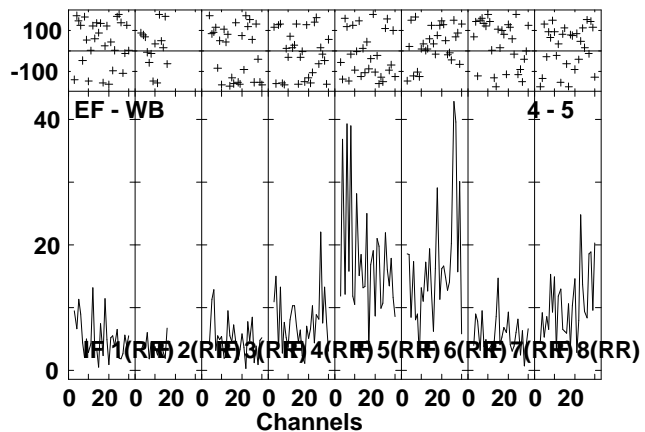
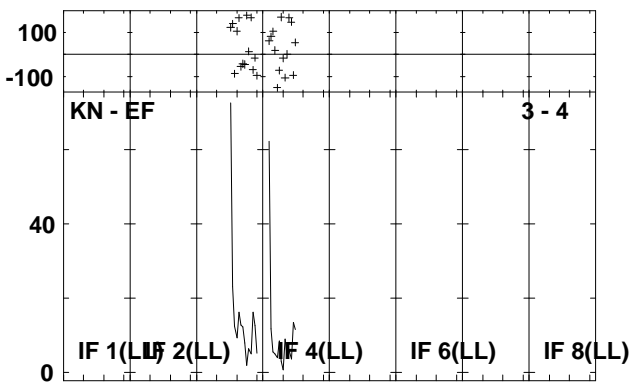
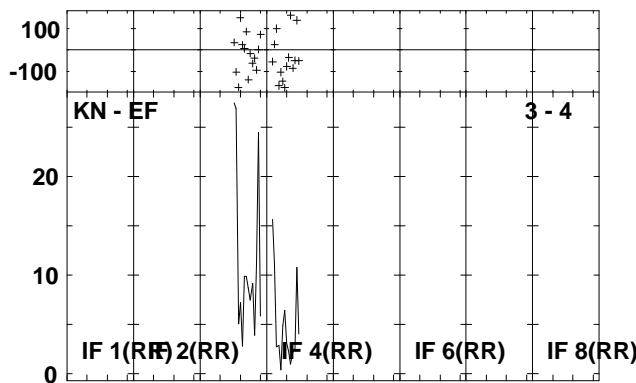
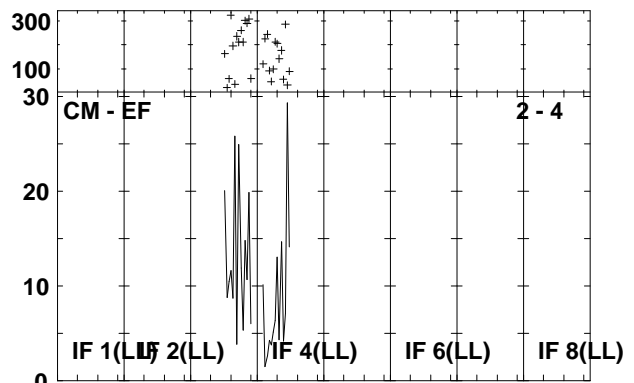
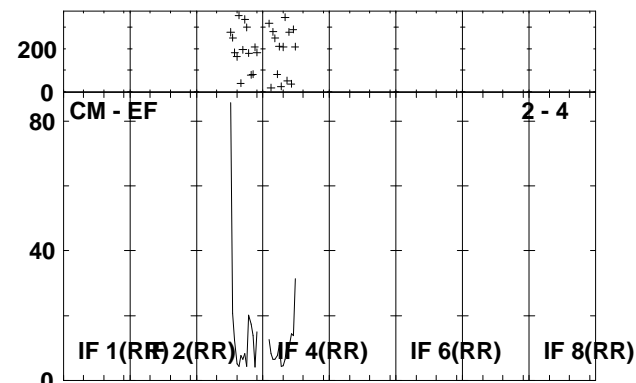
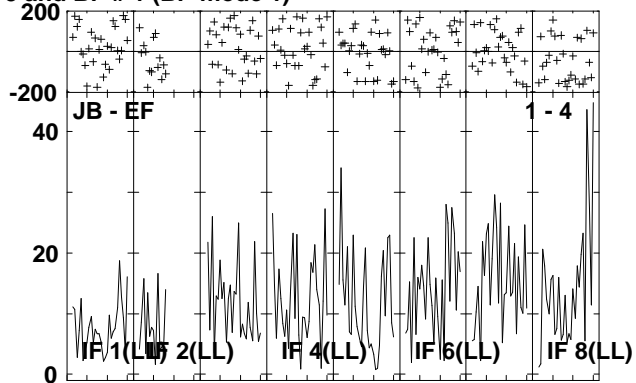
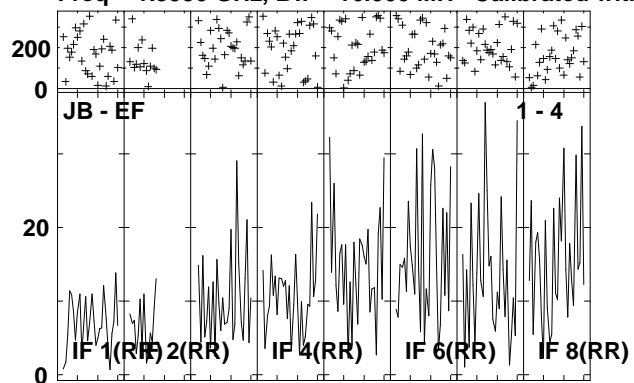

Lower frame: Milli Ampl Jy Top frame: Phas deg
Vector averaged cross-power spectrum Several baselines displayed
Timerange: 00/15:11:30 to 00/15:15:00

Plot file version 139 created 29-APR-2009 14:31:08

IRAS2336 EP064D.UVDATA.1

Freq = 1.5950 GHz, Bw = 16.000 MH Calibrated with CL # 3 and BP # 1 (BP mode 1)

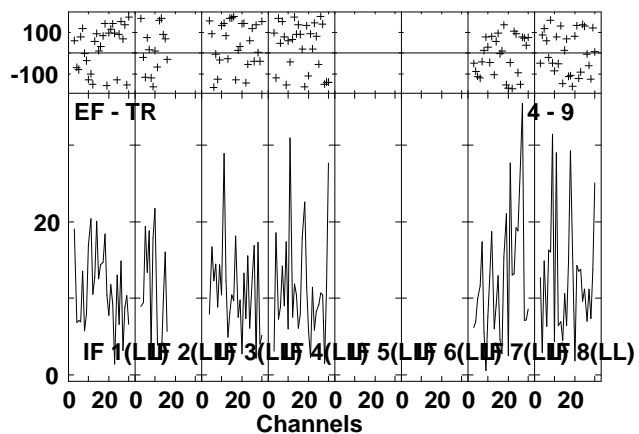
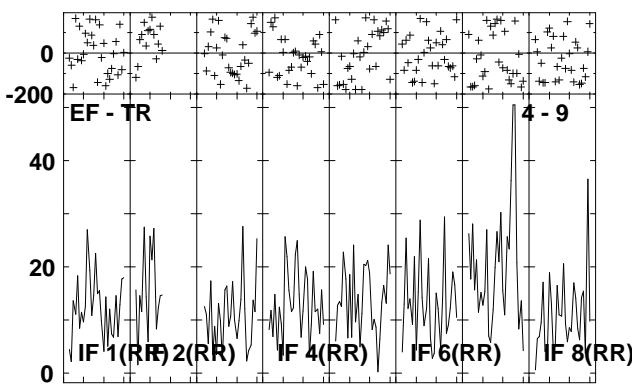
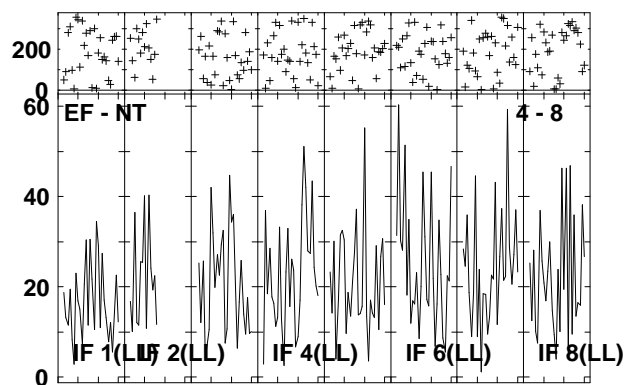
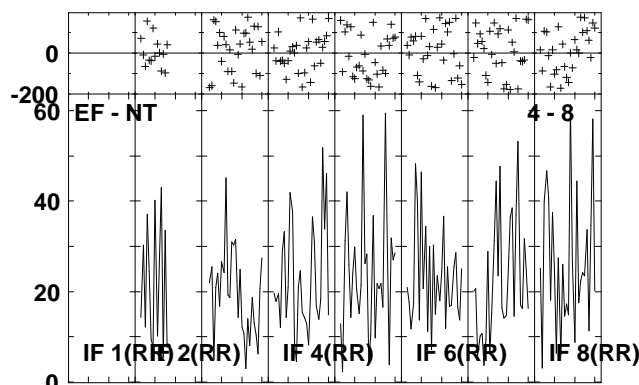
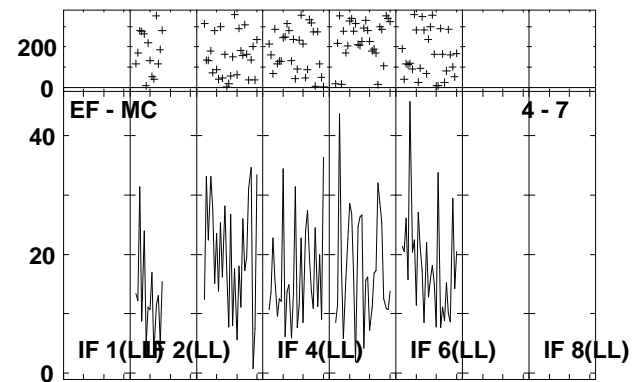
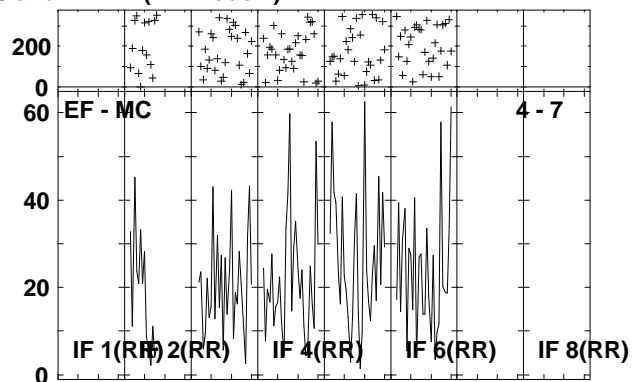
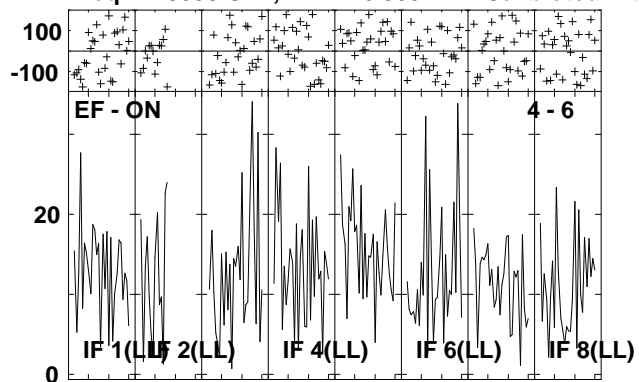

Lower frame: Milli Ampl Jy Top frame: Phas deg
Vector averaged cross-power spectrum Several baselines displayed
Timerange: 00/15:11:30 to 00/15:15:00

Plot file version 140 created 29-APR-2009 14:31:11

J2333+39 EP064D.UVDATA.1

Freq = 1.5950 GHz, Bw = 16.000 MH Calibrated with CL # 3 and BP # 1 (BP mode 1)

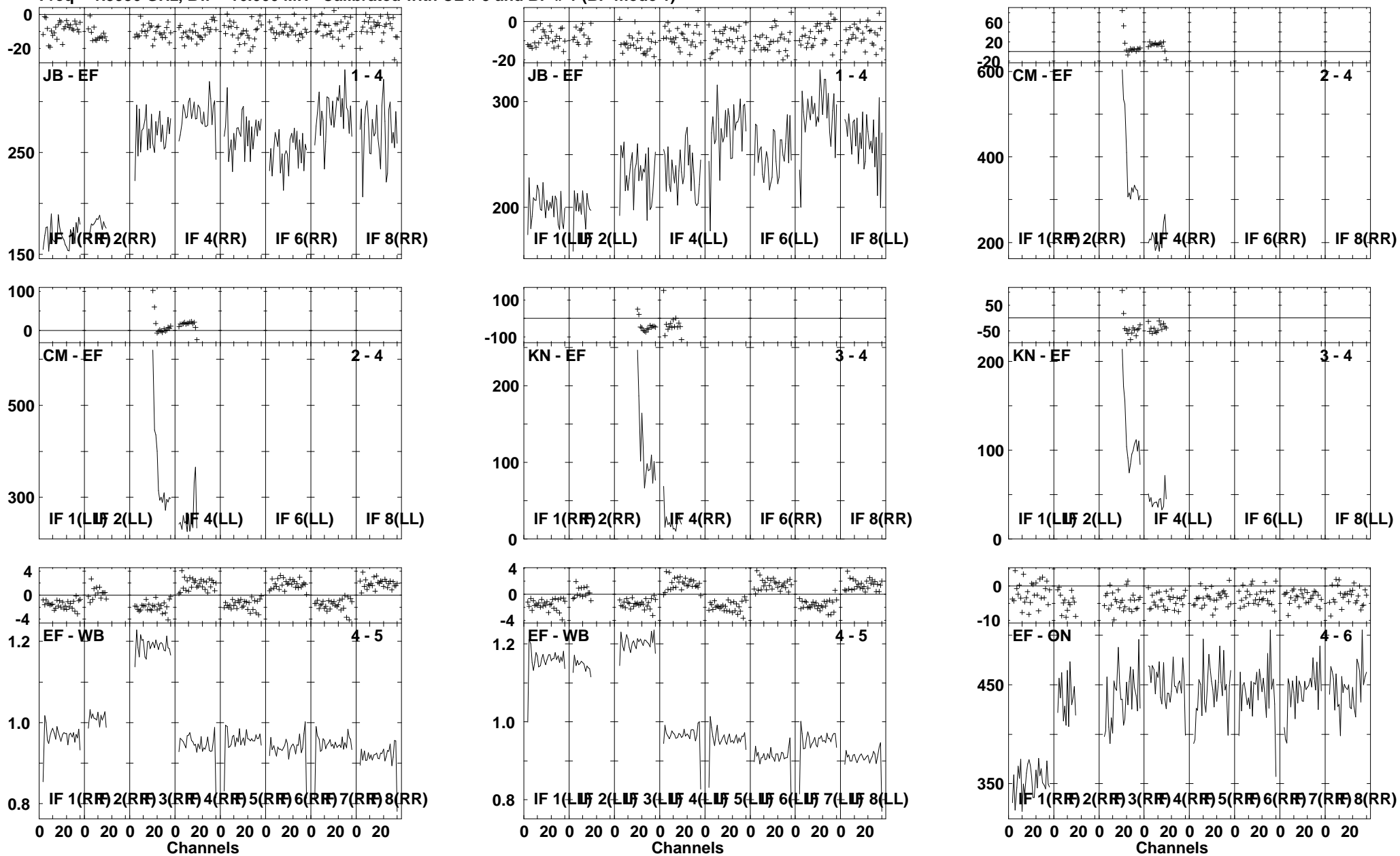

Lower frame: Milli Ampl Jy Top frame: Phas deg
Vector averaged cross-power spectrum Several baselines displayed
Timerange: 00/15:15:02 to 00/15:16:30

Plot file version 141 created 29-APR-2009 14:31:12

J2333+39 EP064D.UVDATA.1

Freq = 1.5950 GHz, Bw = 16.000 MH Calibrated with CL # 3 and BP # 1 (BP mode 1)

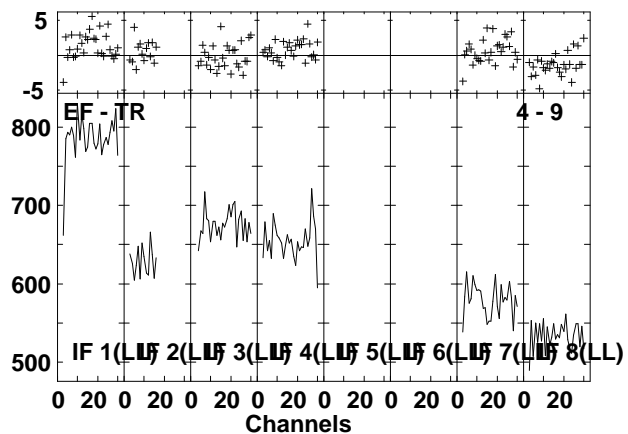
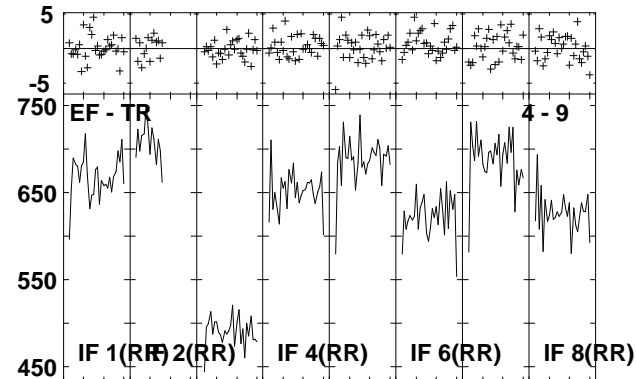
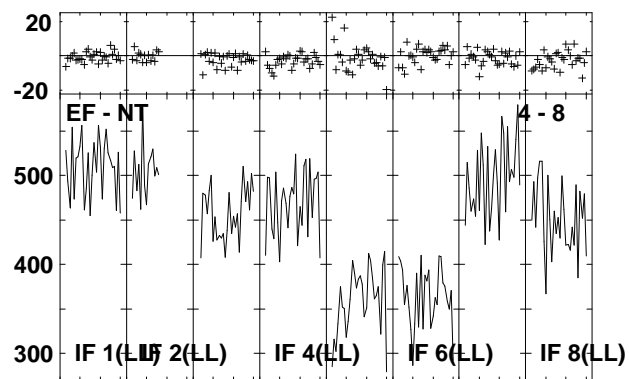
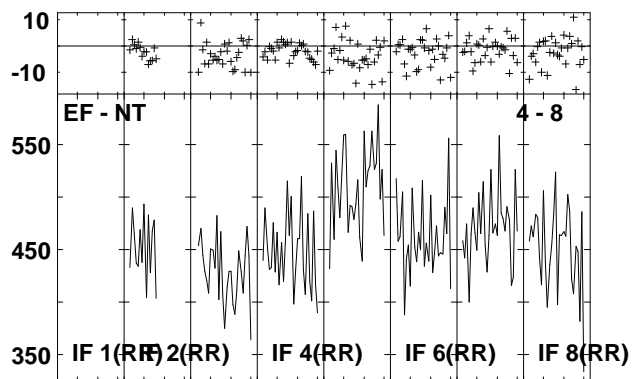
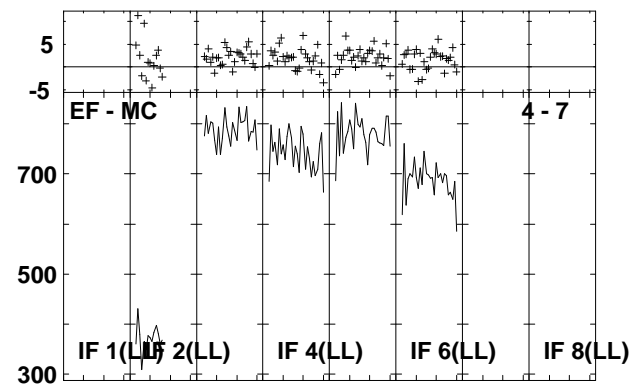
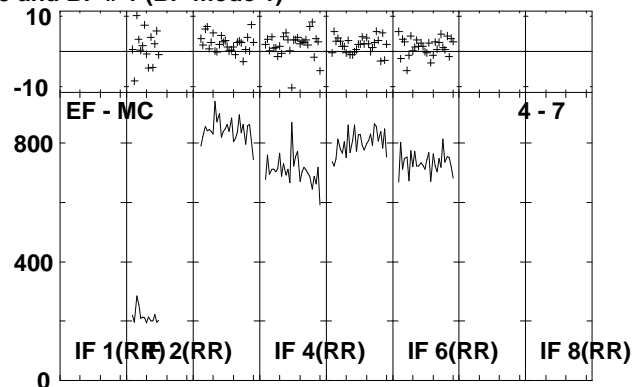
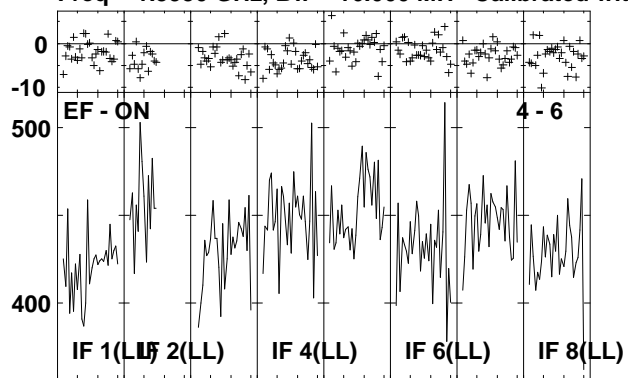

Lower frame: Milli Ampl Jy Top frame: Phas deg
Vector averaged cross-power spectrum Several baselines displayed
Timerange: 00/15:15:02 to 00/15:16:30

Plot file version 142 created 29-APR-2009 14:31:14

IRAS2336 EP064D.UVDATA.1

Freq = 1.5950 GHz, Bw = 16.000 MH Calibrated with CL # 3 and BP # 1 (BP mode 1)

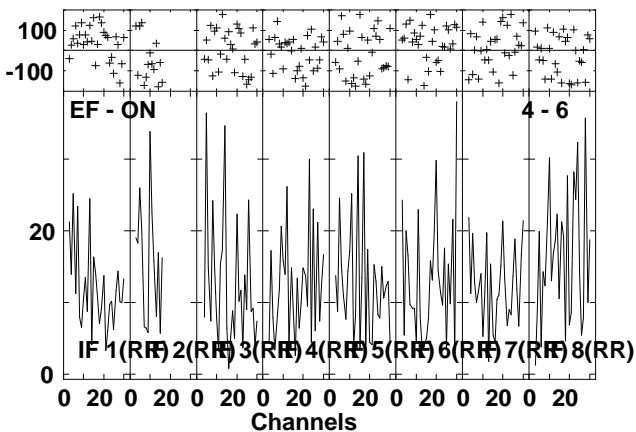
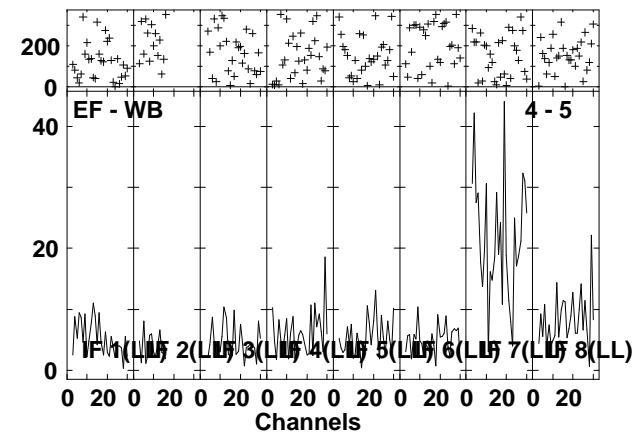
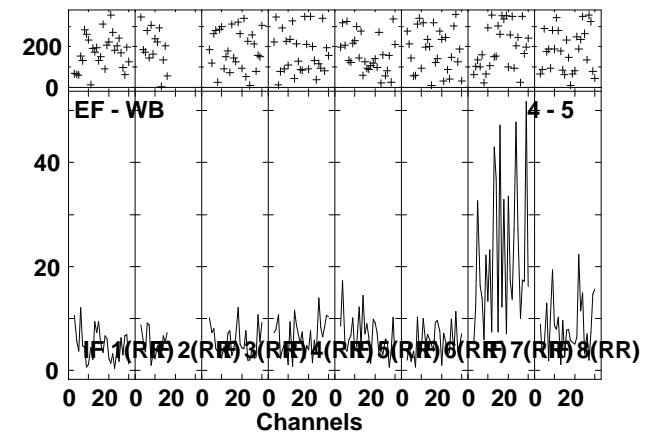
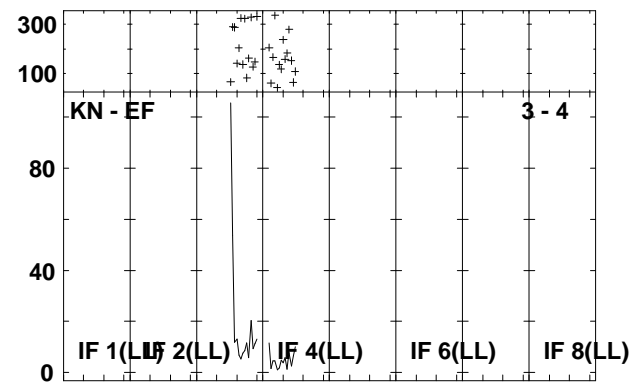
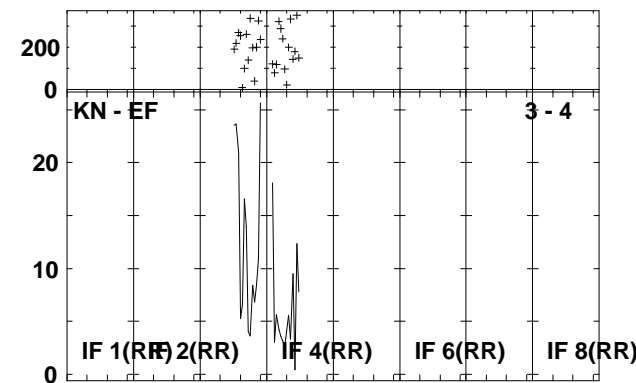
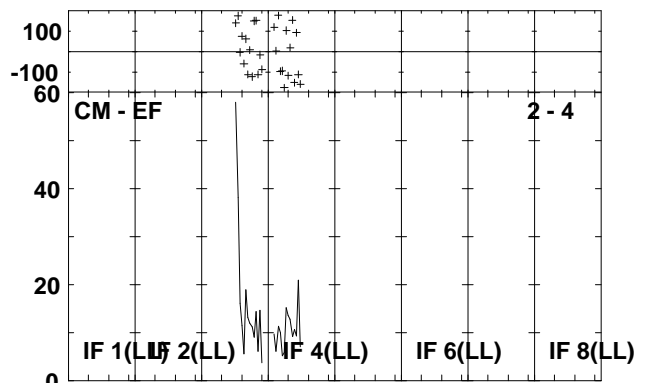
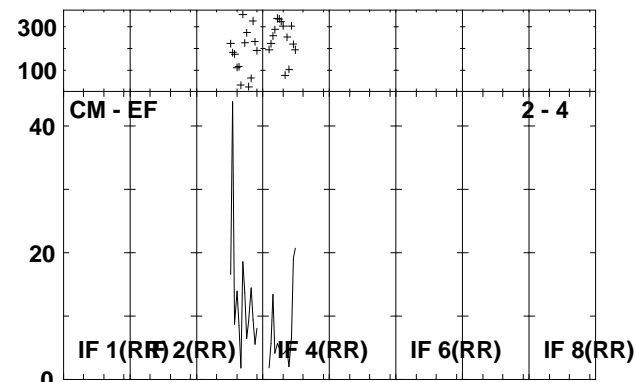
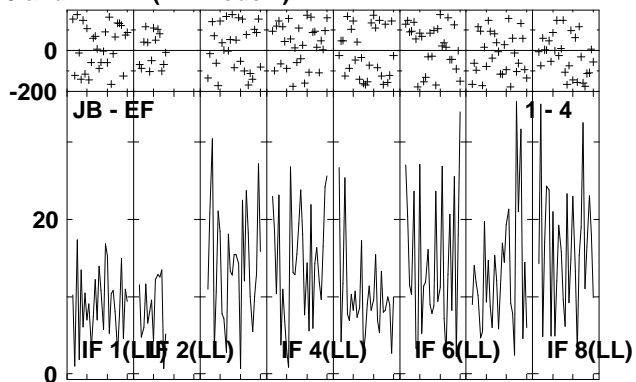
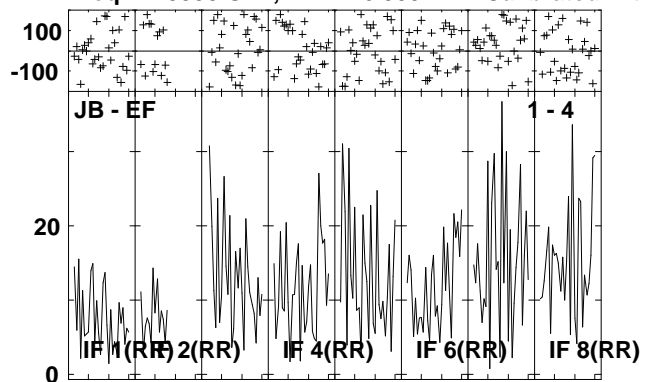

Lower frame: Milli Ampl Jy Top frame: Phas deg
Vector averaged cross-power spectrum Several baselines displayed
Timerange: 00/15:16:32 to 00/15:20:00

Plot file version 143 created 29-APR-2009 14:31:17

IRAS2336 EP064D.UVDATA.1

Freq = 1.5950 GHz, Bw = 16.000 MH Calibrated with CL # 3 and BP # 1 (BP mode 1)

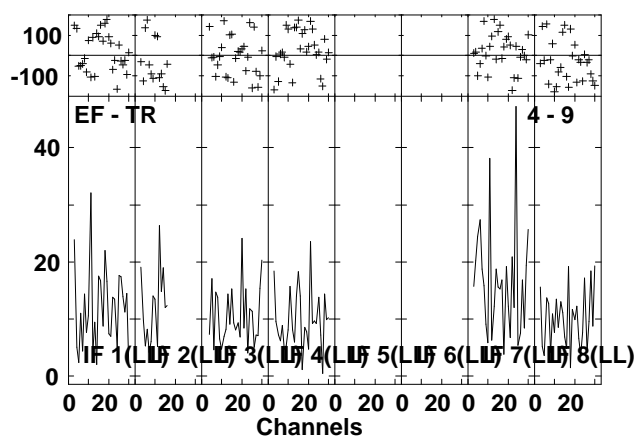
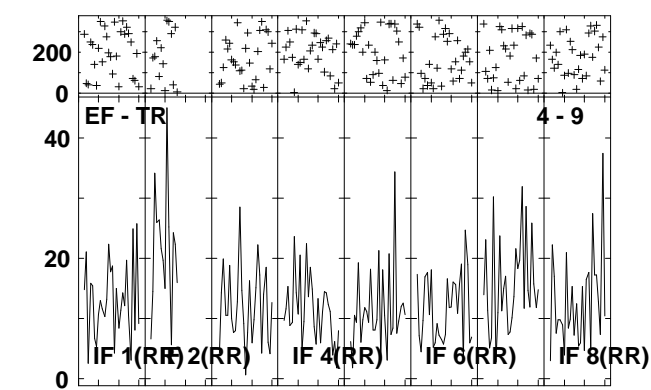
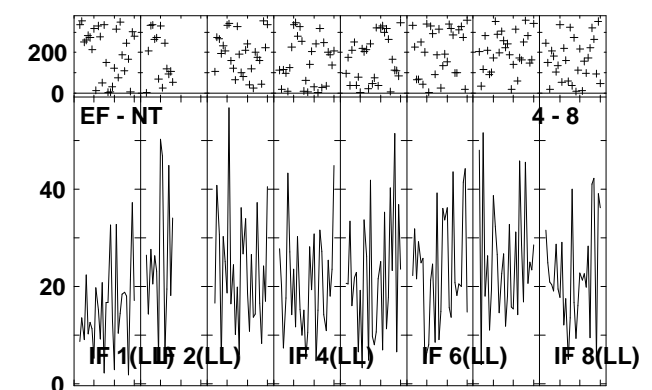
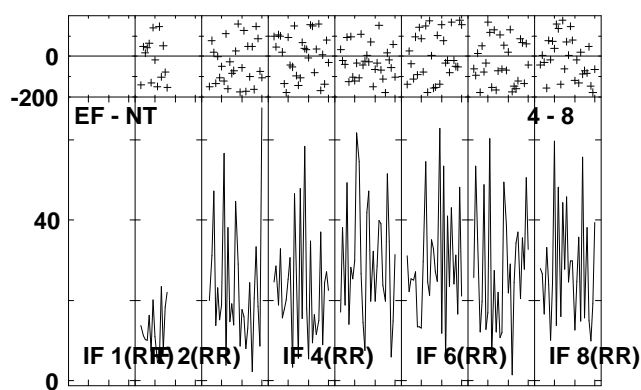
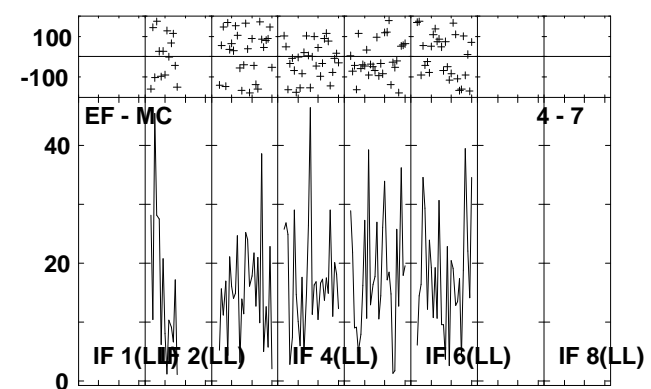
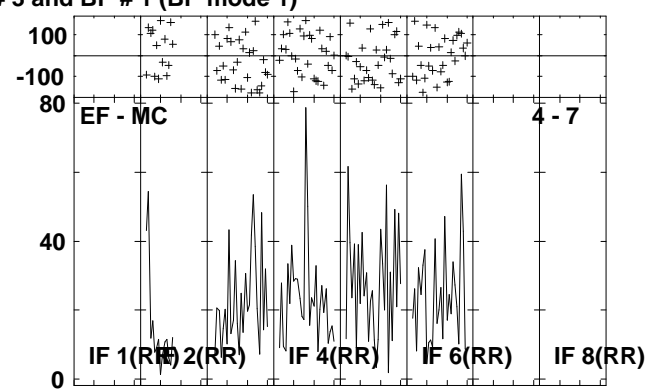
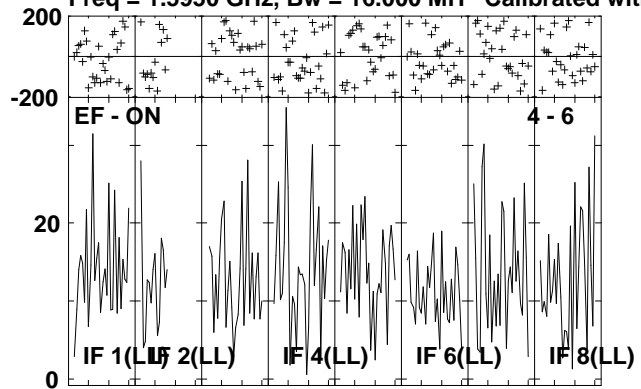

Lower frame: Milli Ampl Jy Top frame: Phas deg
Vector averaged cross-power spectrum Several baselines displayed
Timerange: 00/15:16:32 to 00/15:20:00

Plot file version 144 created 29-APR-2009 14:31:21

J2333+39 EP064D.UVDATA.1

Freq = 1.5950 GHz, Bw = 16.000 MH Calibrated with CL # 3 and BP # 1 (BP mode 1)

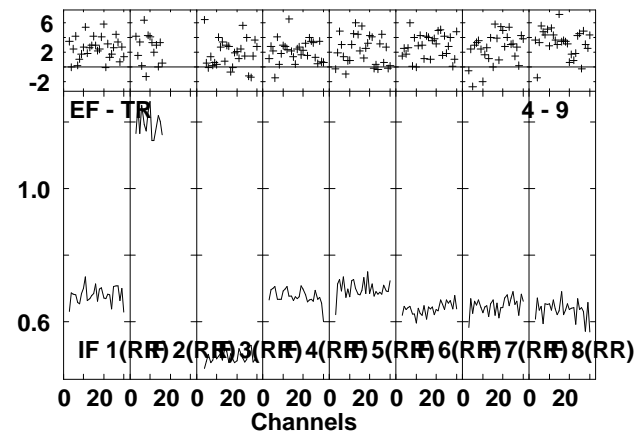
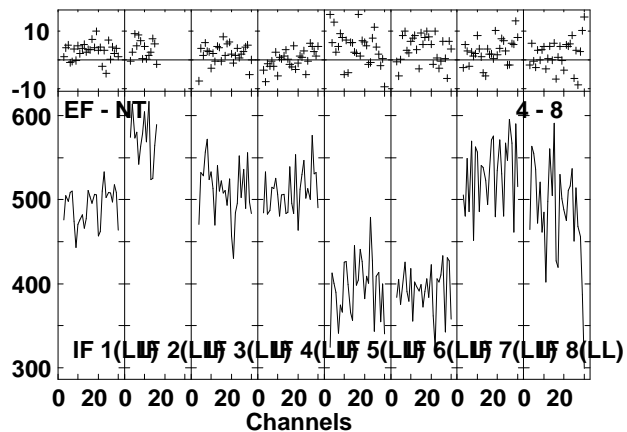
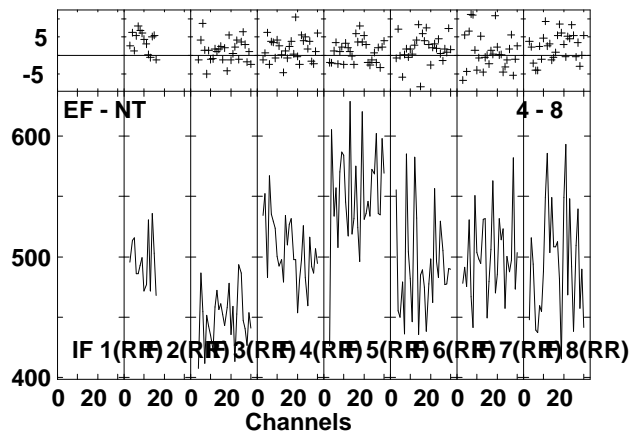
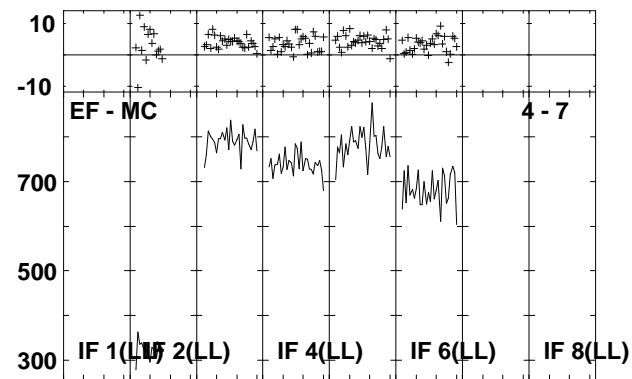
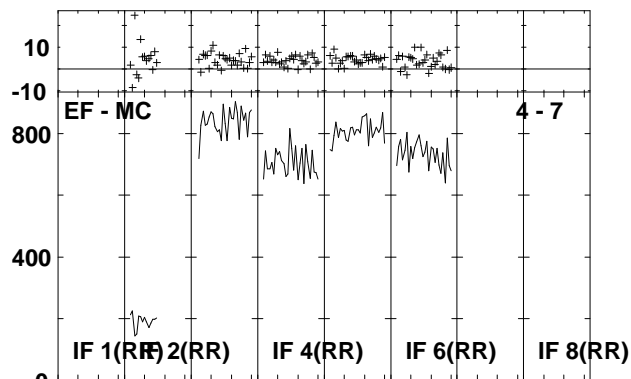
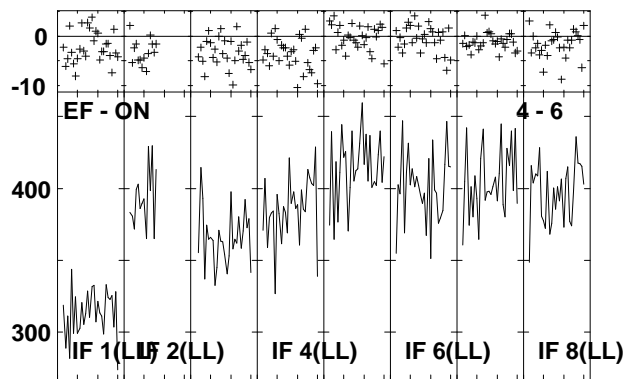
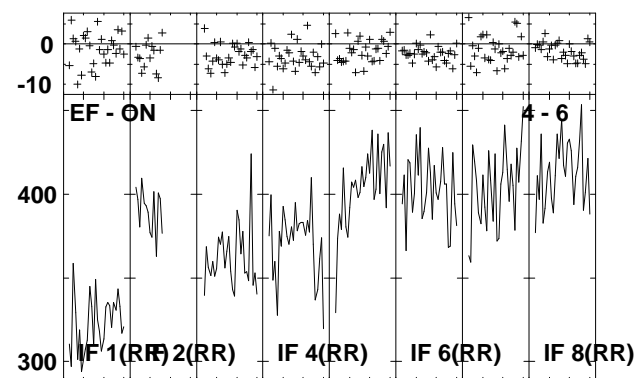
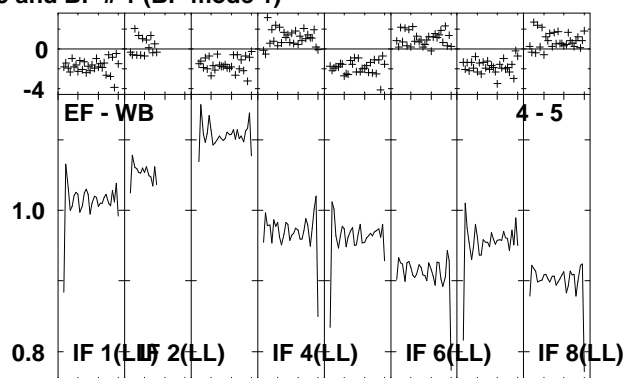
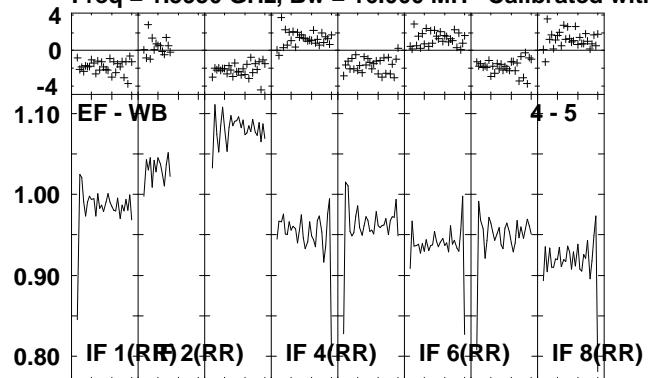

Lower frame: Ampl Jy Top frame: Phas deg
Vector averaged cross-power spectrum Several baselines displayed
Timerange: 00/15:20:02 to 00/15:21:28

Plot file version 145 created 29-APR-2009 14:31:22

J2333+39 EP064D.UVDATA.1

Freq = 1.5950 GHz, Bw = 16.000 MH Calibrated with CL # 3 and BP # 1 (BP mode 1)

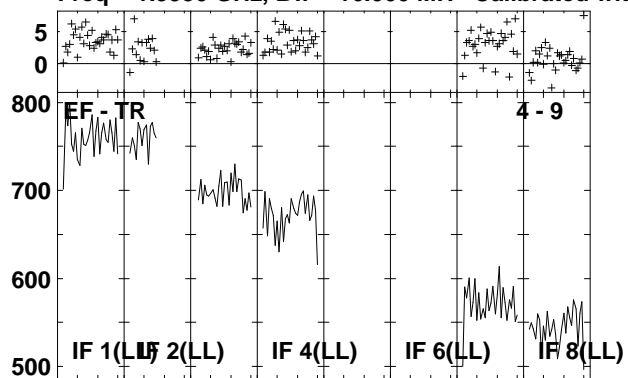

Lower frame: Milli Ampl Jy Top frame: Phas deg
Vector averaged cross-power spectrum Several baselines displayed
Timerange: 00/15:20:02 to 00/15:21:28

Plot file version 146 created 29-APR-2009 14:31:23

IRAS2336 EP064D.UVDATA.1

Freq = 1.5950 GHz, Bw = 16.000 MH Calibrated with CL # 3 and BP # 1 (BP mode 1)

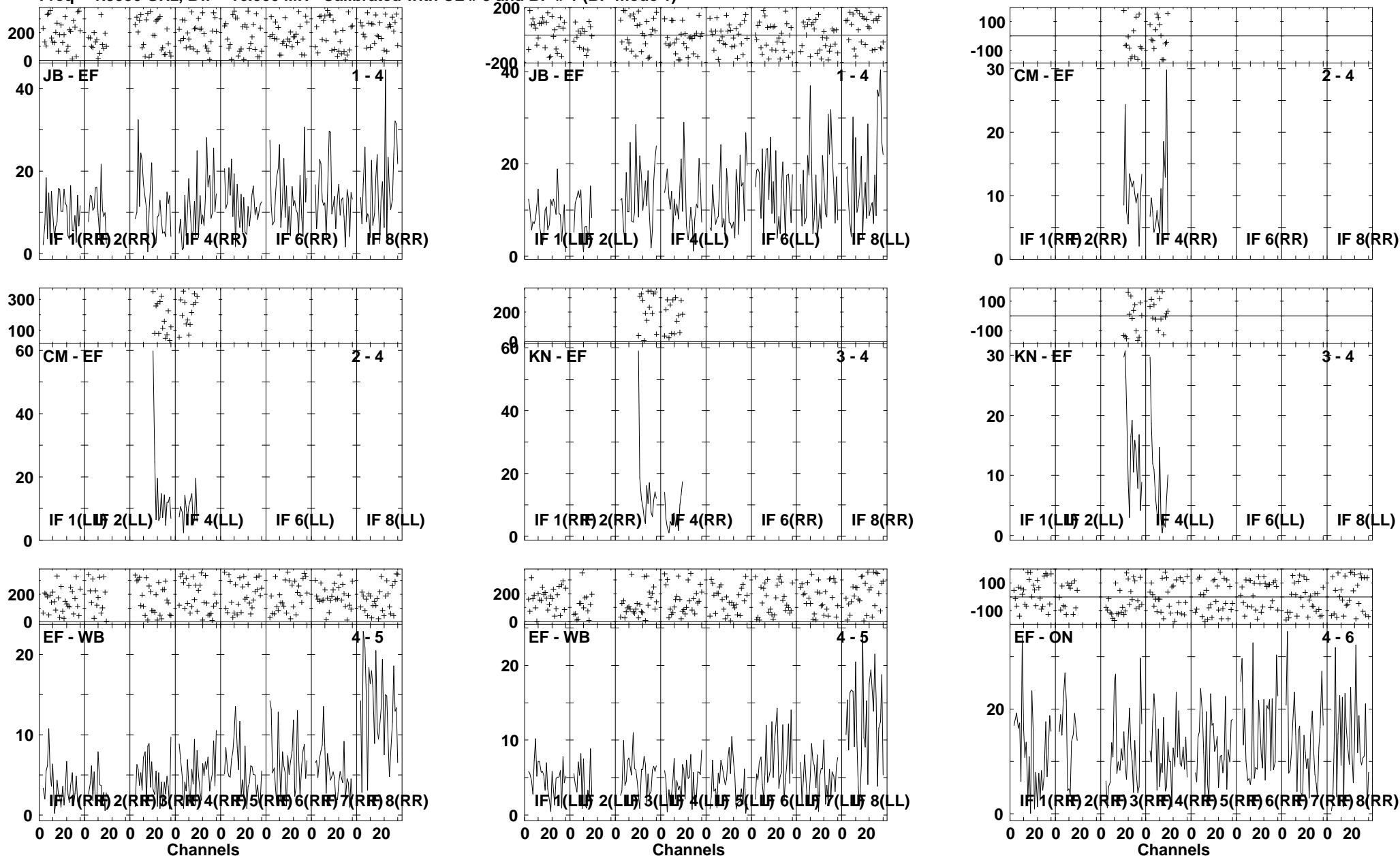

Lower frame: Milli Ampl Jy Top frame: Phas deg
Vector averaged cross-power spectrum Several baselines displayed
Timerange: 00/15:21:32 to 00/15:24:56

Plot file version 147 created 29-APR-2009 14:31:25

IRAS2336 EP064D.UVDATA.1

Freq = 1.5950 GHz, Bw = 16.000 MH Calibrated with CL # 3 and BP # 1 (BP mode 1)

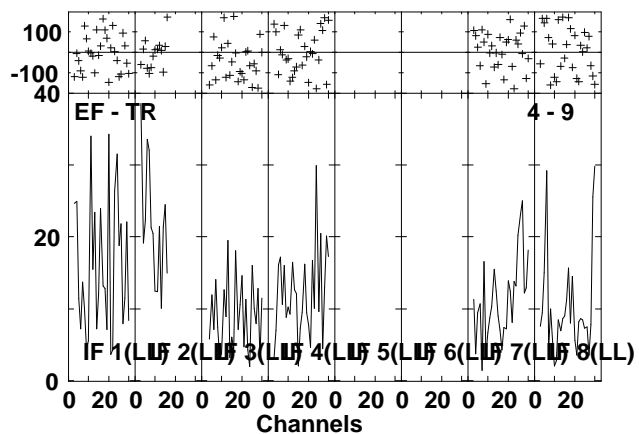
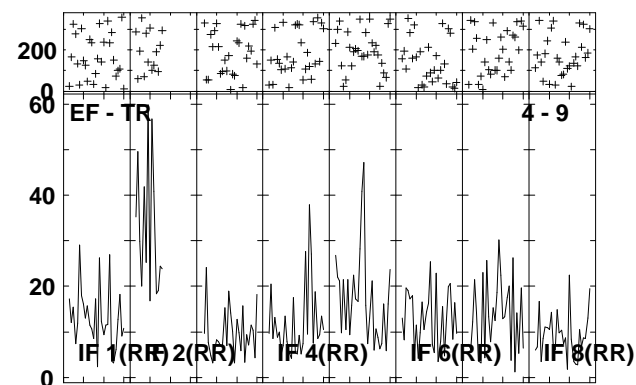
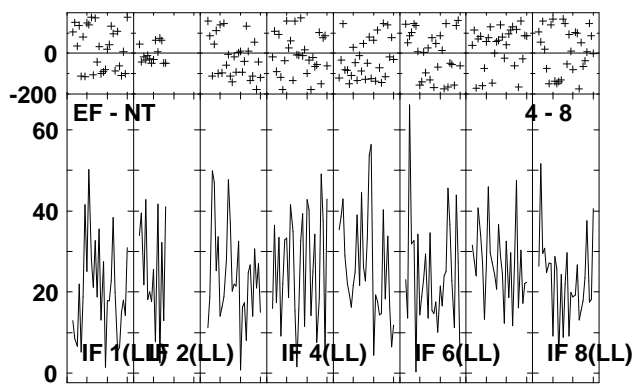
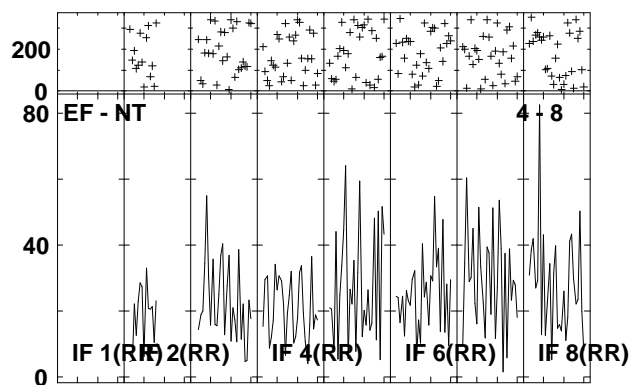
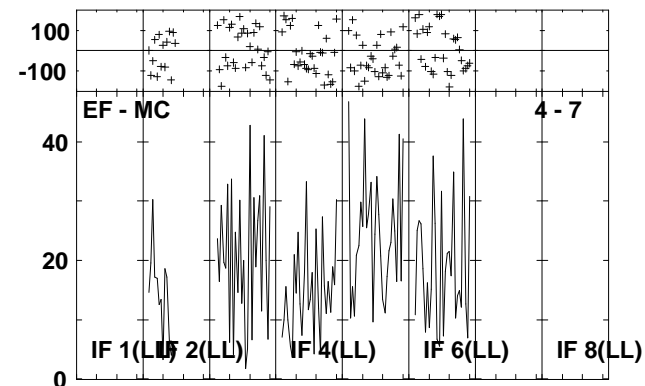
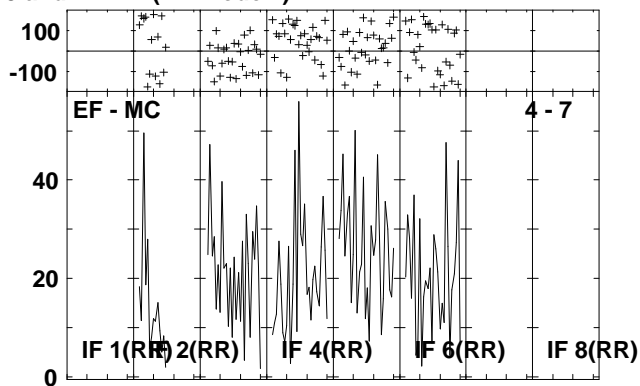
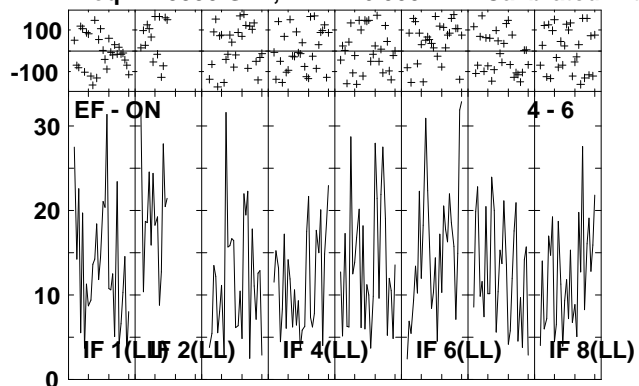

Lower frame: Milli Ampl Jy Top frame: Phas deg
Vector averaged cross-power spectrum Several baselines displayed
Timerange: 00/15:21:32 to 00/15:24:56

Plot file version 148 created 29-APR-2009 14:31:28

J2333+39 EP064D.UVDATA.1

Freq = 1.5950 GHz, Bw = 16.000 MH Calibrated with CL # 3 and BP # 1 (BP mode 1)

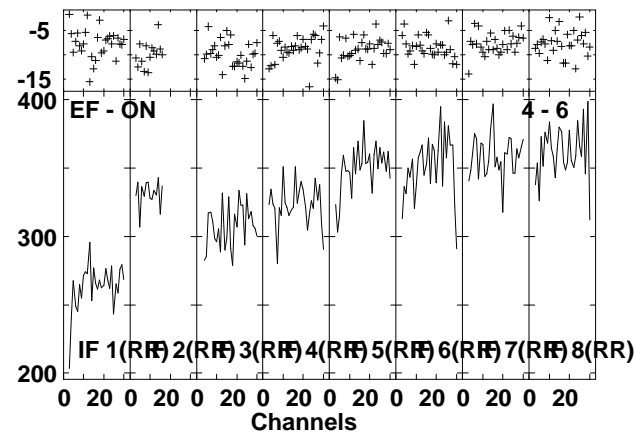
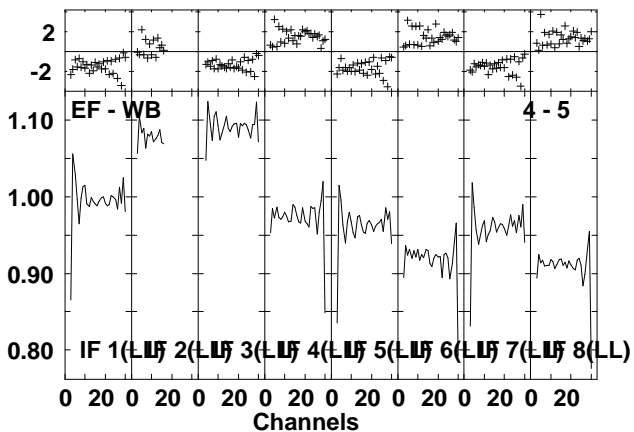
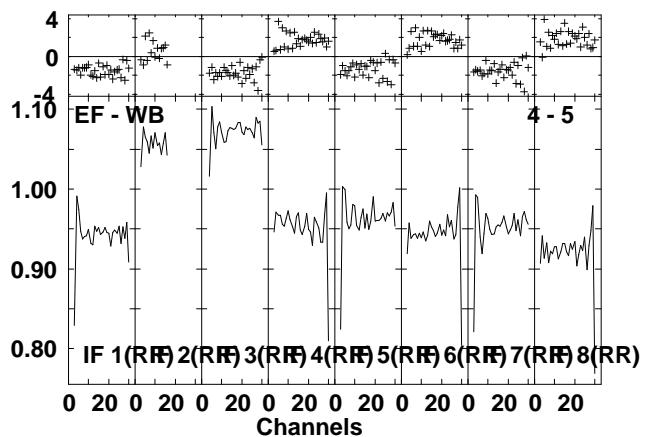
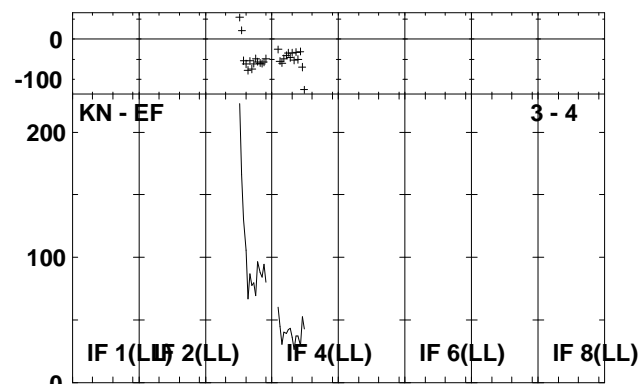
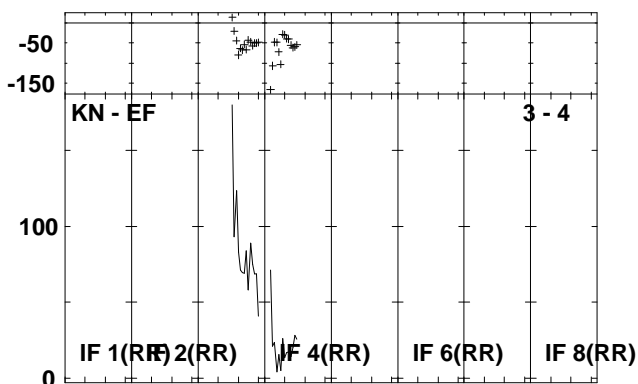
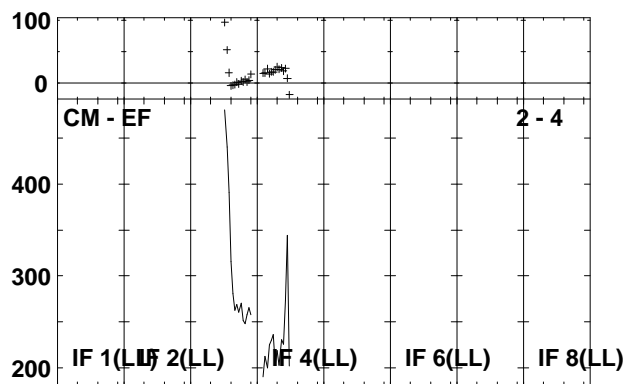
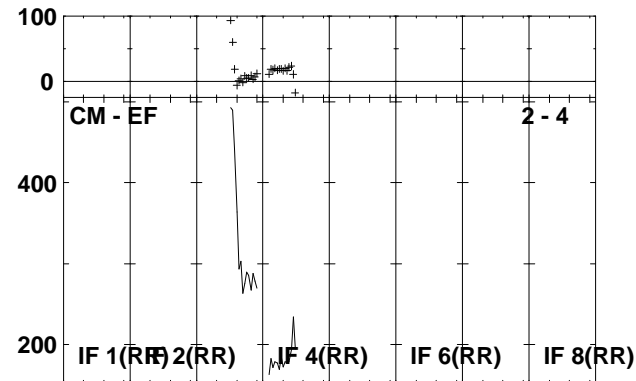
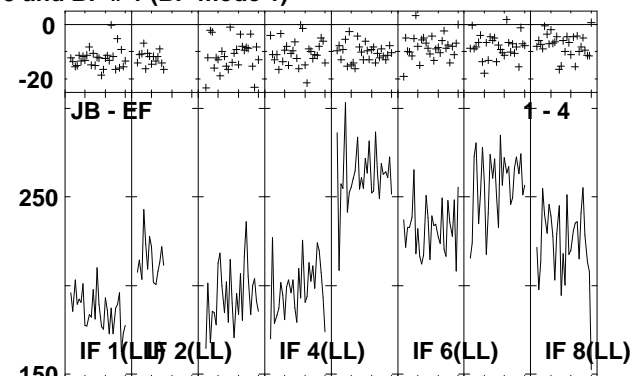
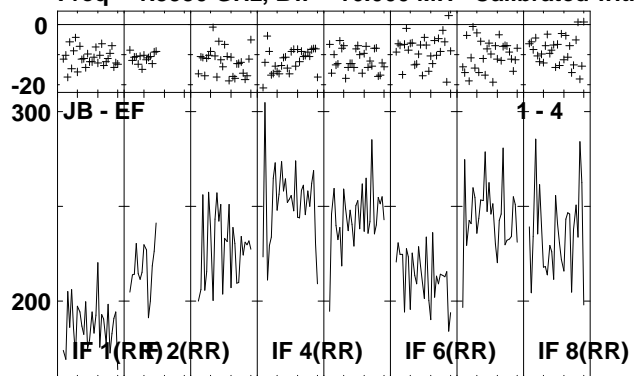

Lower frame: Milli Ampl Jy Top frame: Phas deg
Vector averaged cross-power spectrum Several baselines displayed
Timerange: 00/15:26:00 to 00/15:27:30

Plot file version 149 created 29-APR-2009 14:31:29

J2333+39 EP064D.UVDATA.1

Freq = 1.5950 GHz, Bw = 16.000 MH Calibrated with CL # 3 and BP # 1 (BP mode 1)

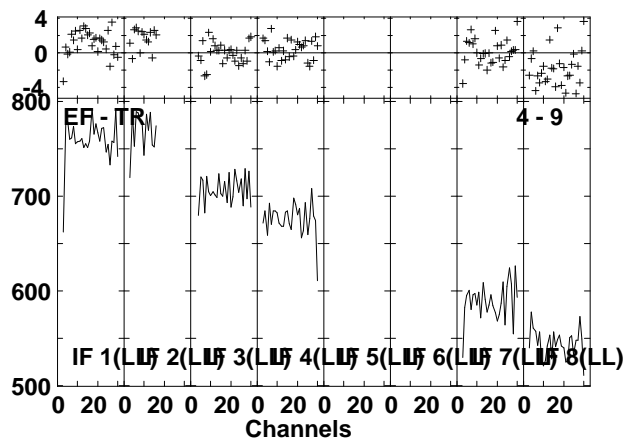
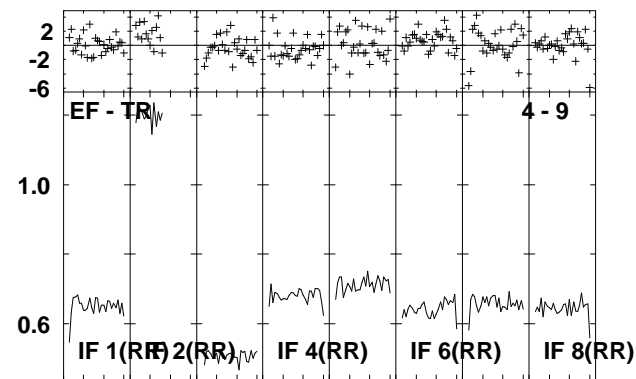
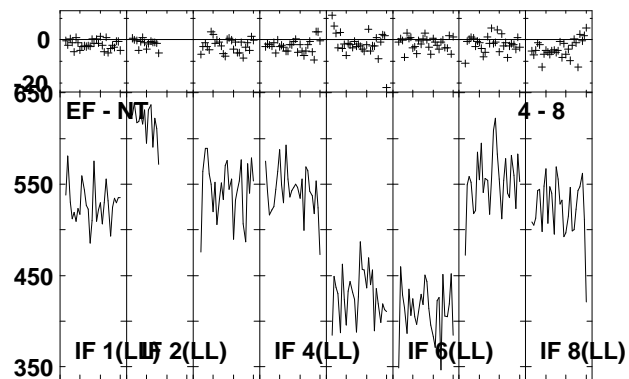
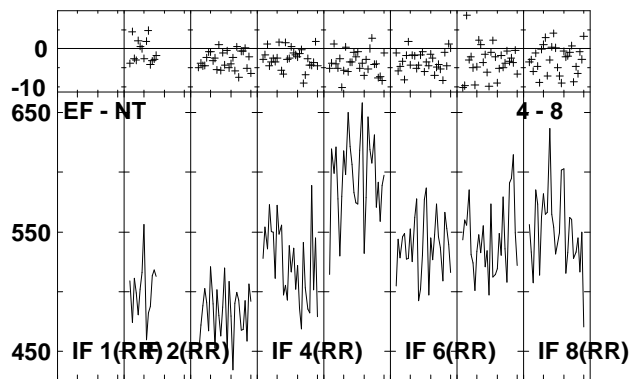
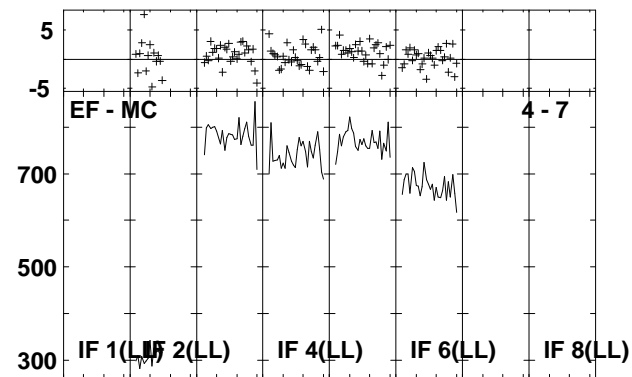
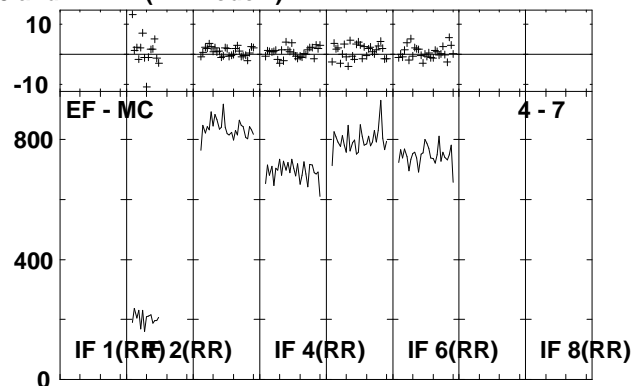
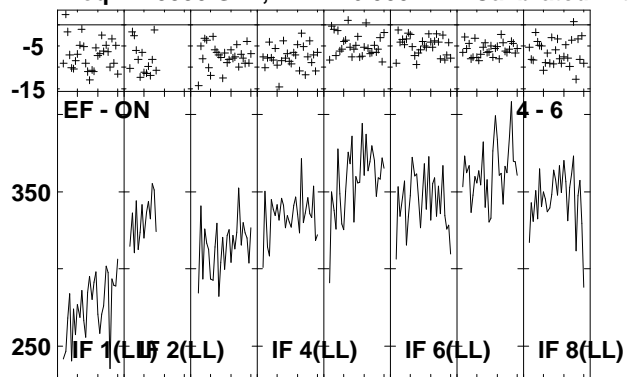

Lower frame: Milli Ampl Jy Top frame: Phas deg
Vector averaged cross-power spectrum Several baselines displayed
Timerange: 00/15:26:00 to 00/15:27:30

Plot file version 150 created 29-APR-2009 14:31:31

IRAS2336 EP064D.UVDATA.1

Freq = 1.5950 GHz, Bw = 16.000 MH Calibrated with CL # 3 and BP # 1 (BP mode 1)

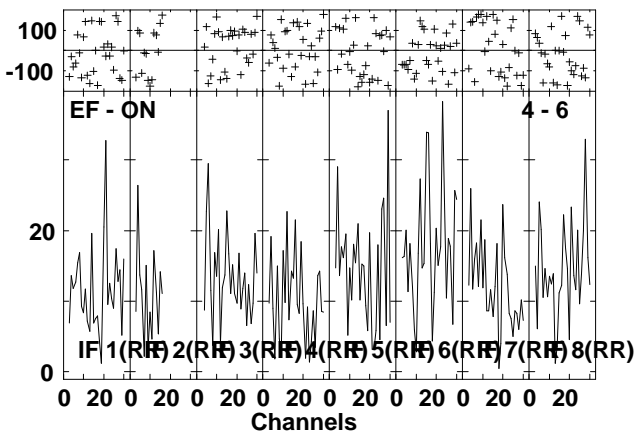
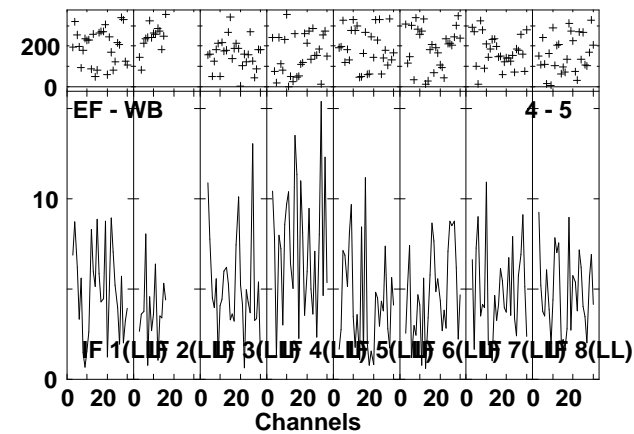
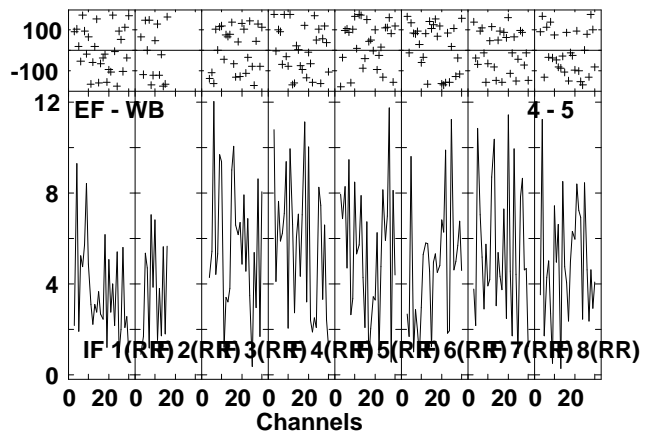
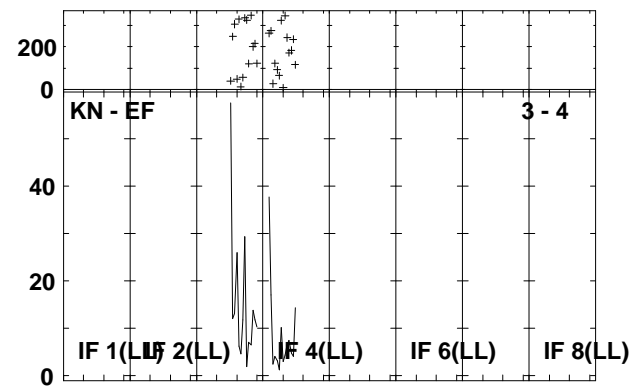
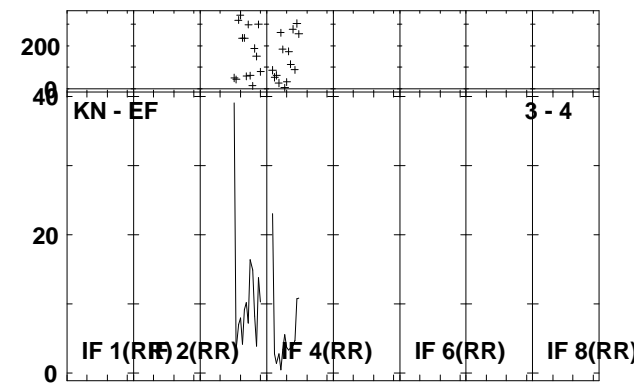
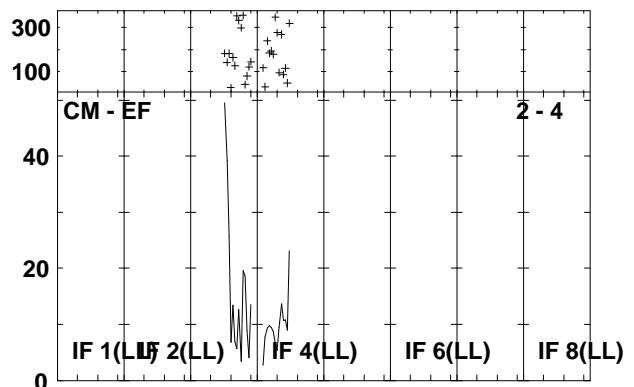
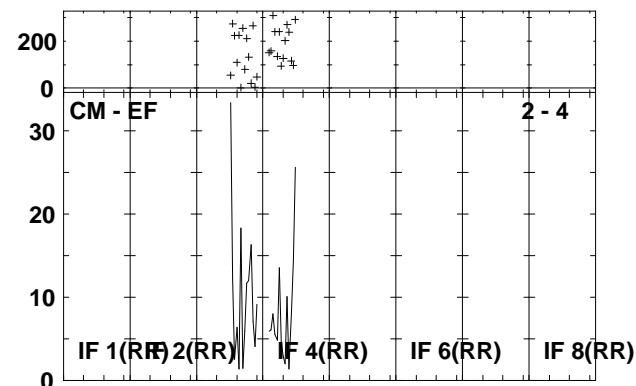
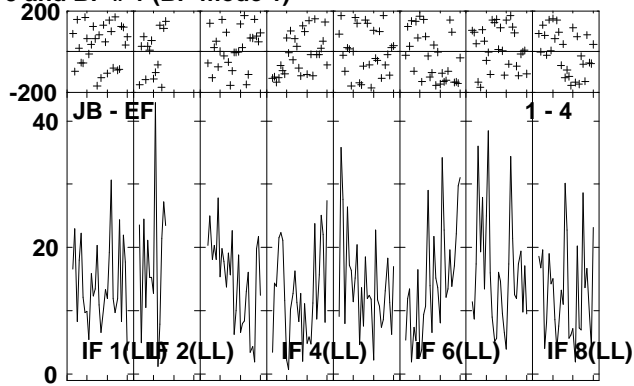
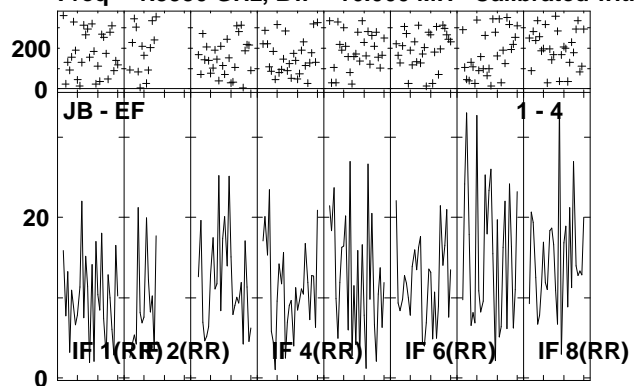

Lower frame: Milli Ampl Jy Top frame: Phas deg
Vector averaged cross-power spectrum Several baselines displayed
Timerange: 00/15:27:32 to 00/15:31:00

Plot file version 151 created 29-APR-2009 14:31:34
 IRAS2336 EP064D.UVDATA.1
 Freq = 1.5950 GHz, Bw = 16.000 MH Calibrated with CL # 3 and BP # 1 (BP mode 1)

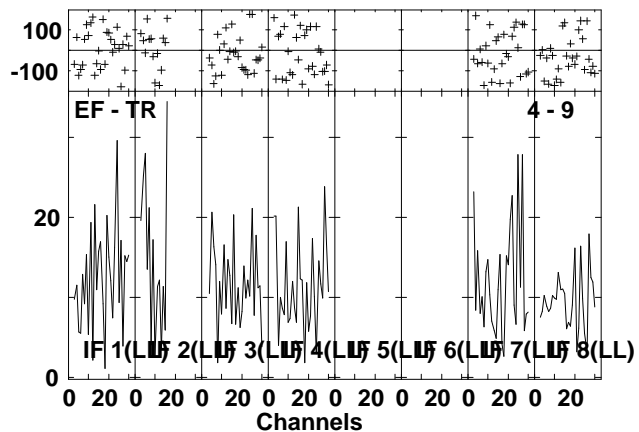
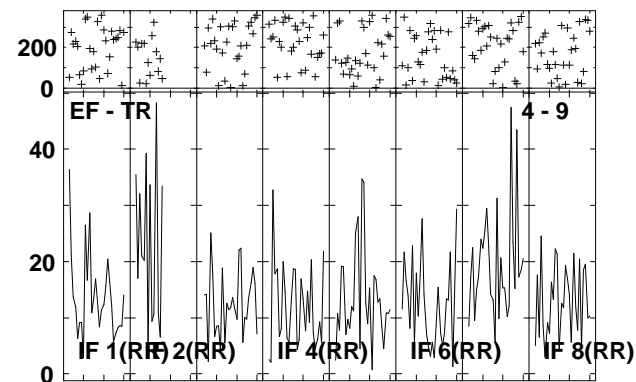
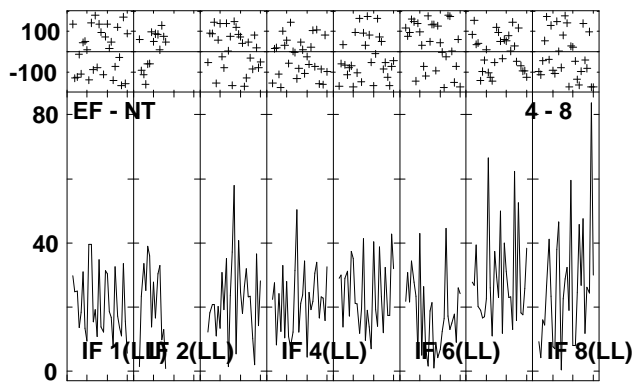
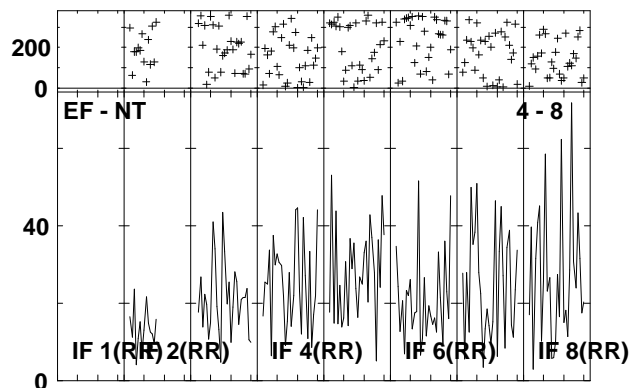
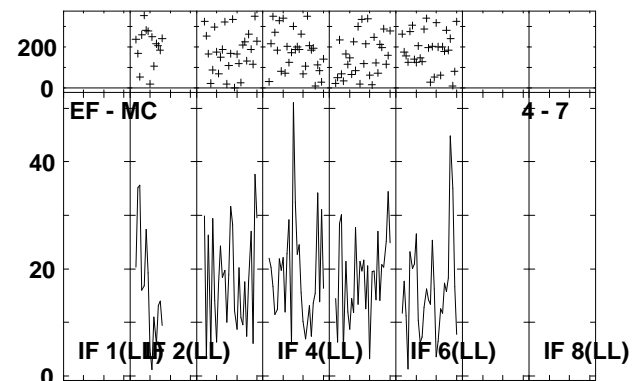
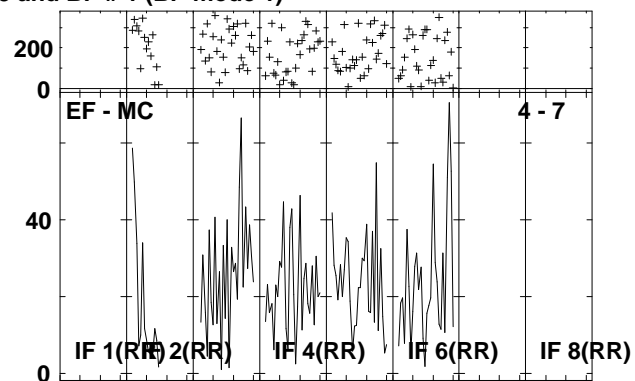
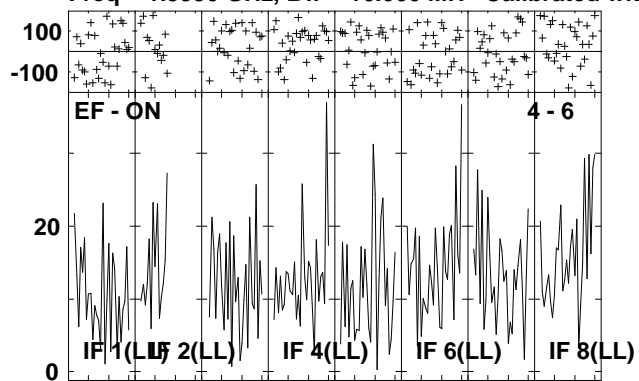

Lower frame: Milli Ampl Jy Top frame: Phas deg
 Vector averaged cross-power spectrum Several baselines displayed
 Timerange: 00/15:27:32 to 00/15:31:00

Plot file version 152 created 29-APR-2009 14:31:39

J2333+39 EP064D.UVDATA.1

Freq = 1.5950 GHz, Bw = 16.000 MH Calibrated with CL # 3 and BP # 1 (BP mode 1)

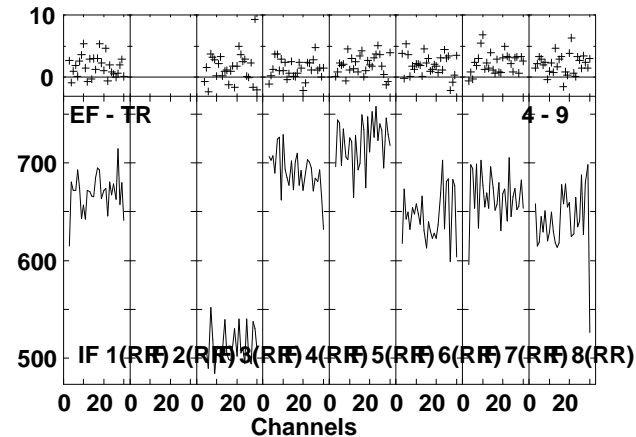
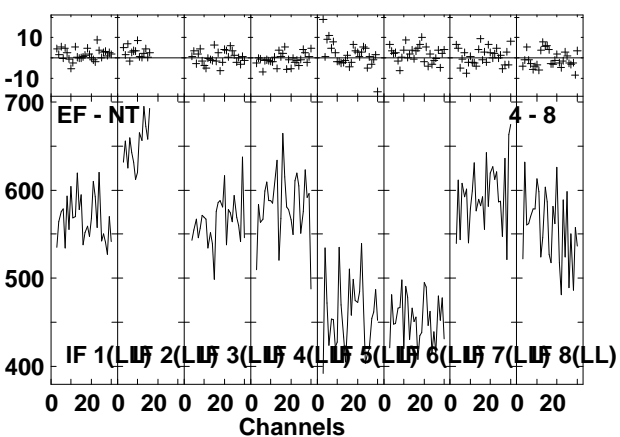
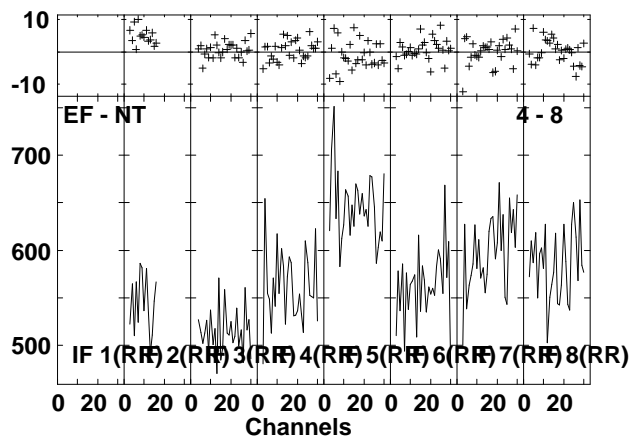
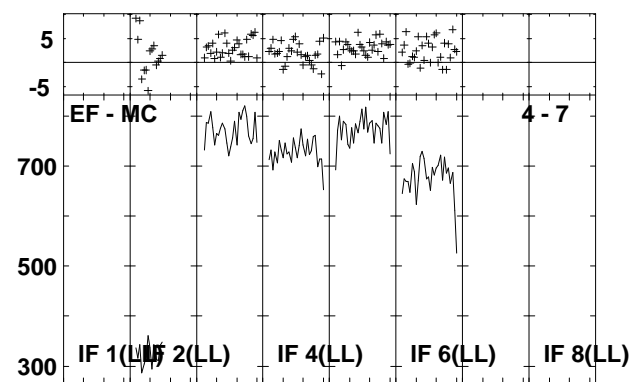
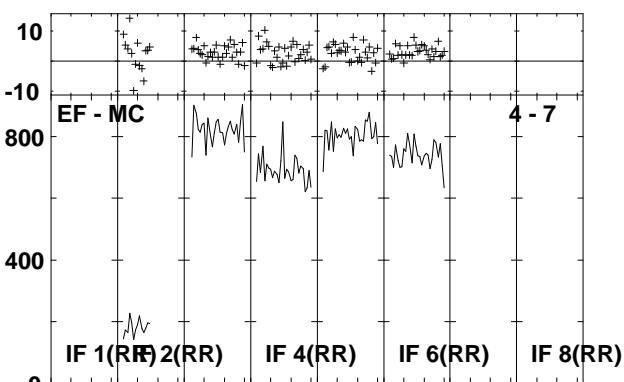
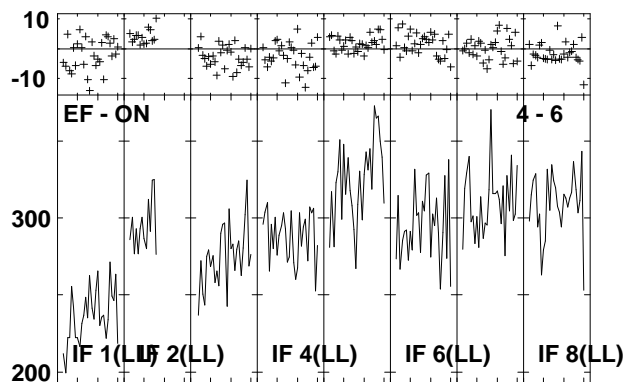
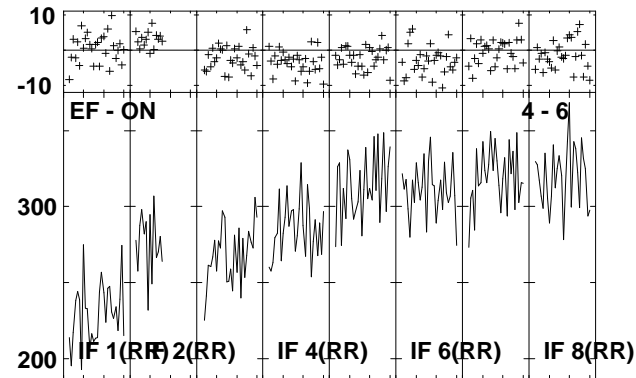
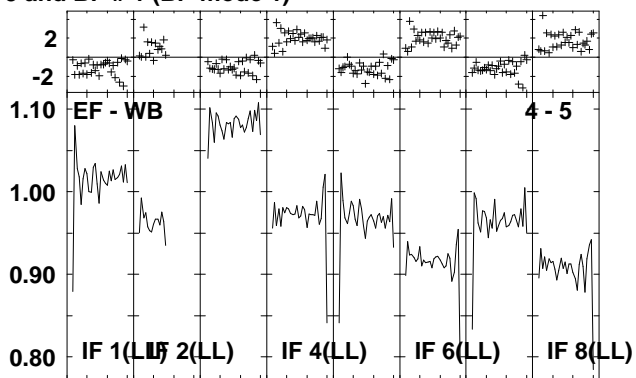
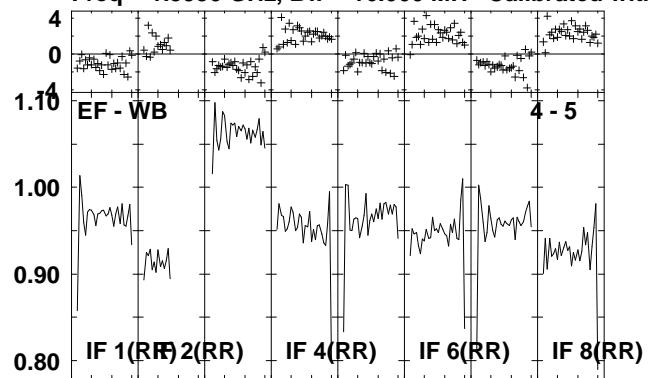

Lower frame: Ampl Jy Top frame: Phas deg
Vector averaged cross-power spectrum Several baselines displayed
Timerange: 00/15:31:02 to 00/15:32:28

Plot file version 153 created 29-APR-2009 14:31:40
J2333+39 EP064D.UVDATA.1
Freq = 1.5950 GHz, Bw = 16.000 MH Calibrated with CL # 3 and BP # 1 (BP mode 1)

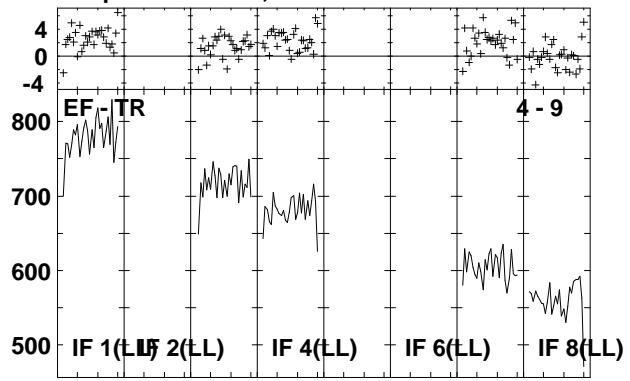

Lower frame: Milli Ampl Jy Top frame: Phas deg
Vector averaged cross-power spectrum Several baselines displayed
Timerange: 00/15:31:02 to 00/15:32:28

Plot file version 154 created 29-APR-2009 14:31:41

IRAS2336 EP064D.UVDATA.1

Freq = 1.5950 GHz, Bw = 16.000 MH Calibrated with CL # 3 and BP # 1 (BP mode 1)

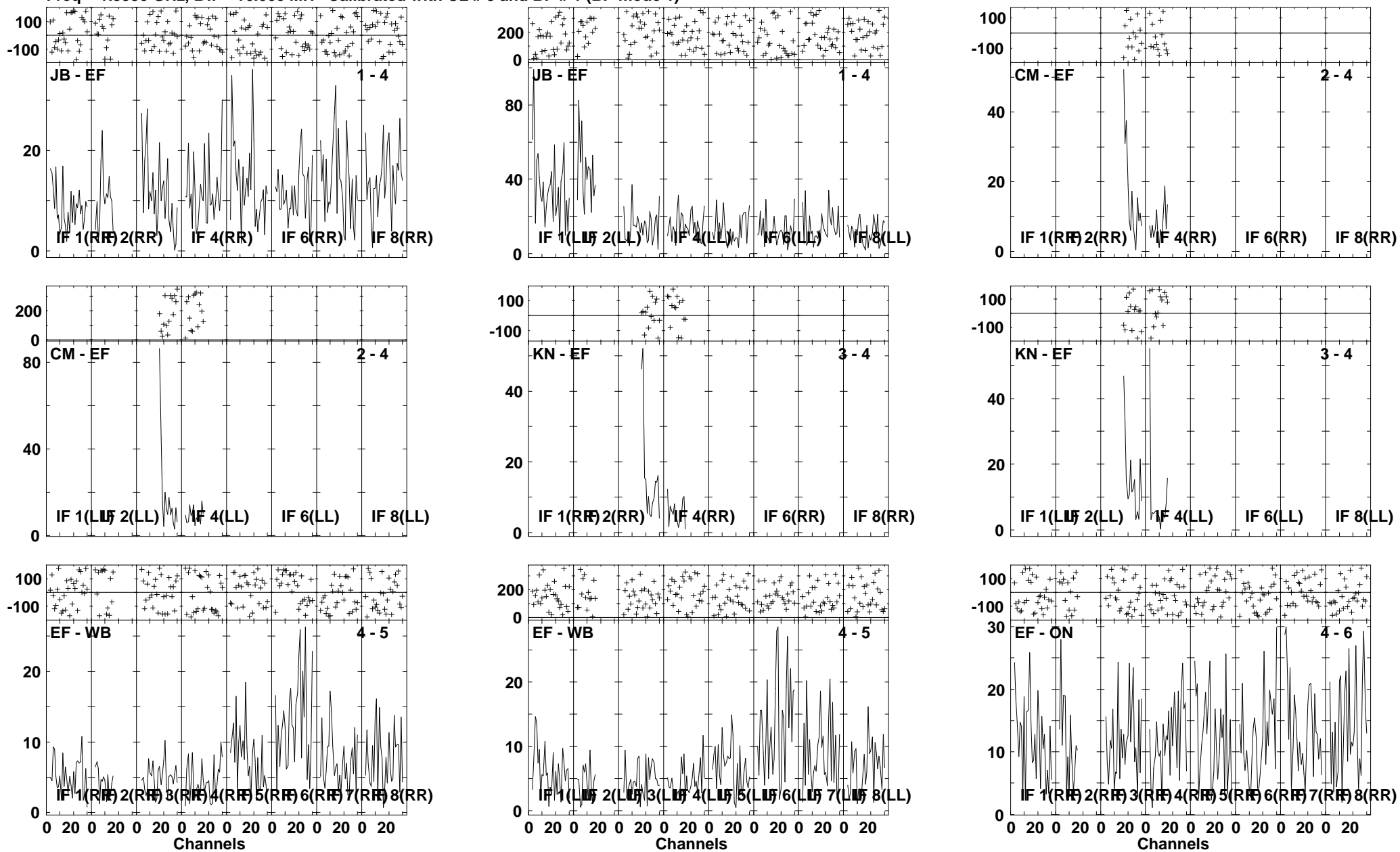

Lower frame: Milli Ampl Jy Top frame: Phas deg
Vector averaged cross-power spectrum Several baselines displayed
Timerange: 00/15:32:30 to 00/15:36:00

Plot file version 155 created 29-APR-2009 14:31:43
 IRAS2336 EP064D.UVDATA.1
 Freq = 1.5950 GHz, Bw = 16.000 MH Calibrated with CL # 3 and BP # 1 (BP mode 1)

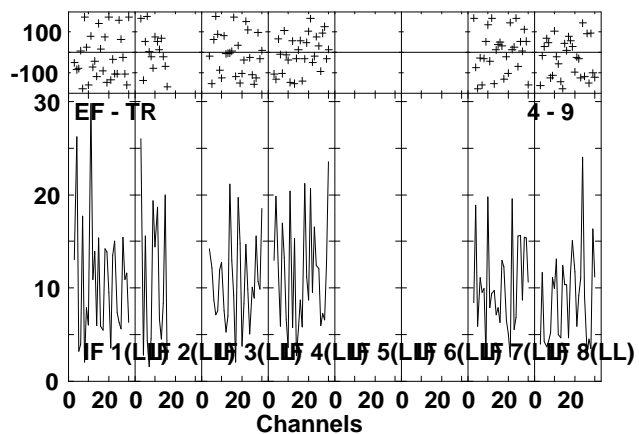
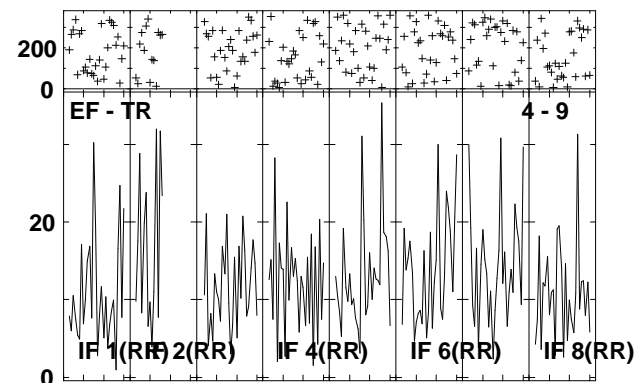
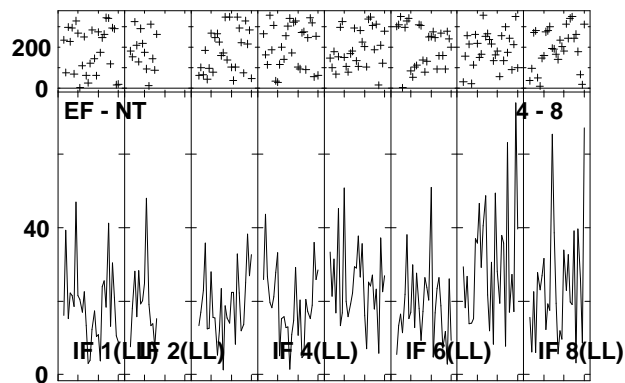
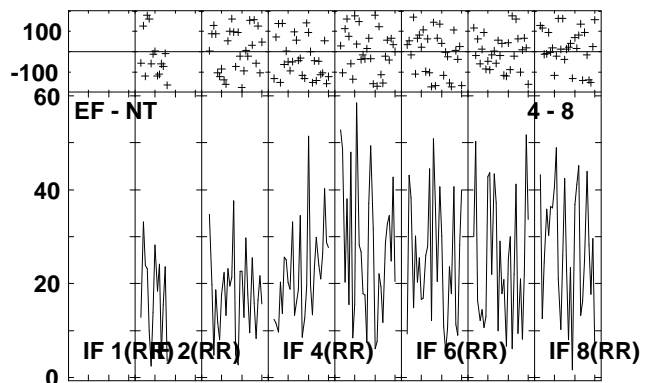
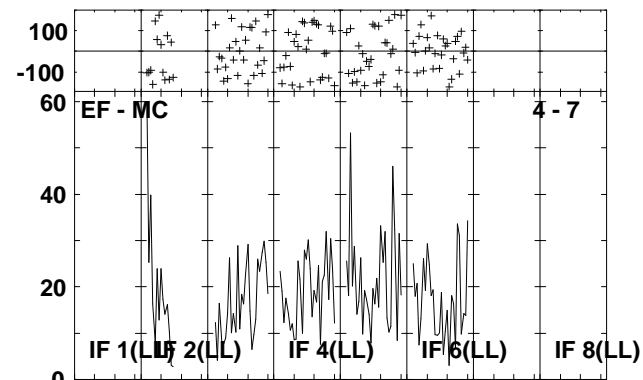
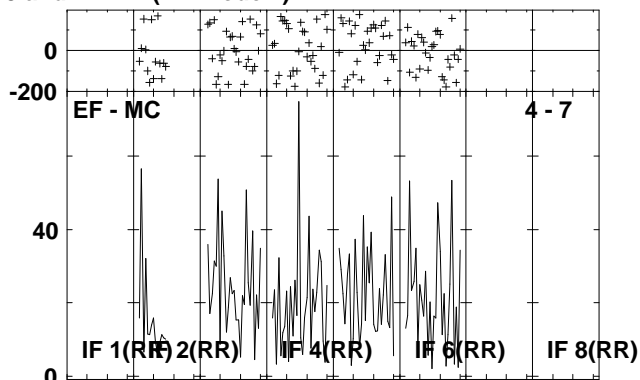
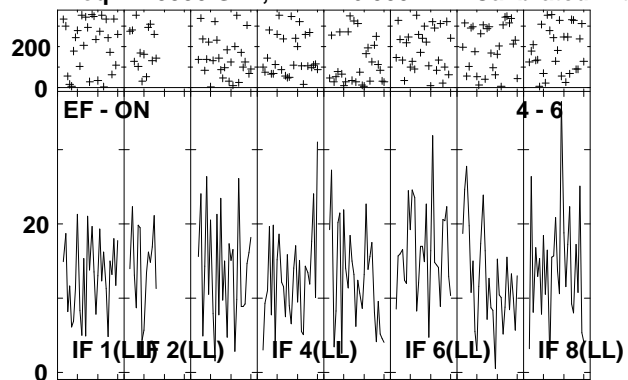

Lower frame: Milli Ampl Jy Top frame: Phas deg
 Vector averaged cross-power spectrum Several baselines displayed
 Timerange: 00/15:32:30 to 00/15:36:00

Plot file version 156 created 29-APR-2009 14:31:47

J2333+39 EP064D.UVDATA.1

Freq = 1.5950 GHz, Bw = 16.000 MH Calibrated with CL # 3 and BP # 1 (BP mode 1)

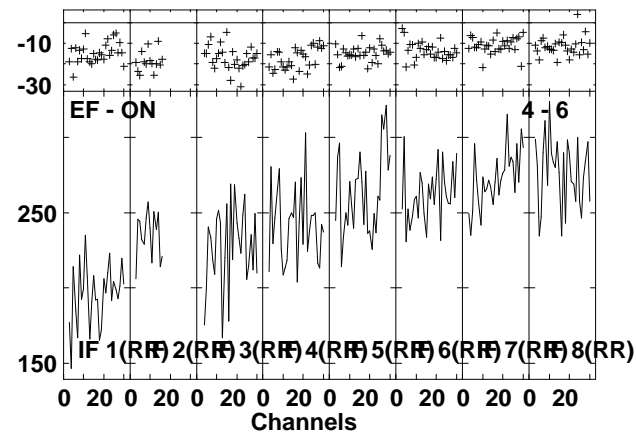
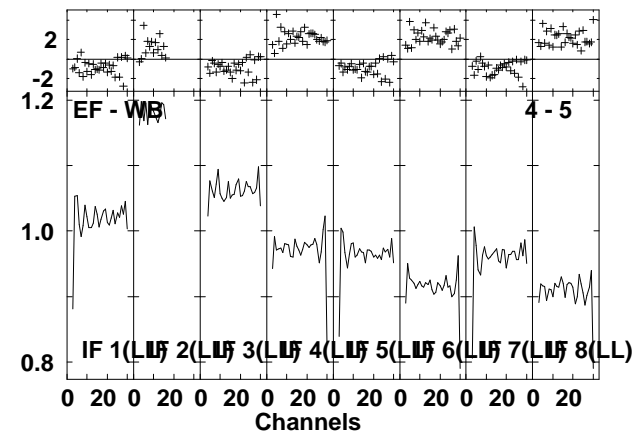
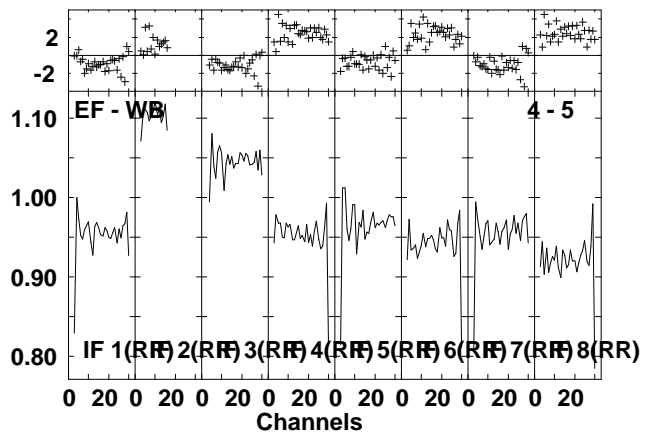
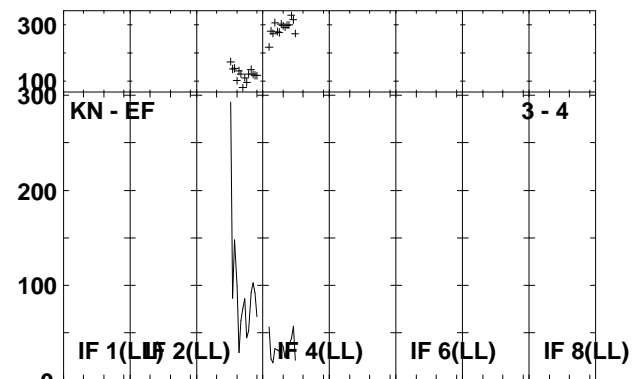
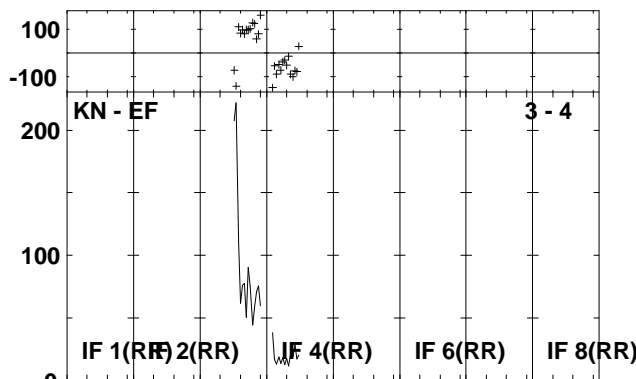
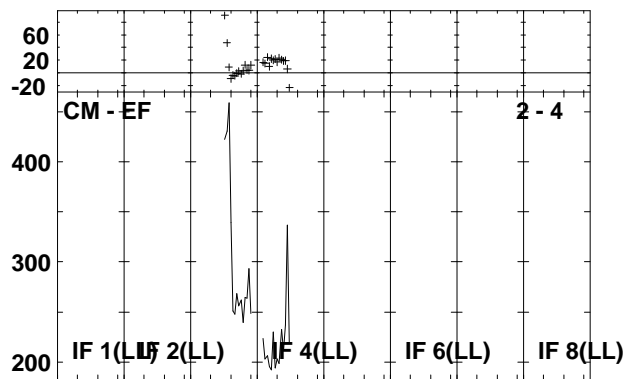
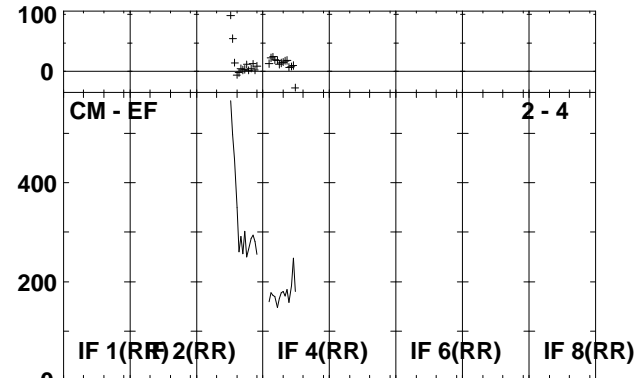
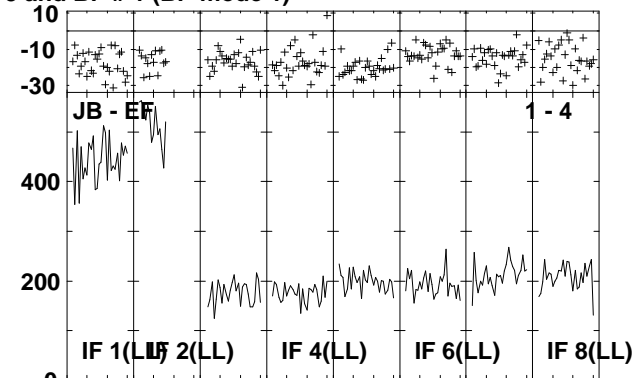
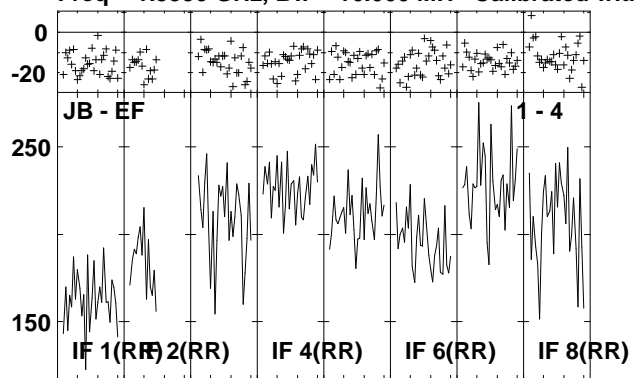

Lower frame: Milli Ampl Jy Top frame: Phas deg
Vector averaged cross-power spectrum Several baselines displayed
Timerange: 00/15:36:02 to 00/15:37:30

Plot file version 157 created 29-APR-2009 14:31:48
 J2333+39 EP064D.UVDATA.1
 Freq = 1.5950 GHz, Bw = 16.000 MH Calibrated with CL # 3 and BP # 1 (BP mode 1)

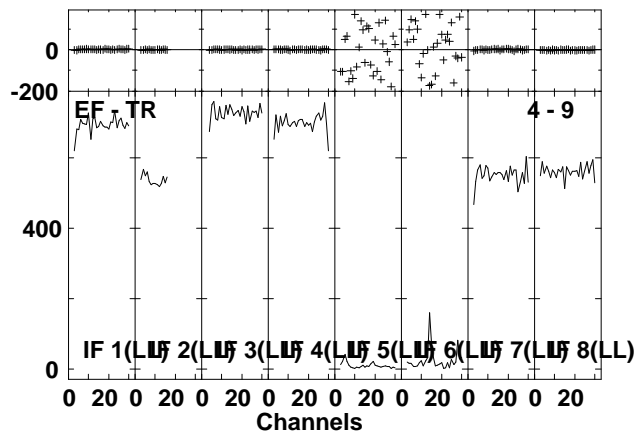
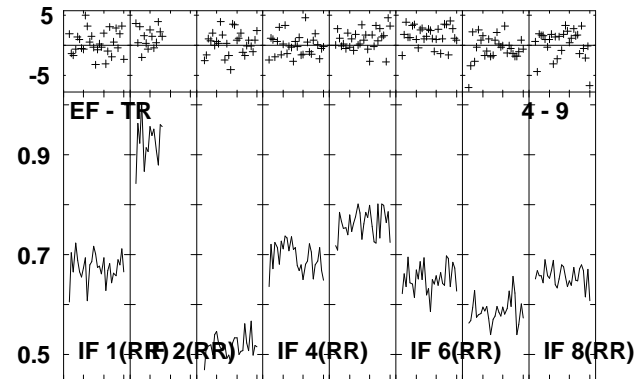
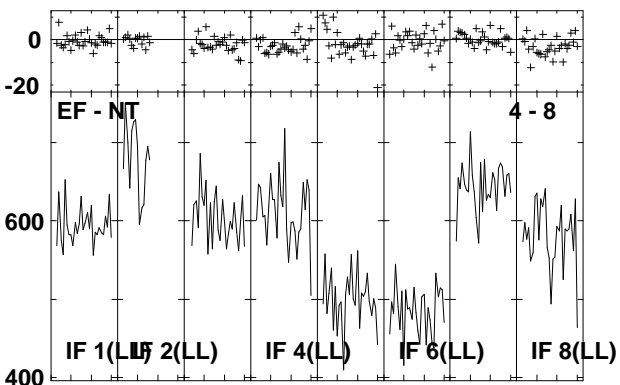
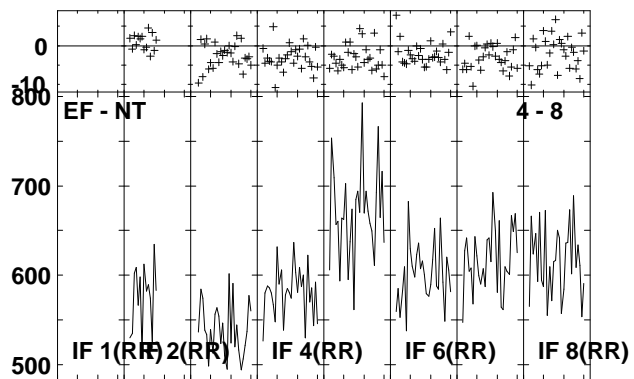
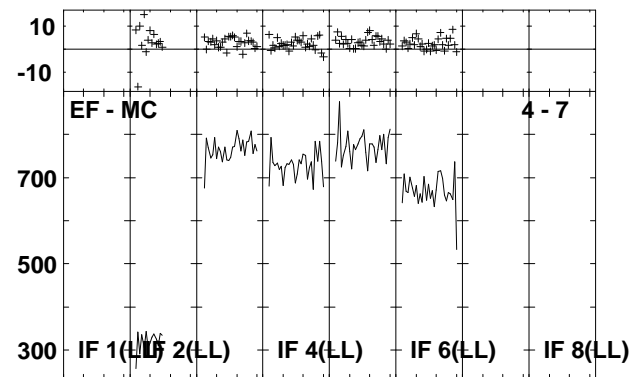
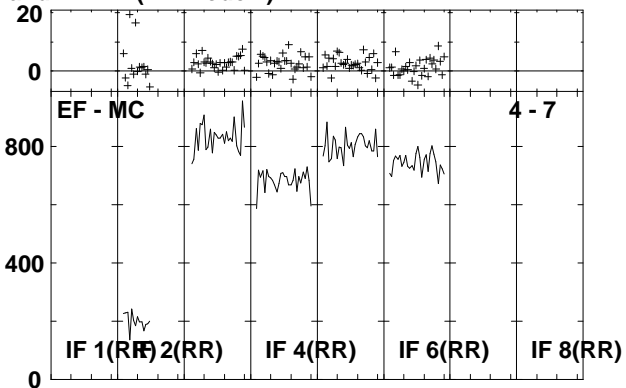
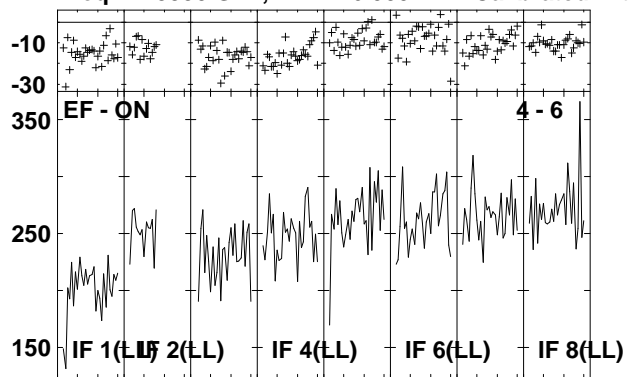

Lower frame: Milli Ampl Jy Top frame: Phas deg
 Vector averaged cross-power spectrum Several baselines displayed
 Timerange: 00/15:36:02 to 00/15:37:30

Plot file version 158 created 29-APR-2009 14:31:50

IRAS2336 EP064D.UVDATA.1

Freq = 1.5950 GHz, Bw = 16.000 MH Calibrated with CL # 3 and BP # 1 (BP mode 1)

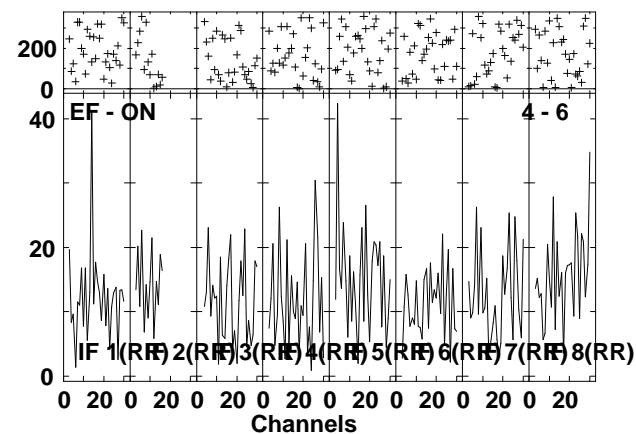
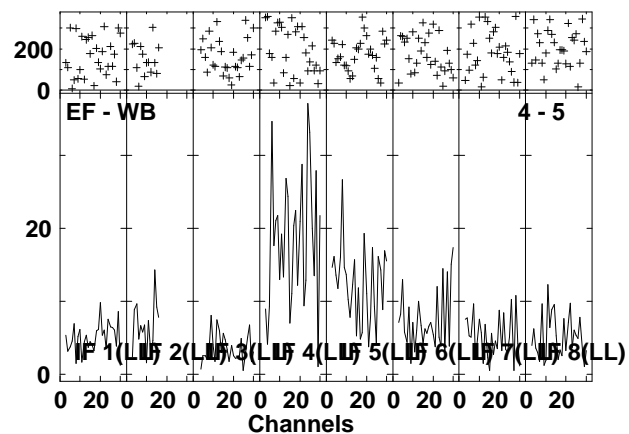
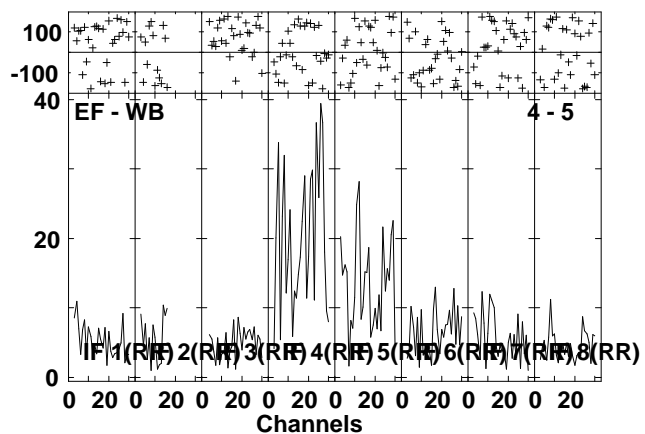
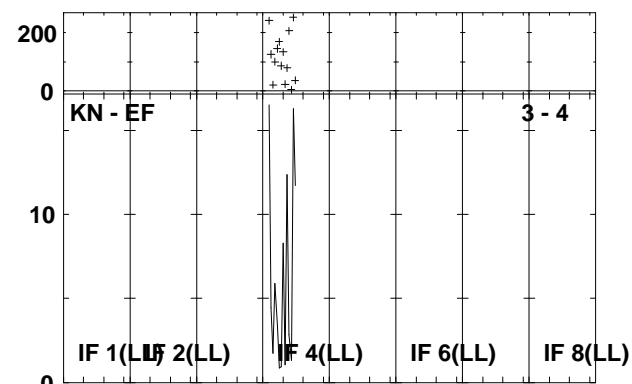
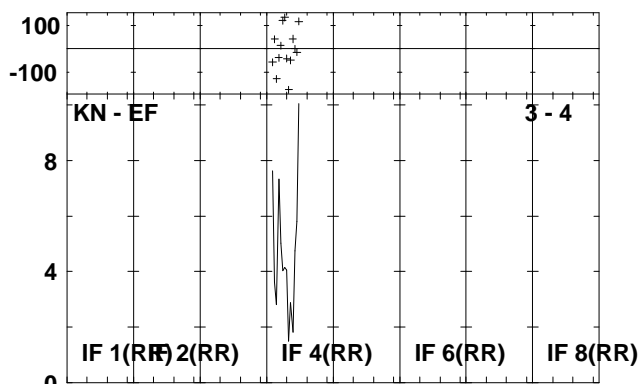
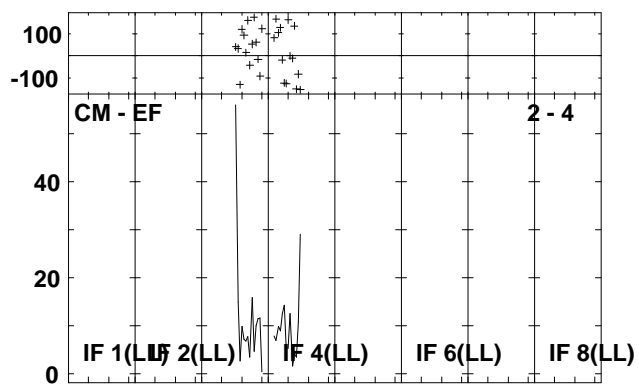
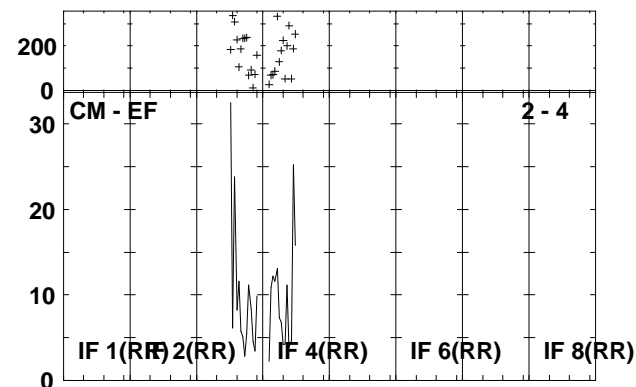
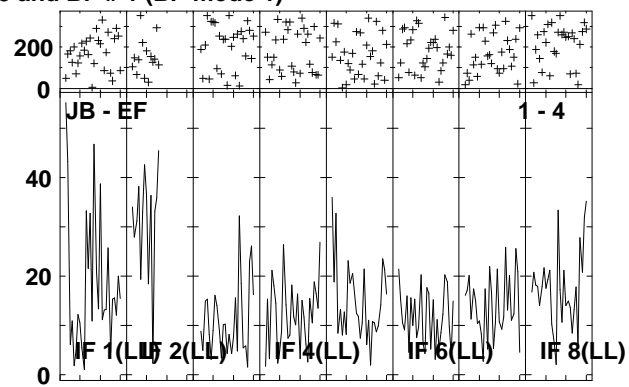
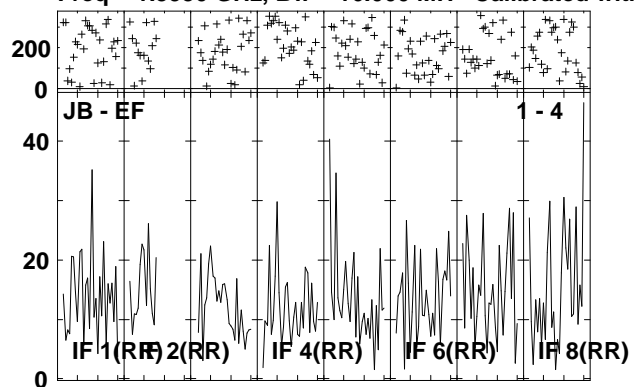

Lower frame: Milli Ampl Jy Top frame: Phas deg
Vector averaged cross-power spectrum Several baselines displayed
Timerange: 00:15:37:32 to 00:15:40:56

Plot file version 159 created 29-APR-2009 14:31:52

IRAS2336 EP064D.UVDATA.1

Freq = 1.5950 GHz, Bw = 16.000 MH Calibrated with CL # 3 and BP # 1 (BP mode 1)

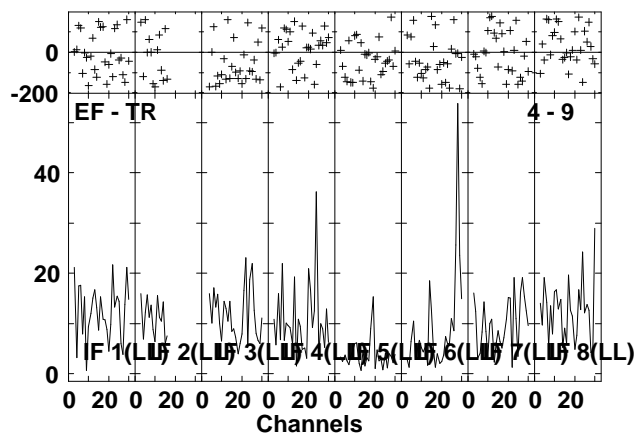
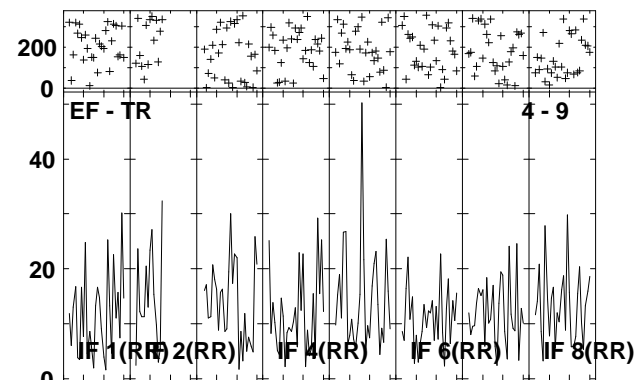
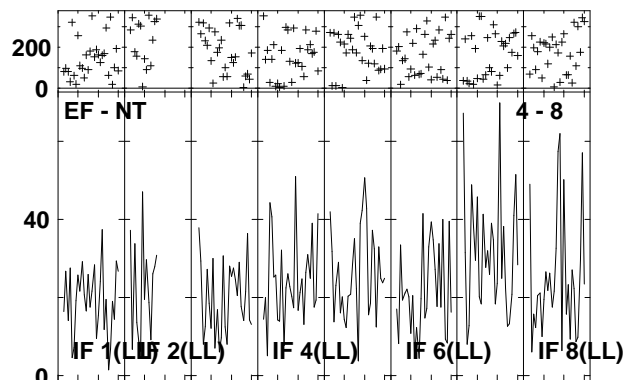
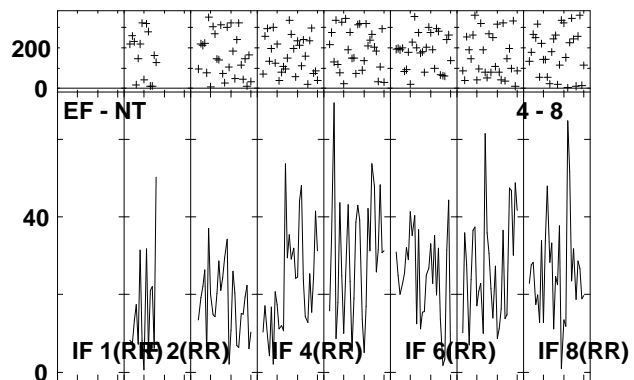
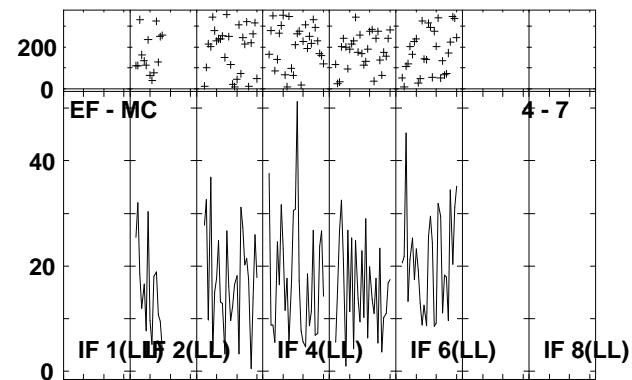
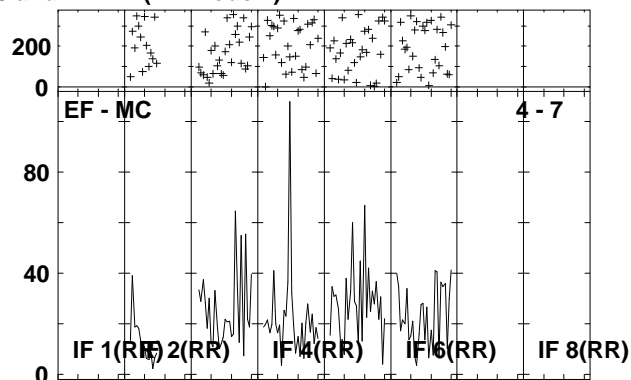
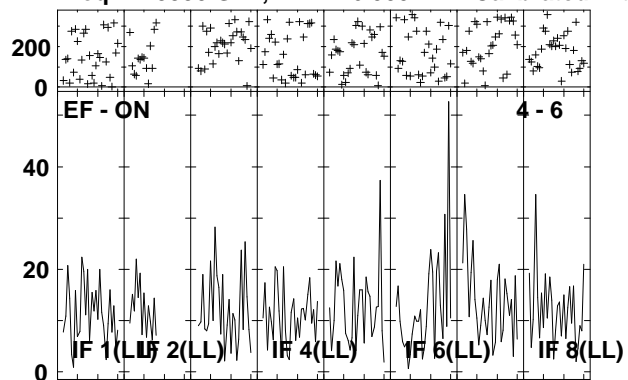

Lower frame: Milli Ampl Jy Top frame: Phas deg
Vector averaged cross-power spectrum Several baselines displayed
Timerange: 00/15:37:32 to 00/15:40:56

Plot file version 160 created 29-APR-2009 14:31:56

J2333+39 EP064D.UVDATA.1

Freq = 1.5950 GHz, Bw = 16.000 MH Calibrated with CL # 3 and BP # 1 (BP mode 1)

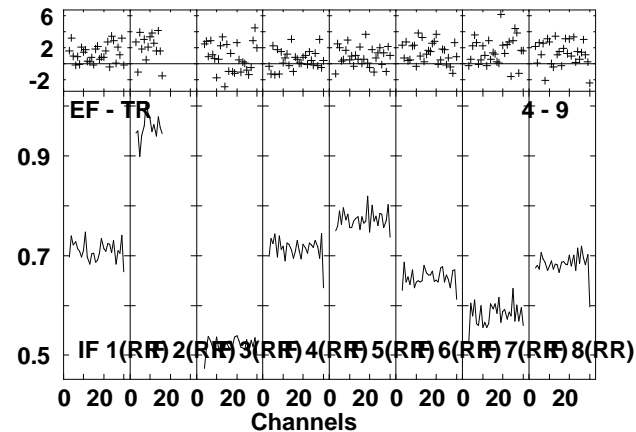
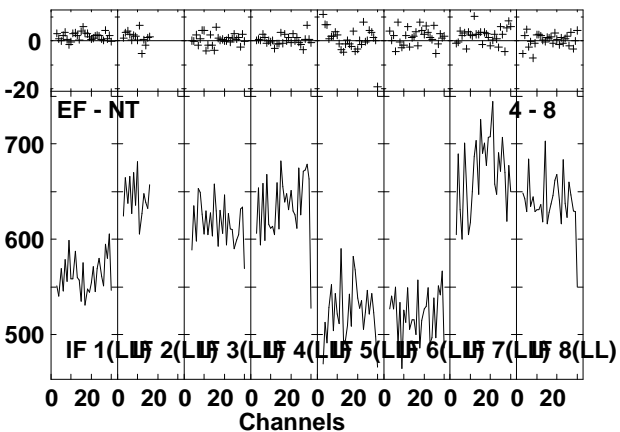
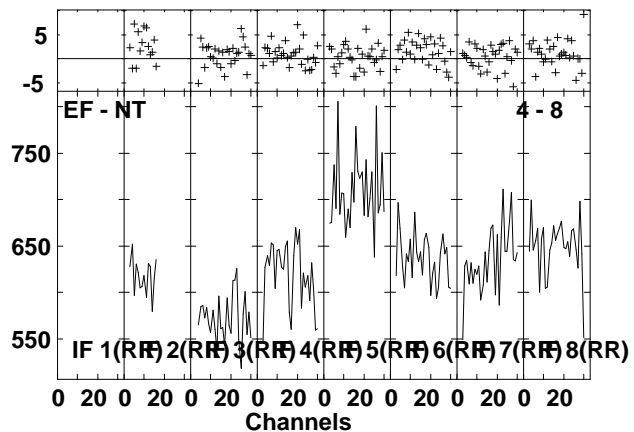
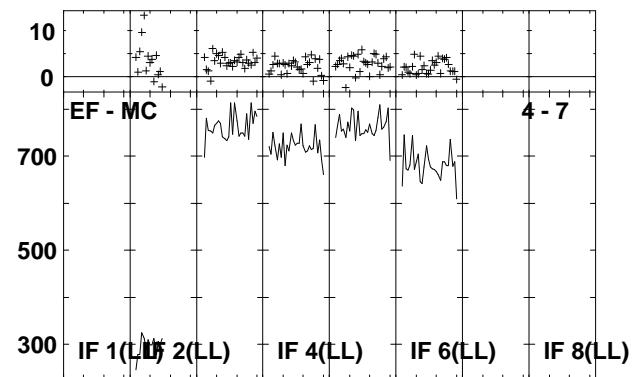
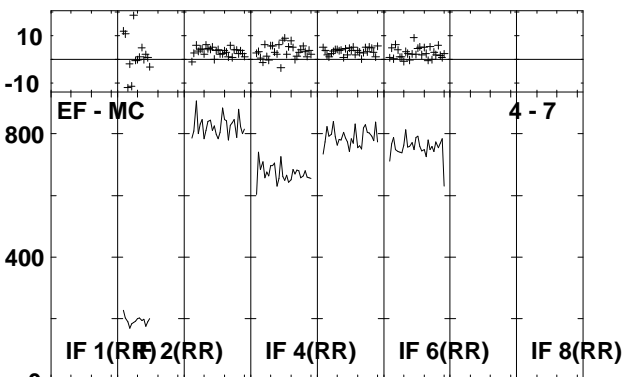
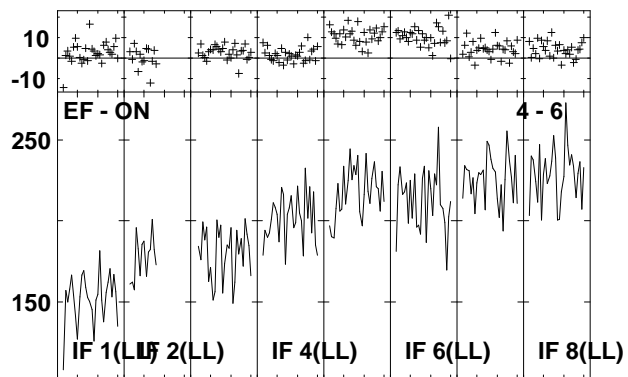
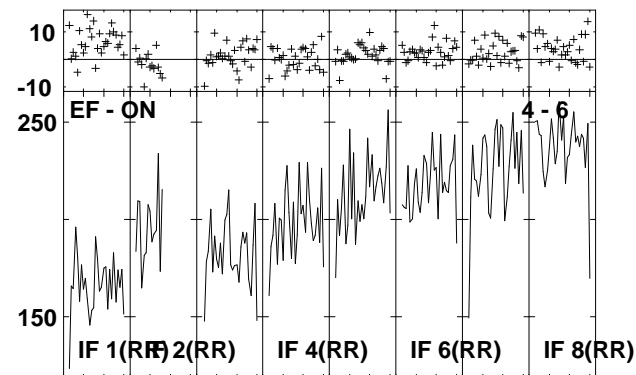
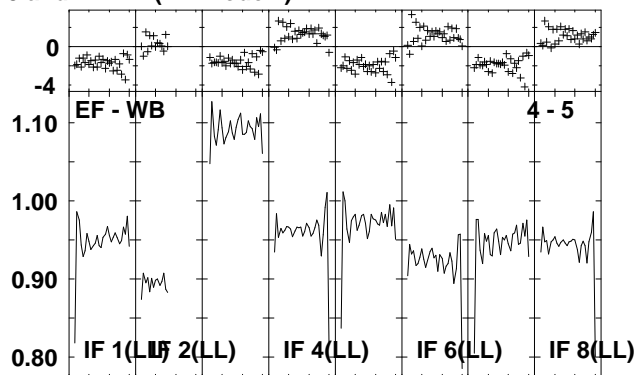
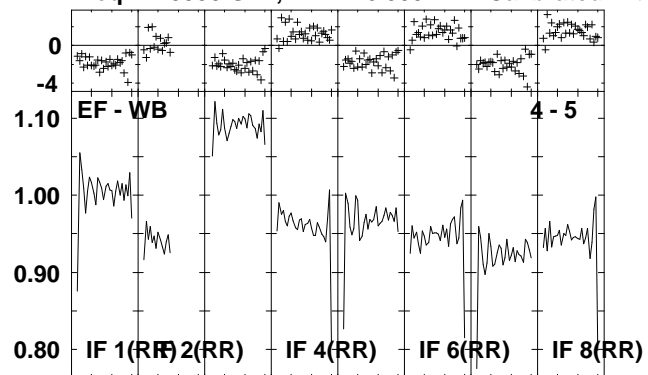

Lower frame: Ampl Jy Top frame: Phas deg
Vector averaged cross-power spectrum Several baselines displayed
Timerange: 00/15:42:01 to 00/15:43:27

Plot file version 161 created 29-APR-2009 14:31:57
J2333+39 EP064D.UVDATA.1
Freq = 1.5950 GHz, Bw = 16.000 MH Calibrated with CL # 3 and BP # 1 (BP mode 1)

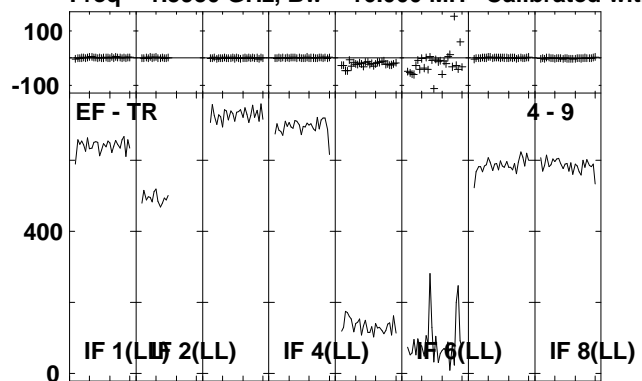

Lower frame: Milli Ampl Jy Top frame: Phas deg
Vector averaged cross-power spectrum Several baselines displayed
Timerange: 00/15:42:01 to 00/15:43:27

Plot file version 162 created 29-APR-2009 14:31:57

IRAS2336 EP064D.UVDATA.1

Freq = 1.5950 GHz, Bw = 16.000 MH Calibrated with CL # 3 and BP # 1 (BP mode 1)

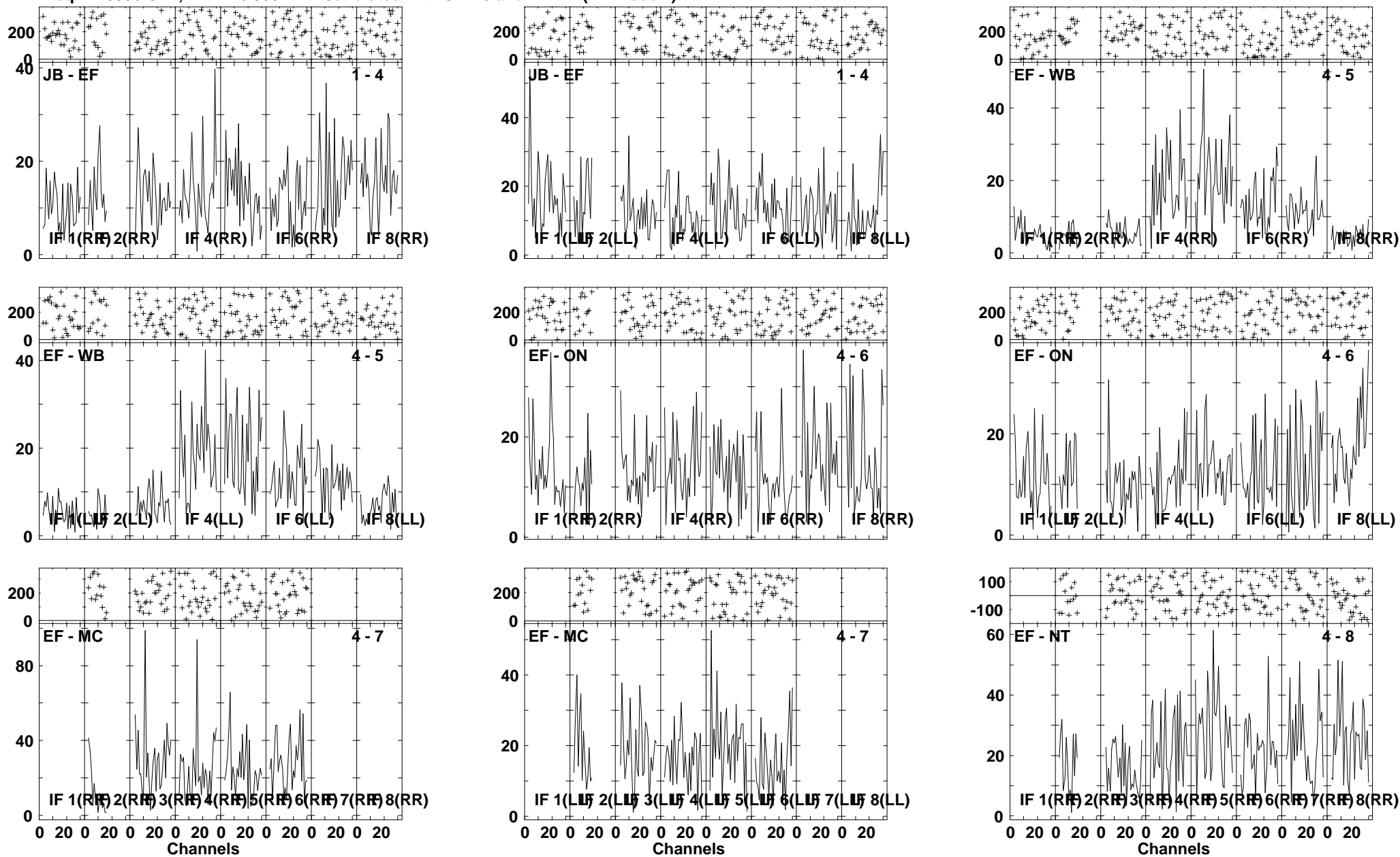

Lower frame: Milli Ampl Jy Top frame: Phas deg
Vector averaged cross-power spectrum Several baselines displayed
Timerange: 00/15:43:32 to 00/15:47:00

Plot file version 163 created 29-APR-2009 14:32:00

IRAS2336 EP064D.UVDATA.1

Freq = 1.5950 GHz, Bw = 16.000 MH Calibrated with CL # 3 and BP # 1 (BP mode 1)

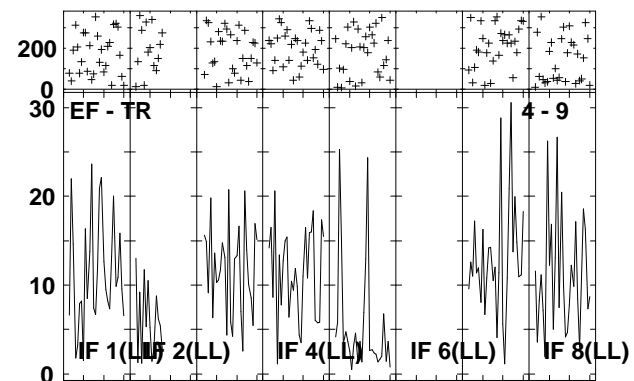
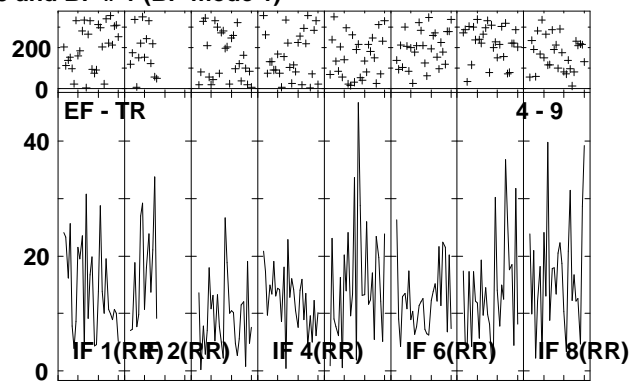
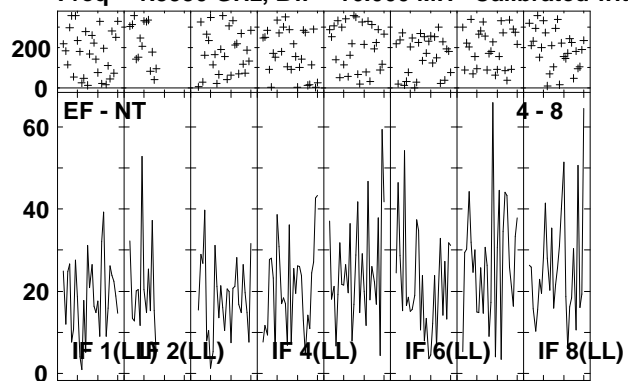

Lower frame: Milli Ampl Jy Top frame: Phas deg
Vector averaged cross-power spectrum Several baselines displayed
Timerange: 00/15:43:32 to 00/15:47:00

Plot file version 164 created 29-APR-2009 14:32:01

J2333+39 EP064D.UVDATA.1

Freq = 1.5950 GHz, Bw = 16.000 MH Calibrated with CL # 3 and BP # 1 (BP mode 1)

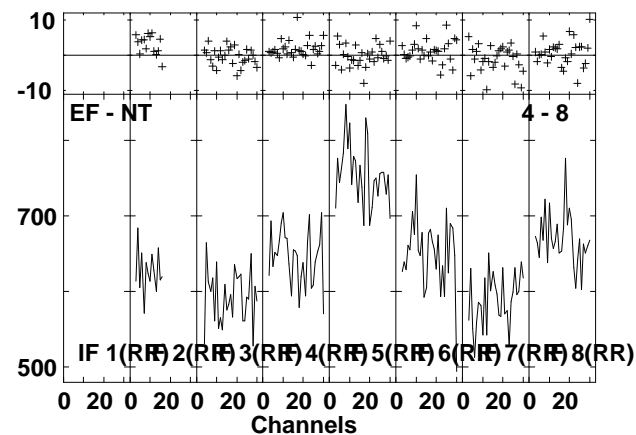
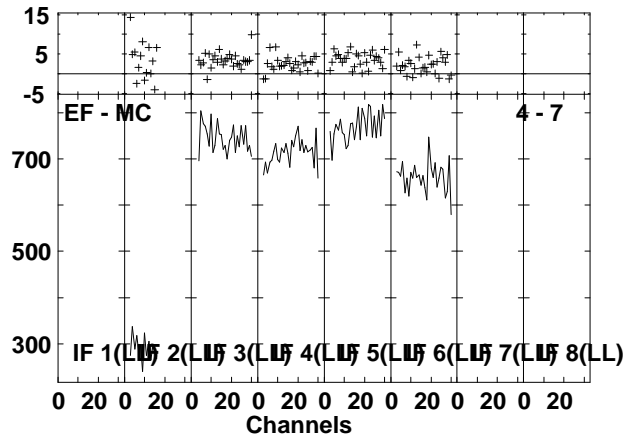
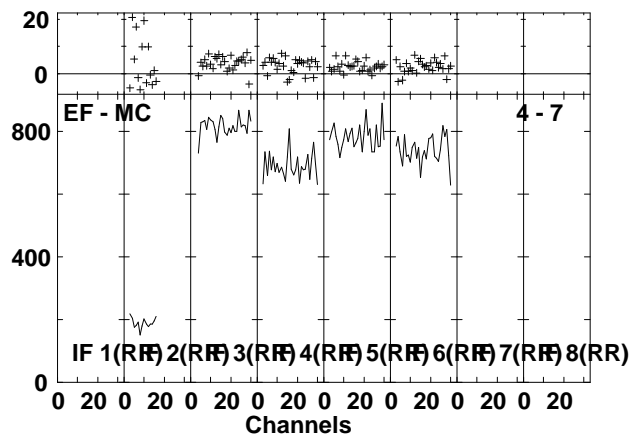
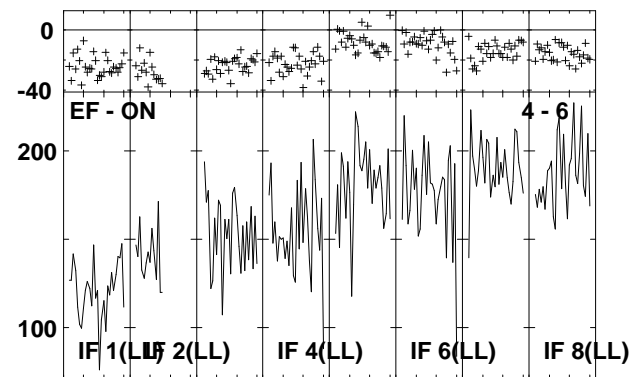
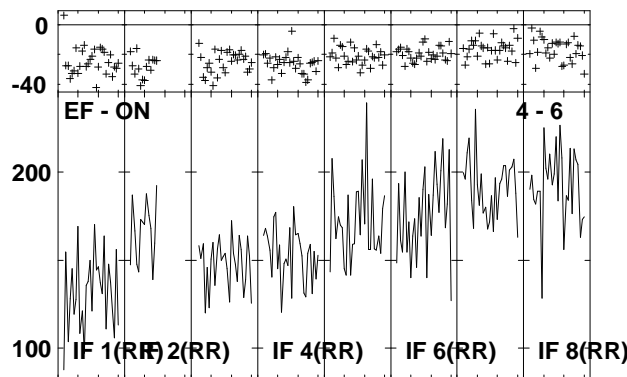
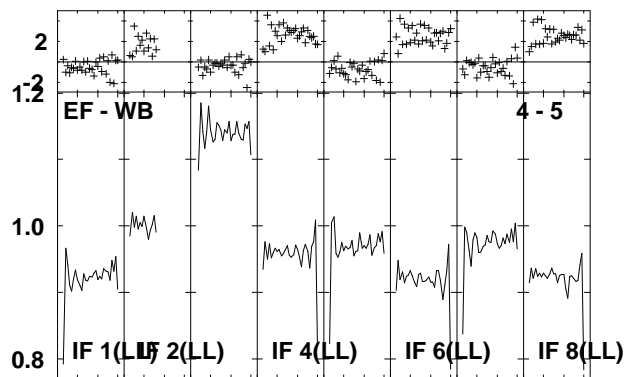
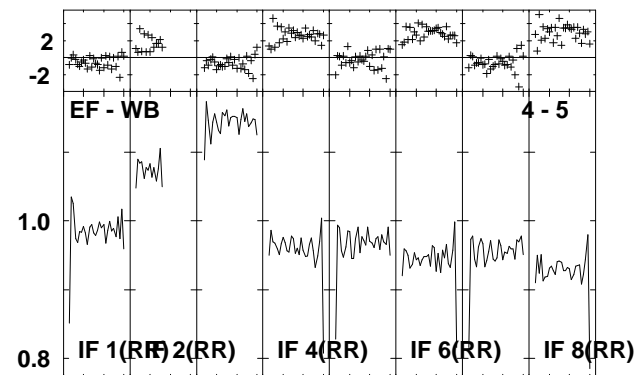
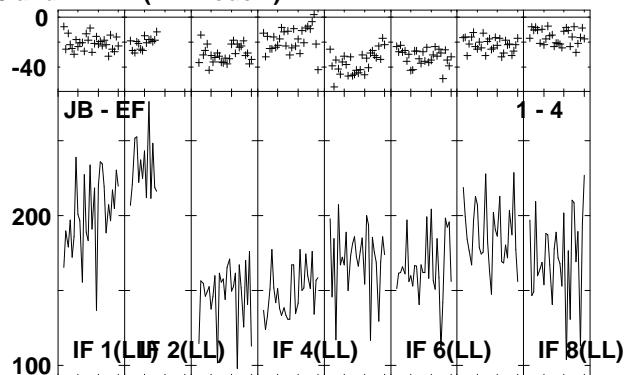
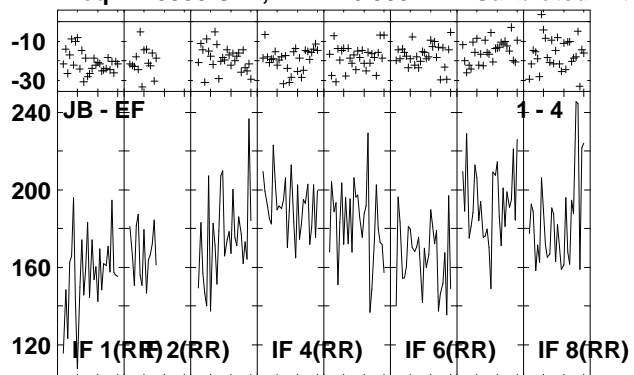

Lower frame: Milli Ampl Jy Top frame: Phas deg
Vector averaged cross-power spectrum Several baselines displayed
Timerange: 00/15:47:02 to 00/15:48:30

Plot file version 165 created 29-APR-2009 14:32:02

J2333+39 EP064D.UVDATA.1

Freq = 1.5950 GHz, Bw = 16.000 MH Calibrated with CL # 3 and BP # 1 (BP mode 1)

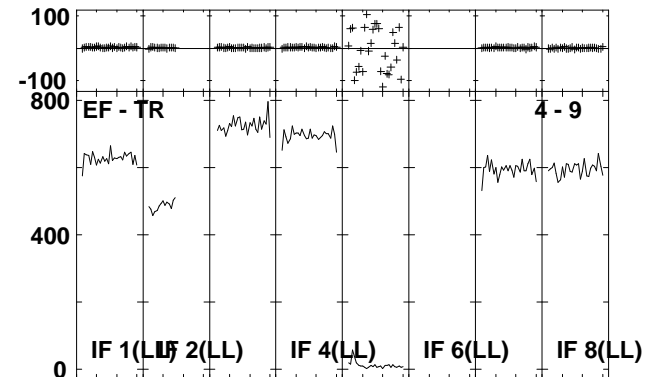
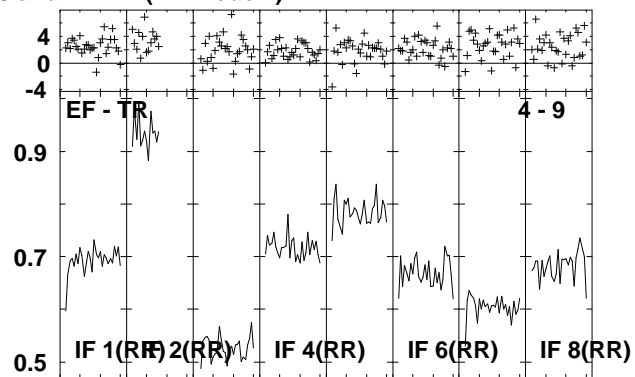
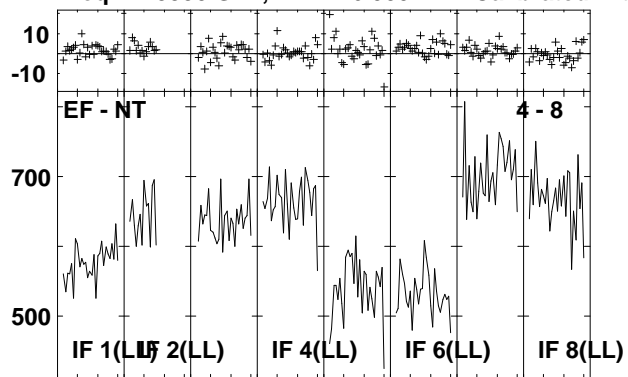

Lower frame: Milli Ampl Jy Top frame: Phas deg
Vector averaged cross-power spectrum Several baselines displayed
Timerange: 00/15:47:02 to 00/15:48:30

Plot file version 166 created 29-APR-2009 14:32:03

IRAS2336 EP064D.UVDATA.1

Freq = 1.5950 GHz, Bw = 16.000 MH Calibrated with CL # 3 and BP # 1 (BP mode 1)

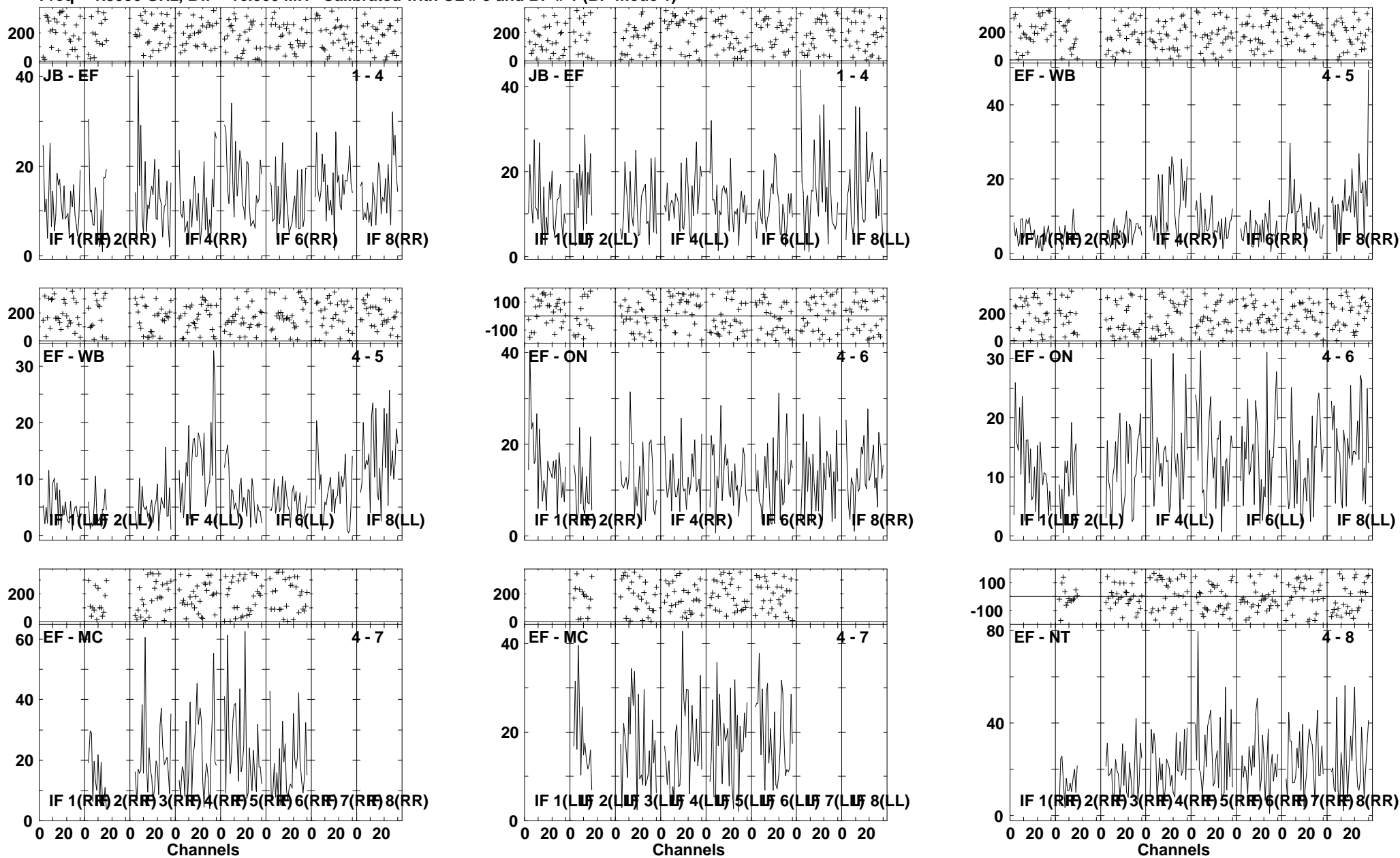

Lower frame: Milli Ampl Jy Top frame: Phas deg
Vector averaged cross-power spectrum Several baselines displayed
Timerange: 00/15:48:32 to 00/15:52:00

Plot file version 167 created 29-APR-2009 14:32:05

IRAS2336 EP064D.UVDATA.1

Freq = 1.5950 GHz, Bw = 16.000 MH Calibrated with CL # 3 and BP # 1 (BP mode 1)

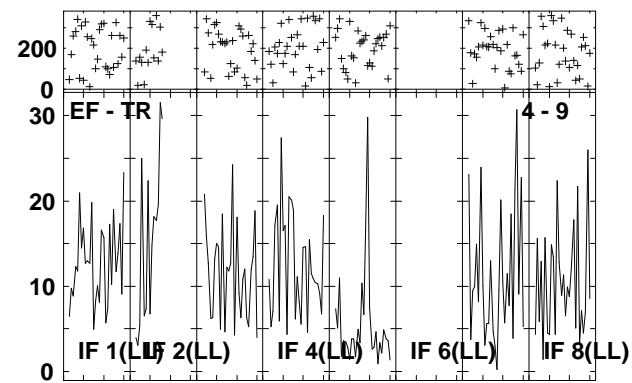
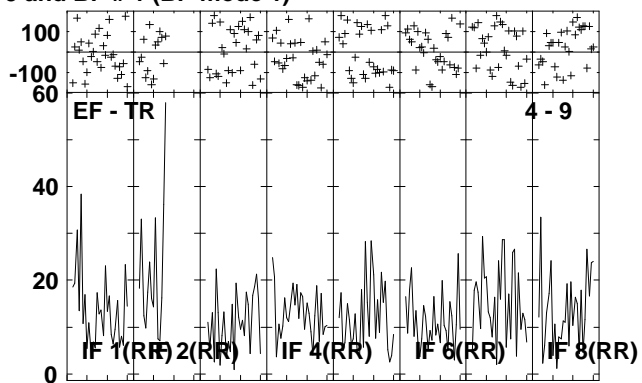
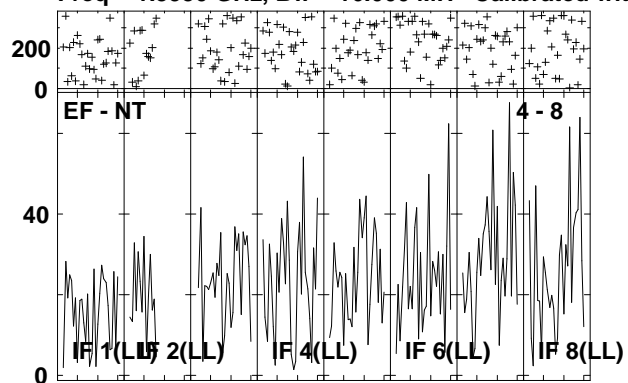

Lower frame: Milli Ampl Jy Top frame: Phas deg
Vector averaged cross-power spectrum Several baselines displayed
Timerange: 00/15:48:32 to 00/15:52:00

Plot file version 168 created 29-APR-2009 14:32:07

J2333+39 EP064D.UVDATA.1

Freq = 1.5950 GHz, Bw = 16.000 MH Calibrated with CL # 3 and BP # 1 (BP mode 1)

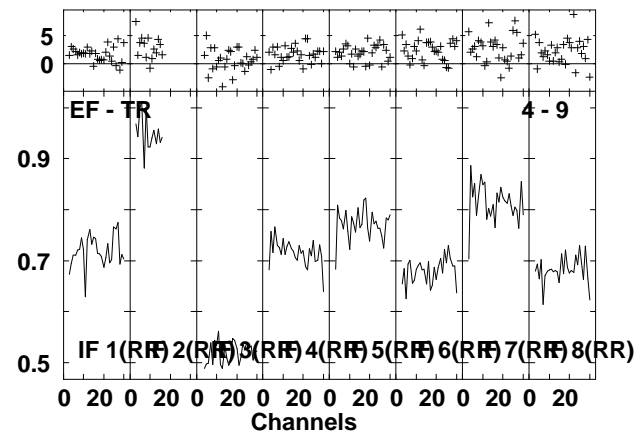
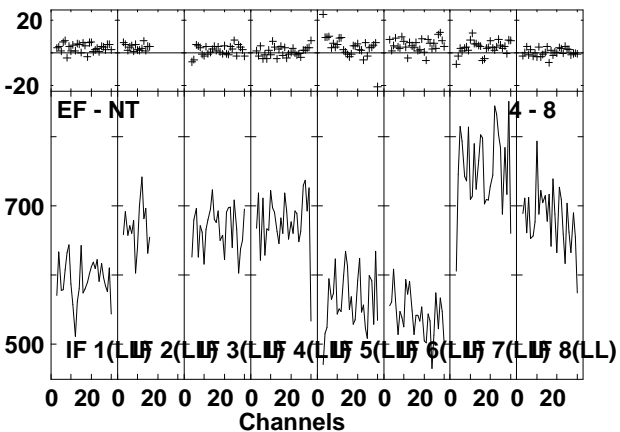
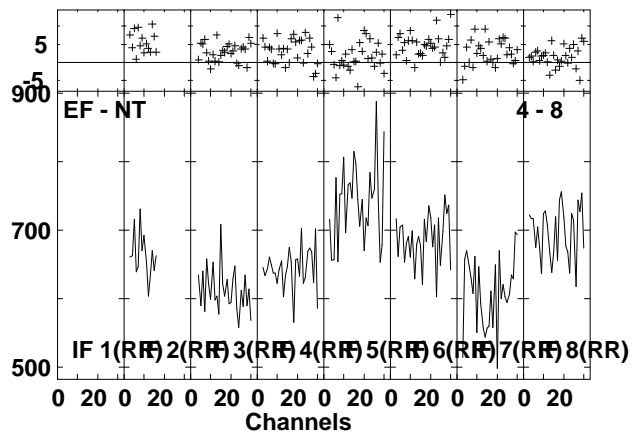
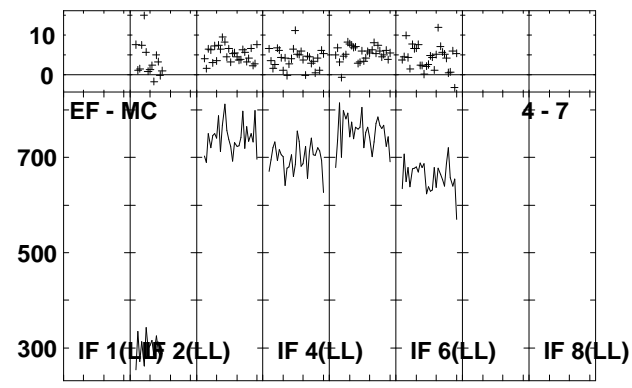
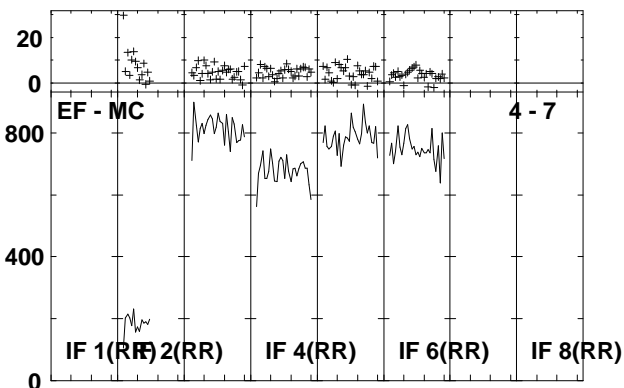
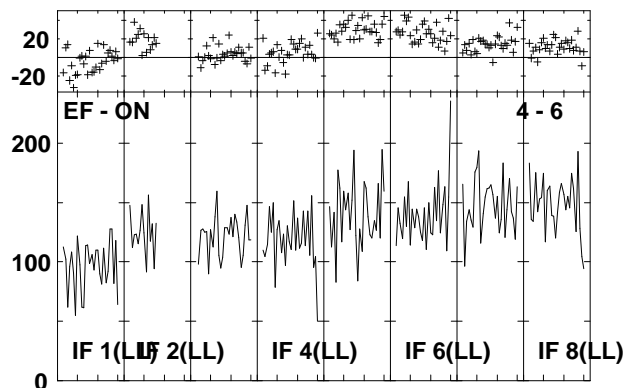
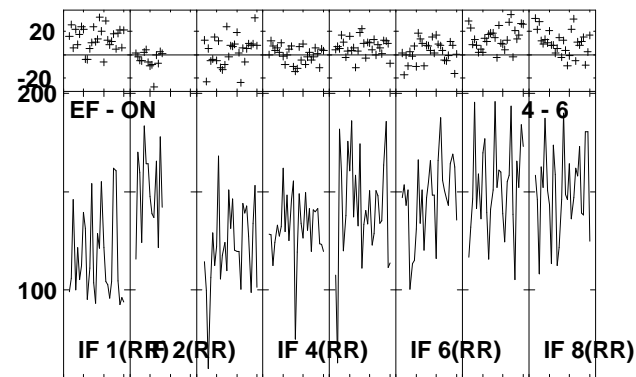
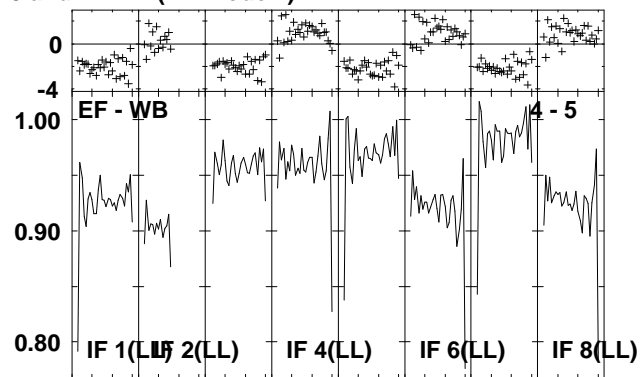
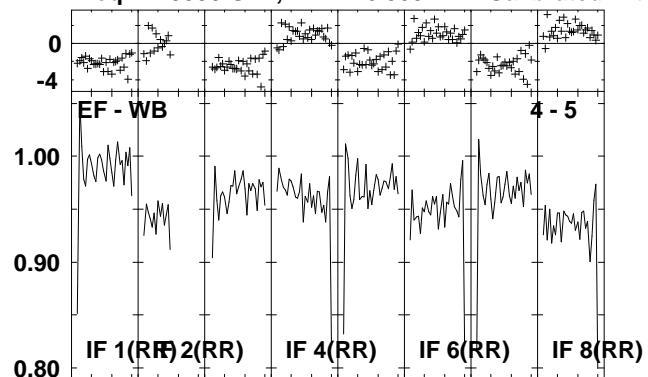

Lower frame: Ampl Jy Top frame: Phas deg
Vector averaged cross-power spectrum Several baselines displayed
Timerange: 00/15:52:02 to 00/15:53:28

Plot file version 169 created 29-APR-2009 14:32:08
J2333+39 EP064D.UVDATA.1
Freq = 1.5950 GHz, Bw = 16.000 MH Calibrated with CL # 3 and BP # 1 (BP mode 1)

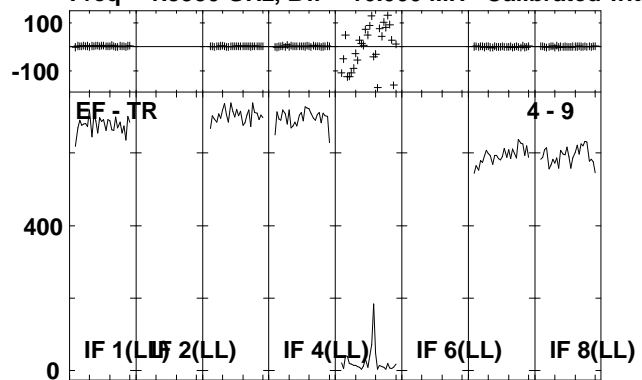

Lower frame: Milli Ampl Jy Top frame: Phas deg
Vector averaged cross-power spectrum Several baselines displayed
Timerange: 00/15:52:02 to 00/15:53:28

Plot file version 170 created 29-APR-2009 14:32:09

IRAS2336 EP064D.UVDATA.1

Freq = 1.5950 GHz, Bw = 16.000 MH Calibrated with CL # 3 and BP # 1 (BP mode 1)

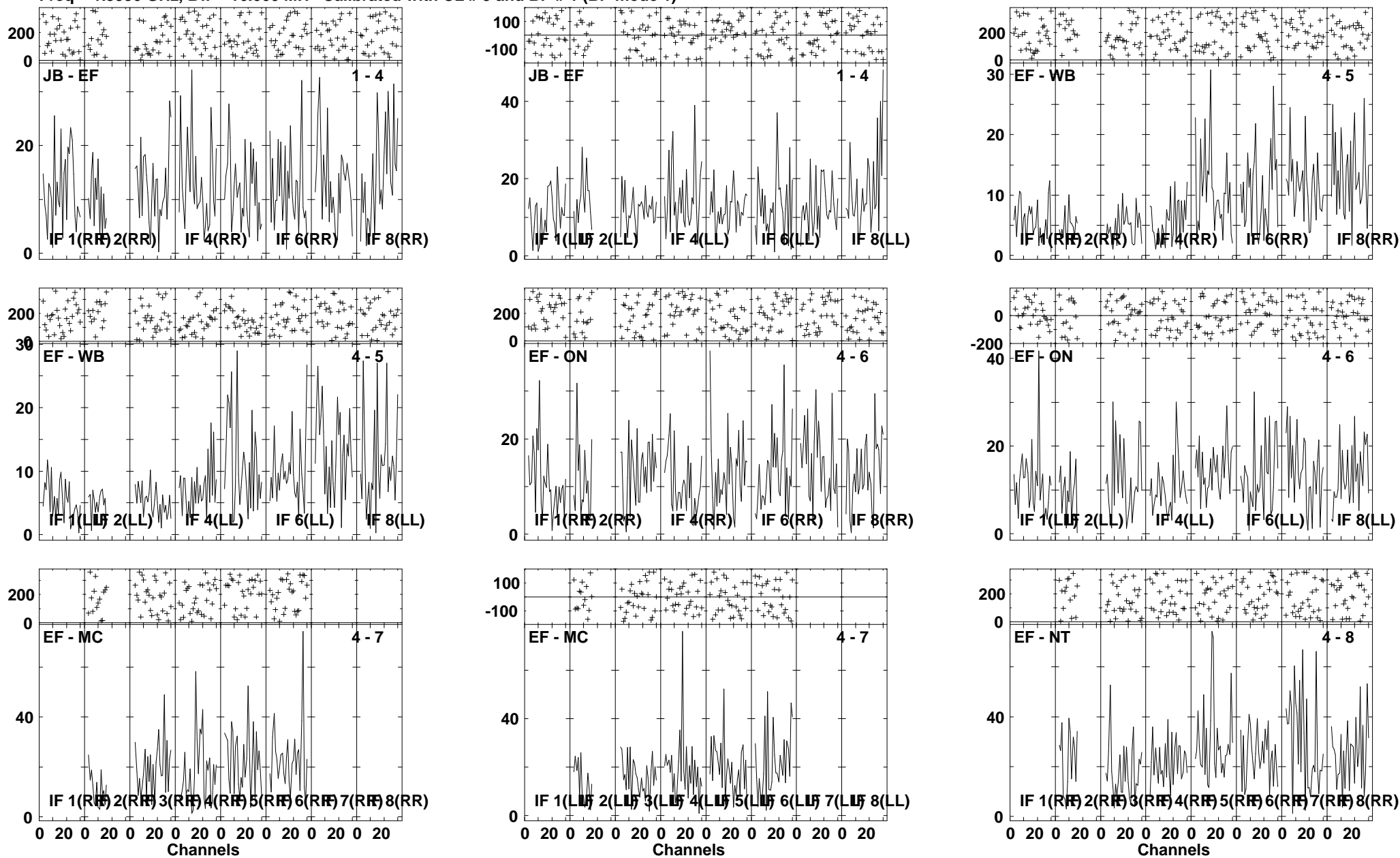

Lower frame: Milli Ampl Jy Top frame: Phas deg
Vector averaged cross-power spectrum Several baselines displayed
Timerange: 00/15:53:30 to 00/15:56:58

Plot file version 171 created 29-APR-2009 14:32:11

IRAS2336 EP064D.UVDATA.1

Freq = 1.5950 GHz, Bw = 16.000 MH Calibrated with CL # 3 and BP # 1 (BP mode 1)

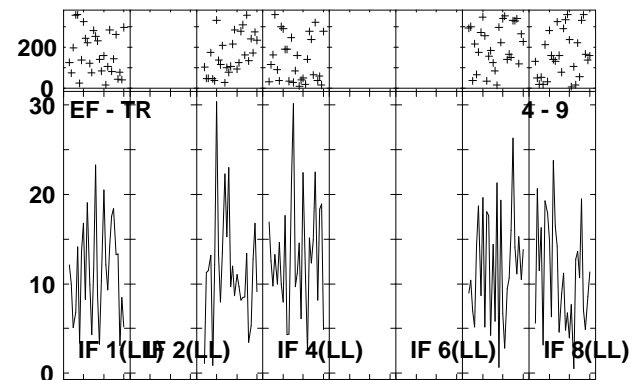
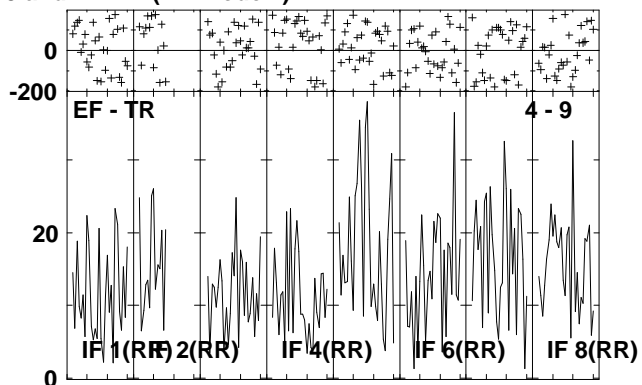
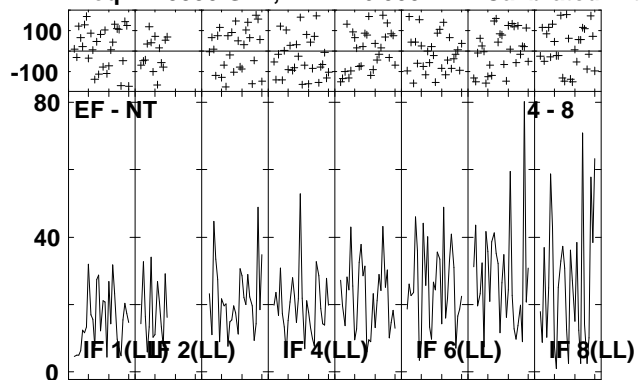

Lower frame: Milli Ampl Jy Top frame: Phas deg
Vector averaged cross-power spectrum Several baselines displayed
Timerange: 00/15:53:30 to 00/15:56:58

Plot file version 172 created 29-APR-2009 14:32:13

J2333+39 EP064D.UVDATA.1

Freq = 1.5950 GHz, Bw = 16.000 MH Calibrated with CL # 3 and BP # 1 (BP mode 1)

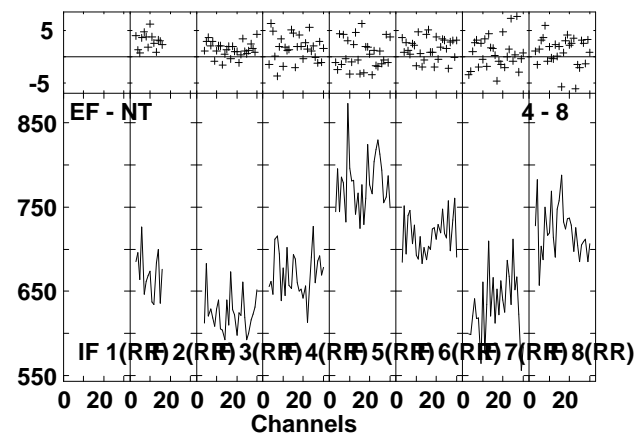
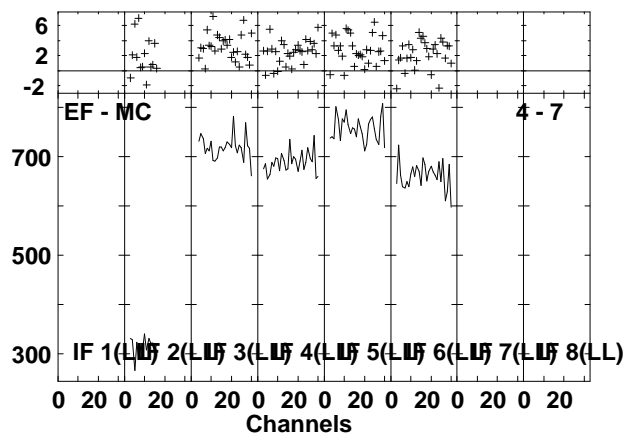
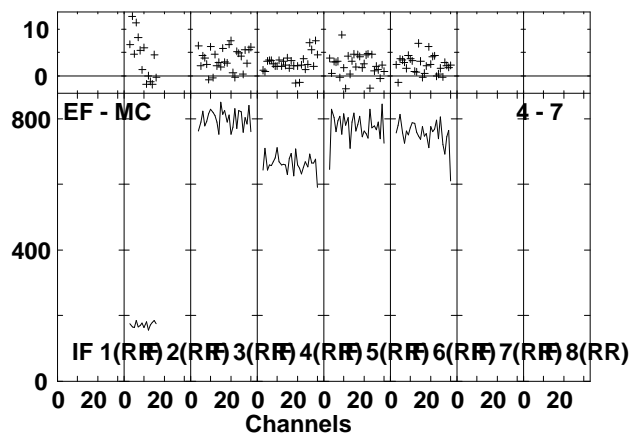
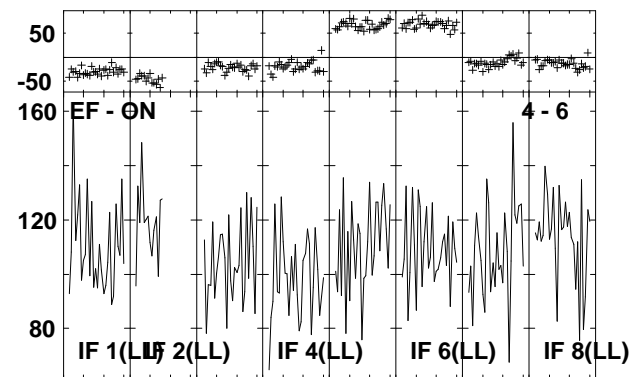
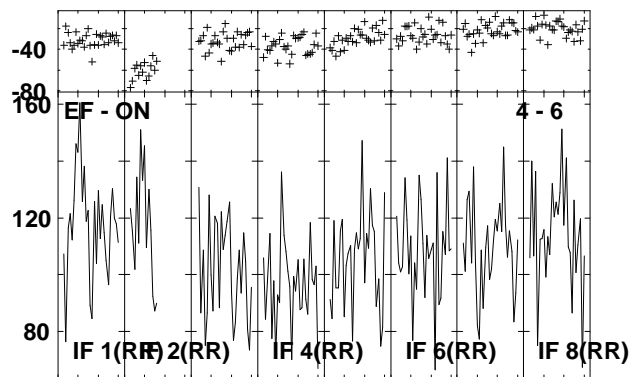
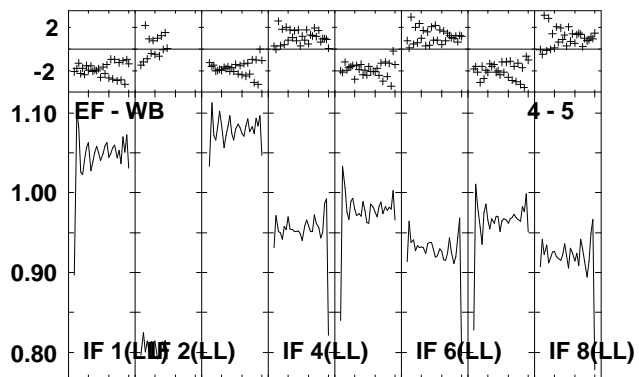
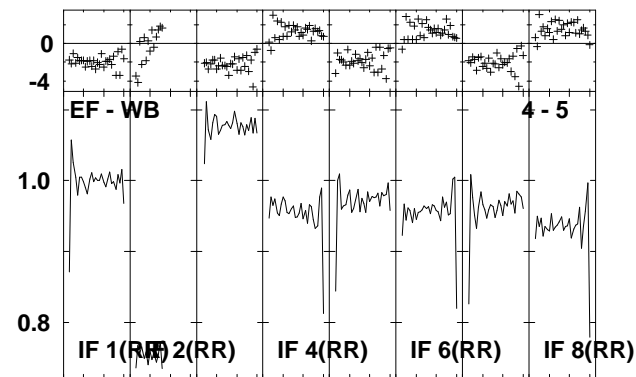
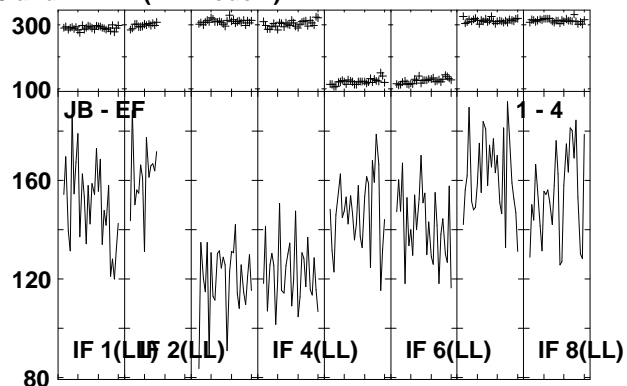
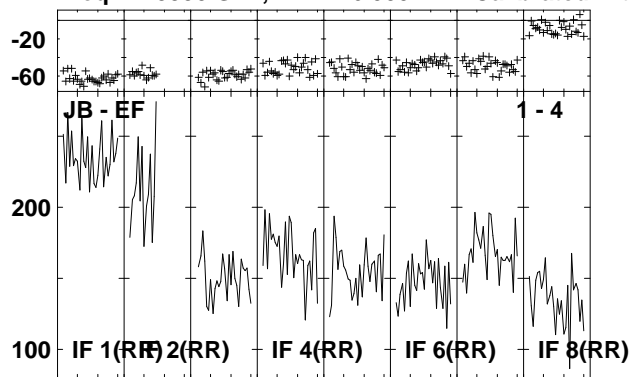

Lower frame: Milli Ampl Jy Top frame: Phas deg
Vector averaged cross-power spectrum Several baselines displayed
Timerange: 00/15:58:02 to 00/15:59:30

Plot file version 173 created 29-APR-2009 14:32:14

J2333+39 EP064D.UVDATA.1

Freq = 1.5950 GHz, Bw = 16.000 MH Calibrated with CL # 3 and BP # 1 (BP mode 1)

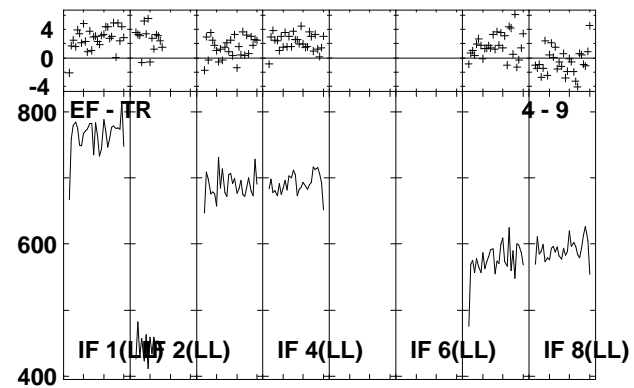
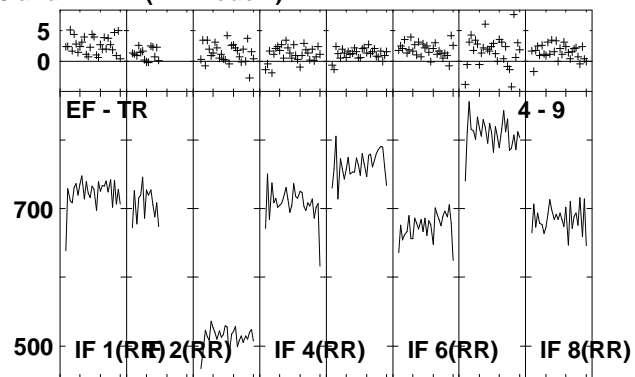
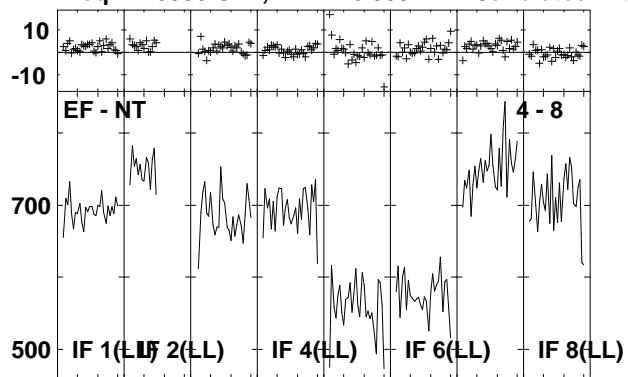

Lower frame: Milli Ampl Jy Top frame: Phas deg
Vector averaged cross-power spectrum Several baselines displayed
Timerange: 00/15:58:02 to 00/15:59:30

Plot file version 174 created 29-APR-2009 14:32:15

IRAS2336 EP064D.UVDATA.1

Freq = 1.5950 GHz, Bw = 16.000 MH Calibrated with CL # 3 and BP # 1 (BP mode 1)

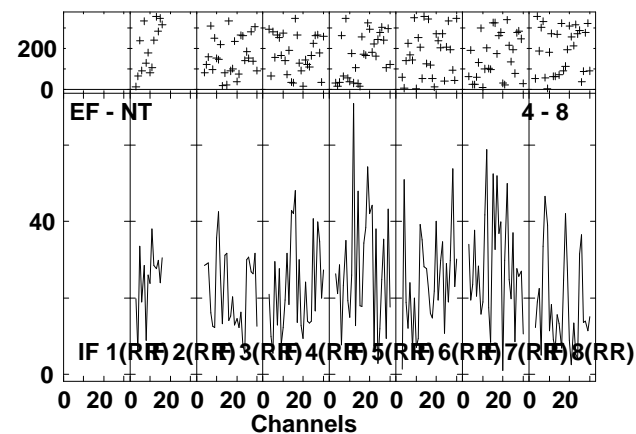
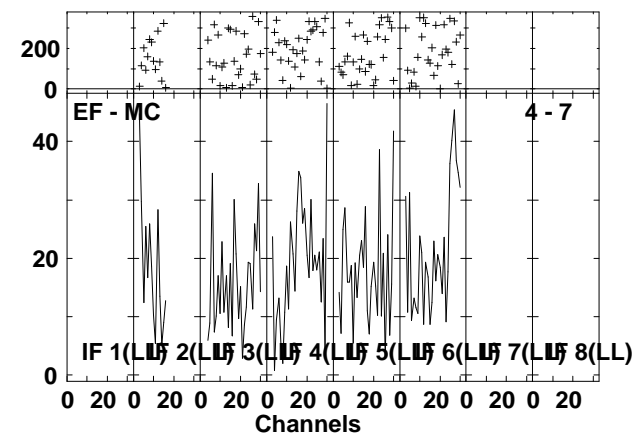
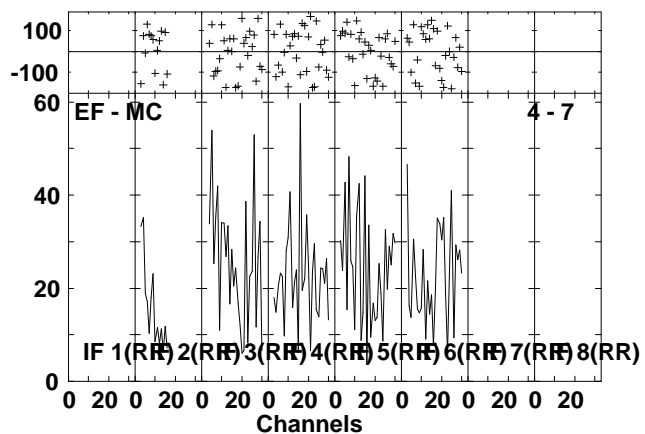
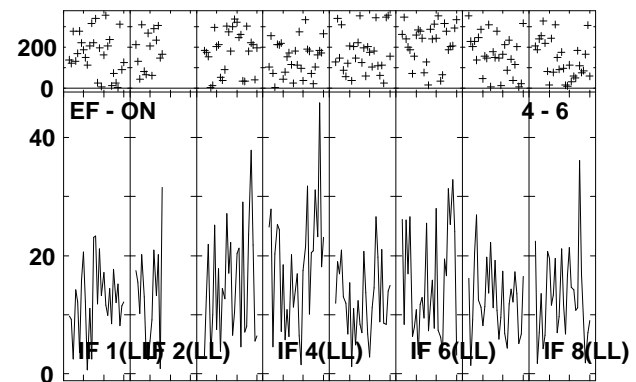
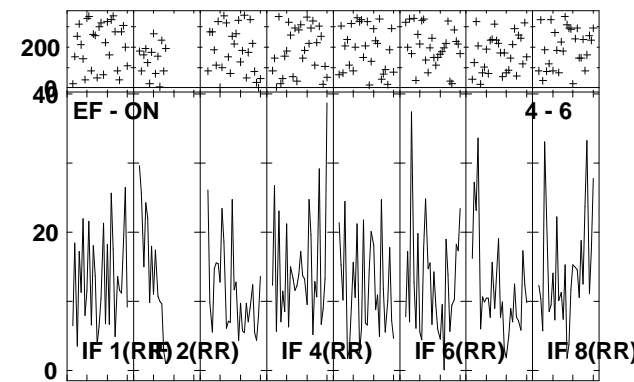
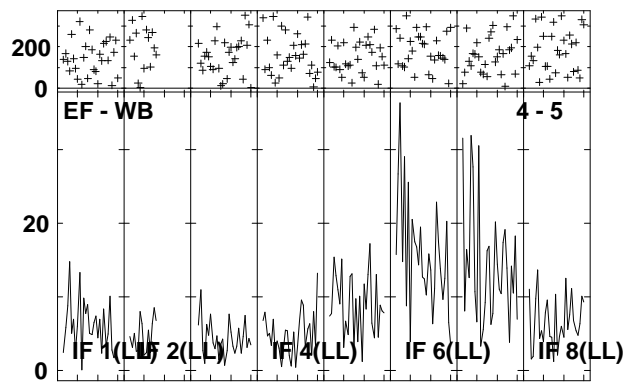
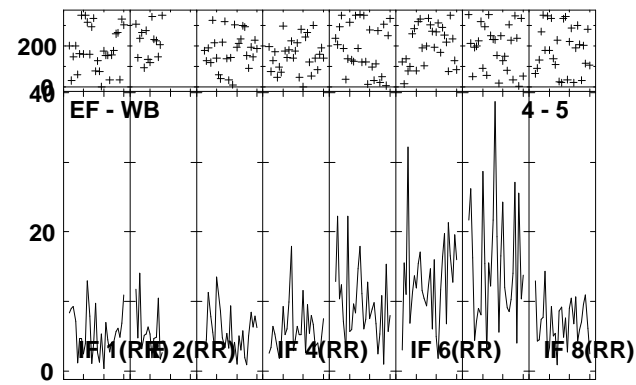
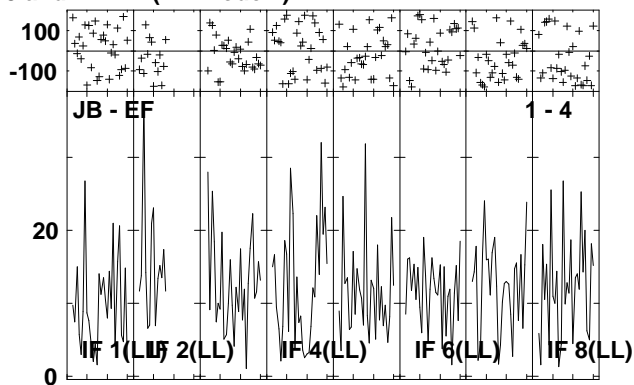
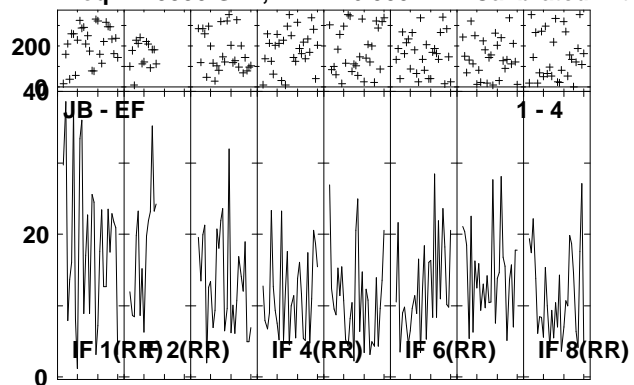

Lower frame: Milli Ampl Jy Top frame: Phas deg
Vector averaged cross-power spectrum Several baselines displayed
Timerange: 00/15:59:32 to 00/16:03:00

Plot file version 175 created 29-APR-2009 14:32:17

IRAS2336 EP064D.UVDATA.1

Freq = 1.5950 GHz, Bw = 16.000 MH Calibrated with CL # 3 and BP # 1 (BP mode 1)

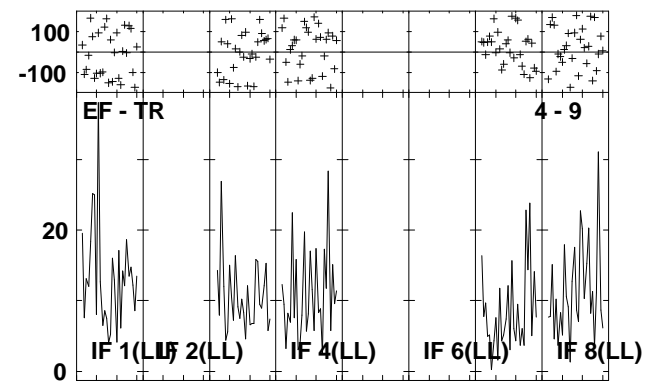
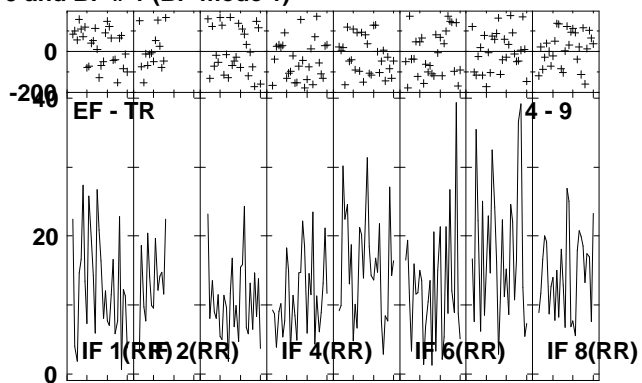
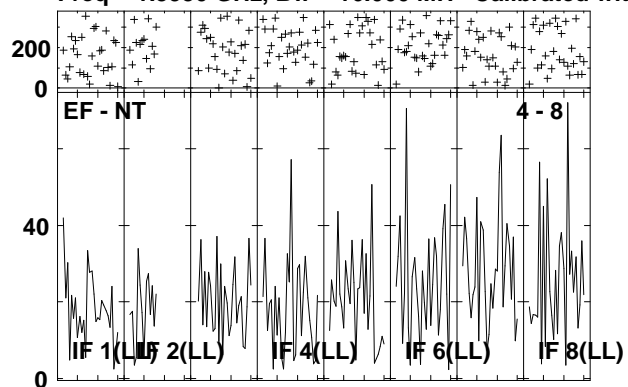

Lower frame: Milli Ampl Jy Top frame: Phas deg
Vector averaged cross-power spectrum Several baselines displayed
Timerange: 00/15:59:32 to 00/16:03:00

Plot file version 176 created 29-APR-2009 14:32:19

J2333+39 EP064D.UVDATA.1

Freq = 1.5950 GHz, Bw = 16.000 MH Calibrated with CL # 3 and BP # 1 (BP mode 1)

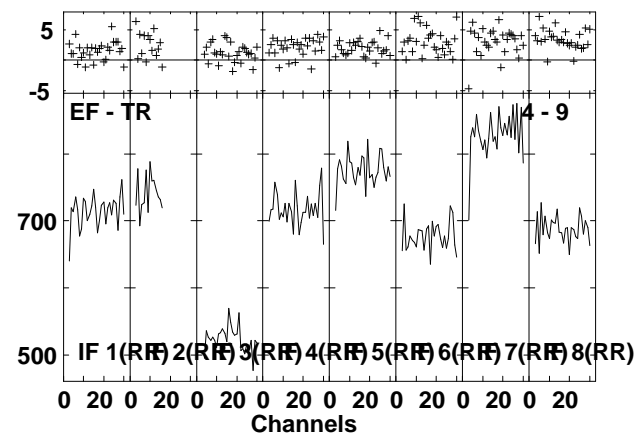
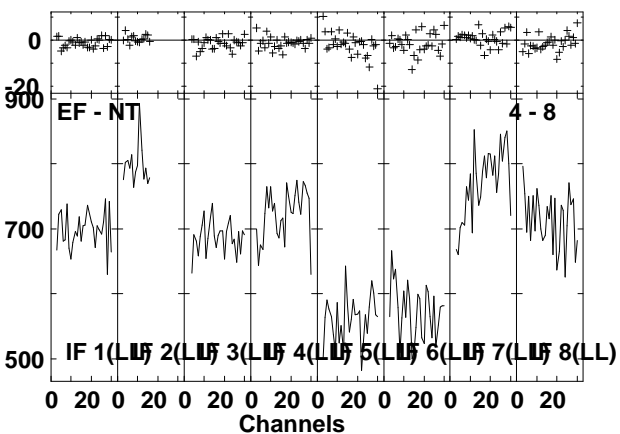
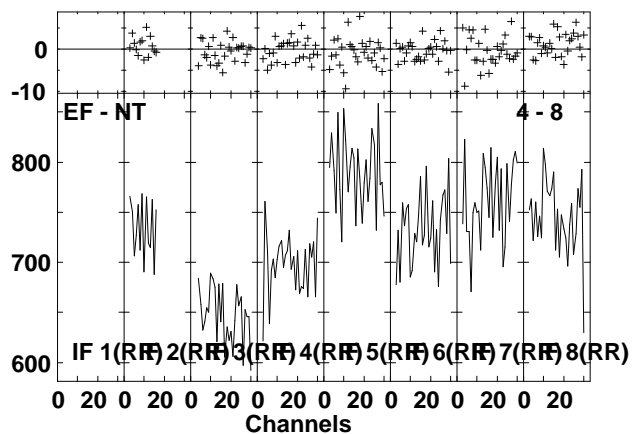
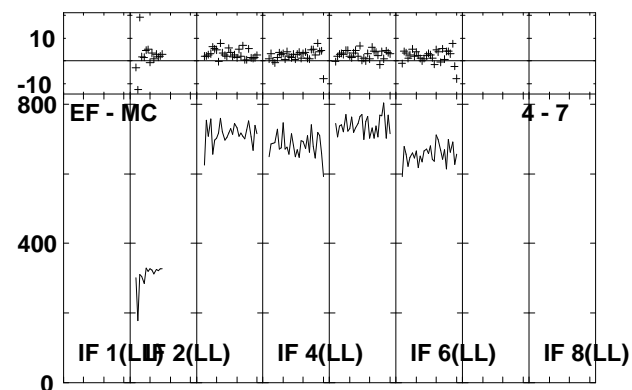
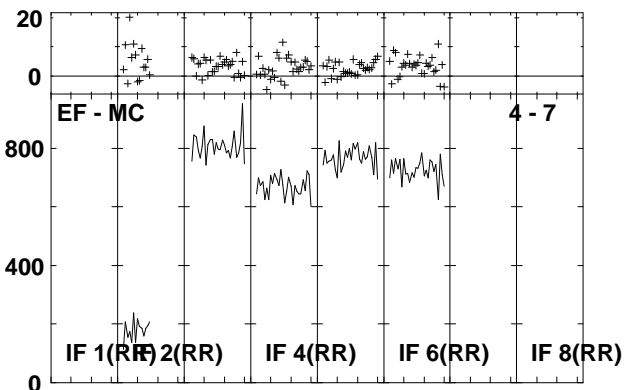
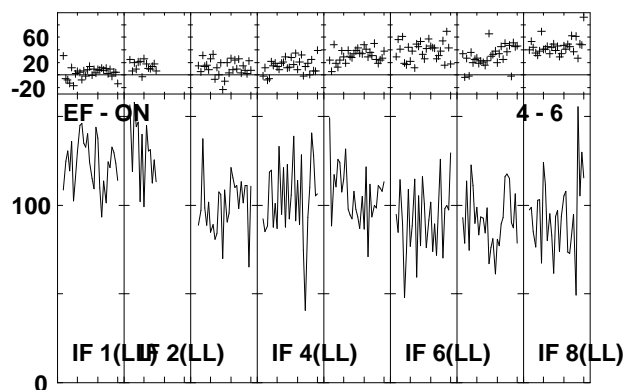
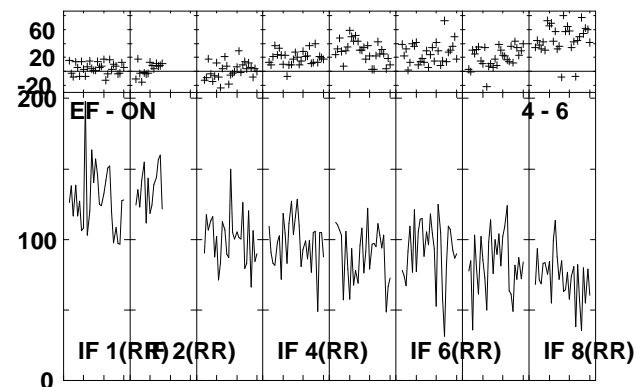
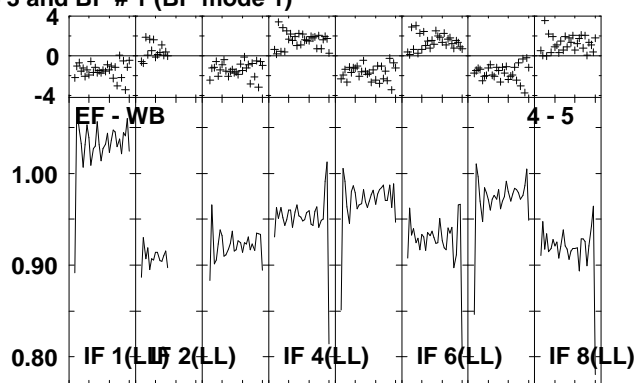
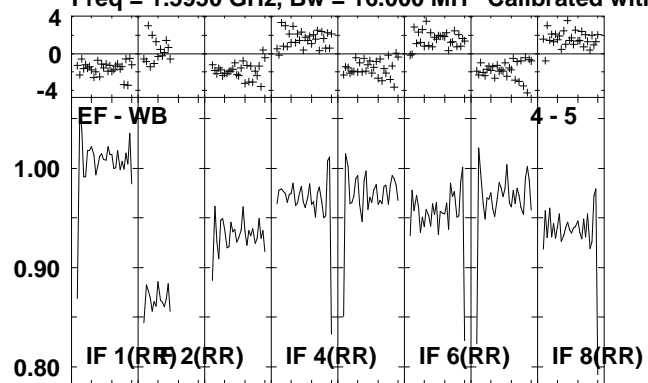

Lower frame: Ampl Jy Top frame: Phas deg
Vector averaged cross-power spectrum Several baselines displayed
Timerange: 00/16:03:06 to 00/16:04:26

Plot file version 177 created 29-APR-2009 14:32:20

J2333+39 EP064D.UVDATA.1

Freq = 1.5950 GHz, Bw = 16.000 MH Calibrated with CL # 3 and BP # 1 (BP mode 1)

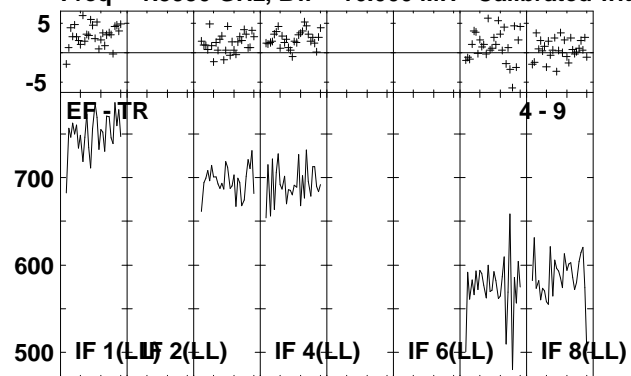

Lower frame: Milli Ampl Jy Top frame: Phas deg
Vector averaged cross-power spectrum Several baselines displayed
Timerange: 00/16:03:06 to 00/16:04:26

Plot file version 178 created 29-APR-2009 14:32:20

IRAS2336 EP064D.UVDATA.1

Freq = 1.5950 GHz, Bw = 16.000 MH Calibrated with CL # 3 and BP # 1 (BP mode 1)

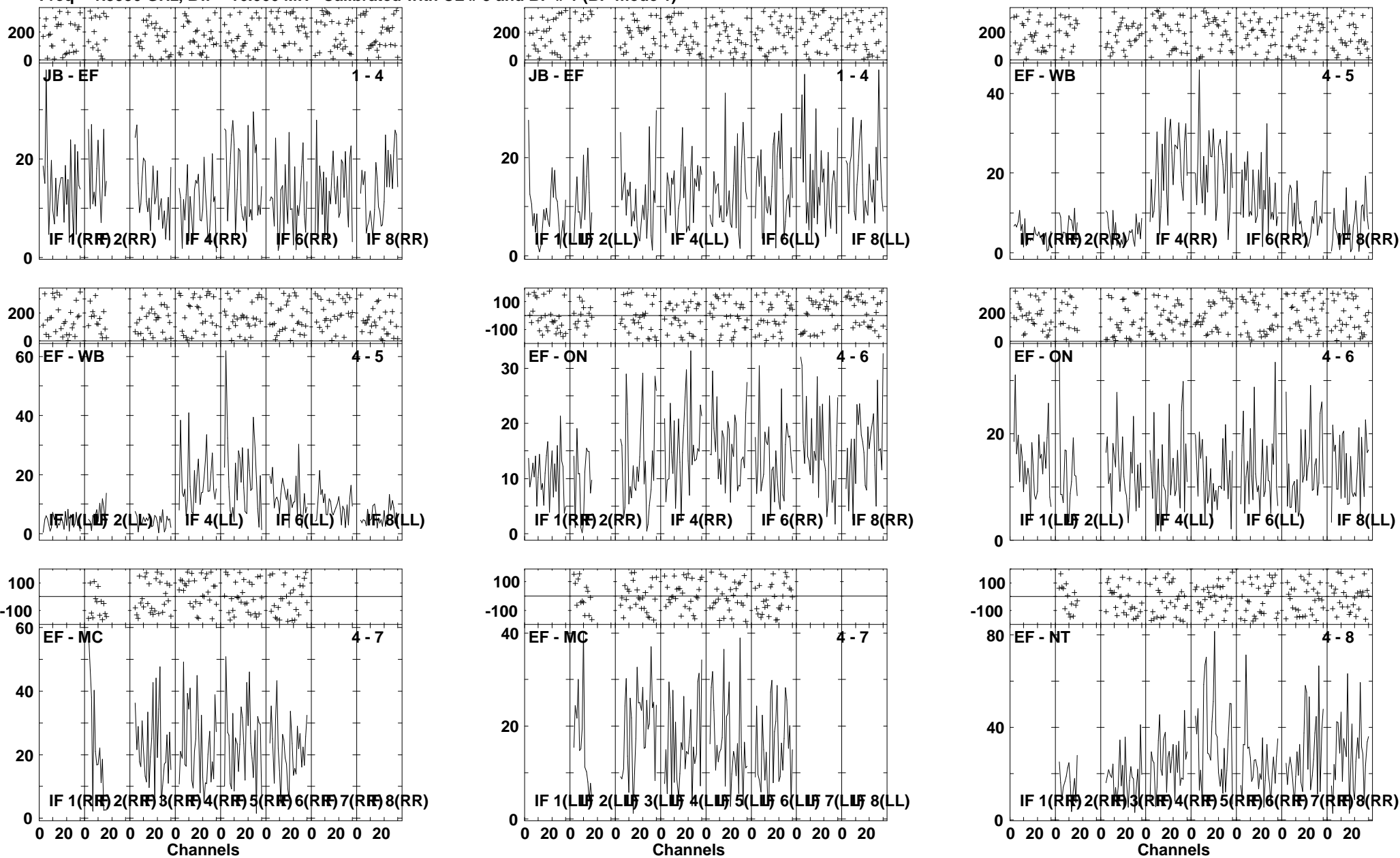

Lower frame: Milli Ampl Jy Top frame: Phas deg
Vector averaged cross-power spectrum Several baselines displayed
Timerange: 00/16:04:31 to 00/16:07:59

Plot file version 179 created 29-APR-2009 14:32:23

IRAS2336 EP064D.UVDATA.1

Freq = 1.5950 GHz, Bw = 16.000 MH Calibrated with CL # 3 and BP # 1 (BP mode 1)

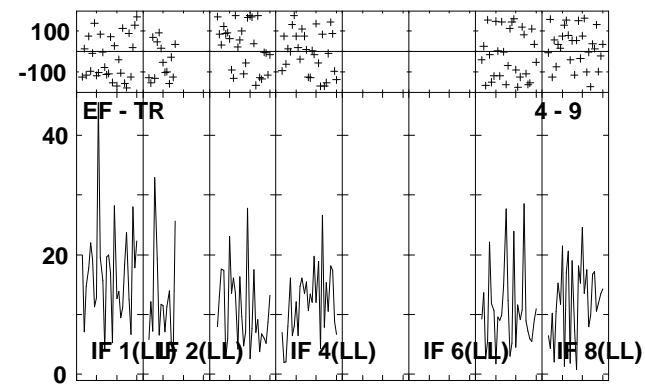
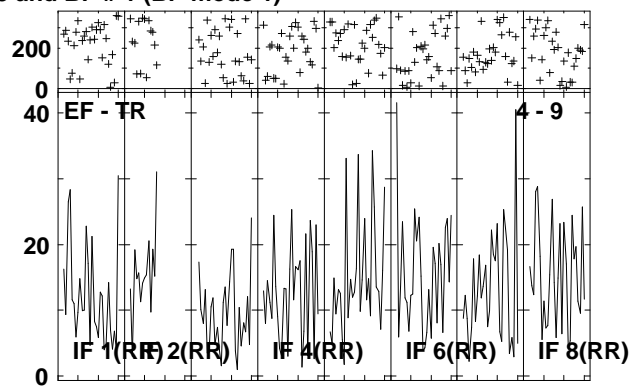
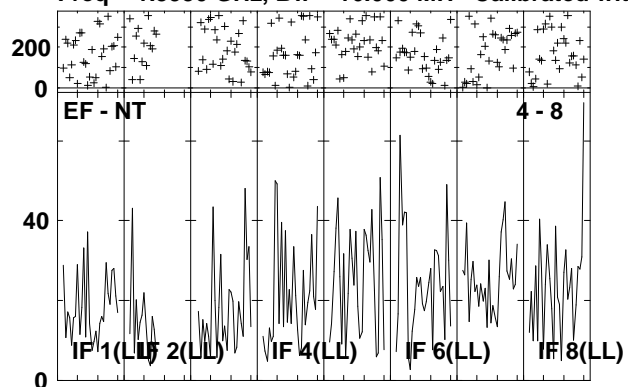

Lower frame: Milli Ampl Jy Top frame: Phas deg
Vector averaged cross-power spectrum Several baselines displayed
Timerange: 00/16:04:31 to 00/16:07:59

Plot file version 180 created 29-APR-2009 14:32:24
 J2333+39 EP064D.UVDATA.1
 Freq = 1.5950 GHz, Bw = 16.000 MH Calibrated with CL # 3 and BP # 1 (BP mode 1)

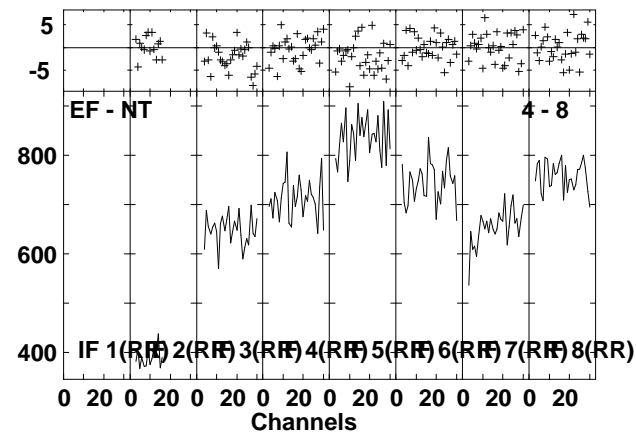
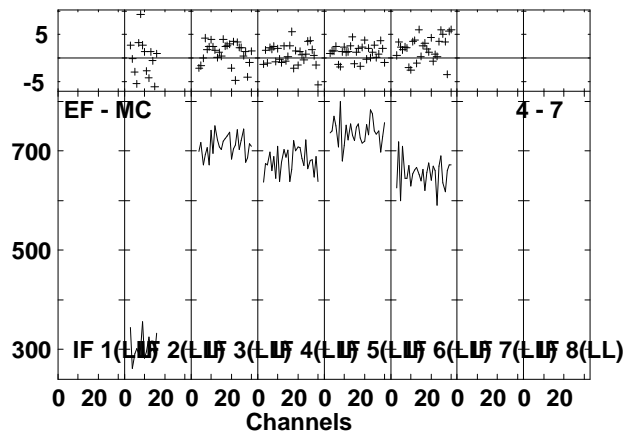
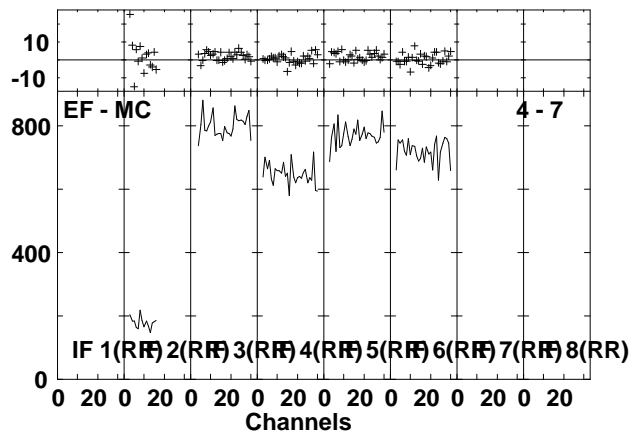
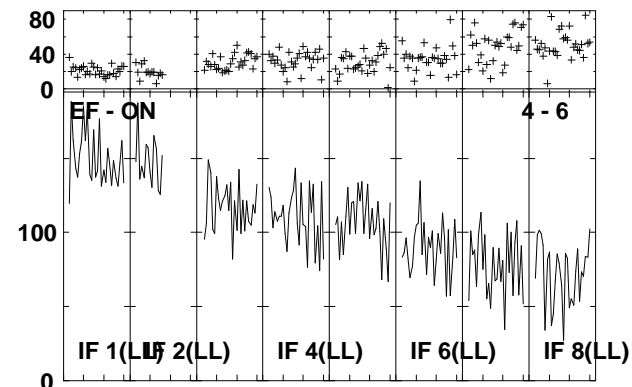
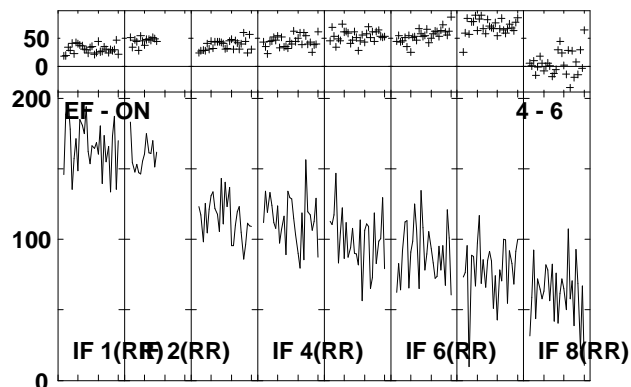
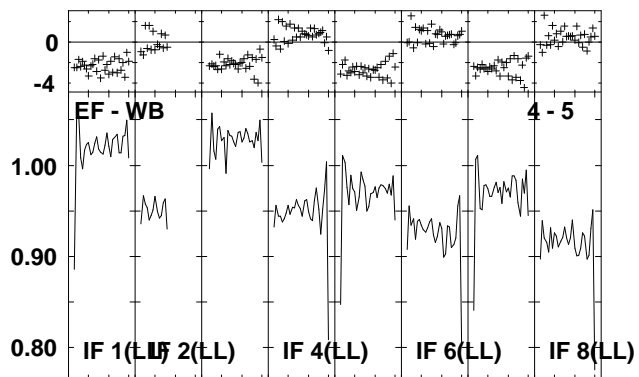
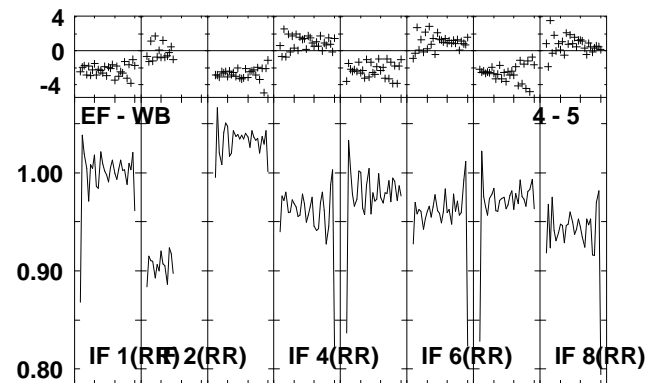
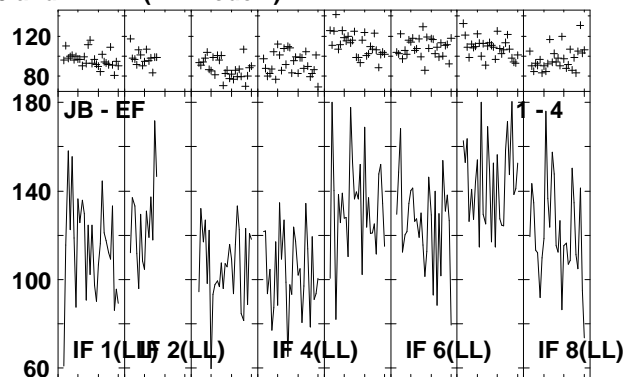
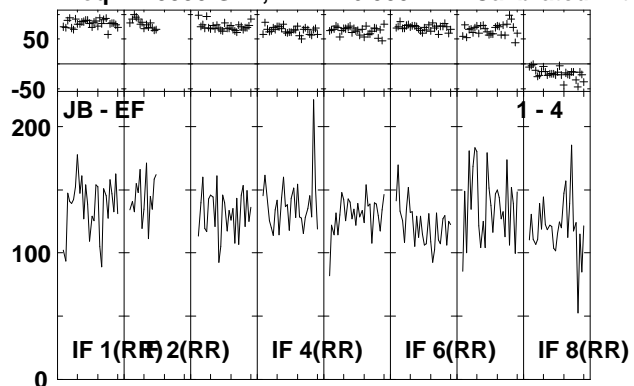

Lower frame: Milli Ampl Jy Top frame: Phas deg
 Vector averaged cross-power spectrum Several baselines displayed
 Timerange: 00/16:08:01 to 00/16:09:31

Plot file version 181 created 29-APR-2009 14:32:25

J2333+39 EP064D.UVDATA.1

Freq = 1.5950 GHz, Bw = 16.000 MH Calibrated with CL # 3 and BP # 1 (BP mode 1)

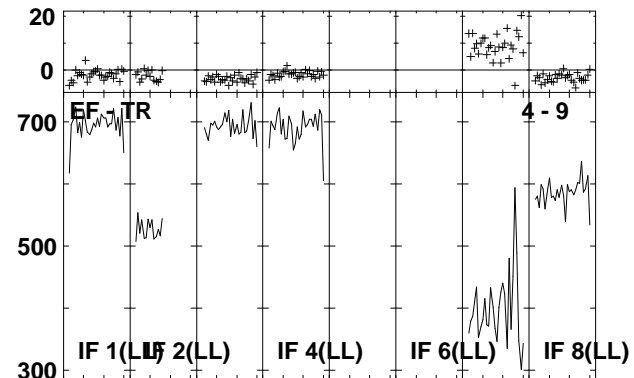
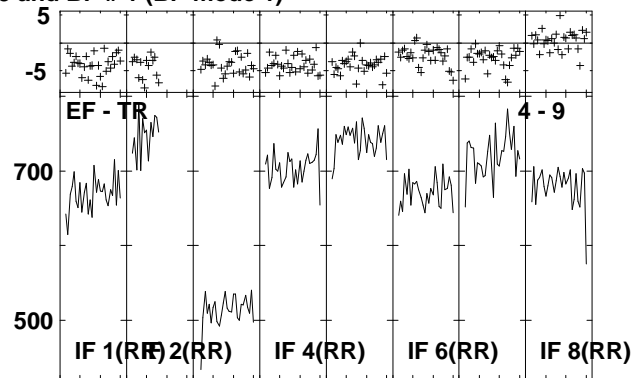
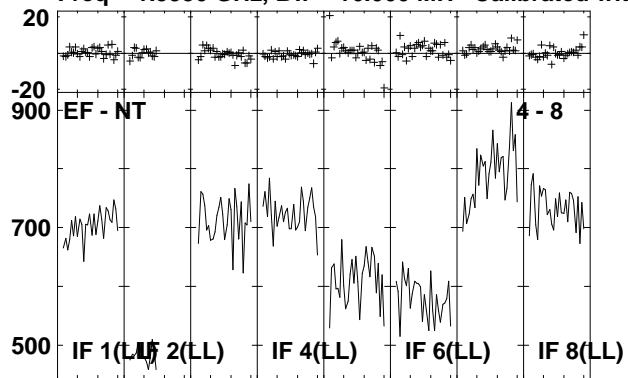

Lower frame: Milli Ampl Jy Top frame: Phas deg
Vector averaged cross-power spectrum Several baselines displayed
Timerange: 00/16:08:01 to 00/16:09:31

Plot file version 182 created 29-APR-2009 14:32:26

IRAS2336 EP064D.UVDATA.1

Freq = 1.5950 GHz, Bw = 16.000 MH Calibrated with CL # 3 and BP # 1 (BP mode 1)

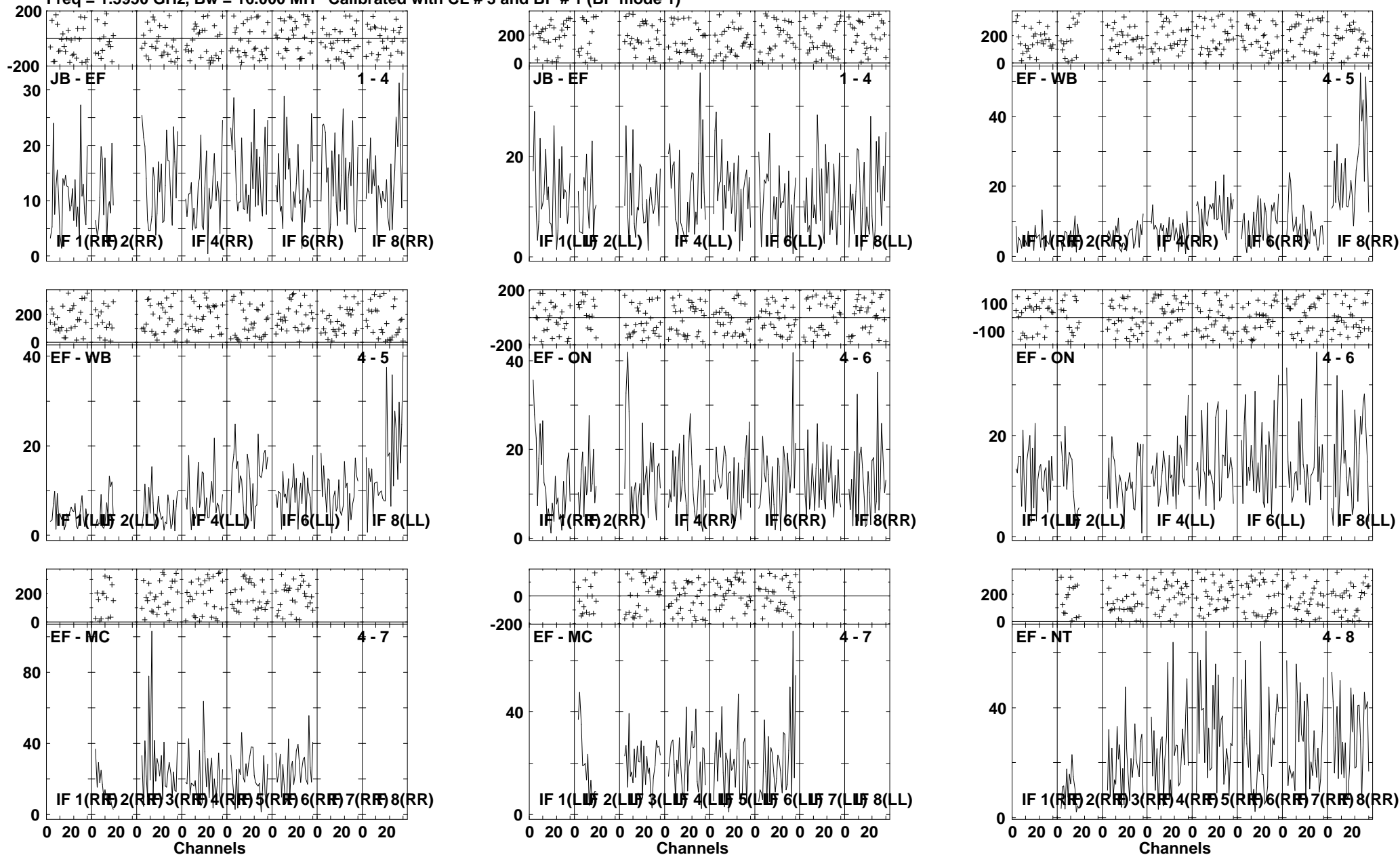

Lower frame: Milli Ampl Jy Top frame: Phas deg
Vector averaged cross-power spectrum Several baselines displayed
Timerange: 00/16:09:33 to 00/16:12:59

Plot file version 183 created 29-APR-2009 14:32:28

IRAS2336 EP064D.UVDATA.1

Freq = 1.5950 GHz, Bw = 16.000 MH Calibrated with CL # 3 and BP # 1 (BP mode 1)

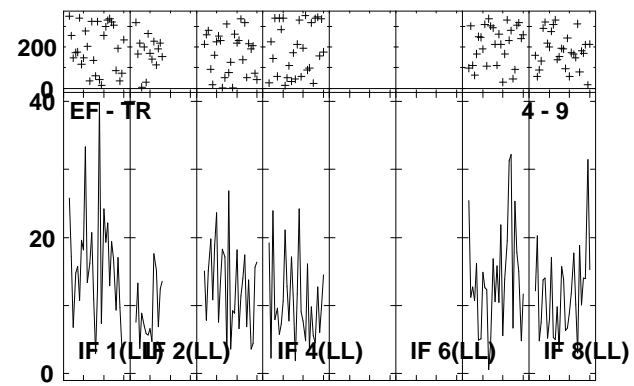
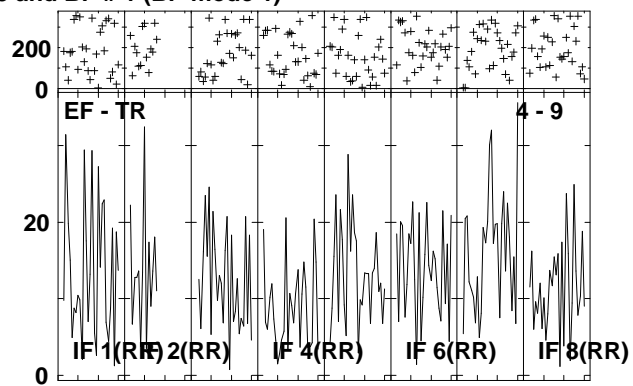
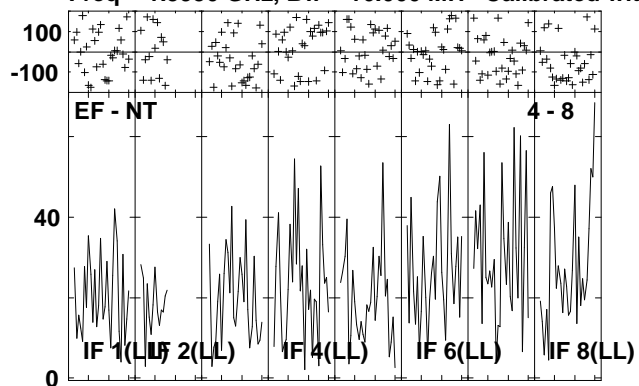

Lower frame: Milli Ampl Jy Top frame: Phas deg
Vector averaged cross-power spectrum Several baselines displayed
Timerange: 00/16:09:33 to 00/16:12:59

Plot file version 184 created 29-APR-2009 14:32:30

J2333+39 EP064D.UVDATA.1

Freq = 1.5950 GHz, Bw = 16.000 MH Calibrated with CL # 3 and BP # 1 (BP mode 1)

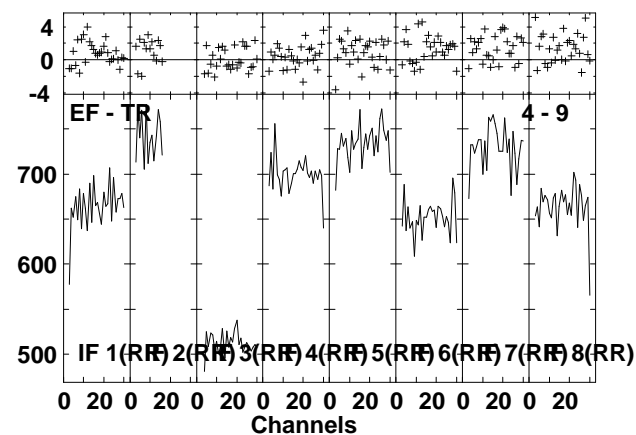
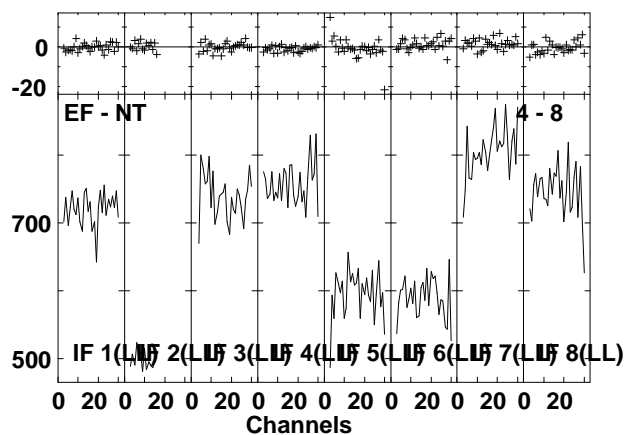
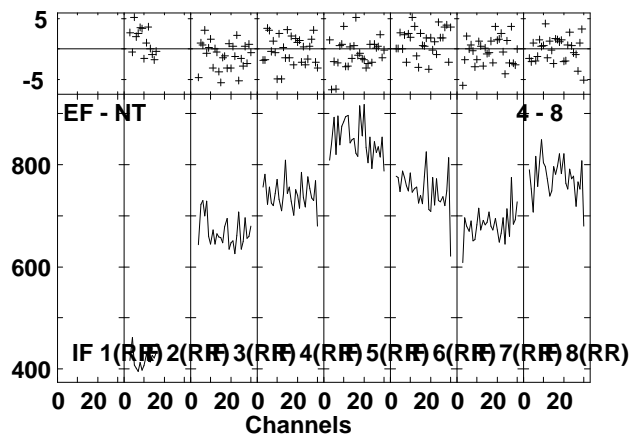
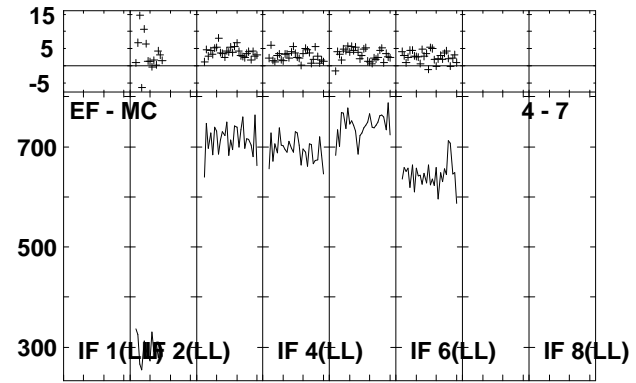
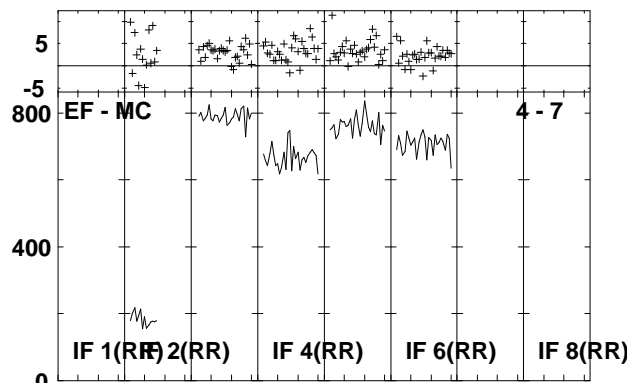
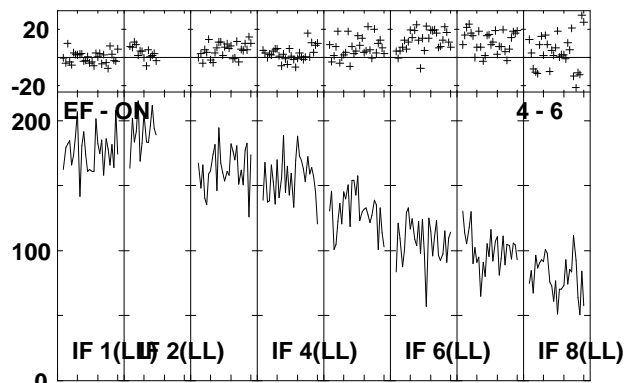
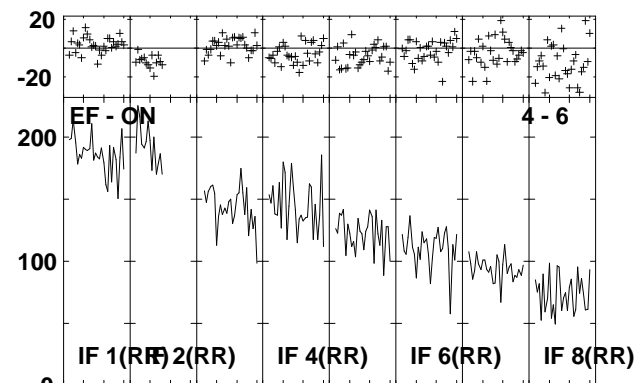
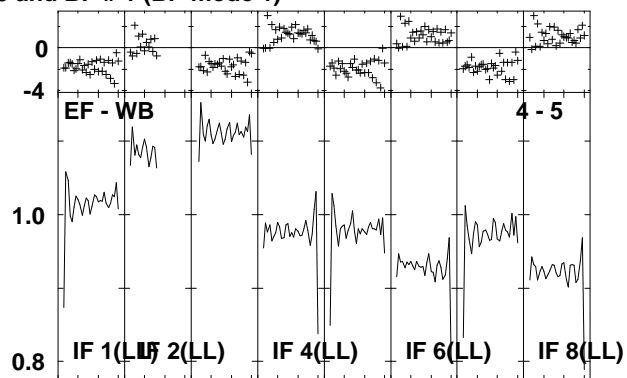
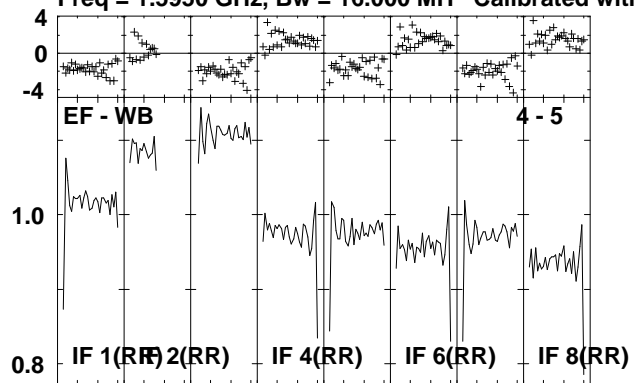

Lower frame: Ampl Jy Top frame: Phas deg
Vector averaged cross-power spectrum Several baselines displayed
Timerange: 00/16:14:01 to 00/16:15:27

Plot file version 185 created 29-APR-2009 14:32:31
J2333+39 EP064D.UVDATA.1
Freq = 1.5950 GHz, Bw = 16.000 MH Calibrated with CL # 3 and BP # 1 (BP mode 1)

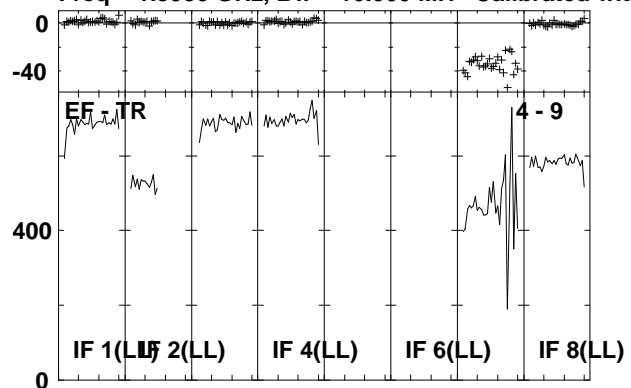

Lower frame: Milli Ampl Jy Top frame: Phas deg
Vector averaged cross-power spectrum Several baselines displayed
Timerange: 00/16:14:01 to 00/16:15:27

Plot file version 186 created 29-APR-2009 14:32:32

IRAS2336 EP064D.UVDATA.1

Freq = 1.5950 GHz, Bw = 16.000 MH Calibrated with CL # 3 and BP # 1 (BP mode 1)

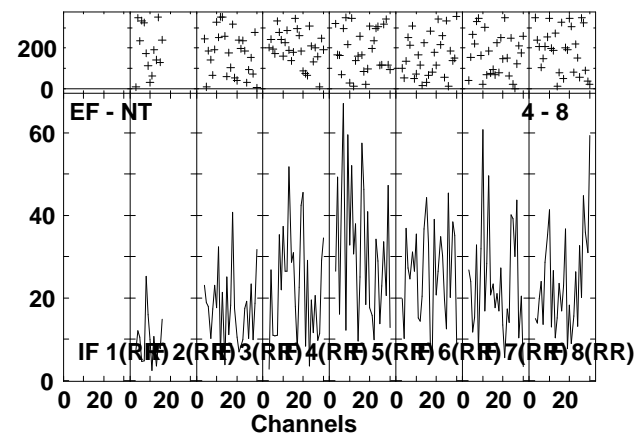
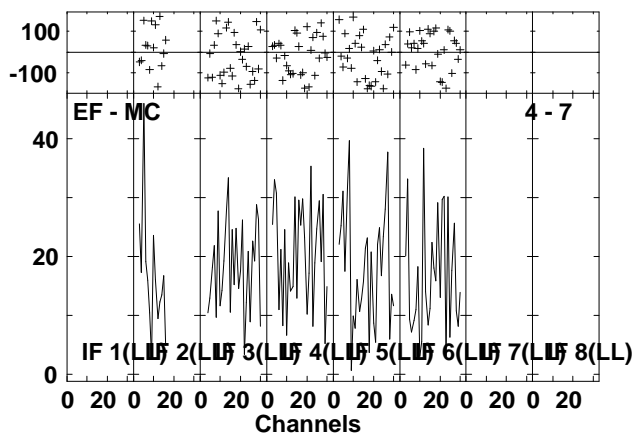
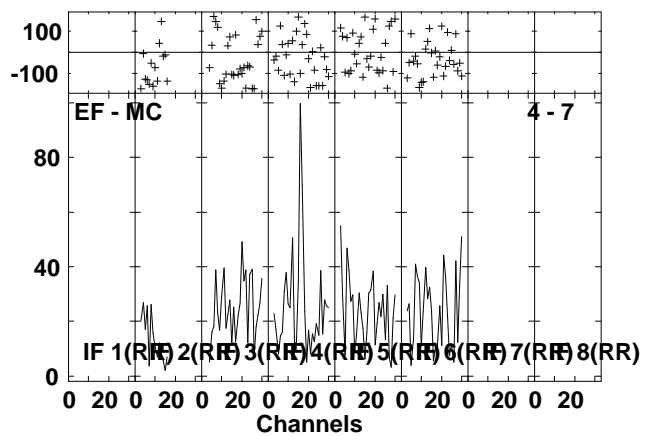
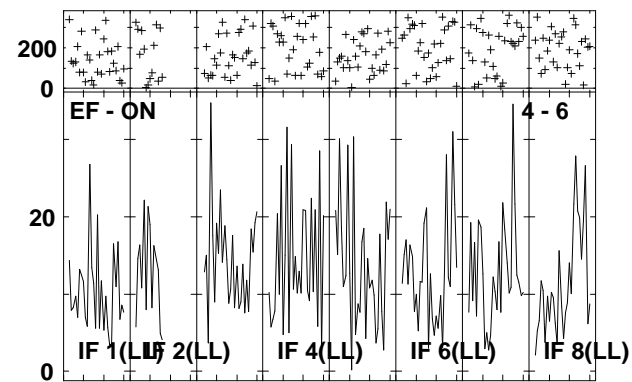
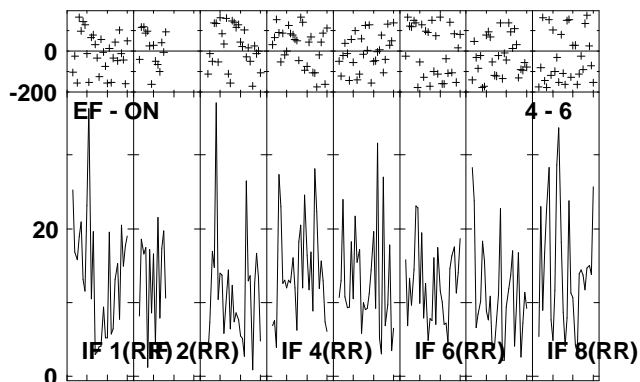
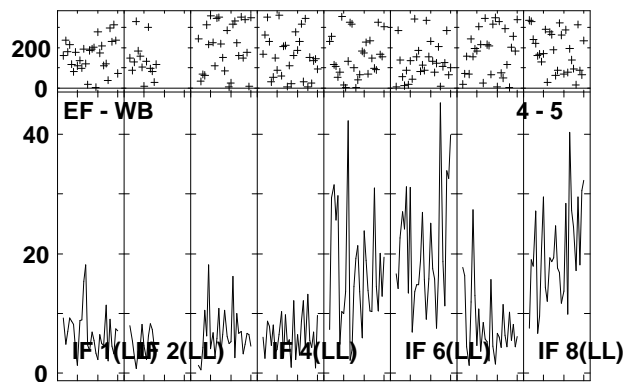
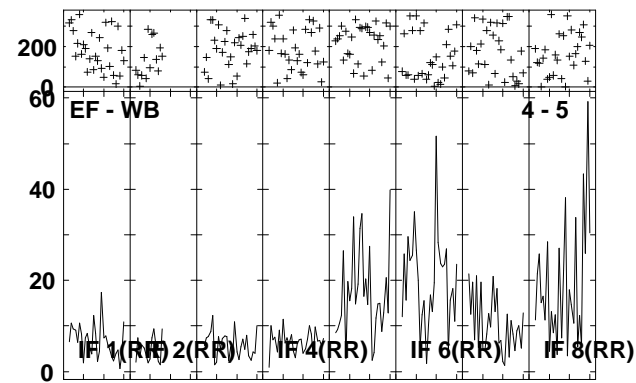
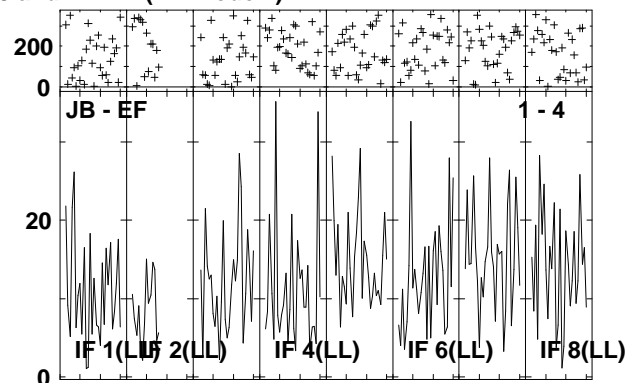
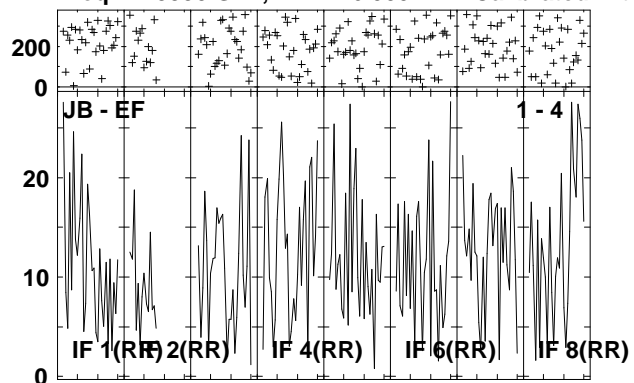

Lower frame: Milli Ampl Jy Top frame: Phas deg
Vector averaged cross-power spectrum Several baselines displayed
Timerange: 00/16:15:29 to 00/16:19:01

Plot file version 187 created 29-APR-2009 14:32:34

IRAS2336 EP064D.UVDATA.1

Freq = 1.5950 GHz, Bw = 16.000 MH Calibrated with CL # 3 and BP # 1 (BP mode 1)

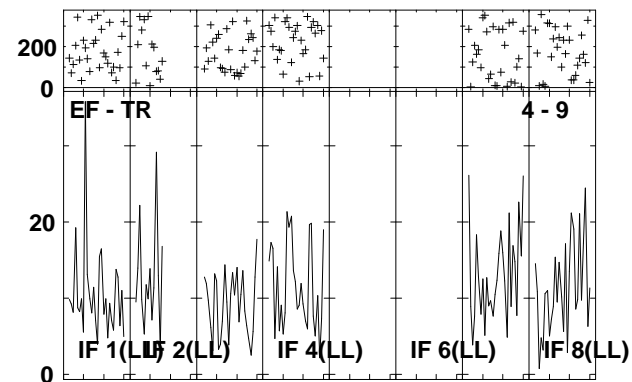
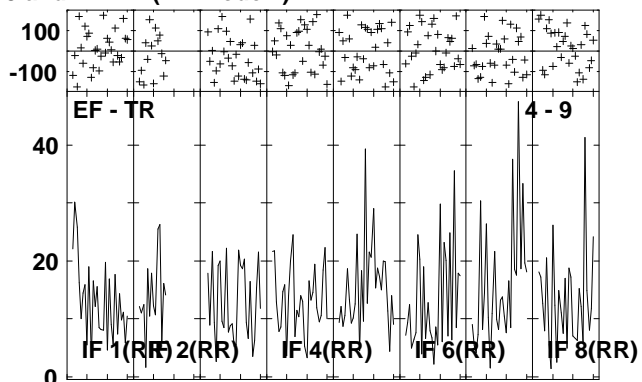
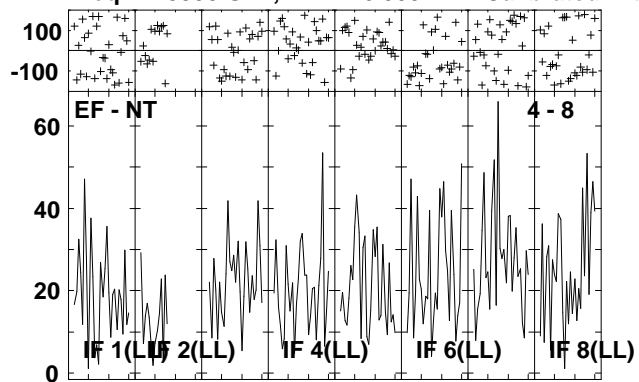

Lower frame: Milli Ampl Jy Top frame: Phas deg
Vector averaged cross-power spectrum Several baselines displayed
Timerange: 00/16:15:29 to 00/16:19:01

Plot file version 188 created 29-APR-2009 14:32:36

J2333+39 EP064D.UVDATA.1

Freq = 1.5950 GHz, Bw = 16.000 MH Calibrated with CL # 3 and BP # 1 (BP mode 1)

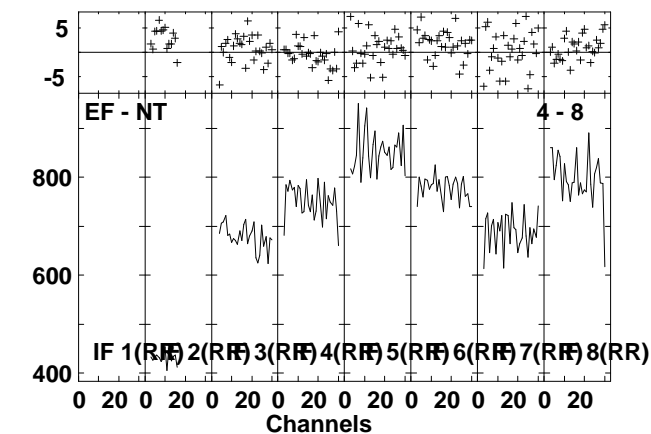
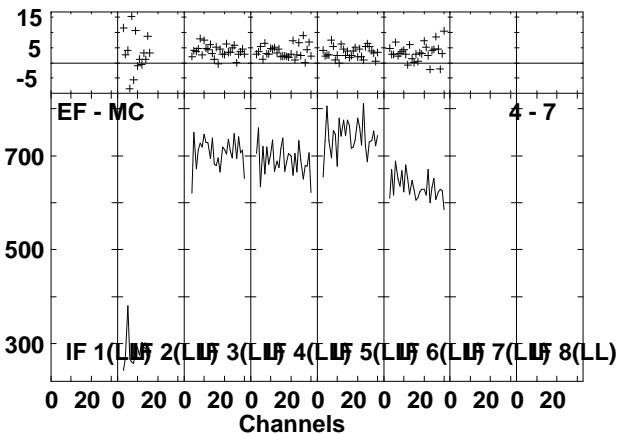
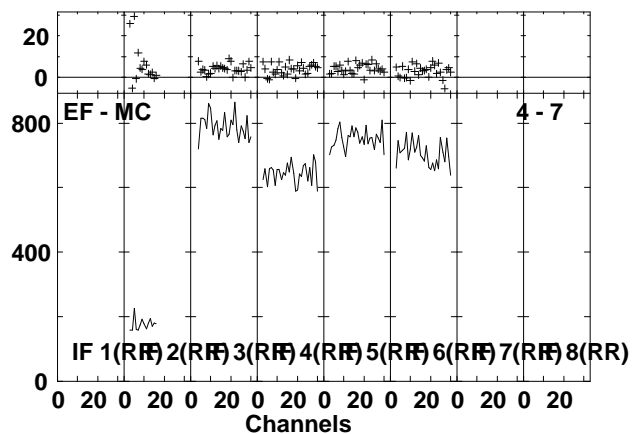
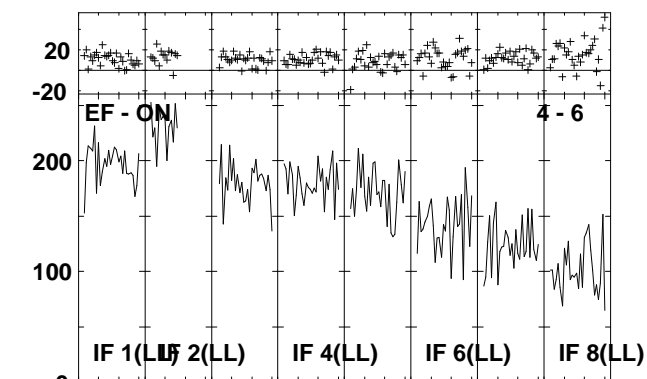
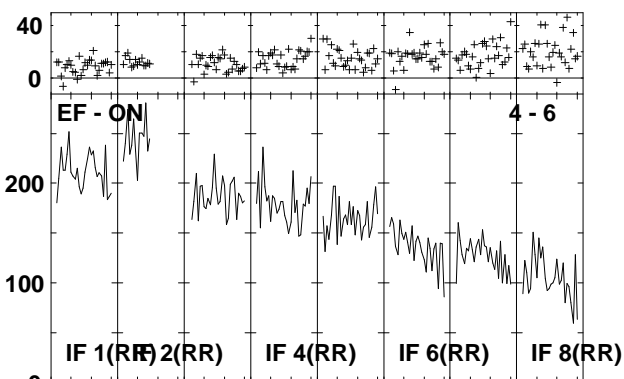
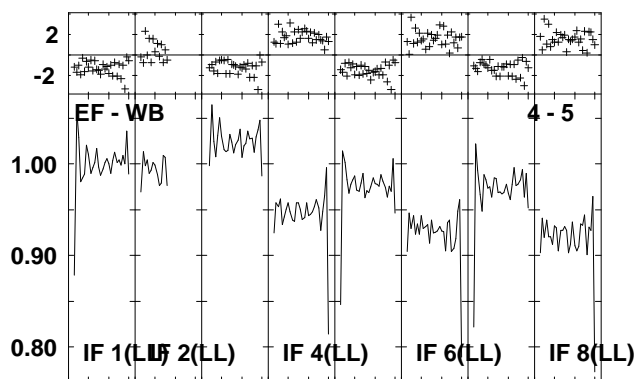
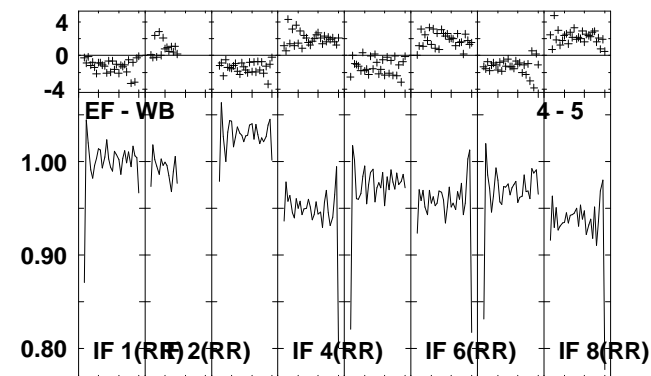
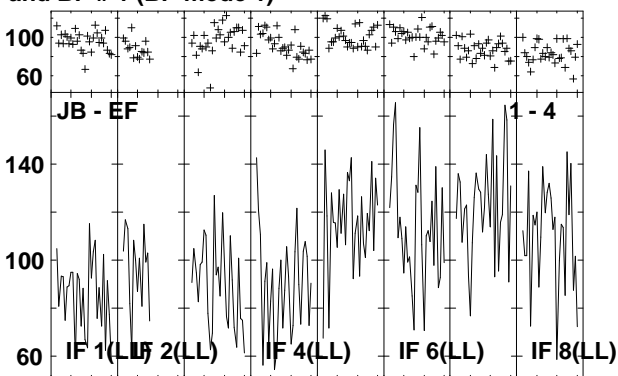
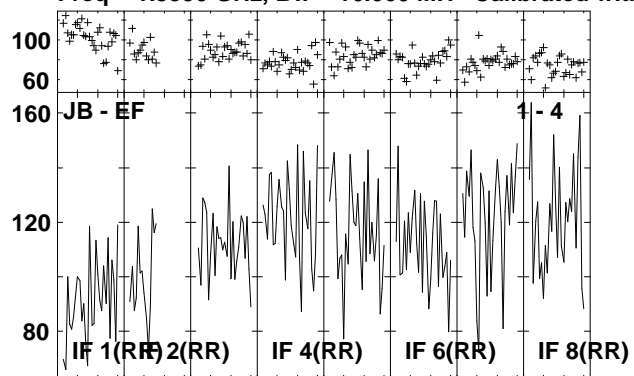

Lower frame: Milli Ampl Jy Top frame: Phas deg
Vector averaged cross-power spectrum Several baselines displayed
Timerange: 00/16:19:03 to 00/16:20:29

Plot file version 189 created 29-APR-2009 14:32:37

J2333+39 EP064D.UVDATA.1

Freq = 1.5950 GHz, Bw = 16.000 MH Calibrated with CL # 3 and BP # 1 (BP mode 1)

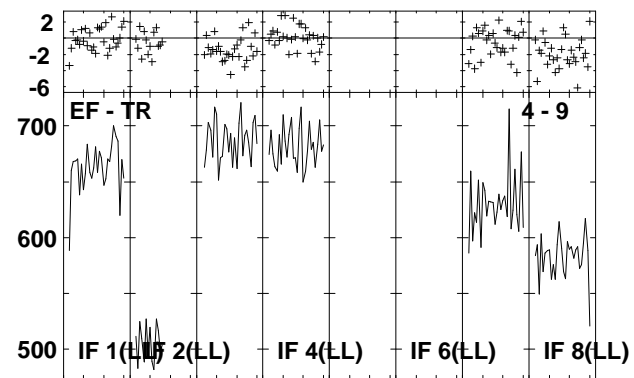
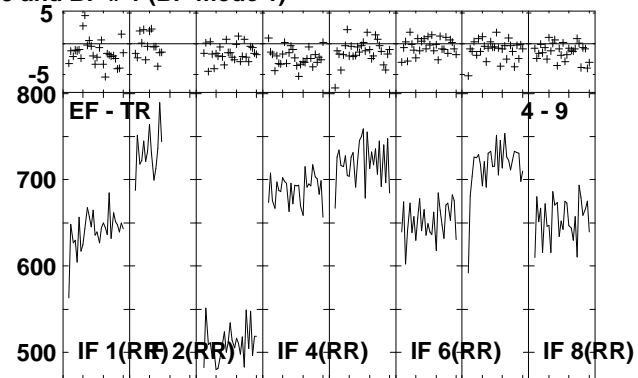
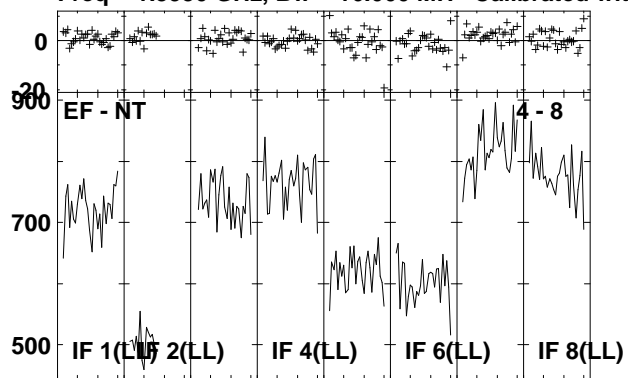

Lower frame: Milli Ampl Jy Top frame: Phas deg
Vector averaged cross-power spectrum Several baselines displayed
Timerange: 00/16:19:03 to 00/16:20:29

Plot file version 190 created 29-APR-2009 14:32:38

IRAS2336 EP064D.UVDATA.1

Freq = 1.5950 GHz, Bw = 16.000 MH Calibrated with CL # 3 and BP # 1 (BP mode 1)

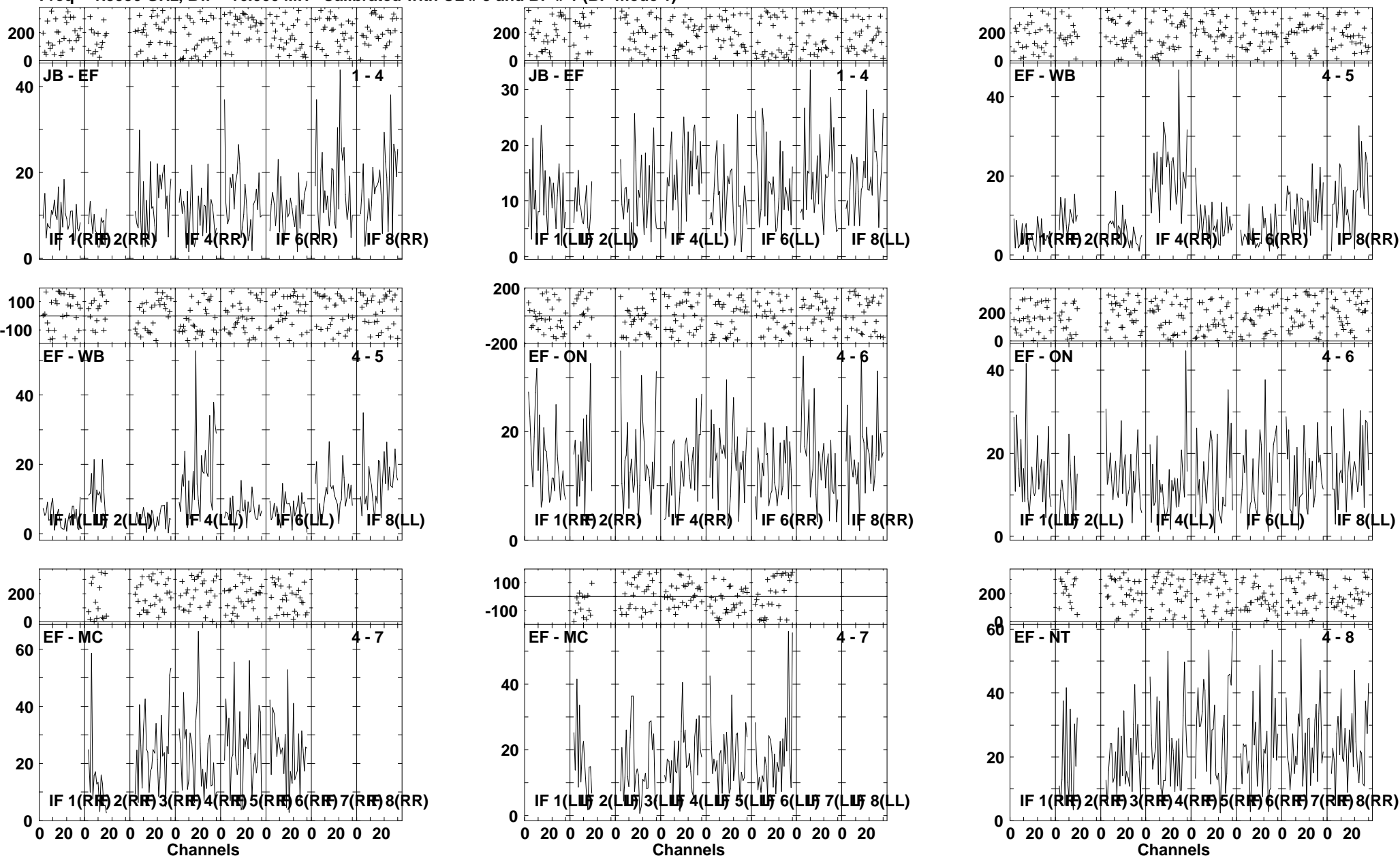

Lower frame: Milli Ampl Jy Top frame: Phas deg
Vector averaged cross-power spectrum Several baselines displayed
Timerange: 00/16:20:31 to 00/16:23:57

Plot file version 191 created 29-APR-2009 14:32:40

IRAS2336 EP064D.UVDATA.1

Freq = 1.5950 GHz, Bw = 16.000 MH Calibrated with CL # 3 and BP # 1 (BP mode 1)

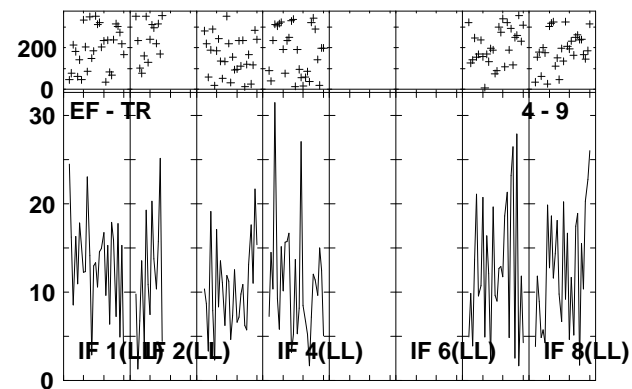
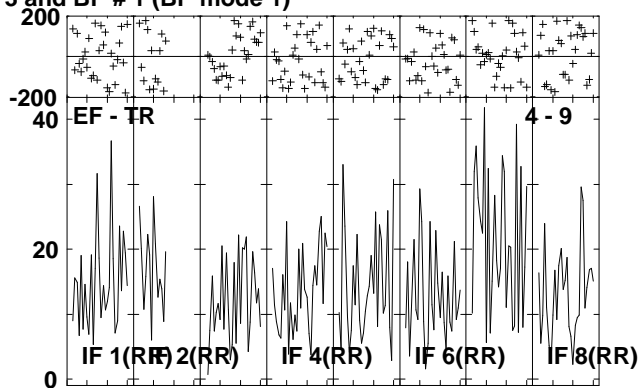
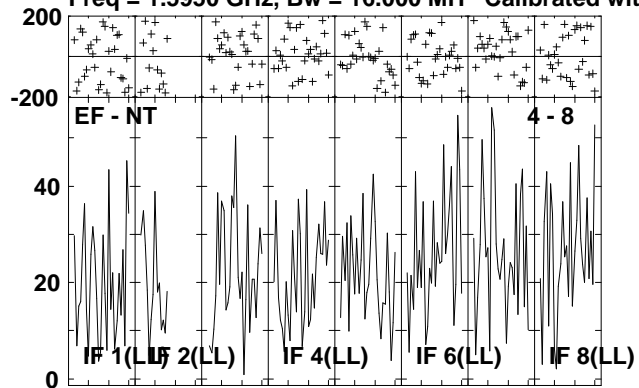

Lower frame: Milli Ampl Jy Top frame: Phas deg
Vector averaged cross-power spectrum Several baselines displayed
Timerange: 00/16:20:31 to 00/16:23:57

Plot file version 192 created 29-APR-2009 14:32:42

J2333+39 EP064D.UVDATA.1

Freq = 1.5950 GHz, Bw = 16.000 MH Calibrated with CL # 3 and BP # 1 (BP mode 1)

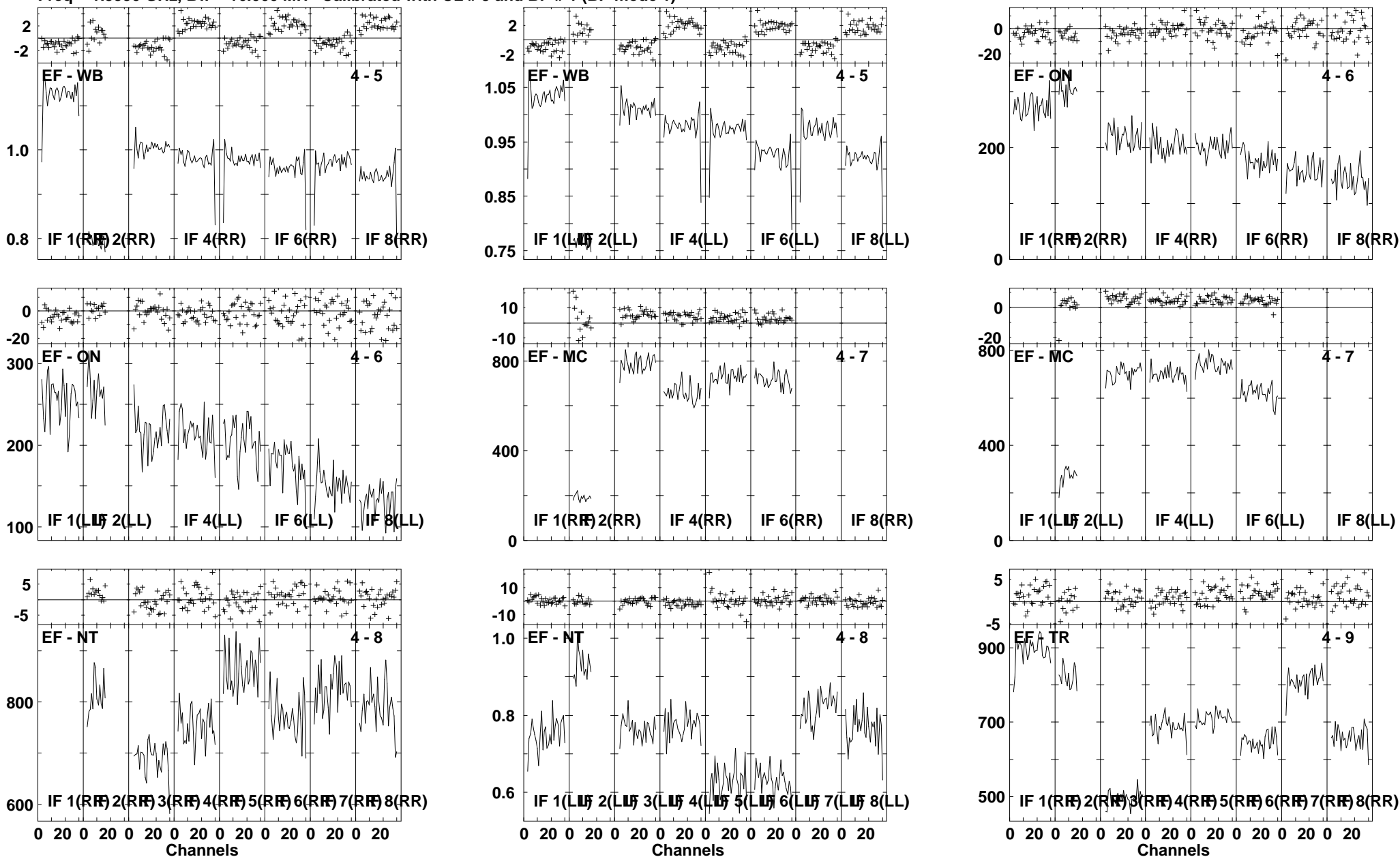

Lower frame: Ampl Jy Top frame: Phas deg
Vector averaged cross-power spectrum Several baselines displayed
Timerange: 00/16:24:07 to 00/16:25:27

Plot file version 193 created 29-APR-2009 14:32:43

J2333+39 EP064D.UVDATA.1

Freq = 1.5950 GHz, Bw = 16.000 MH Calibrated with CL # 3 and BP # 1 (BP mode 1)

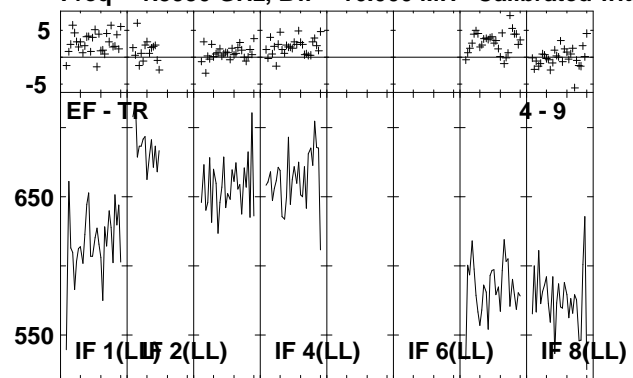

Lower frame: Milli Ampl Jy Top frame: Phas deg
Vector averaged cross-power spectrum Several baselines displayed
Timerange: 00/16:24:07 to 00/16:25:27

Plot file version 194 created 29-APR-2009 14:32:43

IRAS2336 EP064D.UVDATA.1

Freq = 1.5950 GHz, Bw = 16.000 MH Calibrated with CL # 3 and BP # 1 (BP mode 1)

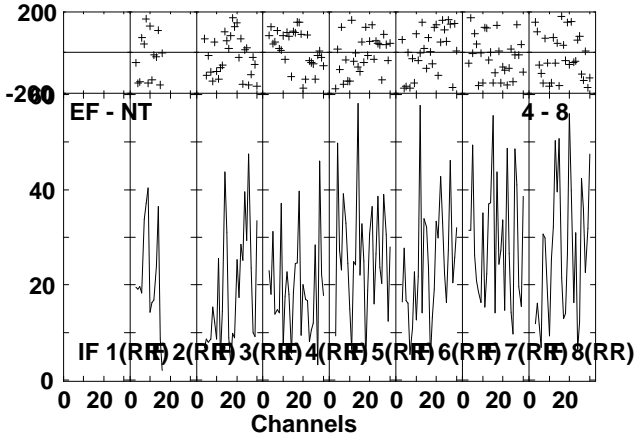
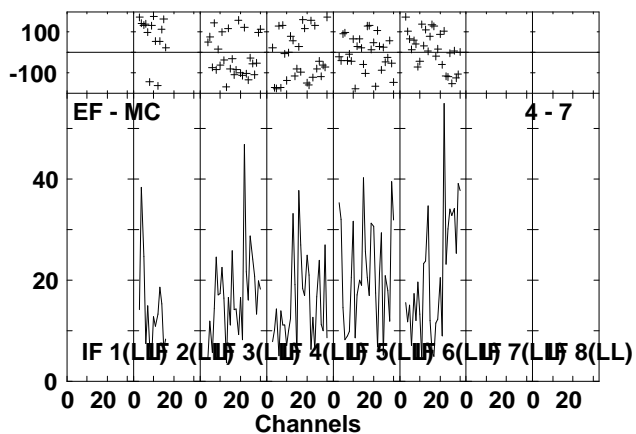
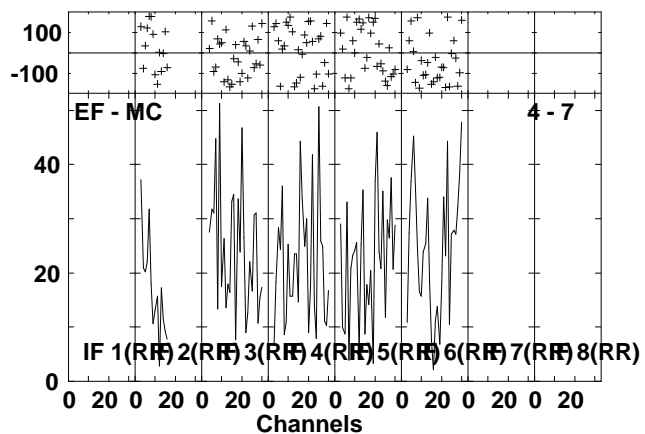
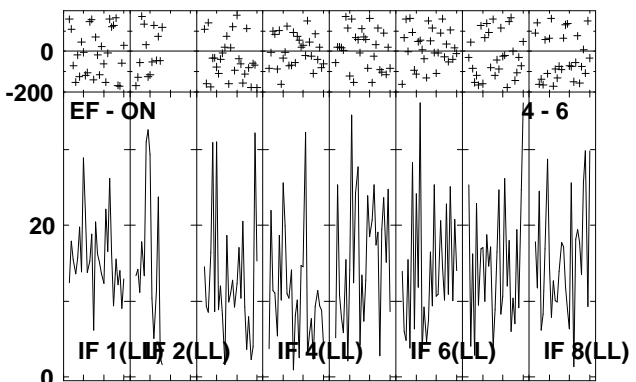
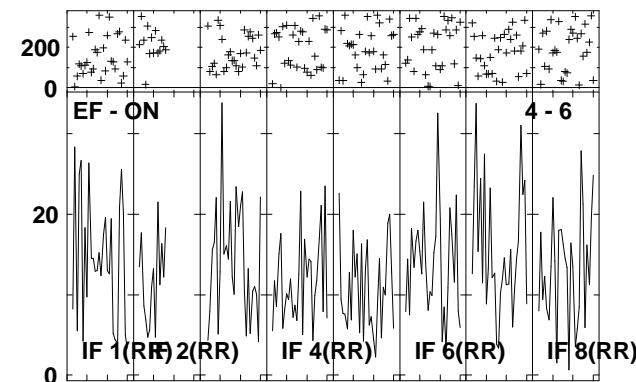
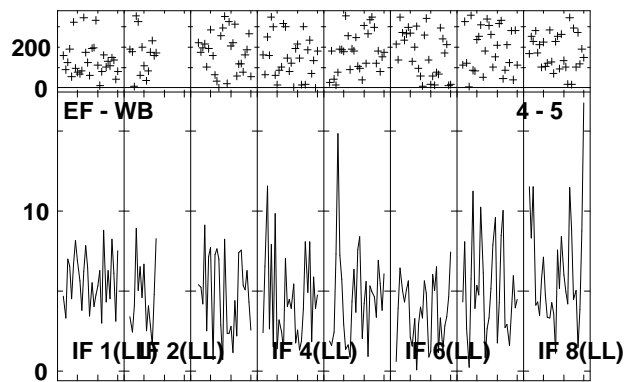
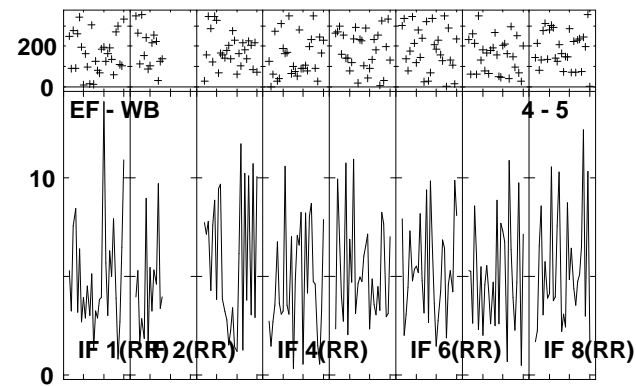
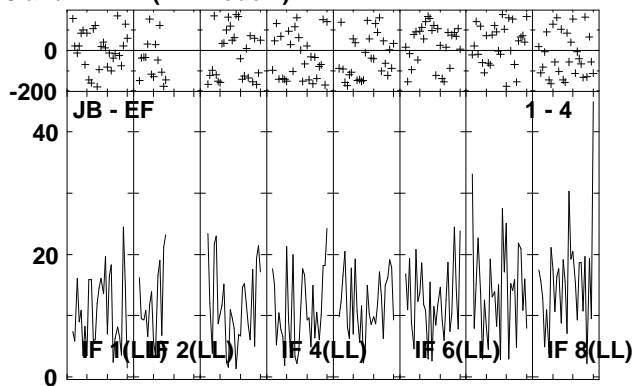
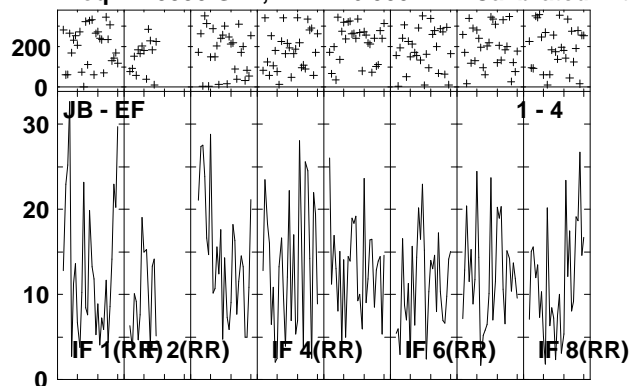

Lower frame: Milli Ampl Jy Top frame: Phas deg
Vector averaged cross-power spectrum Several baselines displayed
Timerange: 00/16:25:31 to 00/16:28:57

Plot file version 195 created 29-APR-2009 14:32:46

IRAS2336 EP064D.UVDATA.1

Freq = 1.5950 GHz, Bw = 16.000 MH Calibrated with CL # 3 and BP # 1 (BP mode 1)

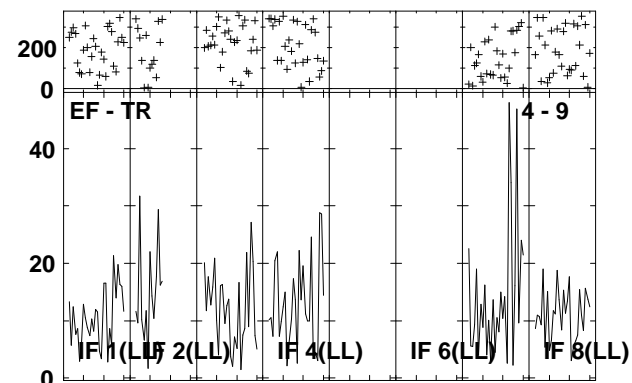
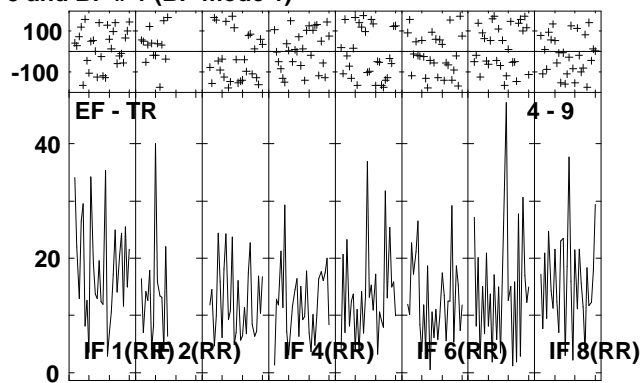
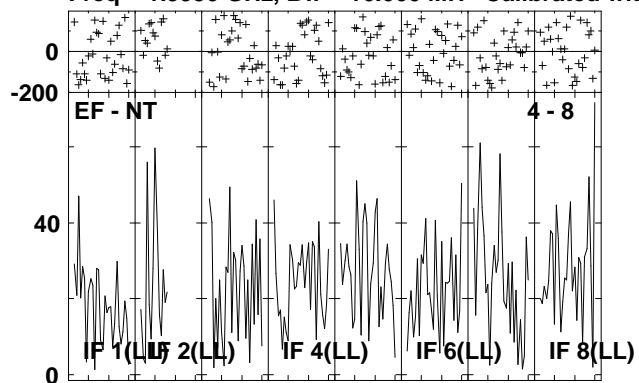

Lower frame: Milli Ampl Jy Top frame: Phas deg
Vector averaged cross-power spectrum Several baselines displayed
Timerange: 00/16:25:31 to 00/16:28:57

Plot file version 196 created 29-APR-2009 14:32:48
 J2321+32 EP064D.UVDATA.1
 Freq = 1.5950 GHz, Bw = 16.000 MH Calibrated with CL # 3 and BP # 1 (BP mode 1)

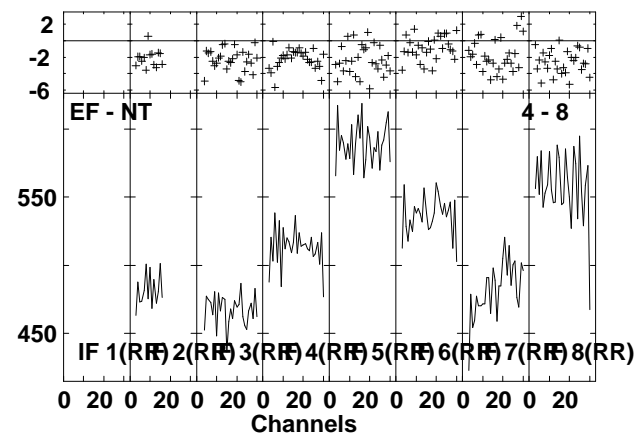
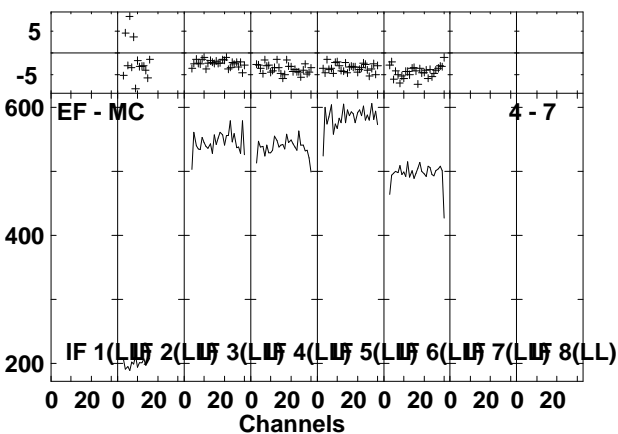
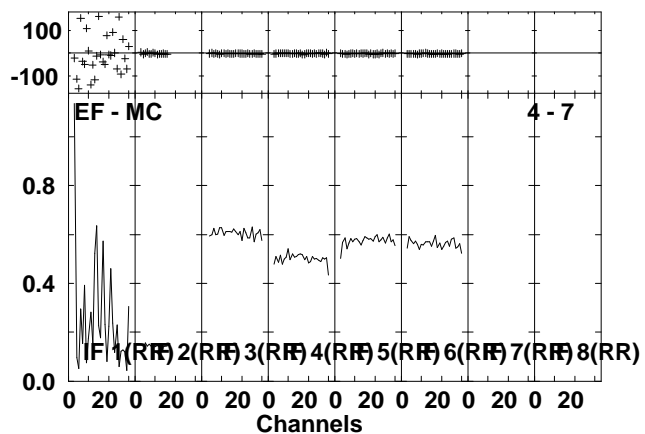
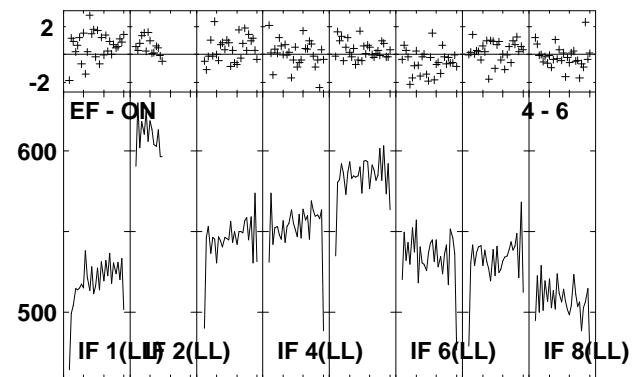
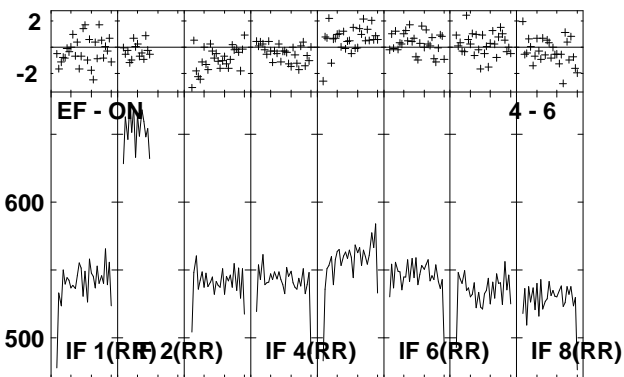
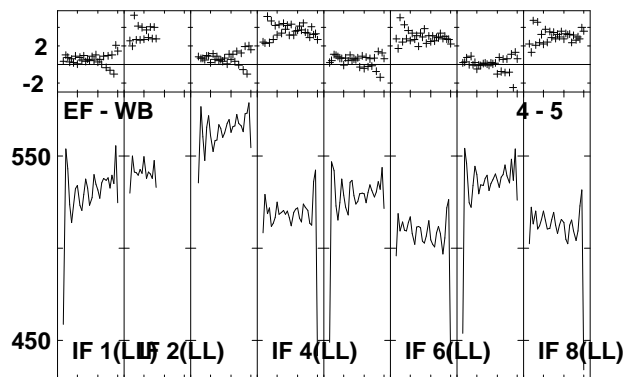
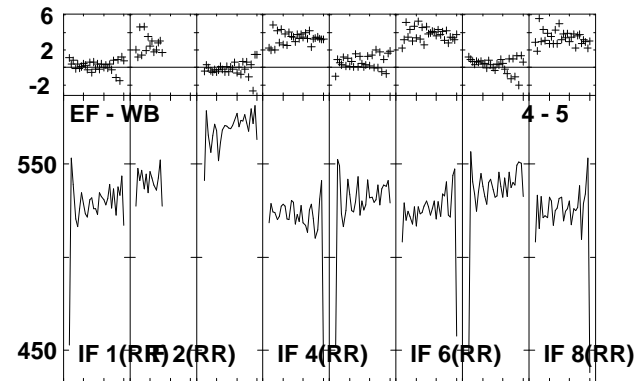
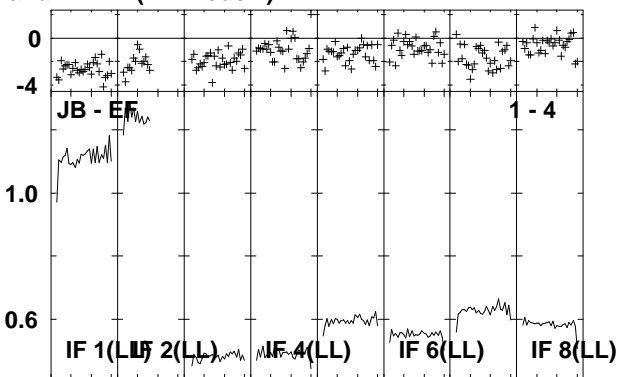
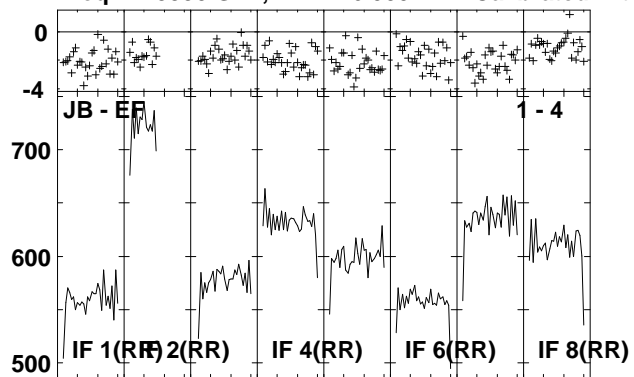

Lower frame: Milli Ampl Jy Top frame: Phas deg
 Vector averaged cross-power spectrum Several baselines displayed
 Timerange: 00/16:30:01 to 00/16:36:59

Plot file version 197 created 29-APR-2009 14:32:54

J2321+32 EP064D.UVDATA.1

Freq = 1.5950 GHz, Bw = 16.000 MH Calibrated with CL # 3 and BP # 1 (BP mode 1)

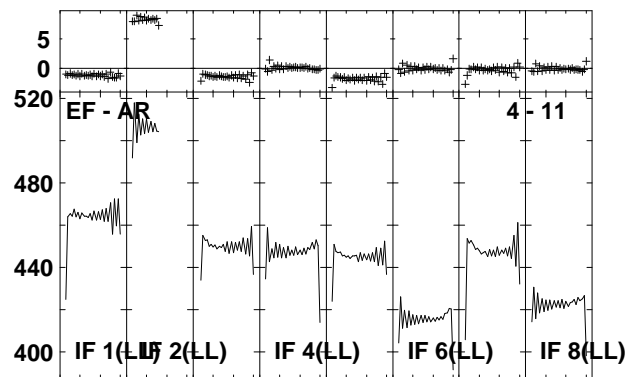
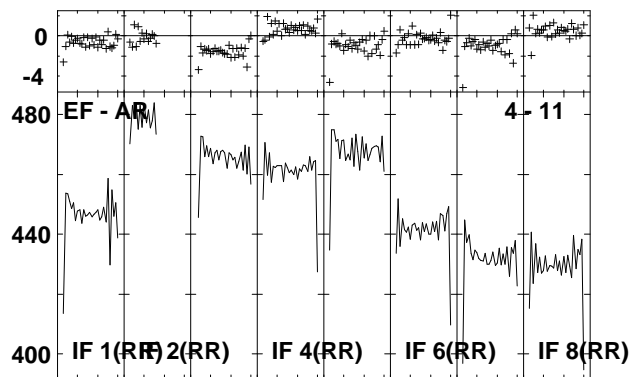
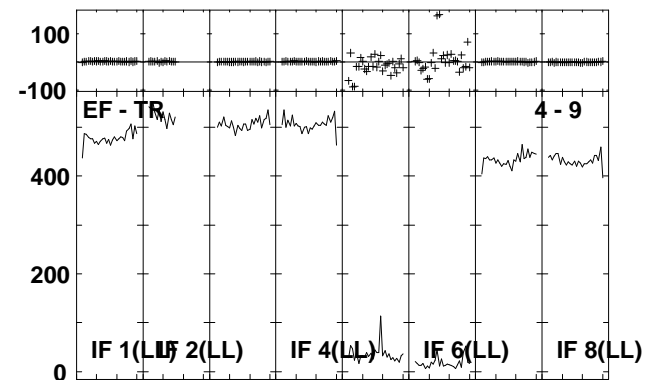
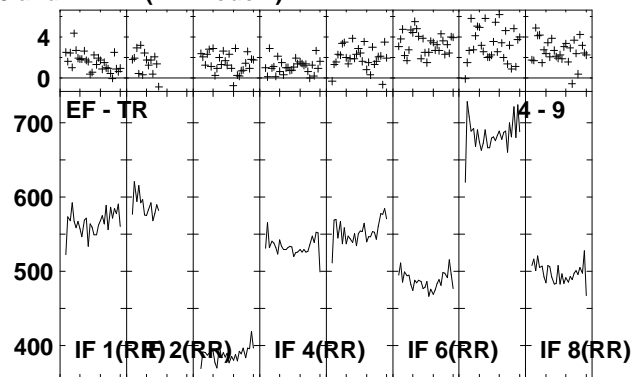
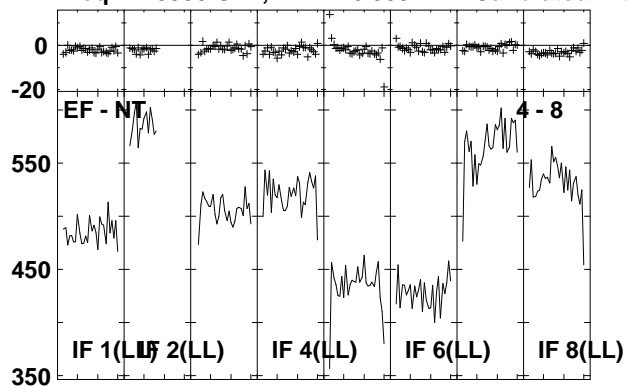

Lower frame: Milli Ampl Jy Top frame: Phas deg
Vector averaged cross-power spectrum Several baselines displayed
Timerange: 00/16:30:01 to 00/16:36:59

Plot file version 198 created 29-APR-2009 14:32:57

J2333+39 EP064D.UVDATA.1

Freq = 1.5950 GHz, Bw = 16.000 MH Calibrated with CL # 3 and BP # 1 (BP mode 1)

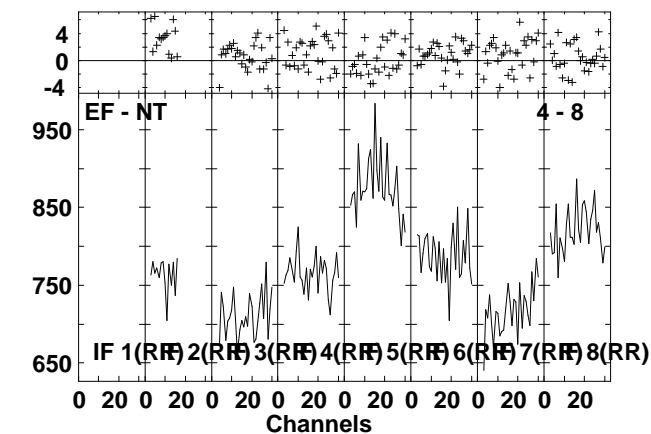
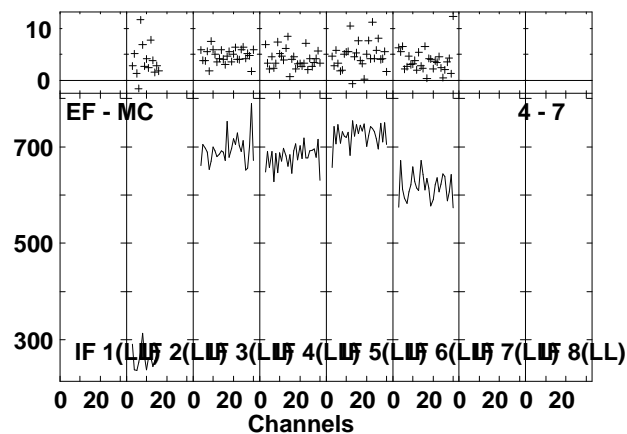
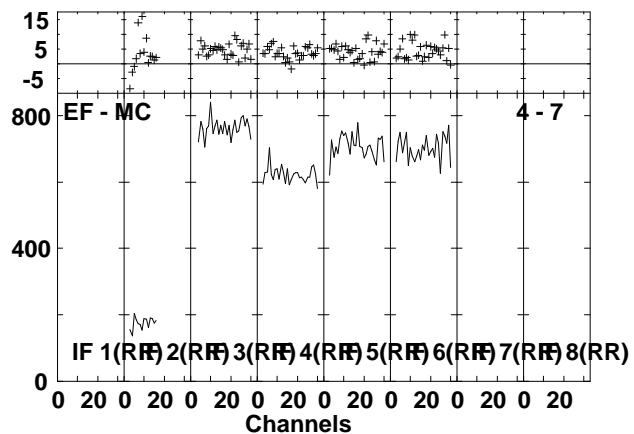
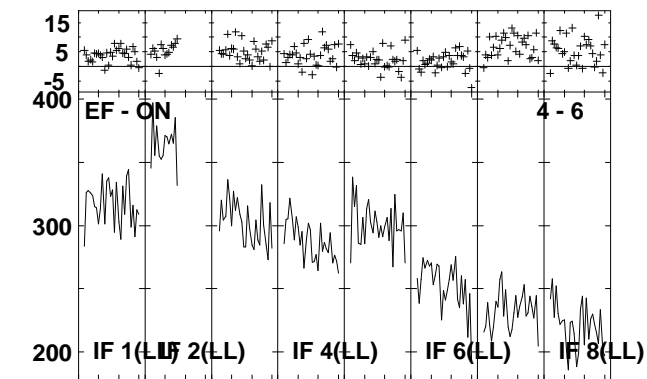
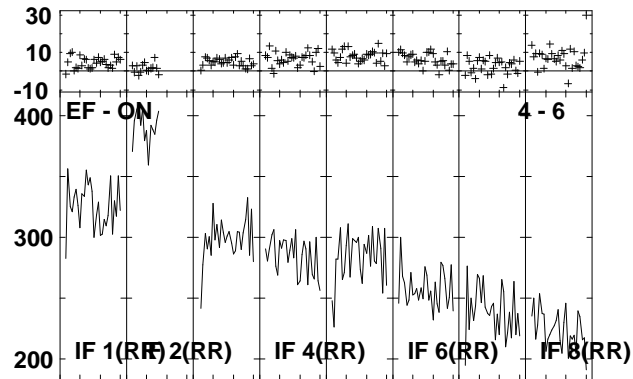
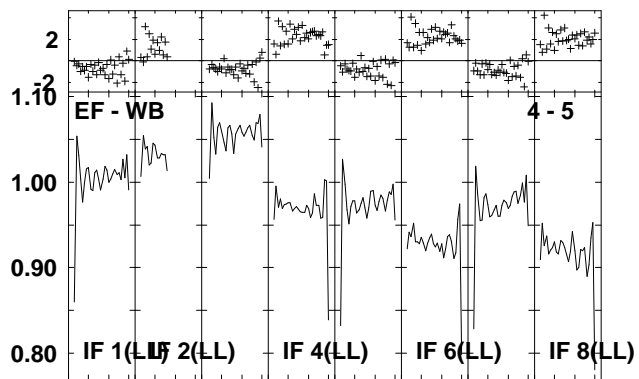
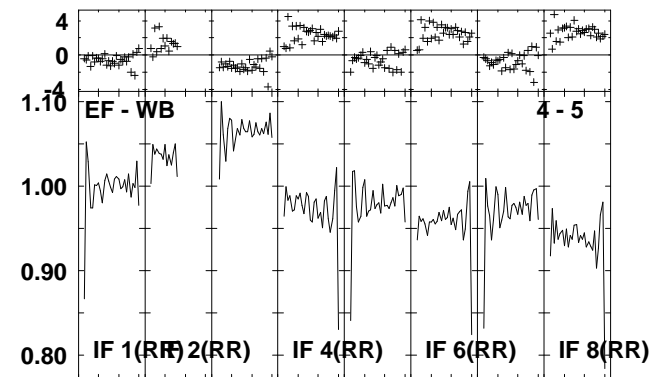
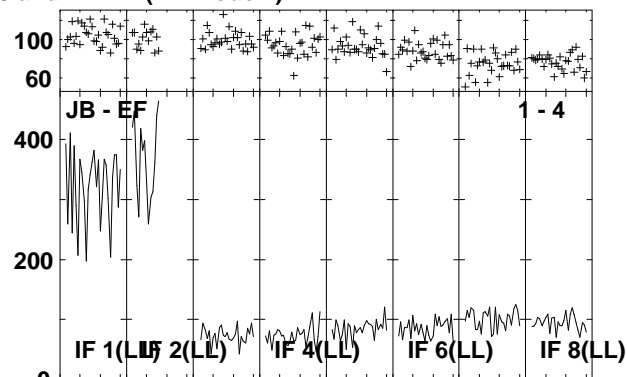
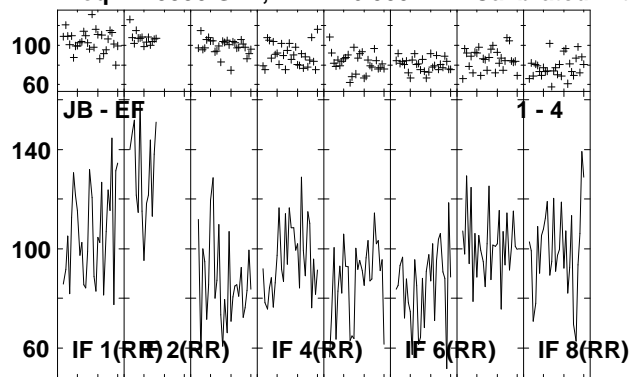

Lower frame: Milli Ampl Jy Top frame: Phas deg
Vector averaged cross-power spectrum Several baselines displayed
Timerange: 00/16:38:01 to 00/16:39:31

Plot file version 199 created 29-APR-2009 14:32:59

J2333+39 EP064D.UVDATA.1

Freq = 1.5950 GHz, Bw = 16.000 MH Calibrated with CL # 3 and BP # 1 (BP mode 1)

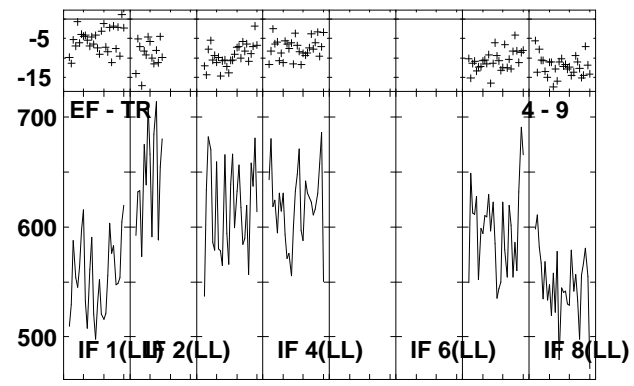
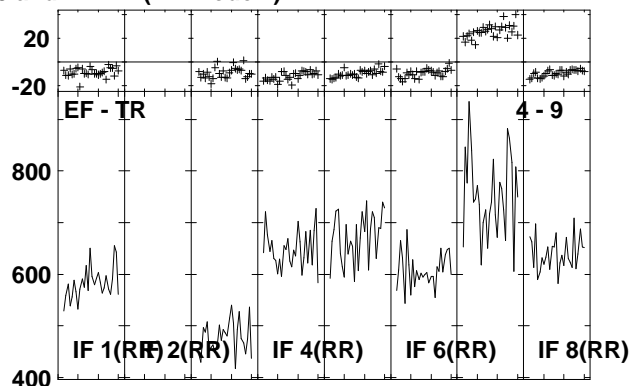
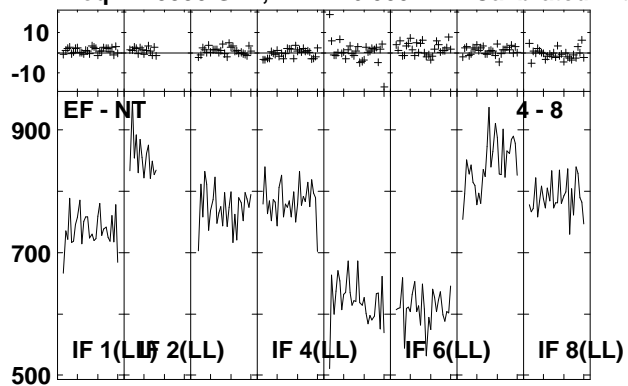

Lower frame: Milli Ampl Jy Top frame: Phas deg
Vector averaged cross-power spectrum Several baselines displayed
Timerange: 00/16:38:01 to 00/16:39:31

Plot file version 200 created 29-APR-2009 14:33:01

IRAS2336 EP064D.UVDATA.1

Freq = 1.5950 GHz, Bw = 16.000 MH Calibrated with CL # 3 and BP # 1 (BP mode 1)

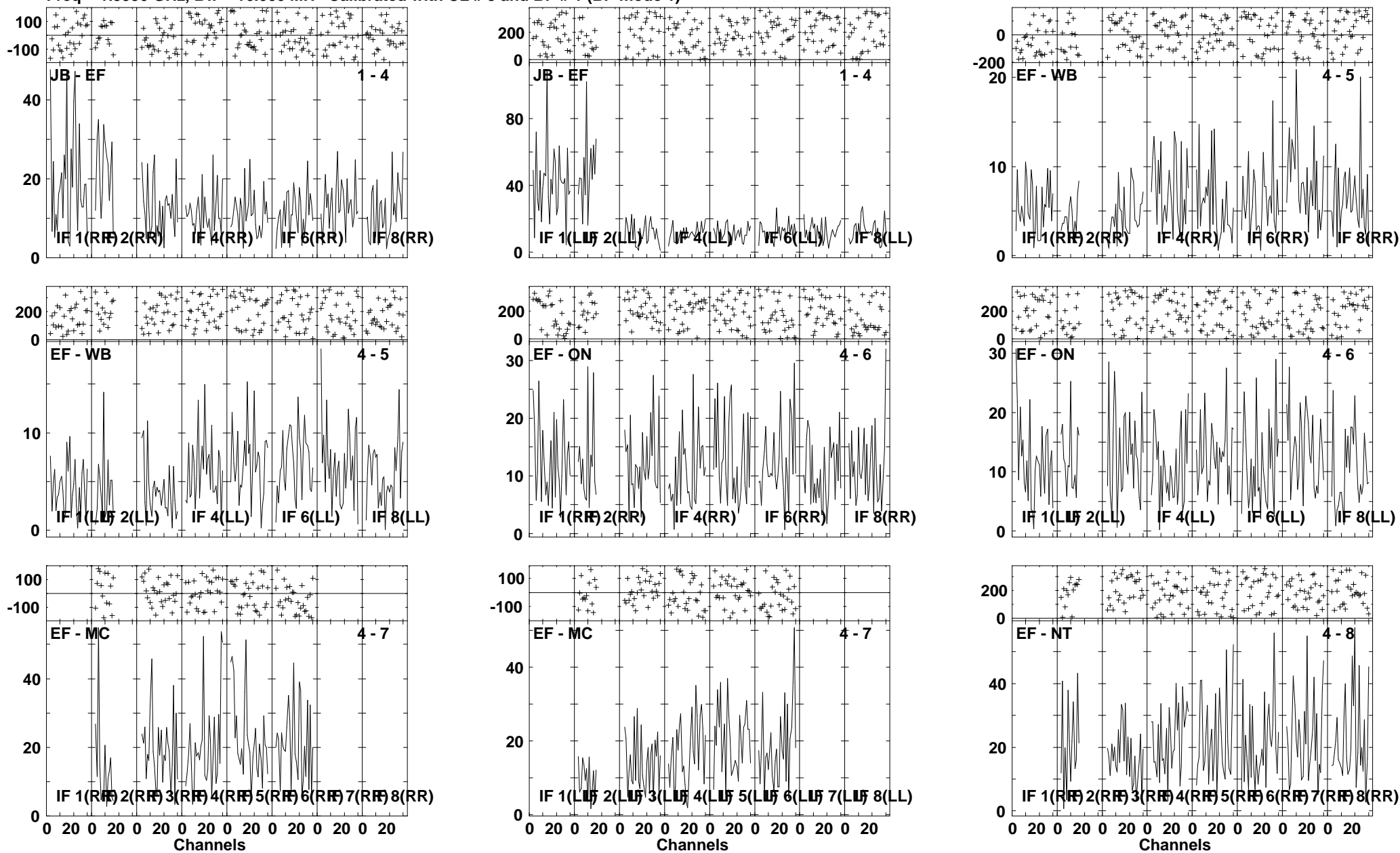

Lower frame: Milli Ampl Jy Top frame: Phas deg
Vector averaged cross-power spectrum Several baselines displayed
Timerange: 00/16:39:33 to 00/16:43:59

Plot file version 201 created 29-APR-2009 14:33:06

IRAS2336 EP064D.UVDATA.1

Freq = 1.5950 GHz, Bw = 16.000 MH Calibrated with CL # 3 and BP # 1 (BP mode 1)

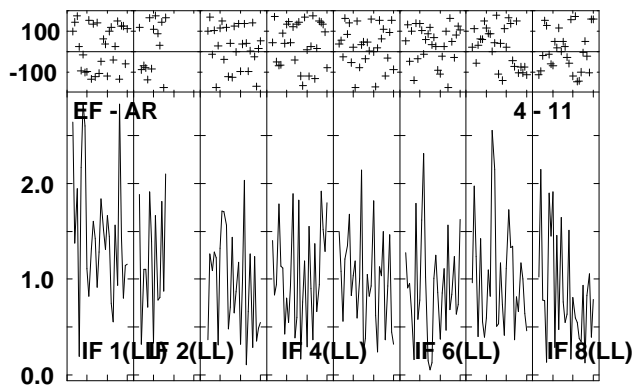
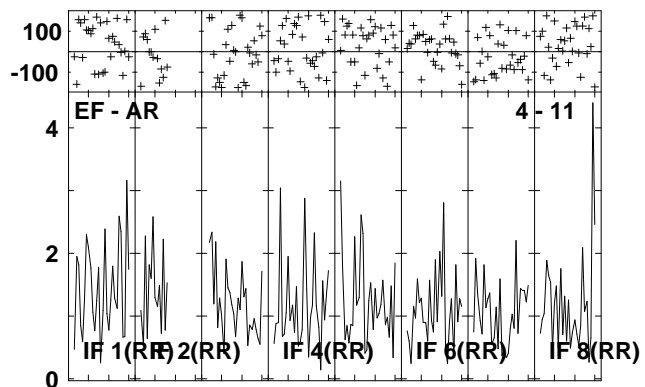
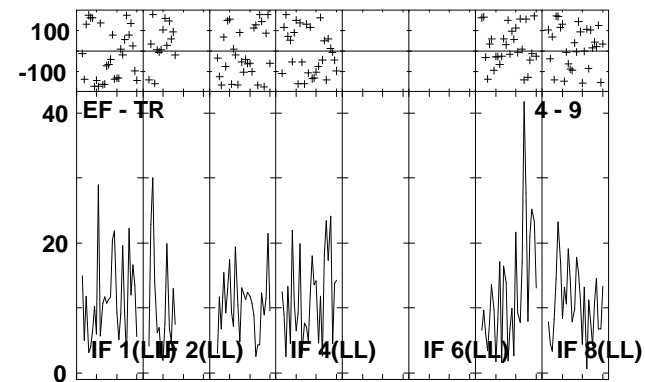
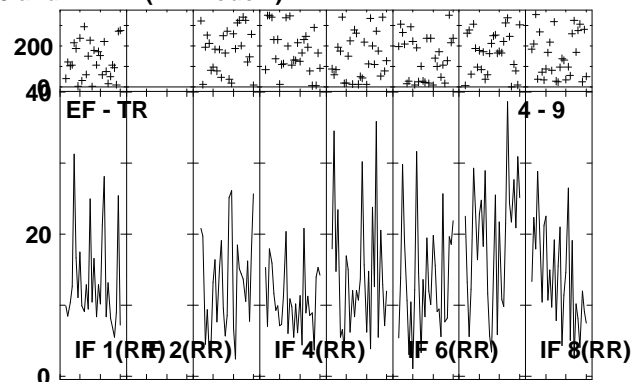
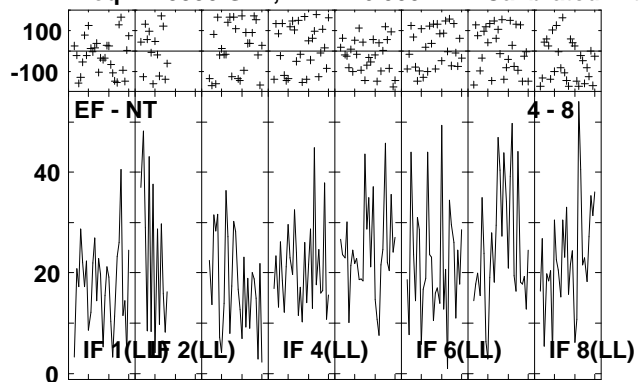

Lower frame: Milli Ampl Jy Top frame: Phas deg
Vector averaged cross-power spectrum Several baselines displayed
Timerange: 00/16:39:33 to 00/16:43:59

Plot file version 202 created 29-APR-2009 14:33:09

J2333+39 EP064D.UVDATA.1

Freq = 1.5950 GHz, Bw = 16.000 MH Calibrated with CL # 3 and BP # 1 (BP mode 1)

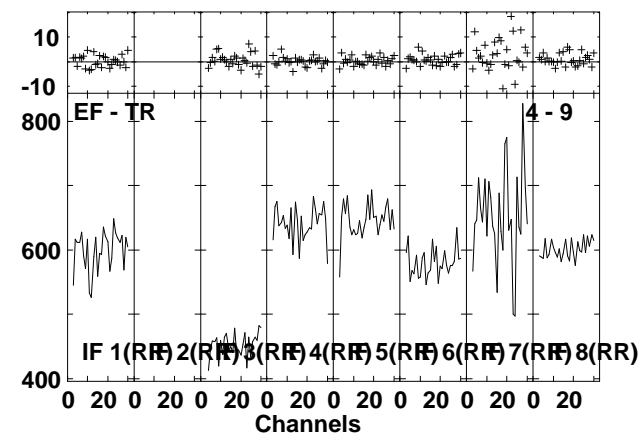
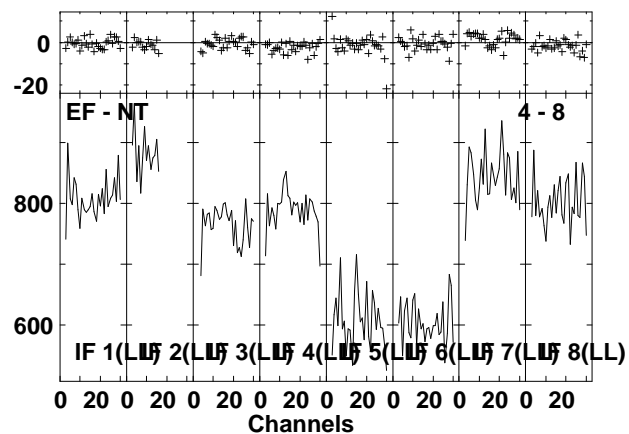
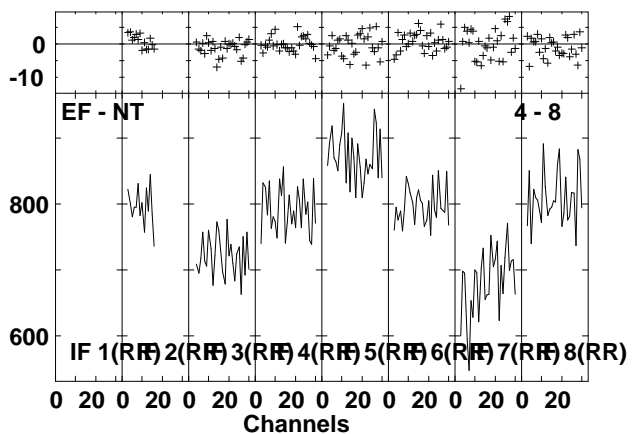
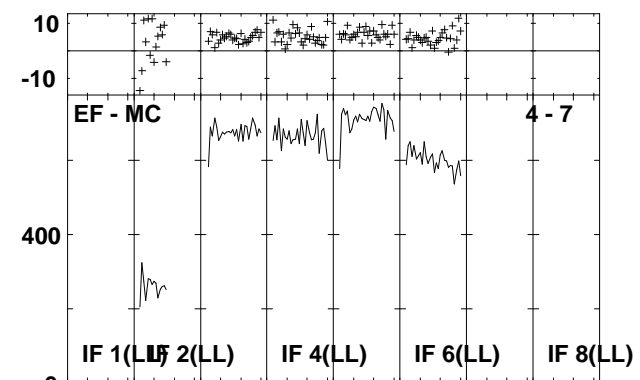
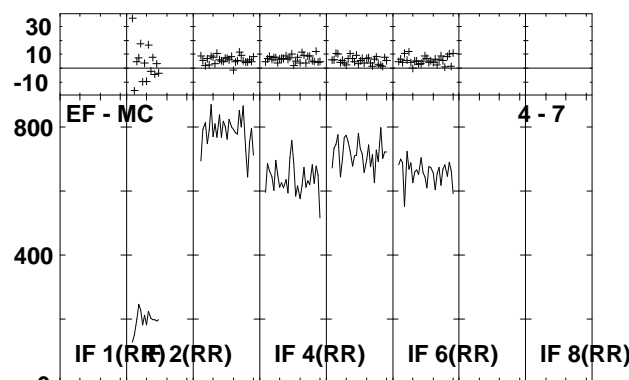
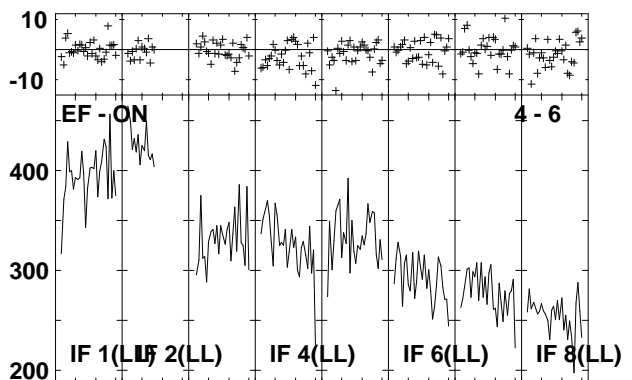
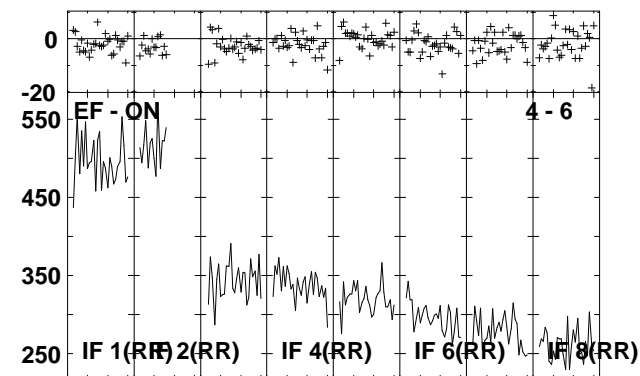
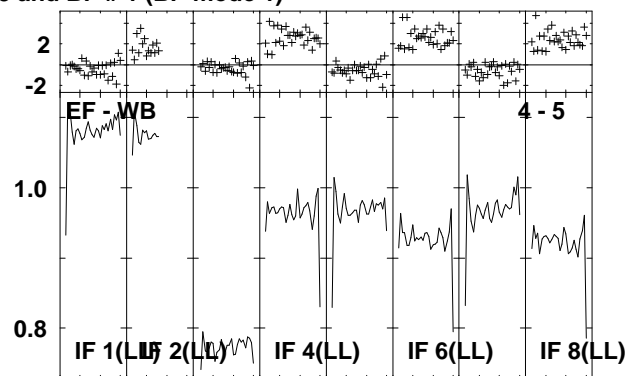
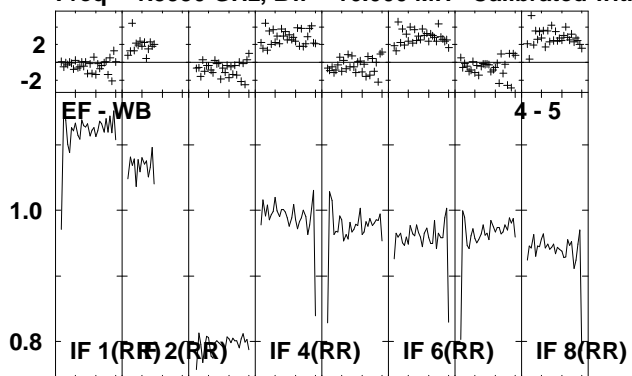

Lower frame: Ampl Jy Top frame: Phas deg
Vector averaged cross-power spectrum Several baselines displayed
Timerange: 00/16:44:01 to 00/16:45:27

Plot file version 203 created 29-APR-2009 14:33:10
J2333+39 EP064D.UVDATA.1
Freq = 1.5950 GHz, Bw = 16.000 MH Calibrated with CL # 3 and BP # 1 (BP mode 1)

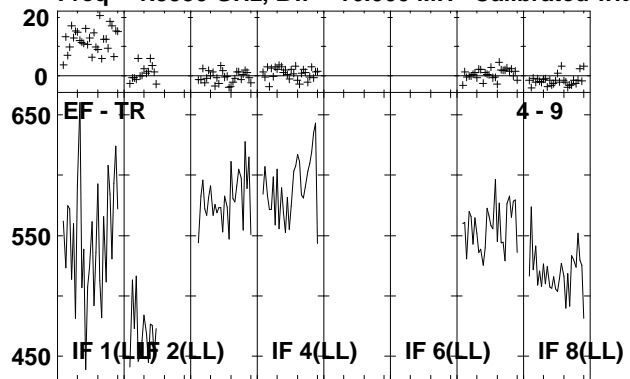

Lower frame: Milli Ampl Jy Top frame: Phas deg
Vector averaged cross-power spectrum Several baselines displayed
Timerange: 00/16:44:01 to 00/16:45:27

Plot file version 204 created 29-APR-2009 14:33:11

IRAS2336 EP064D.UVDATA.1

Freq = 1.5950 GHz, Bw = 16.000 MH Calibrated with CL # 3 and BP # 1 (BP mode 1)

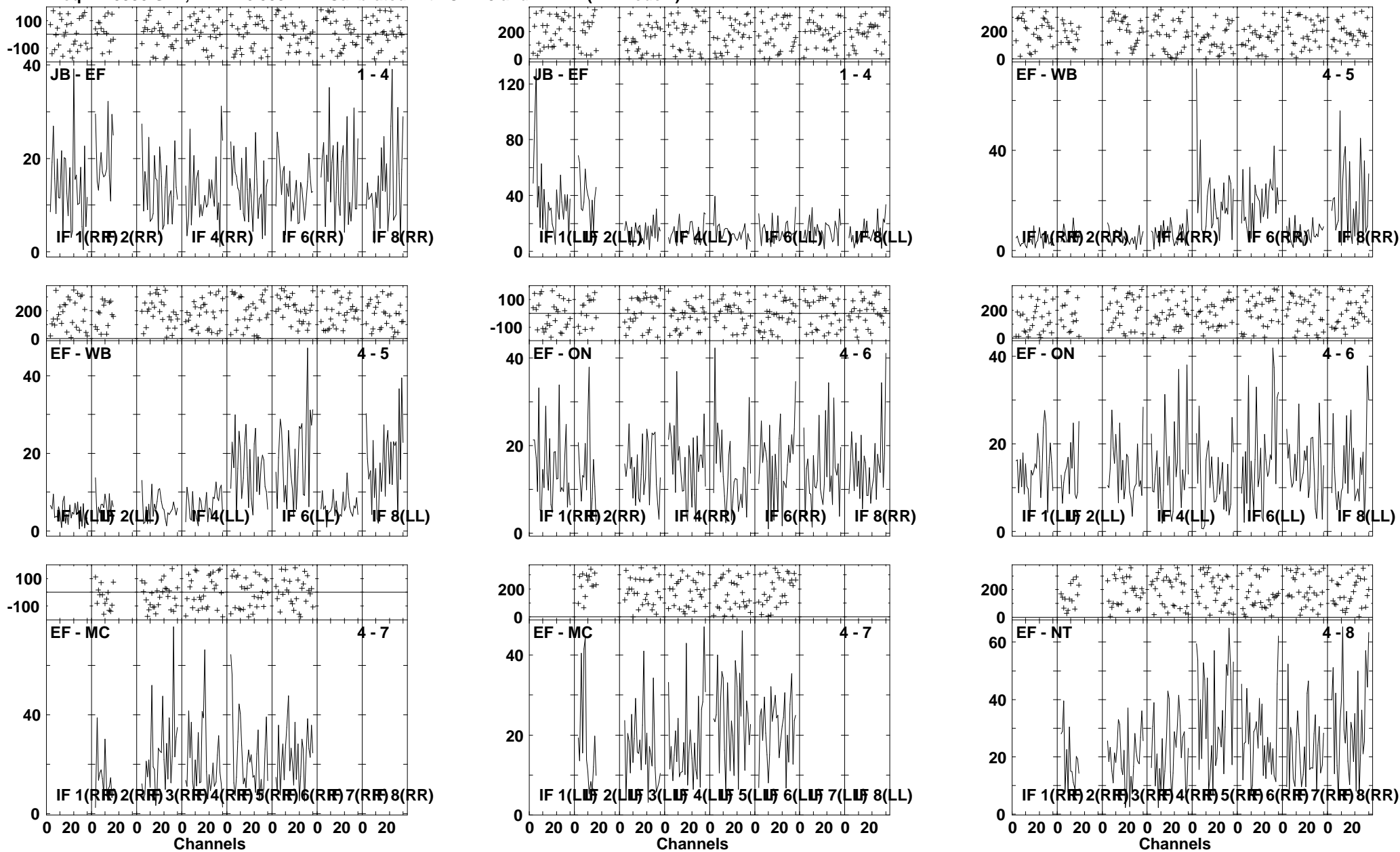

Lower frame: Milli Ampl Jy Top frame: Phas deg
Vector averaged cross-power spectrum Several baselines displayed
Timerange: 00/16:45:29 to 00/16:48:59

Plot file version 205 created 29-APR-2009 14:33:15

IRAS2336 EP064D.UVDATA.1

Freq = 1.5950 GHz, Bw = 16.000 MH Calibrated with CL # 3 and BP # 1 (BP mode 1)

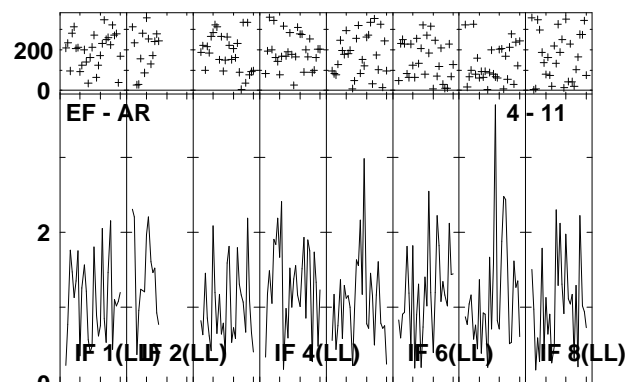
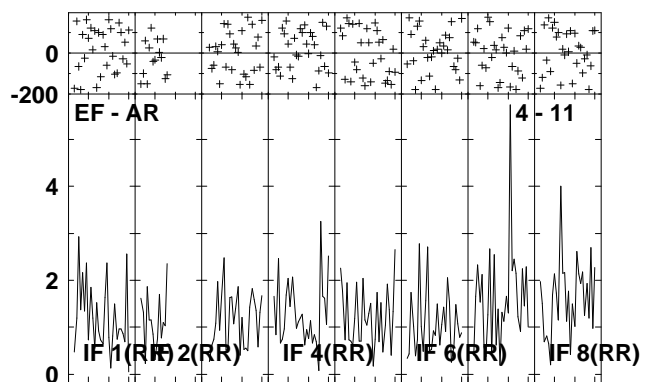
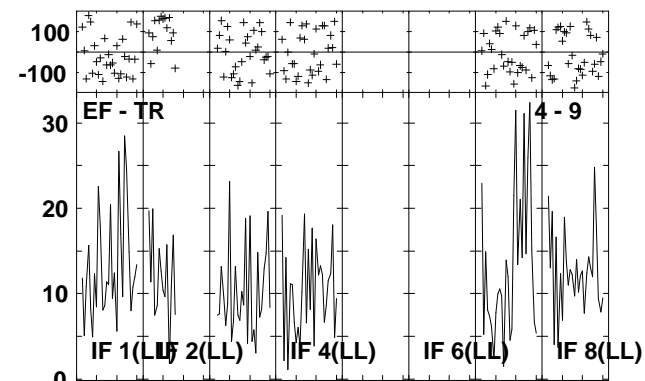
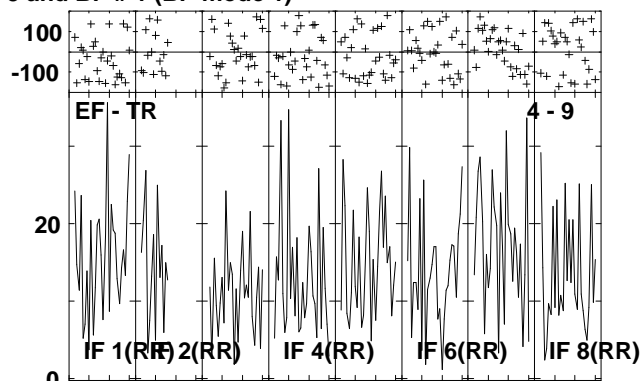
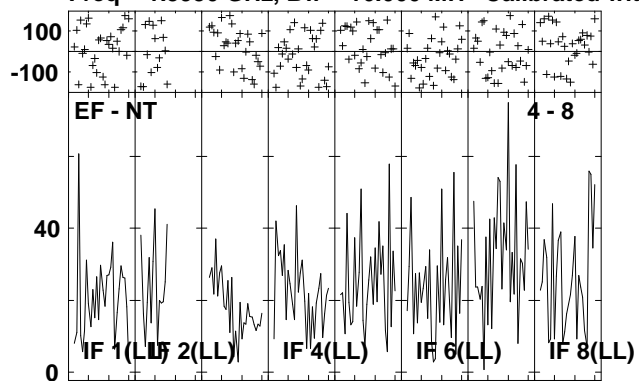

Lower frame: Milli Ampl Jy Top frame: Phas deg
Vector averaged cross-power spectrum Several baselines displayed
Timerange: 00/16:45:29 to 00/16:48:59

Plot file version 206 created 29-APR-2009 14:33:17

J2333+39 EP064D.UVDATA.1

Freq = 1.5950 GHz, Bw = 16.000 MH Calibrated with CL # 3 and BP # 1 (BP mode 1)

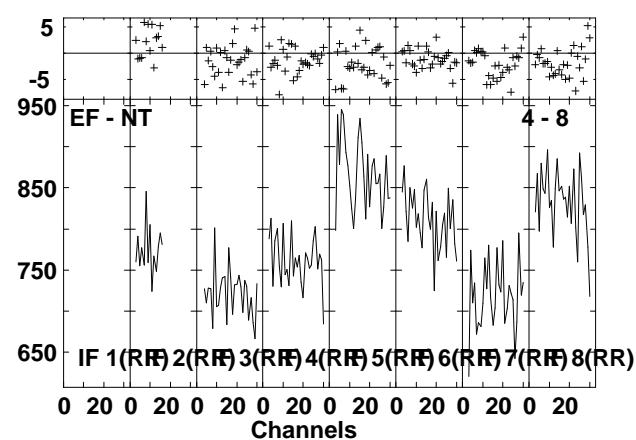
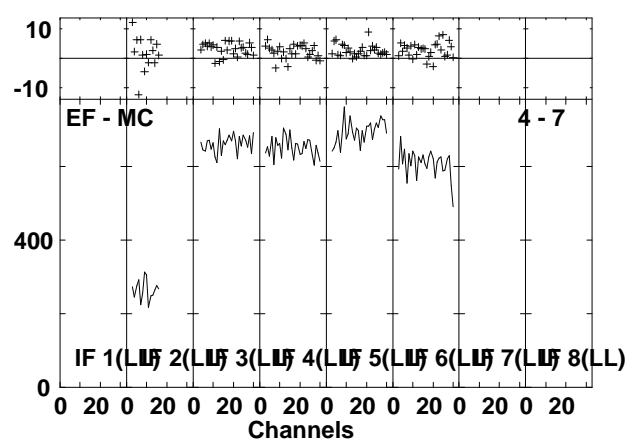
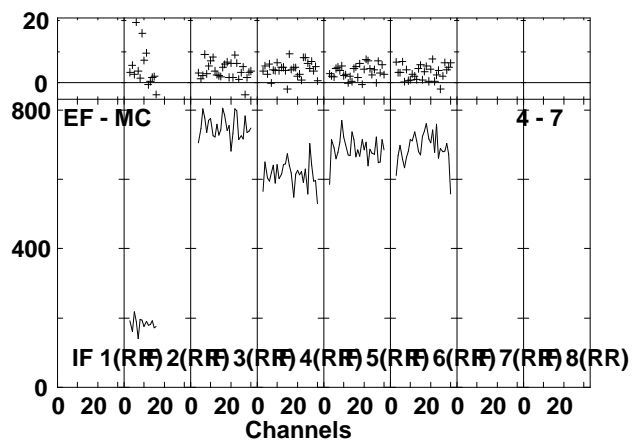
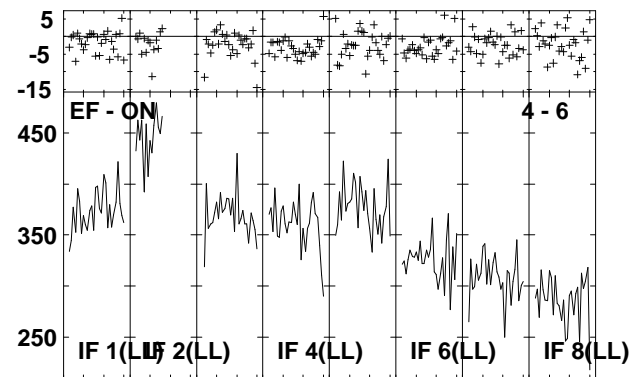
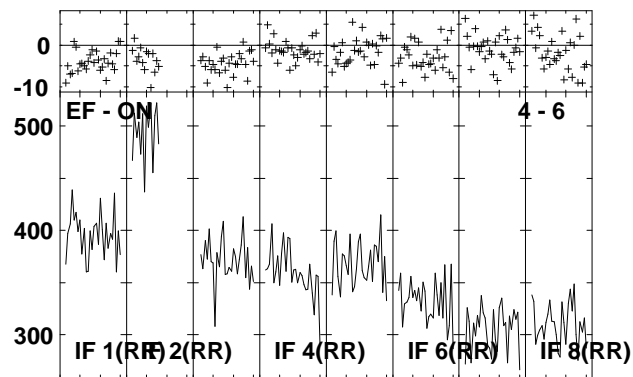
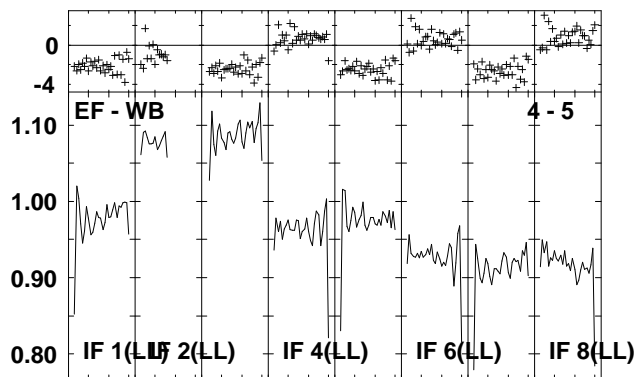
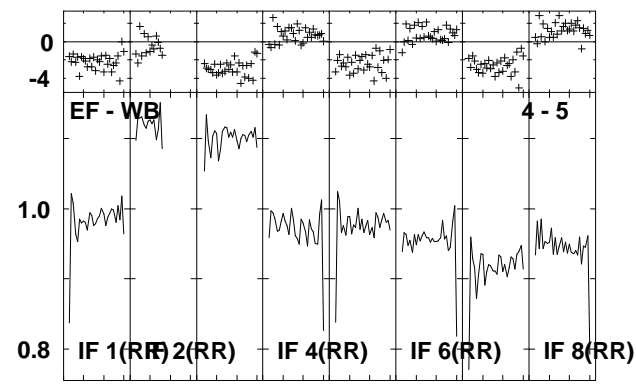
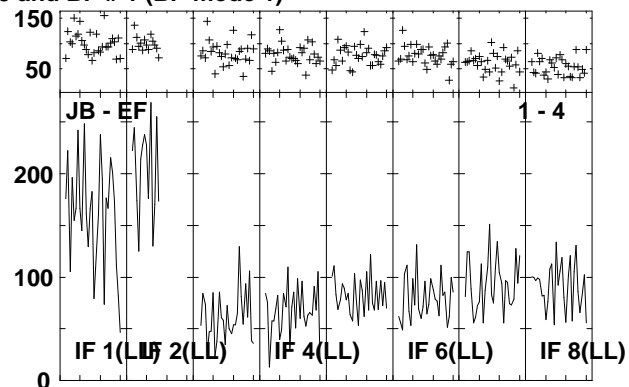
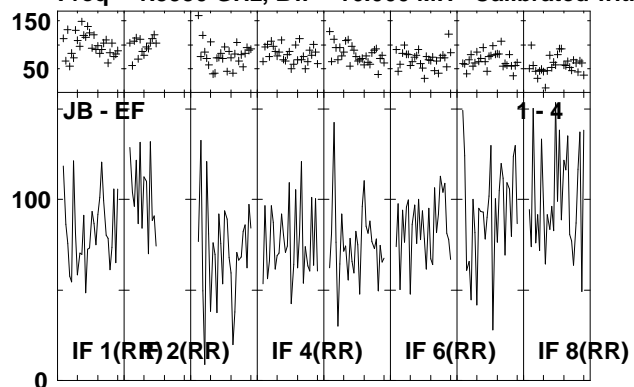

Lower frame: Milli Ampl Jy Top frame: Phas deg
Vector averaged cross-power spectrum Several baselines displayed
Timerange: 00/16:49:01 to 00/16:50:29

Plot file version 207 created 29-APR-2009 14:33:19

J2333+39 EP064D.UVDATA.1

Freq = 1.5950 GHz, Bw = 16.000 MH Calibrated with CL # 3 and BP # 1 (BP mode 1)

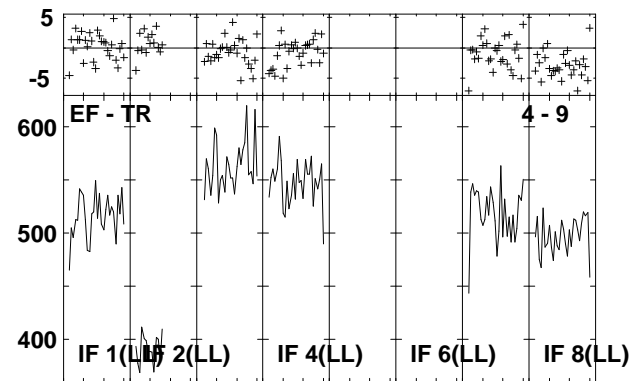
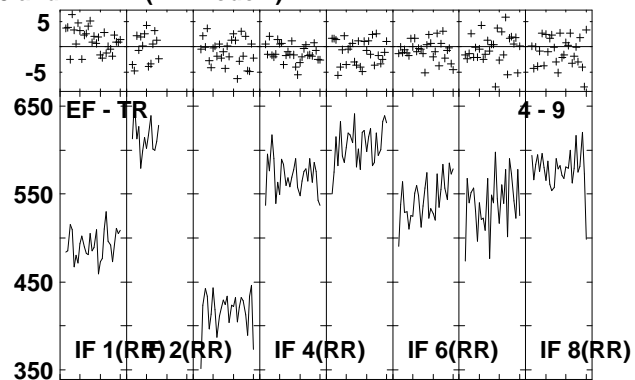
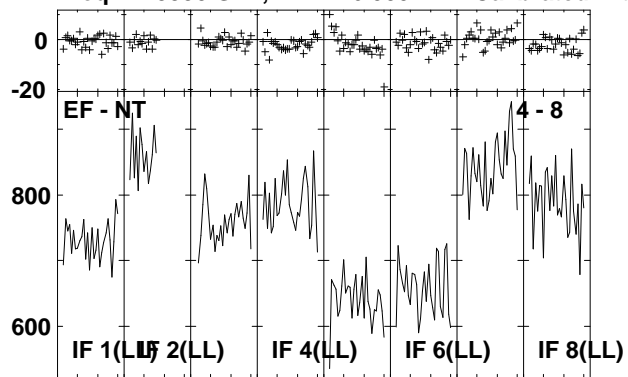

Lower frame: Milli Ampl Jy Top frame: Phas deg
Vector averaged cross-power spectrum Several baselines displayed
Timerange: 00/16:49:01 to 00/16:50:29

Plot file version 208 created 29-APR-2009 14:33:20
 IRAS2336 EP064D.UVDATA.1
 Freq = 1.5950 GHz, Bw = 16.000 MH Calibrated with CL # 3 and BP # 1 (BP mode 1)

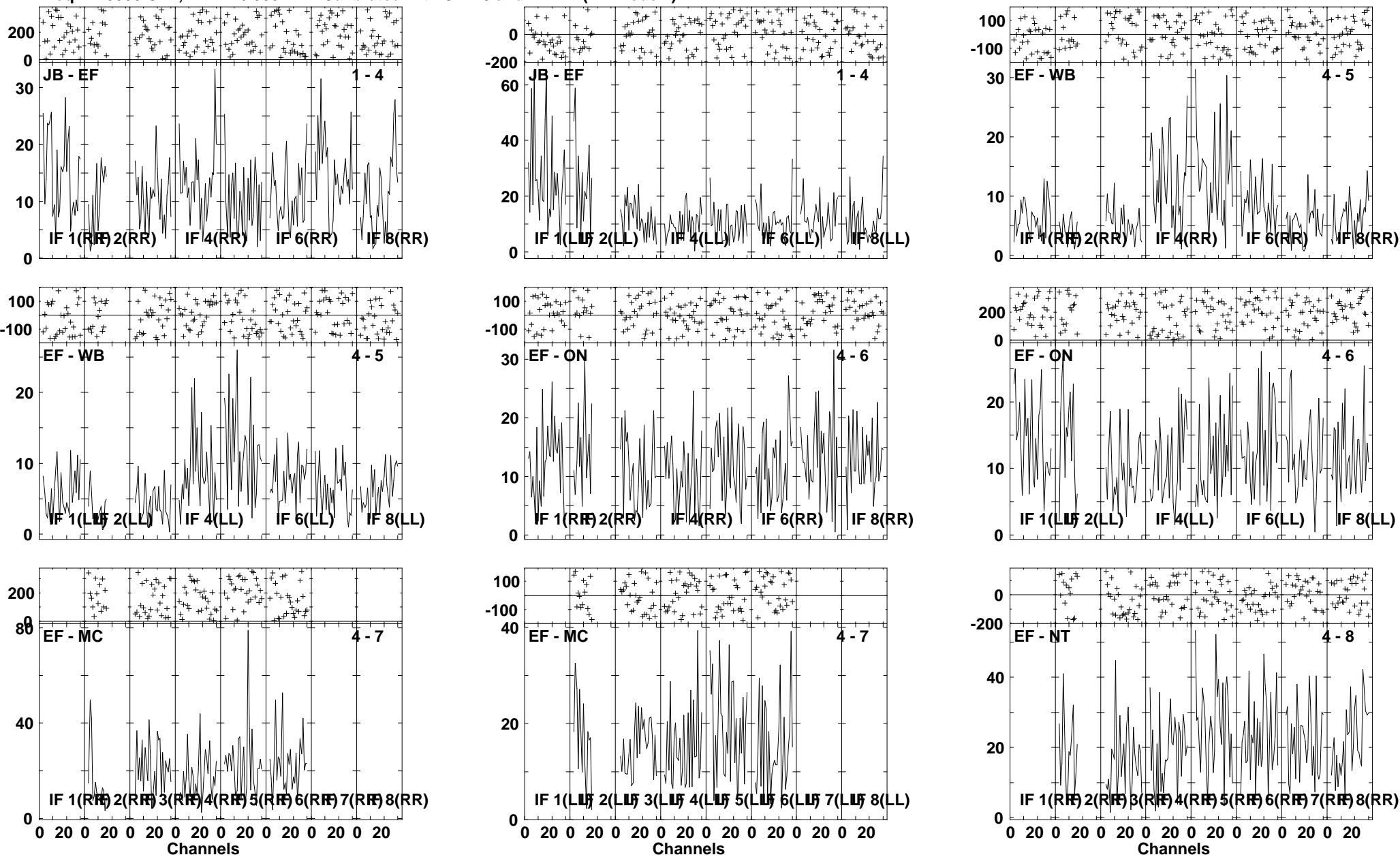

Lower frame: Milli Ampl Jy Top frame: Phas deg
 Vector averaged cross-power spectrum Several baselines displayed
 Timerange: 00/16:50:31 to 00/16:54:59

Plot file version 209 created 29-APR-2009 14:33:25

IRAS2336 EP064D.UVDATA.1

Freq = 1.5950 GHz, Bw = 16.000 MH Calibrated with CL # 3 and BP # 1 (BP mode 1)

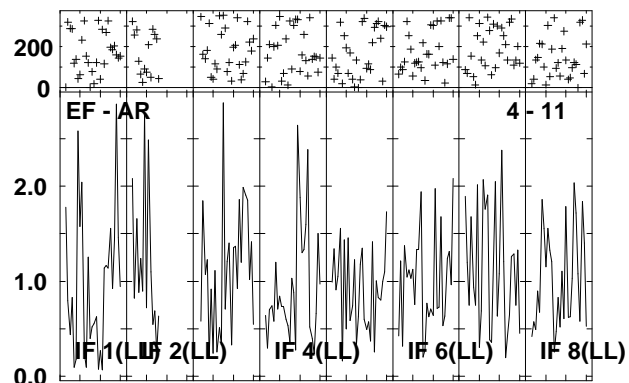
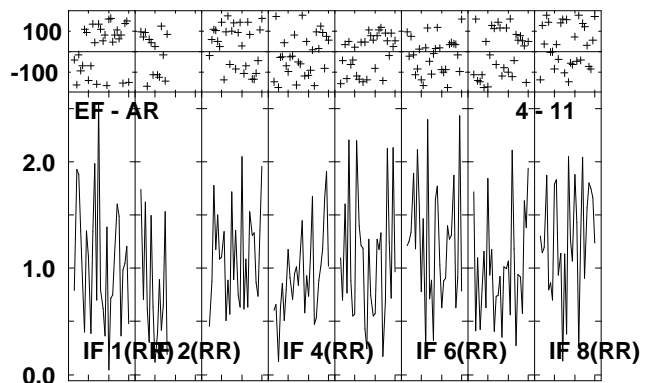
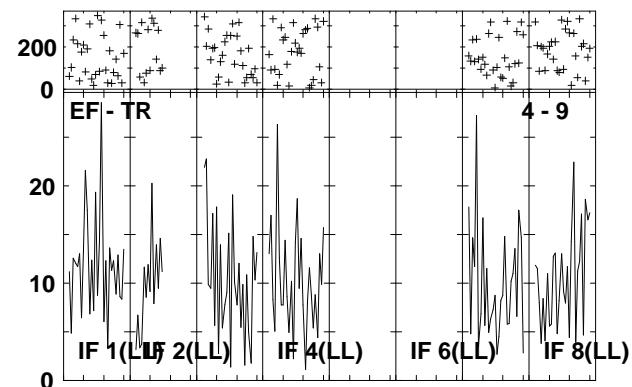
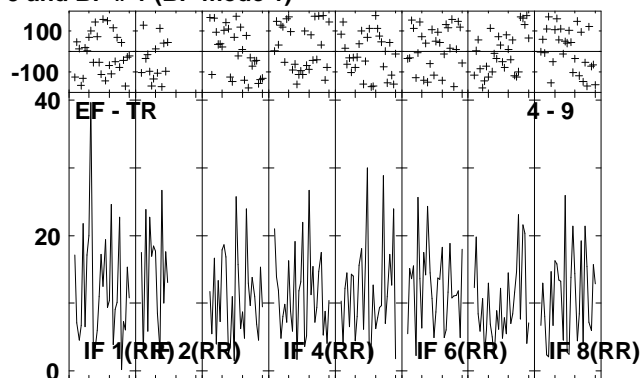
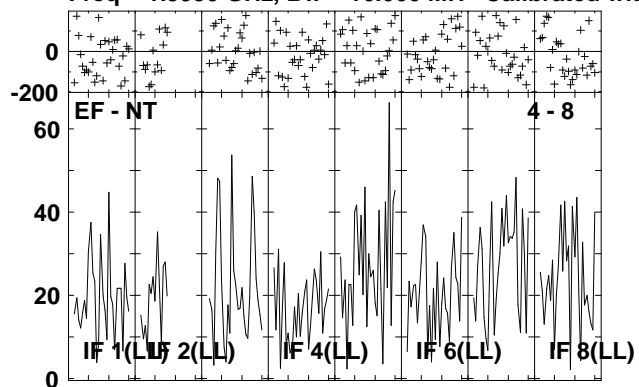

Lower frame: Milli Ampl Jy Top frame: Phas deg
Vector averaged cross-power spectrum Several baselines displayed
Timerange: 00/16:50:31 to 00/16:54:59

Plot file version 210 created 29-APR-2009 14:33:28

J2333+39 EP064D.UVDATA.1

Freq = 1.5950 GHz, Bw = 16.000 MH Calibrated with CL # 3 and BP # 1 (BP mode 1)

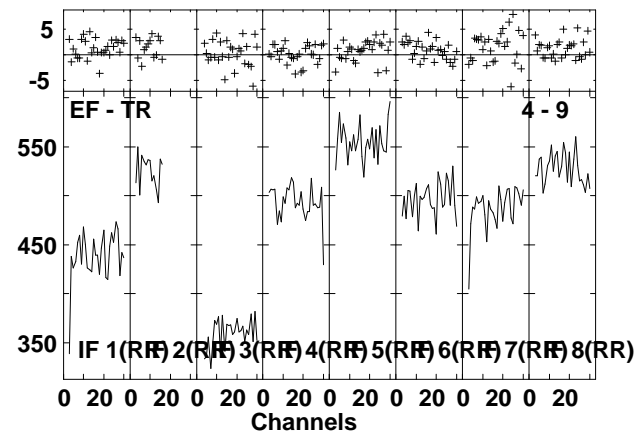
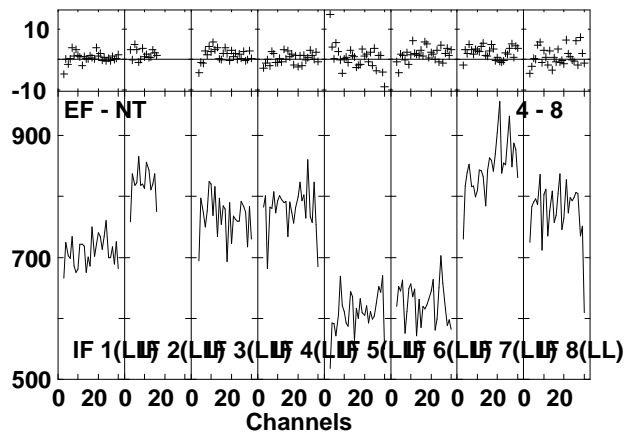
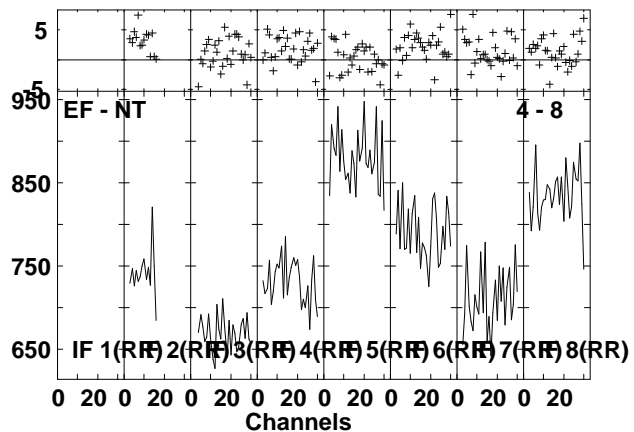
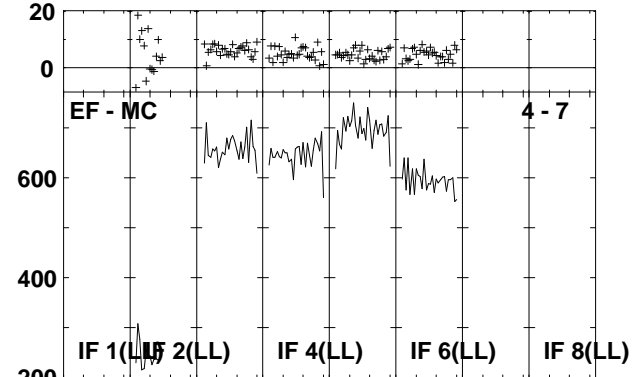
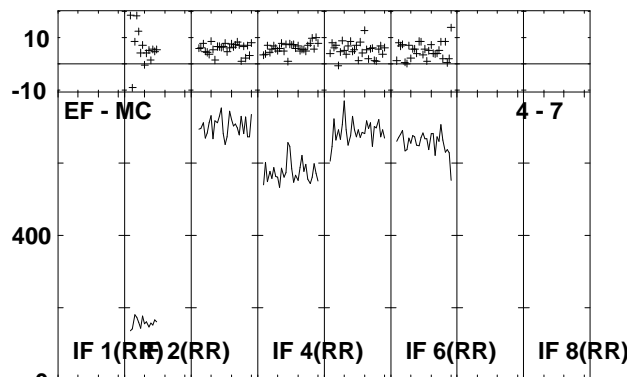
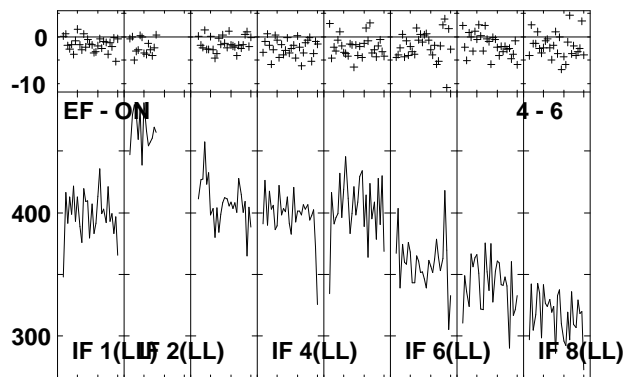
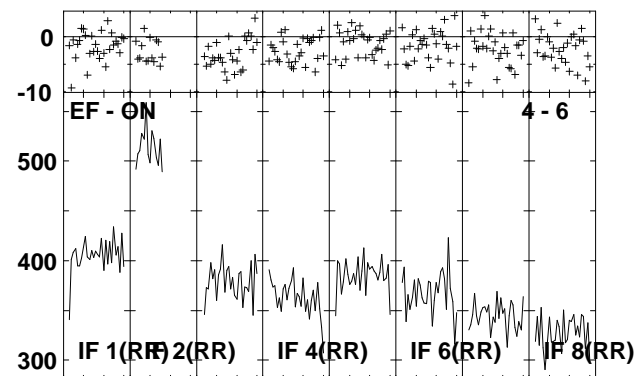
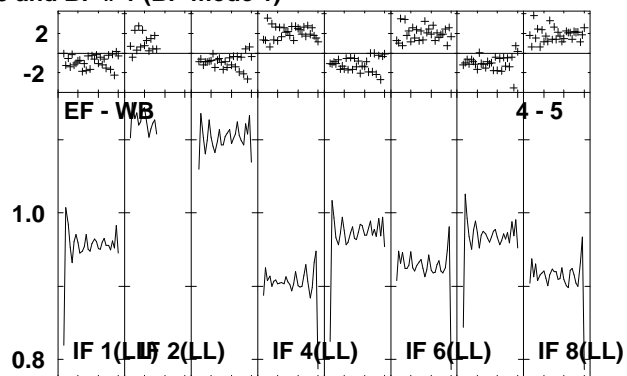
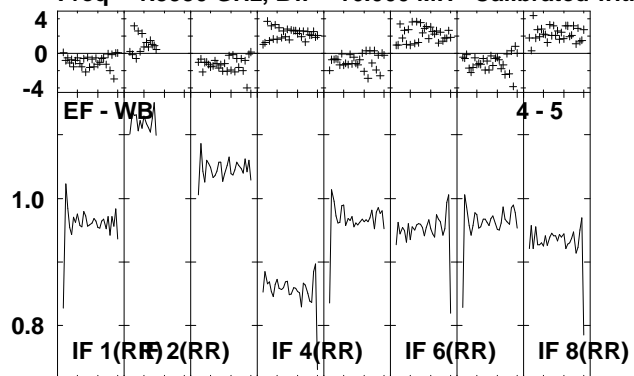

Lower frame: Ampl Jy Top frame: Phas deg
Vector averaged cross-power spectrum Several baselines displayed
Timerange: 00/16:56:01 to 00/16:57:27

Plot file version 211 created 29-APR-2009 14:33:29
J2333+39 EP064D.UVDATA.1
Freq = 1.5950 GHz, Bw = 16.000 MH Calibrated with CL # 3 and BP # 1 (BP mode 1)

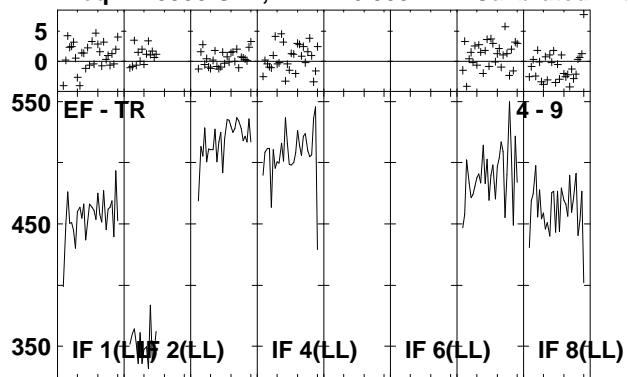

Lower frame: Milli Ampl Jy Top frame: Phas deg
Vector averaged cross-power spectrum Several baselines displayed
Timerange: 00/16:56:01 to 00/16:57:27

Plot file version 212 created 29-APR-2009 14:33:30

IRAS2336 EP064D.UVDATA.1

Freq = 1.5950 GHz, Bw = 16.000 MH Calibrated with CL # 3 and BP # 1 (BP mode 1)

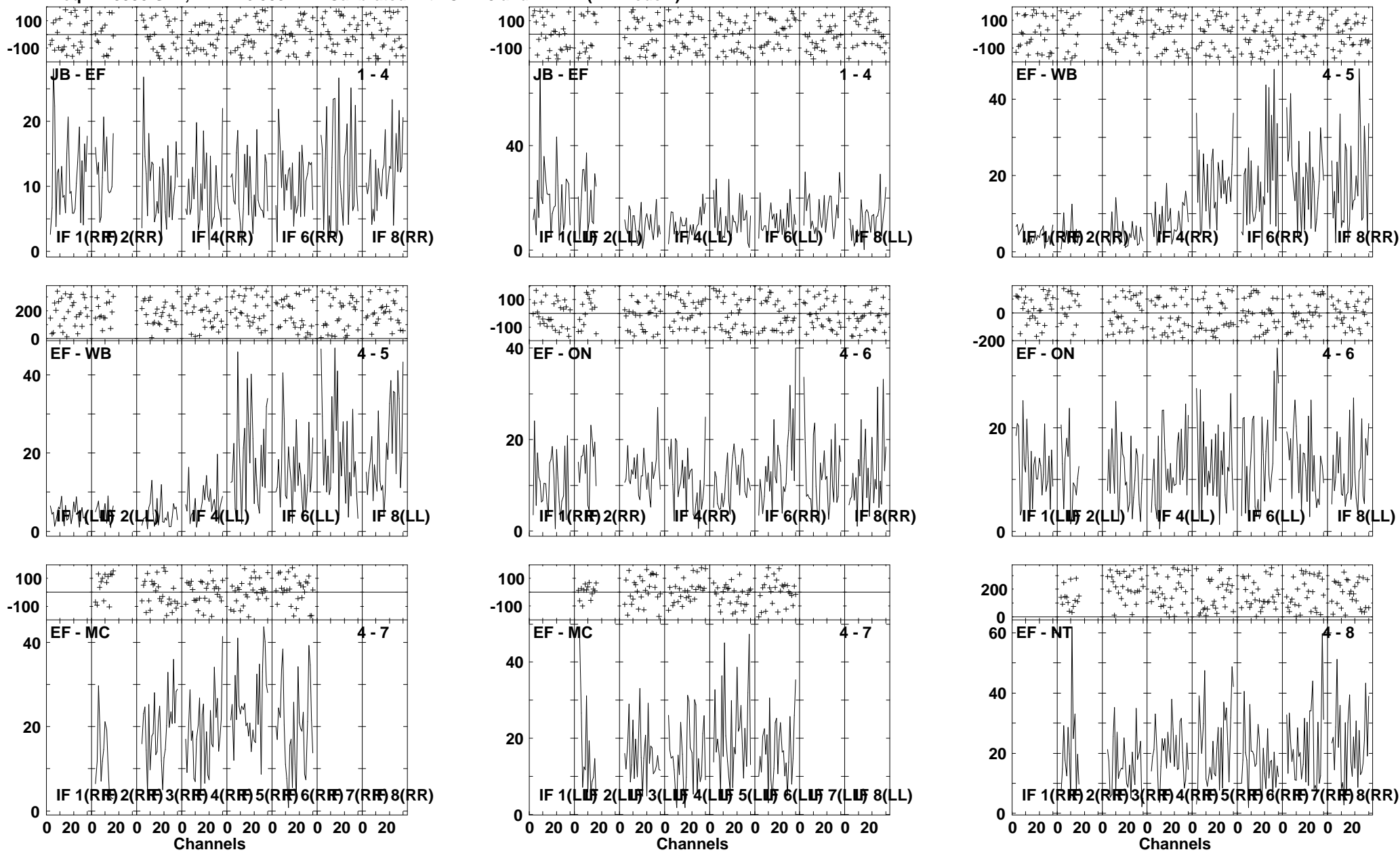

Lower frame: Milli Ampl Jy Top frame: Phas deg
Vector averaged cross-power spectrum Several baselines displayed
Timerange: 00/16:57:29 to 00/17:01:59

Plot file version 213 created 29-APR-2009 14:33:35

IRAS2336 EP064D.UVDATA.1

Freq = 1.5950 GHz, Bw = 16.000 MH Calibrated with CL # 3 and BP # 1 (BP mode 1)

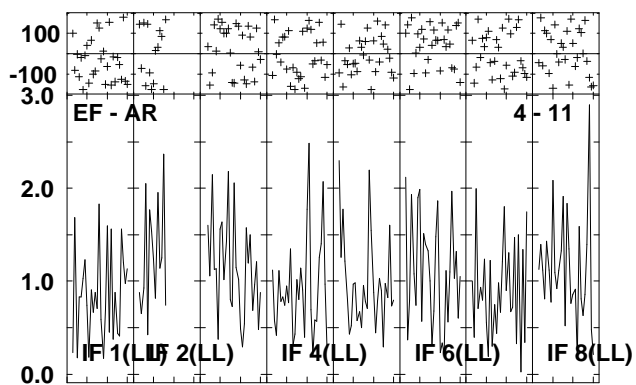
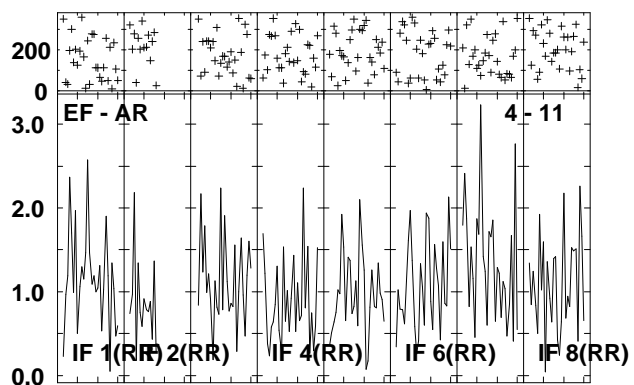
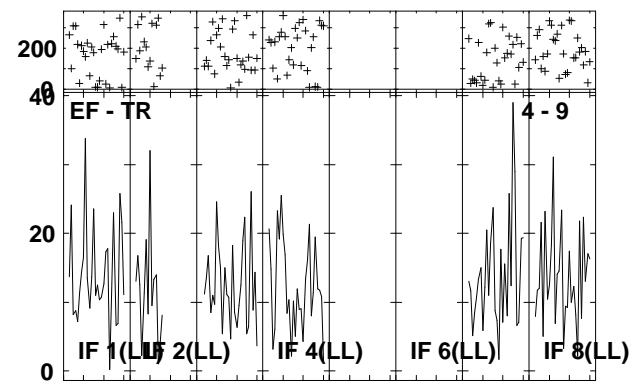
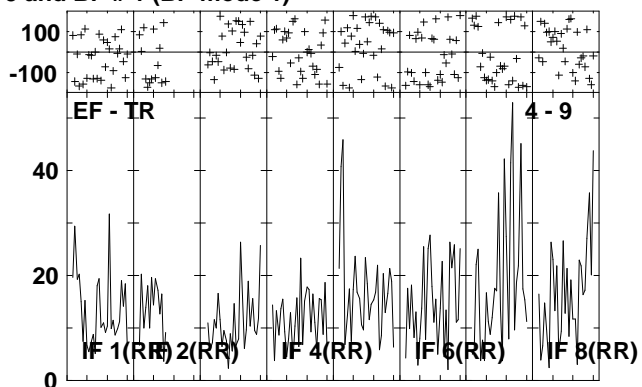
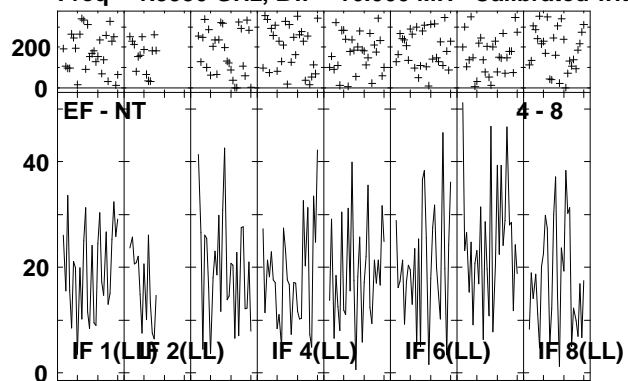

Lower frame: Milli Ampl Jy Top frame: Phas deg
Vector averaged cross-power spectrum Several baselines displayed
Timerange: 00/16:57:29 to 00/17:01:59

Plot file version 214 created 29-APR-2009 14:33:38

J2333+39 EP064D.UVDATA.1

Freq = 1.5950 GHz, Bw = 16.000 MH Calibrated with CL # 3 and BP # 1 (BP mode 1)

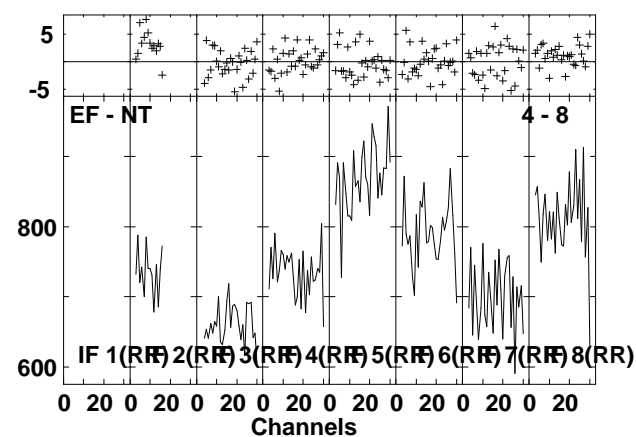
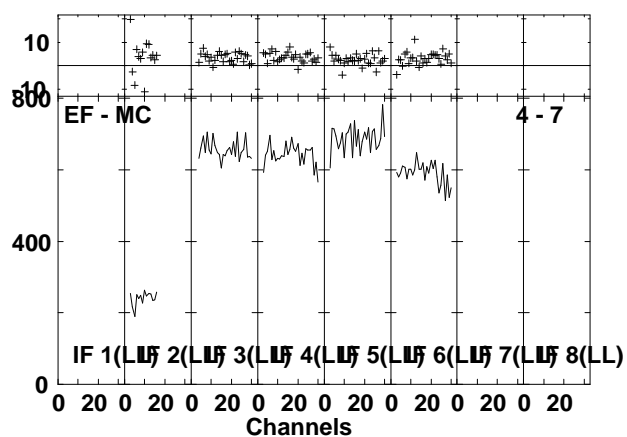
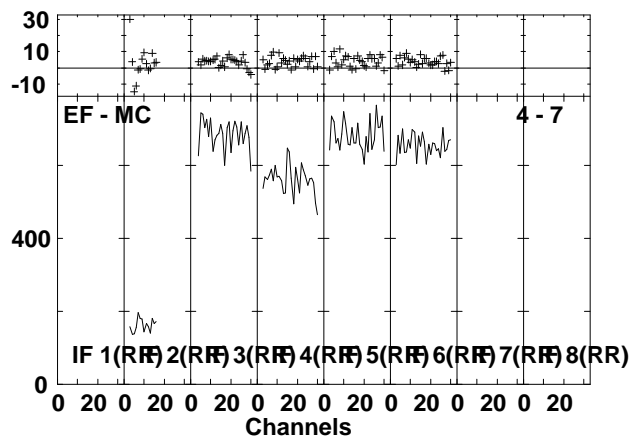
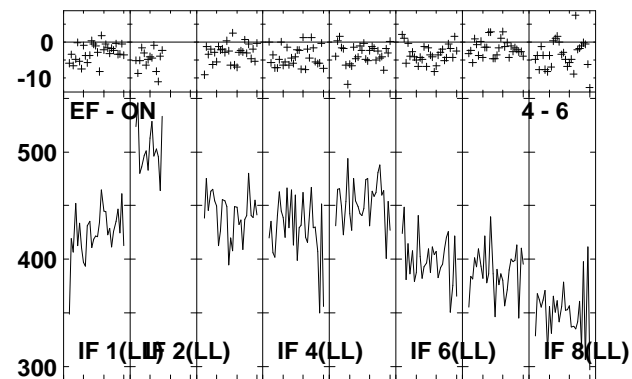
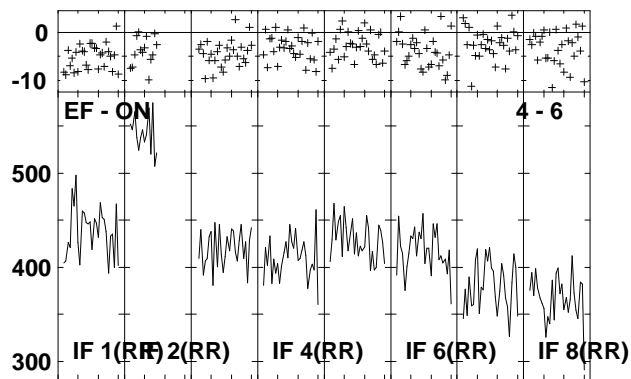
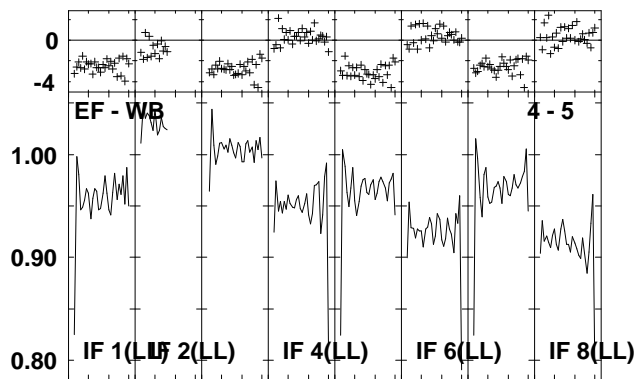
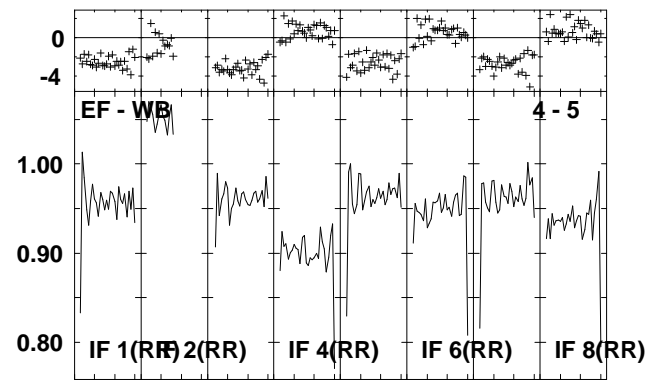
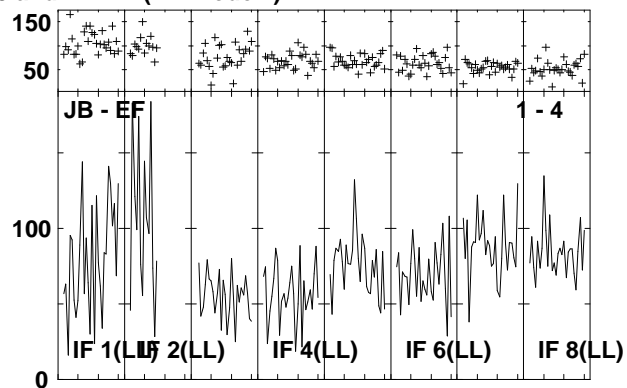
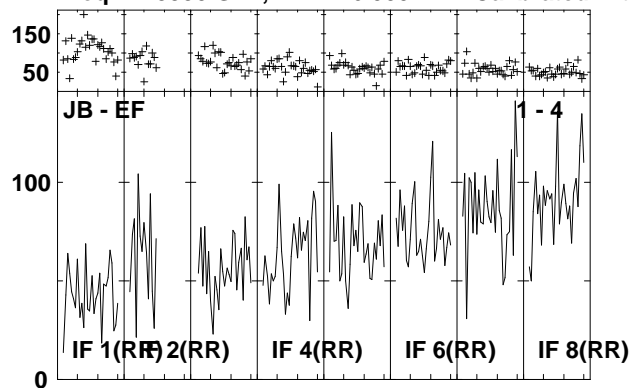

Lower frame: Milli Ampl Jy Top frame: Phas deg
Vector averaged cross-power spectrum Several baselines displayed
Timerange: 00/17:02:01 to 00/17:03:29

Plot file version 215 created 29-APR-2009 14:33:39

J2333+39 EP064D.UVDATA.1

Freq = 1.5950 GHz, Bw = 16.000 MH Calibrated with CL # 3 and BP # 1 (BP mode 1)

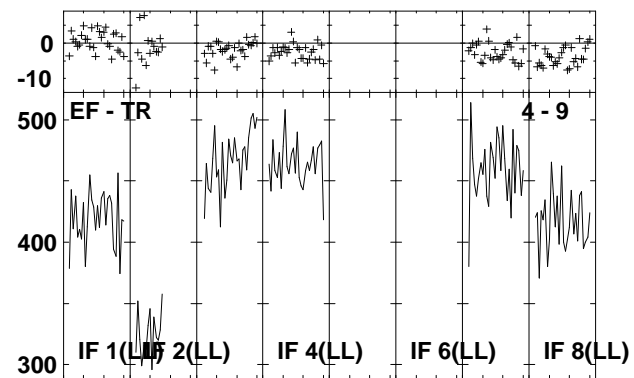
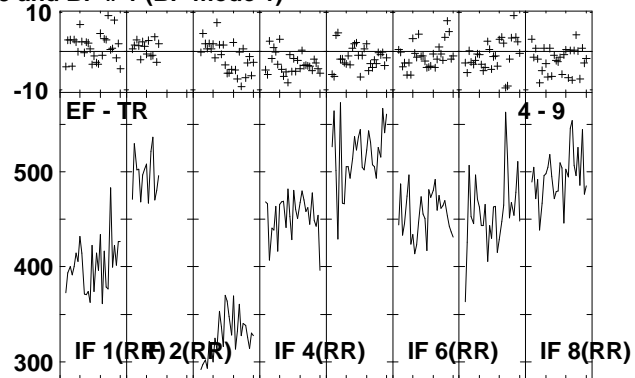
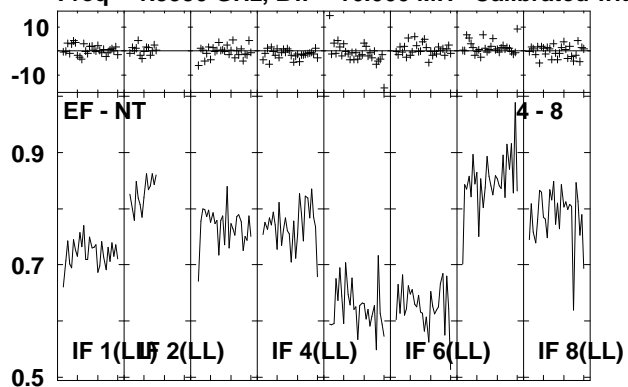

Lower frame: Ampl Jy Top frame: Phas deg
Vector averaged cross-power spectrum Several baselines displayed
Timerange: 00/17:02:01 to 00/17:03:29

Plot file version 216 created 29-APR-2009 14:33:41

IRAS2336 EP064D.UVDATA.1

Freq = 1.5950 GHz, Bw = 16.000 MH Calibrated with CL # 3 and BP # 1 (BP mode 1)

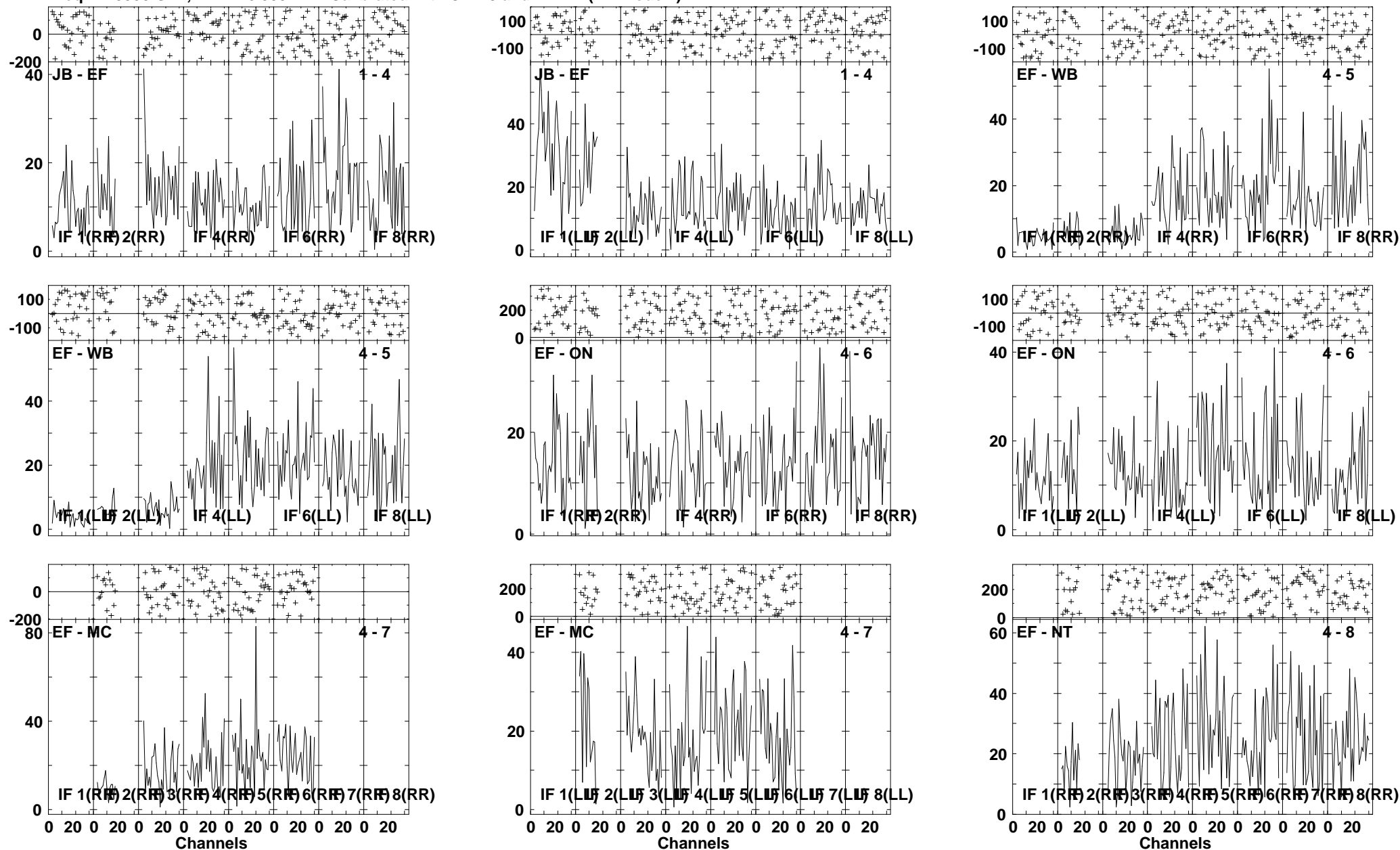

Lower frame: Milli Ampl Jy Top frame: Phas deg
Vector averaged cross-power spectrum Several baselines displayed
Timerange: 00/17:03:31 to 00/17:07:01

Plot file version 217 created 29-APR-2009 14:33:44

IRAS2336 EP064D.UVDATA.1

Freq = 1.5950 GHz, Bw = 16.000 MH Calibrated with CL # 3 and BP # 1 (BP mode 1)

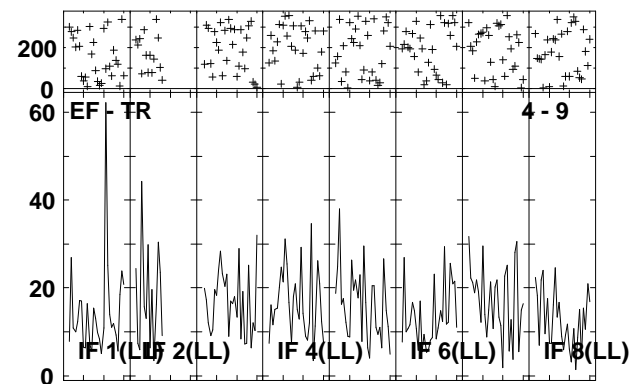
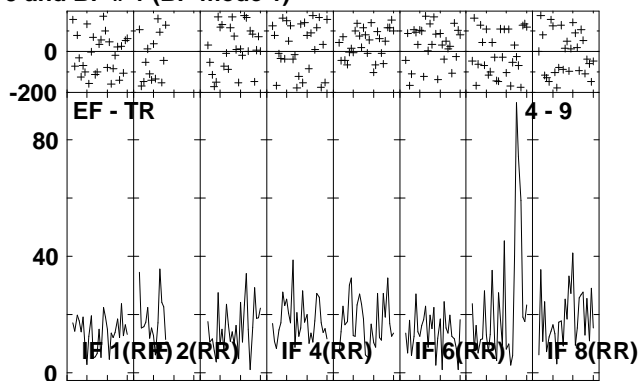
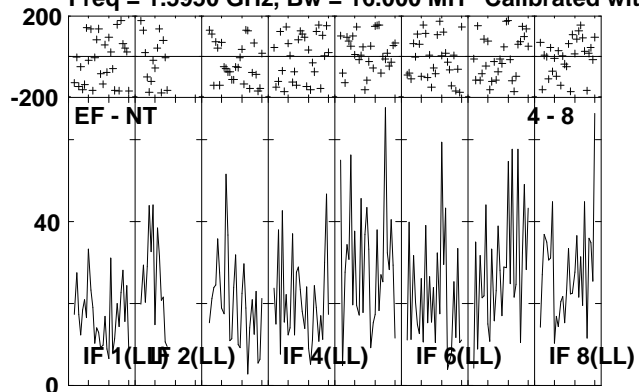

Lower frame: Milli Ampl Jy Top frame: Phas deg
Vector averaged cross-power spectrum Several baselines displayed
Timerange: 00/17:03:31 to 00/17:07:01

Plot file version 218 created 29-APR-2009 14:33:46

J2333+39 EP064D.UVDATA.1

Freq = 1.5950 GHz, Bw = 16.000 MH Calibrated with CL # 3 and BP # 1 (BP mode 1)

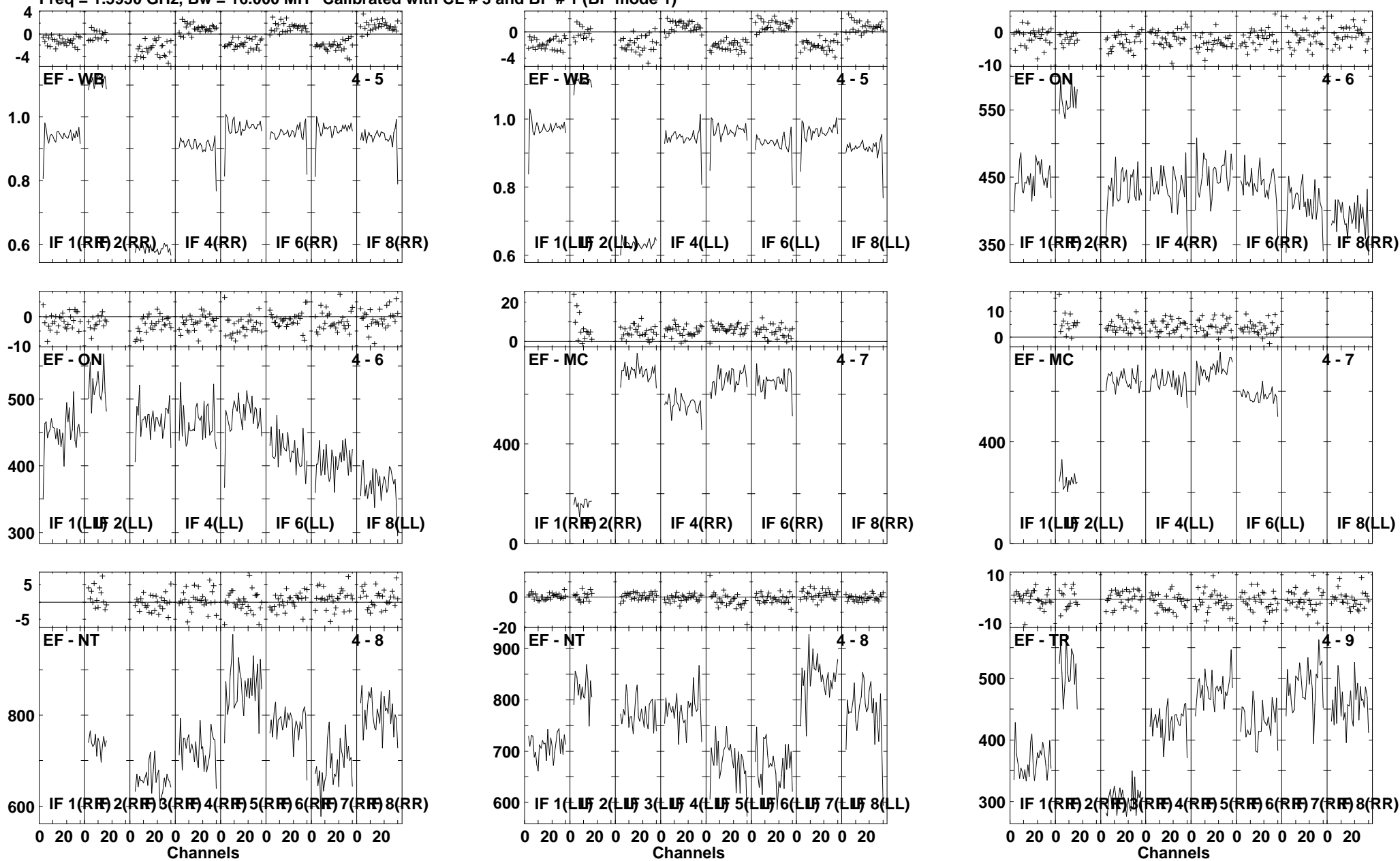

Lower frame: Ampl Jy Top frame: Phas deg
Vector averaged cross-power spectrum Several baselines displayed
Timerange: 00/17:07:03 to 00/17:08:27

Plot file version 219 created 29-APR-2009 14:33:47
J2333+39 EP064D.UVDATA.1
Freq = 1.5950 GHz, Bw = 16.000 MH Calibrated with CL # 3 and BP # 1 (BP mode 1)

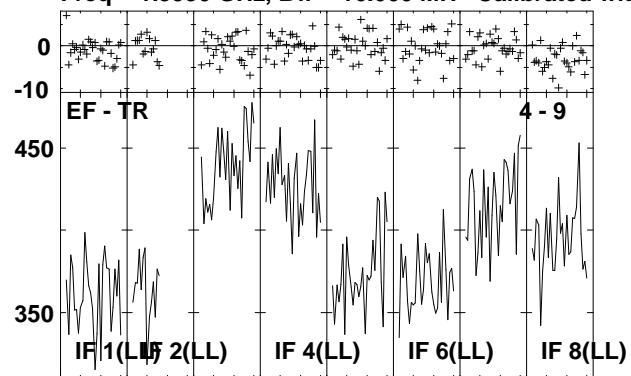

Lower frame: Milli Ampl Jy Top frame: Phas deg
Vector averaged cross-power spectrum Several baselines displayed
Timerange: 00/17:07:03 to 00/17:08:27

Plot file version 220 created 29-APR-2009 14:33:48

IRAS2336 EP064D.UVDATA.1

Freq = 1.5950 GHz, Bw = 16.000 MH Calibrated with CL # 3 and BP # 1 (BP mode 1)

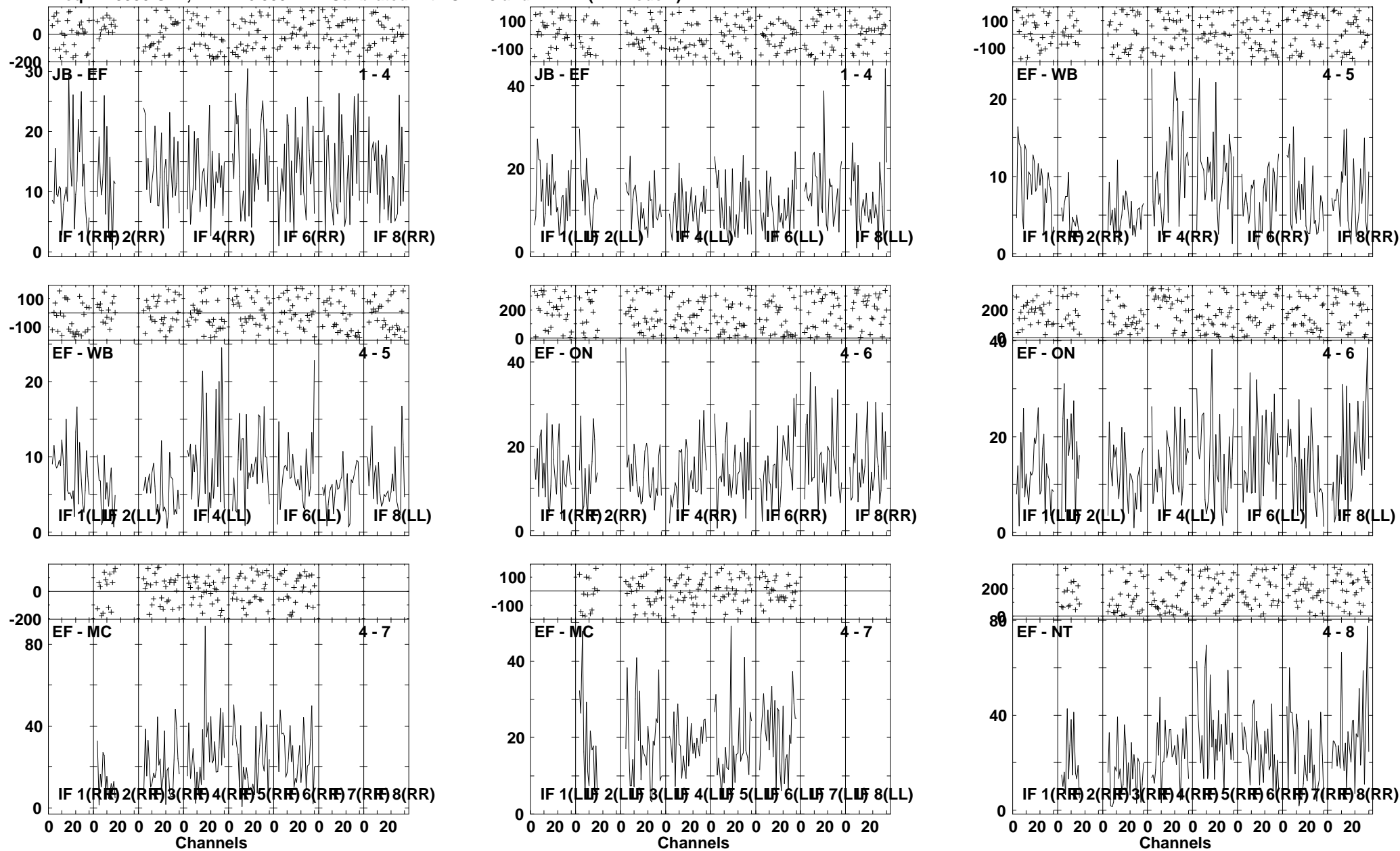

Lower frame: Milli Ampl Jy Top frame: Phas deg
Vector averaged cross-power spectrum Several baselines displayed
Timerange: 00/17:08:29 to 00/17:11:59

Plot file version 221 created 29-APR-2009 14:33:51
 IRAS2336 EP064D.UVDATA.1
 Freq = 1.5950 GHz, Bw = 16.000 MH Calibrated with CL # 3 and BP # 1 (BP mode 1)

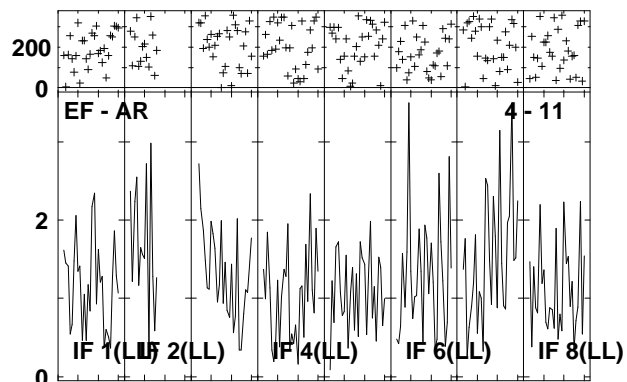
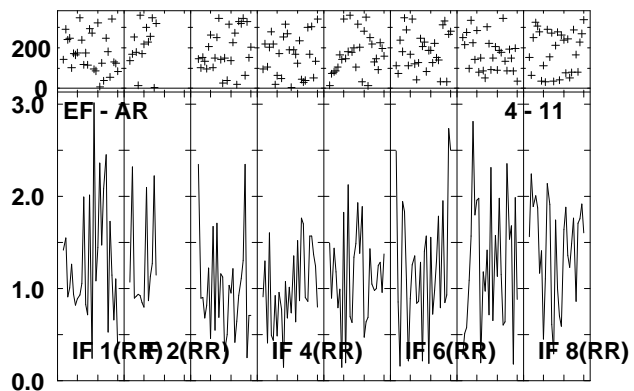
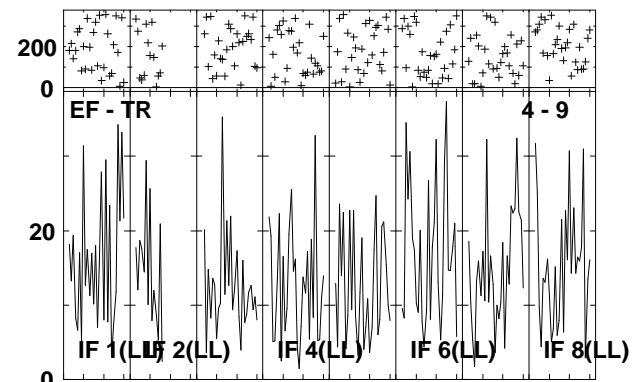
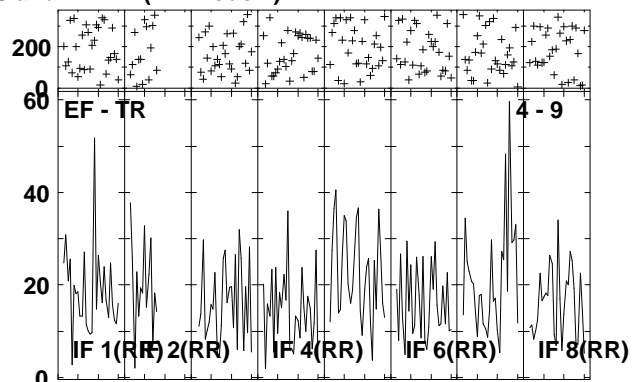
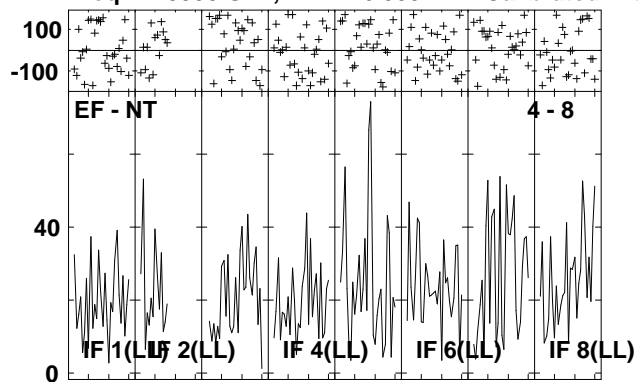

Lower frame: Milli Ampl Jy Top frame: Phas deg
 Vector averaged cross-power spectrum Several baselines displayed
 Timerange: 00/17:08:29 to 00/17:11:59

Plot file version 222 created 29-APR-2009 14:33:54

J2333+39 EP064D.UVDATA.1

Freq = 1.5950 GHz, Bw = 16.000 MH Calibrated with CL # 3 and BP # 1 (BP mode 1)

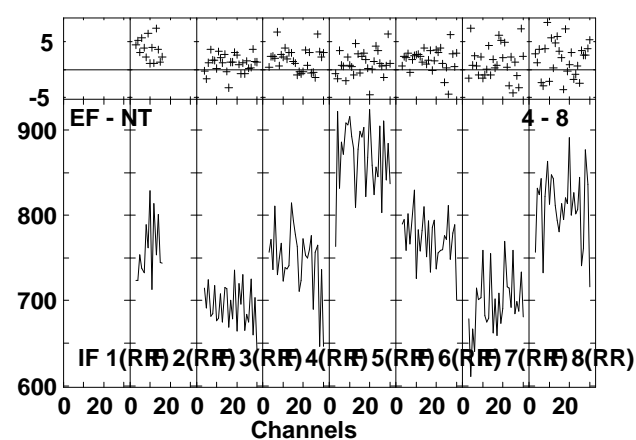
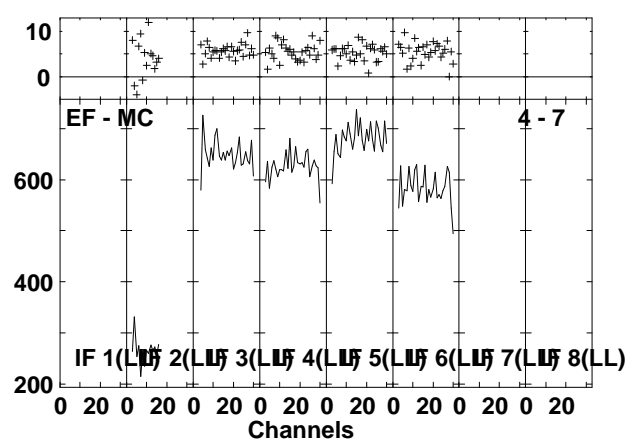
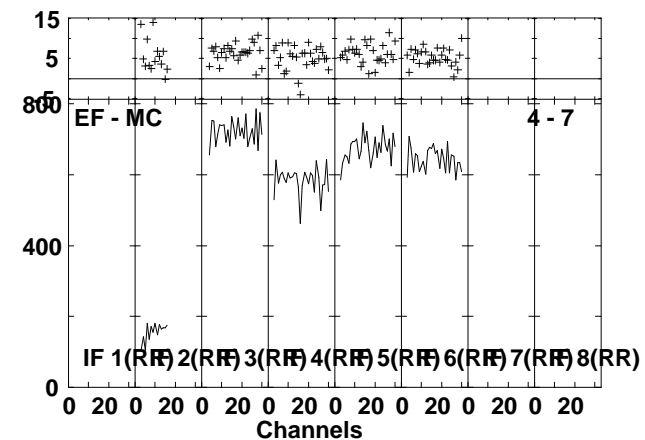
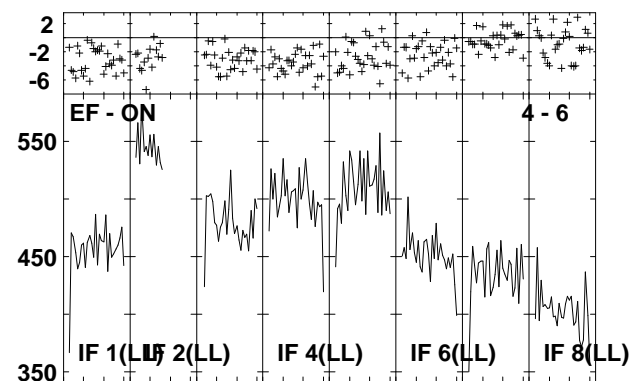
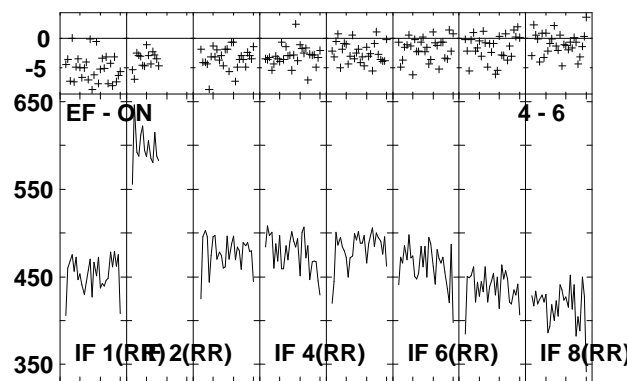
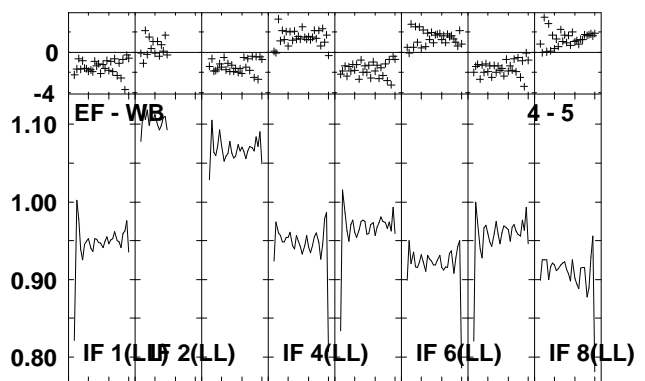
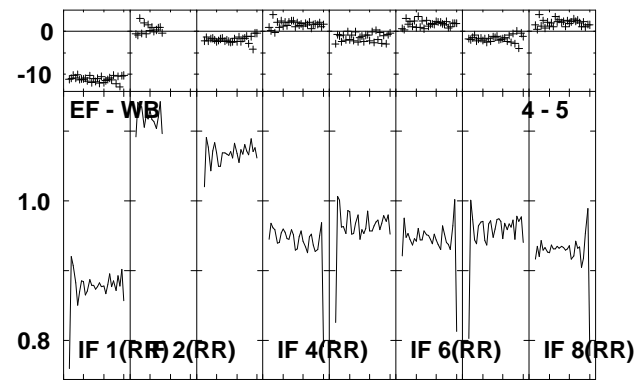
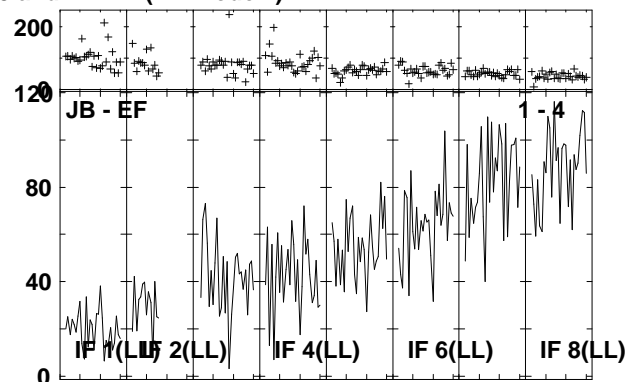
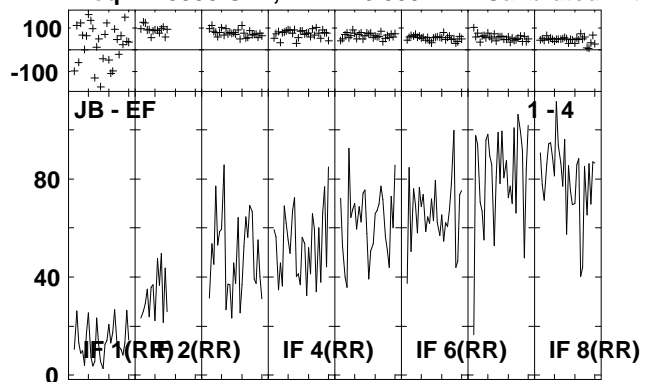

Lower frame: Milli Ampl Jy Top frame: Phas deg
Vector averaged cross-power spectrum Several baselines displayed
Timerange: 00/17:13:01 to 00/17:14:29

Plot file version 223 created 29-APR-2009 14:33:55

J2333+39 EP064D.UVDATA.1

Freq = 1.5950 GHz, Bw = 16.000 MH Calibrated with CL # 3 and BP # 1 (BP mode 1)

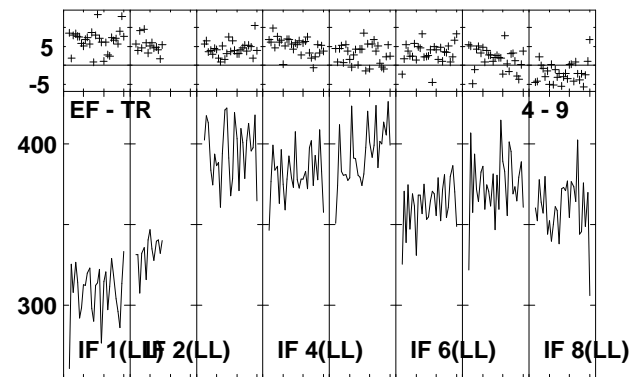
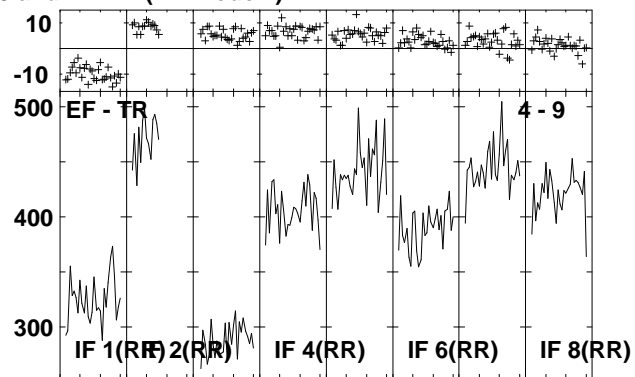
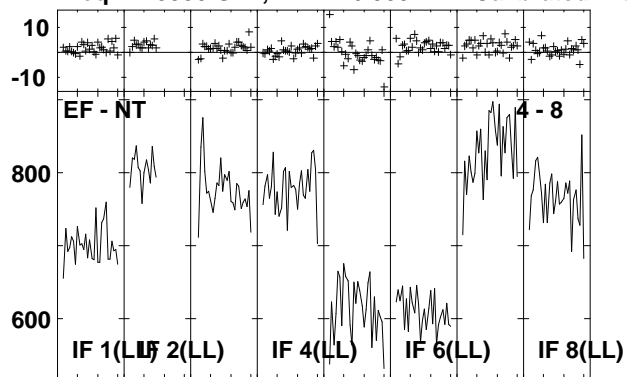

Lower frame: Milli Ampl Jy Top frame: Phas deg
Vector averaged cross-power spectrum Several baselines displayed
Timerange: 00/17:13:01 to 00/17:14:29

Plot file version 224 created 29-APR-2009 14:33:57

IRAS2336 EP064D.UVDATA.1

Freq = 1.5950 GHz, Bw = 16.000 MH Calibrated with CL # 3 and BP # 1 (BP mode 1)

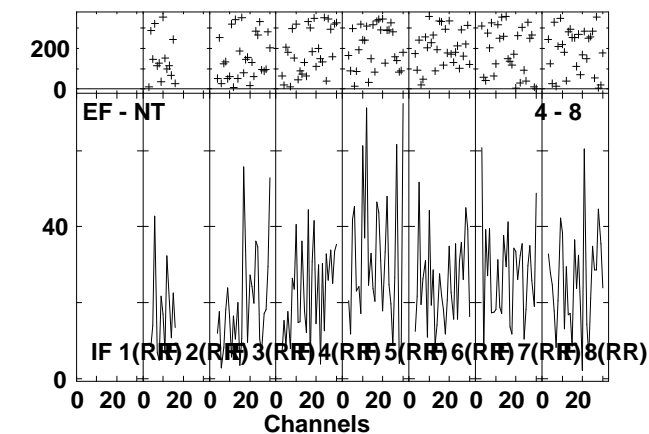
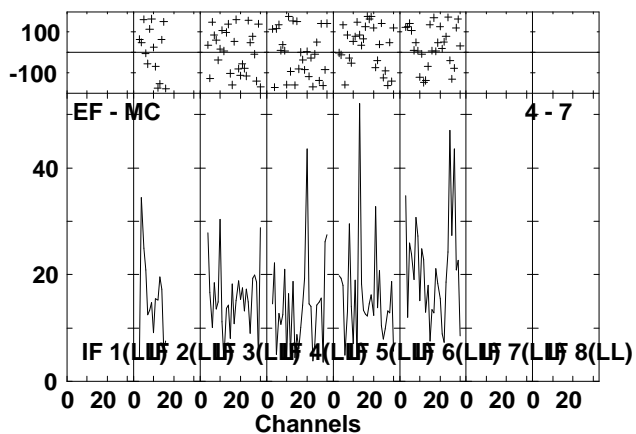
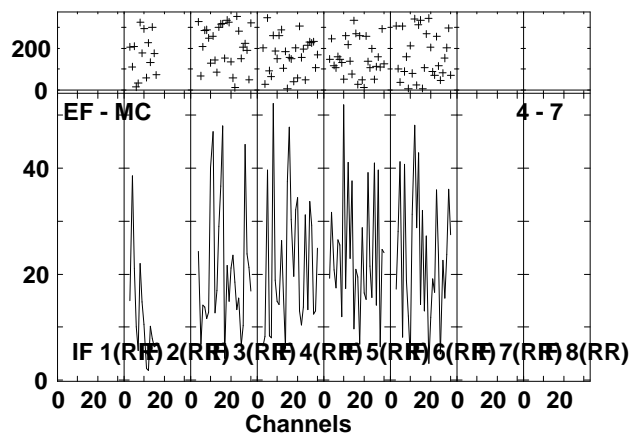
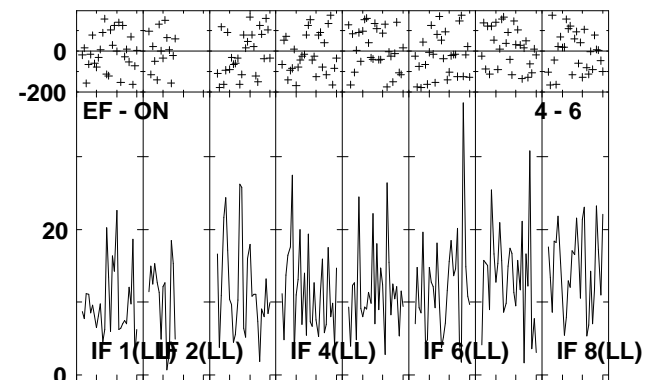
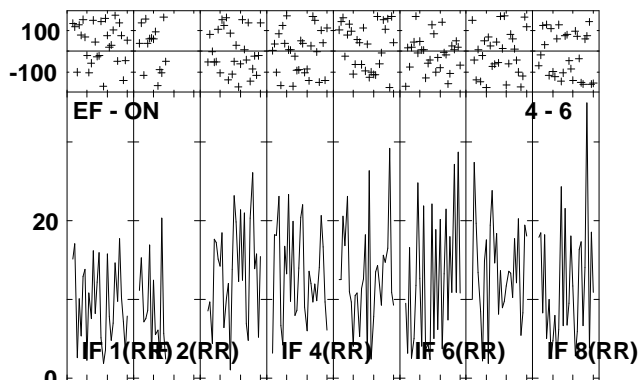
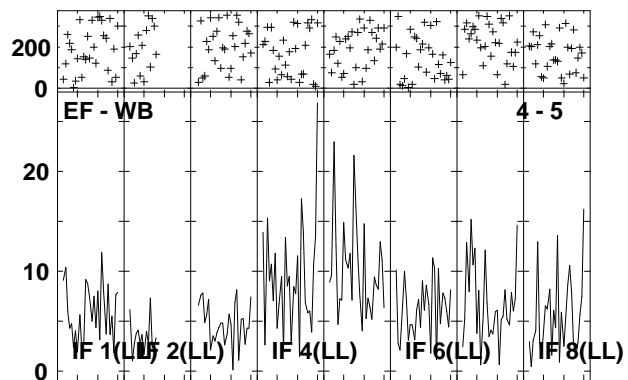
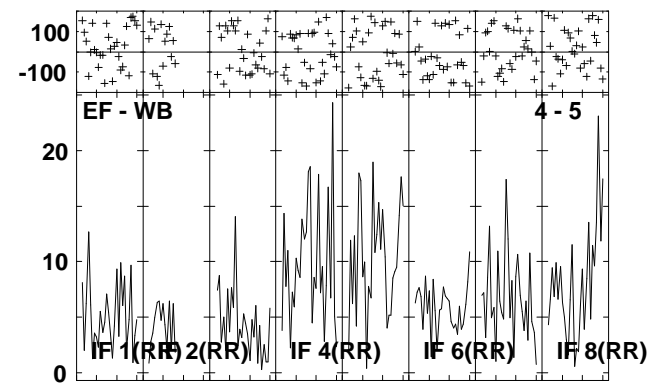
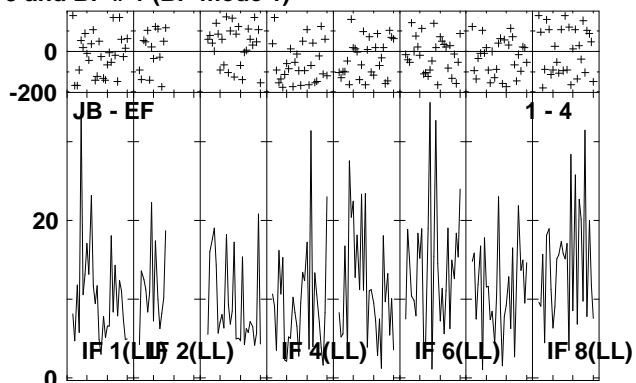
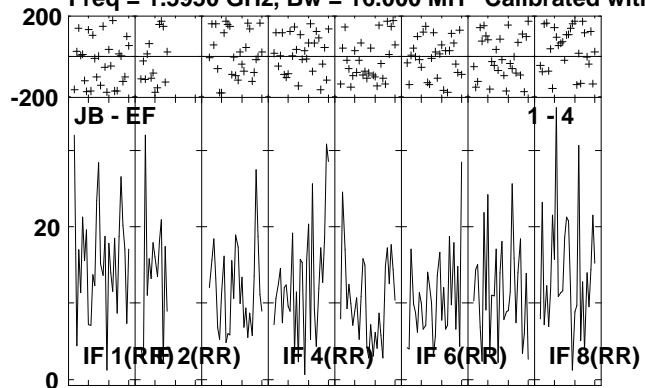

Lower frame: Milli Ampl Jy Top frame: Phas deg
Vector averaged cross-power spectrum Several baselines displayed
Timerange: 00/17:14:32 to 00/17:19:00

Plot file version 225 created 29-APR-2009 14:34:01

IRAS2336 EP064D.UVDATA.1

Freq = 1.5950 GHz, Bw = 16.000 MH Calibrated with CL # 3 and BP # 1 (BP mode 1)

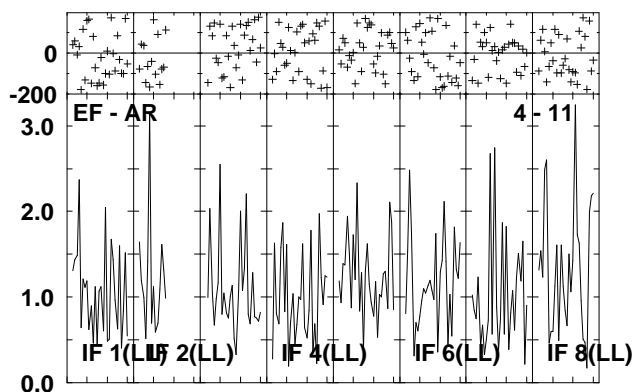
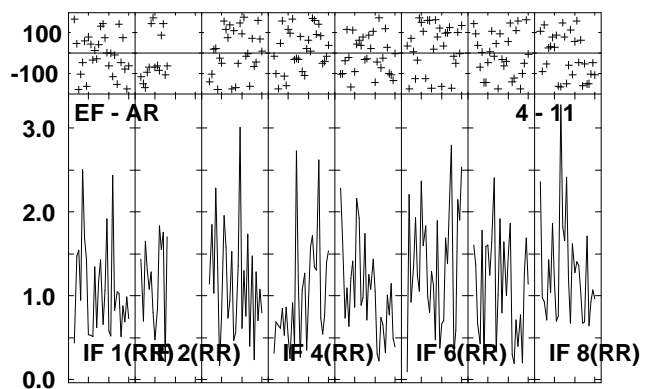
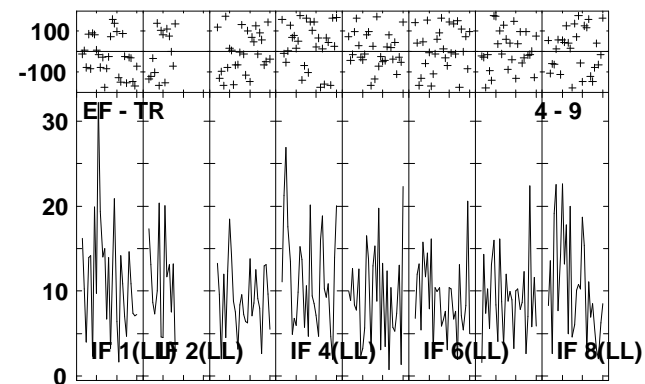
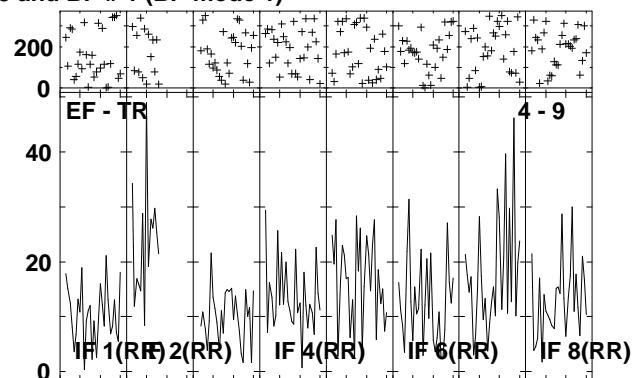
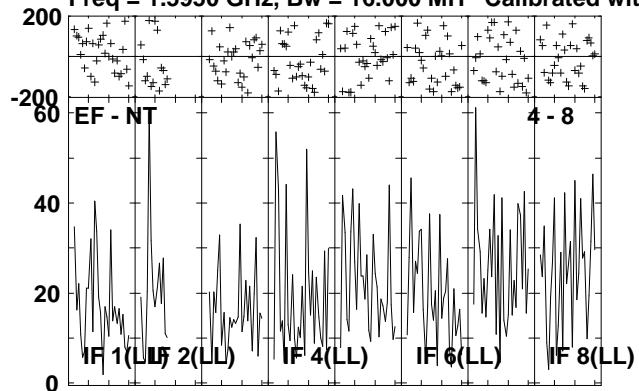

Lower frame: Milli Ampl Jy Top frame: Phas deg
Vector averaged cross-power spectrum Several baselines displayed
Timerange: 00/17:14:32 to 00/17:19:00

Plot file version 226 created 29-APR-2009 14:34:04

J2333+39 EP064D.UVDATA.1

Freq = 1.5950 GHz, Bw = 16.000 MH Calibrated with CL # 3 and BP # 1 (BP mode 1)

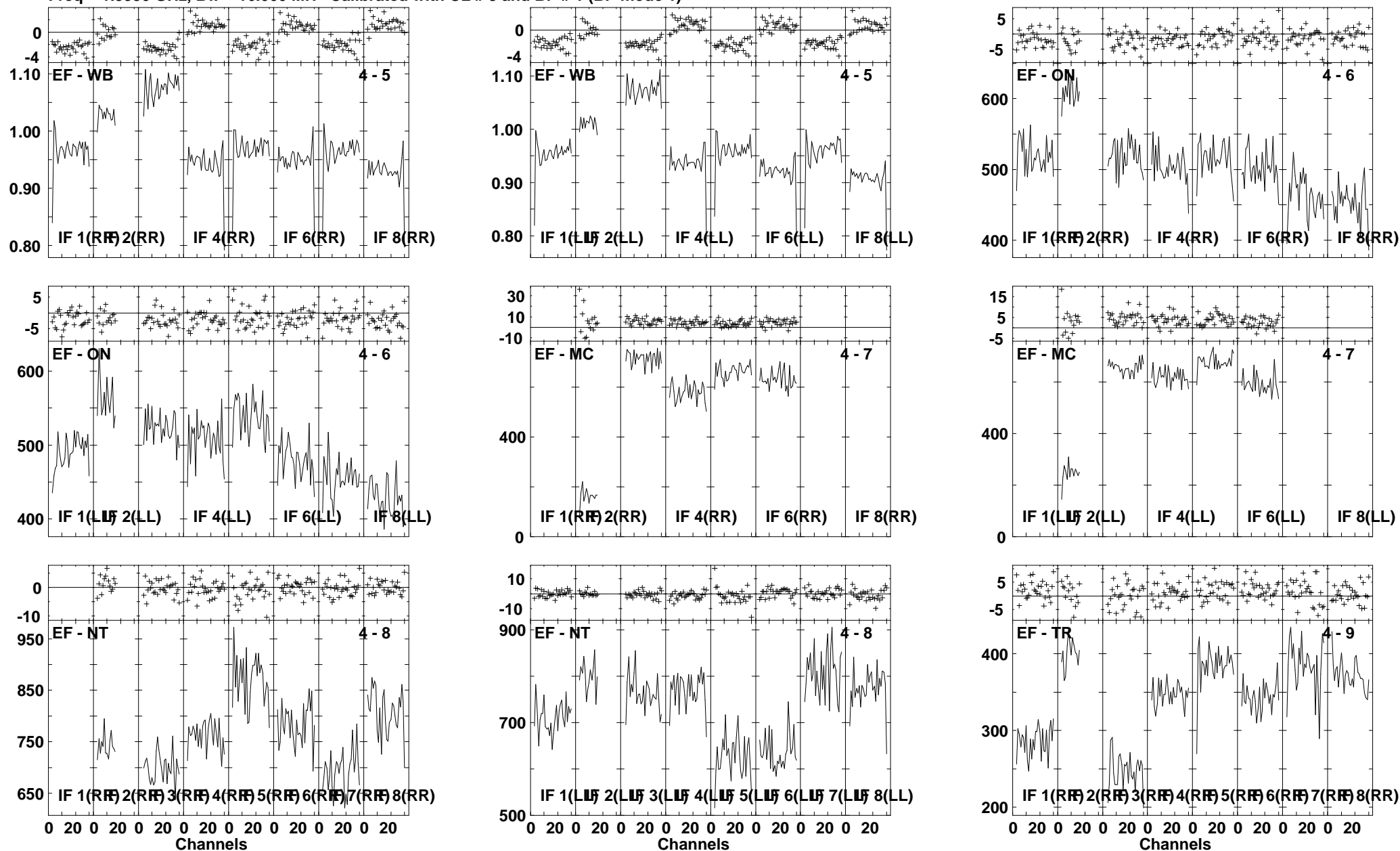

Lower frame: Ampl Jy Top frame: Phas deg
Vector averaged cross-power spectrum Several baselines displayed
Timerange: 00/17:19:02 to 00/17:20:28

Plot file version 227 created 29-APR-2009 14:34:05

J2333+39 EP064D.UVDATA.1

Freq = 1.5950 GHz, Bw = 16.000 MH Calibrated with CL # 3 and BP # 1 (BP mode 1)

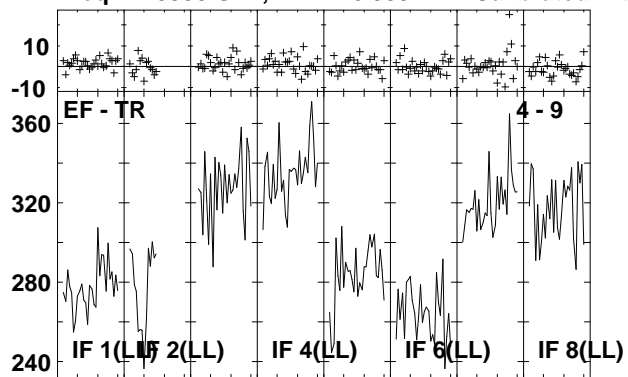

Lower frame: Milli Ampl Jy Top frame: Phas deg
Vector averaged cross-power spectrum Several baselines displayed
Timerange: 00/17:19:02 to 00/17:20:28

Plot file version 228 created 29-APR-2009 14:34:06

IRAS2336 EP064D.UVDATA.1

Freq = 1.5950 GHz, Bw = 16.000 MH Calibrated with CL # 3 and BP # 1 (BP mode 1)

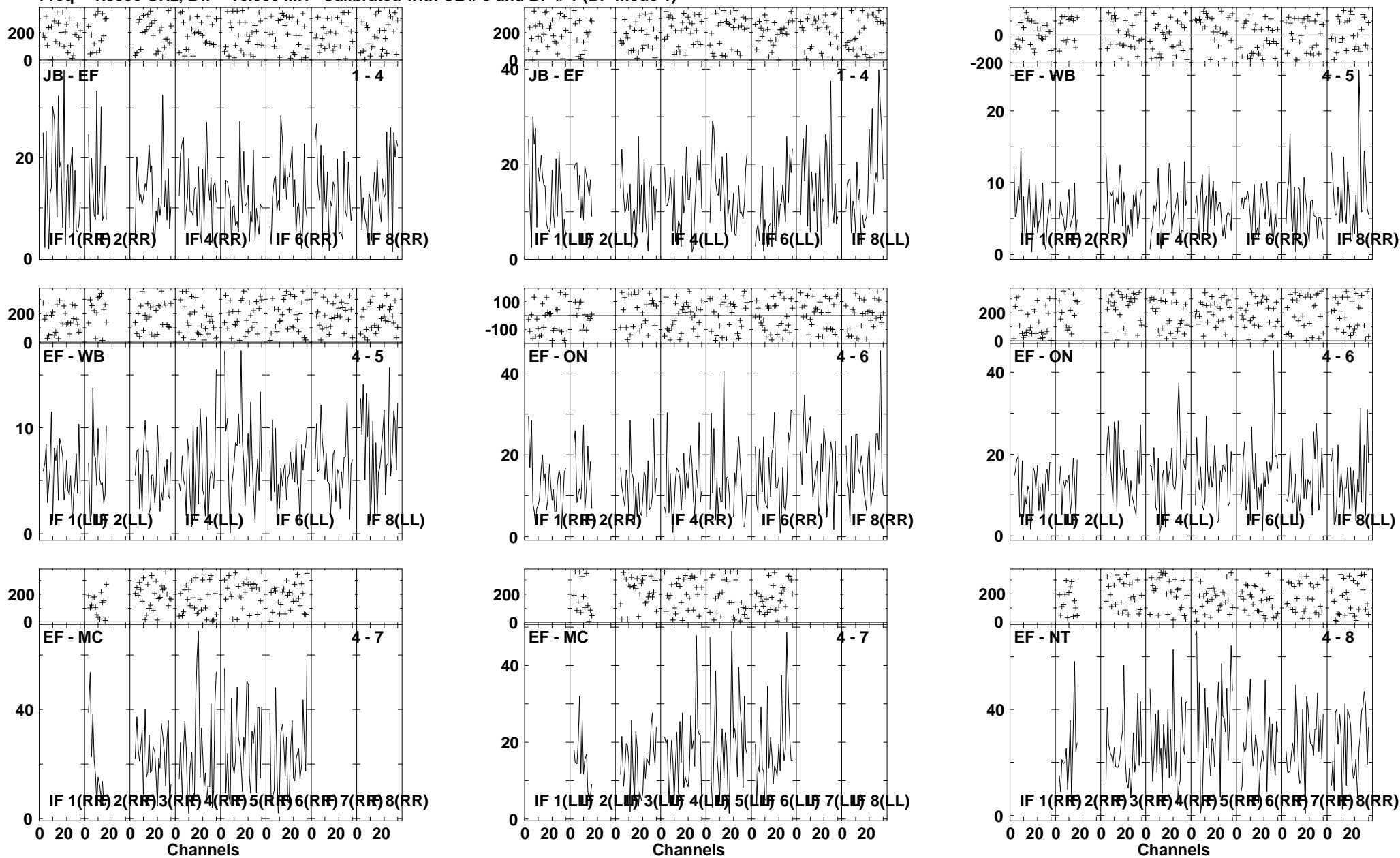

Lower frame: Milli Ampl Jy Top frame: Phas deg
Vector averaged cross-power spectrum Several baselines displayed
Timerange: 00/17:20:30 to 00/17:24:00

Plot file version 229 created 29-APR-2009 14:34:09

IRAS2336 EP064D.UVDATA.1

Freq = 1.5950 GHz, Bw = 16.000 MH Calibrated with CL # 3 and BP # 1 (BP mode 1)

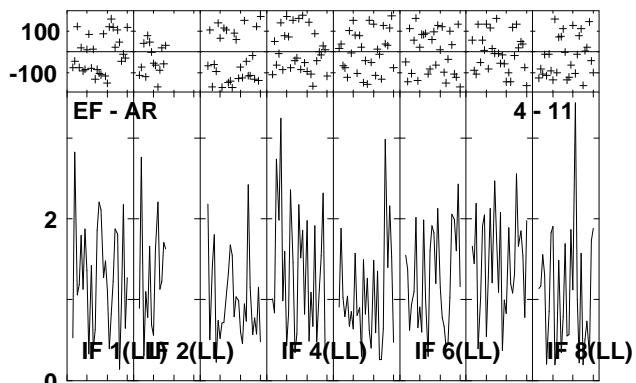
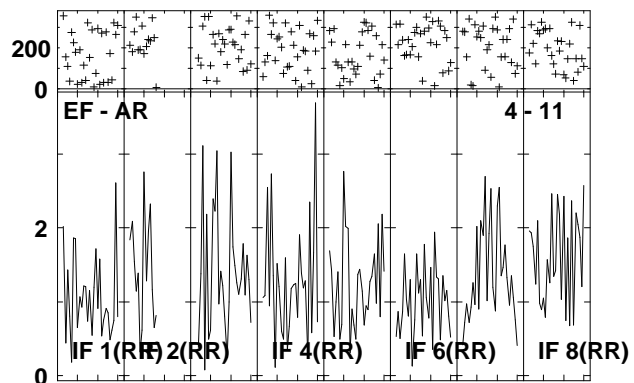
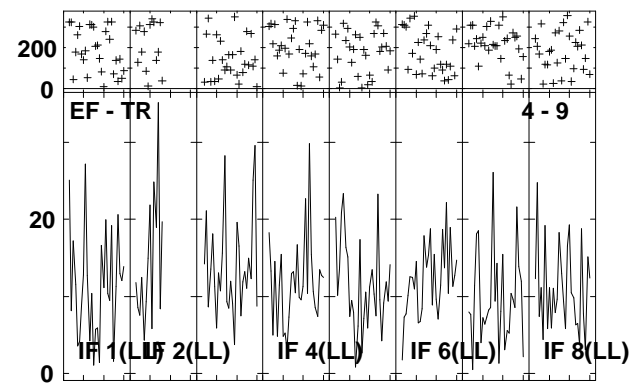
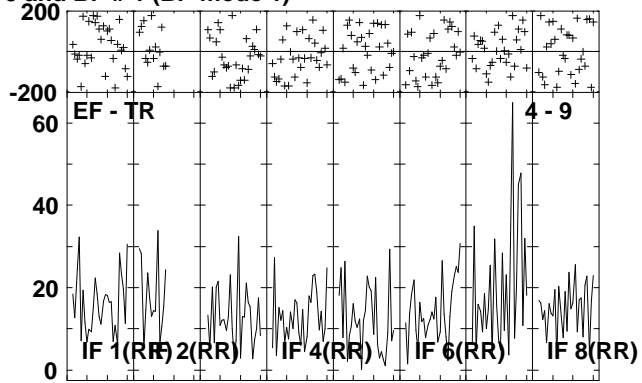
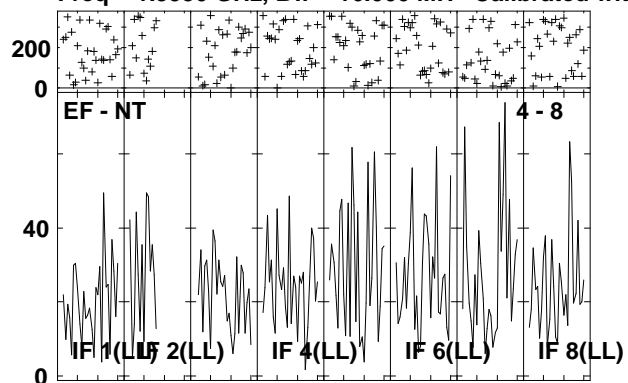

Lower frame: Milli Ampl Jy Top frame: Phas deg
Vector averaged cross-power spectrum Several baselines displayed
Timerange: 00/17:20:30 to 00/17:24:00

Plot file version 230 created 29-APR-2009 14:34:11

J2333+39 EP064D.UVDATA.1

Freq = 1.5950 GHz, Bw = 16.000 MH Calibrated with CL # 3 and BP # 1 (BP mode 1)

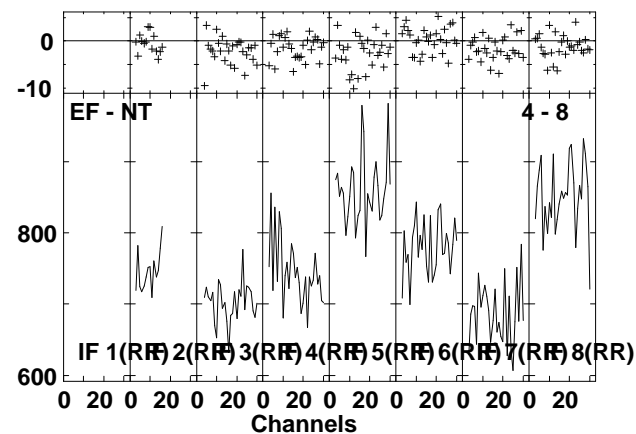
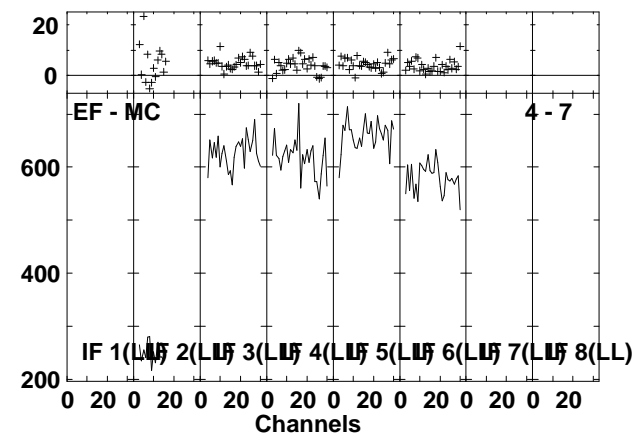
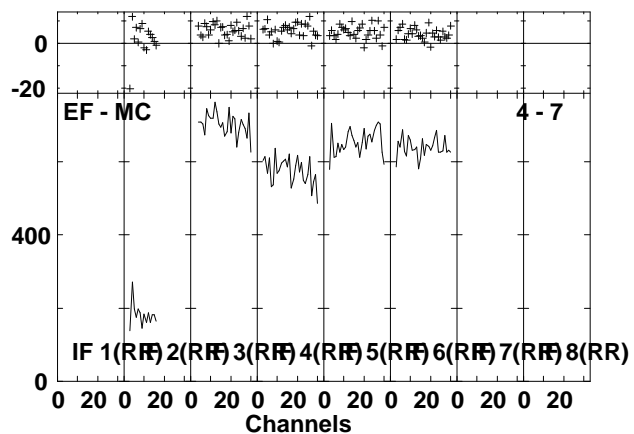
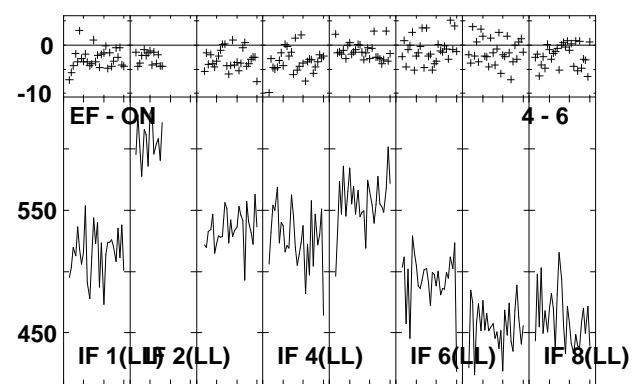
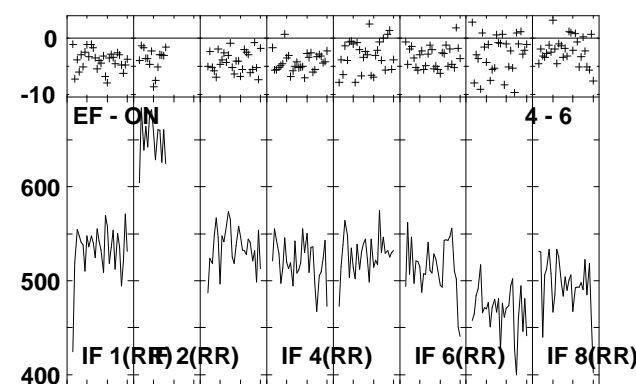
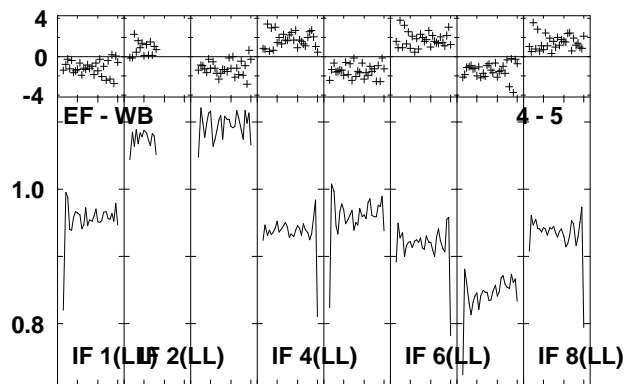
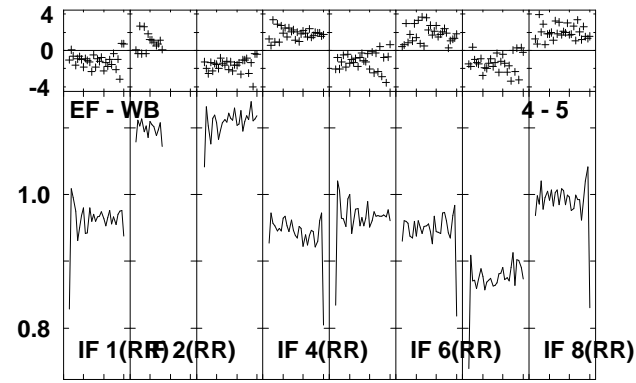
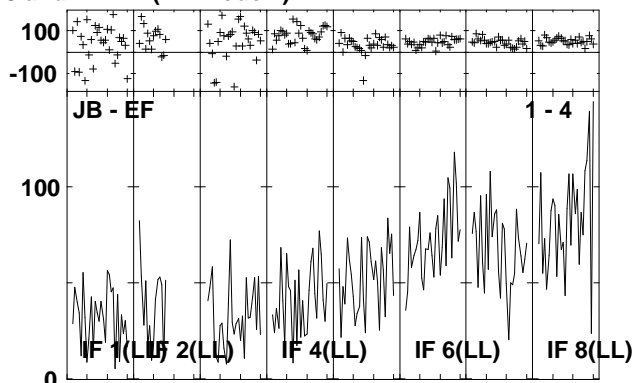
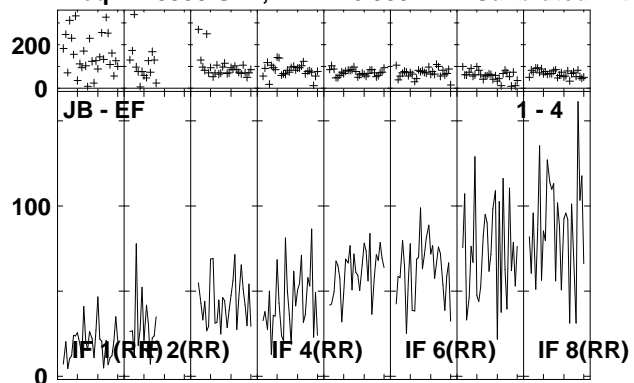

Lower frame: Milli Ampl Jy Top frame: Phas deg
Vector averaged cross-power spectrum Several baselines displayed
Timerange: 00/17:24:02 to 00/17:25:30

Plot file version 231 created 29-APR-2009 14:34:13

J2333+39 EP064D.UVDATA.1

Freq = 1.5950 GHz, Bw = 16.000 MH Calibrated with CL # 3 and BP # 1 (BP mode 1)

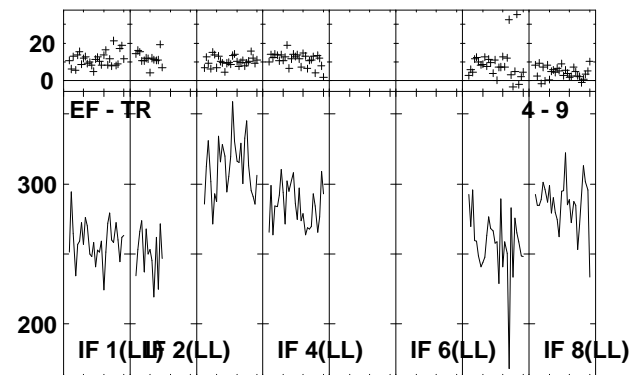
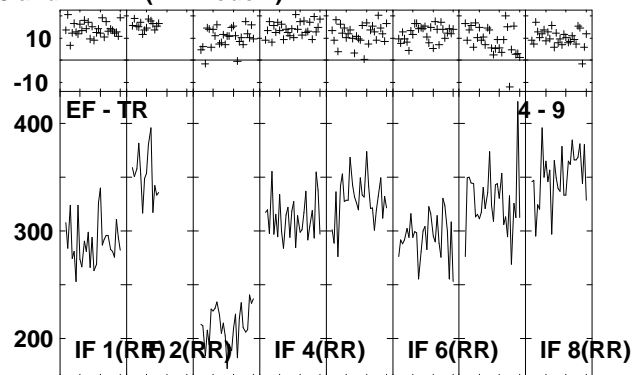
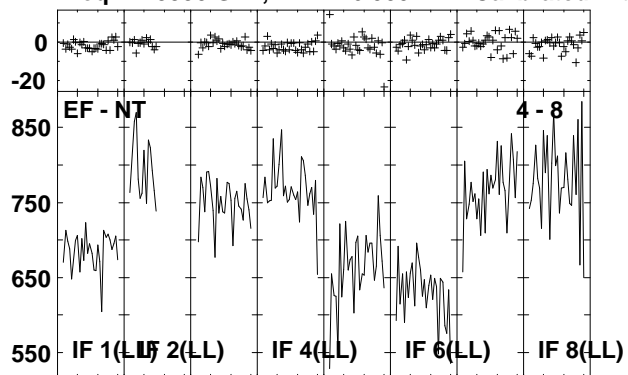

Lower frame: Milli Ampl Jy Top frame: Phas deg
Vector averaged cross-power spectrum Several baselines displayed
Timerange: 00:17:24:02 to 00:17:25:30

Plot file version 232 created 29-APR-2009 14:34:14

IRAS2336 EP064D.UVDATA.1

Freq = 1.5950 GHz, Bw = 16.000 MH Calibrated with CL # 3 and BP # 1 (BP mode 1)

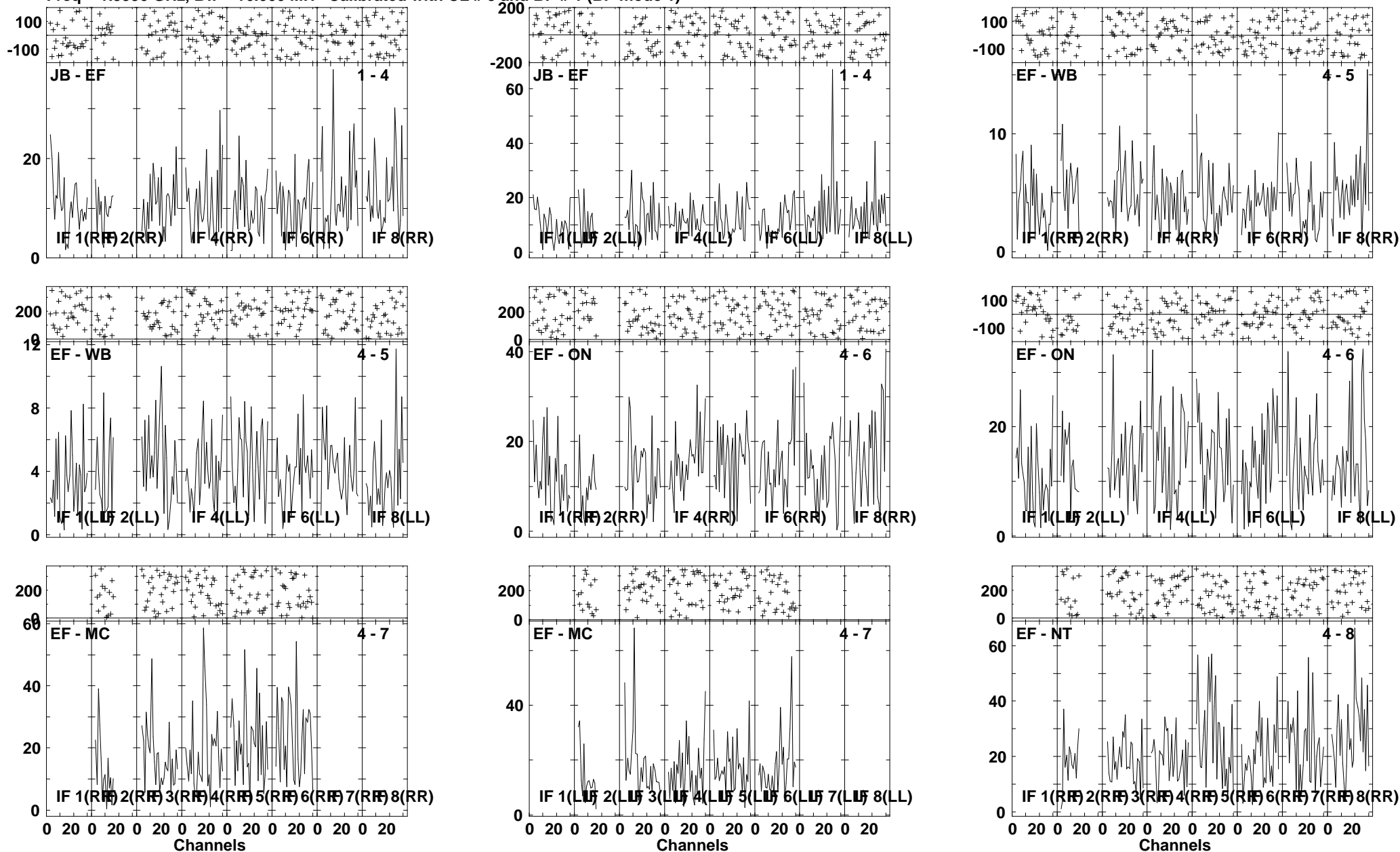

Lower frame: Milli Ampl Jy Top frame: Phas deg
Vector averaged cross-power spectrum Several baselines displayed
Timerange: 00/17:25:32 to 00/17:29:56

Plot file version 233 created 29-APR-2009 14:34:19

IRAS2336 EP064D.UVDATA.1

Freq = 1.5950 GHz, Bw = 16.000 MH Calibrated with CL # 3 and BP # 1 (BP mode 1)

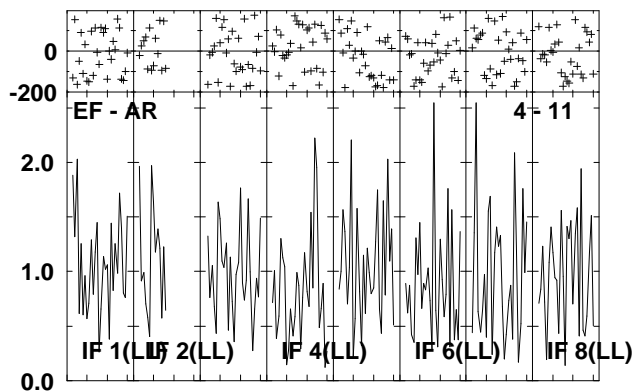
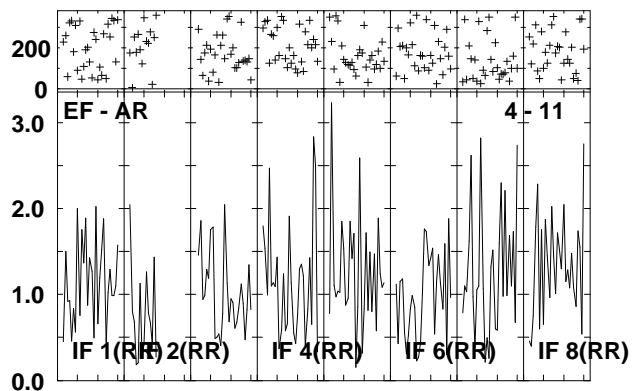
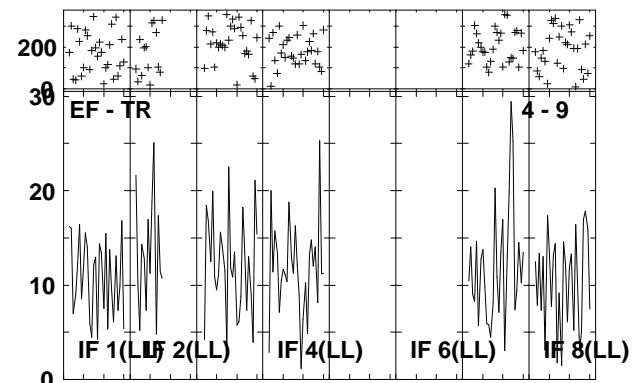
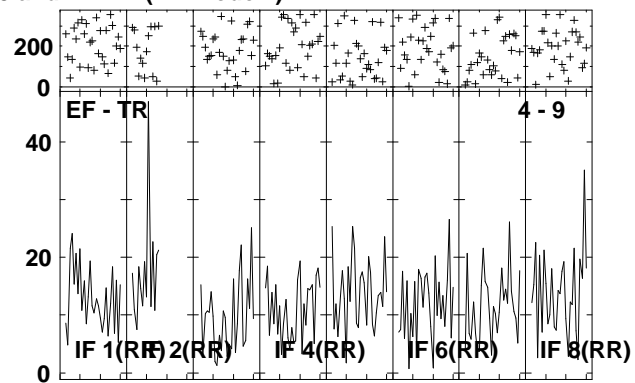
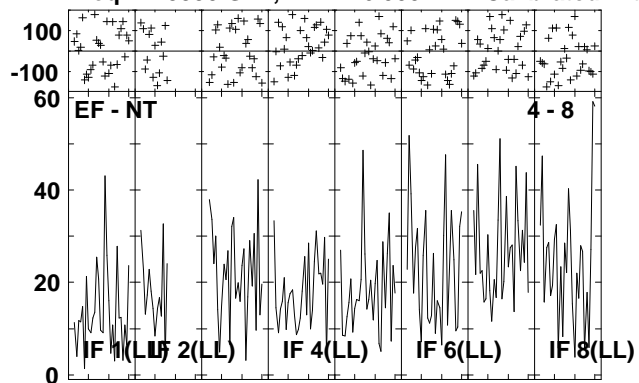

Lower frame: Milli Ampl Jy Top frame: Phas deg
Vector averaged cross-power spectrum Several baselines displayed
Timerange: 00/17:25:32 to 00/17:29:56

Plot file version 234 created 29-APR-2009 14:34:22

J2333+39 EP064D.UVDATA.1

Freq = 1.5950 GHz, Bw = 16.000 MH Calibrated with CL # 3 and BP # 1 (BP mode 1)

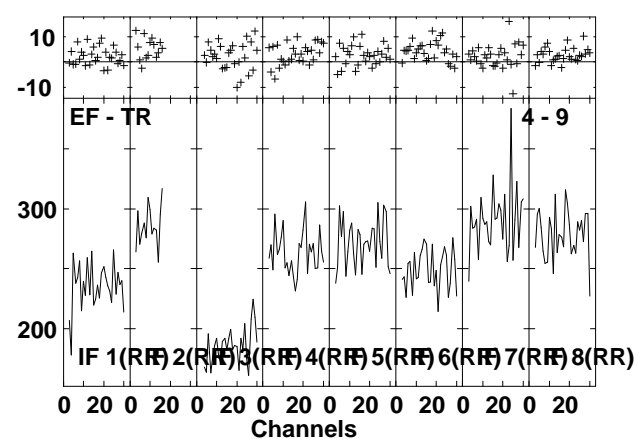
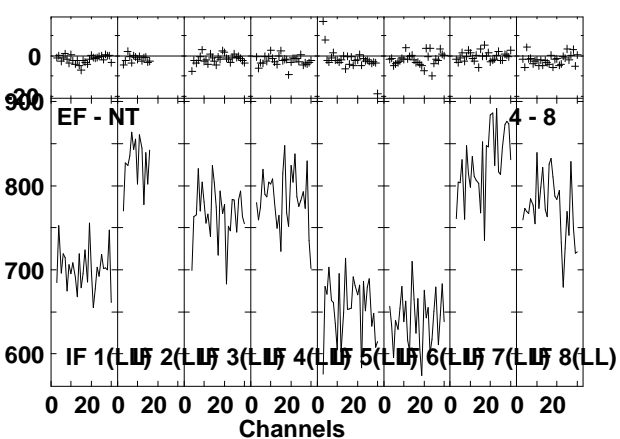
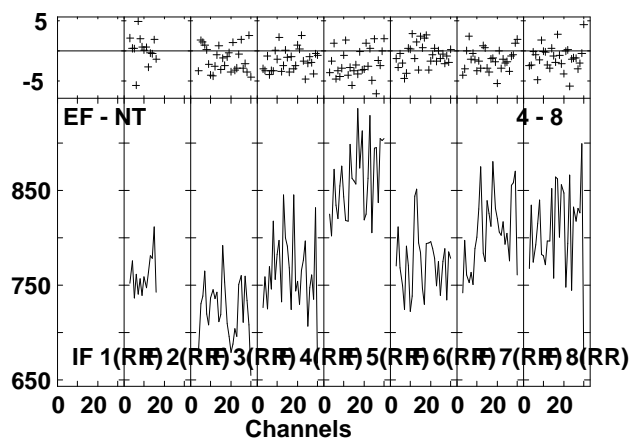
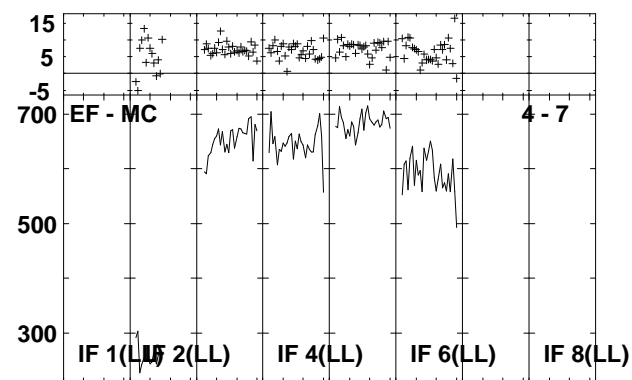
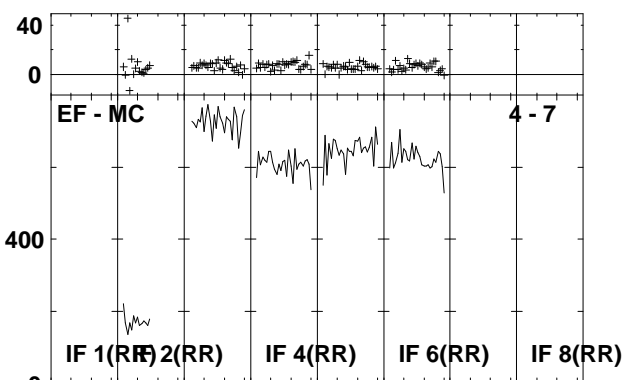
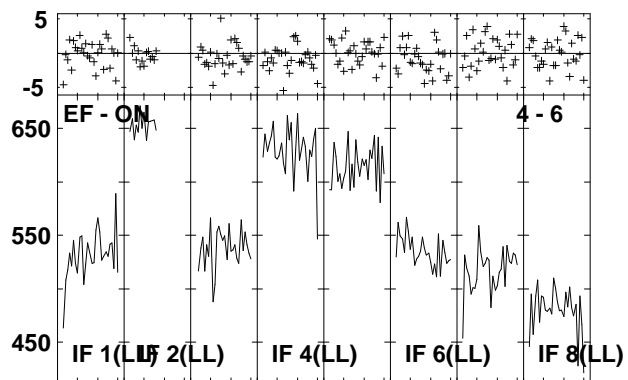
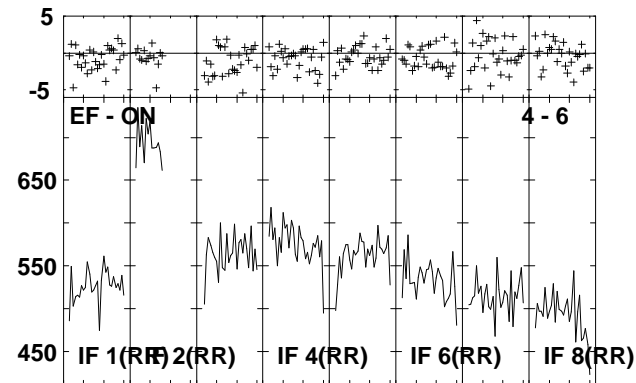
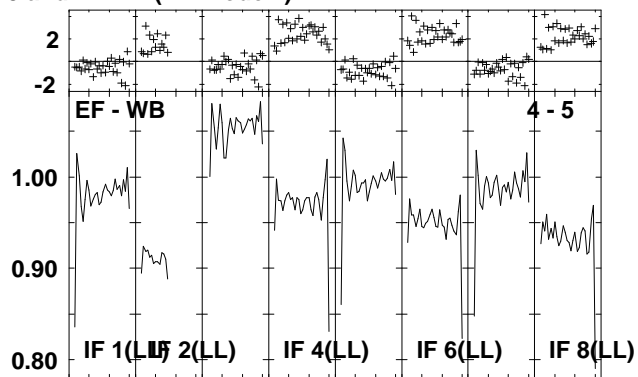
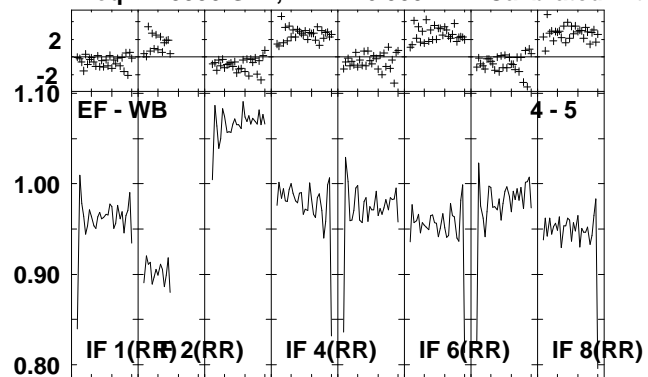

Lower frame: Ampl Jy Top frame: Phas deg
Vector averaged cross-power spectrum Several baselines displayed
Timerange: 00/17:31:02 to 00/17:32:26

Plot file version 235 created 29-APR-2009 14:34:23

J2333+39 EP064D.UVDATA.1

Freq = 1.5950 GHz, Bw = 16.000 MH Calibrated with CL # 3 and BP # 1 (BP mode 1)

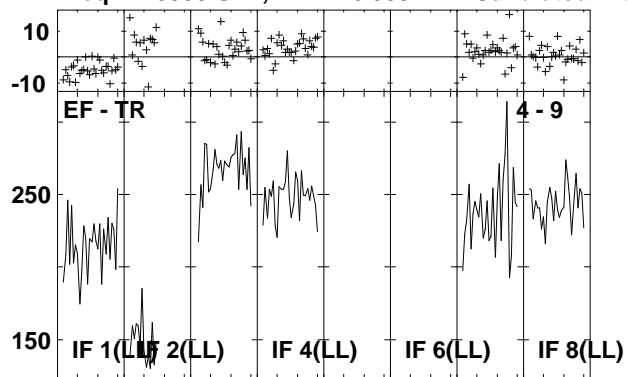

Lower frame: Milli Ampl Jy Top frame: Phas deg
Vector averaged cross-power spectrum Several baselines displayed
Timerange: 00/17:31:02 to 00/17:32:26

Plot file version 236 created 29-APR-2009 14:34:25

IRAS2336 EP064D.UVDATA.1

Freq = 1.5950 GHz, Bw = 16.000 MH Calibrated with CL # 3 and BP # 1 (BP mode 1)

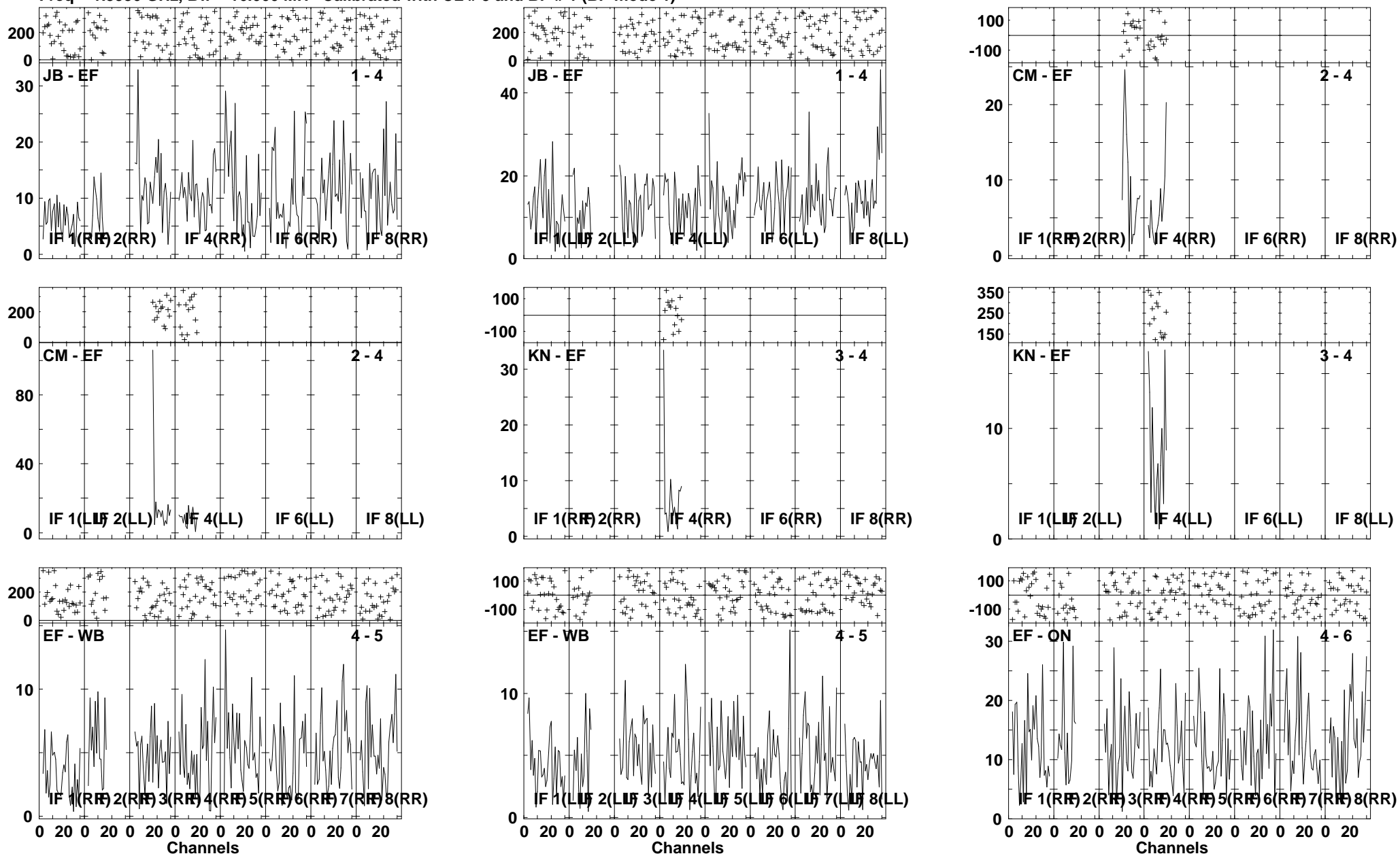

Lower frame: Milli Ampl Jy Top frame: Phas deg
Vector averaged cross-power spectrum Several baselines displayed
Timerange: 00/17:32:31 to 00/17:37:01

Plot file version 237 created 29-APR-2009 14:34:29

IRAS2336 EP064D.UVDATA.1

Freq = 1.5950 GHz, Bw = 16.000 MH Calibrated with CL # 3 and BP # 1 (BP mode 1)

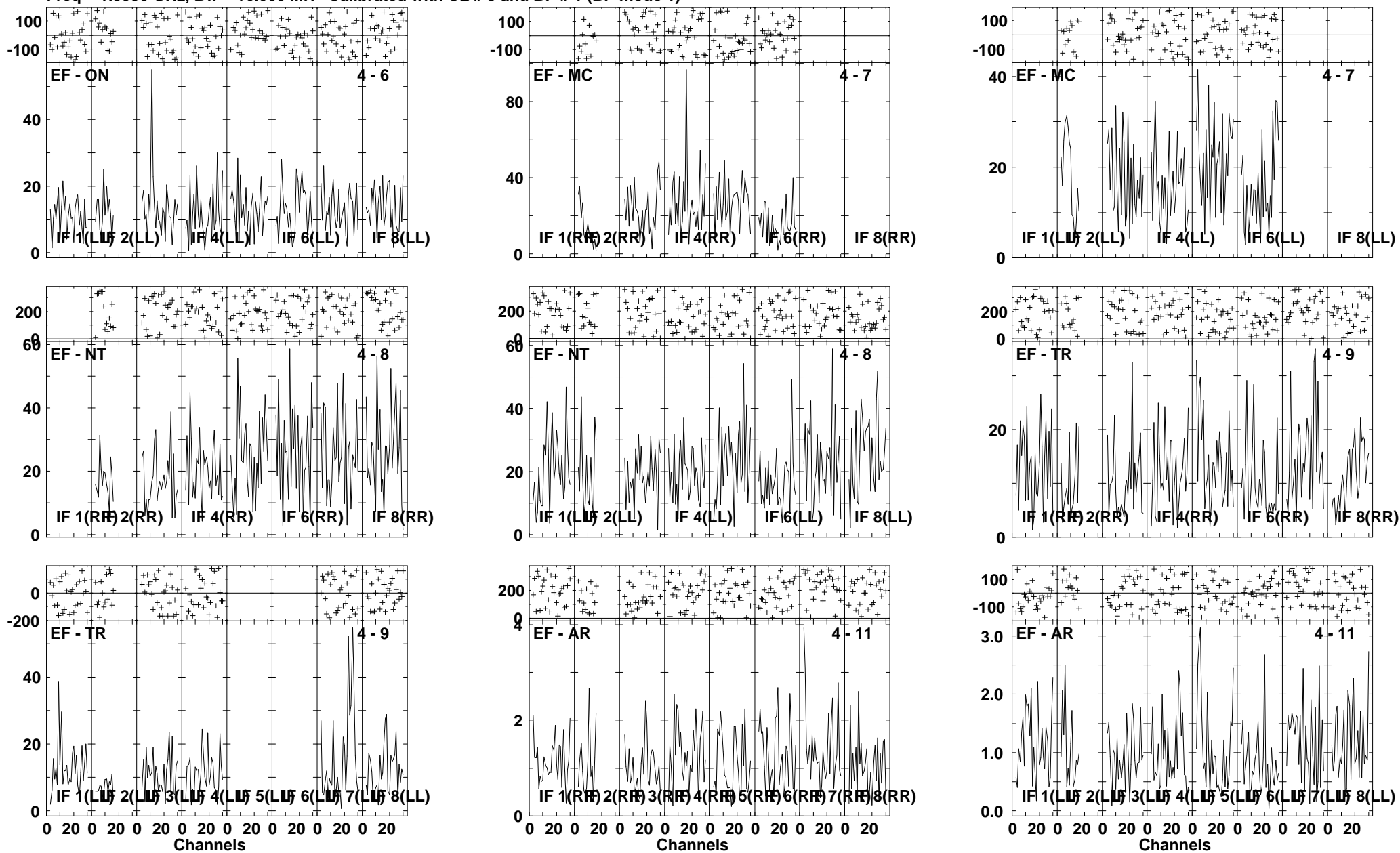

Lower frame: Milli Ampl Jy Top frame: Phas deg
Vector averaged cross-power spectrum Several baselines displayed
Timerange: 00/17:32:31 to 00/17:37:01

Plot file version 238 created 29-APR-2009 14:34:34

J2333+39 EP064D.UVDATA.1

Freq = 1.5950 GHz, Bw = 16.000 MH Calibrated with CL # 3 and BP # 1 (BP mode 1)

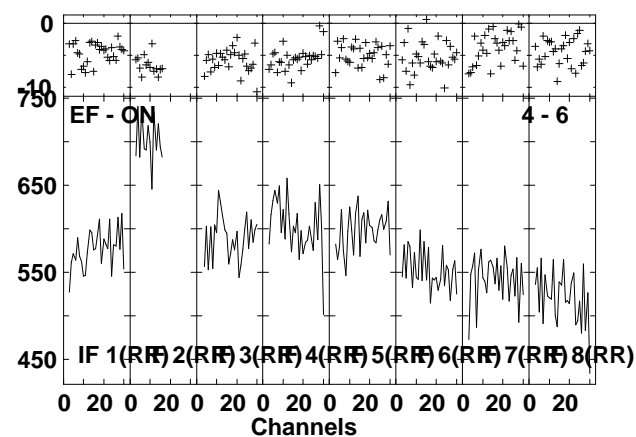
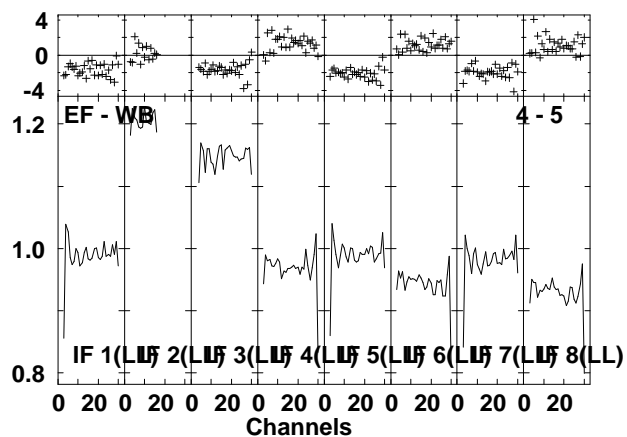
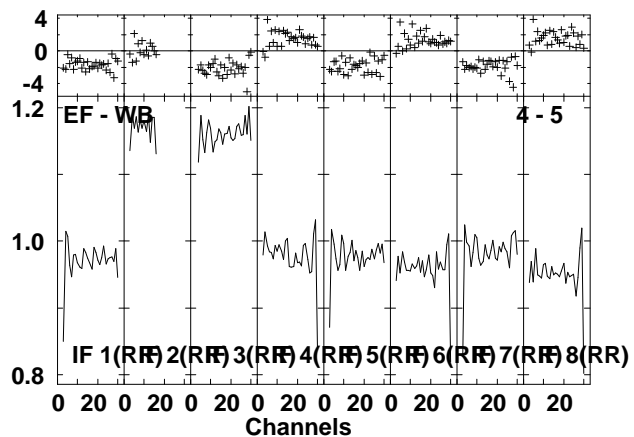
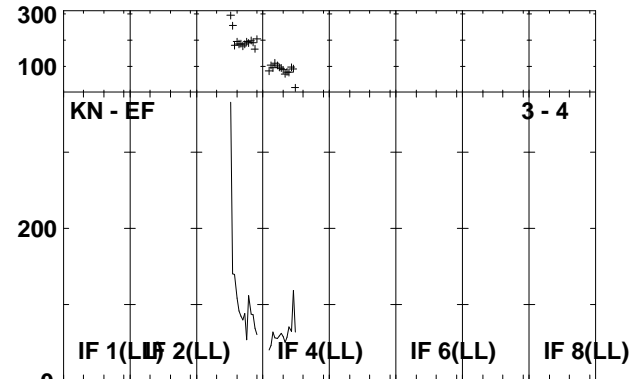
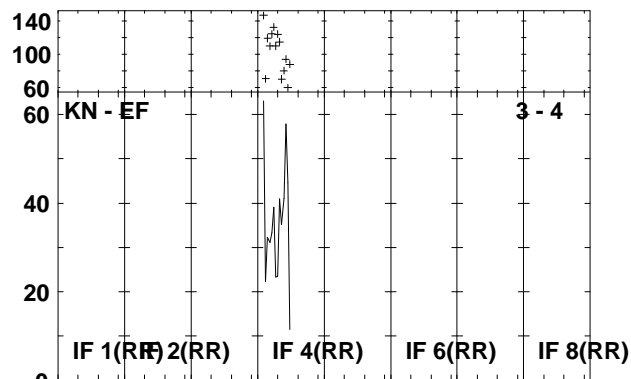
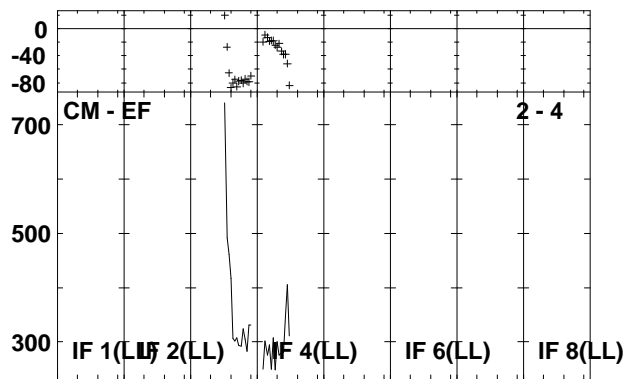
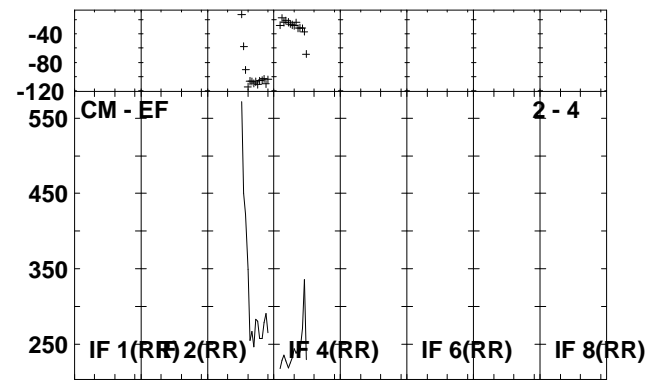
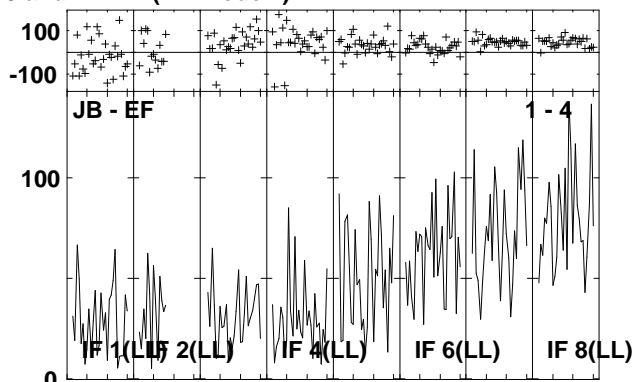
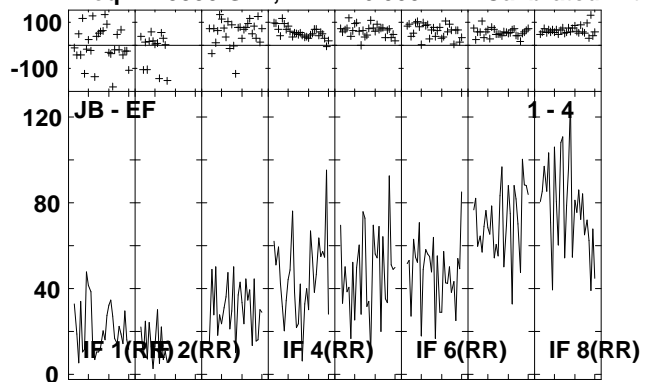

Lower frame: Milli Ampl Jy Top frame: Phas deg
Vector averaged cross-power spectrum Several baselines displayed
Timerange: 00/17:37:03 to 00/17:38:29

Plot file version 239 created 29-APR-2009 14:34:36

J2333+39 EP064D.UVDATA.1

Freq = 1.5950 GHz, Bw = 16.000 MH Calibrated with CL # 3 and BP # 1 (BP mode 1)

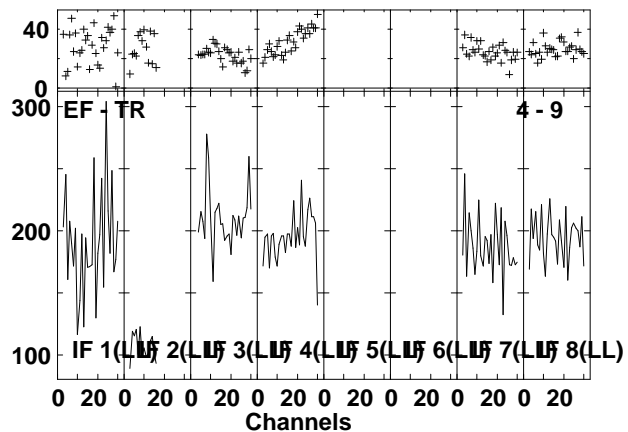
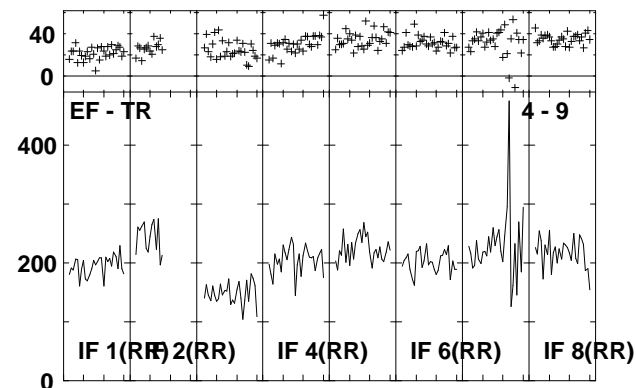
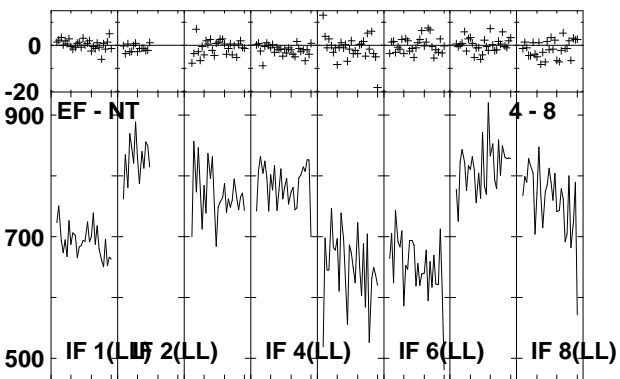
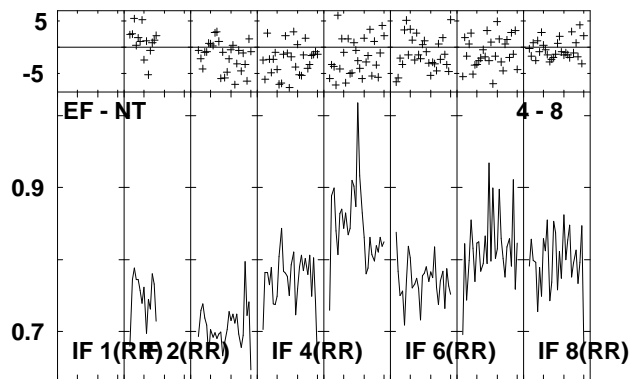
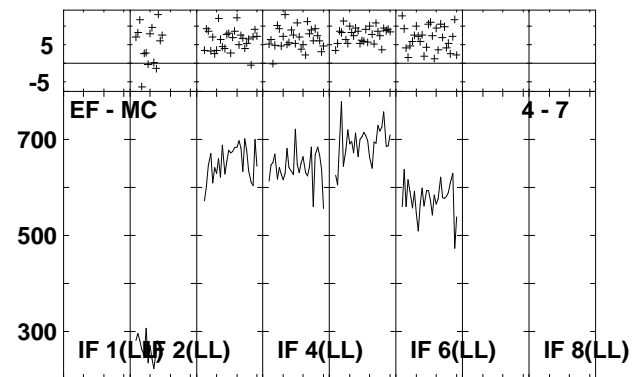
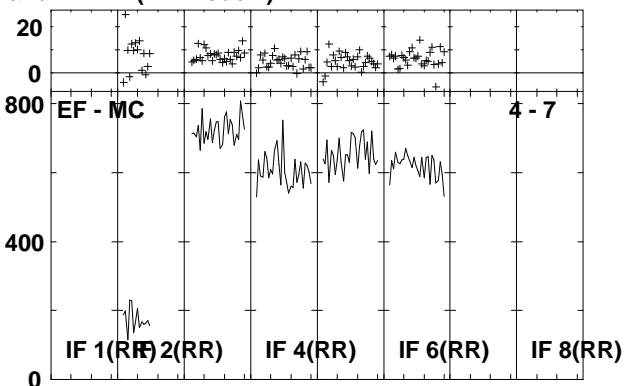
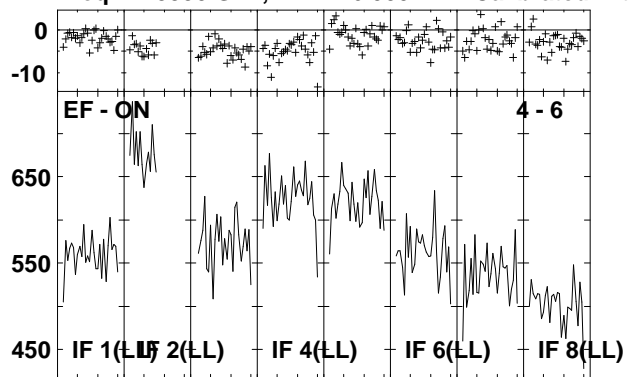

Lower frame: Milli Ampl Jy Top frame: Phas deg
Vector averaged cross-power spectrum Several baselines displayed
Timerange: 00/17:37:03 to 00/17:38:29

Plot file version 240 created 29-APR-2009 14:34:38

IRAS2336 EP064D.UVDATA.1

Freq = 1.5950 GHz, Bw = 16.000 MH Calibrated with CL # 3 and BP # 1 (BP mode 1)

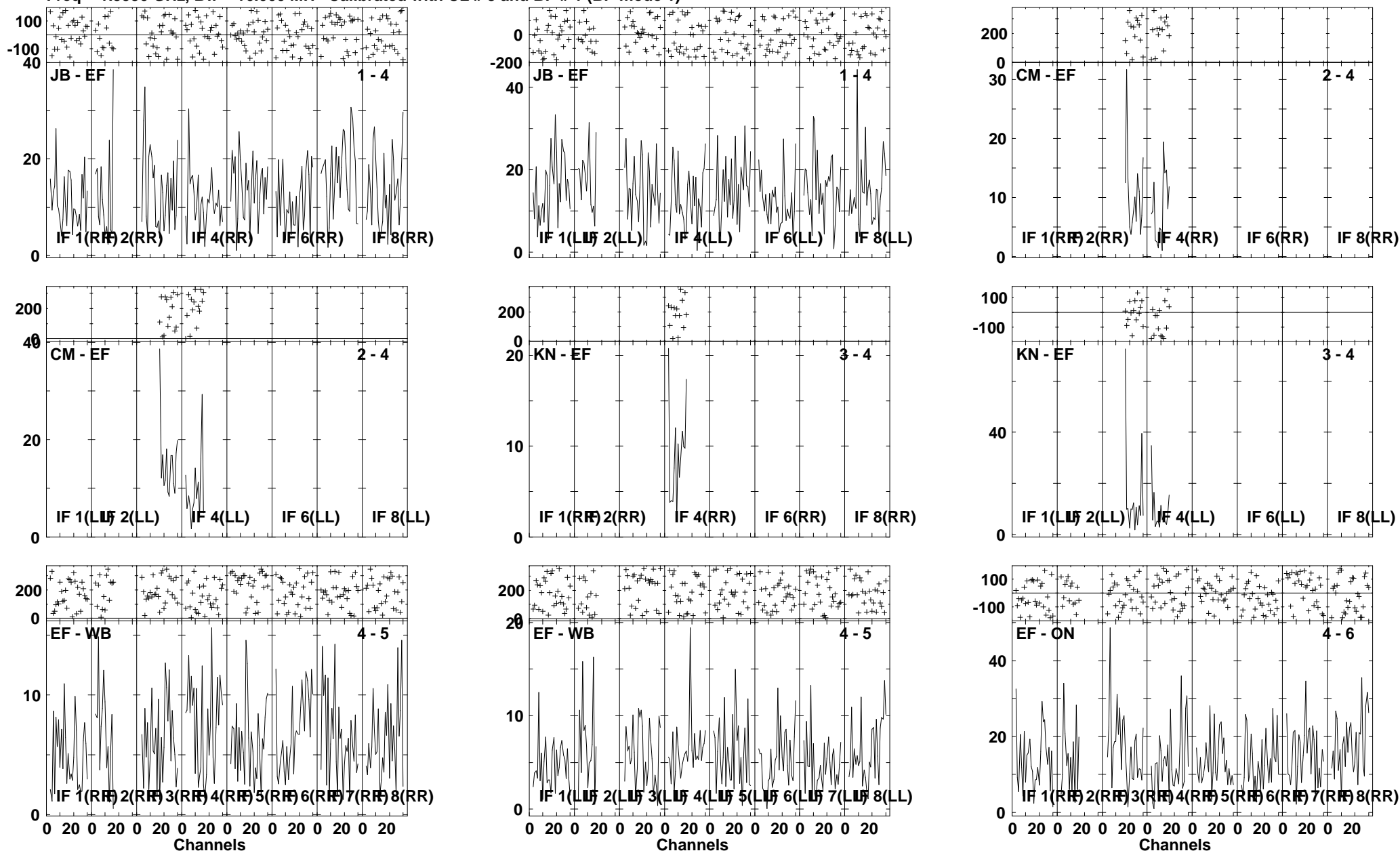

Lower frame: Milli Ampl Jy Top frame: Phas deg
Vector averaged cross-power spectrum Several baselines displayed
Timerange: 00/17:38:31 to 00/17:41:57

Plot file version 241 created 29-APR-2009 14:34:41
 IRAS2336 EP064D.UVDATA.1
 Freq = 1.5950 GHz, Bw = 16.000 MH Calibrated with CL # 3 and BP # 1 (BP mode 1)

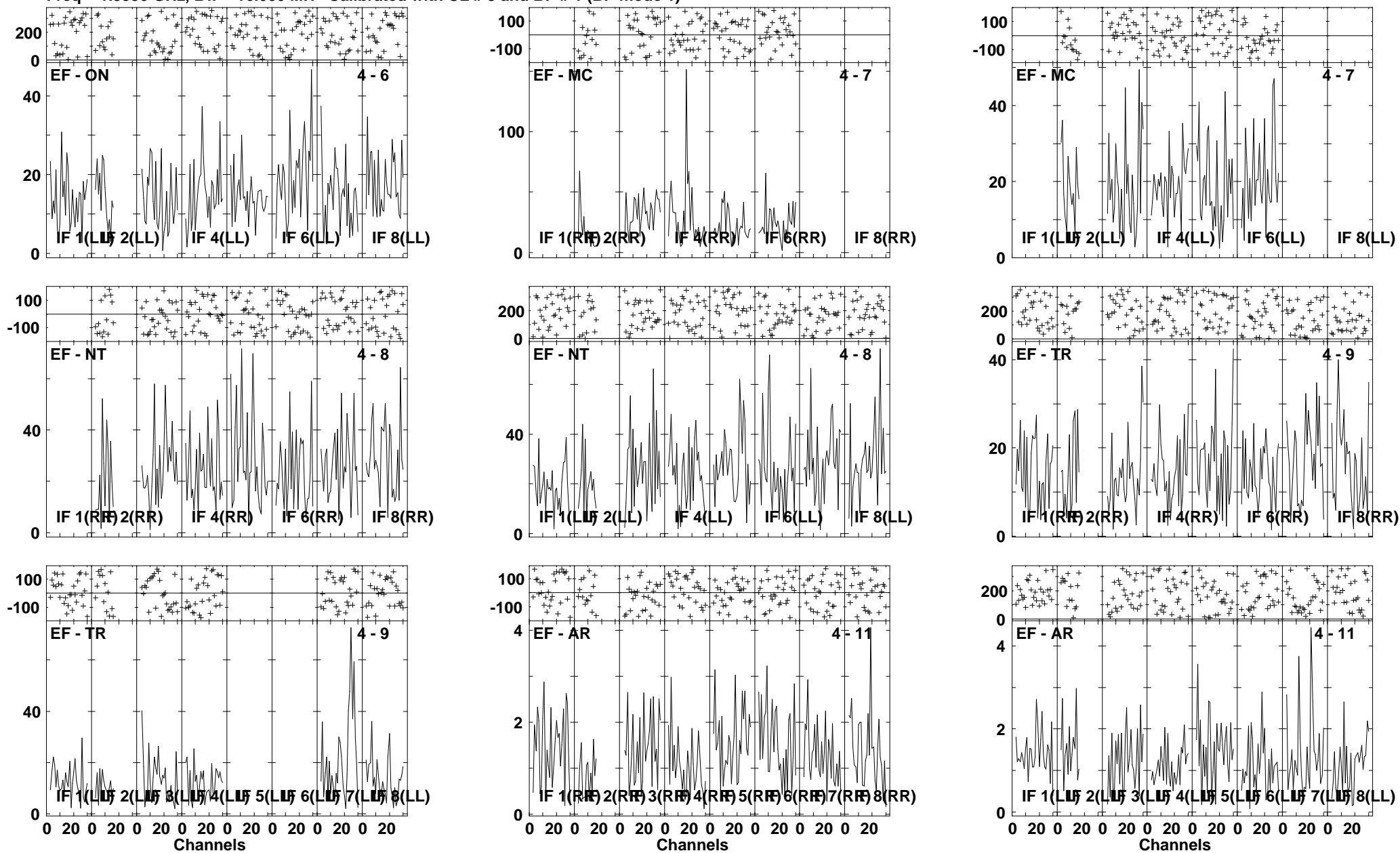

Lower frame: Milli Ampl Jy Top frame: Phas deg
 Vector averaged cross-power spectrum Several baselines displayed
 Timerange: 00/17:38:31 to 00/17:41:57

Plot file version 242 created 29-APR-2009 14:34:46

J2333+39 EP064D.UVDATA.1

Freq = 1.5950 GHz, Bw = 16.000 MH Calibrated with CL # 3 and BP # 1 (BP mode 1)

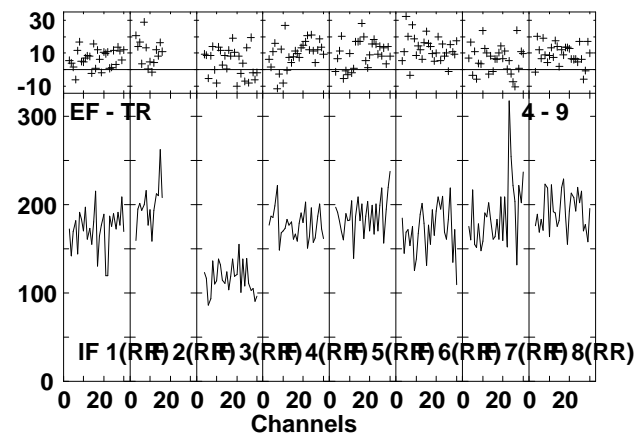
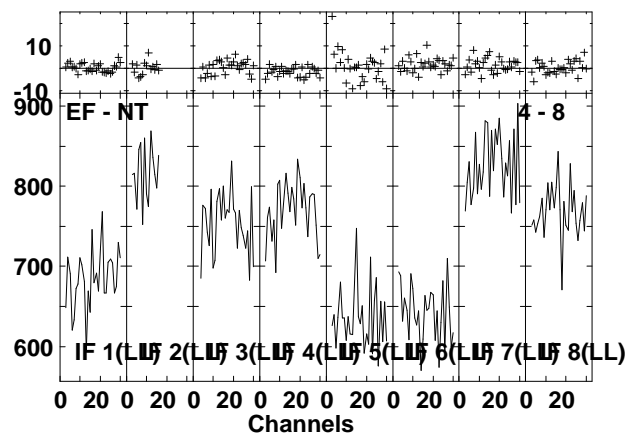
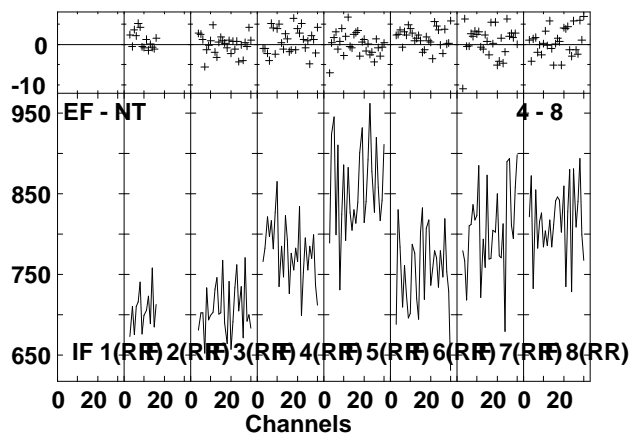
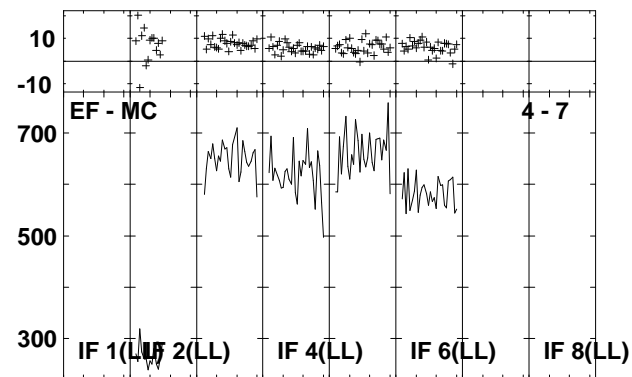
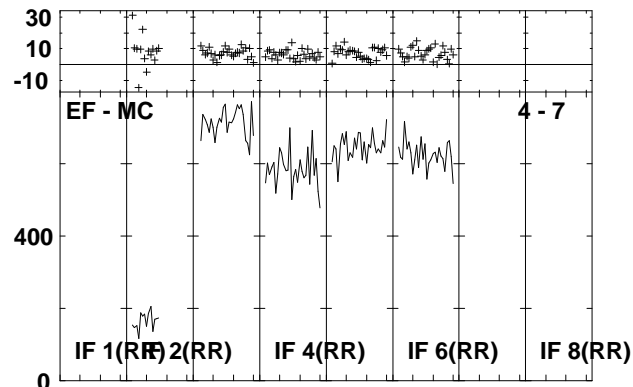
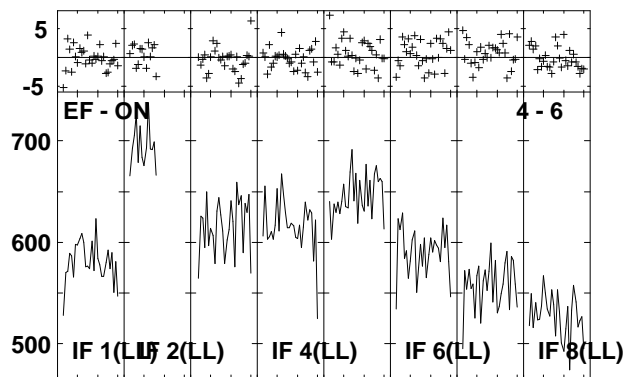
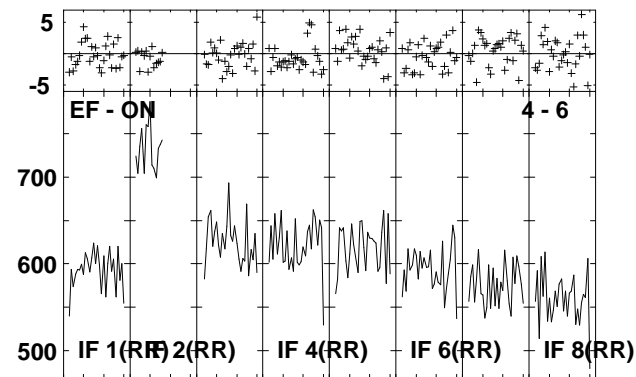
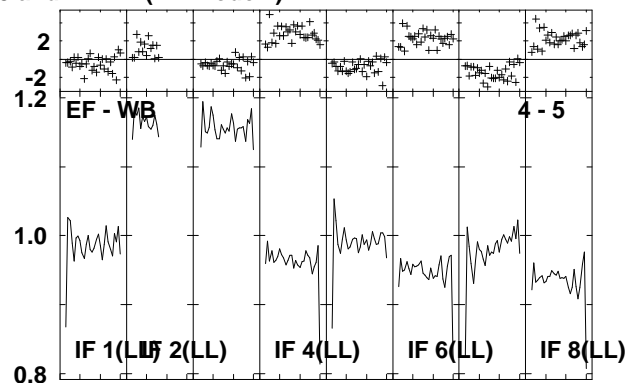
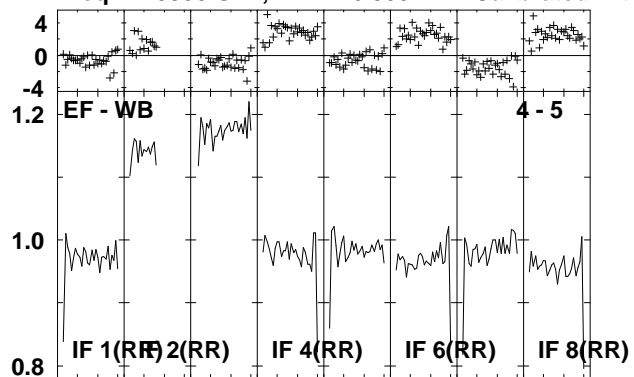

Lower frame: Ampl Jy Top frame: Phas deg
Vector averaged cross-power spectrum Several baselines displayed
Timerange: 00/17:42:06 to 00/17:43:26

Plot file version 243 created 29-APR-2009 14:34:47

J2333+39 EP064D.UVDATA.1

Freq = 1.5950 GHz, Bw = 16.000 MH Calibrated with CL # 3 and BP # 1 (BP mode 1)

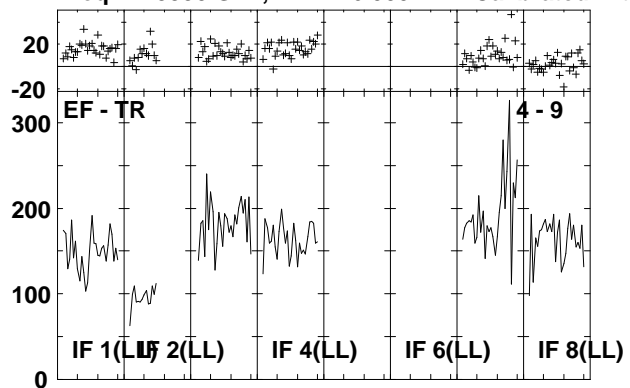

Lower frame: Milli Ampl Jy Top frame: Phas deg
Vector averaged cross-power spectrum Several baselines displayed
Timerange: 00/17:42:06 to 00/17:43:26

Plot file version 244 created 29-APR-2009 14:34:48

IRAS2336 EP064D.UVDATA.1

Freq = 1.5950 GHz, Bw = 16.000 MH Calibrated with CL # 3 and BP # 1 (BP mode 1)

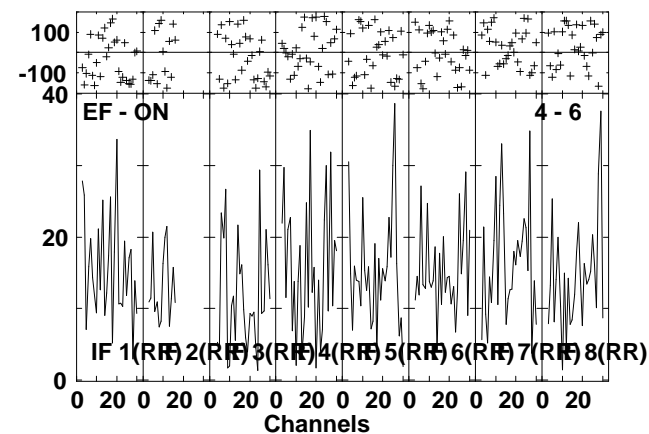
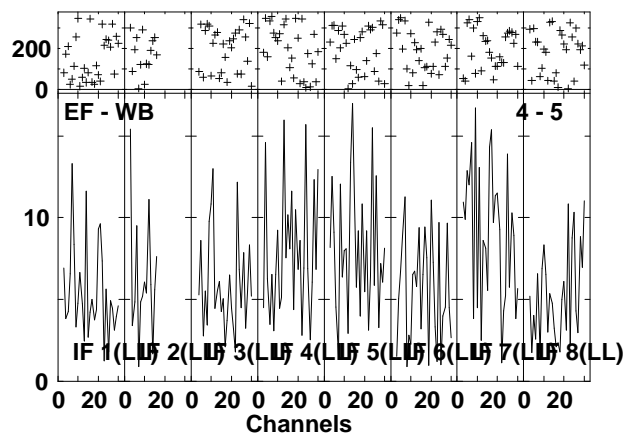
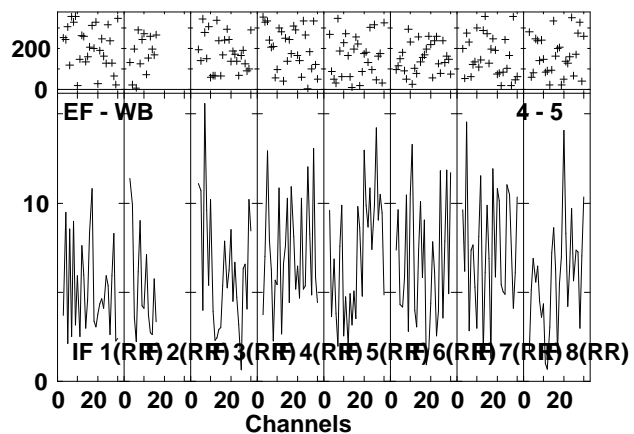
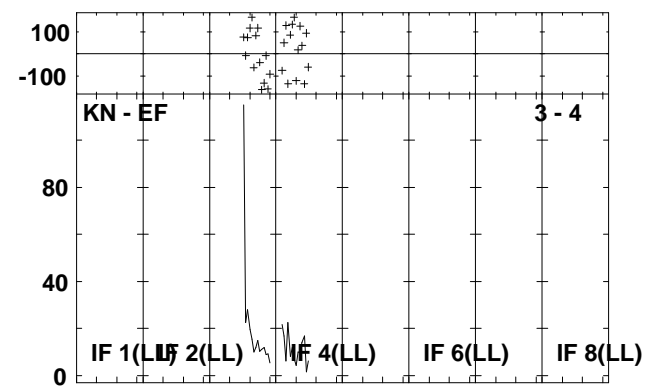
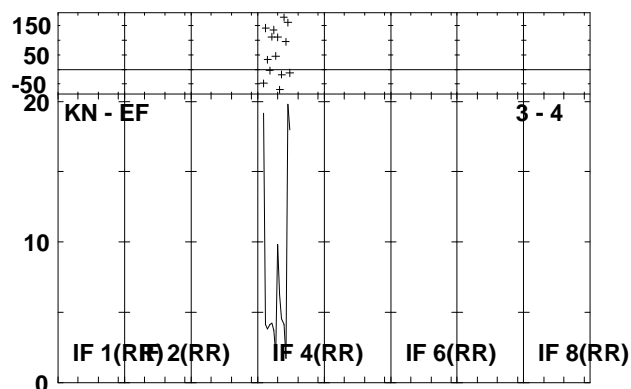
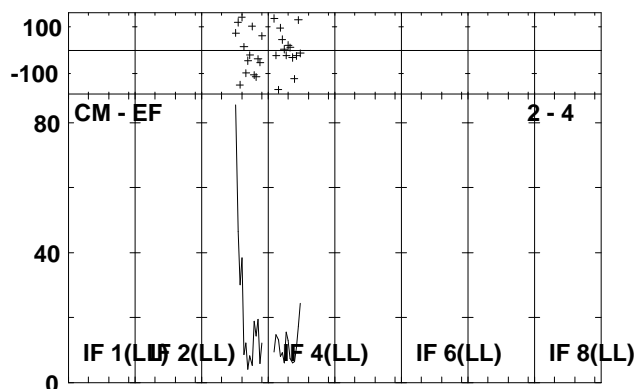
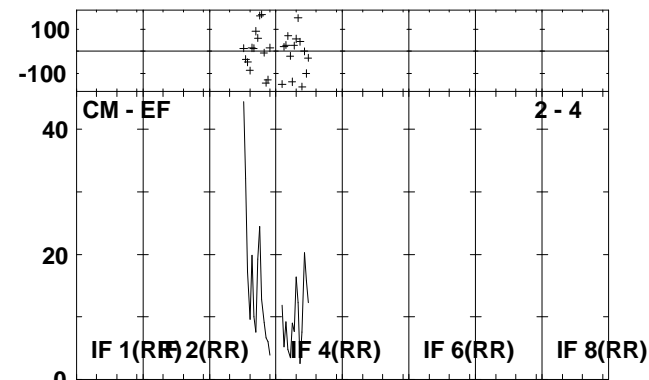
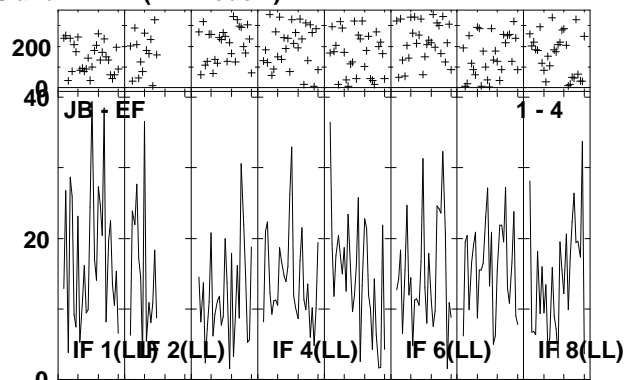
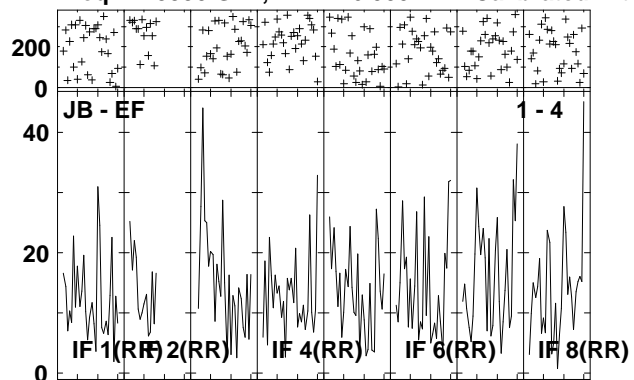

Lower frame: Milli Ampl Jy Top frame: Phas deg
Vector averaged cross-power spectrum Several baselines displayed
Timerange: 00:17:43:31 to 00:17:46:59

Plot file version 245 created 29-APR-2009 14:34:51

IRAS2336 EP064D.UVDATA.1

Freq = 1.5950 GHz, Bw = 16.000 MH Calibrated with CL # 3 and BP # 1 (BP mode 1)

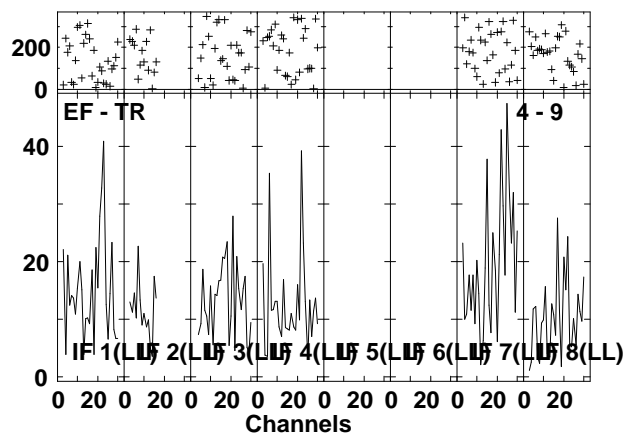
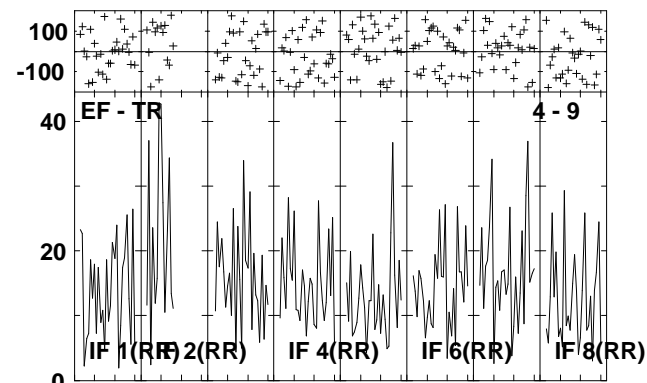
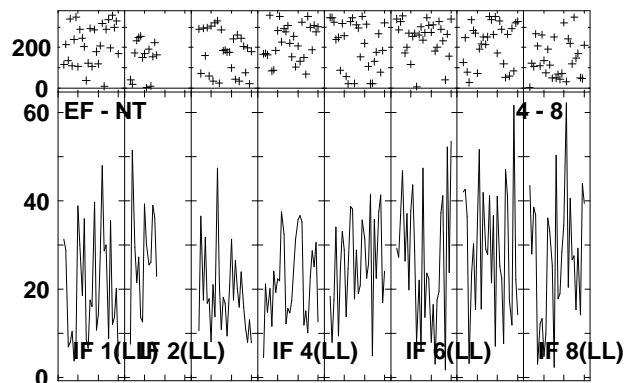
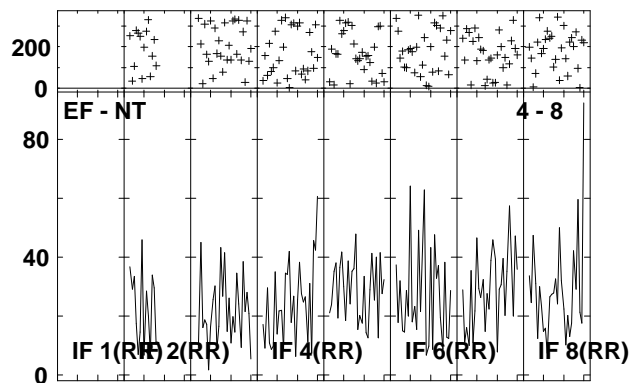
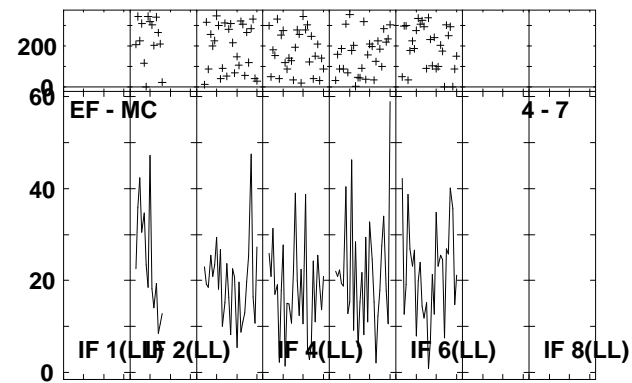
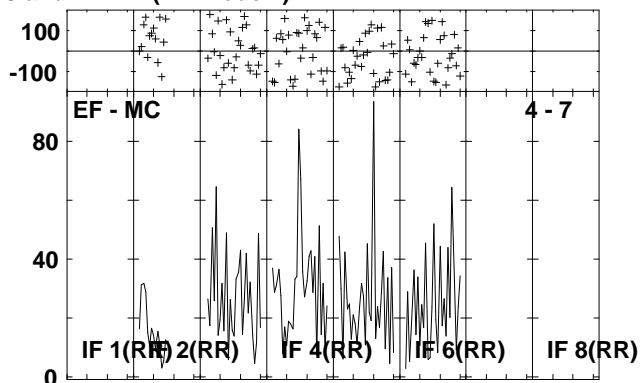
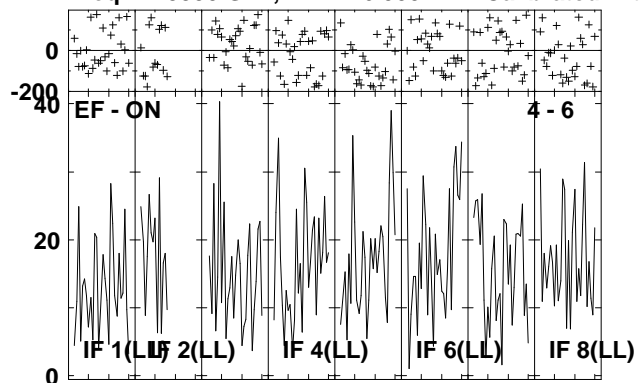

Lower frame: Milli Ampl Jy Top frame: Phas deg
Vector averaged cross-power spectrum Several baselines displayed
Timerange: 00/17:43:31 to 00/17:46:59

Plot file version 246 created 29-APR-2009 14:34:54

J2333+39 EP064D.UVDATA.1

Freq = 1.5950 GHz, Bw = 16.000 MH Calibrated with CL # 3 and BP # 1 (BP mode 1)

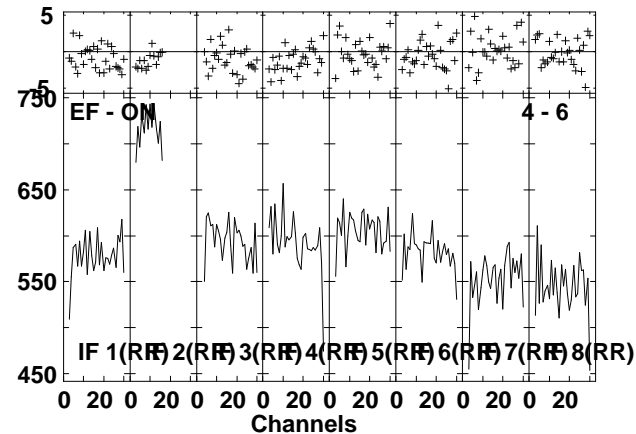
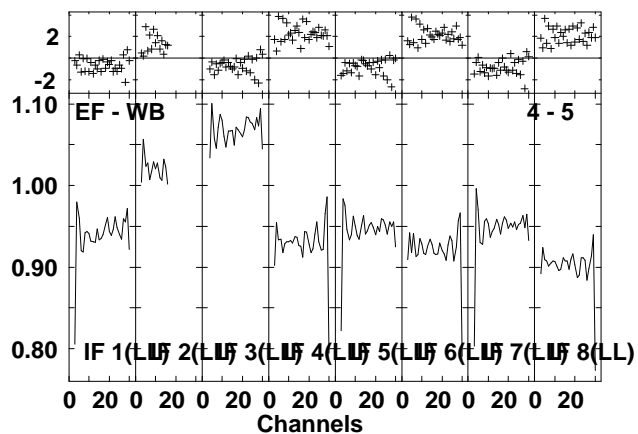
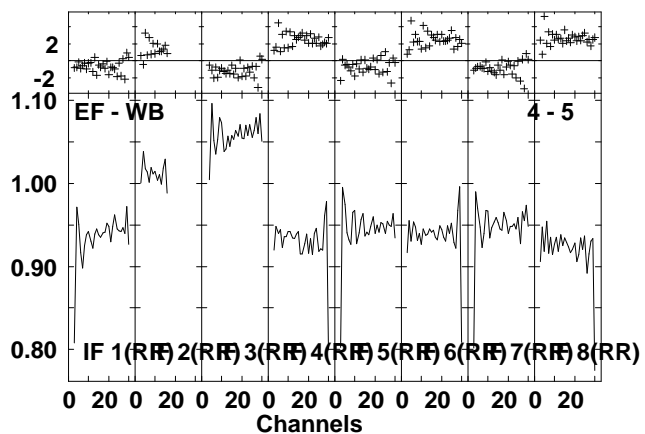
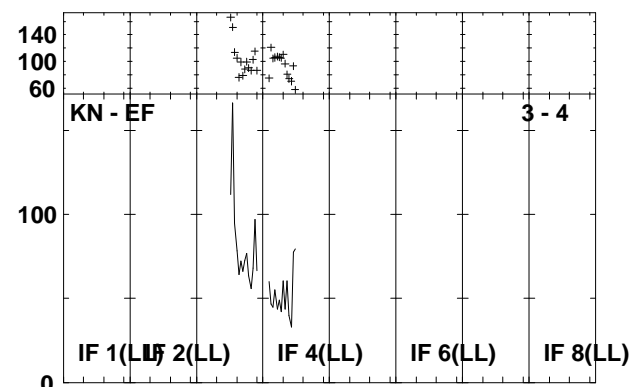
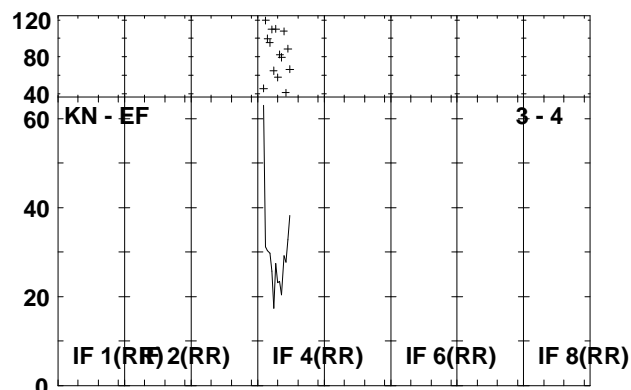
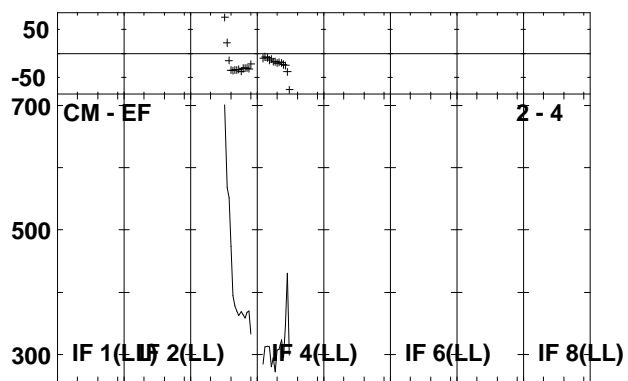
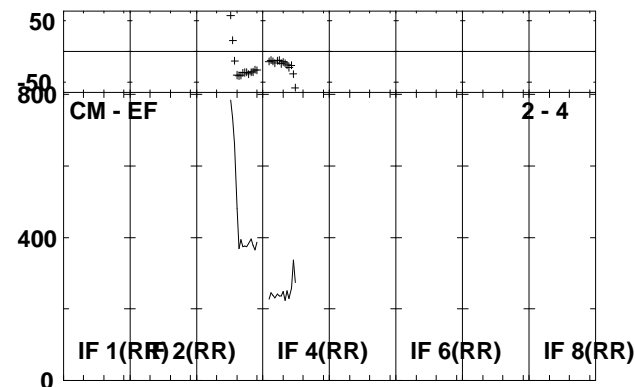
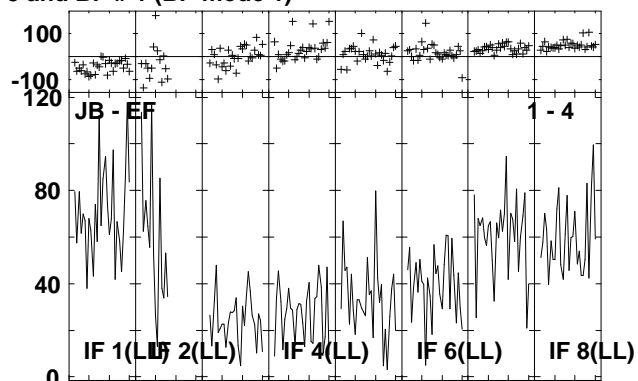
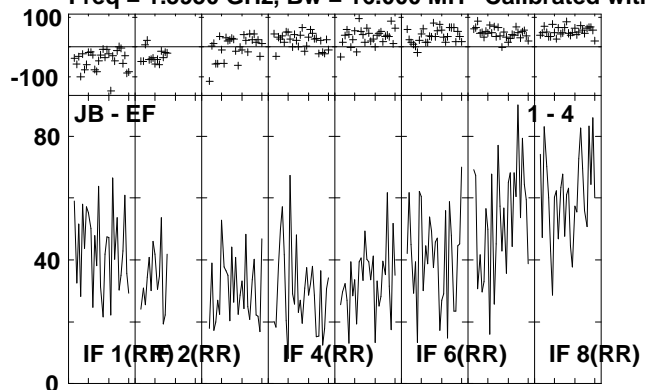

Lower frame: Milli Ampl Jy Top frame: Phas deg
Vector averaged cross-power spectrum Several baselines displayed
Timerange: 00:17:48:01 to 00:17:49:31

Plot file version 247 created 29-APR-2009 14:34:55

J2333+39 EP064D.UVDATA.1

Freq = 1.5950 GHz, Bw = 16.000 MH Calibrated with CL # 3 and BP # 1 (BP mode 1)

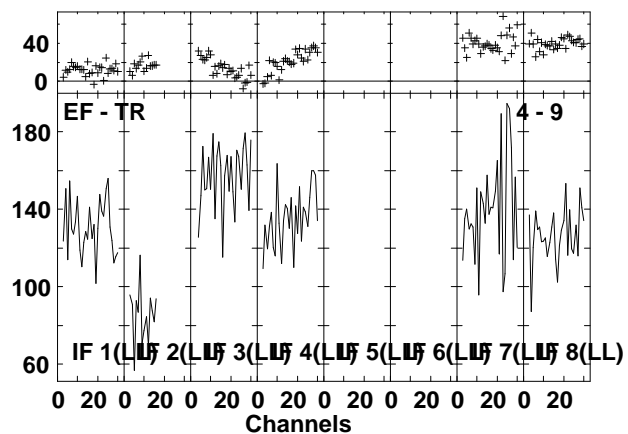
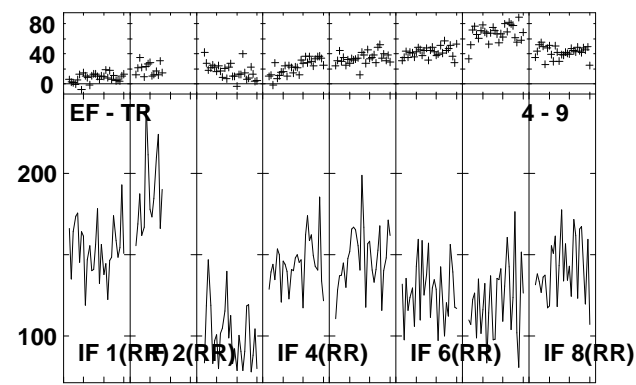
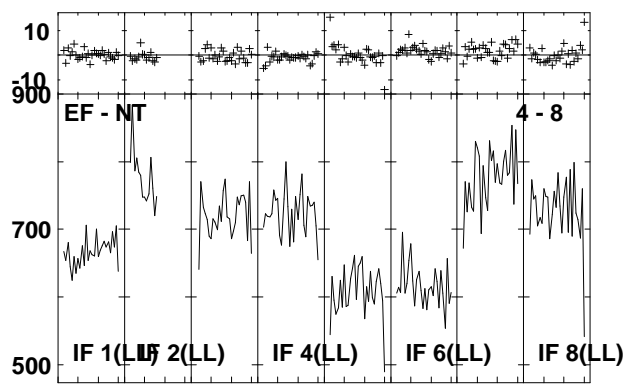
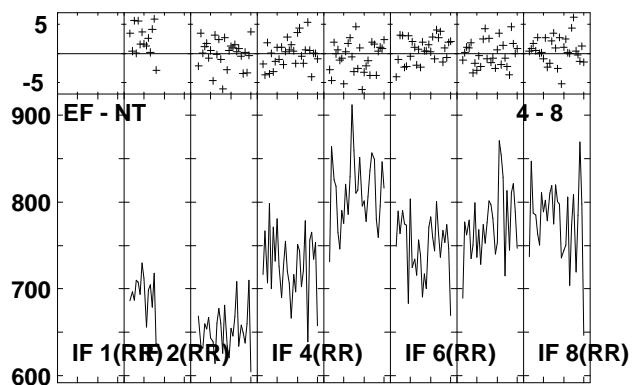
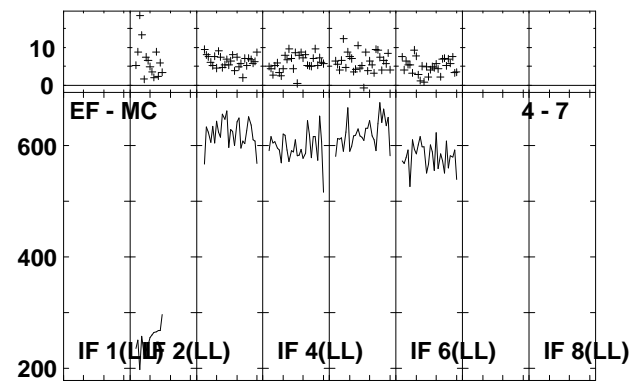
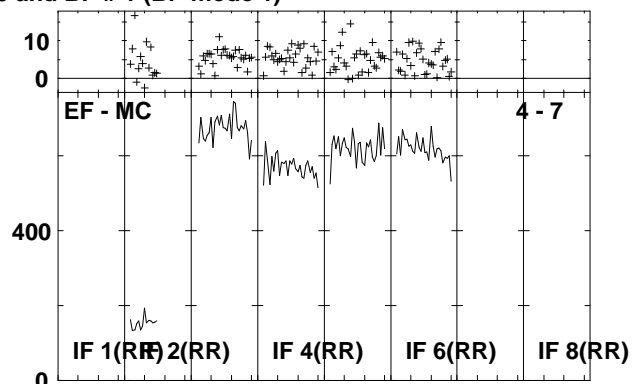
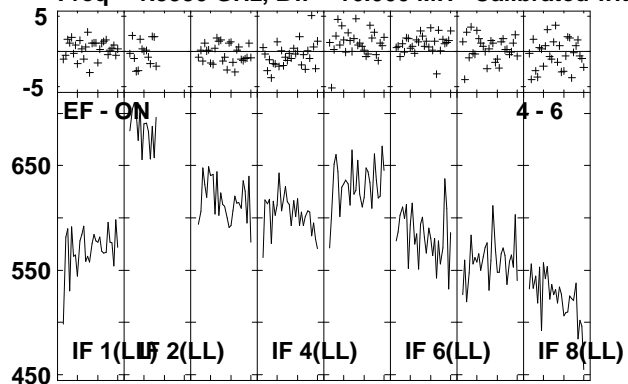

Lower frame: Milli Ampl Jy Top frame: Phas deg
Vector averaged cross-power spectrum Several baselines displayed
Timerange: 00/17:48:01 to 00/17:49:31

Plot file version 248 created 29-APR-2009 14:34:58

IRAS2336 EP064D.UVDATA.1

Freq = 1.5950 GHz, Bw = 16.000 MH Calibrated with CL # 3 and BP # 1 (BP mode 1)

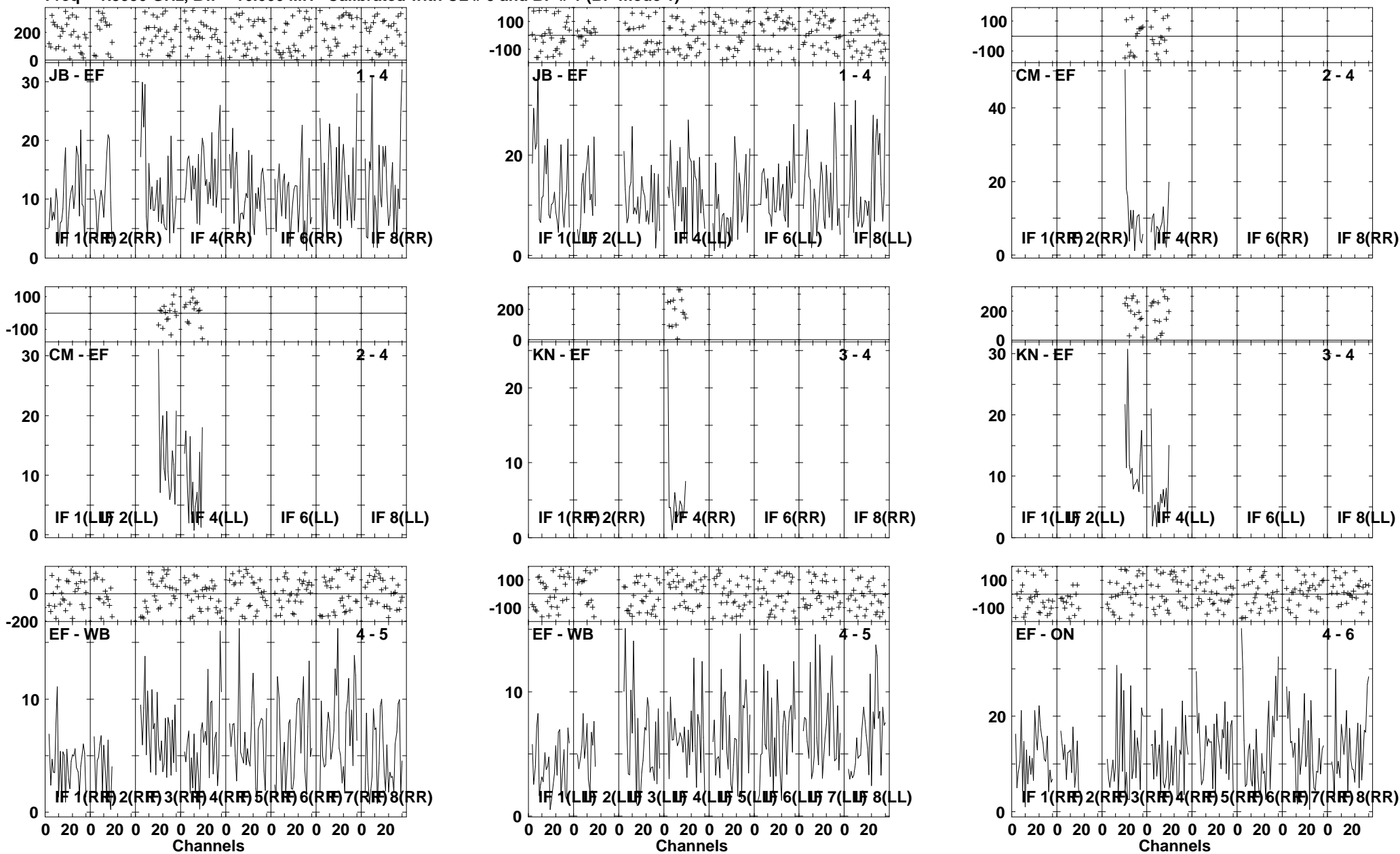

Lower frame: Milli Ampl Jy Top frame: Phas deg
Vector averaged cross-power spectrum Several baselines displayed
Timerange: 00/17:49:33 to 00/17:53:59

Plot file version 249 created 29-APR-2009 14:35:02
 IRAS2336 EP064D.UVDATA.1
 Freq = 1.5950 GHz, Bw = 16.000 MH Calibrated with CL # 3 and BP # 1 (BP mode 1)

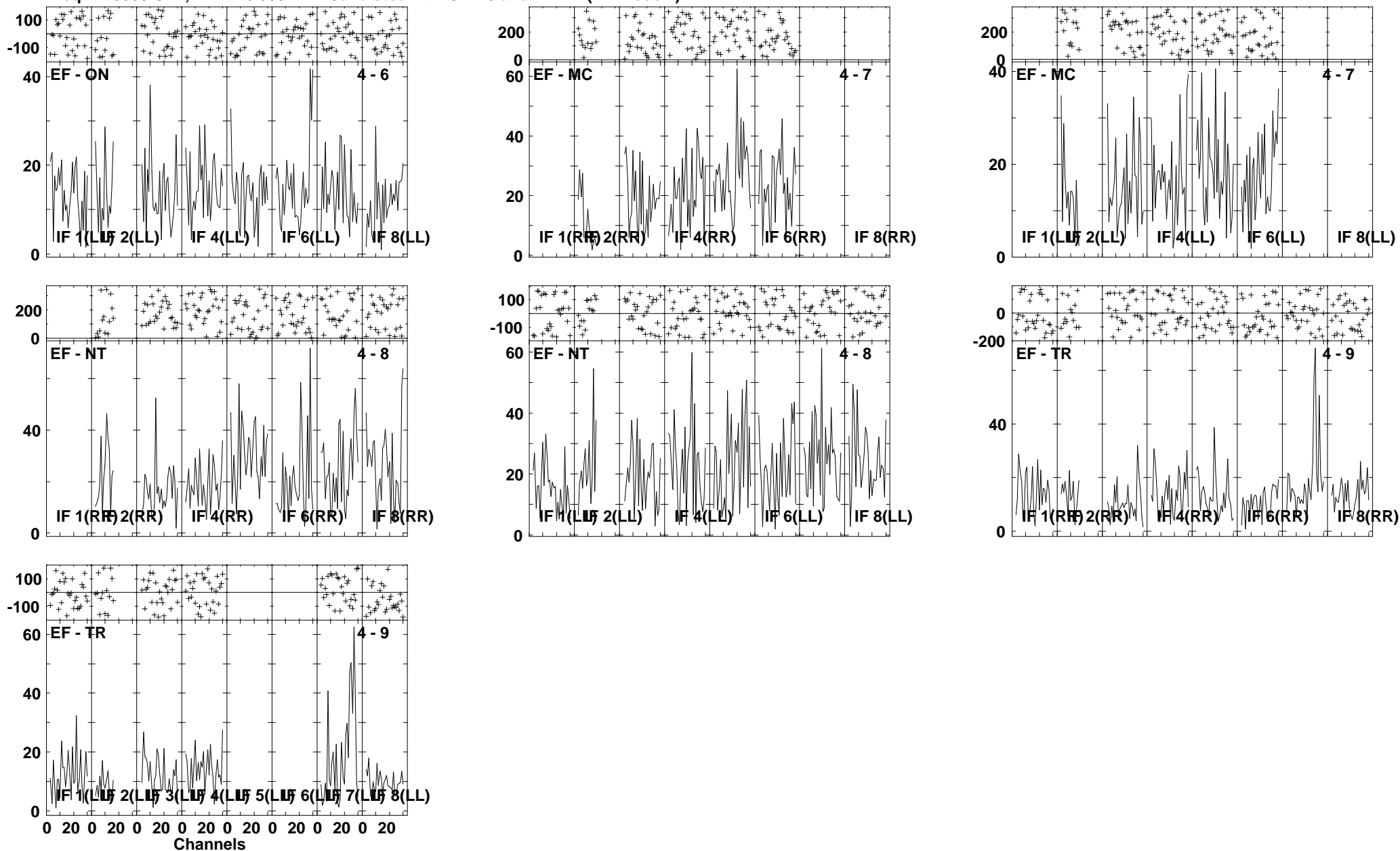

Lower frame: Milli Ampl Jy Top frame: Phas deg
 Vector averaged cross-power spectrum Several baselines displayed
 Timerange: 00/17:49:33 to 00/17:53:59

Plot file version 250 created 29-APR-2009 14:35:07

J2333+39 EP064D.UVDATA.1

Freq = 1.5950 GHz, Bw = 16.000 MH Calibrated with CL # 3 and BP # 1 (BP mode 1)

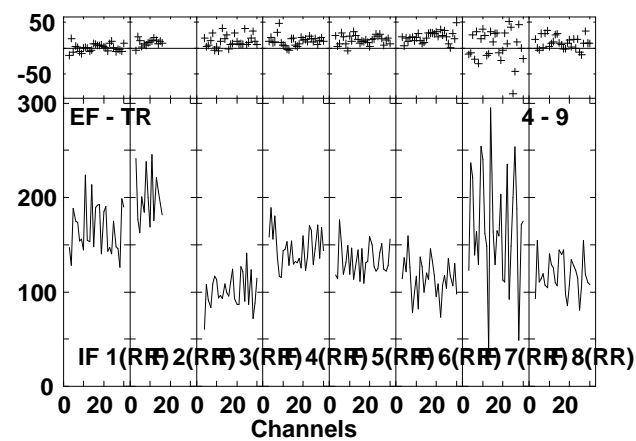
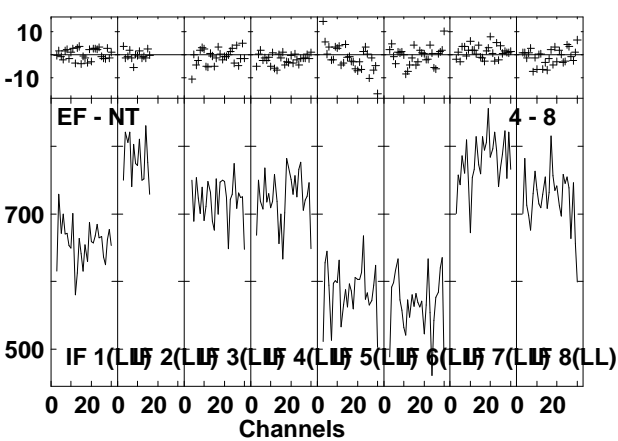
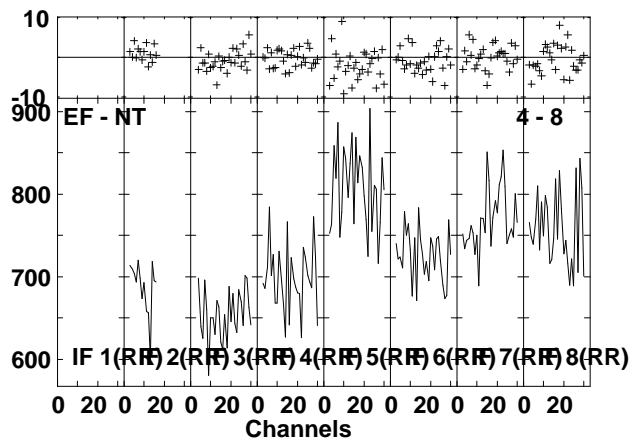
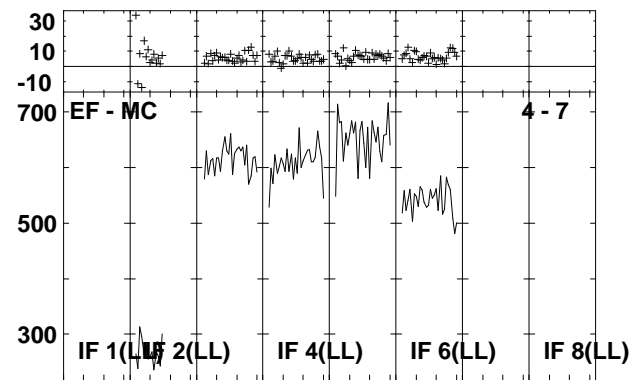
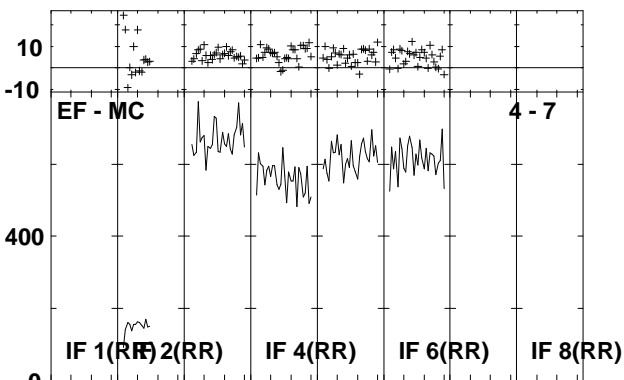
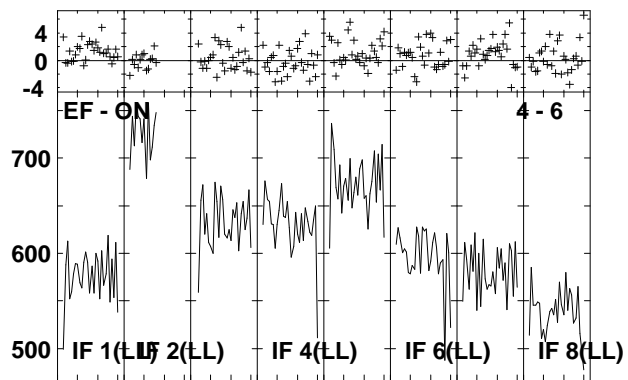
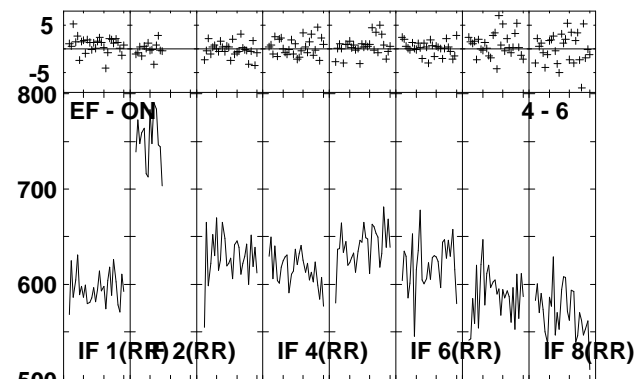
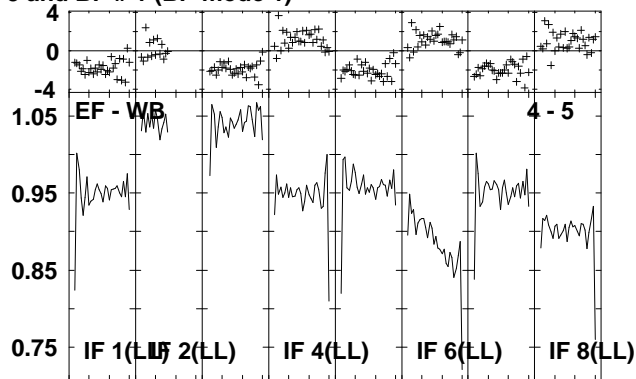
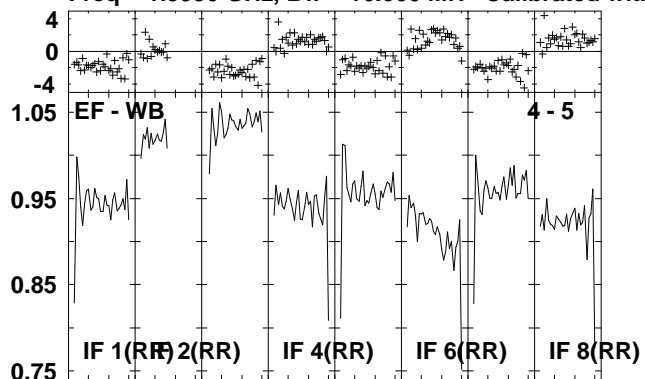

Lower frame: Ampl Jy Top frame: Phas deg
Vector averaged cross-power spectrum Several baselines displayed
Timerange: 00/17:54:01 to 00/17:55:27

Plot file version 251 created 29-APR-2009 14:35:08
J2333+39 EP064D.UVDATA.1
Freq = 1.5950 GHz, Bw = 16.000 MH Calibrated with CL # 3 and BP # 1 (BP mode 1)

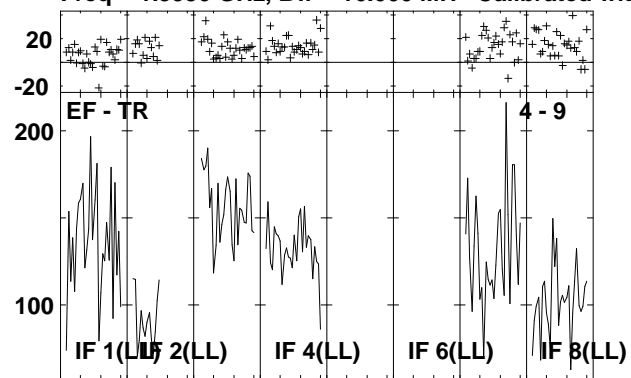

Lower frame: Milli Ampl Jy Top frame: Phas deg
Vector averaged cross-power spectrum Several baselines displayed
Timerange: 00/17:54:01 to 00/17:55:27

Plot file version 252 created 29-APR-2009 14:35:09

IRAS2336 EP064D.UVDATA.1

Freq = 1.5950 GHz, Bw = 16.000 MH Calibrated with CL # 3 and BP # 1 (BP mode 1)

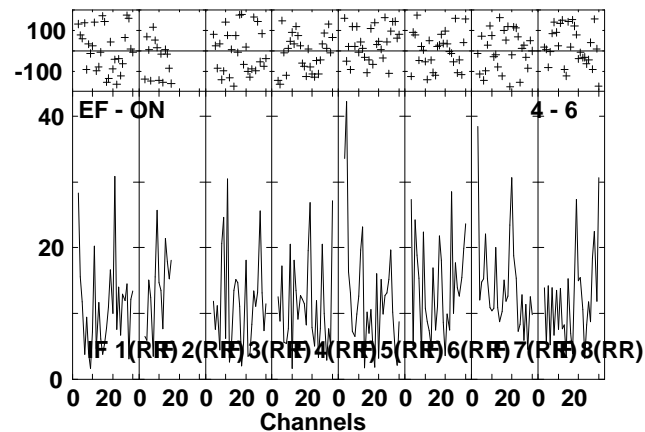
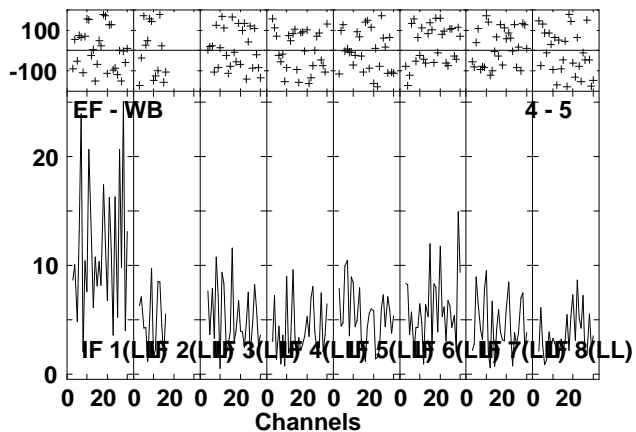
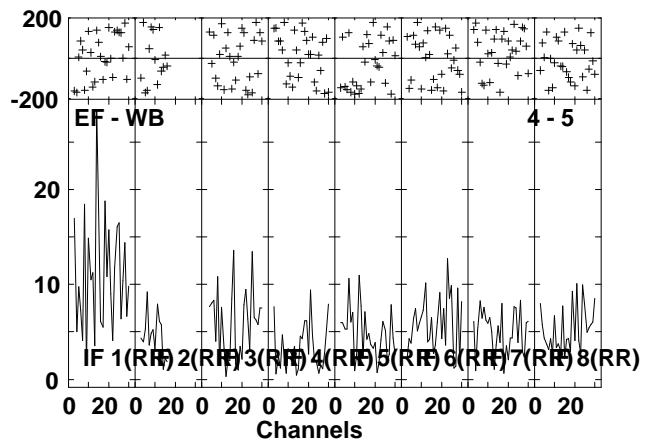
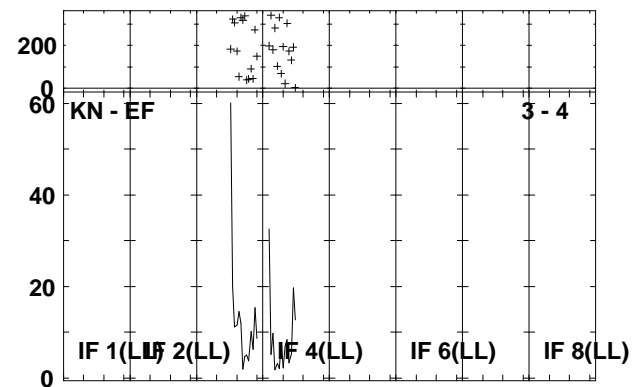
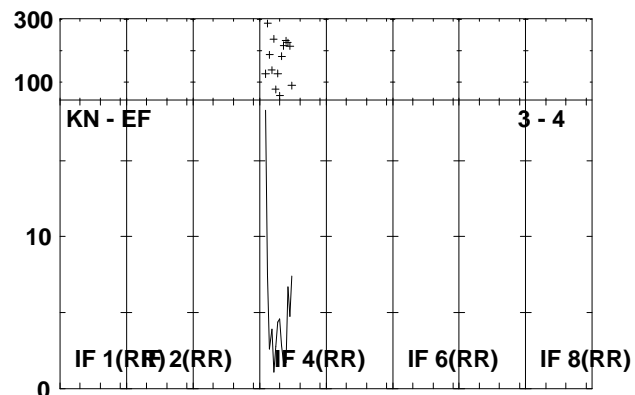
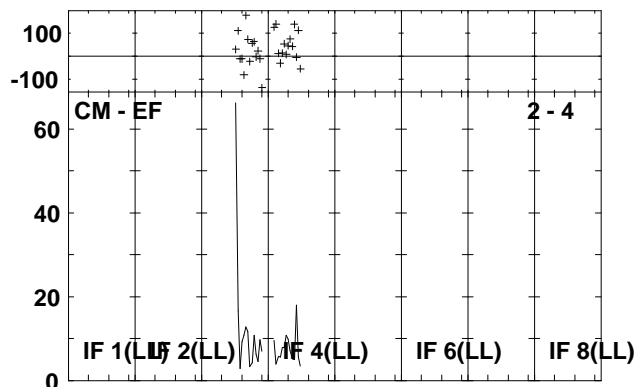
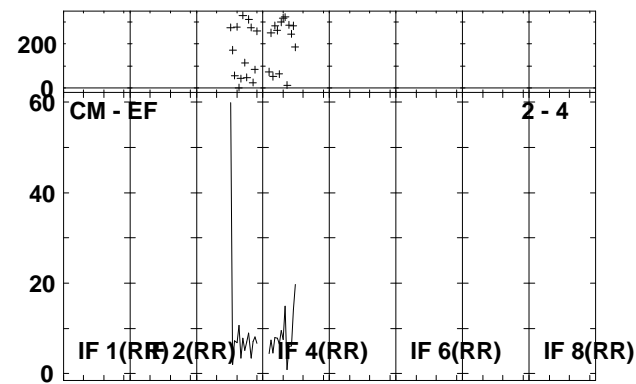
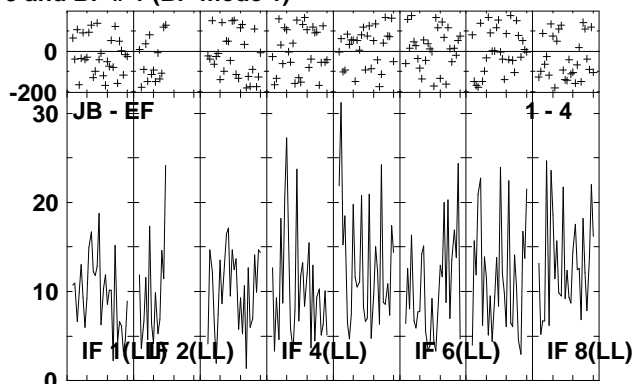
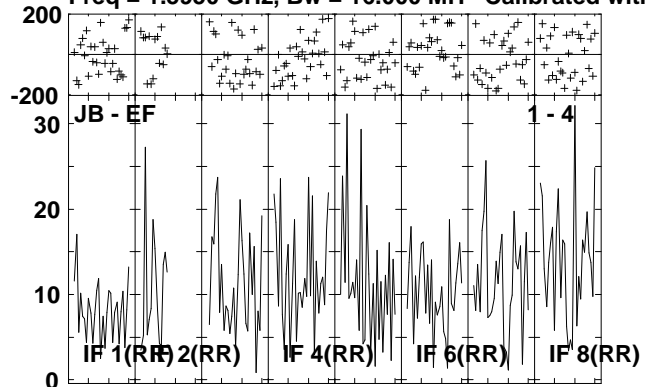

Lower frame: Milli Ampl Jy Top frame: Phas deg
Vector averaged cross-power spectrum Several baselines displayed
Timerange: 00/17:55:29 to 00/17:59:57

Plot file version 253 created 29-APR-2009 14:35:12
 IRAS2336 EP064D.UVDATA.1
 Freq = 1.5950 GHz, Bw = 16.000 MH Calibrated with CL # 3 and BP # 1 (BP mode 1)

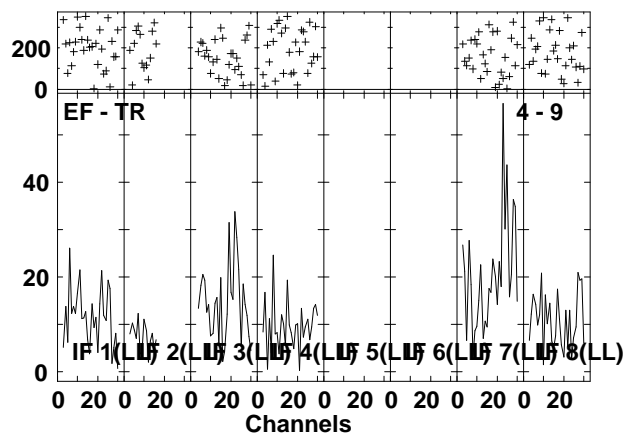
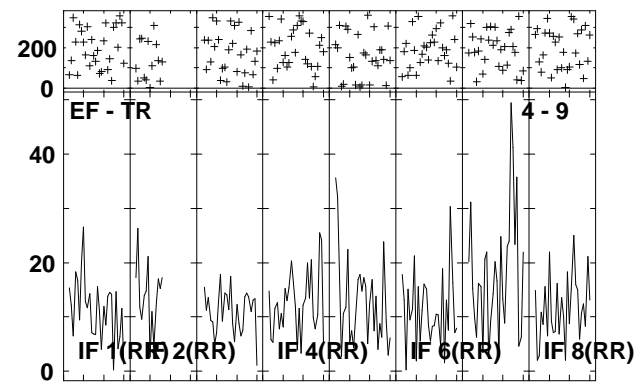
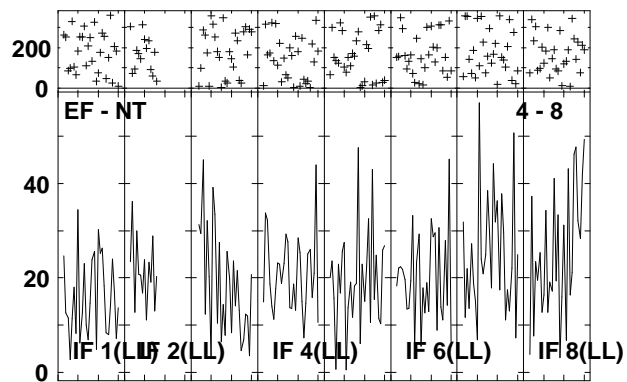
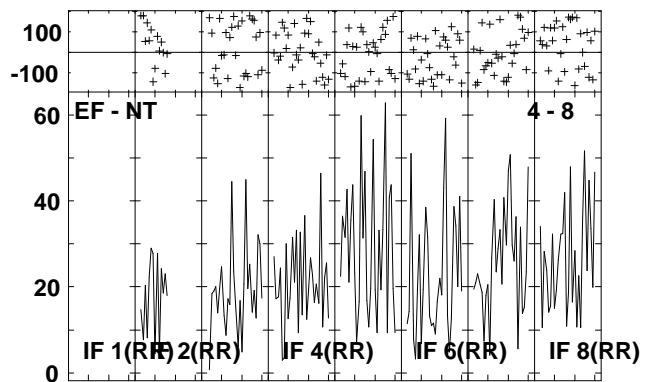
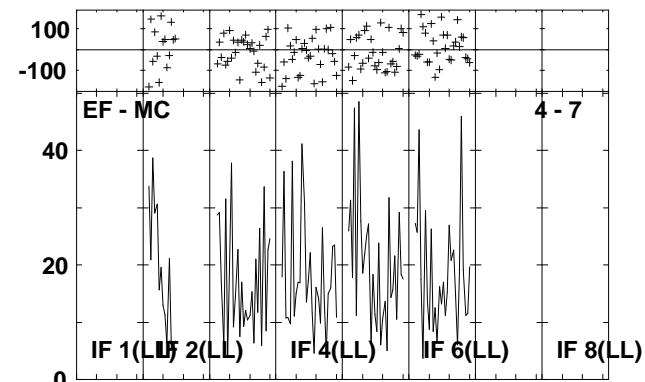
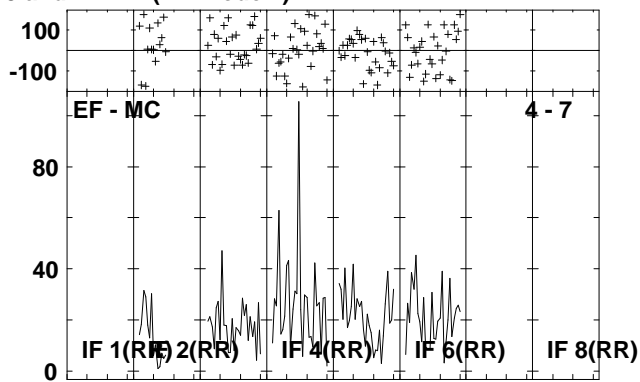
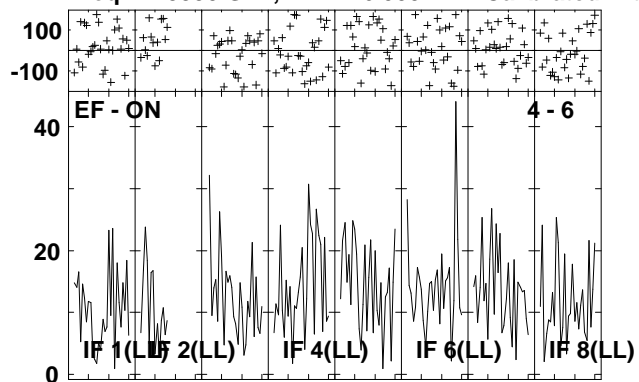

Lower frame: Milli Ampl Jy Top frame: Phas deg
 Vector averaged cross-power spectrum Several baselines displayed
 Timerange: 00/17:55:29 to 00/17:59:57