

Plot file version 1 created 06-JUL-2010 14:40:08

2134+004 EP064J.UVDATA.1

Freq = 1.5950 GHz, Bw = 16.000 MH No calibration applied and no bandpass applied

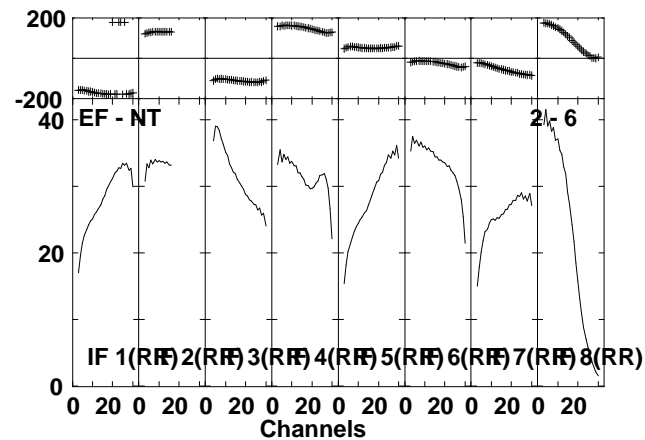
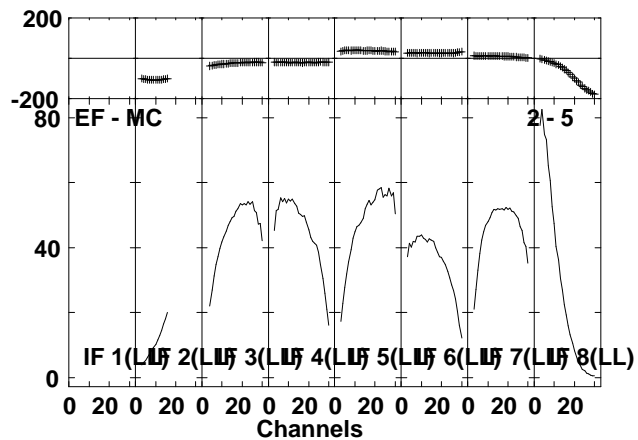
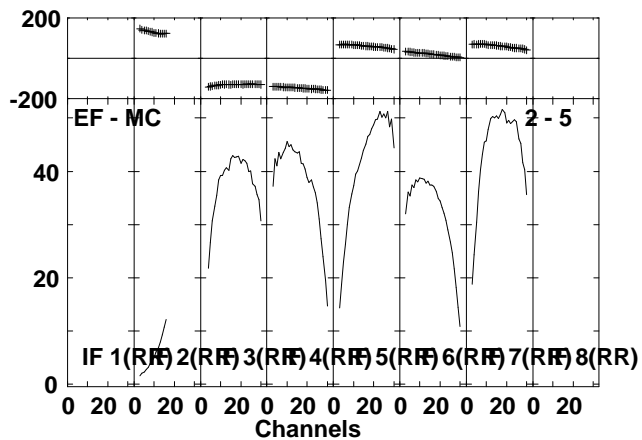
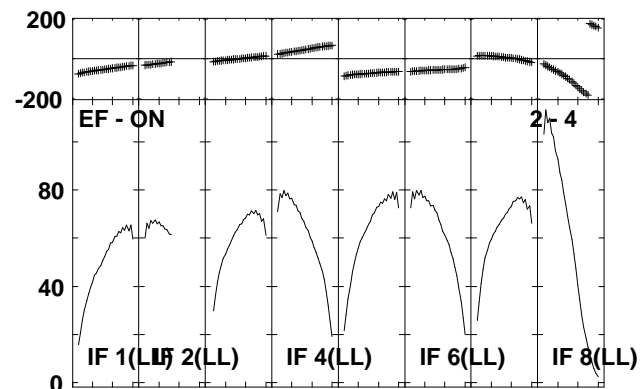
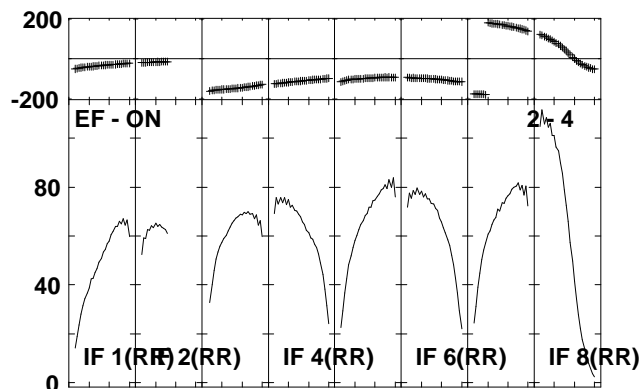
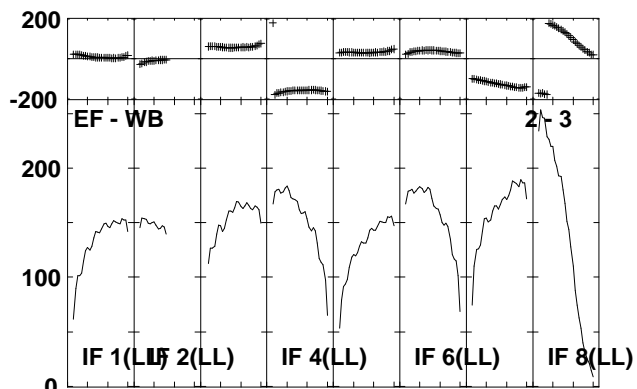
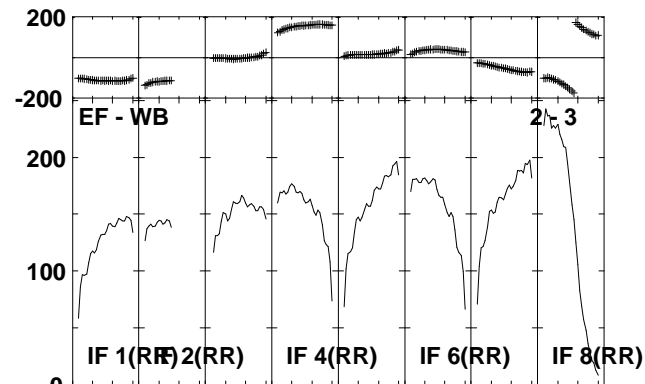
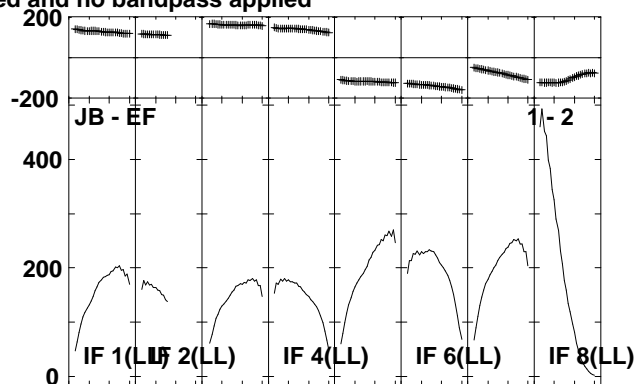
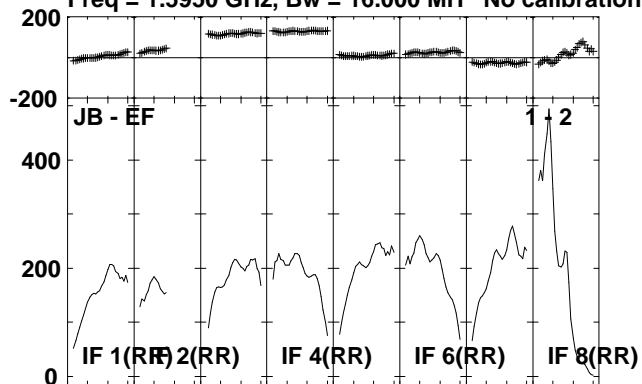

Lower frame: Milli Ampl Jy Top frame: Phas deg
Scalar averaged cross-power spectrum Several baselines displayed
Timerange: 00/11:45:01 to 00/11:51:29

Plot file version 2 created 06-JUL-2010 14:40:10
2134+004 EP064J.UVDATA.1

Freq = 1.5950 GHz, Bw = 16.000 MH No calibration applied and no bandpass applied

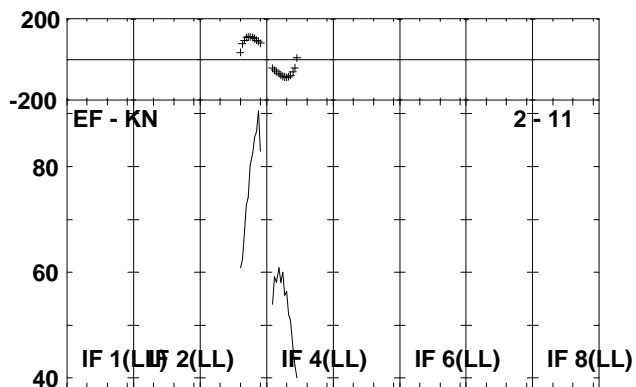
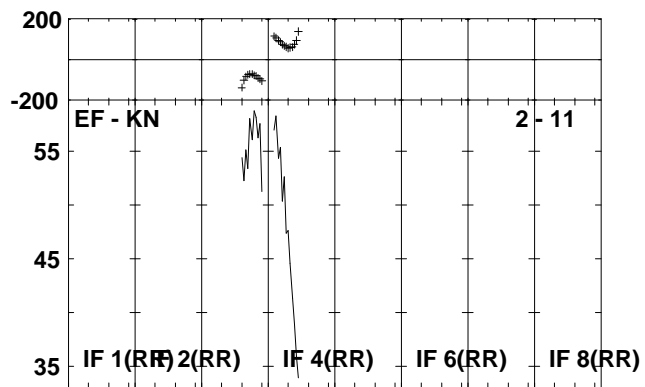
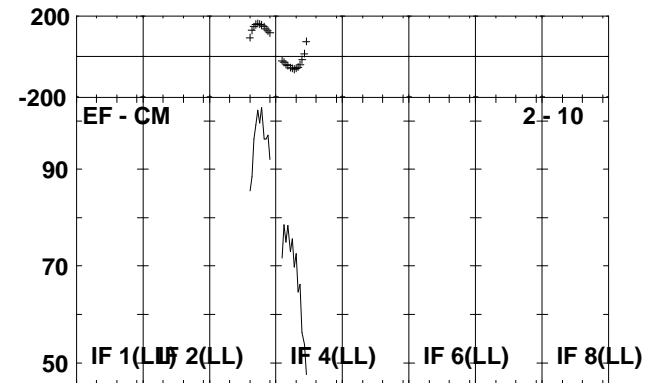
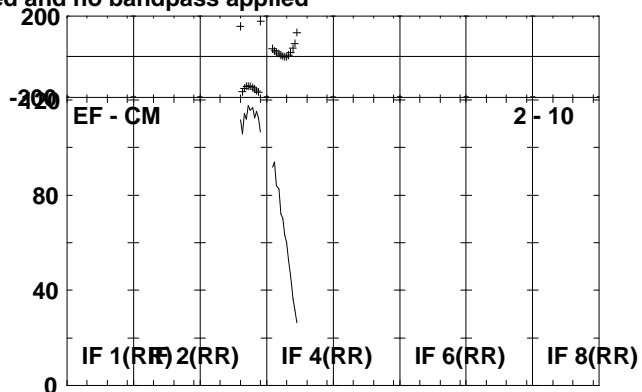
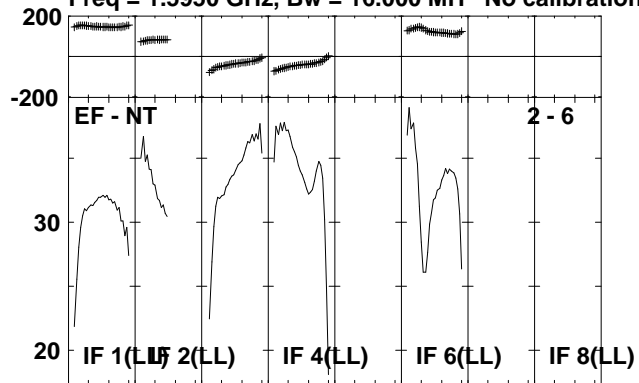

Lower frame: Milli Ampl Jy Top frame: Phas deg
Scalar averaged cross-power spectrum Several baselines displayed
Timerange: 00/11:45:01 to 00/11:51:29

Plot file version 3 created 06-JUL-2010 14:40:13

3C454.3 EP064J.UVDATA.1

Freq = 1.5950 GHz, Bw = 16.000 MH No calibration applied and no bandpass applied

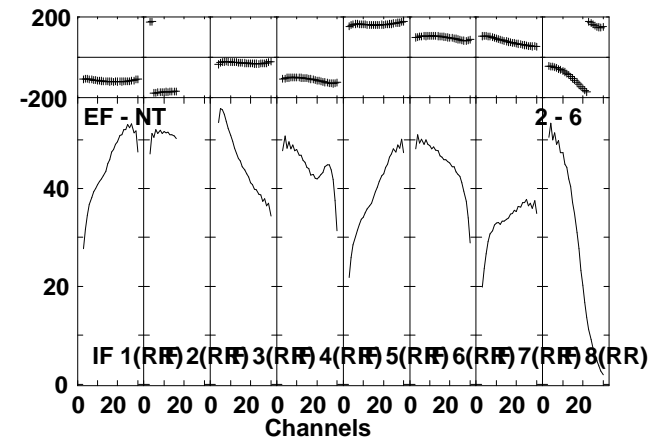
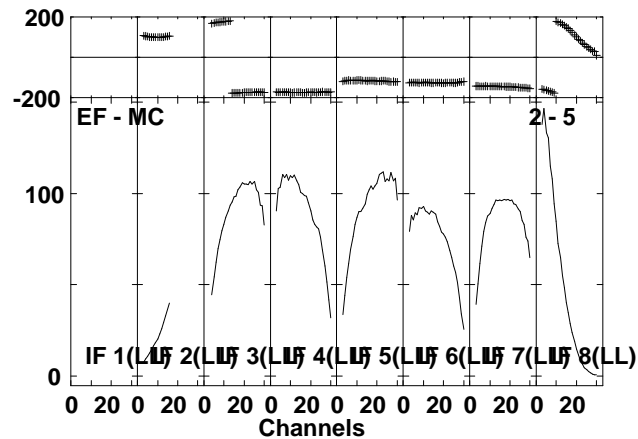
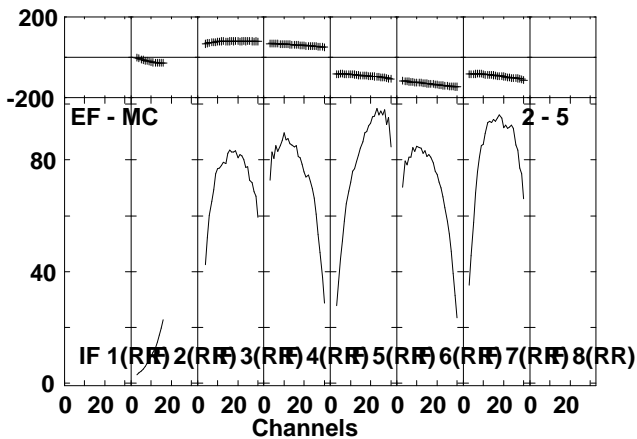
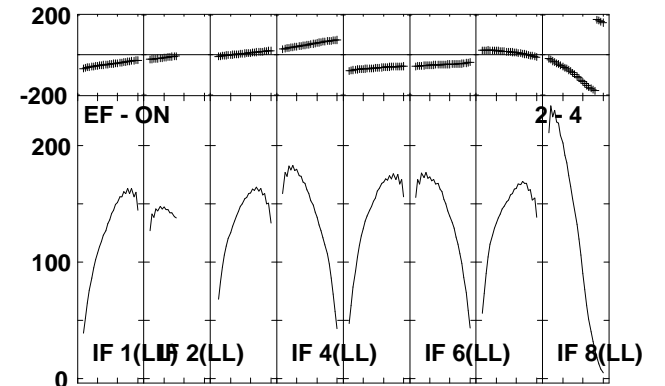
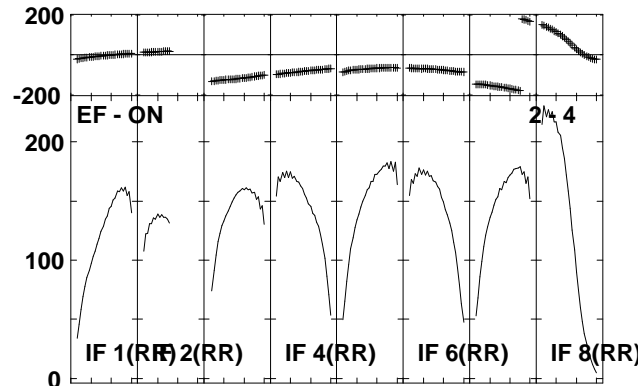
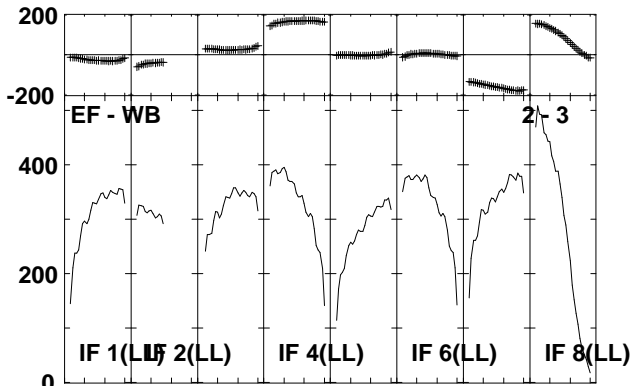
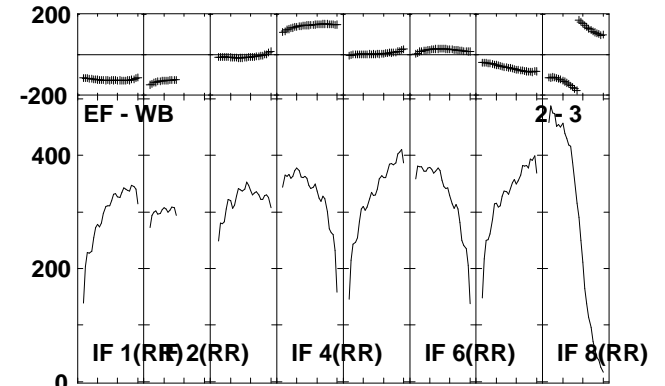
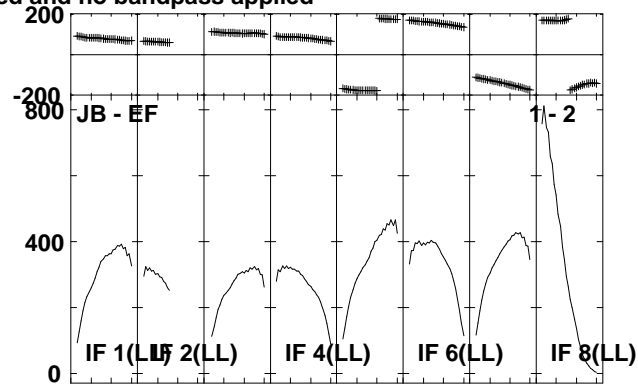
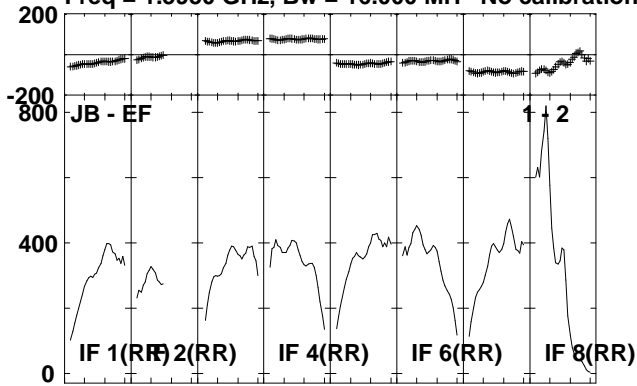

Lower frame: Milli Ampl Jy Top frame: Phas deg
Scalar averaged cross-power spectrum Several baselines displayed
Timerange: 00/11:51:33 to 00/11:57:59

Plot file version 4 created 06-JUL-2010 14:40:16

3C454.3 EP064J.UVDATA.1

Freq = 1.5950 GHz, Bw = 16.000 MH No calibration applied and no bandpass applied

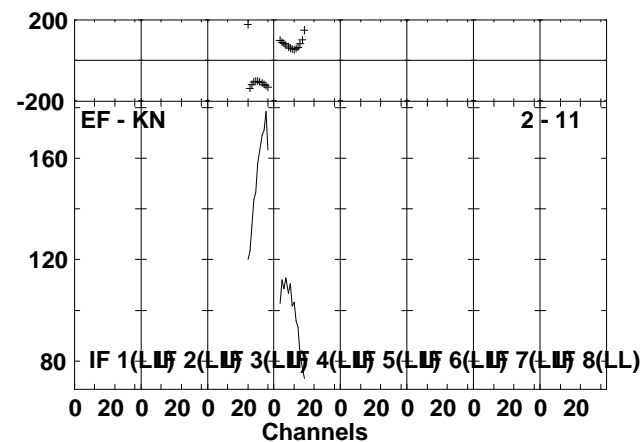
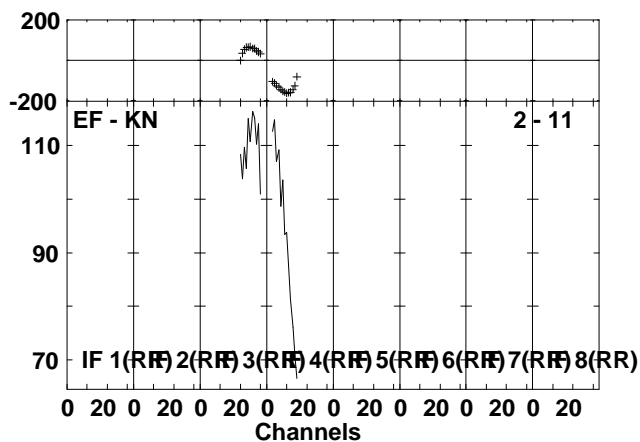
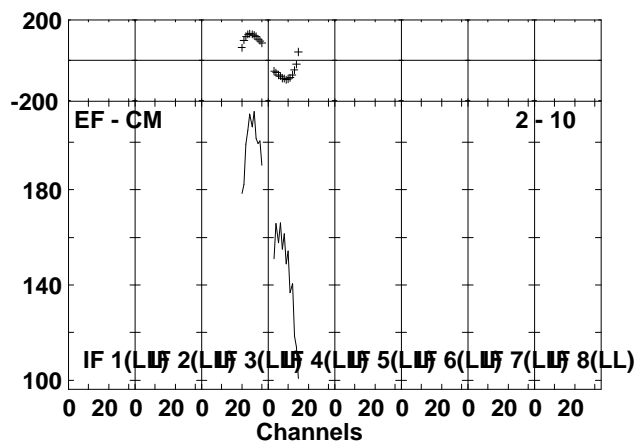
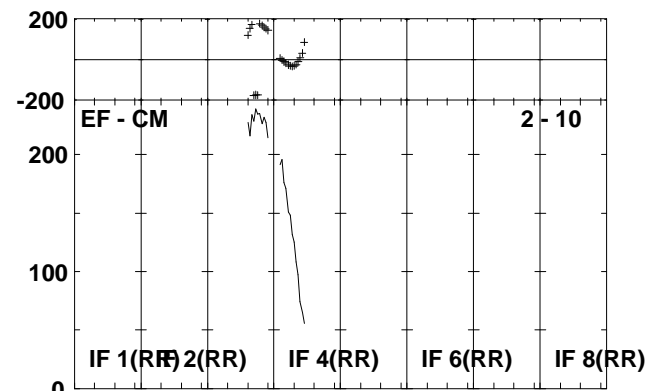
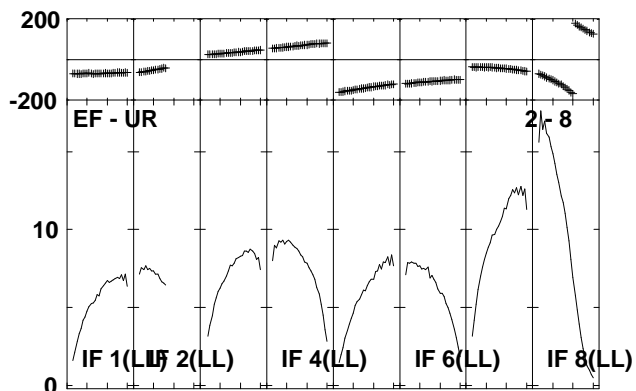
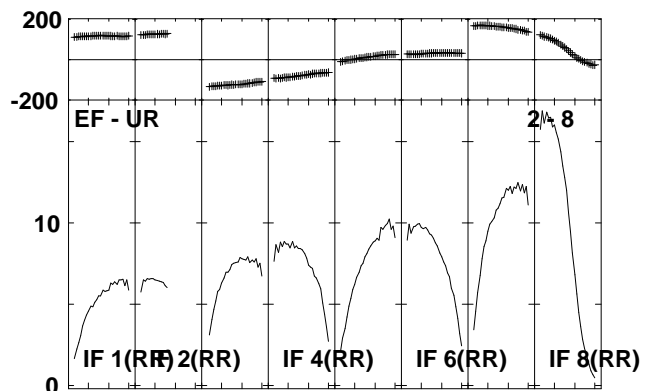
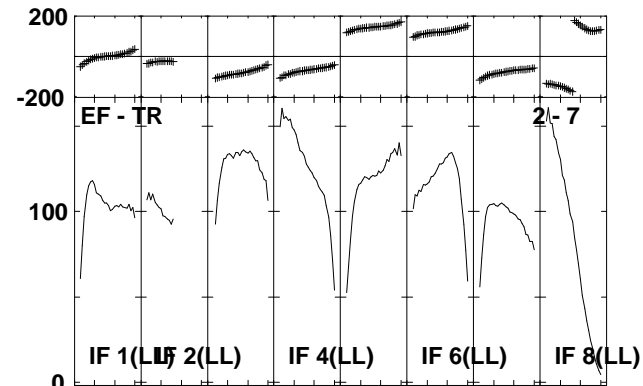
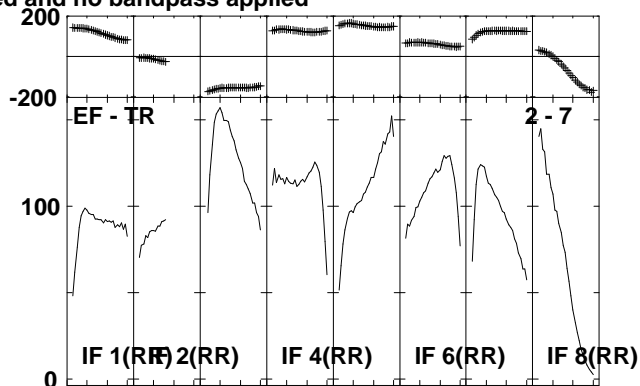
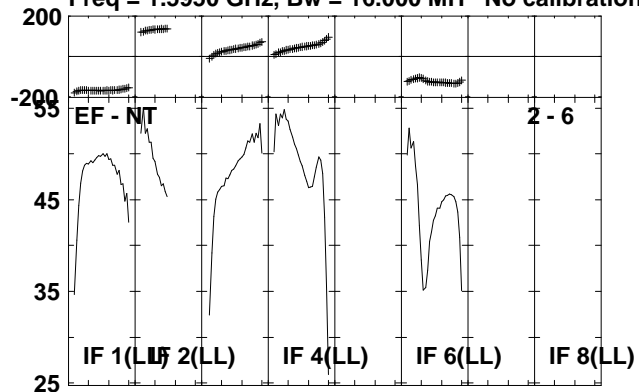

Lower frame: Milli Ampl Jy Top frame: Phas deg
Scalar averaged cross-power spectrum Several baselines displayed
Timerange: 00/11:51:33 to 00/11:57:59

Plot file version 5 created 06-JUL-2010 14:40:20

J2330+33 EP064J.UVDATA.1

Freq = 1.5950 GHz, Bw = 16.000 MH No calibration applied and no bandpass applied

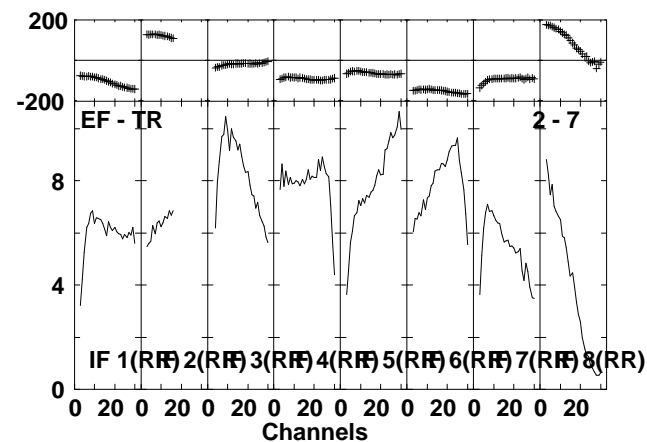
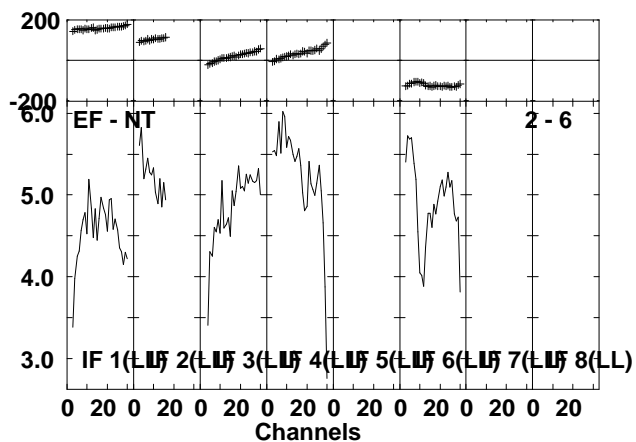
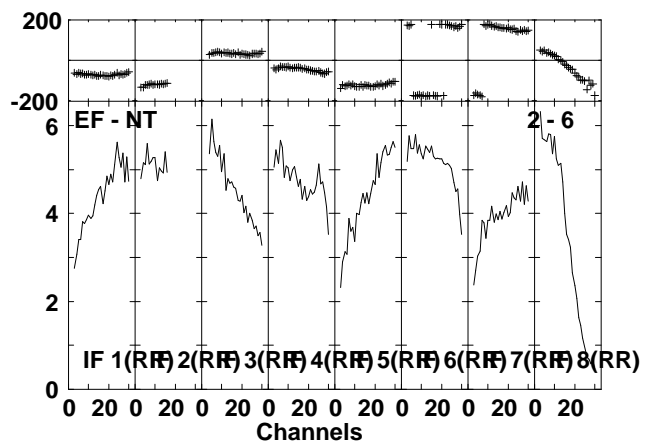
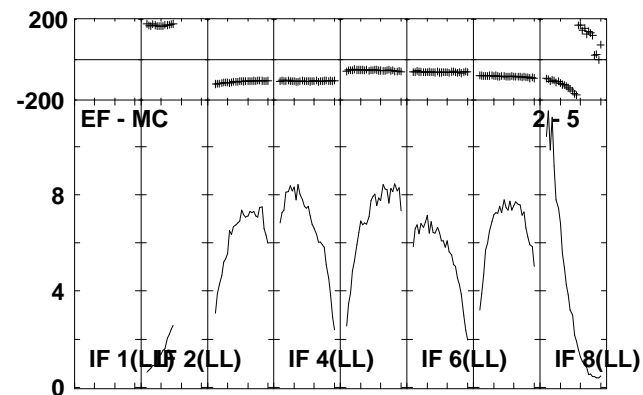
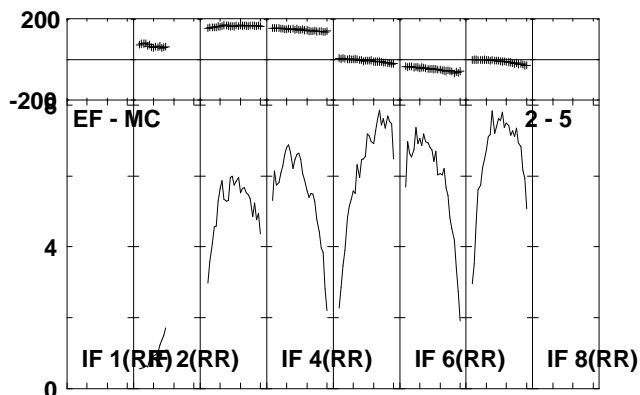
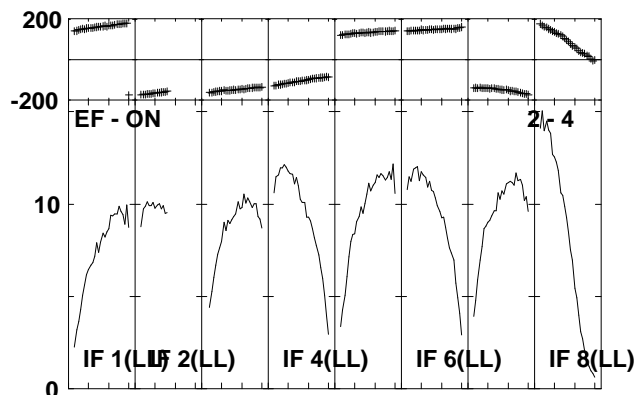
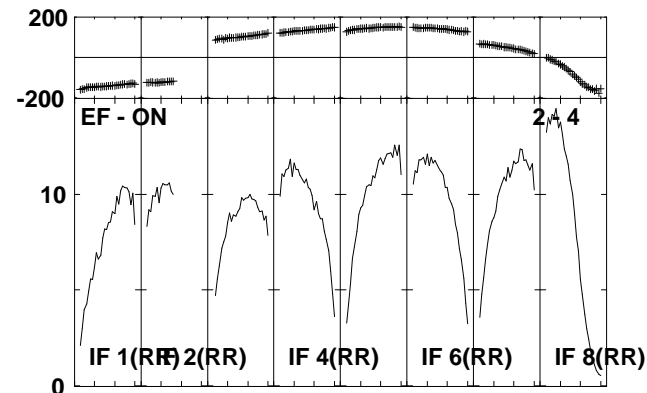
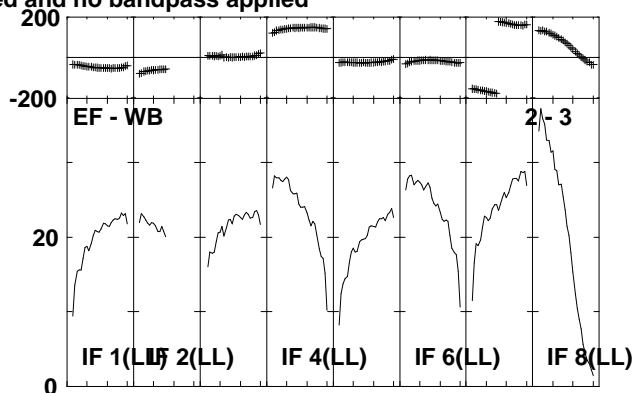
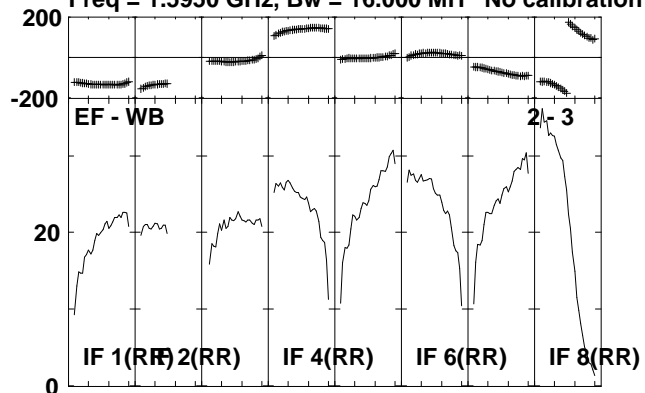

Lower frame: Milli Ampl Jy Top frame: Phas deg
Scalar averaged cross-power spectrum Several baselines displayed
Timerange: 00/11:59:01 to 00/12:00:59

Plot file version 6 created 06-JUL-2010 14:40:21
 J2330+33 EP064J.UVDATA.1

Freq = 1.5950 GHz, Bw = 16.000 MH No calibration applied and no bandpass applied

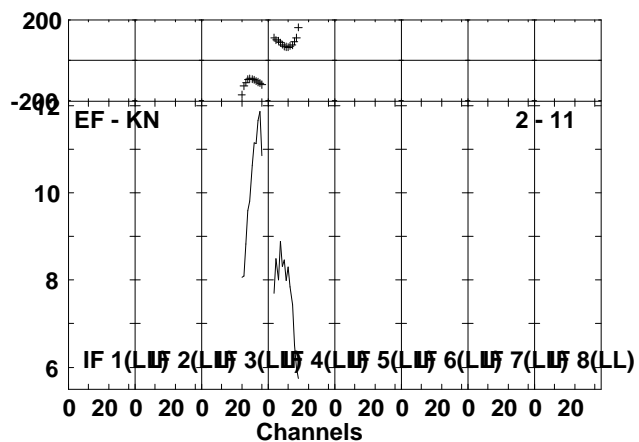
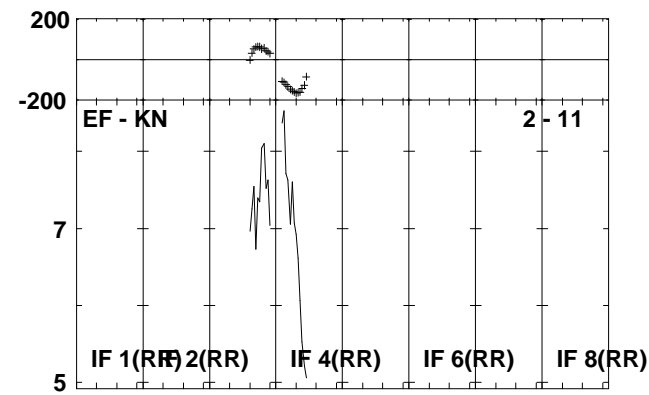
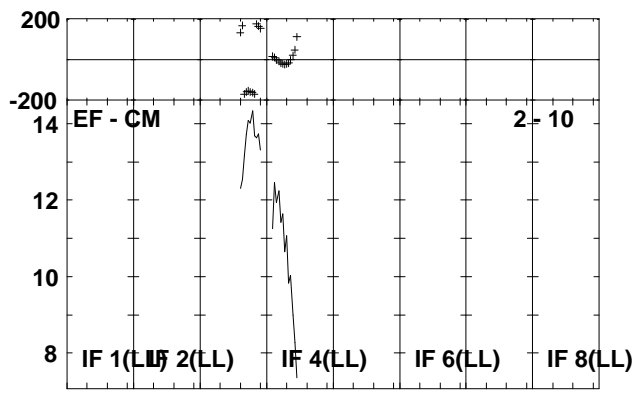
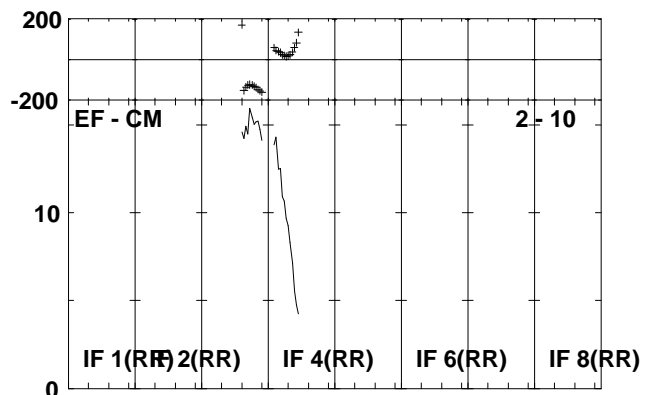
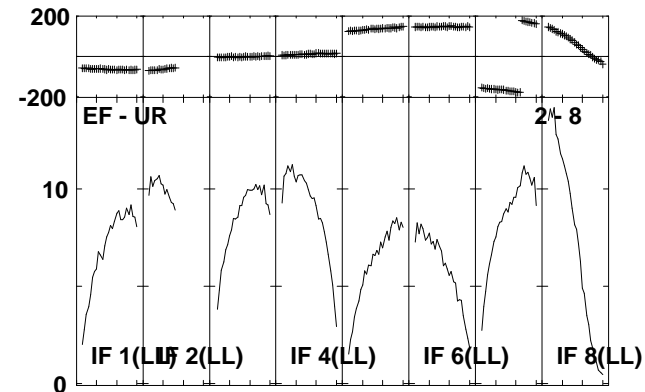
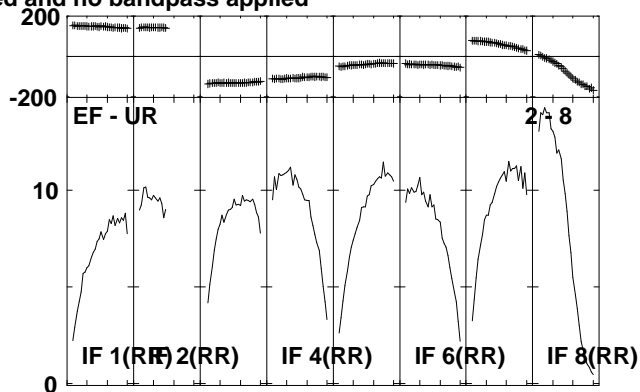
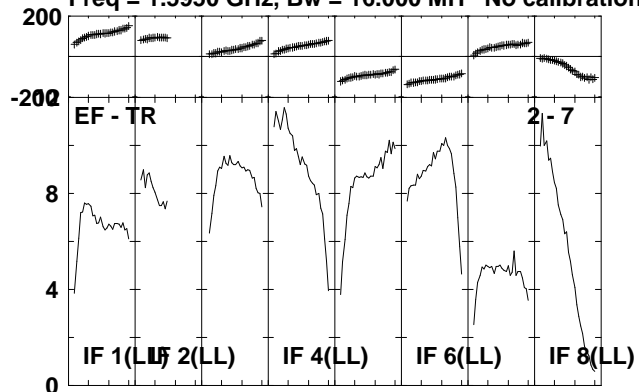

Lower frame: Milli Ampl Jy Top frame: Phas deg
 Scalar averaged cross-power spectrum Several baselines displayed
 Timerange: 00/11:59:01 to 00/12:00:59

Plot file version 7 created 06-JUL-2010 14:40:22

IRAS2336 EP064J.UVDATA.1

Freq = 1.5950 GHz, Bw = 16.000 MH No calibration applied and no bandpass applied

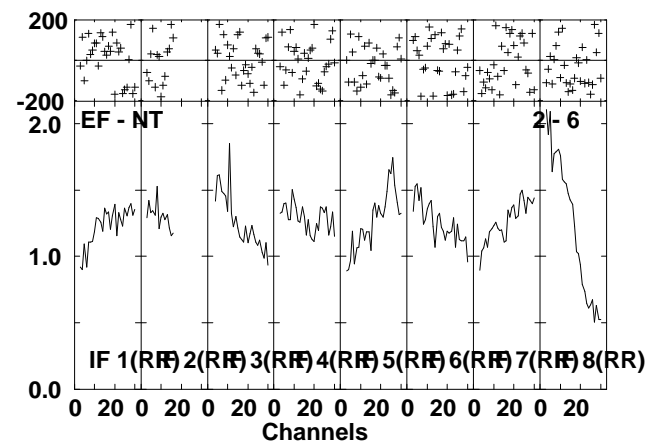
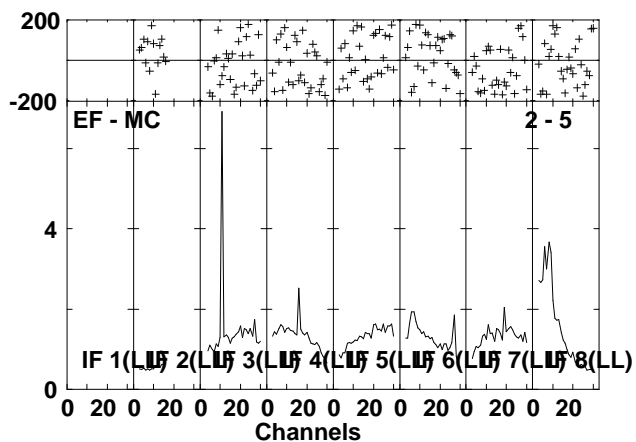
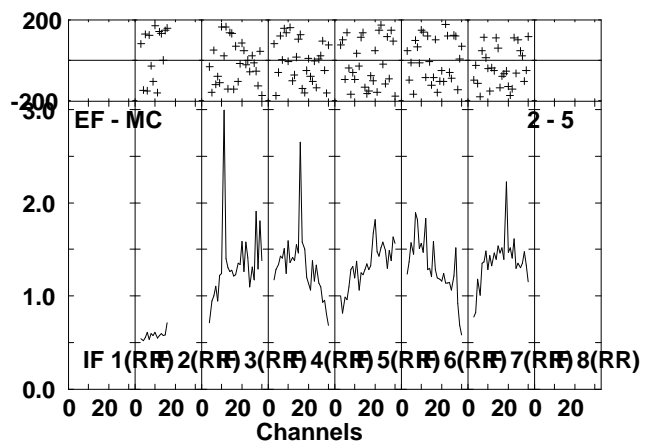
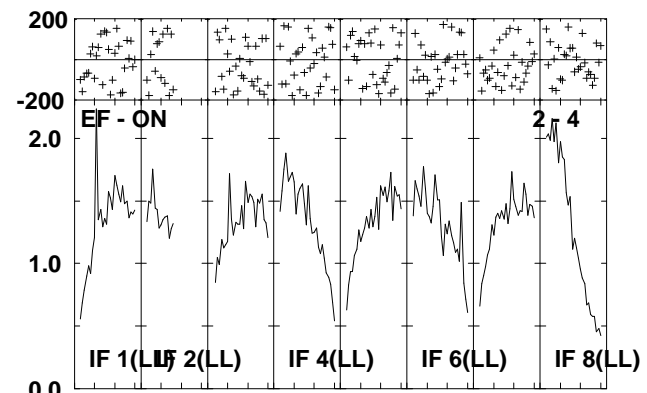
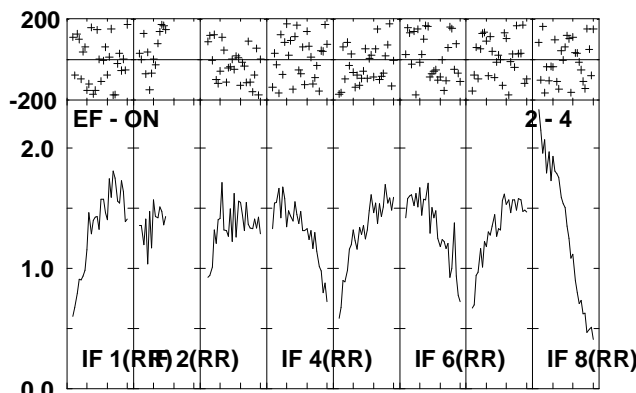
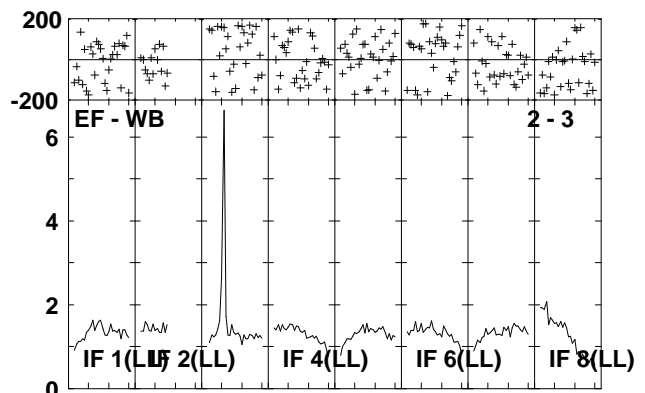
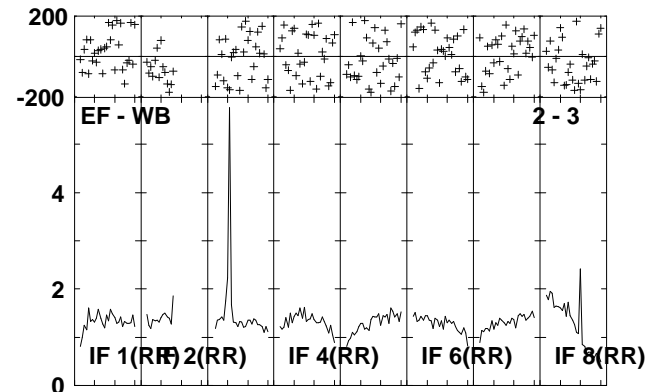
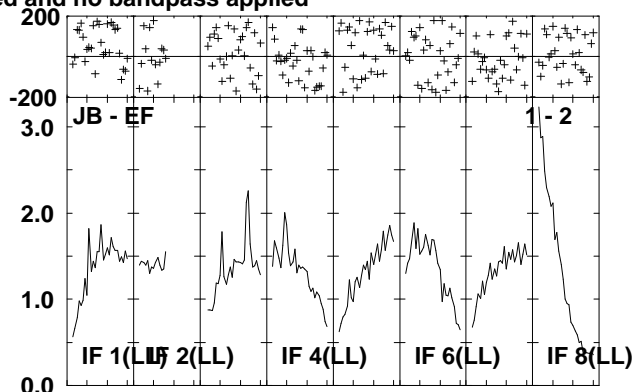
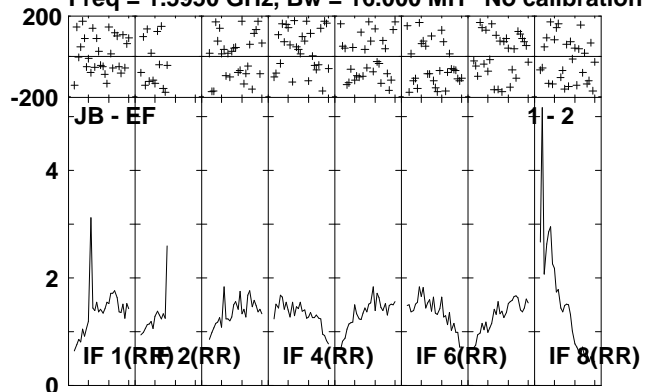

Lower frame: Milli Ampl Jy Top frame: Phas deg
Scalar averaged cross-power spectrum Several baselines displayed
Timerange: 00/12:01:01 to 00/12:04:29

Plot file version 8 created 06-JUL-2010 14:40:24

IRAS2336 EP064J.UVDATA.1

Freq = 1.5950 GHz, Bw = 16.000 MH No calibration applied and no bandpass applied

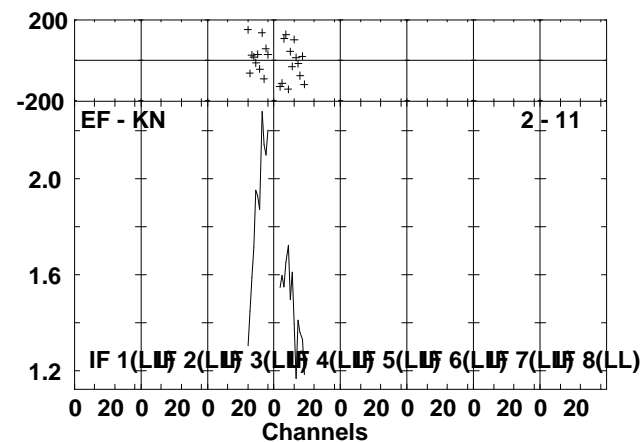
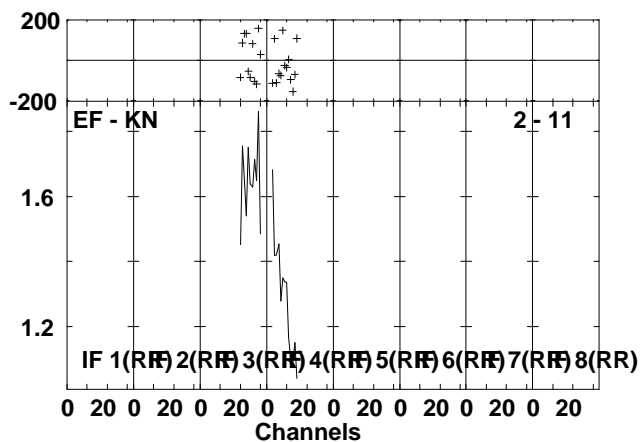
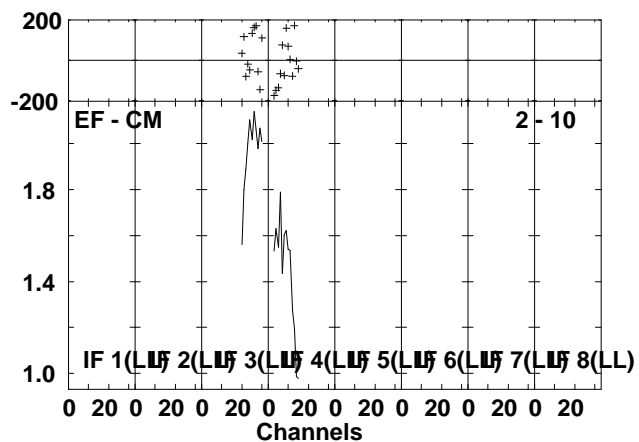
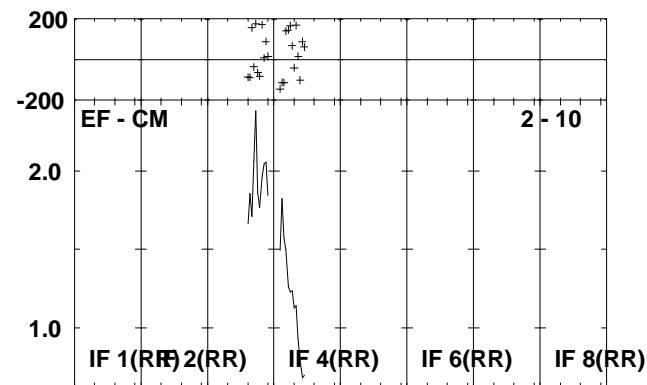
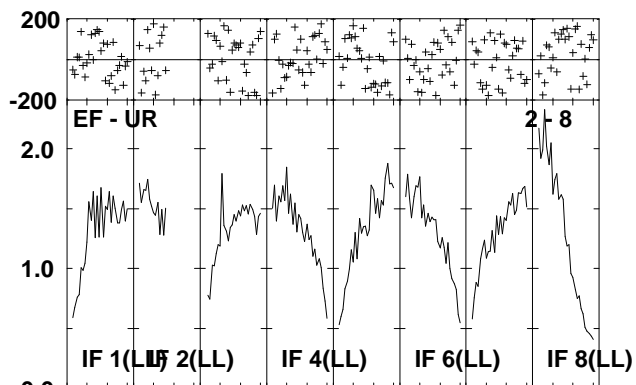
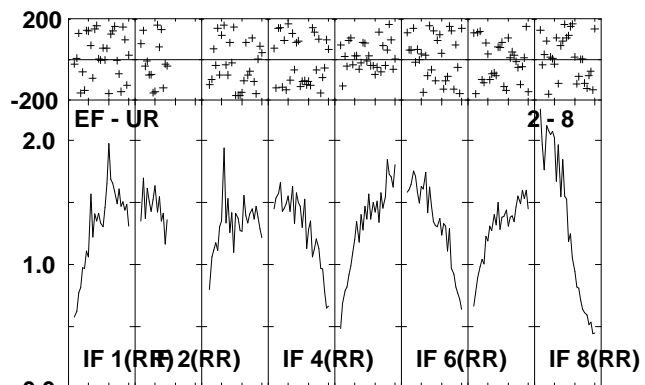
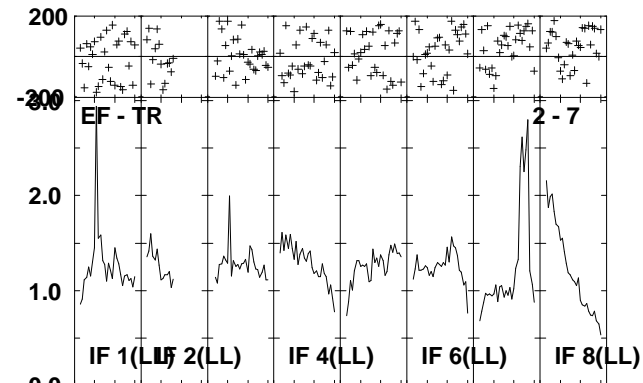
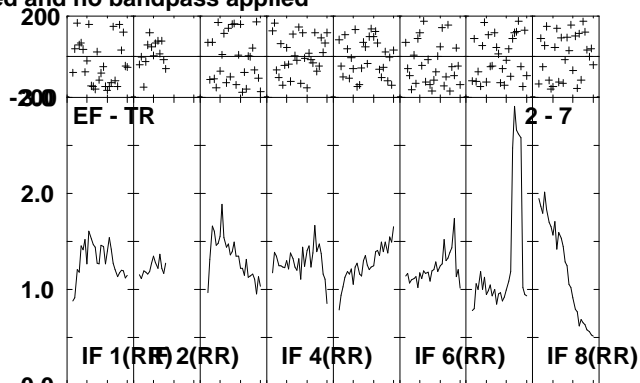
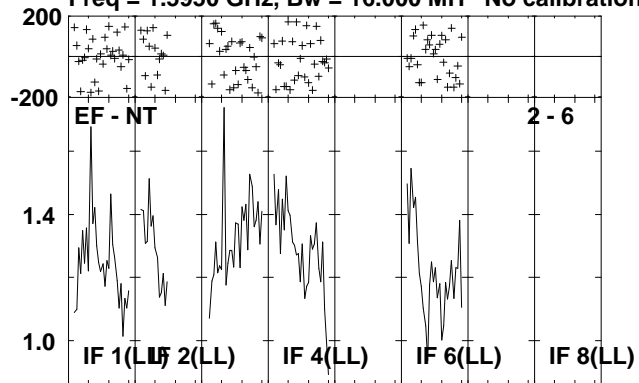

Lower frame: Milli Ampl Jy Top frame: Phas deg
Scalar averaged cross-power spectrum Several baselines displayed
Timerange: 00/12:01:01 to 00/12:04:29

Plot file version 9 created 06-JUL-2010 14:40:26

J2330+33 EP064J.UVDATA.1

Freq = 1.5950 GHz, Bw = 16.000 MH No calibration applied and no bandpass applied

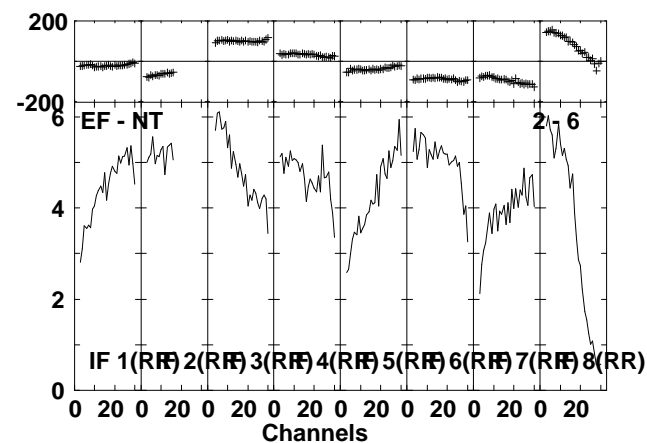
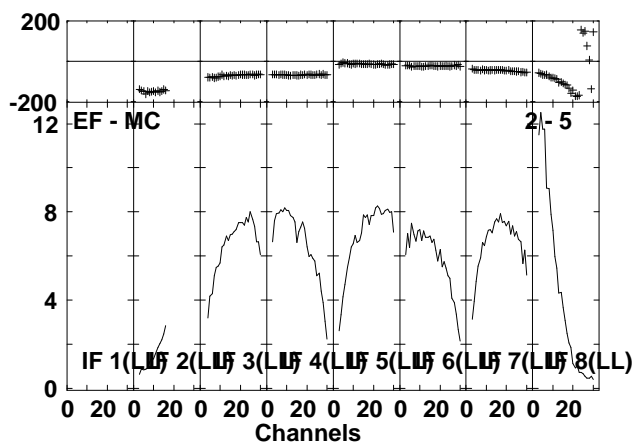
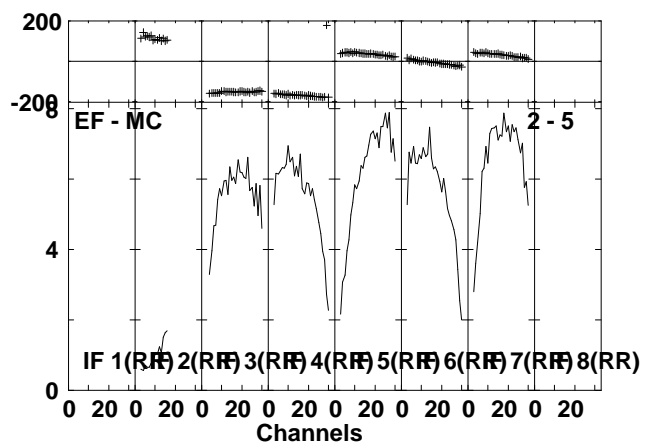
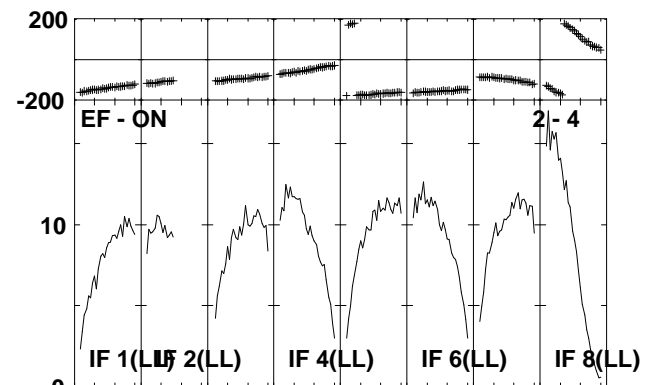
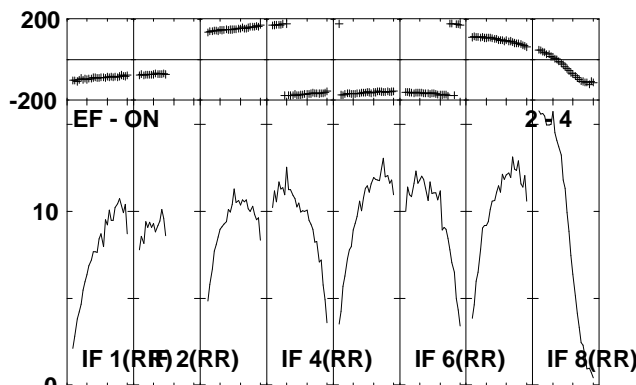
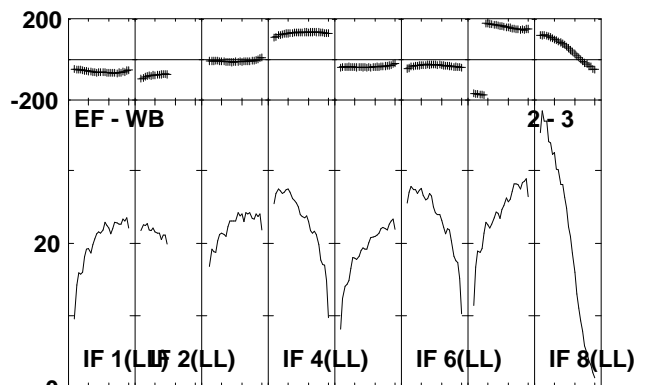
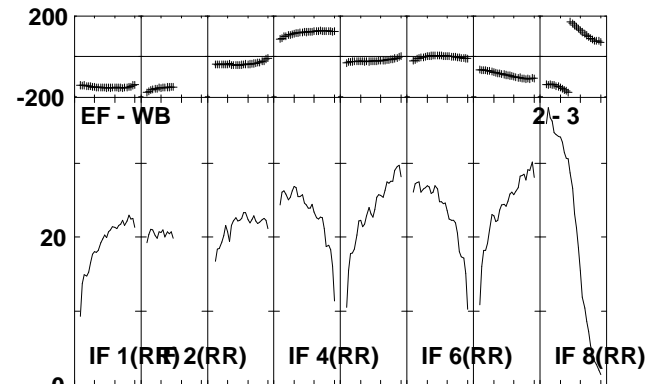
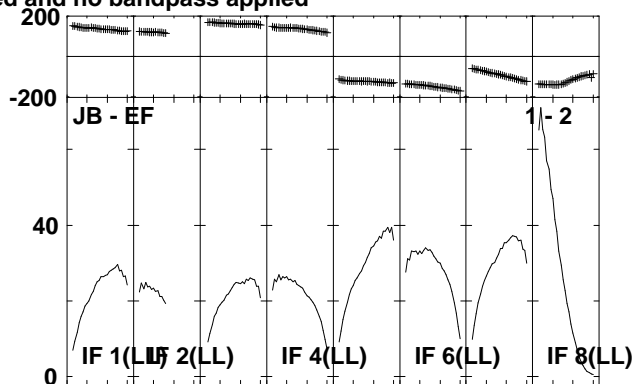
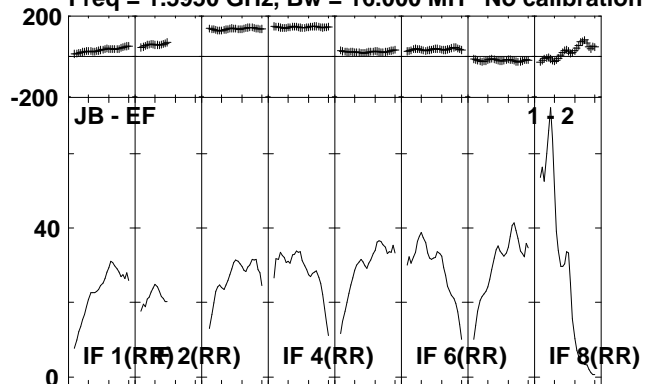

Lower frame: Milli Ampl Jy Top frame: Phas deg
Scalar averaged cross-power spectrum Several baselines displayed
Timerange: 00/12:04:31 to 00/12:06:09

Plot file version 10 created 06-JUL-2010 14:40:27

J2330+33 EP064J.UVDATA.1

Freq = 1.5950 GHz, Bw = 16.000 MH No calibration applied and no bandpass applied

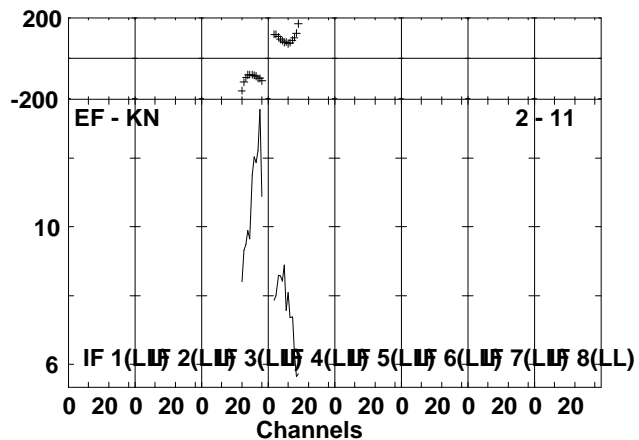
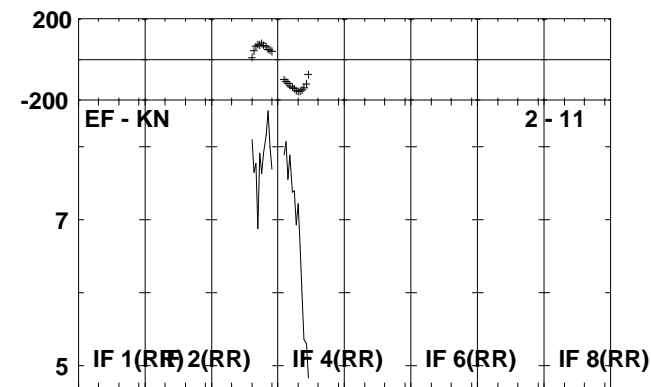
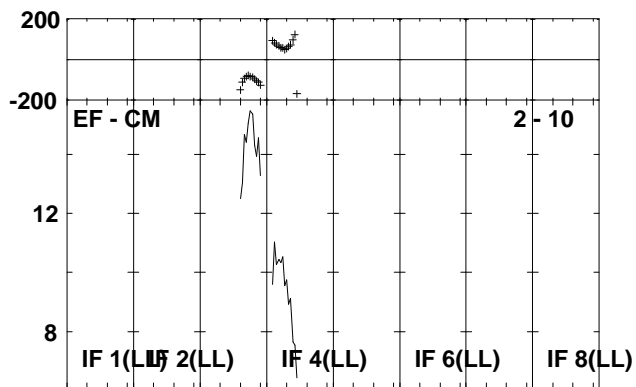
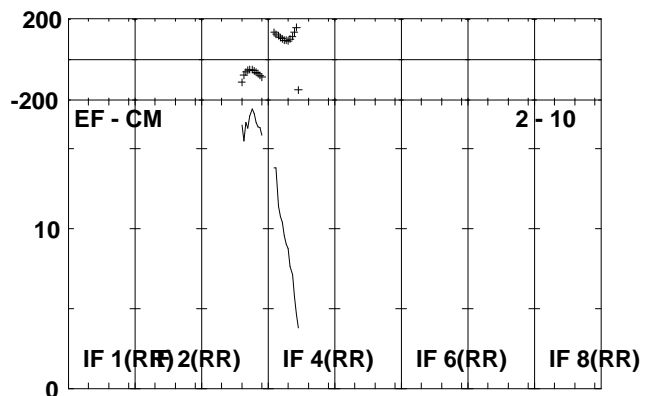
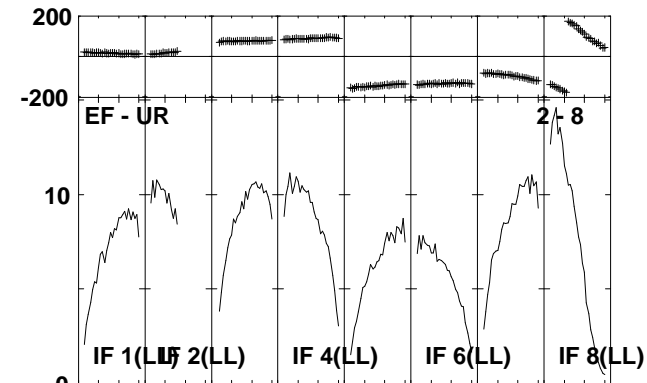
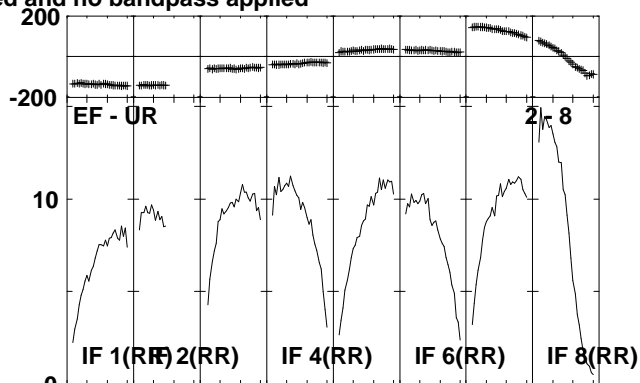
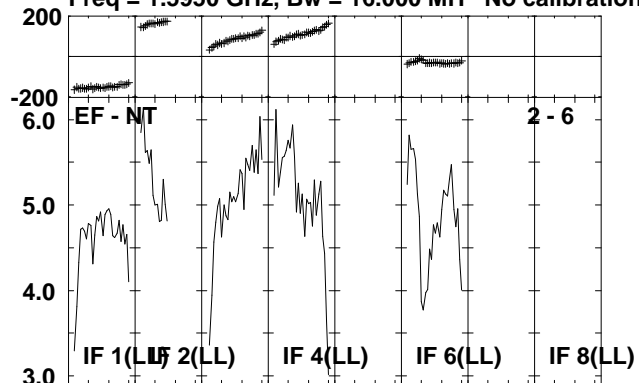

Lower frame: Milli Ampl Jy Top frame: Phas deg
Scalar averaged cross-power spectrum Several baselines displayed
Timerange: 00/12:04:31 to 00/12:06:09

Plot file version 11 created 06-JUL-2010 14:40:28

IRAS2336 EP064J.UVDATA.1

Freq = 1.5950 GHz, Bw = 16.000 MH No calibration applied and no bandpass applied

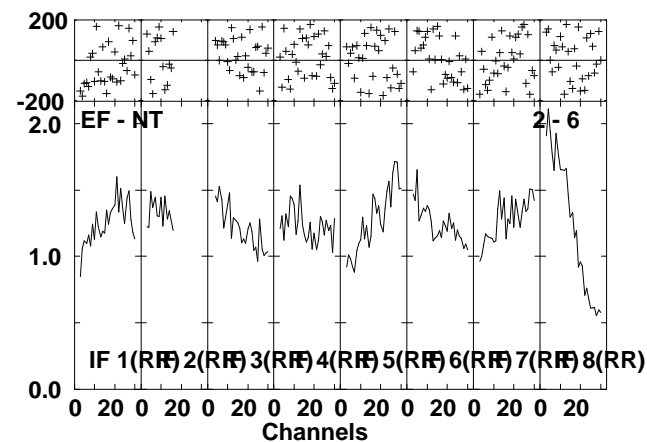
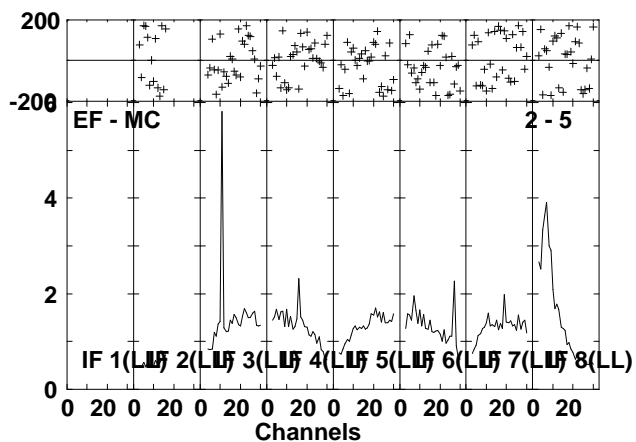
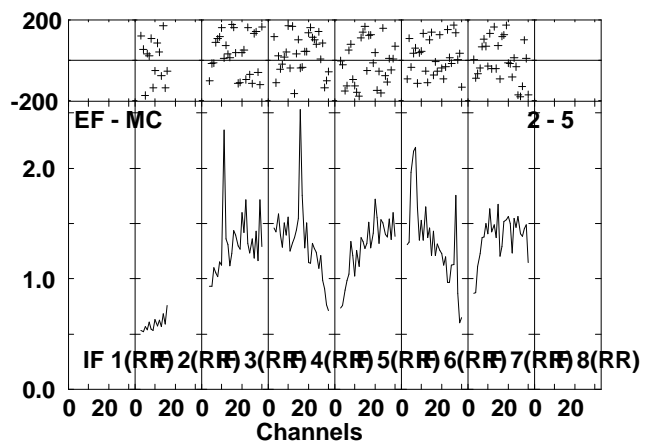
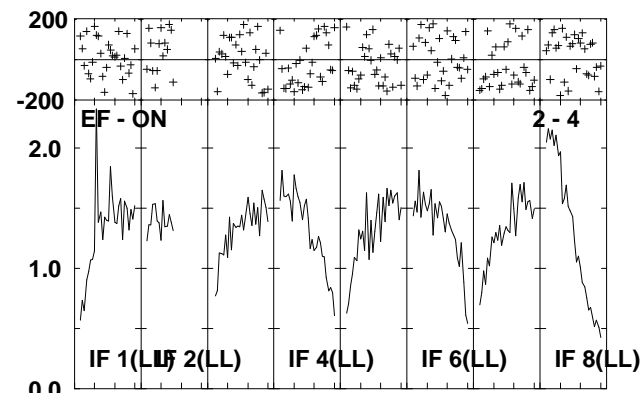
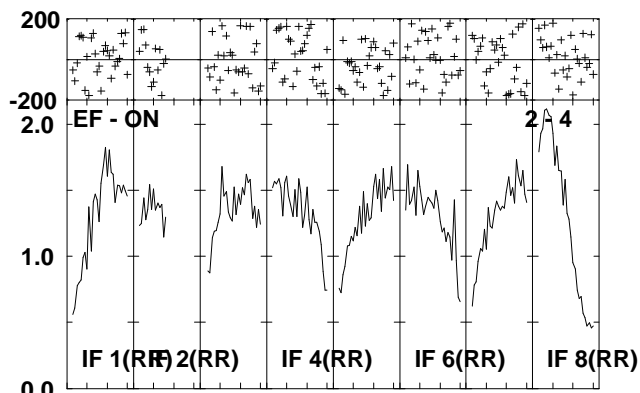
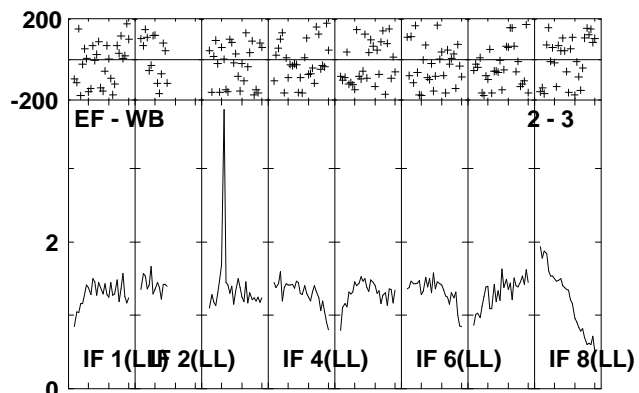
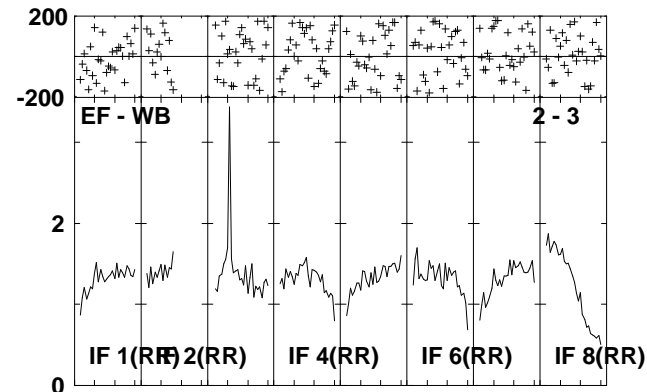
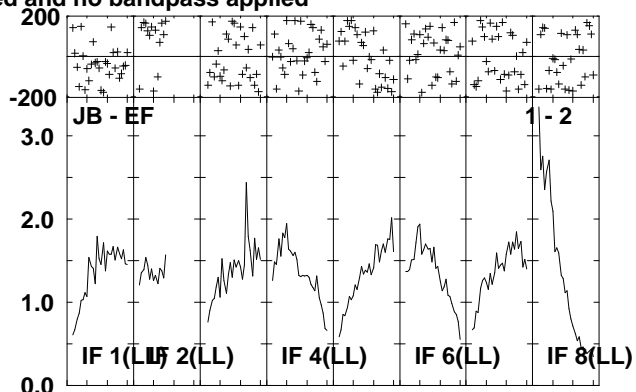
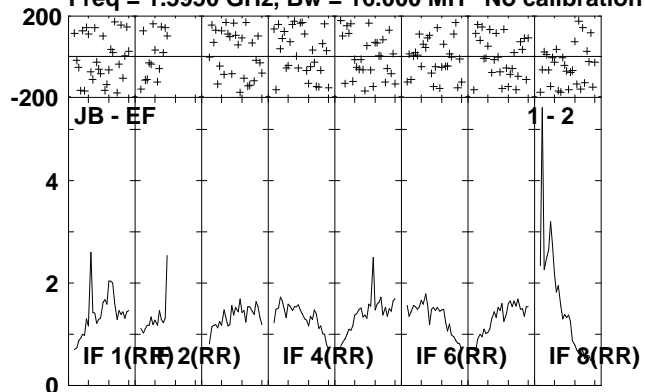

Lower frame: Milli Ampl Jy Top frame: Phas deg
Scalar averaged cross-power spectrum Several baselines displayed
Timerange: 00/12:06:11 to 00/12:08:59

Plot file version 12 created 06-JUL-2010 14:40:29

IRAS2336 EP064J.UVDATA.1

Freq = 1.5950 GHz, Bw = 16.000 MH No calibration applied and no bandpass applied

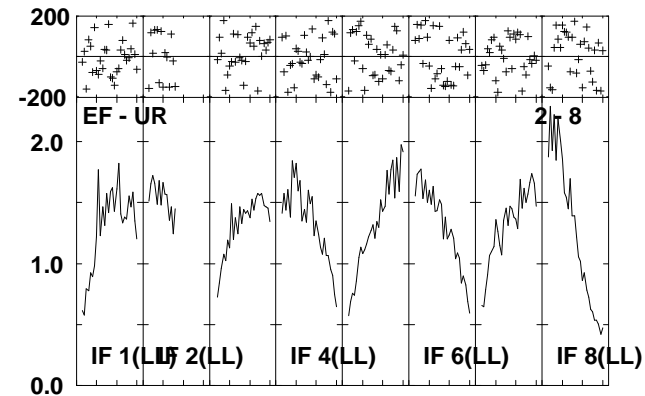
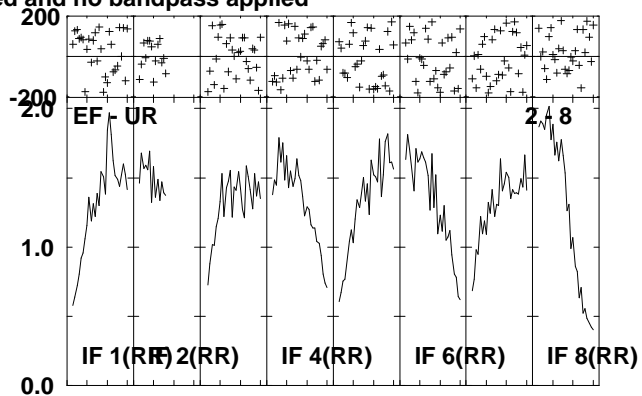
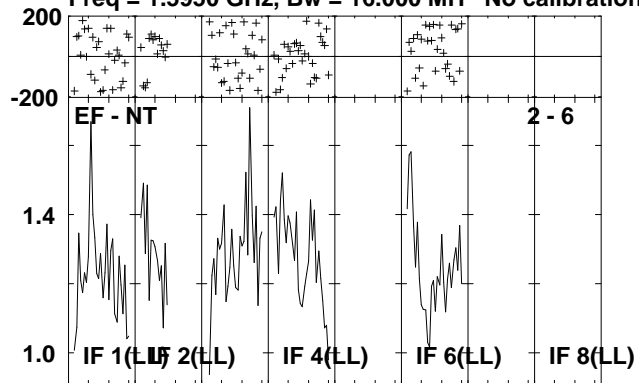

Lower frame: Milli Ampl Jy Top frame: Phas deg
Scalar averaged cross-power spectrum Several baselines displayed
Timerange: 00/12:06:11 to 00/12:08:59

Plot file version 13 created 06-JUL-2010 14:40:30

J2330+33 EP064J.UVDATA.1

Freq = 1.5950 GHz, Bw = 16.000 MH No calibration applied and no bandpass applied

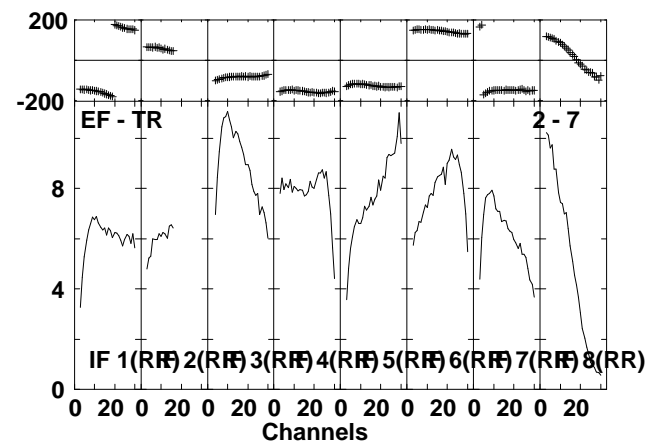
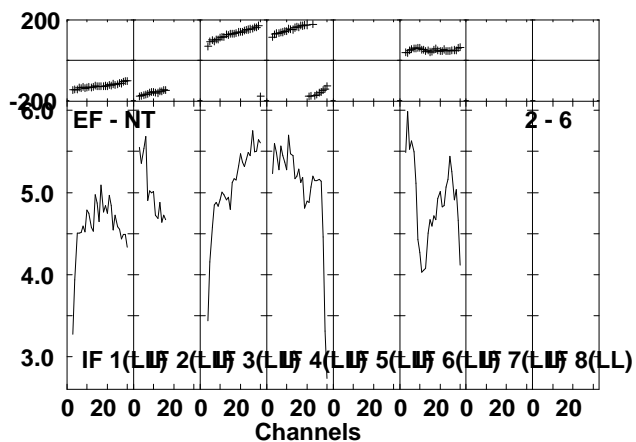
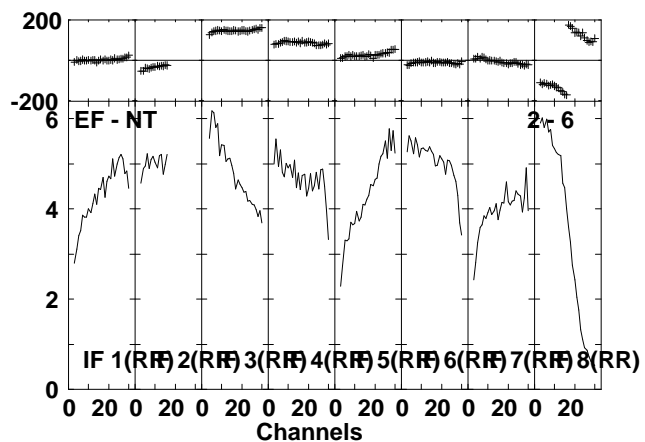
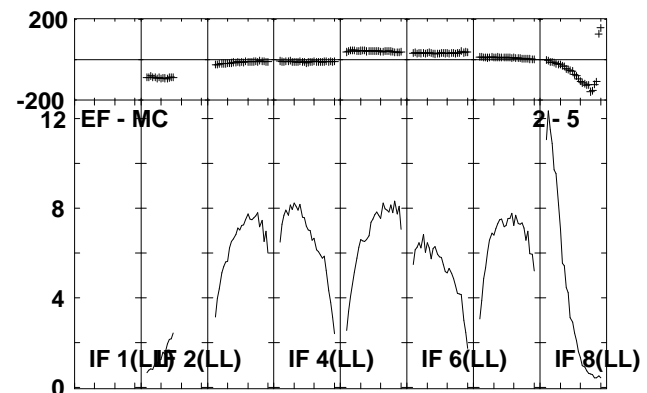
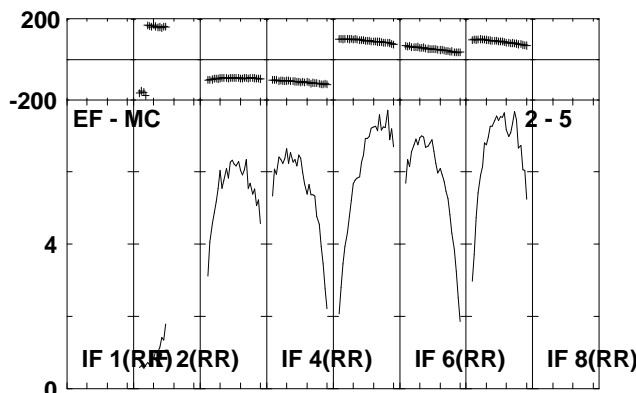
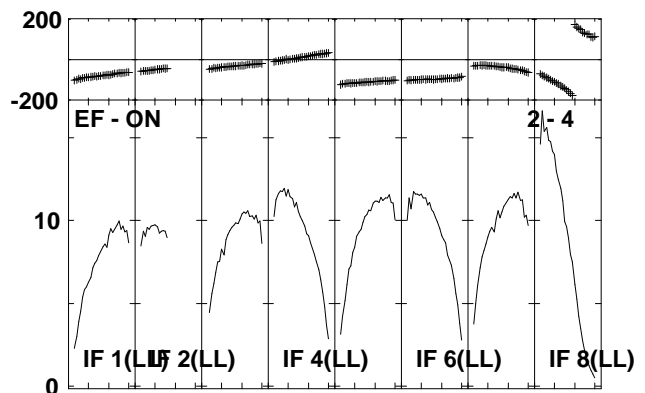
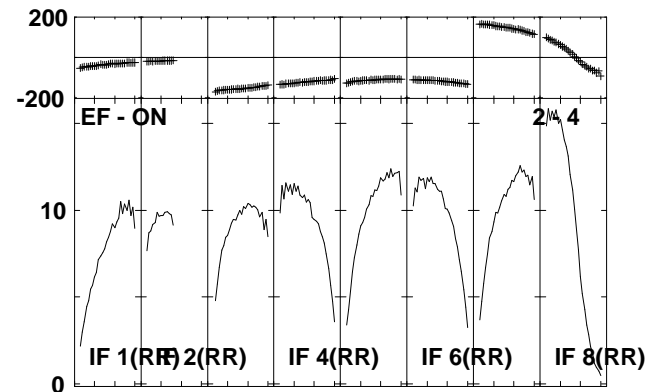
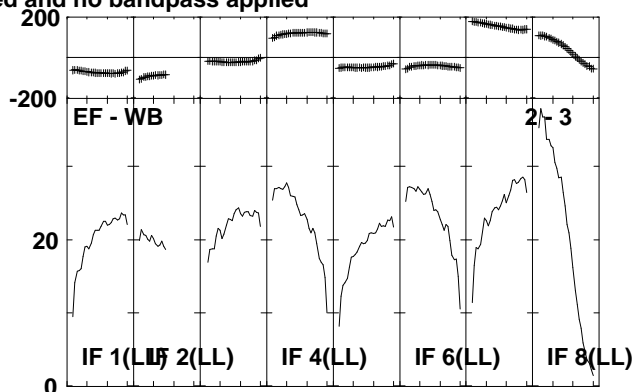
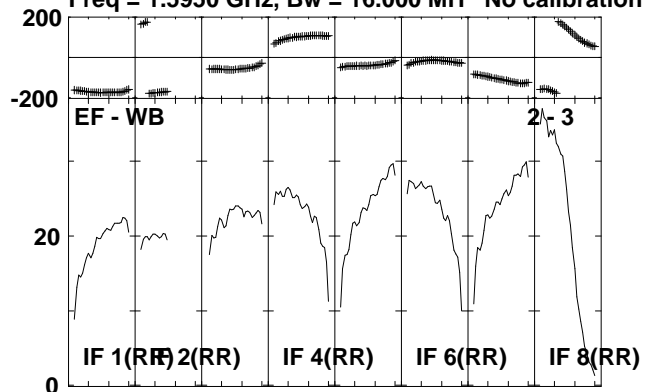

Lower frame: Milli Ampl Jy Top frame: Phas deg
Scalar averaged cross-power spectrum Several baselines displayed
Timerange: 00/12:10:41 to 00/12:12:19

Plot file version 14 created 06-JUL-2010 14:40:31

J2330+33 EP064J.UVDATA.1

Freq = 1.5950 GHz, Bw = 16.000 MH No calibration applied and no bandpass applied

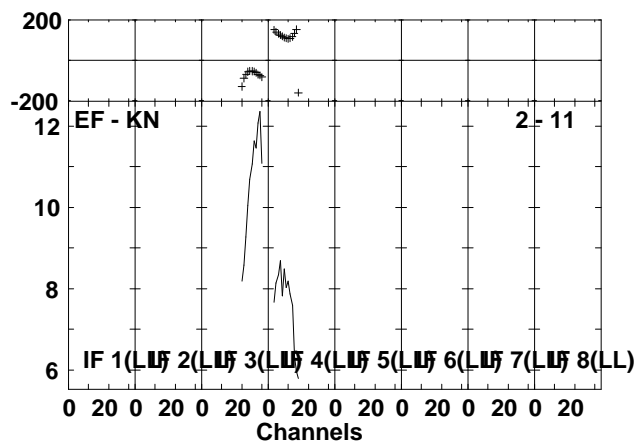
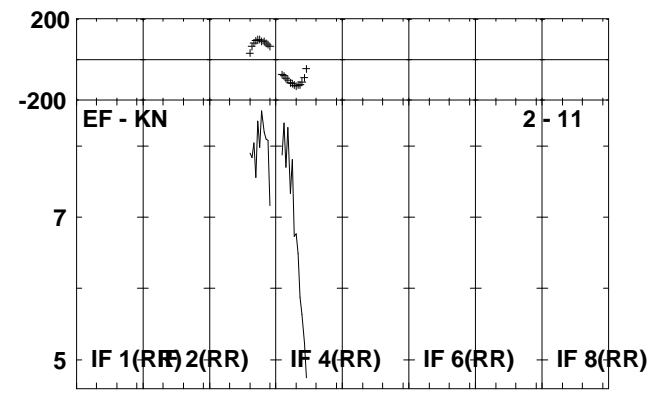
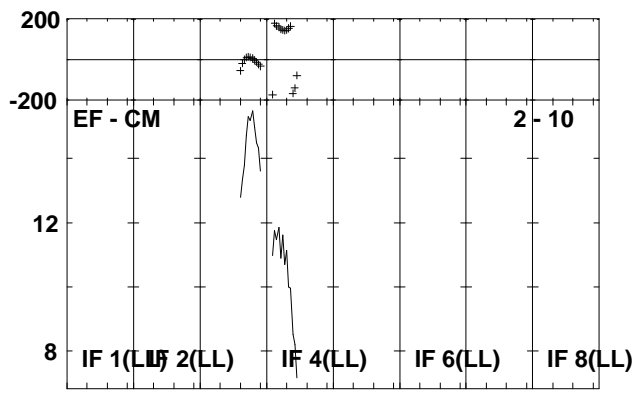
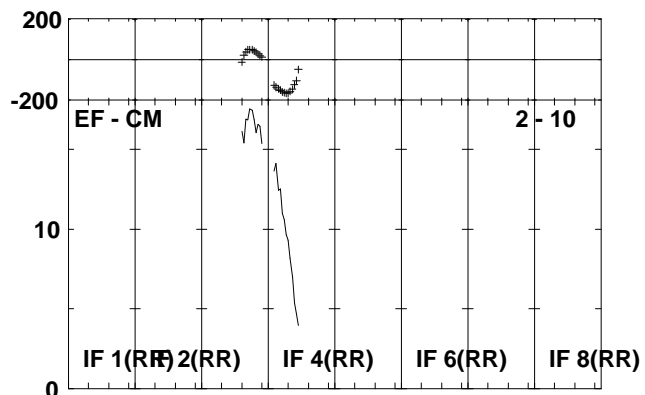
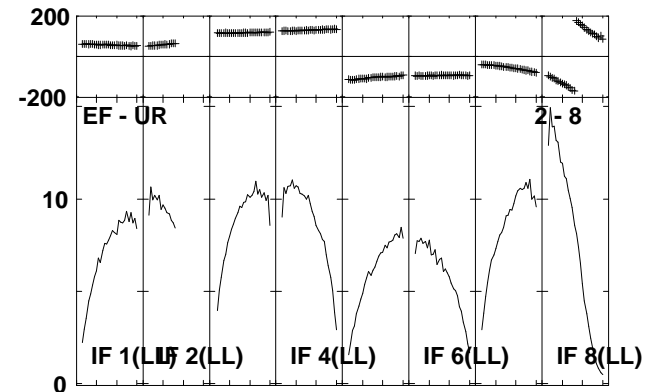
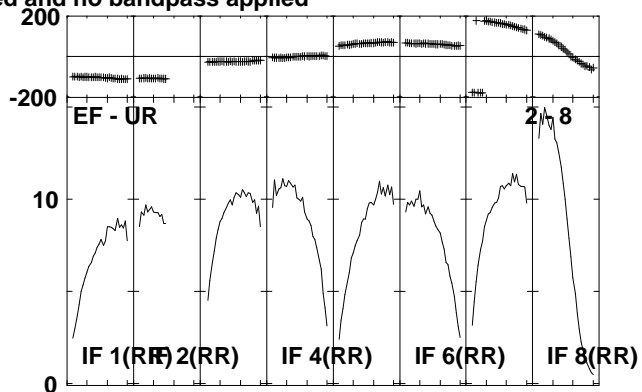
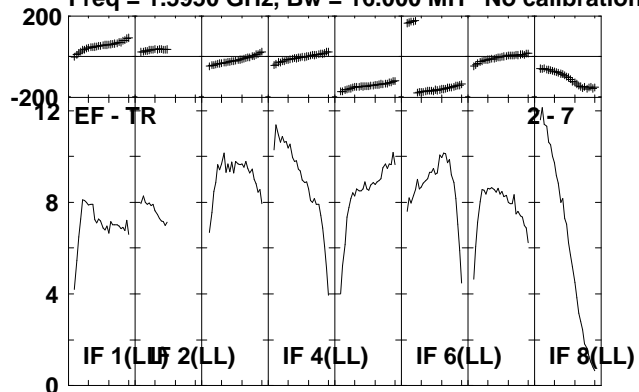

Lower frame: Milli Ampl Jy Top frame: Phas deg
Scalar averaged cross-power spectrum Several baselines displayed
Timerange: 00/12:10:41 to 00/12:12:19

Plot file version 15 created 06-JUL-2010 14:40:32

IRAS2336 EP064J.UVDATA.1

Freq = 1.5950 GHz, Bw = 16.000 MH No calibration applied and no bandpass applied

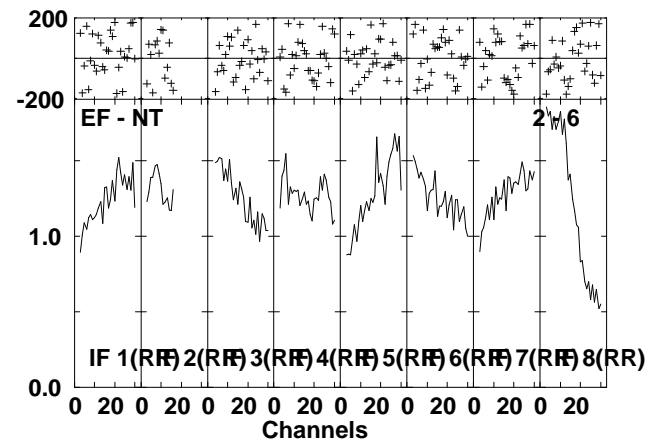
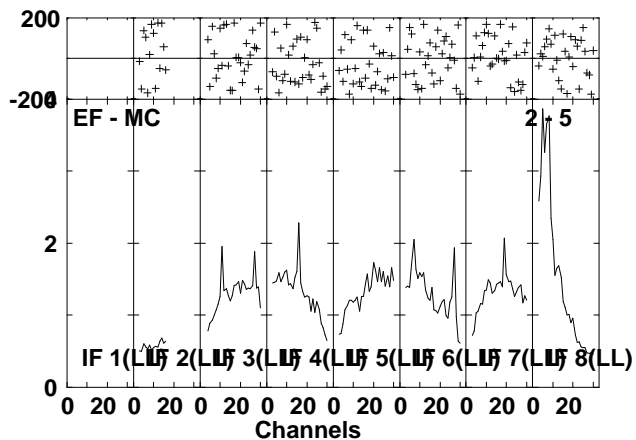
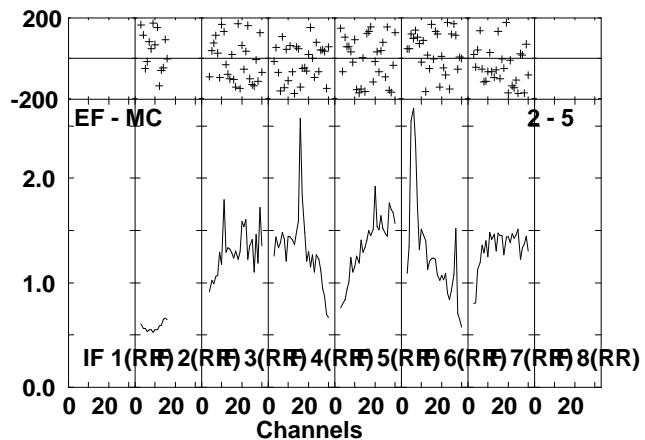
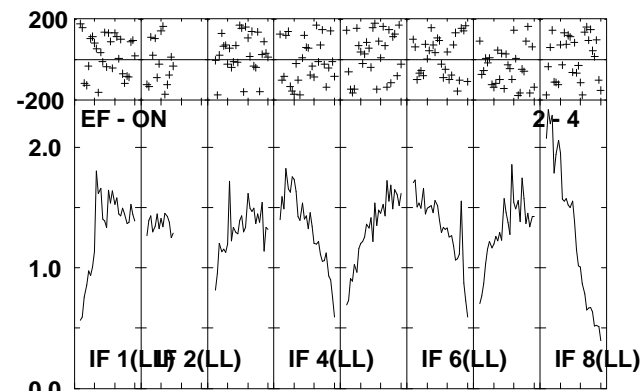
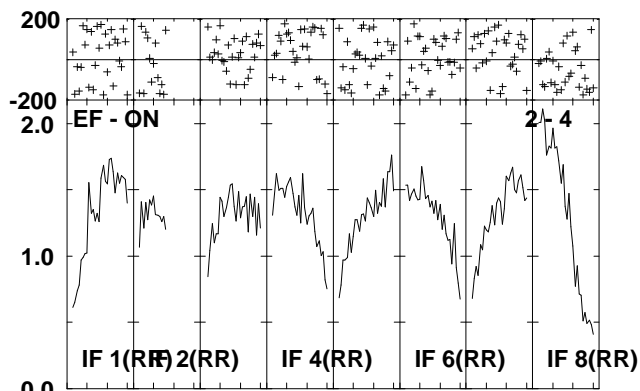
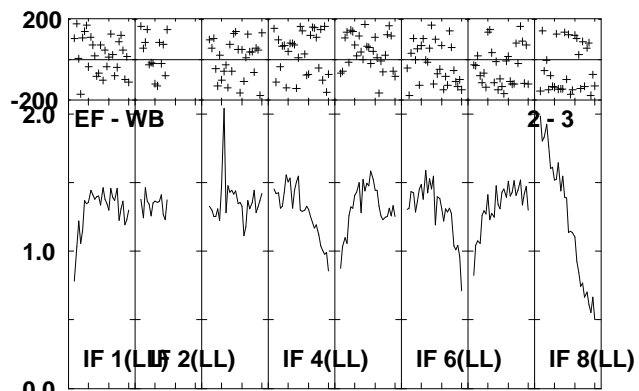
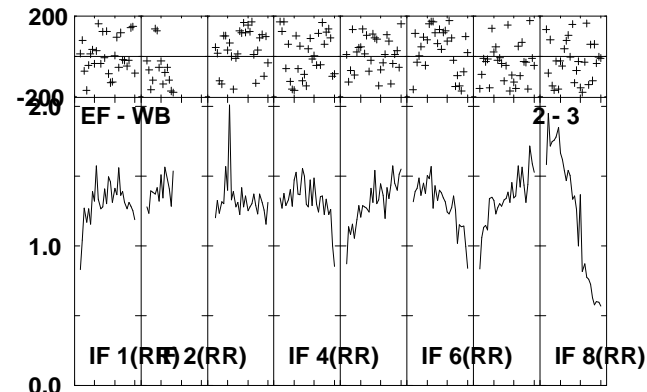
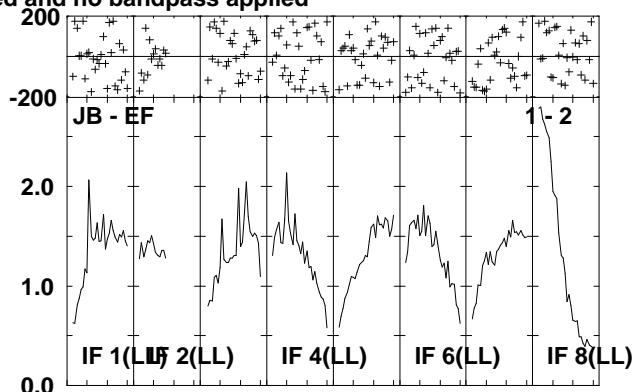
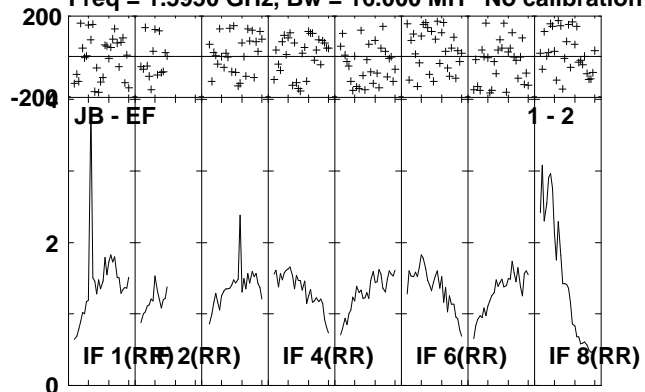

Lower frame: Milli Ampl Jy Top frame: Phas deg
Scalar averaged cross-power spectrum Several baselines displayed
Timerange: 00/12:12:21 to 00/12:15:49

Plot file version 16 created 06-JUL-2010 14:40:34

IRAS2336 EP064J.UVDATA.1

Freq = 1.5950 GHz, Bw = 16.000 MH No calibration applied and no bandpass applied

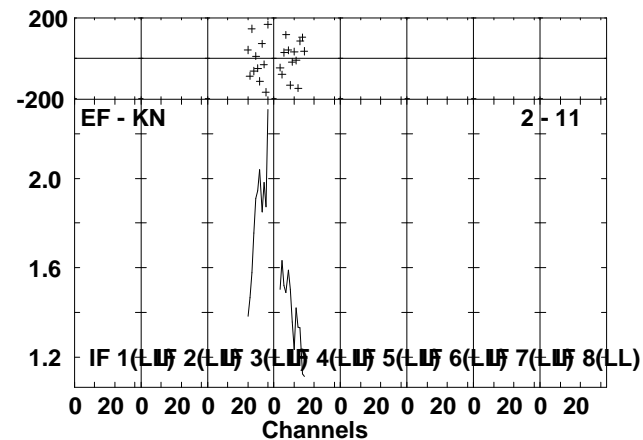
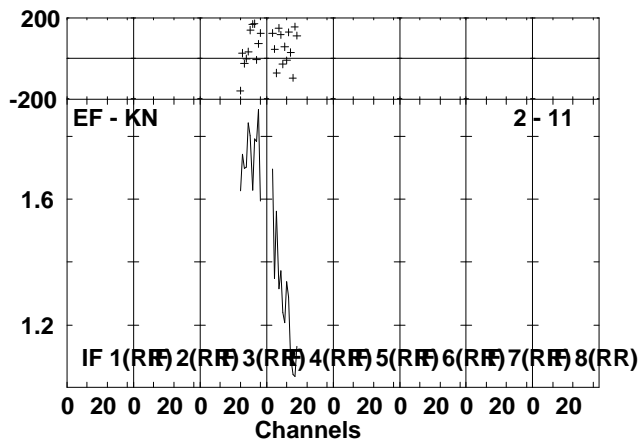
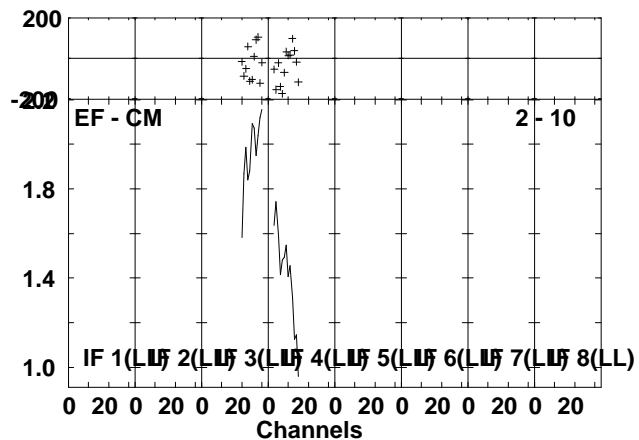
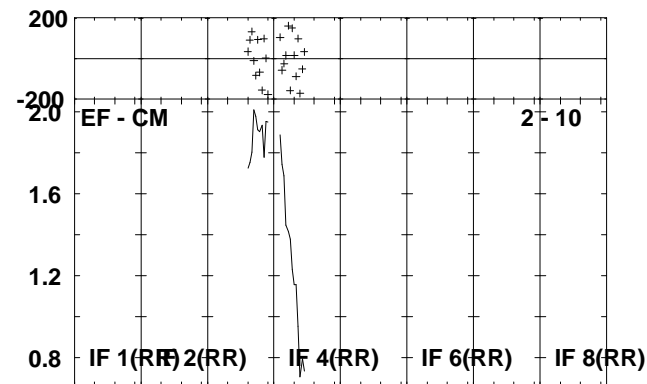
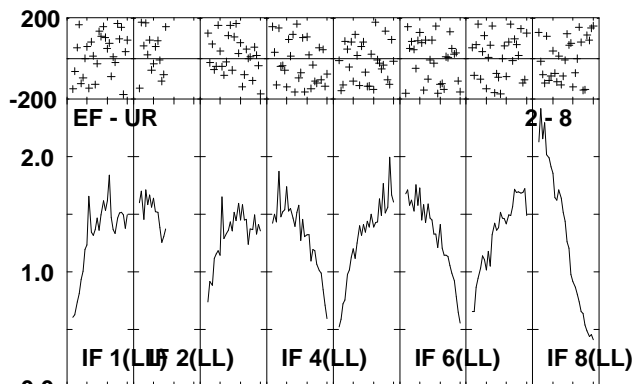
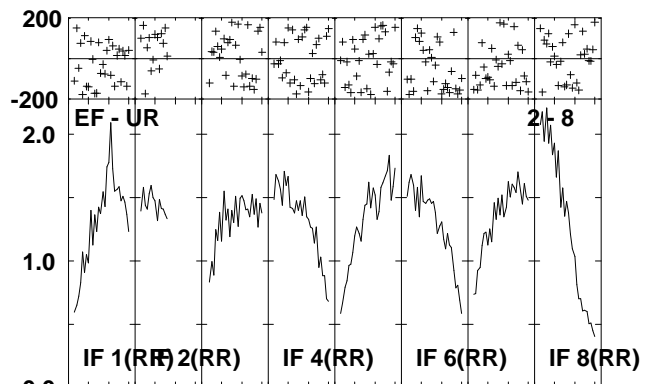
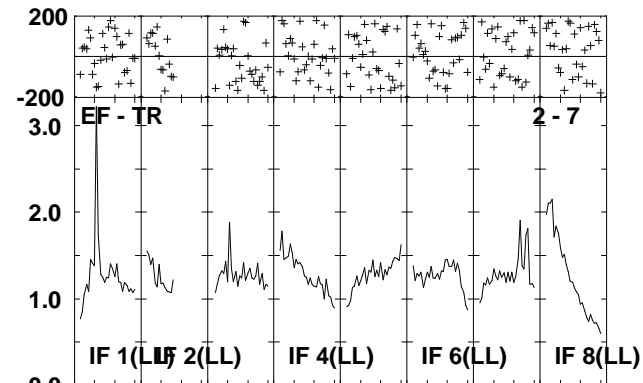
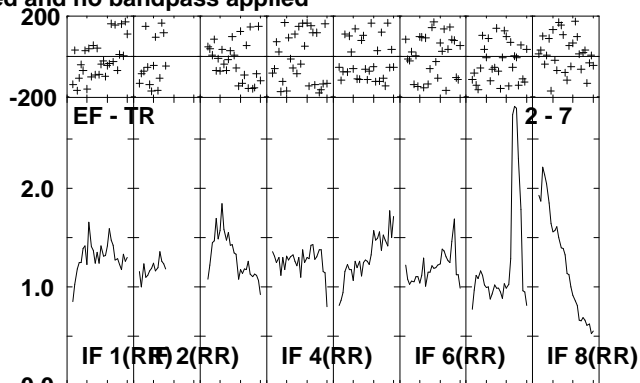
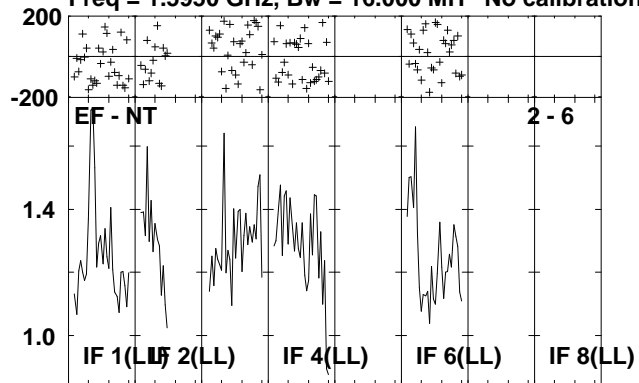

Lower frame: Milli Ampl Jy Top frame: Phas deg
Scalar averaged cross-power spectrum Several baselines displayed
Timerange: 00/12:12:21 to 00/12:15:49

Plot file version 17 created 06-JUL-2010 14:40:36

J2330+33 EP064J.UVDATA.1

Freq = 1.5950 GHz, Bw = 16.000 MH No calibration applied and no bandpass applied

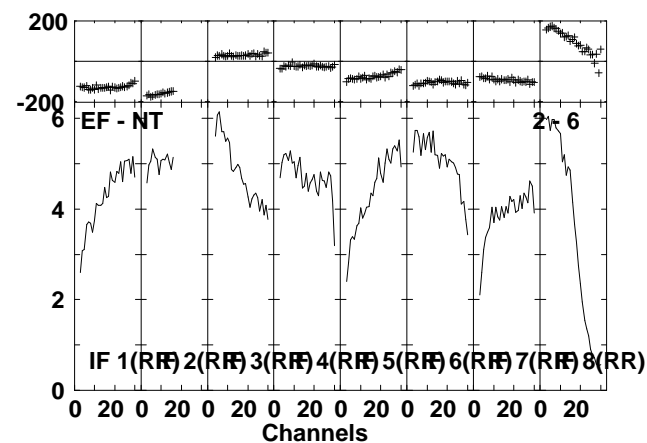
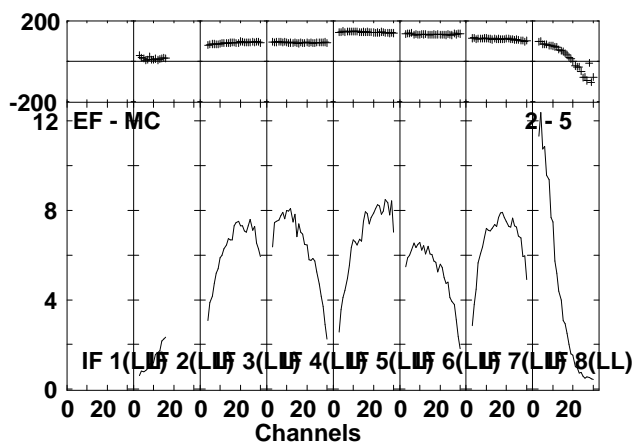
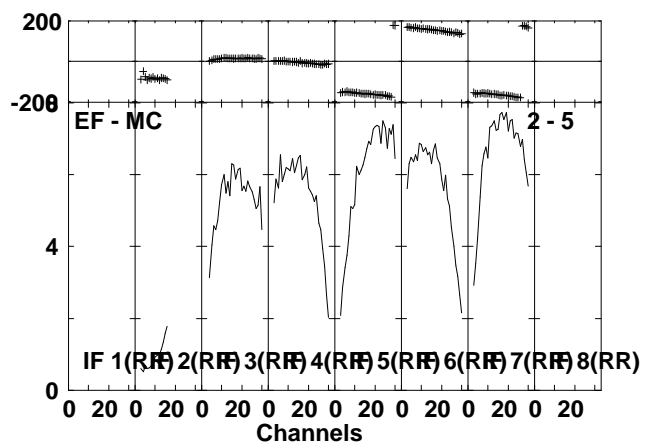
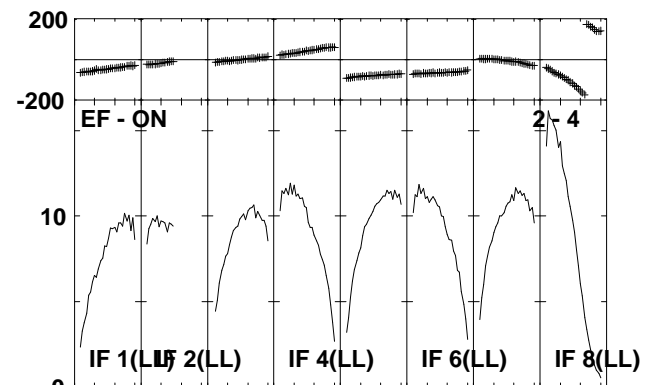
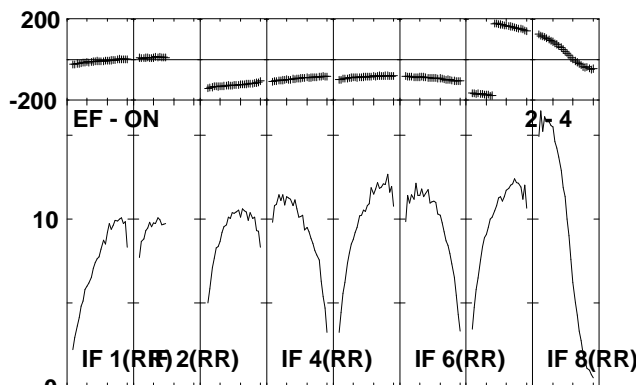
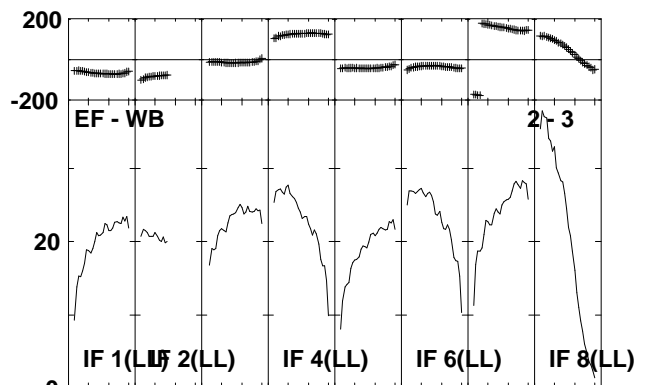
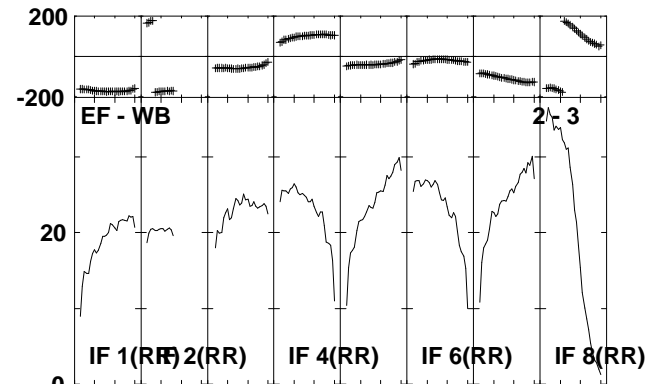
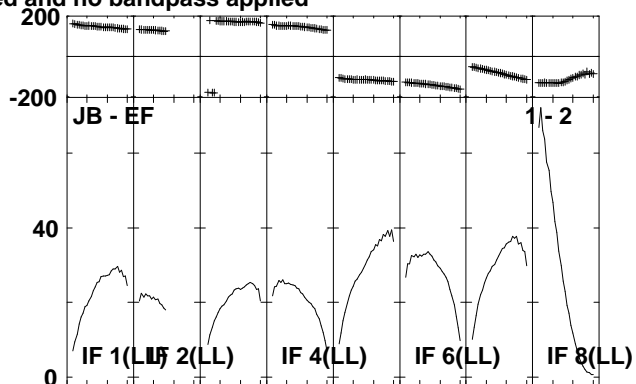
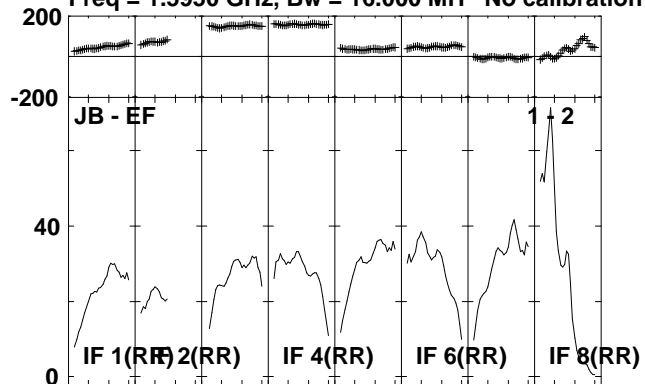

Lower frame: Milli Ampl Jy Top frame: Phas deg
Scalar averaged cross-power spectrum Several baselines displayed
Timerange: 00/12:15:51 to 00/12:17:39

Plot file version 18 created 06-JUL-2010 14:40:37

J2330+33 EP064J.UVDATA.1

Freq = 1.5950 GHz, Bw = 16.000 MH No calibration applied and no bandpass applied

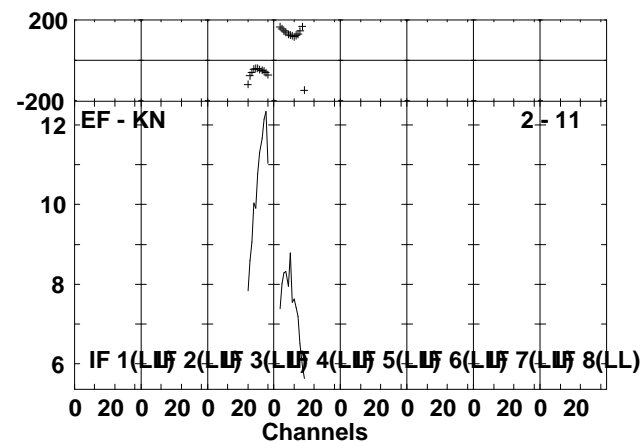
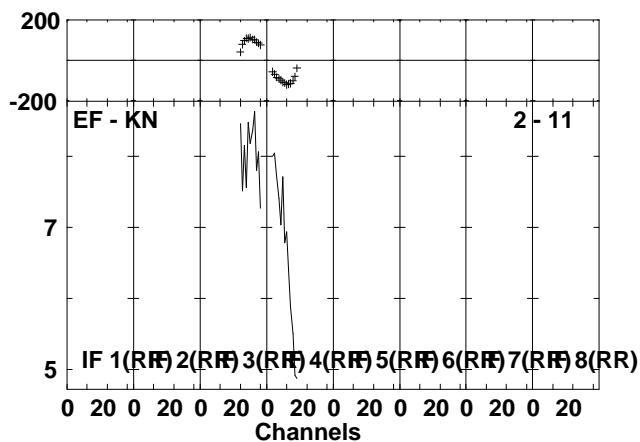
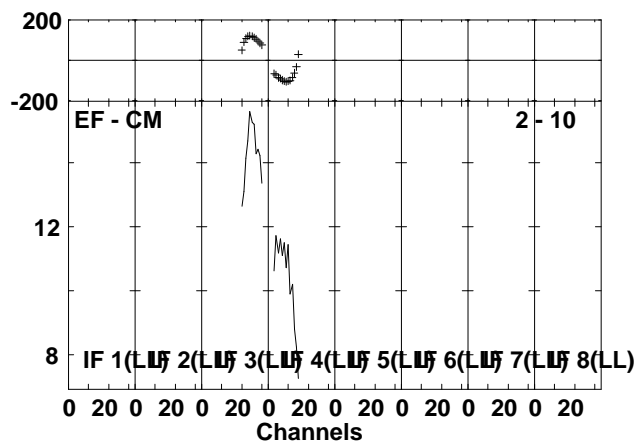
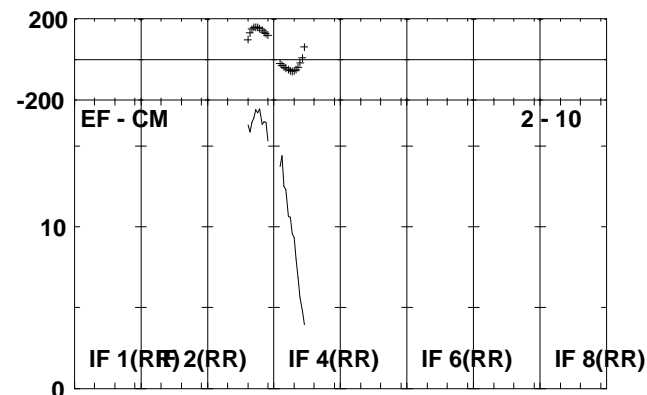
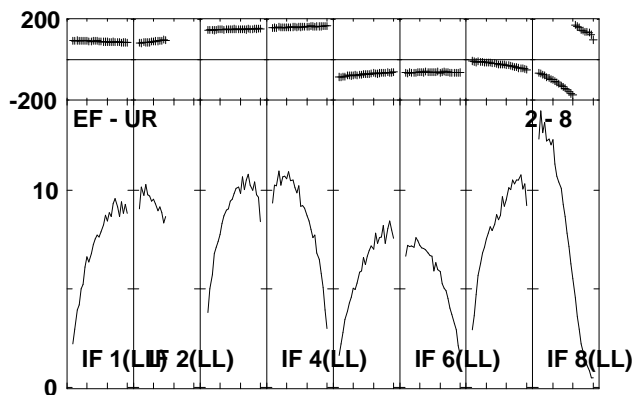
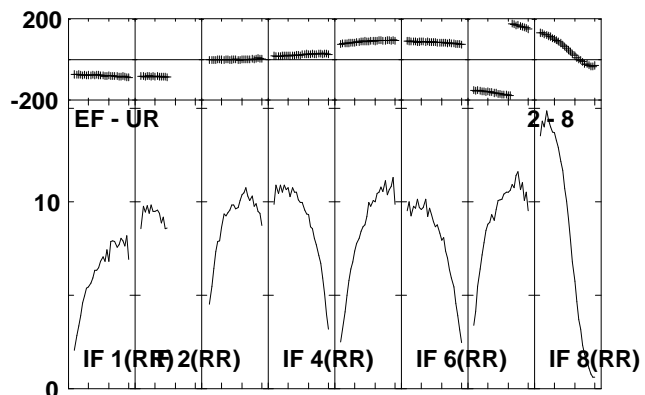
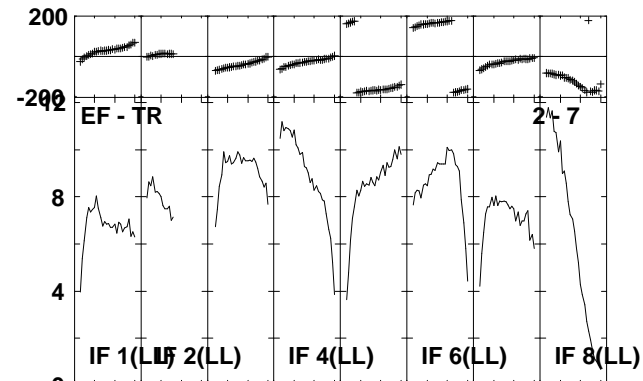
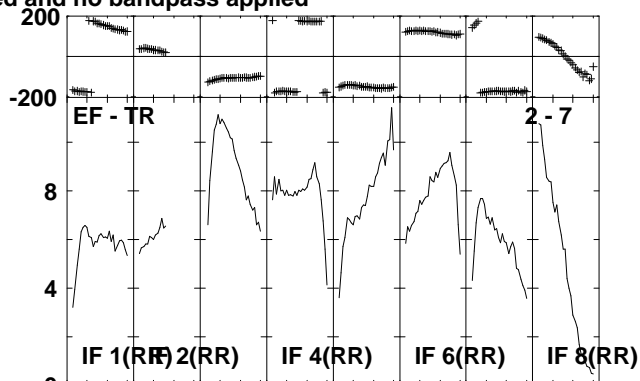
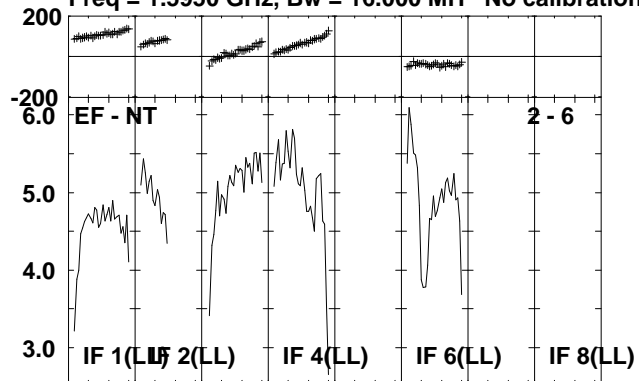

Lower frame: Milli Ampl Jy Top frame: Phas deg
Scalar averaged cross-power spectrum Several baselines displayed
Timerange: 00/12:15:51 to 00/12:17:39

Plot file version 19 created 06-JUL-2010 14:40:39

IRAS2336 EP064J.UVDATA.1

Freq = 1.5950 GHz, Bw = 16.000 MH No calibration applied and no bandpass applied

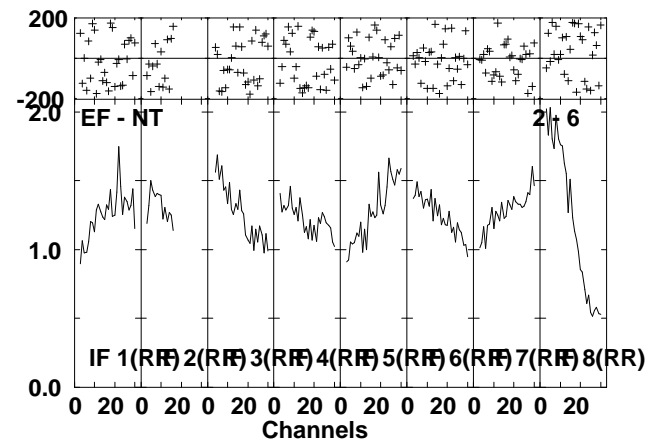
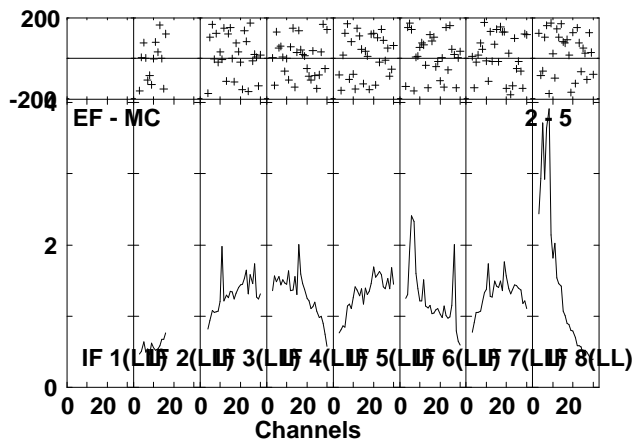
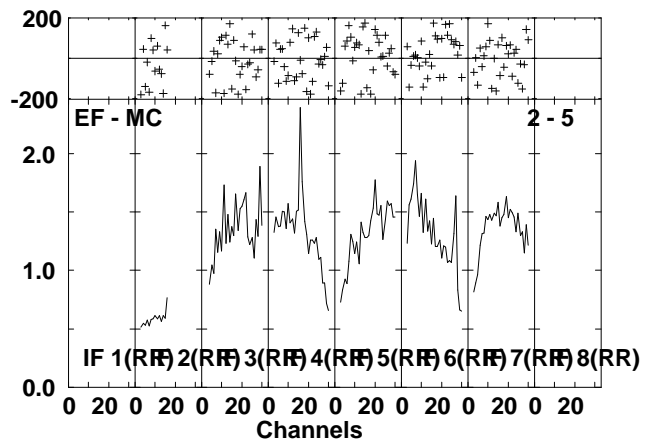
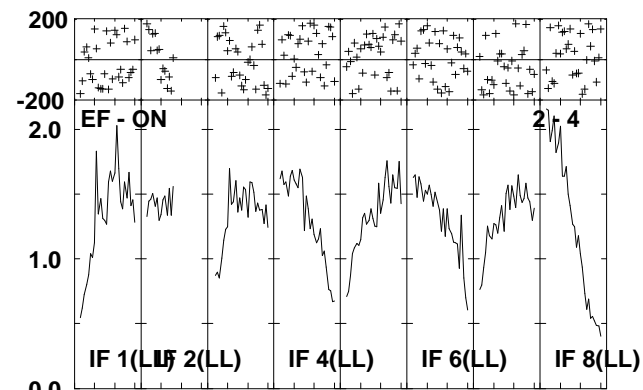
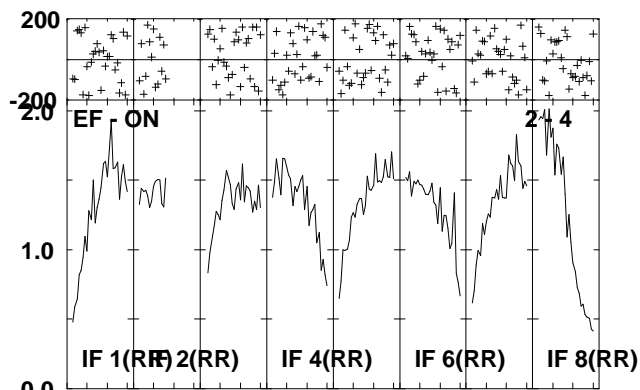
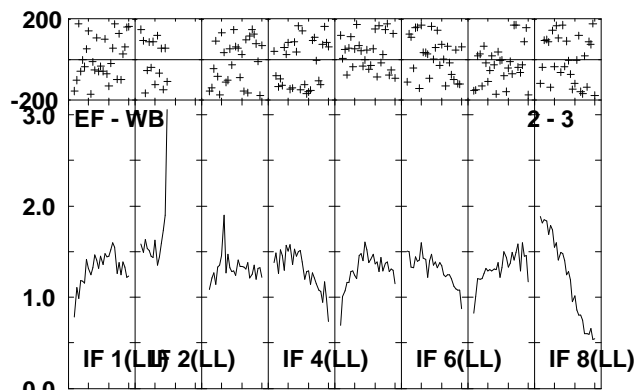
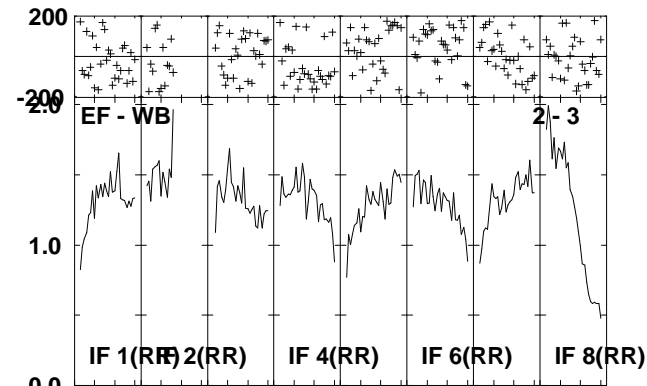
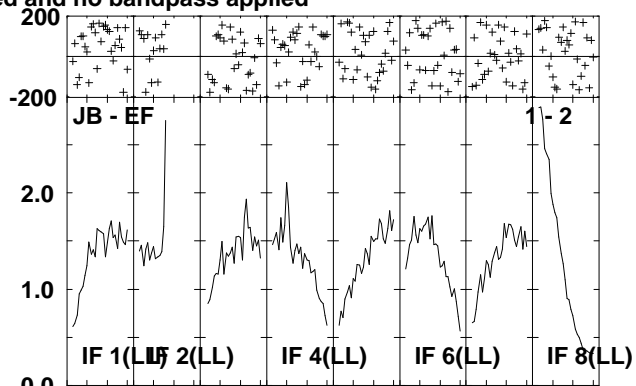
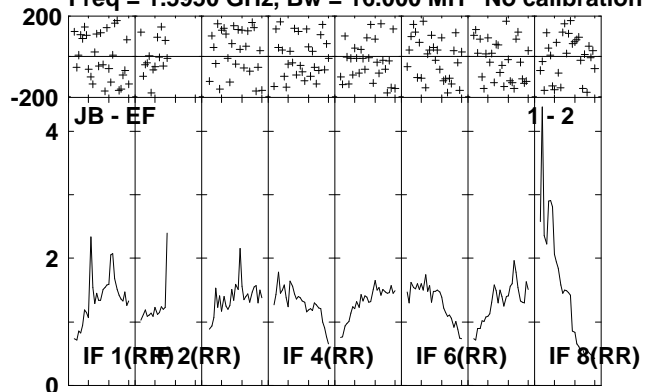

Lower frame: Milli Ampl Jy Top frame: Phas deg
Scalar averaged cross-power spectrum Several baselines displayed
Timerange: 00/12:17:41 to 00/12:21:09

Plot file version 20 created 06-JUL-2010 14:40:41

IRAS2336 EP064J.UVDATA.1

Freq = 1.5950 GHz, Bw = 16.000 MH No calibration applied and no bandpass applied

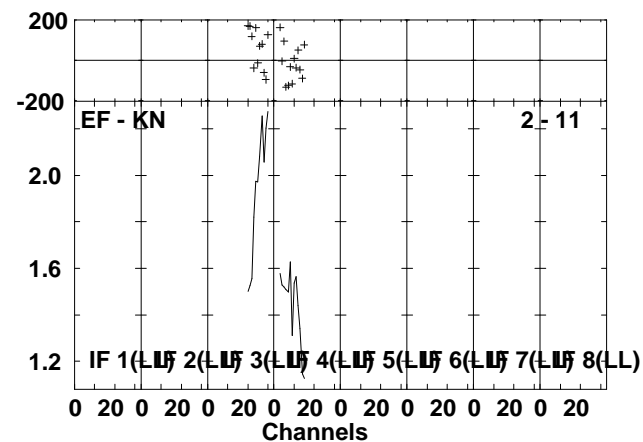
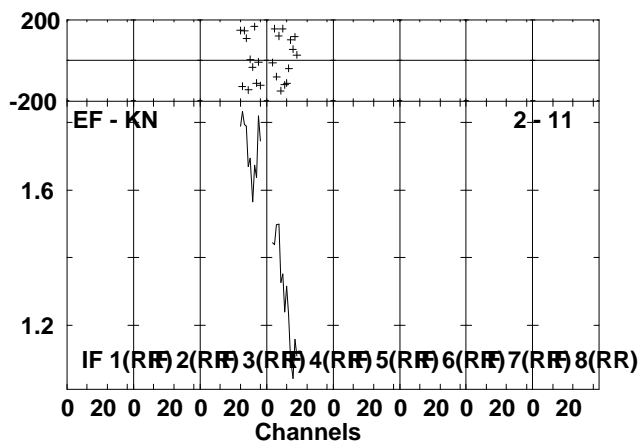
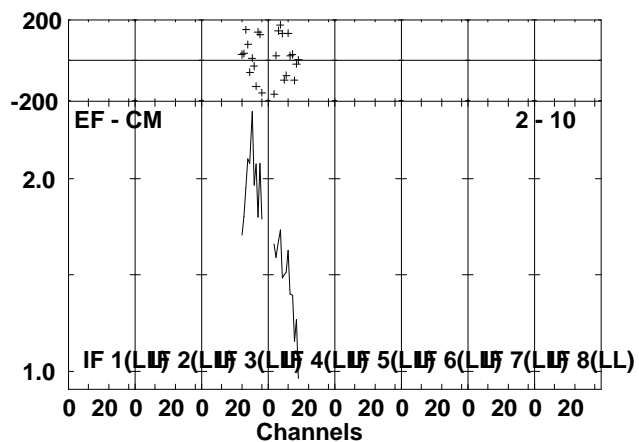
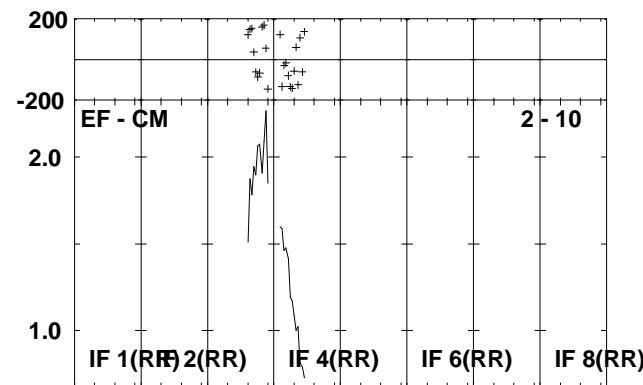
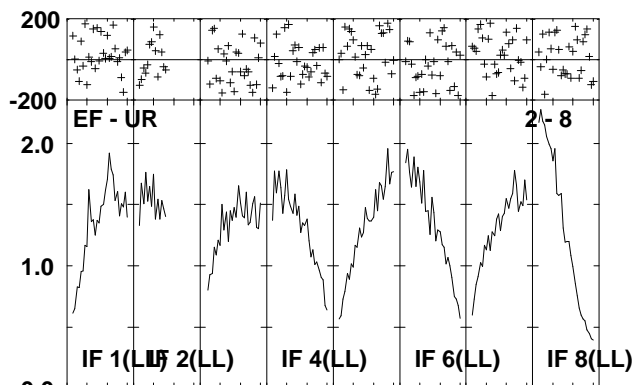
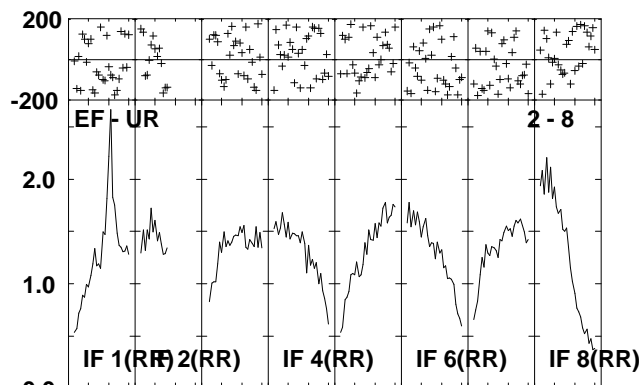
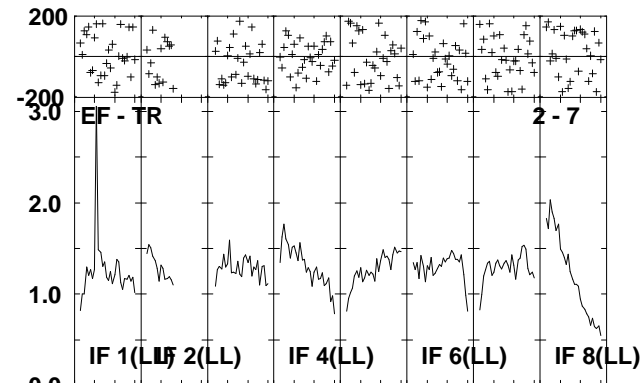
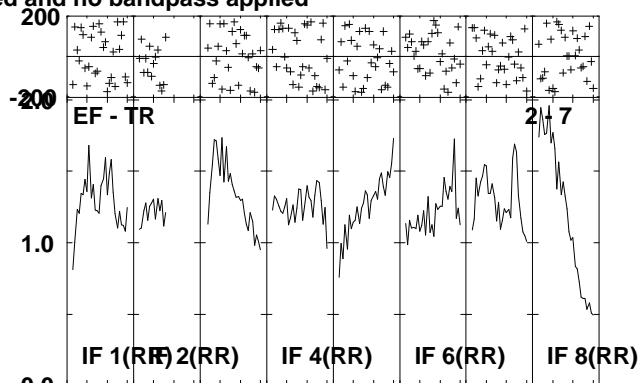
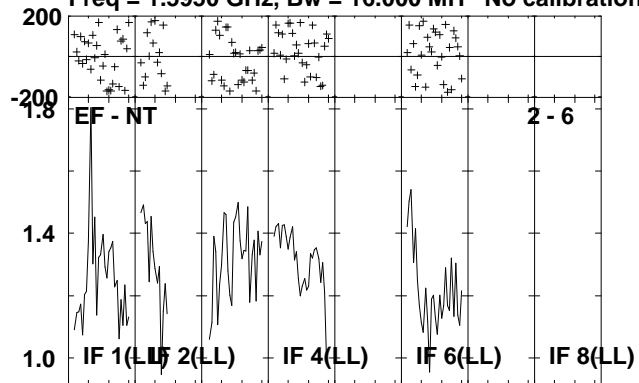

Lower frame: Milli Ampl Jy Top frame: Phas deg
Scalar averaged cross-power spectrum Several baselines displayed
Timerange: 00/12:17:41 to 00/12:21:09

Plot file version 21 created 06-JUL-2010 14:40:44
 J2330+33 EP064J.UVDATA.1

Freq = 1.5950 GHz, Bw = 16.000 MH No calibration applied and no bandpass applied

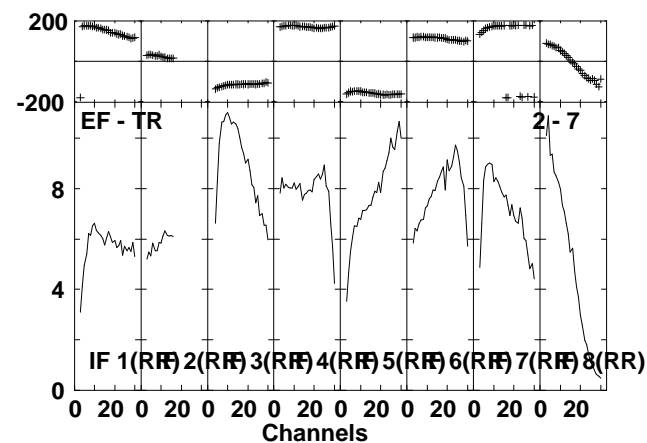
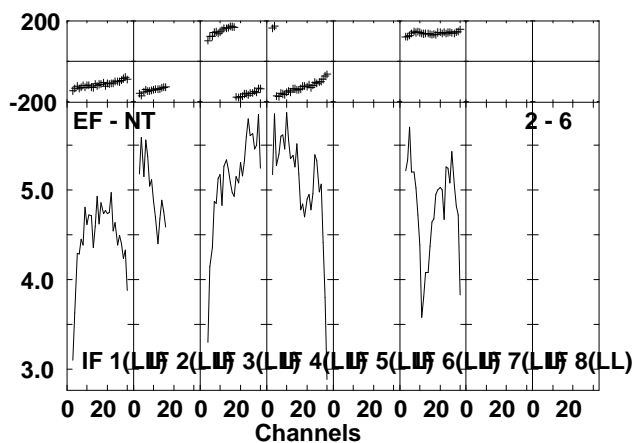
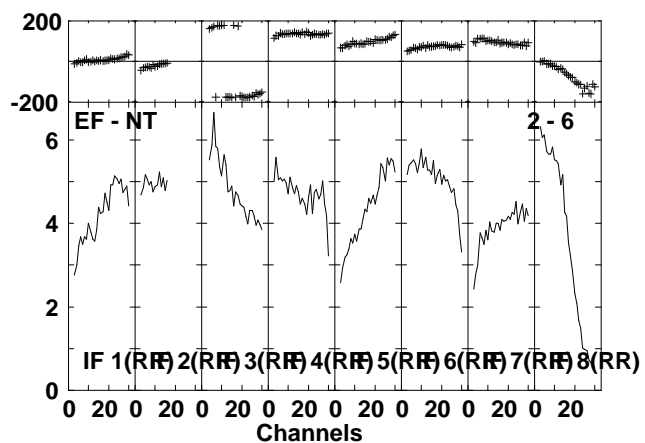
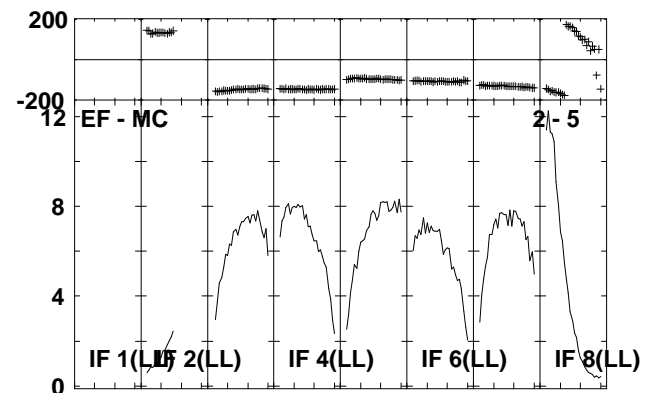
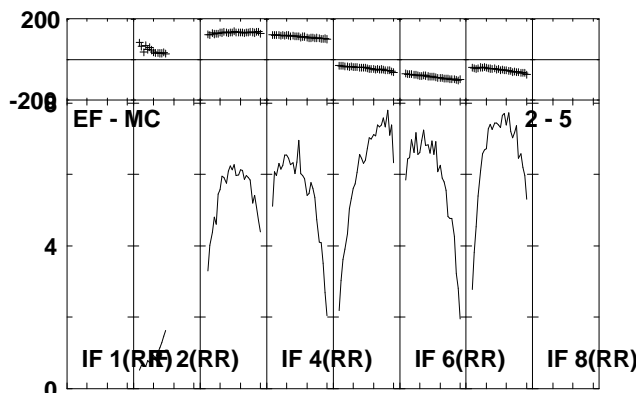
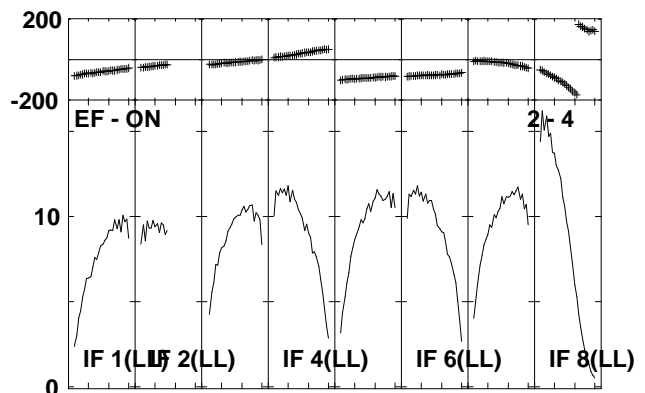
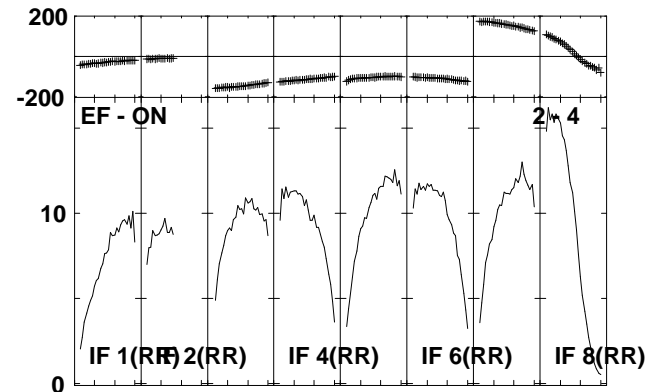
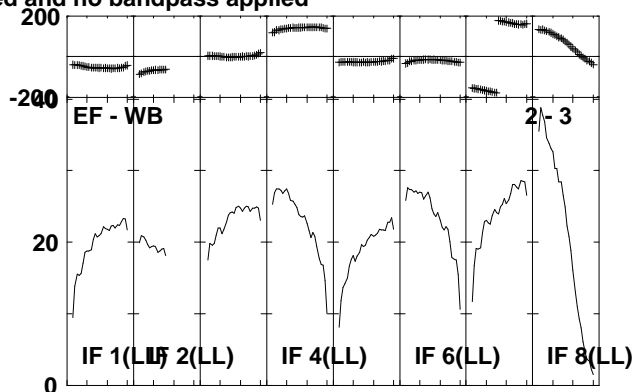
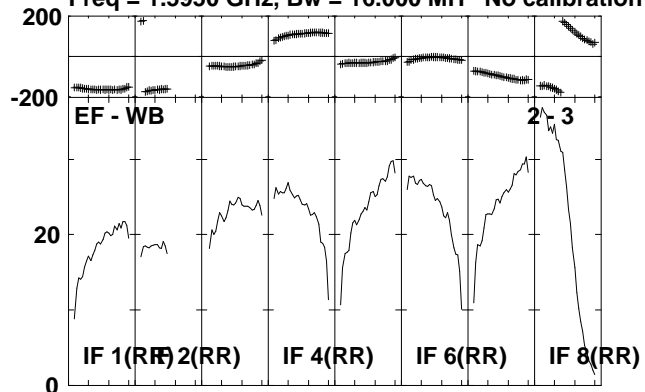

Lower frame: Milli Ampl Jy Top frame: Phas deg
 Scalar averaged cross-power spectrum Several baselines displayed
 Timerange: 00/12:21:11 to 00/12:22:59

Plot file version 22 created 06-JUL-2010 14:40:45

J2330+33 EP064J.UVDATA.1

Freq = 1.5950 GHz, Bw = 16.000 MH No calibration applied and no bandpass applied

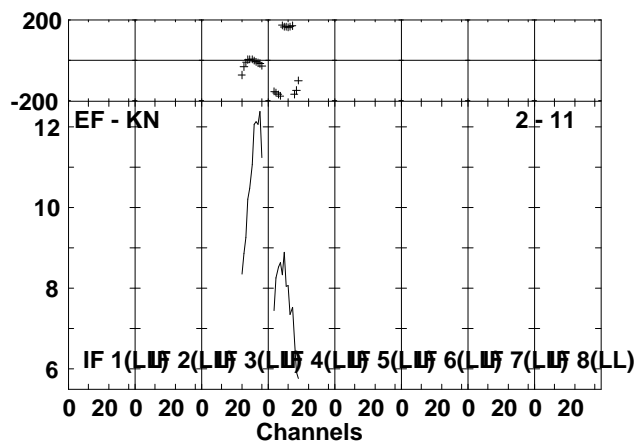
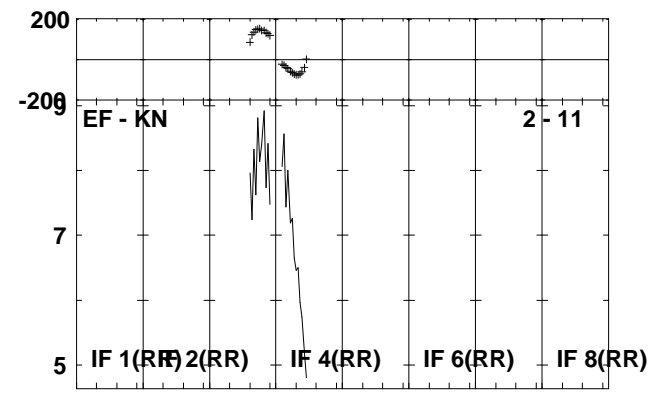
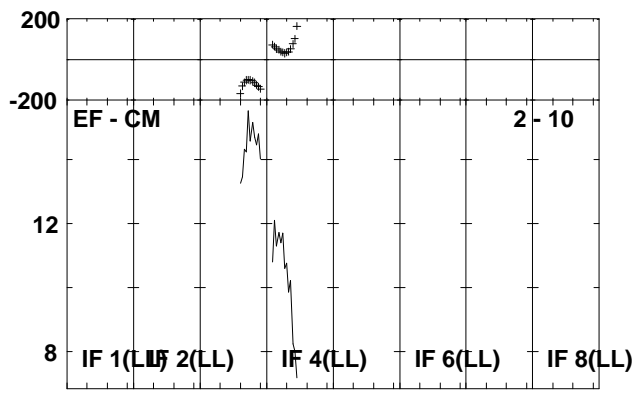
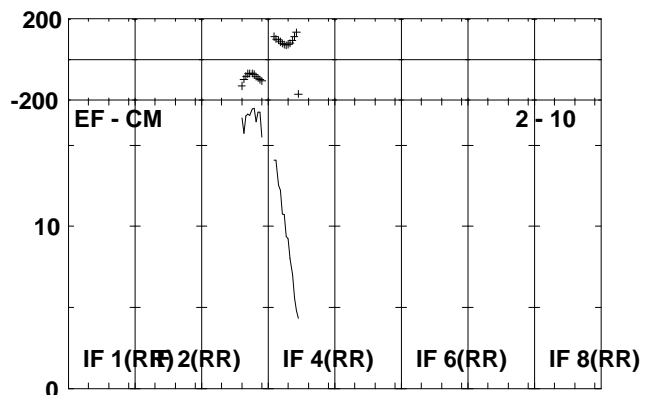
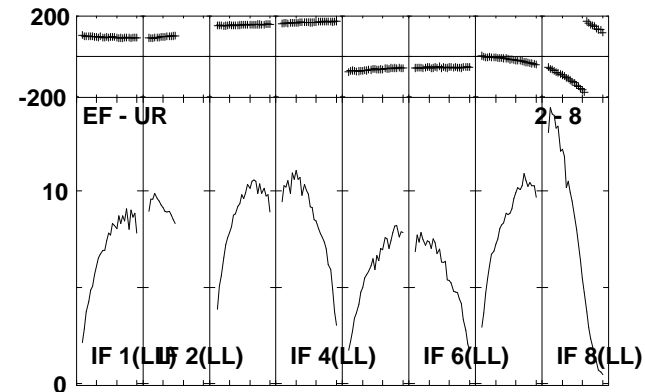
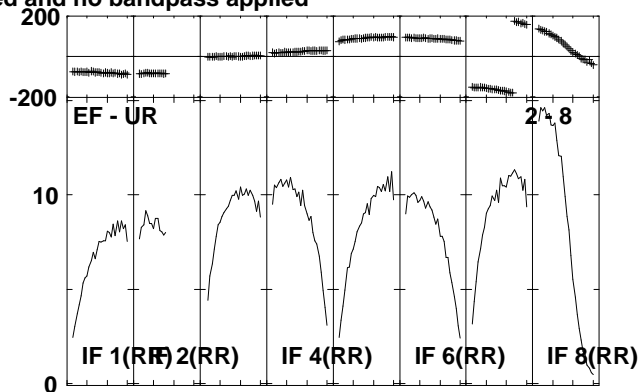
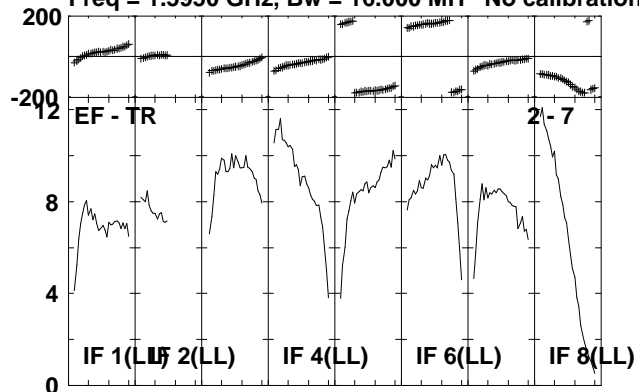

Lower frame: Milli Ampl Jy Top frame: Phas deg
Scalar averaged cross-power spectrum Several baselines displayed
Timerange: 00/12:21:11 to 00/12:22:59

Plot file version 23 created 06-JUL-2010 14:40:46

J2333+39 EP064J.UVDATA.1

Freq = 1.5950 GHz, Bw = 16.000 MH No calibration applied and no bandpass applied

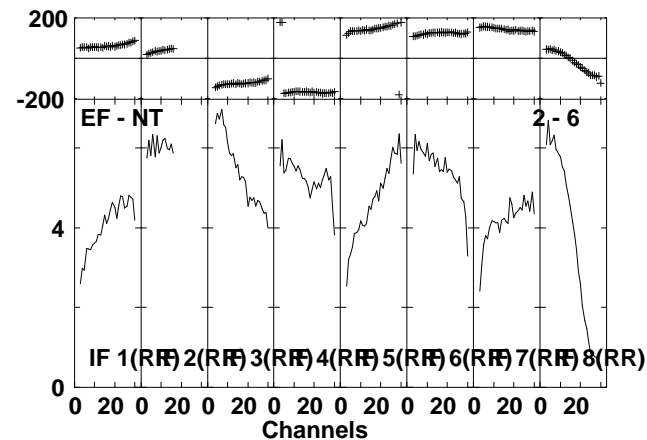
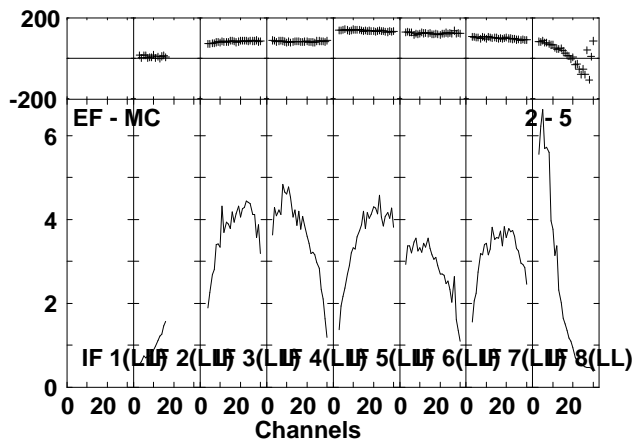
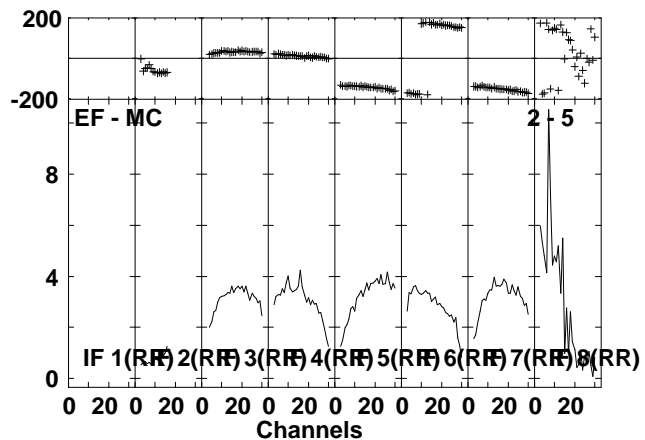
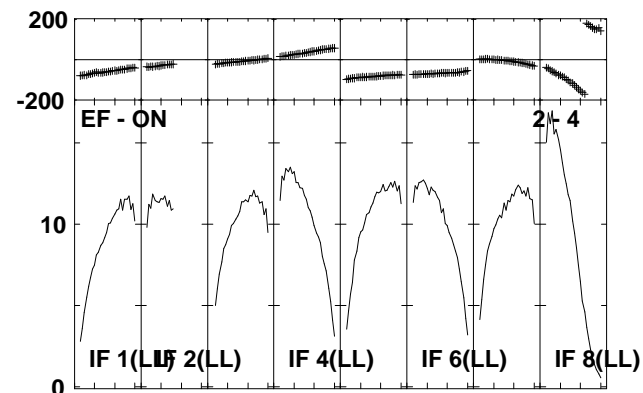
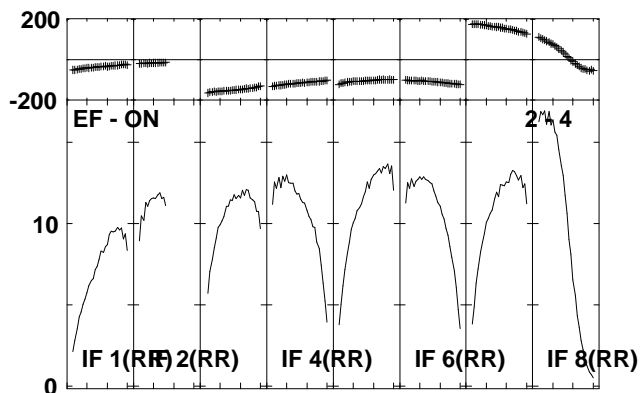
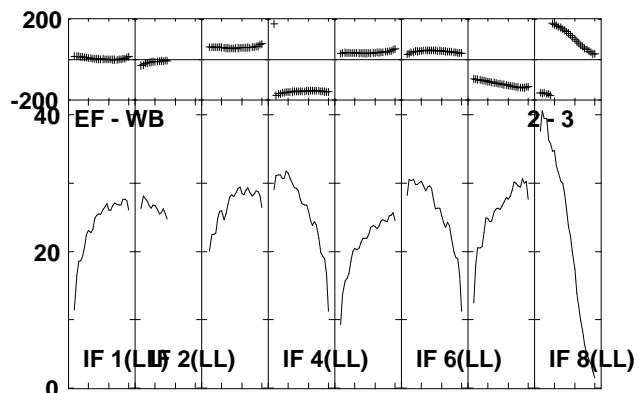
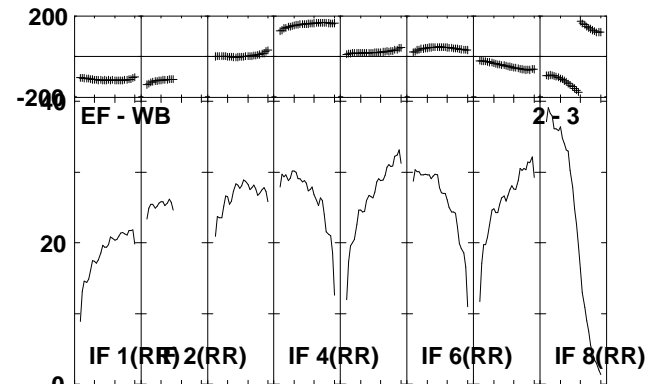
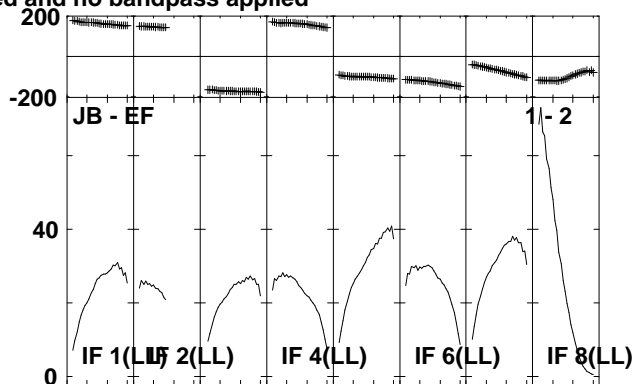
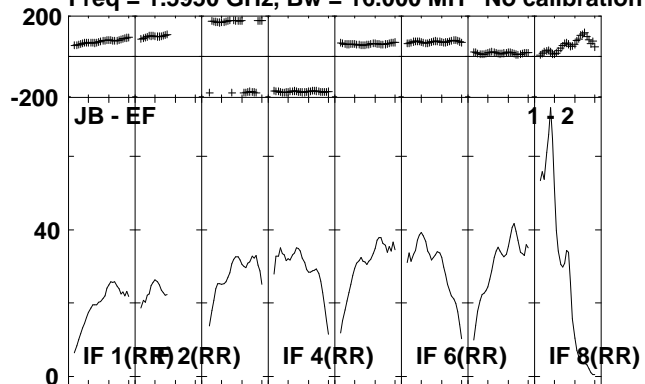

Lower frame: Milli Ampl Jy Top frame: Phas deg
Scalar averaged cross-power spectrum Several baselines displayed
Timerange: 00/12:24:01 to 00/12:25:49

Plot file version 24 created 06-JUL-2010 14:40:47

J2333+39 EP064J.UVDATA.1

Freq = 1.5950 GHz, Bw = 16.000 MH No calibration applied and no bandpass applied

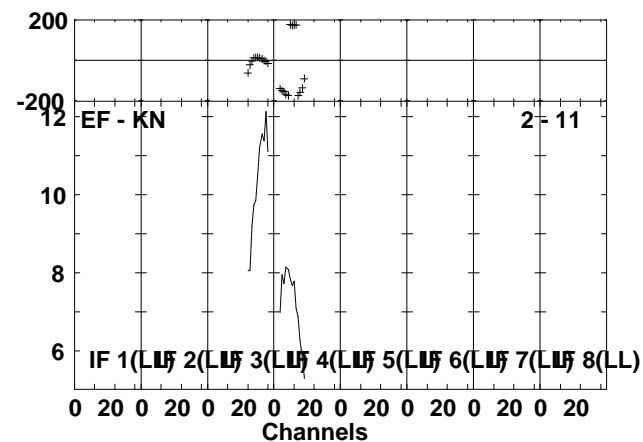
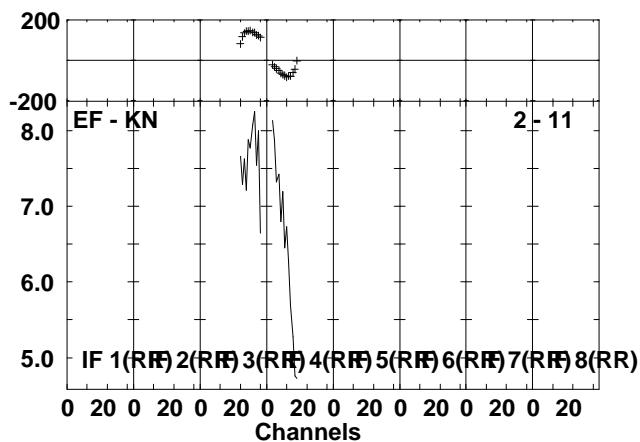
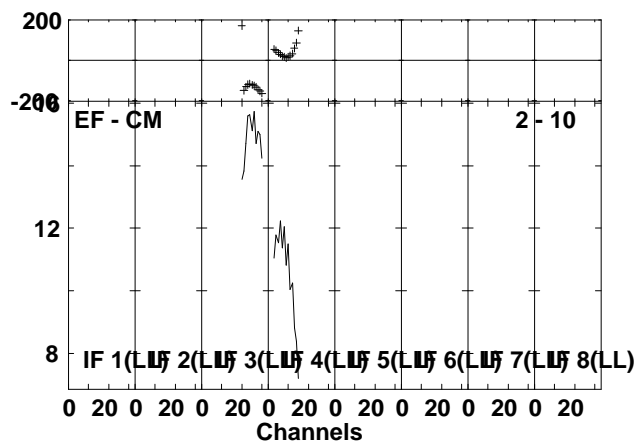
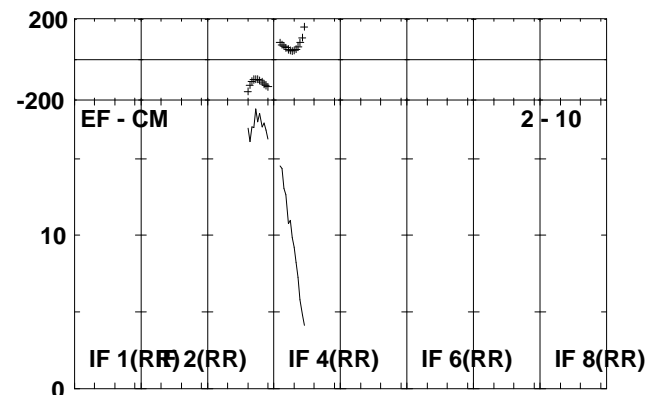
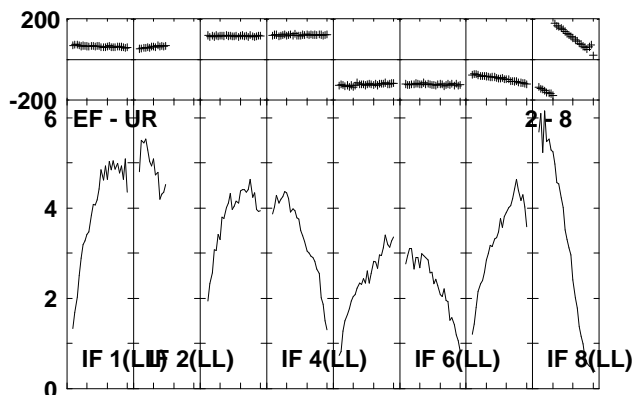
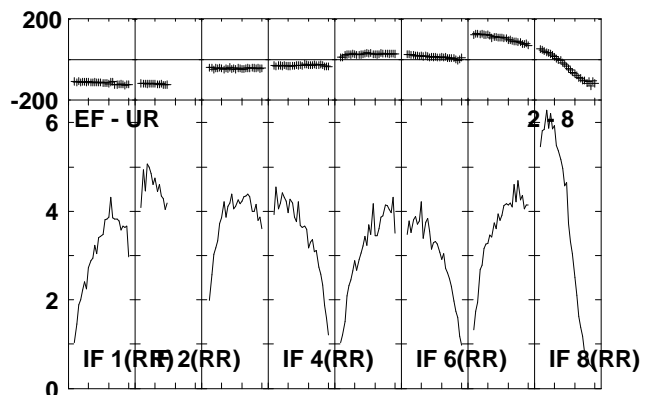
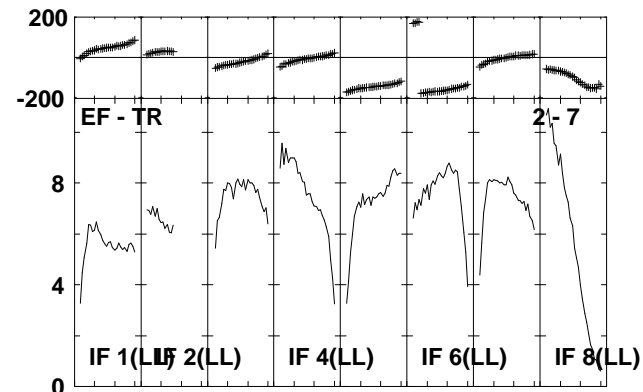
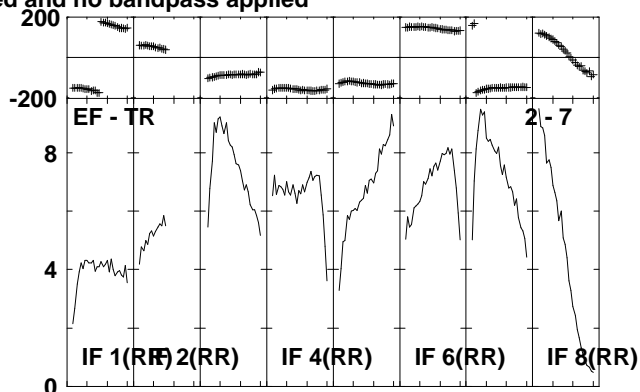
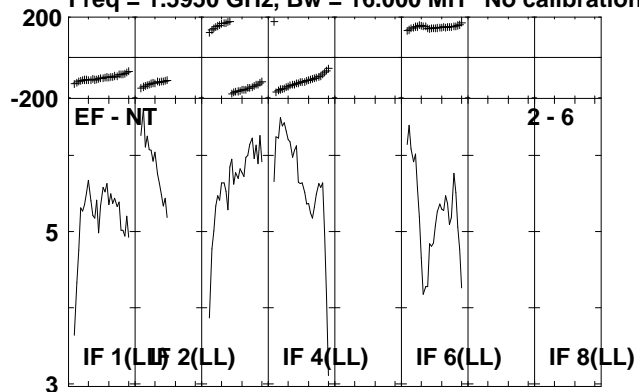

Lower frame: Milli Ampl Jy Top frame: Phas deg
Scalar averaged cross-power spectrum Several baselines displayed
Timerange: 00/12:24:01 to 00/12:25:49

Plot file version 25 created 06-JUL-2010 14:40:48

J2330+33 EP064J.UVDATA.1

Freq = 1.5950 GHz, Bw = 16.000 MH No calibration applied and no bandpass applied

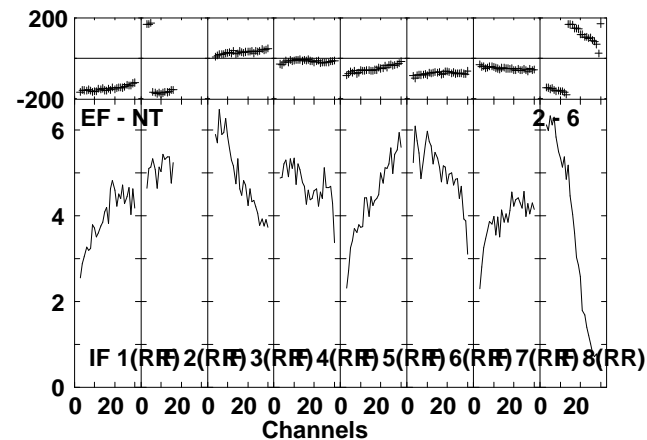
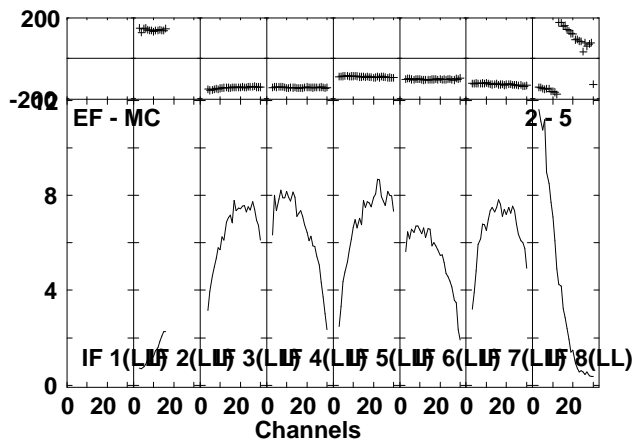
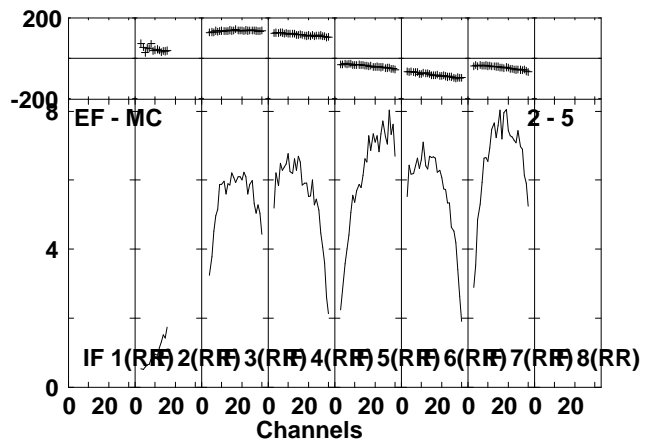
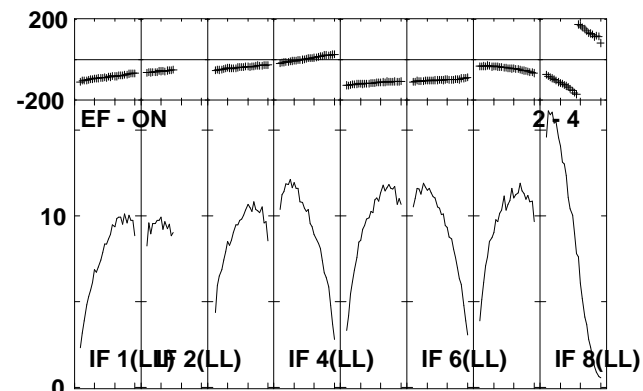
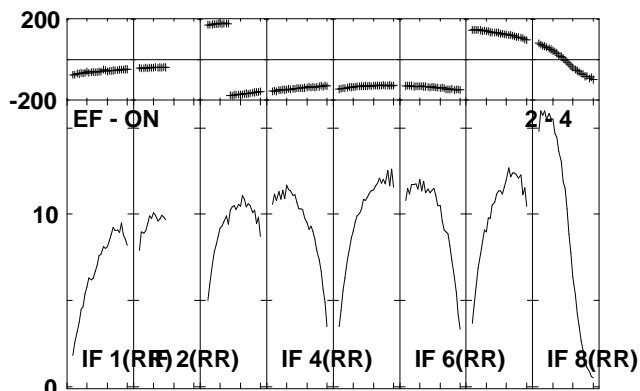
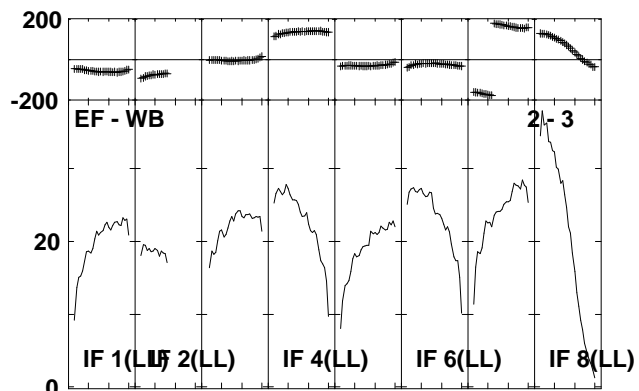
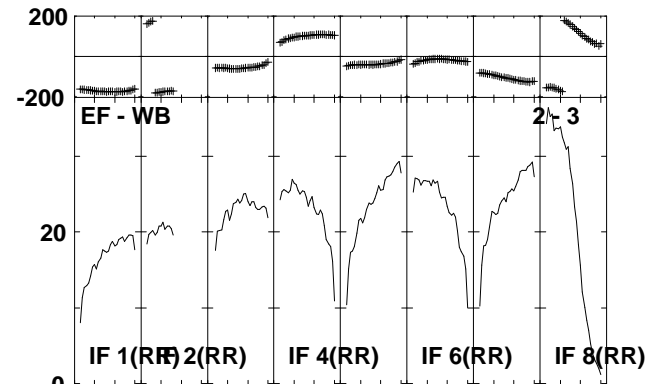
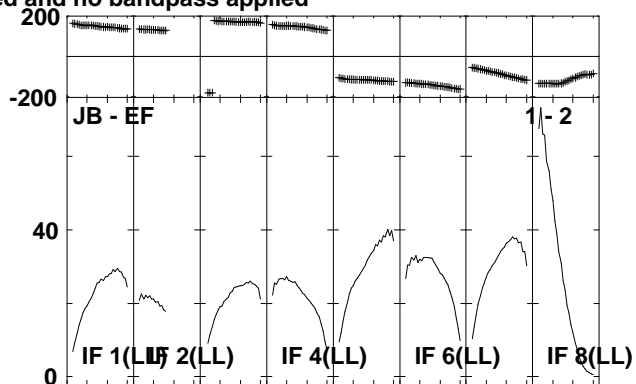
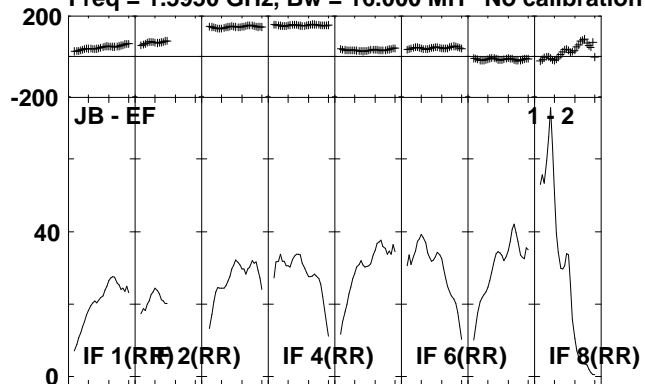

Lower frame: Milli Ampl Jy Top frame: Phas deg
Scalar averaged cross-power spectrum Several baselines displayed
Timerange: 00/12:25:51 to 00/12:27:39

Plot file version 26 created 06-JUL-2010 14:40:49

J2330+33 EP064J.UVDATA.1

Freq = 1.5950 GHz, Bw = 16.000 MH No calibration applied and no bandpass applied

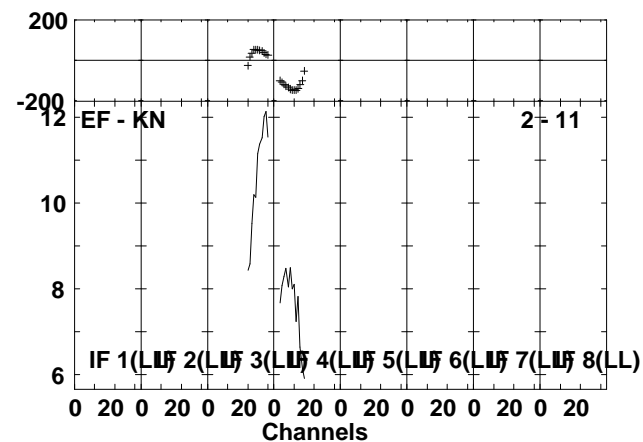
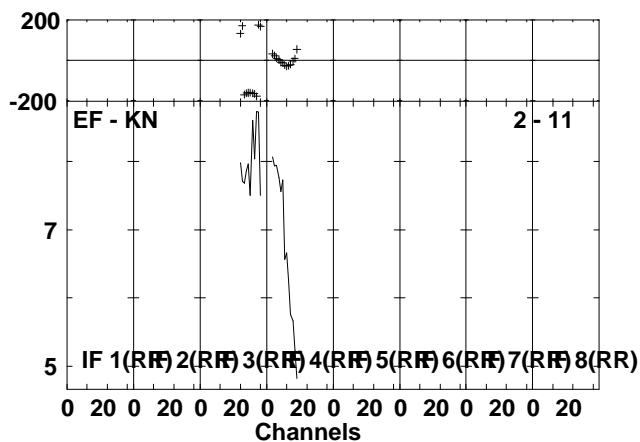
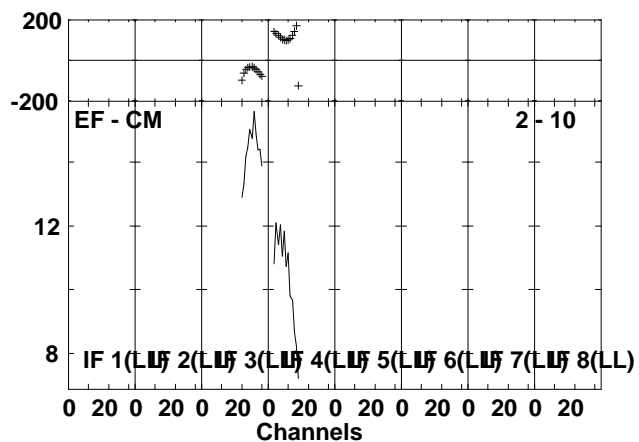
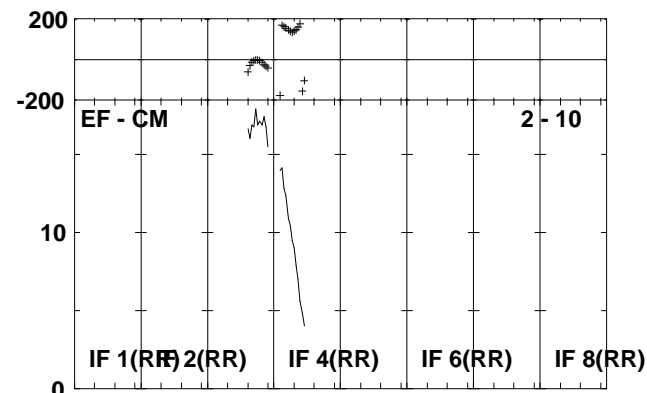
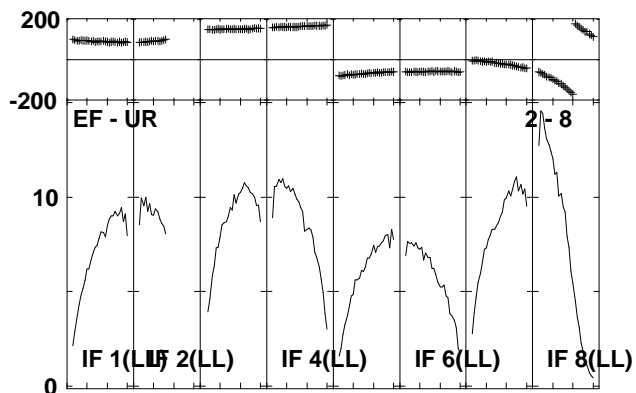
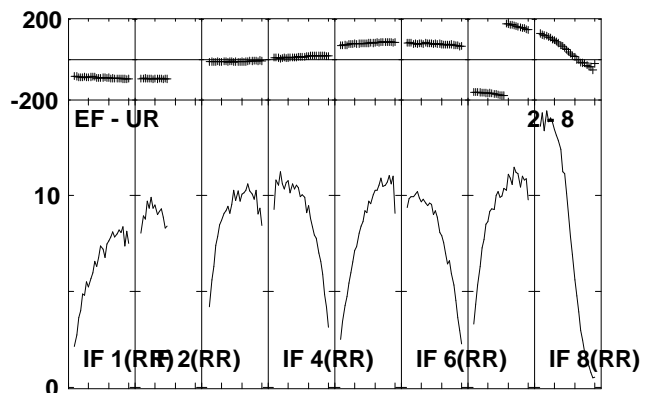
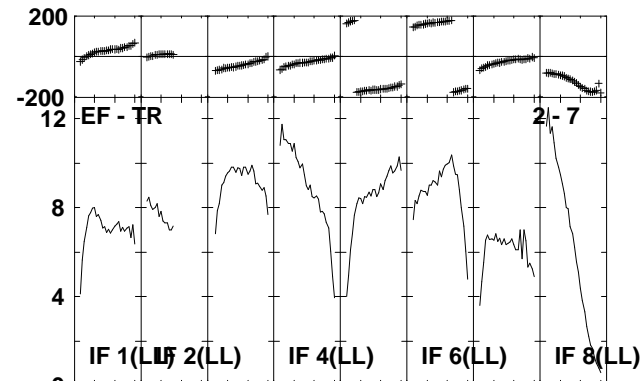
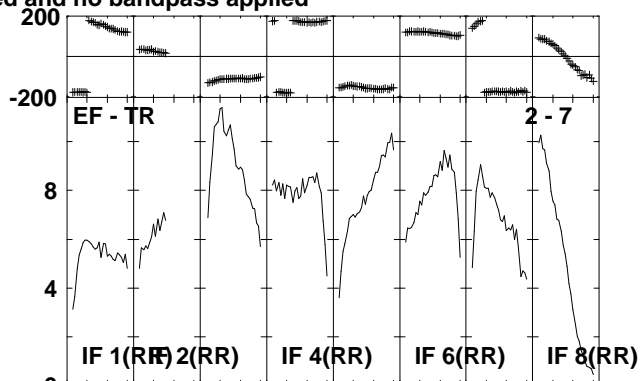
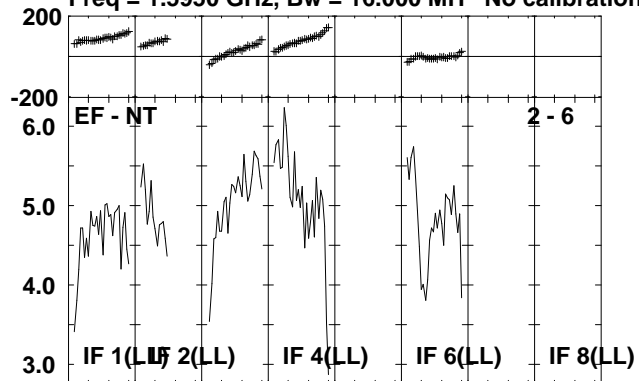

Lower frame: Milli Ampl Jy Top frame: Phas deg
Scalar averaged cross-power spectrum Several baselines displayed
Timerange: 00/12:25:51 to 00/12:27:39

Plot file version 27 created 06-JUL-2010 14:40:51

IRAS2336 EP064J.UVDATA.1

Freq = 1.5950 GHz, Bw = 16.000 MH No calibration applied and no bandpass applied

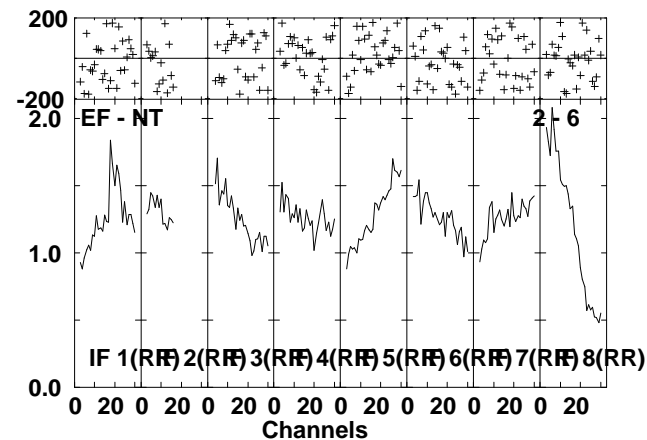
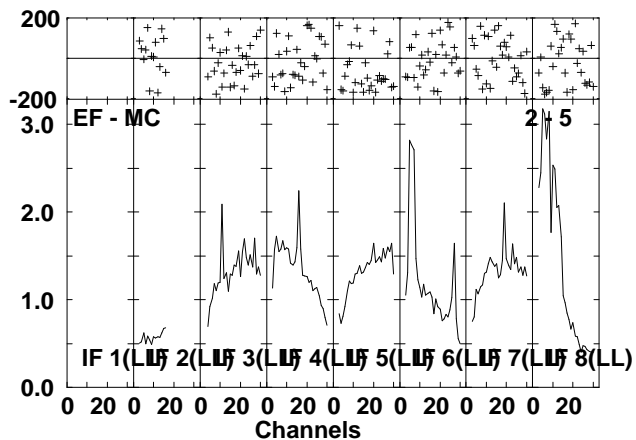
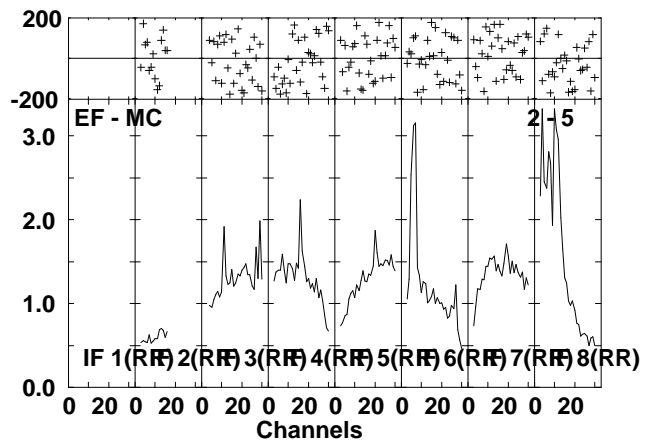
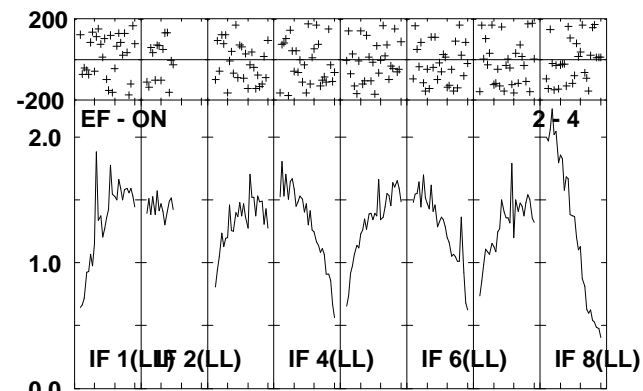
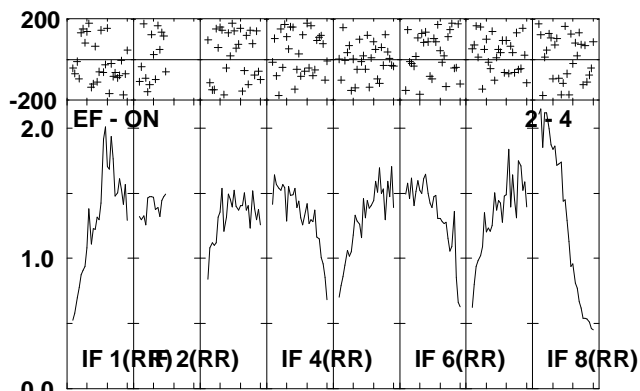
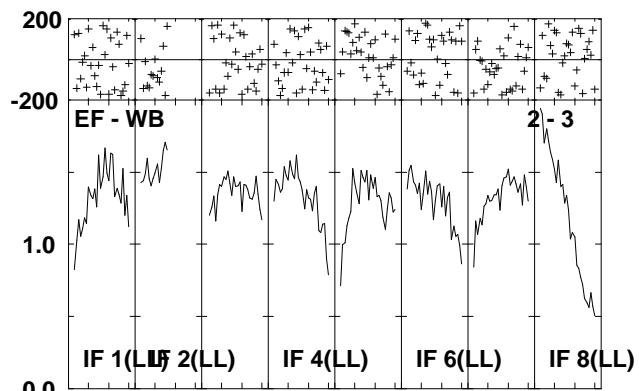
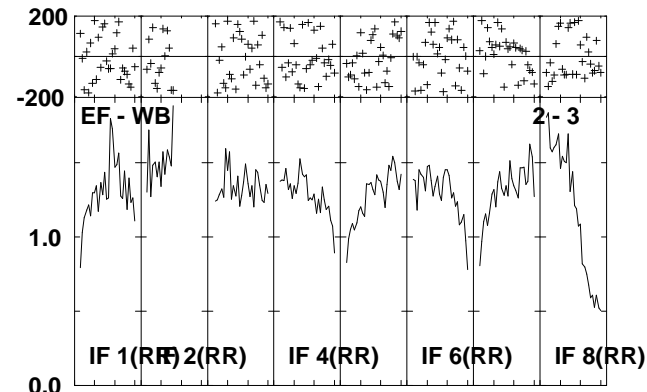
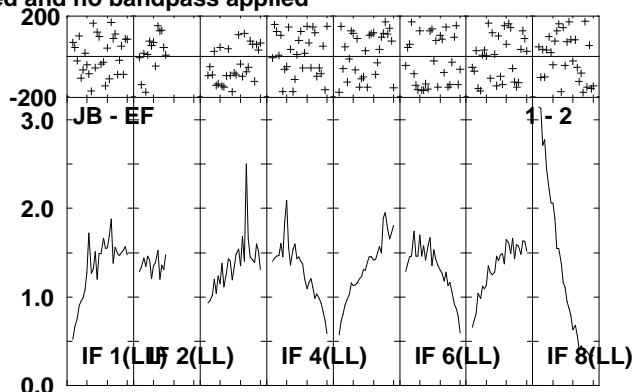
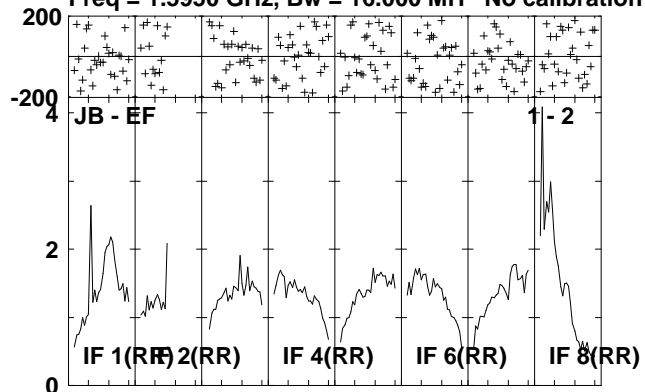

Lower frame: Milli Ampl Jy Top frame: Phas deg
Scalar averaged cross-power spectrum Several baselines displayed
Timerange: 00/12:27:41 to 00/12:31:07

Plot file version 28 created 06-JUL-2010 14:40:53

IRAS2336 EP064J.UVDATA.1

Freq = 1.5950 GHz, Bw = 16.000 MH No calibration applied and no bandpass applied

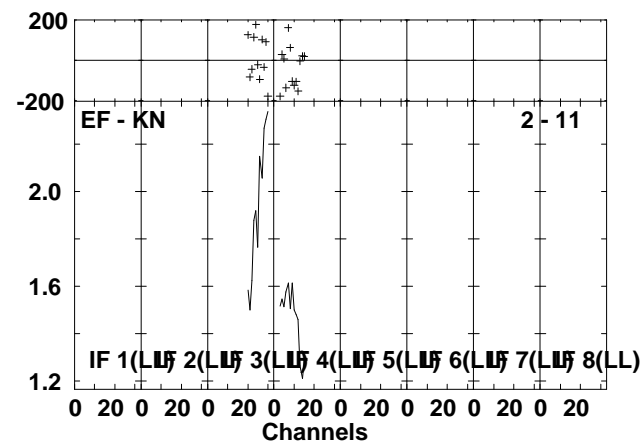
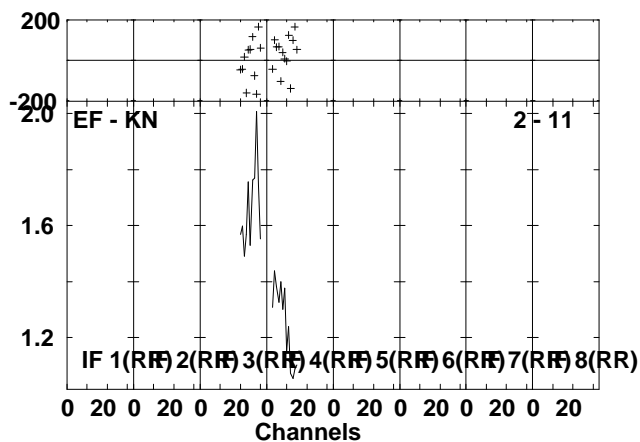
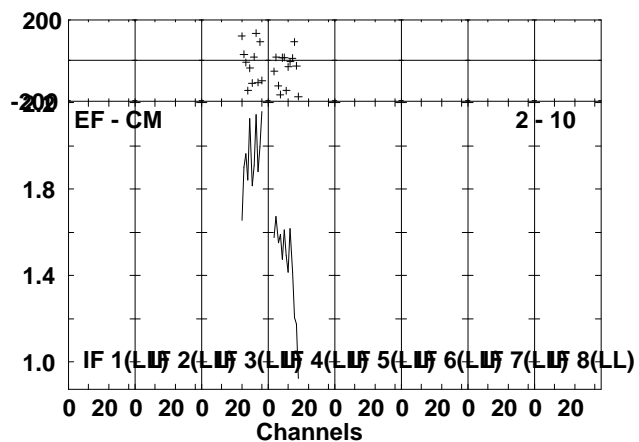
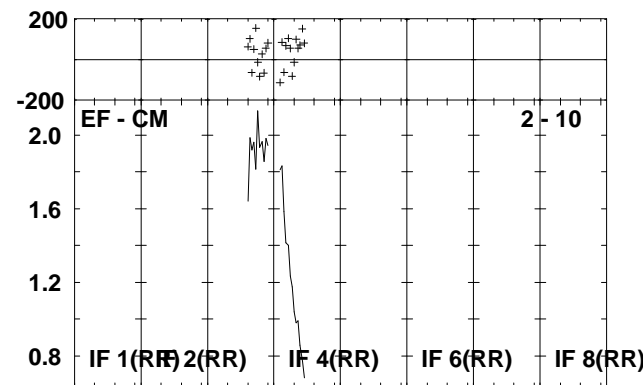
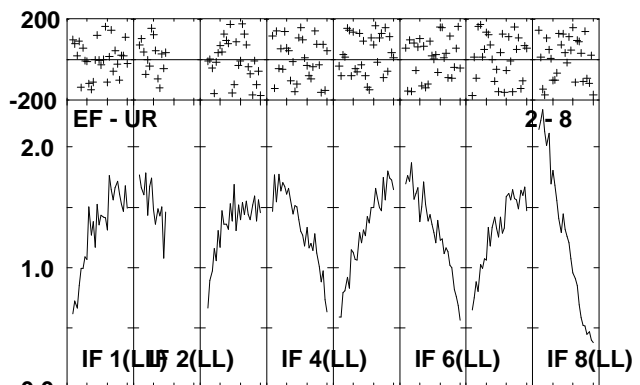
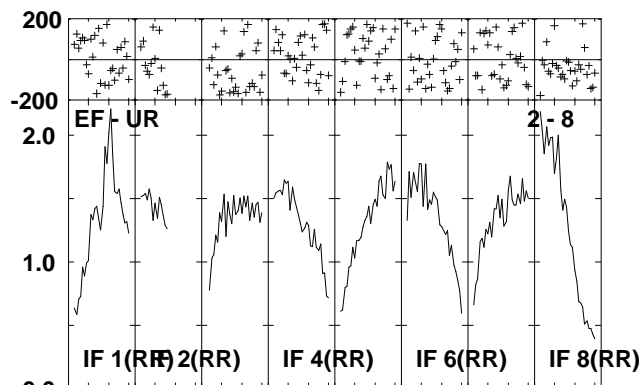
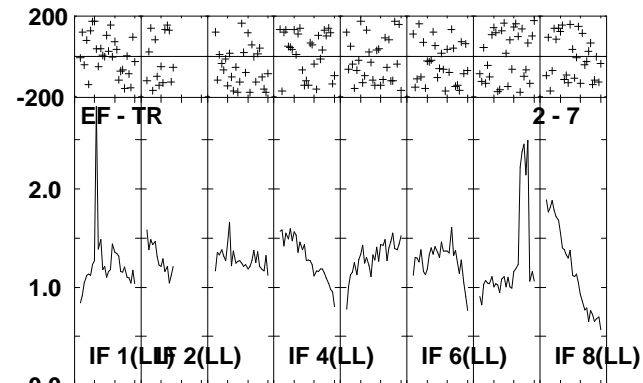
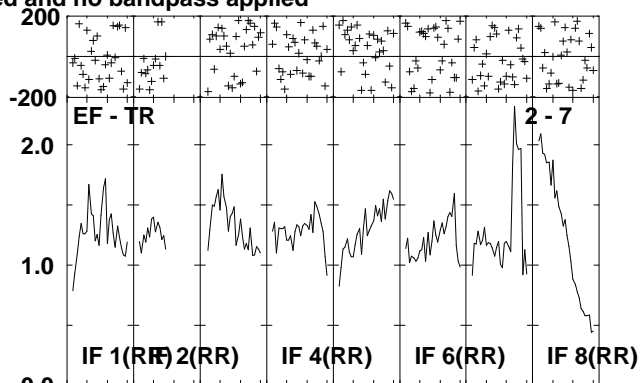
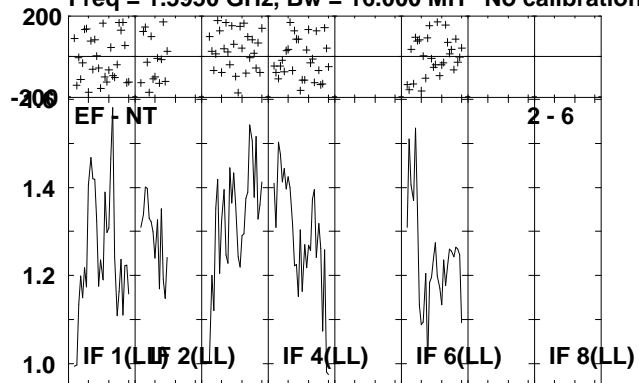

Lower frame: Milli Ampl Jy Top frame: Phas deg
Scalar averaged cross-power spectrum Several baselines displayed
Timerange: 00/12:27:41 to 00/12:31:07

Plot file version 29 created 06-JUL-2010 14:41:01
 J2330+33 EP064J.UVDATA.1

Freq = 1.5950 GHz, Bw = 16.000 MH No calibration applied and no bandpass applied

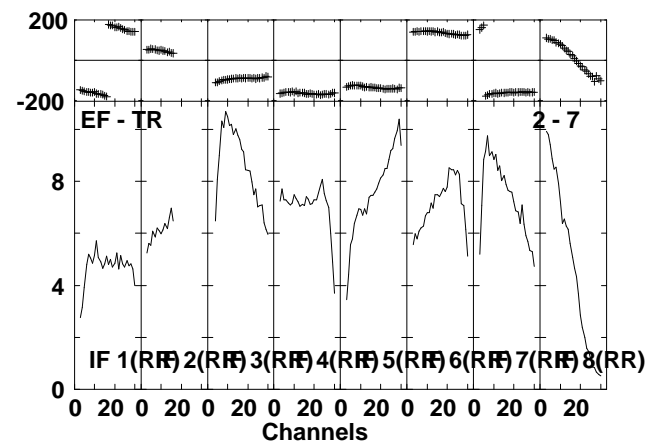
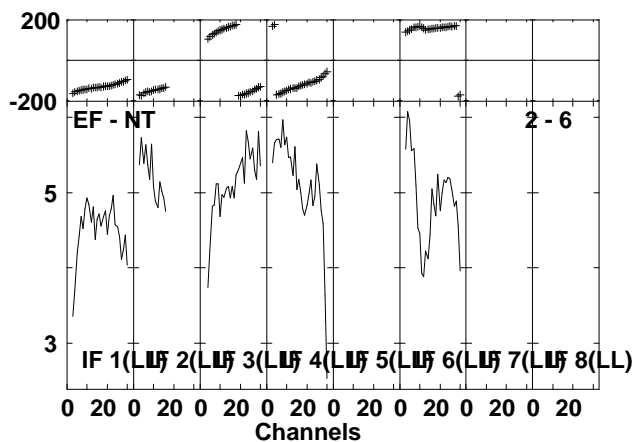
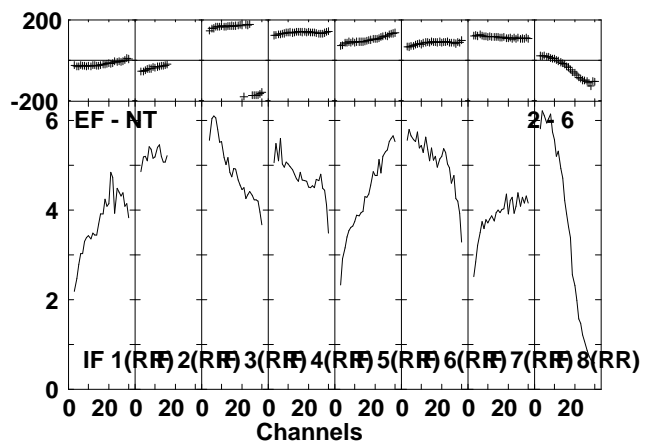
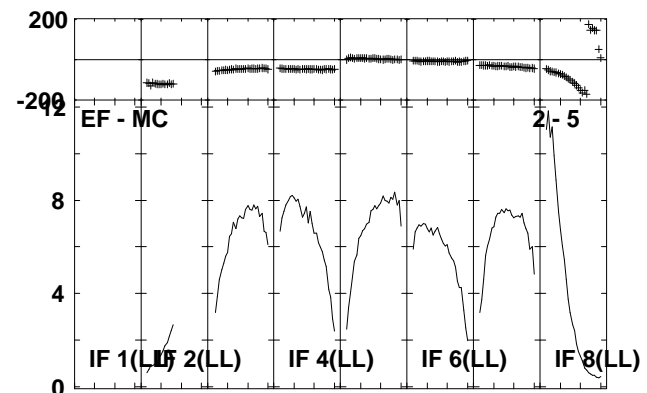
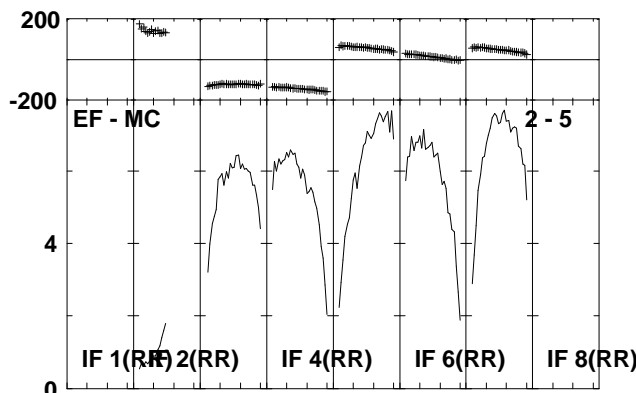
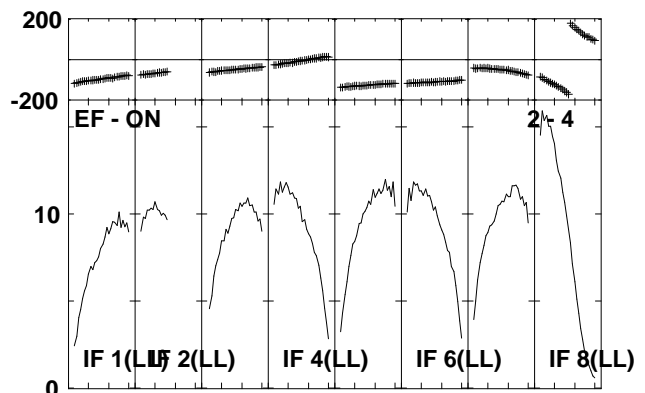
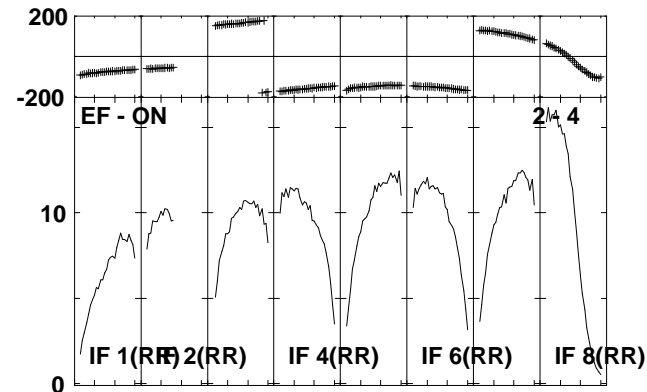
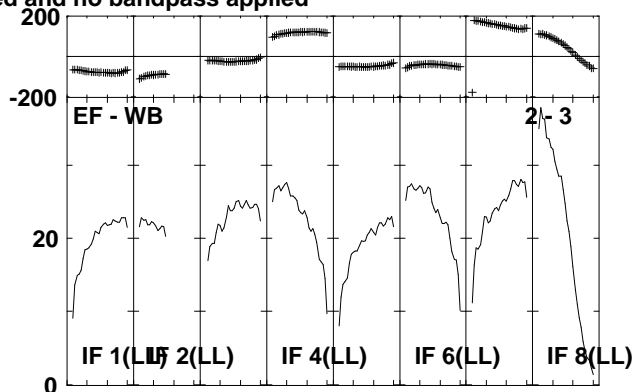
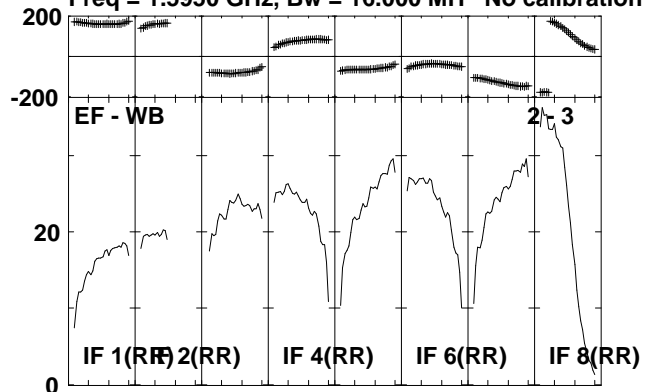

Lower frame: Milli Ampl Jy Top frame: Phas deg
 Scalar averaged cross-power spectrum Several baselines displayed
 Timerange: 00/12:32:11 to 00/12:33:47

Plot file version 30 created 06-JUL-2010 14:41:02

J2330+33 EP064J.UVDATA.1

Freq = 1.5950 GHz, Bw = 16.000 MH No calibration applied and no bandpass applied

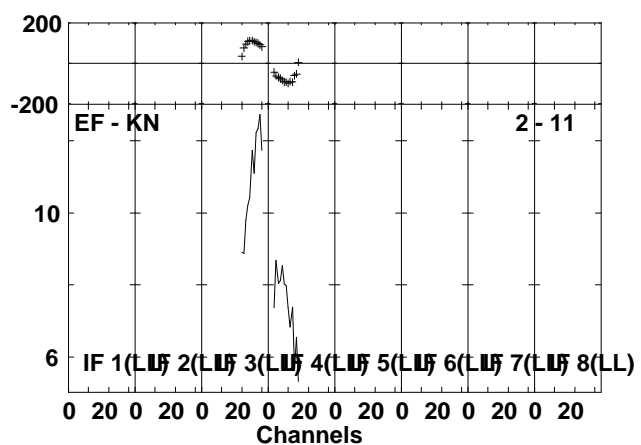
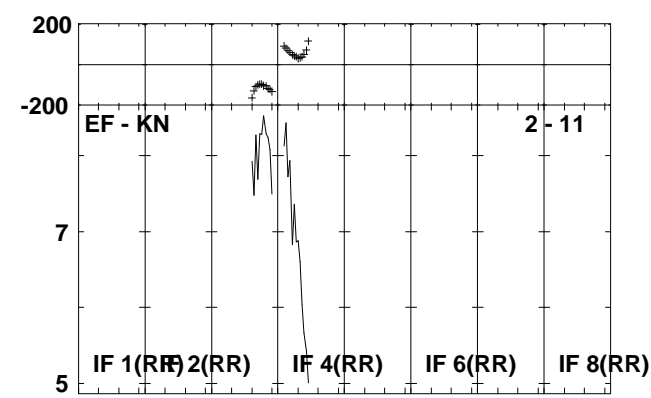
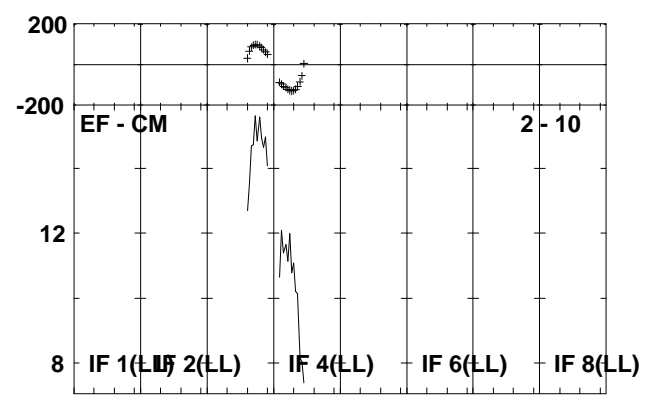
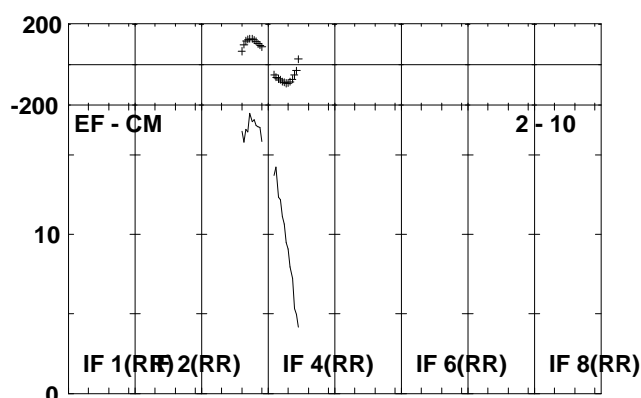
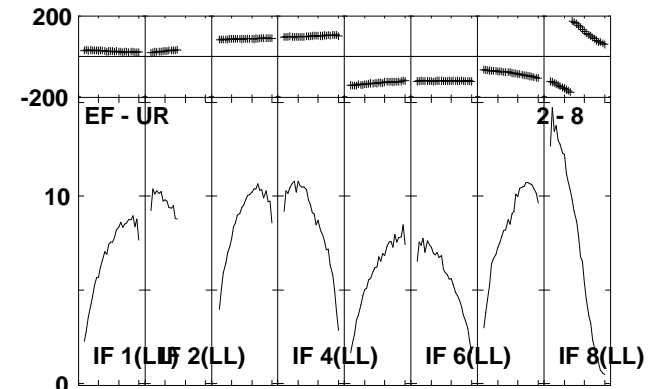
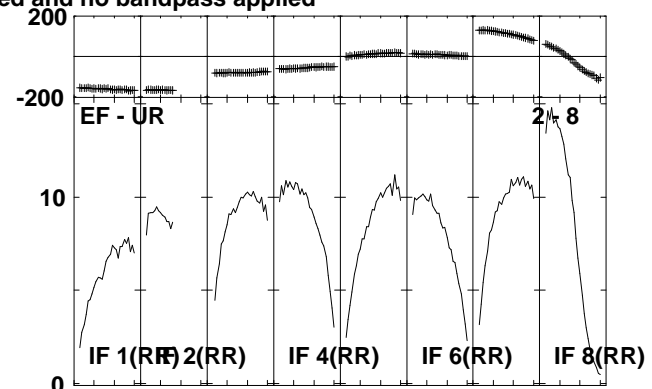
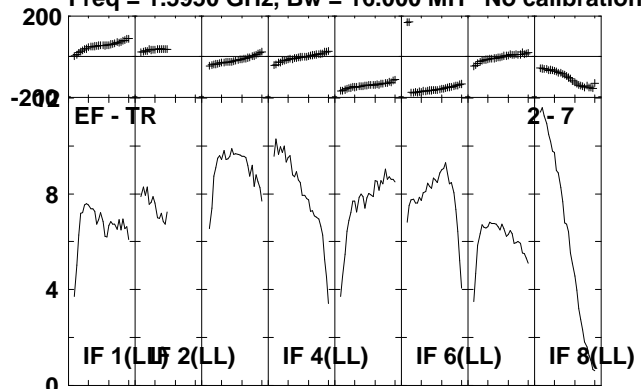

Lower frame: Milli Ampl Jy Top frame: Phas deg
 Scalar averaged cross-power spectrum Several baselines displayed
 Timerange: 00/12:32:11 to 00/12:33:47

Plot file version 31 created 06-JUL-2010 14:41:03

IRAS2336 EP064J.UVDATA.1

Freq = 1.5950 GHz, Bw = 16.000 MH No calibration applied and no bandpass applied

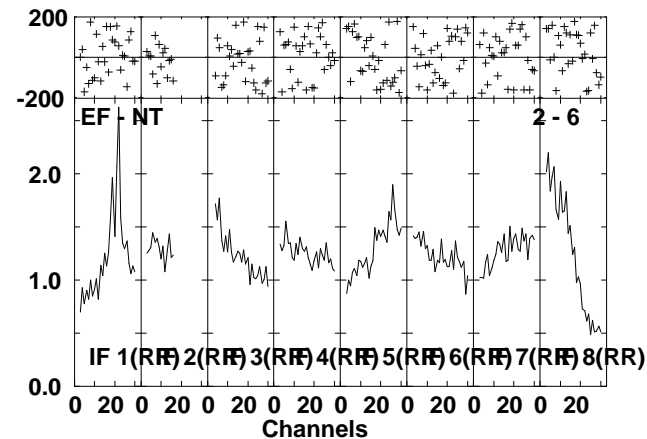
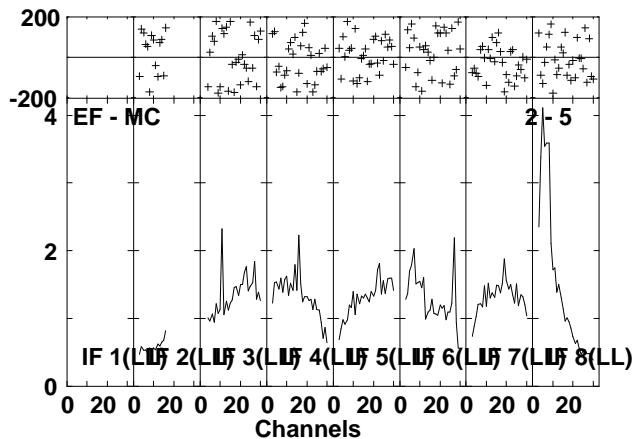
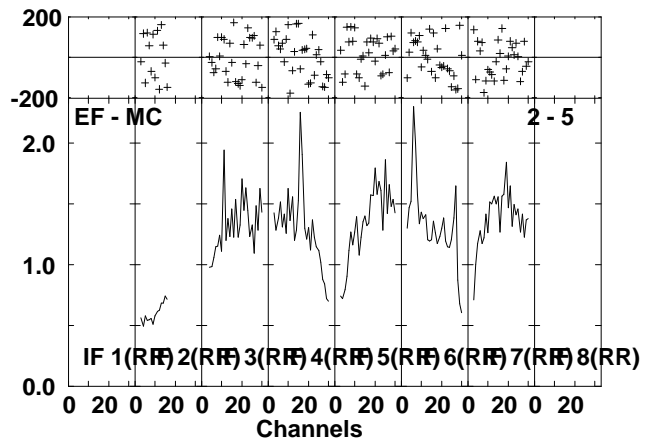
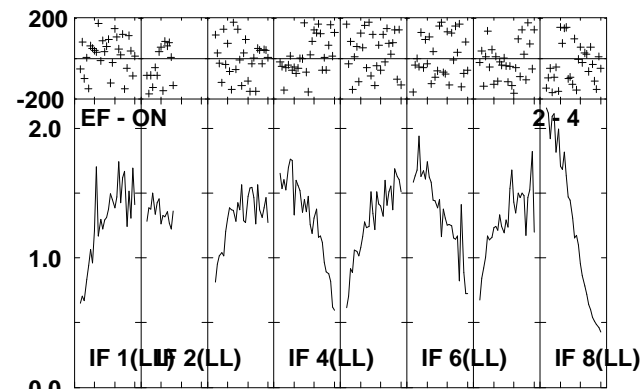
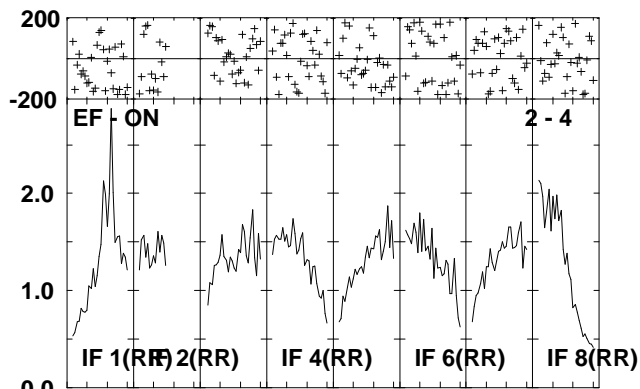
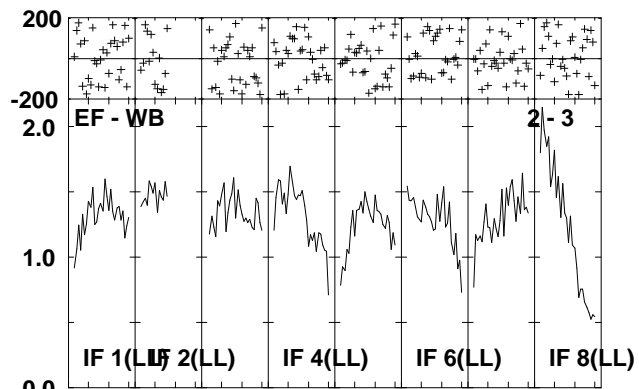
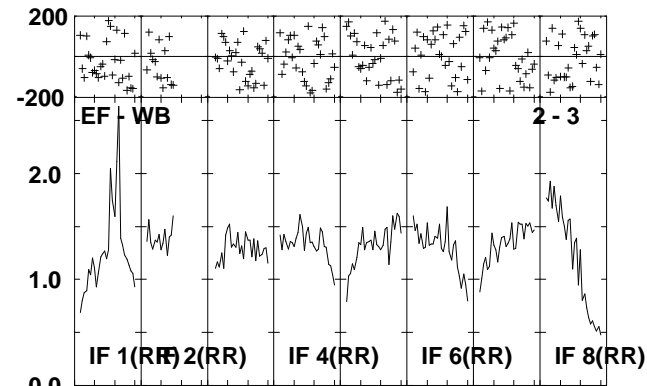
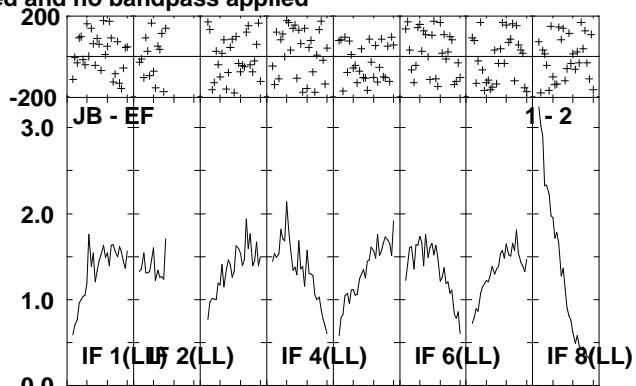
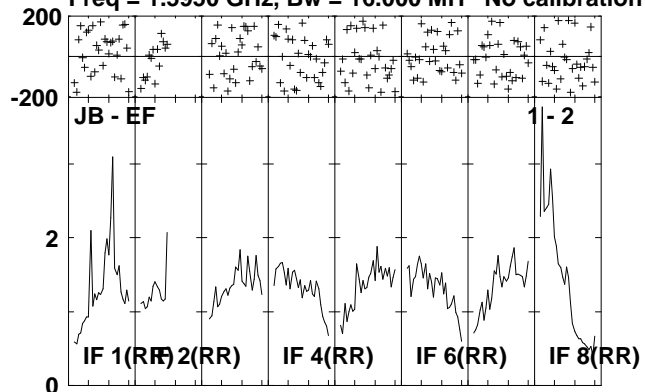

Lower frame: Milli Ampl Jy Top frame: Phas deg
Scalar averaged cross-power spectrum Several baselines displayed
Timerange: 00/12:33:51 to 00/12:37:29

Plot file version 32 created 06-JUL-2010 14:41:04

IRAS2336 EP064J.UVDATA.1

Freq = 1.5950 GHz, Bw = 16.000 MH No calibration applied and no bandpass applied

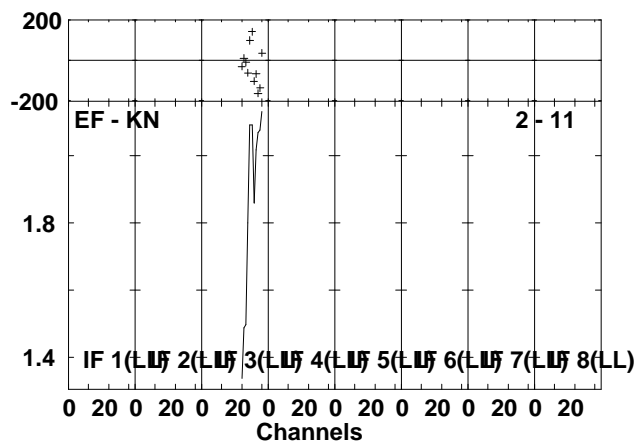
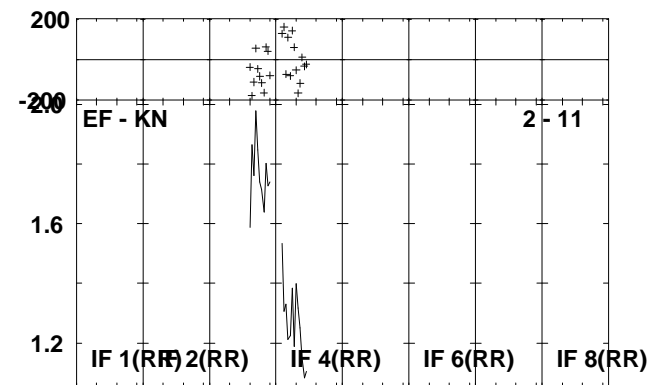
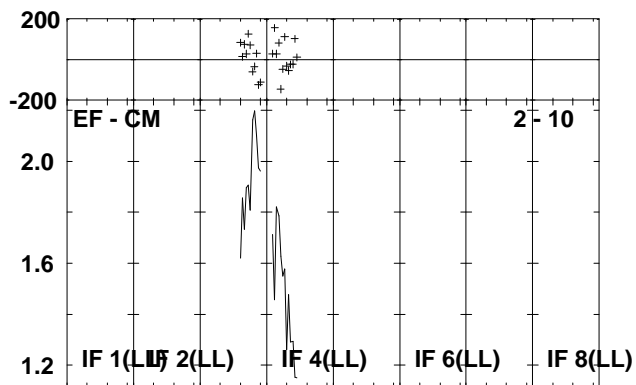
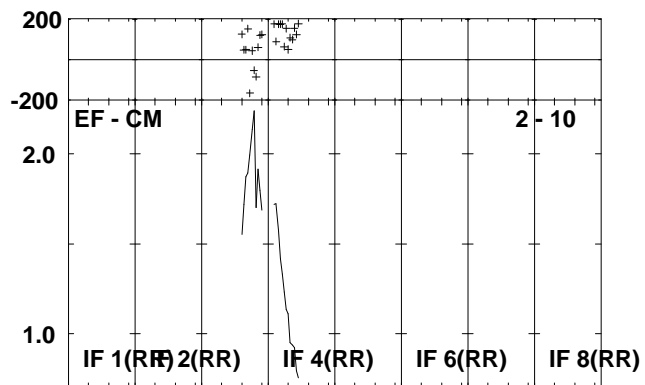
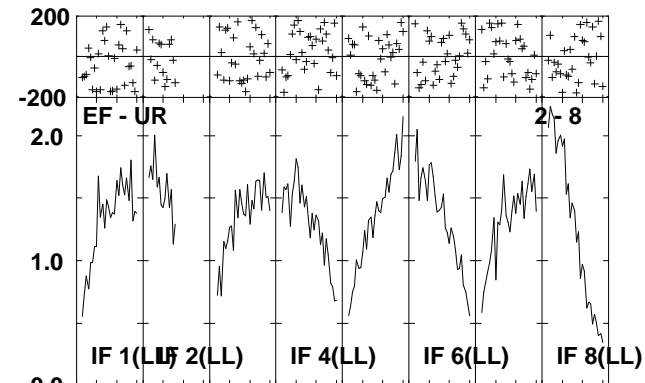
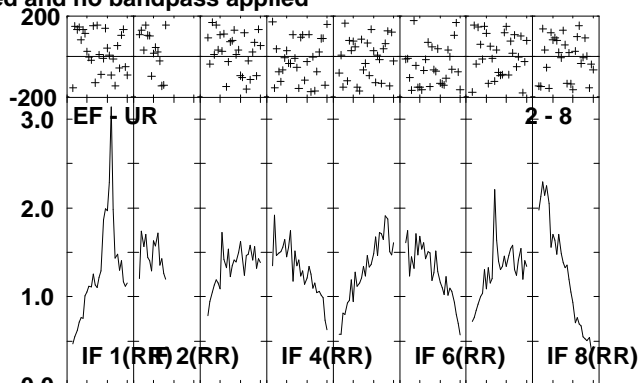
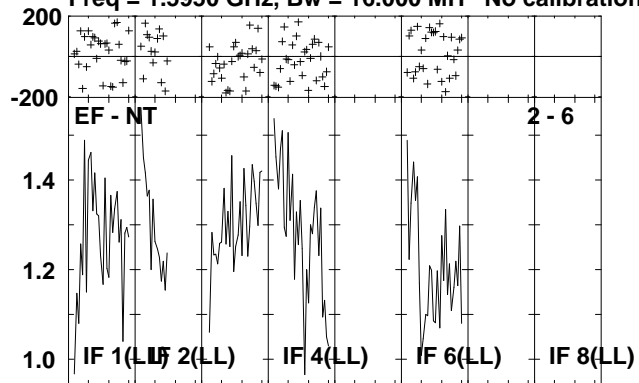

Lower frame: Milli Ampl Jy Top frame: Phas deg
Scalar averaged cross-power spectrum Several baselines displayed
Timerange: 00/12:33:51 to 00/12:37:29

Plot file version 33 created 06-JUL-2010 14:41:06

J2330+33 EP064J.UVDATA.1

Freq = 1.5950 GHz, Bw = 16.000 MH No calibration applied and no bandpass applied

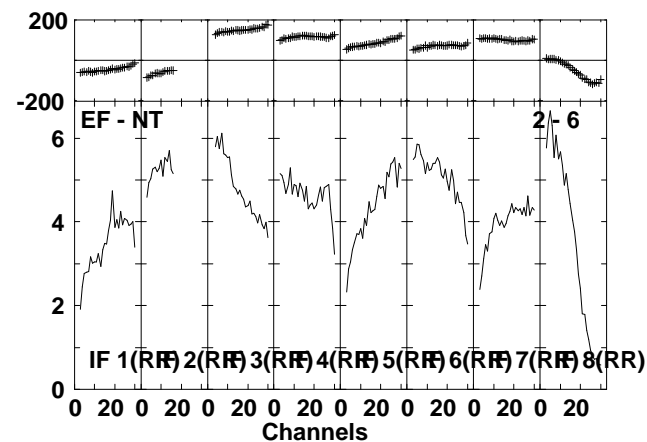
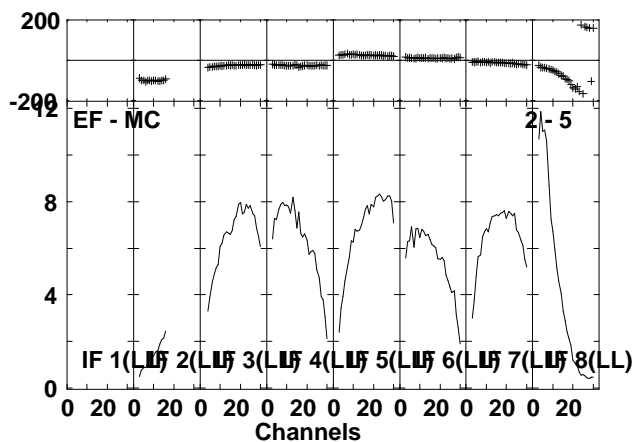
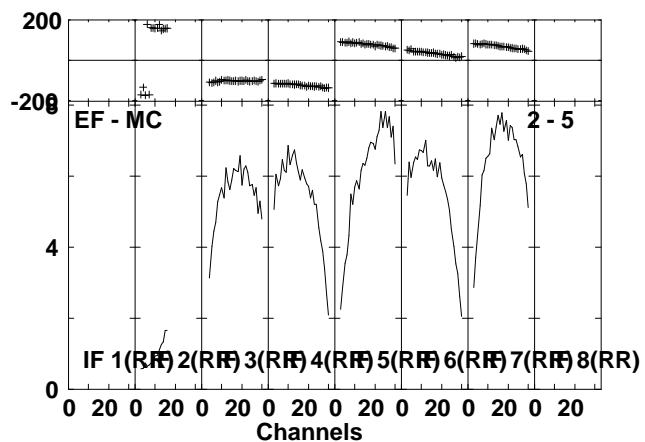
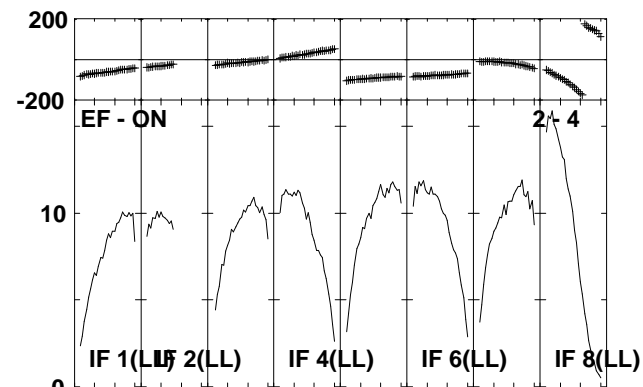
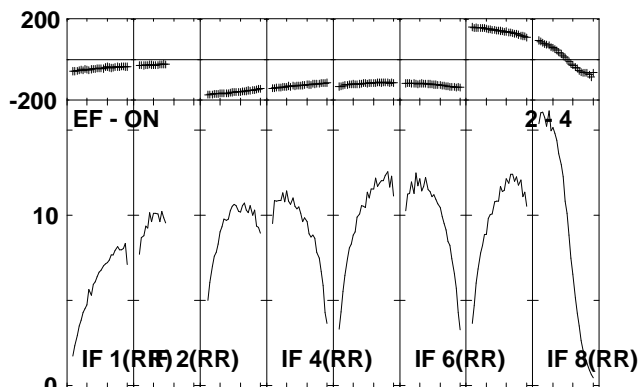
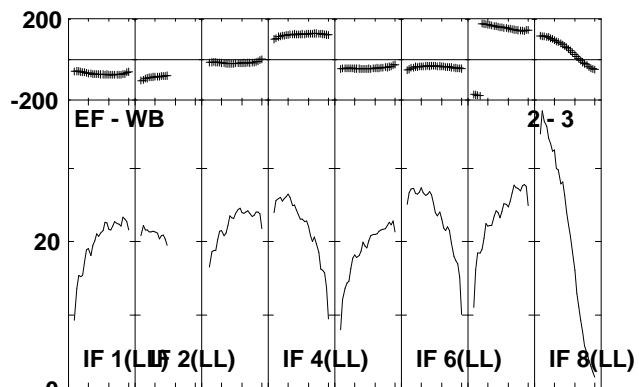
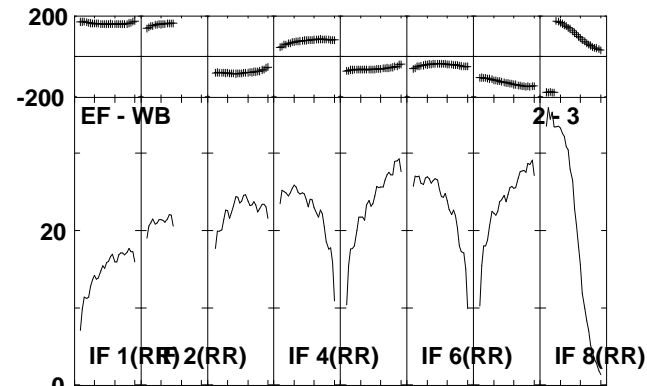
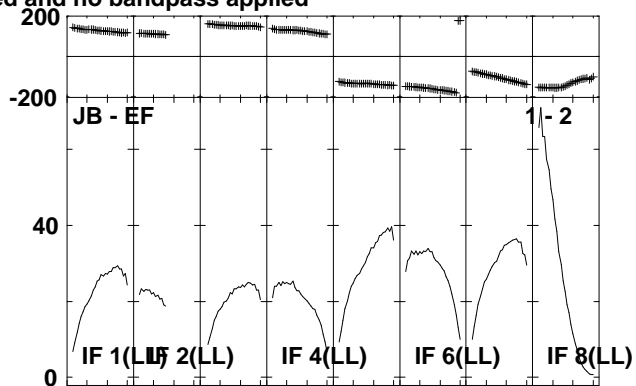
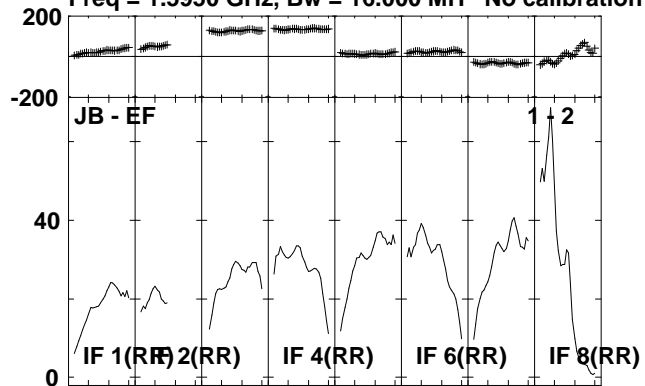

Lower frame: Milli Ampl Jy Top frame: Phas deg
Scalar averaged cross-power spectrum Several baselines displayed
Timerange: 00/12:37:31 to 00/12:39:19

Plot file version 34 created 06-JUL-2010 14:41:07

J2330+33 EP064J.UVDATA.1

Freq = 1.5950 GHz, Bw = 16.000 MH No calibration applied and no bandpass applied

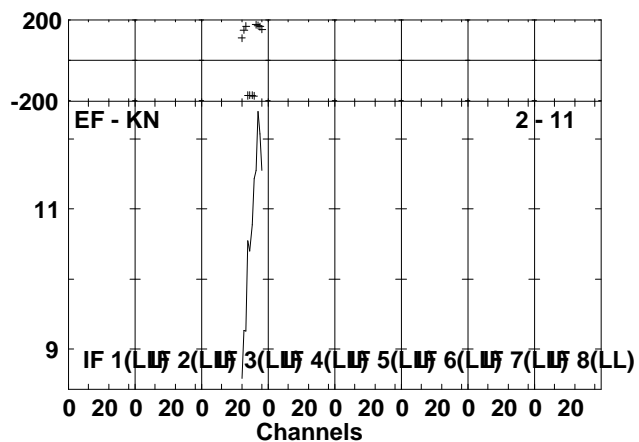
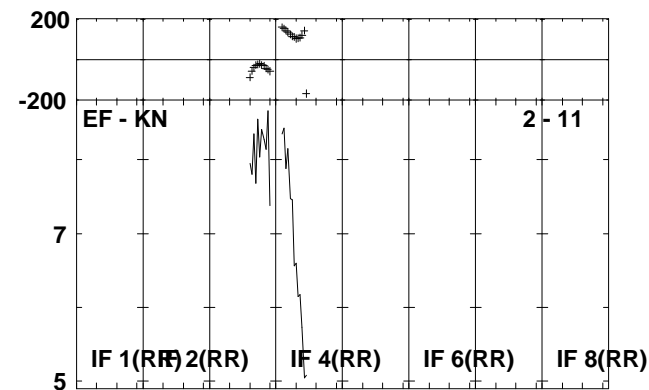
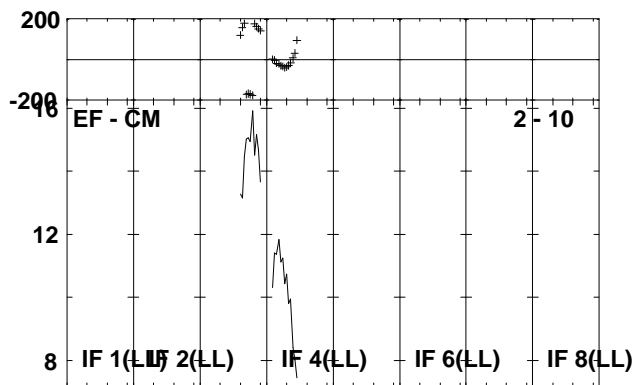
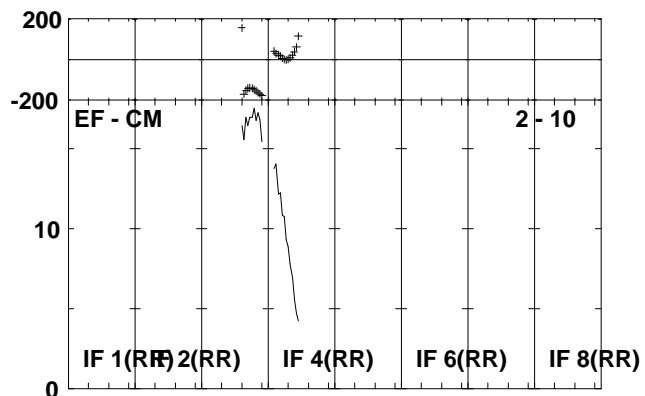
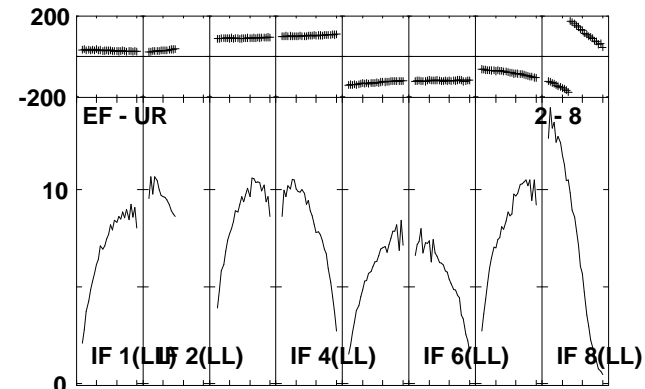
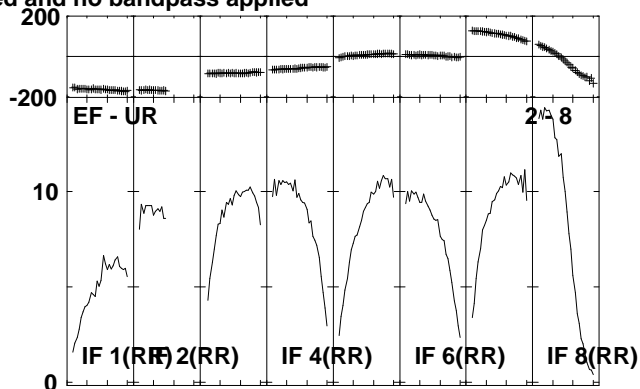
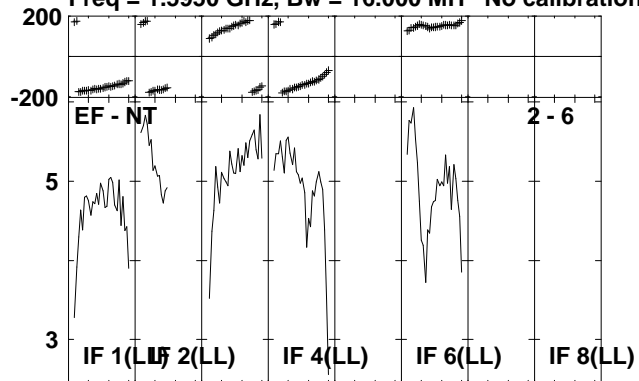

Lower frame: Milli Ampl Jy Top frame: Phas deg
Scalar averaged cross-power spectrum Several baselines displayed
Timerange: 00/12:37:31 to 00/12:39:19

Plot file version 35 created 06-JUL-2010 14:41:09

IRAS2336 EP064J.UVDATA.1

Freq = 1.5950 GHz, Bw = 16.000 MH No calibration applied and no bandpass applied

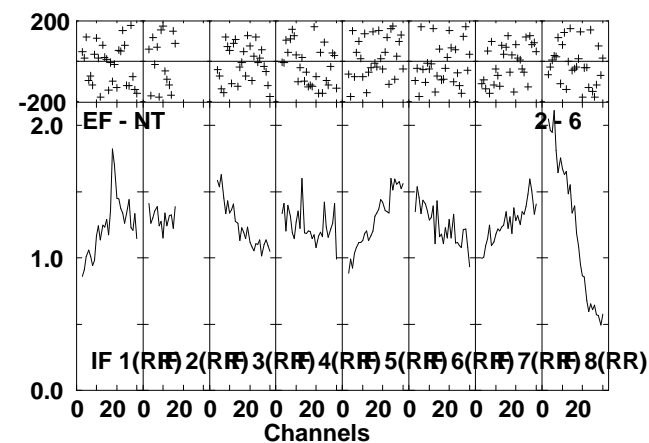
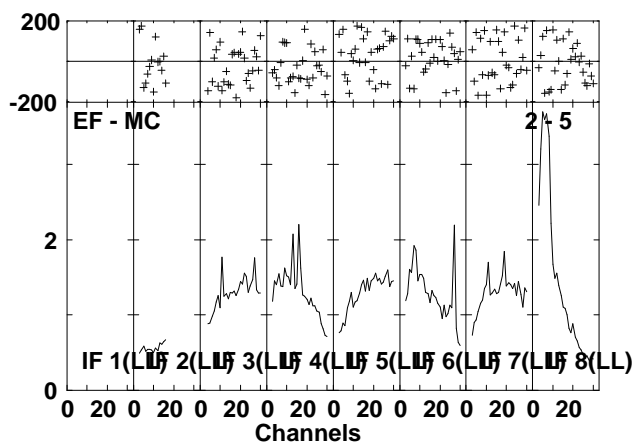
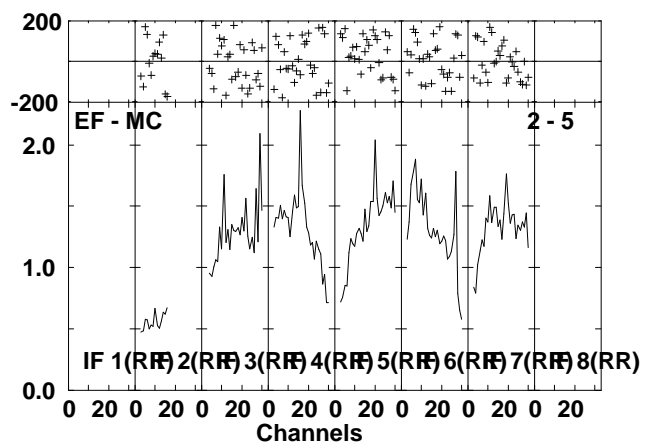
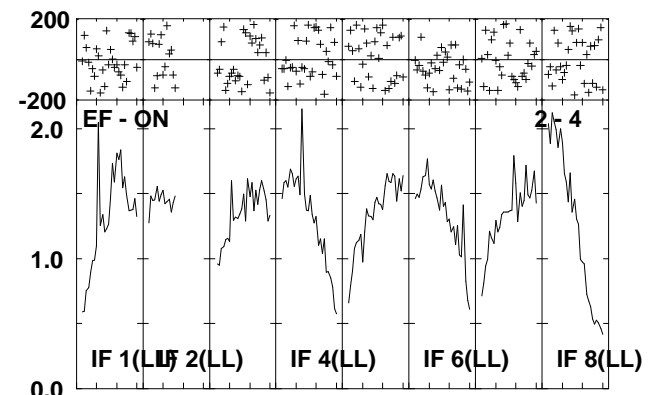
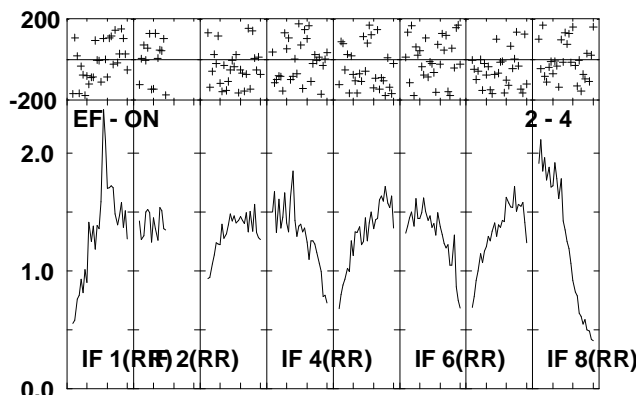
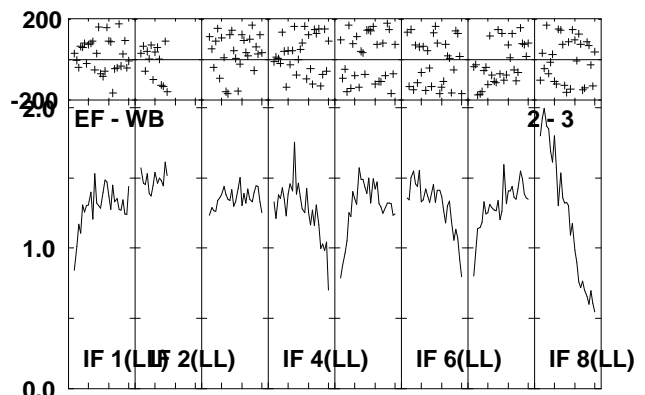
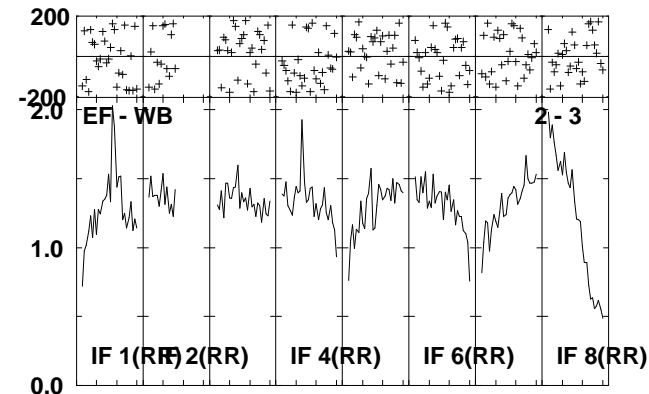
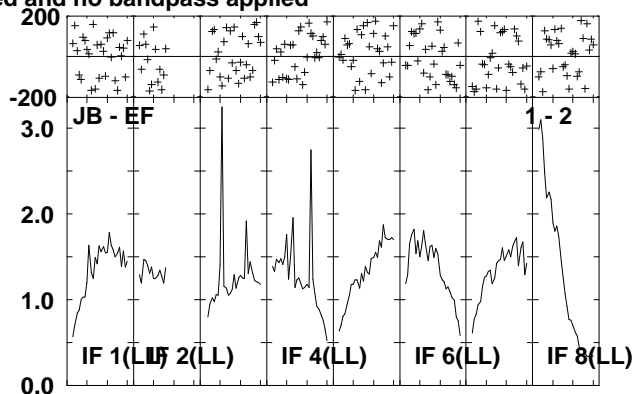
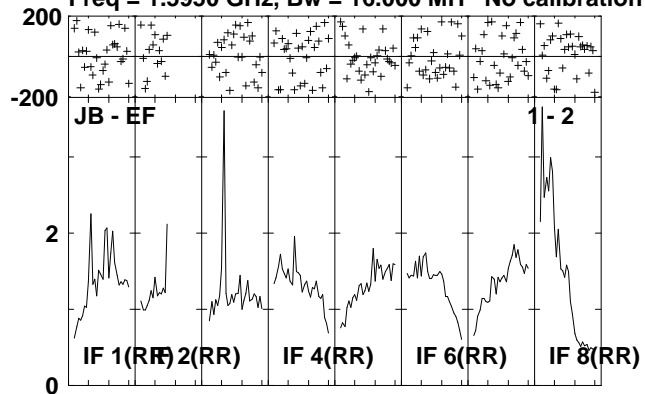

Lower frame: Milli Ampl Jy Top frame: Phas deg
Scalar averaged cross-power spectrum Several baselines displayed
Timerange: 00/12:39:21 to 00/12:42:59

Plot file version 36 created 06-JUL-2010 14:41:10

IRAS2336 EP064J.UVDATA.1

Freq = 1.5950 GHz, Bw = 16.000 MH No calibration applied and no bandpass applied

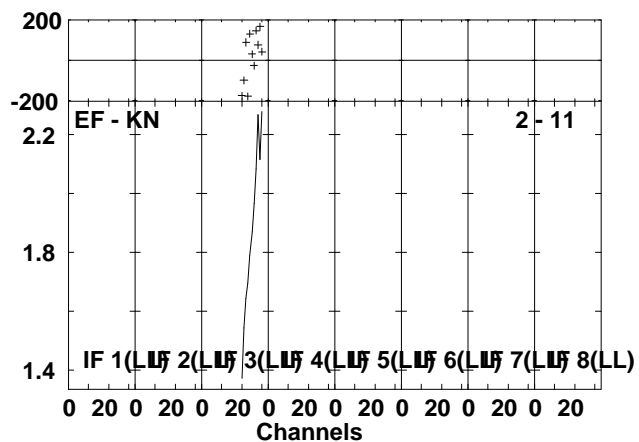
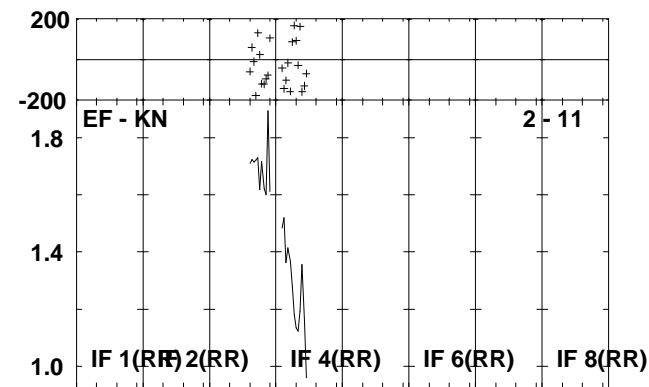
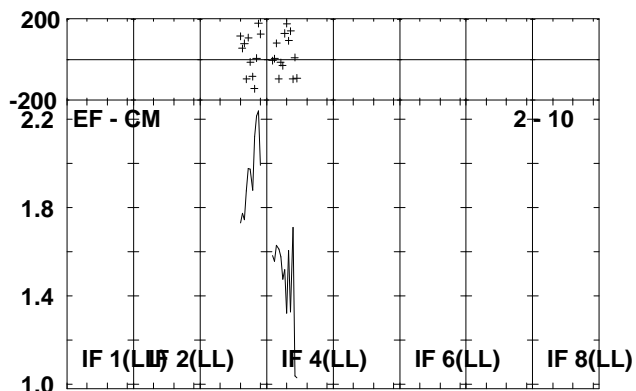
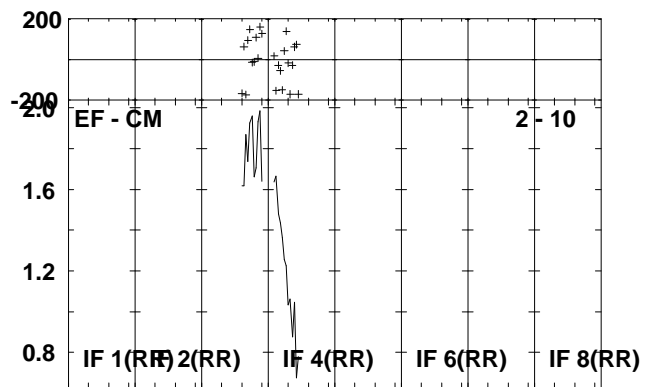
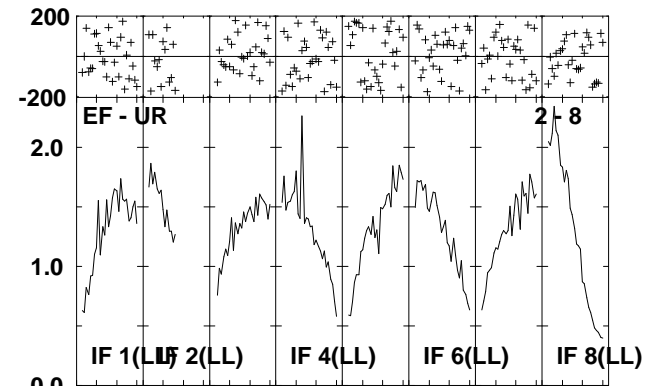
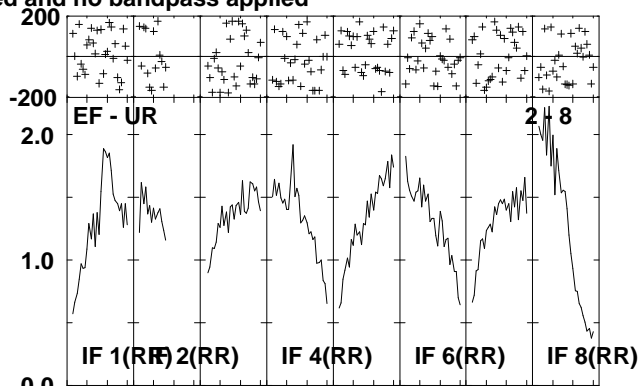
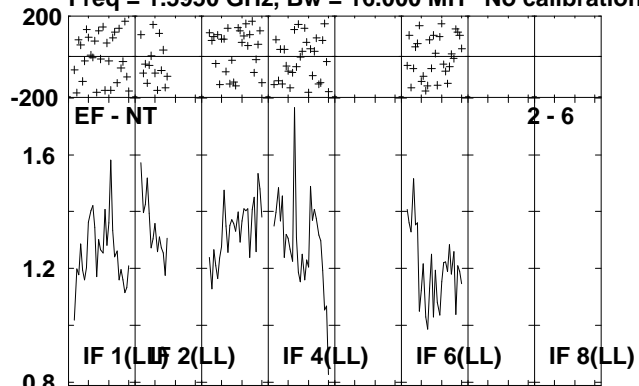

Lower frame: Milli Ampl Jy Top frame: Phas deg
Scalar averaged cross-power spectrum Several baselines displayed
Timerange: 00/12:39:21 to 00/12:42:59

Plot file version 37 created 06-JUL-2010 14:41:13

J2330+33 EP064J.UVDATA.1

Freq = 1.5950 GHz, Bw = 16.000 MH No calibration applied and no bandpass applied

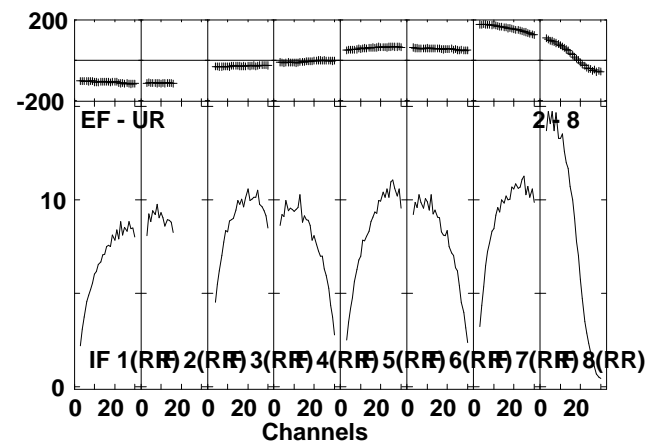
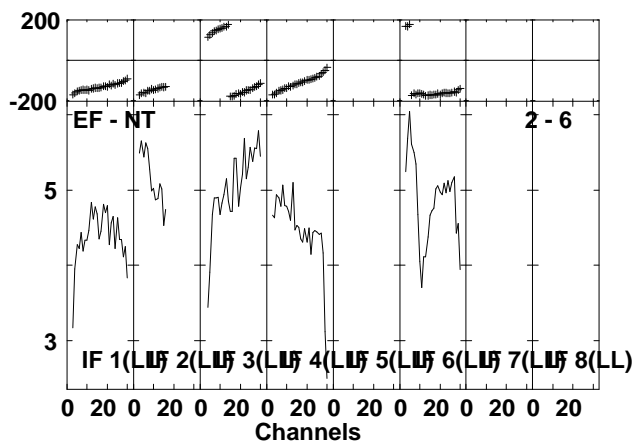
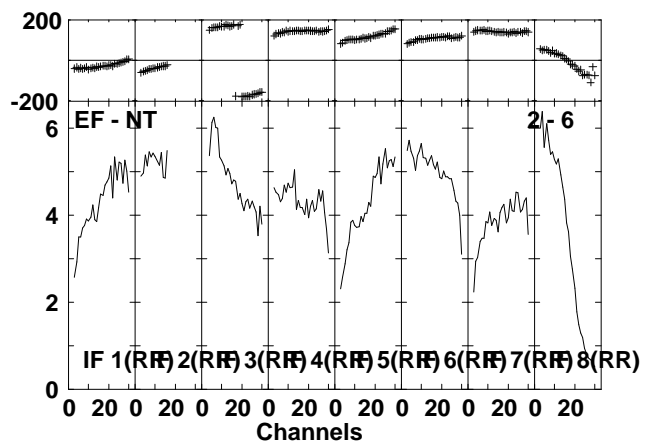
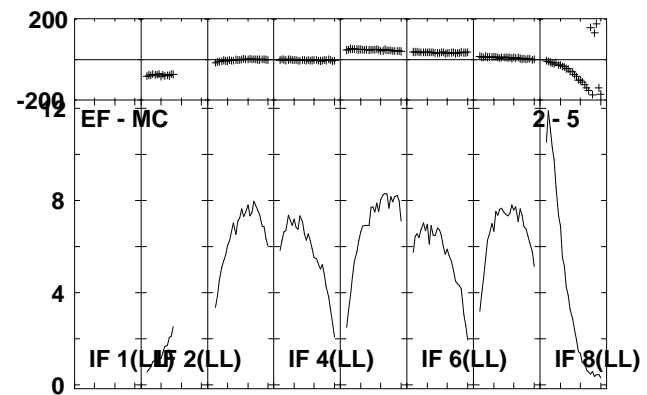
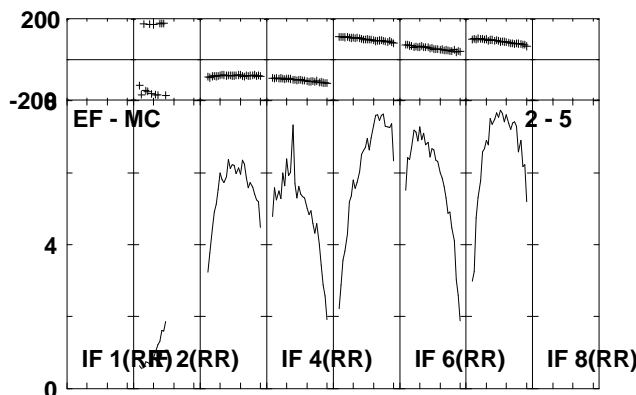
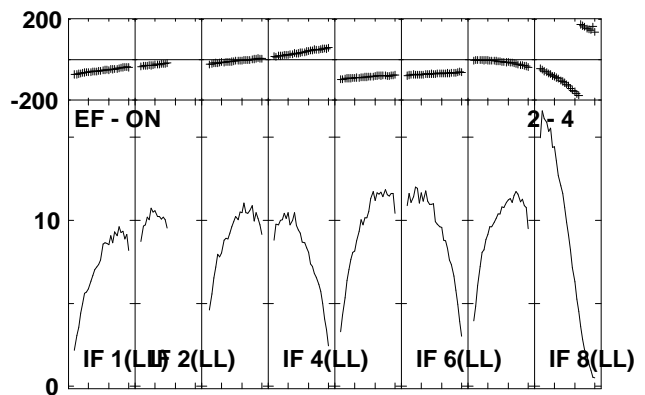
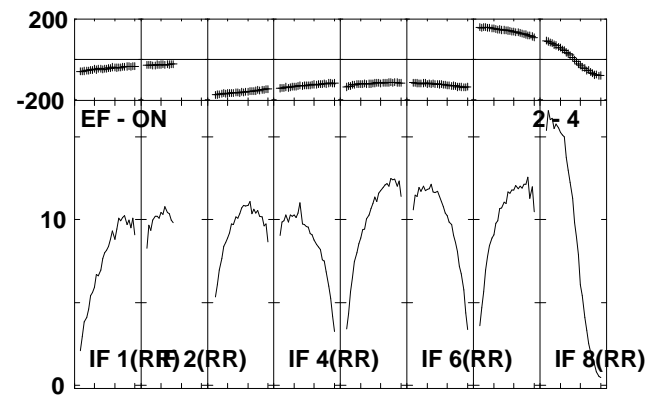
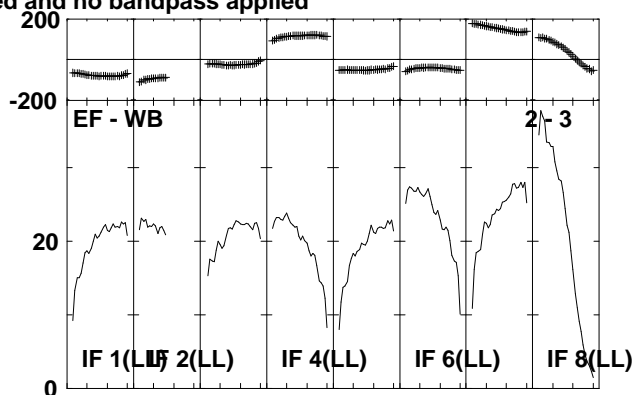
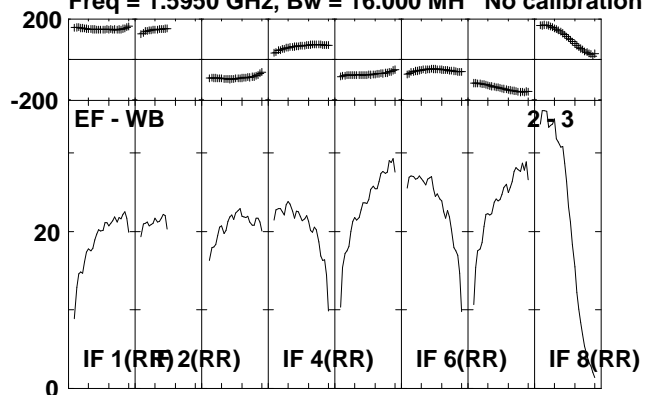

Lower frame: Milli Ampl Jy Top frame: Phas deg
Scalar averaged cross-power spectrum Several baselines displayed
Timerange: 00:12:43:01 to 00:12:44:49

Plot file version 38 created 06-JUL-2010 14:41:13

J2330+33 EP064J.UVDATA.1

Freq = 1.5950 GHz, Bw = 16.000 MH No calibration applied and no bandpass applied

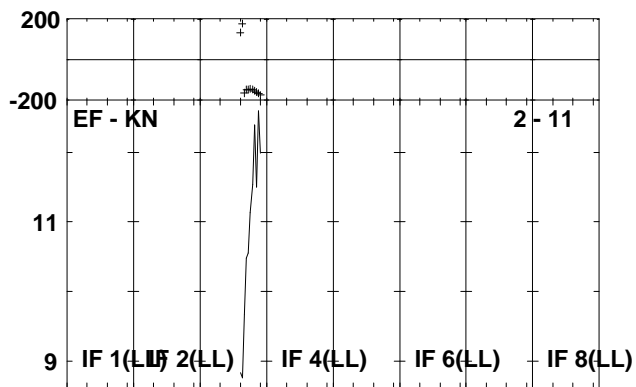
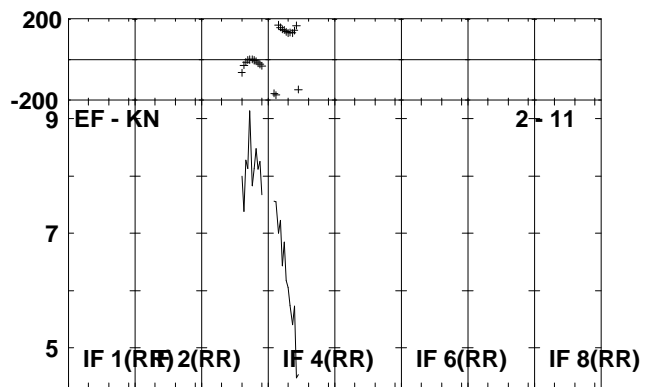
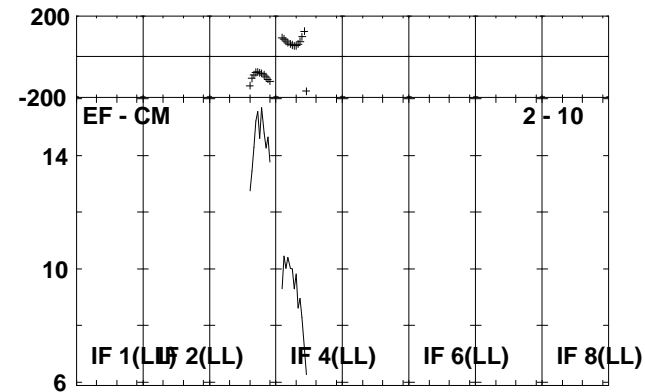
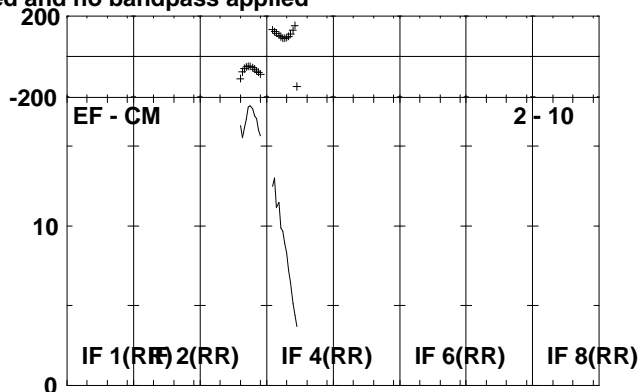
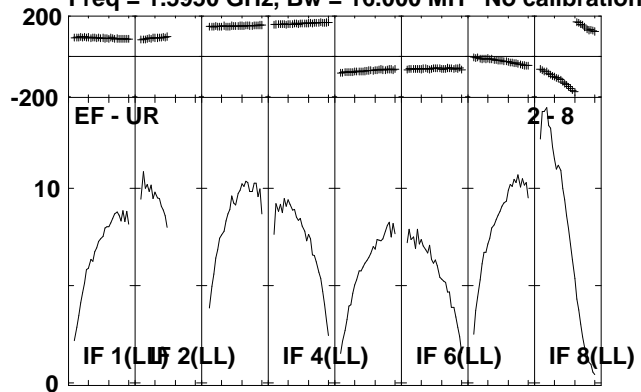

Lower frame: Milli Ampl Jy Top frame: Phas deg
Scalar averaged cross-power spectrum Several baselines displayed
Timerange: 00/12:43:01 to 00/12:44:49

Plot file version 39 created 06-JUL-2010 14:41:14

IRAS2336 EP064J.UVDATA.1

Freq = 1.5950 GHz, Bw = 16.000 MH No calibration applied and no bandpass applied

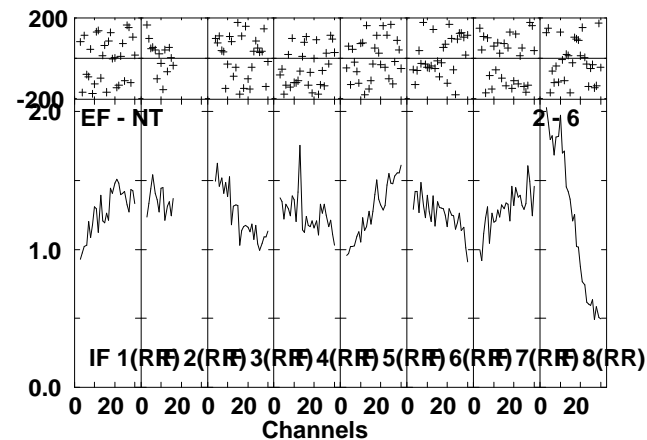
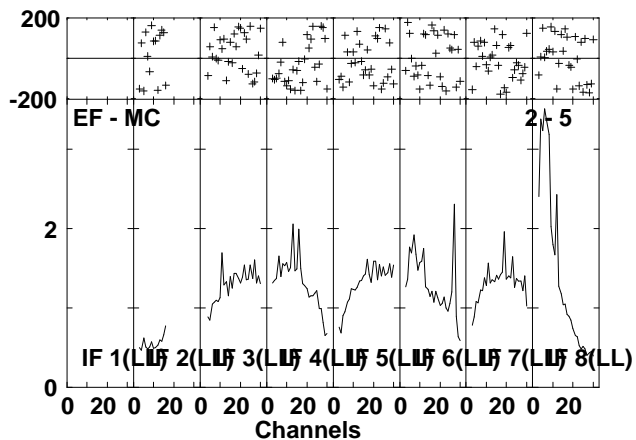
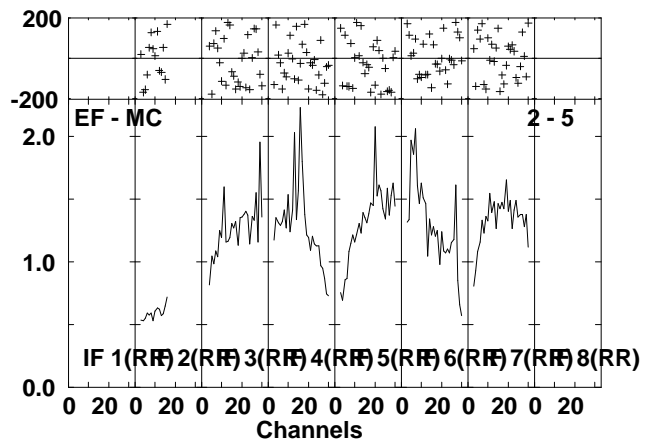
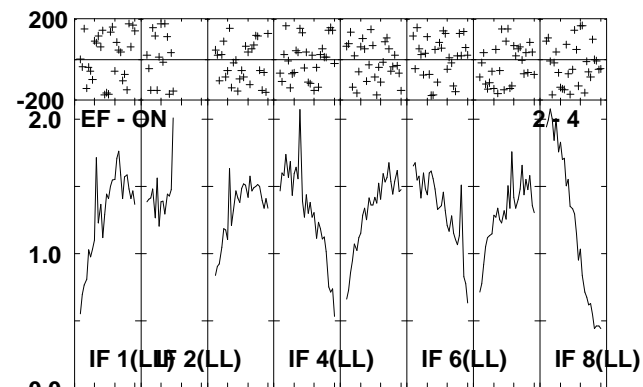
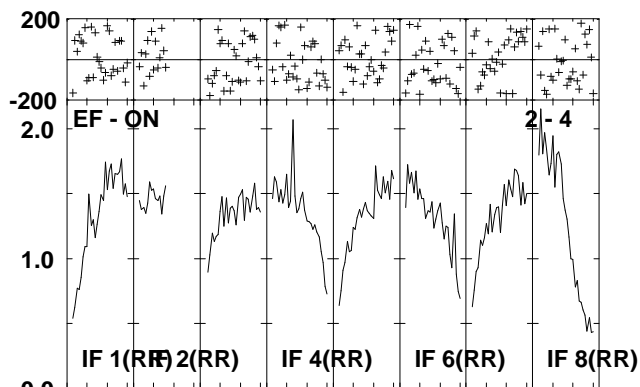
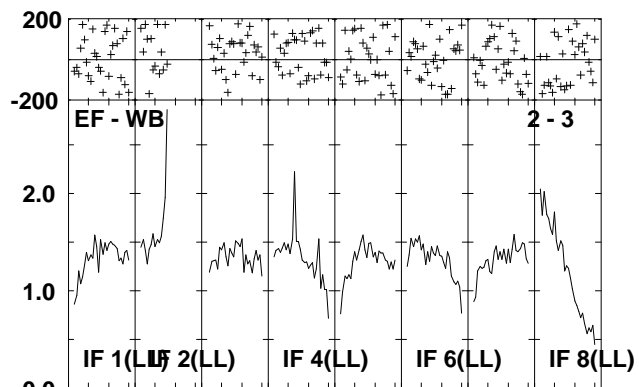
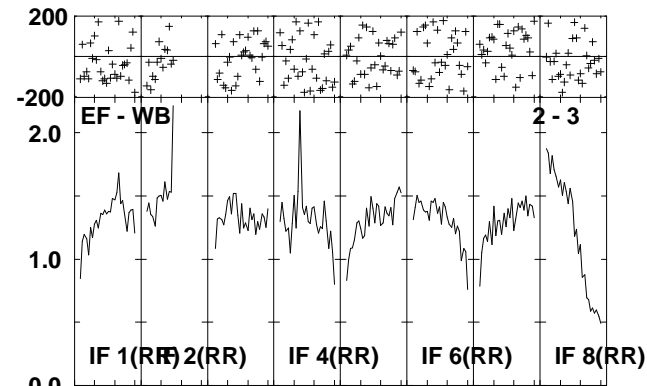
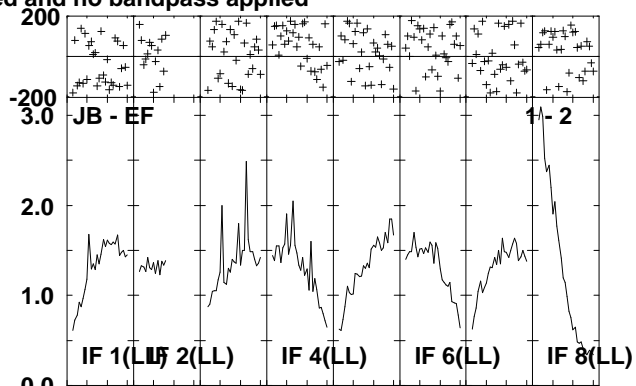
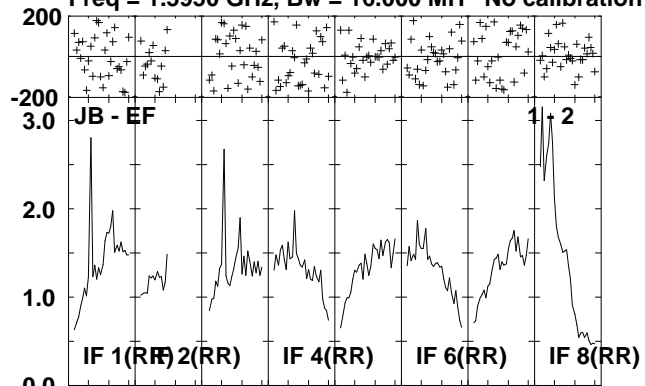

Lower frame: Milli Ampl Jy Top frame: Phas deg
Scalar averaged cross-power spectrum Several baselines displayed
Timerange: 00/12:44:51 to 00/12:48:27

Plot file version 40 created 06-JUL-2010 14:41:16

IRAS2336 EP064J.UVDATA.1

Freq = 1.5950 GHz, Bw = 16.000 MH No calibration applied and no bandpass applied

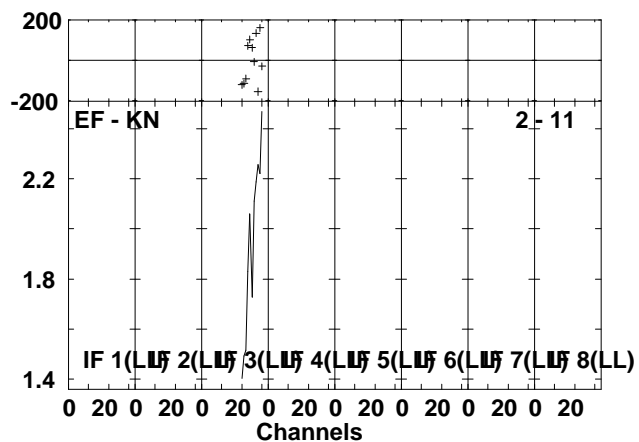
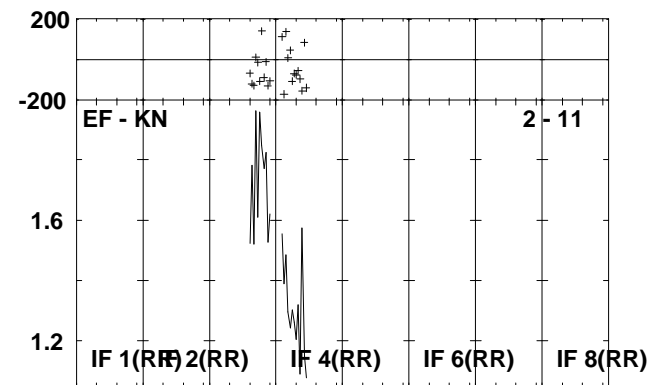
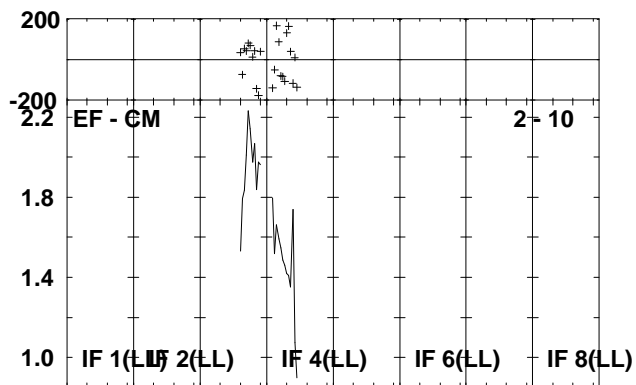
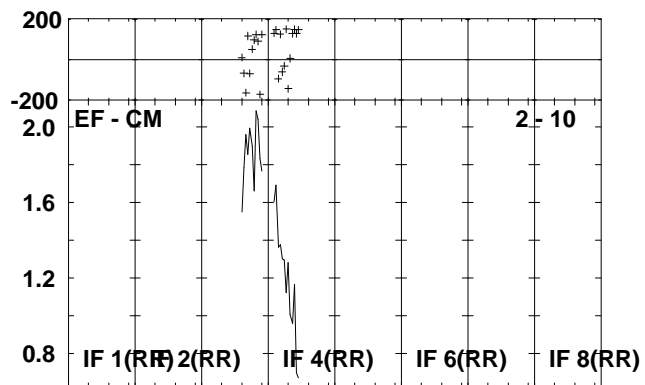
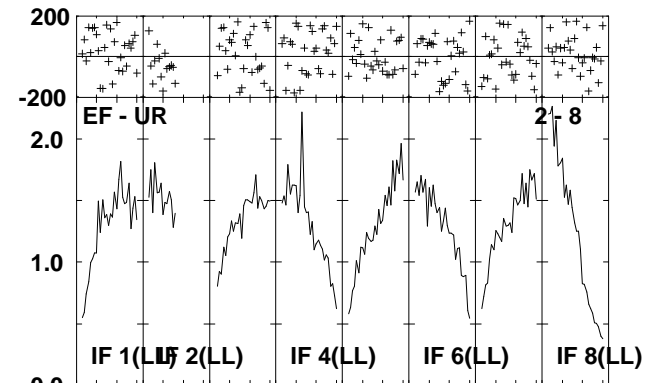
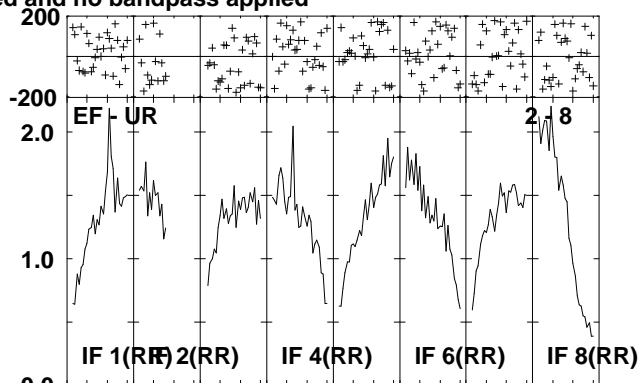
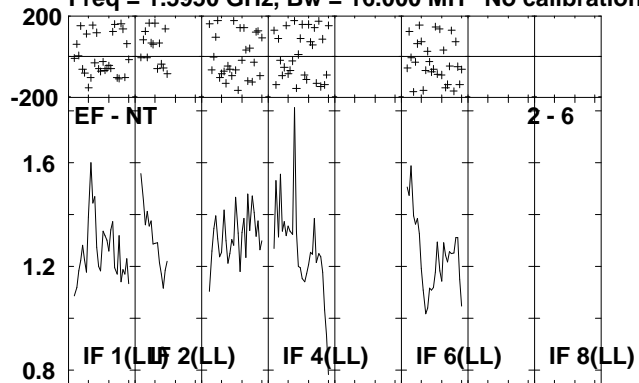

Lower frame: Milli Ampl Jy Top frame: Phas deg
Scalar averaged cross-power spectrum Several baselines displayed
Timerange: 00/12:44:51 to 00/12:48:27

Plot file version 41 created 06-JUL-2010 14:41:18

J2330+33 EP064J.UVDATA.1

Freq = 1.5950 GHz, Bw = 16.000 MH No calibration applied and no bandpass applied

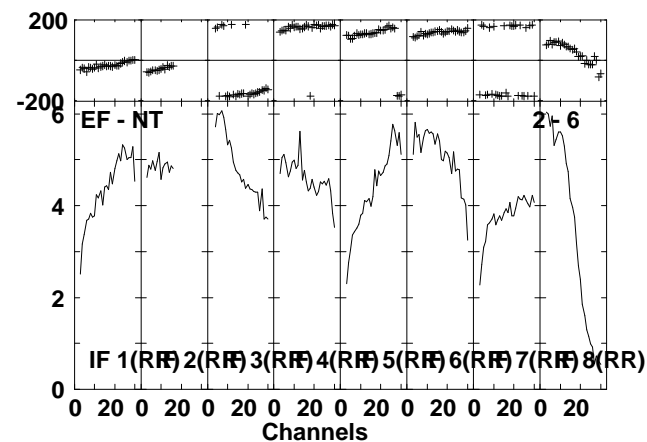
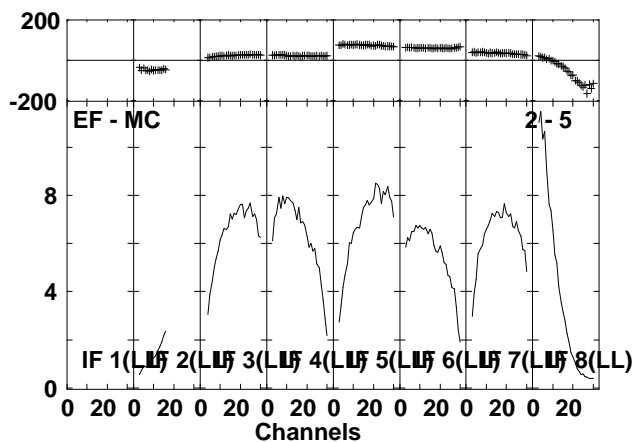
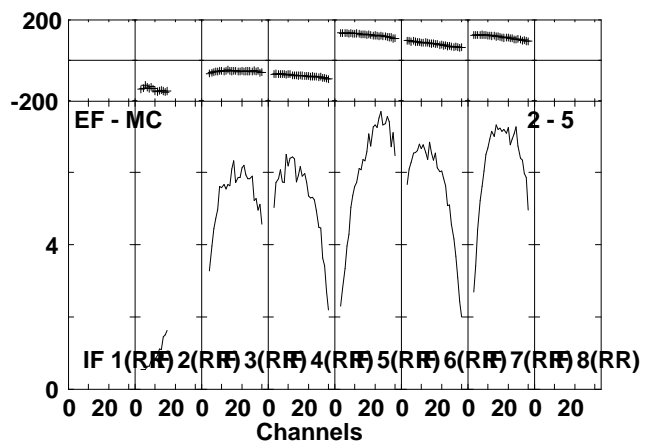
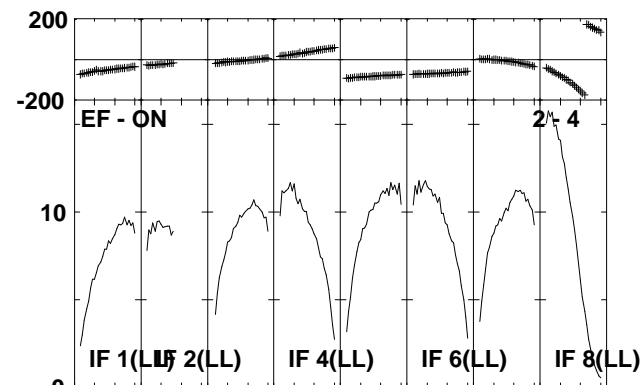
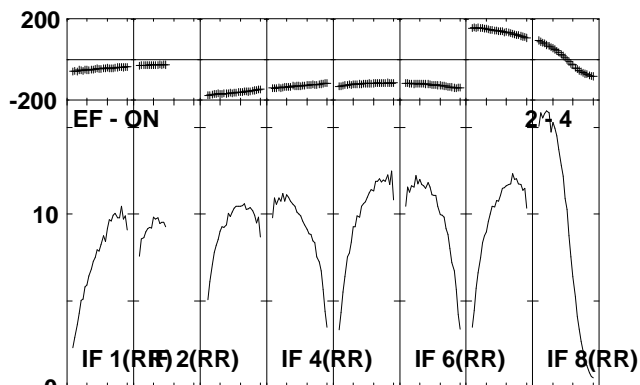
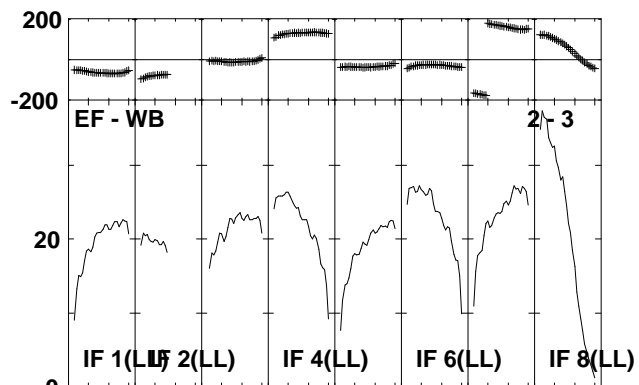
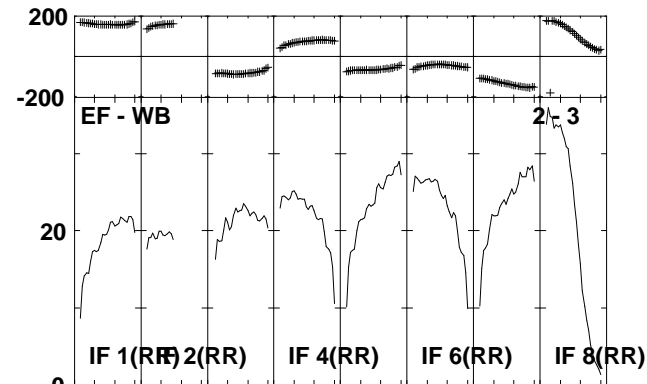
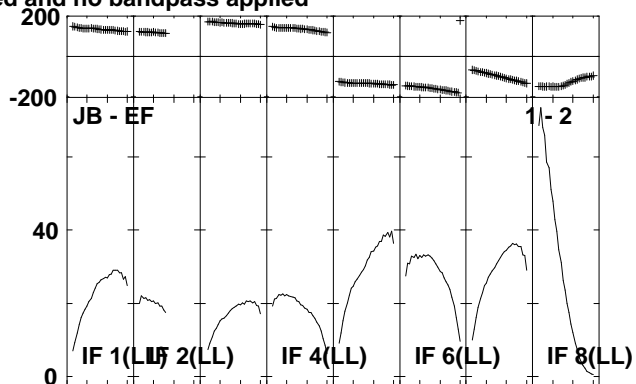
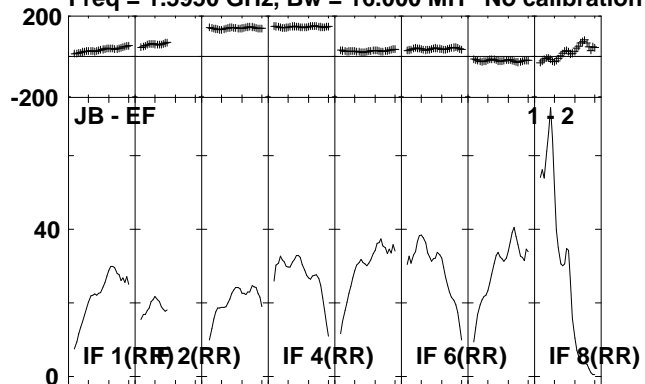

Lower frame: Milli Ampl Jy Top frame: Phas deg
Scalar averaged cross-power spectrum Several baselines displayed
Timerange: 00:12:49:31 to 00:12:51:09

Plot file version 42 created 06-JUL-2010 14:41:19

J2330+33 EP064J.UVDATA.1

Freq = 1.5950 GHz, Bw = 16.000 MH No calibration applied and no bandpass applied

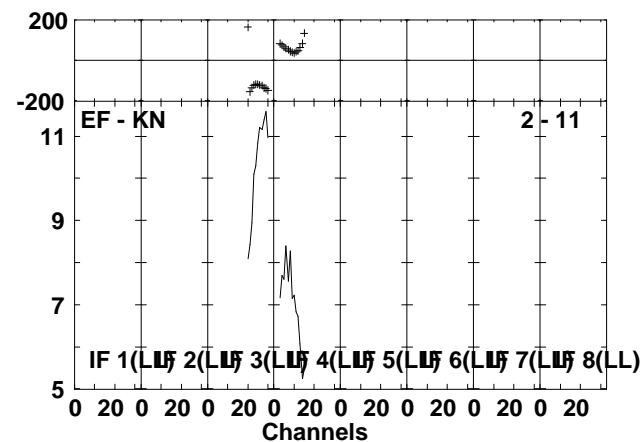
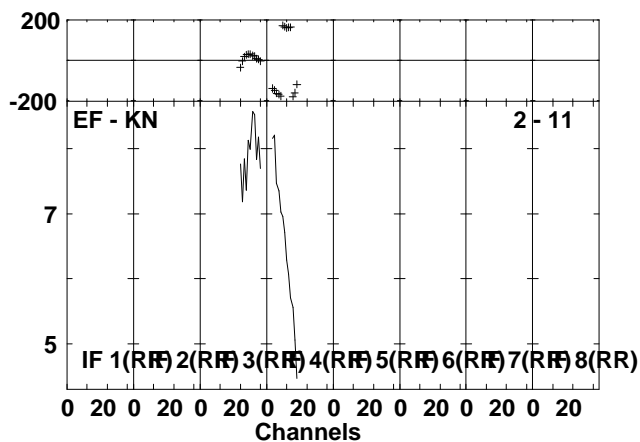
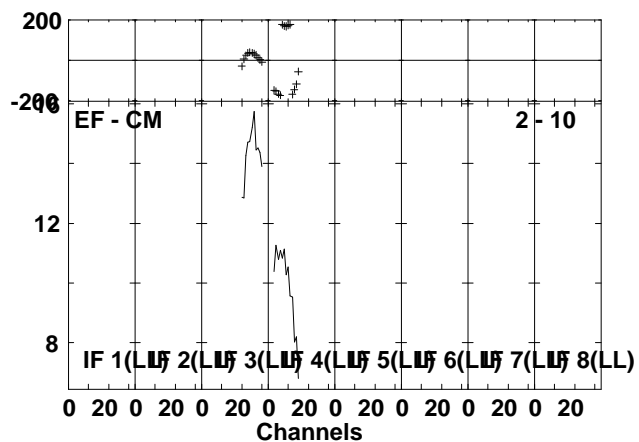
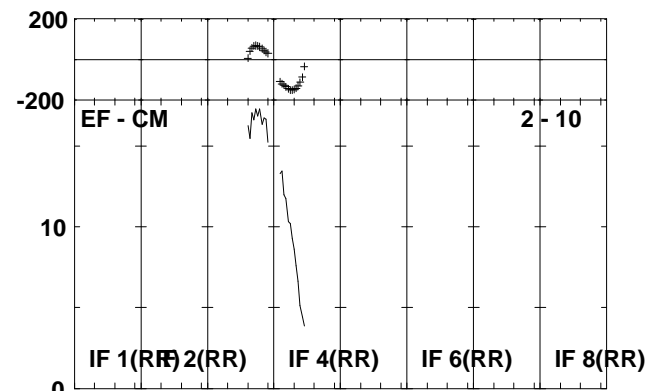
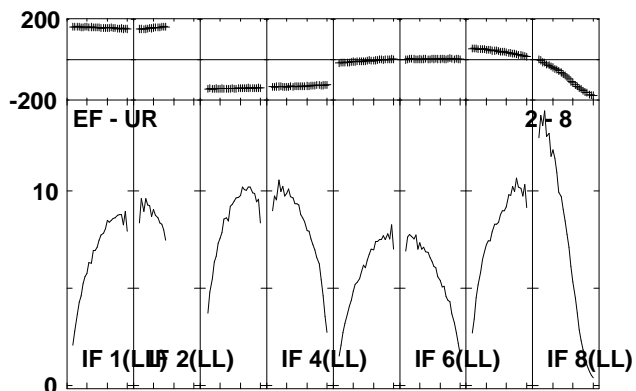
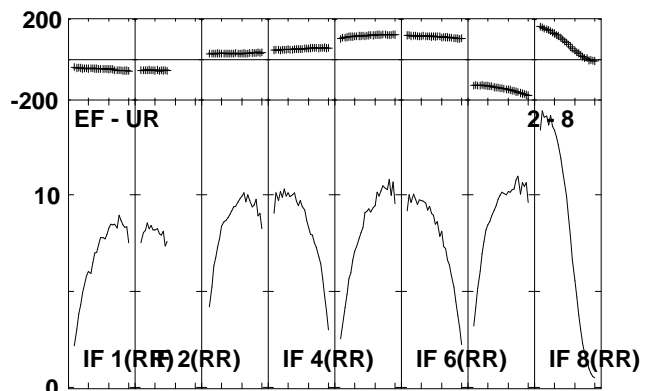
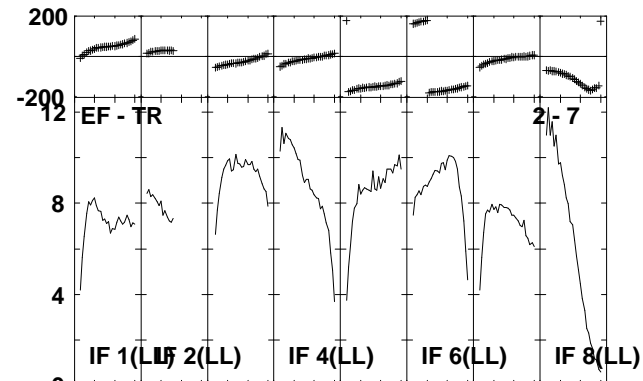
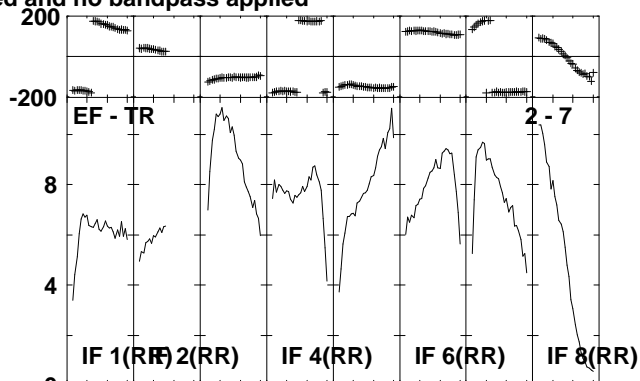
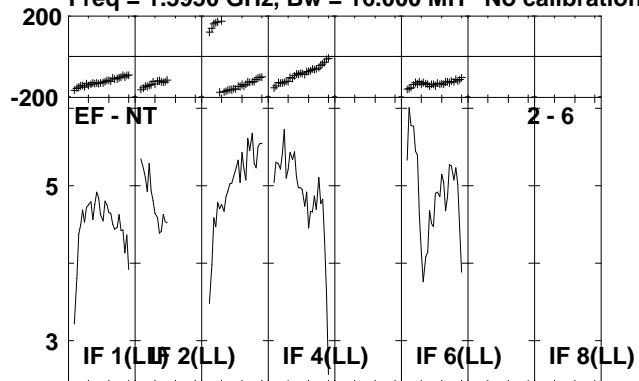

Lower frame: Milli Ampl Jy Top frame: Phas deg
Scalar averaged cross-power spectrum Several baselines displayed
Timerange: 00/12:49:31 to 00/12:51:09

Plot file version 43 created 06-JUL-2010 14:41:21

IRAS2336 EP064J.UVDATA.1

Freq = 1.5950 GHz, Bw = 16.000 MH No calibration applied and no bandpass applied

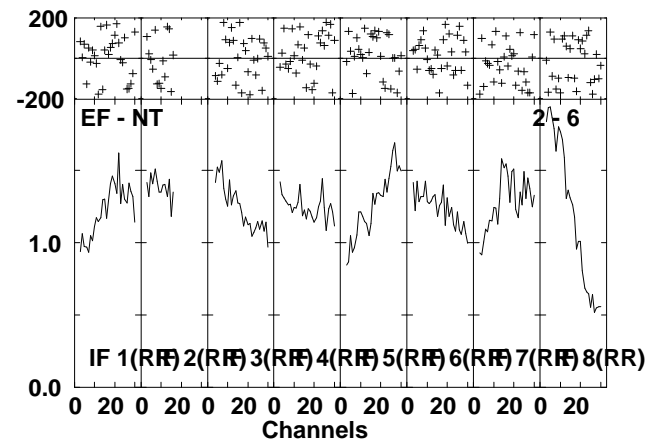
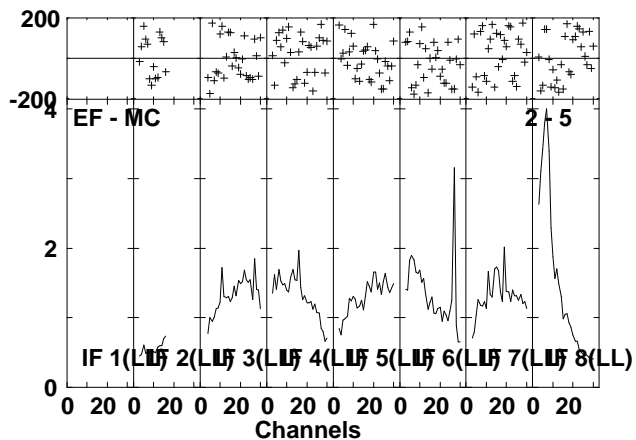
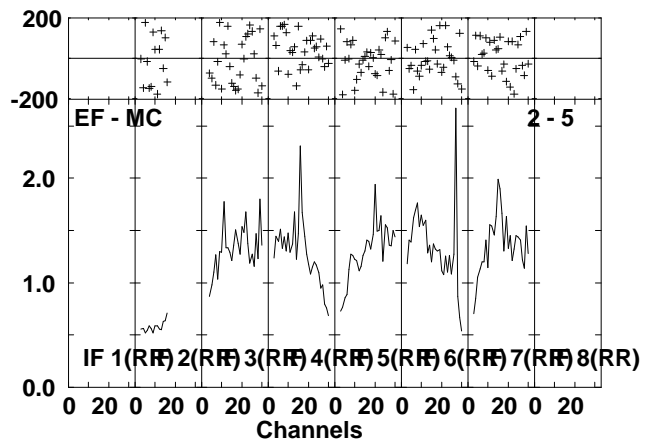
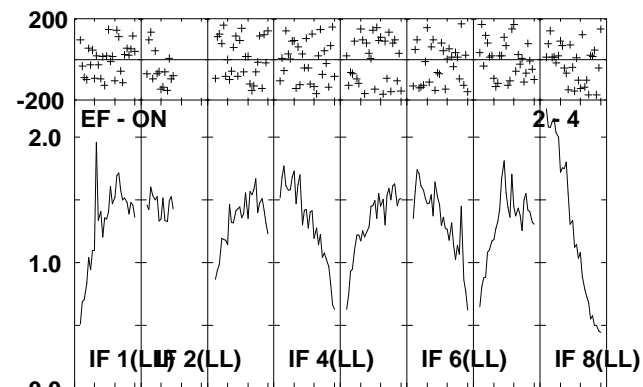
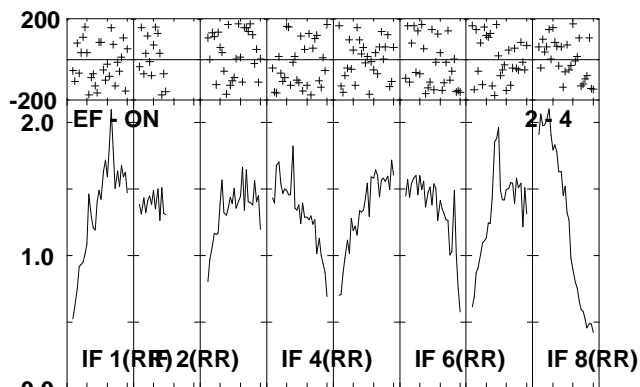
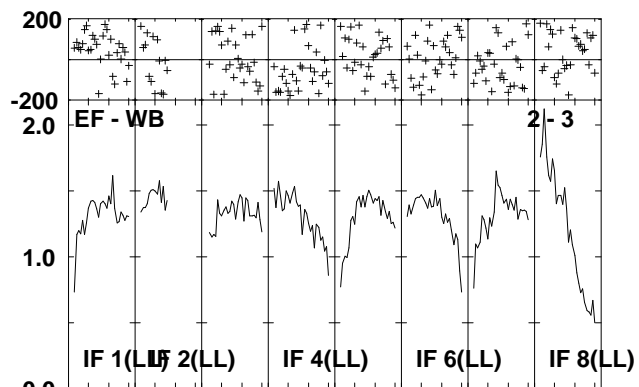
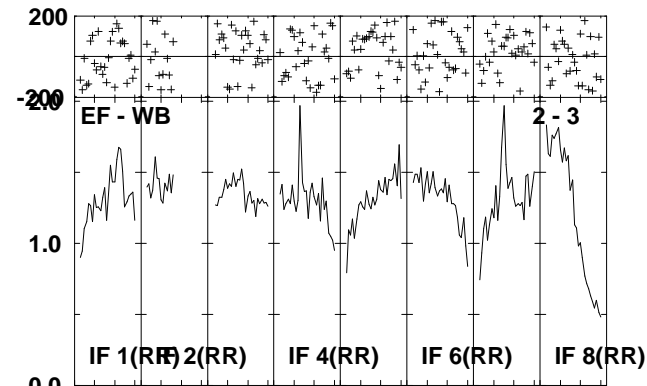
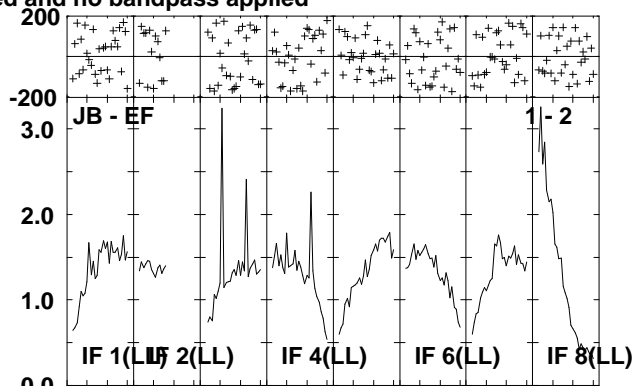
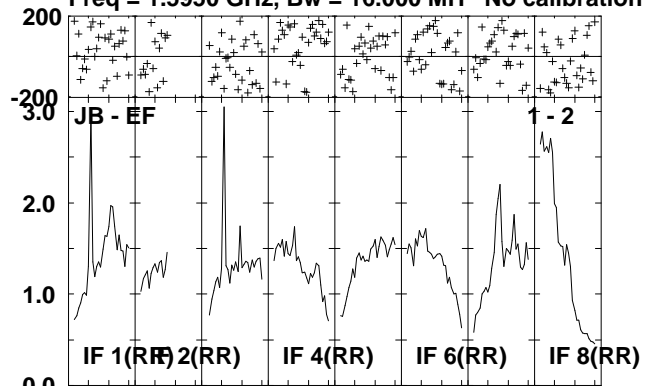

Lower frame: Milli Ampl Jy Top frame: Phas deg
Scalar averaged cross-power spectrum Several baselines displayed
Timerange: 00/12:51:11 to 00/12:54:49

Plot file version 44 created 06-JUL-2010 14:41:23

IRAS2336 EP064J.UVDATA.1

Freq = 1.5950 GHz, Bw = 16.000 MH No calibration applied and no bandpass applied

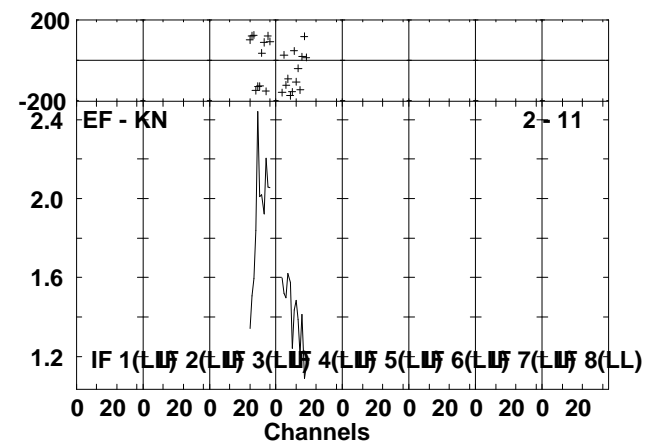
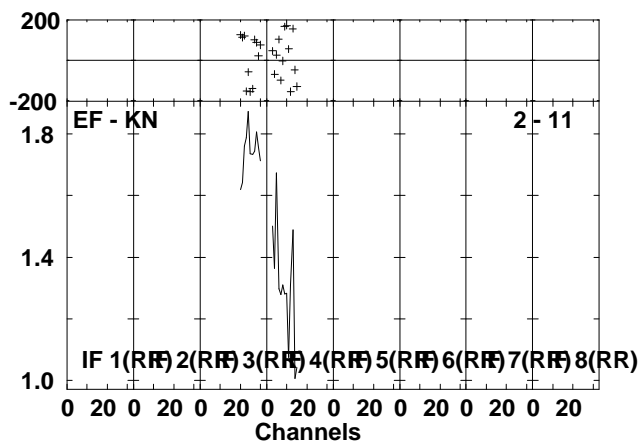
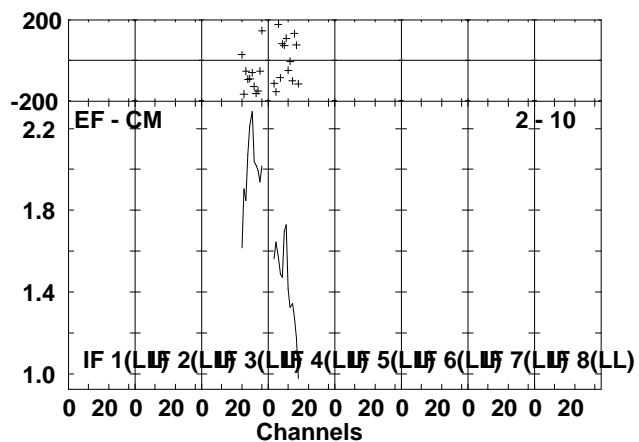
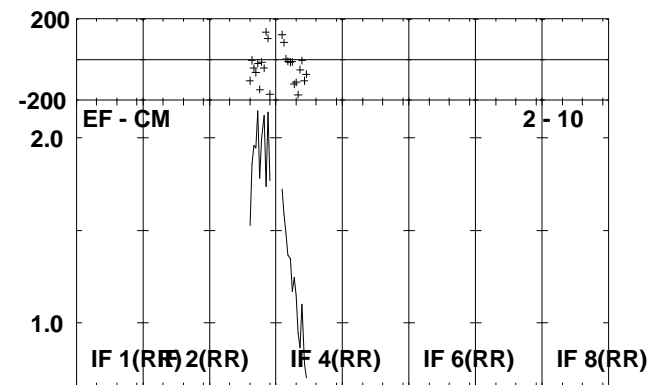
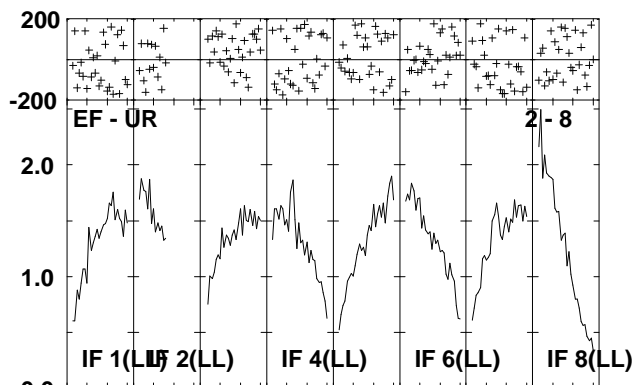
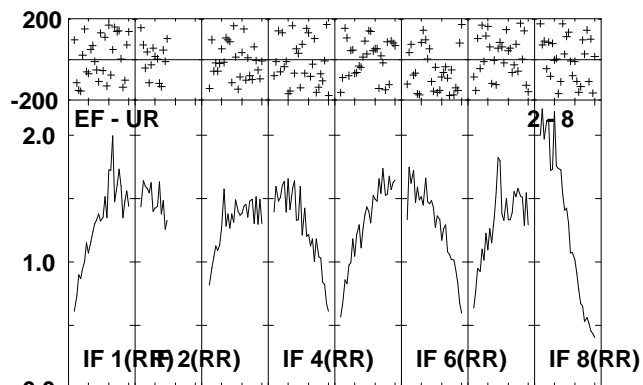
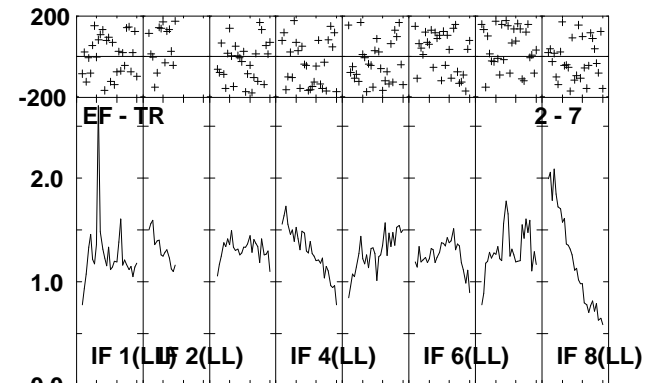
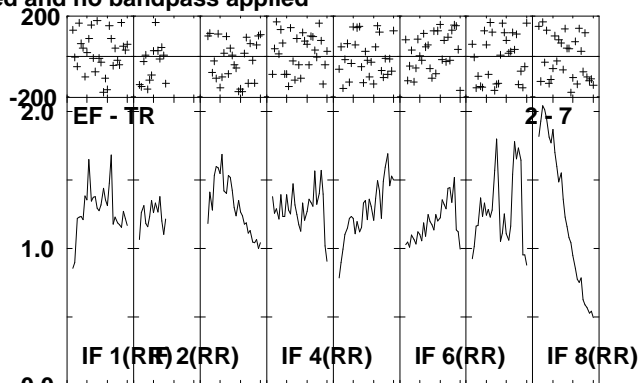
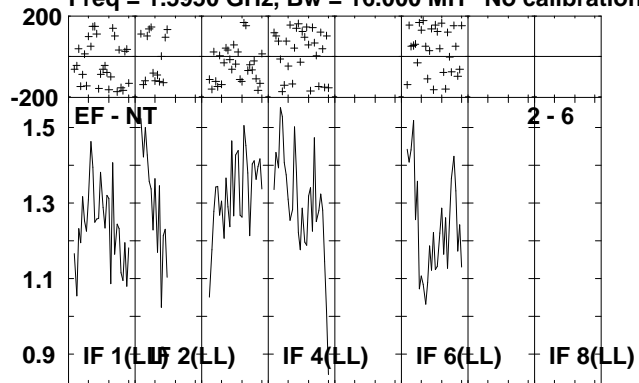

Lower frame: Milli Ampl Jy Top frame: Phas deg
Scalar averaged cross-power spectrum Several baselines displayed
Timerange: 00/12:51:11 to 00/12:54:49

Plot file version 45 created 06-JUL-2010 14:41:26

J2330+33 EP064J.UVDATA.1

Freq = 1.5950 GHz, Bw = 16.000 MH No calibration applied and no bandpass applied

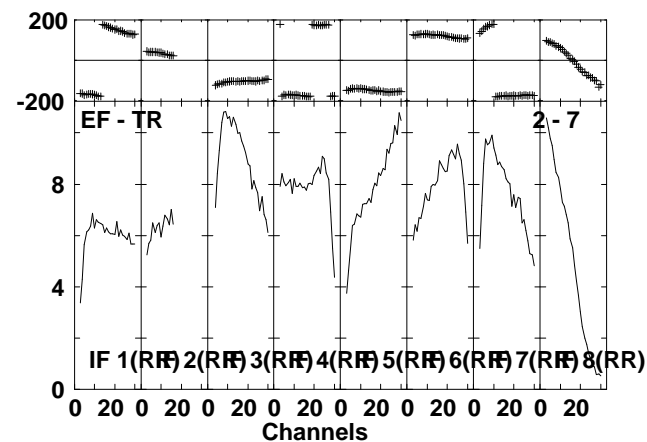
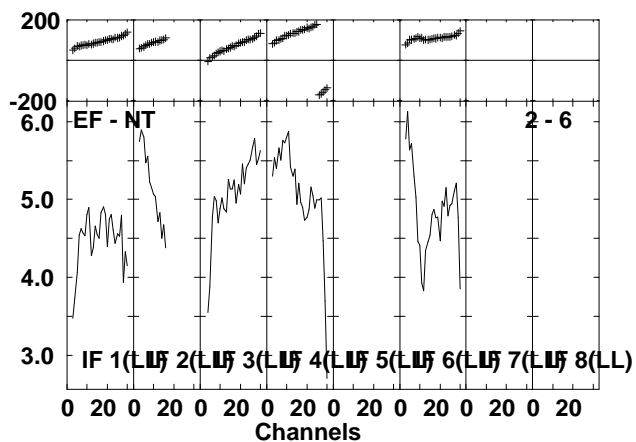
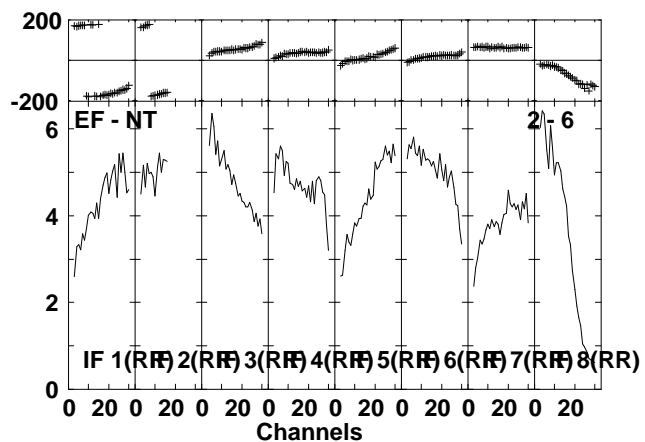
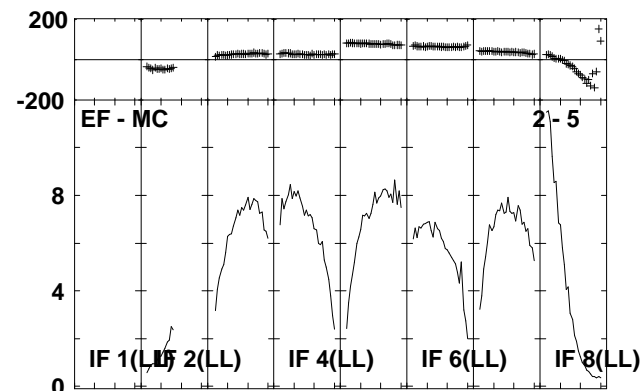
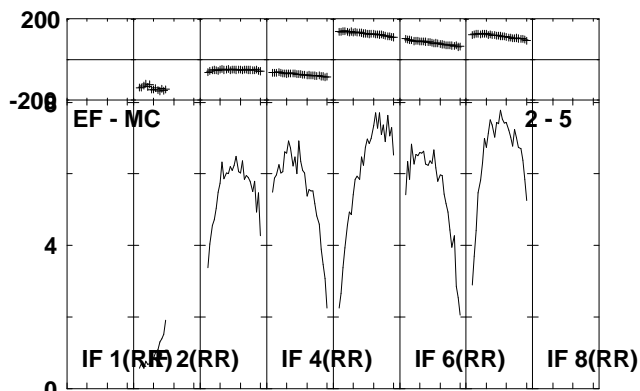
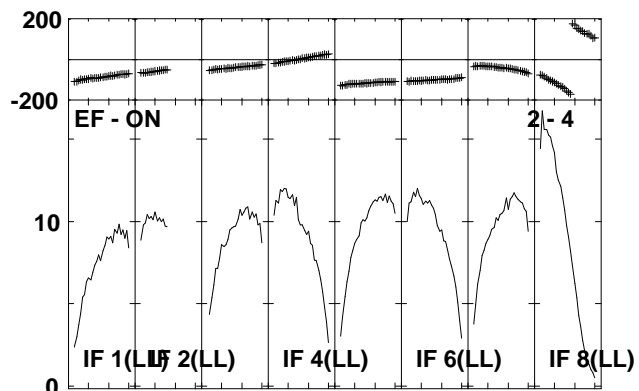
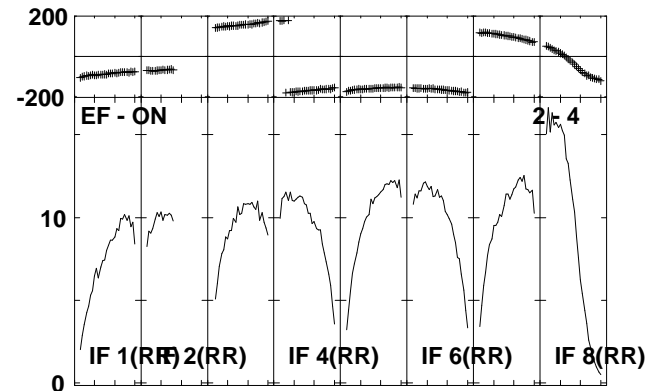
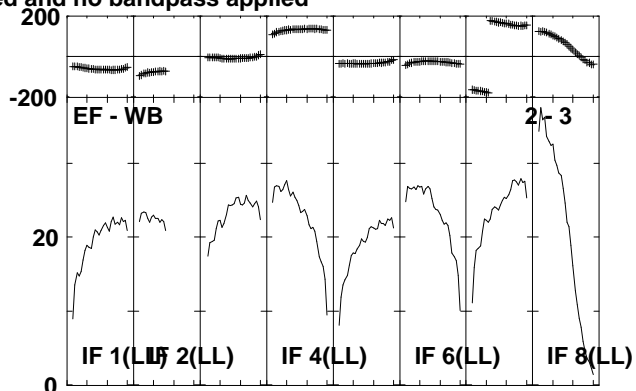
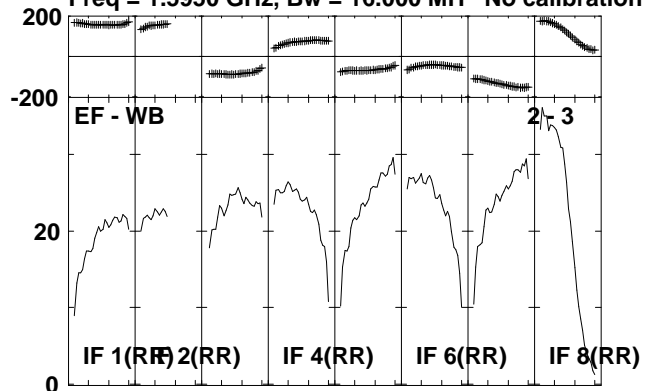

Lower frame: Milli Ampl Jy Top frame: Phas deg
Scalar averaged cross-power spectrum Several baselines displayed
Timerange: 00/12:54:51 to 00/12:56:39

Plot file version 46 created 06-JUL-2010 14:41:27
 J2330+33 EP064J.UVDATA.1

Freq = 1.5950 GHz, Bw = 16.000 MH No calibration applied and no bandpass applied

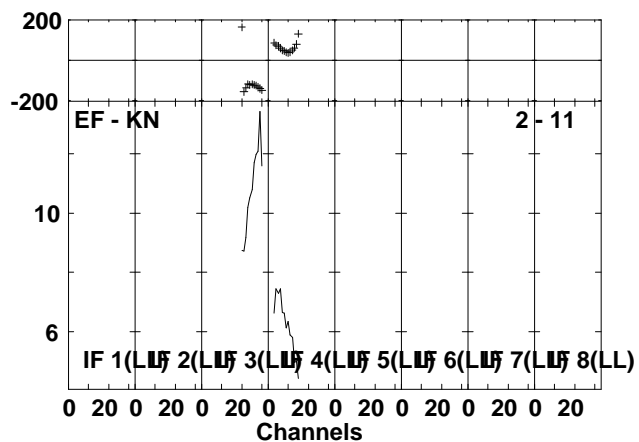
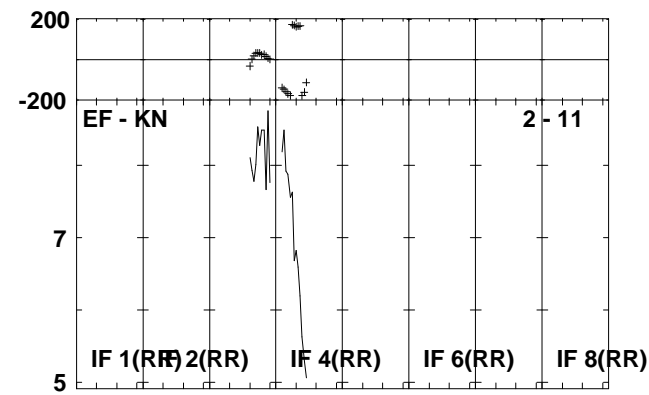
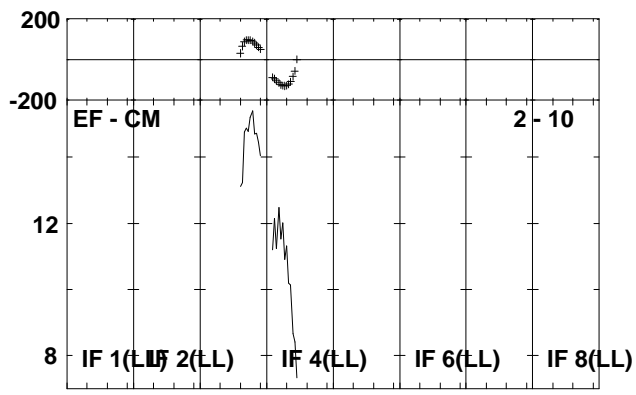
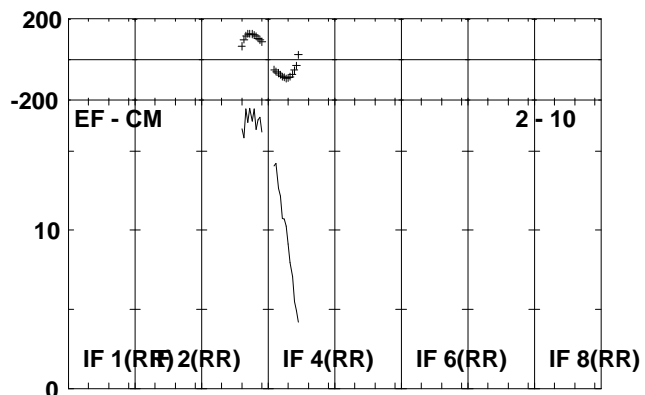
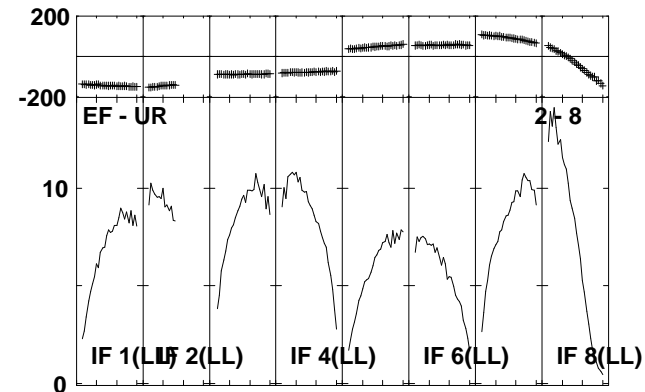
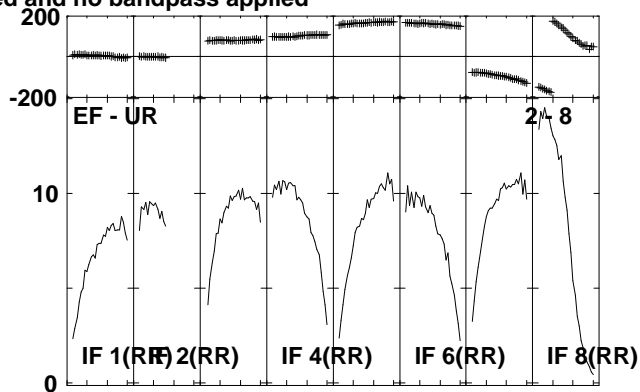
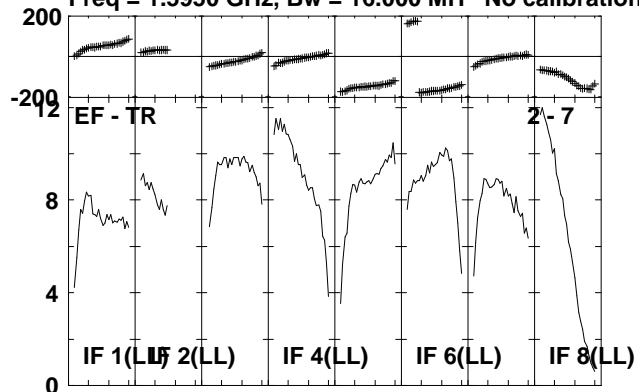

Lower frame: Milli Ampl Jy Top frame: Phas deg
 Scalar averaged cross-power spectrum Several baselines displayed
 Timerange: 00/12:54:51 to 00/12:56:39

Plot file version 47 created 06-JUL-2010 14:41:28

IRAS2336 EP064J.UVDATA.1

Freq = 1.5950 GHz, Bw = 16.000 MH No calibration applied and no bandpass applied

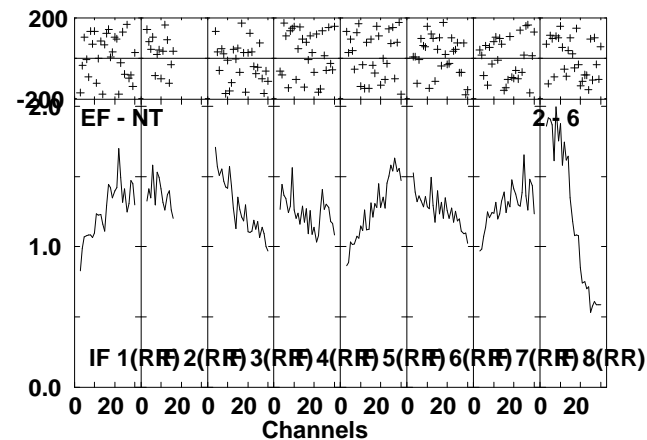
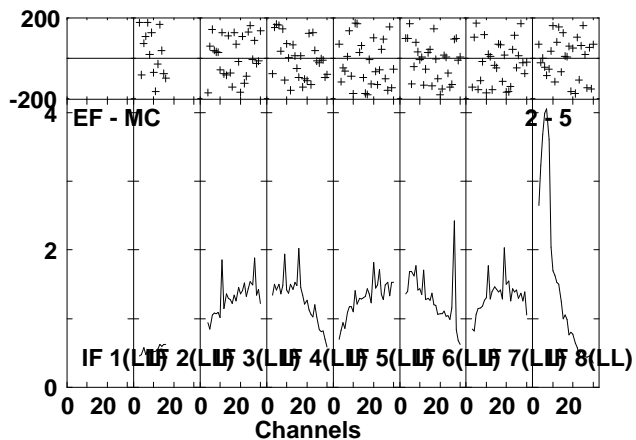
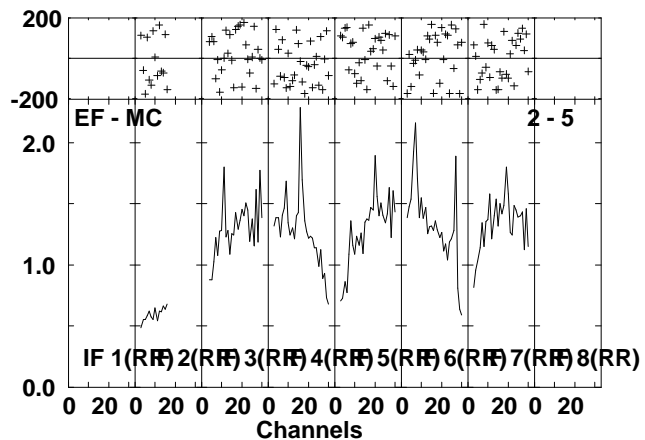
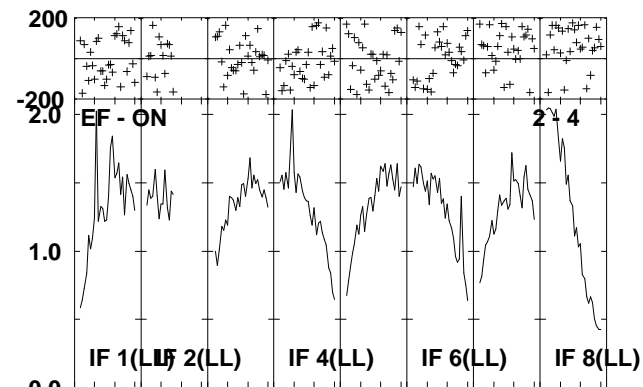
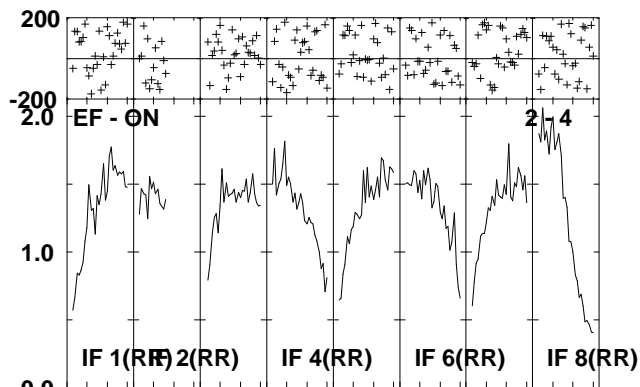
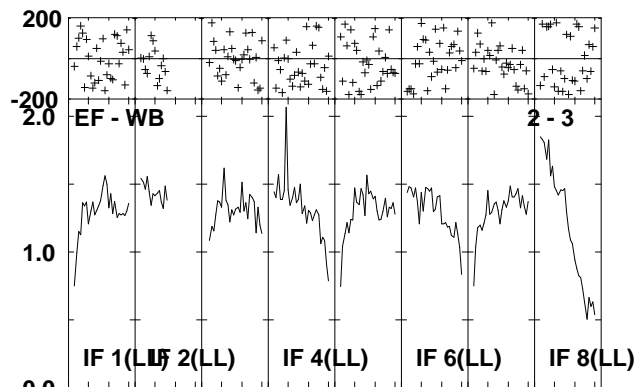
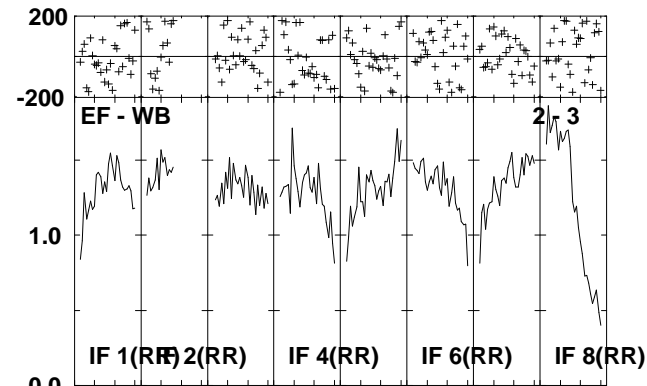
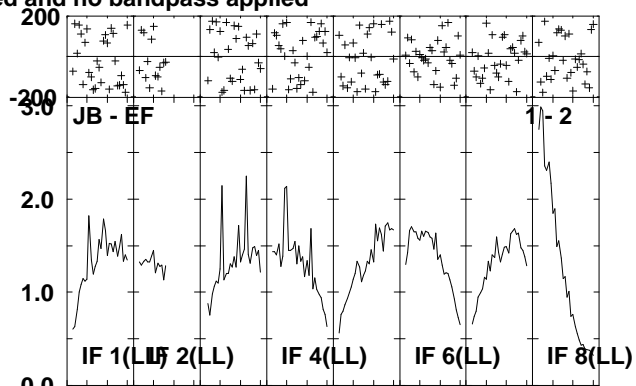
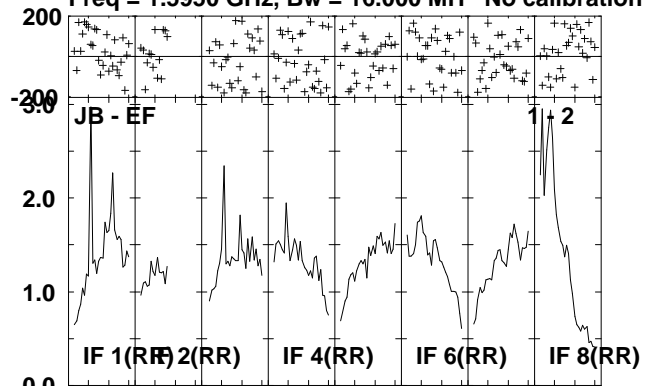

Lower frame: Milli Ampl Jy Top frame: Phas deg
Scalar averaged cross-power spectrum Several baselines displayed
Timerange: 00/12:56:41 to 00/13:00:19

Plot file version 48 created 06-JUL-2010 14:41:30

IRAS2336 EP064J.UVDATA.1

Freq = 1.5950 GHz, Bw = 16.000 MH No calibration applied and no bandpass applied

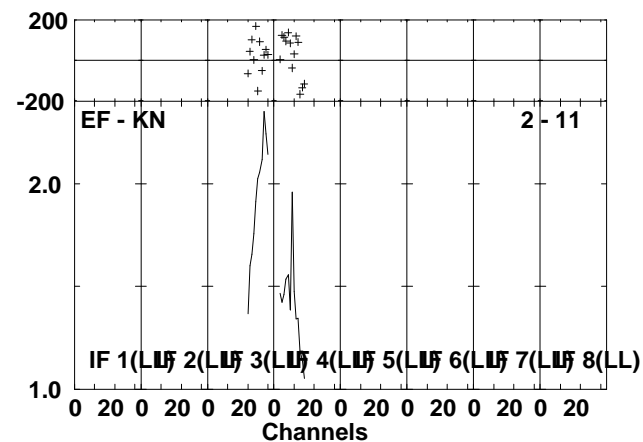
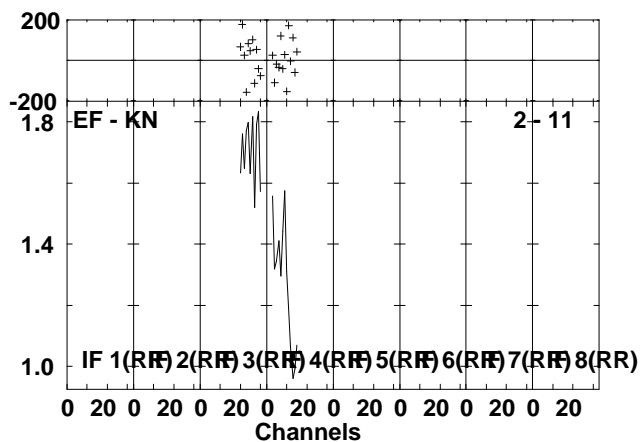
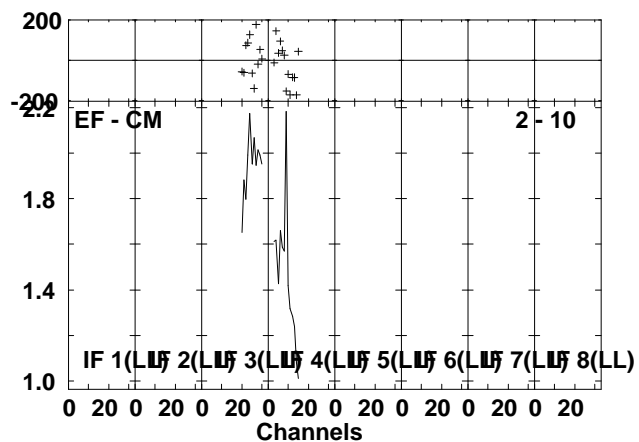
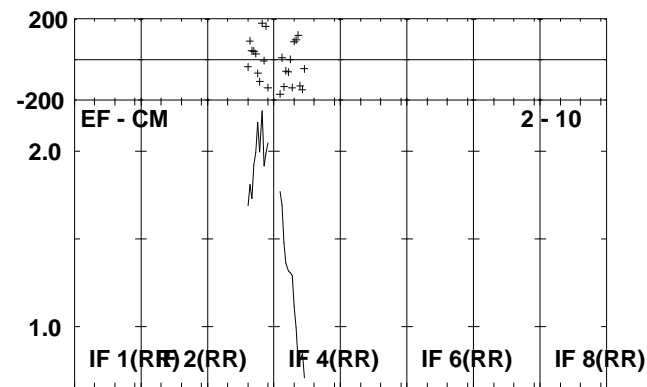
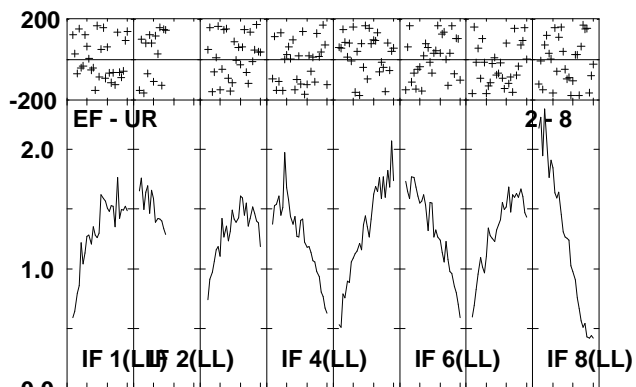
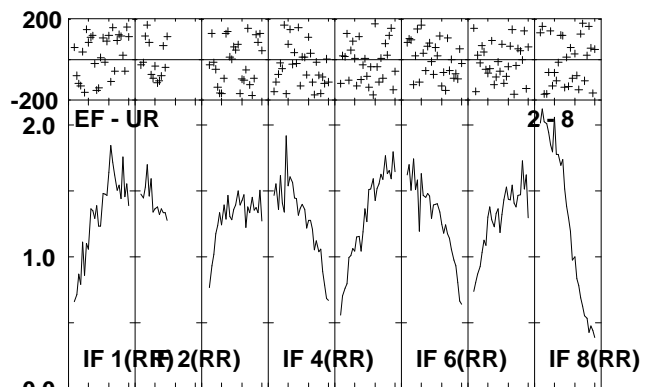
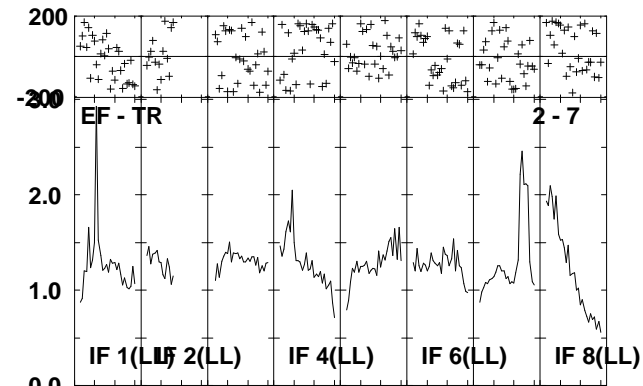
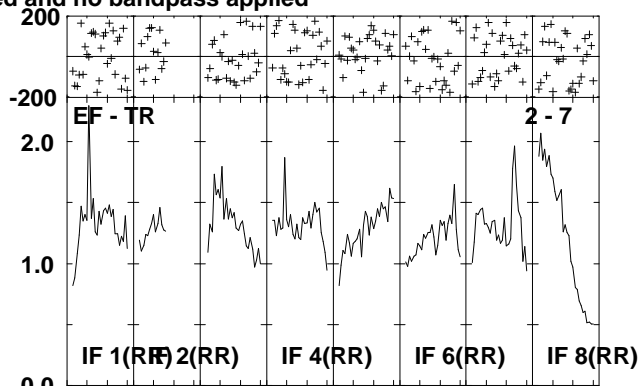
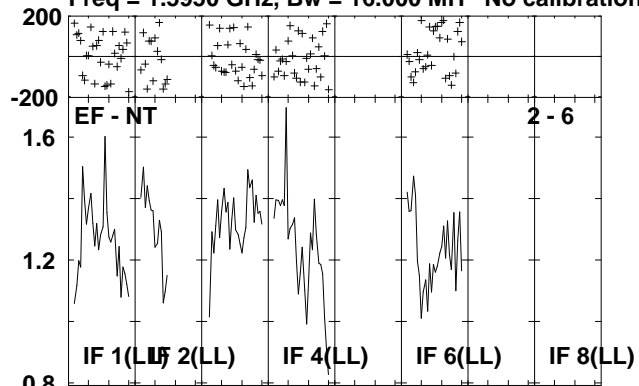

Lower frame: Milli Ampl Jy Top frame: Phas deg
Scalar averaged cross-power spectrum Several baselines displayed
Timerange: 00/12:56:41 to 00/13:00:19

Plot file version 49 created 06-JUL-2010 14:41:33

J2330+33 EP064J.UVDATA.1

Freq = 1.5950 GHz, Bw = 16.000 MH No calibration applied and no bandpass applied

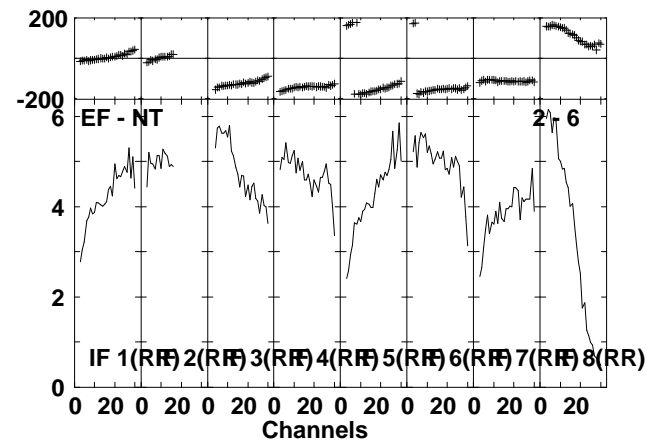
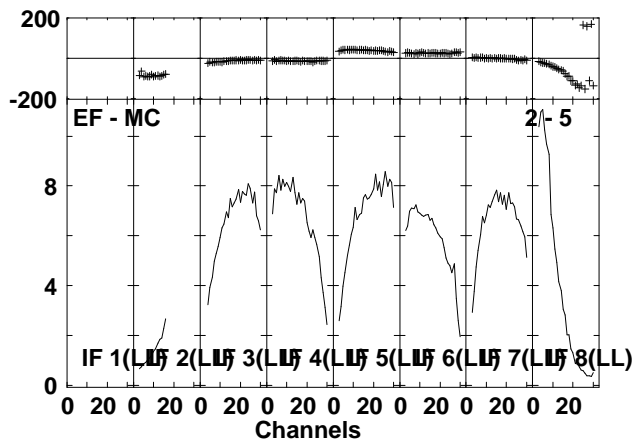
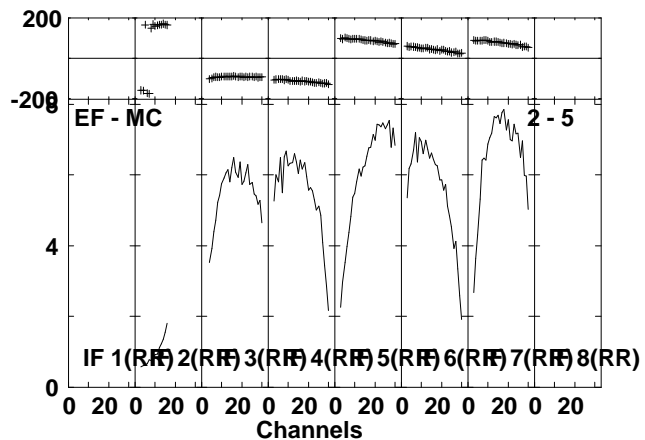
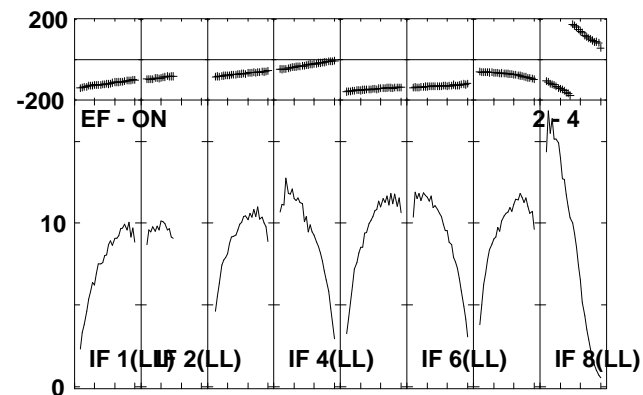
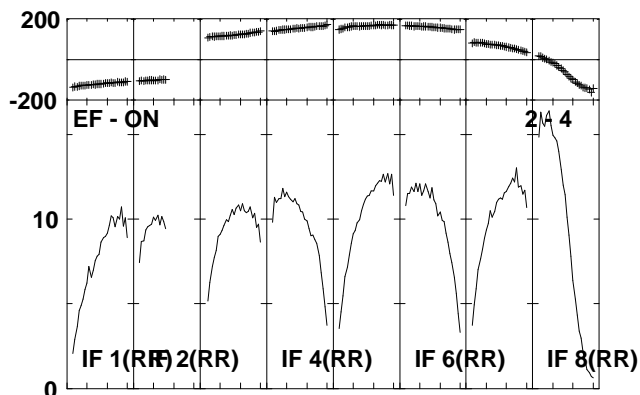
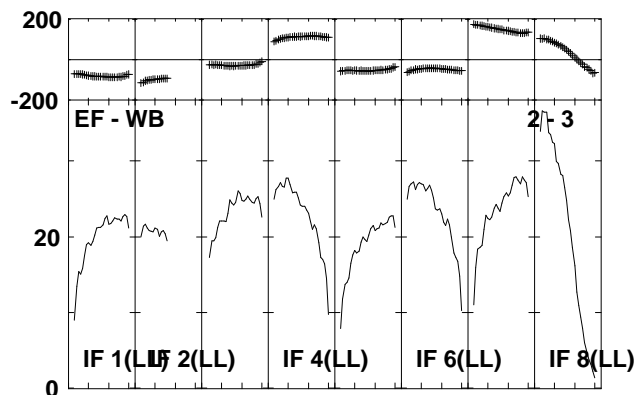
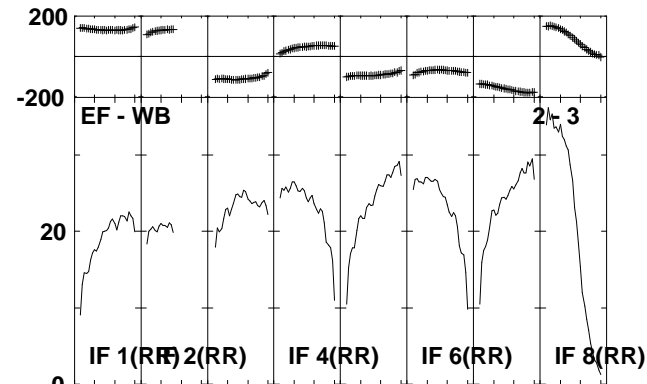
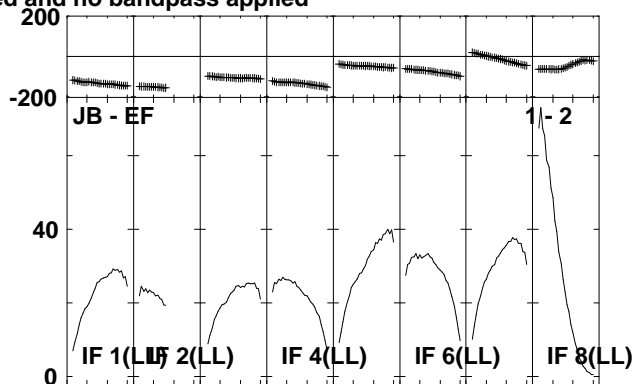
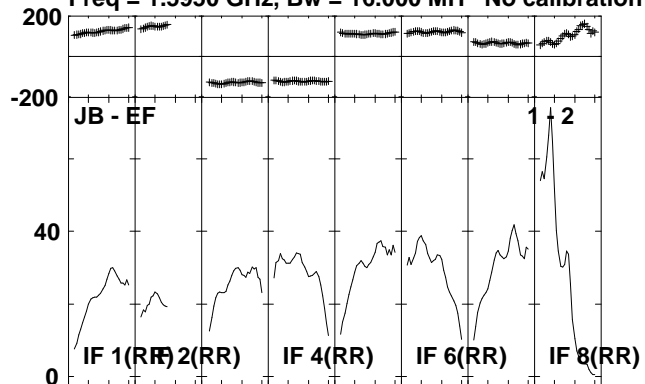

Lower frame: Milli Ampl Jy Top frame: Phas deg
Scalar averaged cross-power spectrum Several baselines displayed
Timerange: 00/13:00:21 to 00/13:02:09

Plot file version 50 created 06-JUL-2010 14:41:34

J2330+33 EP064J.UVDATA.1

Freq = 1.5950 GHz, Bw = 16.000 MH No calibration applied and no bandpass applied

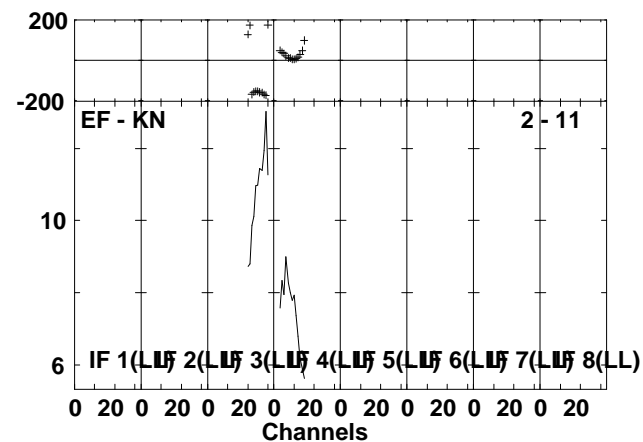
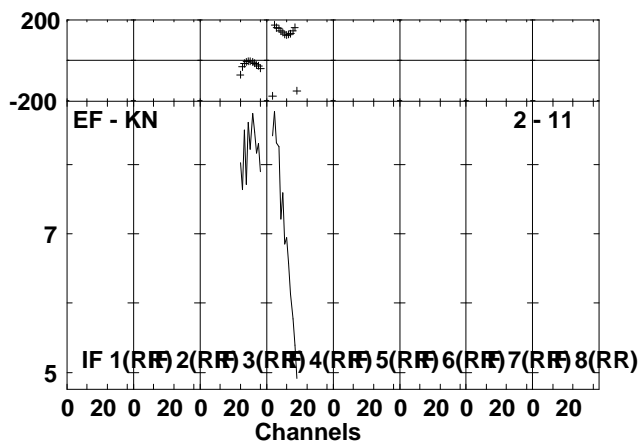
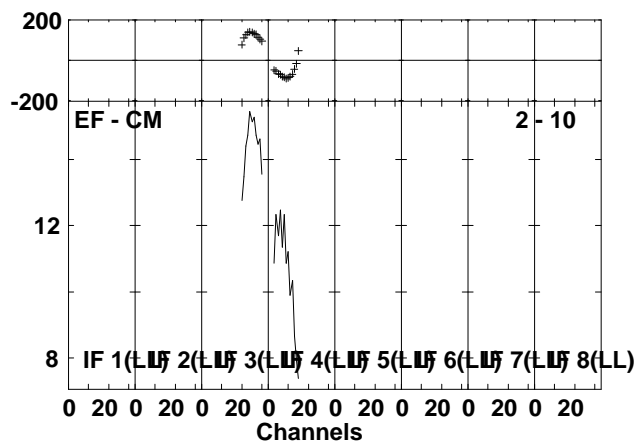
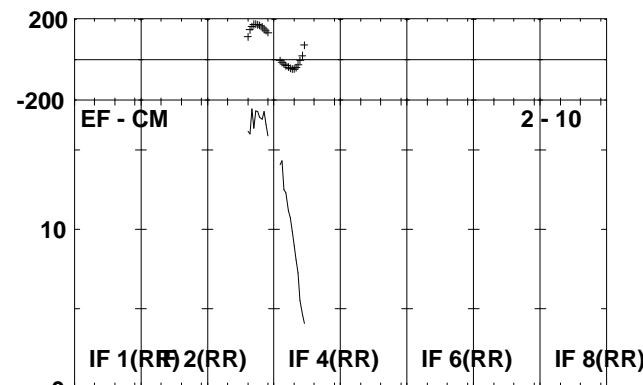
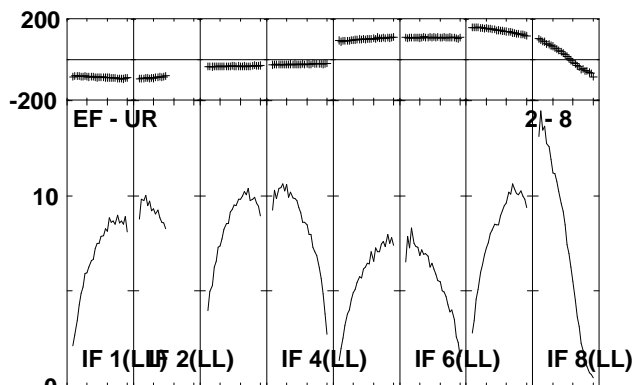
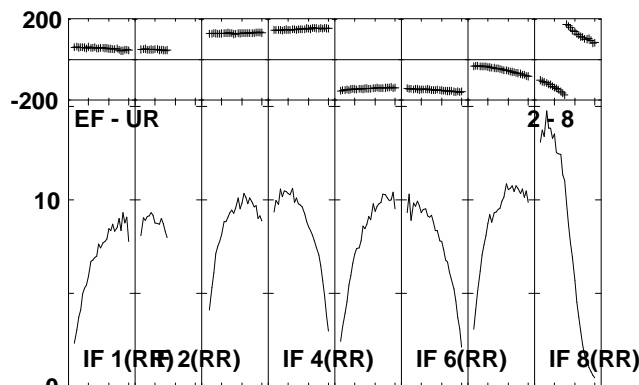
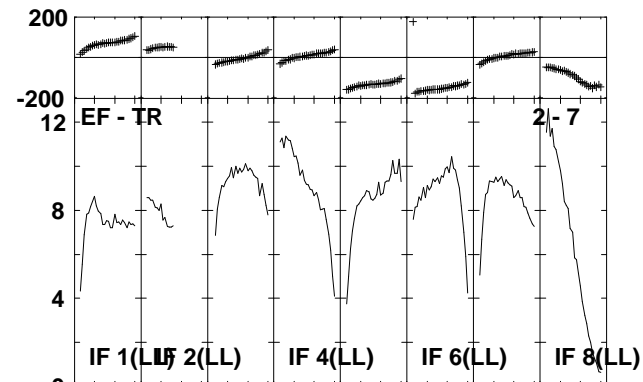
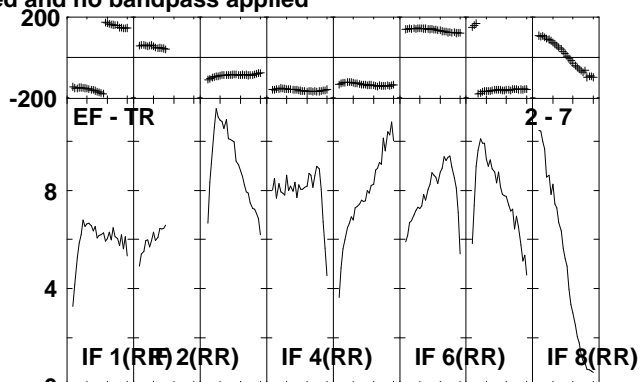
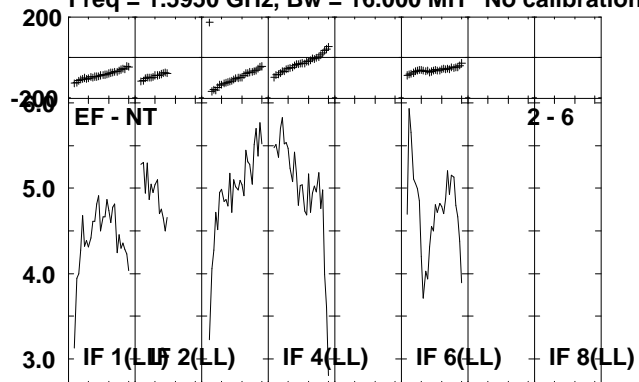

Lower frame: Milli Ampl Jy Top frame: Phas deg
Scalar averaged cross-power spectrum Several baselines displayed
Timerange: 00/13:00:21 to 00/13:02:09

Plot file version 51 created 06-JUL-2010 14:41:36

IRAS2336 EP064J.UVDATA.1

Freq = 1.5950 GHz, Bw = 16.000 MH No calibration applied and no bandpass applied

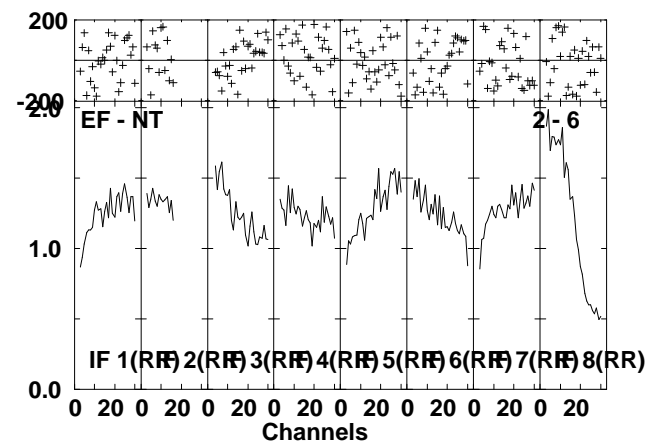
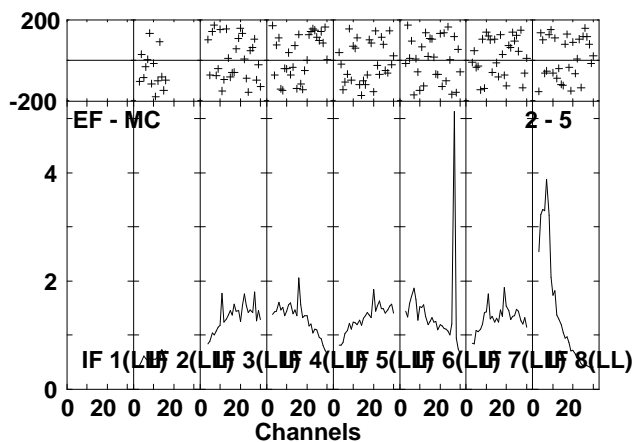
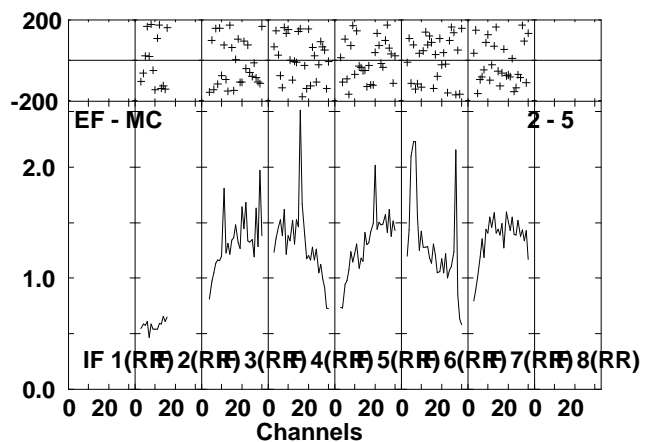
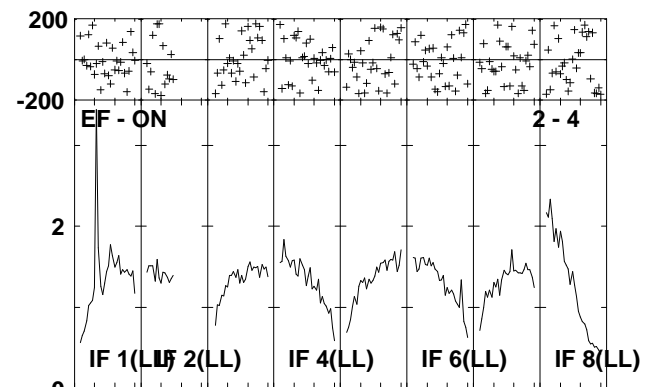
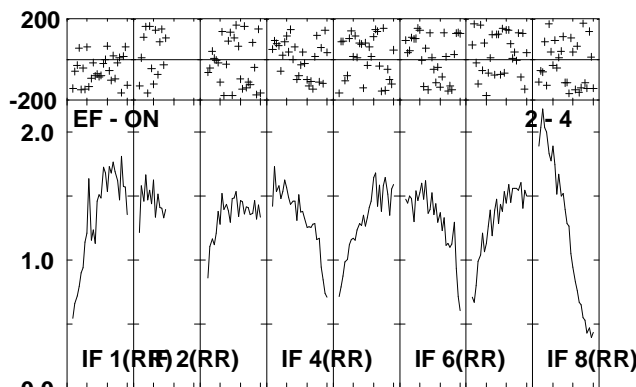
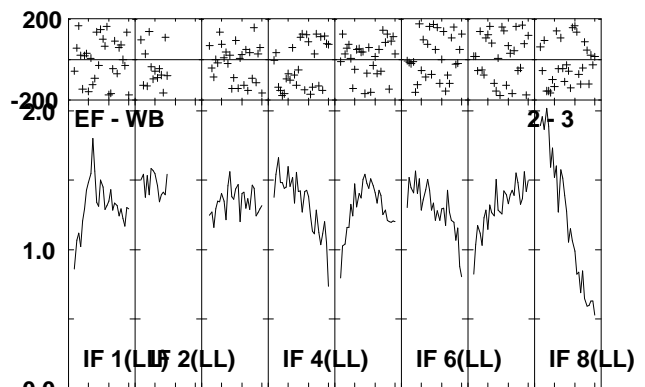
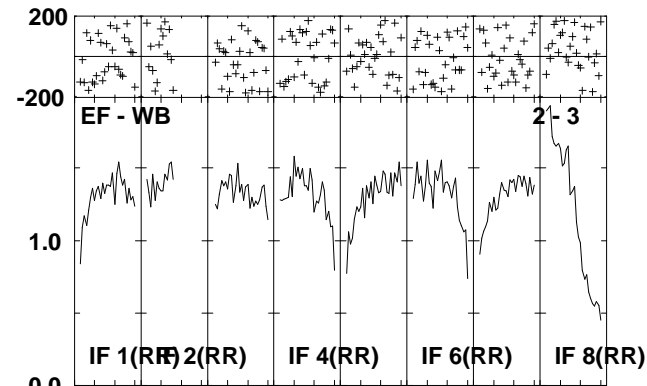
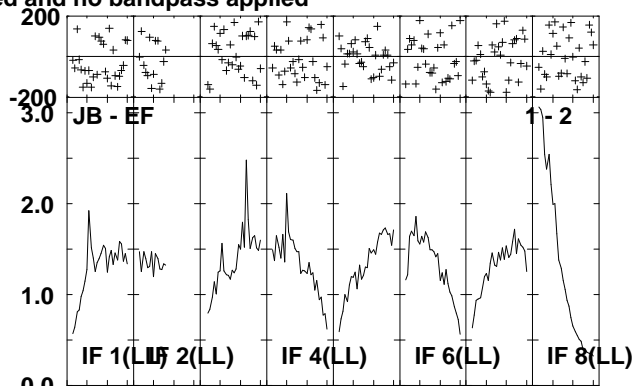
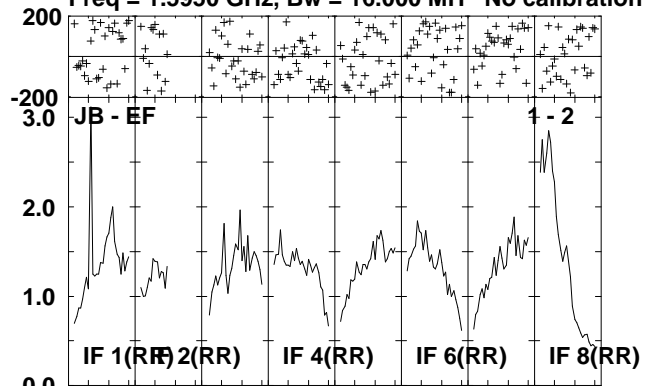

Lower frame: Milli Ampl Jy Top frame: Phas deg
Scalar averaged cross-power spectrum Several baselines displayed
Timerange: 00/13:02:11 to 00/13:05:49

Plot file version 52 created 06-JUL-2010 14:41:38

IRAS2336 EP064J.UVDATA.1

Freq = 1.5950 GHz, Bw = 16.000 MH No calibration applied and no bandpass applied

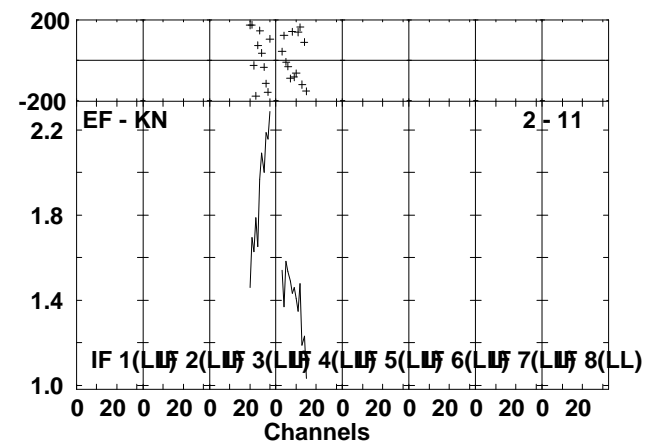
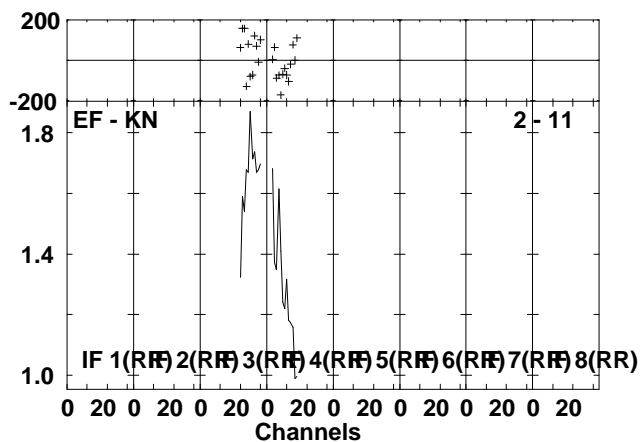
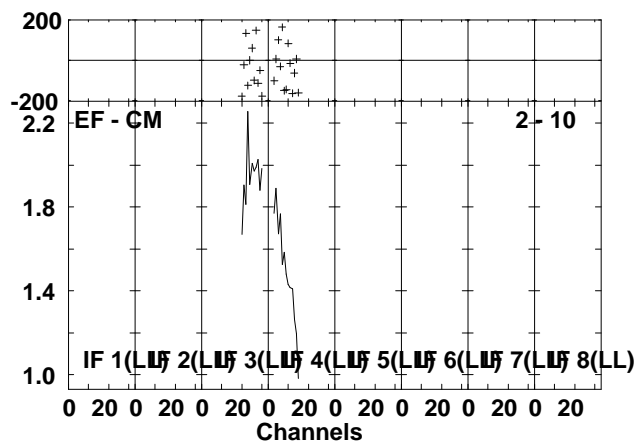
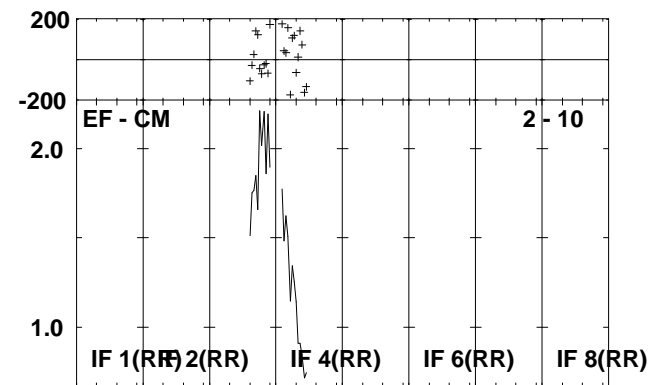
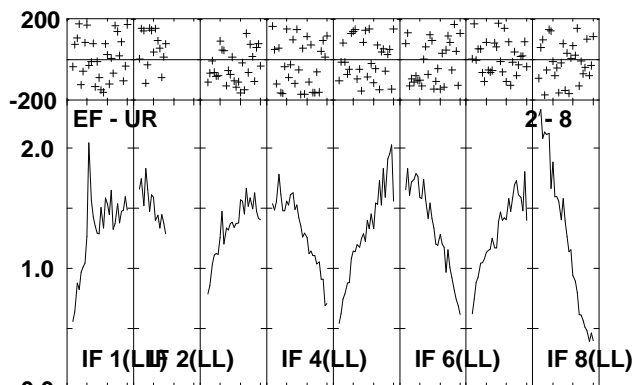
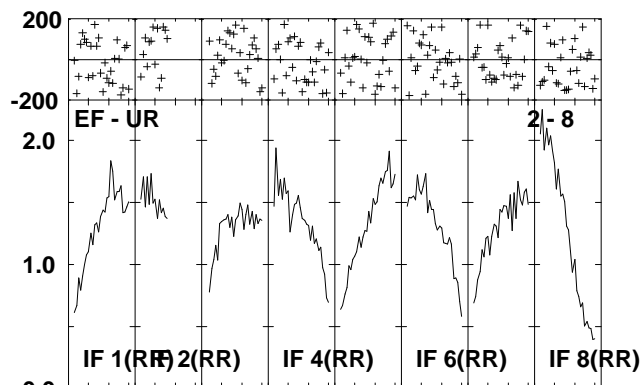
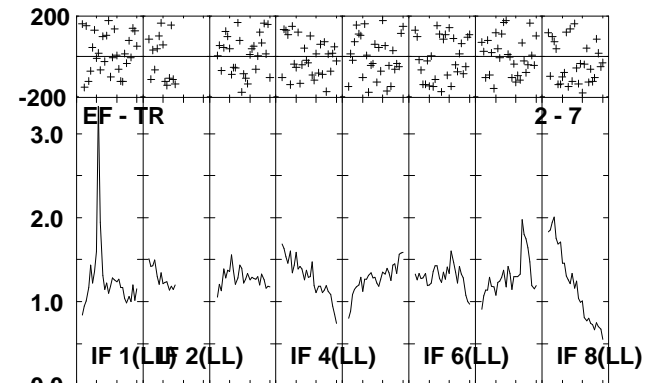
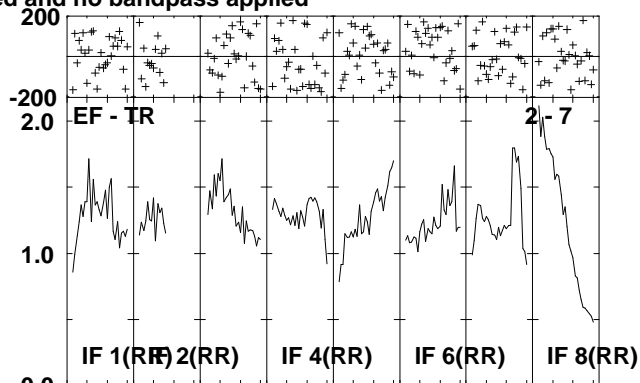
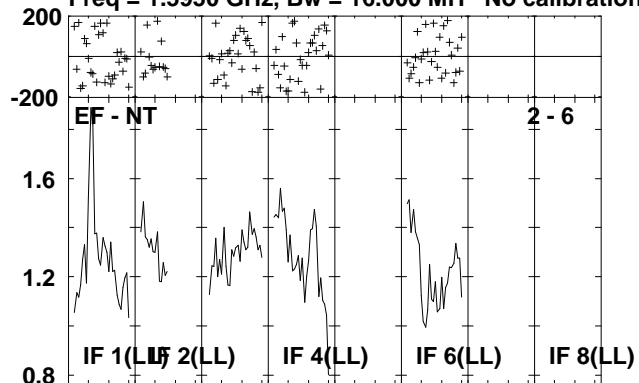

Lower frame: Milli Ampl Jy Top frame: Phas deg
Scalar averaged cross-power spectrum Several baselines displayed
Timerange: 00/13:02:11 to 00/13:05:49

Plot file version 53 created 06-JUL-2010 14:41:40

J2330+33 EP064J.UVDATA.1

Freq = 1.5950 GHz, Bw = 16.000 MH No calibration applied and no bandpass applied

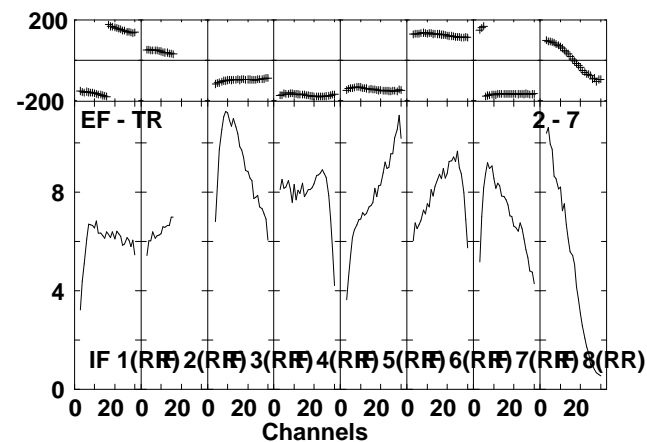
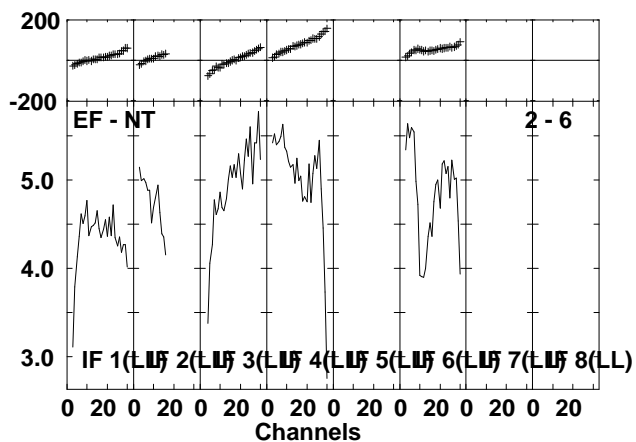
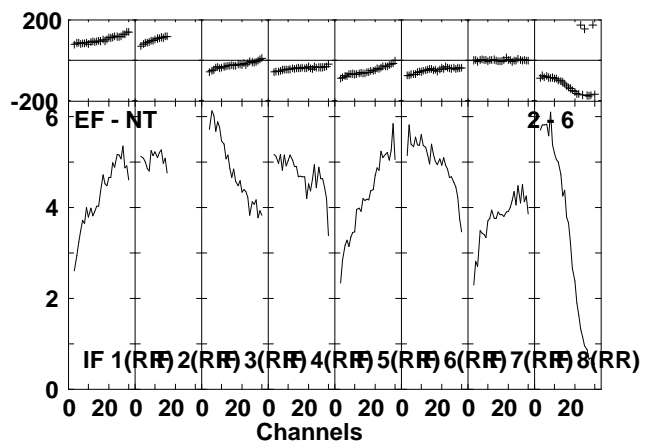
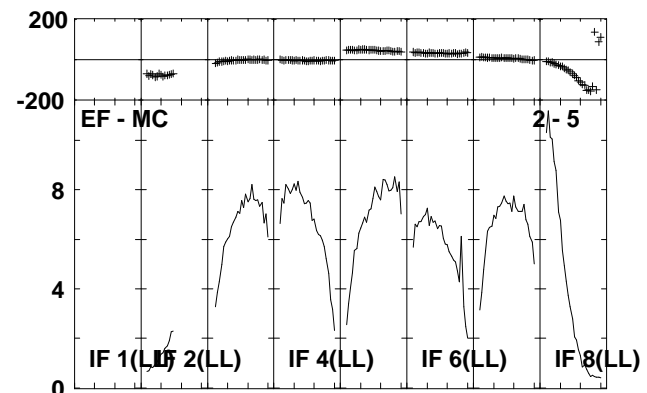
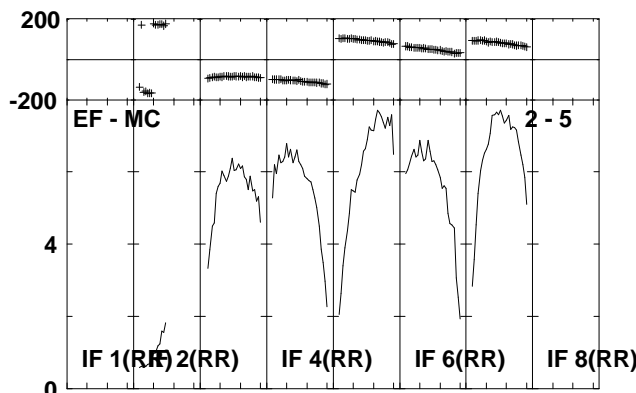
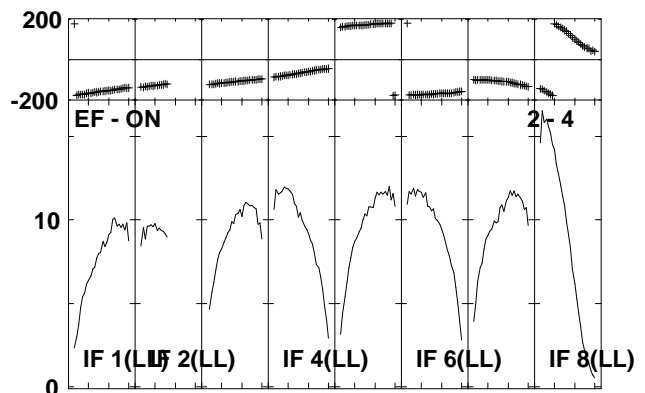
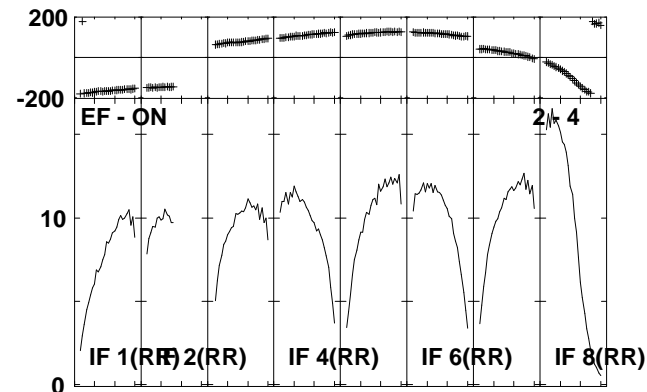
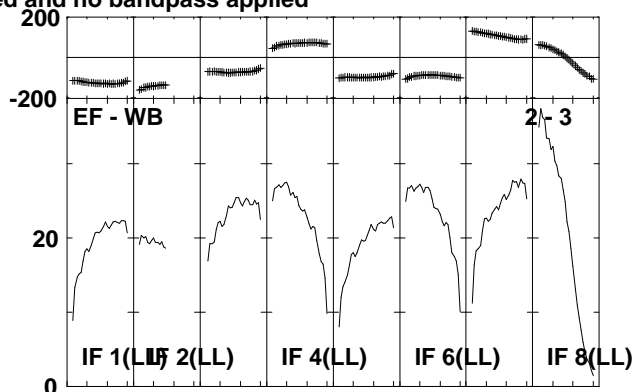
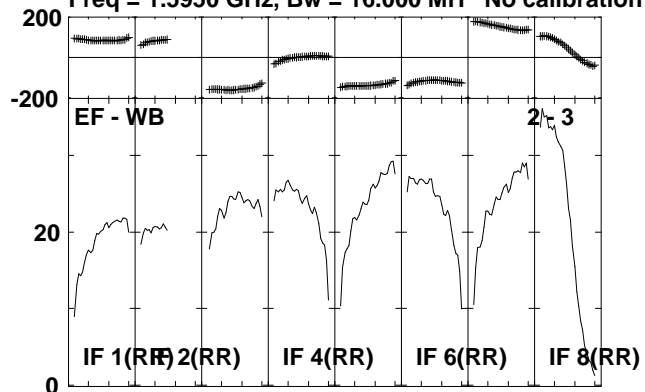

Lower frame: Milli Ampl Jy Top frame: Phas deg
Scalar averaged cross-power spectrum Several baselines displayed
Timerange: 00/13:06:51 to 00/13:08:27

Plot file version 54 created 06-JUL-2010 14:41:41
 J2330+33 EP064J.UVDATA.1

Freq = 1.5950 GHz, Bw = 16.000 MH No calibration applied and no bandpass applied

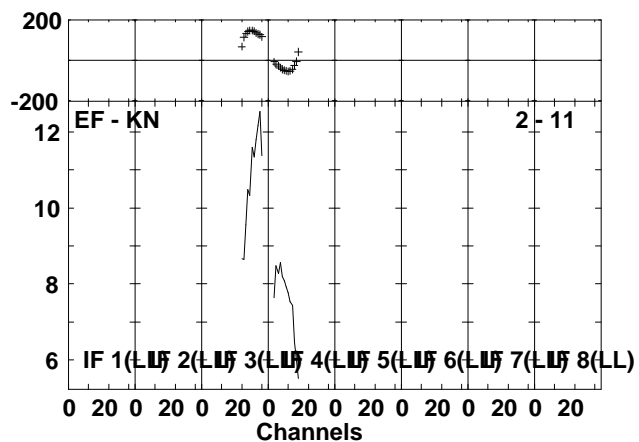
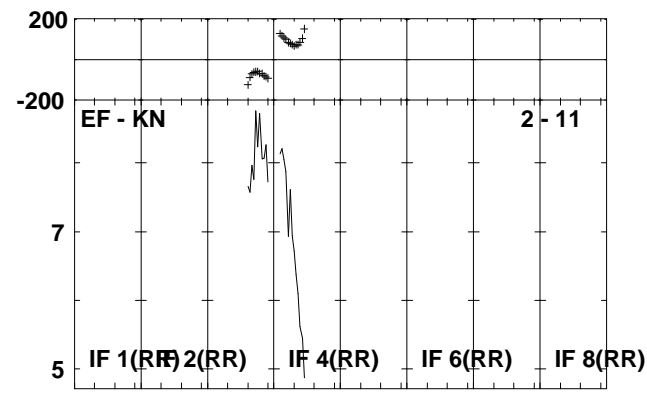
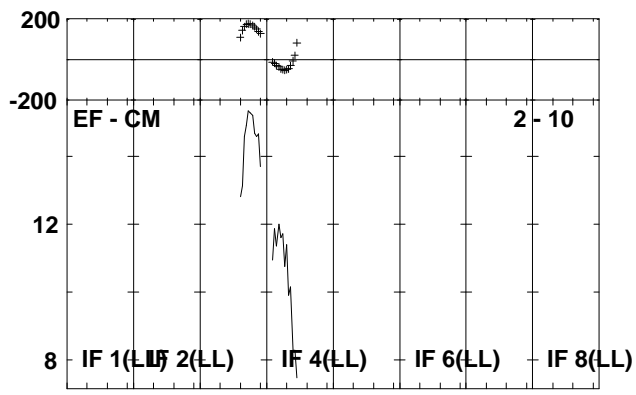
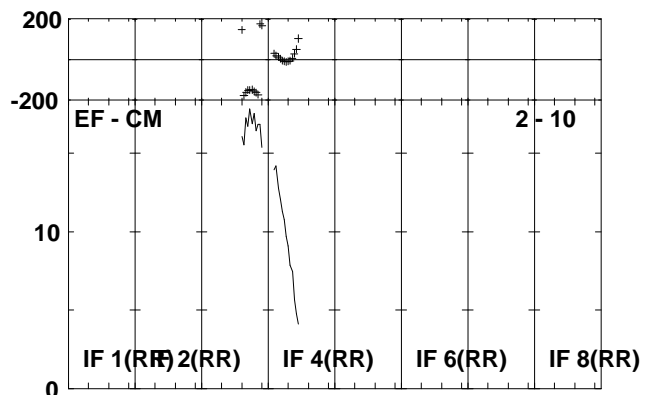
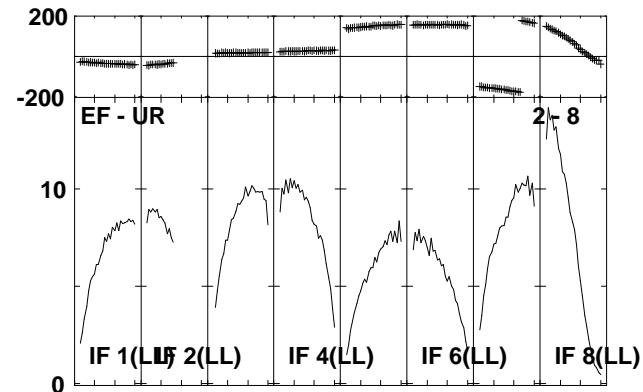
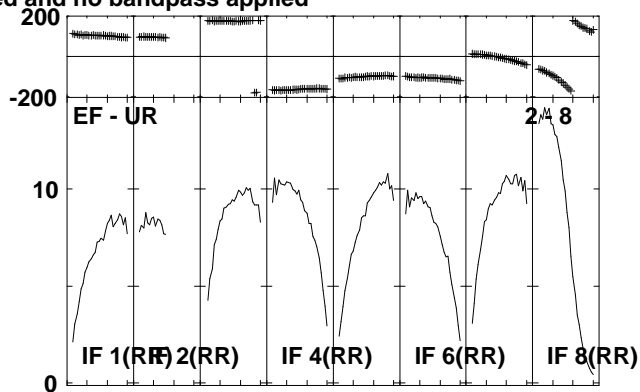
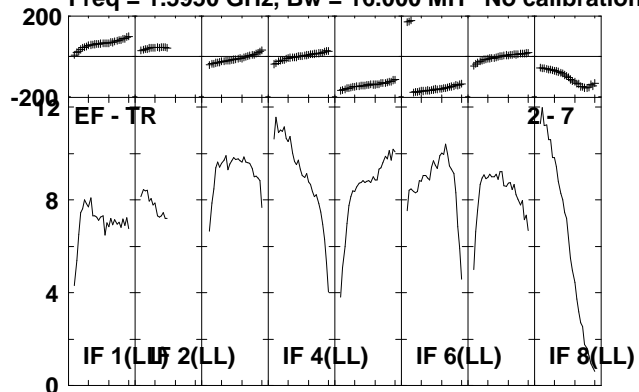

Lower frame: Milli Ampl Jy Top frame: Phas deg
 Scalar averaged cross-power spectrum Several baselines displayed
 Timerange: 00/13:06:51 to 00/13:08:27

Plot file version 55 created 06-JUL-2010 14:41:42

IRAS2336 EP064J.UVDATA.1

Freq = 1.5950 GHz, Bw = 16.000 MH No calibration applied and no bandpass applied

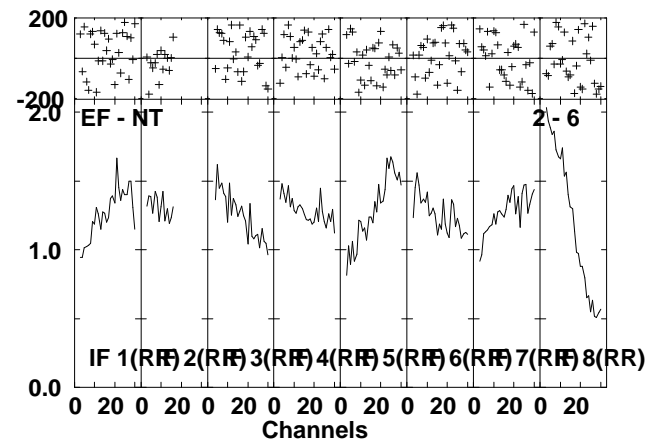
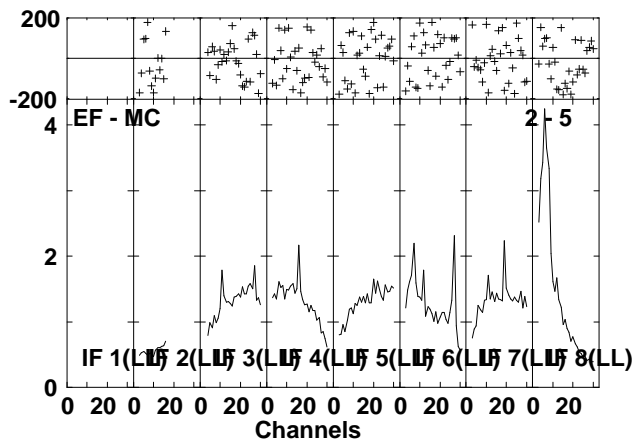
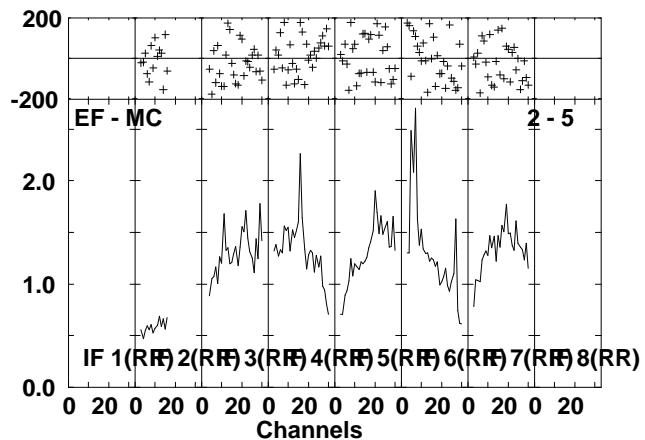
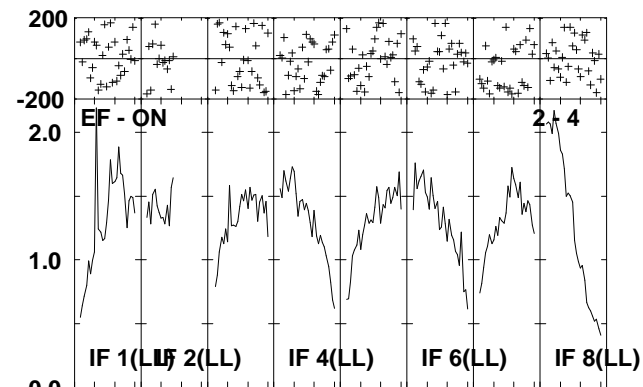
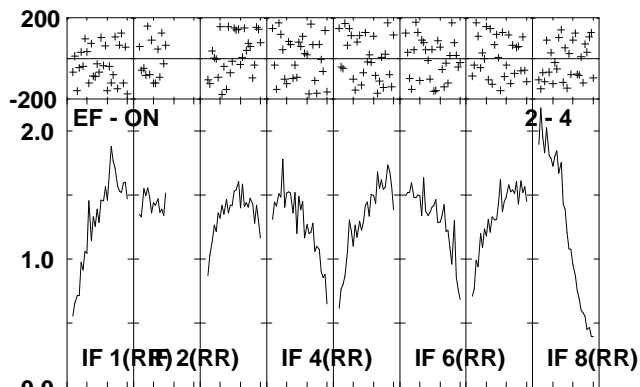
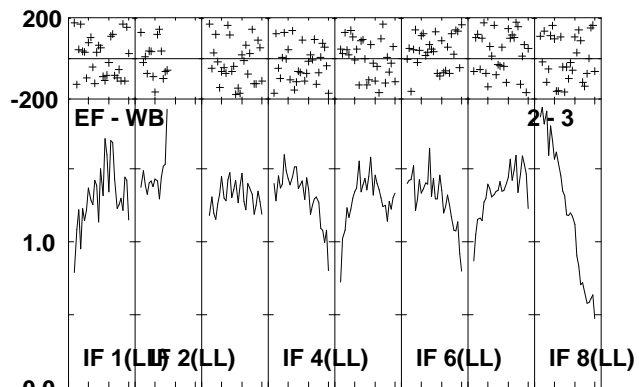
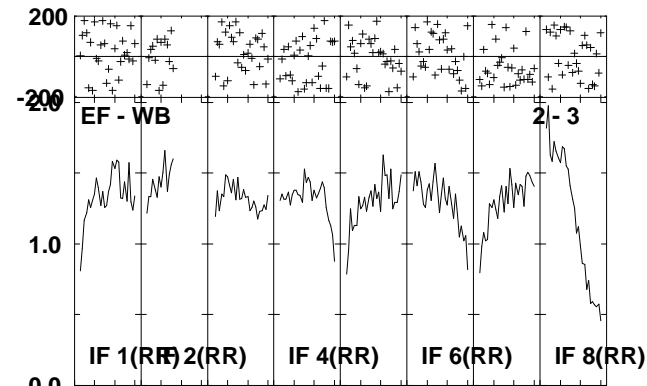
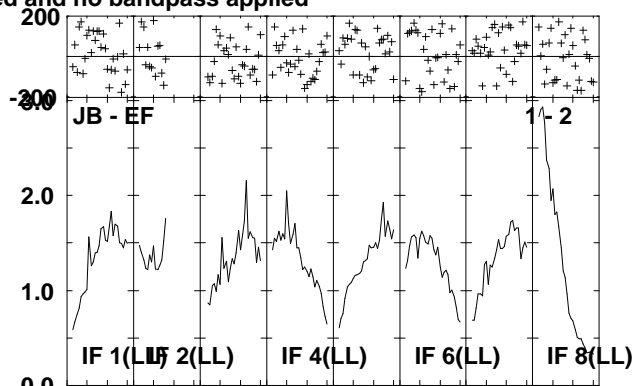
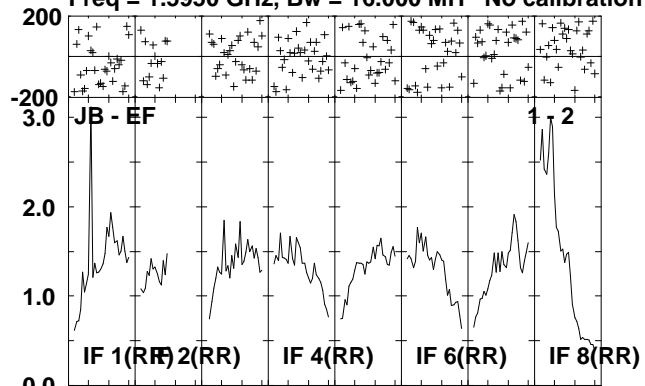

Lower frame: Milli Ampl Jy Top frame: Phas deg
Scalar averaged cross-power spectrum Several baselines displayed
Timerange: 00/13:08:31 to 00/13:12:09

Plot file version 56 created 06-JUL-2010 14:41:44

IRAS2336 EP064J.UVDATA.1

Freq = 1.5950 GHz, Bw = 16.000 MH No calibration applied and no bandpass applied

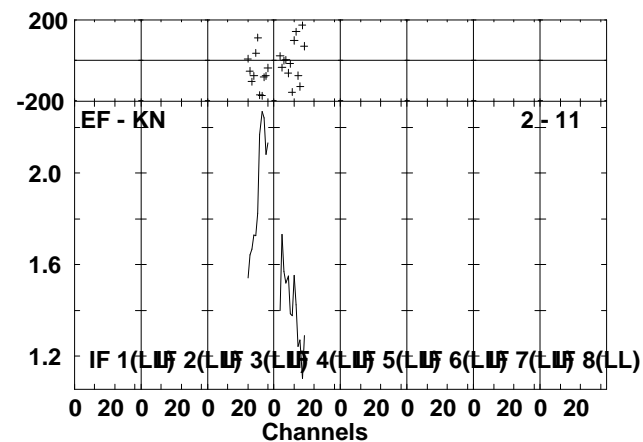
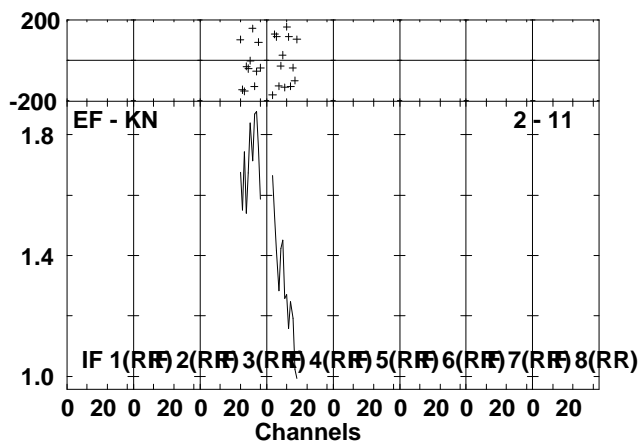
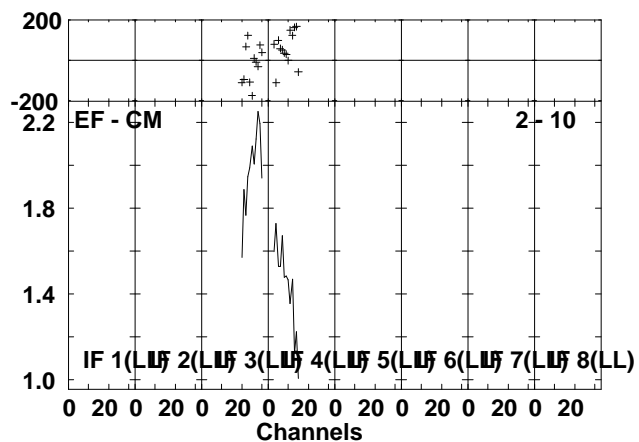
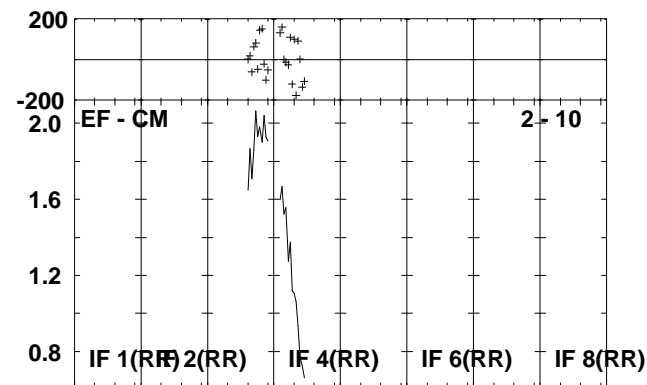
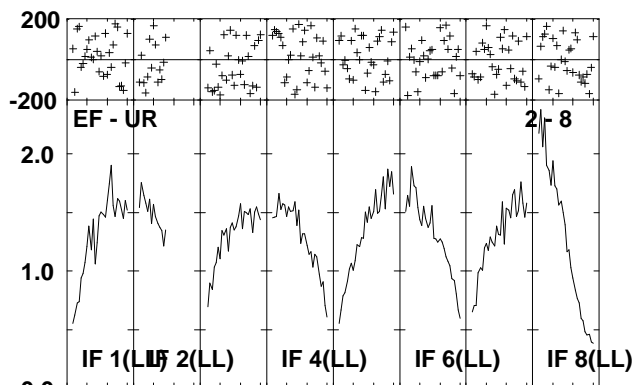
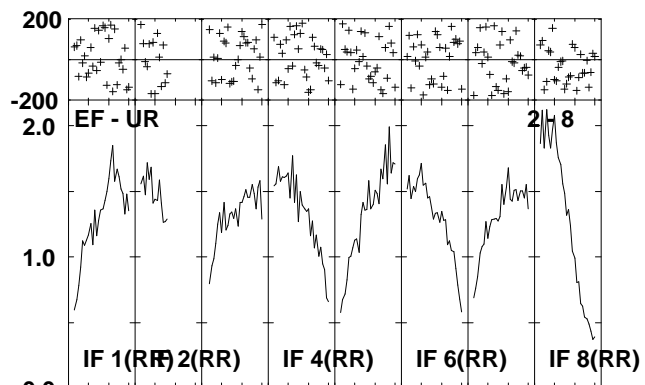
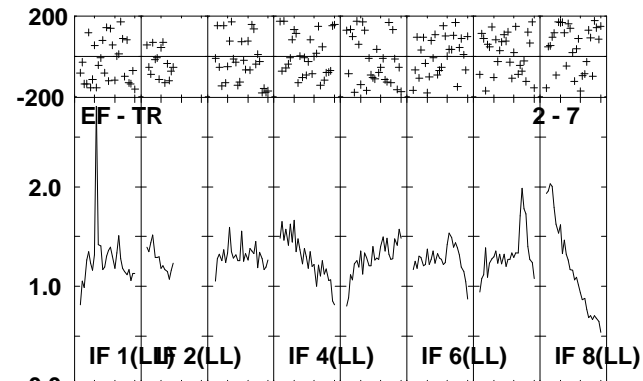
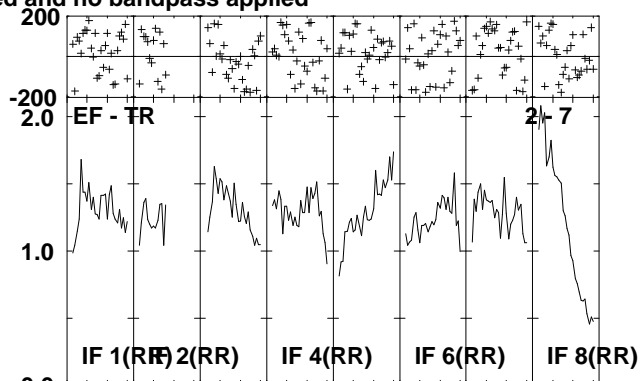
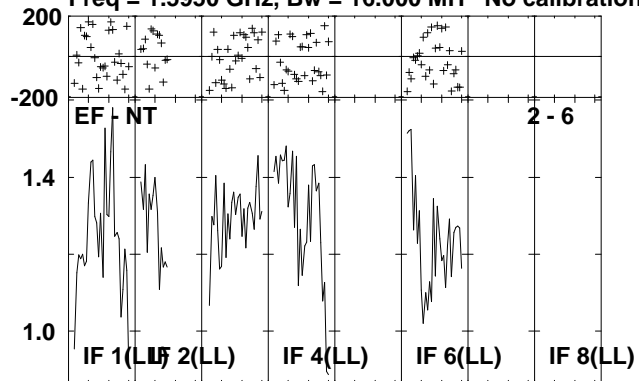

Lower frame: Milli Ampl Jy Top frame: Phas deg
Scalar averaged cross-power spectrum Several baselines displayed
Timerange: 00/13:08:31 to 00/13:12:09

Plot file version 57 created 06-JUL-2010 14:41:47

J2330+33 EP064J.UVDATA.1

Freq = 1.5950 GHz, Bw = 16.000 MH No calibration applied and no bandpass applied

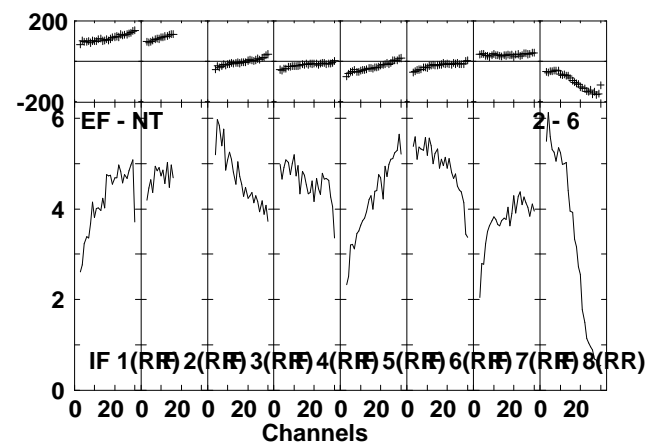
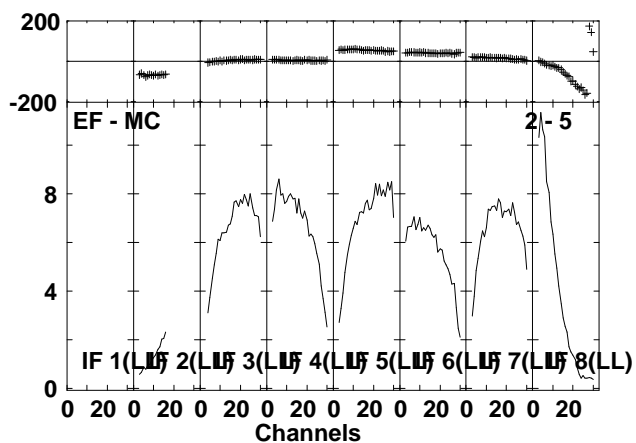
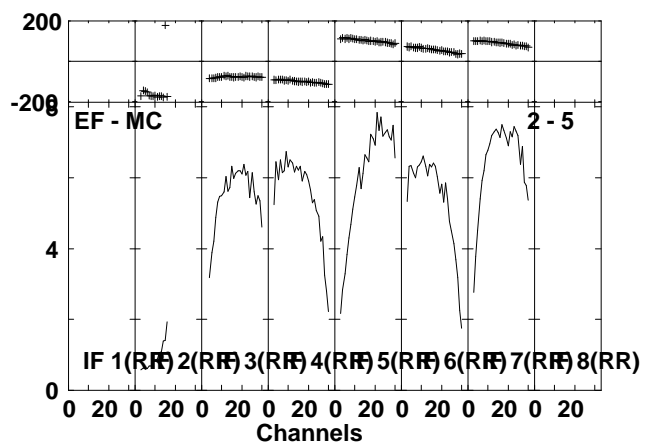
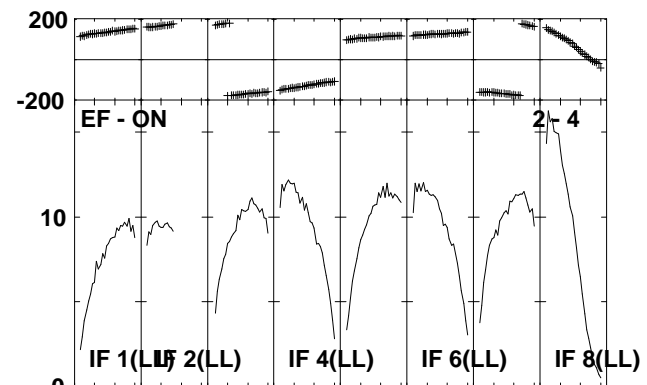
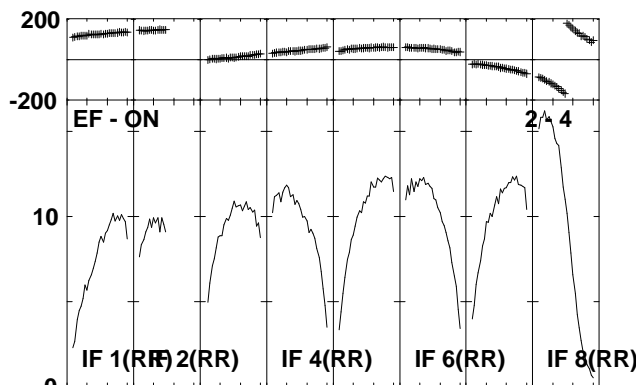
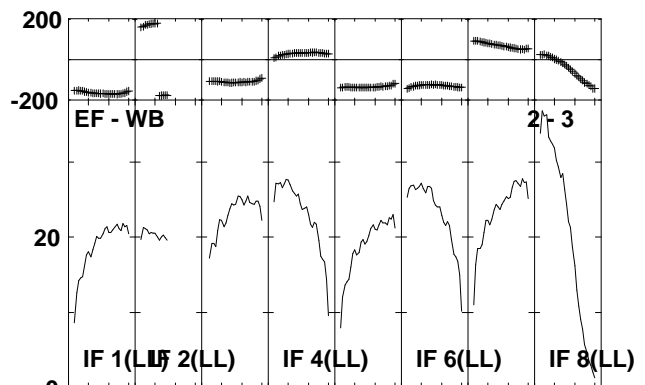
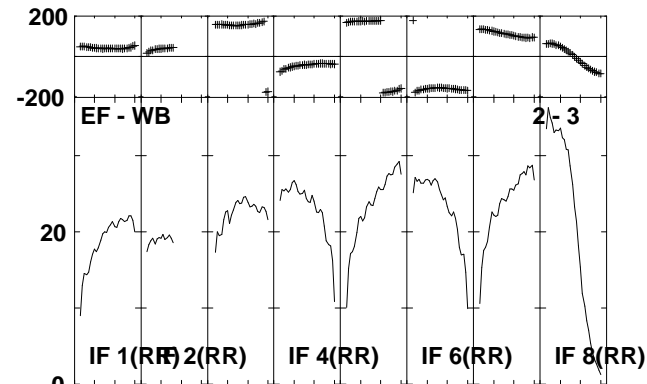
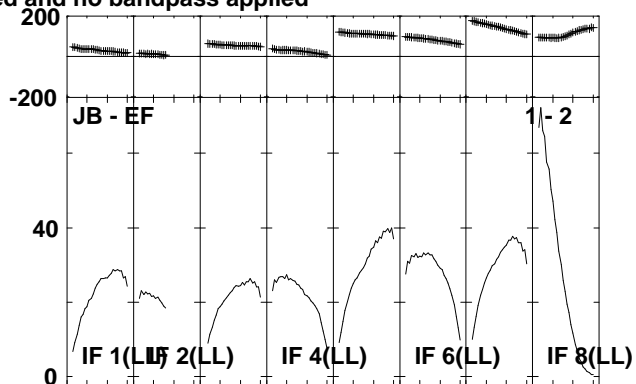
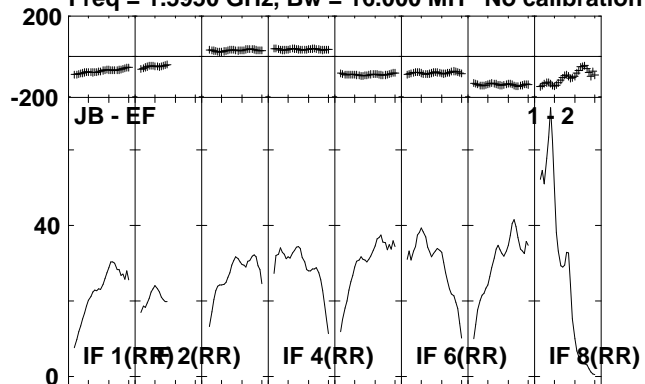

Lower frame: Milli Ampl Jy Top frame: Phas deg
Scalar averaged cross-power spectrum Several baselines displayed
Timerange: 00/13:12:11 to 00/13:13:59

Plot file version 58 created 06-JUL-2010 14:41:48

J2330+33 EP064J.UVDATA.1

Freq = 1.5950 GHz, Bw = 16.000 MH No calibration applied and no bandpass applied

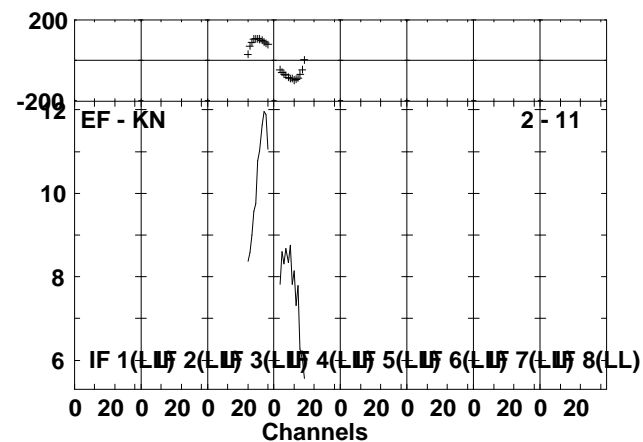
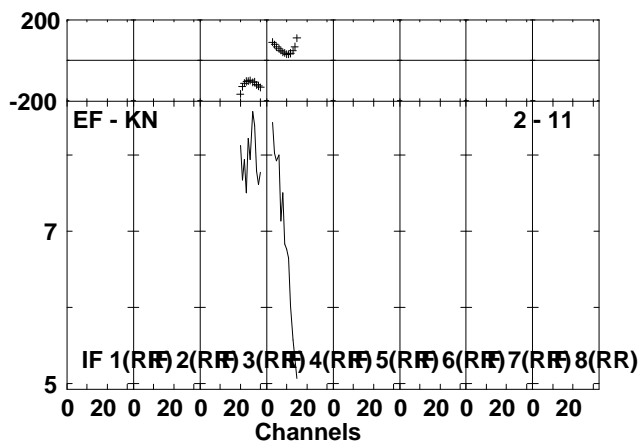
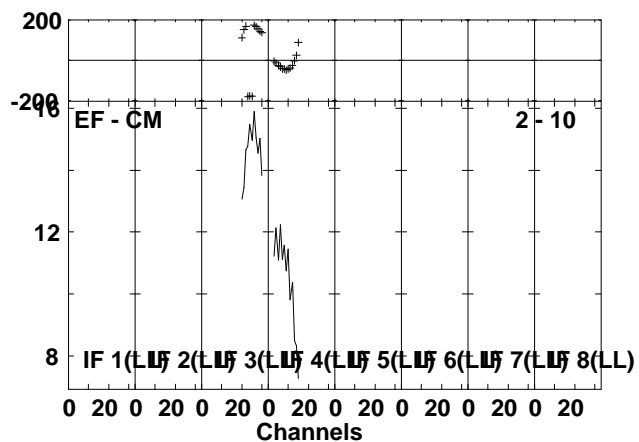
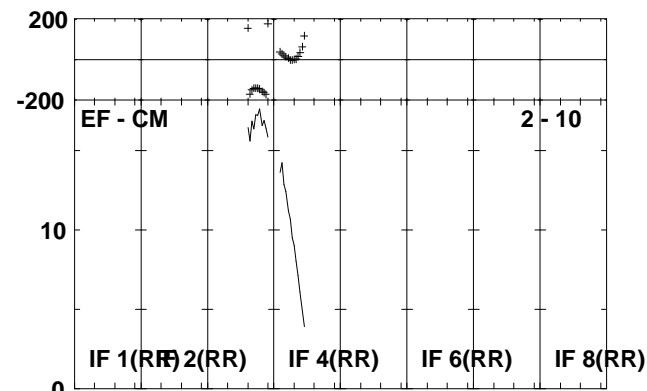
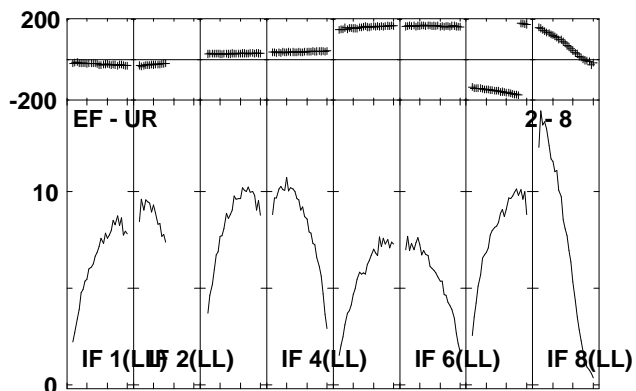
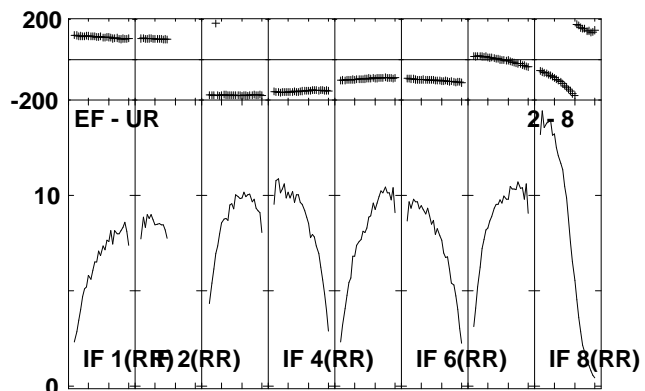
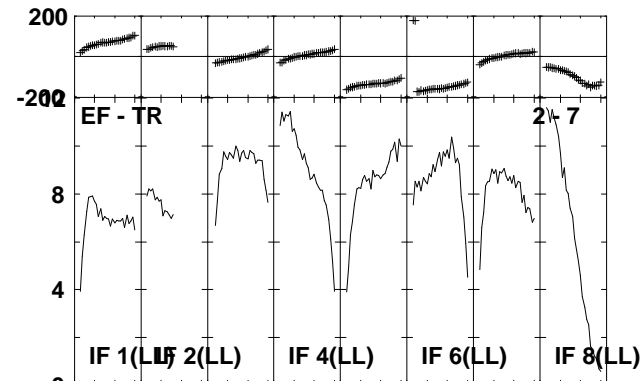
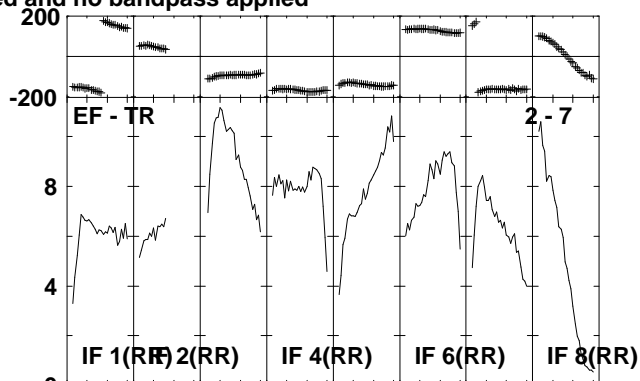
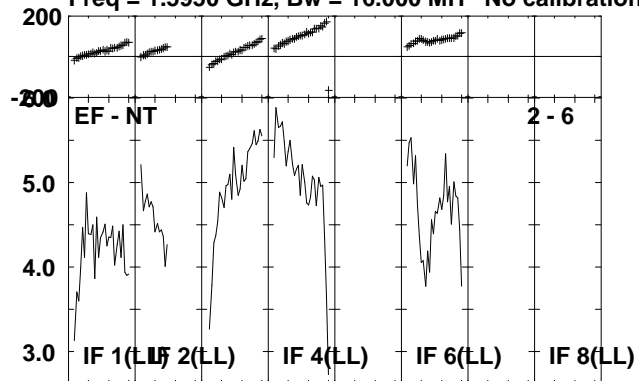

Lower frame: Milli Ampl Jy Top frame: Phas deg
Scalar averaged cross-power spectrum Several baselines displayed
Timerange: 00/13:12:11 to 00/13:13:59

Plot file version 59 created 06-JUL-2010 14:41:49

IRAS2336 EP064J.UVDATA.1

Freq = 1.5950 GHz, Bw = 16.000 MH No calibration applied and no bandpass applied

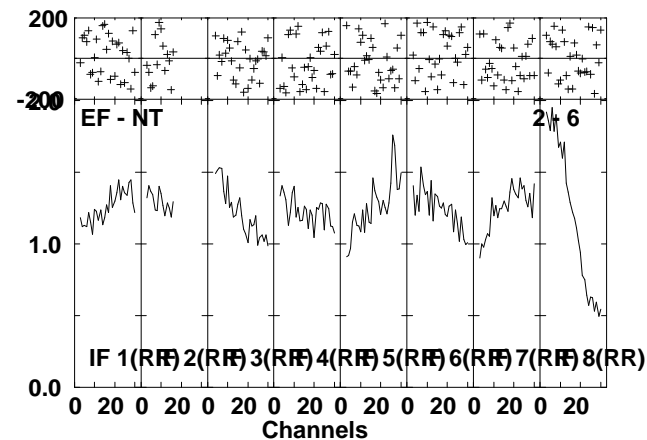
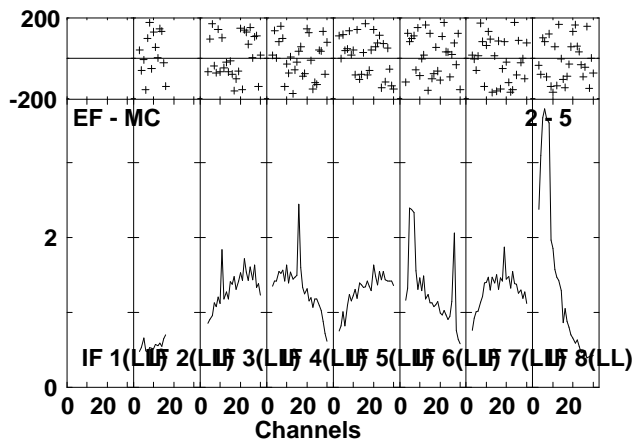
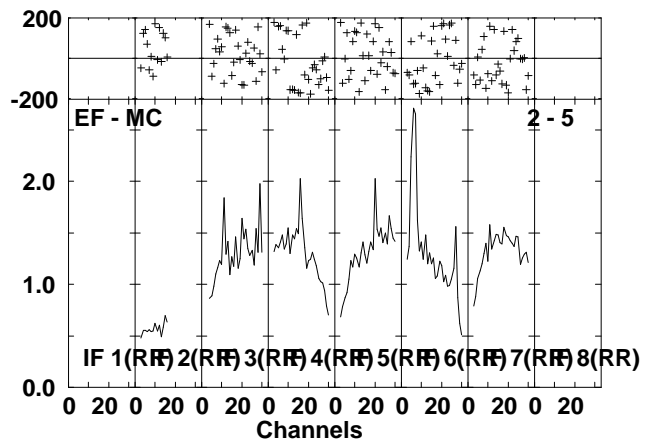
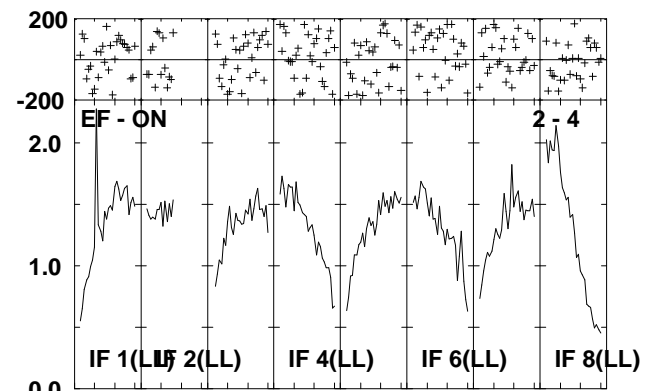
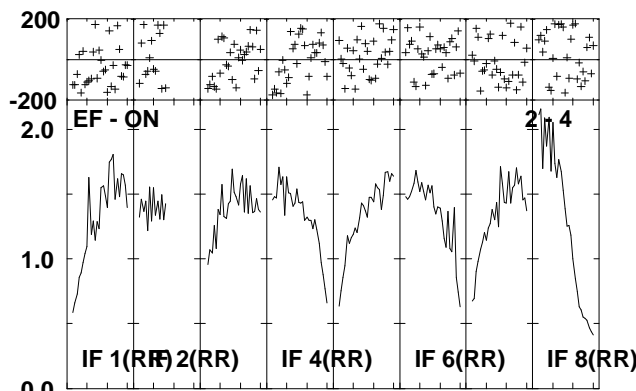
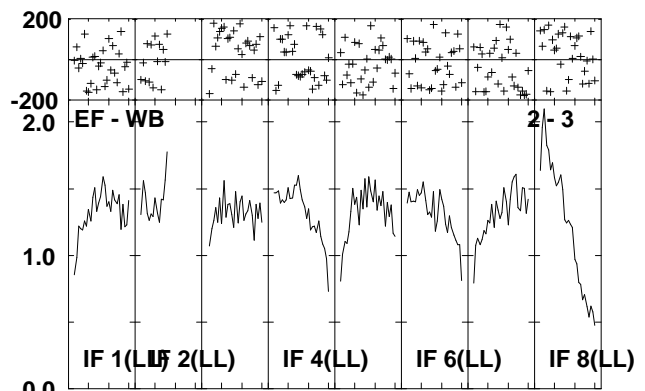
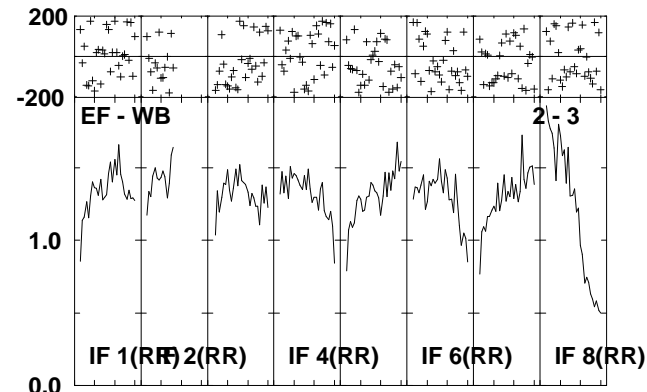
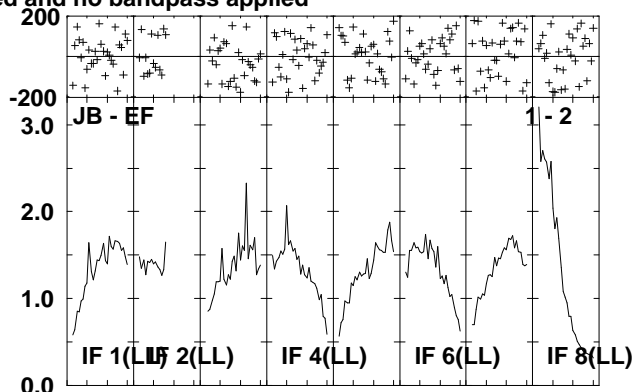
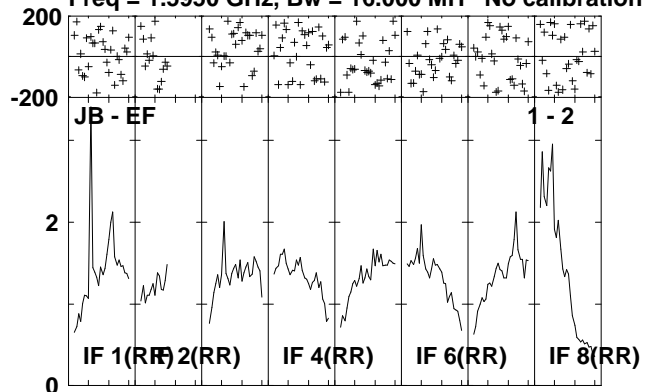

Lower frame: Milli Ampl Jy Top frame: Phas deg
Scalar averaged cross-power spectrum Several baselines displayed
Timerange: 00/13:14:01 to 00/13:17:39

Plot file version 60 created 06-JUL-2010 14:41:51

IRAS2336 EP064J.UVDATA.1

Freq = 1.5950 GHz, Bw = 16.000 MH No calibration applied and no bandpass applied

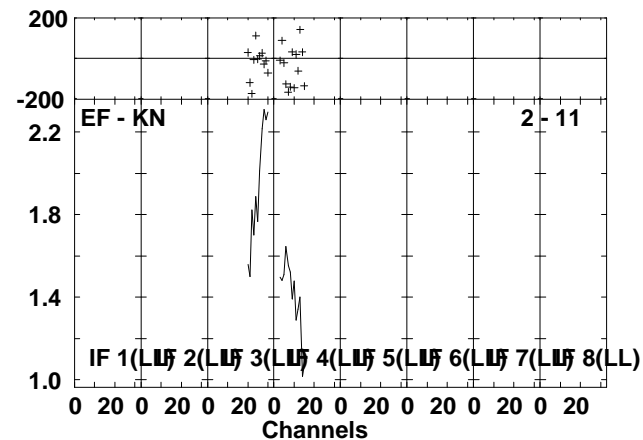
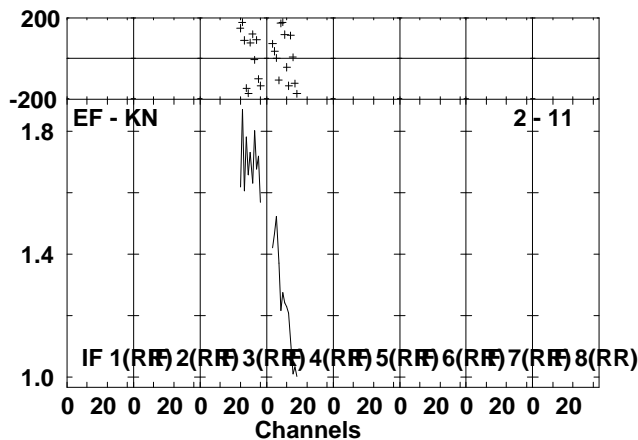
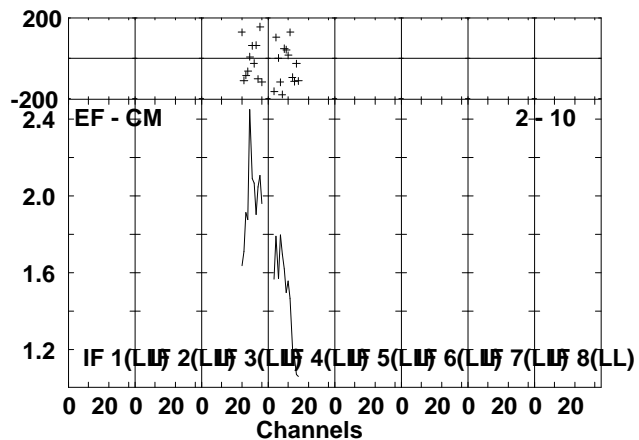
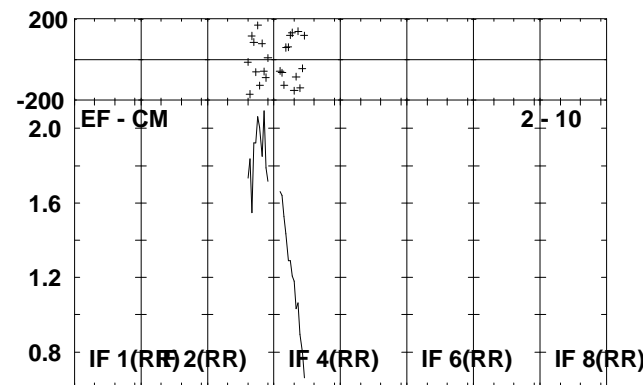
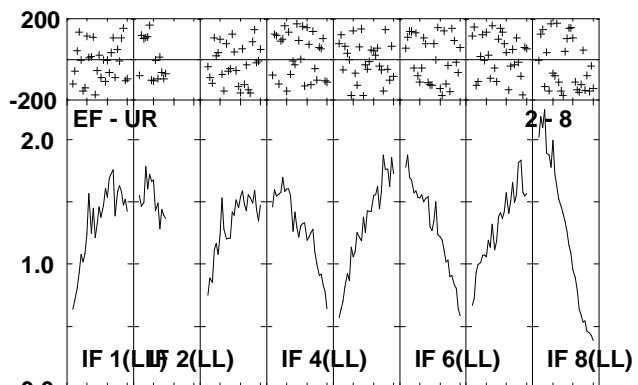
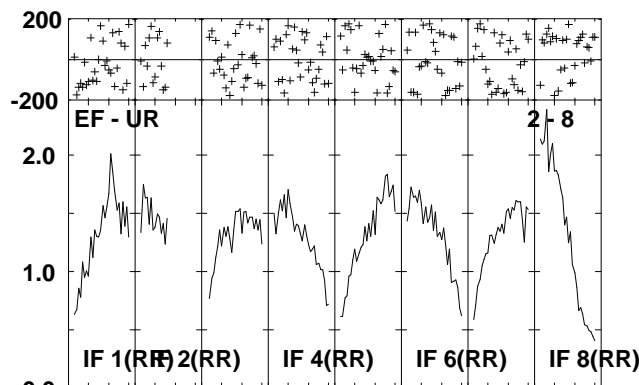
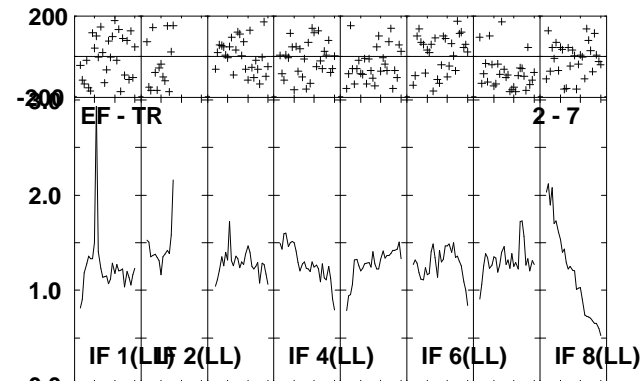
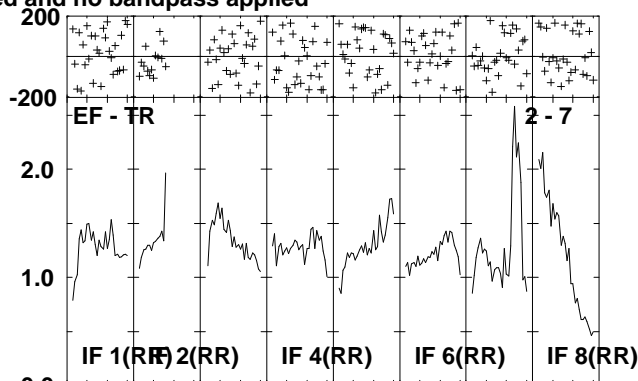
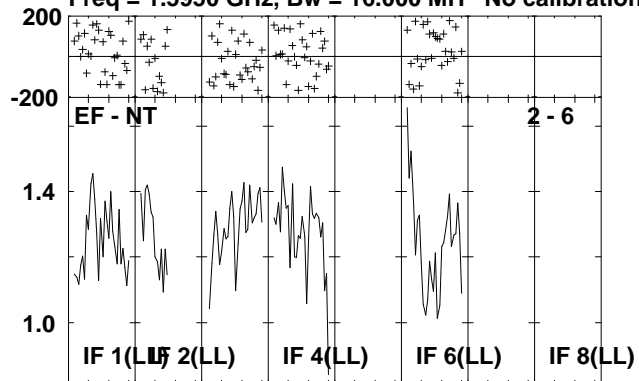

Lower frame: Milli Ampl Jy Top frame: Phas deg
Scalar averaged cross-power spectrum Several baselines displayed
Timerange: 00/13:14:01 to 00/13:17:39

Plot file version 61 created 06-JUL-2010 14:41:54
 J2330+33 EP064J.UVDATA.1

Freq = 1.5950 GHz, Bw = 16.000 MH No calibration applied and no bandpass applied

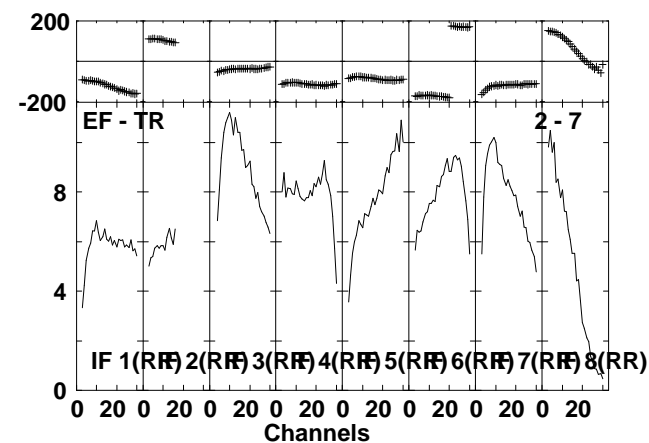
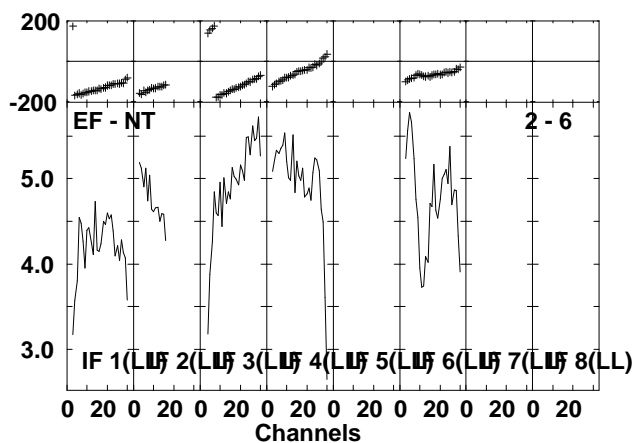
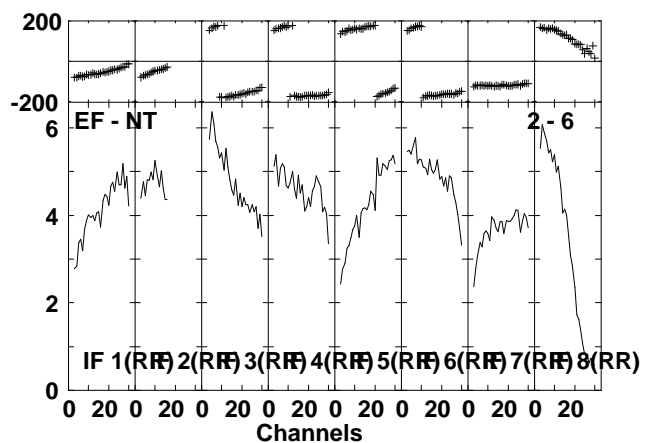
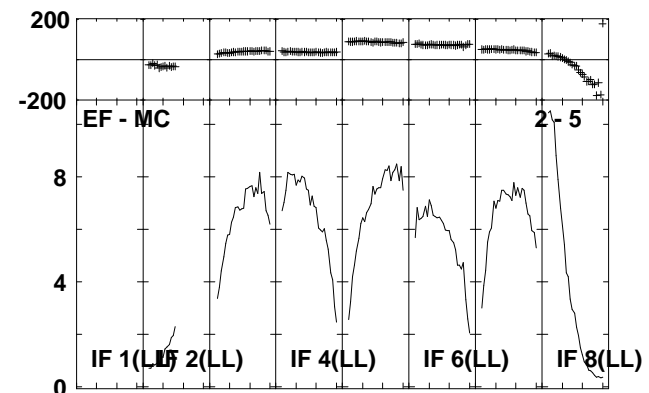
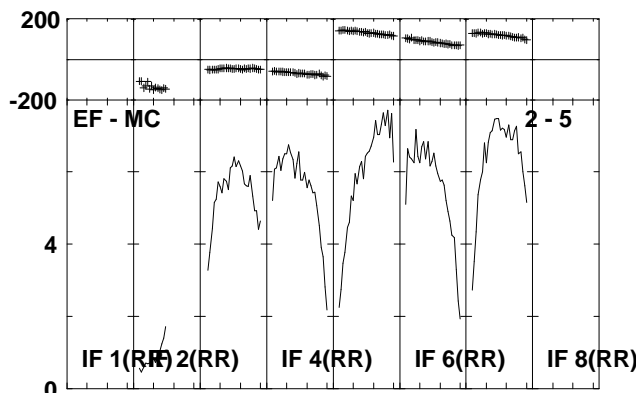
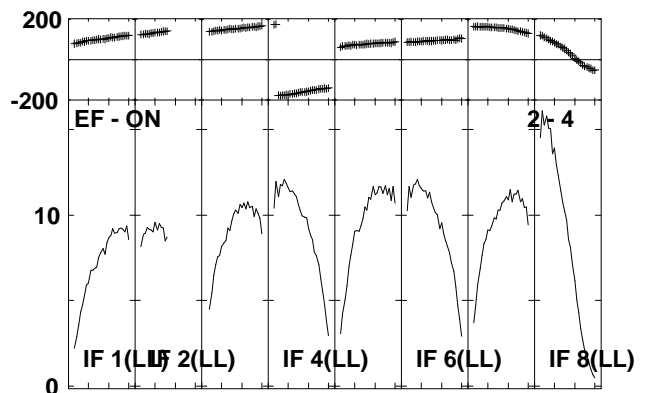
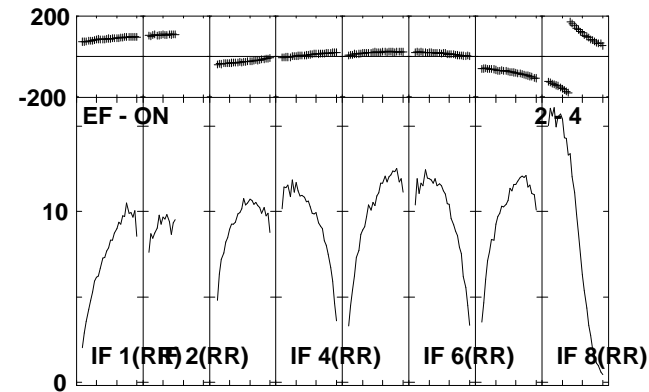
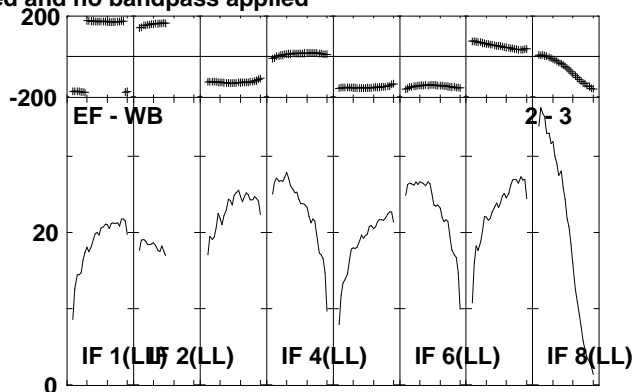
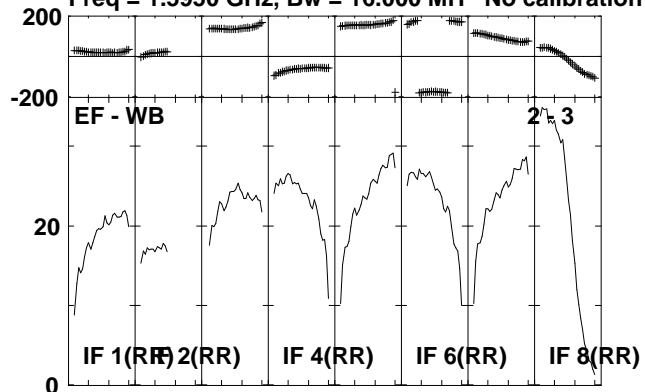

Lower frame: Milli Ampl Jy Top frame: Phas deg
 Scalar averaged cross-power spectrum Several baselines displayed
 Timerange: 00/13:17:41 to 00/13:19:29

Plot file version 62 created 06-JUL-2010 14:41:55

J2330+33 EP064J.UVDATA.1

Freq = 1.5950 GHz, Bw = 16.000 MH No calibration applied and no bandpass applied

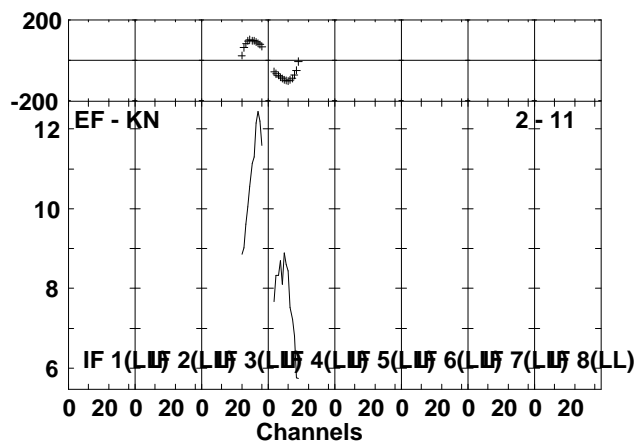
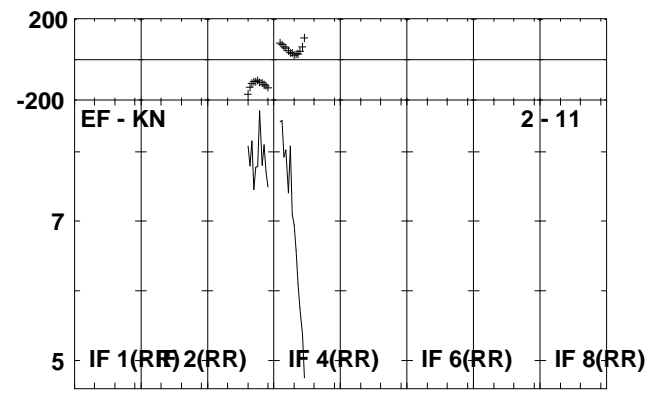
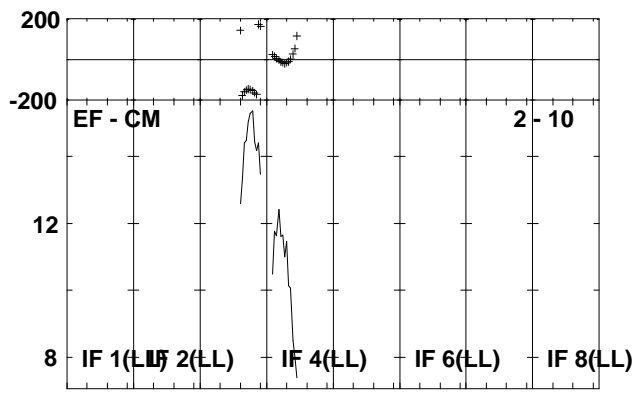
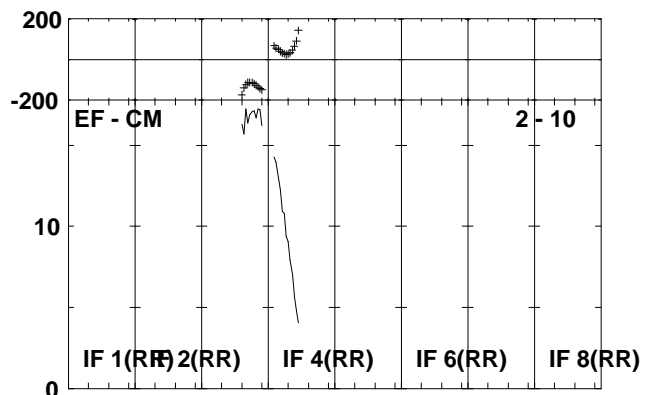
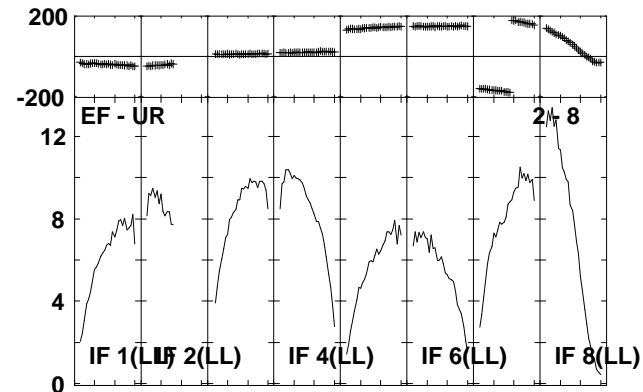
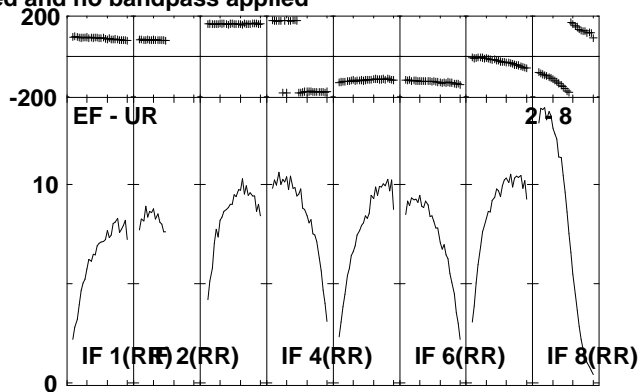
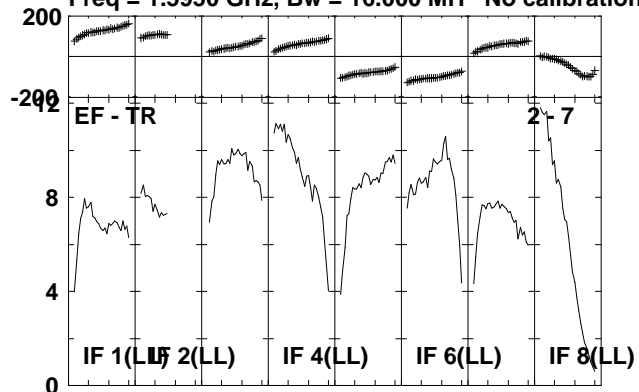

Lower frame: Milli Ampl Jy Top frame: Phas deg
Scalar averaged cross-power spectrum Several baselines displayed
Timerange: 00/13:17:41 to 00/13:19:29

Plot file version 63 created 06-JUL-2010 14:41:57

IRAS2336 EP064J.UVDATA.1

Freq = 1.5950 GHz, Bw = 16.000 MH No calibration applied and no bandpass applied

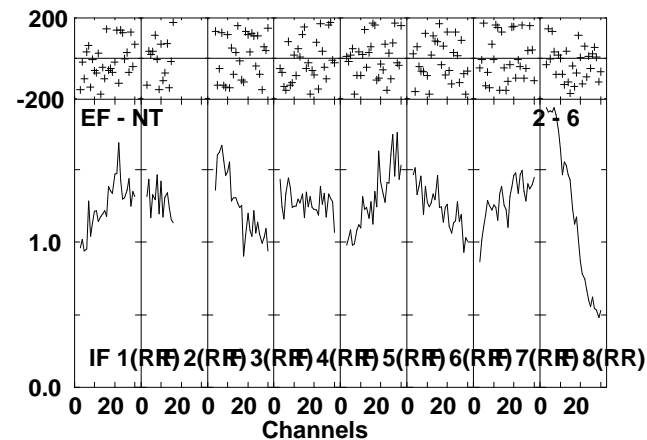
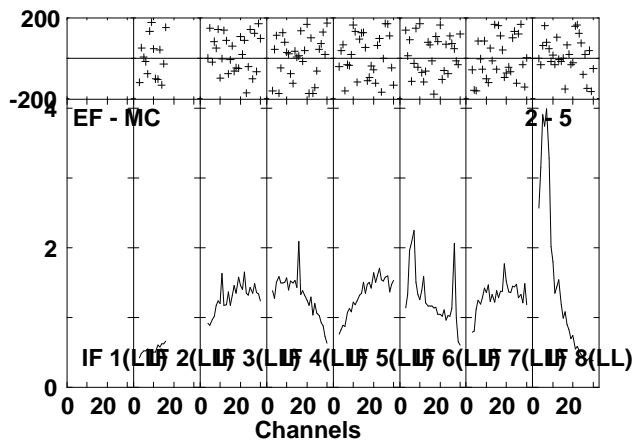
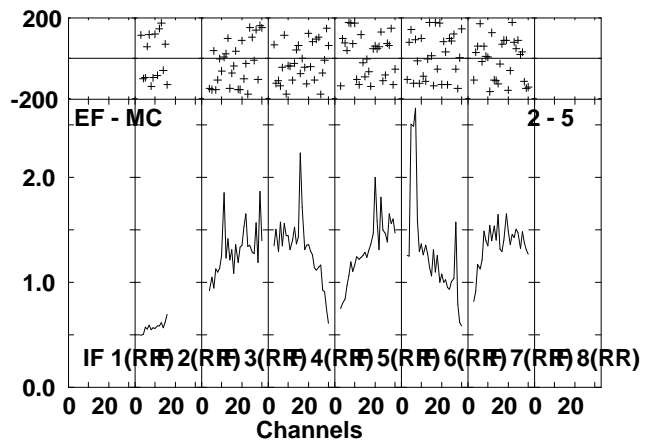
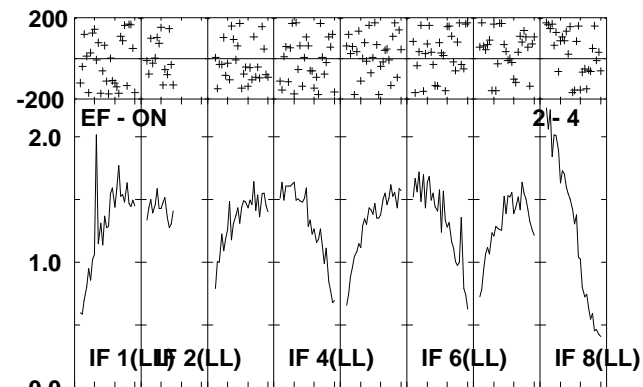
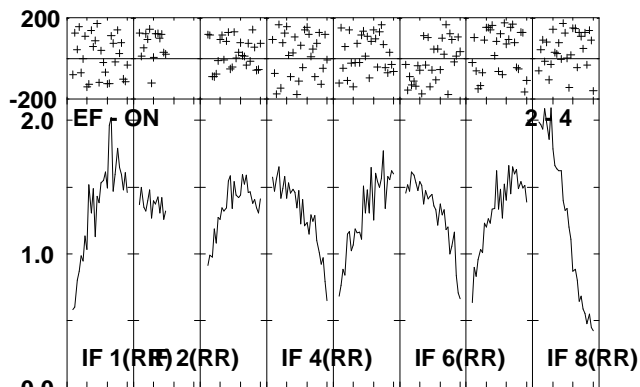
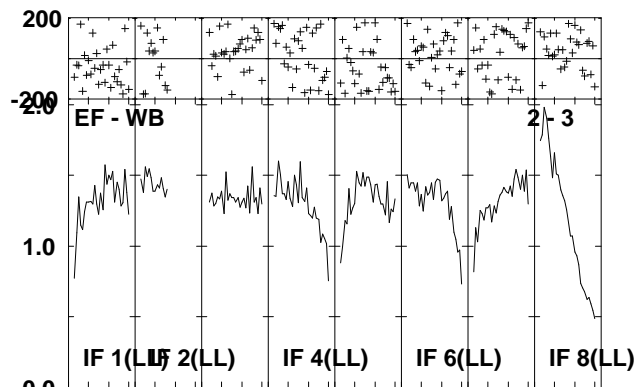
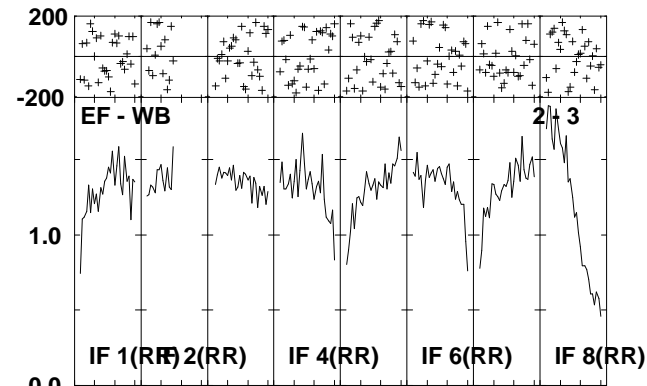
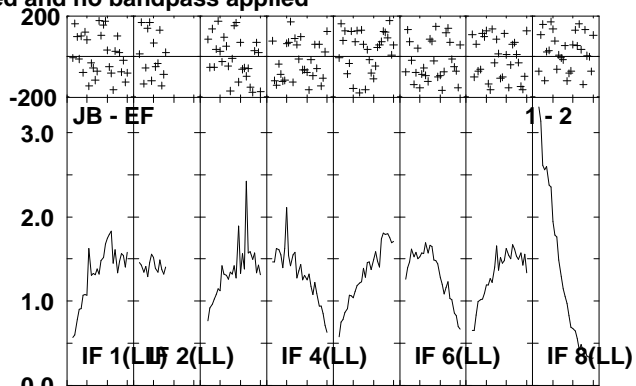
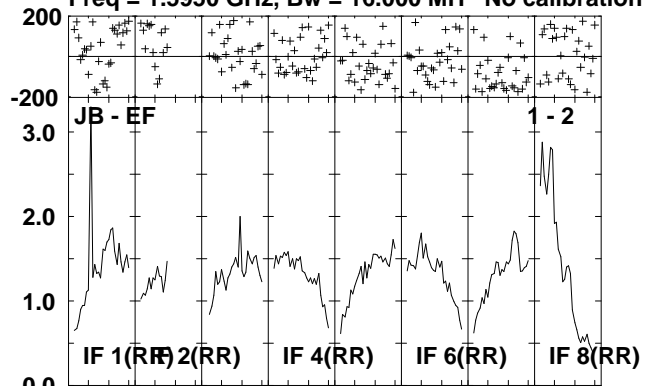

Lower frame: Milli Ampl Jy Top frame: Phas deg
Scalar averaged cross-power spectrum Several baselines displayed
Timerange: 00/13:19:31 to 00/13:23:07

Plot file version 64 created 06-JUL-2010 14:41:59

IRAS2336 EP064J.UVDATA.1

Freq = 1.5950 GHz, Bw = 16.000 MH No calibration applied and no bandpass applied

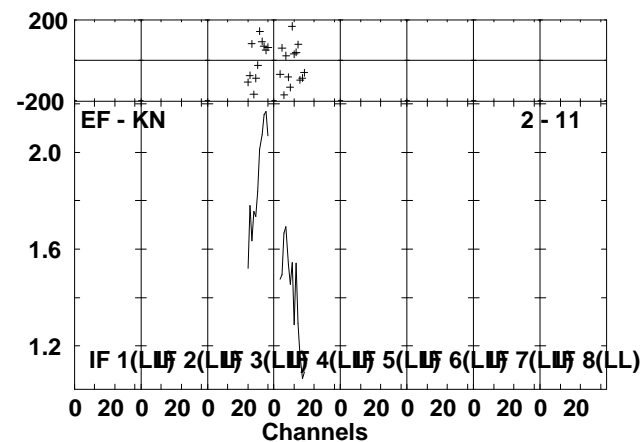
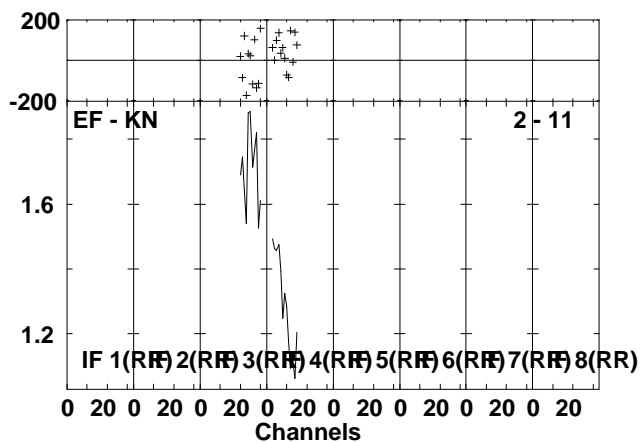
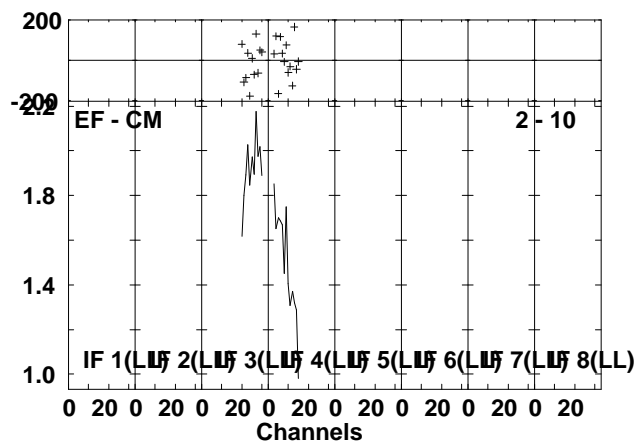
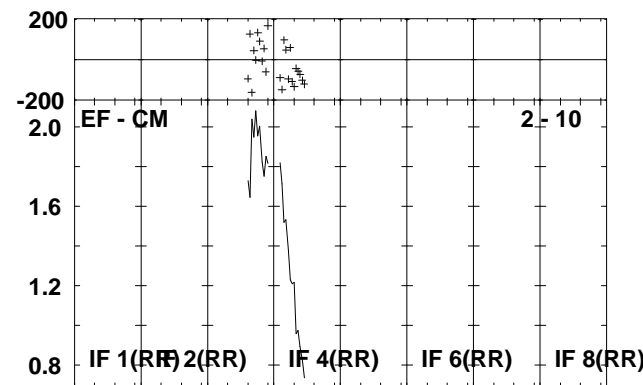
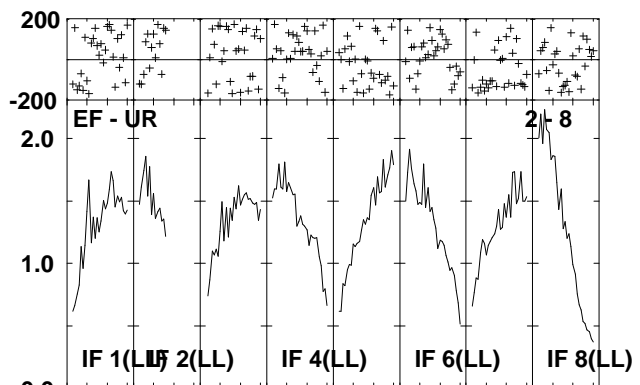
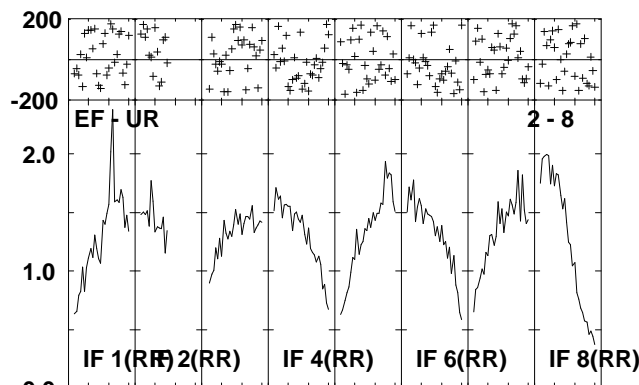
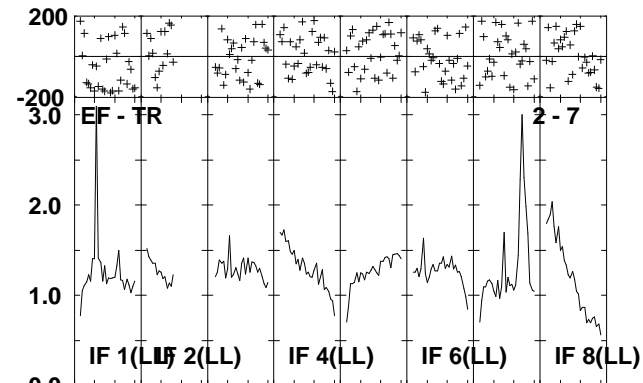
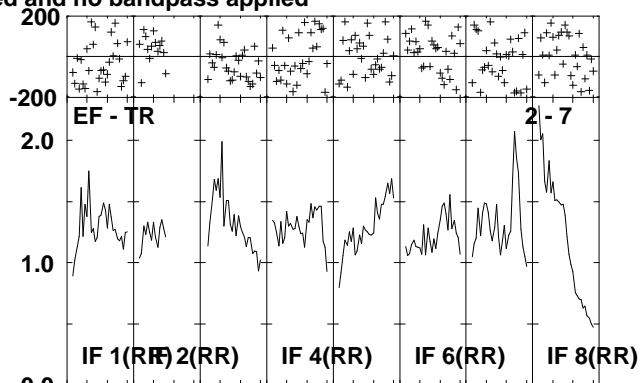
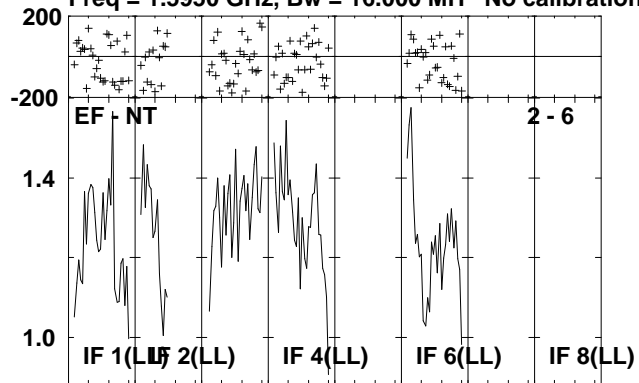

Lower frame: Milli Ampl Jy Top frame: Phas deg
Scalar averaged cross-power spectrum Several baselines displayed
Timerange: 00/13:19:31 to 00/13:23:07

Plot file version 65 created 06-JUL-2010 14:42:01

J2330+33 EP064J.UVDATA.1

Freq = 1.5950 GHz, Bw = 16.000 MH No calibration applied and no bandpass applied

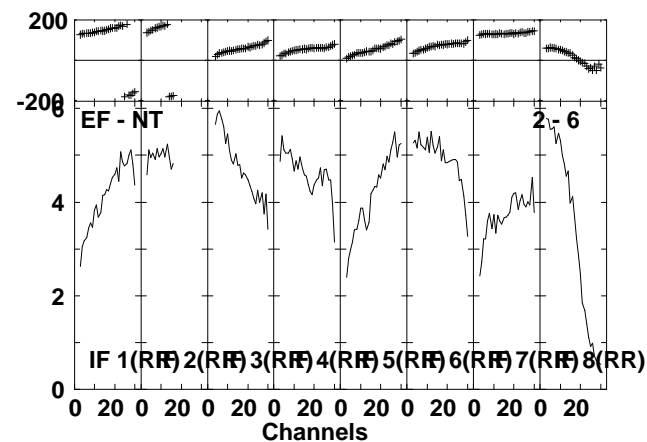
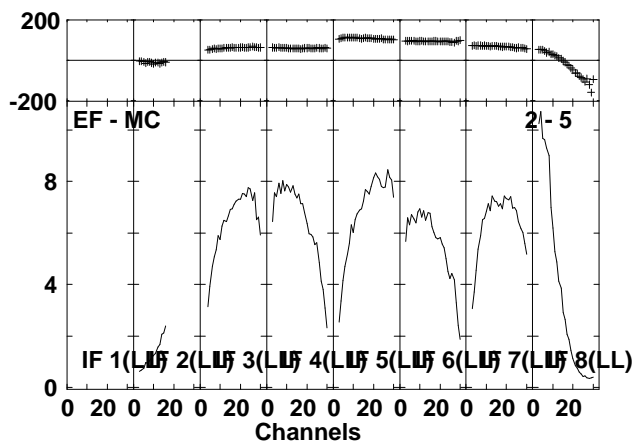
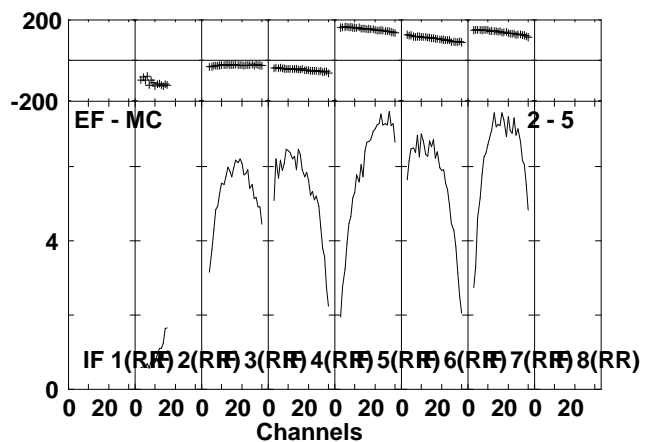
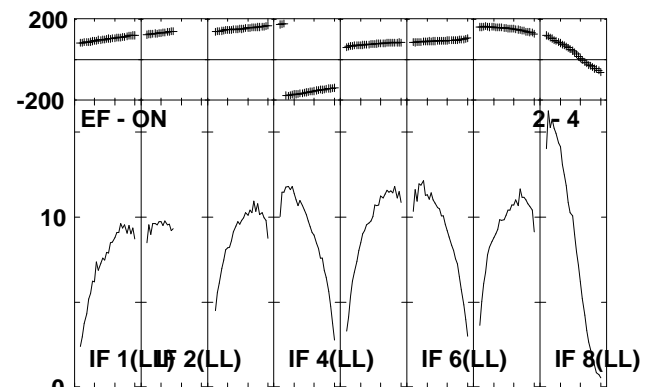
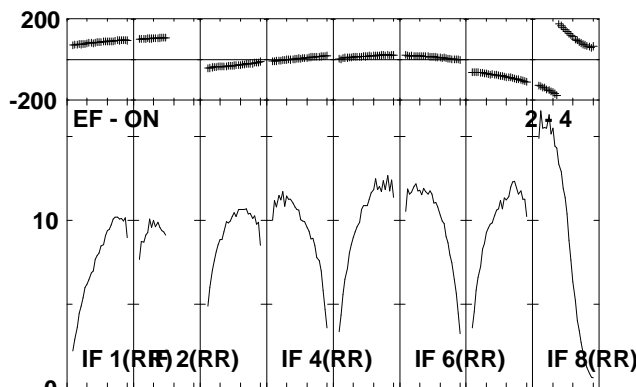
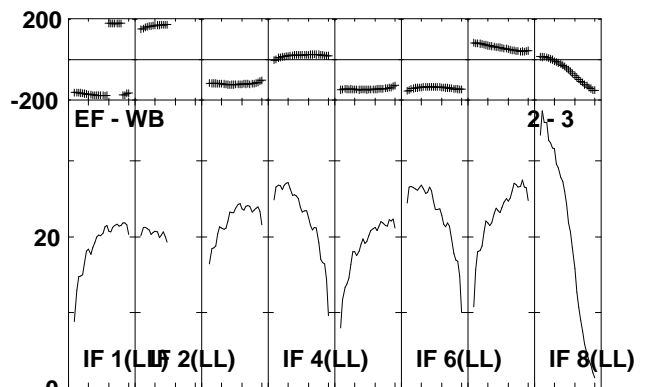
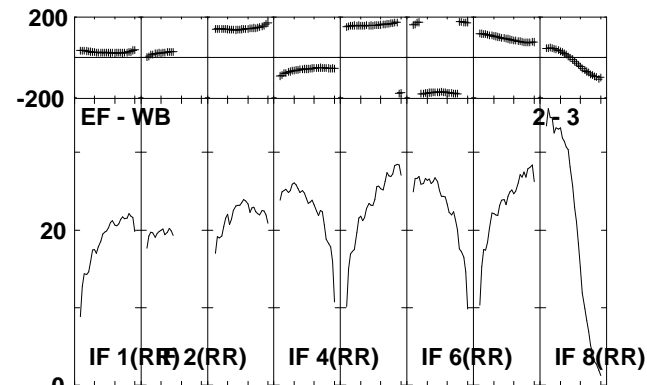
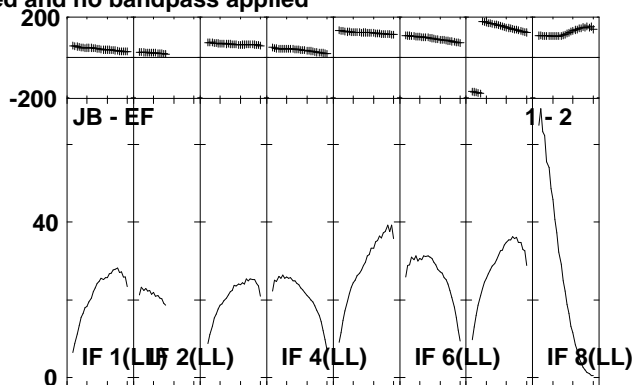
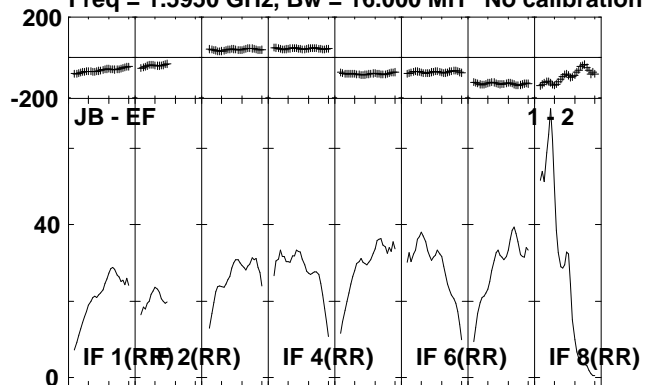

Lower frame: Milli Ampl Jy Top frame: Phas deg
Scalar averaged cross-power spectrum Several baselines displayed
Timerange: 00/13:24:11 to 00/13:25:49

Plot file version 66 created 06-JUL-2010 14:42:02

J2330+33 EP064J.UVDATA.1

Freq = 1.5950 GHz, Bw = 16.000 MH No calibration applied and no bandpass applied

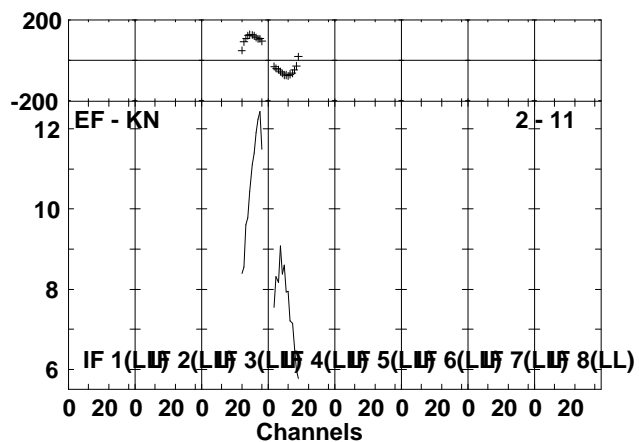
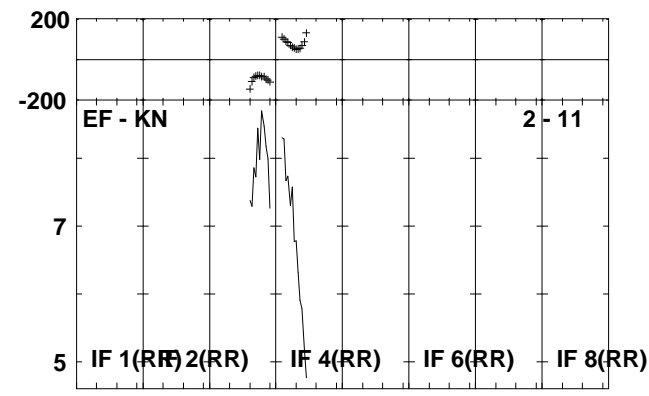
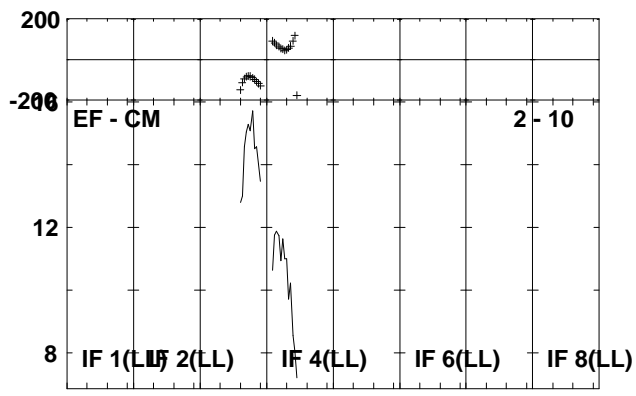
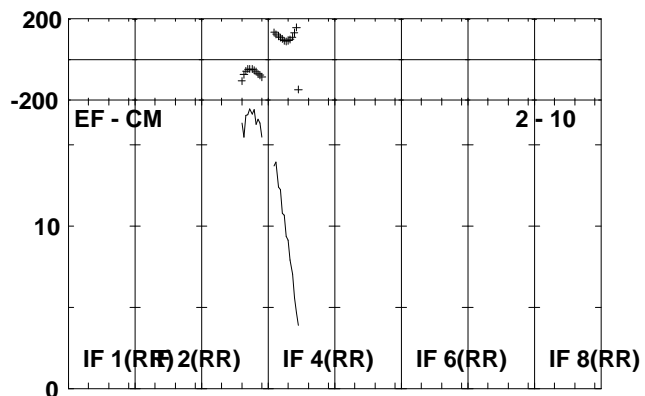
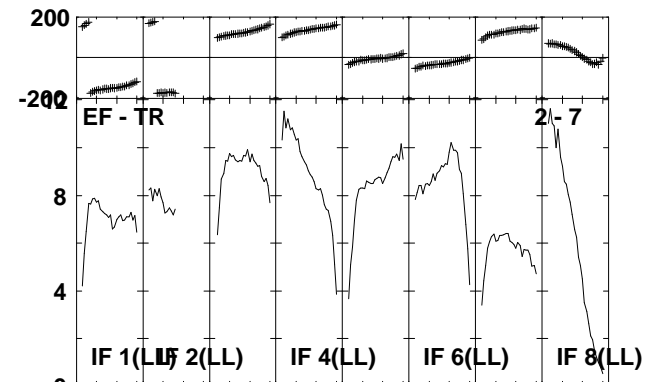
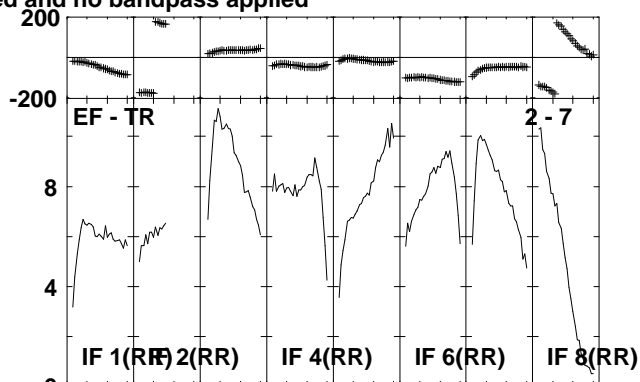
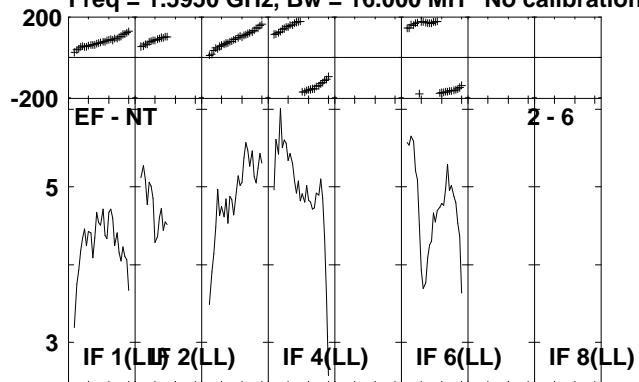

Lower frame: Milli Ampl Jy Top frame: Phas deg
Scalar averaged cross-power spectrum Several baselines displayed
Timerange: 00/13:24:11 to 00/13:25:49

Plot file version 67 created 06-JUL-2010 14:42:04

IRAS2336 EP064J.UVDATA.1

Freq = 1.5950 GHz, Bw = 16.000 MH No calibration applied and no bandpass applied

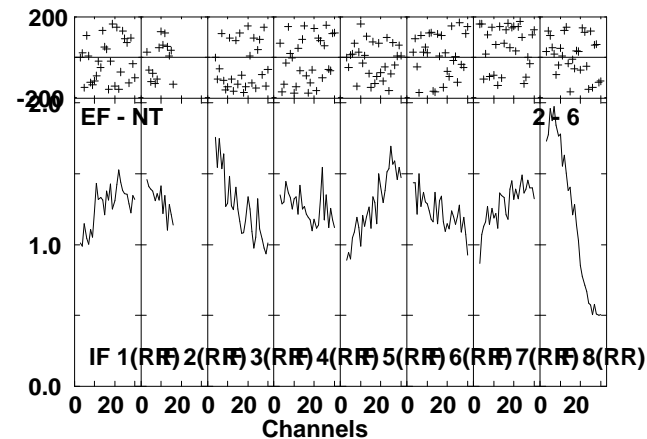
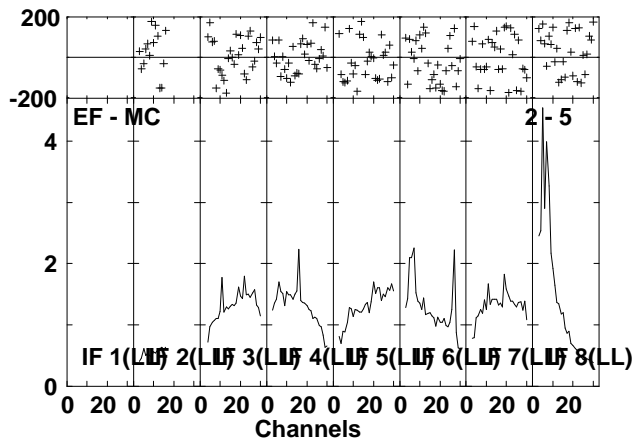
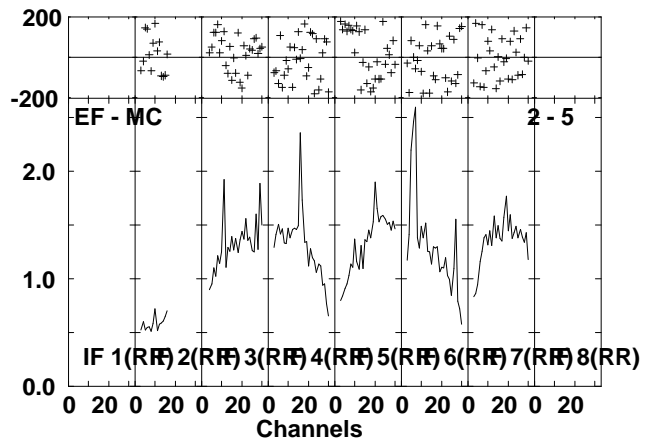
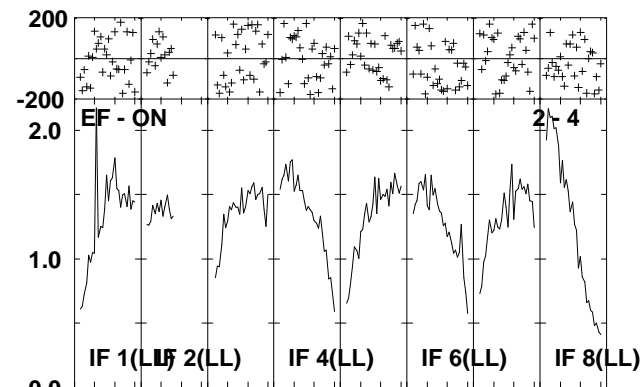
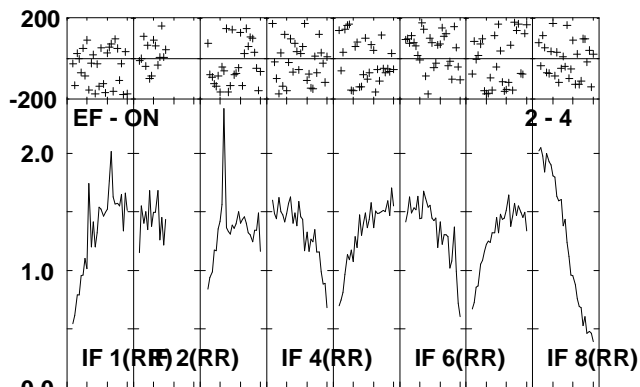
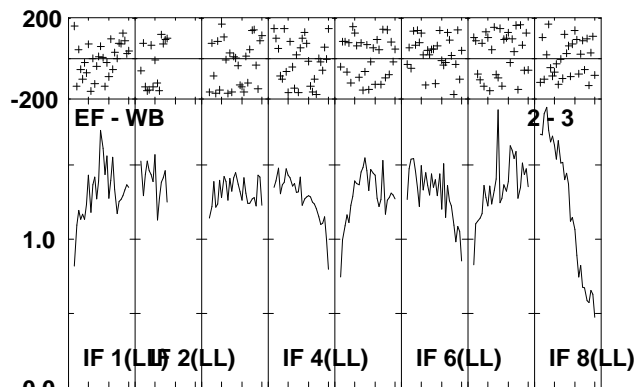
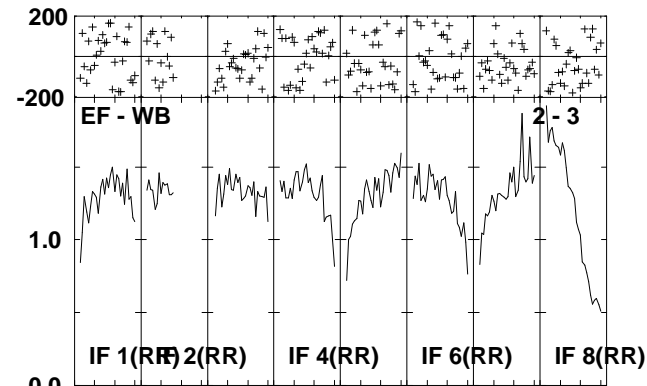
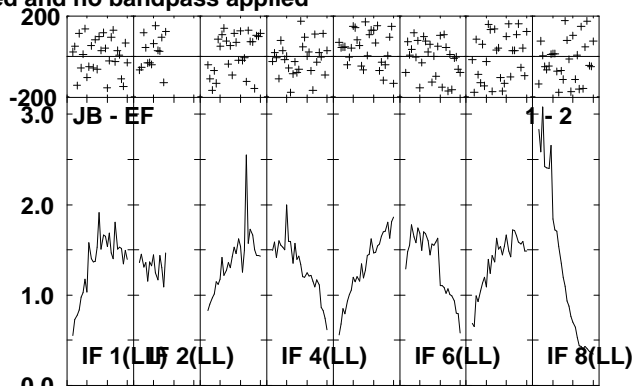
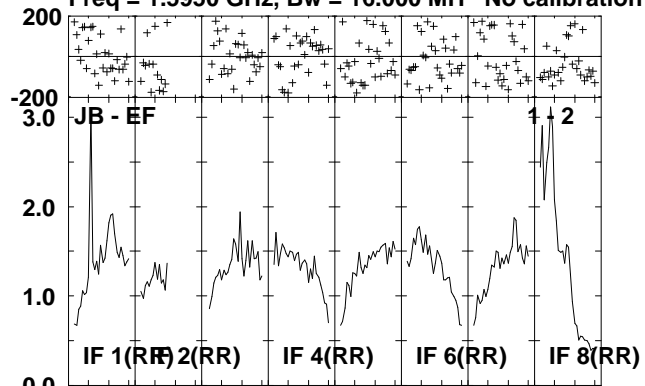

Lower frame: Milli Ampl Jy Top frame: Phas deg
Scalar averaged cross-power spectrum Several baselines displayed
Timerange: 00/13:25:51 to 00/13:29:29

Plot file version 68 created 06-JUL-2010 14:42:05

IRAS2336 EP064J.UVDATA.1

Freq = 1.5950 GHz, Bw = 16.000 MH No calibration applied and no bandpass applied

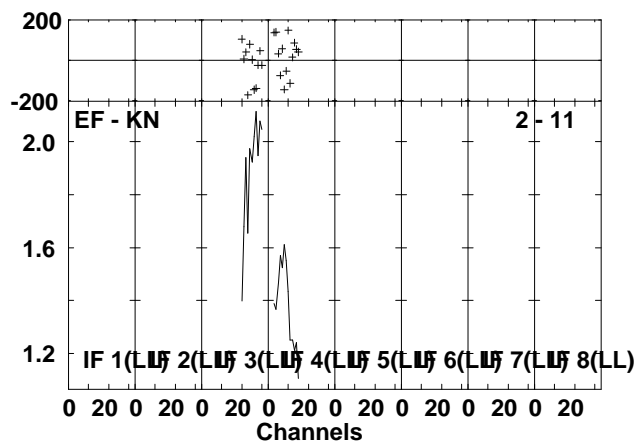
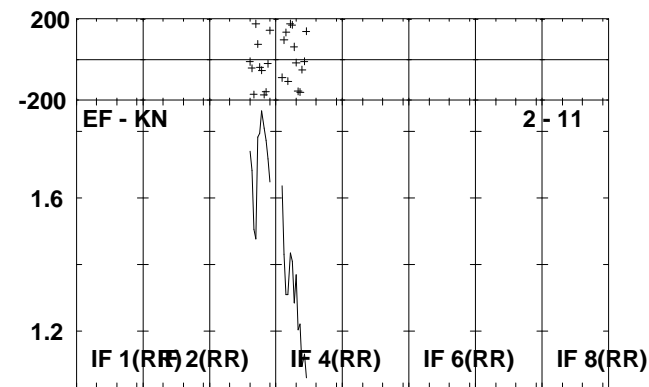
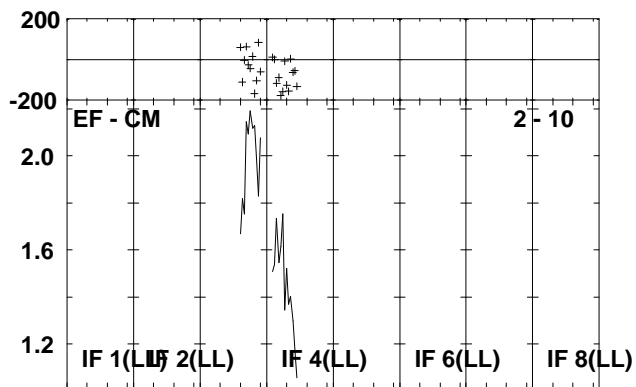
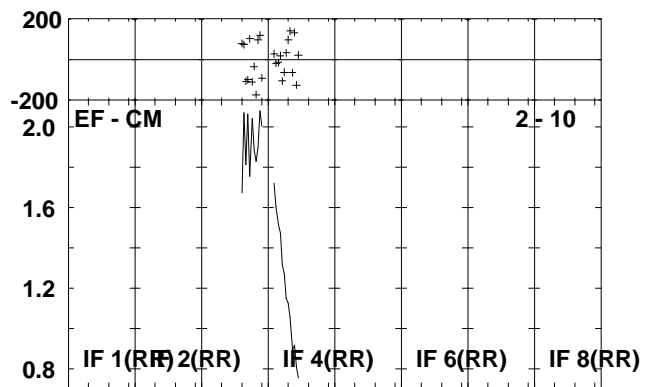
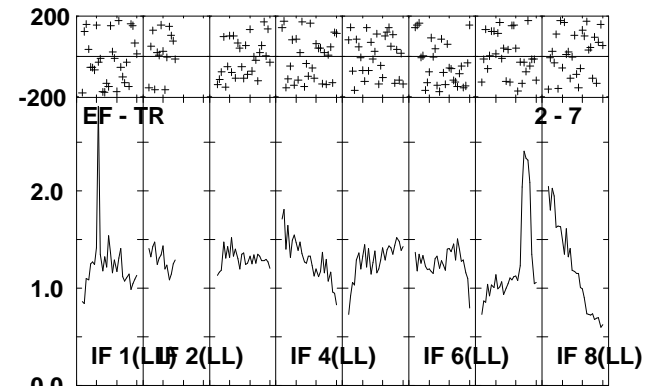
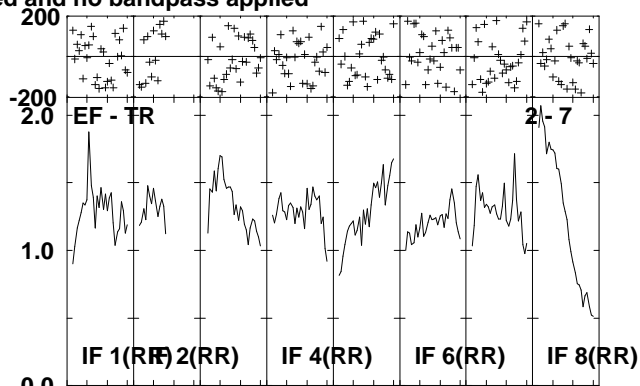
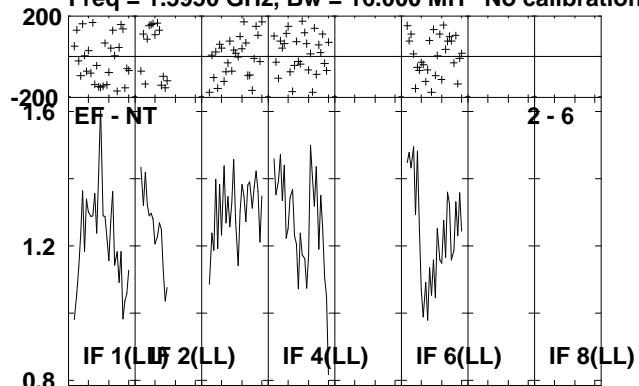

Lower frame: Milli Ampl Jy Top frame: Phas deg
Scalar averaged cross-power spectrum Several baselines displayed
Timerange: 00/13:25:51 to 00/13:29:29

Plot file version 69 created 06-JUL-2010 14:42:08

J2330+33 EP064J.UVDATA.1

Freq = 1.5950 GHz, Bw = 16.000 MH No calibration applied and no bandpass applied

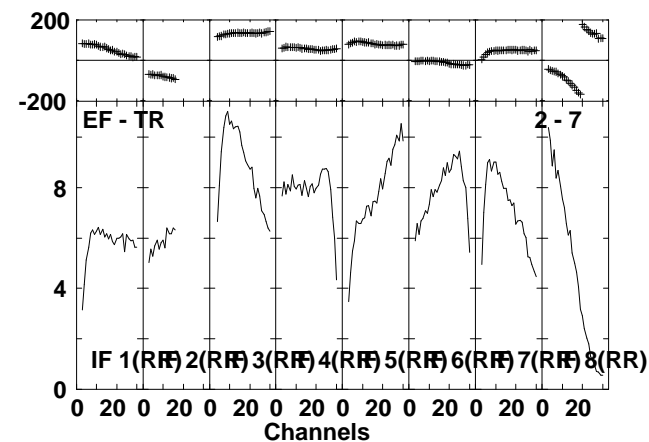
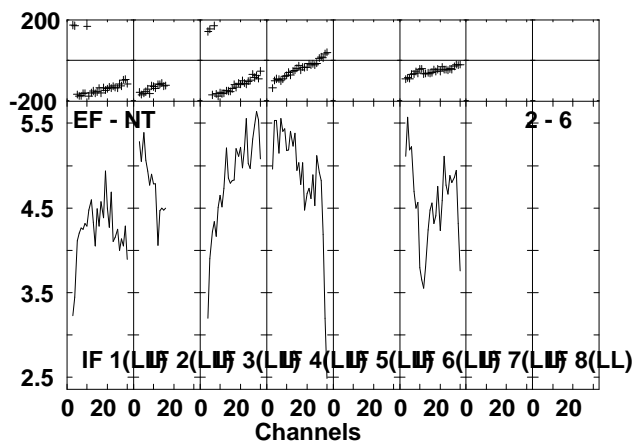
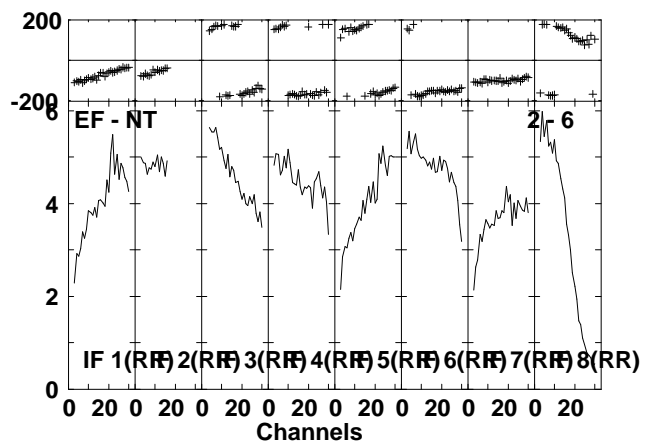
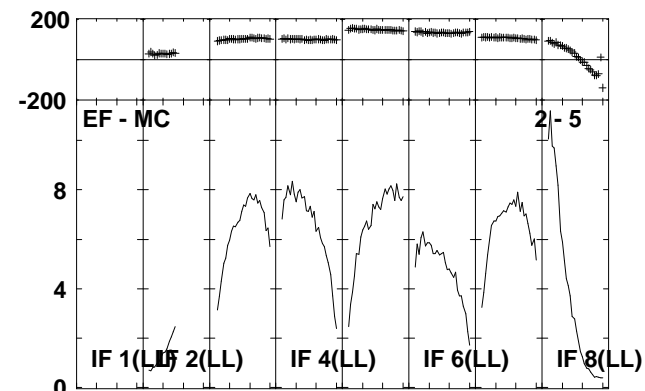
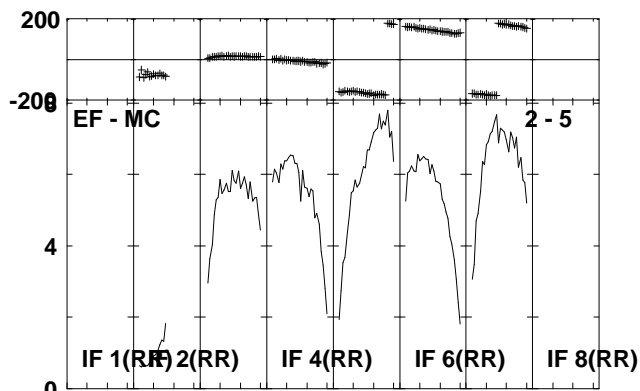
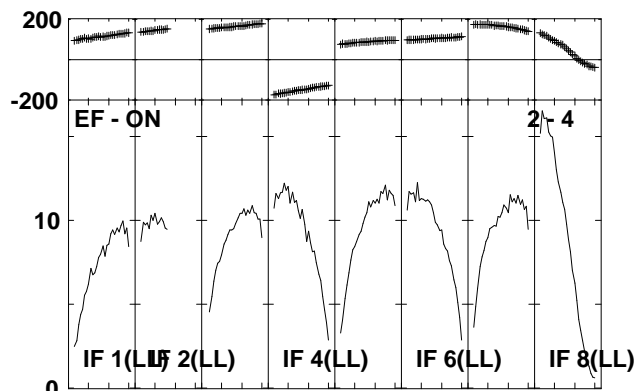
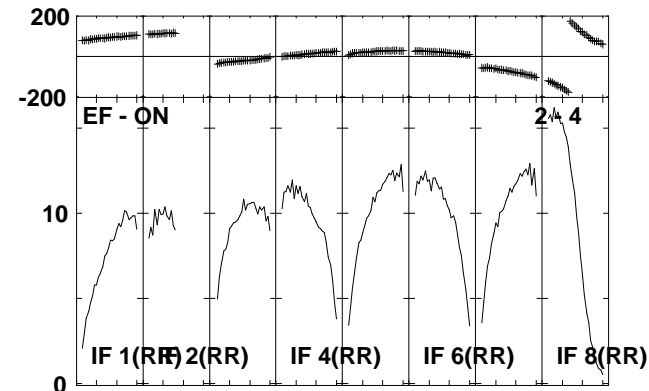
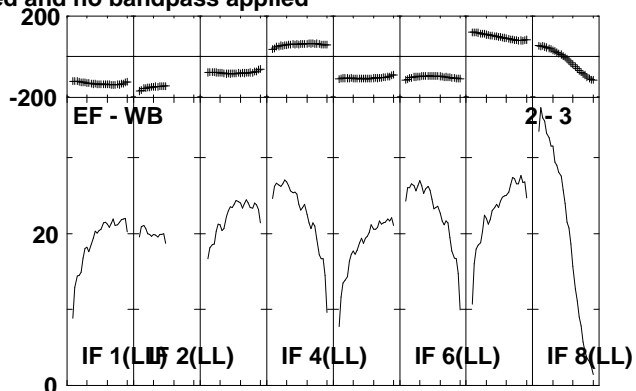
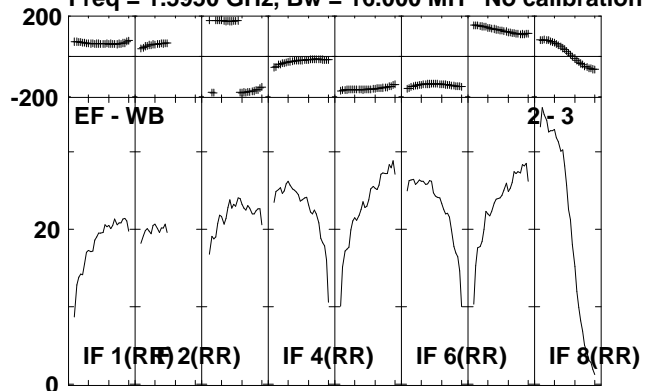

Lower frame: Milli Ampl Jy Top frame: Phas deg
Scalar averaged cross-power spectrum Several baselines displayed
Timerange: 00/13:29:31 to 00/13:31:19

Plot file version 70 created 06-JUL-2010 14:42:08
J2330+33 EP064J.UVDATA.1

Freq = 1.5950 GHz, Bw = 16.000 MH No calibration applied and no bandpass applied

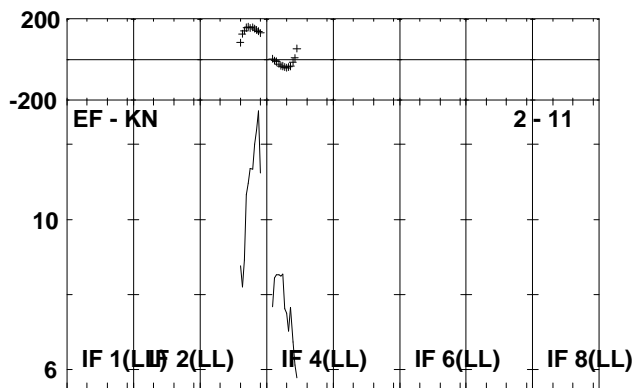
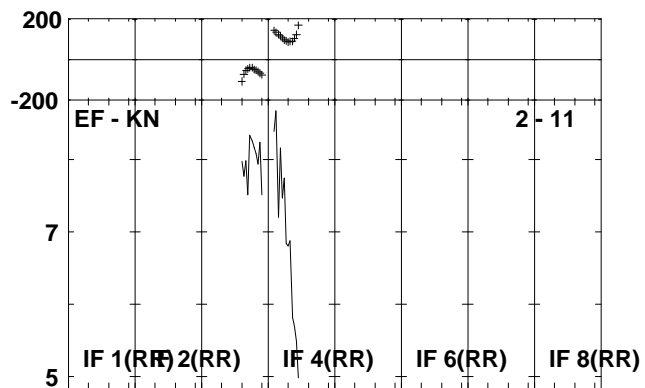
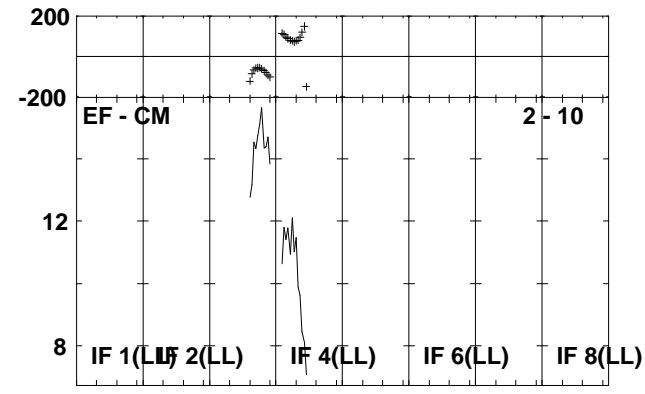
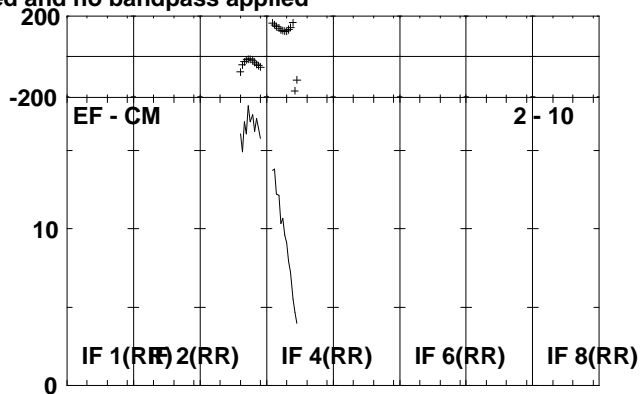
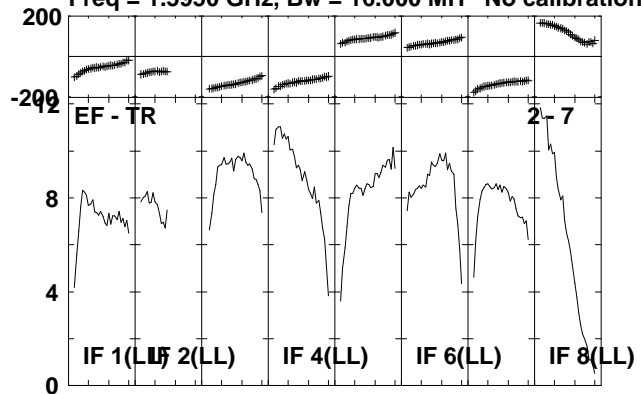

Lower frame: Milli Ampl Jy Top frame: Phas deg
Scalar averaged cross-power spectrum Several baselines displayed
Timerange: 00/13:29:31 to 00/13:31:19

Plot file version 71 created 06-JUL-2010 14:42:15

IRAS2336 EP064J.UVDATA.1

Freq = 1.5950 GHz, Bw = 16.000 MH No calibration applied and no bandpass applied

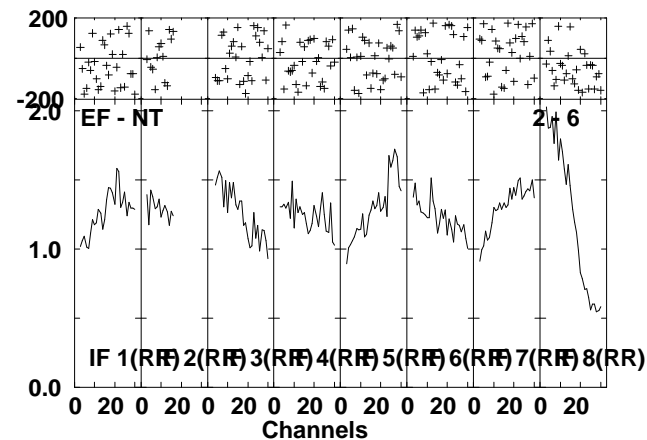
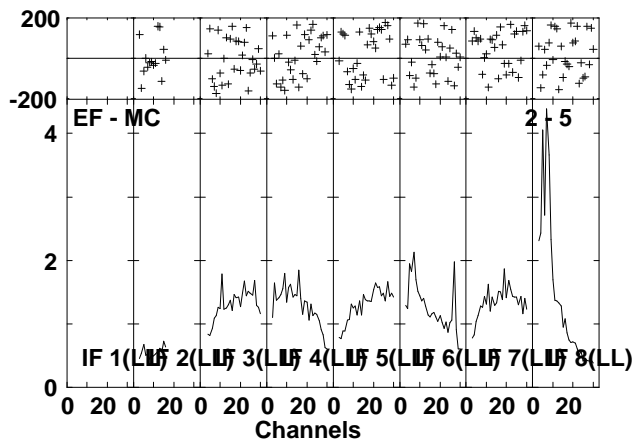
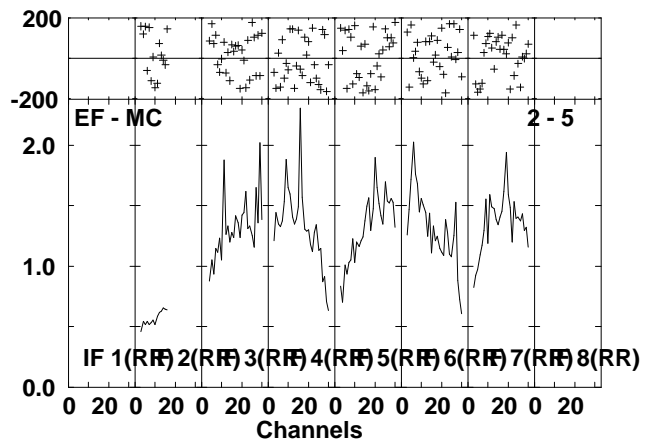
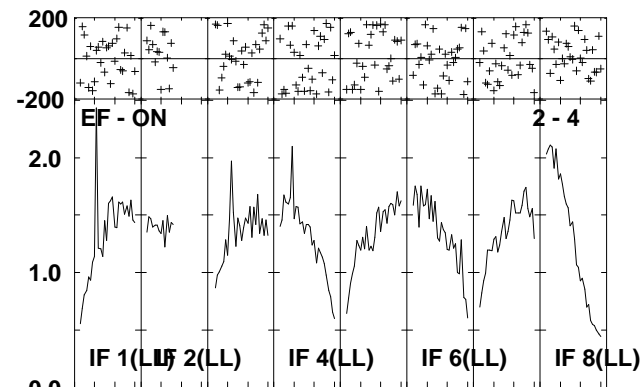
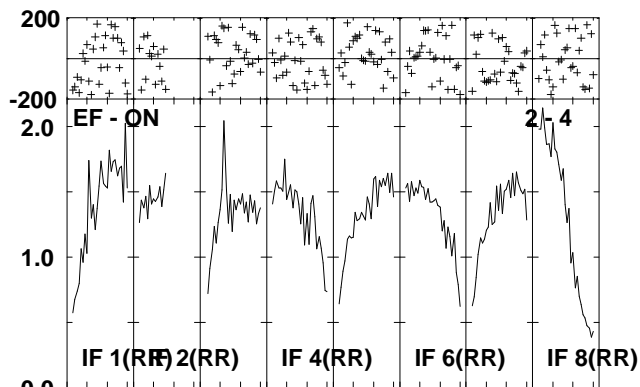
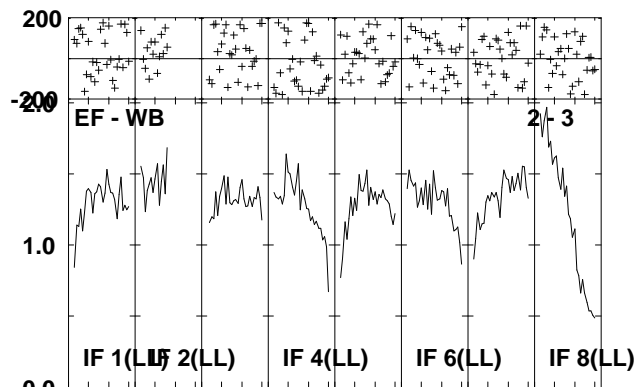
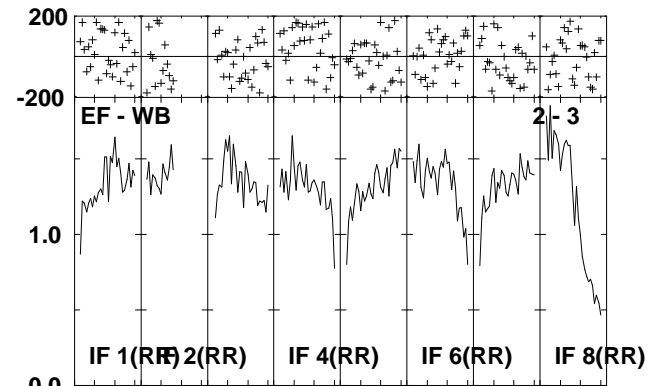
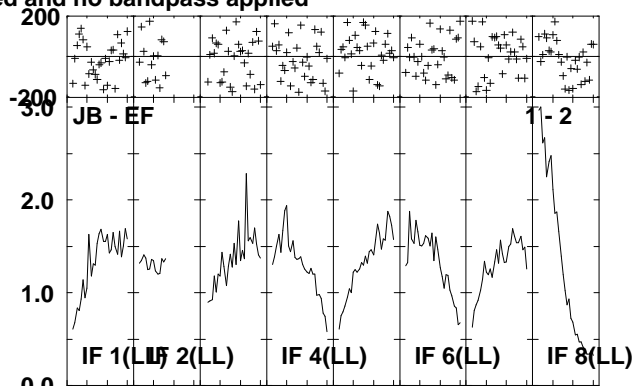
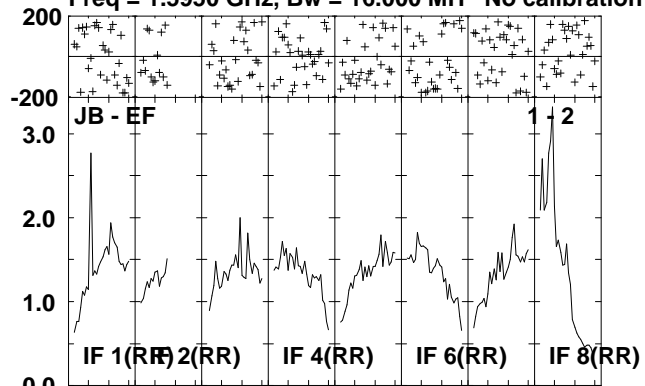

Lower frame: Milli Ampl Jy Top frame: Phas deg
Scalar averaged cross-power spectrum Several baselines displayed
Timerange: 00/13:31:21 to 00/13:34:59

Plot file version 72 created 06-JUL-2010 14:42:16
 IRAS2336 EP064J.UVDATA.1

Freq = 1.5950 GHz, Bw = 16.000 MH No calibration applied and no bandpass applied

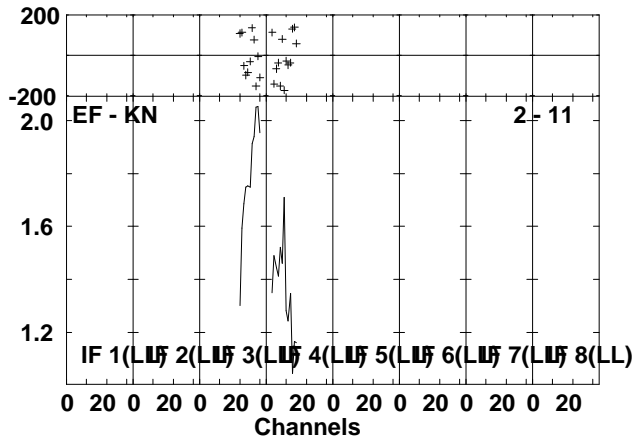
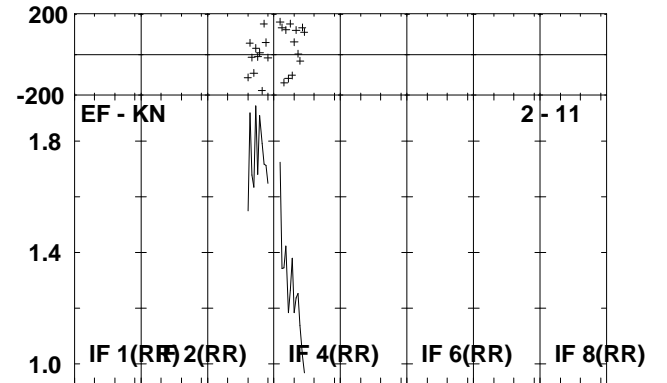
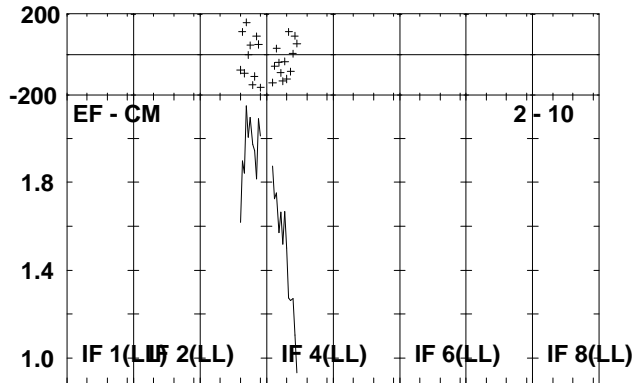
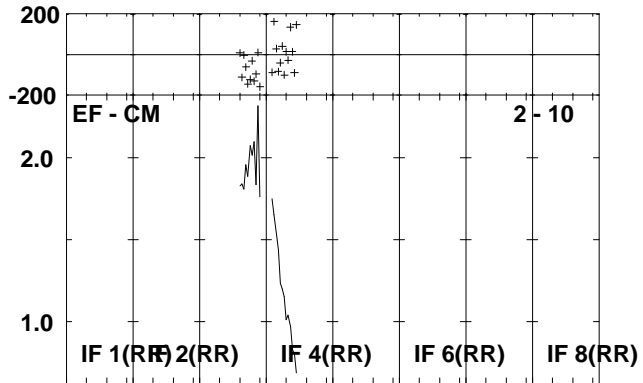
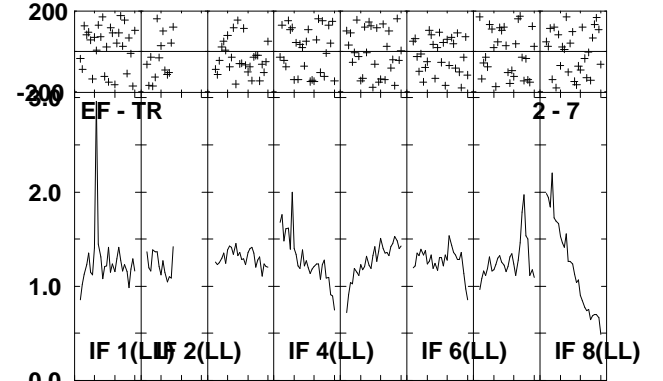
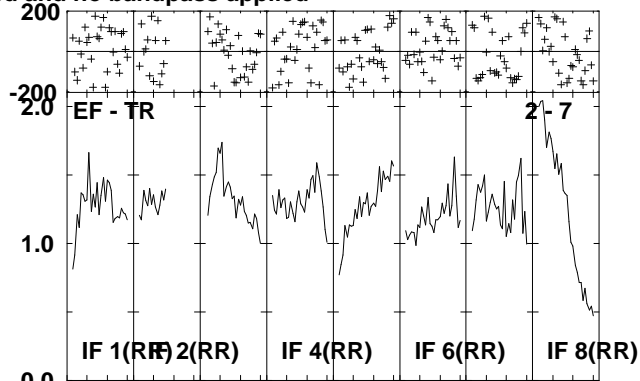
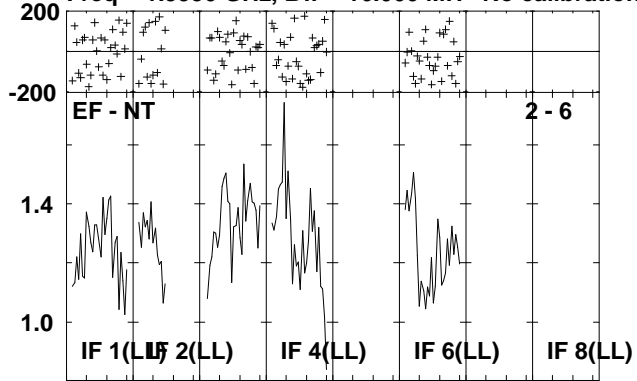

0 20 0 20 0 20 0 20 0 20 0 20 0 20 0 20 0 20
 Channels
 Lower frame: Milli Ampl Jy Top frame: Phas deg
 Scalar averaged cross-power spectrum Several baselines displayed
 Timerange: 00/13:31:21 to 00/13:34:59

Plot file version 73 created 06-JUL-2010 14:42:18

J2330+33 EP064J.UVDATA.1

Freq = 1.5950 GHz, Bw = 16.000 MH No calibration applied and no bandpass applied

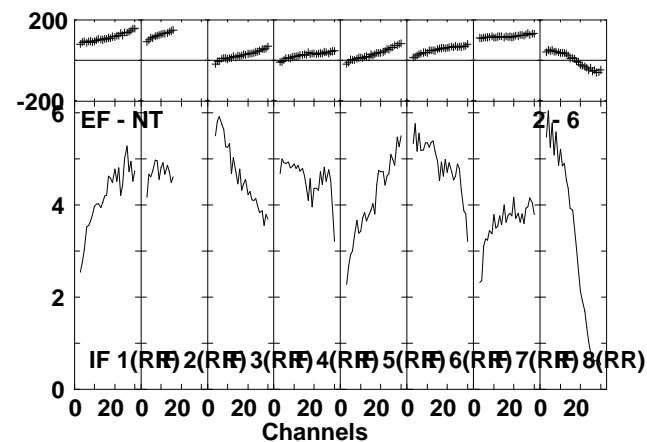
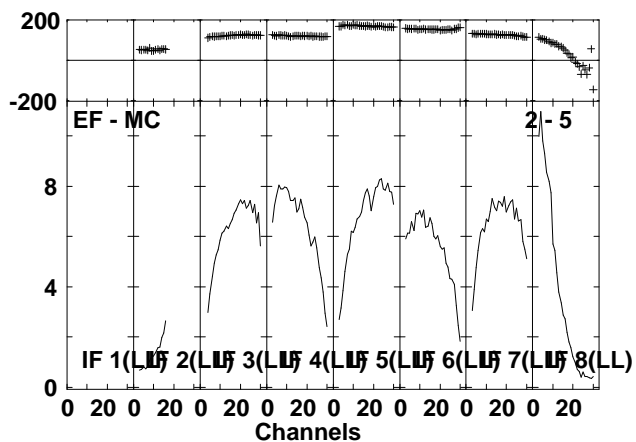
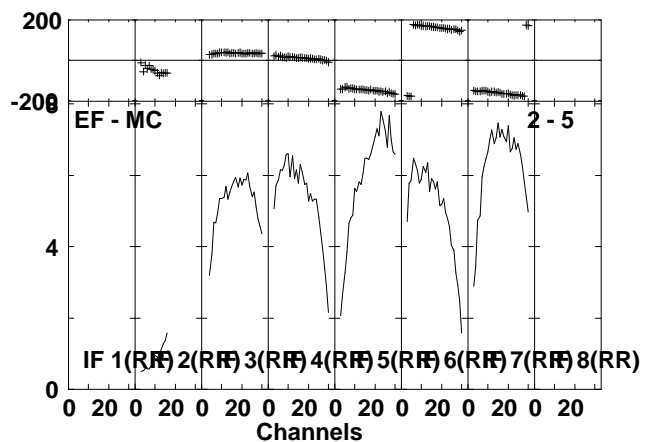
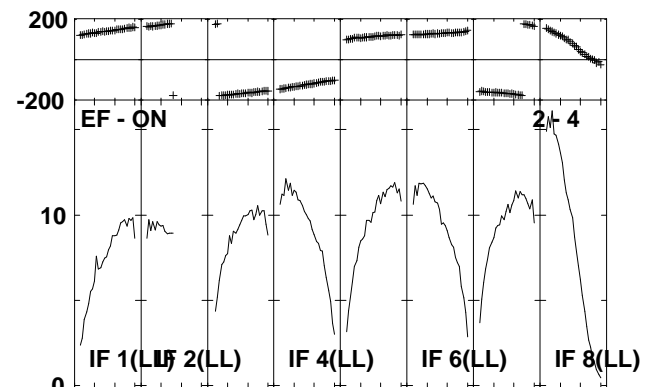
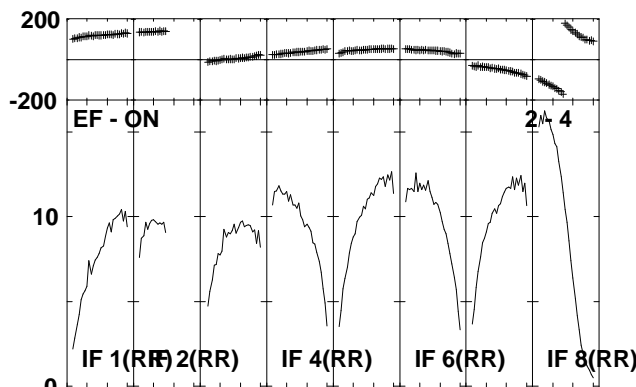
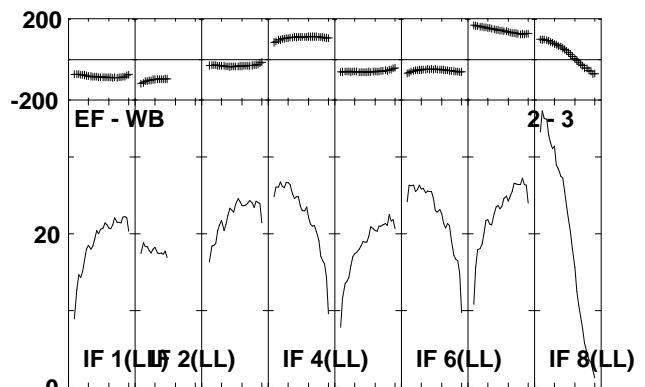
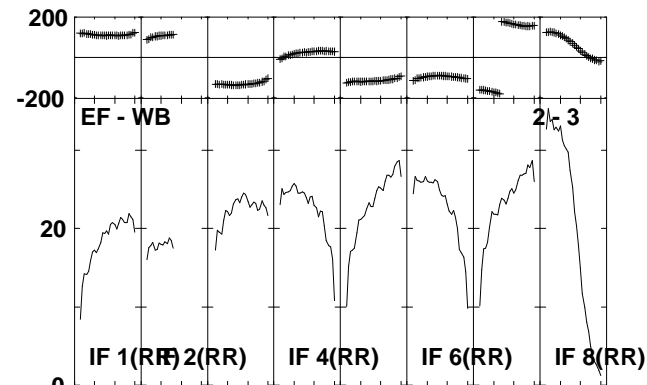
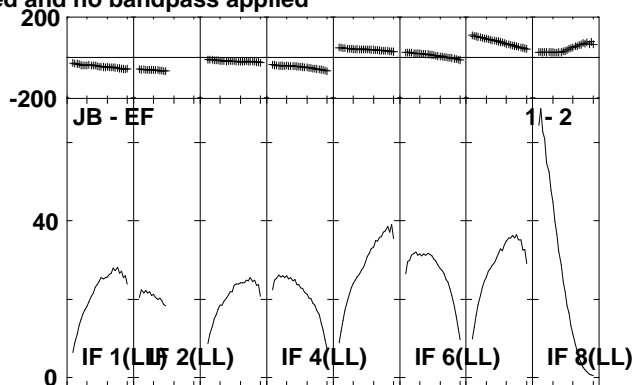
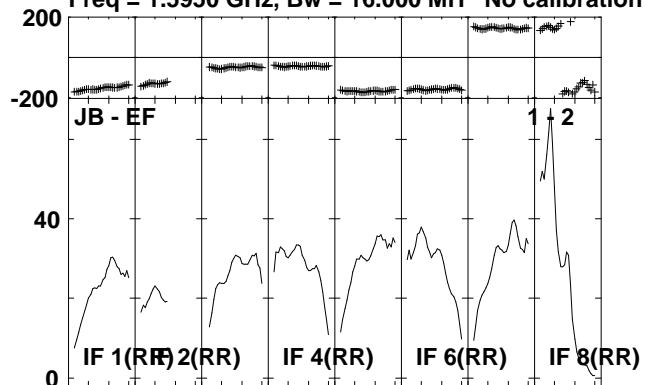

Lower frame: Milli Ampl Jy Top frame: Phas deg
Scalar averaged cross-power spectrum Several baselines displayed
Timerange: 00/13:35:01 to 00/13:36:49

Plot file version 74 created 06-JUL-2010 14:42:19
 J2330+33 EP064J.UVDATA.1

Freq = 1.5950 GHz, Bw = 16.000 MH No calibration applied and no bandpass applied

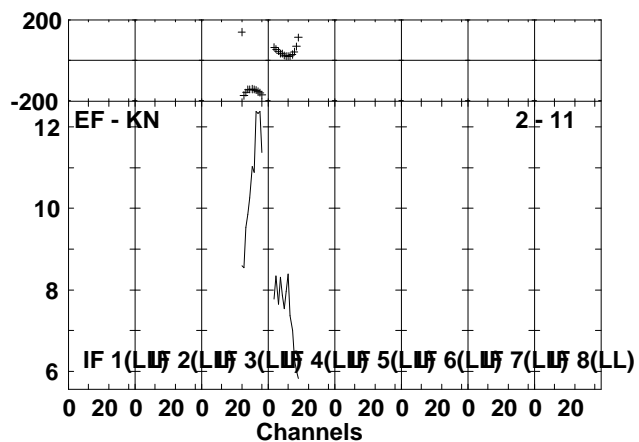
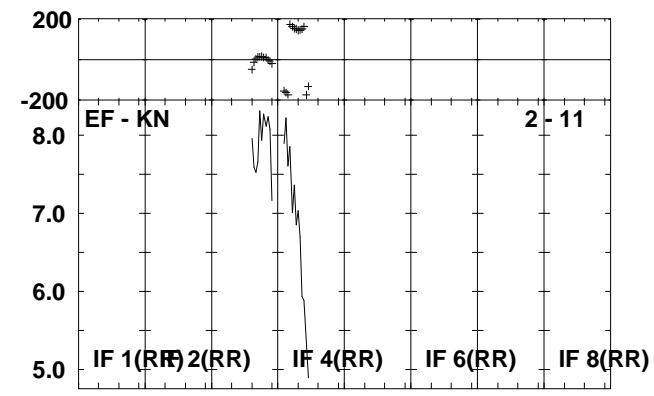
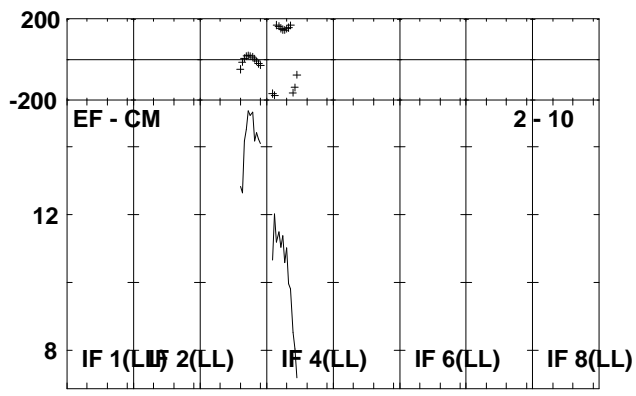
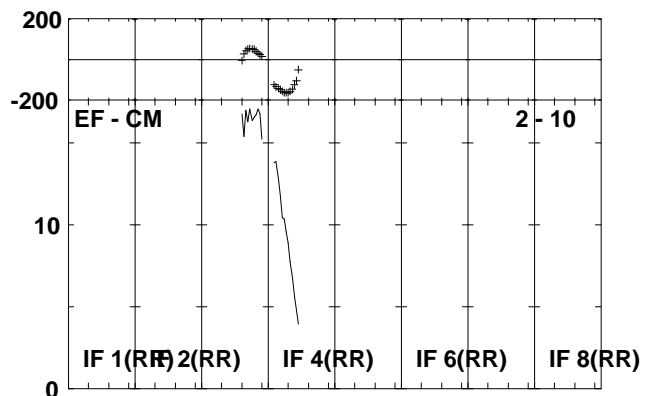
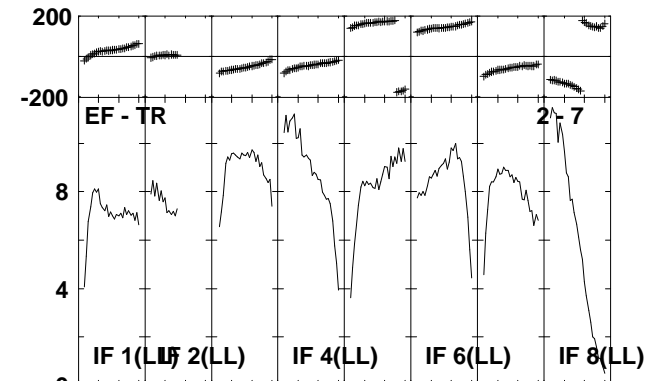
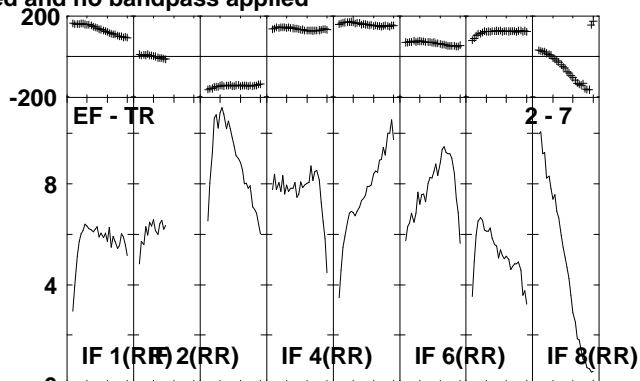
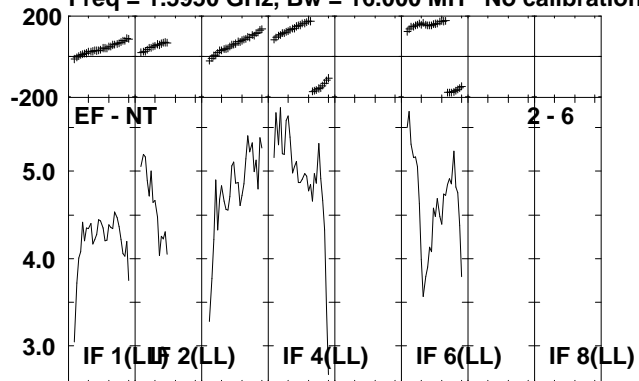

Lower frame: Milli Ampl Jy Top frame: Phas deg
 Scalar averaged cross-power spectrum Several baselines displayed
 Timerange: 00/13:35:01 to 00/13:36:49

Plot file version 75 created 06-JUL-2010 14:42:21

IRAS2336 EP064J.UVDATA.1

Freq = 1.5950 GHz, Bw = 16.000 MH No calibration applied and no bandpass applied

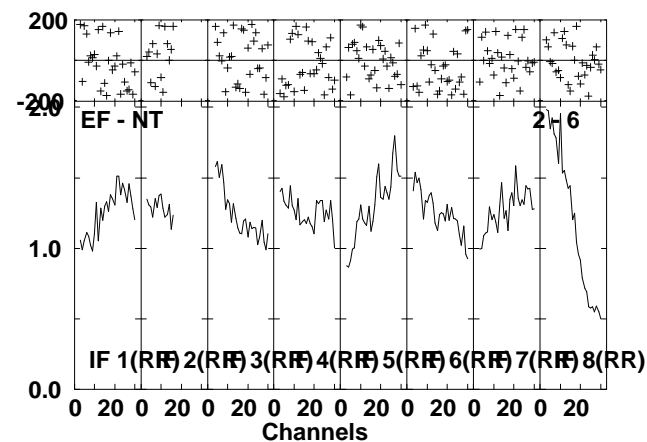
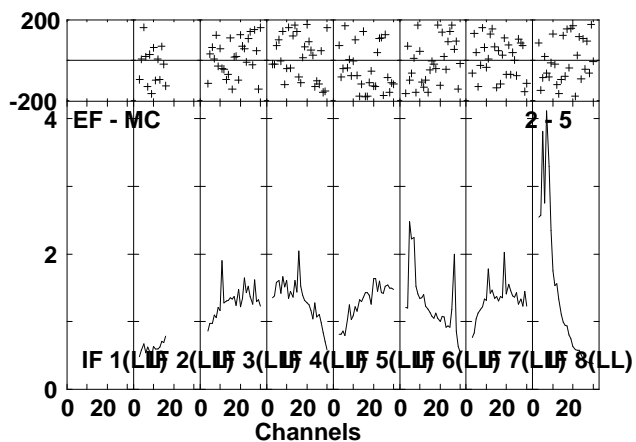
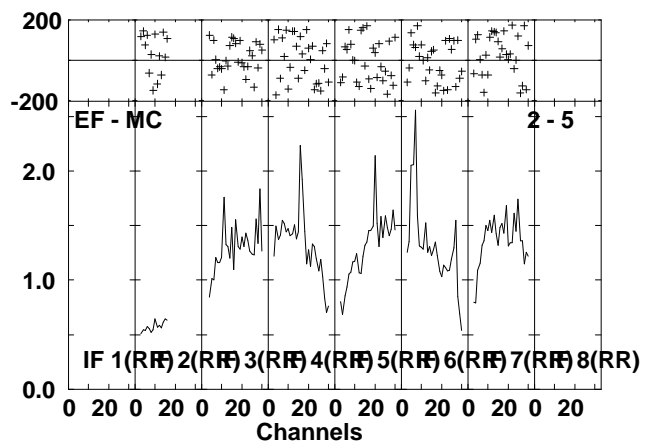
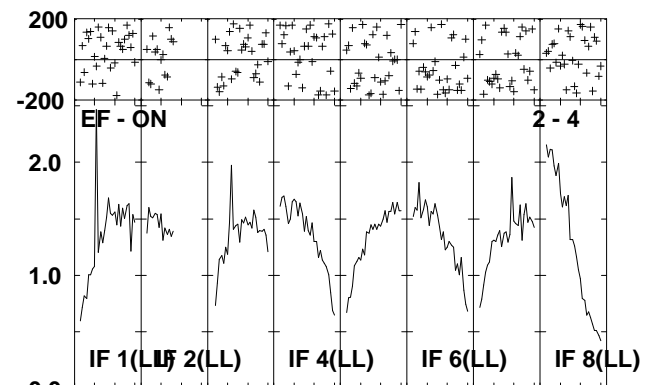
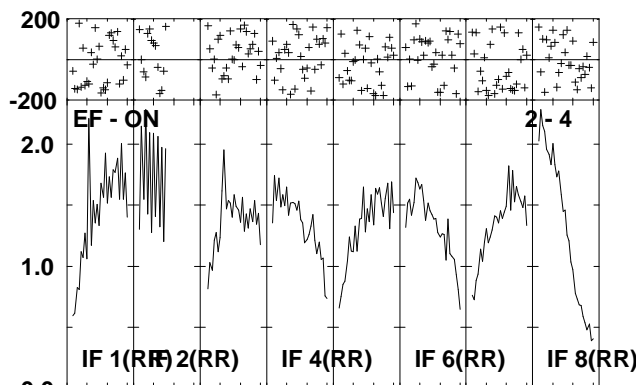
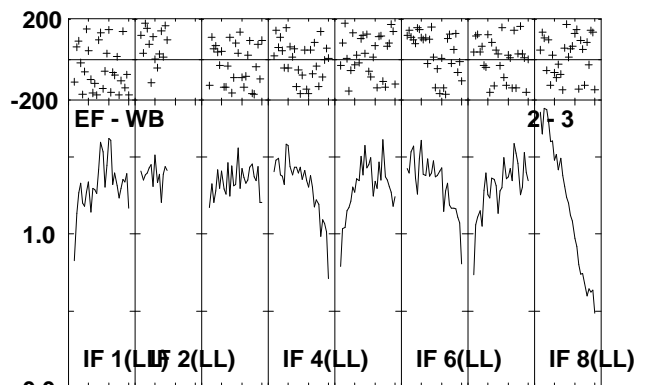
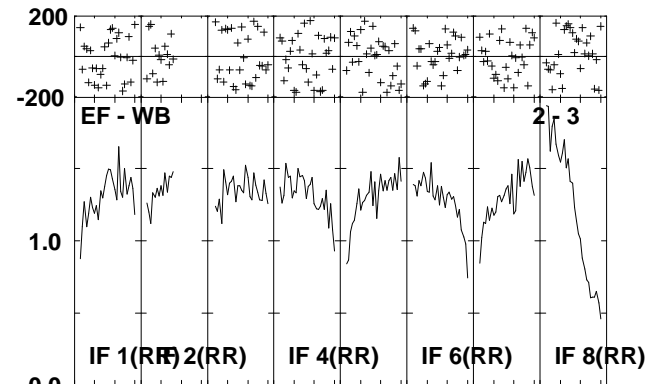
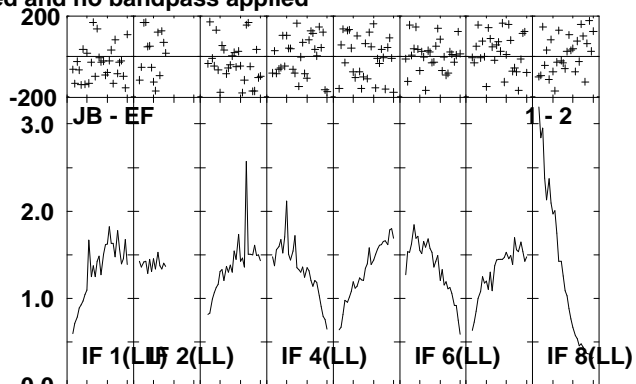
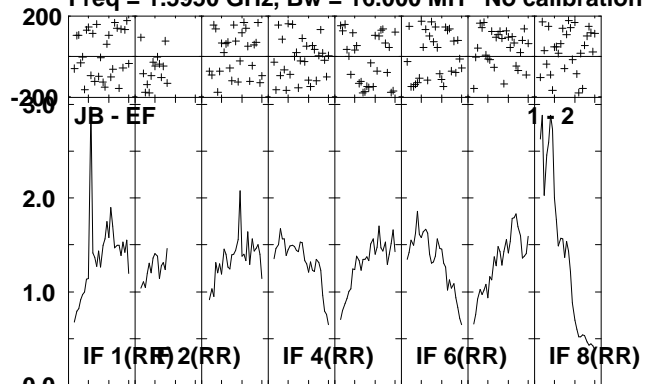

Lower frame: Milli Ampl Jy Top frame: Phas deg
Scalar averaged cross-power spectrum Several baselines displayed
Timerange: 00/13:36:51 to 00/13:40:29

Plot file version 76 created 06-JUL-2010 14:42:22

IRAS2336 EP064J.UVDATA.1

Freq = 1.5950 GHz, Bw = 16.000 MH No calibration applied and no bandpass applied

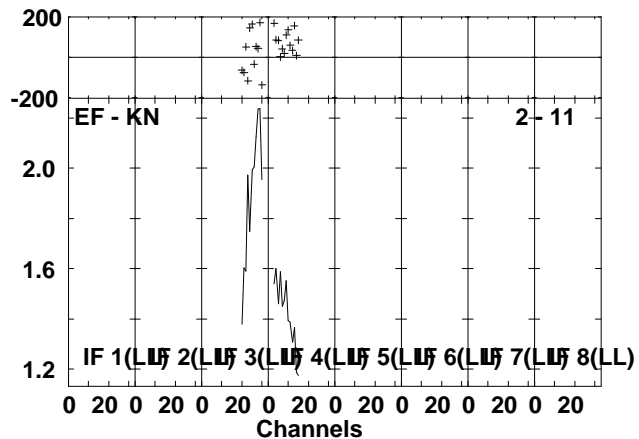
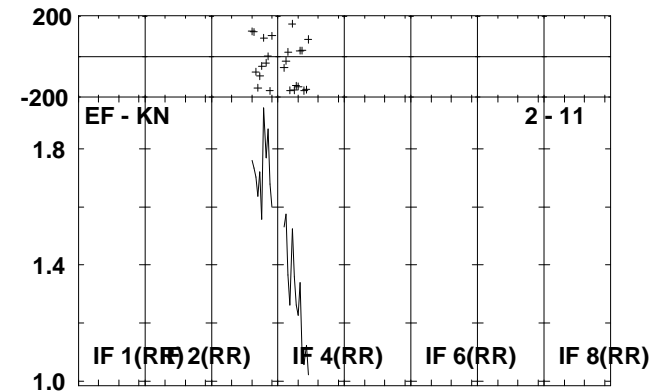
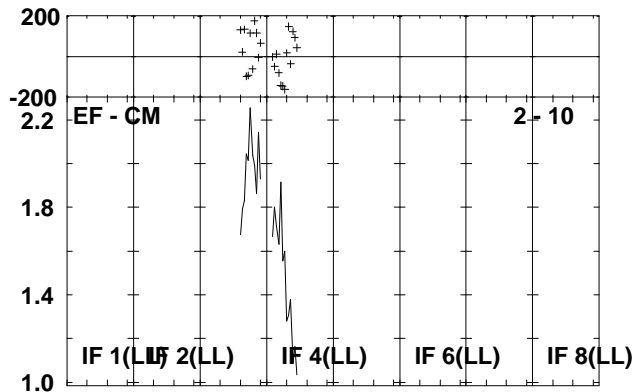
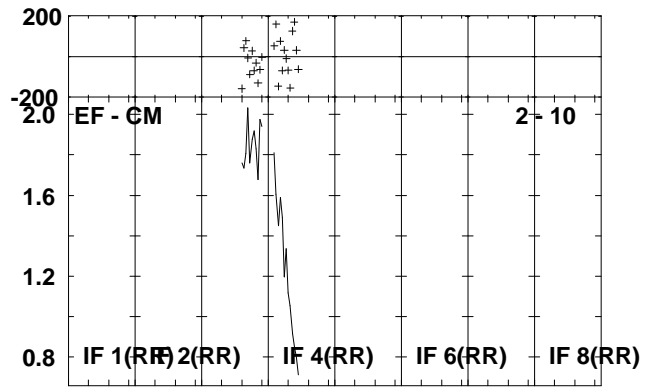
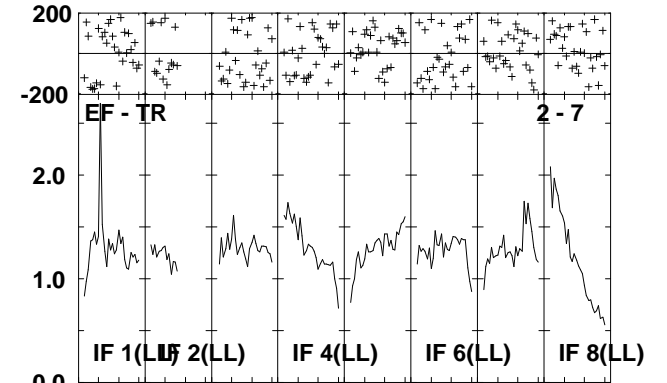
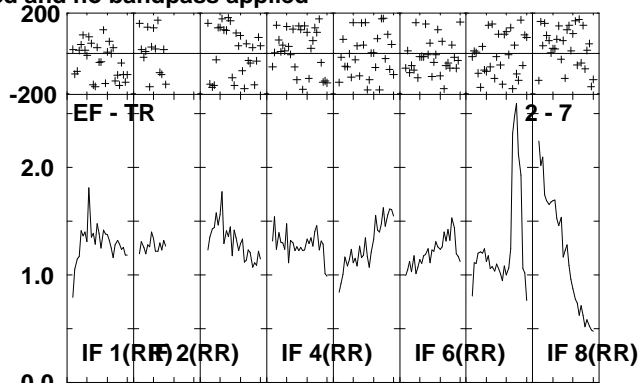
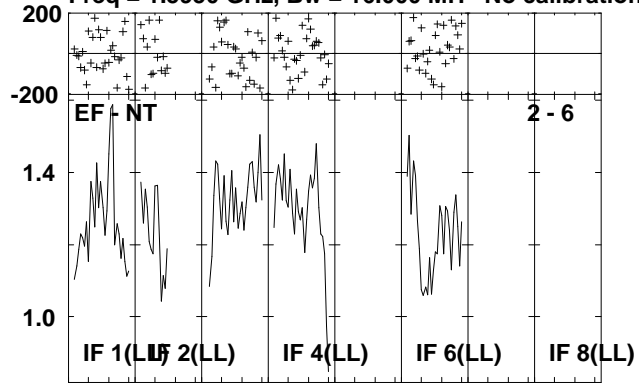

Lower frame: Milli Ampl Jy Top frame: Phas deg
Scalar averaged cross-power spectrum Several baselines displayed
Timerange: 00/13:36:51 to 00/13:40:29

Plot file version 77 created 06-JUL-2010 14:42:25

J2330+33 EP064J.UVDATA.1

Freq = 1.5950 GHz, Bw = 16.000 MH No calibration applied and no bandpass applied

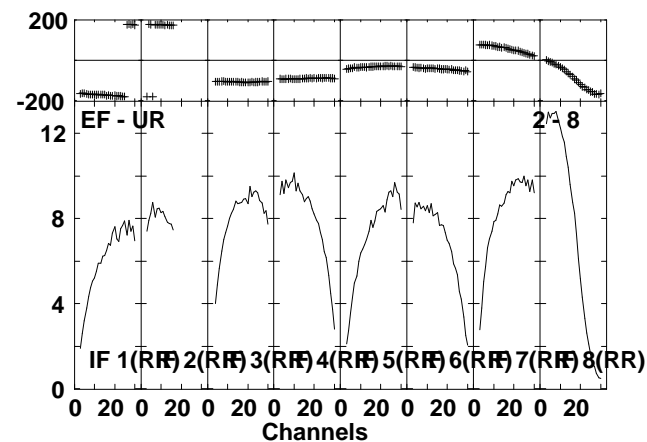
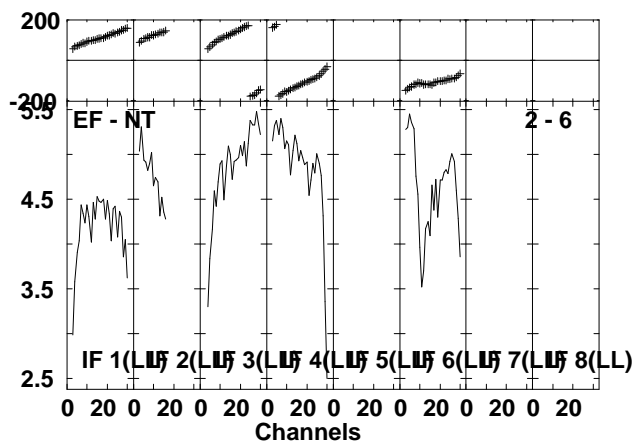
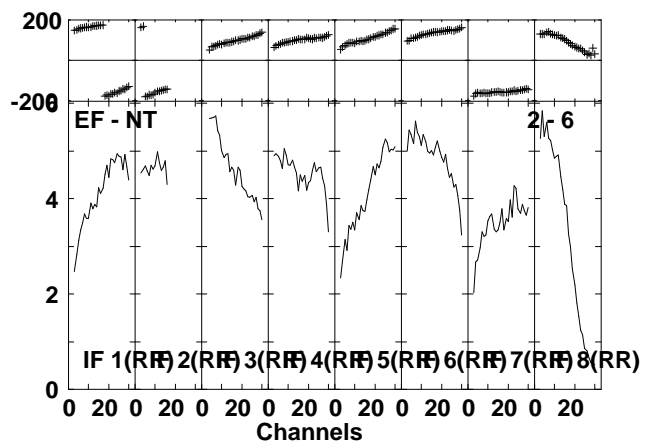
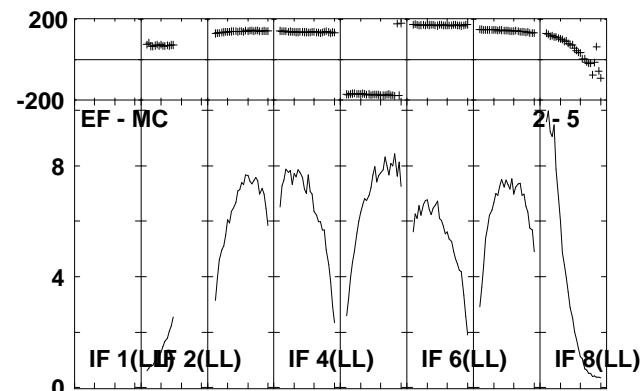
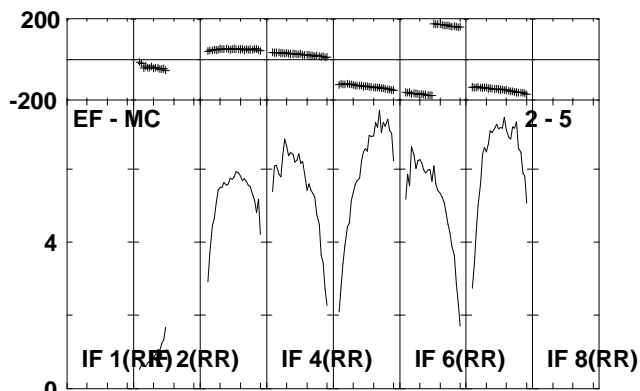
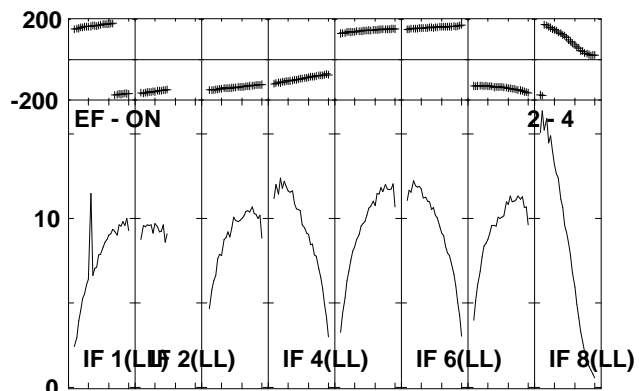
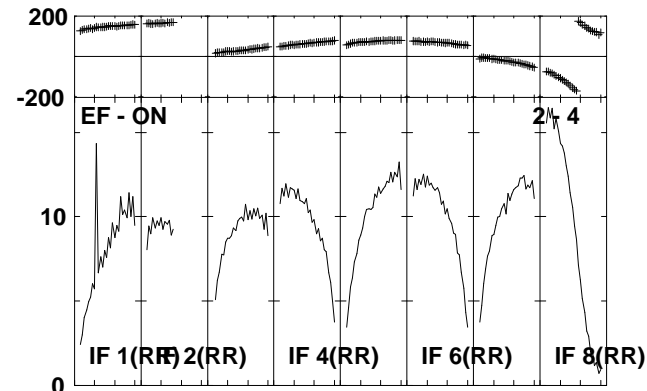
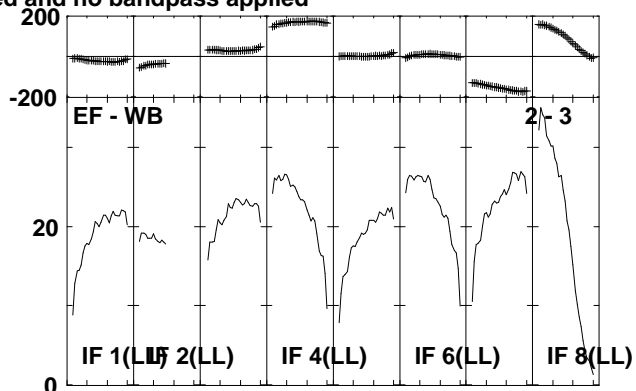
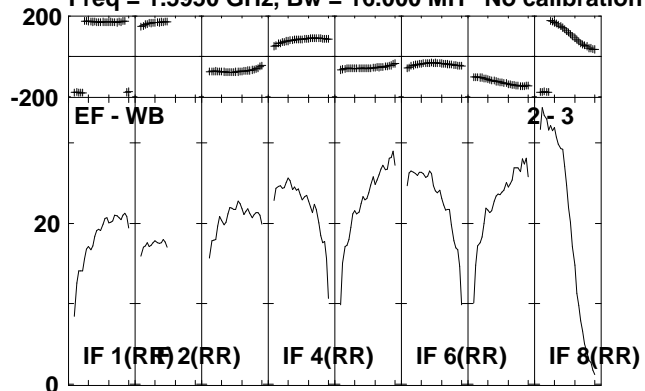

Lower frame: Milli Ampl Jy Top frame: Phas deg
Scalar averaged cross-power spectrum Several baselines displayed
Timerange: 00/13:41:31 to 00/13:43:09

Plot file version 78 created 06-JUL-2010 14:42:25

J2330+33 EP064J.UVDATA.1

Freq = 1.5950 GHz, Bw = 16.000 MH No calibration applied and no bandpass applied

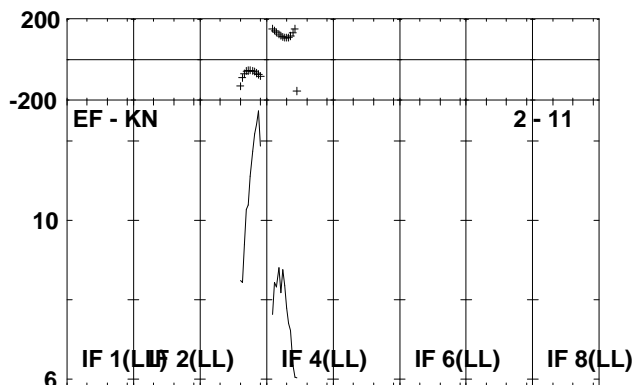
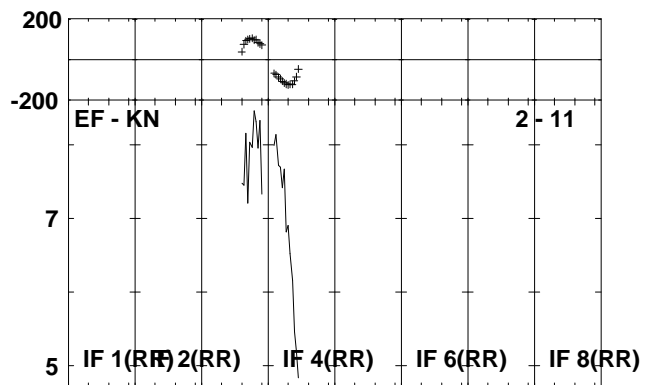
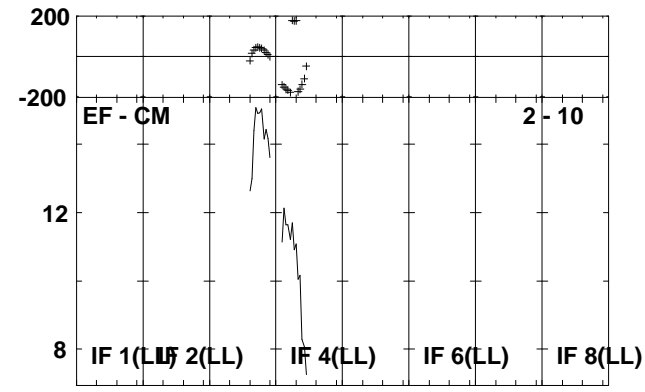
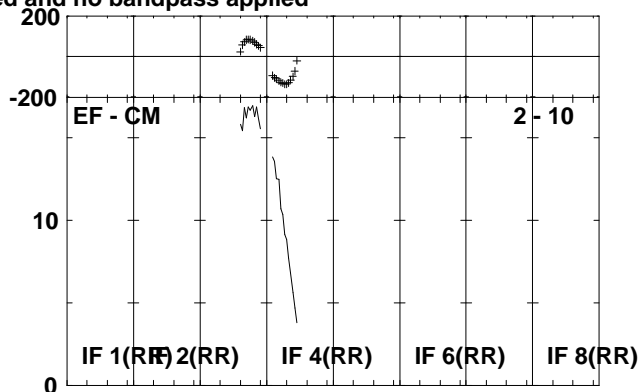
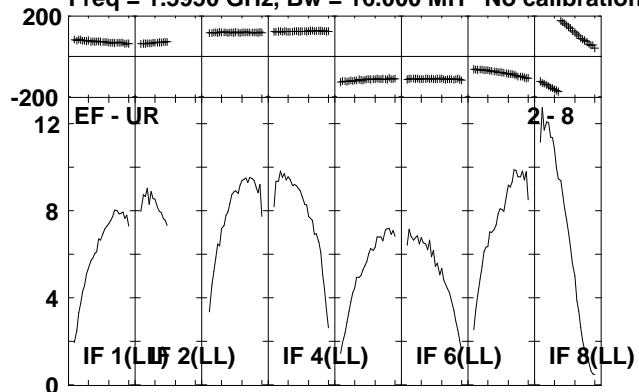

Lower frame: Milli Ampl Jy Top frame: Phas deg
Scalar averaged cross-power spectrum Several baselines displayed
Timerange: 00/13:41:31 to 00/13:43:09

Plot file version 79 created 06-JUL-2010 14:42:26

IRAS2336 EP064J.UVDATA.1

Freq = 1.5950 GHz, Bw = 16.000 MH No calibration applied and no bandpass applied

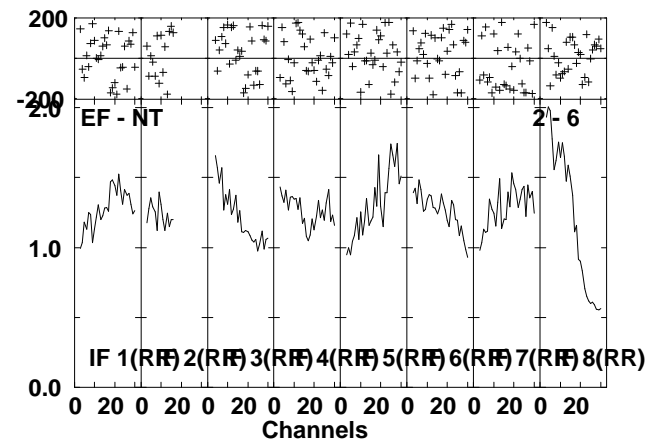
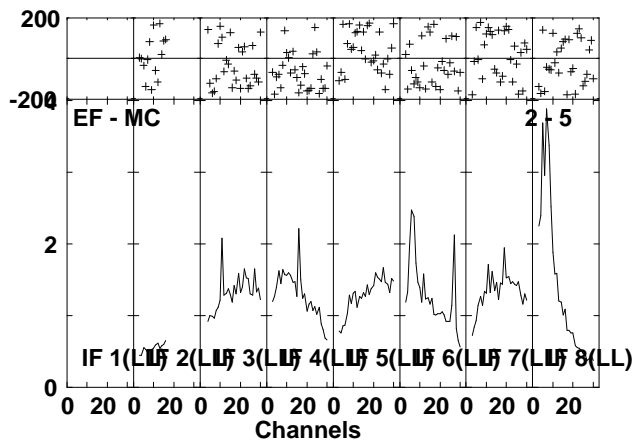
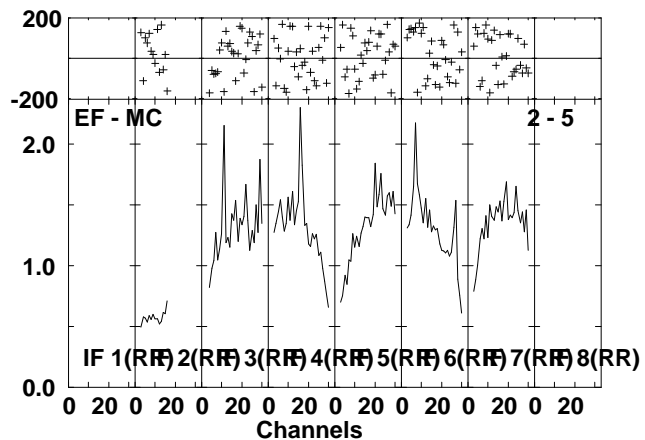
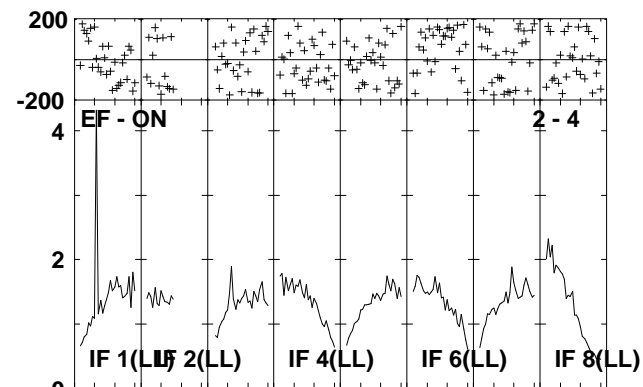
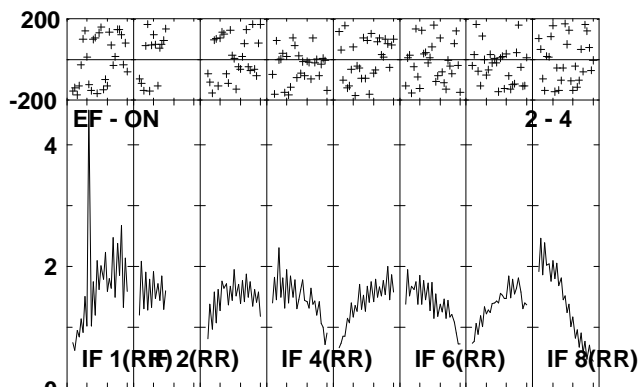
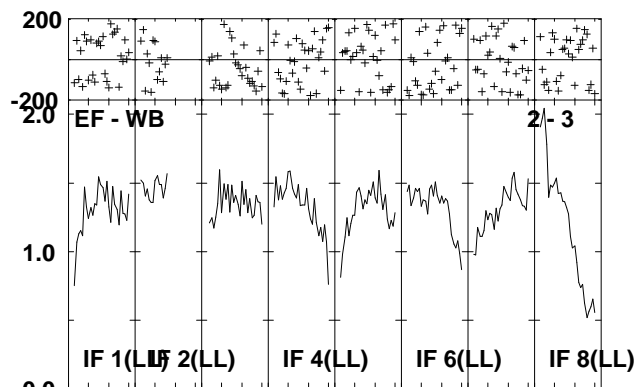
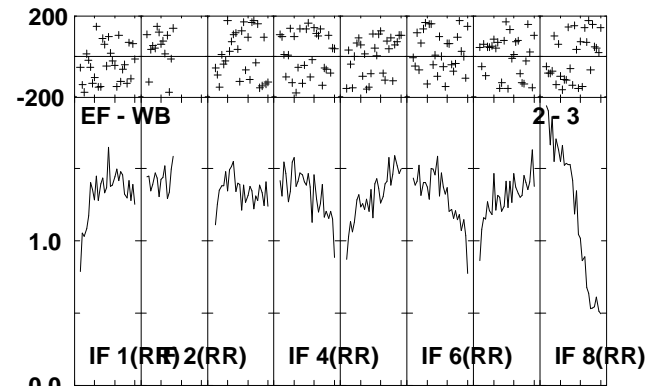
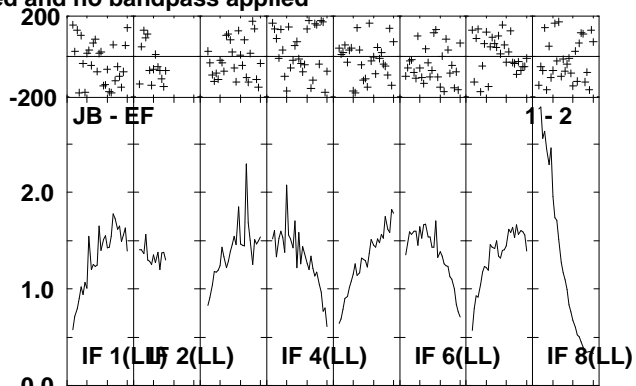
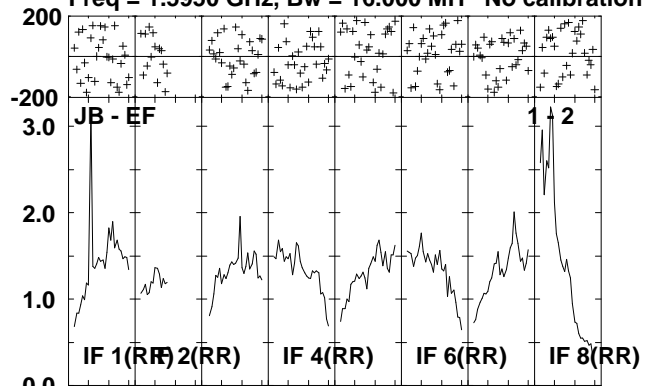

Lower frame: Milli Ampl Jy Top frame: Phas deg
Scalar averaged cross-power spectrum Several baselines displayed
Timerange: 00/13:43:11 to 00/13:46:49

Plot file version 80 created 06-JUL-2010 14:42:28

IRAS2336 EP064J.UVDATA.1

Freq = 1.5950 GHz, Bw = 16.000 MH No calibration applied and no bandpass applied

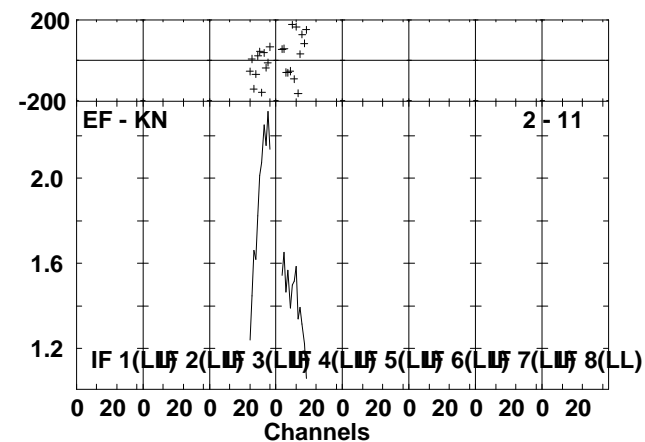
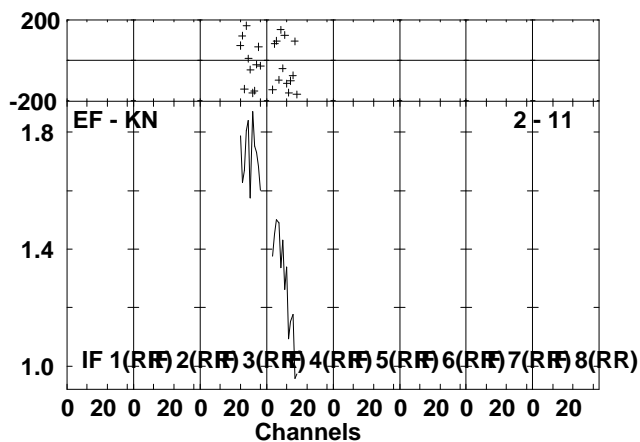
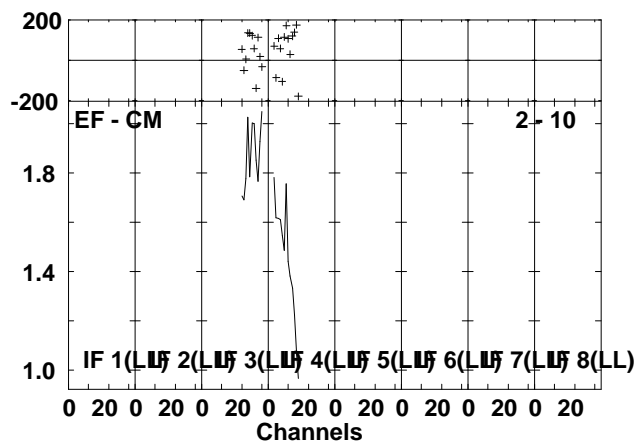
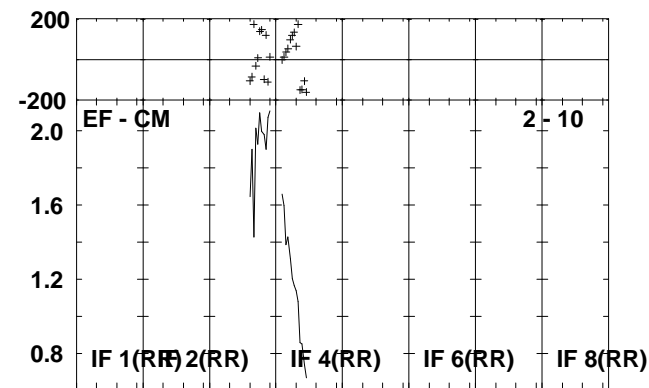
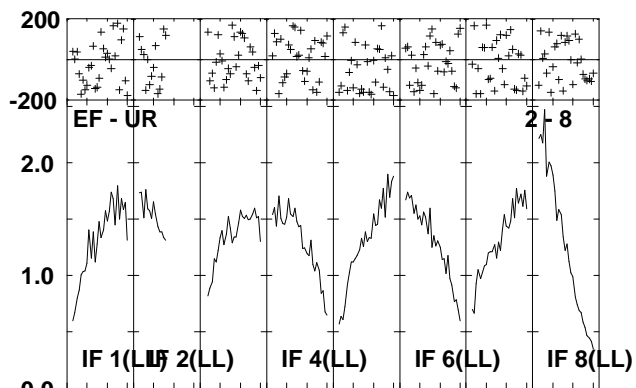
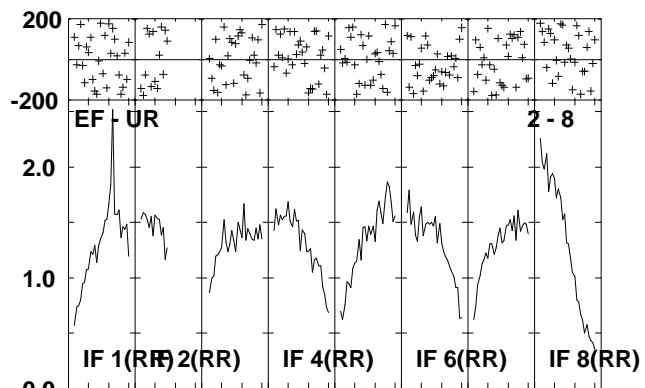
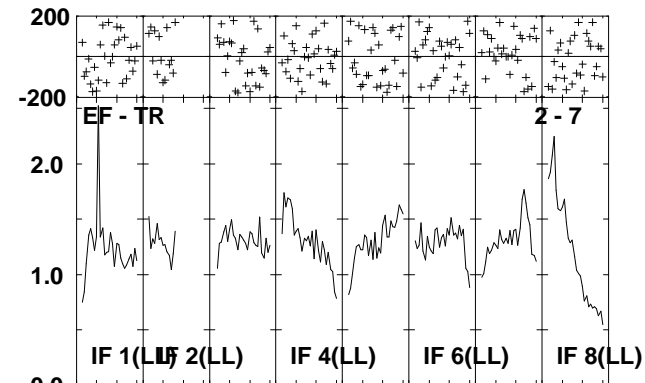
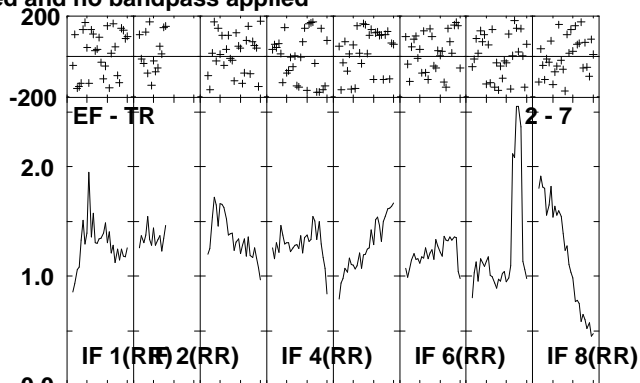
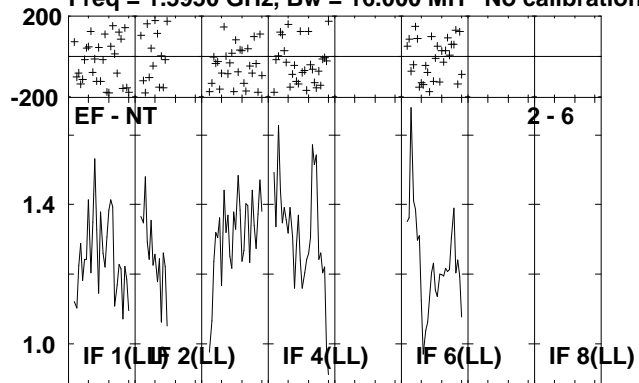

Lower frame: Milli Ampl Jy Top frame: Phas deg
Scalar averaged cross-power spectrum Several baselines displayed
Timerange: 00/13:43:11 to 00/13:46:49

Plot file version 81 created 06-JUL-2010 14:42:30

J2330+33 EP064J.UVDATA.1

Freq = 1.5950 GHz, Bw = 16.000 MH No calibration applied and no bandpass applied

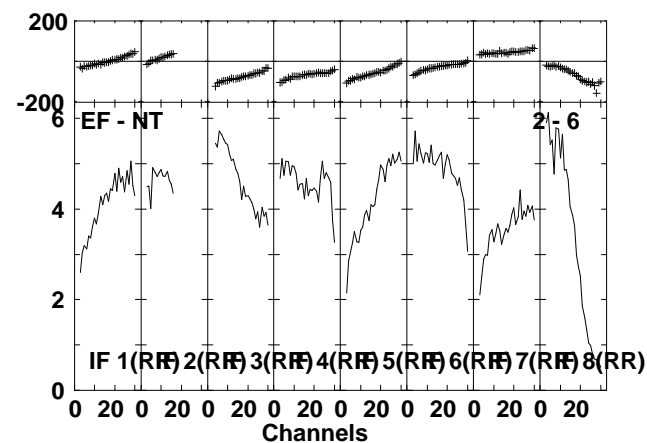
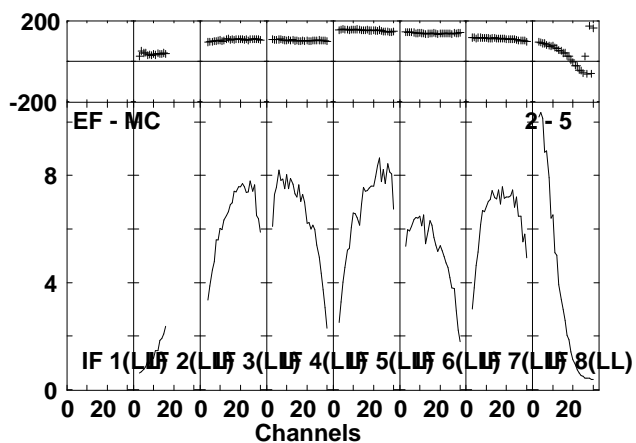
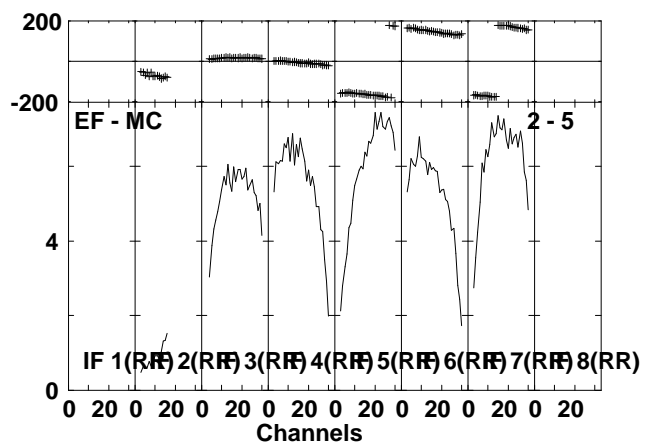
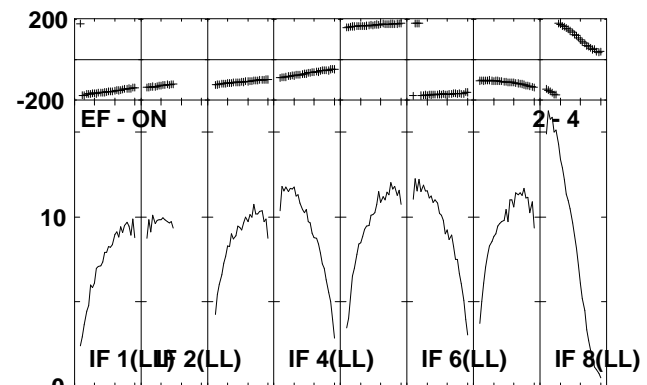
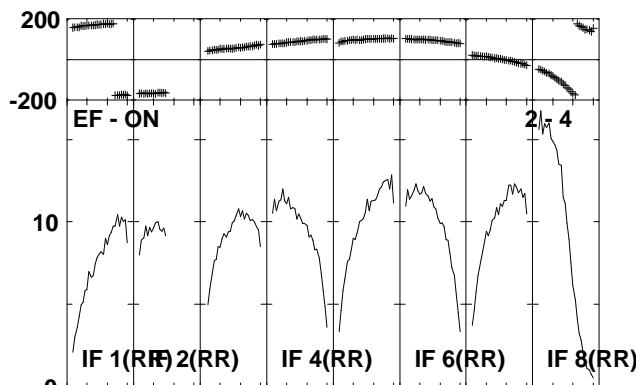
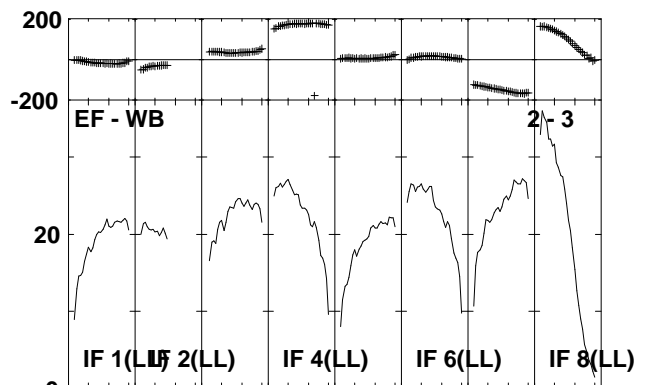
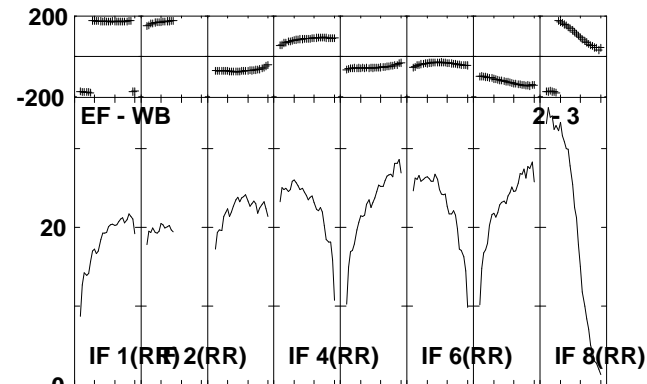
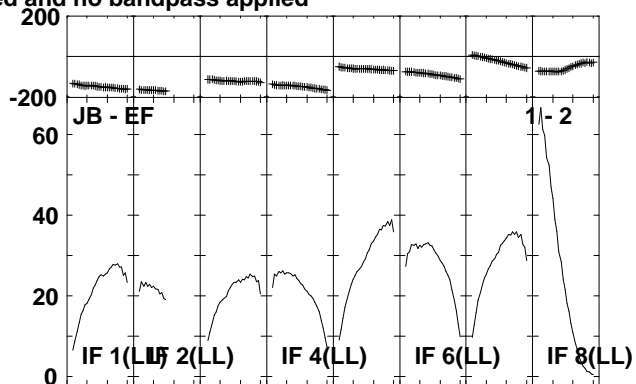
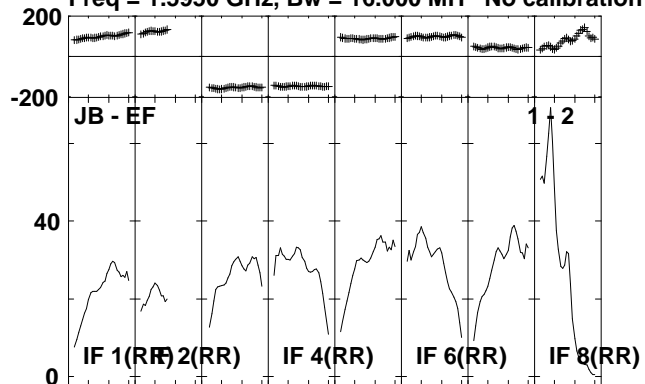

Lower frame: Milli Ampl Jy Top frame: Phas deg
Scalar averaged cross-power spectrum Several baselines displayed
Timerange: 00/13:46:51 to 00/13:48:39

Plot file version 82 created 06-JUL-2010 14:42:32

J2330+33 EP064J.UVDATA.1

Freq = 1.5950 GHz, Bw = 16.000 MH No calibration applied and no bandpass applied

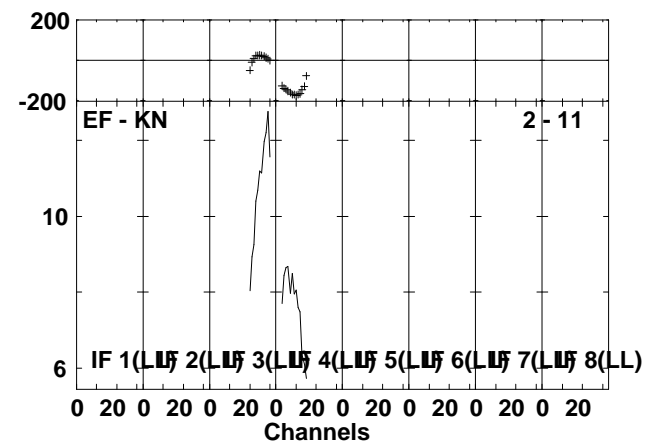
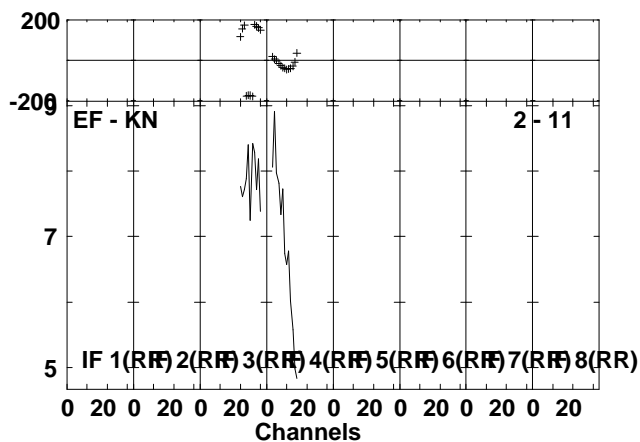
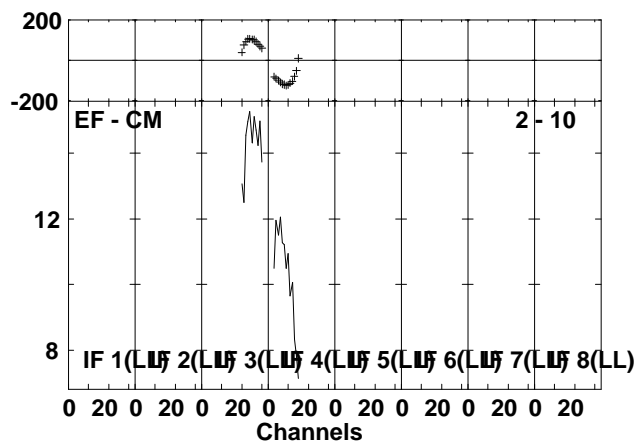
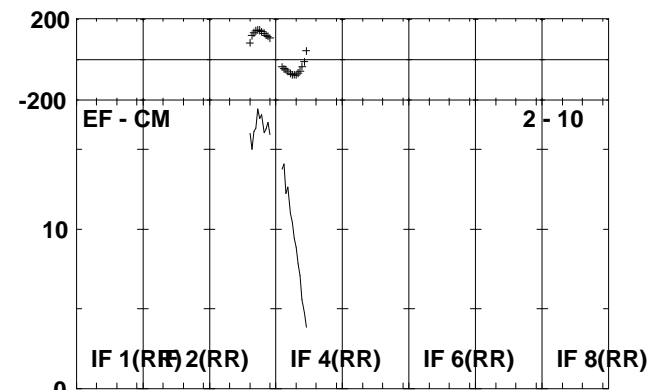
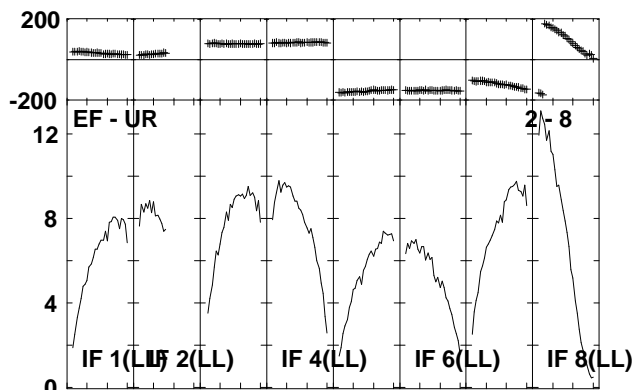
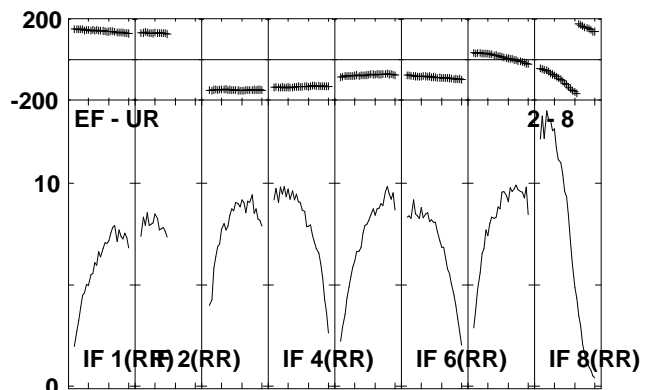
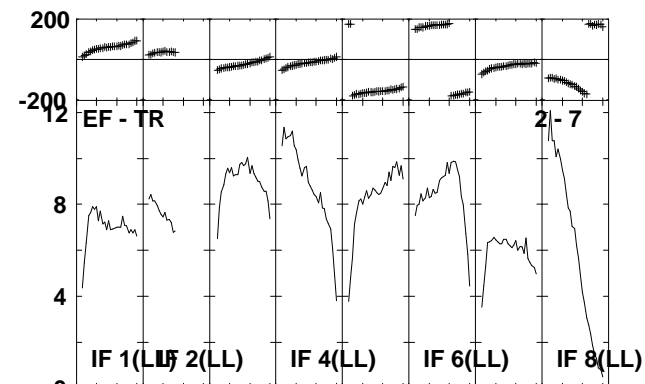
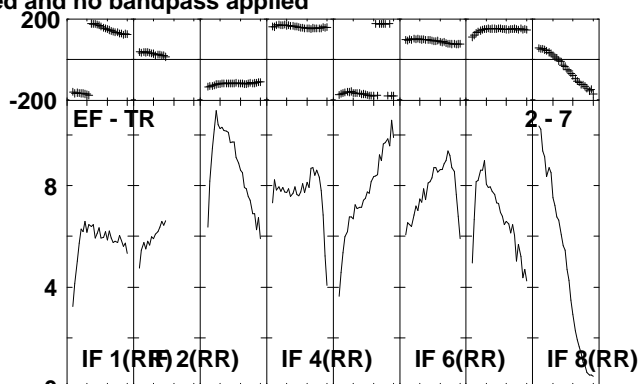
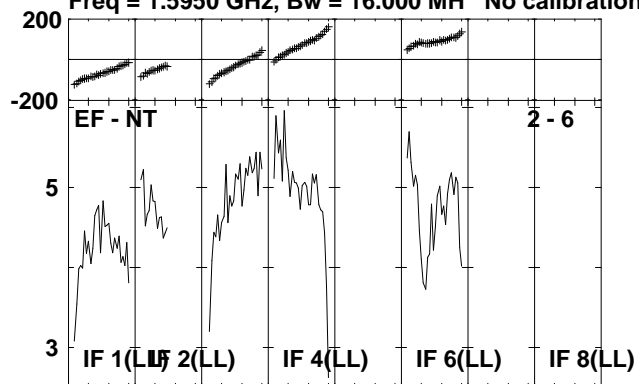

Lower frame: Milli Amps Jy Top frame: Phas deg
Scalar averaged cross-power spectrum Several baselines displayed
Timerange: 00/13:46:51 to 00/13:48:39

Plot file version 83 created 06-JUL-2010 14:42:33

IRAS2336 EP064J.UVDATA.1

Freq = 1.5950 GHz, Bw = 16.000 MH No calibration applied and no bandpass applied

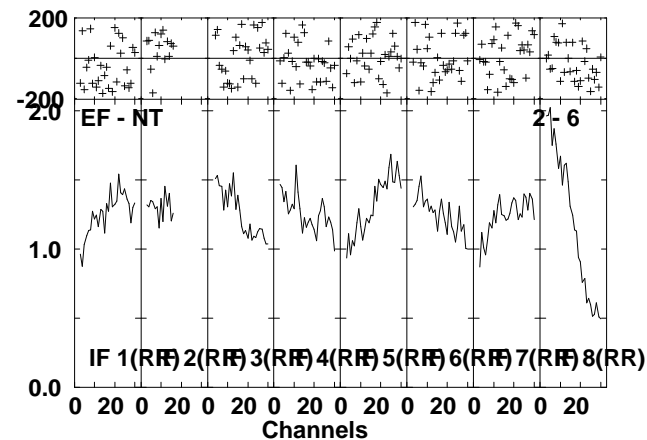
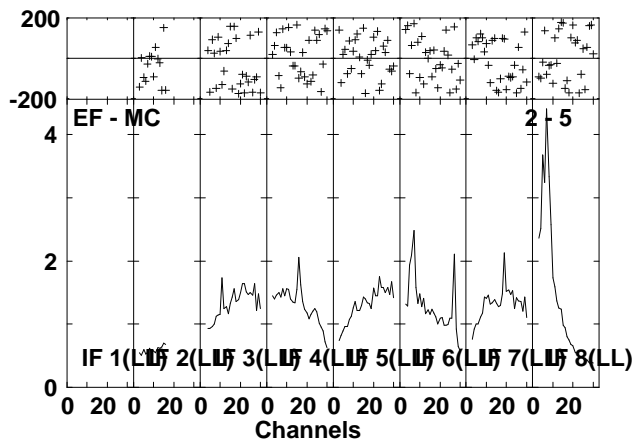
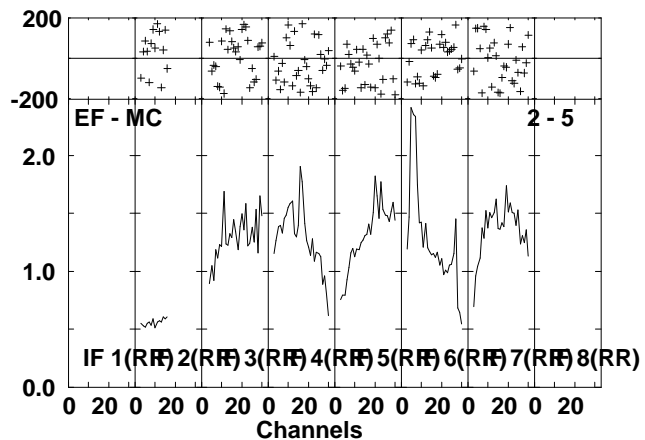
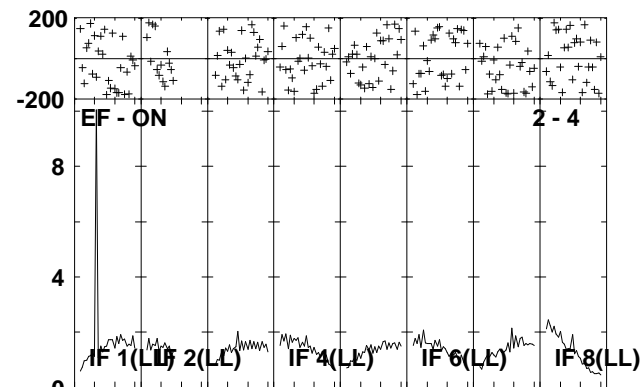
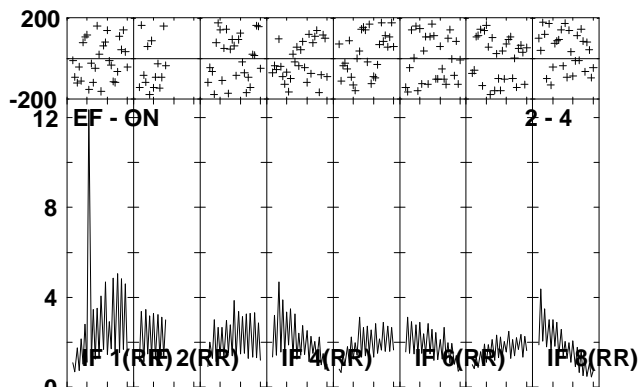
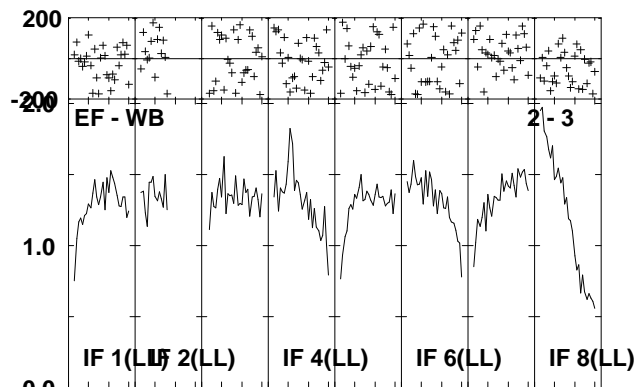
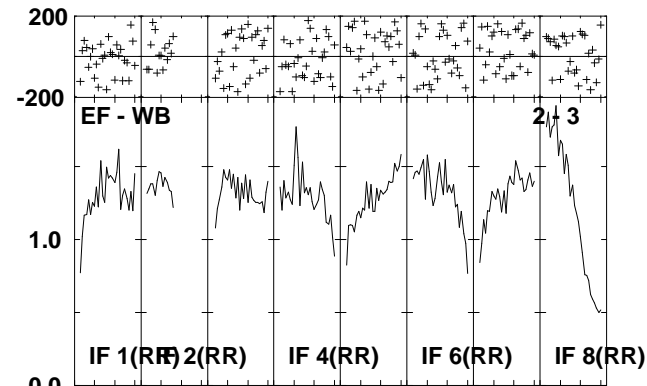
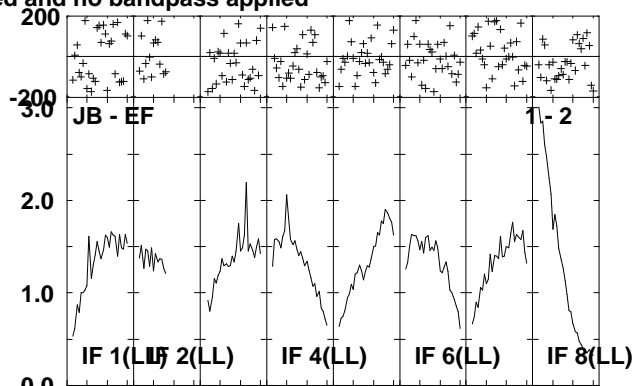
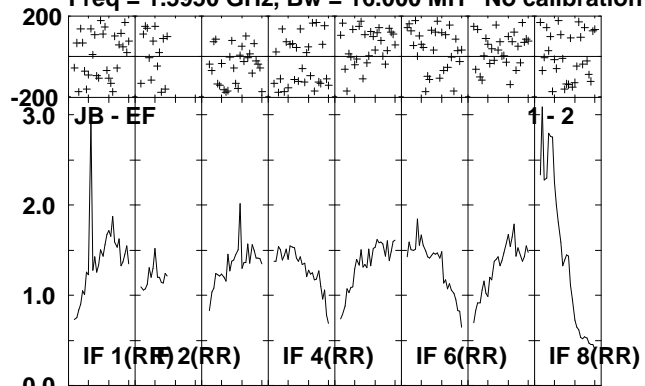

Lower frame: Milli Ampl Jy Top frame: Phas deg
Scalar averaged cross-power spectrum Several baselines displayed
Timerange: 00/13:48:41 to 00/13:52:19

Plot file version 84 created 06-JUL-2010 14:42:35

IRAS2336 EP064J.UVDATA.1

Freq = 1.5950 GHz, Bw = 16.000 MH No calibration applied and no bandpass applied

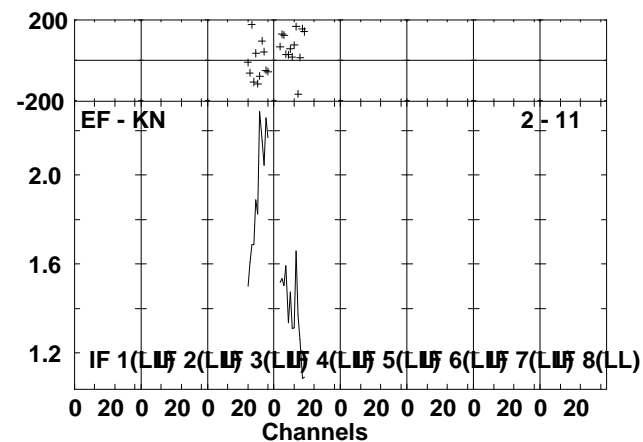
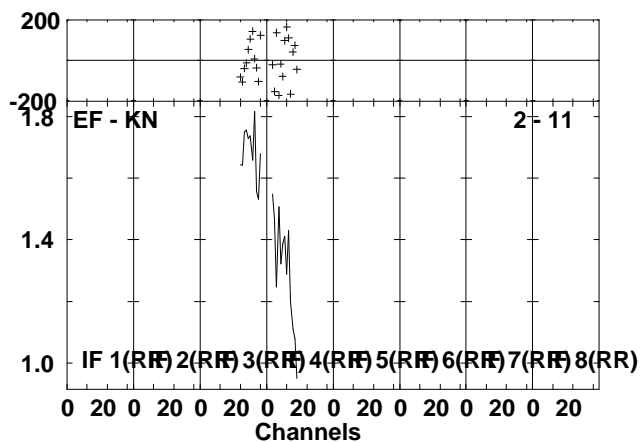
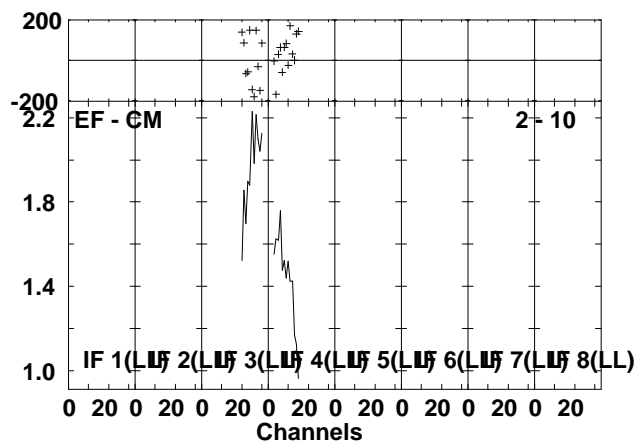
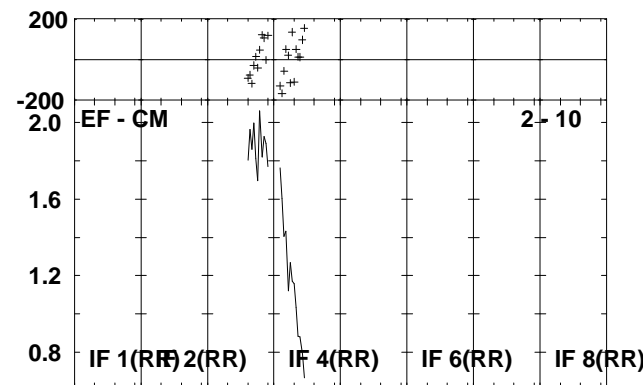
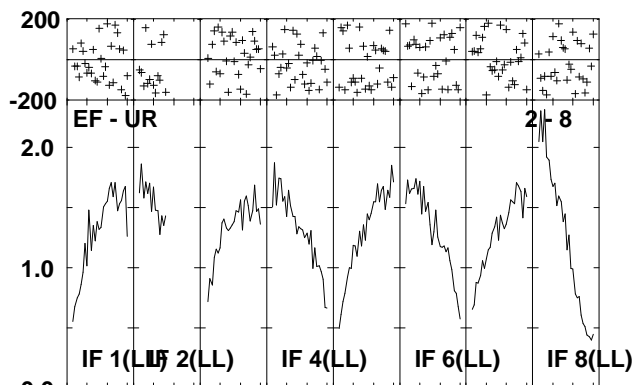
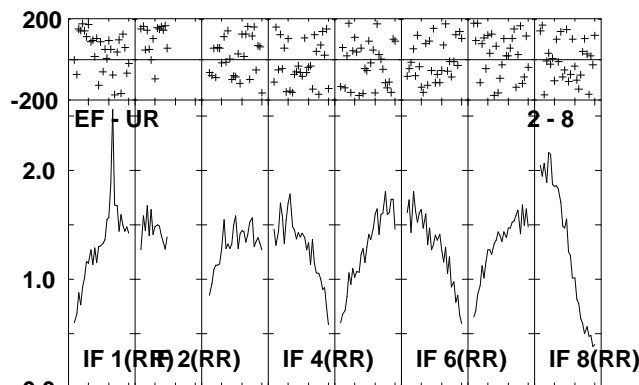
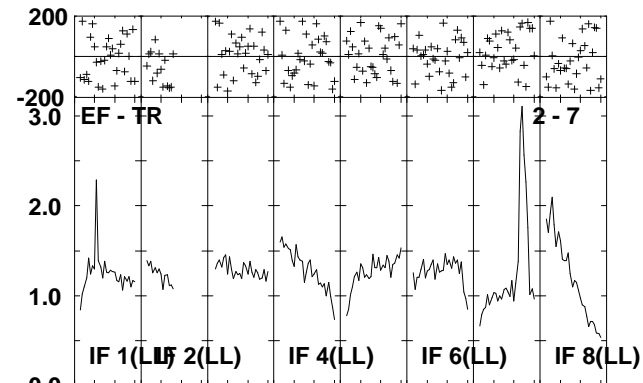
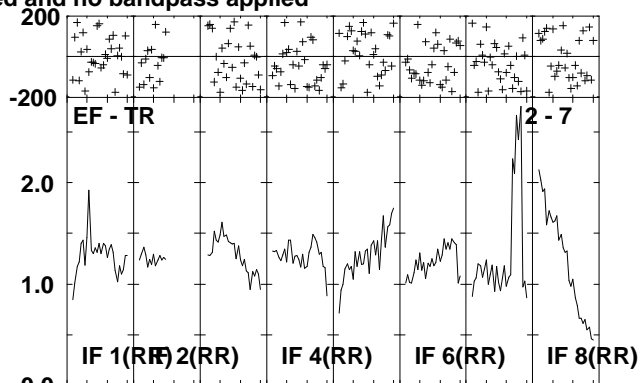
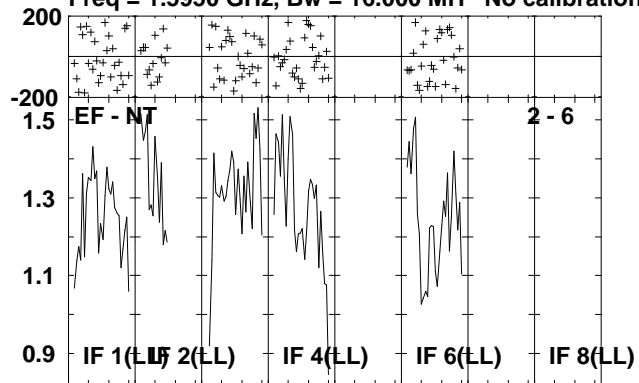

Lower frame: Milli Ampl Jy Top frame: Phas deg
Scalar averaged cross-power spectrum Several baselines displayed
Timerange: 00/13:48:41 to 00/13:52:19

Plot file version 85 created 06-JUL-2010 14:42:38

J2330+33 EP064J.UVDATA.1

Freq = 1.5950 GHz, Bw = 16.000 MH No calibration applied and no bandpass applied

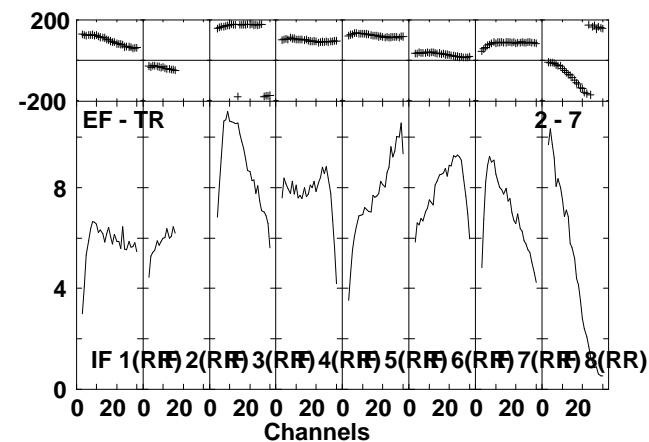
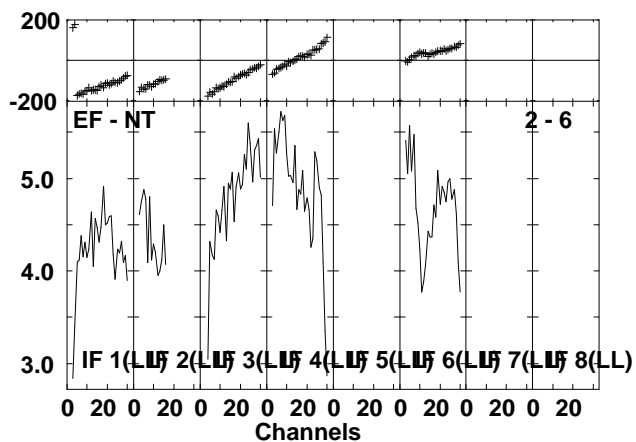
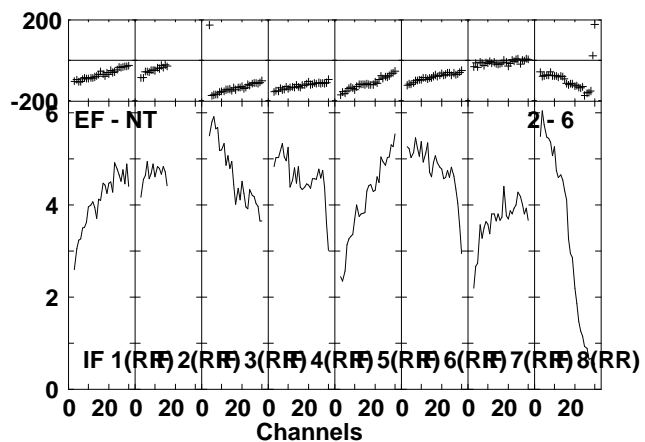
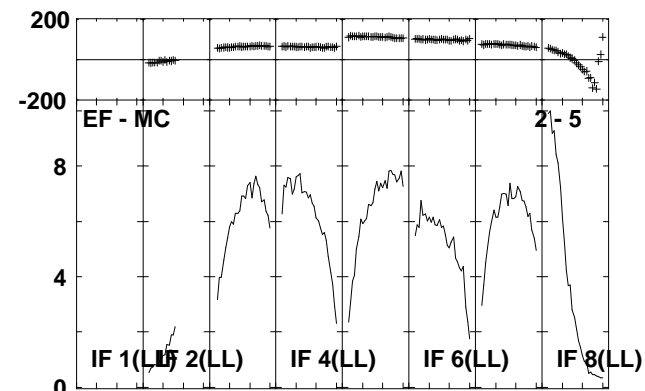
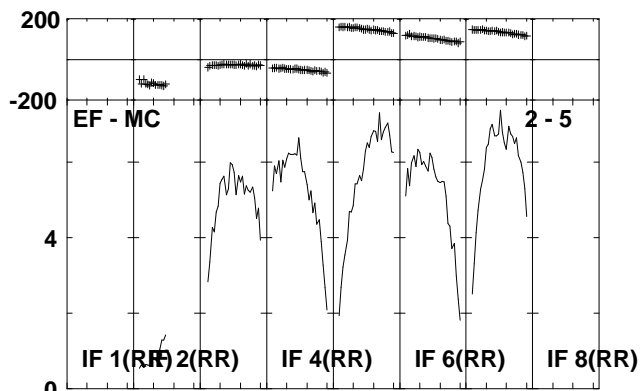
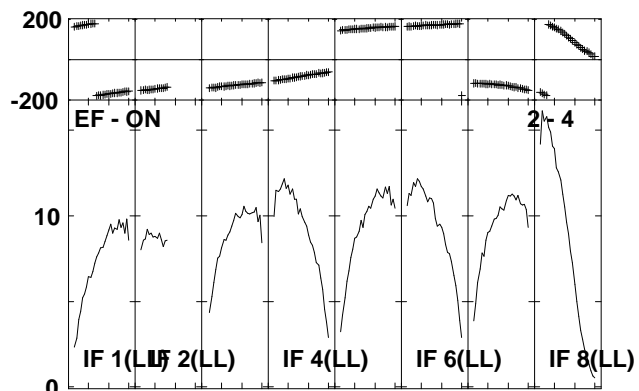
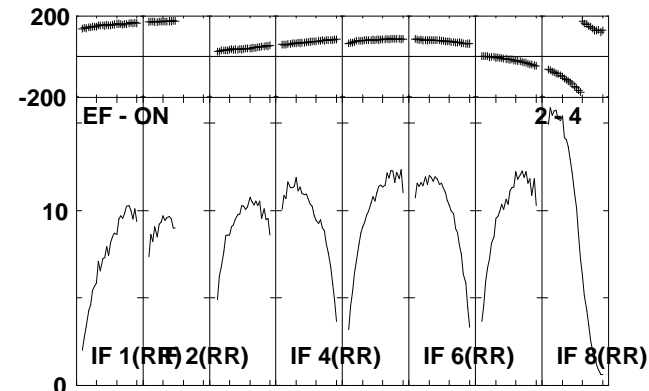
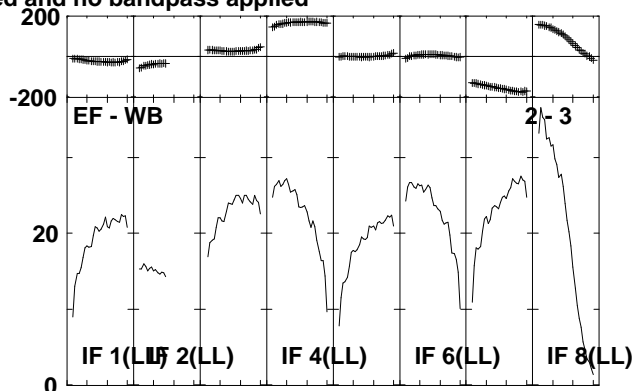
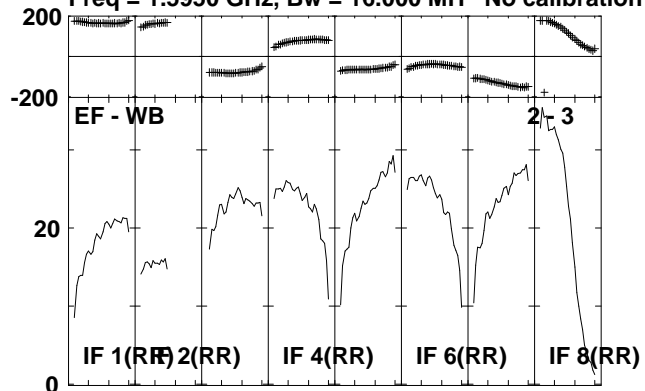

Lower frame: Milli Ampl Jy Top frame: Phas deg
Scalar averaged cross-power spectrum Several baselines displayed
Timerange: 00/13:52:21 to 00/13:54:09

Plot file version 86 created 06-JUL-2010 14:42:39
J2330+33 EP064J.UVDATA.1

Freq = 1.5950 GHz, Bw = 16.000 MH No calibration applied and no bandpass applied

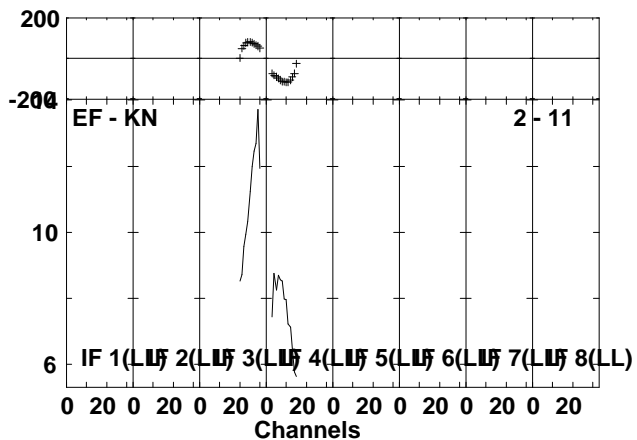
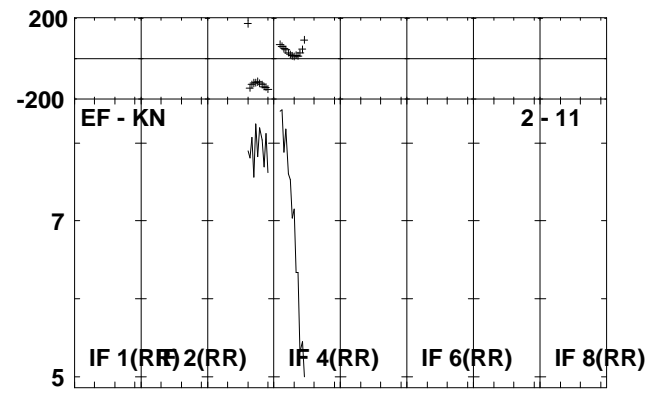
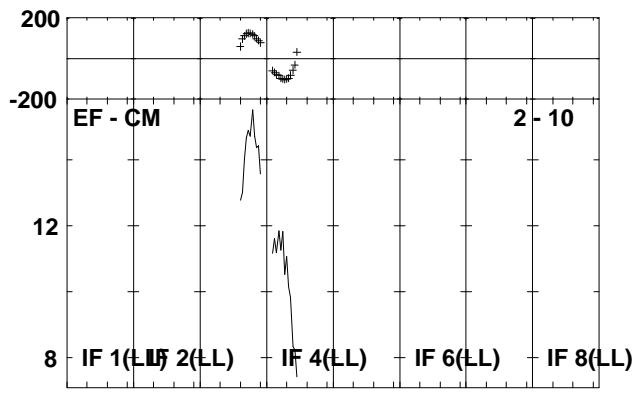
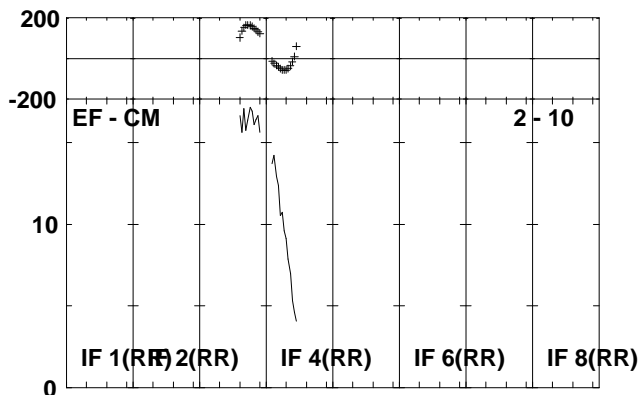
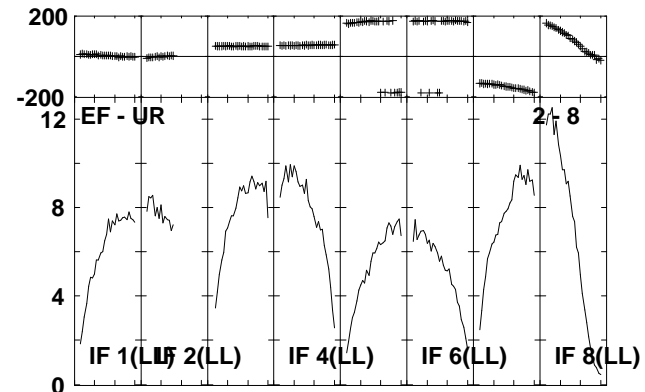
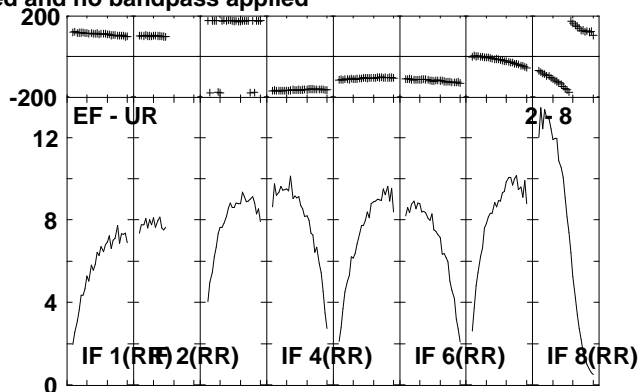
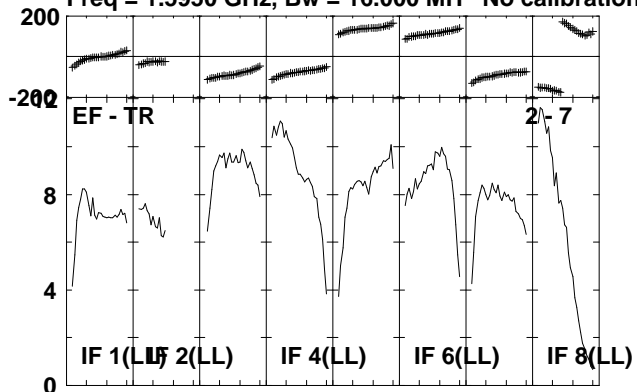

Lower frame: Milli Ampl Jy Top frame: Phas deg
Scalar averaged cross-power spectrum Several baselines displayed
Timerange: 00/13:52:21 to 00/13:54:09

Plot file version 87 created 06-JUL-2010 14:42:40

IRAS2336 EP064J.UVDATA.1

Freq = 1.5950 GHz, Bw = 16.000 MH No calibration applied and no bandpass applied

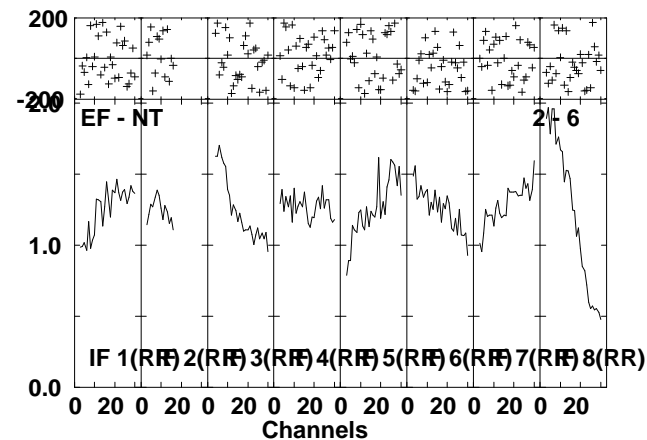
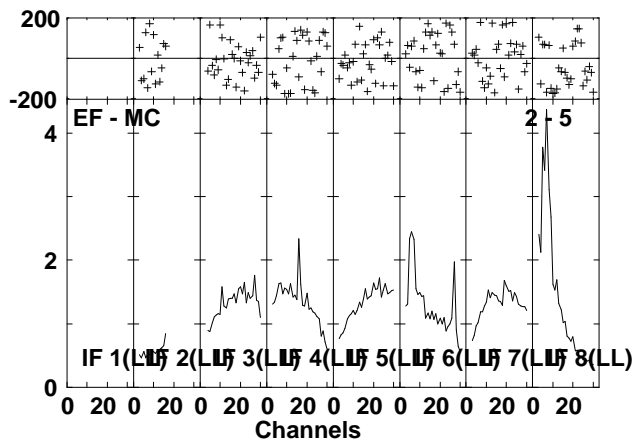
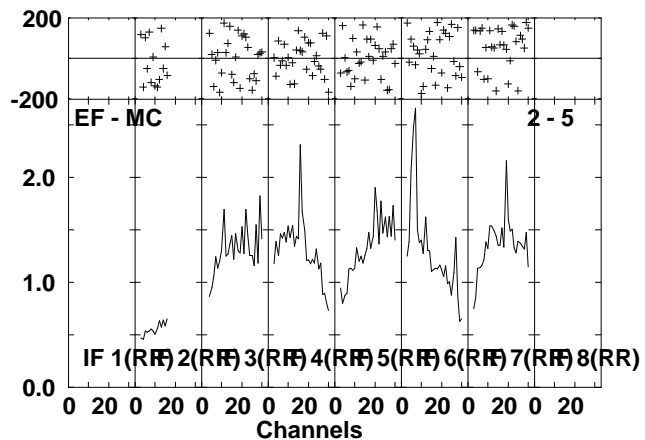
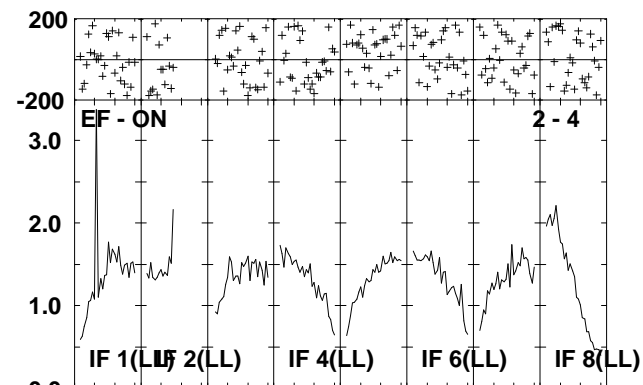
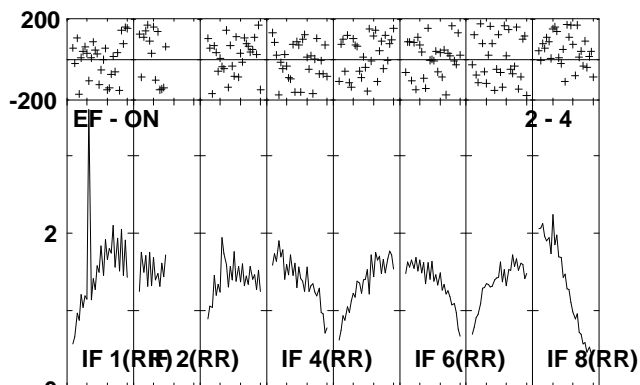
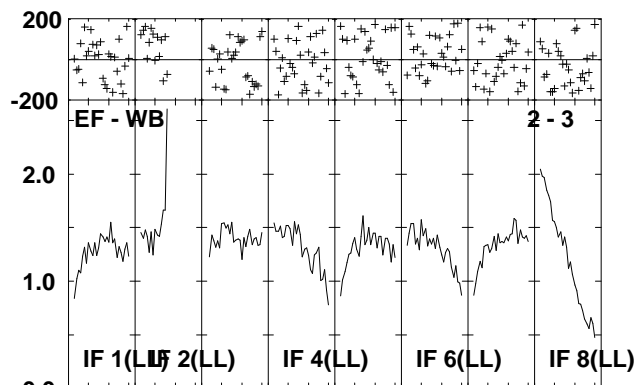
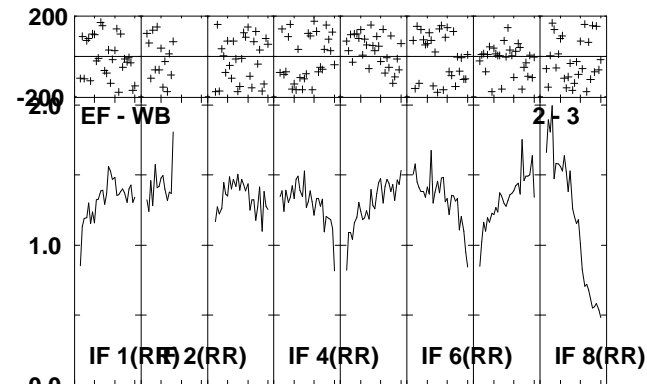
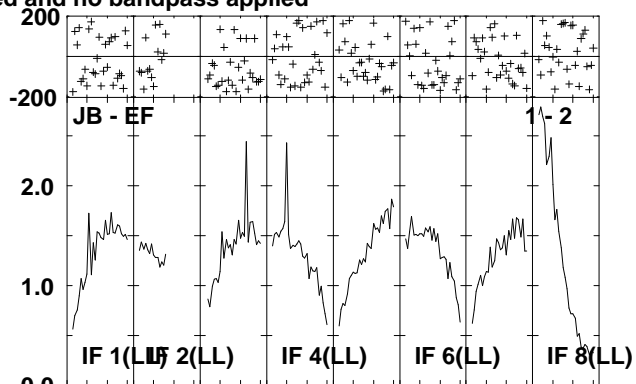
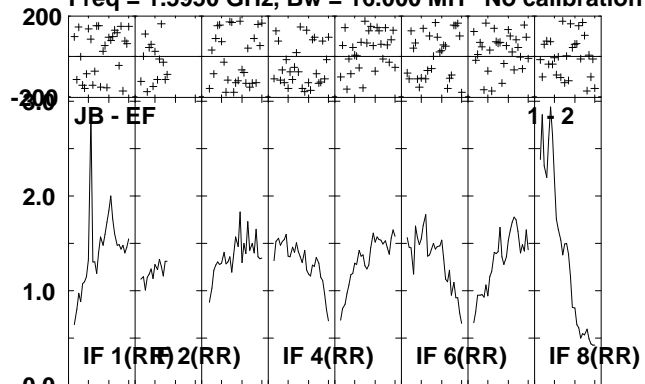

Lower frame: Milli Ampl Jy Top frame: Phas deg
Scalar averaged cross-power spectrum Several baselines displayed
Timerange: 00/13:54:11 to 00/13:57:49

Plot file version 88 created 06-JUL-2010 14:42:42

IRAS2336 EP064J.UVDATA.1

Freq = 1.5950 GHz, Bw = 16.000 MH No calibration applied and no bandpass applied

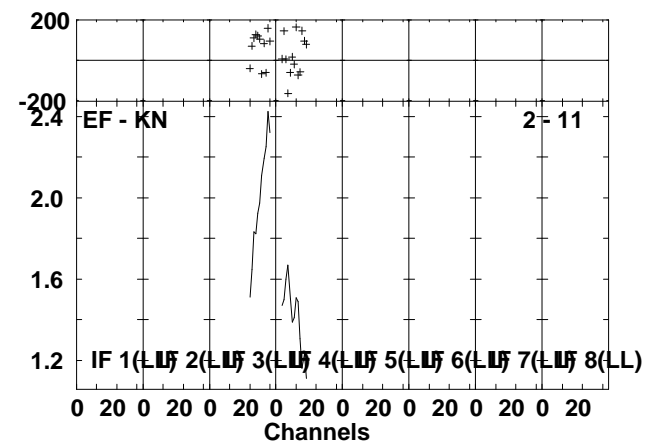
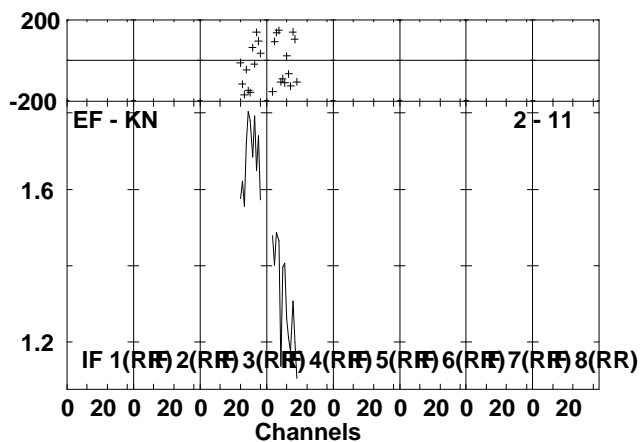
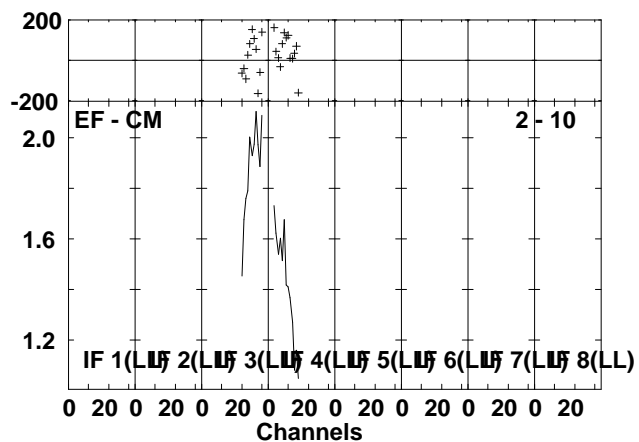
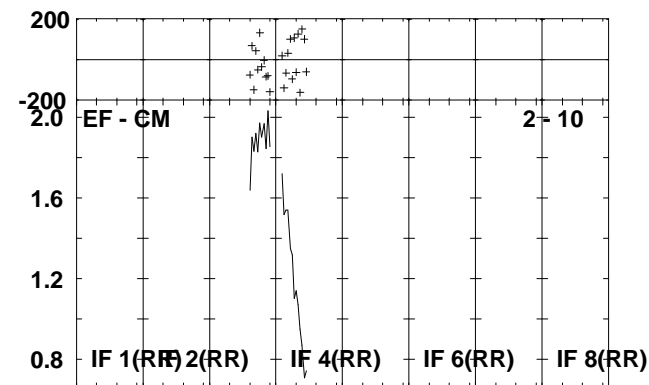
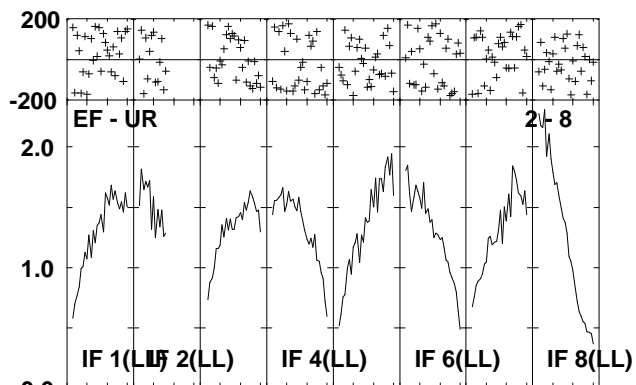
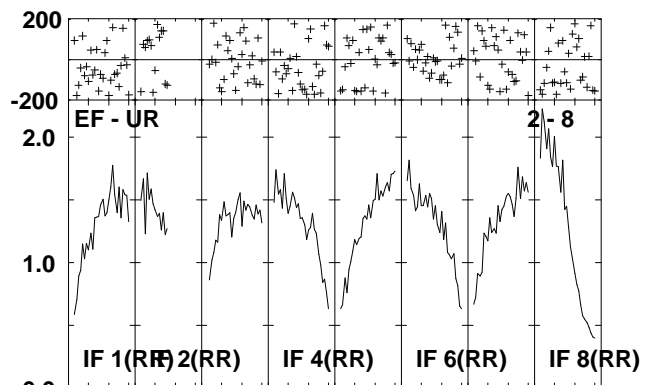
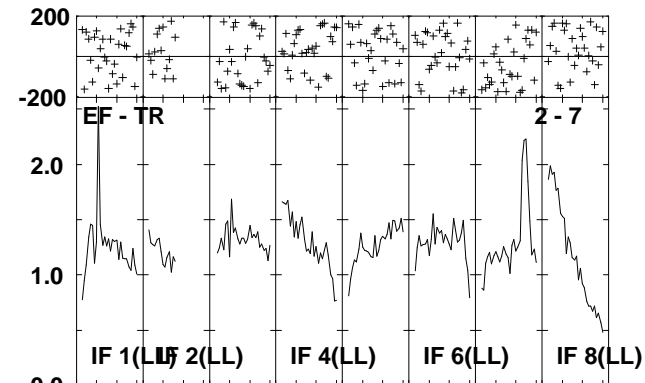
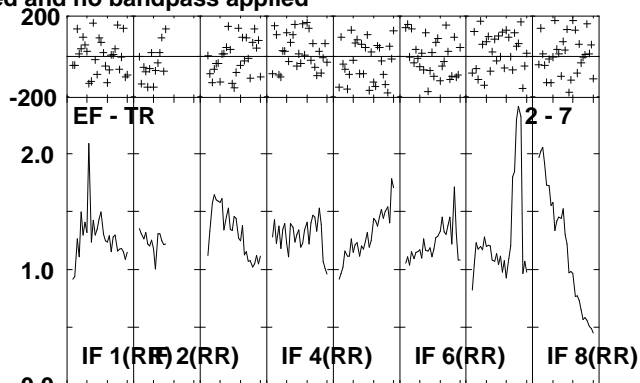
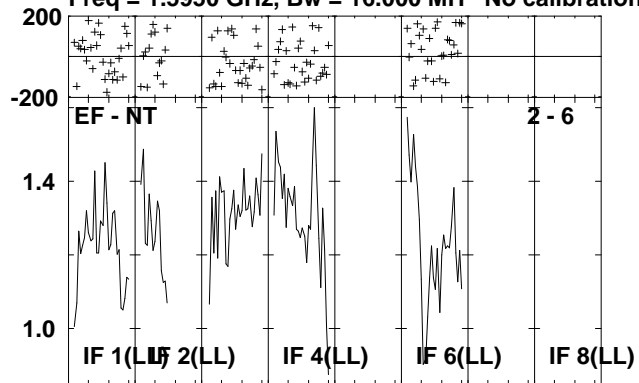

Lower frame: Milli Ampl Jy Top frame: Phas deg
Scalar averaged cross-power spectrum Several baselines displayed
Timerange: 00/13:54:11 to 00/13:57:49

Plot file version 89 created 06-JUL-2010 14:42:45

J2330+33 EP064J.UVDATA.1

Freq = 1.5950 GHz, Bw = 16.000 MH No calibration applied and no bandpass applied

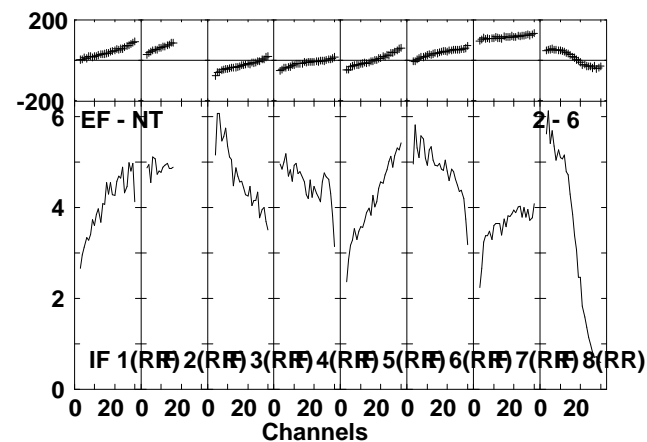
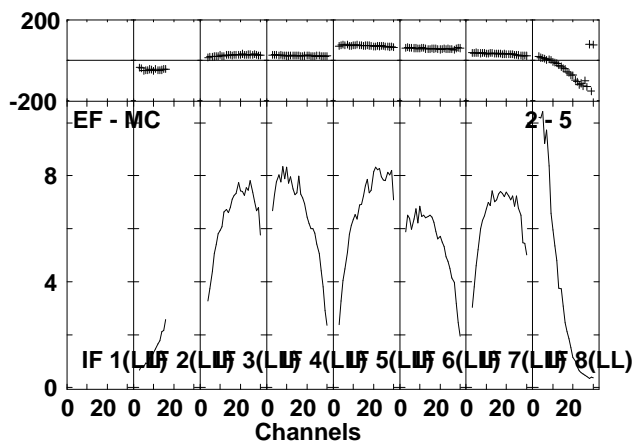
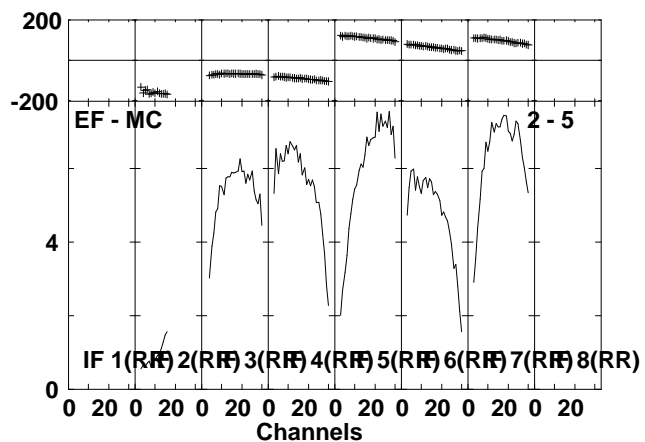
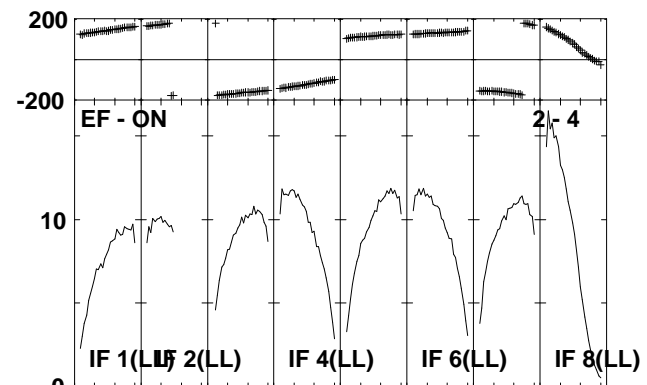
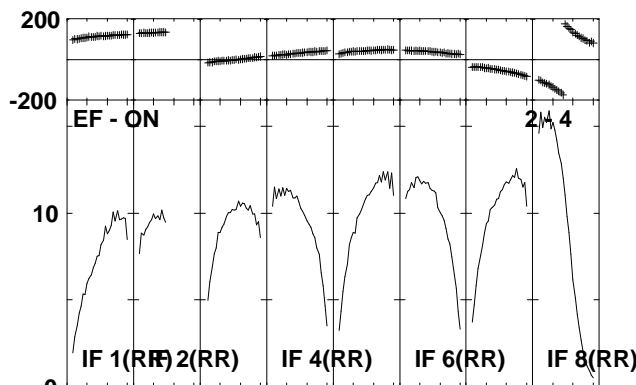
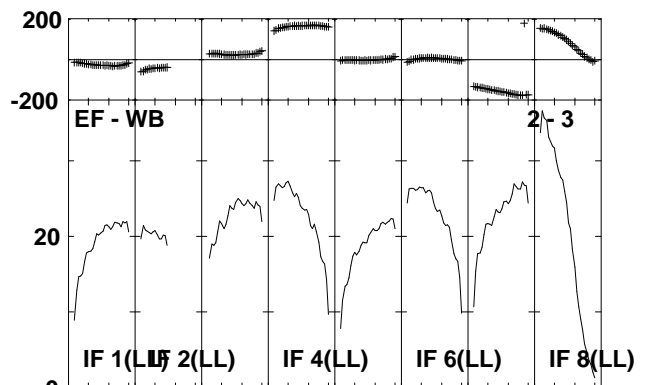
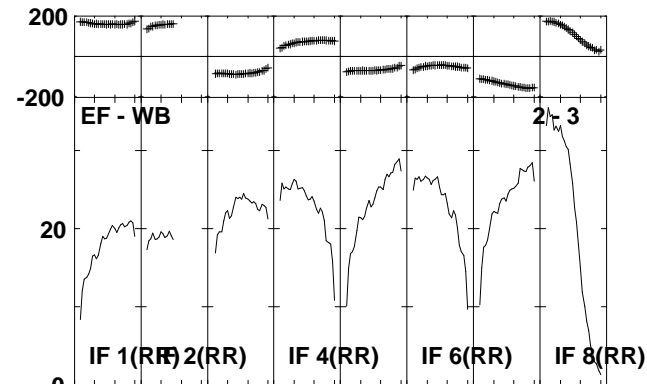
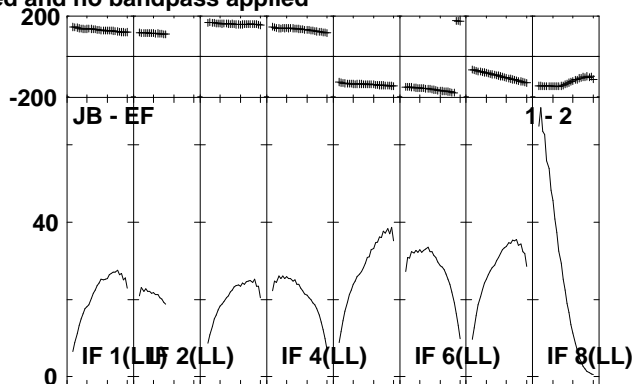
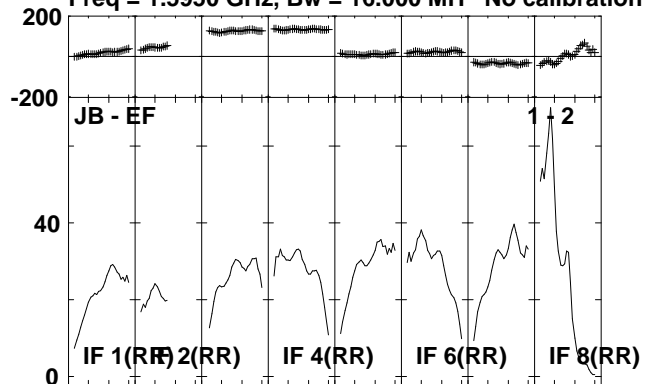

Lower frame: Milli Ampl Jy Top frame: Phas deg
Scalar averaged cross-power spectrum Several baselines displayed
Timerange: 00/13:58:51 to 00/14:00:29

Plot file version 90 created 06-JUL-2010 14:42:46

J2330+33 EP064J.UVDATA.1

Freq = 1.5950 GHz, Bw = 16.000 MH No calibration applied and no bandpass applied

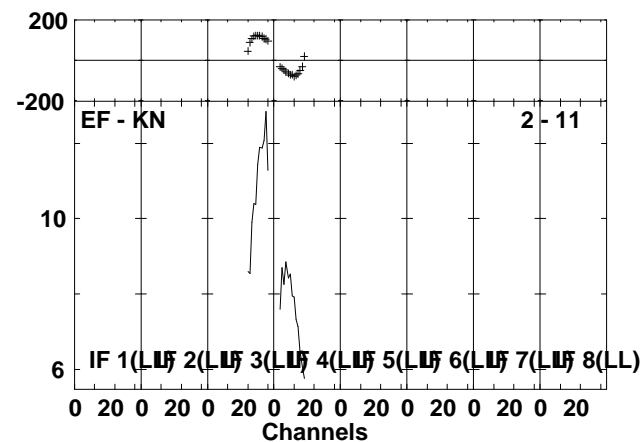
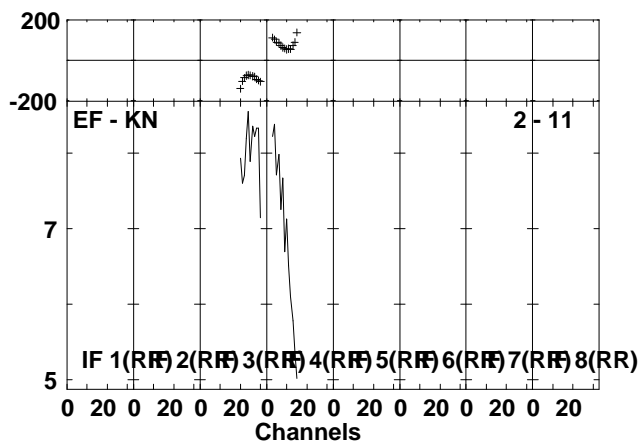
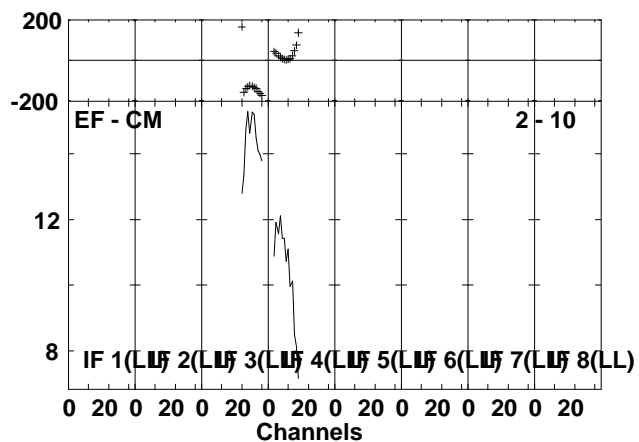
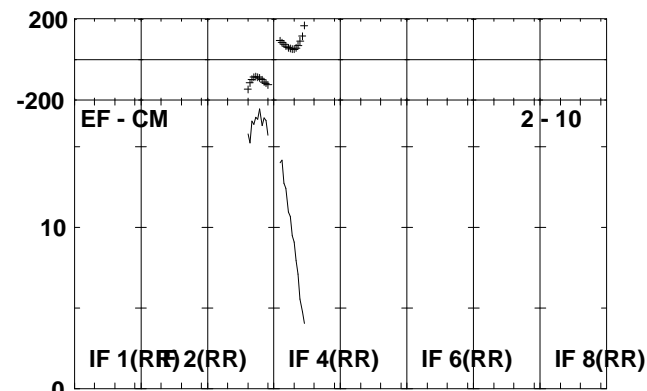
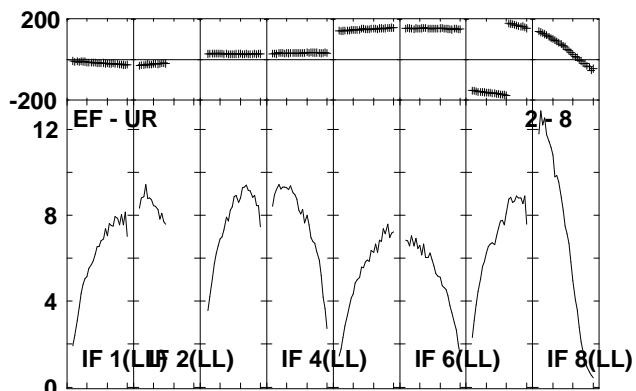
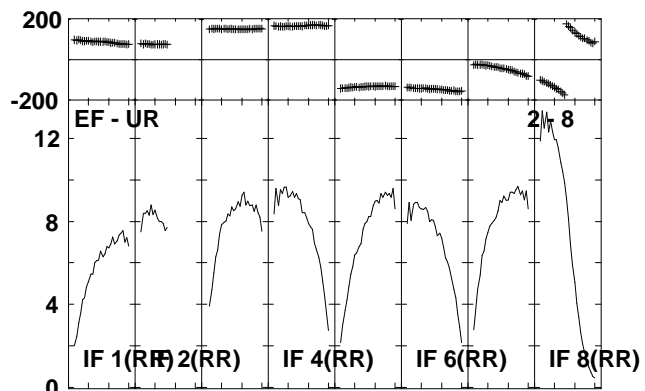
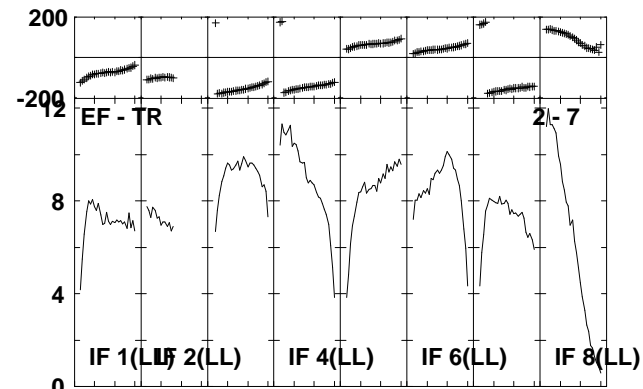
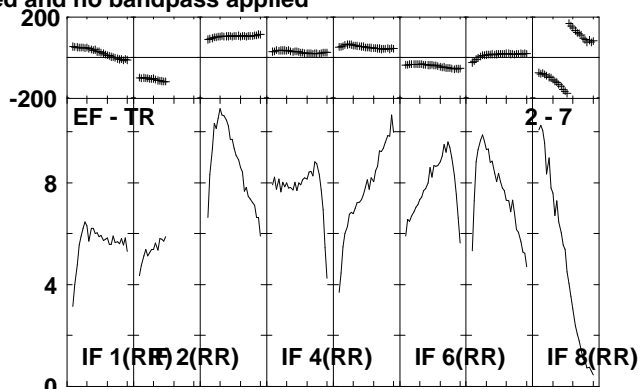
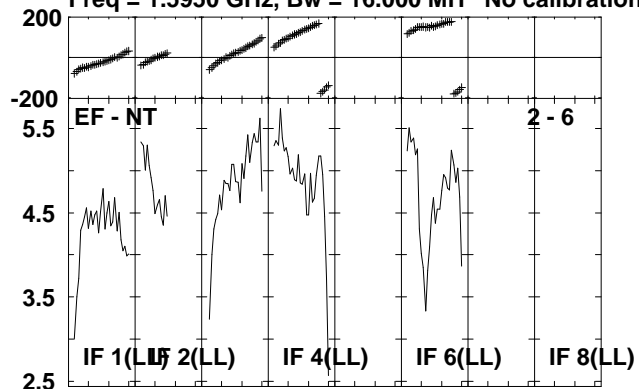

Lower frame: Milli Ampl Jy Top frame: Phas deg
Scalar averaged cross-power spectrum Several baselines displayed
Timerange: 00/13:58:51 to 00/14:00:29

Plot file version 91 created 06-JUL-2010 14:42:48

IRAS2336 EP064J.UVDATA.1

Freq = 1.5950 GHz, Bw = 16.000 MH No calibration applied and no bandpass applied

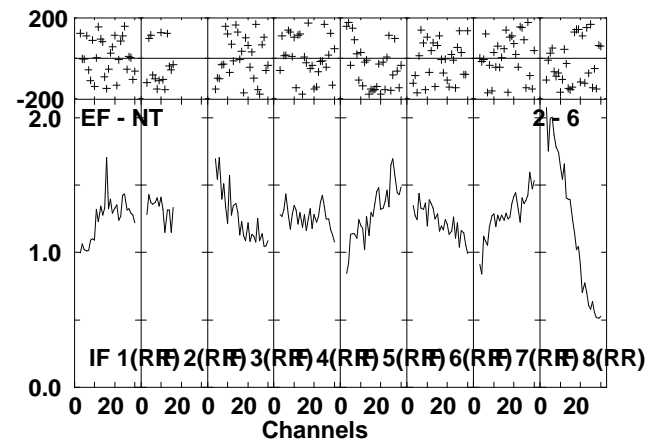
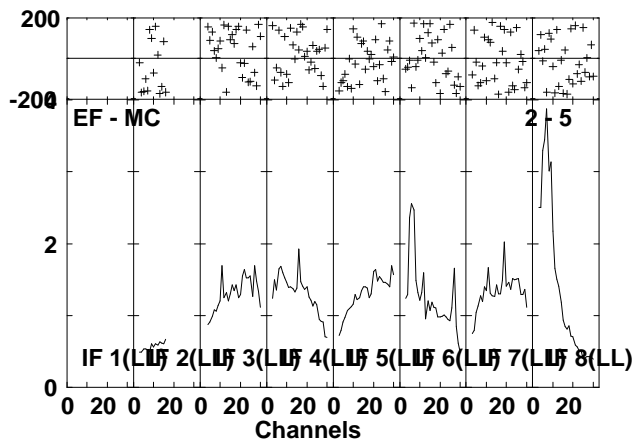
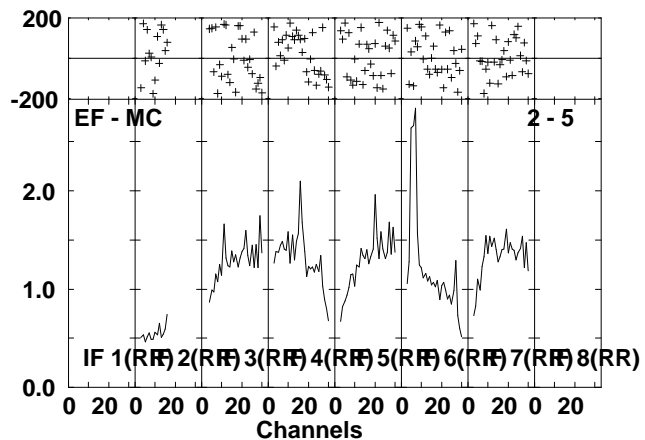
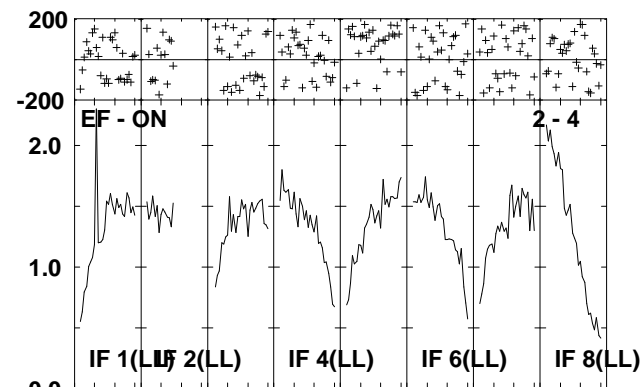
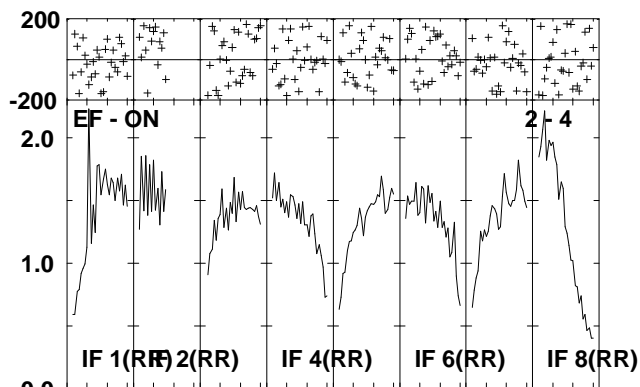
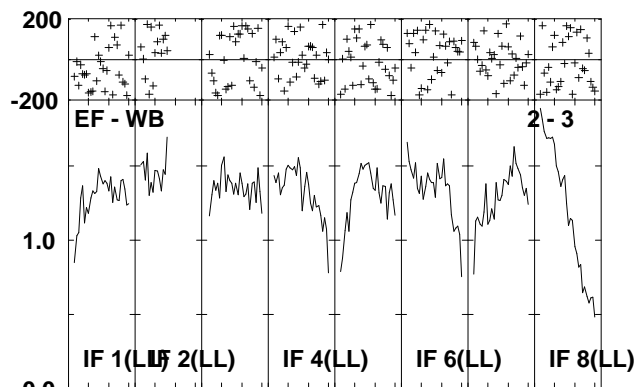
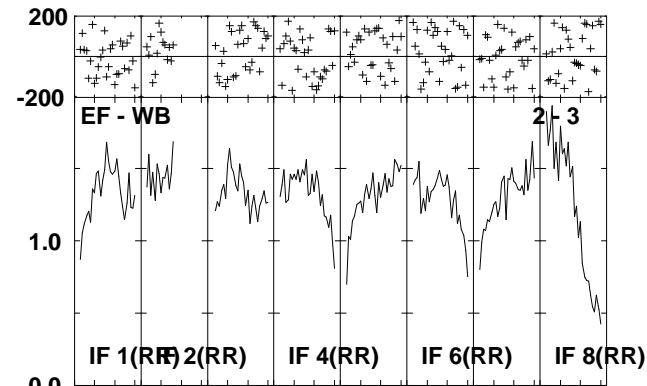
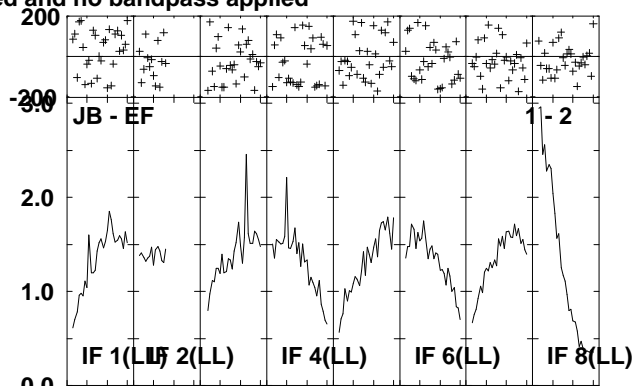
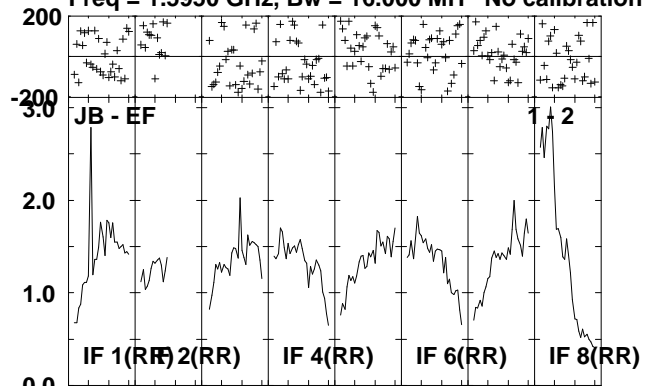

Lower frame: Milli Ampl Jy Top frame: Phas deg
Scalar averaged cross-power spectrum Several baselines displayed
Timerange: 00/14:00:31 to 00/14:04:09

Plot file version 92 created 06-JUL-2010 14:42:50

IRAS2336 EP064J.UVDATA.1

Freq = 1.5950 GHz, Bw = 16.000 MH No calibration applied and no bandpass applied

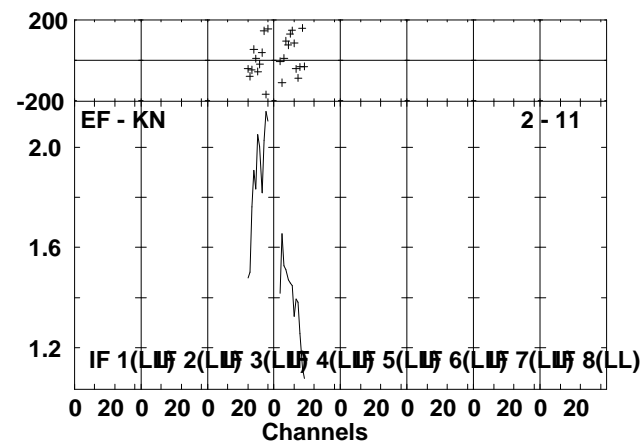
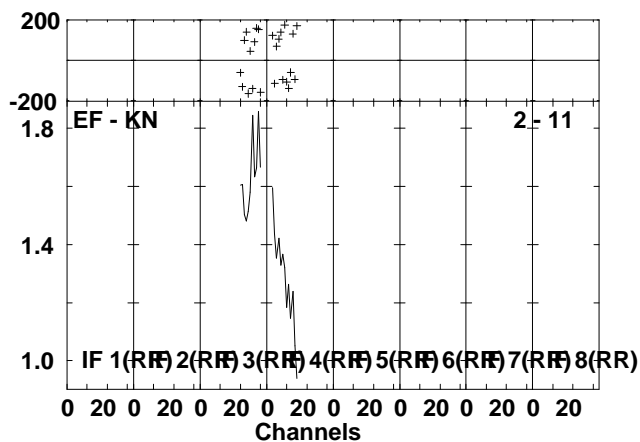
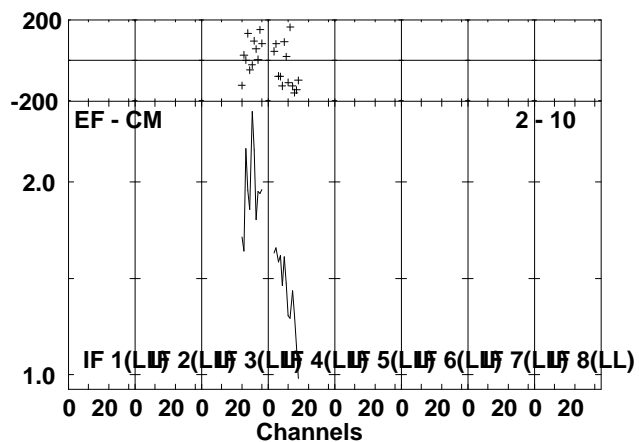
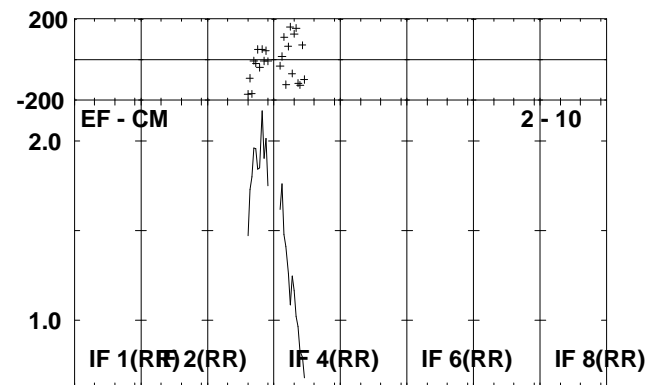
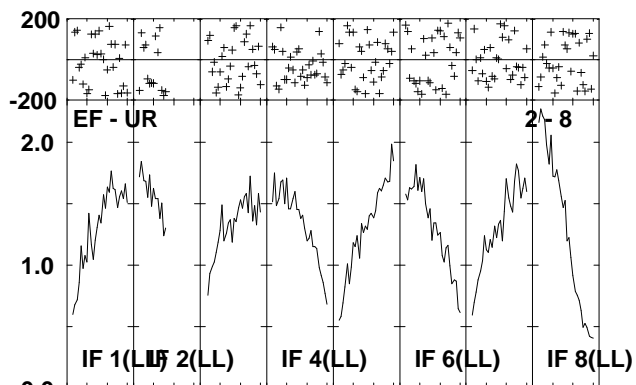
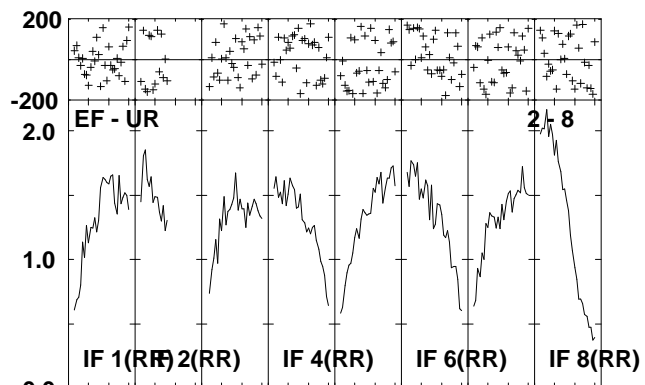
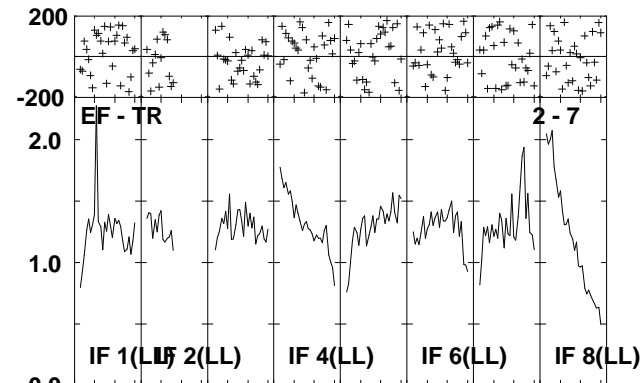
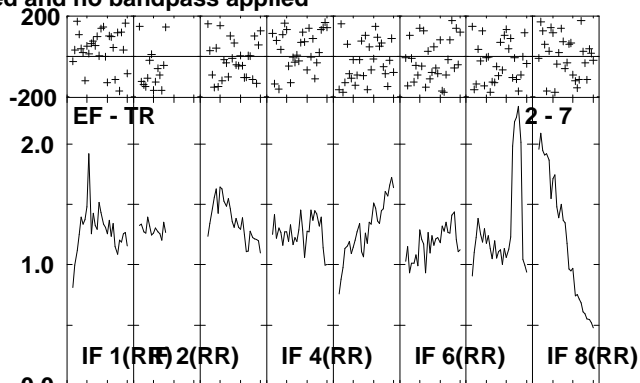
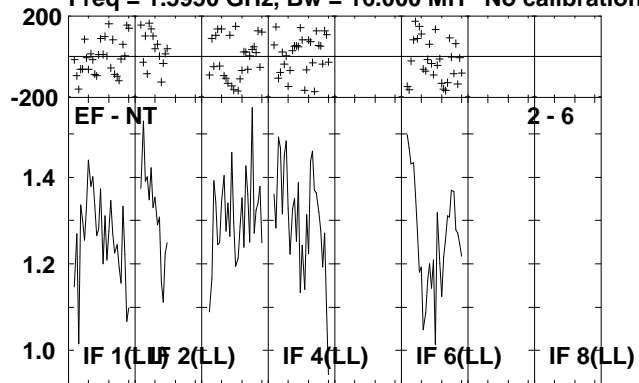

Lower frame: Milli Ampl Jy Top frame: Phas deg
Scalar averaged cross-power spectrum Several baselines displayed
Timerange: 00/14:00:31 to 00/14:04:09

Plot file version 93 created 06-JUL-2010 14:42:53

J2330+33 EP064J.UVDATA.1

Freq = 1.5950 GHz, Bw = 16.000 MH No calibration applied and no bandpass applied

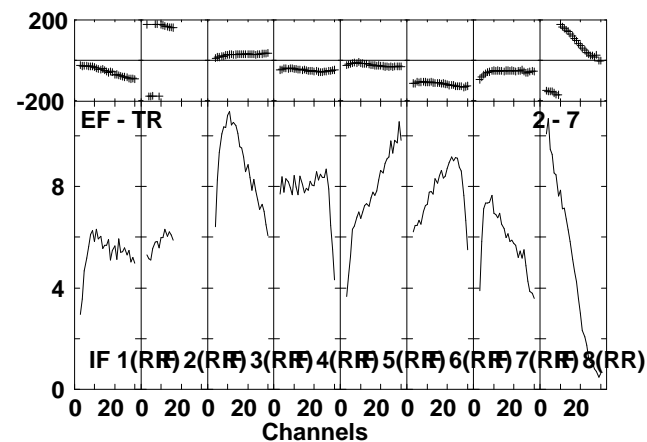
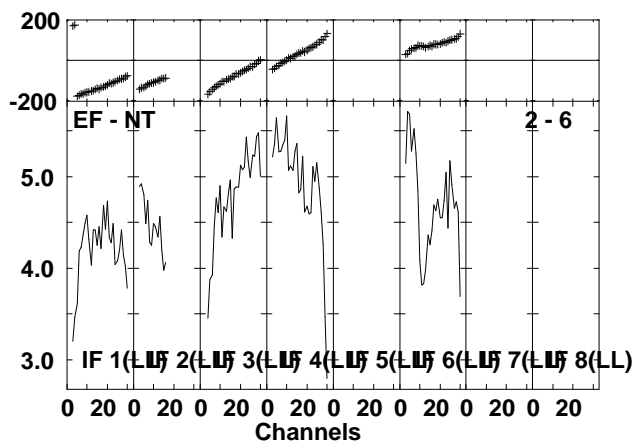
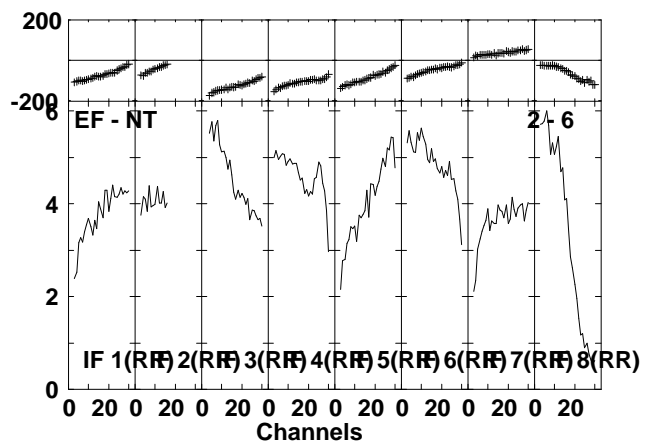
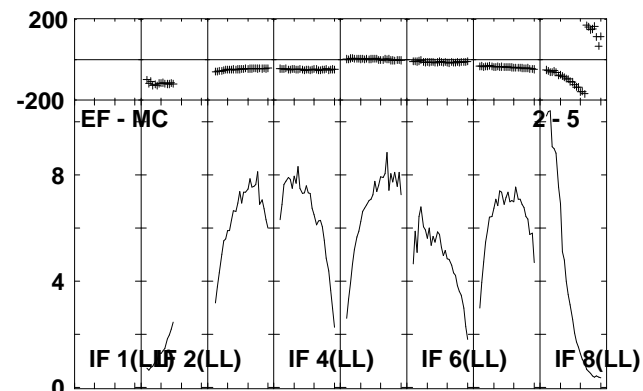
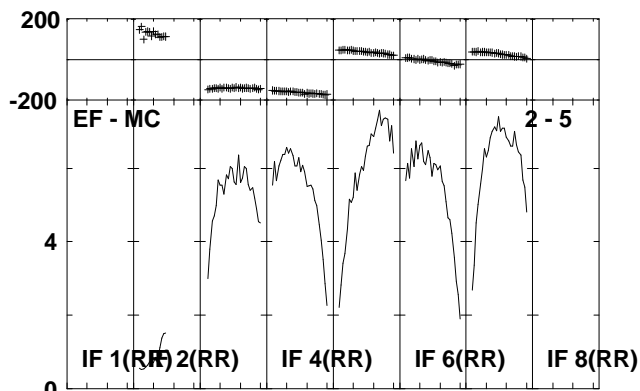
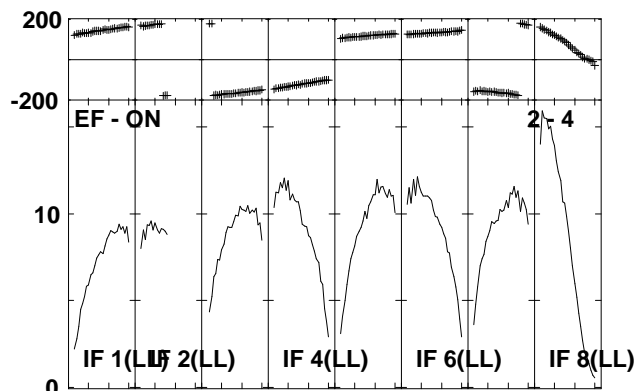
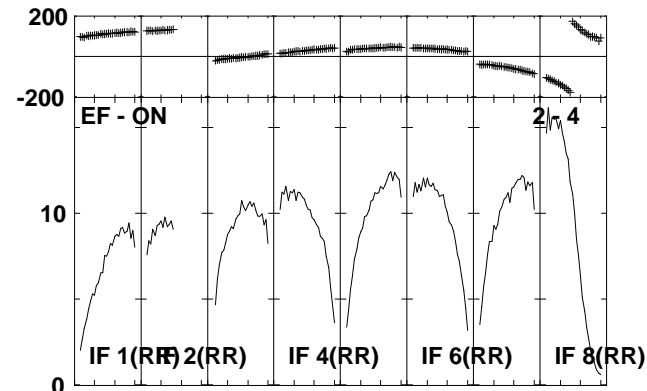
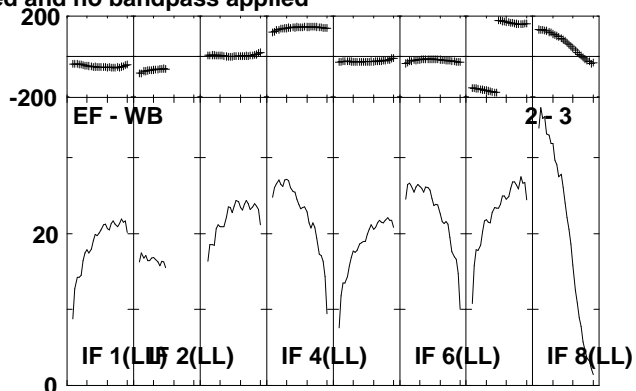
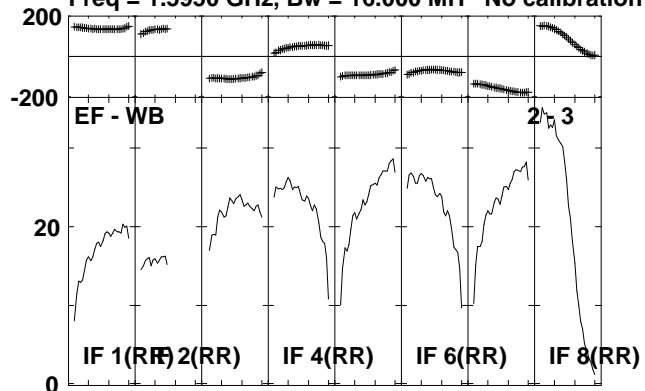

Lower frame: Milli Ampl Jy Top frame: Phas deg
Scalar averaged cross-power spectrum Several baselines displayed
Timerange: 00/14:04:19 to 00/14:05:57

Plot file version 94 created 06-JUL-2010 14:42:53

J2330+33 EP064J.UVDATA.1

Freq = 1.5950 GHz, Bw = 16.000 MH No calibration applied and no bandpass applied

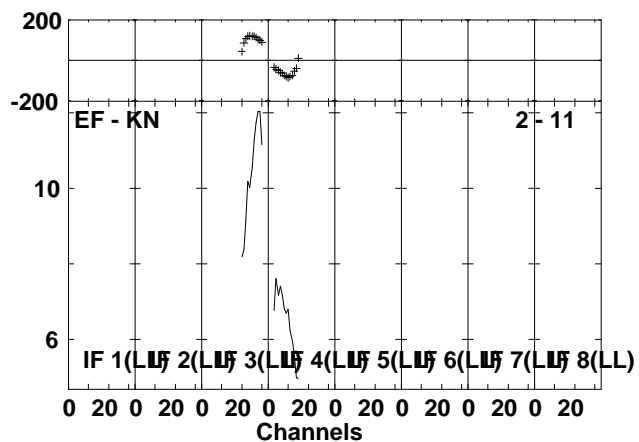
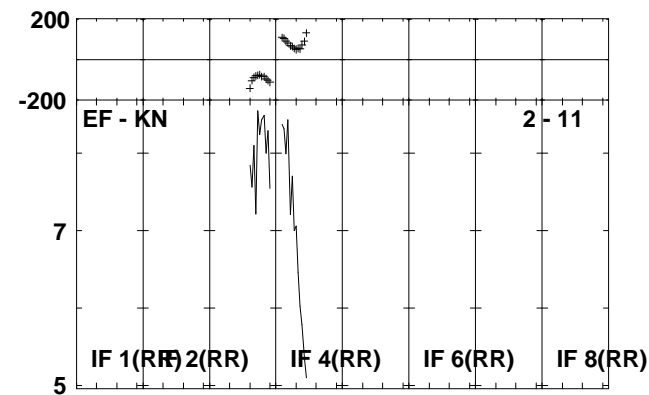
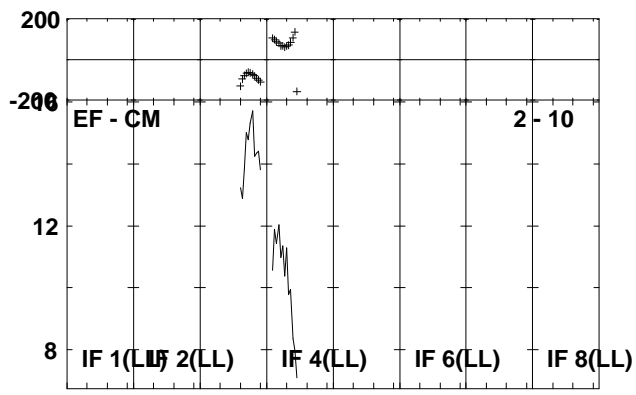
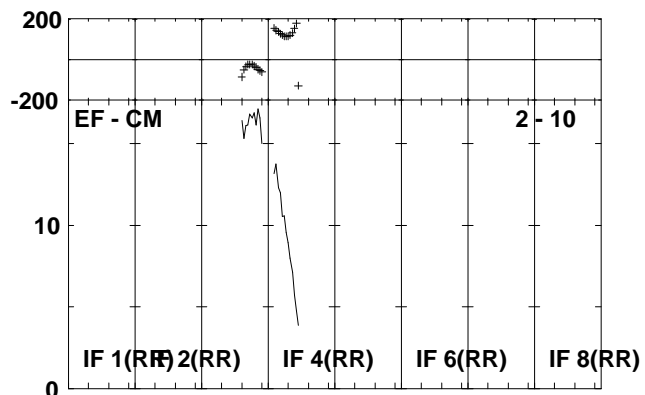
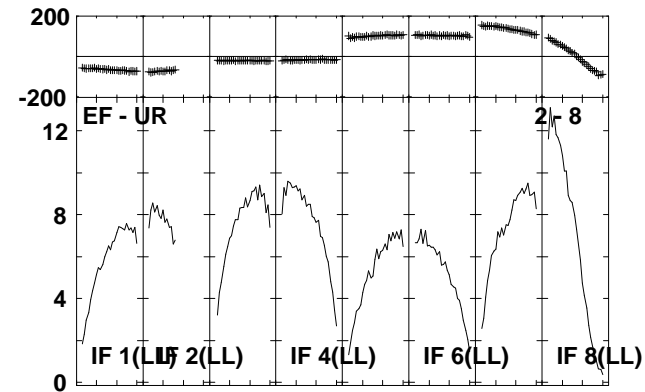
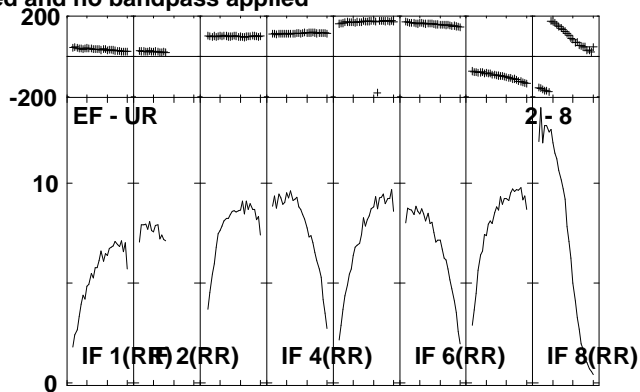
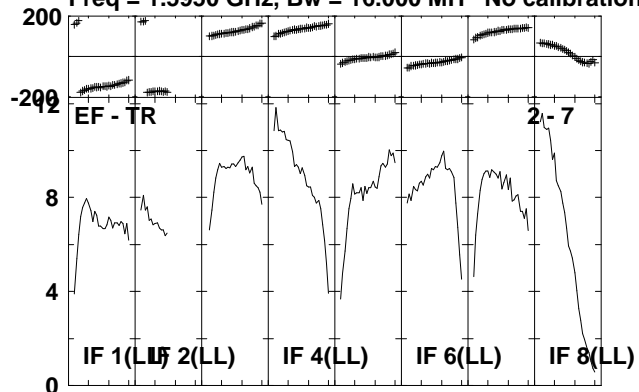

Lower frame: Milli Ampl Jy Top frame: Phas deg
Scalar averaged cross-power spectrum Several baselines displayed
Timerange: 00/14:04:19 to 00/14:05:57

Plot file version 95 created 06-JUL-2010 14:42:54

IRAS2336 EP064J.UVDATA.1

Freq = 1.5950 GHz, Bw = 16.000 MH No calibration applied and no bandpass applied

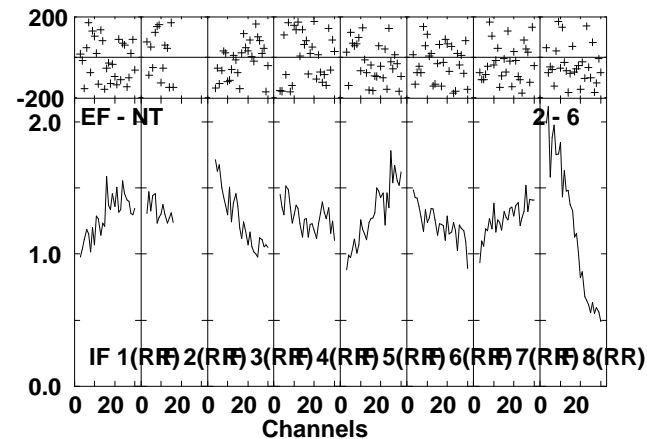
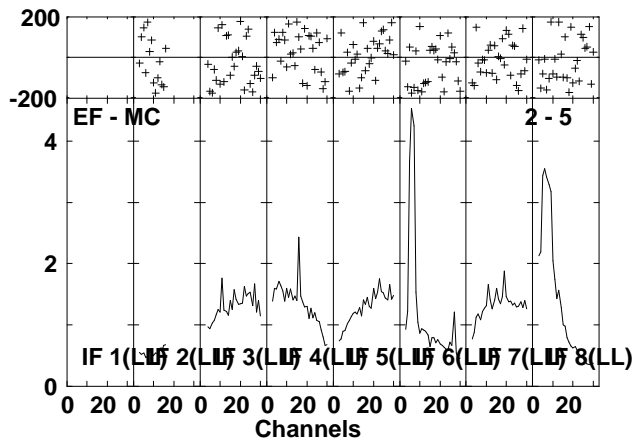
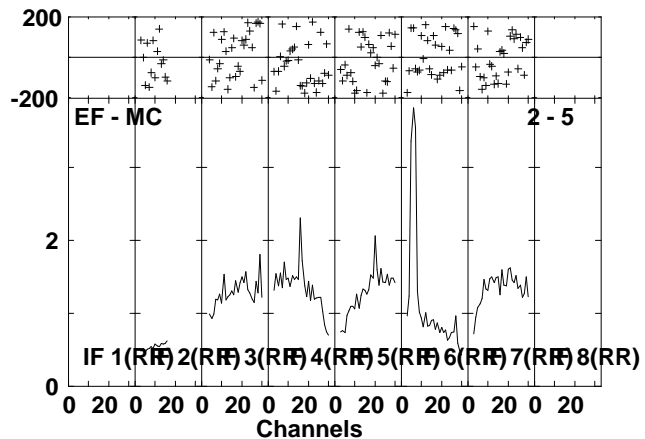
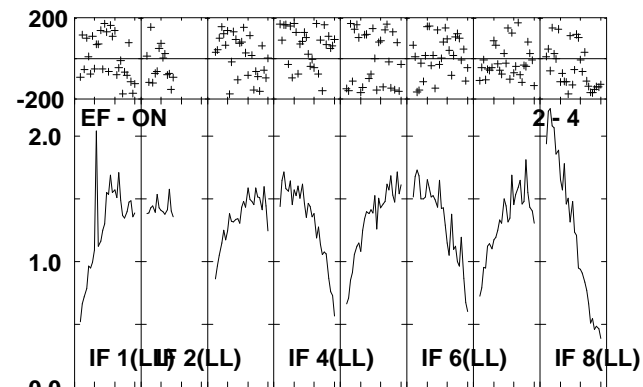
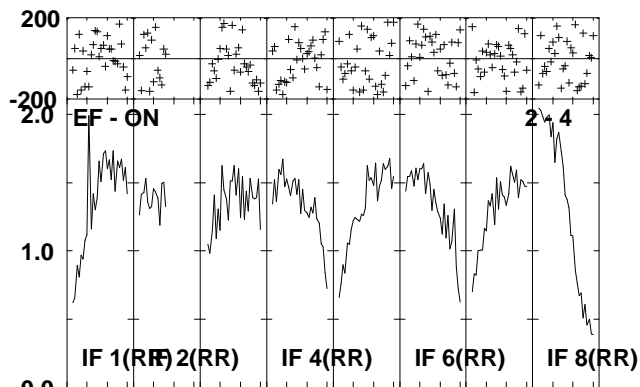
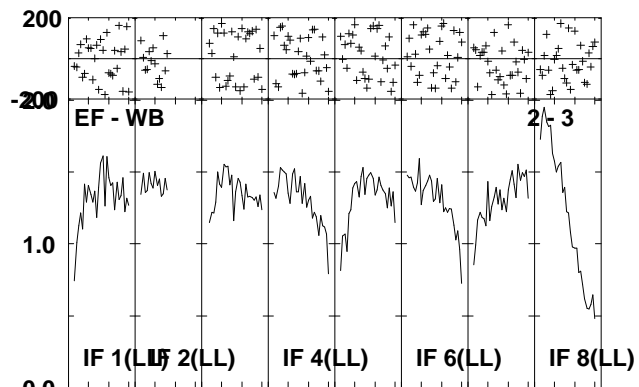
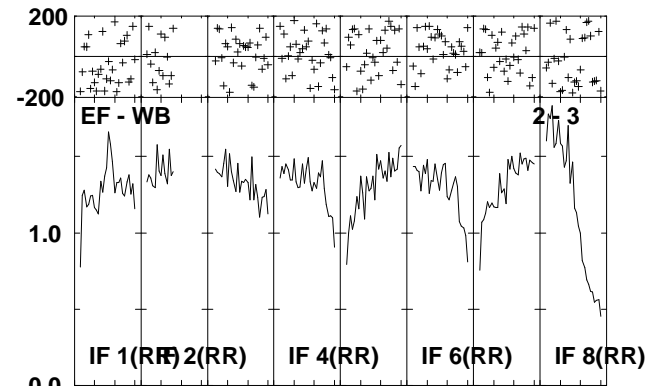
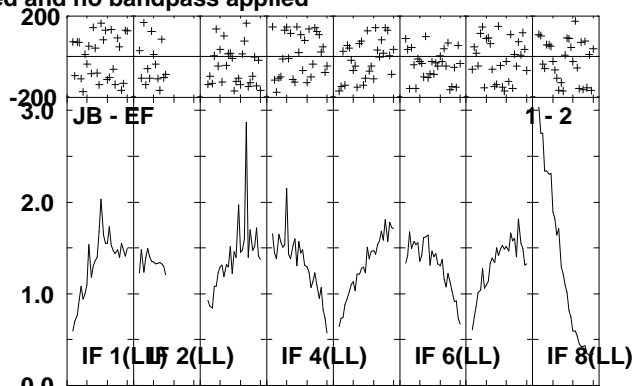
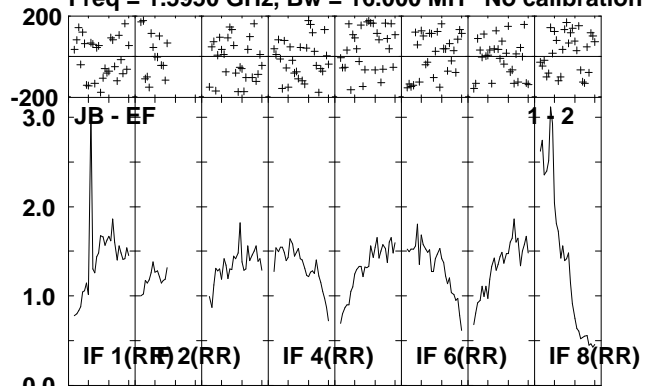

Lower frame: Milli Ampl Jy Top frame: Phas deg
Scalar averaged cross-power spectrum Several baselines displayed
Timerange: 00/14:06:01 to 00/14:09:39

Plot file version 96 created 06-JUL-2010 14:42:56

IRAS2336 EP064J.UVDATA.1

Freq = 1.5950 GHz, Bw = 16.000 MH No calibration applied and no bandpass applied

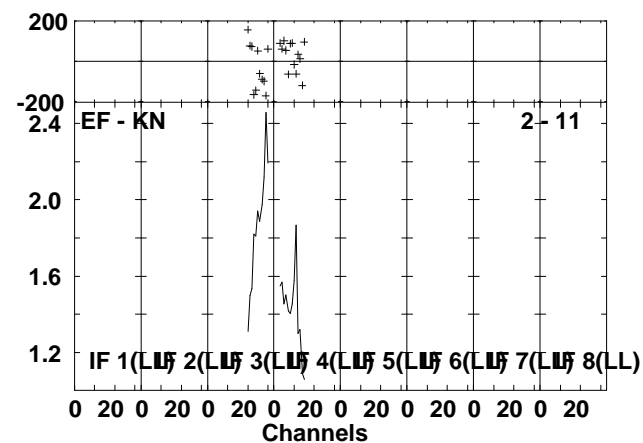
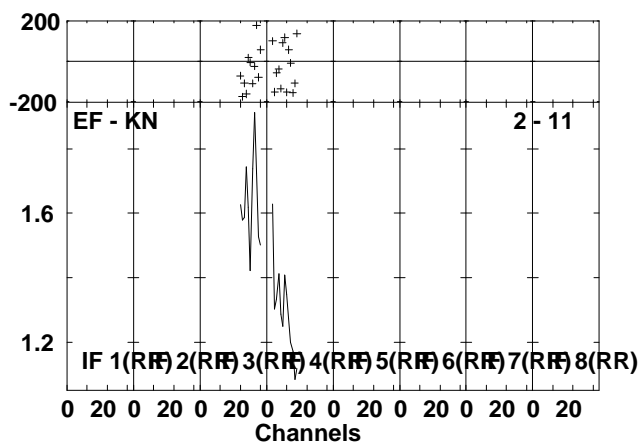
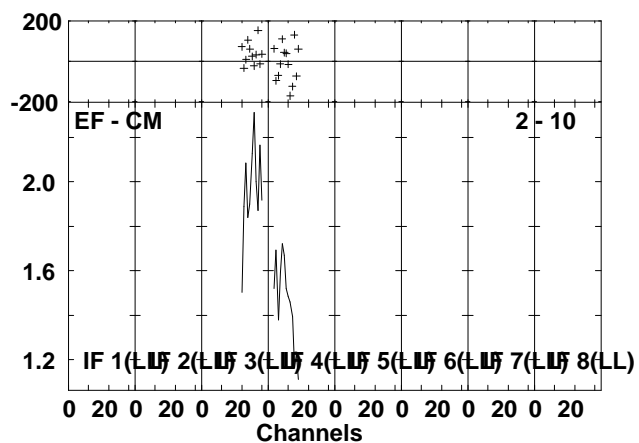
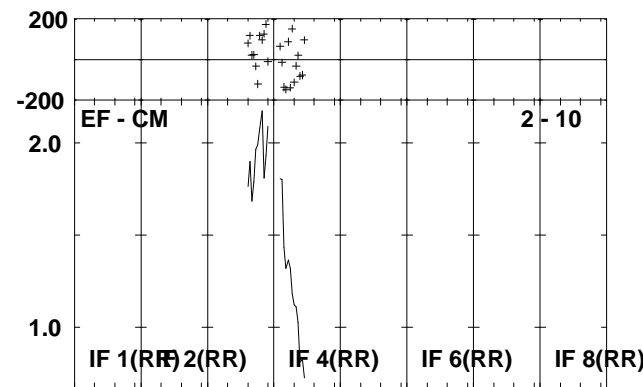
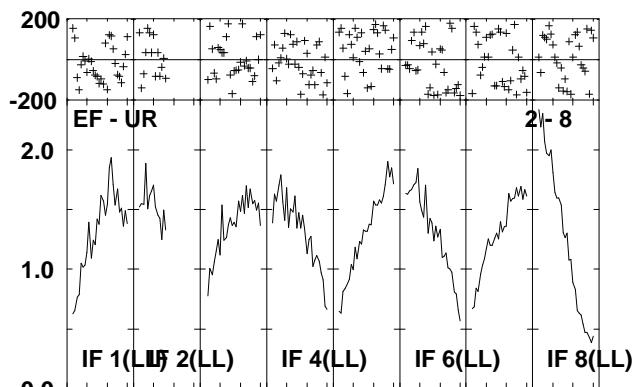
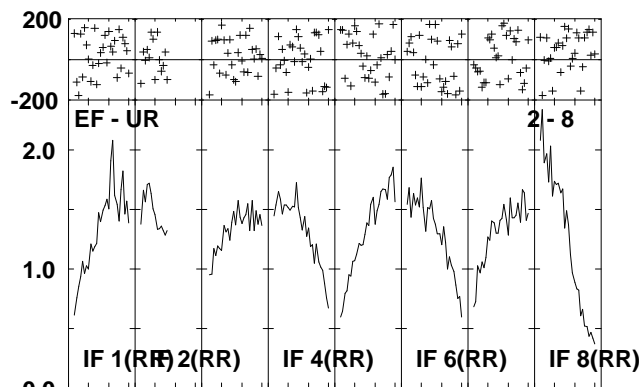
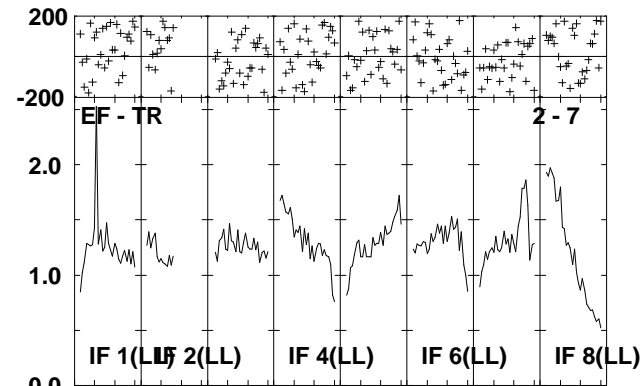
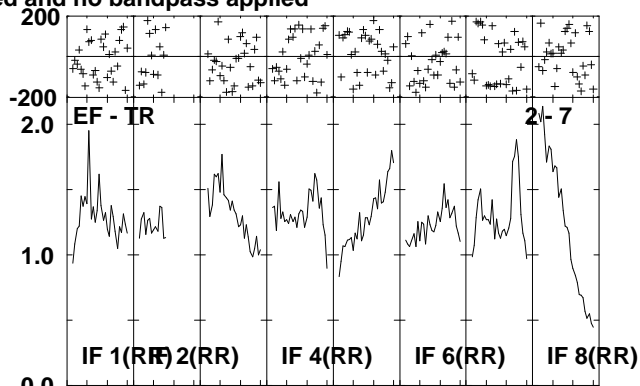
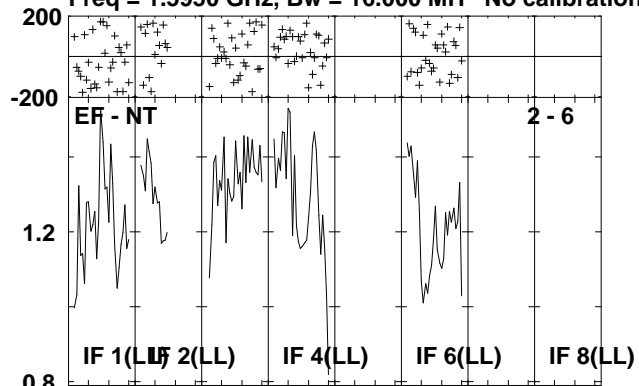

Lower frame: Milli Ampl Jy Top frame: Phas deg
Scalar averaged cross-power spectrum Several baselines displayed
Timerange: 00/14:06:01 to 00/14:09:39

Plot file version 97 created 06-JUL-2010 14:42:59

J2330+33 EP064J.UVDATA.1

Freq = 1.5950 GHz, Bw = 16.000 MH No calibration applied and no bandpass applied

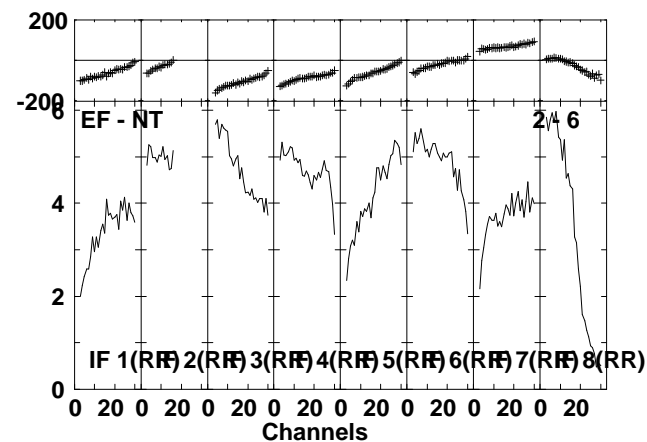
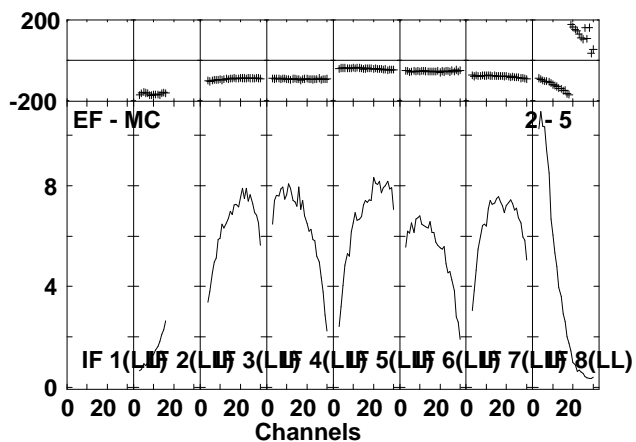
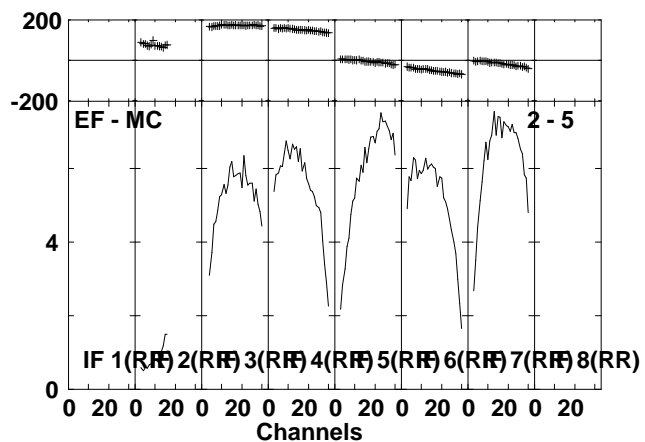
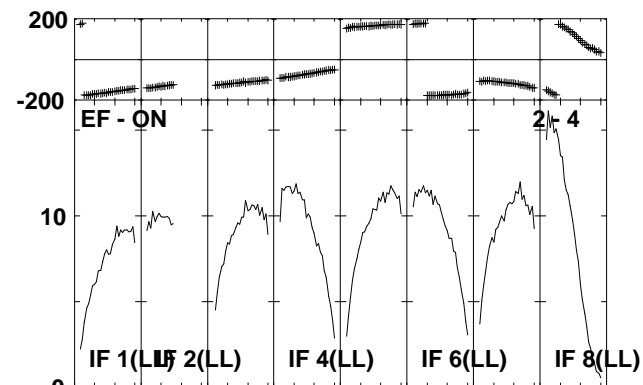
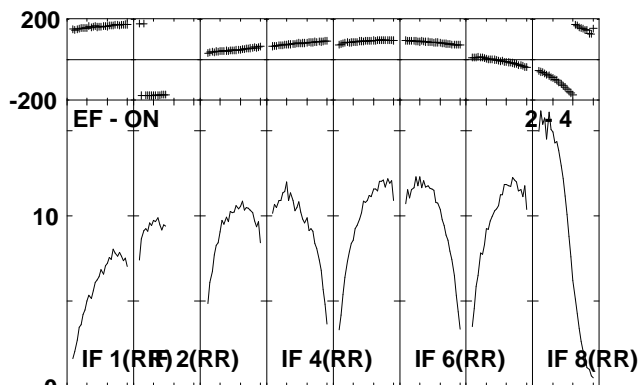
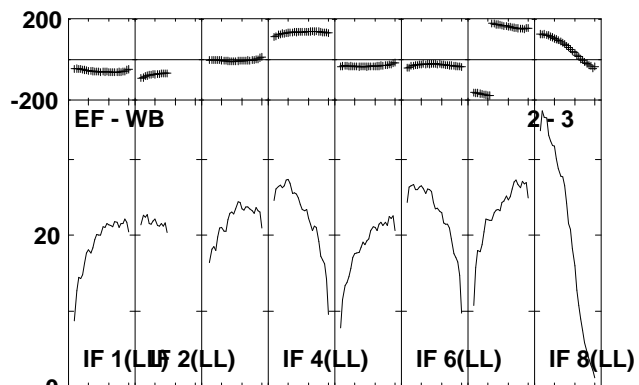
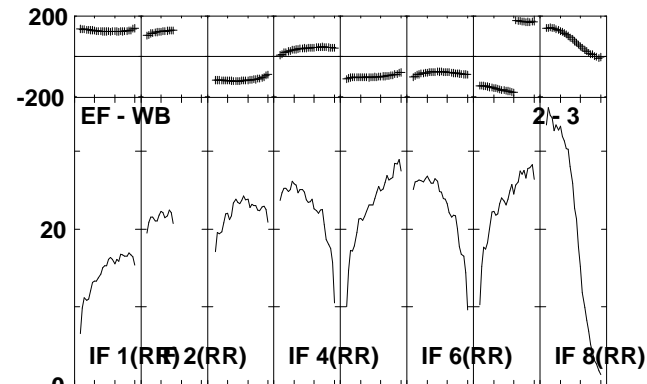
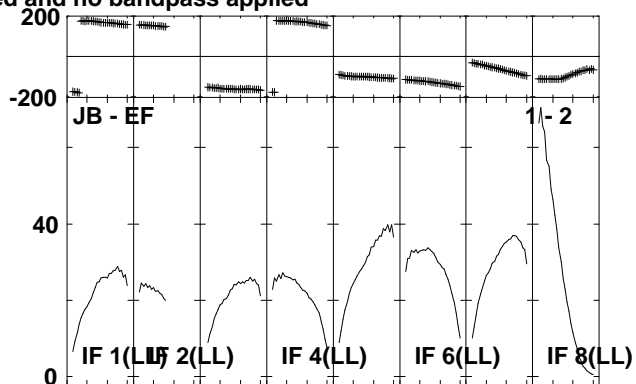
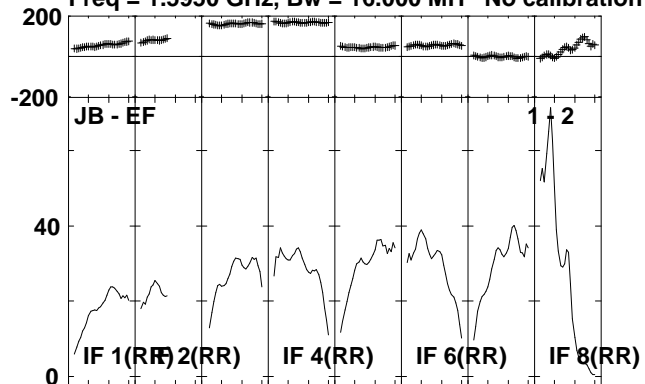

Lower frame: Milli Ampl Jy Top frame: Phas deg
Scalar averaged cross-power spectrum Several baselines displayed
Timerange: 00/14:09:41 to 00/14:11:29

Plot file version 98 created 06-JUL-2010 14:43:00

J2330+33 EP064J.UVDATA.1

Freq = 1.5950 GHz, Bw = 16.000 MH No calibration applied and no bandpass applied

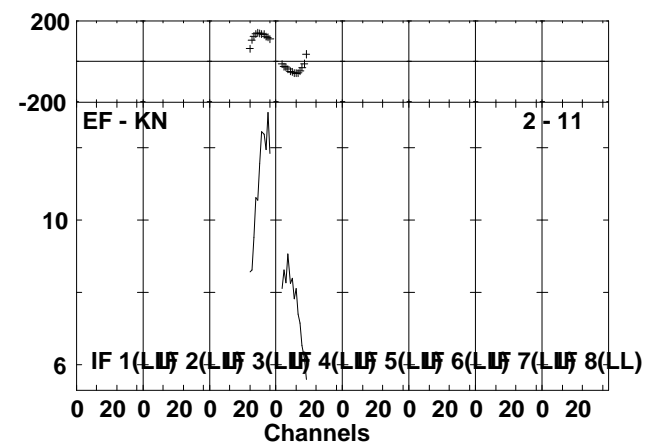
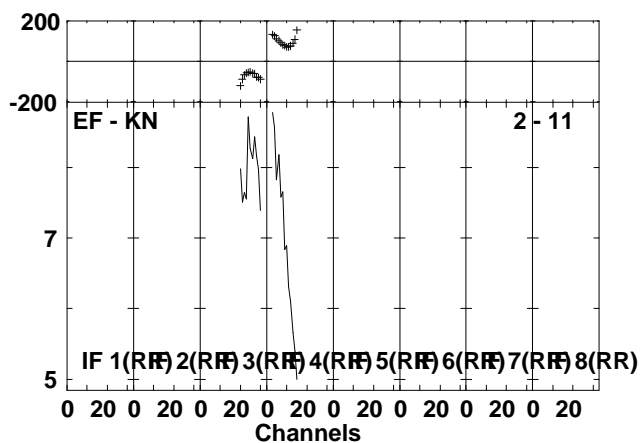
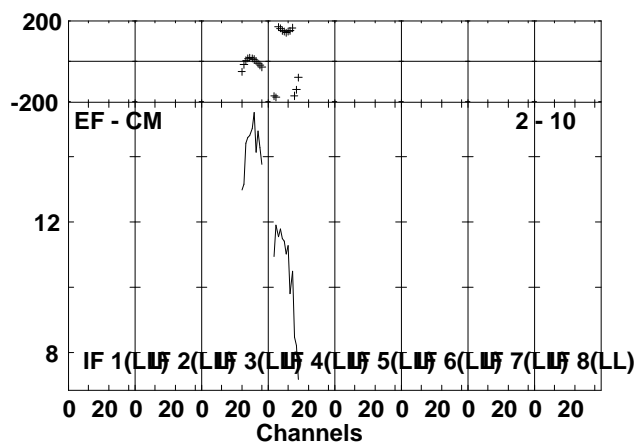
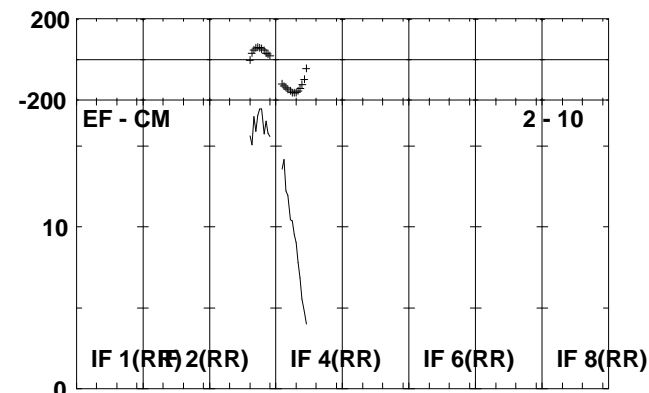
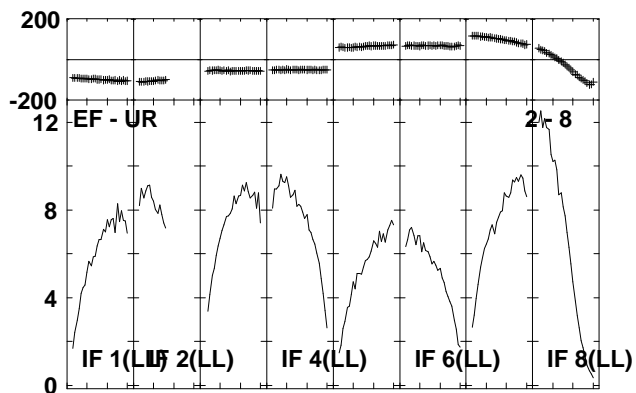
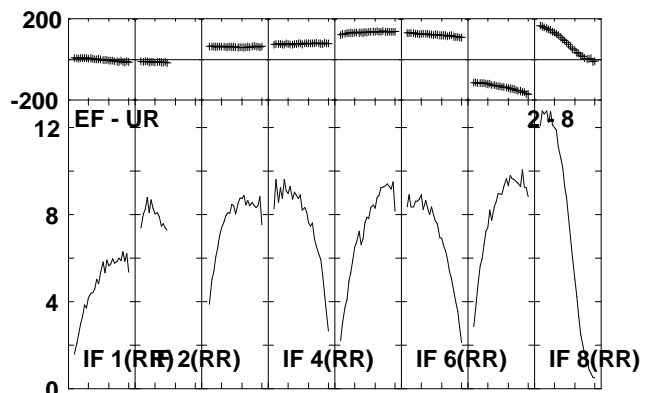
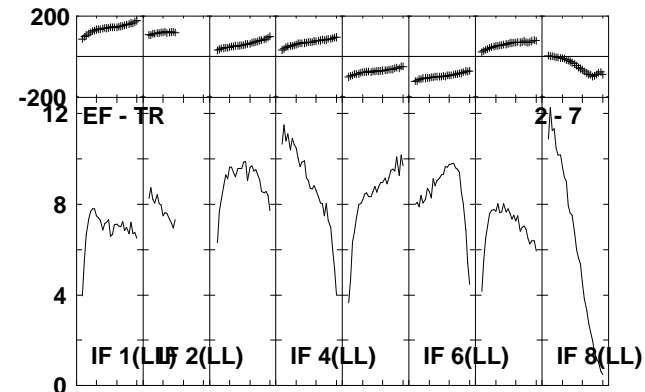
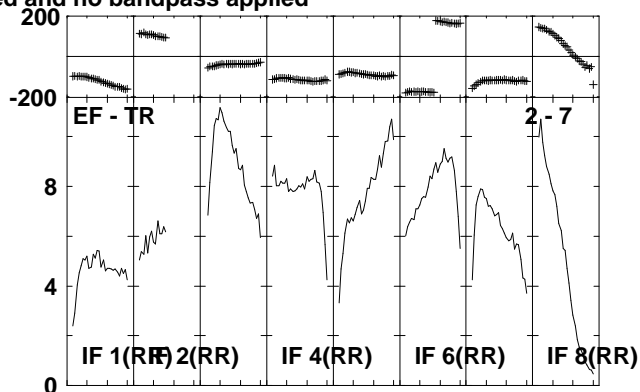
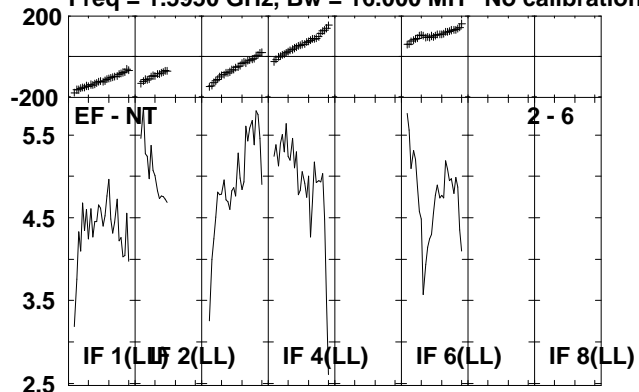

Lower frame: Milli Ampl Jy Top frame: Phas deg
Scalar averaged cross-power spectrum Several baselines displayed
Timerange: 00/14:09:41 to 00/14:11:29

Plot file version 99 created 06-JUL-2010 14:43:02

IRAS2336 EP064J.UVDATA.1

Freq = 1.5950 GHz, Bw = 16.000 MH No calibration applied and no bandpass applied

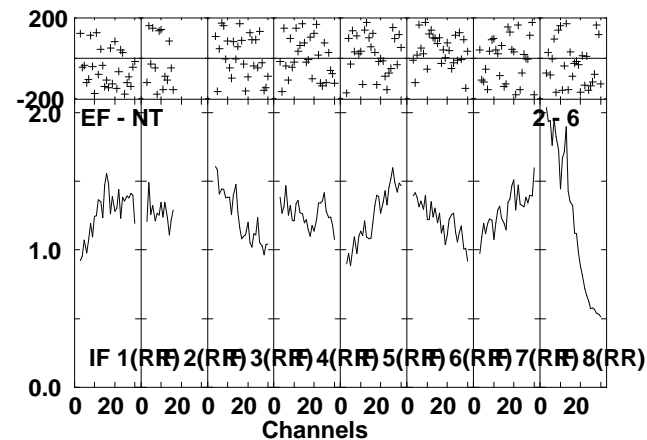
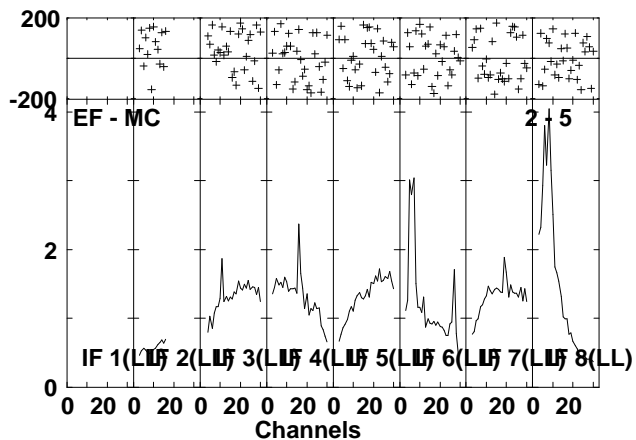
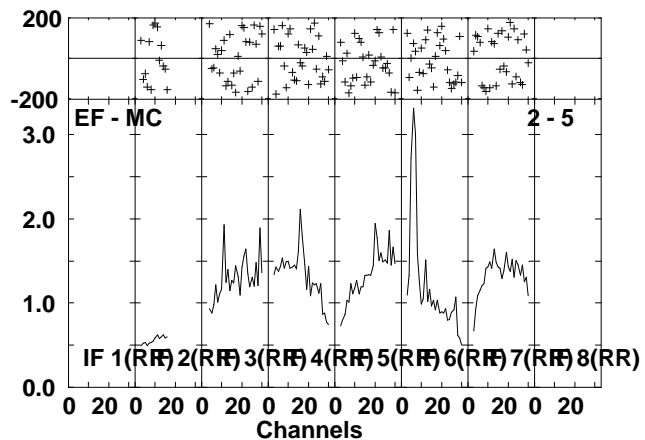
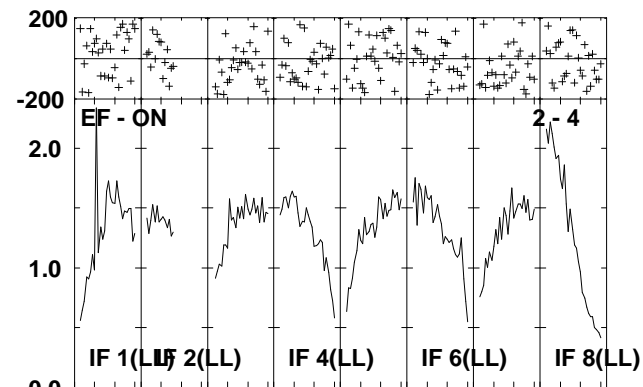
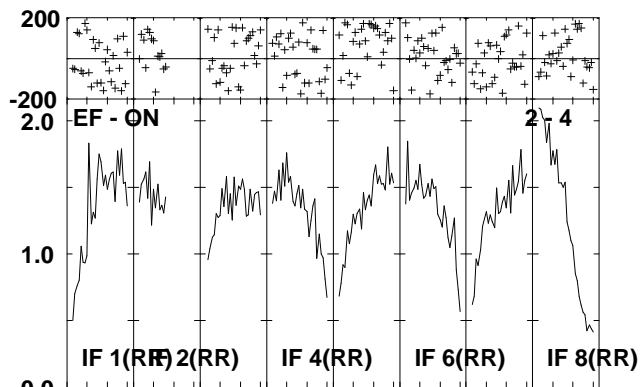
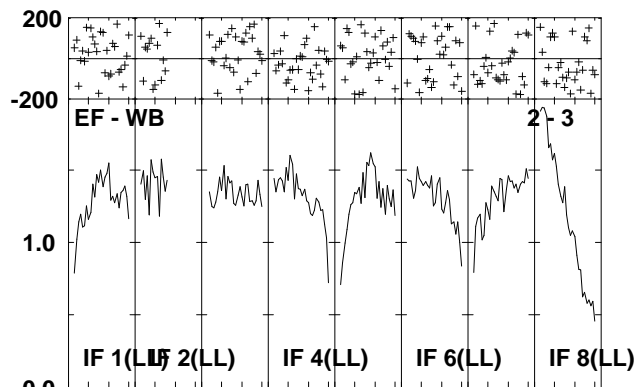
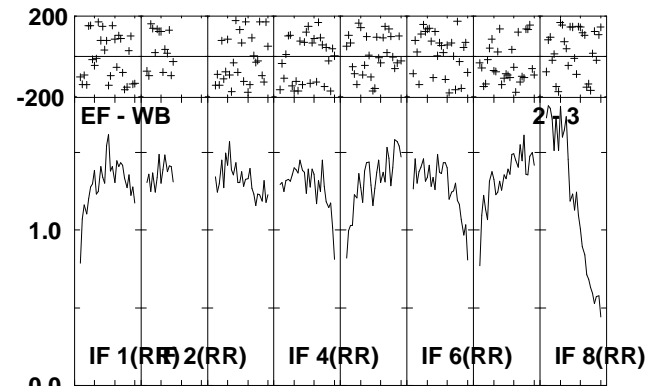
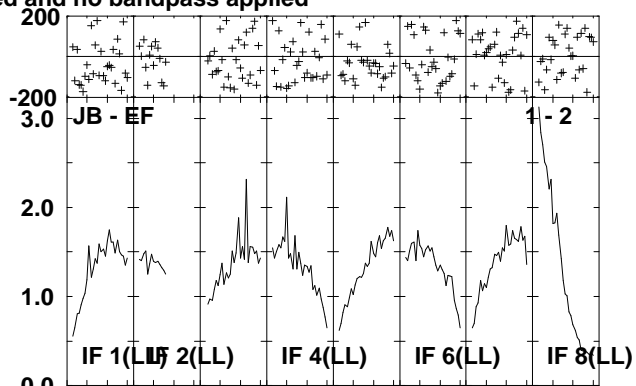
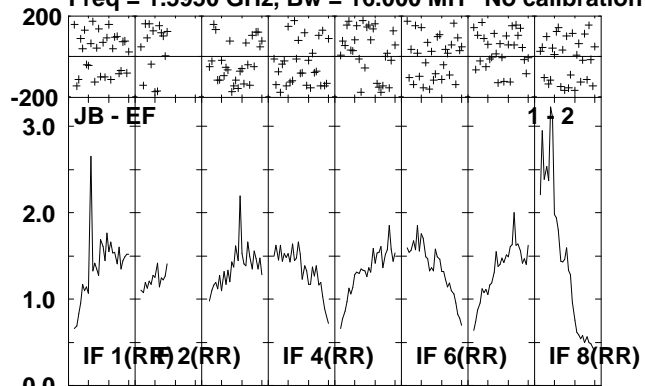

Lower frame: Milli Ampl Jy Top frame: Phas deg
Scalar averaged cross-power spectrum Several baselines displayed
Timerange: 00/14:11:31 to 00/14:15:09

Plot file version 100 created 06-JUL-2010 14:43:04

IRAS2336 EP064J.UVDATA.1

Freq = 1.5950 GHz, Bw = 16.000 MH No calibration applied and no bandpass applied

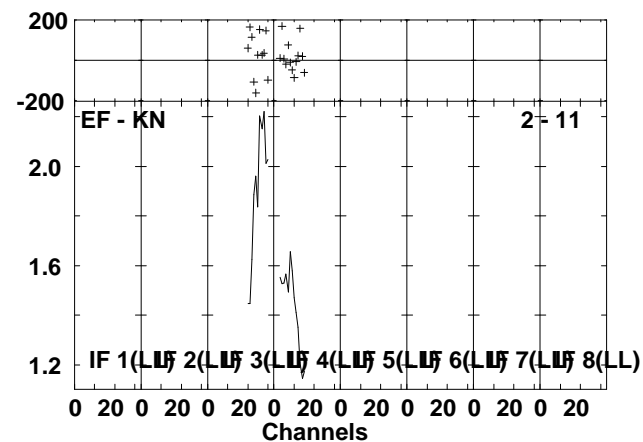
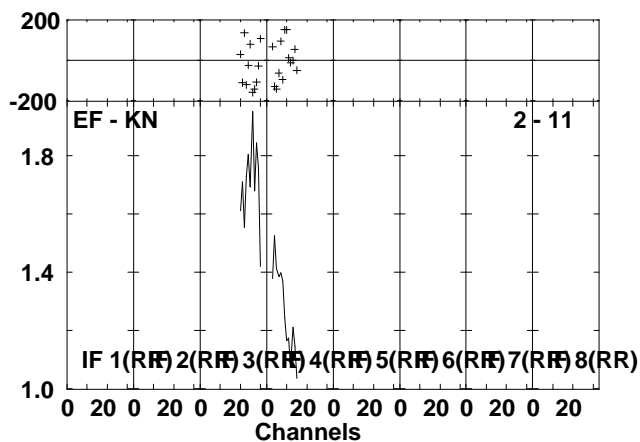
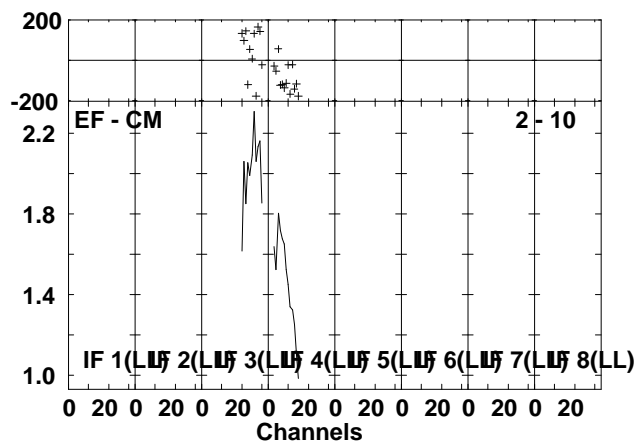
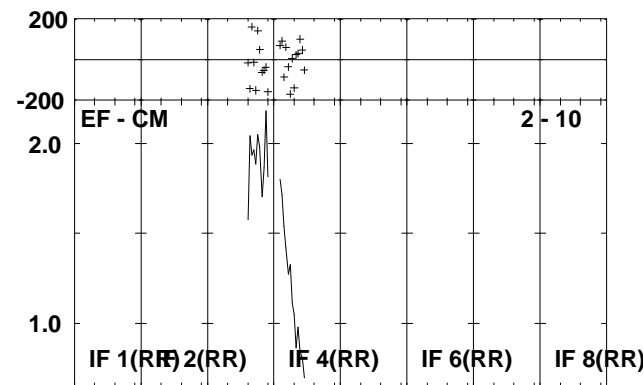
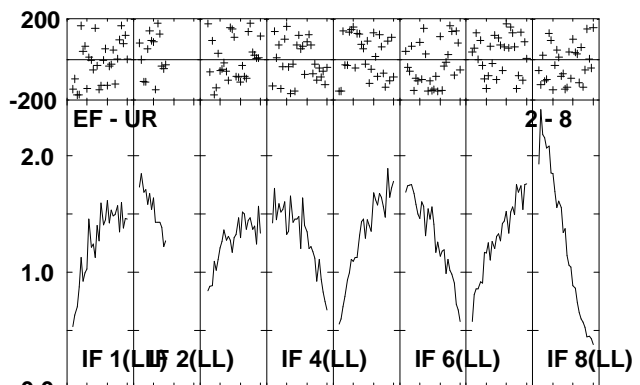
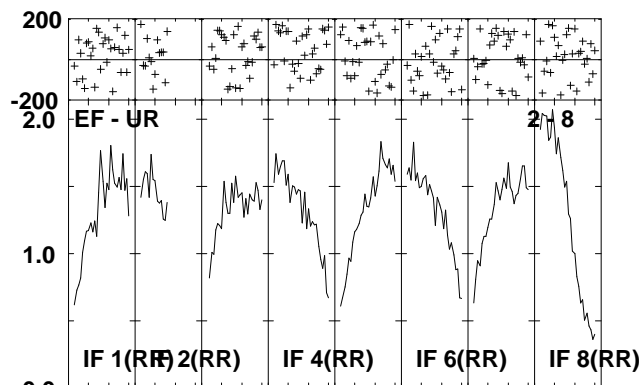
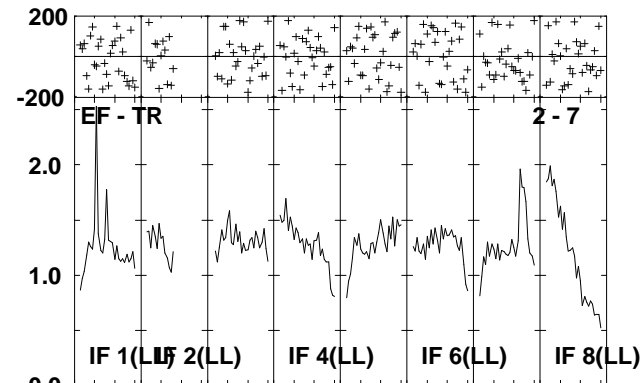
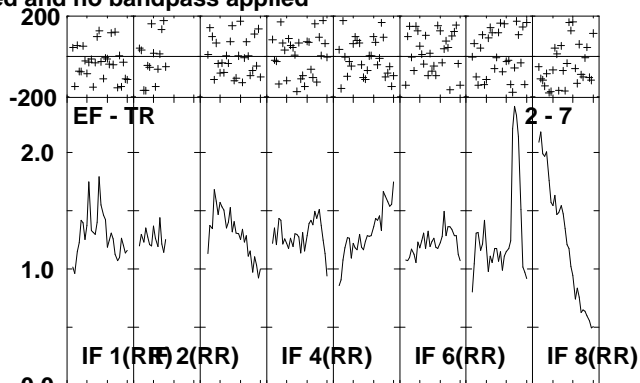
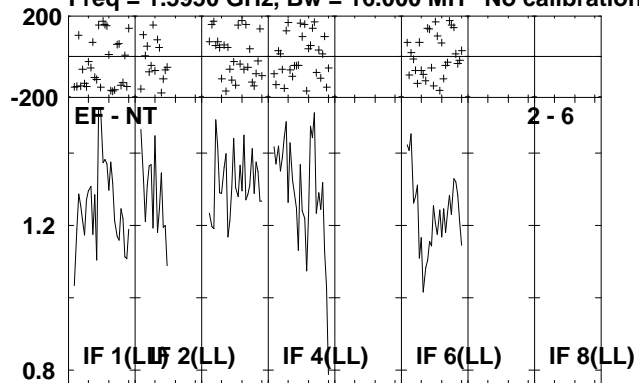

Lower frame: Milli Ampl Jy Top frame: Phas deg
Scalar averaged cross-power spectrum Several baselines displayed
Timerange: 00/14:11:31 to 00/14:15:09

Plot file version 101 created 06-JUL-2010 14:43:07

J2330+33 EP064J.UVDATA.1

Freq = 1.5950 GHz, Bw = 16.000 MH No calibration applied and no bandpass applied

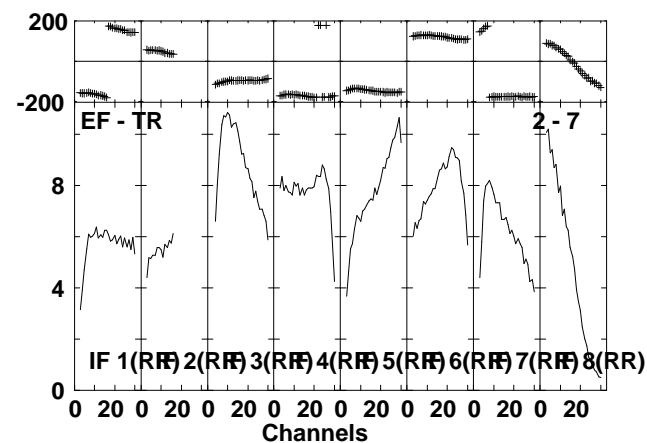
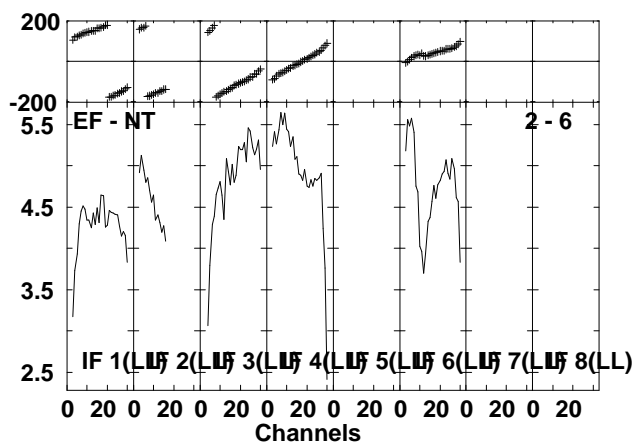
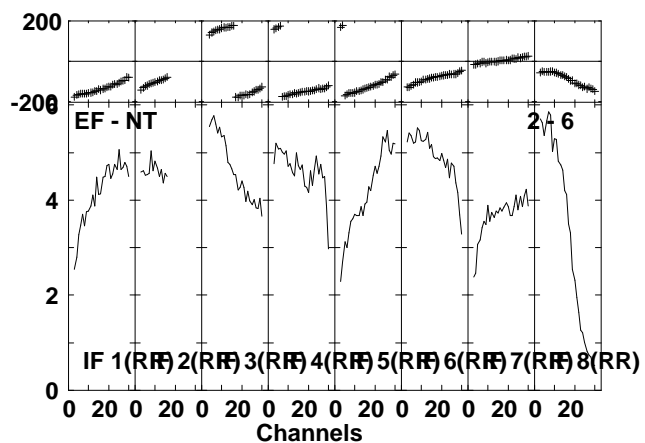
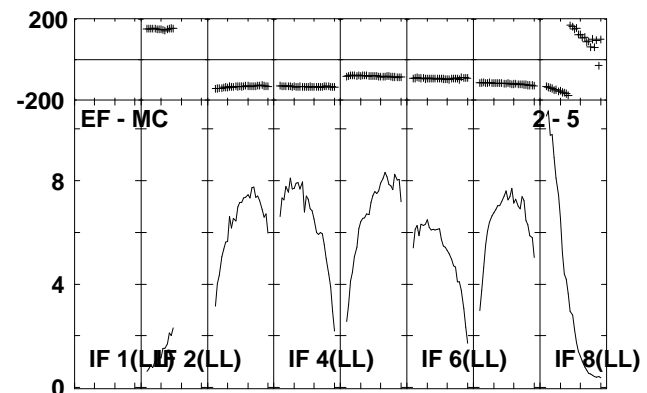
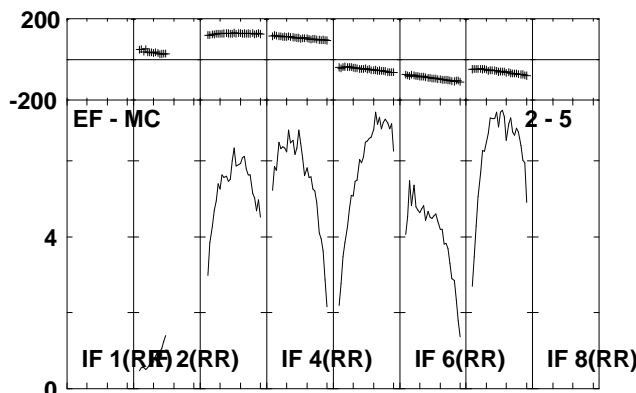
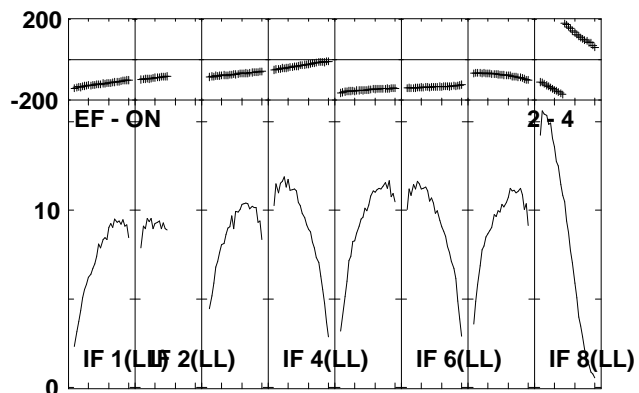
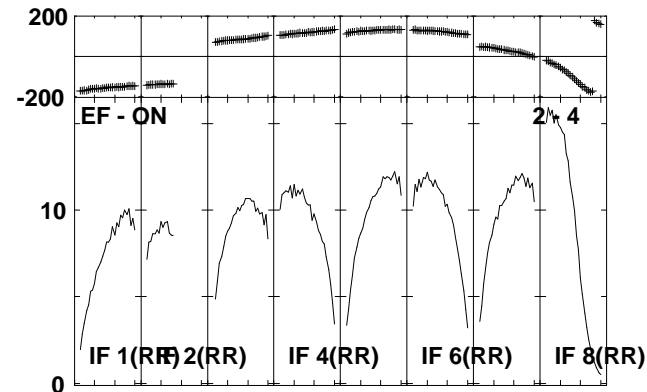
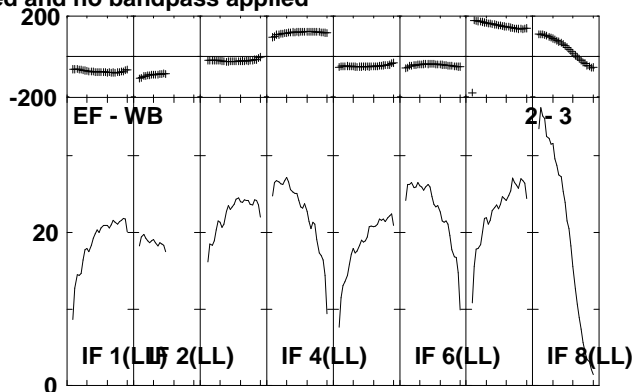
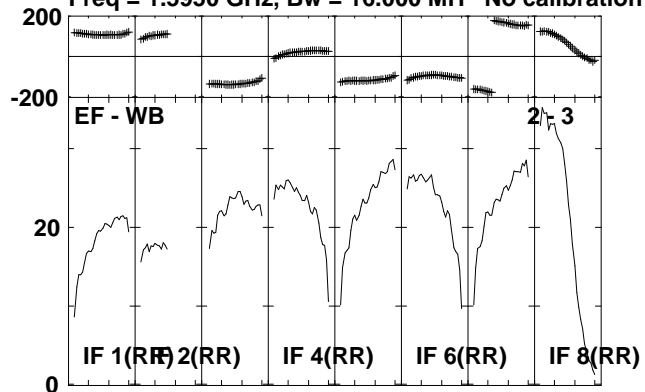

Lower frame: Milli Ampl Jy Top frame: Phas deg
Scalar averaged cross-power spectrum Several baselines displayed
Timerange: 00/14:16:11 to 00/14:17:47

Plot file version 102 created 06-JUL-2010 14:43:07

J2330+33 EP064J.UVDATA.1

Freq = 1.5950 GHz, Bw = 16.000 MH No calibration applied and no bandpass applied

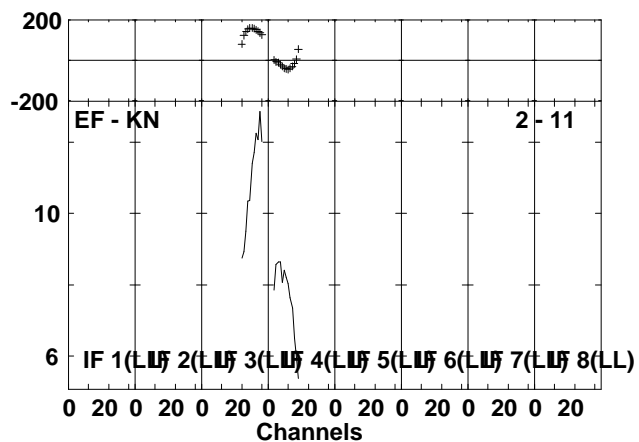
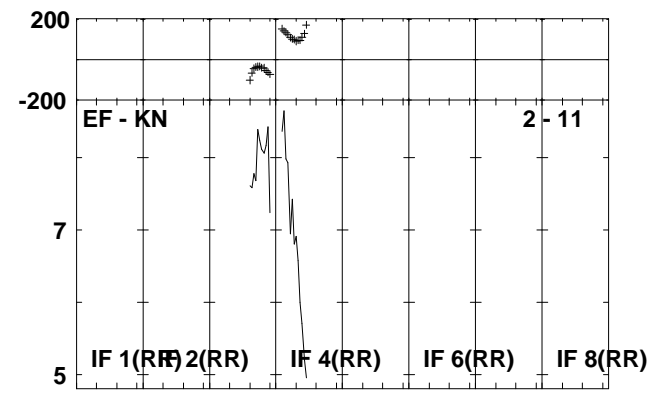
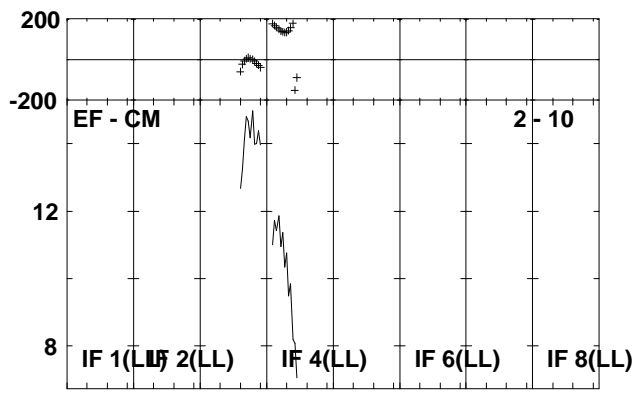
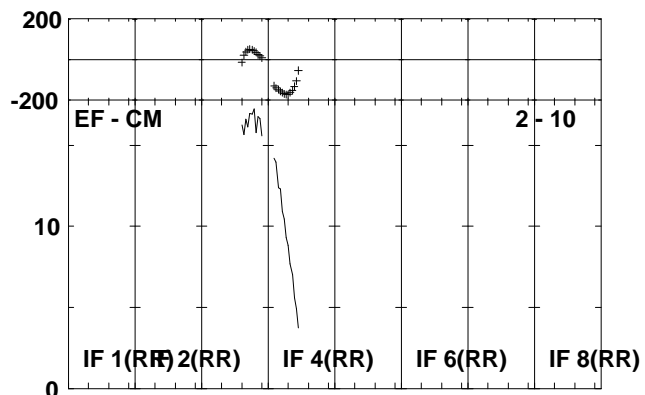
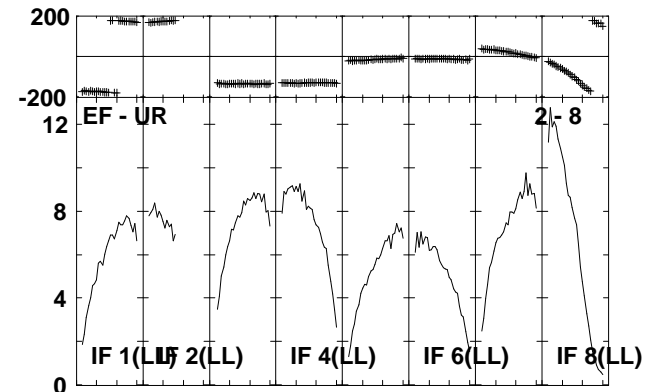
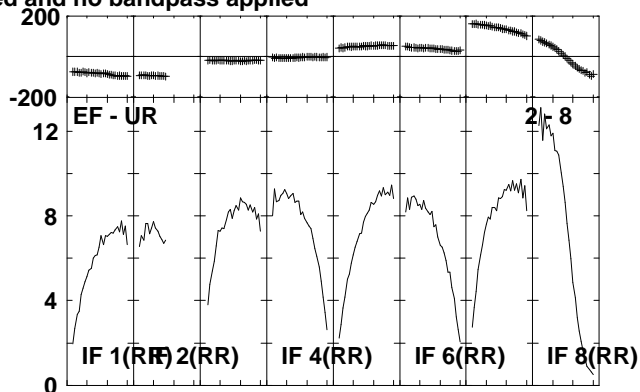
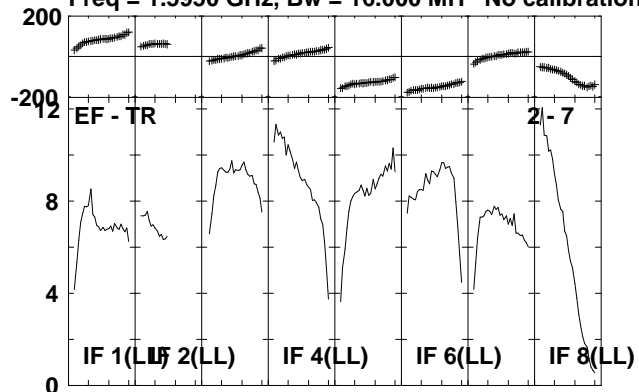

Lower frame: Milli Ampl Jy Top frame: Phas deg
Scalar averaged cross-power spectrum Several baselines displayed
Timerange: 00/14:16:11 to 00/14:17:47

Plot file version 103 created 06-JUL-2010 14:43:09

IRAS2336 EP064J.UVDATA.1

Freq = 1.5950 GHz, Bw = 16.000 MH No calibration applied and no bandpass applied

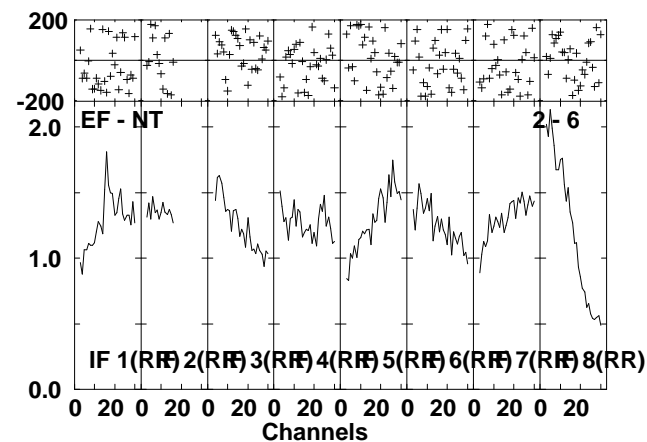
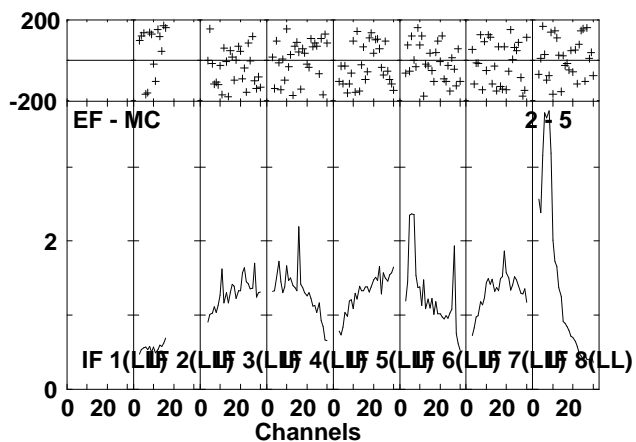
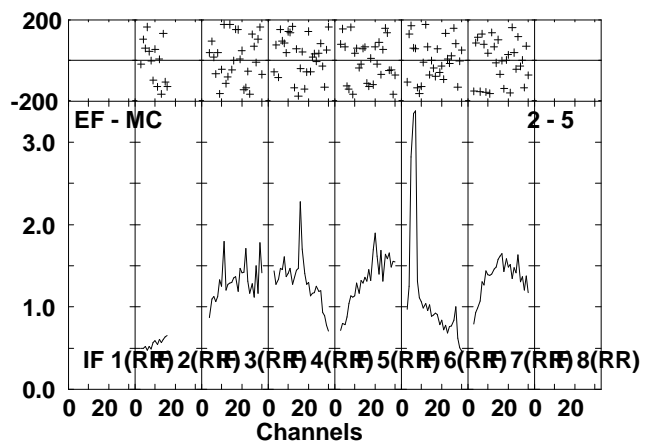
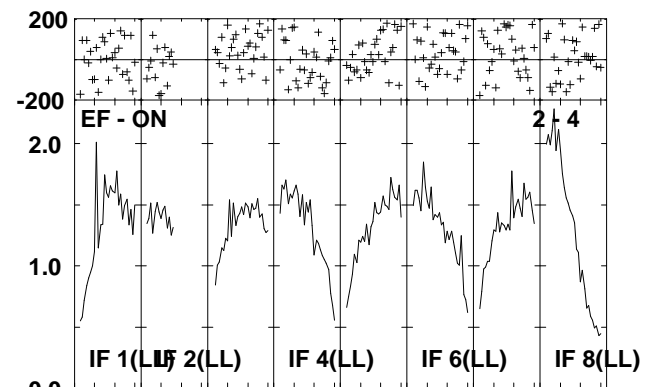
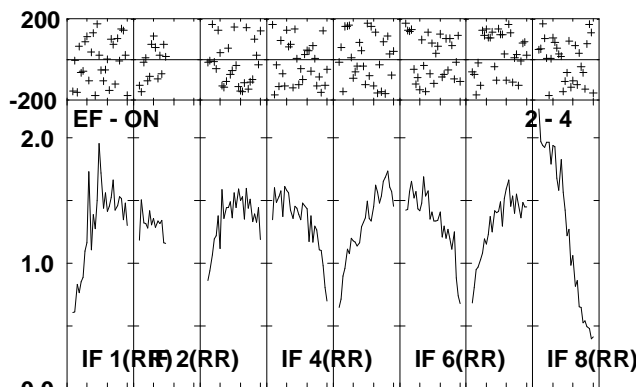
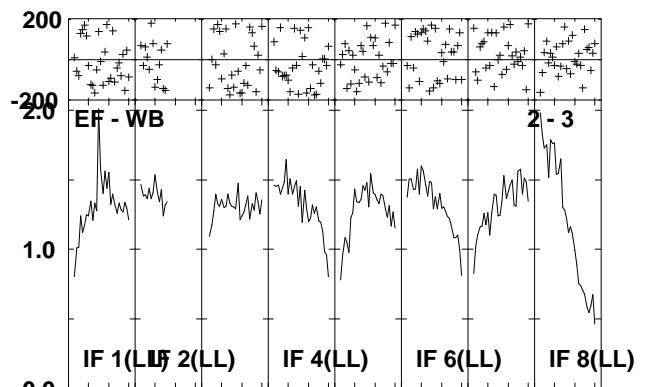
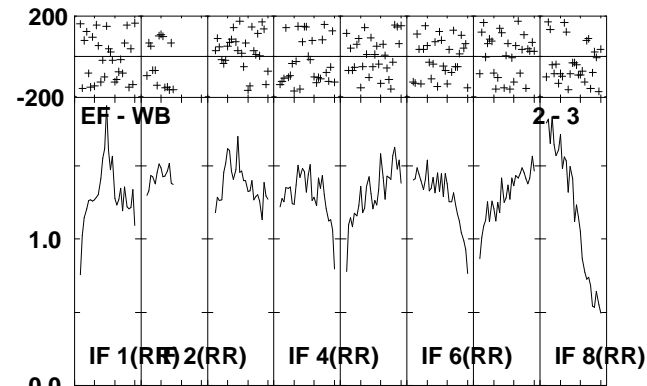
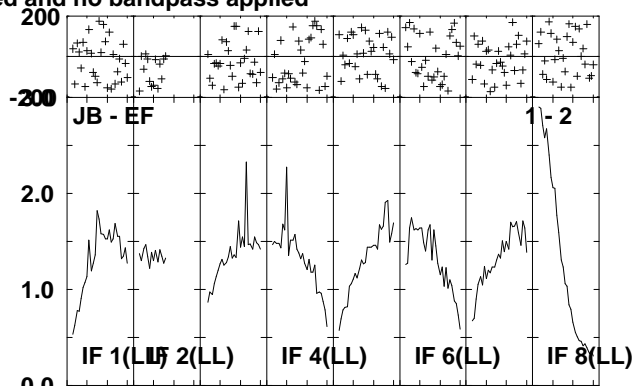
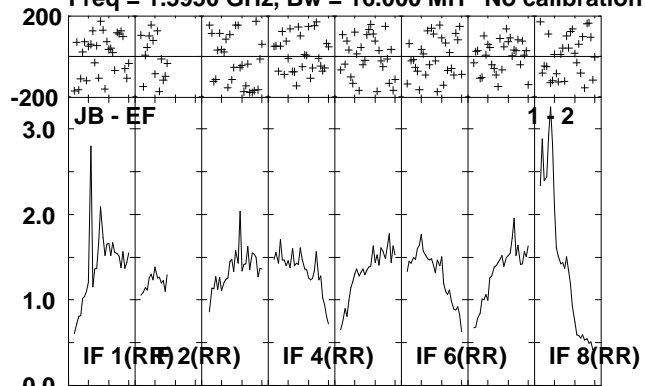

Lower frame: Millli Ampl Jy Top frame: Phas deg
Scalar averaged cross-power spectrum Several baselines displayed
Timerange: 00/14:17:51 to 00/14:21:29

Plot file version 104 created 06-JUL-2010 14:43:10

IRAS2336 EP064J.UVDATA.1

Freq = 1.5950 GHz, Bw = 16.000 MH No calibration applied and no bandpass applied

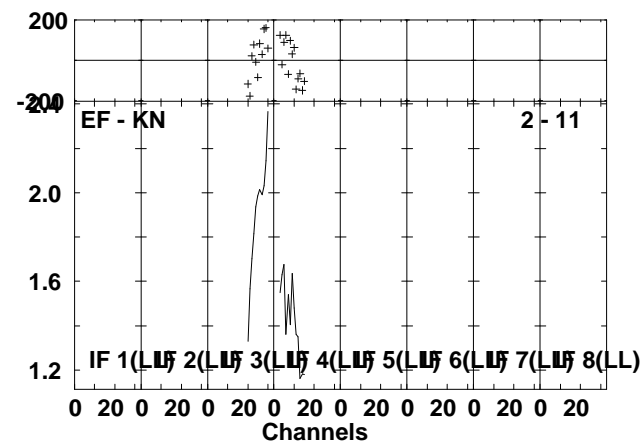
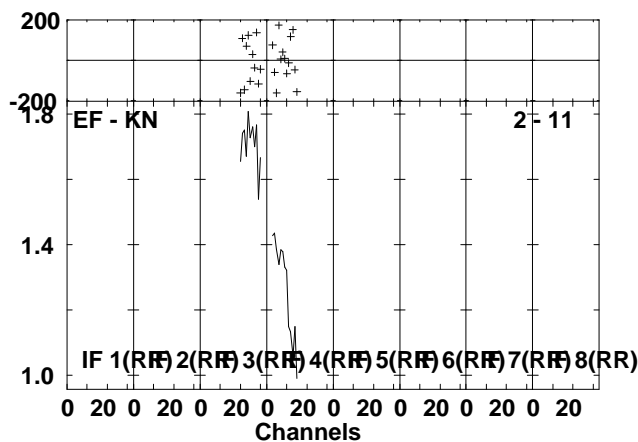
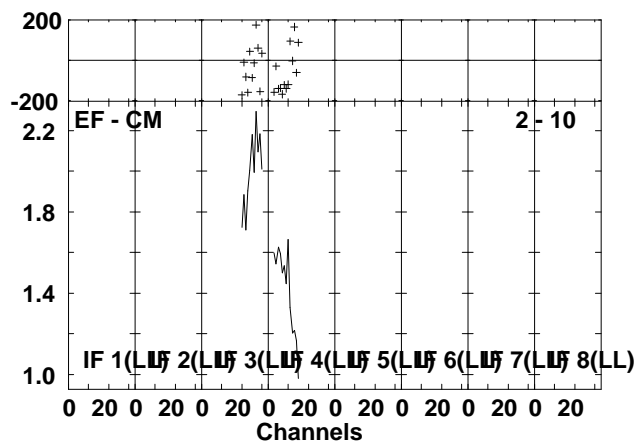
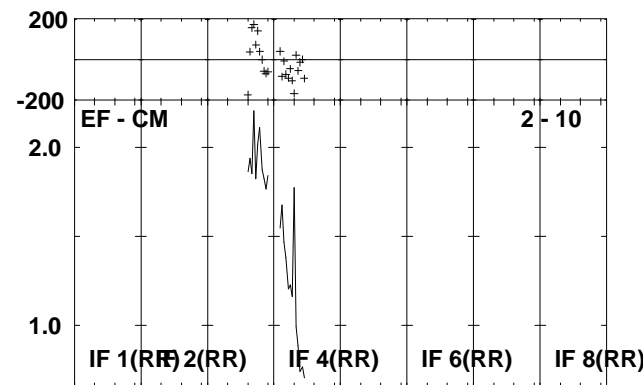
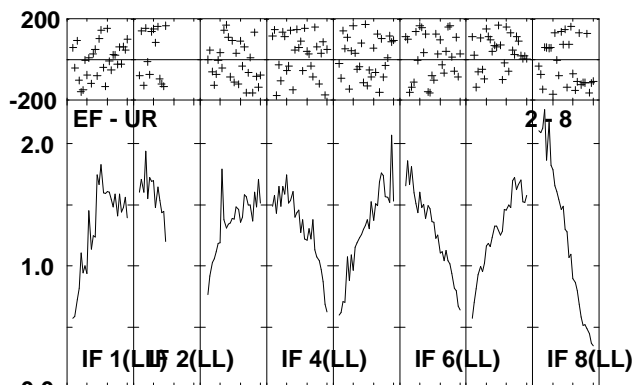
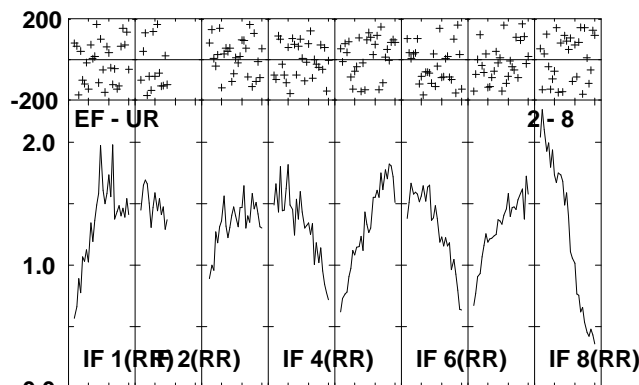
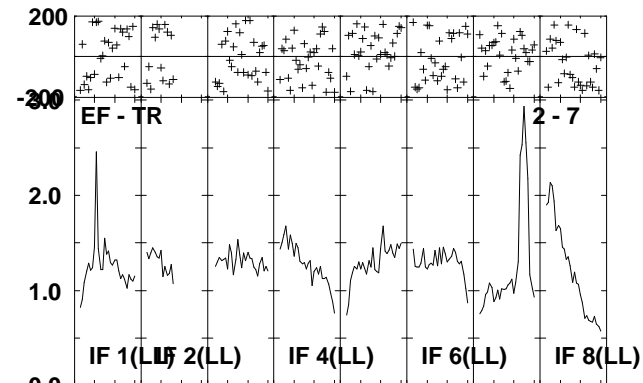
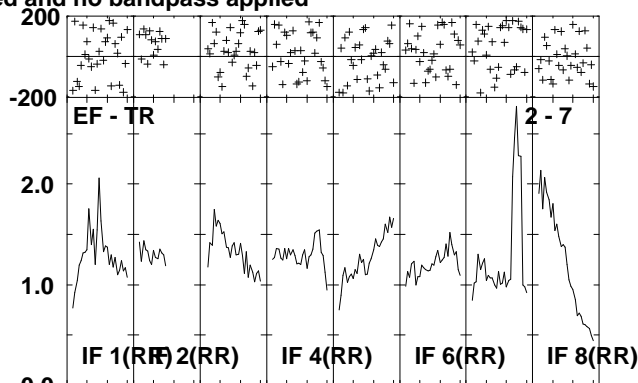
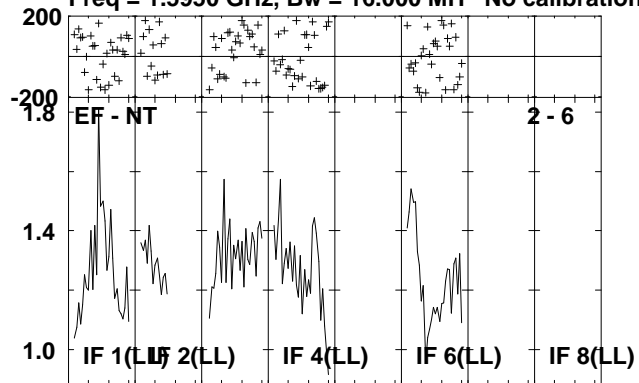

Lower frame: Milli Ampl Jy Top frame: Phas deg
Scalar averaged cross-power spectrum Several baselines displayed
Timerange: 00/14:17:51 to 00/14:21:29

Plot file version 105 created 06-JUL-2010 14:43:13

J2330+33 EP064J.UVDATA.1

Freq = 1.5950 GHz, Bw = 16.000 MH No calibration applied and no bandpass applied

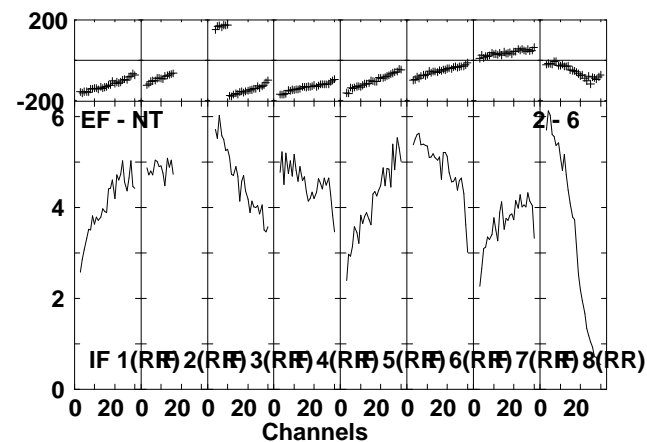
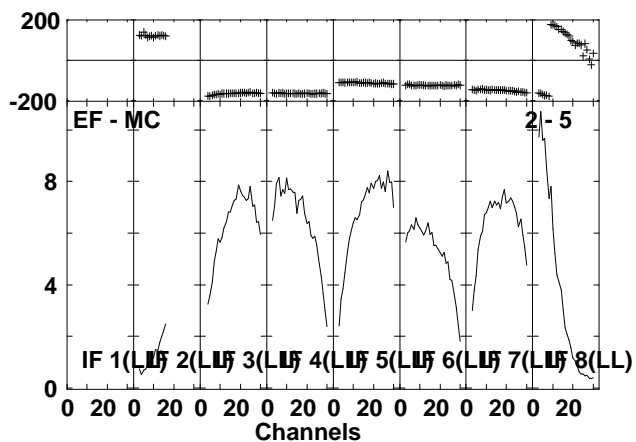
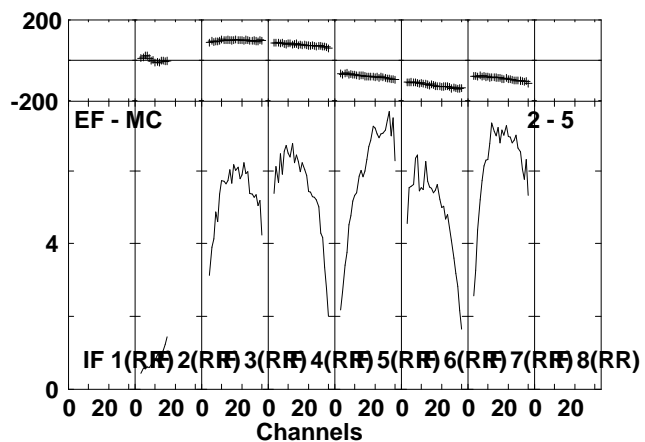
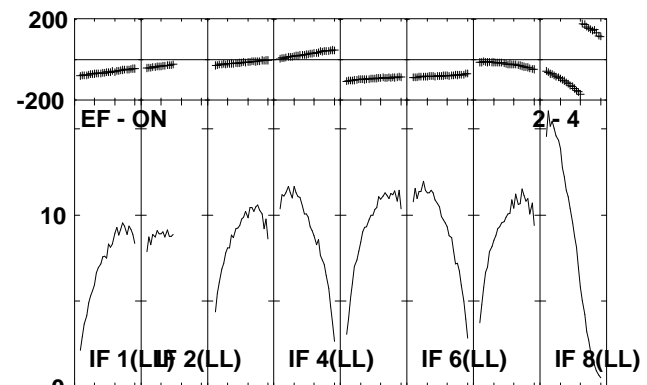
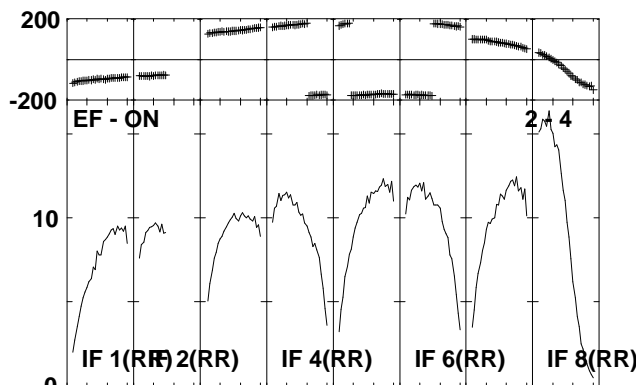
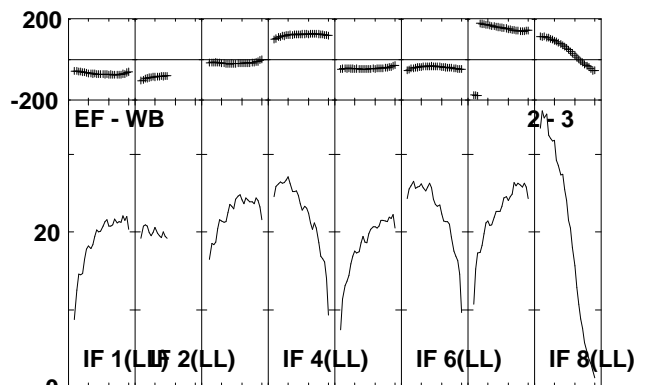
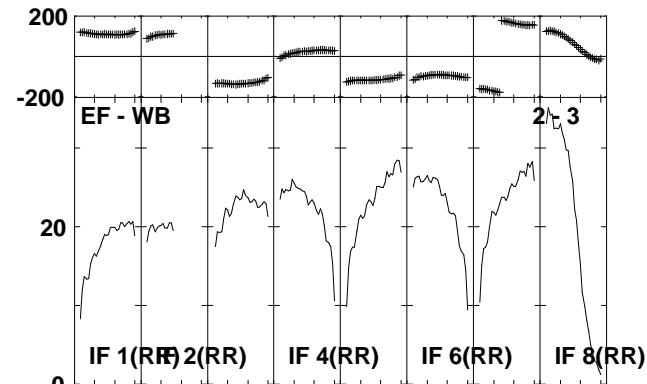
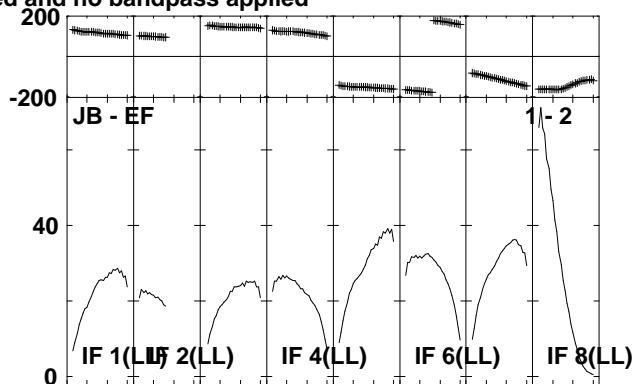
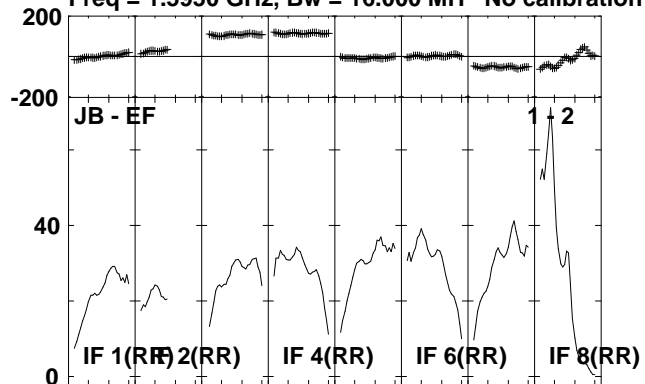

Lower frame: Milli Ampl Jy Top frame: Phas deg
Scalar averaged cross-power spectrum Several baselines displayed
Timerange: 00/14:21:31 to 00/14:23:19

Plot file version 106 created 06-JUL-2010 14:43:14

J2330+33 EP064J.UVDATA.1

Freq = 1.5950 GHz, Bw = 16.000 MH No calibration applied and no bandpass applied

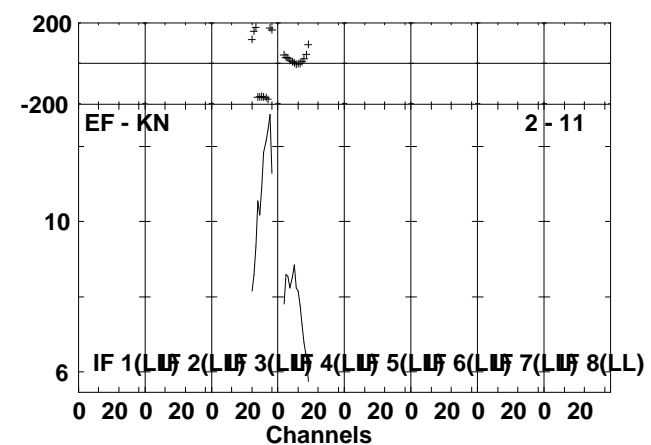
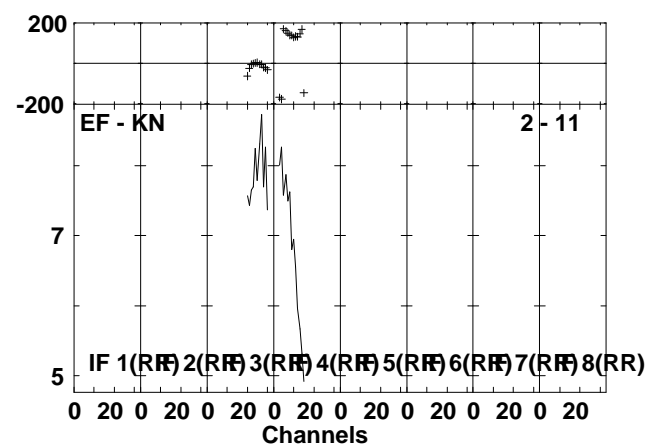
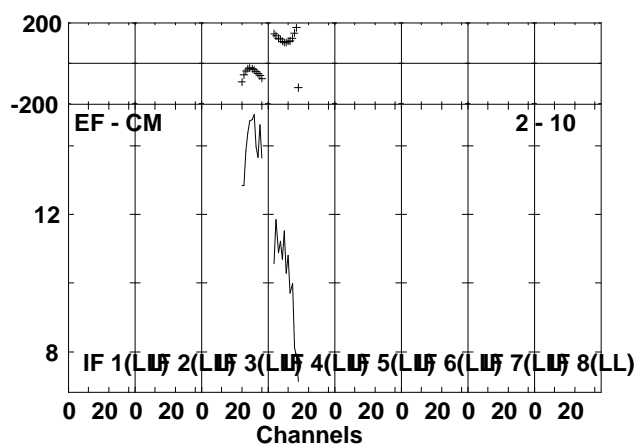
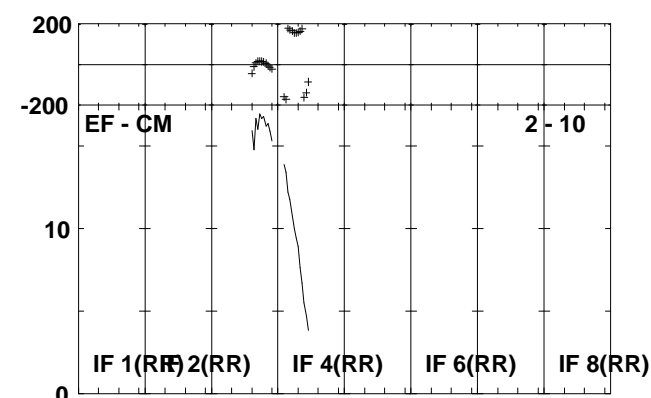
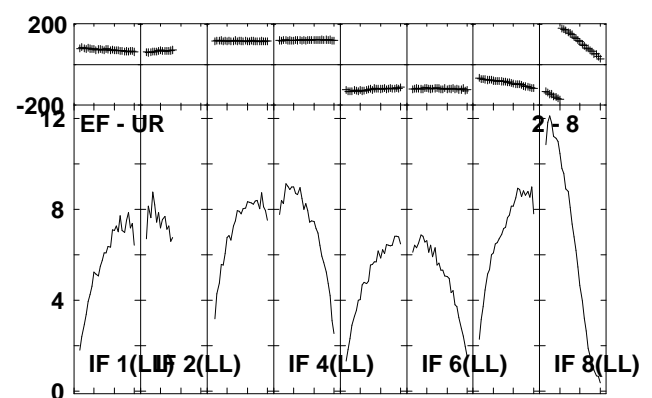
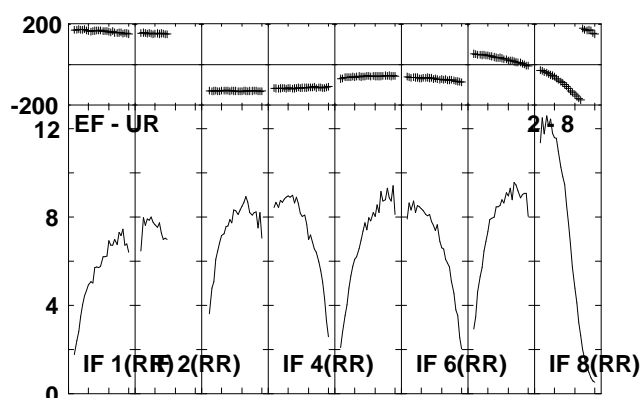
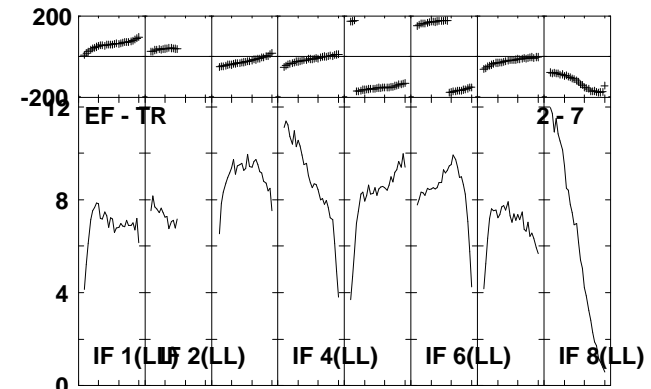
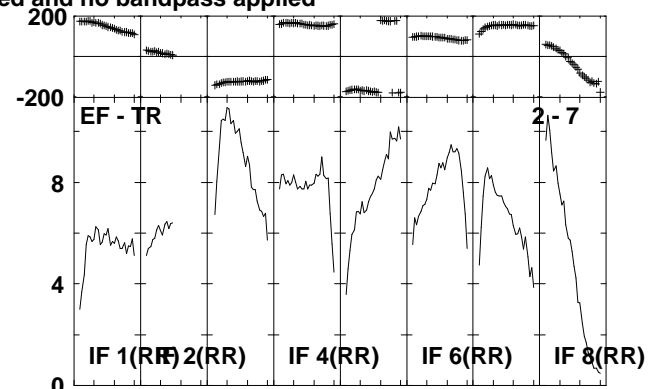
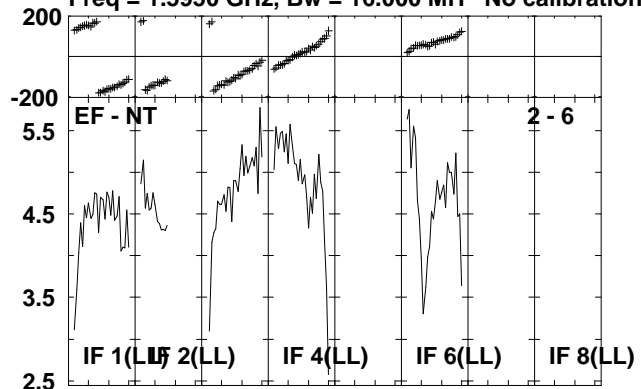

Lower frame: Milli Ampl Jy Top frame: Phas deg
Scalar averaged cross-power spectrum Several baselines displayed
Timerange: 00/14:21:31 to 00/14:23:19

Plot file version 107 created 06-JUL-2010 14:43:16

IRAS2336 EP064J.UVDATA.1

Freq = 1.5950 GHz, Bw = 16.000 MH No calibration applied and no bandpass applied

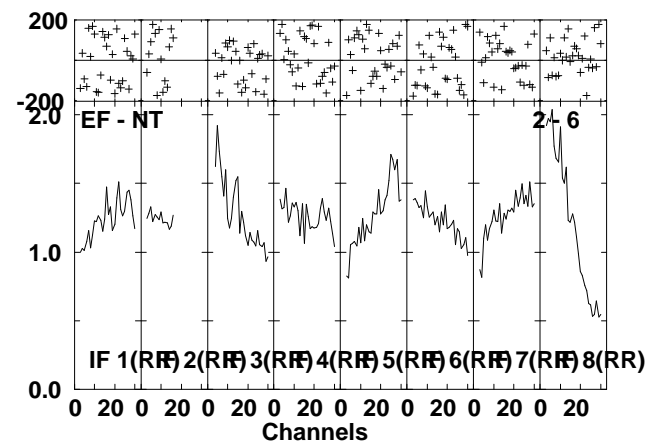
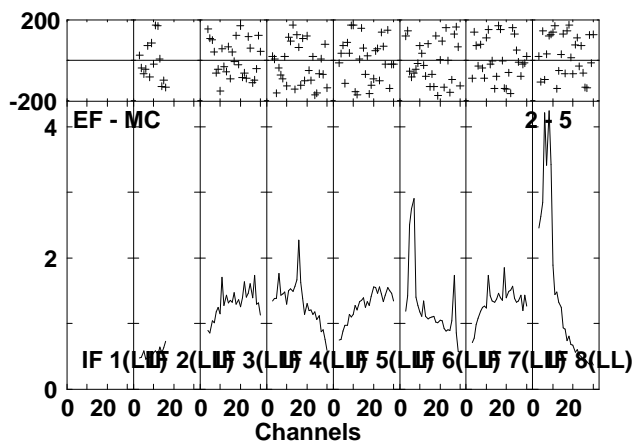
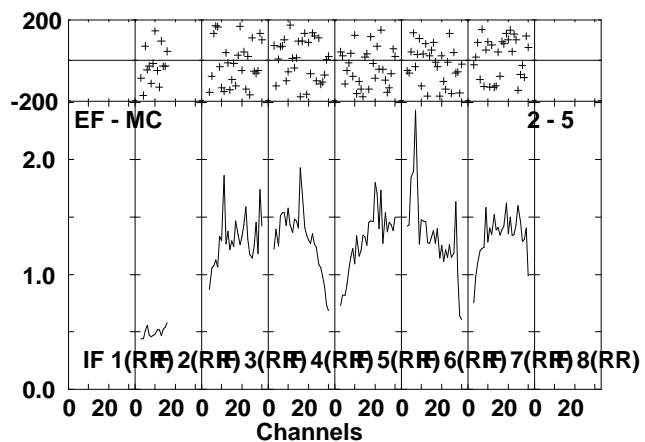
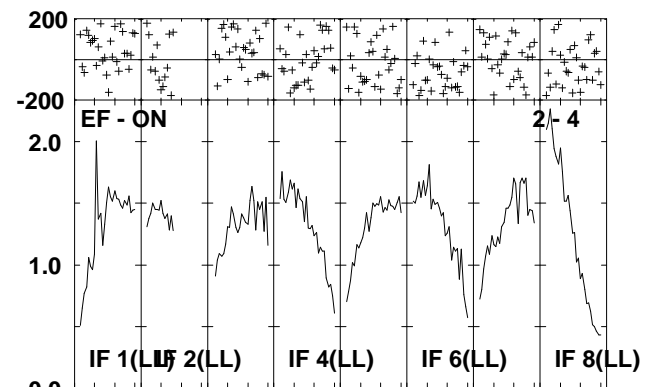
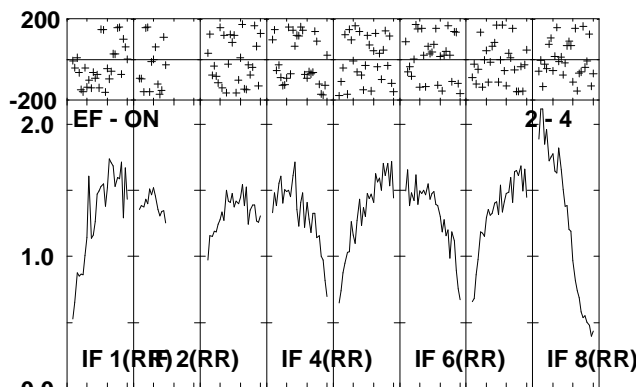
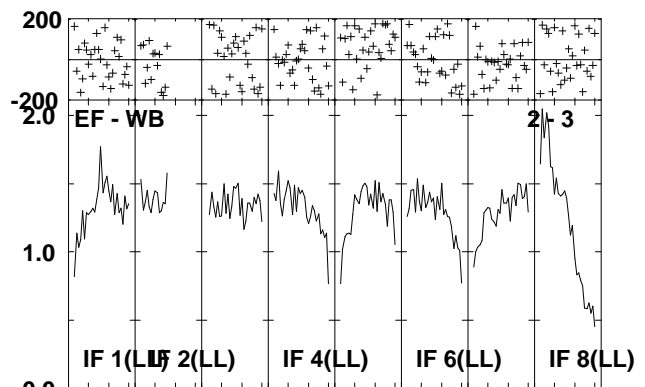
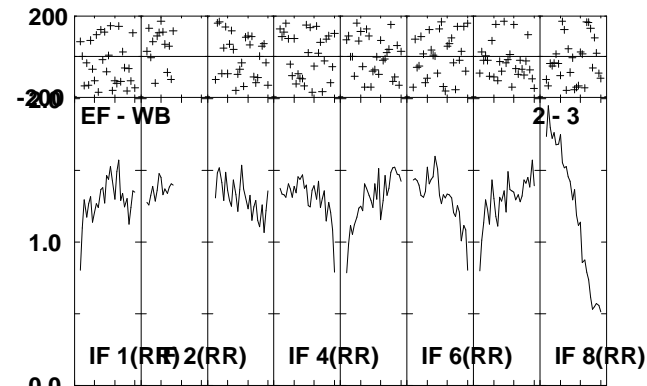
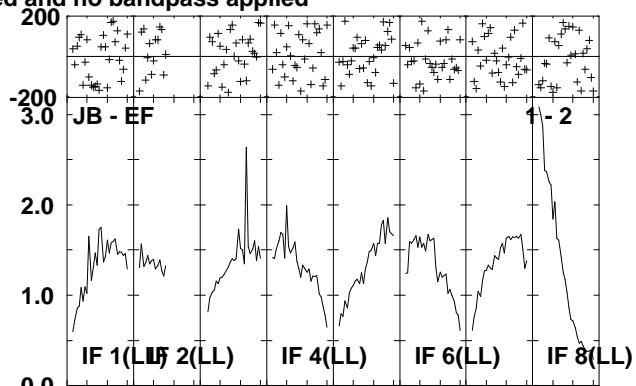
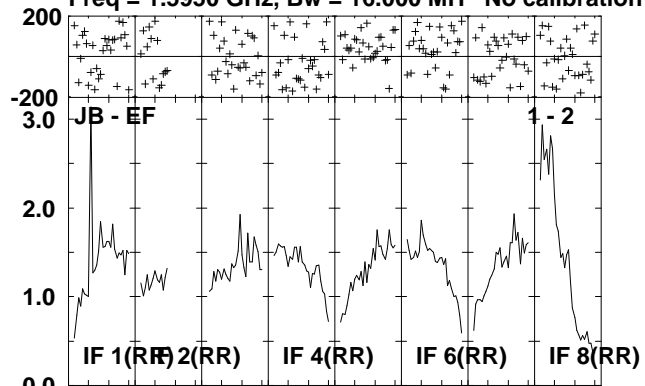

Lower frame: Milli Ampl Jy Top frame: Phas deg
Scalar averaged cross-power spectrum Several baselines displayed
Timerange: 00/14:23:21 to 00/14:26:59

Plot file version 108 created 06-JUL-2010 14:43:23

IRAS2336 EP064J.UVDATA.1

Freq = 1.5950 GHz, Bw = 16.000 MH No calibration applied and no bandpass applied

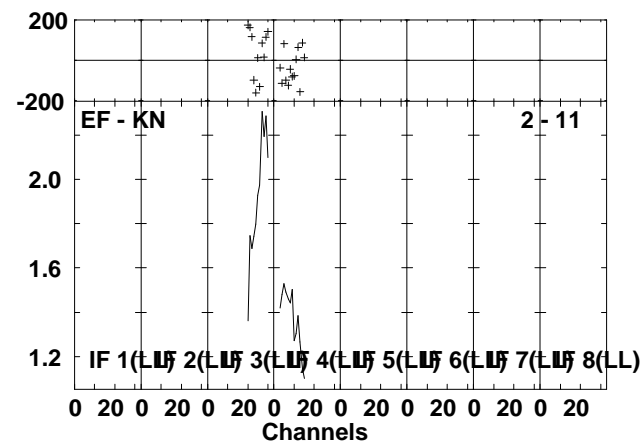
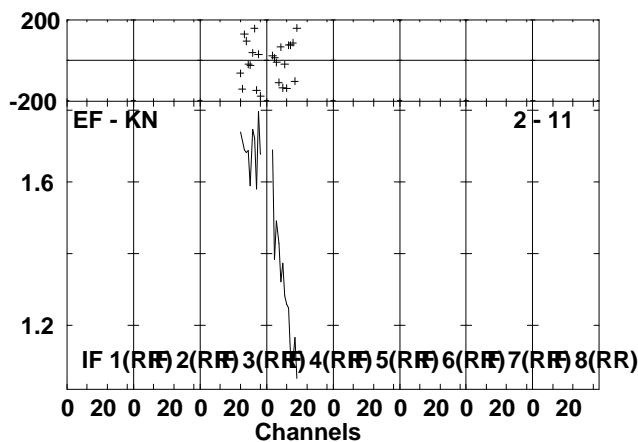
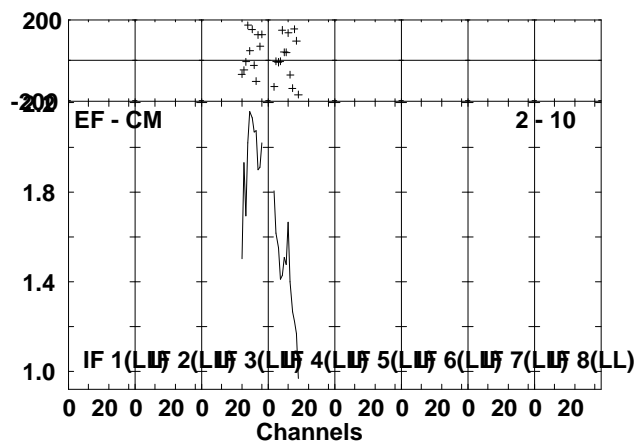
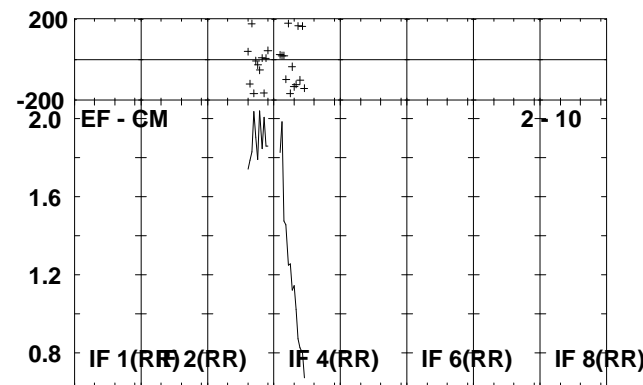
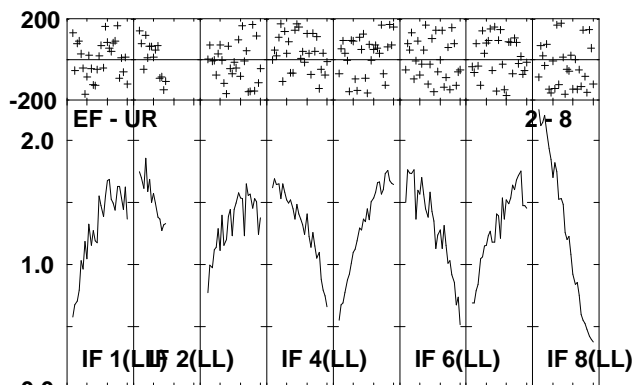
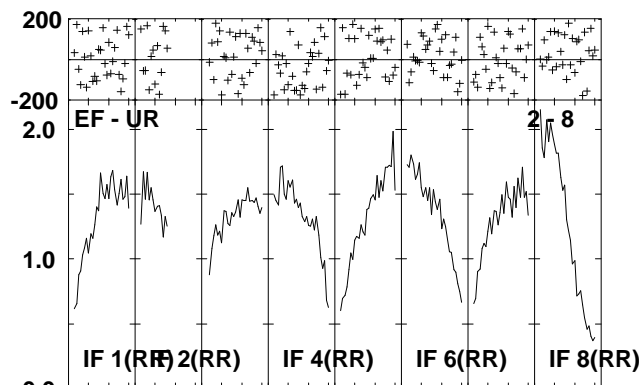
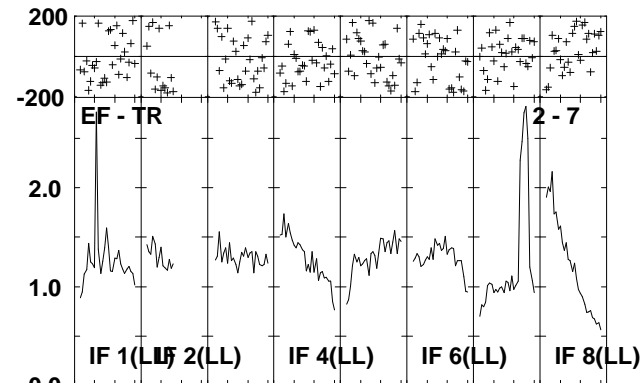
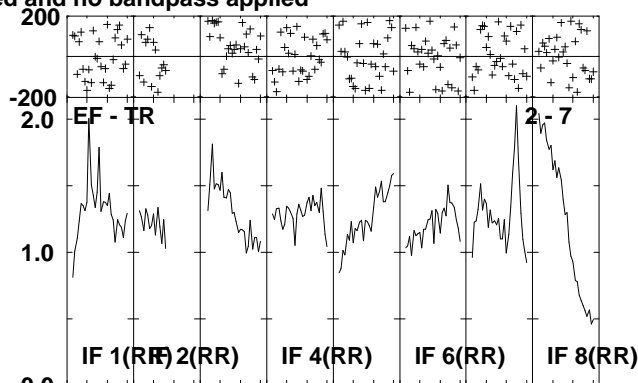
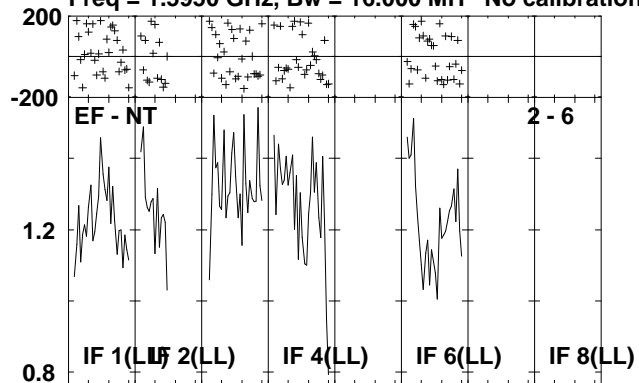

Lower frame: Milli Ampl Jy Top frame: Phas deg
Scalar averaged cross-power spectrum Several baselines displayed
Timerange: 00/14:23:21 to 00/14:26:59

Plot file version 109 created 06-JUL-2010 14:43:26

J2330+33 EP064J.UVDATA.1

Freq = 1.5950 GHz, Bw = 16.000 MH No calibration applied and no bandpass applied

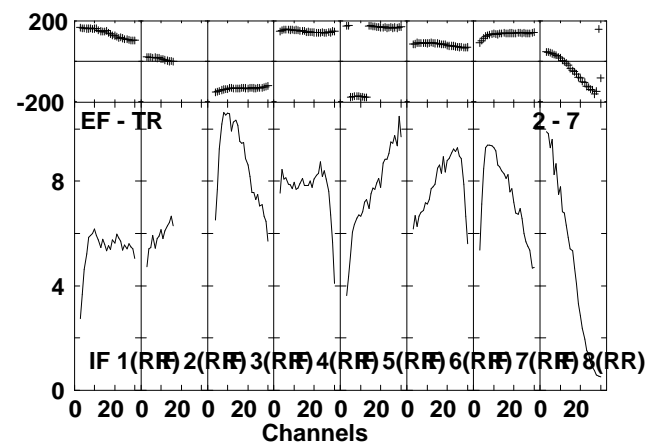
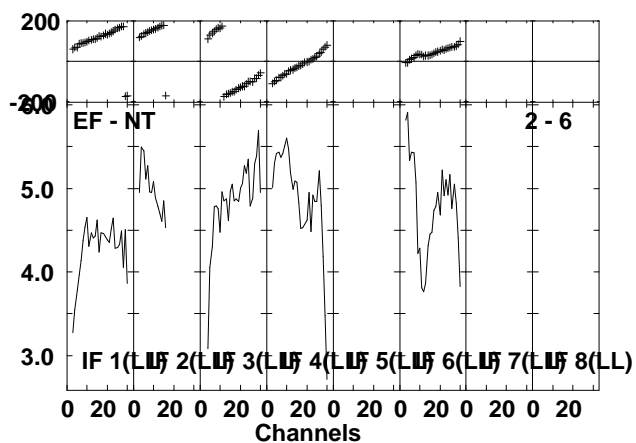
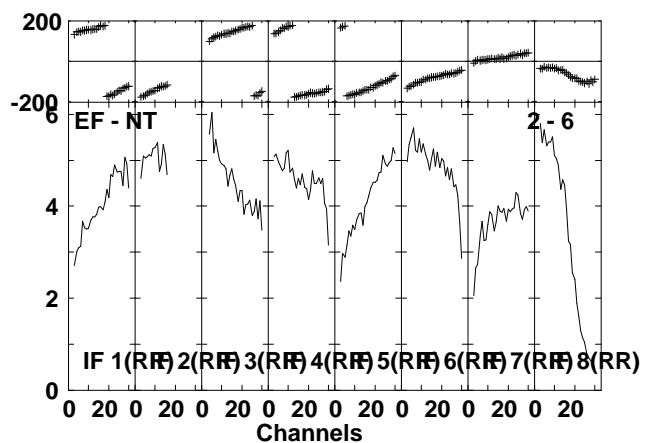
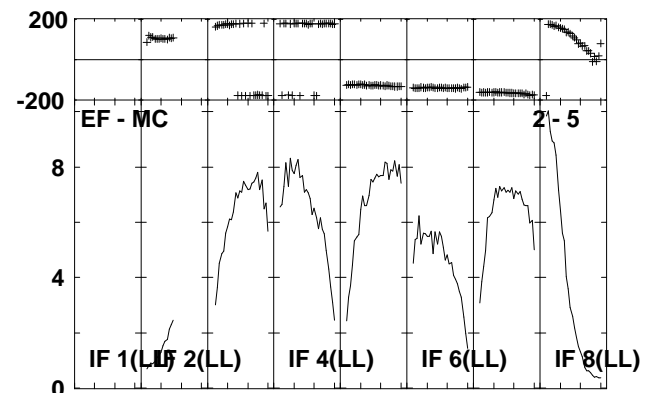
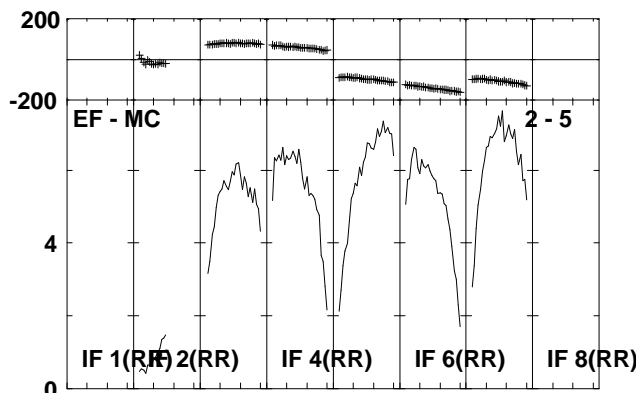
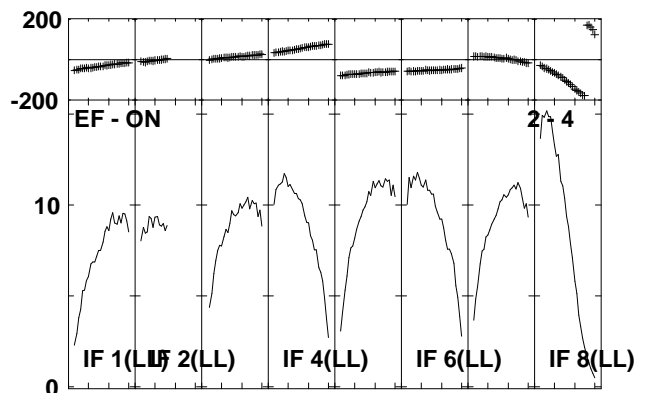
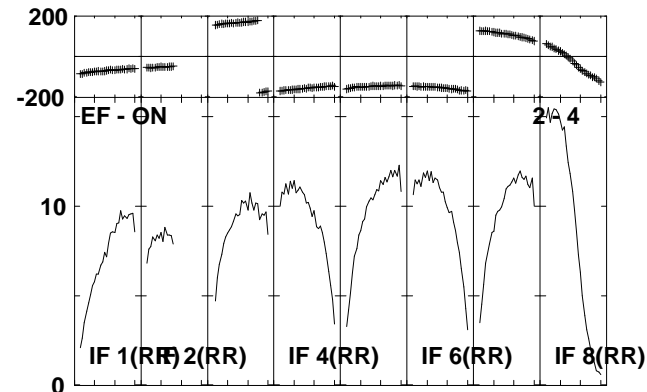
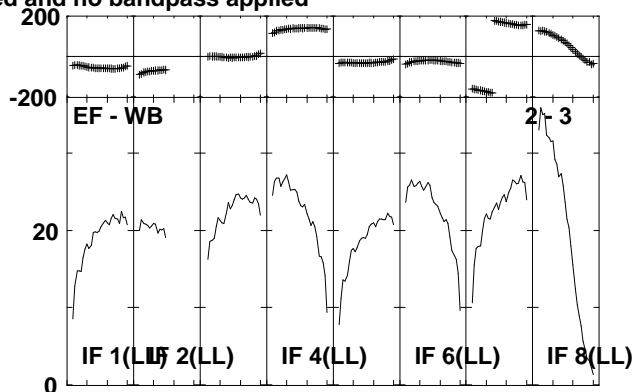
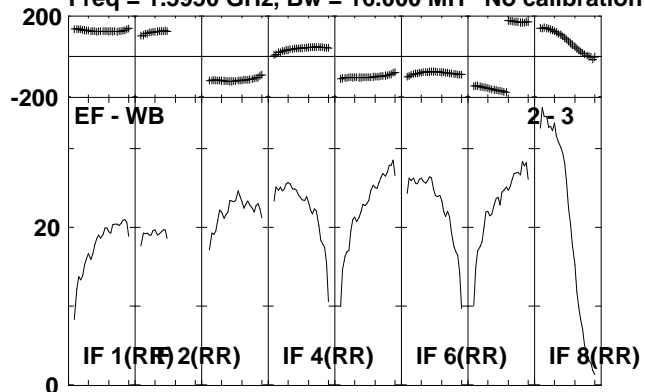

Lower frame: Milli Ampl Jy Top frame: Phas deg
Scalar averaged cross-power spectrum Several baselines displayed
Timerange: 00/14:27:01 to 00/14:28:49

Plot file version 110 created 06-JUL-2010 14:43:27

J2330+33 EP064J.UVDATA.1

Freq = 1.5950 GHz, Bw = 16.000 MH No calibration applied and no bandpass applied

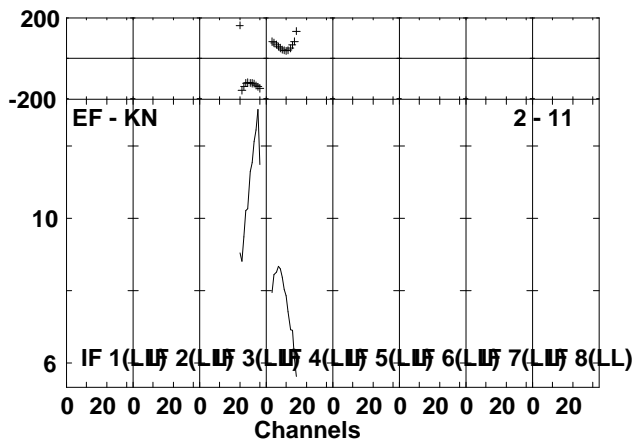
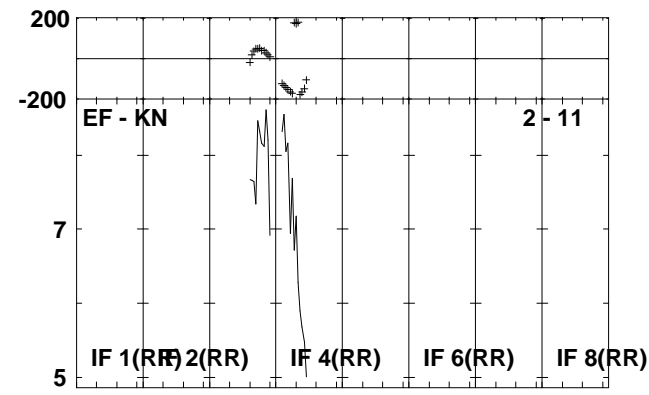
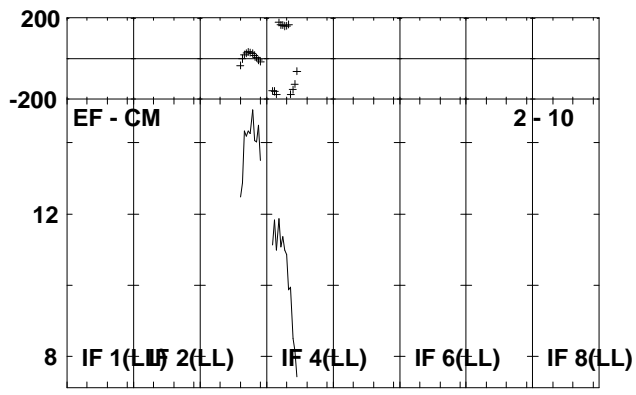
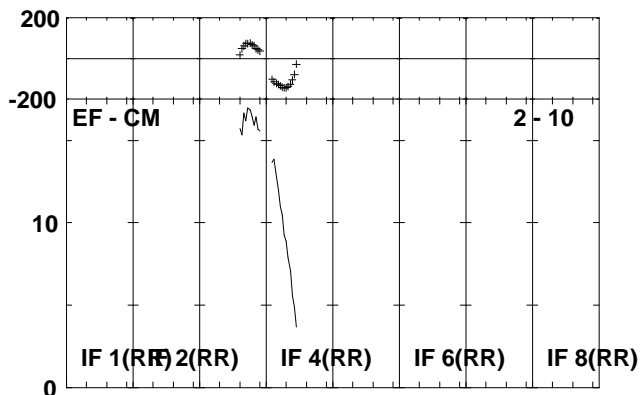
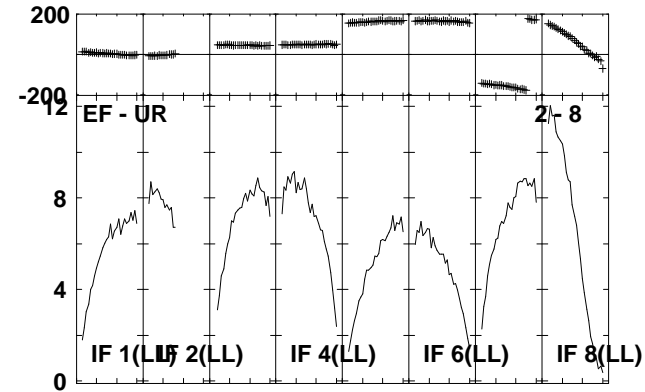
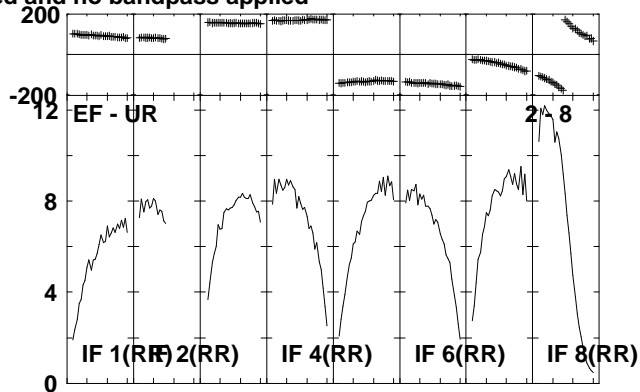
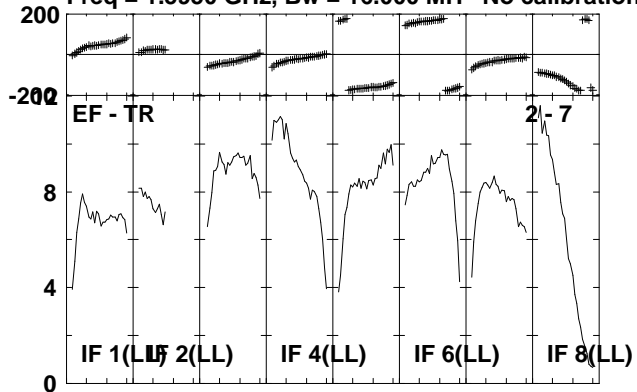

Lower frame: Milli Ampl Jy Top frame: Phas deg
Scalar averaged cross-power spectrum Several baselines displayed
Timerange: 00/14:27:01 to 00/14:28:49

Plot file version 111 created 06-JUL-2010 14:43:28

IRAS2336 EP064J.UVDATA.1

Freq = 1.5950 GHz, Bw = 16.000 MH No calibration applied and no bandpass applied

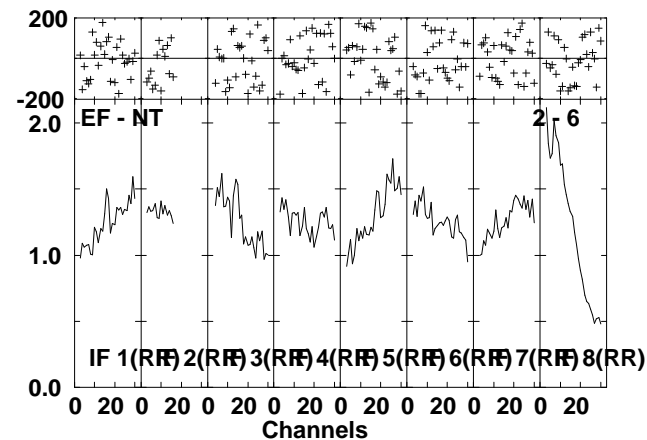
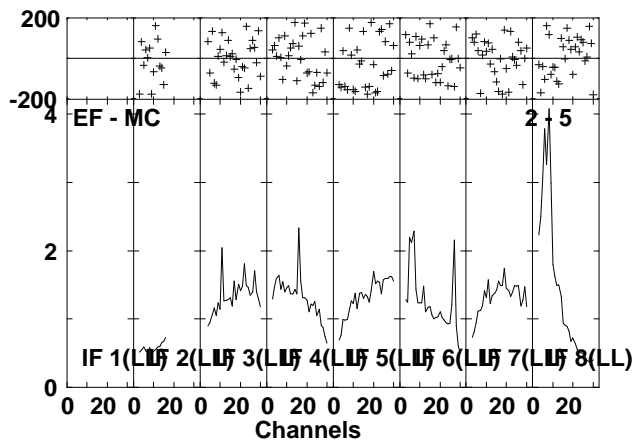
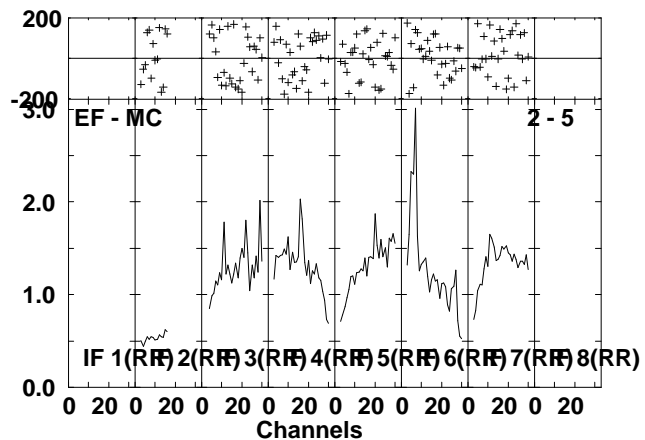
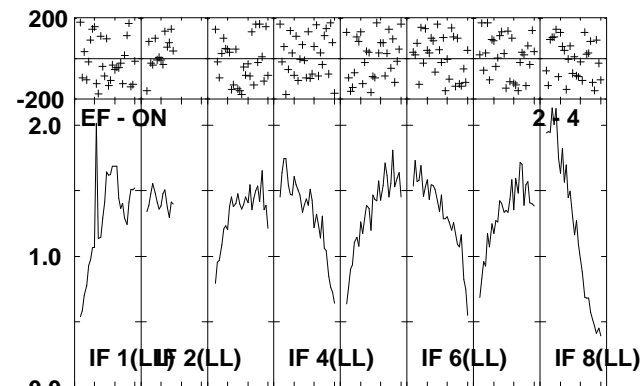
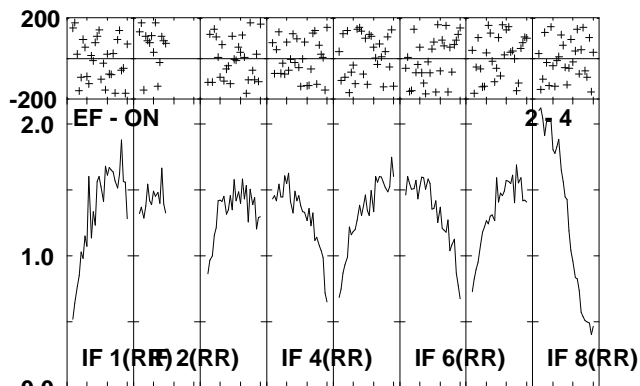
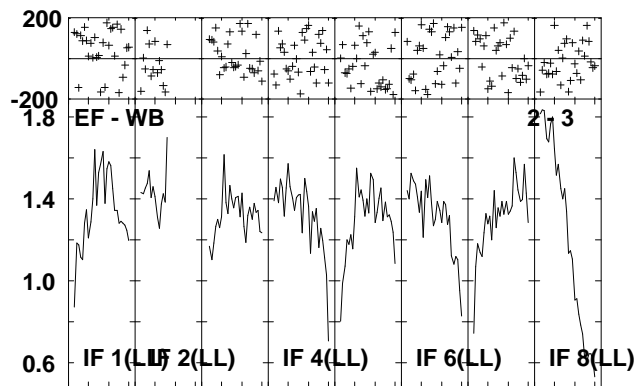
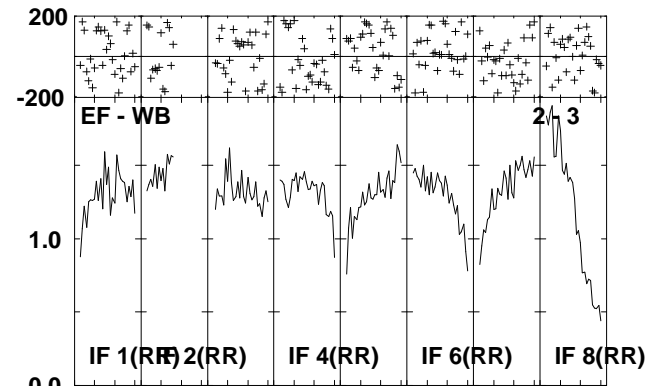
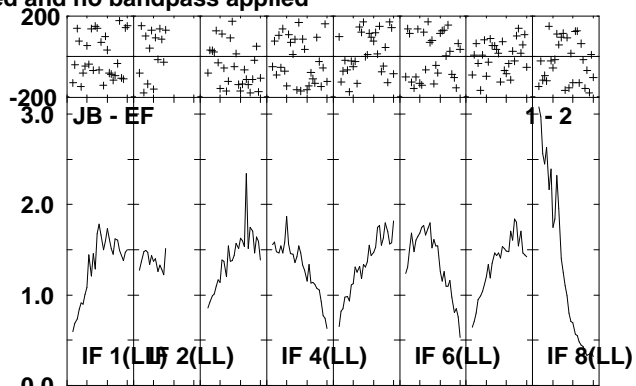
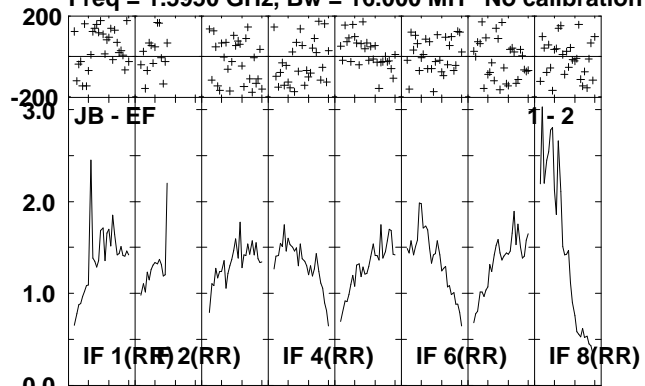

Lower frame: Milli Ampl Jy Top frame: Phas deg
Scalar averaged cross-power spectrum Several baselines displayed
Timerange: 00/14:28:51 to 00/14:32:29

Plot file version 112 created 06-JUL-2010 14:43:30

IRAS2336 EP064J.UVDATA.1

Freq = 1.5950 GHz, Bw = 16.000 MH No calibration applied and no bandpass applied

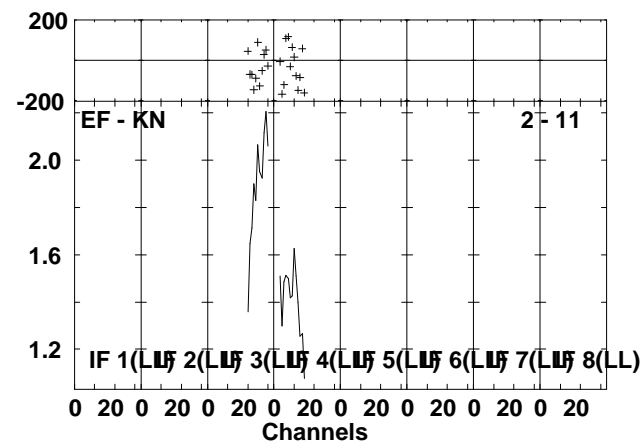
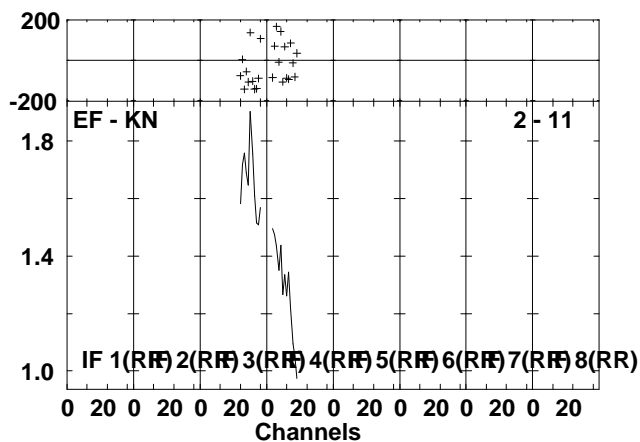
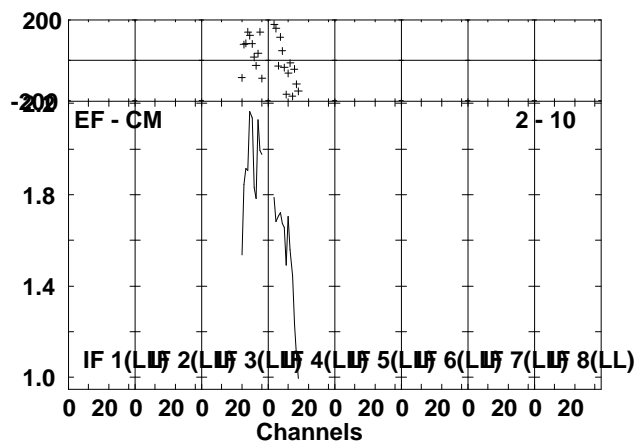
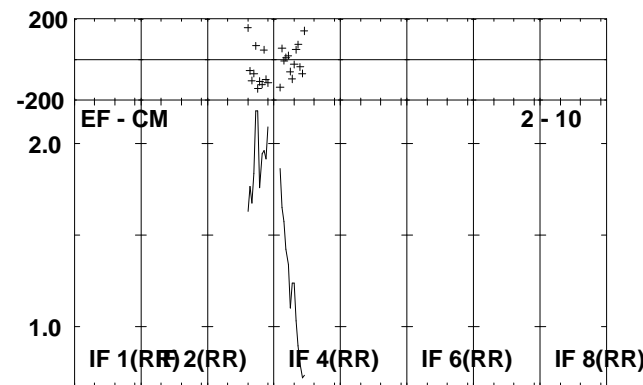
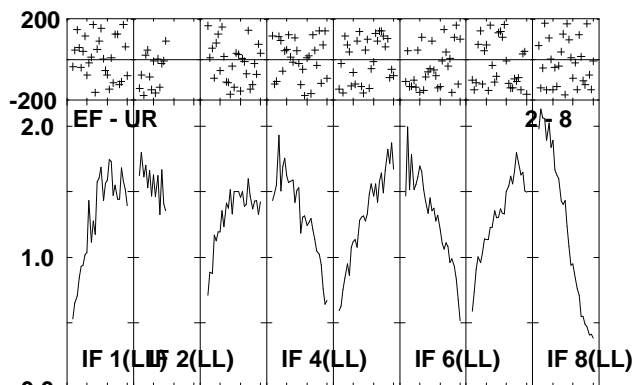
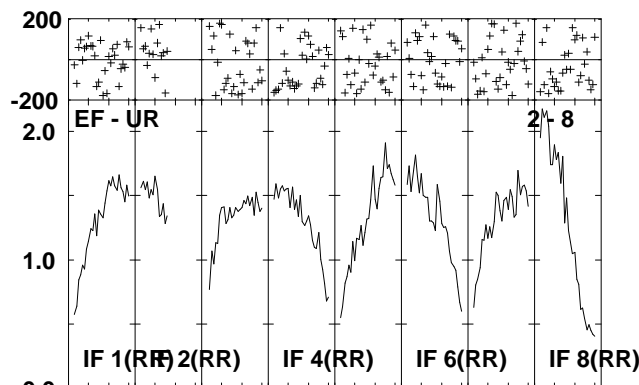
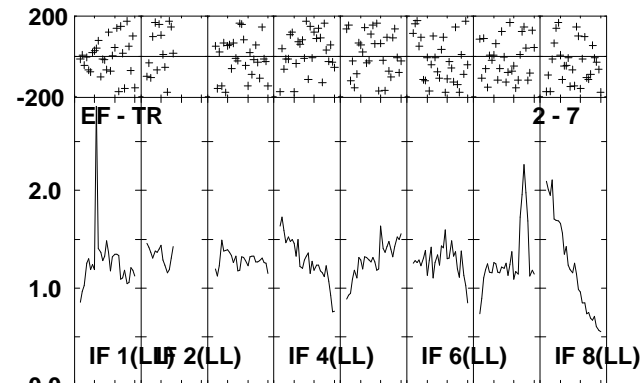
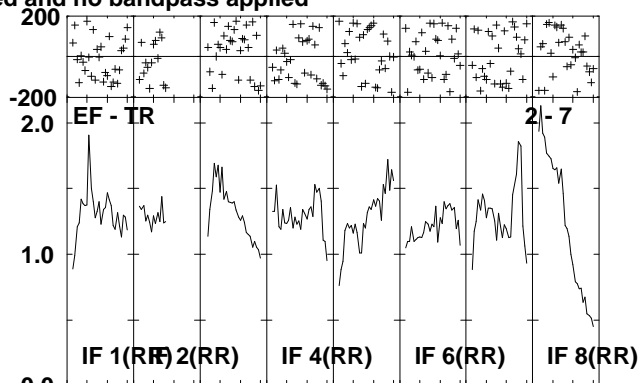
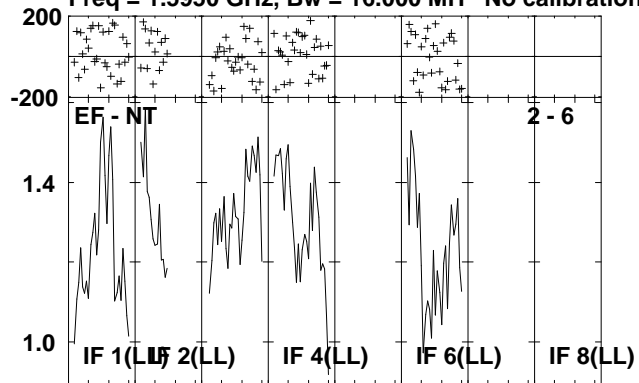

Lower frame: Milli Ampl Jy Top frame: Phas deg
Scalar averaged cross-power spectrum Several baselines displayed
Timerange: 00/14:28:51 to 00/14:32:29

Plot file version 113 created 06-JUL-2010 14:43:33

J2330+33 EP064J.UVDATA.1

Freq = 1.5950 GHz, Bw = 16.000 MH No calibration applied and no bandpass applied

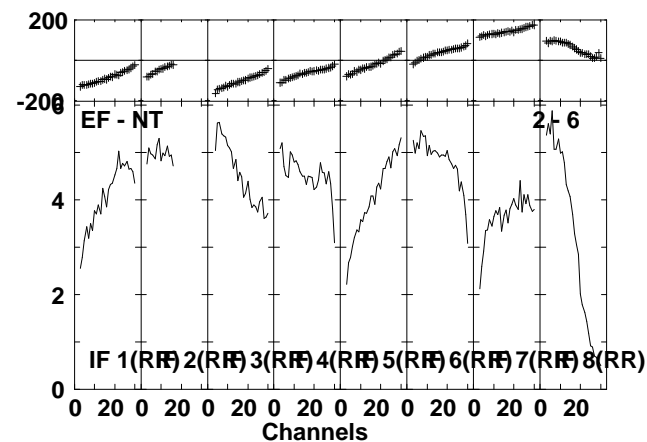
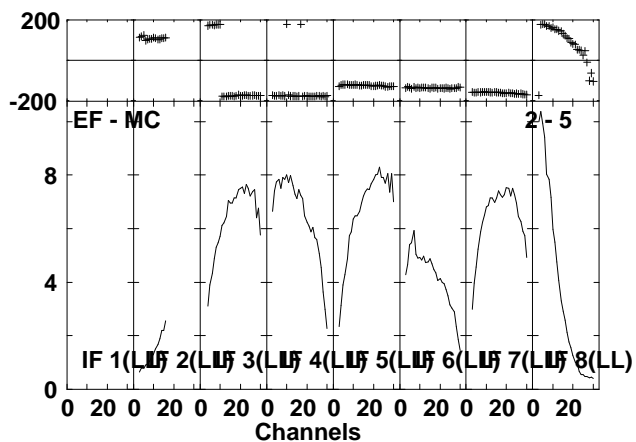
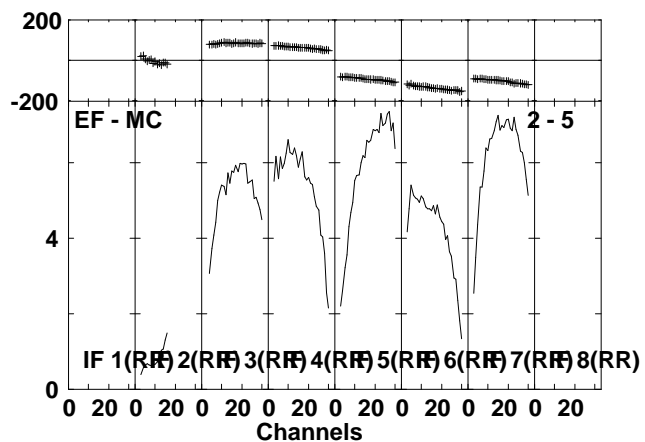
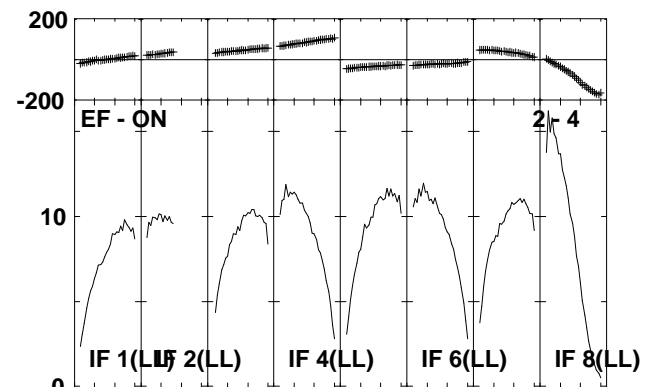
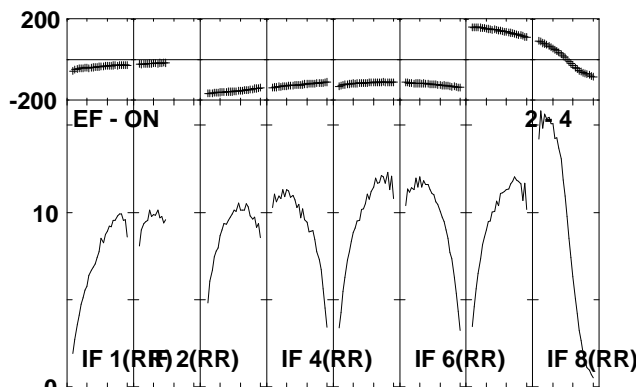
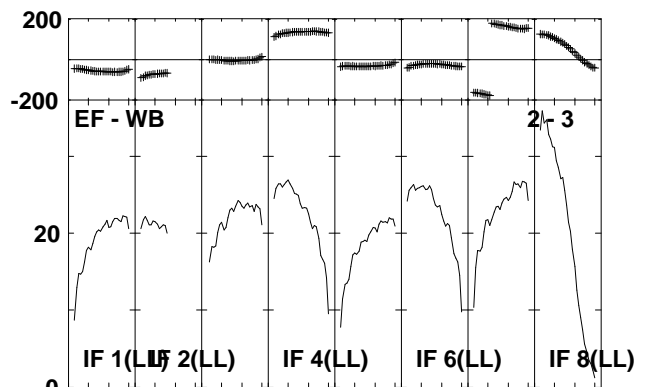
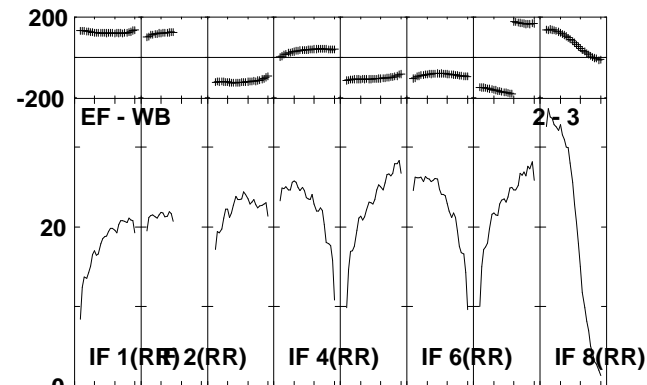
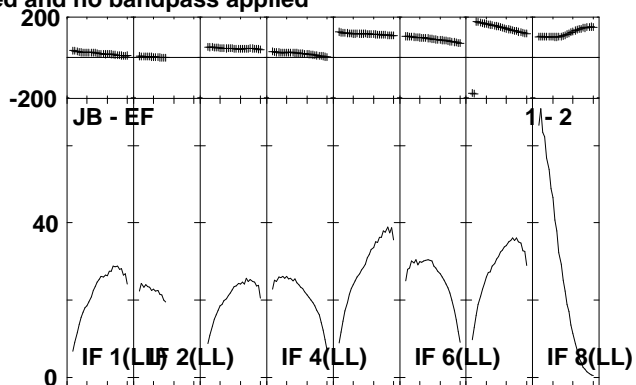
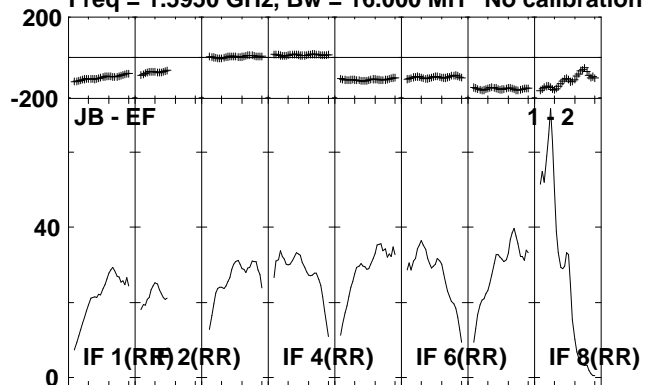

Lower frame: Milli Ampl Jy Top frame: Phas deg
Scalar averaged cross-power spectrum Several baselines displayed
Timerange: 00/14:33:31 to 00/14:35:09

Plot file version 114 created 06-JUL-2010 14:43:34

J2330+33 EP064J.UVDATA.1

Freq = 1.5950 GHz, Bw = 16.000 MH No calibration applied and no bandpass applied

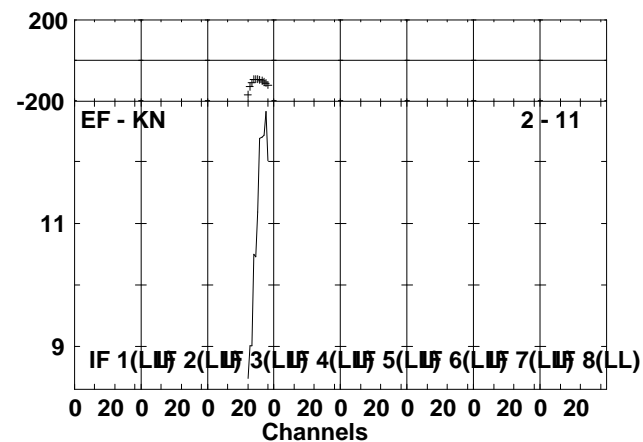
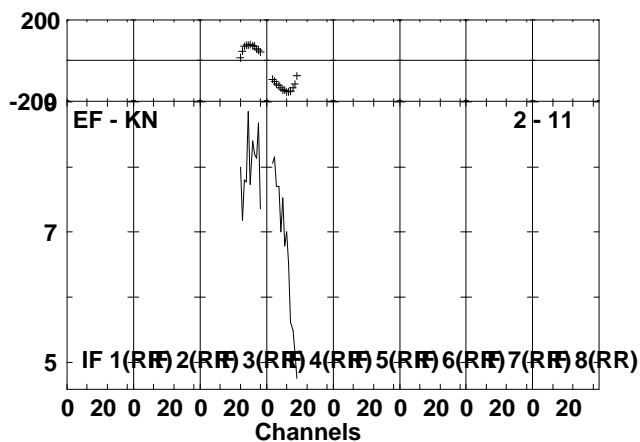
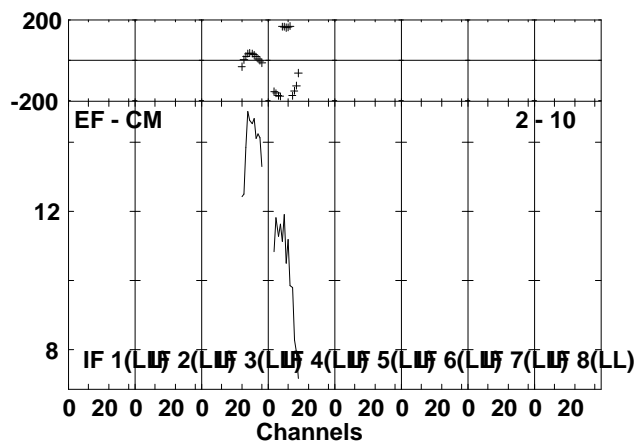
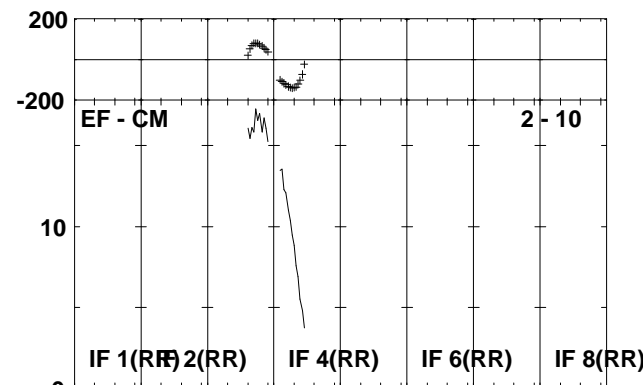
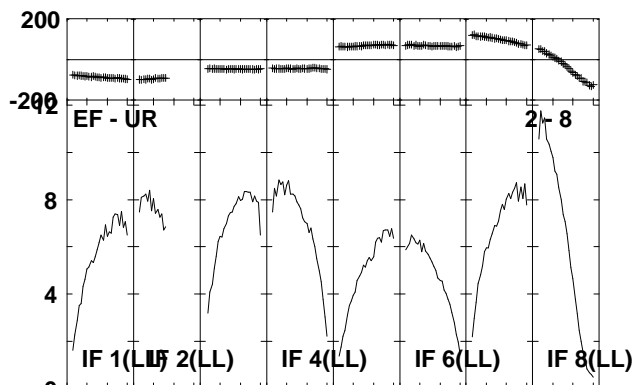
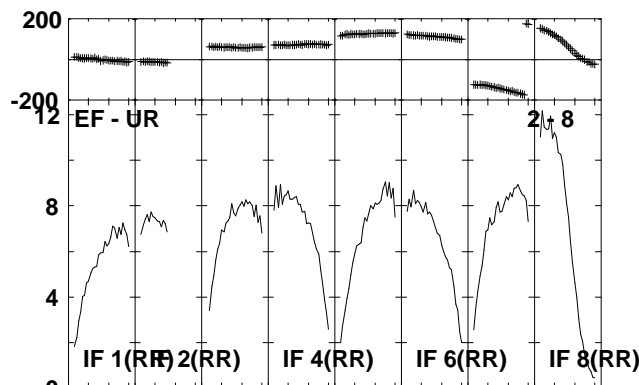
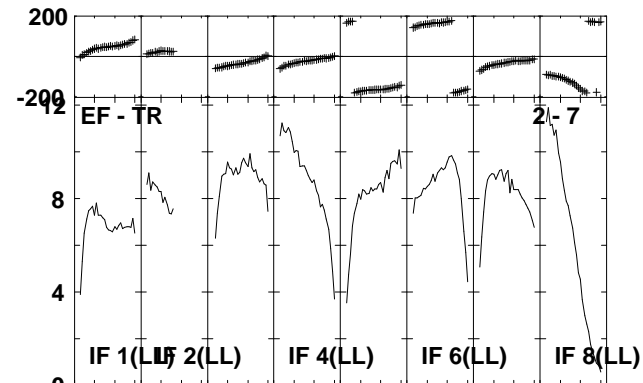
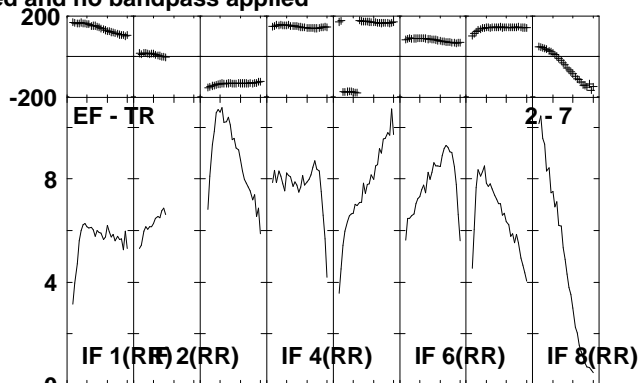
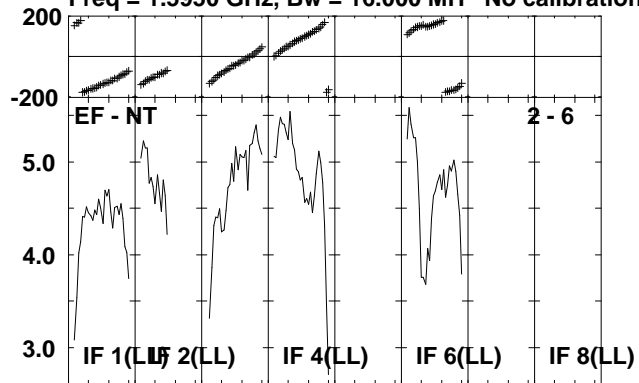

Lower frame: Milli Ampl Jy Top frame: Phas deg
Scalar averaged cross-power spectrum Several baselines displayed
Timerange: 00/14:33:31 to 00/14:35:09

Plot file version 115 created 06-JUL-2010 14:43:36

IRAS2336 EP064J.UVDATA.1

Freq = 1.5950 GHz, Bw = 16.000 MH No calibration applied and no bandpass applied

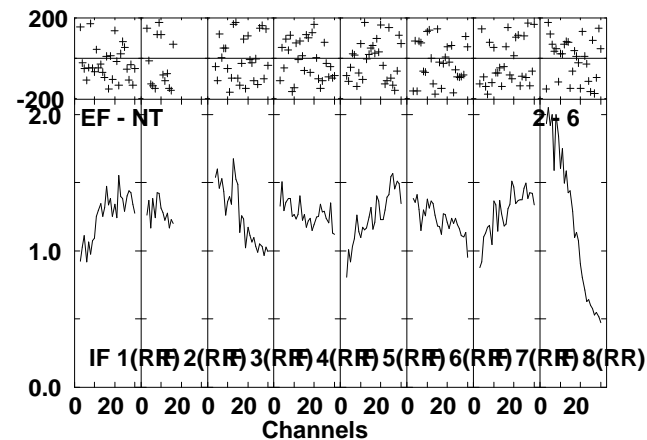
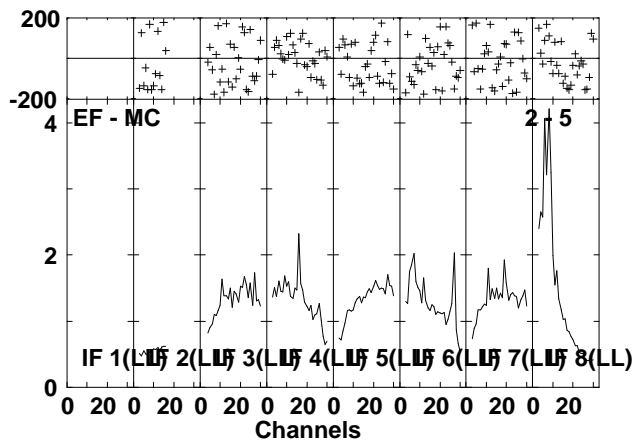
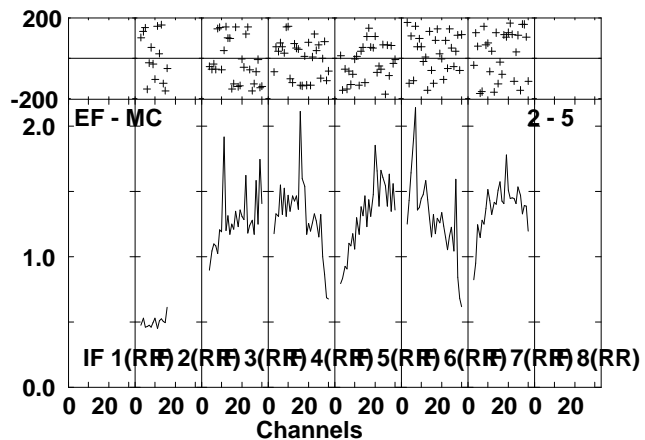
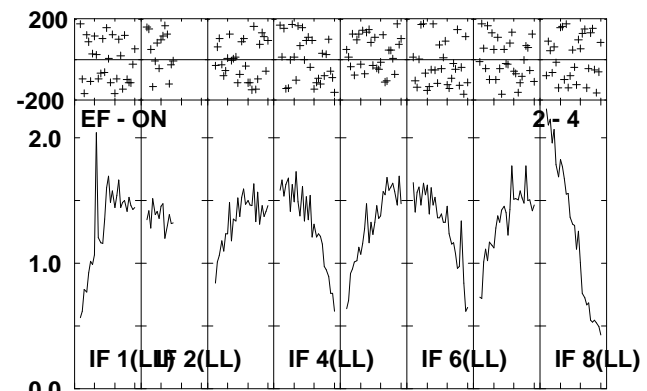
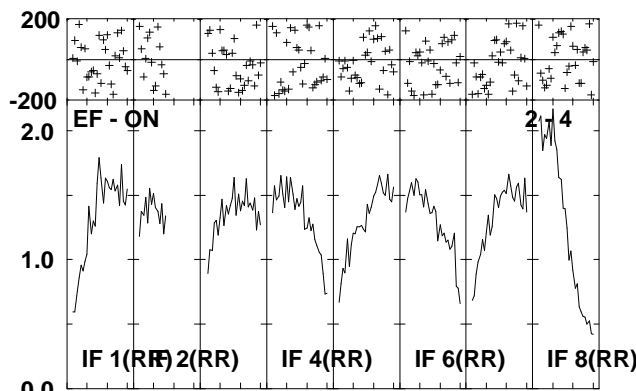
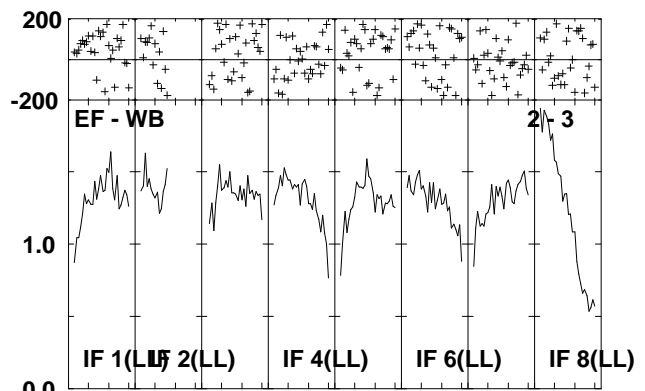
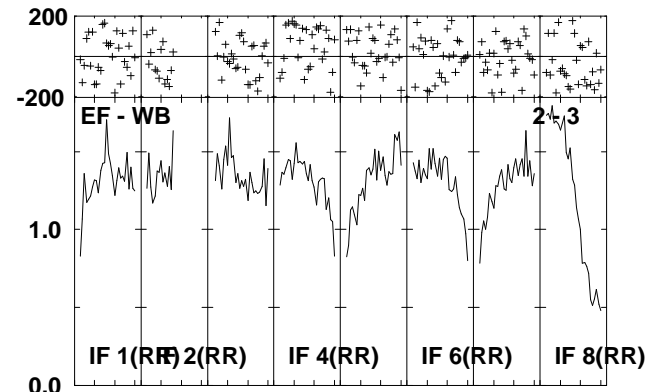
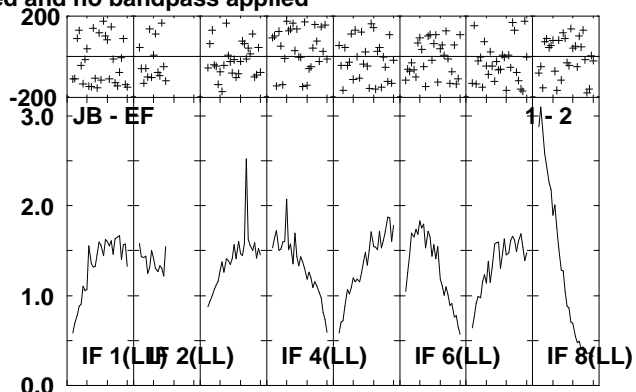
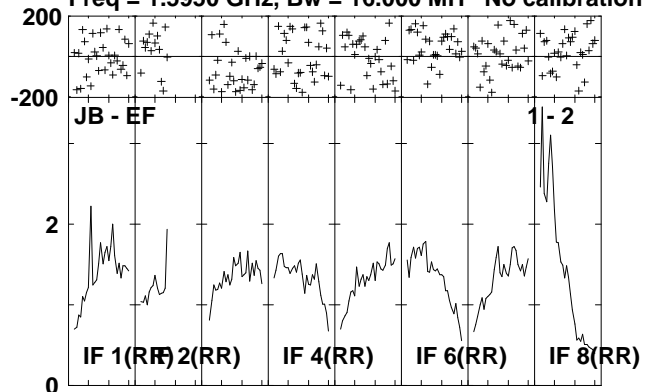

Lower frame: Milli Ampl Jy Top frame: Phas deg
Scalar averaged cross-power spectrum Several baselines displayed
Timerange: 00/14:35:11 to 00/14:38:49

Plot file version 116 created 06-JUL-2010 14:43:38

IRAS2336 EP064J.UVDATA.1

Freq = 1.5950 GHz, Bw = 16.000 MH No calibration applied and no bandpass applied

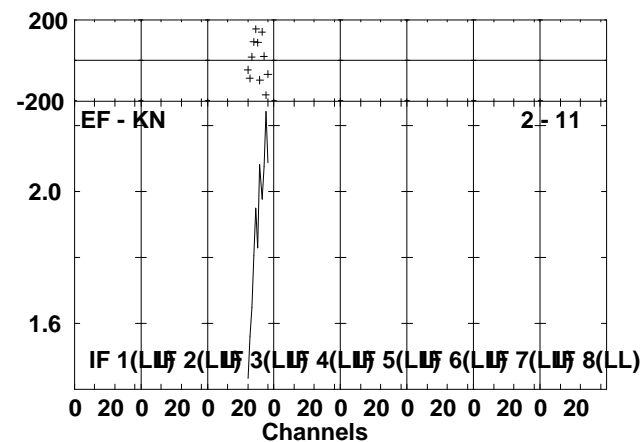
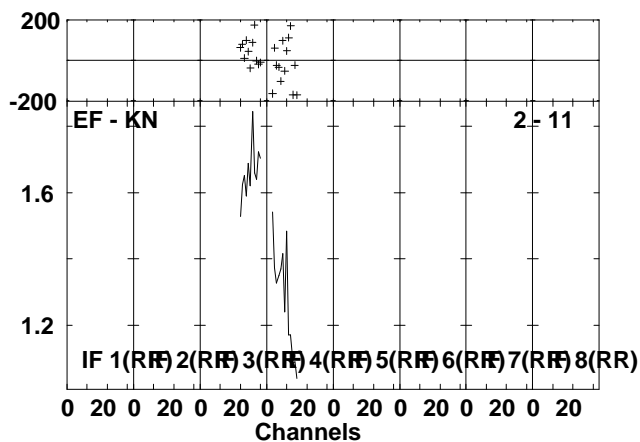
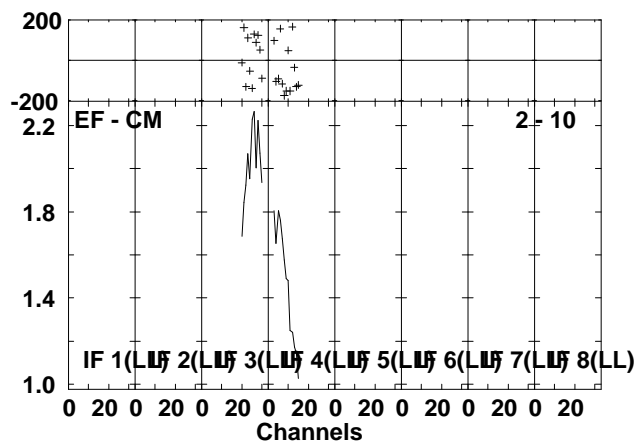
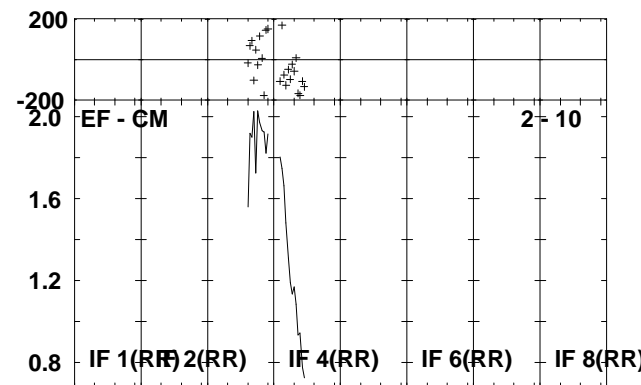
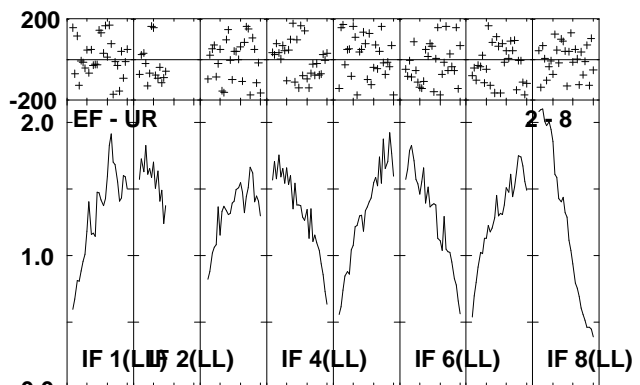
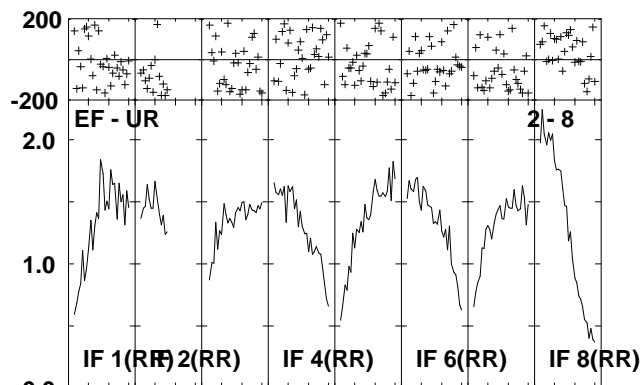
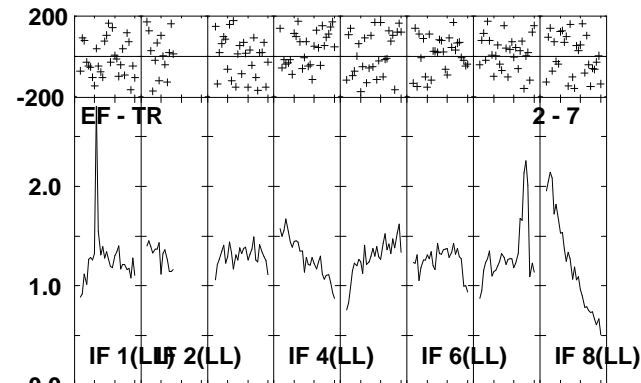
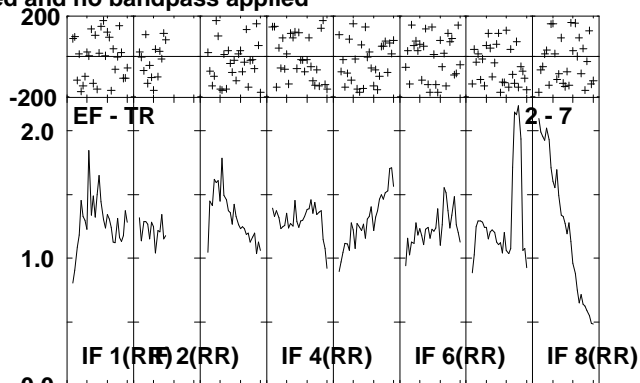
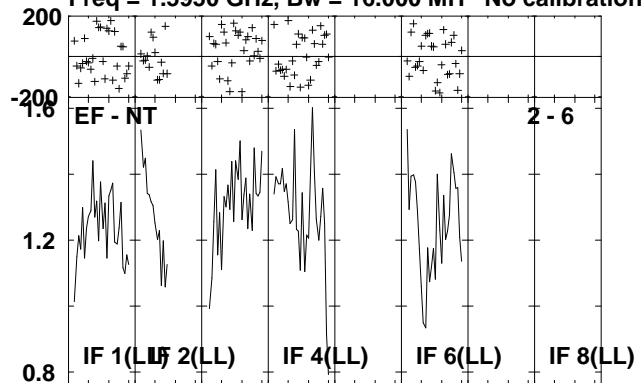

Lower frame: Milli Ampl Jy Top frame: Phas deg
Scalar averaged cross-power spectrum Several baselines displayed
Timerange: 00/14:35:11 to 00/14:38:49

Plot file version 117 created 06-JUL-2010 14:43:41

J2330+33 EP064J.UVDATA.1

Freq = 1.5950 GHz, Bw = 16.000 MH No calibration applied and no bandpass applied

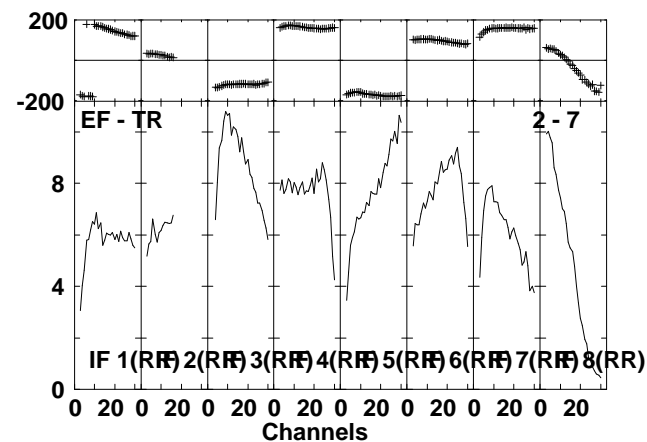
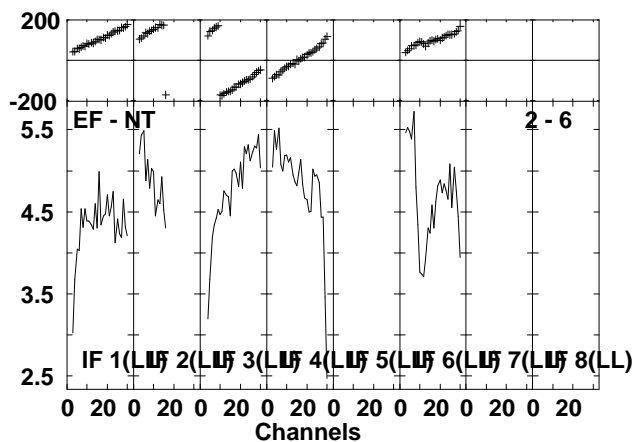
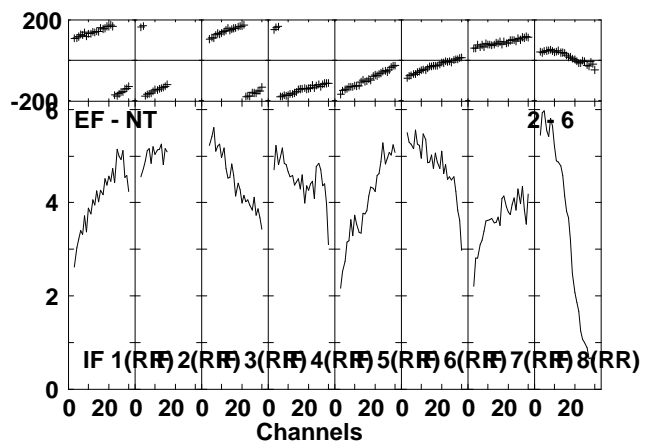
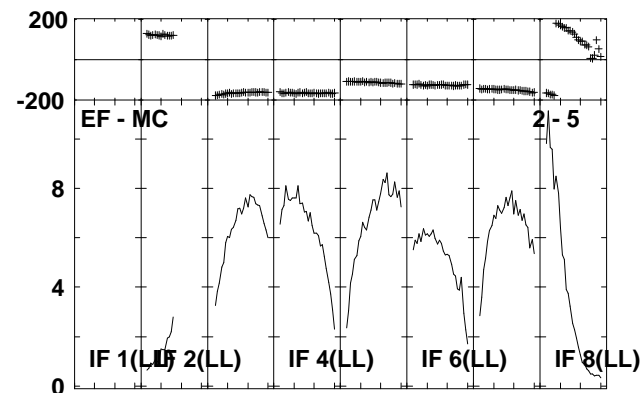
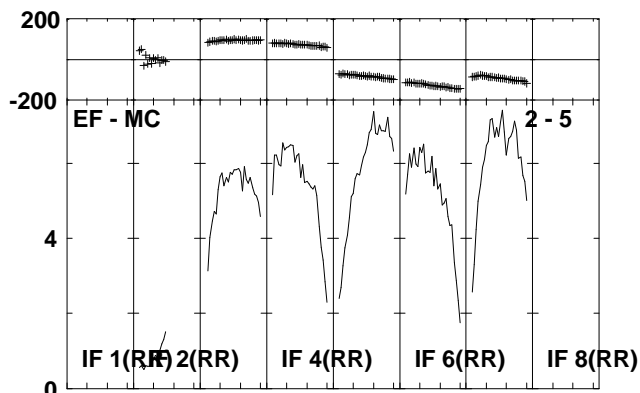
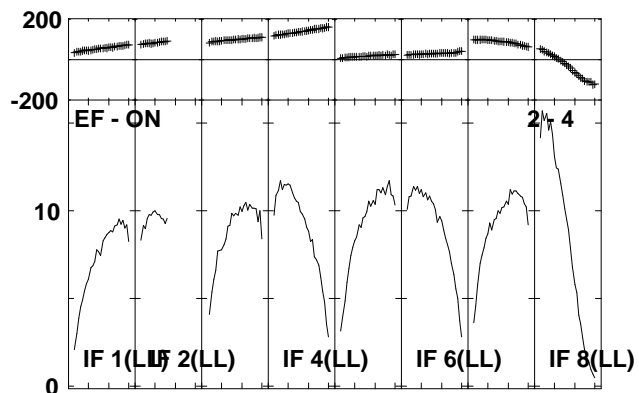
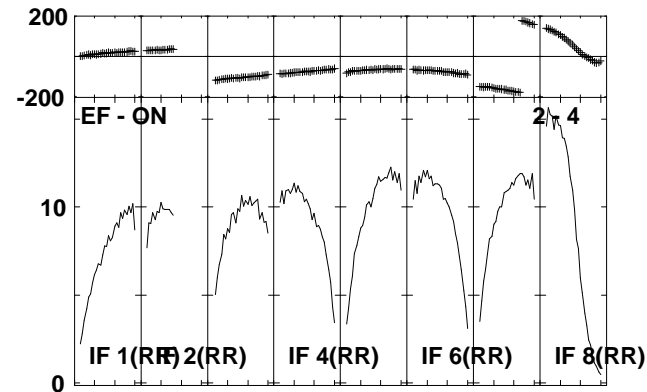
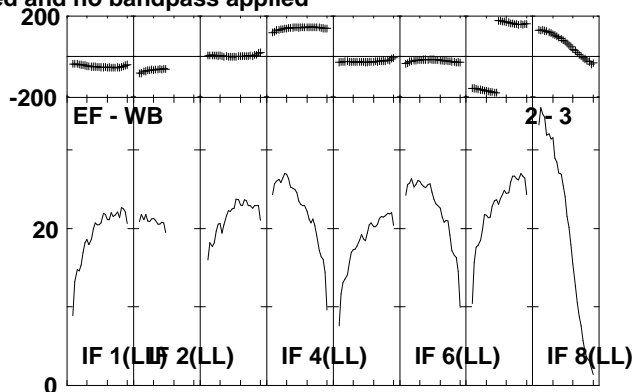
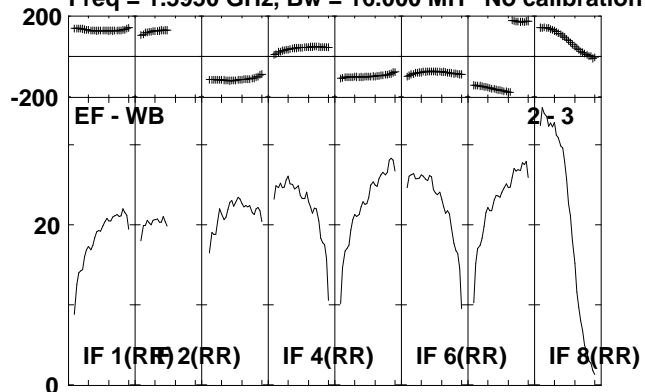

Lower frame: Milli Ampl Jy Top frame: Phas deg
Scalar averaged cross-power spectrum Several baselines displayed
Timerange: 00/14:38:51 to 00/14:40:39

Plot file version 118 created 06-JUL-2010 14:43:41

J2330+33 EP064J.UVDATA.1

Freq = 1.5950 GHz, Bw = 16.000 MH No calibration applied and no bandpass applied

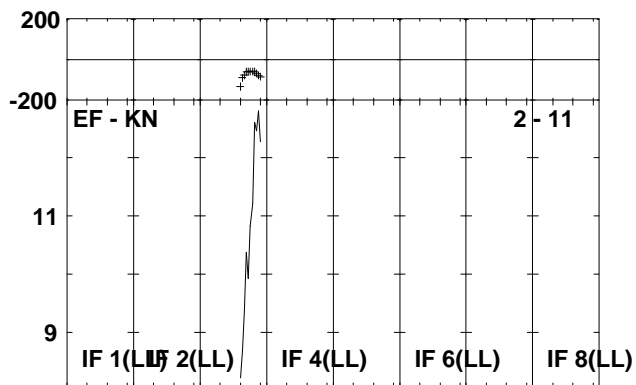
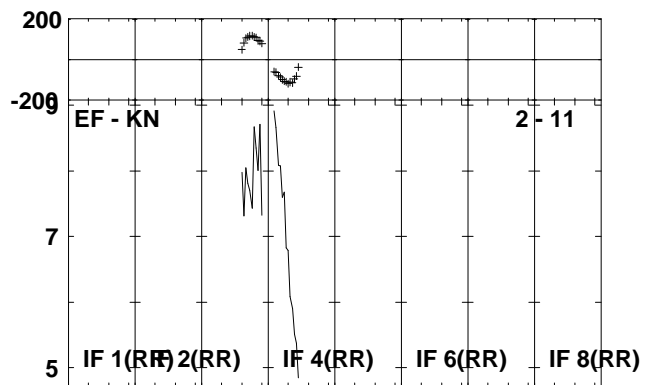
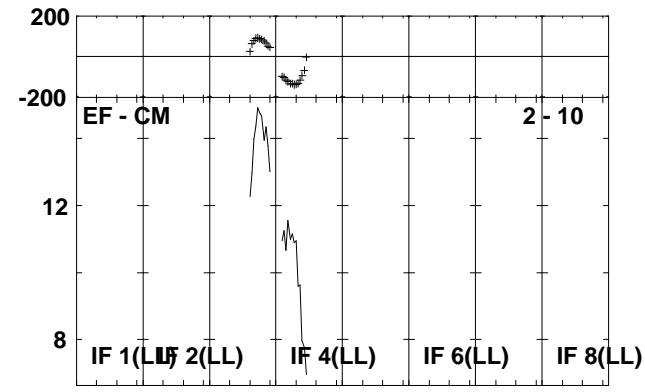
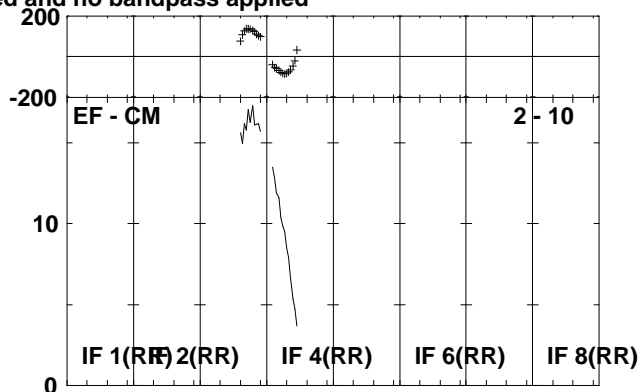
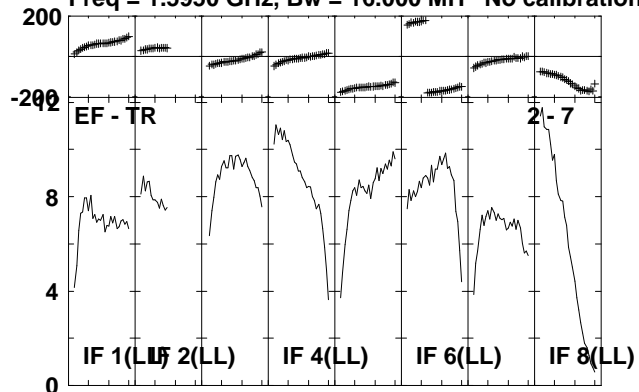

Lower frame: Milli Ampl Jy Top frame: Phas deg
Scalar averaged cross-power spectrum Several baselines displayed
Timerange: 00/14:38:51 to 00/14:40:39

Plot file version 119 created 06-JUL-2010 14:43:43

IRAS2336 EP064J.UVDATA.1

Freq = 1.5950 GHz, Bw = 16.000 MH No calibration applied and no bandpass applied

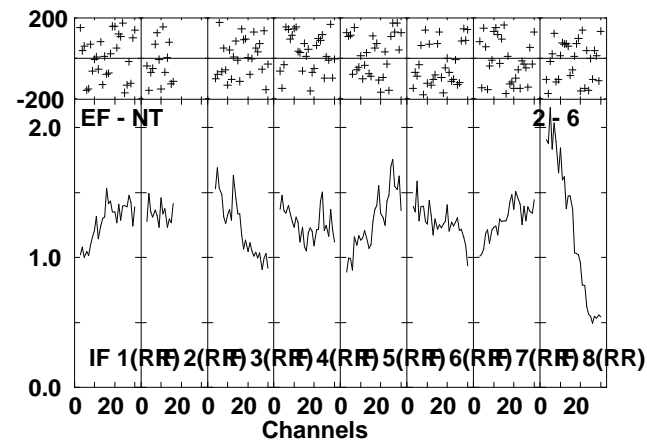
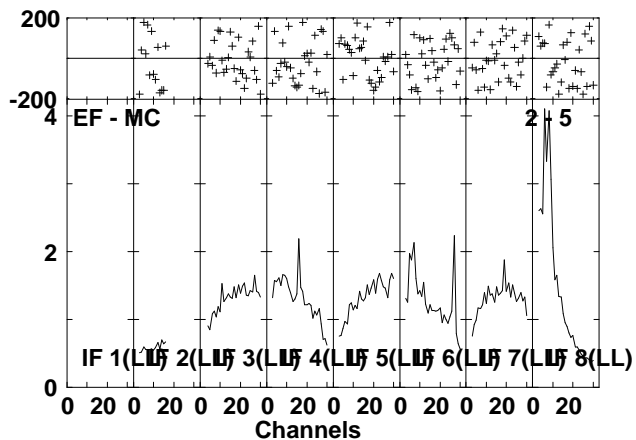
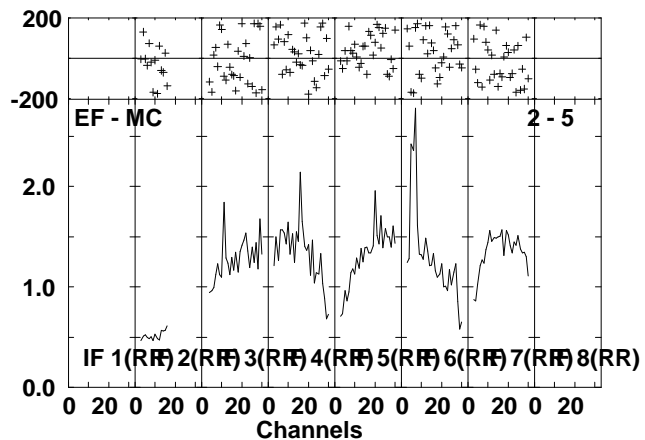
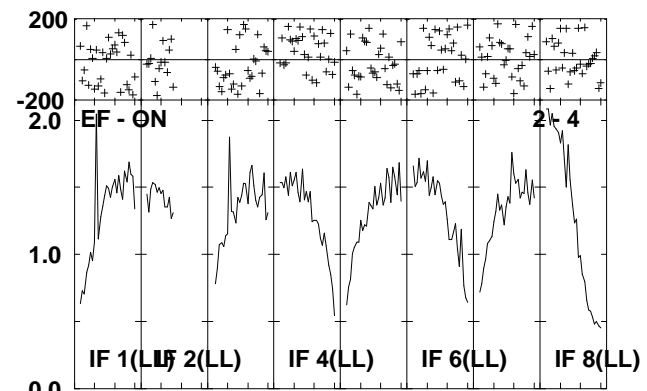
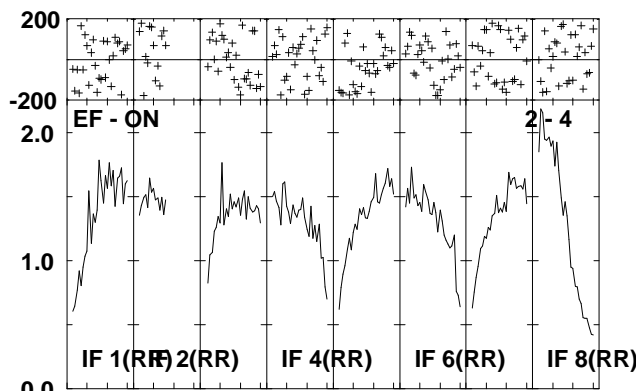
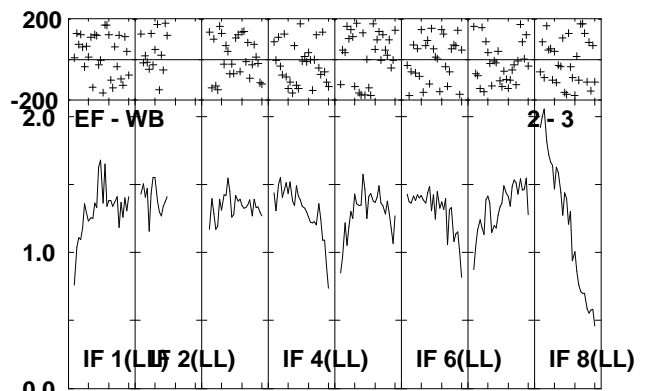
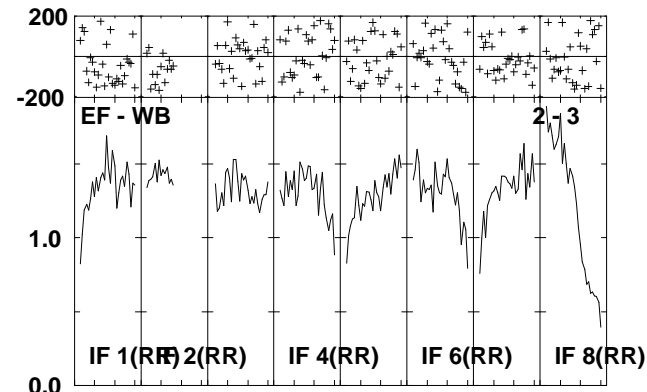
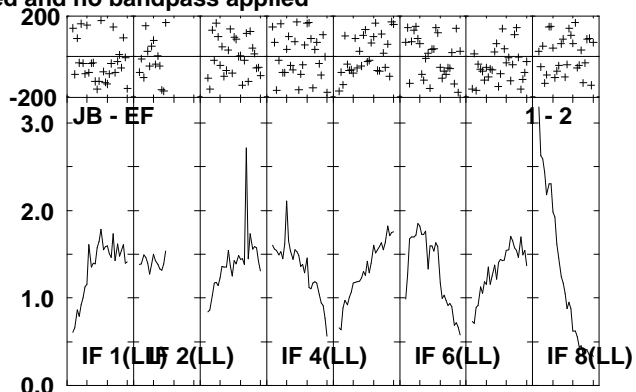
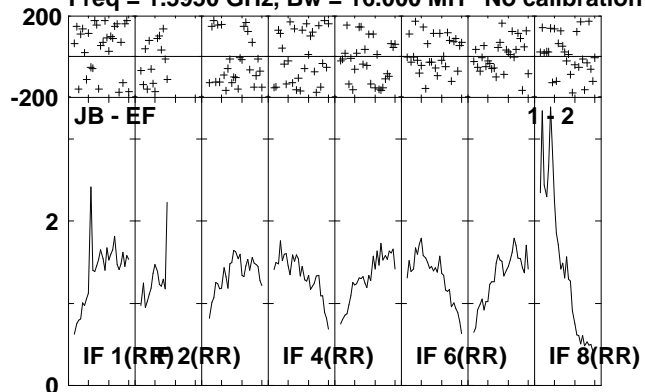

Lower frame: Milli Ampl Jy Top frame: Phas deg
Scalar averaged cross-power spectrum Several baselines displayed
Timerange: 00:14:40:41 to 00:14:44:19

Plot file version 120 created 06-JUL-2010 14:43:45

IRAS2336 EP064J.UVDATA.1

Freq = 1.5950 GHz, Bw = 16.000 MH No calibration applied and no bandpass applied

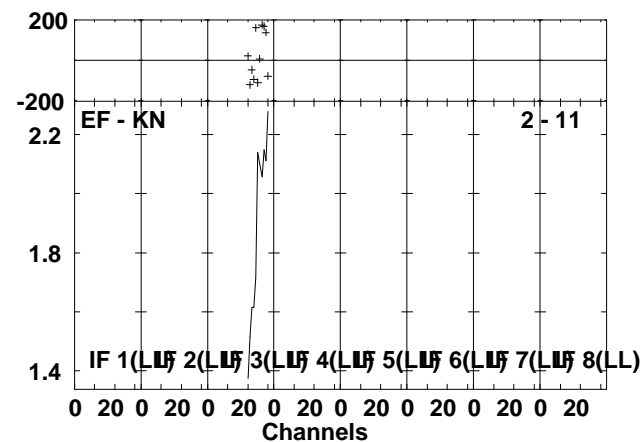
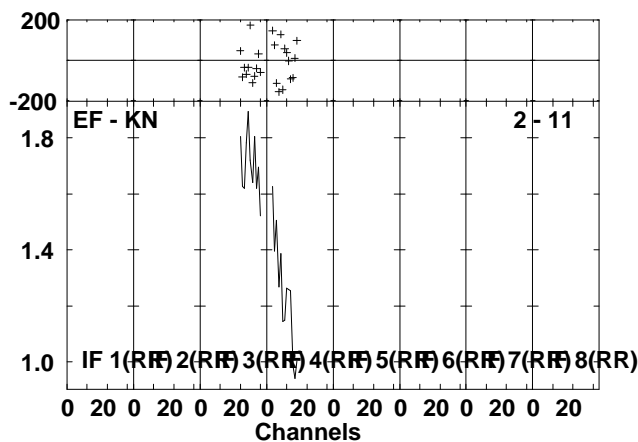
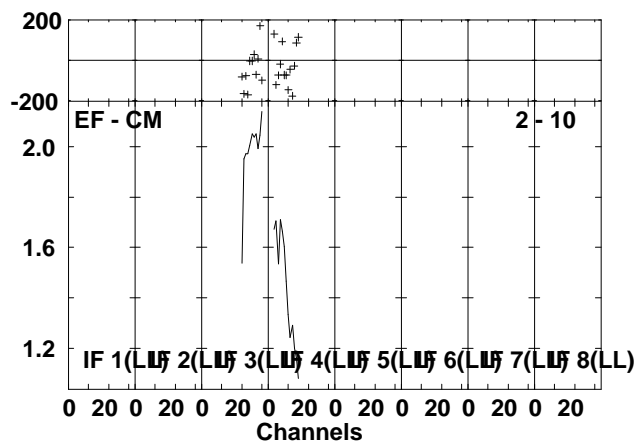
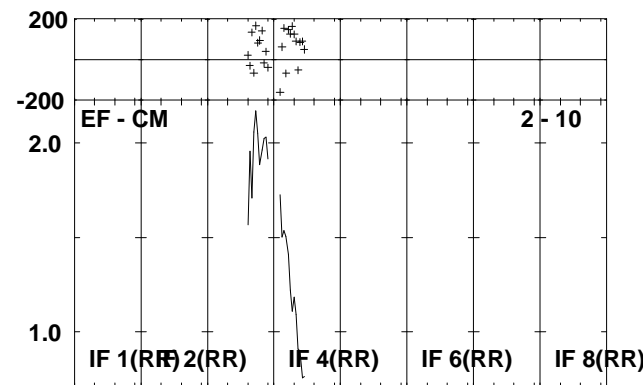
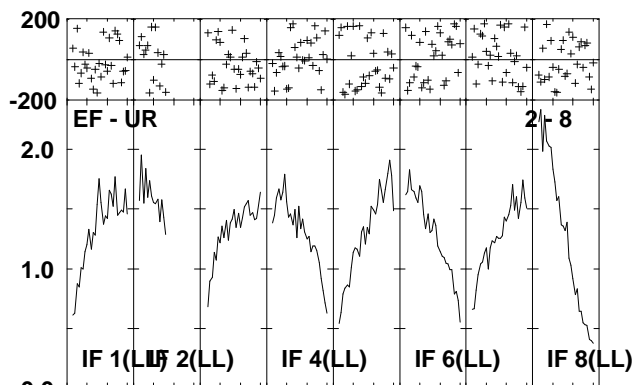
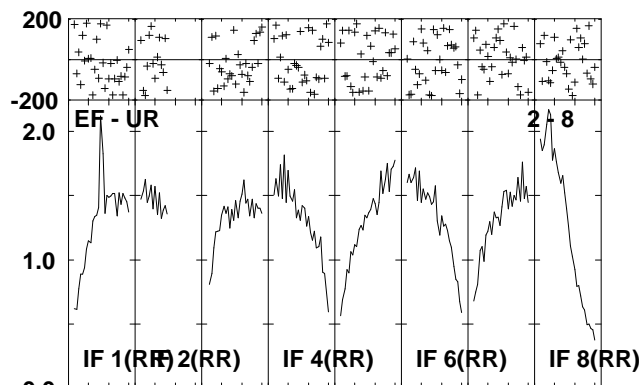
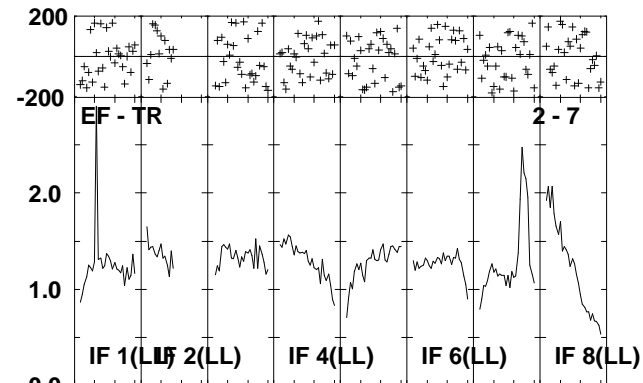
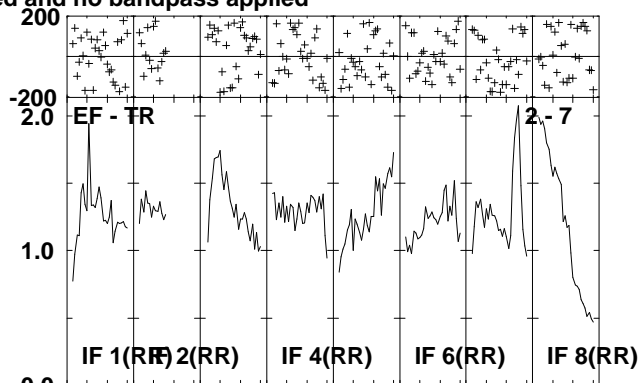
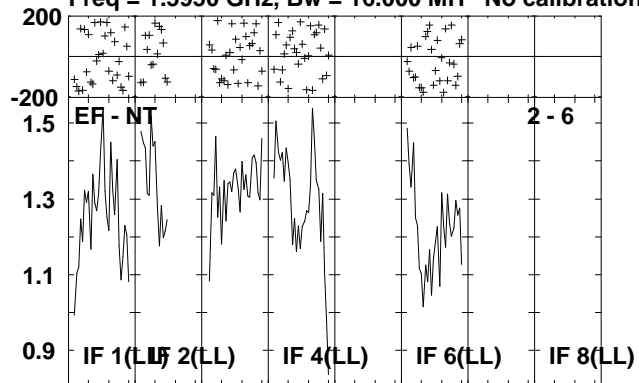

Lower frame: Milli Ampl Jy Top frame: Phas deg
Scalar averaged cross-power spectrum Several baselines displayed
Timerange: 00/14:40:41 to 00/14:44:19

Plot file version 121 created 06-JUL-2010 14:43:47

J2330+33 EP064J.UVDATA.1

Freq = 1.5950 GHz, Bw = 16.000 MH No calibration applied and no bandpass applied

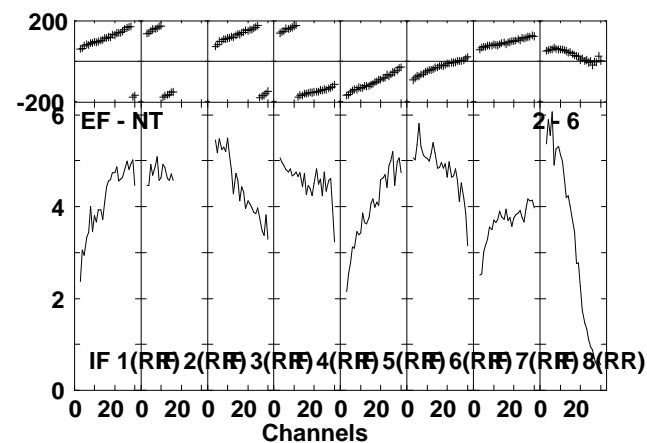
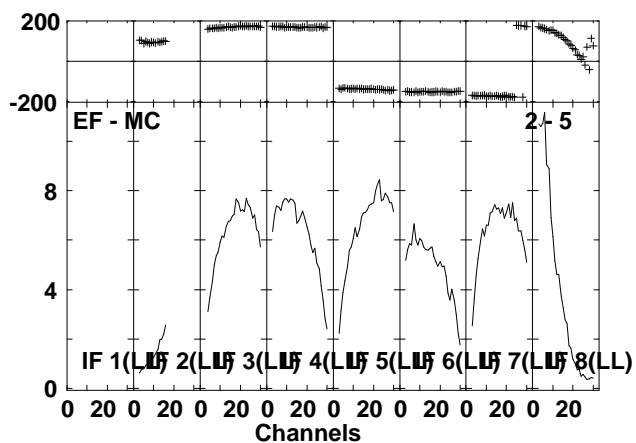
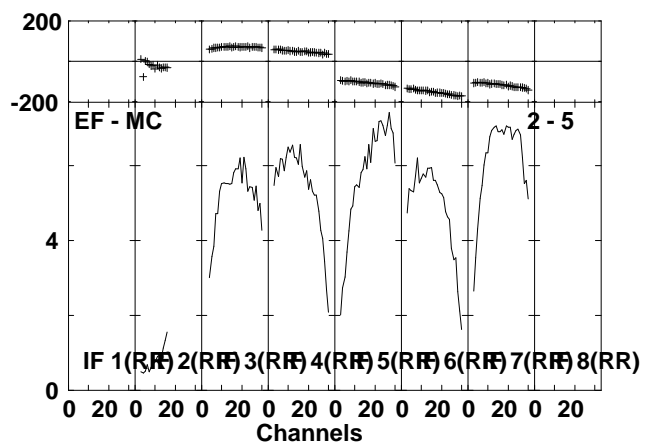
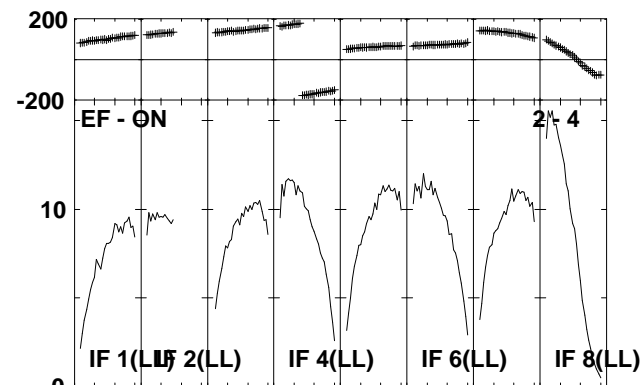
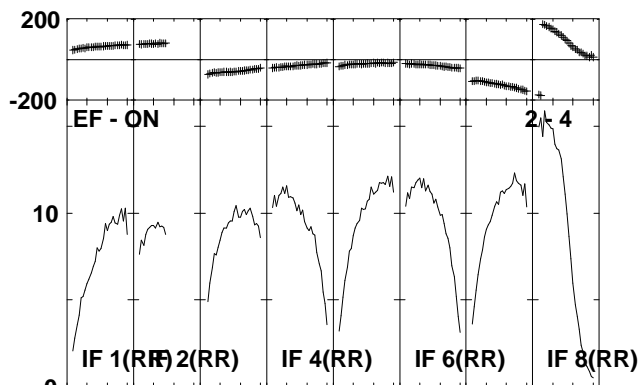
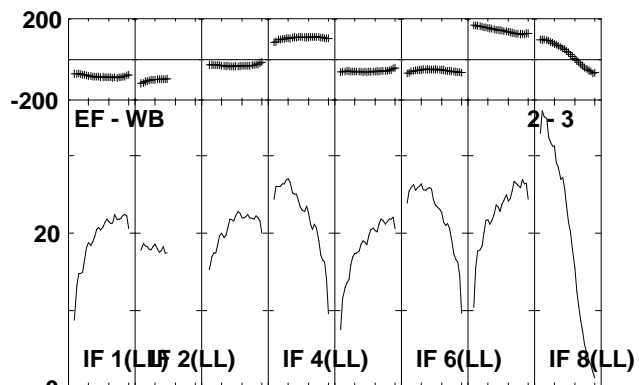
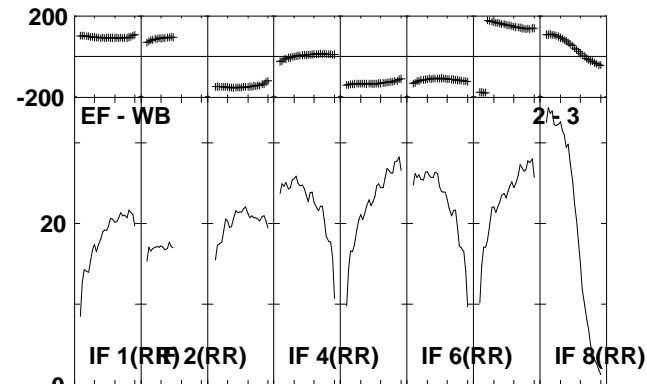
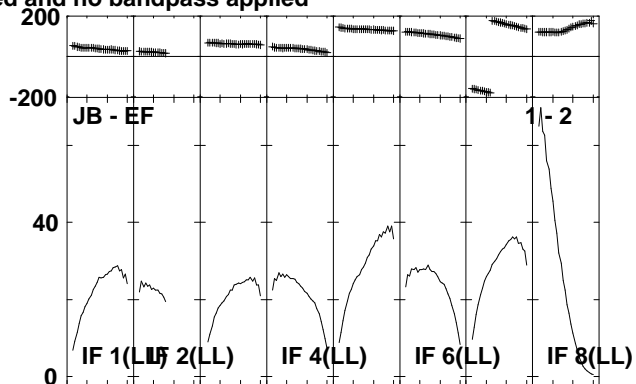
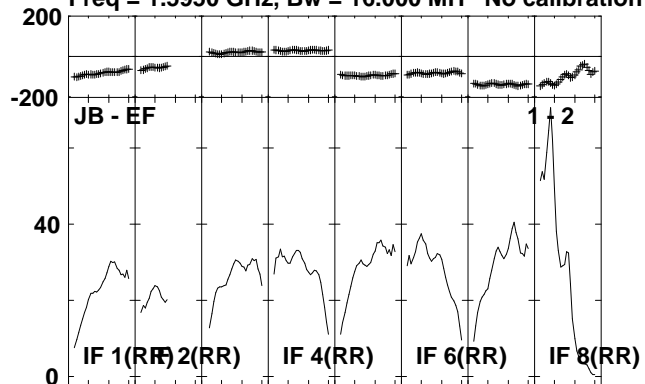

Lower frame: Milli Ampl Jy Top frame: Phas deg
Scalar averaged cross-power spectrum Several baselines displayed
Timerange: 00/14:44:27 to 00/14:46:09

Plot file version 122 created 06-JUL-2010 14:43:48

J2330+33 EP064J.UVDATA.1

Freq = 1.5950 GHz, Bw = 16.000 MH No calibration applied and no bandpass applied

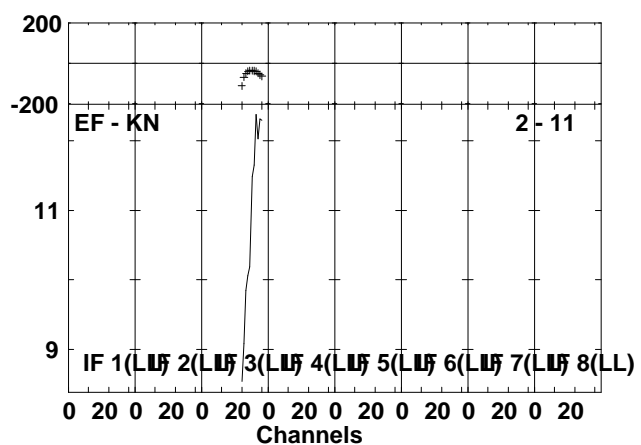
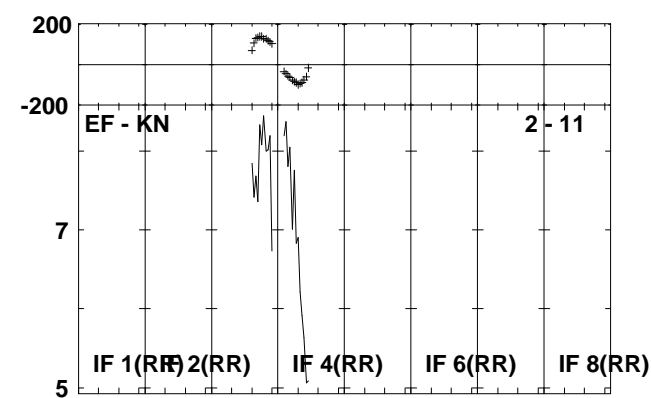
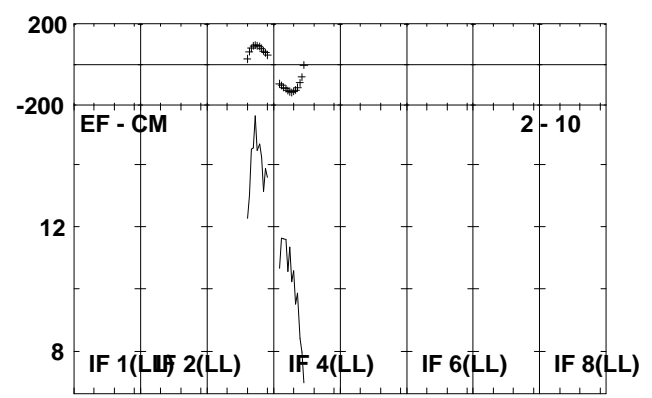
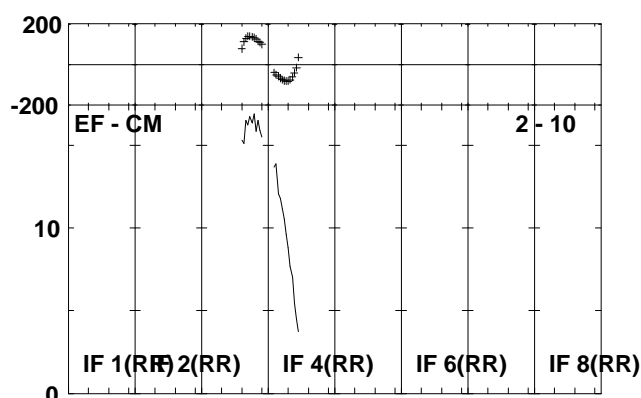
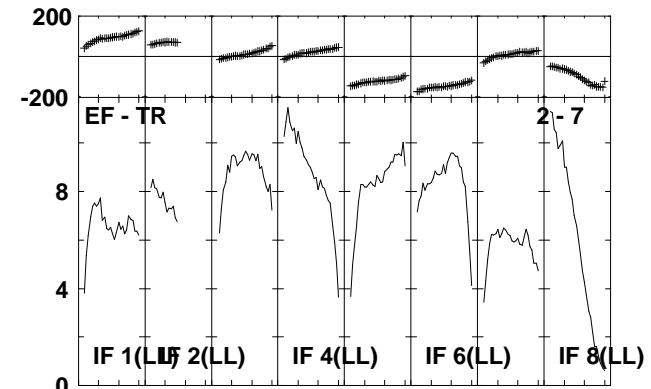
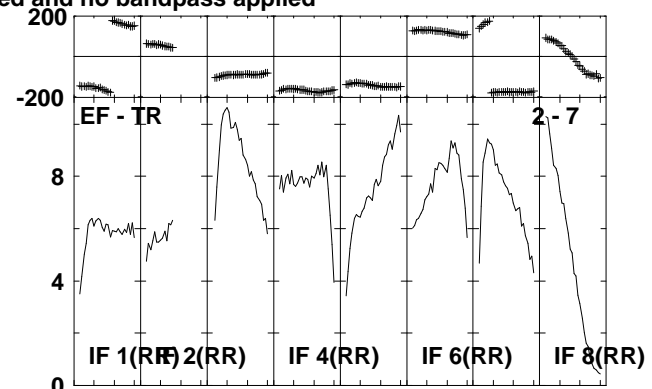
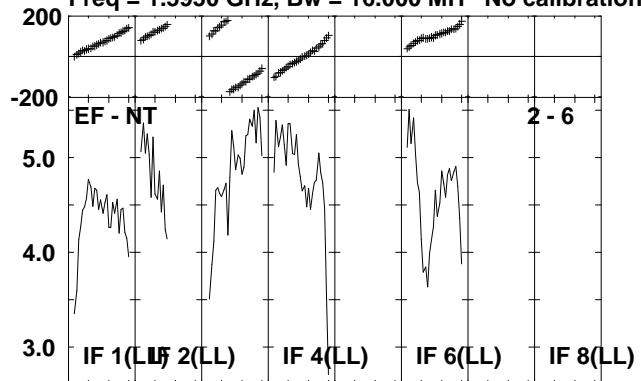

Lower frame: Milli Ampl Jy Top frame: Phas deg
Scalar averaged cross-power spectrum Several baselines displayed
Timerange: 00/14:44:27 to 00/14:46:09

Plot file version 123 created 06-JUL-2010 14:43:49

IRAS2336 EP064J.UVDATA.1

Freq = 1.5950 GHz, Bw = 16.000 MH No calibration applied and no bandpass applied

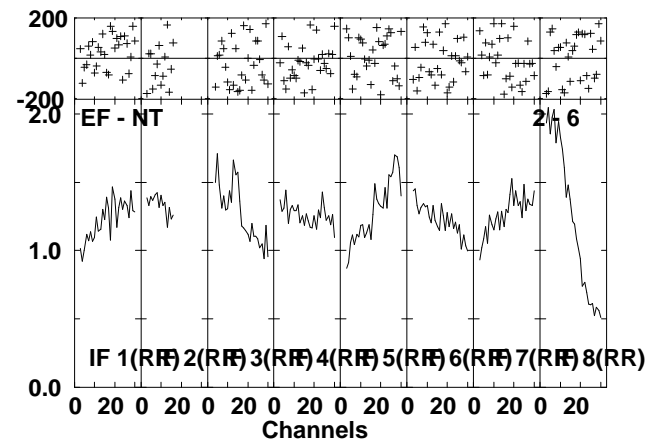
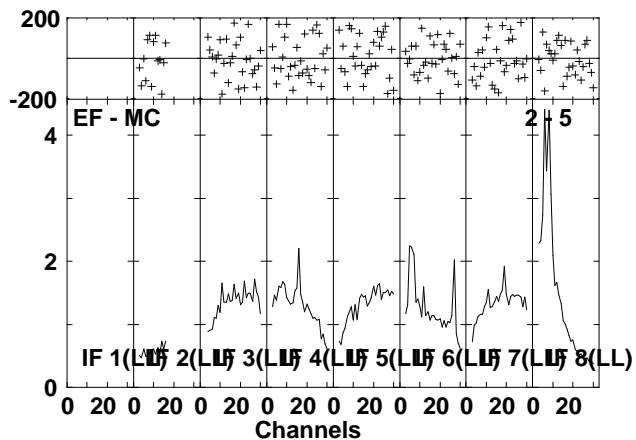
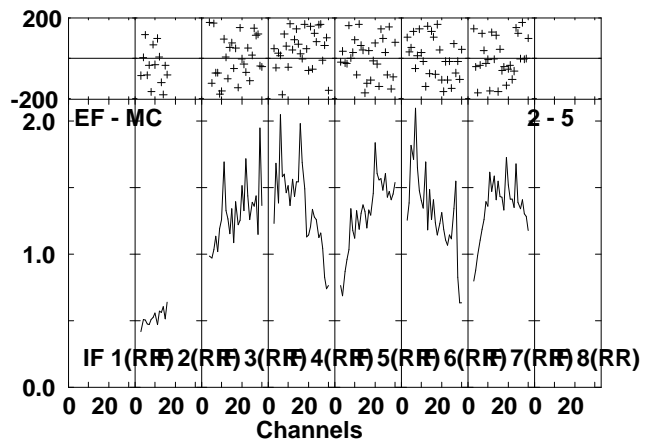
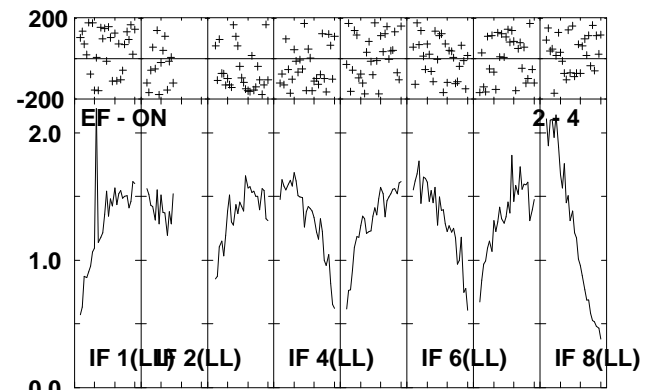
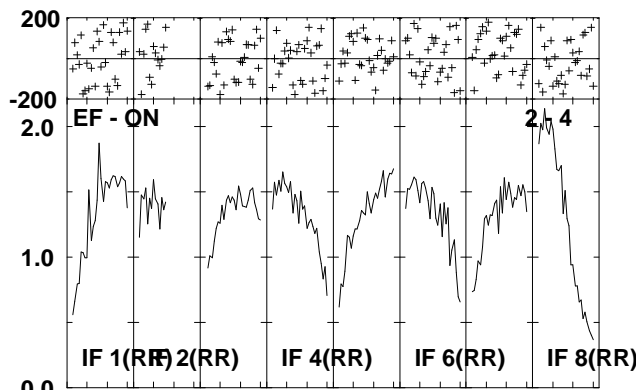
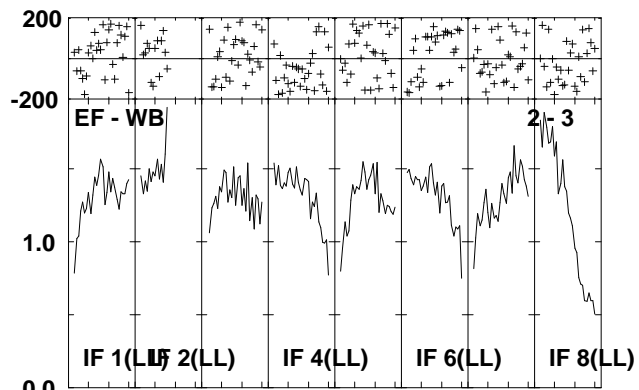
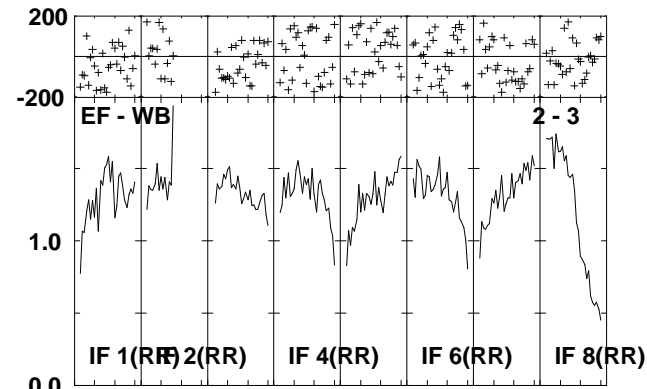
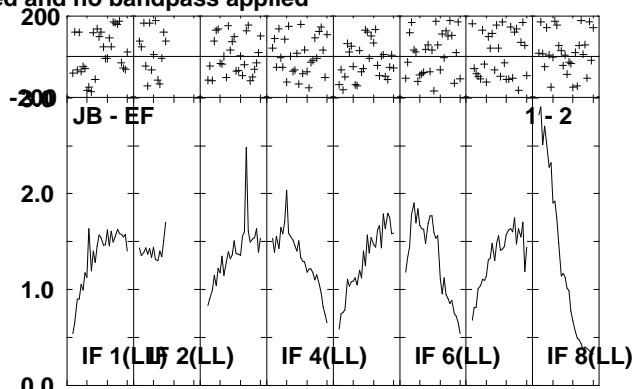
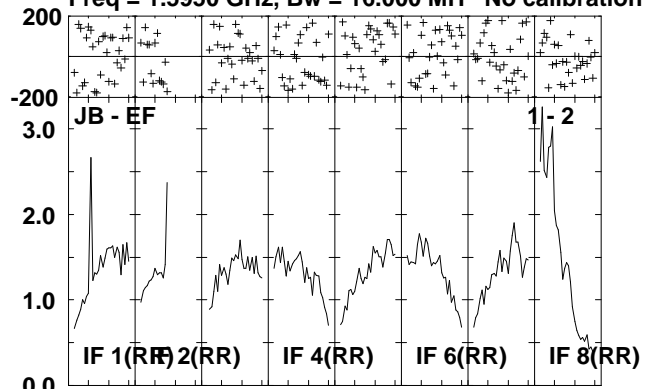

Lower frame: Milli Ampl Jy Top frame: Phas deg
Scalar averaged cross-power spectrum Several baselines displayed
Timerange: 00/14:46:13 to 00/14:49:49

Plot file version 124 created 06-JUL-2010 14:43:51

IRAS2336 EP064J.UVDATA.1

Freq = 1.5950 GHz, Bw = 16.000 MH No calibration applied and no bandpass applied

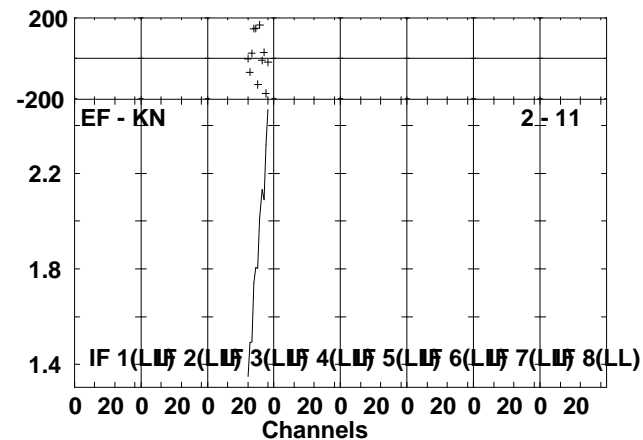
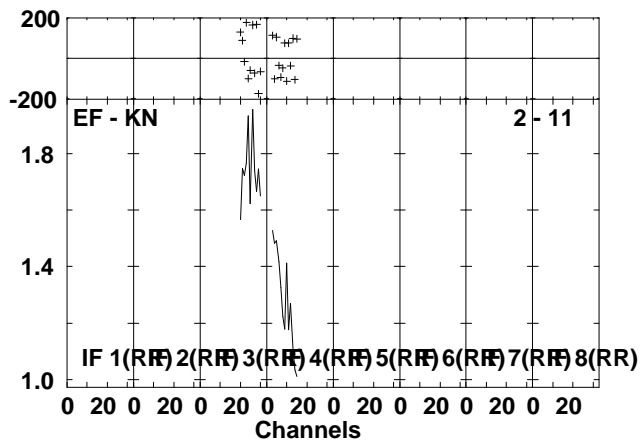
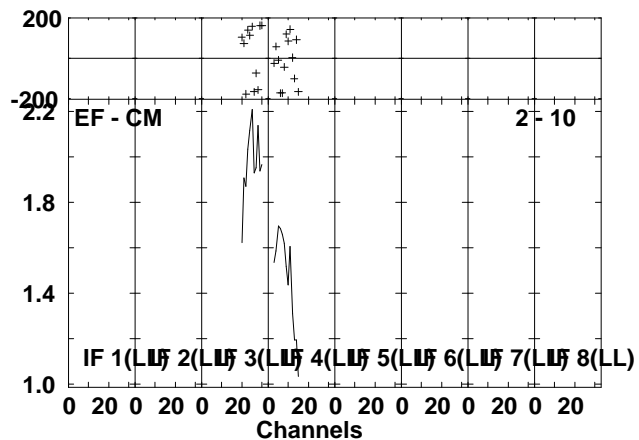
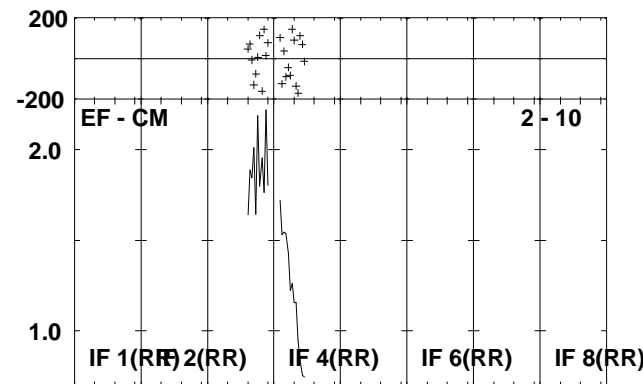
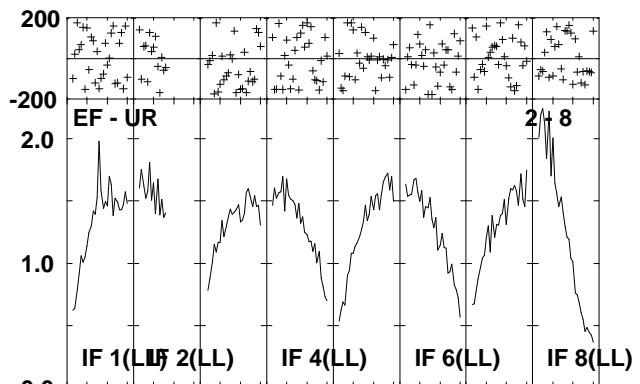
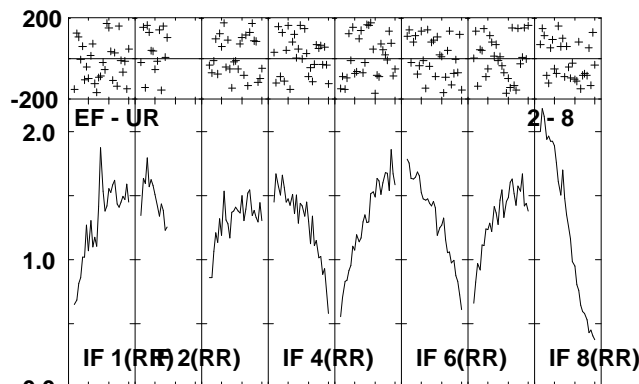
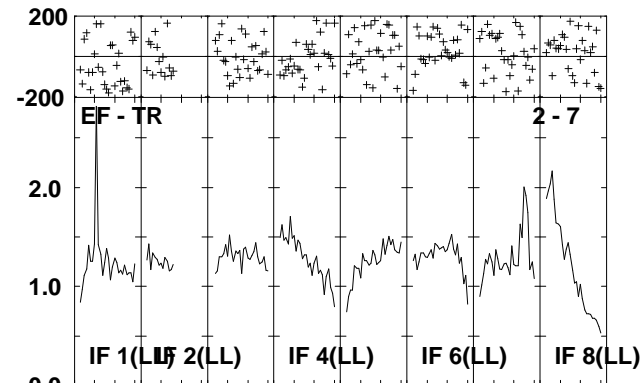
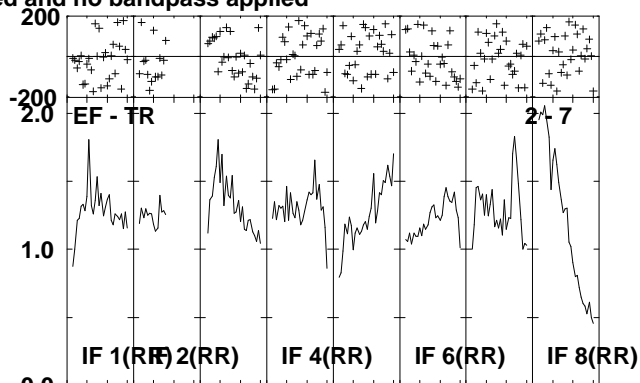
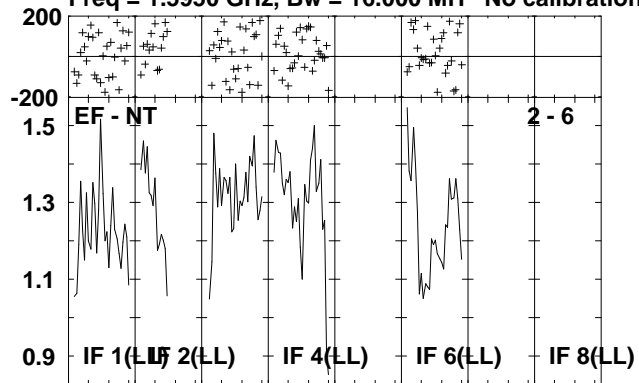

Lower frame: Milli Ampl Jy Top frame: Phas deg
Scalar averaged cross-power spectrum Several baselines displayed
Timerange: 00/14:46:13 to 00/14:49:29

Plot file version 125 created 06-JUL-2010 14:43:53

J2330+33 EP064J.UVDATA.1

Freq = 1.5950 GHz, Bw = 16.000 MH No calibration applied and no bandpass applied

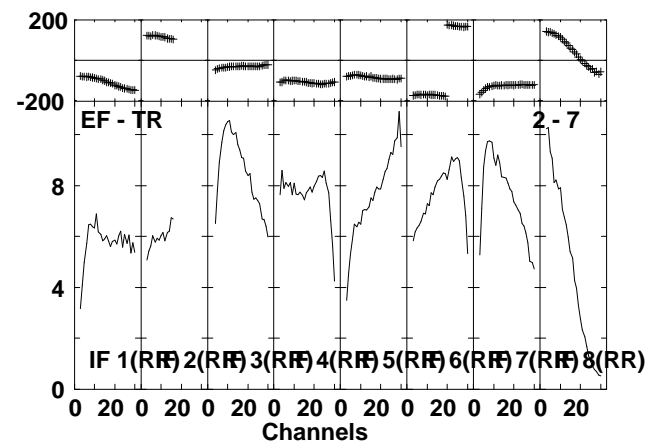
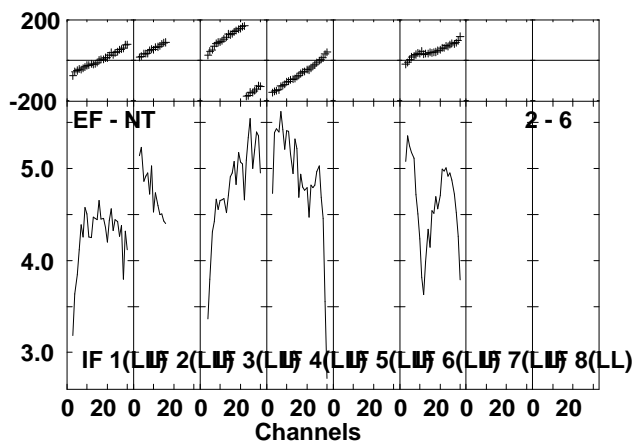
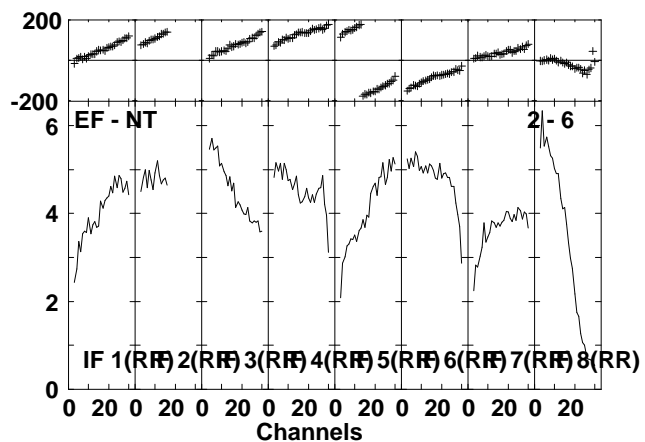
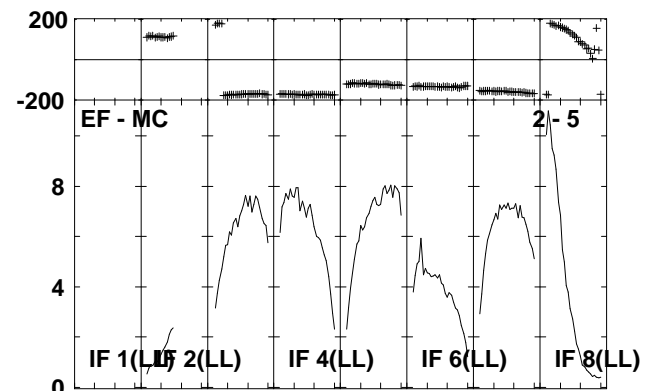
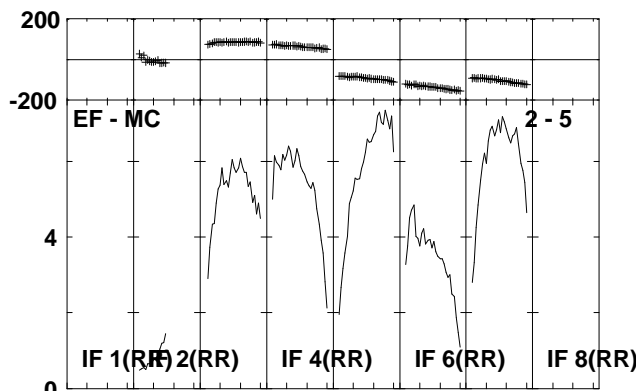
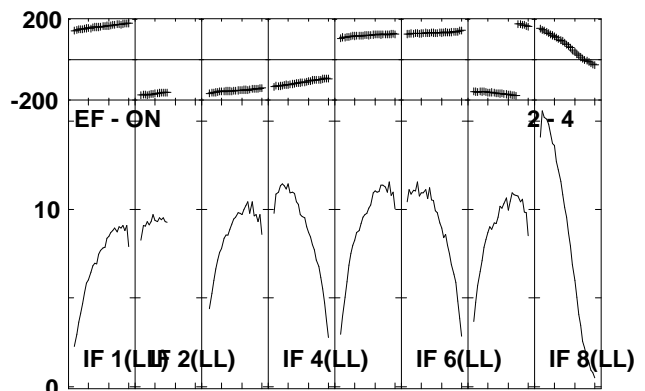
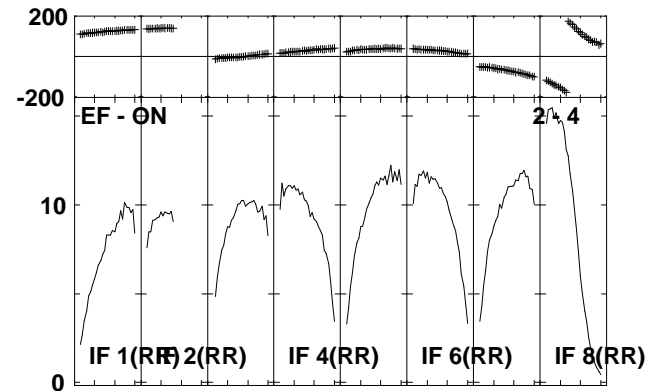
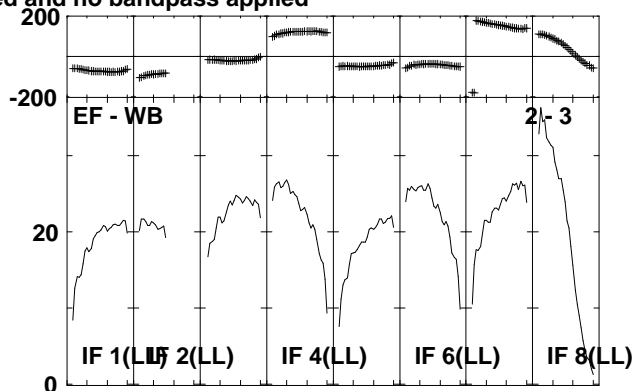
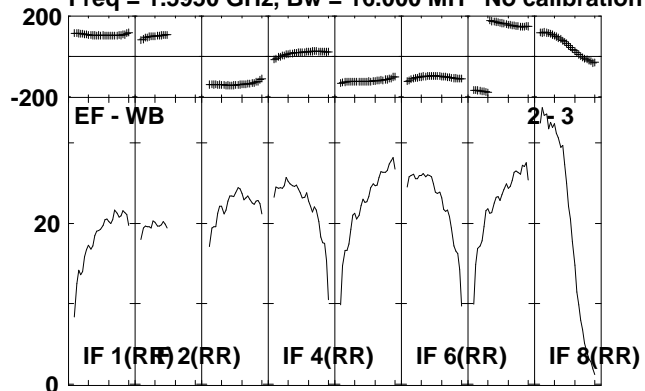

Lower frame: Milli Ampl Jy Top frame: Phas deg
Scalar averaged cross-power spectrum Several baselines displayed
Timerange: 00/14:50:51 to 00/14:52:29

Plot file version 126 created 06-JUL-2010 14:43:54
J2330+33 EP064J.UVDATA.1

Freq = 1.5950 GHz, Bw = 16.000 MH No calibration applied and no bandpass applied

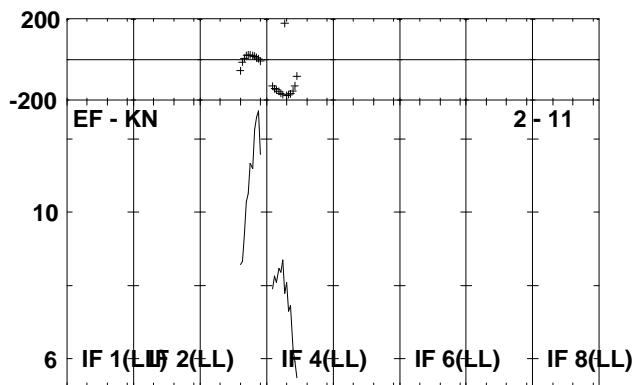
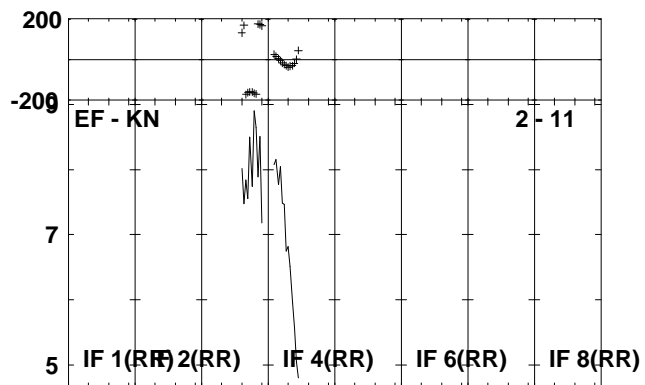
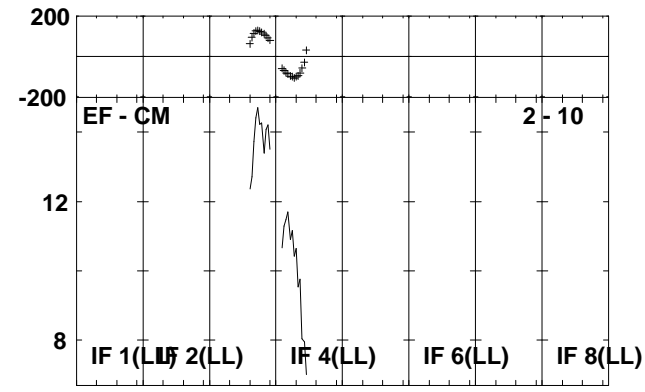
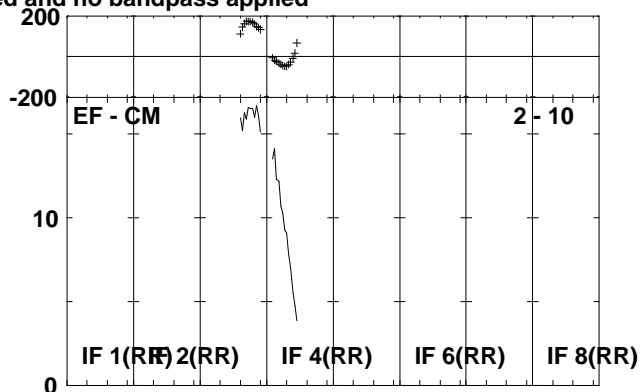
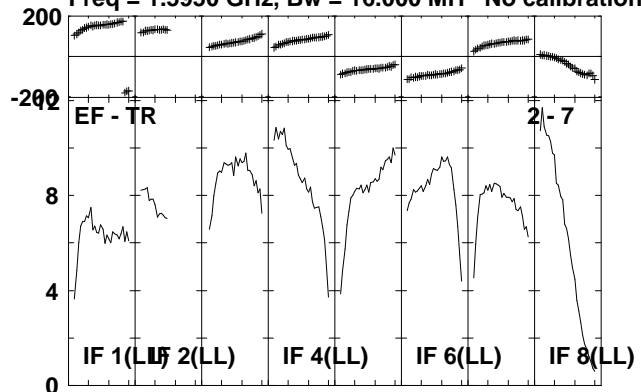

Lower frame: Milli Ampl Jy Top frame: Phas deg
Scalar averaged cross-power spectrum Several baselines displayed
Timerange: 00/14:50:51 to 00/14:52:29

Plot file version 127 created 06-JUL-2010 14:43:55

IRAS2336 EP064J.UVDATA.1

Freq = 1.5950 GHz, Bw = 16.000 MH No calibration applied and no bandpass applied

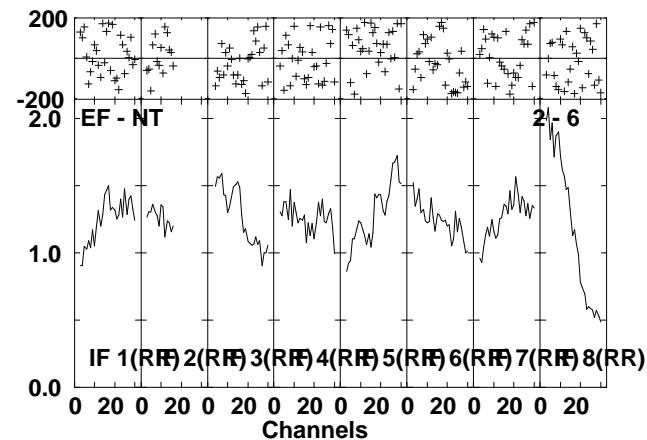
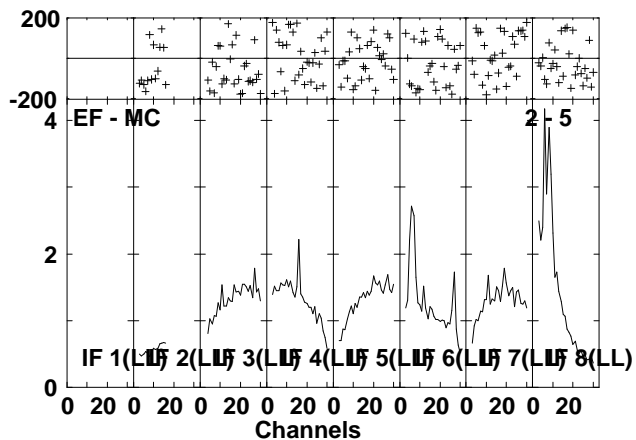
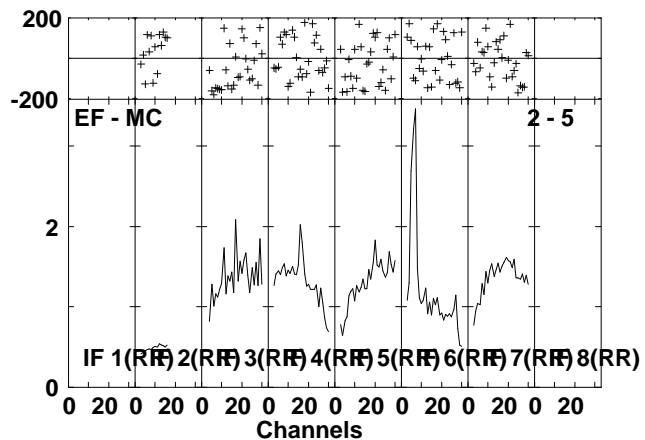
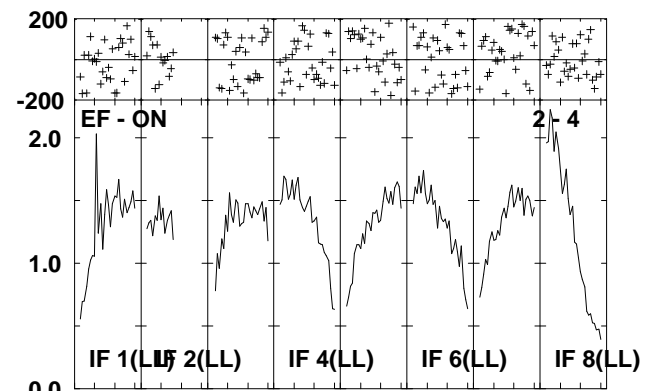
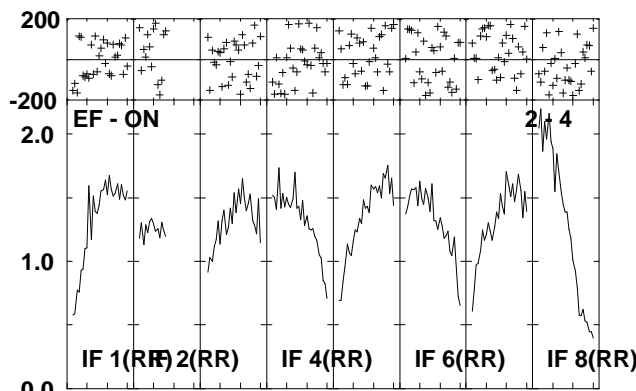
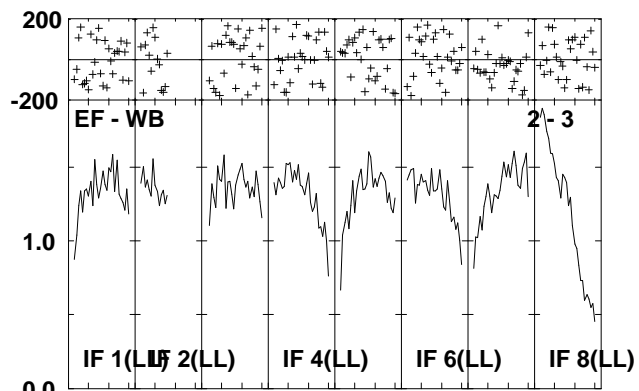
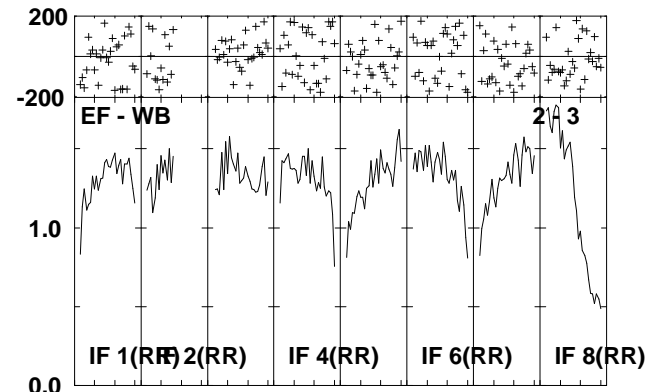
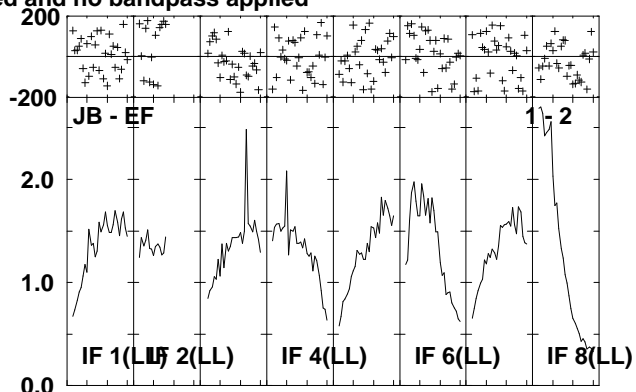
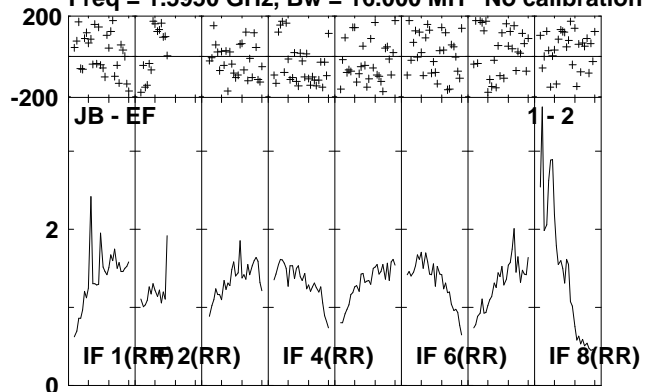

Lower frame: Milli Ampl Jy Top frame: Phas deg
Scalar averaged cross-power spectrum Several baselines displayed
Timerange: 00/14:52:31 to 00/14:56:09

Plot file version 128 created 06-JUL-2010 14:43:57

IRAS2336 EP064J.UVDATA.1

Freq = 1.5950 GHz, Bw = 16.000 MH No calibration applied and no bandpass applied

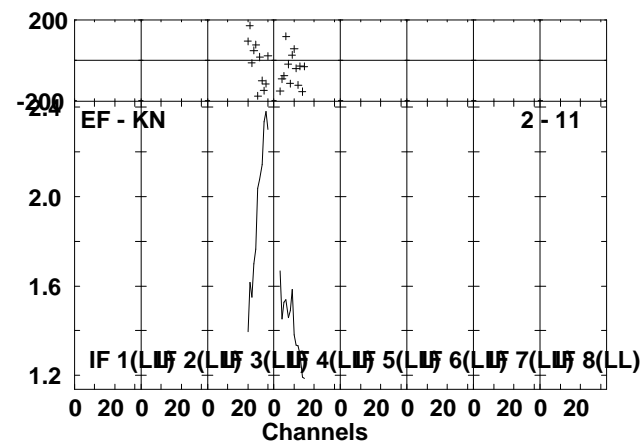
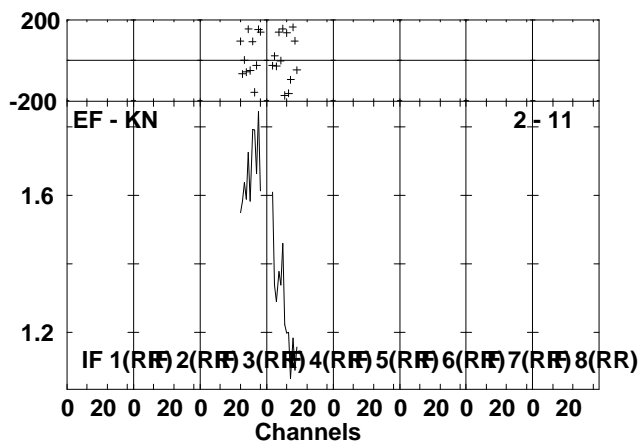
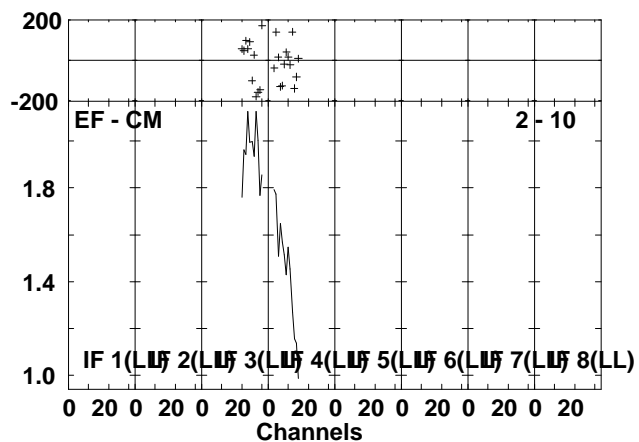
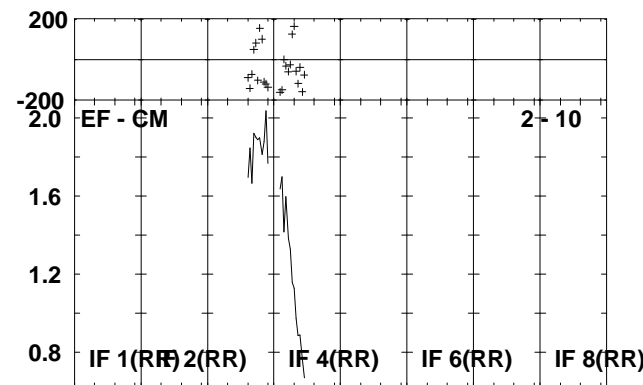
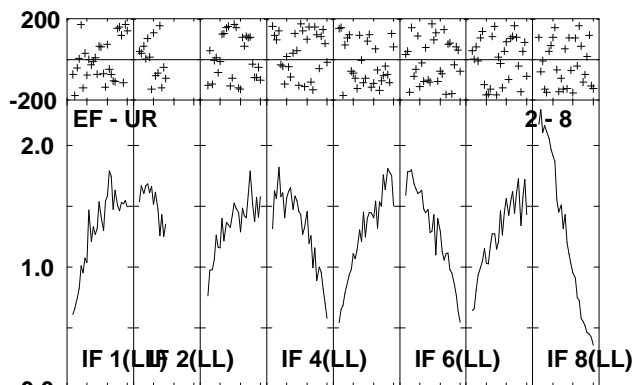
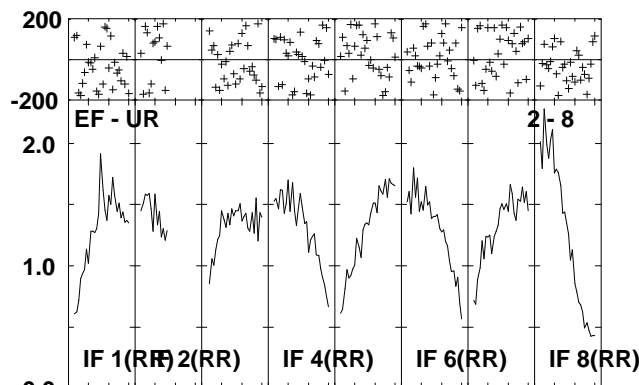
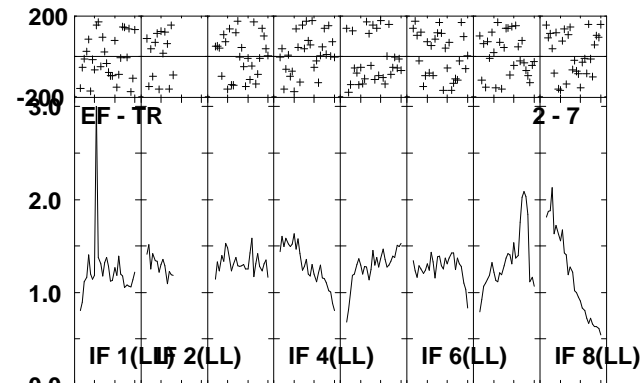
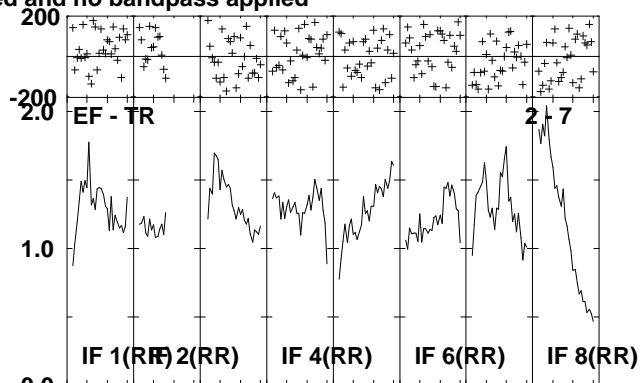
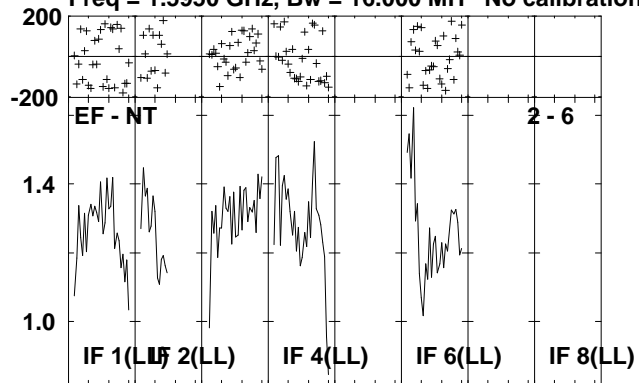

Lower frame: Milli Ampl Jy Top frame: Phas deg
Scalar averaged cross-power spectrum Several baselines displayed
Timerange: 00/14:52:31 to 00/14:56:09

Plot file version 129 created 06-JUL-2010 14:44:00

J2330+33 EP064J.UVDATA.1

Freq = 1.5950 GHz, Bw = 16.000 MH No calibration applied and no bandpass applied

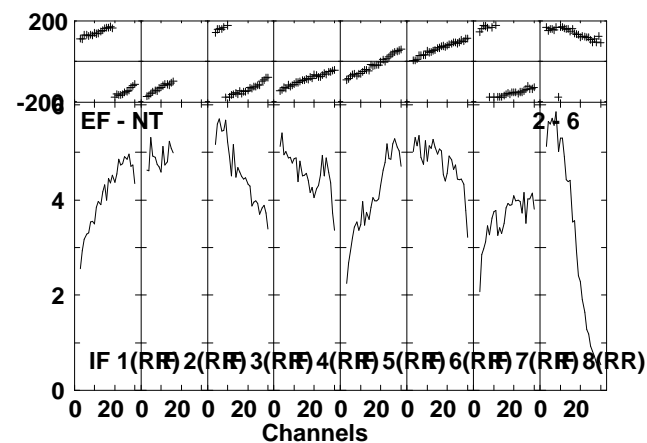
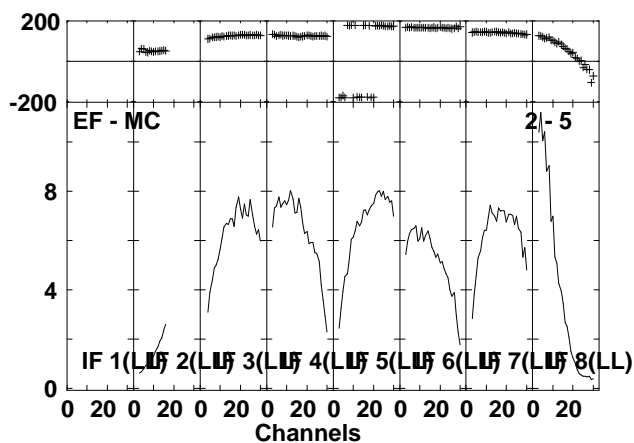
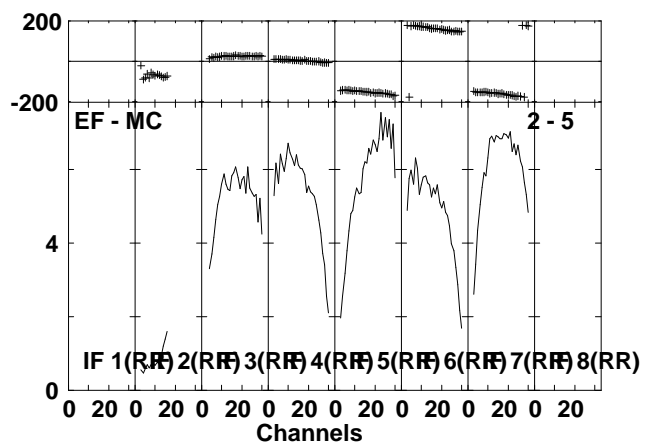
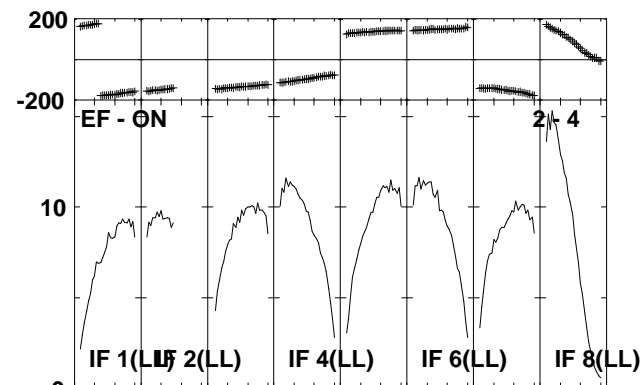
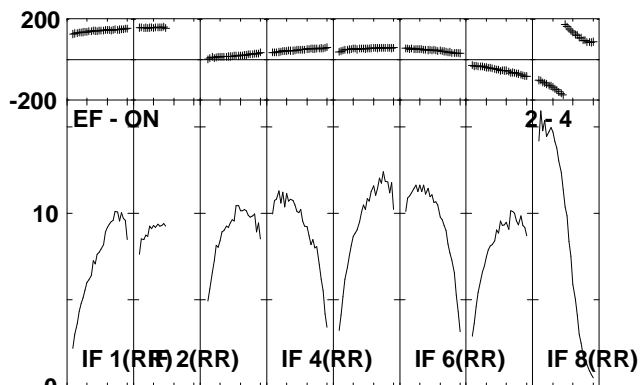
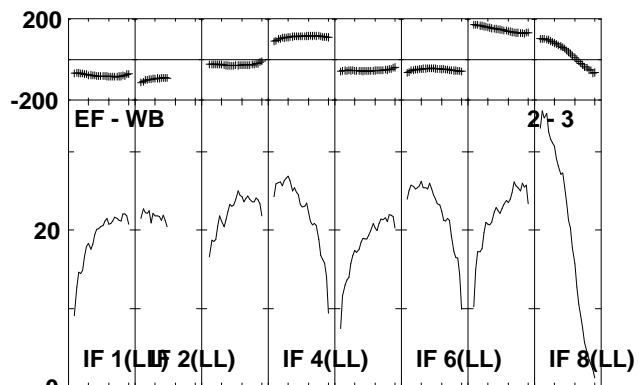
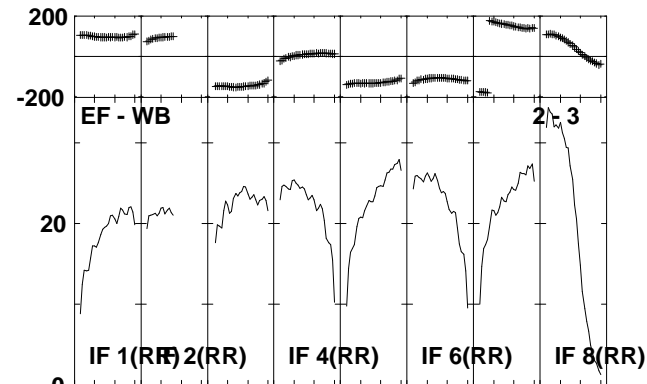
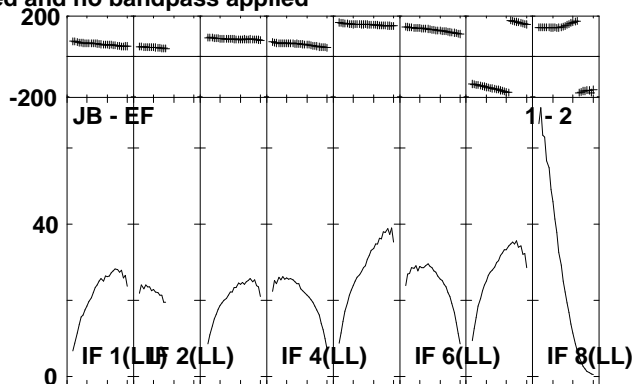
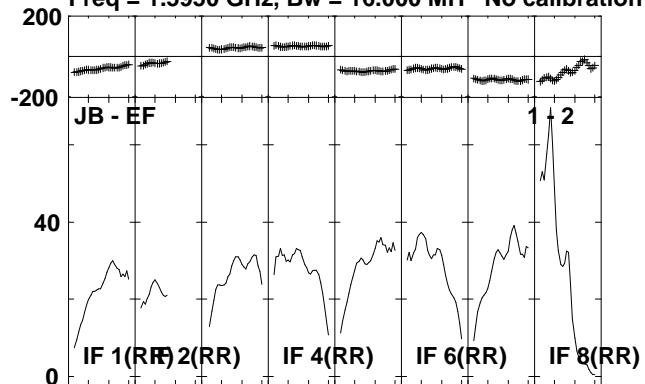

Lower frame: Milli Ampl Jy Top frame: Phas deg
Scalar averaged cross-power spectrum Several baselines displayed
Timerange: 00/14:56:11 to 00/14:57:59

Plot file version 130 created 06-JUL-2010 14:44:01

J2330+33 EP064J.UVDATA.1

Freq = 1.5950 GHz, Bw = 16.000 MH No calibration applied and no bandpass applied

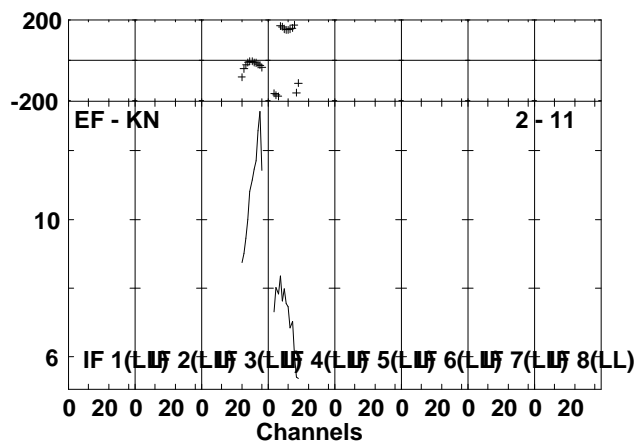
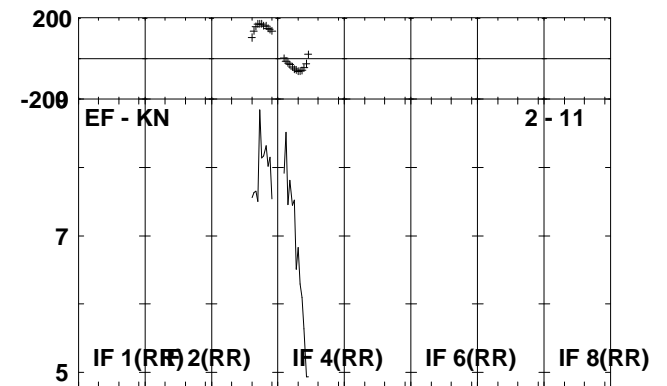
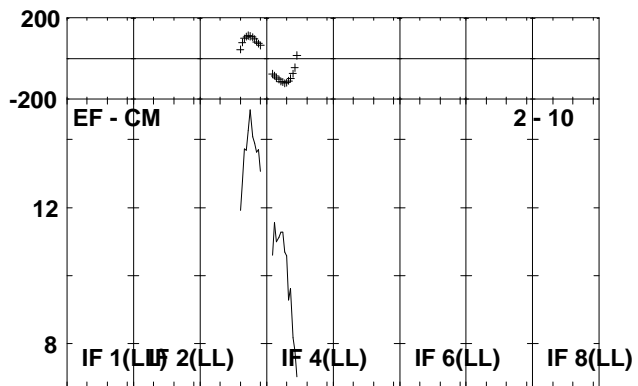
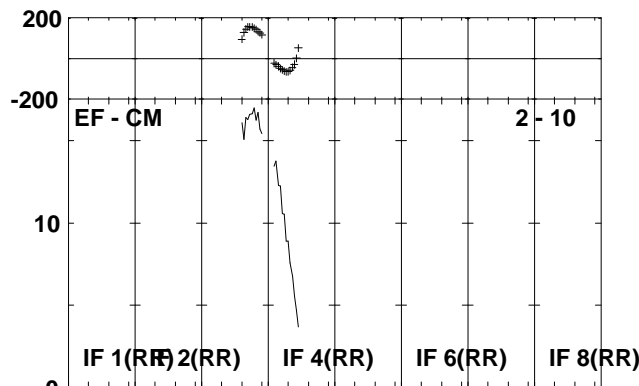
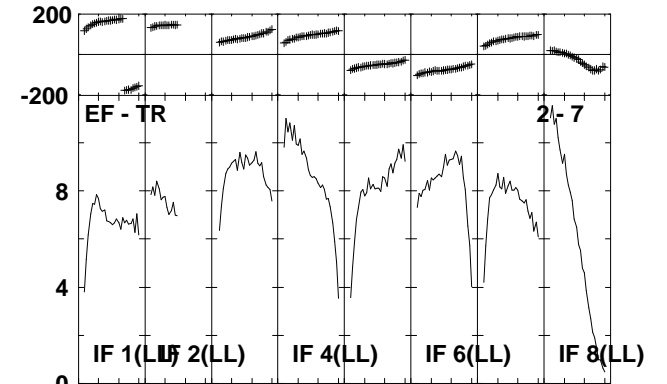
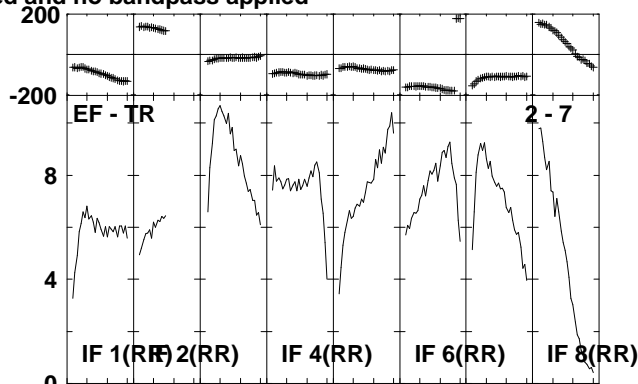
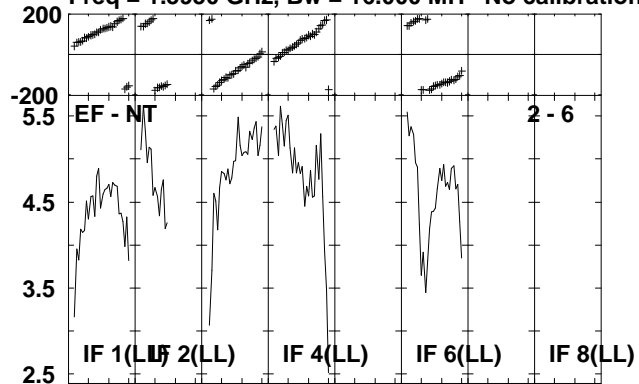

Lower frame: Milli Ampl Jy Top frame: Phas deg
 Scalar averaged cross-power spectrum Several baselines displayed
 Timerange: 00/14:56:11 to 00/14:57:59

Plot file version 131 created 06-JUL-2010 14:44:03

IRAS2336 EP064J.UVDATA.1

Freq = 1.5950 GHz, Bw = 16.000 MH No calibration applied and no bandpass applied

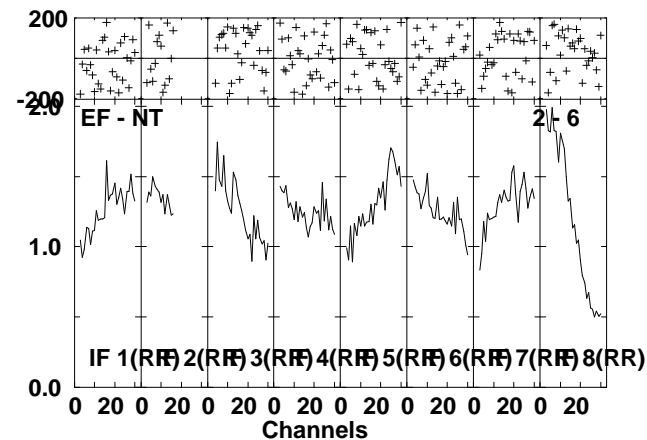
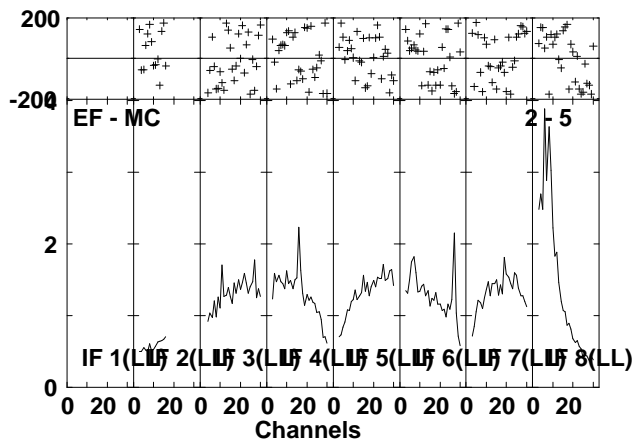
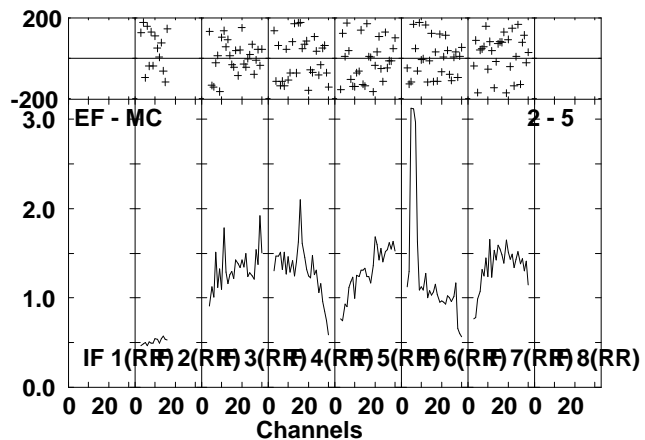
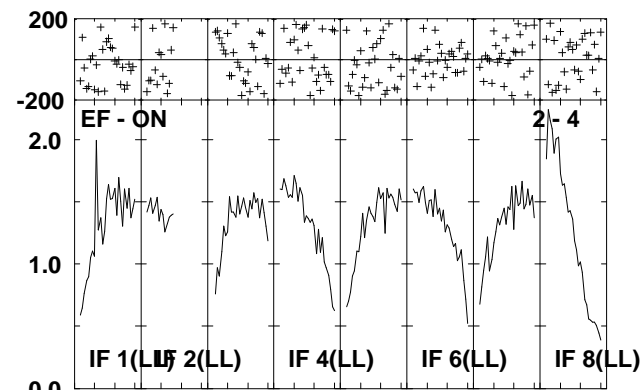
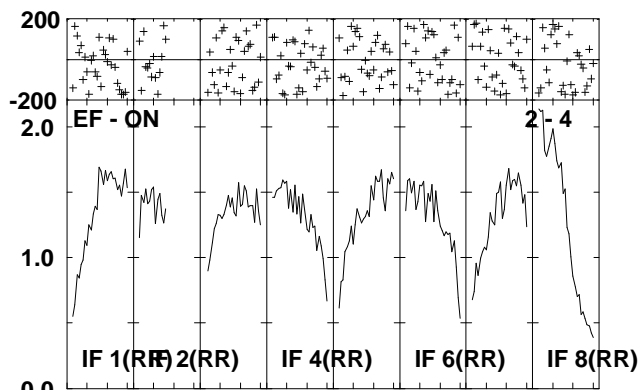
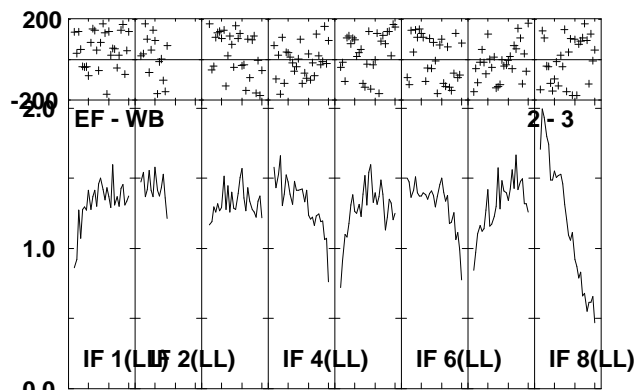
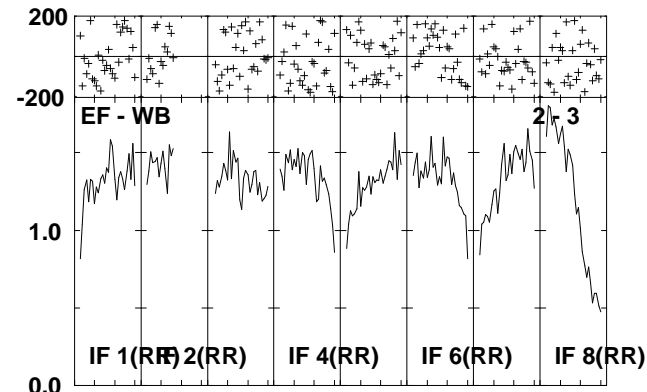
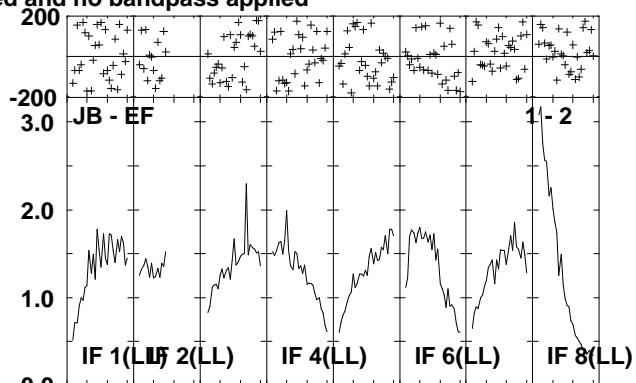
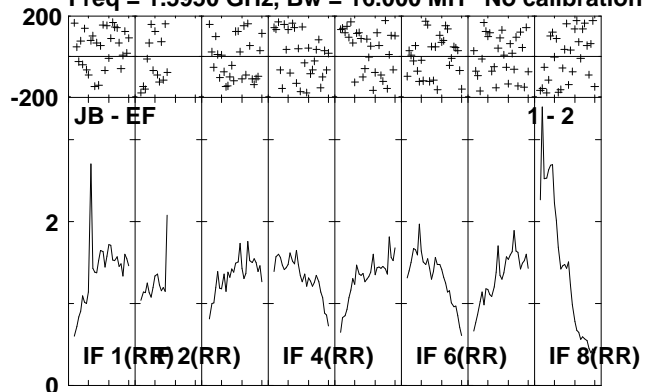

Lower frame: Milli Ampl Jy Top frame: Phas deg
Scalar averaged cross-power spectrum Several baselines displayed
Timerange: 00/14:58:01 to 00/15:01:39

Plot file version 132 created 06-JUL-2010 14:44:05

IRAS2336 EP064J.UVDATA.1

Freq = 1.5950 GHz, Bw = 16.000 MH No calibration applied and no bandpass applied

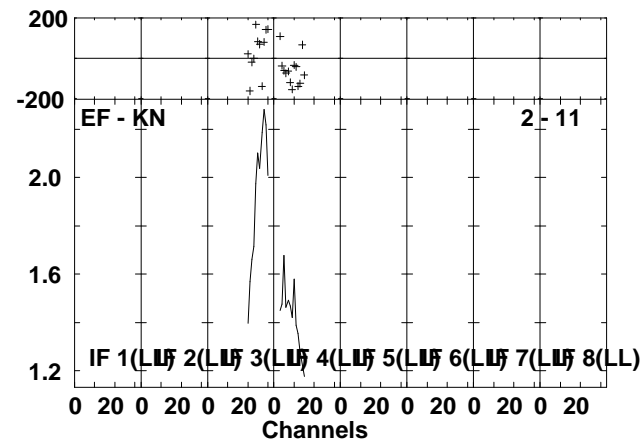
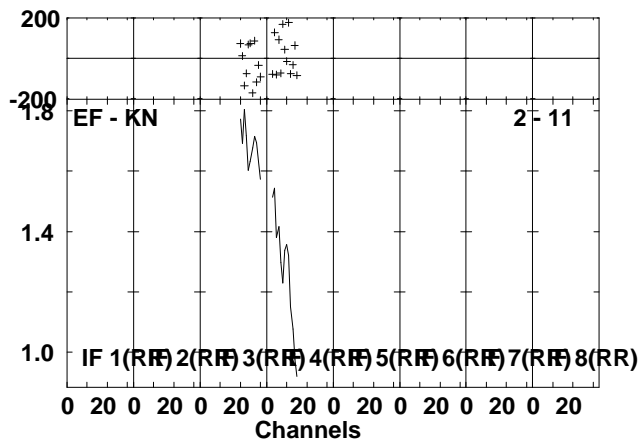
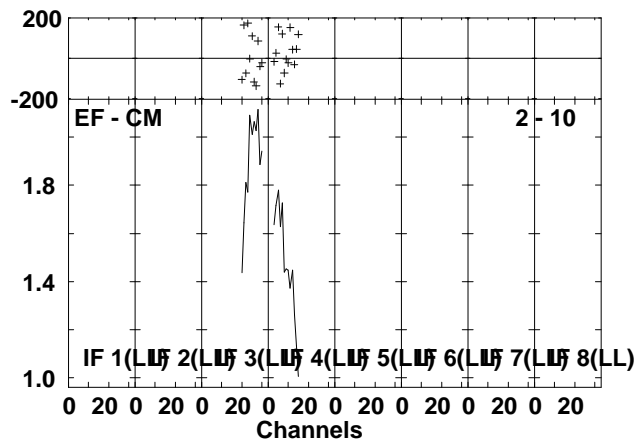
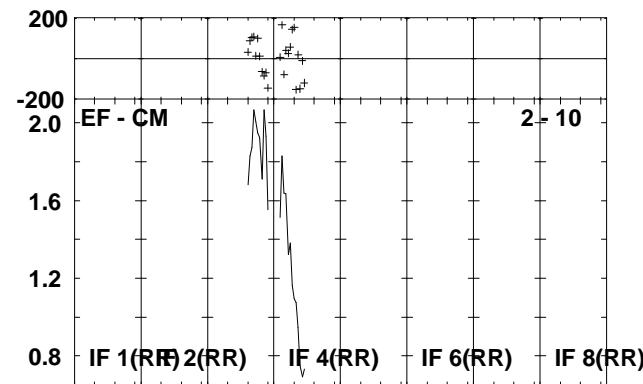
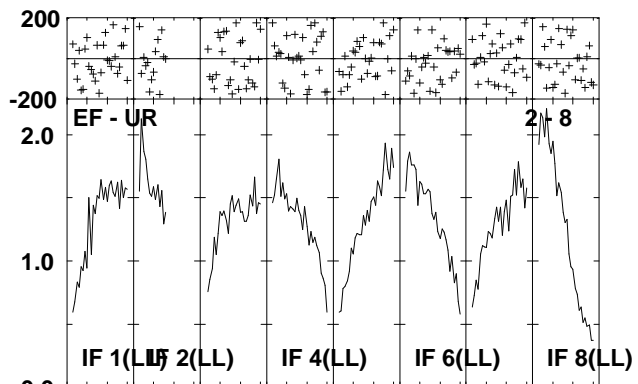
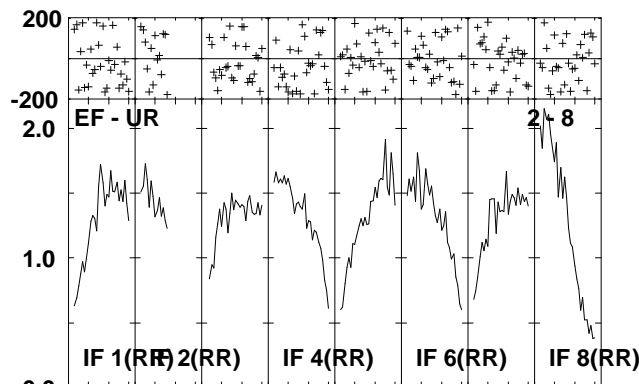
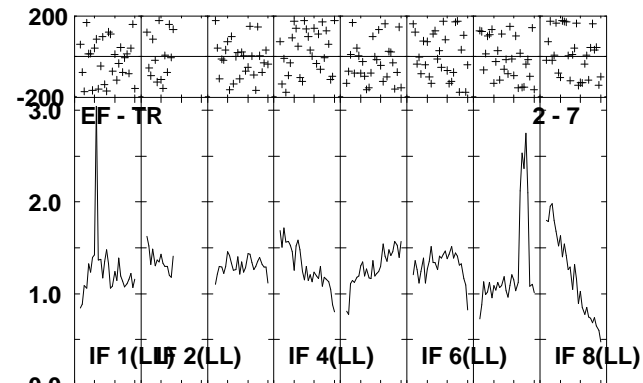
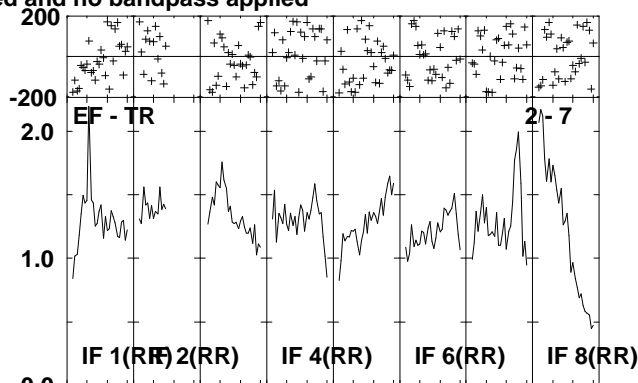
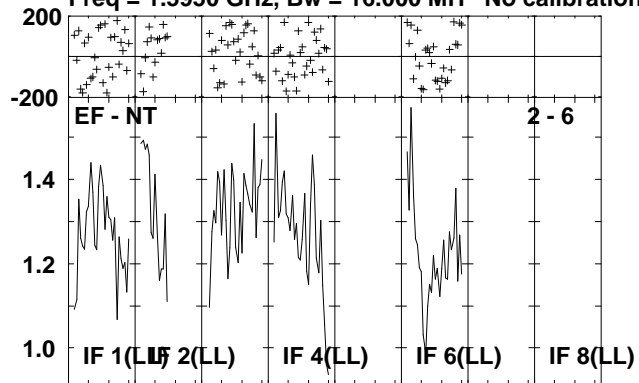

Lower frame: Milli Ampl Jy Top frame: Phas deg
Scalar averaged cross-power spectrum Several baselines displayed
Timerange: 00/14:58:01 to 00/15:01:39

Plot file version 133 created 06-JUL-2010 14:44:07

J2330+33 EP064J.UVDATA.1

Freq = 1.5950 GHz, Bw = 16.000 MH No calibration applied and no bandpass applied

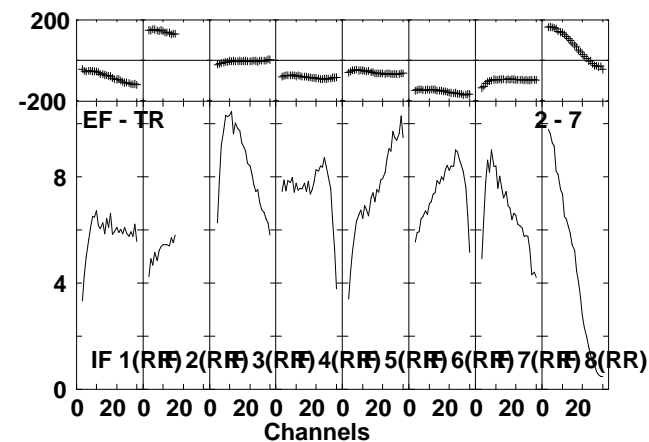
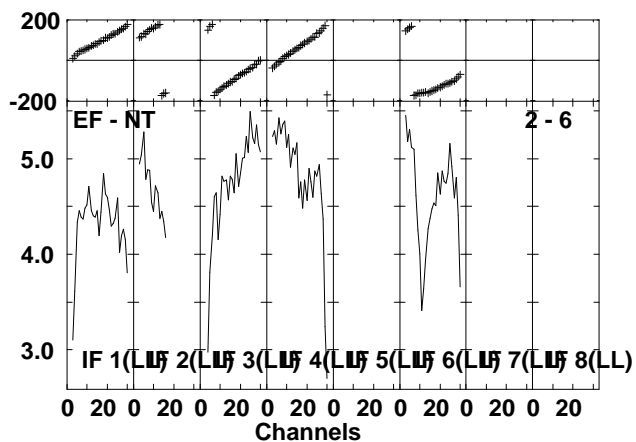
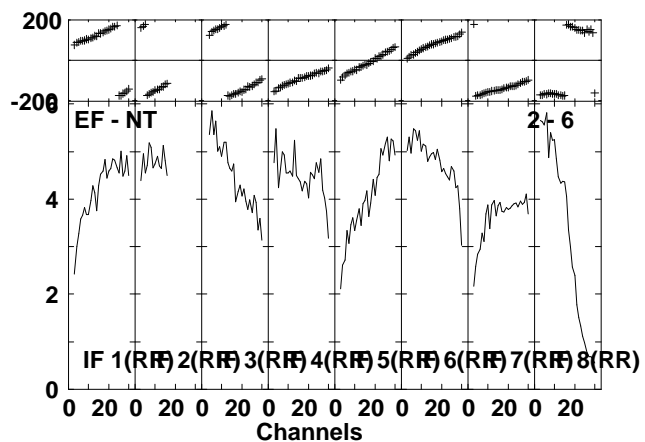
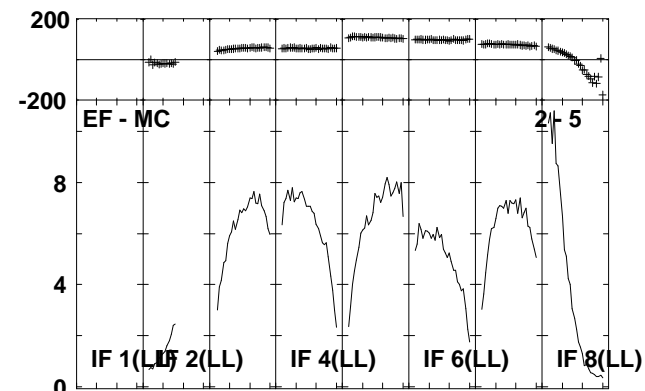
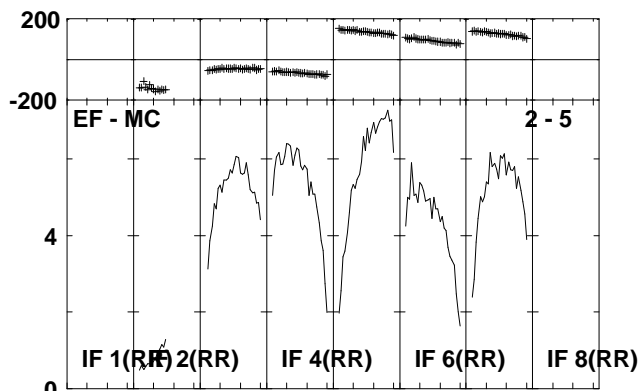
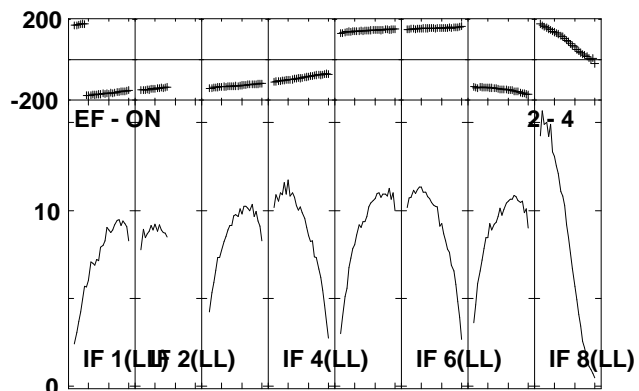
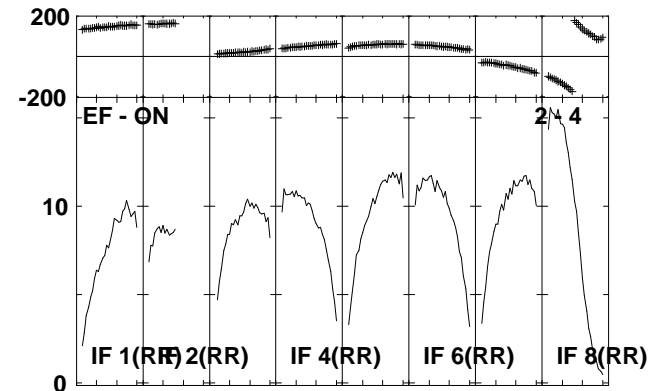
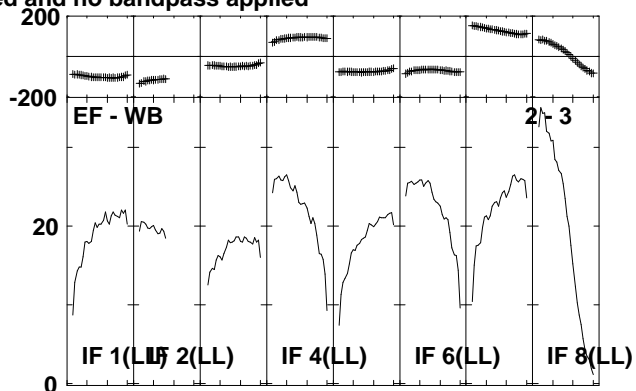
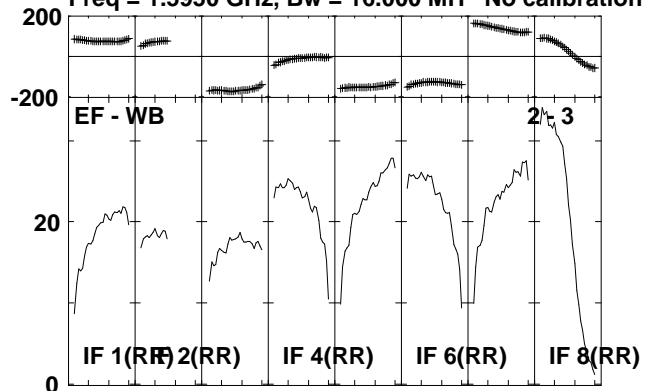

Lower frame: Milli Ampl Jy Top frame: Phas deg
Scalar averaged cross-power spectrum Several baselines displayed
Timerange: 00/15:01:47 to 00/15:03:27

Plot file version 134 created 06-JUL-2010 14:44:08

J2330+33 EP064J.UVDATA.1

Freq = 1.5950 GHz, Bw = 16.000 MH No calibration applied and no bandpass applied

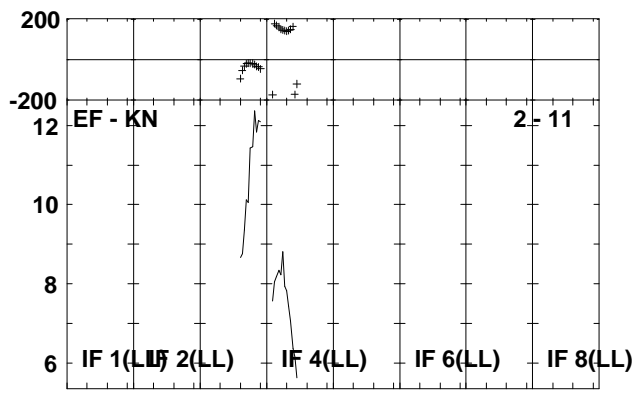
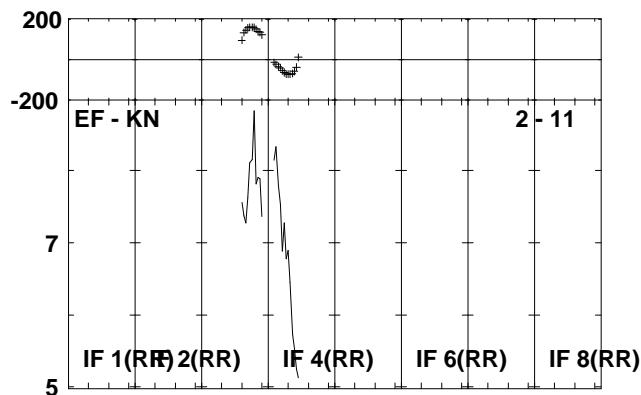
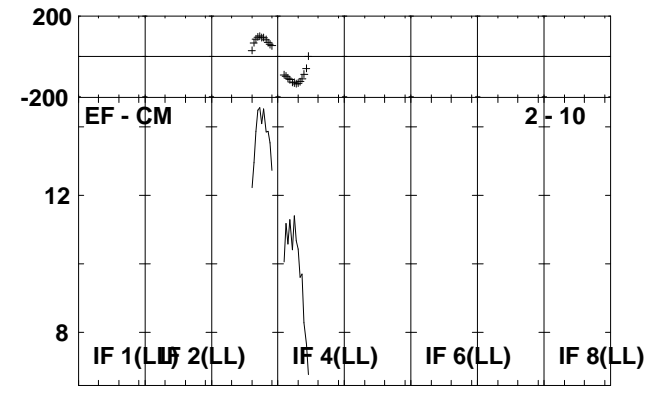
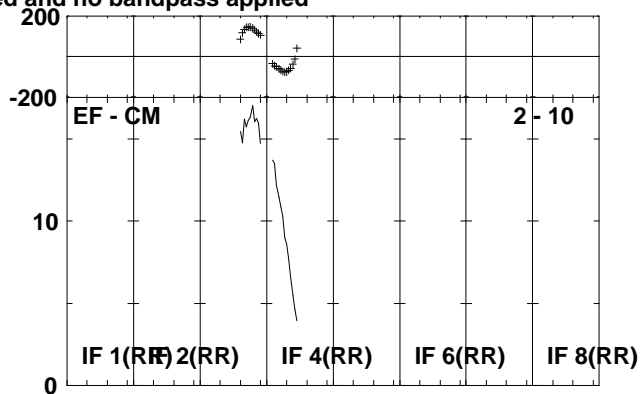
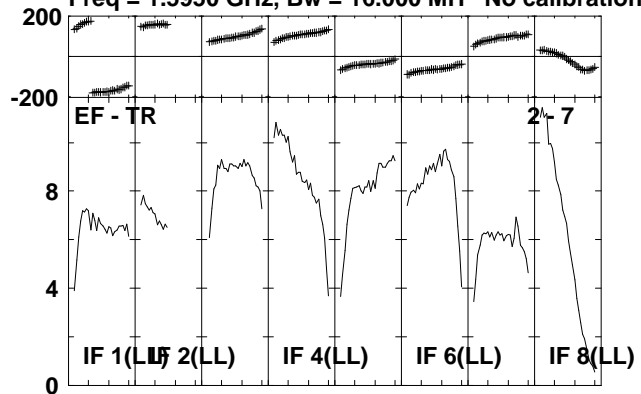

Lower frame: Milli Ampl Jy Top frame: Phas deg
Scalar averaged cross-power spectrum Several baselines displayed
Timerange: 00/15:01:47 to 00/15:03:27

Plot file version 135 created 06-JUL-2010 14:44:09

IRAS2336 EP064J.UVDATA.1

Freq = 1.5950 GHz, Bw = 16.000 MH No calibration applied and no bandpass applied

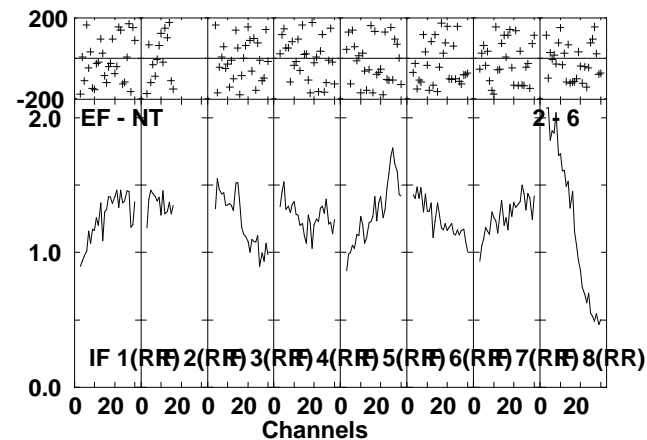
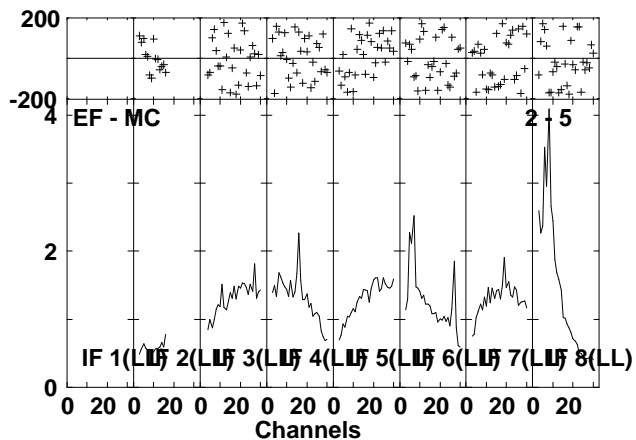
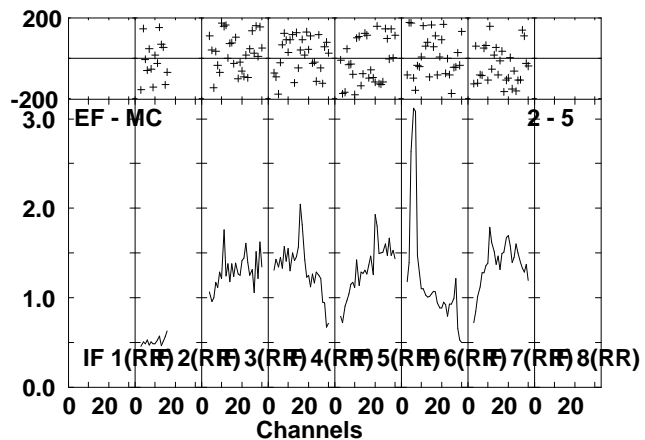
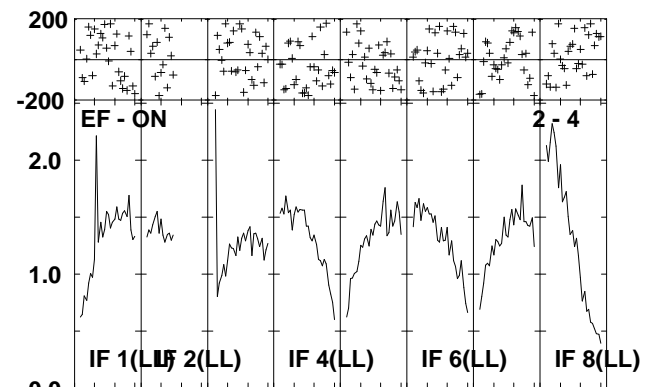
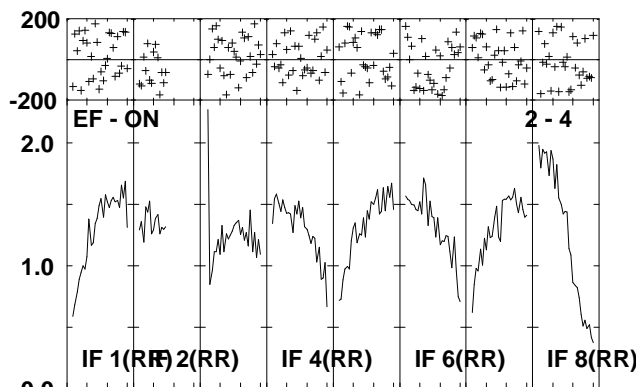
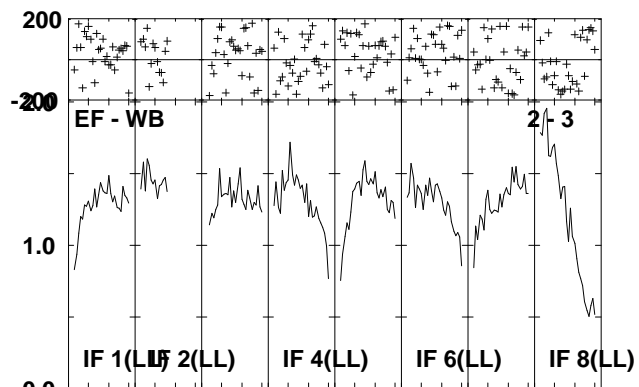
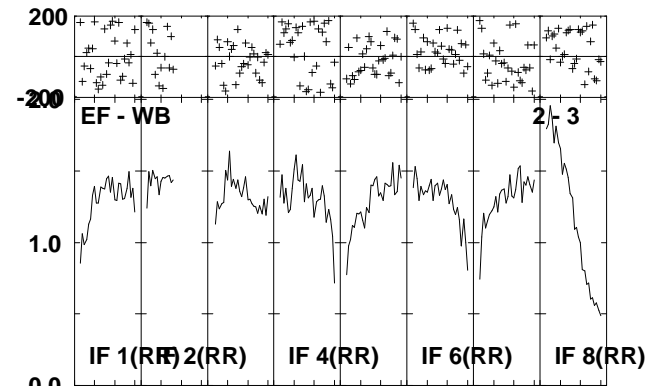
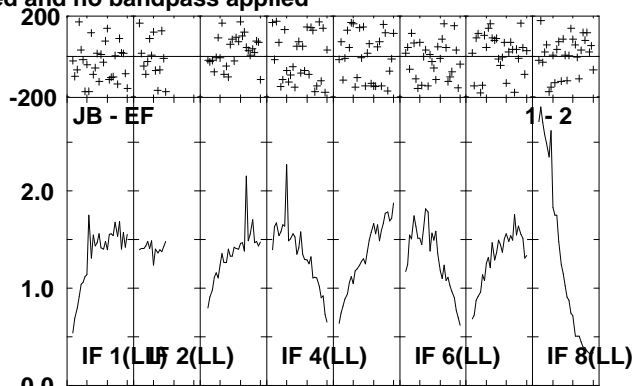
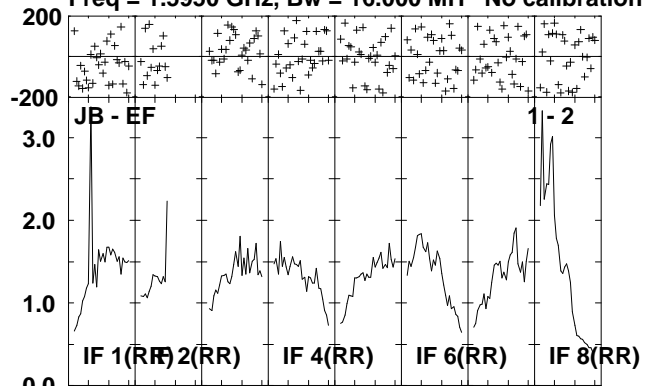

Lower frame: Milli Ampl Jy Top frame: Phas deg
Scalar averaged cross-power spectrum Several baselines displayed
Timerange: 00:15:03:31 to 00:15:07:09

Plot file version 136 created 06-JUL-2010 14:44:10

IRAS2336 EP064J.UVDATA.1

Freq = 1.5950 GHz, Bw = 16.000 MH No calibration applied and no bandpass applied

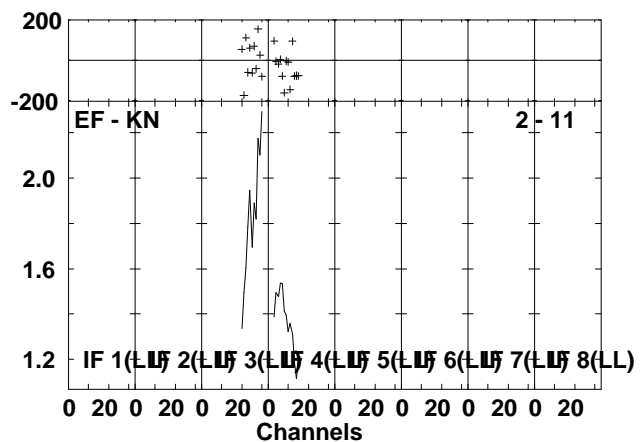
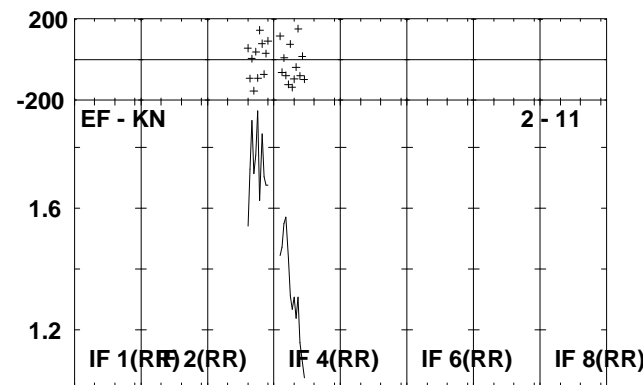
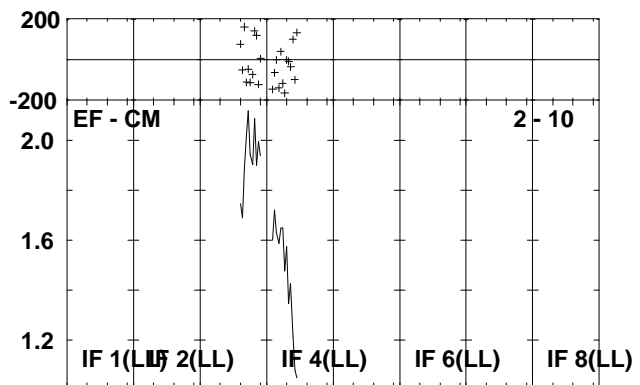
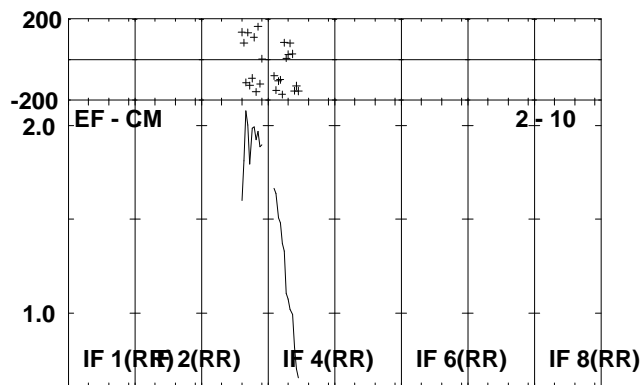
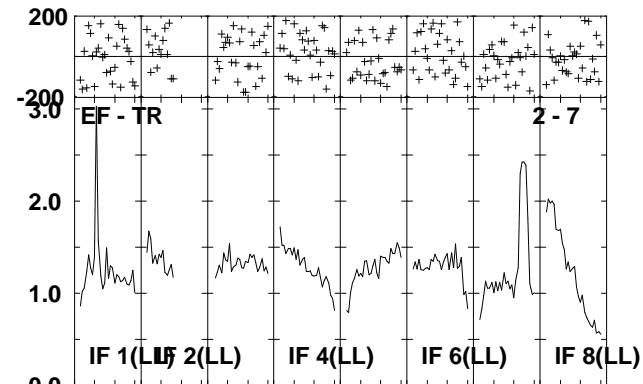
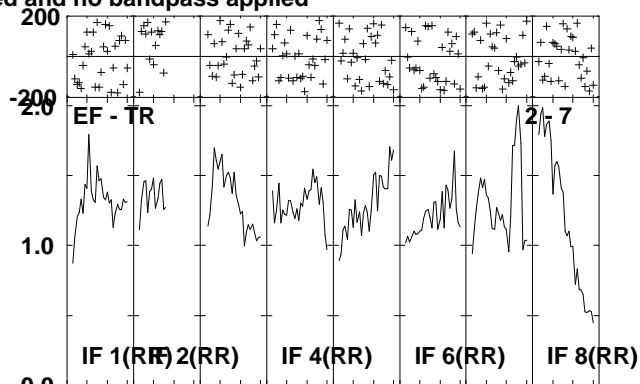
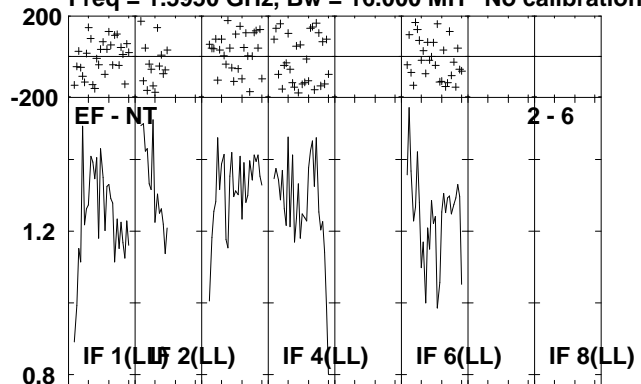

0 20 0 20 0 20 0 20 0 20 0 20 0 20 0 20 0 20 0 20
Channels
Lower frame: Milli Ampl Jy Top frame: Phas deg
Scalar averaged cross-power spectrum Several baselines displayed
Timerange: 00/15:03:31 to 00/15:07:09

Plot file version 137 created 06-JUL-2010 14:44:12

J2330+33 EP064J.UVDATA.1

Freq = 1.5950 GHz, Bw = 16.000 MH No calibration applied and no bandpass applied

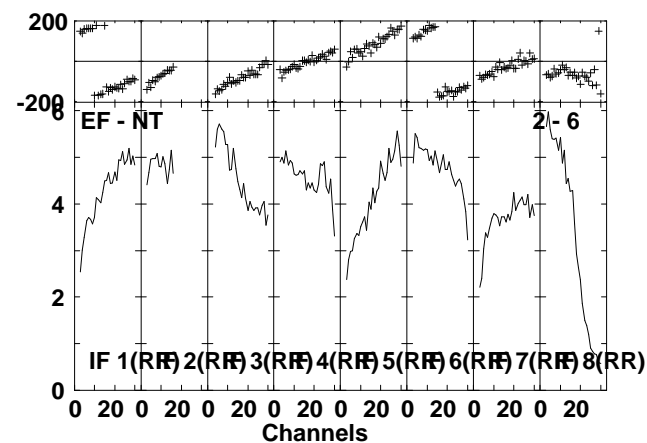
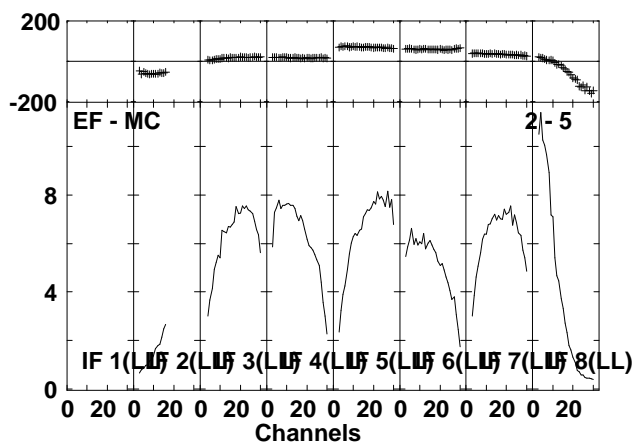
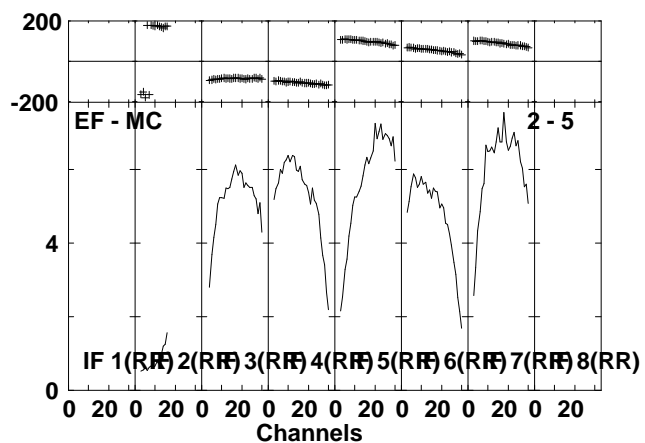
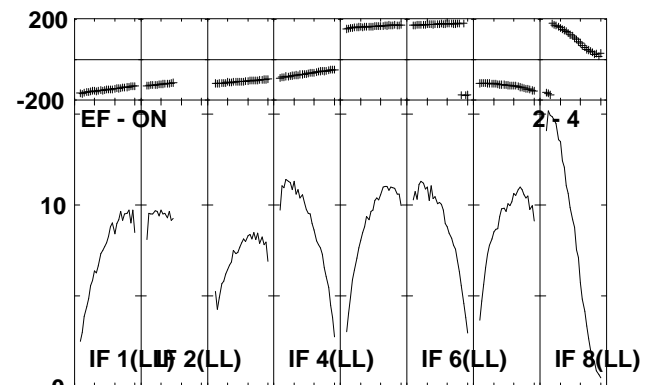
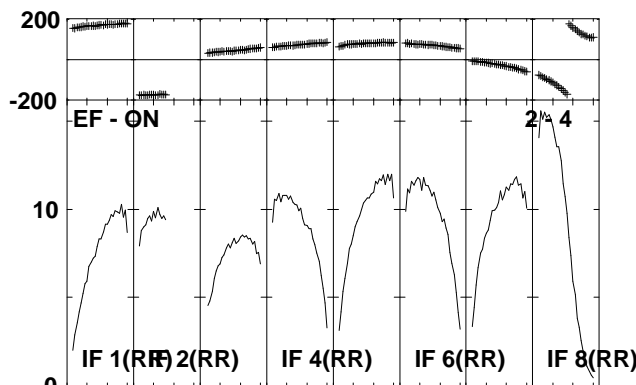
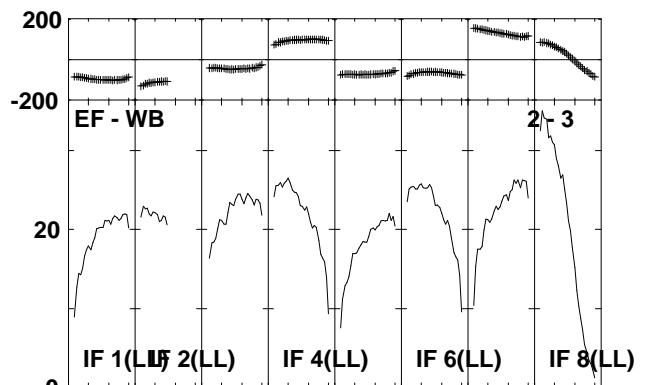
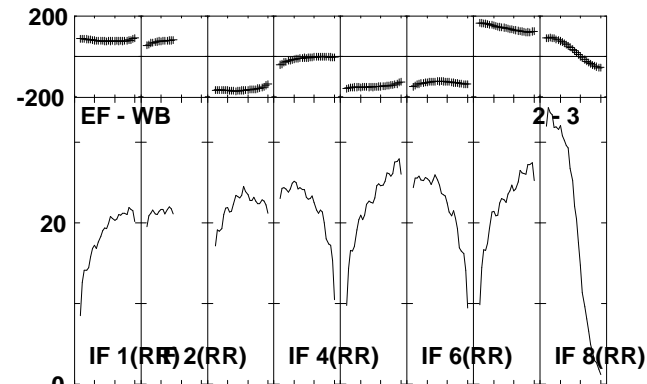
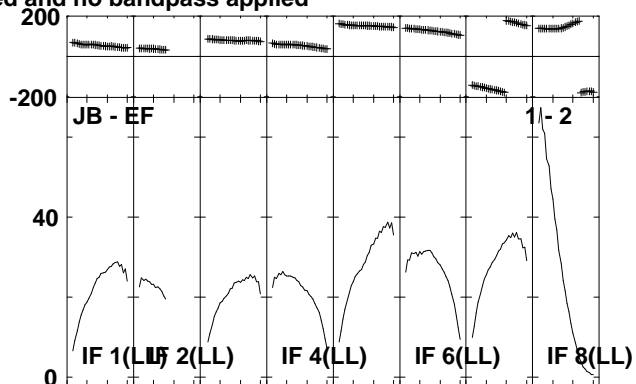
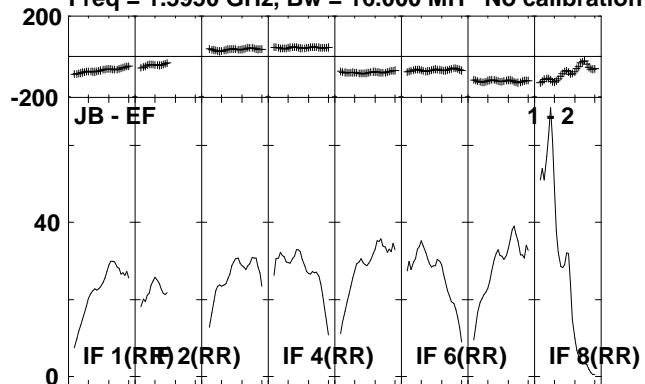

Lower frame: Milli Ampl Jy Top frame: Phas deg
Scalar averaged cross-power spectrum Several baselines displayed
Timerange: 00/15:08:11 to 00/15:09:49

Plot file version 138 created 06-JUL-2010 14:44:13

J2330+33 EP064J.UVDATA.1

Freq = 1.5950 GHz, Bw = 16.000 MH No calibration applied and no bandpass applied

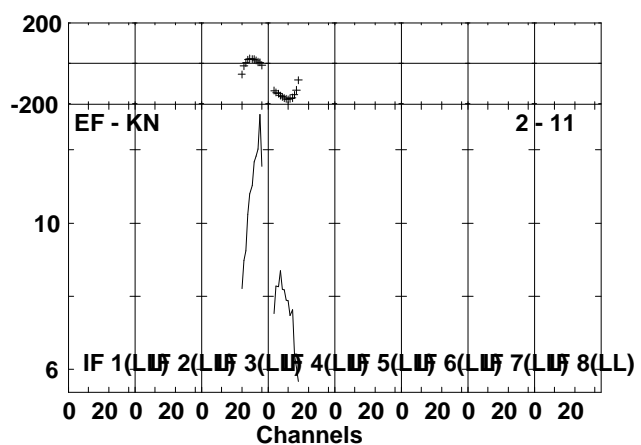
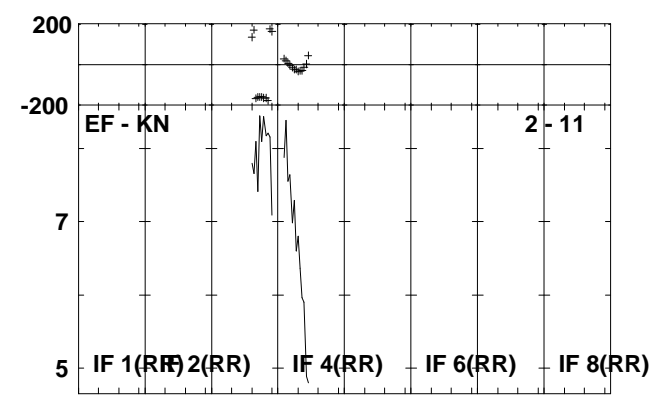
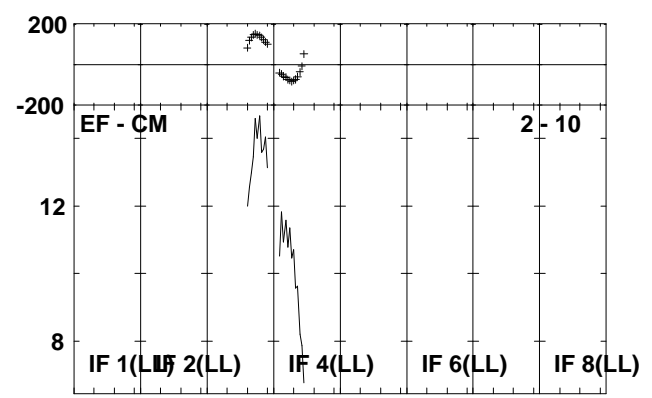
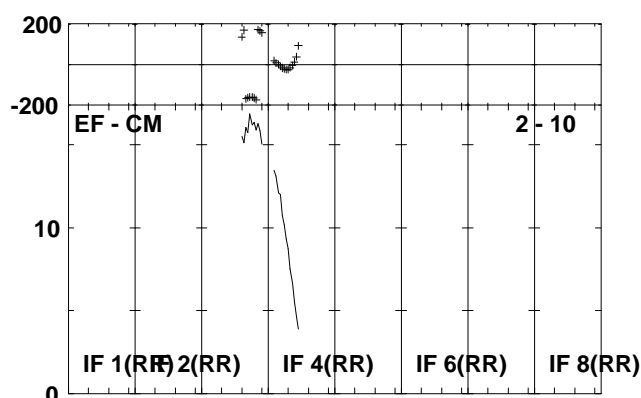
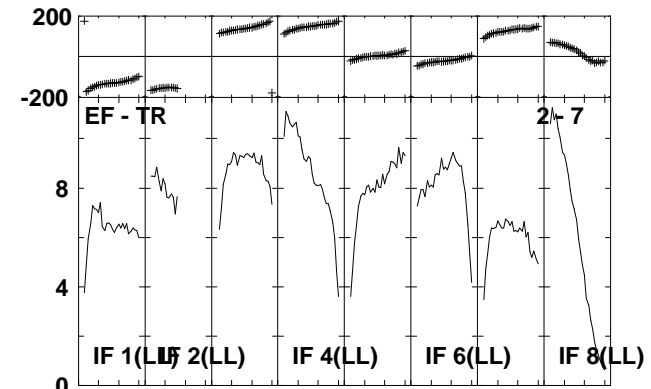
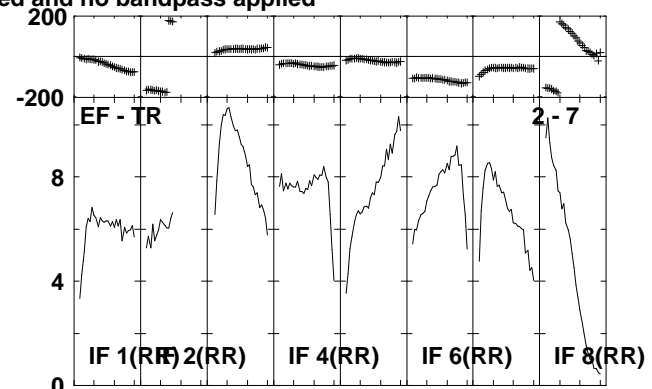
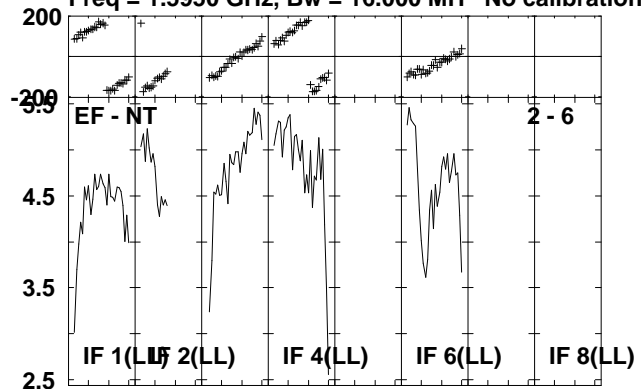

Lower frame: Milli Ampl Jy Top frame: Phas deg
Scalar averaged cross-power spectrum Several baselines displayed
Timerange: 00/15:08:11 to 00/15:09:49

Plot file version 139 created 06-JUL-2010 14:44:14

IRAS2336 EP064J.UVDATA.1

Freq = 1.5950 GHz, Bw = 16.000 MH No calibration applied and no bandpass applied

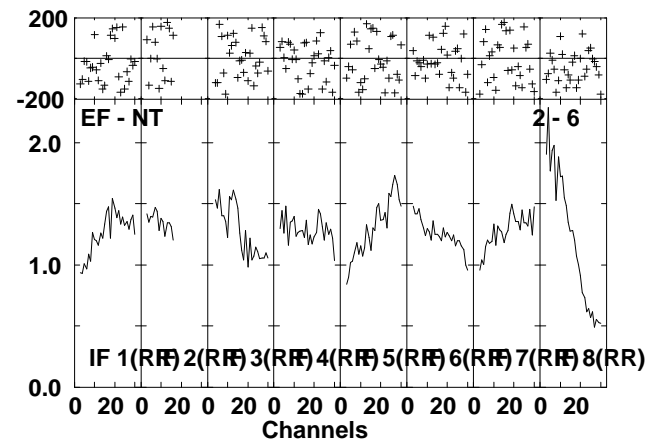
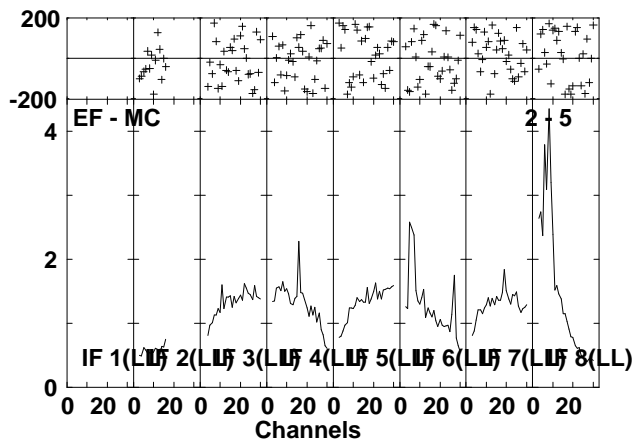
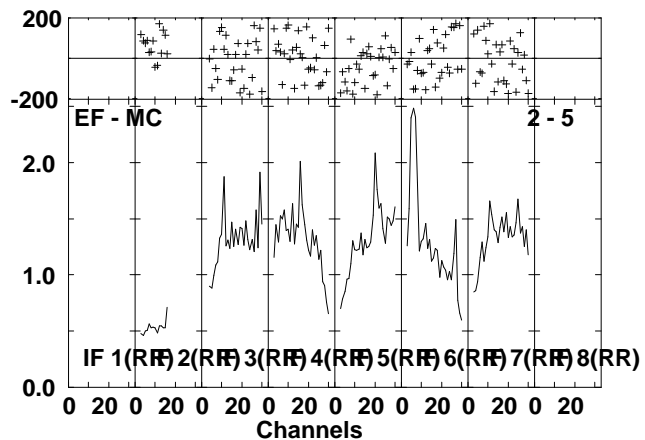
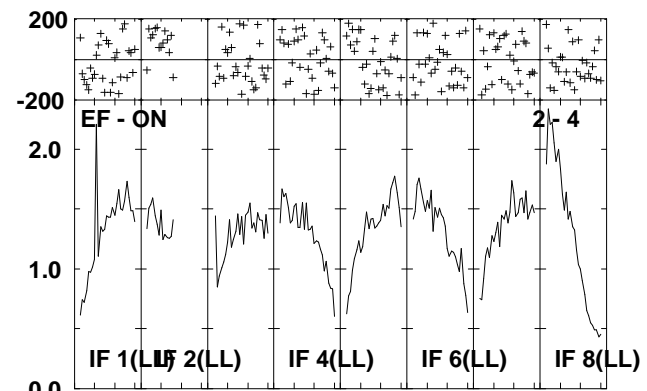
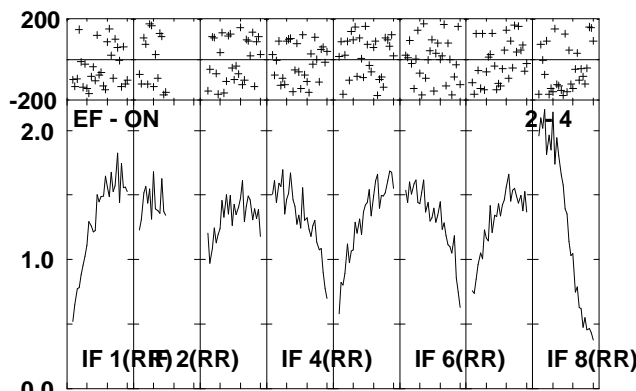
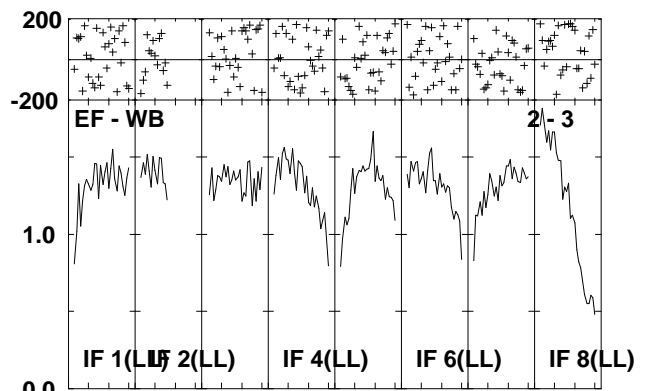
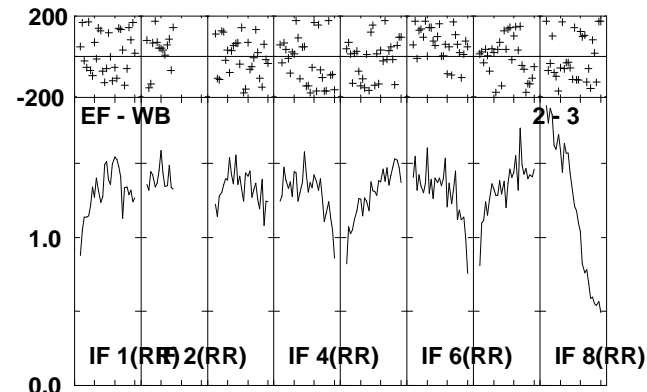
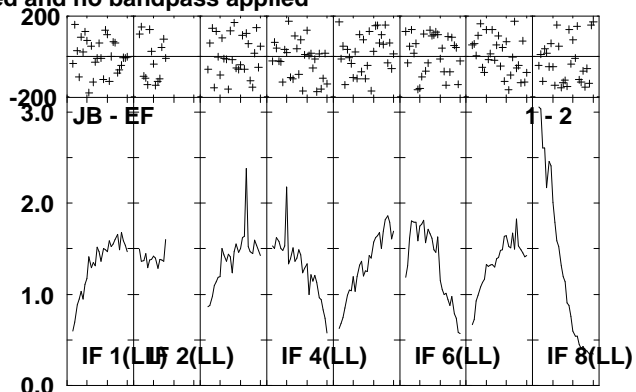
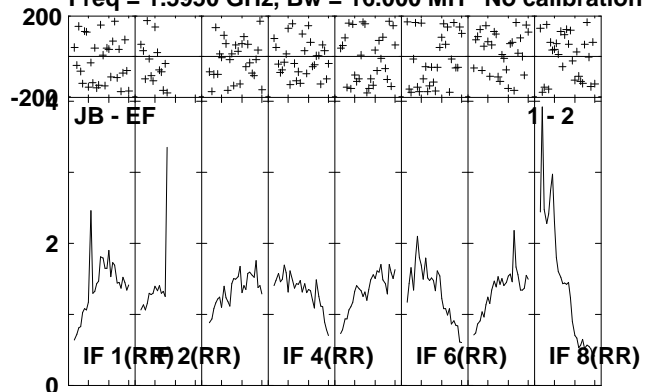

Lower frame: Milli Ampl Jy Top frame: Phas deg
Scalar averaged cross-power spectrum Several baselines displayed
Timerange: 00/15:09:51 to 00/15:13:29

Plot file version 140 created 06-JUL-2010 14:44:16

IRAS2336 EP064J.UVDATA.1

Freq = 1.5950 GHz, Bw = 16.000 MH No calibration applied and no bandpass applied

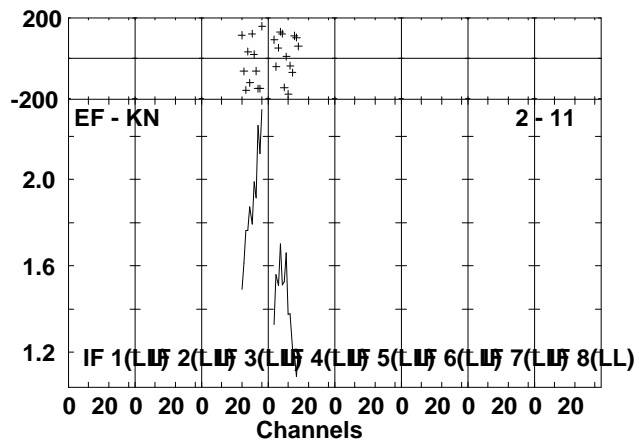
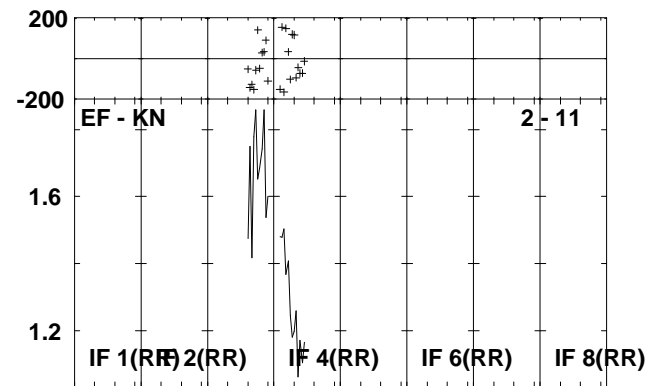
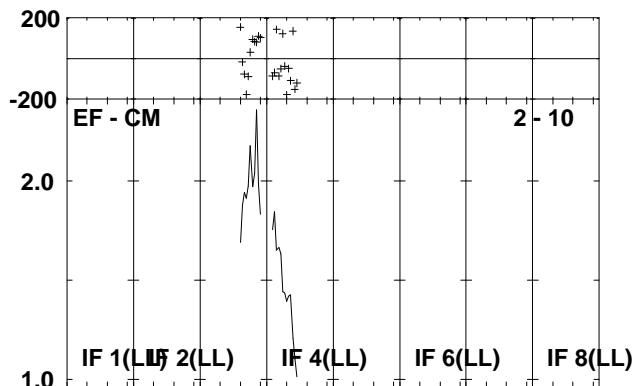
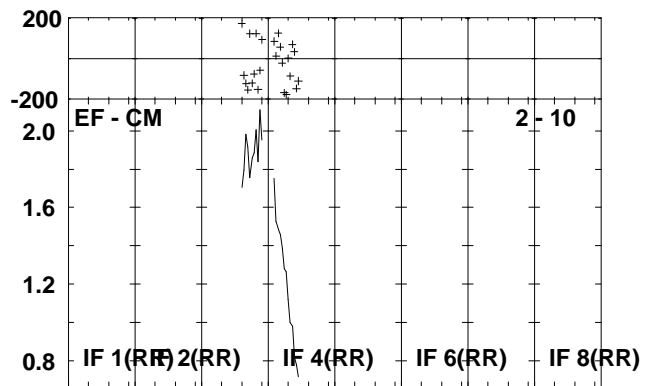
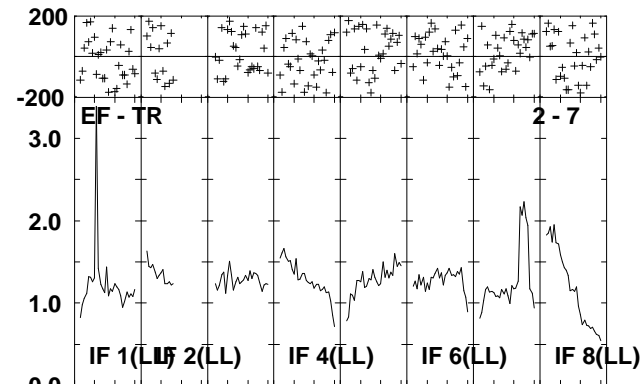
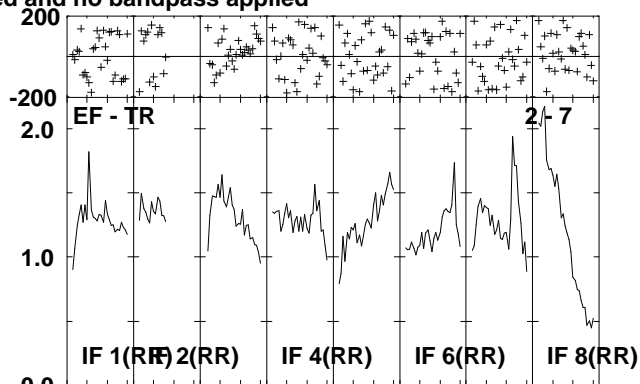
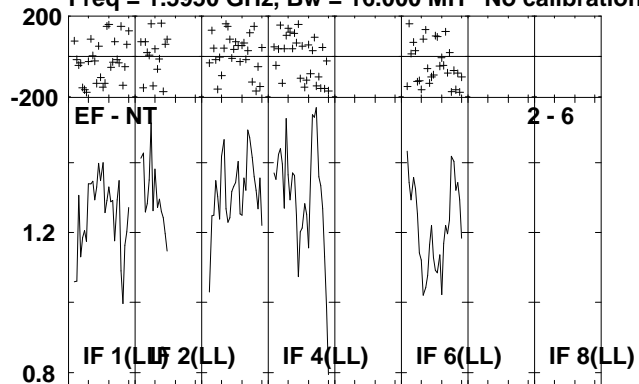

Lower frame: Milli Ampl Jy Top frame: Phas deg
Scalar averaged cross-power spectrum Several baselines displayed
Timerange: 00/15:09:51 to 00/15:13:29

Plot file version 141 created 06-JUL-2010 14:44:18

J2330+33 EP064J.UVDATA.1

Freq = 1.5950 GHz, Bw = 16.000 MH No calibration applied and no bandpass applied

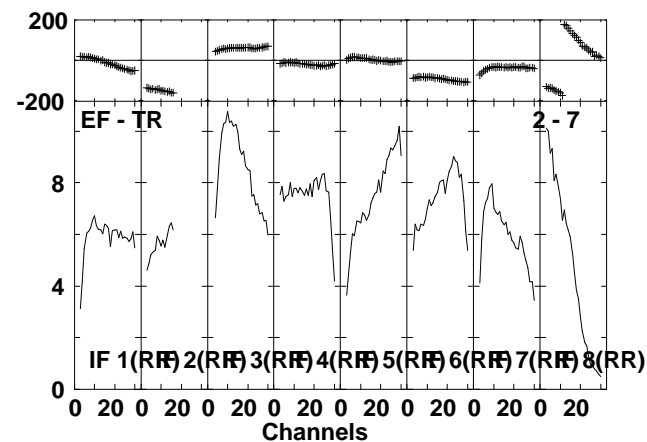
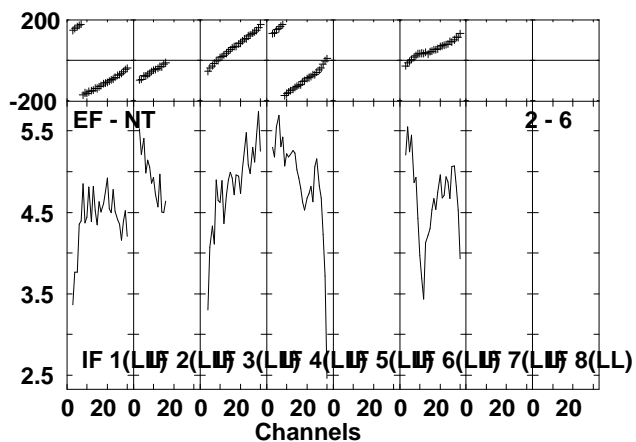
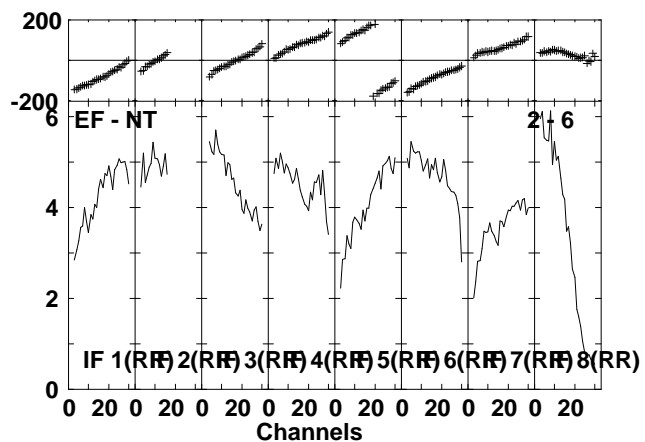
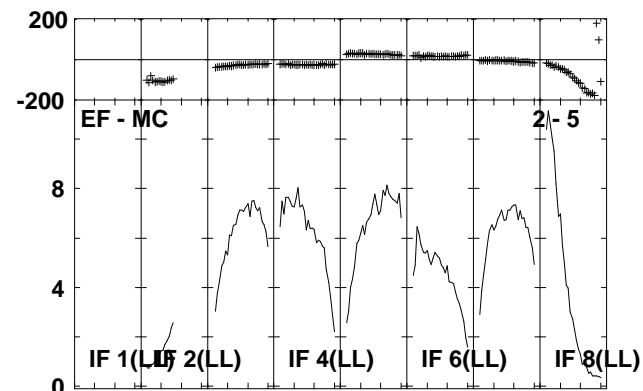
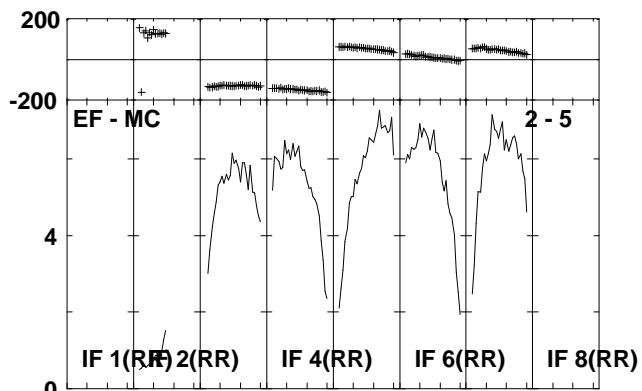
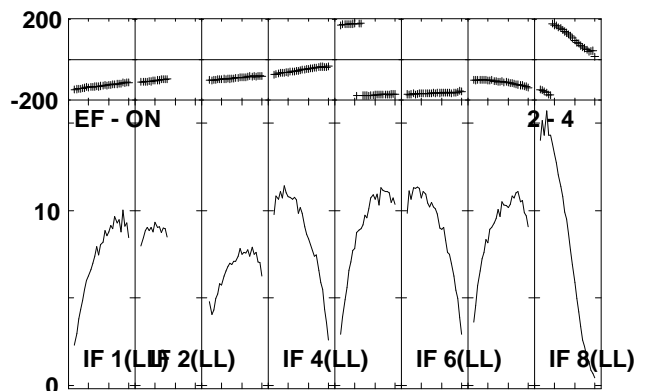
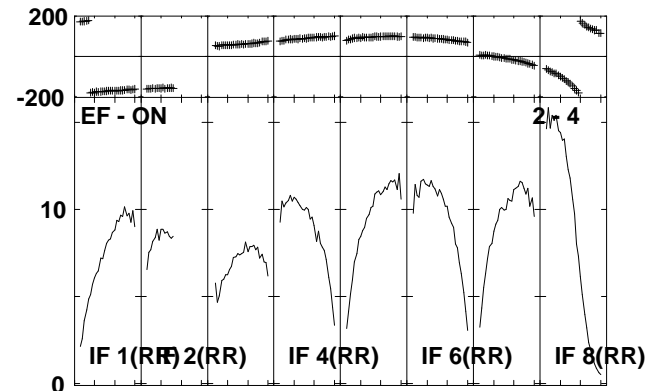
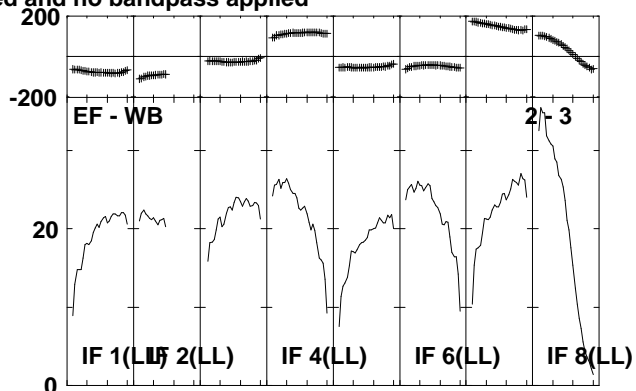
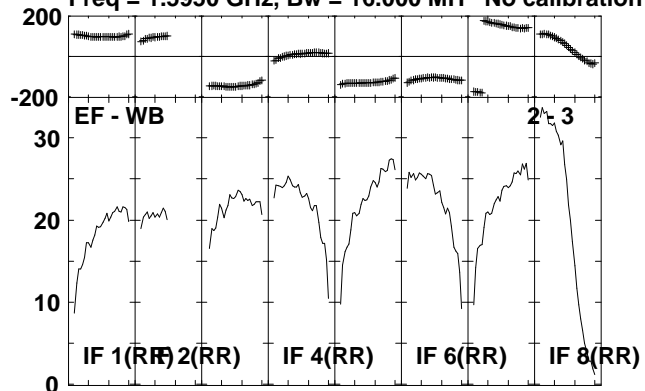

Lower frame: Milli Ampl Jy Top frame: Phas deg
Scalar averaged cross-power spectrum Several baselines displayed
Timerange: 00/15:13:31 to 00/15:15:19

Plot file version 142 created 06-JUL-2010 14:44:19
J2330+33 EP064J.UVDATA.1

Freq = 1.5950 GHz, Bw = 16.000 MH No calibration applied and no bandpass applied

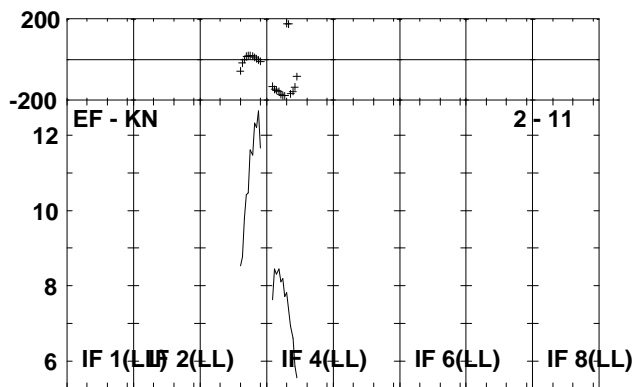
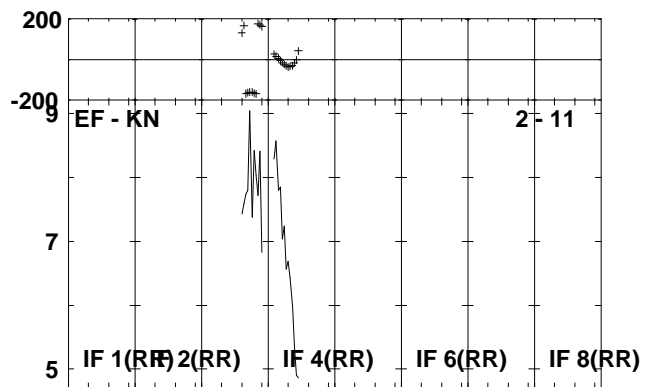
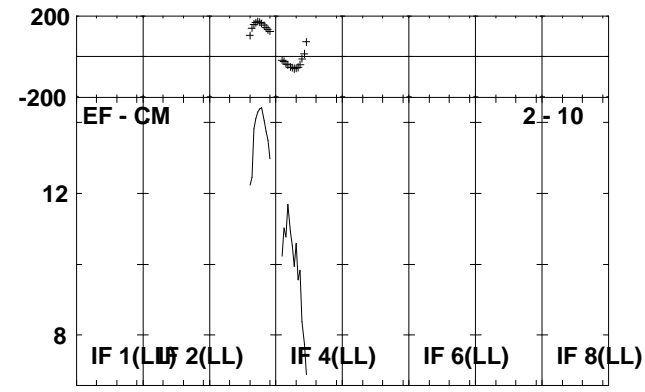
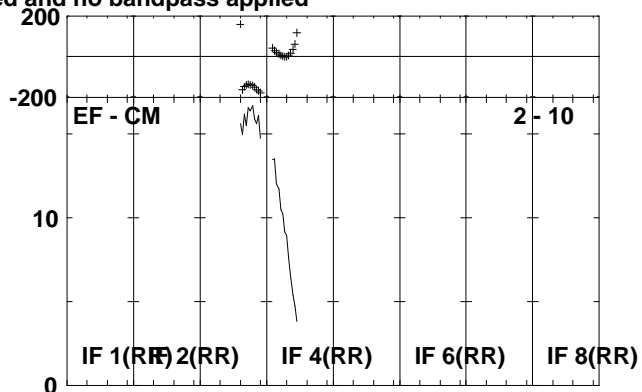
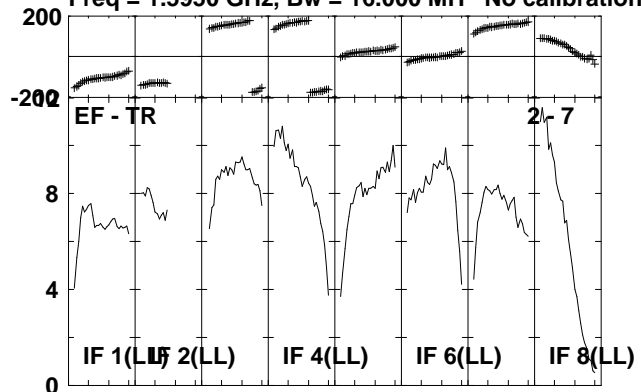

Lower frame: Milli Ampl Jy Top frame: Phas deg
Scalar averaged cross-power spectrum Several baselines displayed
Timerange: 00/15:13:31 to 00/15:15:19

Plot file version 143 created 06-JUL-2010 14:44:20

IRAS2336 EP064J.UVDATA.1

Freq = 1.5950 GHz, Bw = 16.000 MH No calibration applied and no bandpass applied

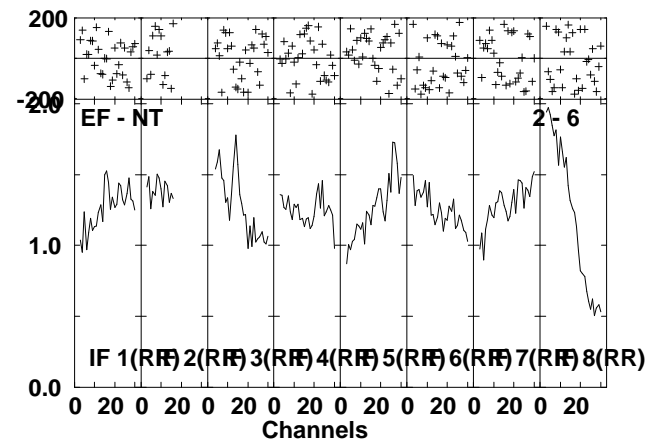
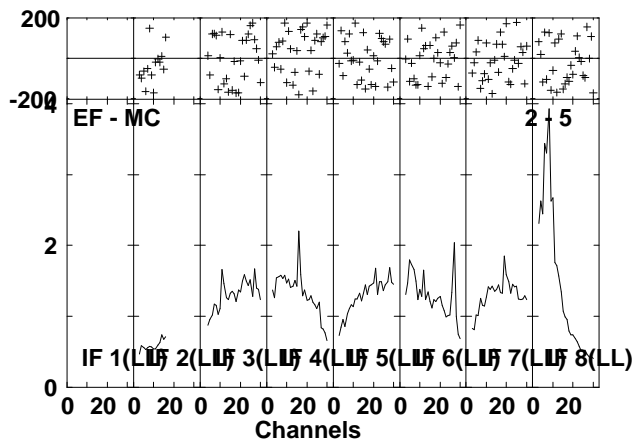
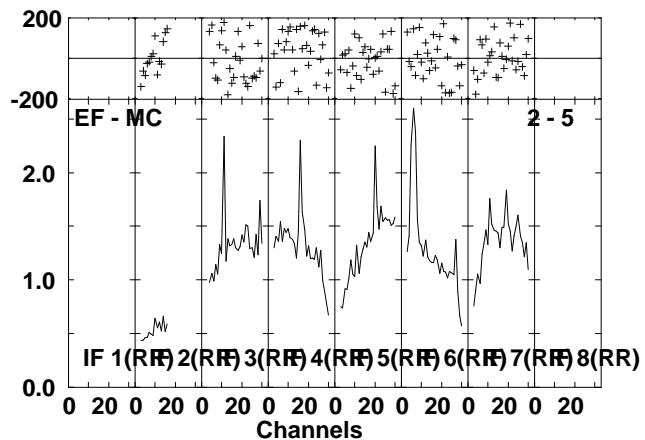
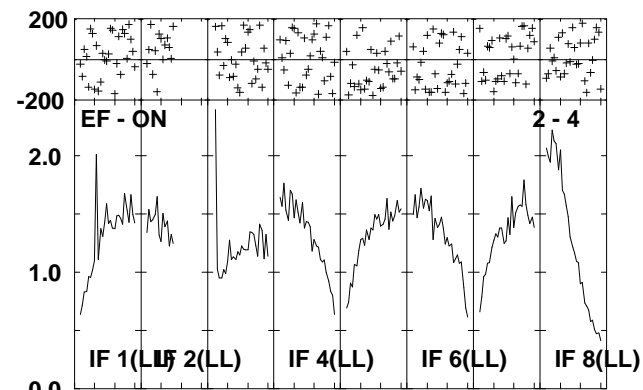
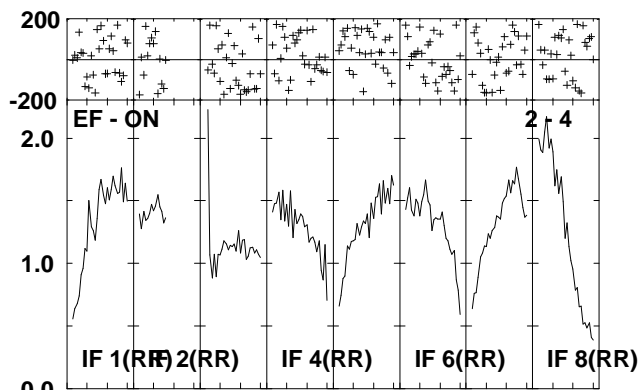
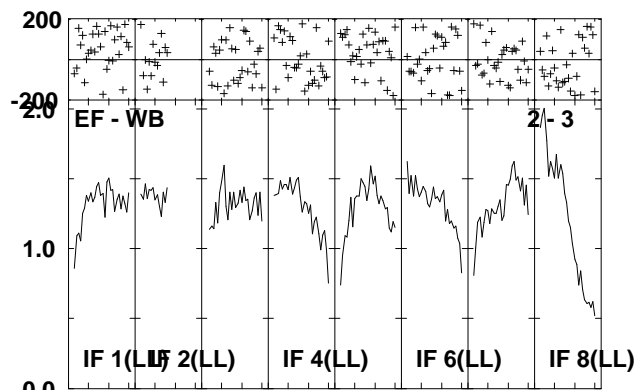
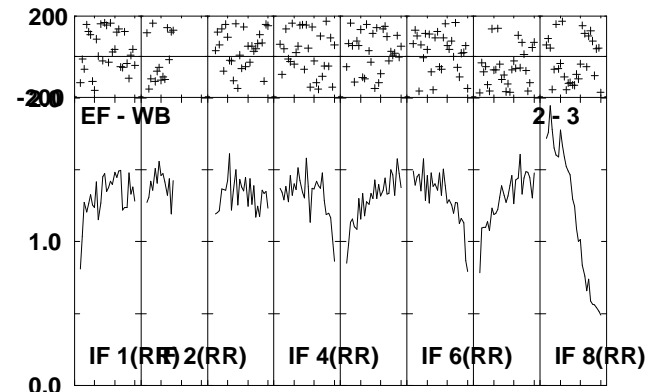
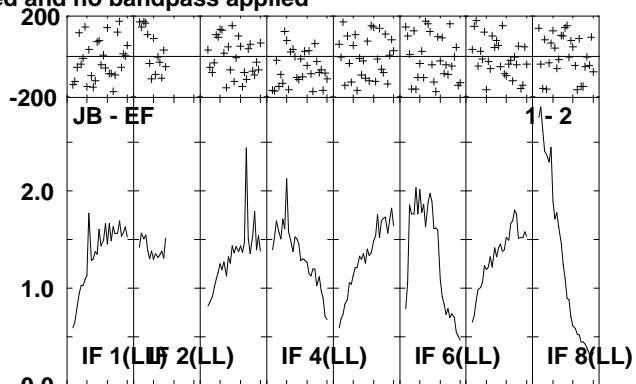
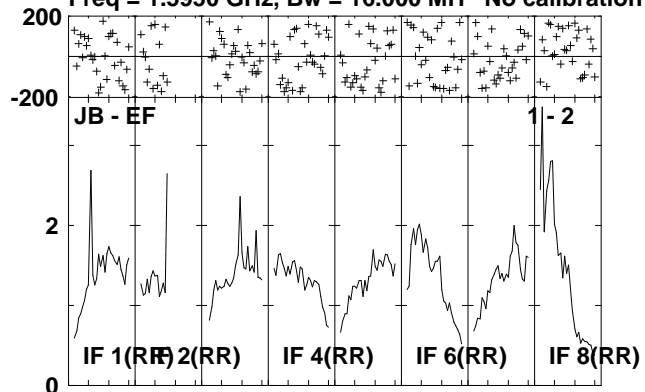

Lower frame: Milli Ampl Jy Top frame: Phas deg
Scalar averaged cross-power spectrum Several baselines displayed
Timerange: 00/15:15:21 to 00/15:18:59

Plot file version 144 created 06-JUL-2010 14:44:22

IRAS2336 EP064J.UVDATA.1

Freq = 1.5950 GHz, Bw = 16.000 MH No calibration applied and no bandpass applied

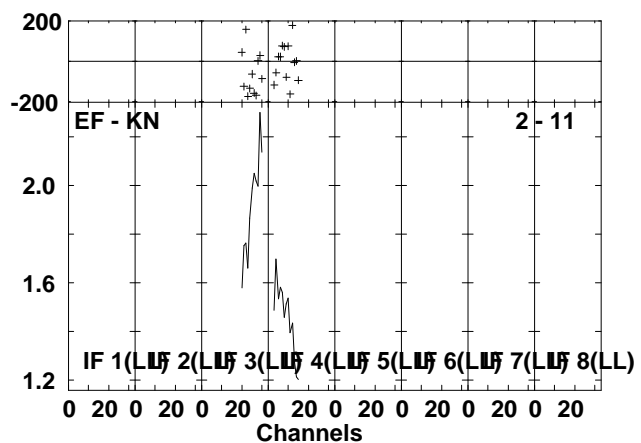
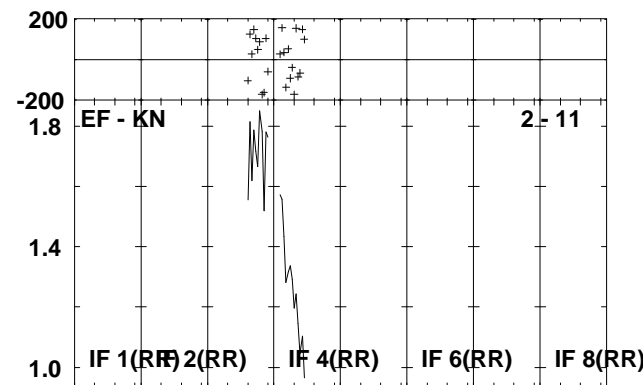
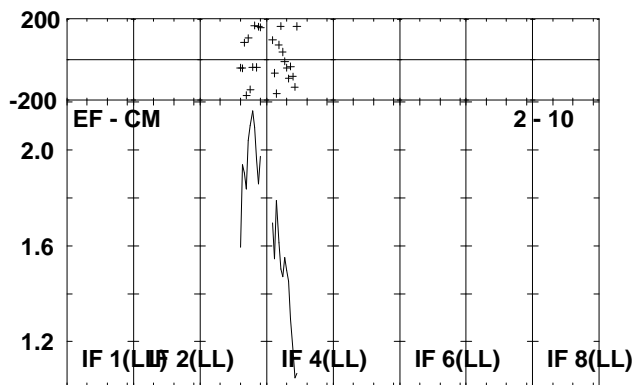
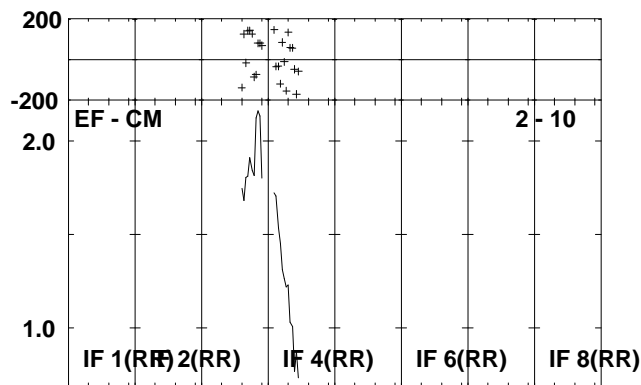
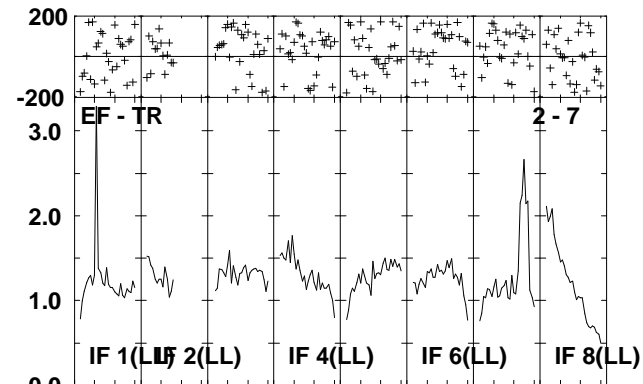
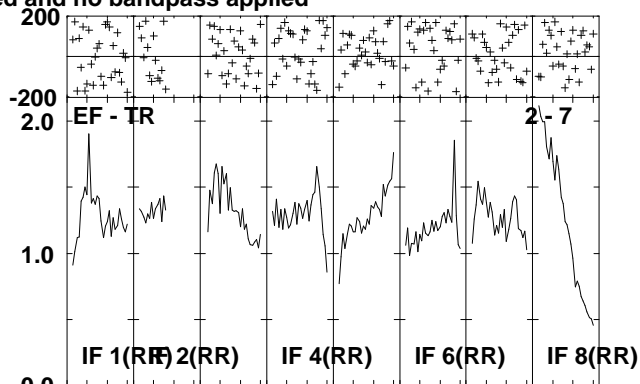
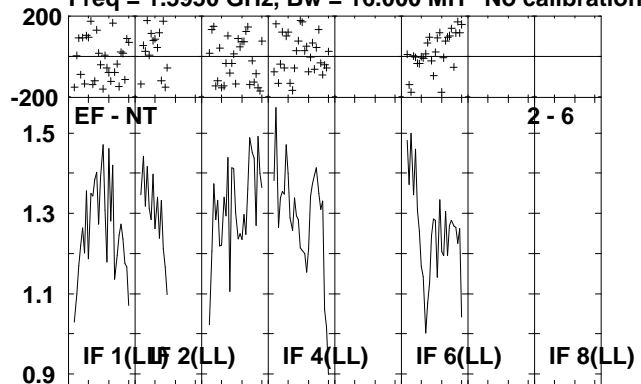

Lower frame: Milli Ampl Jy Top frame: Phas deg
Scalar averaged cross-power spectrum Several baselines displayed
Timerange: 00/15:15:21 to 00/15:18:59

Plot file version 145 created 06-JUL-2010 14:44:24

J2330+33 EP064J.UVDATA.1

Freq = 1.5950 GHz, Bw = 16.000 MH No calibration applied and no bandpass applied

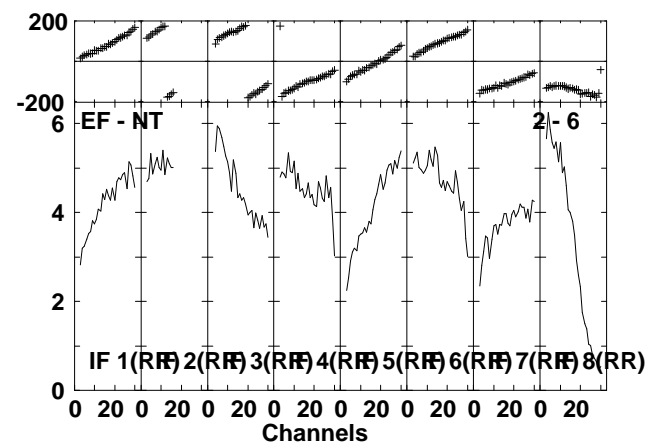
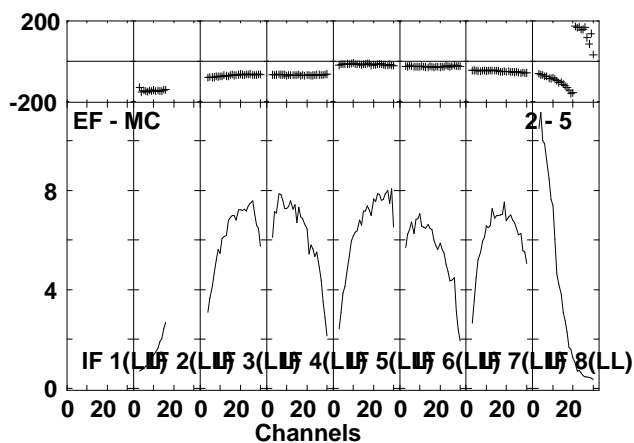
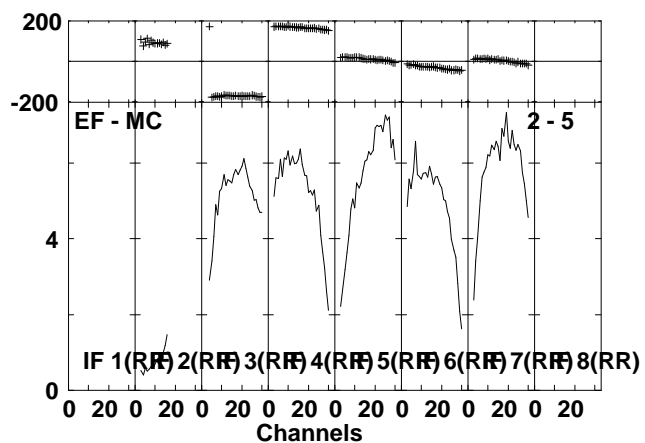
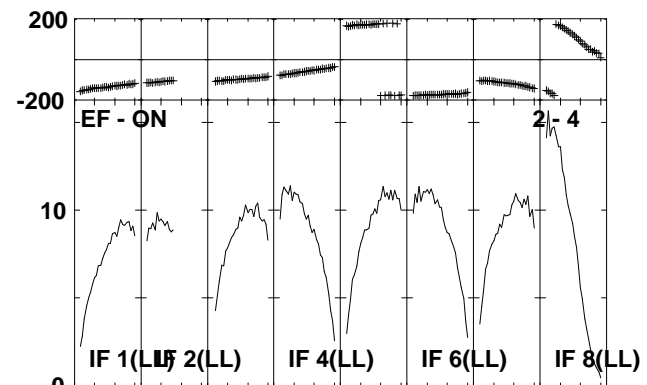
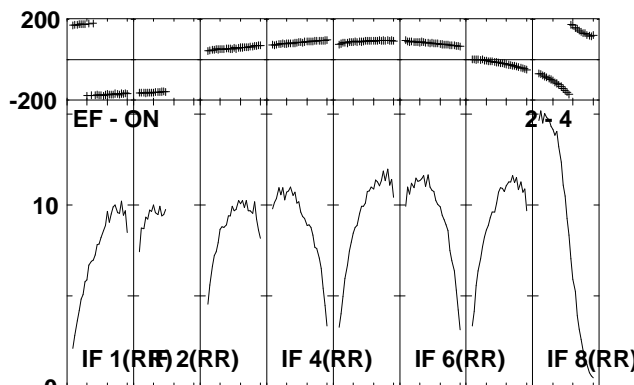
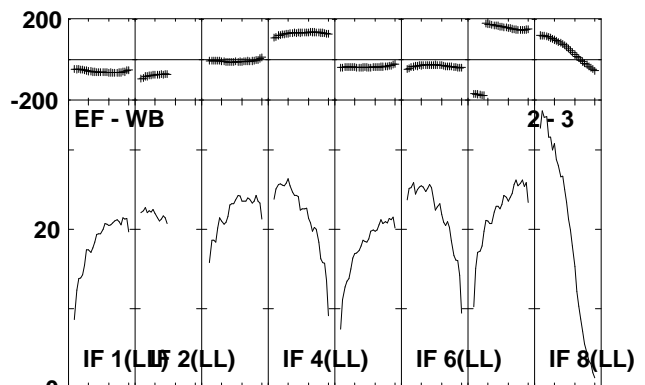
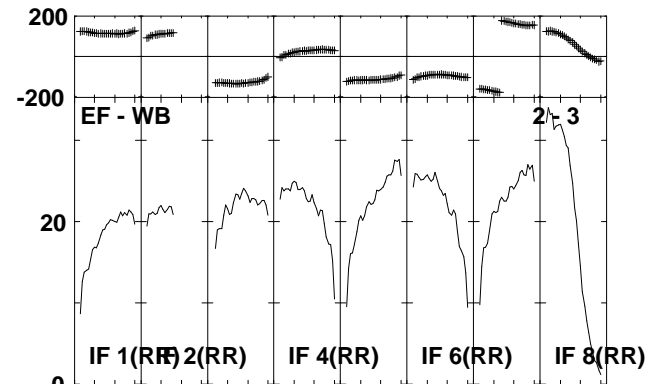
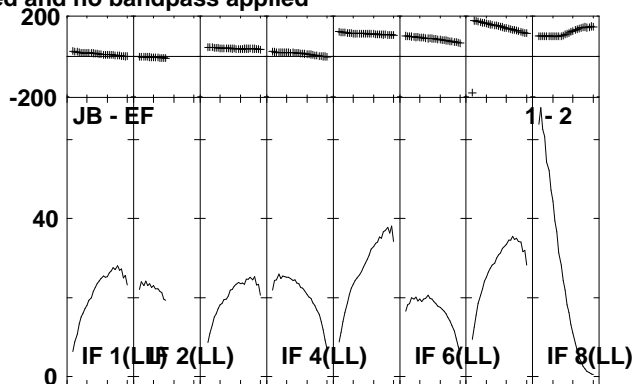
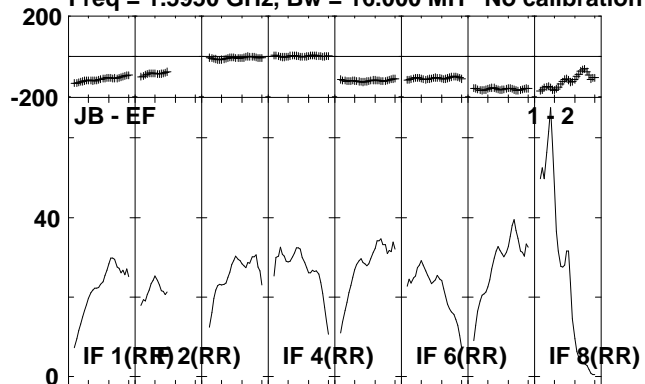

Lower frame: Milli Amp Jy Top frame: Phas deg
Scalar averaged cross-power spectrum Several baselines displayed
Timerange: 00/15:19:01 to 00/15:20:49

Plot file version 146 created 06-JUL-2010 14:44:25

J2330+33 EP064J.UVDATA.1

Freq = 1.5950 GHz, Bw = 16.000 MH No calibration applied and no bandpass applied

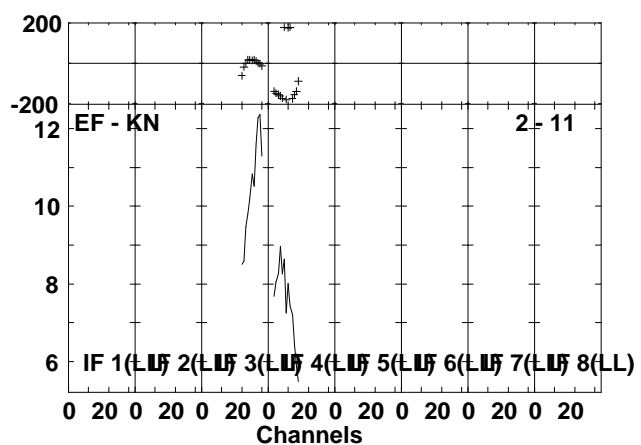
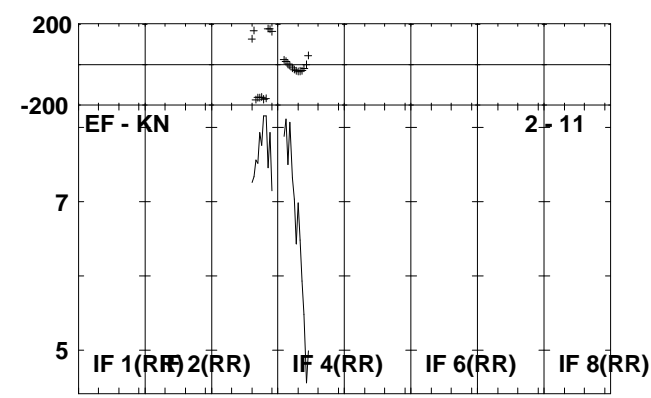
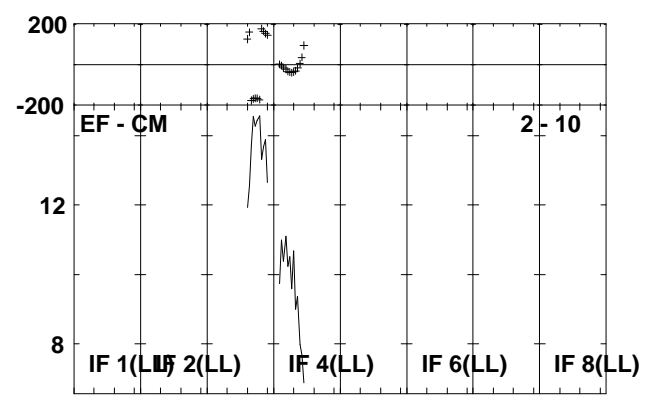
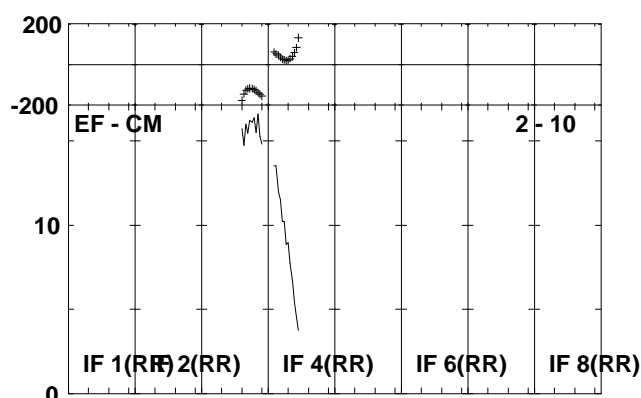
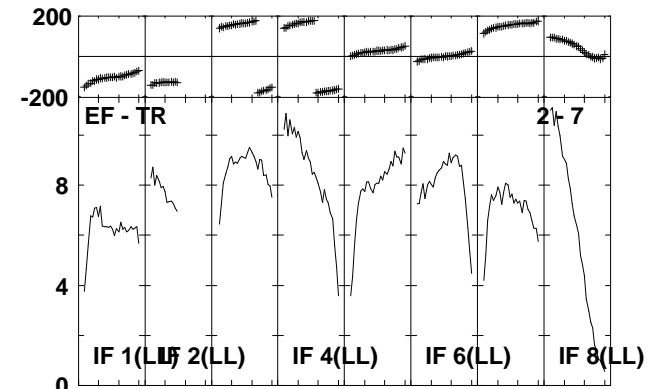
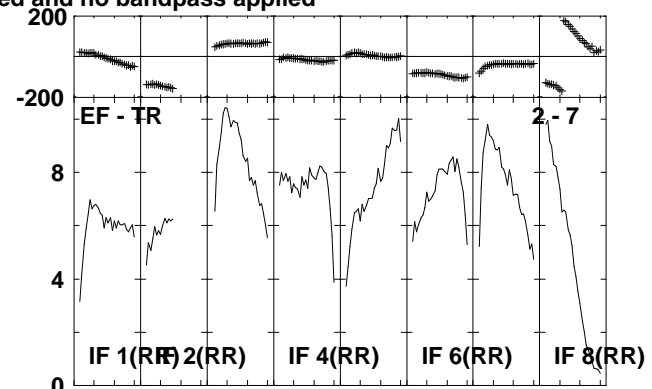
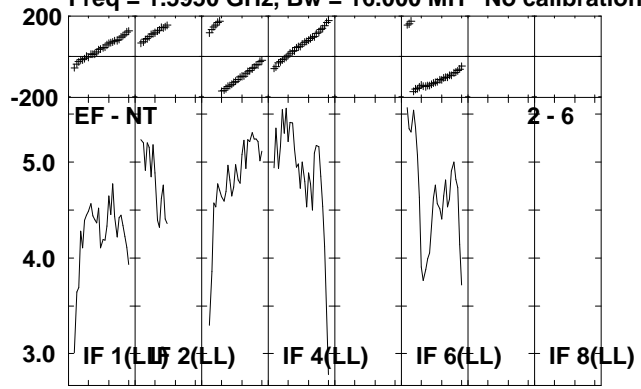

Lower frame: Milli Ampl Jy Top frame: Phas deg
Scalar averaged cross-power spectrum Several baselines displayed
Timerange: 00/15:19:01 to 00/15:20:49

Plot file version 147 created 06-JUL-2010 14:44:26

IRAS2336 EP064J.UVDATA.1

Freq = 1.5950 GHz, Bw = 16.000 MH No calibration applied and no bandpass applied

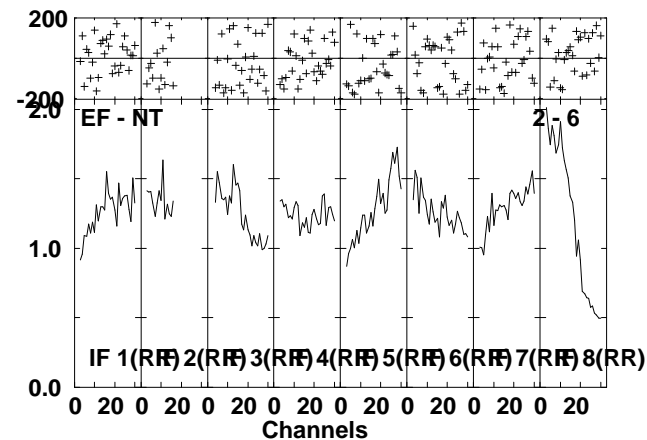
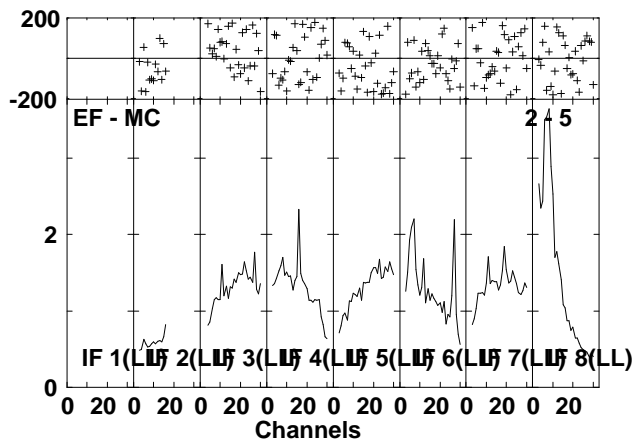
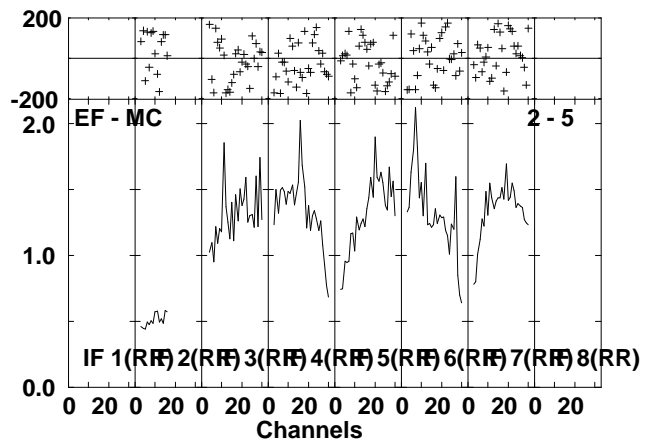
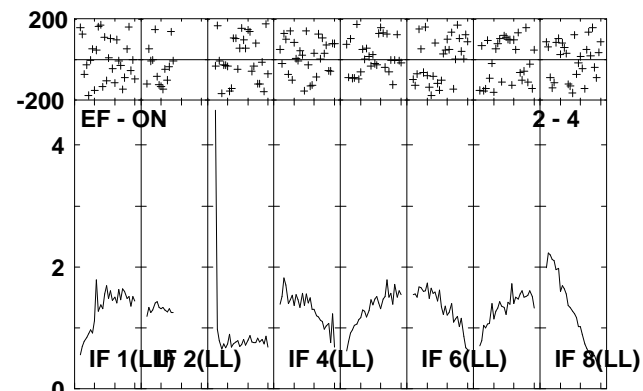
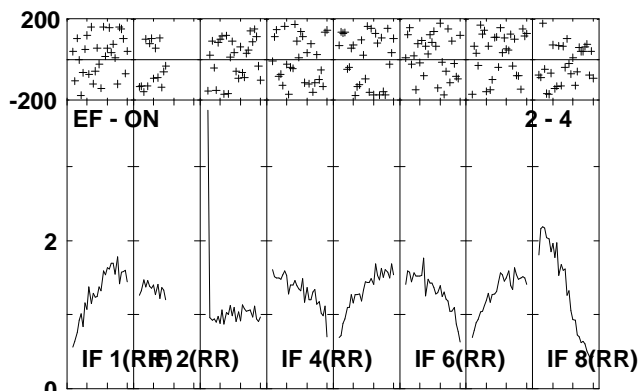
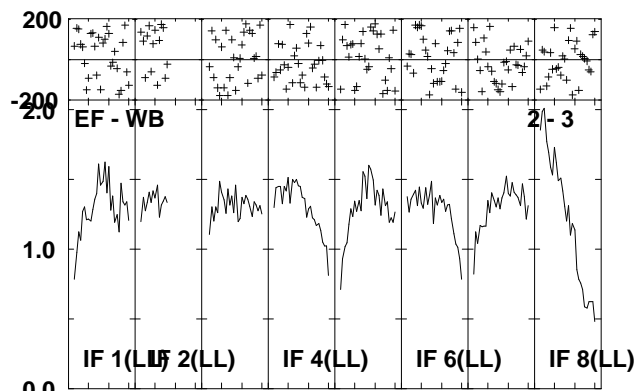
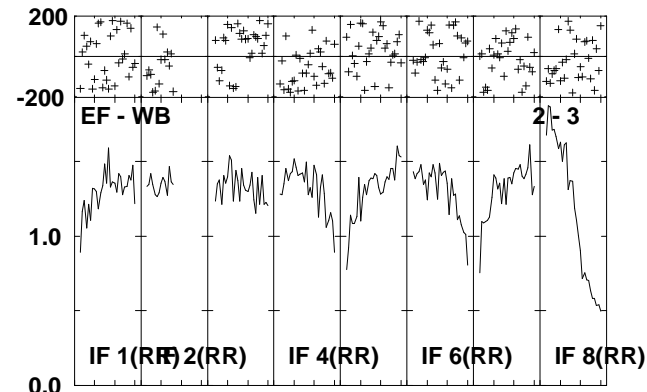
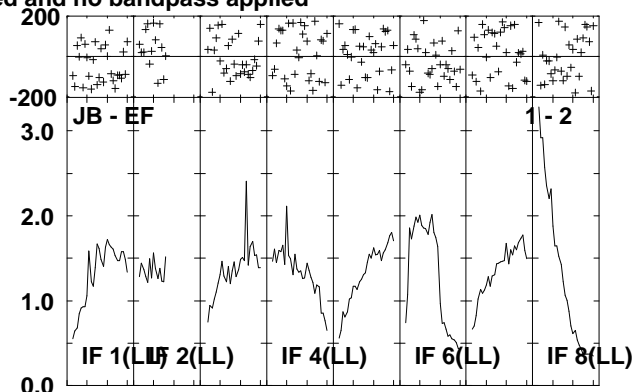
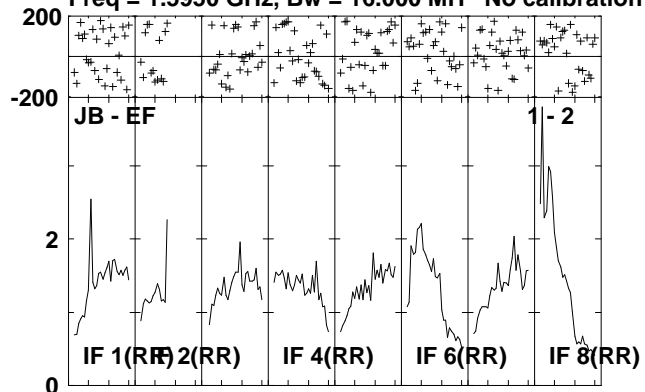

Lower frame: Milli Ampl Jy Top frame: Phas deg
Scalar averaged cross-power spectrum Several baselines displayed
Timerange: 00/15:20:51 to 00/15:24:27

Plot file version 148 created 06-JUL-2010 14:44:28

IRAS2336 EP064J.UVDATA.1

Freq = 1.5950 GHz, Bw = 16.000 MH No calibration applied and no bandpass applied

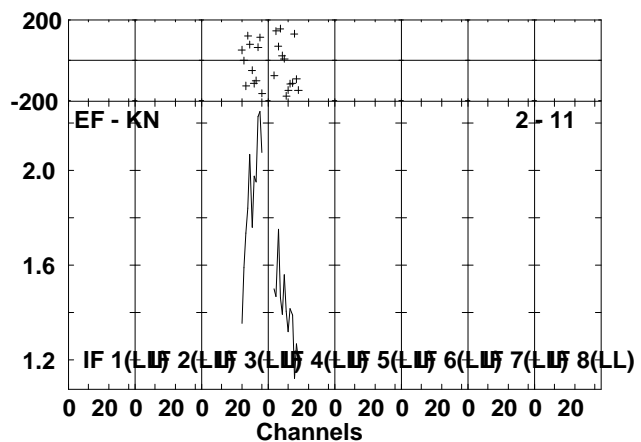
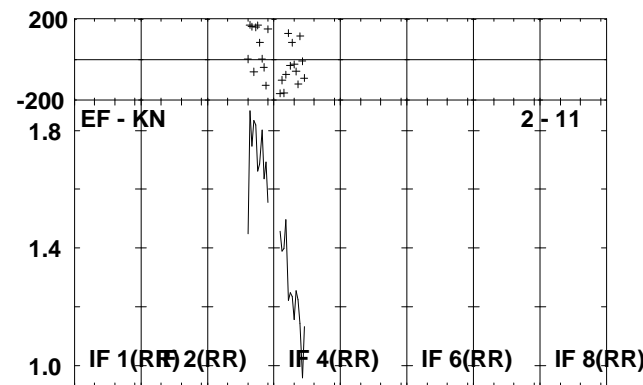
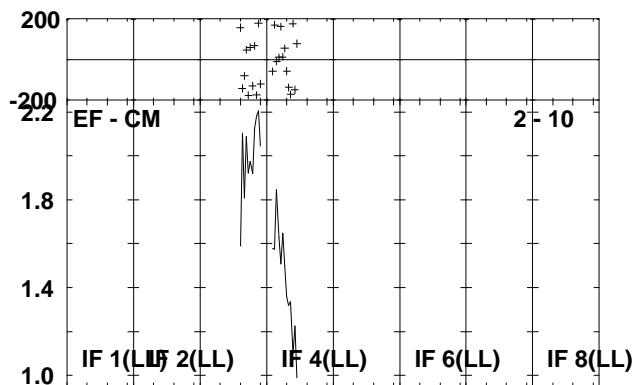
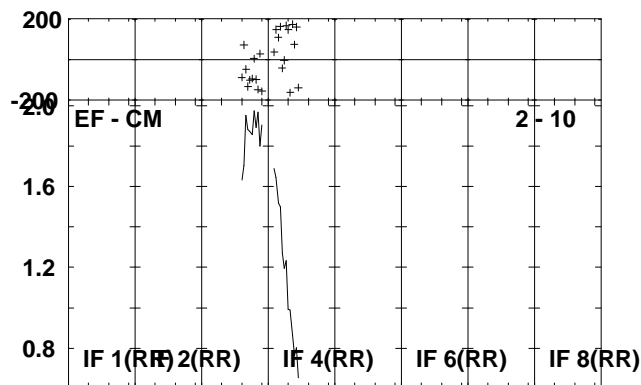
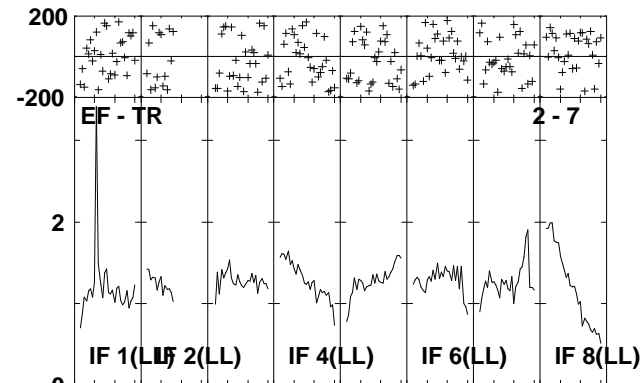
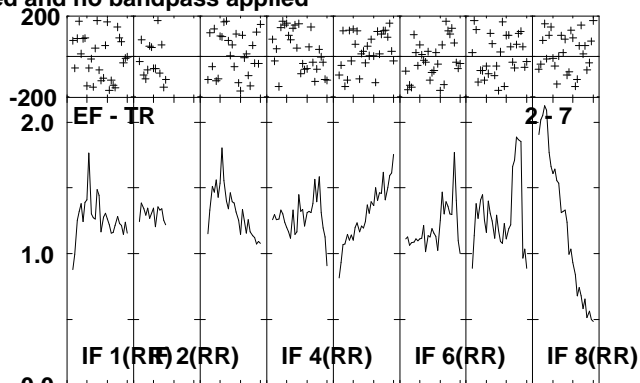
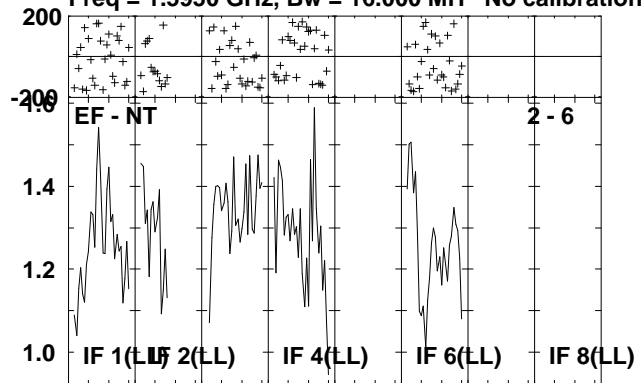

Lower frame: Milli Ampl Jy Top frame: Phas deg
Scalar averaged cross-power spectrum Several baselines displayed
Timerange: 00/15:20:51 to 00/15:24:27

Plot file version 149 created 06-JUL-2010 14:44:35

J2330+33 EP064J.UVDATA.1

Freq = 1.5950 GHz, Bw = 16.000 MH No calibration applied and no bandpass applied

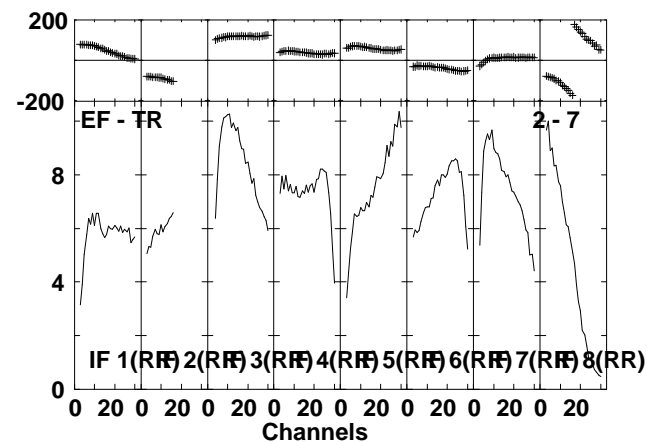
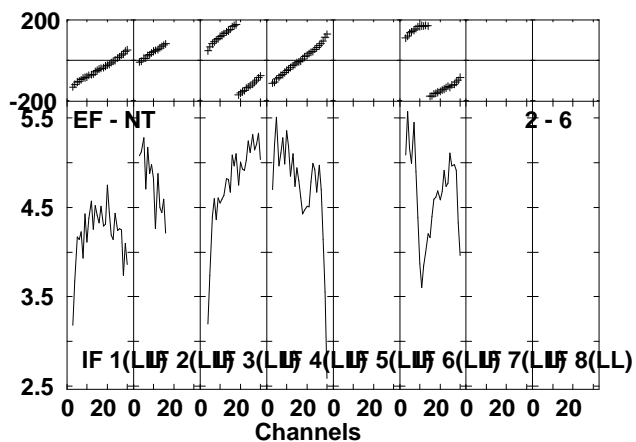
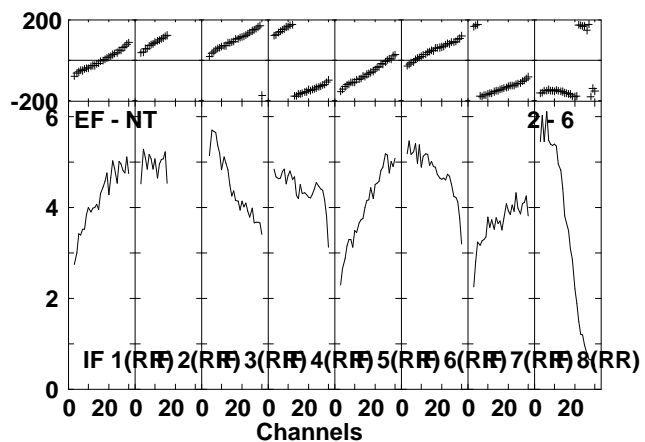
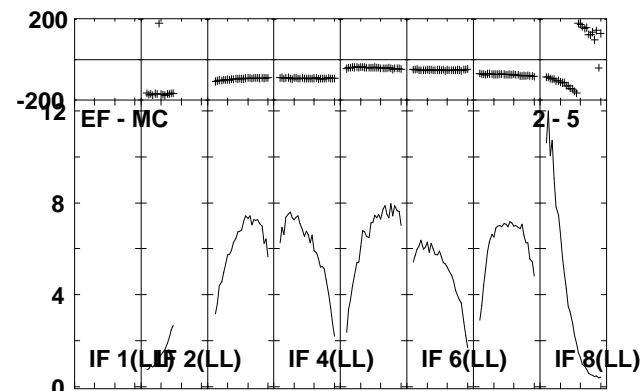
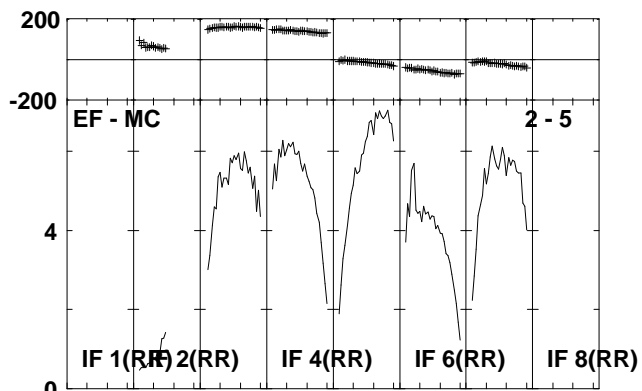
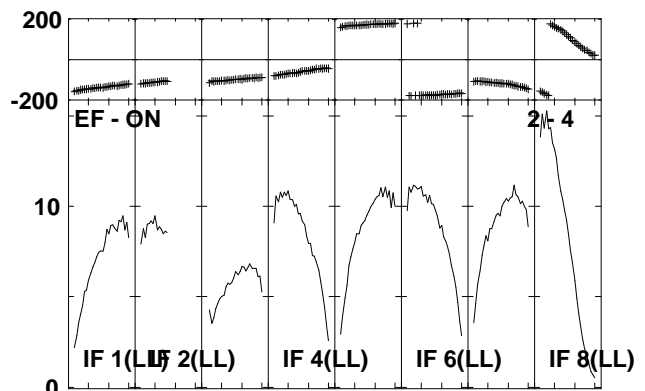
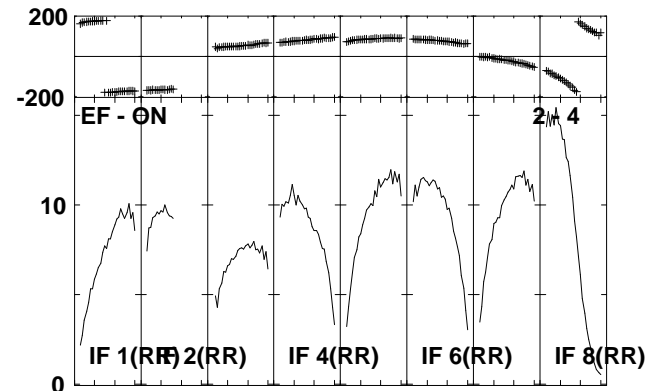
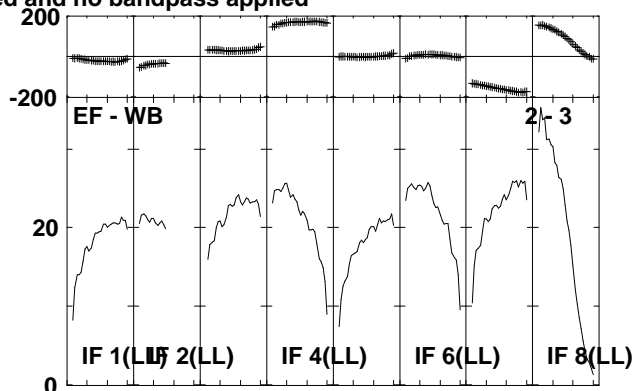
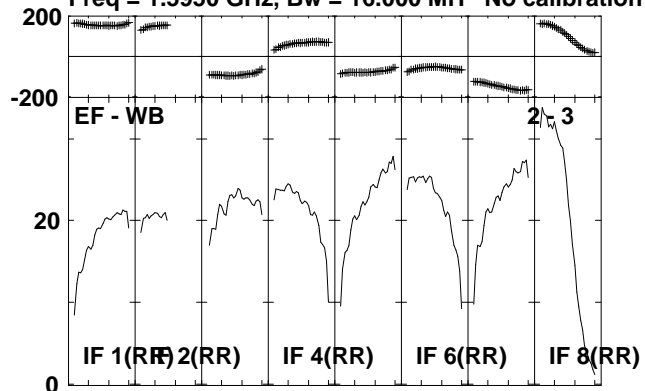

Lower frame: Milli Ampl Jy Top frame: Phas deg
Scalar averaged cross-power spectrum Several baselines displayed
Timerange: 00/15:25:31 to 00/15:27:07

Plot file version 150 created 06-JUL-2010 14:44:36

J2330+33 EP064J.UVDATA.1

Freq = 1.5950 GHz, Bw = 16.000 MH No calibration applied and no bandpass applied

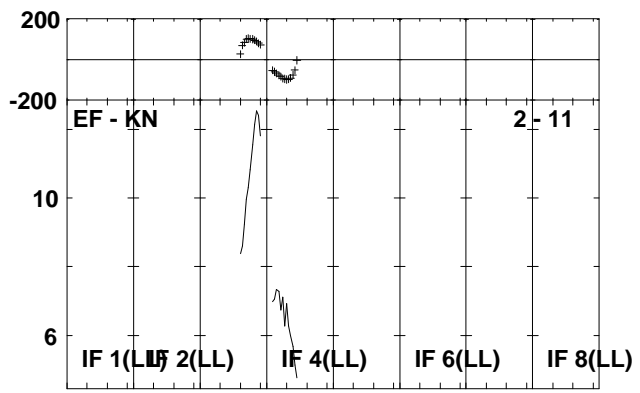
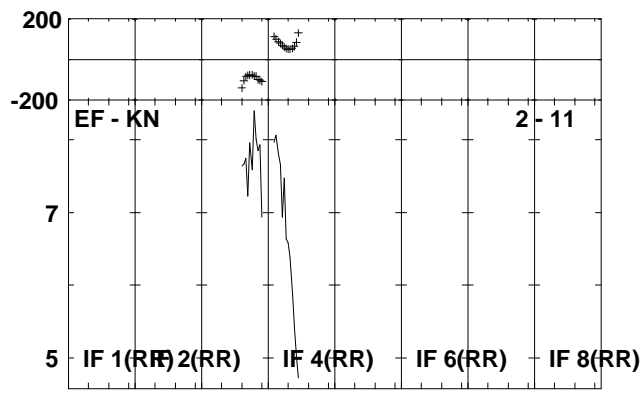
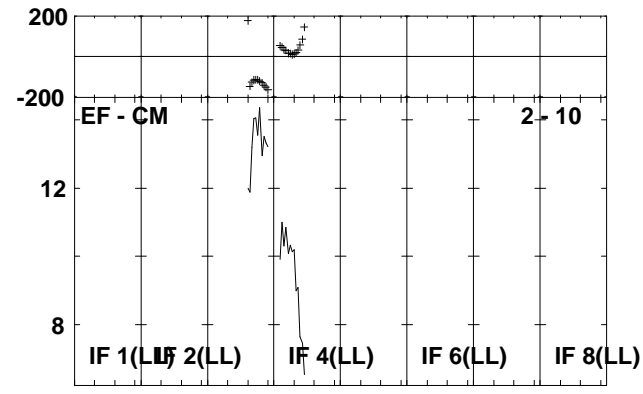
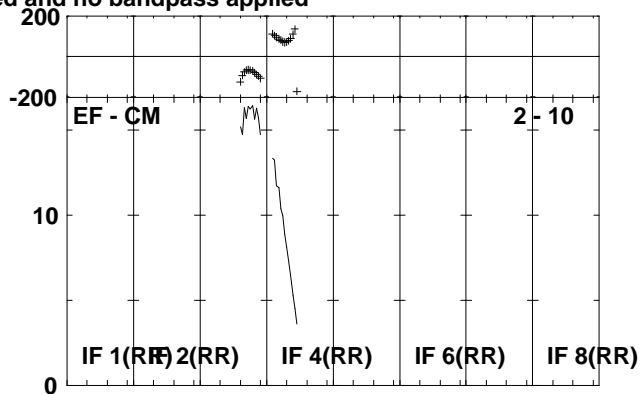
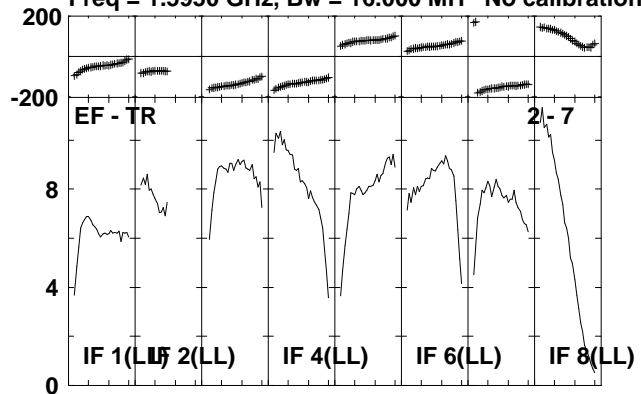

Lower frame: Milli Ampl Jy Top frame: Phas deg
Scalar averaged cross-power spectrum Several baselines displayed
Timerange: 00/15:25:31 to 00/15:27:07

Plot file version 151 created 06-JUL-2010 14:44:37

IRAS2336 EP064J.UVDATA.1

Freq = 1.5950 GHz, Bw = 16.000 MH No calibration applied and no bandpass applied

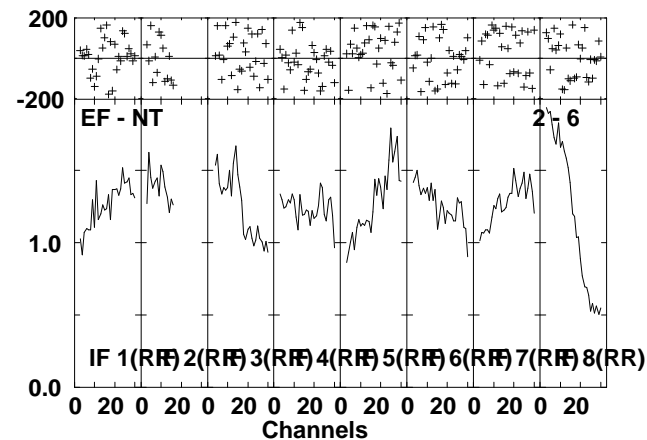
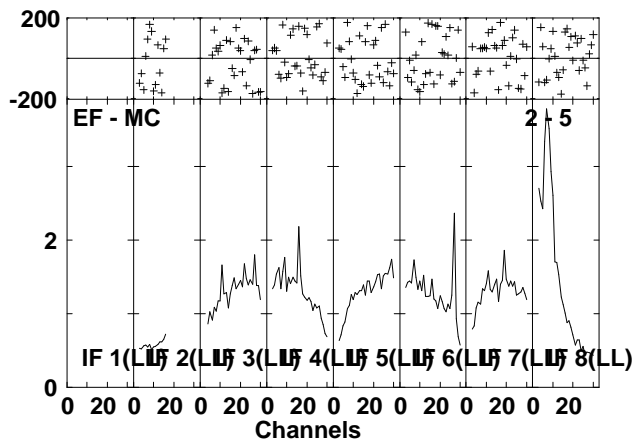
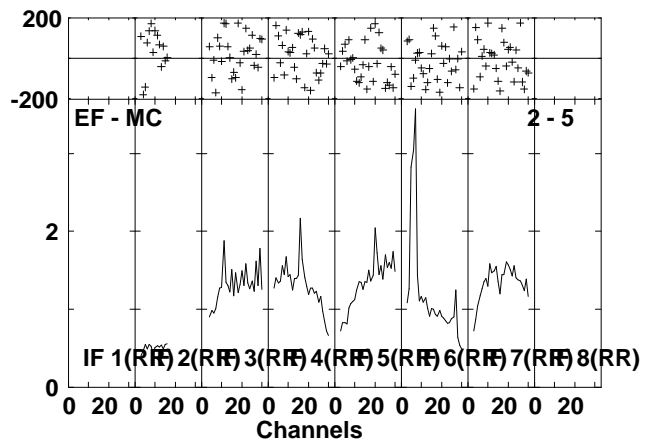
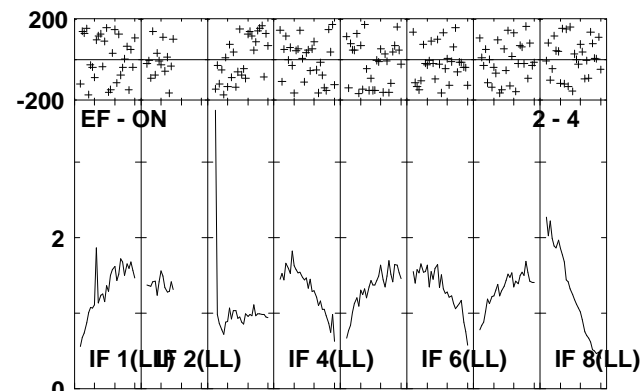
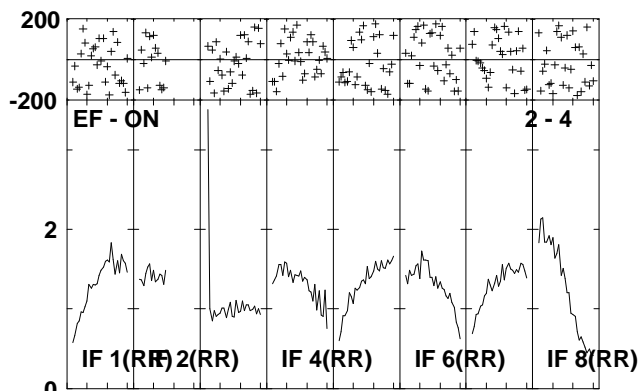
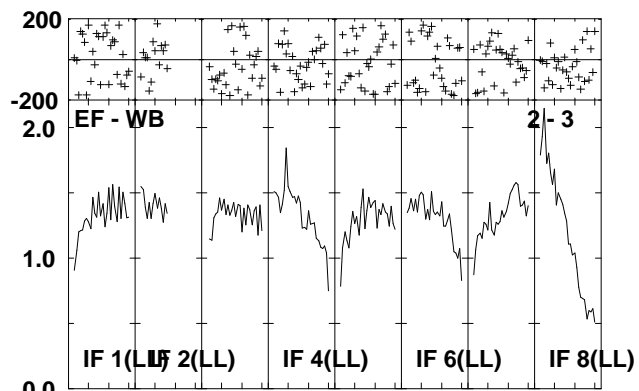
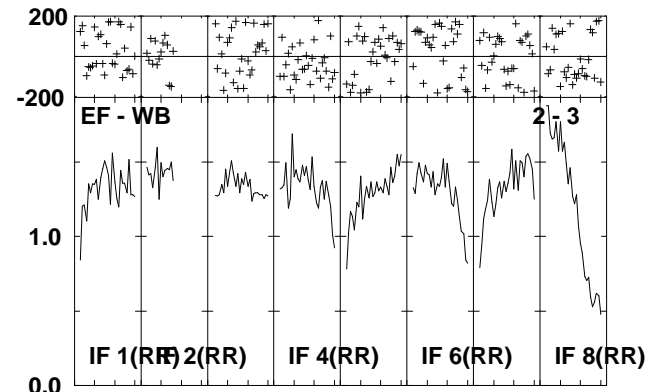
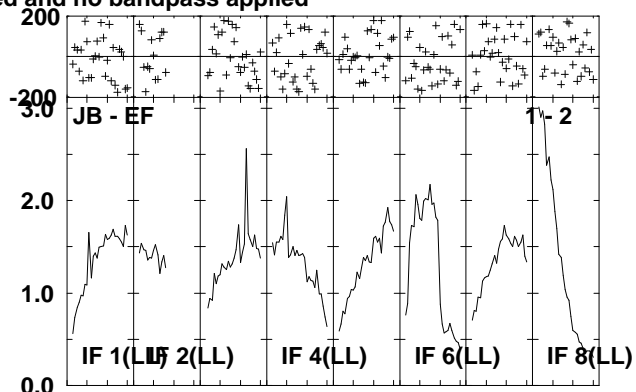
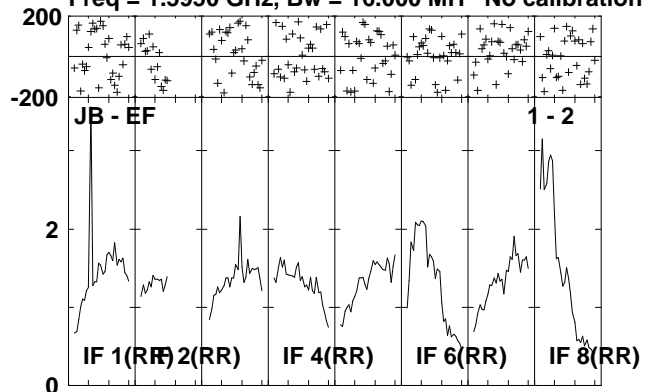

Lower frame: Milli Ampl Jy Top frame: Phas deg
Scalar averaged cross-power spectrum Several baselines displayed
Timerange: 00/15:27:11 to 00/15:30:49

Plot file version 152 created 06-JUL-2010 14:44:38

IRAS2336 EP064J.UVDATA.1

Freq = 1.5950 GHz, Bw = 16.000 MH No calibration applied and no bandpass applied

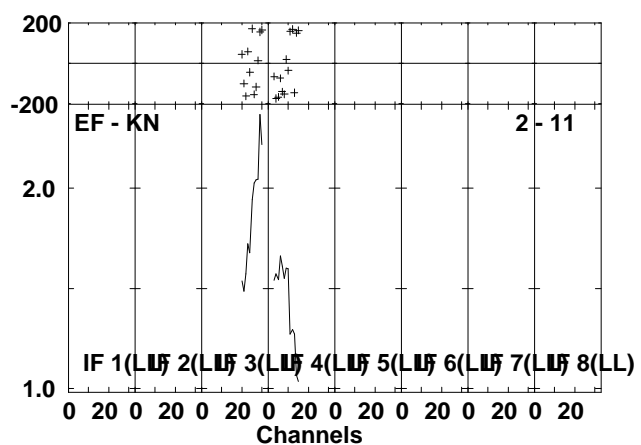
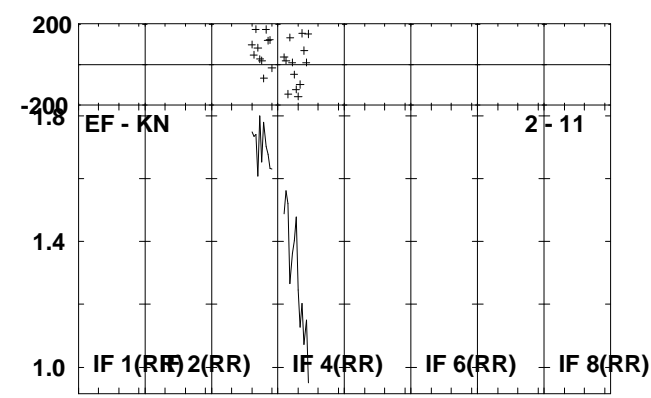
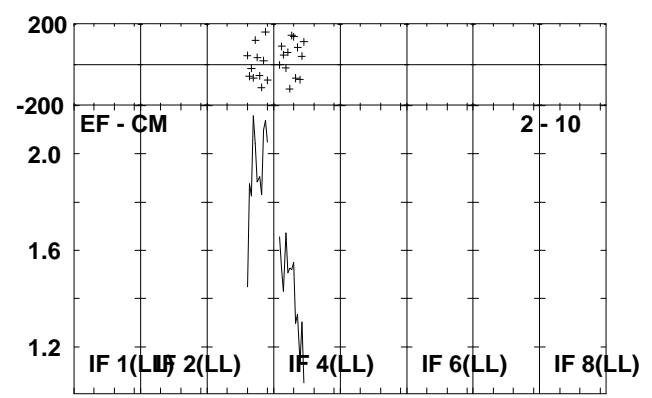
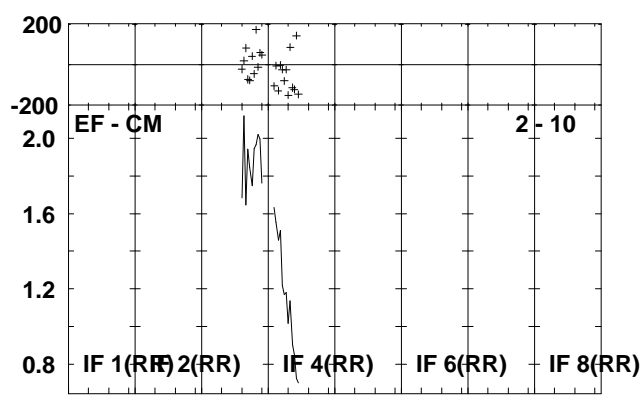
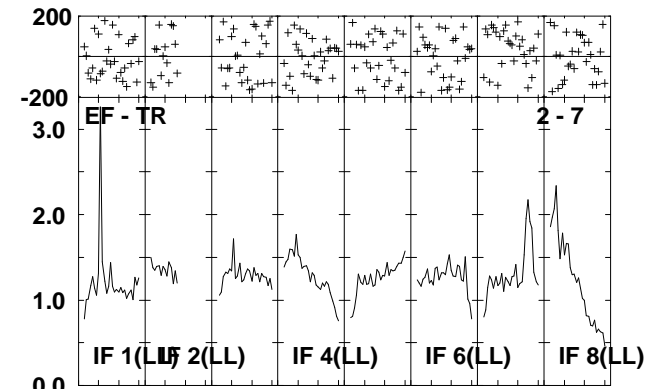
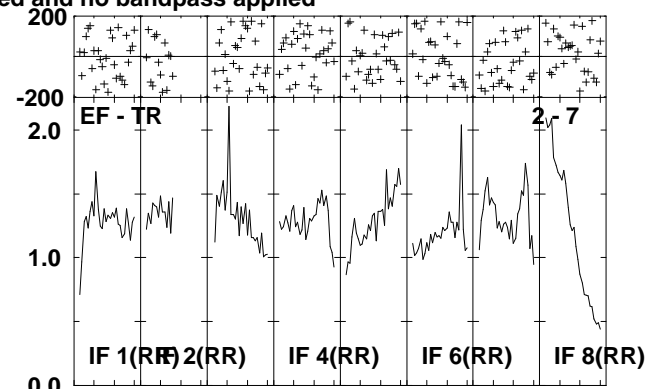
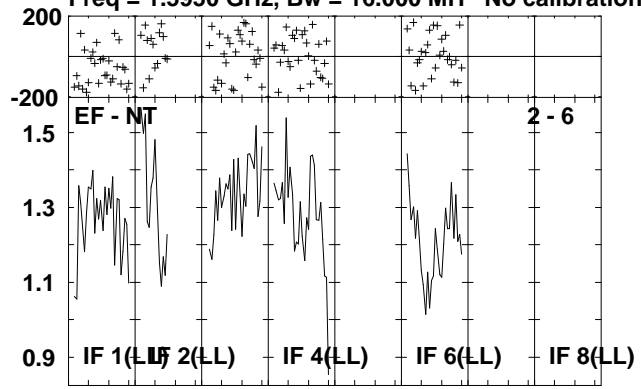

Lower frame: Milli Ampl Jy Top frame: Phas deg
Scalar averaged cross-power spectrum Several baselines displayed
Timerange: 00/15:27:11 to 00/15:30:49

Plot file version 153 created 06-JUL-2010 14:44:40

J2330+33 EP064J.UVDATA.1

Freq = 1.5950 GHz, Bw = 16.000 MH No calibration applied and no bandpass applied

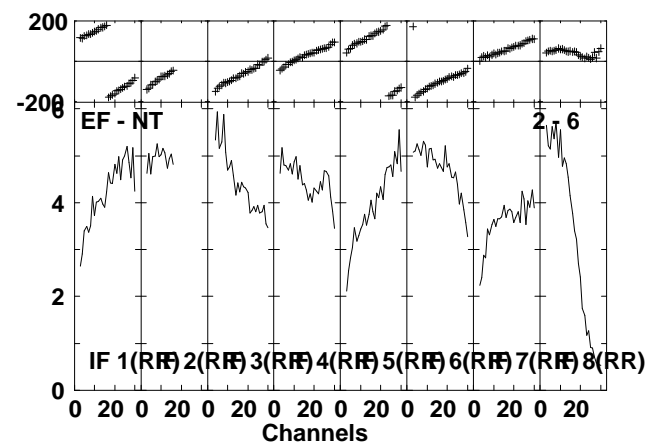
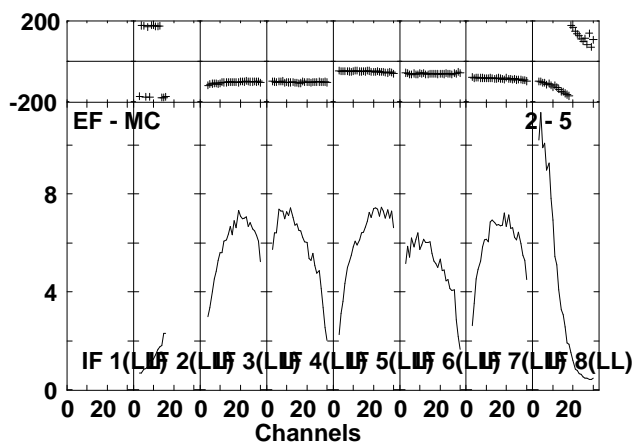
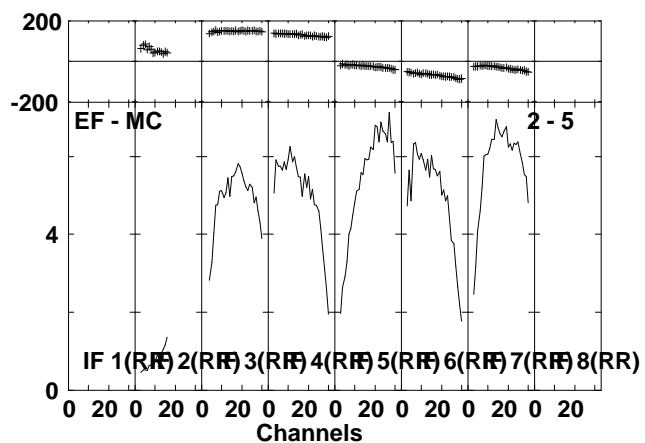
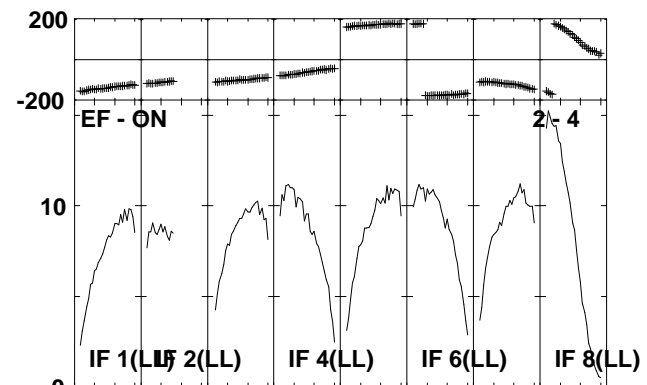
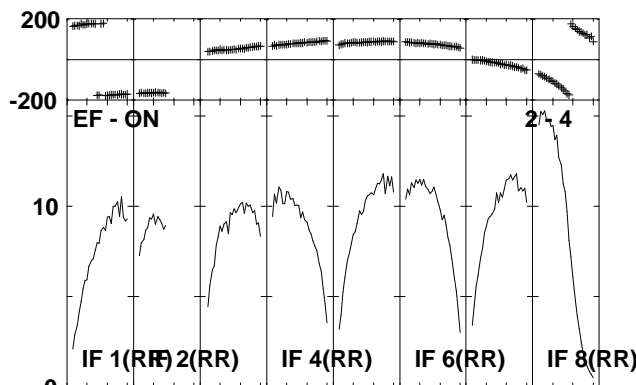
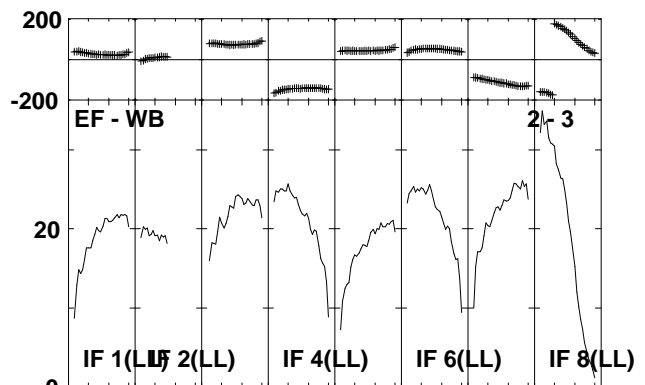
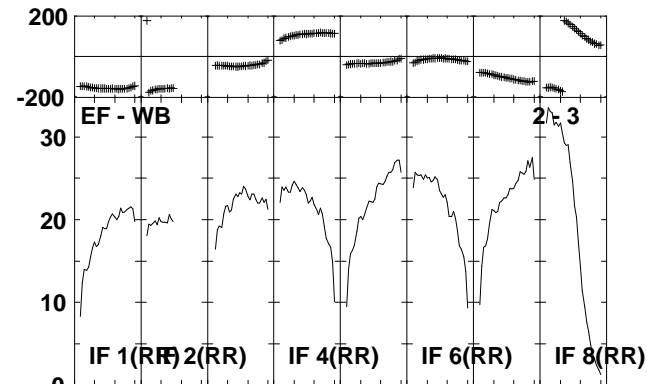
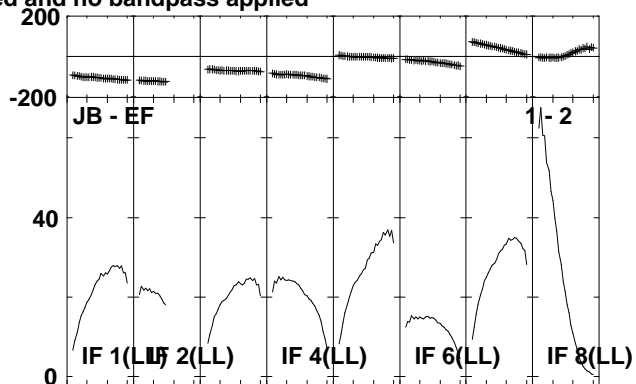
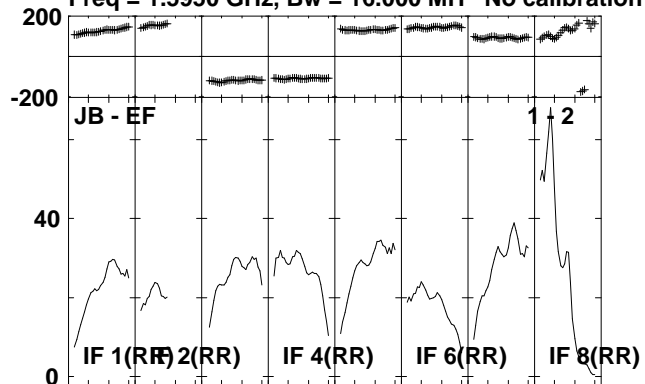

Lower frame: Milli Ampl Jy Top frame: Phas deg
Scalar averaged cross-power spectrum Several baselines displayed
Timerange: 00/15:30:51 to 00/15:32:39

Plot file version 154 created 06-JUL-2010 14:44:41

J2330+33 EP064J.UVDATA.1

Freq = 1.5950 GHz, Bw = 16.000 MH No calibration applied and no bandpass applied

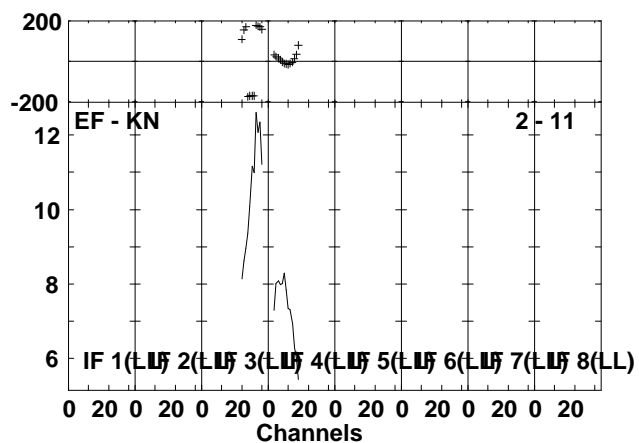
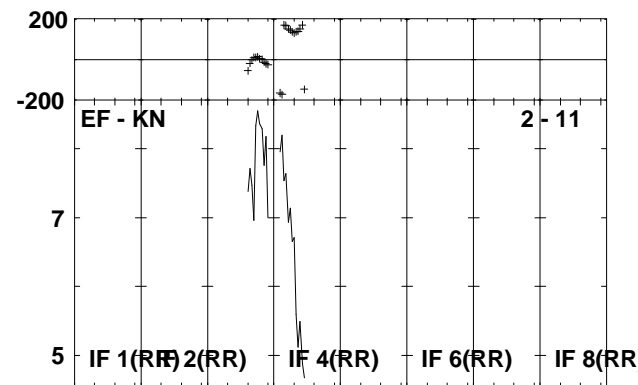
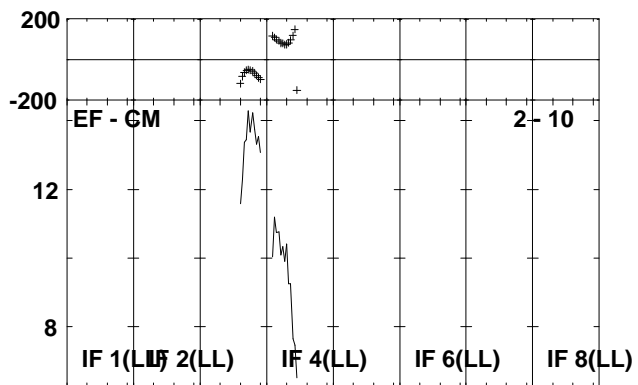
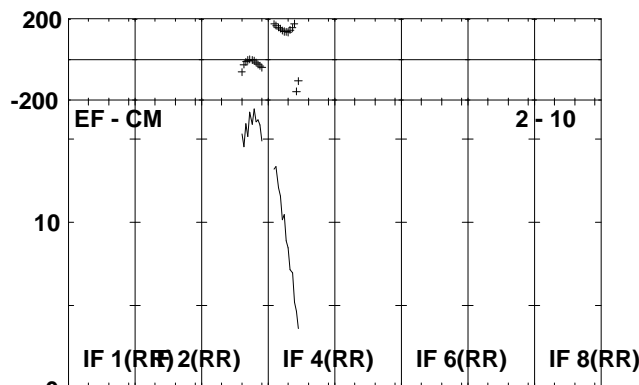
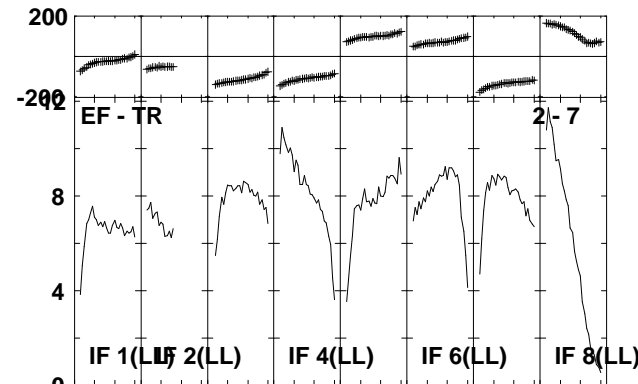
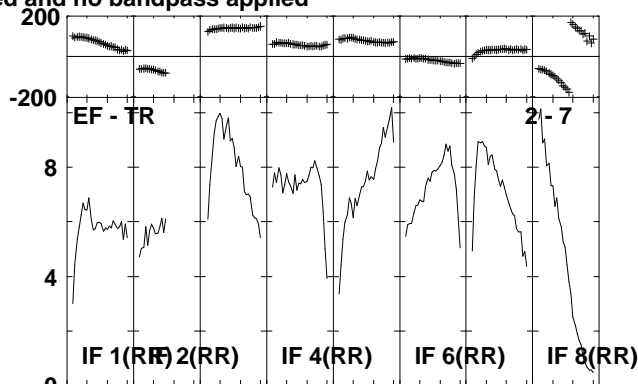
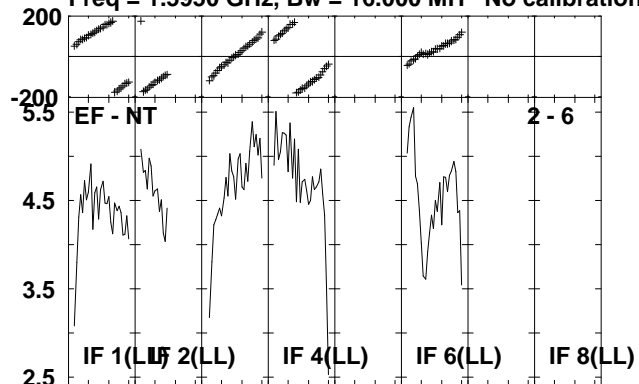

Lower frame: Milli Ampl Jy Top frame: Phas deg
Scalar averaged cross-power spectrum Several baselines displayed
Timerange: 00/15:30:51 to 00/15:32:39

Plot file version 155 created 06-JUL-2010 14:44:43

IRAS2336 EP064J.UVDATA.1

Freq = 1.5950 GHz, Bw = 16.000 MH No calibration applied and no bandpass applied

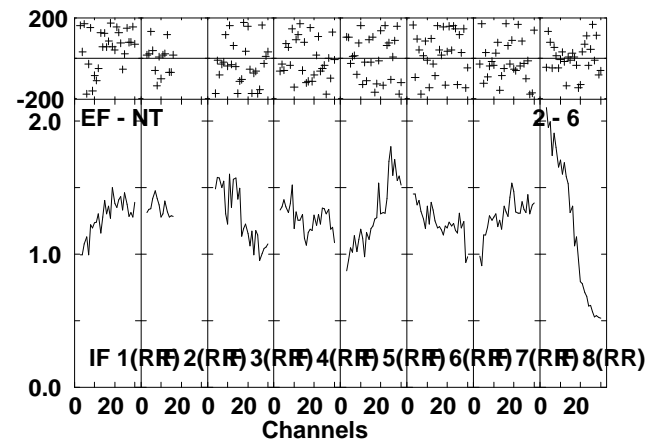
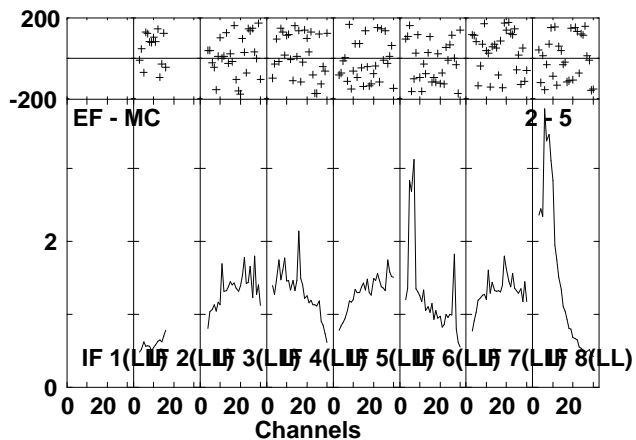
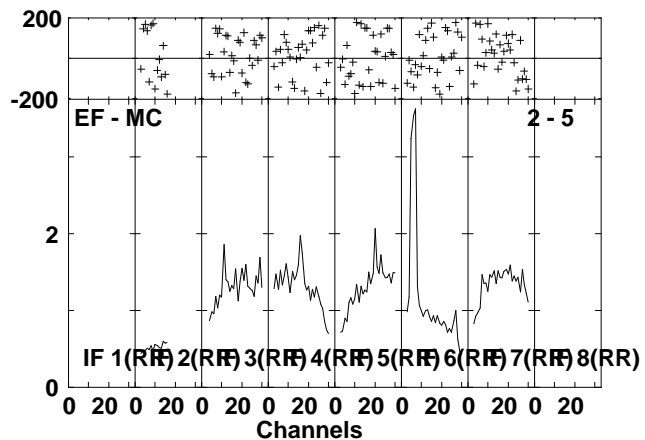
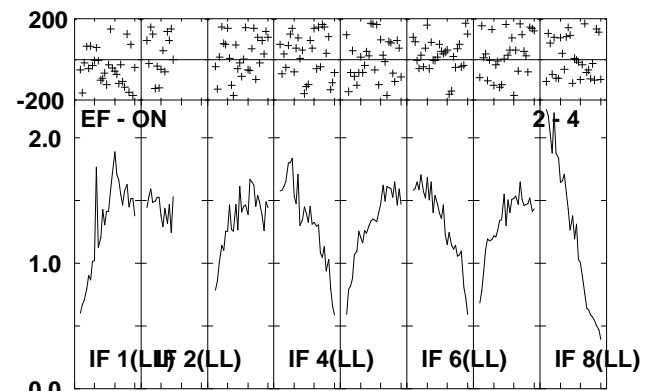
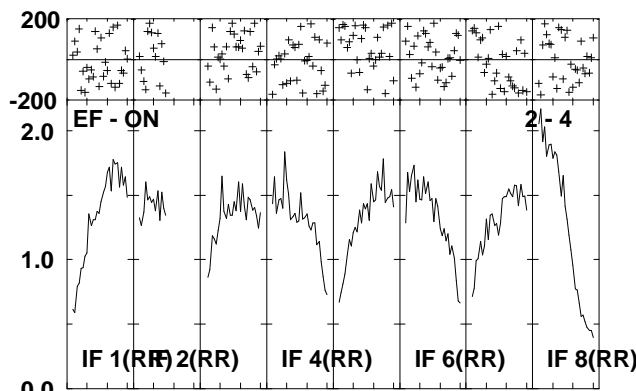
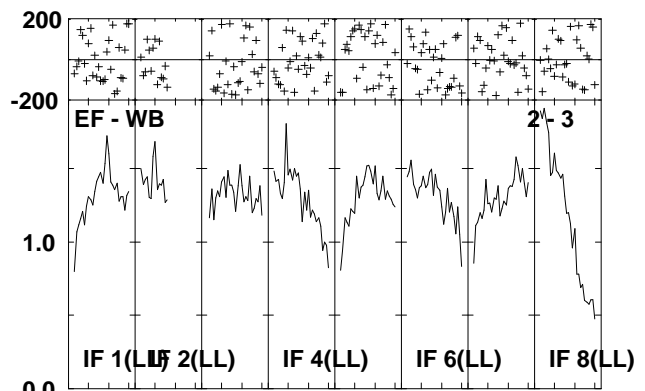
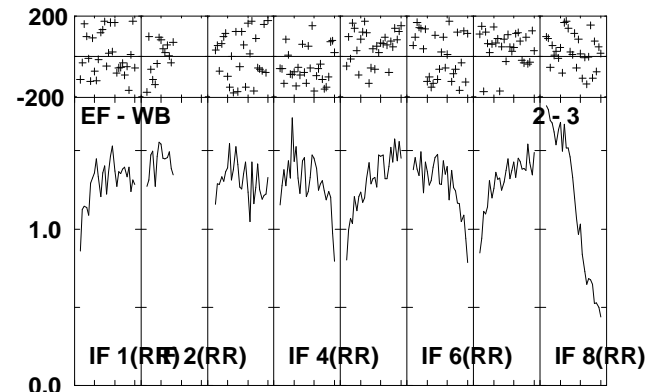
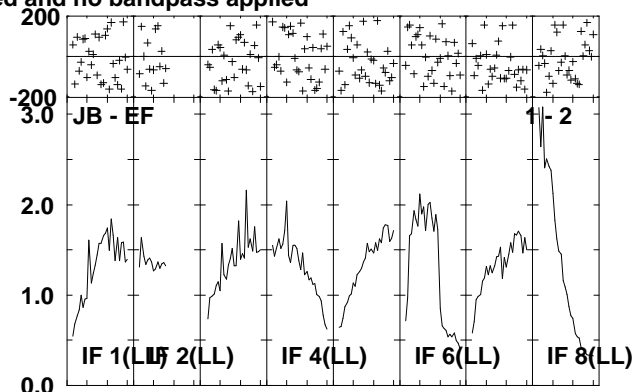
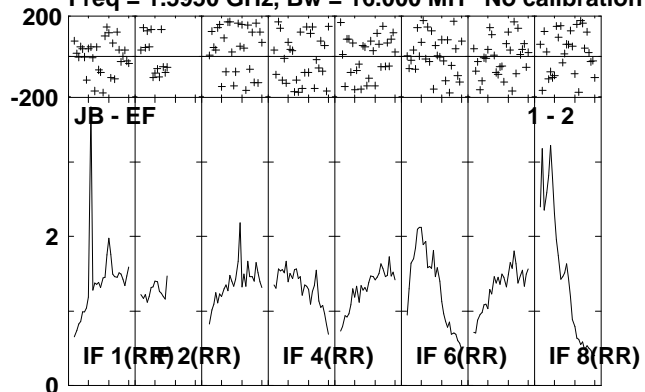

Lower frame: Milli Ampl Jy Top frame: Phas deg
Scalar averaged cross-power spectrum Several baselines displayed
Timerange: 00/15:32:41 to 00/15:36:19

Plot file version 156 created 06-JUL-2010 14:44:44

IRAS2336 EP064J.UVDATA.1

Freq = 1.5950 GHz, Bw = 16.000 MH No calibration applied and no bandpass applied

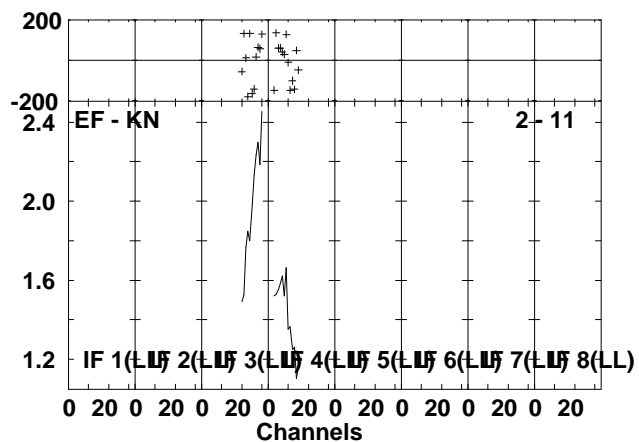
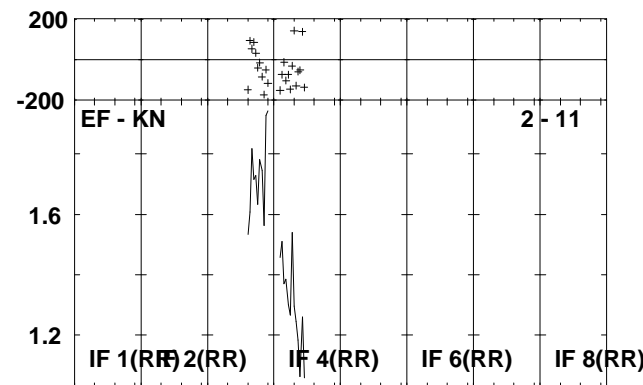
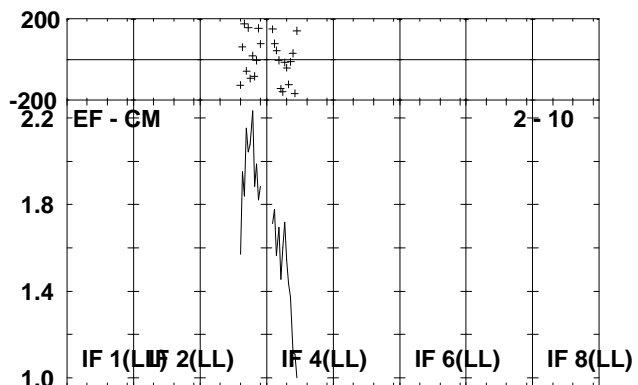
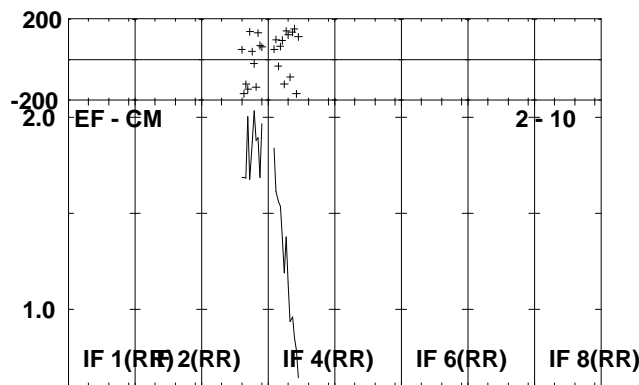
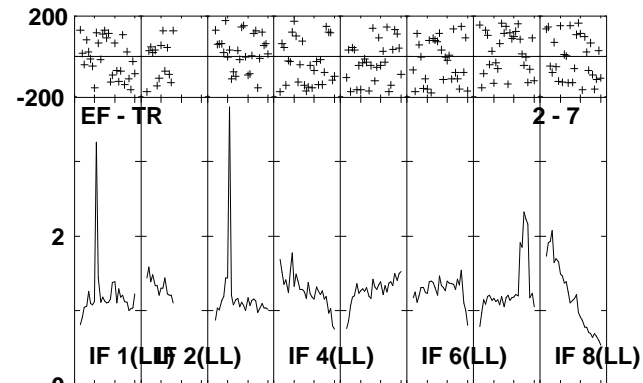
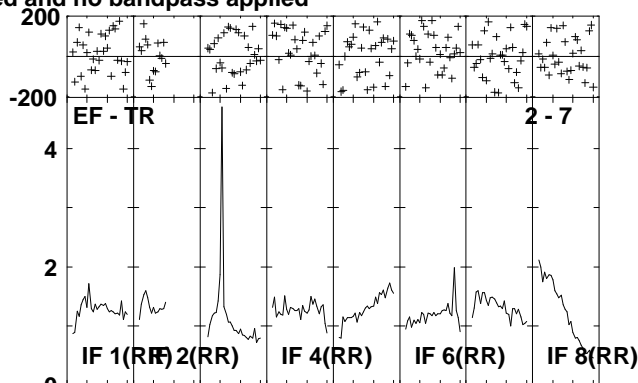
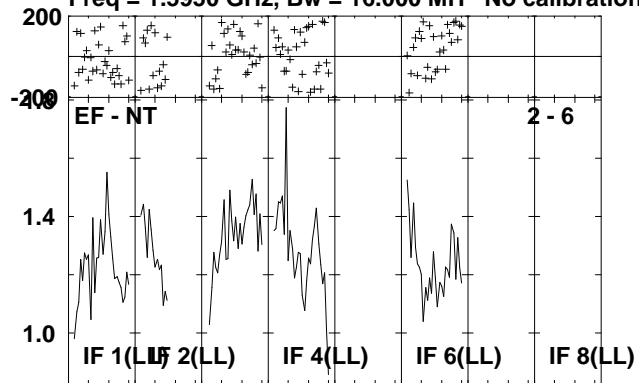

Lower frame: Milli Ampl Jy Top frame: Phas deg
Scalar averaged cross-power spectrum Several baselines displayed
Timerange: 00/15:32:41 to 00/15:36:19

Plot file version 157 created 06-JUL-2010 14:44:47

J2330+33 EP064J.UVDATA.1

Freq = 1.5950 GHz, Bw = 16.000 MH No calibration applied and no bandpass applied

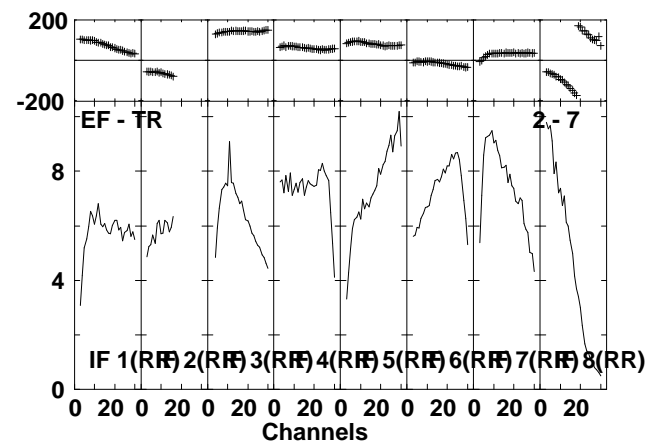
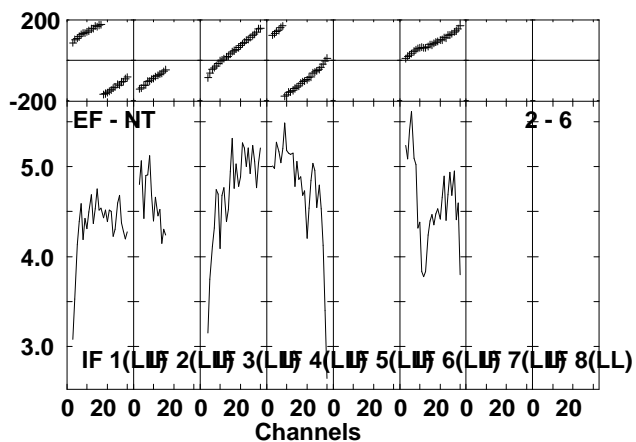
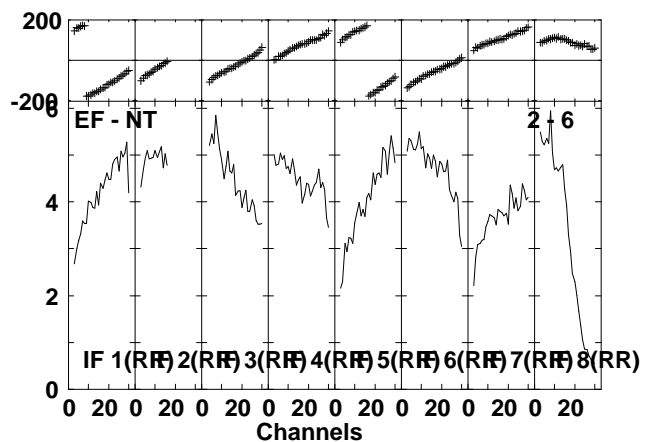
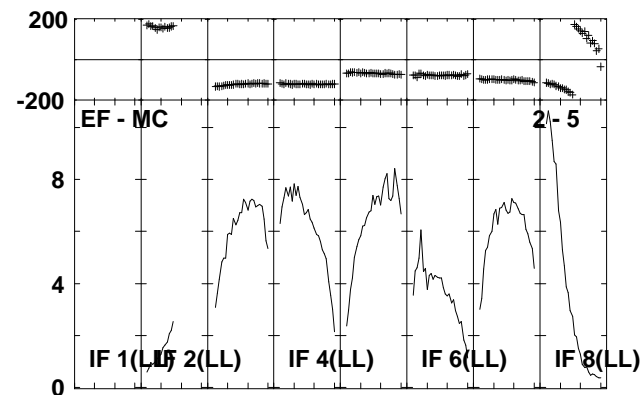
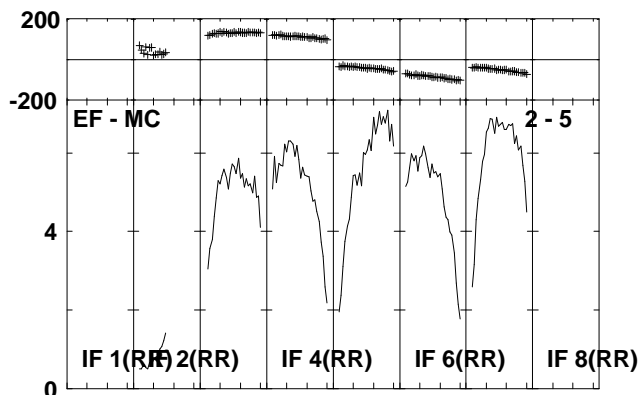
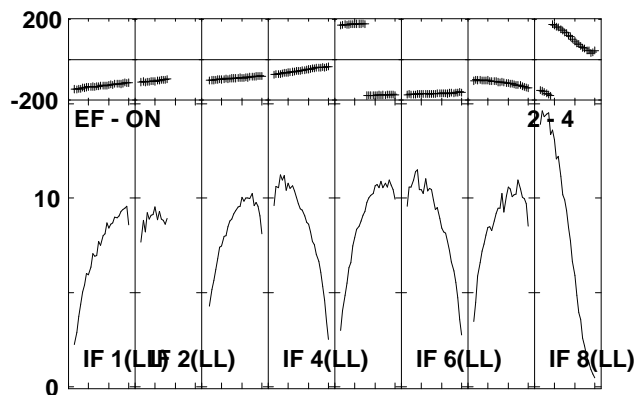
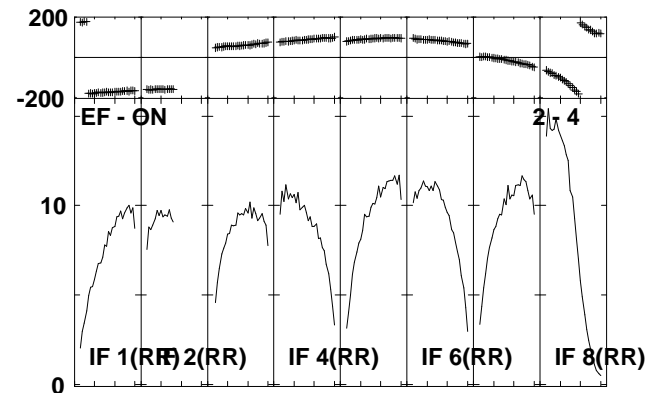
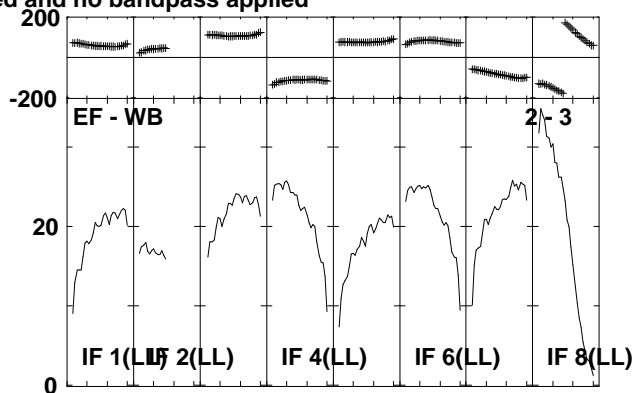
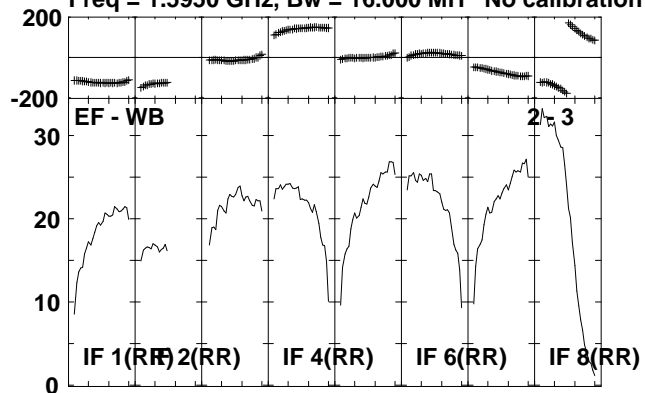

Lower frame: Milli Ampl Jy Top frame: Phas deg
Scalar averaged cross-power spectrum Several baselines displayed
Timerange: 00/15:36:21 to 00/15:38:09

Plot file version 158 created 06-JUL-2010 14:44:47

J2330+33 EP064J.UVDATA.1

Freq = 1.5950 GHz, Bw = 16.000 MH No calibration applied and no bandpass applied

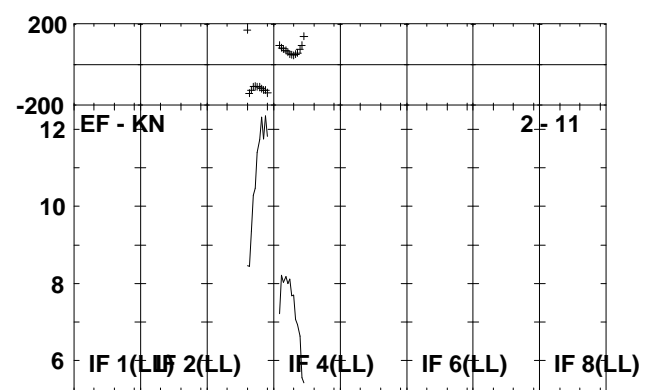
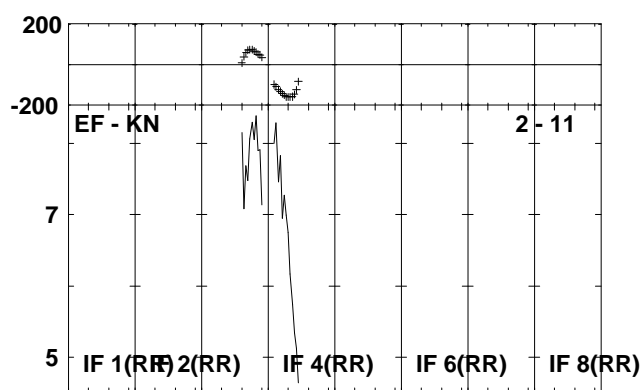
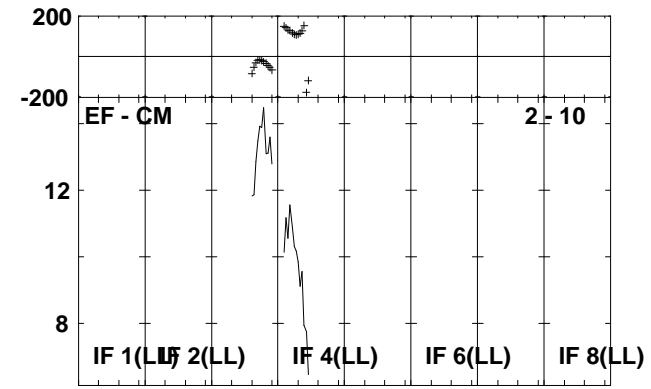
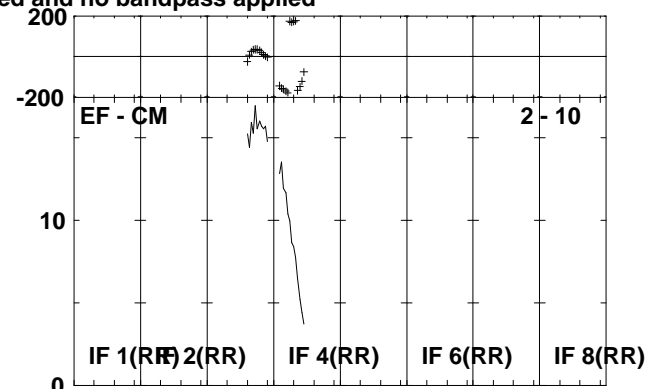
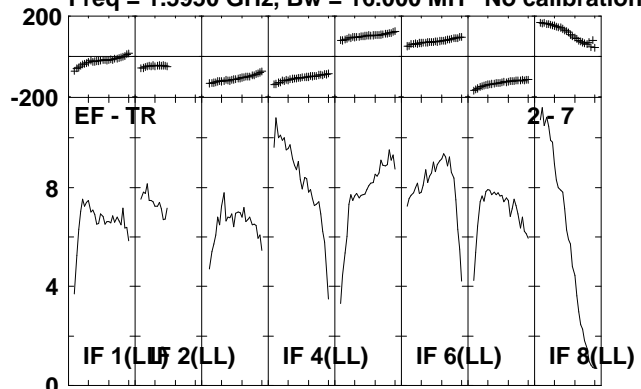

Lower frame: Milli Ampl Jy Top frame: Phas deg
Scalar averaged cross-power spectrum Several baselines displayed
Timerange: 00/15:36:21 to 00/15:38:09

Plot file version 159 created 06-JUL-2010 14:44:48

IRAS2336 EP064J.UVDATA.1

Freq = 1.5950 GHz, Bw = 16.000 MH No calibration applied and no bandpass applied

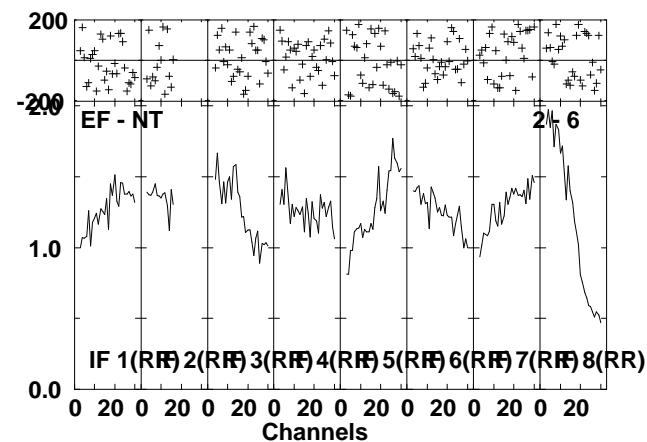
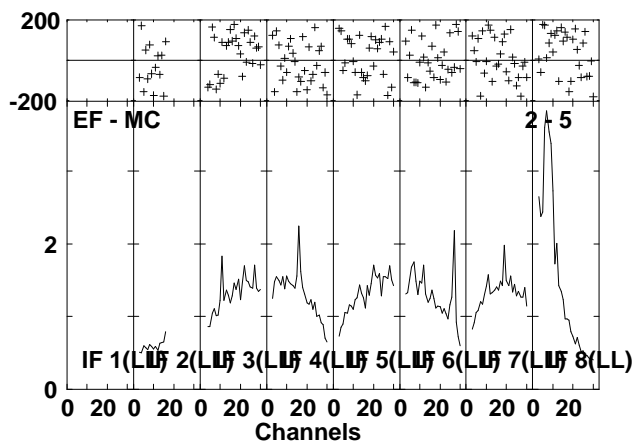
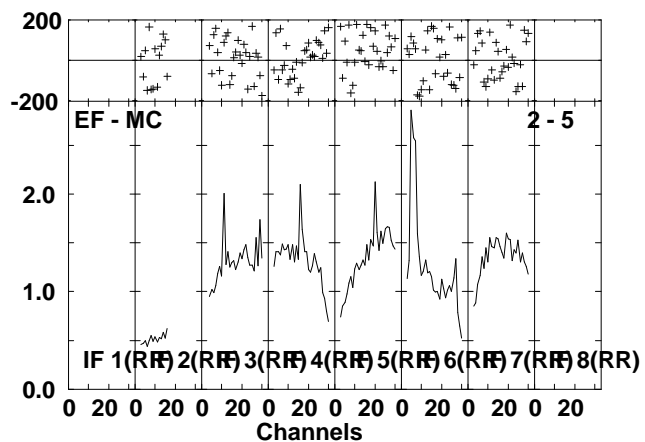
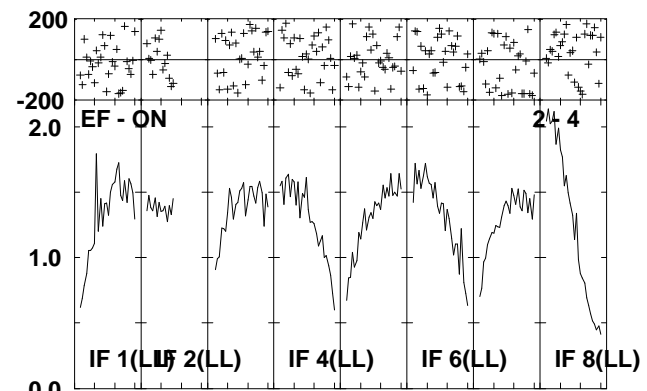
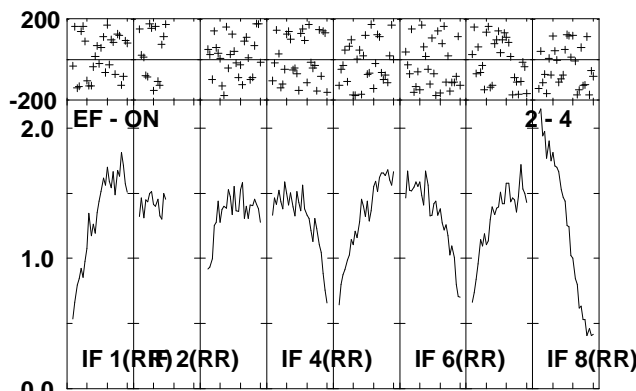
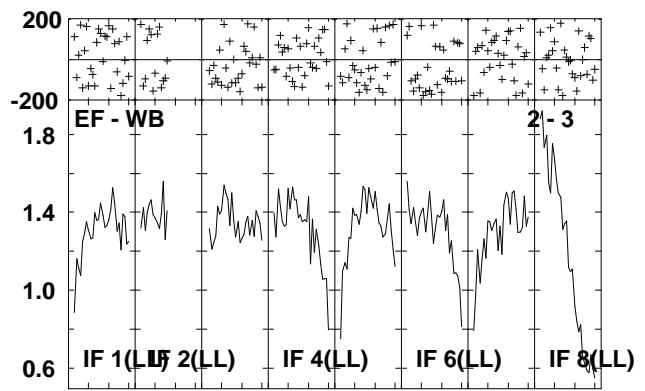
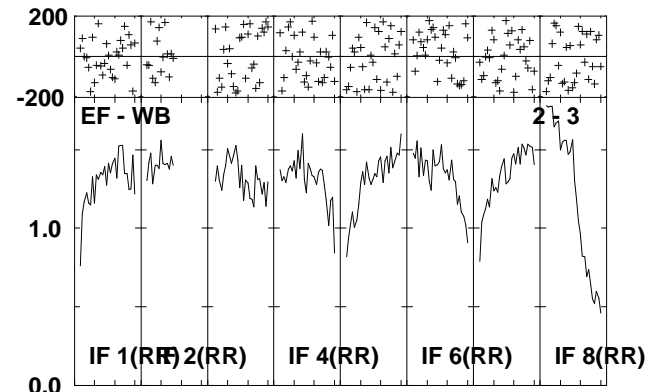
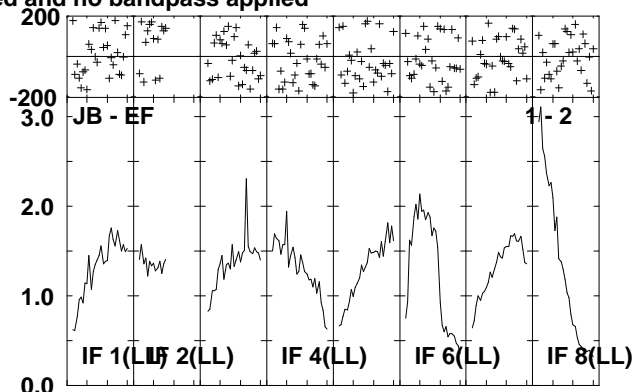
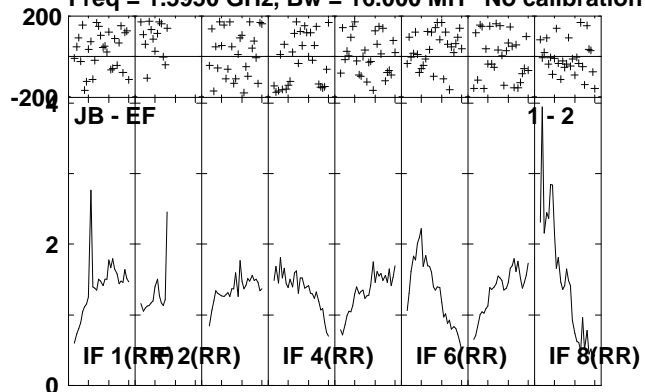

Lower frame: Milli Ampl Jy Top frame: Phas deg
Scalar averaged cross-power spectrum Several baselines displayed
Timerange: 00/15:38:11 to 00/15:41:49

Plot file version 160 created 06-JUL-2010 14:44:50

IRAS2336 EP064J.UVDATA.1

Freq = 1.5950 GHz, Bw = 16.000 MH No calibration applied and no bandpass applied

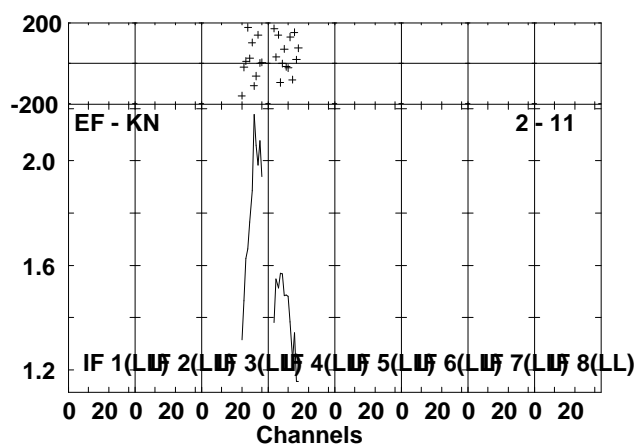
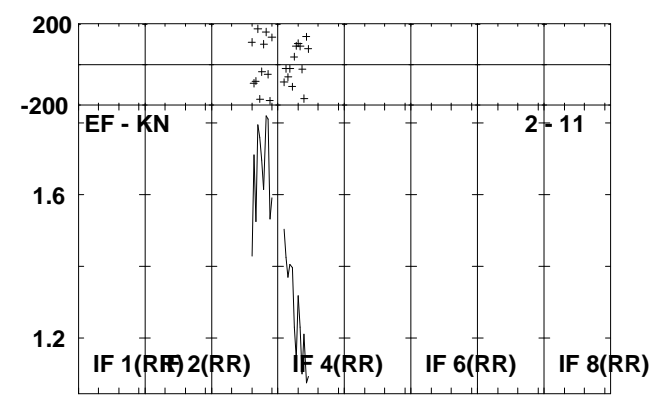
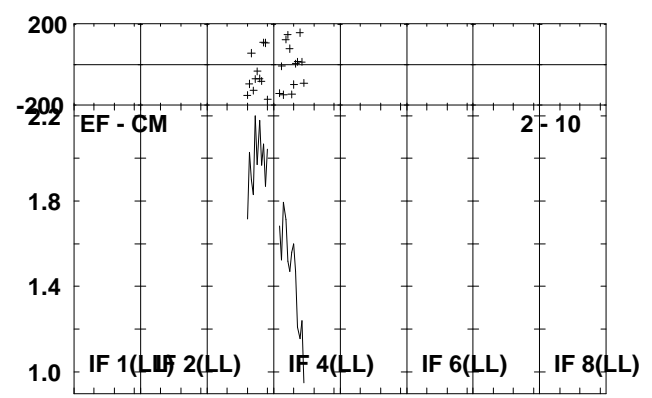
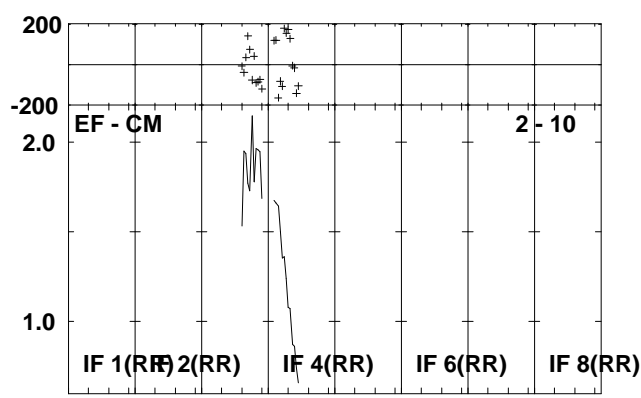
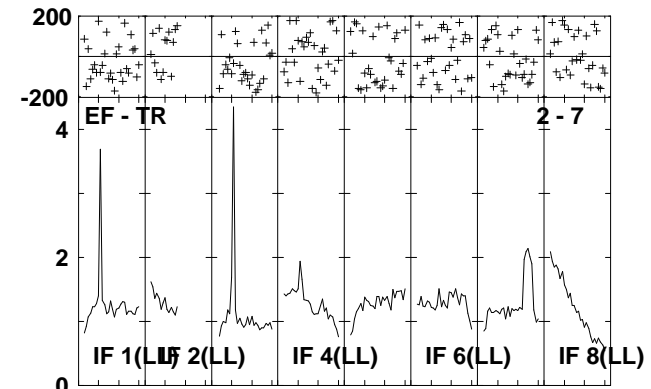
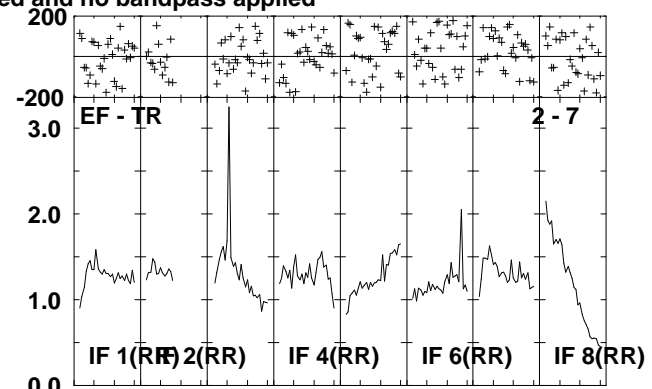
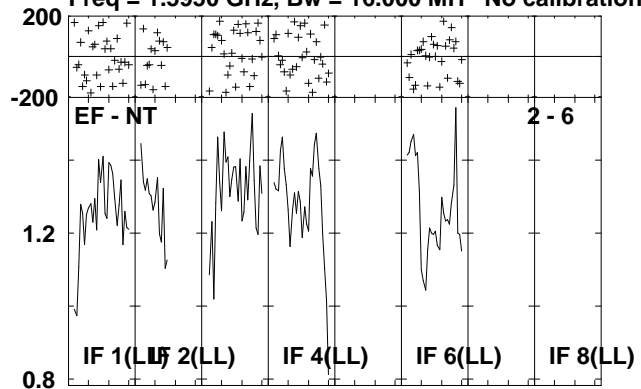

Lower frame: Milli Ampl Jy Top frame: Phas deg
Scalar averaged cross-power spectrum Several baselines displayed
Timerange: 00/15:38:11 to 00/15:41:49

Plot file version 161 created 06-JUL-2010 14:44:52

J2330+33 EP064J.UVDATA.1

Freq = 1.5950 GHz, Bw = 16.000 MH No calibration applied and no bandpass applied

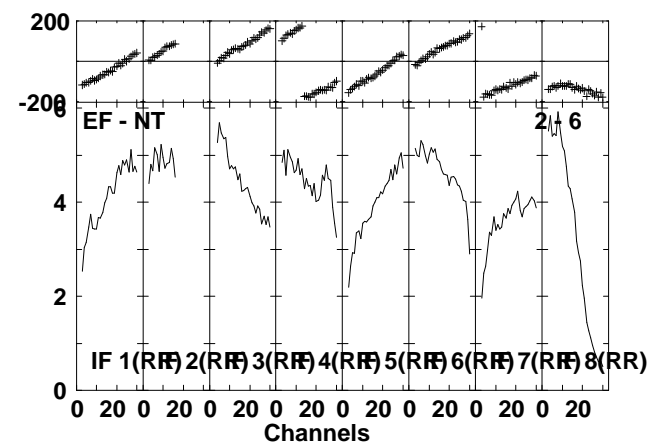
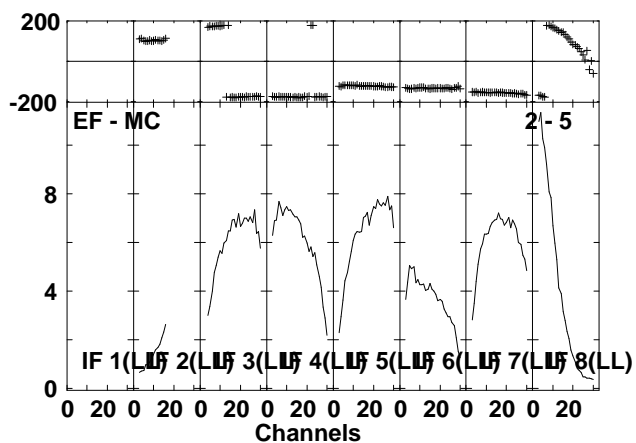
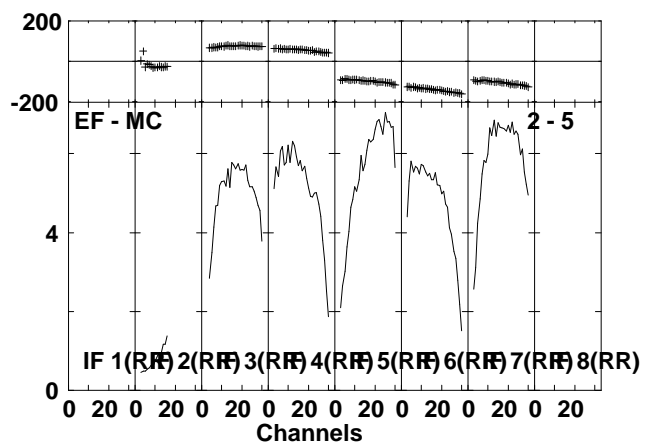
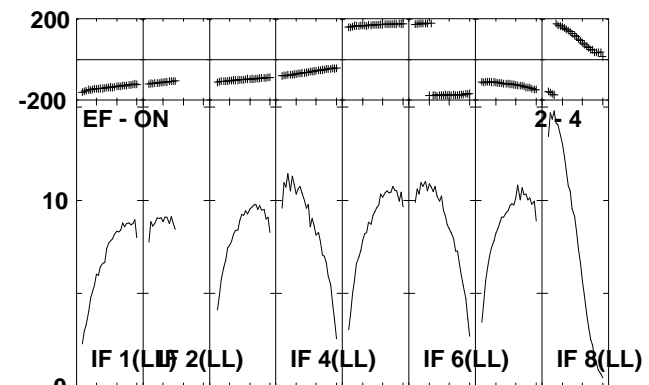
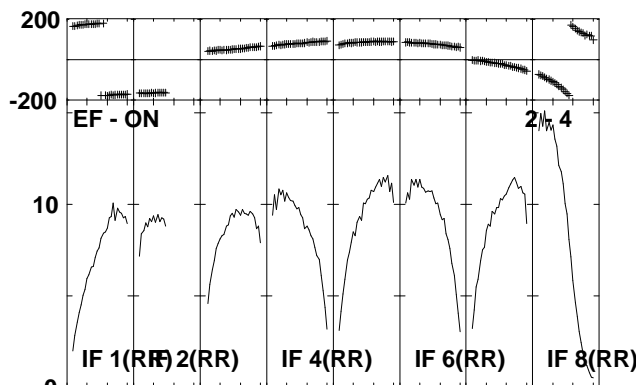
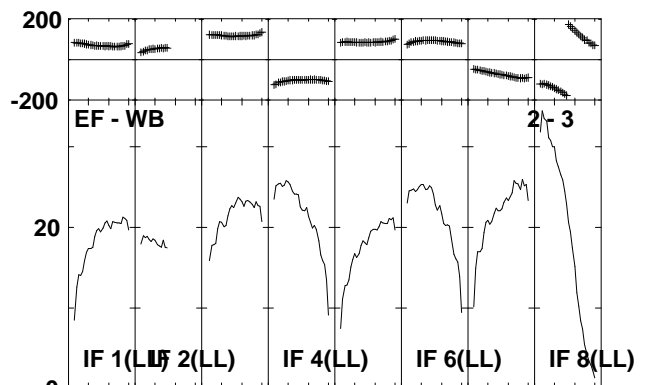
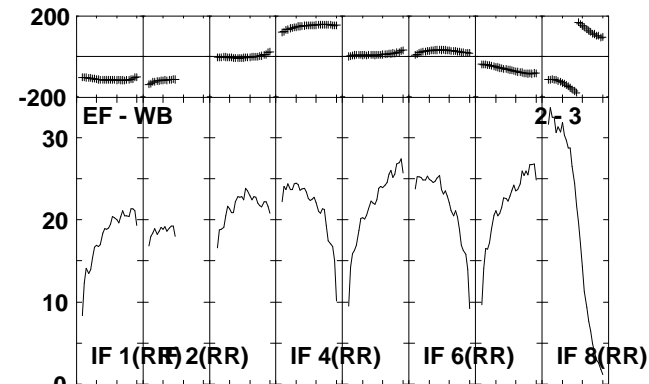
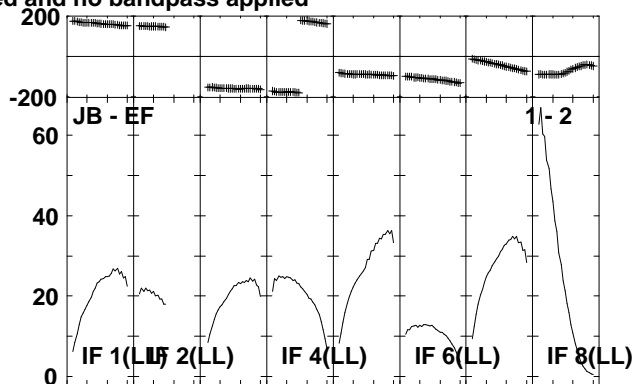
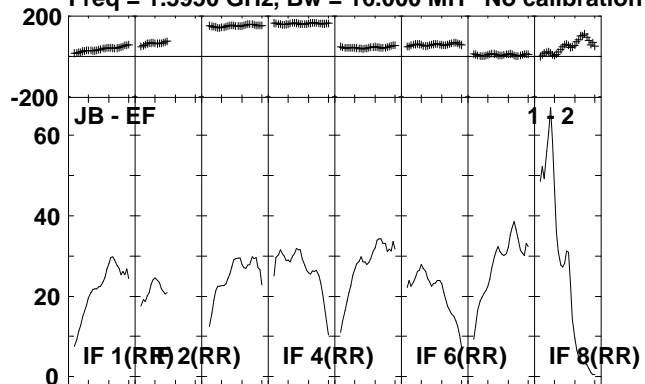

Lower frame: Milli Ampl Jy Top frame: Phas deg
Scalar averaged cross-power spectrum Several baselines displayed
Timerange: 00/15:42:51 to 00/15:44:27

Plot file version 162 created 06-JUL-2010 14:44:53

J2330+33 EP064J.UVDATA.1

Freq = 1.5950 GHz, Bw = 16.000 MH No calibration applied and no bandpass applied

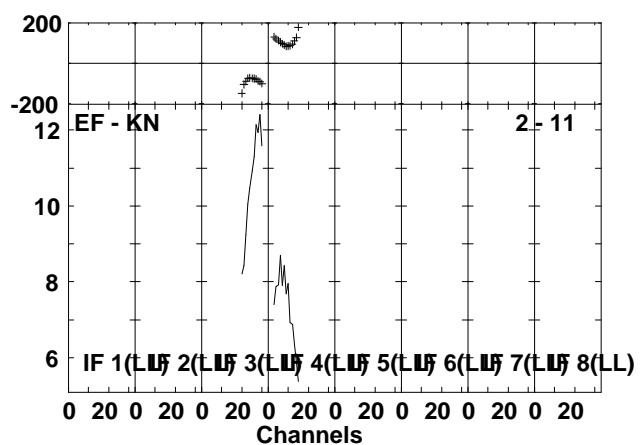
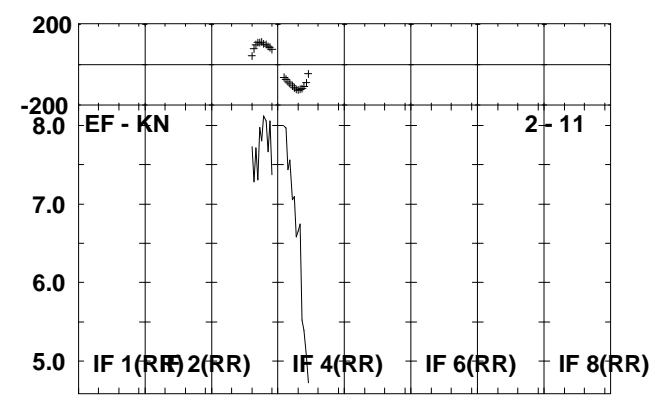
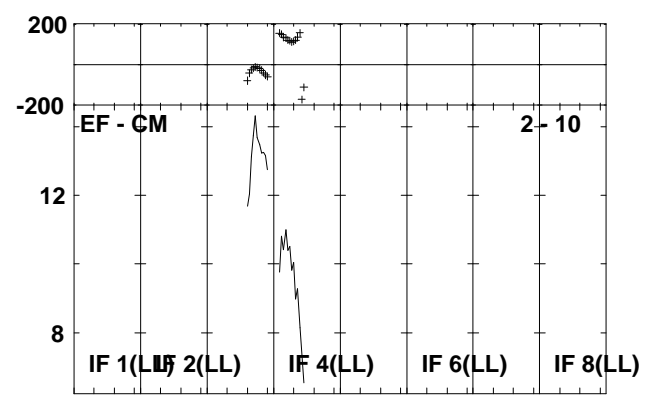
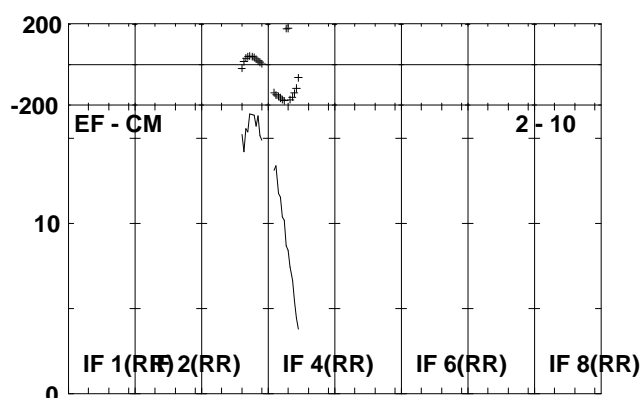
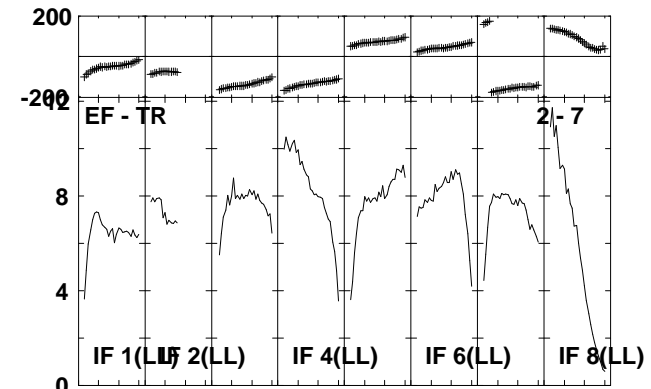
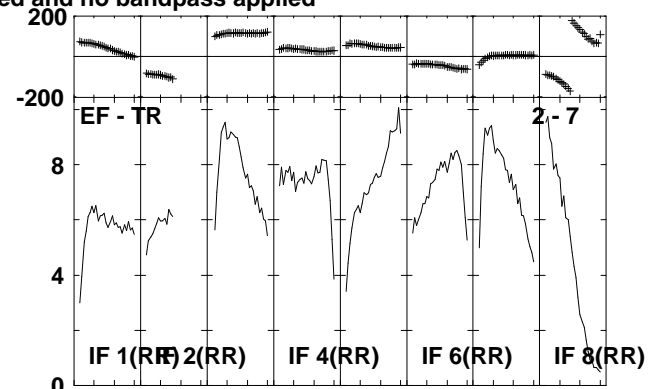
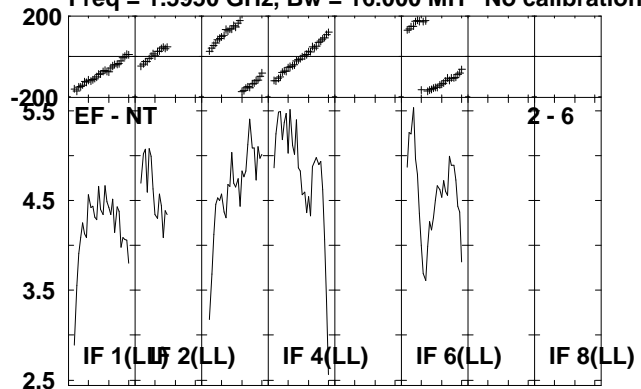

Lower frame: Milli Ampl Jy Top frame: Phas deg
Scalar averaged cross-power spectrum Several baselines displayed
Timerange: 00/15:42:51 to 00/15:44:27

Plot file version 163 created 06-JUL-2010 14:44:54

IRAS2336 EP064J.UVDATA.1

Freq = 1.5950 GHz, Bw = 16.000 MH No calibration applied and no bandpass applied

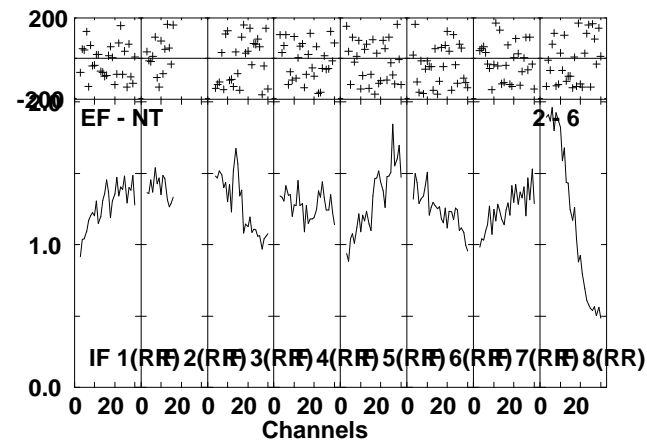
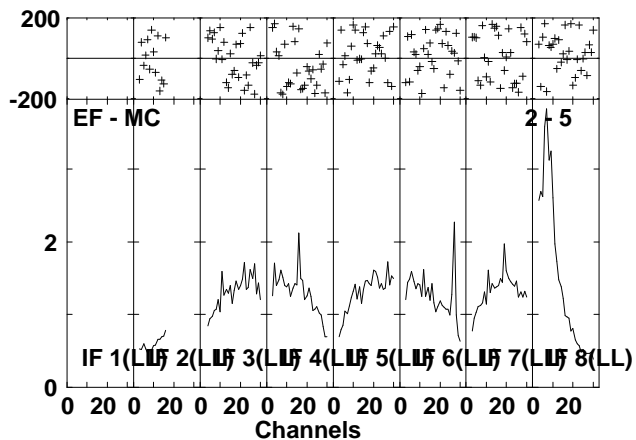
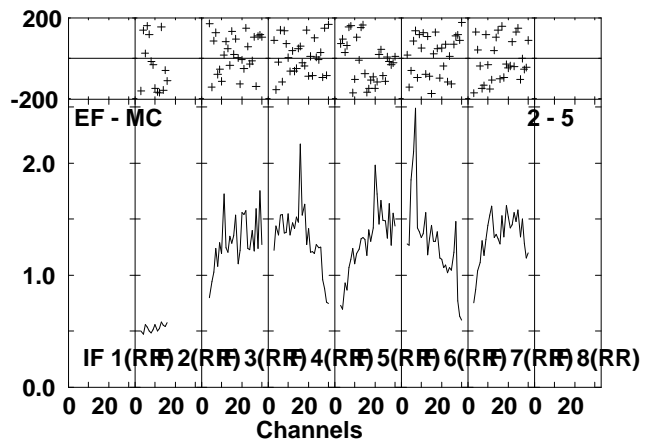
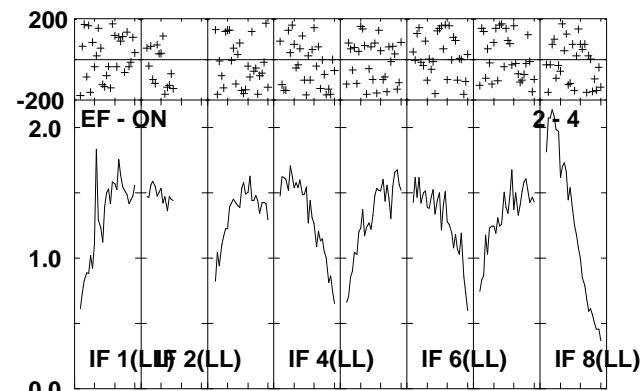
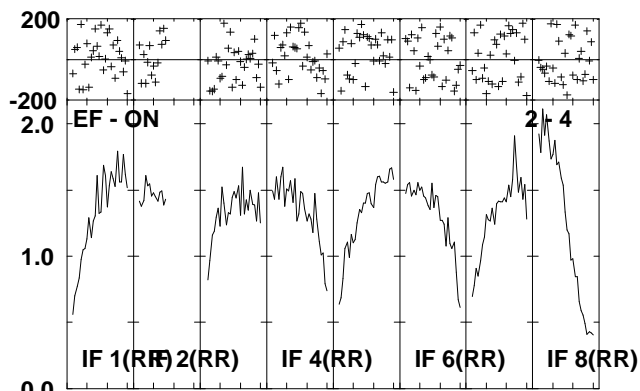
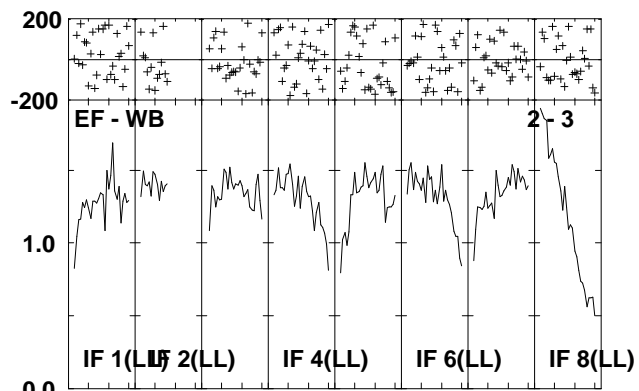
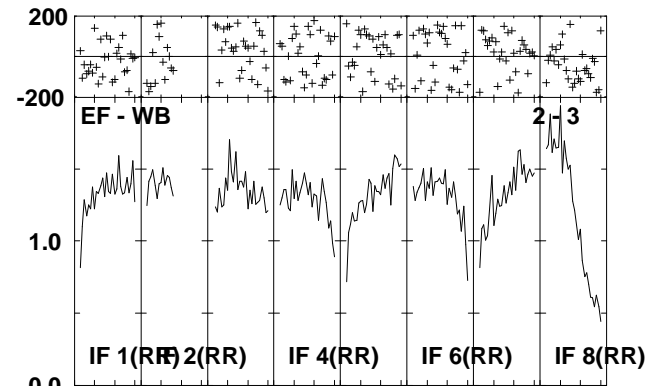
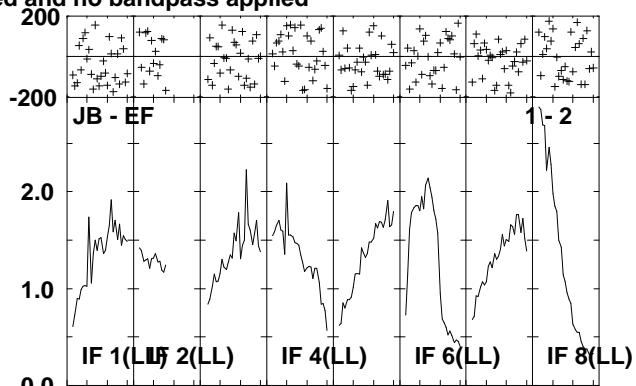
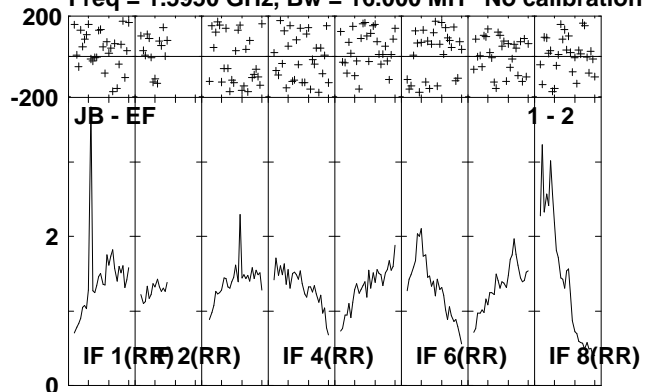

Lower frame: Milli Ampl Jy Top frame: Phas deg
Scalar averaged cross-power spectrum Several baselines displayed
Timerange: 00/15:44:37 to 00/15:48:09

Plot file version 164 created 06-JUL-2010 14:44:56

IRAS2336 EP064J.UVDATA.1

Freq = 1.5950 GHz, Bw = 16.000 MH No calibration applied and no bandpass applied

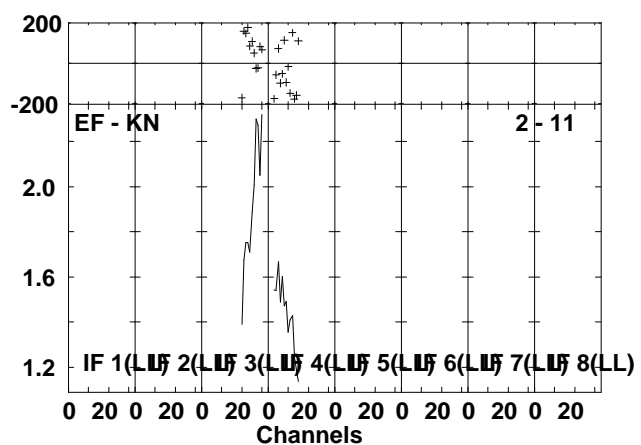
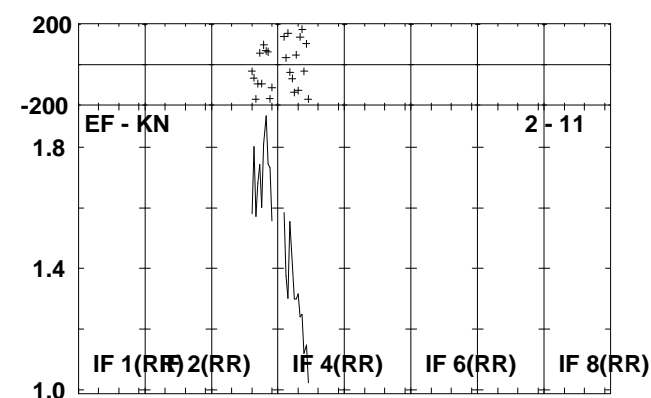
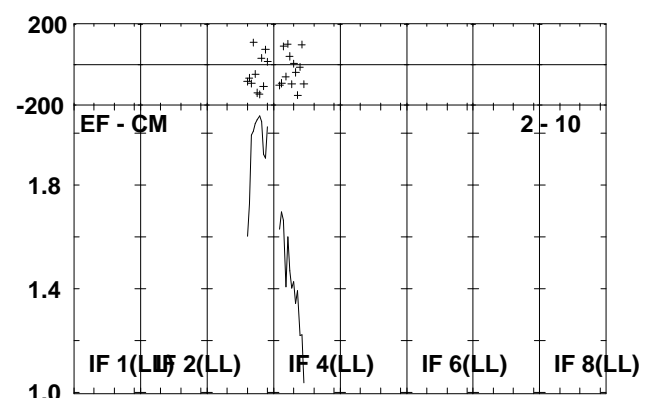
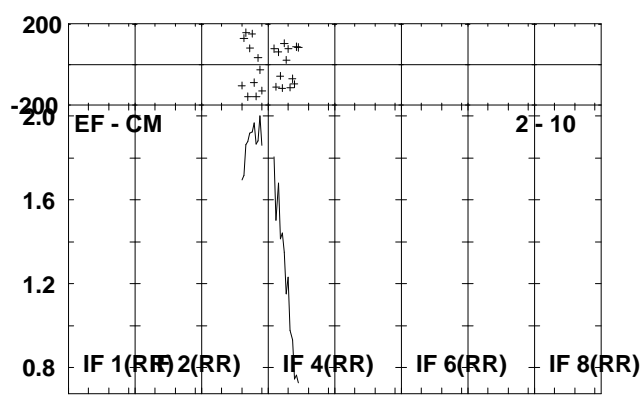
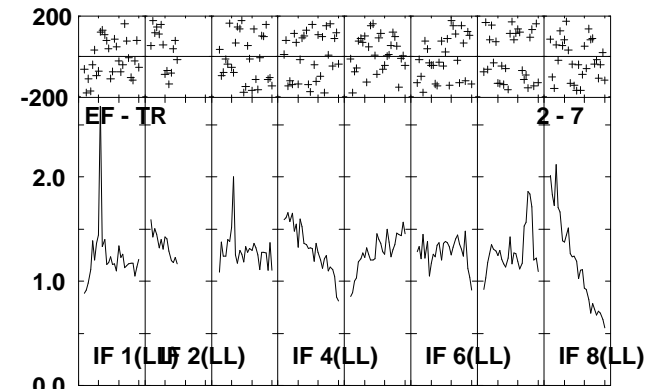
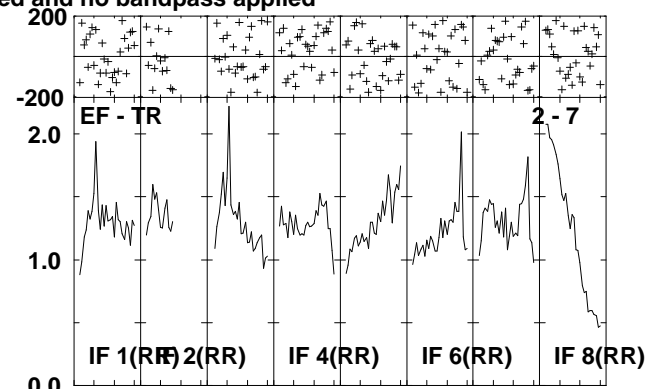
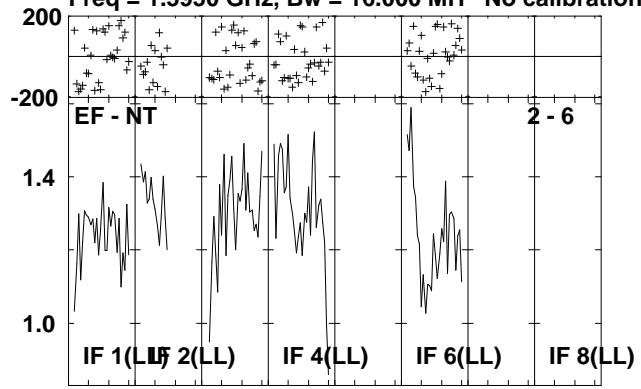

Lower frame: Milli Ampl Jy Top frame: Phas deg
Scalar averaged cross-power spectrum Several baselines displayed
Timerange: 00/15:44:37 to 00/15:48:09

Plot file version 165 created 06-JUL-2010 14:44:58

J2330+33 EP064J.UVDATA.1

Freq = 1.5950 GHz, Bw = 16.000 MH No calibration applied and no bandpass applied

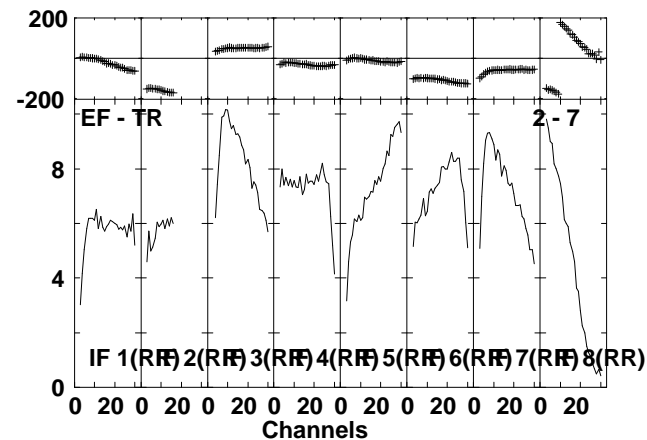
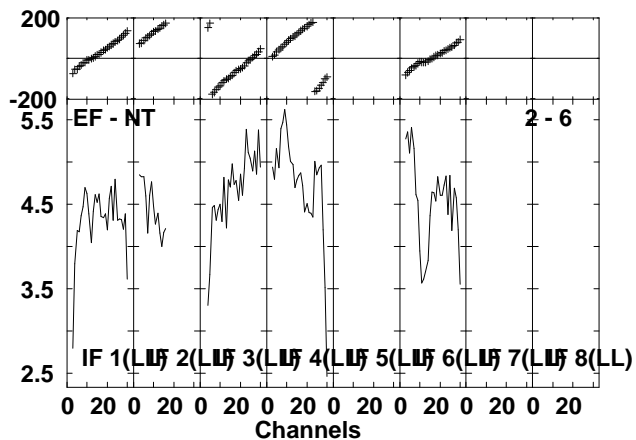
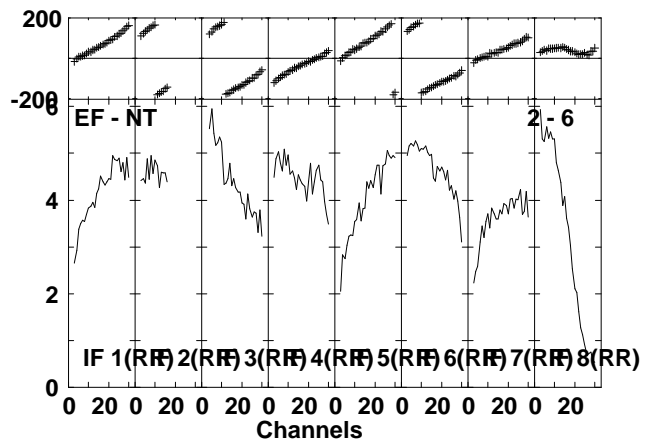
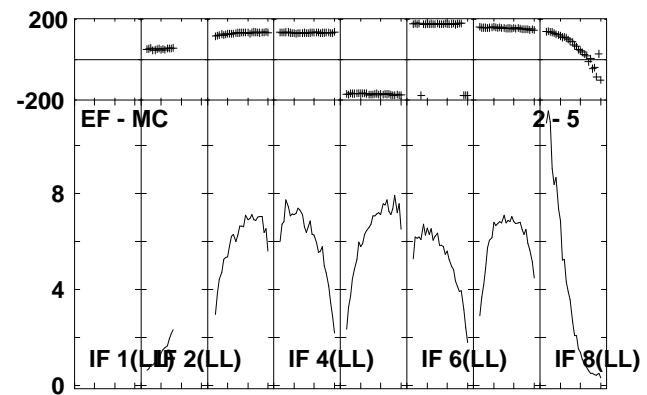
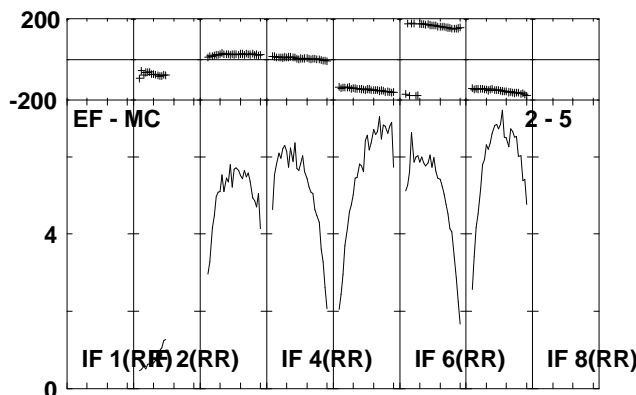
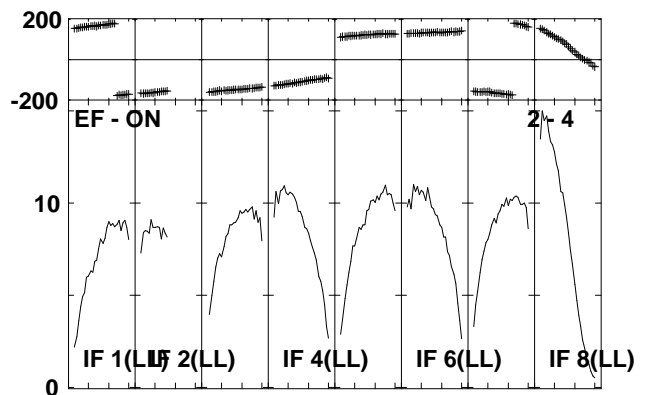
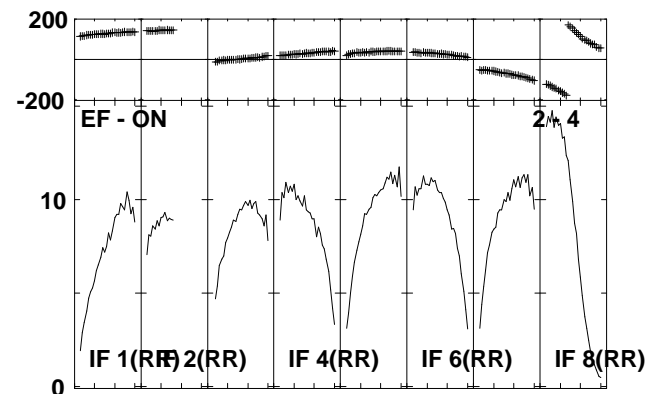
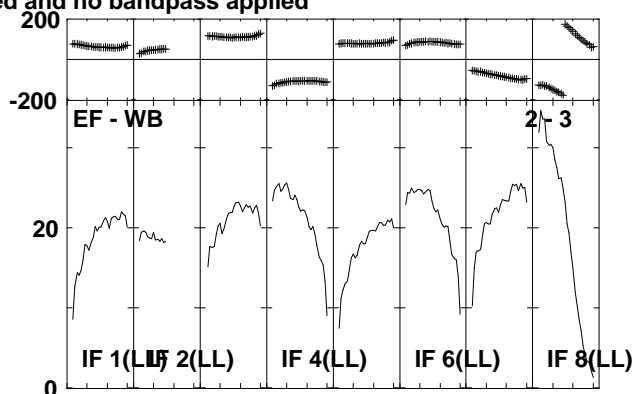
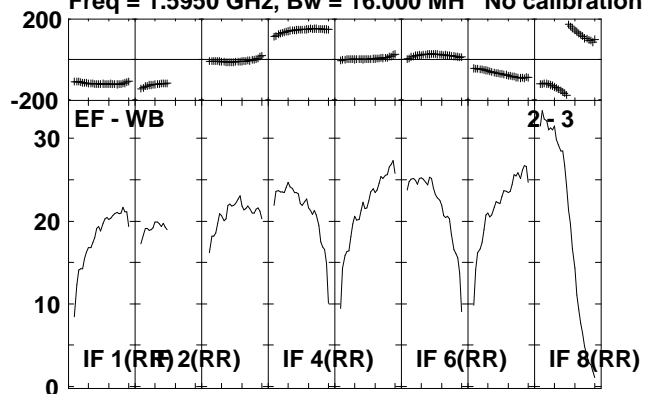

Lower frame: Milli Ampl Jy Top frame: Phas deg
Scalar averaged cross-power spectrum Several baselines displayed
Timerange: 00/15:48:11 to 00/15:49:59

Plot file version 166 created 06-JUL-2010 14:44:58

J2330+33 EP064J.UVDATA.1

Freq = 1.5950 GHz, Bw = 16.000 MH No calibration applied and no bandpass applied

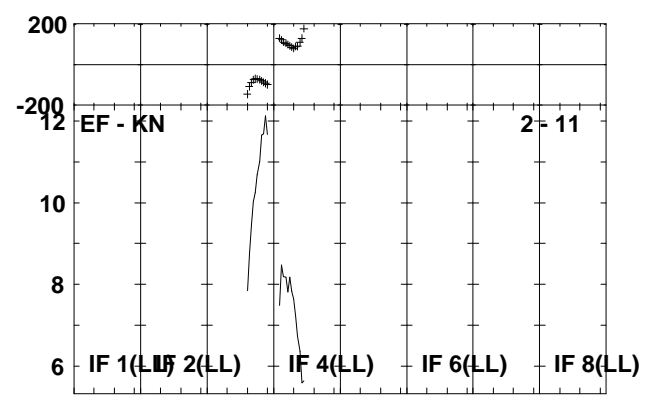
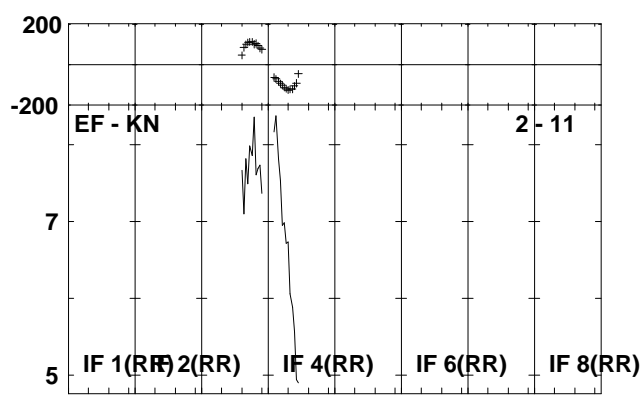
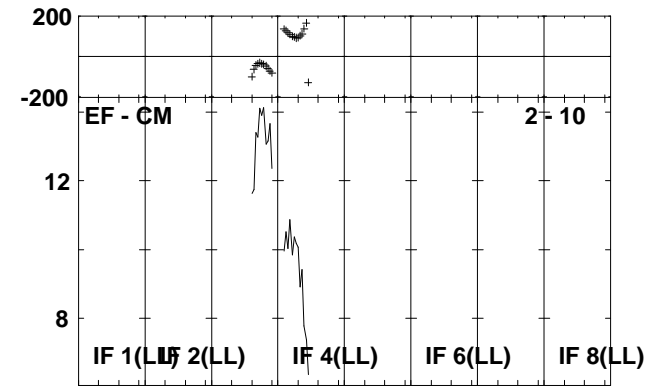
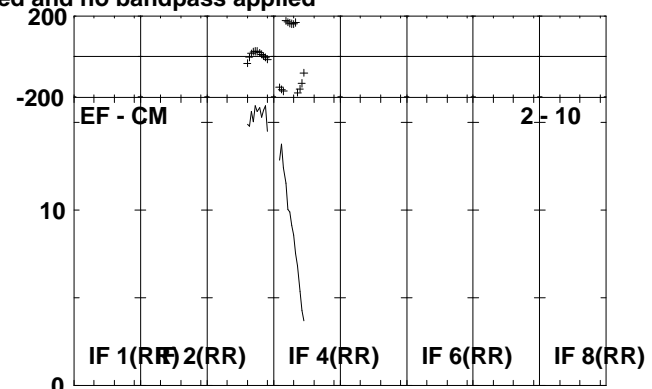
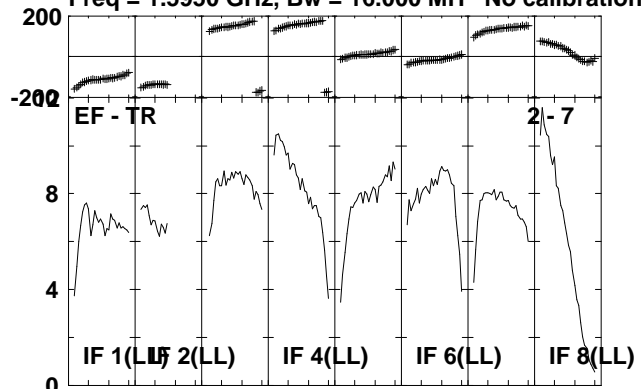

Lower frame: Milli Ampl Jy Top frame: Phas deg
Scalar averaged cross-power spectrum Several baselines displayed
Timerange: 00/15:48:11 to 00/15:49:59

Plot file version 167 created 06-JUL-2010 14:44:59

IRAS2336 EP064J.UVDATA.1

Freq = 1.5950 GHz, Bw = 16.000 MH No calibration applied and no bandpass applied

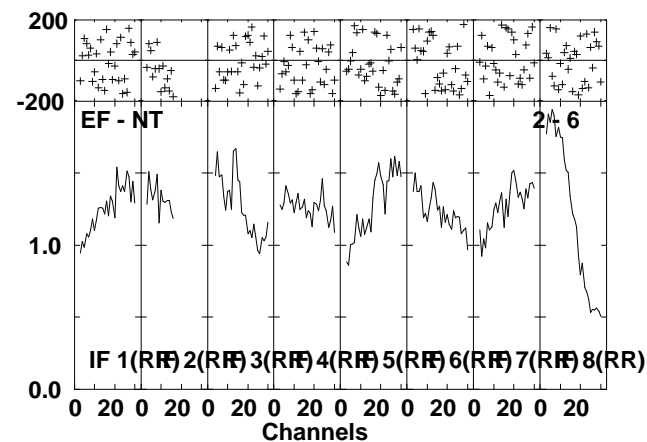
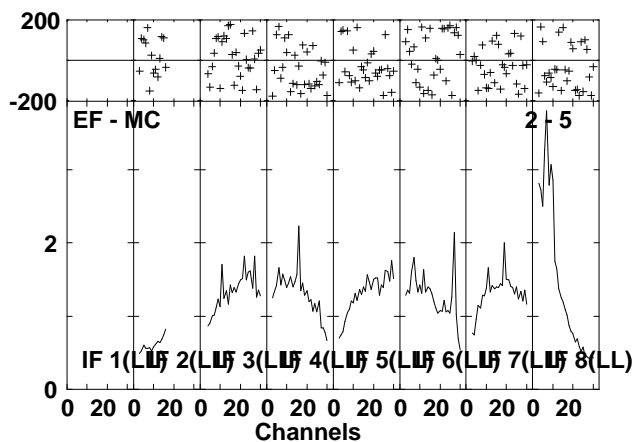
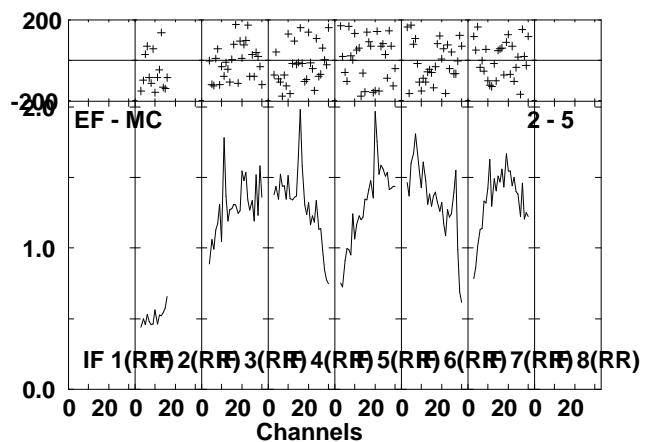
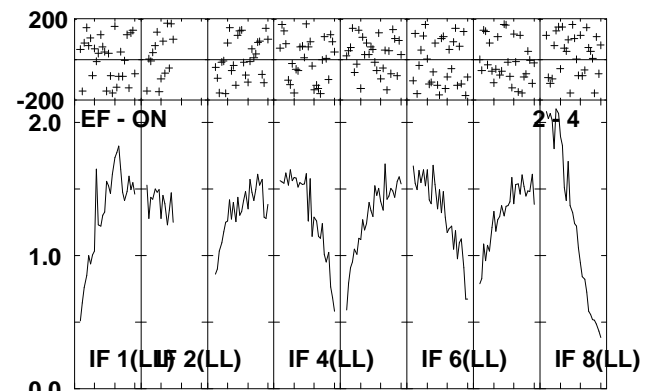
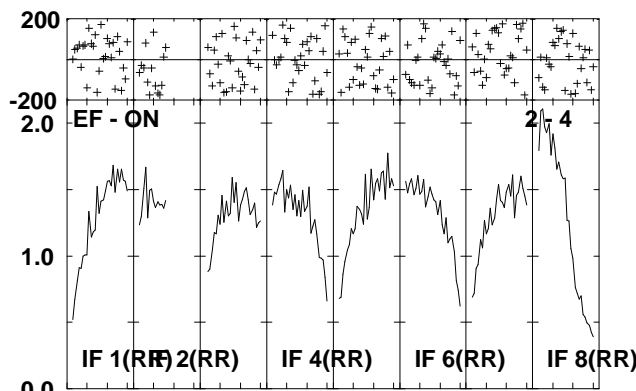
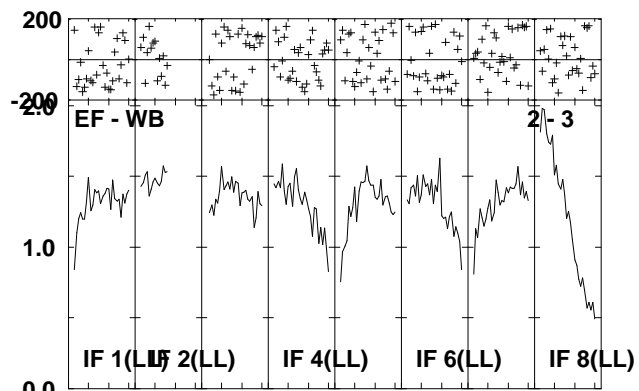
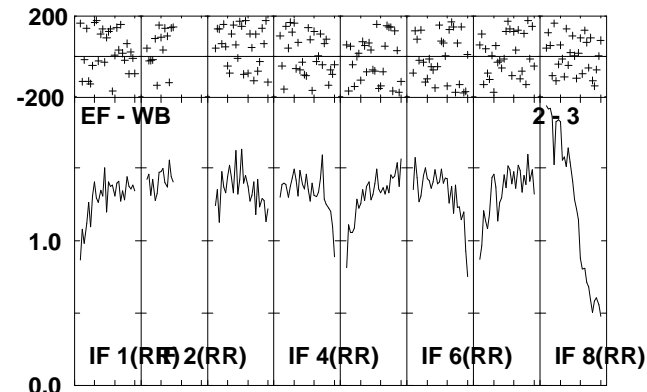
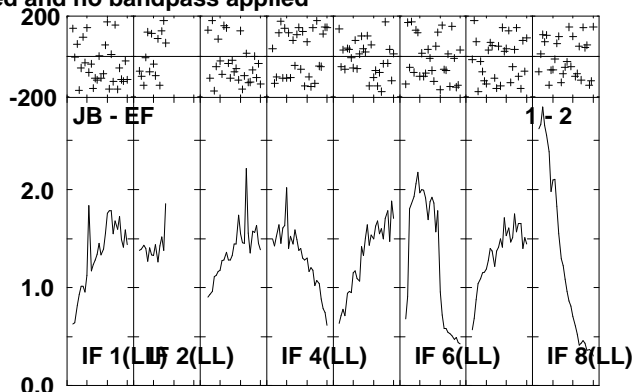
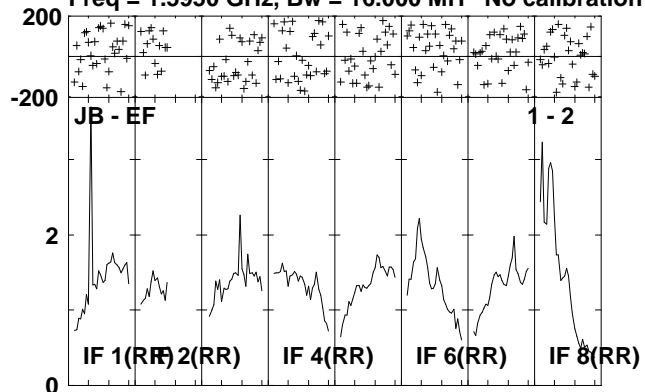

Lower frame: Milli Ampl Jy Top frame: Phas deg
Scalar averaged cross-power spectrum Several baselines displayed
Timerange: 00/15:50:01 to 00/15:53:39

Plot file version 168 created 06-JUL-2010 14:45:01

IRAS2336 EP064J.UVDATA.1

Freq = 1.5950 GHz, Bw = 16.000 MH No calibration applied and no bandpass applied

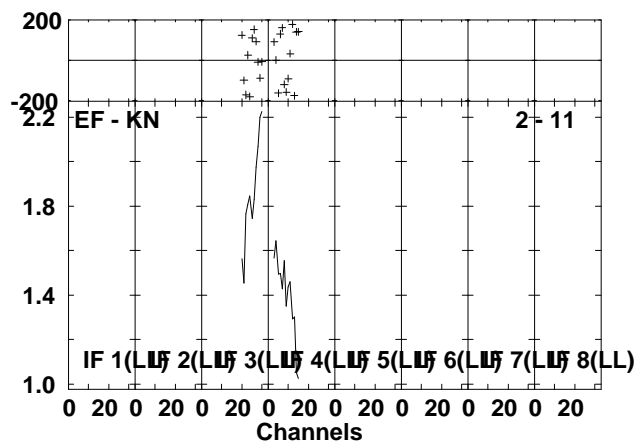
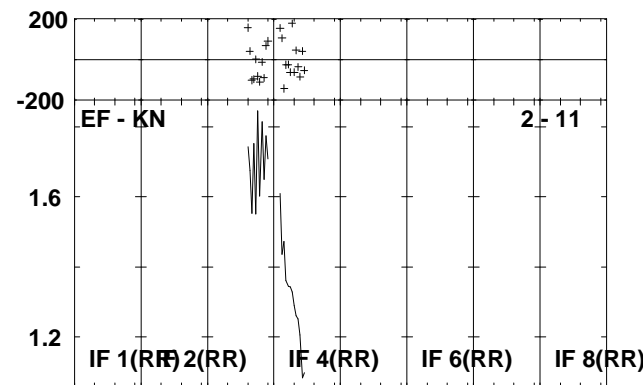
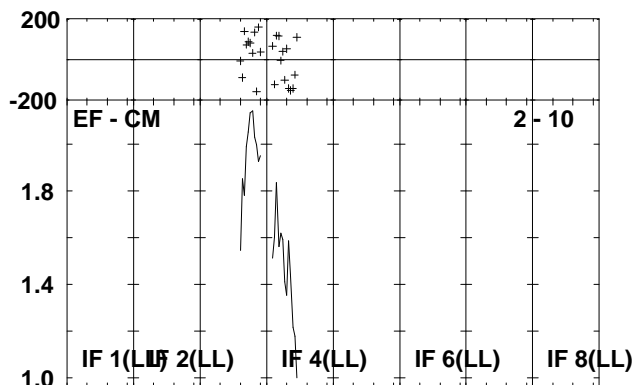
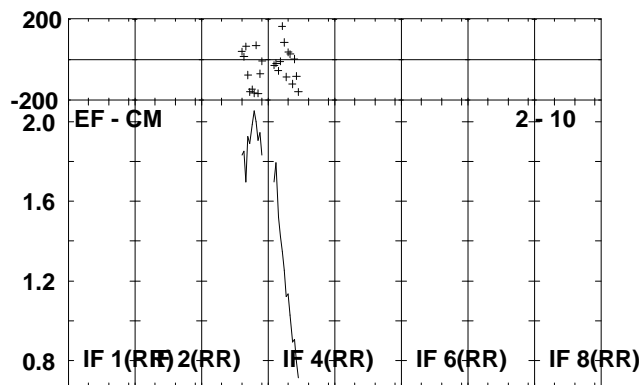
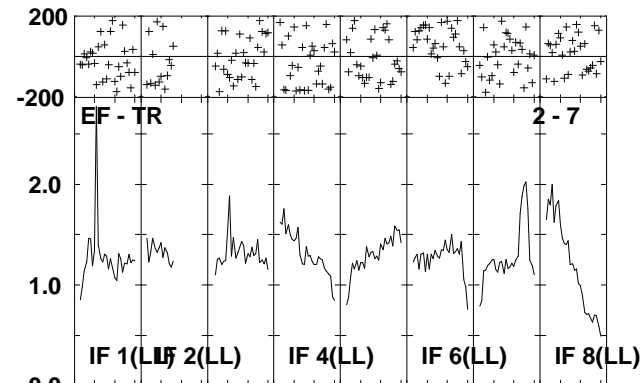
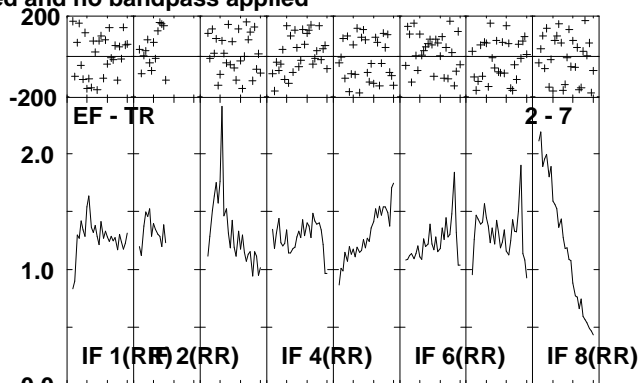
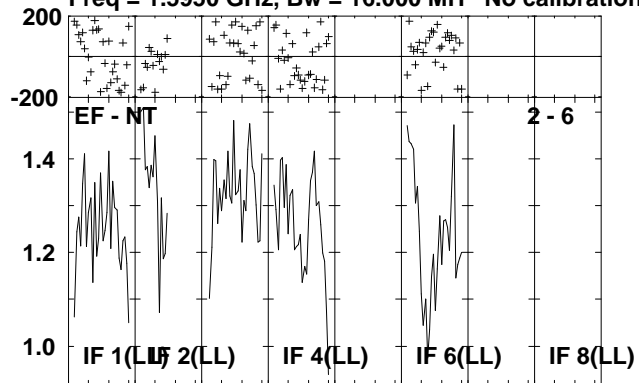

Lower frame: Milli Ampl Jy Top frame: Phas deg
Scalar averaged cross-power spectrum Several baselines displayed
Timerange: 00/15:50:01 to 00/15:53:39

Plot file version 169 created 06-JUL-2010 14:45:03

J2330+33 EP064J.UVDATA.1

Freq = 1.5950 GHz, Bw = 16.000 MH No calibration applied and no bandpass applied

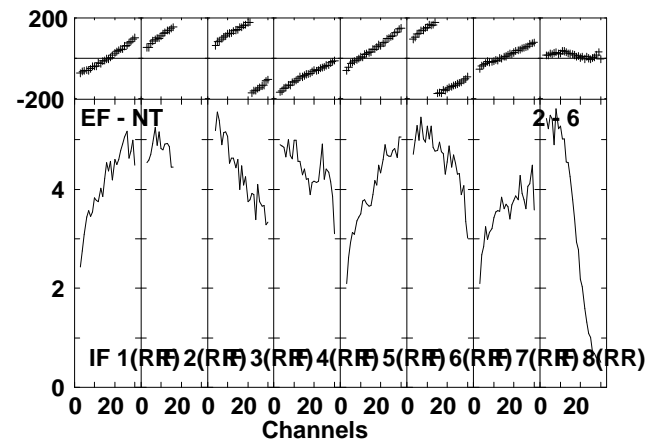
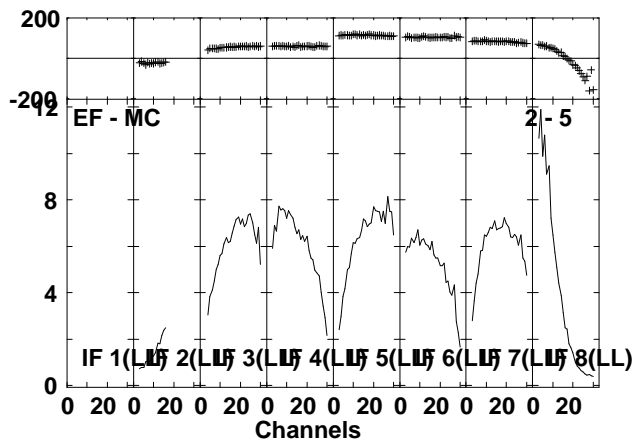
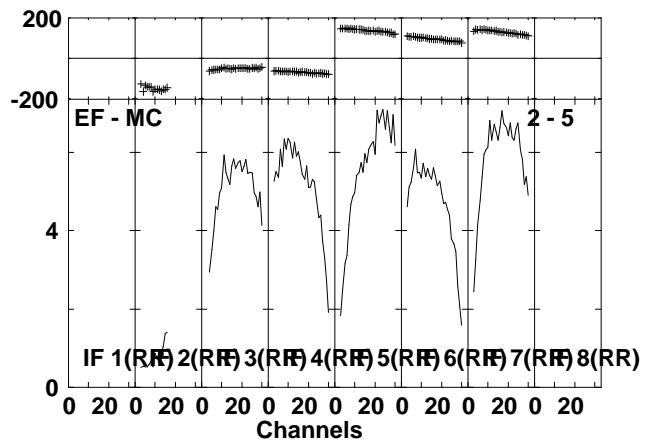
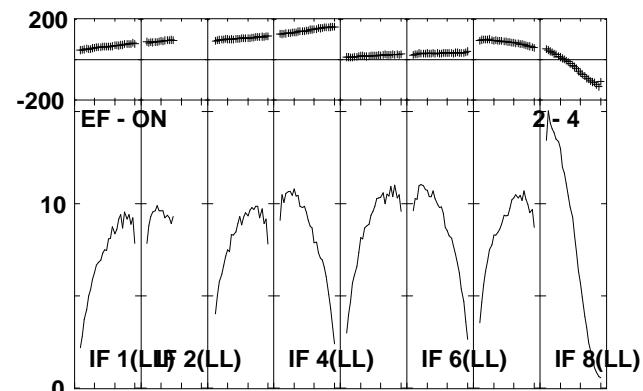
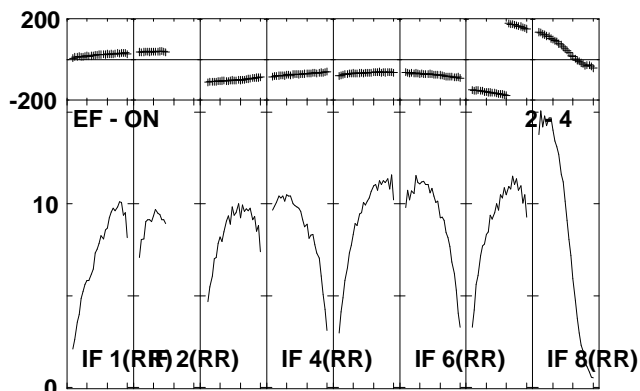
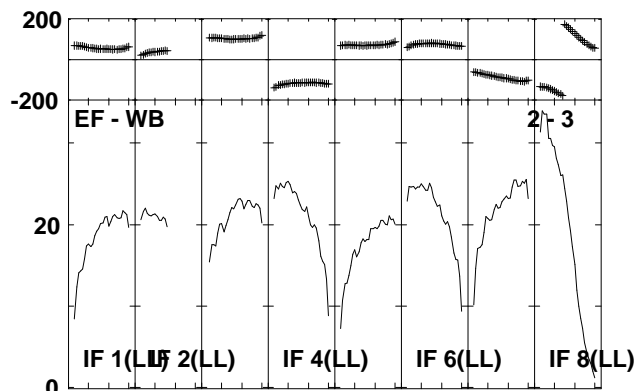
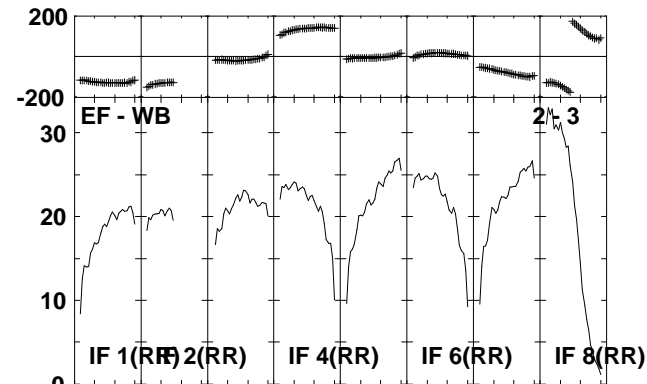
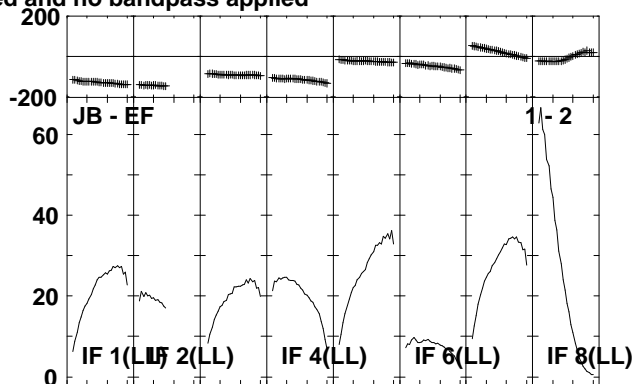
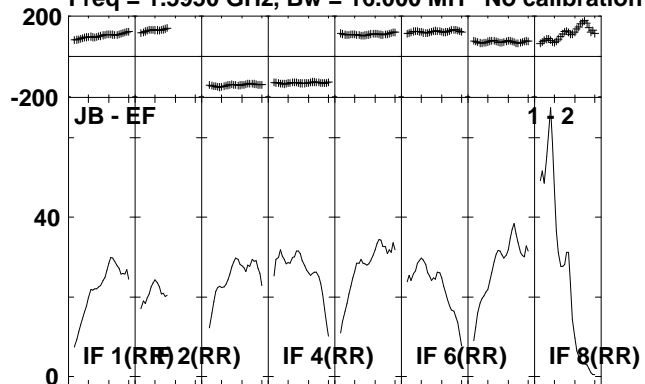

Lower frame: Milli Ampl Jy Top frame: Phas deg
Scalar averaged cross-power spectrum Several baselines displayed
Timerange: 00/15:53:41 to 00/15:55:29

Plot file version 170 created 06-JUL-2010 14:45:04

J2330+33 EP064J.UVDATA.1

Freq = 1.5950 GHz, Bw = 16.000 MH No calibration applied and no bandpass applied

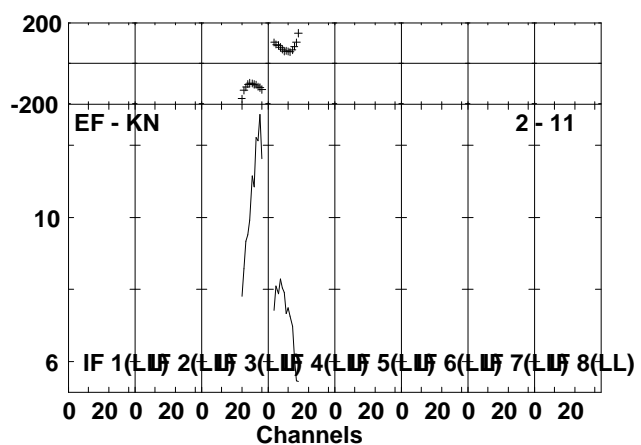
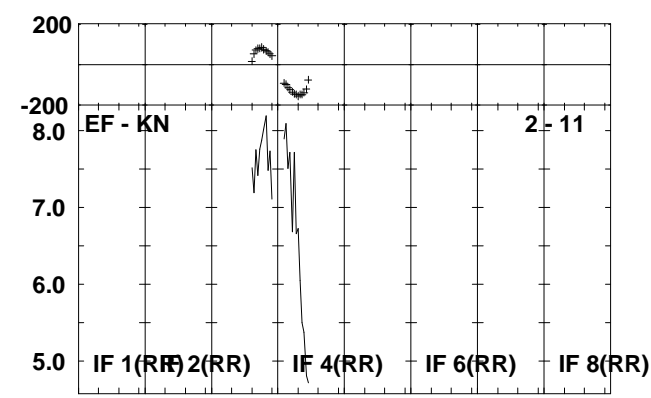
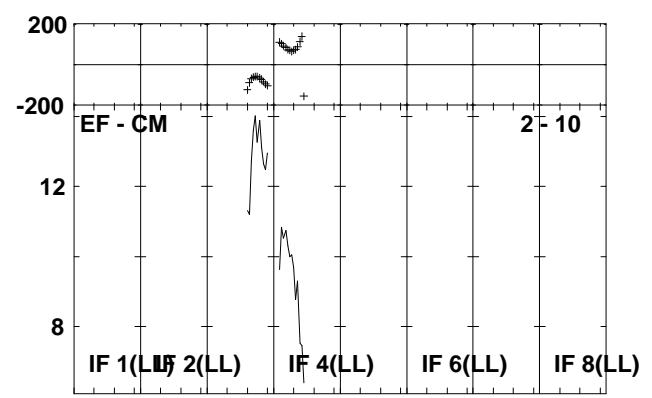
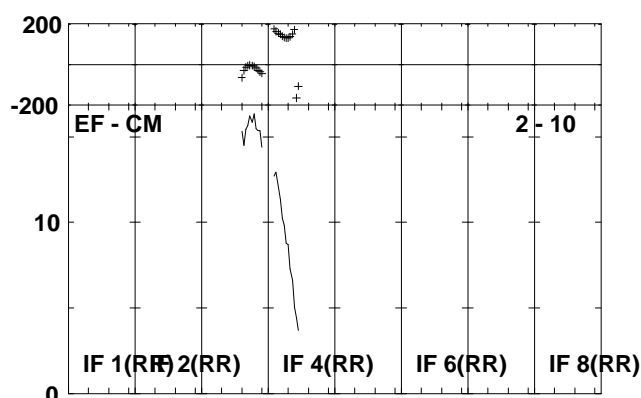
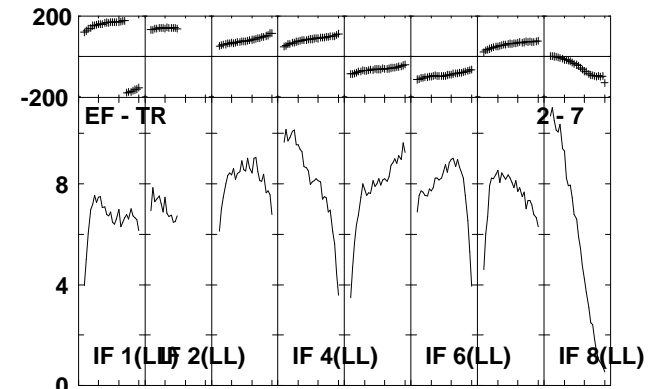
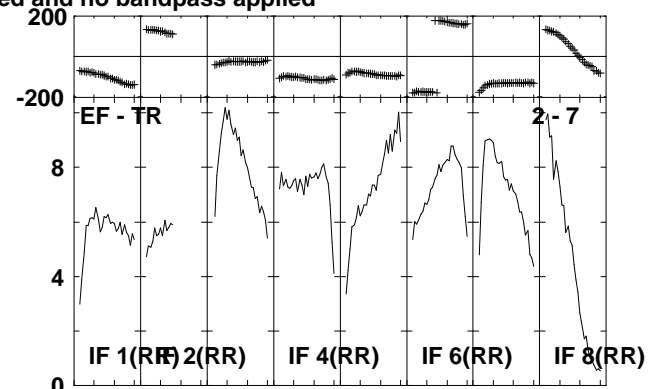
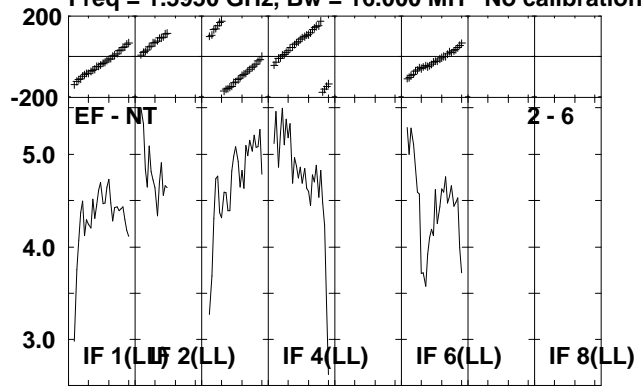

Lower frame: Milli Ampl Jy Top frame: Phas deg
Scalar averaged cross-power spectrum Several baselines displayed
Timerange: 00/15:53:41 to 00/15:55:29

Plot file version 171 created 06-JUL-2010 14:45:06

IRAS2336 EP064J.UVDATA.1

Freq = 1.5950 GHz, Bw = 16.000 MH No calibration applied and no bandpass applied

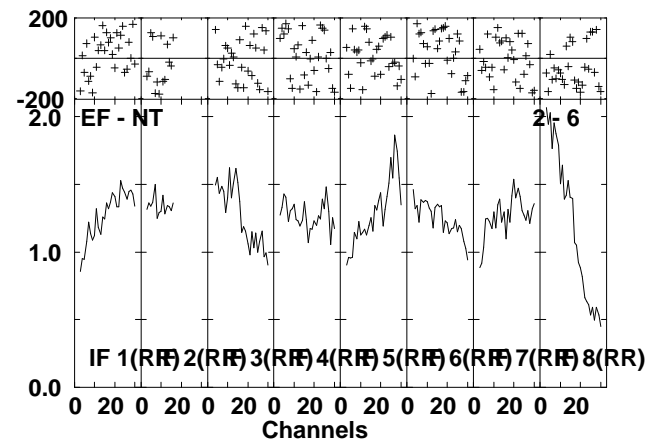
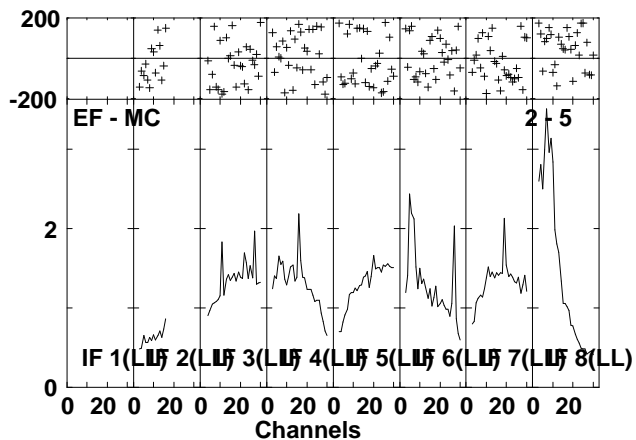
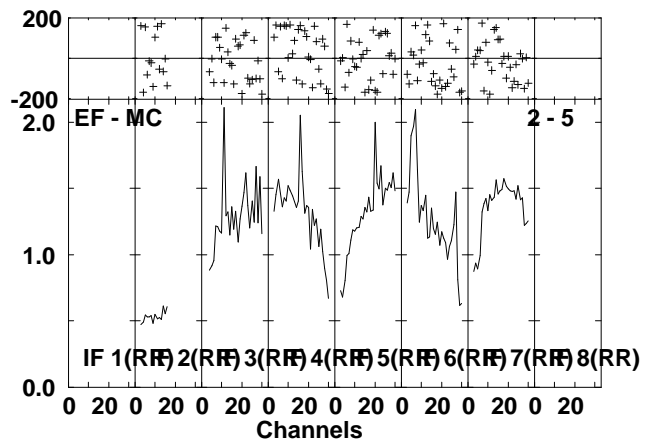
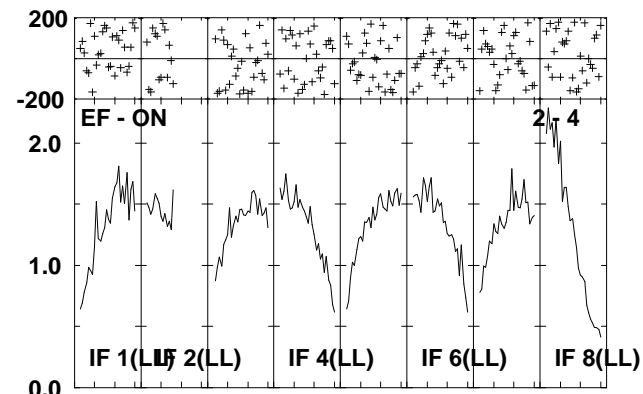
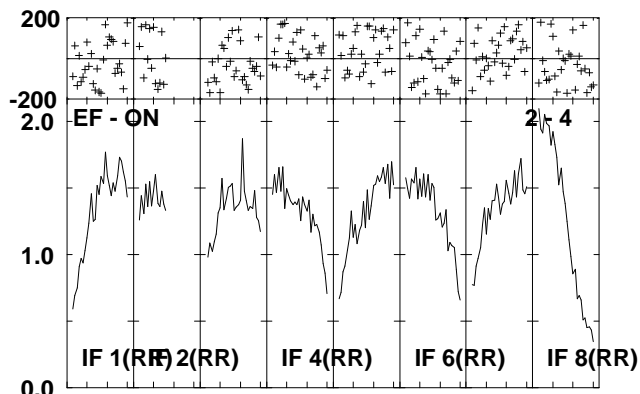
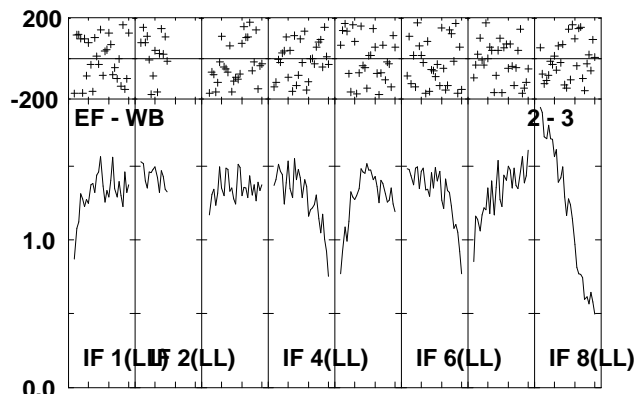
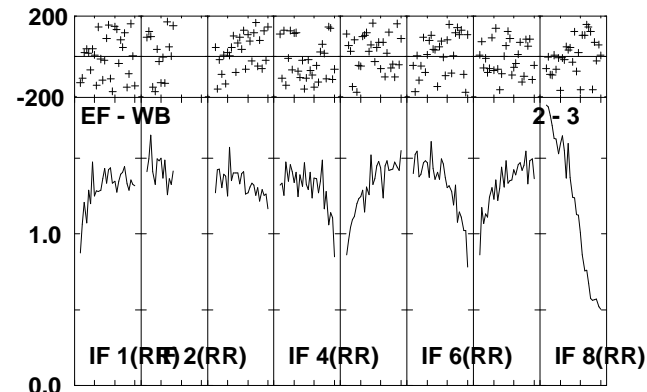
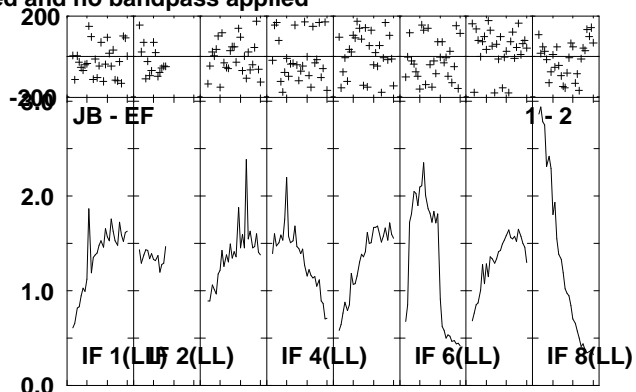
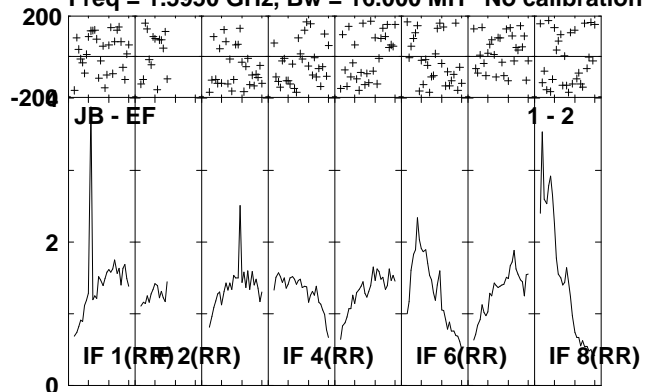

Lower frame: Milli Ampl Jy Top frame: Phas deg
Scalar averaged cross-power spectrum Several baselines displayed
Timerange: 00/15:55:31 to 00/15:59:09

Plot file version 172 created 06-JUL-2010 14:45:07

IRAS2336 EP064J.UVDATA.1

Freq = 1.5950 GHz, Bw = 16.000 MH No calibration applied and no bandpass applied

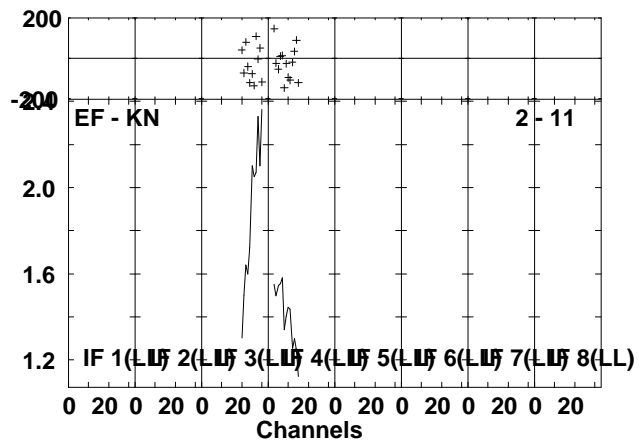
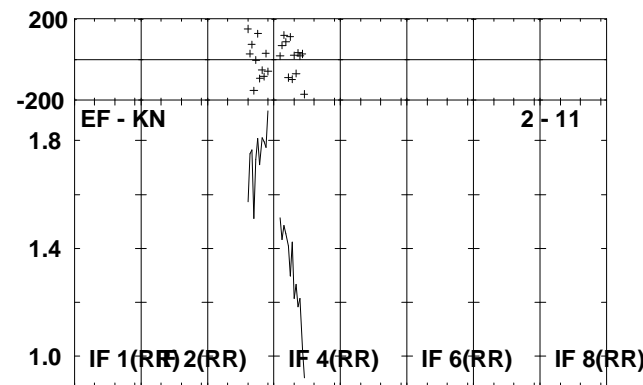
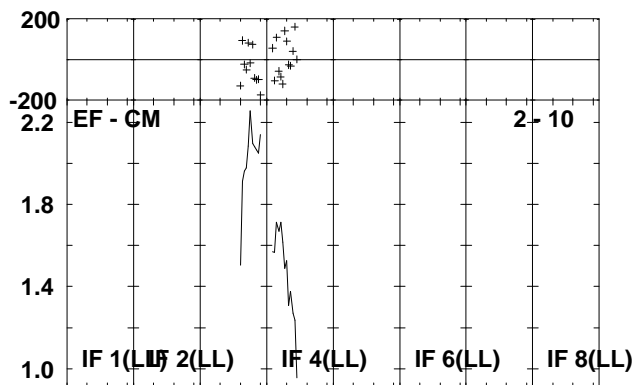
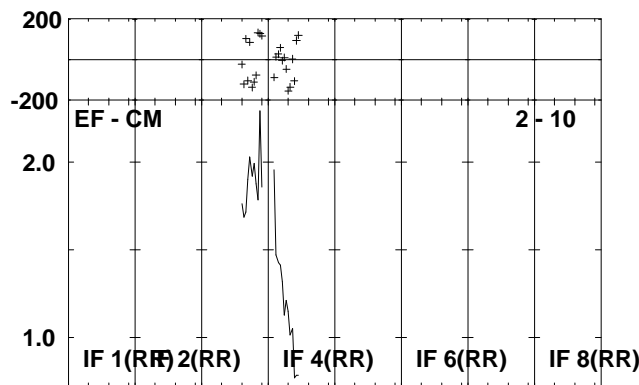
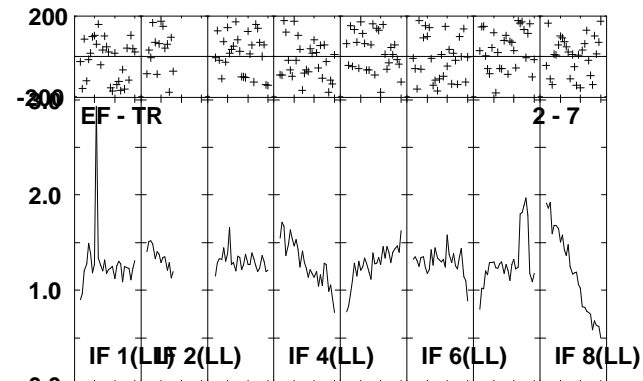
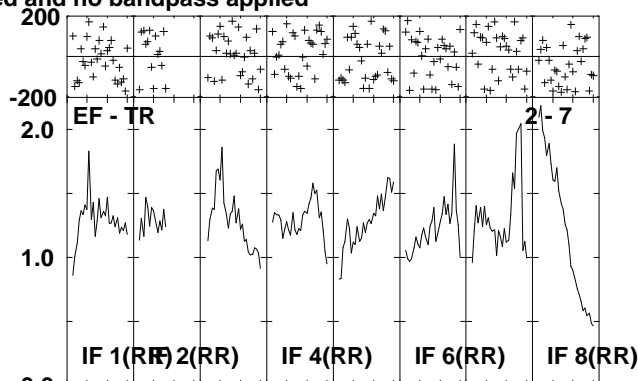
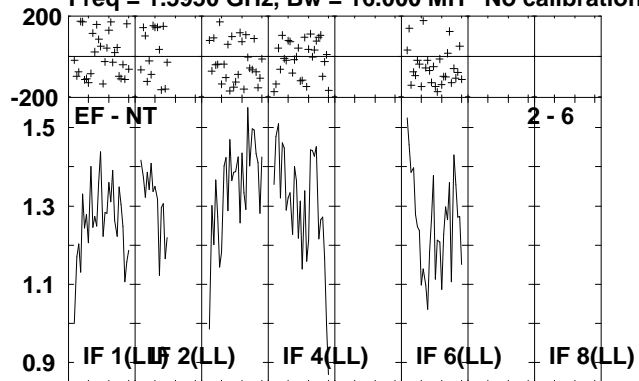

Lower frame: Milli Ampl Jy Top frame: Phas deg
Scalar averaged cross-power spectrum Several baselines displayed
Timerange: 00/15:55:31 to 00/15:59:09

Plot file version 173 created 06-JUL-2010 14:45:10

J2330+33 EP064J.UVDATA.1

Freq = 1.5950 GHz, Bw = 16.000 MH No calibration applied and no bandpass applied

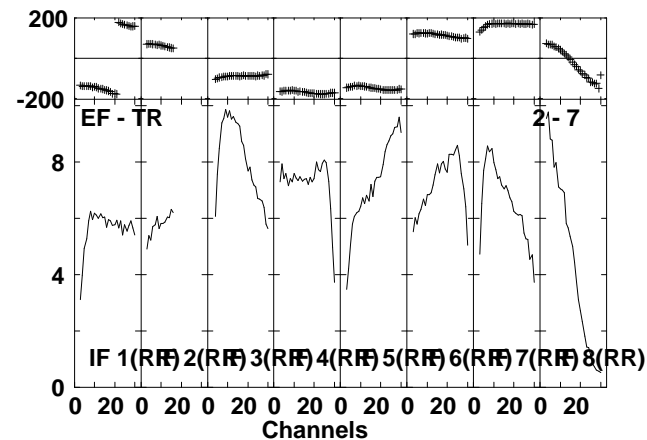
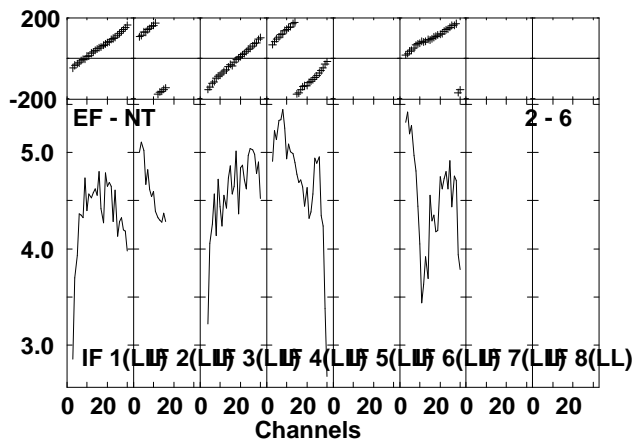
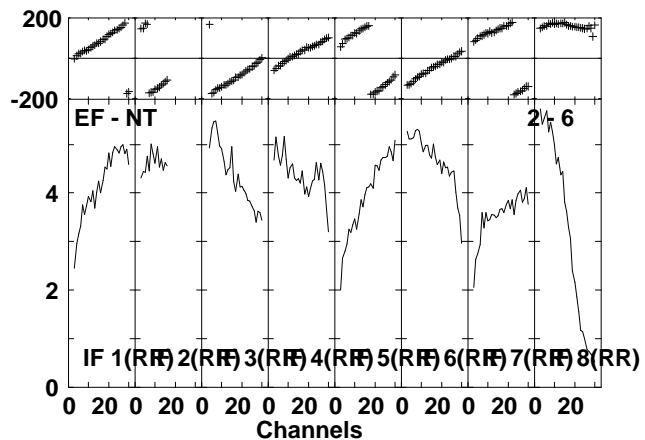
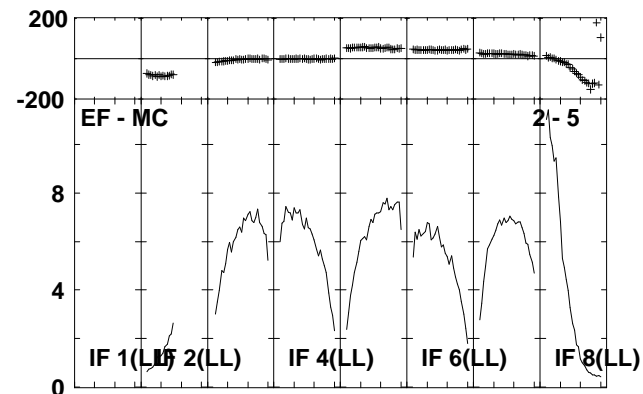
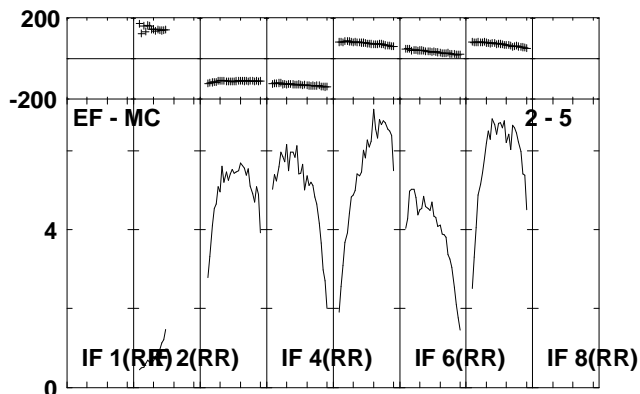
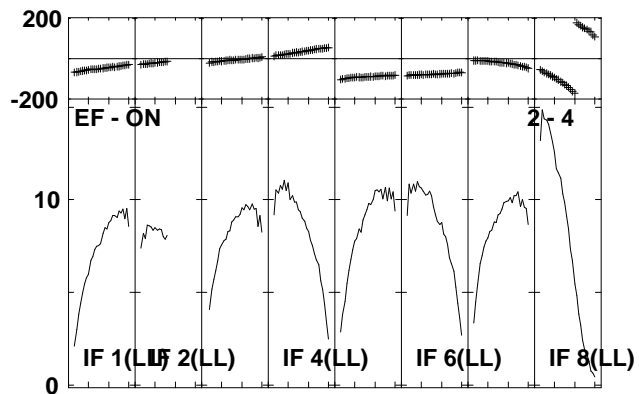
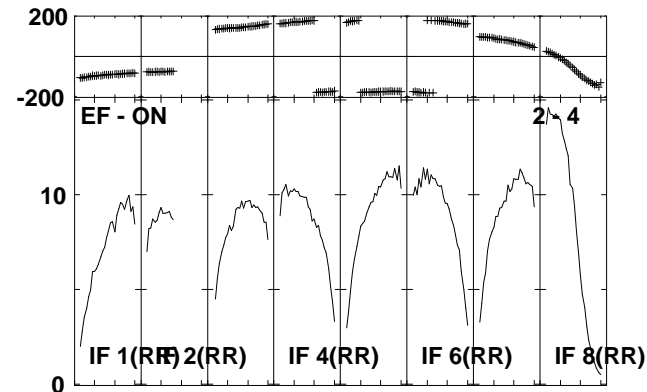
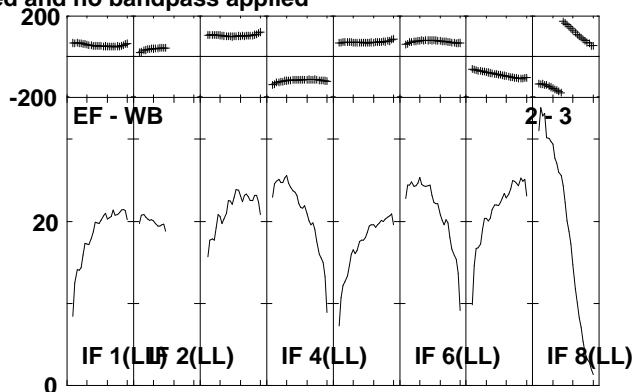
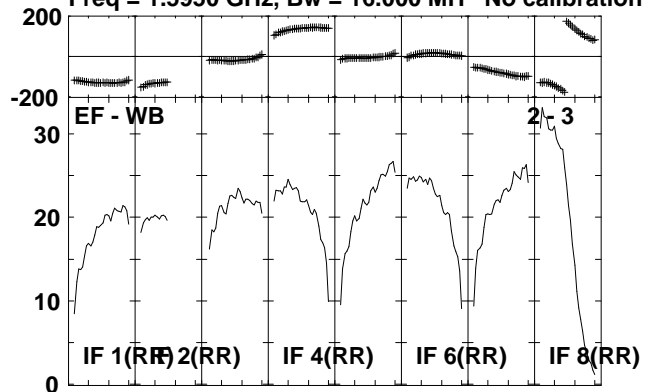

Lower frame: Milli Ampl Jy Top frame: Phas deg
Scalar averaged cross-power spectrum Several baselines displayed
Timerange: 00/16:00:11 to 00/16:01:47

Plot file version 174 created 06-JUL-2010 14:45:10

J2330+33 EP064J.UVDATA.1

Freq = 1.5950 GHz, Bw = 16.000 MH No calibration applied and no bandpass applied

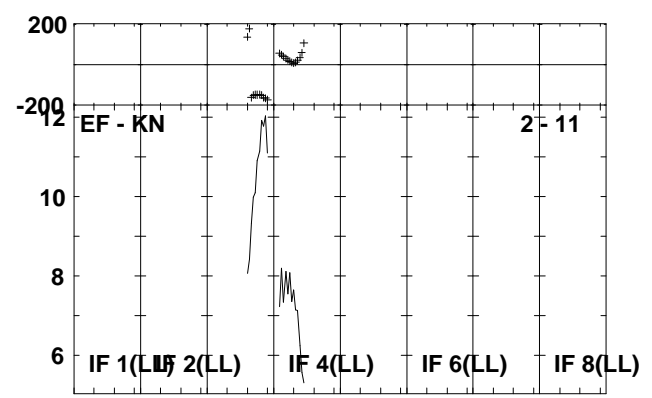
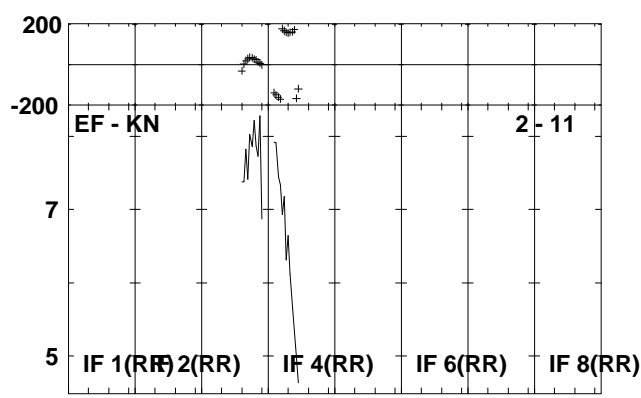
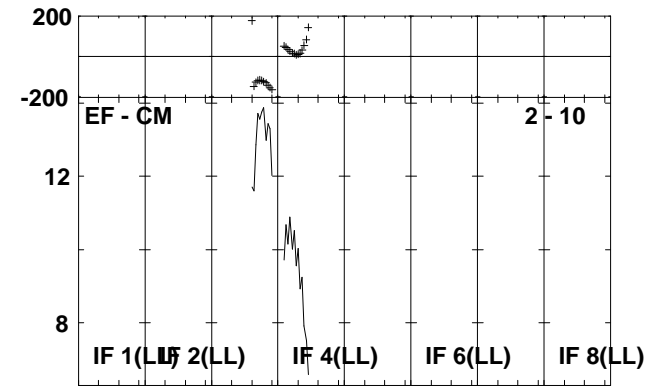
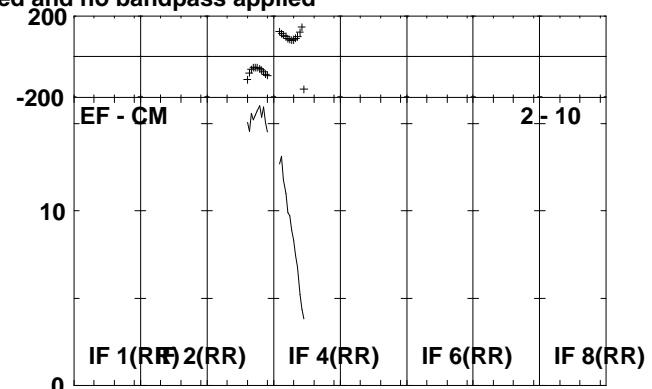
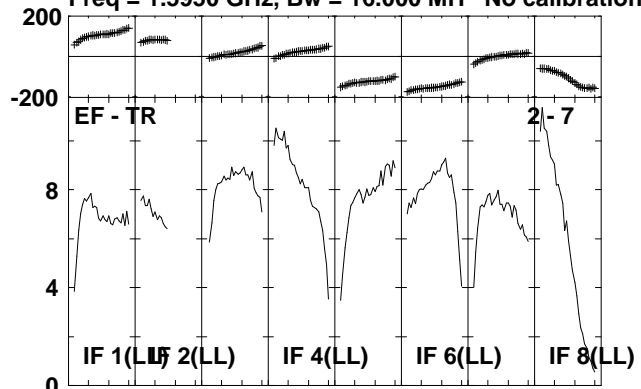

Lower frame: Milli Ampl Jy Top frame: Phas deg
Scalar averaged cross-power spectrum Several baselines displayed
Timerange: 00/16:00:11 to 00/16:01:47

Plot file version 175 created 06-JUL-2010 14:45:11

IRAS2336 EP064J.UVDATA.1

Freq = 1.5950 GHz, Bw = 16.000 MH No calibration applied and no bandpass applied

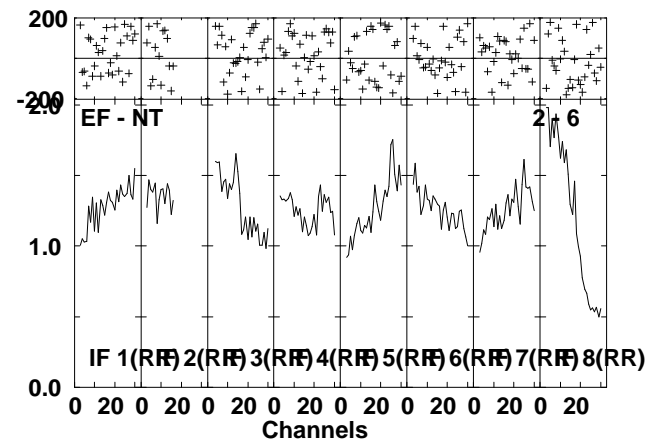
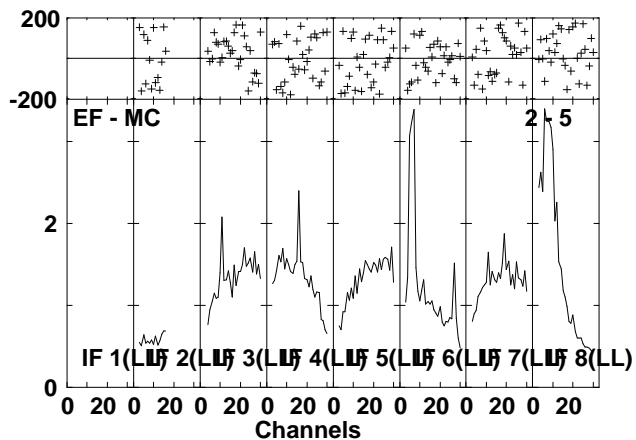
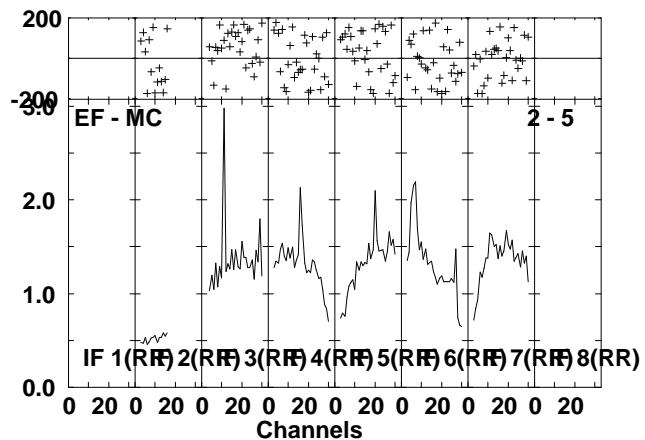
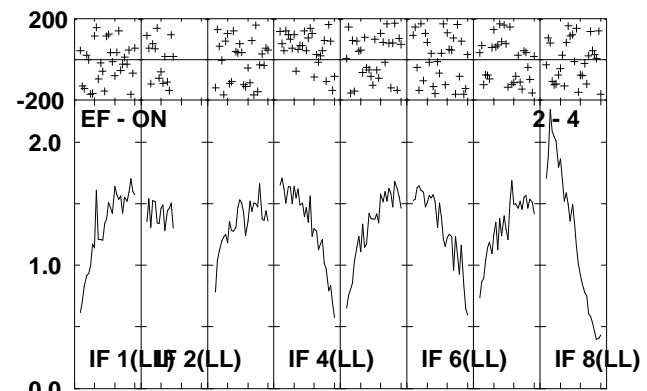
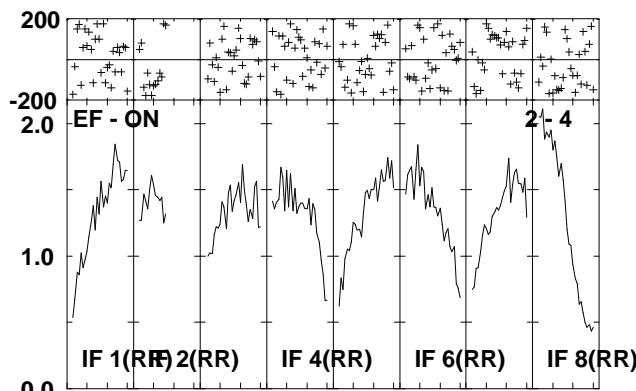
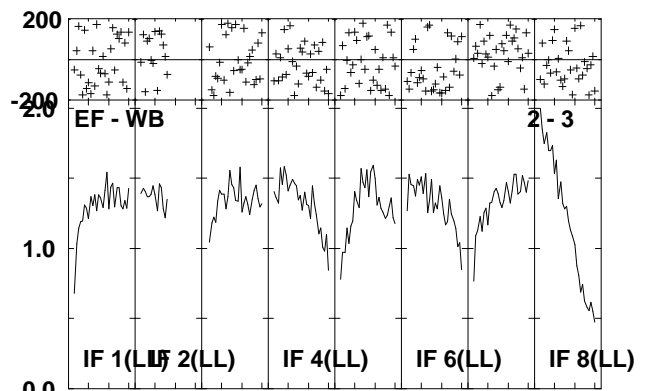
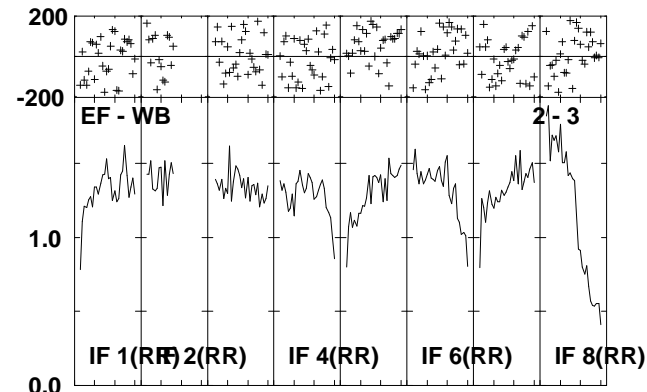
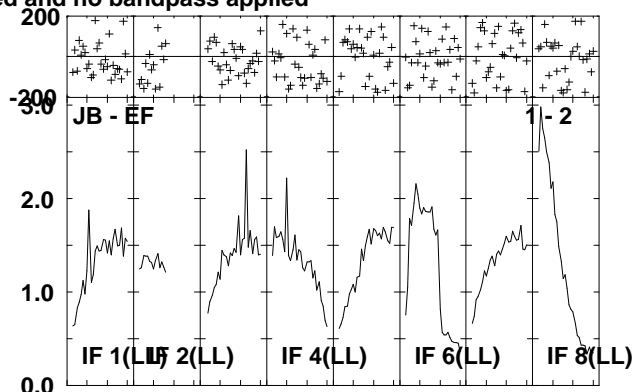
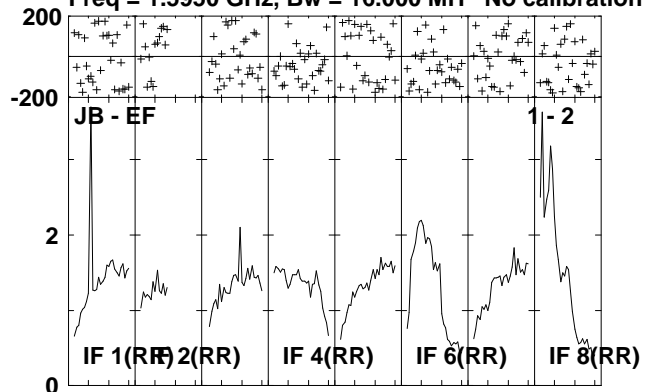

Lower frame: Milli Ampl Jy Top frame: Phas deg
Scalar averaged cross-power spectrum Several baselines displayed
Timerange: 00/16:01:51 to 00/16:05:29

Plot file version 176 created 06-JUL-2010 14:45:13

IRAS2336 EP064J.UVDATA.1

Freq = 1.5950 GHz, Bw = 16.000 MH No calibration applied and no bandpass applied

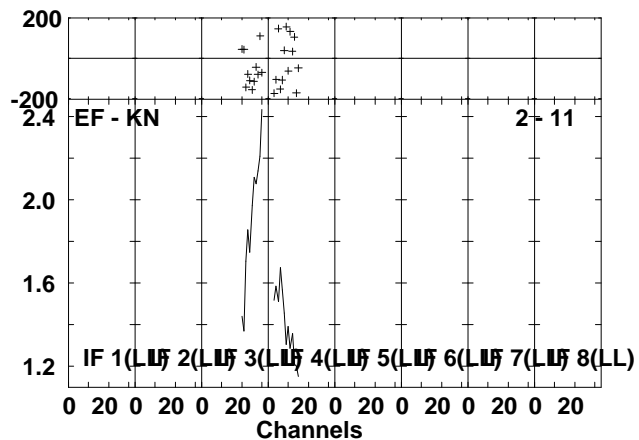
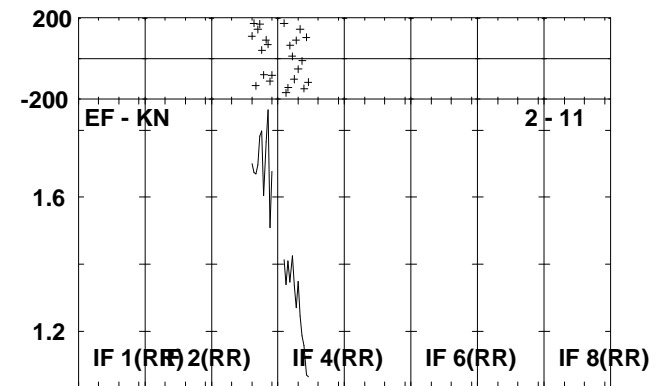
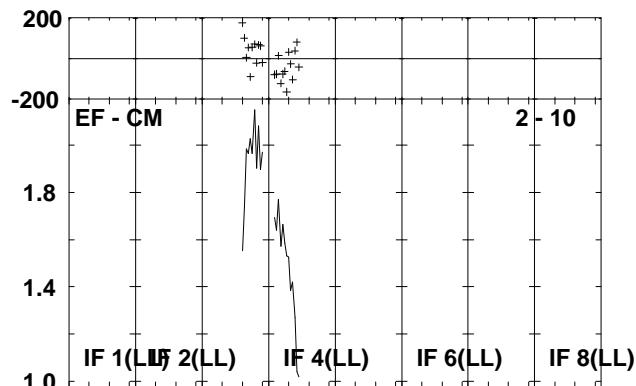
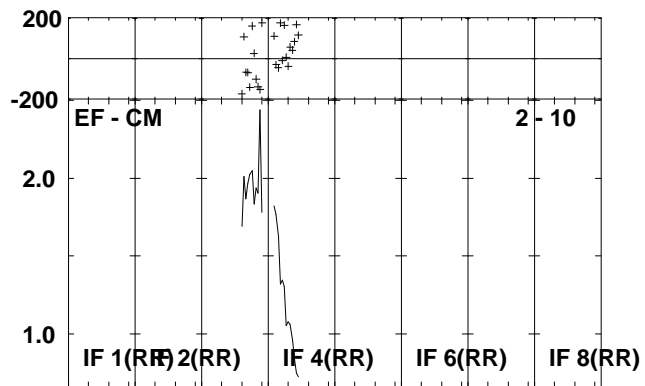
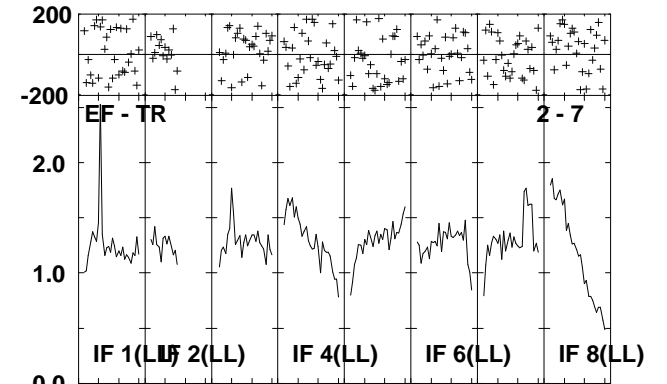
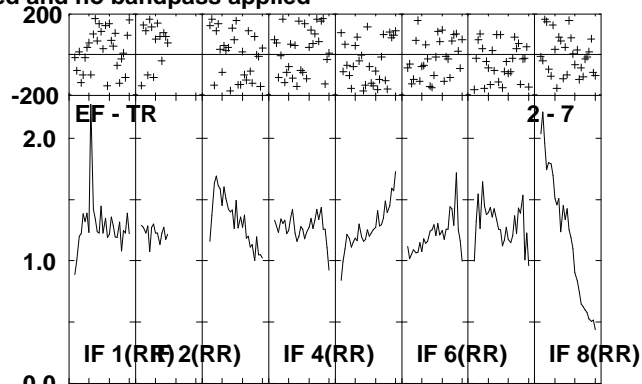
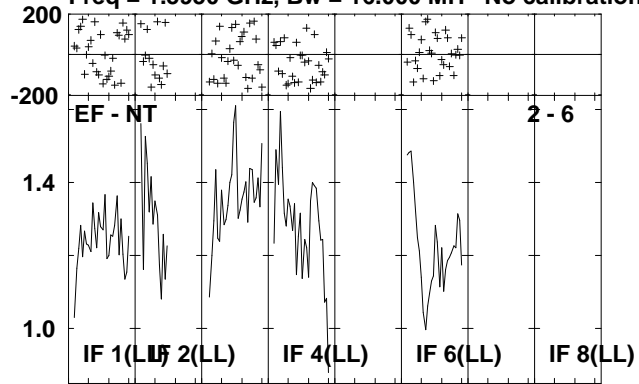

Lower frame: Milli Ampl Jy Top frame: Phas deg
Scalar averaged cross-power spectrum Several baselines displayed
Timerange: 00/16:01:51 to 00/16:05:29

Plot file version 177 created 06-JUL-2010 14:45:14

J2330+33 EP064J.UVDATA.1

Freq = 1.5950 GHz, Bw = 16.000 MH No calibration applied and no bandpass applied

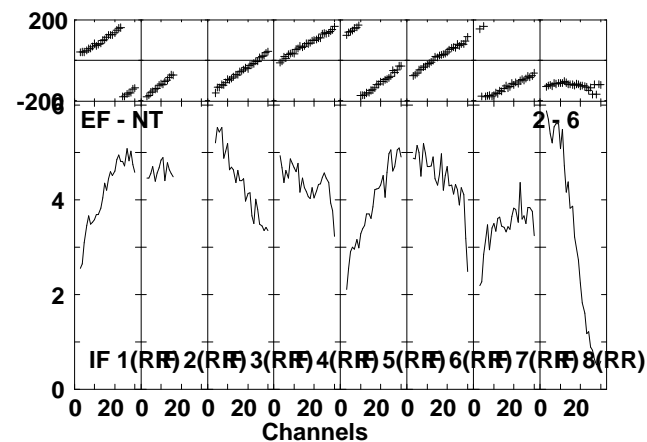
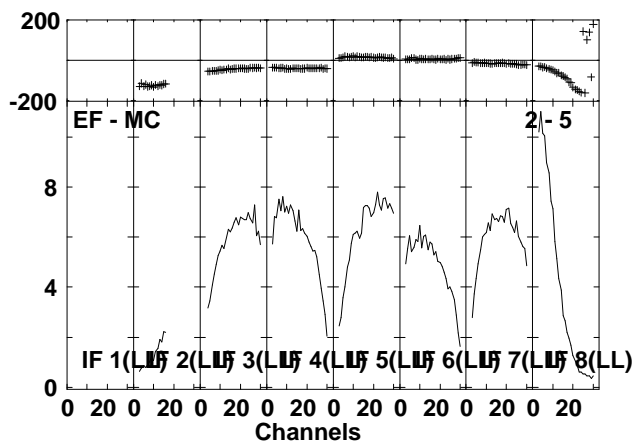
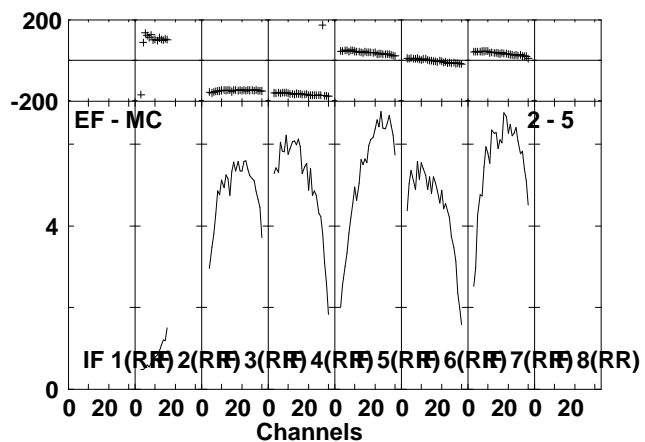
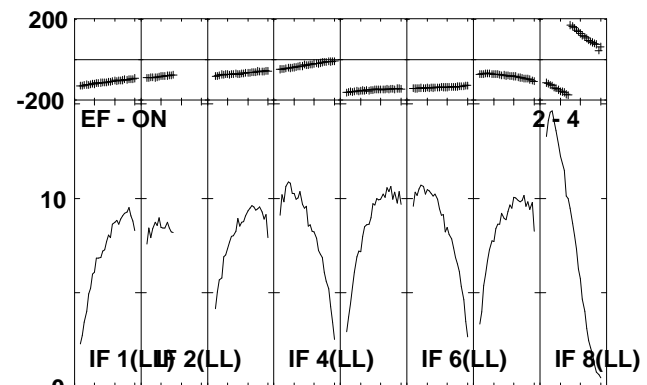
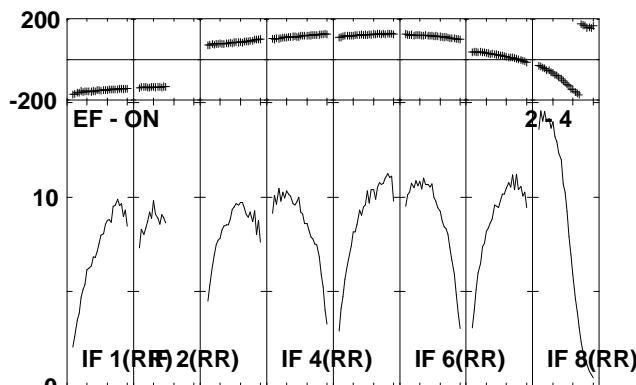
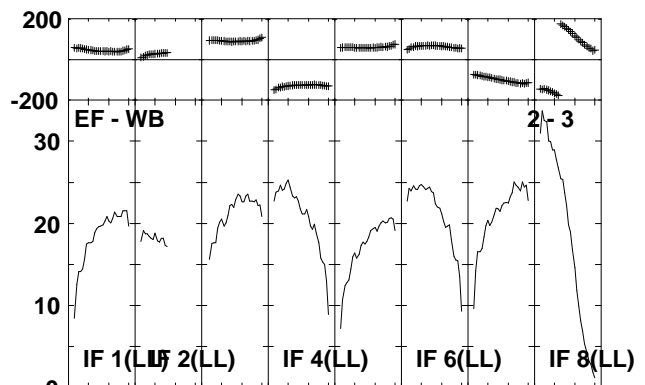
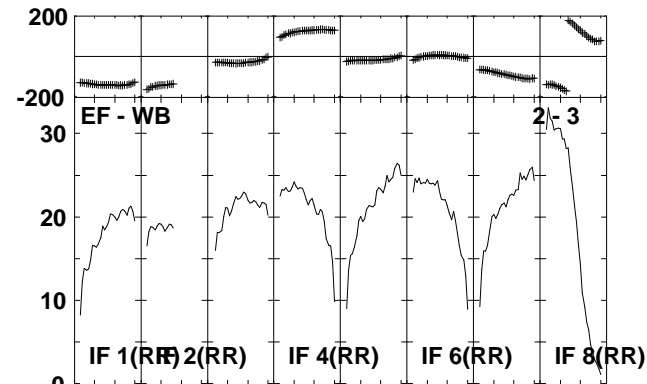
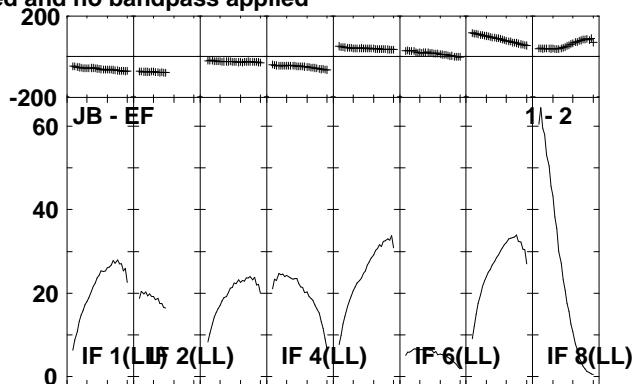
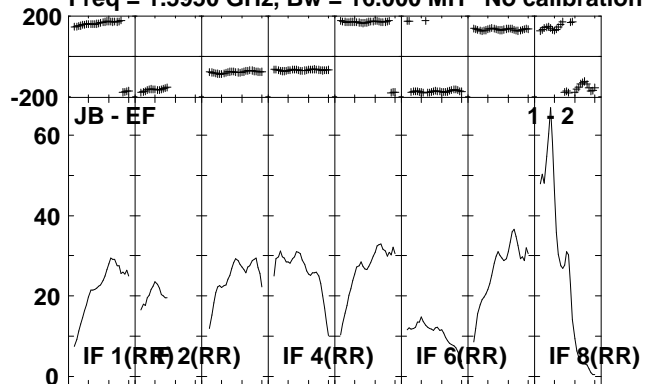

Lower frame: Milli Ampl Jy Top frame: Phas deg
Scalar averaged cross-power spectrum Several baselines displayed
Timerange: 00/16:05:31 to 00/16:07:19

Plot file version 178 created 06-JUL-2010 14:45:15

J2330+33 EP064J.UVDATA.1

Freq = 1.5950 GHz, Bw = 16.000 MH No calibration applied and no bandpass applied

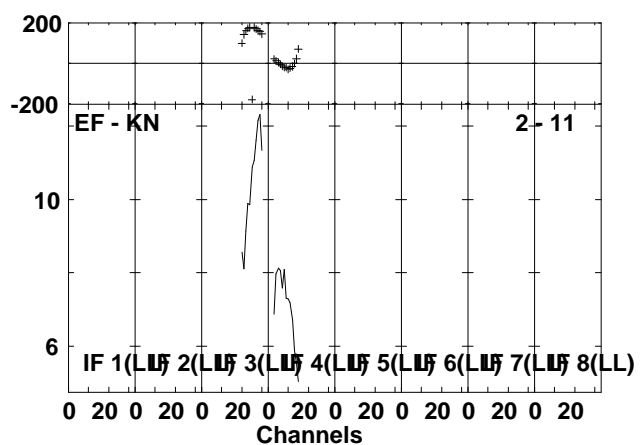
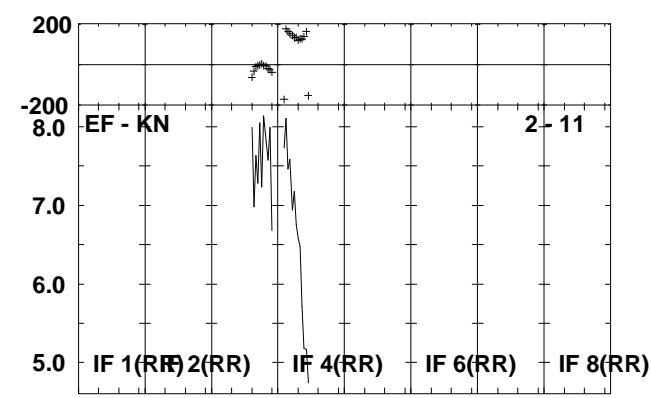
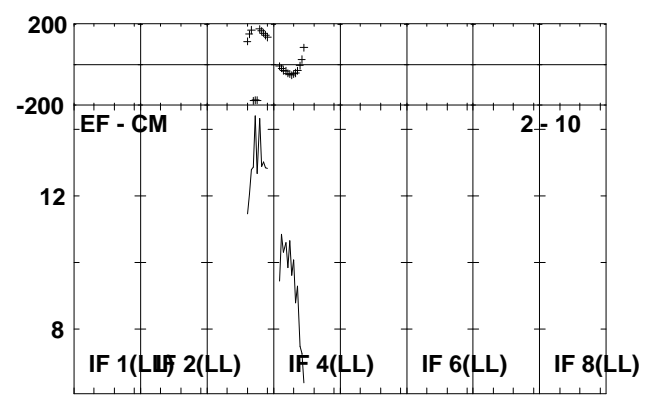
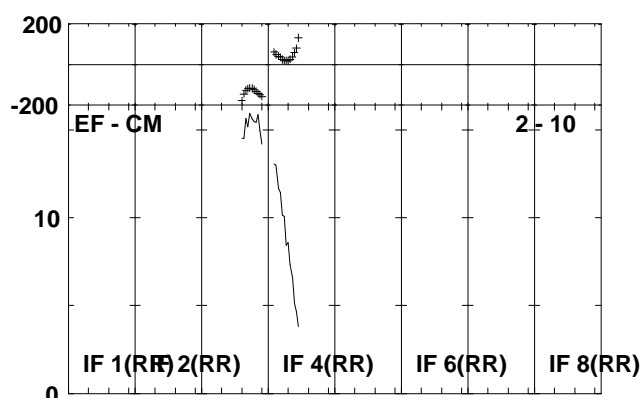
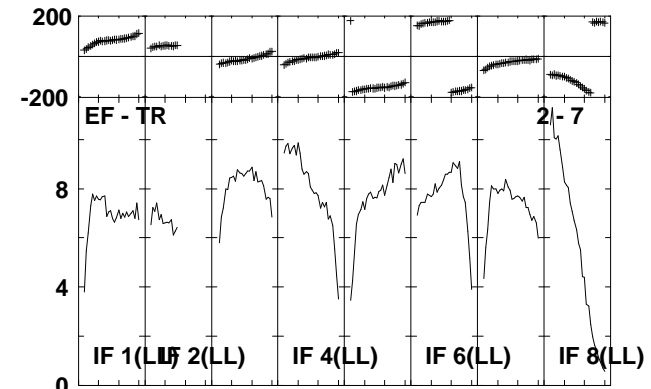
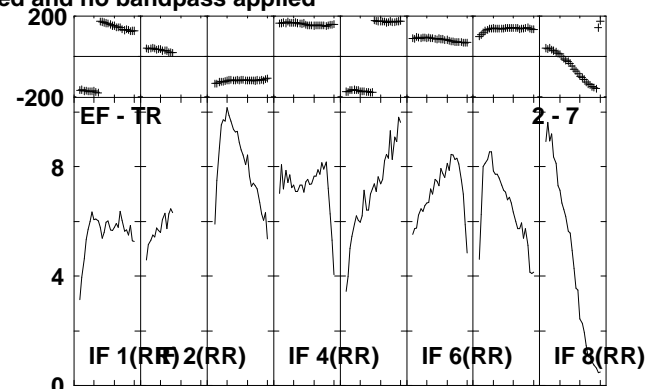
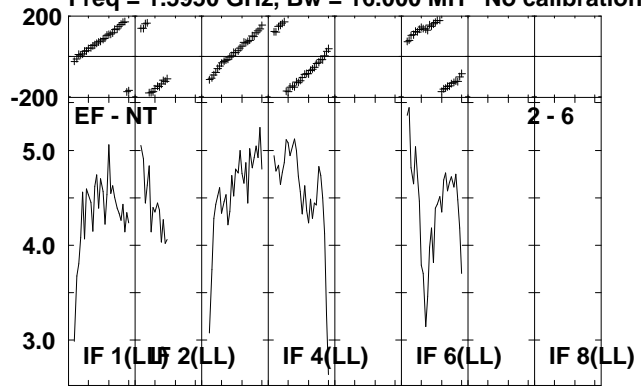

Lower frame: Milli Ampl Jy Top frame: Phas deg
Scalar averaged cross-power spectrum Several baselines displayed
Timerange: 00/16:05:31 to 00/16:07:19

Plot file version 179 created 06-JUL-2010 14:45:17

IRAS2336 EP064J.UVDATA.1

Freq = 1.5950 GHz, Bw = 16.000 MH No calibration applied and no bandpass applied

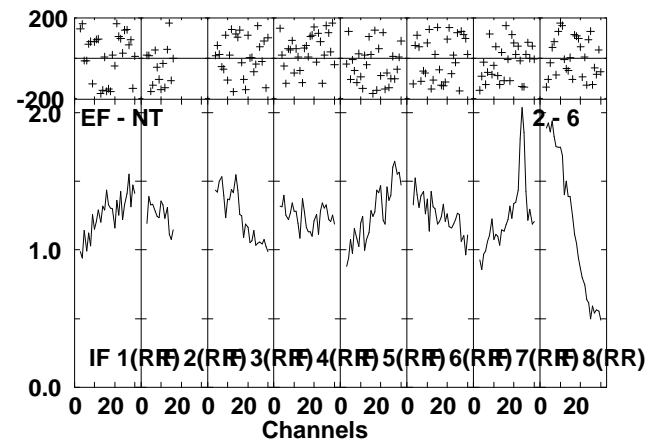
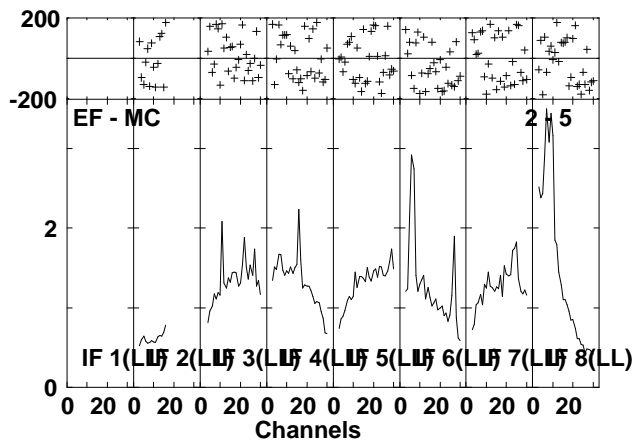
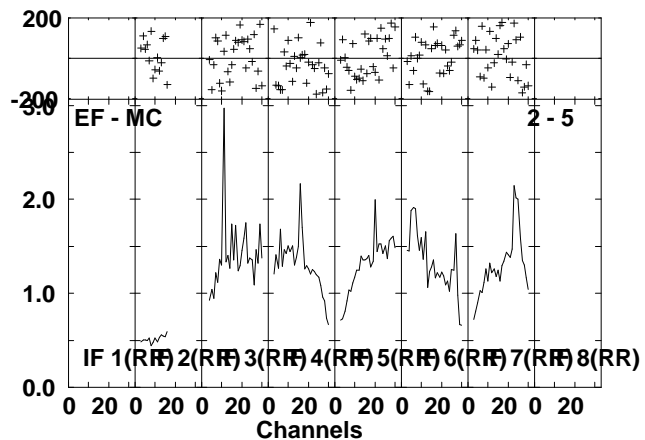
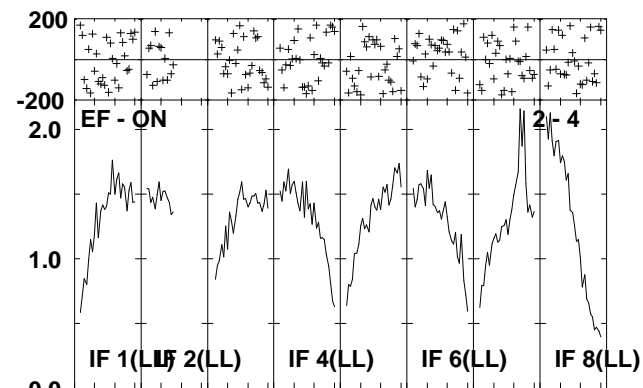
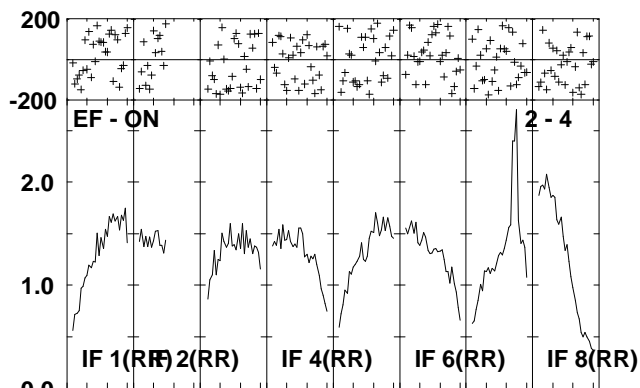
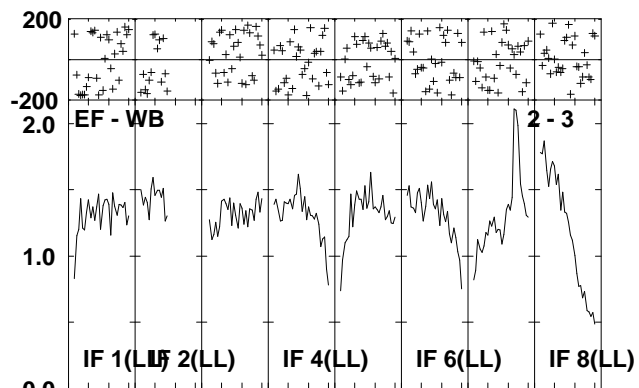
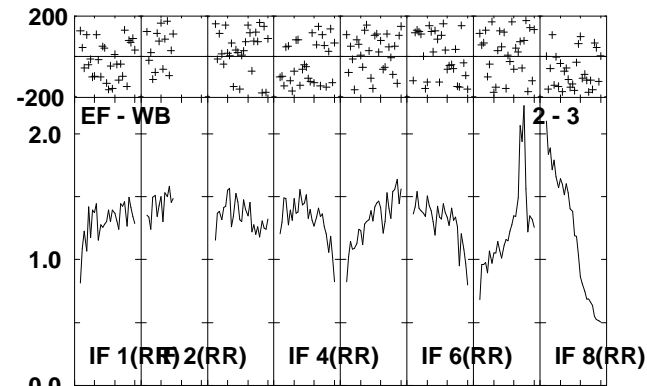
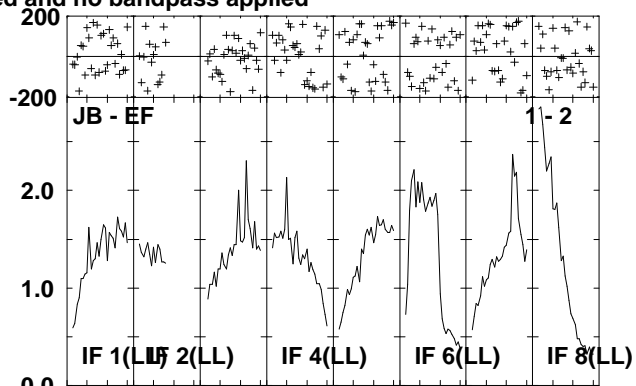
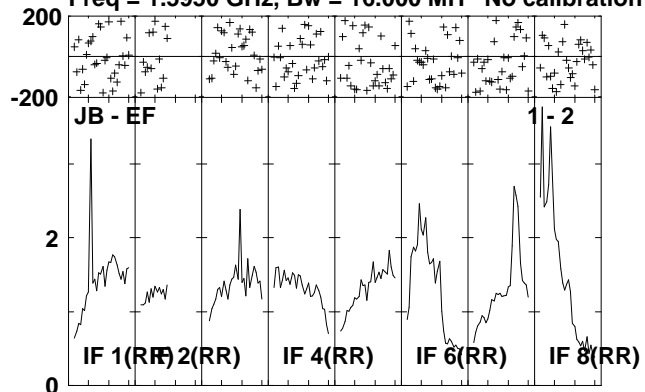

Lower frame: Milli Ampl Jy Top frame: Phas deg
Scalar averaged cross-power spectrum Several baselines displayed
Timerange: 00/16:07:21 to 00/16:10:59

Plot file version 180 created 06-JUL-2010 14:45:18

IRAS2336 EP064J.UVDATA.1

Freq = 1.5950 GHz, Bw = 16.000 MH No calibration applied and no bandpass applied

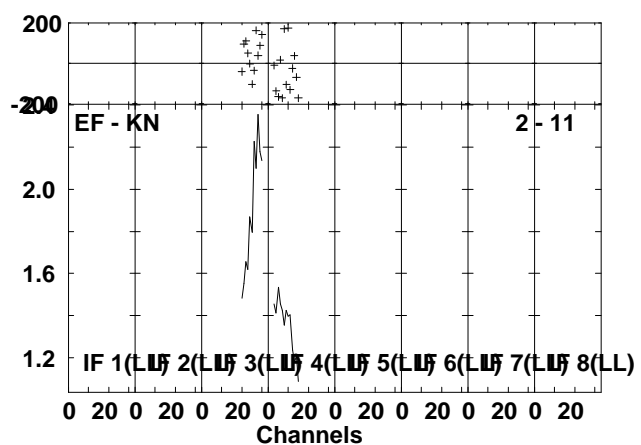
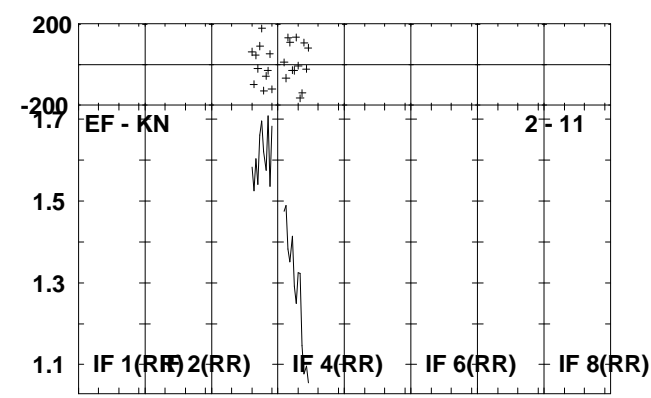
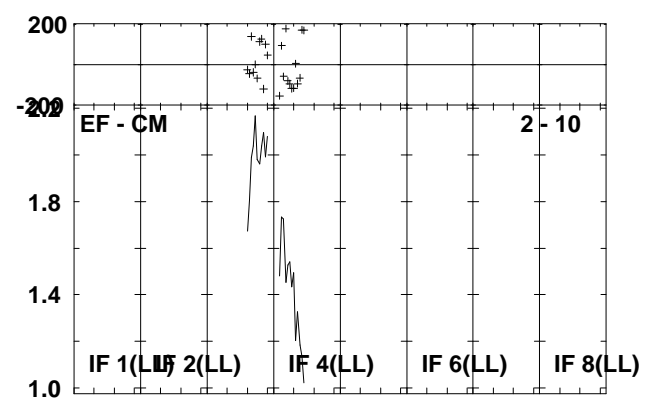
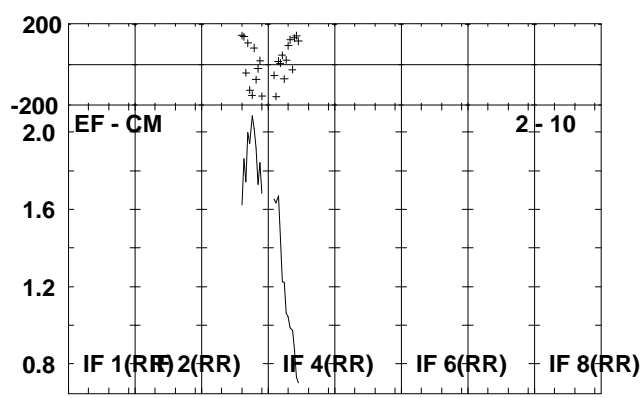
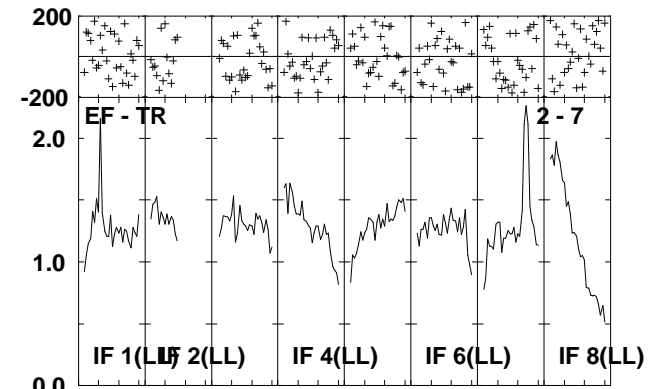
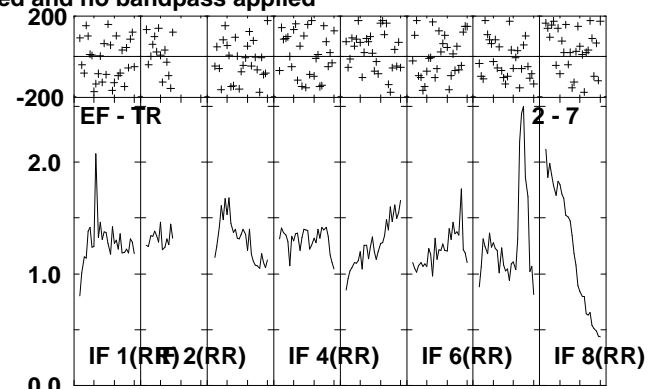
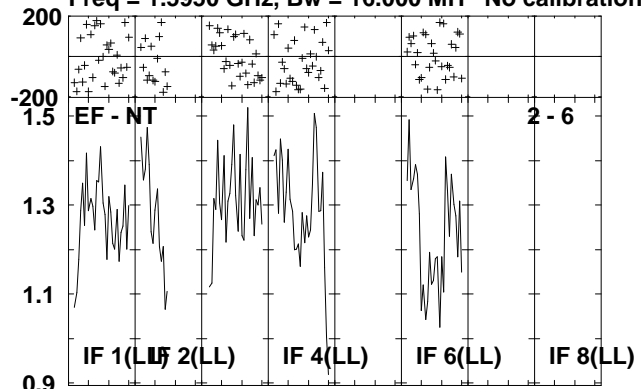

Lower frame: Milli Ampl Jy Top frame: Phas deg
Scalar averaged cross-power spectrum Several baselines displayed
Timerange: 00/16:07:21 to 00/16:10:59

Plot file version 181 created 06-JUL-2010 14:45:21

J2330+33 EP064J.UVDATA.1

Freq = 1.5950 GHz, Bw = 16.000 MH No calibration applied and no bandpass applied

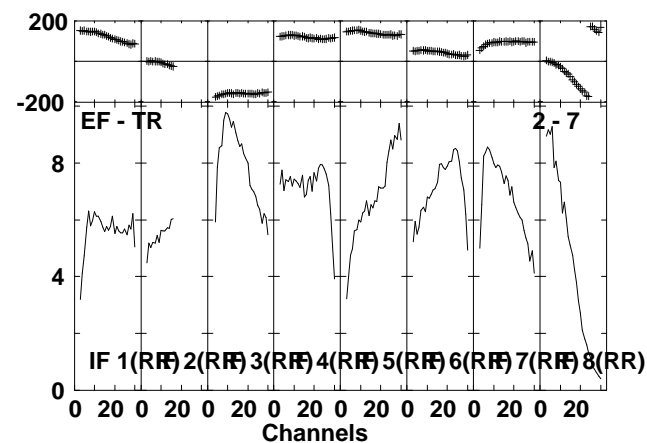
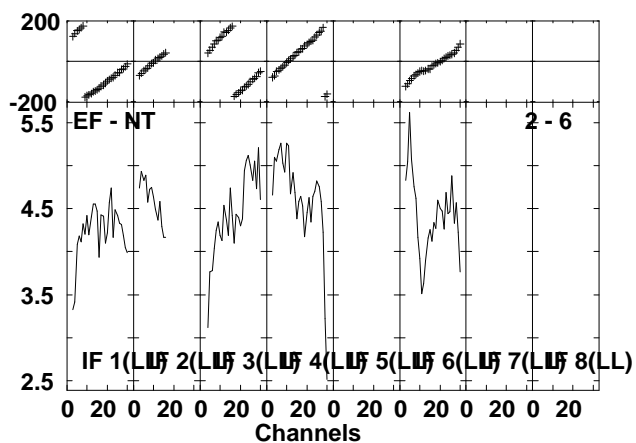
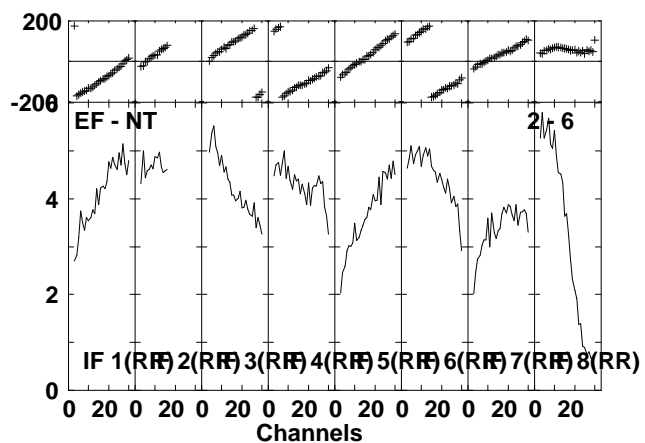
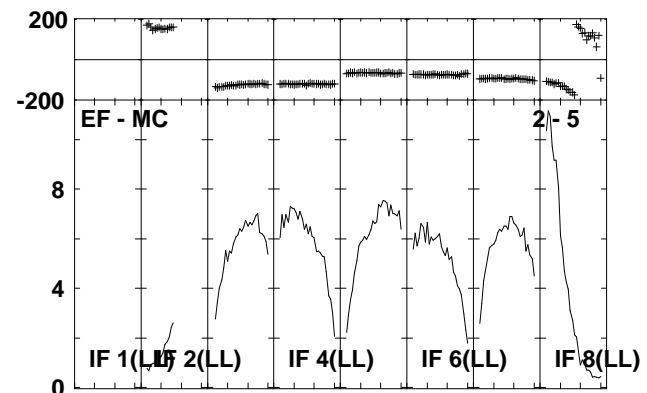
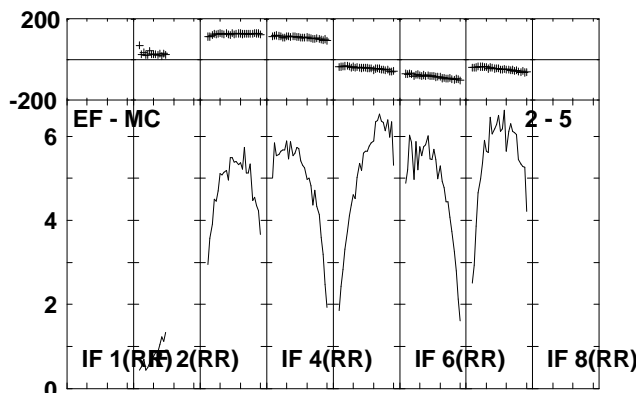
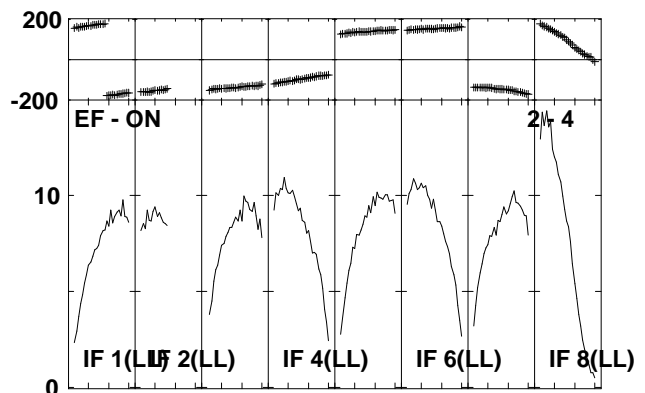
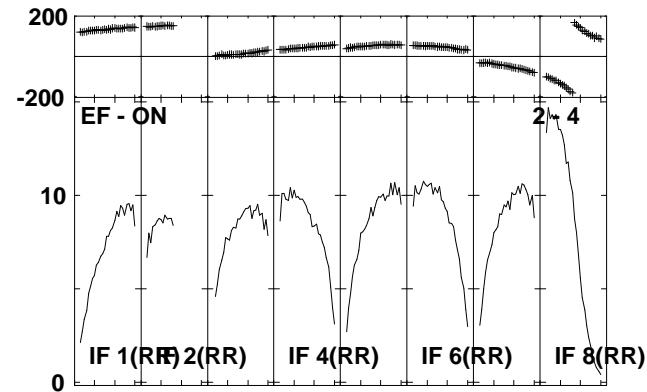
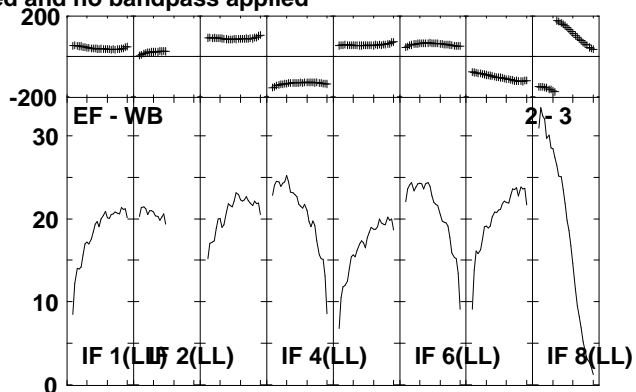
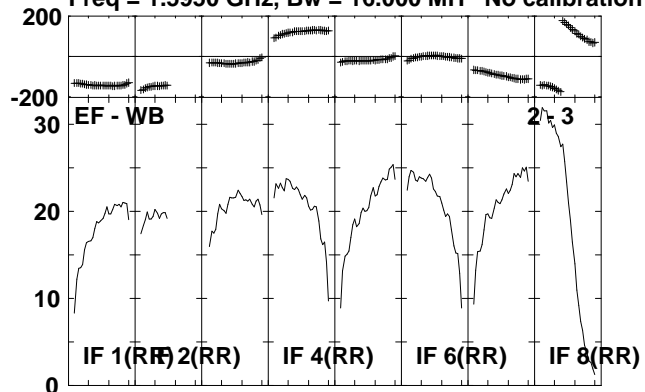

Lower frame: Milli Ampl Jy Top frame: Phas deg
Scalar averaged cross-power spectrum Several baselines displayed
Timerange: 00/16:11:01 to 00/16:12:49

Plot file version 182 created 06-JUL-2010 14:45:21

J2330+33 EP064J.UVDATA.1

Freq = 1.5950 GHz, Bw = 16.000 MH No calibration applied and no bandpass applied

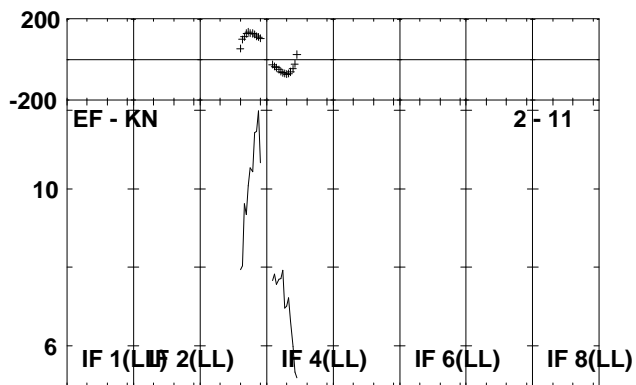
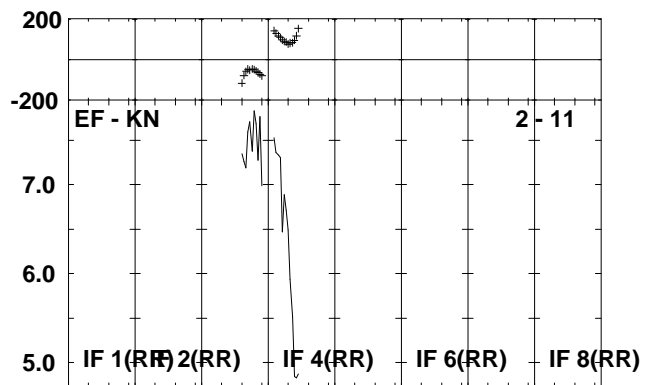
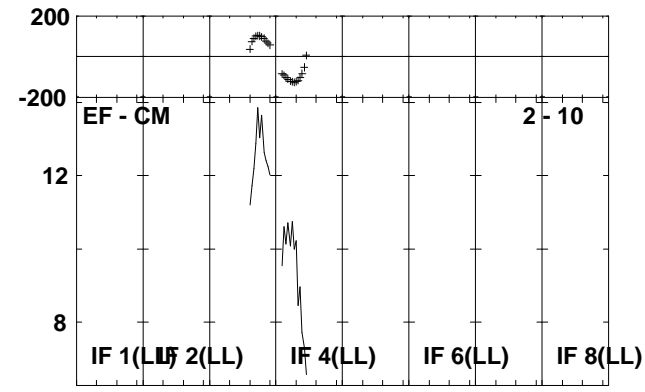
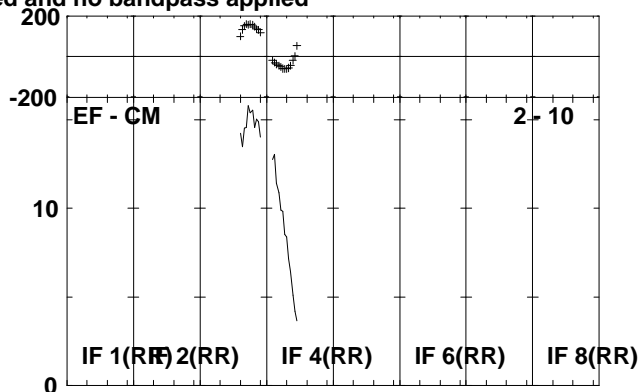
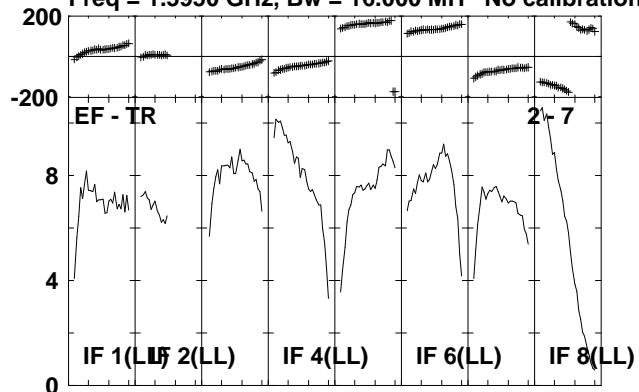

Lower frame: Milli Ampl Jy Top frame: Phas deg
Scalar averaged cross-power spectrum Several baselines displayed
Timerange: 00/16:11:01 to 00/16:12:49

Plot file version 183 created 06-JUL-2010 14:45:22

IRAS2336 EP064J.UVDATA.1

Freq = 1.5950 GHz, Bw = 16.000 MH No calibration applied and no bandpass applied

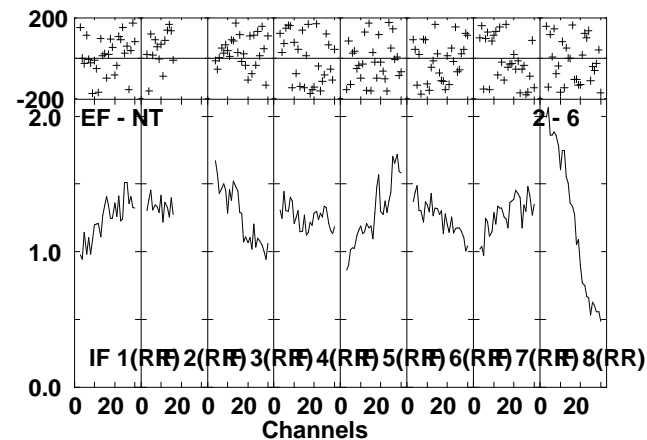
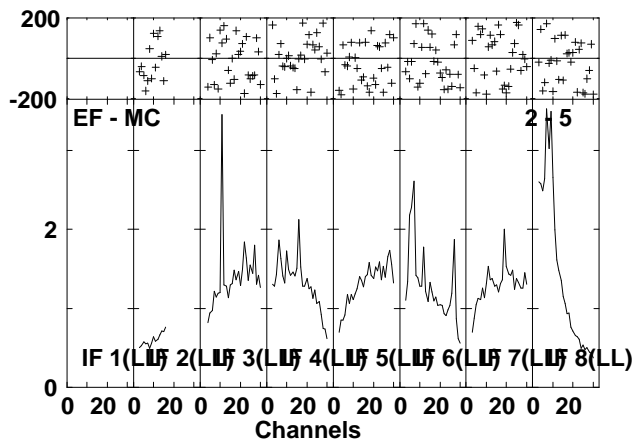
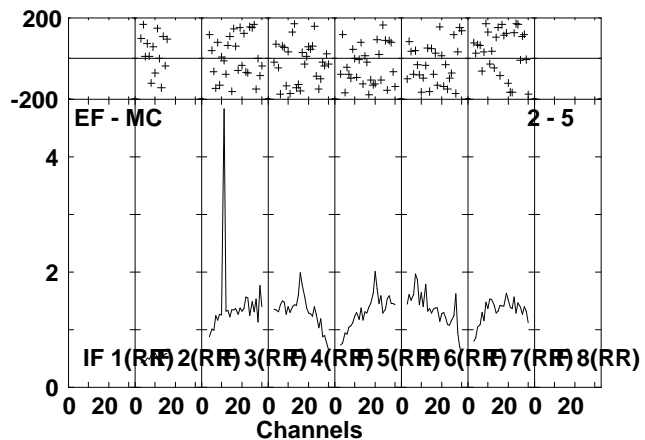
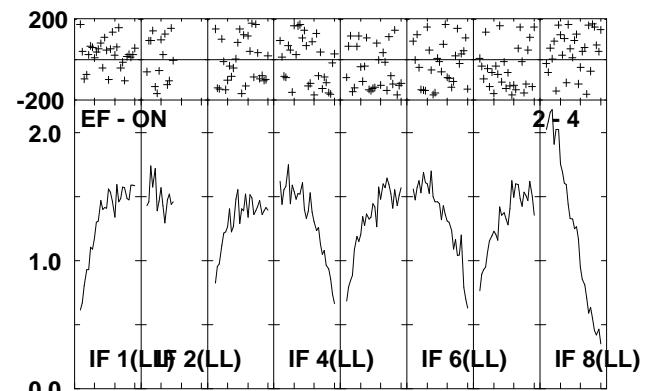
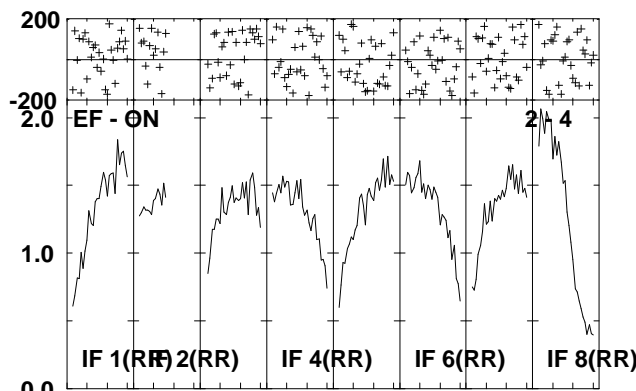
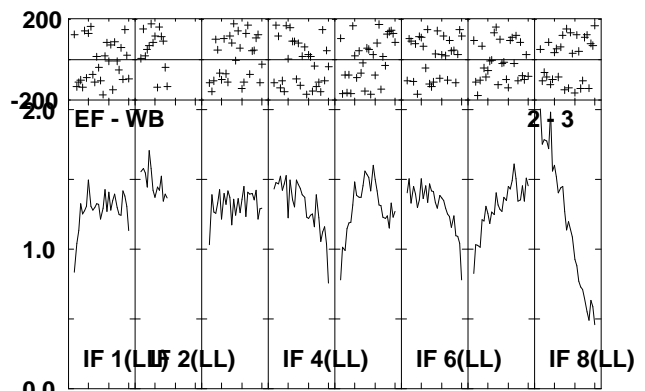
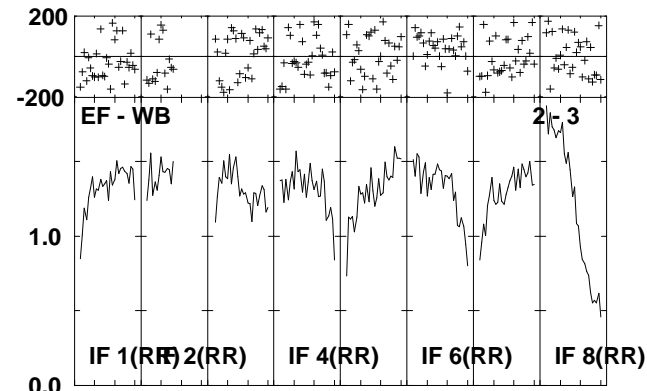
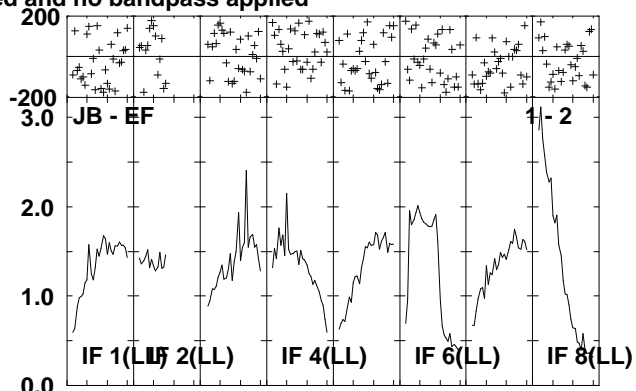
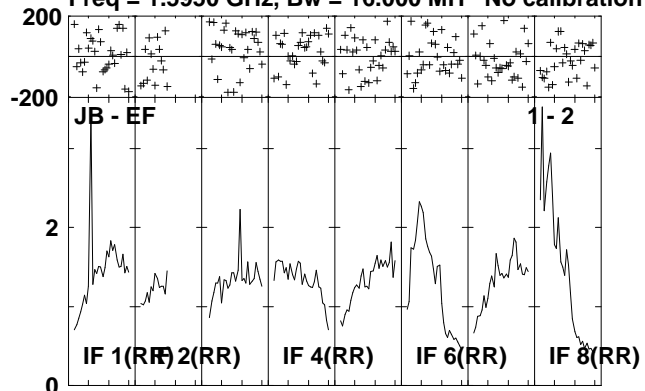

Lower frame: Milli Ampl Jy Top frame: Phas deg
Scalar averaged cross-power spectrum Several baselines displayed
Timerange: 00/16:12:51 to 00/16:16:29

Plot file version 184 created 06-JUL-2010 14:45:24

IRAS2336 EP064J.UVDATA.1

Freq = 1.5950 GHz, Bw = 16.000 MH No calibration applied and no bandpass applied

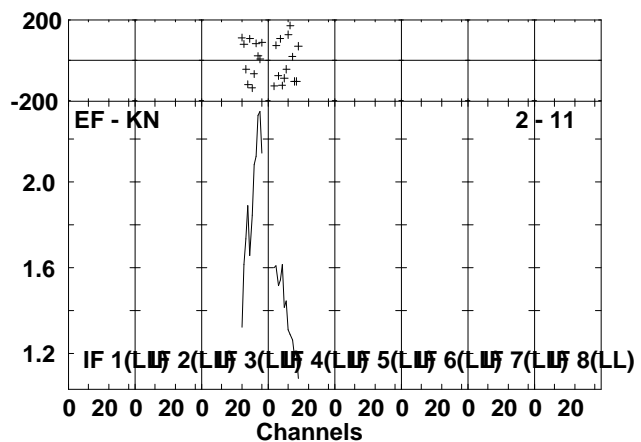
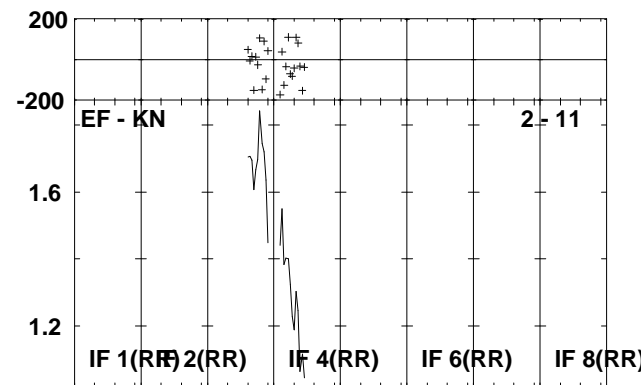
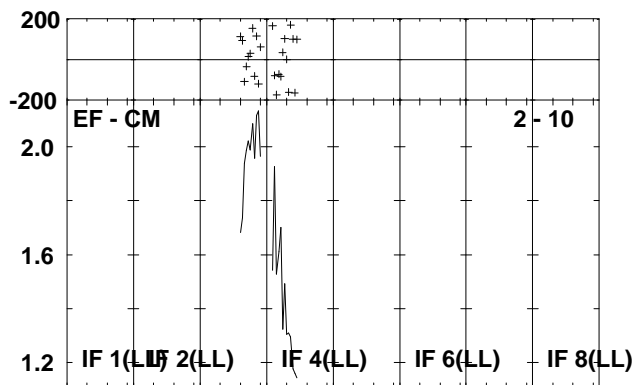
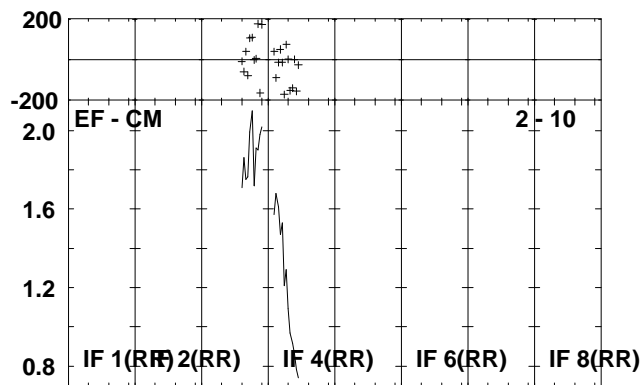
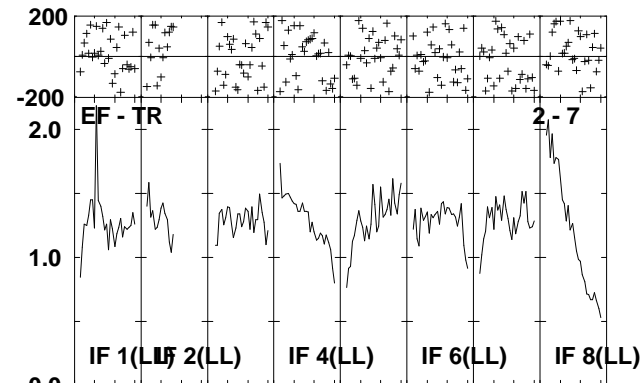
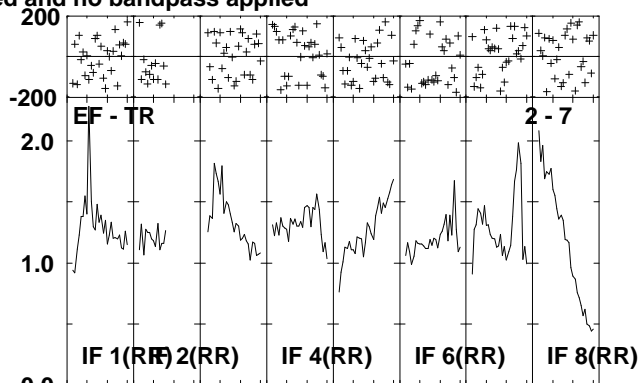
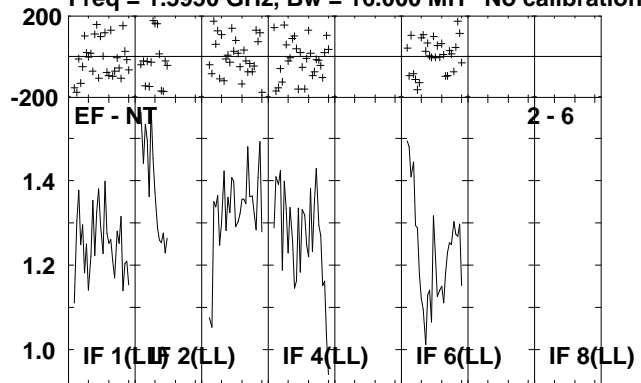

0 20 0 20 0 20 0 20 0 20 0 20 0 20 0 20 0 20
Channels
Lower frame: Milli Ampl Jy Top frame: Phas deg
Scalar averaged cross-power spectrum Several baselines displayed
Timerange: 00/16:12:51 to 00/16:16:29

Plot file version 185 created 06-JUL-2010 14:45:26

J2330+33 EP064J.UVDATA.1

Freq = 1.5950 GHz, Bw = 16.000 MH No calibration applied and no bandpass applied

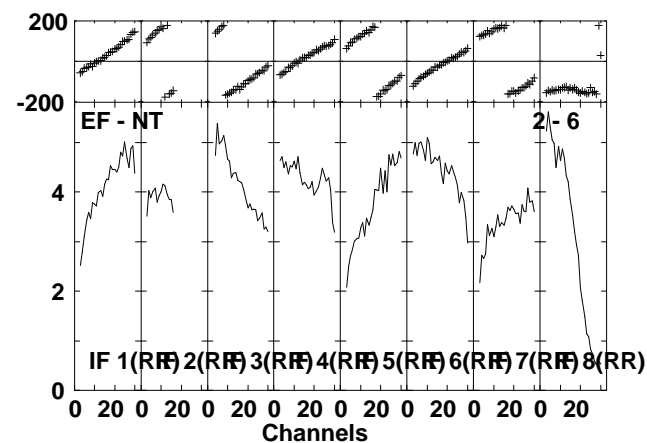
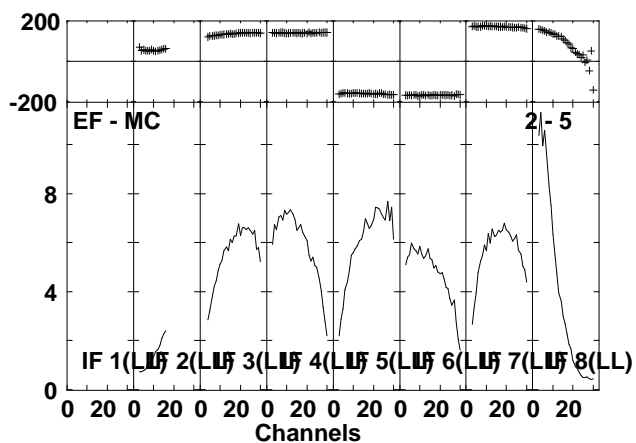
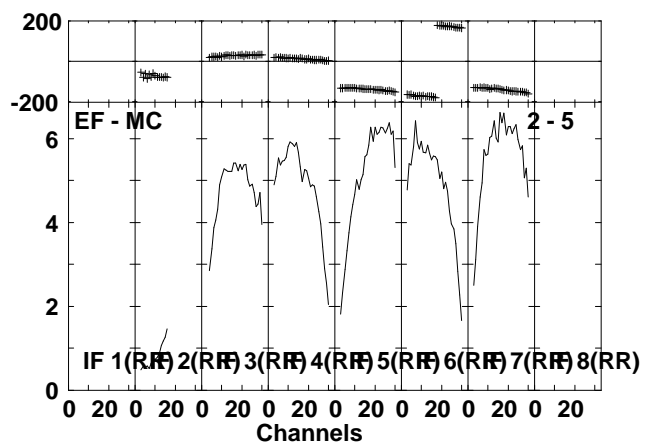
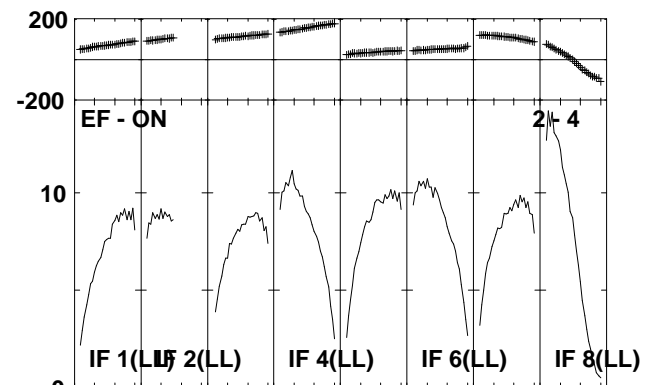
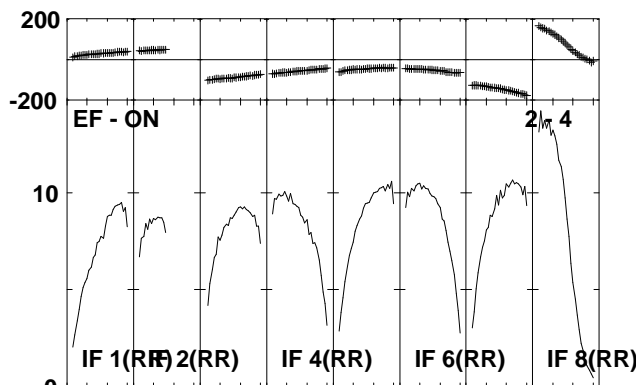
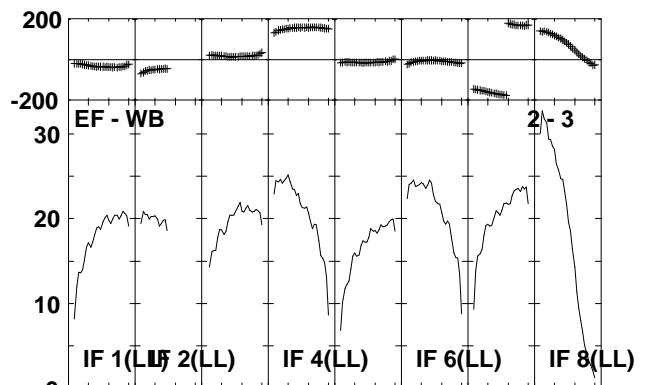
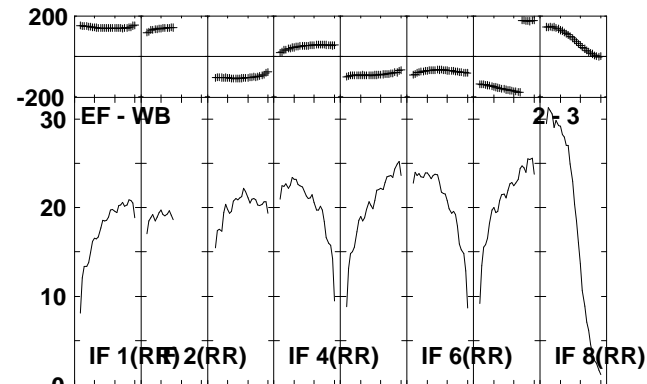
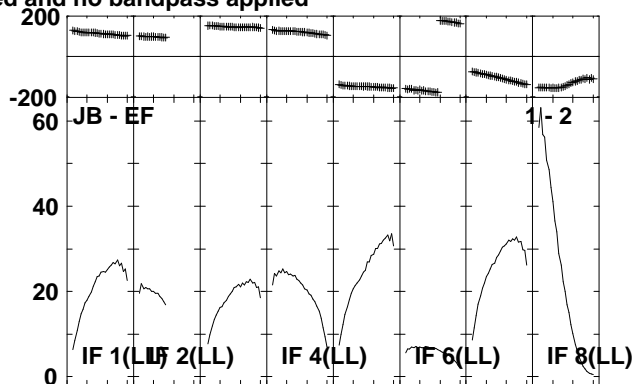
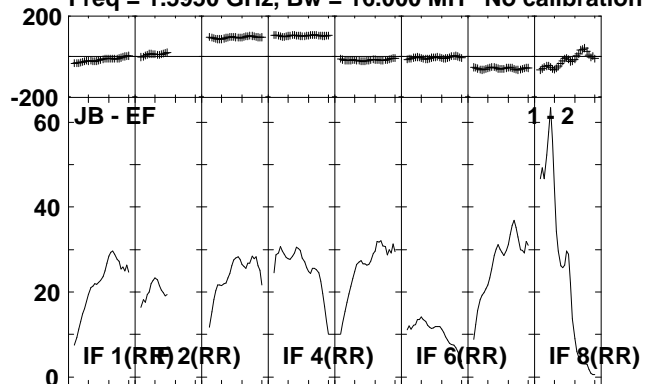

Lower frame: Milli Ampl Jy Top frame: Phas deg
Scalar averaged cross-power spectrum Several baselines displayed
Timerange: 00/16:17:31 to 00/16:19:19

Plot file version 186 created 06-JUL-2010 14:45:27

J2330+33 EP064J.UVDATA.1

Freq = 1.5950 GHz, Bw = 16.000 MH No calibration applied and no bandpass applied

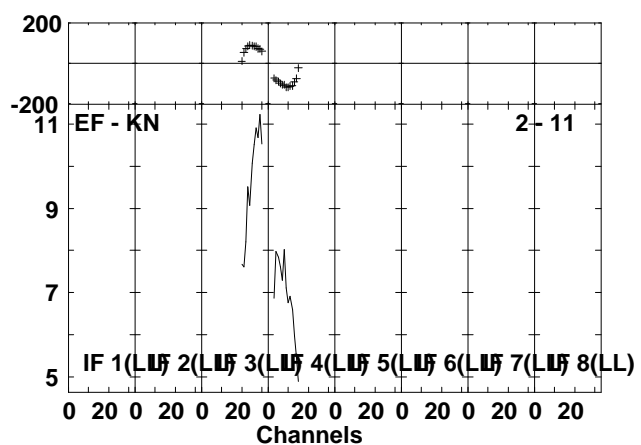
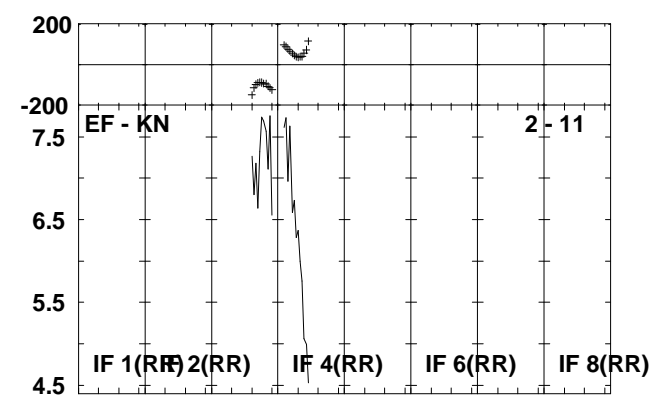
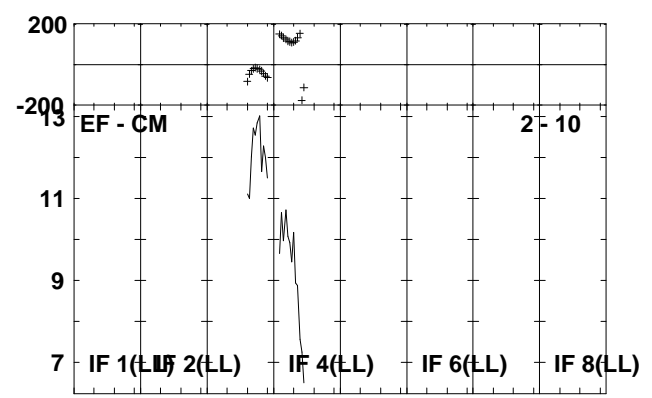
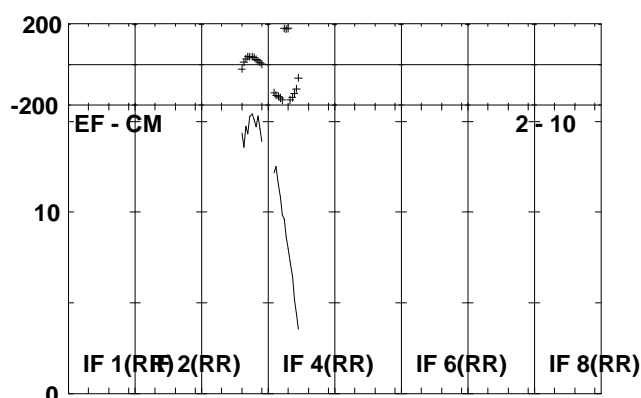
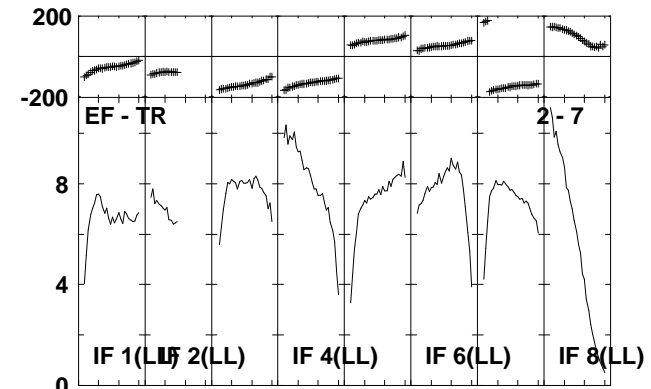
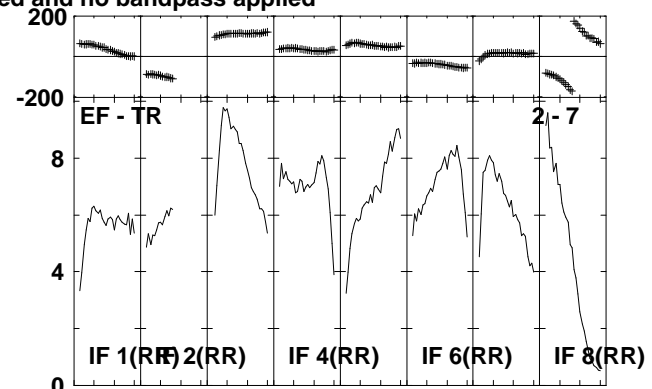
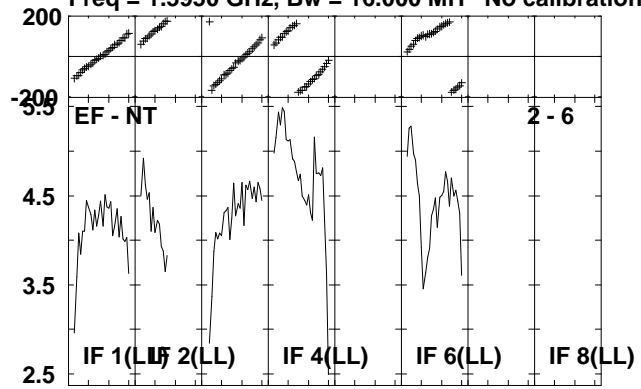

Lower frame: Milli Ampl Jy Top frame: Phas deg
Scalar averaged cross-power spectrum Several baselines displayed
Timerange: 00/16:17:31 to 00/16:19:19

Plot file version 187 created 06-JUL-2010 14:45:29

IRAS2336 EP064J.UVDATA.1

Freq = 1.5950 GHz, Bw = 16.000 MH No calibration applied and no bandpass applied

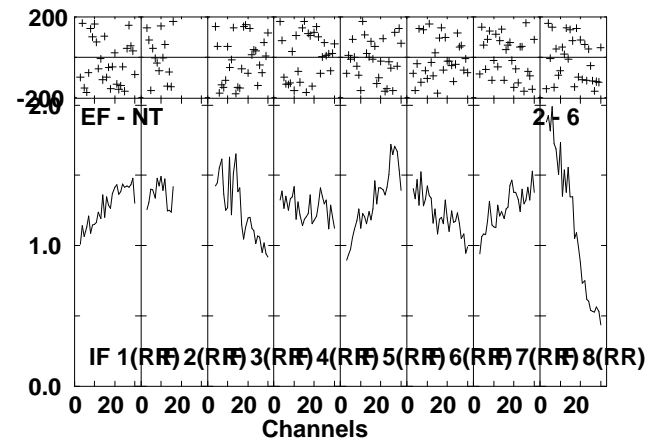
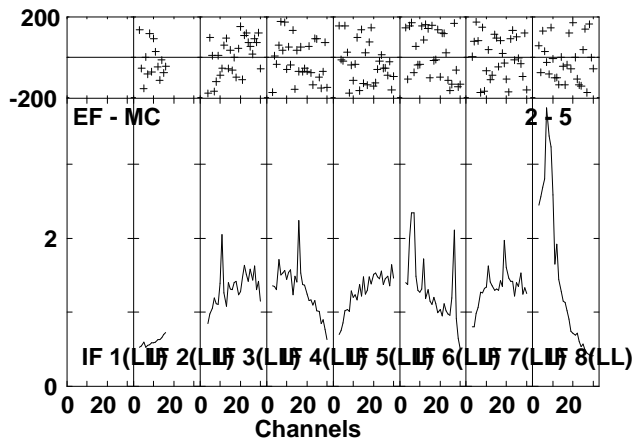
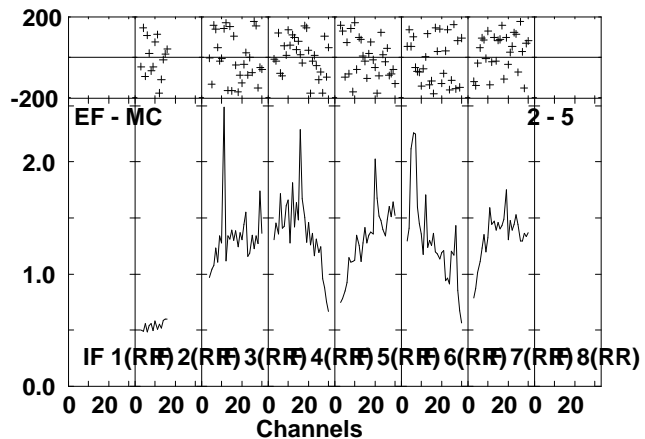
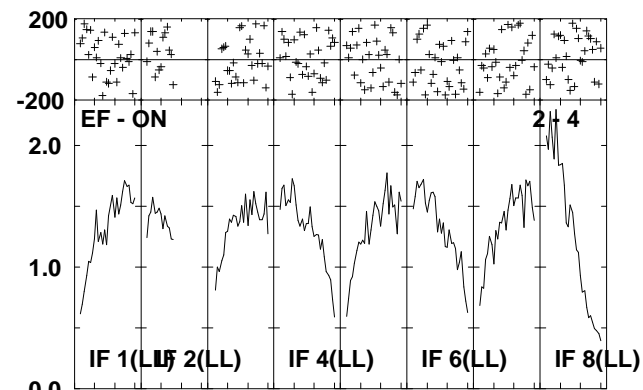
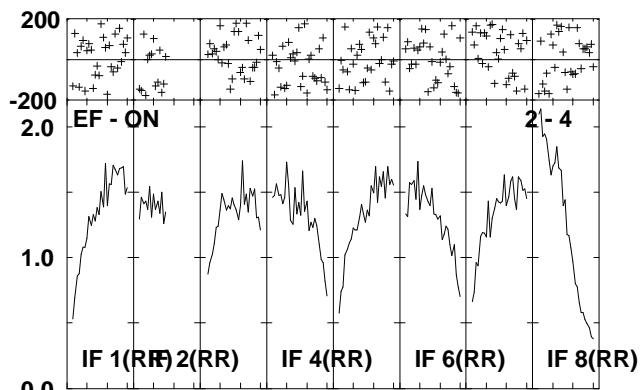
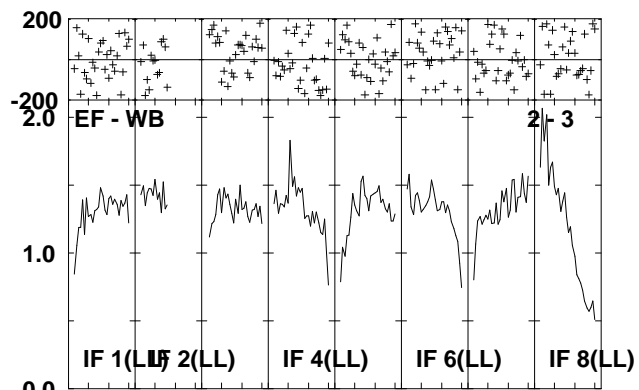
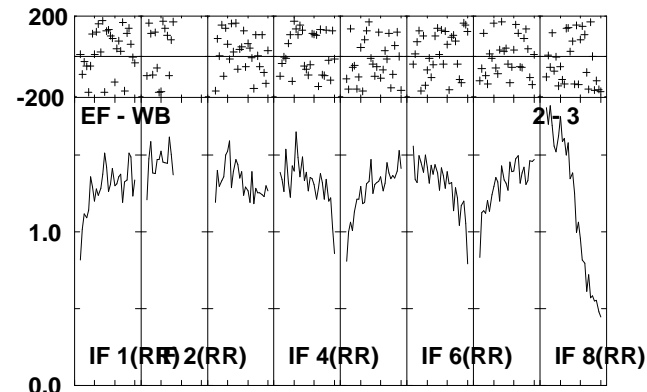
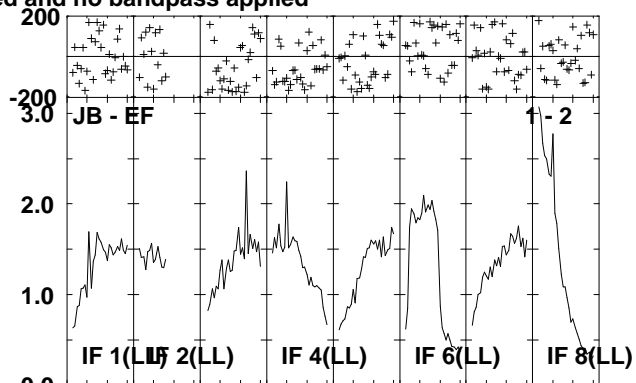
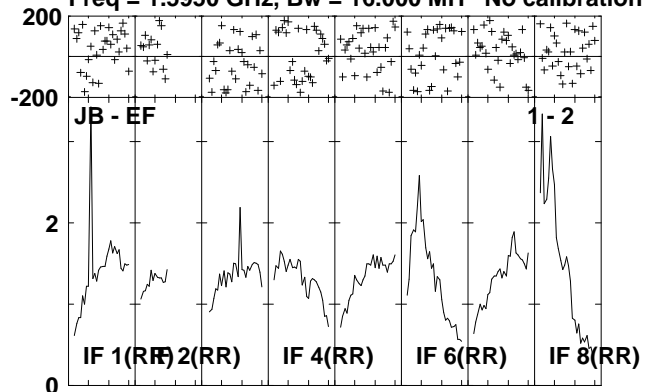

Lower frame: Milli Ampl Jy Top frame: Phas deg
Scalar averaged cross-power spectrum Several baselines displayed
Timerange: 00/16:19:21 to 00/16:22:59

Plot file version 188 created 06-JUL-2010 14:45:30

IRAS2336 EP064J.UVDATA.1

Freq = 1.5950 GHz, Bw = 16.000 MH No calibration applied and no bandpass applied

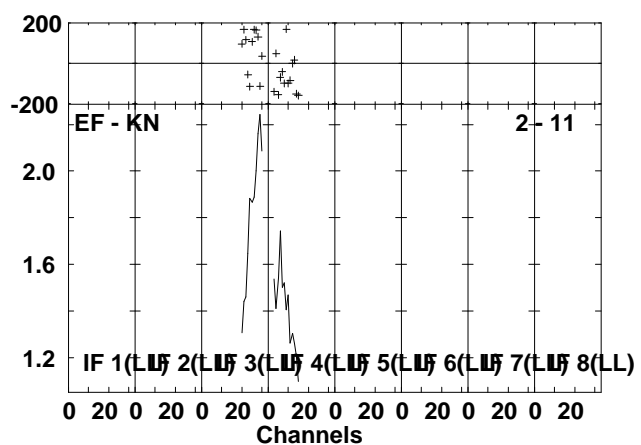
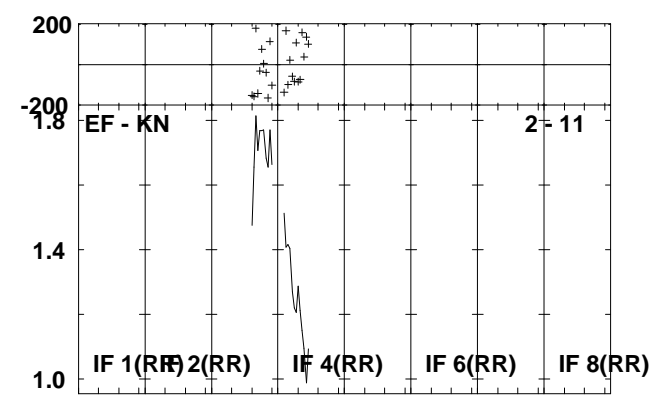
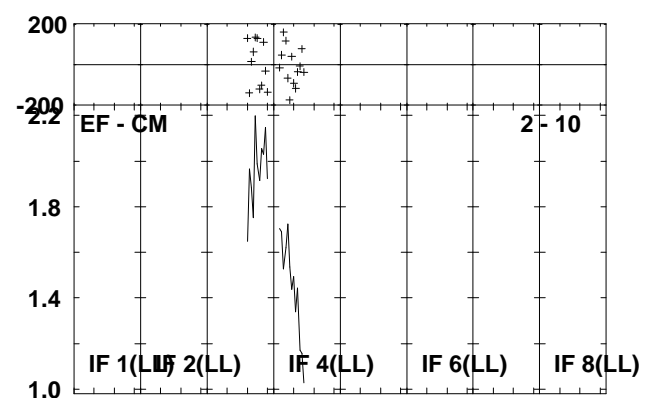
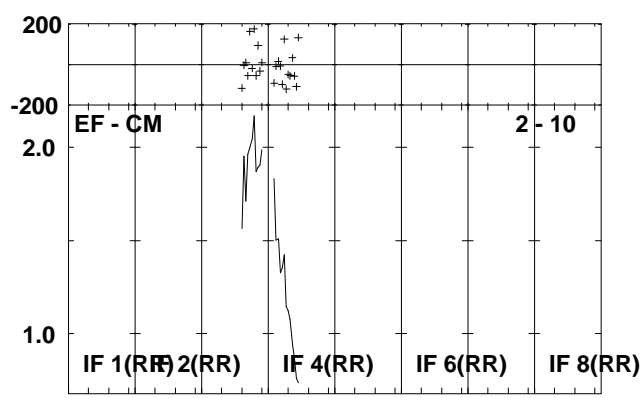
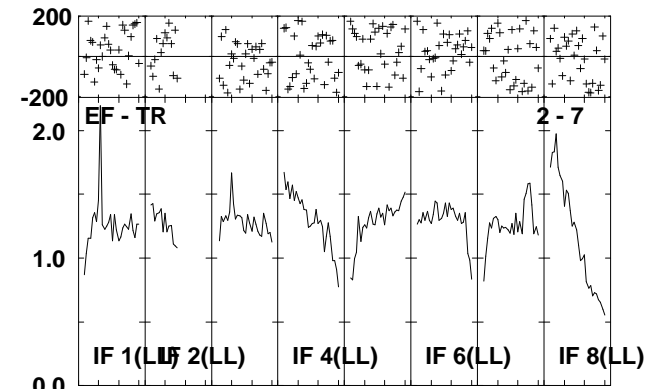
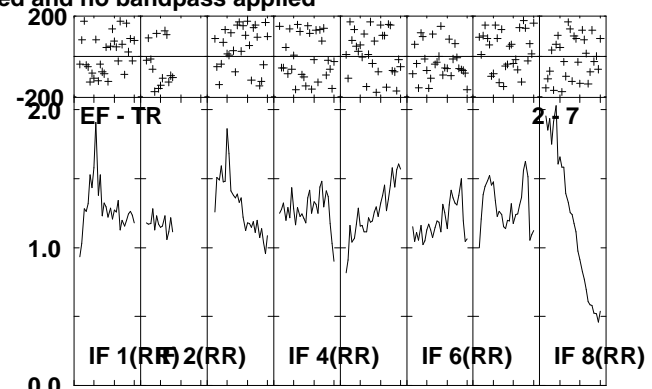
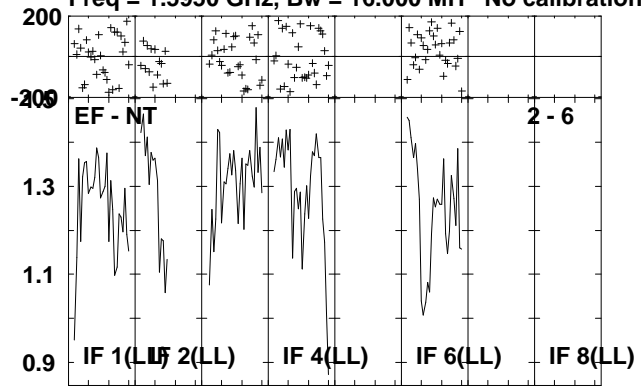

Lower frame: Milli Ampl Jy Top frame: Phas deg
Scalar averaged cross-power spectrum Several baselines displayed
Timerange: 00/16:19:21 to 00/16:22:59

Plot file version 189 created 06-JUL-2010 14:45:33

J2330+33 EP064J.UVDATA.1

Freq = 1.5950 GHz, Bw = 16.000 MH No calibration applied and no bandpass applied

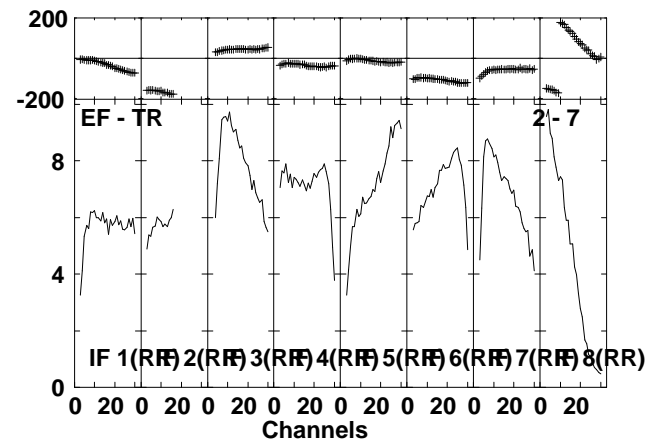
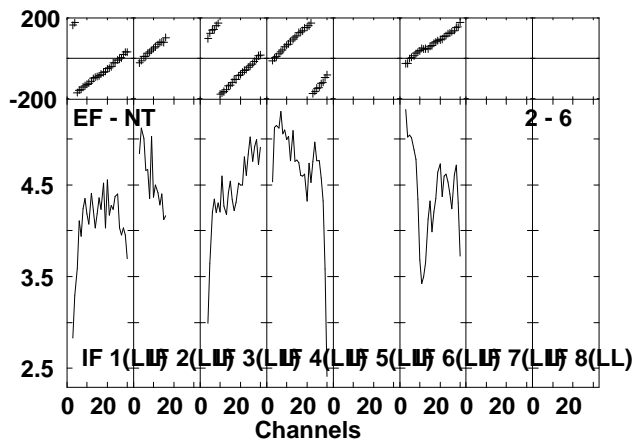
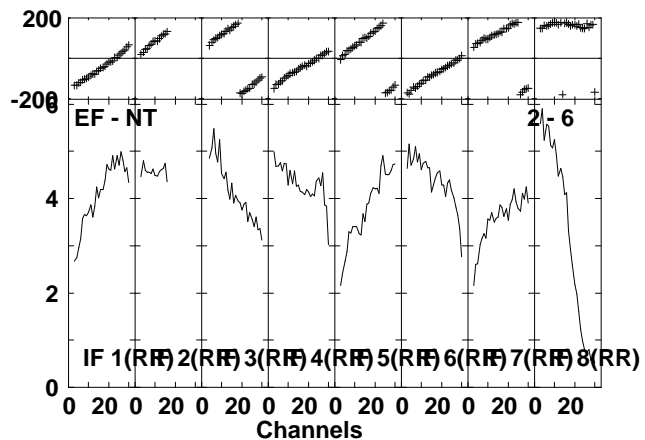
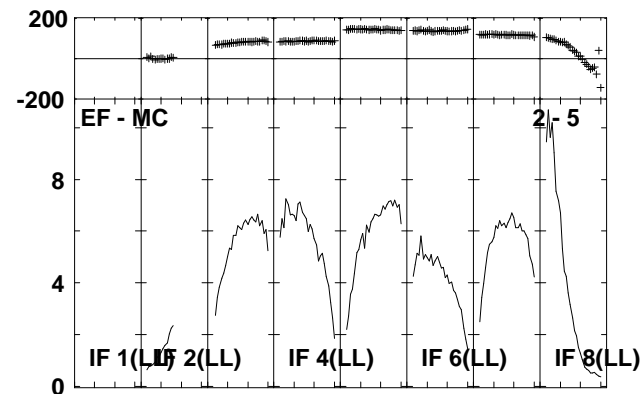
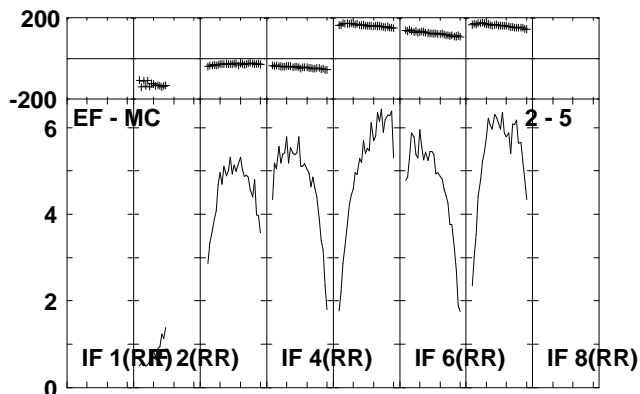
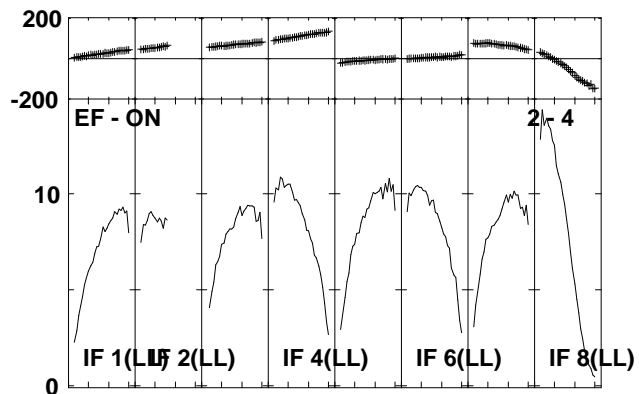
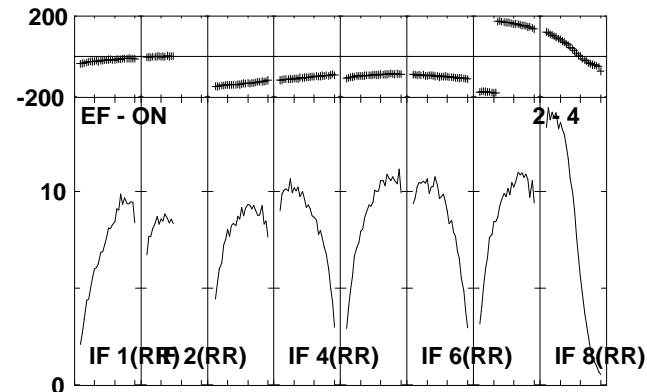
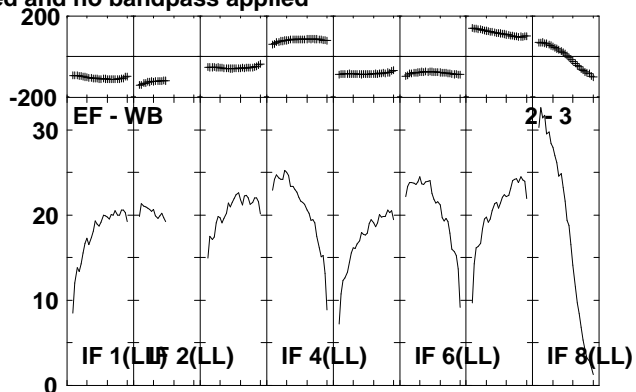
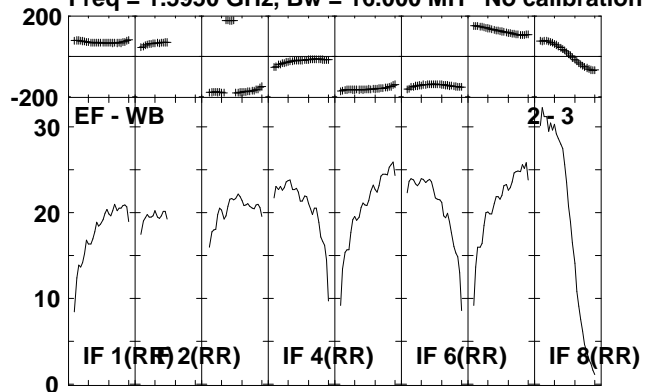

Lower frame: Milli Ampl Jy Top frame: Phas deg
Scalar averaged cross-power spectrum Several baselines displayed
Timerange: 00/16:23:01 to 00/16:24:59

Plot file version 190 created 06-JUL-2010 14:45:33

J2330+33 EP064J.UVDATA.1

Freq = 1.5950 GHz, Bw = 16.000 MH No calibration applied and no bandpass applied

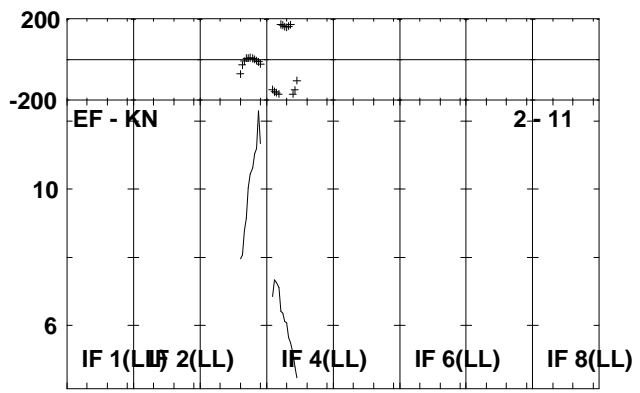
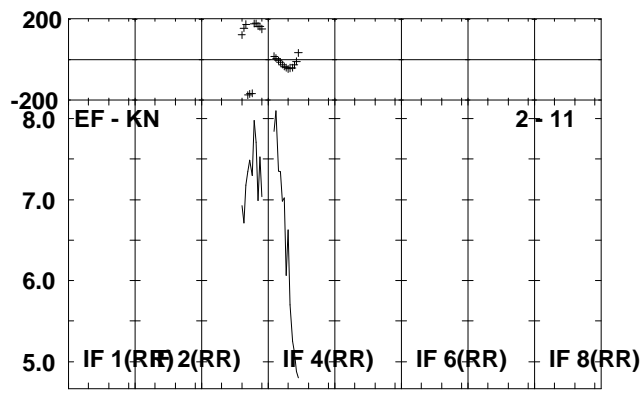
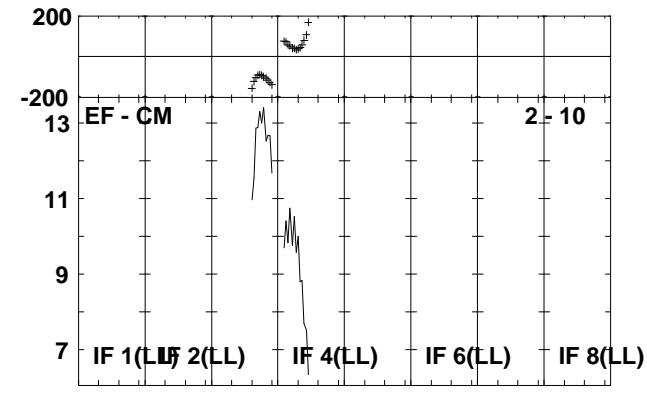
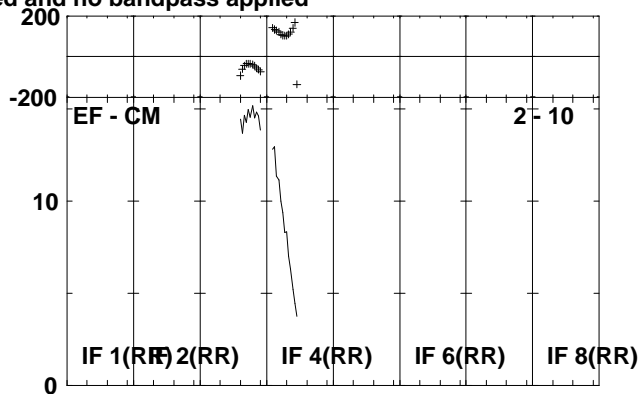
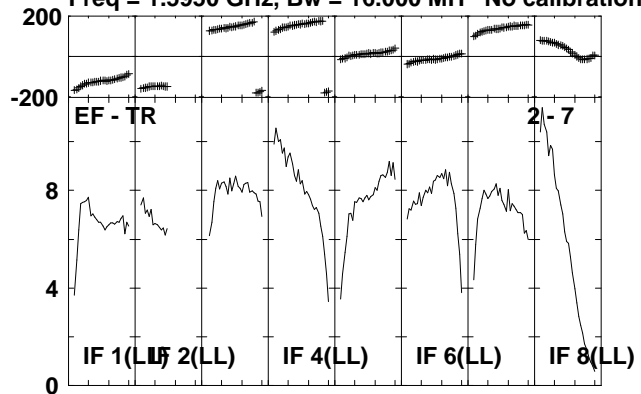

Lower frame: Milli Ampl Jy Top frame: Phas deg
Scalar averaged cross-power spectrum Several baselines displayed
Timerange: 00/16:23:01 to 00/16:24:59

Plot file version 191 created 06-JUL-2010 14:45:34

IRAS2336 EP064J.UVDATA.1

Freq = 1.5950 GHz, Bw = 16.000 MH No calibration applied and no bandpass applied

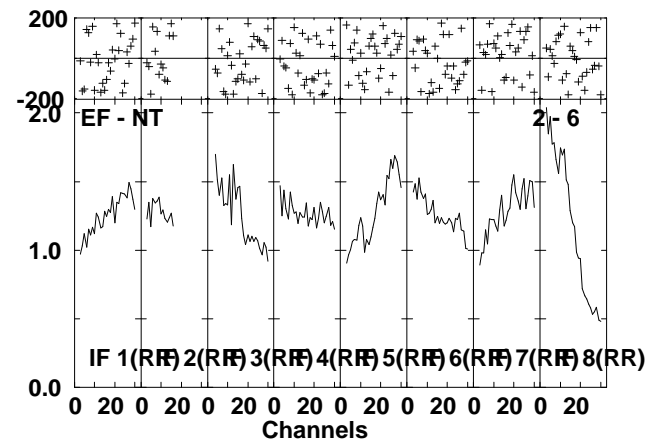
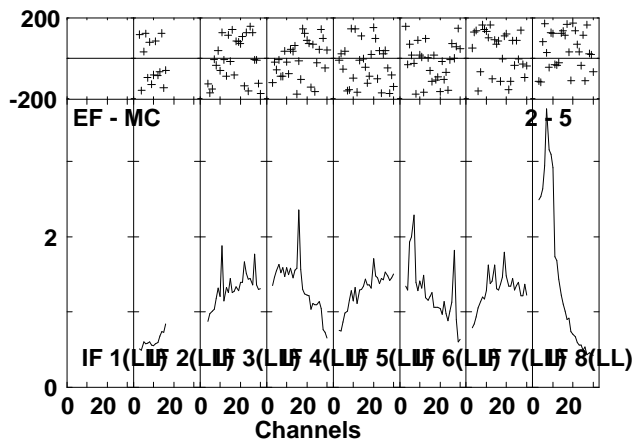
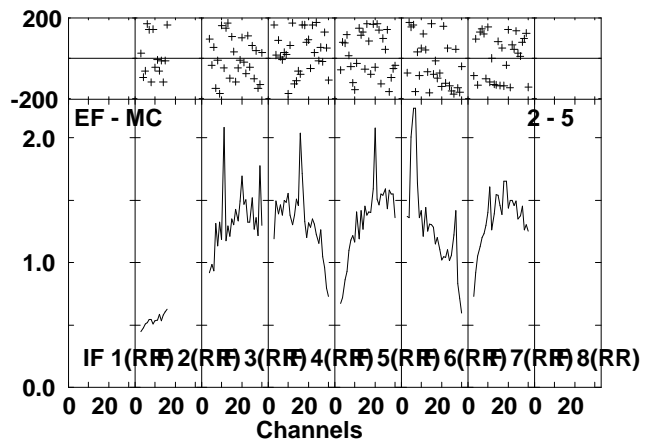
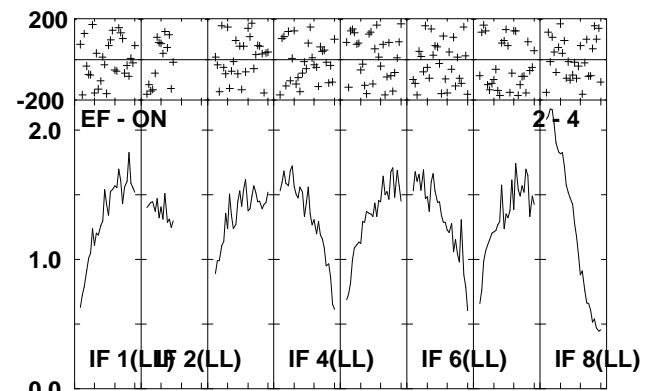
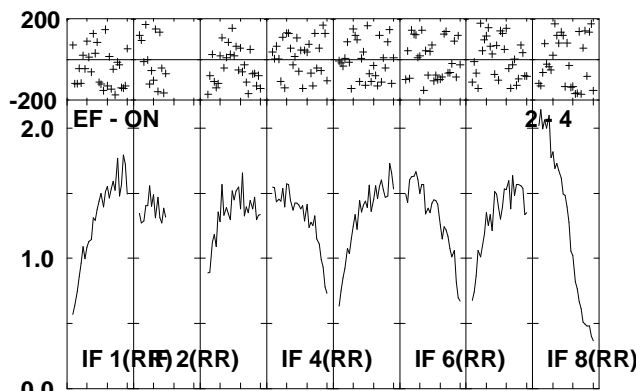
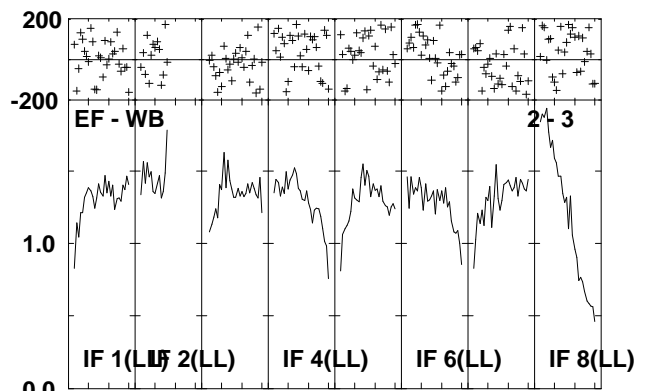
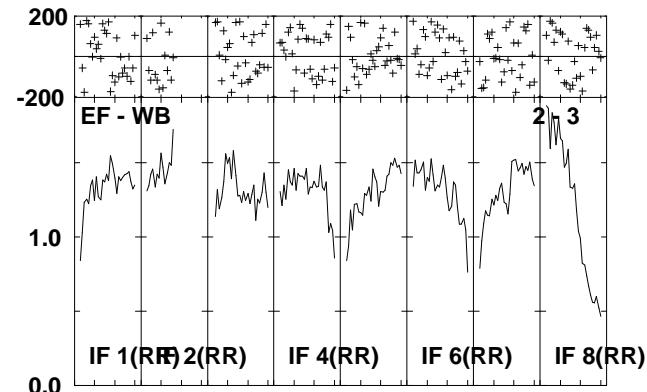
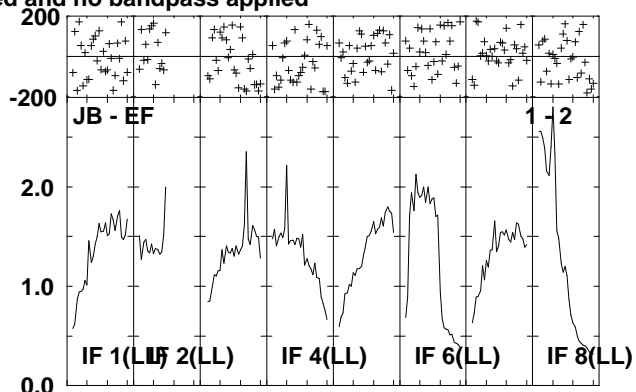
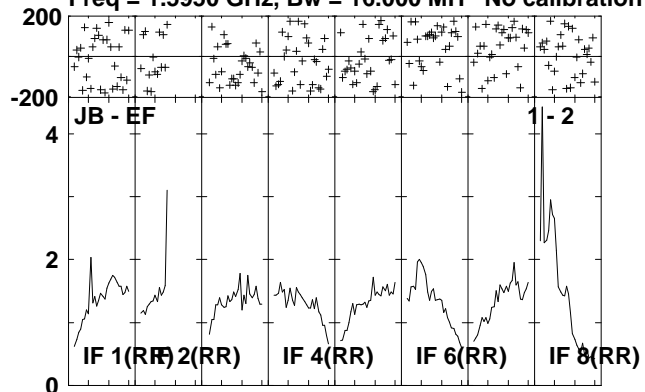

Lower frame: Milli Ampl Jy Top frame: Phas deg
Scalar averaged cross-power spectrum Several baselines displayed
Timerange: 00/16:25:01 to 00/16:29:19

Plot file version 193 created 06-JUL-2010 14:45:38

J2330+33 EP064J.UVDATA.1

Freq = 1.5950 GHz, Bw = 16.000 MH No calibration applied and no bandpass applied

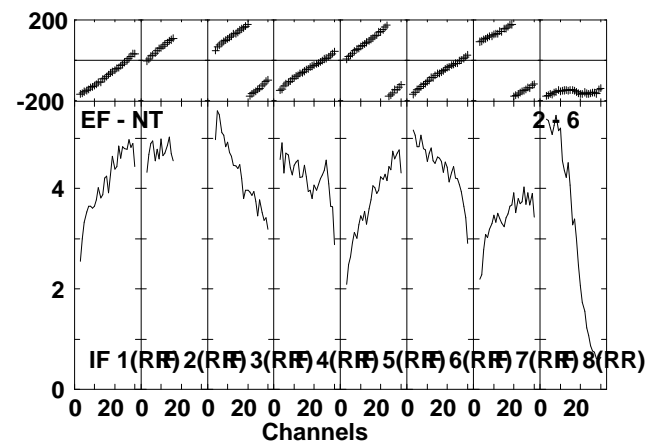
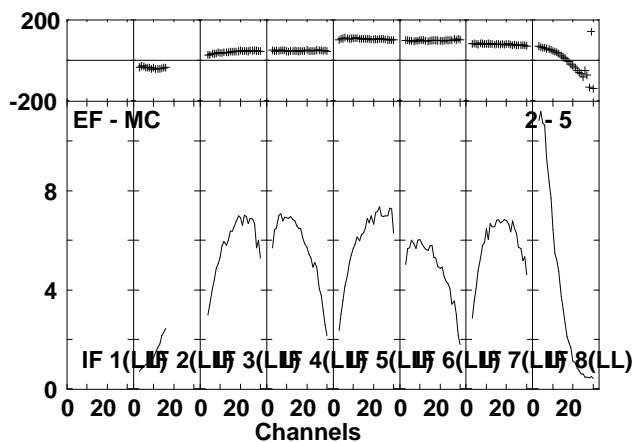
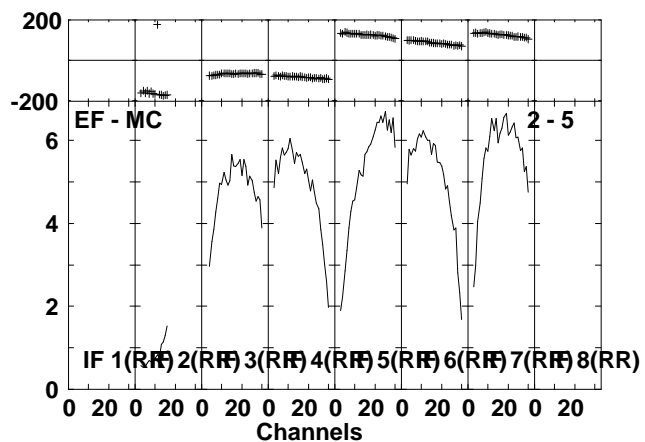
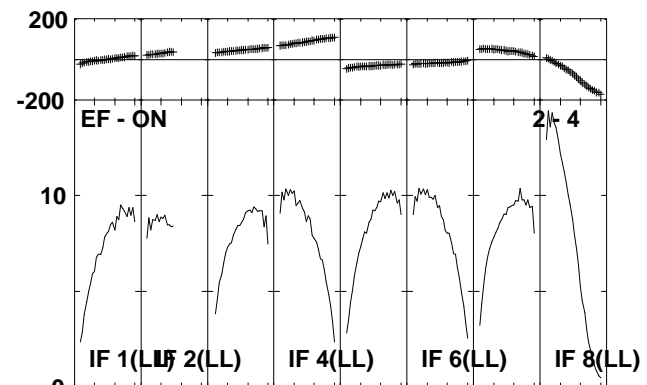
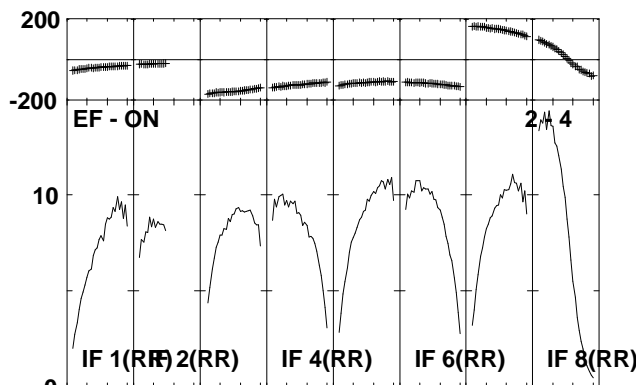
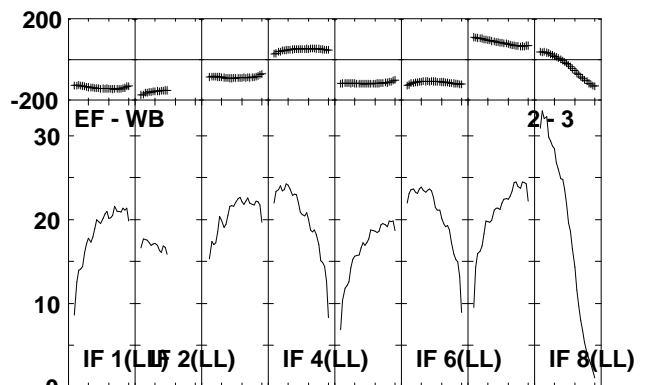
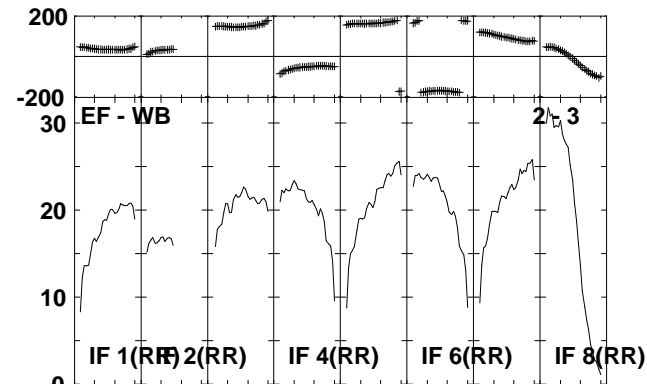
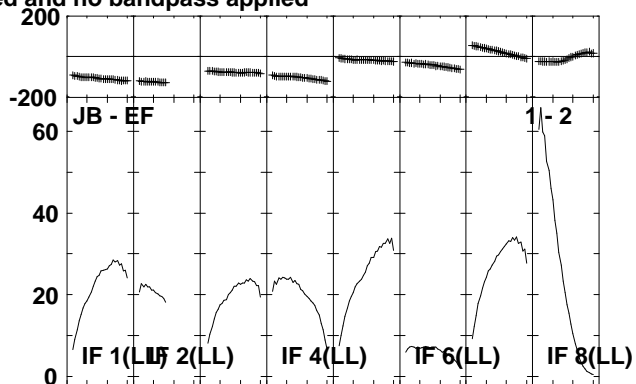
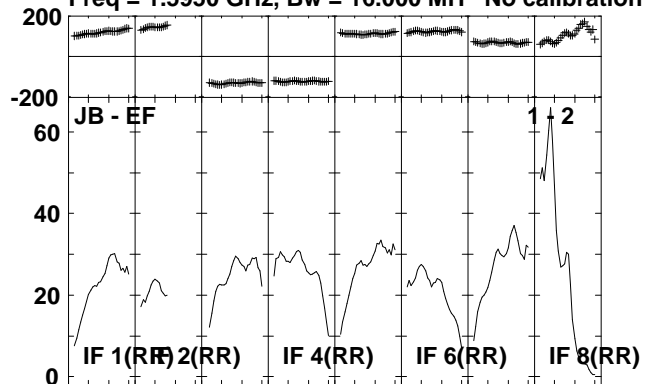

Lower frame: Milli Ampl Jy Top frame: Phas deg
Scalar averaged cross-power spectrum Several baselines displayed
Timerange: 00/16:30:21 to 00/16:32:19

Plot file version 194 created 06-JUL-2010 14:45:39

J2330+33 EP064J.UVDATA.1

Freq = 1.5950 GHz, Bw = 16.000 MH No calibration applied and no bandpass applied

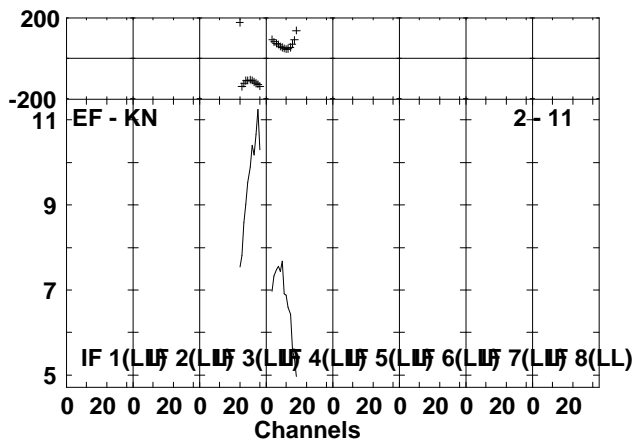
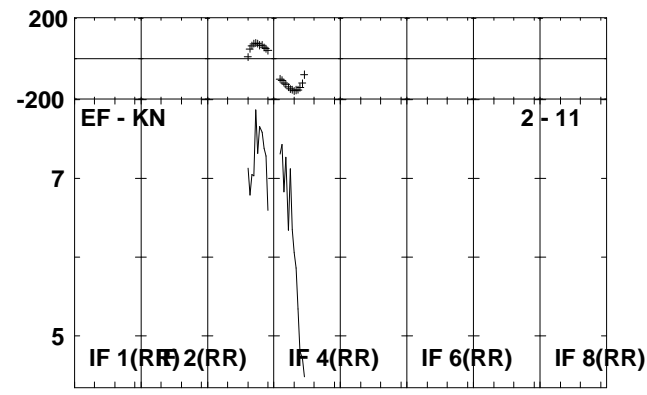
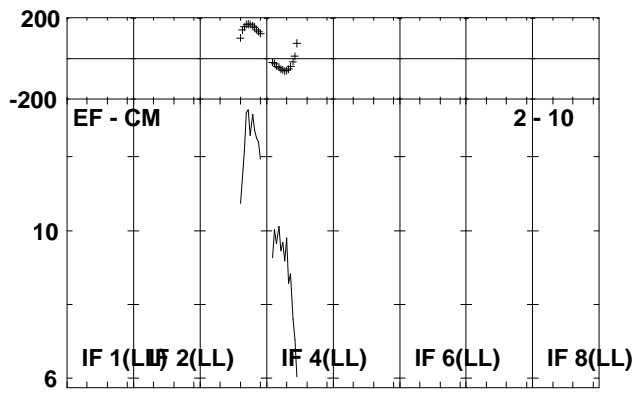
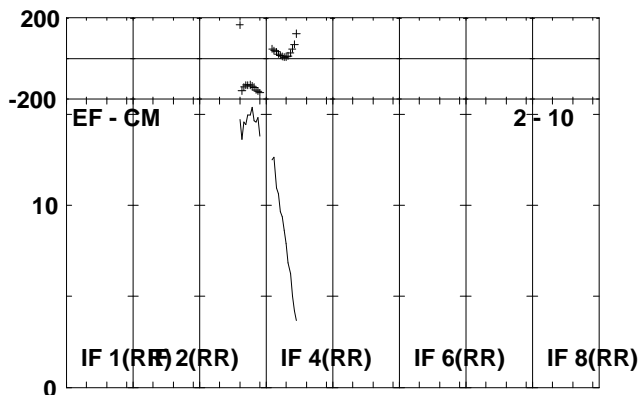
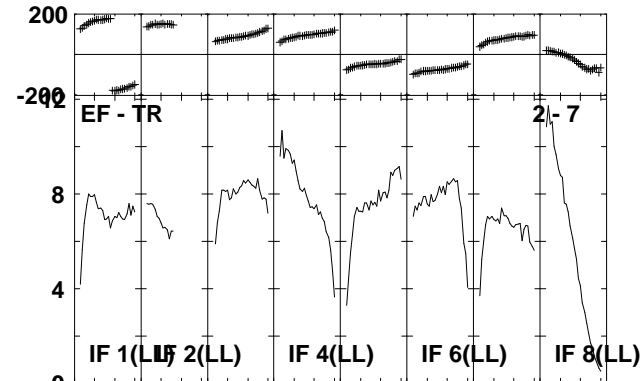
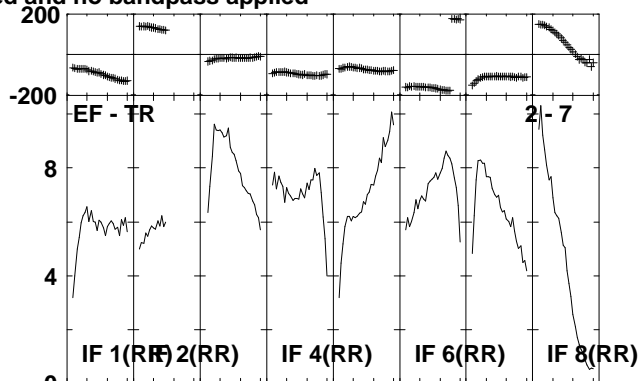
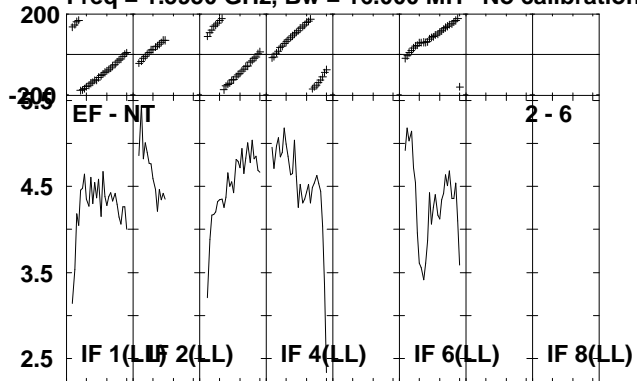

Lower frame: Milli Ampl Jy Top frame: Phas deg
 Scalar averaged cross-power spectrum Several baselines displayed
 Timerange: 00/16:30:21 to 00/16:32:19

Plot file version 195 created 06-JUL-2010 14:45:46

IRAS2336 EP064J.UVDATA.1

Freq = 1.5950 GHz, Bw = 16.000 MH No calibration applied and no bandpass applied

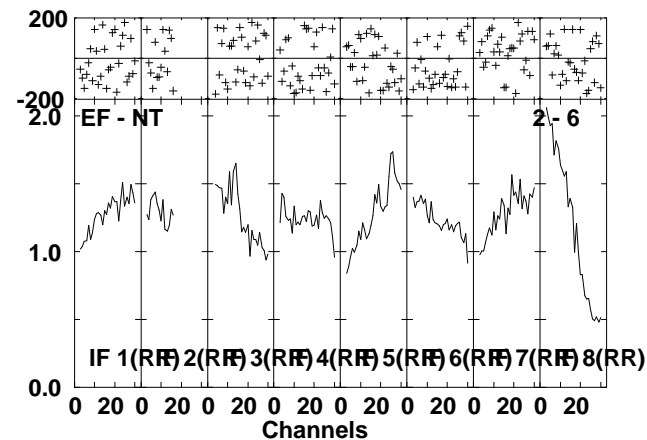
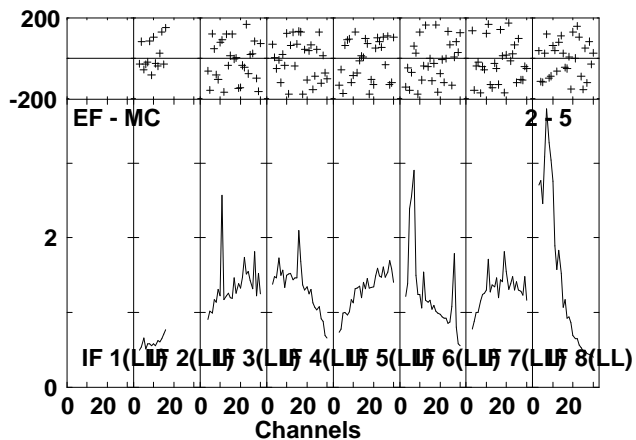
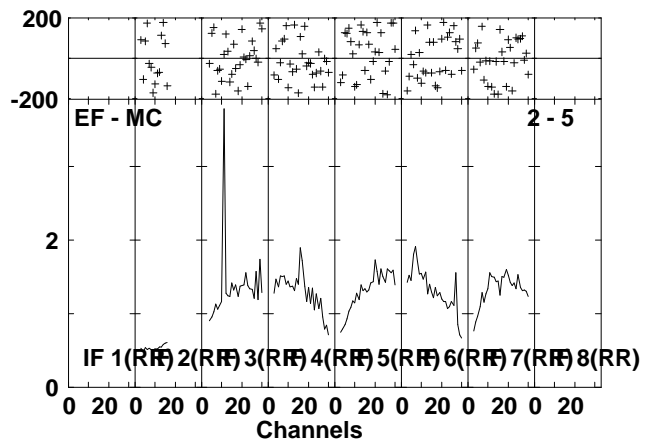
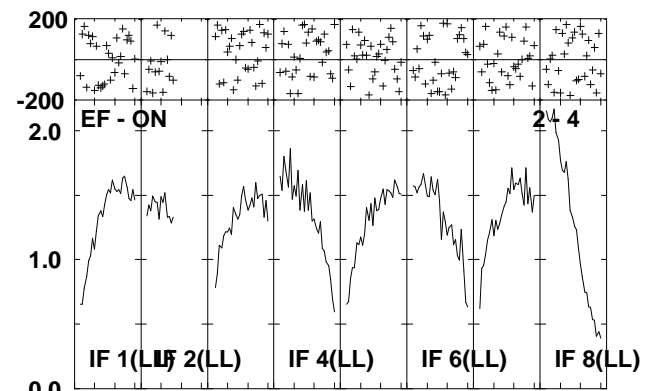
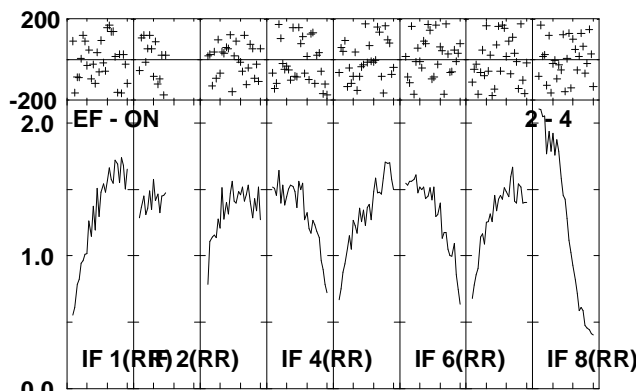
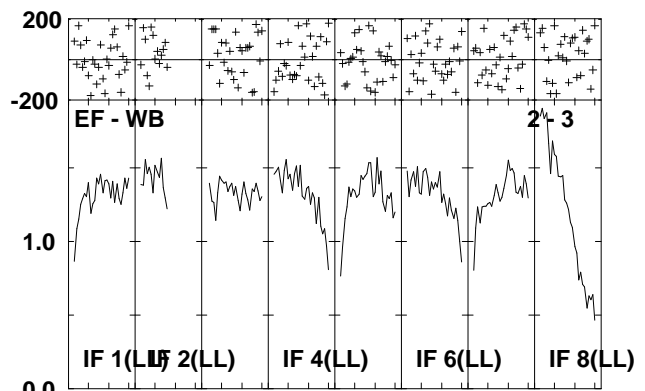
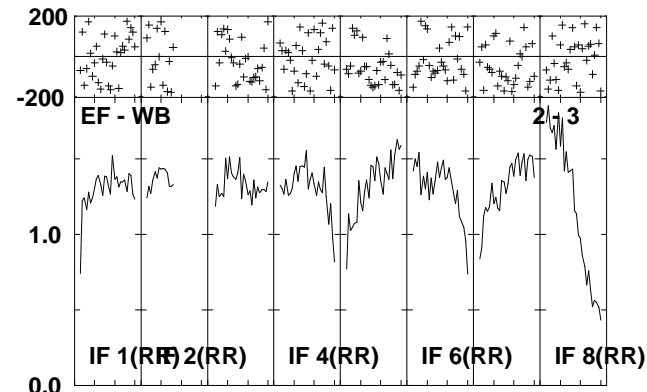
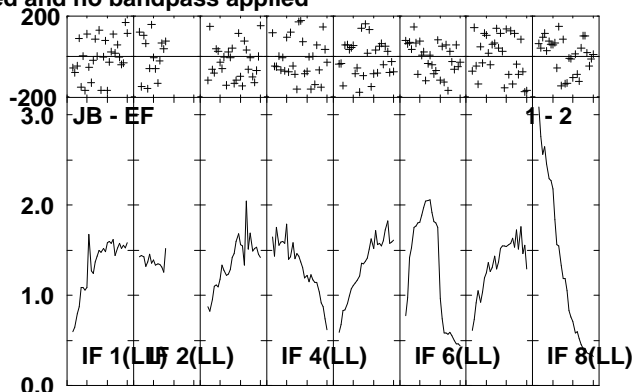
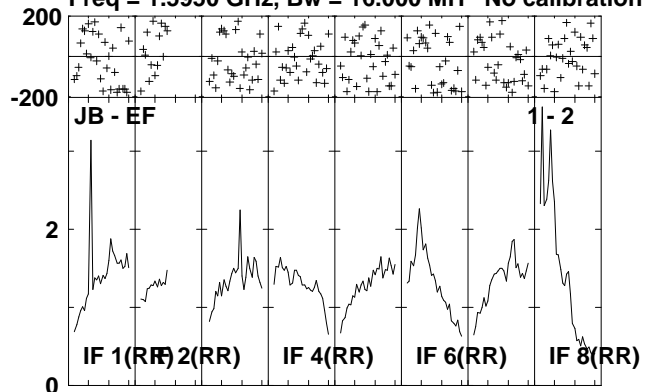

Lower frame: Milli Ampl Jy Top frame: Phas deg
Scalar averaged cross-power spectrum Several baselines displayed
Timerange: 00/16:32:27 to 00/16:36:39

Plot file version 196 created 06-JUL-2010 14:45:48

IRAS2336 EP064J.UVDATA.1

Freq = 1.5950 GHz, Bw = 16.000 MH No calibration applied and no bandpass applied

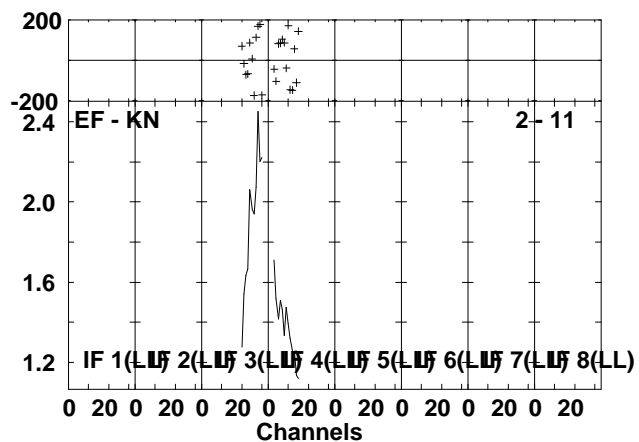
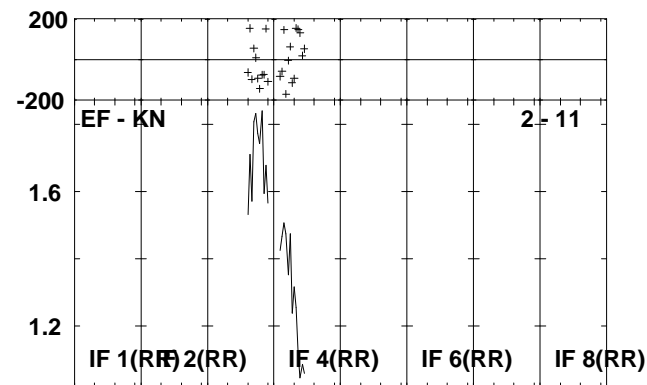
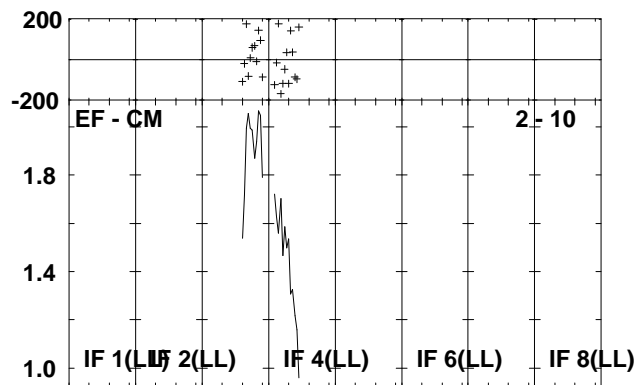
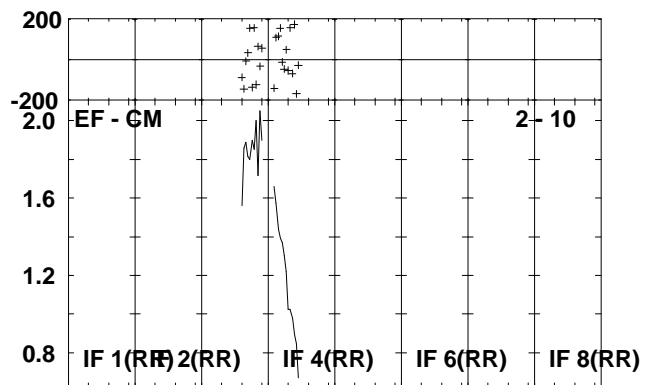
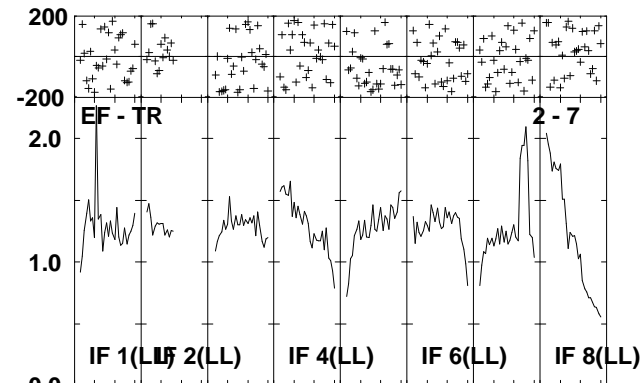
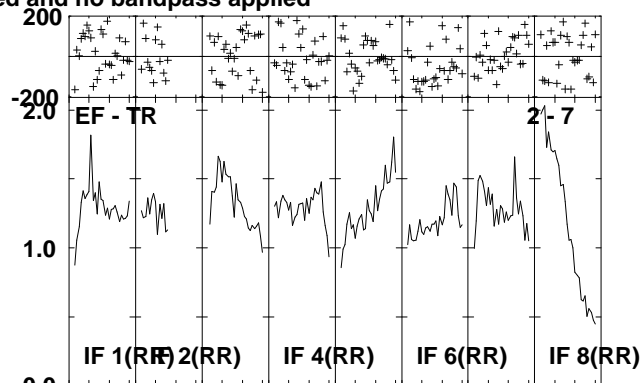
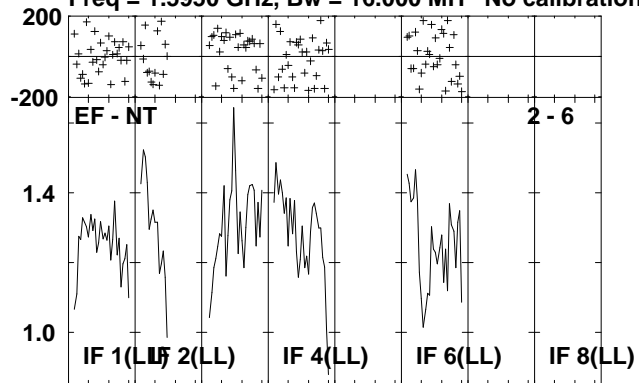

Lower frame: Milli Ampl Jy Top frame: Phas deg
Scalar averaged cross-power spectrum Several baselines displayed
Timerange: 00/16:32:27 to 00/16:36:39

Plot file version 197 created 06-JUL-2010 14:45:50

J2330+33 EP064J.UVDATA.1

Freq = 1.5950 GHz, Bw = 16.000 MH No calibration applied and no bandpass applied

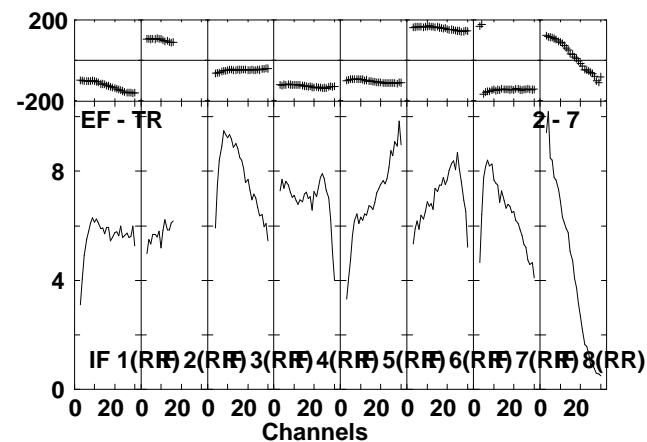
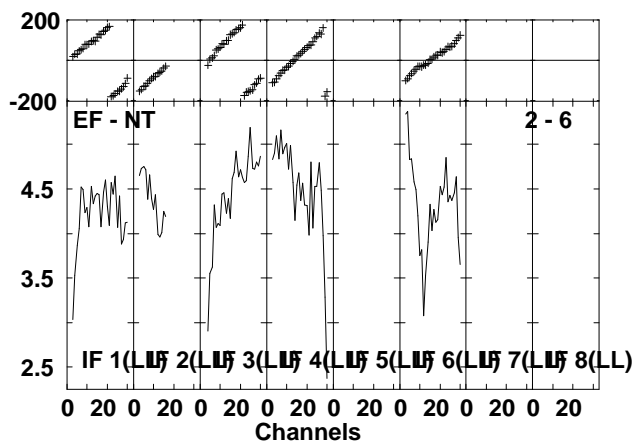
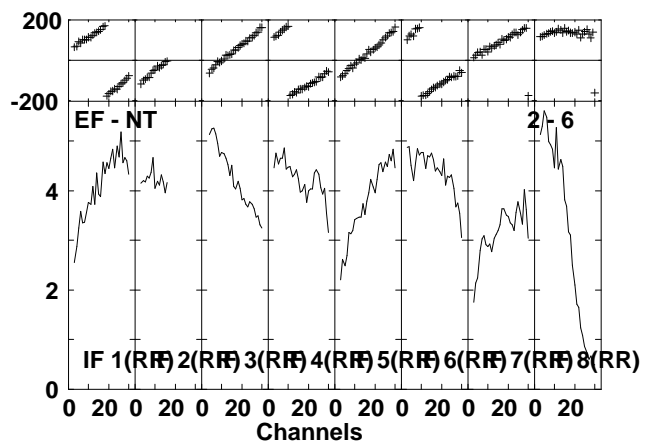
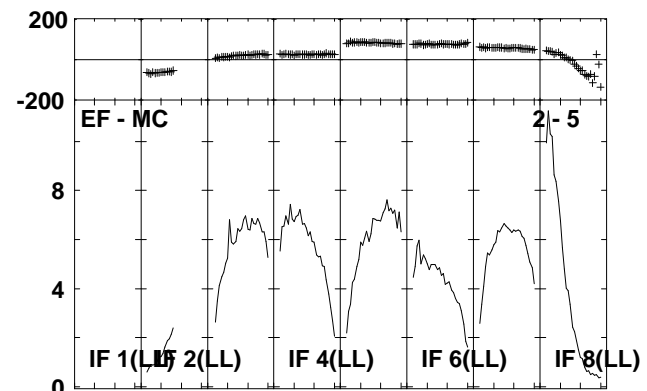
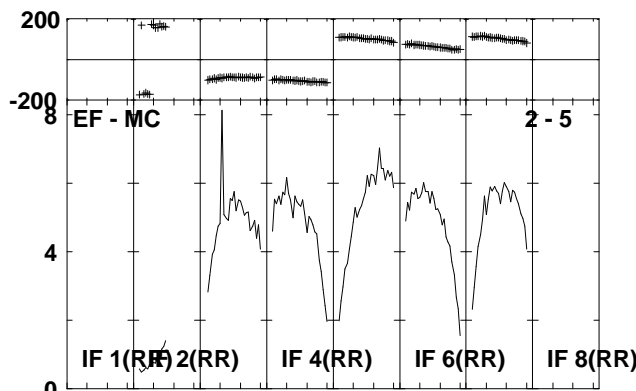
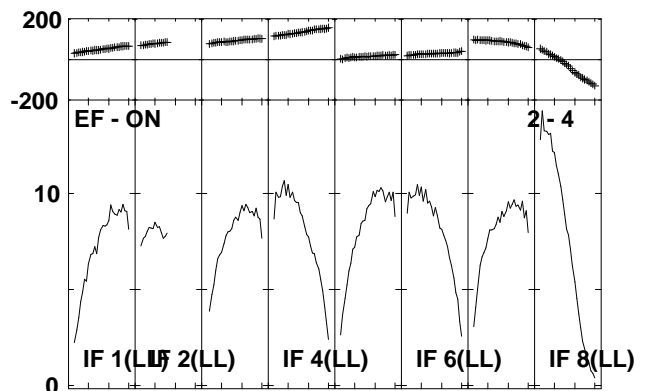
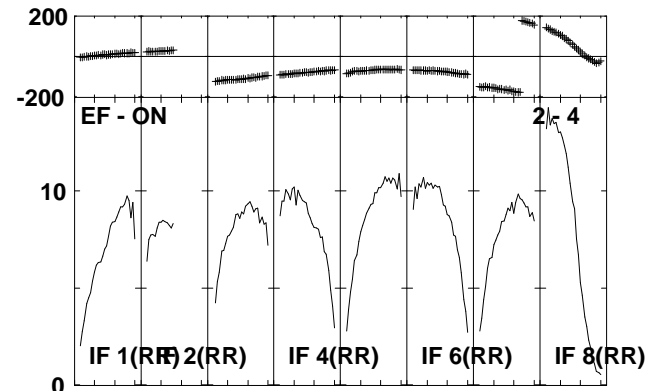
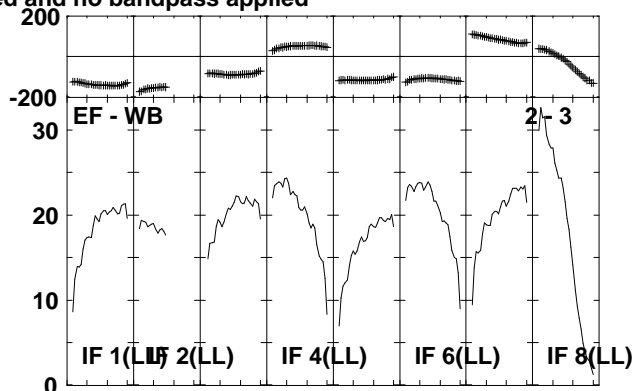
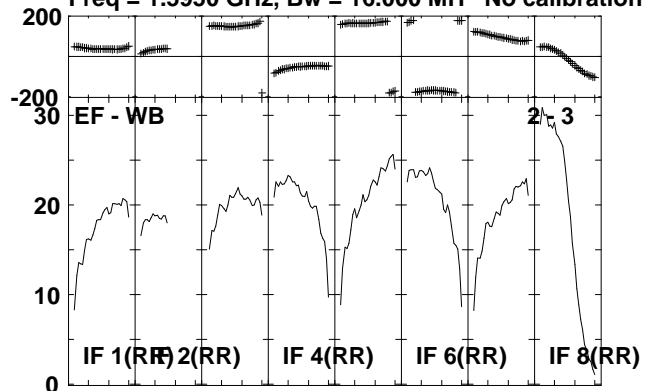

Lower frame: Milli Ampl Jy Top frame: Phas deg
Scalar averaged cross-power spectrum Several baselines displayed
Timerange: 00/16:36:41 to 00/16:38:37

Plot file version 198 created 06-JUL-2010 14:45:51

J2330+33 EP064J.UVDATA.1

Freq = 1.5950 GHz, Bw = 16.000 MH No calibration applied and no bandpass applied

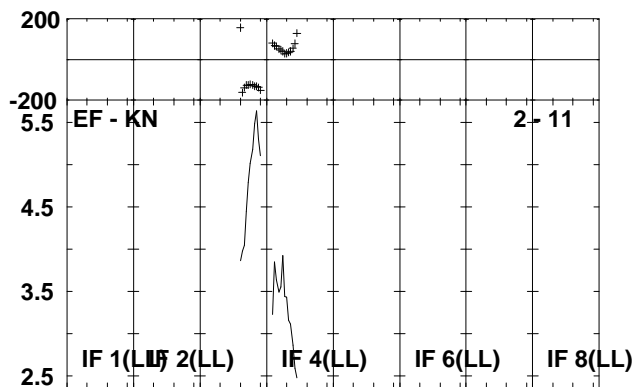
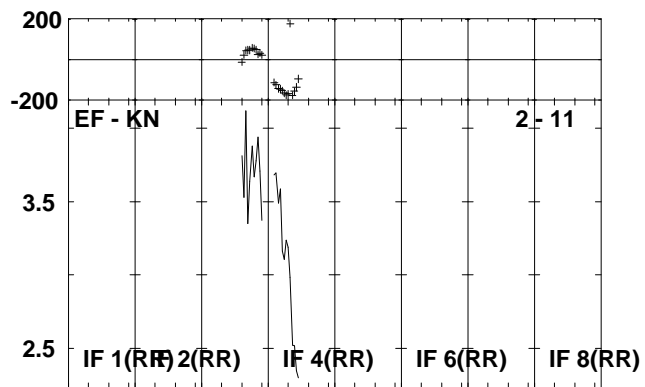
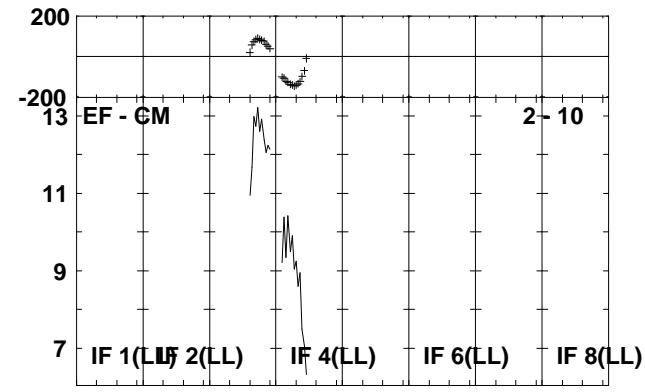
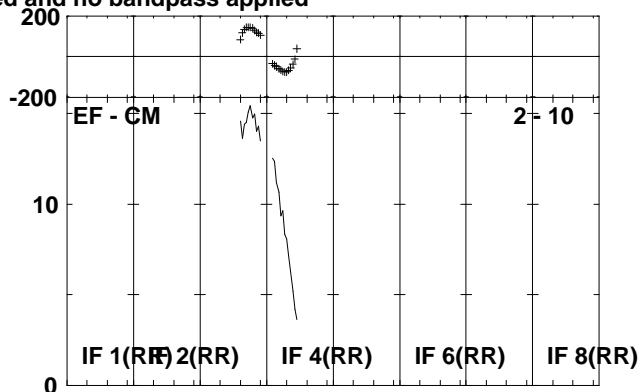
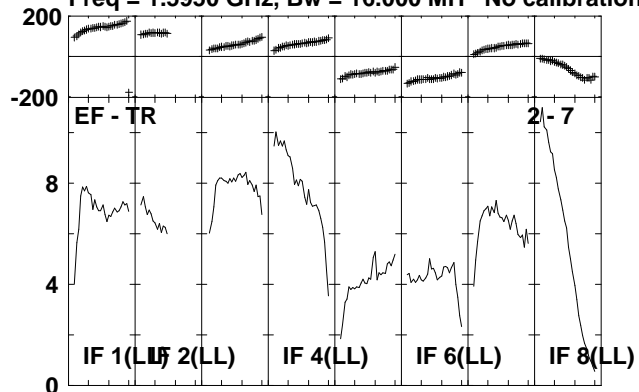

Lower frame: Milli Ampl Jy Top frame: Phas deg
Scalar averaged cross-power spectrum Several baselines displayed
Timerange: 00/16:36:41 to 00/16:38:37

Plot file version 199 created 06-JUL-2010 14:45:52

IRAS2336 EP064J.UVDATA.1

Freq = 1.5950 GHz, Bw = 16.000 MH No calibration applied and no bandpass applied

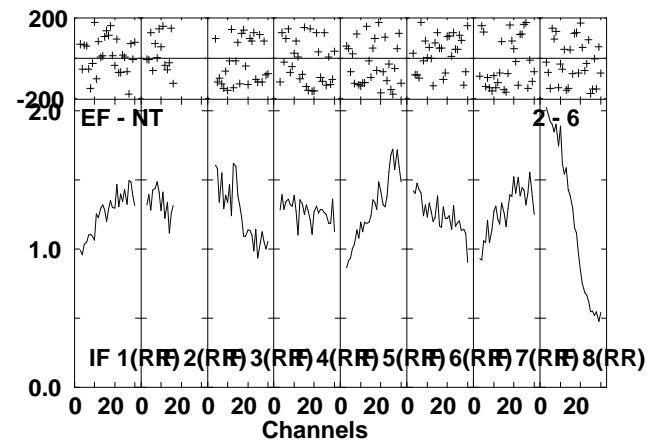
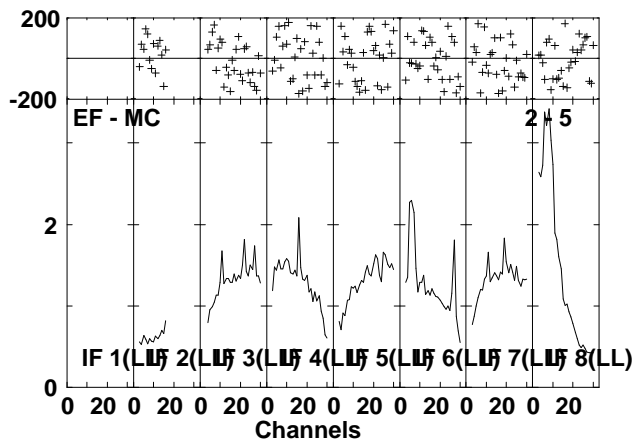
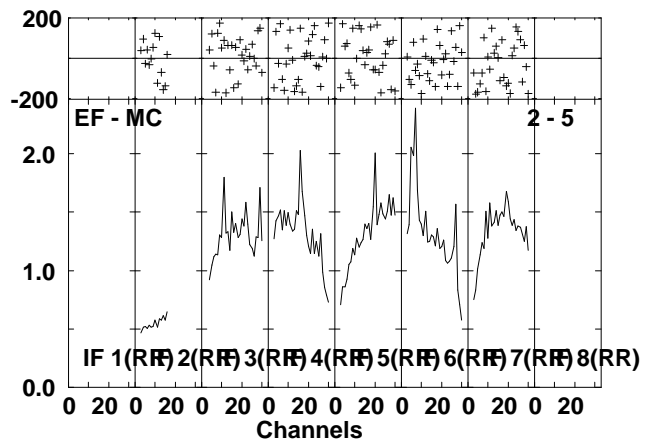
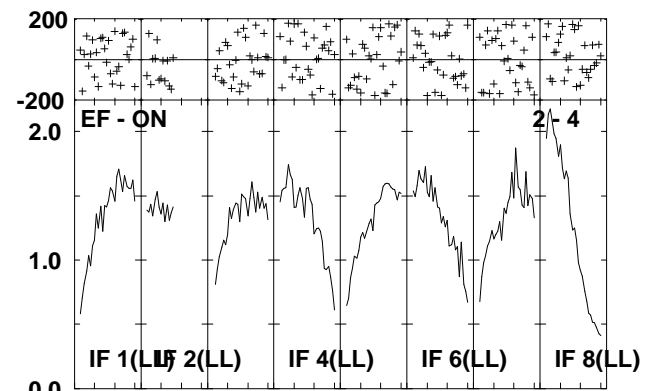
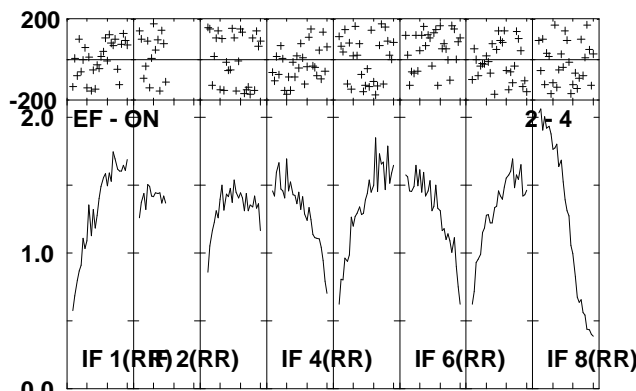
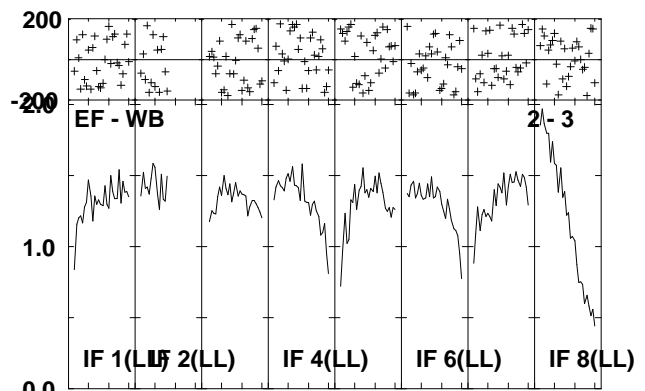
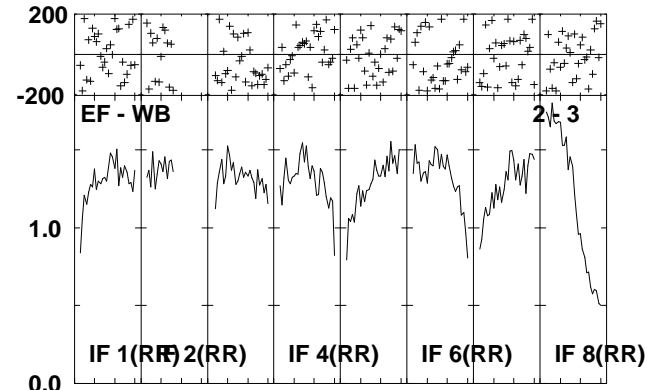
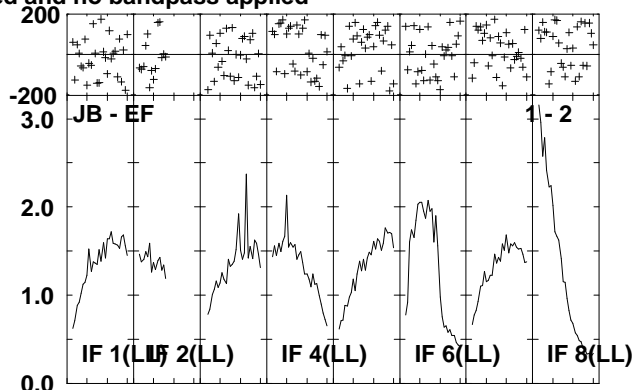
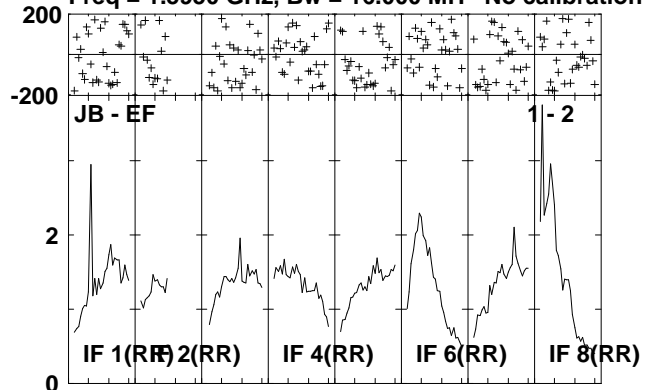

Lower frame: Milli Ampl Jy Top frame: Phas deg
Scalar averaged cross-power spectrum Several baselines displayed
Timerange: 00/16:38:41 to 00/16:42:57

Plot file version 200 created 06-JUL-2010 14:45:54

IRAS2336 EP064J.UVDATA.1

Freq = 1.5950 GHz, Bw = 16.000 MH No calibration applied and no bandpass applied

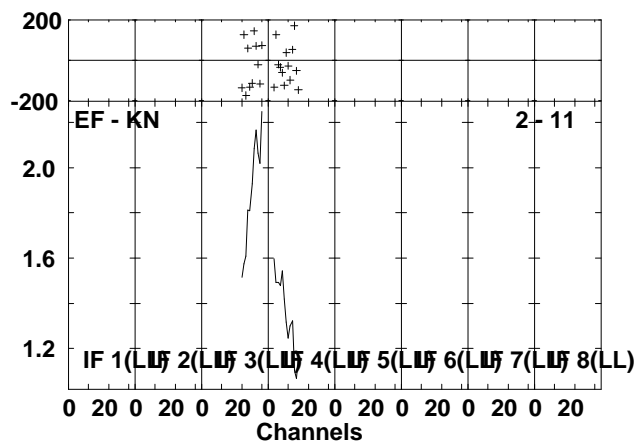
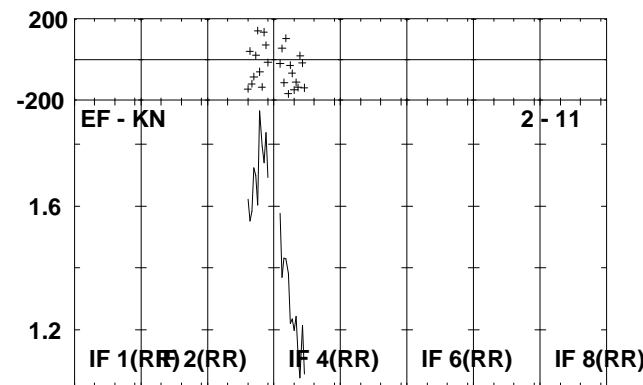
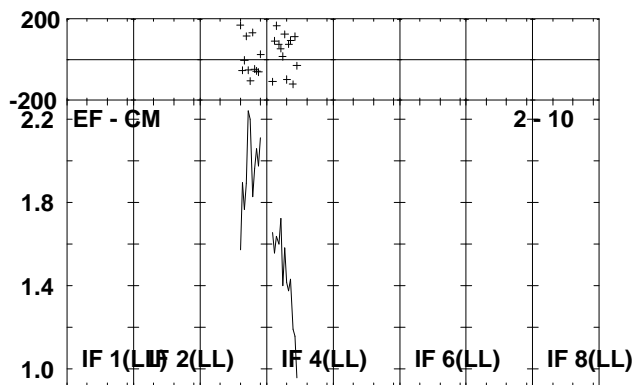
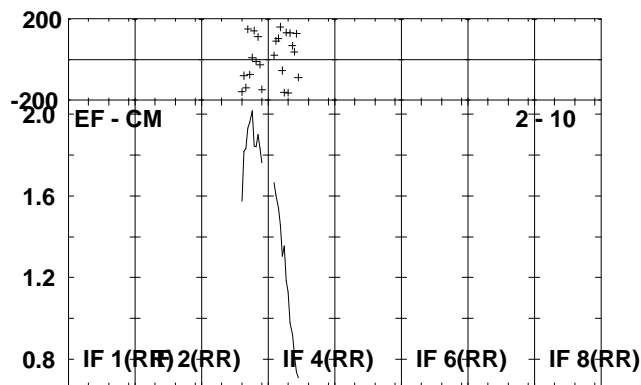
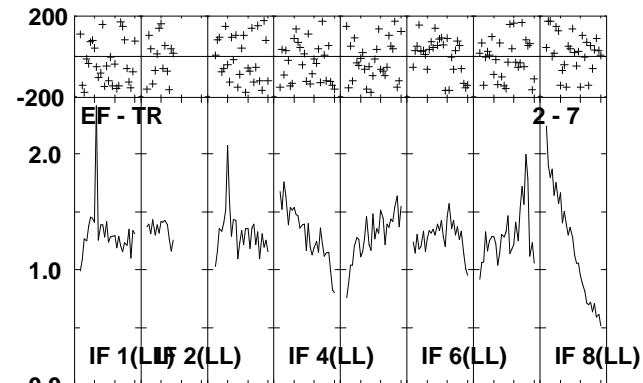
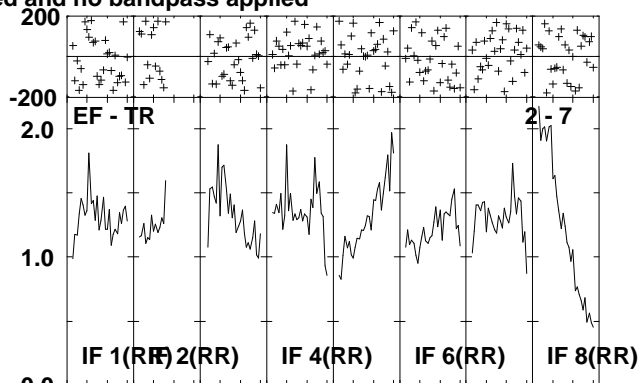
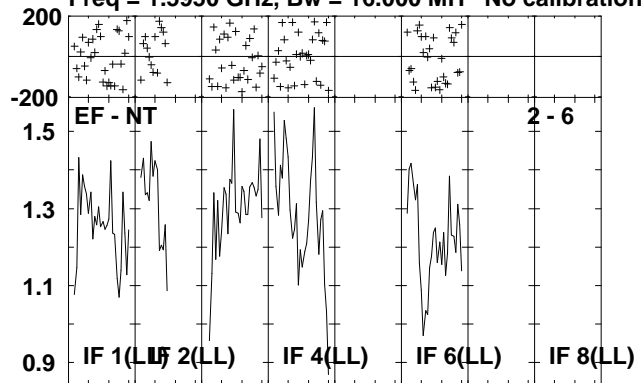

Lower frame: Milli Ampl Jy Top frame: Phas deg
Scalar averaged cross-power spectrum Several baselines displayed
Timerange: 00/16:38:41 to 00/16:42:57

Plot file version 201 created 06-JUL-2010 14:45:56

J2330+33 EP064J.UVDATA.1

Freq = 1.5950 GHz, Bw = 16.000 MH No calibration applied and no bandpass applied

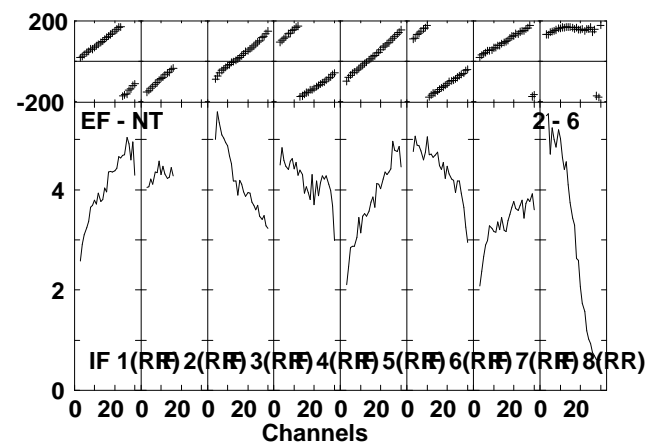
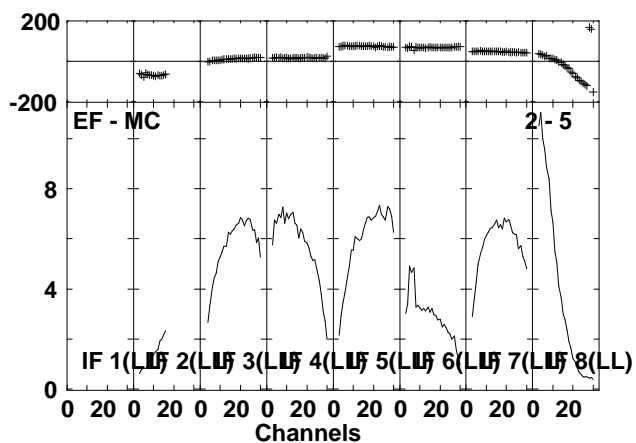
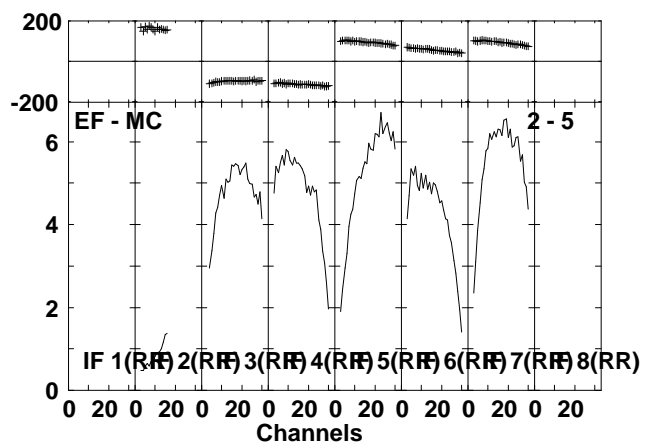
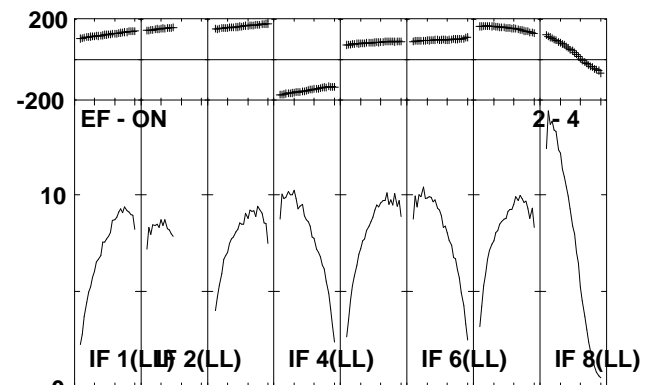
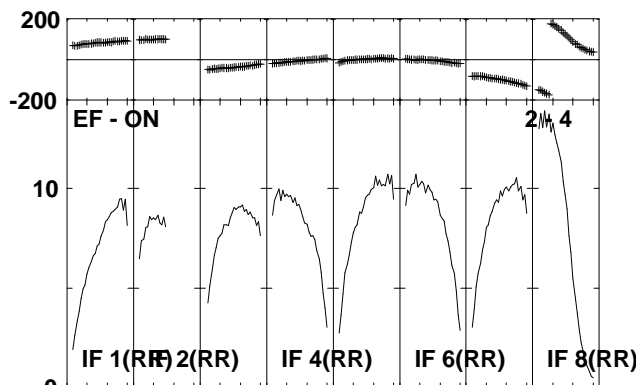
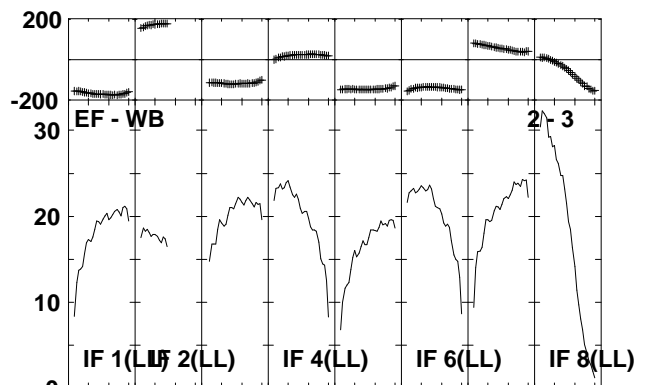
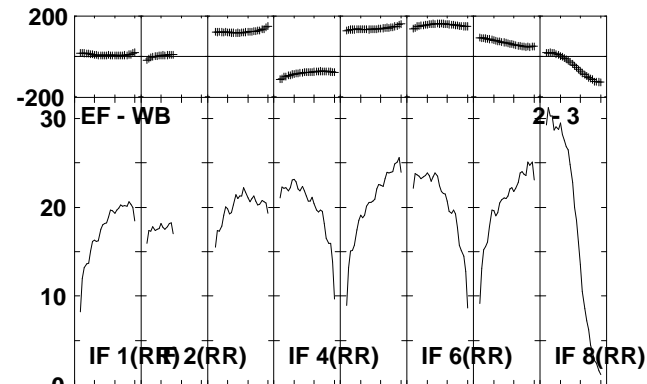
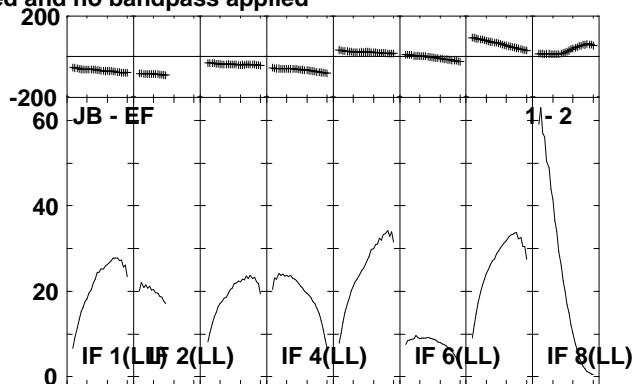
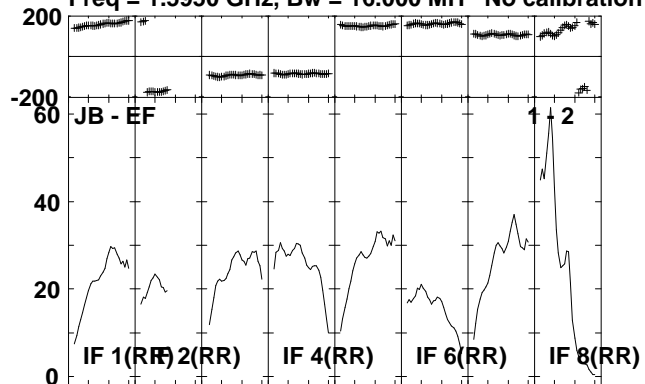

Lower frame: Milli Ampl Jy Top frame: Phas deg
Scalar averaged cross-power spectrum Several baselines displayed
Timerange: 00/16:44:01 to 00/16:45:59

Plot file version 202 created 06-JUL-2010 14:45:57

J2330+33 EP064J.UVDATA.1

Freq = 1.5950 GHz, Bw = 16.000 MH No calibration applied and no bandpass applied

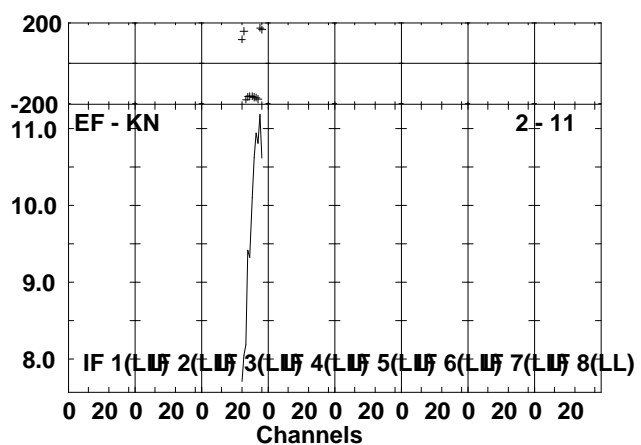
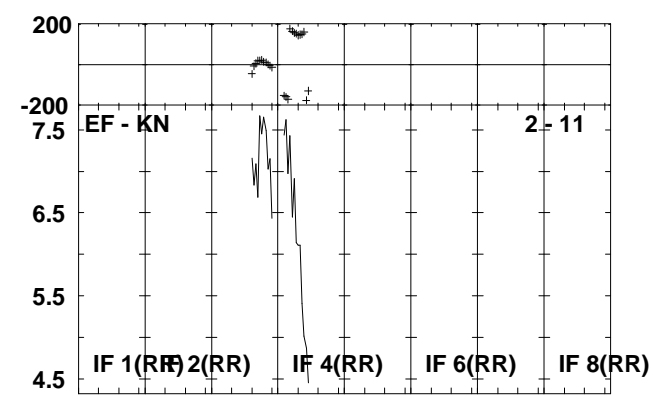
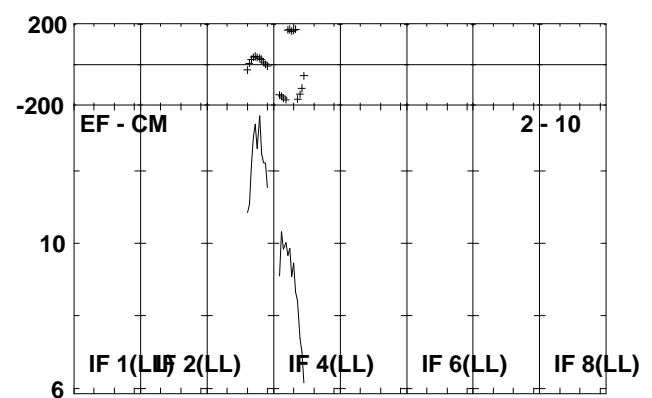
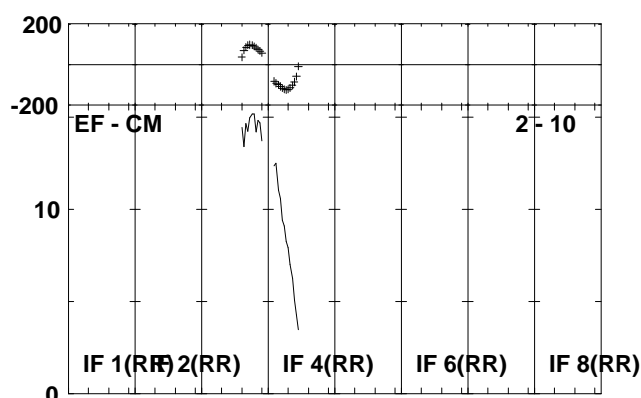
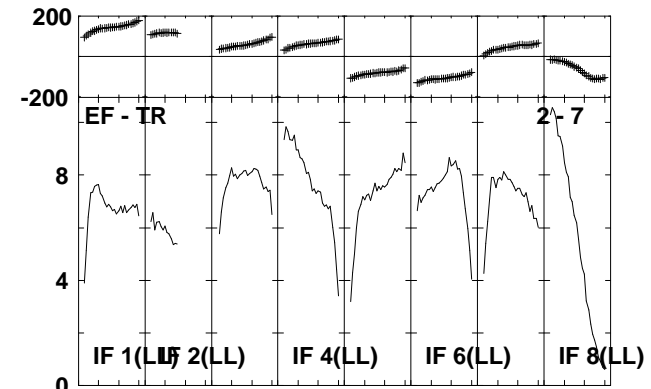
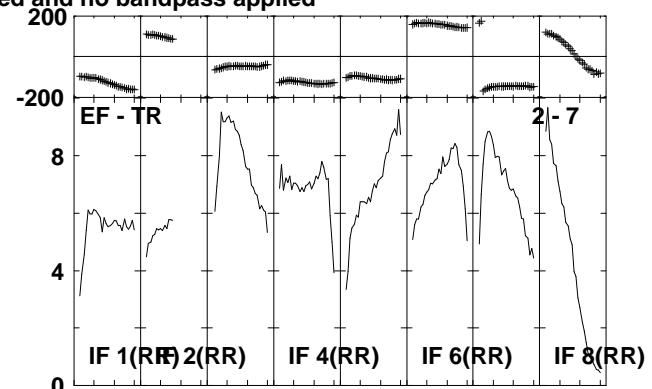
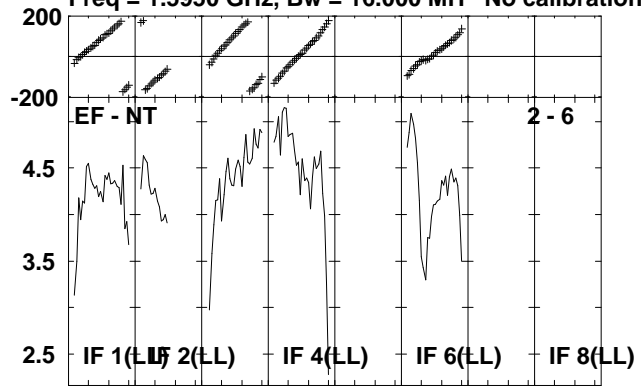

Lower frame: Milli Ampl Jy Top frame: Phas deg
Scalar averaged cross-power spectrum Several baselines displayed
Timerange: 00/16:44:01 to 00/16:45:59

Plot file version 203 created 06-JUL-2010 14:45:59

IRAS2336 EP064J.UVDATA.1

Freq = 1.5950 GHz, Bw = 16.000 MH No calibration applied and no bandpass applied

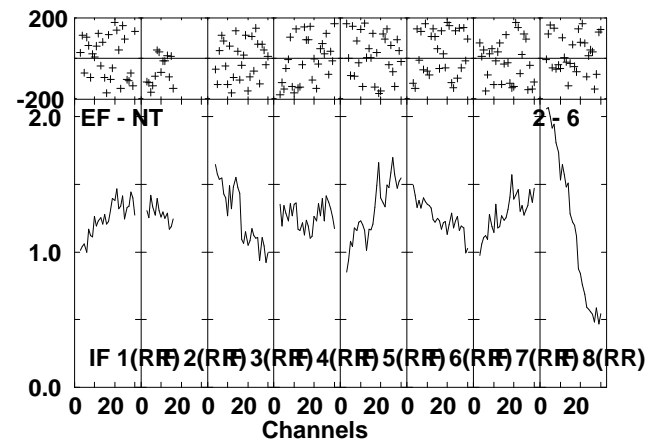
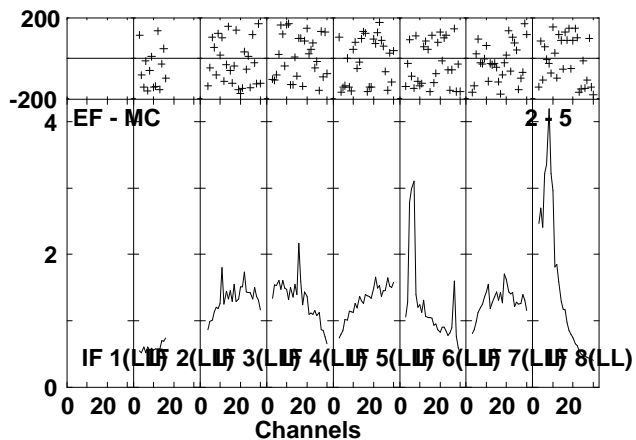
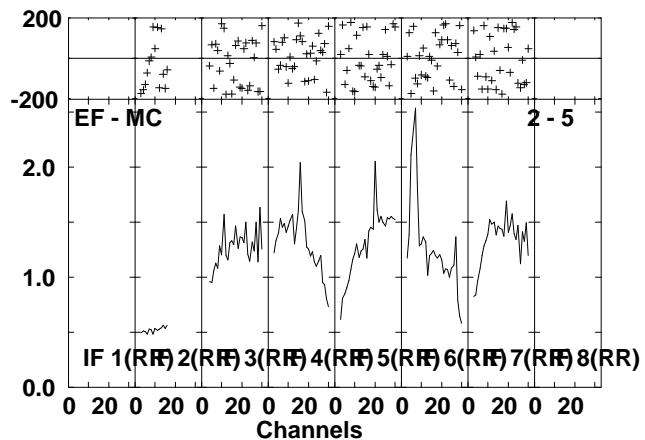
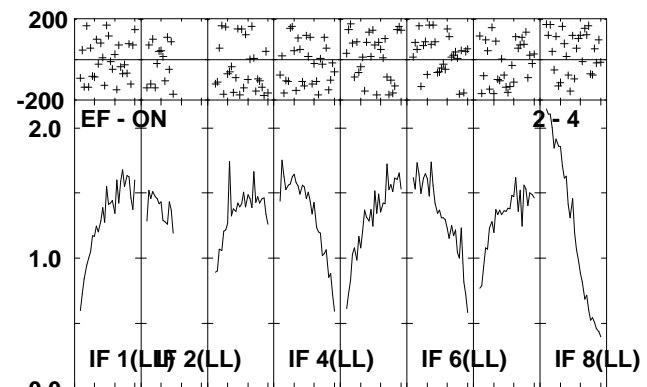
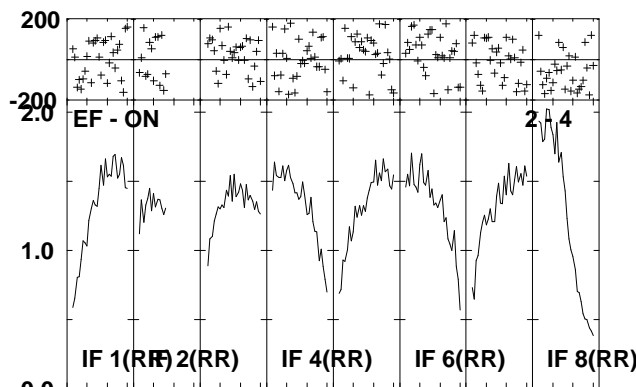
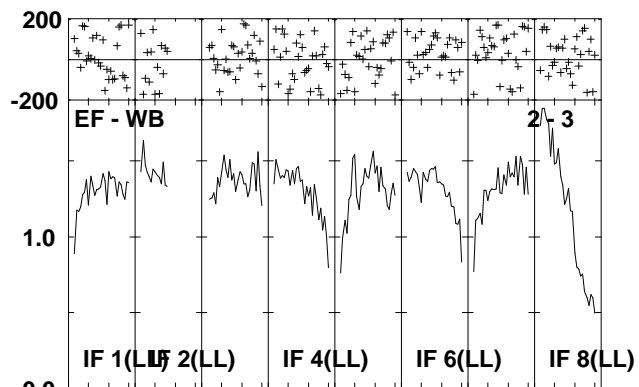
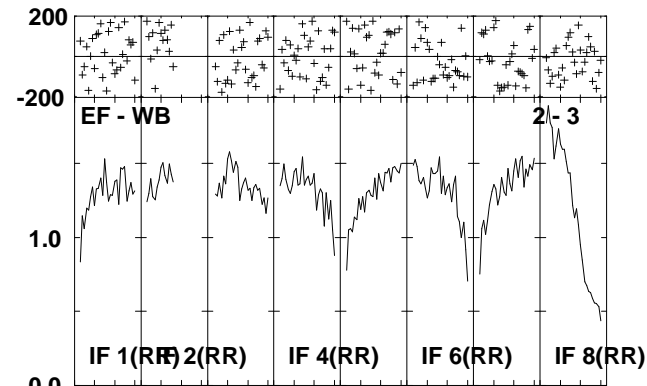
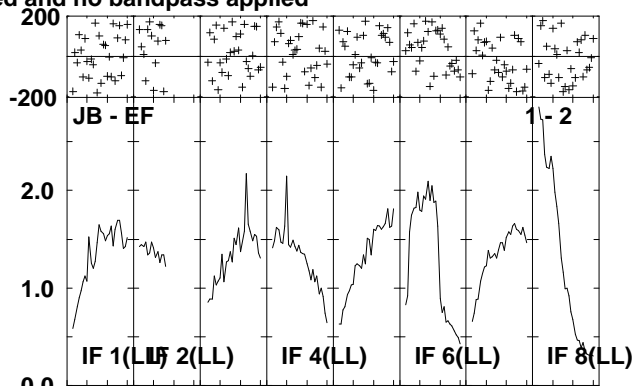
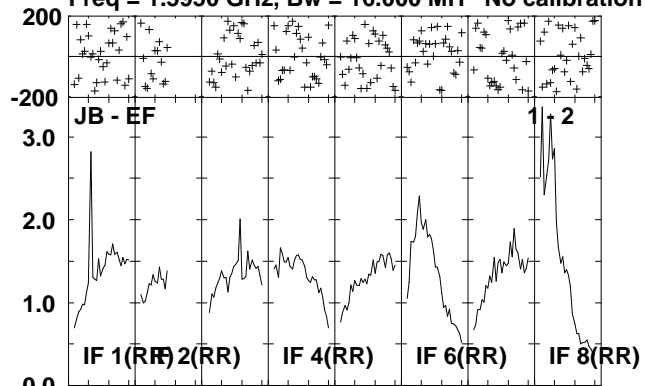

Lower frame: Milli Ampl Jy Top frame: Phas deg
Scalar averaged cross-power spectrum Several baselines displayed
Timerange: 00/16:46:01 to 00/16:50:19

Plot file version 204 created 06-JUL-2010 14:46:00

IRAS2336 EP064J.UVDATA.1

Freq = 1.5950 GHz, Bw = 16.000 MH No calibration applied and no bandpass applied

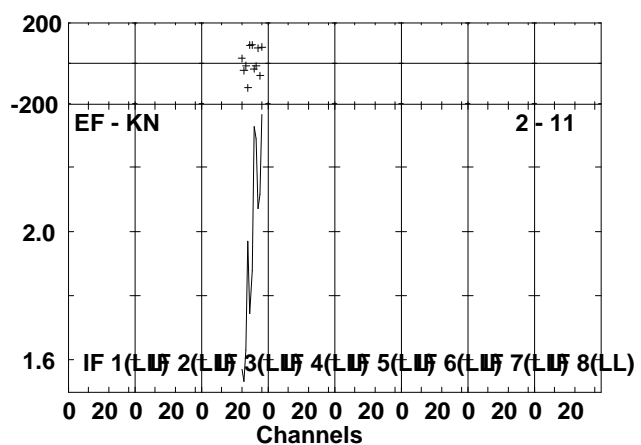
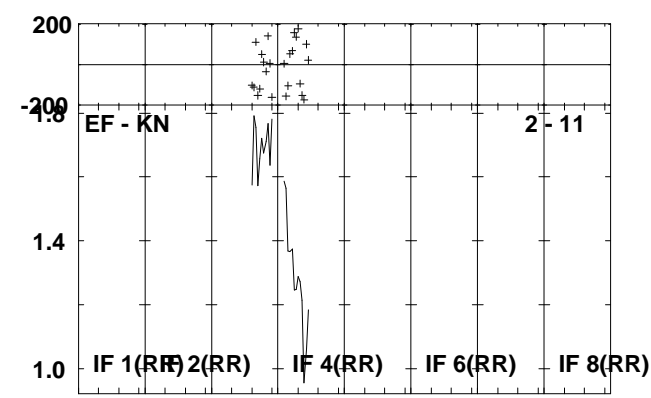
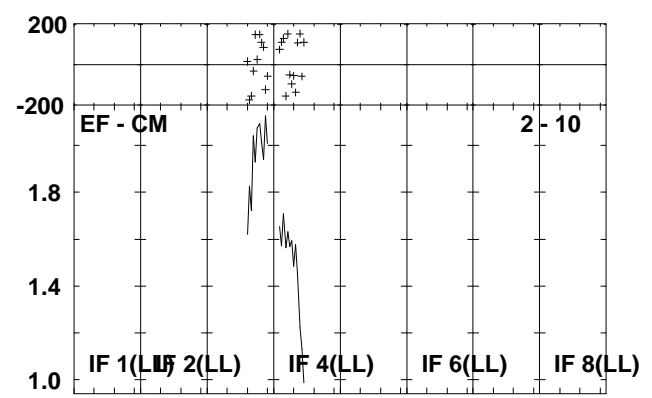
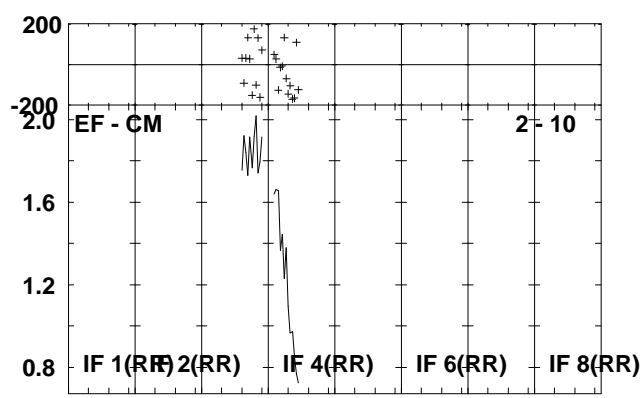
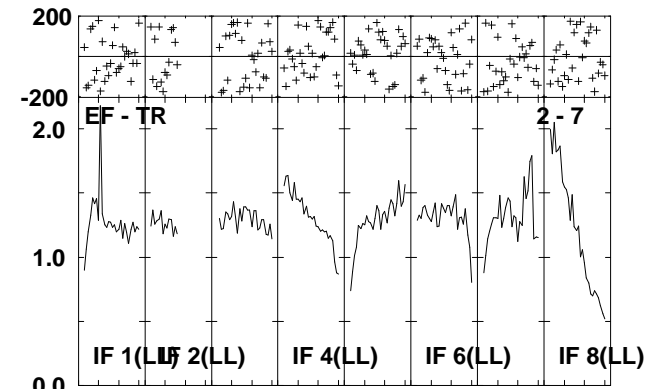
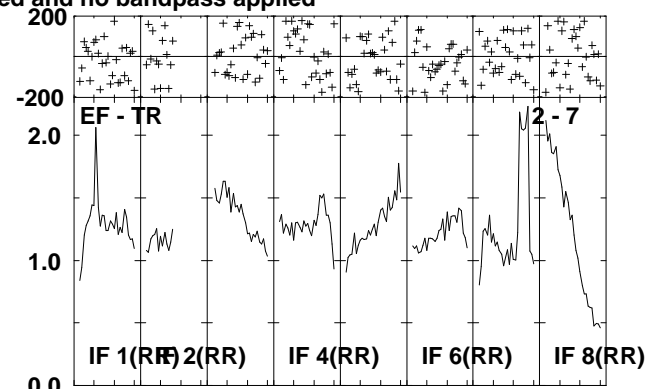
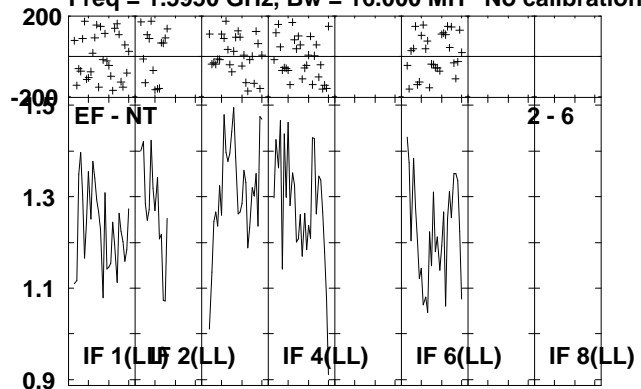

Lower frame: Milli Ampl Jy Top frame: Phas deg
Scalar averaged cross-power spectrum Several baselines displayed
Timerange: 00/16:46:01 to 00/16:50:19

Plot file version 205 created 06-JUL-2010 14:46:03

J2330+33 EP064J.UVDATA.1

Freq = 1.5950 GHz, Bw = 16.000 MH No calibration applied and no bandpass applied

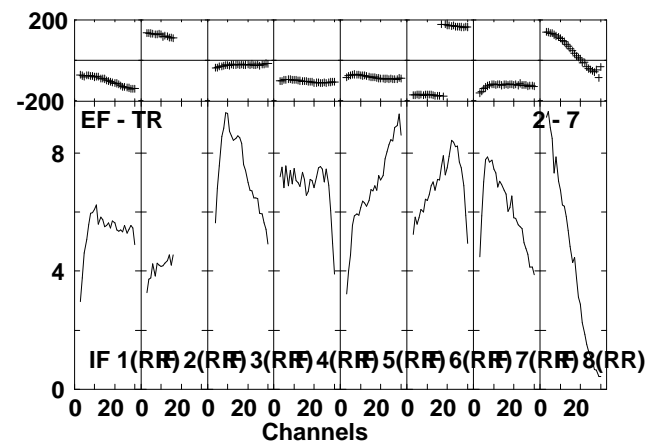
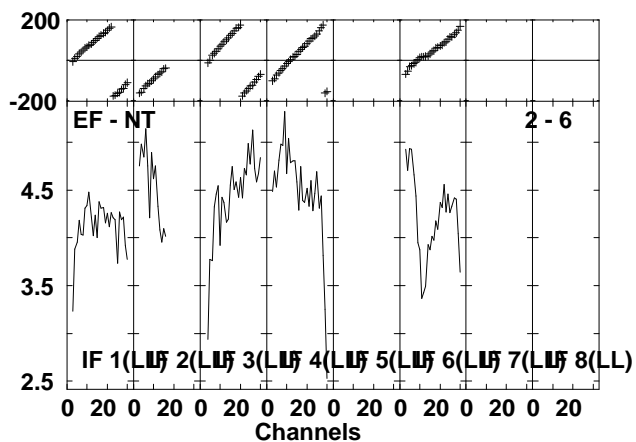
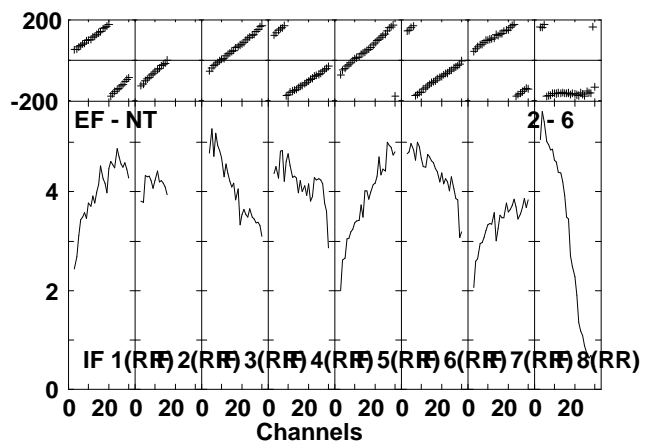
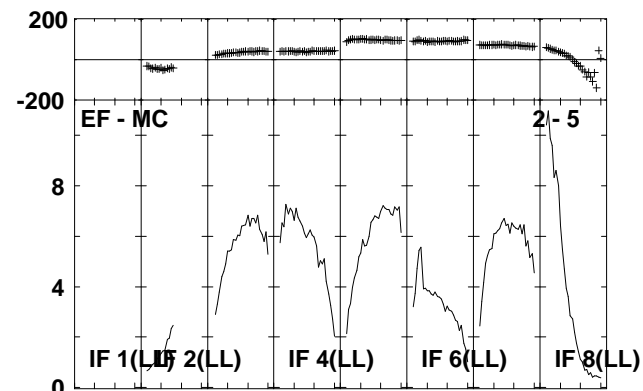
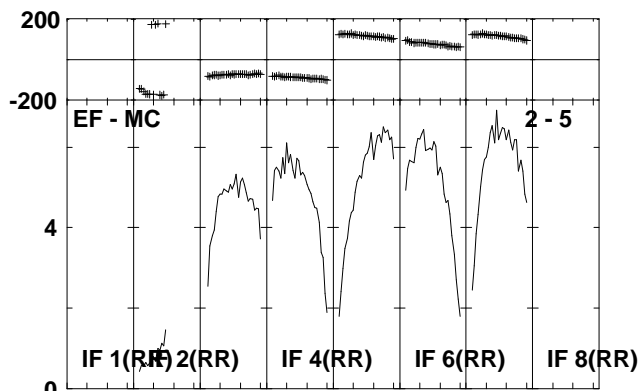
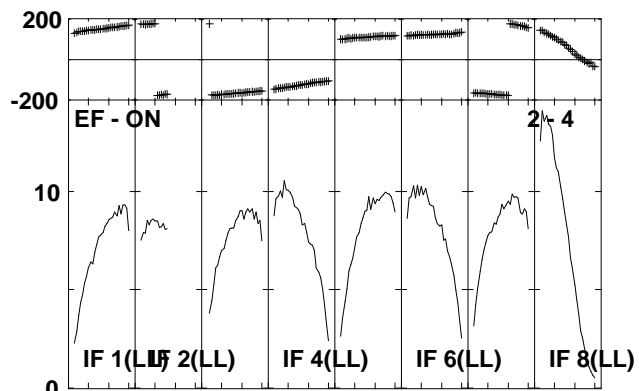
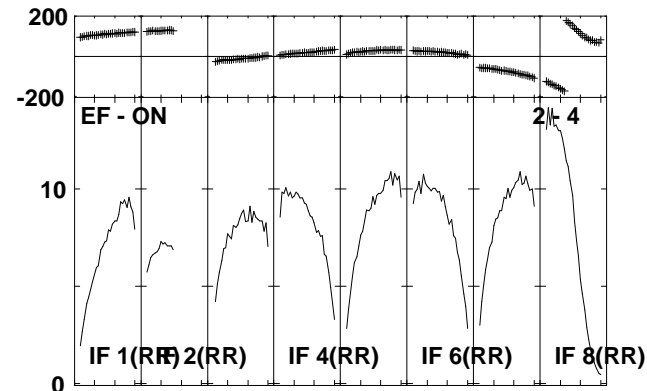
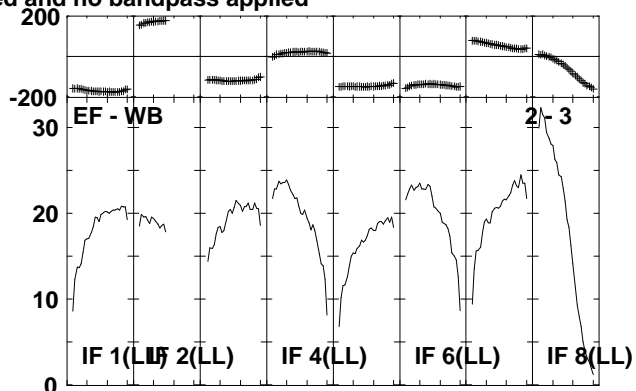
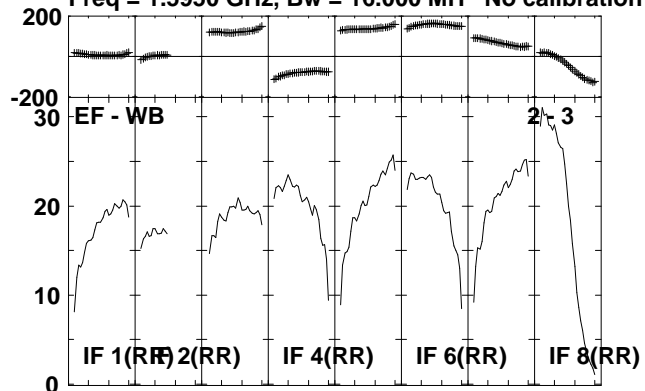

Lower frame: Milli Ampl Jy Top frame: Phas deg
Scalar averaged cross-power spectrum Several baselines displayed
Timerange: 00/16:50:21 to 00/16:52:19

Plot file version 206 created 06-JUL-2010 14:46:04

J2330+33 EP064J.UVDATA.1

Freq = 1.5950 GHz, Bw = 16.000 MH No calibration applied and no bandpass applied

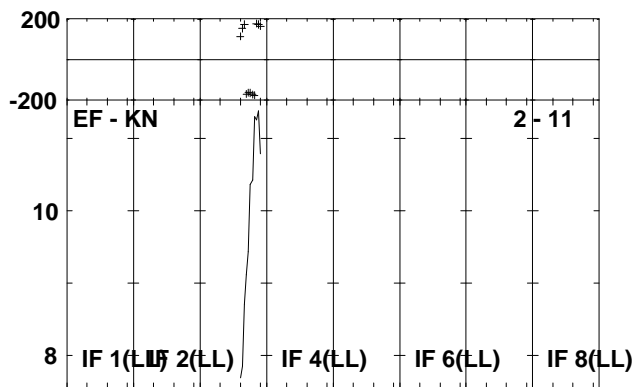
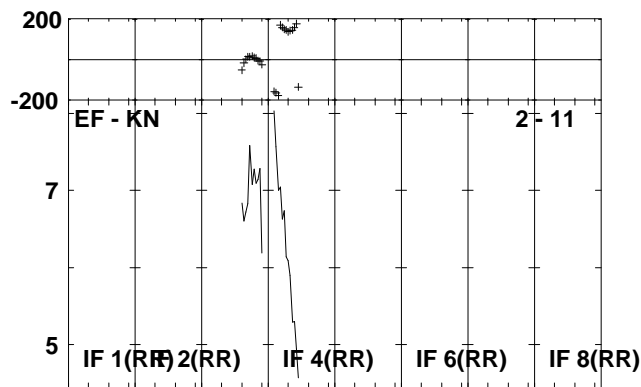
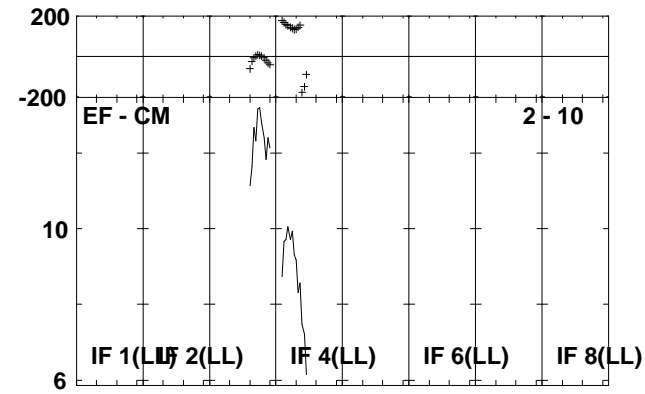
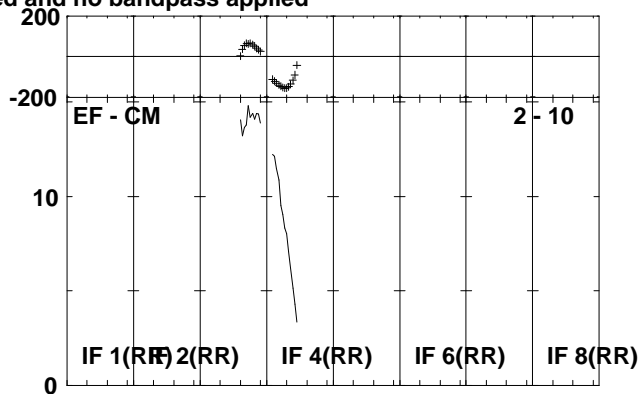
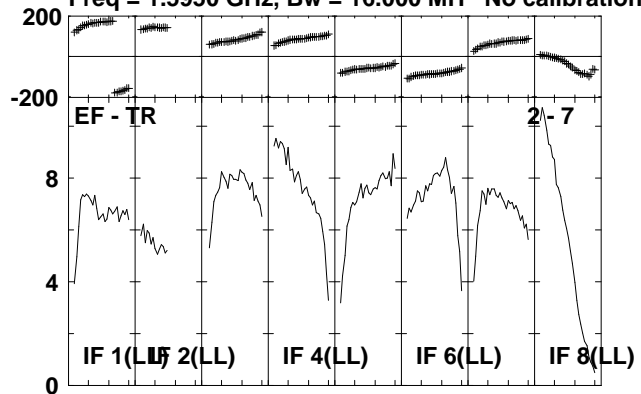

Lower frame: Milli Ampl Jy Top frame: Phas deg
Scalar averaged cross-power spectrum Several baselines displayed
Timerange: 00/16:50:21 to 00/16:52:19

Plot file version 207 created 06-JUL-2010 14:46:05

IRAS2336 EP064J.UVDATA.1

Freq = 1.5950 GHz, Bw = 16.000 MH No calibration applied and no bandpass applied

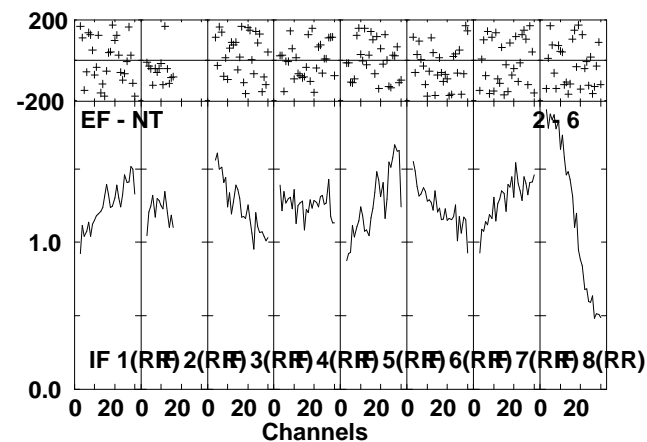
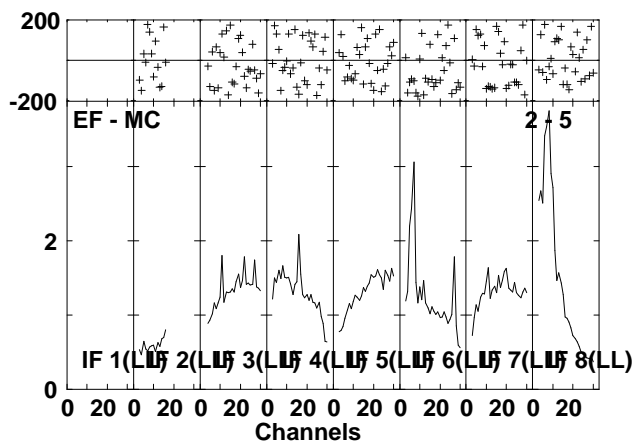
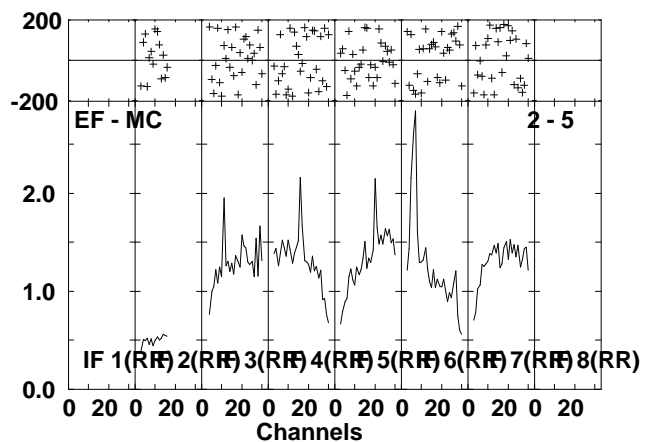
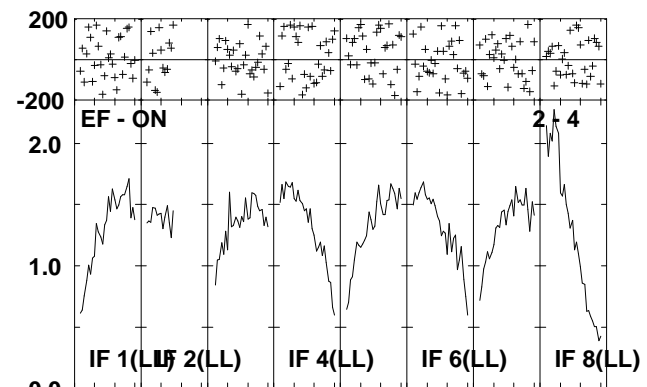
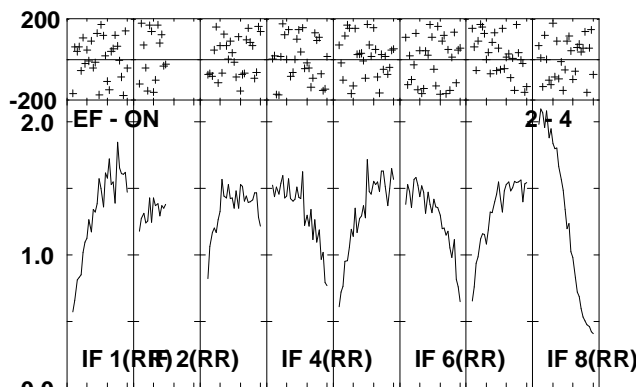
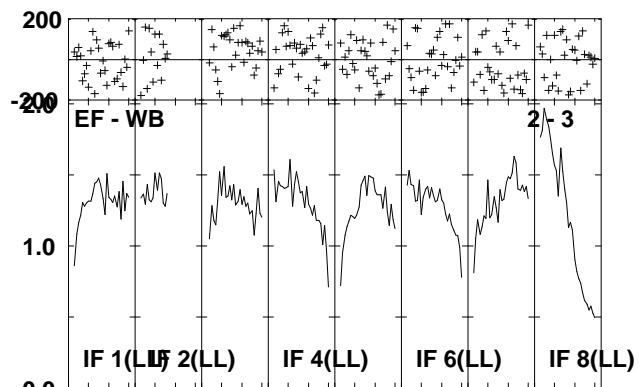
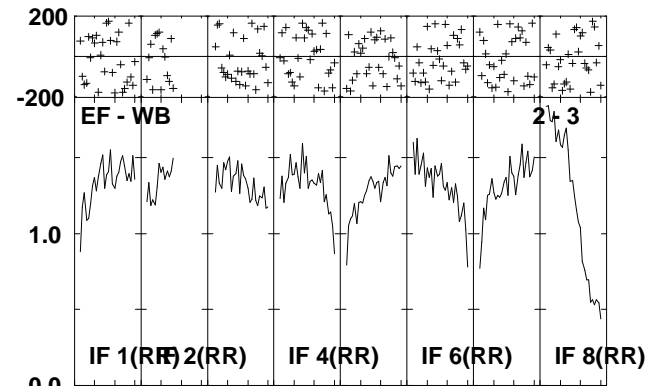
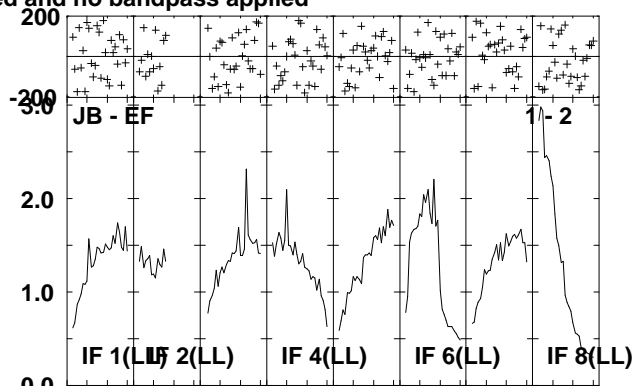
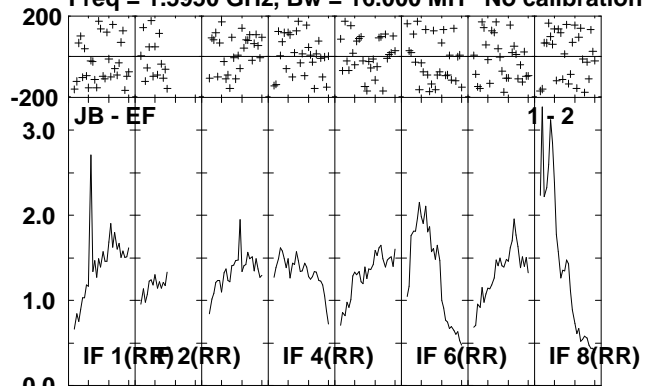

Lower frame: Milli Ampl Jy Top frame: Phas deg
Scalar averaged cross-power spectrum Several baselines displayed
Timerange: 00/16:52:21 to 00/16:56:37

Plot file version 208 created 06-JUL-2010 14:46:07

IRAS2336 EP064J.UVDATA.1

Freq = 1.5950 GHz, Bw = 16.000 MH No calibration applied and no bandpass applied

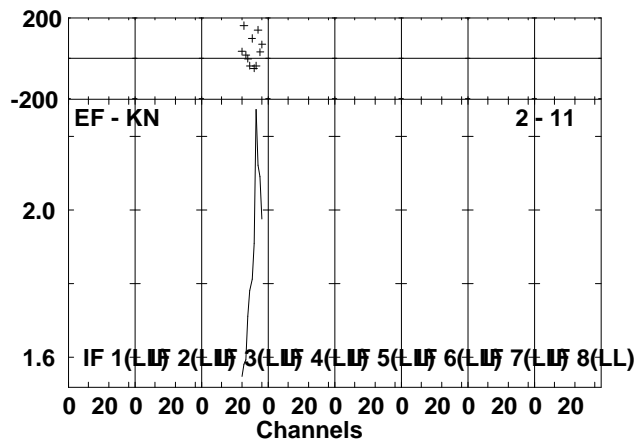
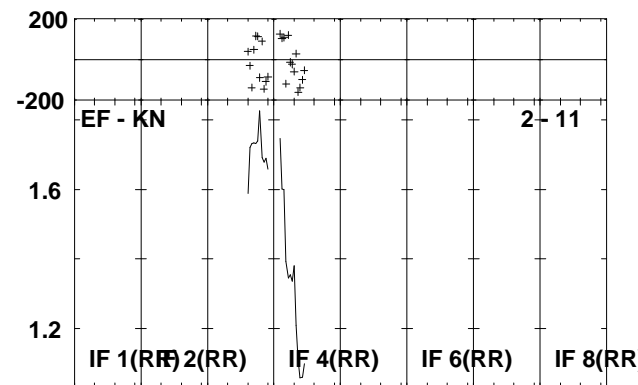
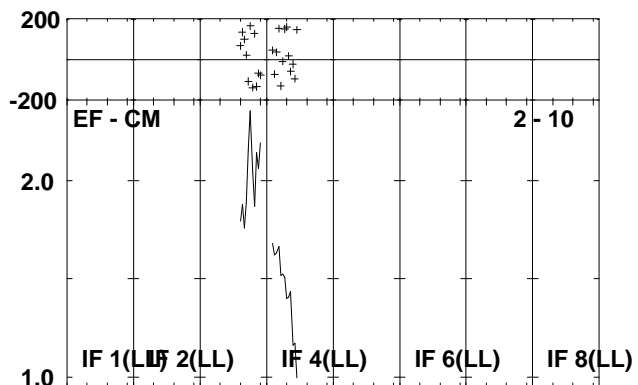
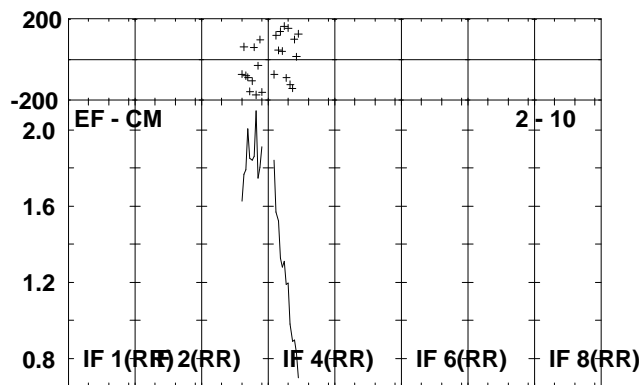
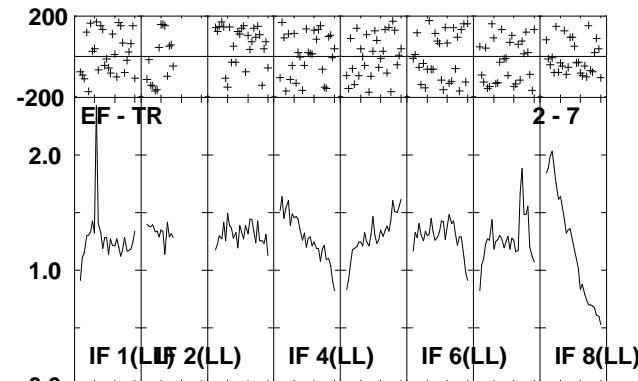
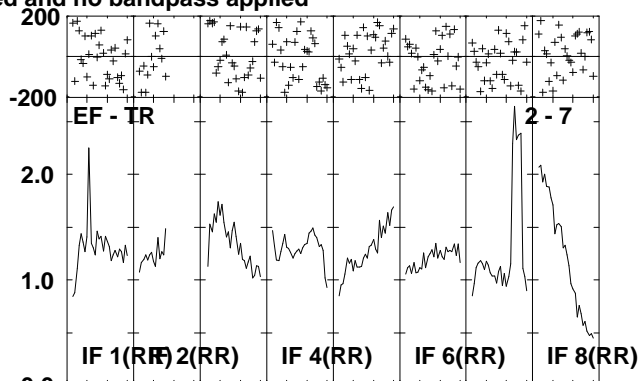
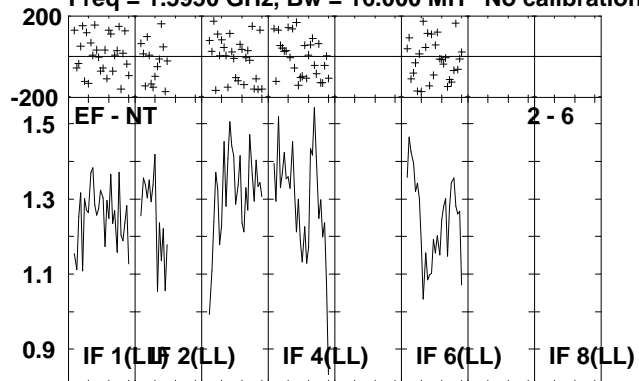

Lower frame: Milli Ampl Jy Top frame: Phas deg
 Scalar averaged cross-power spectrum Several baselines displayed
 Timerange: 00/16:52:21 to 00/16:56:37

Plot file version 209 created 06-JUL-2010 14:46:10

J2330+33 EP064J.UVDATA.1

Freq = 1.5950 GHz, Bw = 16.000 MH No calibration applied and no bandpass applied

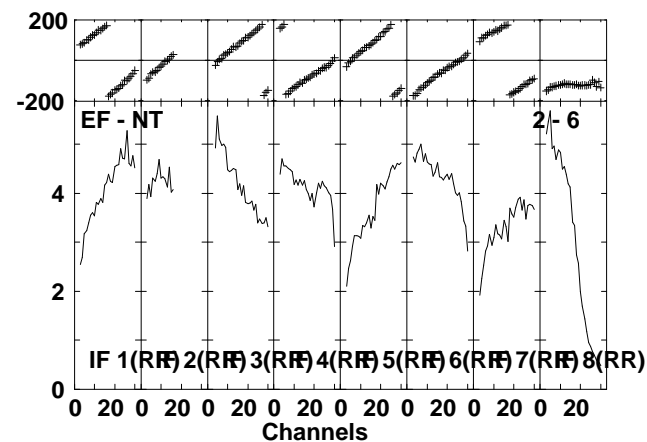
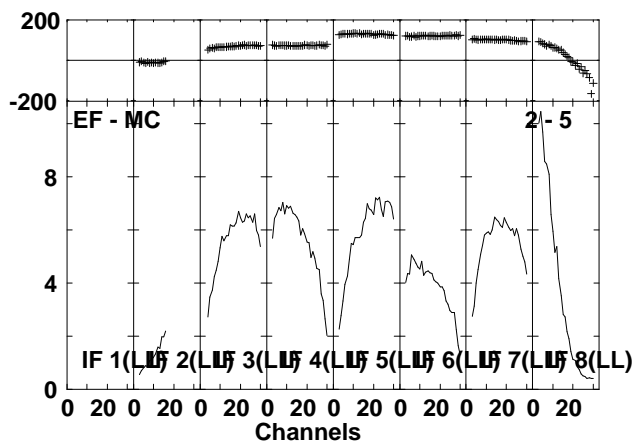
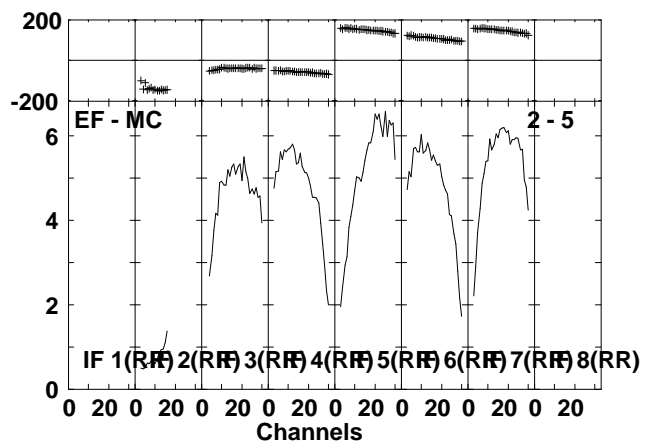
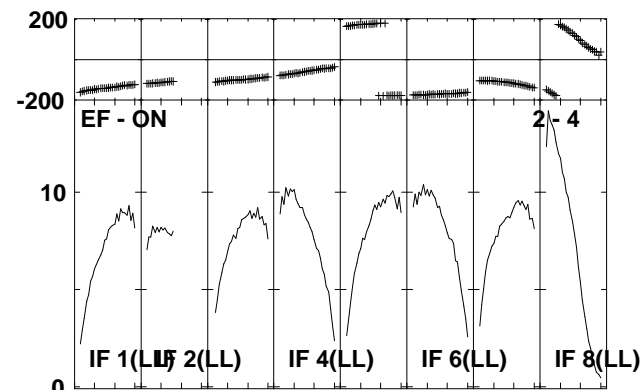
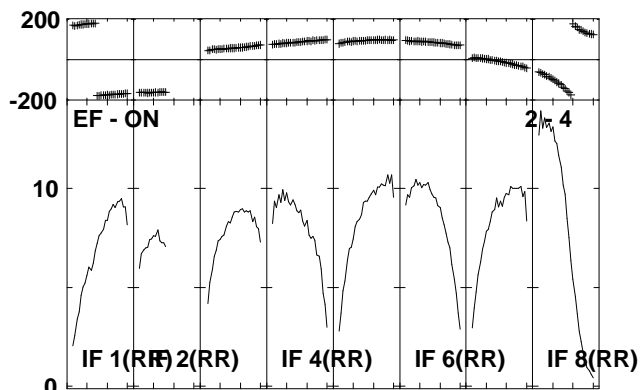
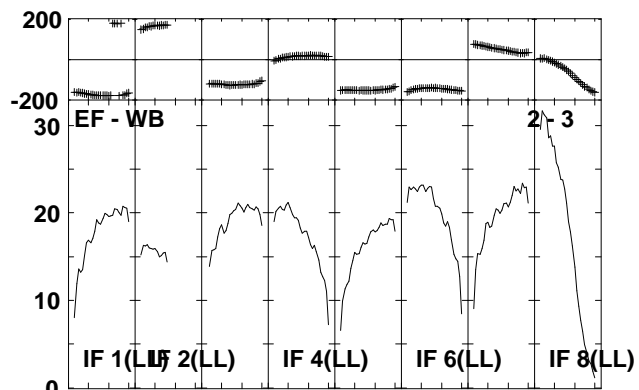
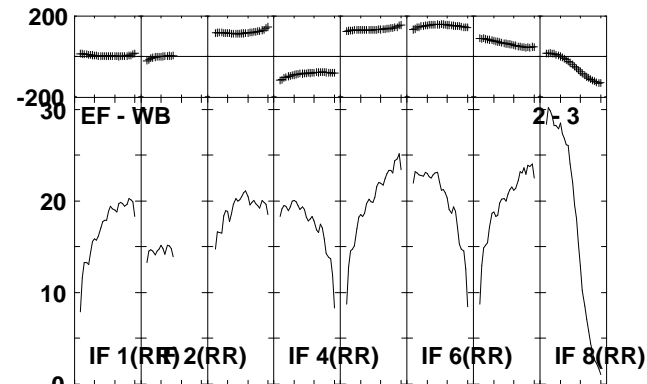
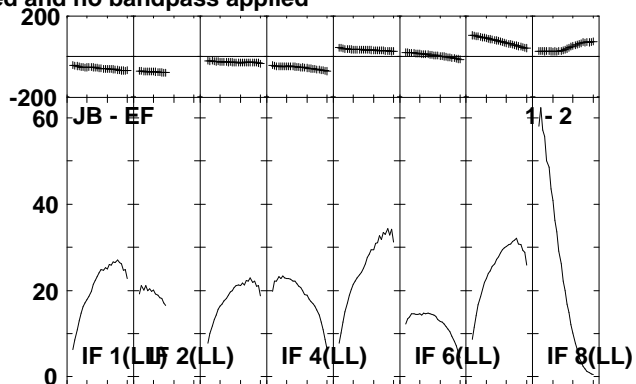
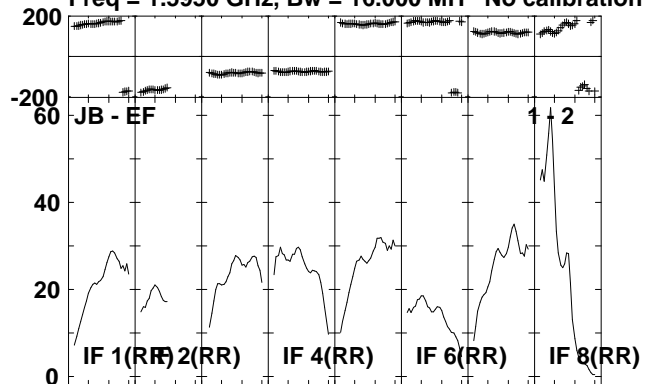

Lower frame: Milli Ampl Jy Top frame: Phas deg
Scalar averaged cross-power spectrum Several baselines displayed
Timerange: 00/16:57:51 to 00/16:59:39

Plot file version 210 created 06-JUL-2010 14:46:11

J2330+33 EP064J.UVDATA.1

Freq = 1.5950 GHz, Bw = 16.000 MH No calibration applied and no bandpass applied

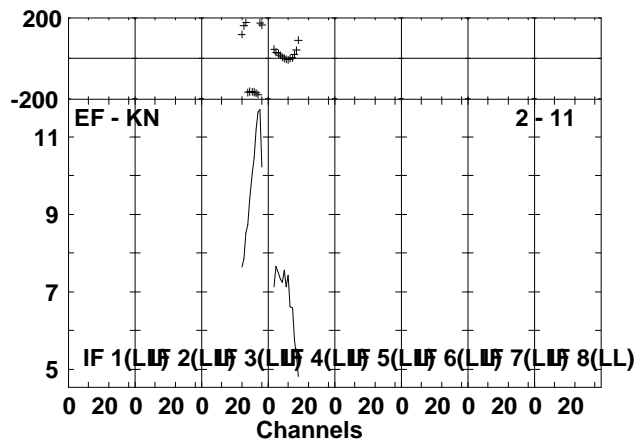
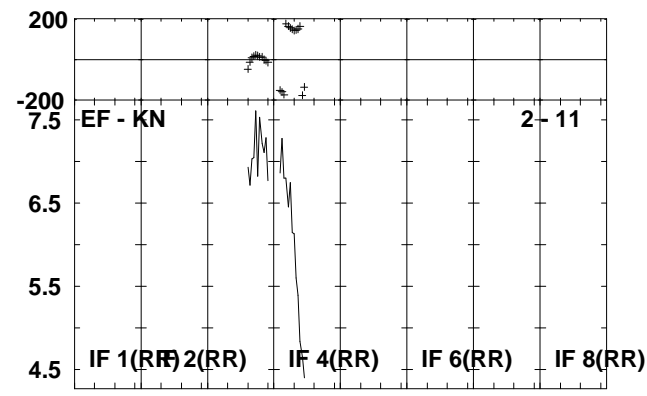
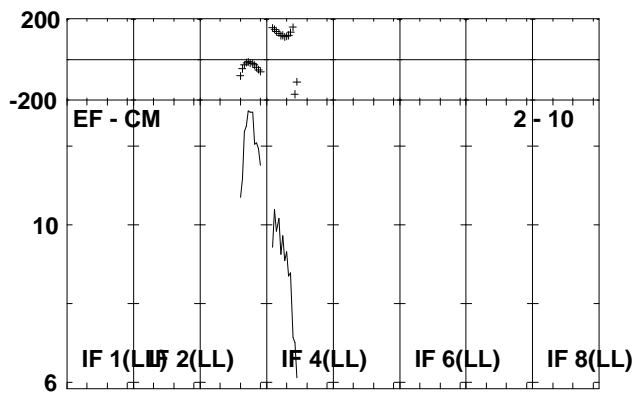
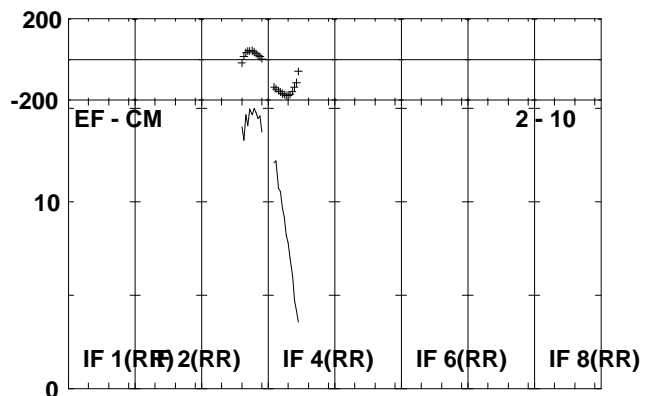
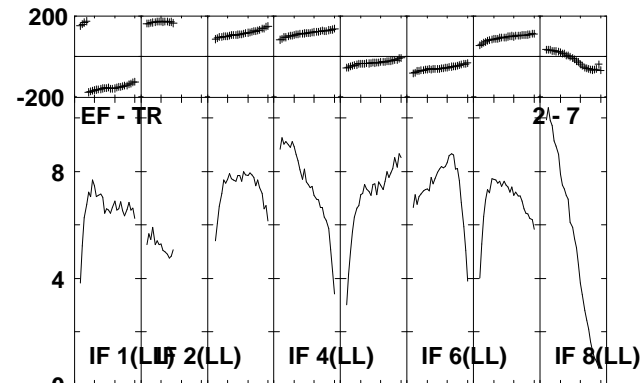
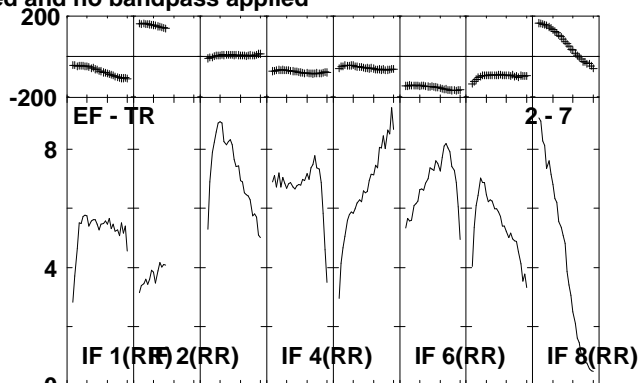
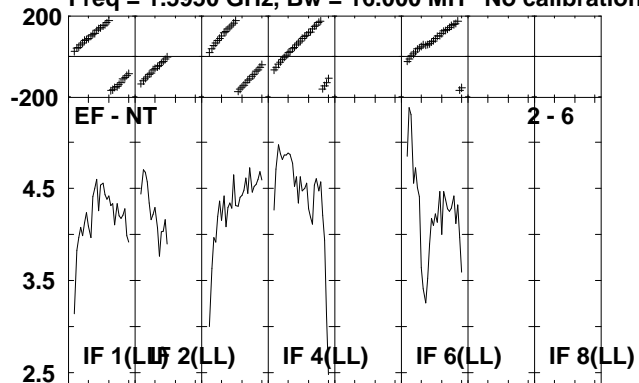

Lower frame: Milli Ampl Jy Top frame: Phas deg
Scalar averaged cross-power spectrum Several baselines displayed
Timerange: 00/16:57:51 to 00/16:59:39

Plot file version 211 created 06-JUL-2010 14:46:12

IRAS2336 EP064J.UVDATA.1

Freq = 1.5950 GHz, Bw = 16.000 MH No calibration applied and no bandpass applied

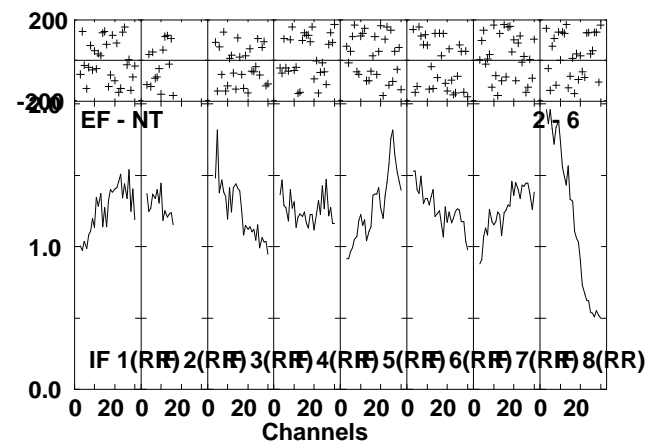
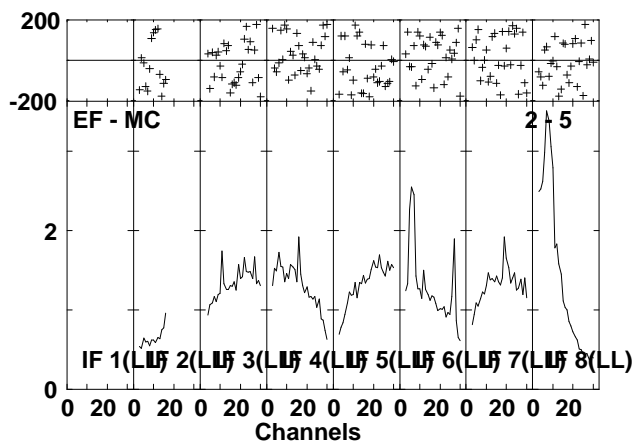
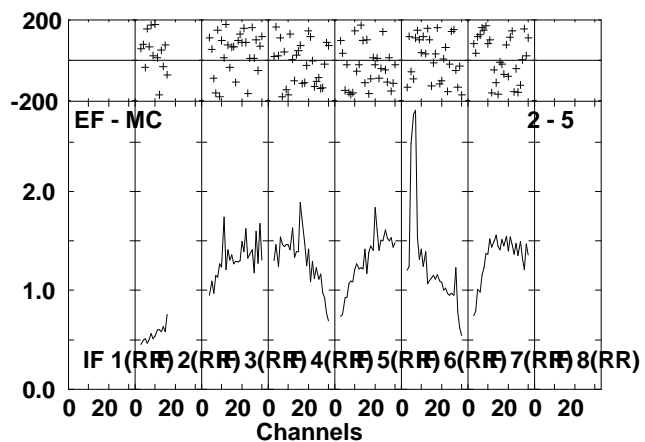
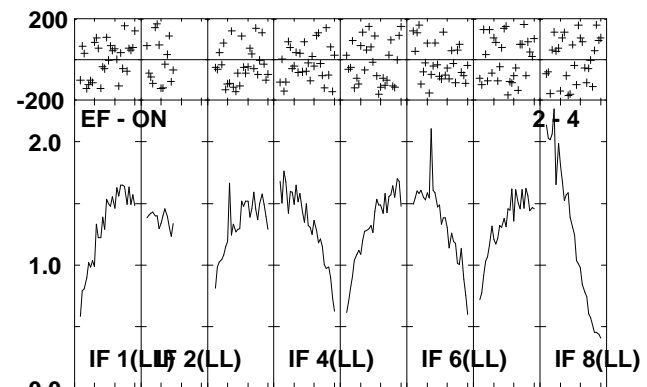
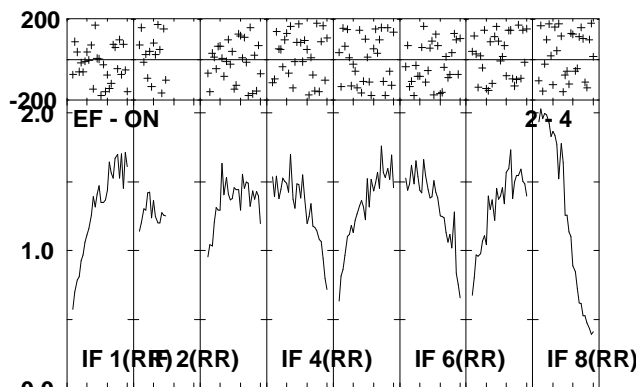
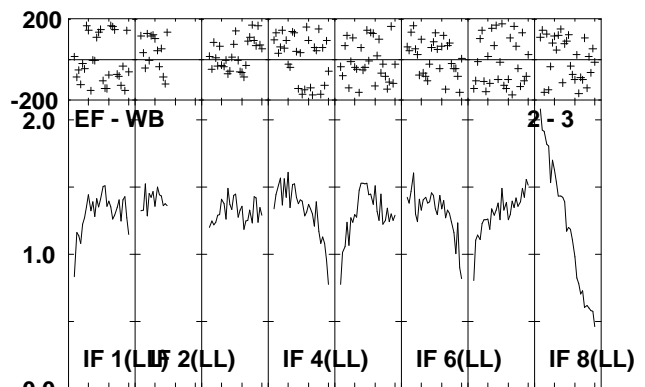
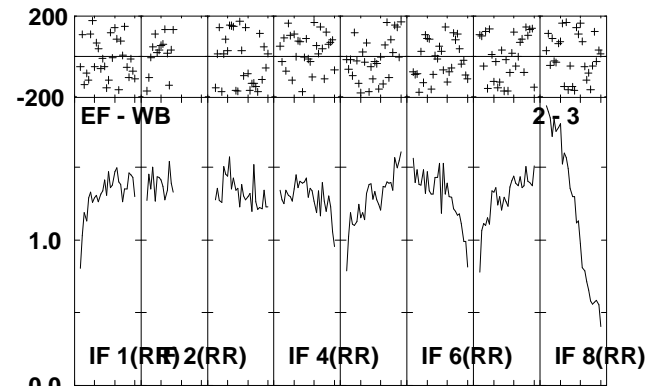
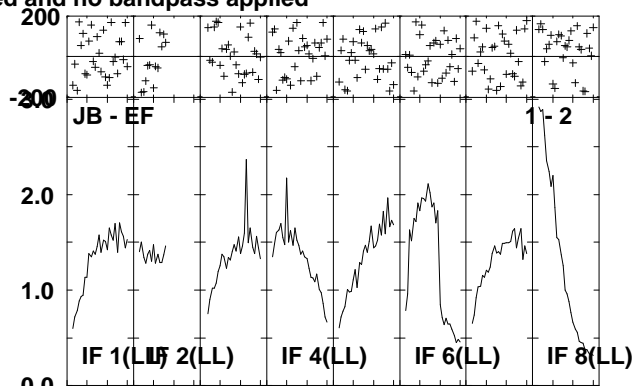
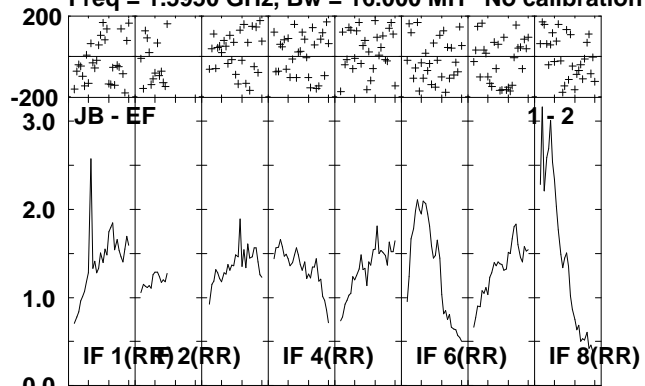

Lower frame: Milli Ampl Jy Top frame: Phas deg
Scalar averaged cross-power spectrum Several baselines displayed
Timerange: 00/16:59:41 to 00/17:03:59

Plot file version 212 created 06-JUL-2010 14:46:14

IRAS2336 EP064J.UVDATA.1

Freq = 1.5950 GHz, Bw = 16.000 MH No calibration applied and no bandpass applied

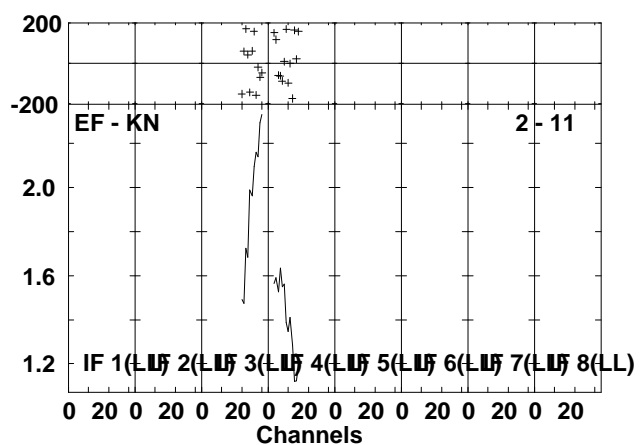
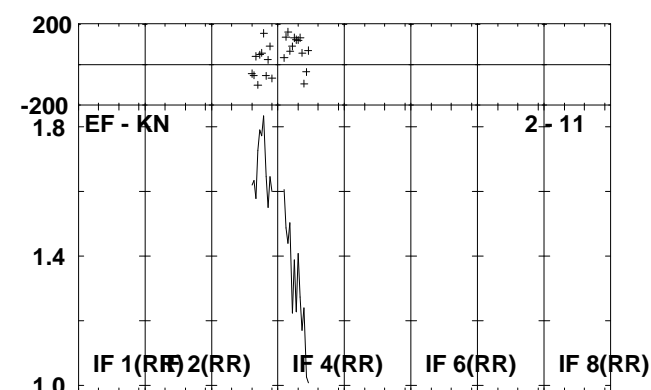
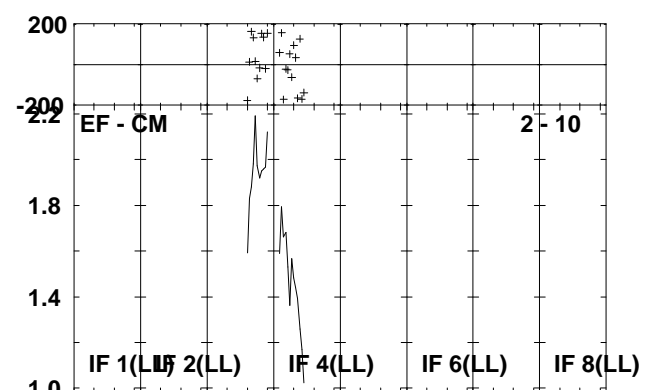
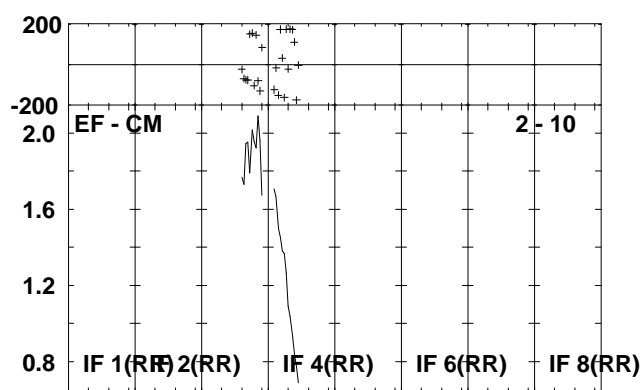
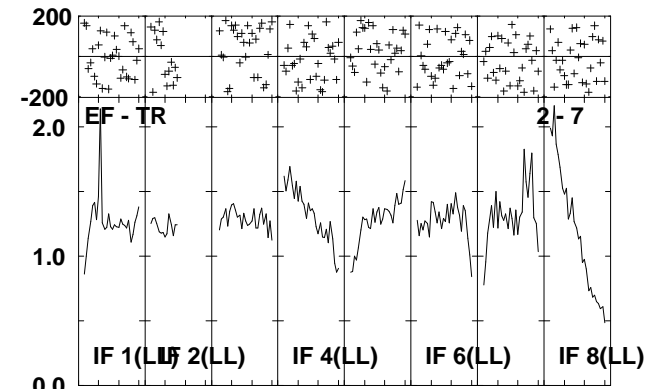
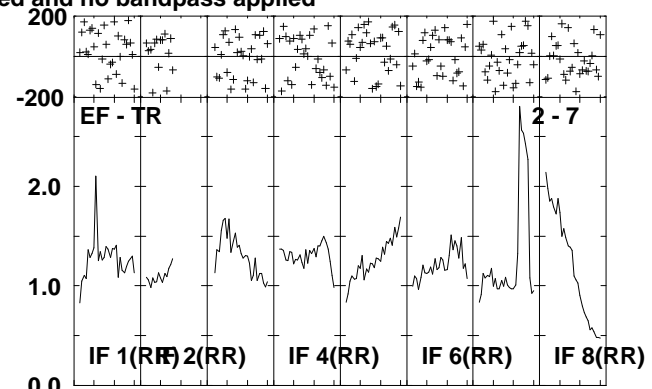
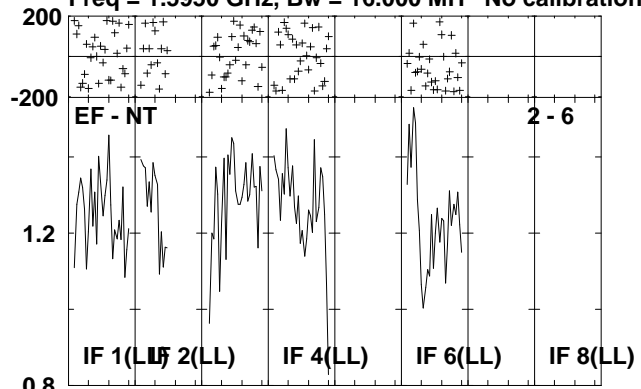

Lower frame: Milli Ampl Jy Top frame: Phas deg
Scalar averaged cross-power spectrum Several baselines displayed
Timerange: 00/16:59:41 to 00/17:03:59

Plot file version 213 created 06-JUL-2010 14:46:17

J2330+33 EP064J.UVDATA.1

Freq = 1.5950 GHz, Bw = 16.000 MH No calibration applied and no bandpass applied

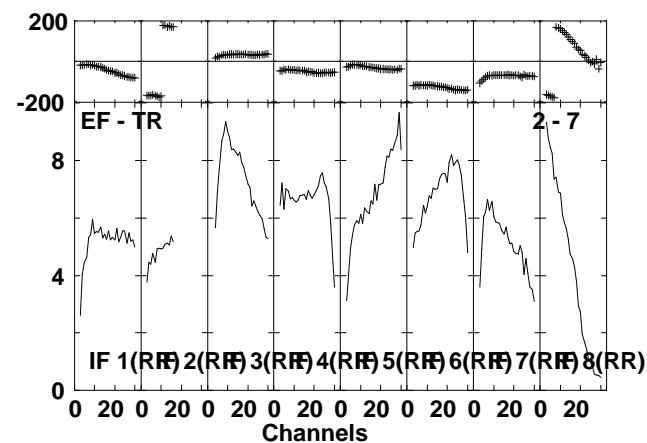
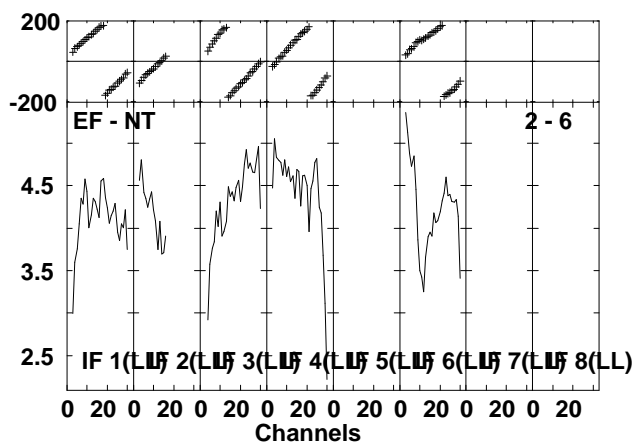
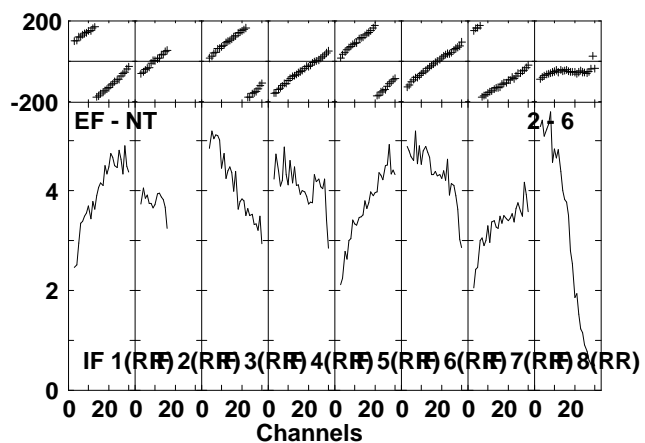
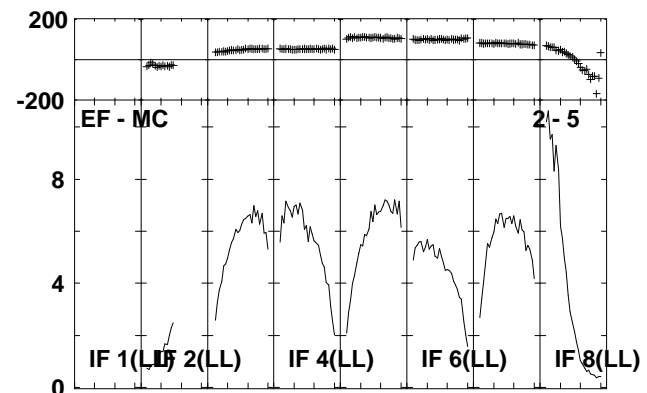
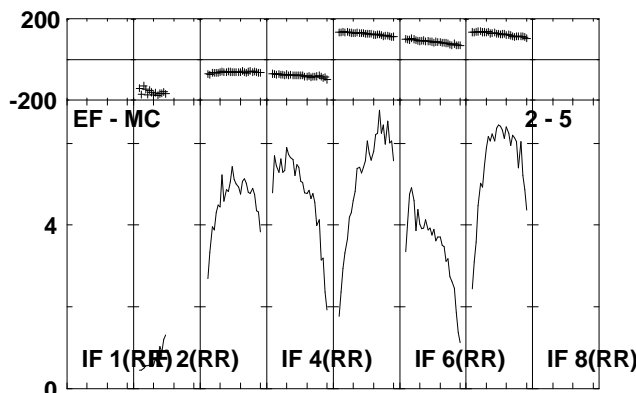
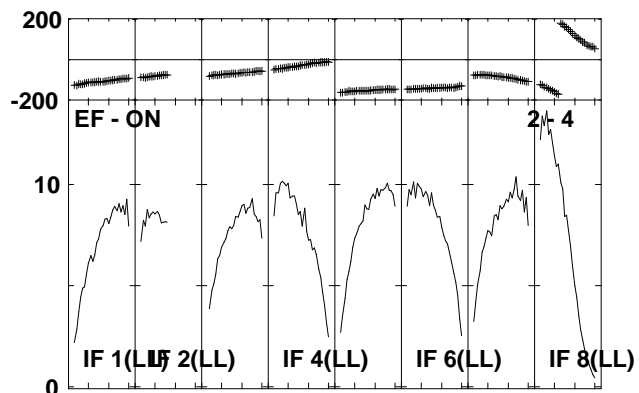
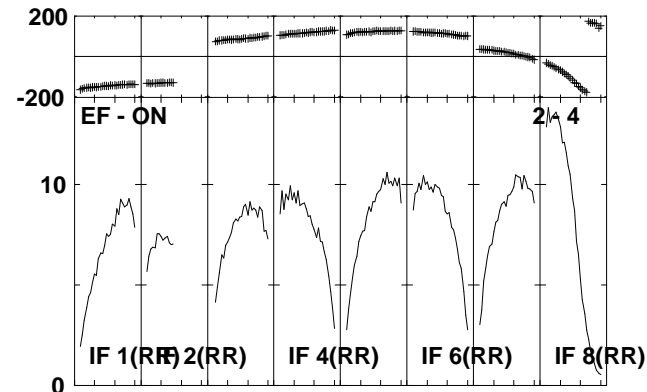
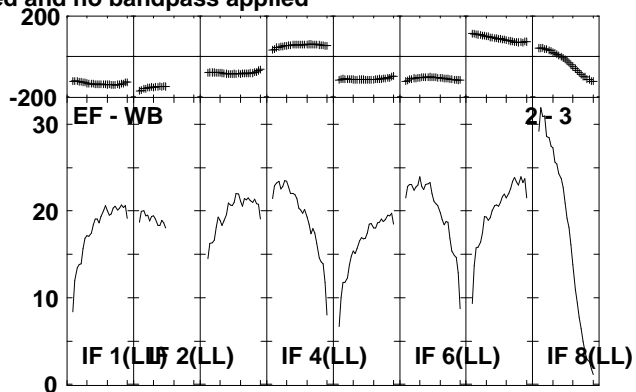
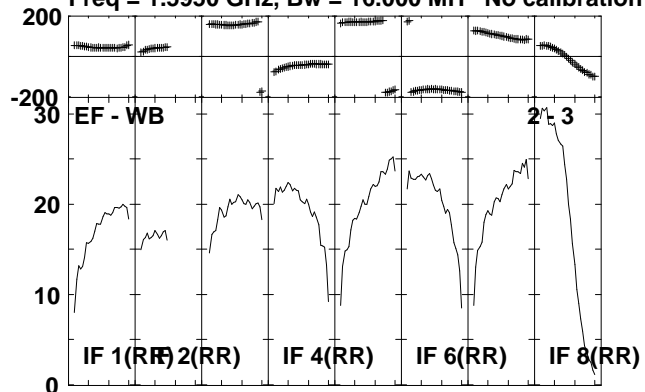

Lower frame: Milli Ampl Jy Top frame: Phas deg
Scalar averaged cross-power spectrum Several baselines displayed
Timerange: 00/17:04:01 to 00/17:05:59

Plot file version 214 created 06-JUL-2010 14:46:18

J2330+33 EP064J.UVDATA.1

Freq = 1.5950 GHz, Bw = 16.000 MH No calibration applied and no bandpass applied

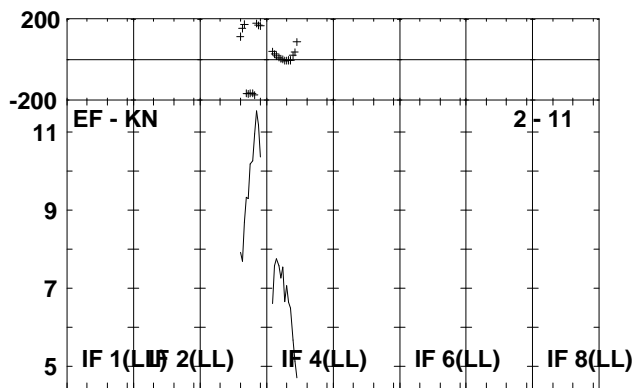
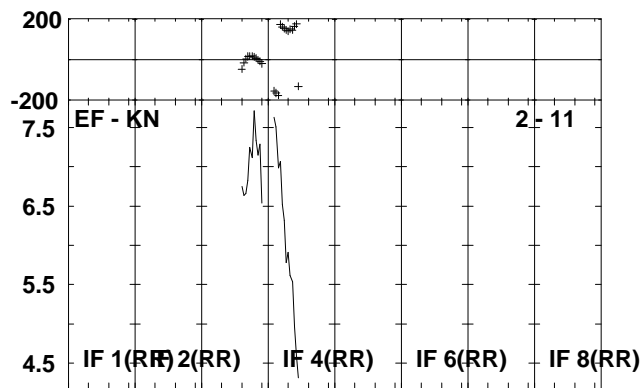
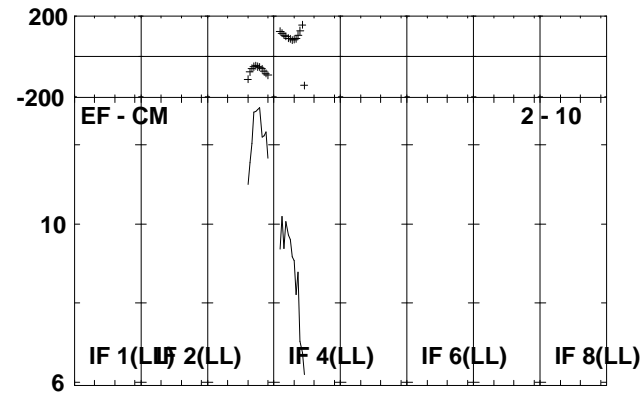
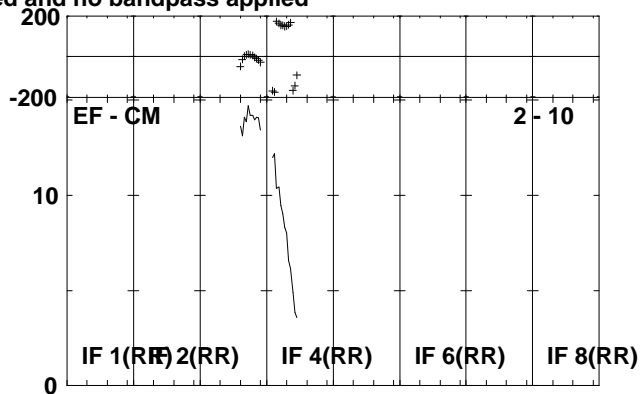
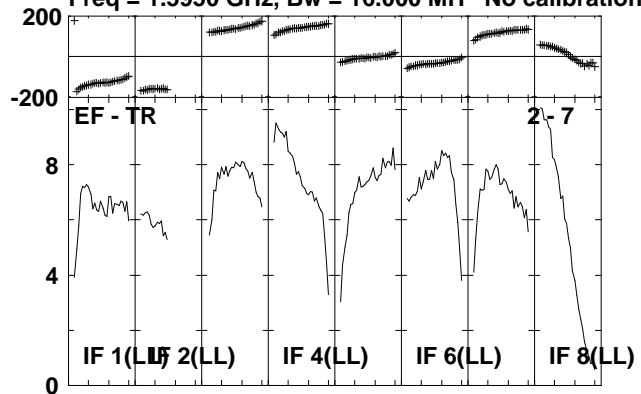

Lower frame: Milli Ampl Jy Top frame: Phas deg
Scalar averaged cross-power spectrum Several baselines displayed
Timerange: 00/17:04:01 to 00/17:05:59

Plot file version 215 created 06-JUL-2010 14:46:19

IRAS2336 EP064J.UVDATA.1

Freq = 1.5950 GHz, Bw = 16.000 MH No calibration applied and no bandpass applied

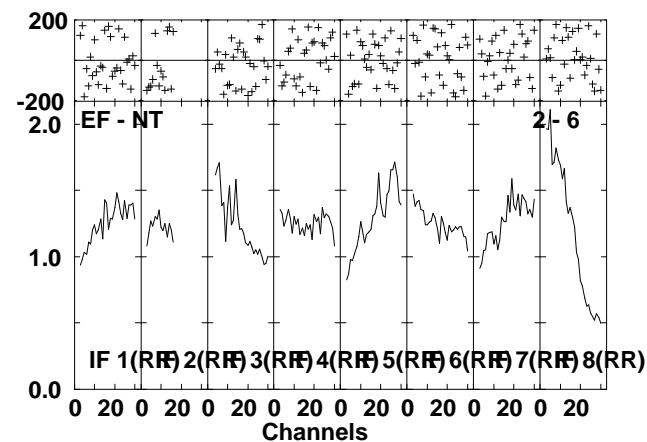
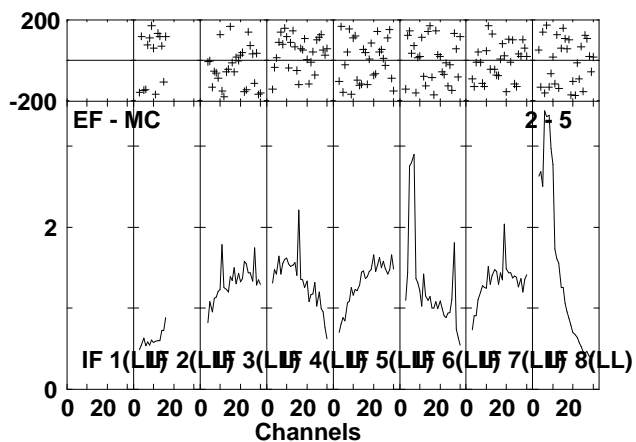
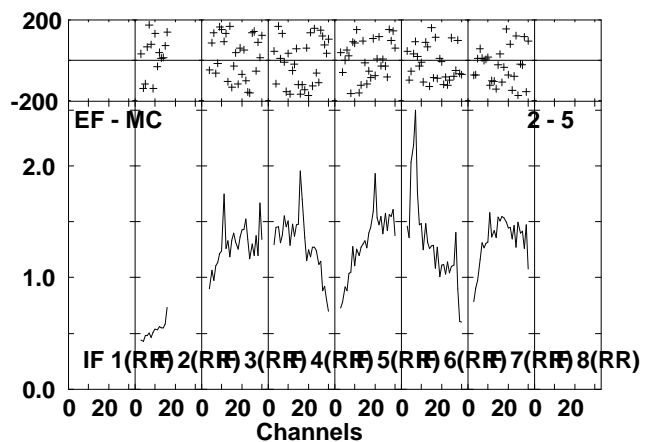
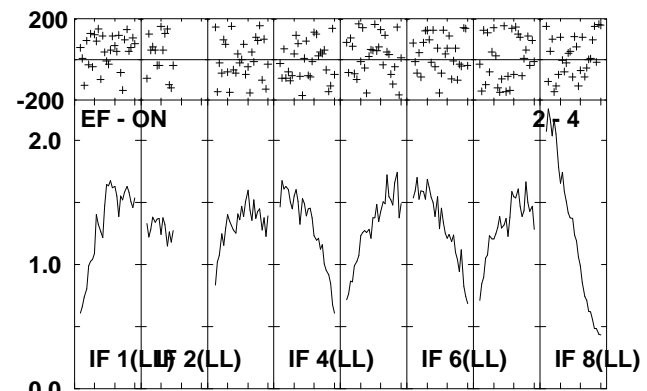
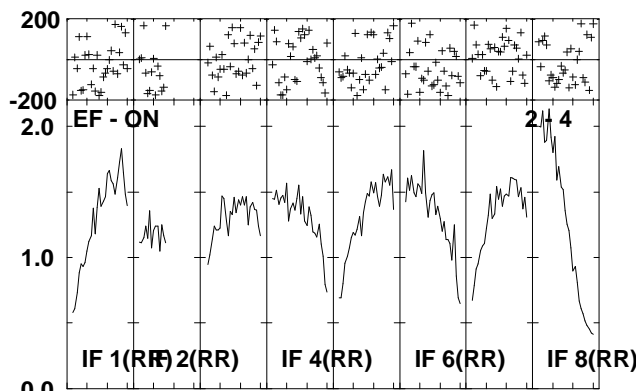
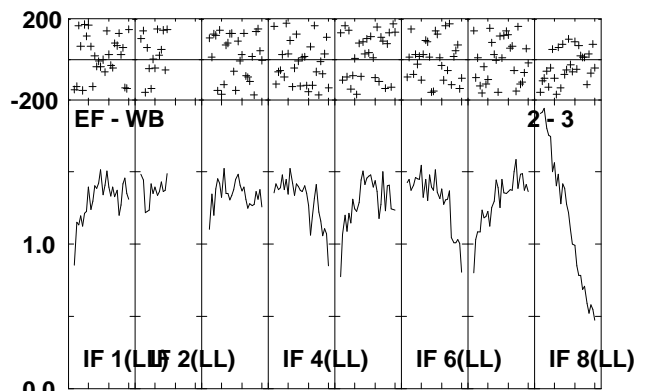
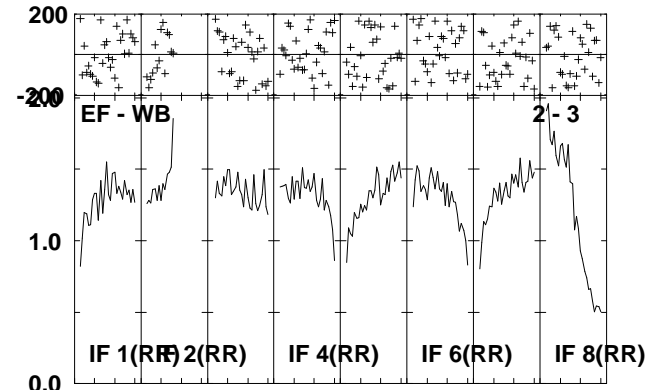
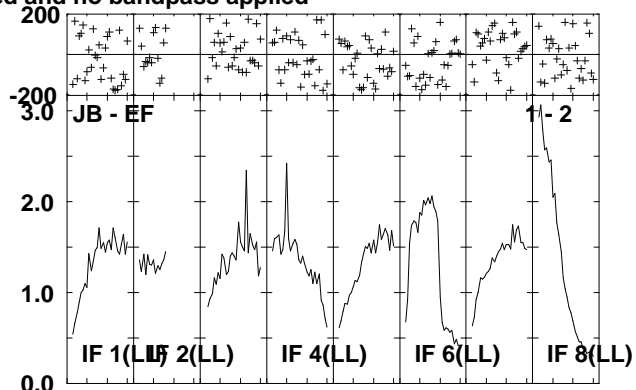
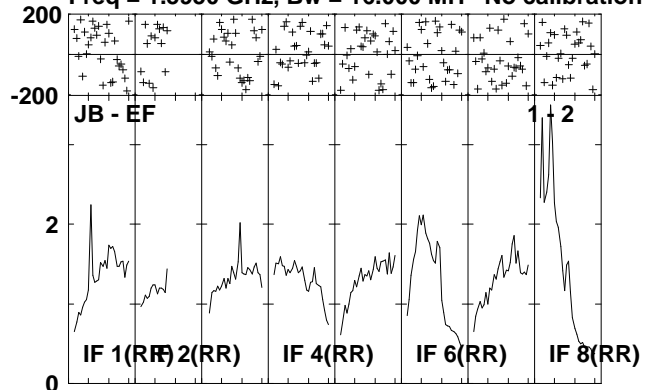

Lower frame: Milli Ampl Jy Top frame: Phas deg
Scalar averaged cross-power spectrum Several baselines displayed
Timerange: 00/17:06:01 to 00/17:10:17

Plot file version 216 created 06-JUL-2010 14:46:21

IRAS2336 EP064J.UVDATA.1

Freq = 1.5950 GHz, Bw = 16.000 MH No calibration applied and no bandpass applied

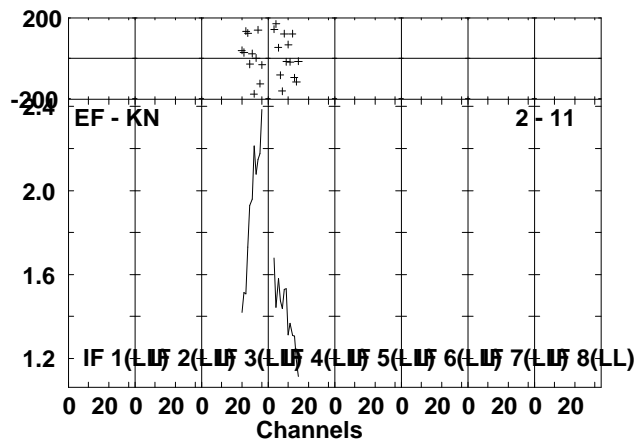
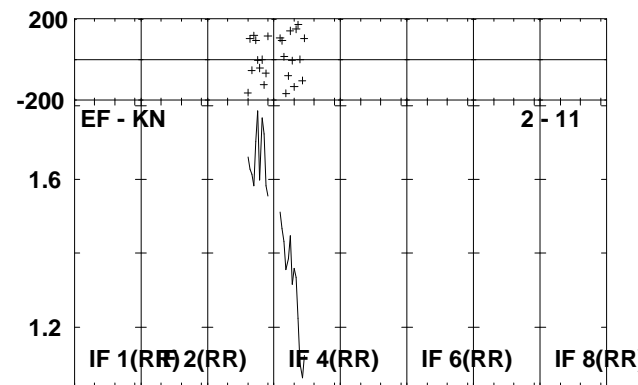
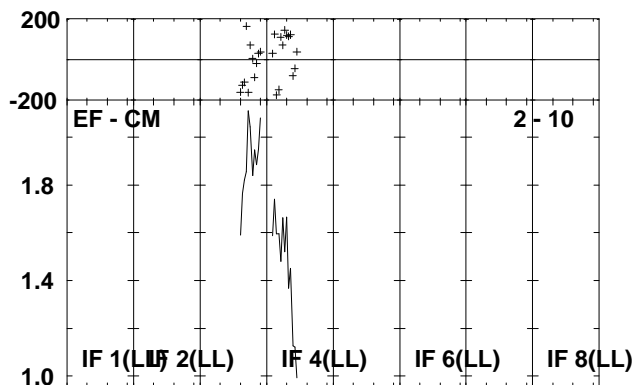
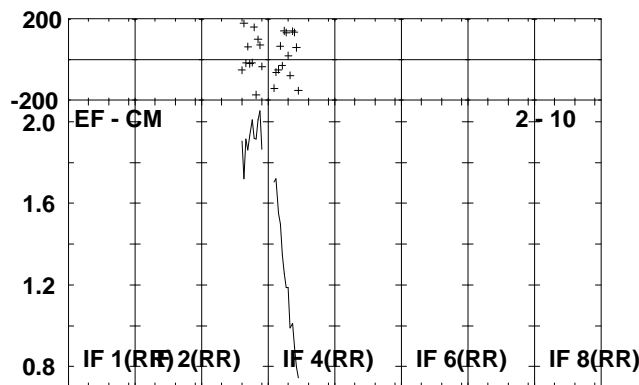
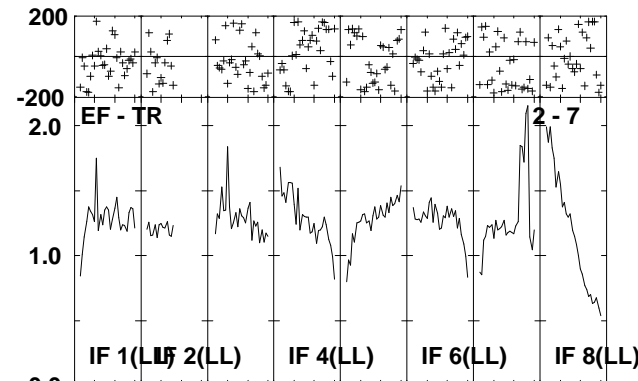
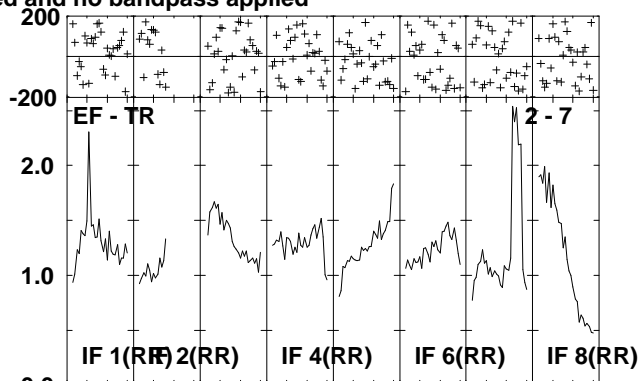
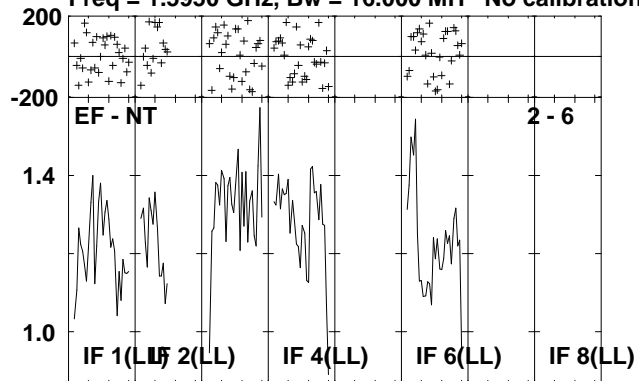

Lower frame: Milli Ampl Jy Top frame: Phas deg
Scalar averaged cross-power spectrum Several baselines displayed
Timerange: 00/17:06:01 to 00/17:10:17

Plot file version 217 created 06-JUL-2010 14:46:23

J2330+33 EP064J.UVDATA.1

Freq = 1.5950 GHz, Bw = 16.000 MH No calibration applied and no bandpass applied

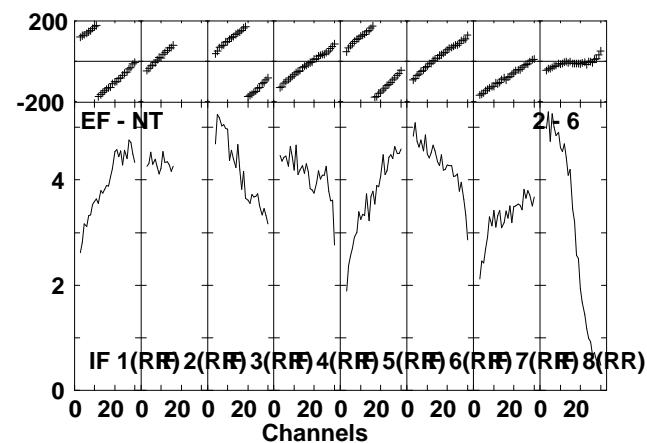
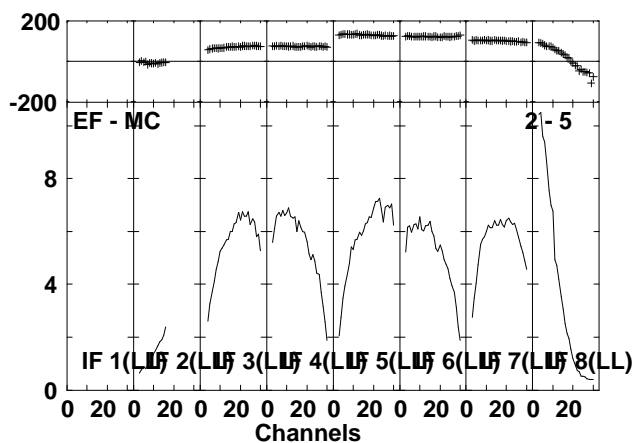
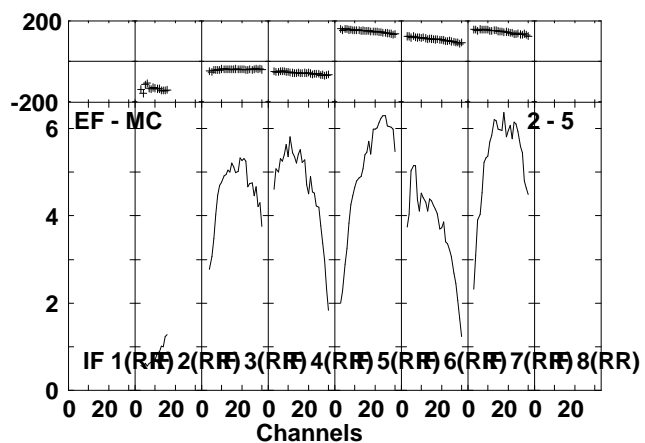
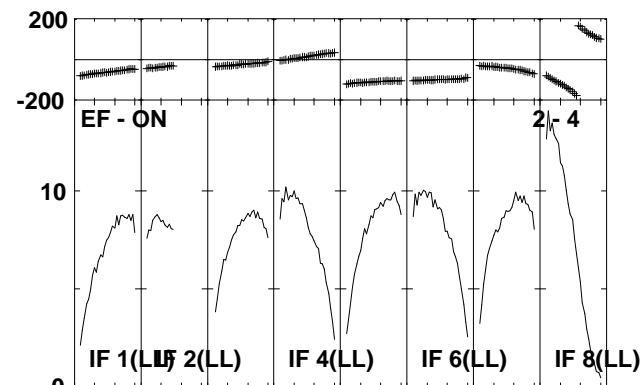
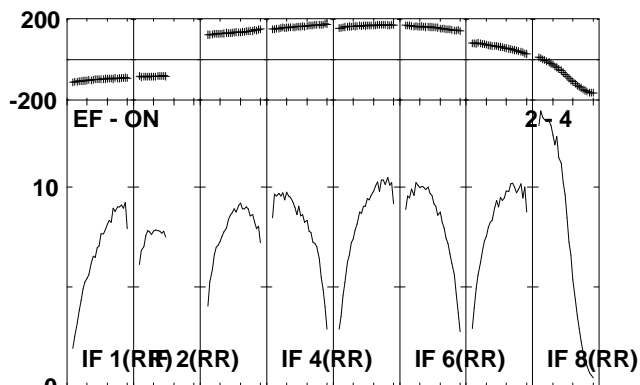
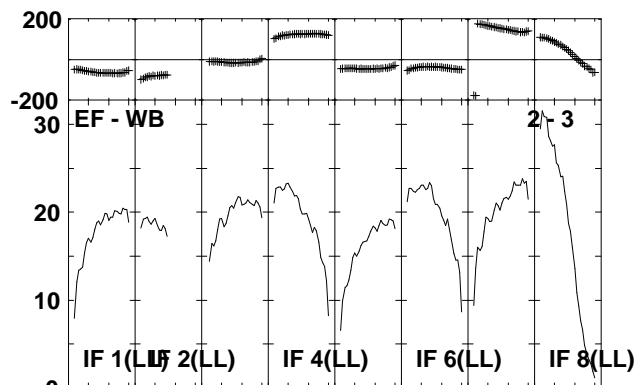
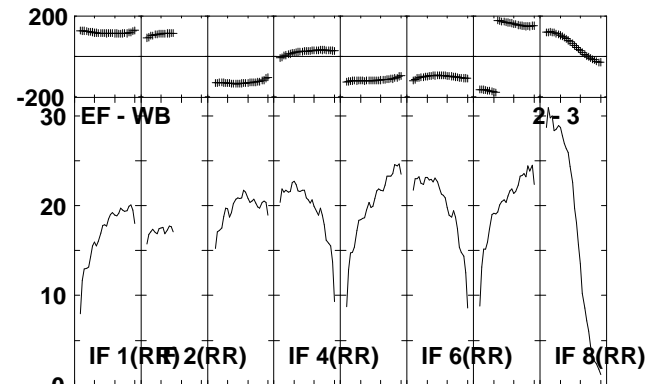
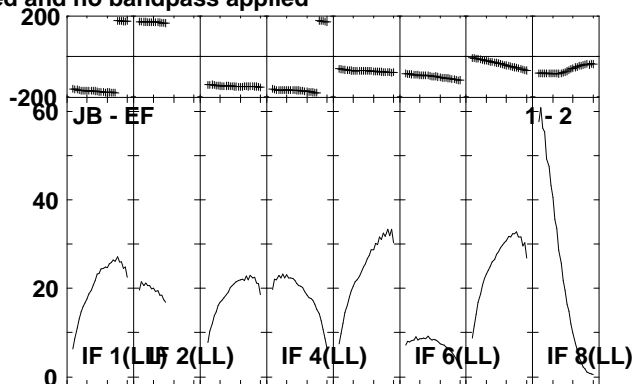
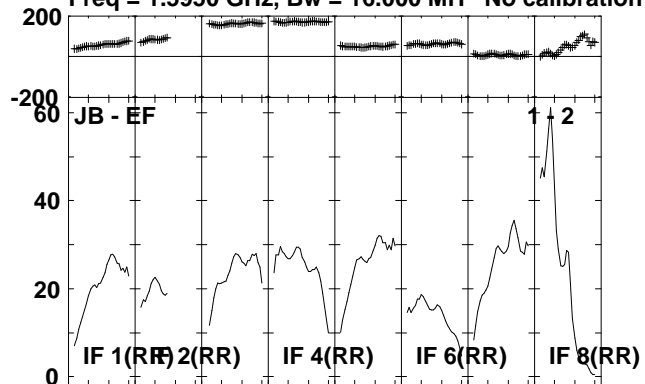

Lower frame: Milli Ampl Jy Top frame: Phas deg
Scalar averaged cross-power spectrum Several baselines displayed
Timerange: 00/17:11:33 to 00/17:13:19

Plot file version 219 created 06-JUL-2010 14:46:26

IRAS2336 EP064J.UVDATA.1

Freq = 1.5950 GHz, Bw = 16.000 MH No calibration applied and no bandpass applied

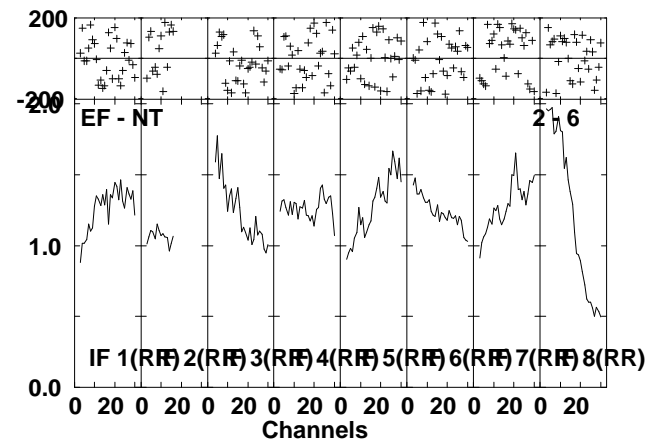
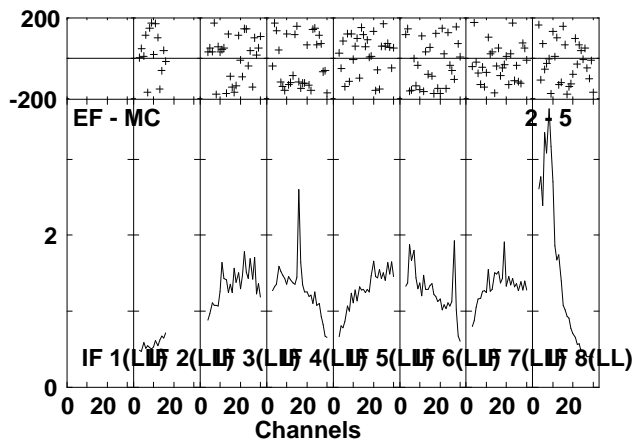
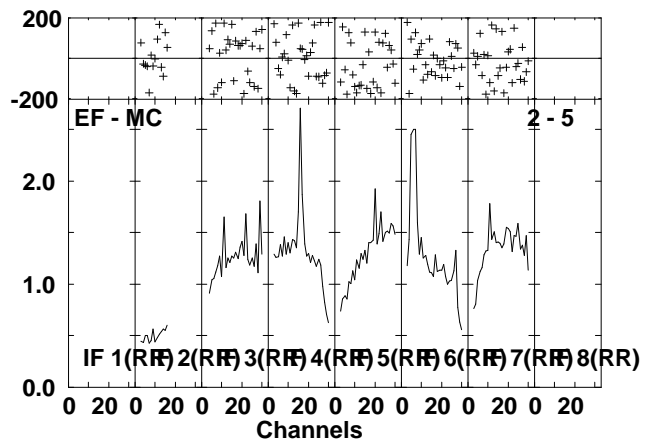
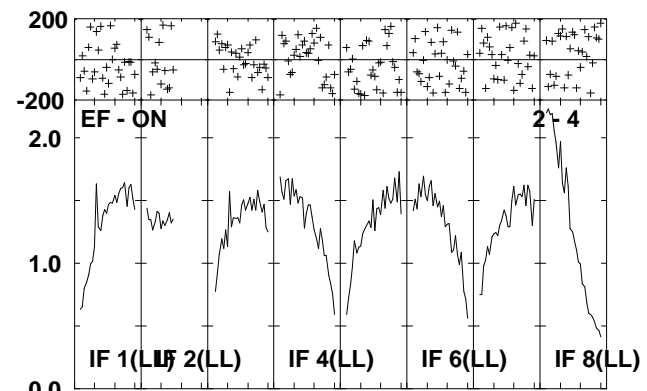
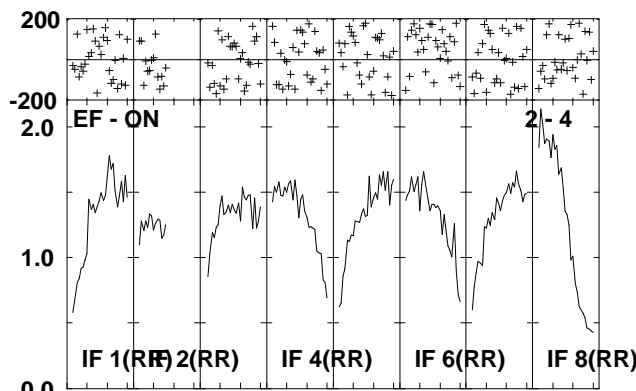
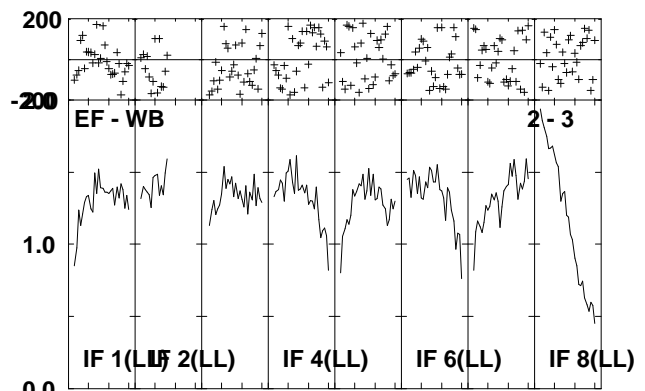
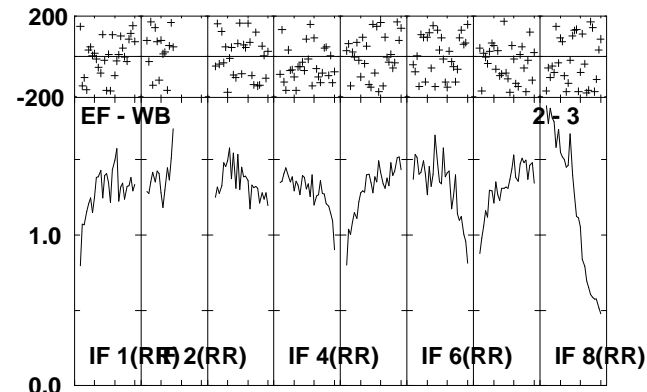
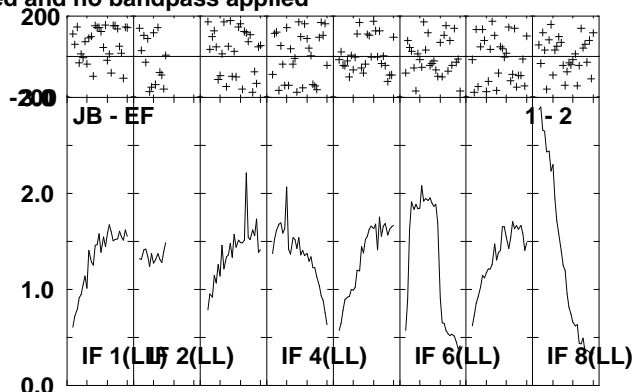
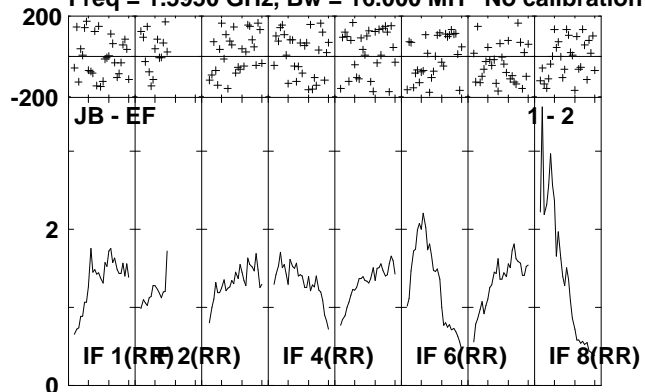

Lower frame: Milli Ampl Jy Top frame: Phas deg
Scalar averaged cross-power spectrum Several baselines displayed
Timerange: 00/17:13:21 to 00/17:17:39

Plot file version 220 created 06-JUL-2010 14:46:27

IRAS2336 EP064J.UVDATA.1

Freq = 1.5950 GHz, Bw = 16.000 MH No calibration applied and no bandpass applied

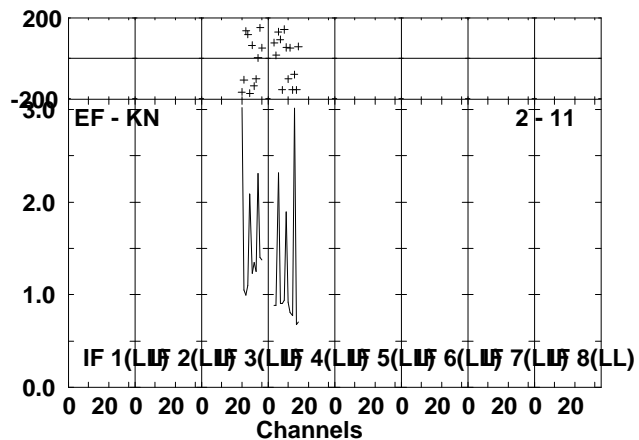
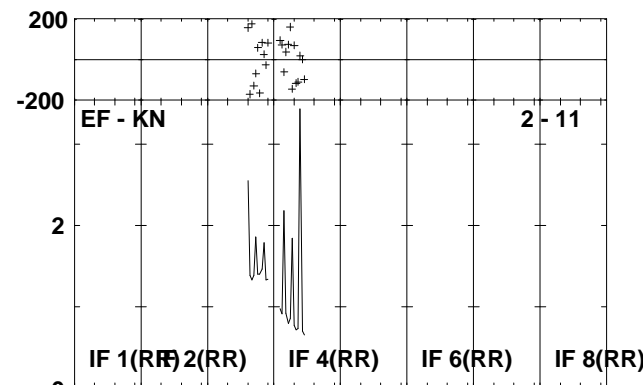
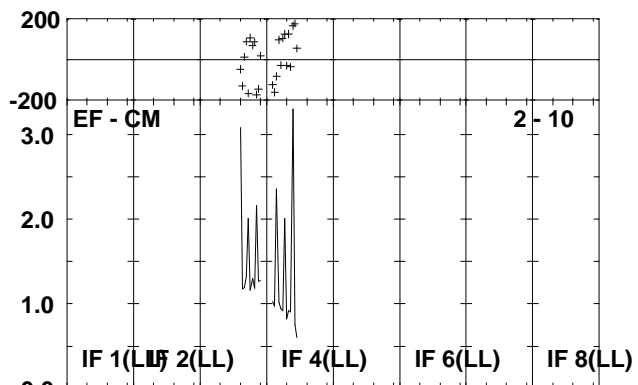
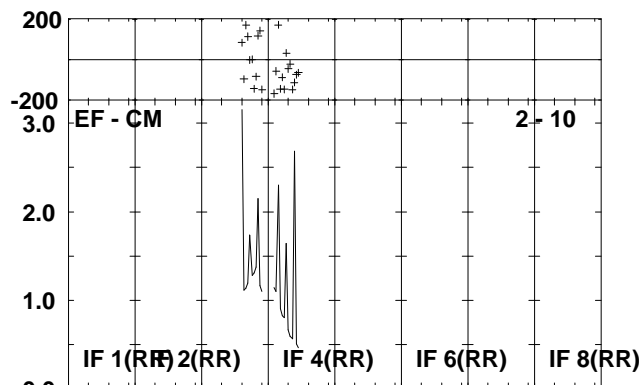
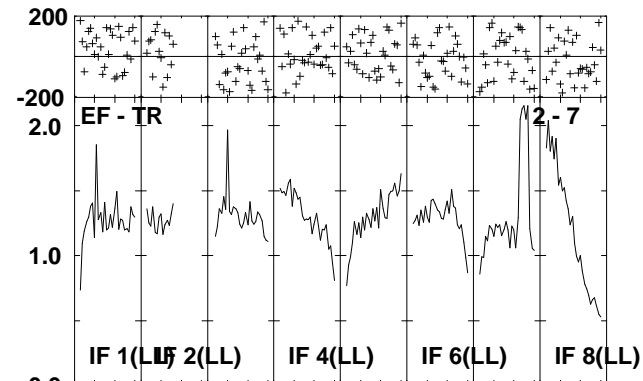
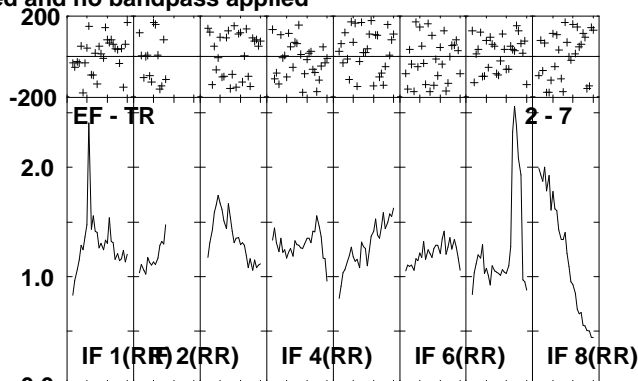
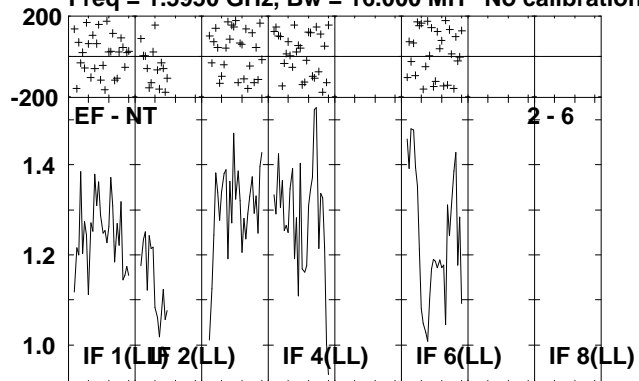

Lower frame: Milli Ampl Jy Top frame: Phas deg
Scalar averaged cross-power spectrum Several baselines displayed
Timerange: 00/17:13:21 to 00/17:17:39

Plot file version 221 created 06-JUL-2010 14:46:30

J2330+33 EP064J.UVDATA.1

Freq = 1.5950 GHz, Bw = 16.000 MH No calibration applied and no bandpass applied

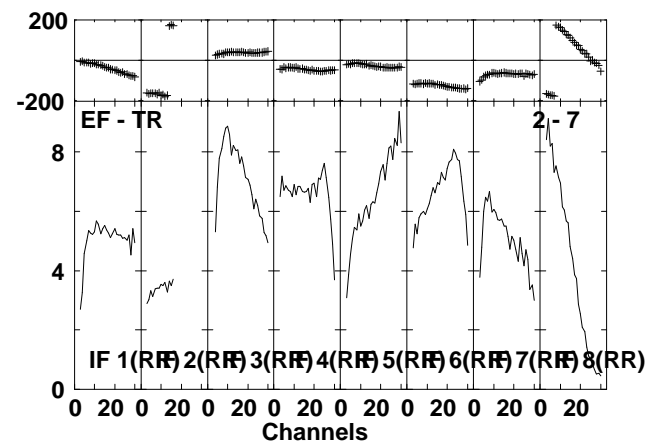
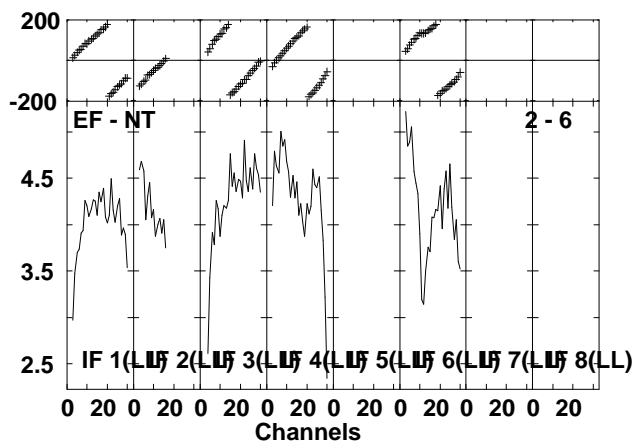
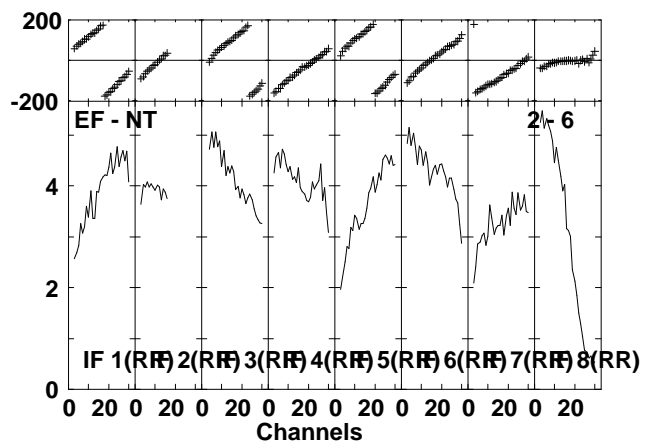
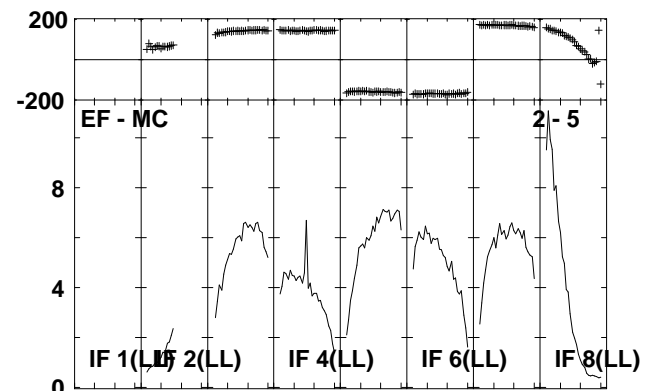
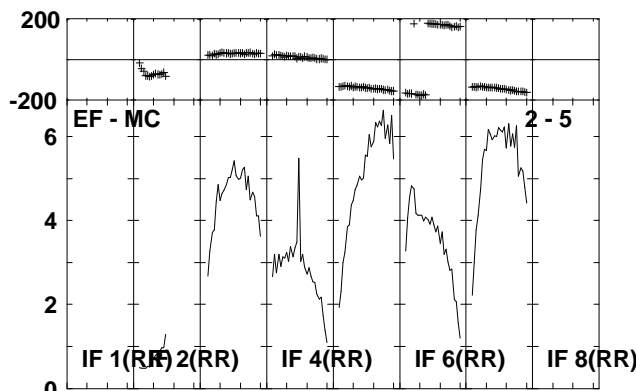
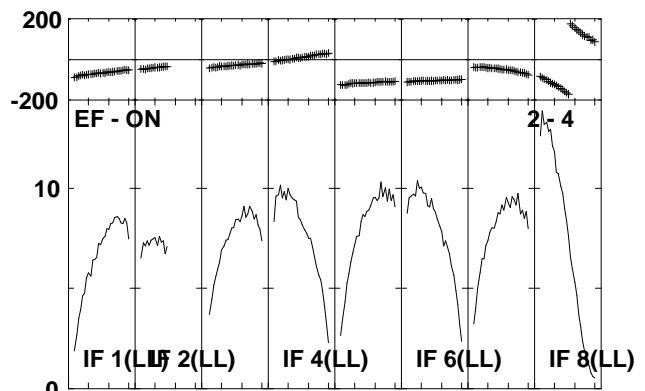
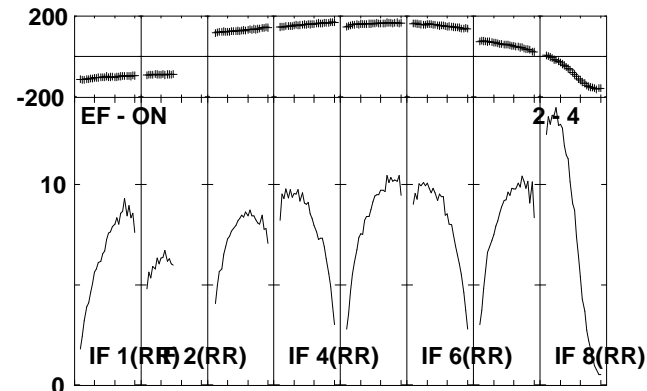
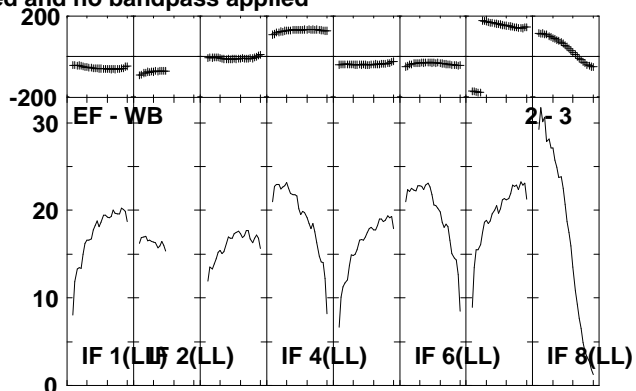
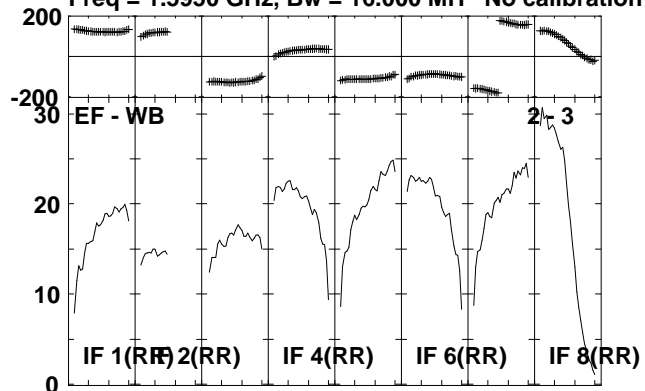

Lower frame: Milli Ampl Jy Top frame: Phas deg
Scalar averaged cross-power spectrum Several baselines displayed
Timerange: 00/17:17:41 to 00/17:19:39

Plot file version 222 created 06-JUL-2010 14:46:31

J2330+33 EP064J.UVDATA.1

Freq = 1.5950 GHz, Bw = 16.000 MH No calibration applied and no bandpass applied

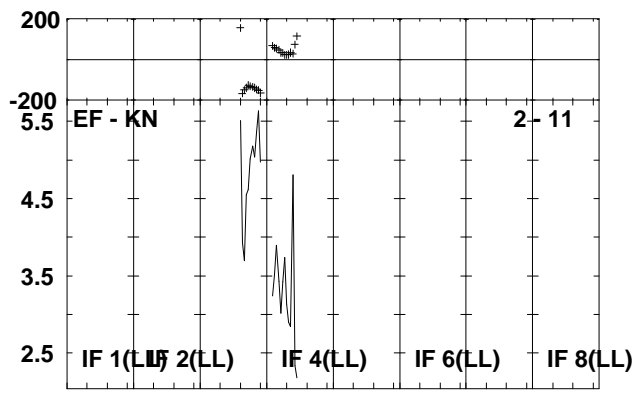
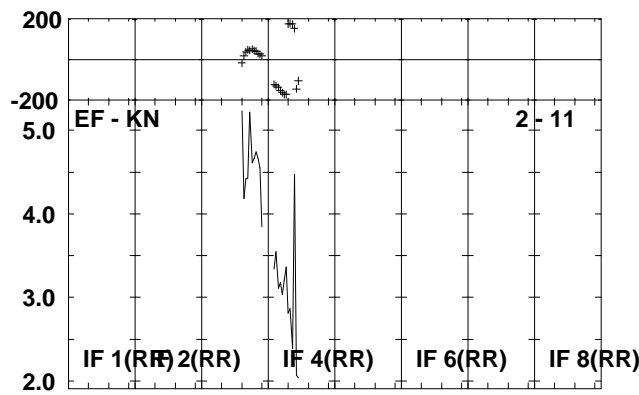
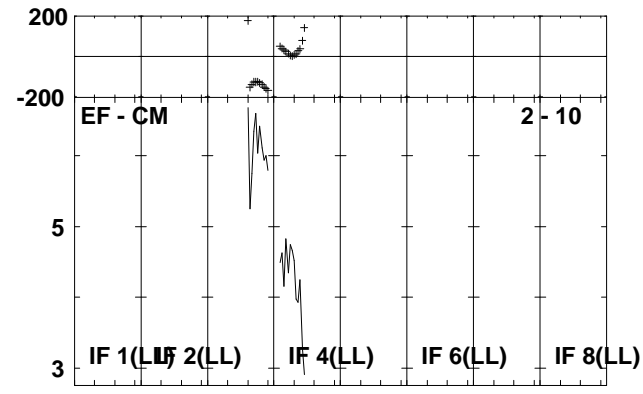
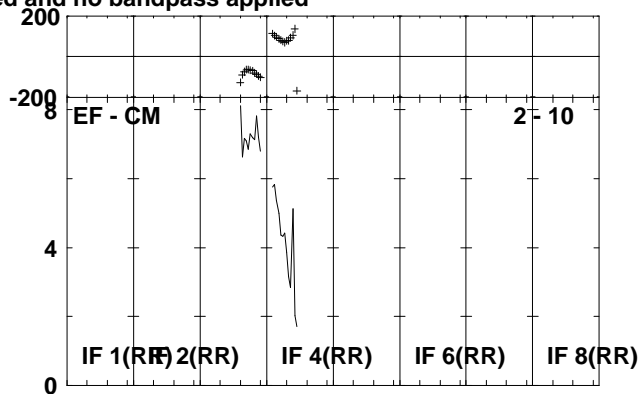
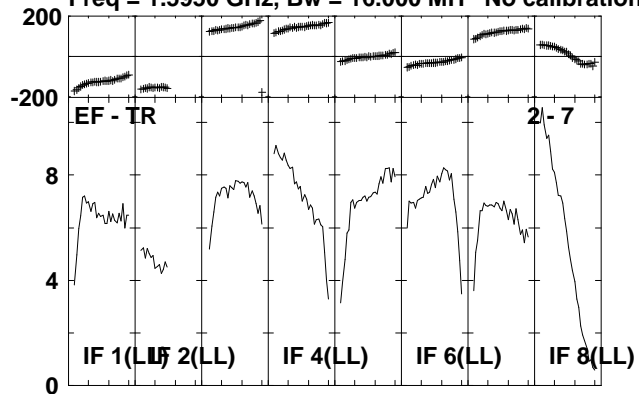

Lower frame: Milli Ampl Jy Top frame: Phas deg
Scalar averaged cross-power spectrum Several baselines displayed
Timerange: 00/17:17:41 to 00/17:19:39

Plot file version 223 created 06-JUL-2010 14:46:32

IRAS2336 EP064J.UVDATA.1

Freq = 1.5950 GHz, Bw = 16.000 MH No calibration applied and no bandpass applied

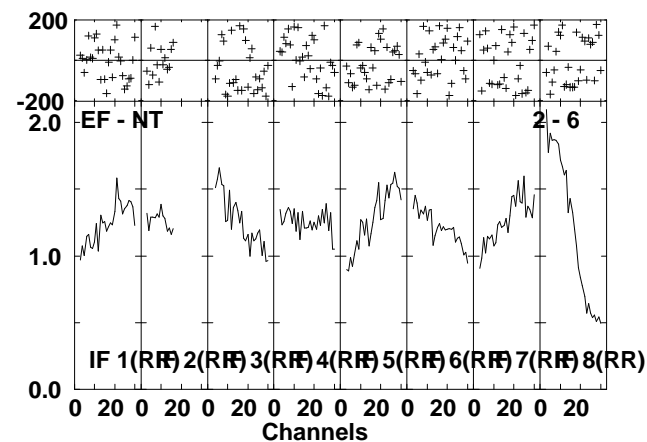
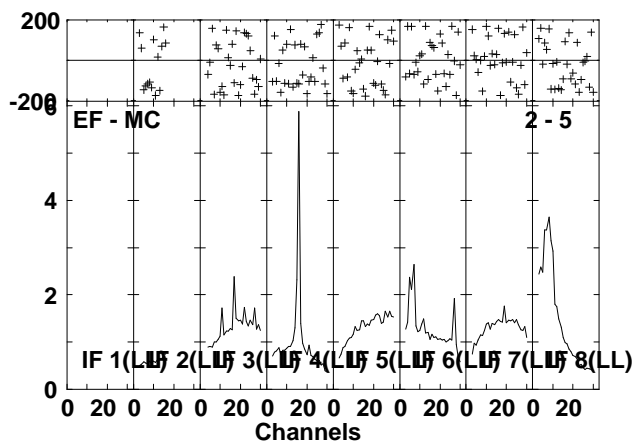
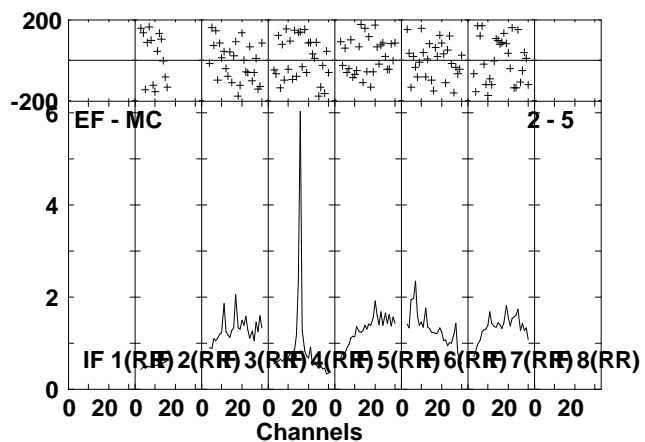
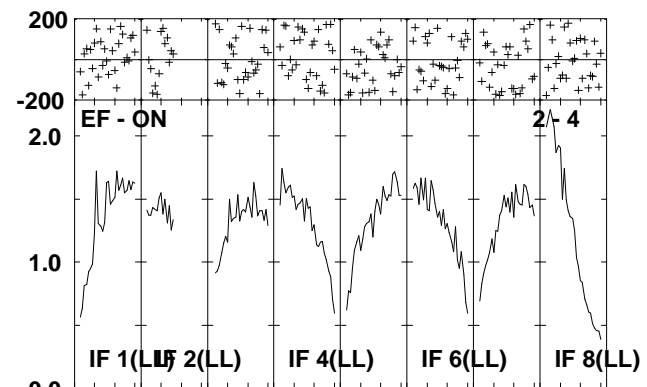
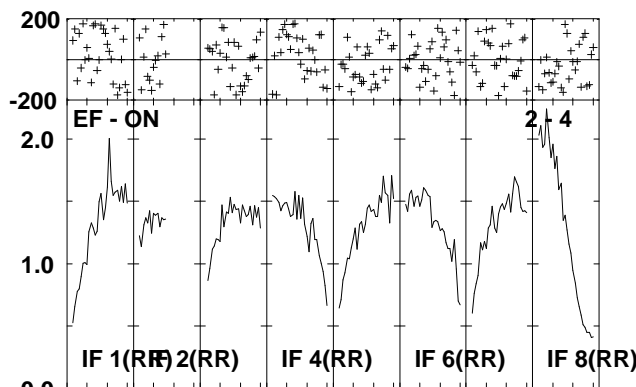
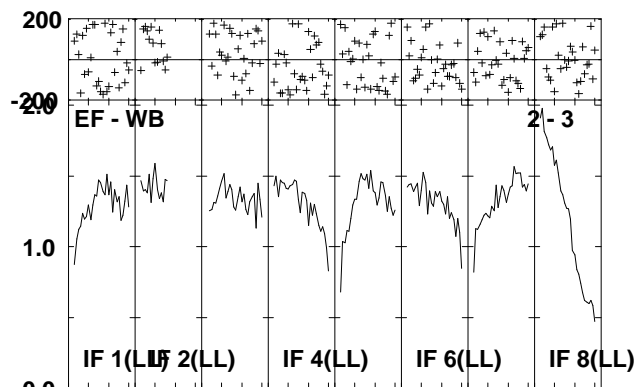
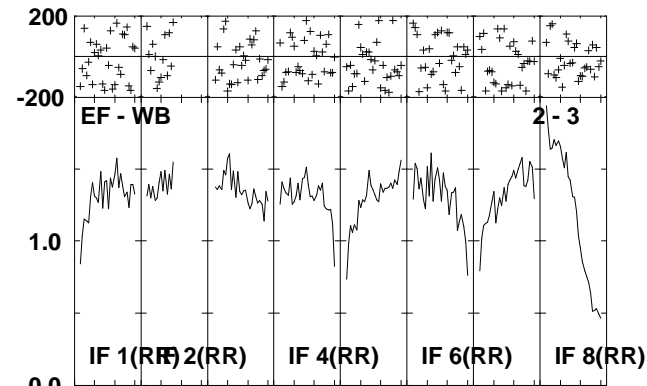
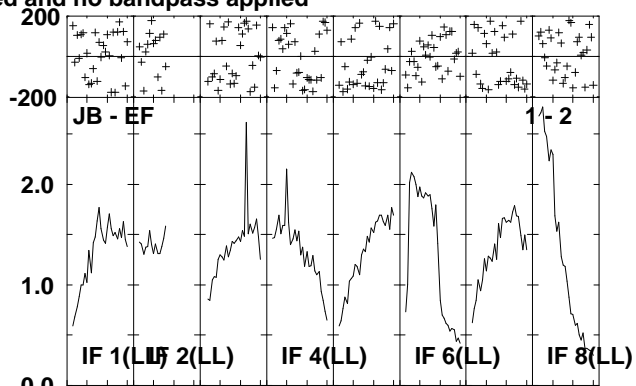
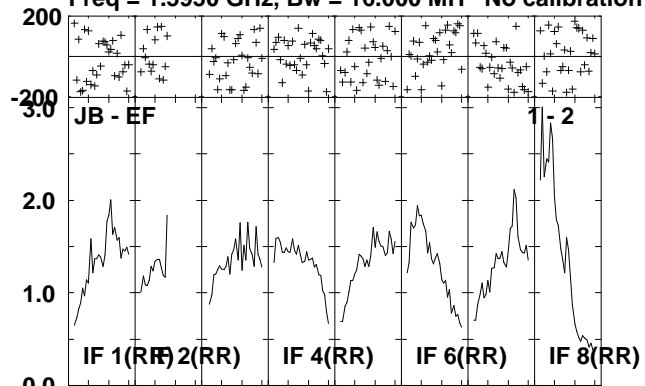

Lower frame: Milli Ampl Jy Top frame: Phas deg
Scalar averaged cross-power spectrum Several baselines displayed
Timerange: 00/17:19:41 to 00/17:23:59

Plot file version 224 created 06-JUL-2010 14:46:34

IRAS2336 EP064J.UVDATA.1

Freq = 1.5950 GHz, Bw = 16.000 MH No calibration applied and no bandpass applied

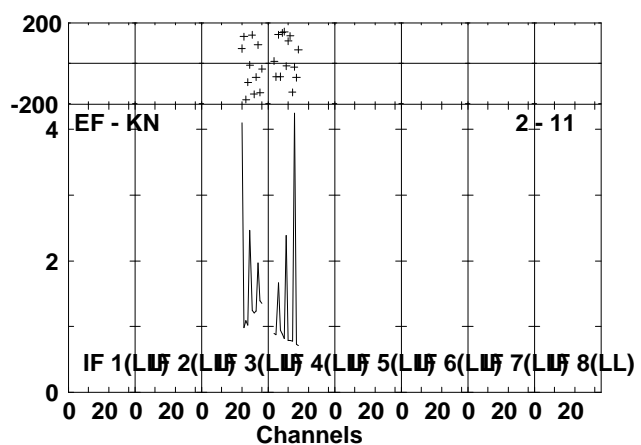
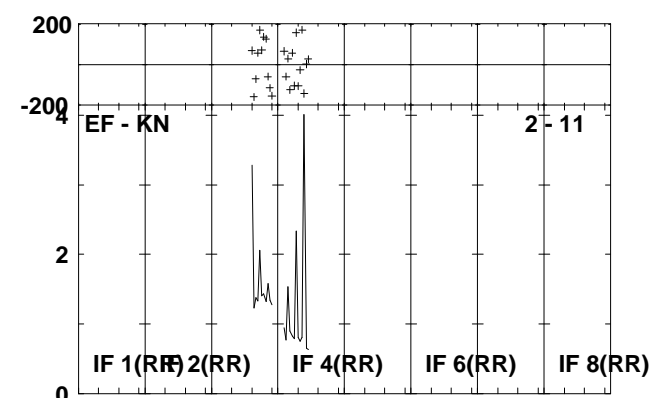
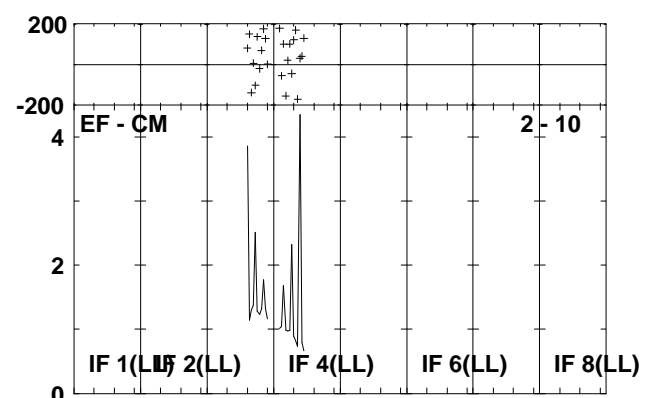
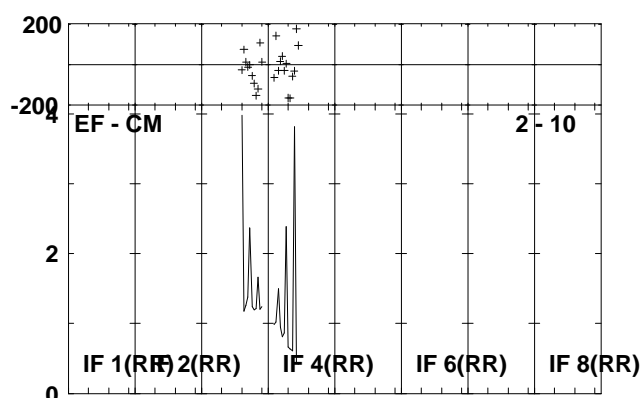
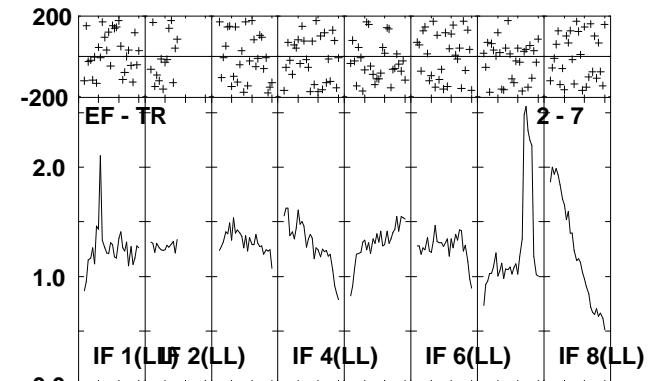
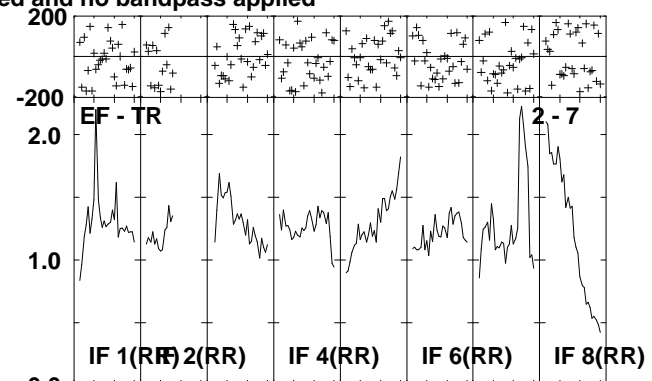
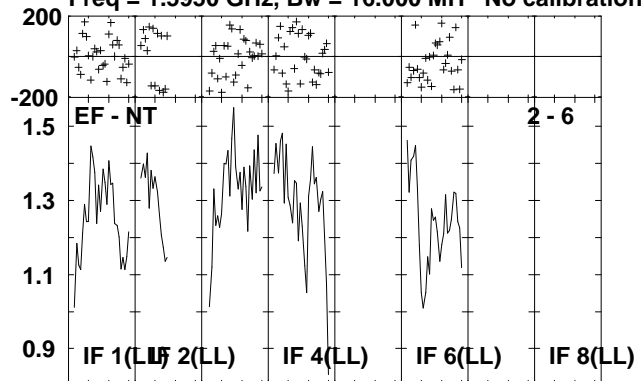

Lower frame: Milli Ampl Jy Top frame: Phas deg
Scalar averaged cross-power spectrum Several baselines displayed
Timerange: 00/17:19:41 to 00/17:23:59

Plot file version 225 created 06-JUL-2010 14:46:37

J2330+33 EP064J.UVDATA.1

Freq = 1.5950 GHz, Bw = 16.000 MH No calibration applied and no bandpass applied

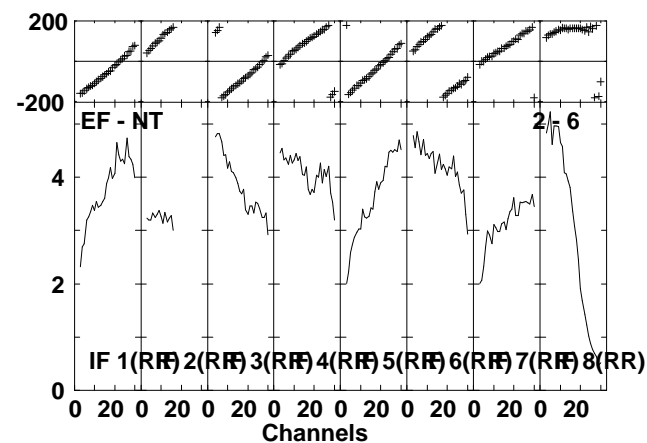
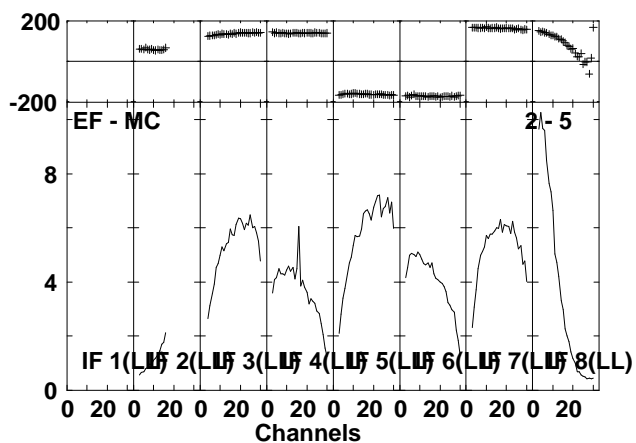
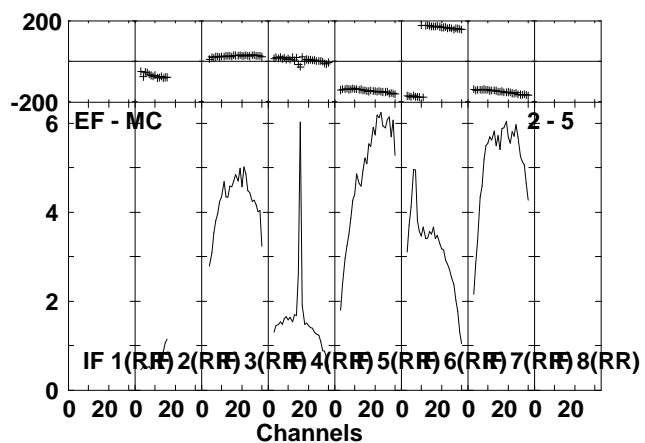
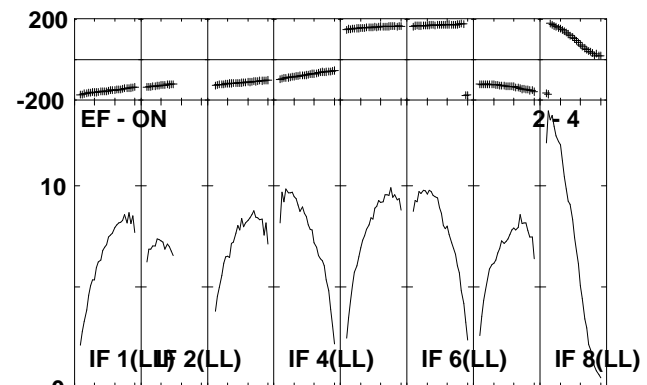
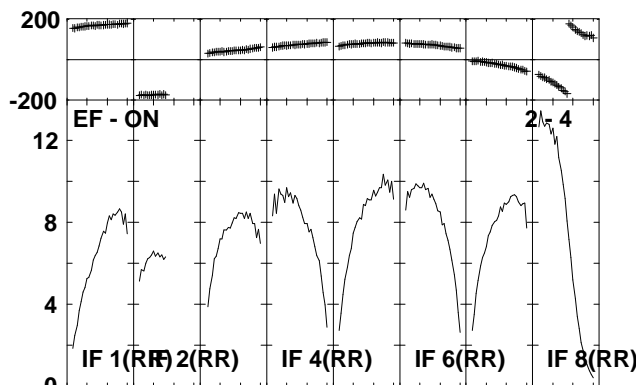
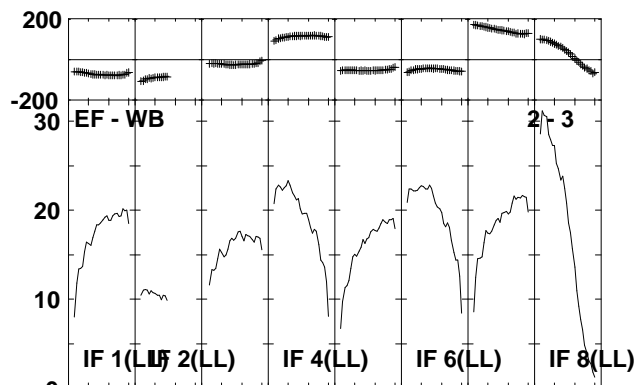
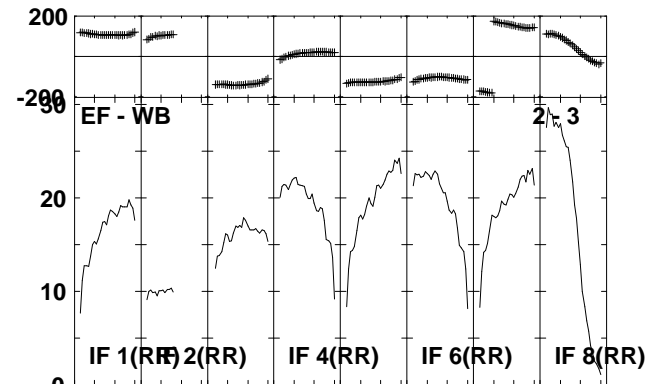
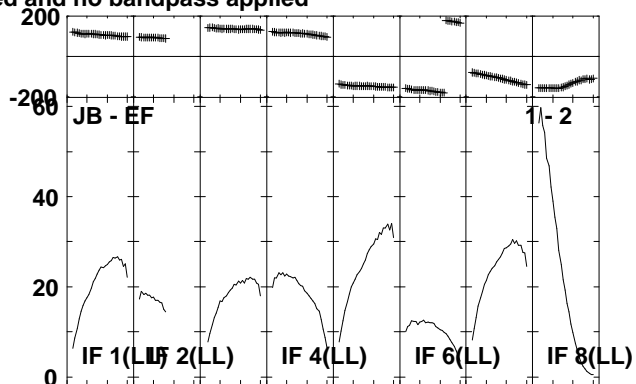
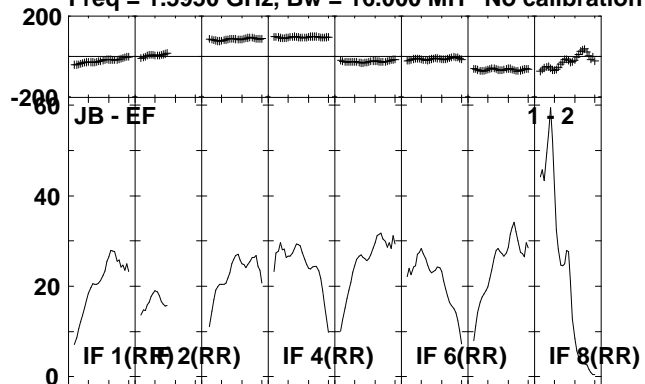

Lower frame: Milli Ampl Jy Top frame: Phas deg
Scalar averaged cross-power spectrum Several baselines displayed
Timerange: 00/17:25:13 to 00/17:26:59

Plot file version 226 created 06-JUL-2010 14:46:37

J2330+33 EP064J.UVDATA.1

Freq = 1.5950 GHz, Bw = 16.000 MH No calibration applied and no bandpass applied

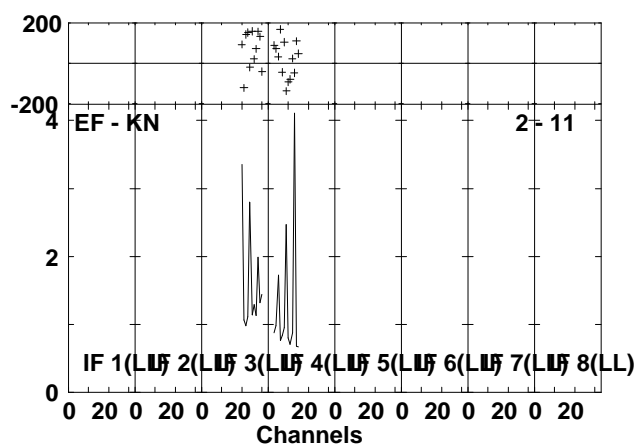
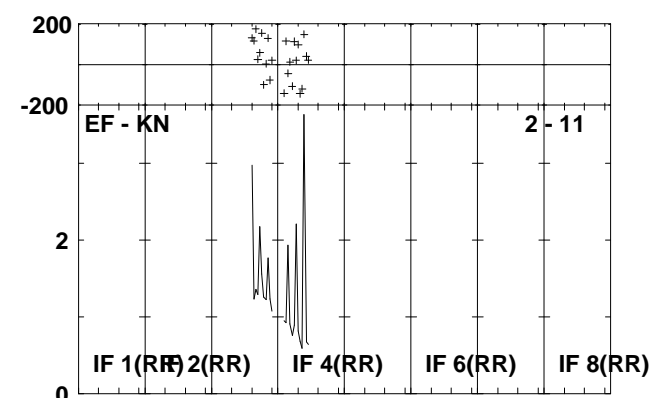
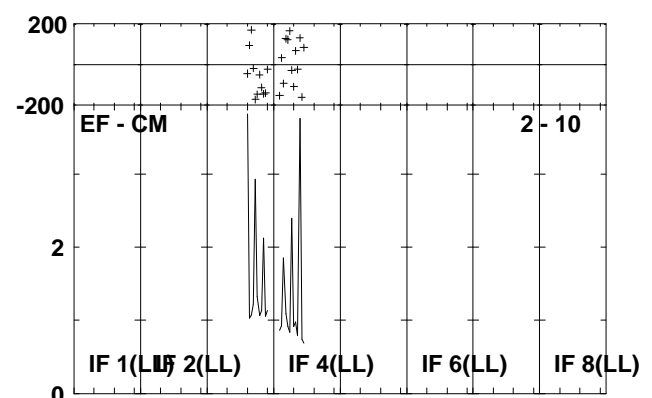
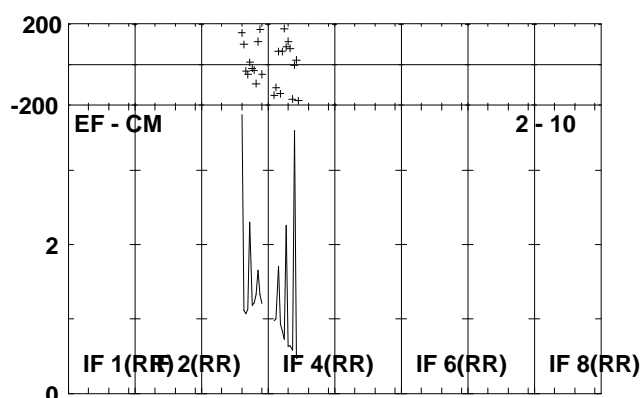
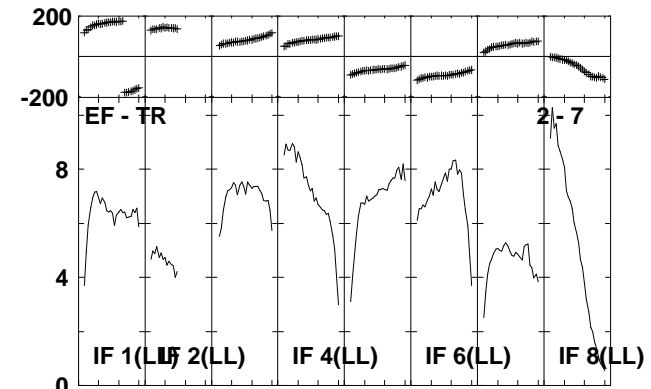
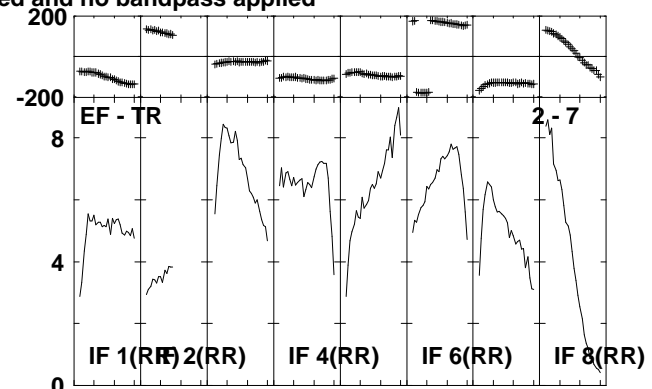
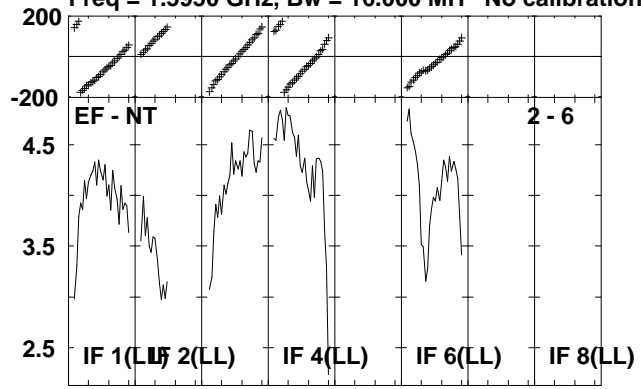

Lower frame: Milli Ampl Jy Top frame: Phas deg
Scalar averaged cross-power spectrum Several baselines displayed
Timerange: 00/17:25:13 to 00/17:26:59

Plot file version 227 created 06-JUL-2010 14:46:39

IRAS2336 EP064J.UVDATA.1

Freq = 1.5950 GHz, Bw = 16.000 MH No calibration applied and no bandpass applied

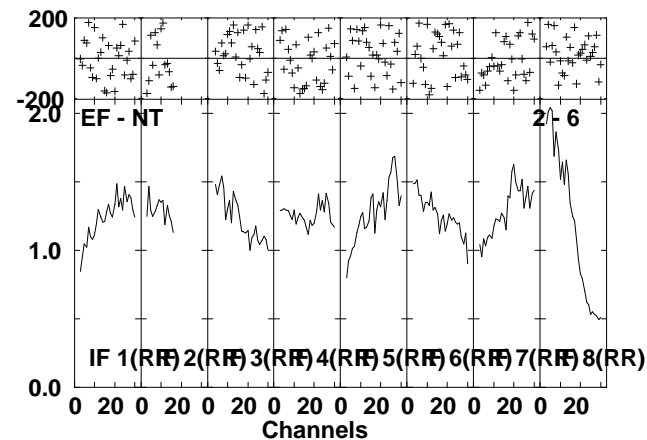
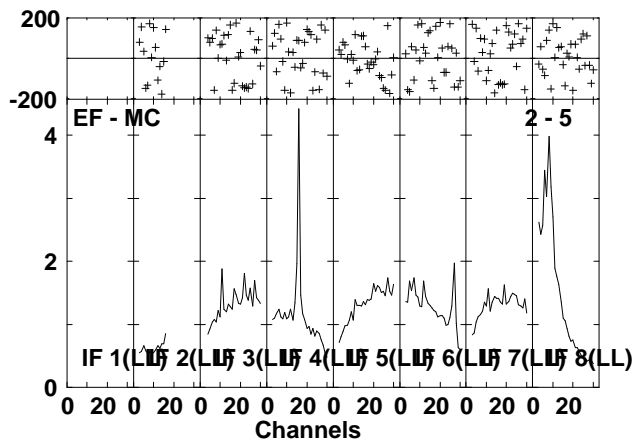
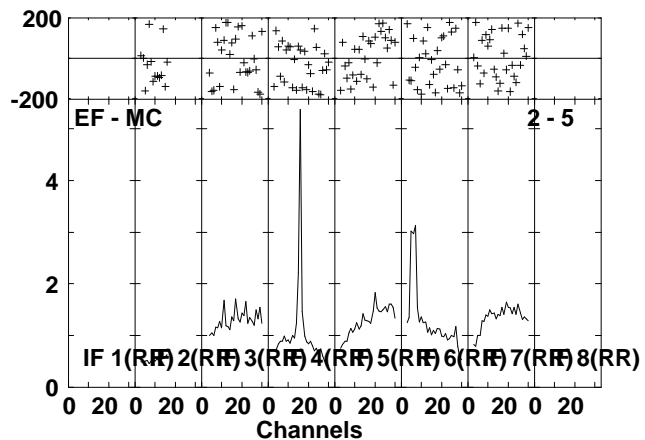
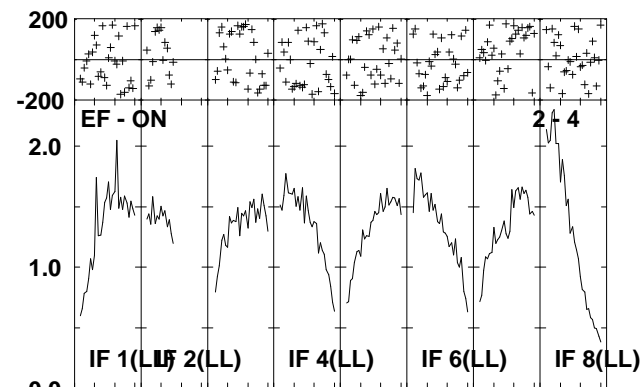
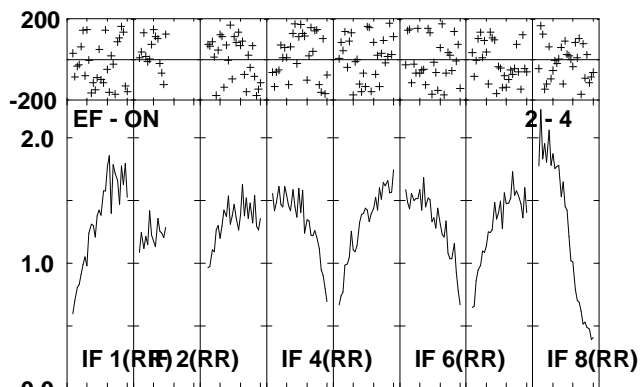
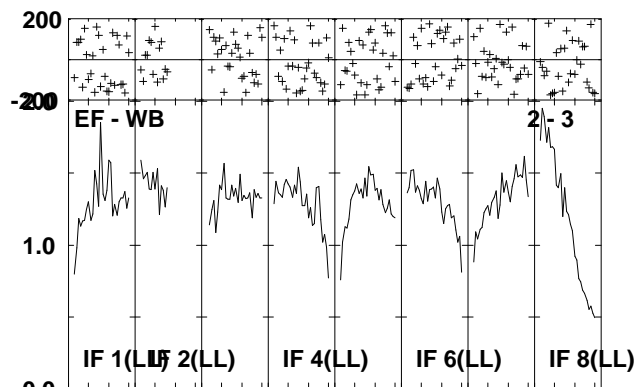
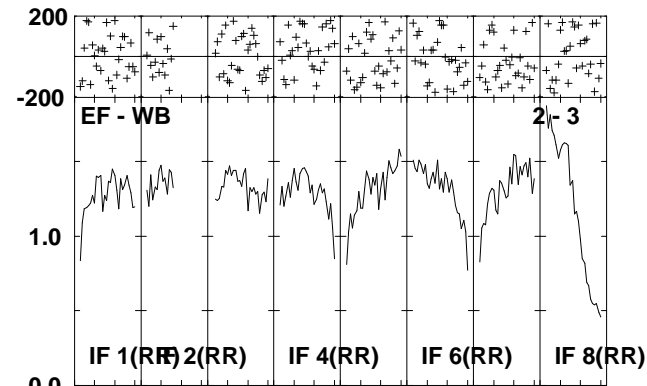
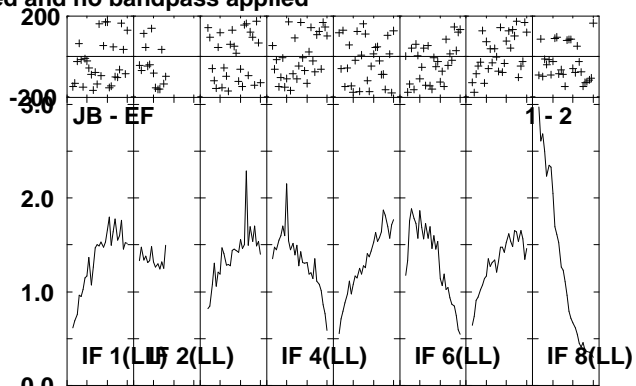
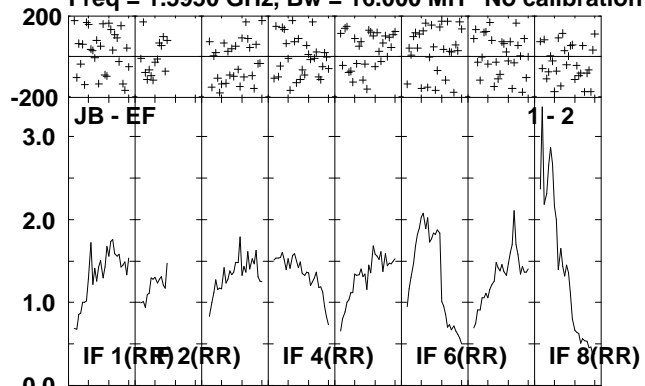

Lower frame: Milli Ampl Jy Top frame: Phas deg
Scalar averaged cross-power spectrum Several baselines displayed
Timerange: 00:17:27:01 to 00:17:31:19

Plot file version 228 created 06-JUL-2010 14:46:41

IRAS2336 EP064J.UVDATA.1

Freq = 1.5950 GHz, Bw = 16.000 MH No calibration applied and no bandpass applied

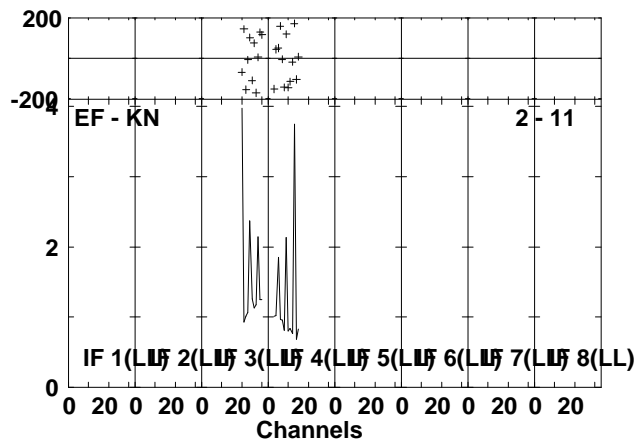
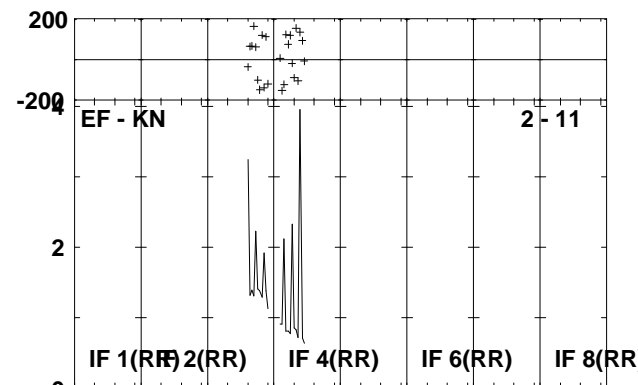
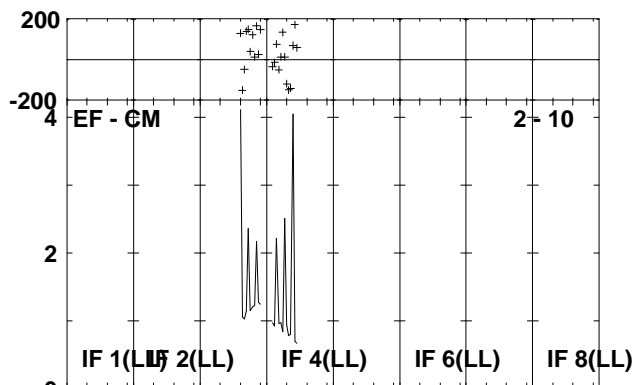
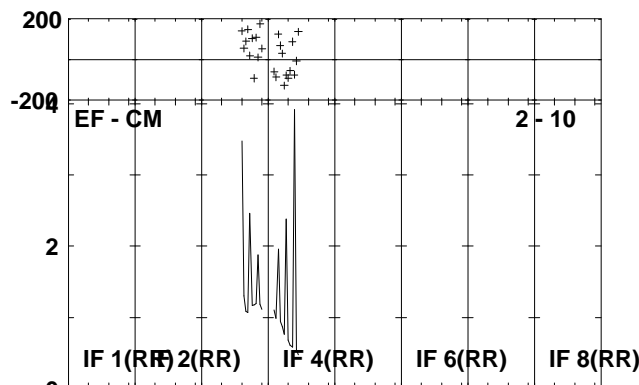
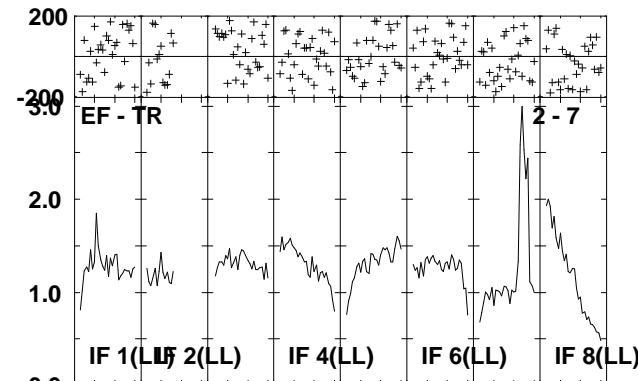
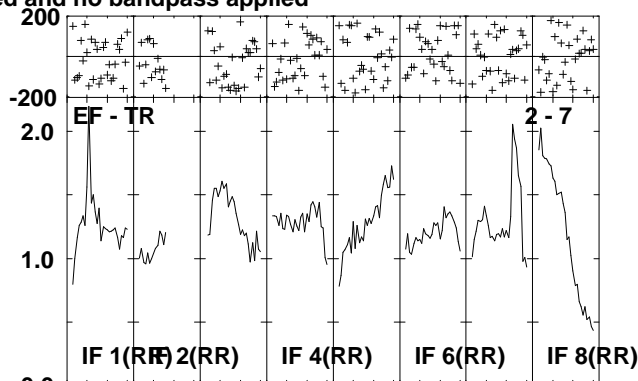
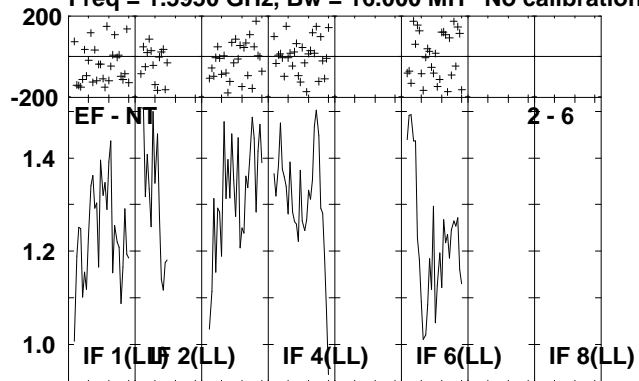

Lower frame: Milli Ampl Jy Top frame: Phas deg
Scalar averaged cross-power spectrum Several baselines displayed
Timerange: 00/17:27:01 to 00/17:31:19

Plot file version 229 created 06-JUL-2010 14:46:43

J2330+33 EP064J.UVDATA.1

Freq = 1.5950 GHz, Bw = 16.000 MH No calibration applied and no bandpass applied

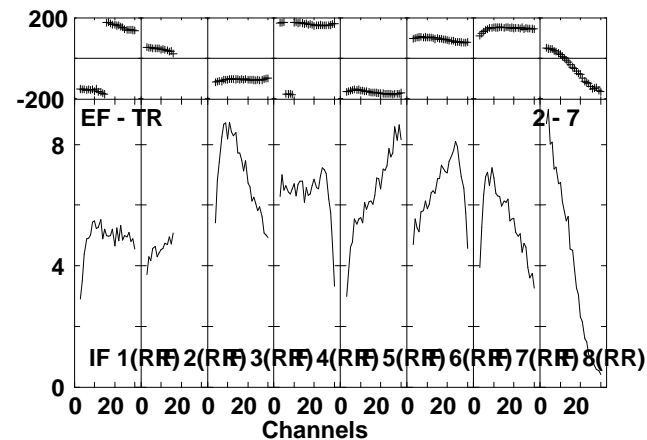
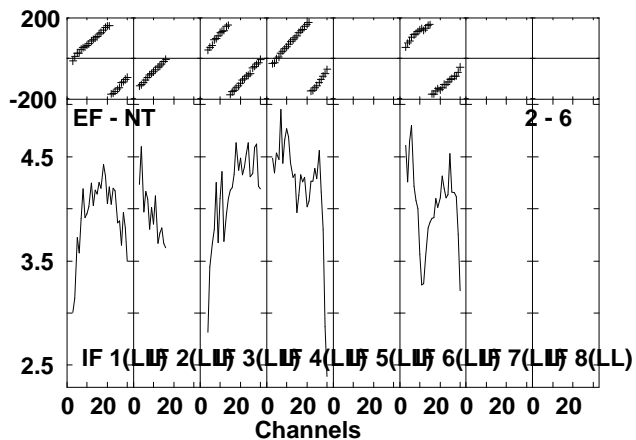
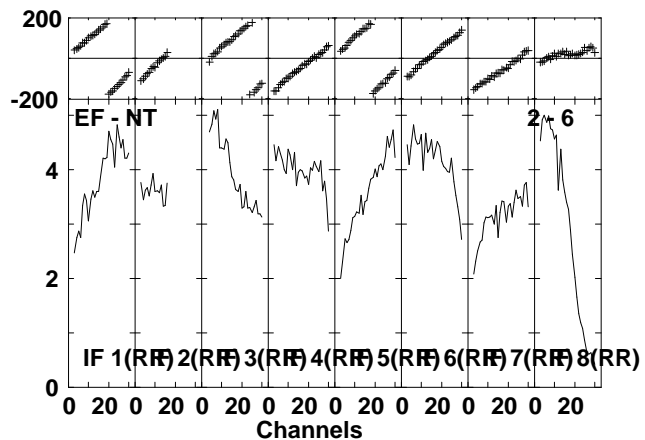
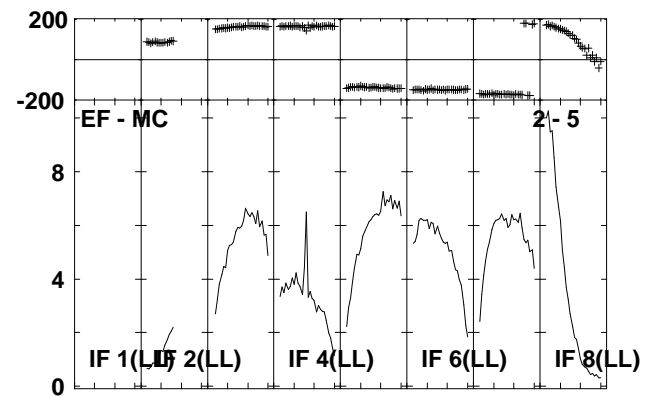
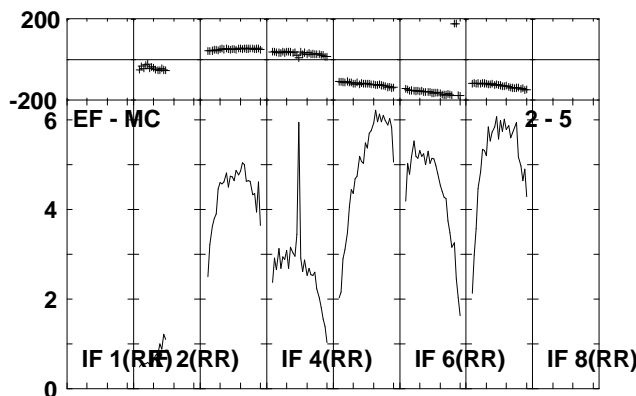
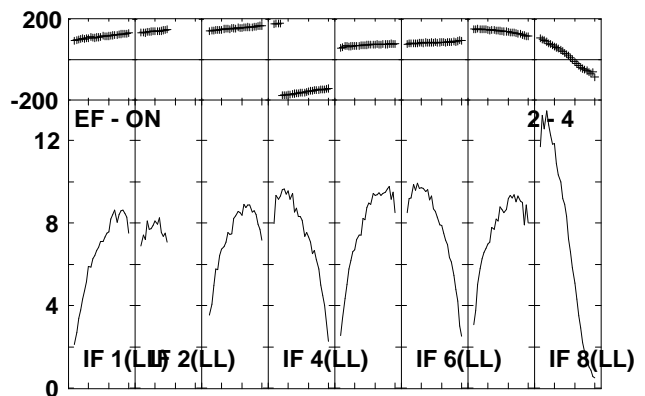
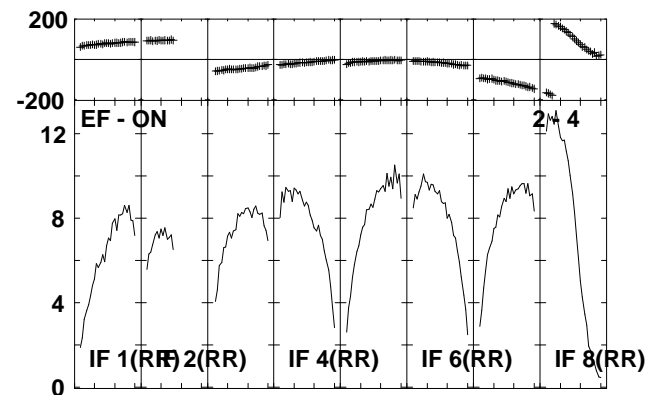
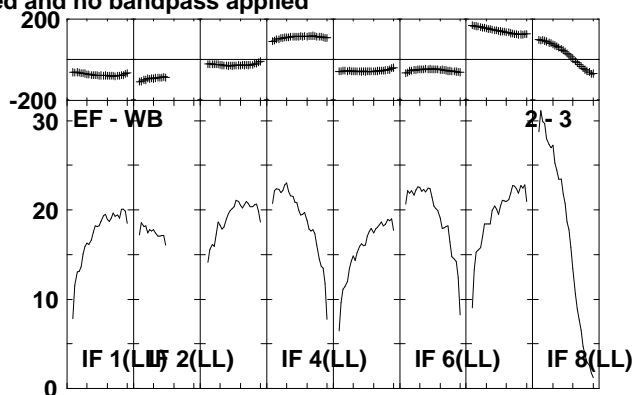
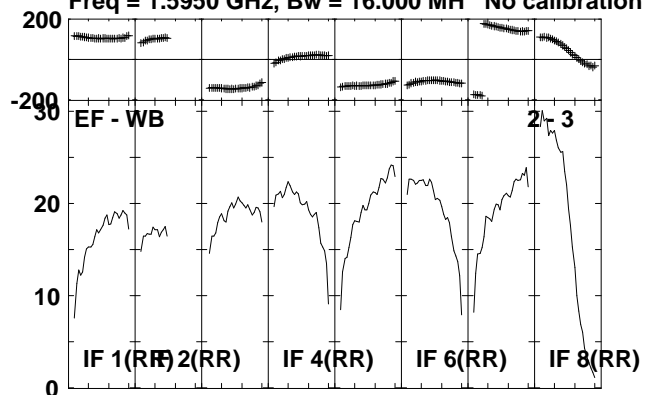

Lower frame: Milli Ampl Jy Top frame: Phas deg
Scalar averaged cross-power spectrum Several baselines displayed
Timerange: 00/17:31:21 to 00/17:33:19

Plot file version 230 created 06-JUL-2010 14:46:44
J2330+33 EP064J.UVDATA.1

Freq = 1.5950 GHz, Bw = 16.000 MH No calibration applied and no bandpass applied

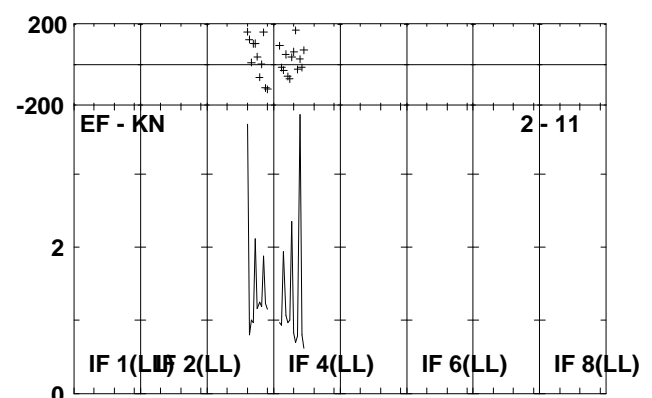
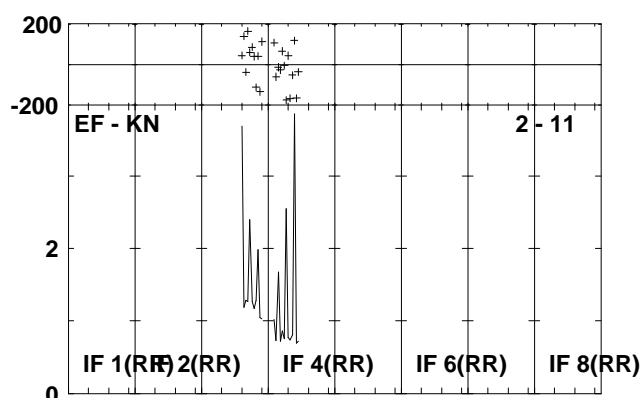
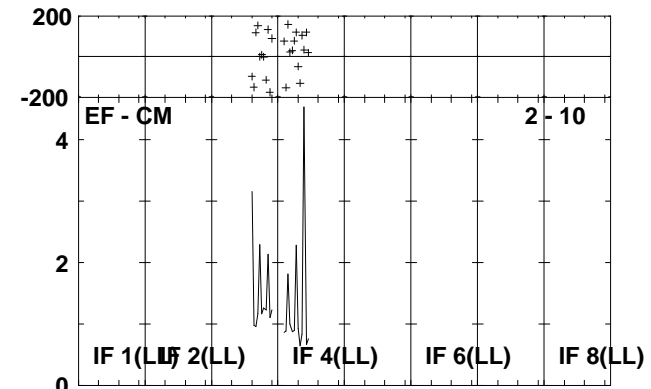
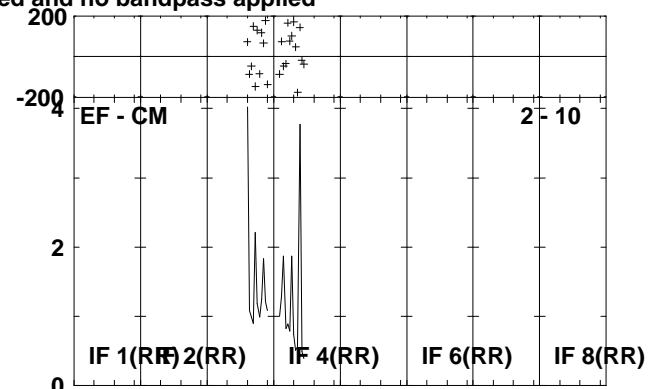
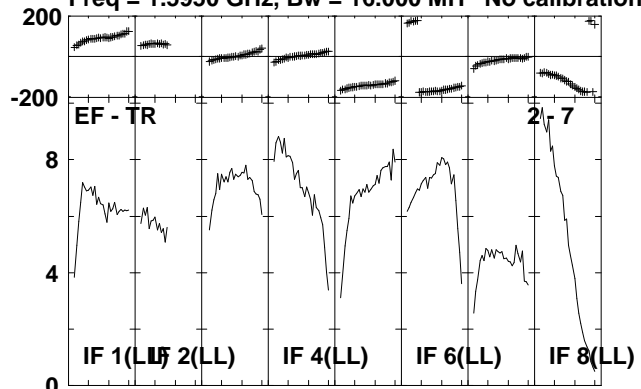

Lower frame: Milli Ampl Jy Top frame: Phas deg
Scalar averaged cross-power spectrum Several baselines displayed
Timerange: 00:17:31:21 to 00:17:33:19

Plot file version 231 created 06-JUL-2010 14:46:45

IRAS2336 EP064J.UVDATA.1

Freq = 1.5950 GHz, Bw = 16.000 MH No calibration applied and no bandpass applied

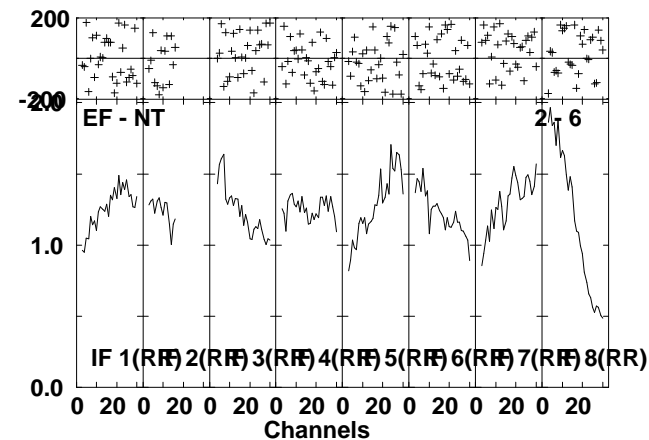
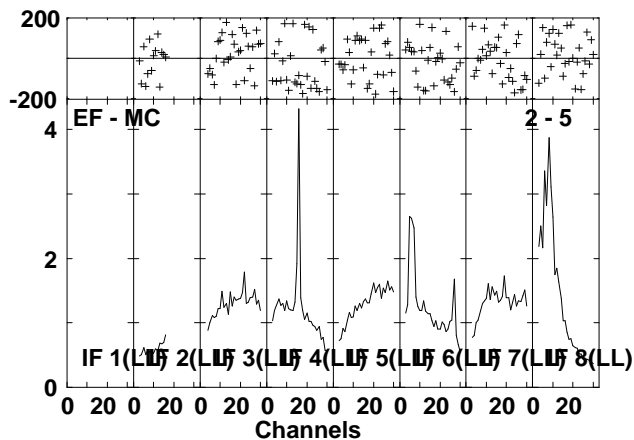
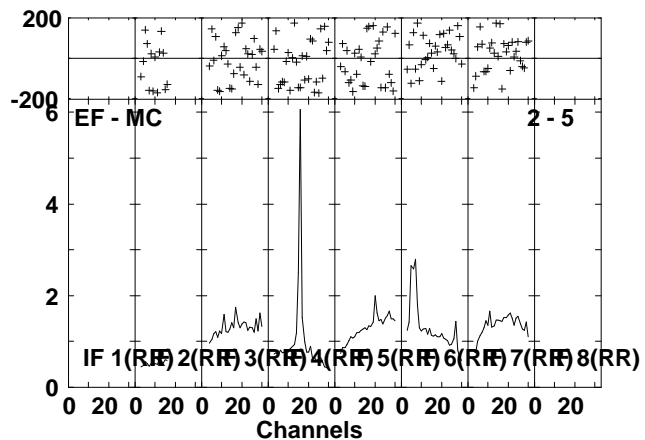
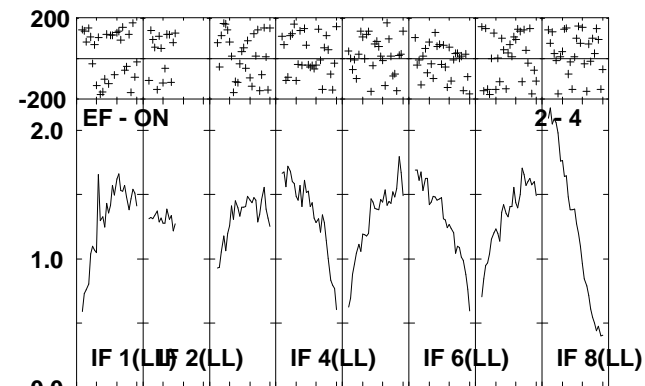
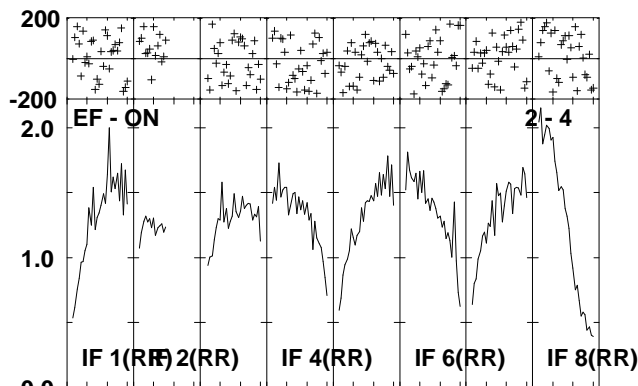
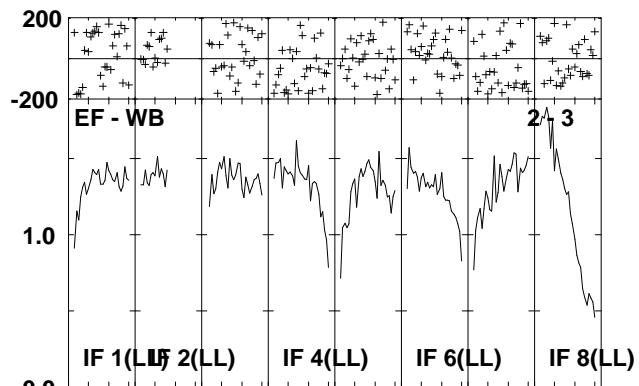
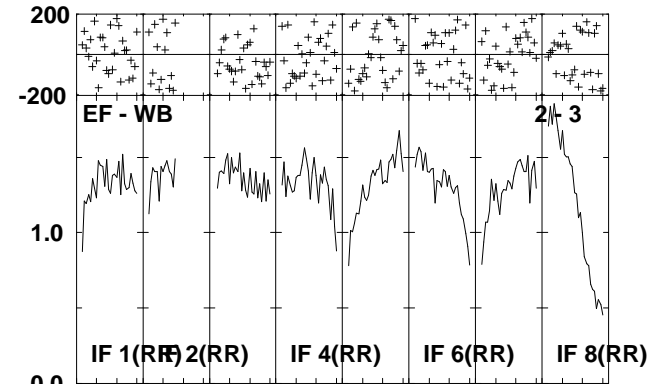
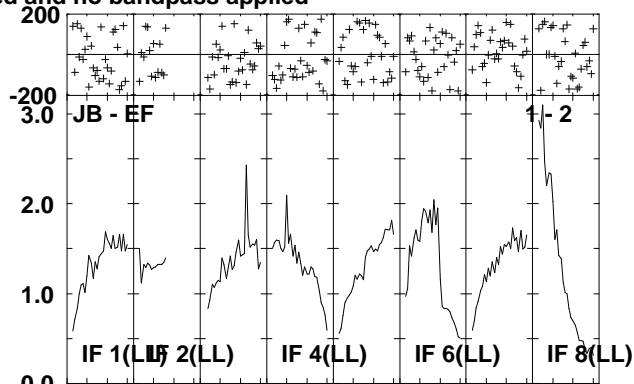
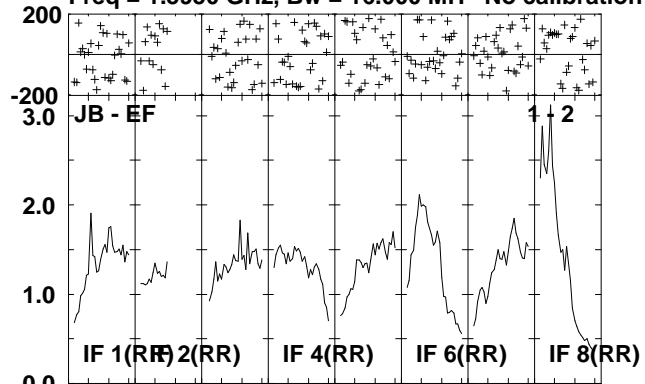

Lower frame: Milli Ampl Jy Top frame: Phas deg
Scalar averaged cross-power spectrum Several baselines displayed
Timerange: 00/17:33:21 to 00/17:37:39

Plot file version 232 created 06-JUL-2010 14:46:47

IRAS2336 EP064J.UVDATA.1

Freq = 1.5950 GHz, Bw = 16.000 MH No calibration applied and no bandpass applied

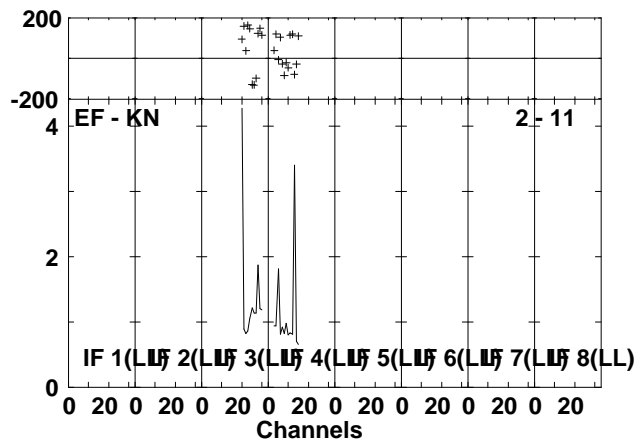
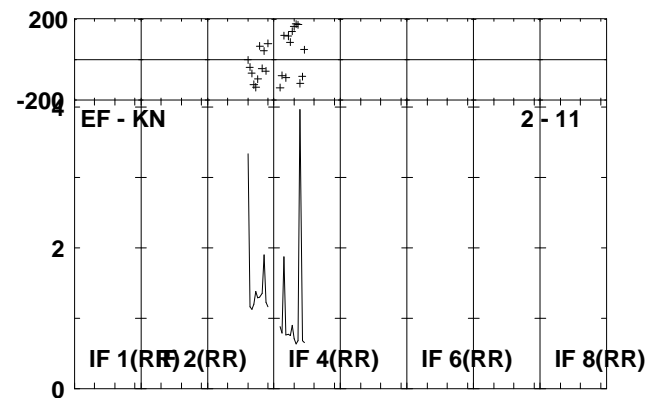
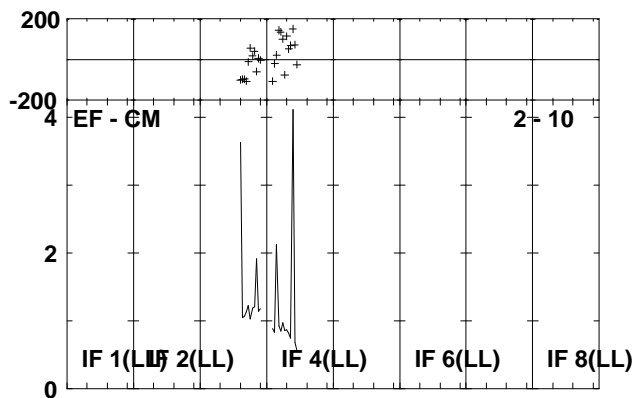
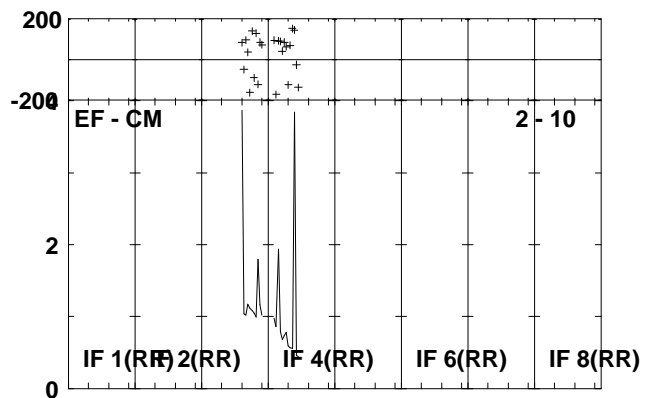
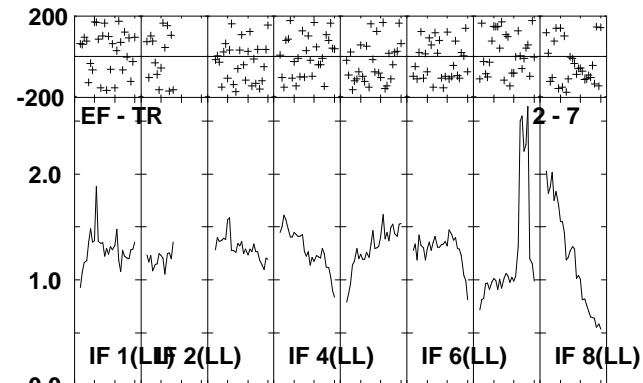
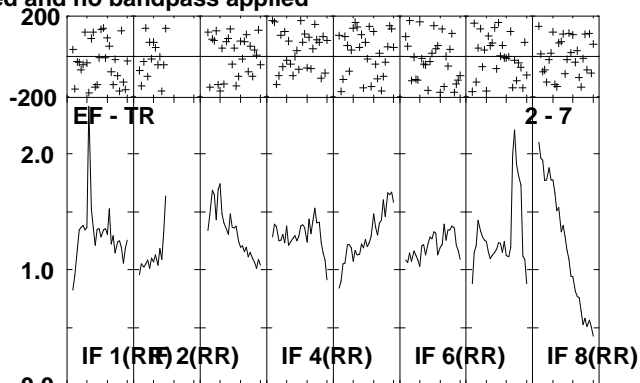
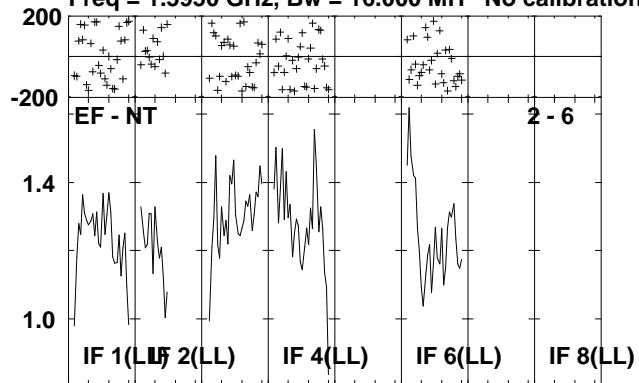

Lower frame: Milli Ampl Jy Top frame: Phas deg
Scalar averaged cross-power spectrum Several baselines displayed
Timerange: 00/17:33:21 to 00/17:37:39

Plot file version 233 created 06-JUL-2010 14:46:50

J2330+33 EP064J.UVDATA.1

Freq = 1.5950 GHz, Bw = 16.000 MH No calibration applied and no bandpass applied

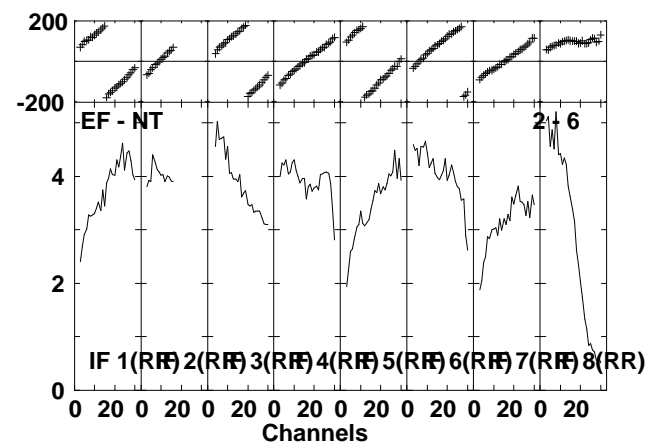
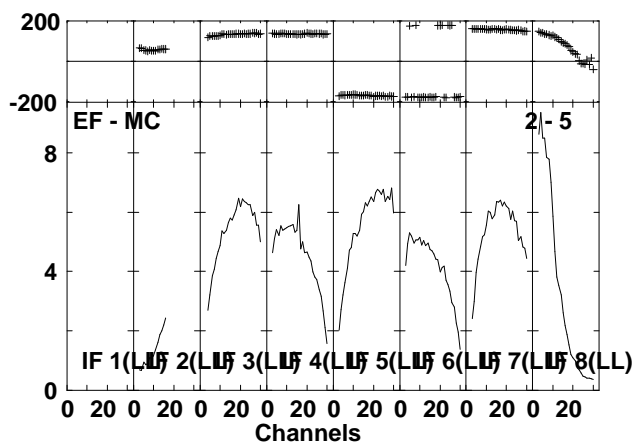
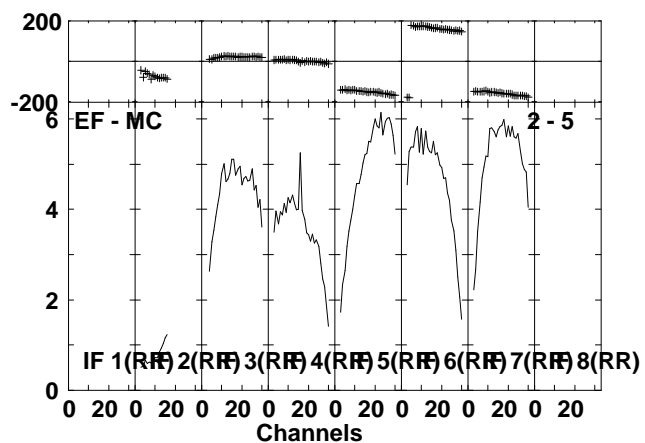
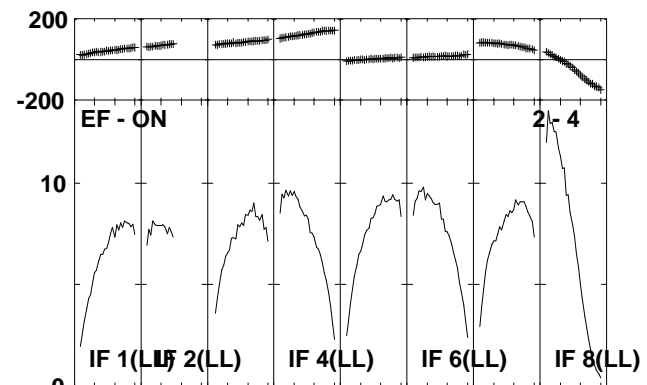
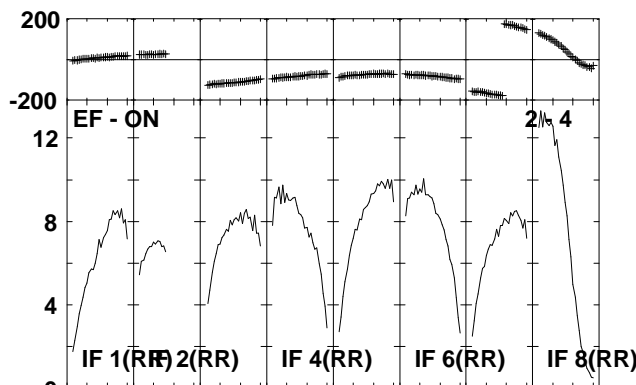
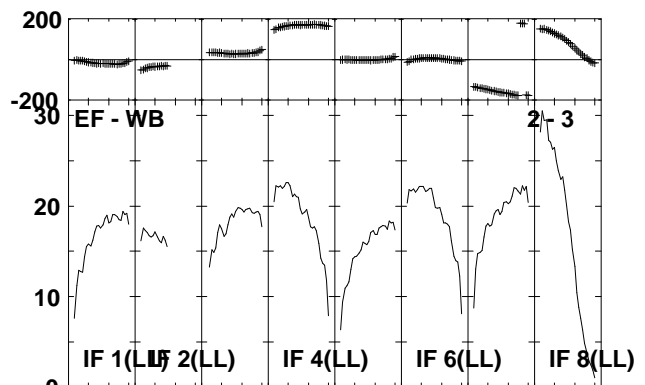
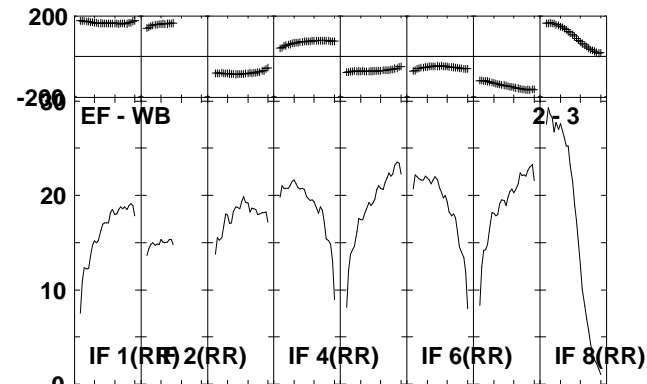
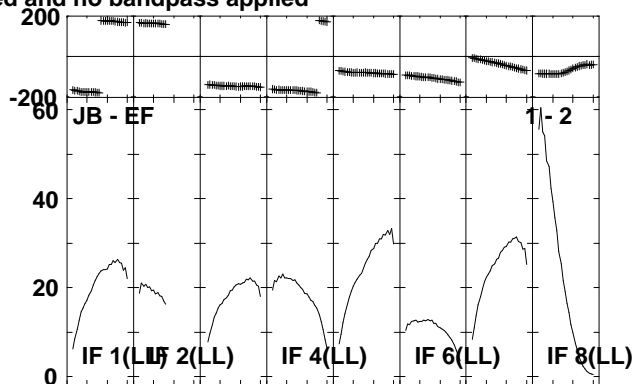
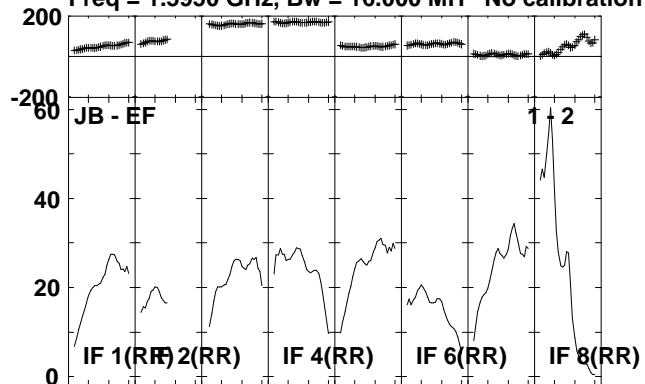

Lower frame: Milli Ampl Jy Top frame: Phas deg
Scalar averaged cross-power spectrum Several baselines displayed
Timerange: 00/17:38:41 to 00/17:40:39

Plot file version 234 created 06-JUL-2010 14:46:50

J2330+33 EP064J.UVDATA.1

Freq = 1.5950 GHz, Bw = 16.000 MH No calibration applied and no bandpass applied

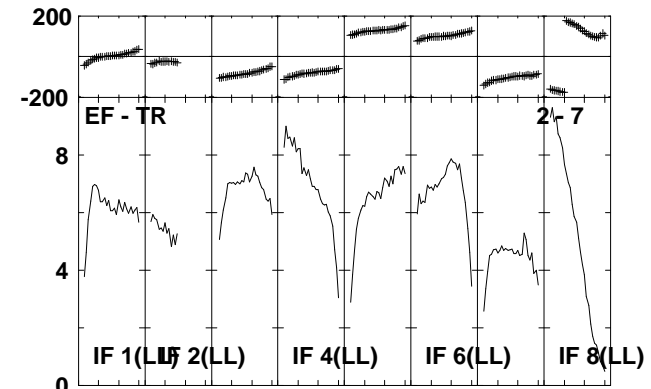
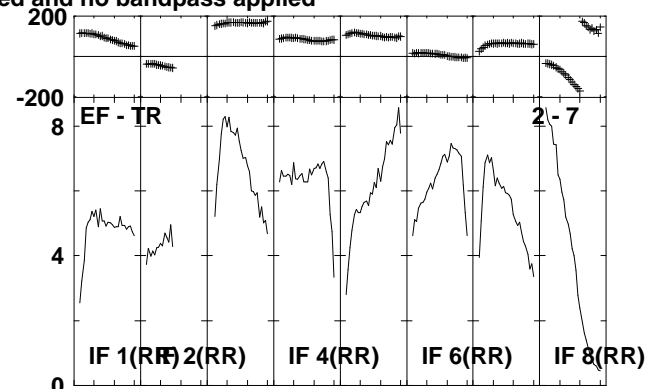
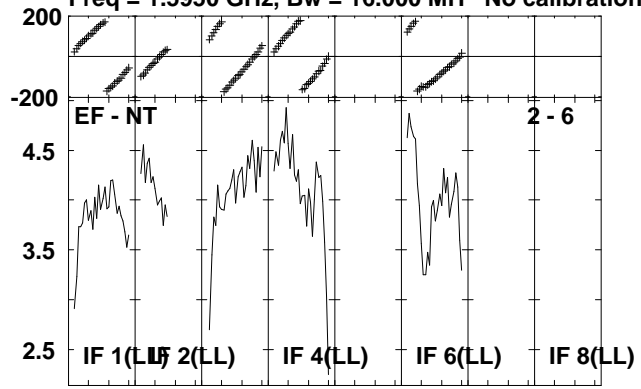

Lower frame: Milli Ampl Jy Top frame: Phas deg
Scalar averaged cross-power spectrum Several baselines displayed
Timerange: 00/17:38:41 to 00/17:40:39

Plot file version 235 created 06-JUL-2010 14:46:55

IRAS2336 EP064J.UVDATA.1

Freq = 1.5950 GHz, Bw = 16.000 MH No calibration applied and no bandpass applied

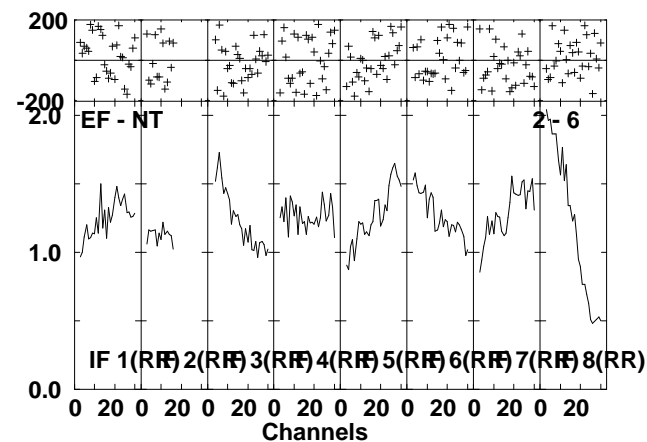
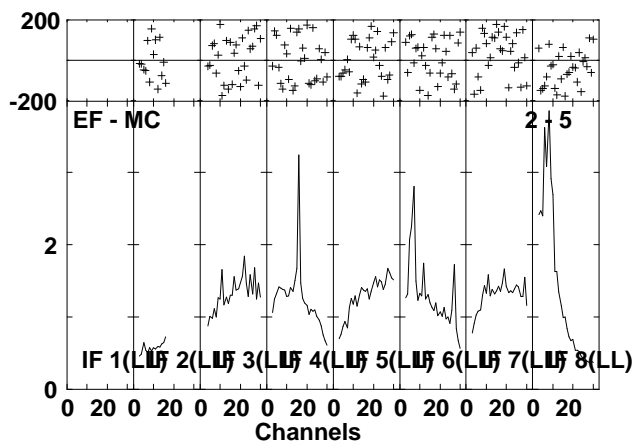
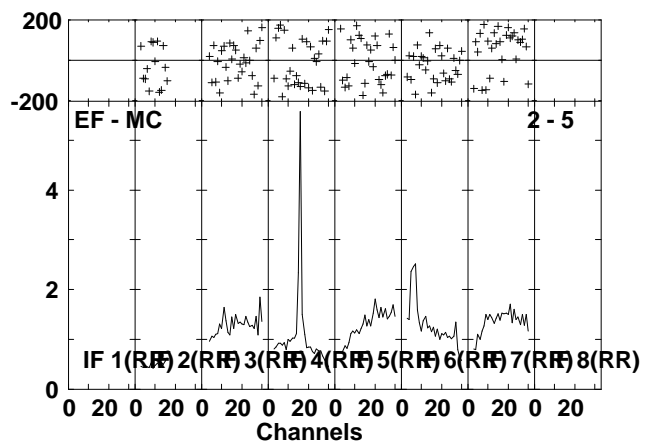
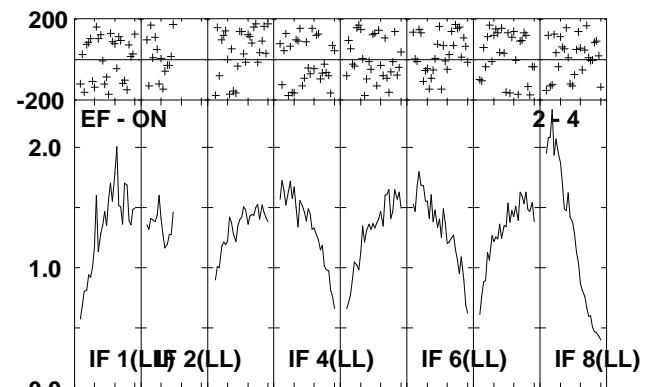
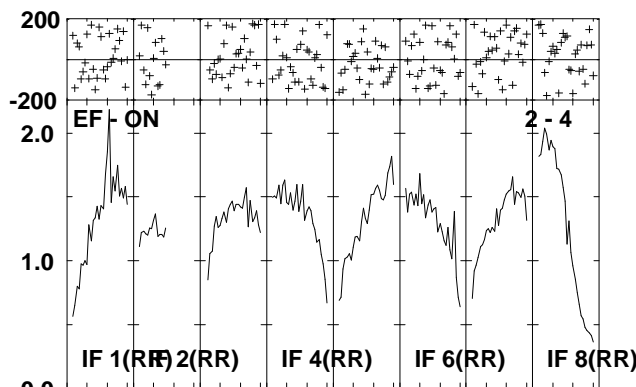
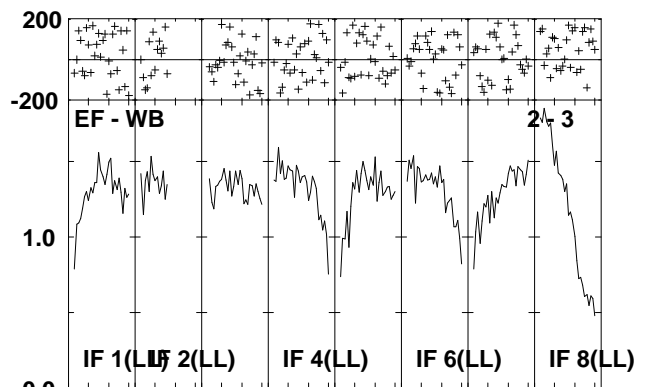
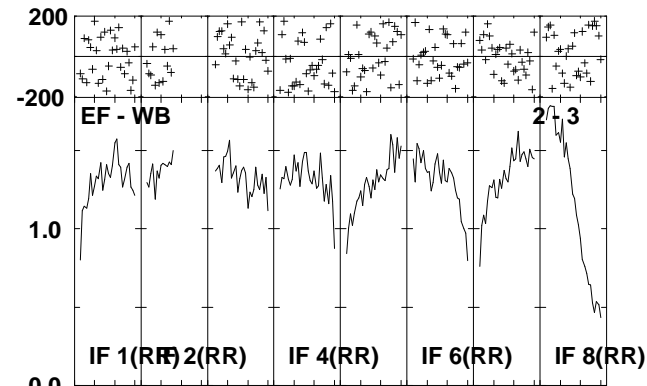
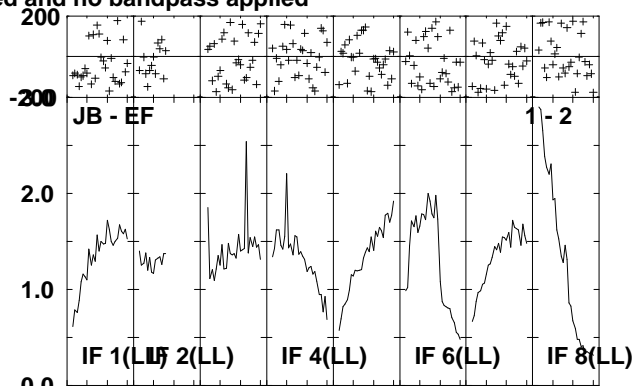
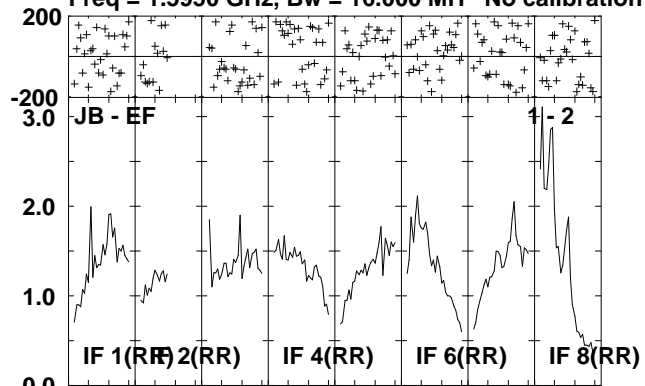

Lower frame: Milli Ampl Jy Top frame: Phas deg
Scalar averaged cross-power spectrum Several baselines displayed
Timerange: 00:17:40:41 to 00:17:44:57

Plot file version 236 created 06-JUL-2010 14:46:57

IRAS2336 EP064J.UVDATA.1

Freq = 1.5950 GHz, Bw = 16.000 MH No calibration applied and no bandpass applied

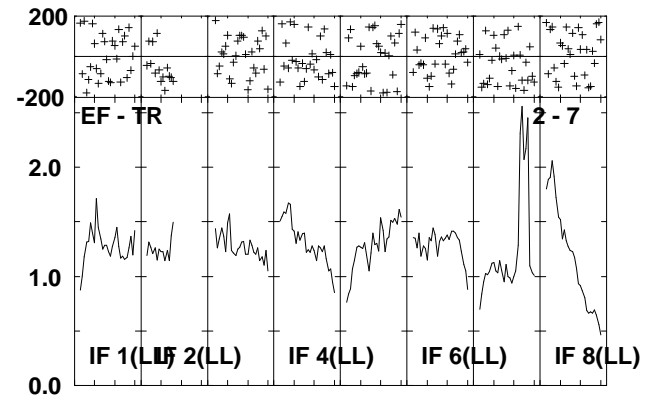
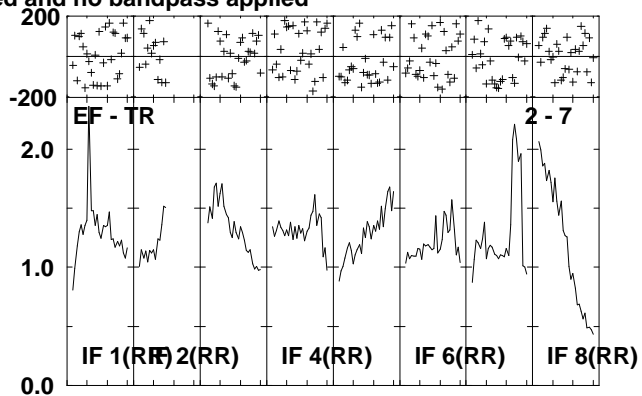
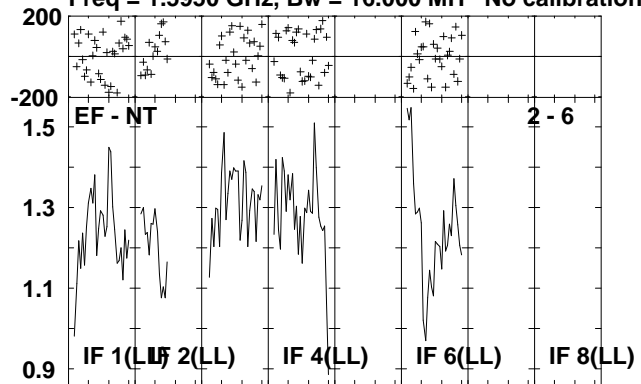

Lower frame: Milli Ampl Jy Top frame: Phas deg
Scalar averaged cross-power spectrum Several baselines displayed
Timerange: 00/17:40:41 to 00/17:44:57