

Plot file version 1 created 06-JUL-2010 12:00:20

2134+004 EP064L.UVDATA.1

Freq = 4.9270 GHz, Bw = 16.000 MH No calibration applied and no bandpass applied

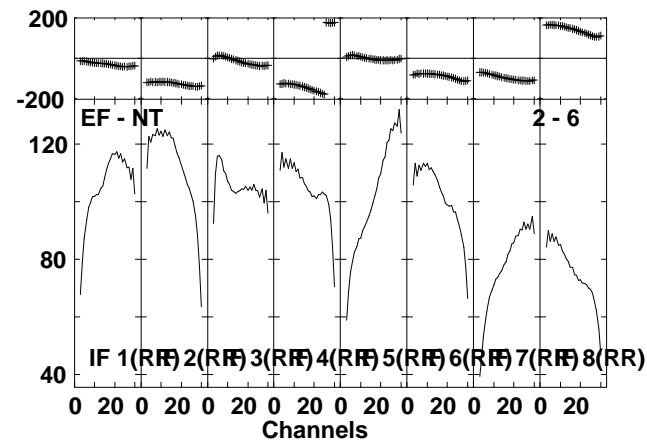
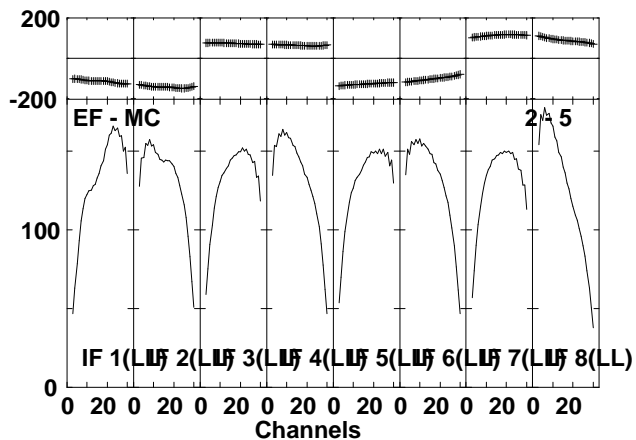
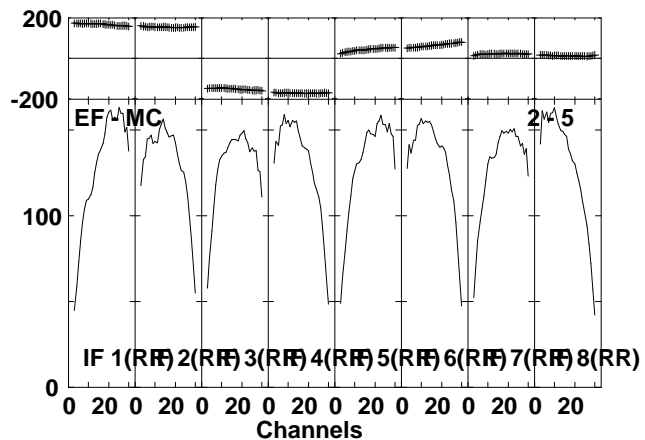
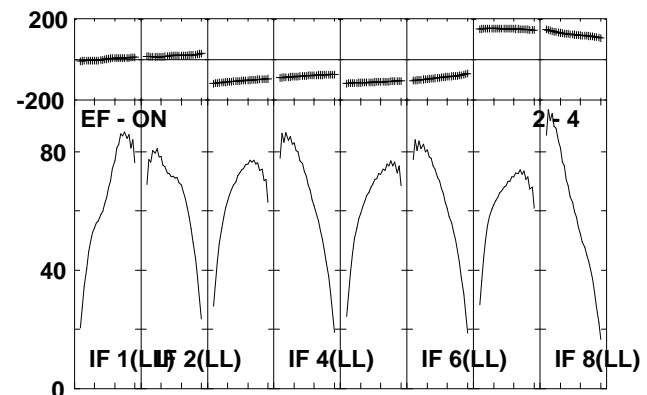
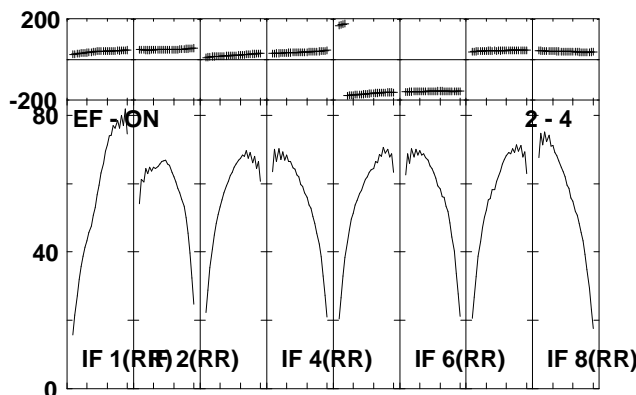
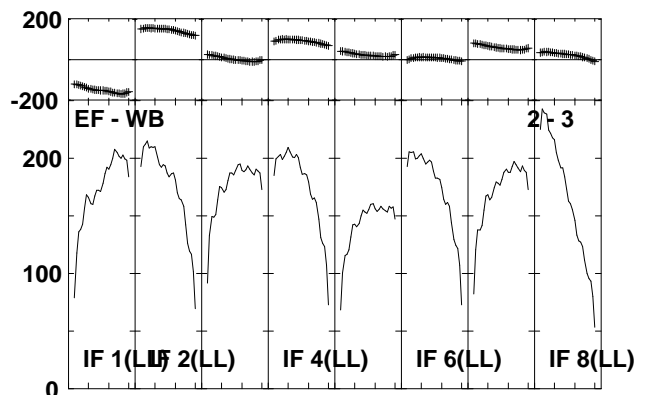
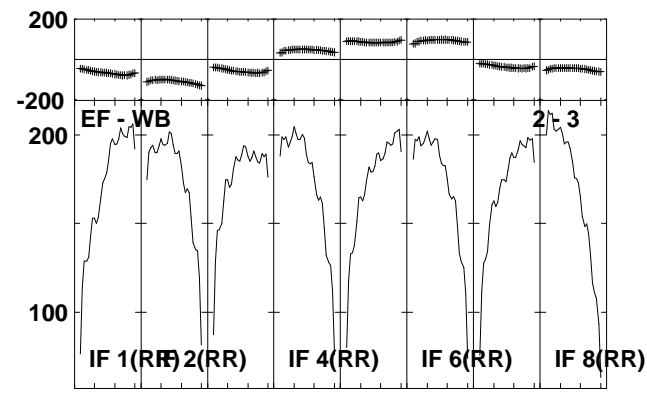
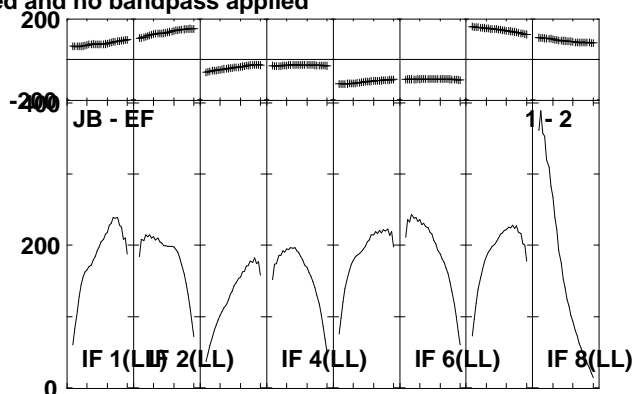
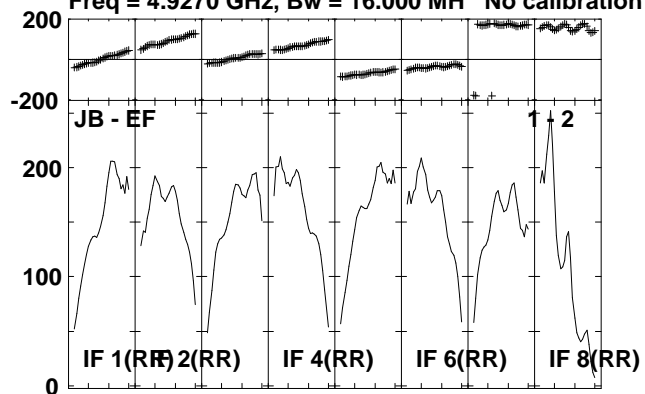

Lower frame: Milli Ampl Jy Top frame: Phas deg
Scalar averaged cross-power spectrum Several baselines displayed
Timerange: 00/11:00:01 to 00/11:06:27

Plot file version 2 created 06-JUL-2010 12:00:23

2134+004 EP064L.UVDATA.1

Freq = 4.9270 GHz, Bw = 16.000 MH No calibration applied and no bandpass applied

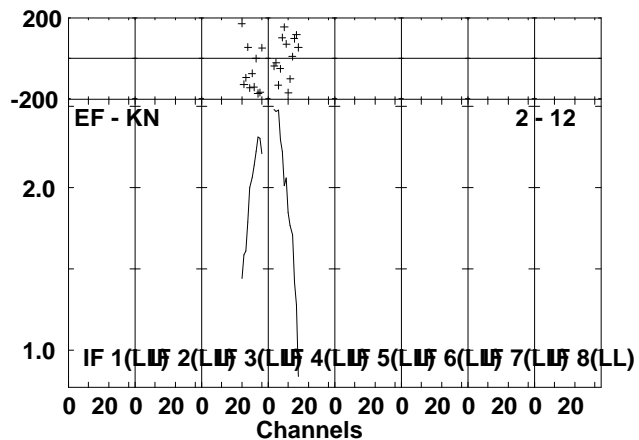
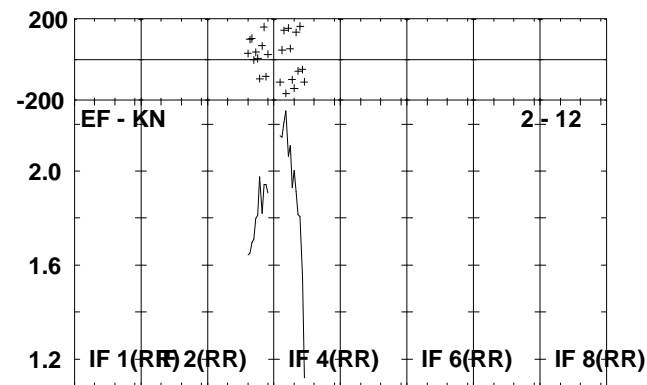
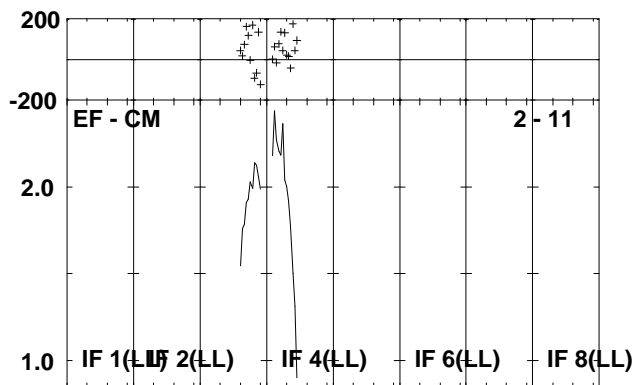
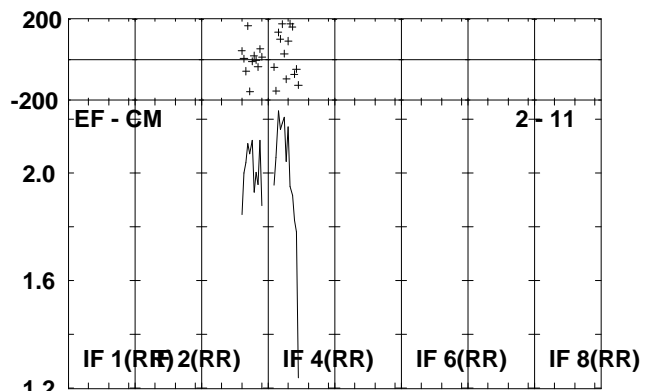
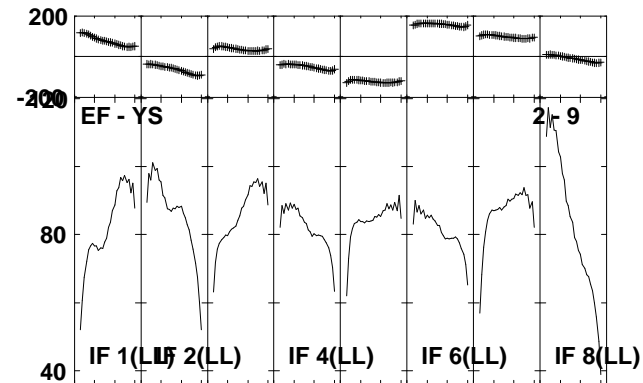
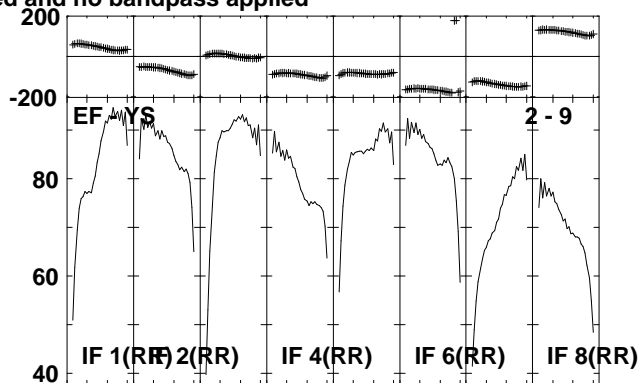
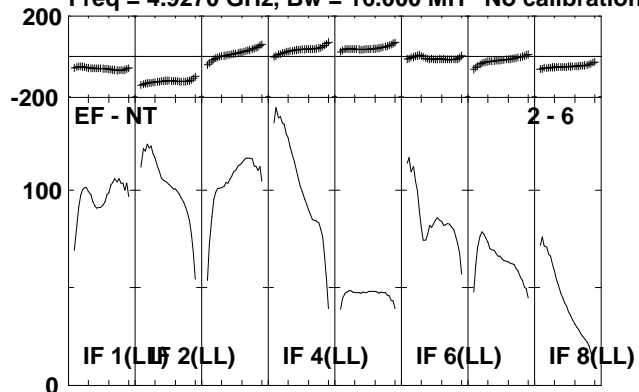

Lower frame: Milli Ampl Jy Top frame: Phas deg
Scalar averaged cross-power spectrum Several baselines displayed
Timerange: 00/11:00:01 to 00/11:06:27

Plot file version 3 created 06-JUL-2010 12:00:28

3C454.3 EP064L.UVDATA.1

Freq = 4.9270 GHz, Bw = 16.000 MH No calibration applied and no bandpass applied

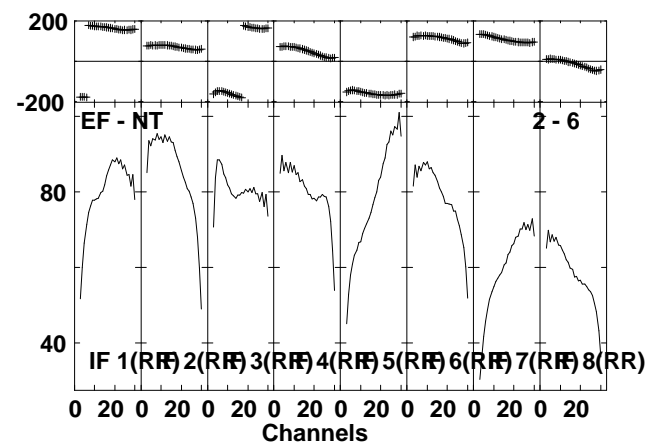
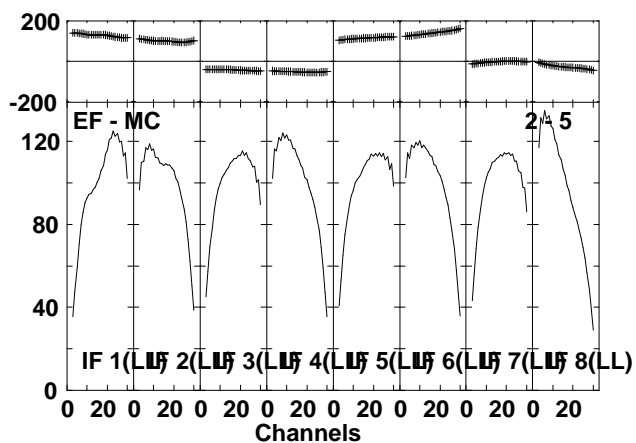
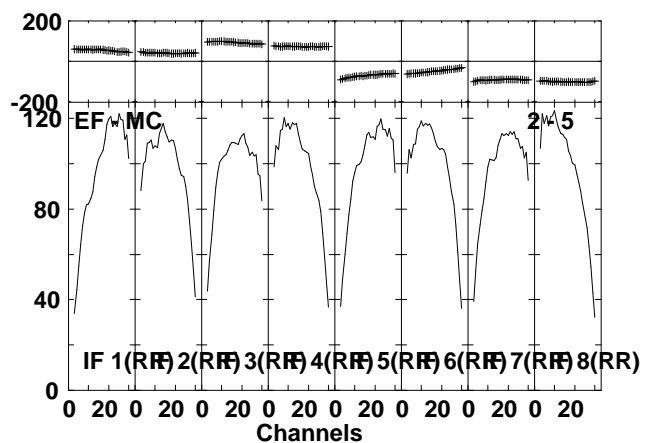
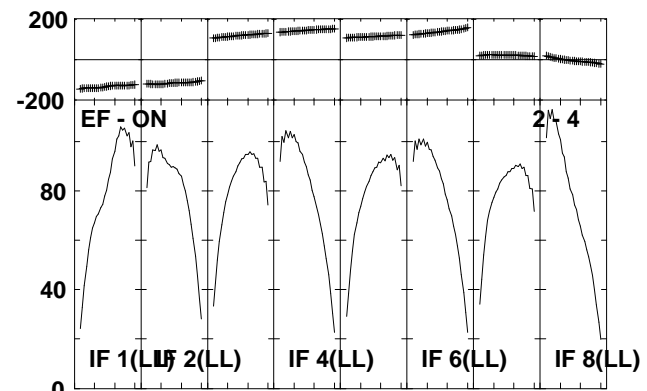
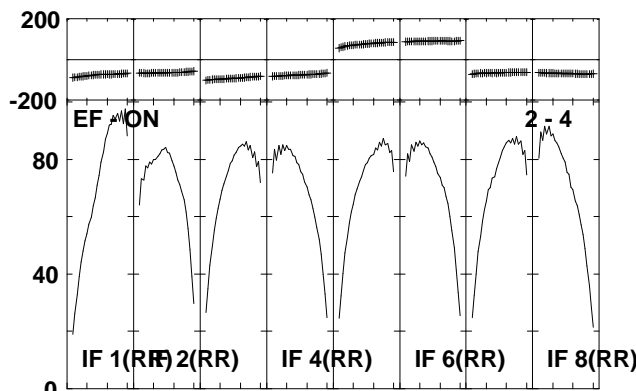
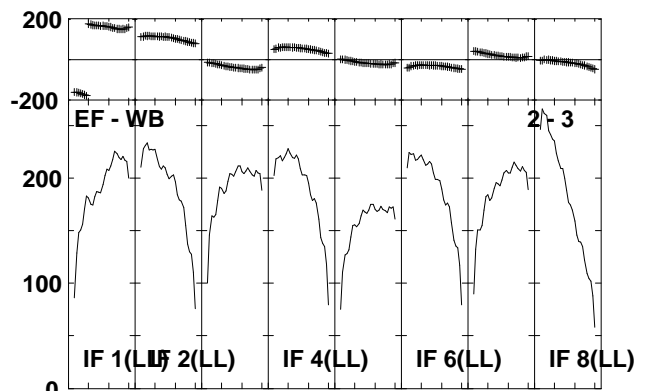
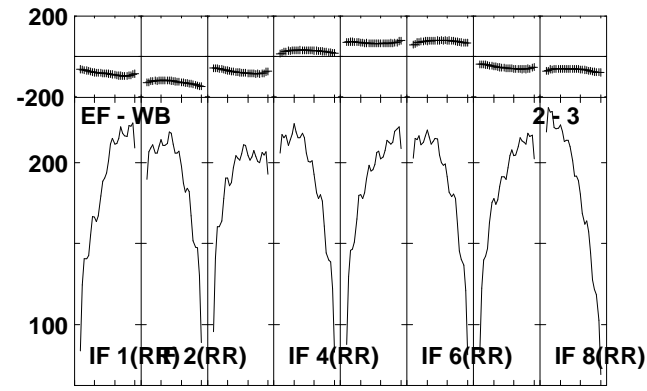
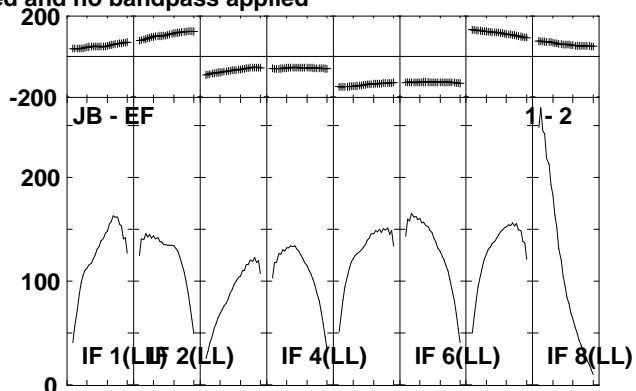
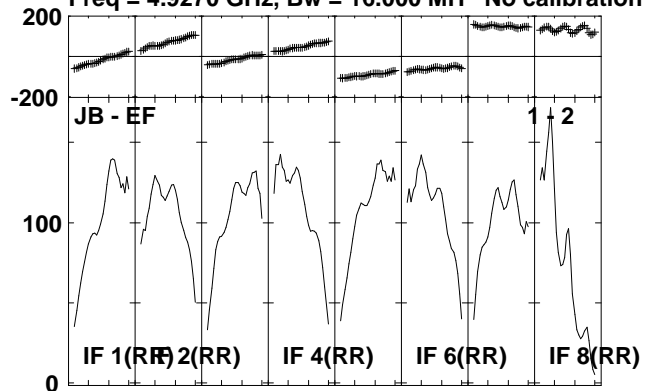

Lower frame: Milli Ampl Jy Top frame: Phas deg
Scalar averaged cross-power spectrum Several baselines displayed
Timerange: 00/11:06:33 to 00/11:12:57

Plot file version 4 created 06-JUL-2010 12:00:30

3C454.3 EP064L.UVDATA.1

Freq = 4.9270 GHz, Bw = 16.000 MH No calibration applied and no bandpass applied

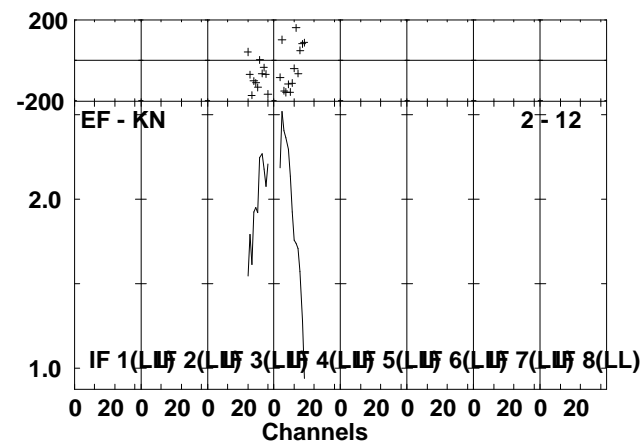
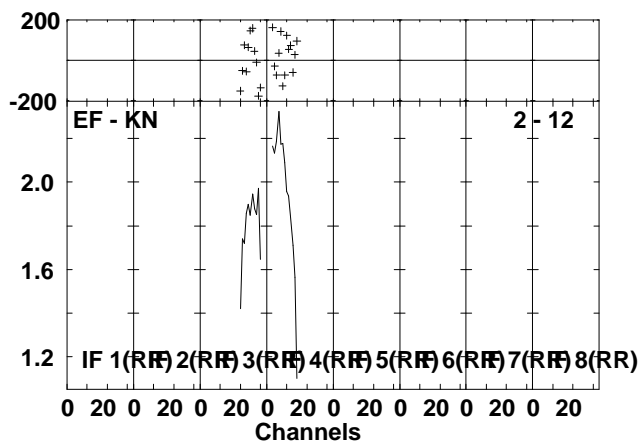
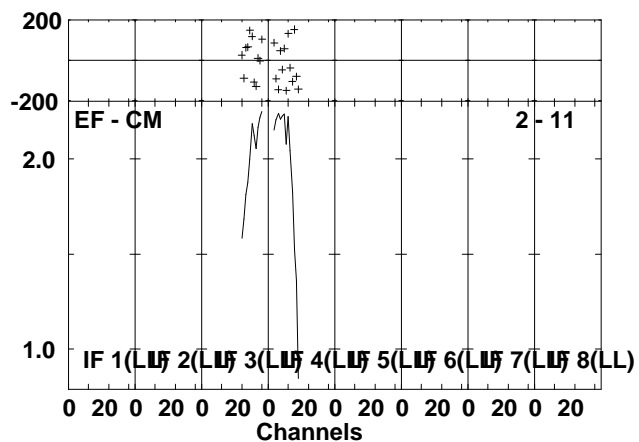
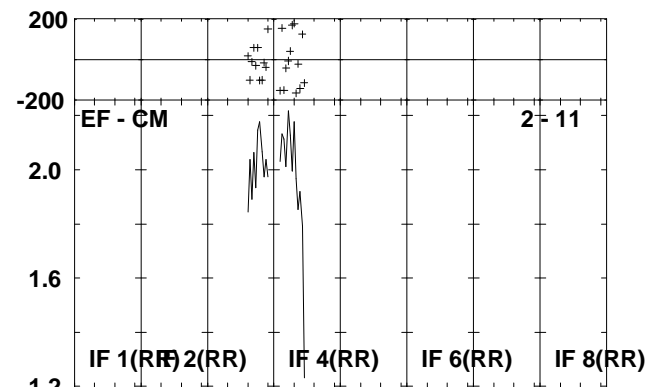
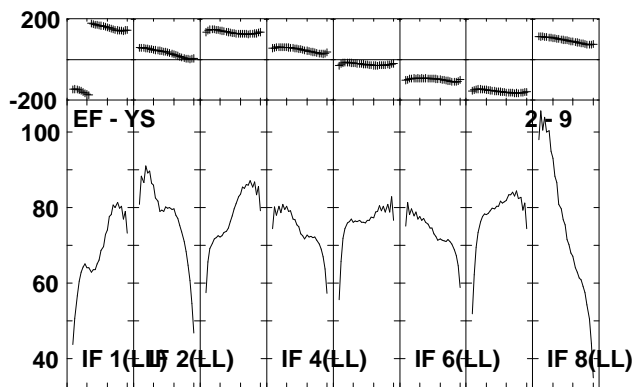
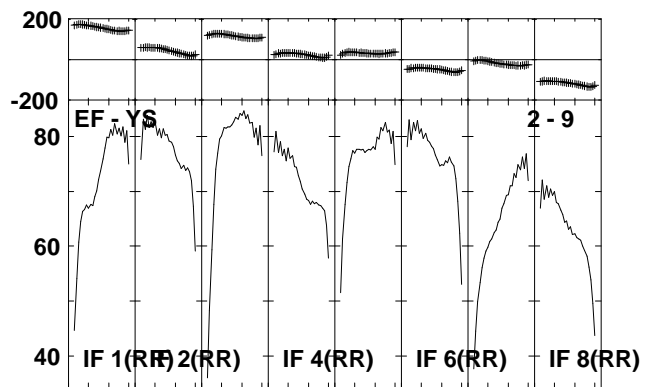
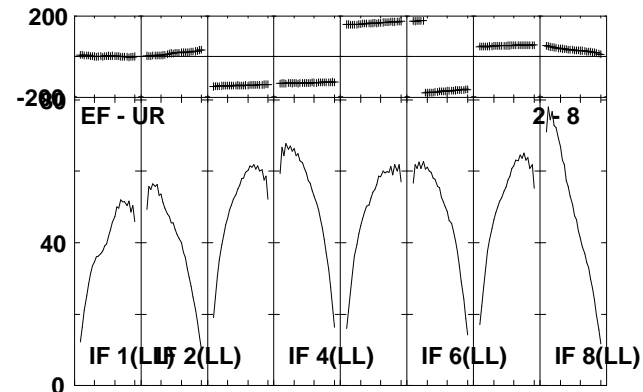
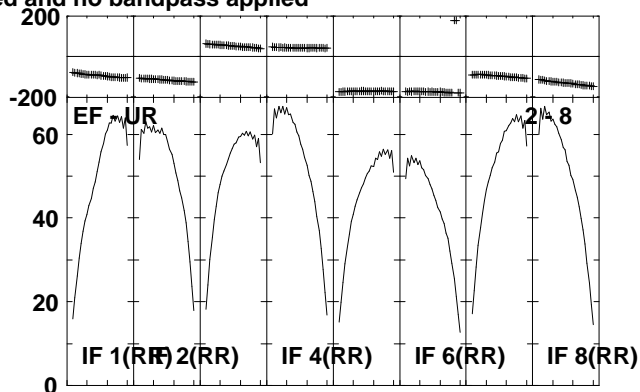
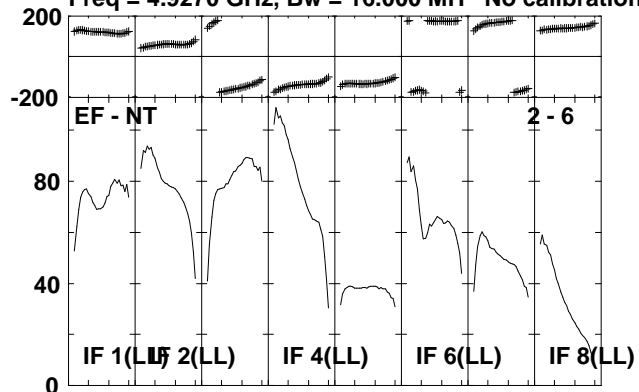

Lower frame: Milli Ampl Jy Top frame: Phas deg
Scalar averaged cross-power spectrum Several baselines displayed
Timerange: 00/11:06:33 to 00/11:12:57

Plot file version 5 created 06-JUL-2010 12:00:35

J2330+33 EP064L.UVDATA.1

Freq = 4.9270 GHz, Bw = 16.000 MH No calibration applied and no bandpass applied

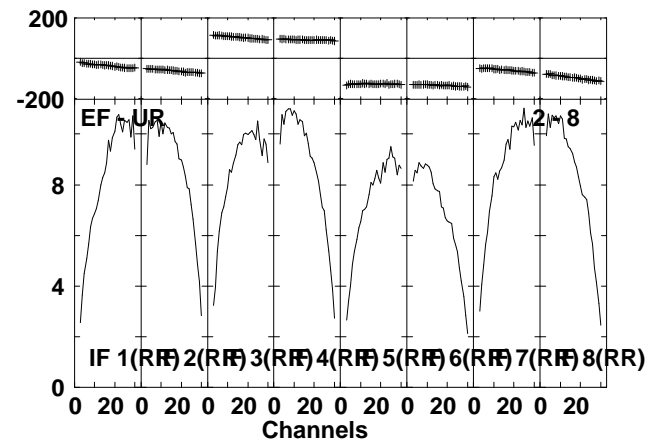
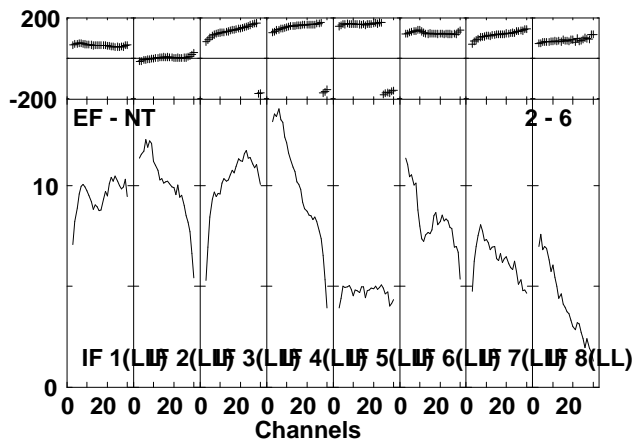
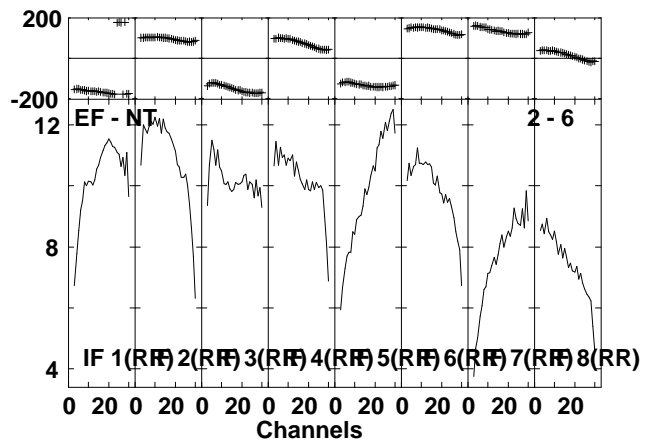
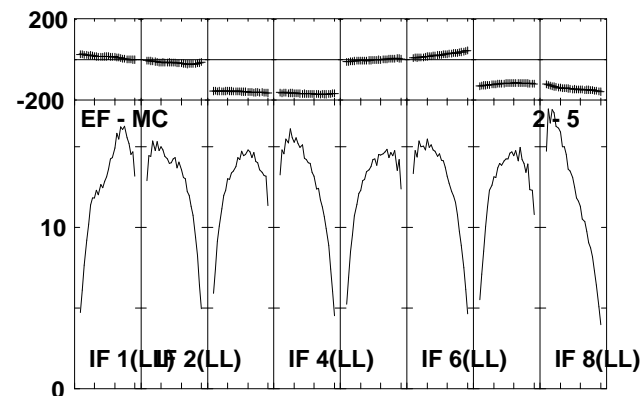
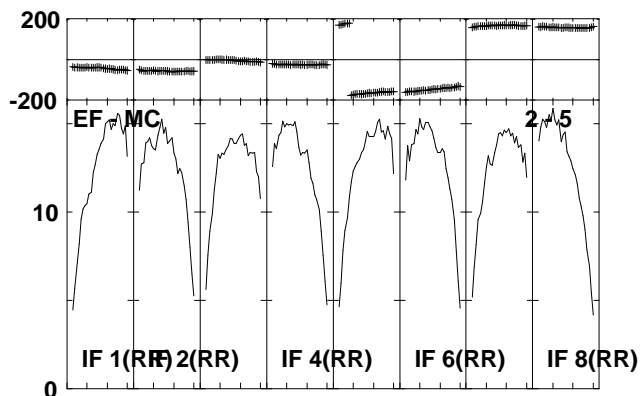
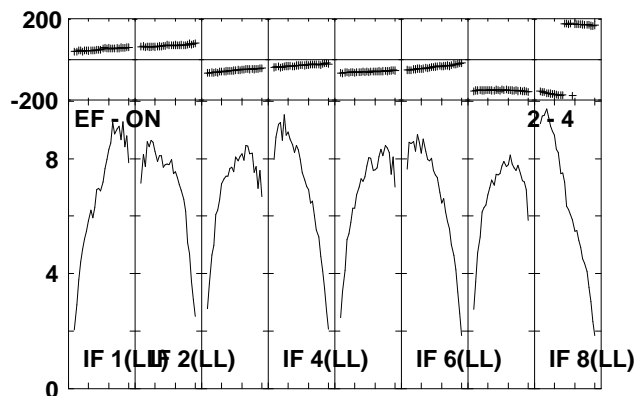
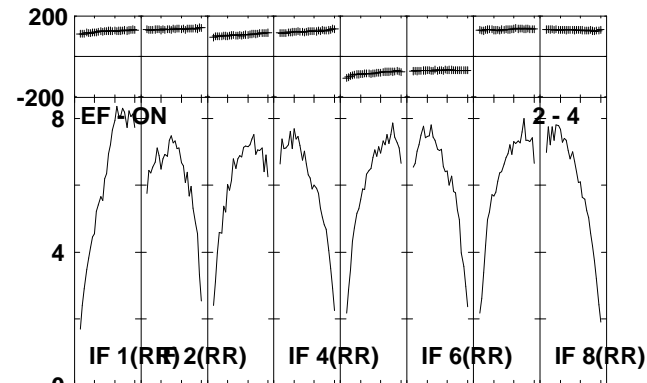
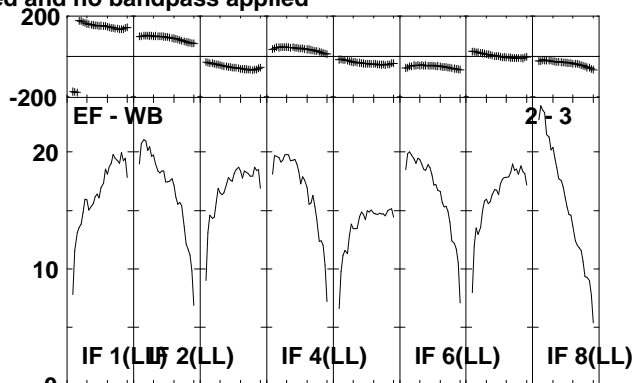
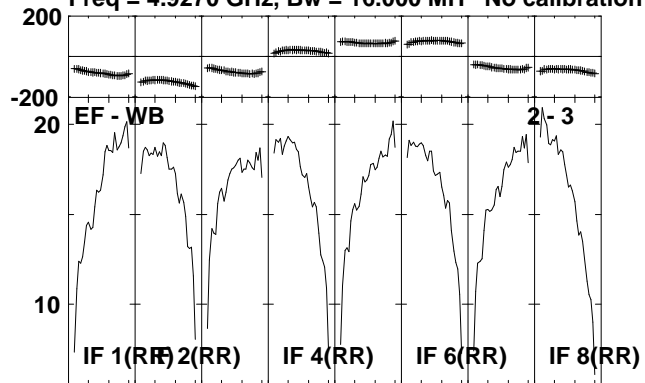

Lower frame: Milli Ampl Jy Top frame: Phas deg
Scalar averaged cross-power spectrum Several baselines displayed
Timerange: 00/11:14:01 to 00/11:15:57

Plot file version 6 created 06-JUL-2010 12:00:36

J2330+33 EP064L.UVDATA.1

Freq = 4.9270 GHz, Bw = 16.000 MH No calibration applied and no bandpass applied

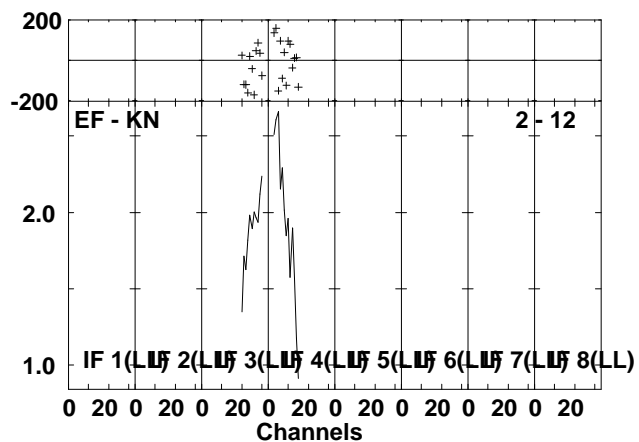
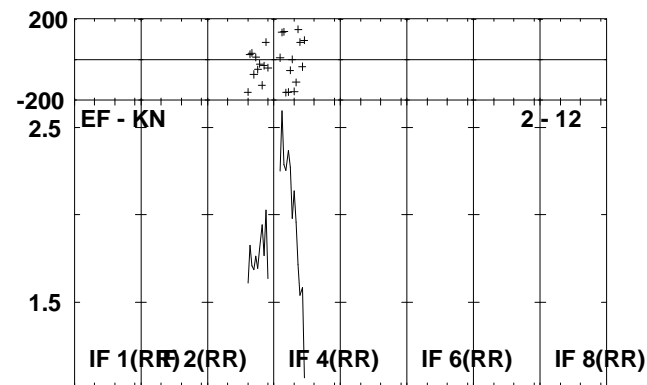
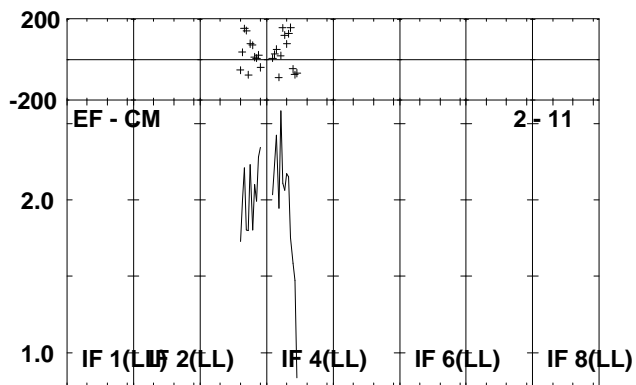
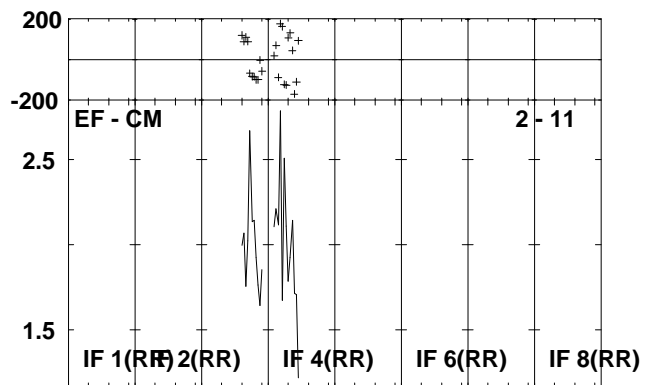
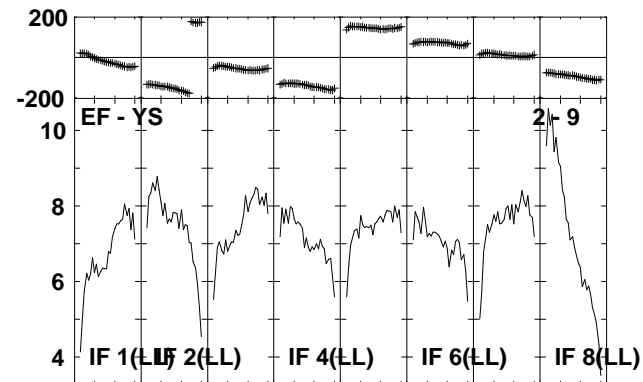
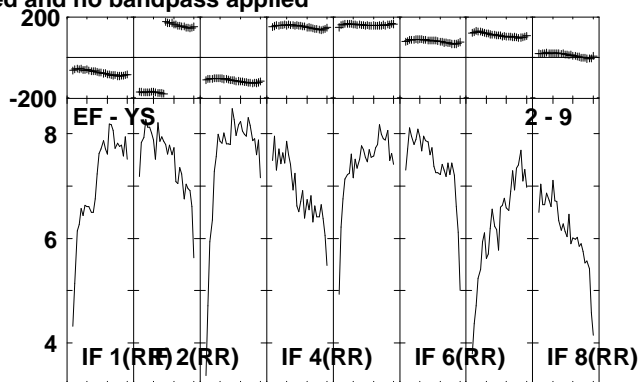
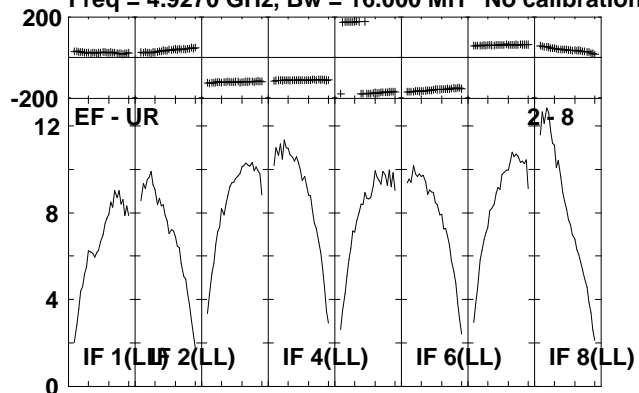

Lower frame: Milli Ampl Jy Top frame: Phas deg
Scalar averaged cross-power spectrum Several baselines displayed
Timerange: 00/11:14:01 to 00/11:15:57

Plot file version 7 created 06-JUL-2010 12:00:37

IRAS2336 EP064L.UVDATA.1

Freq = 4.9270 GHz, Bw = 16.000 MH No calibration applied and no bandpass applied

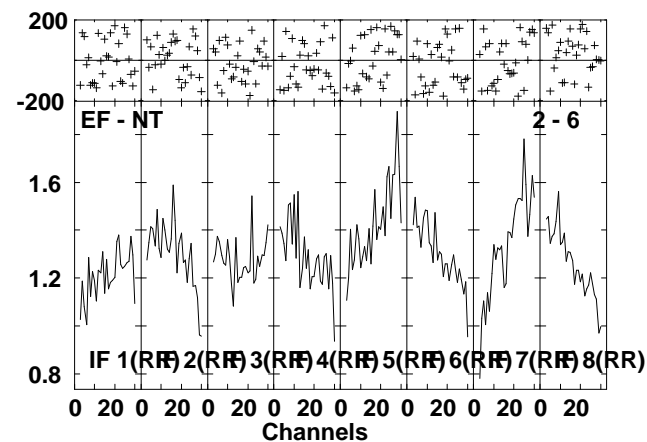
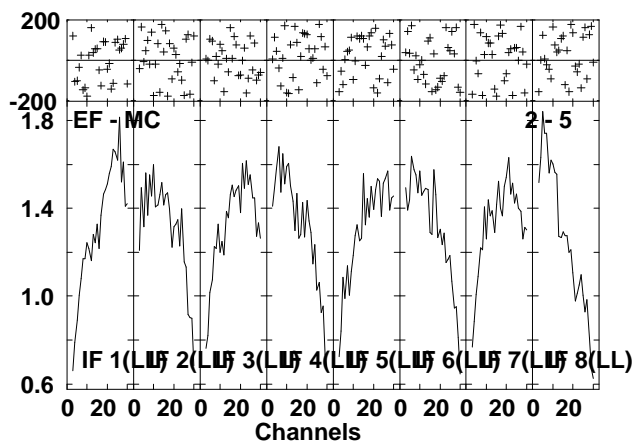
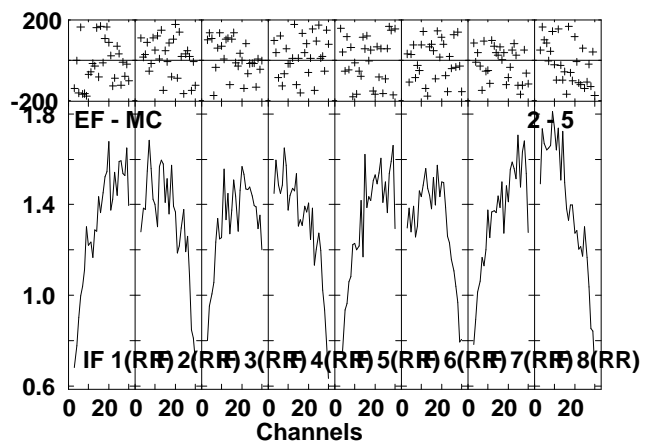
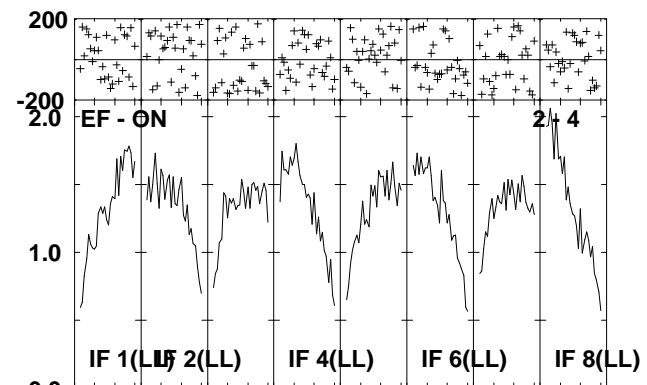
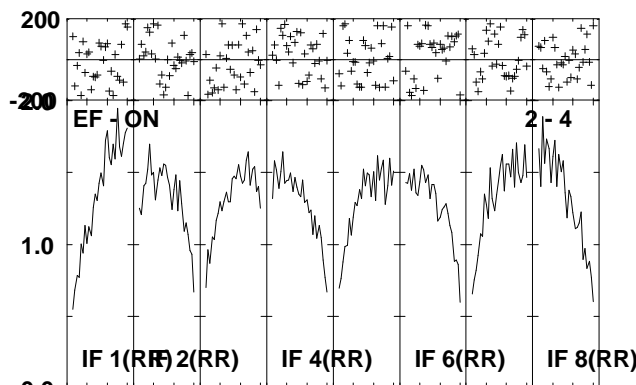
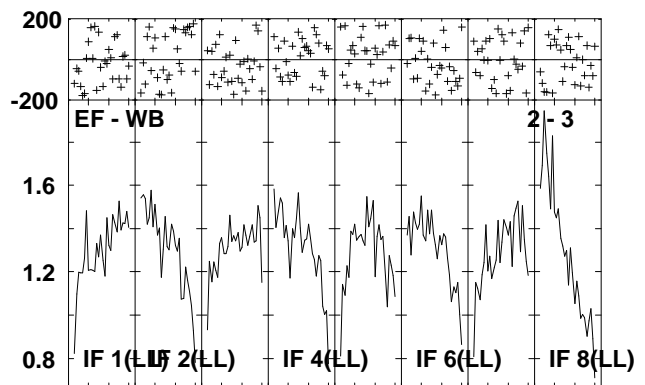
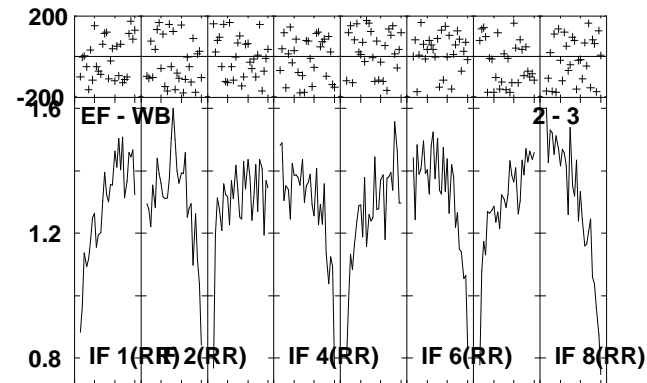
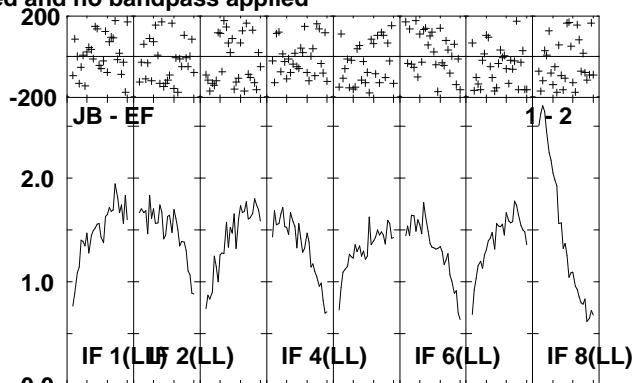
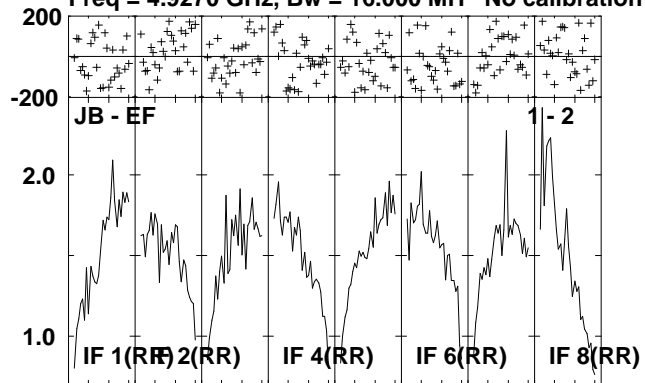

Lower frame: Milli Ampl Jy Top frame: Phas deg
Scalar averaged cross-power spectrum Several baselines displayed
Timerange: 00/11:16:01 to 00/11:19:29

Plot file version 8 created 06-JUL-2010 12:00:39

IRAS2336 EP064L.UVDATA.1

Freq = 4.9270 GHz, Bw = 16.000 MH No calibration applied and no bandpass applied

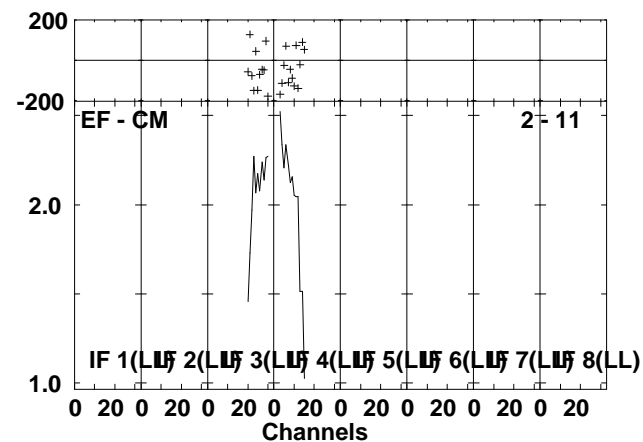
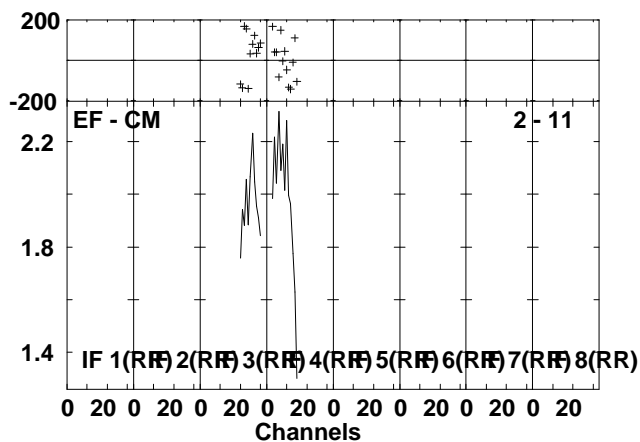
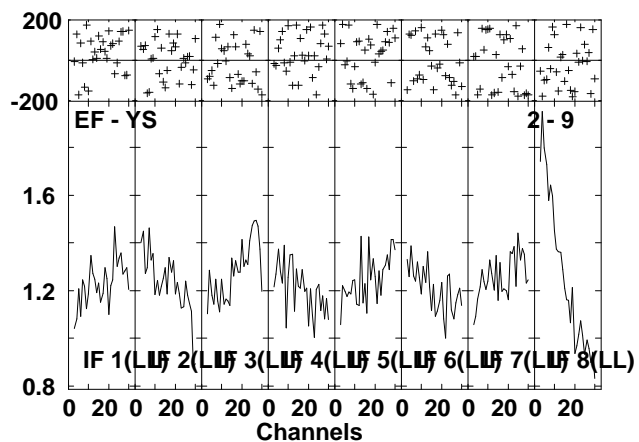
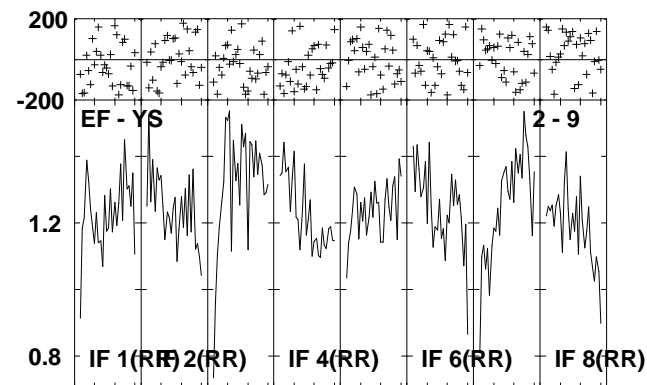
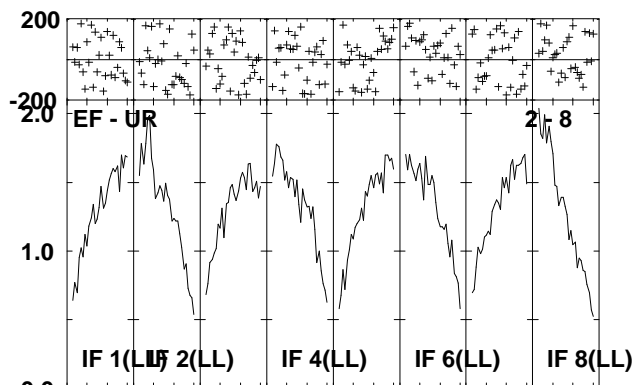
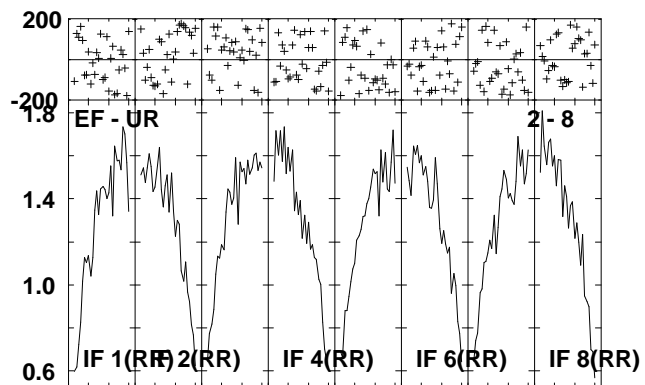
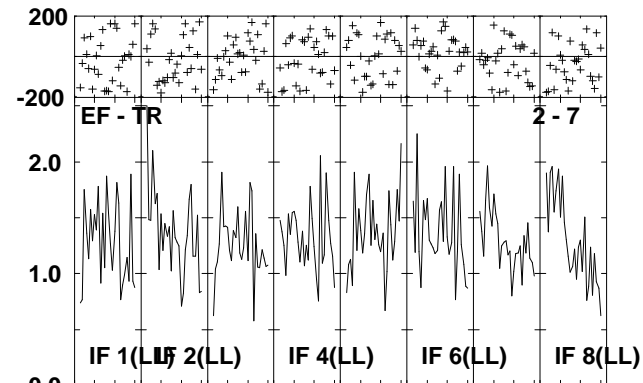
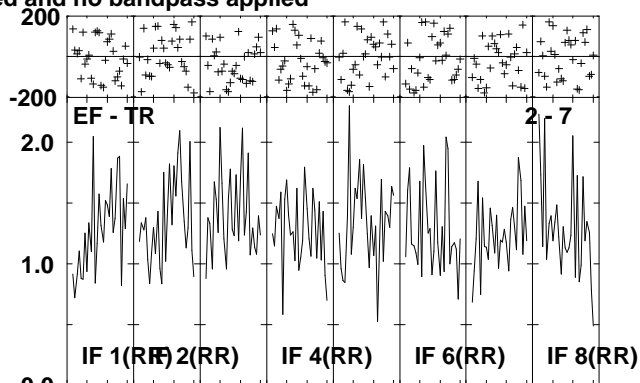
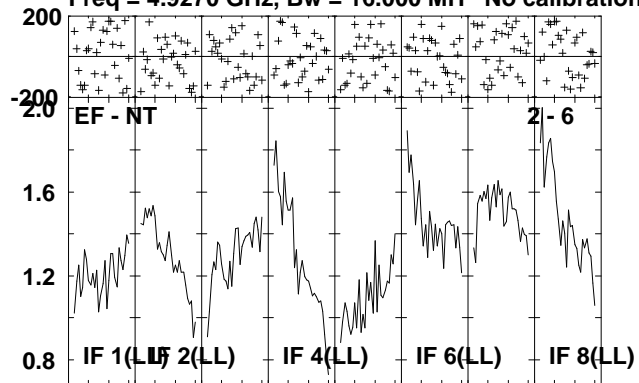

Lower frame: Milli Ampl Jy Top frame: Phas deg
Scalar averaged cross-power spectrum Several baselines displayed
Timerange: 00/11:16:01 to 00/11:19:29

Plot file version 9 created 06-JUL-2010 12:00:42

IRAS2336 EP064L.UVDATA.1

Freq = 4.9270 GHz, Bw = 16.000 MH No calibration applied and no bandpass applied

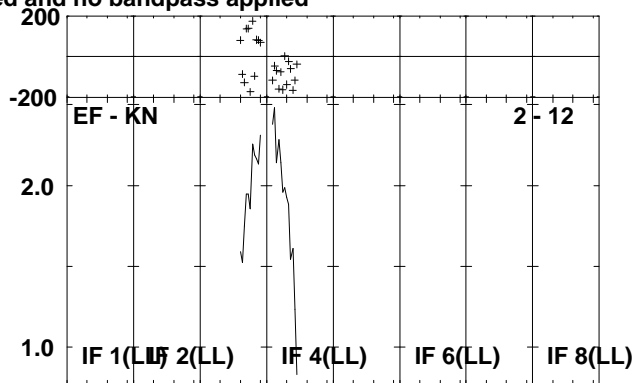
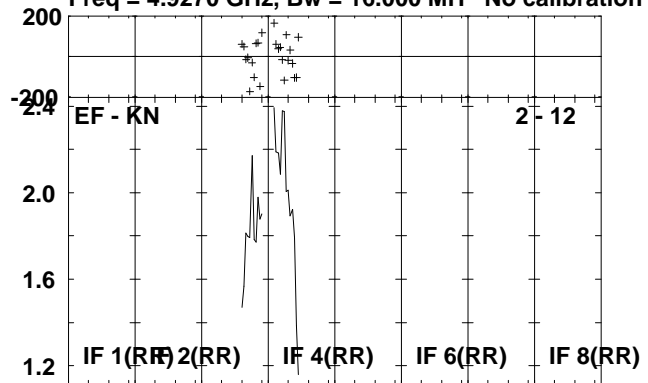

Lower frame: Milli Ampl Jy Top frame: Phas deg
Scalar averaged cross-power spectrum Several baselines displayed
Timerange: 00/11:16:01 to 00/11:19:29

Plot file version 10 created 06-JUL-2010 12:00:42

J2330+33 EP064L.UVDATA.1

Freq = 4.9270 GHz, Bw = 16.000 MH No calibration applied and no bandpass applied

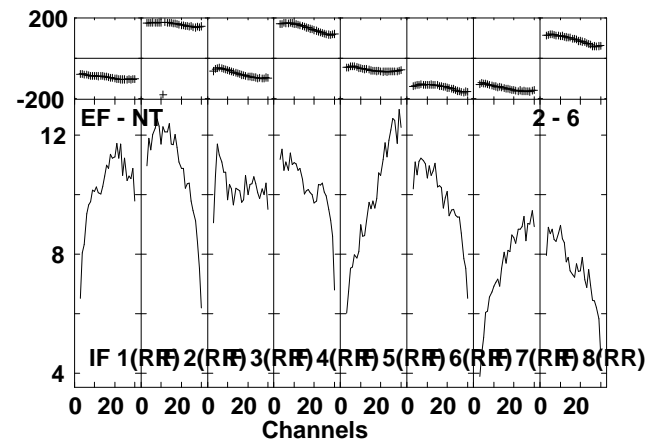
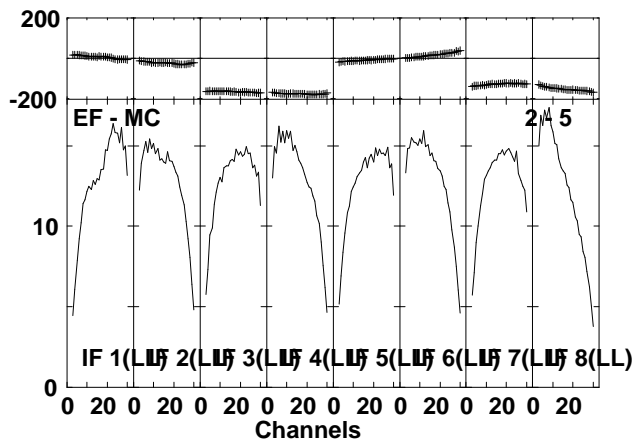
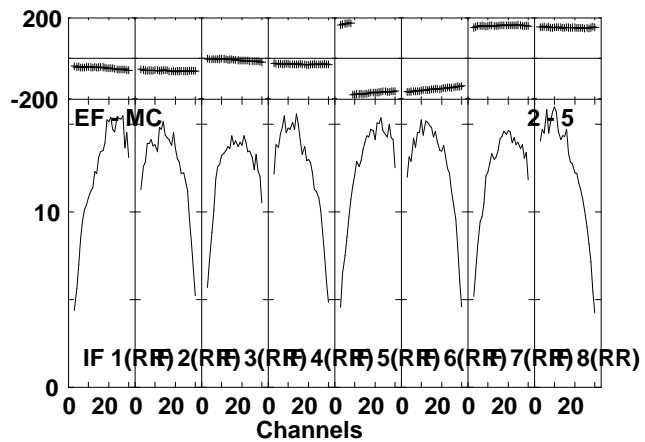
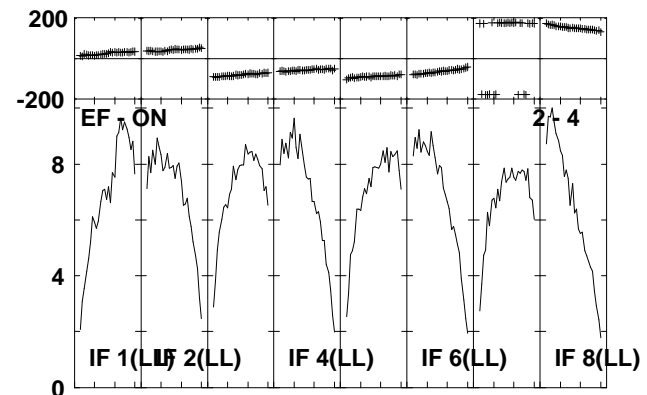
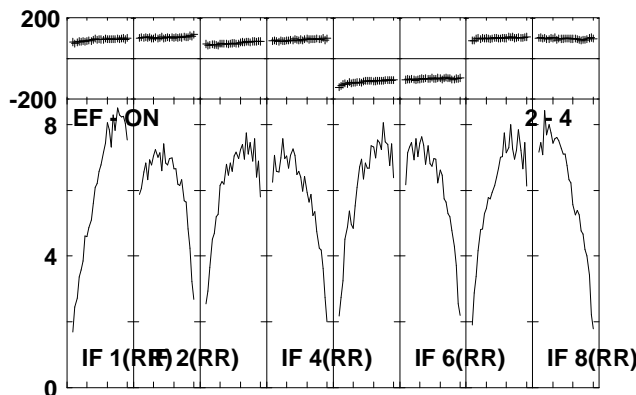
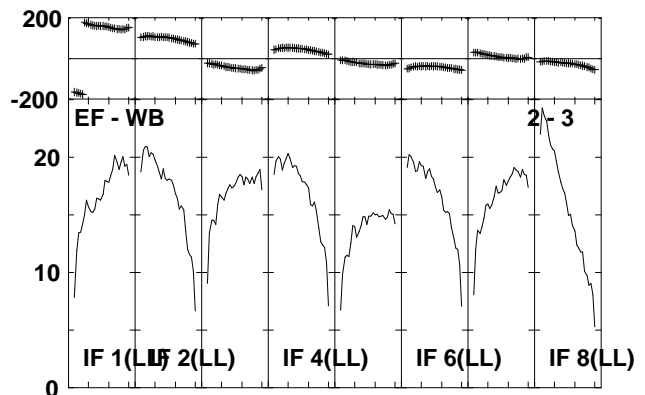
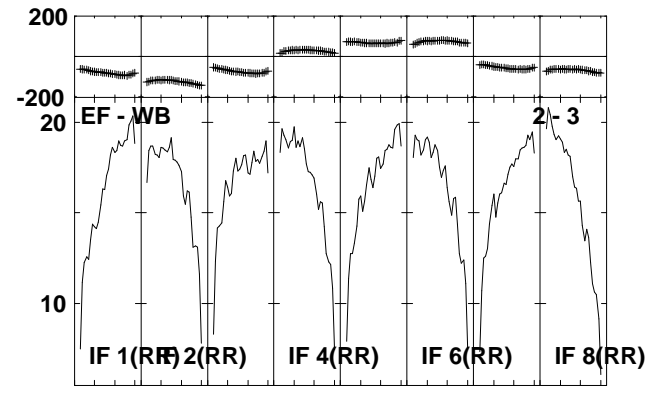
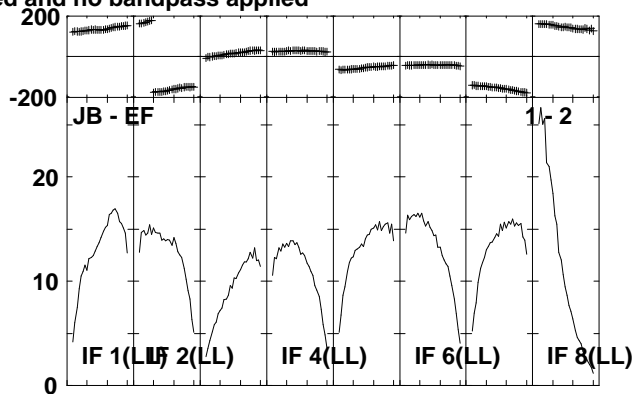
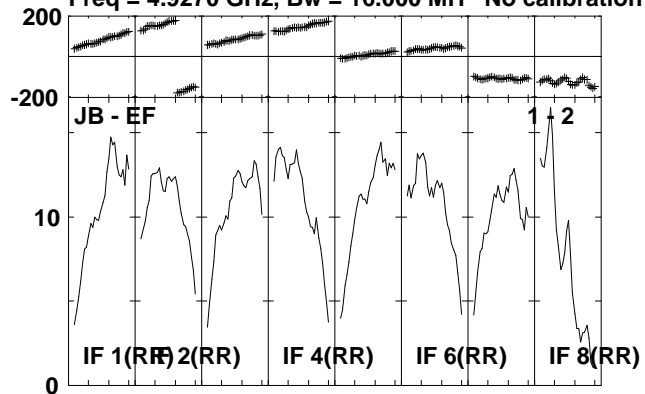

Lower frame: Milli Ampl Jy Top frame: Phas deg
Scalar averaged cross-power spectrum Several baselines displayed
Timerange: 00/11:19:31 to 00/11:21:09

Plot file version 11 created 06-JUL-2010 12:00:43

J2330+33 EP064L.UVDATA.1

Freq = 4.9270 GHz, Bw = 16.000 MH No calibration applied and no bandpass applied

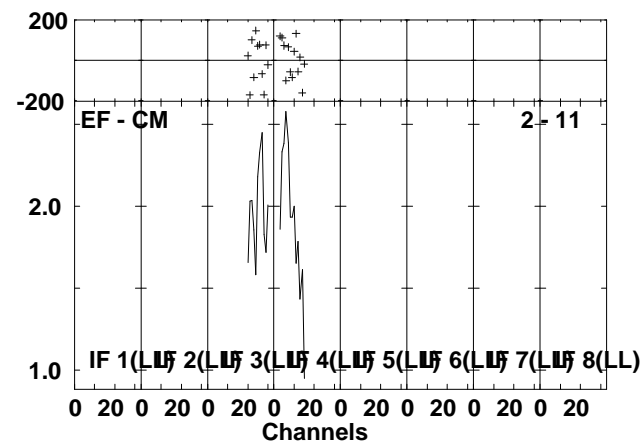
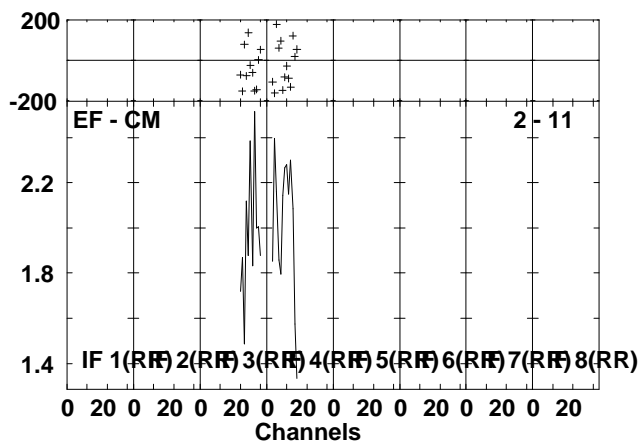
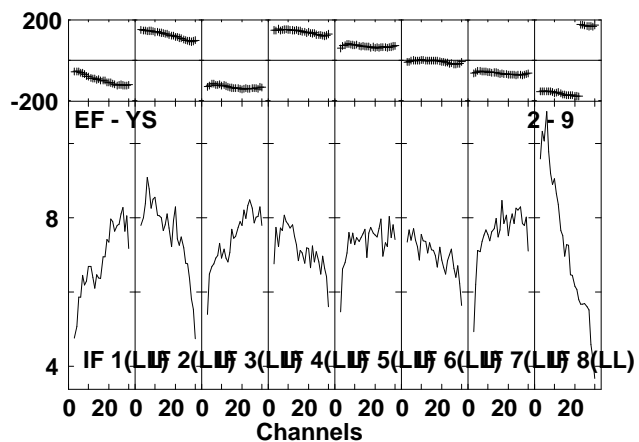
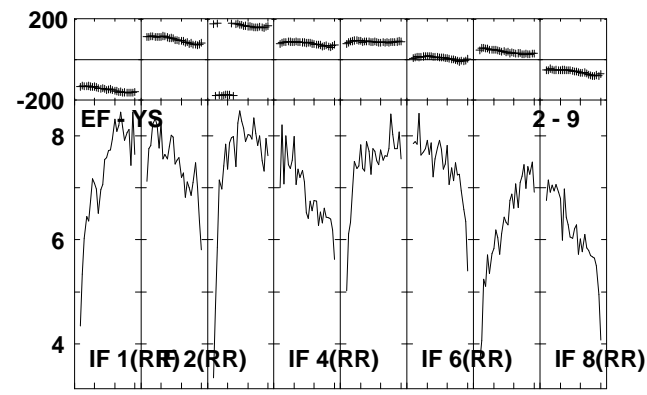
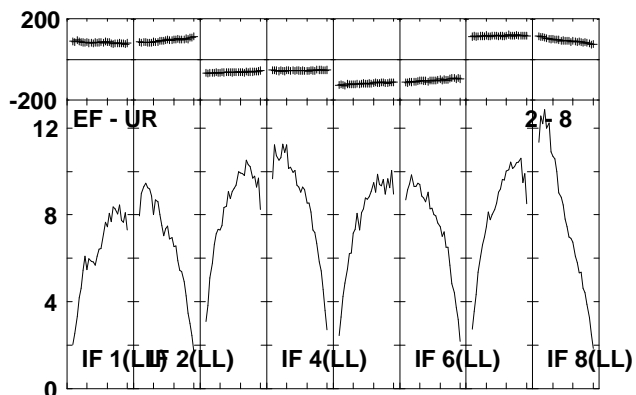
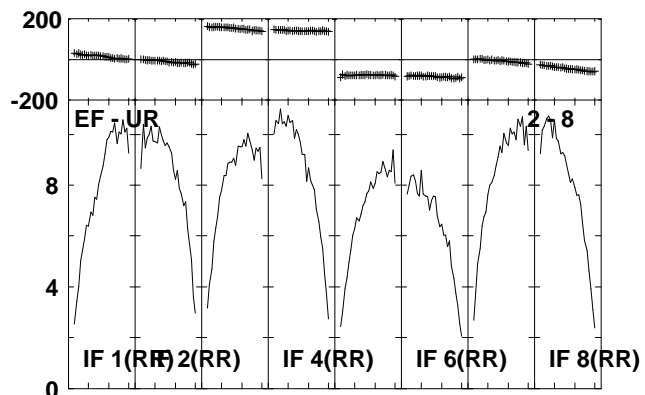
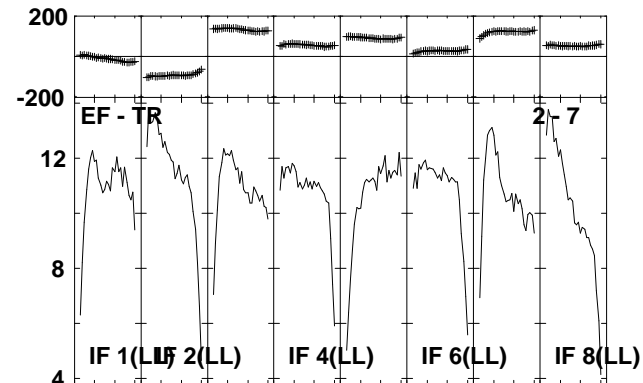
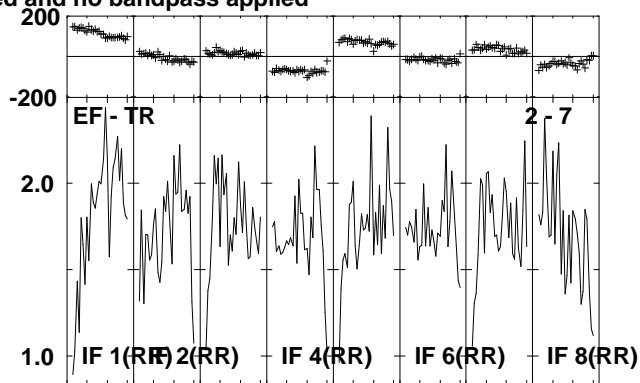
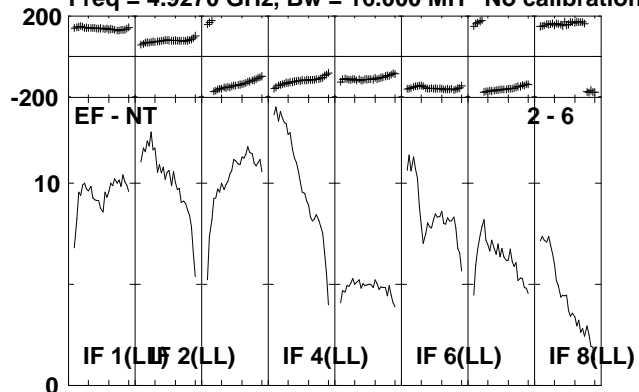

Lower frame: Milli Ampl Jy Top frame: Phas deg
Scalar averaged cross-power spectrum Several baselines displayed
Timerange: 00/11:19:31 to 00/11:21:09

Plot file version 12 created 06-JUL-2010 12:00:50

J2330+33 EP064L.UVDATA.1

Freq = 4.9270 GHz, Bw = 16.000 MH No calibration applied and no bandpass applied

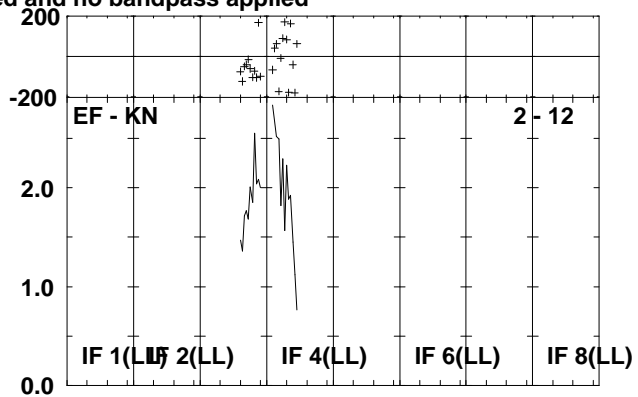
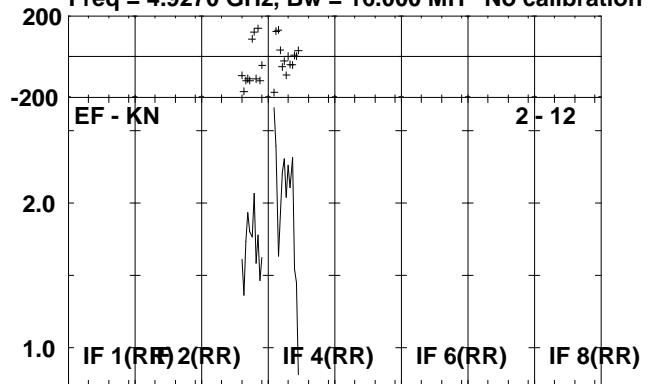

Lower frame: Milli Ampl Jy Top frame: Phas deg
Scalar averaged cross-power spectrum Several baselines displayed
Timerange: 00/11:19:31 to 00/11:21:09

Plot file version 13 created 06-JUL-2010 12:00:51

IRAS2336 EP064L.UVDATA.1

Freq = 4.9270 GHz, Bw = 16.000 MH No calibration applied and no bandpass applied

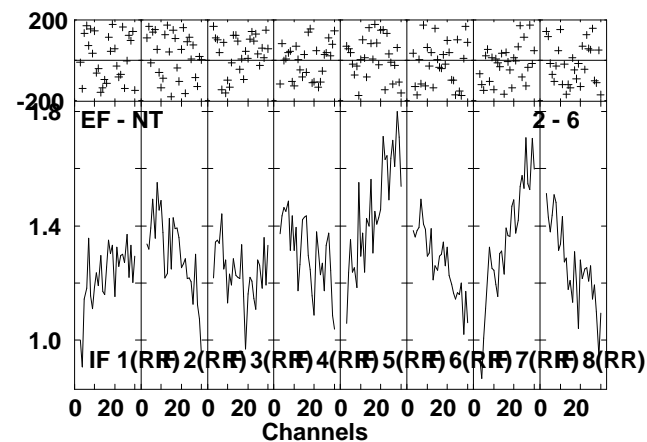
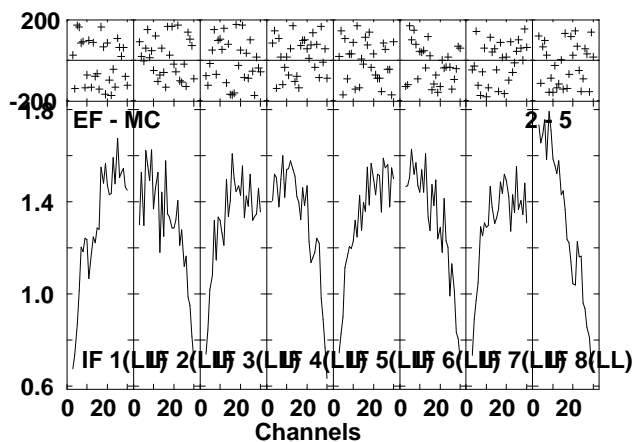
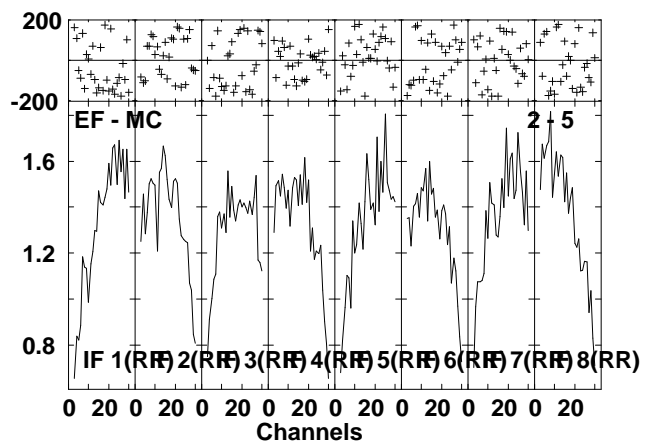
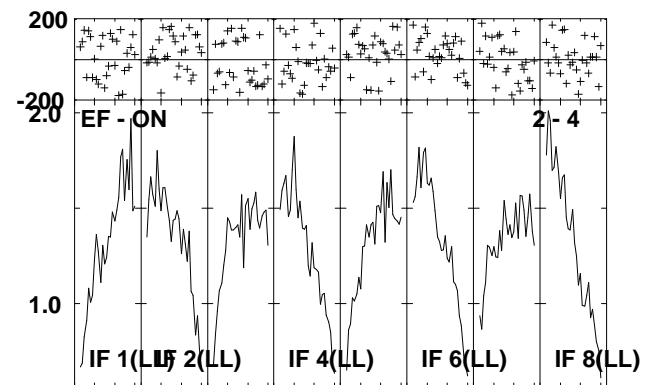
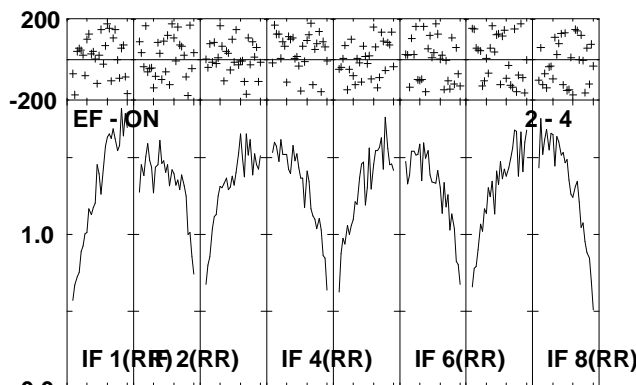
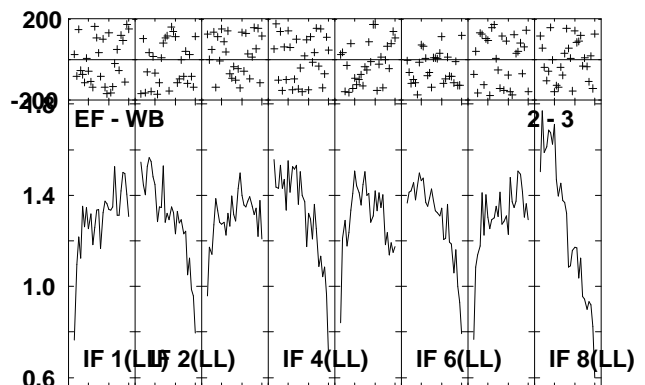
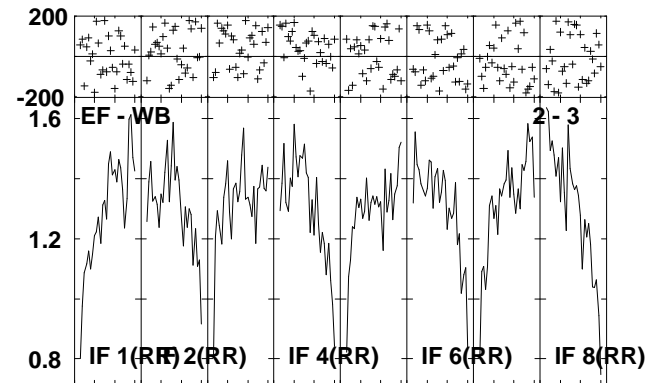
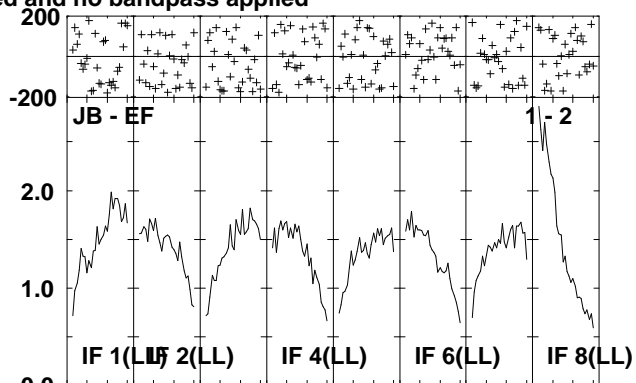
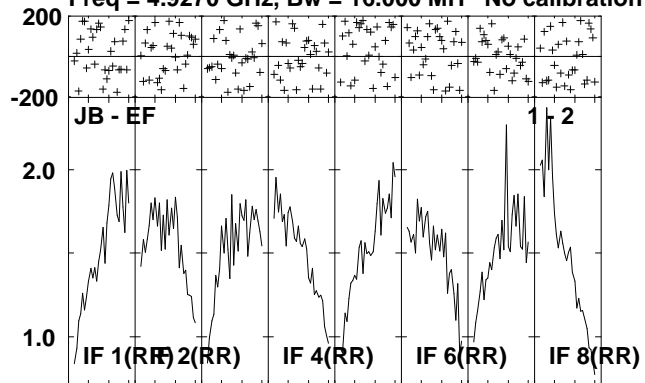

Lower frame: Milli Ampl Jy Top frame: Phas deg
Scalar averaged cross-power spectrum Several baselines displayed
Timerange: 00/11:21:11 to 00/11:24:39

Plot file version 14 created 06-JUL-2010 12:00:53

IRAS2336 EP064L.UVDATA.1

Freq = 4.9270 GHz, Bw = 16.000 MH No calibration applied and no bandpass applied

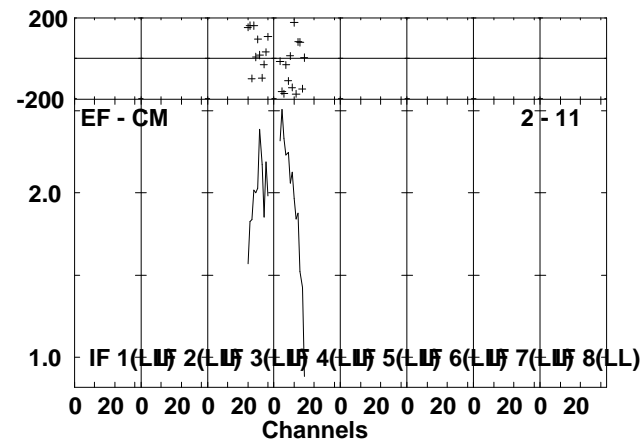
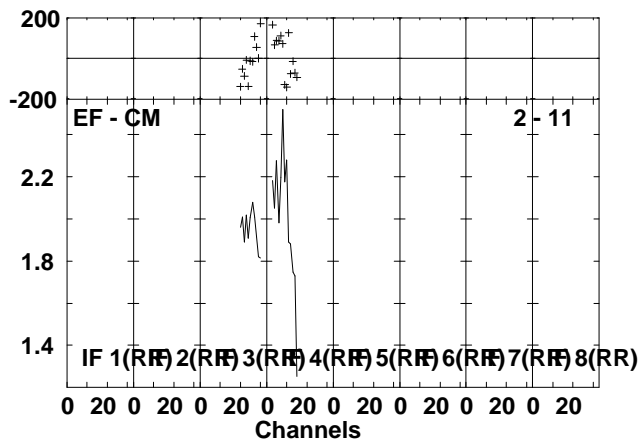
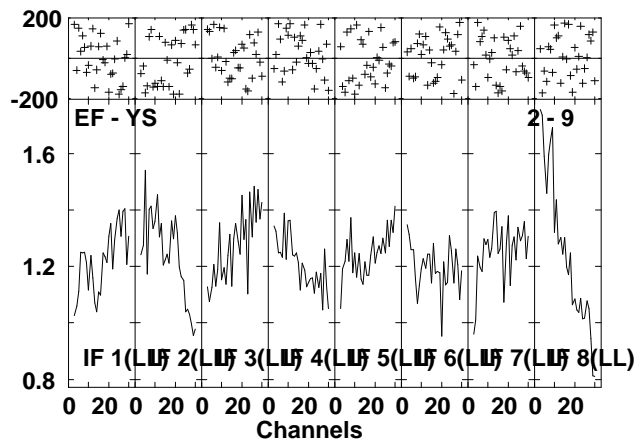
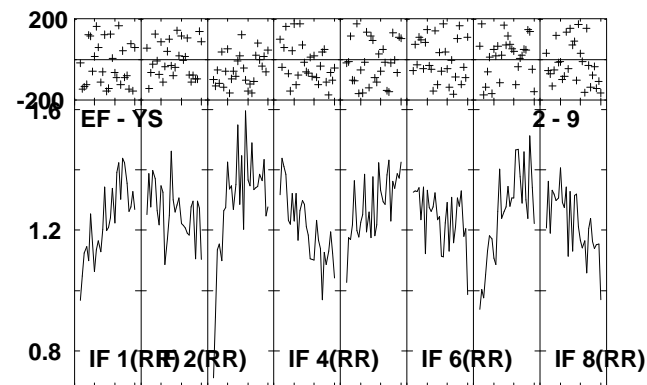
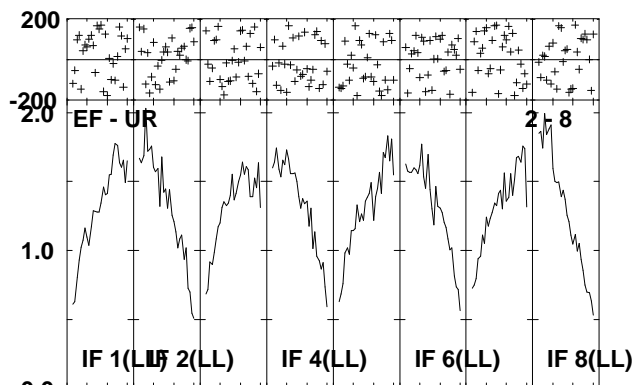
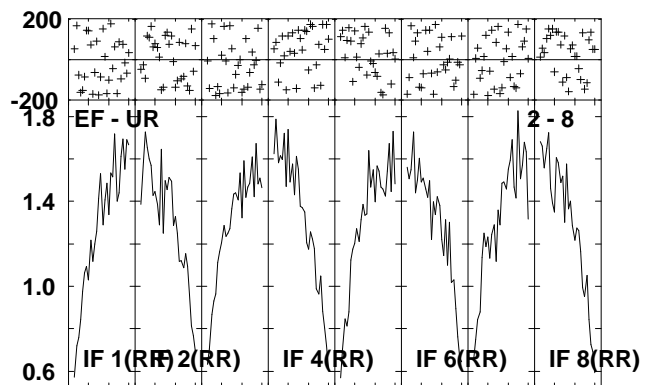
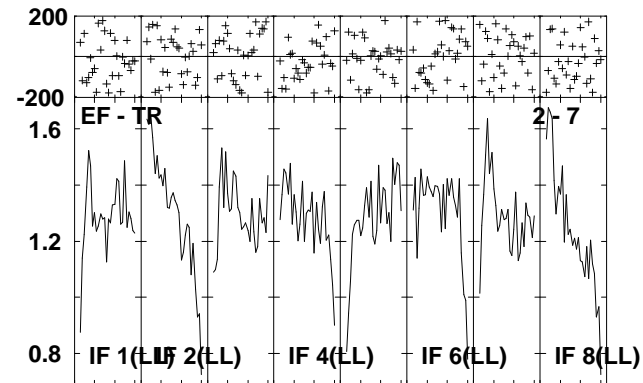
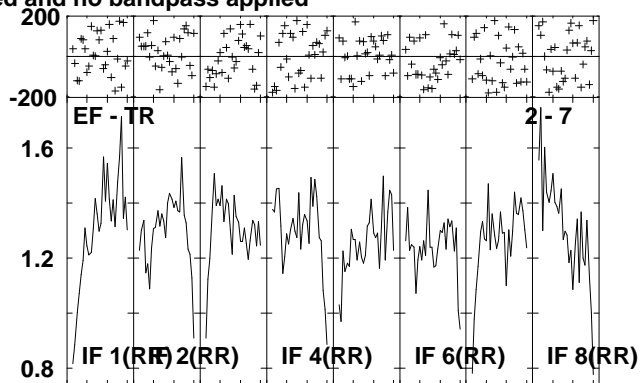
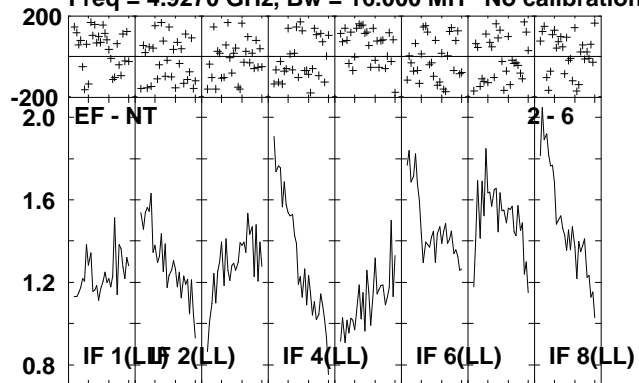

Lower frame: Milli Ampl Jy Top frame: Phas deg
Scalar averaged cross-power spectrum Several baselines displayed
Timerange: 00/11:21:11 to 00/11:24:39

Plot file version 15 created 06-JUL-2010 12:00:57

IRAS2336 EP064L.UVDATA.1

Freq = 4.9270 GHz, Bw = 16.000 MH No calibration applied and no bandpass applied

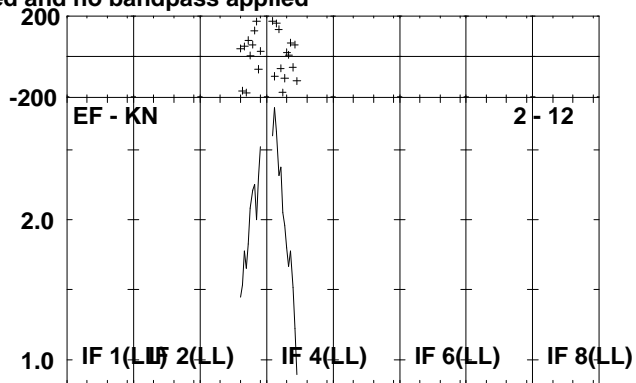
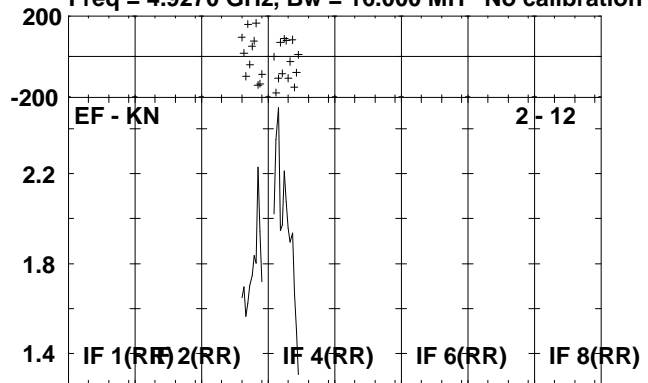

Lower frame: Milli Ampl Jy Top frame: Phas deg
Scalar averaged cross-power spectrum Several baselines displayed
Timerange: 00/11:21:11 to 00/11:24:39

Plot file version 16 created 06-JUL-2010 12:00:57

J2330+33 EP064L.UVDATA.1

Freq = 4.9270 GHz, Bw = 16.000 MH No calibration applied and no bandpass applied

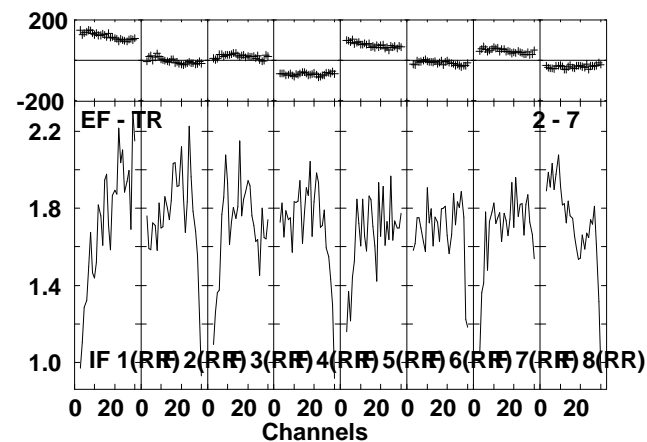
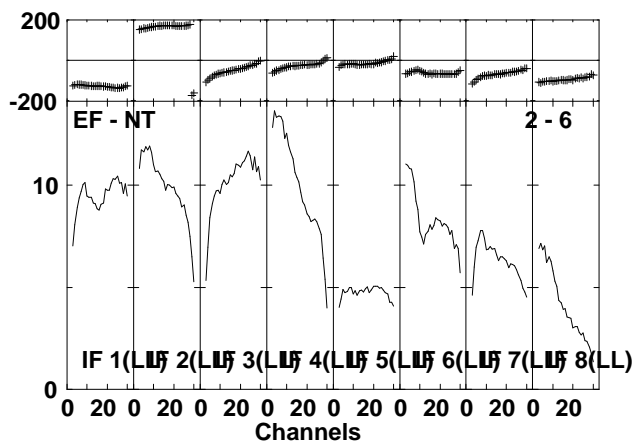
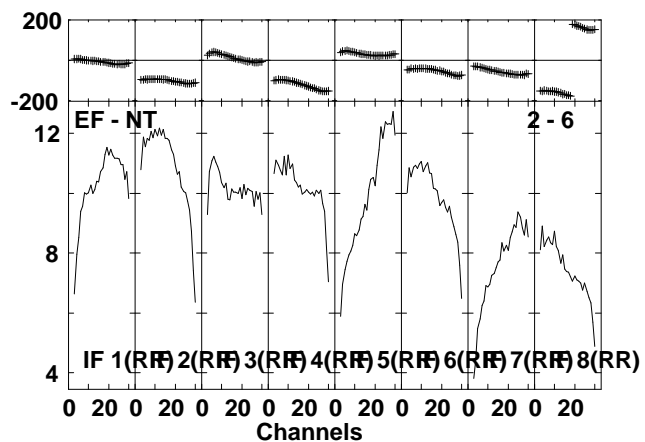
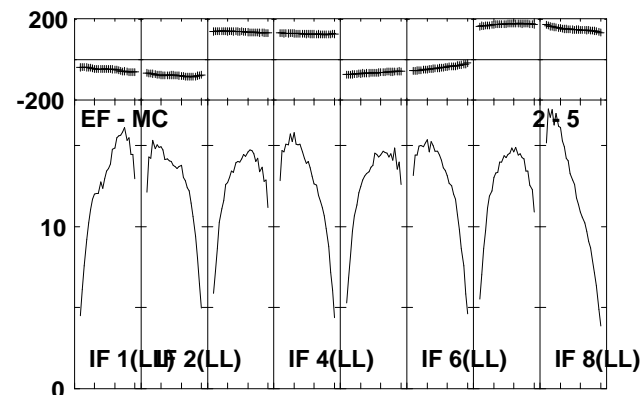
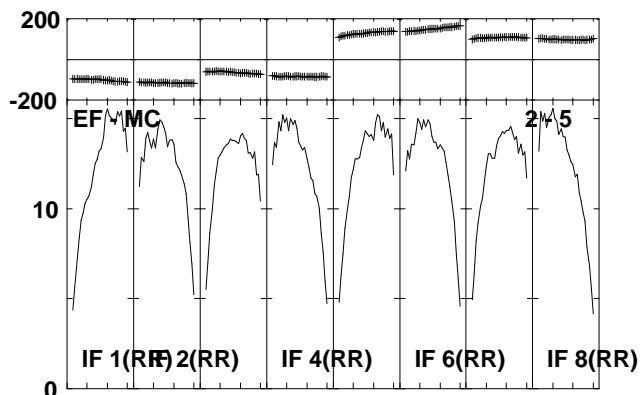
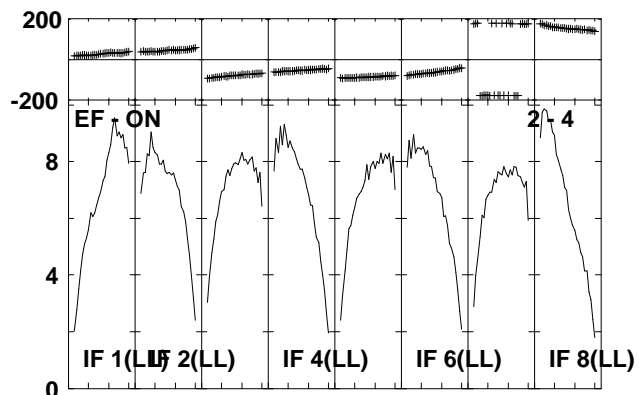
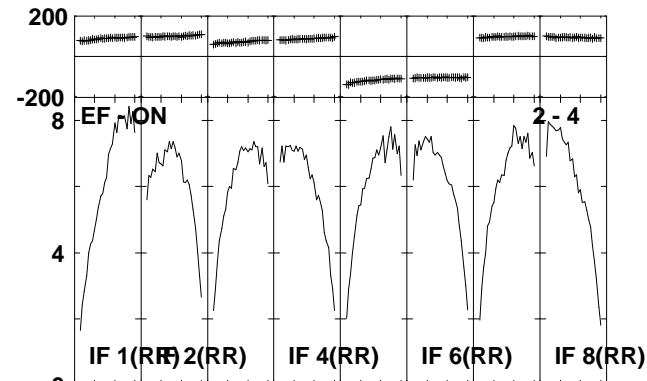
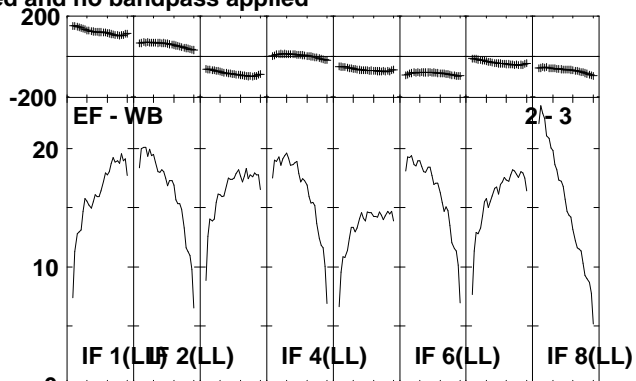
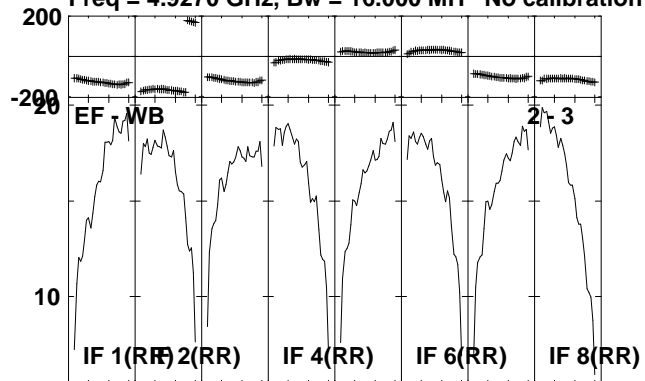

Lower frame: Milli Ampl Jy Top frame: Phas deg
Scalar averaged cross-power spectrum Several baselines displayed
Timerange: 00/11:25:41 to 00/11:27:19

Plot file version 17 created 06-JUL-2010 12:00:58

J2330+33 EP064L.UVDATA.1

Freq = 4.9270 GHz, Bw = 16.000 MH No calibration applied and no bandpass applied

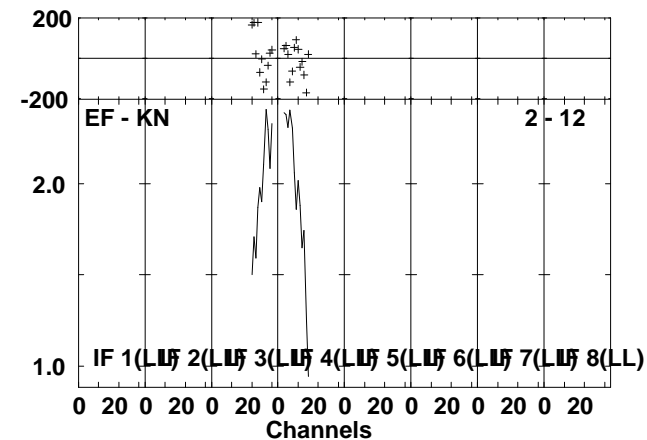
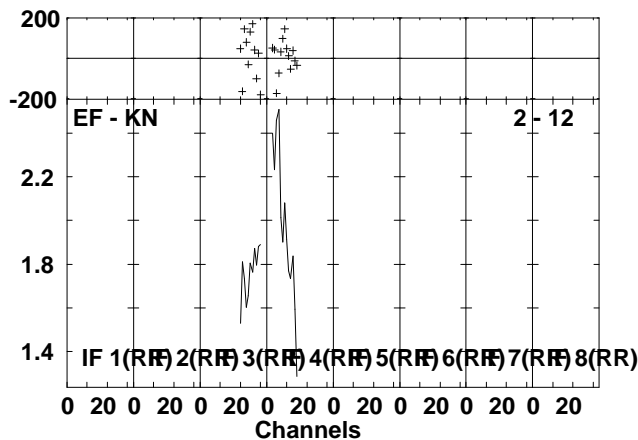
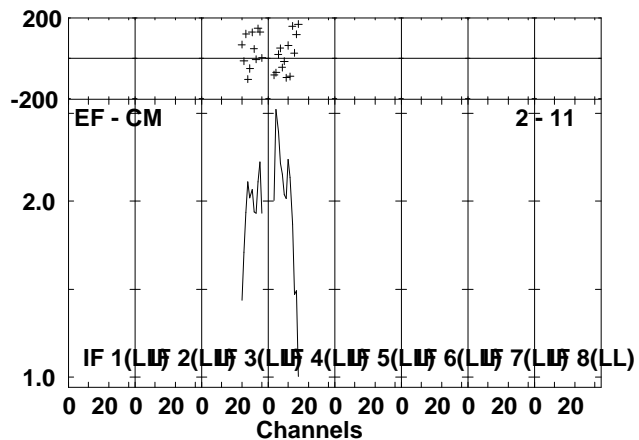
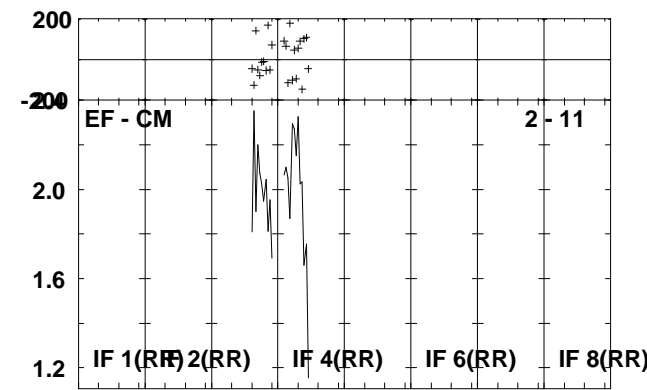
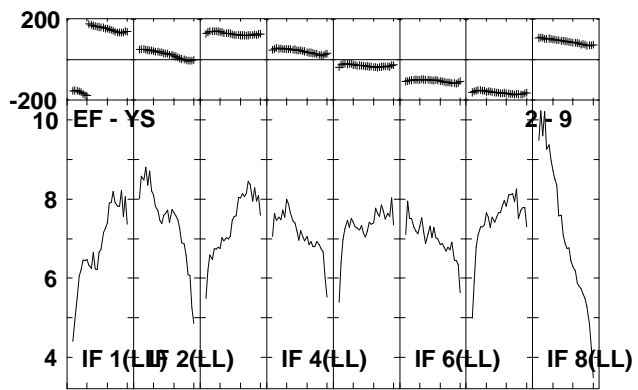
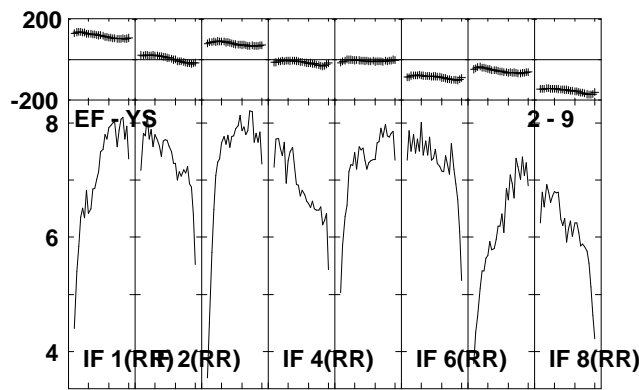
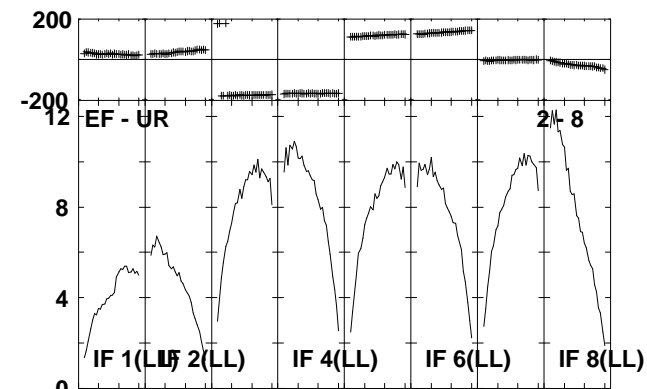
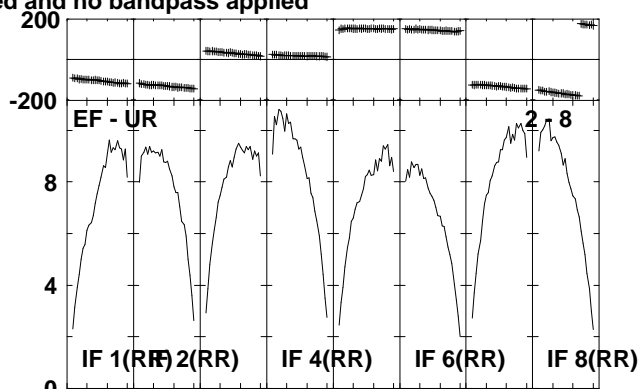
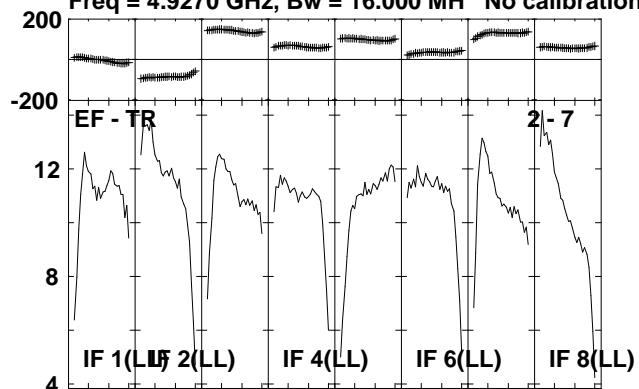

Lower frame: Milli Ampl Jy Top frame: Phas deg
Scalar averaged cross-power spectrum Several baselines displayed
Timerange: 00/11:25:41 to 00/11:27:19

Plot file version 18 created 06-JUL-2010 12:01:00

IRAS2336 EP064L.UVDATA.1

Freq = 4.9270 GHz, Bw = 16.000 MH No calibration applied and no bandpass applied

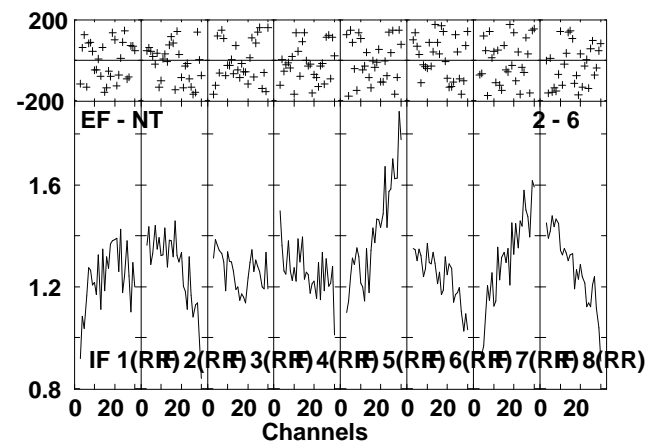
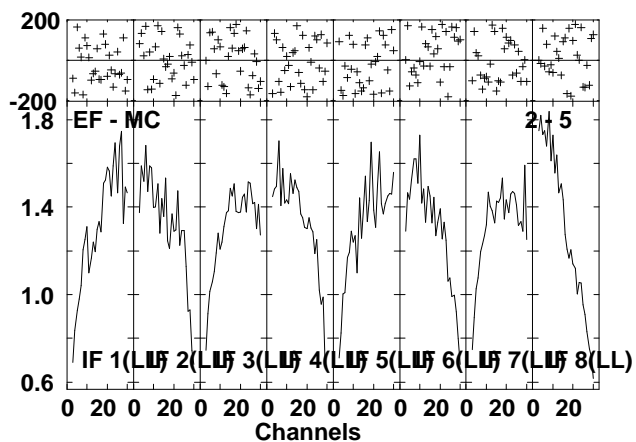
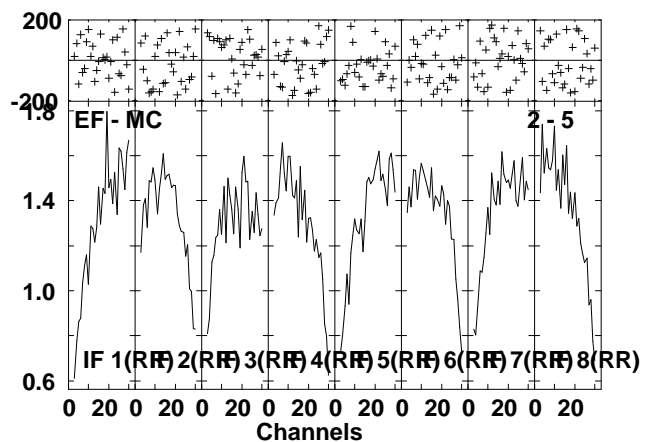
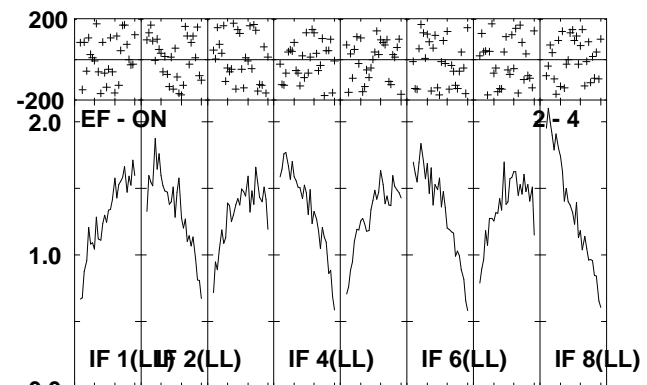
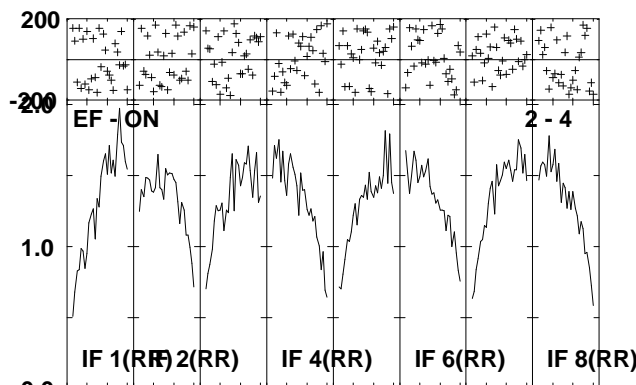
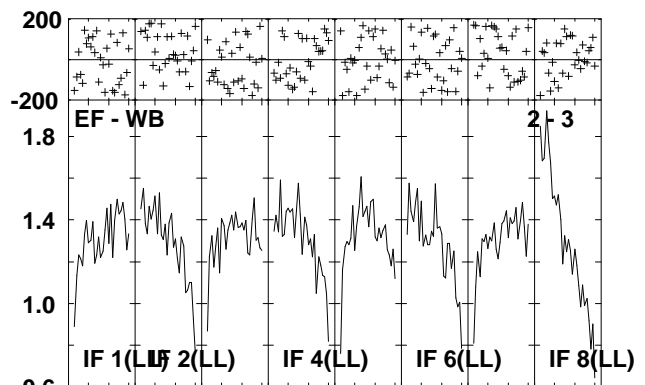
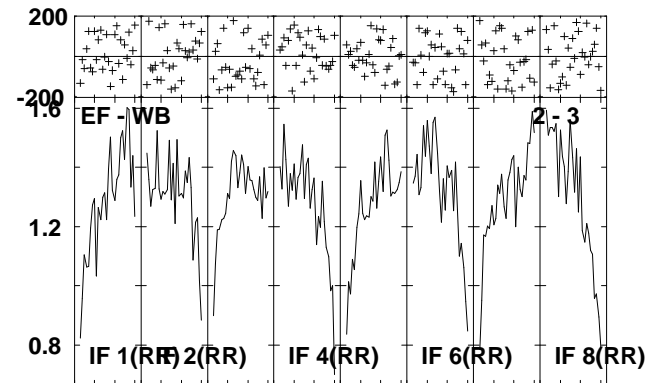
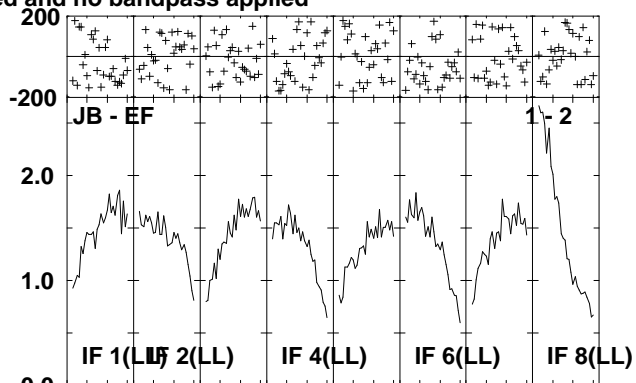
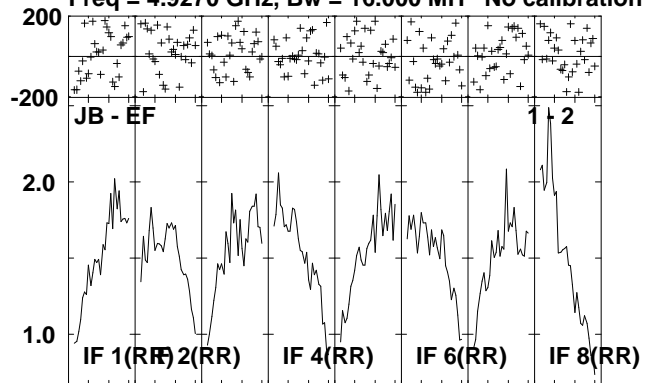

Lower frame: Milli Ampl Jy Top frame: Phas deg
Scalar averaged cross-power spectrum Several baselines displayed
Timerange: 00/11:27:21 to 00/11:30:47

Plot file version 19 created 06-JUL-2010 12:01:02

IRAS2336 EP064L.UVDATA.1

Freq = 4.9270 GHz, Bw = 16.000 MH No calibration applied and no bandpass applied

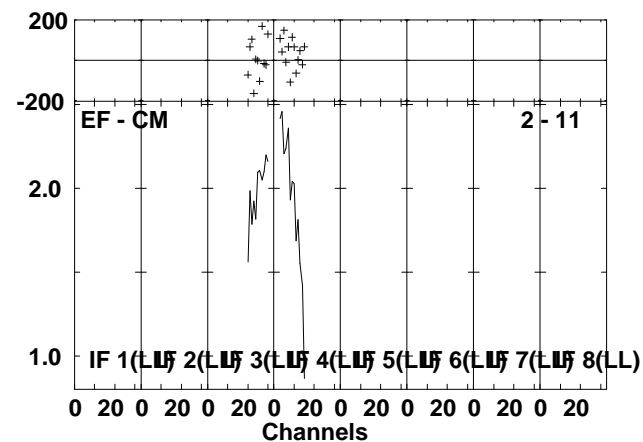
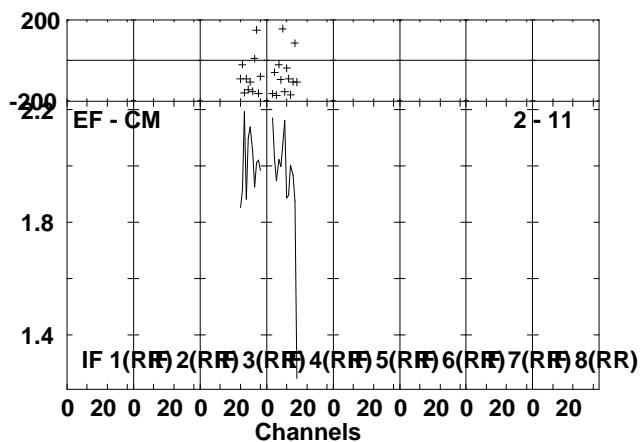
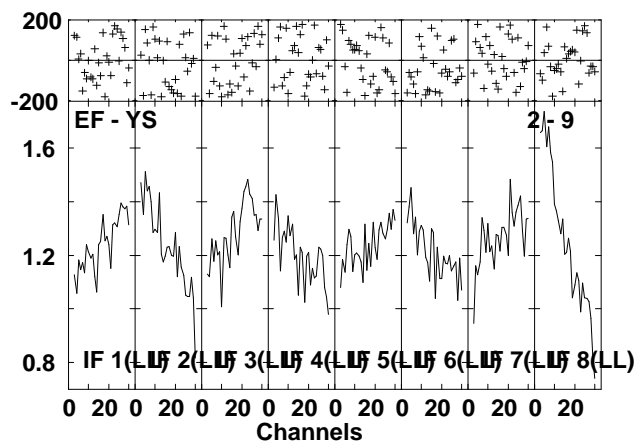
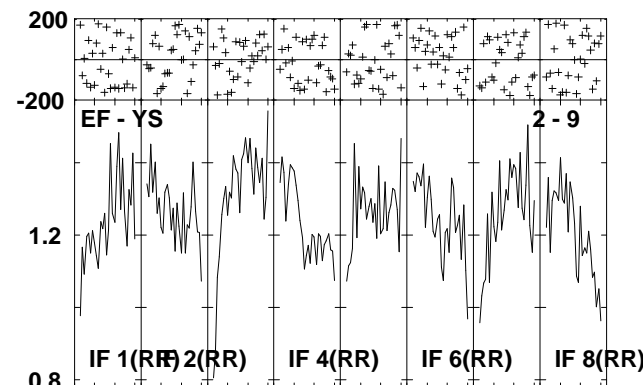
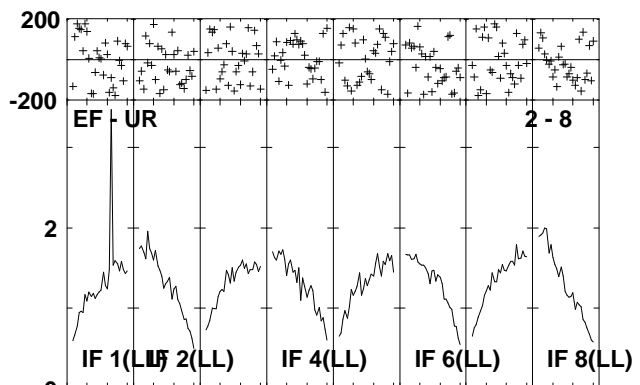
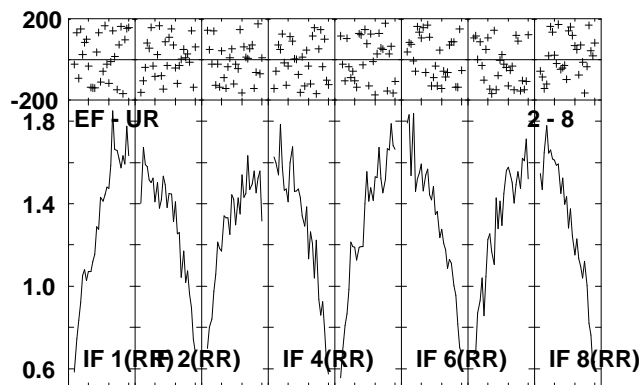
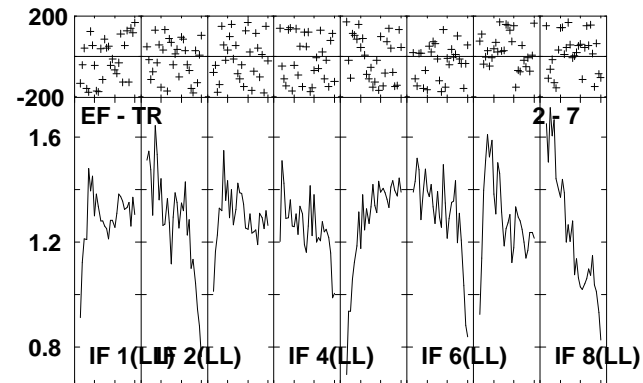
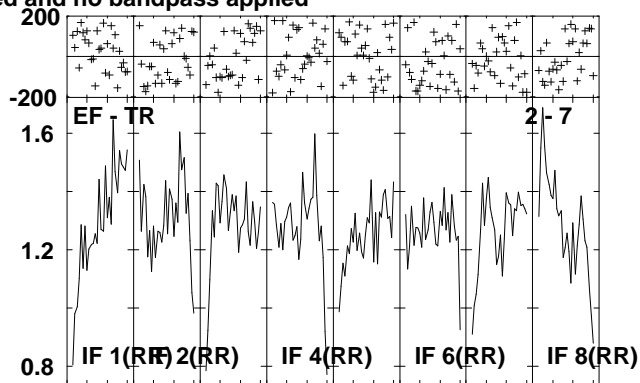
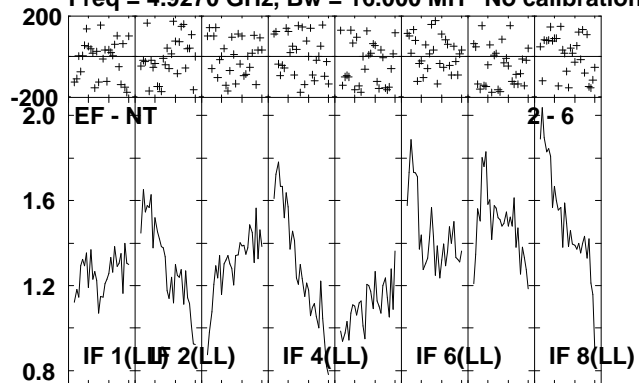

Lower frame: Milli Ampl Jy Top frame: Phas deg
Scalar averaged cross-power spectrum Several baselines displayed
Timerange: 00/11:27:21 to 00/11:30:47

Plot file version 20 created 06-JUL-2010 12:01:06

IRAS2336 EP064L.UVDATA.1

Freq = 4.9270 GHz, Bw = 16.000 MH No calibration applied and no bandpass applied

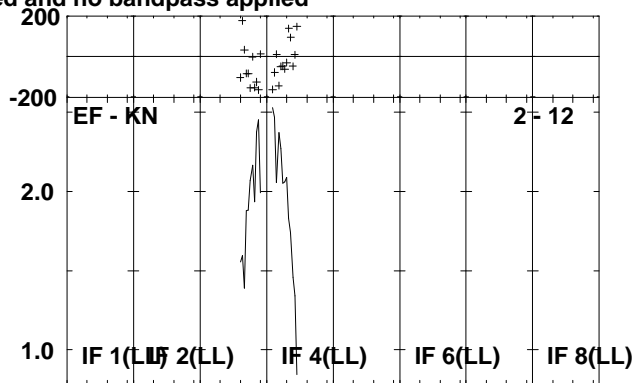
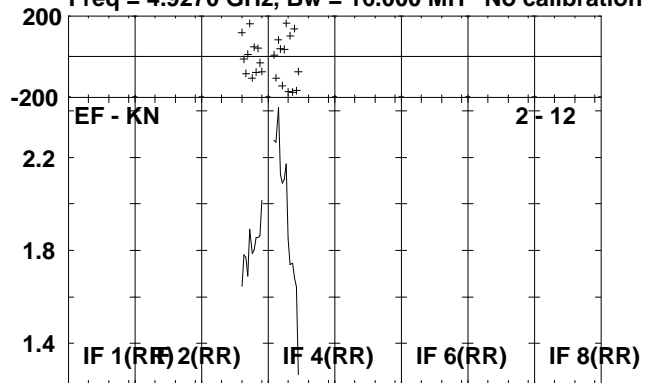

Lower frame: Milli Ampl Jy Top frame: Phas deg
Scalar averaged cross-power spectrum Several baselines displayed
Timerange: 00/11:27:21 to 00/11:30:47

Plot file version 21 created 06-JUL-2010 12:01:06

J2330+33 EP064L.UVDATA.1

Freq = 4.9270 GHz, Bw = 16.000 MH No calibration applied and no bandpass applied

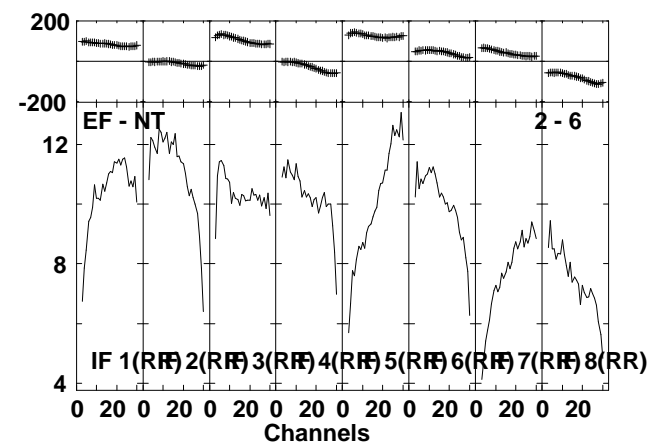
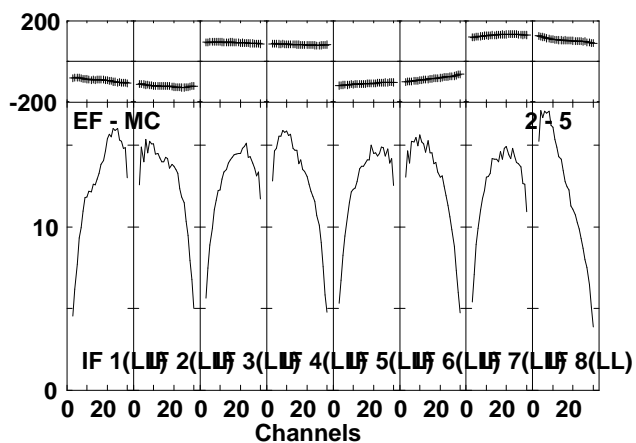
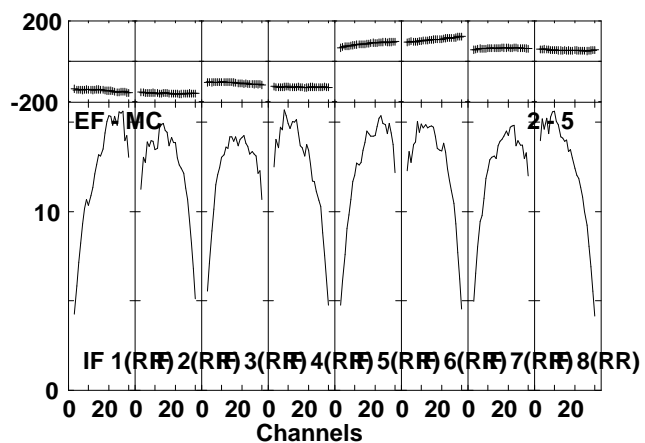
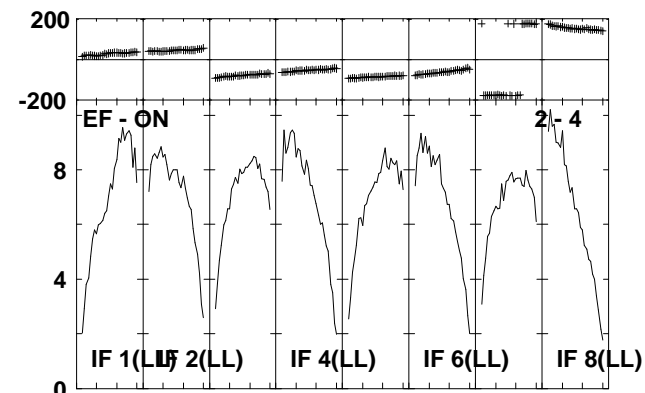
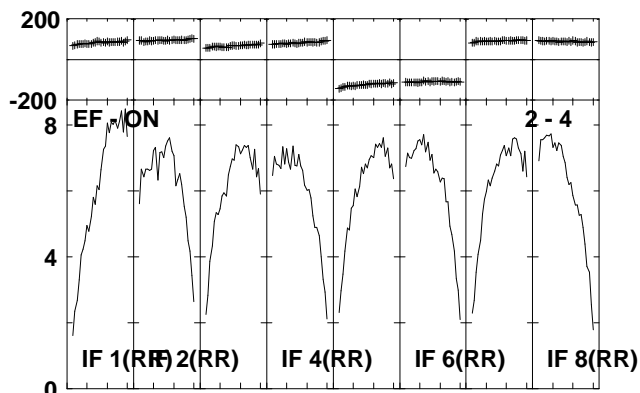
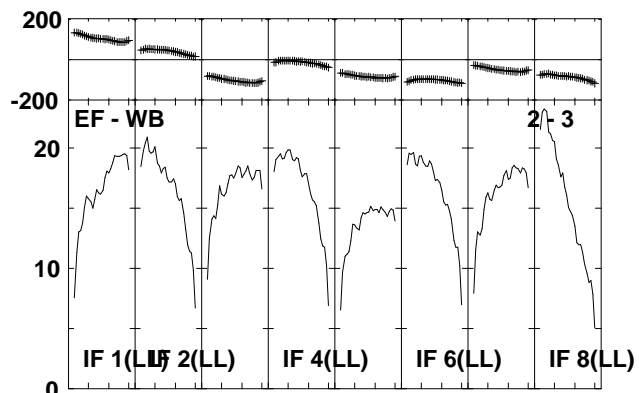
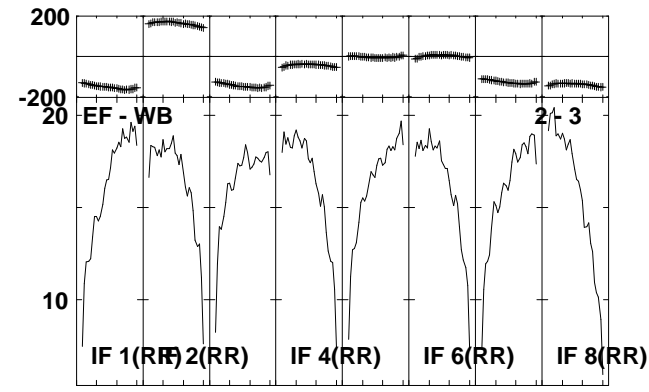
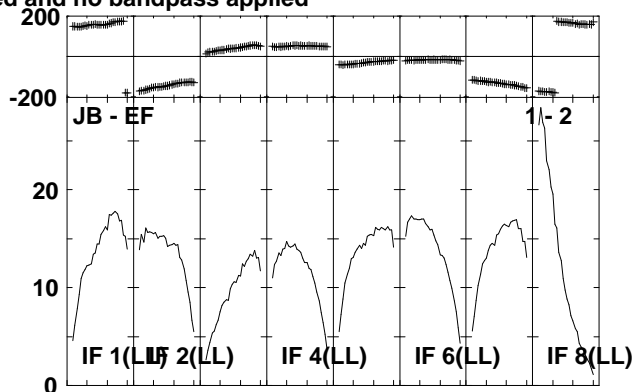
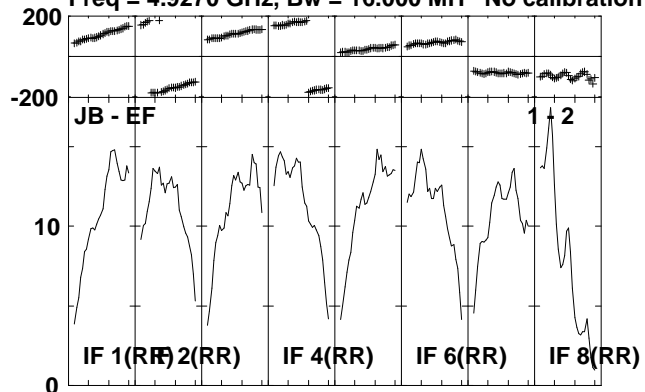

Lower frame: Milli Ampl Jy Top frame: Phas deg
Scalar averaged cross-power spectrum Several baselines displayed
Timerange: 00/11:31:01 to 00/11:32:39

Plot file version 22 created 06-JUL-2010 12:01:07

J2330+33 EP064L.UVDATA.1

Freq = 4.9270 GHz, Bw = 16.000 MH No calibration applied and no bandpass applied

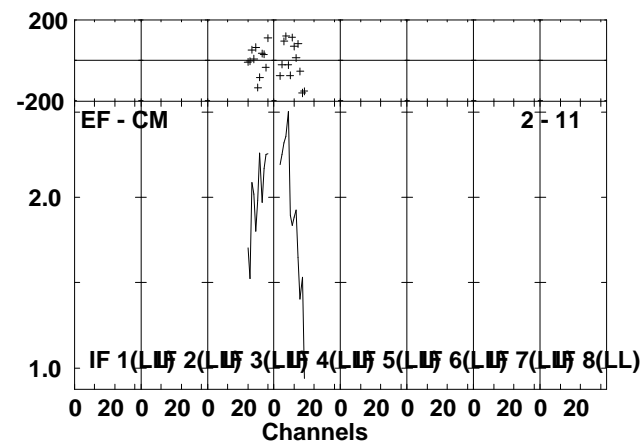
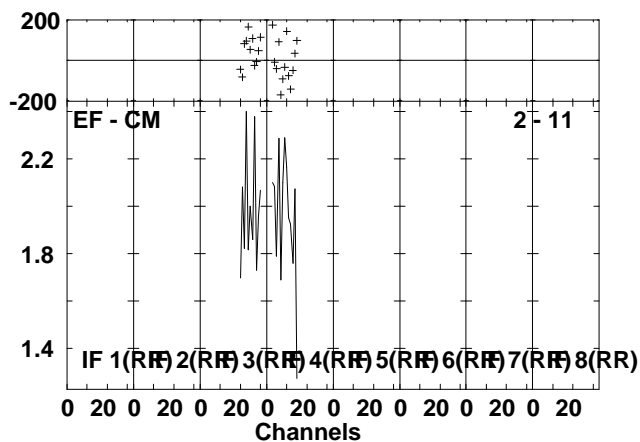
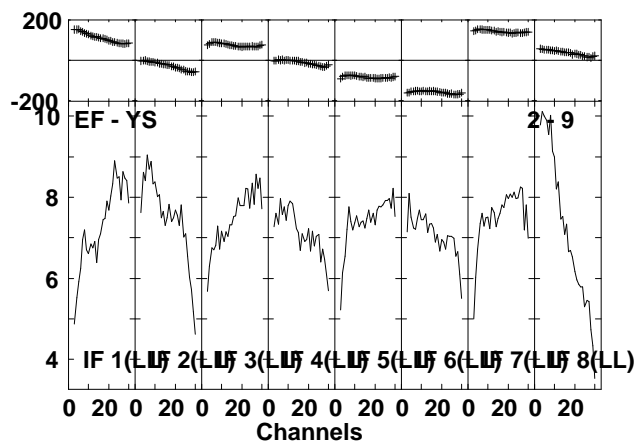
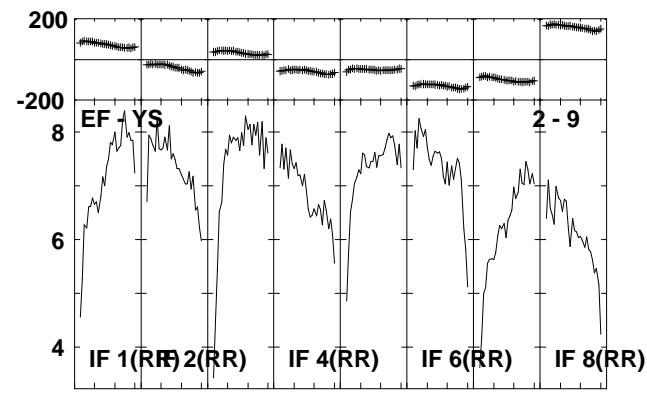
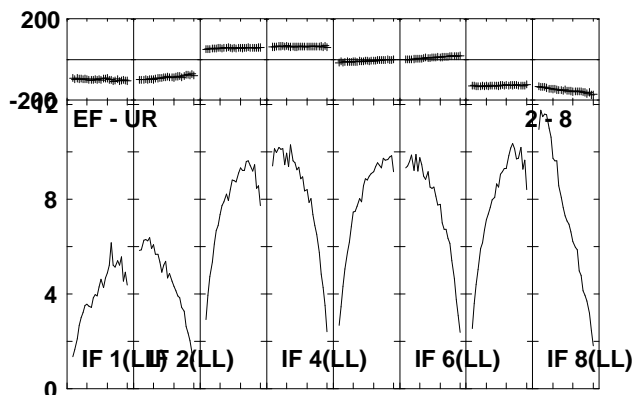
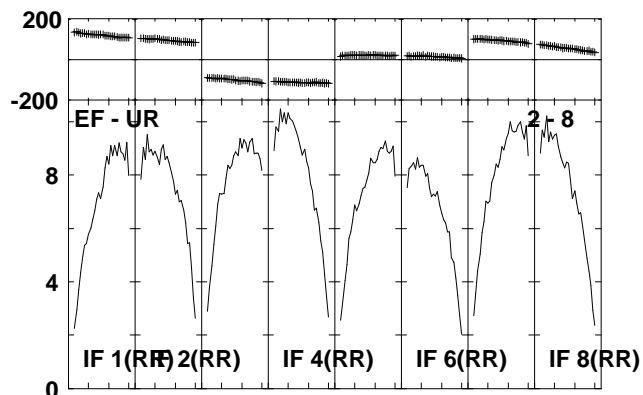
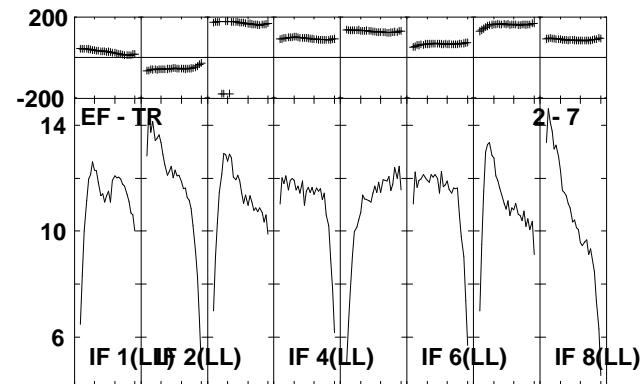
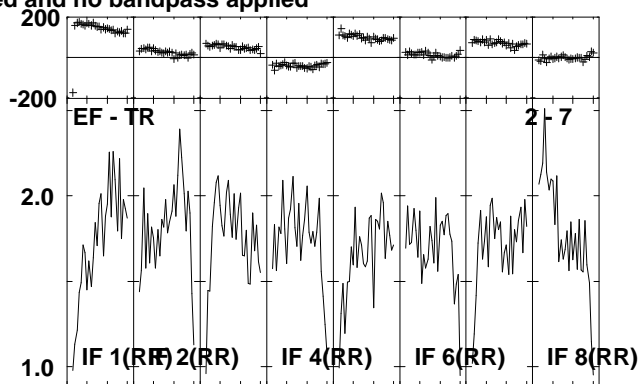
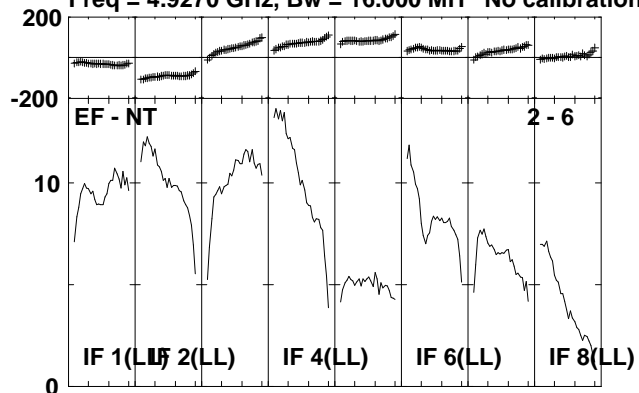

Lower frame: Milli Ampl Jy Top frame: Phas deg
Scalar averaged cross-power spectrum Several baselines displayed
Timerange: 00/11:31:01 to 00/11:32:39

Plot file version 23 created 06-JUL-2010 12:01:08

J2330+33 EP064L.UVDATA.1

Freq = 4.9270 GHz, Bw = 16.000 MH No calibration applied and no bandpass applied

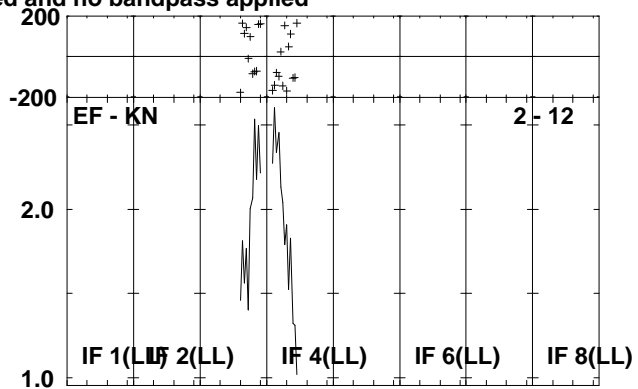
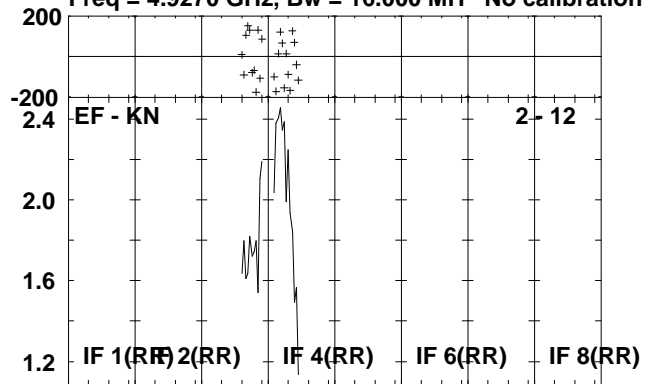

Lower frame: Milli Ampl Jy Top frame: Phas deg
Scalar averaged cross-power spectrum Several baselines displayed
Timerange: 00/11:31:01 to 00/11:32:39

Plot file version 24 created 06-JUL-2010 12:01:09

IRAS2336 EP064L.UVDATA.1

Freq = 4.9270 GHz, Bw = 16.000 MH No calibration applied and no bandpass applied

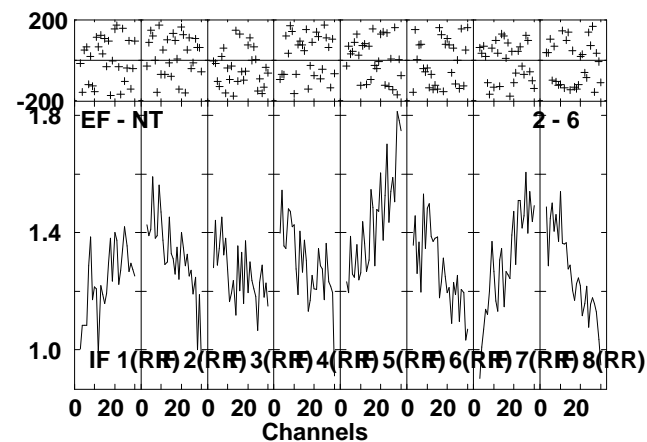
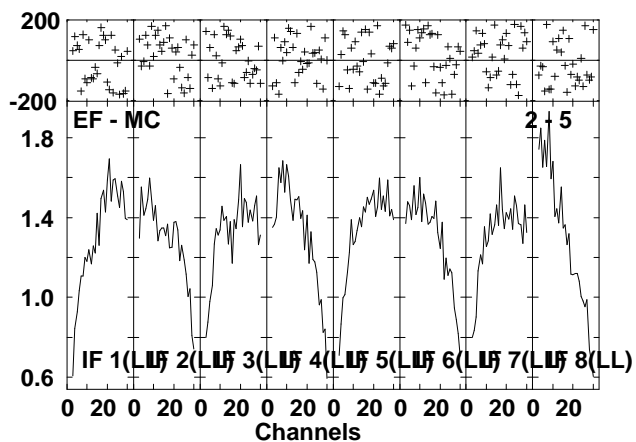
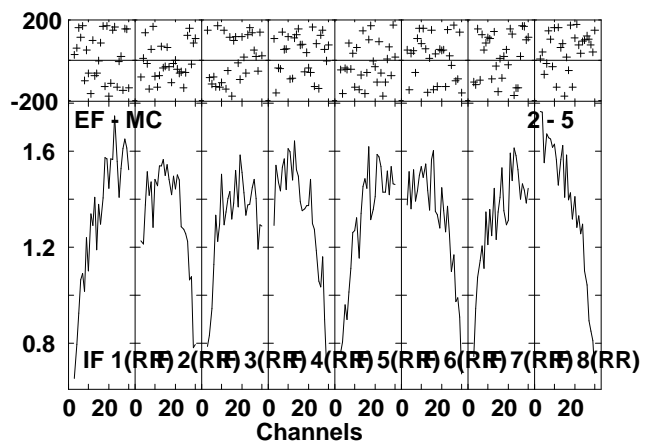
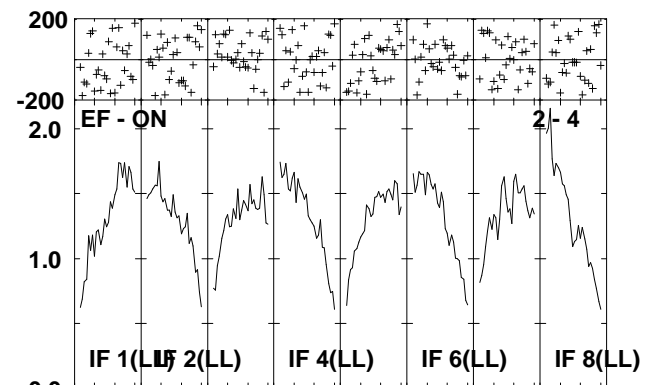
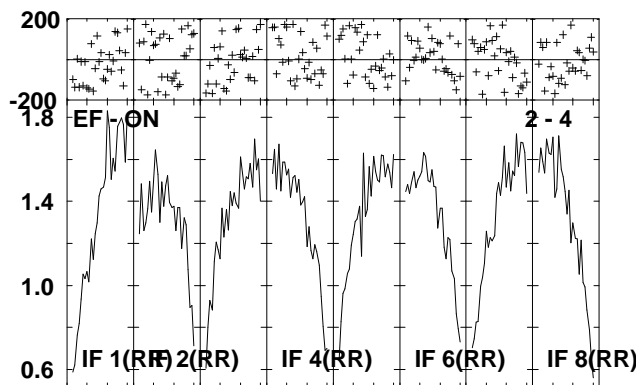
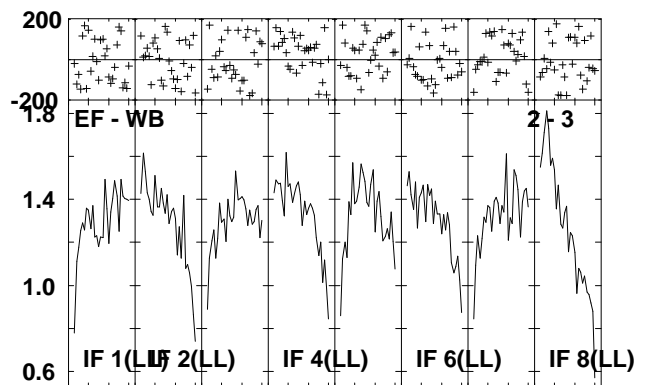
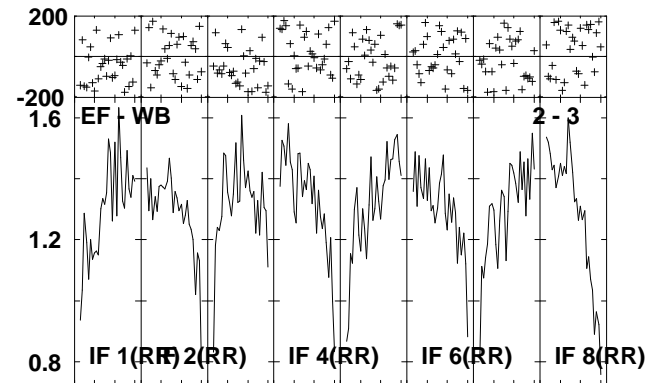
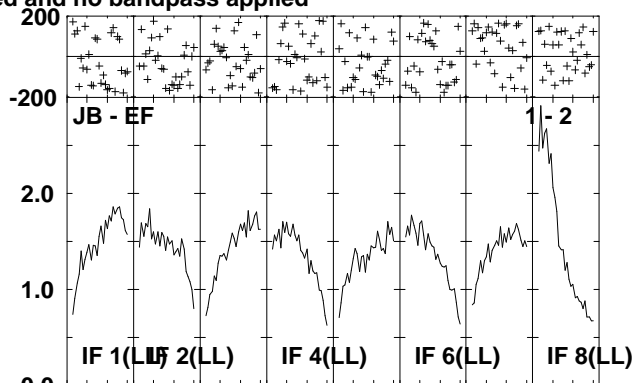
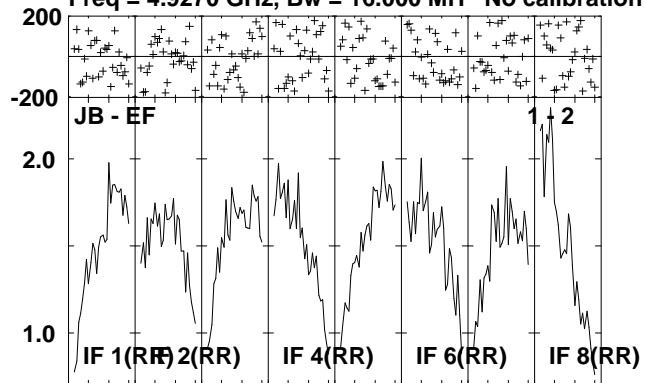

Lower frame: Milli Ampl Jy Top frame: Phas deg
Scalar averaged cross-power spectrum Several baselines displayed
Timerange: 00/11:32:41 to 00/11:36:09

Plot file version 25 created 06-JUL-2010 12:01:11

IRAS2336 EP064L.UVDATA.1

Freq = 4.9270 GHz, Bw = 16.000 MH No calibration applied and no bandpass applied

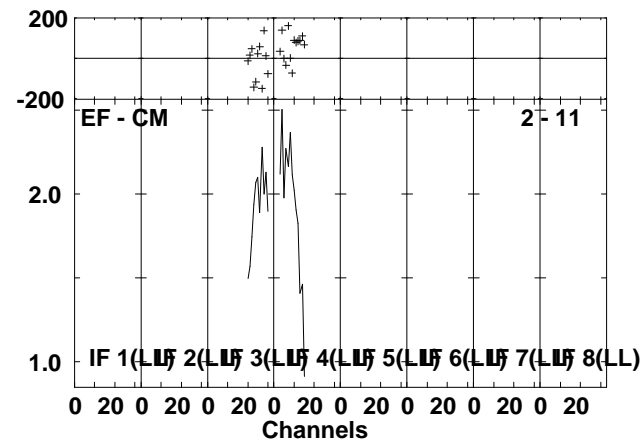
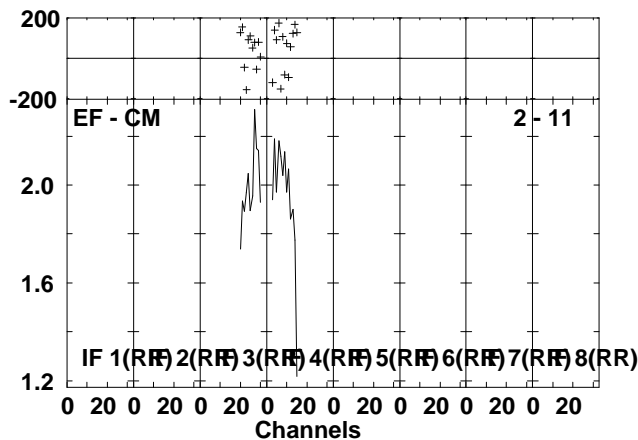
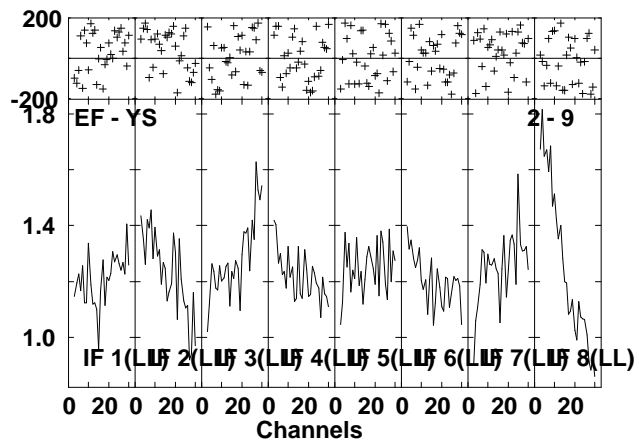
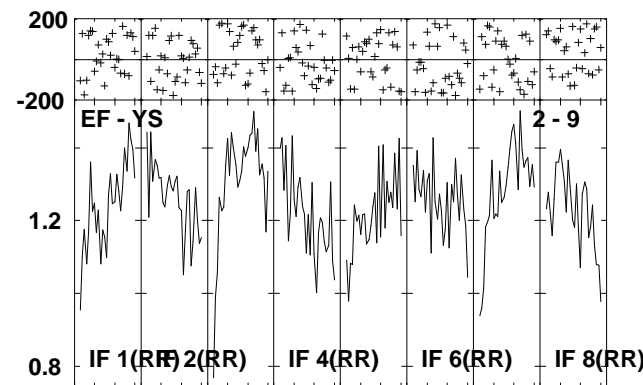
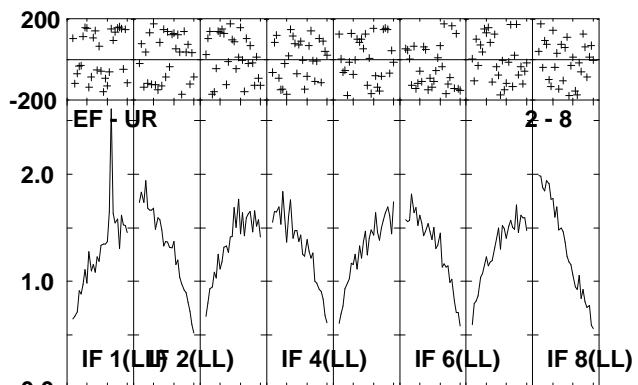
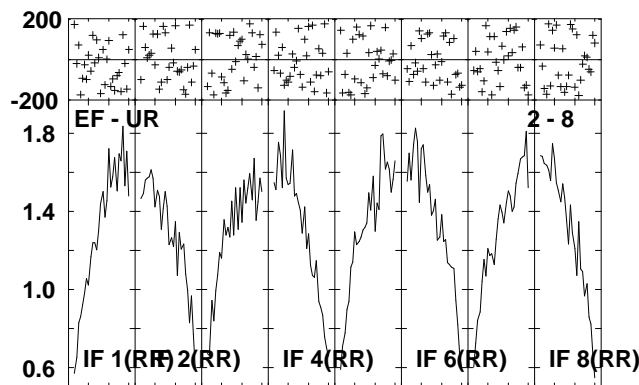
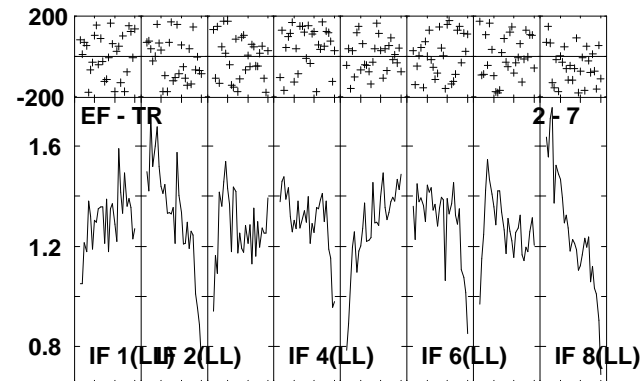
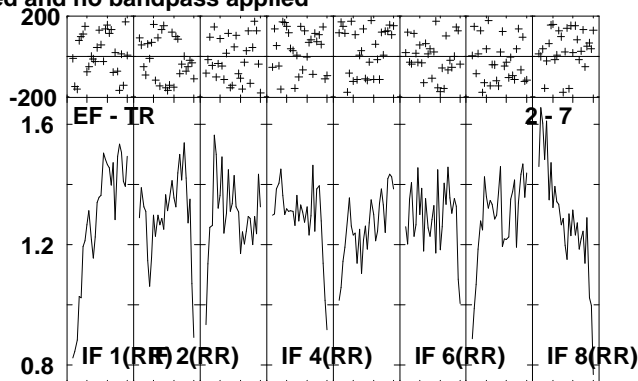
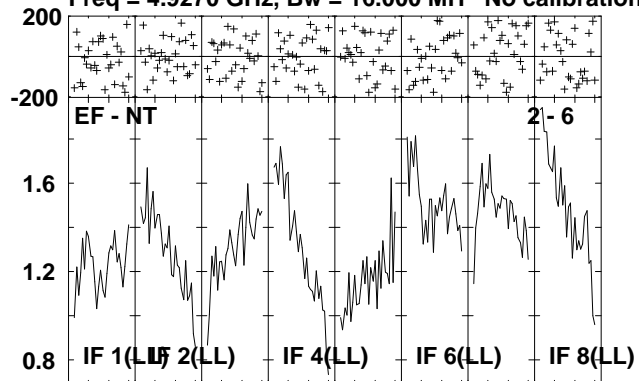

Lower frame: Milli Ampl Jy Top frame: Phas deg
Scalar averaged cross-power spectrum Several baselines displayed
Timerange: 00/11:32:41 to 00/11:36:09

Plot file version 26 created 06-JUL-2010 12:01:14

IRAS2336 EP064L.UVDATA.1

Freq = 4.9270 GHz, Bw = 16.000 MH No calibration applied and no bandpass applied

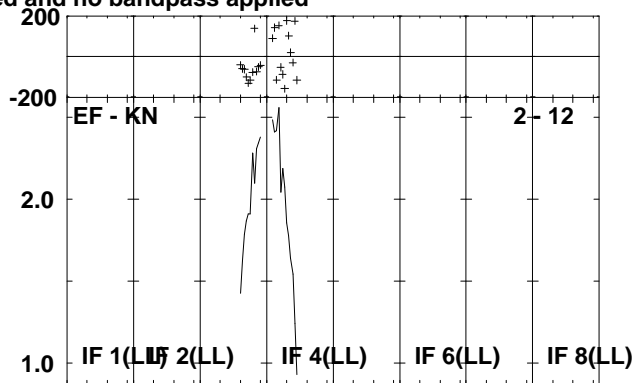
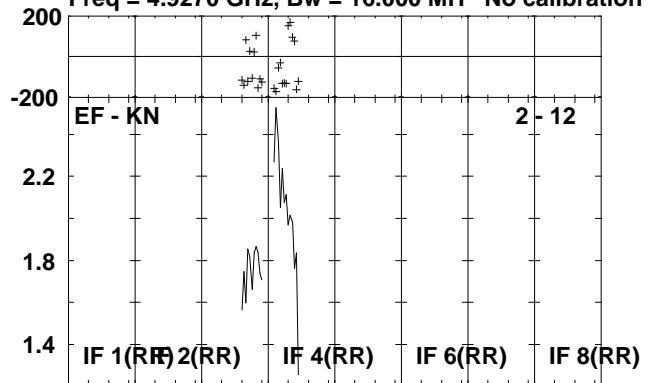

Lower frame: Milli Ampl Jy Top frame: Phas deg
Scalar averaged cross-power spectrum Several baselines displayed
Timerange: 00/11:32:41 to 00/11:36:09

Plot file version 27 created 06-JUL-2010 12:01:15

J2330+33 EP064L.UVDATA.1

Freq = 4.9270 GHz, Bw = 16.000 MH No calibration applied and no bandpass applied

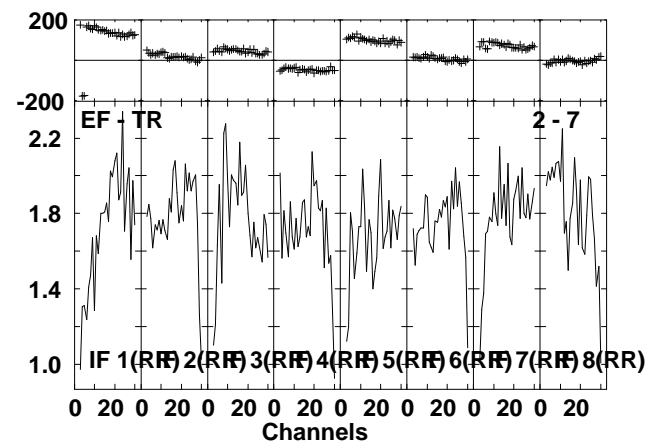
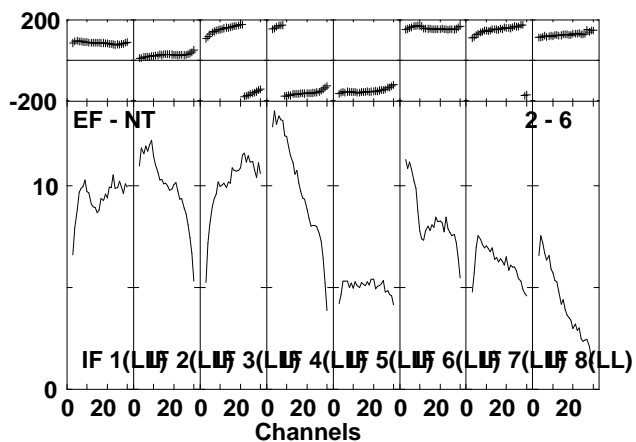
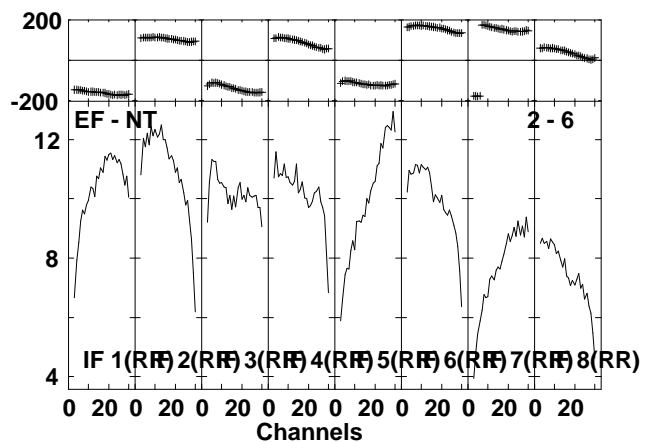
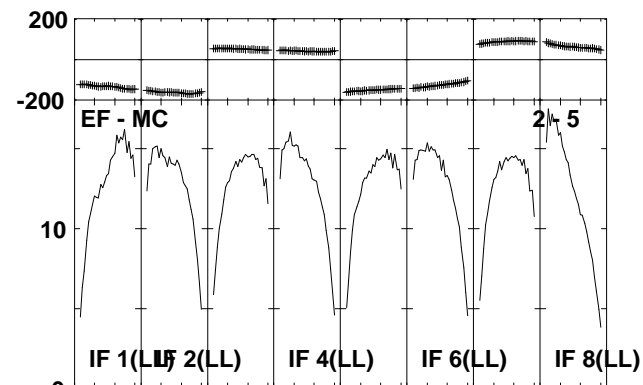
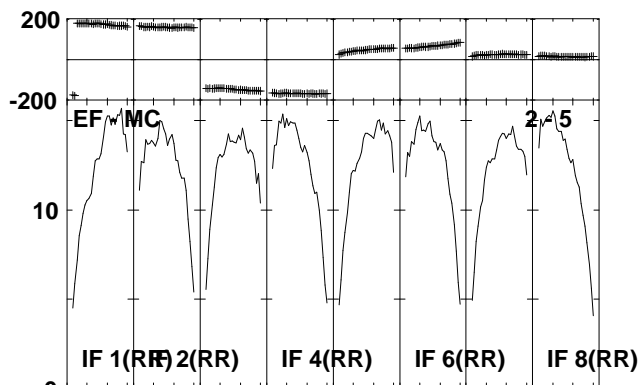
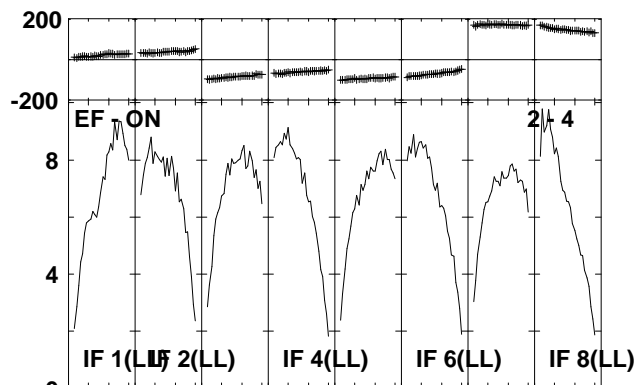
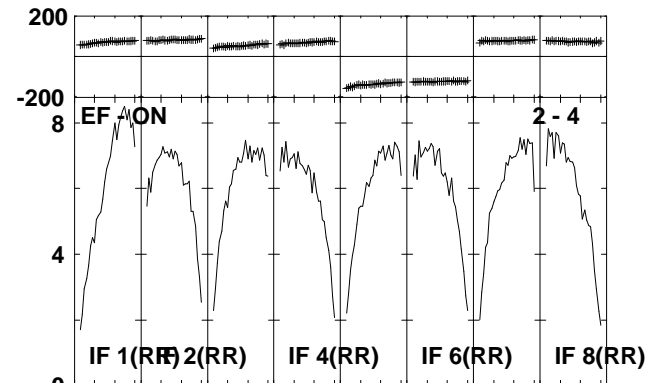
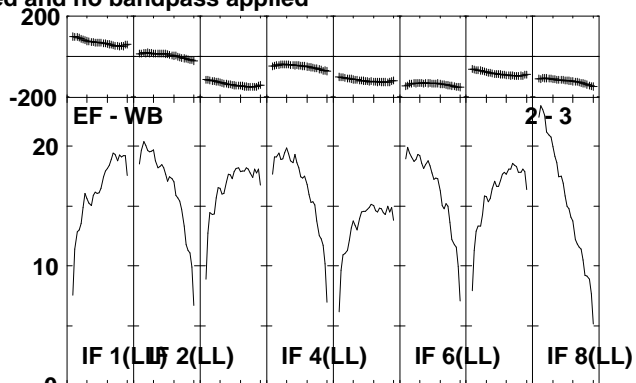
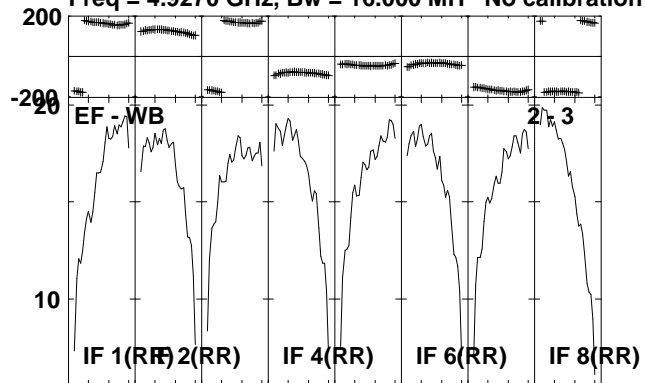

Lower frame: Milli Ampl Jy Top frame: Phas deg
Scalar averaged cross-power spectrum Several baselines displayed
Timerange: 00/11:36:21 to 00/11:37:57

Plot file version 28 created 06-JUL-2010 12:01:16

J2330+33 EP064L.UVDATA.1

Freq = 4.9270 GHz, Bw = 16.000 MH No calibration applied and no bandpass applied

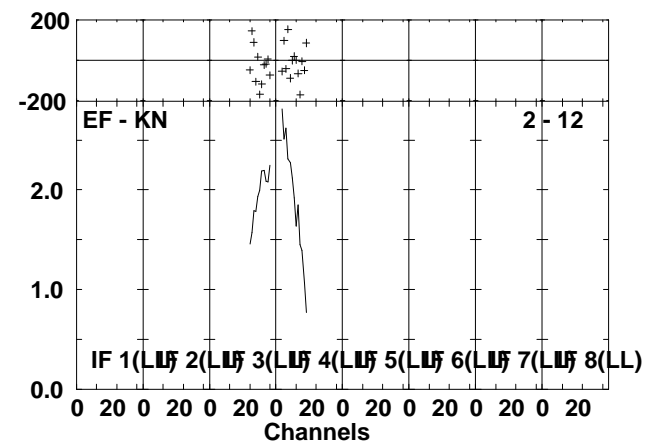
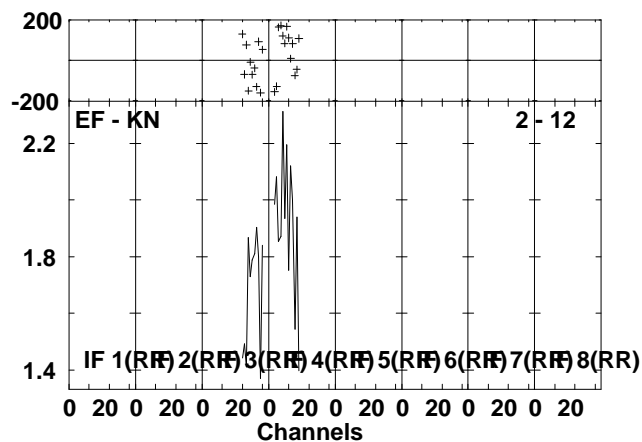
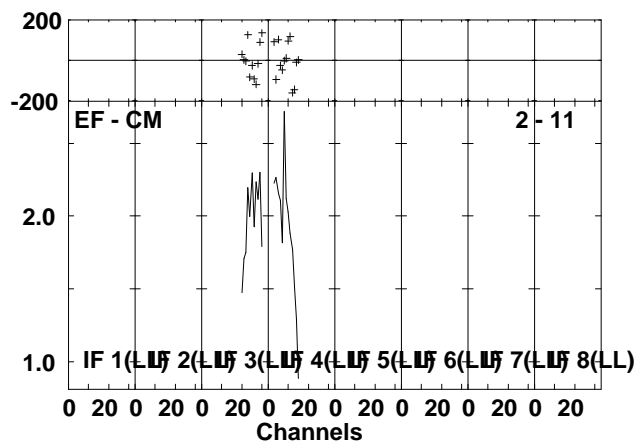
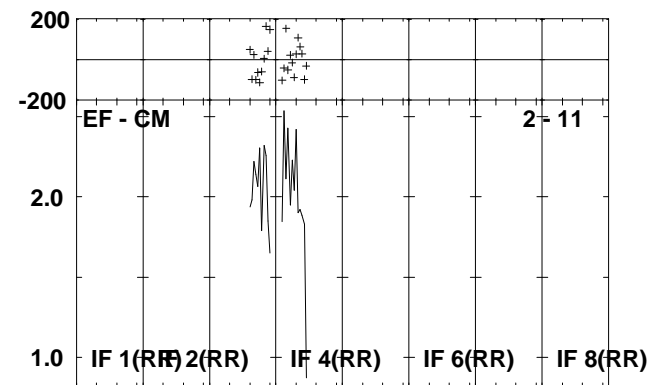
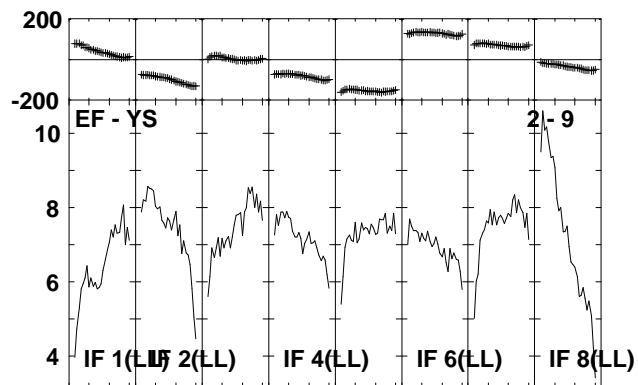
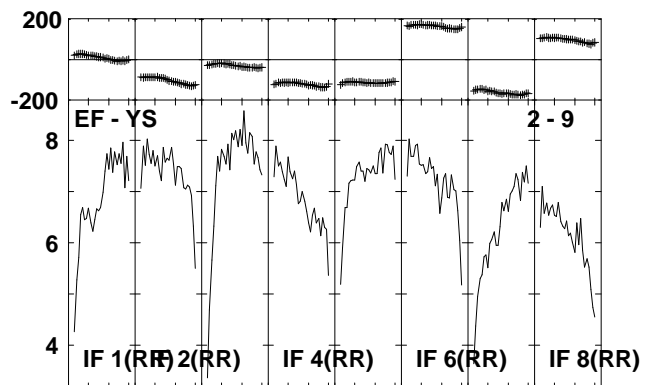
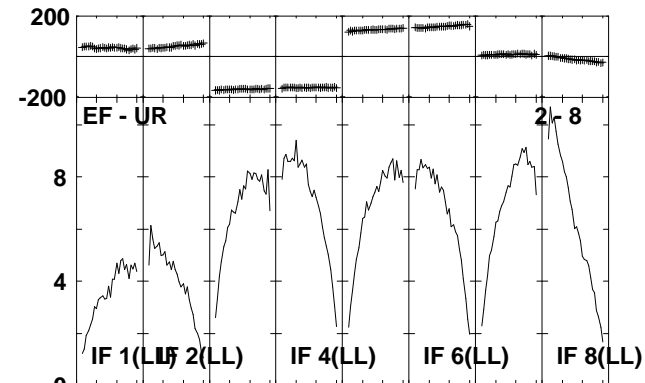
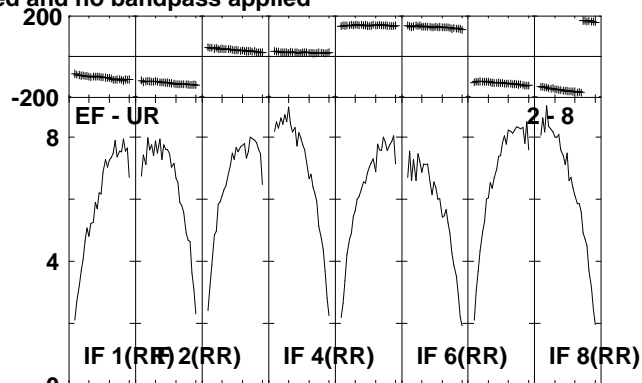
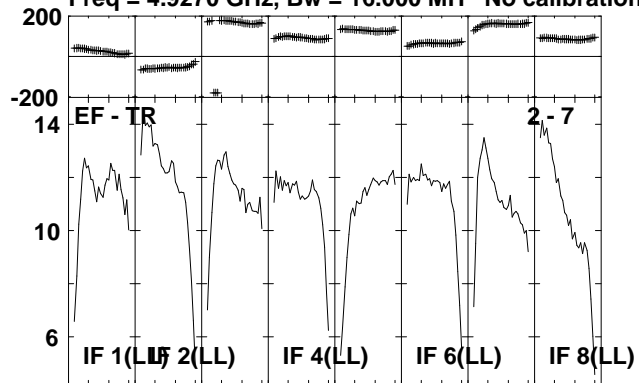

Lower frame: Milli Ampl Jy Top frame: Phas deg
Scalar averaged cross-power spectrum Several baselines displayed
Timerange: 00/11:36:21 to 00/11:37:57

Plot file version 29 created 06-JUL-2010 12:01:17

J2333+39 EP064L.UVDATA.1

Freq = 4.9270 GHz, Bw = 16.000 MH No calibration applied and no bandpass applied

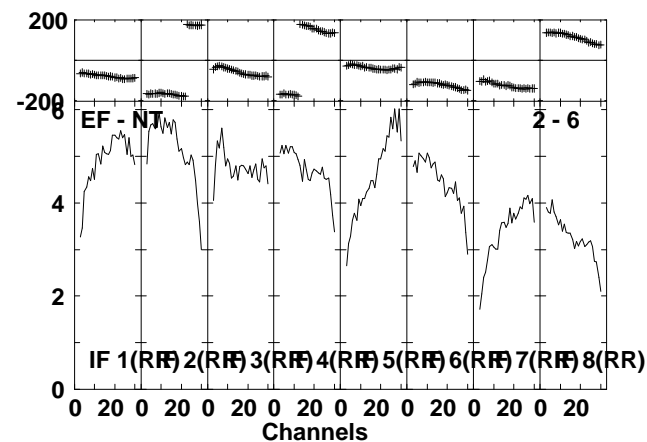
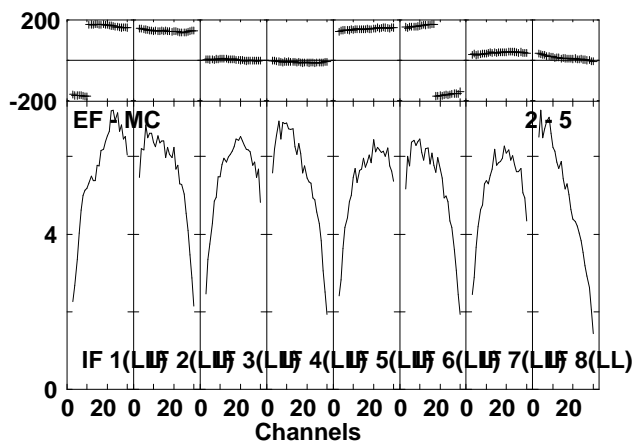
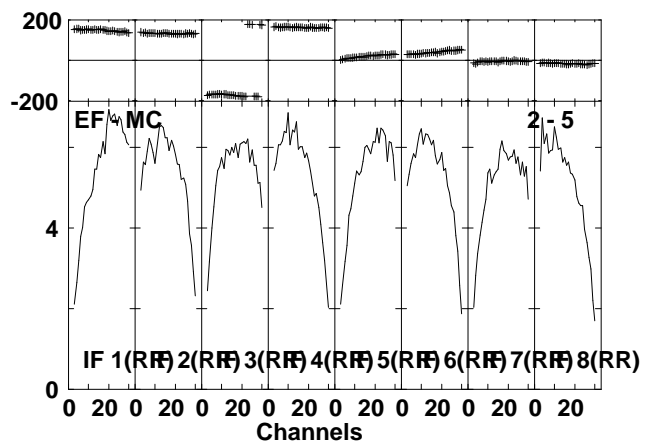
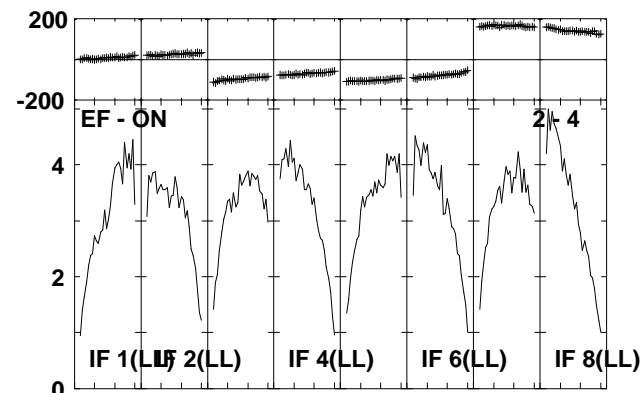
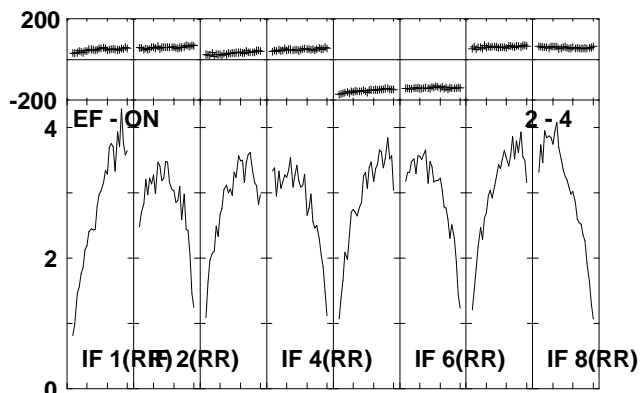
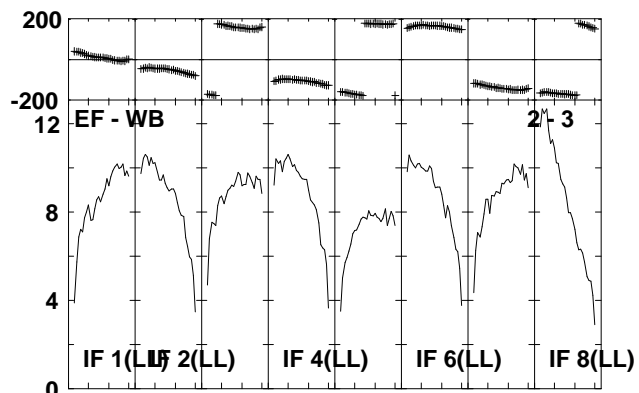
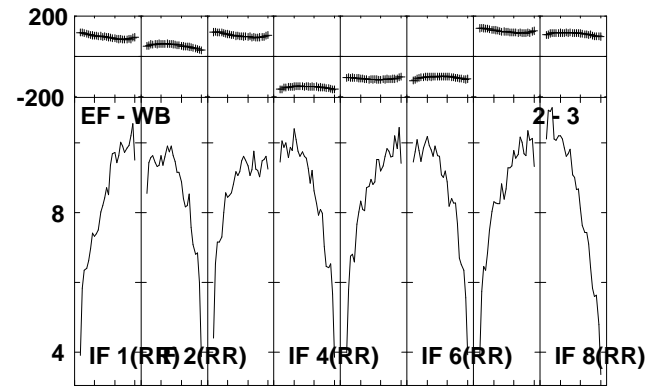
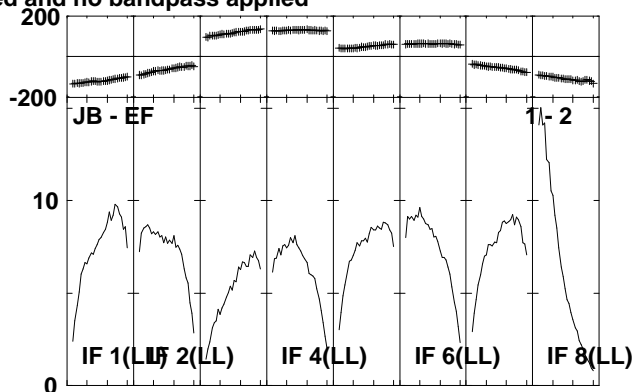
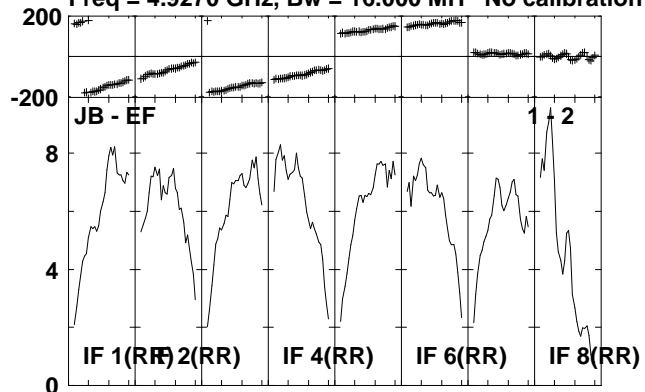

Lower frame: Milli Ampl Jy Top frame: Phas deg
Scalar averaged cross-power spectrum Several baselines displayed
Timerange: 00/11:39:01 to 00/11:40:49

Plot file version 30 created 06-JUL-2010 12:01:18

J2333+39 EP064L.UVDATA.1

Freq = 4.9270 GHz, Bw = 16.000 MH No calibration applied and no bandpass applied

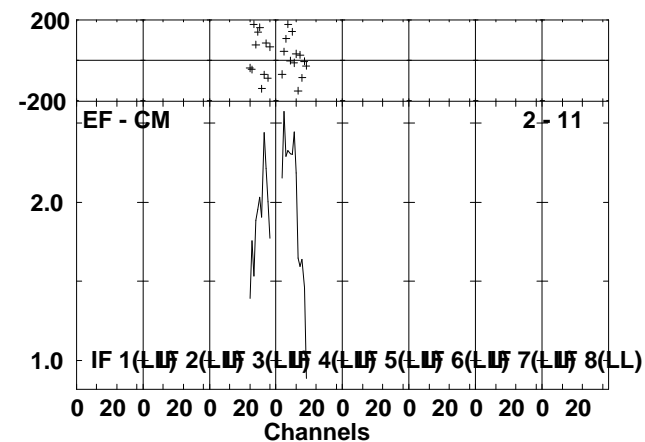
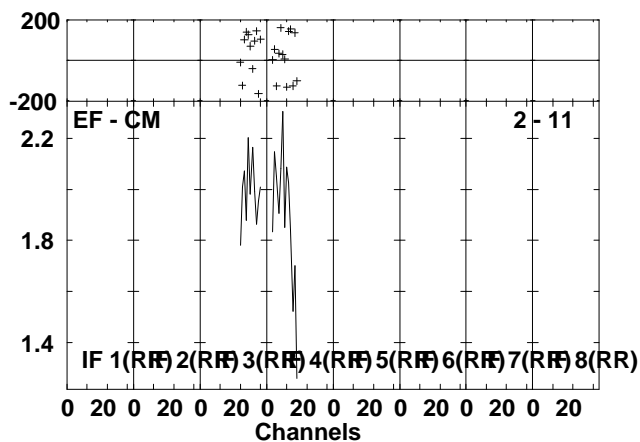
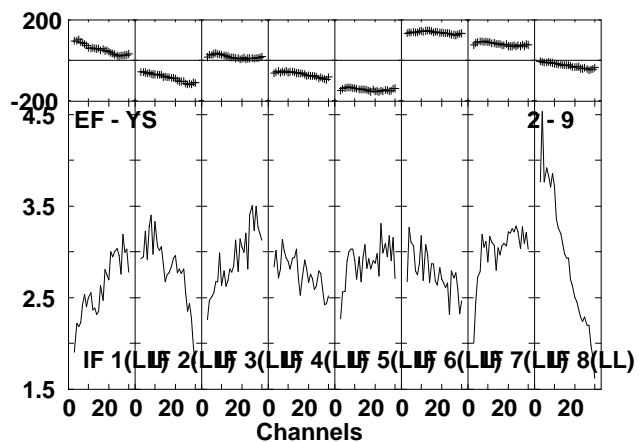
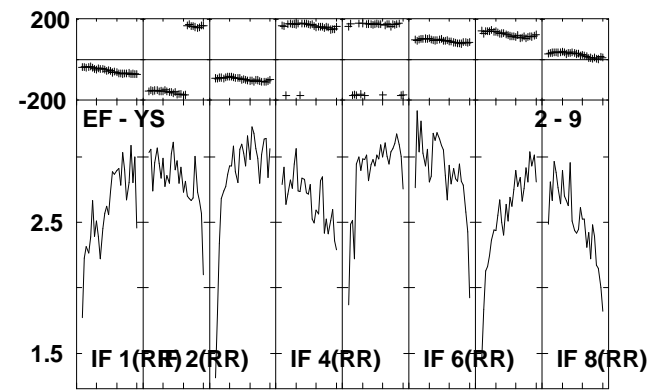
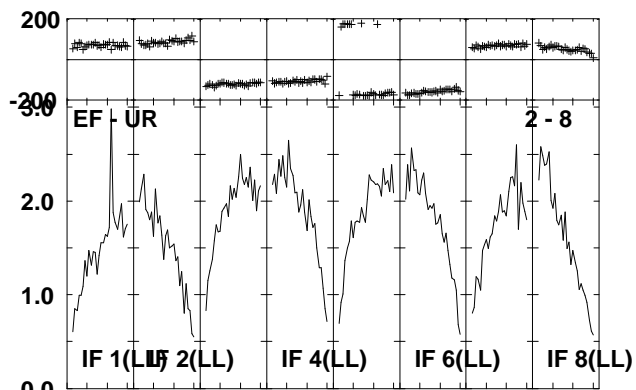
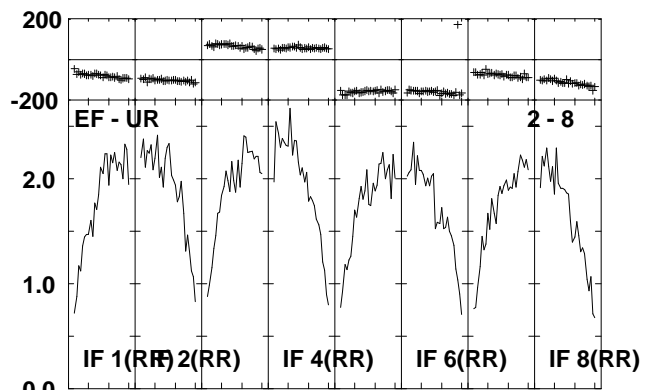
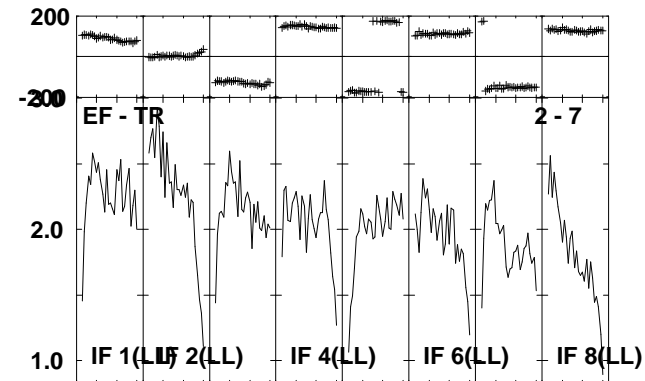
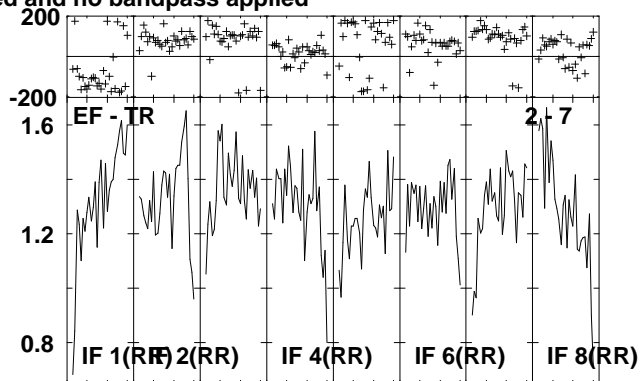
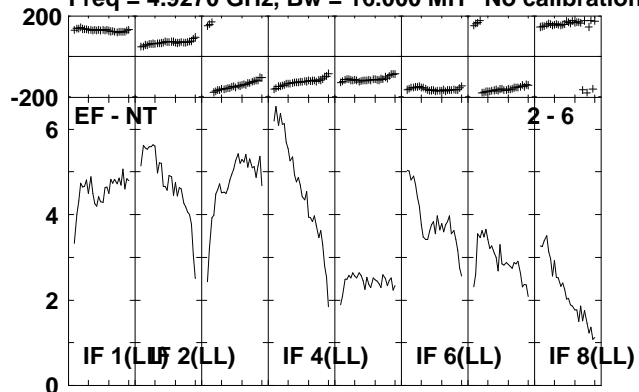

Lower frame: Milli Ampl Jy Top frame: Phas deg
Scalar averaged cross-power spectrum Several baselines displayed
Timerange: 00/11:39:01 to 00/11:40:49

Plot file version 31 created 06-JUL-2010 12:01:20

J2333+39 EP064L.UVDATA.1

Freq = 4.9270 GHz, Bw = 16.000 MH No calibration applied and no bandpass applied

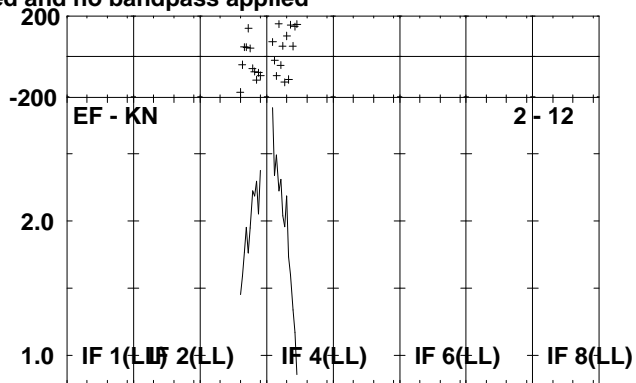
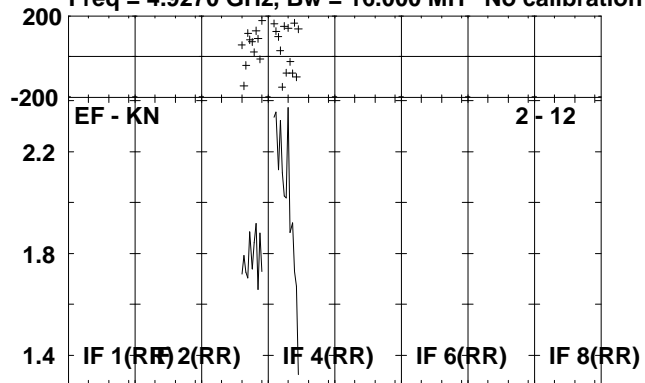

Lower frame: Milli Ampl Jy Top frame: Phas deg
Scalar averaged cross-power spectrum Several baselines displayed
Timerange: 00/11:39:01 to 00/11:40:49

Plot file version 32 created 06-JUL-2010 12:01:20

J2330+33 EP064L.UVDATA.1

Freq = 4.9270 GHz, Bw = 16.000 MH No calibration applied and no bandpass applied

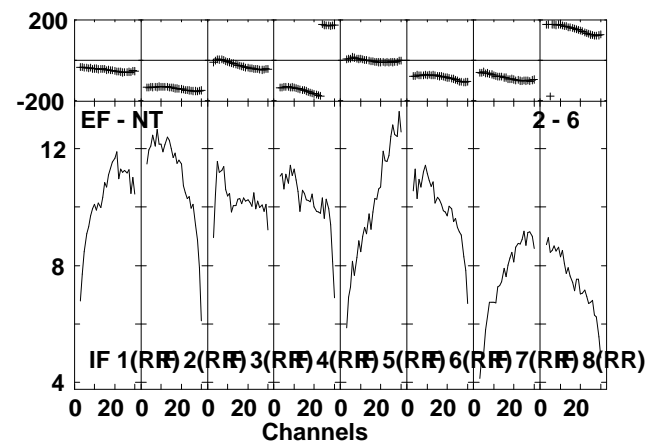
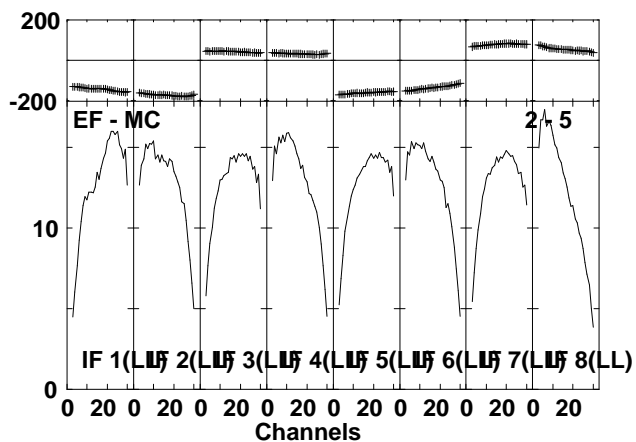
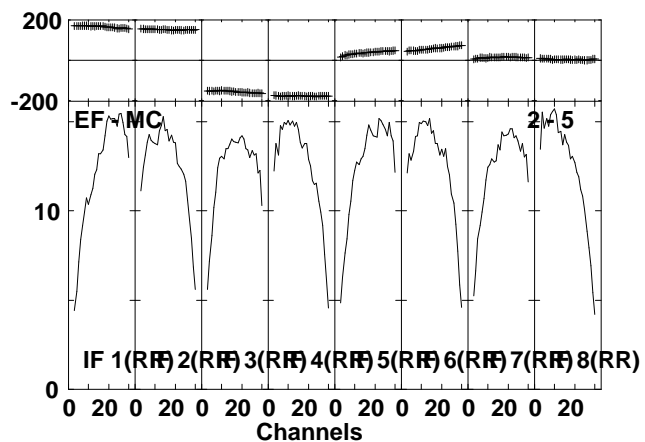
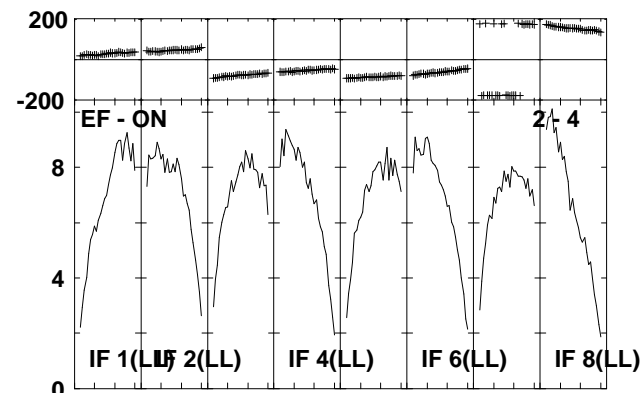
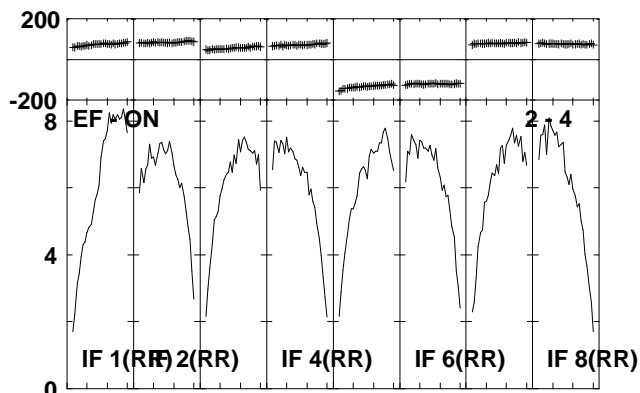
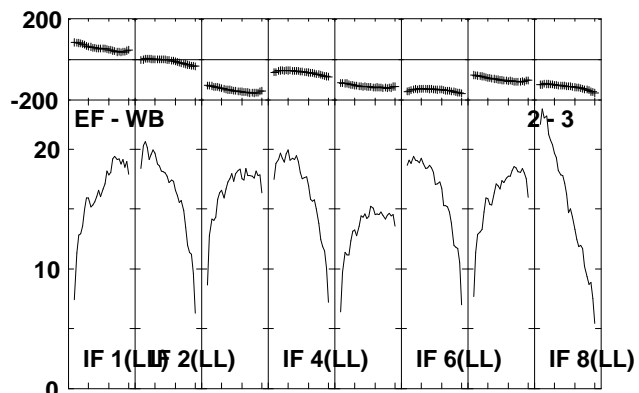
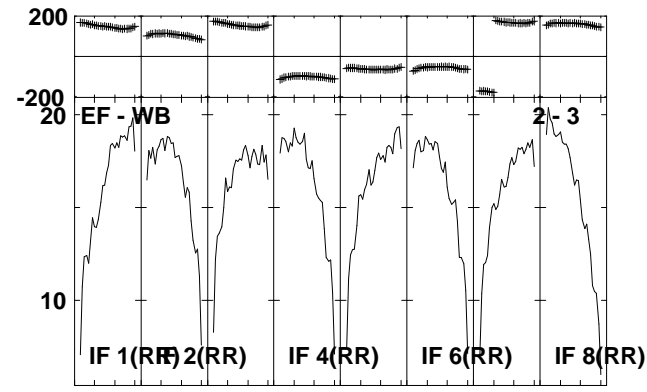
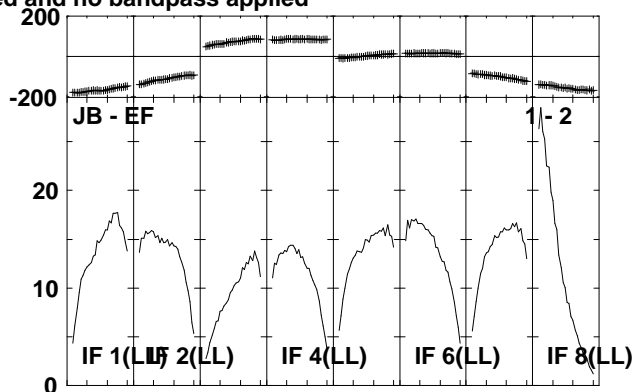
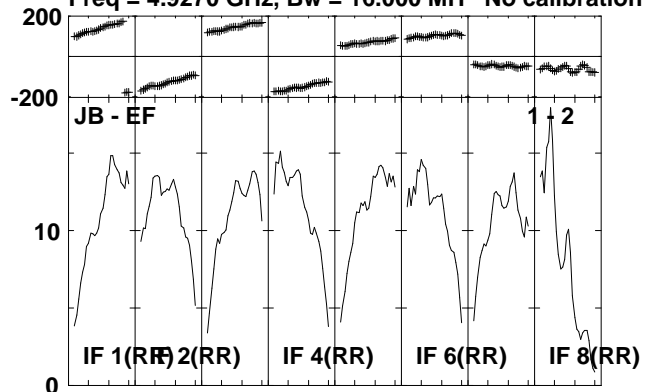

Lower frame: Milli Ampl Jy Top frame: Phas deg
Scalar averaged cross-power spectrum Several baselines displayed
Timerange: 00/11:40:51 to 00/11:42:39

Plot file version 33 created 06-JUL-2010 12:01:21

J2330+33 EP064L.UVDATA.1

Freq = 4.9270 GHz, Bw = 16.000 MH No calibration applied and no bandpass applied

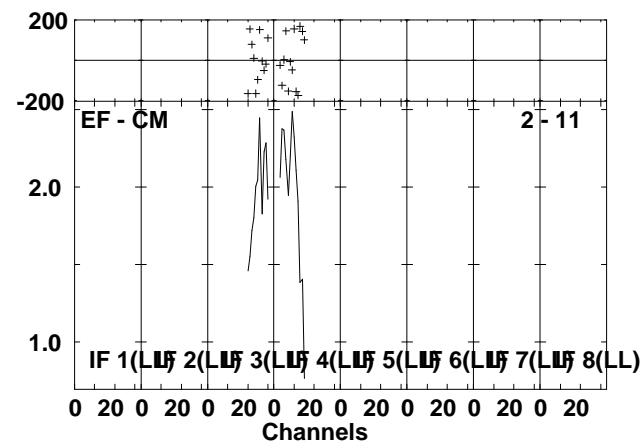
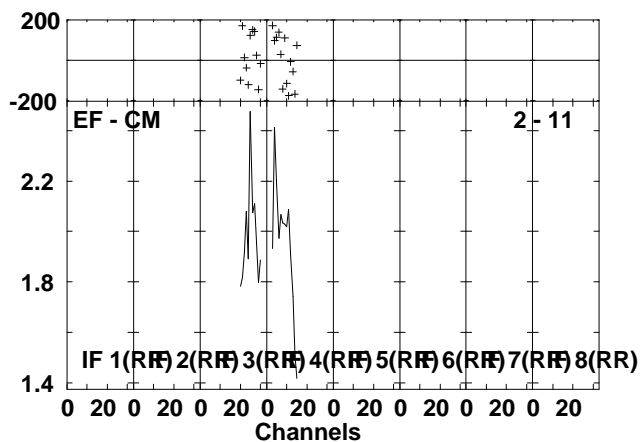
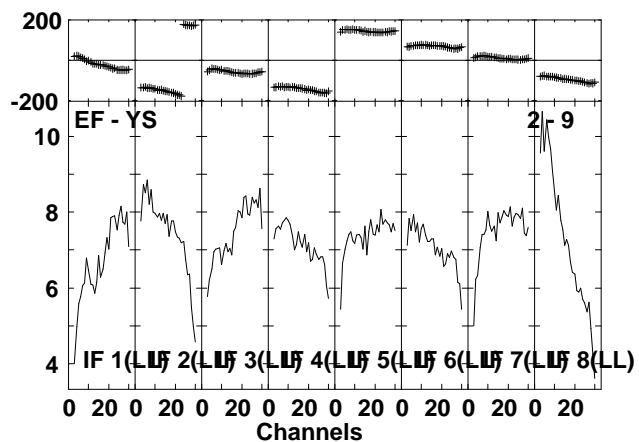
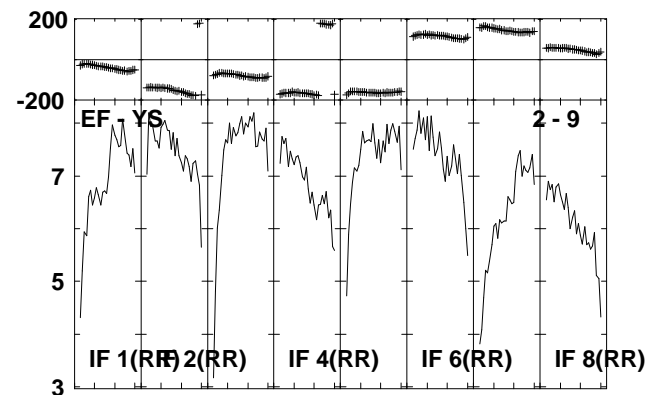
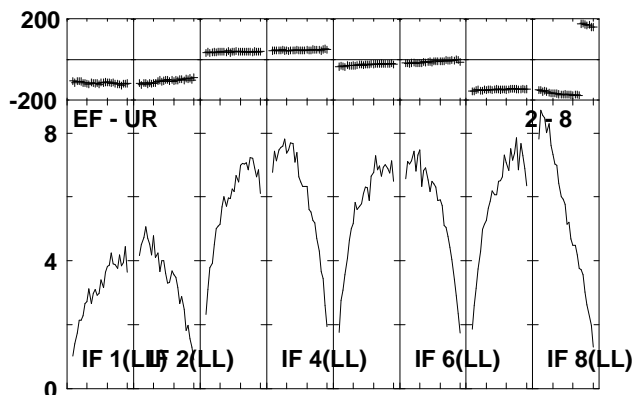
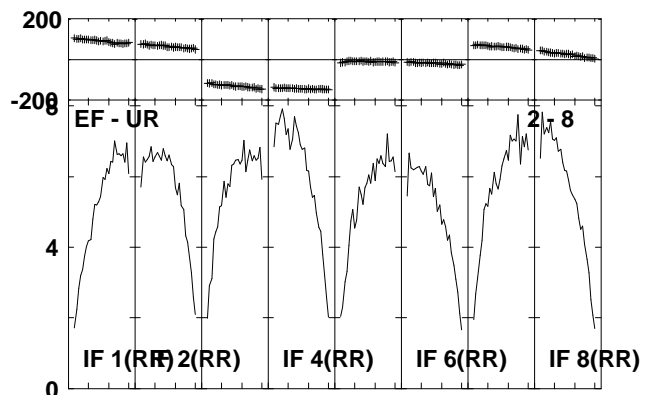
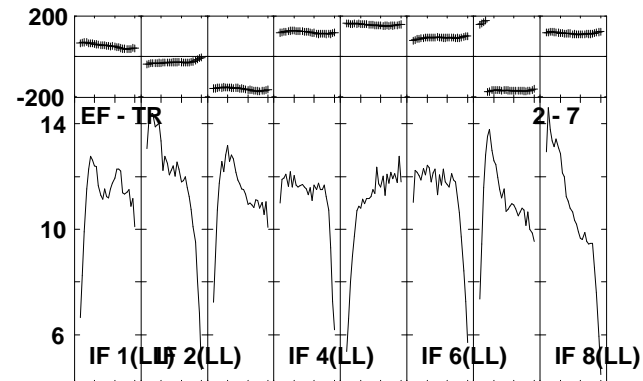
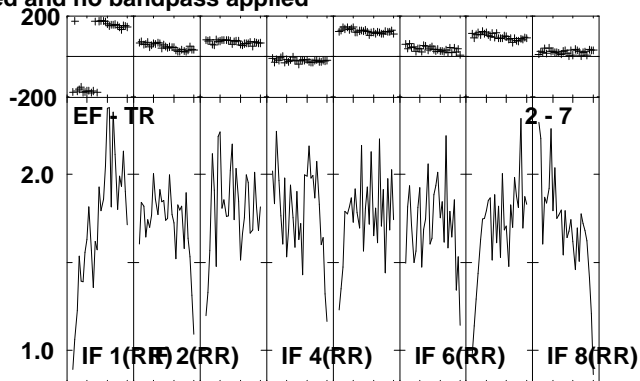
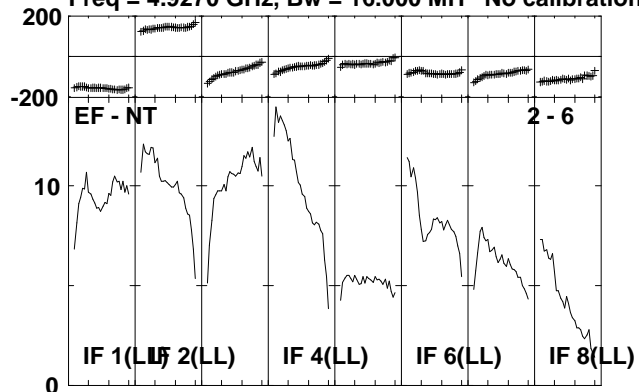

Lower frame: Milli Ampl Jy Top frame: Phas deg
Scalar averaged cross-power spectrum Several baselines displayed
Timerange: 00/11:40:51 to 00/11:42:39

Plot file version 34 created 06-JUL-2010 12:01:23

J2330+33 EP064L.UVDATA.1

Freq = 4.9270 GHz, Bw = 16.000 MH No calibration applied and no bandpass applied

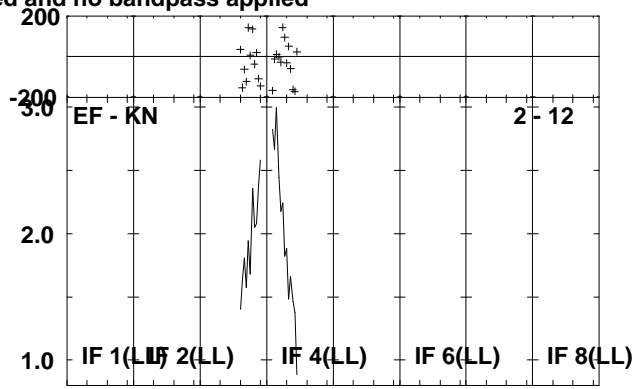
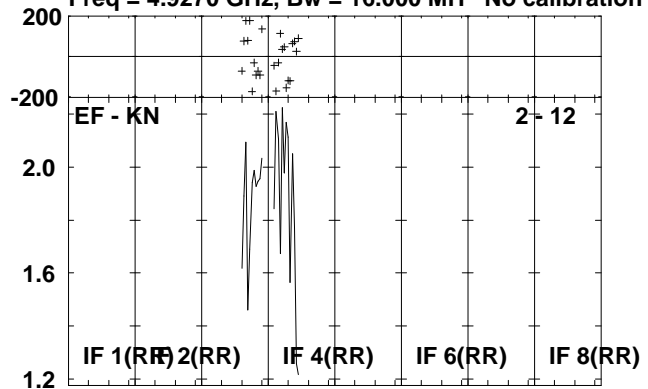

Lower frame: Milli Ampl Jy Top frame: Phas deg
Scalar averaged cross-power spectrum Several baselines displayed
Timerange: 00/11:40:51 to 00/11:42:39

Plot file version 35 created 06-JUL-2010 12:01:24

IRAS2336 EP064L.UVDATA.1

Freq = 4.9270 GHz, Bw = 16.000 MH No calibration applied and no bandpass applied

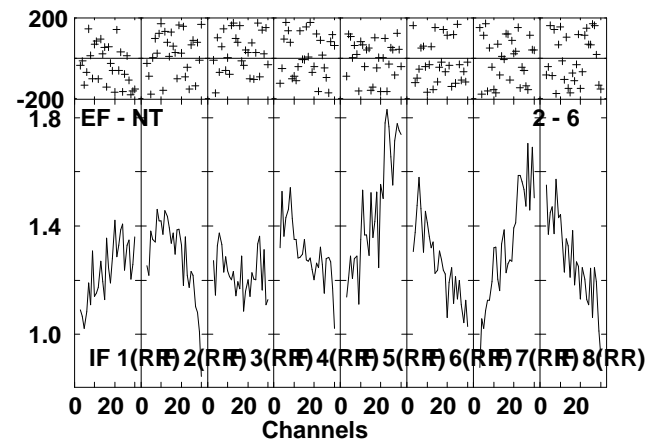
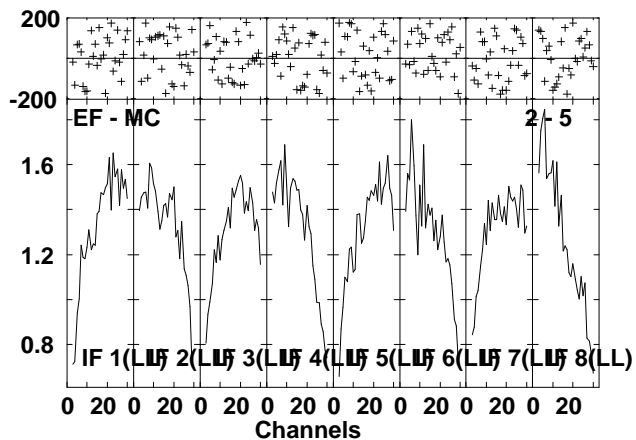
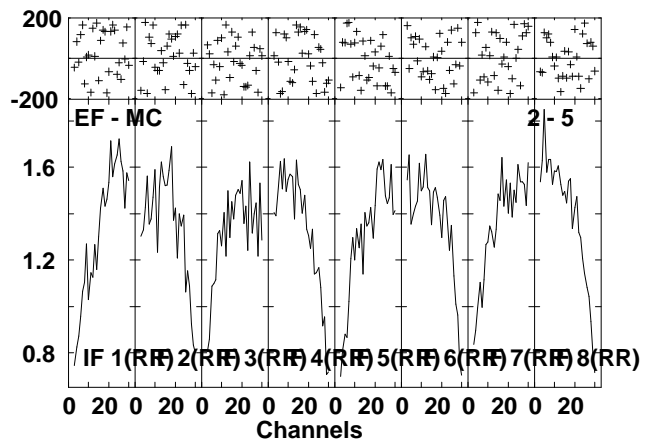
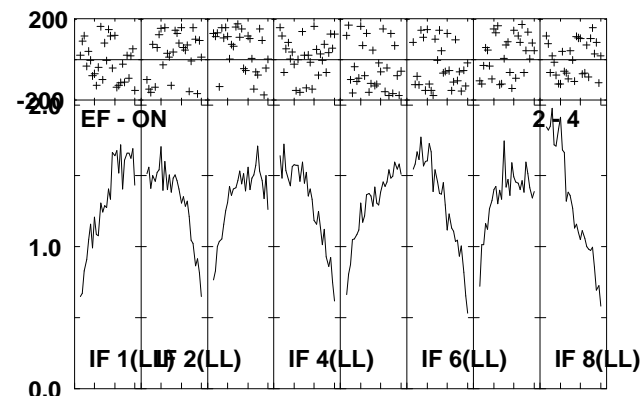
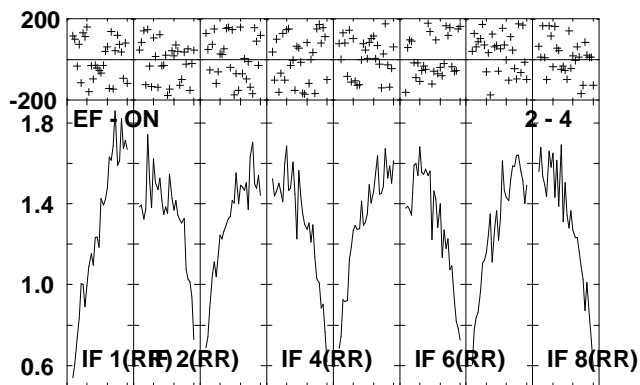
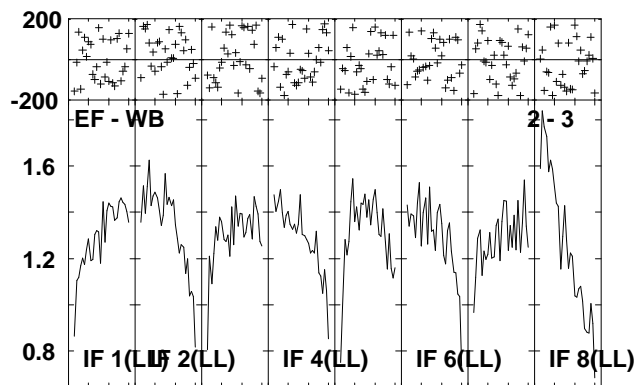
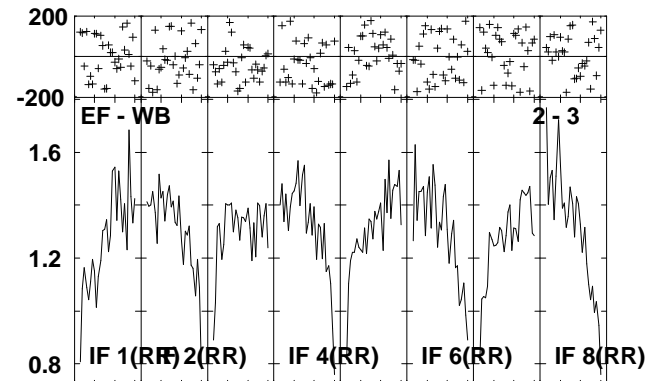
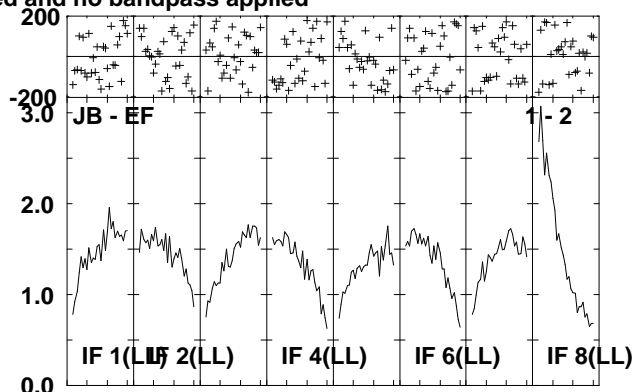
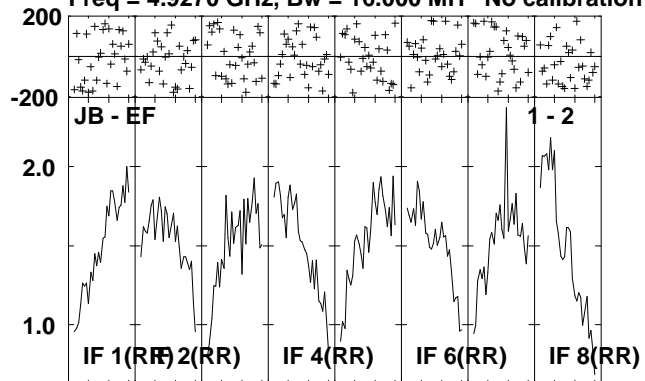

Lower frame: Milli Ampl Jy Top frame: Phas deg
Scalar averaged cross-power spectrum Several baselines displayed
Timerange: 00/11:42:41 to 00/11:46:09

Plot file version 36 created 06-JUL-2010 12:01:26
 IRAS2336 EP064L.UVDATA.1
 Freq = 4.9270 GHz, Bw = 16.000 MH No calibration applied and no bandpass applied

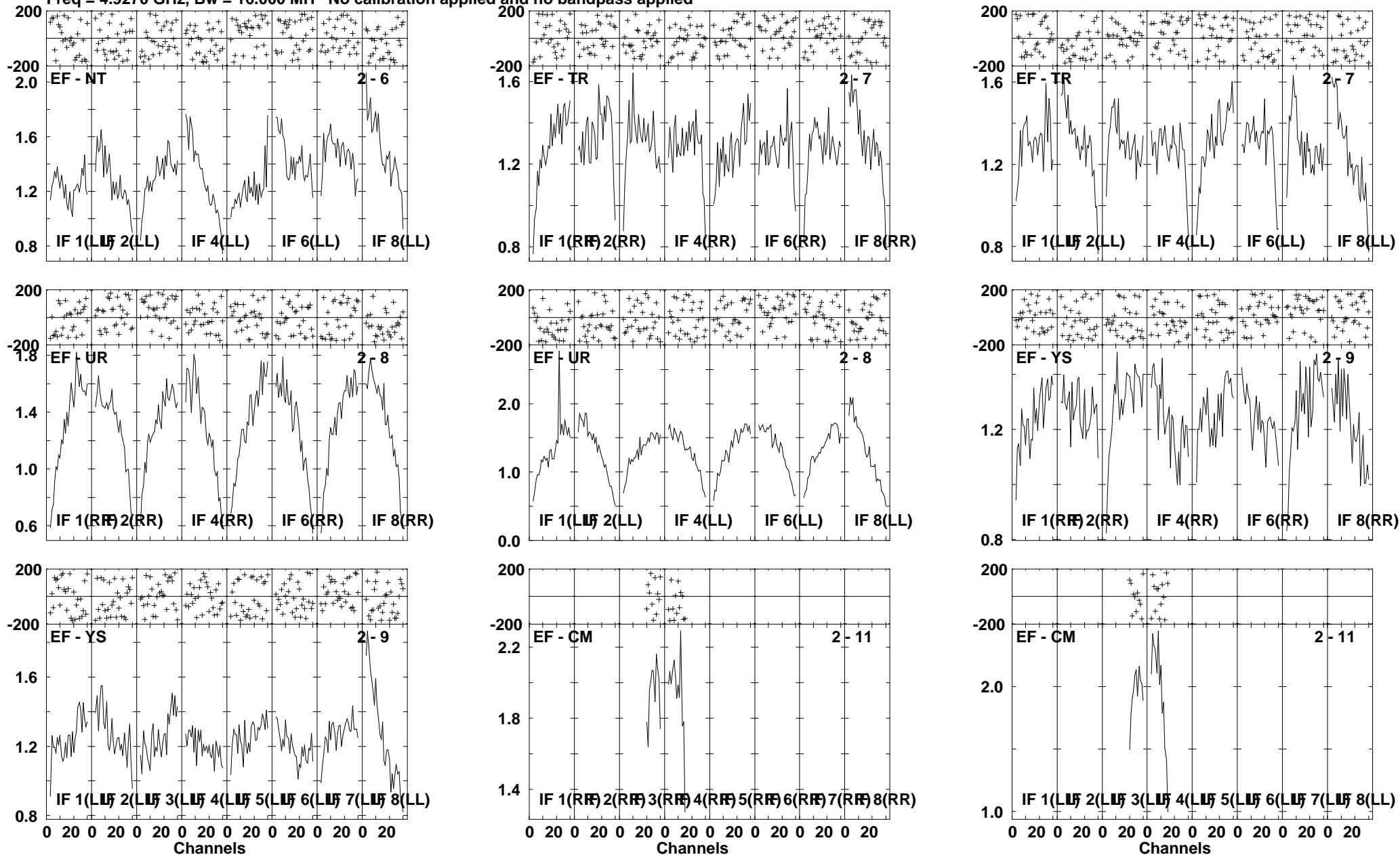

Lower frame: Milli Ampl Jy Top frame: Phas deg
 Scalar averaged cross-power spectrum Several baselines displayed
 Timerange: 00/11:42:41 to 00/11:46:09

Plot file version 37 created 06-JUL-2010 12:01:30

IRAS2336 EP064L.UVDATA.1

Freq = 4.9270 GHz, Bw = 16.000 MH No calibration applied and no bandpass applied

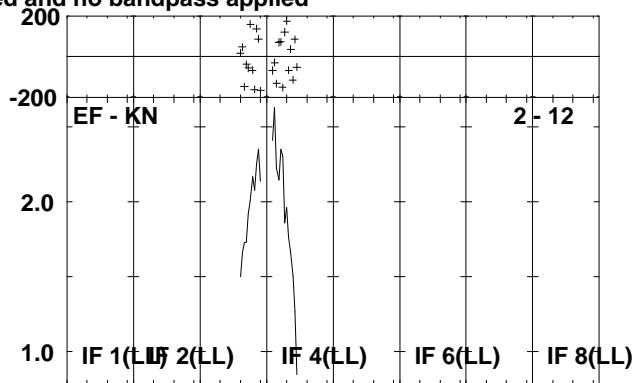
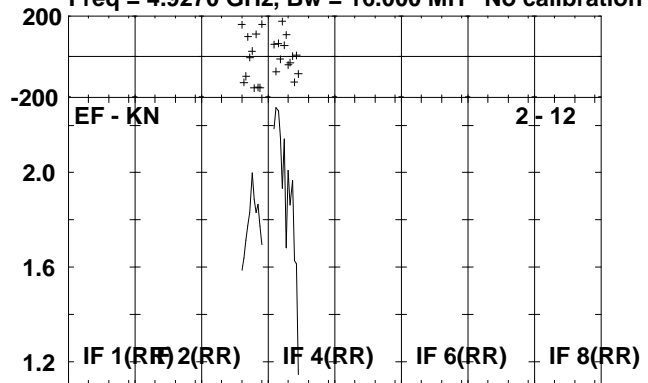

Lower frame: Milli Ampl Jy Top frame: Phas deg
Scalar averaged cross-power spectrum Several baselines displayed
Timerange: 00/11:42:41 to 00/11:46:09

Plot file version 38 created 06-JUL-2010 12:01:30

J2330+33 EP064L.UVDATA.1

Freq = 4.9270 GHz, Bw = 16.000 MH No calibration applied and no bandpass applied

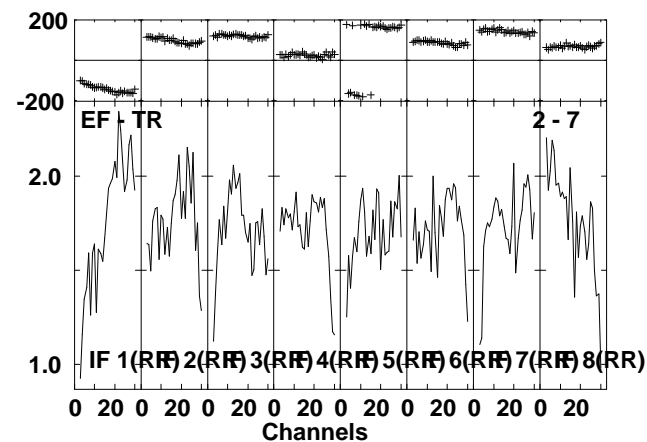
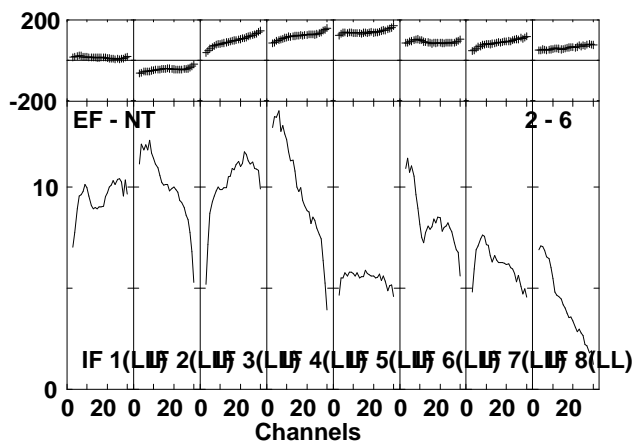
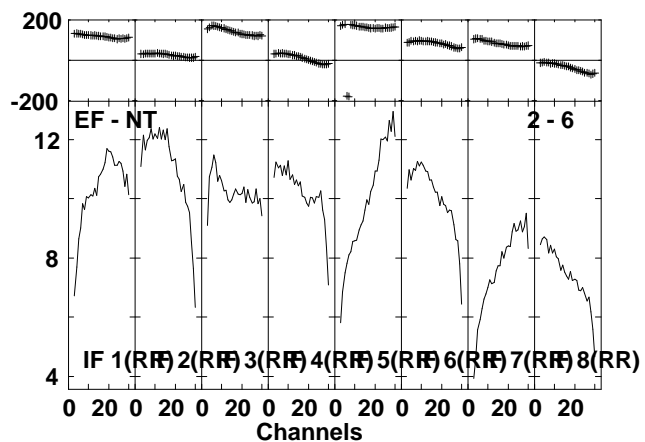
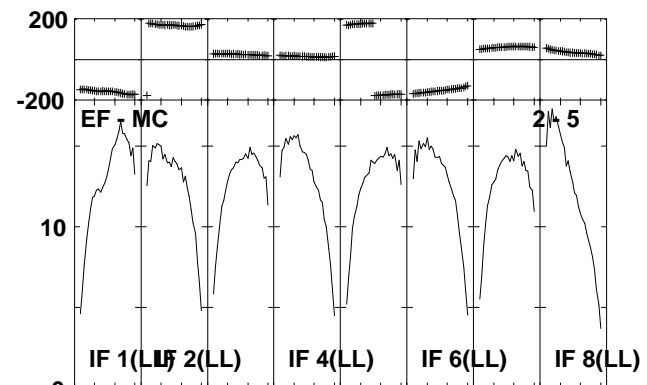
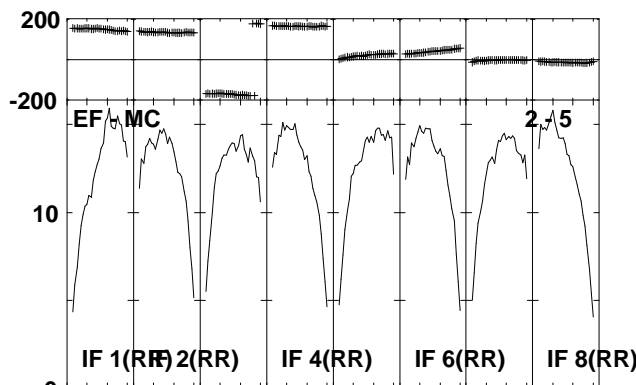
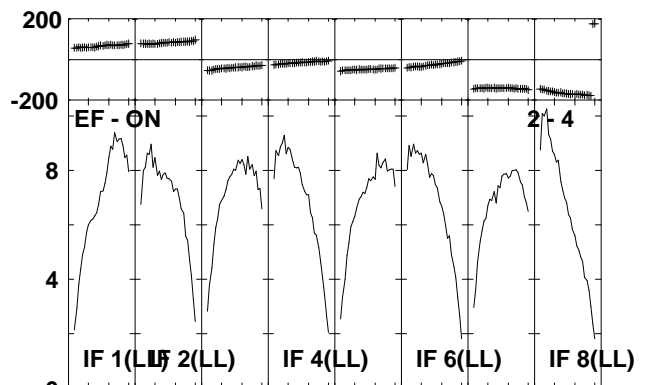
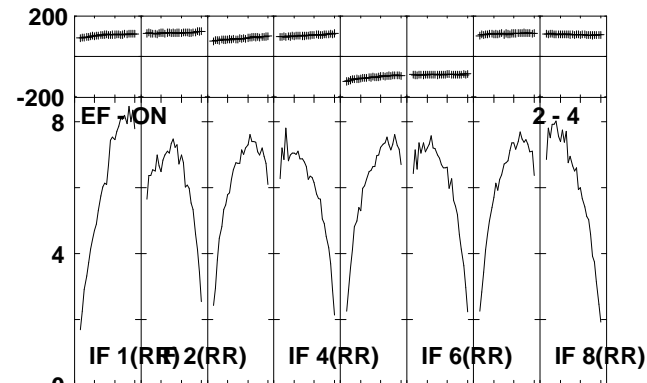
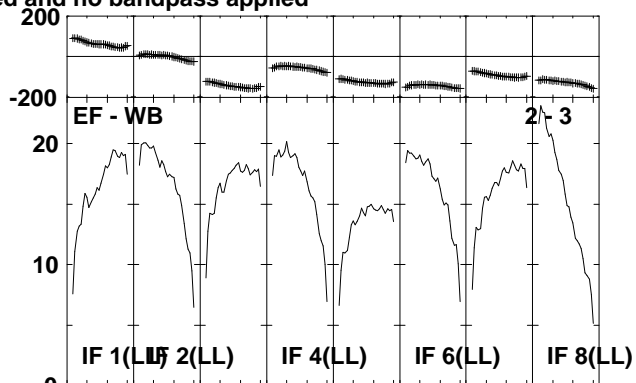
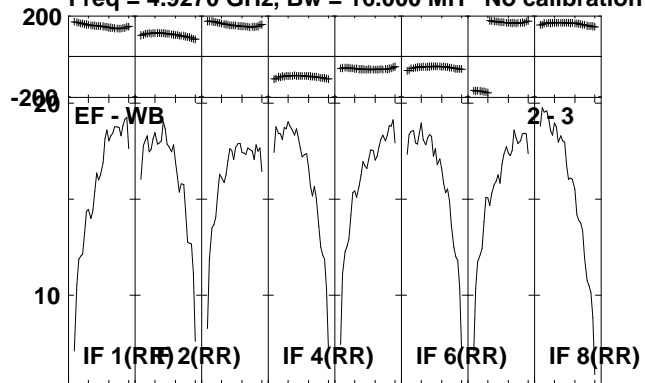

Lower frame: Milli Ampl Jy Top frame: Phas deg
Scalar averaged cross-power spectrum Several baselines displayed
Timerange: 00/11:47:11 to 00/11:48:49

Plot file version 39 created 06-JUL-2010 12:01:31

J2330+33 EP064L.UVDATA.1

Freq = 4.9270 GHz, Bw = 16.000 MH No calibration applied and no bandpass applied

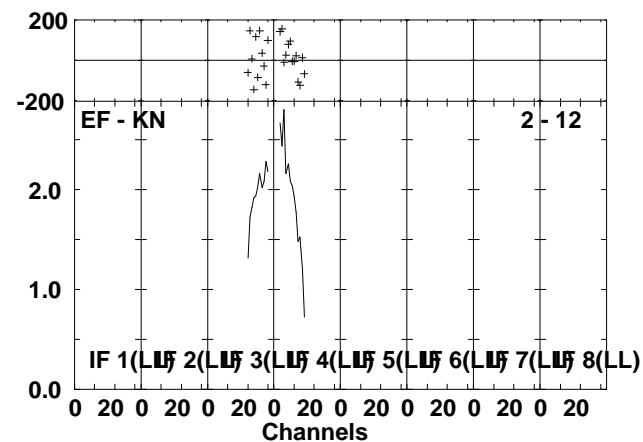
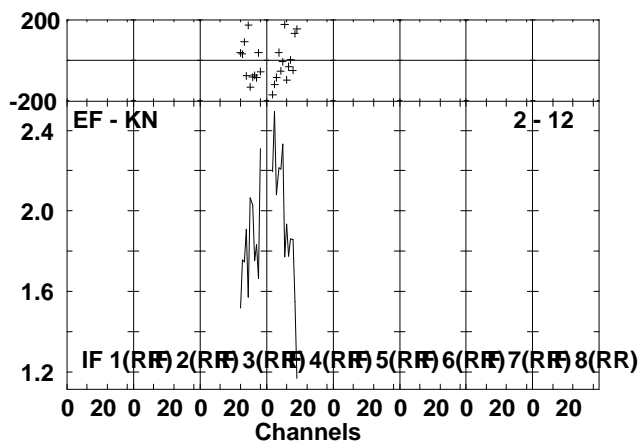
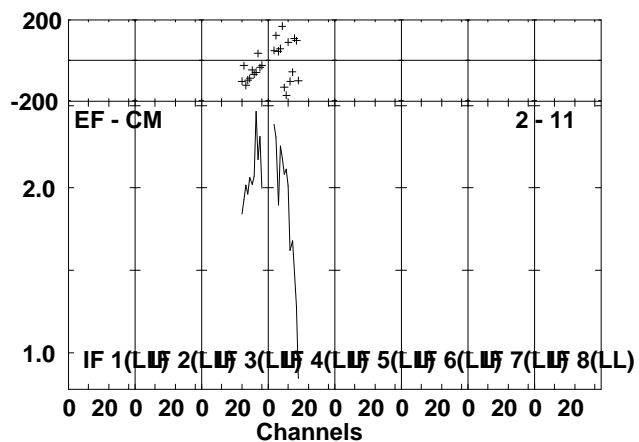
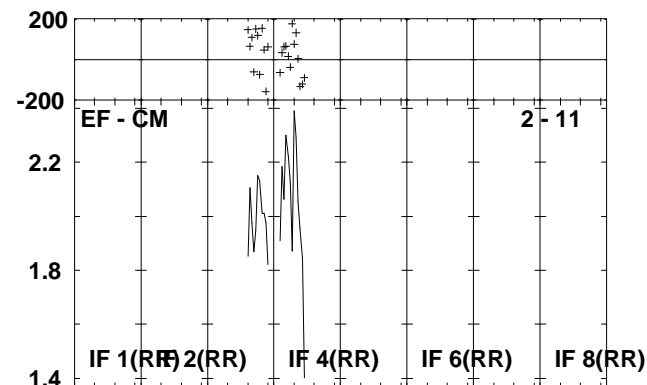
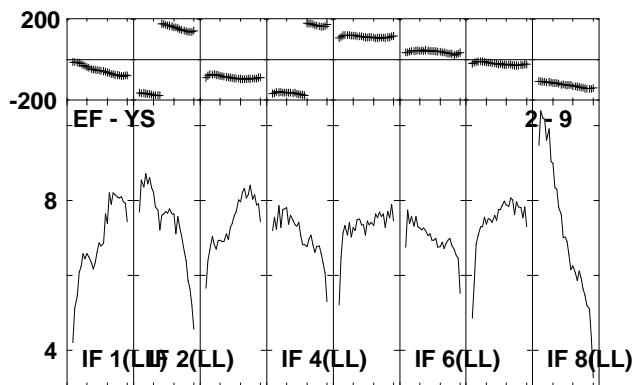
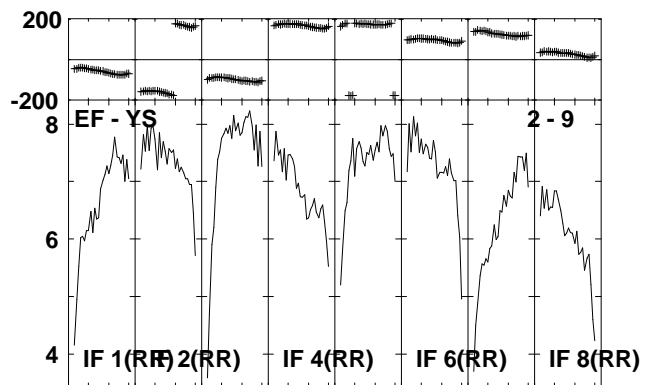
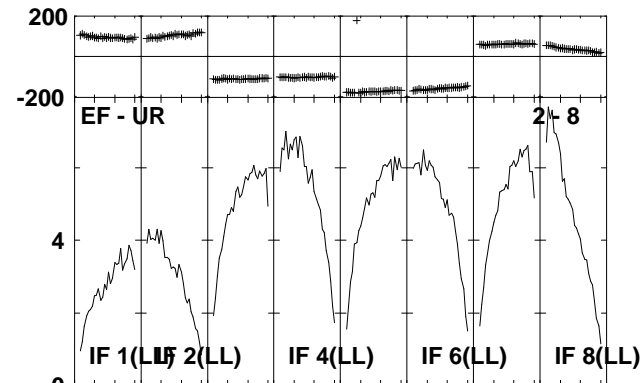
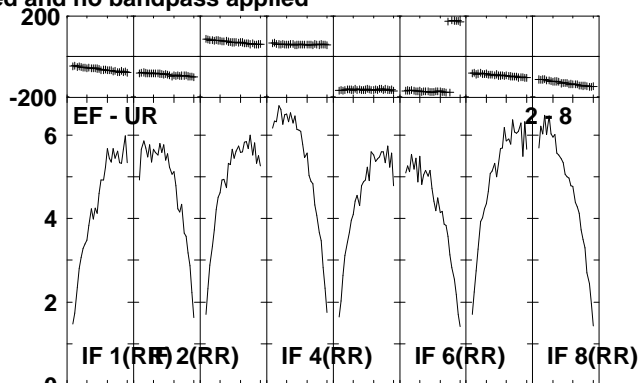
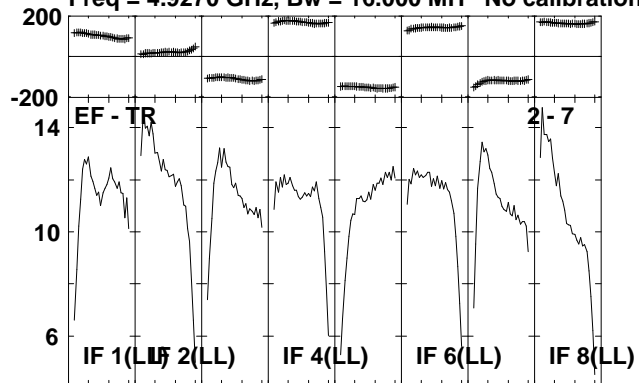

Lower frame: Milli Ampl Jy Top frame: Phas deg
Scalar averaged cross-power spectrum Several baselines displayed
Timerange: 00/11:47:11 to 00/11:48:49

Plot file version 40 created 06-JUL-2010 12:01:33

IRAS2336 EP064L.UVDATA.1

Freq = 4.9270 GHz, Bw = 16.000 MH No calibration applied and no bandpass applied

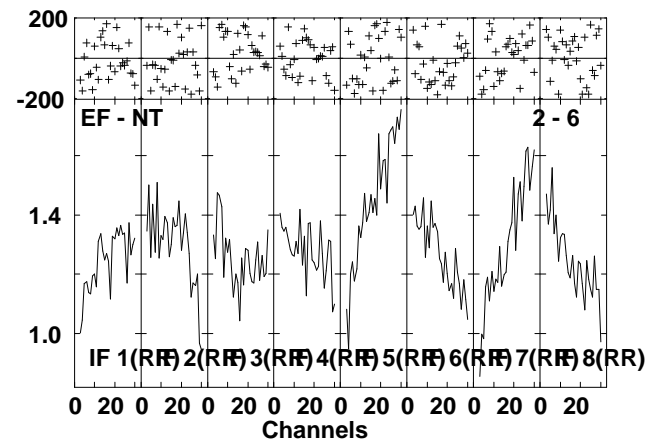
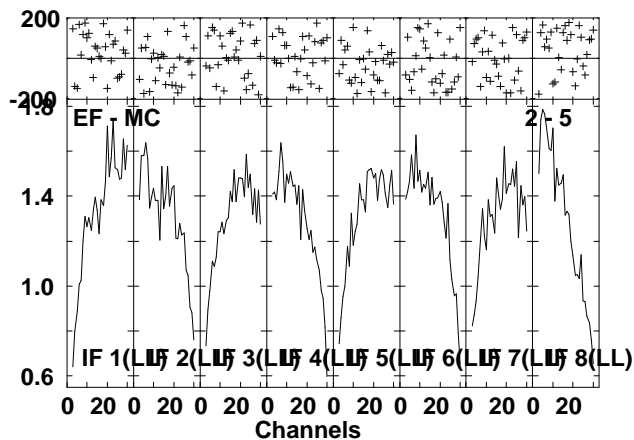
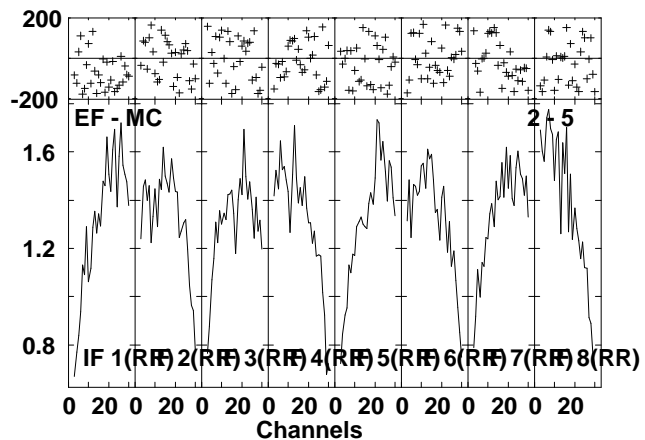
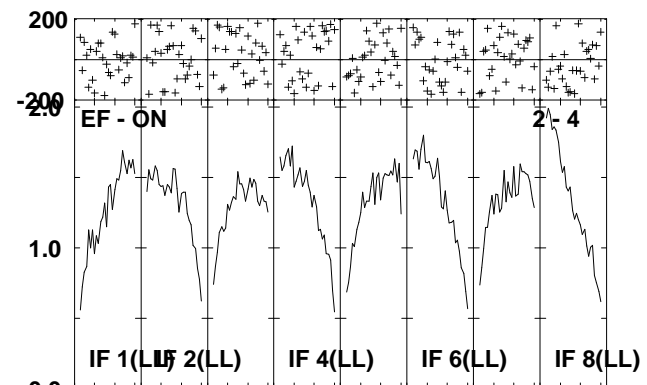
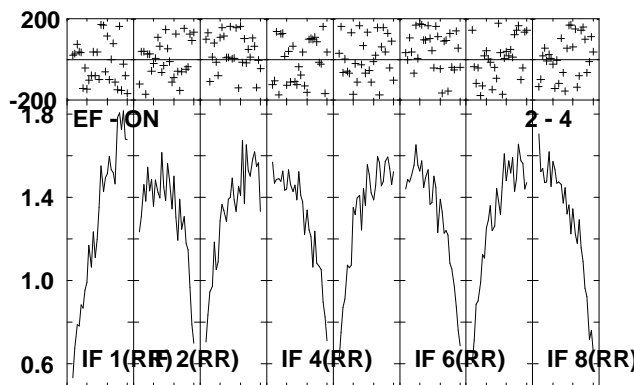
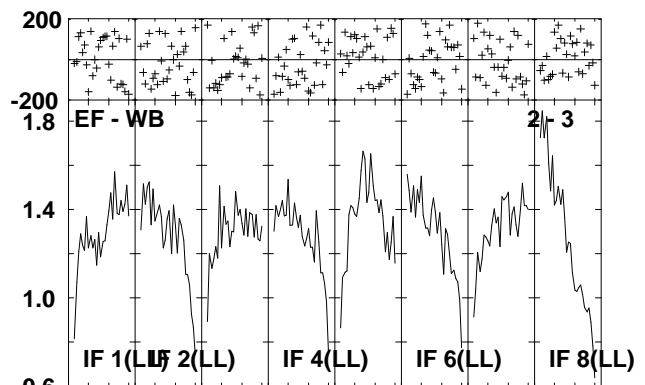
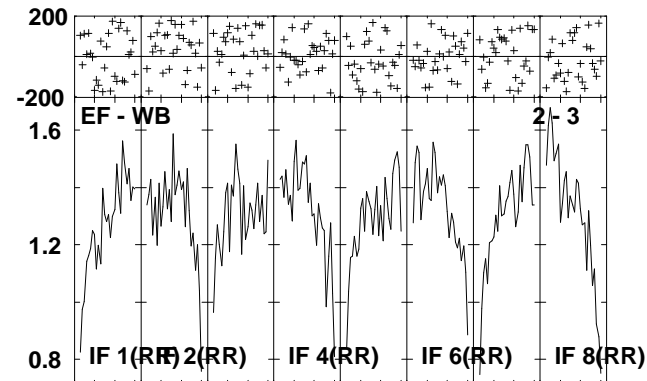
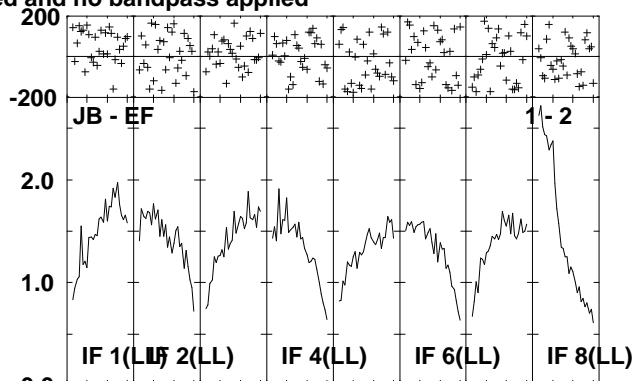
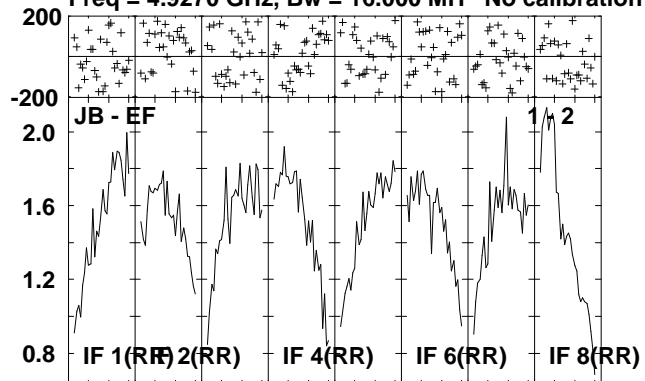

Lower frame: Milli Ampl Jy Top frame: Phas deg
Scalar averaged cross-power spectrum Several baselines displayed
Timerange: 00/11:48:51 to 00/11:52:29

Plot file version 41 created 06-JUL-2010 12:01:35

IRAS2336 EP064L.UVDATA.1

Freq = 4.9270 GHz, Bw = 16.000 MH No calibration applied and no bandpass applied

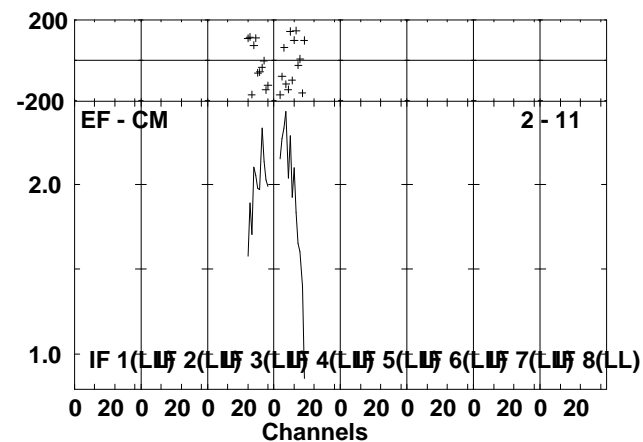
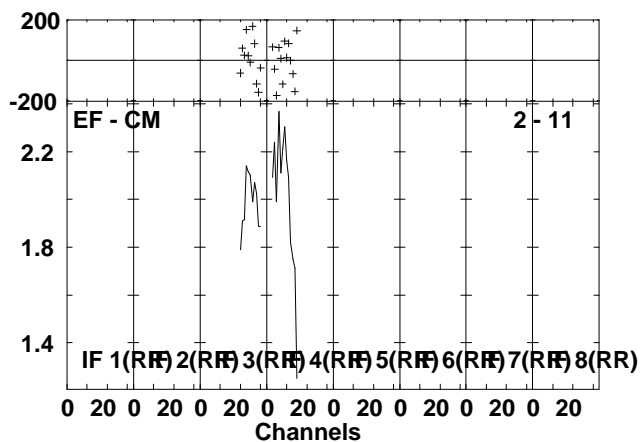
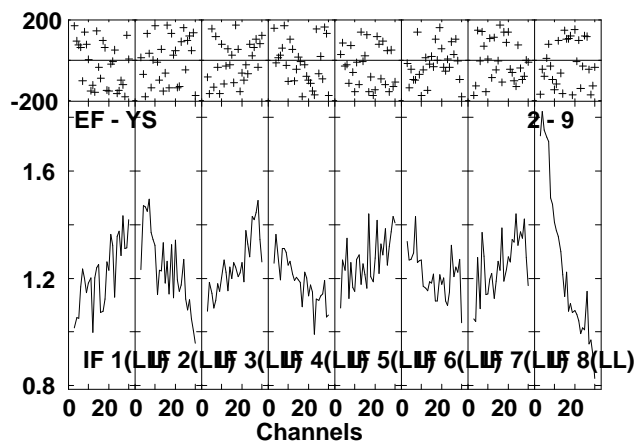
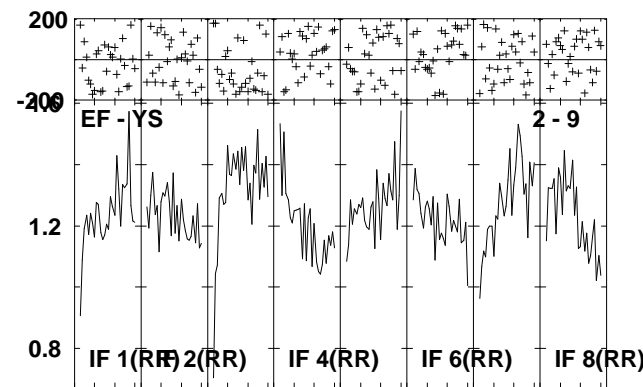
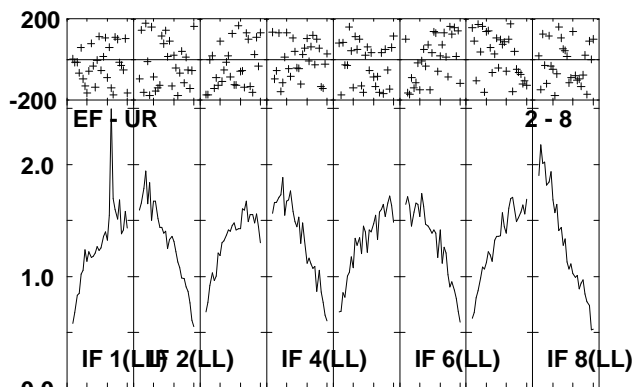
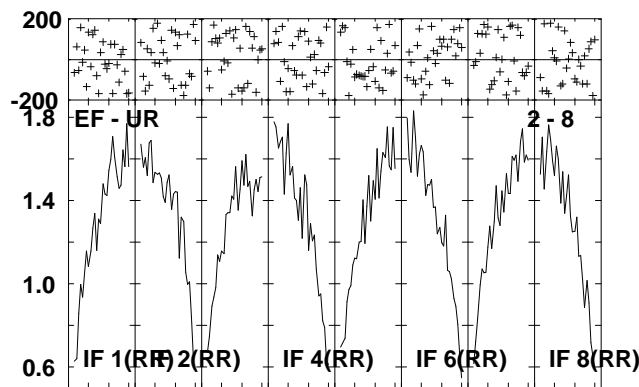
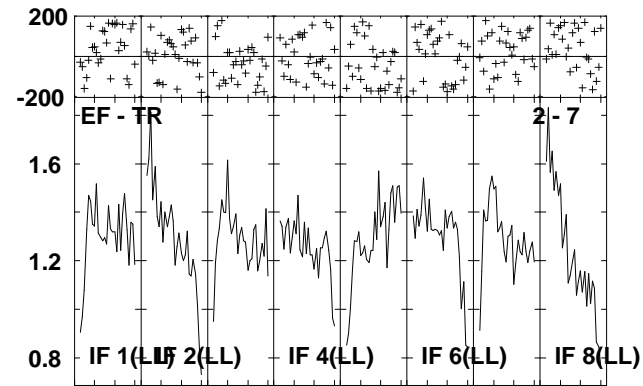
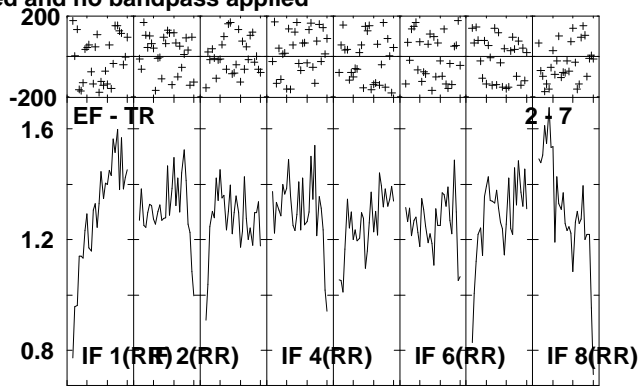
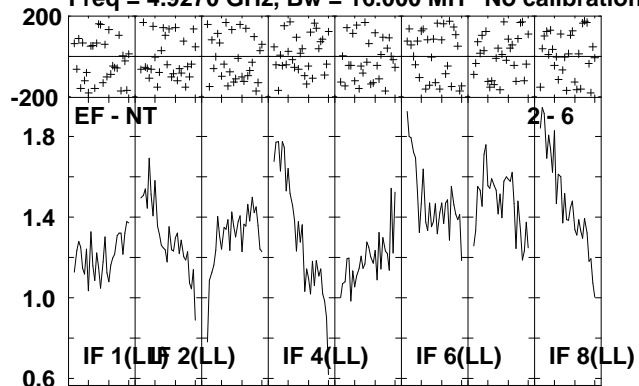

Lower frame: Milli Ampl Jy Top frame: Phas deg
Scalar averaged cross-power spectrum Several baselines displayed
Timerange: 00/11:48:51 to 00/11:52:29

Plot file version 42 created 06-JUL-2010 12:01:39

IRAS2336 EP064L.UVDATA.1

Freq = 4.9270 GHz, Bw = 16.000 MH No calibration applied and no bandpass applied

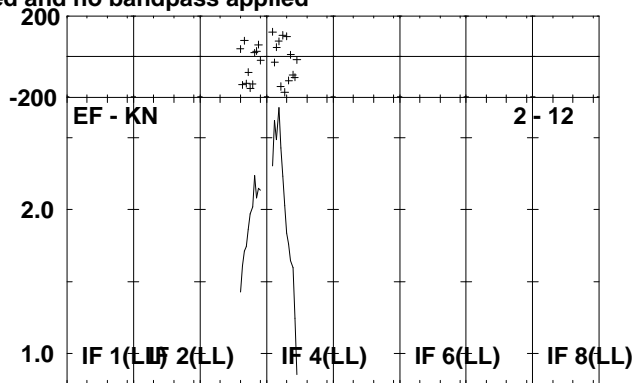
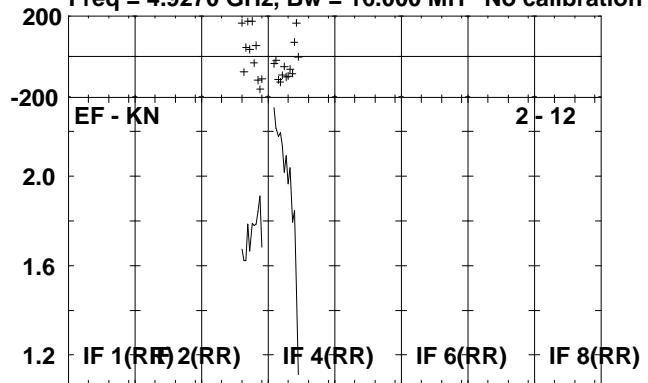

Lower frame: Milli Ampl Jy Top frame: Phas deg
Scalar averaged cross-power spectrum Several baselines displayed
Timerange: 00/11:48:51 to 00/11:52:29

Plot file version 43 created 06-JUL-2010 12:01:39

J2330+33 EP064L.UVDATA.1

Freq = 4.9270 GHz, Bw = 16.000 MH No calibration applied and no bandpass applied

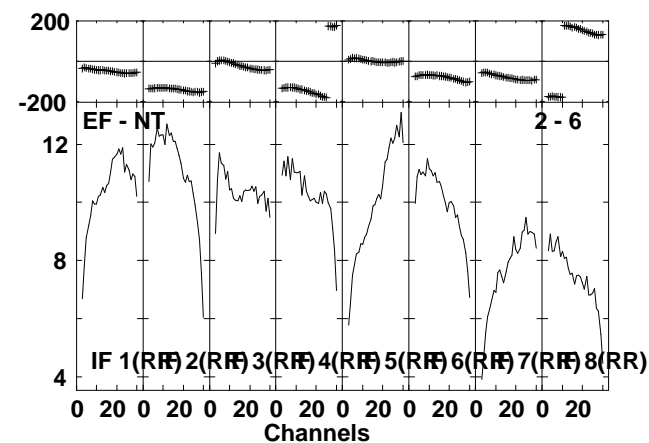
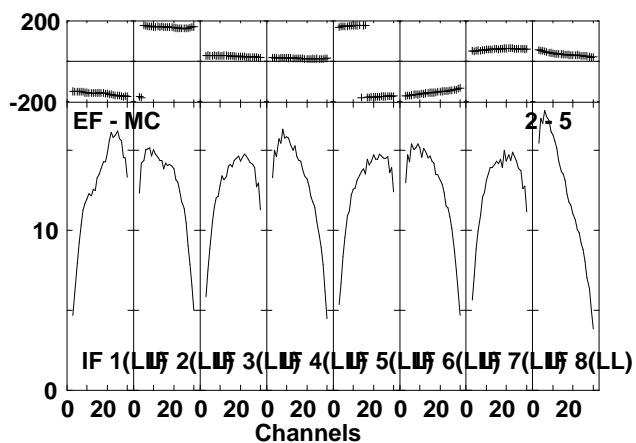
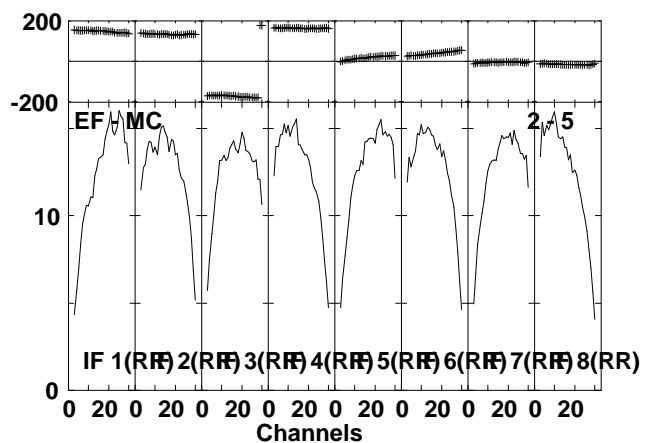
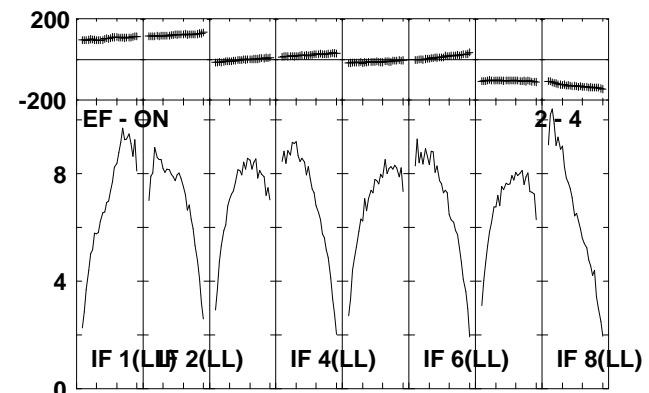
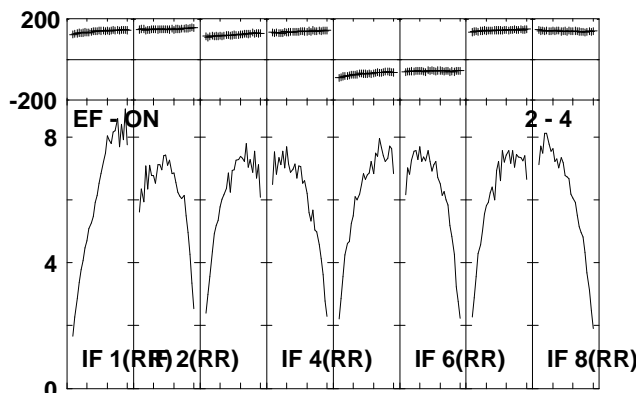
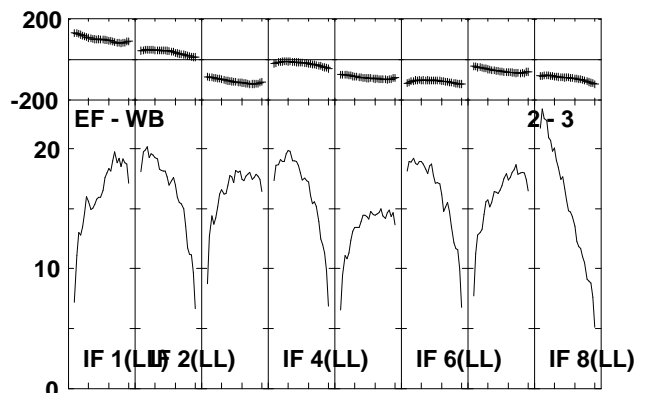
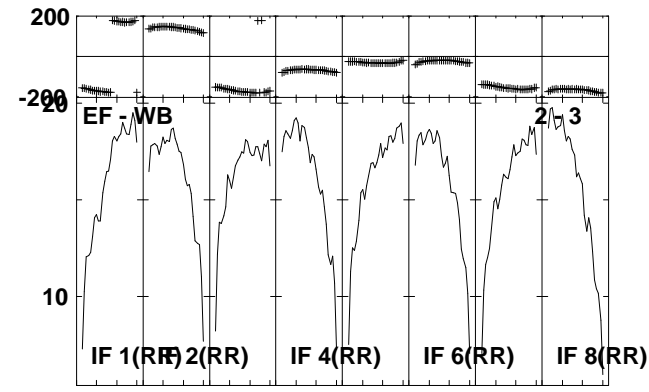
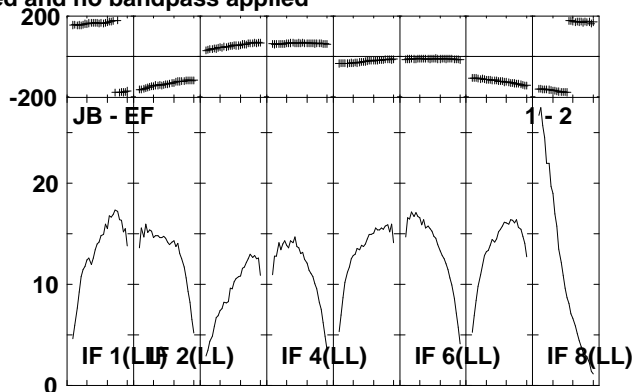
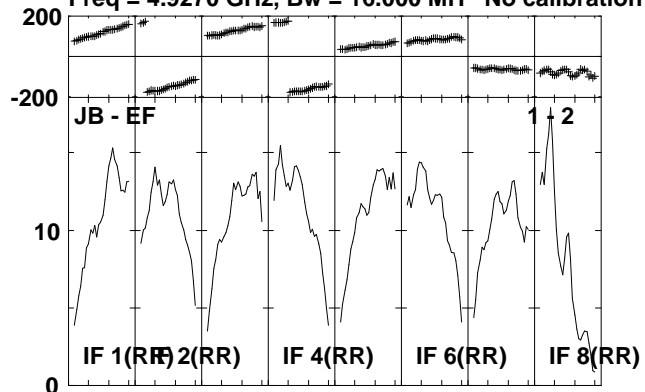

Lower frame: Milli Ampl Jy Top frame: Phas deg
Scalar averaged cross-power spectrum Several baselines displayed
Timerange: 00/11:52:31 to 00/11:54:19

Plot file version 44 created 06-JUL-2010 12:01:40

J2330+33 EP064L.UVDATA.1

Freq = 4.9270 GHz, Bw = 16.000 MH No calibration applied and no bandpass applied

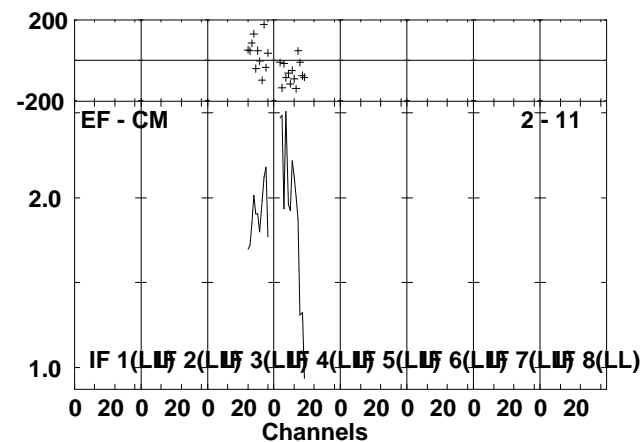
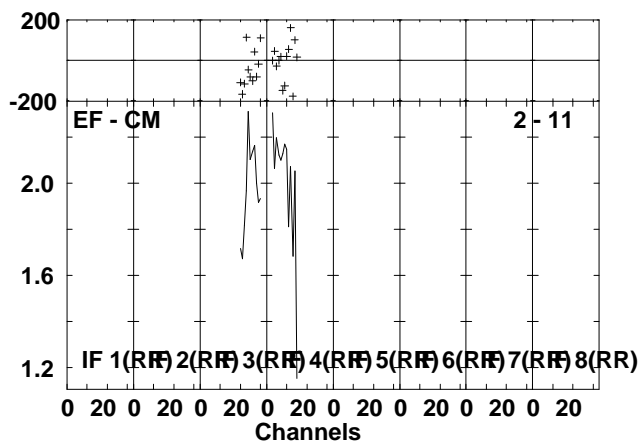
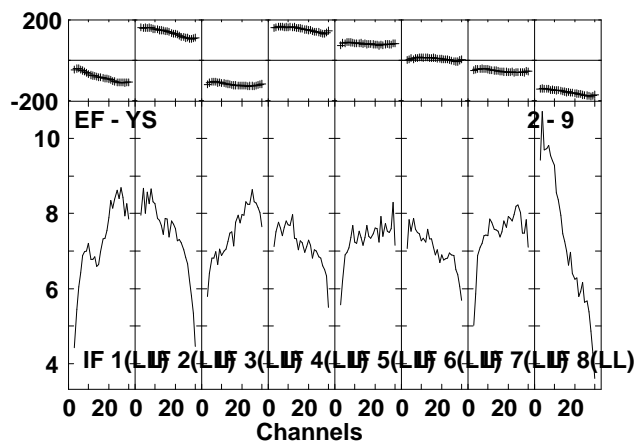
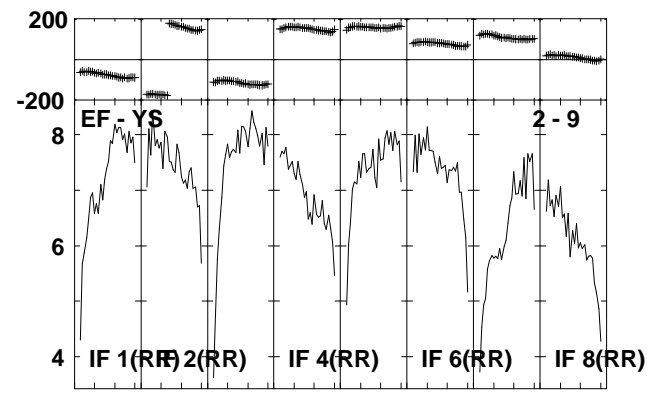
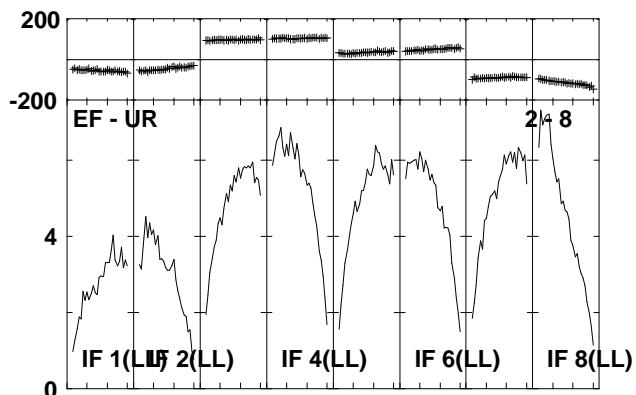
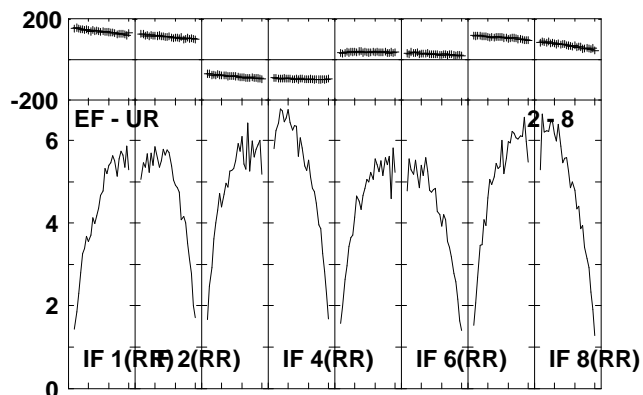
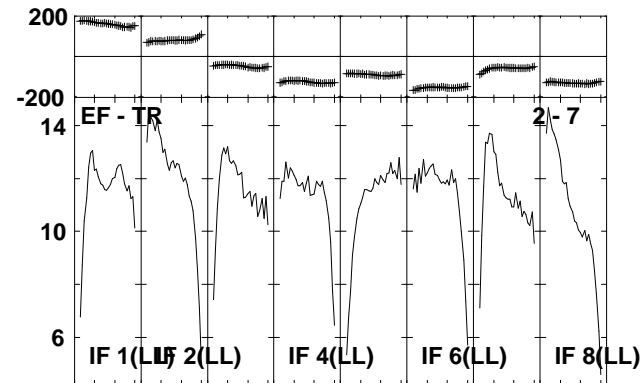
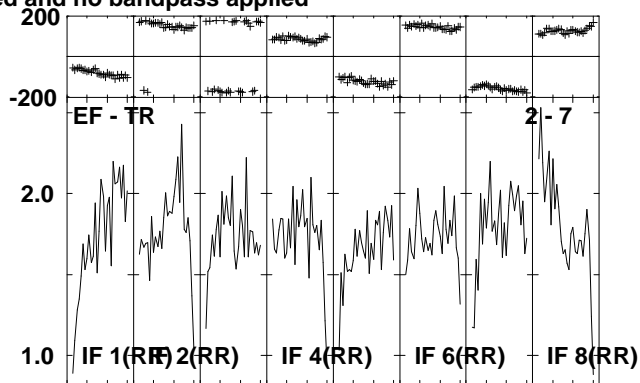
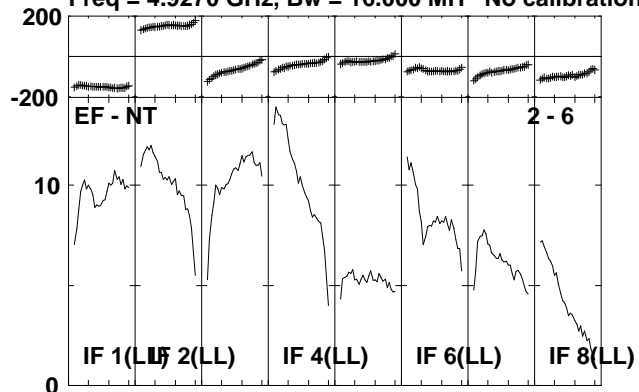

Lower frame: Milli Ampl Jy Top frame: Phas deg
Scalar averaged cross-power spectrum Several baselines displayed
Timerange: 00/11:52:31 to 00/11:54:19

Plot file version 45 created 06-JUL-2010 12:01:42

J2330+33 EP064L.UVDATA.1

Freq = 4.9270 GHz, Bw = 16.000 MH No calibration applied and no bandpass applied

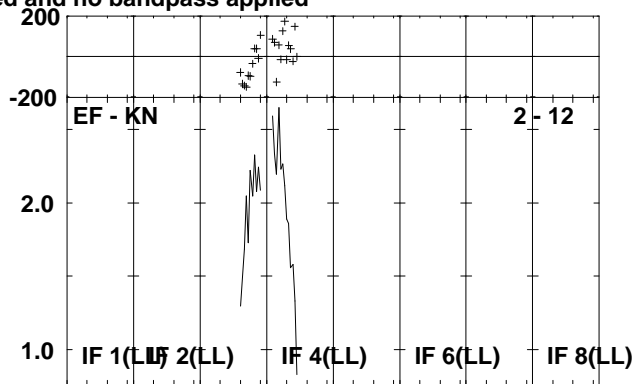
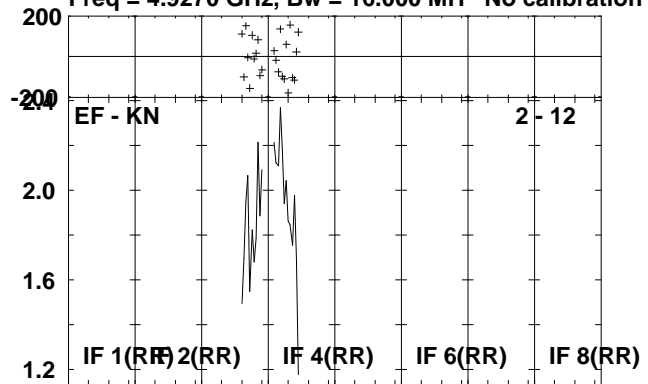

Lower frame: Milli Ampl Jy Top frame: Phas deg
Scalar averaged cross-power spectrum Several baselines displayed
Timerange: 00/11:52:31 to 00/11:54:19

Plot file version 46 created 06-JUL-2010 12:01:43

IRAS2336 EP064L.UVDATA.1

Freq = 4.9270 GHz, Bw = 16.000 MH No calibration applied and no bandpass applied

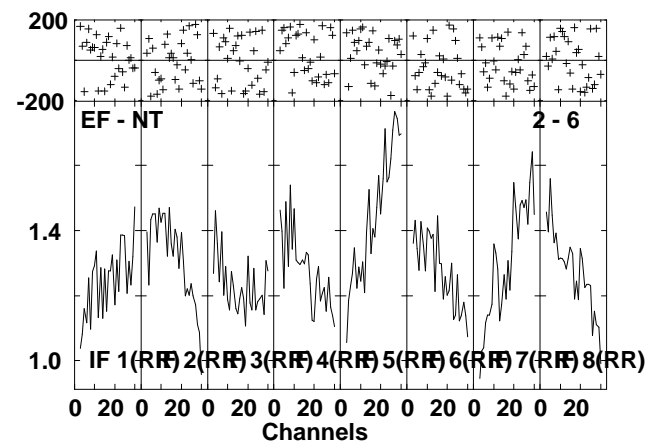
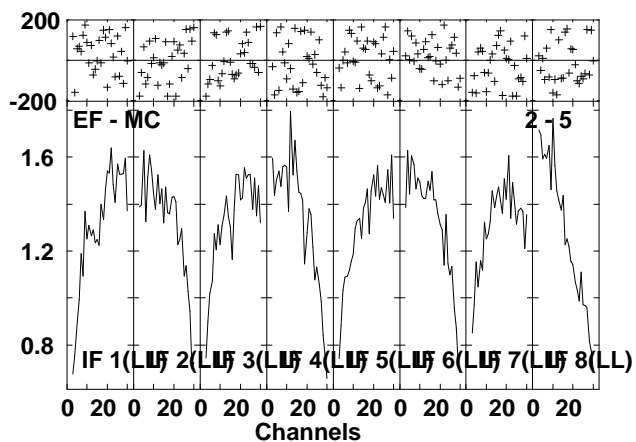
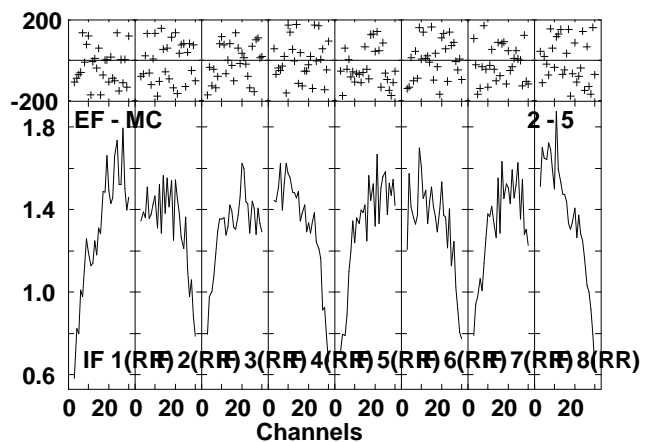
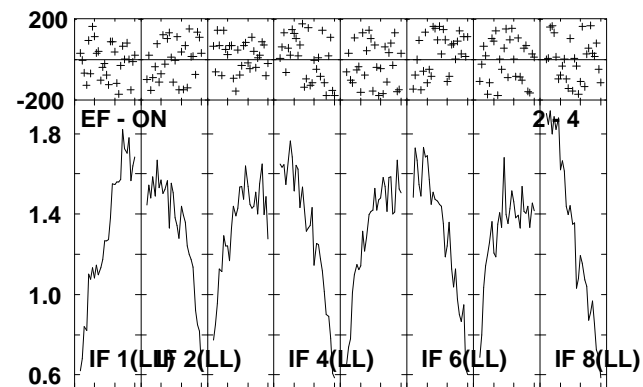
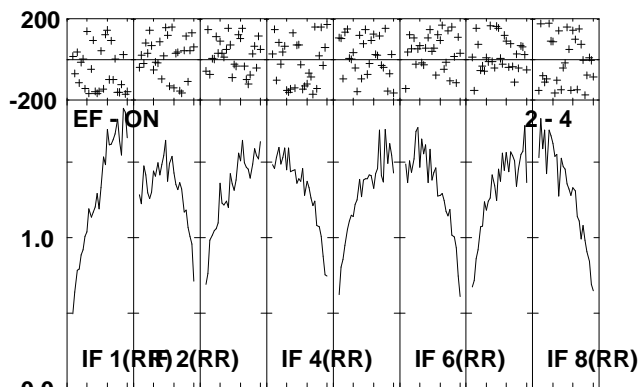
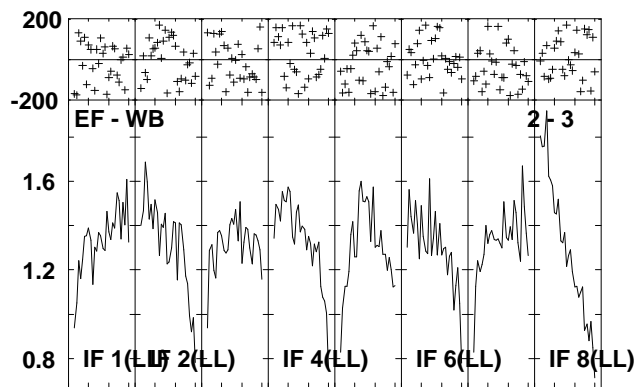
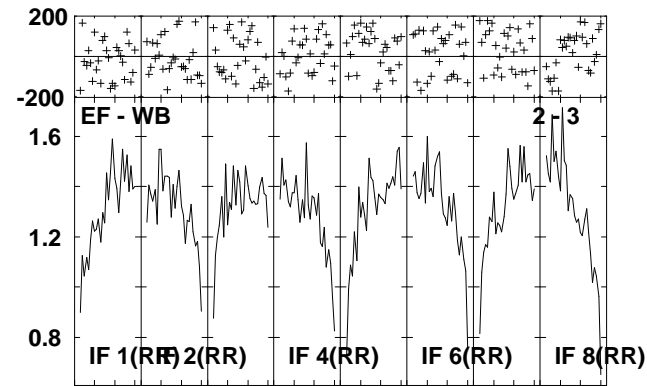
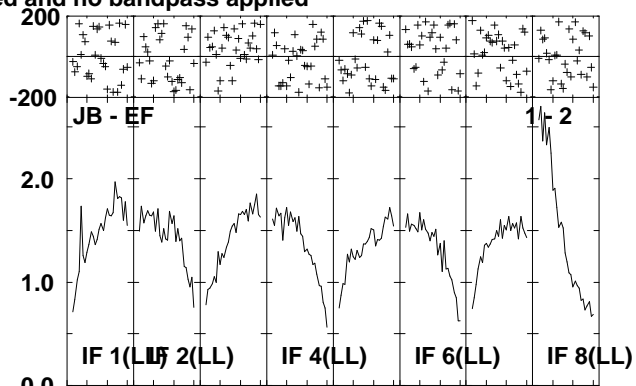
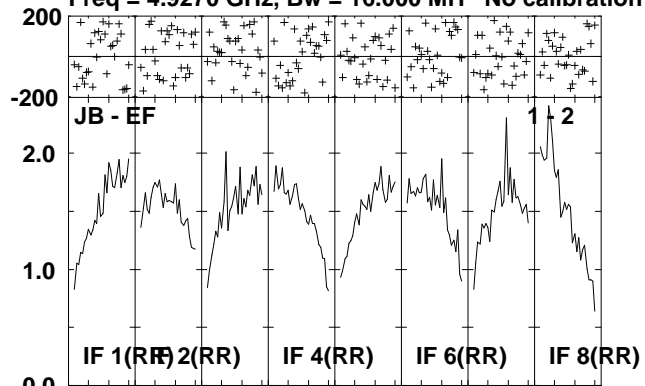

Lower frame: Milli Ampl Jy Top frame: Phas deg
Scalar averaged cross-power spectrum Several baselines displayed
Timerange: 00/11:54:31 to 00/11:57:59

Plot file version 47 created 06-JUL-2010 12:01:45

IRAS2336 EP064L.UVDATA.1

Freq = 4.9270 GHz, Bw = 16.000 MH No calibration applied and no bandpass applied

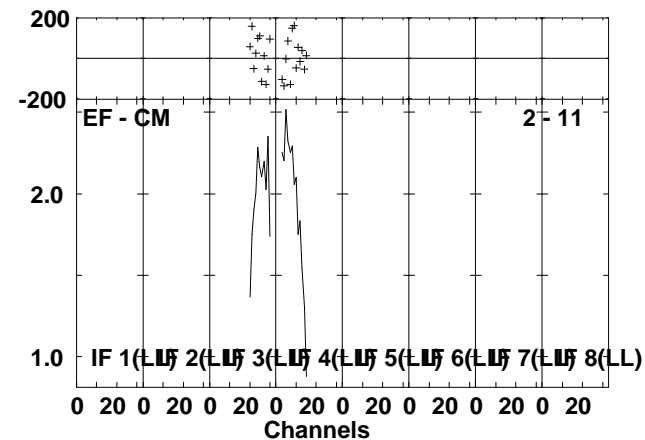
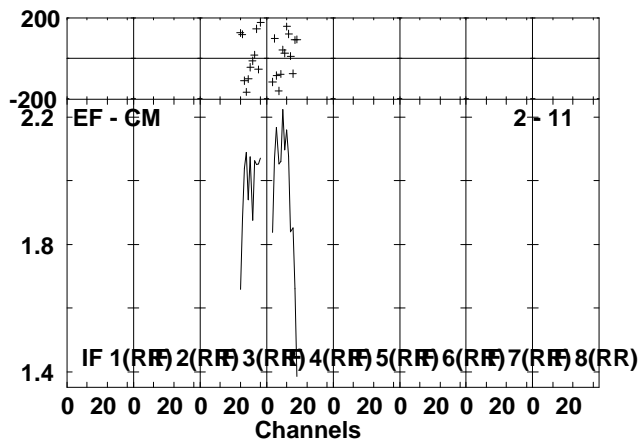
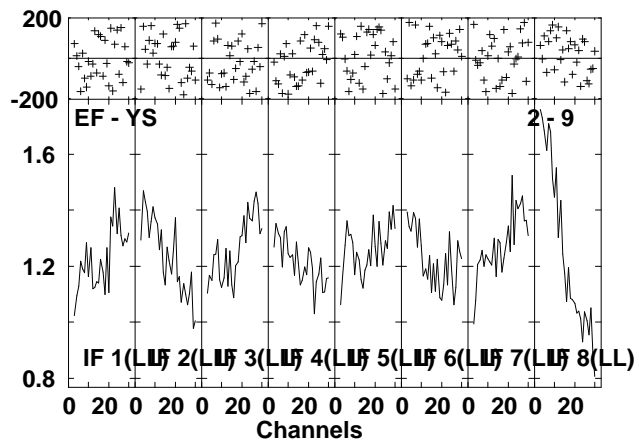
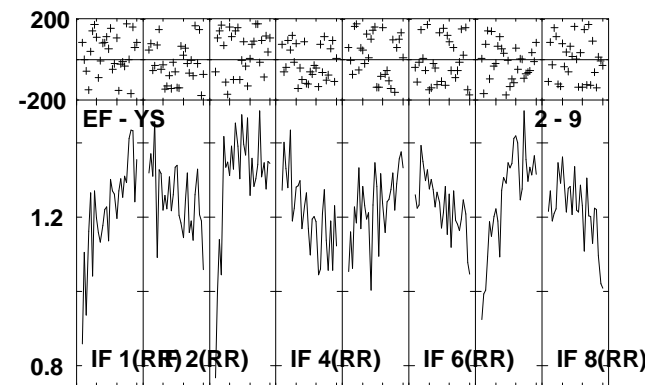
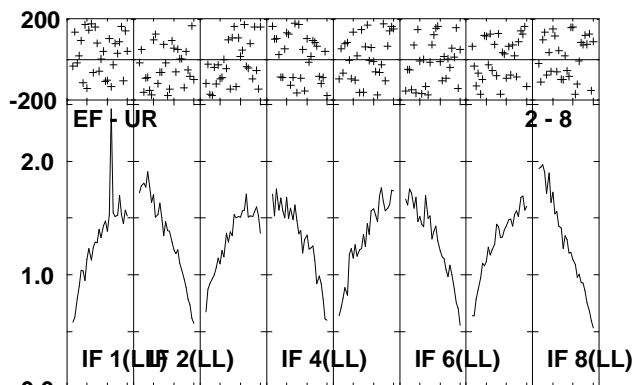
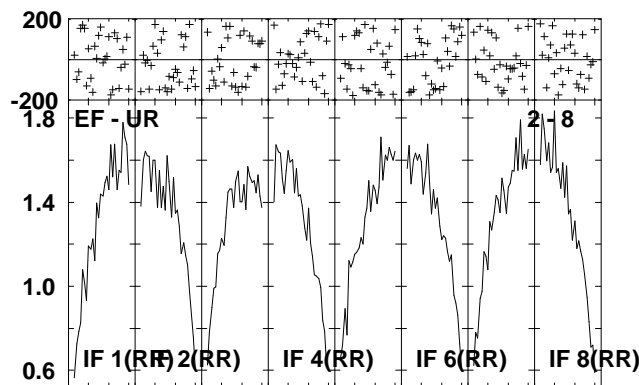
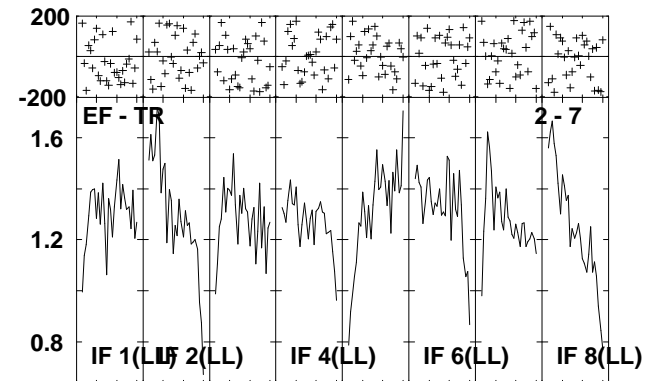
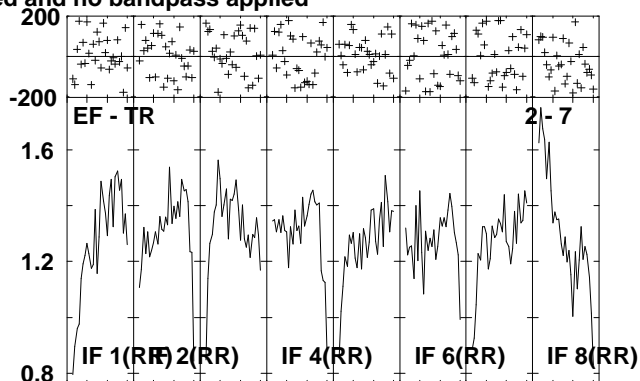
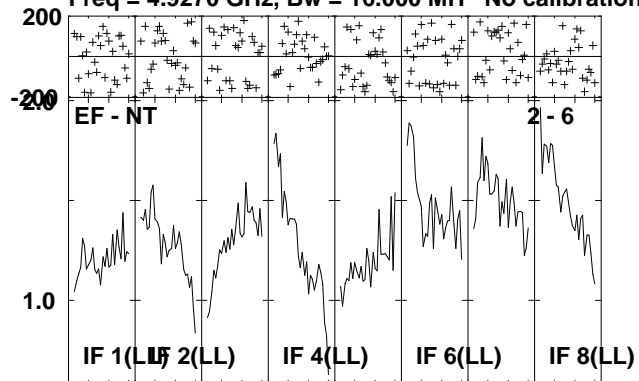

Lower frame: Milli Ampl Jy Top frame: Phas deg
Scalar averaged cross-power spectrum Several baselines displayed
Timerange: 00/11:54:31 to 00/11:57:59

Plot file version 48 created 06-JUL-2010 12:01:48

IRAS2336 EP064L.UVDATA.1

Freq = 4.9270 GHz, Bw = 16.000 MH No calibration applied and no bandpass applied

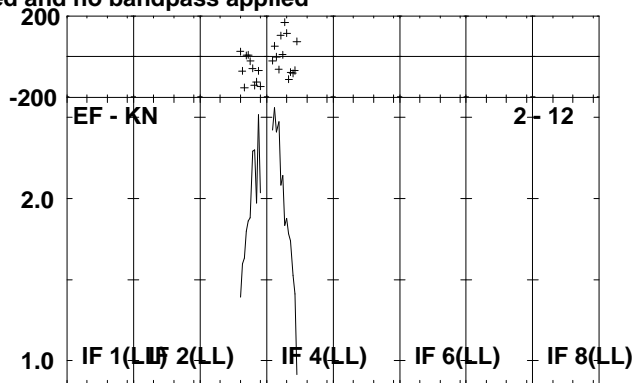
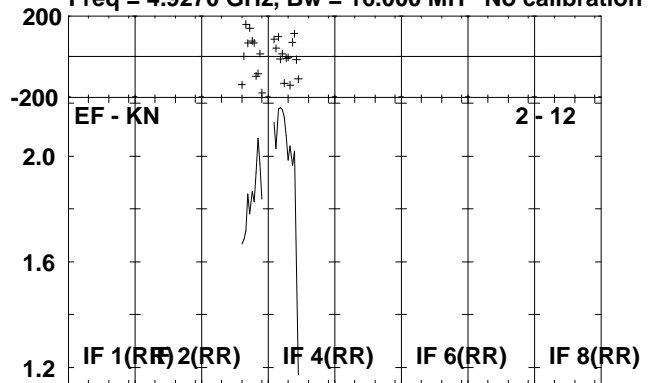

Lower frame: Milli Ampl Jy Top frame: Phas deg
Scalar averaged cross-power spectrum Several baselines displayed
Timerange: 00/11:54:31 to 00/11:57:59

Plot file version 49 created 06-JUL-2010 12:01:49

J2330+33 EP064L.UVDATA.1

Freq = 4.9270 GHz, Bw = 16.000 MH No calibration applied and no bandpass applied

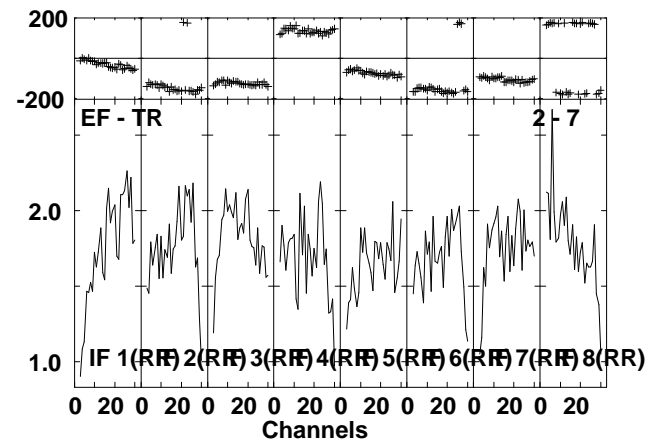
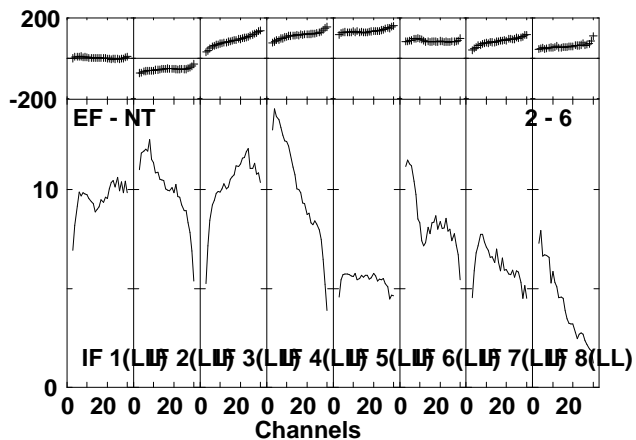
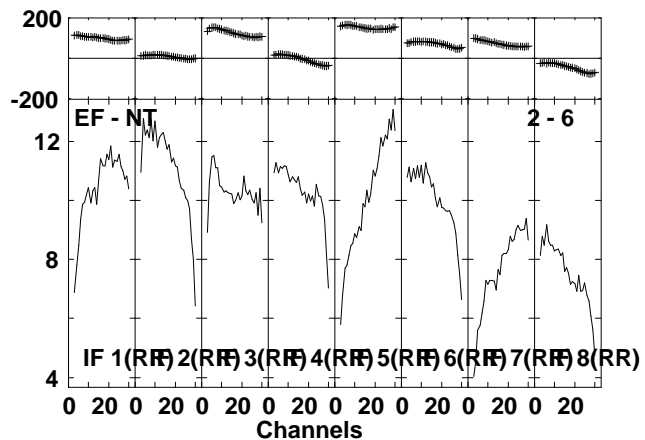
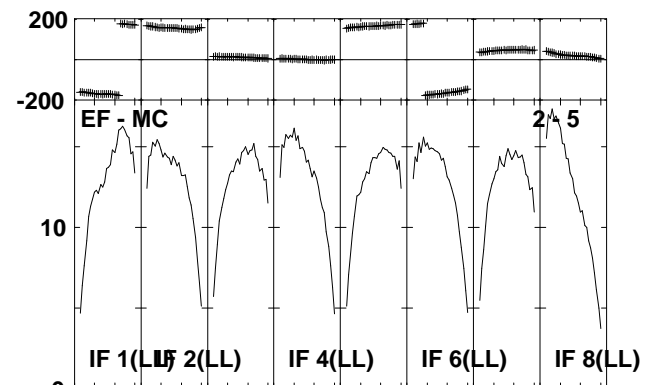
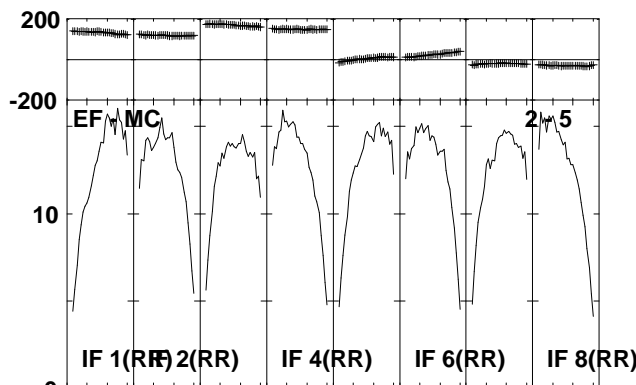
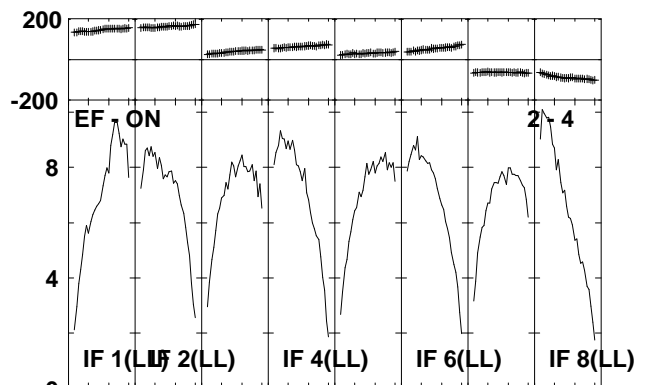
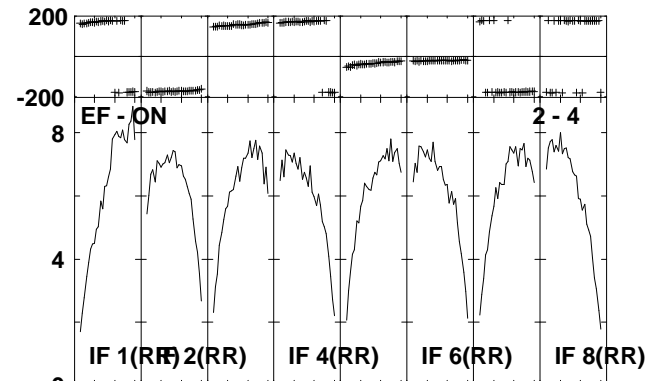
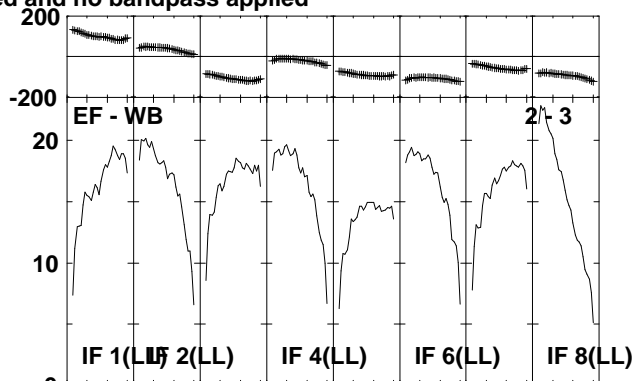
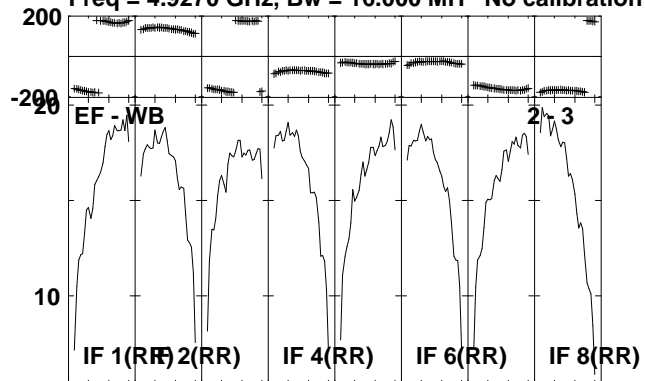

Lower frame: Milli Ampl Jy Top frame: Phas deg
Scalar averaged cross-power spectrum Several baselines displayed
Timerange: 00/11:58:01 to 00/11:59:47

Plot file version 50 created 06-JUL-2010 12:01:50

J2330+33 EP064L.UVDATA.1

Freq = 4.9270 GHz, Bw = 16.000 MH No calibration applied and no bandpass applied

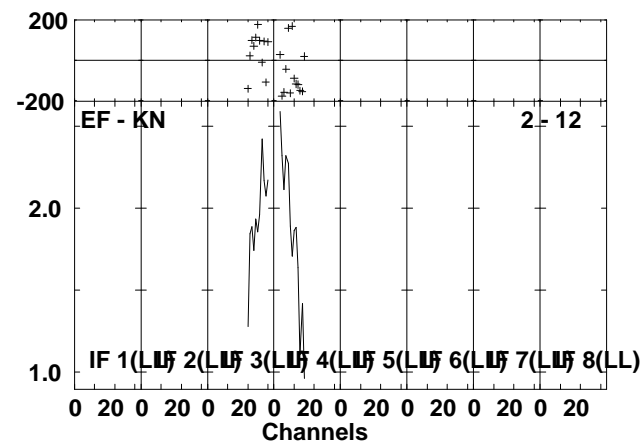
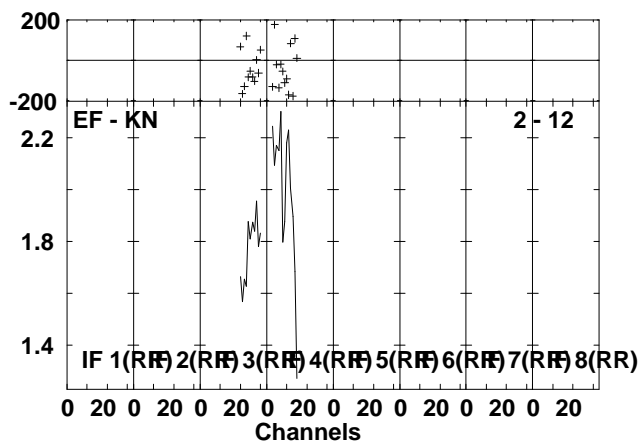
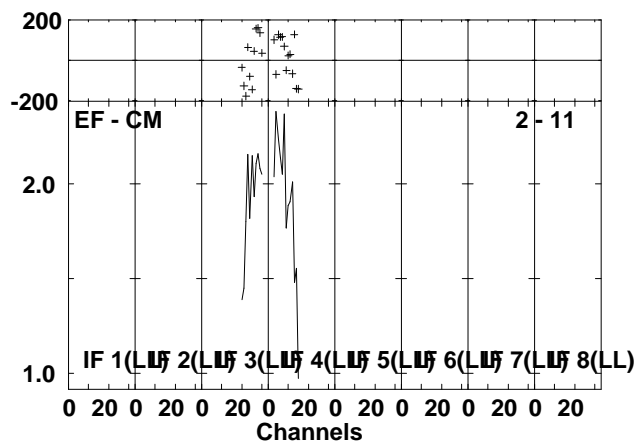
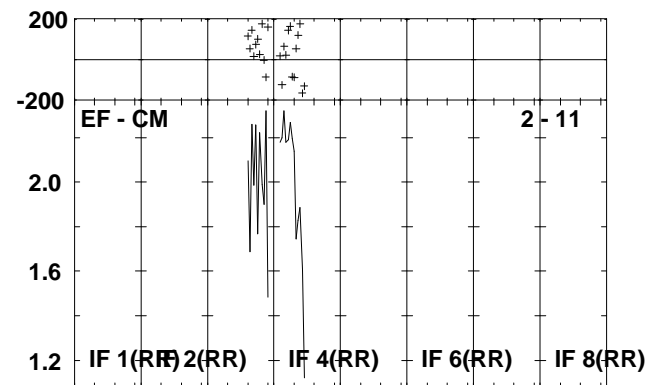
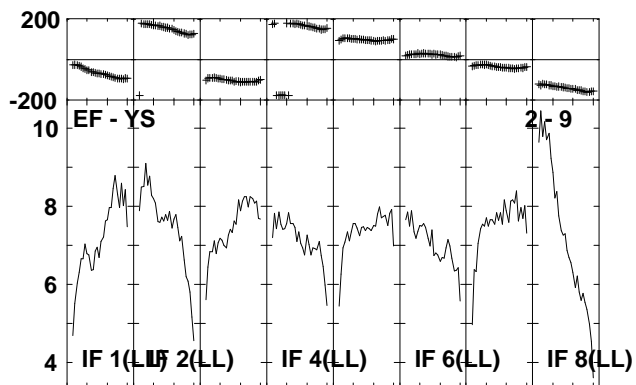
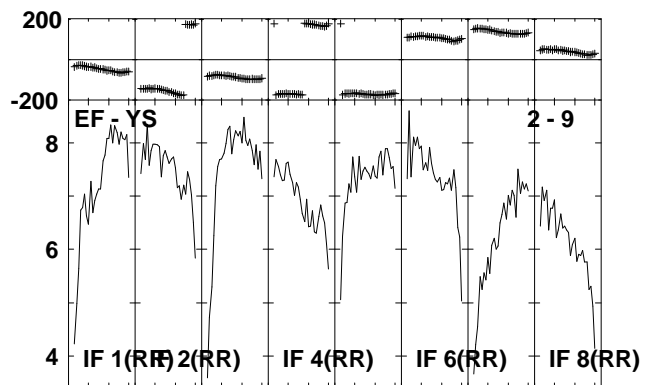
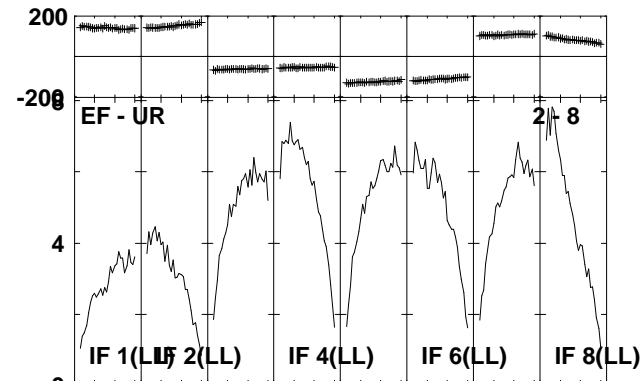
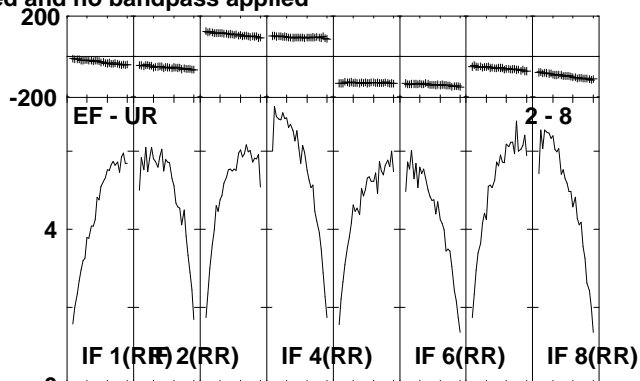
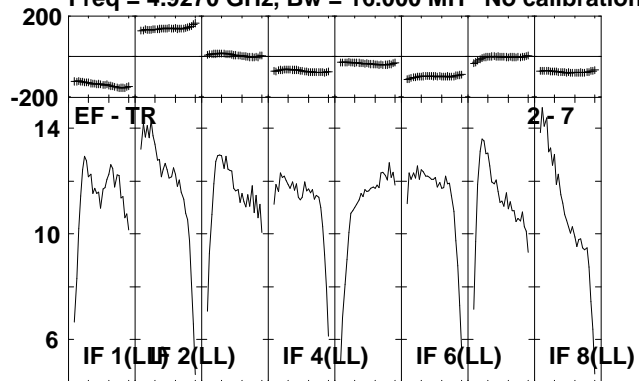

Lower frame: Milli Ampl Jy Top frame: Phas deg
Scalar averaged cross-power spectrum Several baselines displayed
Timerange: 00/11:58:01 to 00/11:59:47

Plot file version 51 created 06-JUL-2010 12:01:52

IRAS2336 EP064L.UVDATA.1

Freq = 4.9270 GHz, Bw = 16.000 MH No calibration applied and no bandpass applied

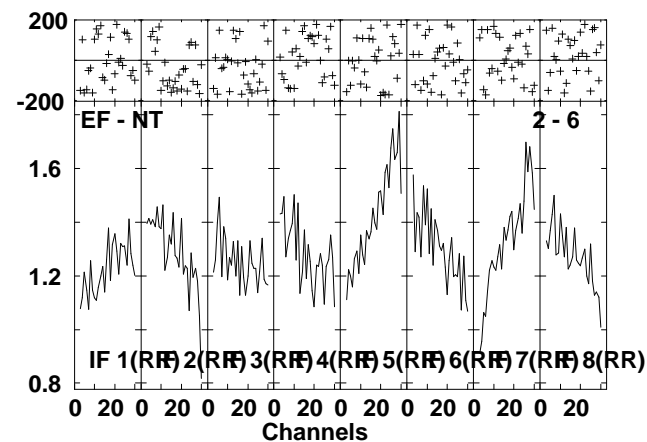
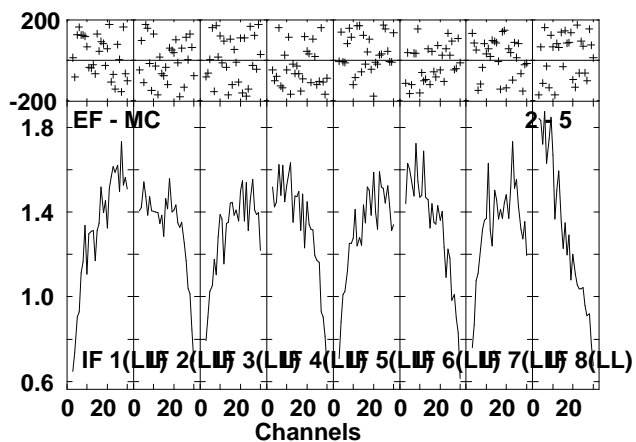
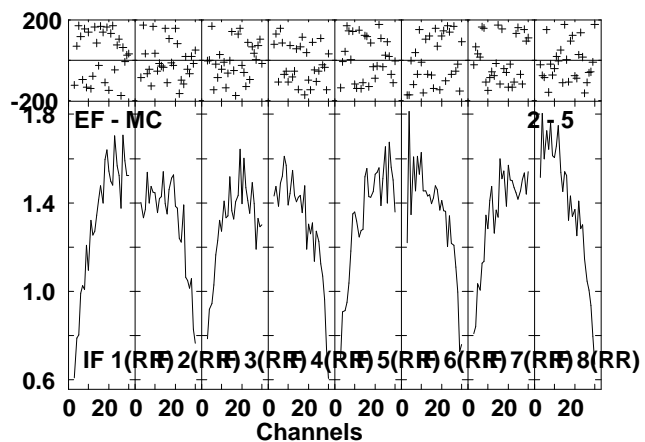
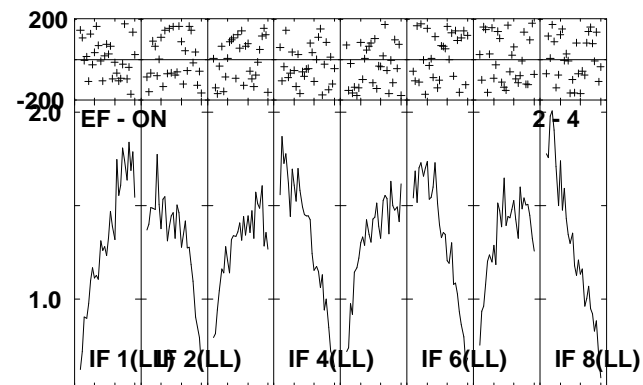
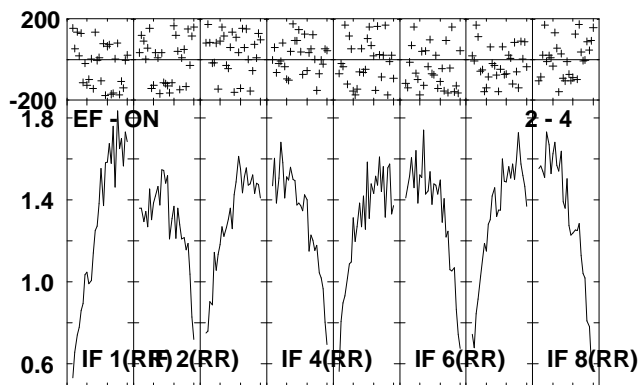
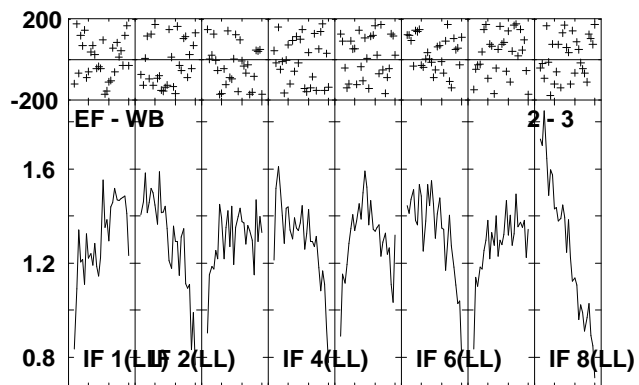
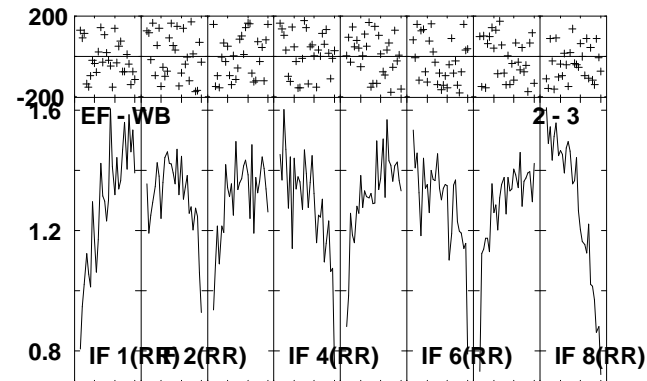
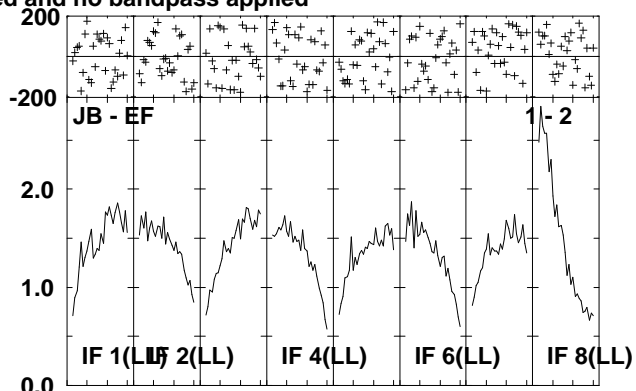
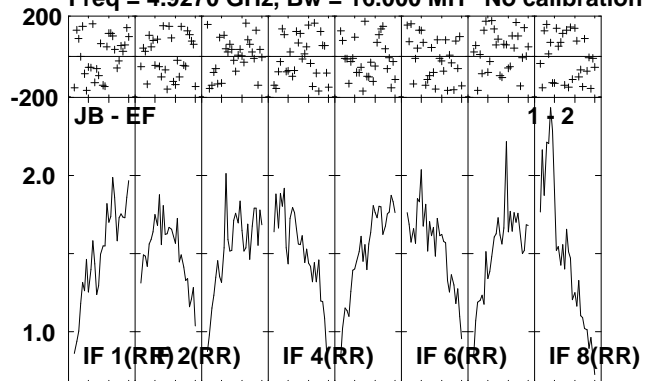

Lower frame: Milli Ampl Jy Top frame: Phas deg
Scalar averaged cross-power spectrum Several baselines displayed
Timerange: 00/11:59:51 to 00/12:03:27

Plot file version 53 created 06-JUL-2010 12:01:57

IRAS2336 EP064L.UVDATA.1

Freq = 4.9270 GHz, Bw = 16.000 MH No calibration applied and no bandpass applied

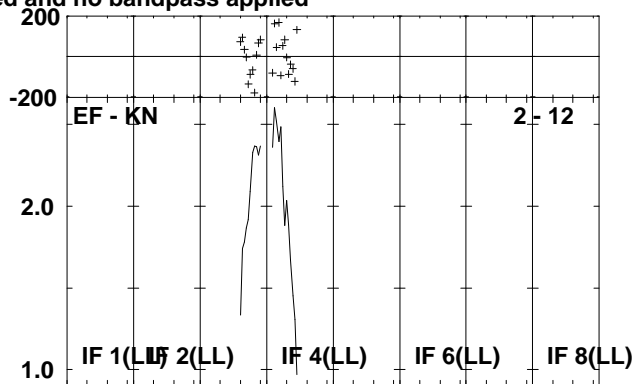
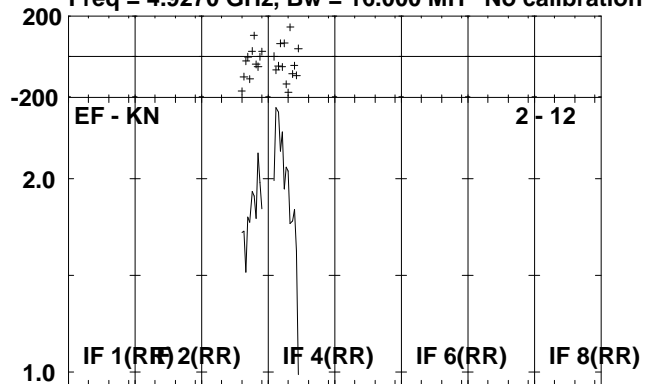

Lower frame: Milli Ampl Jy Top frame: Phas deg
Scalar averaged cross-power spectrum Several baselines displayed
Timerange: 00/11:59:51 to 00/12:03:27

Plot file version 54 created 06-JUL-2010 12:01:57

J2330+33 EP064L.UVDATA.1

Freq = 4.9270 GHz, Bw = 16.000 MH No calibration applied and no bandpass applied

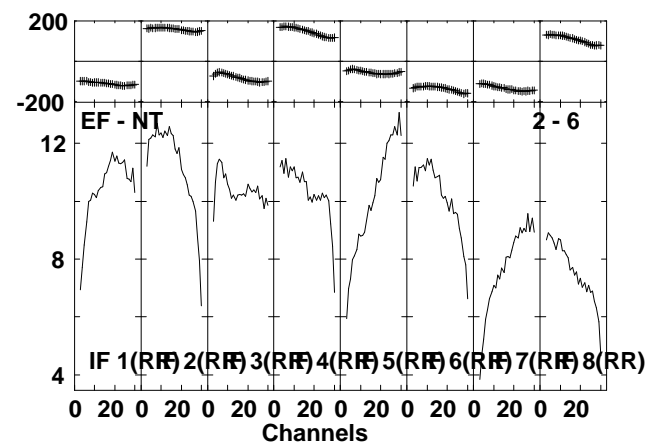
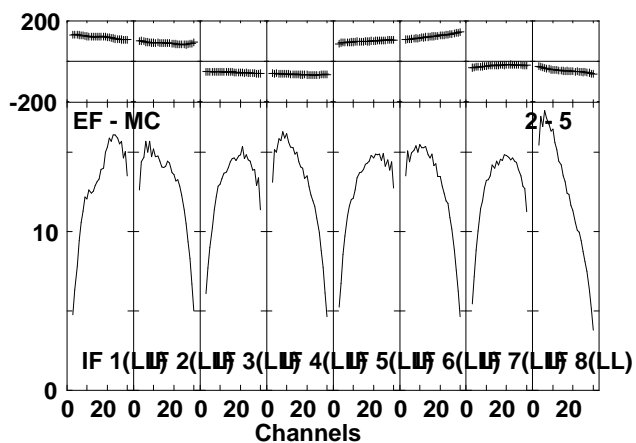
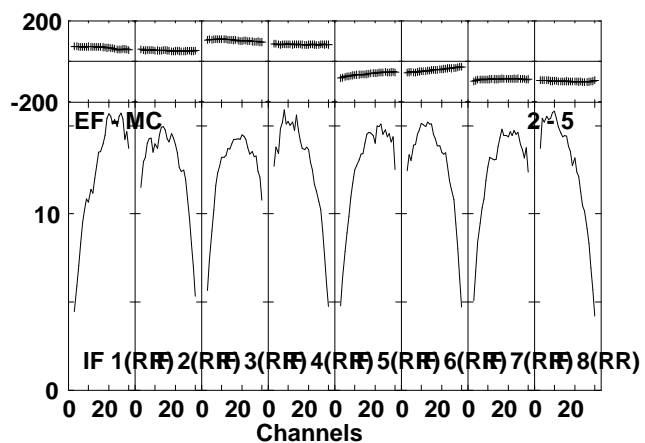
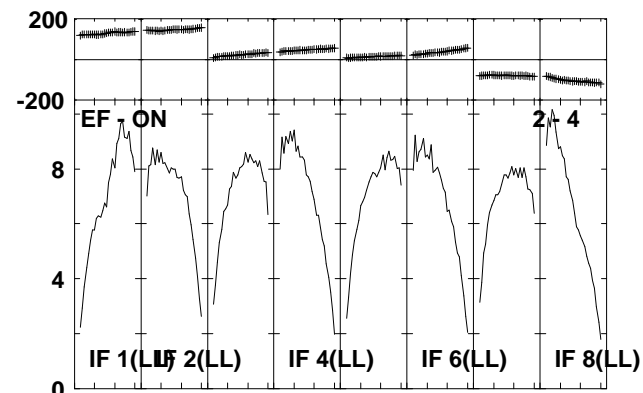
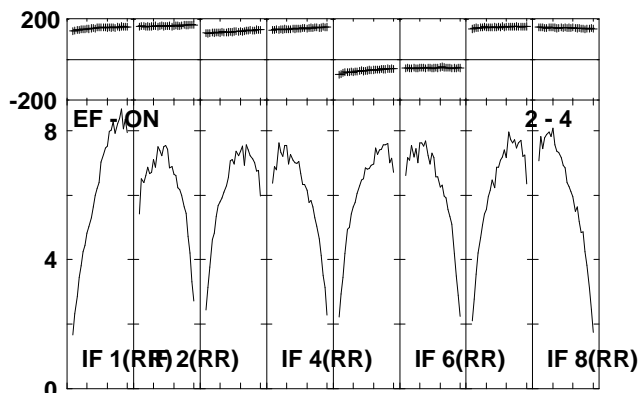
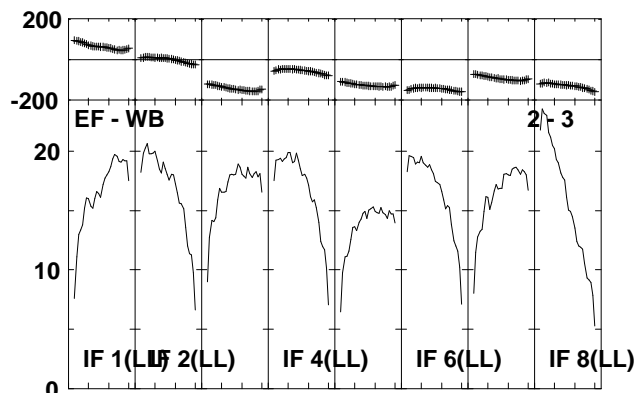
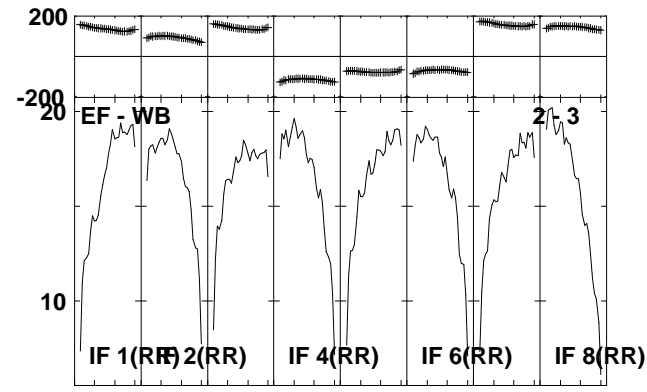
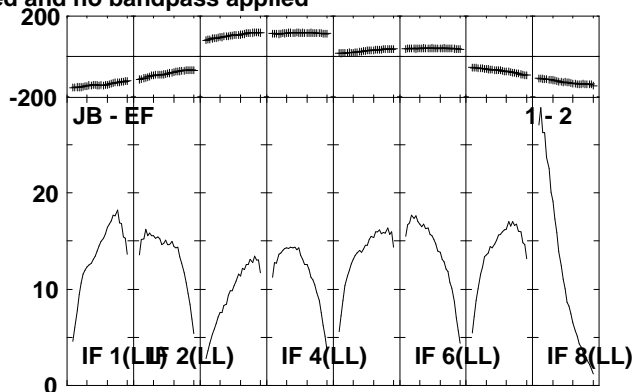
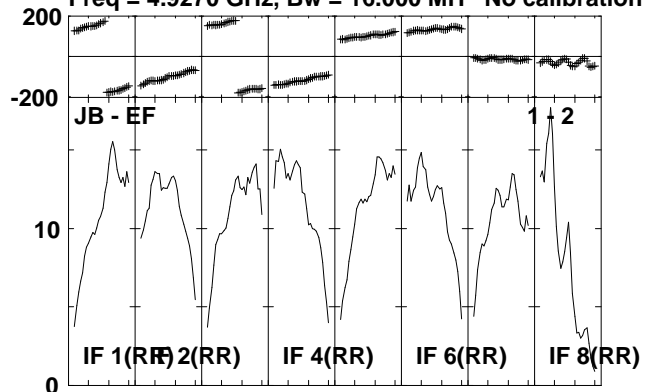

Lower frame: Milli Ampl Jy Top frame: Phas deg
Scalar averaged cross-power spectrum Several baselines displayed
Timerange: 00/12:04:31 to 00/12:06:09

Plot file version 55 created 06-JUL-2010 12:01:58

J2330+33 EP064L.UVDATA.1

Freq = 4.9270 GHz, Bw = 16.000 MH No calibration applied and no bandpass applied

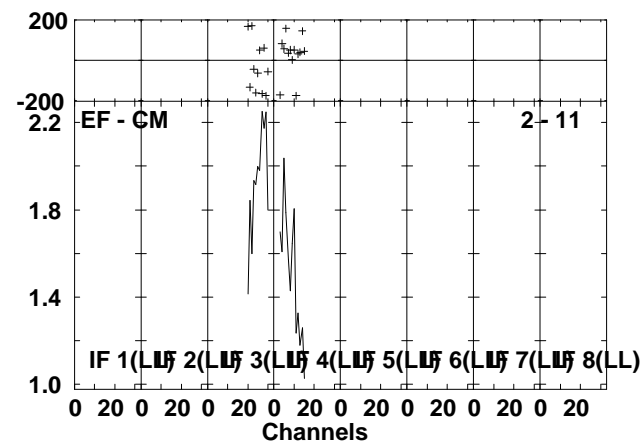
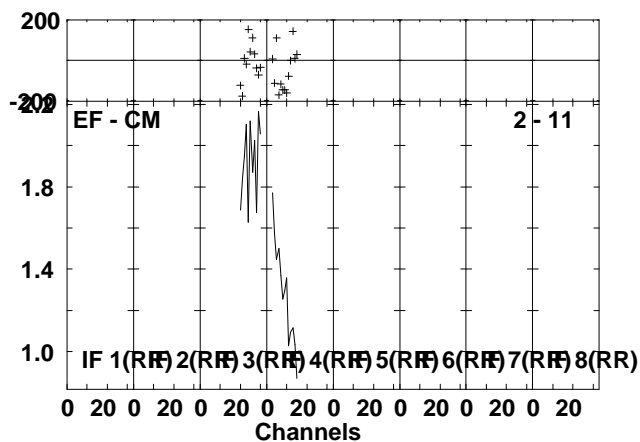
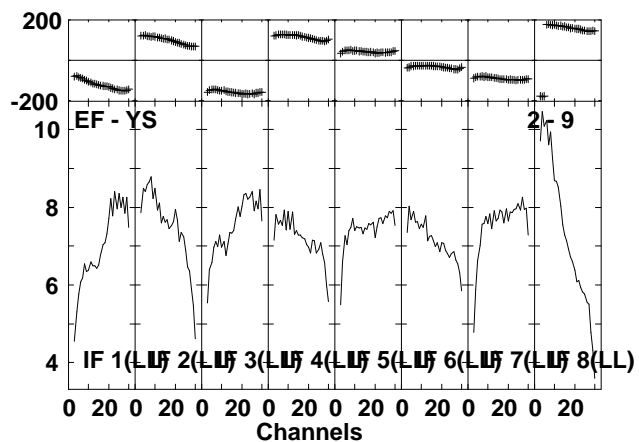
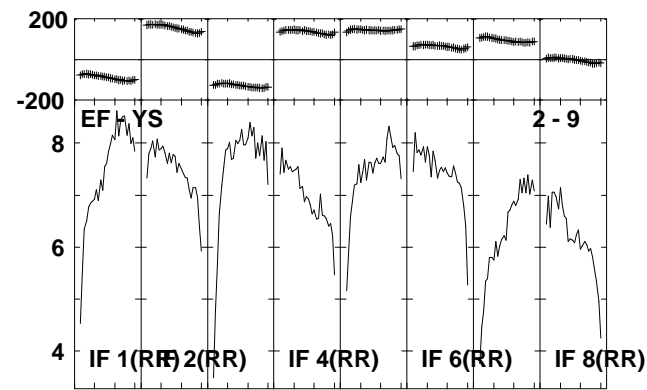
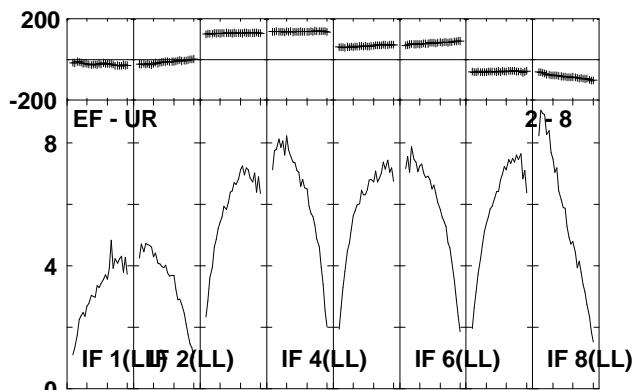
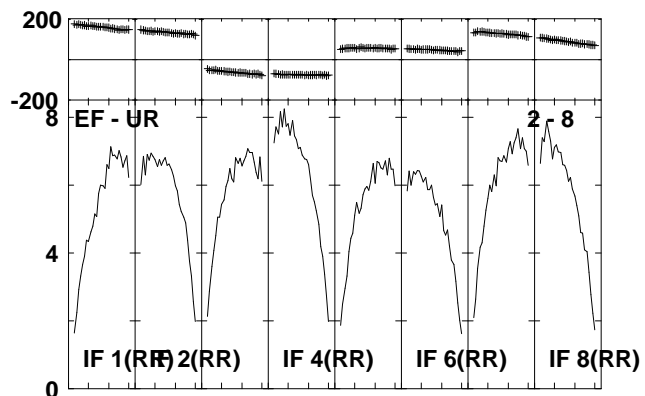
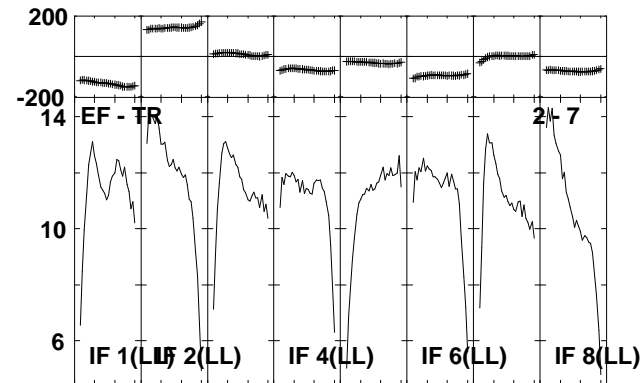
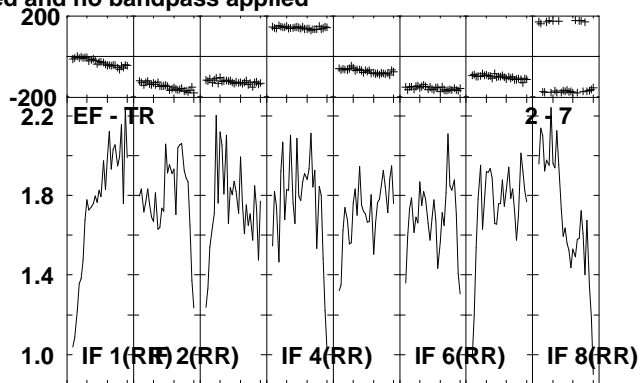
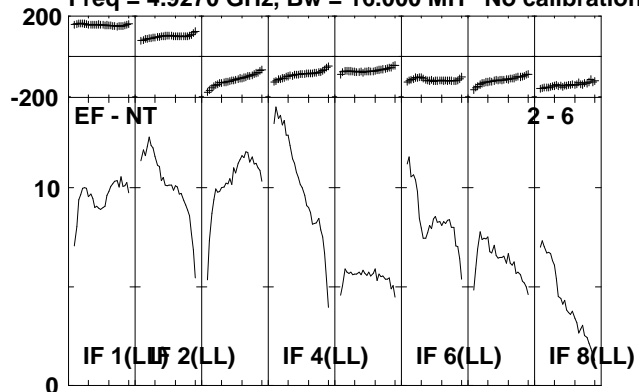

Lower frame: Milli Ampl Jy Top frame: Phas deg
Scalar averaged cross-power spectrum Several baselines displayed
Timerange: 00/12:04:31 to 00/12:06:09

Plot file version 56 created 06-JUL-2010 12:02:00

J2330+33 EP064L.UVDATA.1

Freq = 4.9270 GHz, Bw = 16.000 MH No calibration applied and no bandpass applied

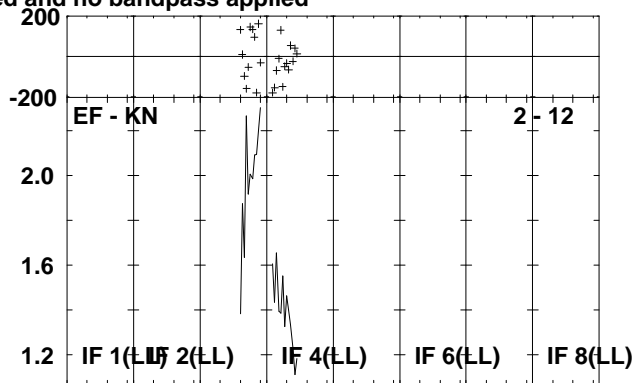
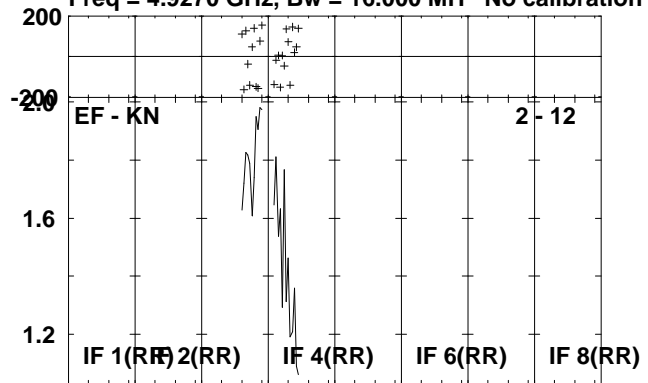

Lower frame: Milli Ampl Jy Top frame: Phas deg
Scalar averaged cross-power spectrum Several baselines displayed
Timerange: 00/12:04:31 to 00/12:06:09

Plot file version 57 created 06-JUL-2010 12:02:01

IRAS2336 EP064L.UVDATA.1

Freq = 4.9270 GHz, Bw = 16.000 MH No calibration applied and no bandpass applied

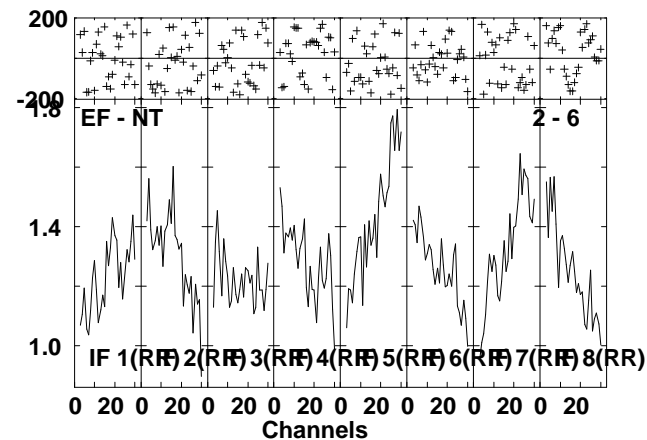
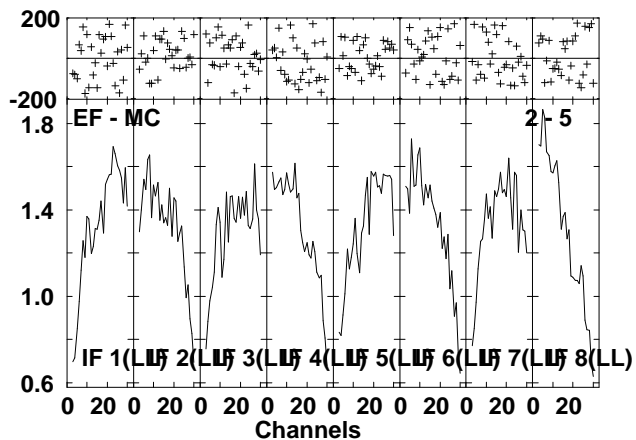
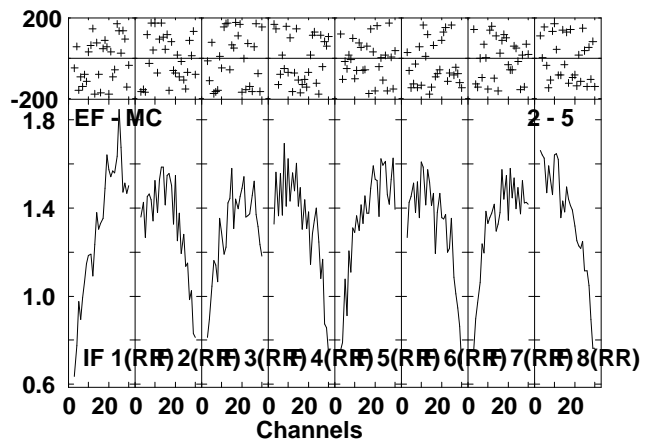
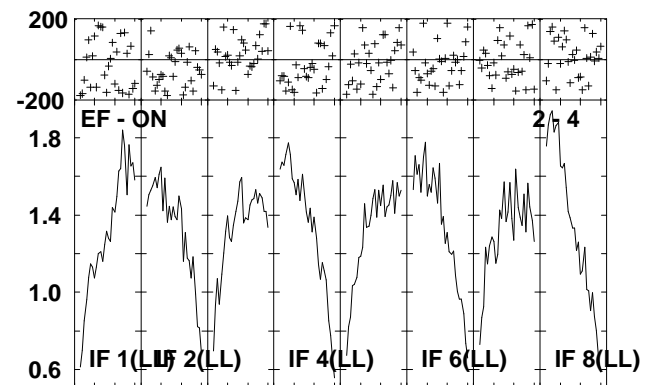
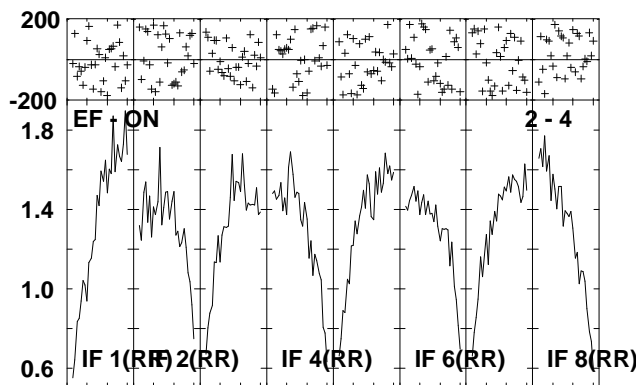
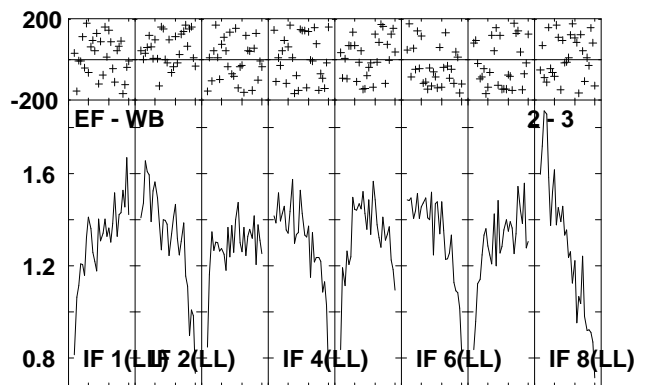
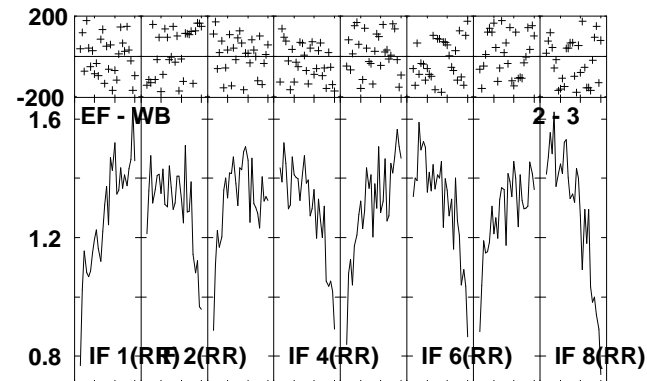
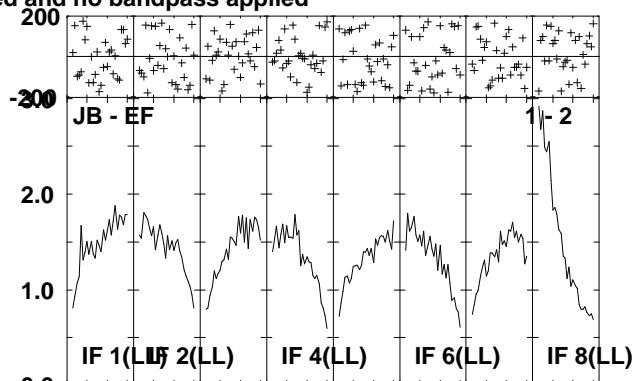
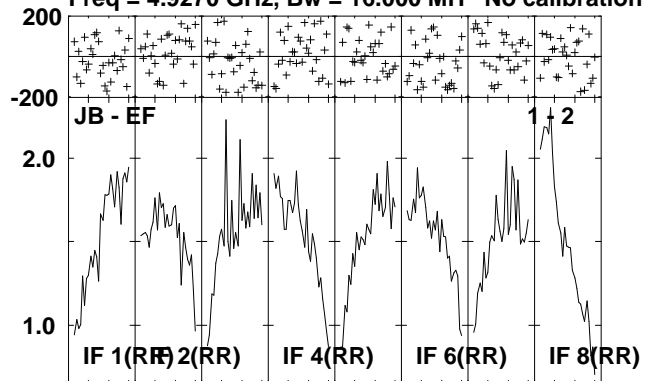

Lower frame: Milli Ampl Jy Top frame: Phas deg
Scalar averaged cross-power spectrum Several baselines displayed
Timerange: 00/12:06:11 to 00/12:09:49

Plot file version 58 created 06-JUL-2010 12:02:03

IRAS2336 EP064L.UVDATA.1

Freq = 4.9270 GHz, Bw = 16.000 MH No calibration applied and no bandpass applied

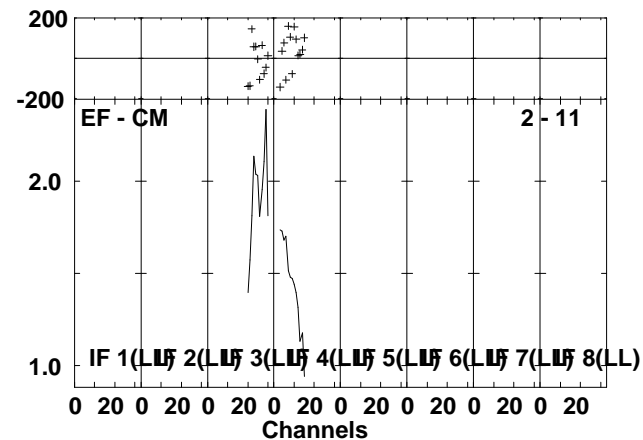
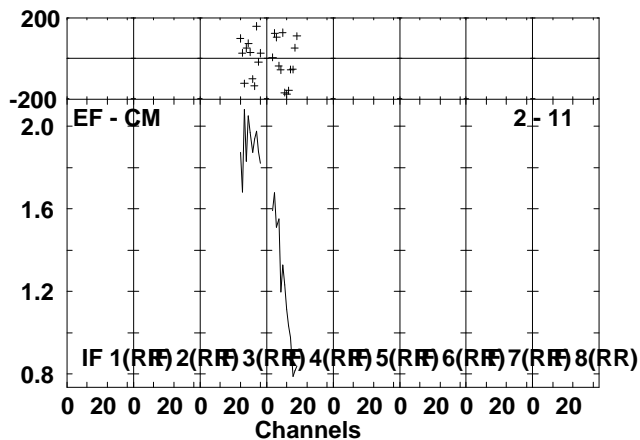
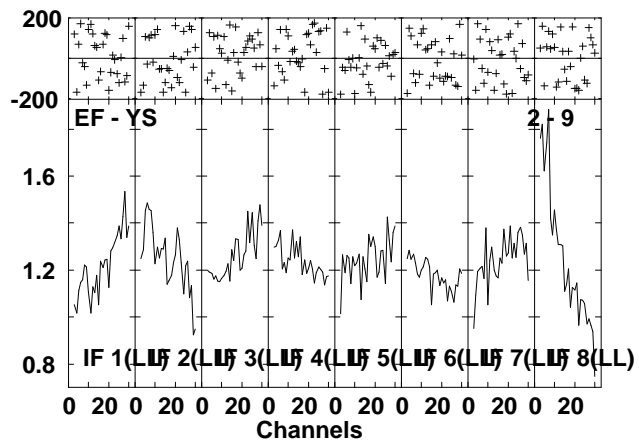
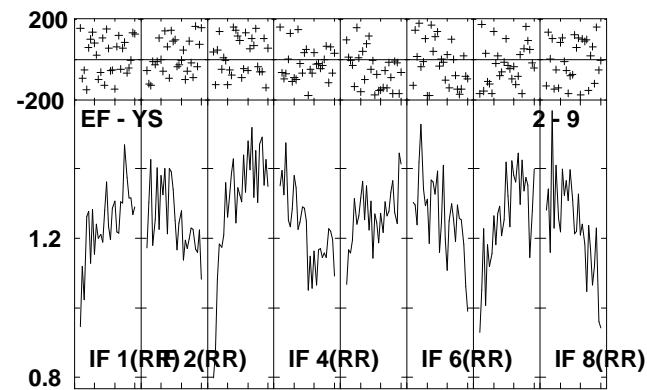
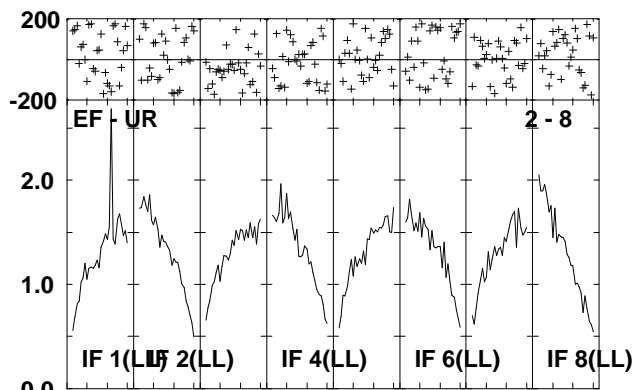
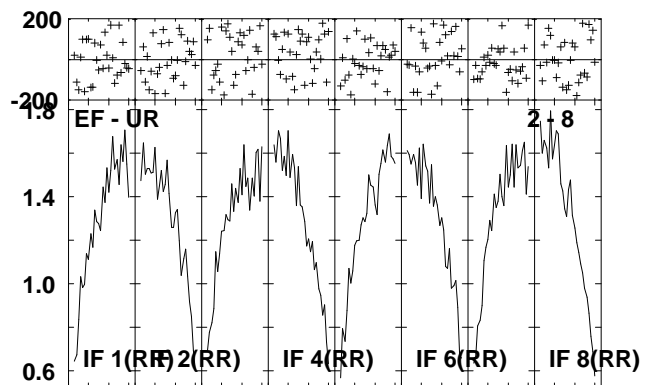
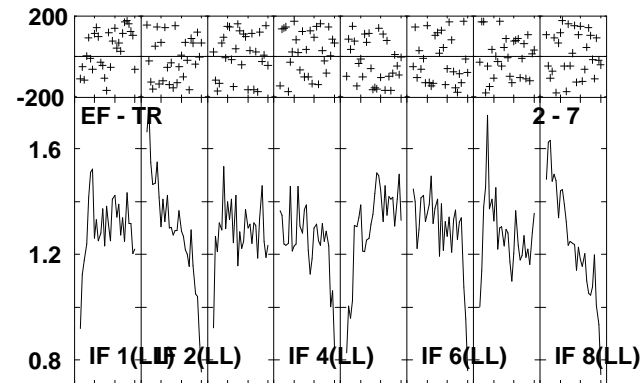
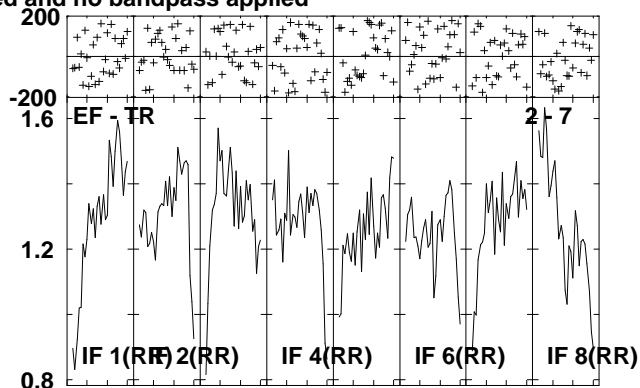
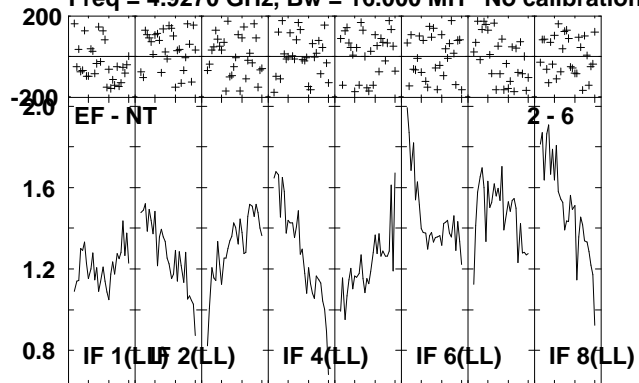

Lower frame: Milli Ampl Jy Top frame: Phas deg
Scalar averaged cross-power spectrum Several baselines displayed
Timerange: 00/12:06:11 to 00/12:09:49

Plot file version 59 created 06-JUL-2010 12:02:07

IRAS2336 EP064L.UVDATA.1

Freq = 4.9270 GHz, Bw = 16.000 MH No calibration applied and no bandpass applied

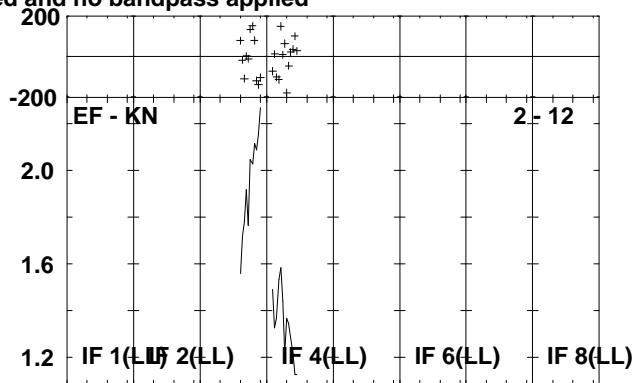
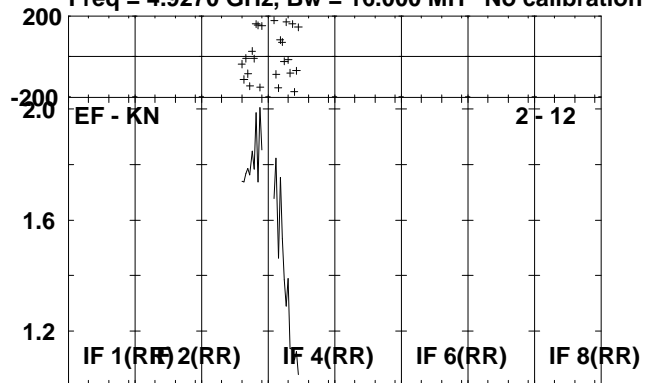

Lower frame: Milli Ampl Jy Top frame: Phas deg
Scalar averaged cross-power spectrum Several baselines displayed
Timerange: 00/12:06:11 to 00/12:09:49

Plot file version 60 created 06-JUL-2010 12:02:08

J2330+33 EP064L.UVDATA.1

Freq = 4.9270 GHz, Bw = 16.000 MH No calibration applied and no bandpass applied

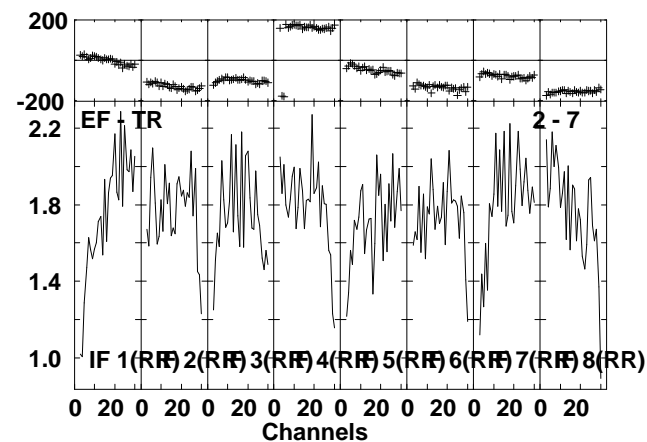
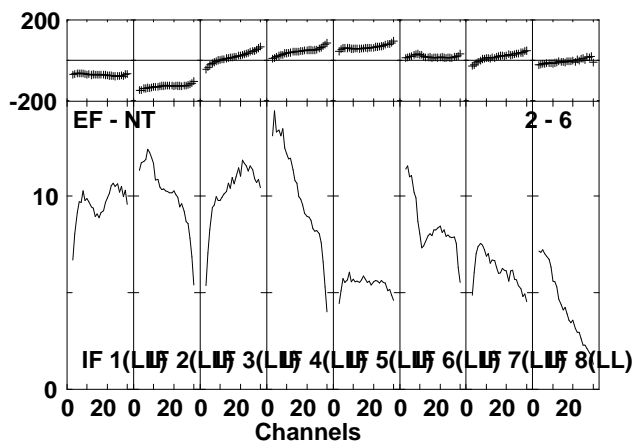
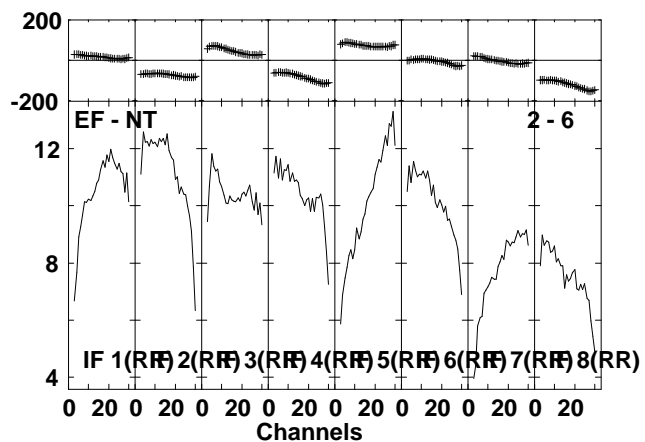
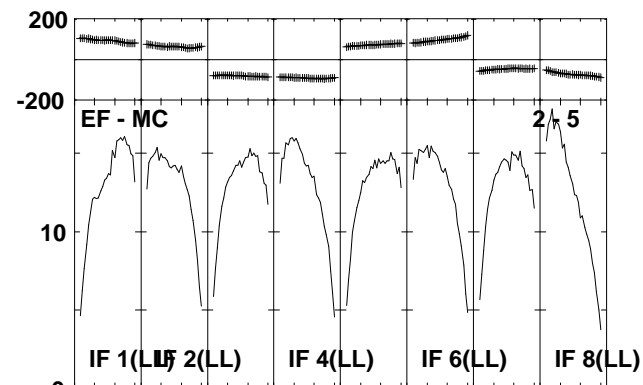
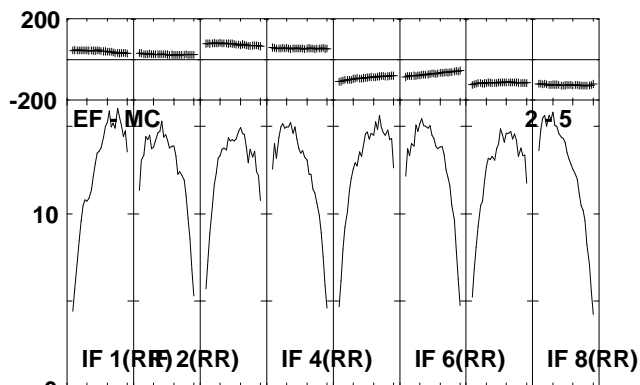
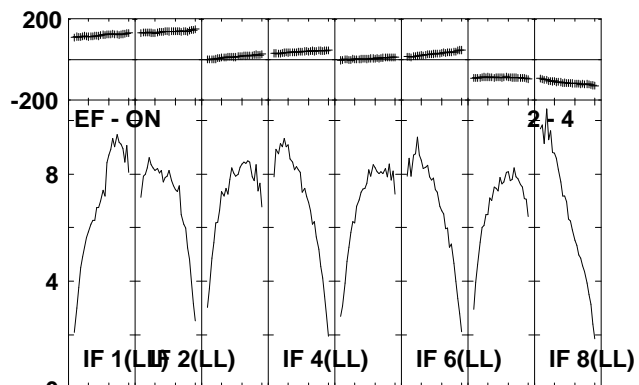
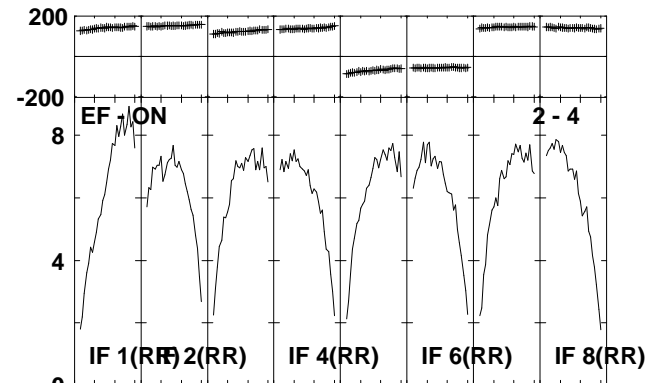
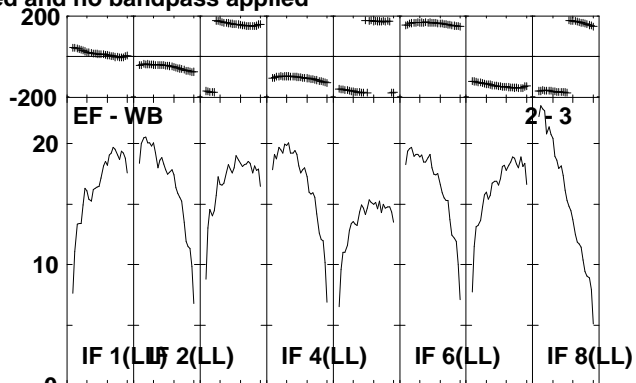
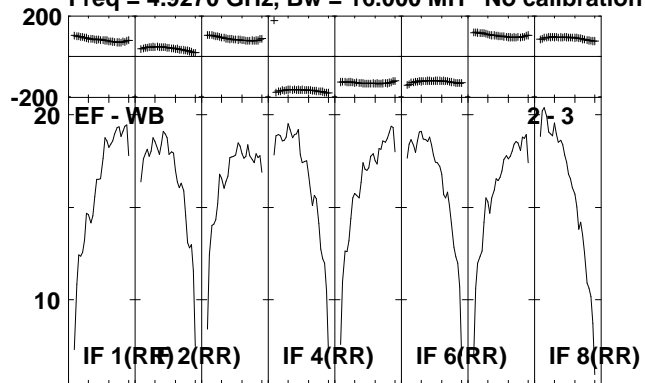

Lower frame: Milli Ampl Jy Top frame: Phas deg
Scalar averaged cross-power spectrum Several baselines displayed
Timerange: 00/12:09:51 to 00/12:11:39

Plot file version 61 created 06-JUL-2010 12:02:09

J2330+33 EP064L.UVDATA.1

Freq = 4.9270 GHz, Bw = 16.000 MH No calibration applied and no bandpass applied

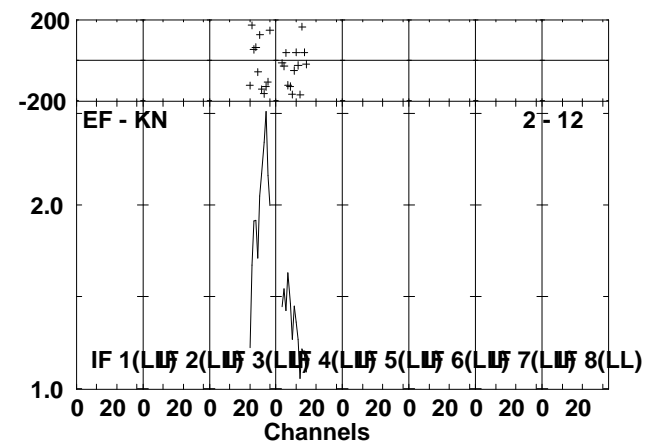
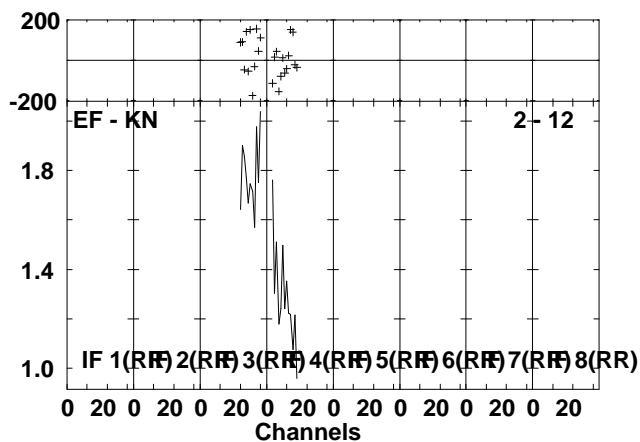
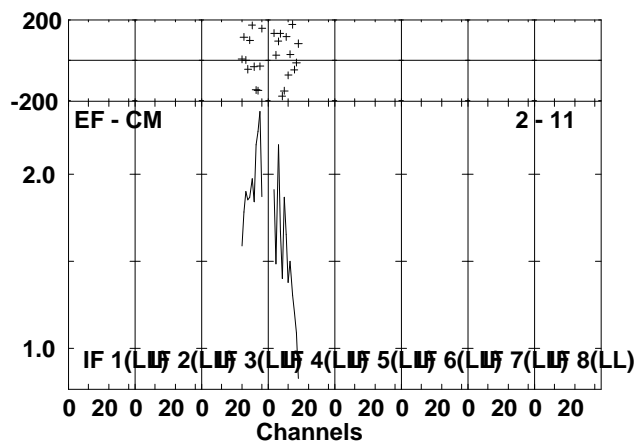
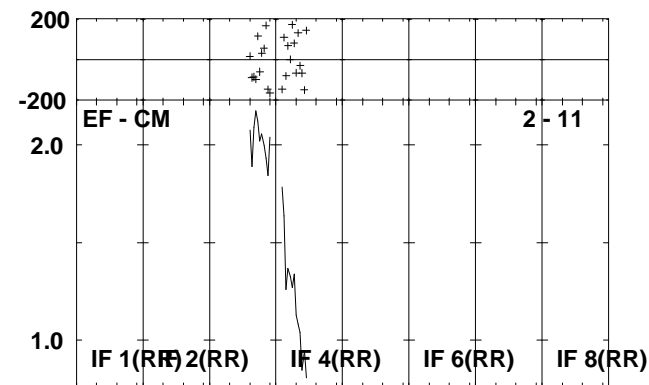
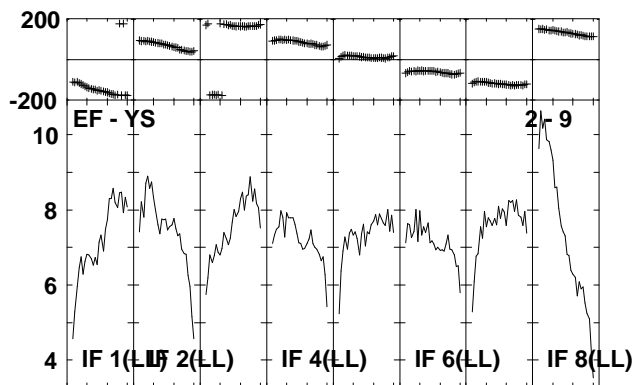
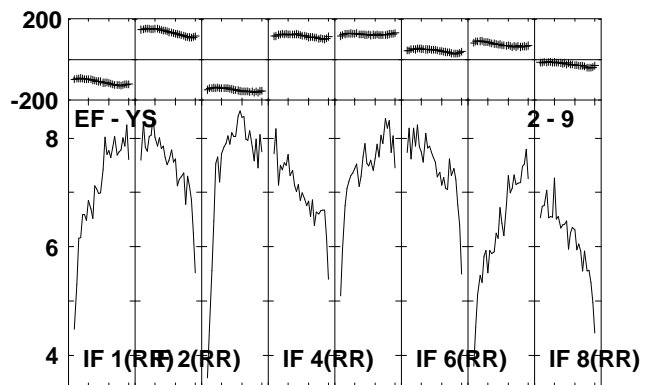
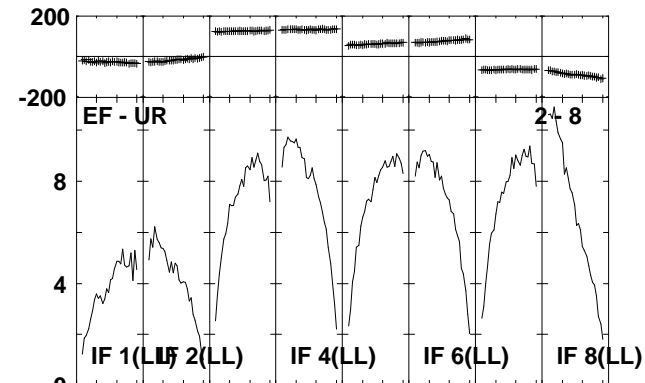
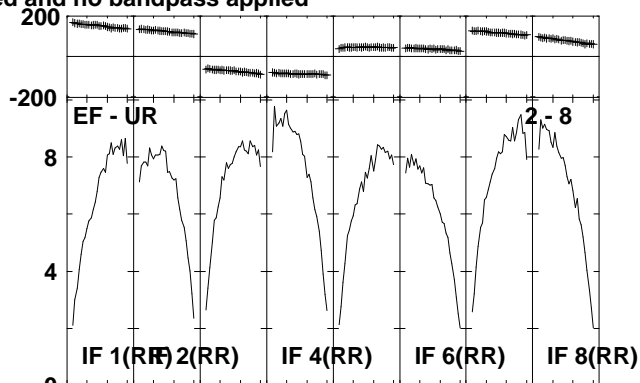
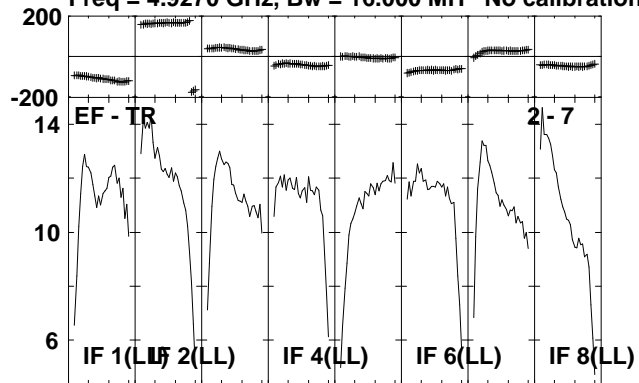

Lower frame: Milli Ampl Jy Top frame: Phas deg
Scalar averaged cross-power spectrum Several baselines displayed
Timerange: 00/12:09:51 to 00/12:11:39

Plot file version 62 created 06-JUL-2010 12:02:11

IRAS2336 EP064L.UVDATA.1

Freq = 4.9270 GHz, Bw = 16.000 MH No calibration applied and no bandpass applied

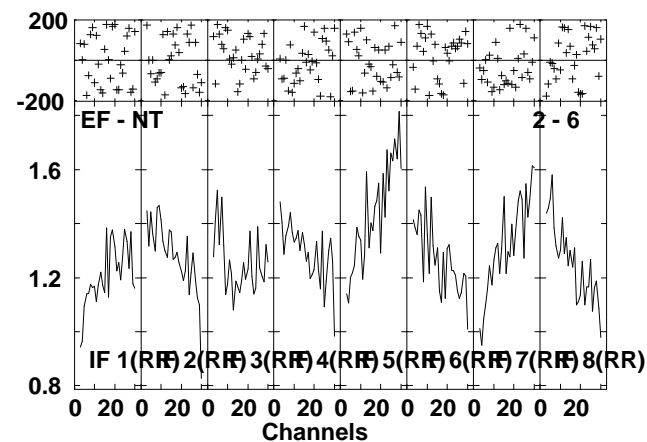
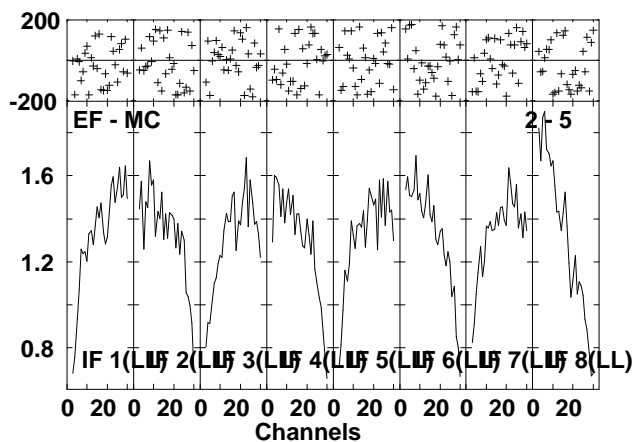
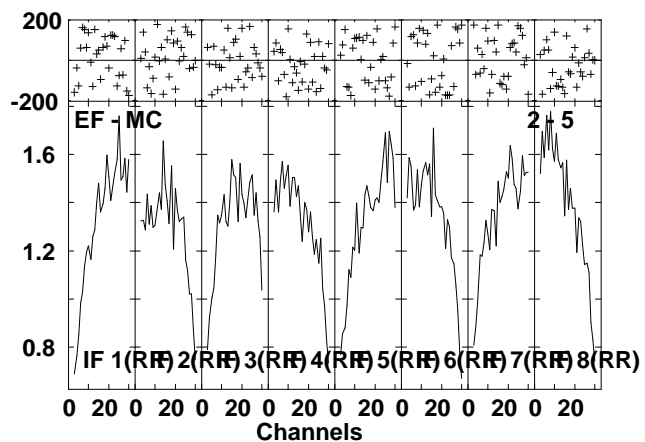
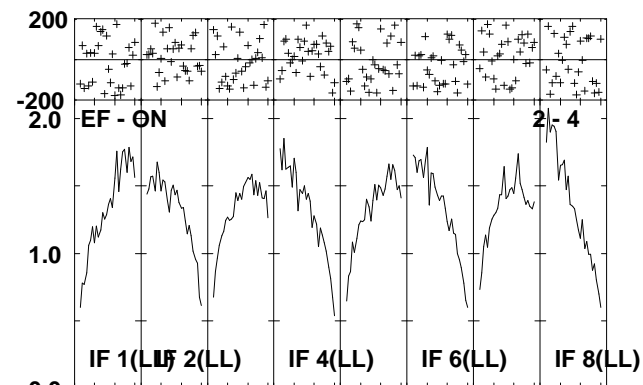
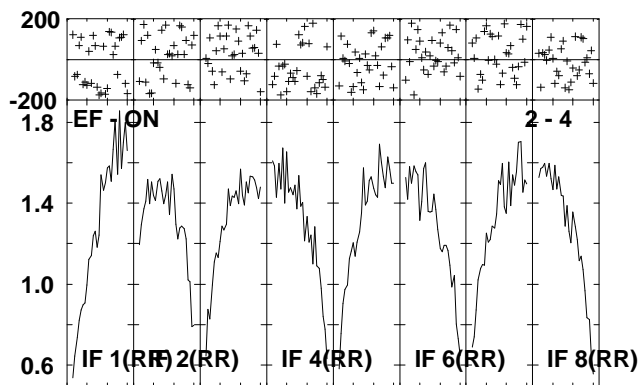
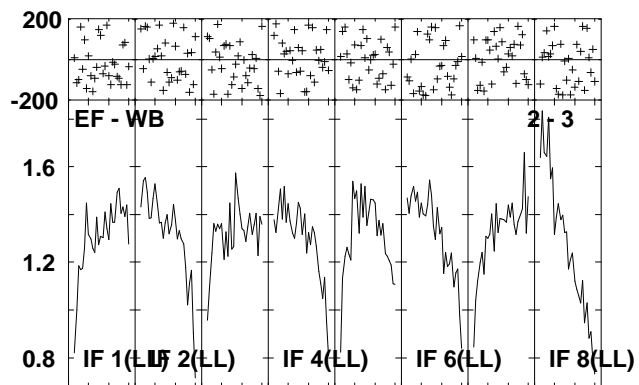
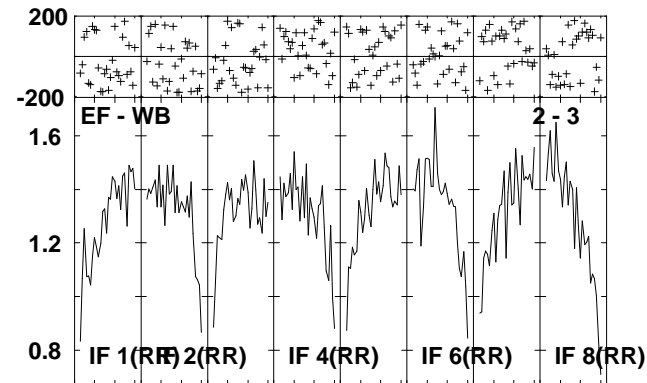
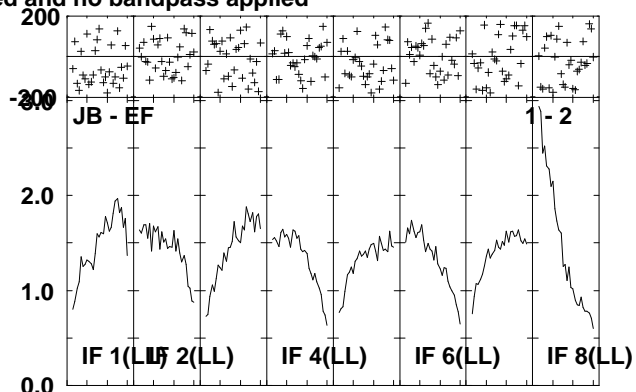
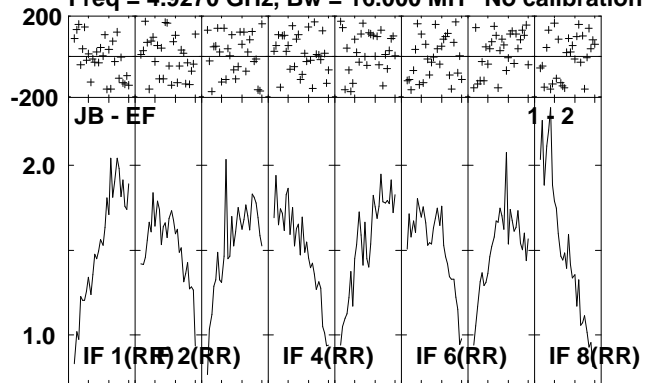

Lower frame: Milli Ampl Jy Top frame: Phas deg
Scalar averaged cross-power spectrum Several baselines displayed
Timerange: 00/12:11:41 to 00/12:15:19

Plot file version 63 created 06-JUL-2010 12:02:13

IRAS2336 EP064L.UVDATA.1

Freq = 4.9270 GHz, Bw = 16.000 MH No calibration applied and no bandpass applied

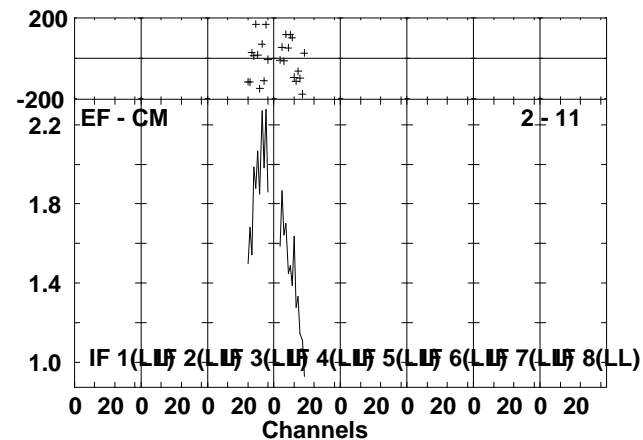
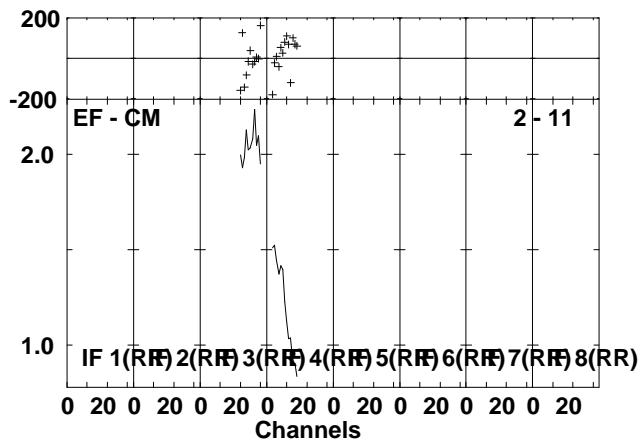
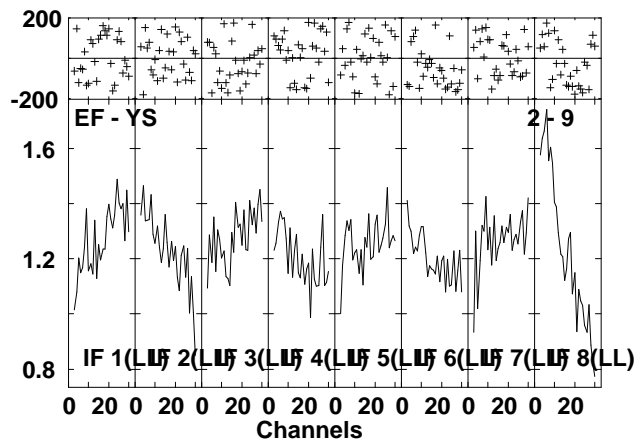
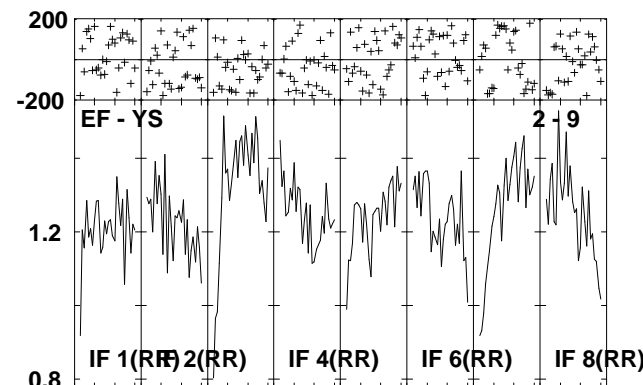
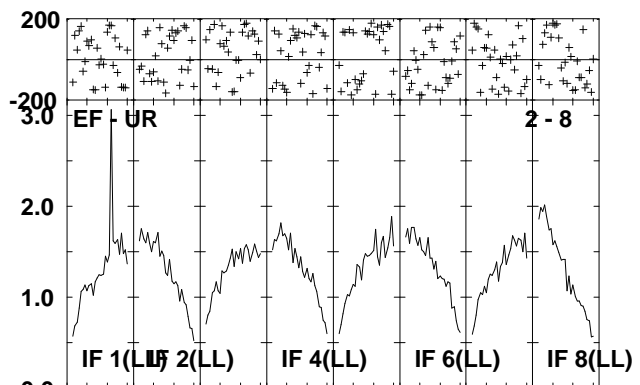
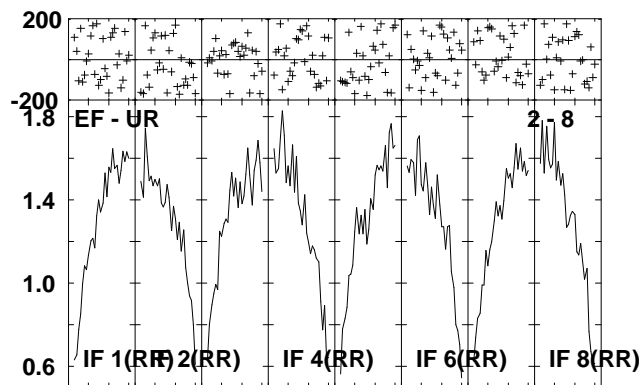
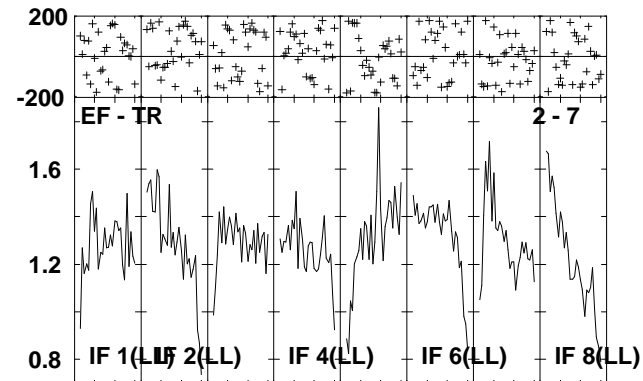
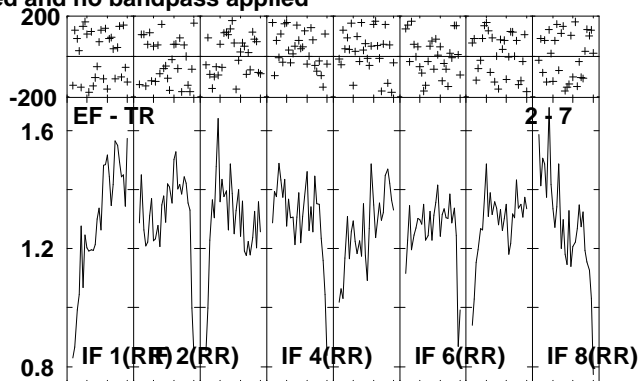
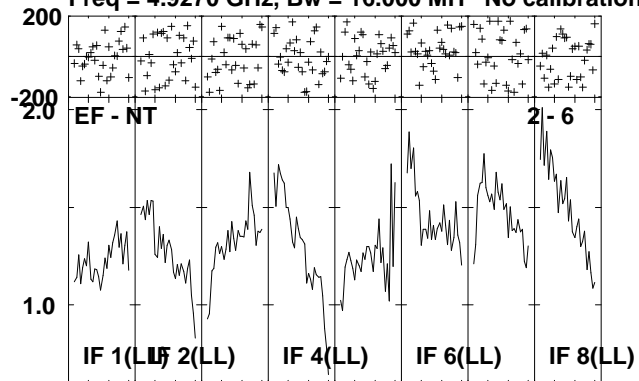

Lower frame: Milli Ampl Jy Top frame: Phas deg
Scalar averaged cross-power spectrum Several baselines displayed
Timerange: 00:12:11:41 to 00:12:15:19

Plot file version 64 created 06-JUL-2010 12:02:17

IRAS2336 EP064L.UVDATA.1

Freq = 4.9270 GHz, Bw = 16.000 MH No calibration applied and no bandpass applied

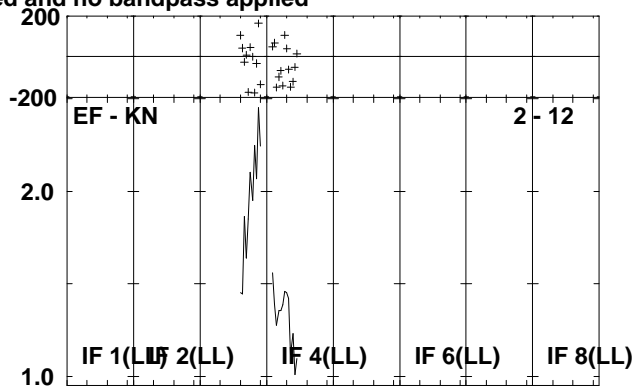
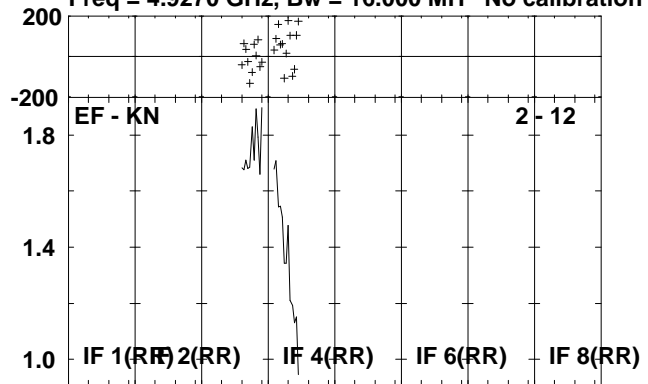

Lower frame: Milli Ampl Jy Top frame: Phas deg
Scalar averaged cross-power spectrum Several baselines displayed
Timerange: 00/12:11:41 to 00/12:15:19

Plot file version 65 created 06-JUL-2010 12:02:17

J2330+33 EP064L.UVDATA.1

Freq = 4.9270 GHz, Bw = 16.000 MH No calibration applied and no bandpass applied

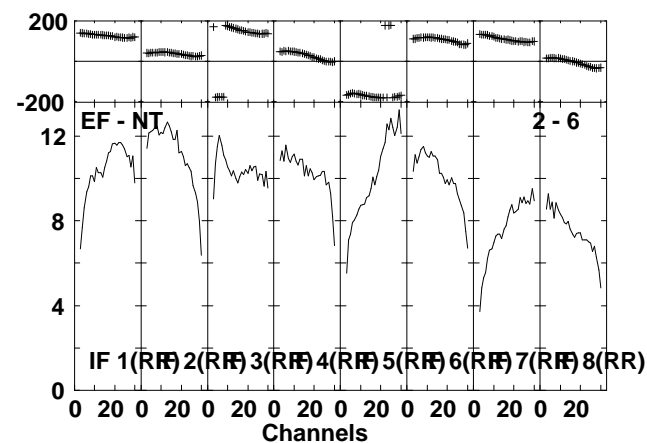
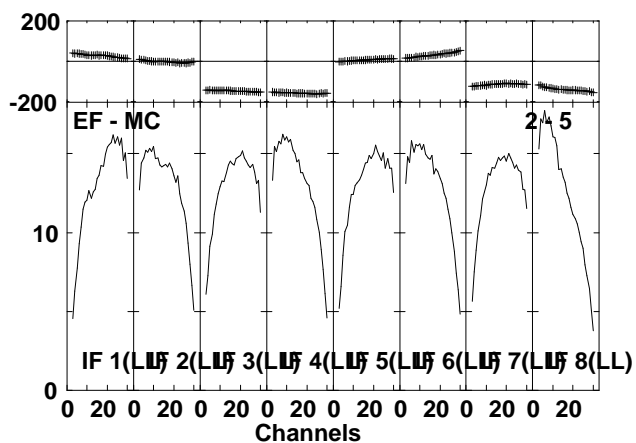
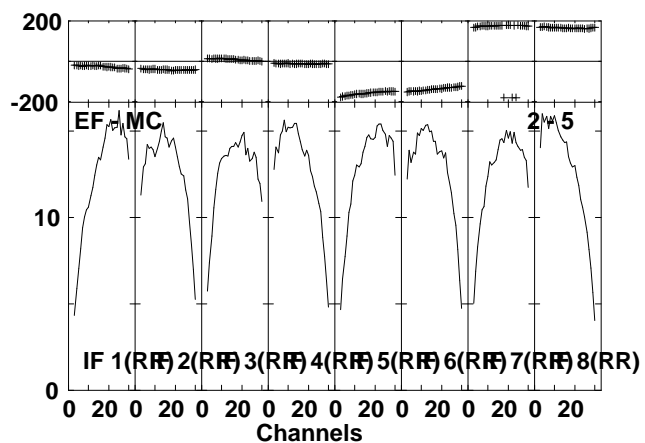
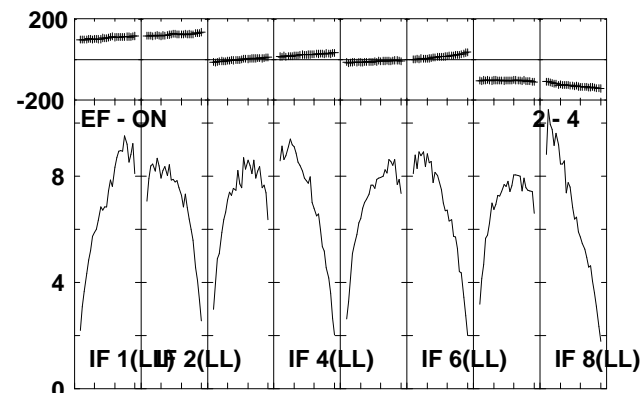
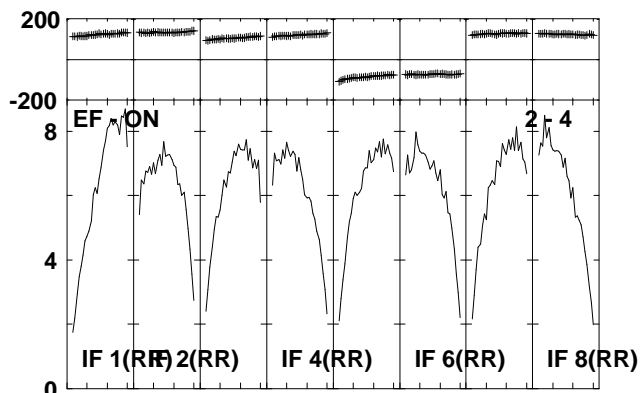
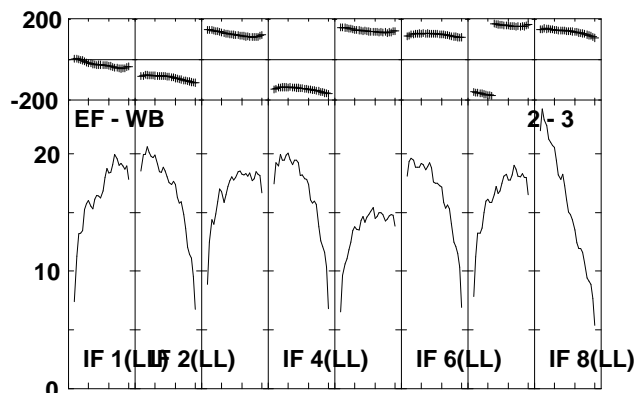
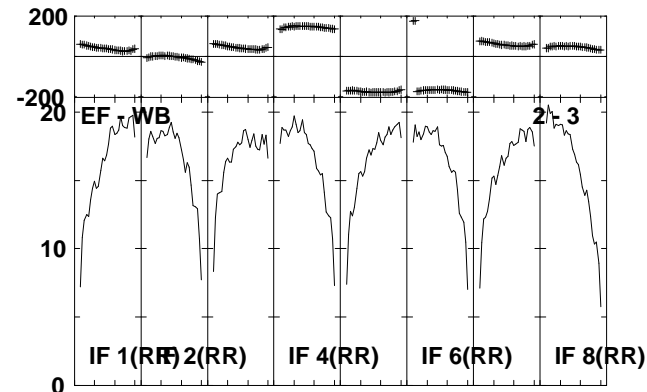
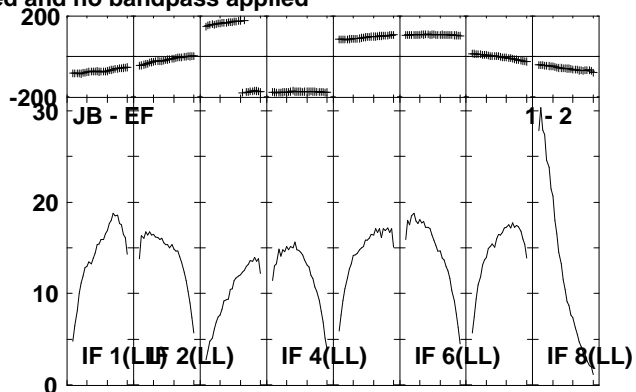
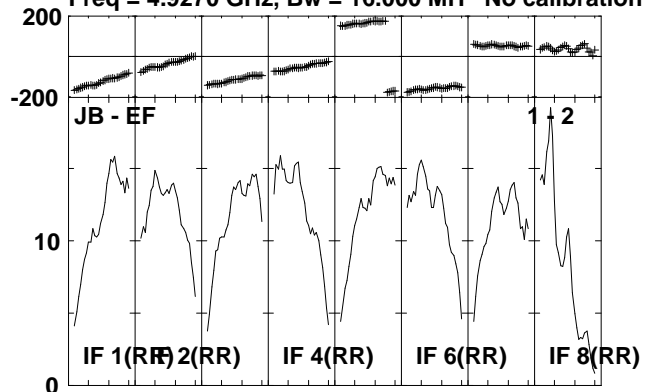

Lower frame: Milli Ampl Jy Top frame: Phas deg
Scalar averaged cross-power spectrum Several baselines displayed
Timerange: 00/12:15:31 to 00/12:17:09

Plot file version 66 created 06-JUL-2010 12:02:18

J2330+33 EP064L.UVDATA.1

Freq = 4.9270 GHz, Bw = 16.000 MH No calibration applied and no bandpass applied

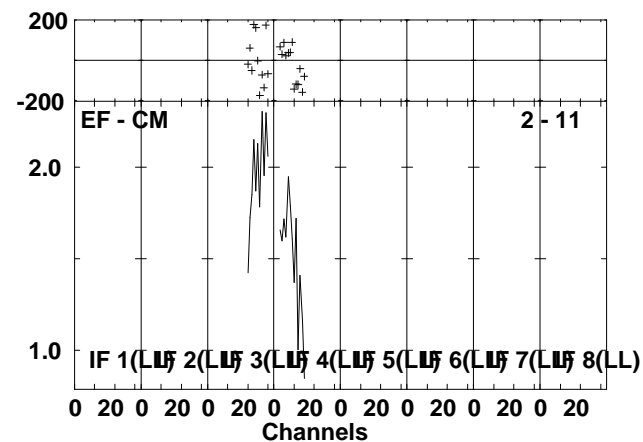
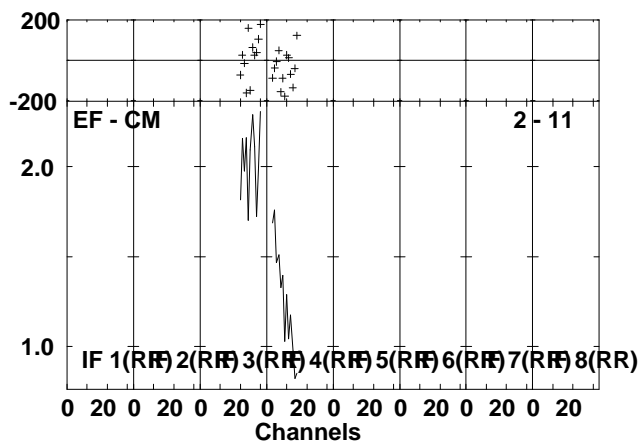
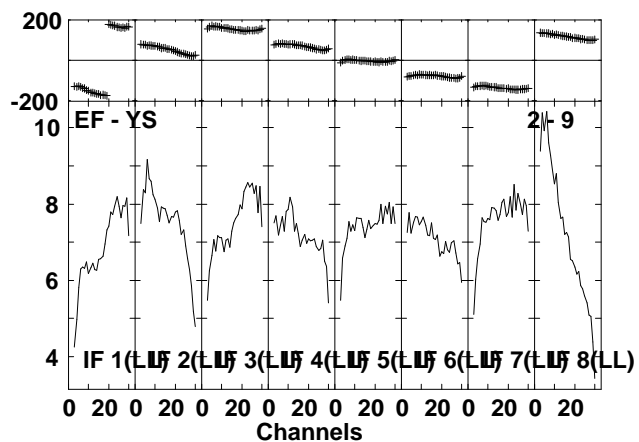
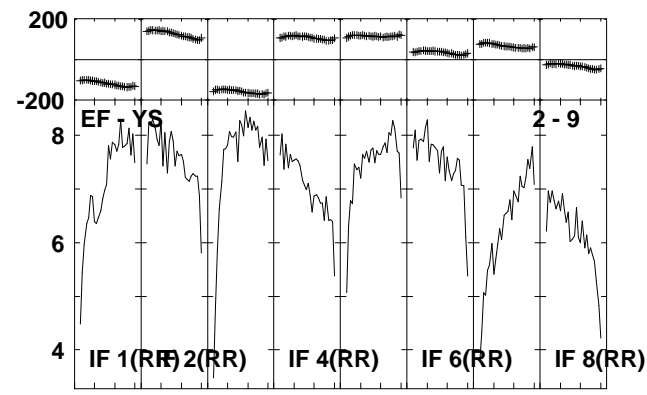
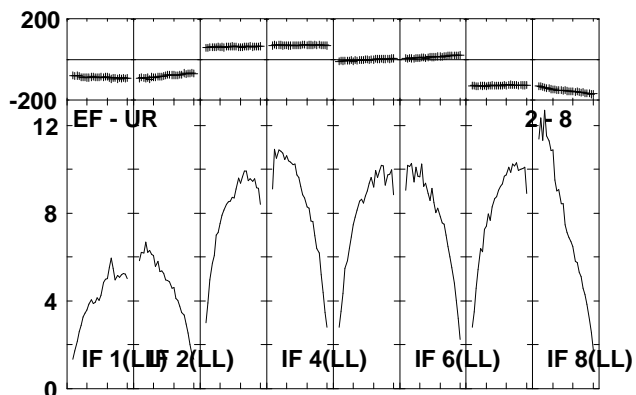
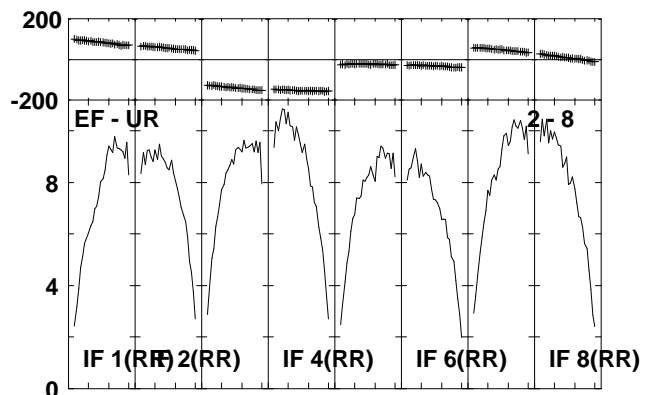
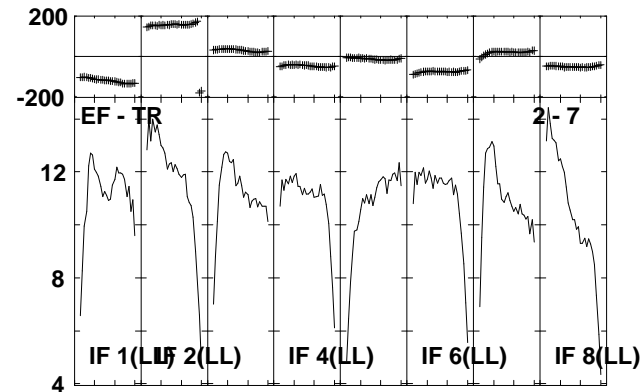
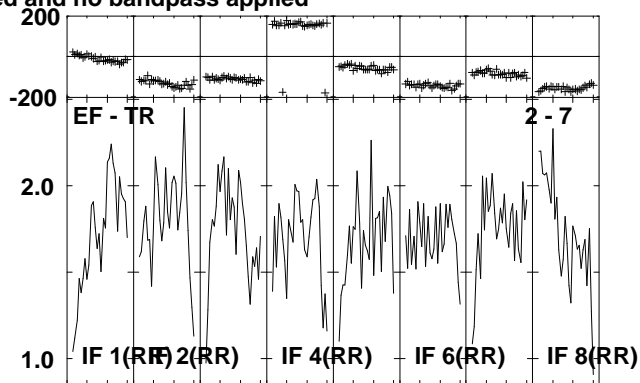
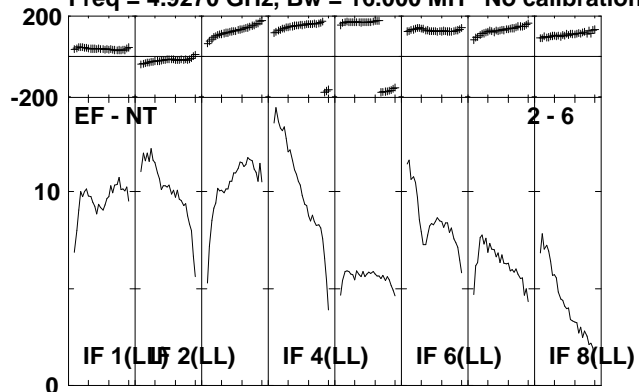

Lower frame: Milli Ampl Jy Top frame: Phas deg
Scalar averaged cross-power spectrum Several baselines displayed
Timerange: 00:12:15:31 to 00:12:17:09

Plot file version 67 created 06-JUL-2010 12:02:19

J2330+33 EP064L.UVDATA.1

Freq = 4.9270 GHz, Bw = 16.000 MH No calibration applied and no bandpass applied

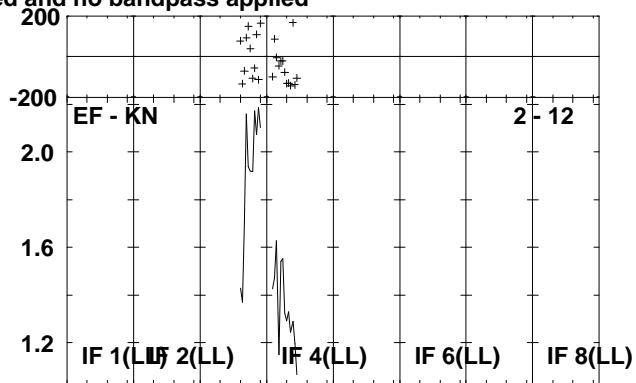
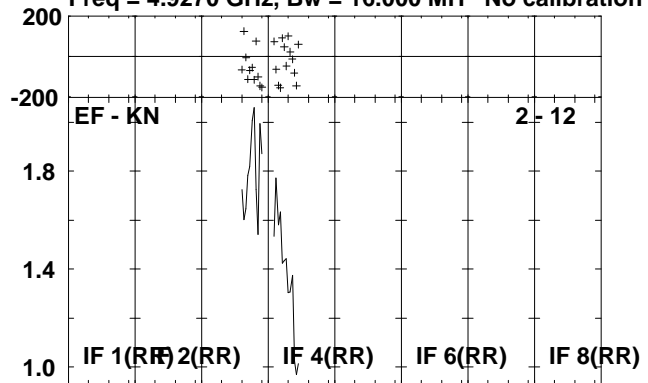

Lower frame: Milli Ampl Jy Top frame: Phas deg
Scalar averaged cross-power spectrum Several baselines displayed
Timerange: 00/12:15:31 to 00/12:17:09

Plot file version 68 created 06-JUL-2010 12:02:20

IRAS2336 EP064L.UVDATA.1

Freq = 4.9270 GHz, Bw = 16.000 MH No calibration applied and no bandpass applied

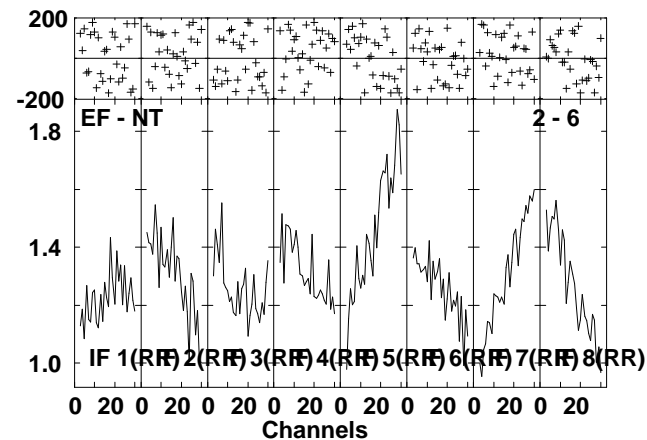
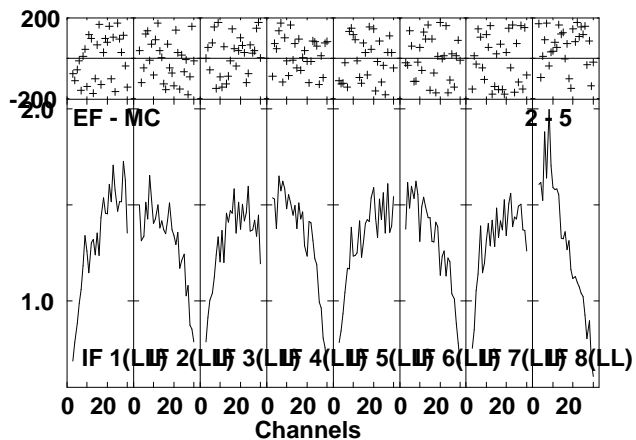
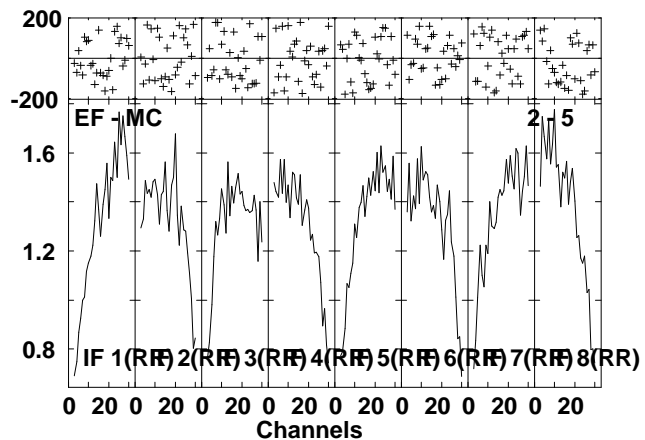
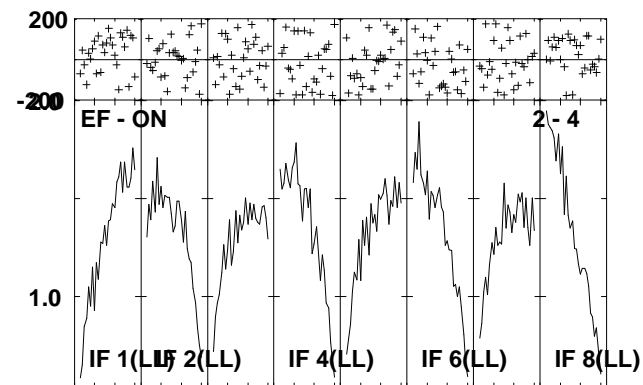
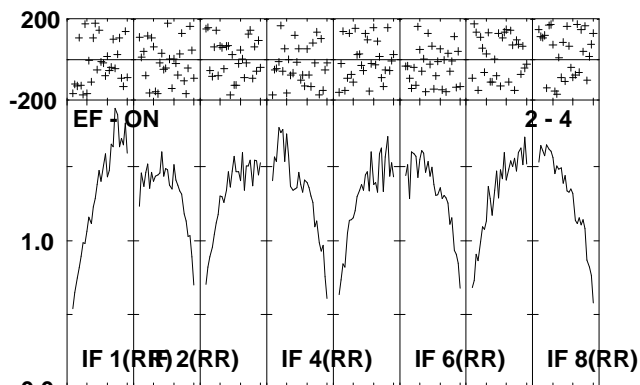
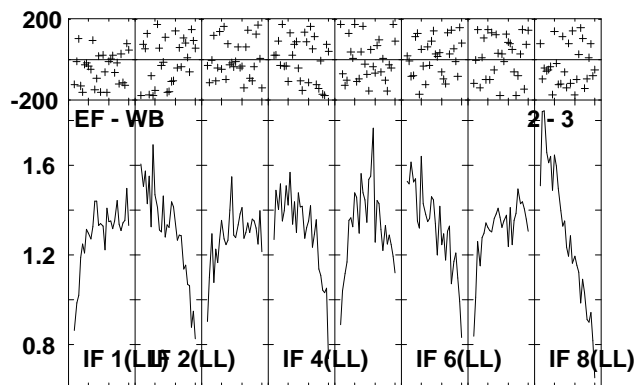
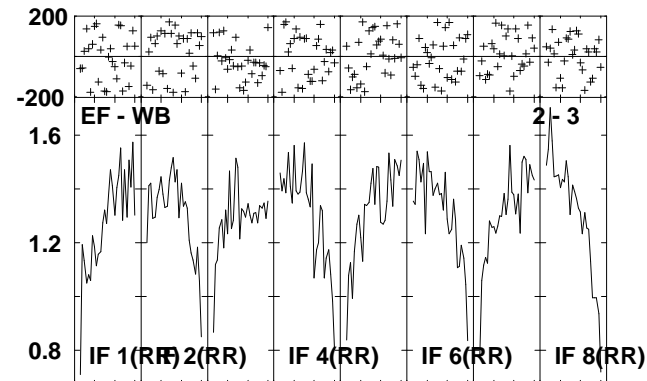
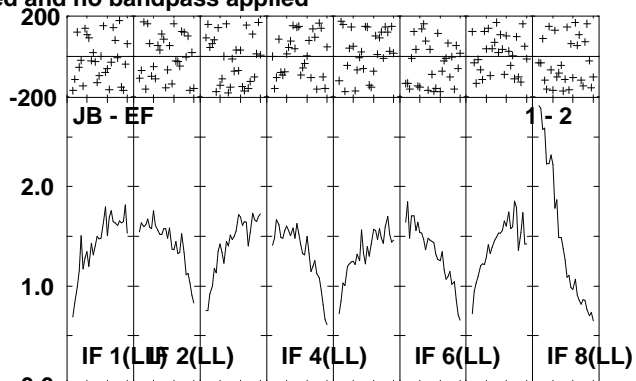
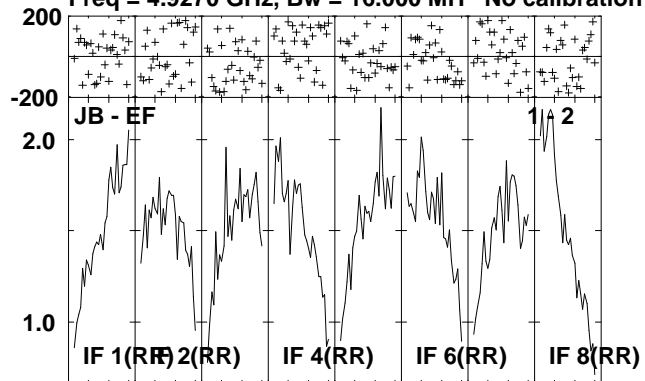

Lower frame: Milli Ampl Jy Top frame: Phas deg
Scalar averaged cross-power spectrum Several baselines displayed
Timerange: 00/12:17:11 to 00/12:20:47

Plot file version 70 created 06-JUL-2010 12:02:31

IRAS2336 EP064L.UVDATA.1

Freq = 4.9270 GHz, Bw = 16.000 MH No calibration applied and no bandpass applied

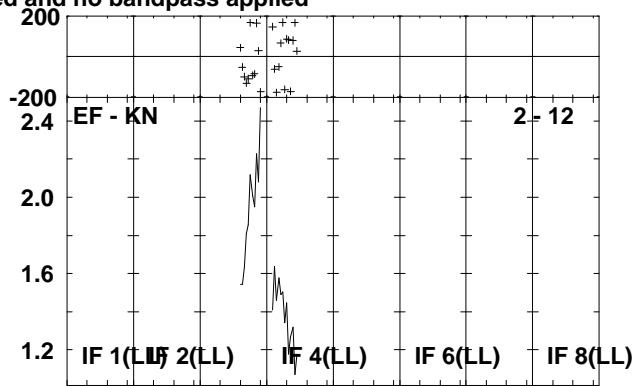
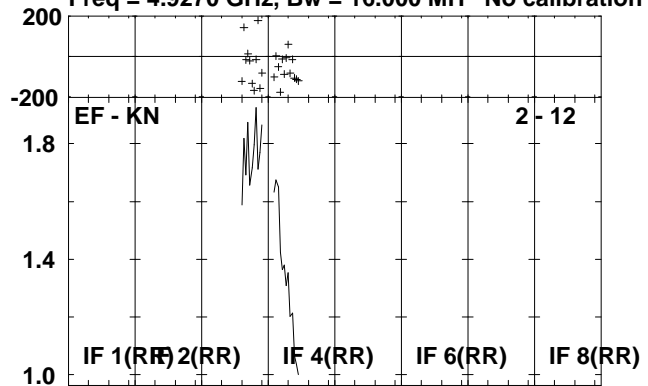

Lower frame: Milli Ampl Jy Top frame: Phas deg
Scalar averaged cross-power spectrum Several baselines displayed
Timerange: 00/12:17:11 to 00/12:20:47

Plot file version 71 created 06-JUL-2010 12:02:32

J2330+33 EP064L.UVDATA.1

Freq = 4.9270 GHz, Bw = 16.000 MH No calibration applied and no bandpass applied

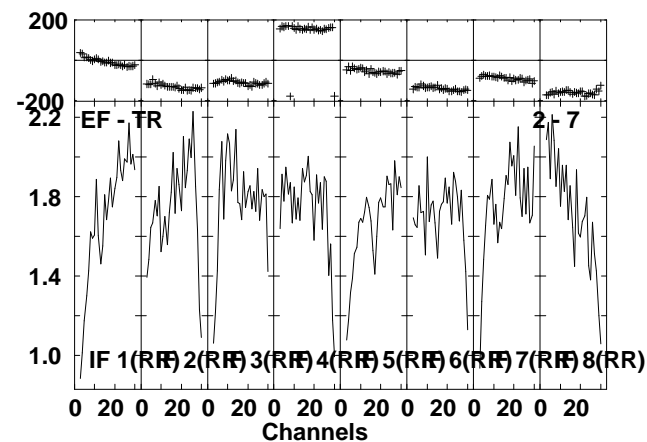
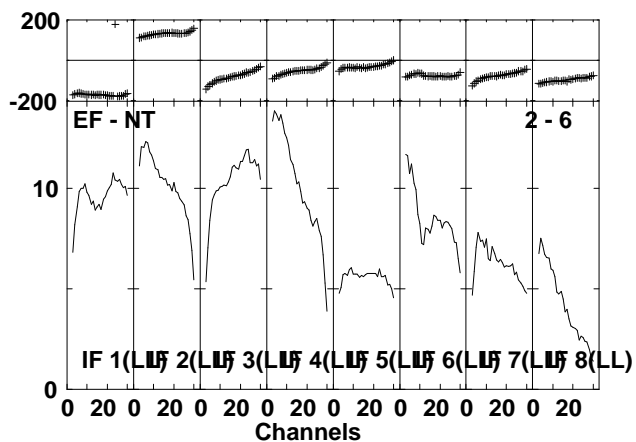
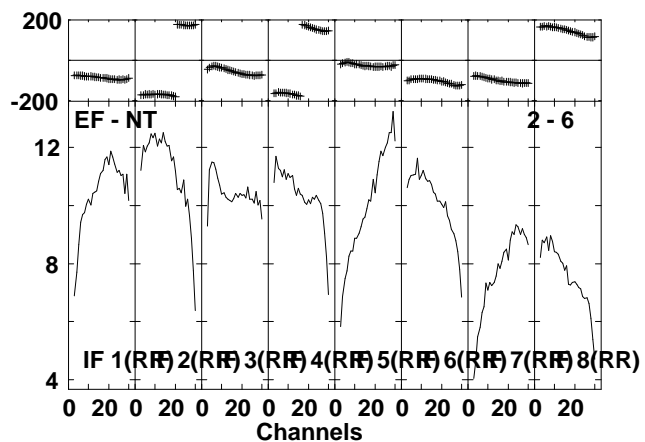
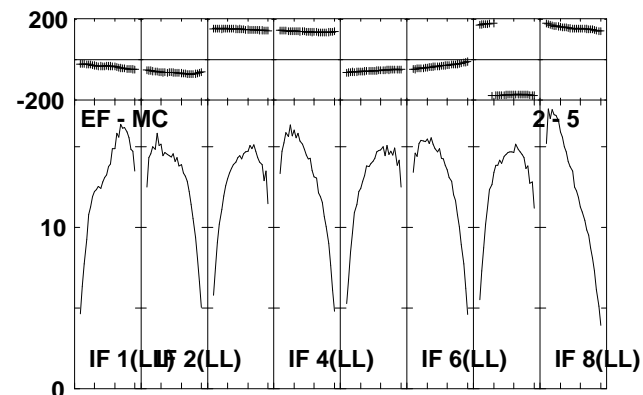
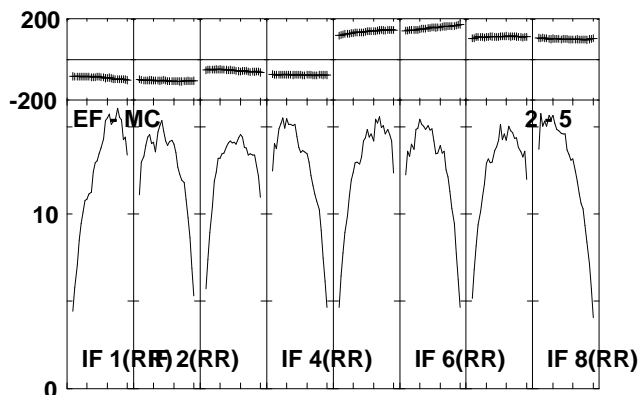
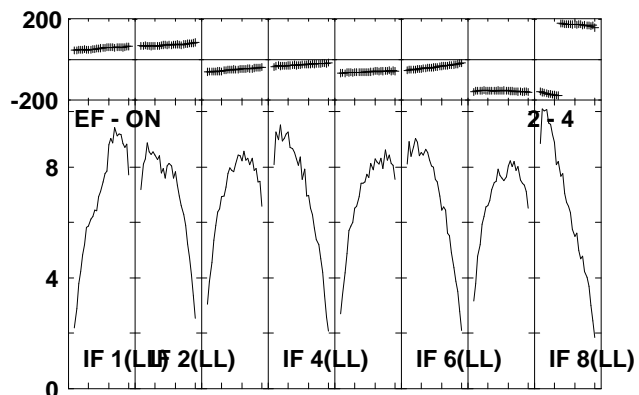
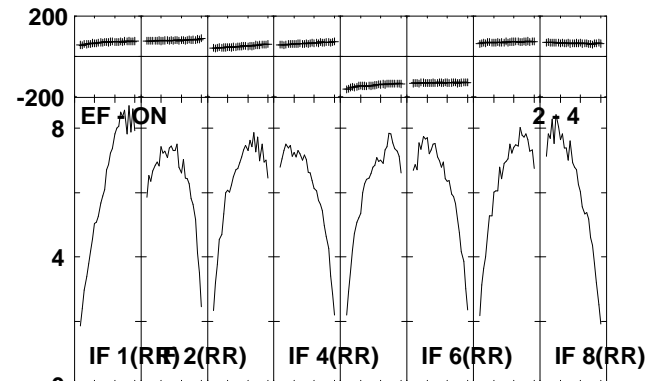
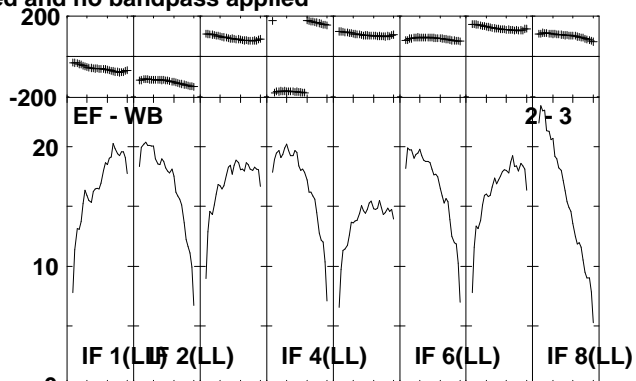
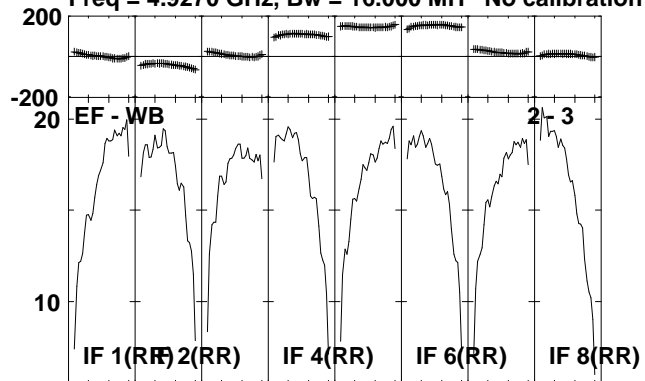

Lower frame: Milli Ampl Jy Top frame: Phas deg
Scalar averaged cross-power spectrum Several baselines displayed
Timerange: 00/12:21:51 to 00/12:23:27

Plot file version 72 created 06-JUL-2010 12:02:33

J2330+33 EP064L.UVDATA.1

Freq = 4.9270 GHz, Bw = 16.000 MH No calibration applied and no bandpass applied

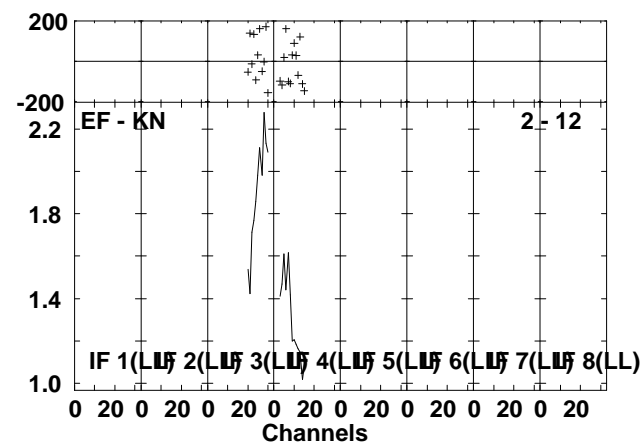
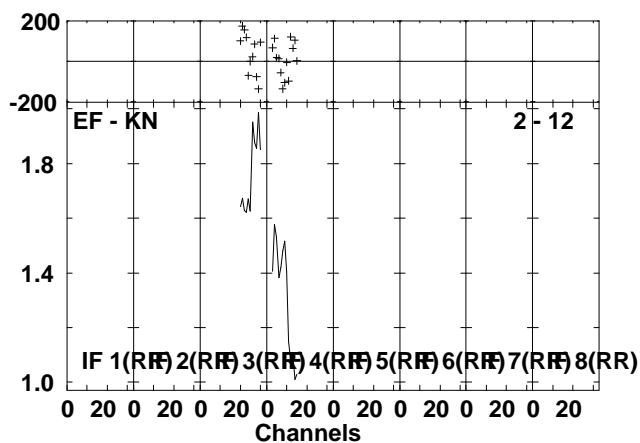
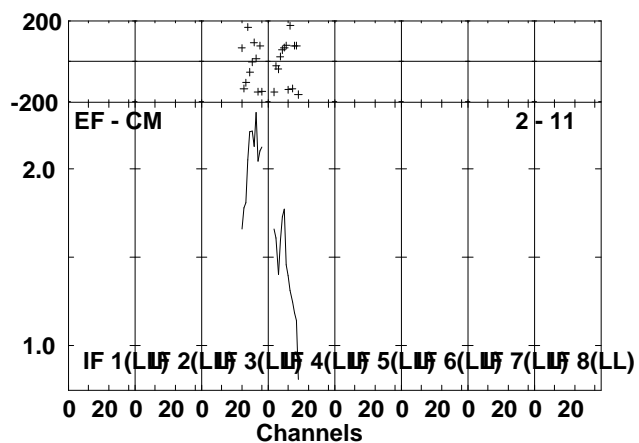
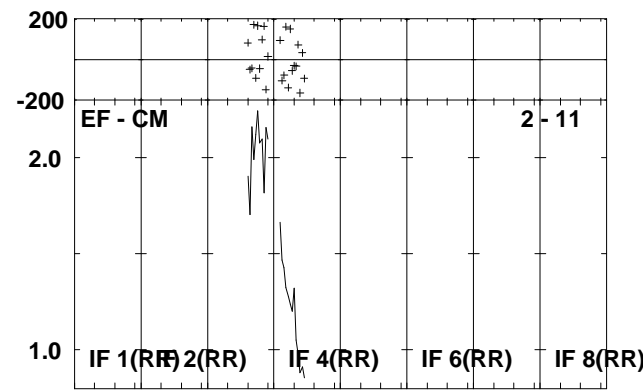
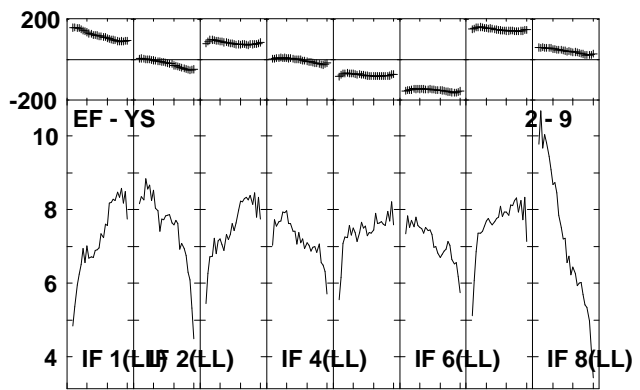
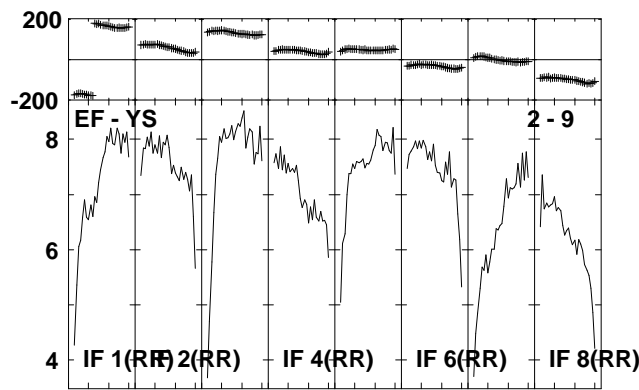
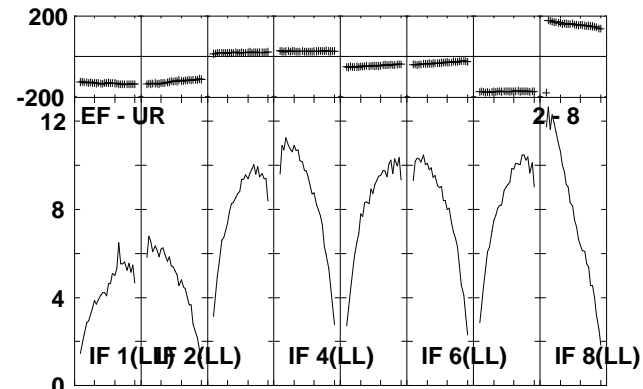
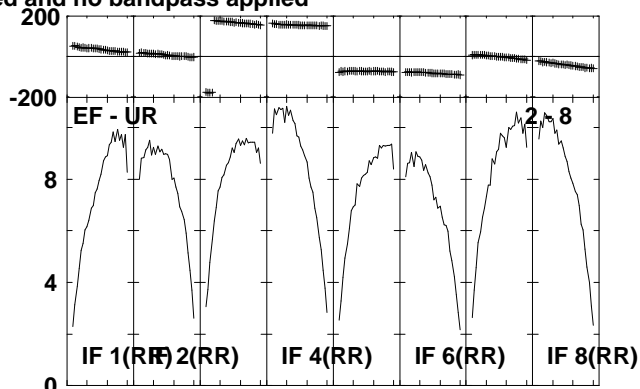
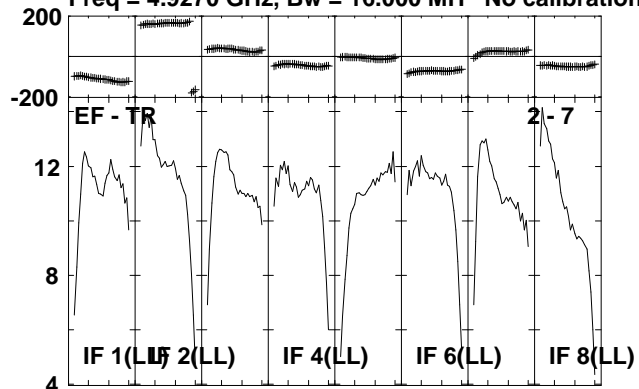

Lower frame: Milli Ampl Jy Top frame: Phas deg
Scalar averaged cross-power spectrum Several baselines displayed
Timerange: 00/12:21:51 to 00/12:23:27

Plot file version 73 created 06-JUL-2010 12:02:34

IRAS2336 EP064L.UVDATA.1

Freq = 4.9270 GHz, Bw = 16.000 MH No calibration applied and no bandpass applied

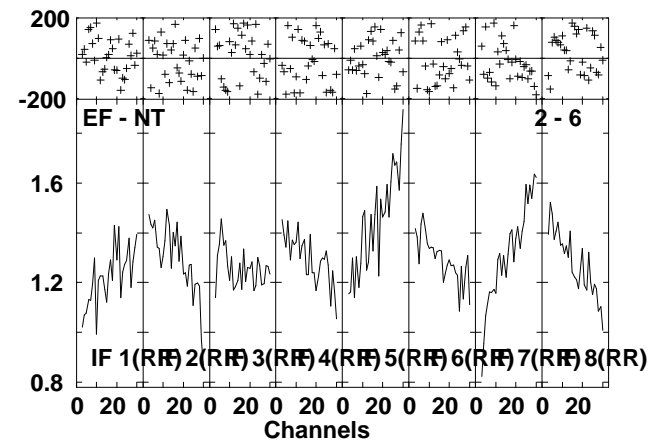
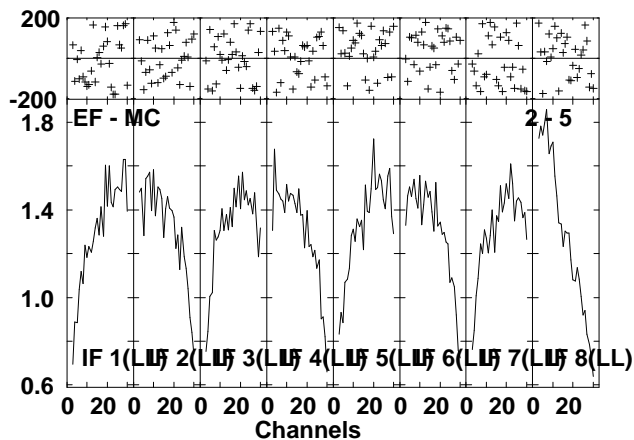
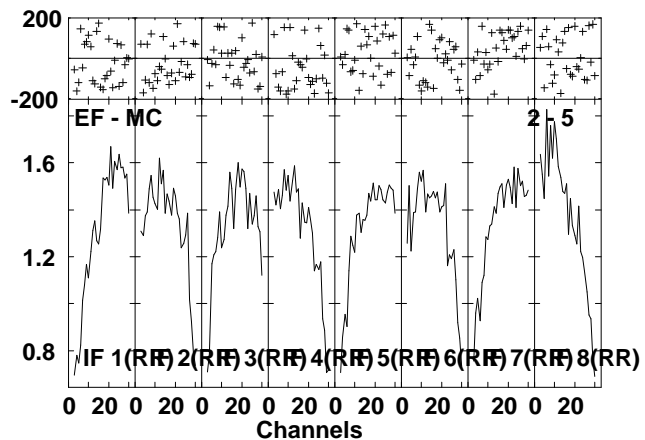
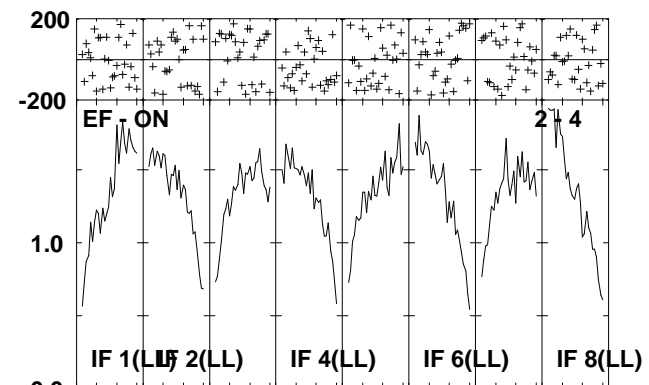
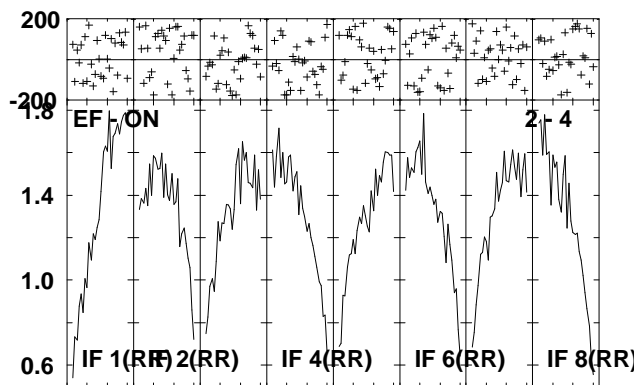
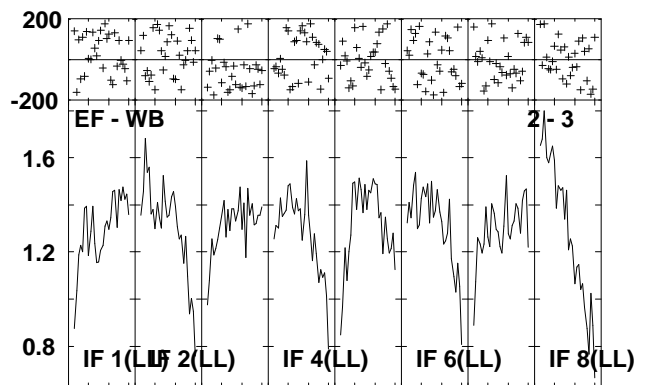
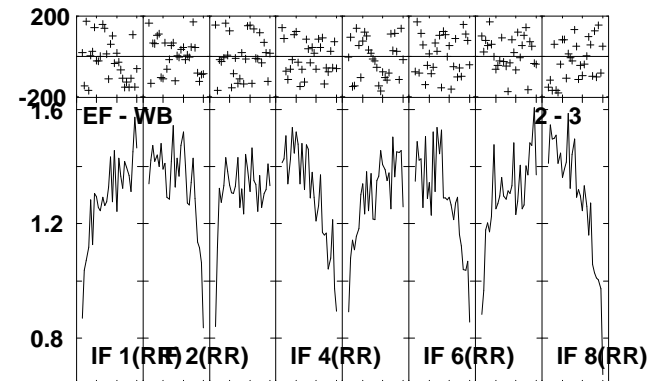
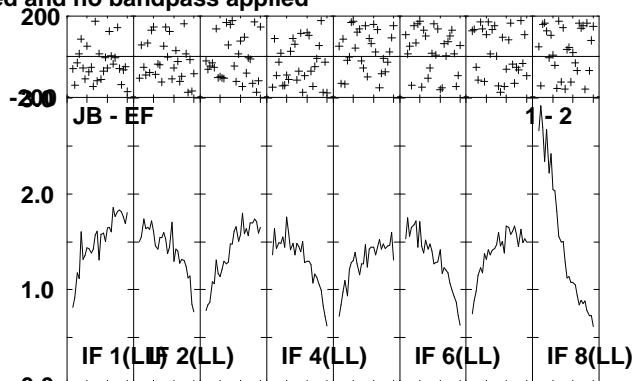
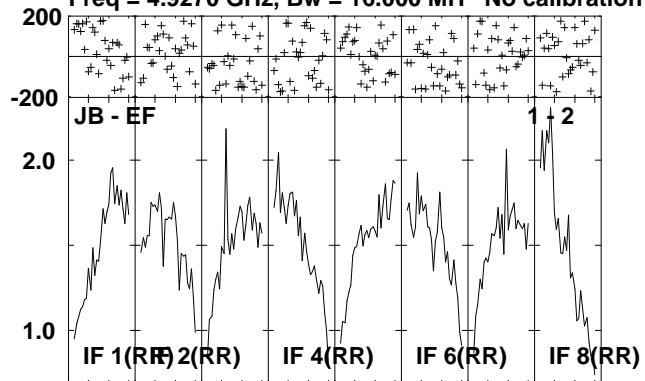

Lower frame: Milli Ampl Jy Top frame: Phas deg
Scalar averaged cross-power spectrum Several baselines displayed
Timerange: 00/12:23:31 to 00/12:27:09

Plot file version 74 created 06-JUL-2010 12:02:37

IRAS2336 EP064L.UVDATA.1

Freq = 4.9270 GHz, Bw = 16.000 MH No calibration applied and no bandpass applied

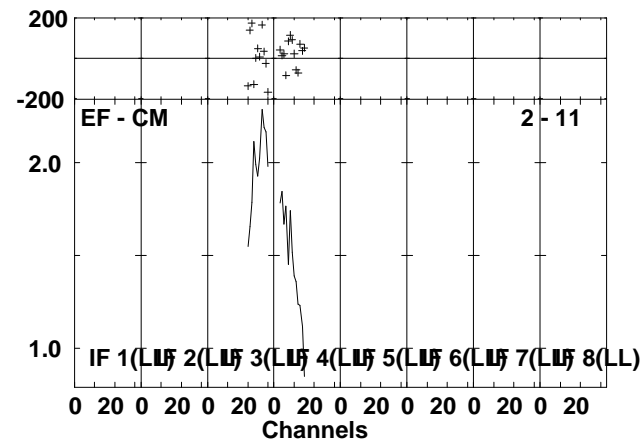
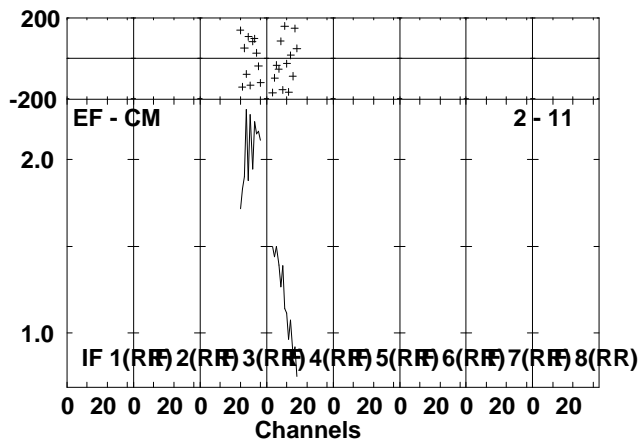
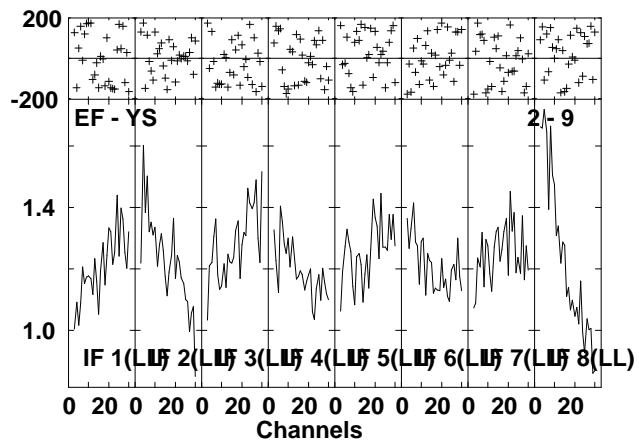
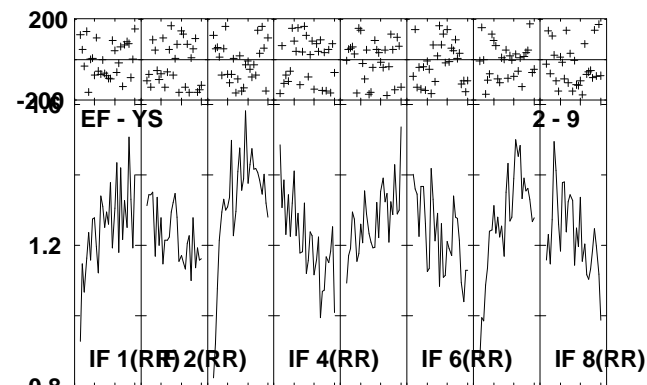
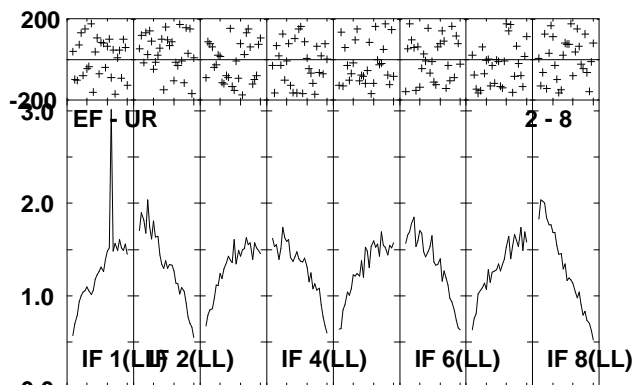
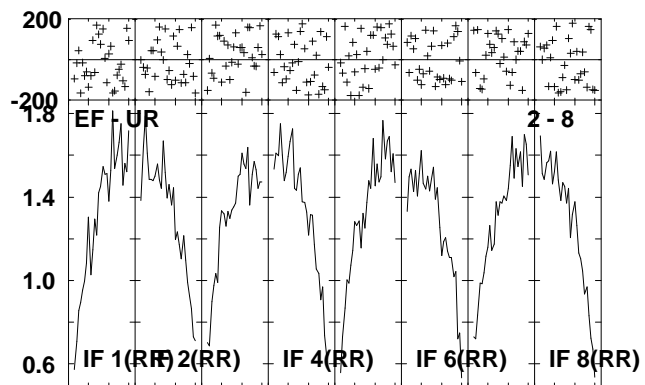
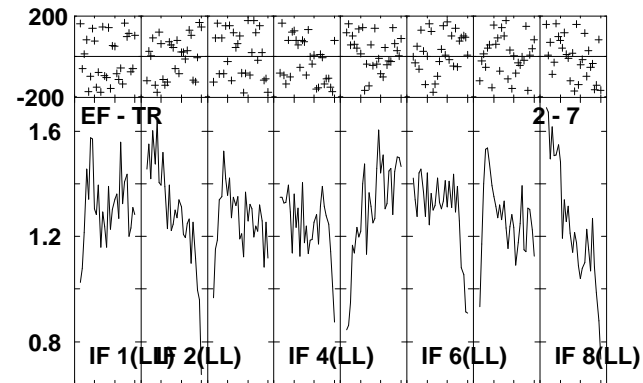
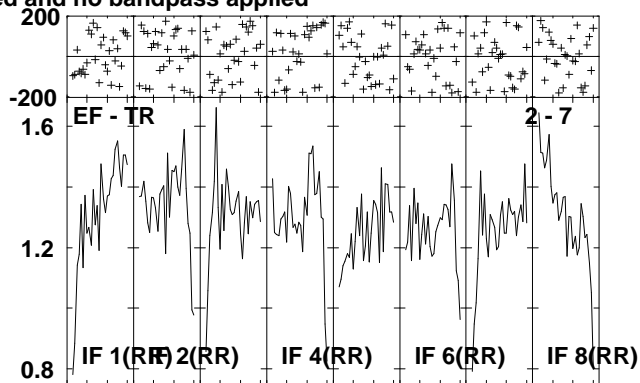
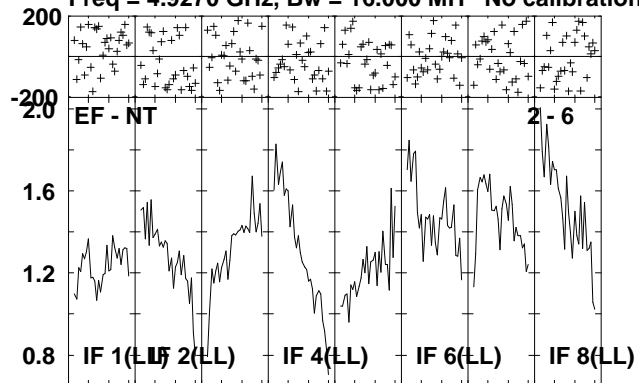

Lower frame: Milli Ampl Jy Top frame: Phas deg
Scalar averaged cross-power spectrum Several baselines displayed
Timerange: 00/12:23:31 to 00/12:27:09

Plot file version 75 created 06-JUL-2010 12:02:40

IRAS2336 EP064L.UVDATA.1

Freq = 4.9270 GHz, Bw = 16.000 MH No calibration applied and no bandpass applied

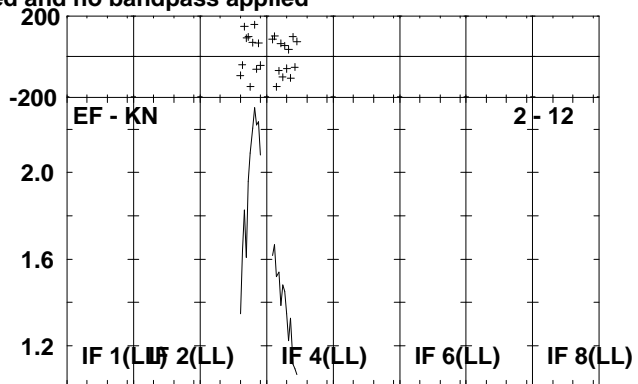
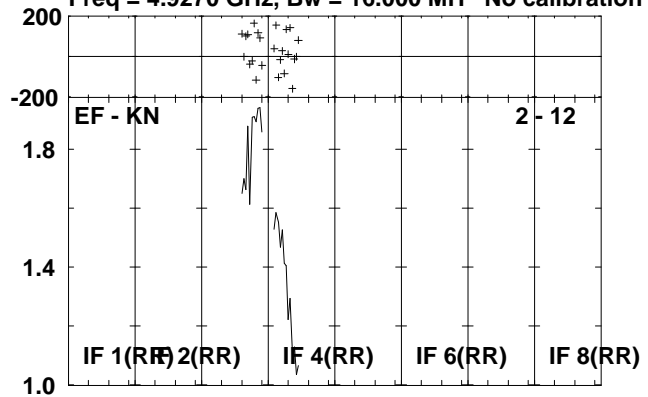

Lower frame: Milli Ampl Jy Top frame: Phas deg
Scalar averaged cross-power spectrum Several baselines displayed
Timerange: 00/12:23:31 to 00/12:27:09

Plot file version 76 created 06-JUL-2010 12:02:40

J2330+33 EP064L.UVDATA.1

Freq = 4.9270 GHz, Bw = 16.000 MH No calibration applied and no bandpass applied

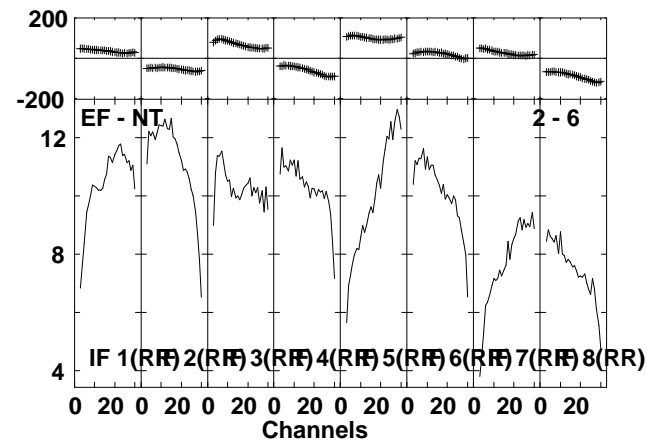
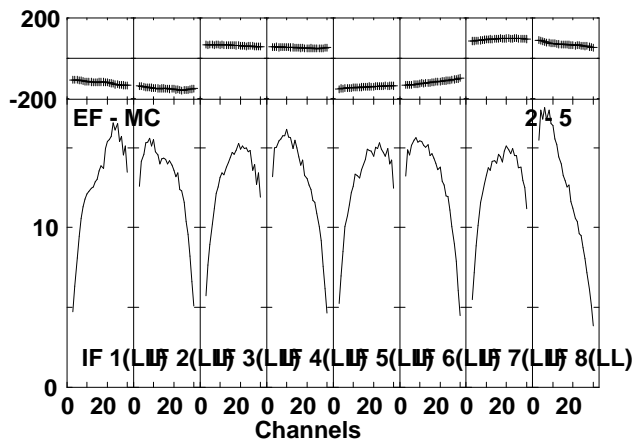
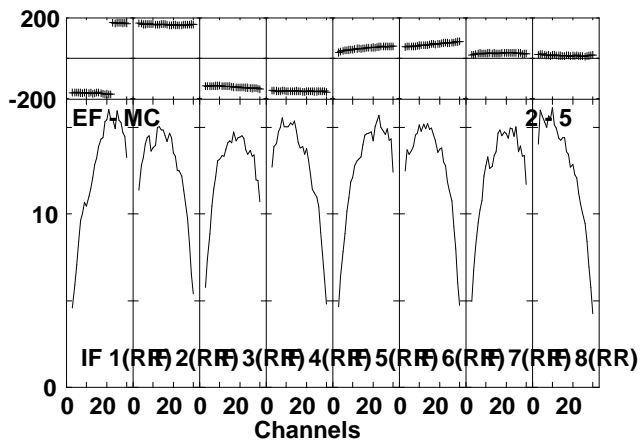
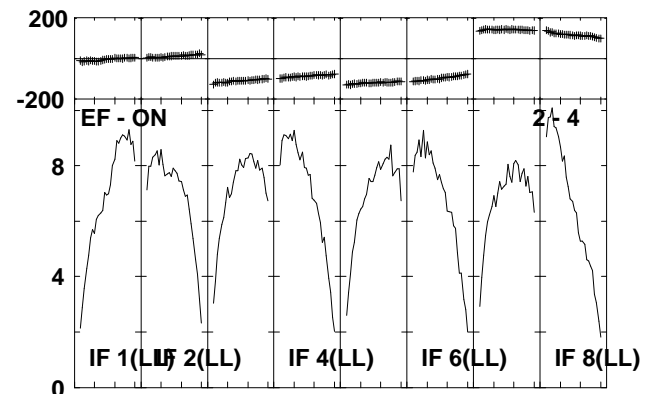
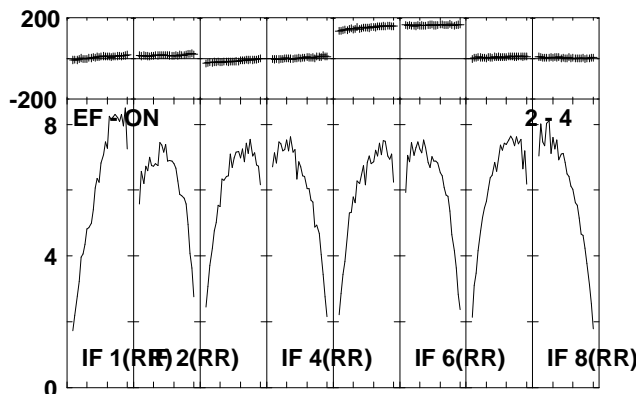
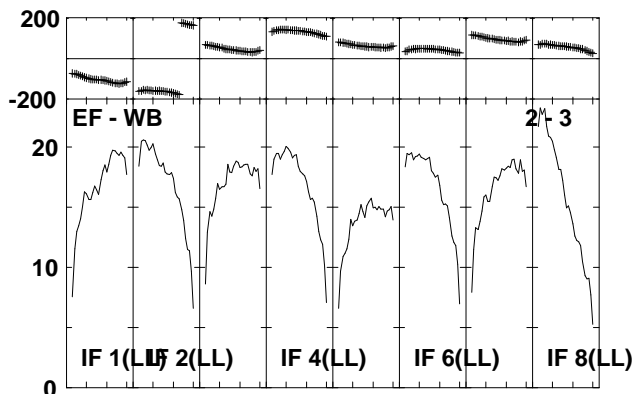
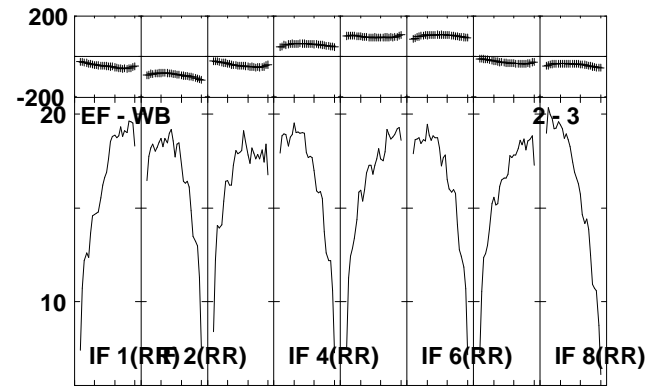
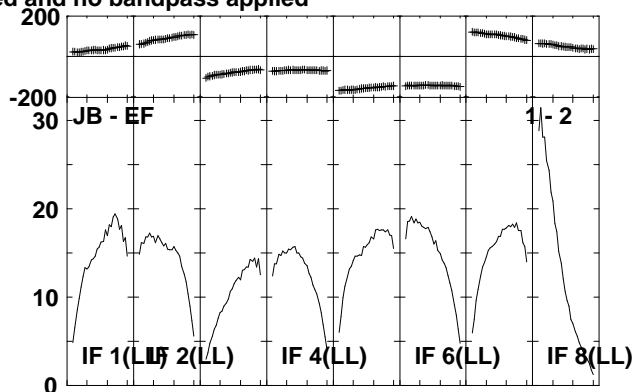
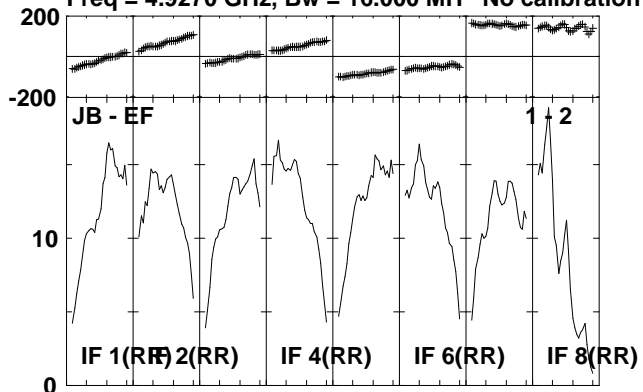

Lower frame: Milli Ampl Jy Top frame: Phas deg
Scalar averaged cross-power spectrum Several baselines displayed
Timerange: 00/12:27:11 to 00/12:28:59

Plot file version 77 created 06-JUL-2010 12:02:42

J2330+33 EP064L.UVDATA.1

Freq = 4.9270 GHz, Bw = 16.000 MH No calibration applied and no bandpass applied

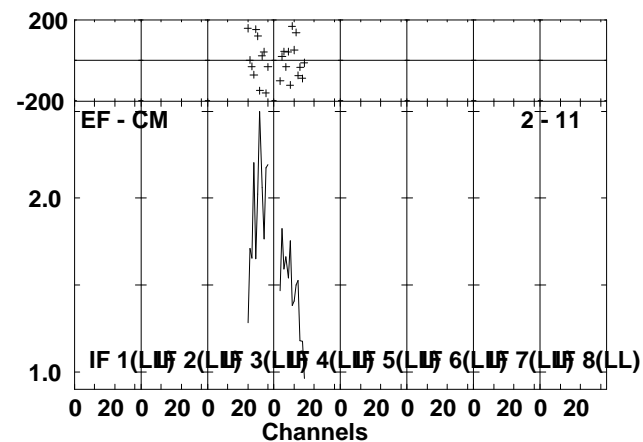
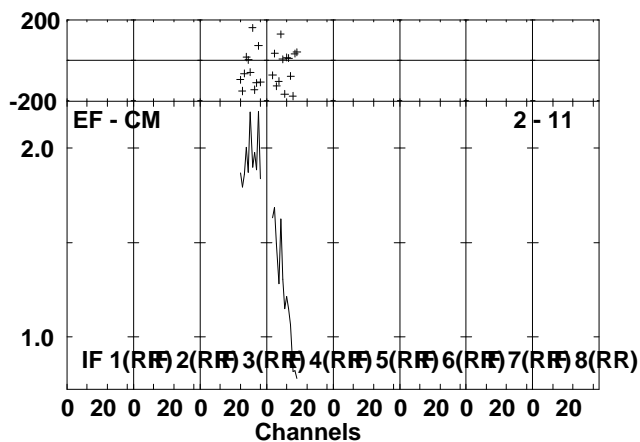
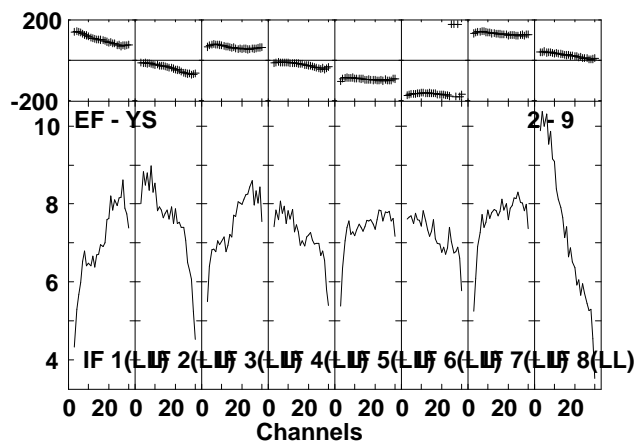
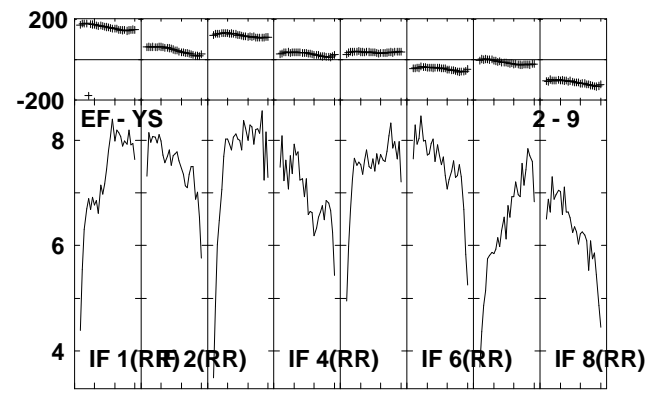
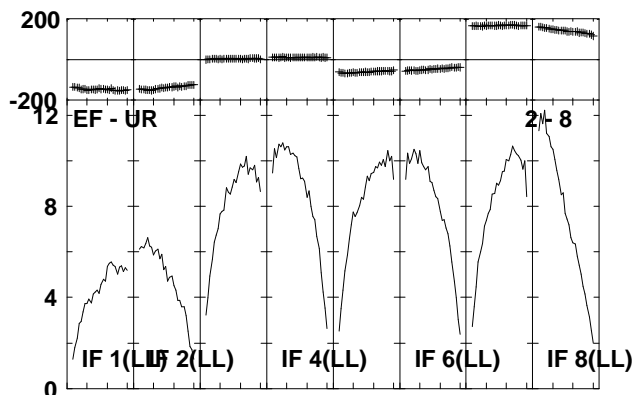
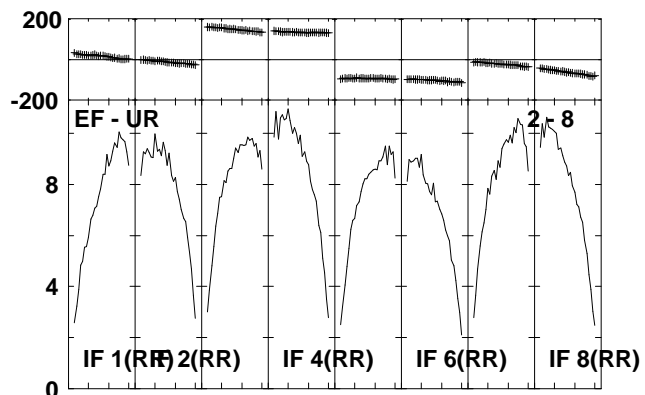
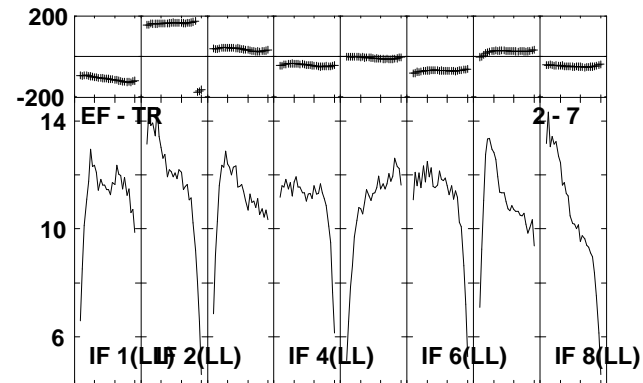
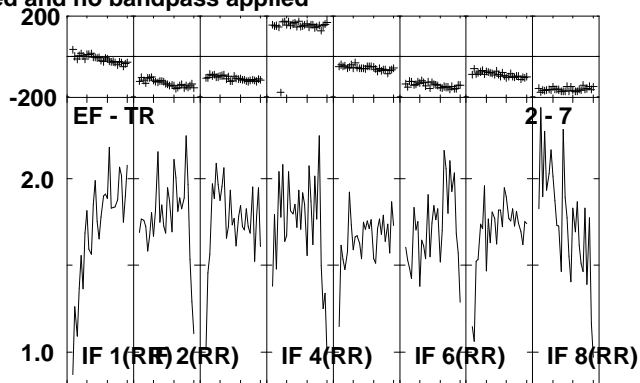
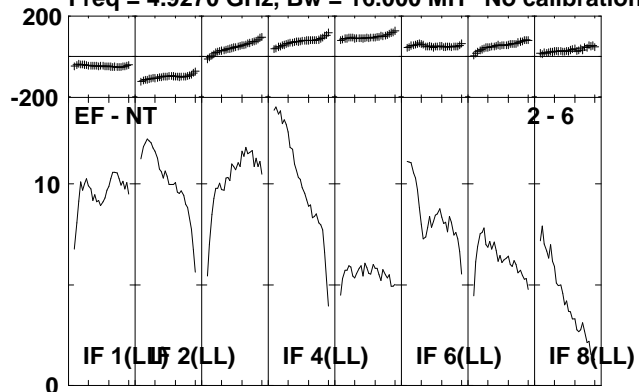

Lower frame: Milli Ampl Jy Top frame: Phas deg
Scalar averaged cross-power spectrum Several baselines displayed
Timerange: 00/12:27:11 to 00/12:28:59

Plot file version 78 created 06-JUL-2010 12:02:43

J2330+33 EP064L.UVDATA.1

Freq = 4.9270 GHz, Bw = 16.000 MH No calibration applied and no bandpass applied

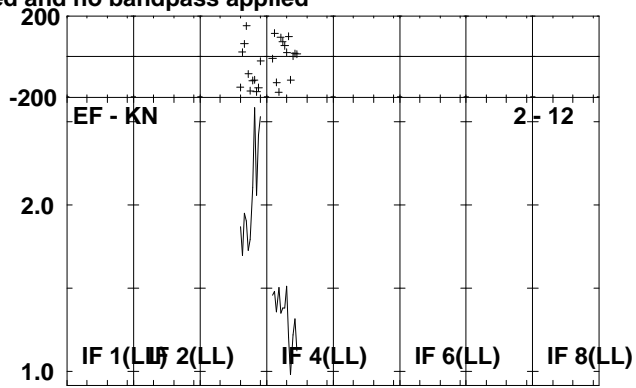
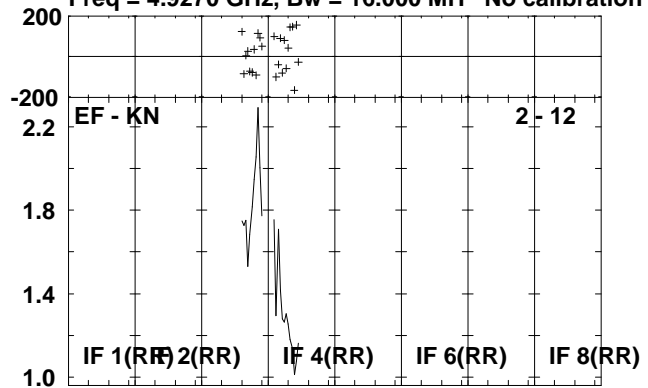

Lower frame: Milli Ampl Jy Top frame: Phas deg
Scalar averaged cross-power spectrum Several baselines displayed
Timerange: 00/12:27:11 to 00/12:28:59

Plot file version 79 created 06-JUL-2010 12:02:44

IRAS2336 EP064L.UVDATA.1

Freq = 4.9270 GHz, Bw = 16.000 MH No calibration applied and no bandpass applied

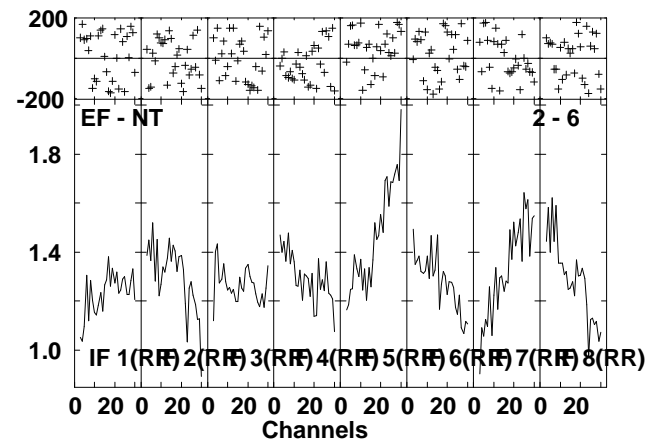
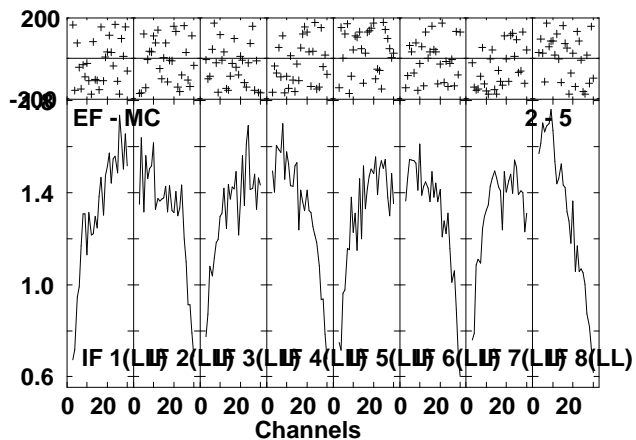
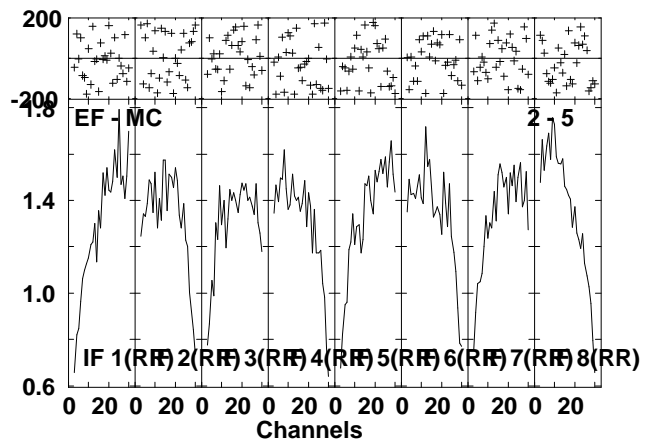
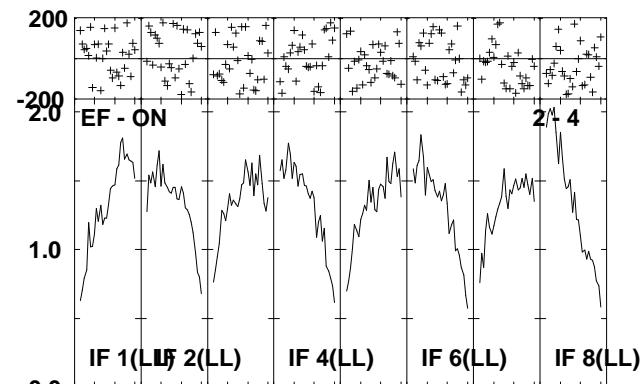
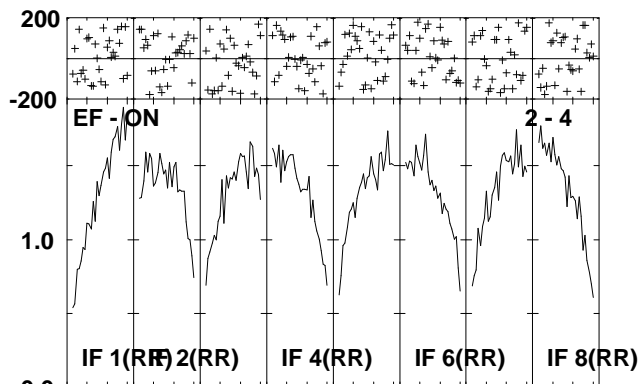
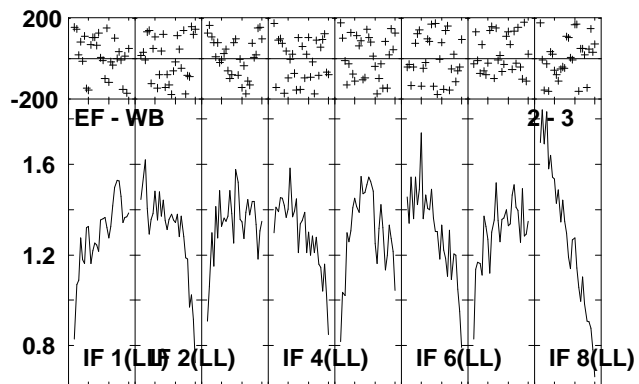
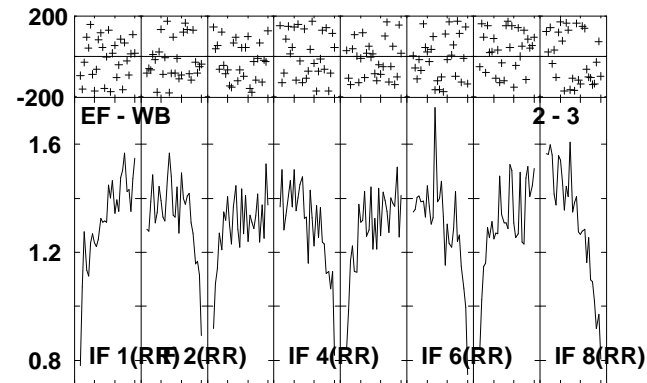
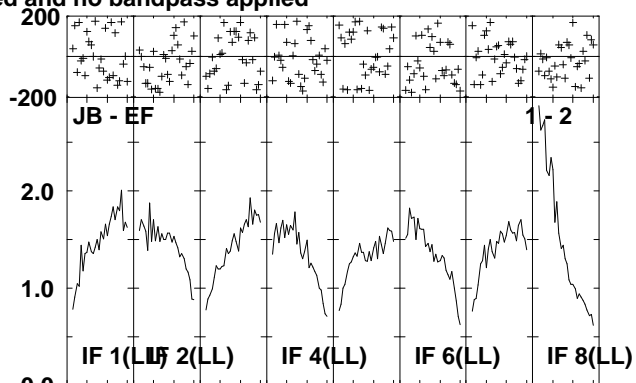
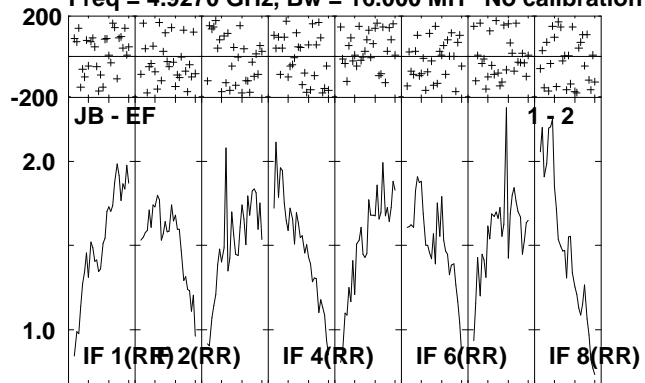

Lower frame: Milli Ampl Jy Top frame: Phas deg
Scalar averaged cross-power spectrum Several baselines displayed
Timerange: 00/12:29:01 to 00/12:32:39

Plot file version 80 created 06-JUL-2010 12:02:47

IRAS2336 EP064L.UVDATA.1

Freq = 4.9270 GHz, Bw = 16.000 MH No calibration applied and no bandpass applied

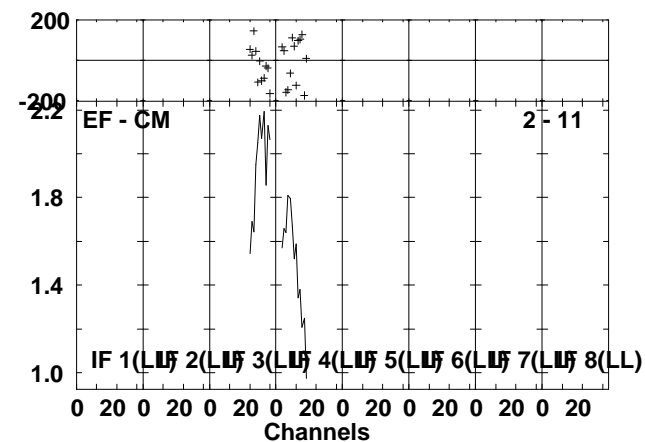
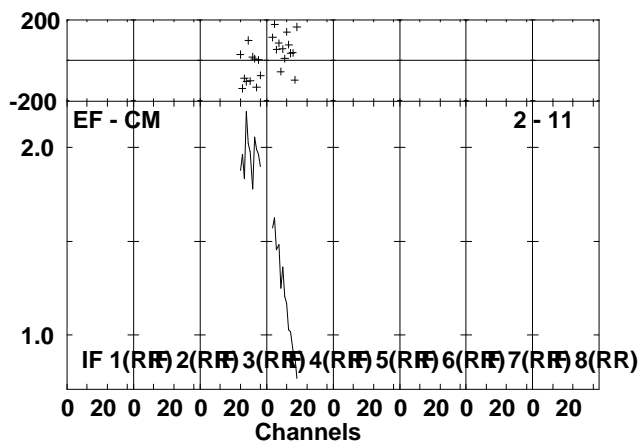
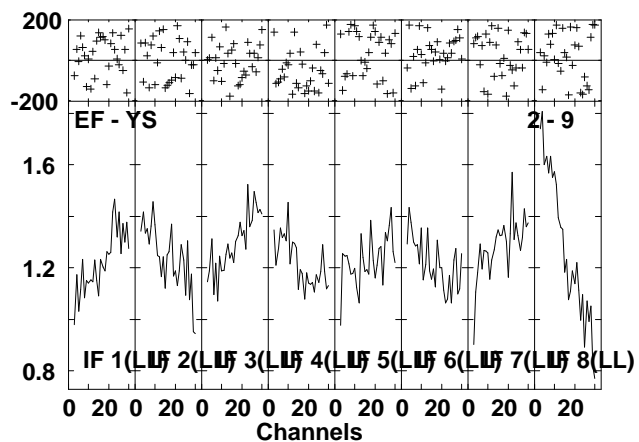
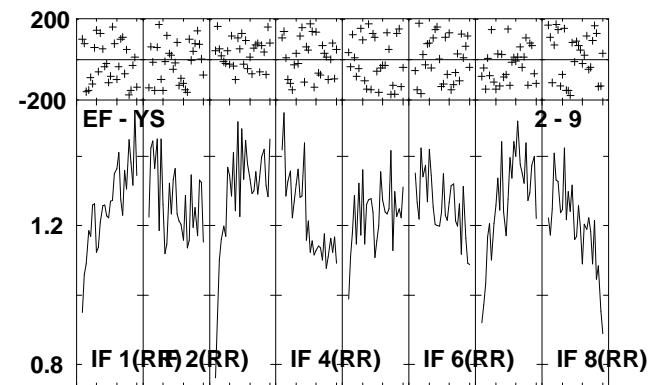
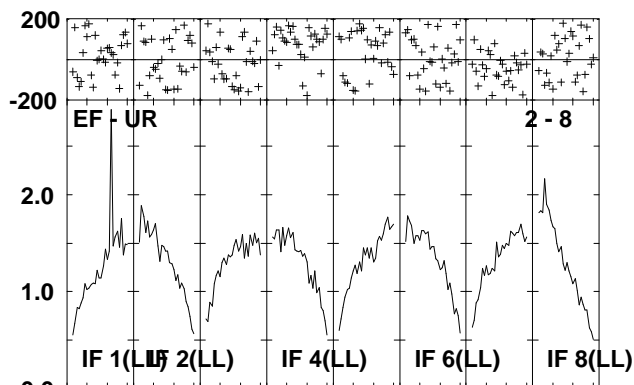
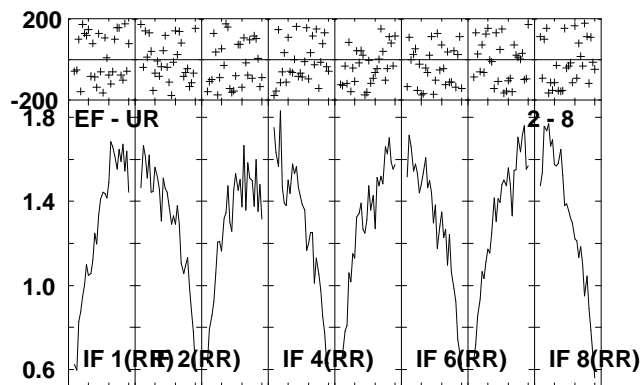
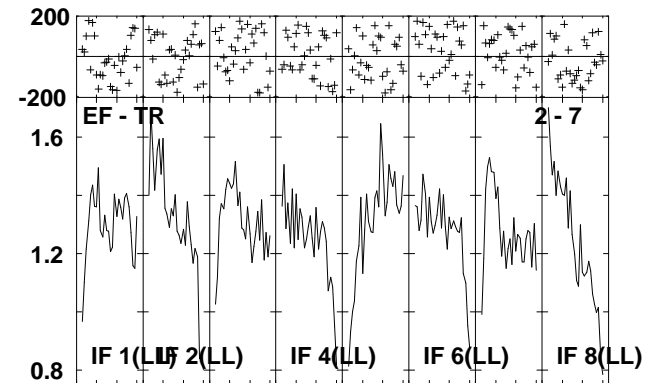
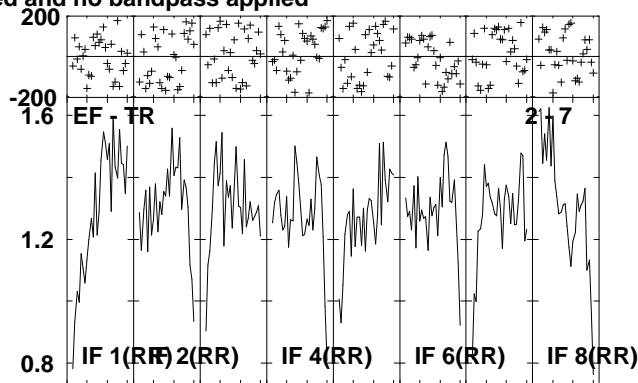
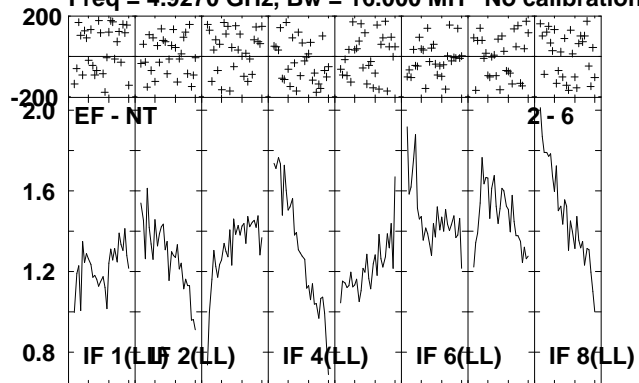

Lower frame: Milli Ampl Jy Top frame: Phas deg
Scalar averaged cross-power spectrum Several baselines displayed
Timerange: 00:12:29:01 to 00:12:32:39

Plot file version 81 created 06-JUL-2010 12:02:50

IRAS2336 EP064L.UVDATA.1

Freq = 4.9270 GHz, Bw = 16.000 MH No calibration applied and no bandpass applied

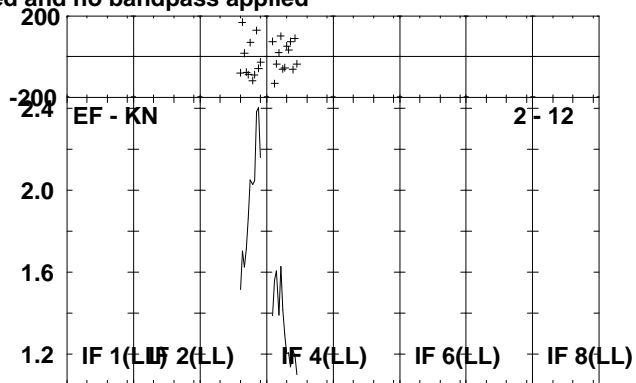
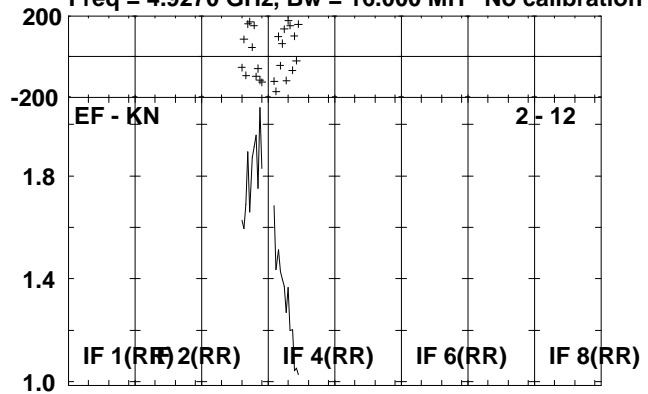

Lower frame: Milli Ampl Jy Top frame: Phas deg
Scalar averaged cross-power spectrum Several baselines displayed
Timerange: 00/12:29:01 to 00/12:32:39

Plot file version 82 created 06-JUL-2010 12:02:51

J2330+33 EP064L.UVDATA.1

Freq = 4.9270 GHz, Bw = 16.000 MH No calibration applied and no bandpass applied

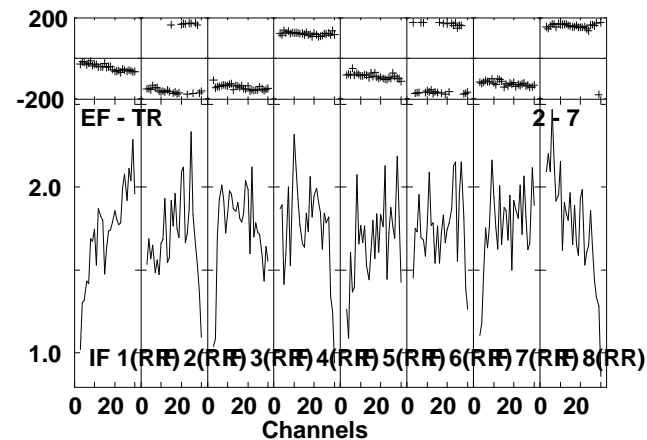
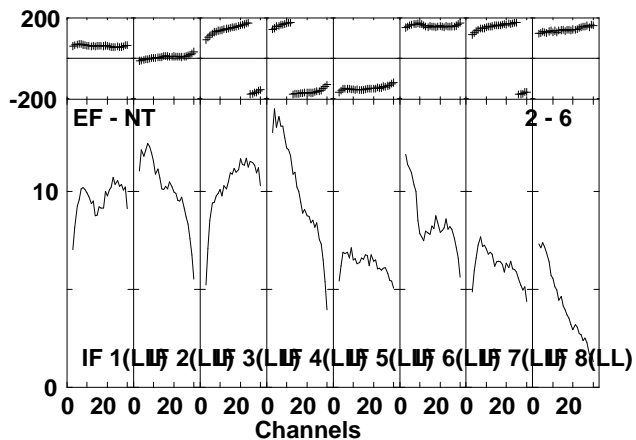
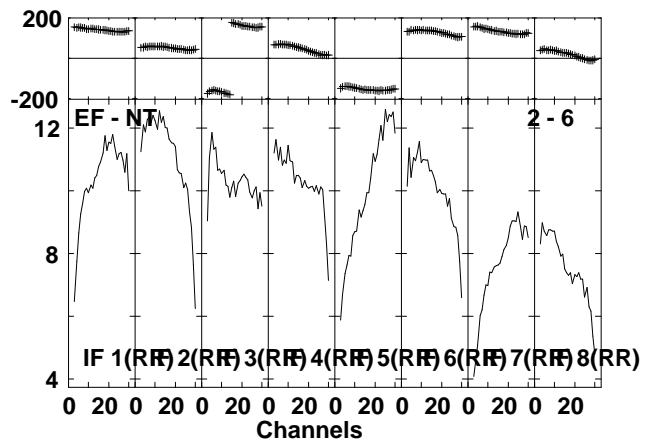
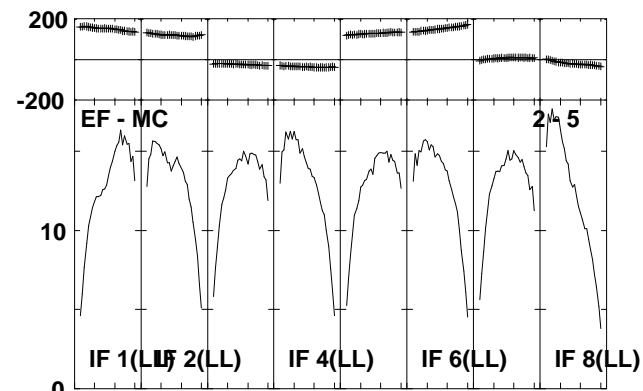
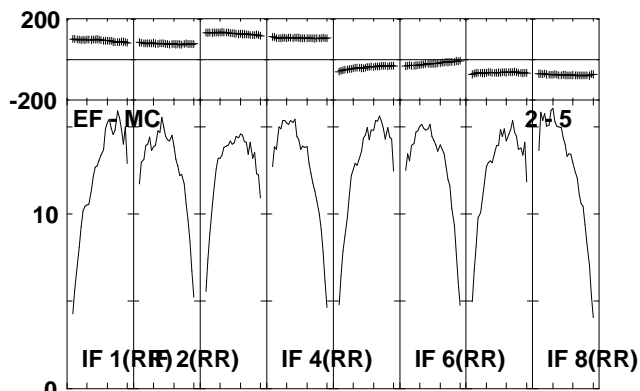
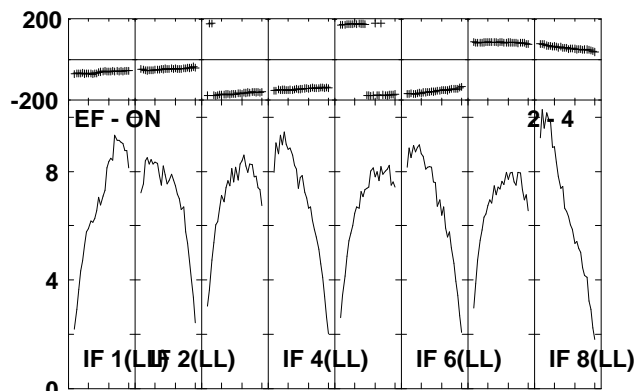
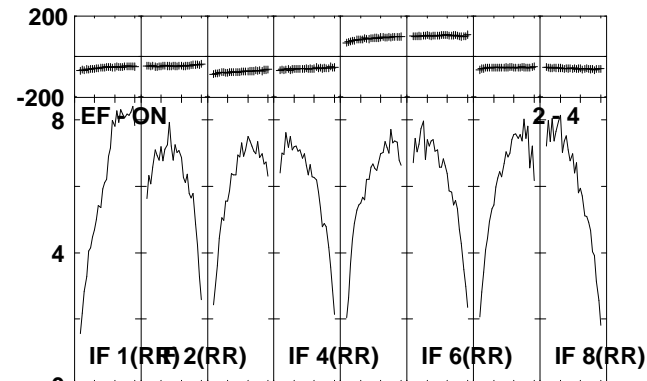
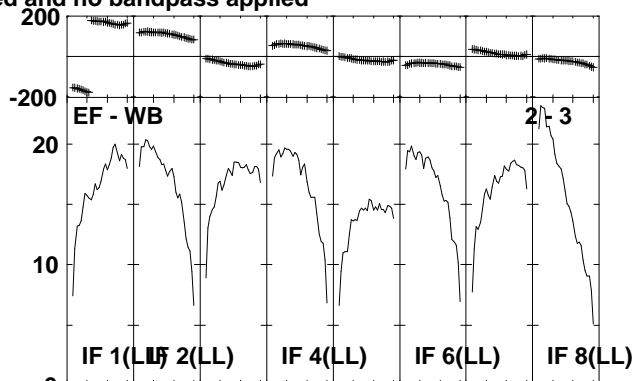
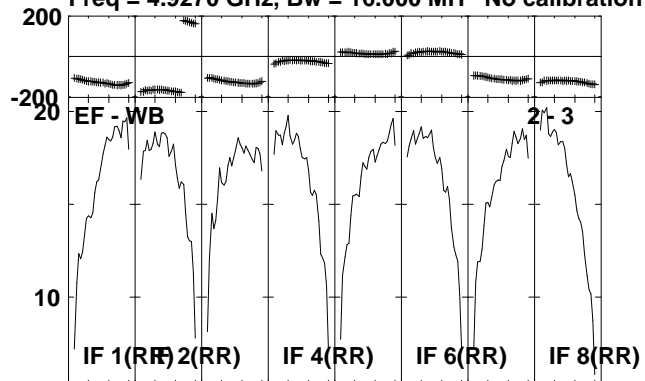

Lower frame: Milli Ampl Jy Top frame: Phas deg
Scalar averaged cross-power spectrum Several baselines displayed
Timerange: 00/12:32:41 to 00/12:34:29

Plot file version 83 created 06-JUL-2010 12:02:52

J2330+33 EP064L.UVDATA.1

Freq = 4.9270 GHz, Bw = 16.000 MH No calibration applied and no bandpass applied

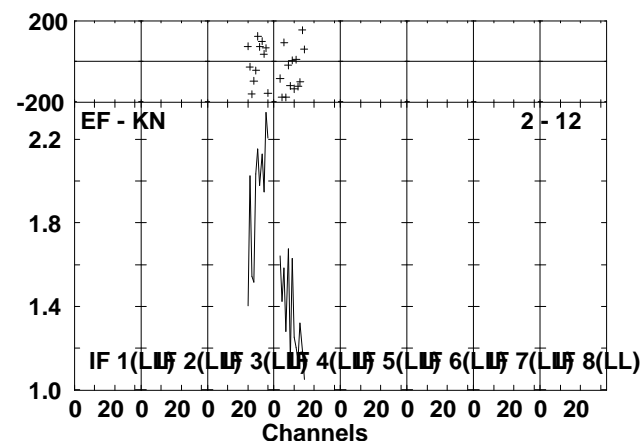
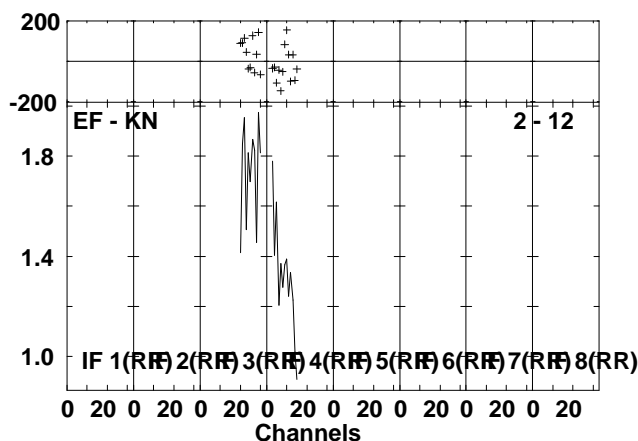
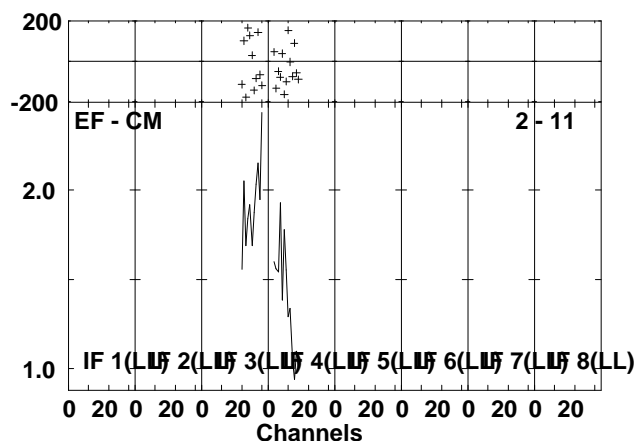
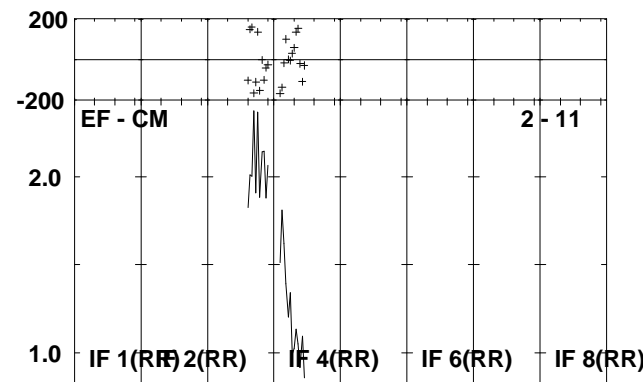
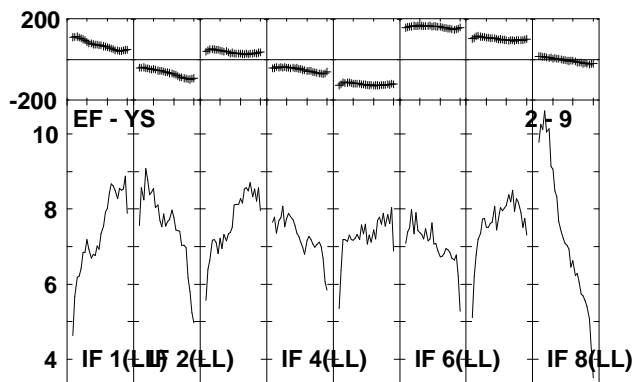
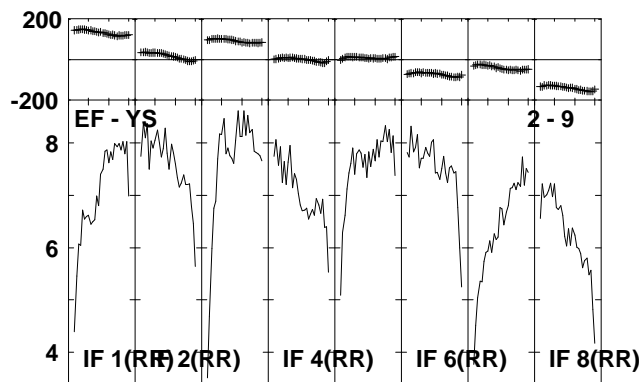
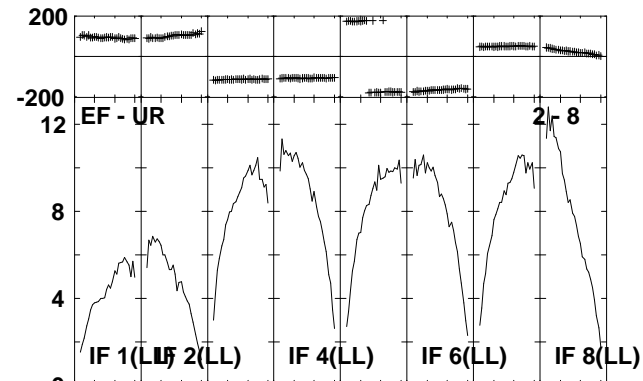
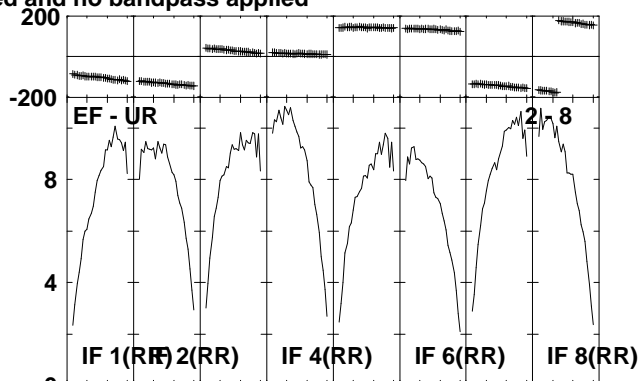
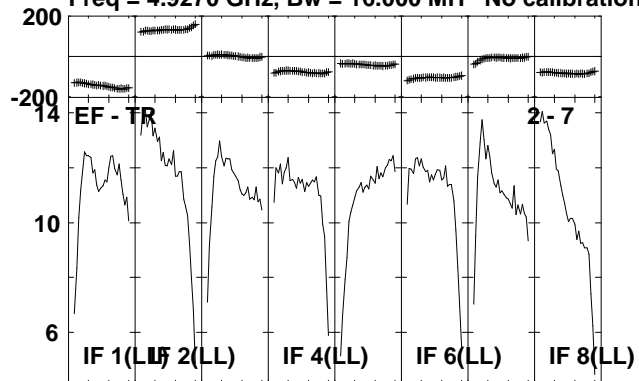

Lower frame: Milli Ampl Jy Top frame: Phas deg
Scalar averaged cross-power spectrum Several baselines displayed
Timerange: 00/12:32:41 to 00/12:34:29

Plot file version 84 created 06-JUL-2010 12:02:54

IRAS2336 EP064L.UVDATA.1

Freq = 4.9270 GHz, Bw = 16.000 MH No calibration applied and no bandpass applied

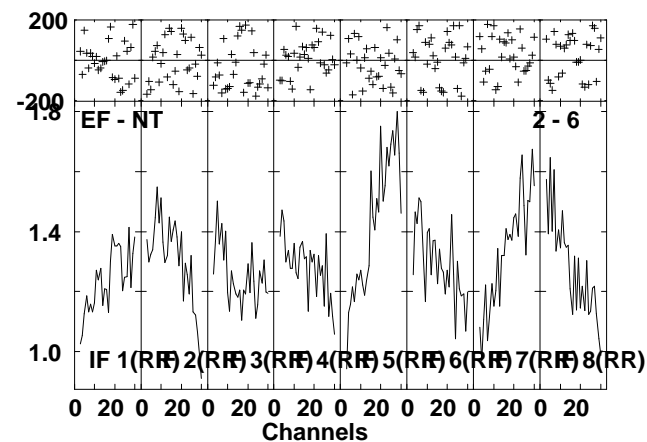
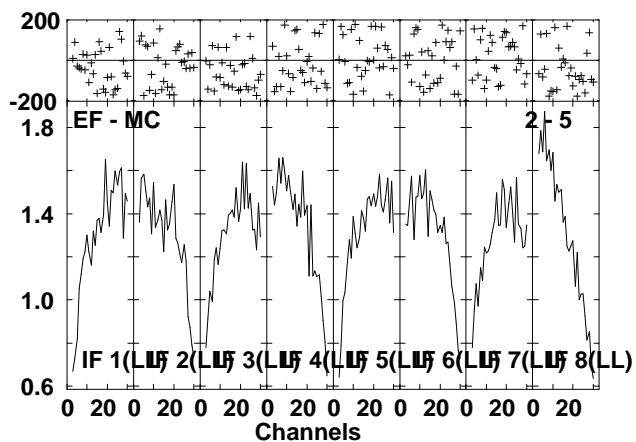
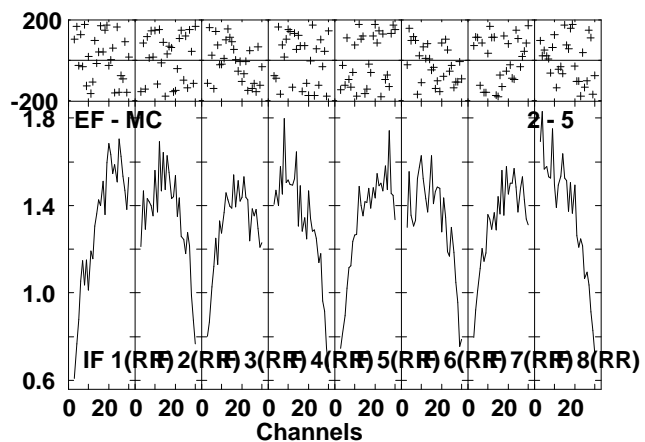
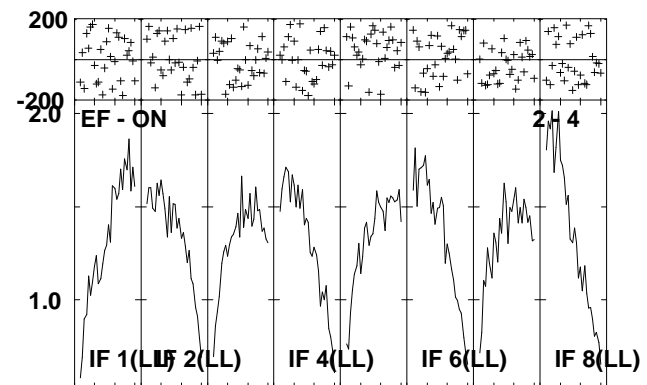
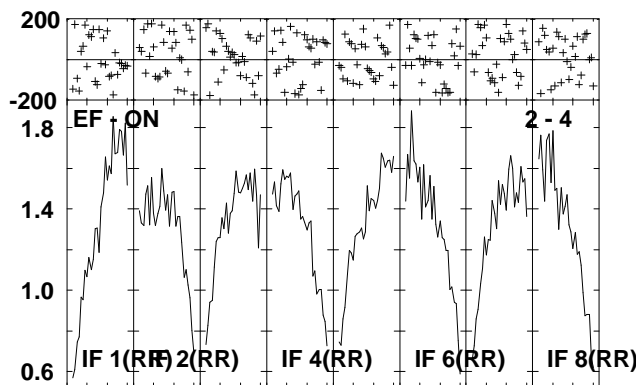
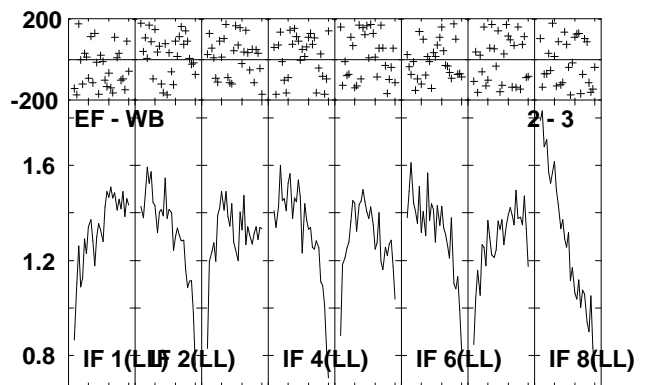
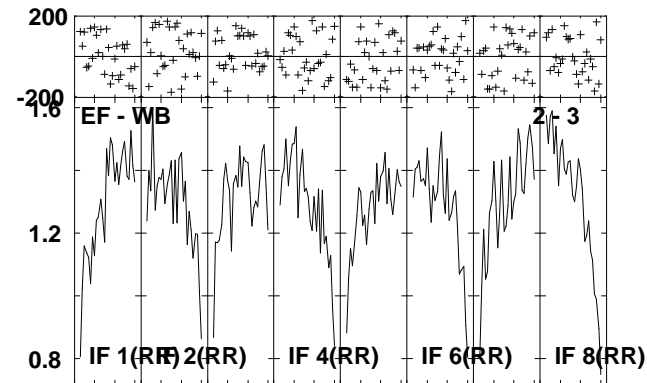
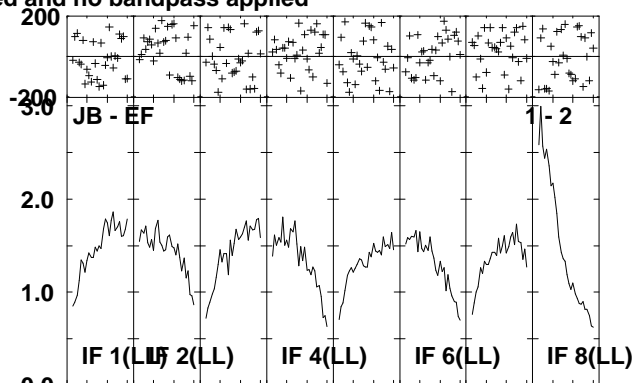
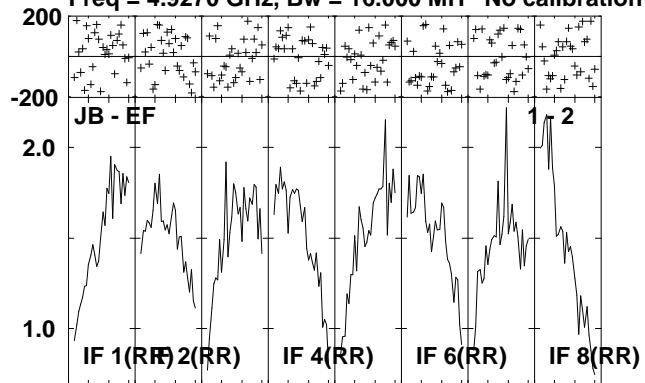

Lower frame: Milli Ampl Jy Top frame: Phas deg
Scalar averaged cross-power spectrum Several baselines displayed
Timerange: 00/12:34:31 to 00/12:38:07

Plot file version 85 created 06-JUL-2010 12:02:56

IRAS2336 EP064L.UVDATA.1

Freq = 4.9270 GHz, Bw = 16.000 MH No calibration applied and no bandpass applied

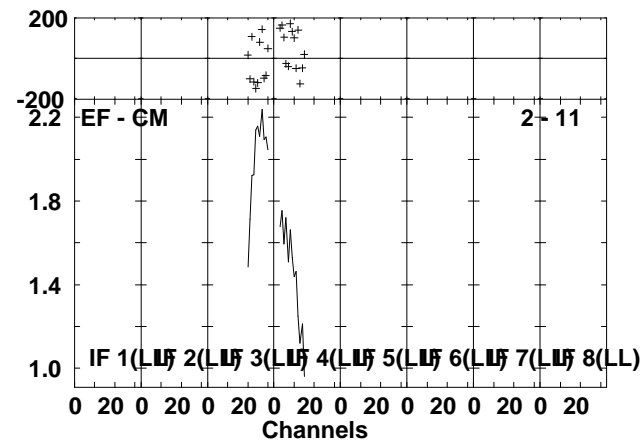
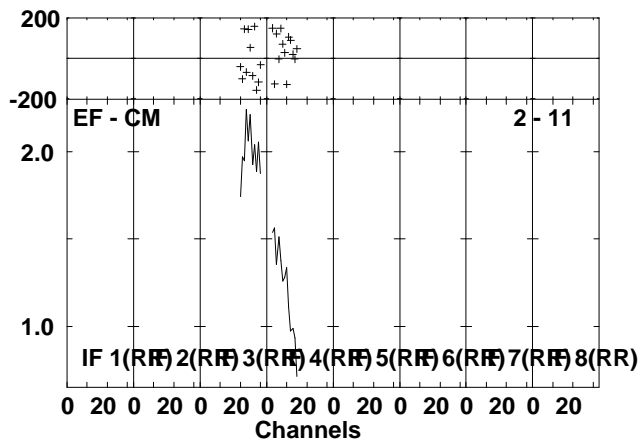
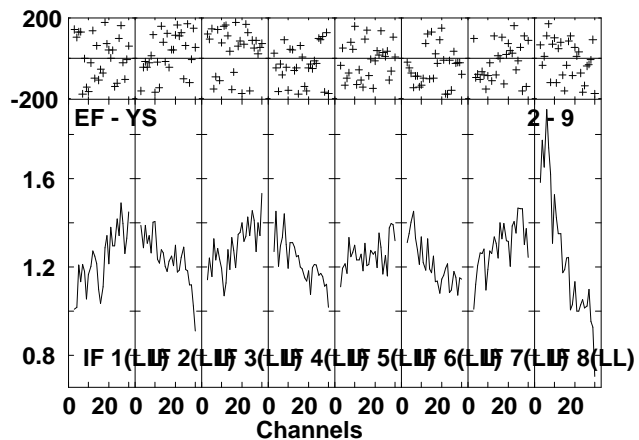
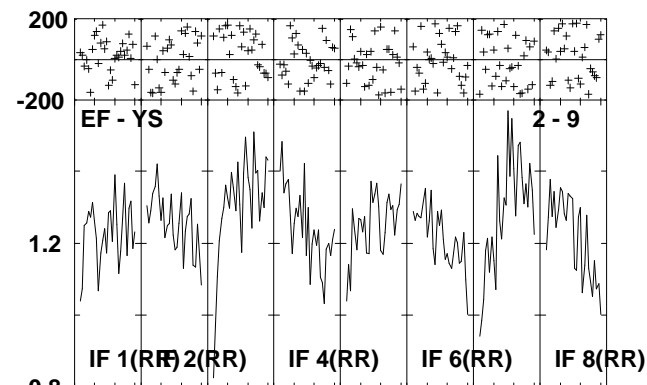
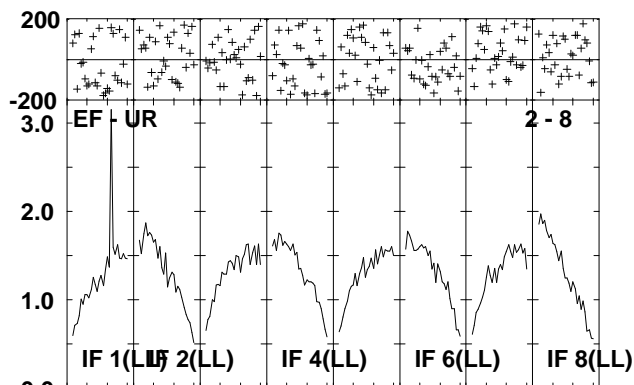
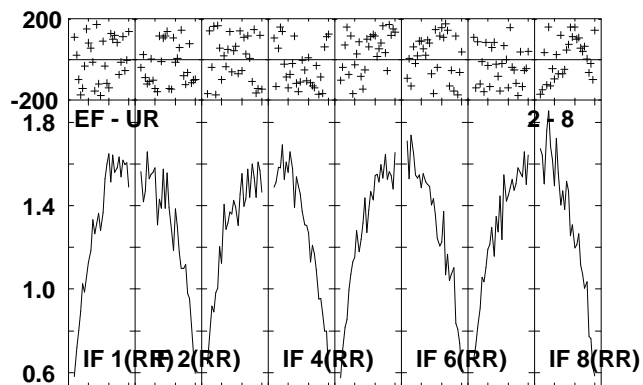
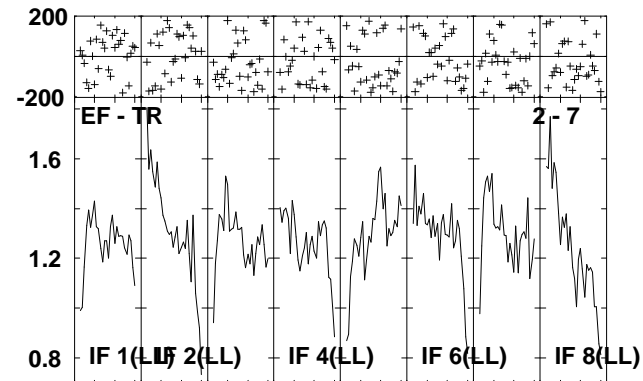
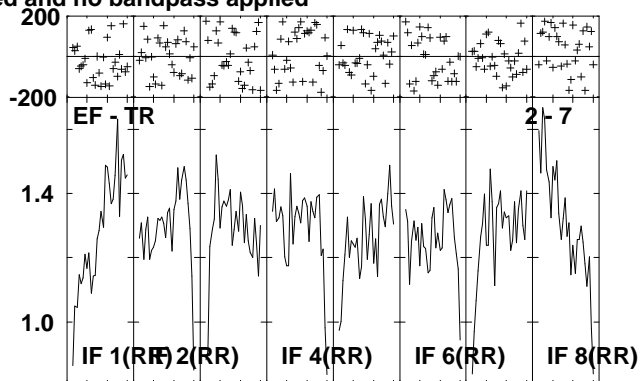
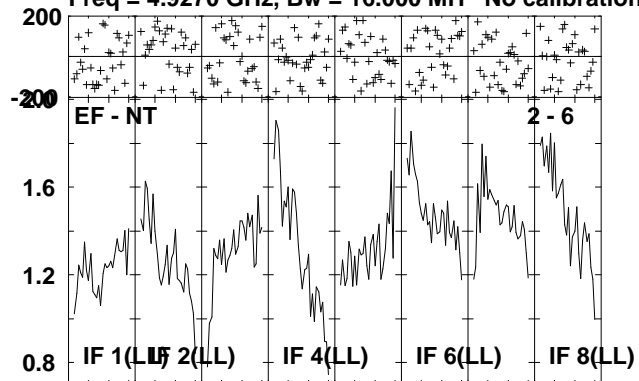

Lower frame: Milli Ampl Jy Top frame: Phas deg
Scalar averaged cross-power spectrum Several baselines displayed
Timerange: 00/12:34:31 to 00/12:38:07

Plot file version 86 created 06-JUL-2010 12:03:00

IRAS2336 EP064L.UVDATA.1

Freq = 4.9270 GHz, Bw = 16.000 MH No calibration applied and no bandpass applied

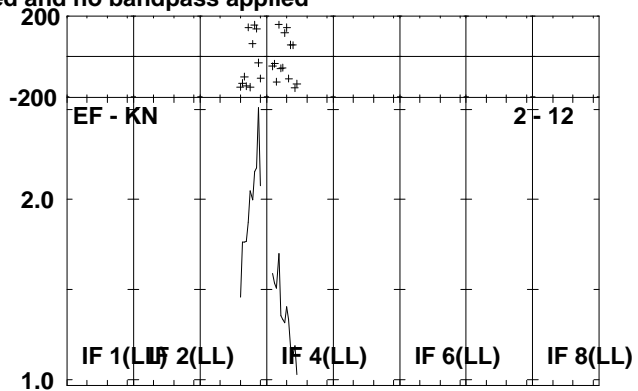
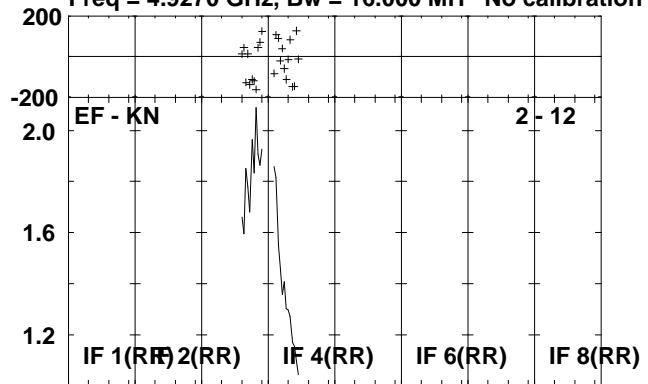

Lower frame: Milli Ampl Jy Top frame: Phas deg
Scalar averaged cross-power spectrum Several baselines displayed
Timerange: 00/12:34:31 to 00/12:38:07

Plot file version 87 created 06-JUL-2010 12:03:00

J2330+33 EP064L.UVDATA.1

Freq = 4.9270 GHz, Bw = 16.000 MH No calibration applied and no bandpass applied

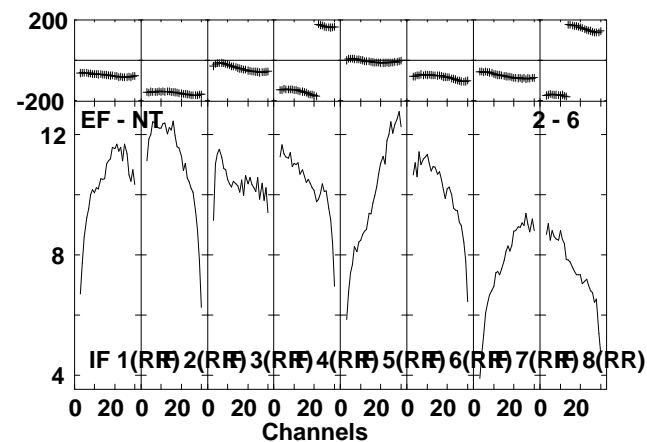
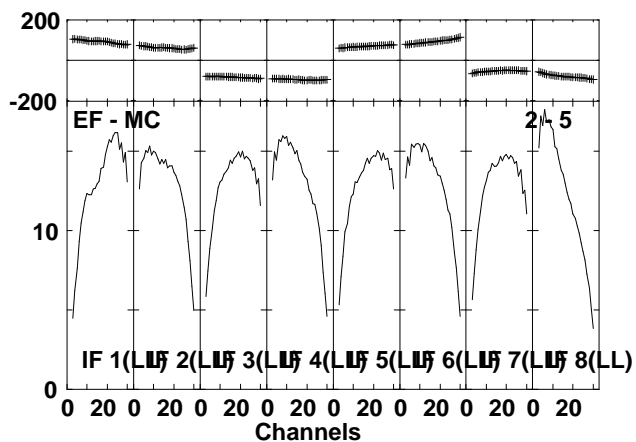
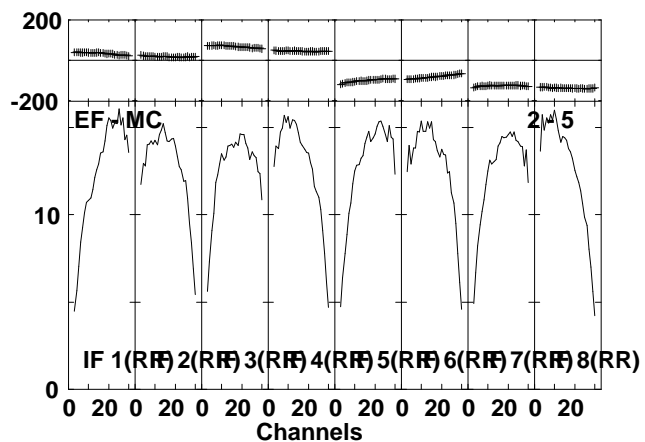
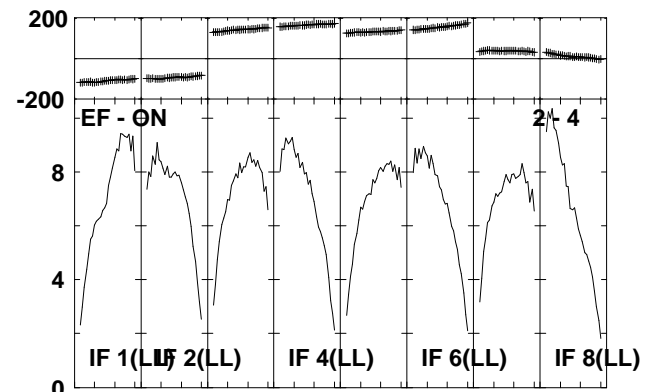
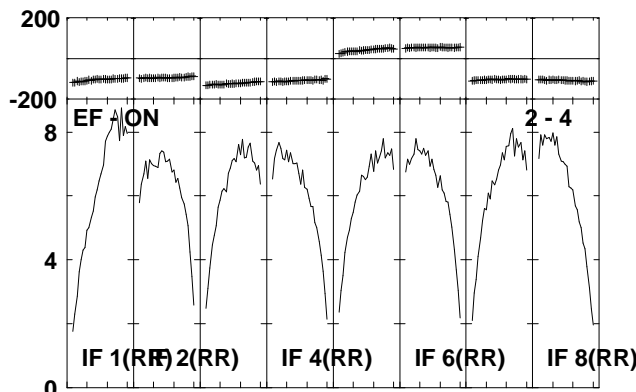
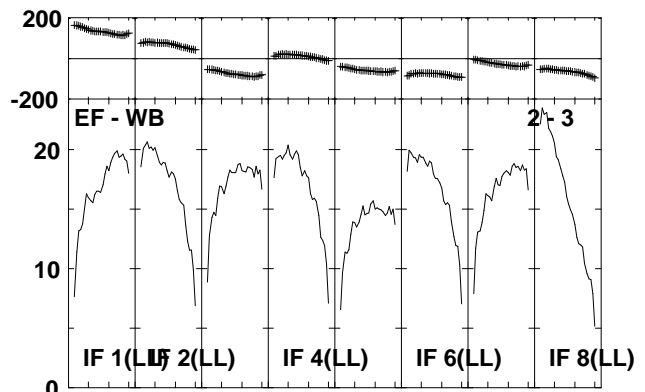
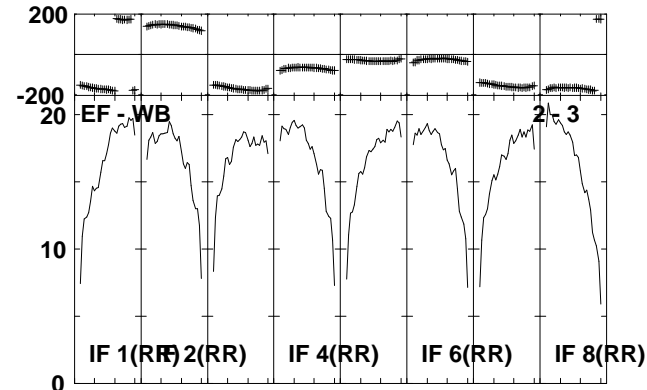
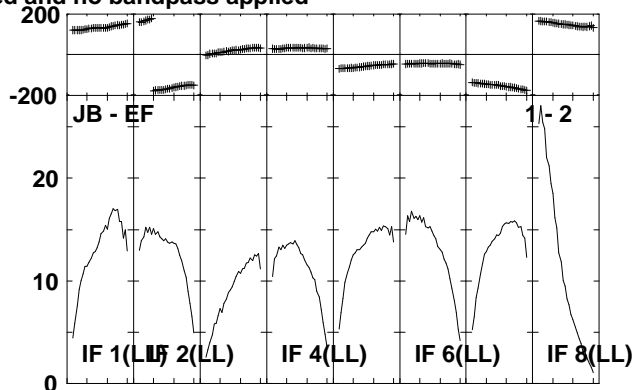
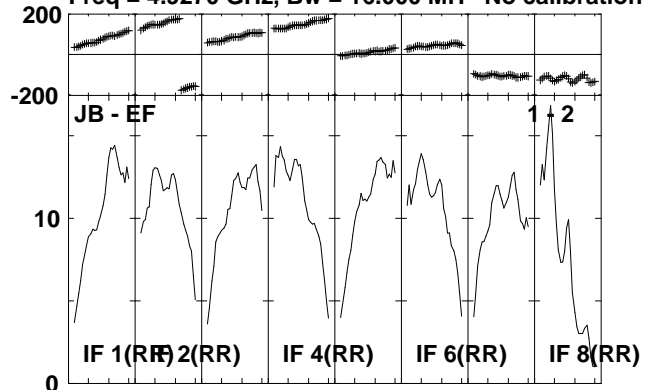

Lower frame: Milli Ampl Jy Top frame: Phas deg
Scalar averaged cross-power spectrum Several baselines displayed
Timerange: 00/12:39:11 to 00/12:40:49

Plot file version 88 created 06-JUL-2010 12:03:02

J2330+33 EP064L.UVDATA.1

Freq = 4.9270 GHz, Bw = 16.000 MH No calibration applied and no bandpass applied

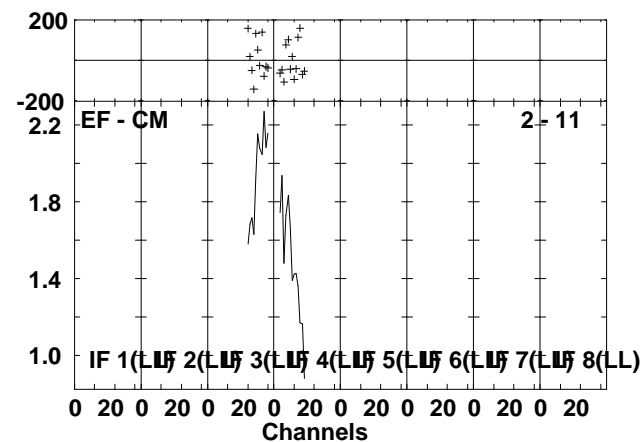
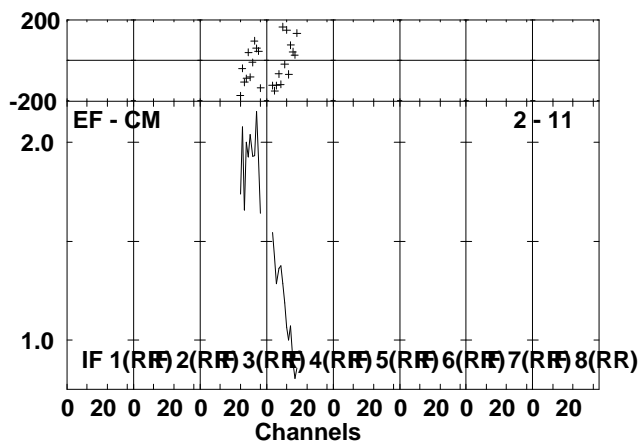
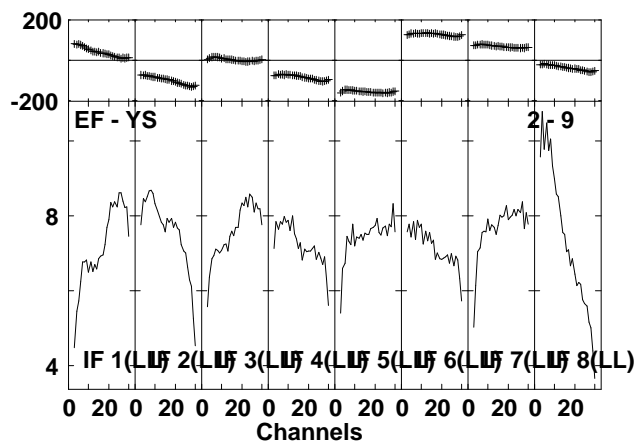
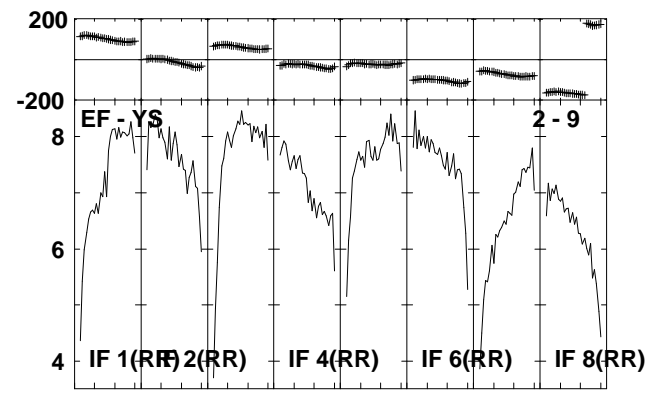
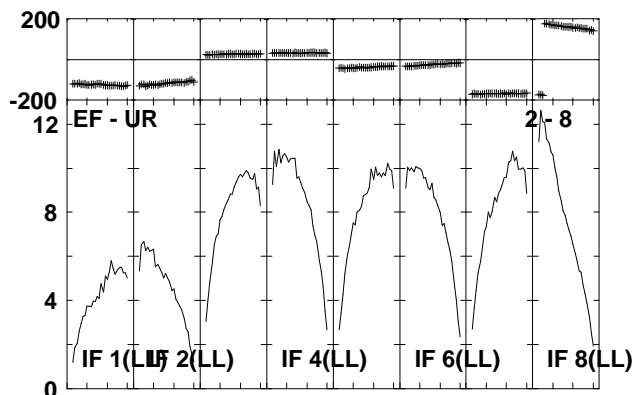
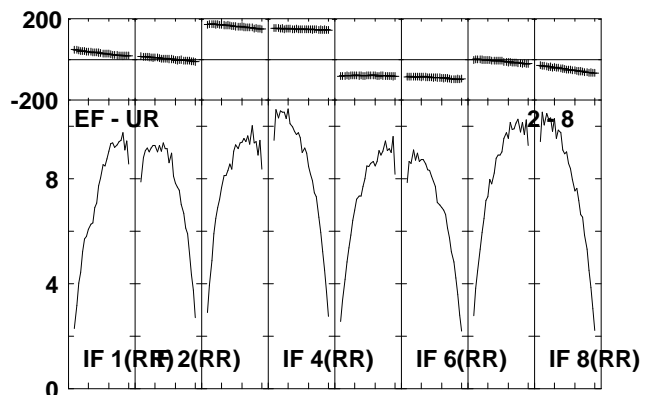
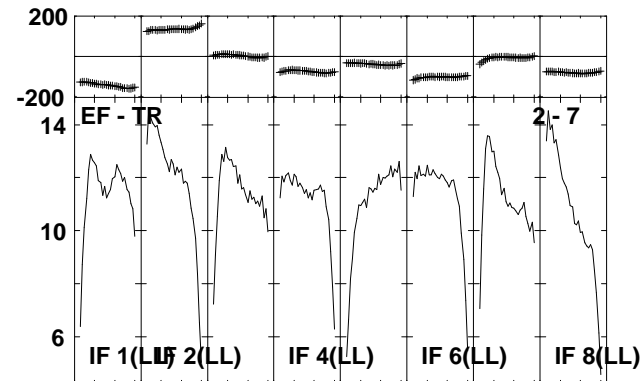
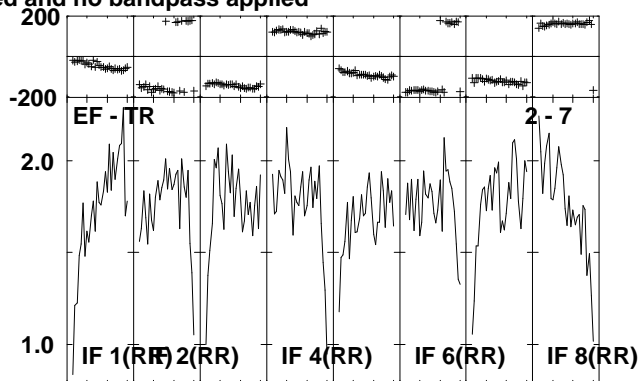
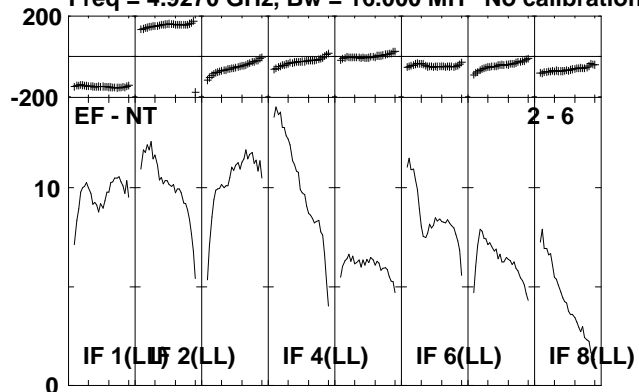

Lower frame: Milli Ampl Jy Top frame: Phas deg
Scalar averaged cross-power spectrum Several baselines displayed
Timerange: 00/12:39:11 to 00/12:40:49

Plot file version 89 created 06-JUL-2010 12:03:03

J2330+33 EP064L.UVDATA.1

Freq = 4.9270 GHz, Bw = 16.000 MH No calibration applied and no bandpass applied

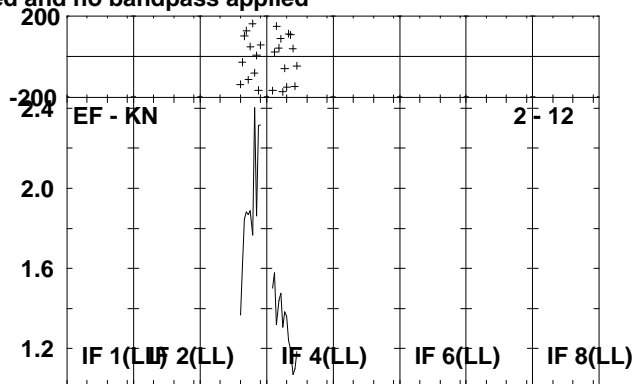
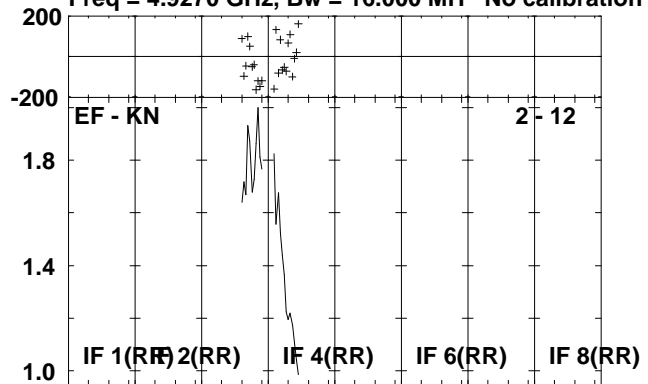

Lower frame: Milli Ampl Jy Top frame: Phas deg
Scalar averaged cross-power spectrum Several baselines displayed
Timerange: 00/12:39:11 to 00/12:40:49

Plot file version 90 created 06-JUL-2010 12:03:04

IRAS2336 EP064L.UVDATA.1

Freq = 4.9270 GHz, Bw = 16.000 MH No calibration applied and no bandpass applied

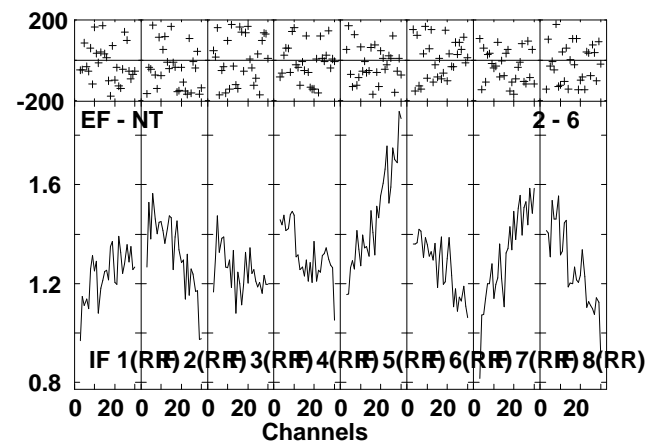
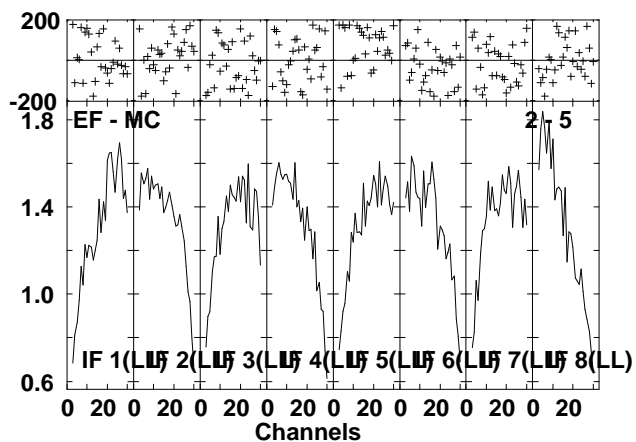
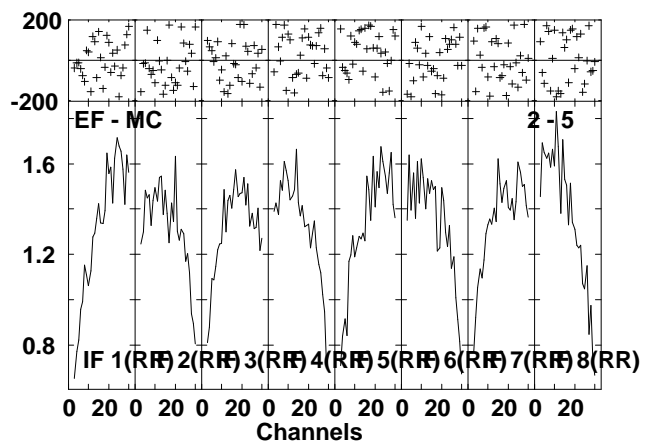
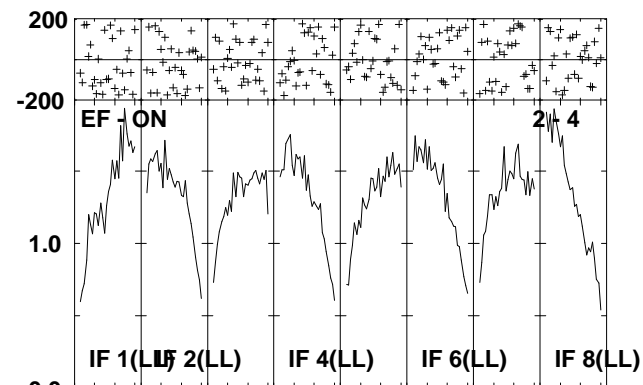
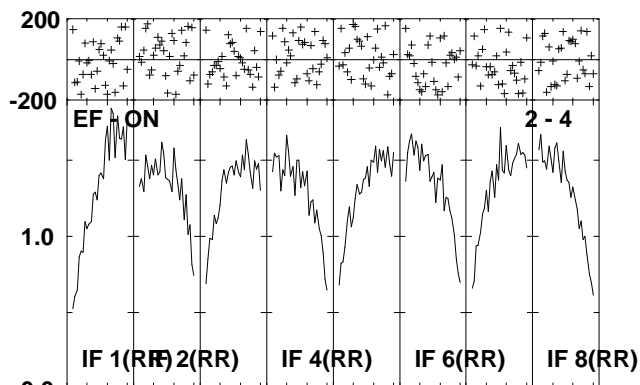
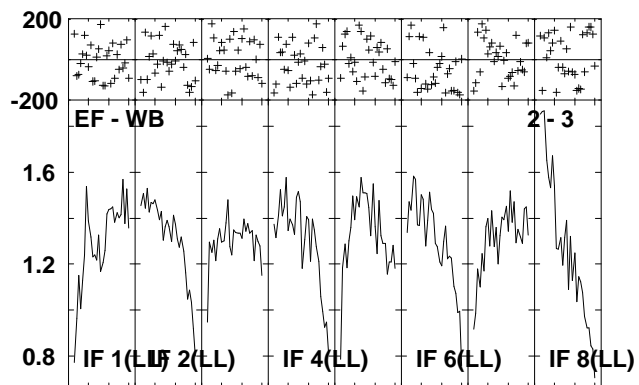
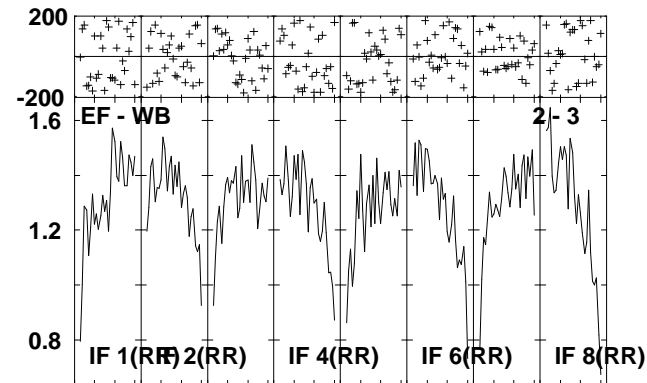
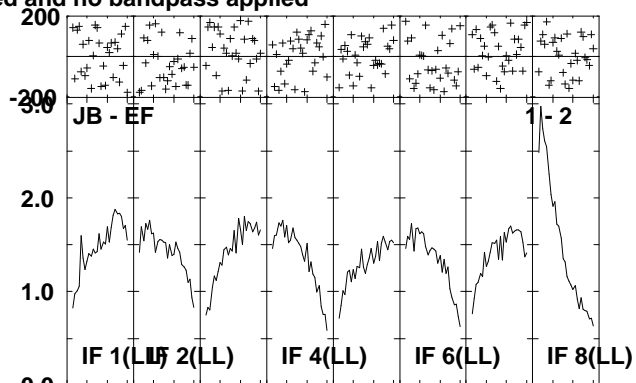
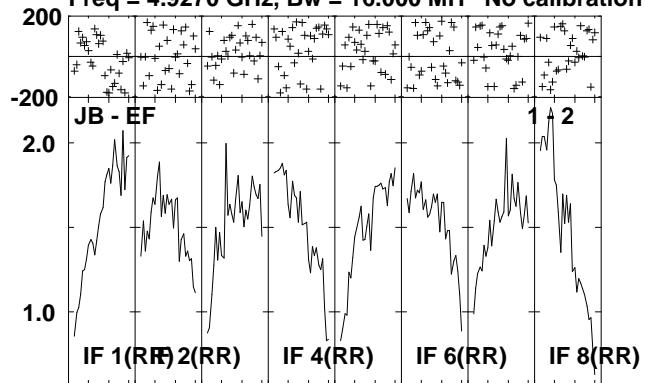

Lower frame: Milli Ampl Jy Top frame: Phas deg
Scalar averaged cross-power spectrum Several baselines displayed
Timerange: 00:12:40:51 to 00:12:44:29

Plot file version 91 created 06-JUL-2010 12:03:06

IRAS2336 EP064L.UVDATA.1

Freq = 4.9270 GHz, Bw = 16.000 MH No calibration applied and no bandpass applied

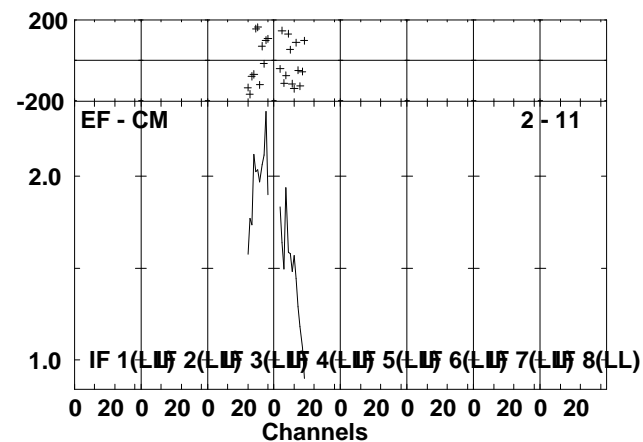
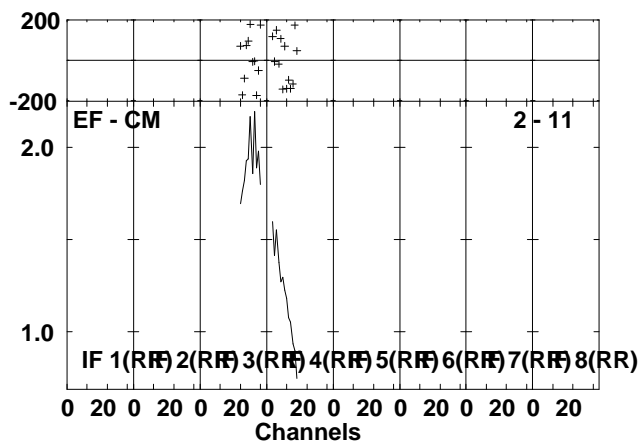
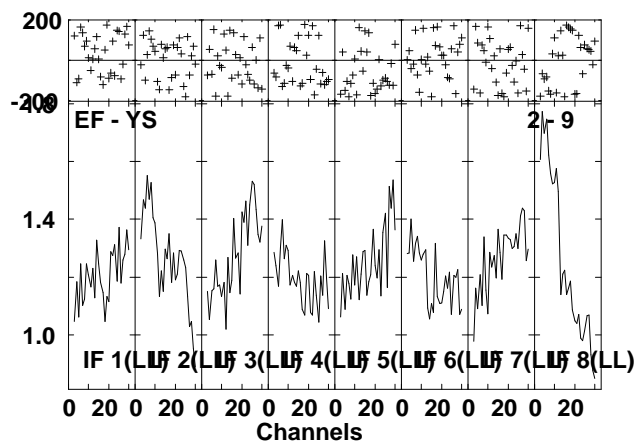
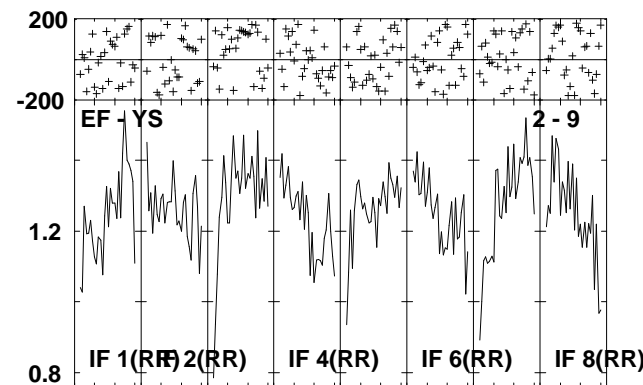
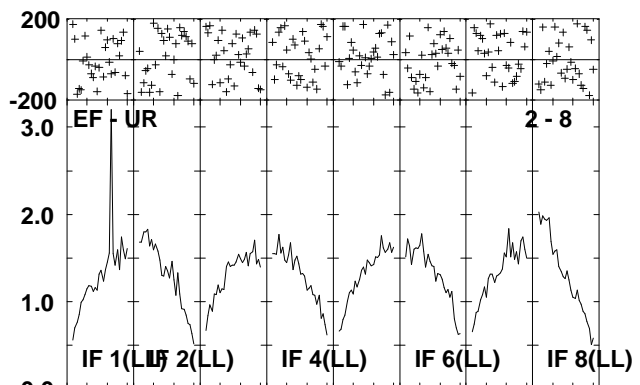
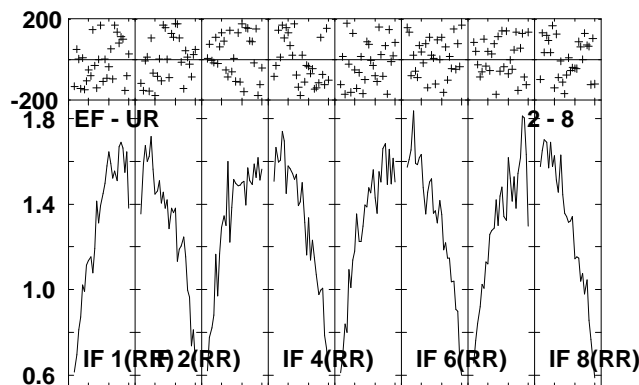
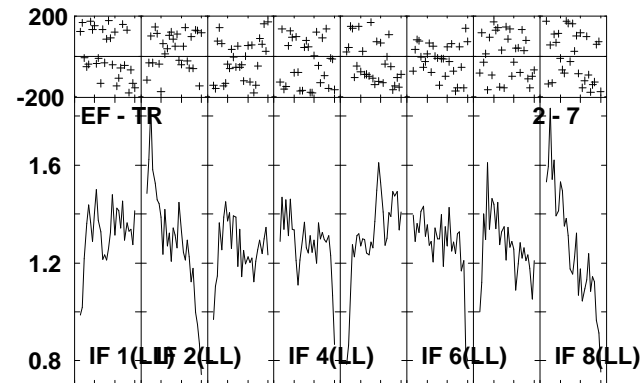
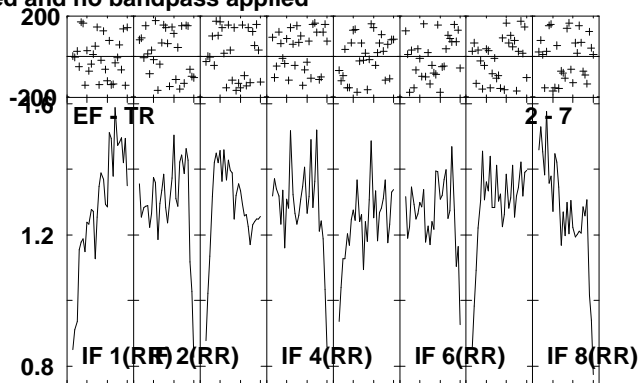
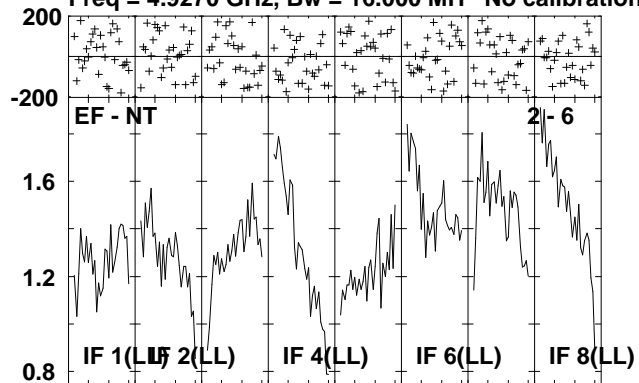

Lower frame: Milli Ampl Jy Top frame: Phas deg
Scalar averaged cross-power spectrum Several baselines displayed
Timerange: 00:12:40:51 to 00:12:44:29

Plot file version 92 created 06-JUL-2010 12:03:10

IRAS2336 EP064L.UVDATA.1

Freq = 4.9270 GHz, Bw = 16.000 MH No calibration applied and no bandpass applied

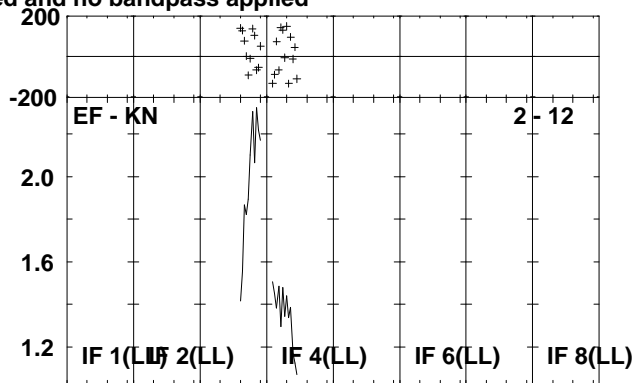
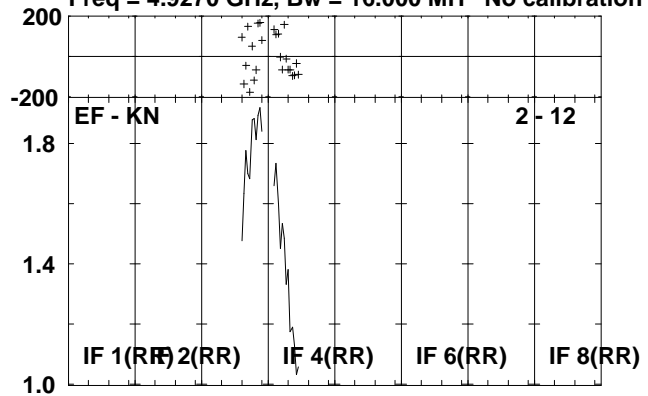

Lower frame: Milli Ampl Jy Top frame: Phas deg
Scalar averaged cross-power spectrum Several baselines displayed
Timerange: 00/12:40:51 to 00/12:44:29

Plot file version 93 created 06-JUL-2010 12:03:11

J2330+33 EP064L.UVDATA.1

Freq = 4.9270 GHz, Bw = 16.000 MH No calibration applied and no bandpass applied

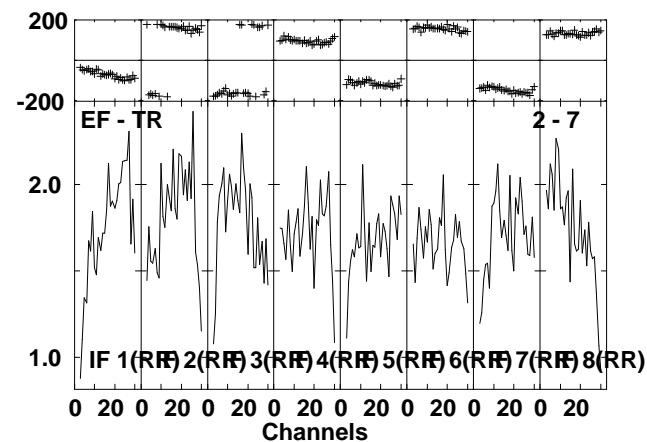
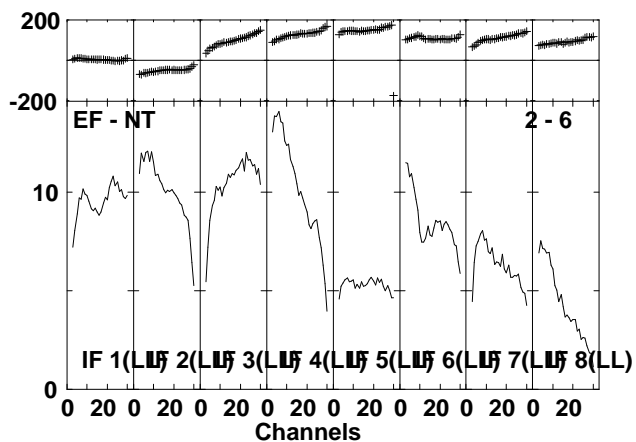
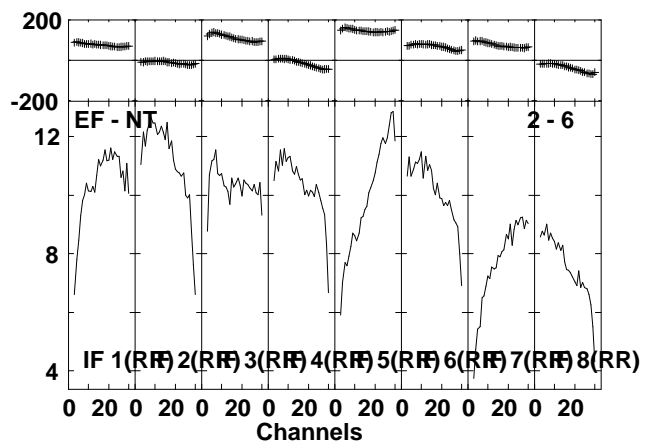
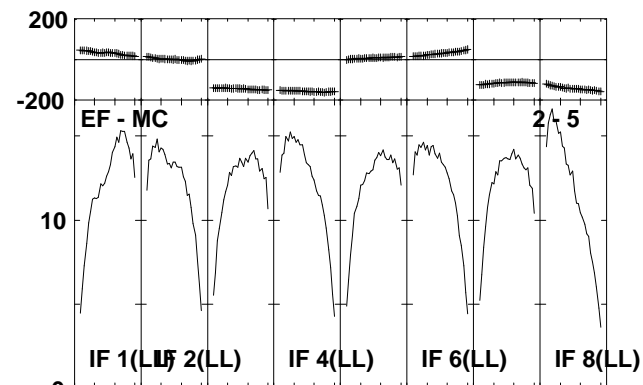
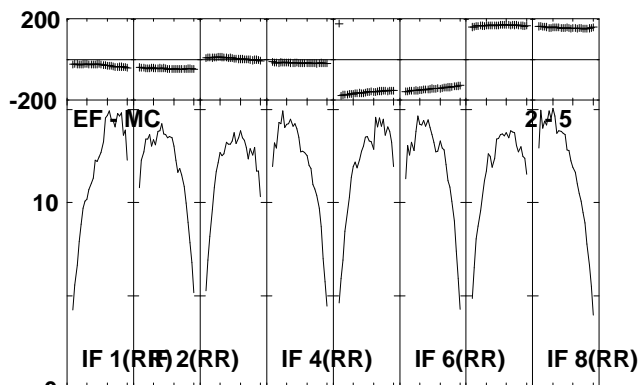
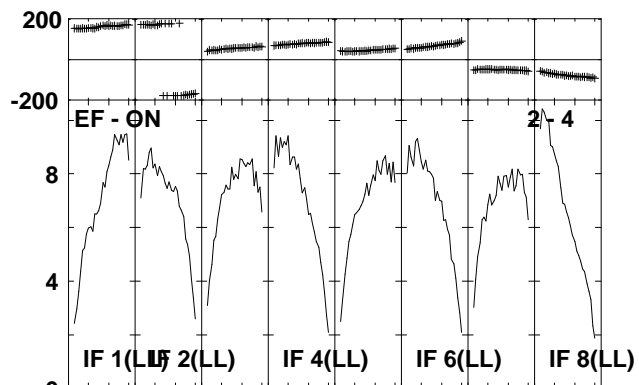
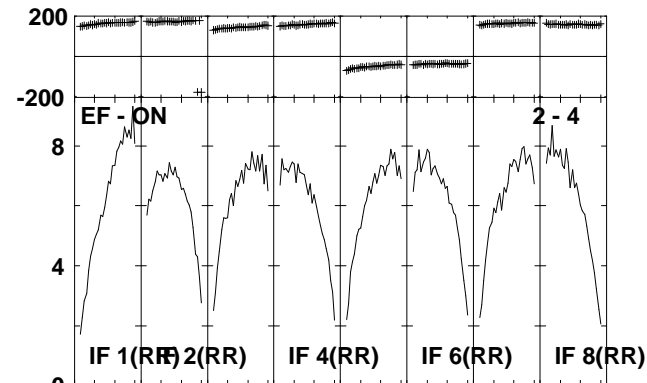
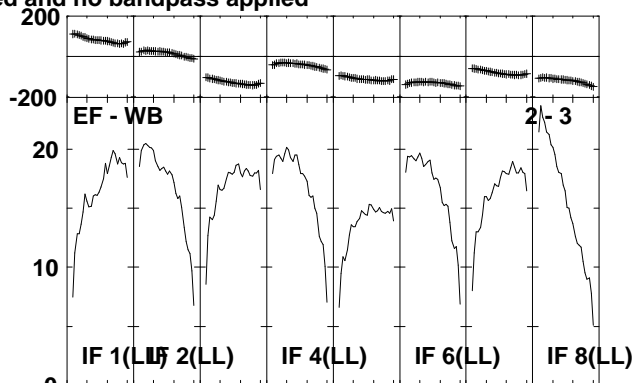
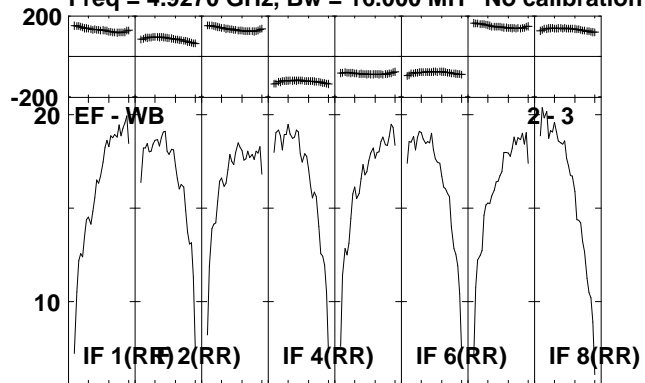

Lower frame: Milli Ampl Jy Top frame: Phas deg
Scalar averaged cross-power spectrum Several baselines displayed
Timerange: 00:12:44:31 to 00:12:46:19

Plot file version 94 created 06-JUL-2010 12:03:12

J2330+33 EP064L.UVDATA.1

Freq = 4.9270 GHz, Bw = 16.000 MH No calibration applied and no bandpass applied

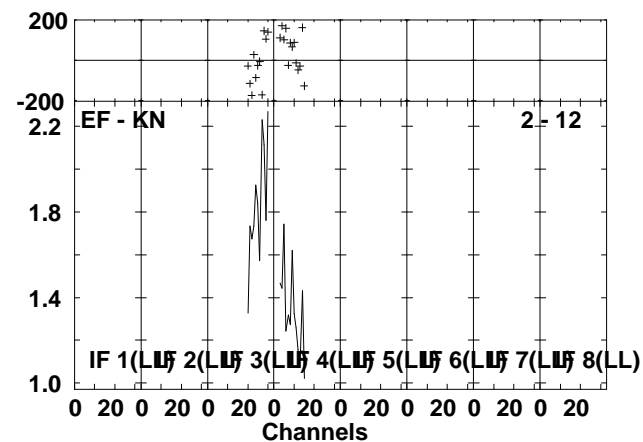
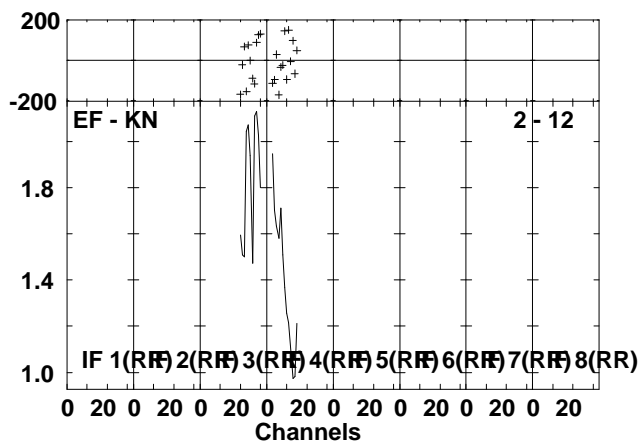
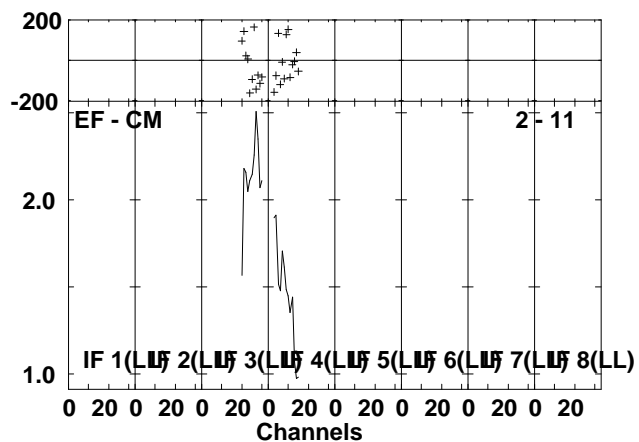
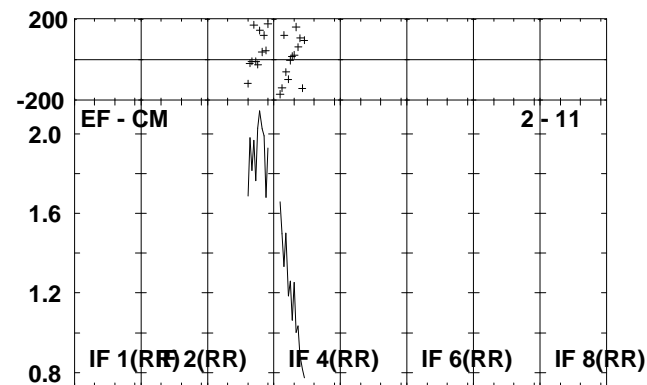
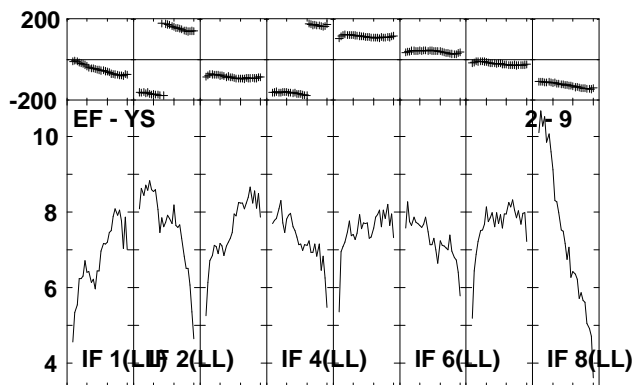
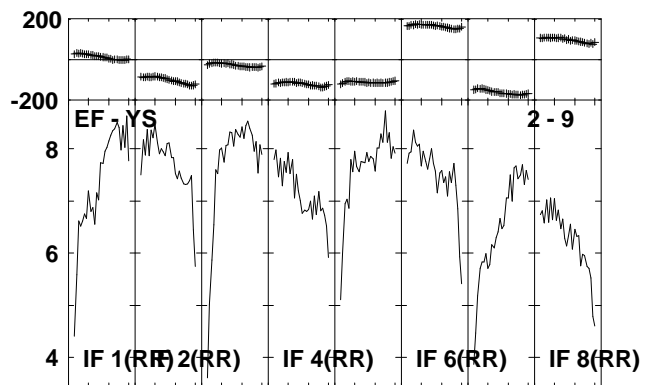
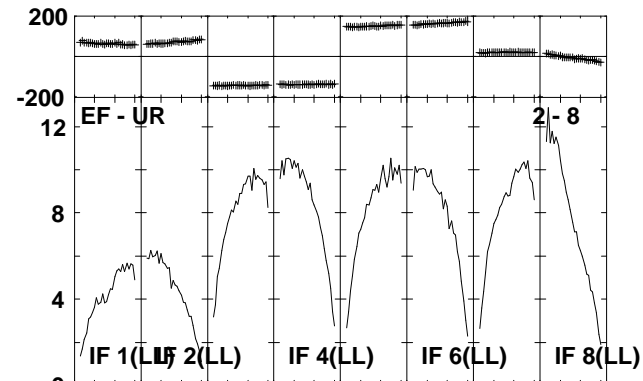
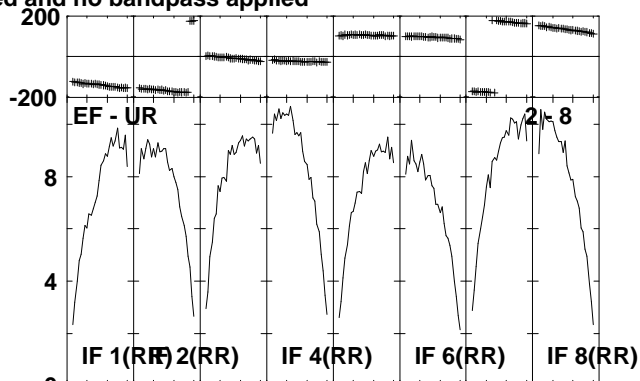
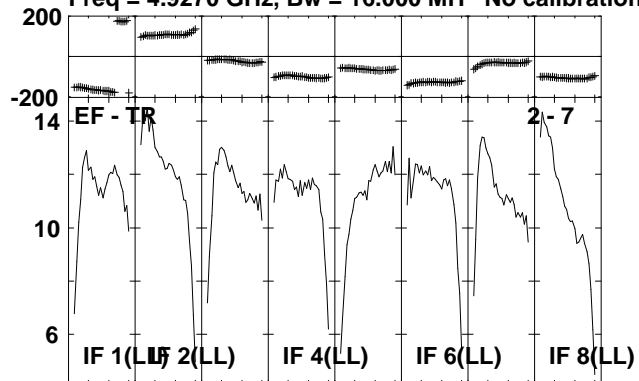

Lower frame: Milli Ampl Jy Top frame: Phas deg
Scalar averaged cross-power spectrum Several baselines displayed
Timerange: 00/12:44:31 to 00/12:46:19

Plot file version 95 created 06-JUL-2010 12:03:14

IRAS2336 EP064L.UVDATA.1

Freq = 4.9270 GHz, Bw = 16.000 MH No calibration applied and no bandpass applied

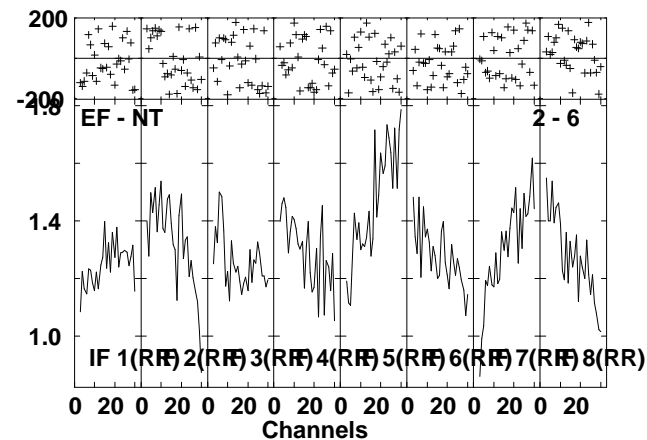
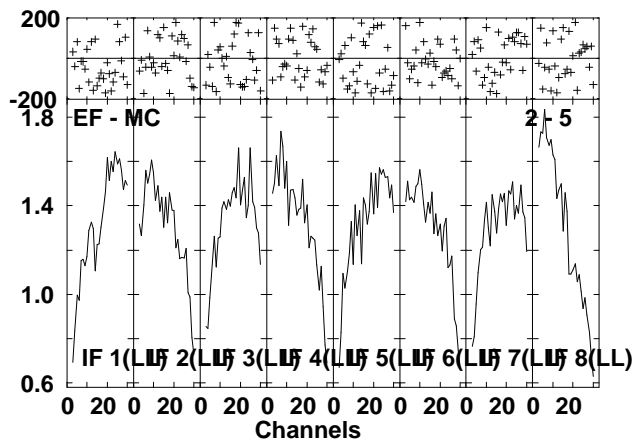
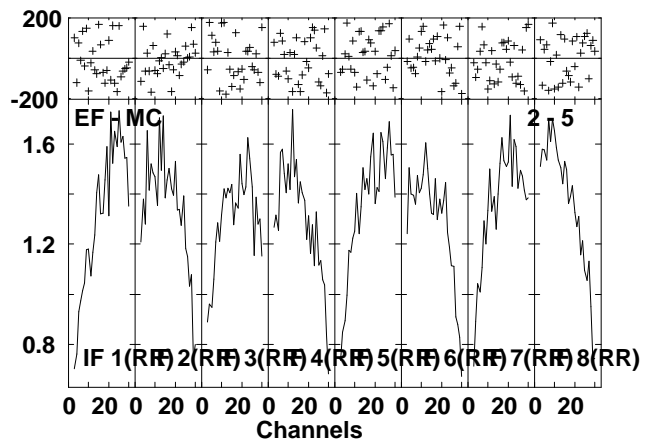
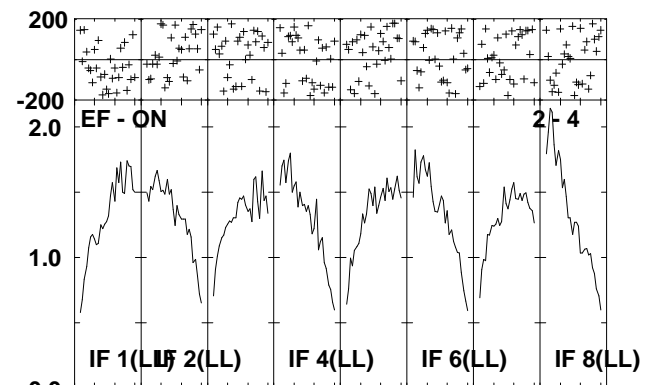
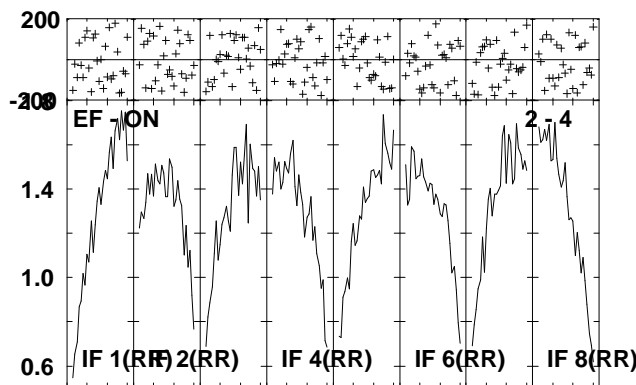
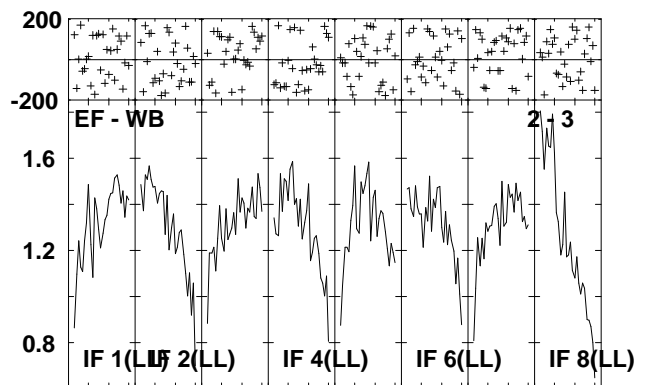
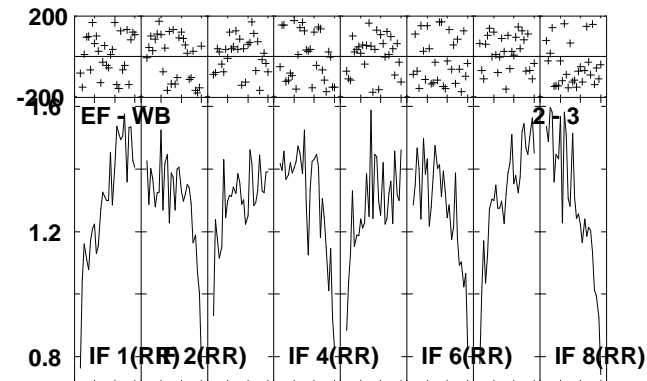
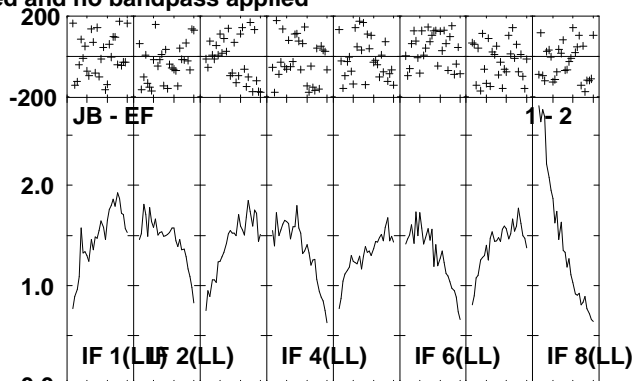
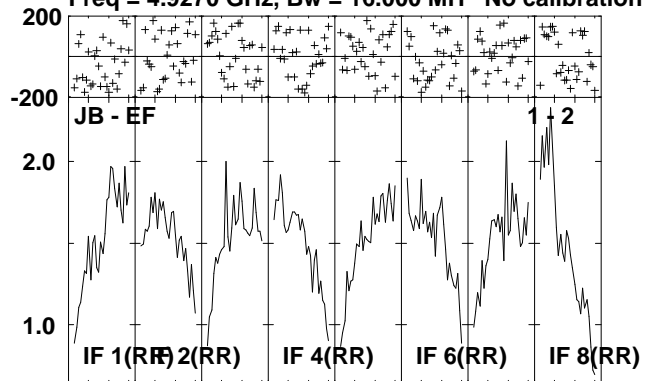

Lower frame: Milli Ampl Jy Top frame: Phas deg
Scalar averaged cross-power spectrum Several baselines displayed
Timerange: 00:12:46:21 to 00:12:49:59

Plot file version 96 created 06-JUL-2010 12:03:21

IRAS2336 EP064L.UVDATA.1

Freq = 4.9270 GHz, Bw = 16.000 MH No calibration applied and no bandpass applied

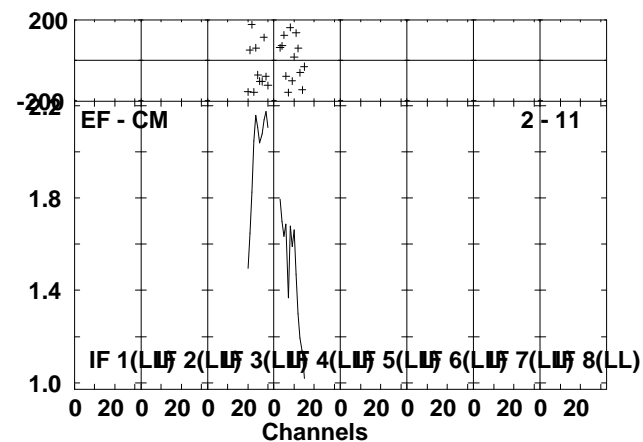
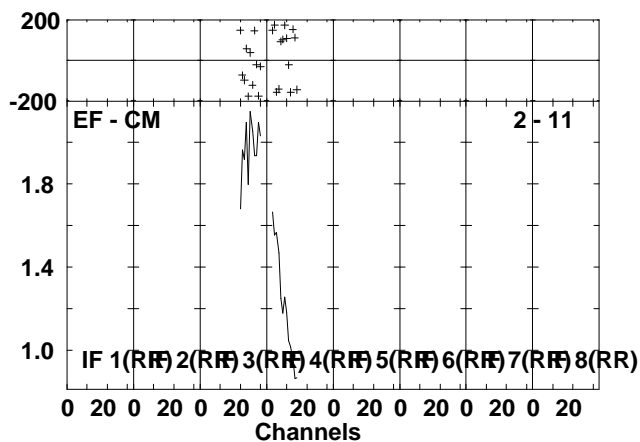
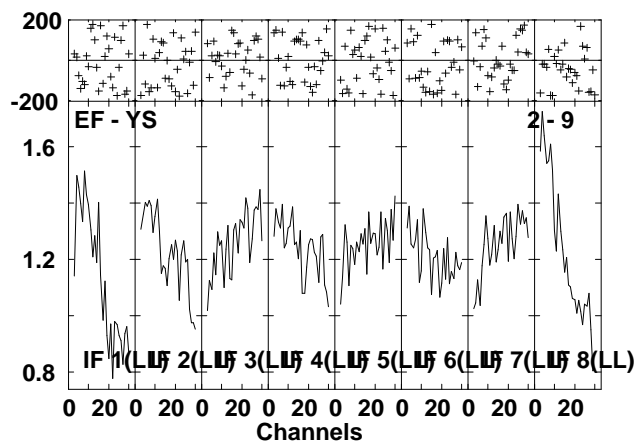
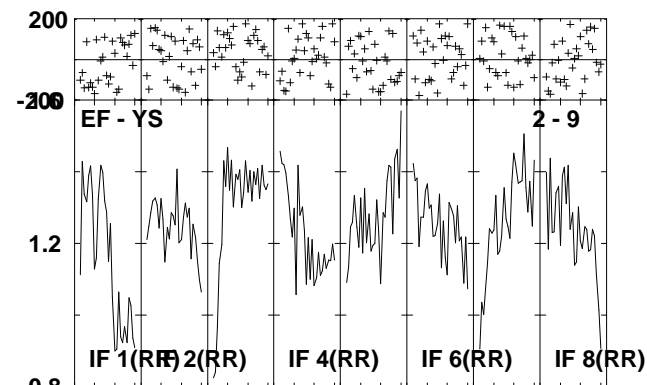
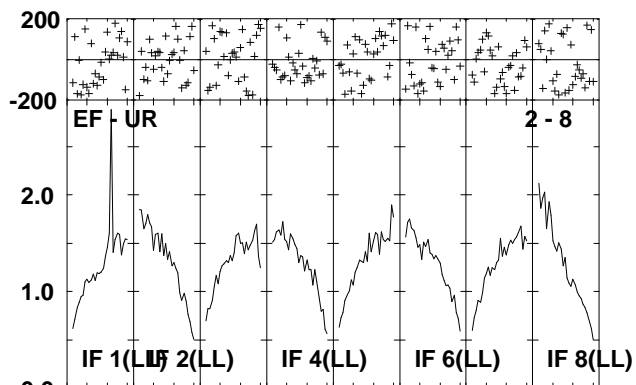
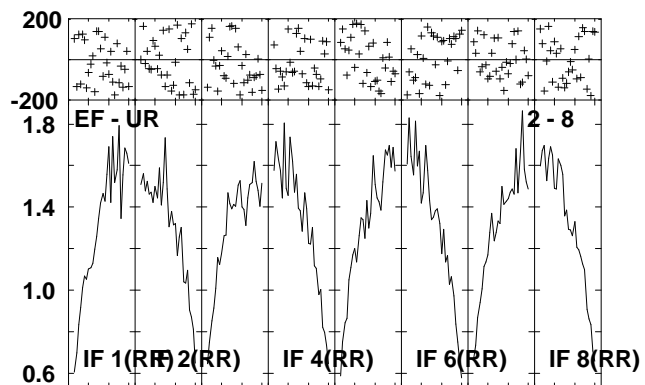
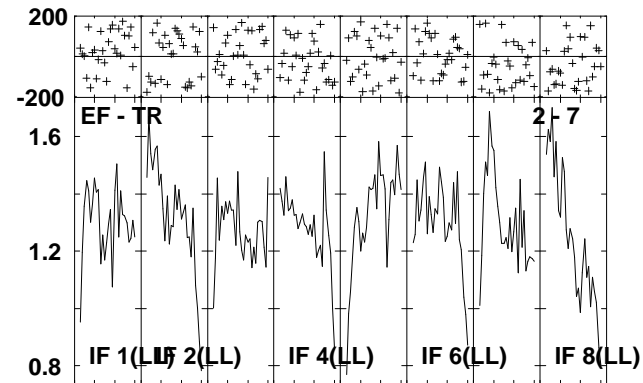
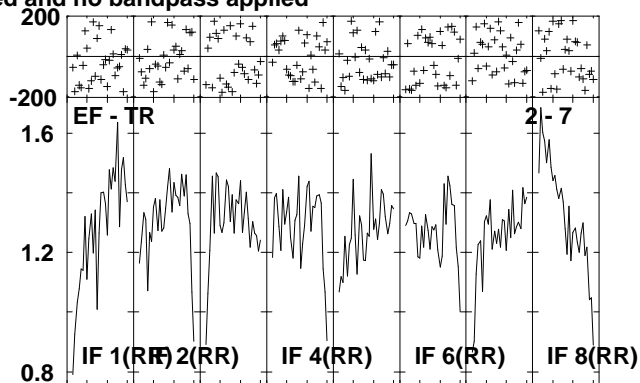
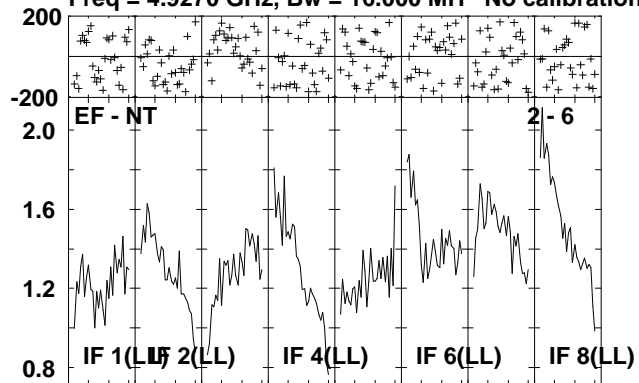

Lower frame: Milli Ampl Jy Top frame: Phas deg
Scalar averaged cross-power spectrum Several baselines displayed
Timerange: 00:12:46:21 to 00:12:49:59

Plot file version 97 created 06-JUL-2010 12:03:25

IRAS2336 EP064L.UVDATA.1

Freq = 4.9270 GHz, Bw = 16.000 MH No calibration applied and no bandpass applied

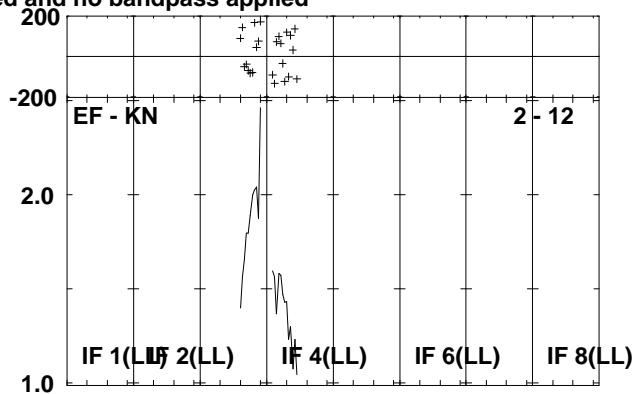
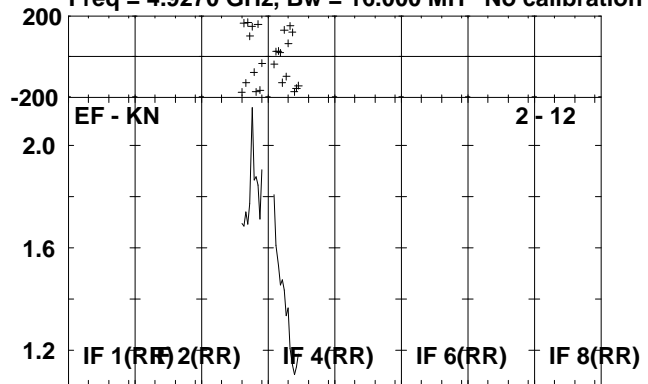

Lower frame: Milli Ampl Jy Top frame: Phas deg
Scalar averaged cross-power spectrum Several baselines displayed
Timerange: 00/12:46:21 to 00/12:49:59

Plot file version 98 created 06-JUL-2010 12:03:25

J2330+33 EP064L.UVDATA.1

Freq = 4.9270 GHz, Bw = 16.000 MH No calibration applied and no bandpass applied

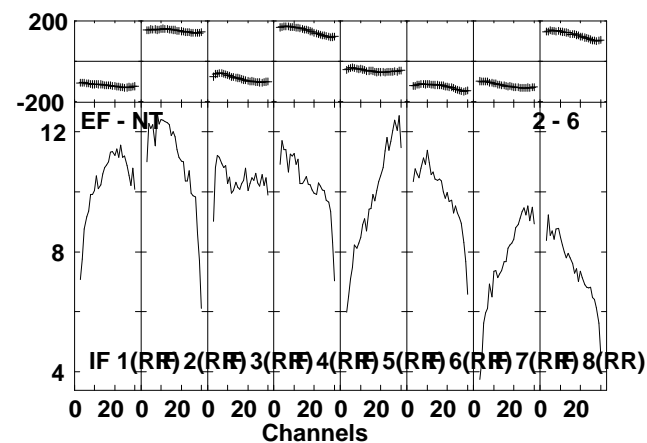
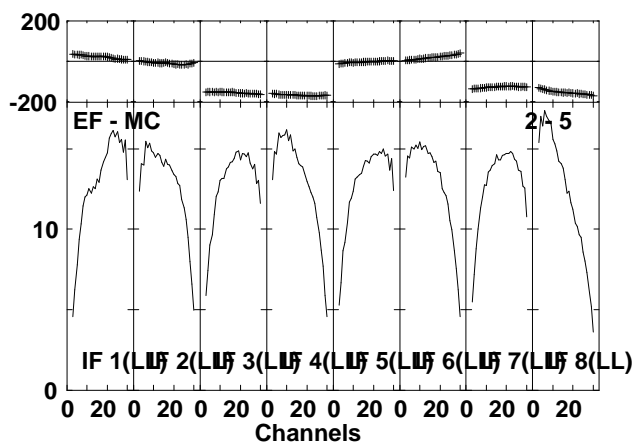
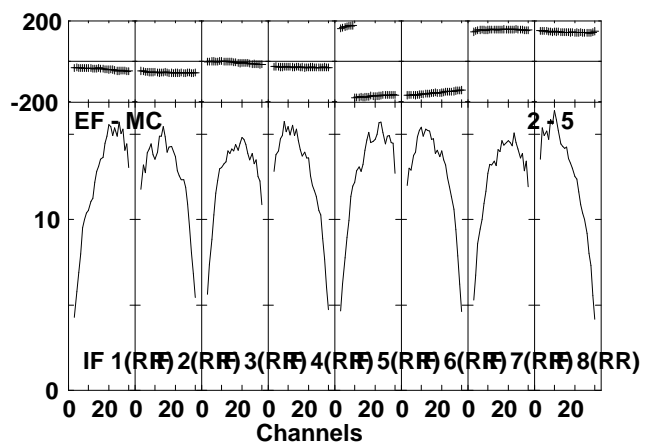
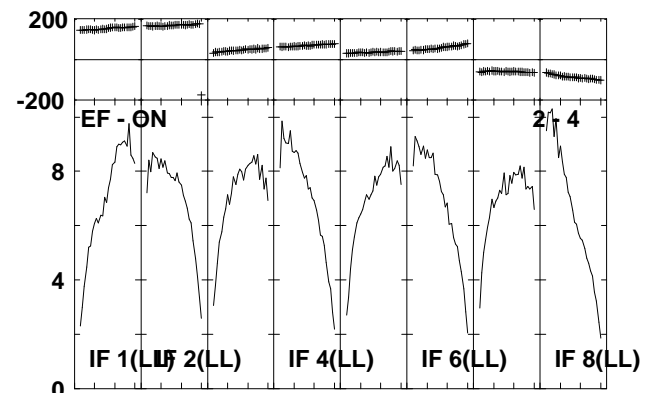
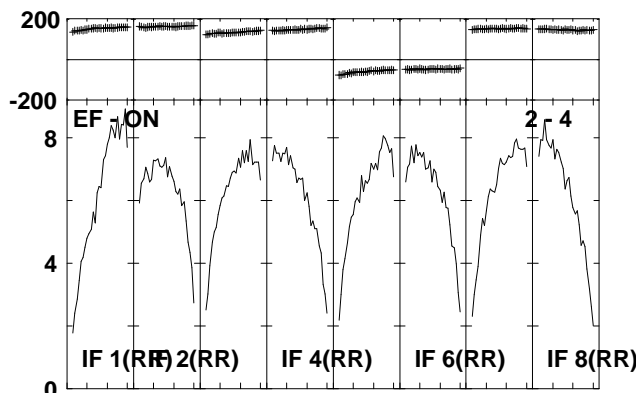
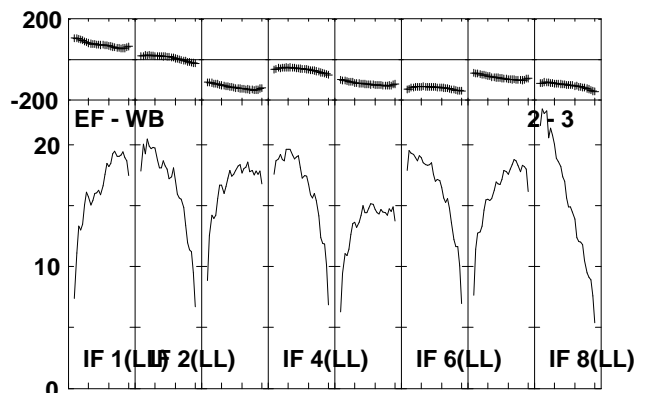
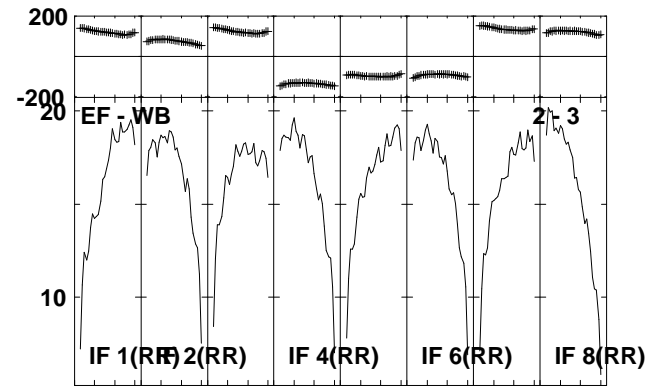
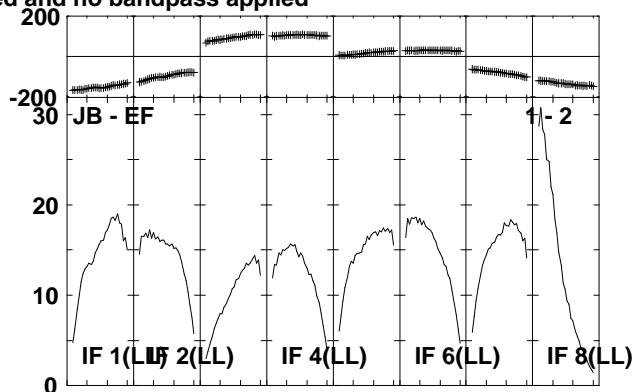
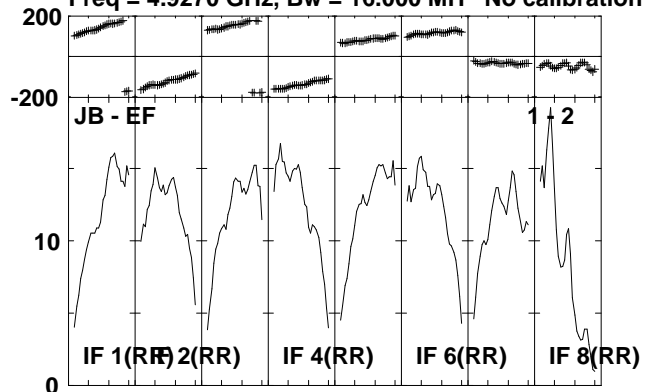

Lower frame: Milli Ampl Jy Top frame: Phas deg
Scalar averaged cross-power spectrum Several baselines displayed
Timerange: 00:12:50:01 to 00:12:51:49

Plot file version 99 created 06-JUL-2010 12:03:27

J2330+33 EP064L.UVDATA.1

Freq = 4.9270 GHz, Bw = 16.000 MH No calibration applied and no bandpass applied

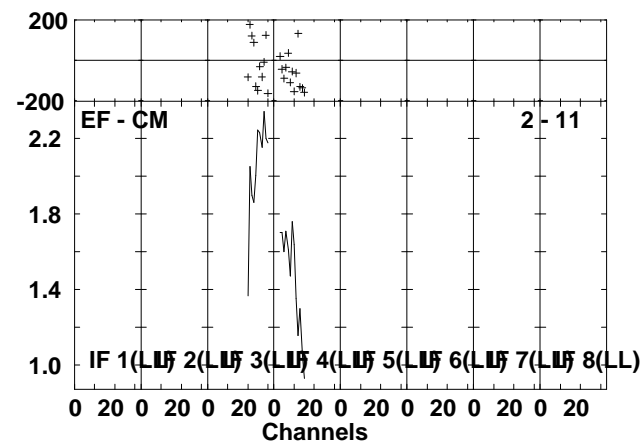
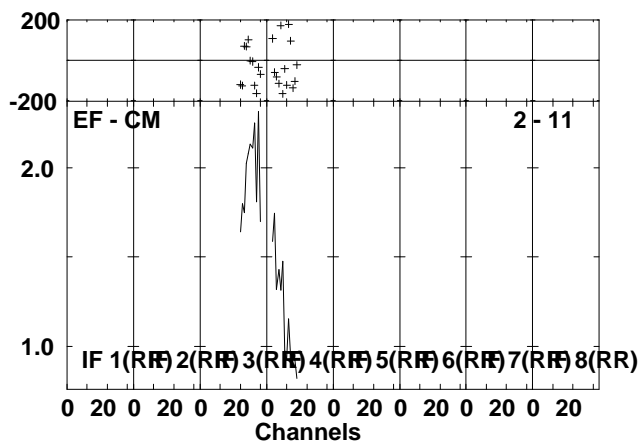
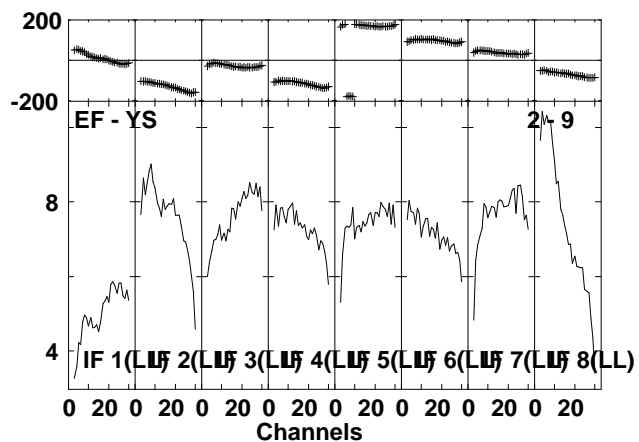
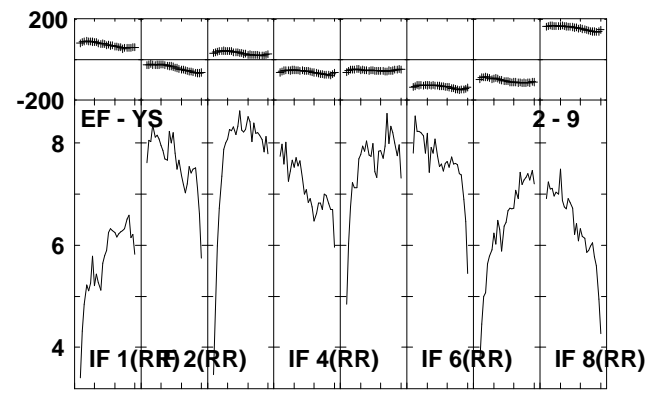
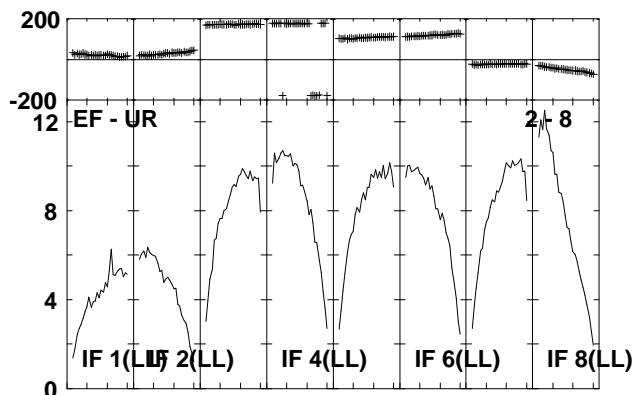
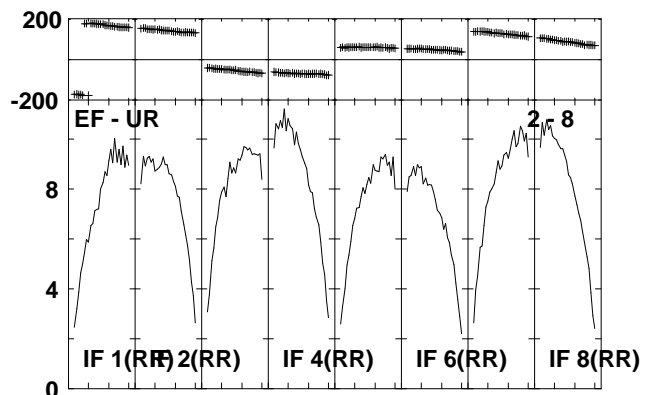
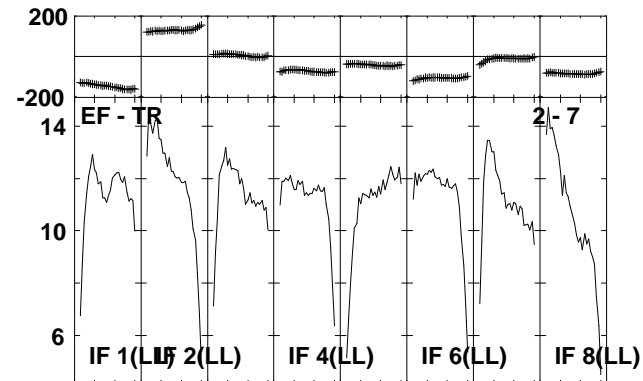
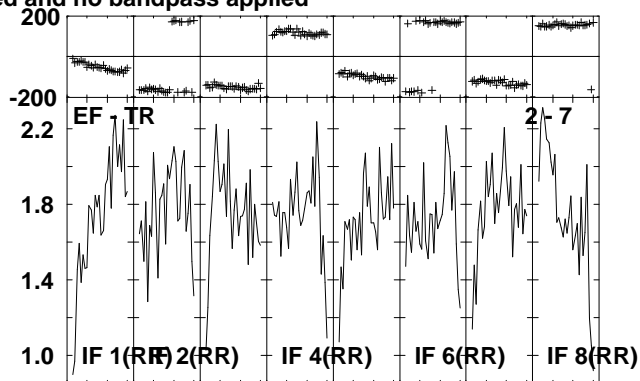
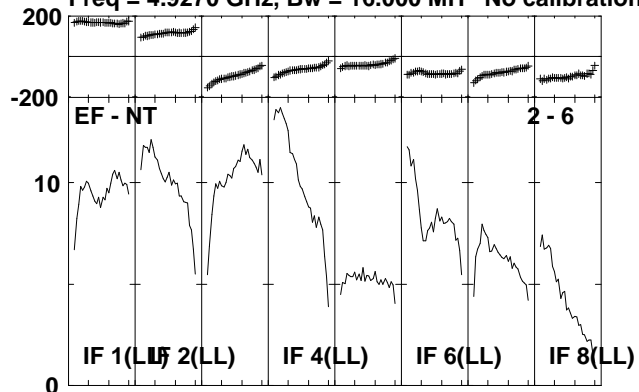

Lower frame: Milli Ampl Jy Top frame: Phas deg
Scalar averaged cross-power spectrum Several baselines displayed
Timerange: 00:12:50:01 to 00:12:51:49

Plot file version 100 created 06-JUL-2010 12:03:28

J2330+33 EP064L.UVDATA.1

Freq = 4.9270 GHz, Bw = 16.000 MH No calibration applied and no bandpass applied

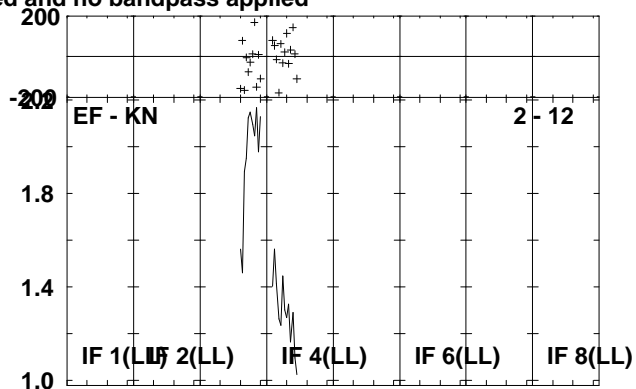
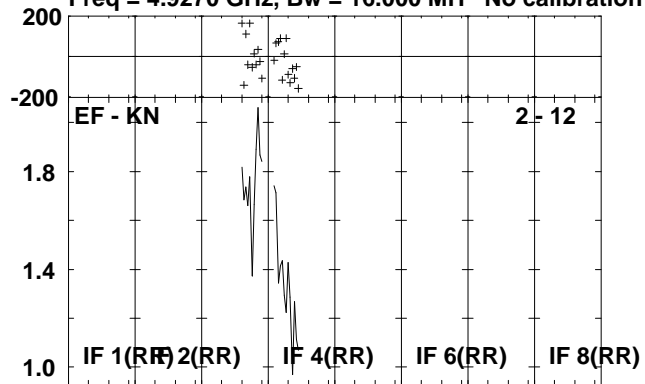

Lower frame: Milli Ampl Jy Top frame: Phas deg
Scalar averaged cross-power spectrum Several baselines displayed
Timerange: 00/12:50:01 to 00/12:51:49

Plot file version 101 created 06-JUL-2010 12:03:29

IRAS2336 EP064L.UVDATA.1

Freq = 4.9270 GHz, Bw = 16.000 MH No calibration applied and no bandpass applied

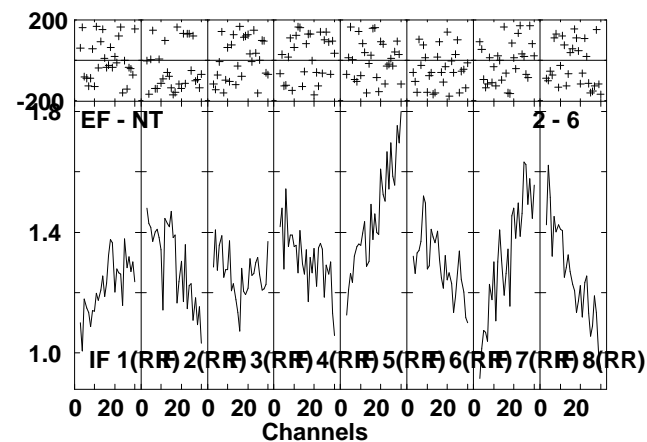
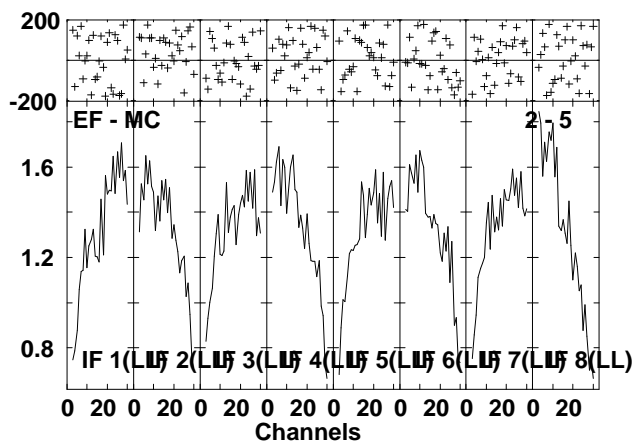
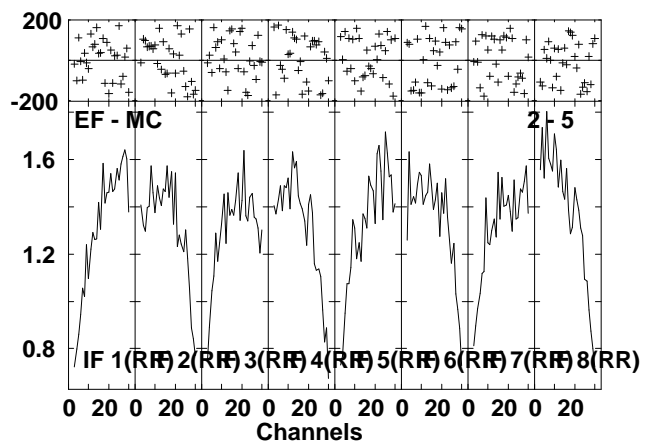
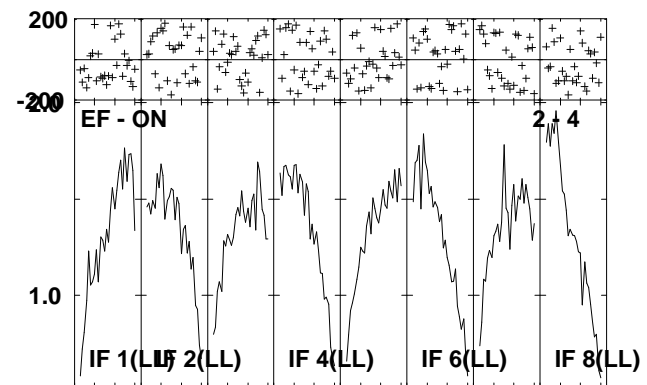
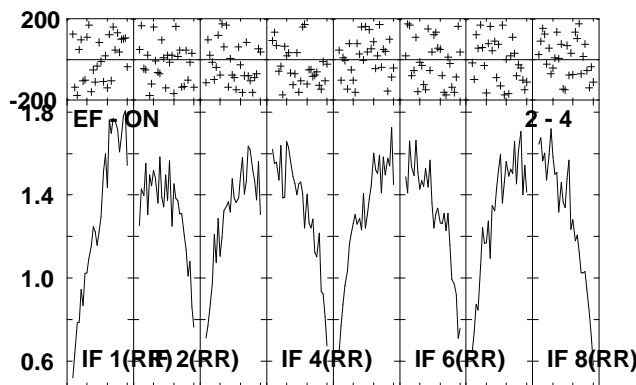
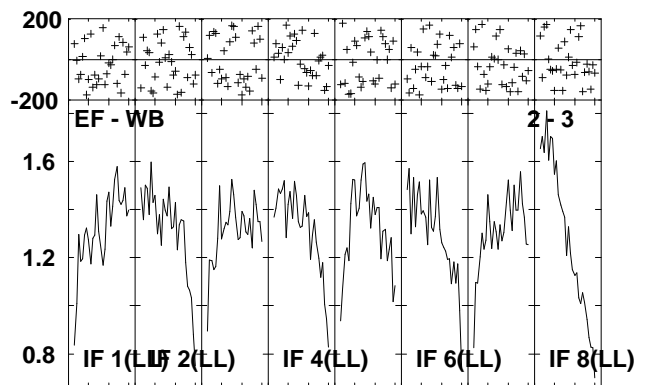
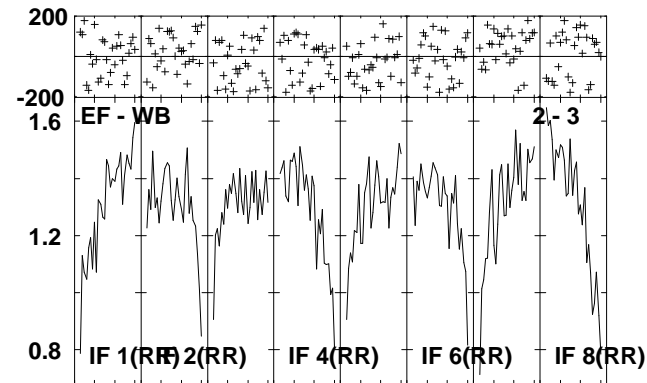
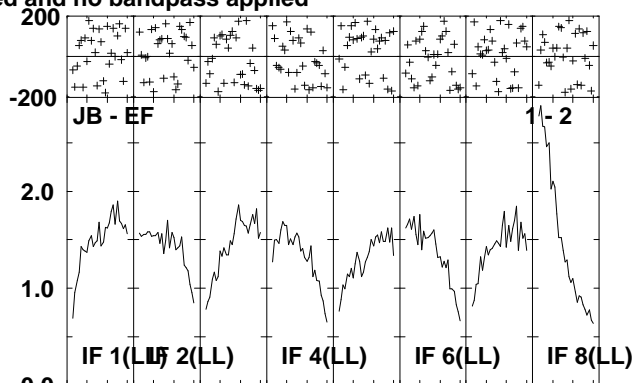
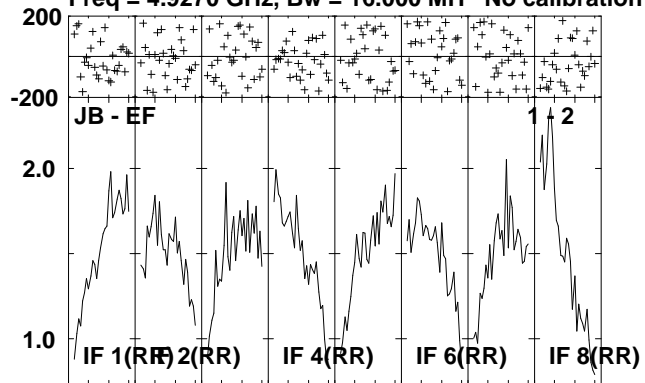

Lower frame: Milli Ampl Jy Top frame: Phas deg
Scalar averaged cross-power spectrum Several baselines displayed
Timerange: 00/12:51:51 to 00/12:55:27

Plot file version 102 created 06-JUL-2010 12:03:32

IRAS2336 EP064L.UVDATA.1

Freq = 4.9270 GHz, Bw = 16.000 MH No calibration applied and no bandpass applied

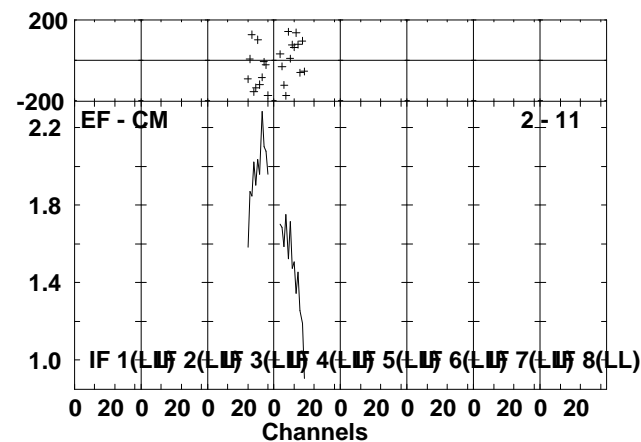
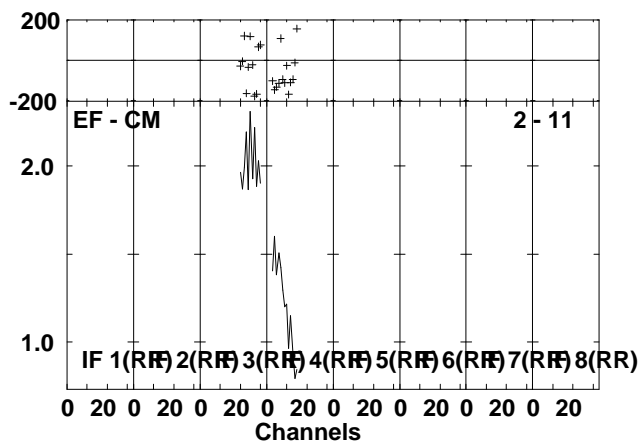
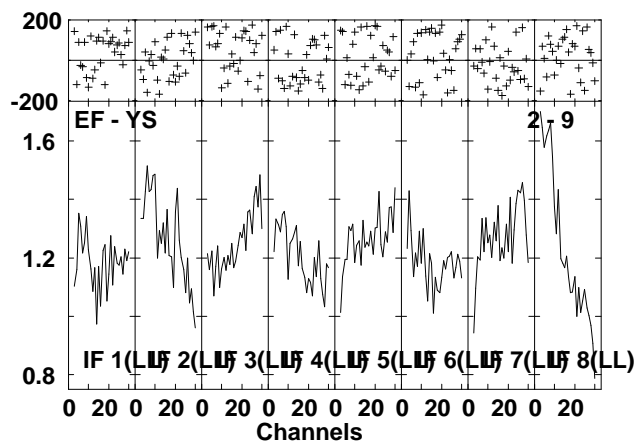
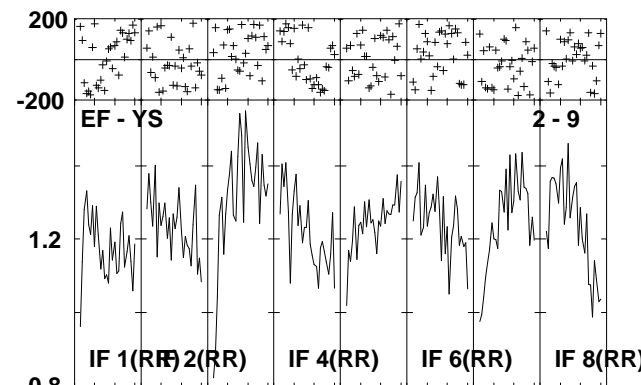
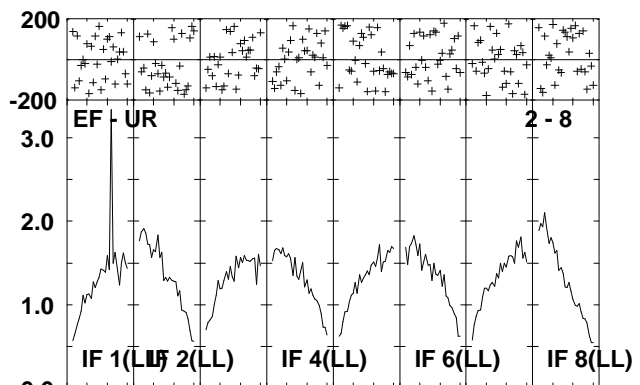
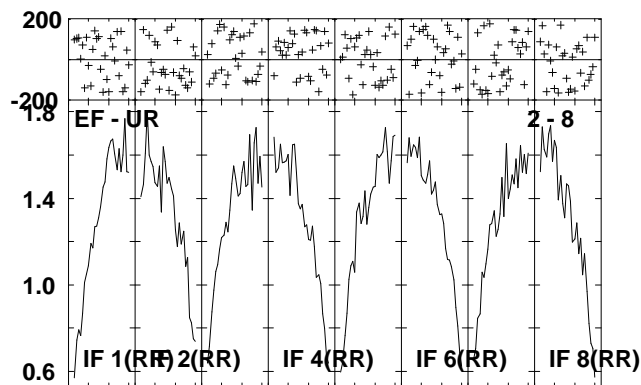
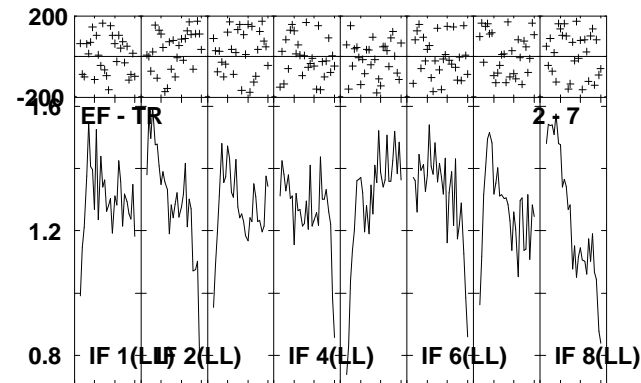
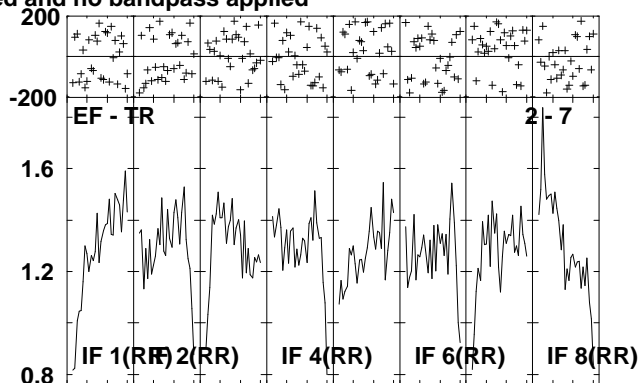
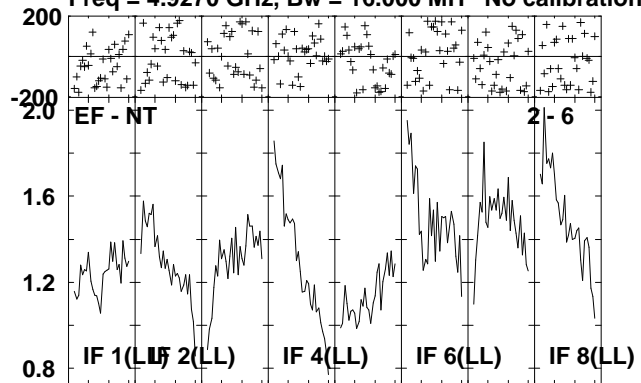

Lower frame: Milli Ampl Jy Top frame: Phas deg
Scalar averaged cross-power spectrum Several baselines displayed
Timerange: 00:12:51:51 to 00:12:55:27

Plot file version 103 created 06-JUL-2010 12:03:35

IRAS2336 EP064L.UVDATA.1

Freq = 4.9270 GHz, Bw = 16.000 MH No calibration applied and no bandpass applied

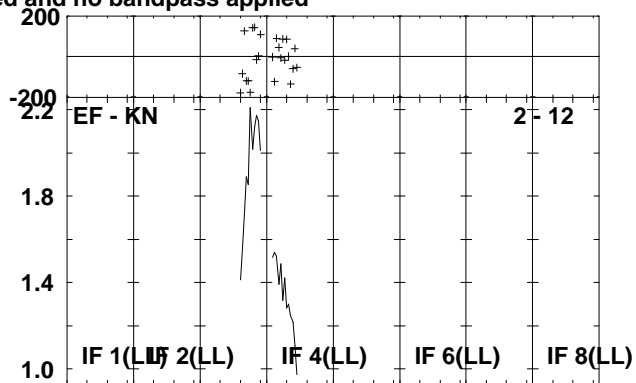
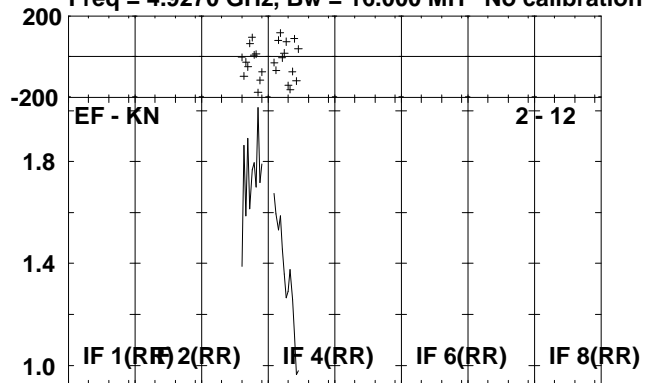

Lower frame: Milli Ampl Jy Top frame: Phas deg
Scalar averaged cross-power spectrum Several baselines displayed
Timerange: 00/12:51:51 to 00/12:55:27

Plot file version 104 created 06-JUL-2010 12:03:36

J2330+33 EP064L.UVDATA.1

Freq = 4.9270 GHz, Bw = 16.000 MH No calibration applied and no bandpass applied

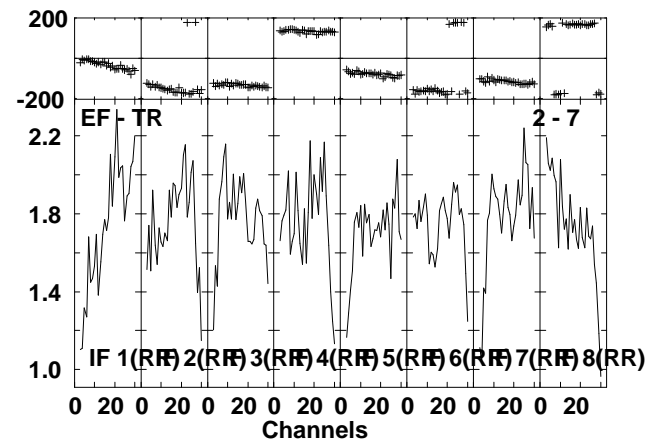
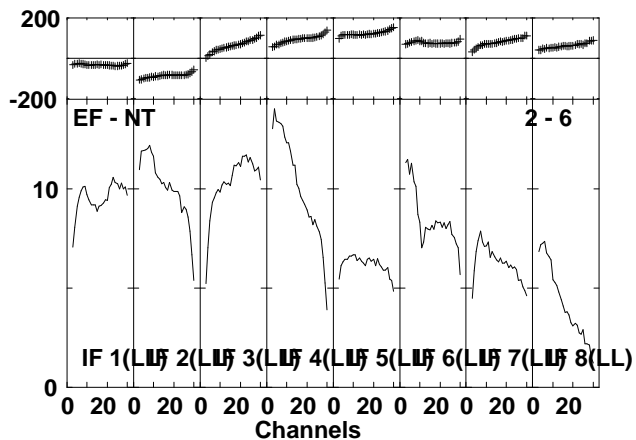
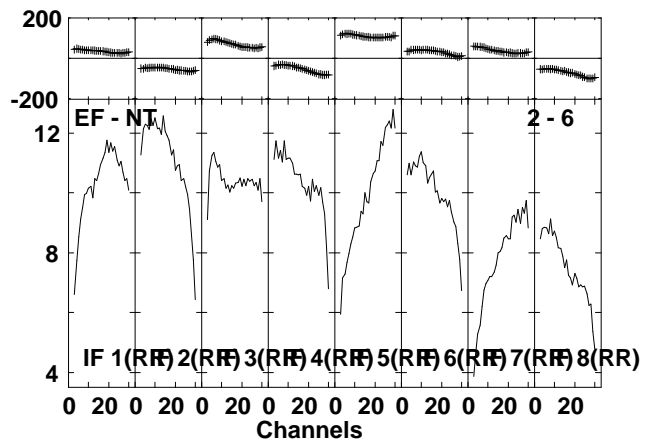
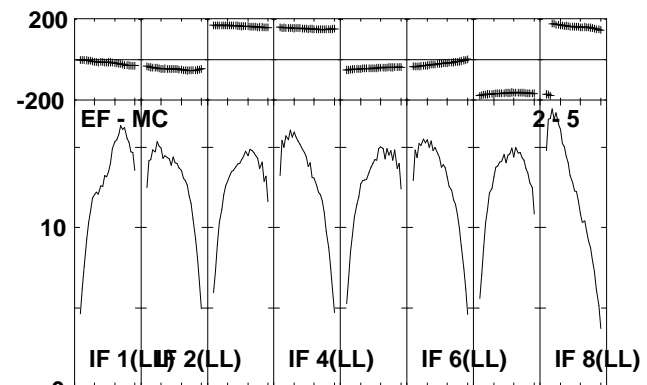
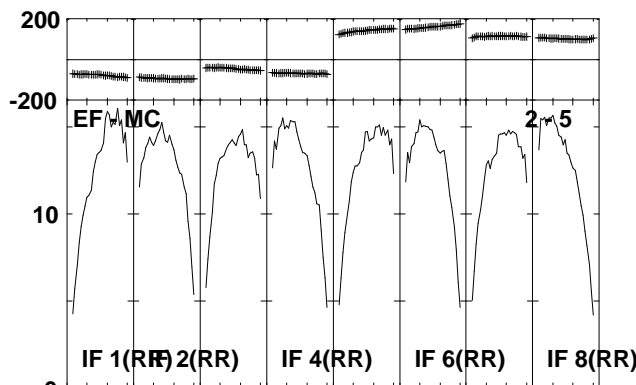
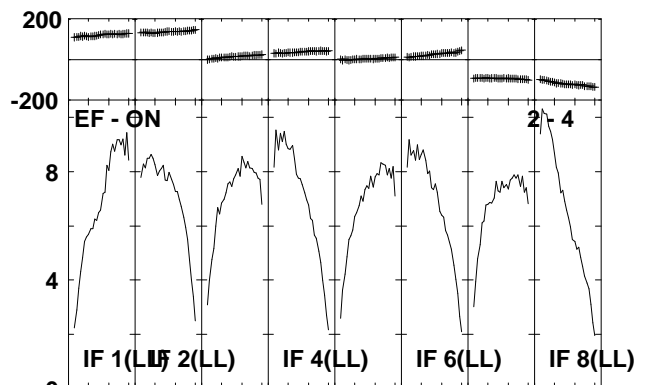
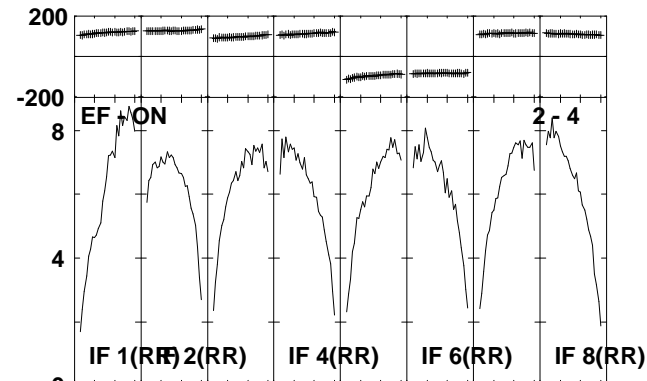
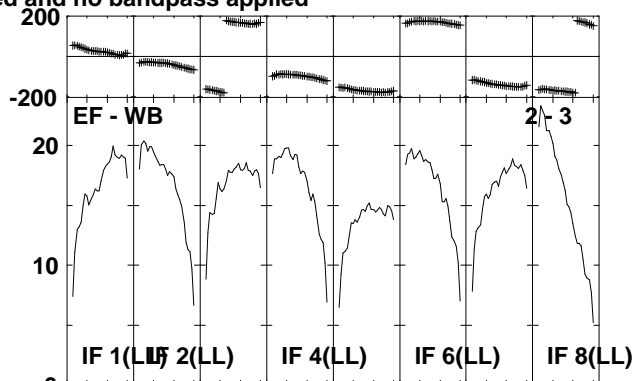
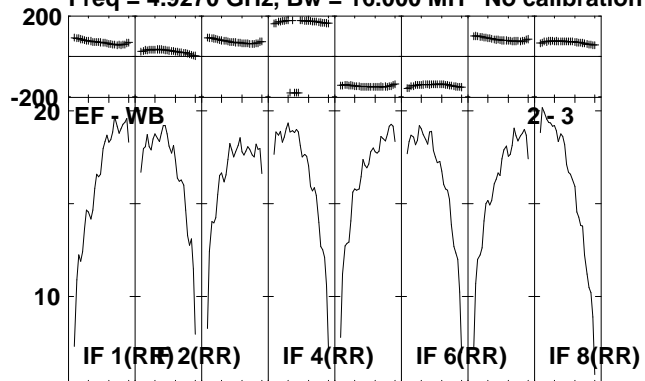

Lower frame: Milli Ampl Jy Top frame: Phas deg
Scalar averaged cross-power spectrum Several baselines displayed
Timerange: 00:12:56:31 to 00:12:58:07

Plot file version 105 created 06-JUL-2010 12:03:37

J2330+33 EP064L.UVDATA.1

Freq = 4.9270 GHz, Bw = 16.000 MH No calibration applied and no bandpass applied

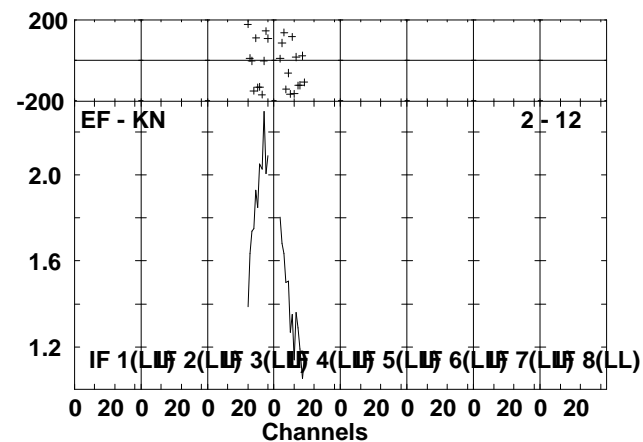
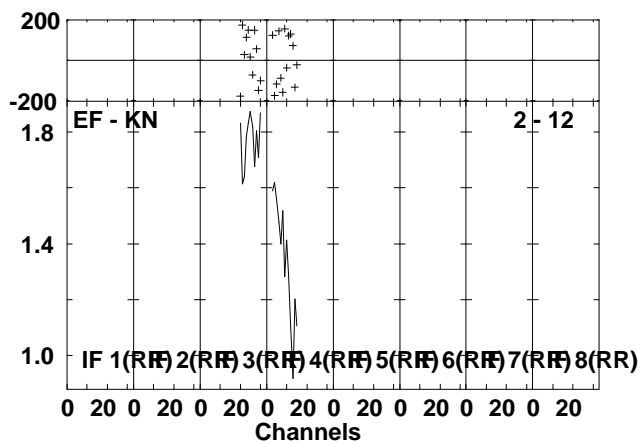
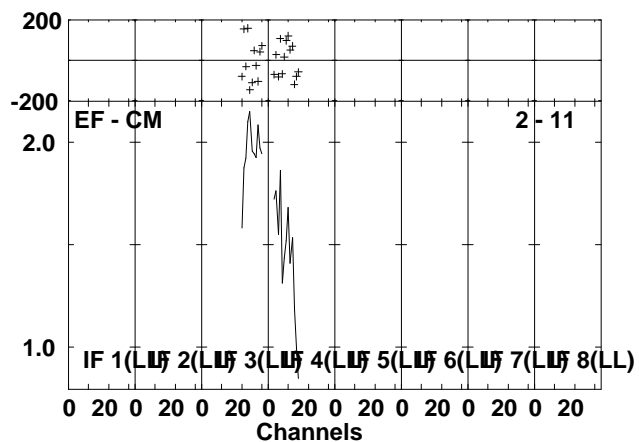
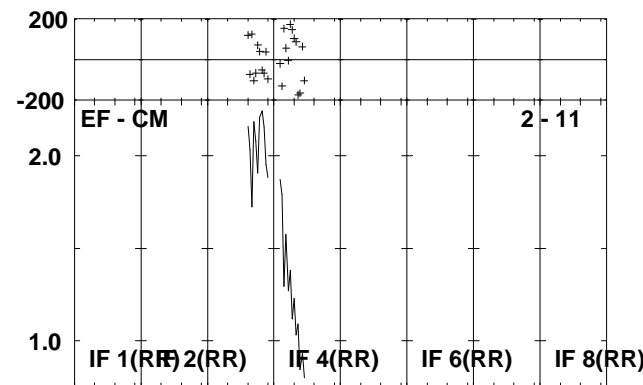
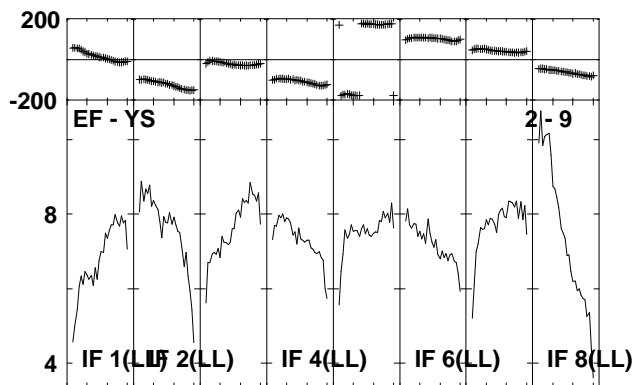
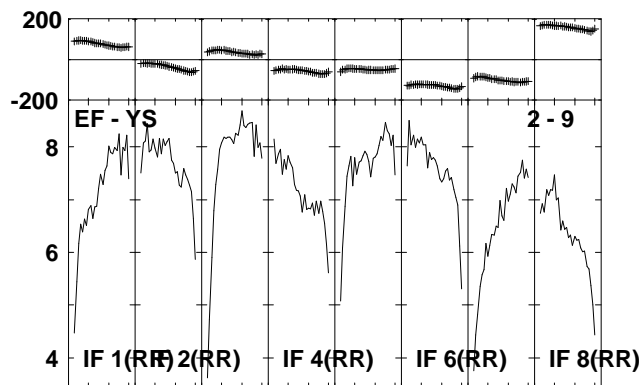
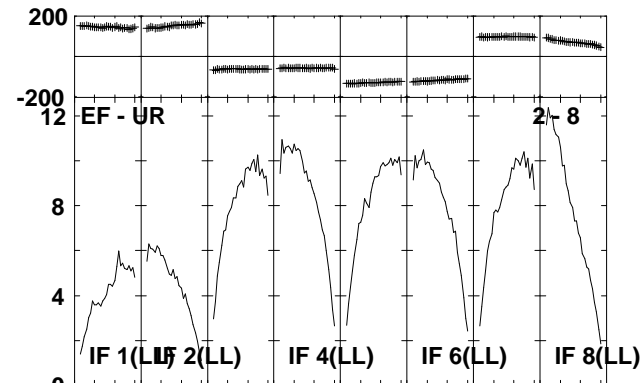
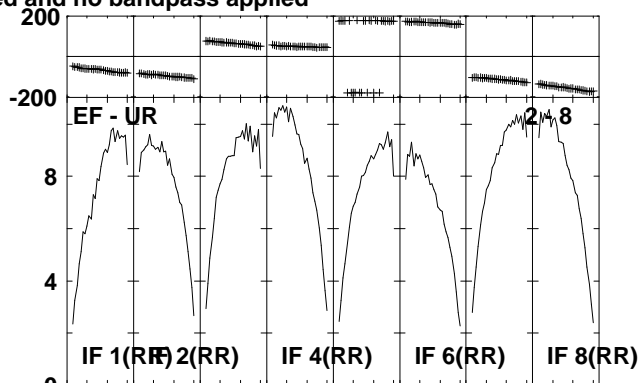
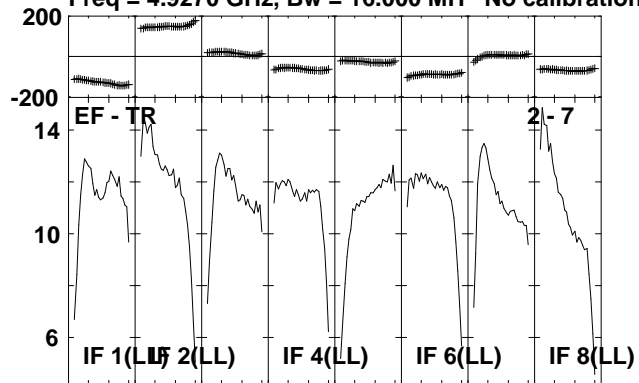

Lower frame: Milli Ampl Jy Top frame: Phas deg
Scalar averaged cross-power spectrum Several baselines displayed
Timerange: 00/12:56:31 to 00/12:58:07

Plot file version 106 created 06-JUL-2010 12:03:38

IRAS2336 EP064L.UVDATA.1

Freq = 4.9270 GHz, Bw = 16.000 MH No calibration applied and no bandpass applied

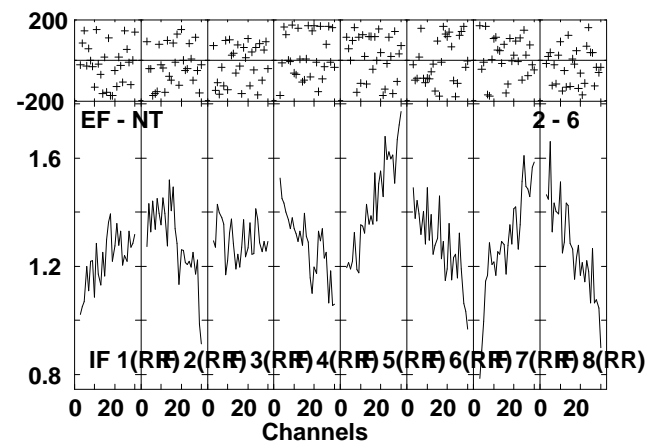
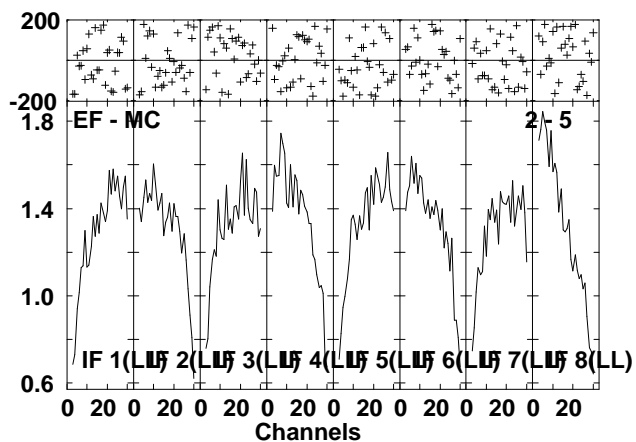
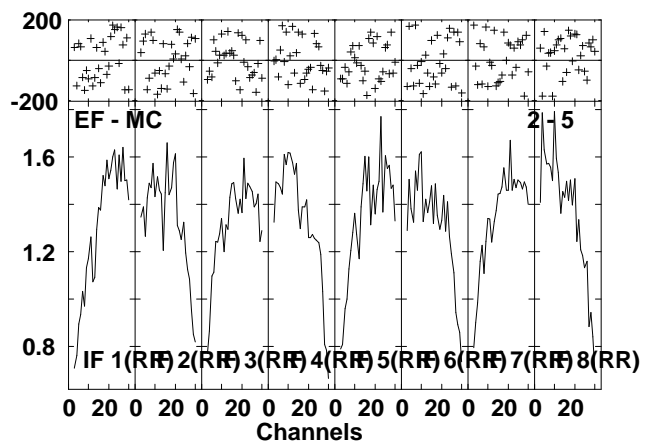
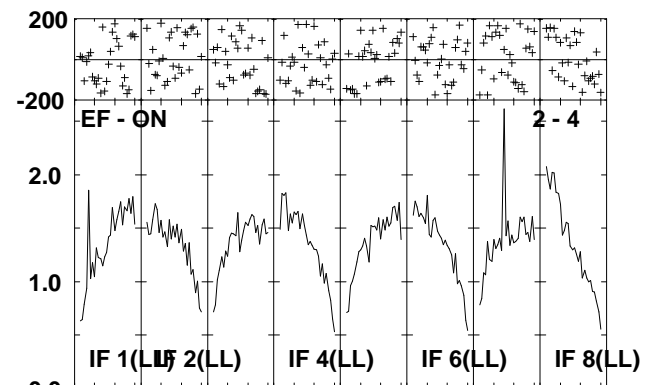
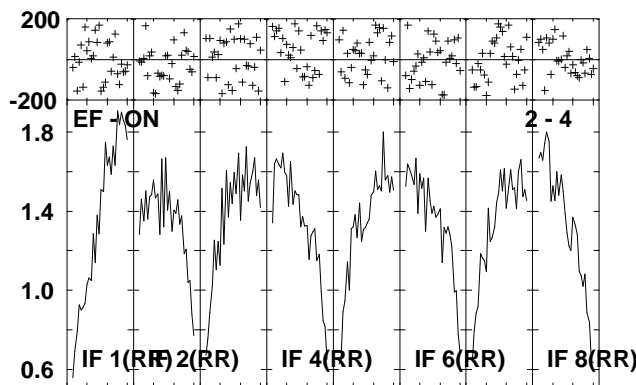
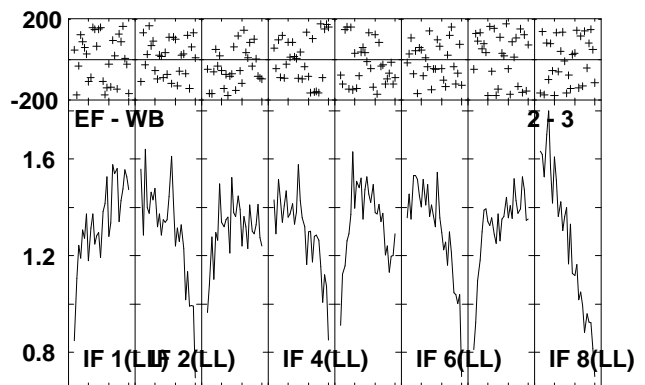
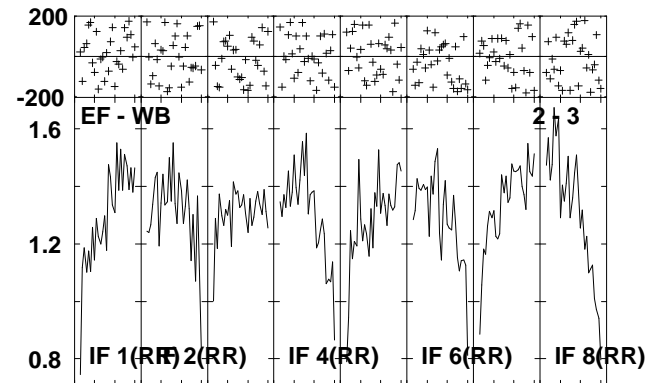
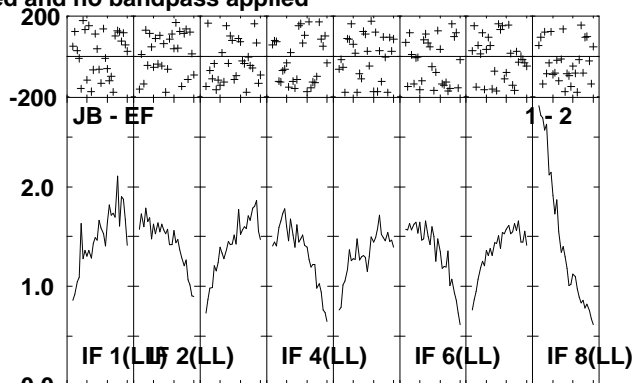
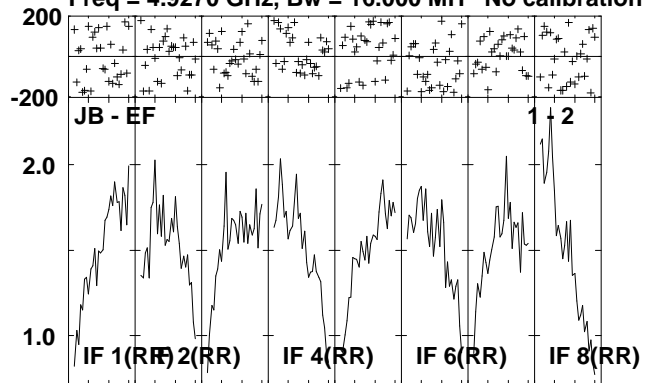

Lower frame: Milli Ampl Jy Top frame: Phas deg
Scalar averaged cross-power spectrum Several baselines displayed
Timerange: 00/12:58:11 to 00/13:01:49

Plot file version 107 created 06-JUL-2010 12:03:41

IRAS2336 EP064L.UVDATA.1

Freq = 4.9270 GHz, Bw = 16.000 MH No calibration applied and no bandpass applied

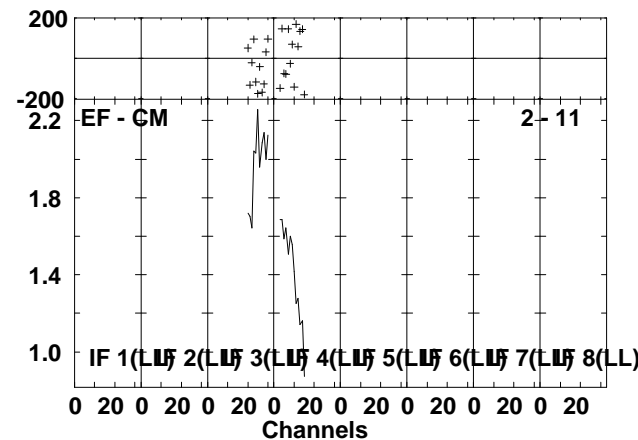
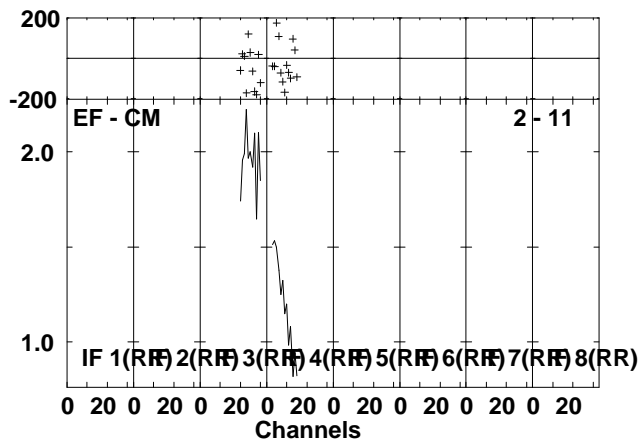
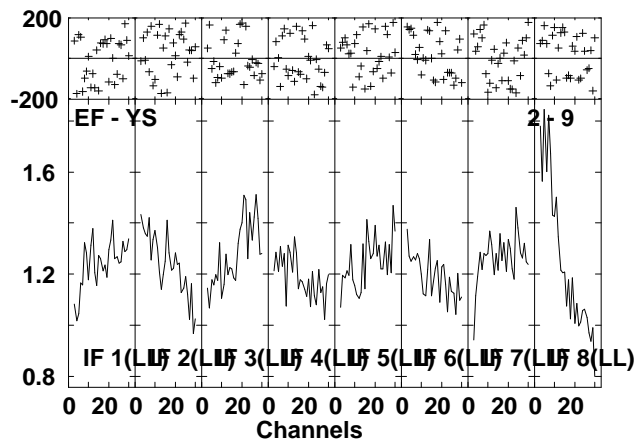
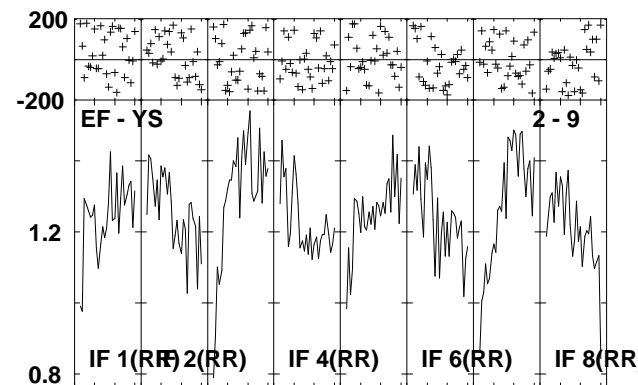
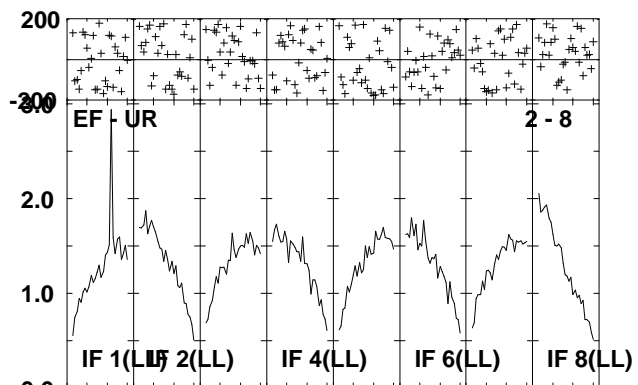
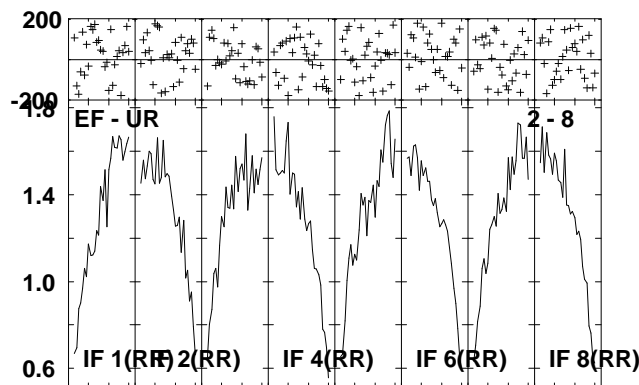
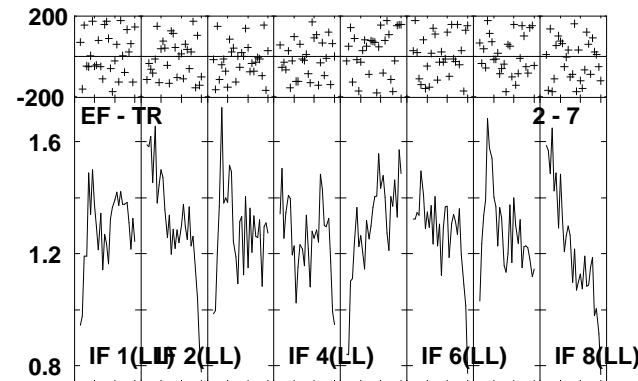
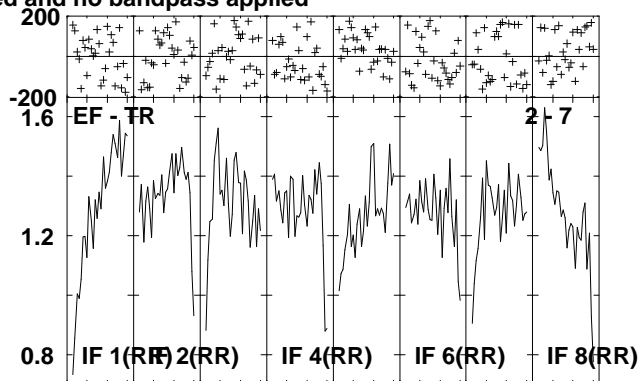
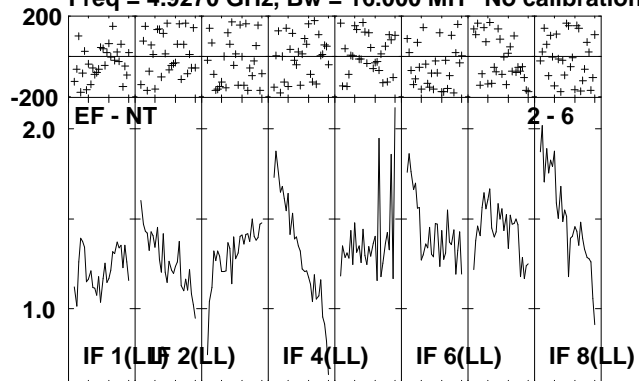

Lower frame: Milli Ampl Jy Top frame: Phas deg
Scalar averaged cross-power spectrum Several baselines displayed
Timerange: 00/12:58:11 to 00/13:01:49

Plot file version 108 created 06-JUL-2010 12:03:44

IRAS2336 EP064L.UVDATA.1

Freq = 4.9270 GHz, Bw = 16.000 MH No calibration applied and no bandpass applied

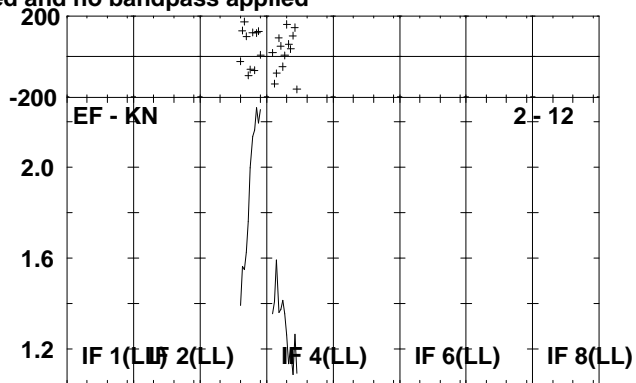
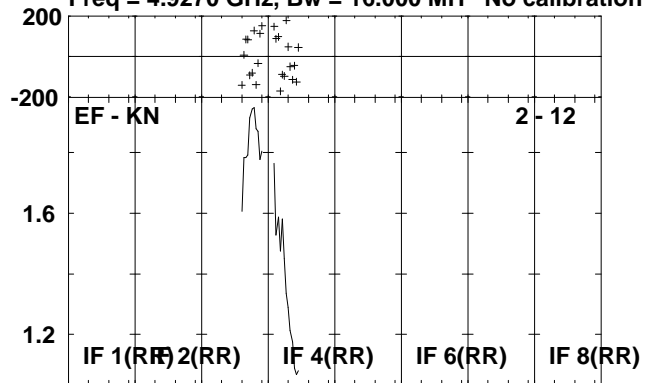

Lower frame: Milli Ampl Jy Top frame: Phas deg
Scalar averaged cross-power spectrum Several baselines displayed
Timerange: 00/12:58:11 to 00/13:01:49

Plot file version 109 created 06-JUL-2010 12:03:44

J2330+33 EP064L.UVDATA.1

Freq = 4.9270 GHz, Bw = 16.000 MH No calibration applied and no bandpass applied

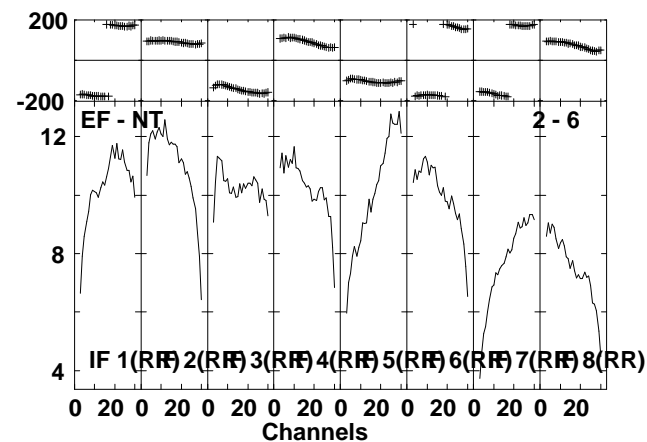
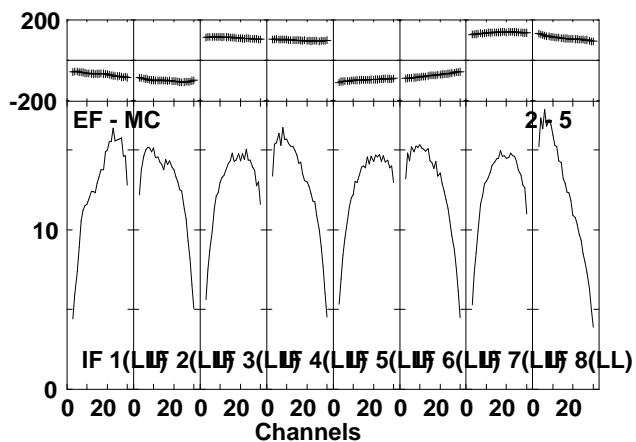
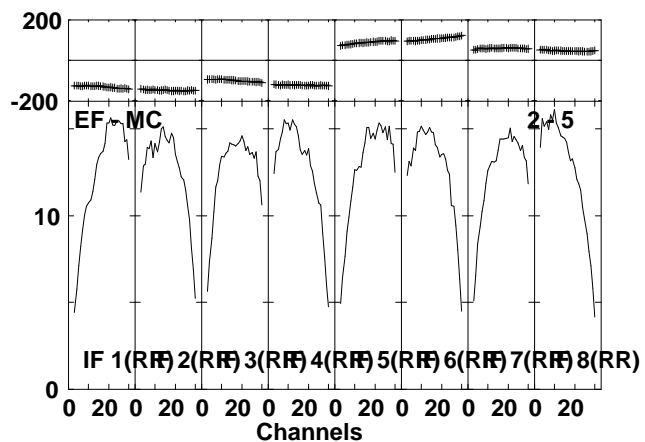
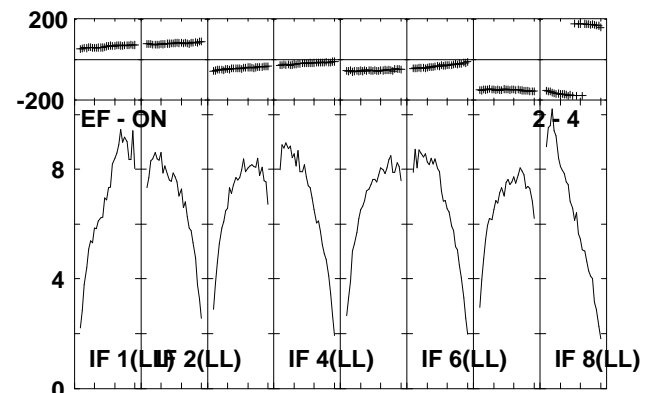
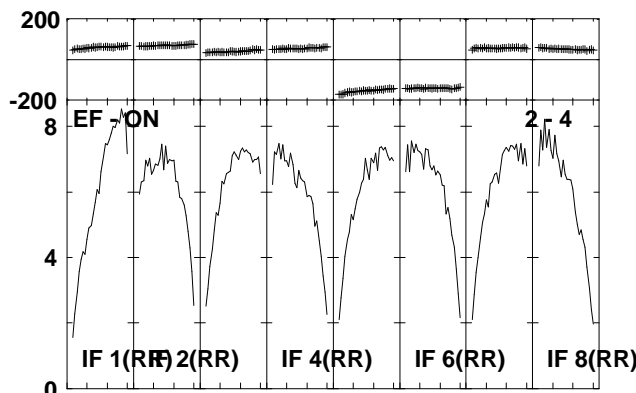
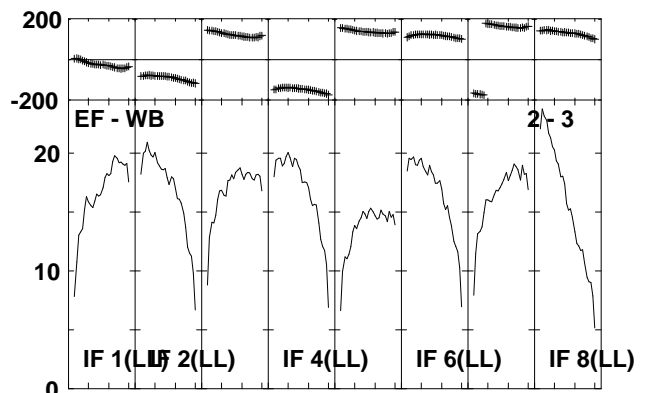
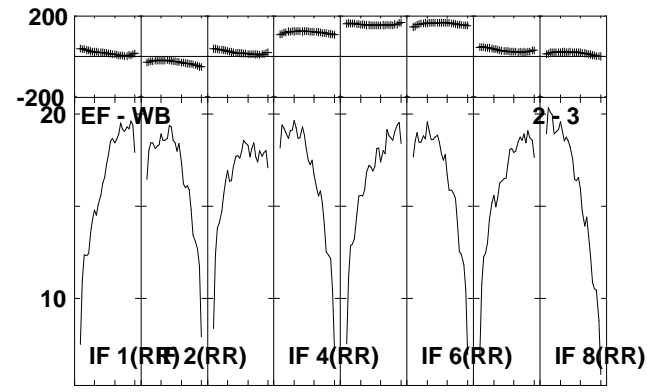
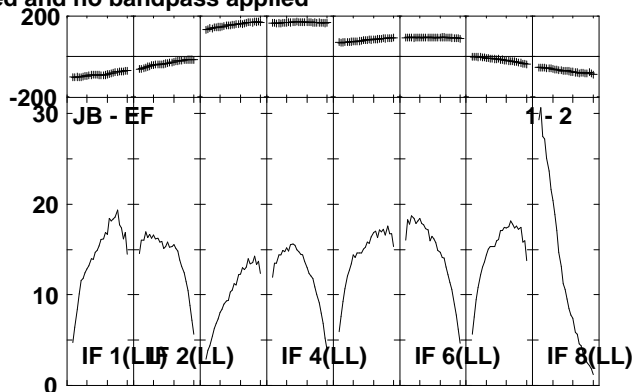
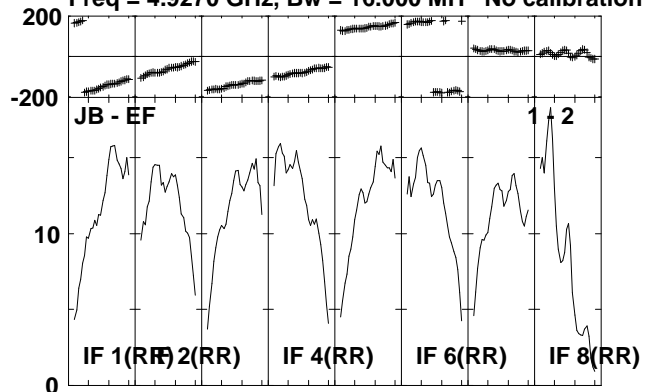

Lower frame: Milli Ampl Jy Top frame: Phas deg
Scalar averaged cross-power spectrum Several baselines displayed
Timerange: 00/13:01:51 to 00/13:03:39

Plot file version 110 created 06-JUL-2010 12:03:45

J2330+33 EP064L.UVDATA.1

Freq = 4.9270 GHz, Bw = 16.000 MH No calibration applied and no bandpass applied

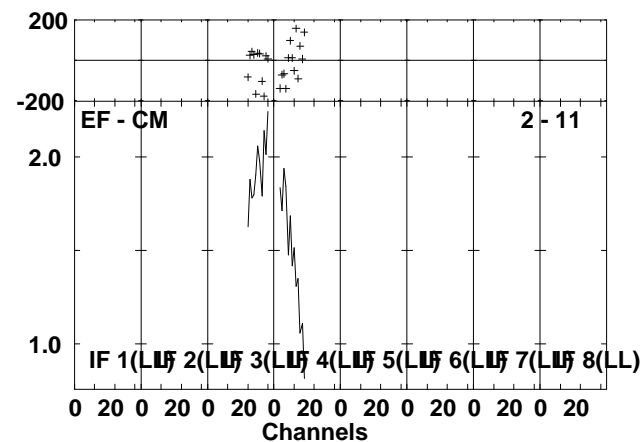
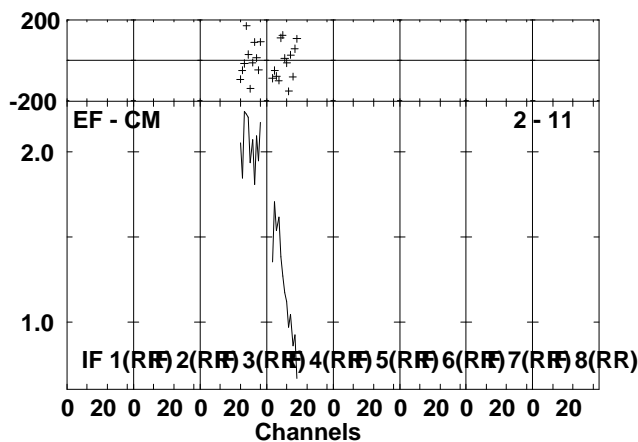
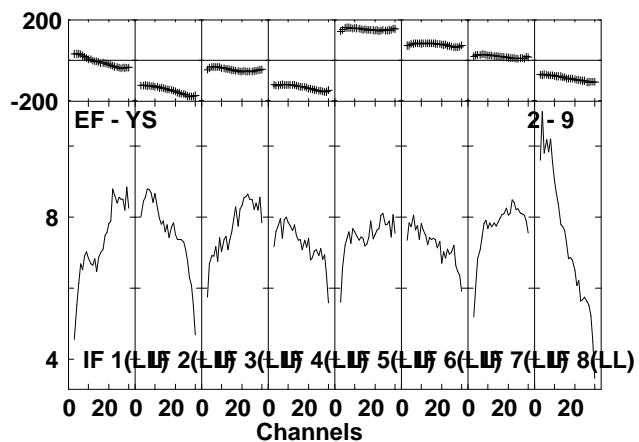
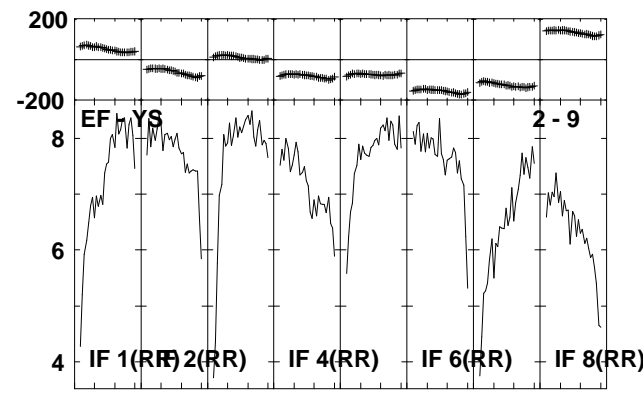
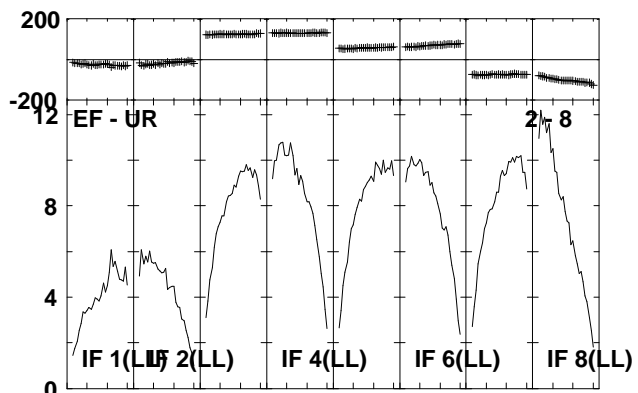
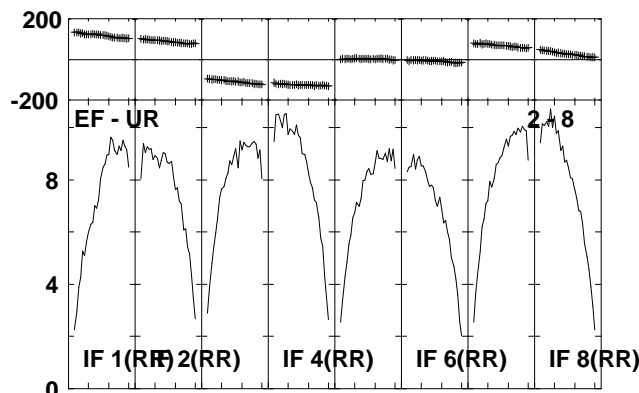
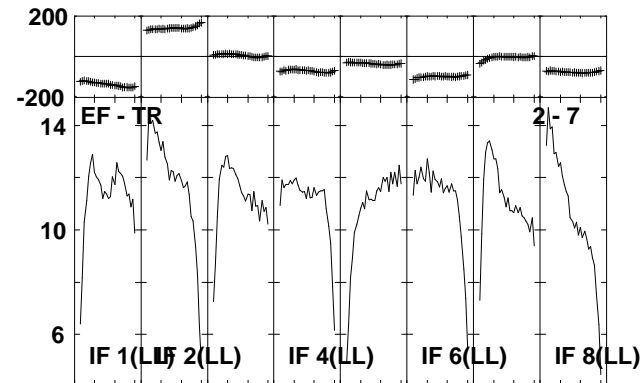
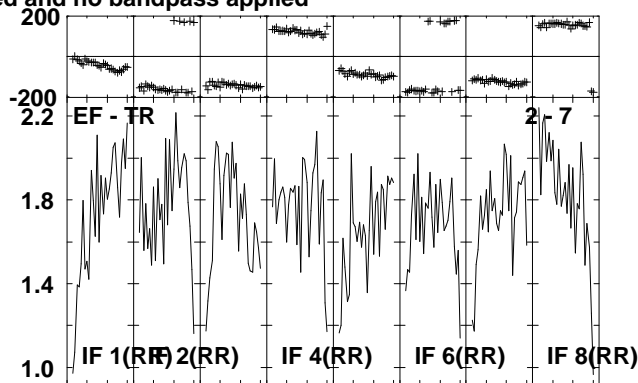
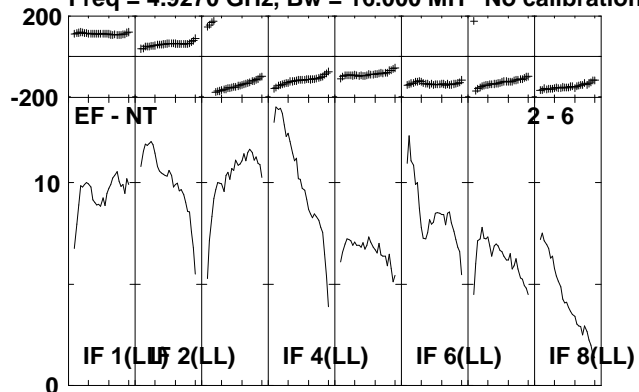

Lower frame: Milli Ampl Jy Top frame: Phas deg
Scalar averaged cross-power spectrum Several baselines displayed
Timerange: 00/13:01:51 to 00/13:03:39

Plot file version 111 created 06-JUL-2010 12:03:47

J2330+33 EP064L.UVDATA.1

Freq = 4.9270 GHz, Bw = 16.000 MH No calibration applied and no bandpass applied

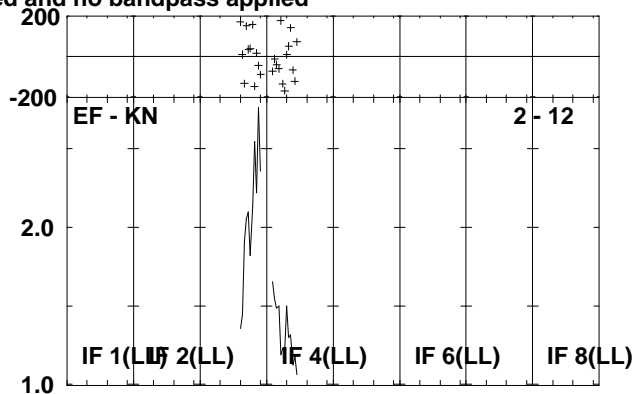
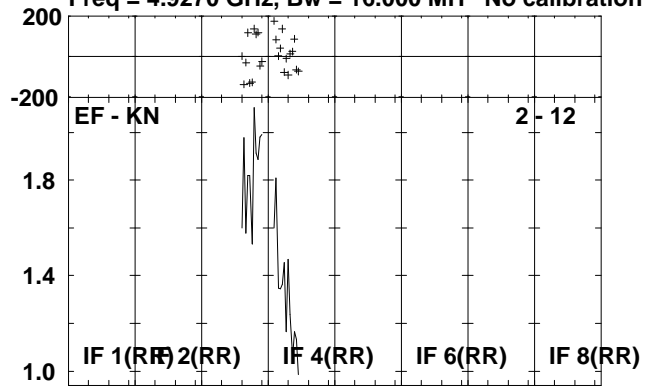

Lower frame: Milli Ampl Jy Top frame: Phas deg
Scalar averaged cross-power spectrum Several baselines displayed
Timerange: 00/13:01:51 to 00/13:03:39

Plot file version 112 created 06-JUL-2010 12:03:48

IRAS2336 EP064L.UVDATA.1

Freq = 4.9270 GHz, Bw = 16.000 MH No calibration applied and no bandpass applied

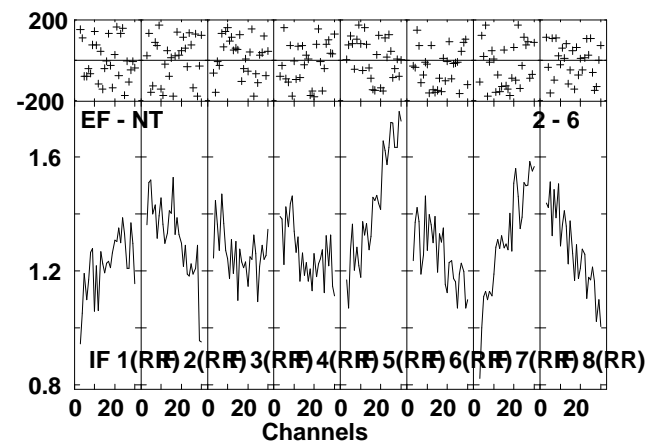
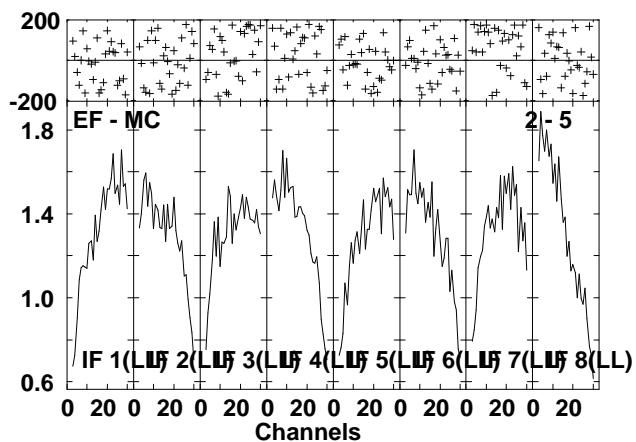
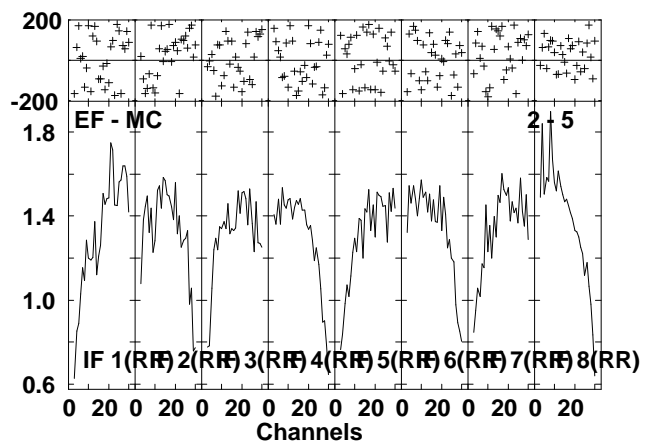
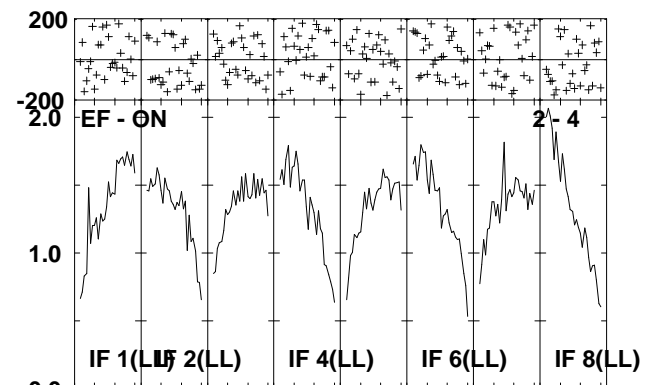
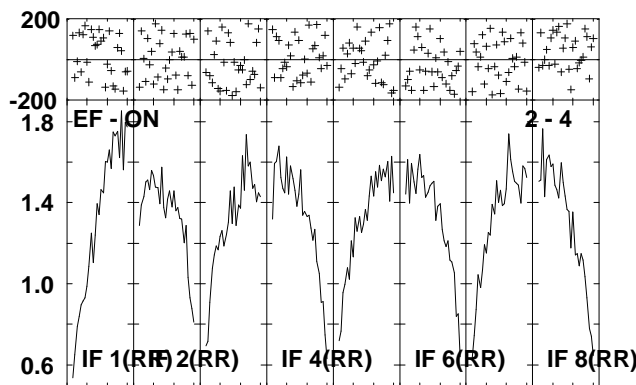
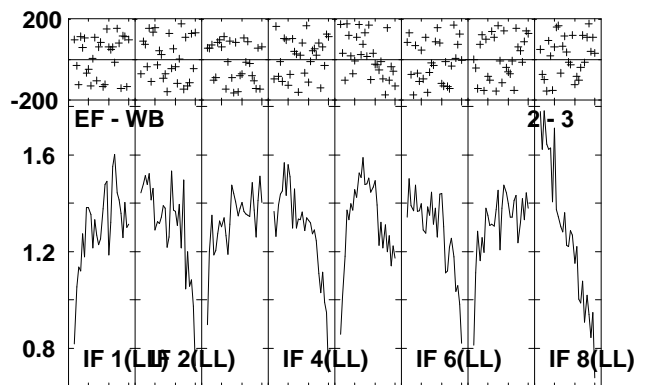
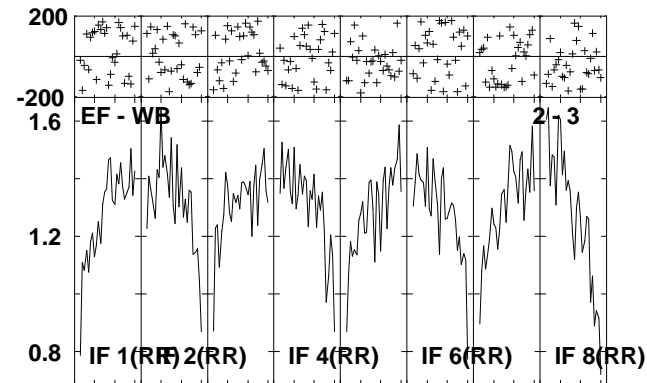
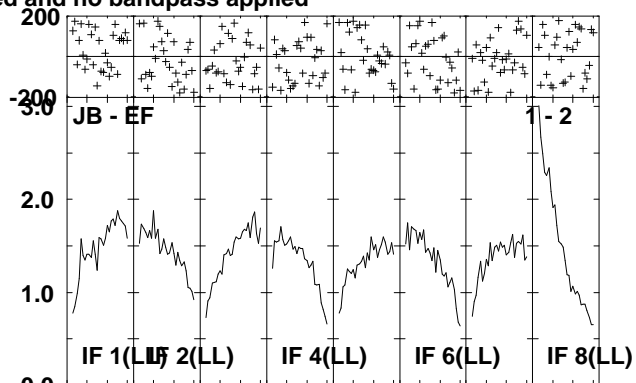
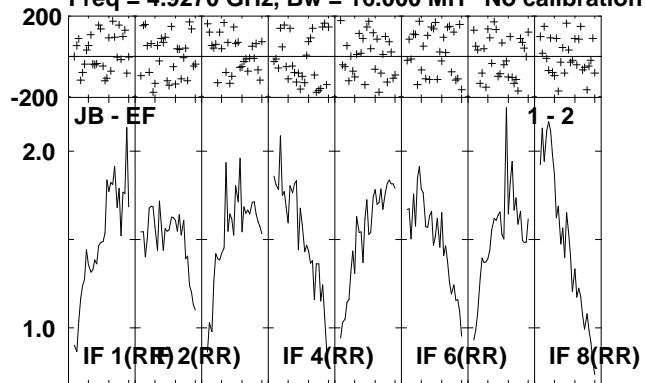

Lower frame: Milli Ampl Jy Top frame: Phas deg
Scalar averaged cross-power spectrum Several baselines displayed
Timerange: 00/13:03:41 to 00/13:07:19

Plot file version 113 created 06-JUL-2010 12:03:50

IRAS2336 EP064L.UVDATA.1

Freq = 4.9270 GHz, Bw = 16.000 MH No calibration applied and no bandpass applied

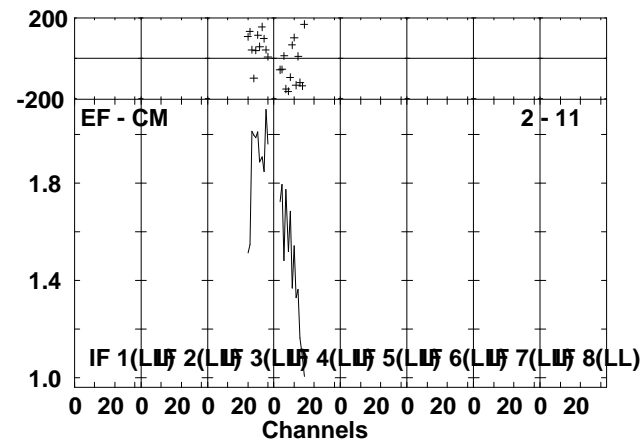
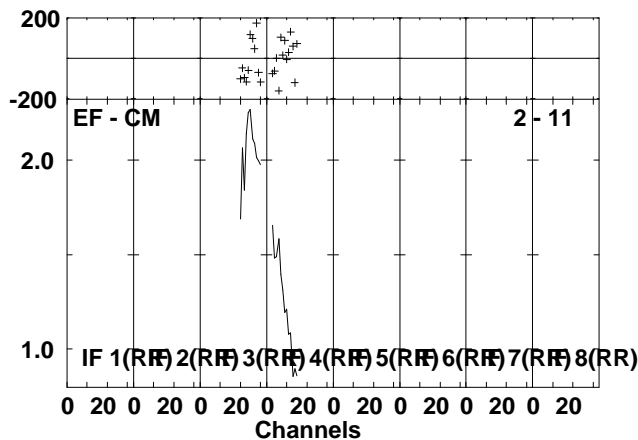
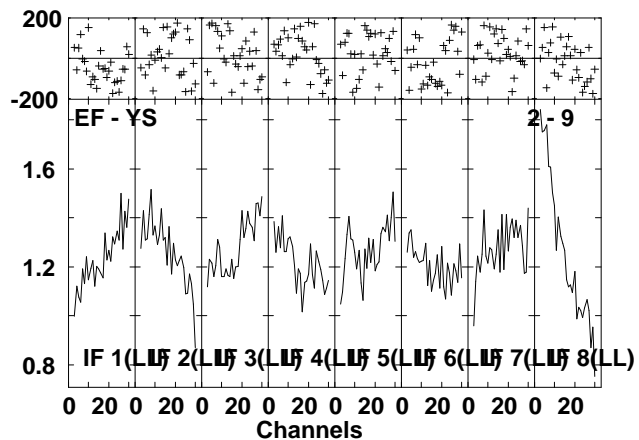
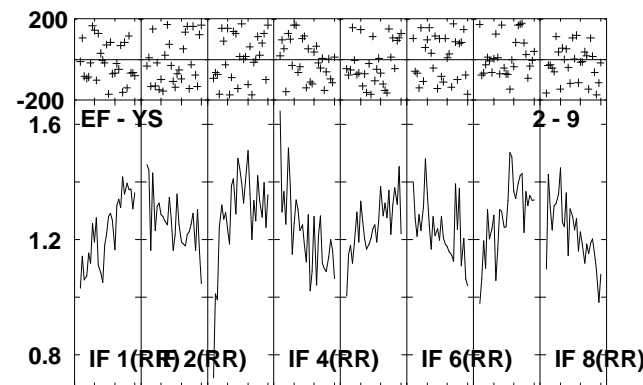
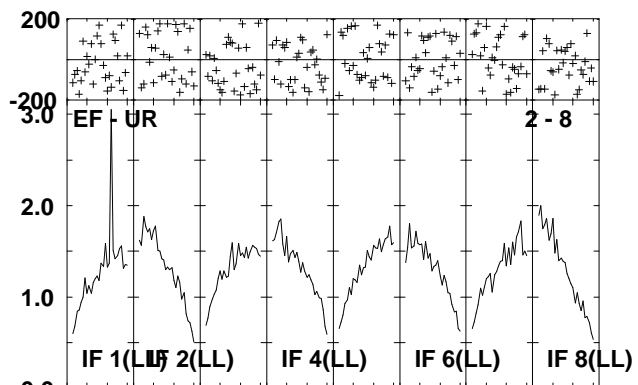
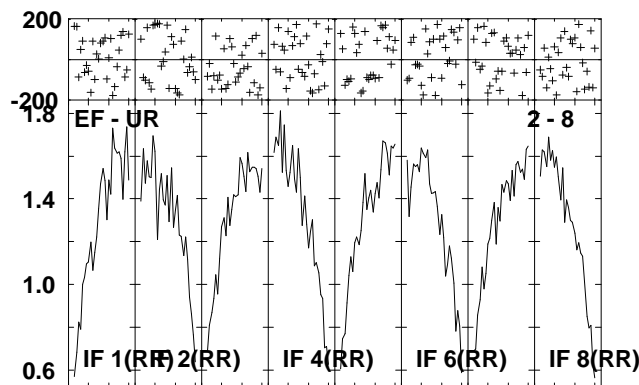
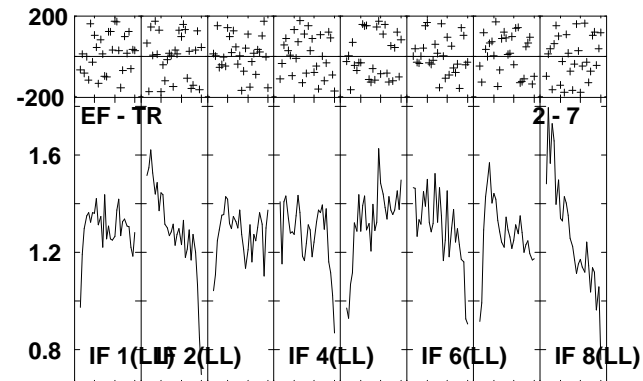
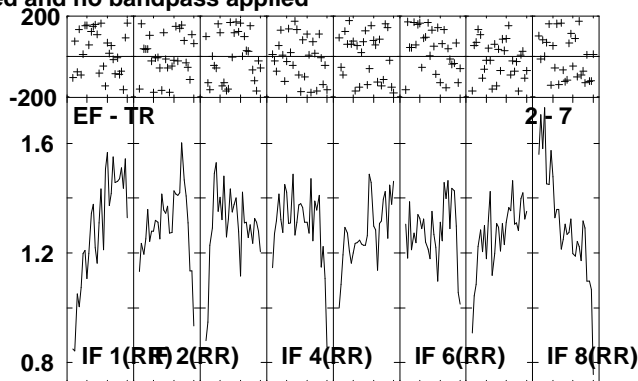
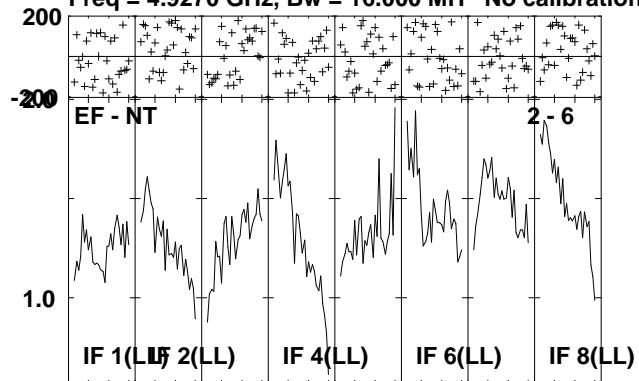

Lower frame: Milli Ampl Jy Top frame: Phas deg
Scalar averaged cross-power spectrum Several baselines displayed
Timerange: 00/13:03:41 to 00/13:07:19

Plot file version 114 created 06-JUL-2010 12:03:54

IRAS2336 EP064L.UVDATA.1

Freq = 4.9270 GHz, Bw = 16.000 MH No calibration applied and no bandpass applied

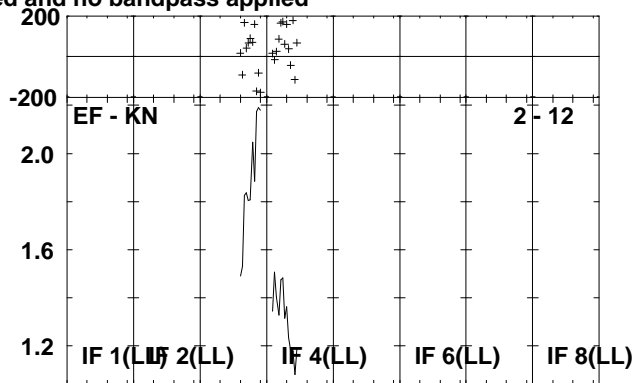
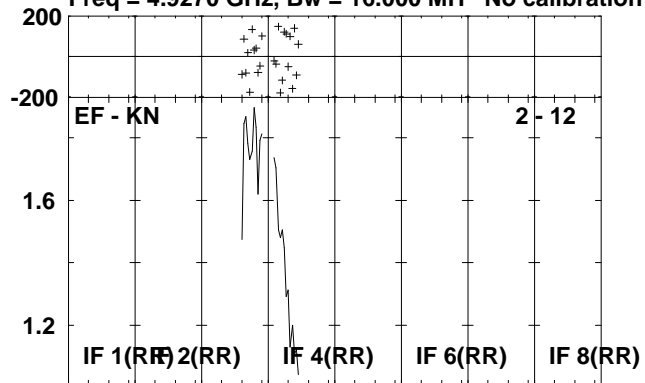

Lower frame: Milli Ampl Jy Top frame: Phas deg
Scalar averaged cross-power spectrum Several baselines displayed
Timerange: 00/13:03:41 to 00/13:07:19

Plot file version 115 created 06-JUL-2010 12:03:55

J2330+33 EP064L.UVDATA.1

Freq = 4.9270 GHz, Bw = 16.000 MH No calibration applied and no bandpass applied

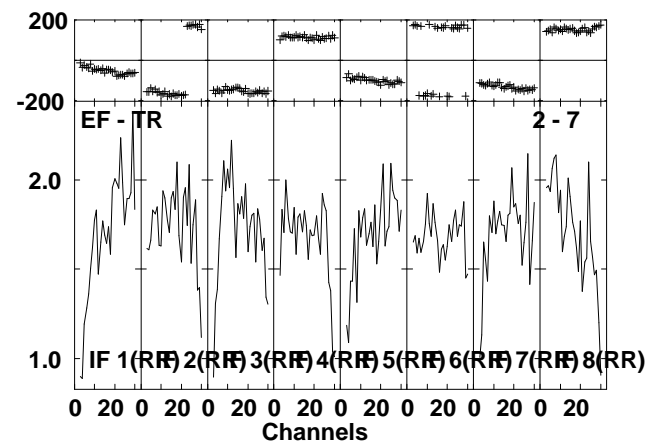
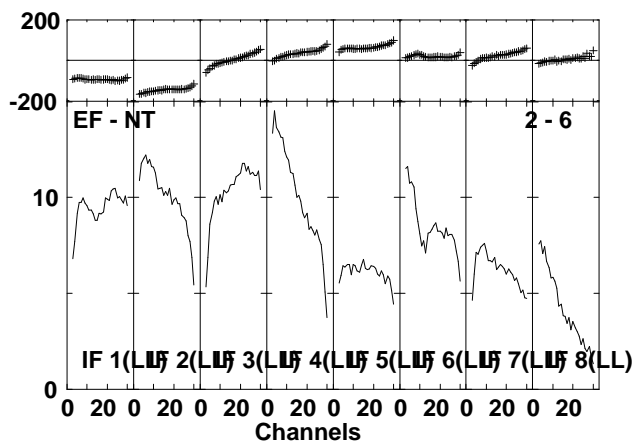
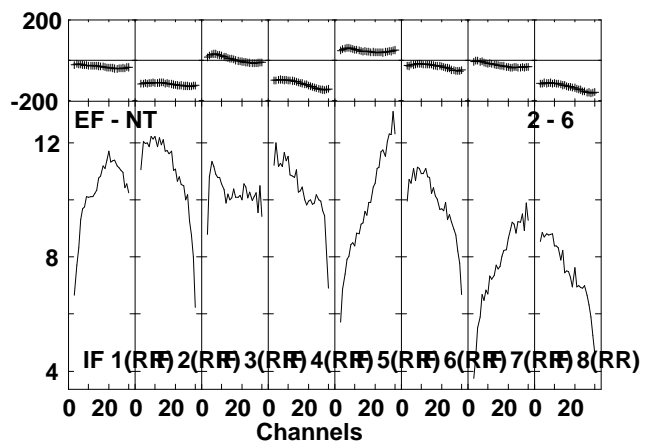
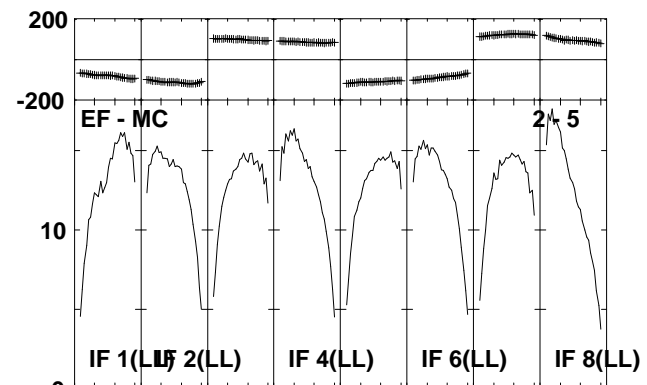
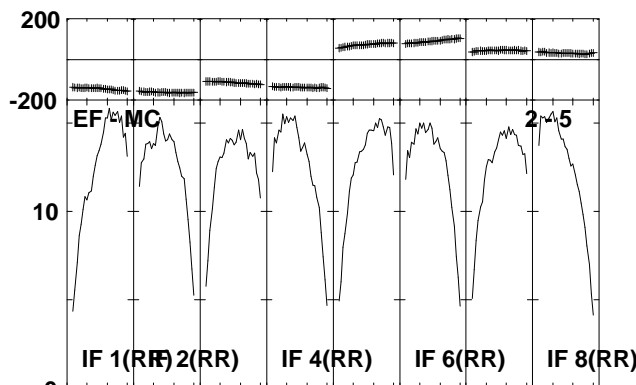
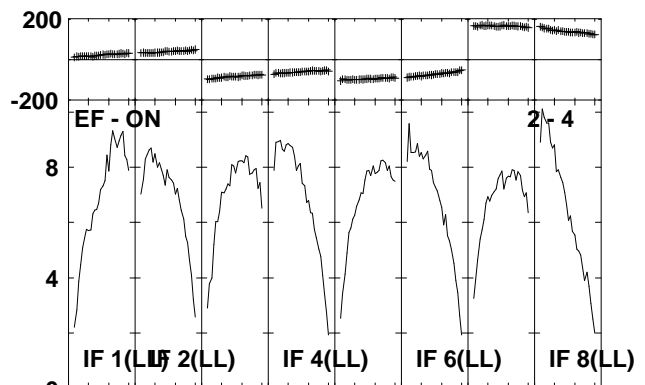
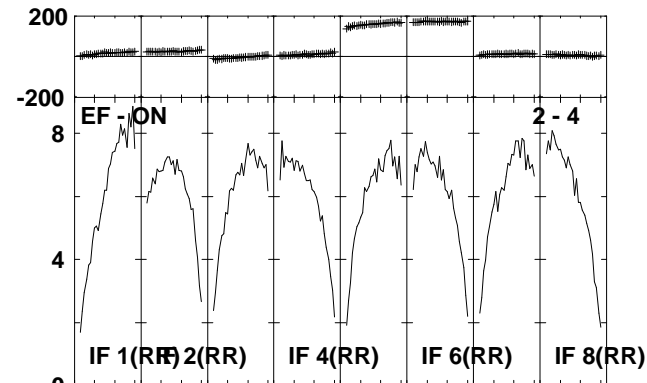
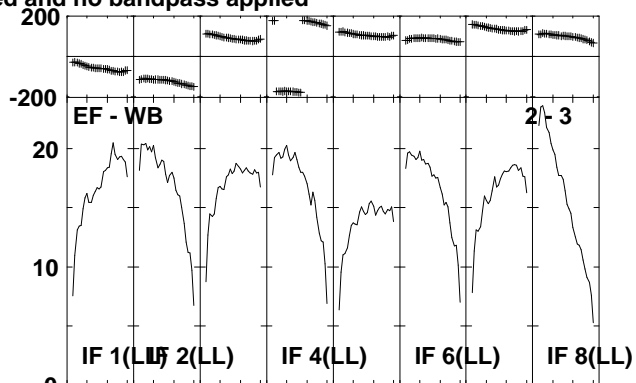
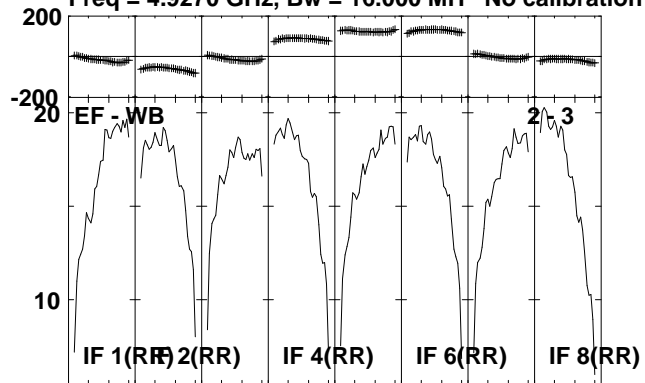

Lower frame: Milli Ampl Jy Top frame: Phas deg
Scalar averaged cross-power spectrum Several baselines displayed
Timerange: 00/13:07:21 to 00/13:09:09

Plot file version 116 created 06-JUL-2010 12:03:56

J2330+33 EP064L.UVDATA.1

Freq = 4.9270 GHz, Bw = 16.000 MH No calibration applied and no bandpass applied

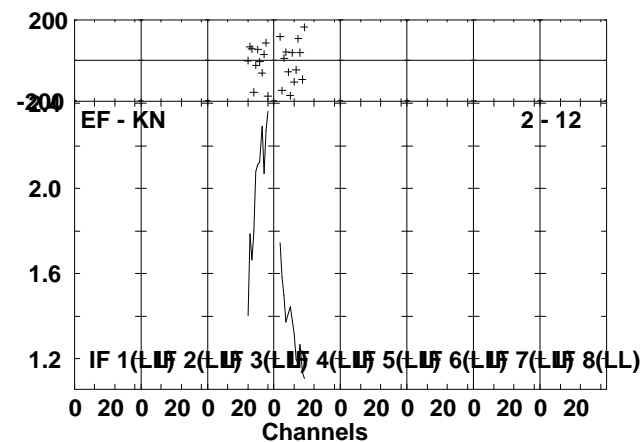
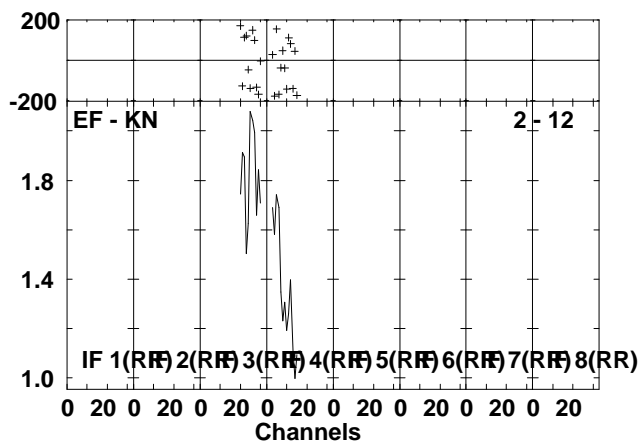
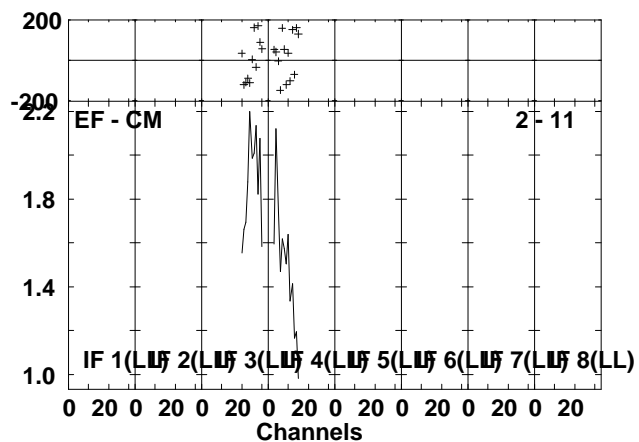
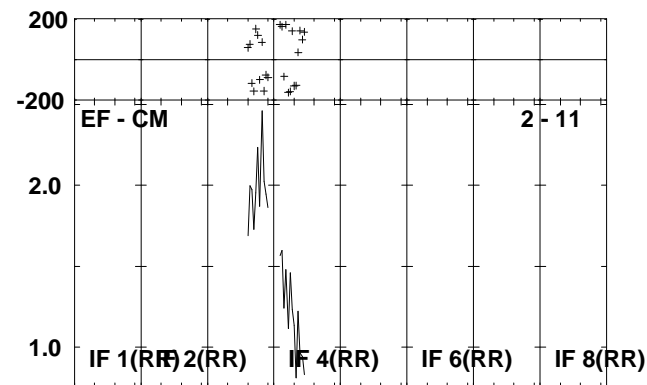
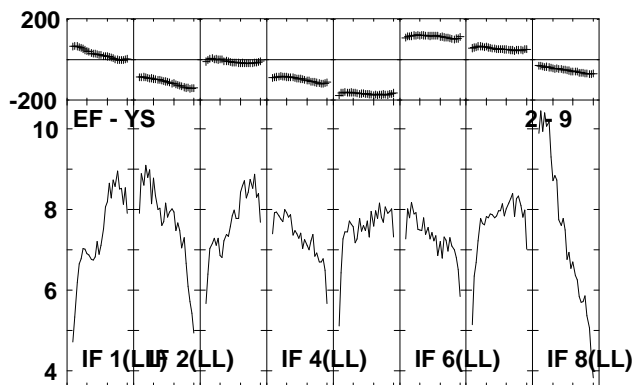
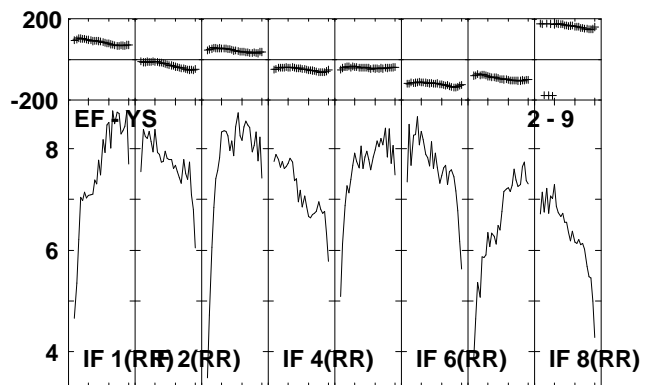
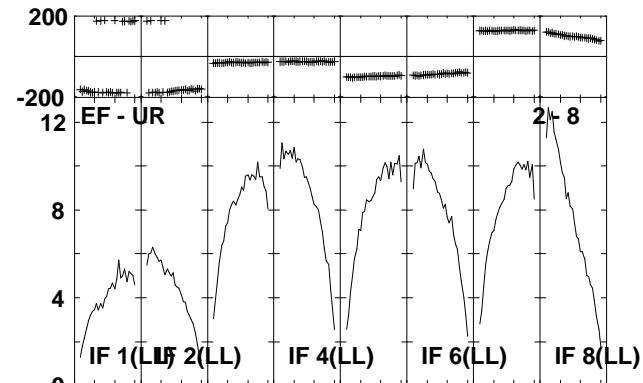
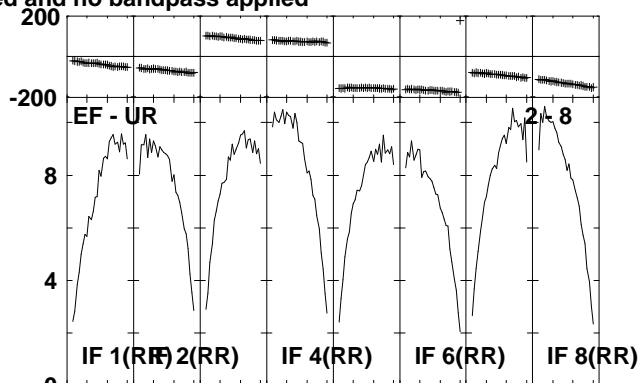
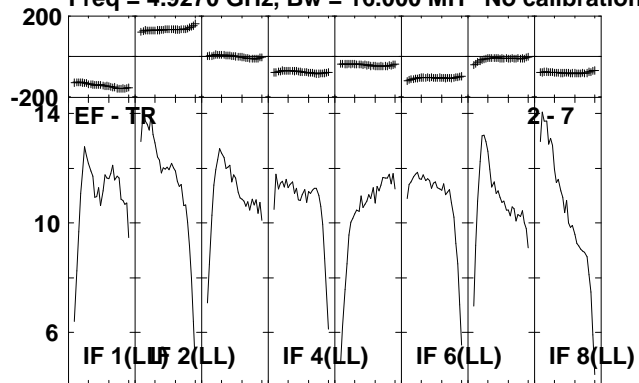

Lower frame: Milli Ampl Jy Top frame: Phas deg
Scalar averaged cross-power spectrum Several baselines displayed
Timerange: 00/13:07:21 to 00/13:09:09

Plot file version 117 created 06-JUL-2010 12:03:58

IRAS2336 EP064L.UVDATA.1

Freq = 4.9270 GHz, Bw = 16.000 MH No calibration applied and no bandpass applied

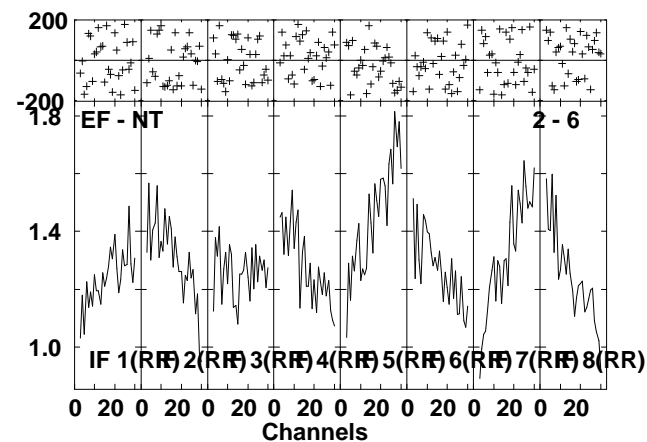
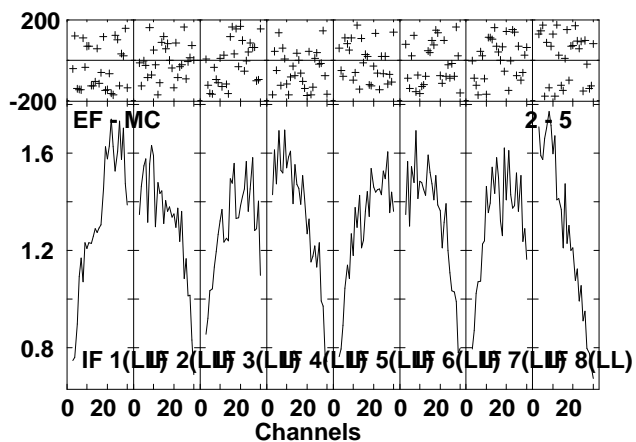
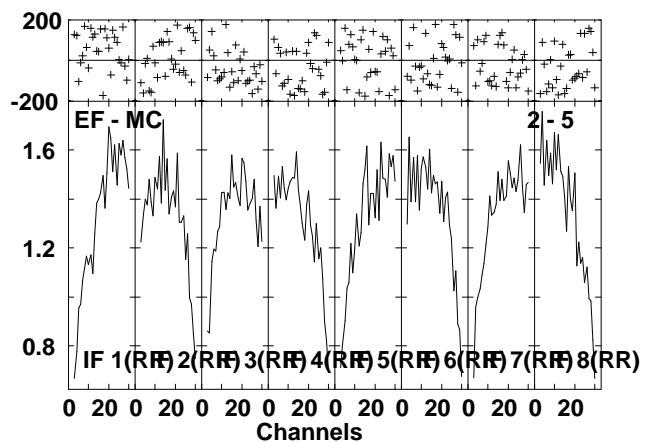
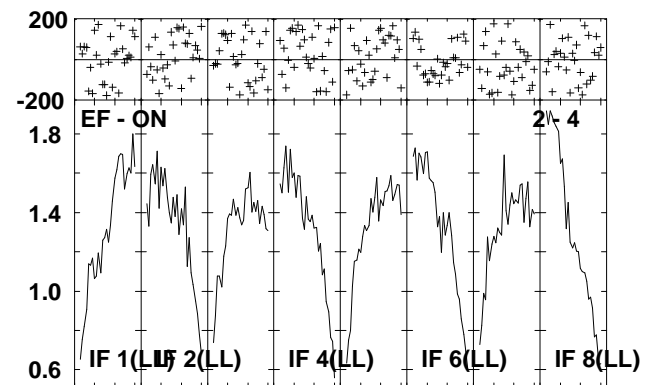
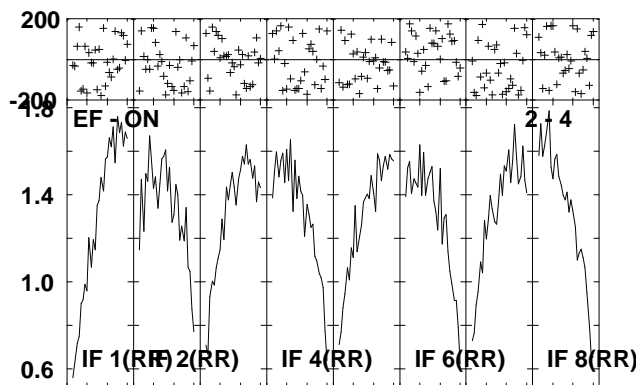
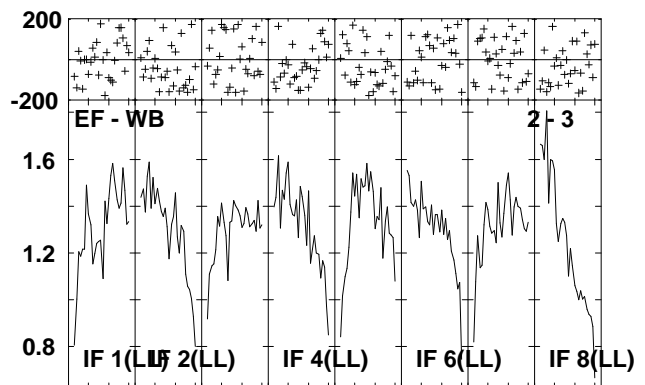
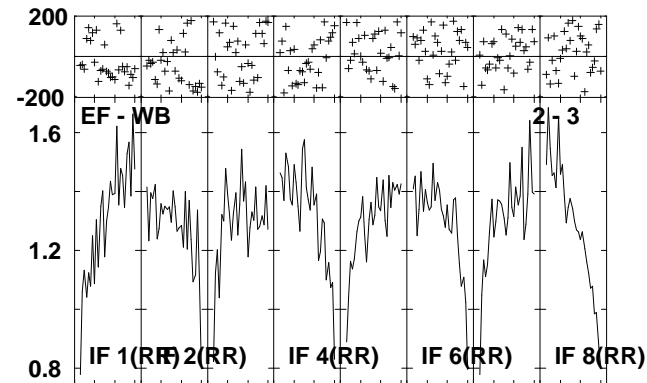
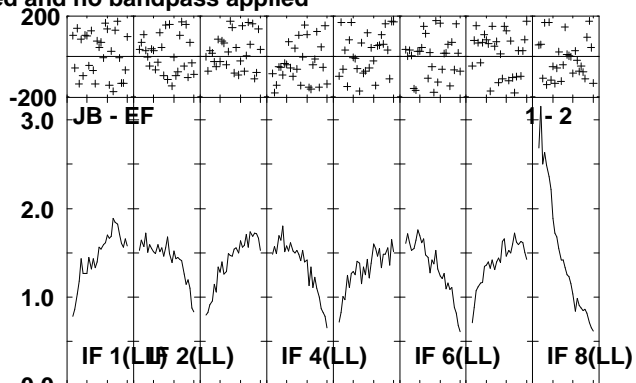
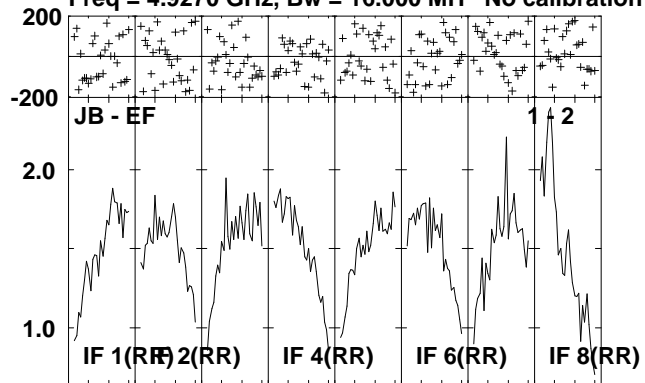

Lower frame: Milli Ampl Jy Top frame: Phas deg
Scalar averaged cross-power spectrum Several baselines displayed
Timerange: 00/13:09:11 to 00/13:12:47

Plot file version 118 created 06-JUL-2010 12:04:00

IRAS2336 EP064L.UVDATA.1

Freq = 4.9270 GHz, Bw = 16.000 MH No calibration applied and no bandpass applied

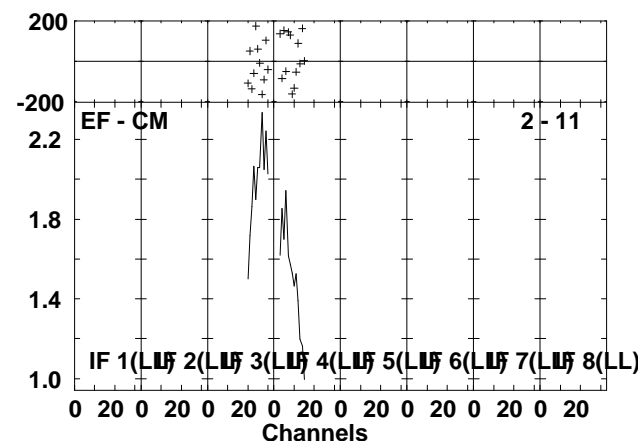
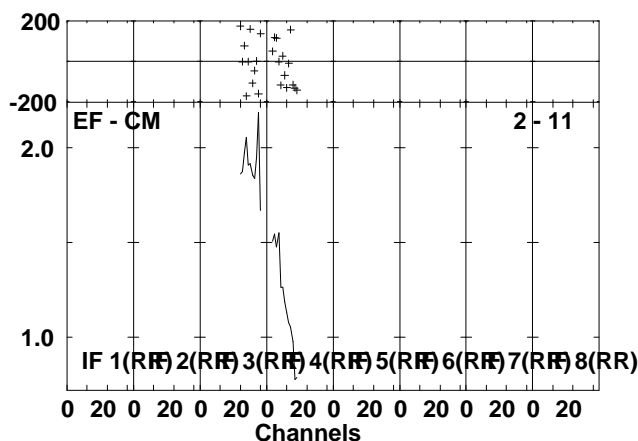
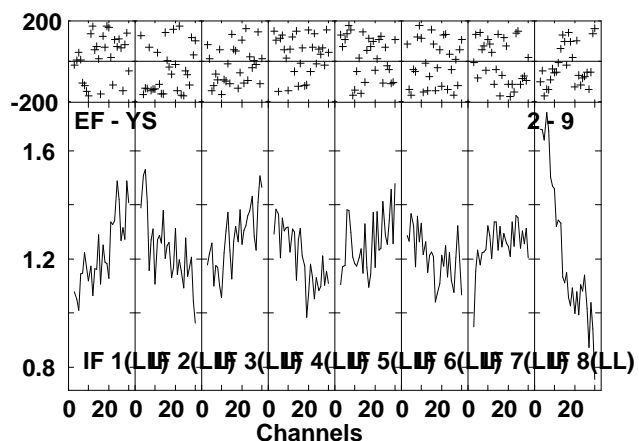
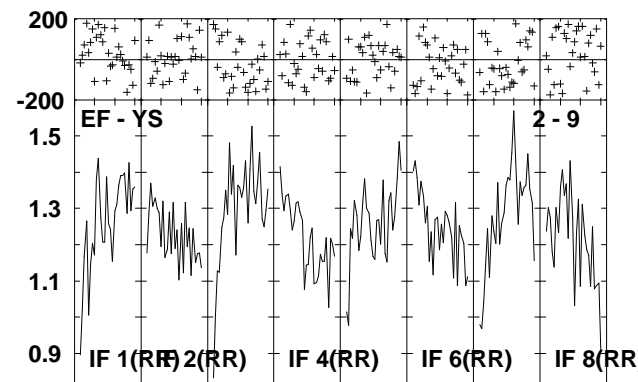
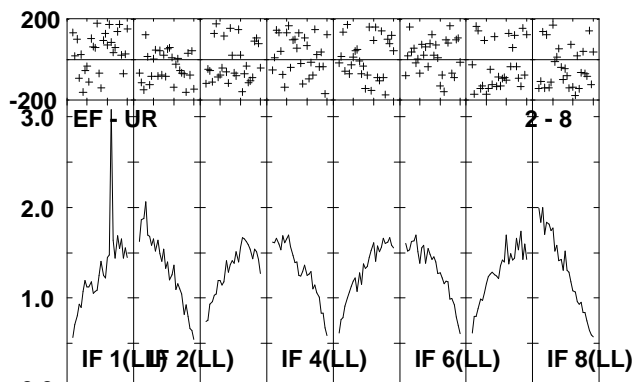
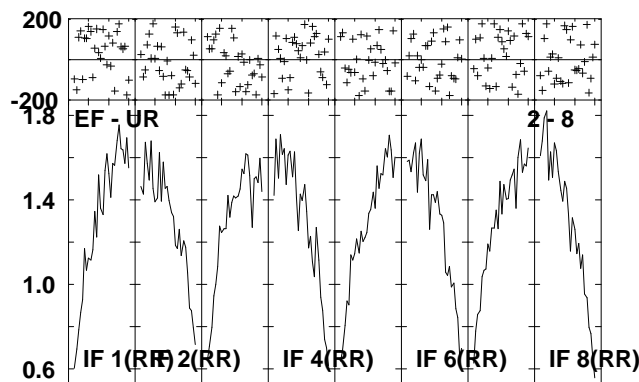
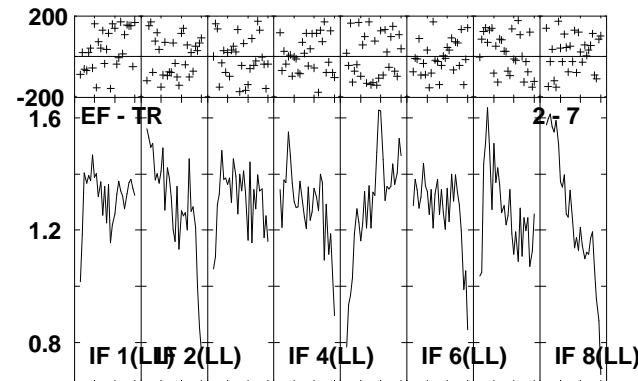
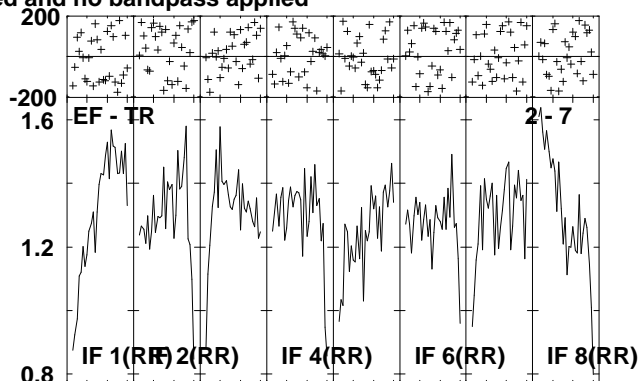
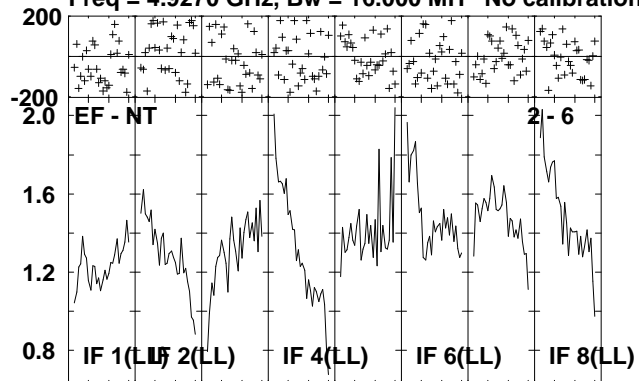

Lower frame: Milli Ampl Jy Top frame: Phas deg
Scalar averaged cross-power spectrum Several baselines displayed
Timerange: 00/13:09:11 to 00/13:12:47

Plot file version 119 created 06-JUL-2010 12:04:04

IRAS2336 EP064L.UVDATA.1

Freq = 4.9270 GHz, Bw = 16.000 MH No calibration applied and no bandpass applied

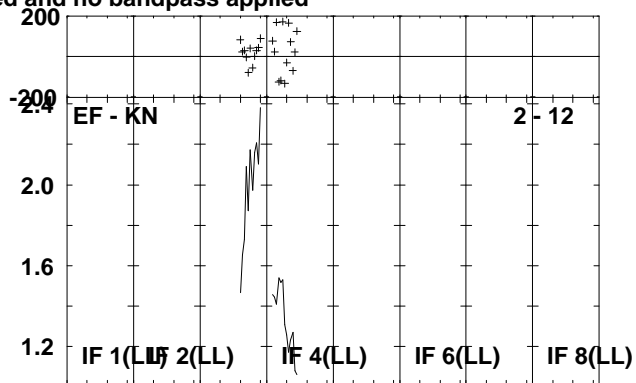
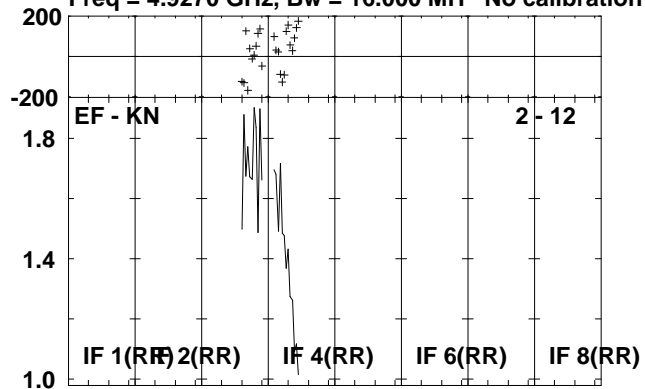

Lower frame: Milli Ampl Jy Top frame: Phas deg
Scalar averaged cross-power spectrum Several baselines displayed
Timerange: 00/13:09:11 to 00/13:12:47

Plot file version 120 created 06-JUL-2010 12:04:04

J2330+33 EP064L.UVDATA.1

Freq = 4.9270 GHz, Bw = 16.000 MH No calibration applied and no bandpass applied

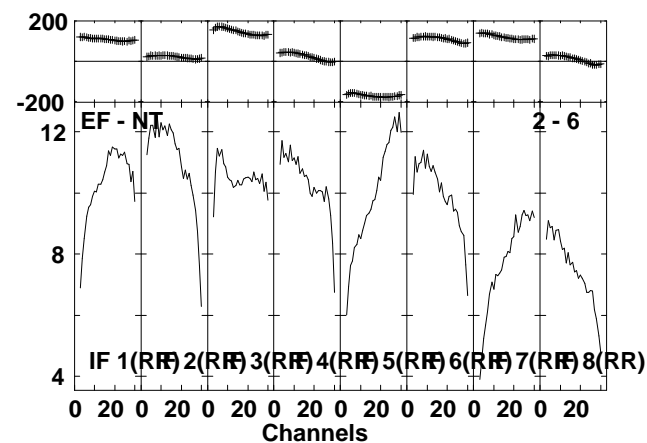
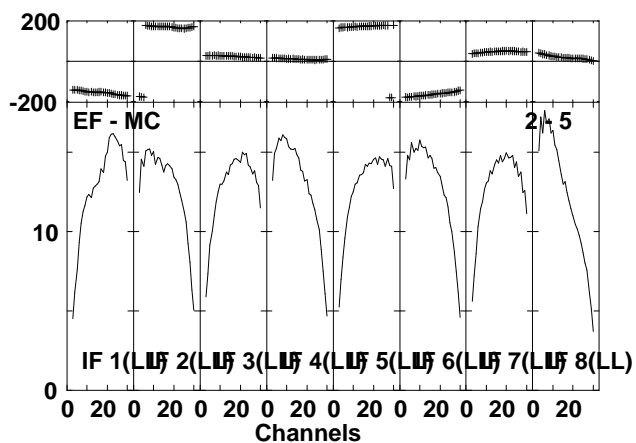
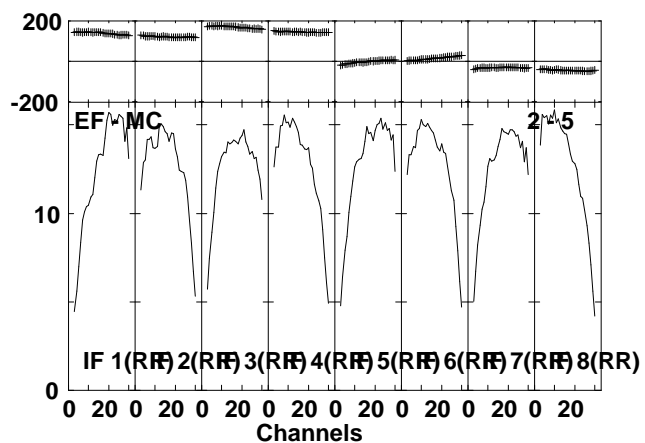
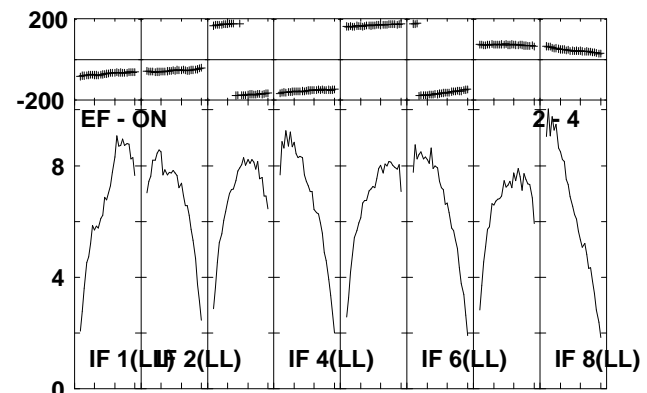
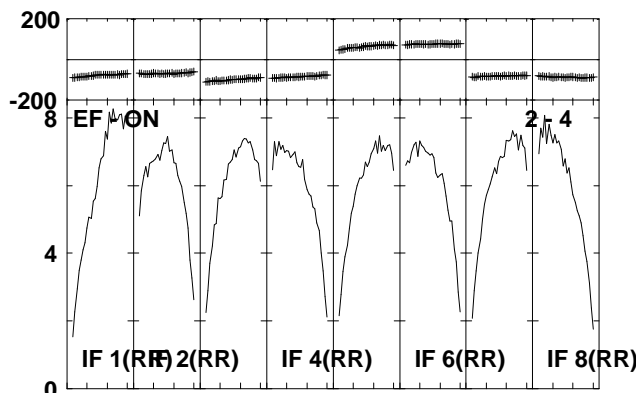
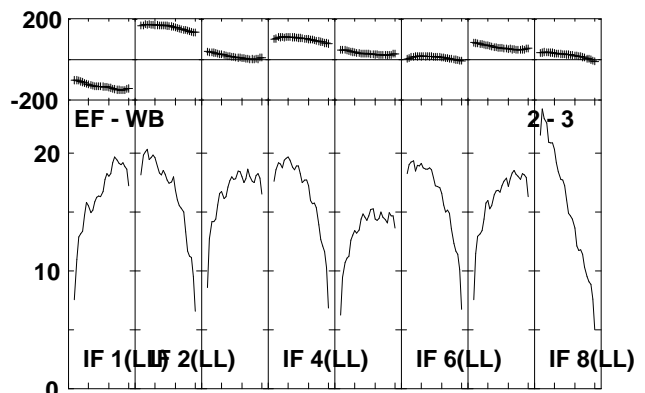
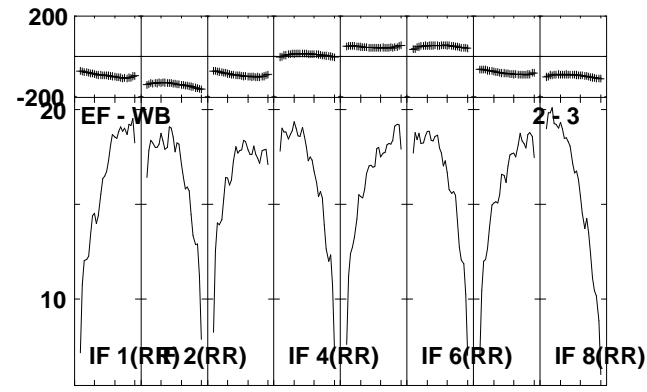
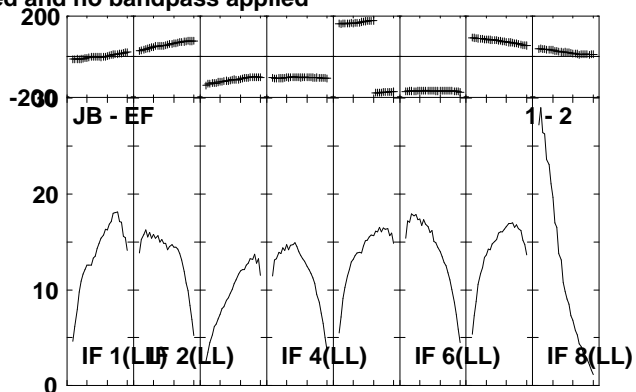
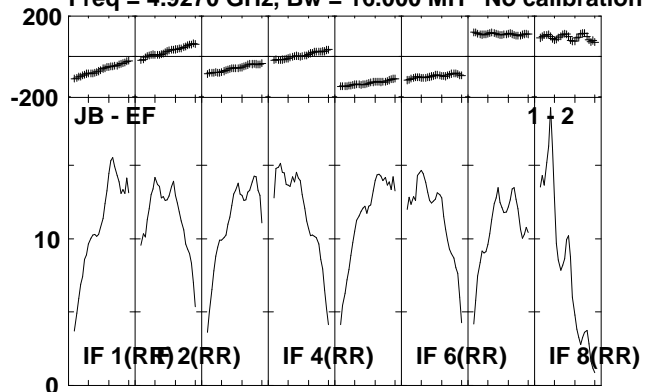

Lower frame: Milli Ampl Jy Top frame: Phas deg
Scalar averaged cross-power spectrum Several baselines displayed
Timerange: 00/13:13:51 to 00/13:15:29

Plot file version 121 created 06-JUL-2010 12:04:05

J2330+33 EP064L.UVDATA.1

Freq = 4.9270 GHz, Bw = 16.000 MH No calibration applied and no bandpass applied

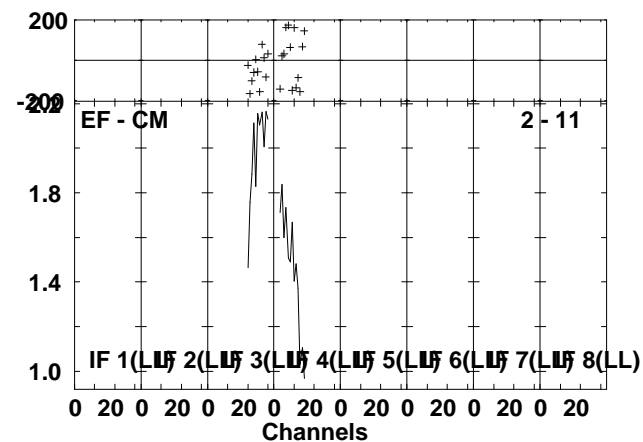
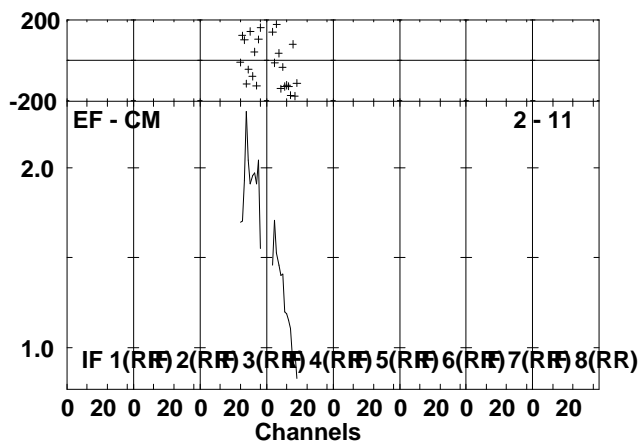
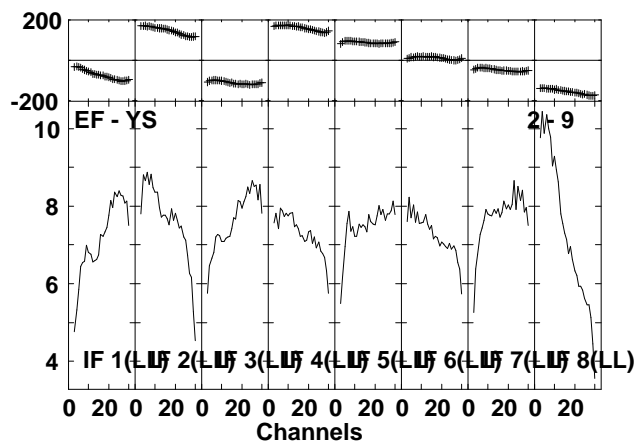
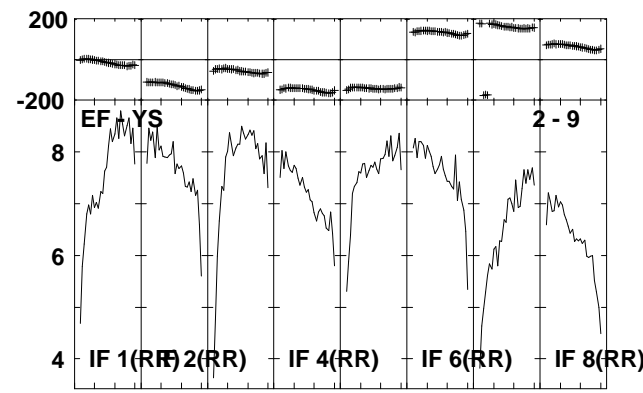
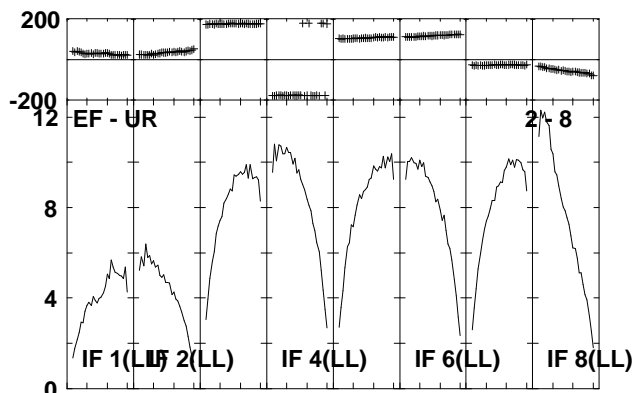
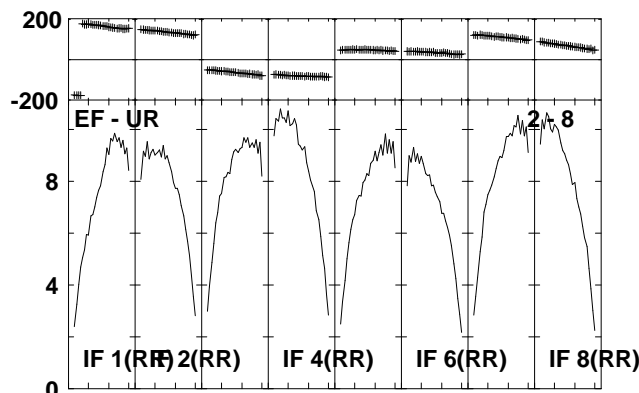
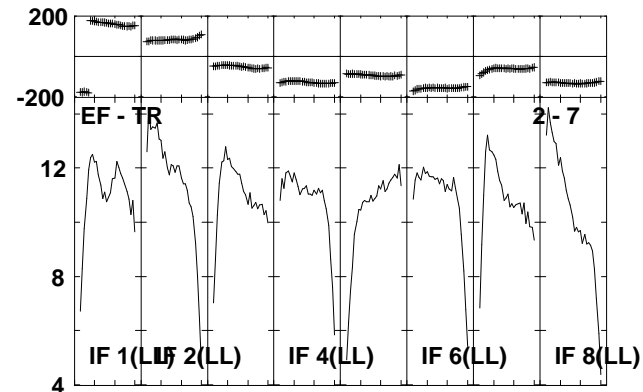
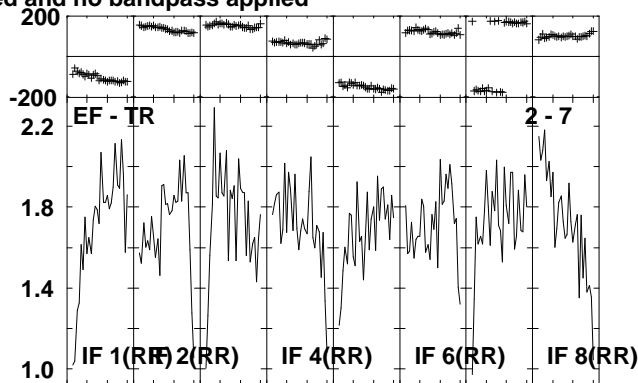
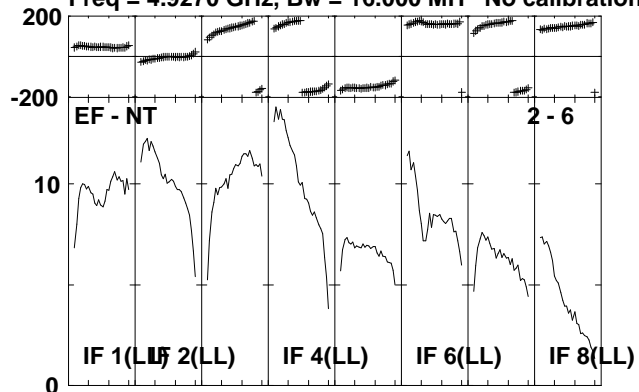

Lower frame: Milli Ampl Jy Top frame: Phas deg
Scalar averaged cross-power spectrum Several baselines displayed
Timerange: 00/13:13:51 to 00/13:15:29

Plot file version 122 created 06-JUL-2010 12:04:07

J2330+33 EP064L.UVDATA.1

Freq = 4.9270 GHz, Bw = 16.000 MH No calibration applied and no bandpass applied

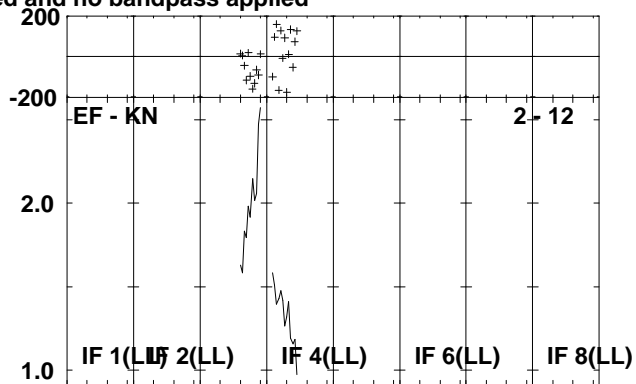
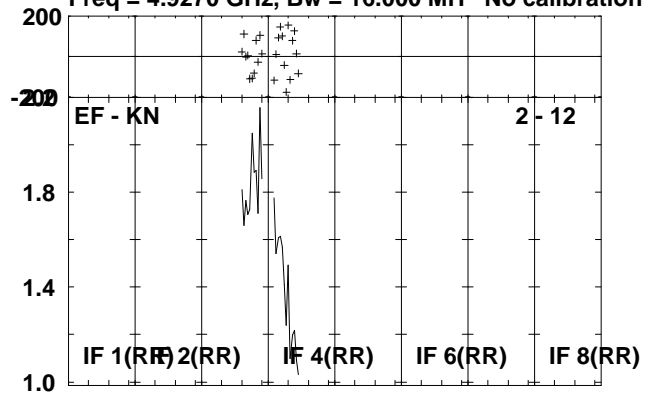

Lower frame: Milli Ampl Jy Top frame: Phas deg
Scalar averaged cross-power spectrum Several baselines displayed
Timerange: 00/13:13:51 to 00/13:15:29

Plot file version 123 created 06-JUL-2010 12:04:08

IRAS2336 EP064L.UVDATA.1

Freq = 4.9270 GHz, Bw = 16.000 MH No calibration applied and no bandpass applied

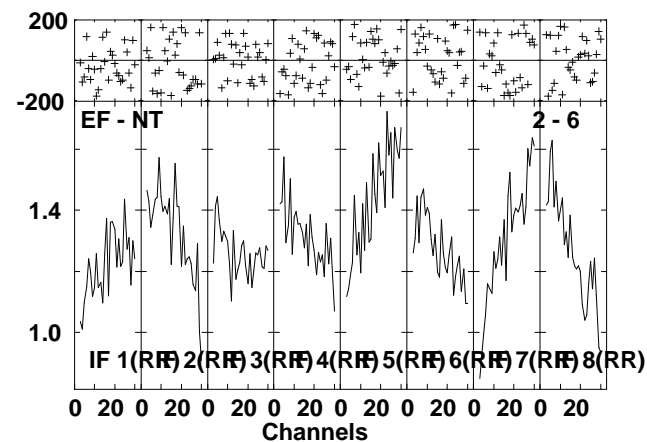
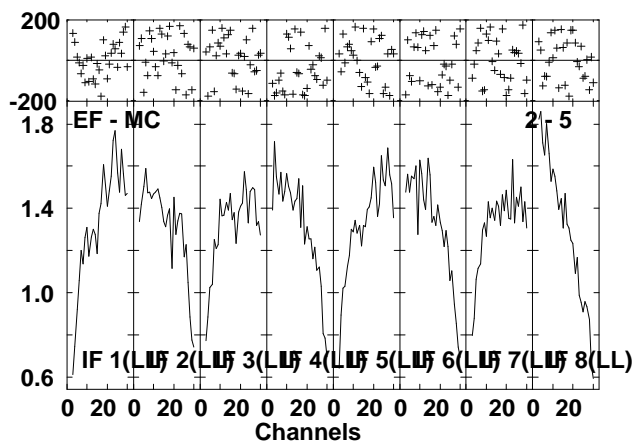
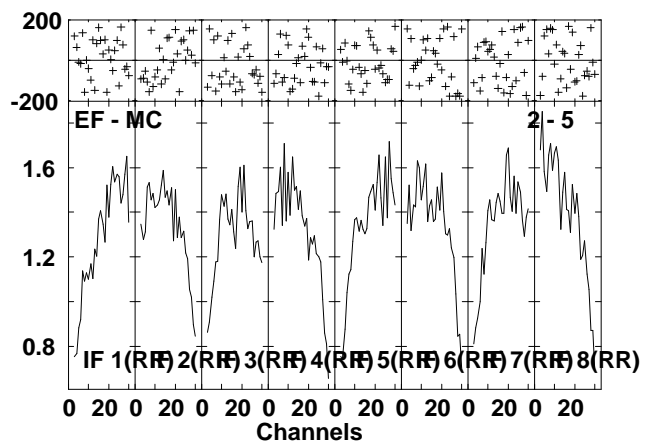
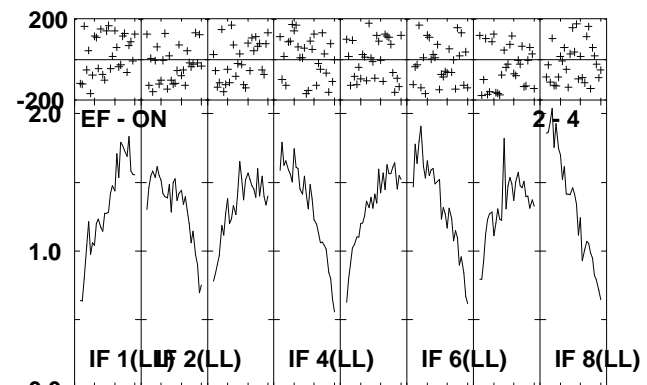
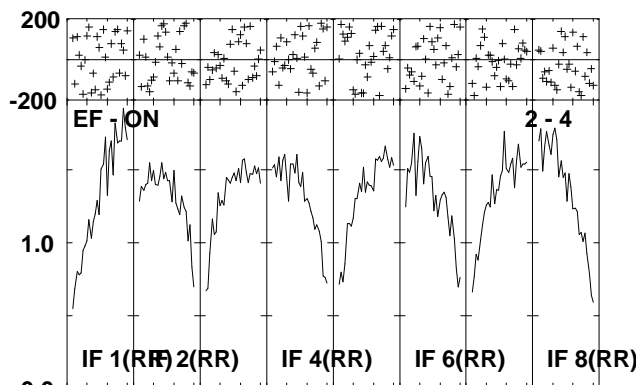
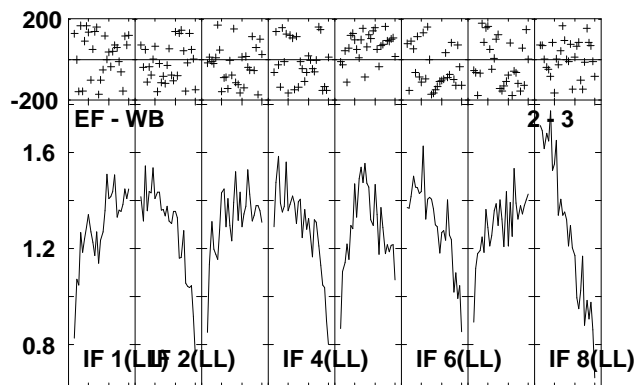
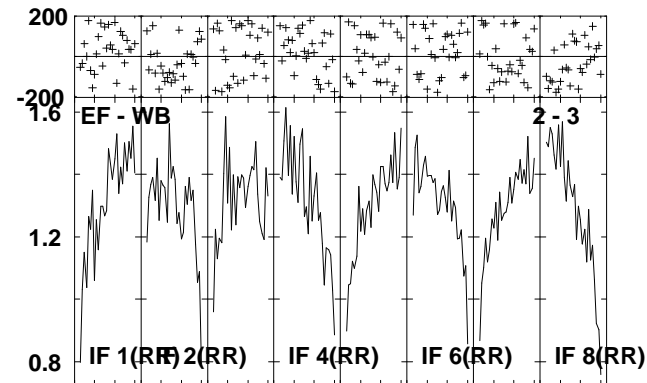
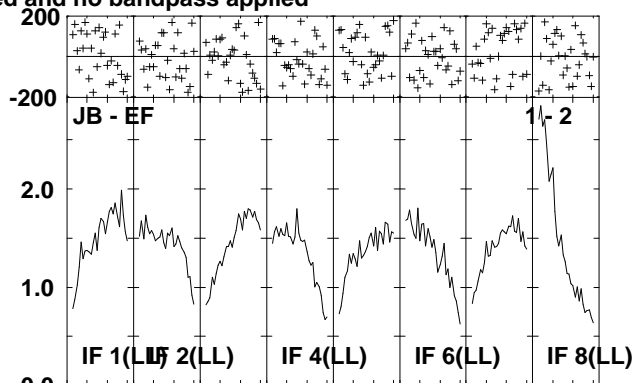
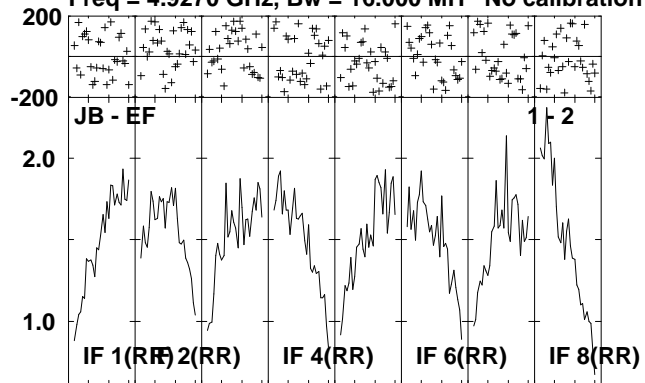

Lower frame: Milli Ampl Jy Top frame: Phas deg
Scalar averaged cross-power spectrum Several baselines displayed
Timerange: 00/13:15:31 to 00/13:19:09

Plot file version 124 created 06-JUL-2010 12:04:10

IRAS2336 EP064L.UVDATA.1

Freq = 4.9270 GHz, Bw = 16.000 MH No calibration applied and no bandpass applied

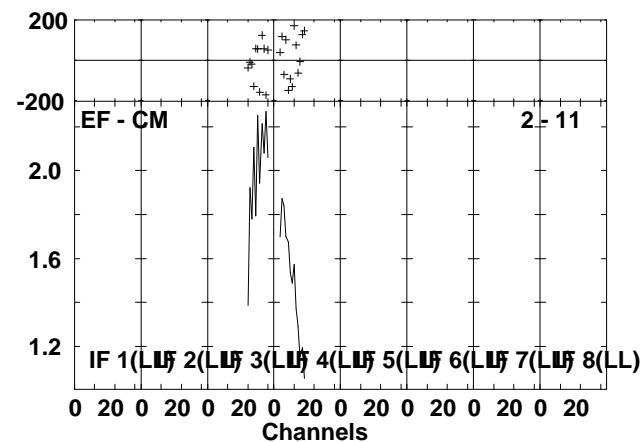
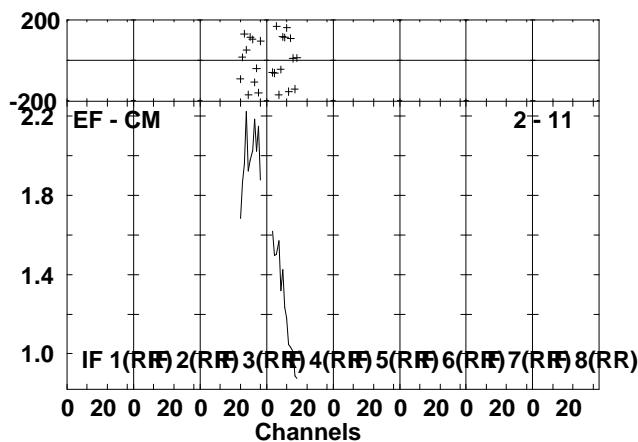
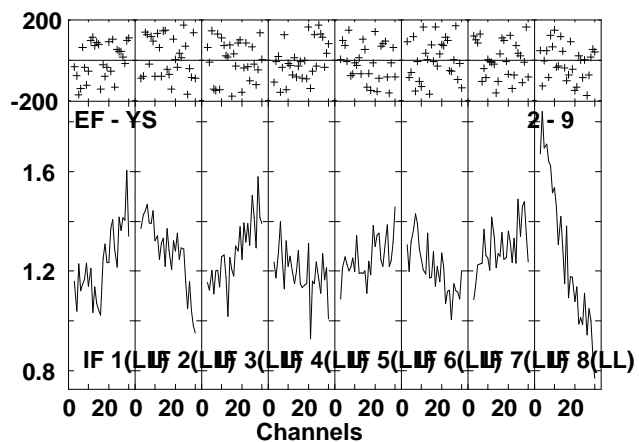
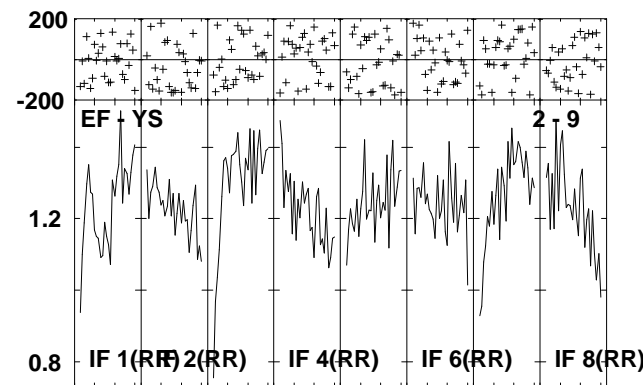
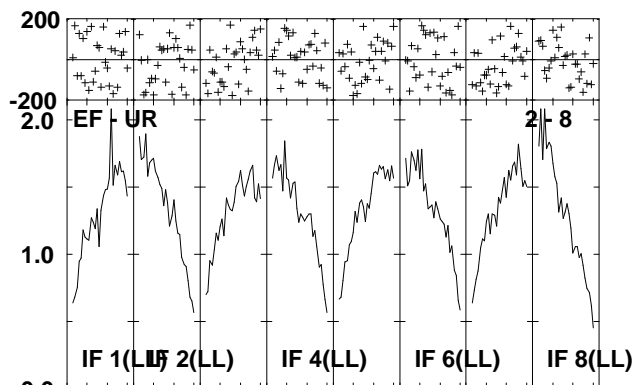
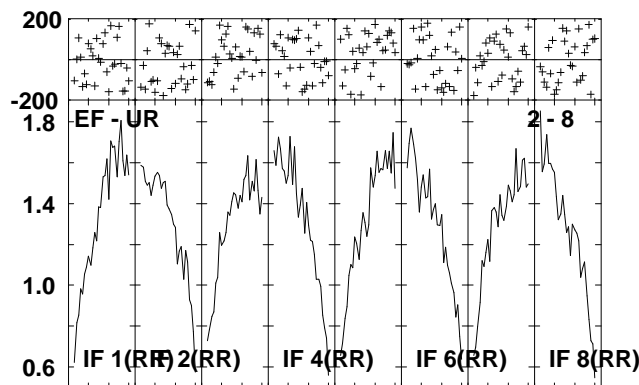
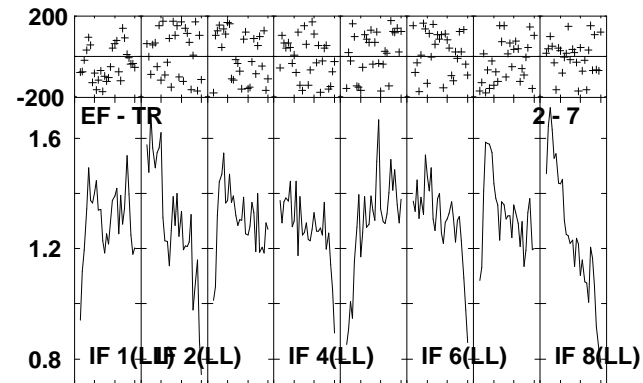
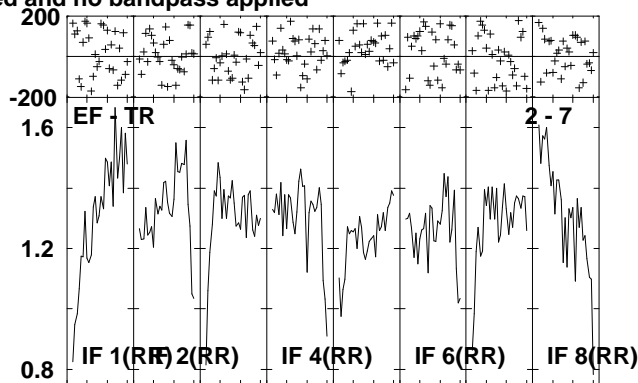
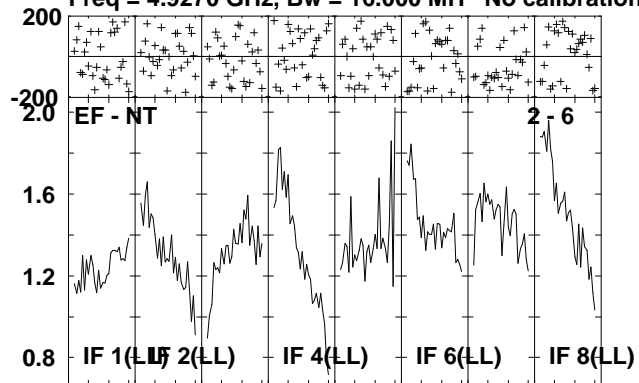

Lower frame: Milli Ampl Jy Top frame: Phas deg
Scalar averaged cross-power spectrum Several baselines displayed
Timerange: 00/13:15:31 to 00/13:19:09

Plot file version 125 created 06-JUL-2010 12:04:19

IRAS2336 EP064L.UVDATA.1

Freq = 4.9270 GHz, Bw = 16.000 MH No calibration applied and no bandpass applied

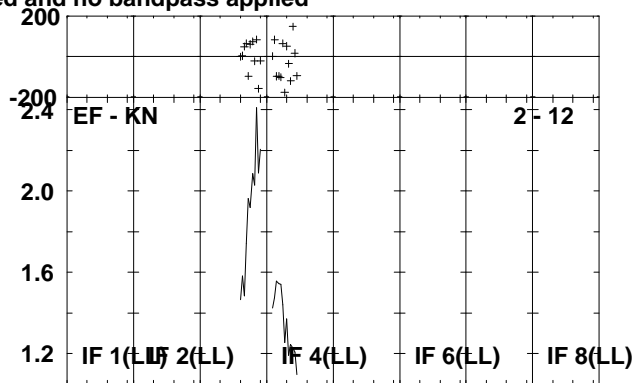
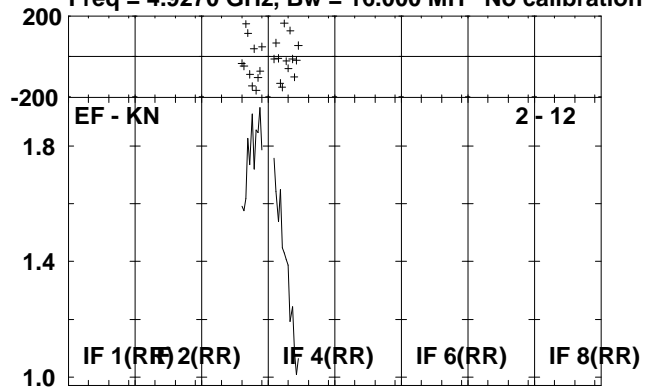

Lower frame: Milli Ampl Jy Top frame: Phas deg
Scalar averaged cross-power spectrum Several baselines displayed
Timerange: 00/13:15:31 to 00/13:19:09

Plot file version 126 created 06-JUL-2010 12:04:20

J2330+33 EP064L.UVDATA.1

Freq = 4.9270 GHz, Bw = 16.000 MH No calibration applied and no bandpass applied

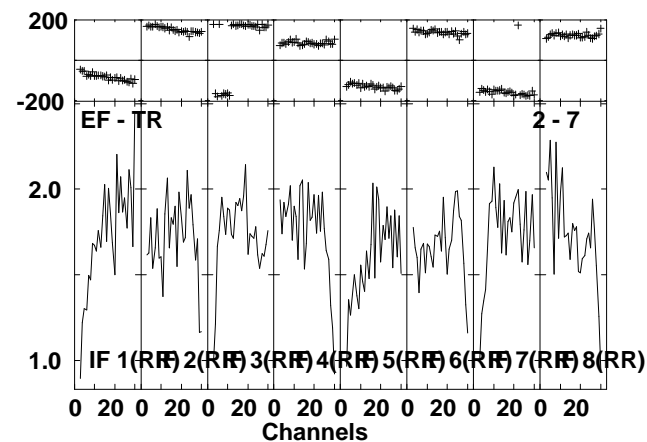
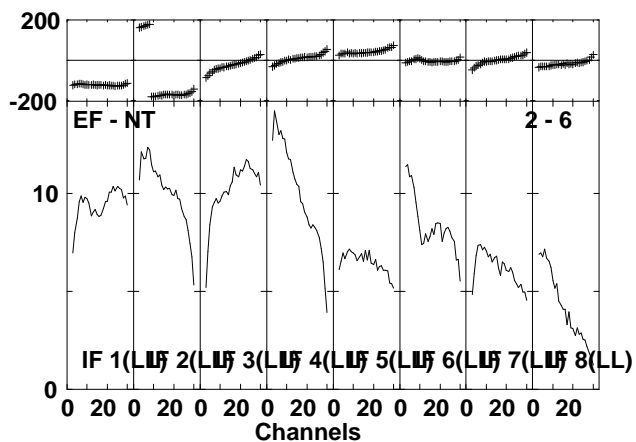
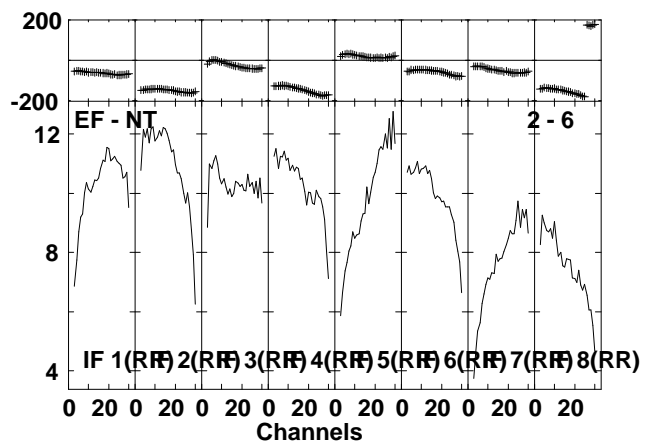
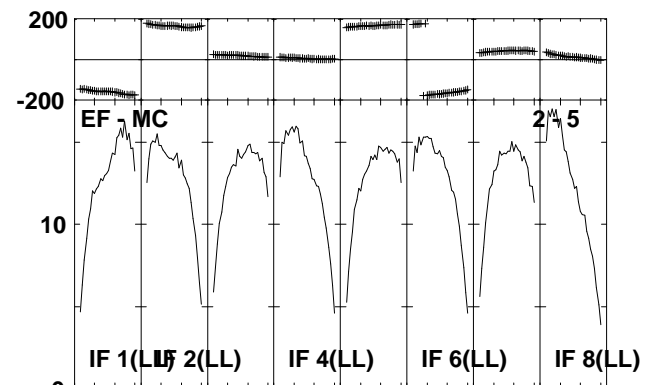
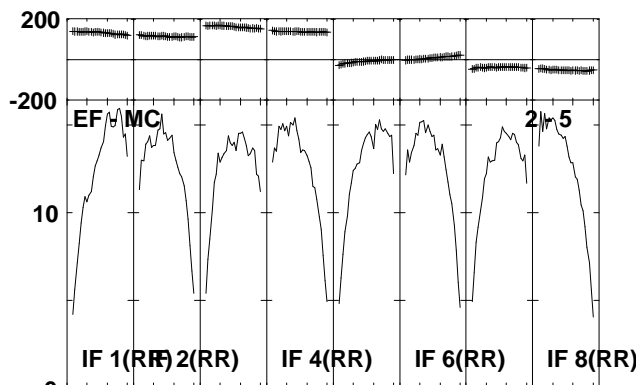
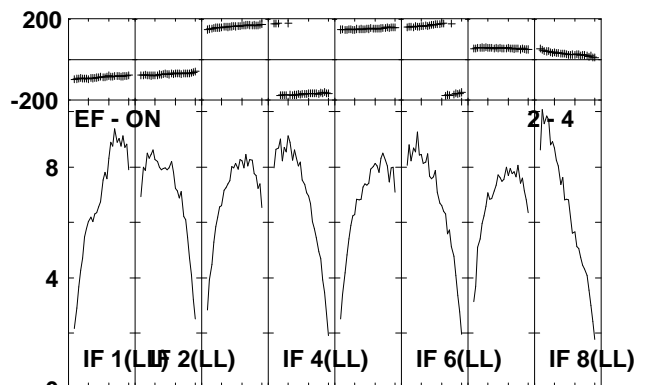
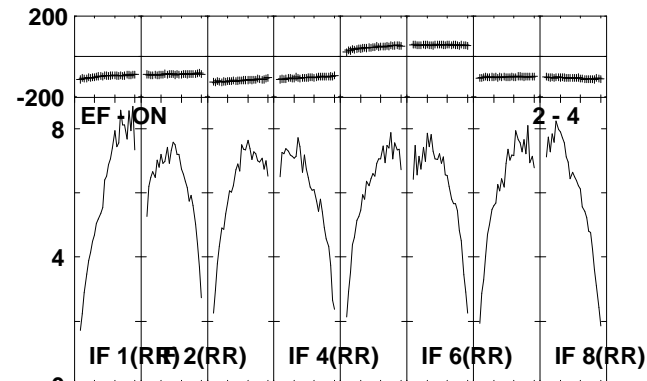
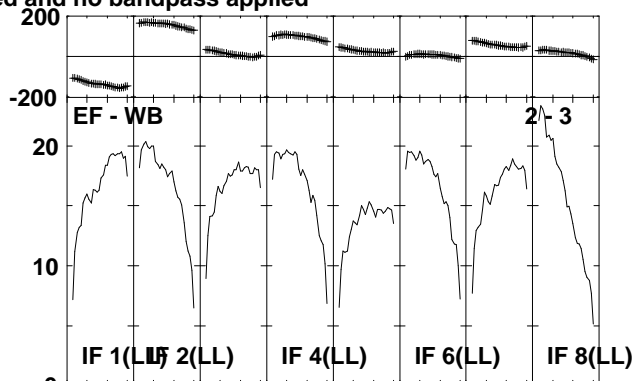
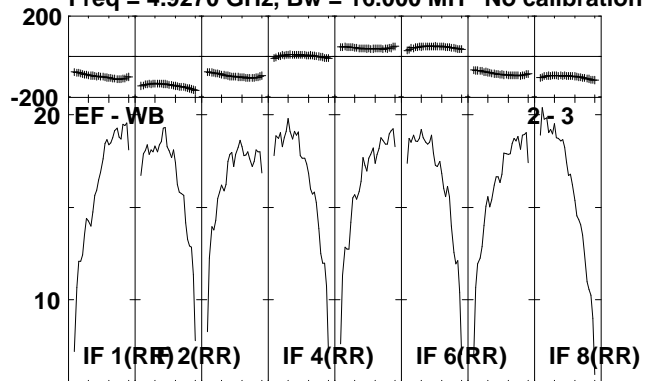

Lower frame: Milli Ampl Jy Top frame: Phas deg
Scalar averaged cross-power spectrum Several baselines displayed
Timerange: 00/13:19:11 to 00/13:20:59

Plot file version 127 created 06-JUL-2010 12:04:21

J2330+33 EP064L.UVDATA.1

Freq = 4.9270 GHz, Bw = 16.000 MH No calibration applied and no bandpass applied

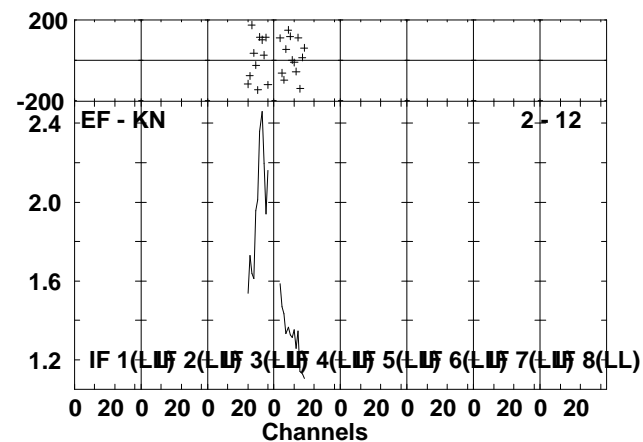
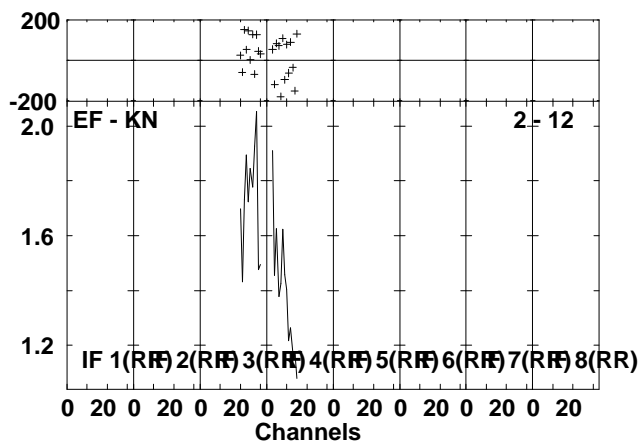
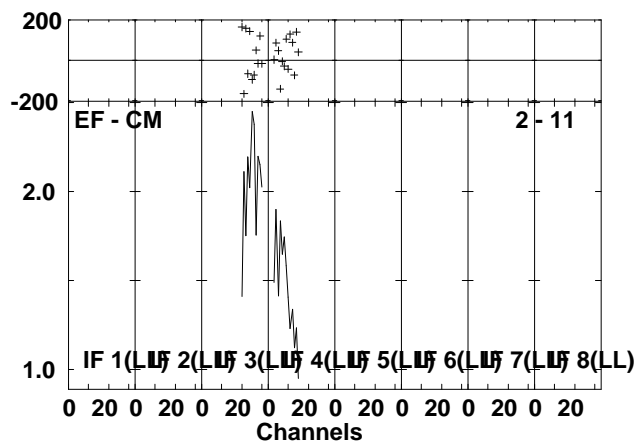
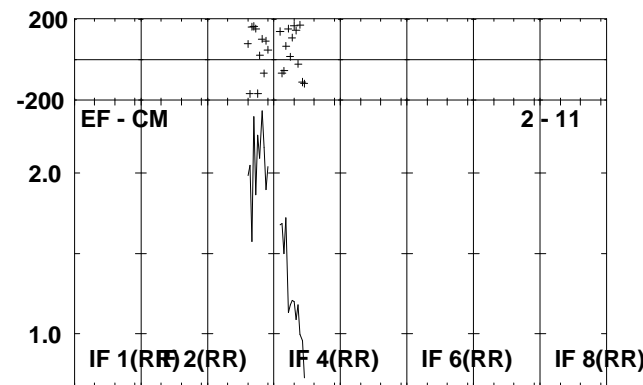
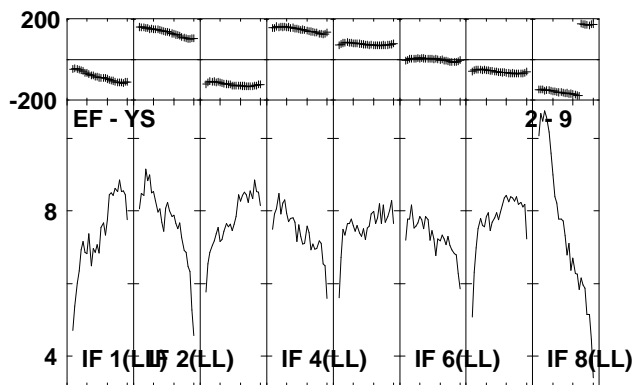
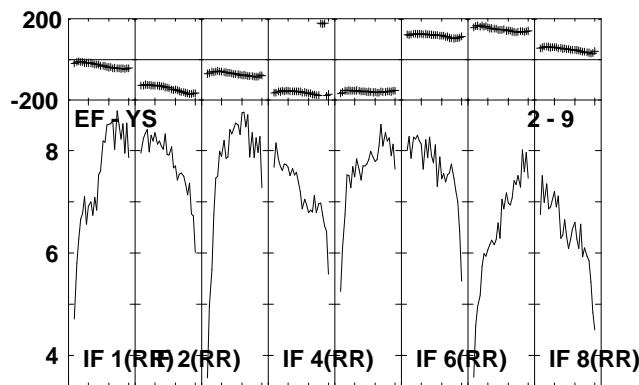
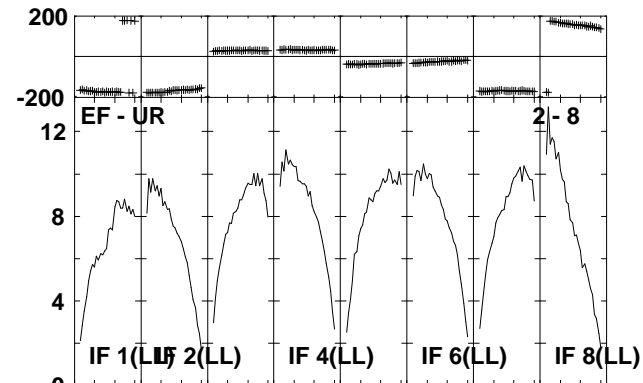
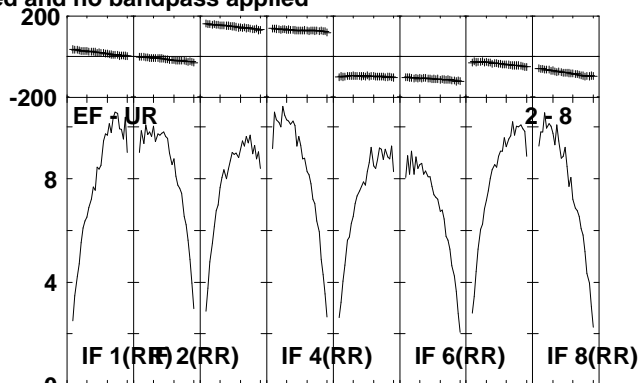
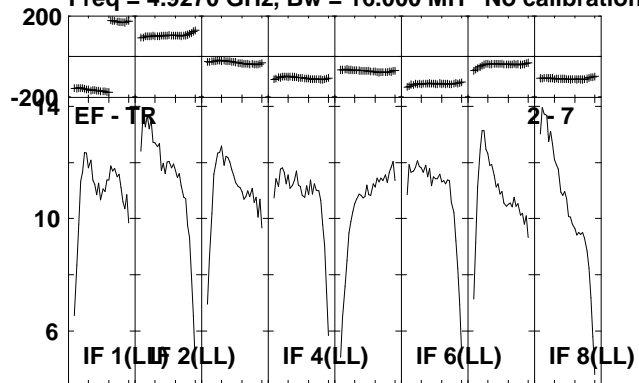

Lower frame: Milli Ampl Jy Top frame: Phas deg
Scalar averaged cross-power spectrum Several baselines displayed
Timerange: 00/13:19:11 to 00/13:20:59

Plot file version 128 created 06-JUL-2010 12:04:23

IRAS2336 EP064L.UVDATA.1

Freq = 4.9270 GHz, Bw = 16.000 MH No calibration applied and no bandpass applied

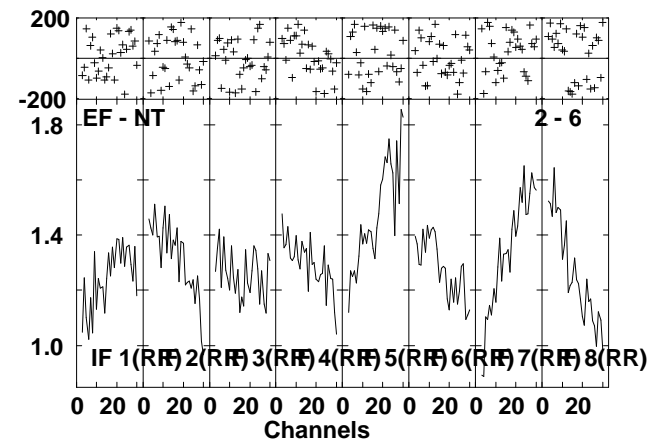
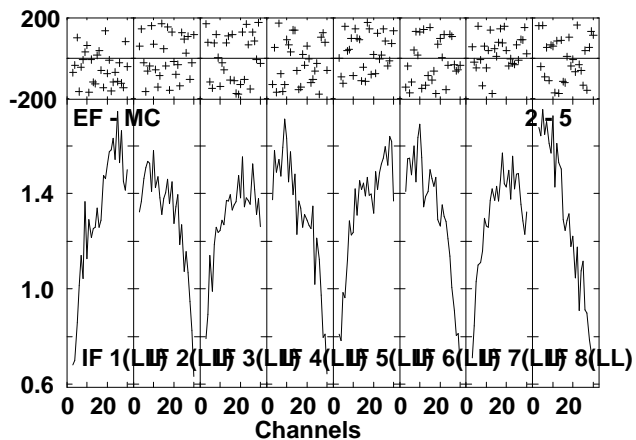
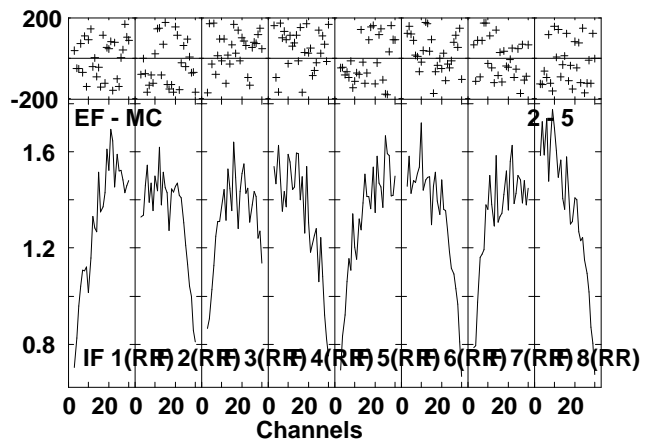
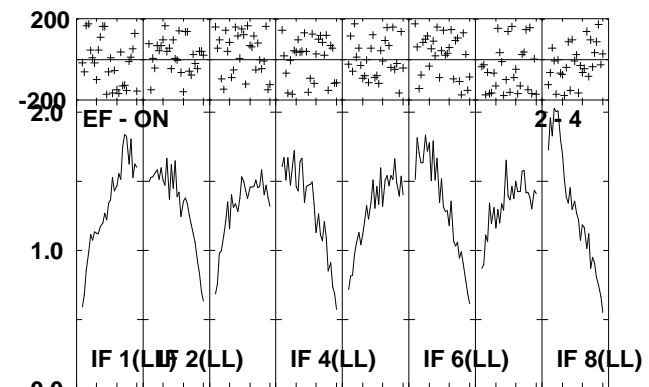
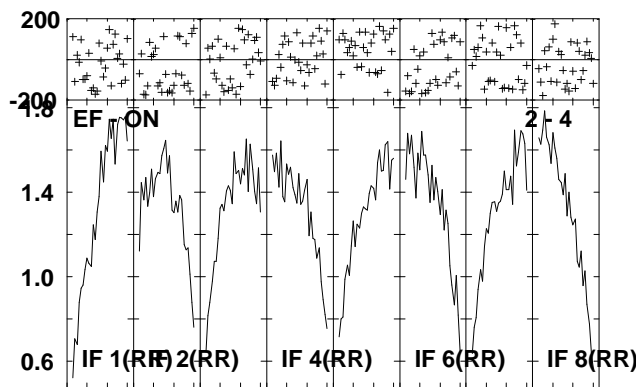
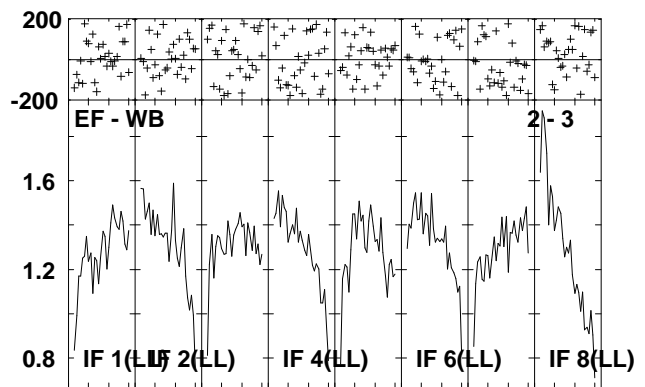
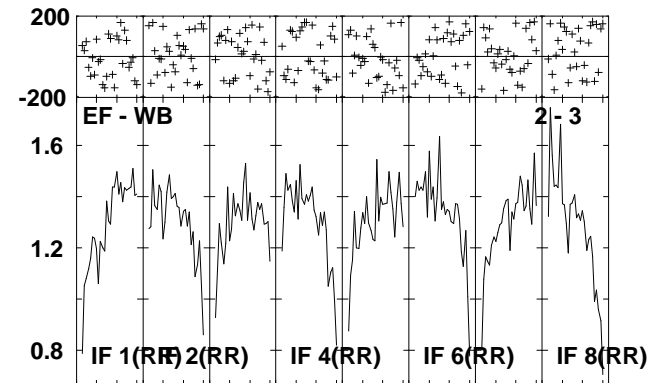
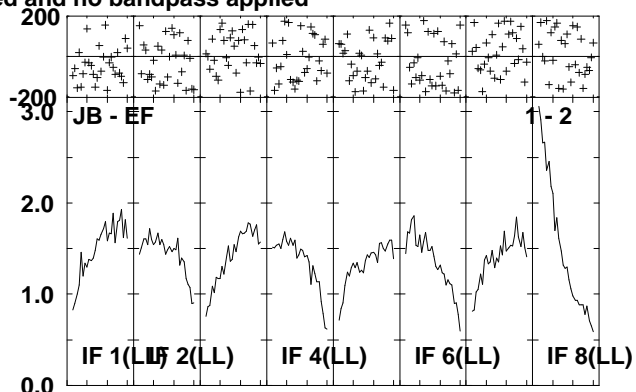
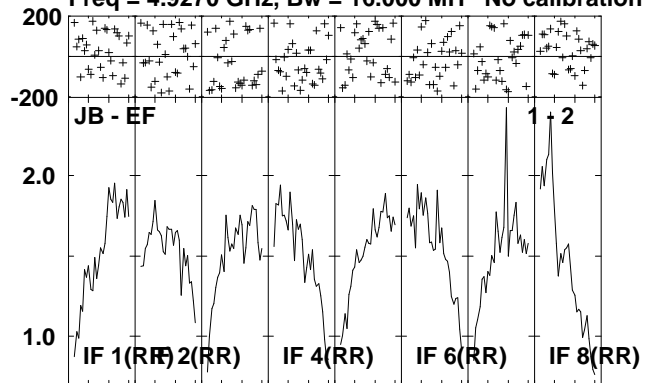

Lower frame: Milli Ampl Jy Top frame: Phas deg
Scalar averaged cross-power spectrum Several baselines displayed
Timerange: 00/13:21:01 to 00/13:24:39

Plot file version 129 created 06-JUL-2010 12:04:25

IRAS2336 EP064L.UVDATA.1

Freq = 4.9270 GHz, Bw = 16.000 MH No calibration applied and no bandpass applied

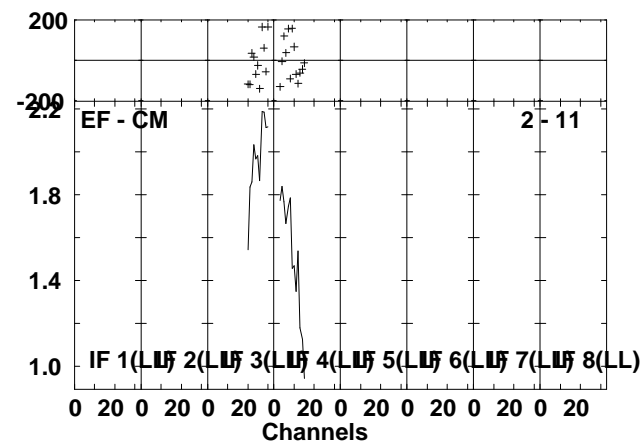
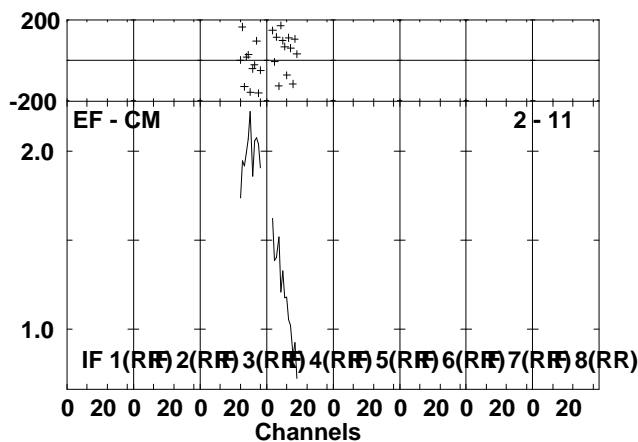
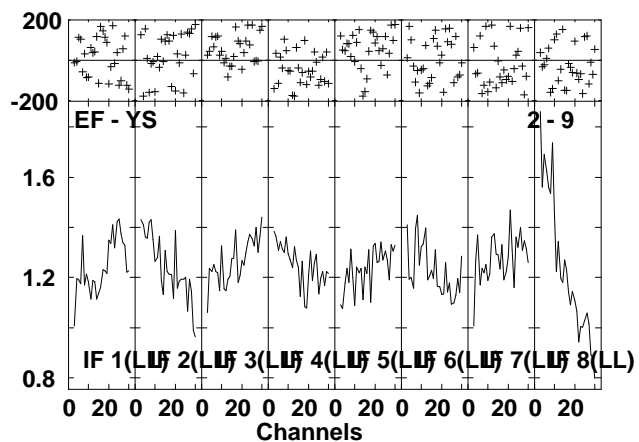
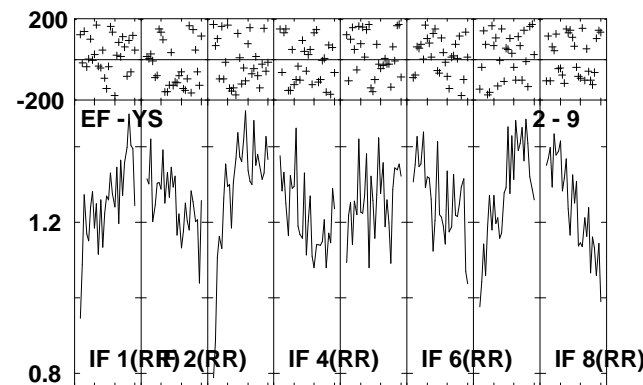
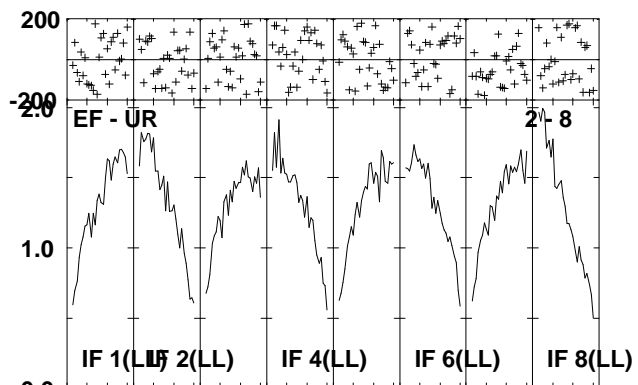
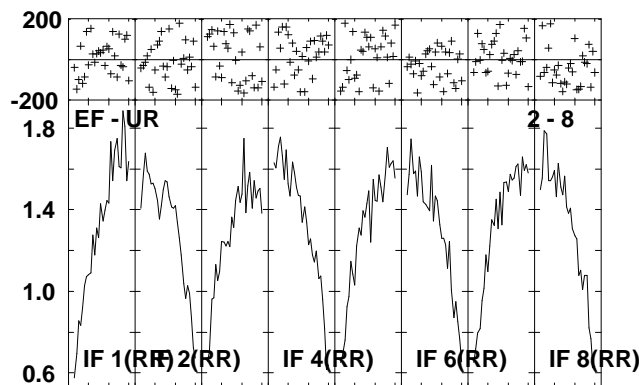
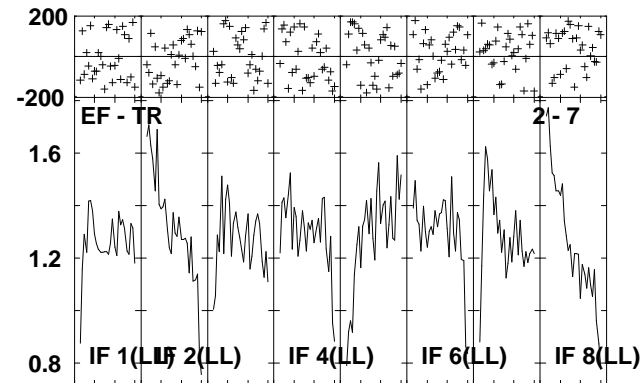
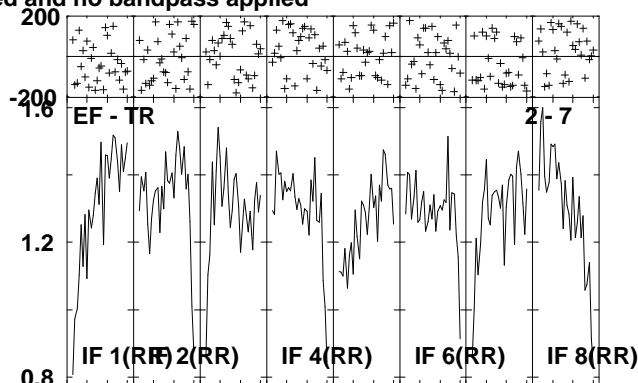
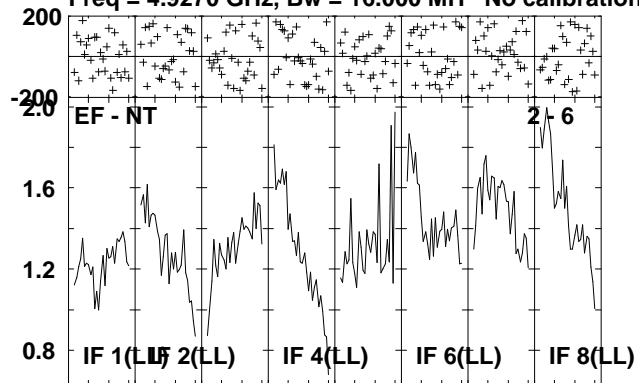

Lower frame: Milli Ampl Jy Top frame: Phas deg
Scalar averaged cross-power spectrum Several baselines displayed
Timerange: 00/13:21:01 to 00/13:24:39

Plot file version 130 created 06-JUL-2010 12:04:29

IRAS2336 EP064L.UVDATA.1

Freq = 4.9270 GHz, Bw = 16.000 MH No calibration applied and no bandpass applied

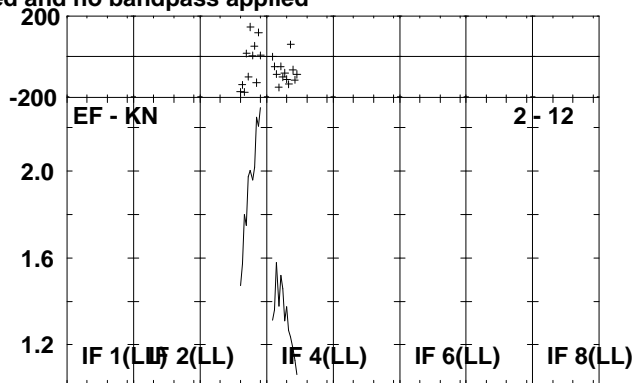
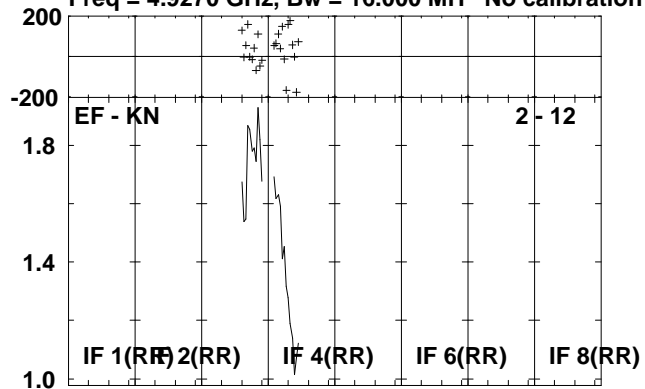

Lower frame: Milli Ampl Jy Top frame: Phas deg
Scalar averaged cross-power spectrum Several baselines displayed
Timerange: 00/13:21:01 to 00/13:24:39

Plot file version 131 created 06-JUL-2010 12:04:29

J2330+33 EP064L.UVDATA.1

Freq = 4.9270 GHz, Bw = 16.000 MH No calibration applied and no bandpass applied

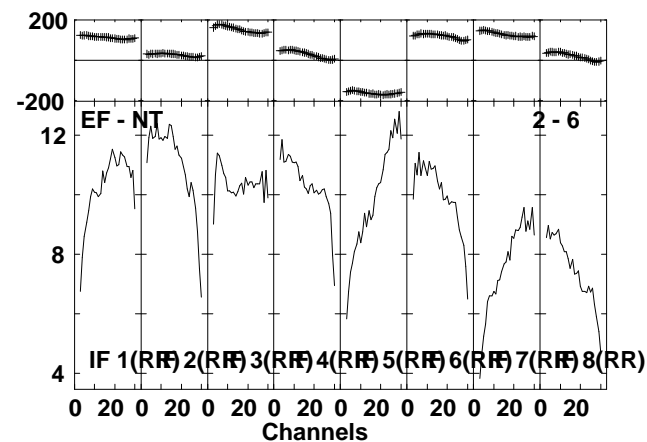
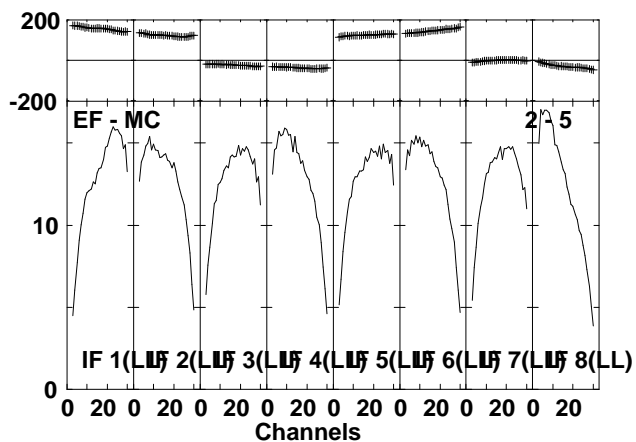
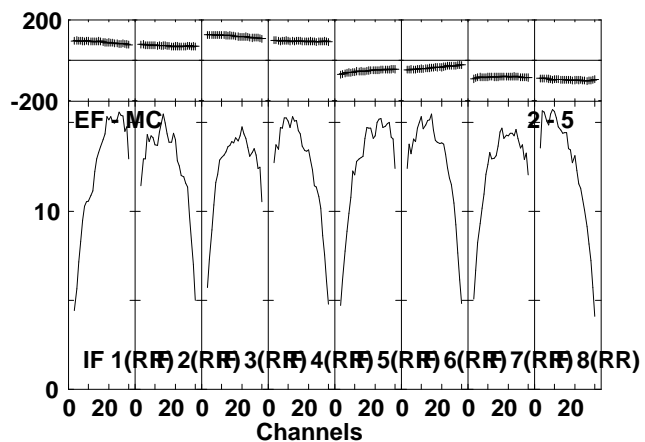
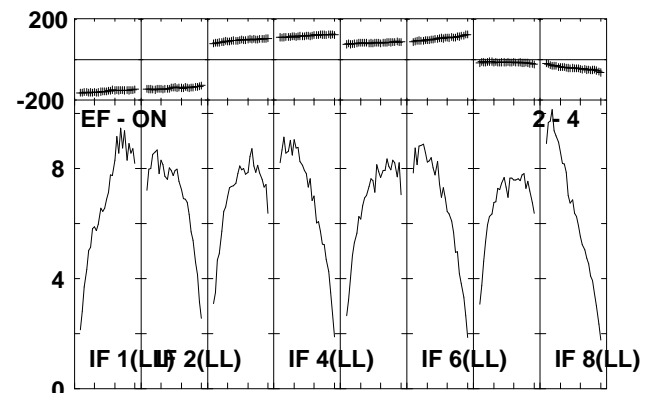
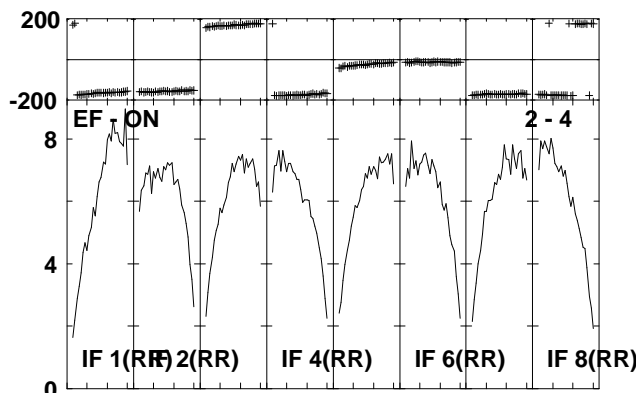
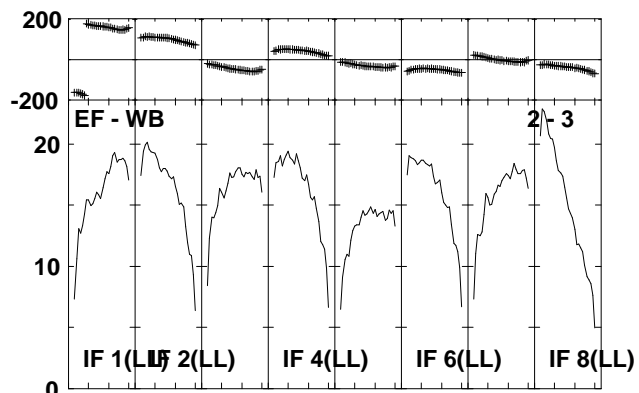
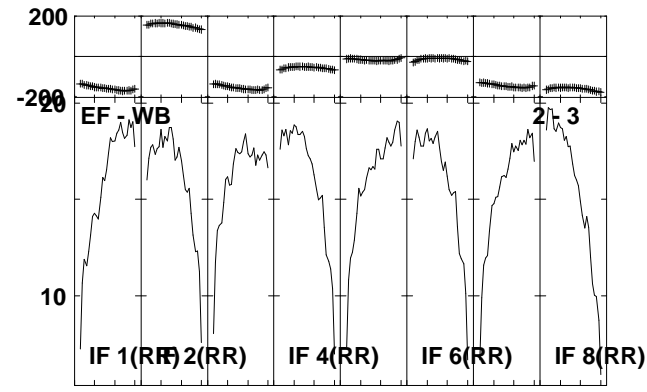
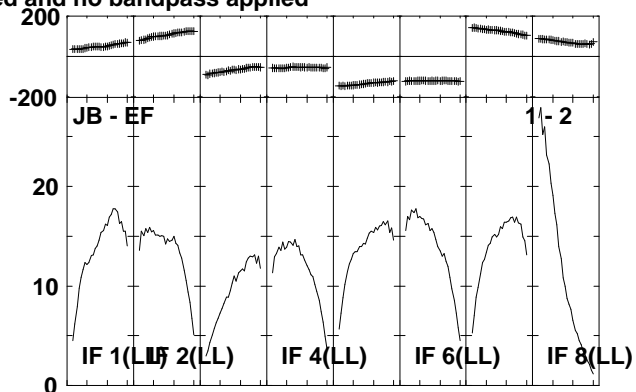
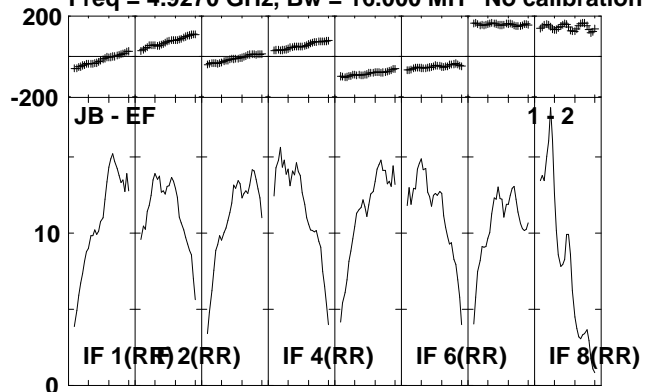

Lower frame: Milli Ampl Jy Top frame: Phas deg
Scalar averaged cross-power spectrum Several baselines displayed
Timerange: 00/13:24:41 to 00/13:26:29

Plot file version 132 created 06-JUL-2010 12:04:30

J2330+33 EP064L.UVDATA.1

Freq = 4.9270 GHz, Bw = 16.000 MH No calibration applied and no bandpass applied

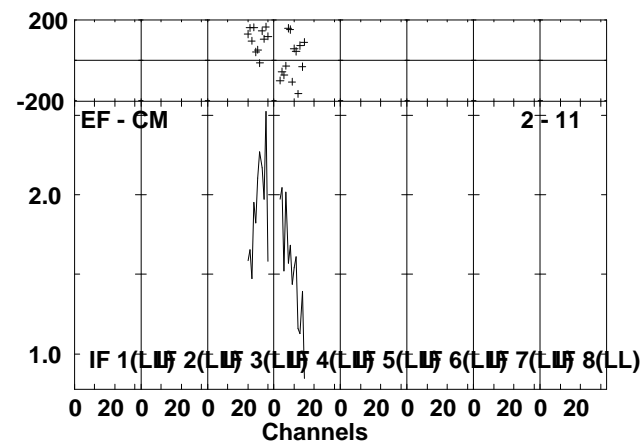
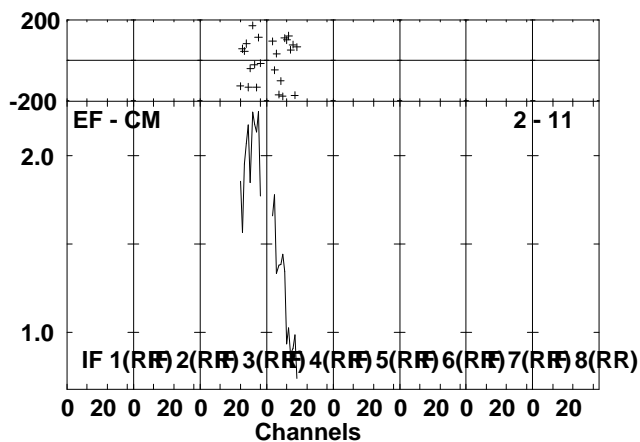
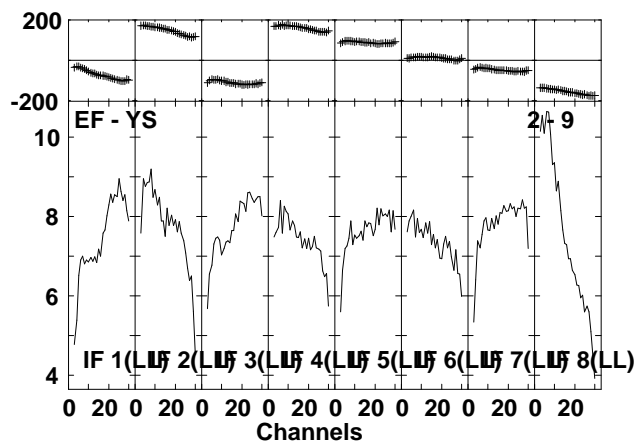
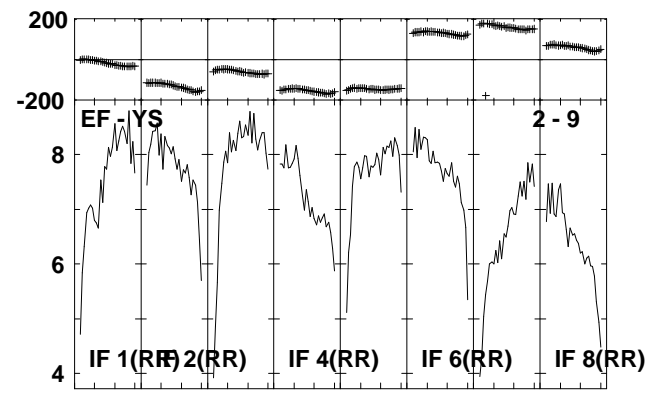
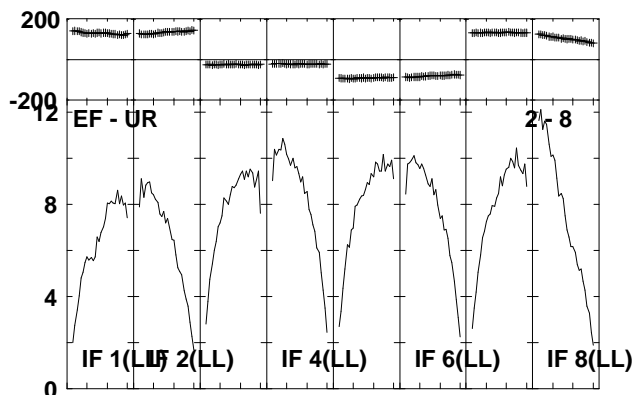
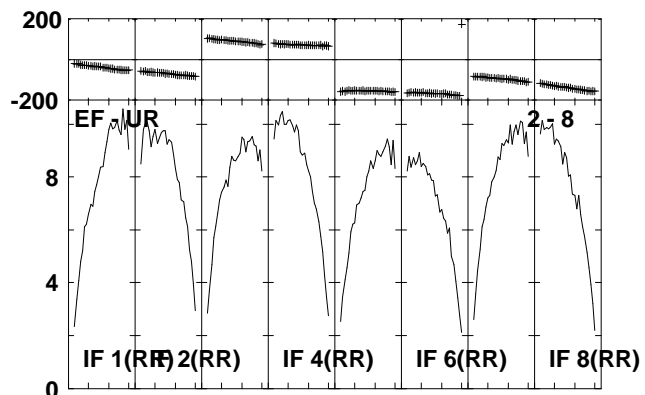
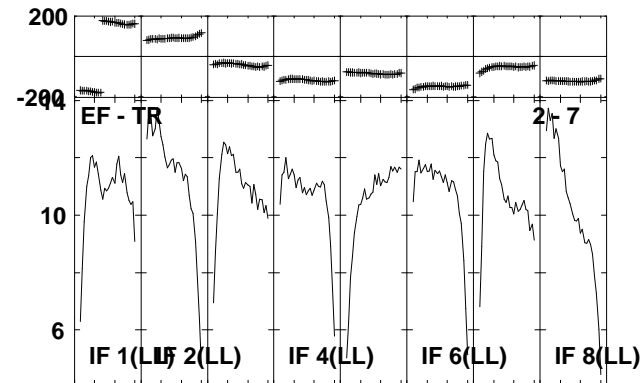
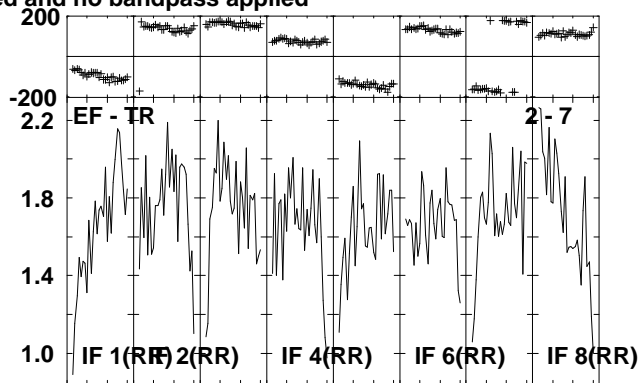
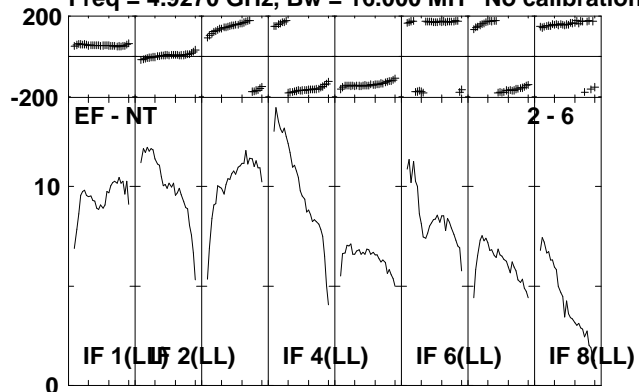

Lower frame: Milli Ampl Jy Top frame: Phas deg
Scalar averaged cross-power spectrum Several baselines displayed
Timerange: 00/13:24:41 to 00/13:26:29

Plot file version 133 created 06-JUL-2010 12:04:32

J2330+33 EP064L.UVDATA.1

Freq = 4.9270 GHz, Bw = 16.000 MH No calibration applied and no bandpass applied

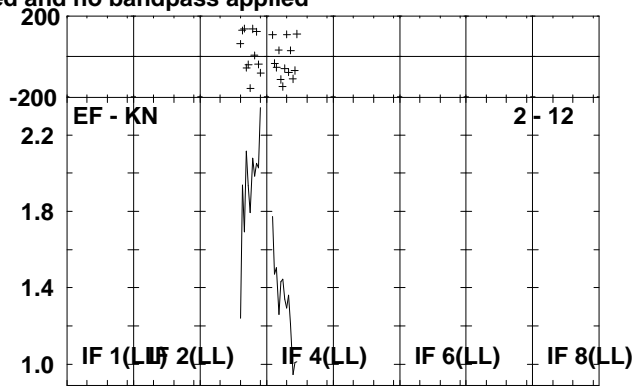
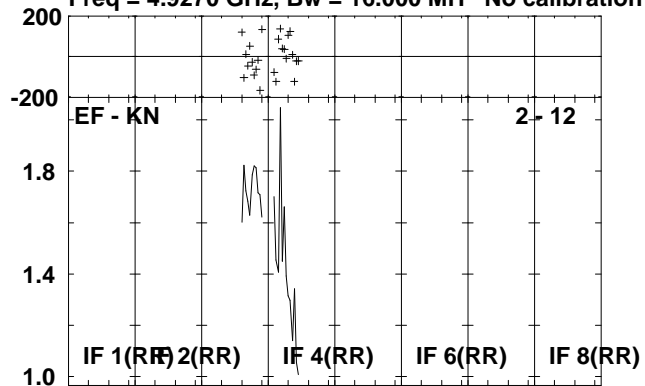

Lower frame: Milli Ampl Jy Top frame: Phas deg
Scalar averaged cross-power spectrum Several baselines displayed
Timerange: 00/13:24:41 to 00/13:26:29

Plot file version 134 created 06-JUL-2010 12:04:33

IRAS2336 EP064L.UVDATA.1

Freq = 4.9270 GHz, Bw = 16.000 MH No calibration applied and no bandpass applied

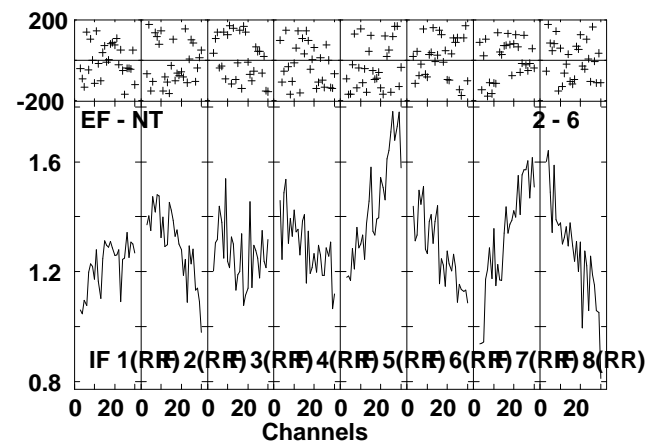
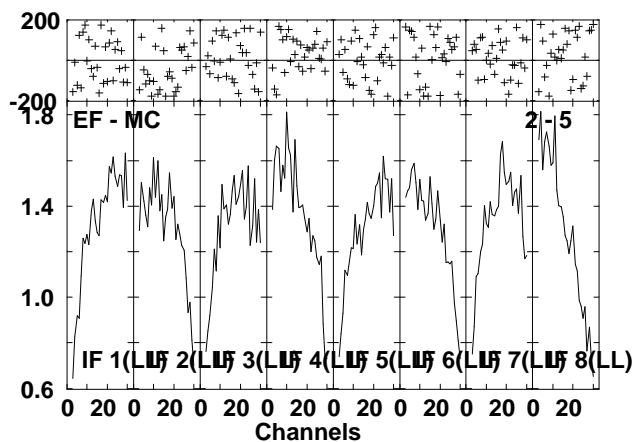
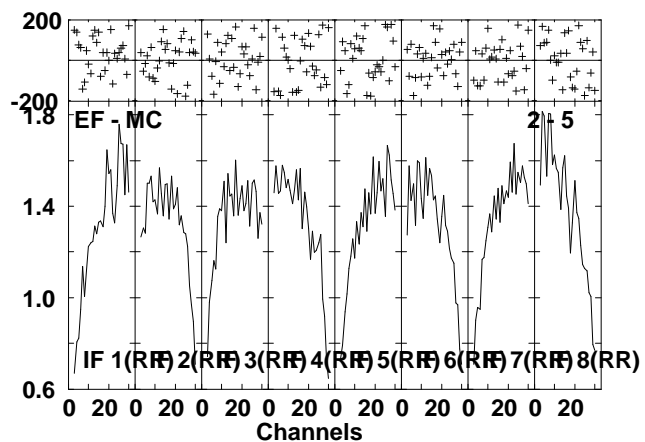
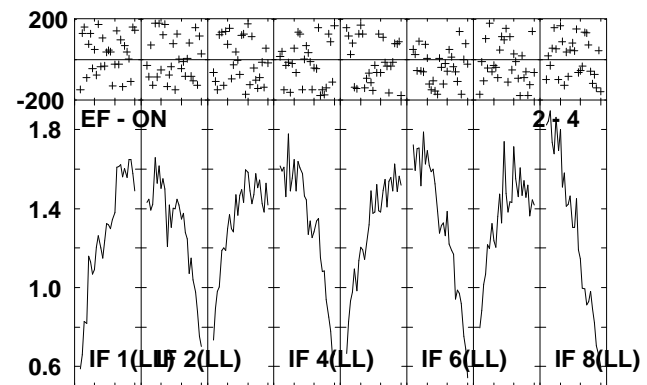
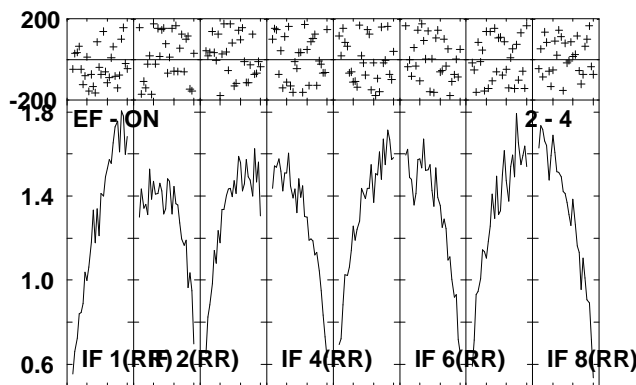
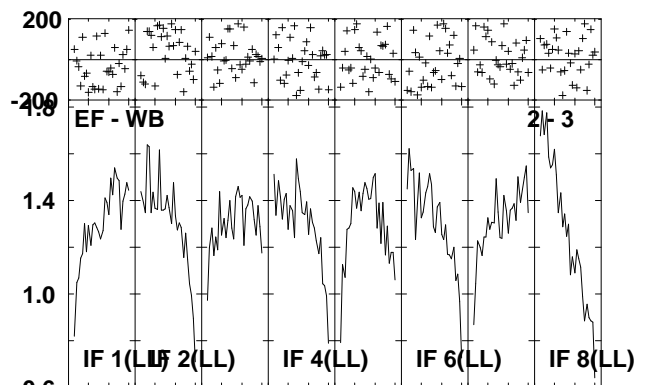
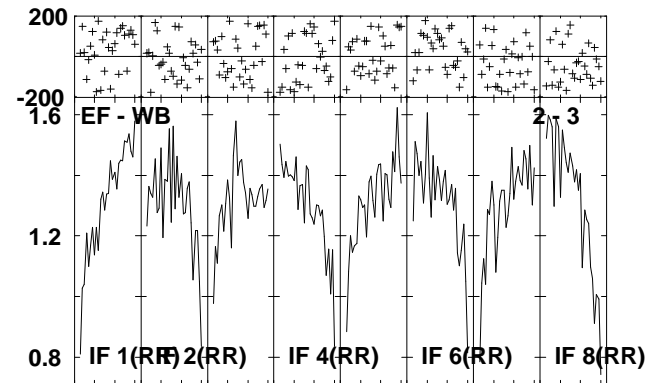
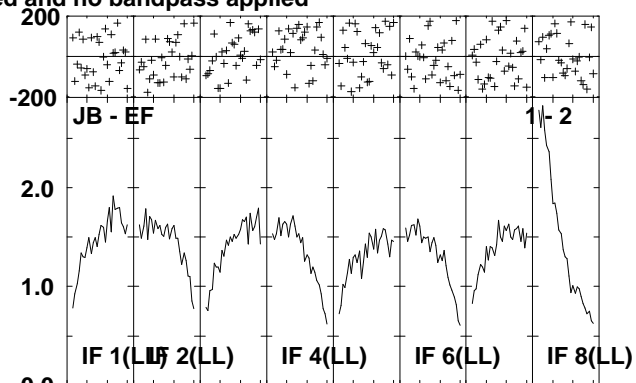
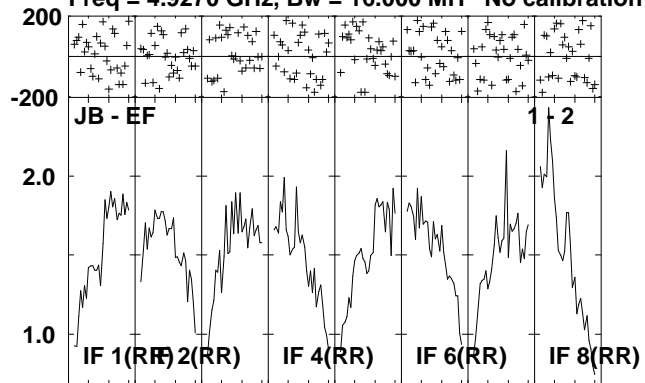

Lower frame: Milli Ampl Jy Top frame: Phas deg
Scalar averaged cross-power spectrum Several baselines displayed
Timerange: 00/13:26:31 to 00/13:30:09

Plot file version 135 created 06-JUL-2010 12:04:35

IRAS2336 EP064L.UVDATA.1

Freq = 4.9270 GHz, Bw = 16.000 MH No calibration applied and no bandpass applied

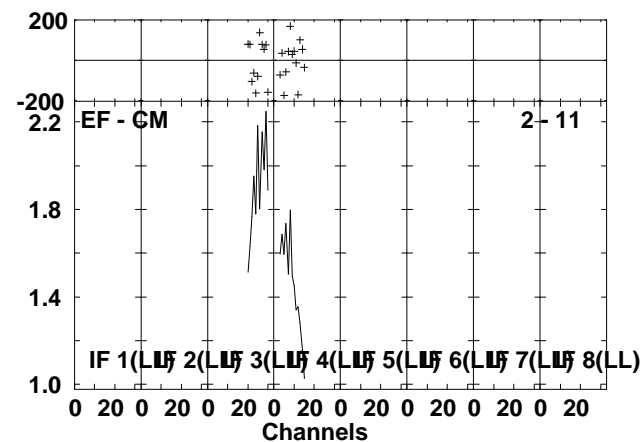
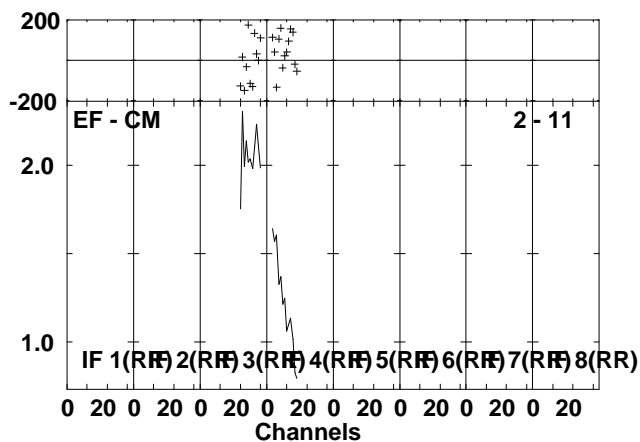
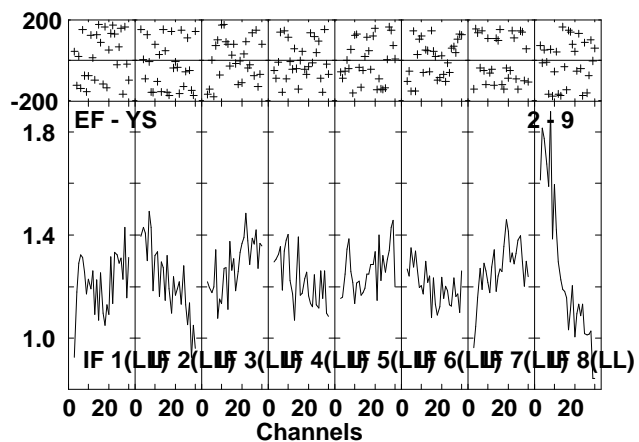
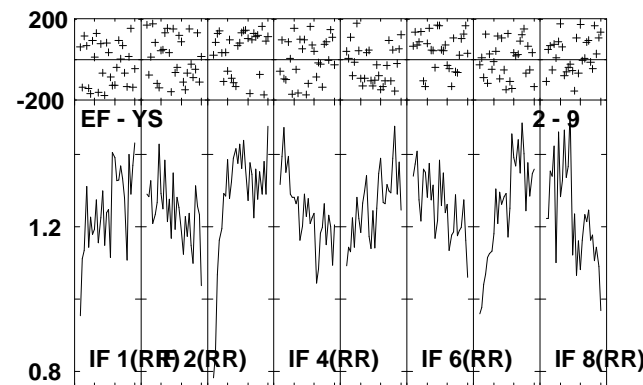
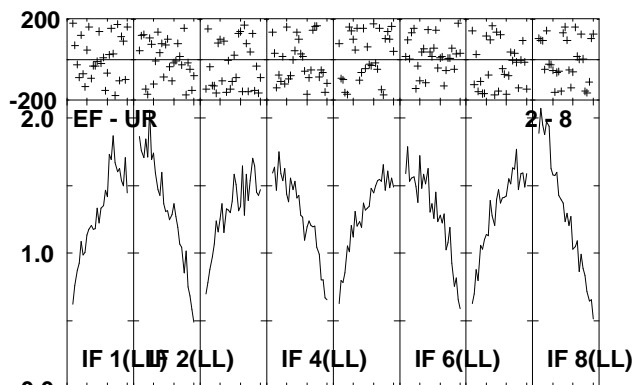
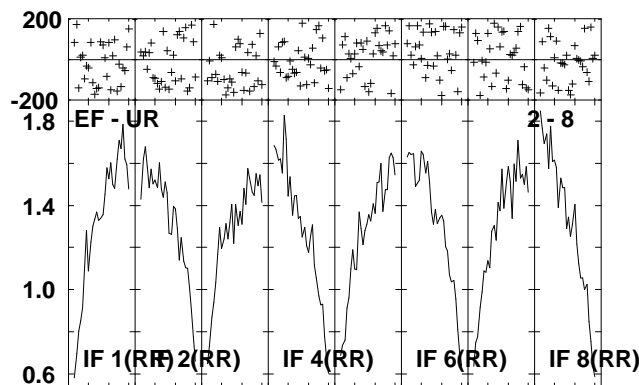
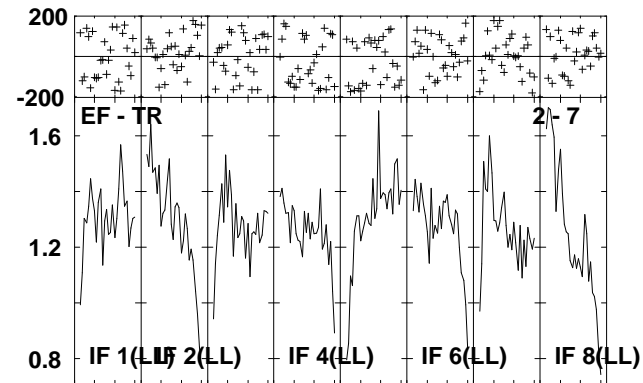
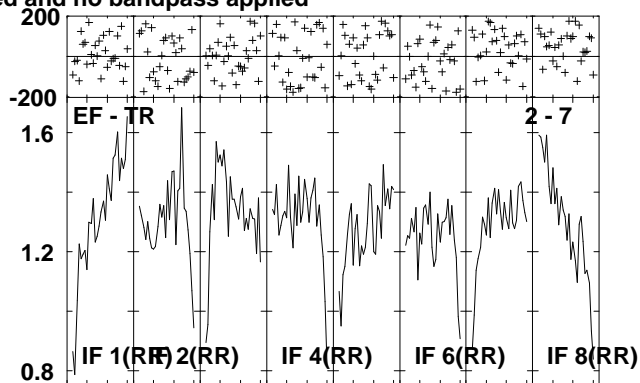
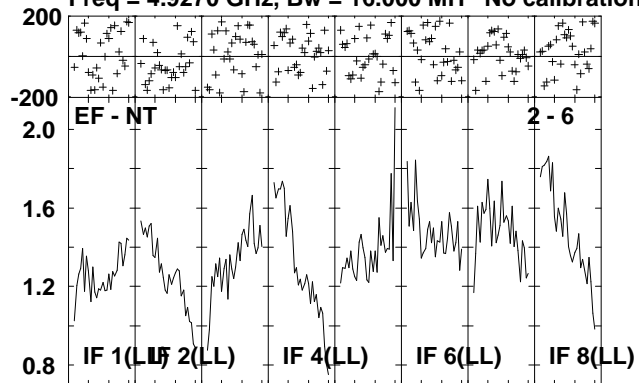

Lower frame: Milli Ampl Jy Top frame: Phas deg
Scalar averaged cross-power spectrum Several baselines displayed
Timerange: 00/13:26:31 to 00/13:30:09

Plot file version 136 created 06-JUL-2010 12:04:39

IRAS2336 EP064L.UVDATA.1

Freq = 4.9270 GHz, Bw = 16.000 MH No calibration applied and no bandpass applied

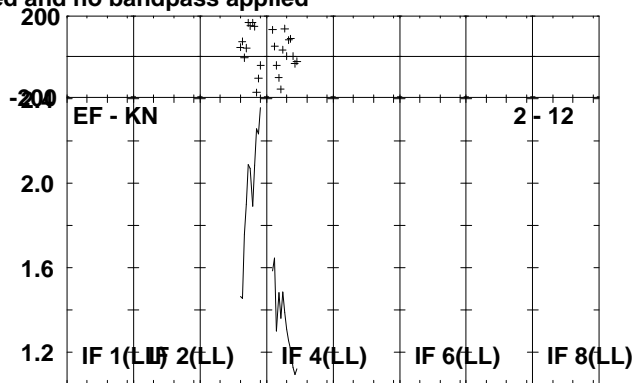
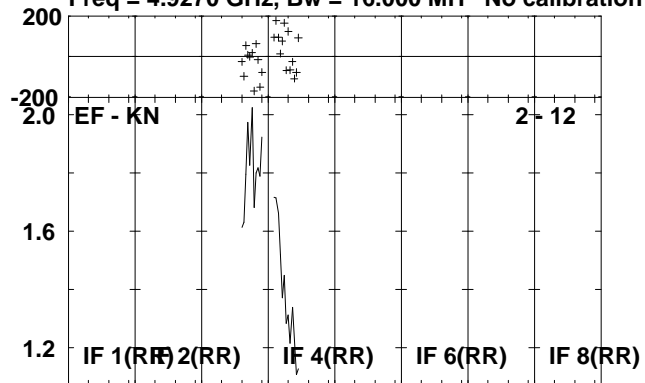

Lower frame: Milli Ampl Jy Top frame: Phas deg
Scalar averaged cross-power spectrum Several baselines displayed
Timerange: 00/13:26:31 to 00/13:30:09

Plot file version 137 created 06-JUL-2010 12:04:39

J2330+33 EP064L.UVDATA.1

Freq = 4.9270 GHz, Bw = 16.000 MH No calibration applied and no bandpass applied

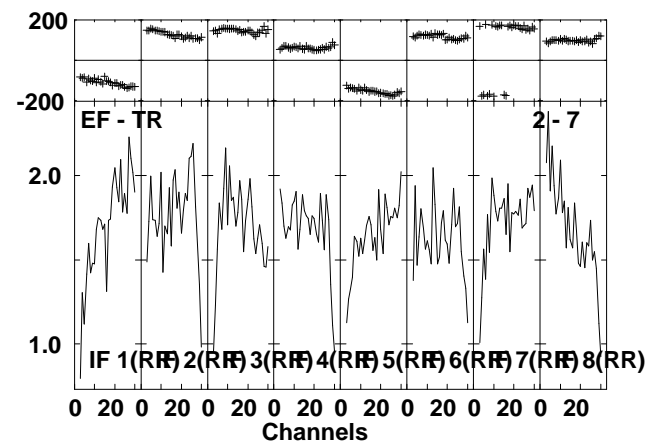
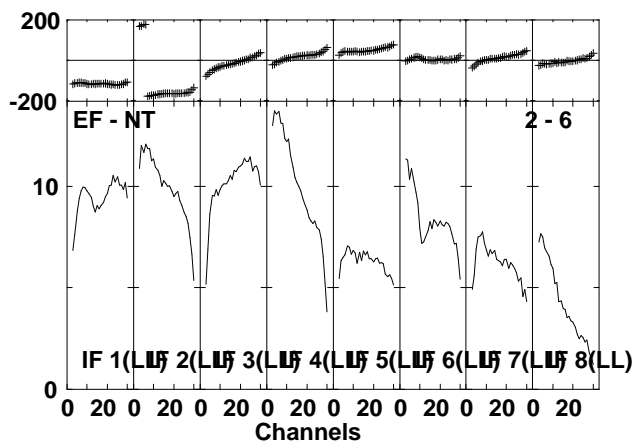
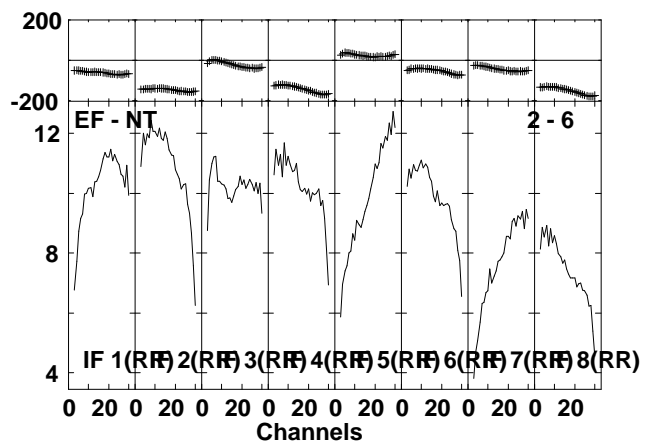
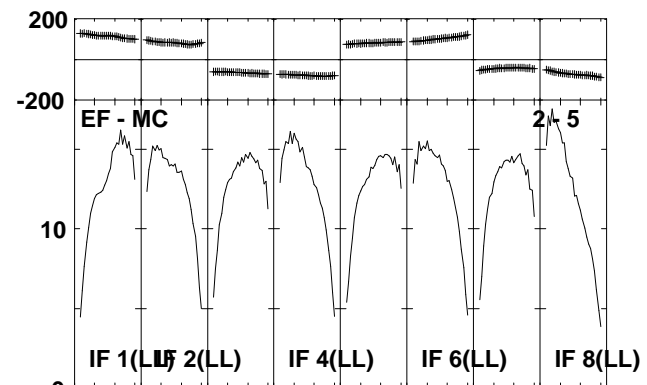
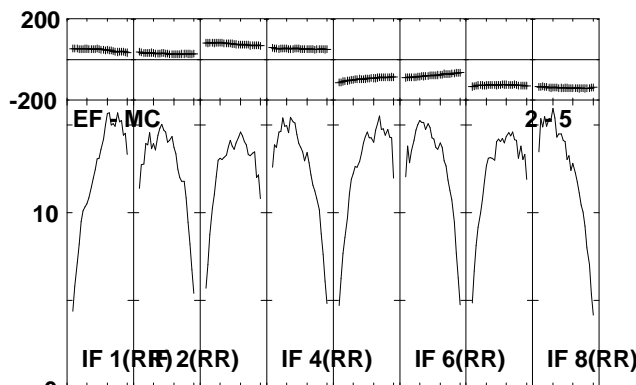
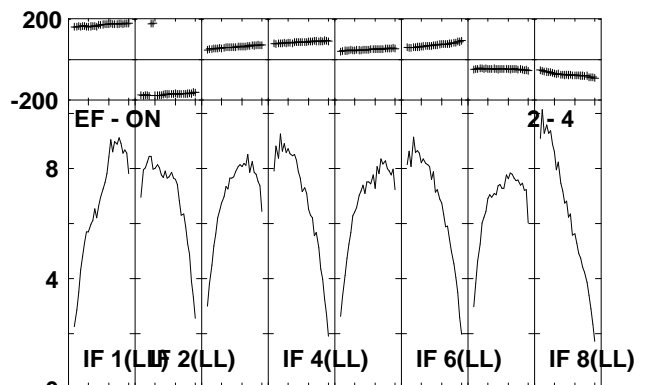
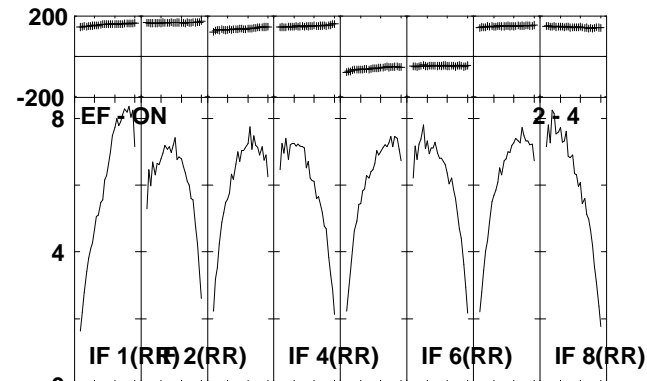
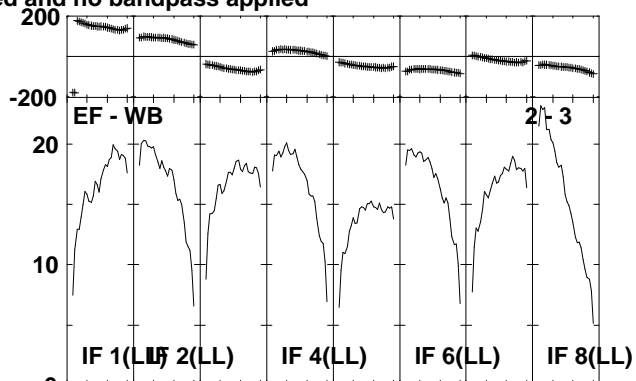
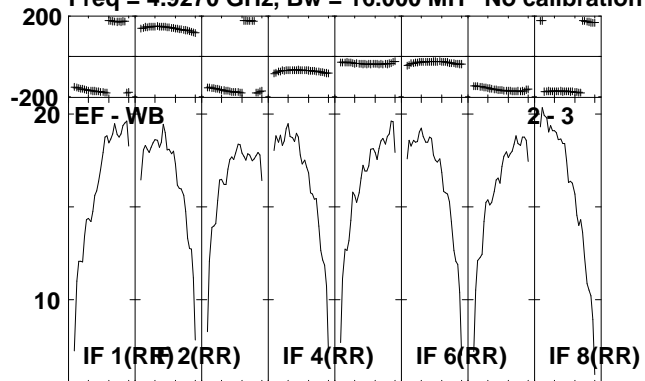

Lower frame: Milli Ampl Jy Top frame: Phas deg
Scalar averaged cross-power spectrum Several baselines displayed
Timerange: 00/13:31:11 to 00/13:32:49

Plot file version 138 created 06-JUL-2010 12:04:40

J2330+33 EP064L.UVDATA.1

Freq = 4.9270 GHz, Bw = 16.000 MH No calibration applied and no bandpass applied

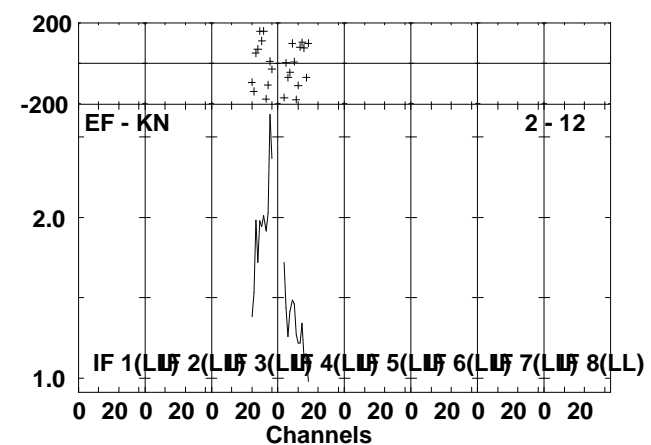
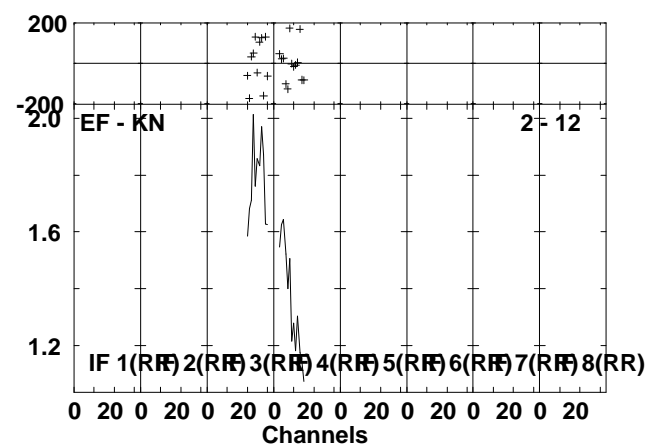
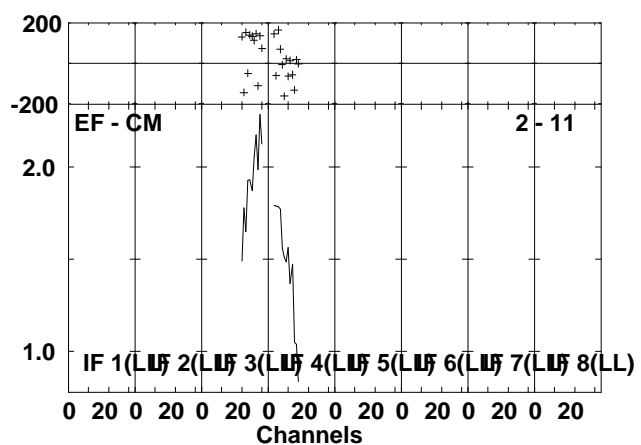
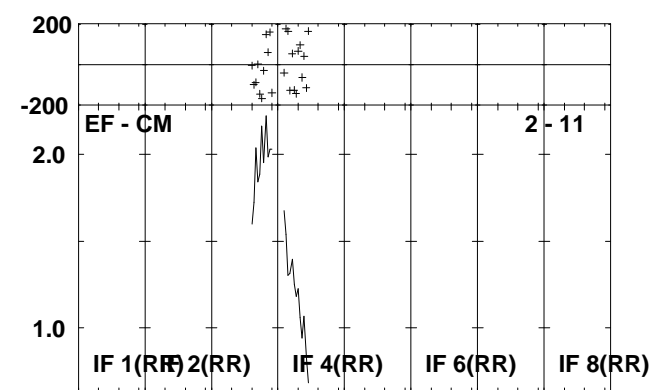
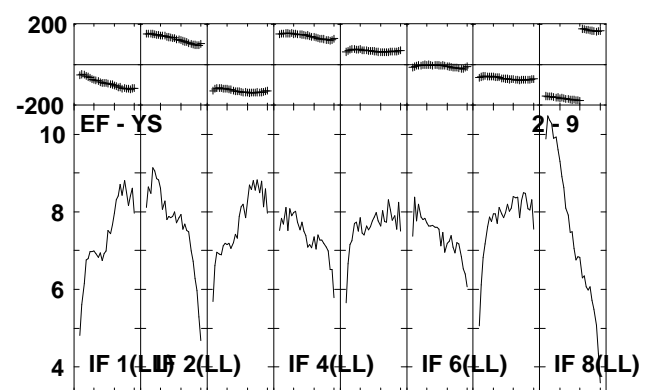
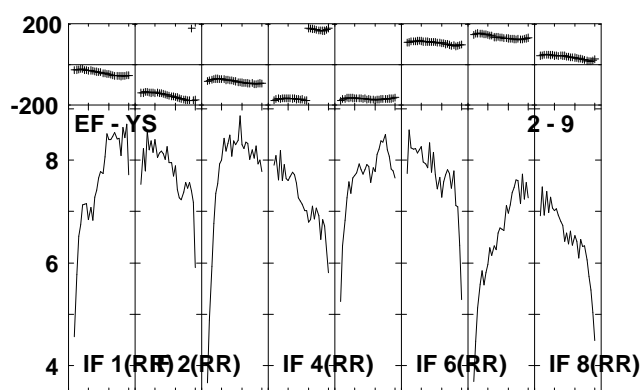
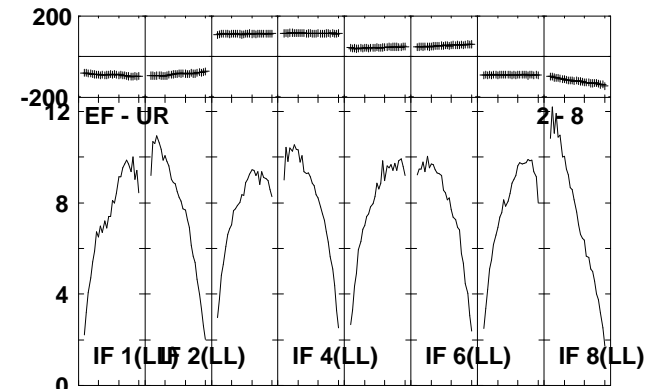
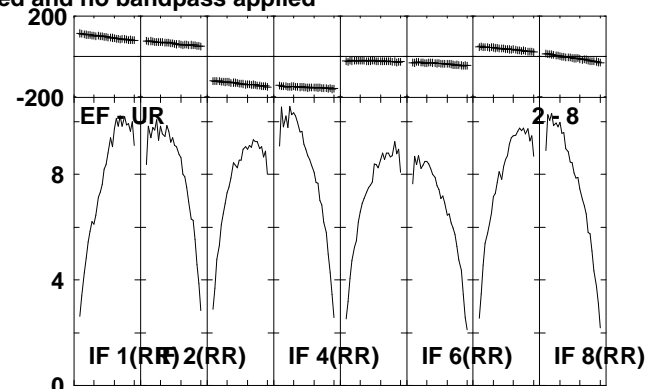
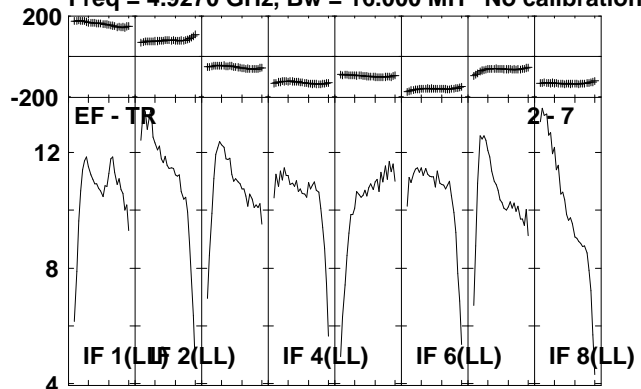

Lower frame: Milli Ampl Jy Top frame: Phas deg
Scalar averaged cross-power spectrum Several baselines displayed
Timerange: 00/13:31:11 to 00/13:32:49

Plot file version 139 created 06-JUL-2010 12:04:42

IRAS2336 EP064L.UVDATA.1

Freq = 4.9270 GHz, Bw = 16.000 MH No calibration applied and no bandpass applied

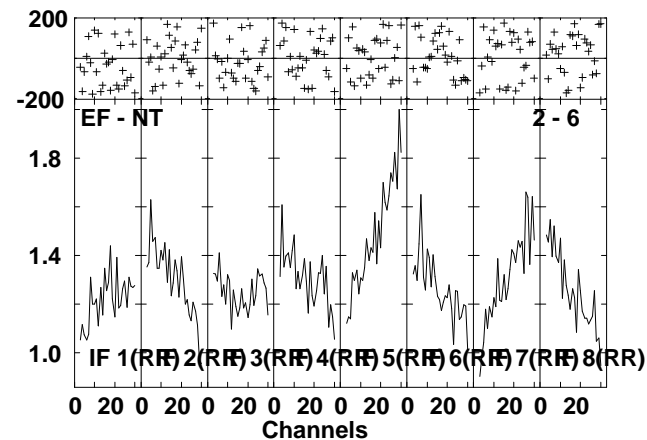
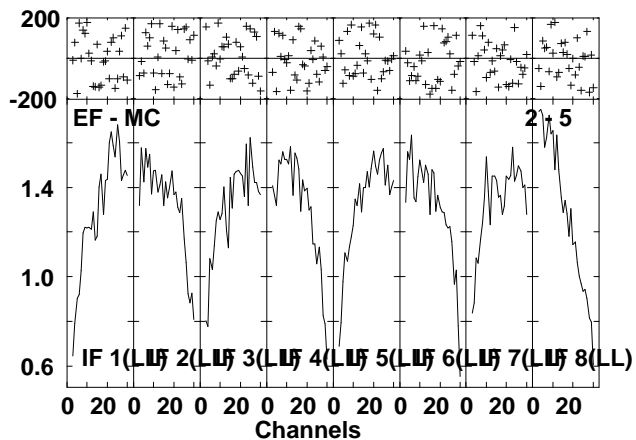
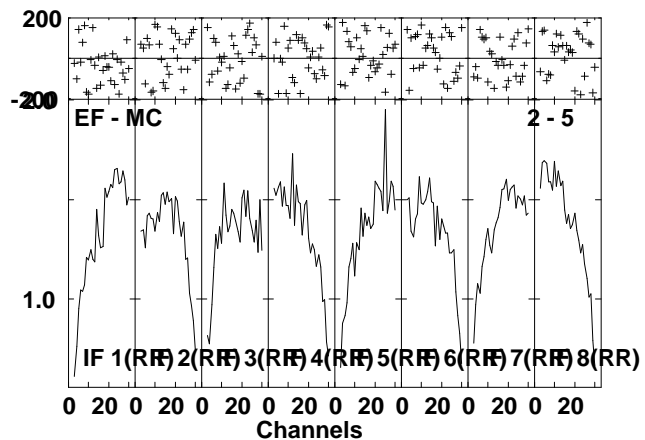
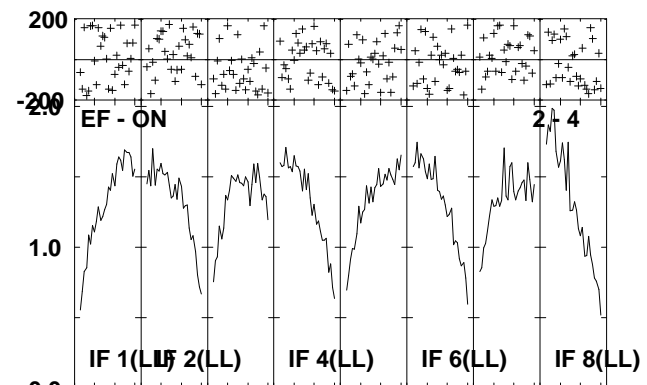
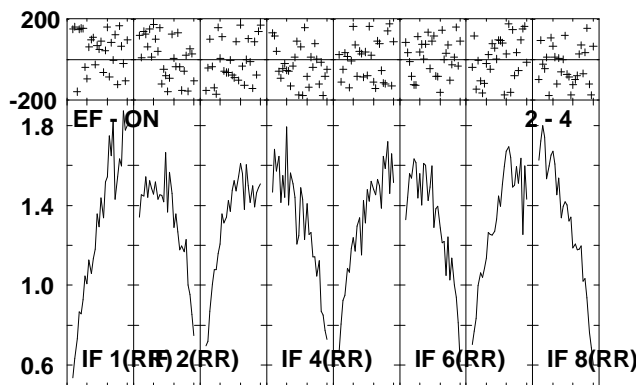
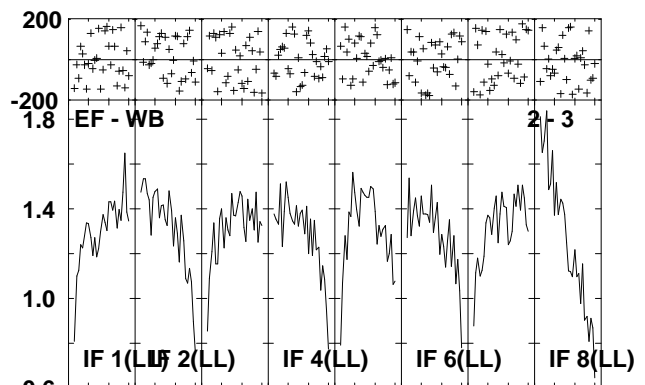
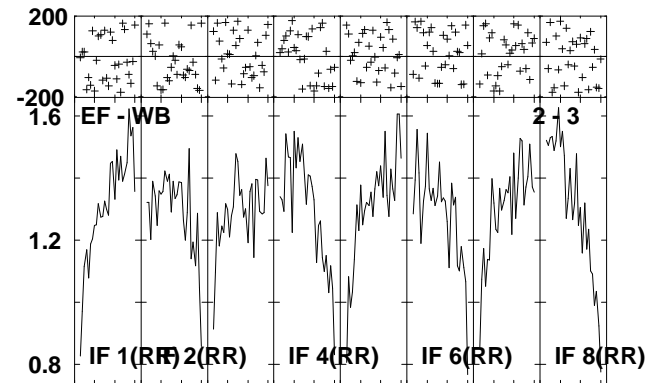
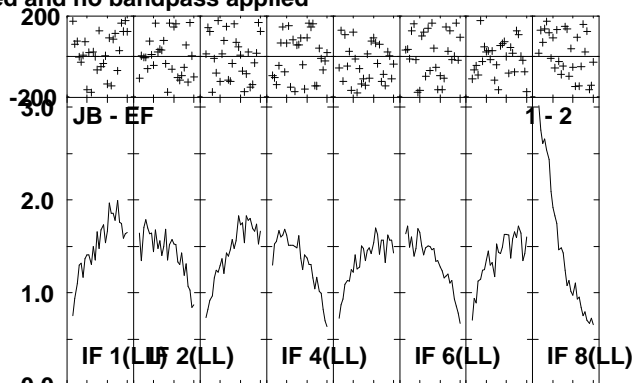
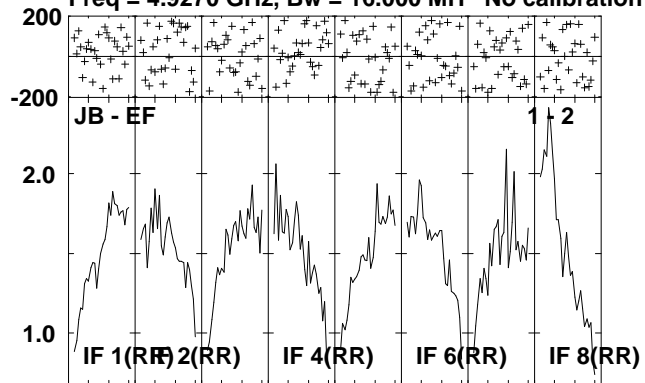

Lower frame: Milli Ampl Jy Top frame: Phas deg
Scalar averaged cross-power spectrum Several baselines displayed
Timerange: 00/13:32:51 to 00/13:36:29

Plot file version 140 created 06-JUL-2010 12:04:45

IRAS2336 EP064L.UVDATA.1

Freq = 4.9270 GHz, Bw = 16.000 MH No calibration applied and no bandpass applied

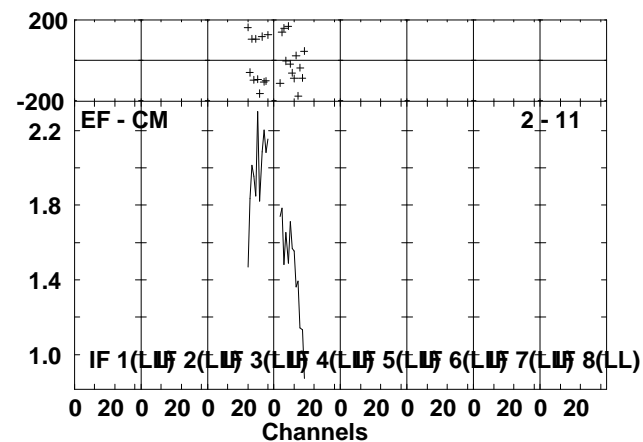
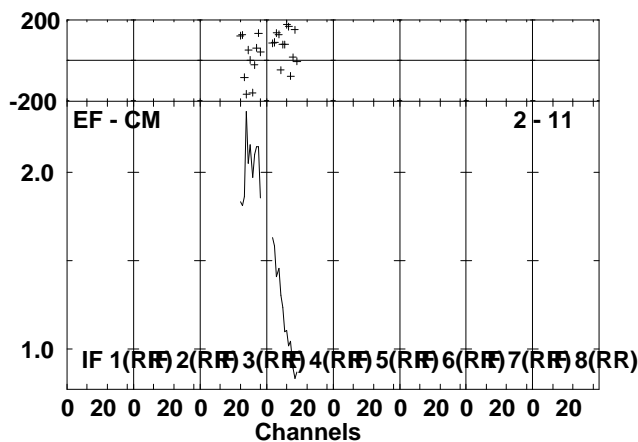
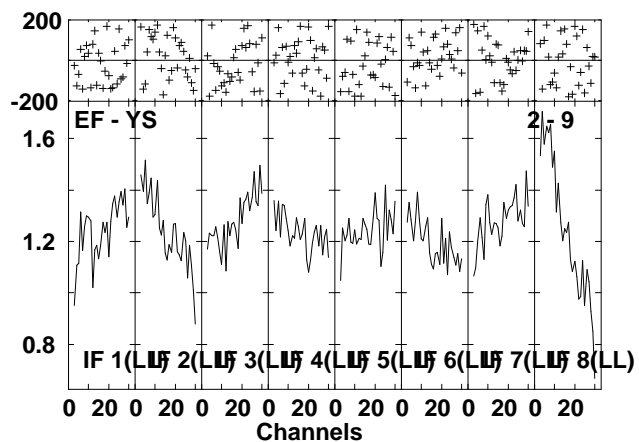
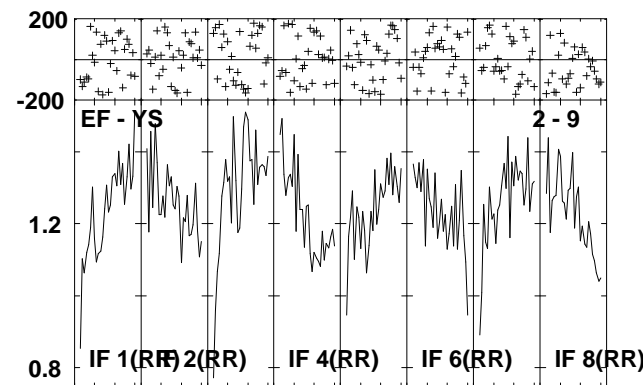
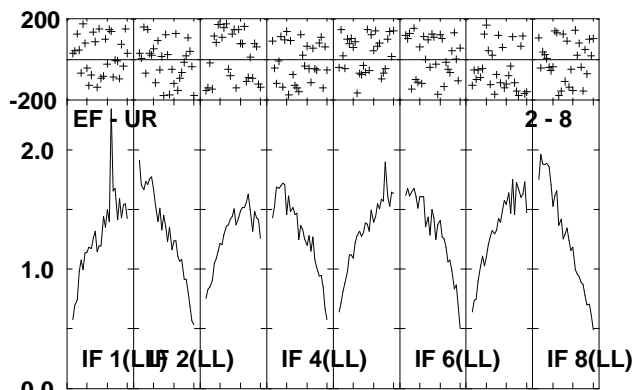
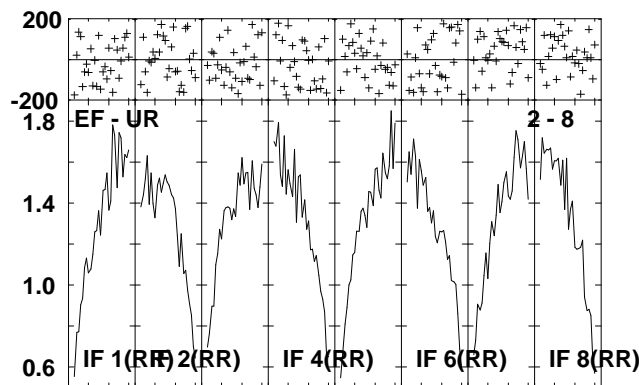
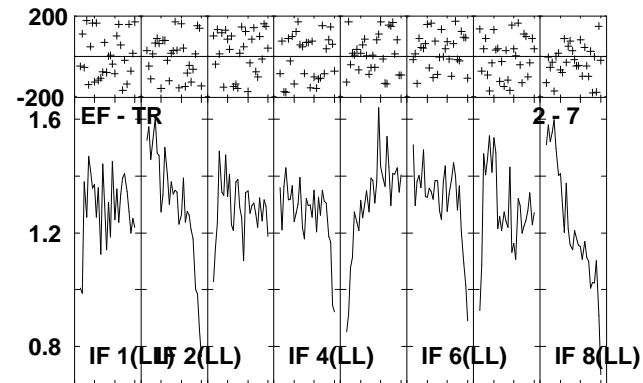
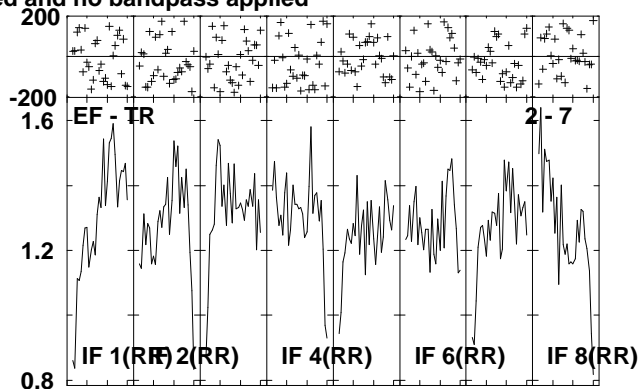
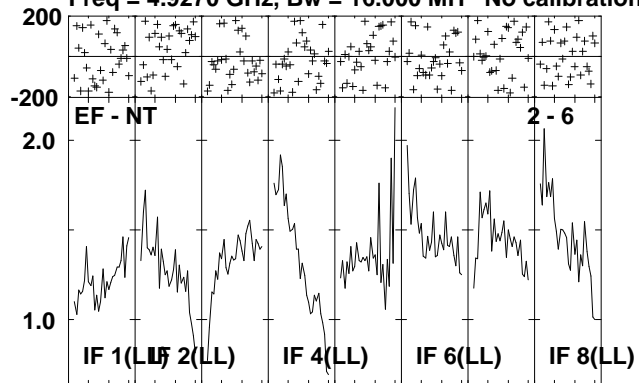

Lower frame: Milli Ampl Jy Top frame: Phas deg
Scalar averaged cross-power spectrum Several baselines displayed
Timerange: 00/13:32:51 to 00/13:36:29

Plot file version 141 created 06-JUL-2010 12:04:48

IRAS2336 EP064L.UVDATA.1

Freq = 4.9270 GHz, Bw = 16.000 MH No calibration applied and no bandpass applied

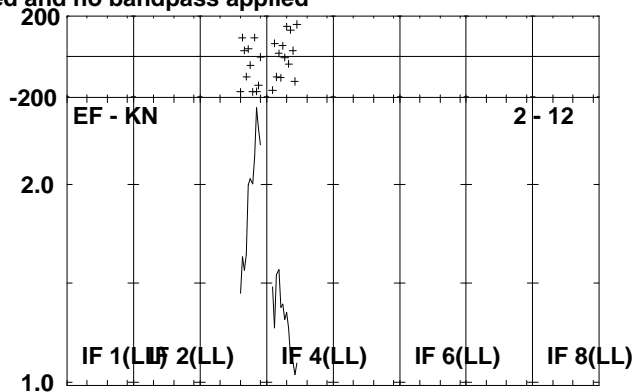
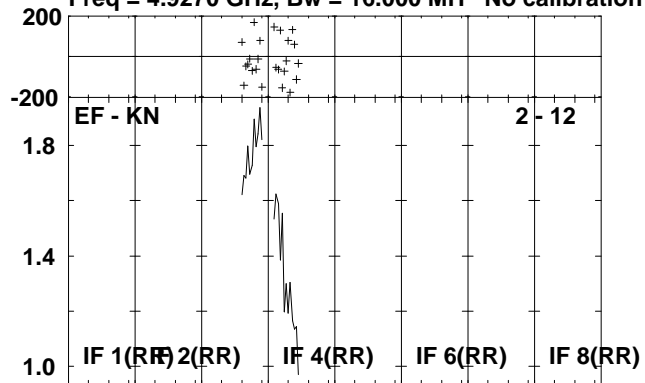

Lower frame: Milli Ampl Jy Top frame: Phas deg
Scalar averaged cross-power spectrum Several baselines displayed
Timerange: 00/13:32:51 to 00/13:36:29

Plot file version 142 created 06-JUL-2010 12:04:49

J2330+33 EP064L.UVDATA.1

Freq = 4.9270 GHz, Bw = 16.000 MH No calibration applied and no bandpass applied

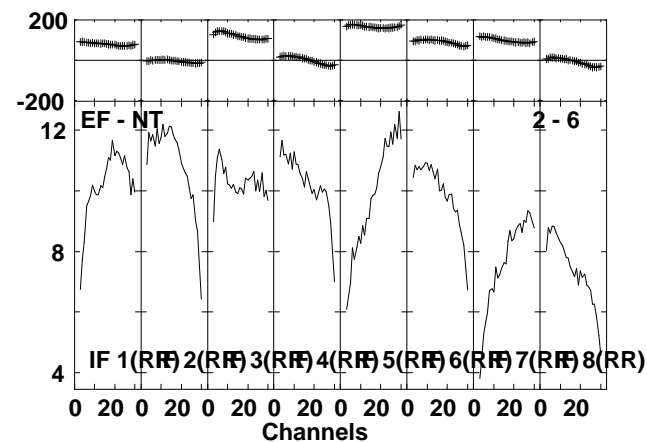
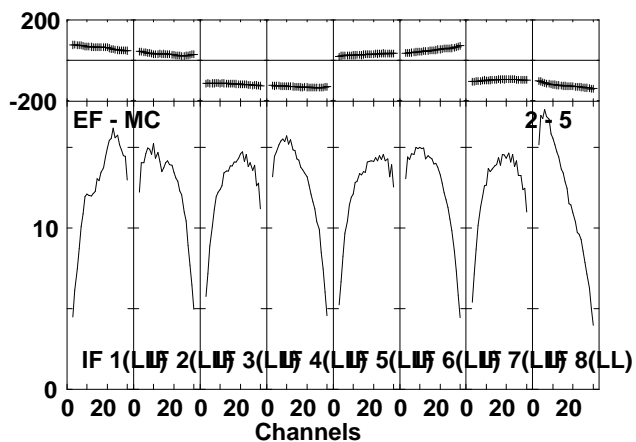
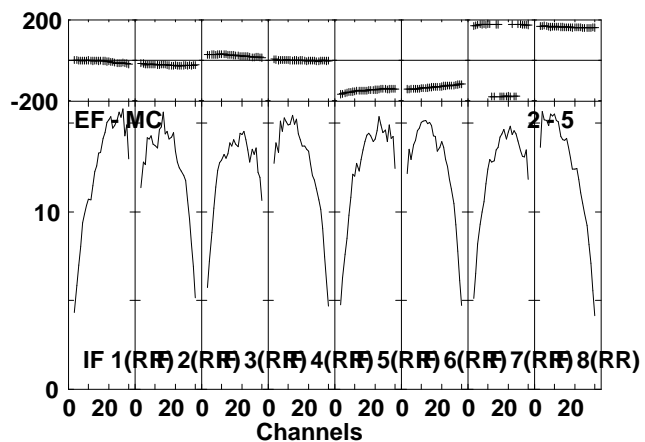
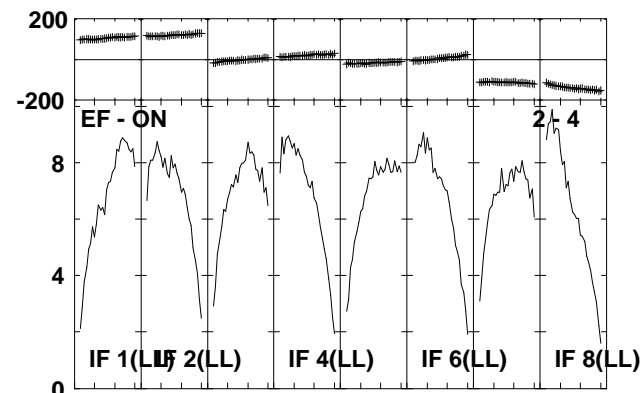
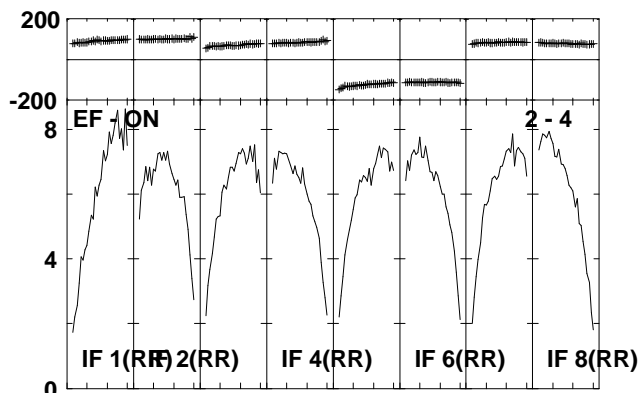
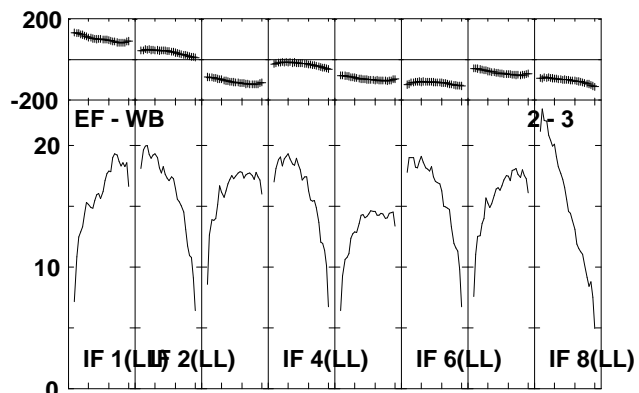
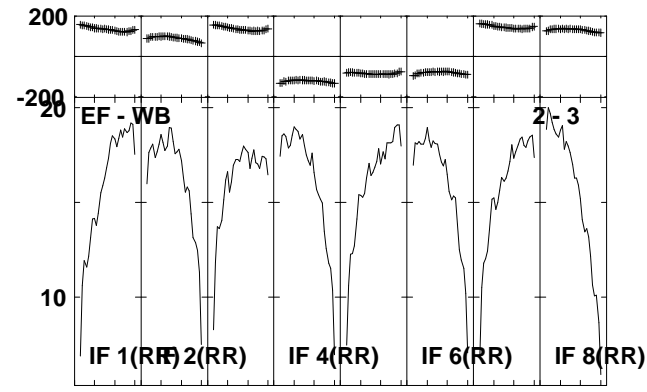
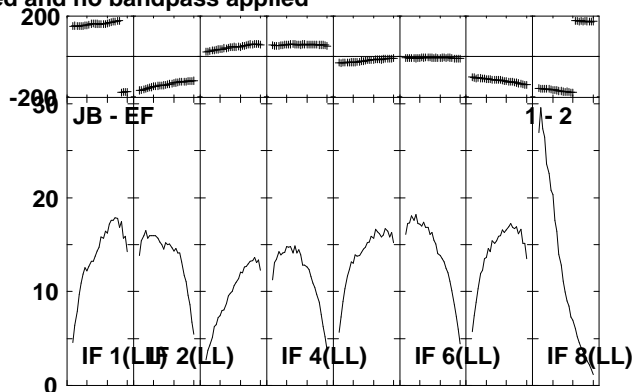
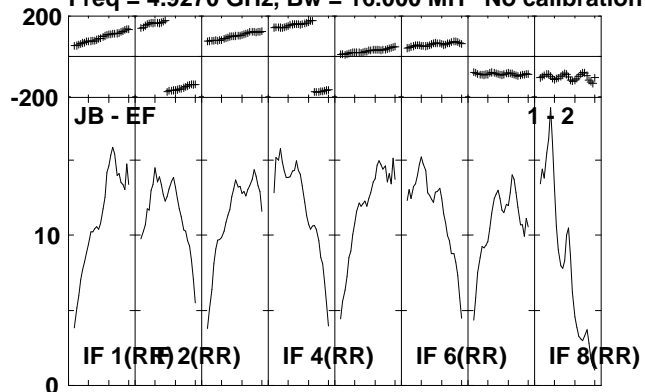

Lower frame: Milli Ampl Jy Top frame: Phas deg
Scalar averaged cross-power spectrum Several baselines displayed
Timerange: 00/13:36:31 to 00/13:38:19

Plot file version 143 created 06-JUL-2010 12:04:50

J2330+33 EP064L.UVDATA.1

Freq = 4.9270 GHz, Bw = 16.000 MH No calibration applied and no bandpass applied

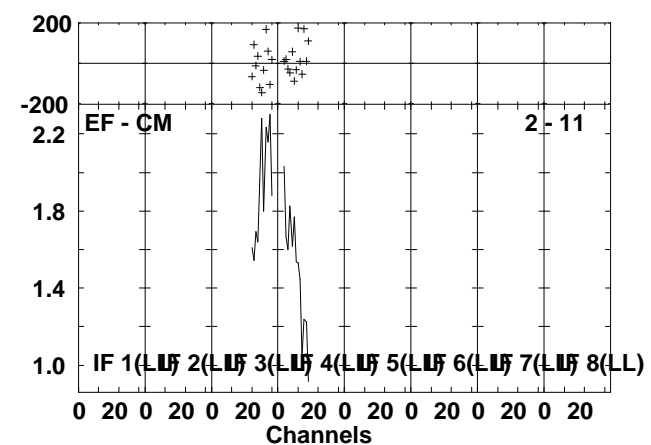
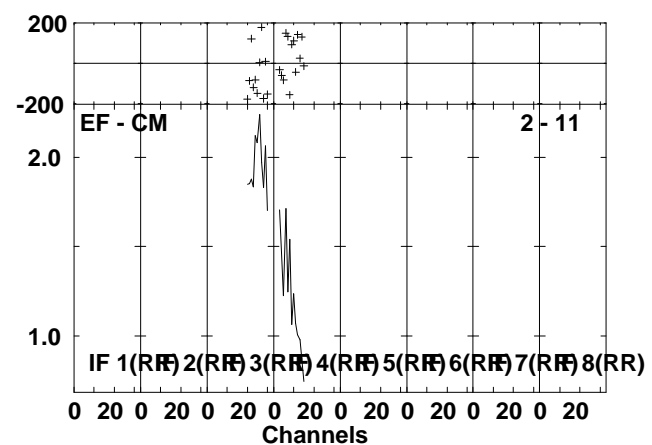
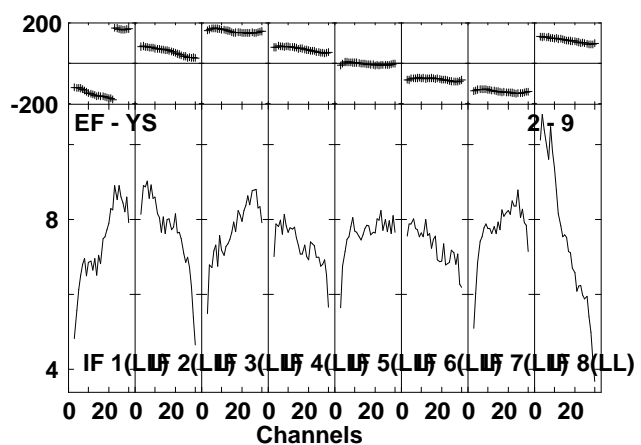
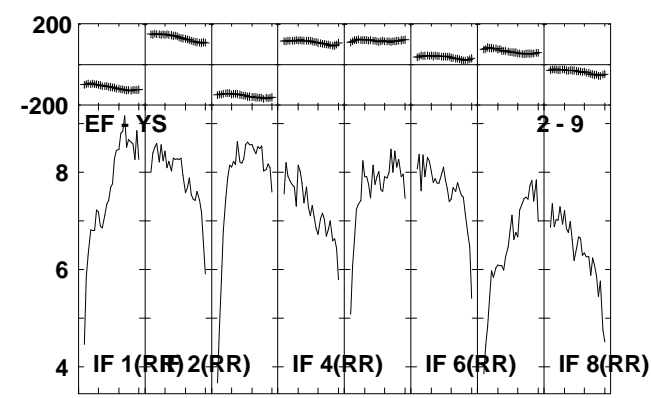
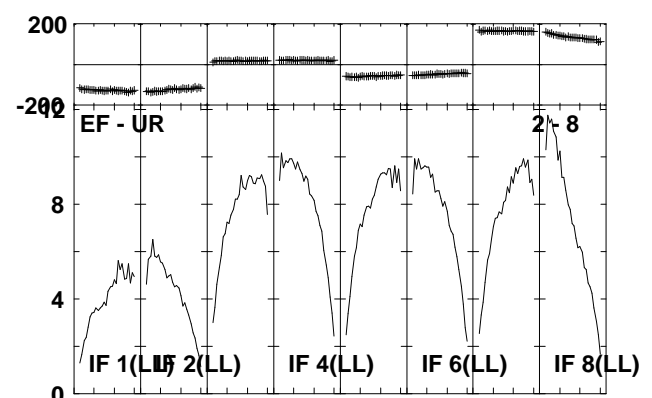
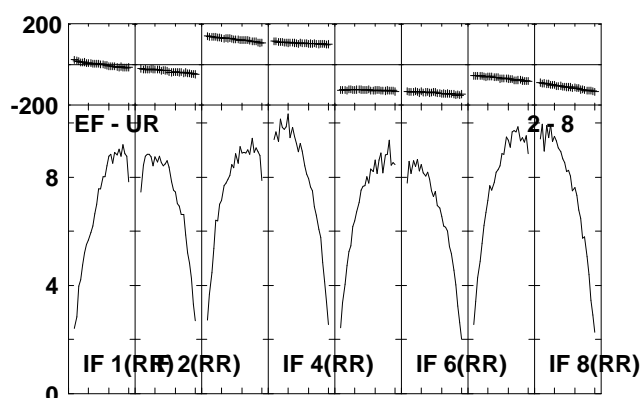
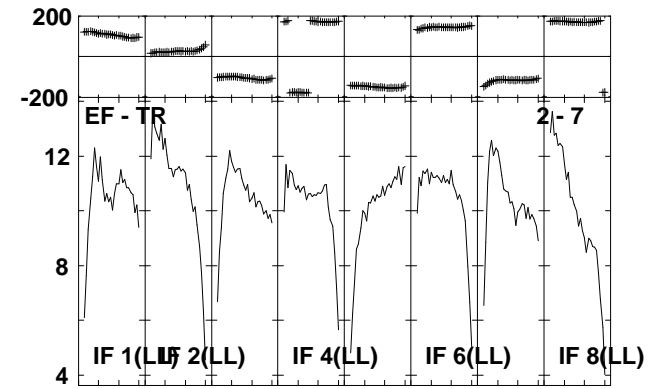
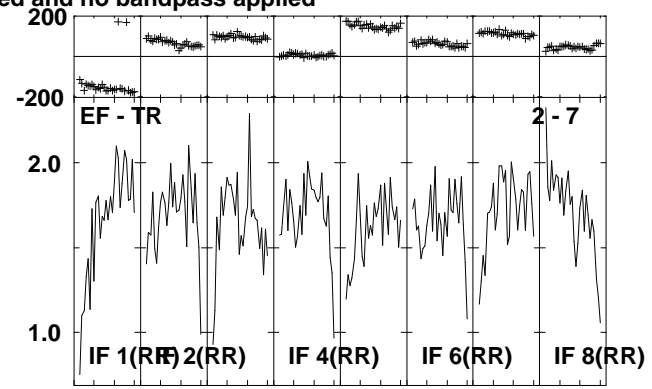
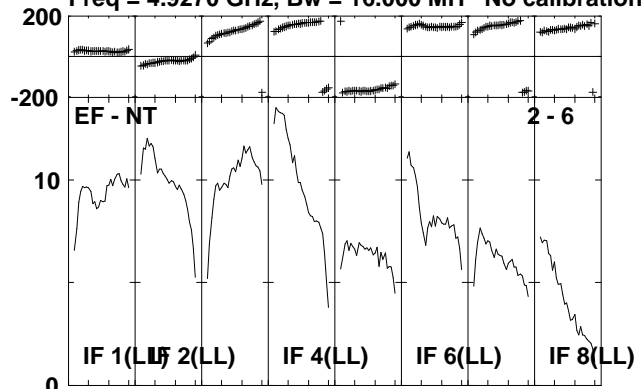

Lower frame: Milli Ampl Jy Top frame: Phas deg
Scalar averaged cross-power spectrum Several baselines displayed
Timerange: 00/13:36:31 to 00/13:38:19

Plot file version 144 created 06-JUL-2010 12:04:52

J2330+33 EP064L.UVDATA.1

Freq = 4.9270 GHz, Bw = 16.000 MH No calibration applied and no bandpass applied

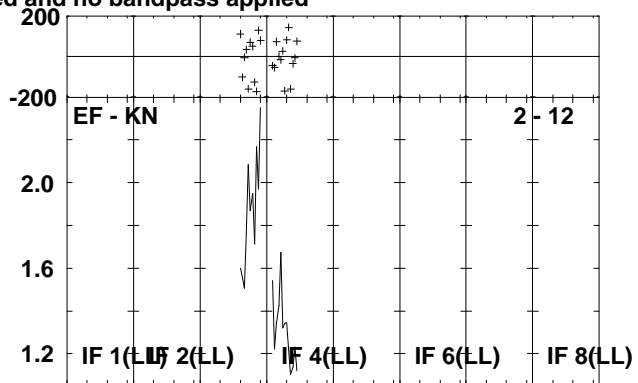
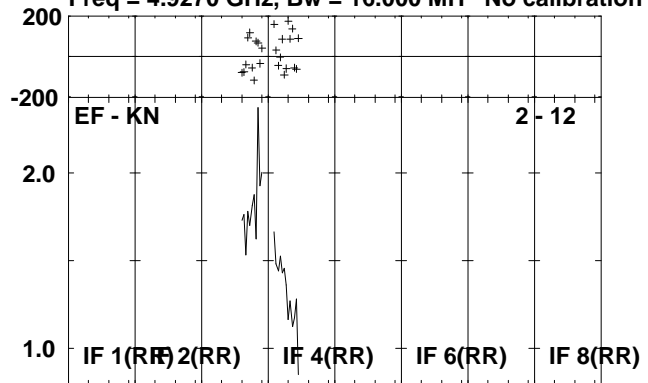

Lower frame: Milli Ampl Jy Top frame: Phas deg
Scalar averaged cross-power spectrum Several baselines displayed
Timerange: 00/13:36:31 to 00/13:38:19

Plot file version 145 created 06-JUL-2010 12:04:52

IRAS2336 EP064L.UVDATA.1

Freq = 4.9270 GHz, Bw = 16.000 MH No calibration applied and no bandpass applied

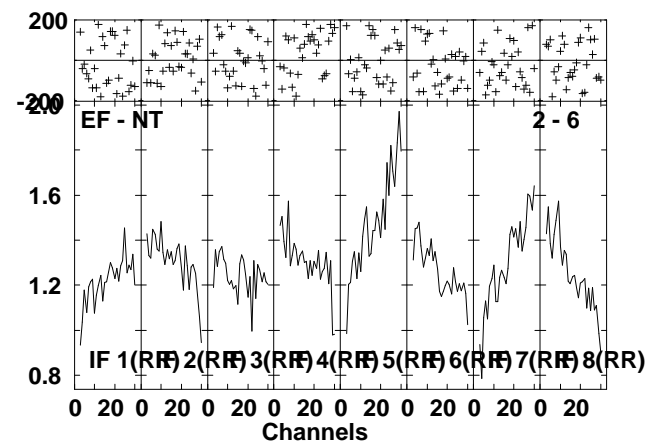
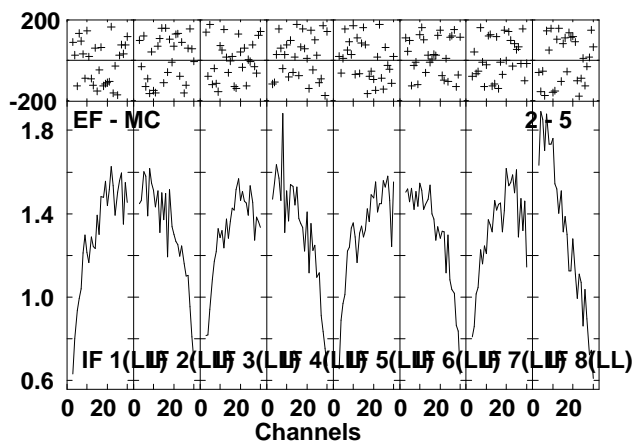
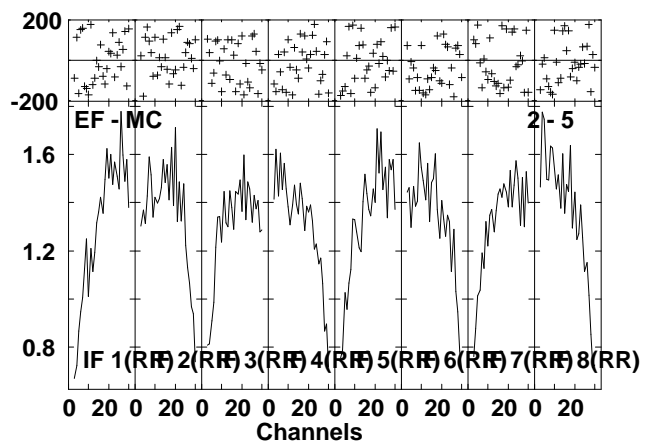
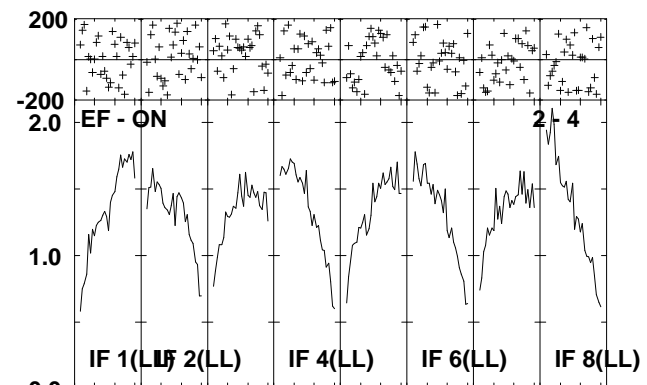
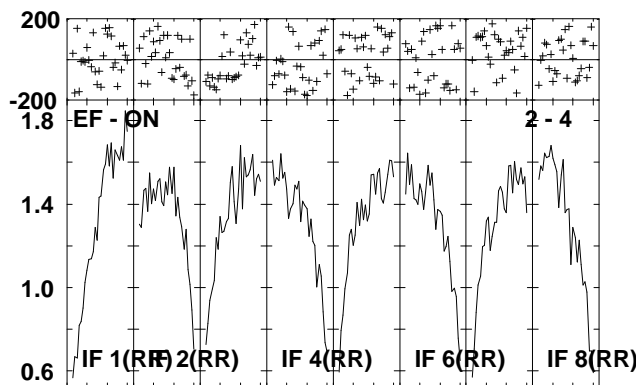
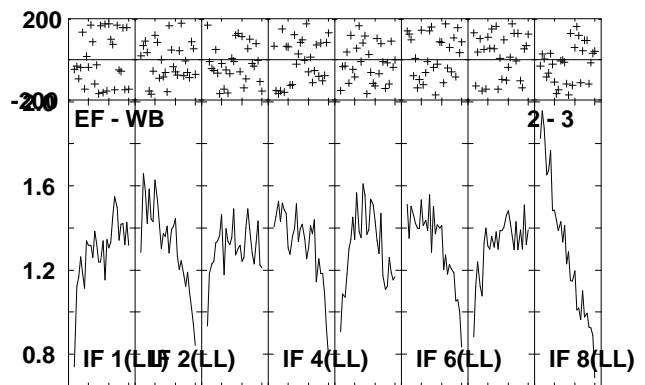
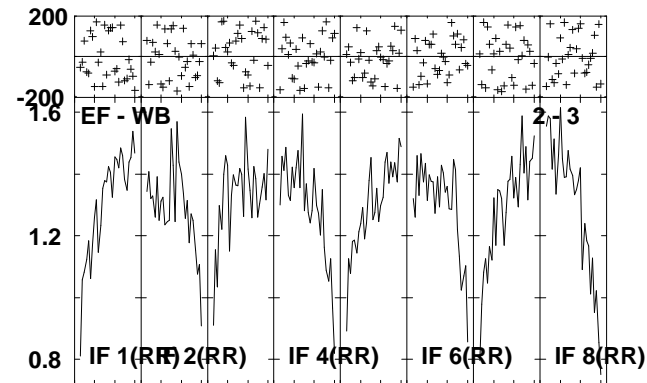
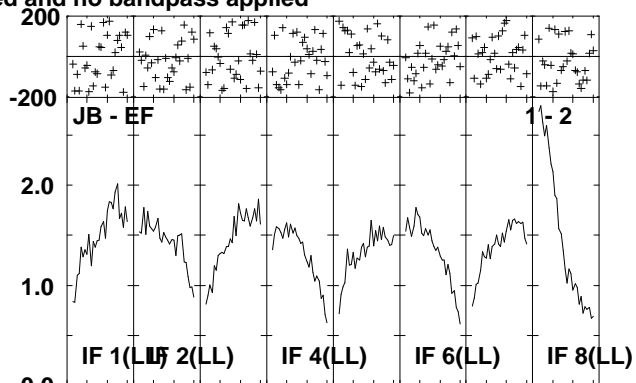
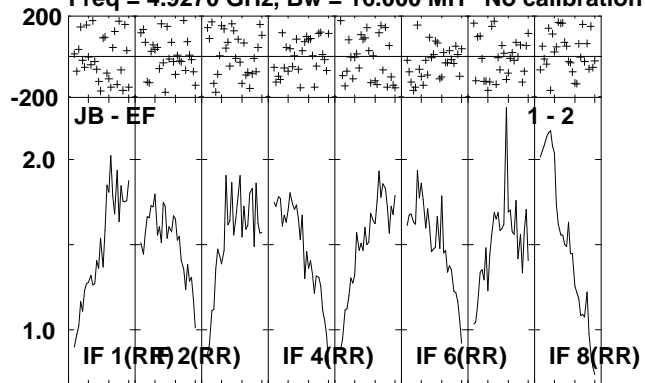

Lower frame: Milli Ampl Jy Top frame: Phas deg
Scalar averaged cross-power spectrum Several baselines displayed
Timerange: 00/13:38:27 to 00/13:41:59

Plot file version 146 created 06-JUL-2010 12:04:54

IRAS2336 EP064L.UVDATA.1

Freq = 4.9270 GHz, Bw = 16.000 MH No calibration applied and no bandpass applied

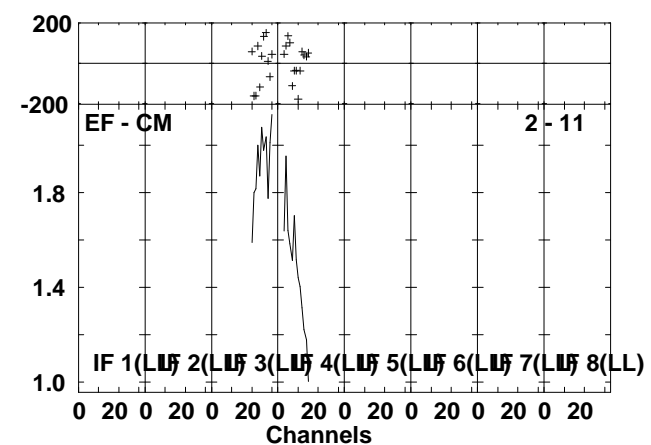
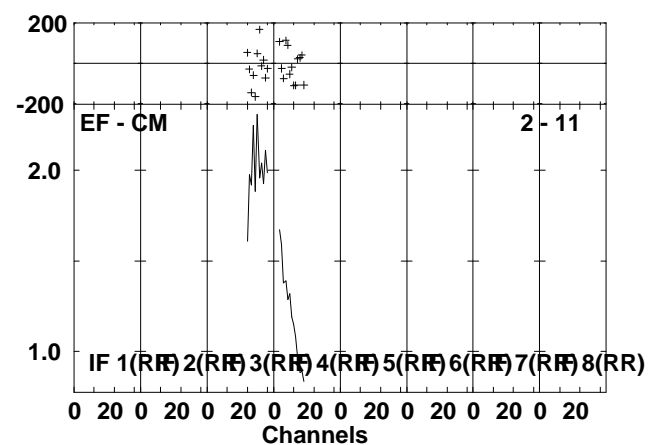
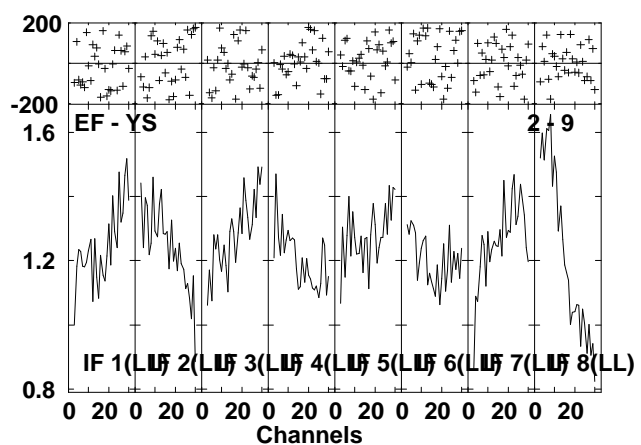
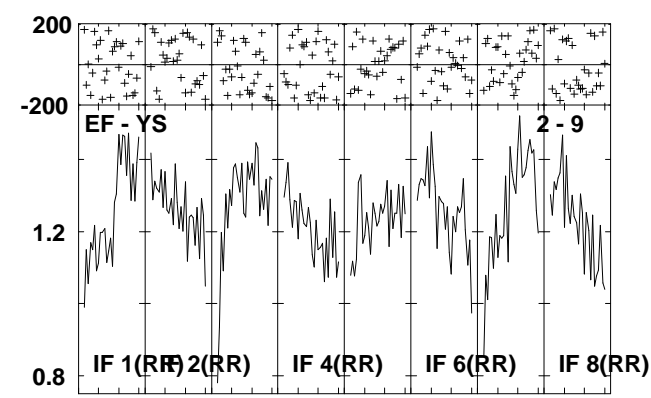
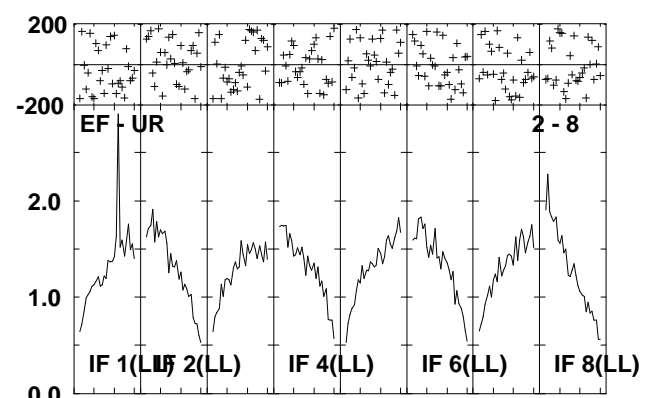
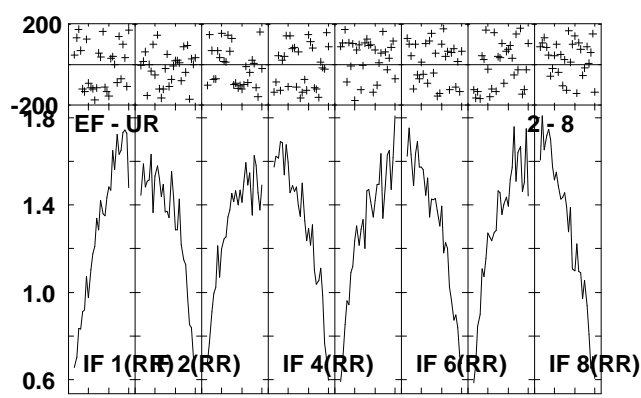
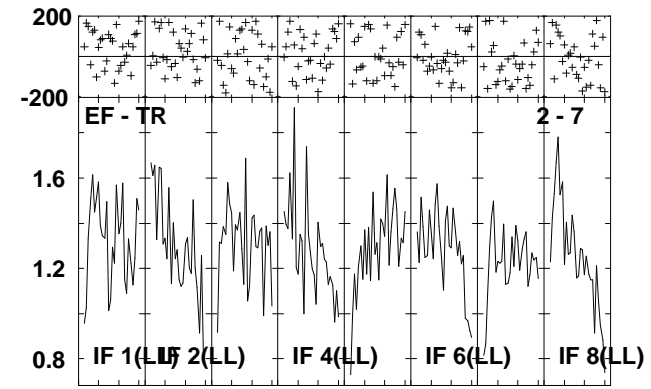
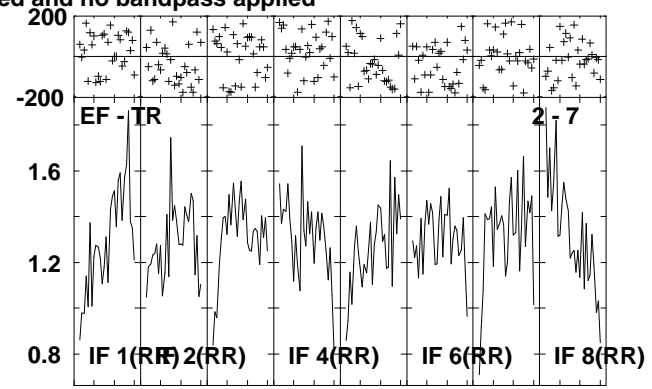
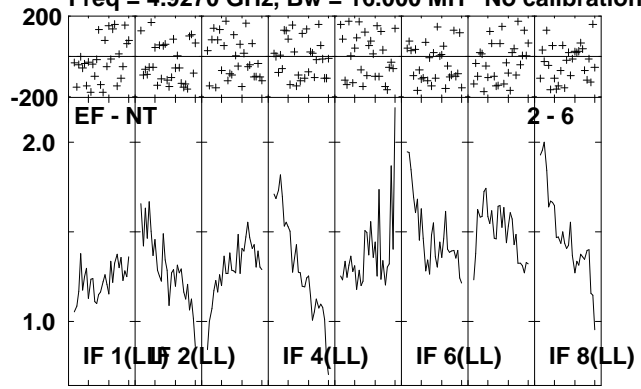

Lower frame: Milli Ampl Jy Top frame: Phas deg
Scalar averaged cross-power spectrum Several baselines displayed
Timerange: 00/13:38:27 to 00/13:41:59

Plot file version 147 created 06-JUL-2010 12:04:57

IRAS2336 EP064L.UVDATA.1

Freq = 4.9270 GHz, Bw = 16.000 MH No calibration applied and no bandpass applied

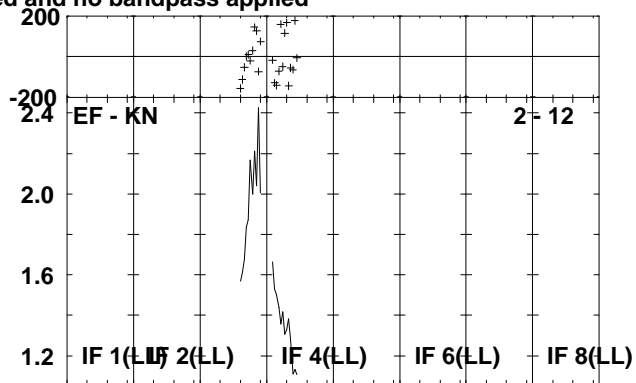
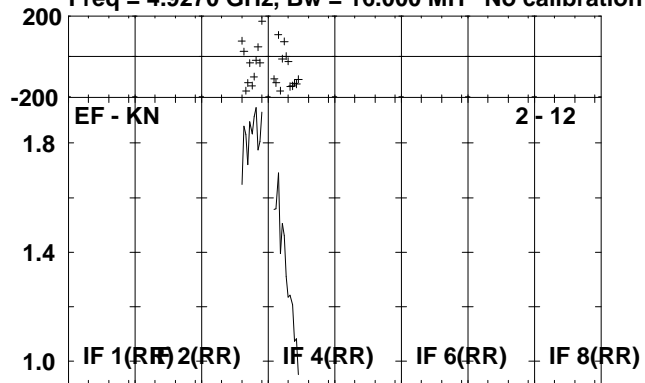

Lower frame: Milli Ampl Jy Top frame: Phas deg
Scalar averaged cross-power spectrum Several baselines displayed
Timerange: 00/13:38:27 to 00/13:41:59

Plot file version 148 created 06-JUL-2010 12:04:58

J2330+33 EP064L.UVDATA.1

Freq = 4.9270 GHz, Bw = 16.000 MH No calibration applied and no bandpass applied

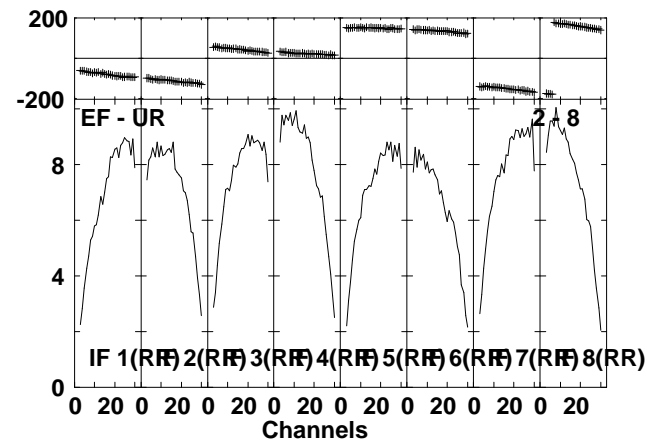
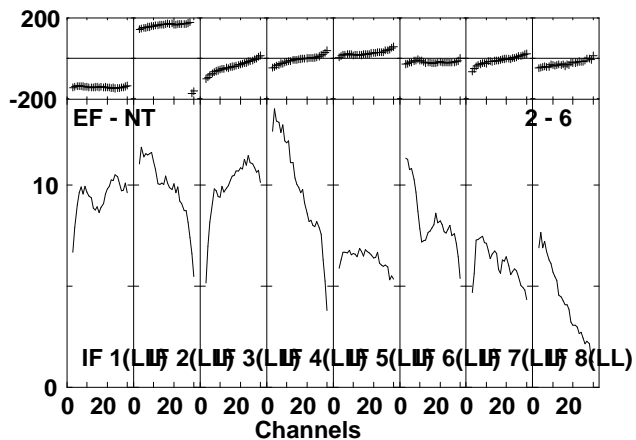
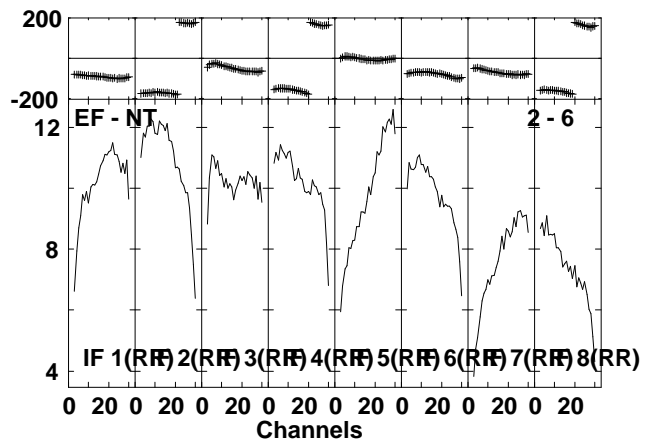
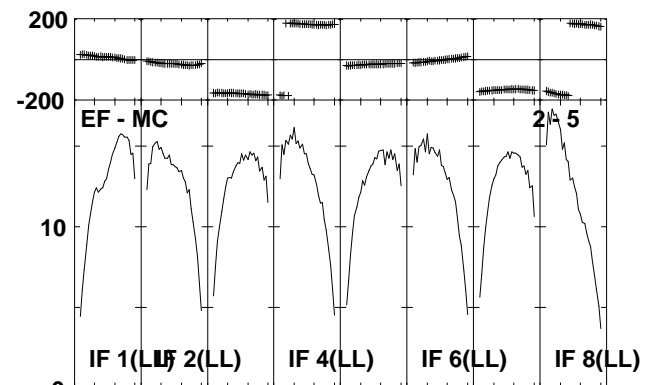
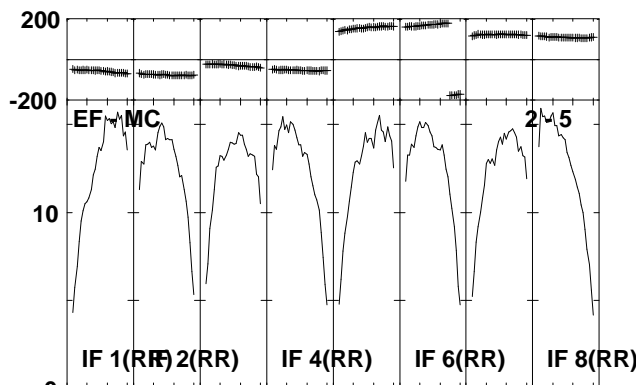
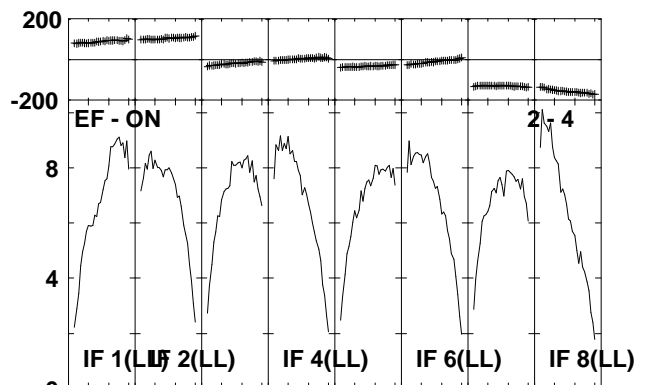
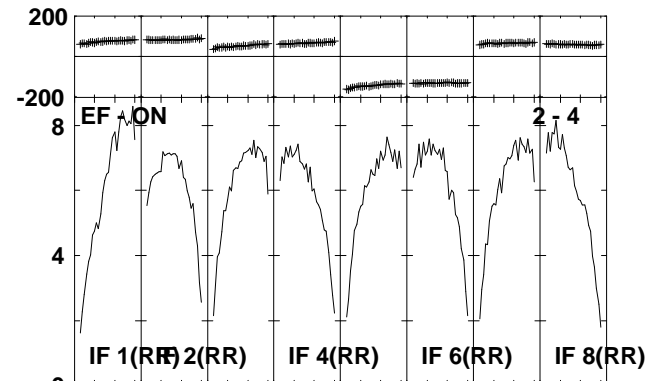
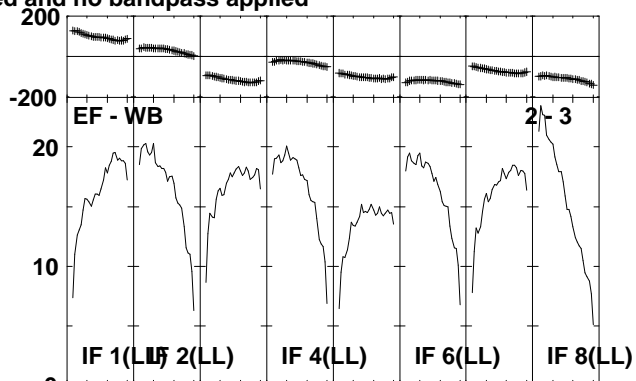
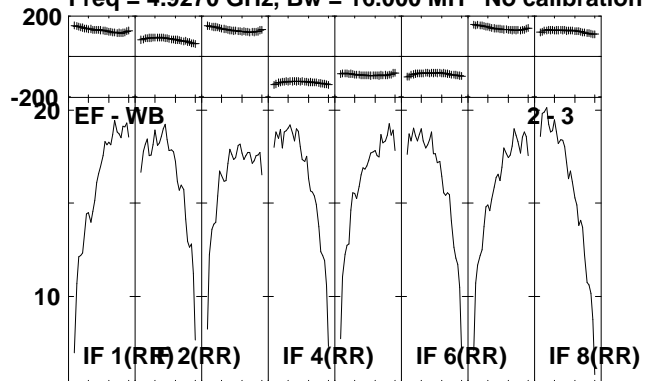

Lower frame: Milli Ampl Jy Top frame: Phas deg
Scalar averaged cross-power spectrum Several baselines displayed
Timerange: 00/13:42:01 to 00/13:43:49

Plot file version 149 created 06-JUL-2010 12:04:59

J2330+33 EP064L.UVDATA.1

Freq = 4.9270 GHz, Bw = 16.000 MH No calibration applied and no bandpass applied

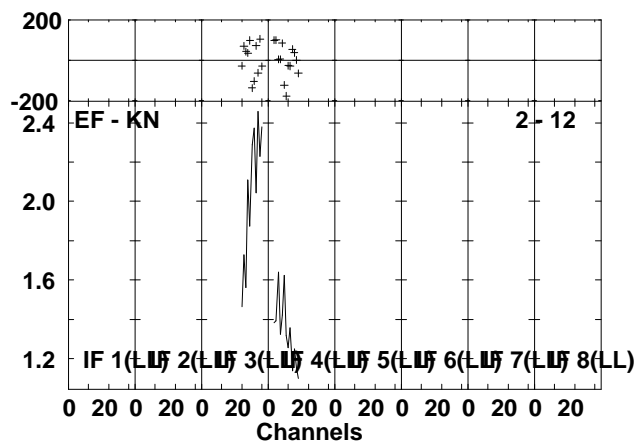
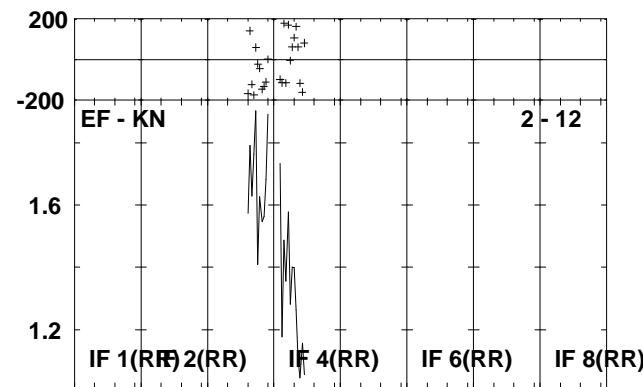
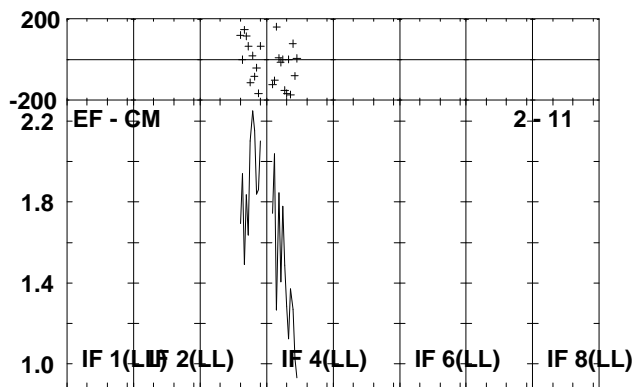
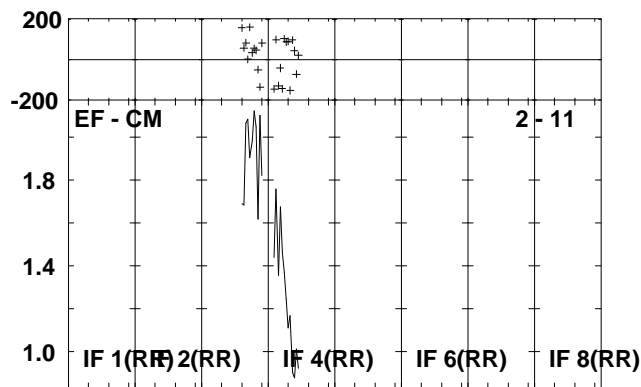
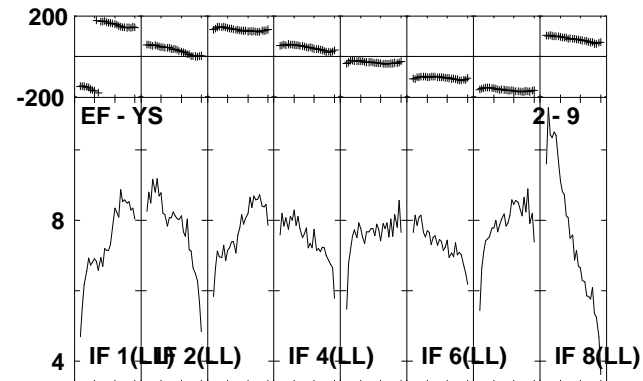
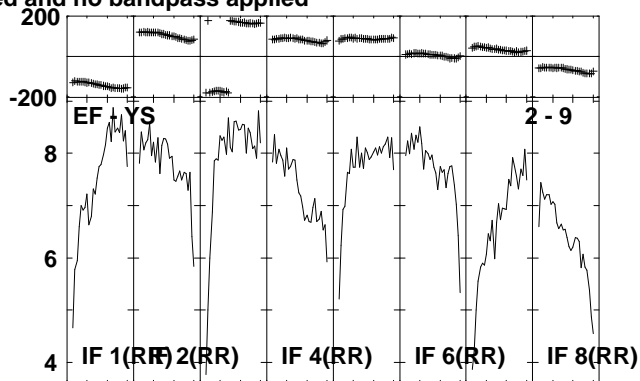
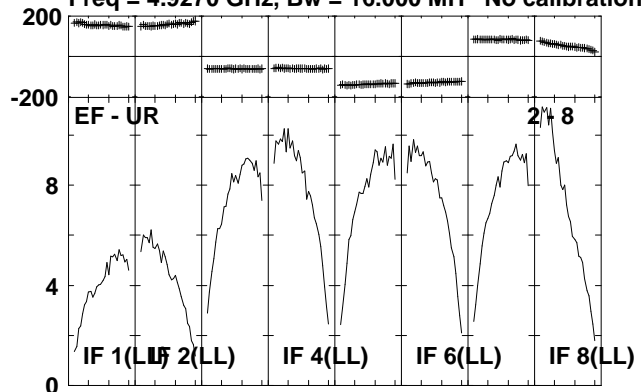

Lower frame: Milli Ampl Jy Top frame: Phas deg
Scalar averaged cross-power spectrum Several baselines displayed
Timerange: 00/13:42:01 to 00/13:43:49

Plot file version 150 created 06-JUL-2010 12:05:00

IRAS2336 EP064L.UVDATA.1

Freq = 4.9270 GHz, Bw = 16.000 MH No calibration applied and no bandpass applied

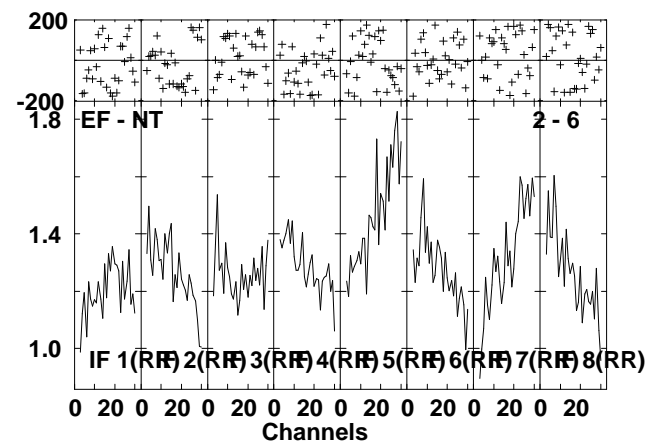
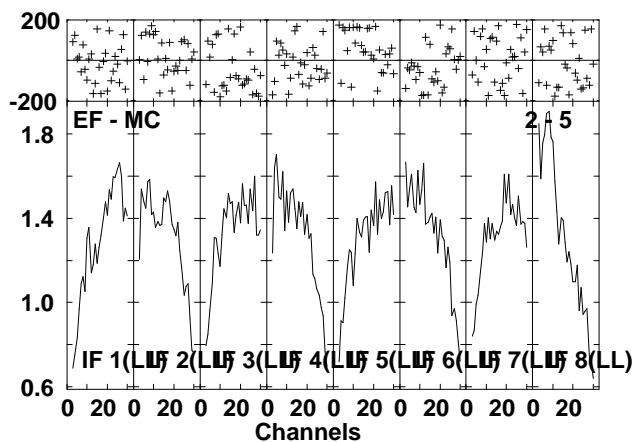
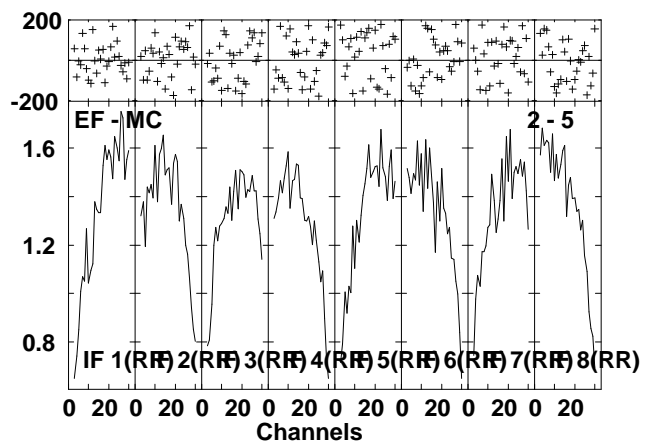
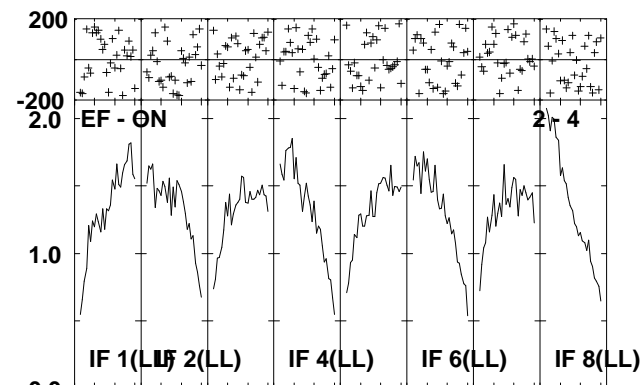
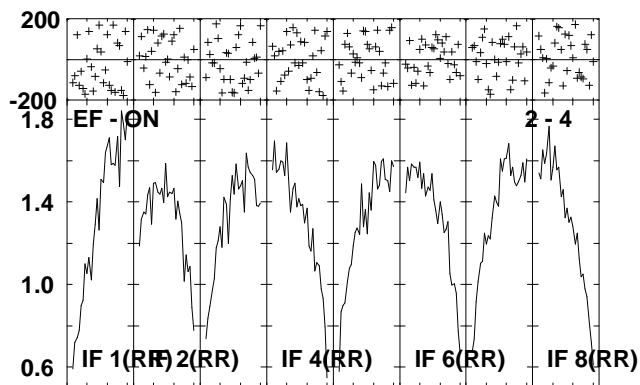
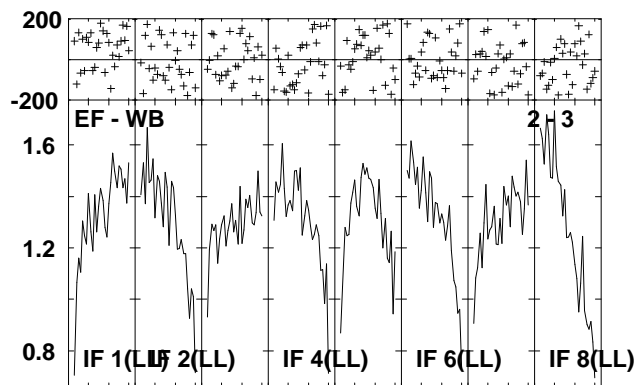
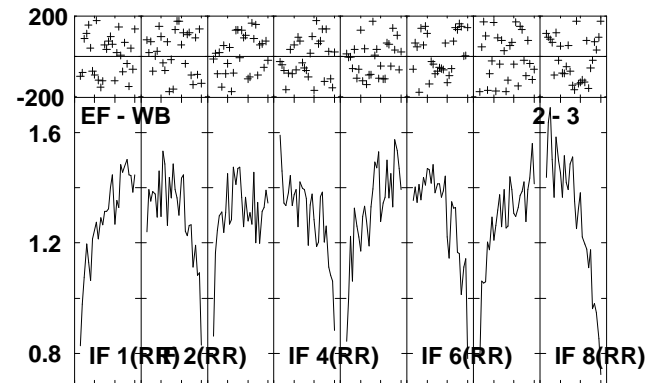
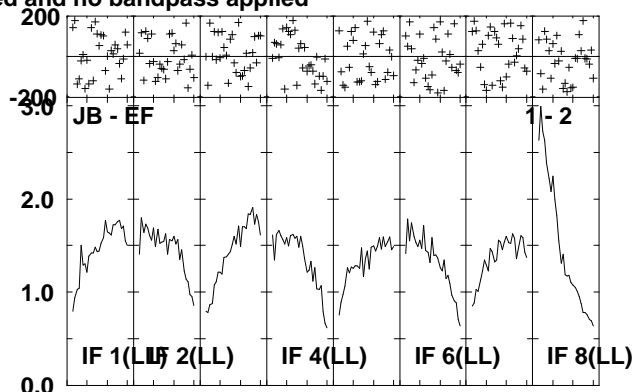
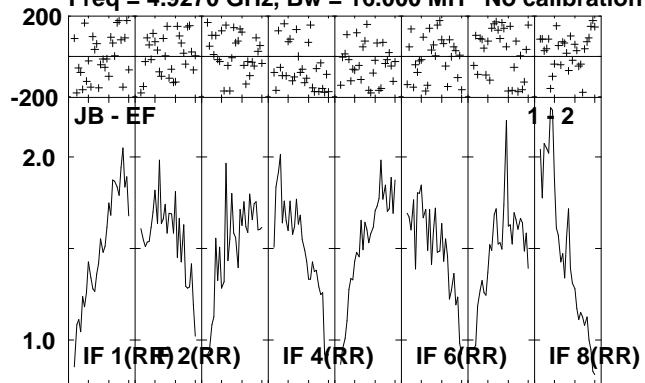

Lower frame: Milli Ampl Jy Top frame: Phas deg
Scalar averaged cross-power spectrum Several baselines displayed
Timerange: 00/13:43:51 to 00/13:47:29

Plot file version 151 created 06-JUL-2010 12:05:02

IRAS2336 EP064L.UVDATA.1

Freq = 4.9270 GHz, Bw = 16.000 MH No calibration applied and no bandpass applied

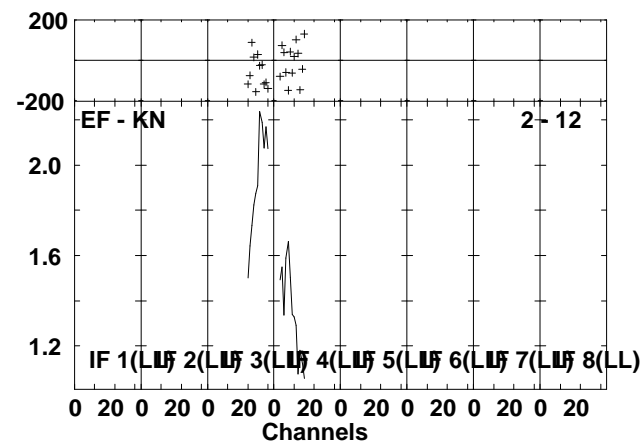
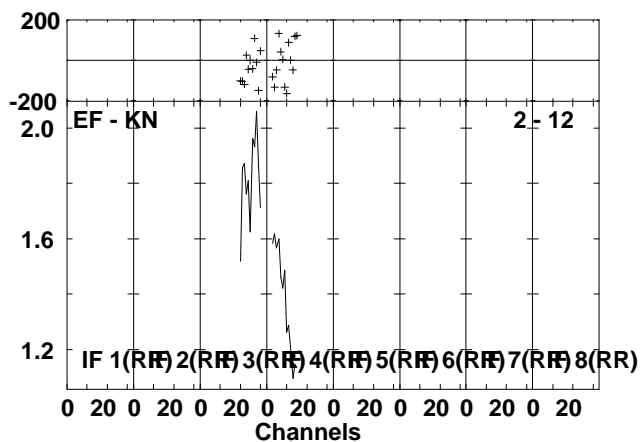
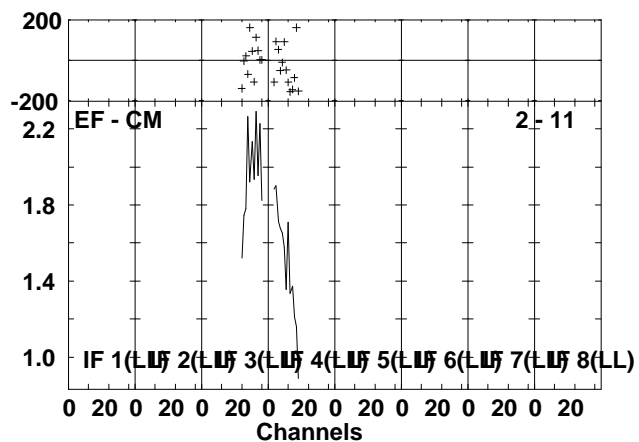
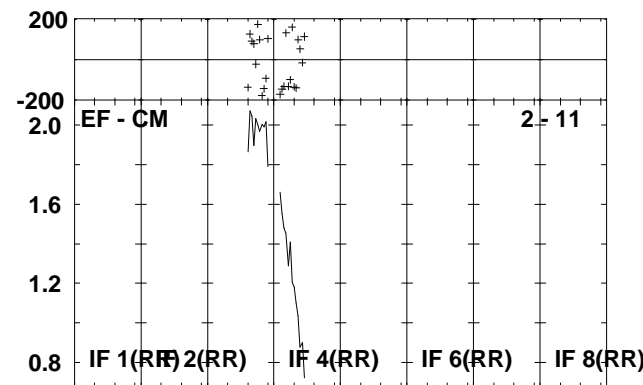
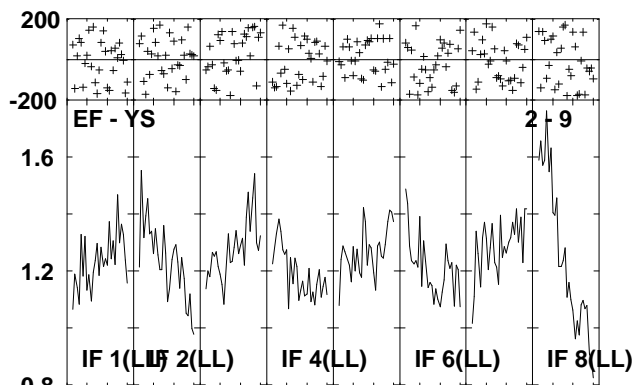
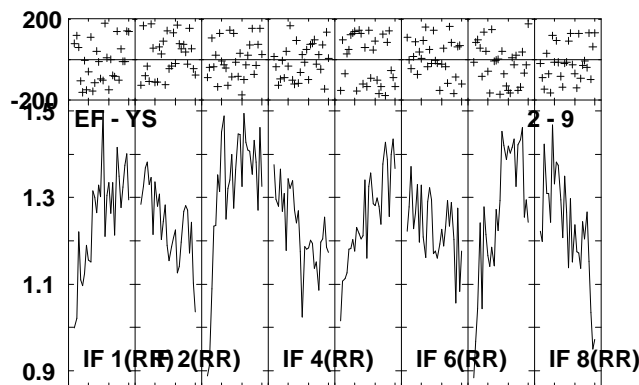
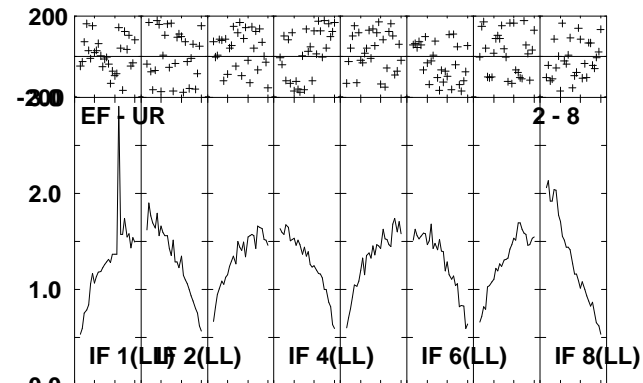
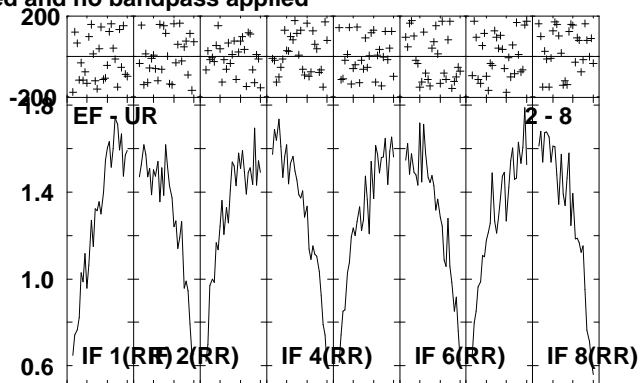
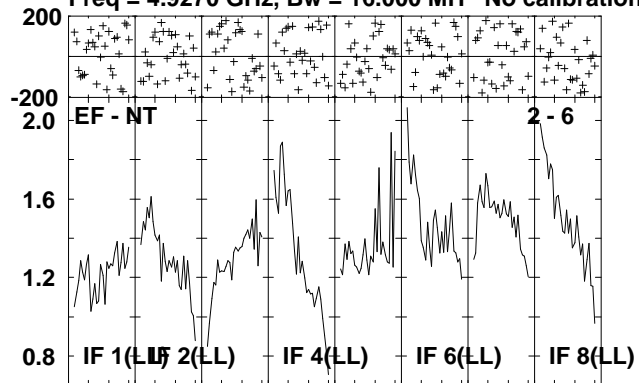

Lower frame: Milli Ampl Jy Top frame: Phas deg
Scalar averaged cross-power spectrum Several baselines displayed
Timerange: 00/13:43:51 to 00/13:47:29

Plot file version 152 created 06-JUL-2010 12:05:05

J2330+33 EP064L.UVDATA.1

Freq = 4.9270 GHz, Bw = 16.000 MH No calibration applied and no bandpass applied

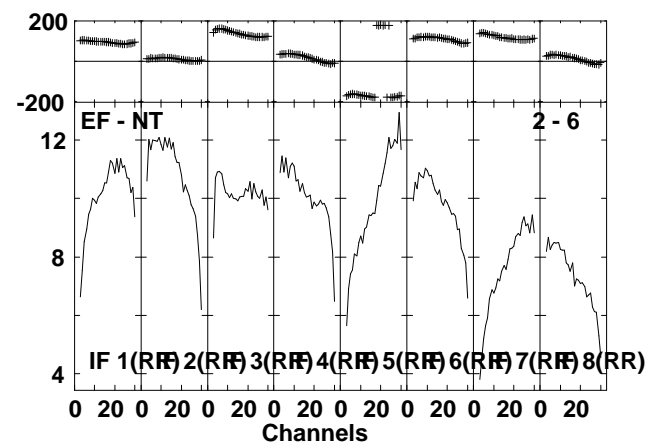
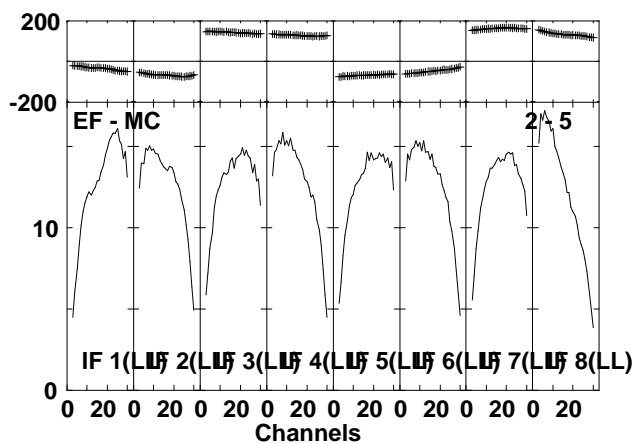
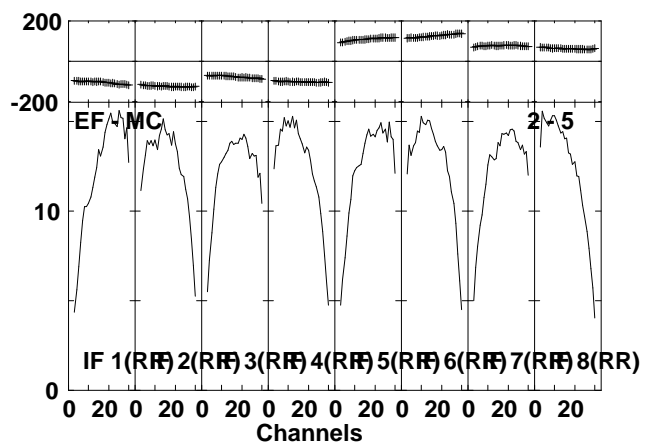
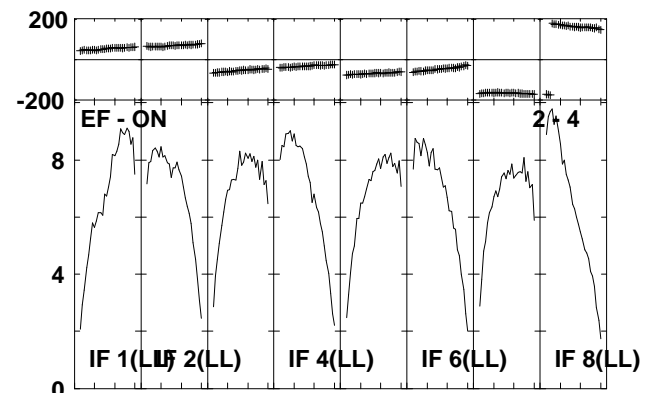
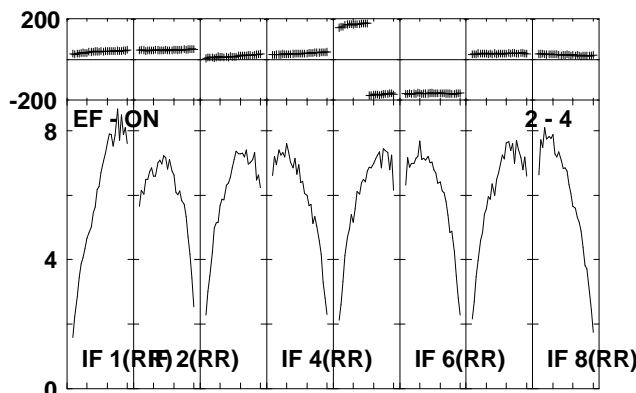
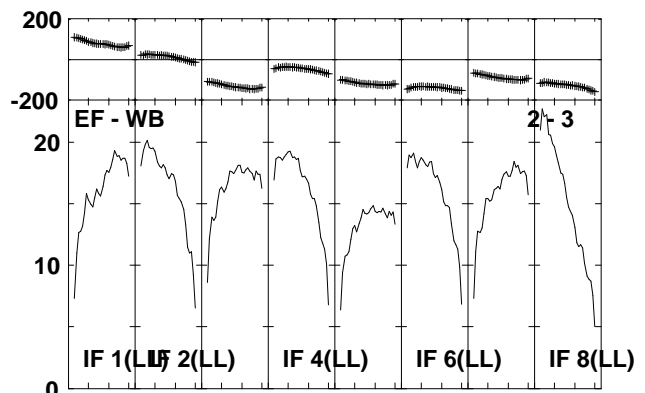
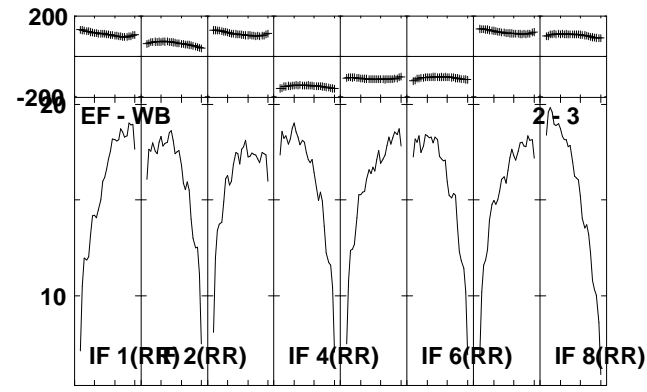
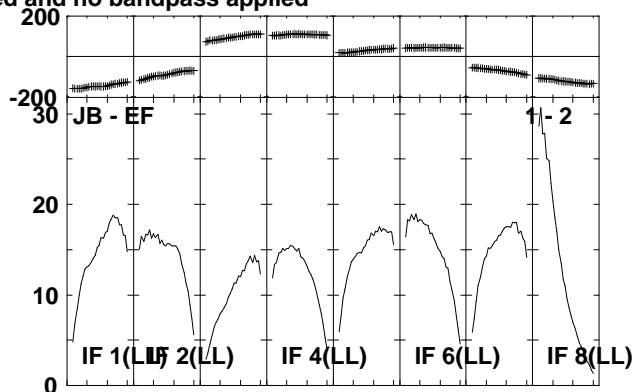
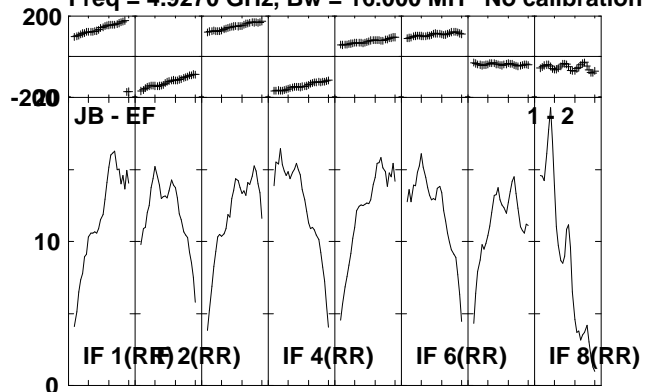

Lower frame: Milli Ampl Jy Top frame: Phas deg
Scalar averaged cross-power spectrum Several baselines displayed
Timerange: 00/13:48:31 to 00/13:50:07

Plot file version 153 created 06-JUL-2010 12:05:06

J2330+33 EP064L.UVDATA.1

Freq = 4.9270 GHz, Bw = 16.000 MH No calibration applied and no bandpass applied

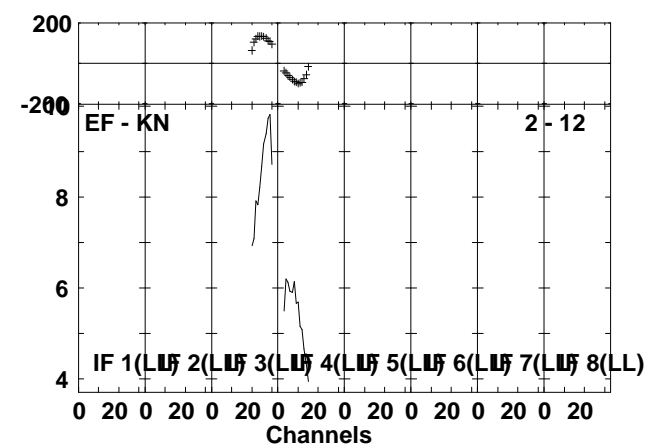
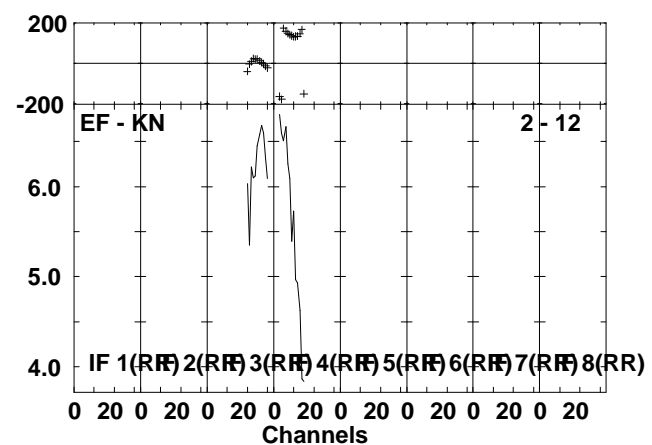
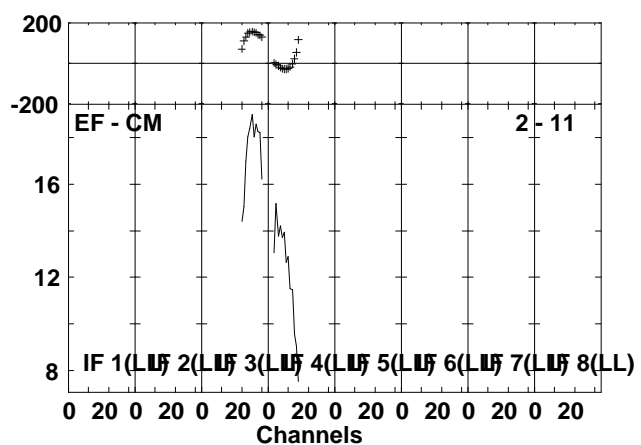
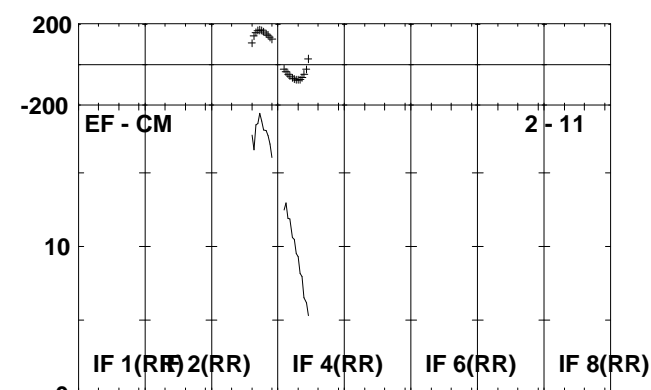
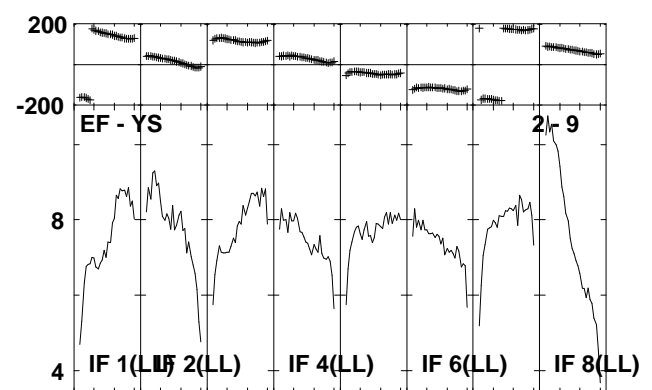
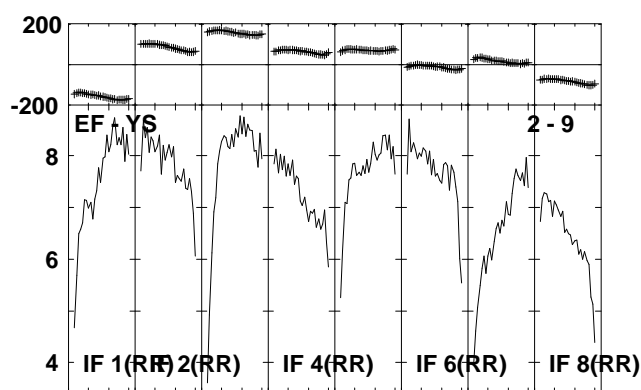
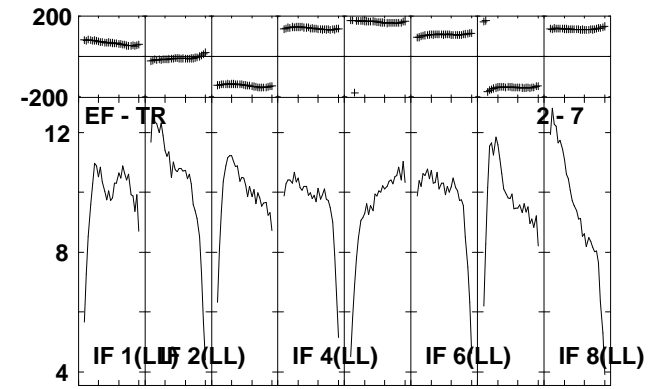
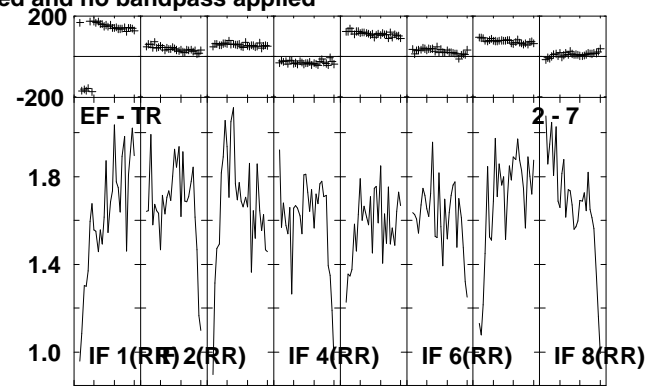
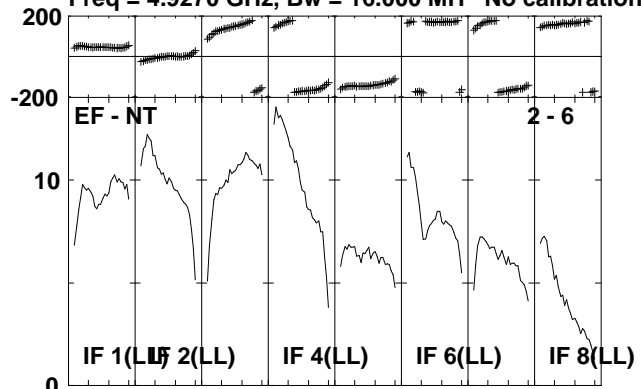

Lower frame: Milli Ampl Jy Top frame: Phas deg
Scalar averaged cross-power spectrum Several baselines displayed
Timerange: 00/13:48:31 to 00/13:50:07

Plot file version 154 created 06-JUL-2010 12:05:08

IRAS2336 EP064L.UVDATA.1

Freq = 4.9270 GHz, Bw = 16.000 MH No calibration applied and no bandpass applied

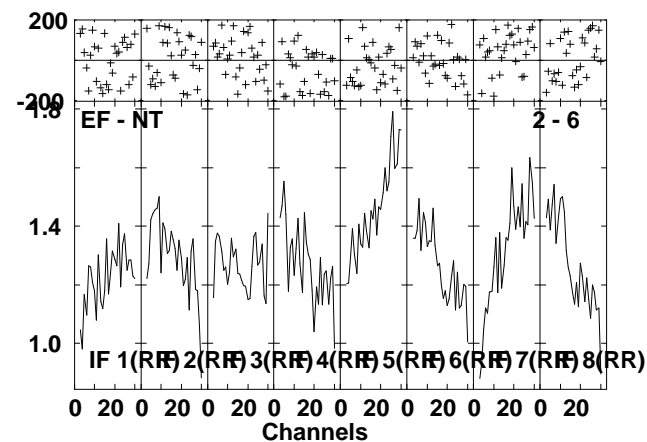
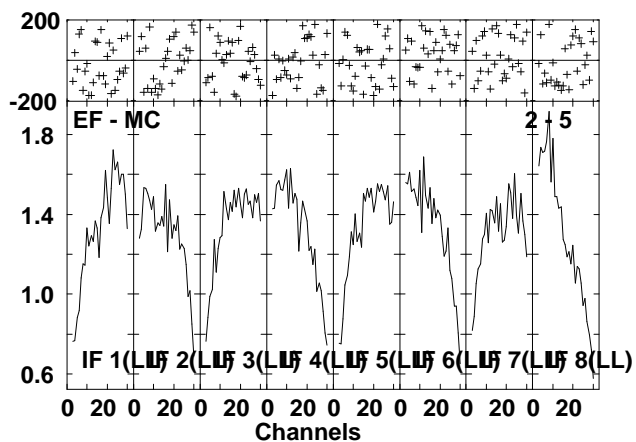
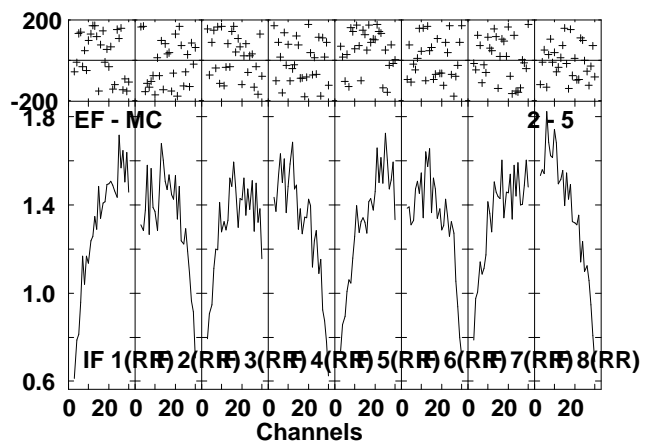
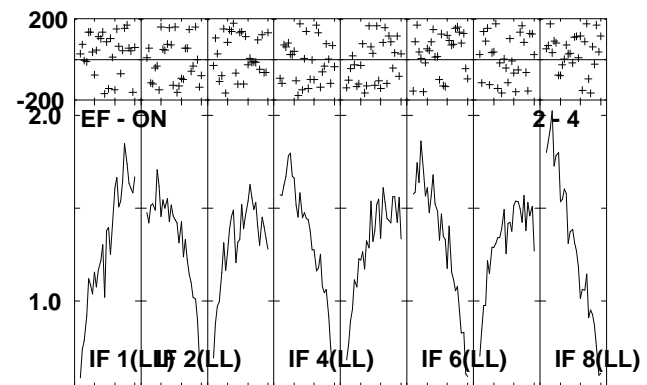
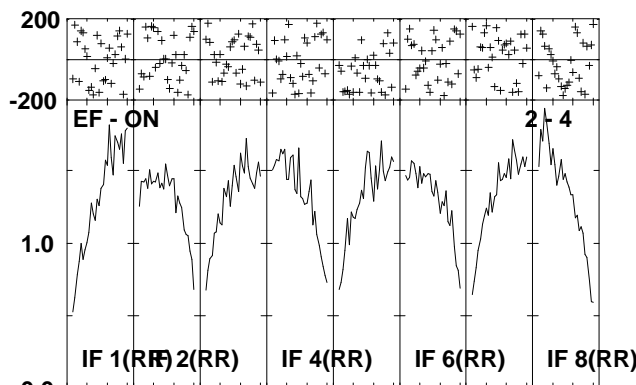
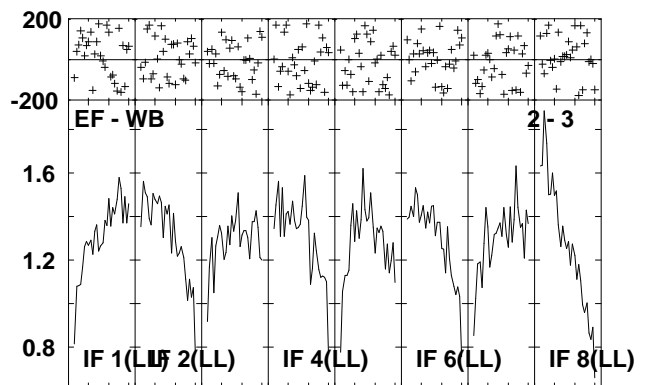
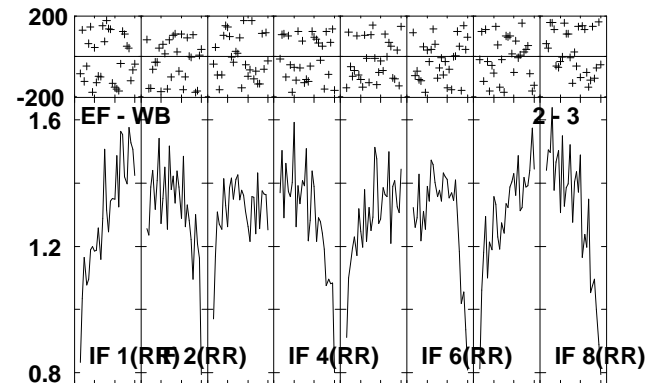
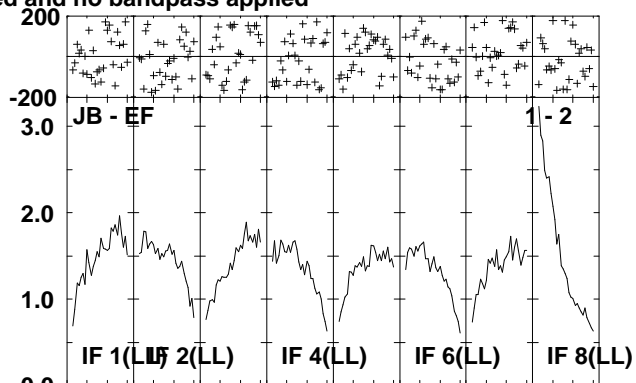
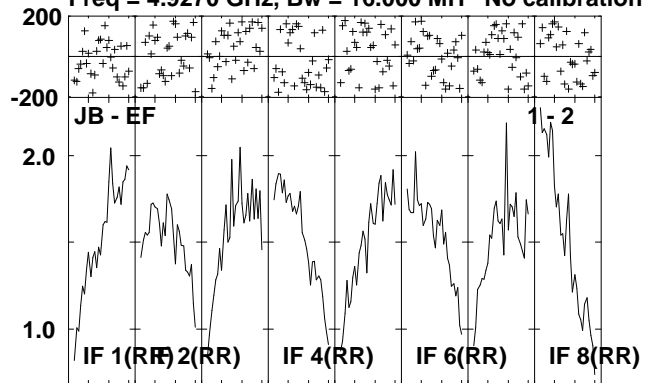

Lower frame: Milli Ampl Jy Top frame: Phas deg
Scalar averaged cross-power spectrum Several baselines displayed
Timerange: 00/13:50:13 to 00/13:53:49

Plot file version 155 created 06-JUL-2010 12:05:11

IRAS2336 EP064L.UVDATA.1

Freq = 4.9270 GHz, Bw = 16.000 MH No calibration applied and no bandpass applied

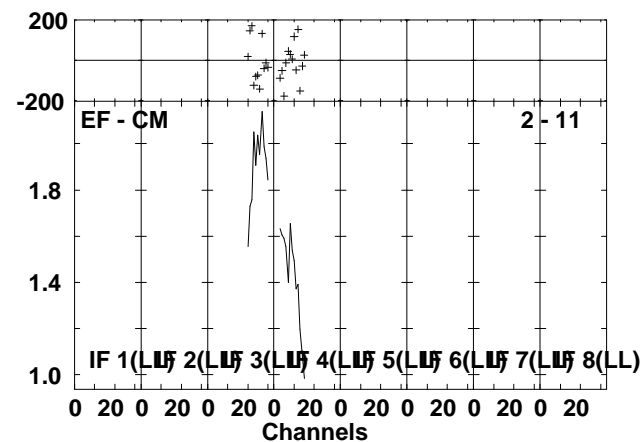
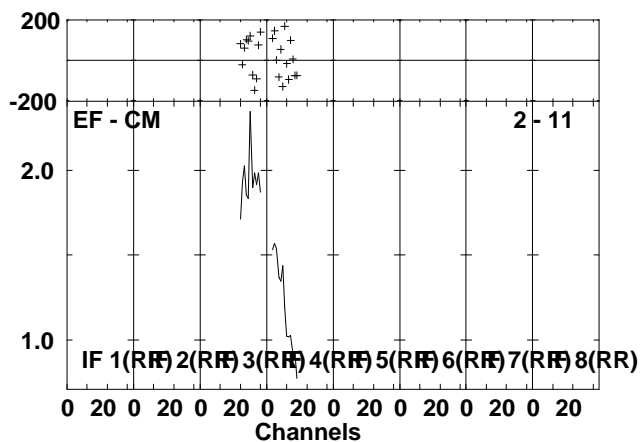
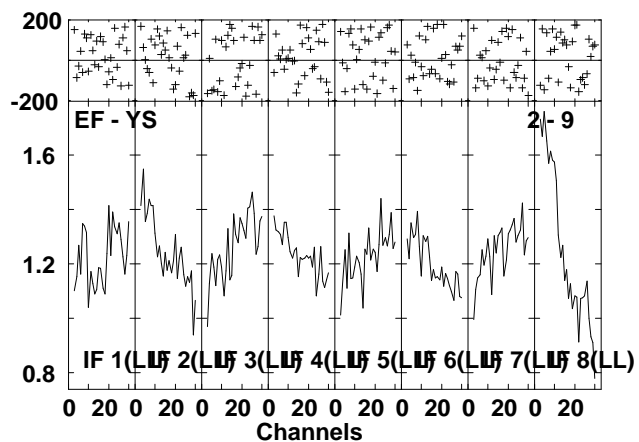
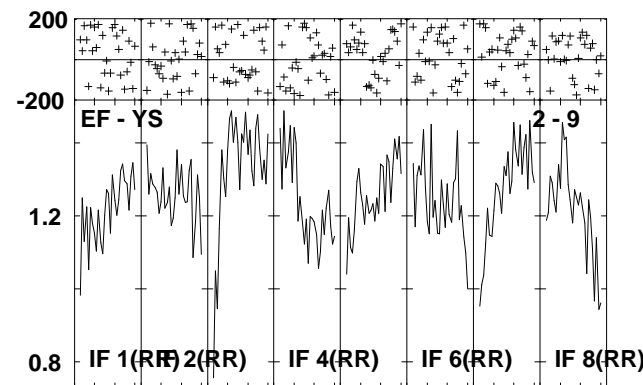
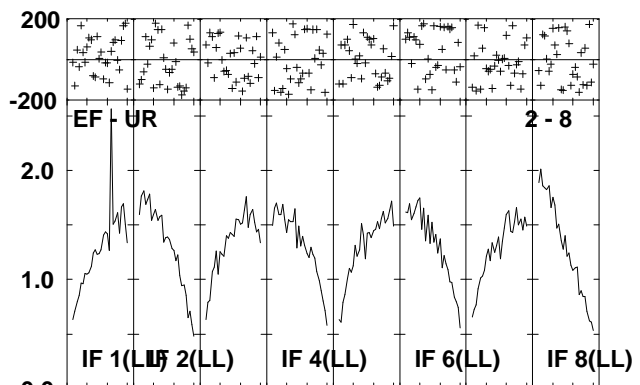
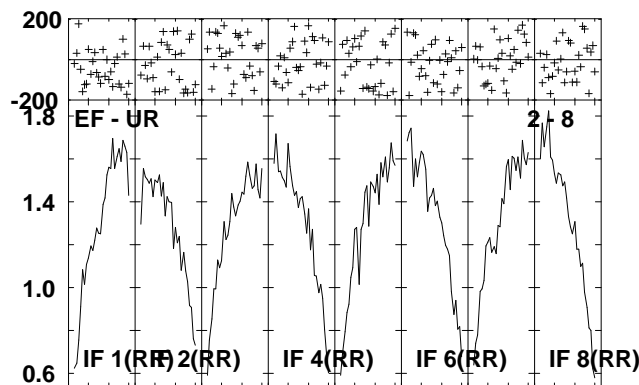
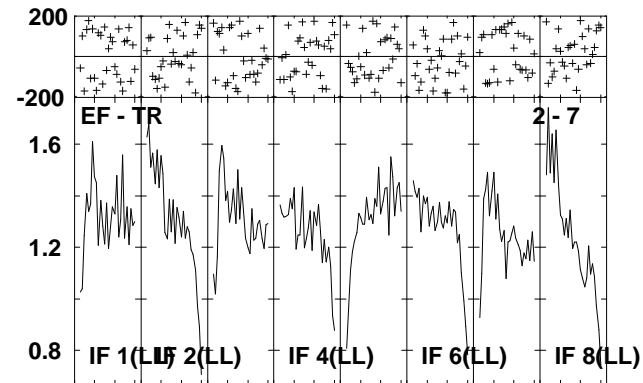
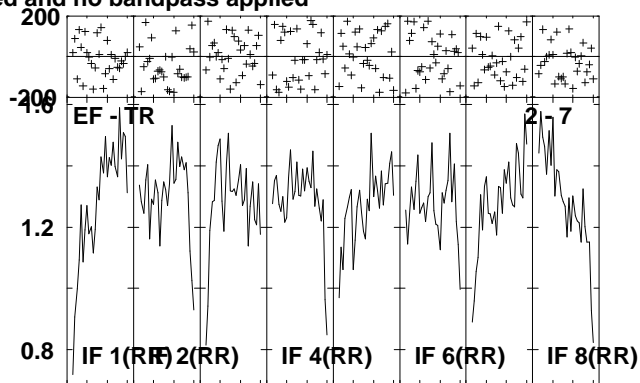
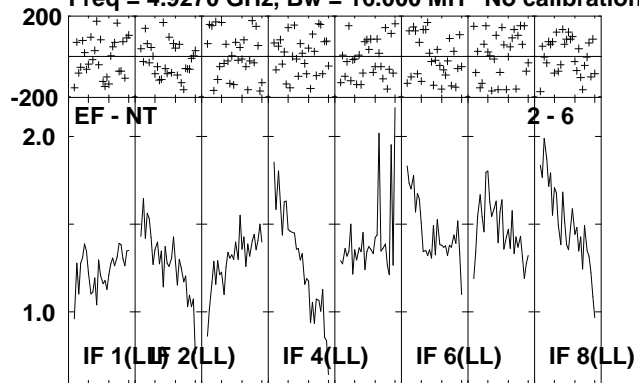

Lower frame: Milli Ampl Jy Top frame: Phas deg
Scalar averaged cross-power spectrum Several baselines displayed
Timerange: 00/13:50:13 to 00/13:53:49

Plot file version 156 created 06-JUL-2010 12:05:14

IRAS2336 EP064L.UVDATA.1

Freq = 4.9270 GHz, Bw = 16.000 MH No calibration applied and no bandpass applied

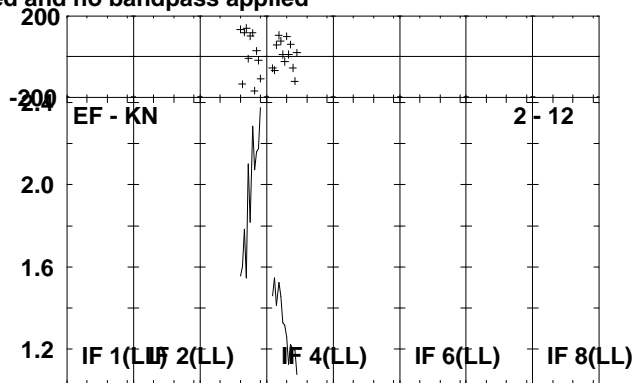
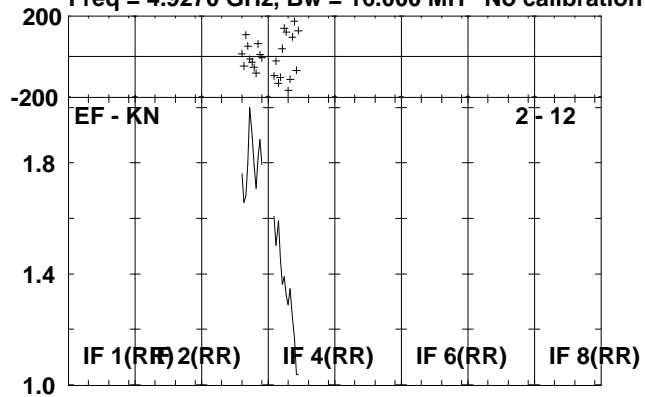

Lower frame: Milli Ampl Jy Top frame: Phas deg
Scalar averaged cross-power spectrum Several baselines displayed
Timerange: 00/13:50:13 to 00/13:53:49

Plot file version 157 created 06-JUL-2010 12:05:14

J2330+33 EP064L.UVDATA.1

Freq = 4.9270 GHz, Bw = 16.000 MH No calibration applied and no bandpass applied

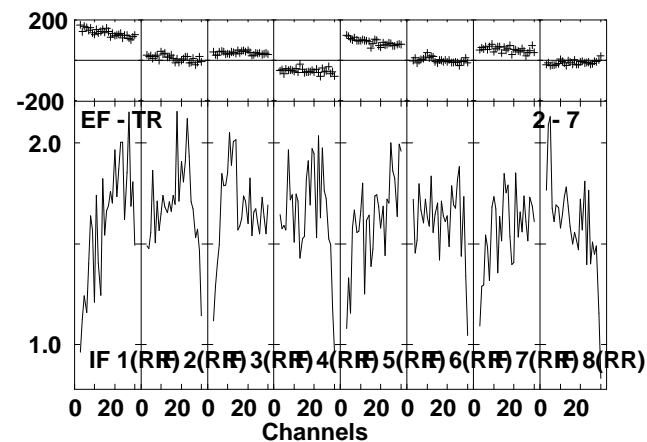
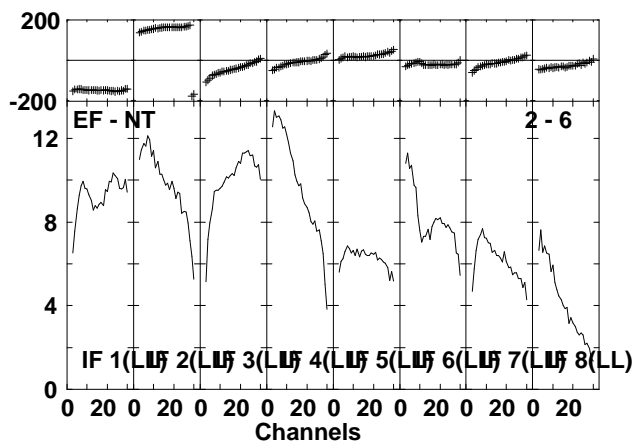
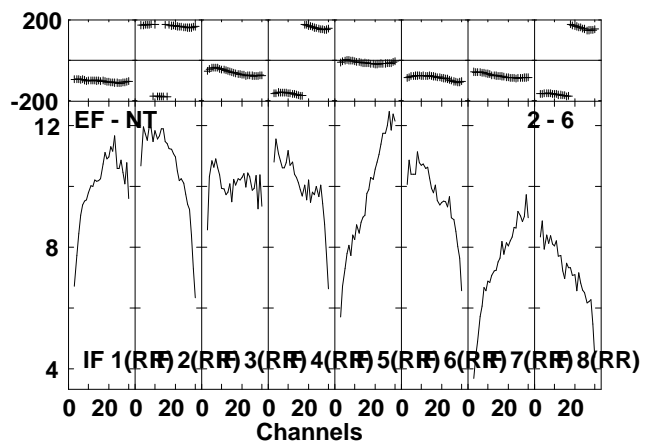
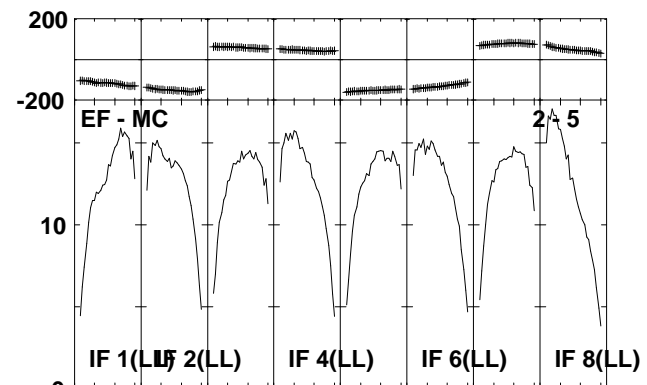
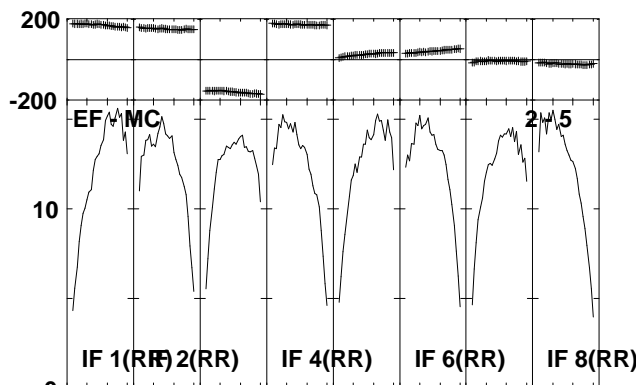
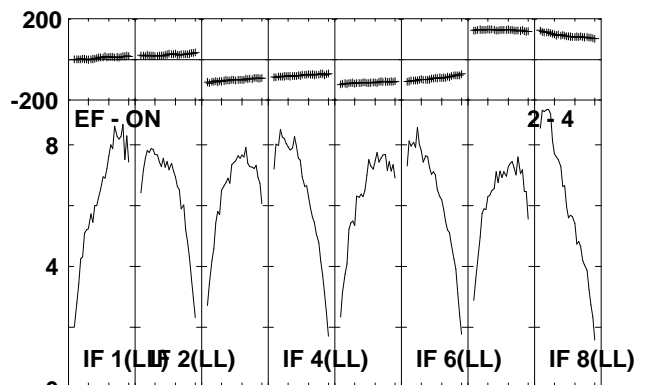
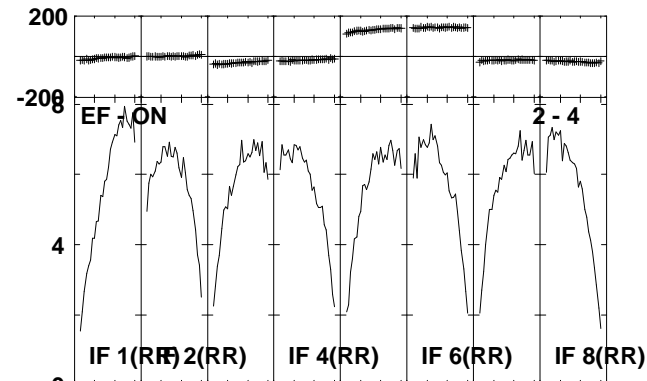
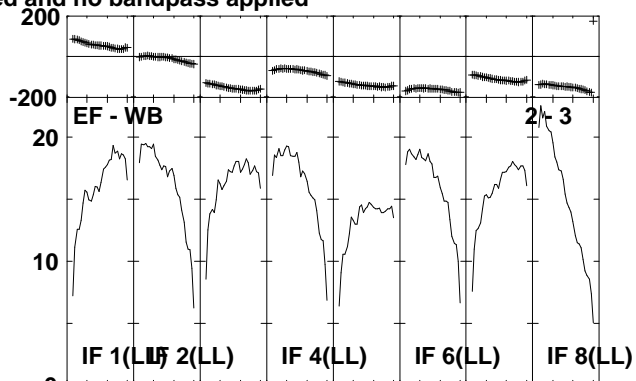
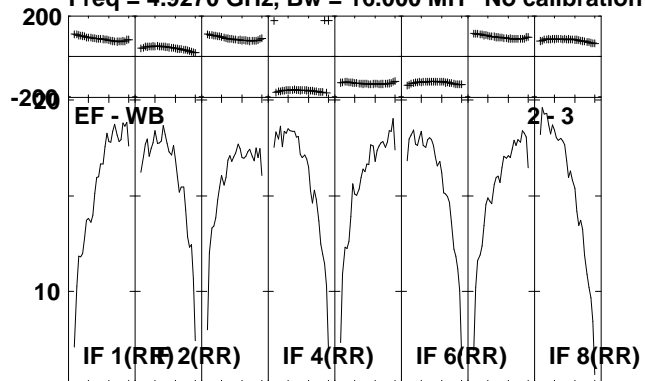

Lower frame: Milli Ampl Jy Top frame: Phas deg
Scalar averaged cross-power spectrum Several baselines displayed
Timerange: 00/13:53:51 to 00/13:55:39

Plot file version 159 created 06-JUL-2010 12:05:17

IRAS2336 EP064L.UVDATA.1

Freq = 4.9270 GHz, Bw = 16.000 MH No calibration applied and no bandpass applied

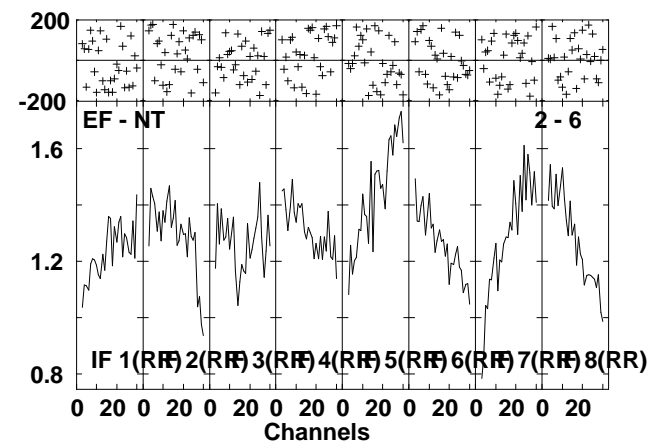
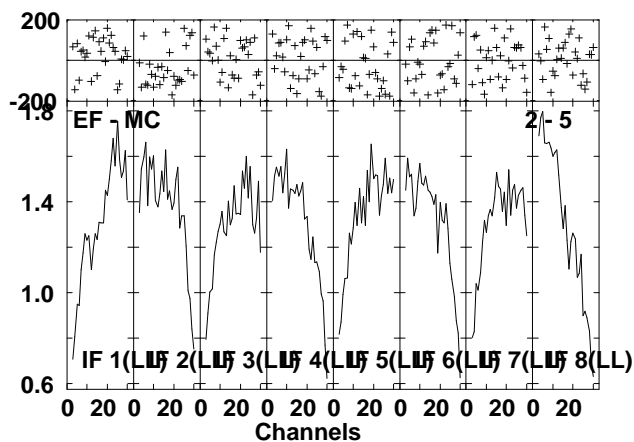
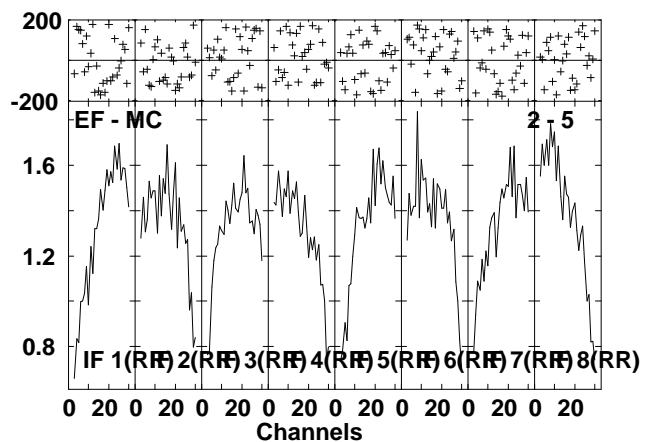
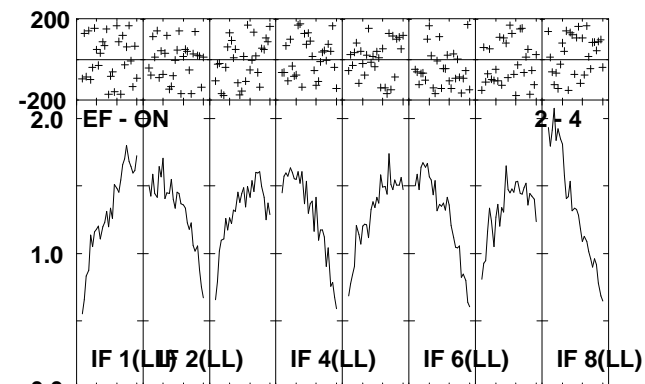
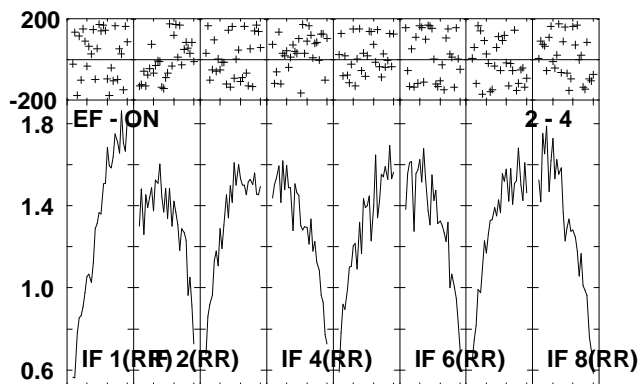
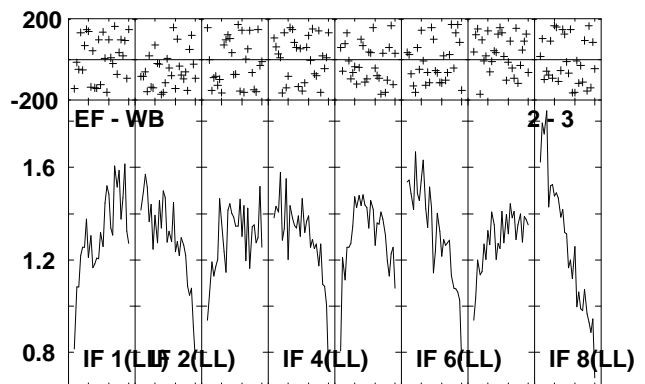
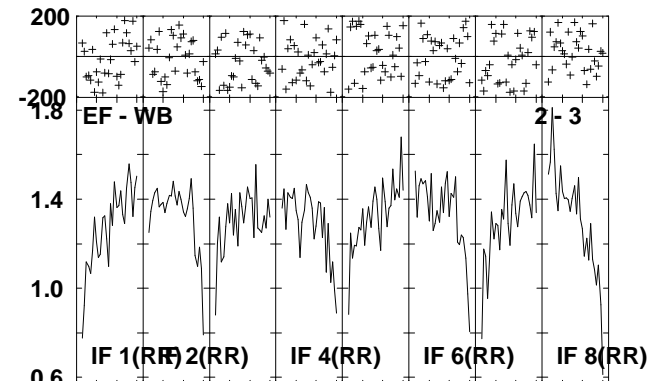
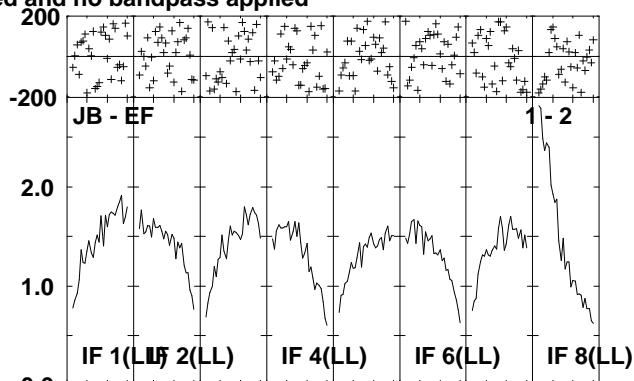
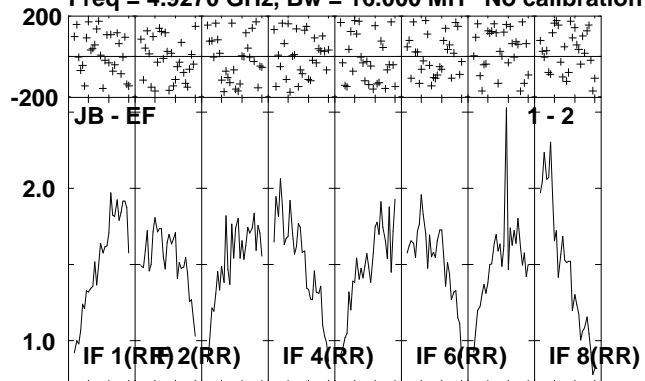

Lower frame: Milli Ampl Jy Top frame: Phas deg
Scalar averaged cross-power spectrum Several baselines displayed
Timerange: 00/13:55:41 to 00/13:59:19

Plot file version 161 created 06-JUL-2010 12:05:23

IRAS2336 EP064L.UVDATA.1

Freq = 4.9270 GHz, Bw = 16.000 MH No calibration applied and no bandpass applied

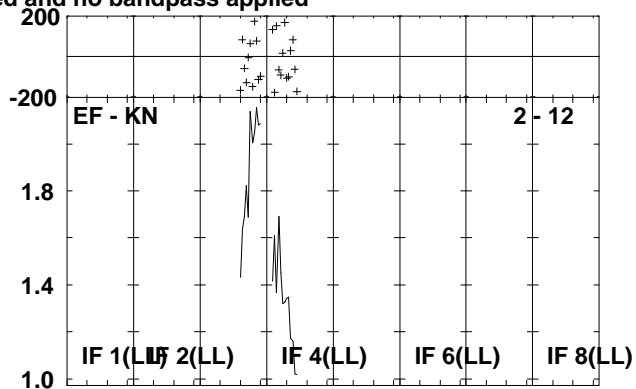
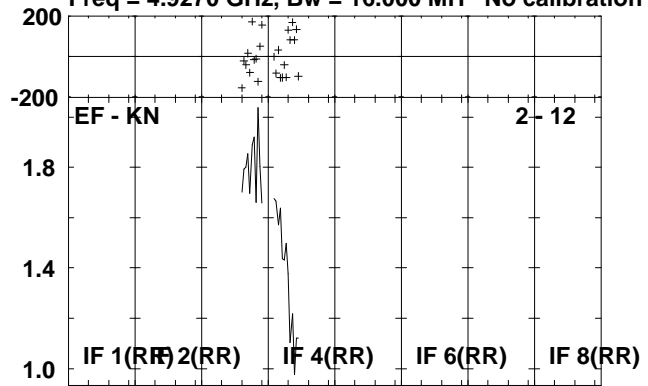

Lower frame: Milli Ampl Jy Top frame: Phas deg
Scalar averaged cross-power spectrum Several baselines displayed
Timerange: 00/13:55:41 to 00/13:59:19

Plot file version 162 created 06-JUL-2010 12:05:23

J2330+33 EP064L.UVDATA.1

Freq = 4.9270 GHz, Bw = 16.000 MH No calibration applied and no bandpass applied

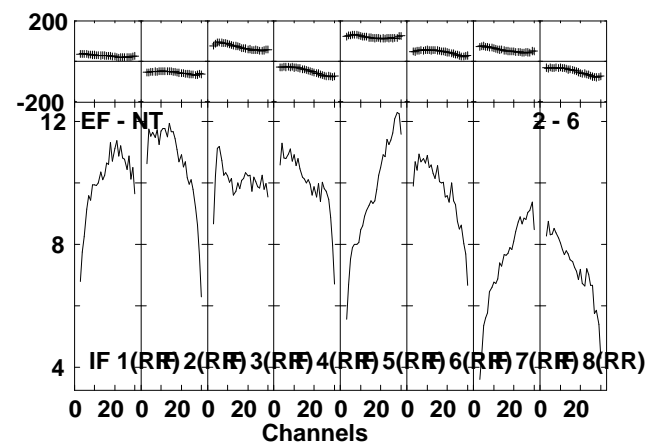
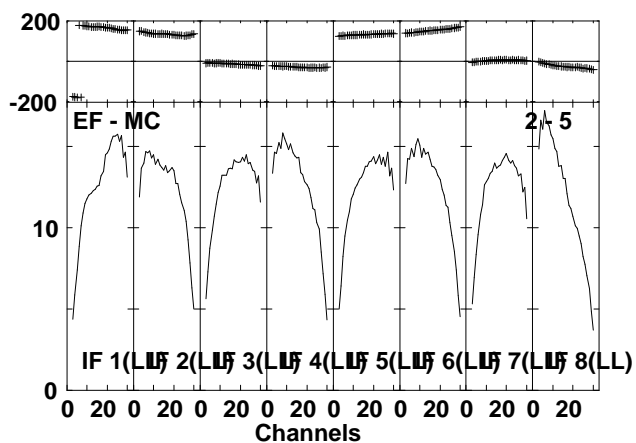
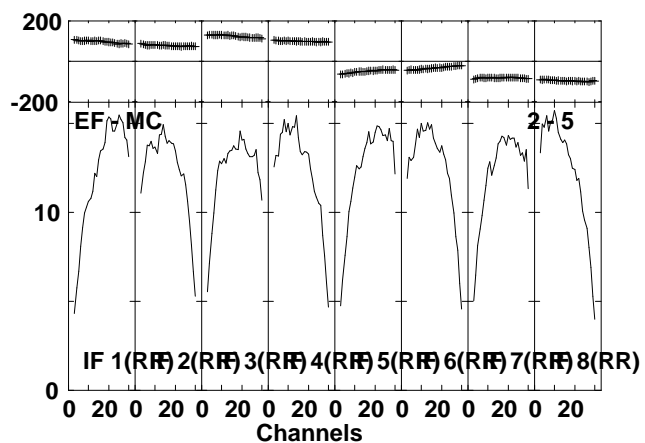
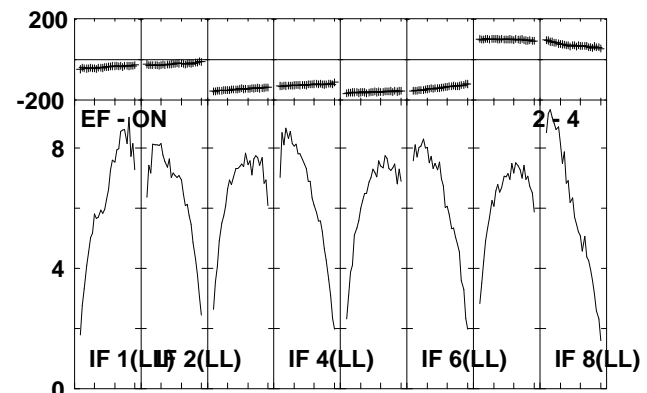
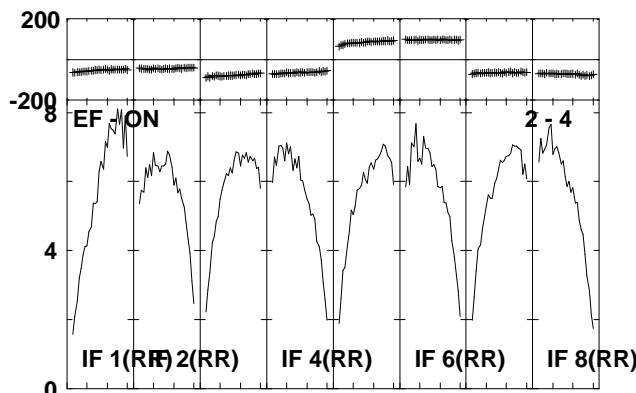
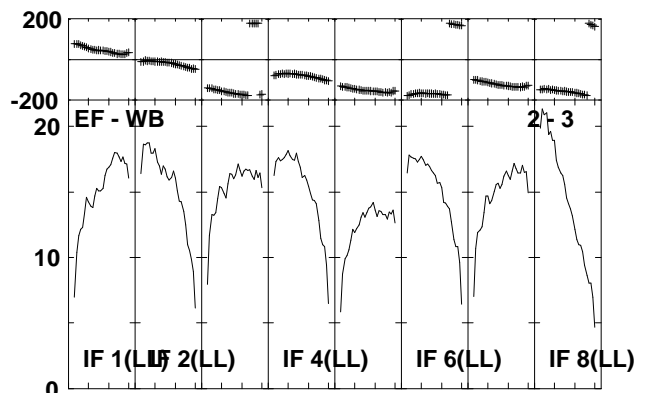
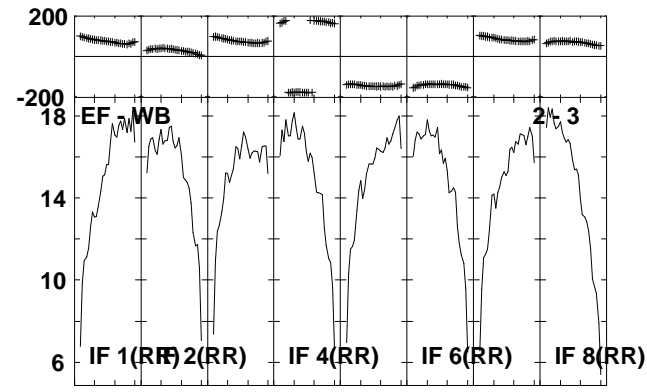
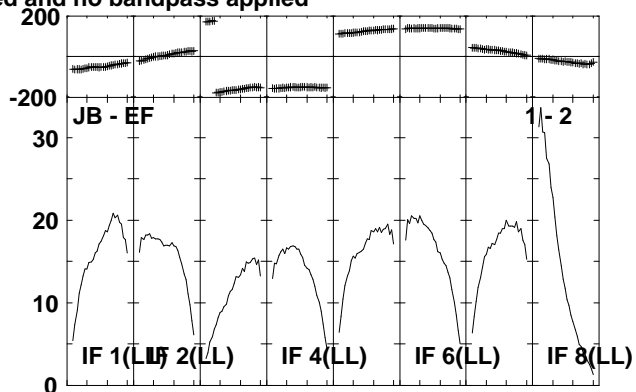
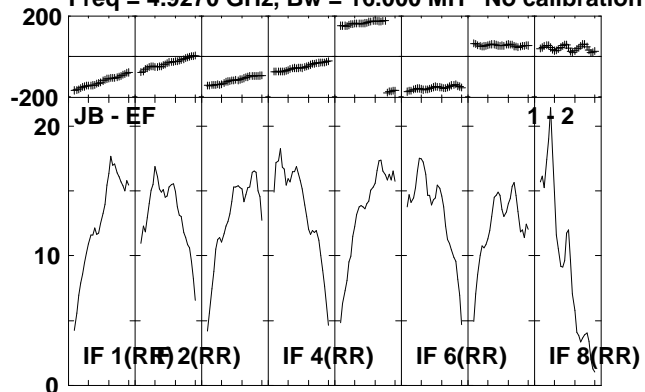

Lower frame: Milli Ampl Jy Top frame: Phas deg
Scalar averaged cross-power spectrum Several baselines displayed
Timerange: 00/13:59:21 to 00/14:01:09

Plot file version 163 created 06-JUL-2010 12:05:24

J2330+33 EP064L.UVDATA.1

Freq = 4.9270 GHz, Bw = 16.000 MH No calibration applied and no bandpass applied

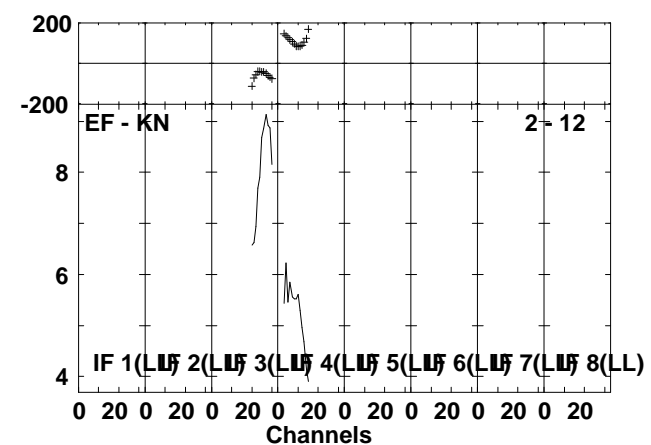
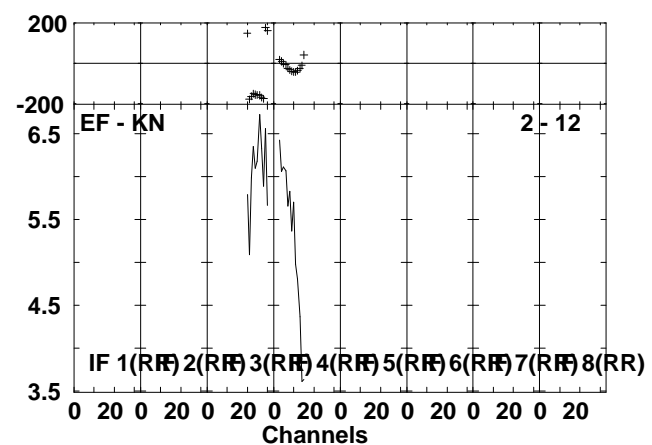
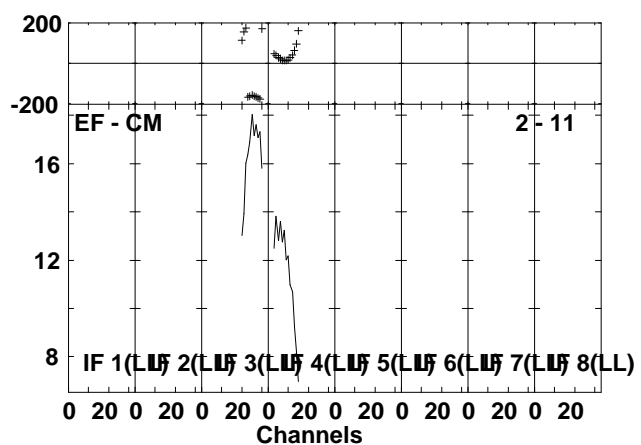
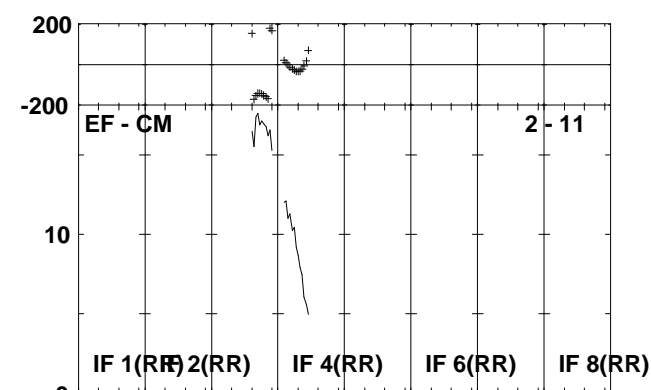
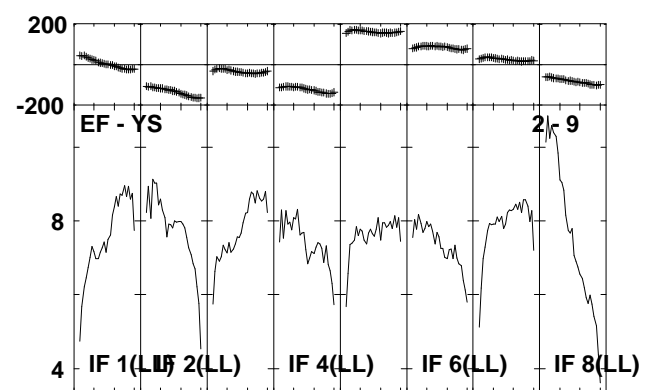
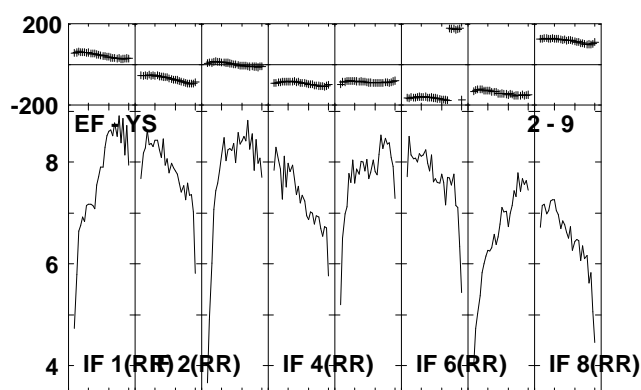
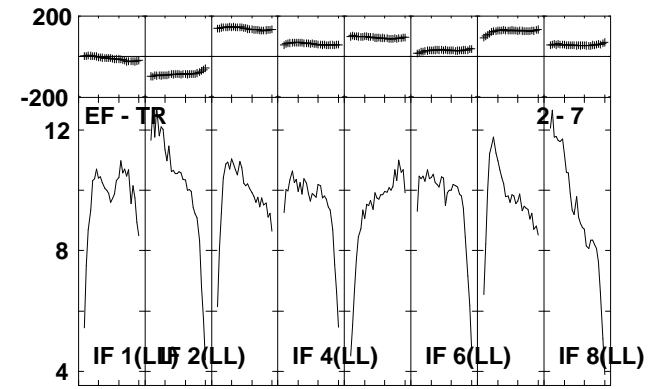
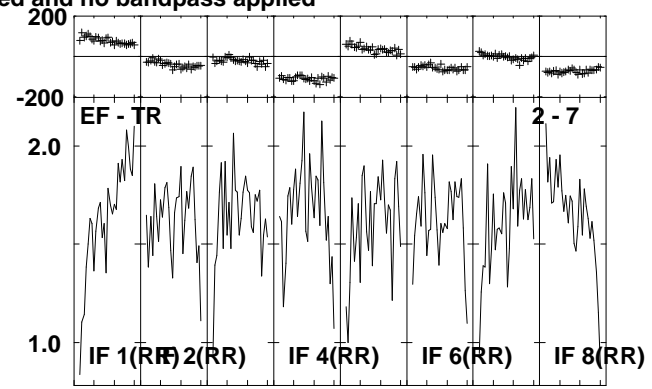
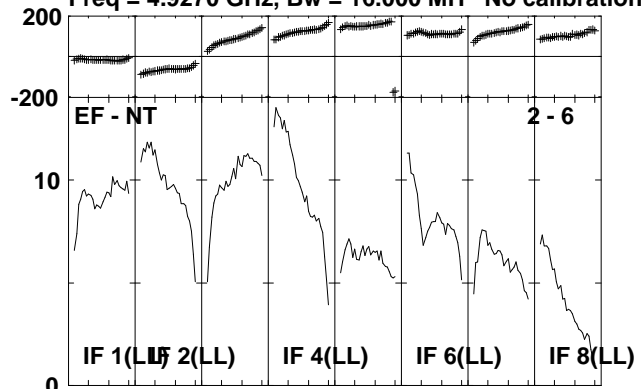

Lower frame: Milli Ampl Jy Top frame: Phas deg
Scalar averaged cross-power spectrum Several baselines displayed
Timerange: 00/13:59:21 to 00/14:01:09

Plot file version 164 created 06-JUL-2010 12:05:27

IRAS2336 EP064L.UVDATA.1

Freq = 4.9270 GHz, Bw = 16.000 MH No calibration applied and no bandpass applied

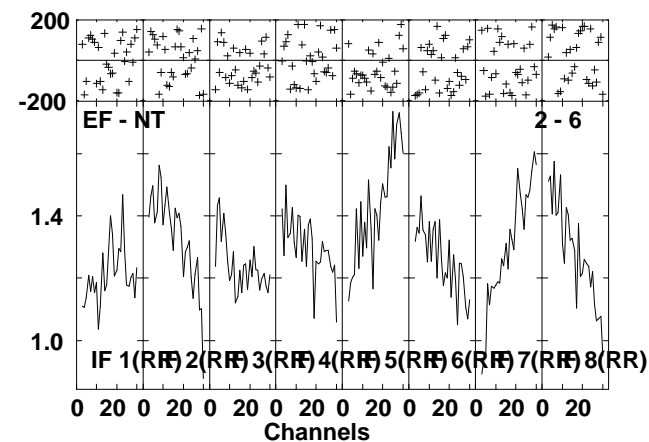
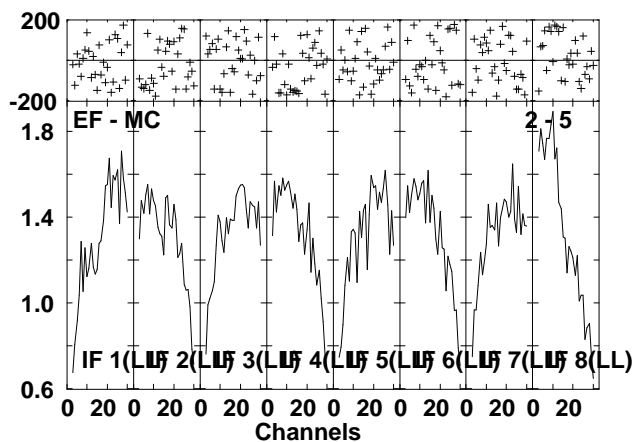
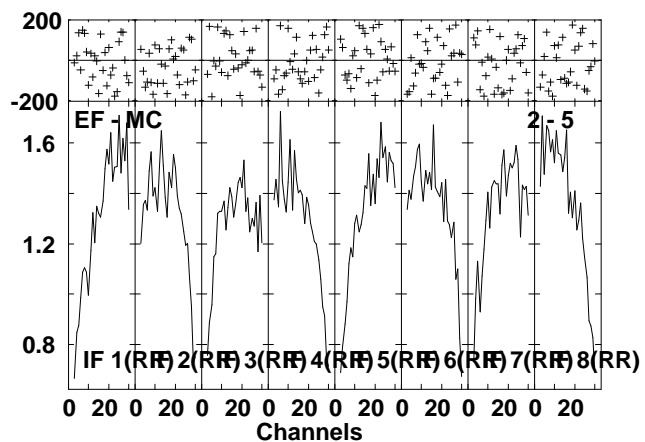
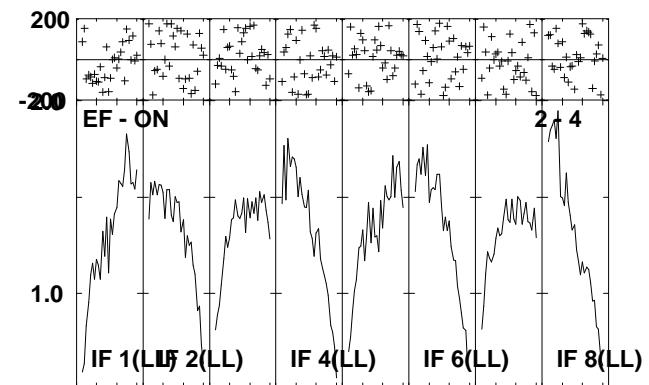
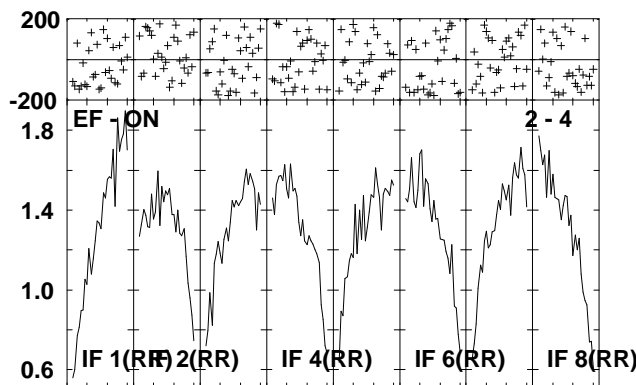
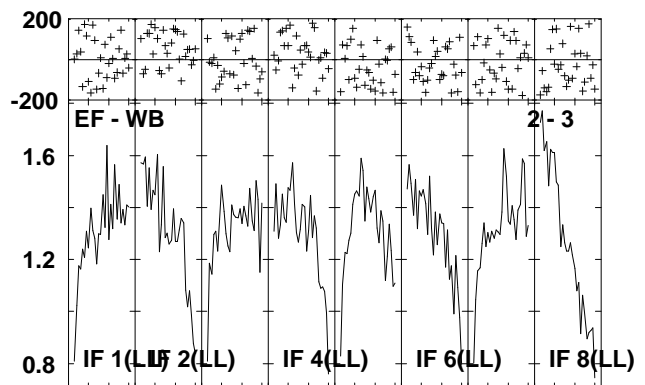
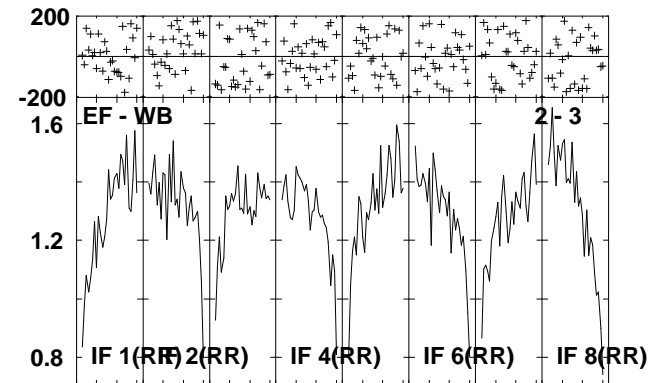
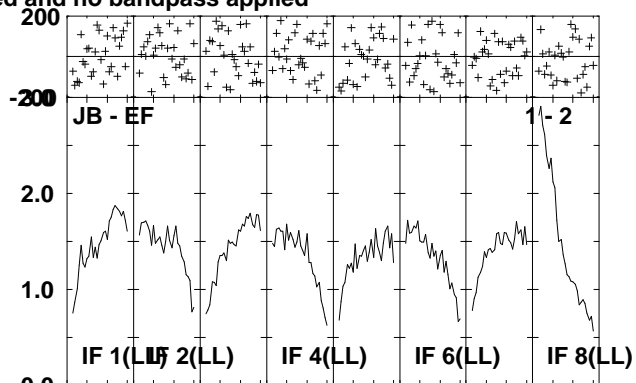
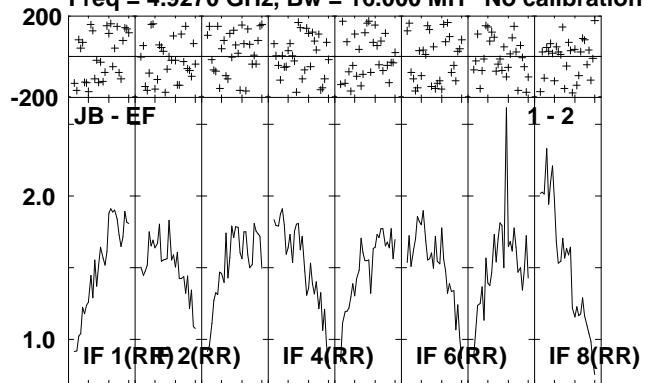

Lower frame: Milli Ampl Jy Top frame: Phas deg
Scalar averaged cross-power spectrum Several baselines displayed
Timerange: 00/14:01:11 to 00/14:04:49

Plot file version 165 created 06-JUL-2010 12:05:29

IRAS2336 EP064L.UVDATA.1

Freq = 4.9270 GHz, Bw = 16.000 MH No calibration applied and no bandpass applied

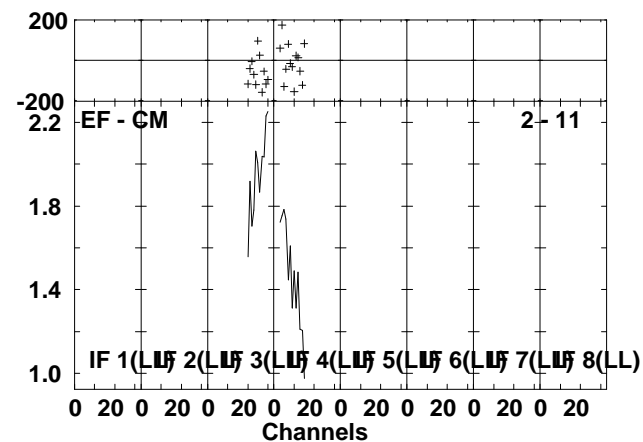
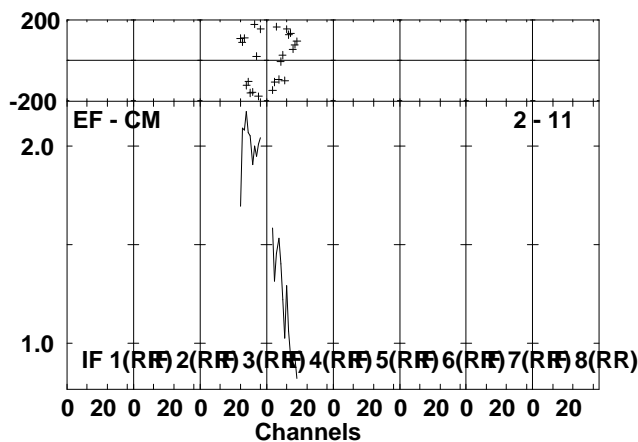
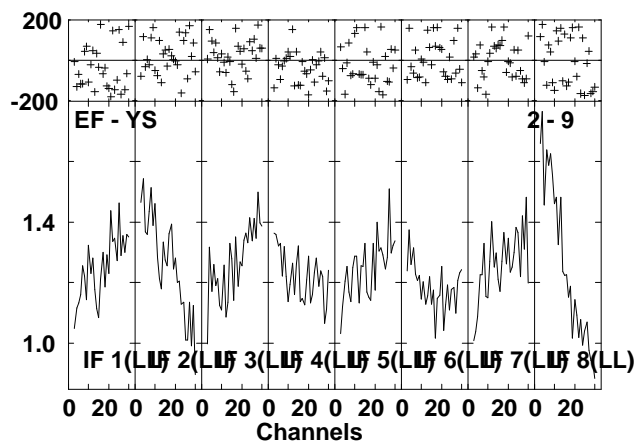
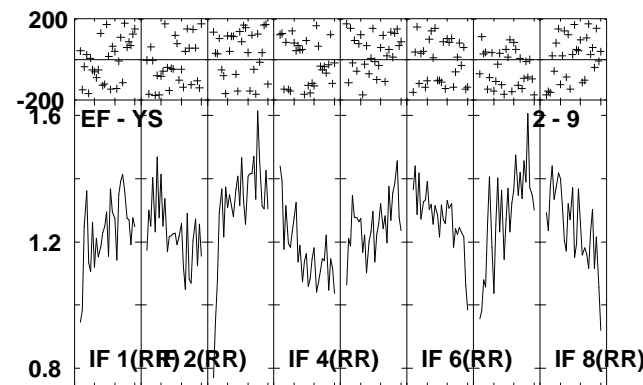
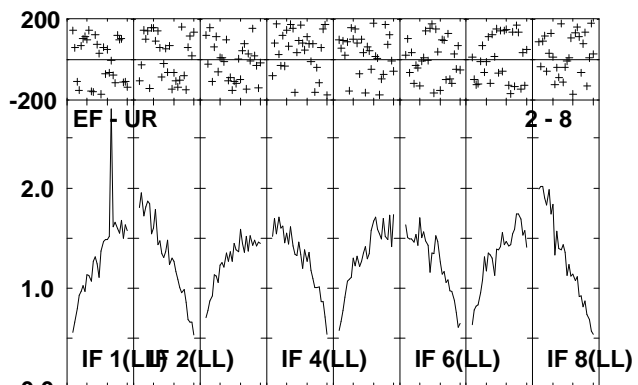
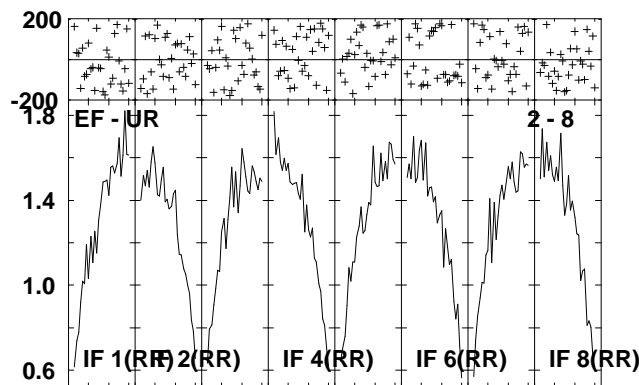
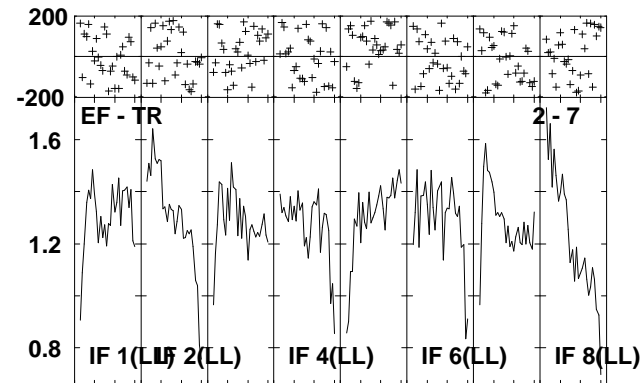
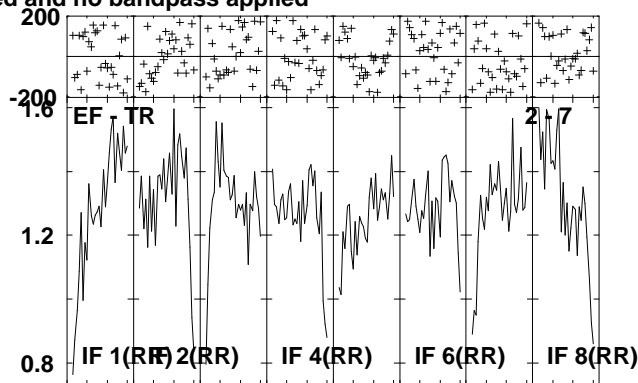
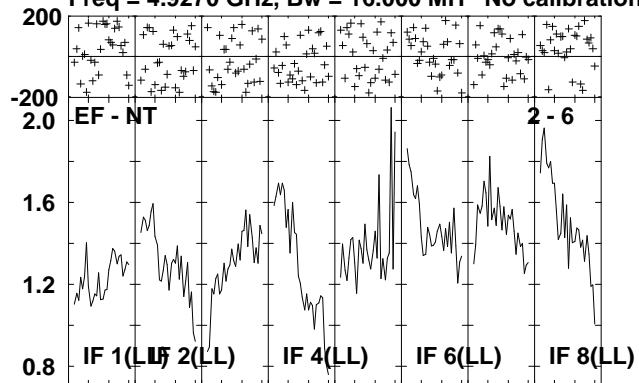

Lower frame: Milli Ampl Jy Top frame: Phas deg
Scalar averaged cross-power spectrum Several baselines displayed
Timerange: 00/14:01:11 to 00/14:04:49

Plot file version 166 created 06-JUL-2010 12:05:33

IRAS2336 EP064L.UVDATA.1

Freq = 4.9270 GHz, Bw = 16.000 MH No calibration applied and no bandpass applied

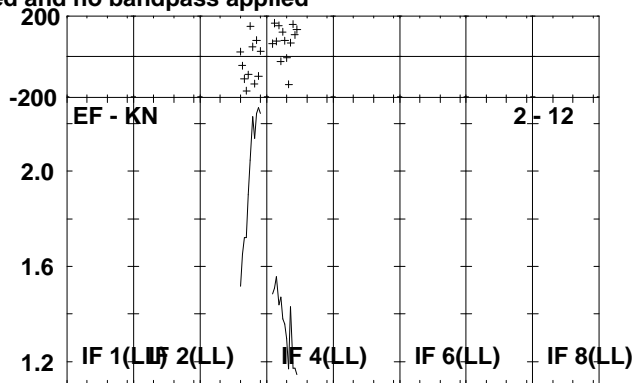
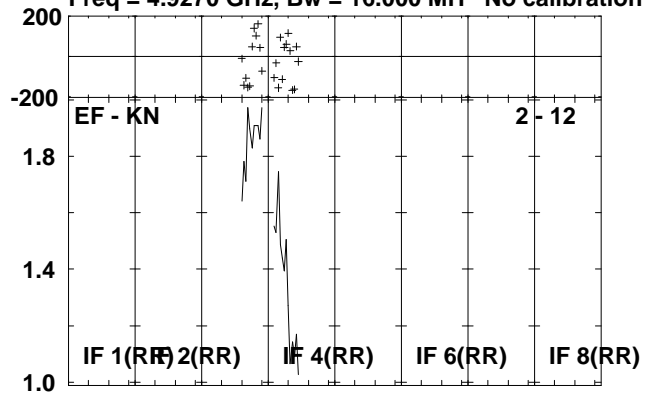

Lower frame: Milli Ampl Jy Top frame: Phas deg
Scalar averaged cross-power spectrum Several baselines displayed
Timerange: 00/14:01:11 to 00/14:04:49

Plot file version 167 created 06-JUL-2010 12:05:33

J2330+33 EP064L.UVDATA.1

Freq = 4.9270 GHz, Bw = 16.000 MH No calibration applied and no bandpass applied

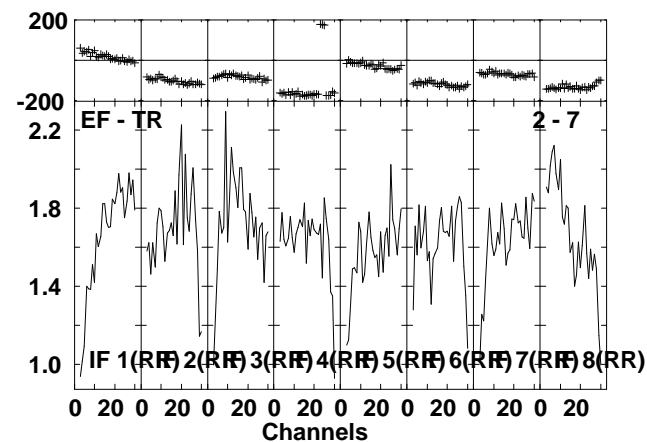
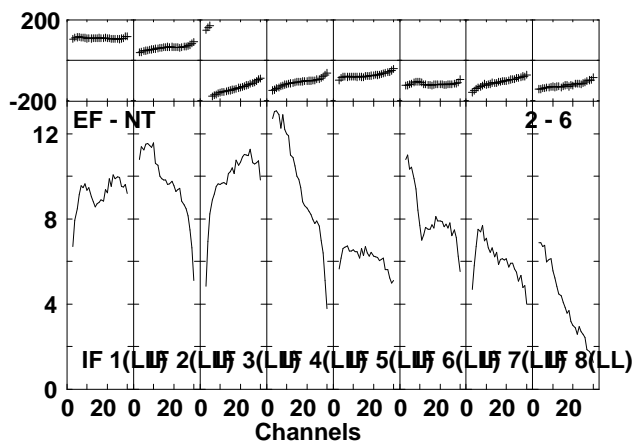
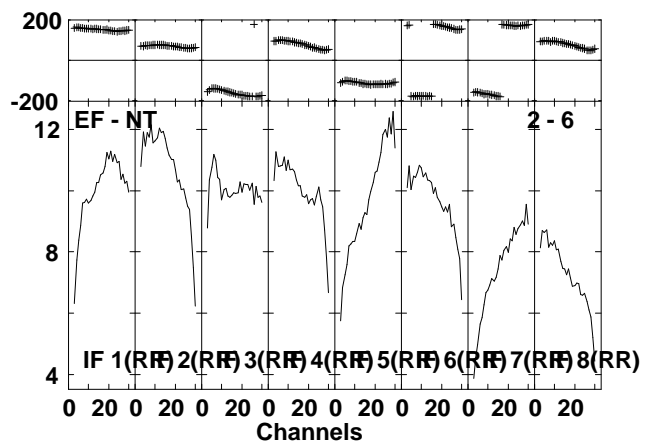
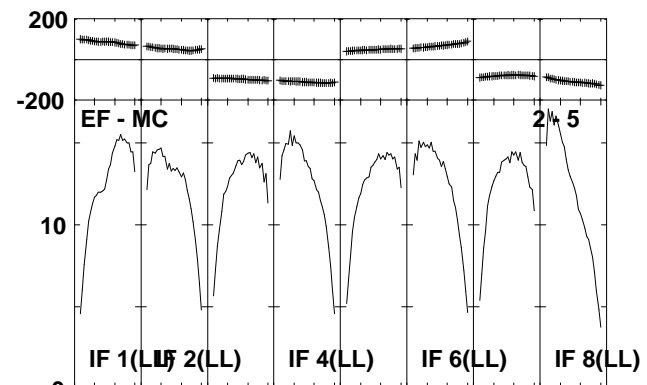
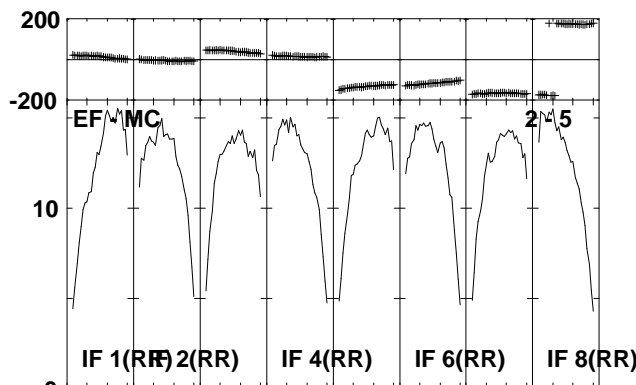
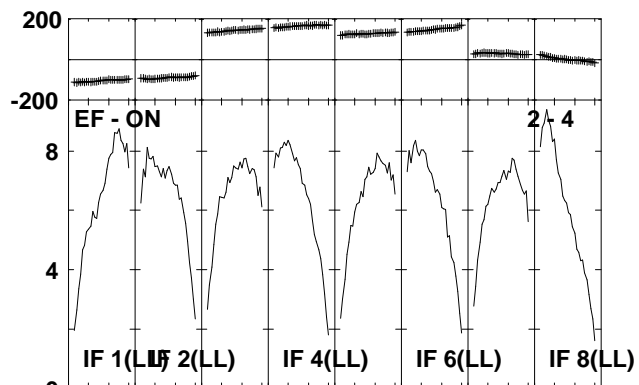
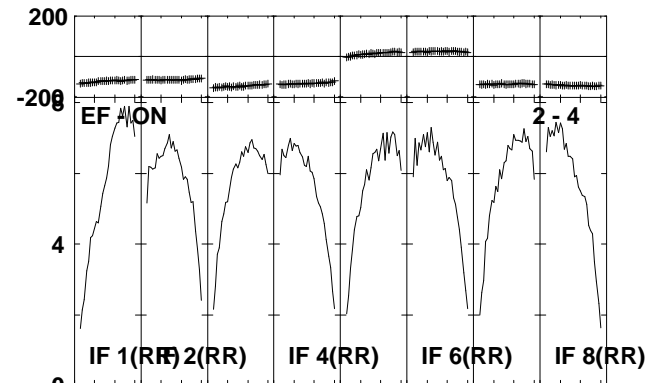
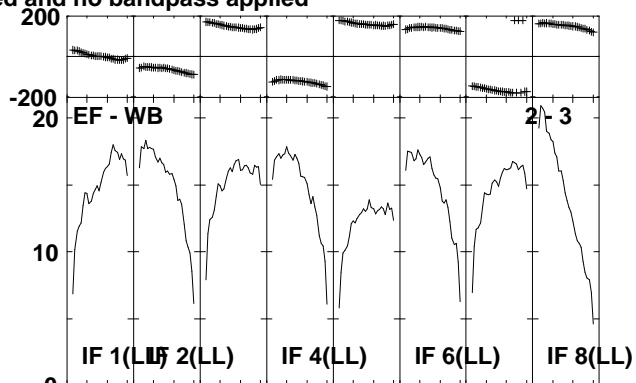
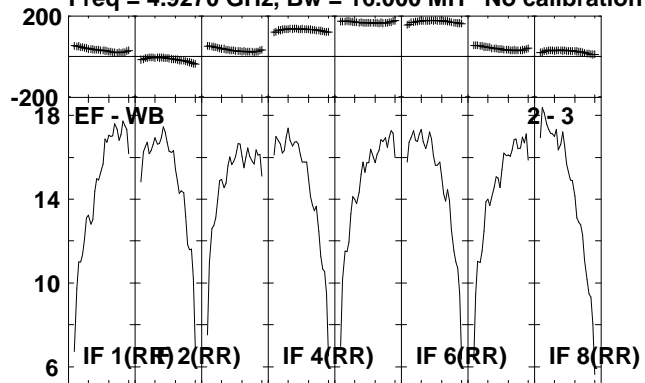

Lower frame: Milli Ampl Jy Top frame: Phas deg
Scalar averaged cross-power spectrum Several baselines displayed
Timerange: 00/14:05:51 to 00/14:07:27

Plot file version 168 created 06-JUL-2010 12:05:34

J2330+33 EP064L.UVDATA.1

Freq = 4.9270 GHz, Bw = 16.000 MH No calibration applied and no bandpass applied

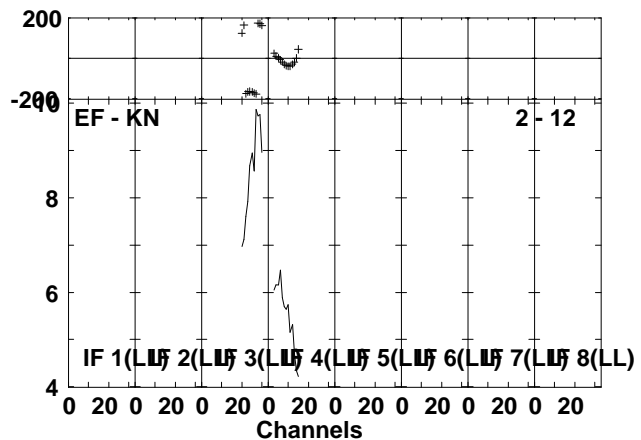
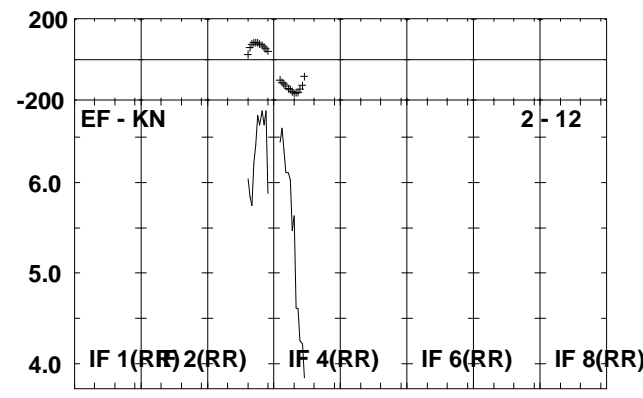
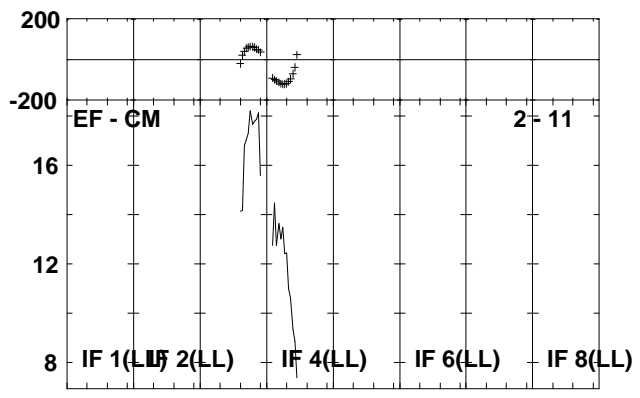
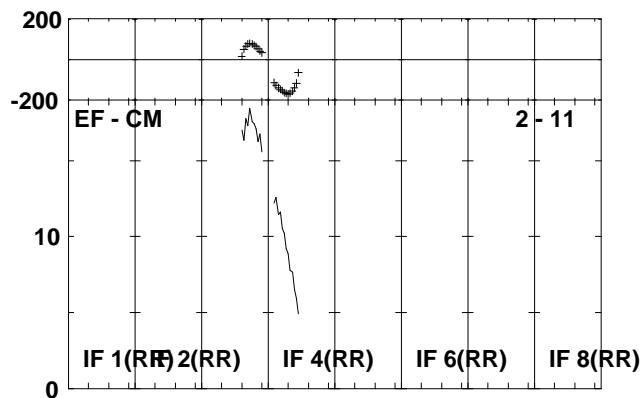
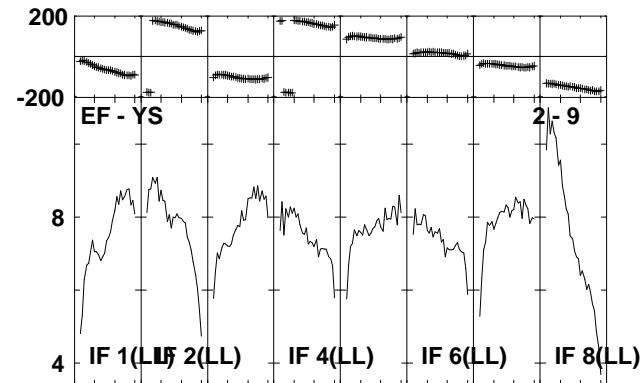
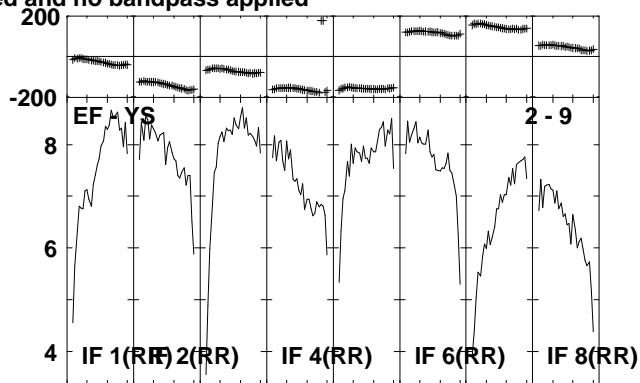
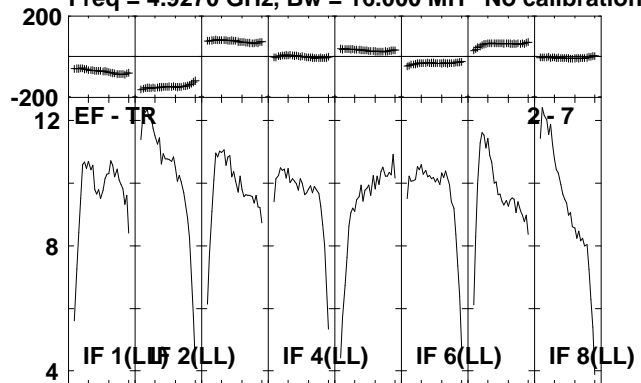

Lower frame: Milli Ampl Jy Top frame: Phas deg
Scalar averaged cross-power spectrum Several baselines displayed
Timerange: 00/14:05:51 to 00/14:07:27

Plot file version 169 created 06-JUL-2010 12:05:35

IRAS2336 EP064L.UVDATA.1

Freq = 4.9270 GHz, Bw = 16.000 MH No calibration applied and no bandpass applied

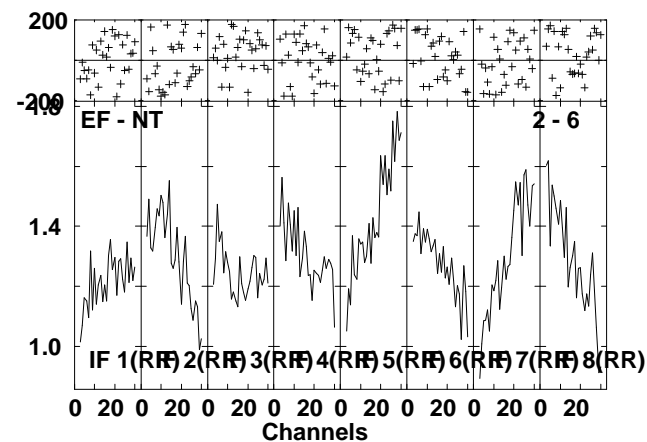
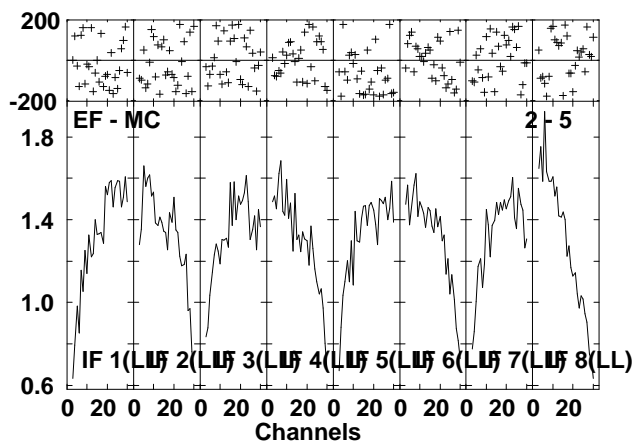
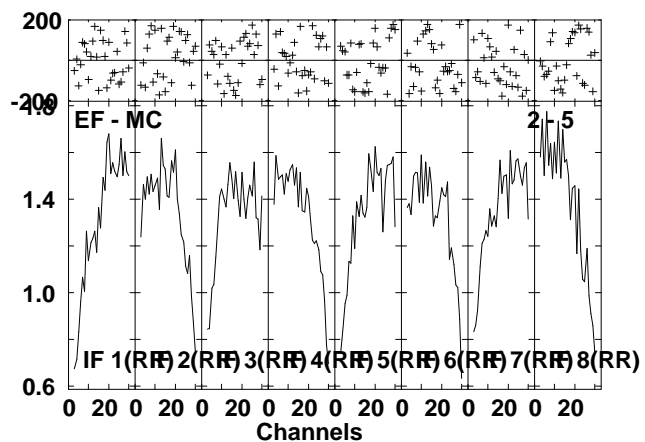
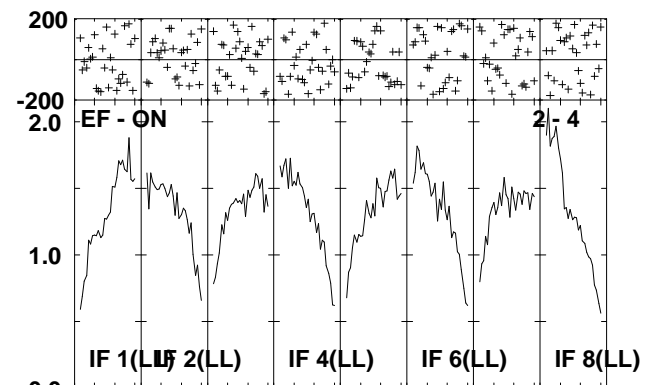
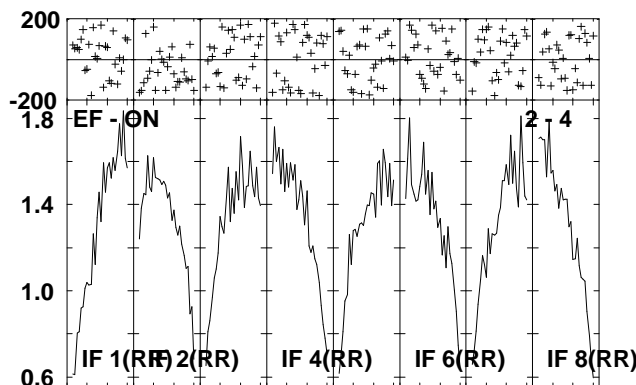
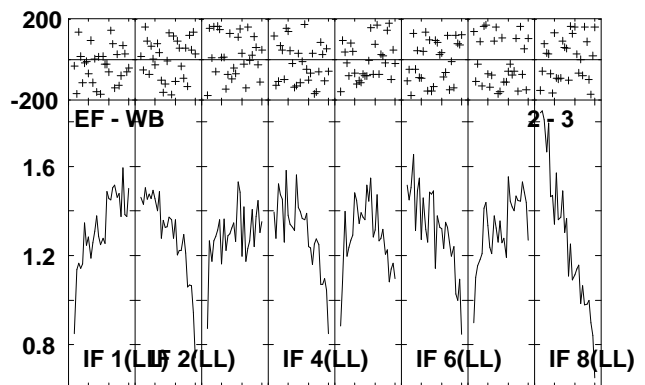
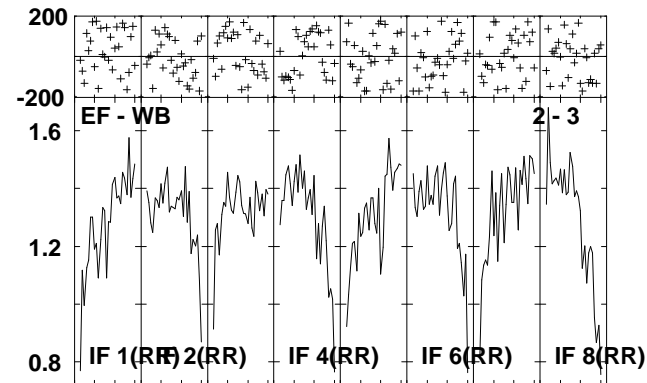
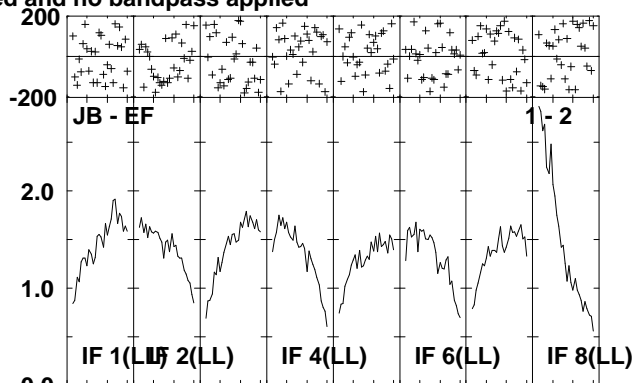
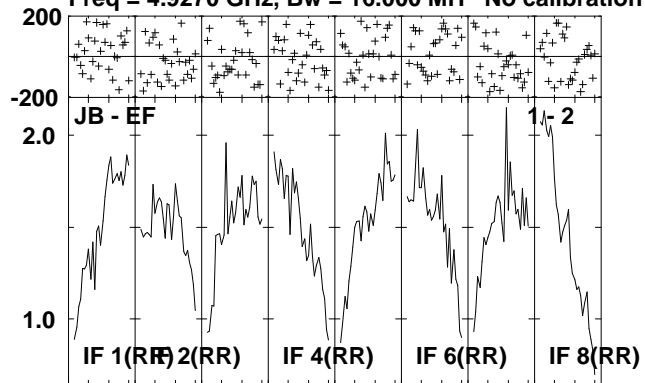

Lower frame: Milli Ampl Jy Top frame: Phas deg
Scalar averaged cross-power spectrum Several baselines displayed
Timerange: 00/14:07:31 to 00/14:11:07

Plot file version 170 created 06-JUL-2010 12:05:37

IRAS2336 EP064L.UVDATA.1

Freq = 4.9270 GHz, Bw = 16.000 MH No calibration applied and no bandpass applied

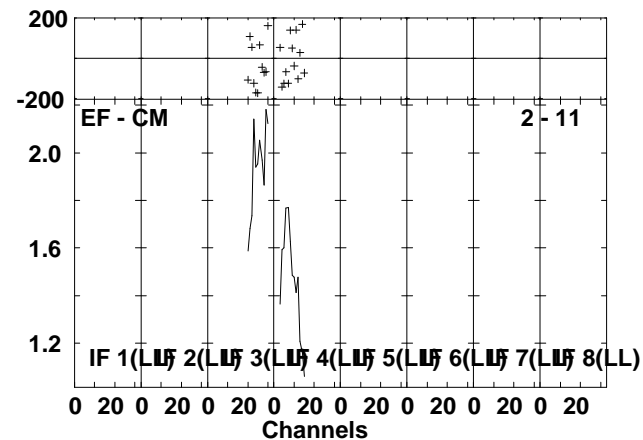
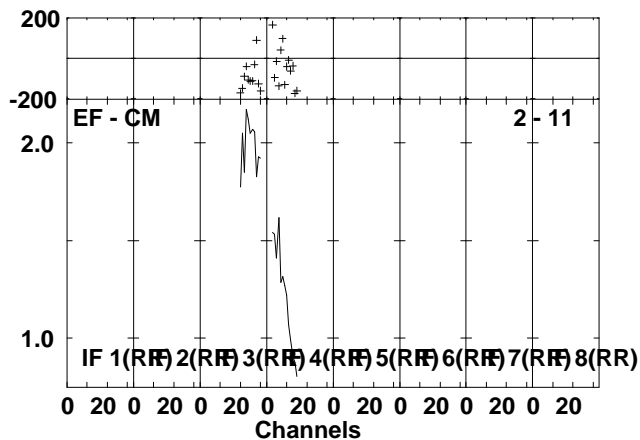
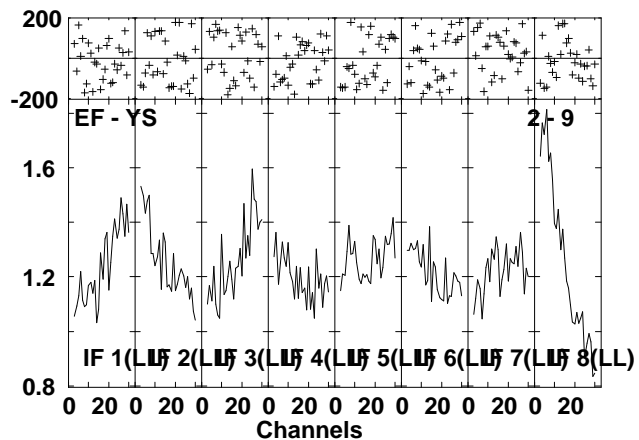
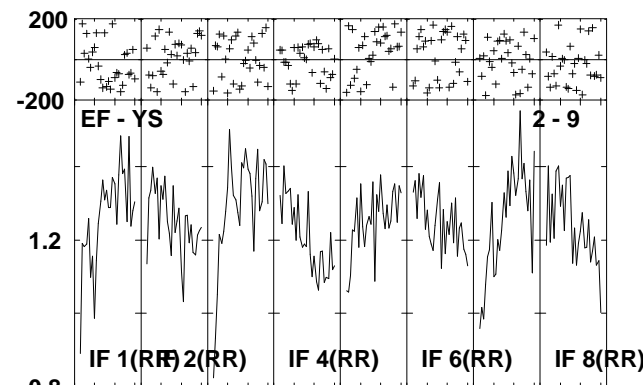
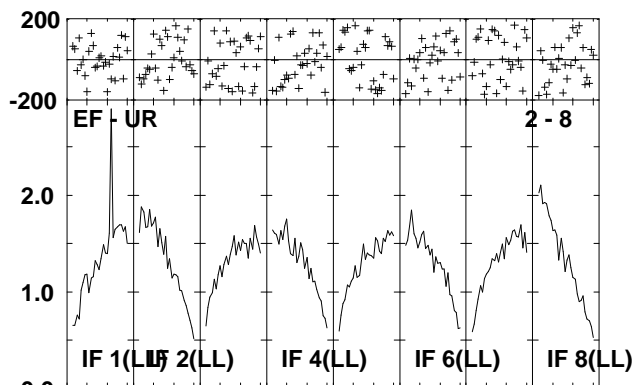
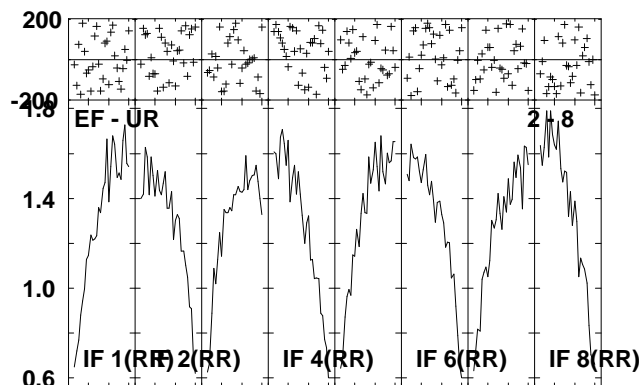
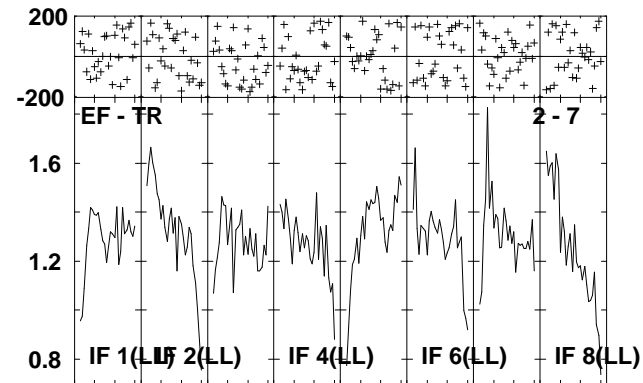
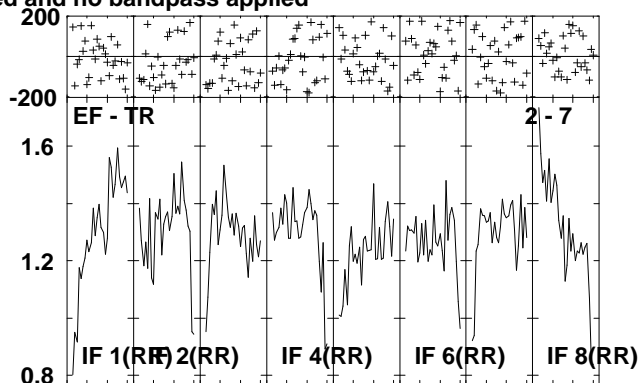
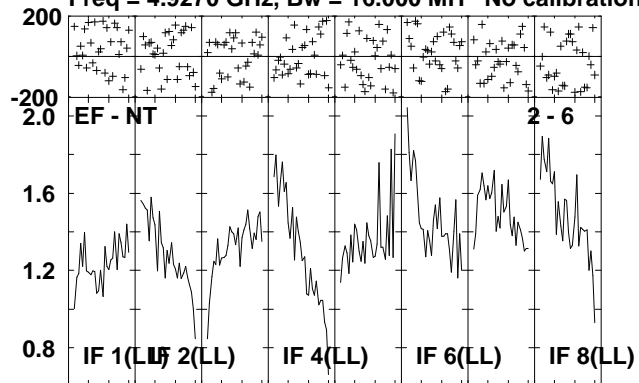

Lower frame: Milli Ampl Jy Top frame: Phas deg
Scalar averaged cross-power spectrum Several baselines displayed
Timerange: 00/14:07:31 to 00/14:11:07

Plot file version 171 created 06-JUL-2010 12:05:41

IRAS2336 EP064L.UVDATA.1

Freq = 4.9270 GHz, Bw = 16.000 MH No calibration applied and no bandpass applied

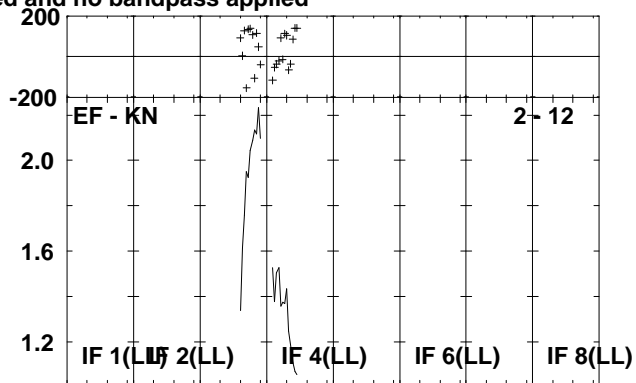
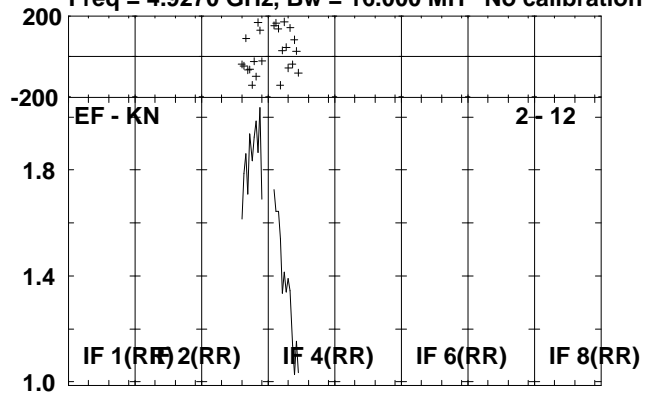

Lower frame: Milli Ampl Jy Top frame: Phas deg
Scalar averaged cross-power spectrum Several baselines displayed
Timerange: 00/14:07:31 to 00/14:11:07

Plot file version 172 created 06-JUL-2010 12:05:41

J2330+33 EP064L.UVDATA.1

Freq = 4.9270 GHz, Bw = 16.000 MH No calibration applied and no bandpass applied

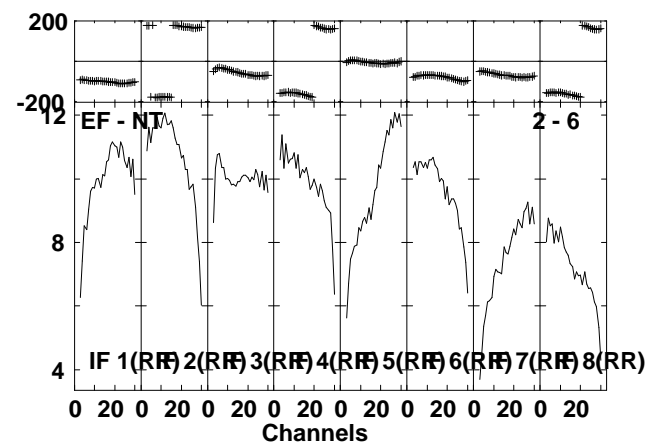
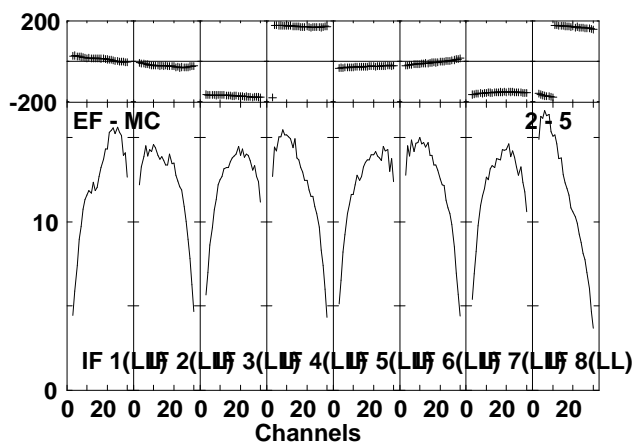
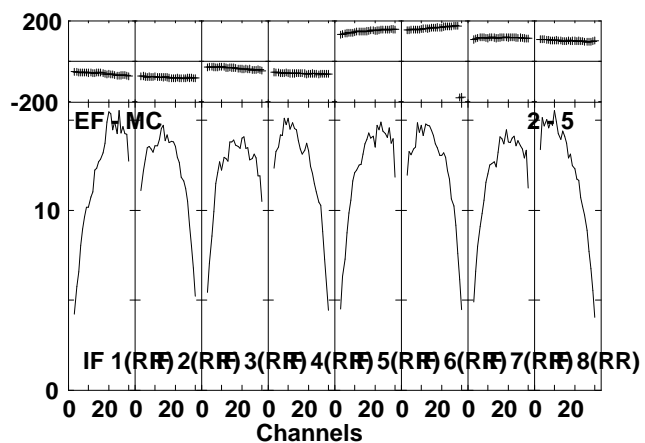
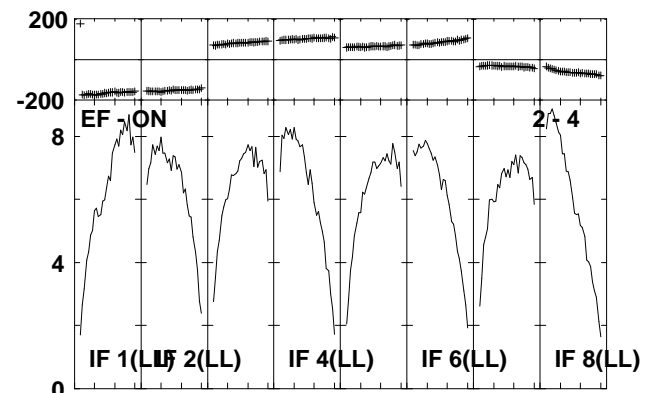
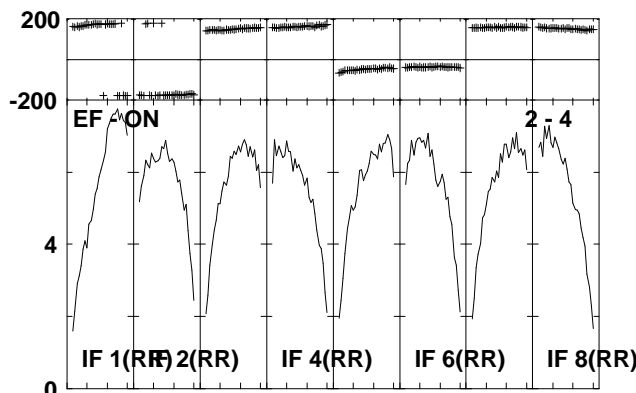
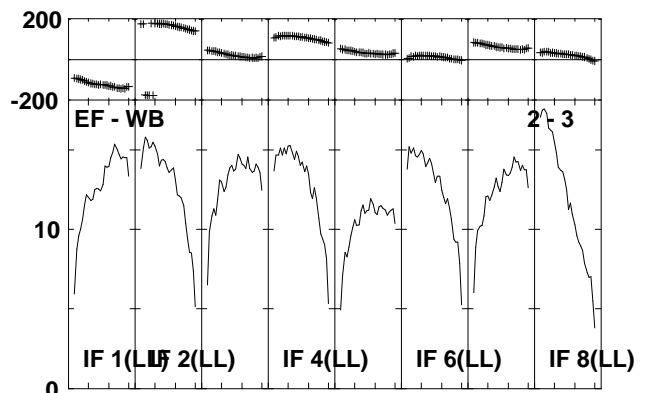
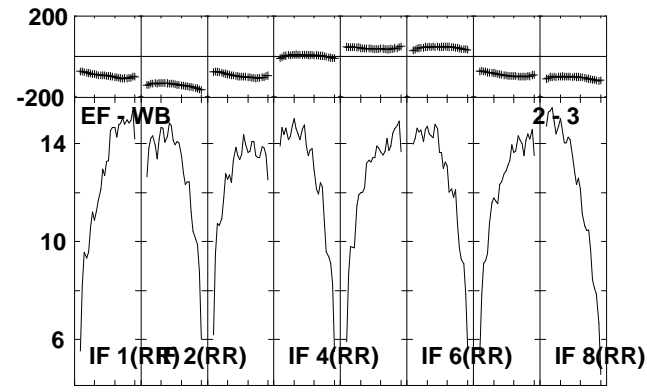
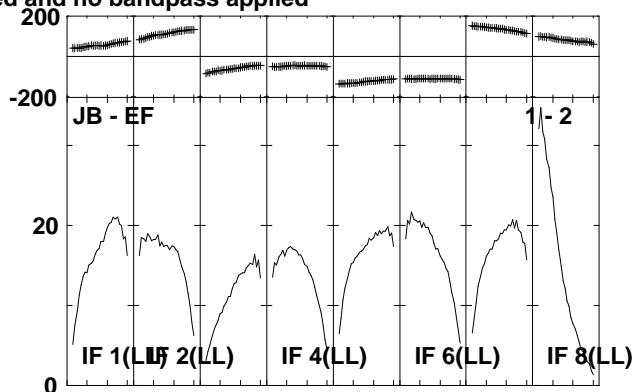
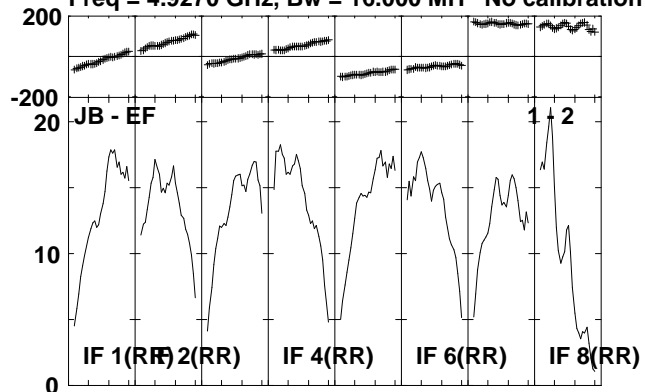

Lower frame: Milli Ampl Jy Top frame: Phas deg
Scalar averaged cross-power spectrum Several baselines displayed
Timerange: 00/14:11:17 to 00/14:12:59

Plot file version 173 created 06-JUL-2010 12:05:42

J2330+33 EP064L.UVDATA.1

Freq = 4.9270 GHz, Bw = 16.000 MH No calibration applied and no bandpass applied

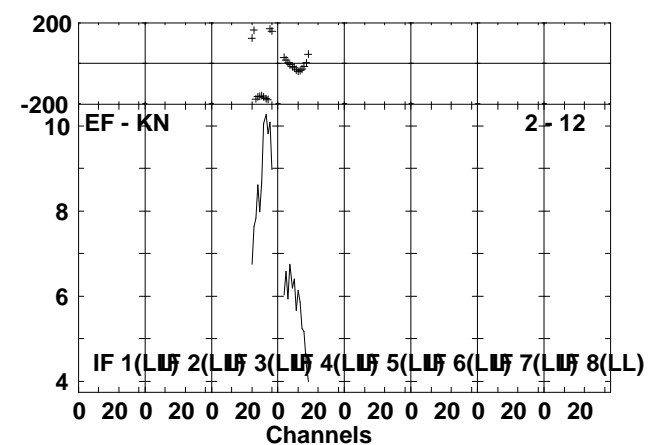
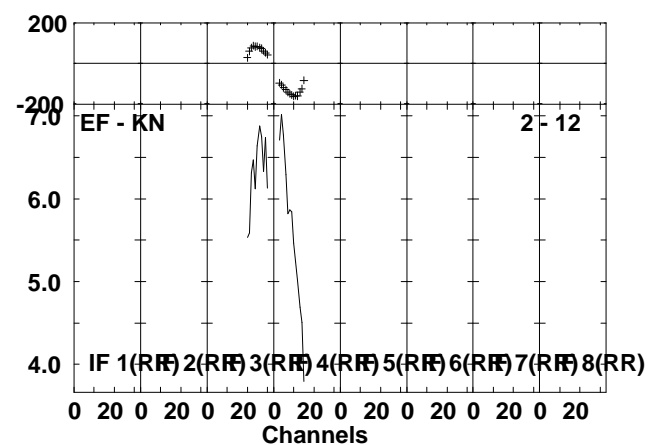
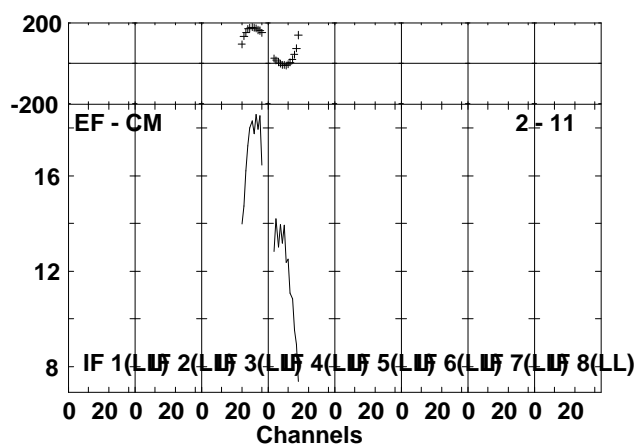
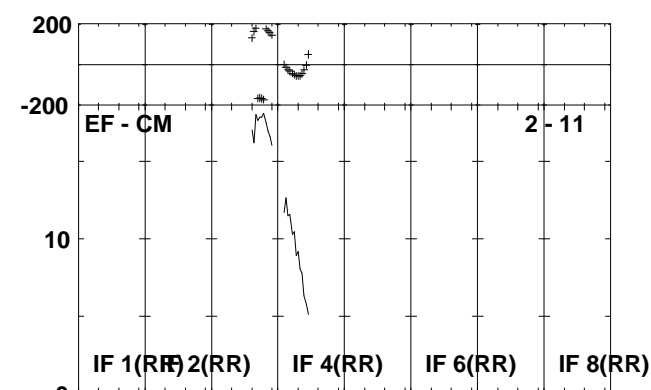
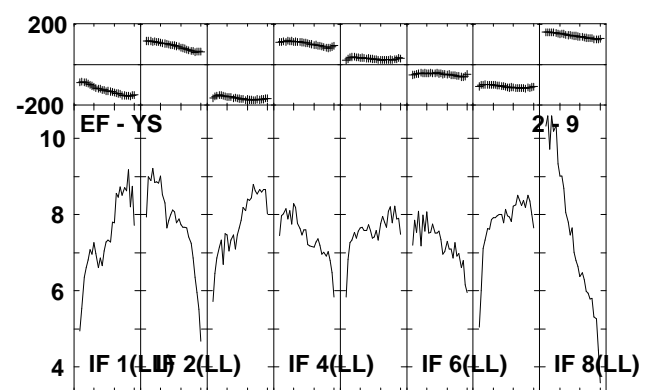
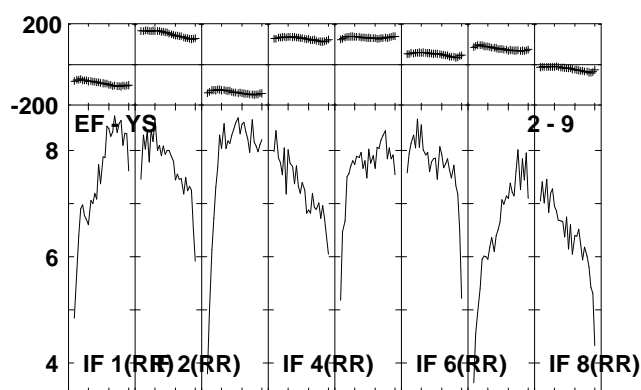
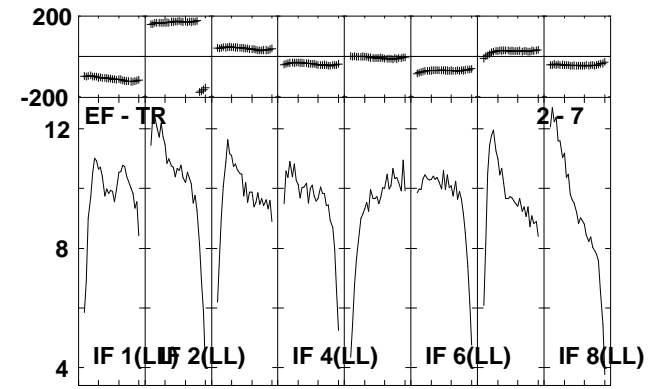
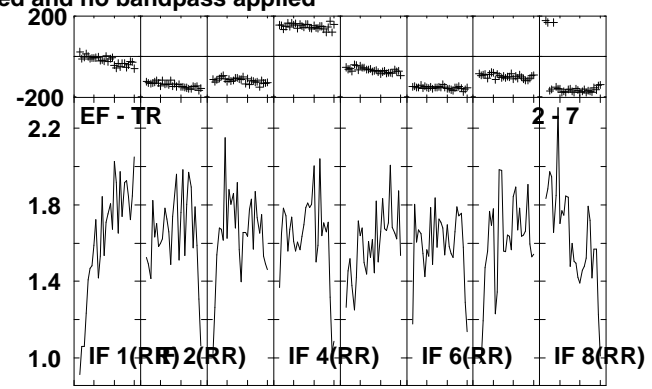
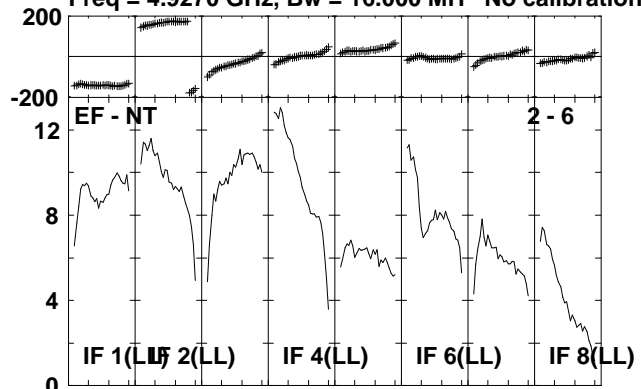

Lower frame: Milli Ampl Jy Top frame: Phas deg
Scalar averaged cross-power spectrum Several baselines displayed
Timerange: 00/14:11:17 to 00/14:12:59

Plot file version 174 created 06-JUL-2010 12:05:43

IRAS2336 EP064L.UVDATA.1

Freq = 4.9270 GHz, Bw = 16.000 MH No calibration applied and no bandpass applied

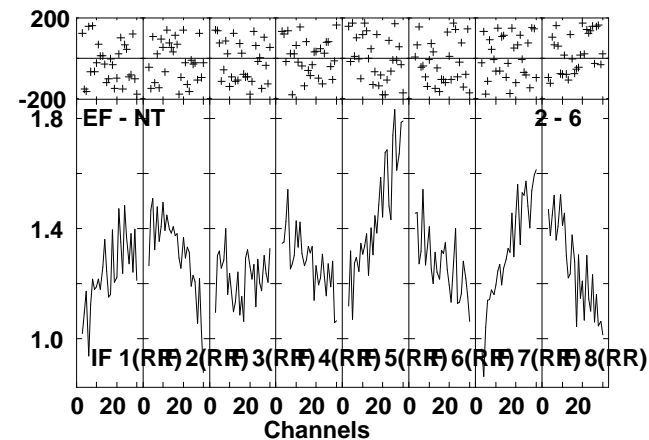
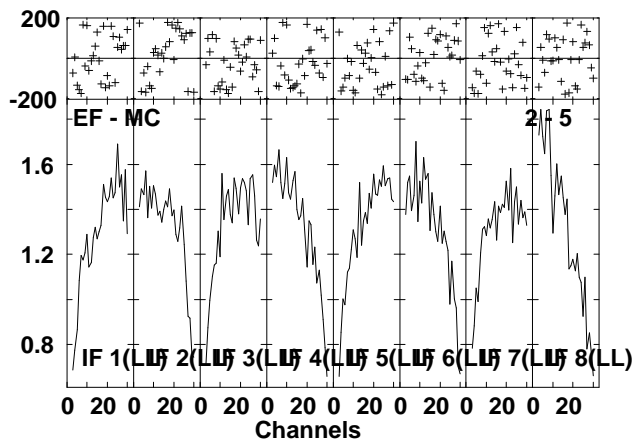
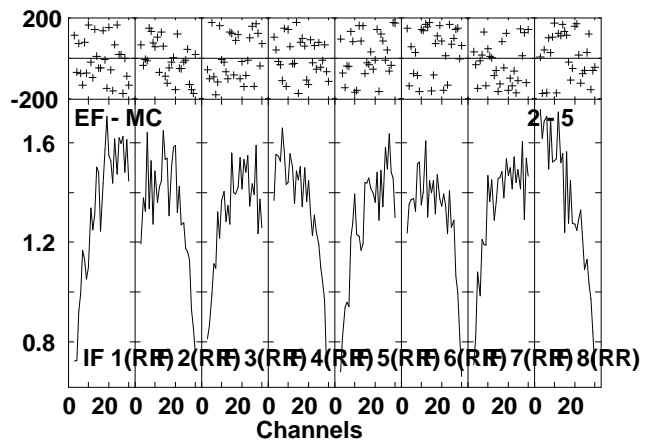
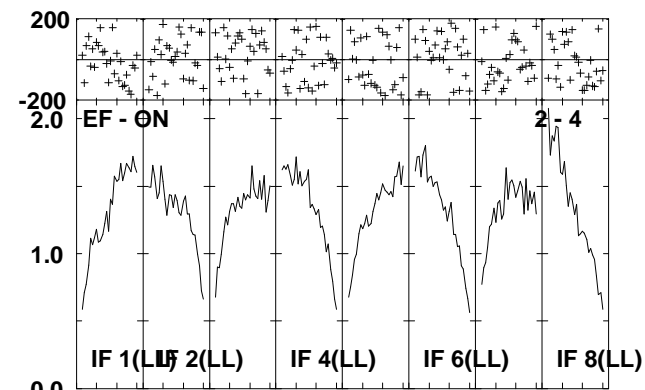
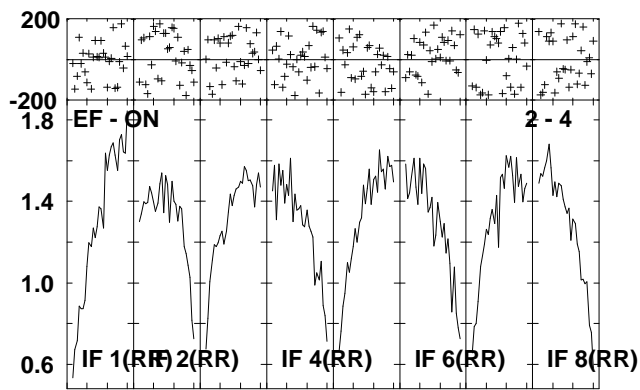
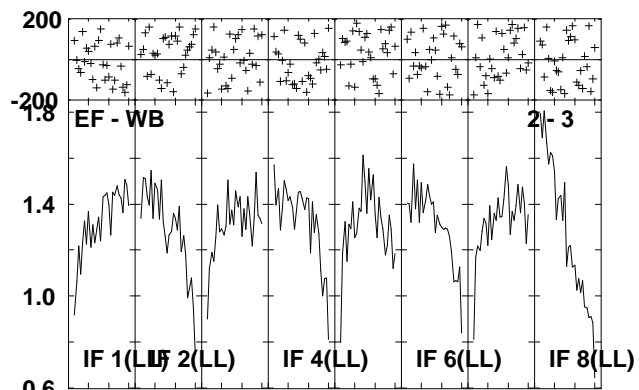
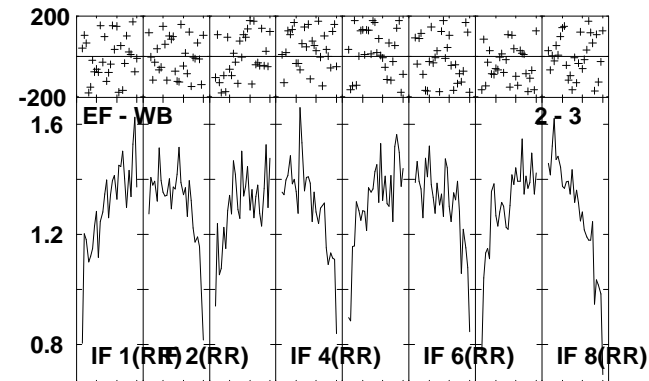
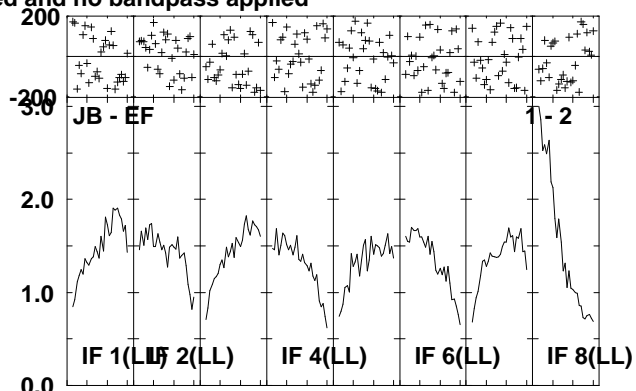
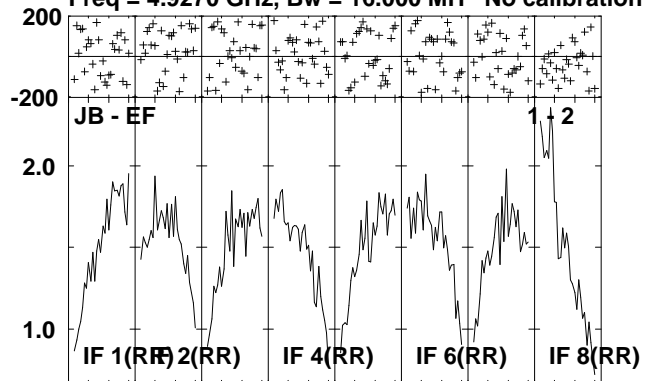

Lower frame: Milli Ampl Jy Top frame: Phas deg
Scalar averaged cross-power spectrum Several baselines displayed
Timerange: 00/14:13:01 to 00/14:16:39

Plot file version 175 created 06-JUL-2010 12:05:45

IRAS2336 EP064L.UVDATA.1

Freq = 4.9270 GHz, Bw = 16.000 MH No calibration applied and no bandpass applied

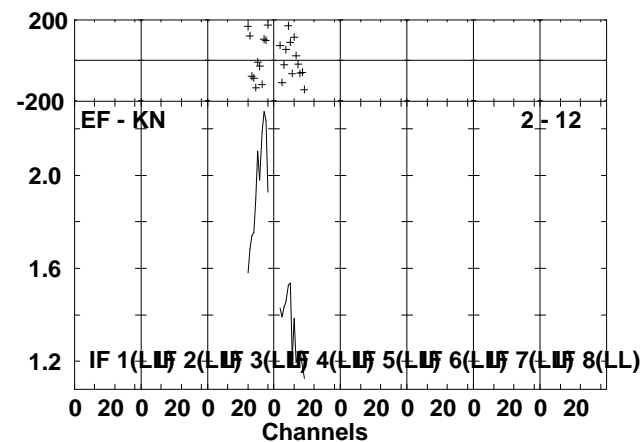
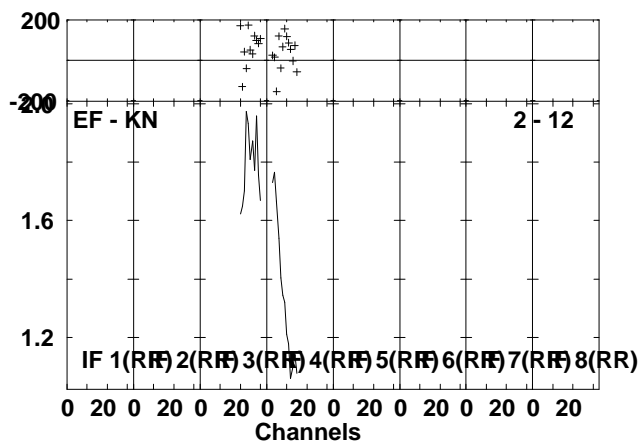
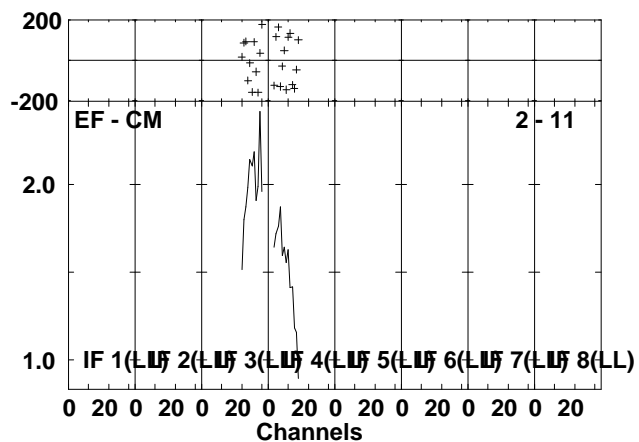
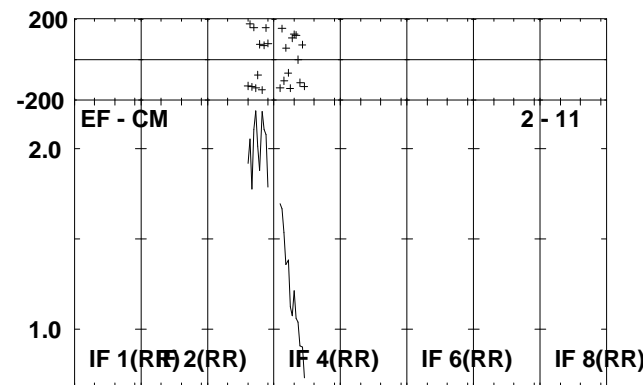
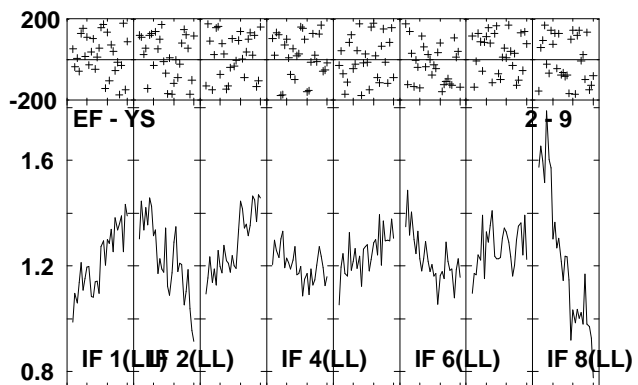
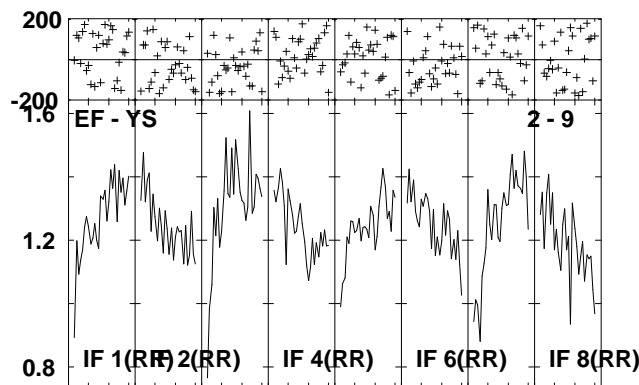
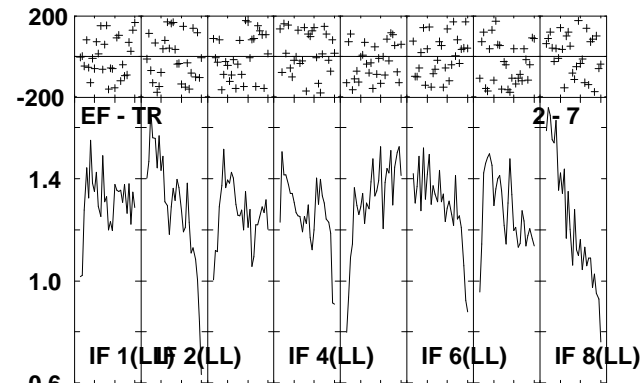
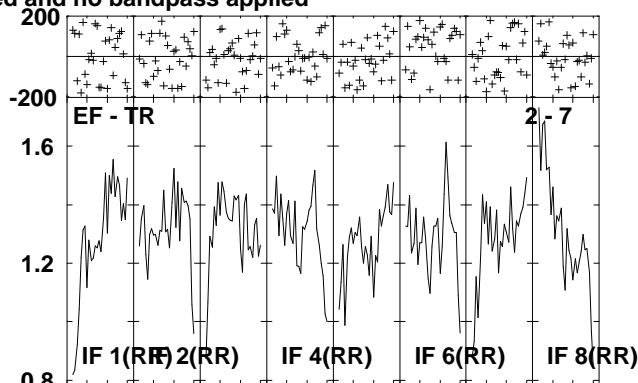
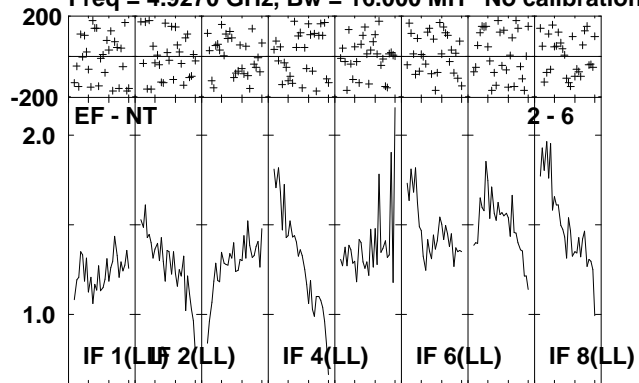

Lower frame: Milli Ampl Jy Top frame: Phas deg
Scalar averaged cross-power spectrum Several baselines displayed
Timerange: 00/14:13:01 to 00/14:16:39

Plot file version 176 created 06-JUL-2010 12:05:49

J2330+33 EP064L.UVDATA.1

Freq = 4.9270 GHz, Bw = 16.000 MH No calibration applied and no bandpass applied

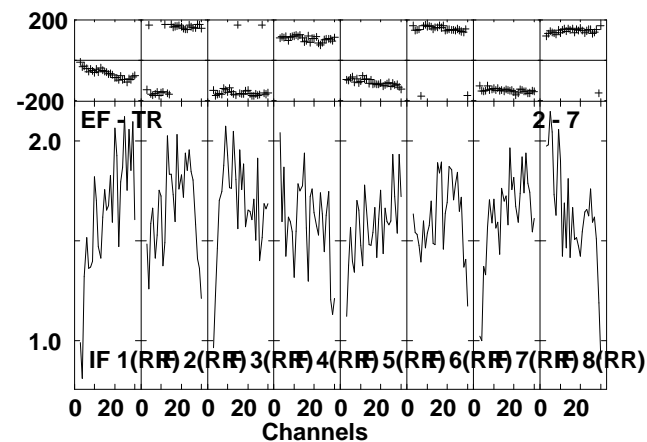
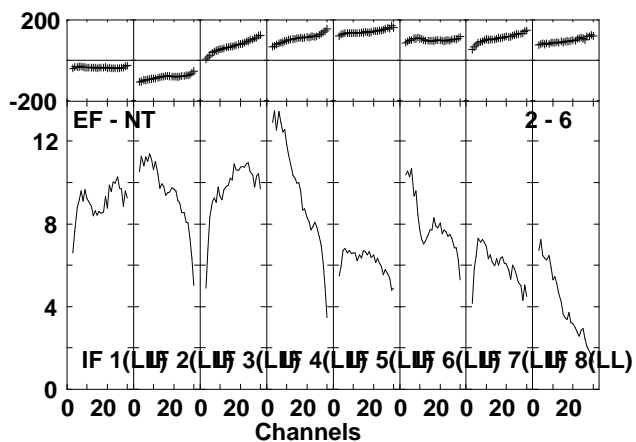
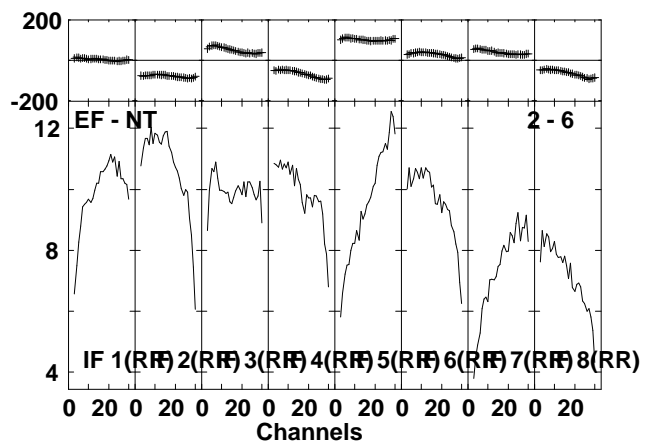
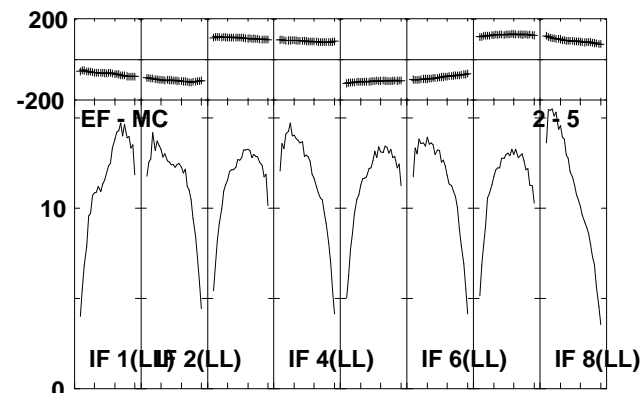
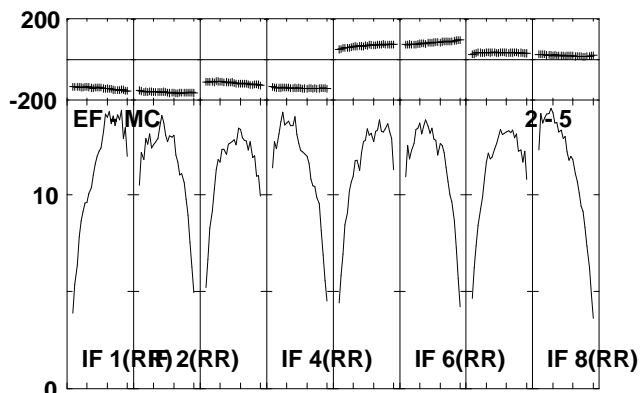
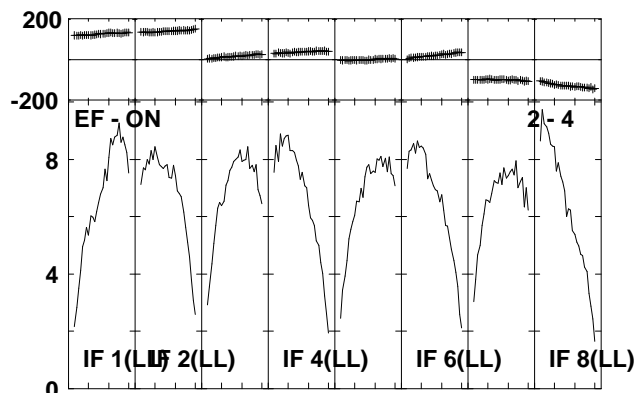
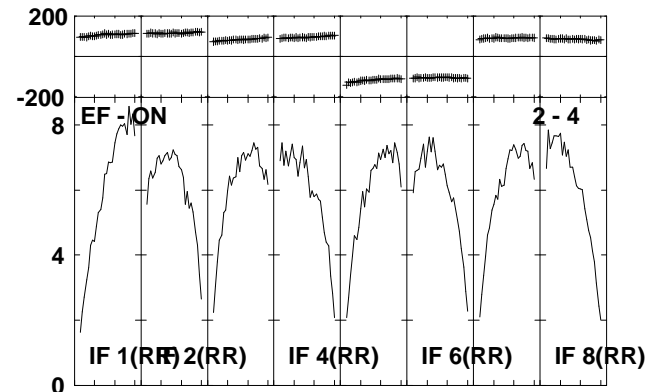
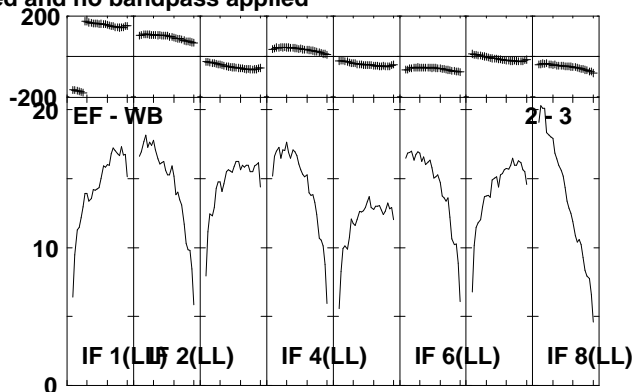
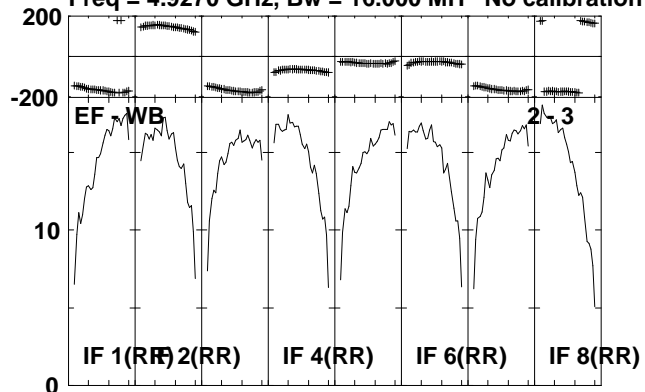

Lower frame: Milli Ampl Jy Top frame: Phas deg
Scalar averaged cross-power spectrum Several baselines displayed
Timerange: 00/14:16:41 to 00/14:18:29

Plot file version 177 created 06-JUL-2010 12:05:50

J2330+33 EP064L.UVDATA.1

Freq = 4.9270 GHz, Bw = 16.000 MH No calibration applied and no bandpass applied

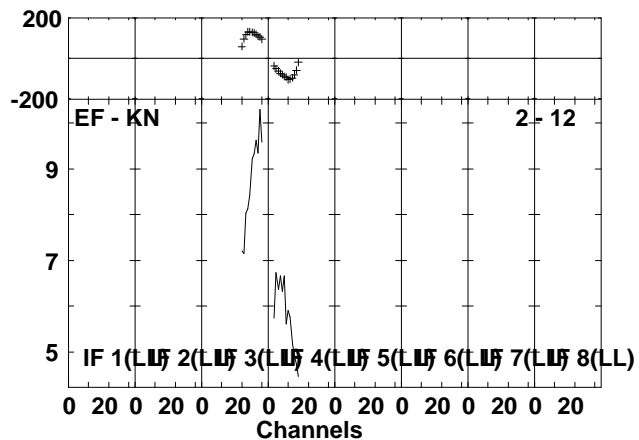
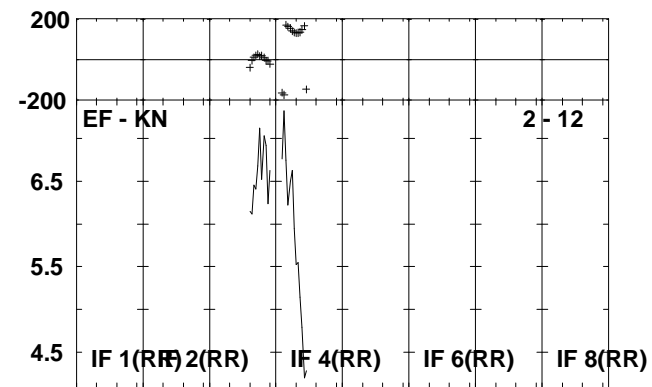
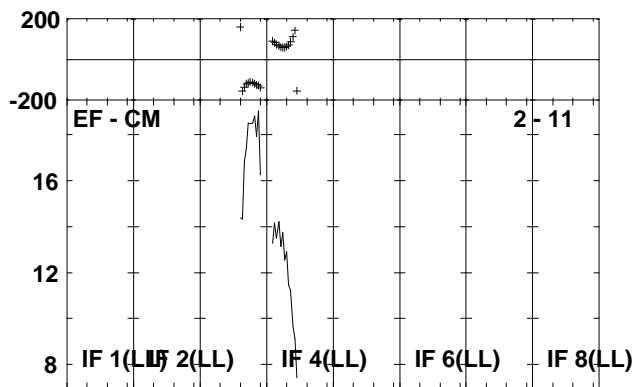
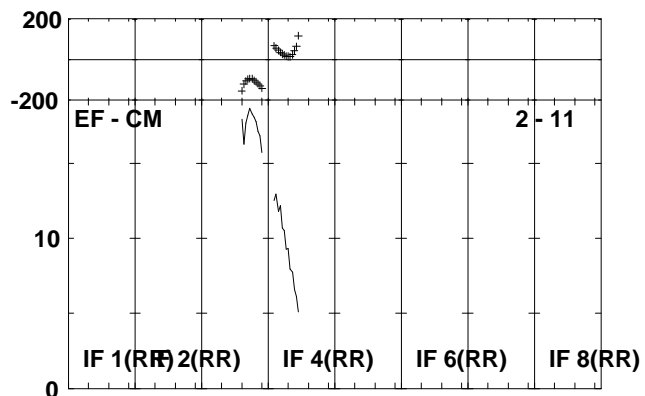
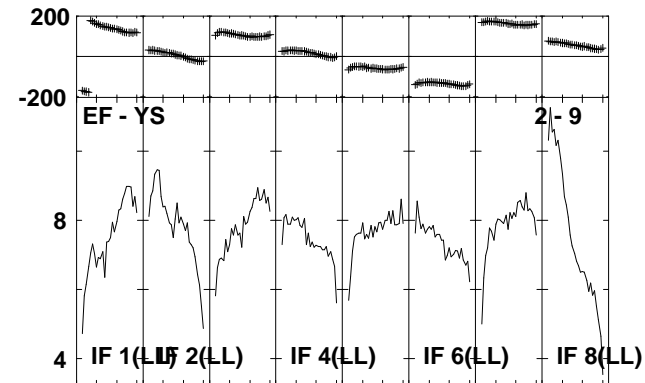
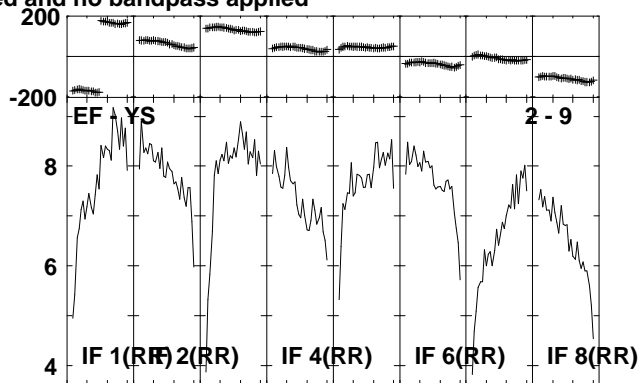
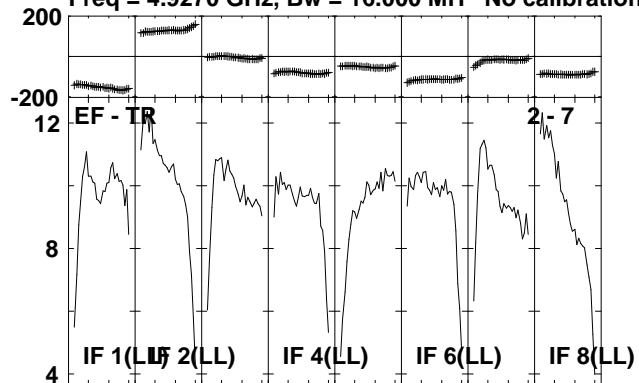

Lower frame: Milli Ampl Jy Top frame: Phas deg
 Scalar averaged cross-power spectrum Several baselines displayed
 Timerange: 00/14:16:41 to 00/14:18:29

Plot file version 178 created 06-JUL-2010 12:05:51

IRAS2336 EP064L.UVDATA.1

Freq = 4.9270 GHz, Bw = 16.000 MH No calibration applied and no bandpass applied

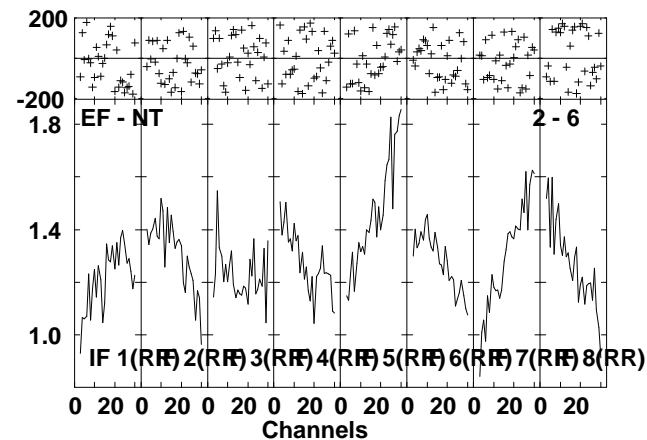
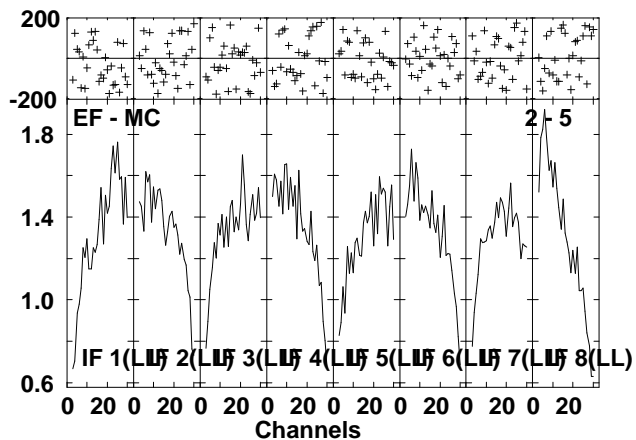
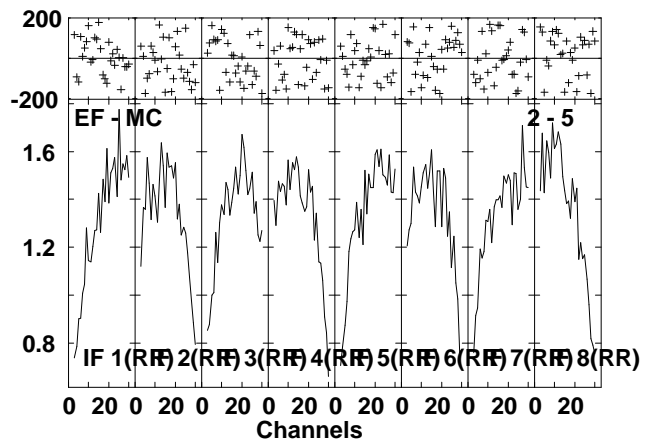
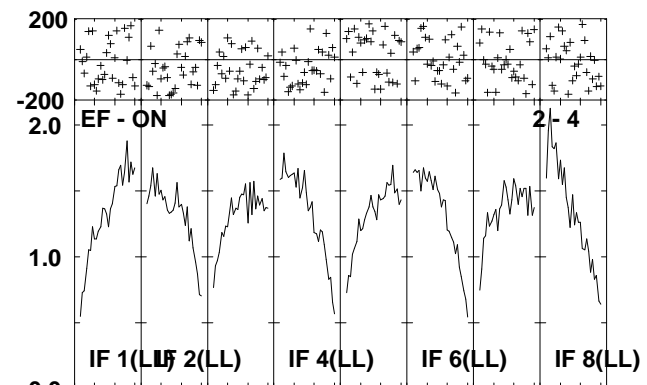
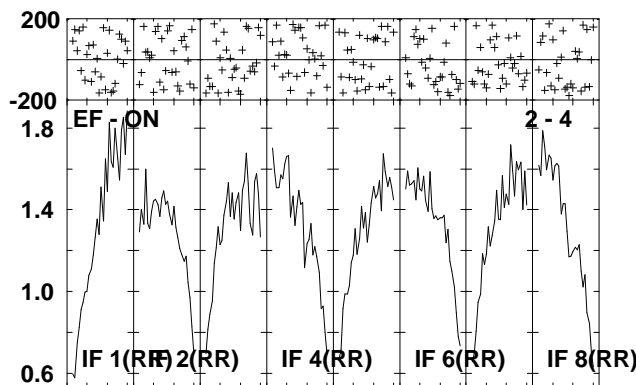
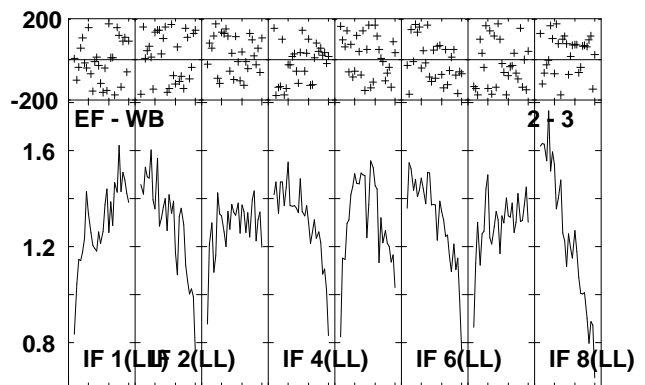
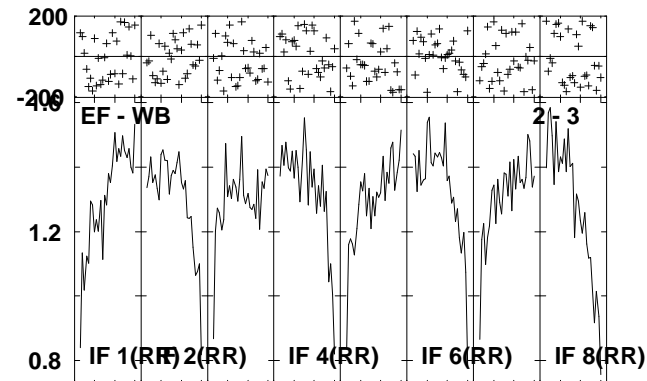
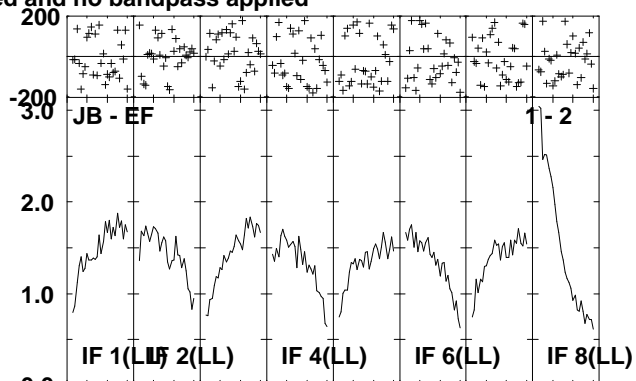
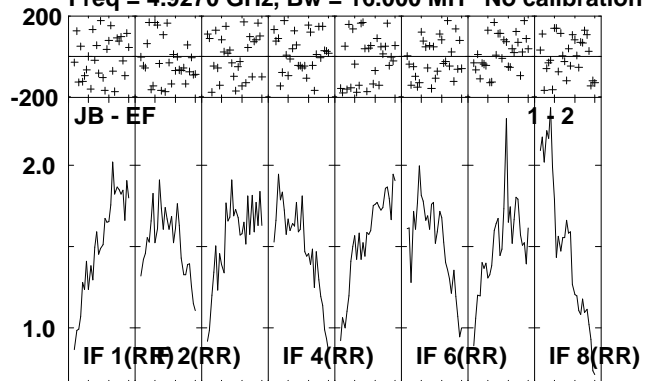

Lower frame: Milli Ampl Jy Top frame: Phas deg
Scalar averaged cross-power spectrum Several baselines displayed
Timerange: 00/14:18:31 to 00/14:22:09

Plot file version 179 created 06-JUL-2010 12:05:53

IRAS2336 EP064L.UVDATA.1

Freq = 4.9270 GHz, Bw = 16.000 MH No calibration applied and no bandpass applied

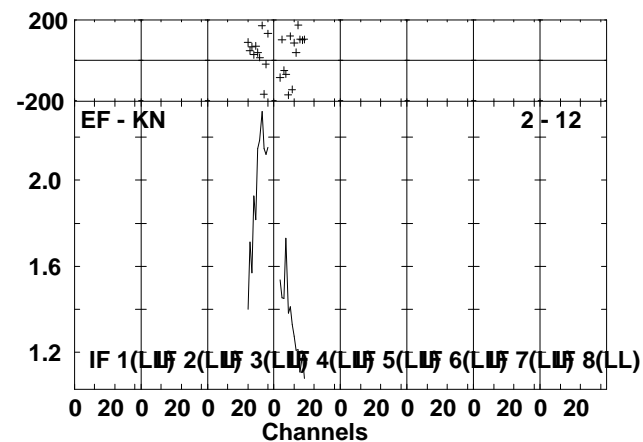
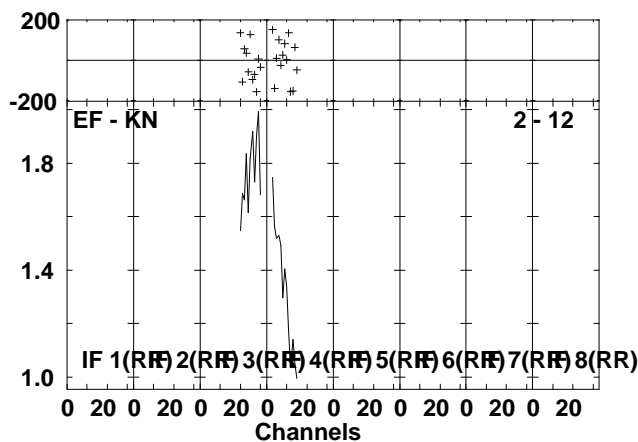
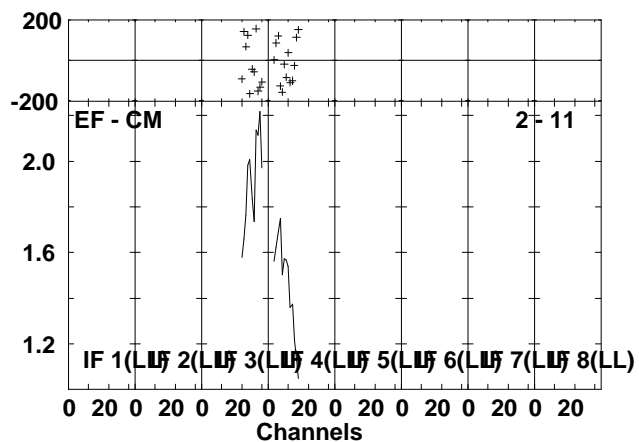
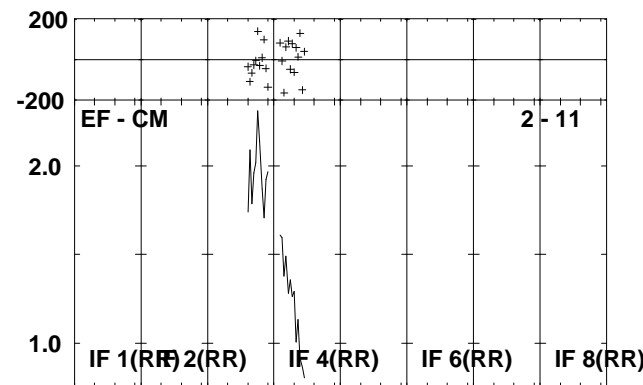
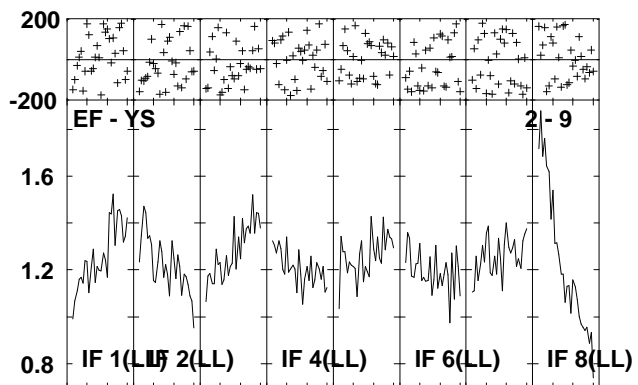
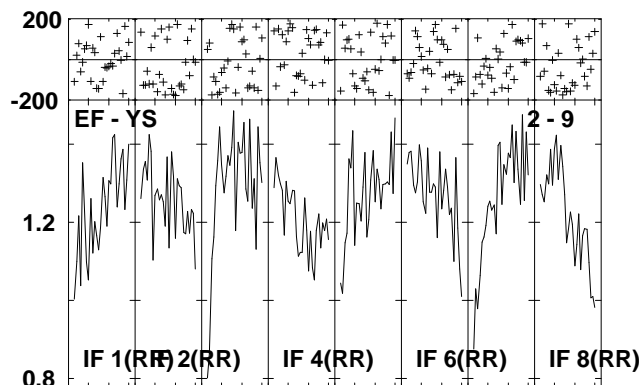
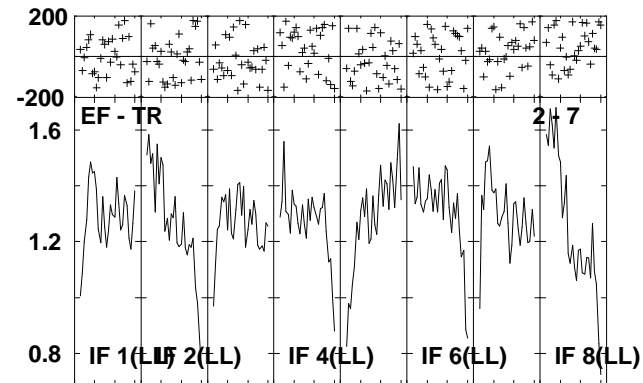
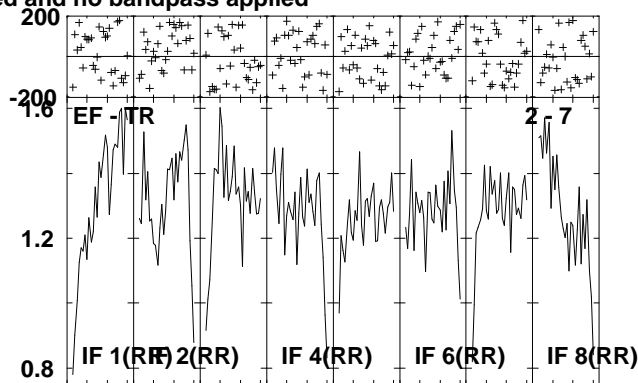
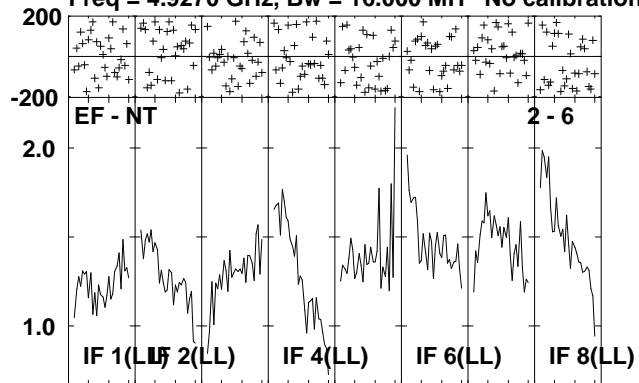

Lower frame: Milli Ampl Jy Top frame: Phas deg
Scalar averaged cross-power spectrum Several baselines displayed
Timerange: 00/14:18:31 to 00/14:22:09

Plot file version 180 created 06-JUL-2010 12:05:57

J2330+33 EP064L.UVDATA.1

Freq = 4.9270 GHz, Bw = 16.000 MH No calibration applied and no bandpass applied

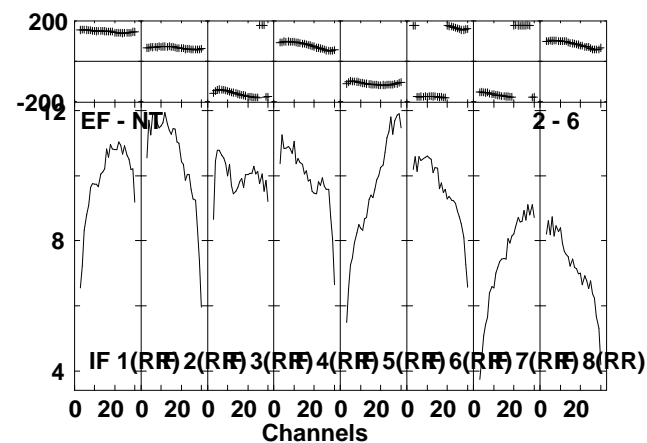
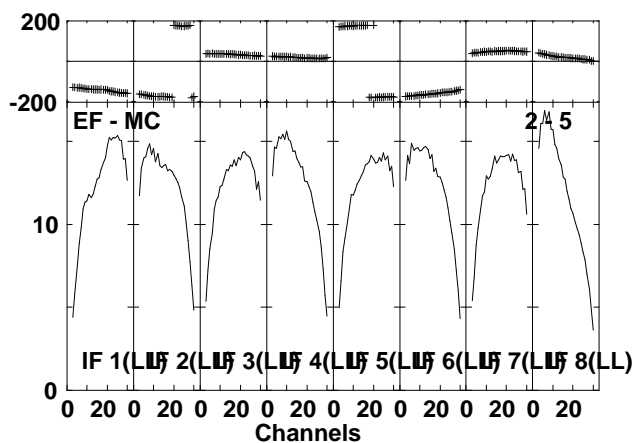
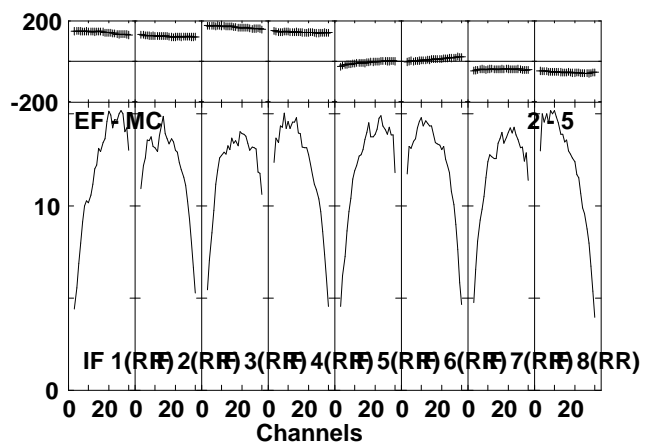
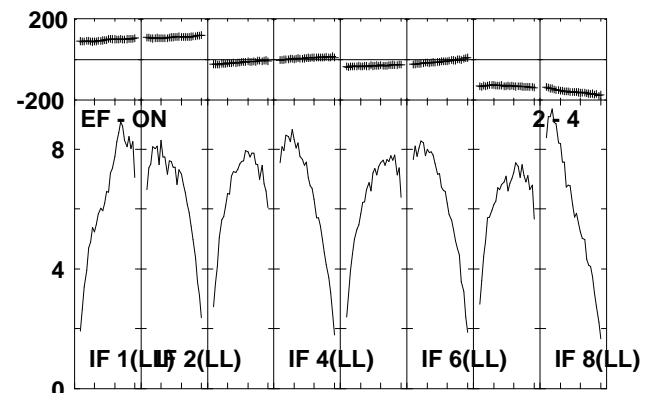
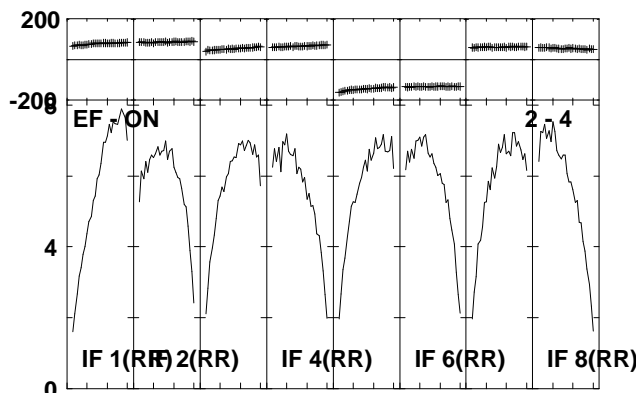
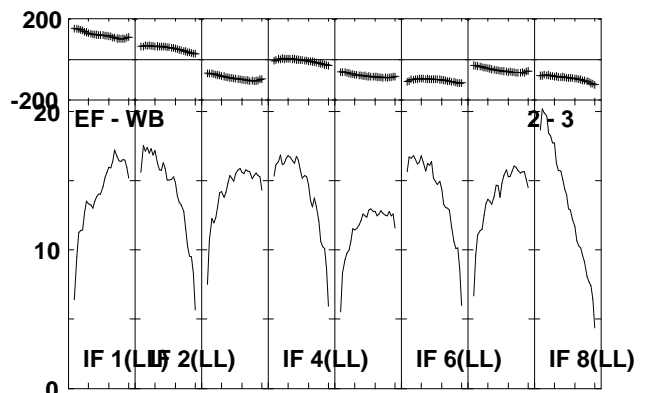
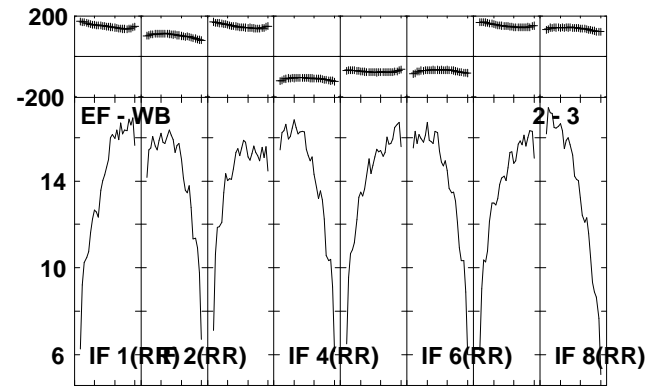
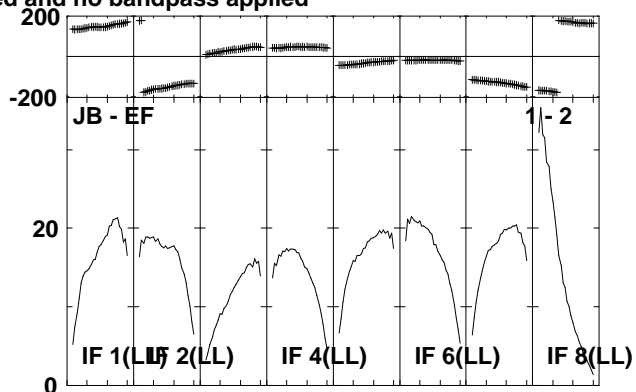
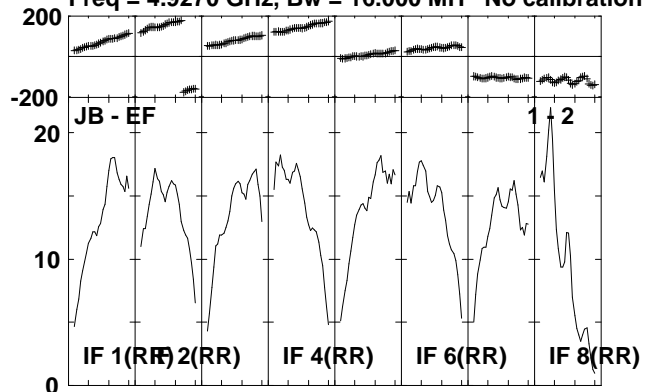

Lower frame: Milli Ampl Jy Top frame: Phas deg
Scalar averaged cross-power spectrum Several baselines displayed
Timerange: 00/14:23:11 to 00/14:24:49

Plot file version 181 created 06-JUL-2010 12:05:58

J2330+33 EP064L.UVDATA.1

Freq = 4.9270 GHz, Bw = 16.000 MH No calibration applied and no bandpass applied

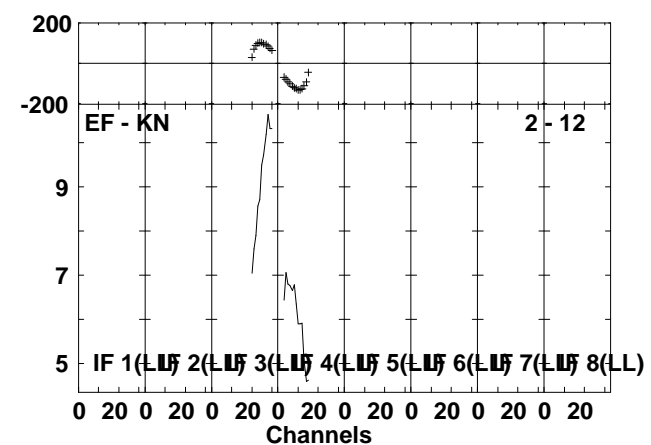
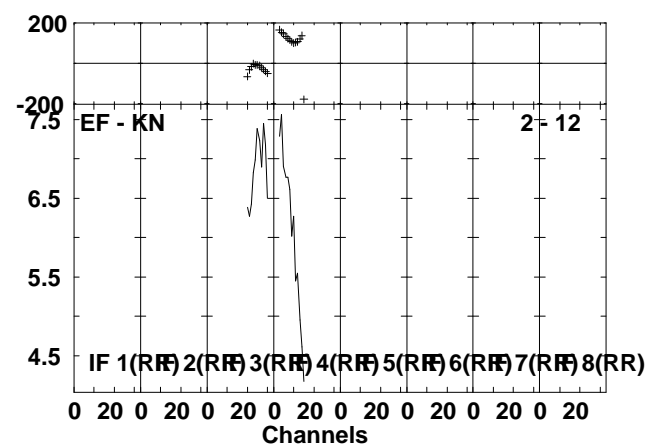
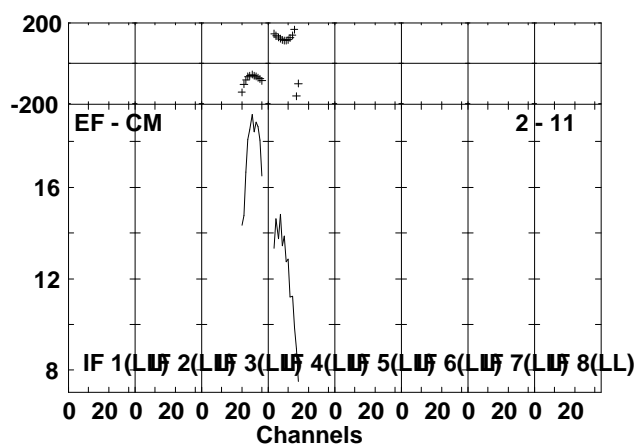
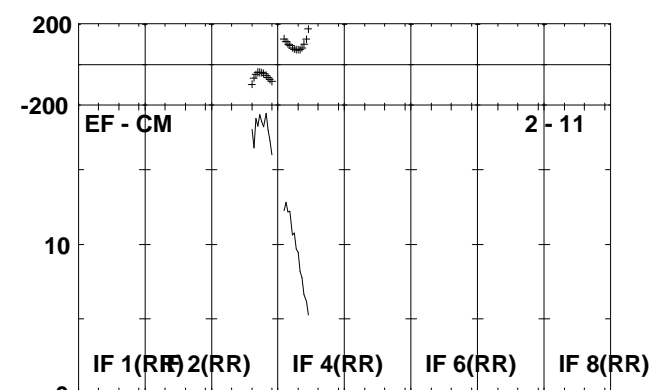
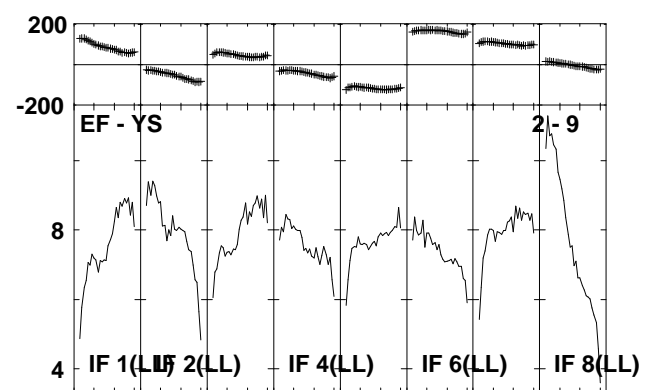
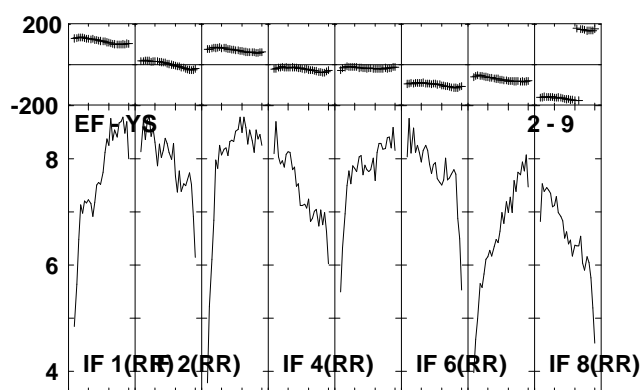
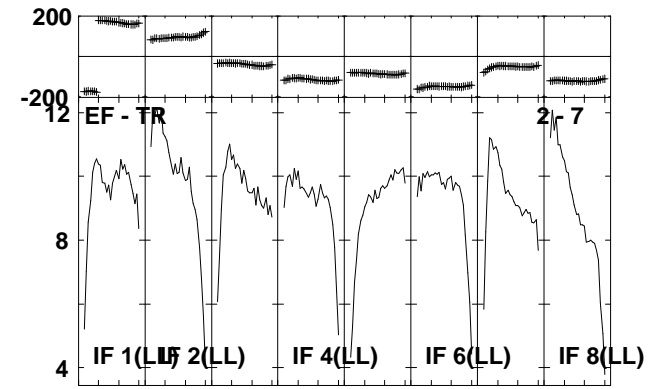
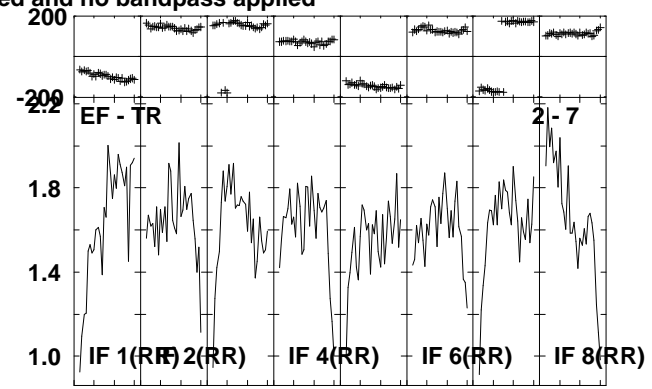
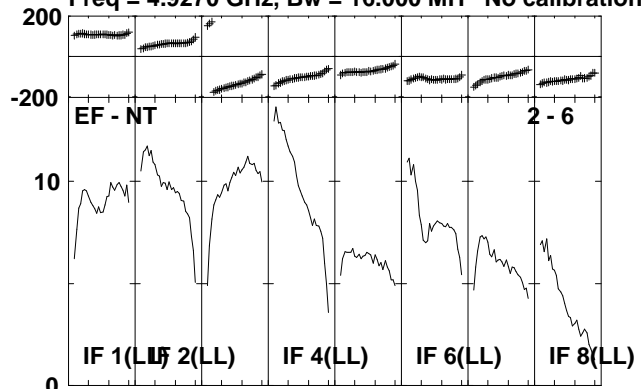

Lower frame: Milli Ampl Jy Top frame: Phas deg
Scalar averaged cross-power spectrum Several baselines displayed
Timerange: 00/14:23:11 to 00/14:24:49

Plot file version 182 created 06-JUL-2010 12:06:03

IRAS2336 EP064L.UVDATA.1

Freq = 4.9270 GHz, Bw = 16.000 MH No calibration applied and no bandpass applied

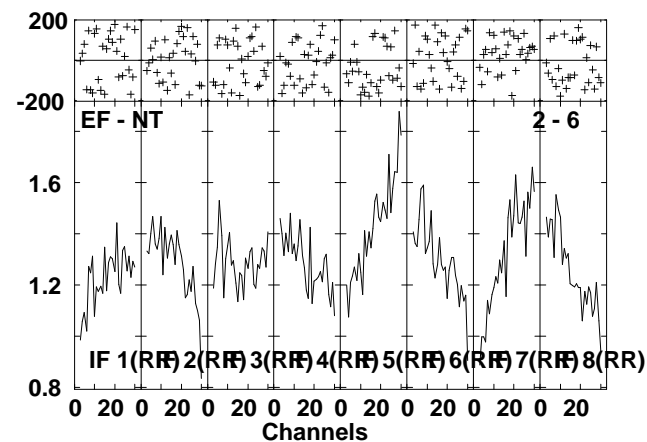
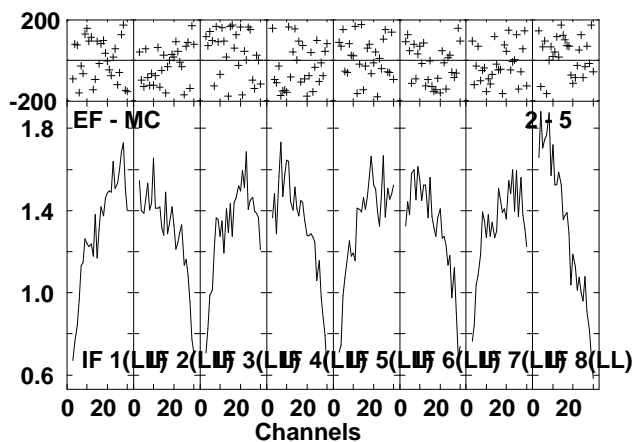
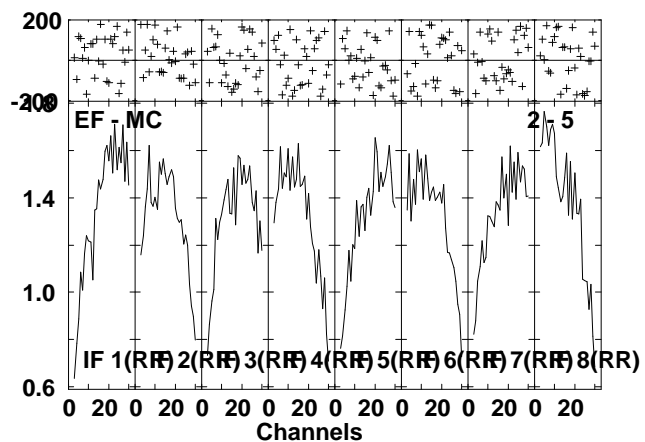
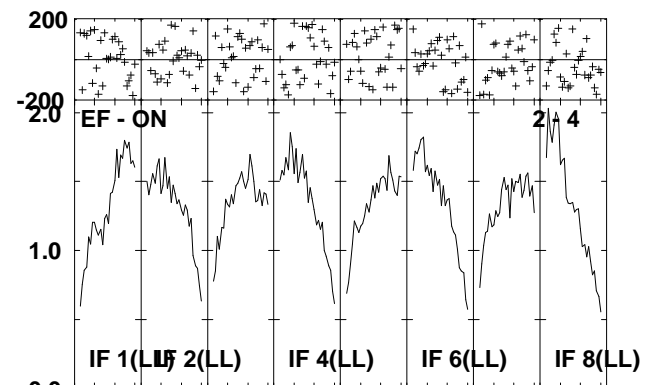
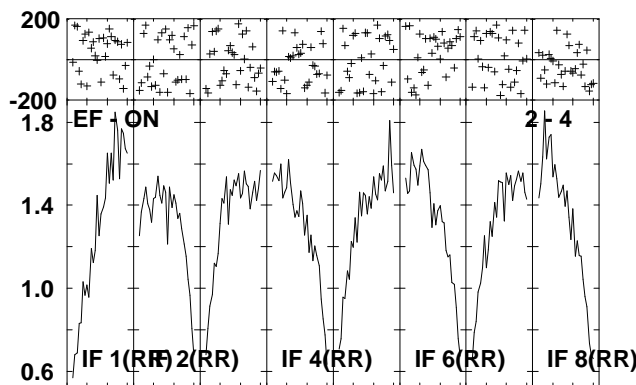
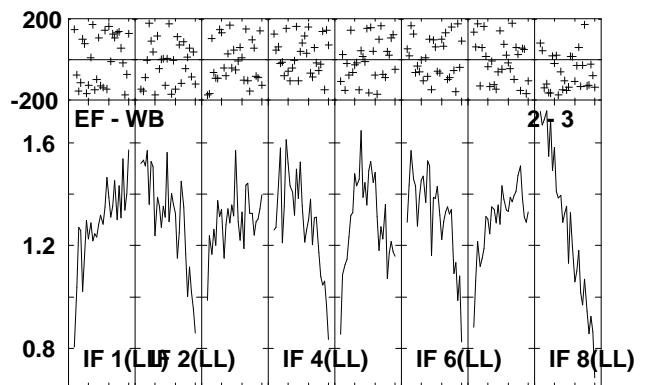
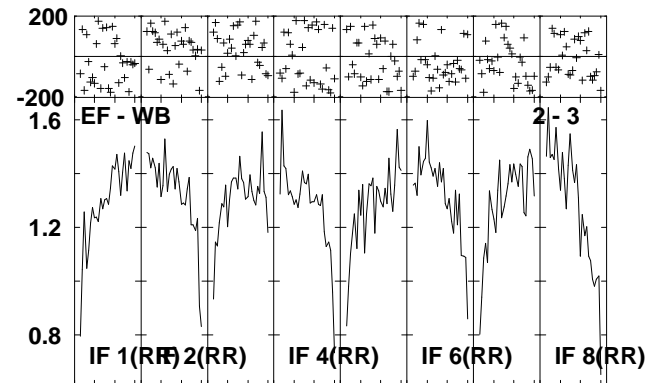
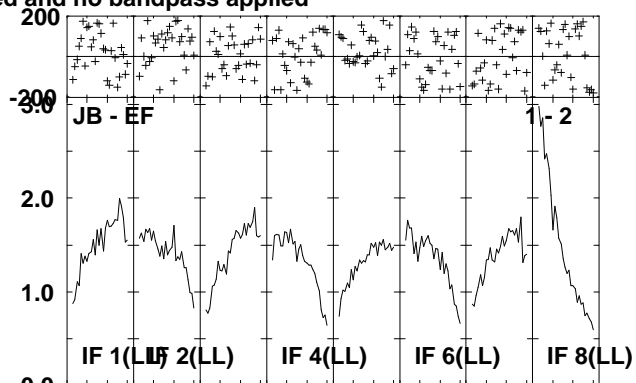
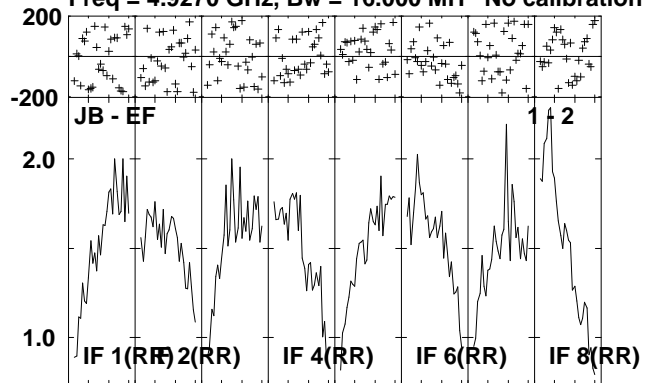

Lower frame: Milli Ampl Jy Top frame: Phas deg
Scalar averaged cross-power spectrum Several baselines displayed
Timerange: 00/14:24:51 to 00/14:28:29

Plot file version 183 created 06-JUL-2010 12:06:06

IRAS2336 EP064L.UVDATA.1

Freq = 4.9270 GHz, Bw = 16.000 MH No calibration applied and no bandpass applied

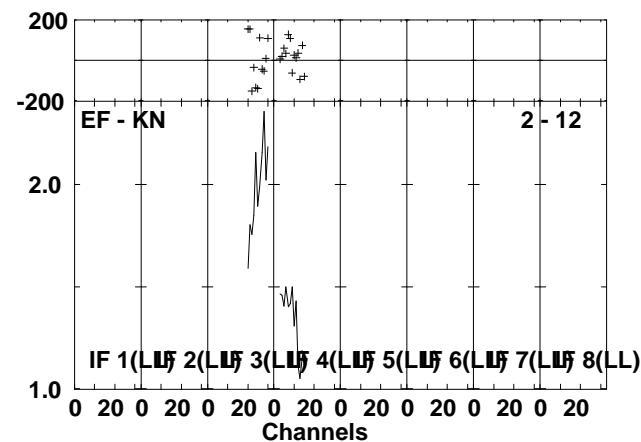
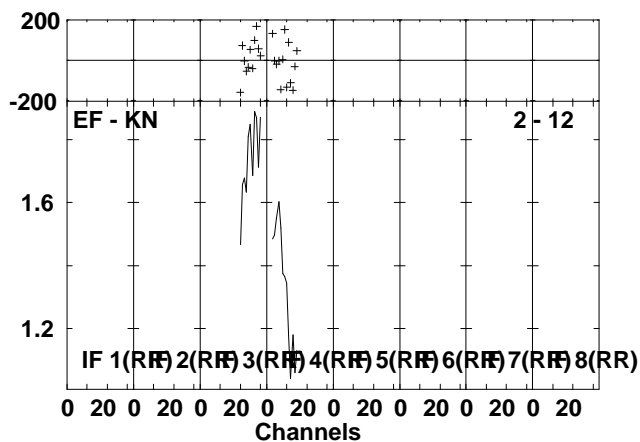
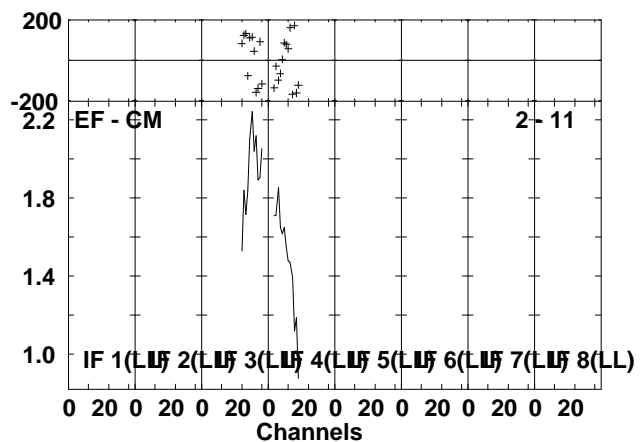
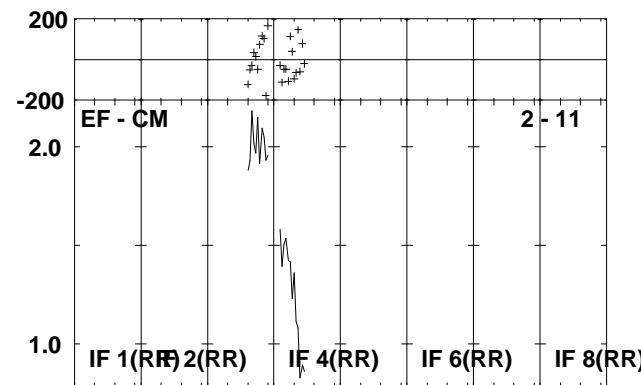
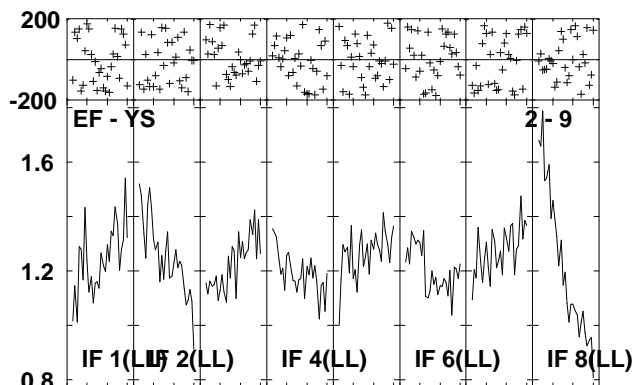
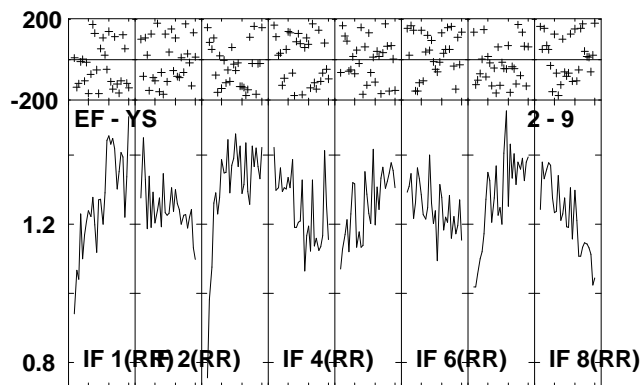
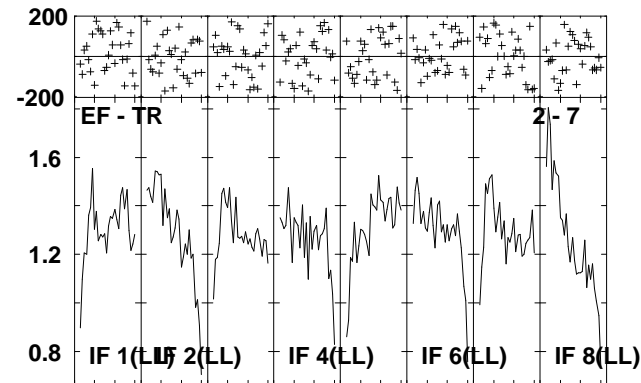
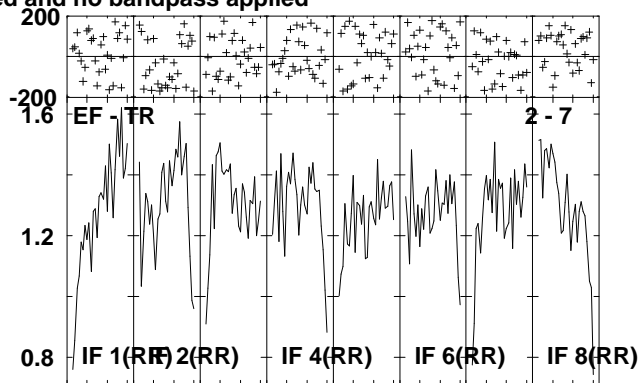
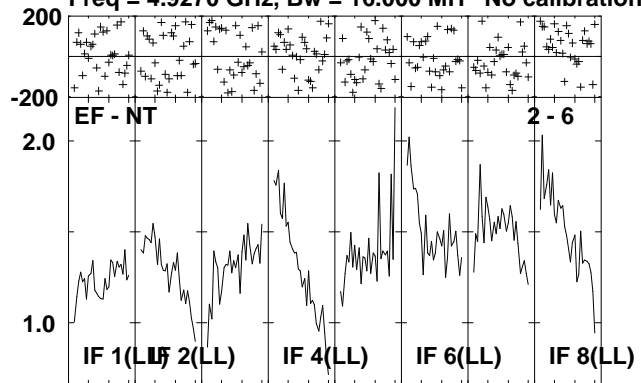

Lower frame: Milli Ampl Jy Top frame: Phas deg
Scalar averaged cross-power spectrum Several baselines displayed
Timerange: 00/14:24:51 to 00/14:28:29

Plot file version 184 created 06-JUL-2010 12:06:10

J2330+33 EP064L.UVDATA.1

Freq = 4.9270 GHz, Bw = 16.000 MH No calibration applied and no bandpass applied

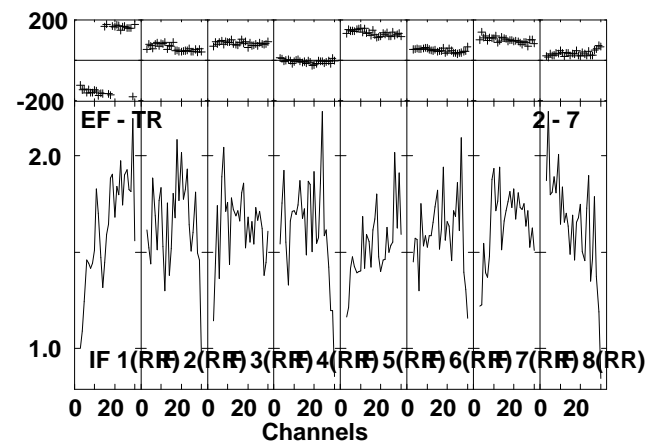
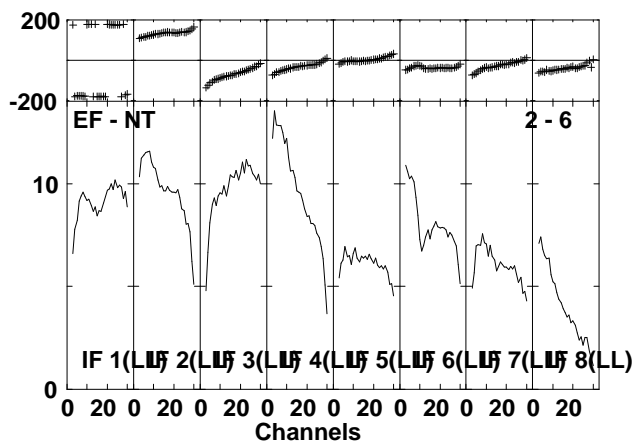
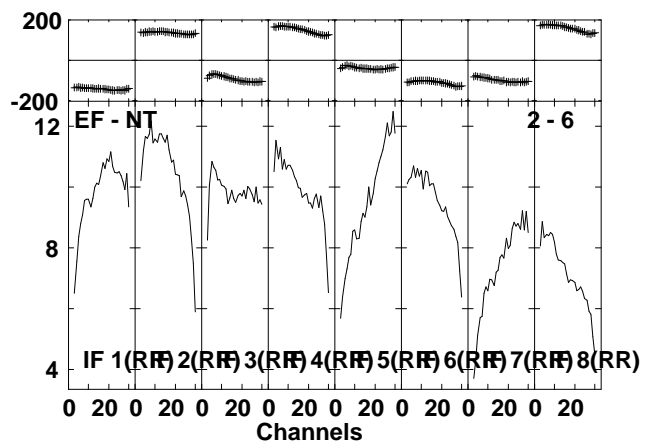
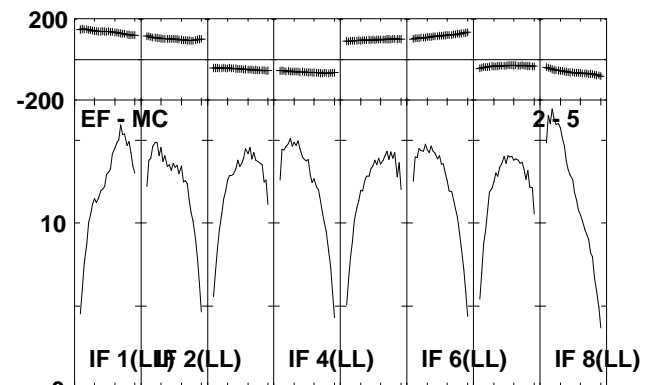
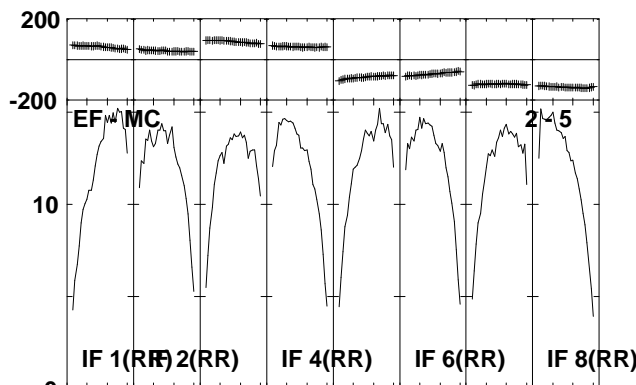
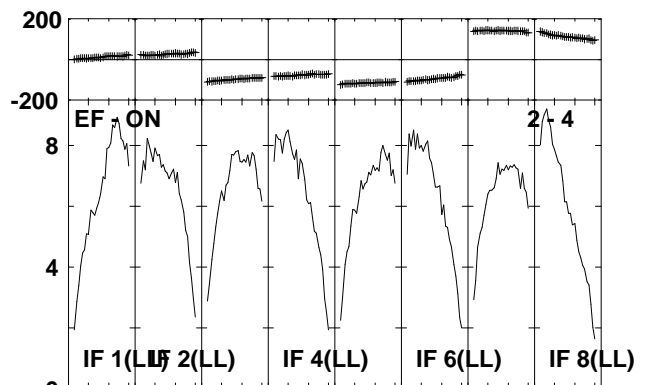
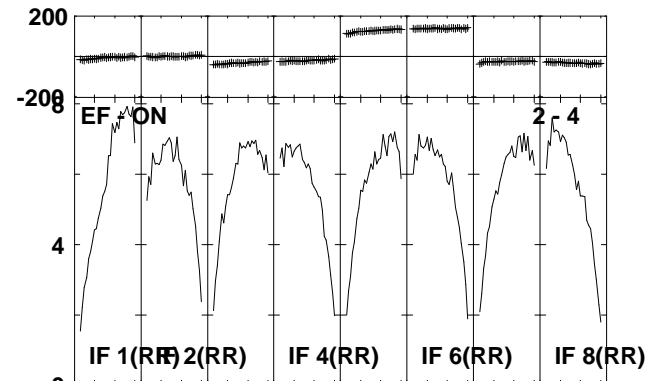
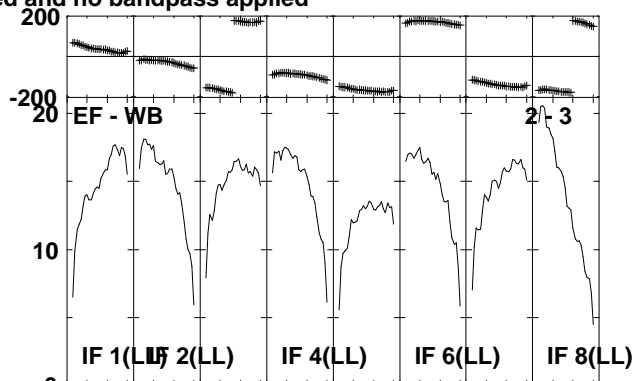
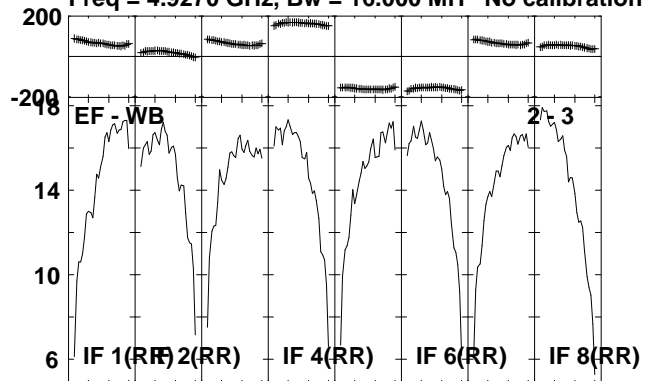

Lower frame: Milli Ampl Jy Top frame: Phas deg
Scalar averaged cross-power spectrum Several baselines displayed
Timerange: 00/14:28:31 to 00/14:30:19

Plot file version 185 created 06-JUL-2010 12:06:11

J2330+33 EP064L.UVDATA.1

Freq = 4.9270 GHz, Bw = 16.000 MH No calibration applied and no bandpass applied

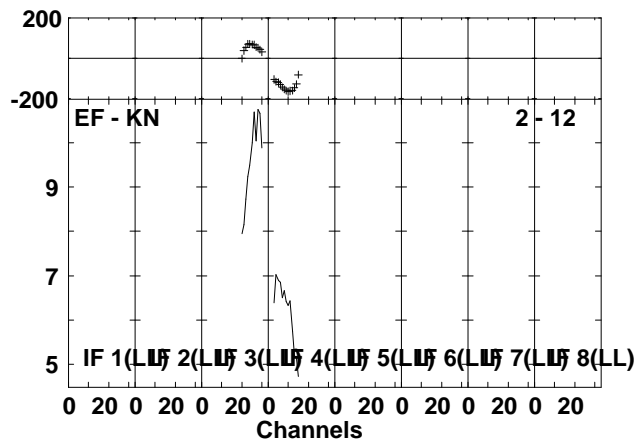
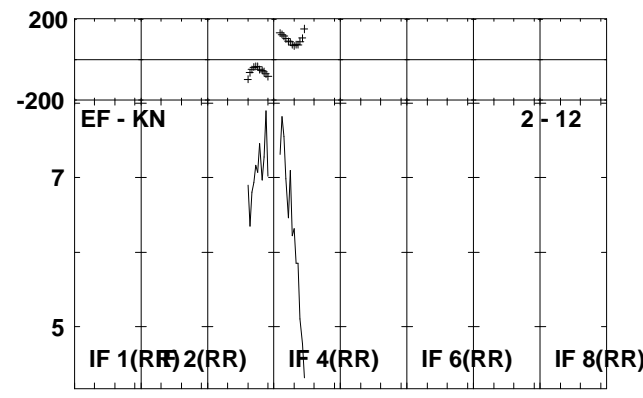
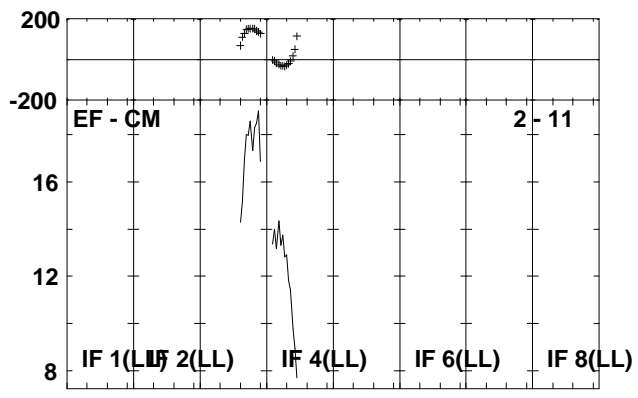
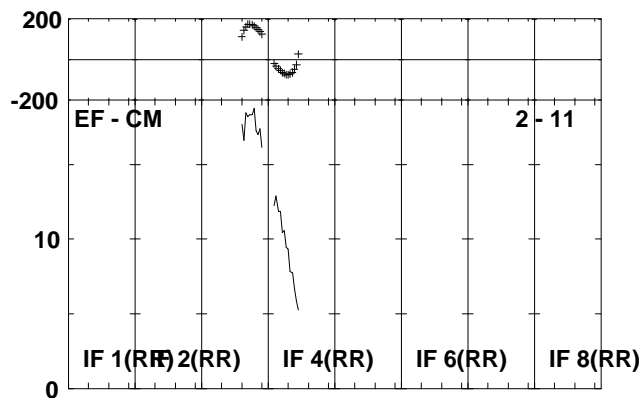
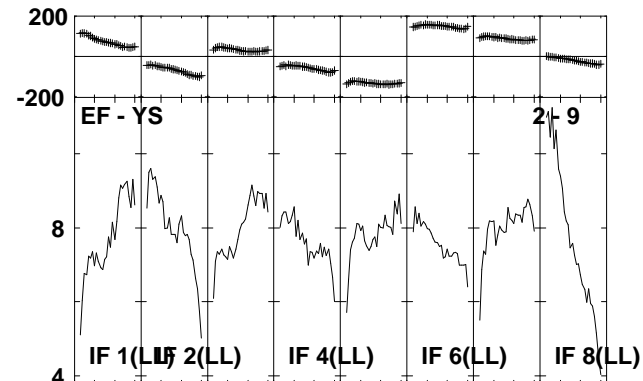
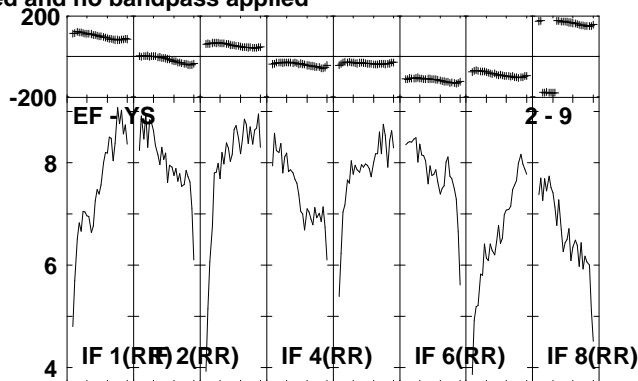
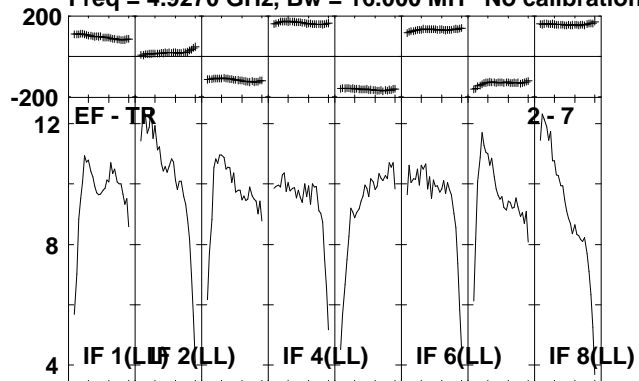

Lower frame: Milli Ampl Jy Top frame: Phas deg
Scalar averaged cross-power spectrum Several baselines displayed
Timerange: 00/14:28:31 to 00/14:30:19

Plot file version 186 created 06-JUL-2010 12:06:12

IRAS2336 EP064L.UVDATA.1

Freq = 4.9270 GHz, Bw = 16.000 MH No calibration applied and no bandpass applied

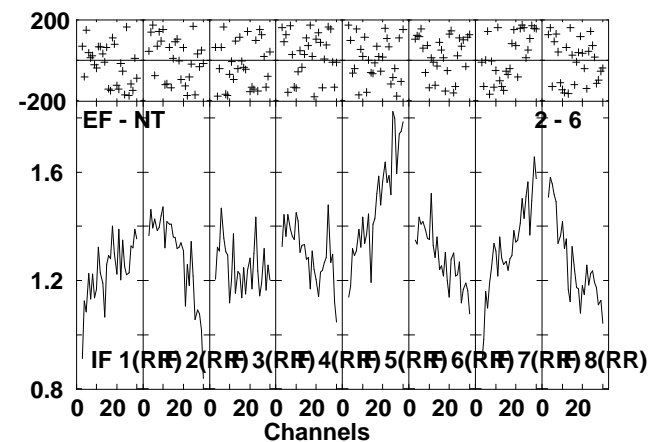
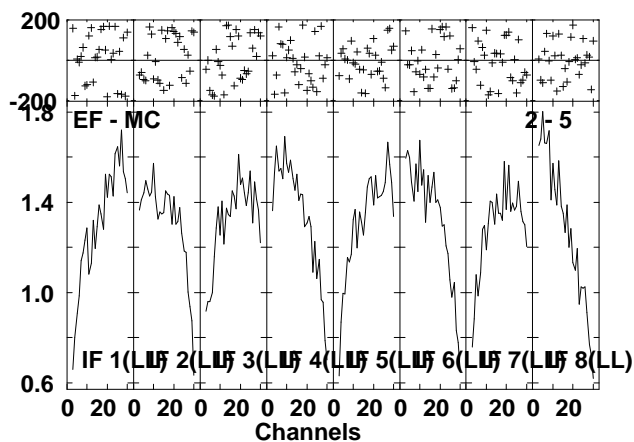
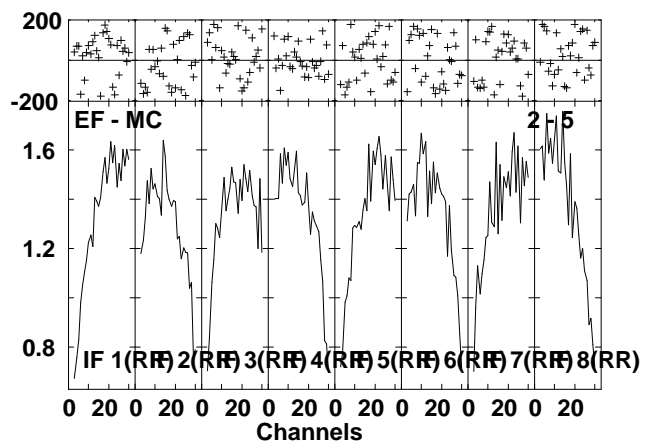
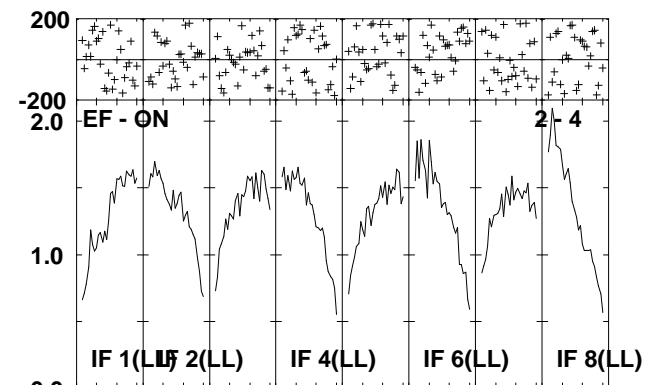
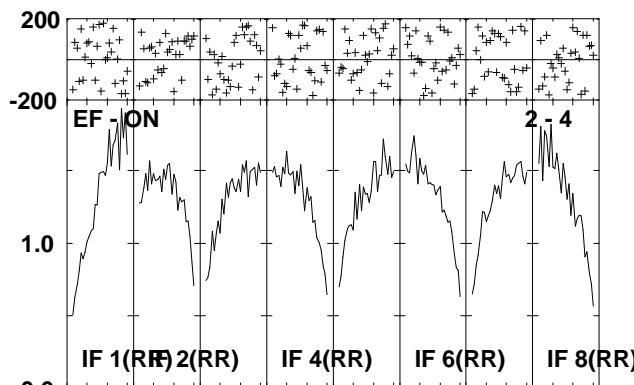
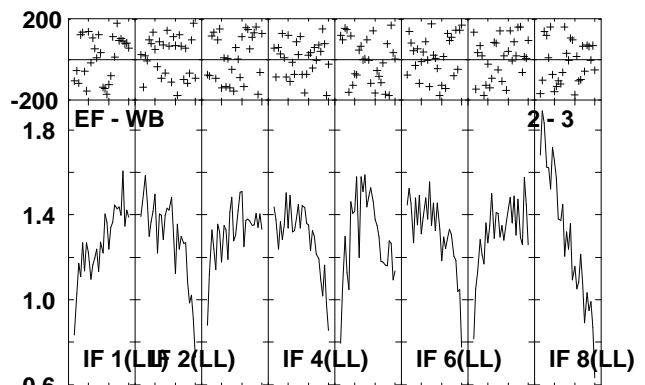
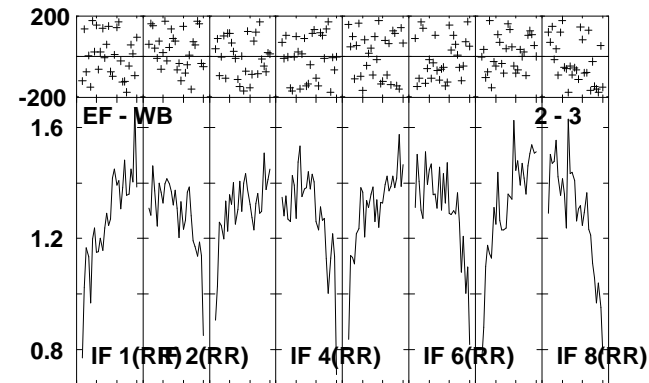
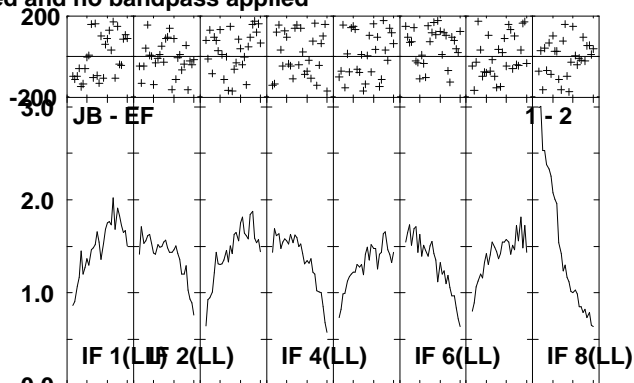
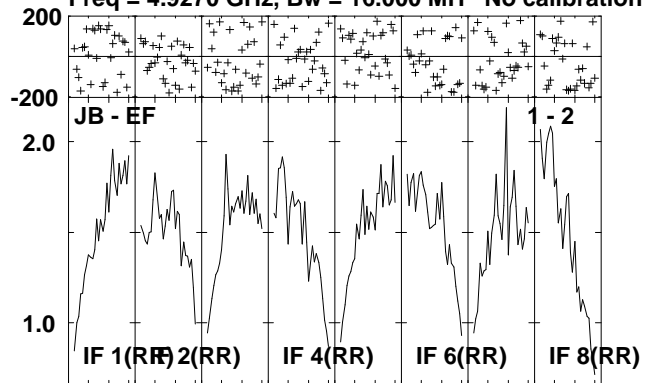

Lower frame: Milli Ampl Jy Top frame: Phas deg
Scalar averaged cross-power spectrum Several baselines displayed
Timerange: 00/14:30:21 to 00/14:33:59

Plot file version 187 created 06-JUL-2010 12:06:14

IRAS2336 EP064L.UVDATA.1

Freq = 4.9270 GHz, Bw = 16.000 MH No calibration applied and no bandpass applied

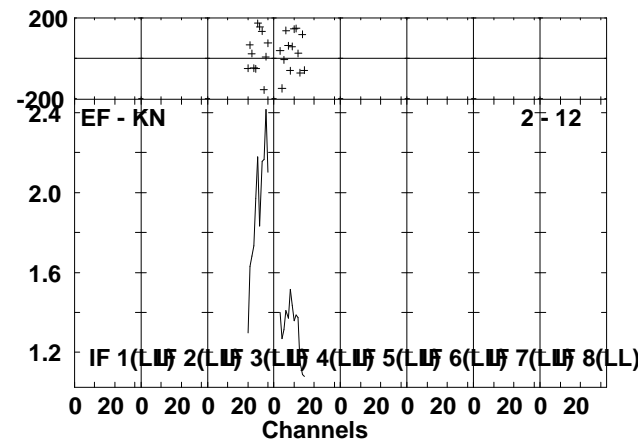
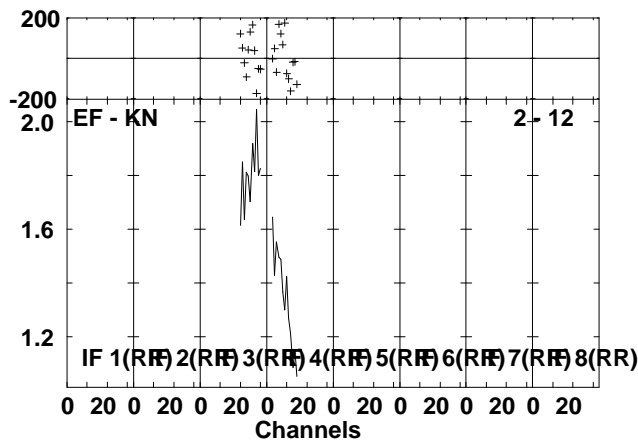
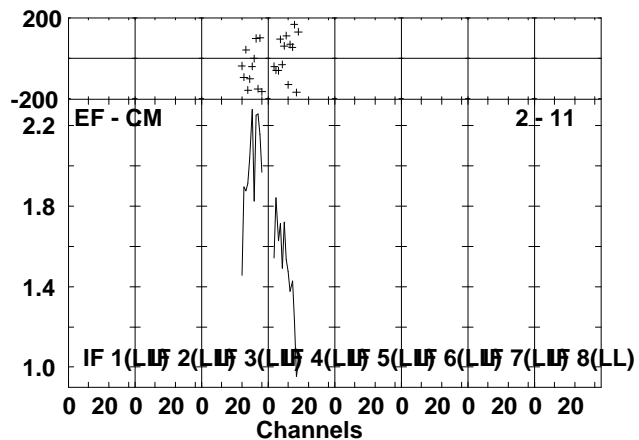
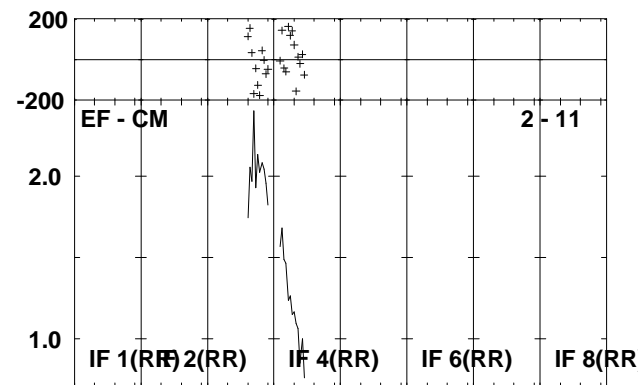
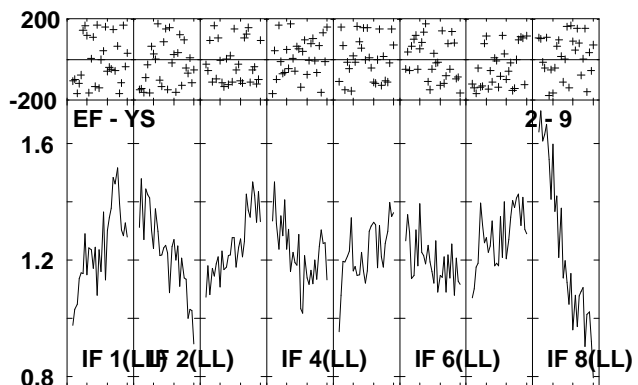
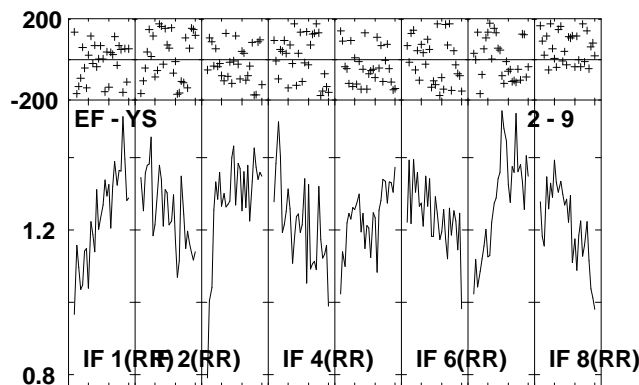
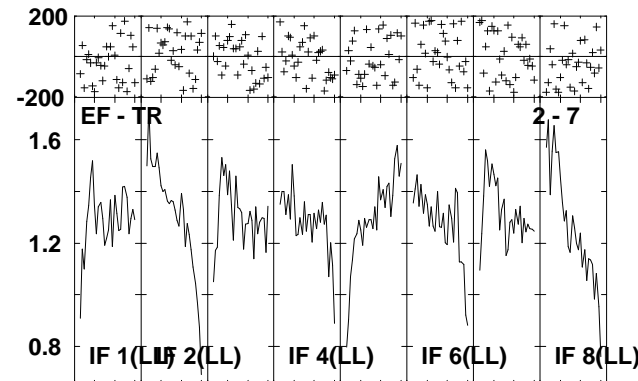
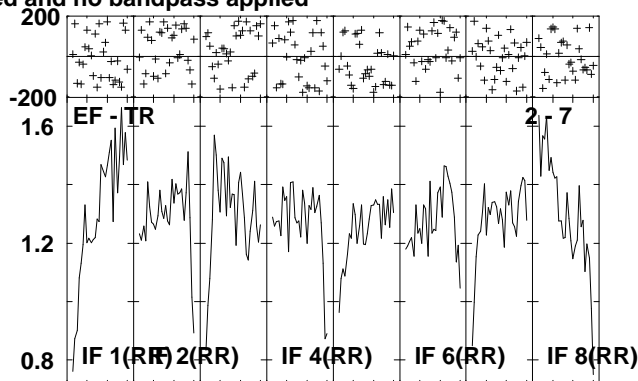
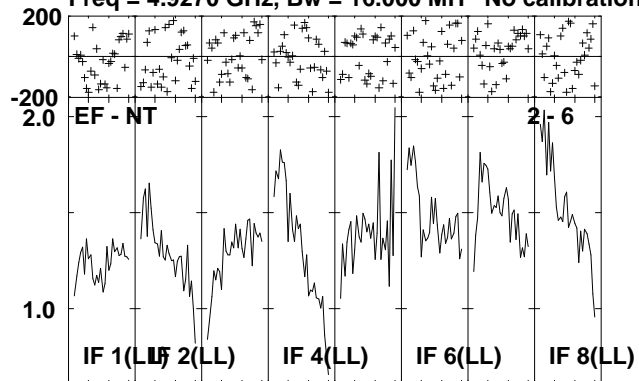

Lower frame: Milli Ampl Jy Top frame: Phas deg
Scalar averaged cross-power spectrum Several baselines displayed
Timerange: 00/14:30:21 to 00/14:33:59

Plot file version 188 created 06-JUL-2010 12:06:18

J2330+33 EP064L.UVDATA.1

Freq = 4.9270 GHz, Bw = 16.000 MH No calibration applied and no bandpass applied

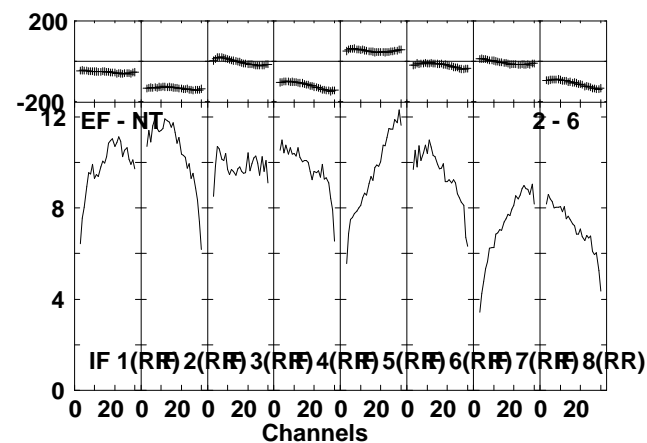
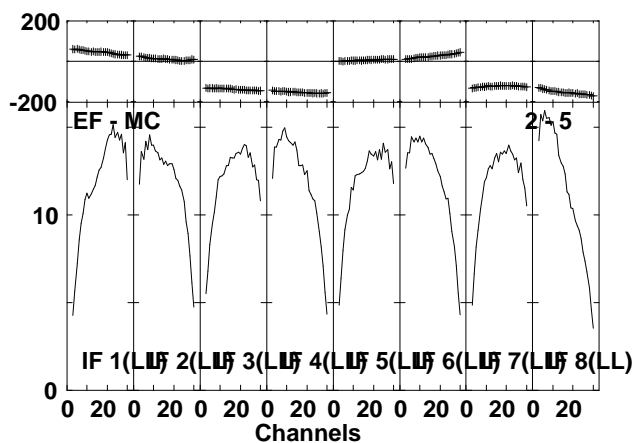
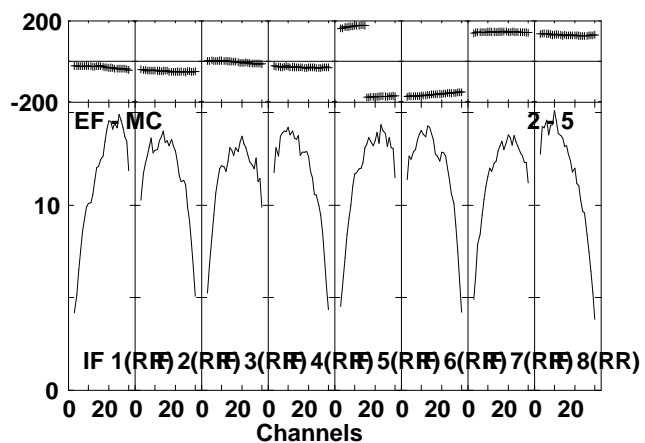
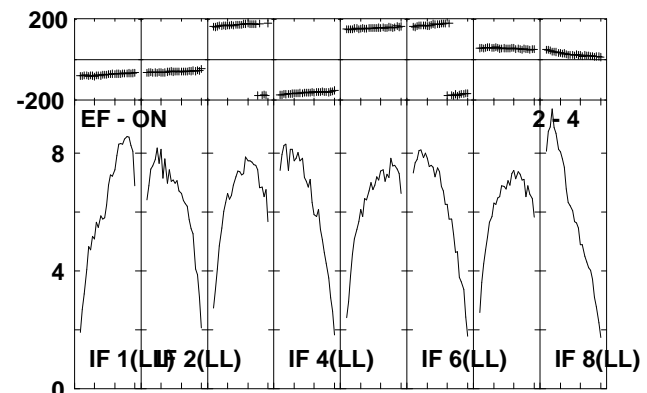
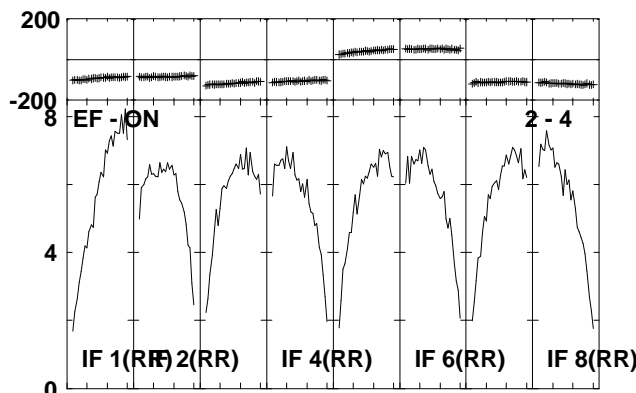
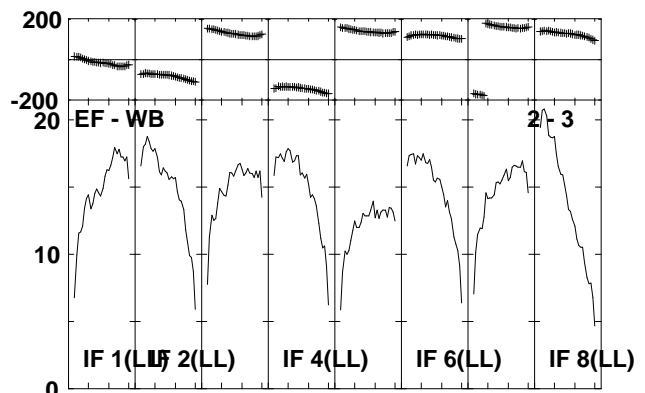
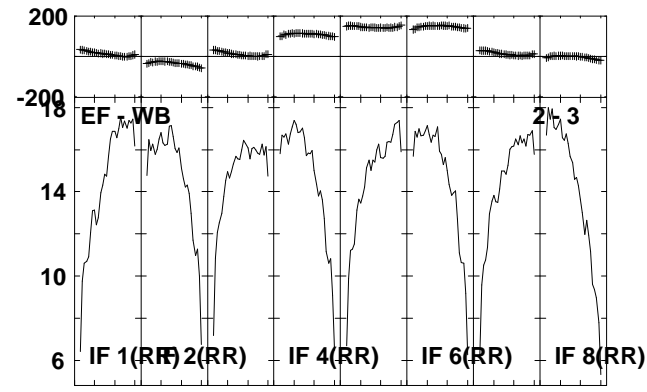
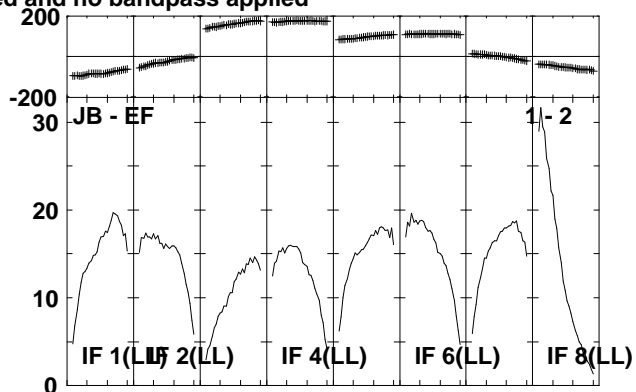
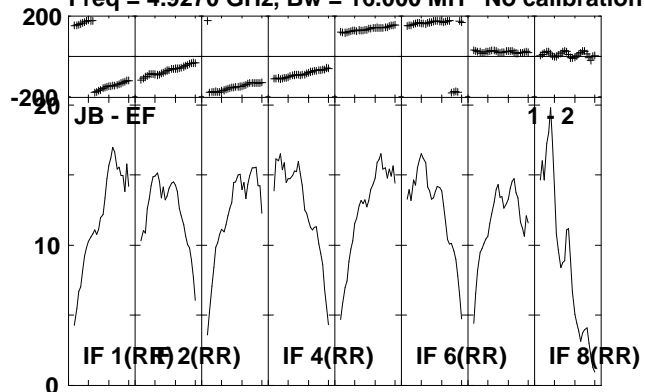

Lower frame: Milli Ampl Jy Top frame: Phas deg
Scalar averaged cross-power spectrum Several baselines displayed
Timerange: 00/14:34:01 to 00/14:35:49

Plot file version 189 created 06-JUL-2010 12:06:19

J2330+33 EP064L.UVDATA.1

Freq = 4.9270 GHz, Bw = 16.000 MH No calibration applied and no bandpass applied

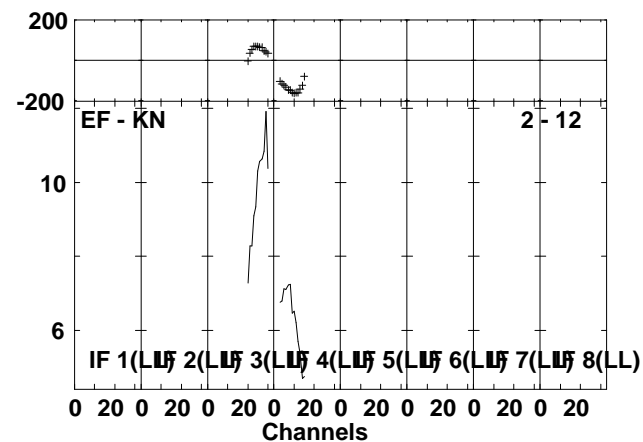
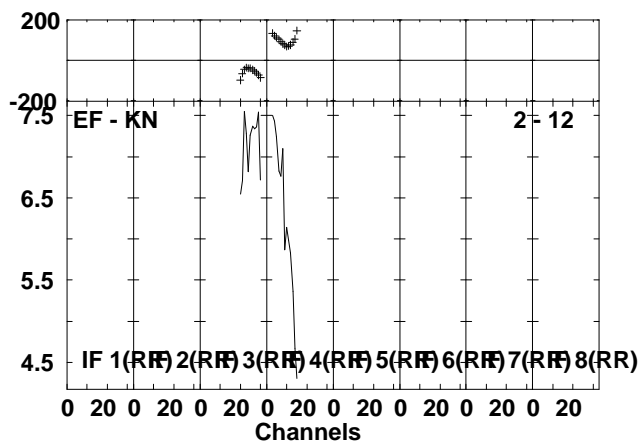
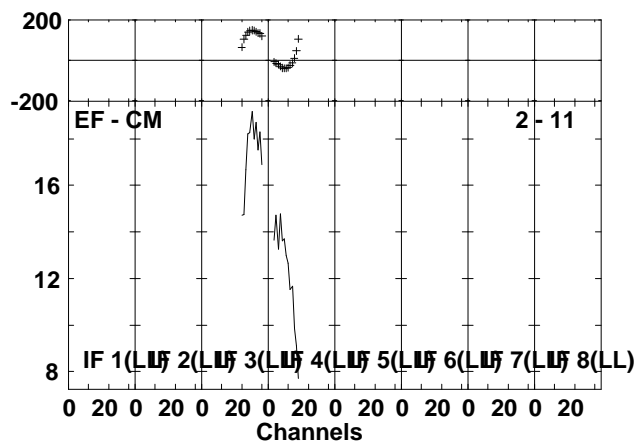
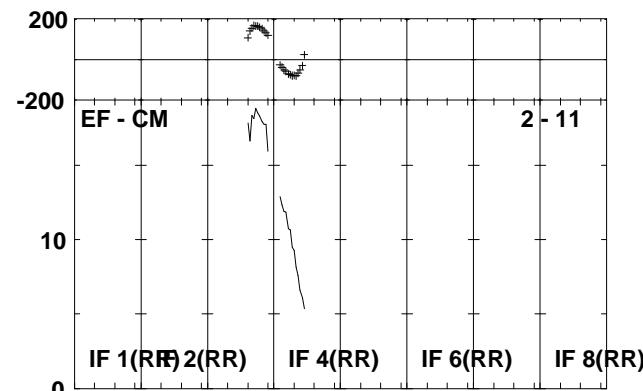
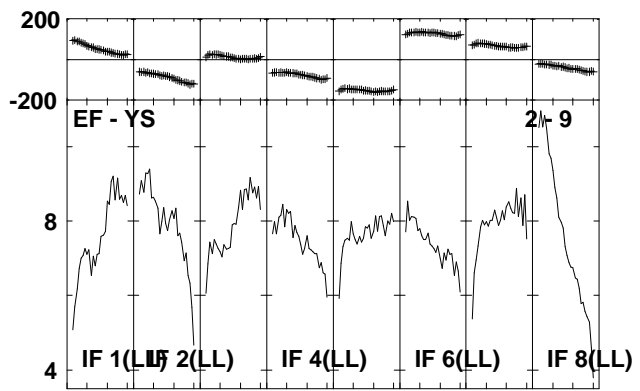
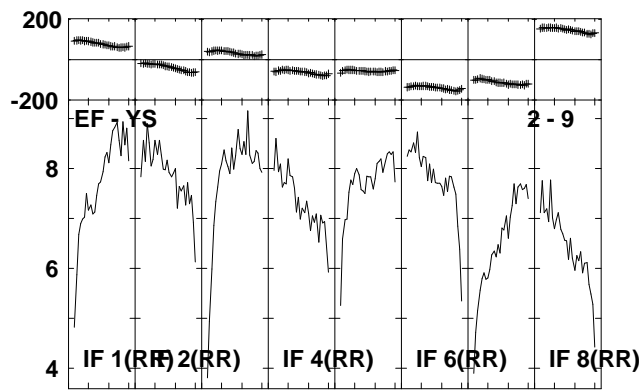
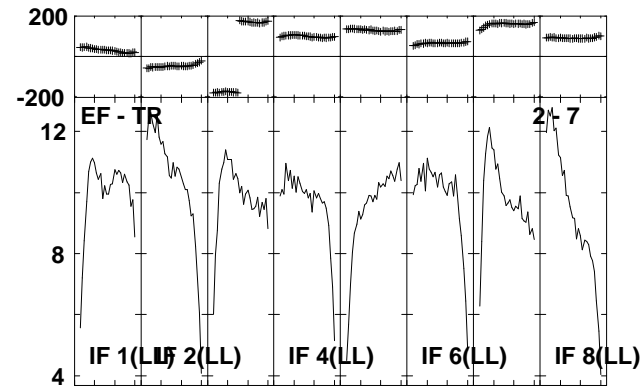
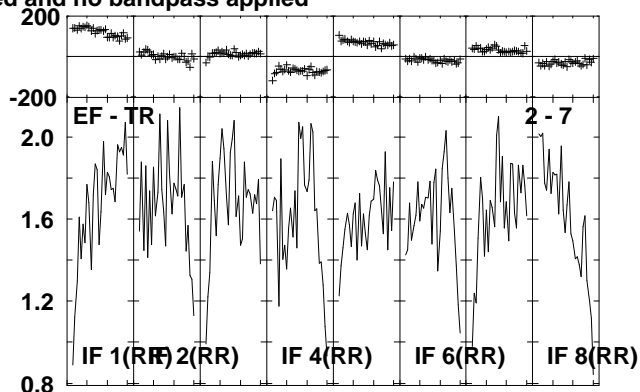
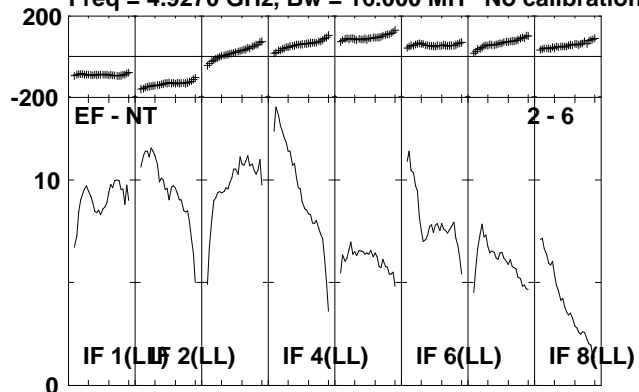

Lower frame: Milli Ampl Jy Top frame: Phas deg
Scalar averaged cross-power spectrum Several baselines displayed
Timerange: 00/14:34:01 to 00/14:35:49

Plot file version 190 created 06-JUL-2010 12:06:21

IRAS2336 EP064L.UVDATA.1

Freq = 4.9270 GHz, Bw = 16.000 MH No calibration applied and no bandpass applied

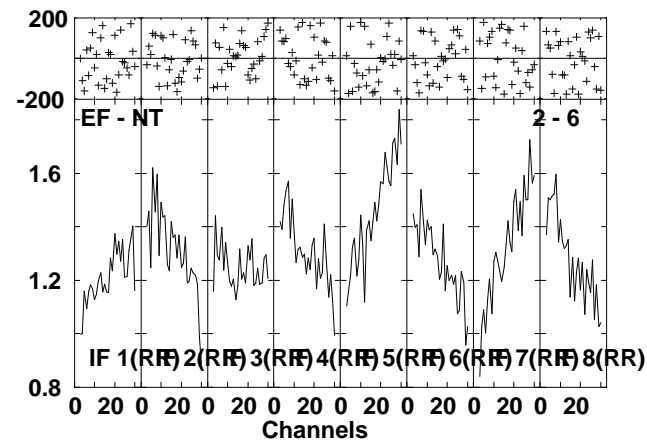
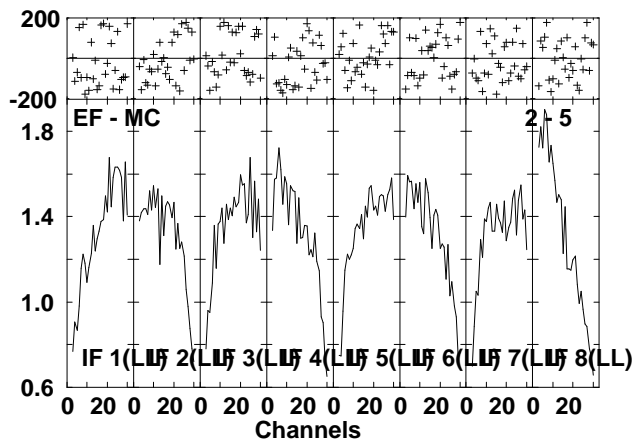
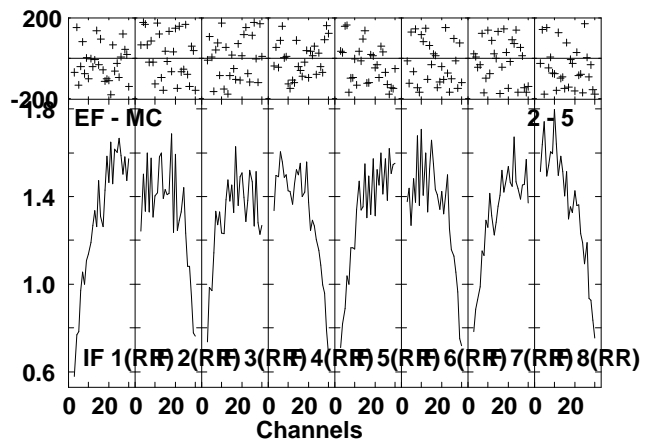
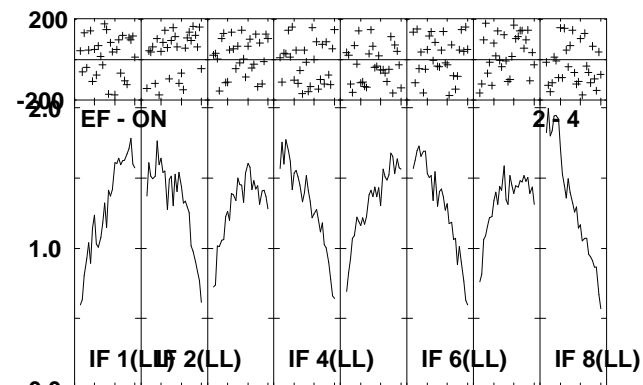
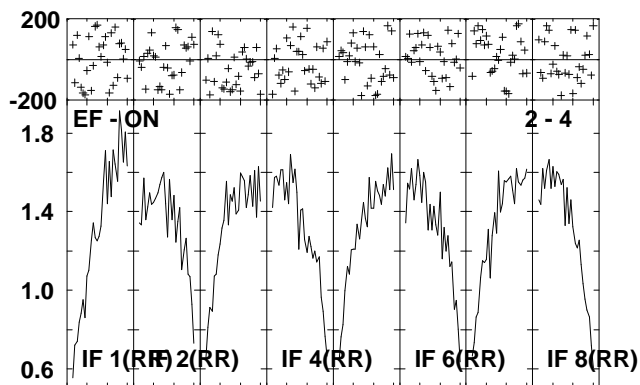
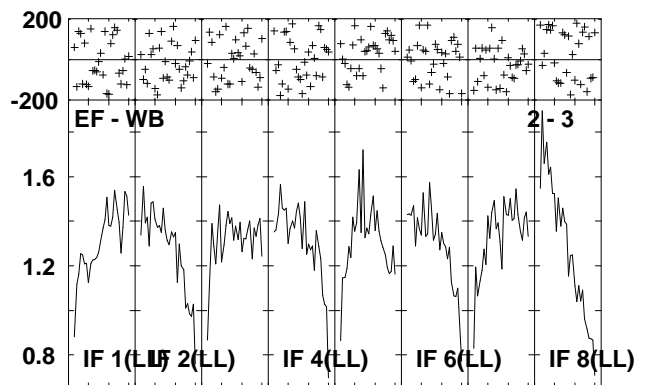
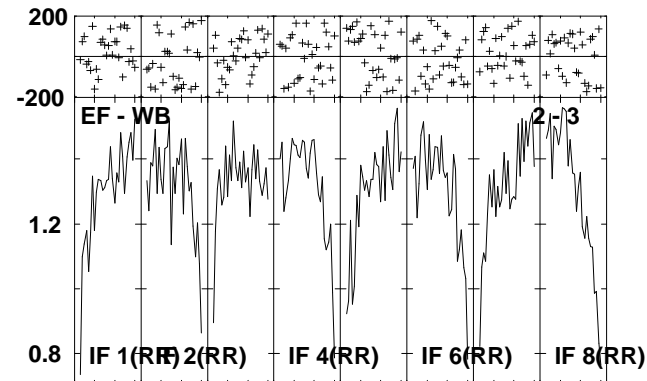
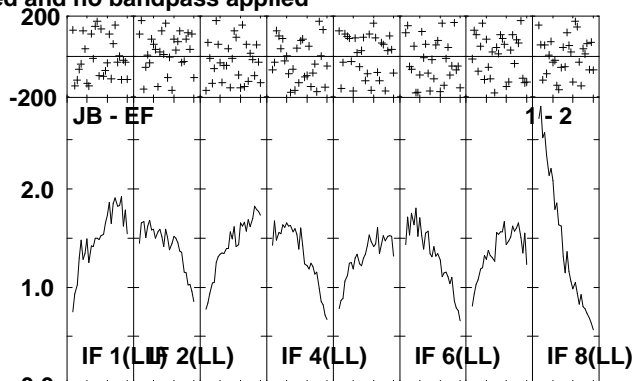
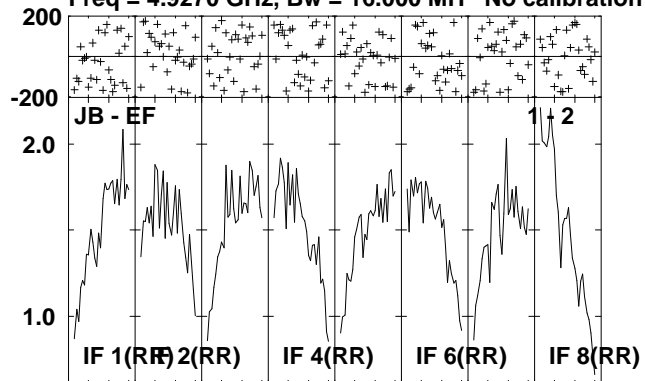

Lower frame: Milli Ampl Jy Top frame: Phas deg
Scalar averaged cross-power spectrum Several baselines displayed
Timerange: 00/14:35:51 to 00/14:39:27

Plot file version 191 created 06-JUL-2010 12:06:23

IRAS2336 EP064L.UVDATA.1

Freq = 4.9270 GHz, Bw = 16.000 MH No calibration applied and no bandpass applied

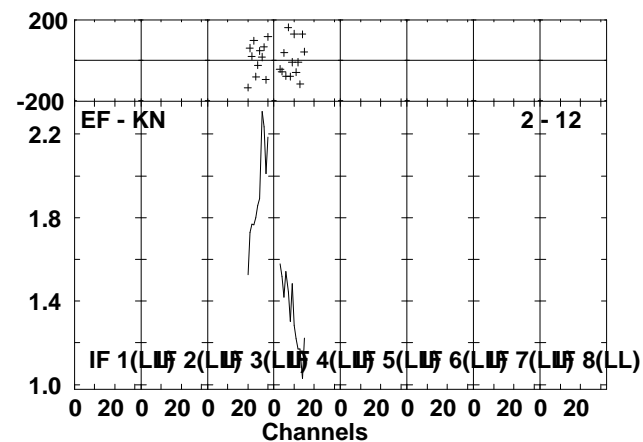
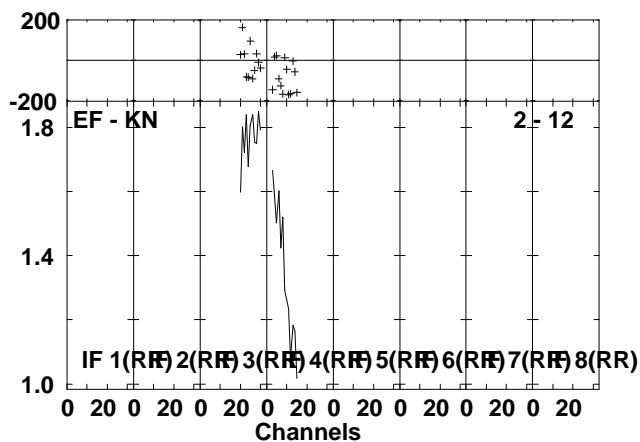
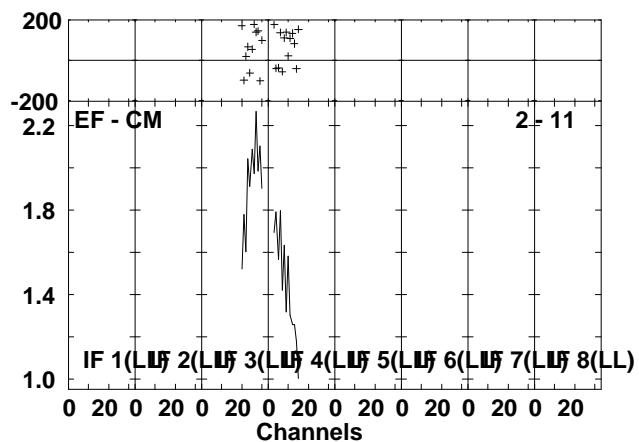
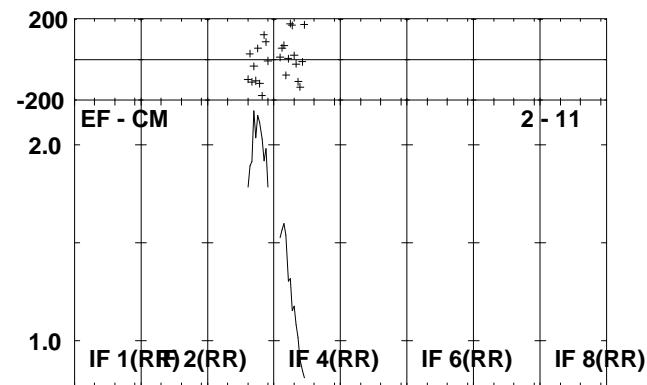
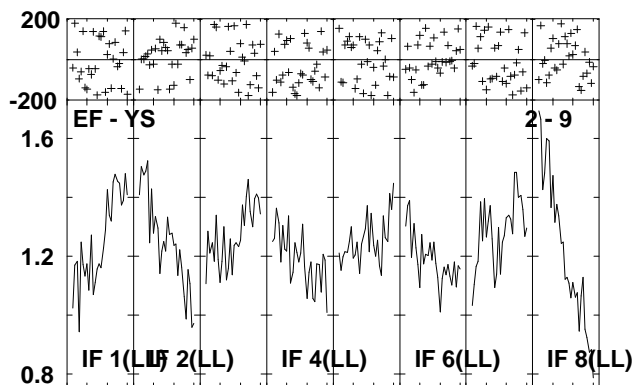
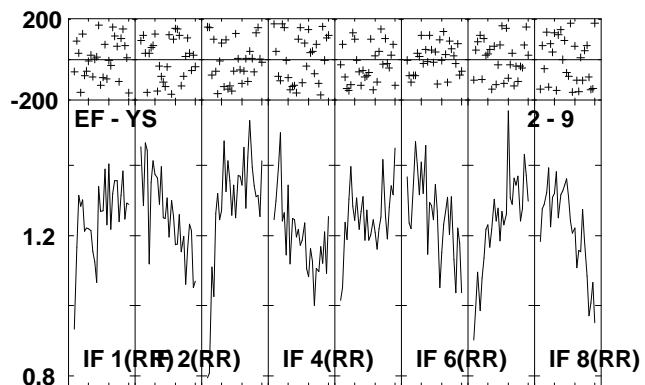
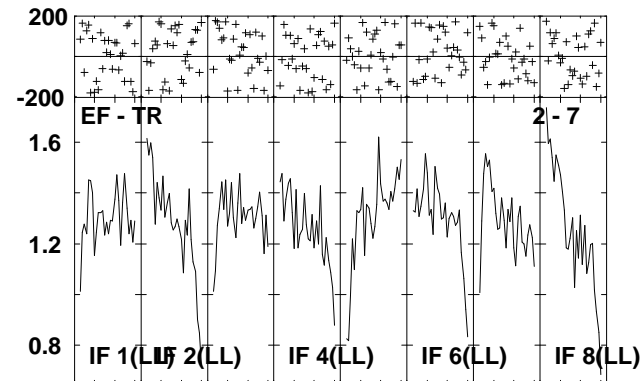
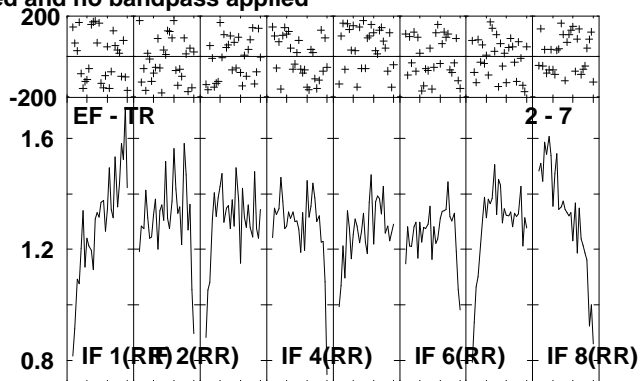
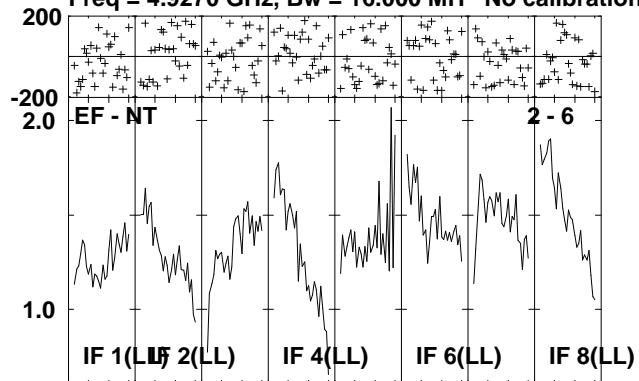

Lower frame: Milli Ampl Jy Top frame: Phas deg
Scalar averaged cross-power spectrum Several baselines displayed
Timerange: 00/14:35:51 to 00/14:39:27

Plot file version 192 created 06-JUL-2010 12:06:26

J2330+33 EP064L.UVDATA.1

Freq = 4.9270 GHz, Bw = 16.000 MH No calibration applied and no bandpass applied

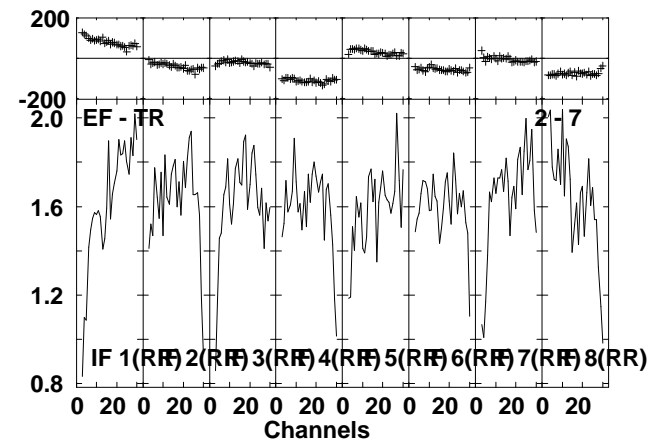
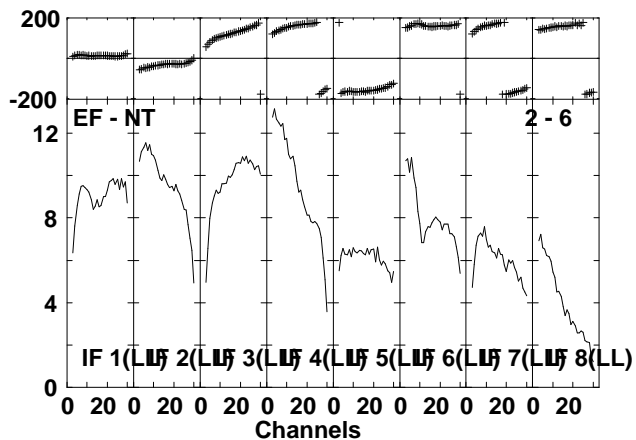
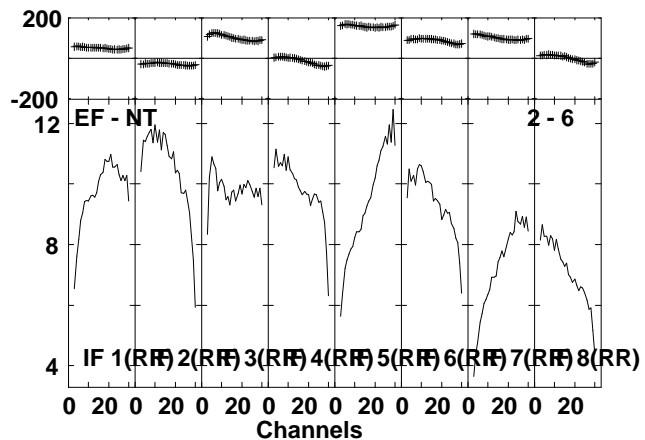
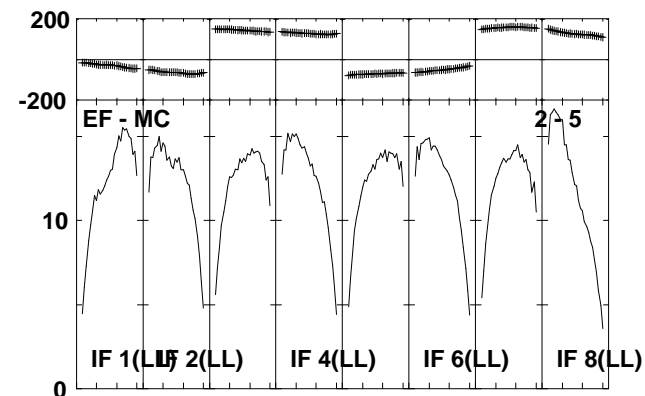
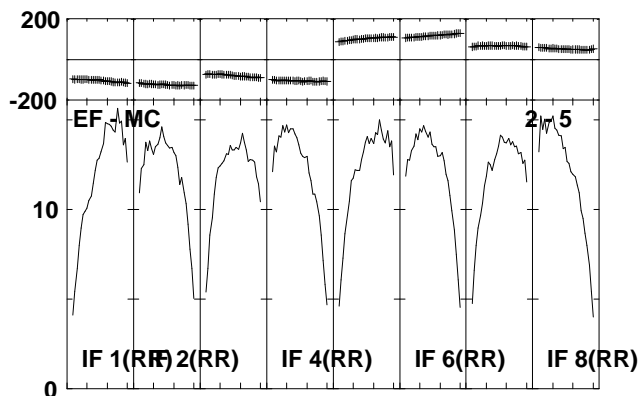
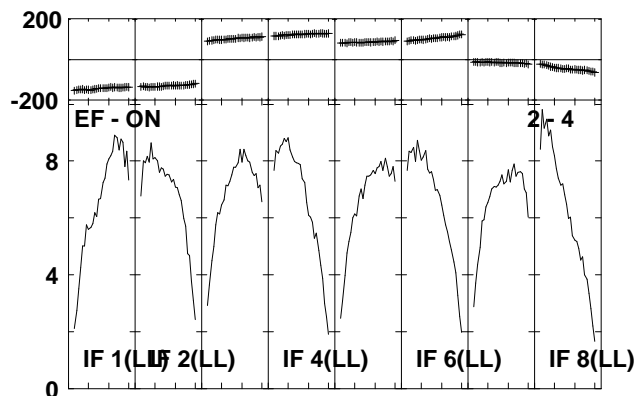
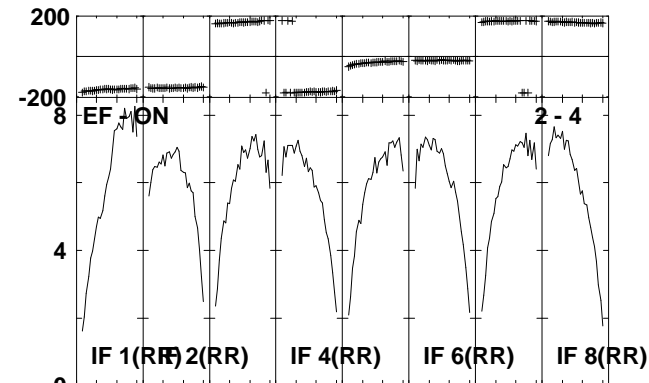
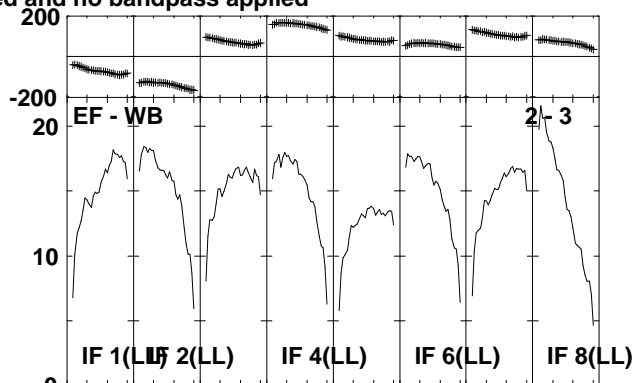
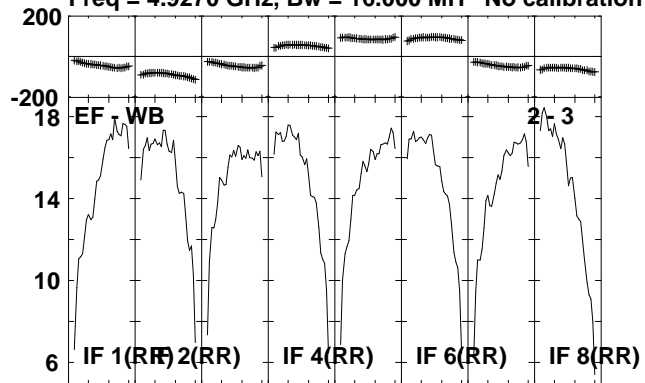

Lower frame: Milli Ampl Jy Top frame: Phas deg
Scalar averaged cross-power spectrum Several baselines displayed
Timerange: 00/14:40:31 to 00/14:42:07

Plot file version 193 created 06-JUL-2010 12:06:27

J2330+33 EP064L.UVDATA.1

Freq = 4.9270 GHz, Bw = 16.000 MH No calibration applied and no bandpass applied

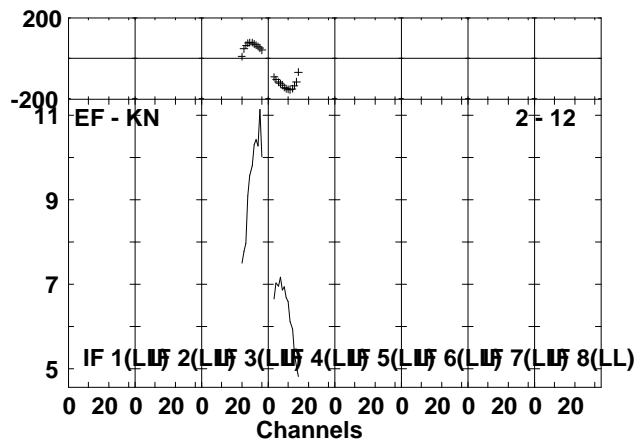
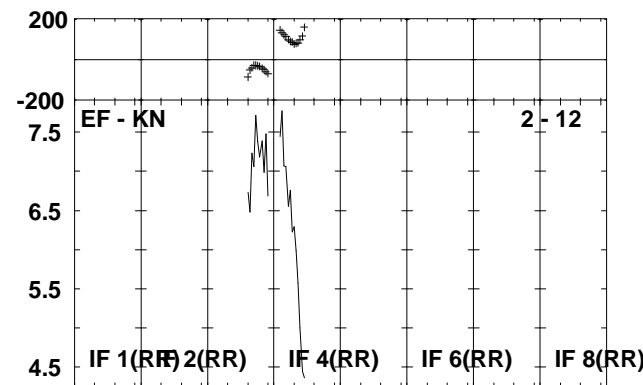
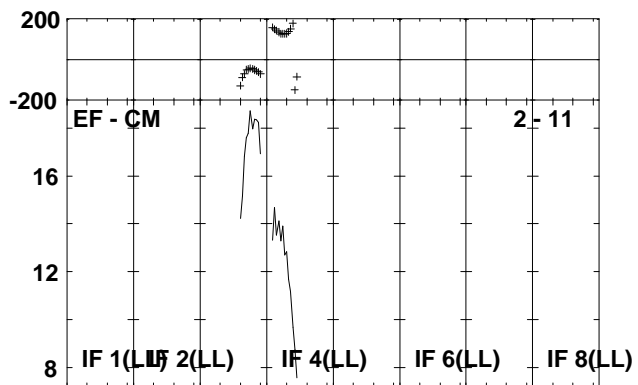
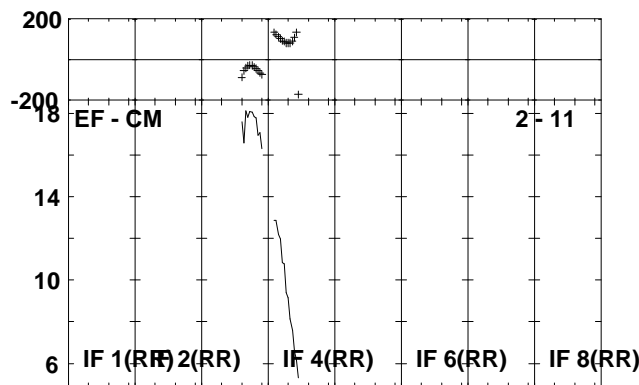
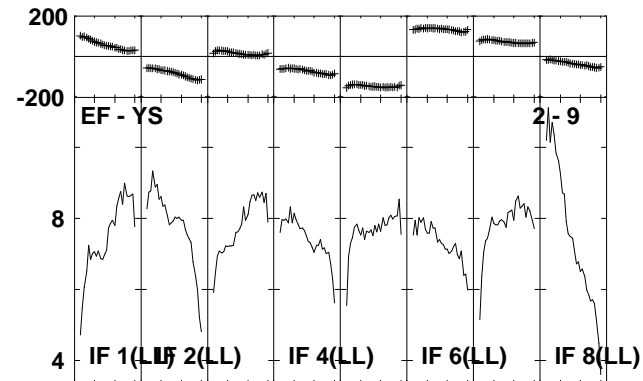
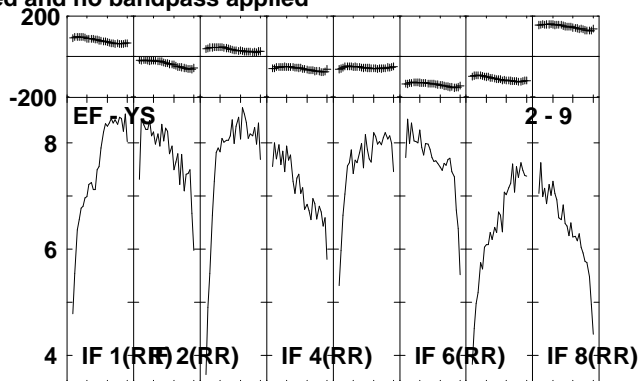
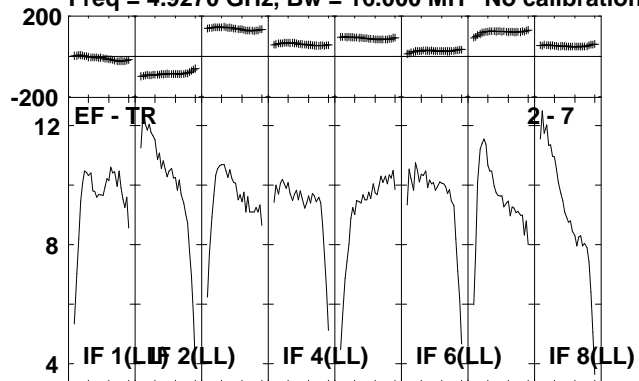

Lower frame: Milli Ampl Jy Top frame: Phas deg
Scalar averaged cross-power spectrum Several baselines displayed
Timerange: 00/14:40:31 to 00/14:42:07

Plot file version 195 created 06-JUL-2010 12:06:30

IRAS2336 EP064L.UVDATA.1

Freq = 4.9270 GHz, Bw = 16.000 MH No calibration applied and no bandpass applied

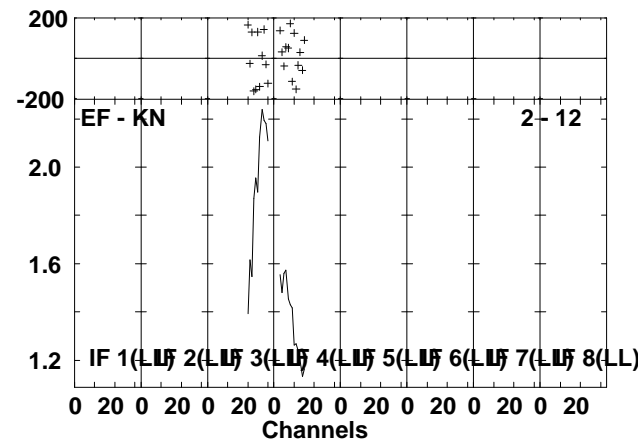
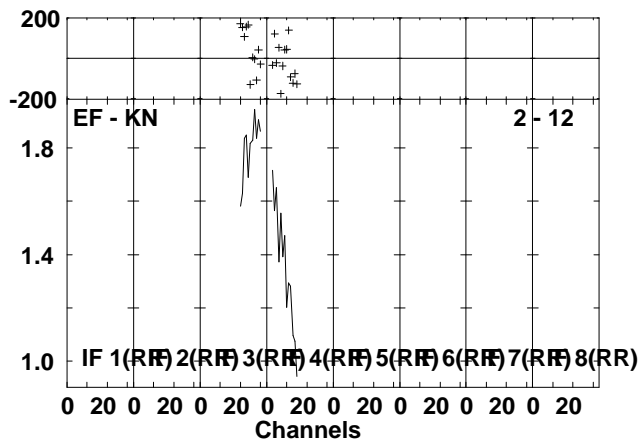
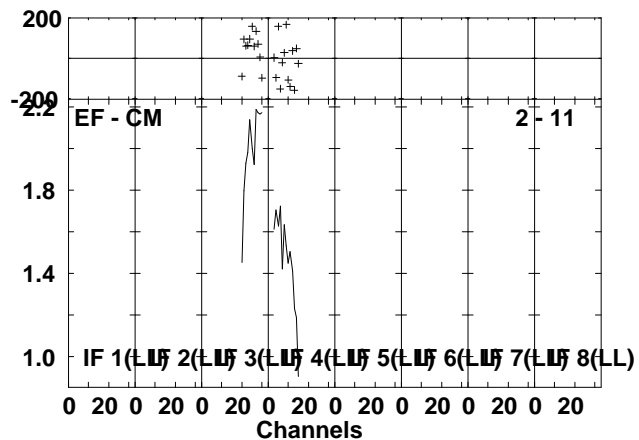
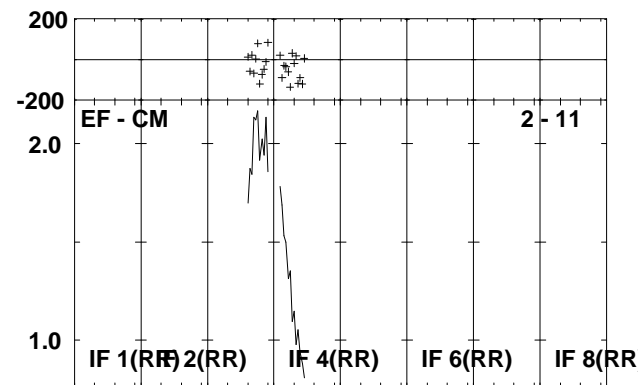
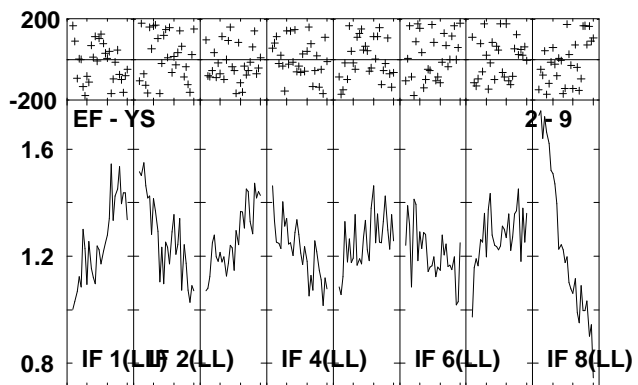
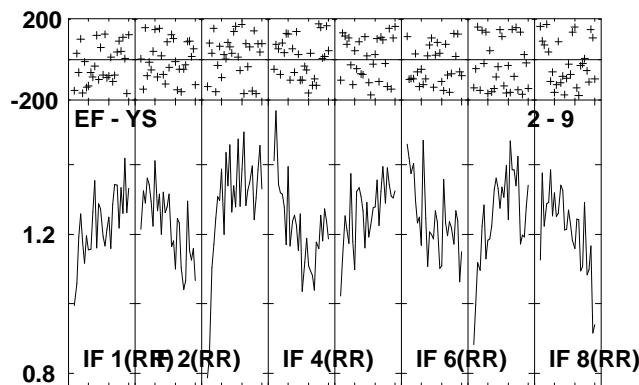
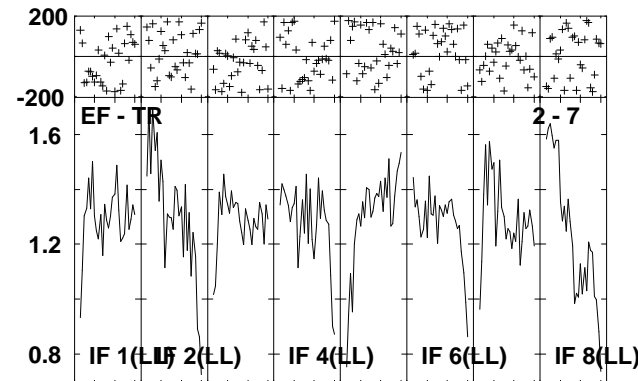
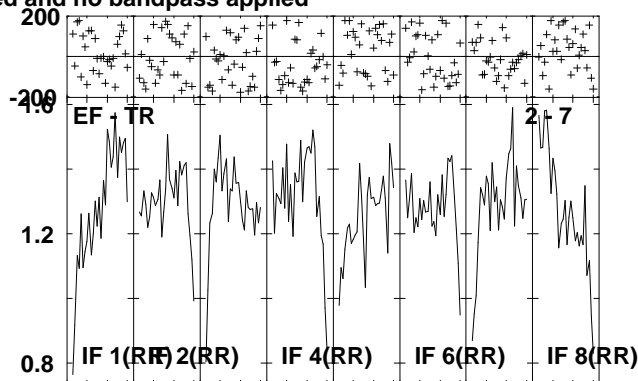
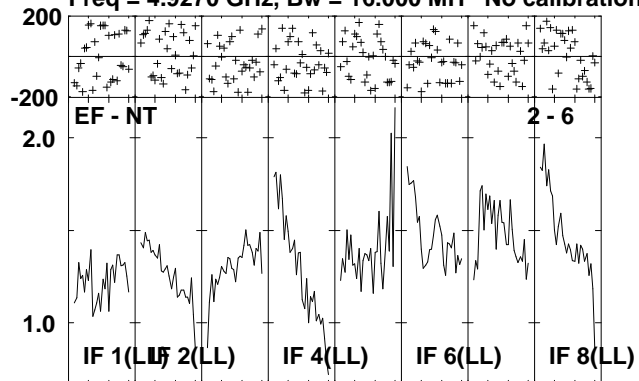

Lower frame: Milli Ampl Jy Top frame: Phas deg
Scalar averaged cross-power spectrum Several baselines displayed
Timerange: 00/14:42:11 to 00/14:45:49

Plot file version 196 created 06-JUL-2010 12:06:33

J2330+33 EP064L.UVDATA.1

Freq = 4.9270 GHz, Bw = 16.000 MH No calibration applied and no bandpass applied

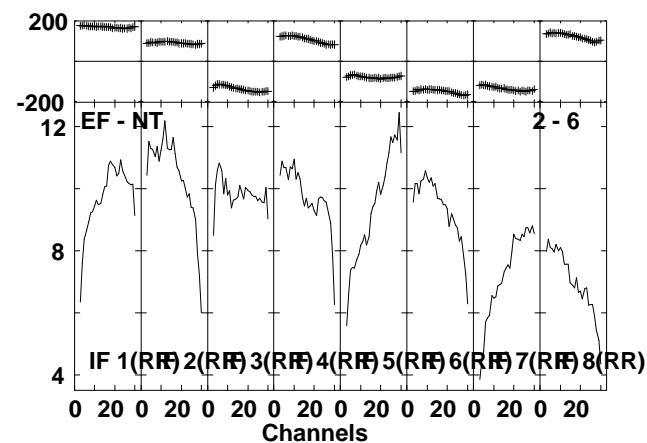
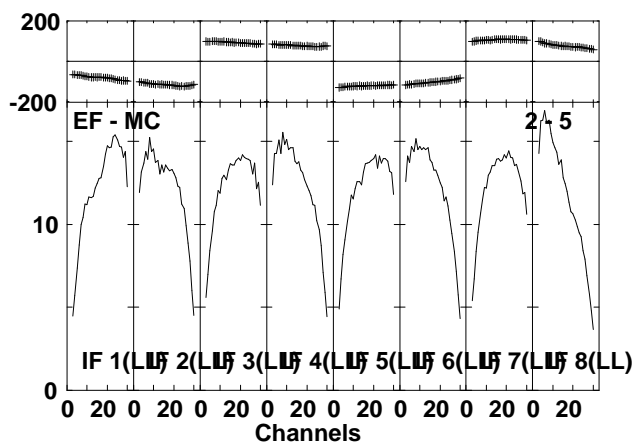
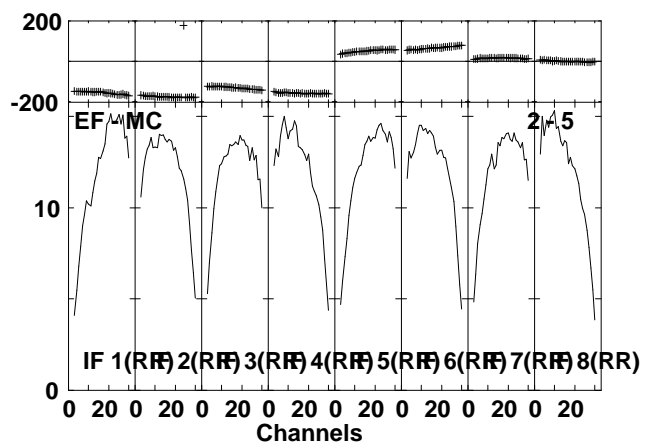
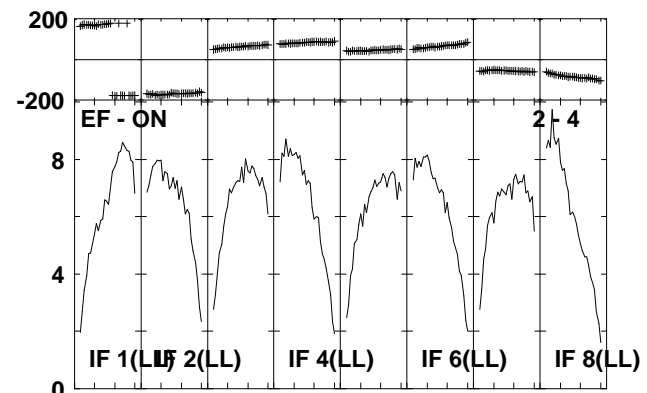
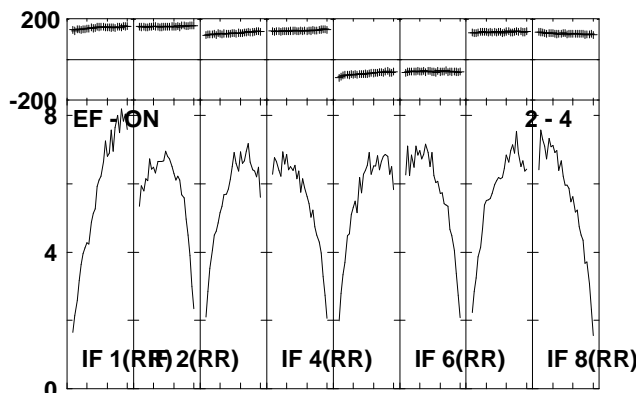
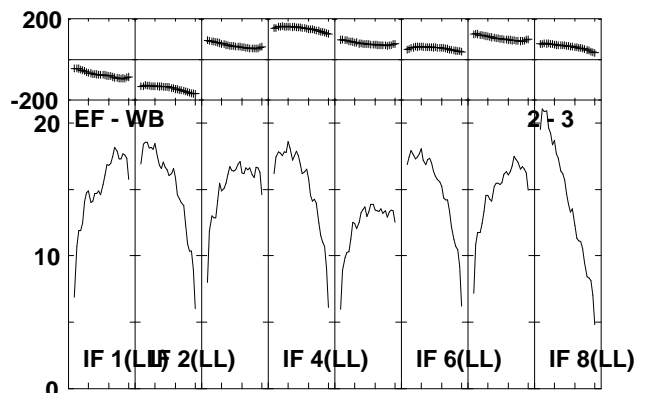
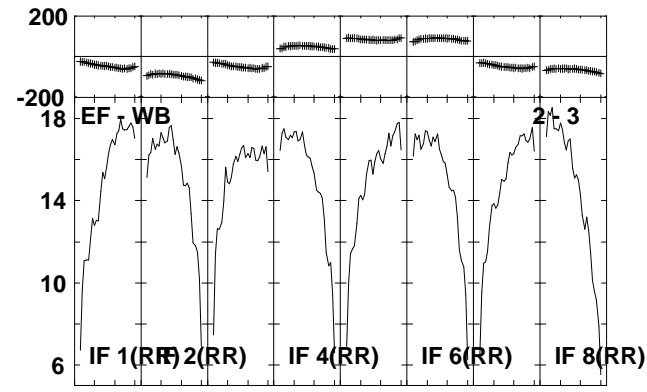
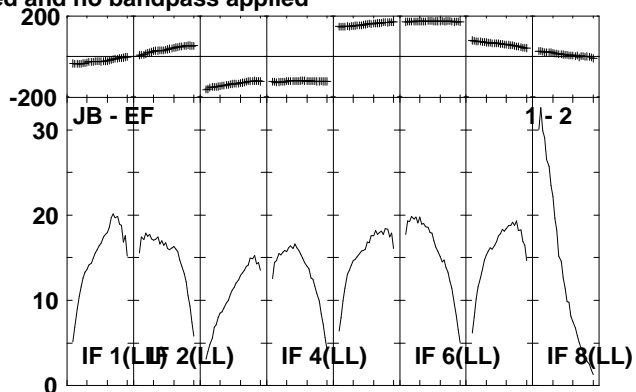
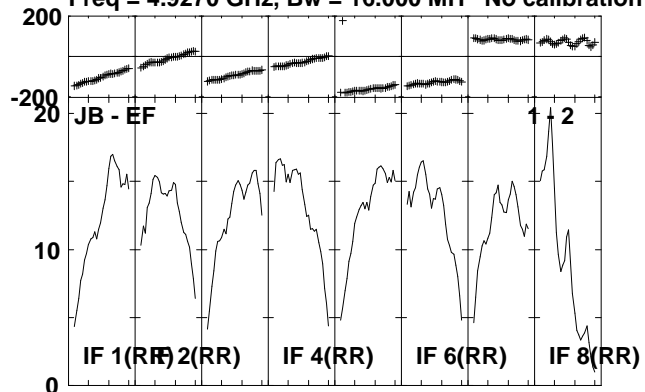

Lower frame: Milli Ampl Jy Top frame: Phas deg
Scalar averaged cross-power spectrum Several baselines displayed
Timerange: 00/14:45:51 to 00/14:47:39

Plot file version 197 created 06-JUL-2010 12:06:34

J2330+33 EP064L.UVDATA.1

Freq = 4.9270 GHz, Bw = 16.000 MH No calibration applied and no bandpass applied

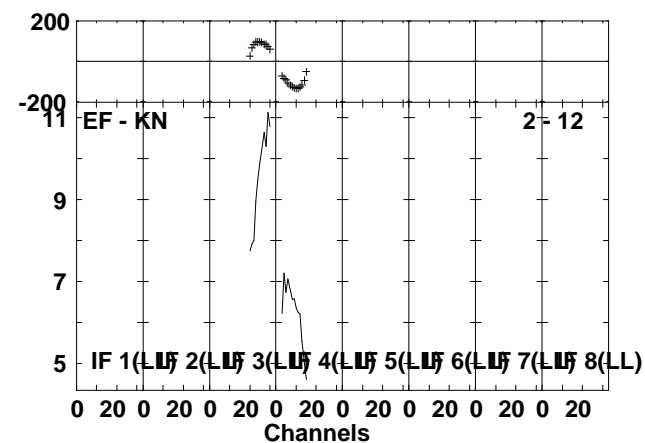
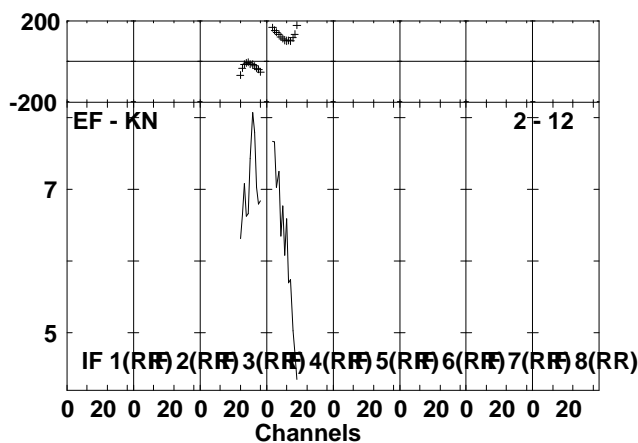
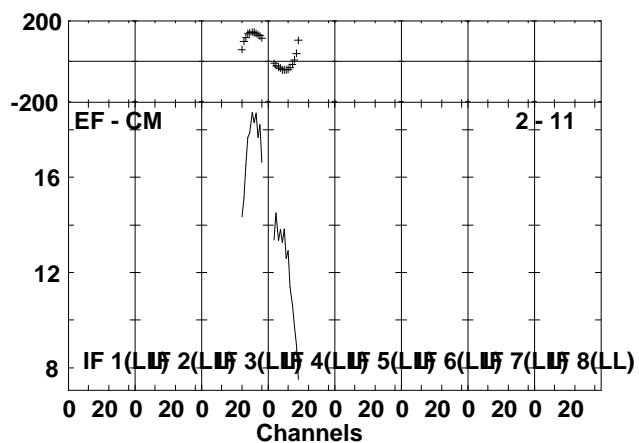
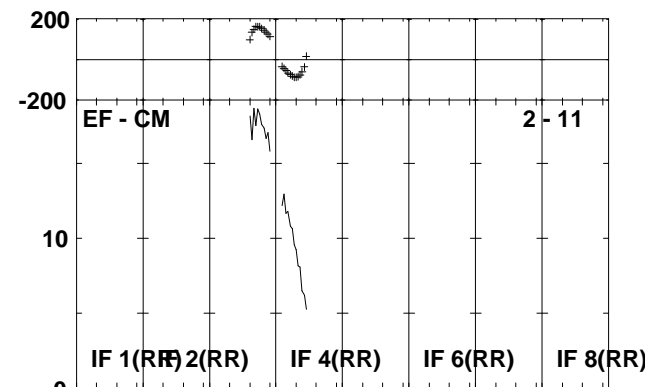
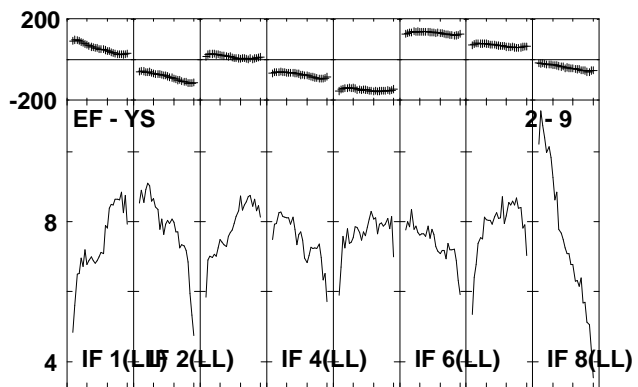
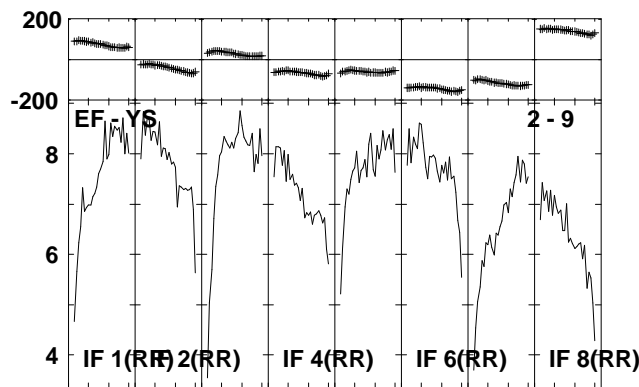
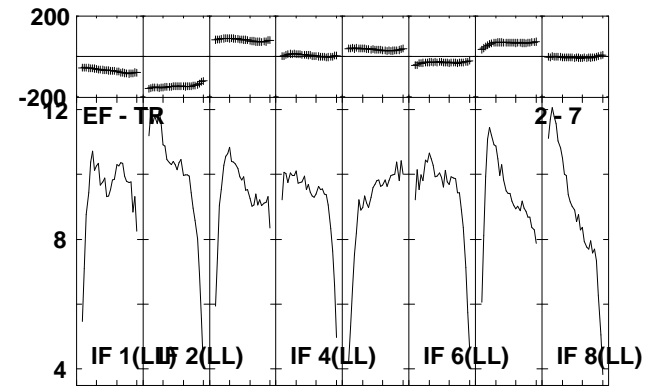
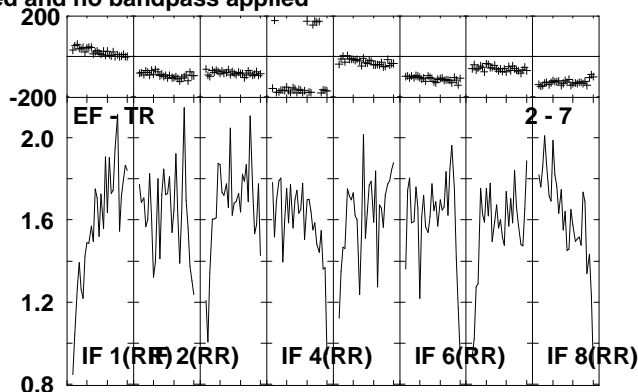
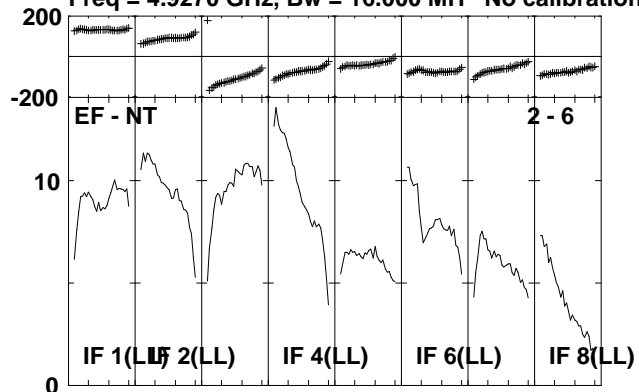

Lower frame: Milli Ampl Jy Top frame: Phas deg
Scalar averaged cross-power spectrum Several baselines displayed
Timerange: 00/14:45:51 to 00/14:47:39

Plot file version 198 created 06-JUL-2010 12:06:36

IRAS2336 EP064L.UVDATA.1

Freq = 4.9270 GHz, Bw = 16.000 MH No calibration applied and no bandpass applied

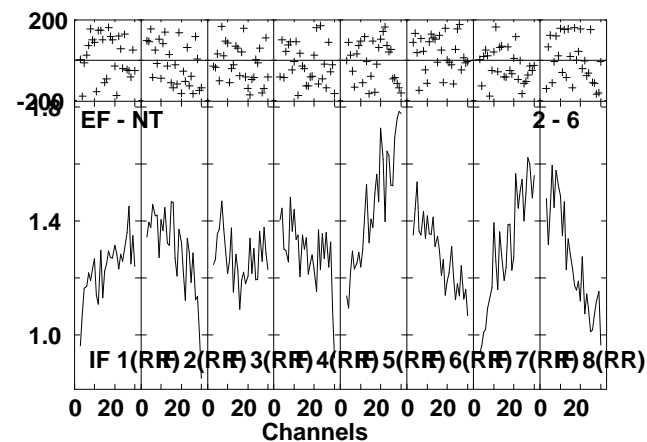
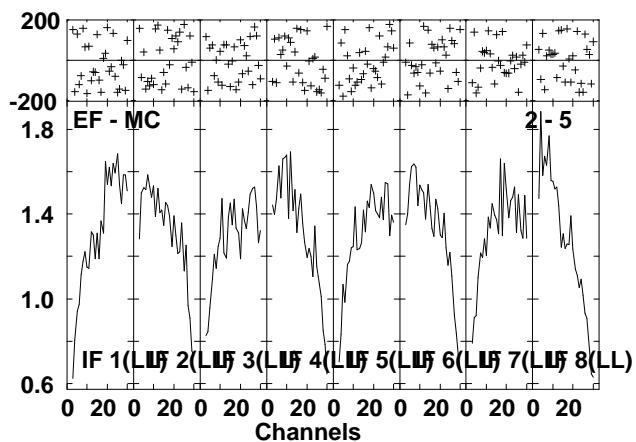
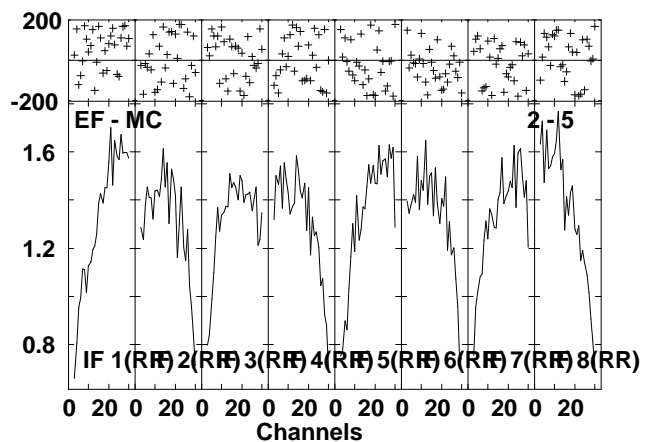
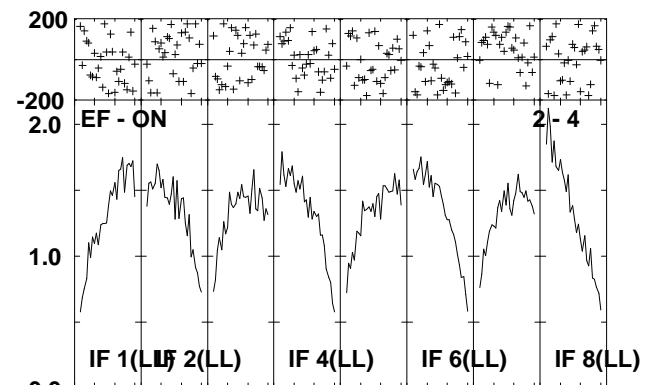
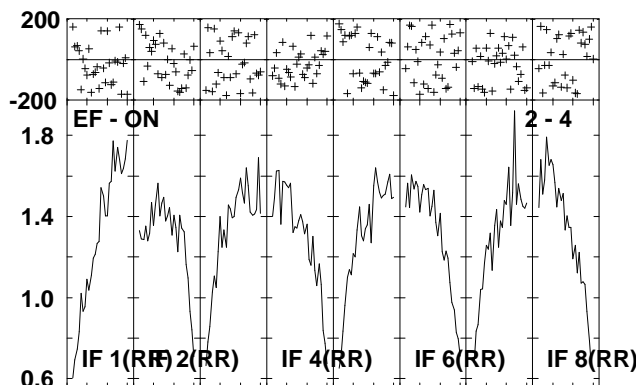
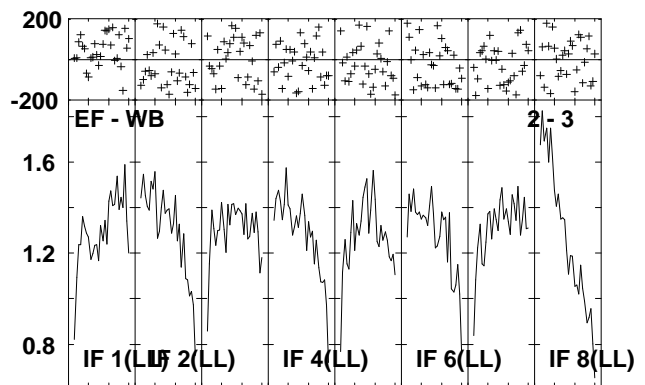
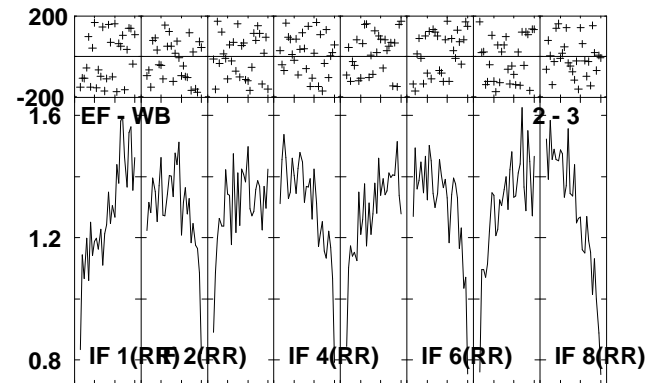
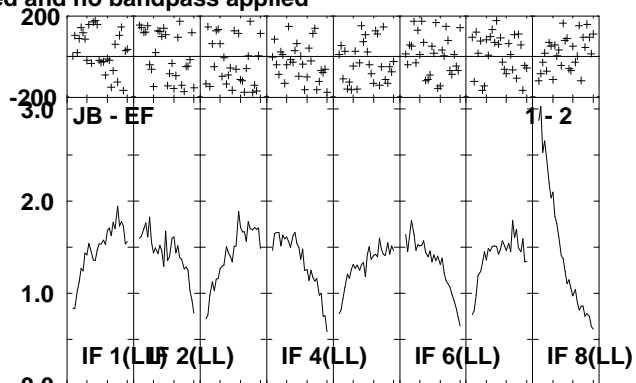
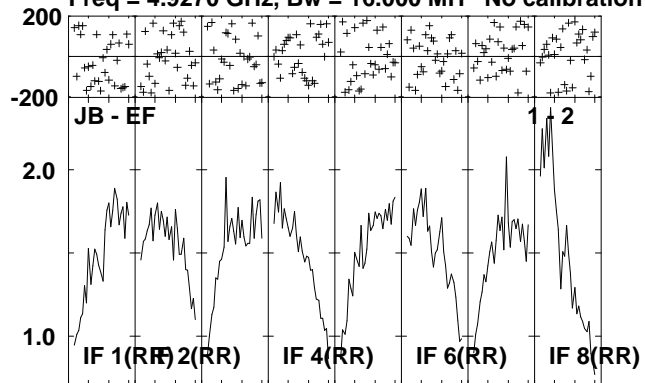

Lower frame: Milli Ampl Jy Top frame: Phas deg
Scalar averaged cross-power spectrum Several baselines displayed
Timerange: 00/14:47:41 to 00/14:51:19

Plot file version 199 created 06-JUL-2010 12:06:38

IRAS2336 EP064L.UVDATA.1

Freq = 4.9270 GHz, Bw = 16.000 MH No calibration applied and no bandpass applied

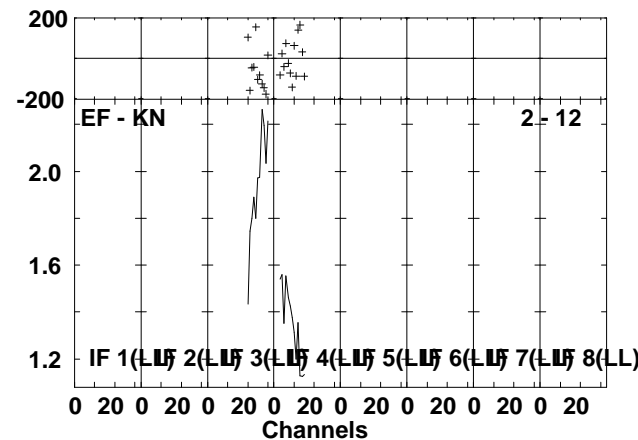
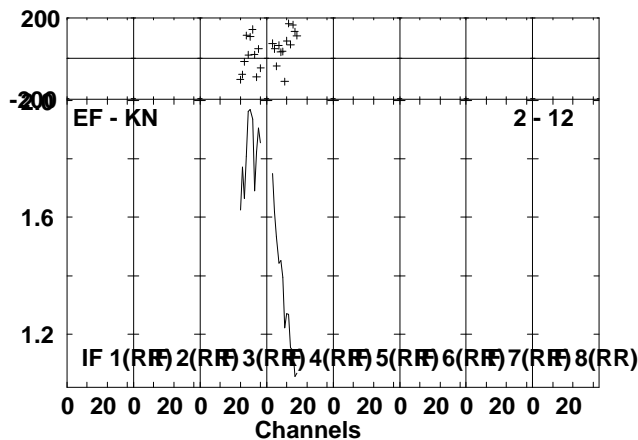
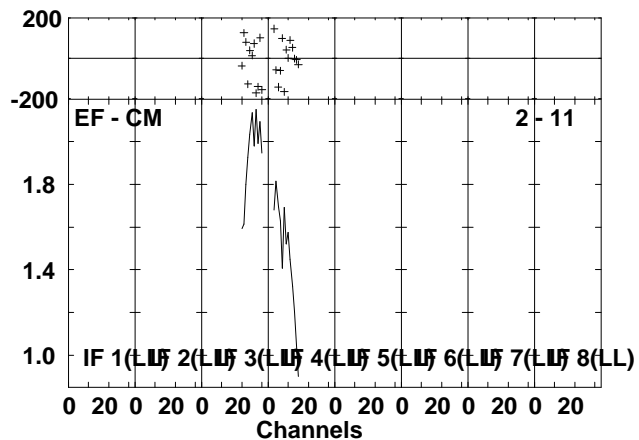
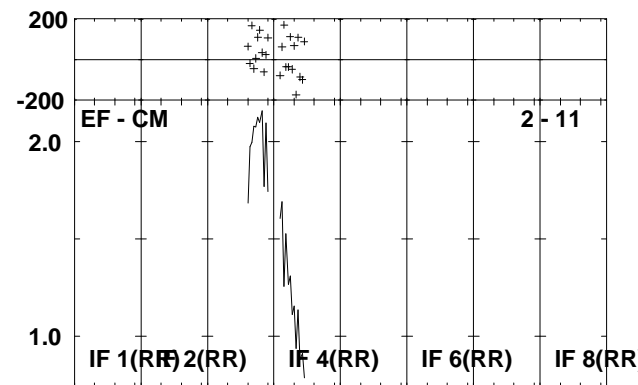
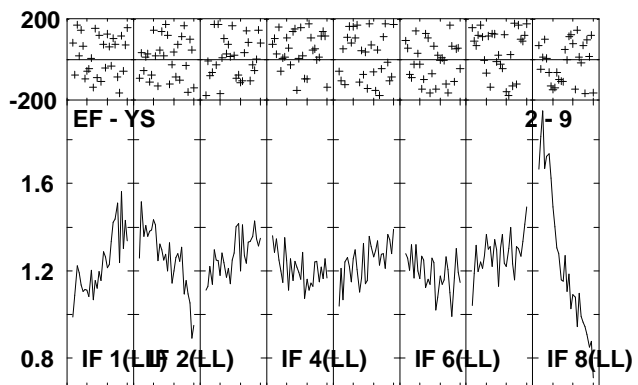
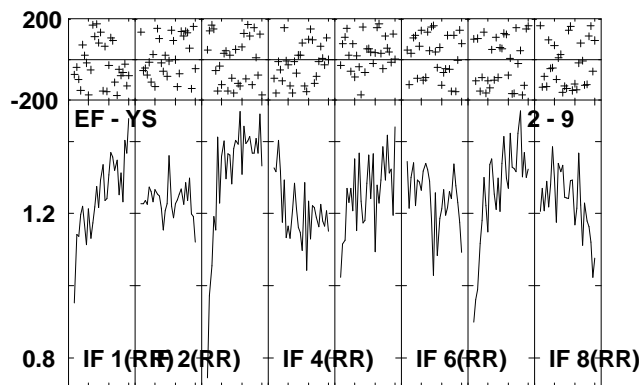
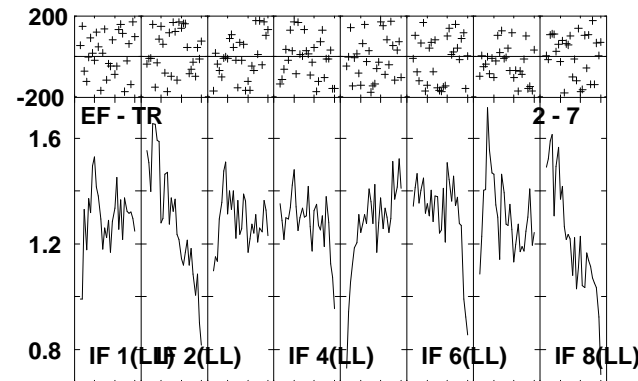
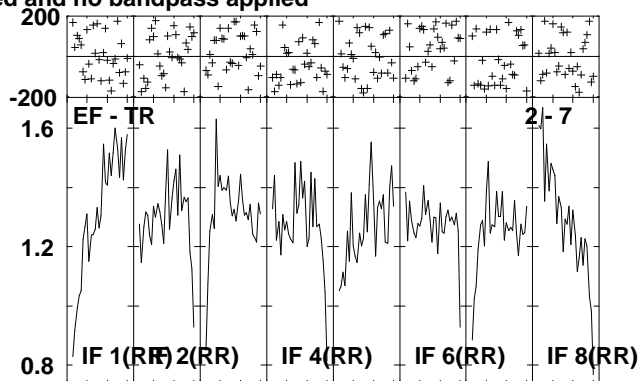
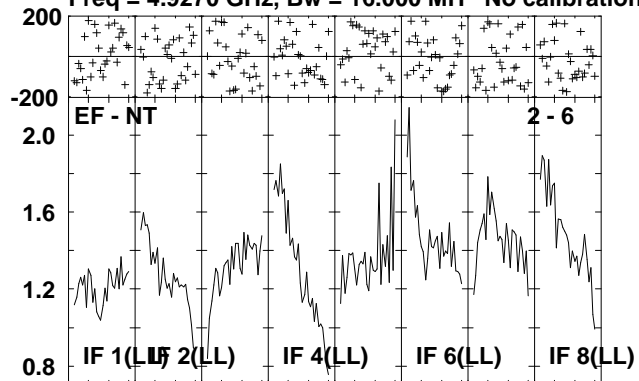

Lower frame: Milli Ampl Jy Top frame: Phas deg
Scalar averaged cross-power spectrum Several baselines displayed
Timerange: 00/14:47:41 to 00/14:51:19

Plot file version 200 created 06-JUL-2010 12:06:41

J2330+33 EP064L.UVDATA.1

Freq = 4.9270 GHz, Bw = 16.000 MH No calibration applied and no bandpass applied

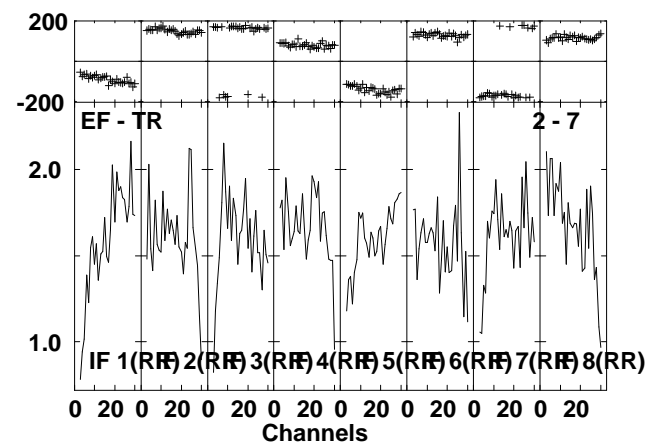
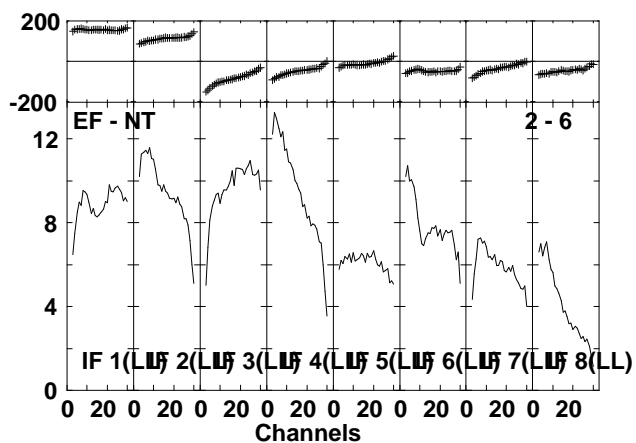
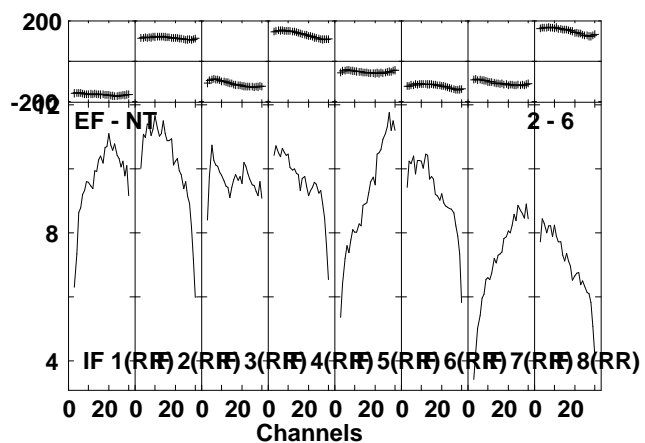
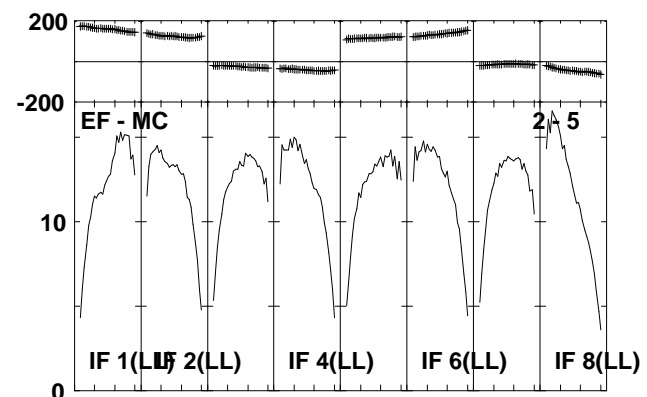
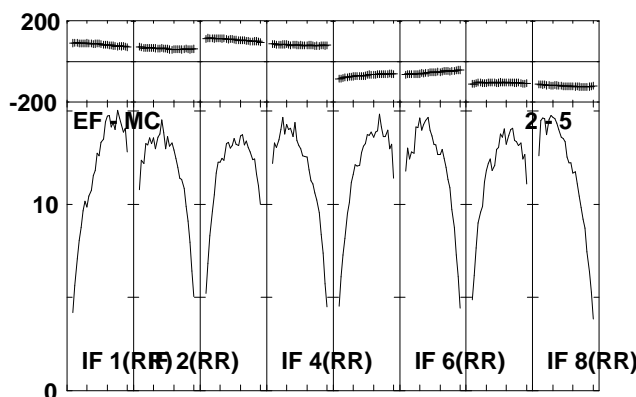
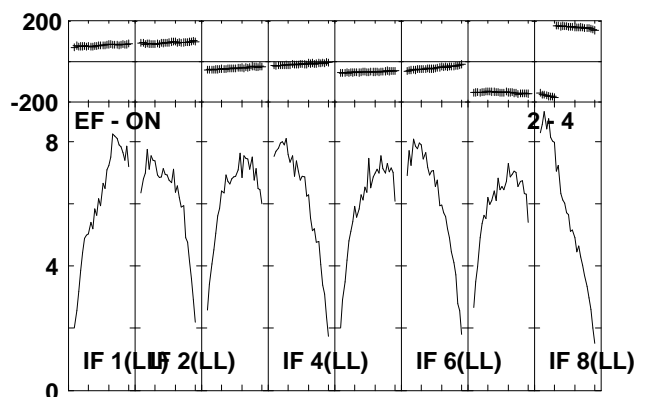
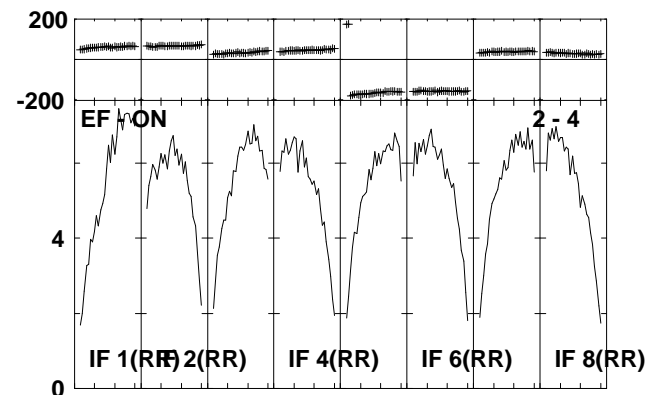
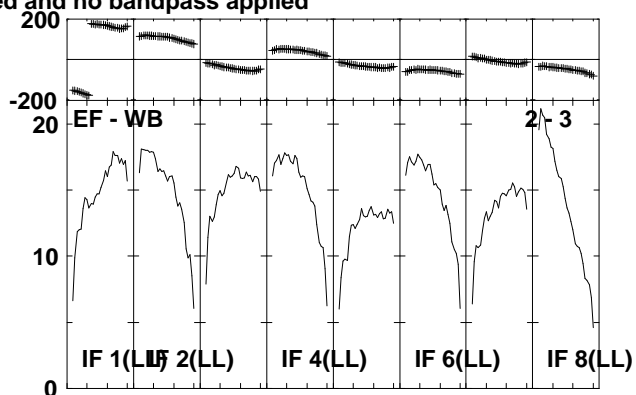
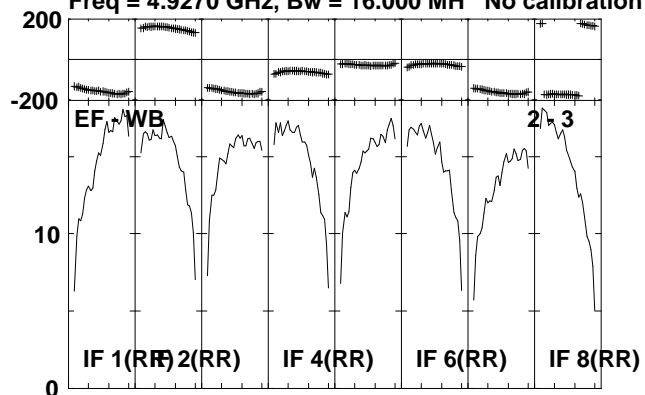

Lower frame: Milli Ampl Jy Top frame: Phas deg
Scalar averaged cross-power spectrum Several baselines displayed
Timerange: 00/14:51:21 to 00/14:53:09

Plot file version 202 created 06-JUL-2010 12:06:44

IRAS2336 EP064L.UVDATA.1

Freq = 4.9270 GHz, Bw = 16.000 MH No calibration applied and no bandpass applied

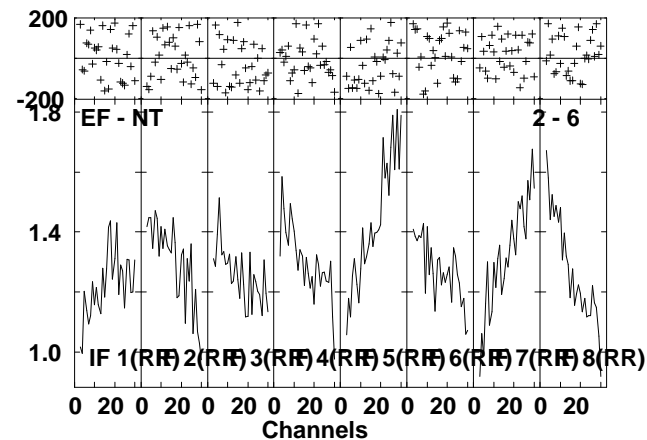
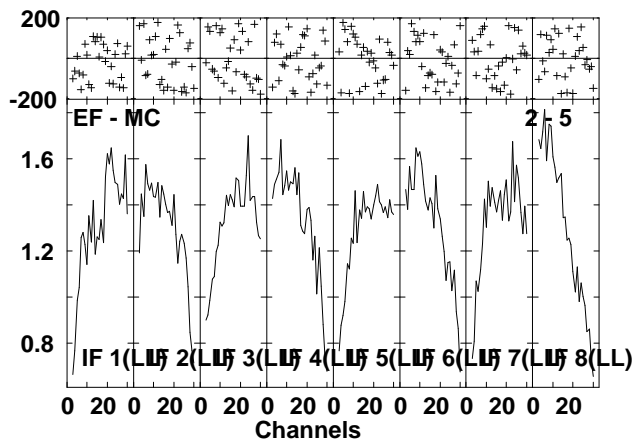
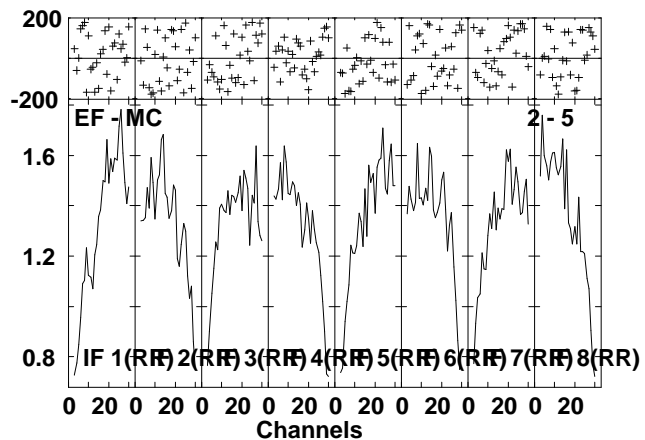
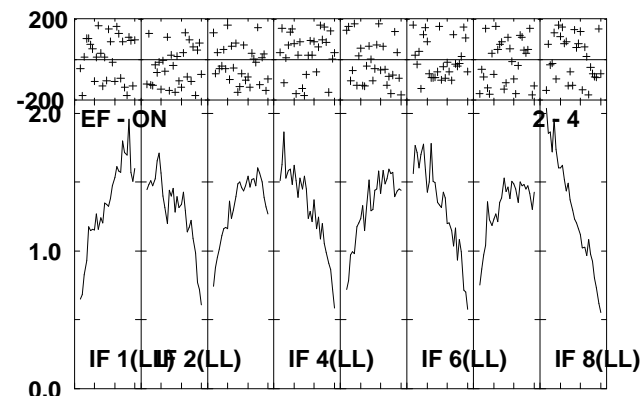
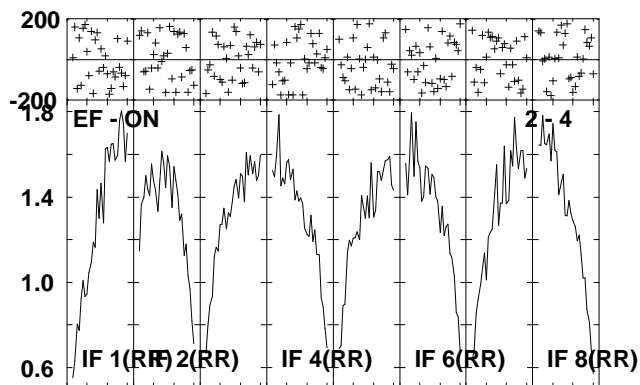
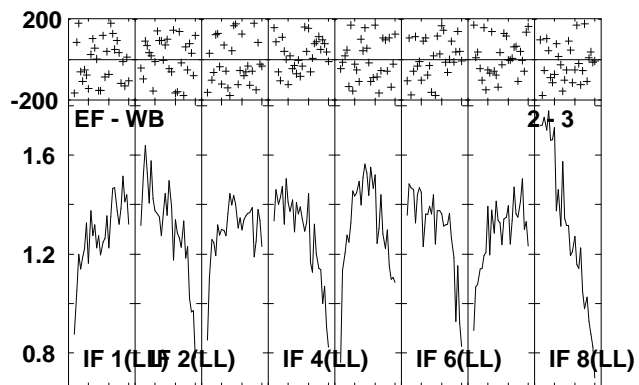
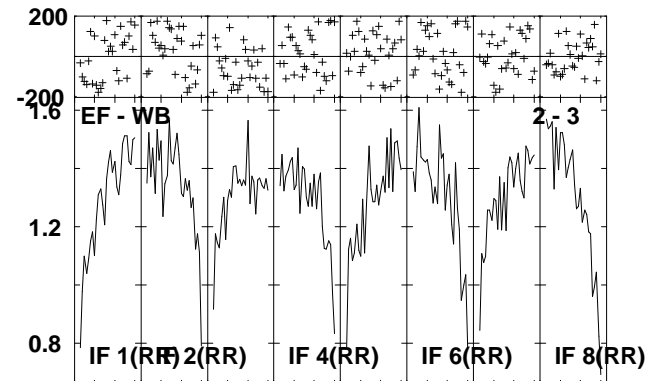
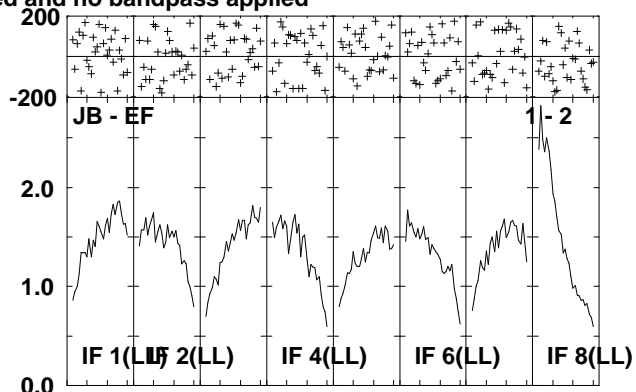
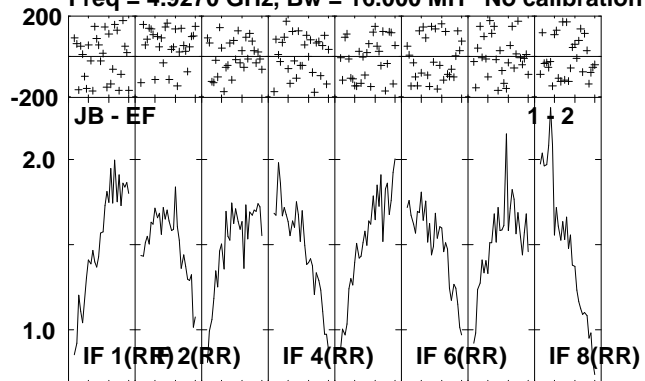

Lower frame: Milli Ampl Jy Top frame: Phas deg
Scalar averaged cross-power spectrum Several baselines displayed
Timerange: 00/14:53:11 to 00/14:56:49

Plot file version 203 created 06-JUL-2010 12:06:46

IRAS2336 EP064L.UVDATA.1

Freq = 4.9270 GHz, Bw = 16.000 MH No calibration applied and no bandpass applied

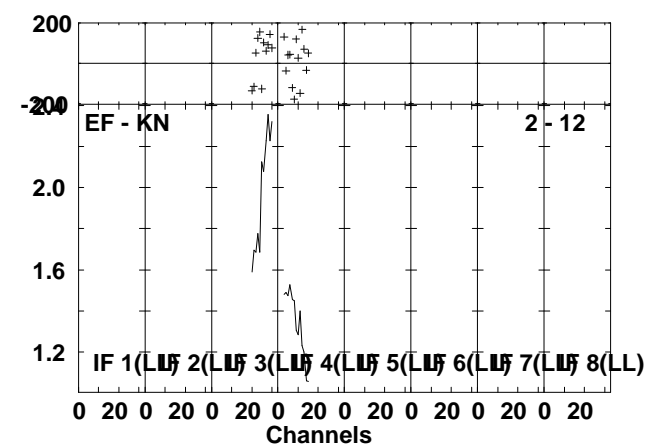
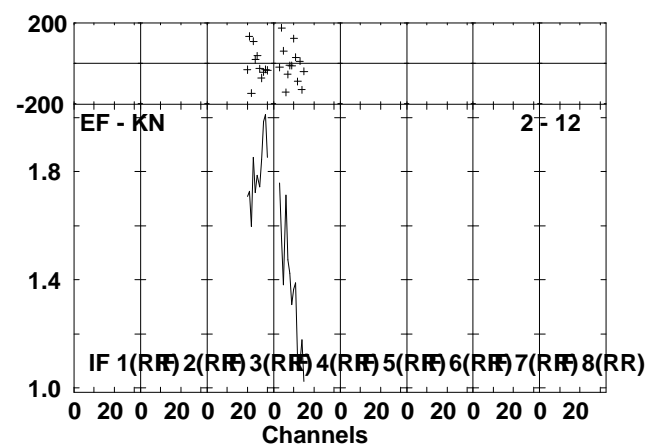
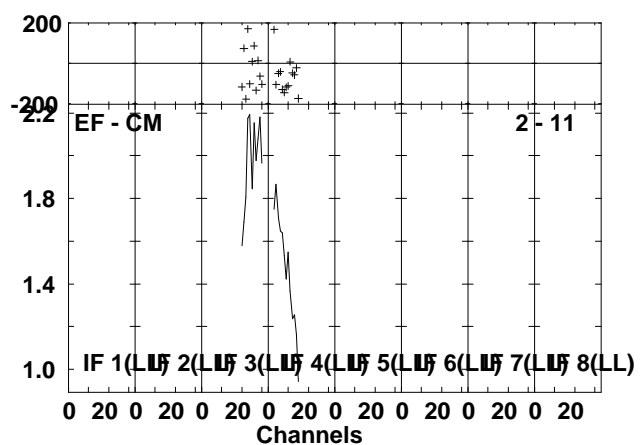
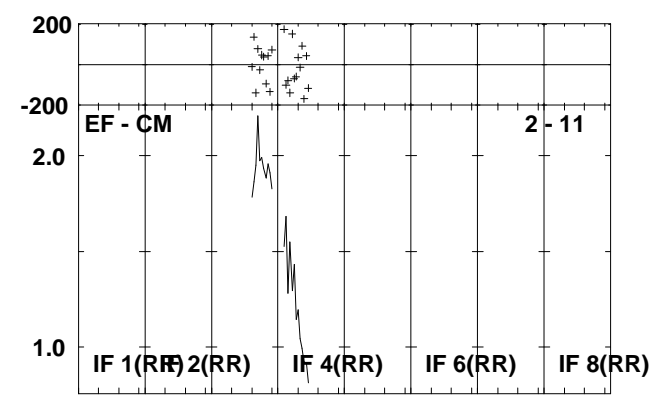
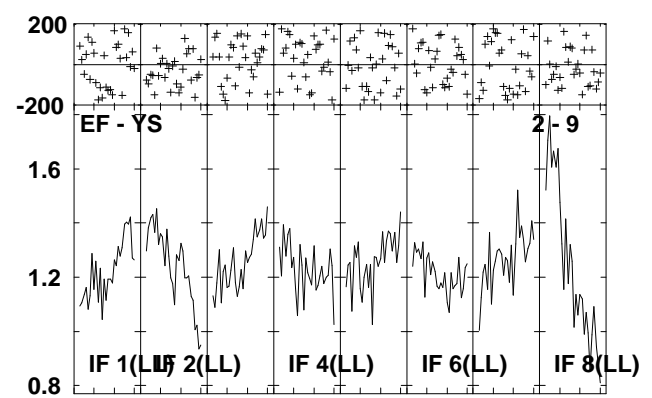
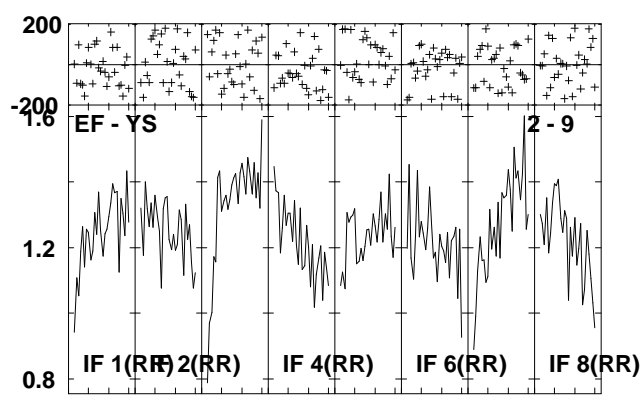
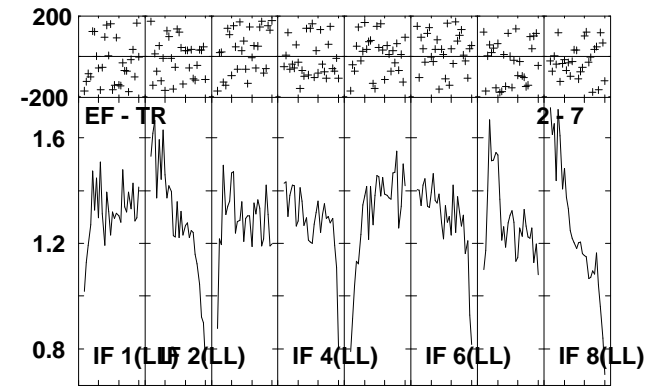
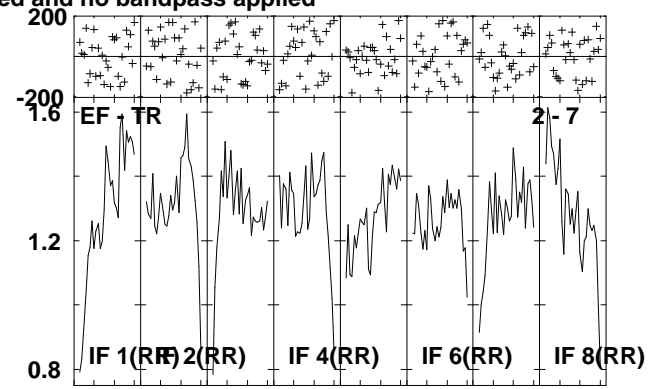
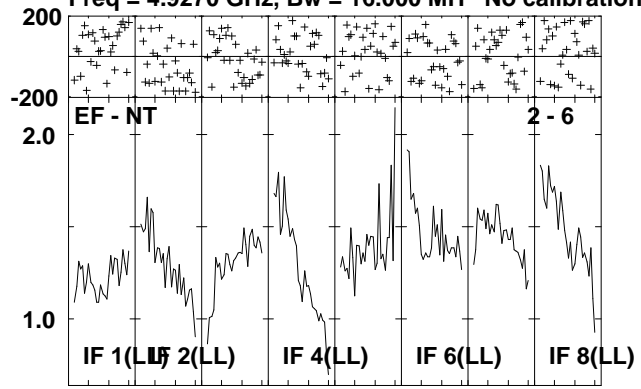

Lower frame: Milli Ampl Jy Top frame: Phas deg
Scalar averaged cross-power spectrum Several baselines displayed
Timerange: 00/14:53:11 to 00/14:56:49

Plot file version 204 created 06-JUL-2010 12:06:49

J2330+33 EP064L.UVDATA.1

Freq = 4.9270 GHz, Bw = 16.000 MH No calibration applied and no bandpass applied

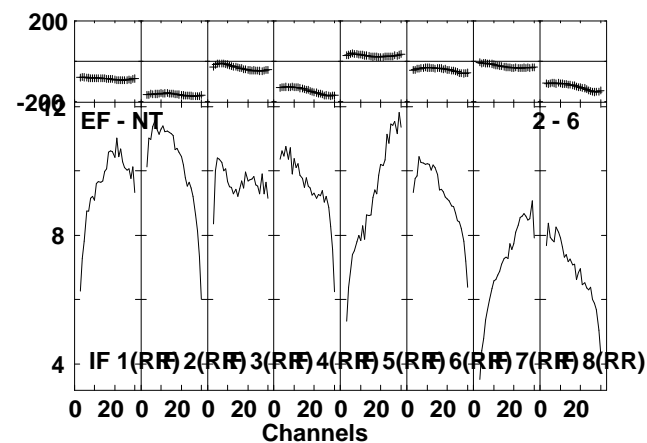
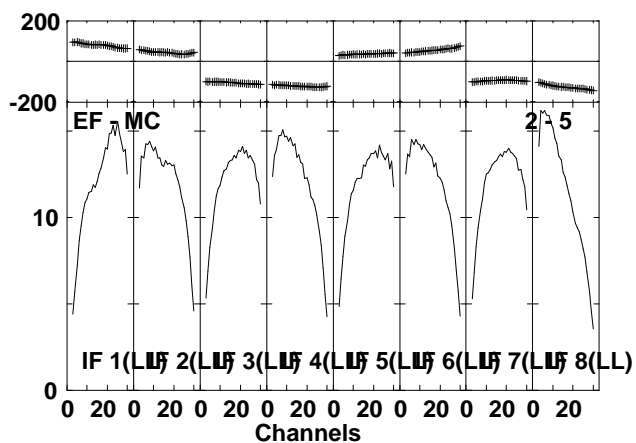
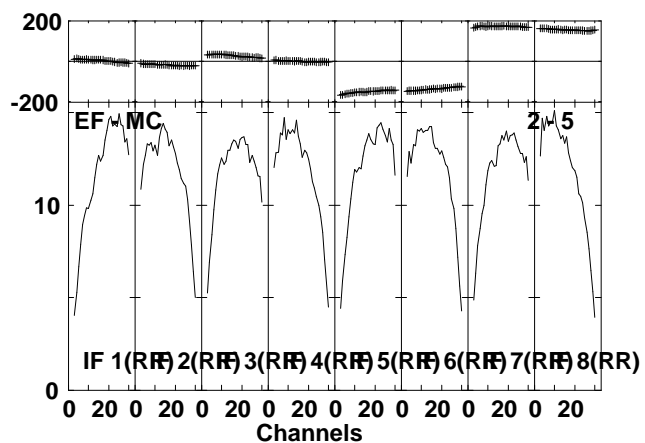
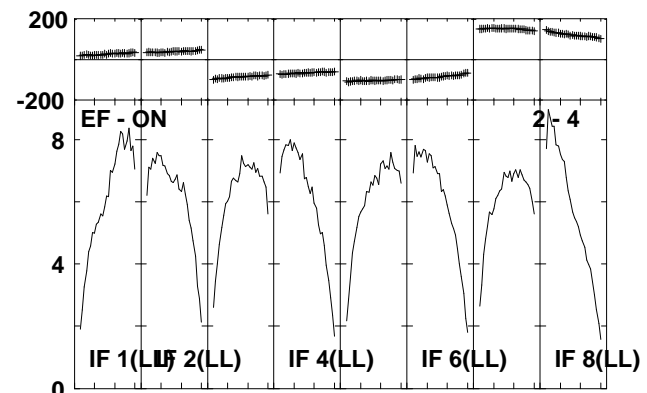
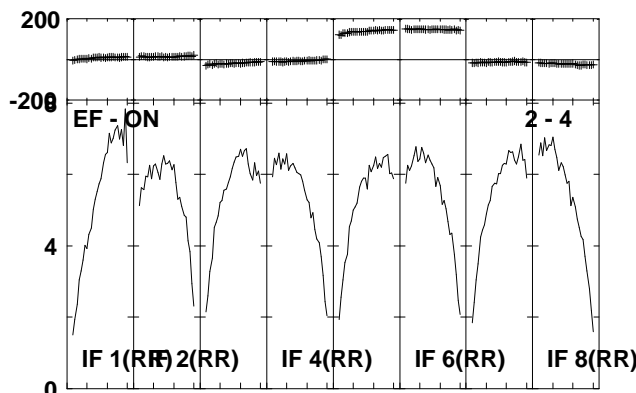
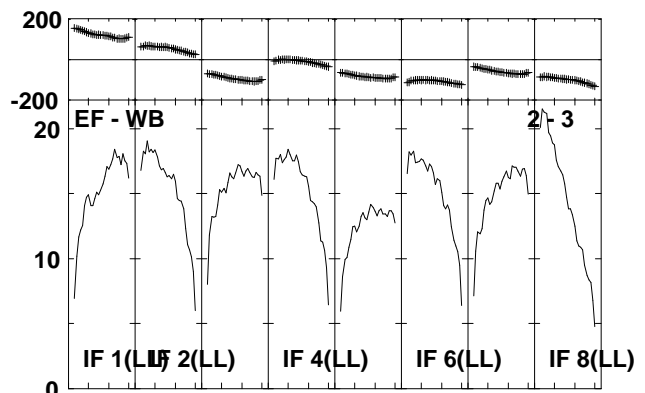
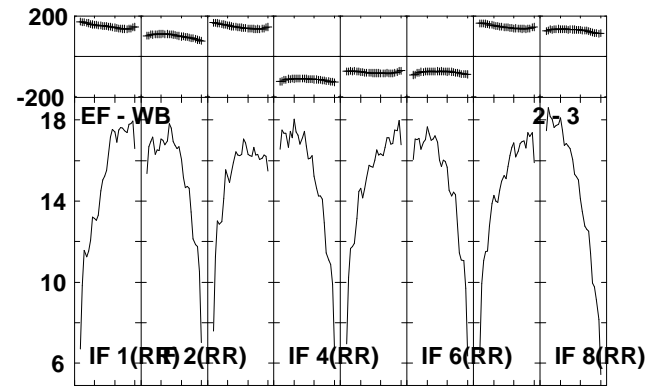
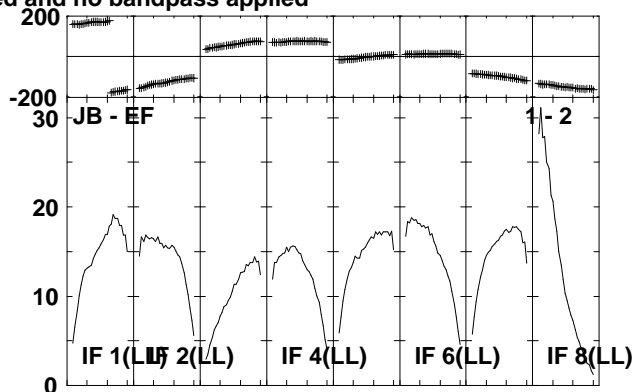
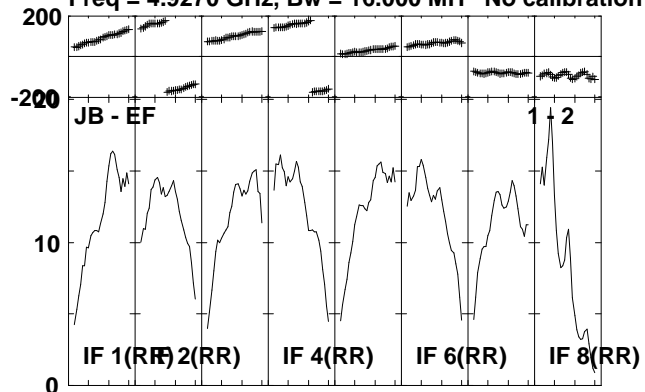

Lower frame: Milli Ampl Jy Top frame: Phas deg
Scalar averaged cross-power spectrum Several baselines displayed
Timerange: 00/14:57:51 to 00/14:59:29

Plot file version 205 created 06-JUL-2010 12:06:50

J2330+33 EP064L.UVDATA.1

Freq = 4.9270 GHz, Bw = 16.000 MH No calibration applied and no bandpass applied

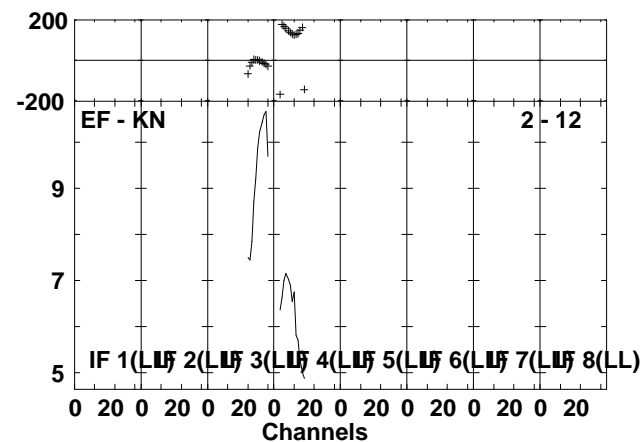
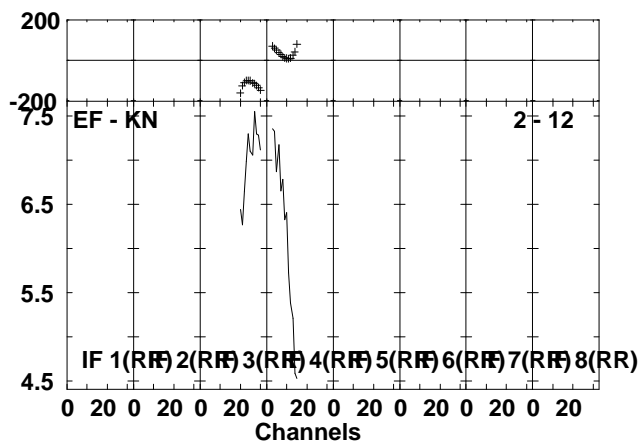
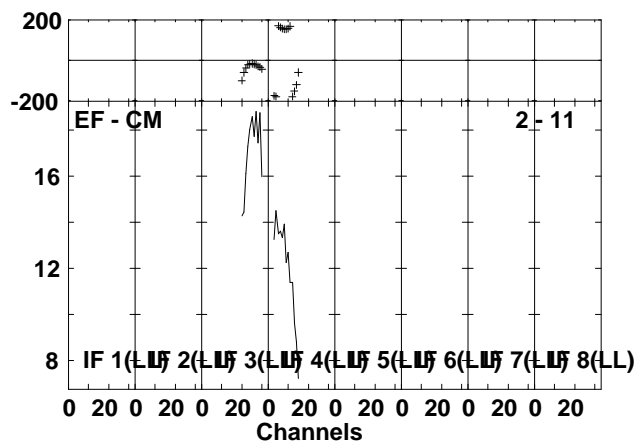
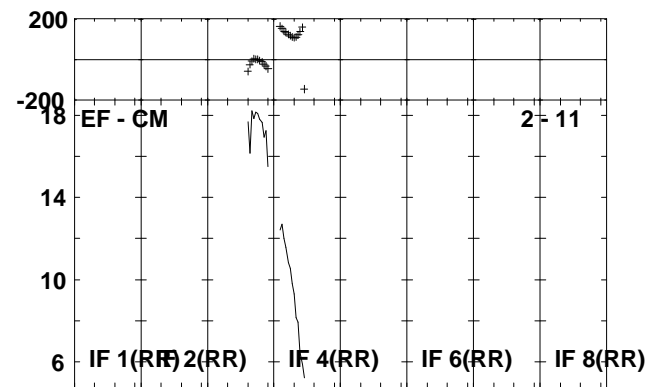
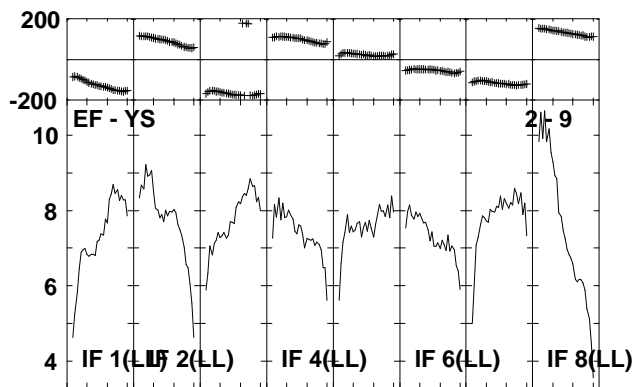
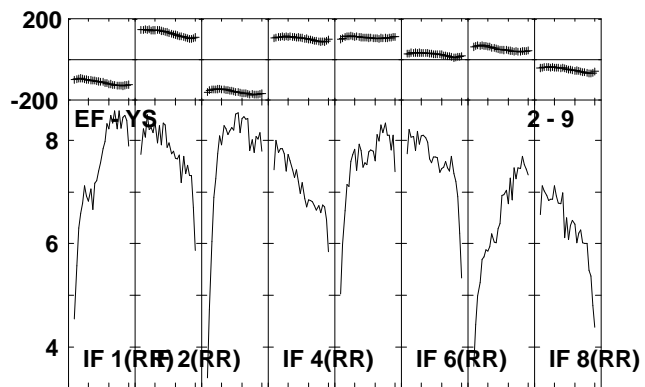
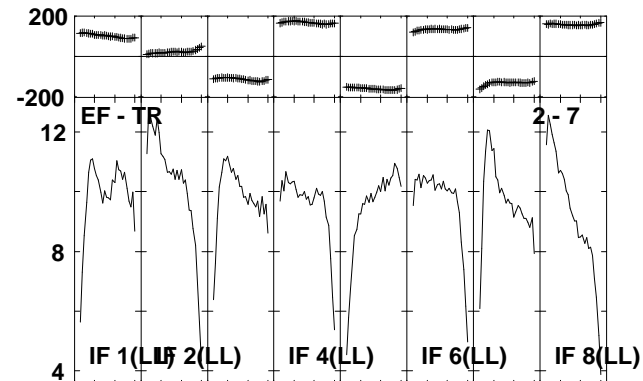
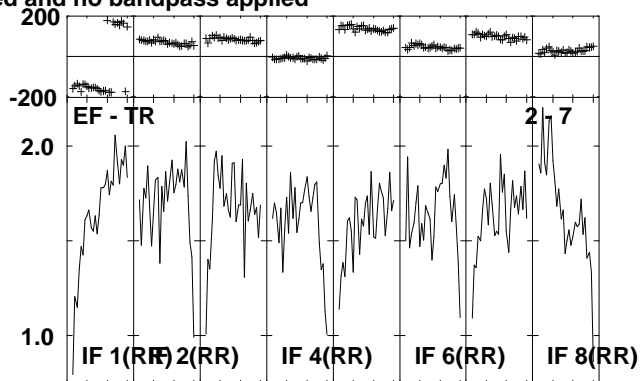
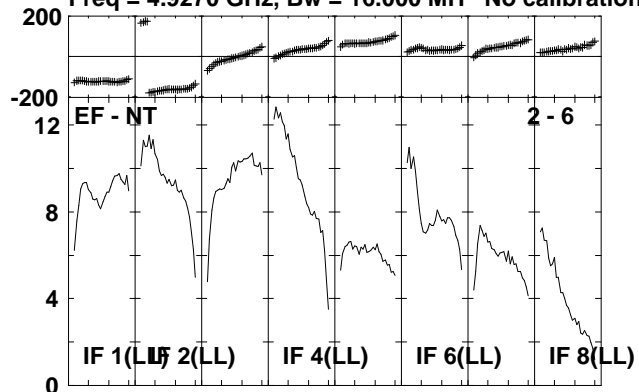

Lower frame: Milli Ampl Jy Top frame: Phas deg
Scalar averaged cross-power spectrum Several baselines displayed
Timerange: 00/14:57:51 to 00/14:59:29

Plot file version 206 created 06-JUL-2010 12:06:52

IRAS2336 EP064L.UVDATA.1

Freq = 4.9270 GHz, Bw = 16.000 MH No calibration applied and no bandpass applied

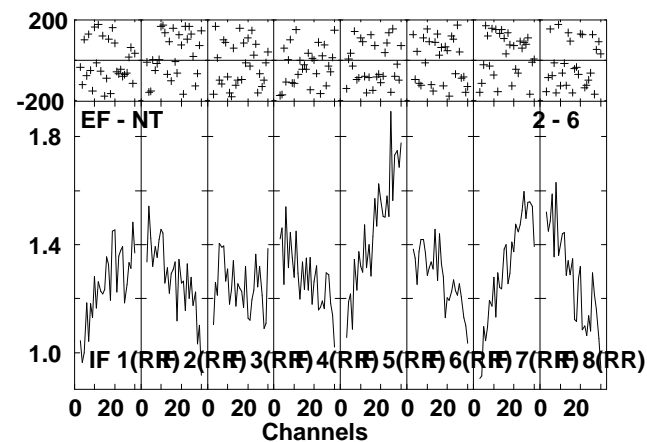
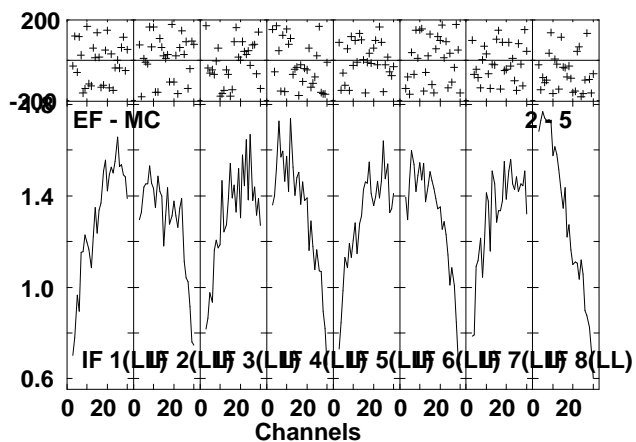
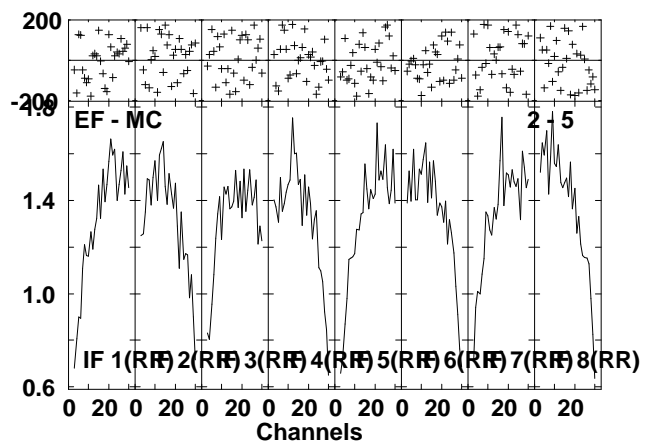
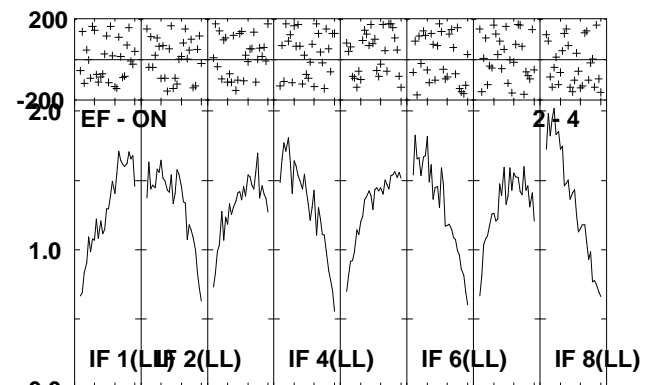
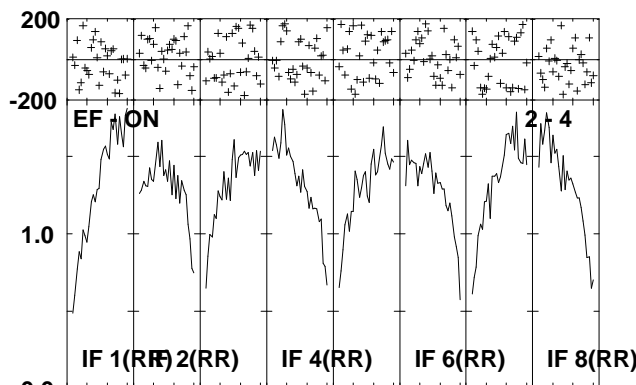
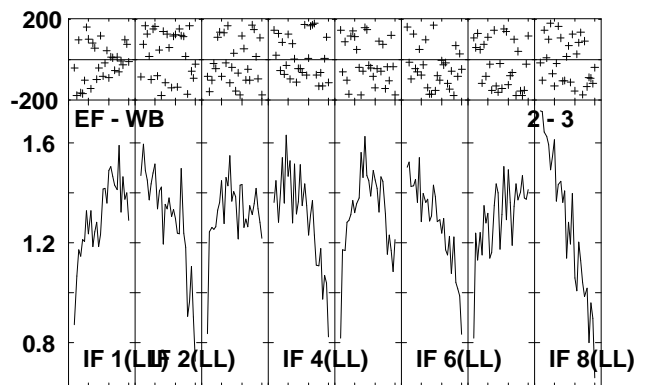
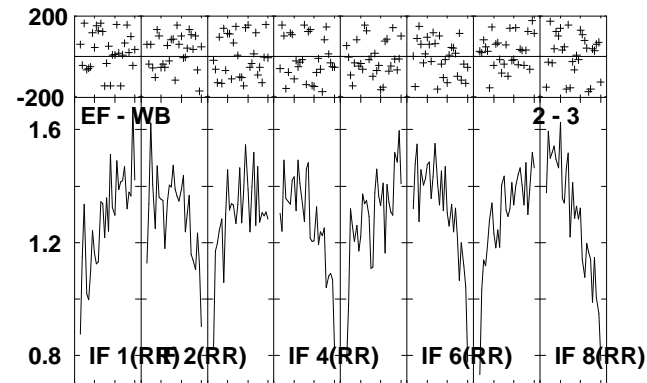
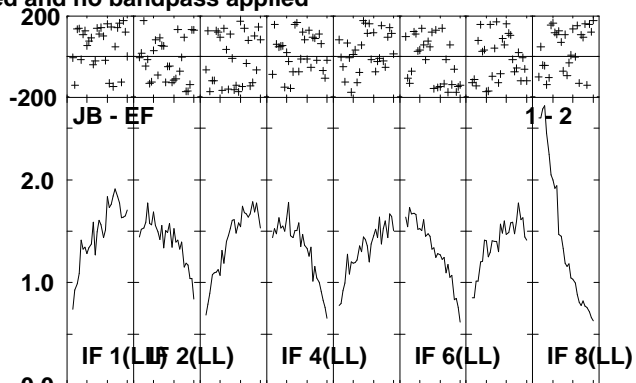
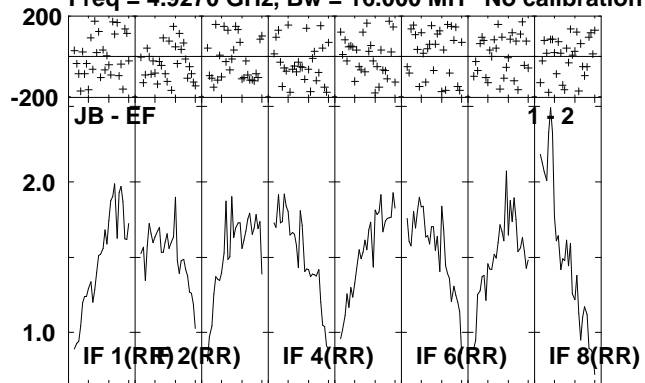

Lower frame: Milli Ampl Jy Top frame: Phas deg
Scalar averaged cross-power spectrum Several baselines displayed
Timerange: 00/14:59:31 to 00/15:03:09

Plot file version 207 created 06-JUL-2010 12:06:59

IRAS2336 EP064L.UVDATA.1

Freq = 4.9270 GHz, Bw = 16.000 MH No calibration applied and no bandpass applied

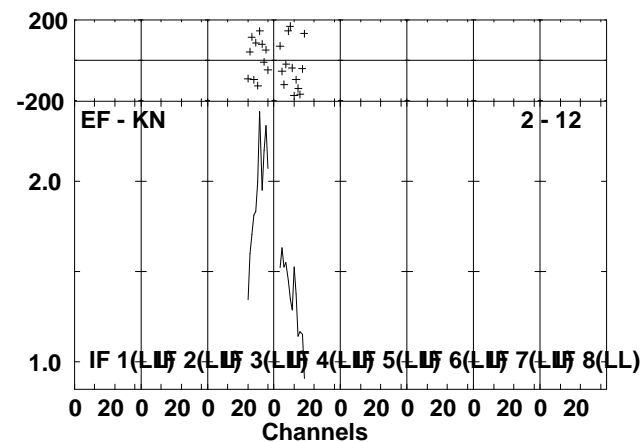
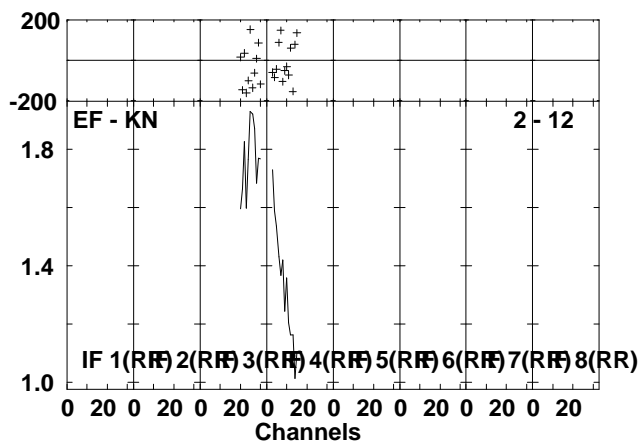
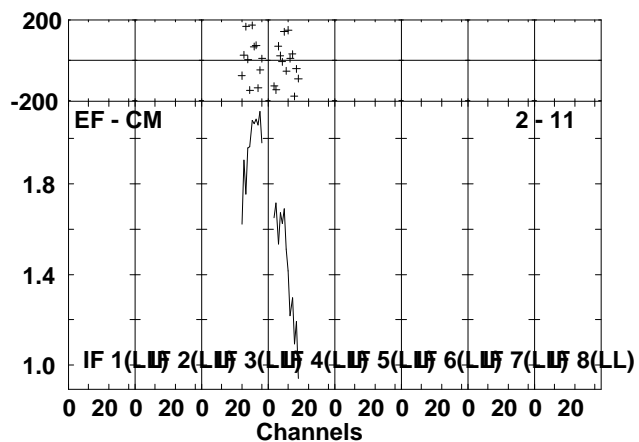
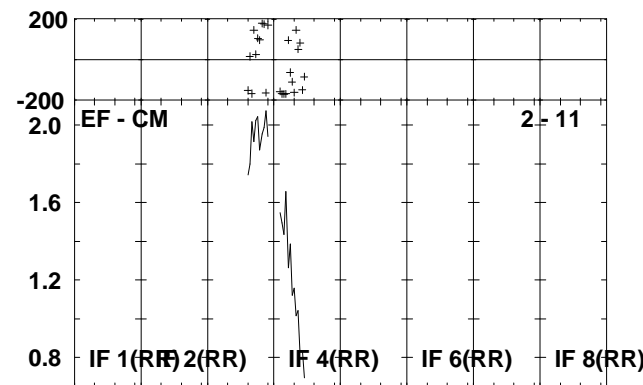
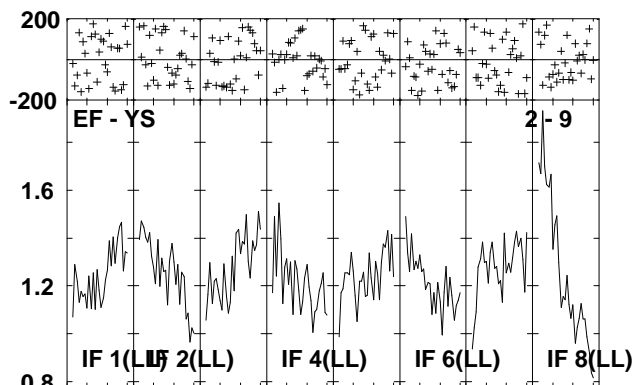
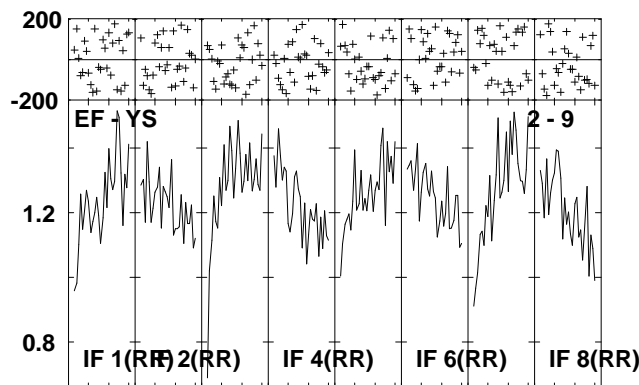
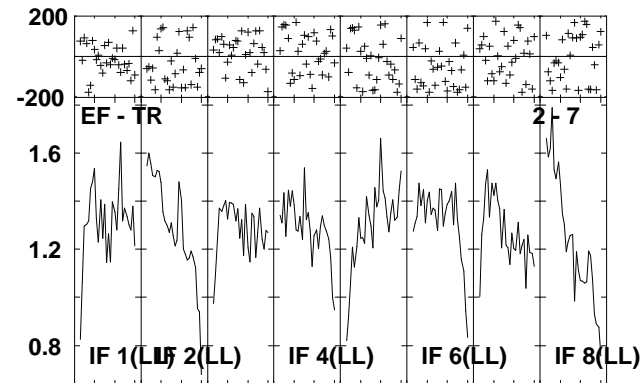
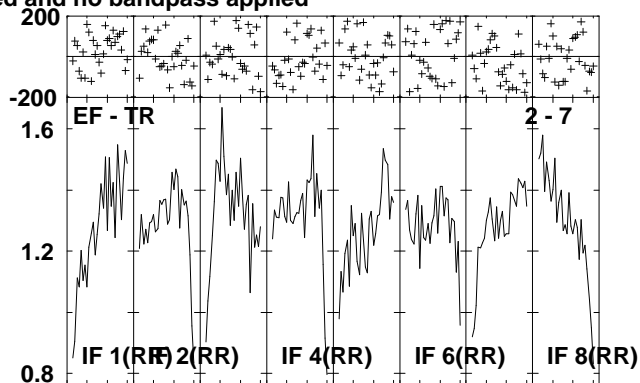
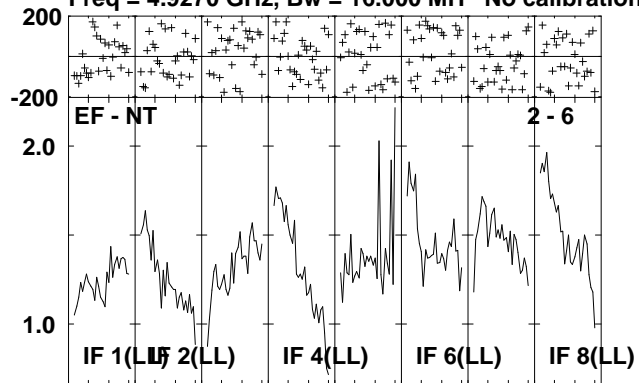

Lower frame: Milli Ampl Jy Top frame: Phas deg
Scalar averaged cross-power spectrum Several baselines displayed
Timerange: 00/14:59:31 to 00/15:03:09

Plot file version 208 created 06-JUL-2010 12:07:03

J2330+33 EP064L.UVDATA.1

Freq = 4.9270 GHz, Bw = 16.000 MH No calibration applied and no bandpass applied

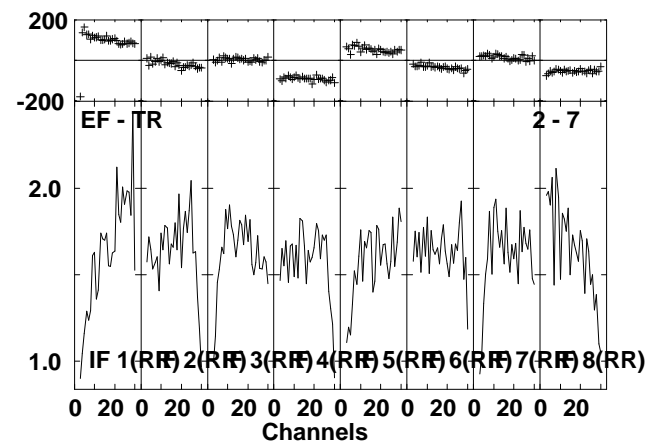
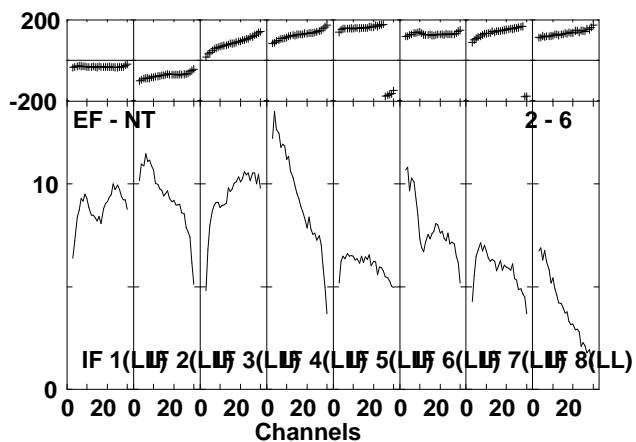
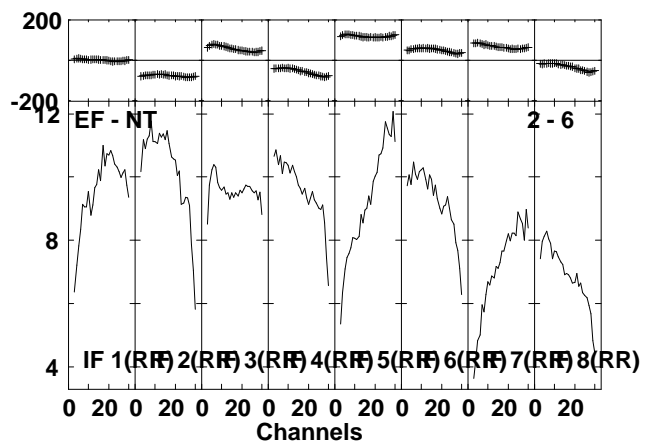
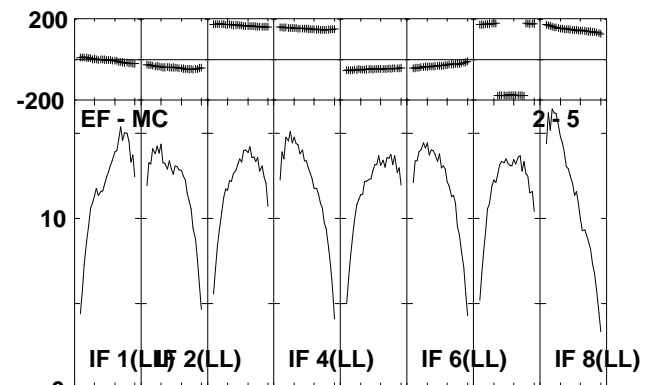
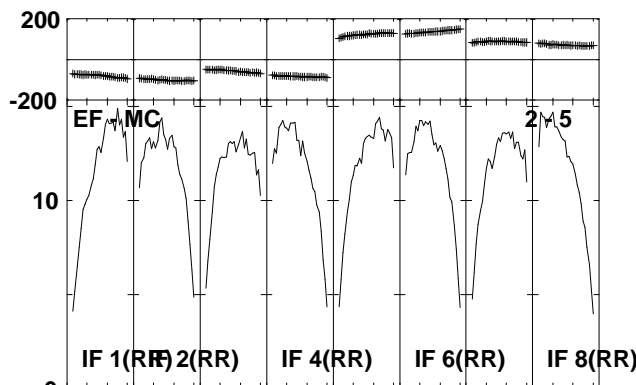
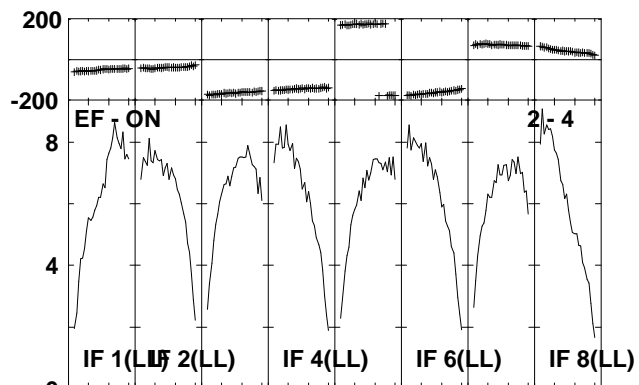
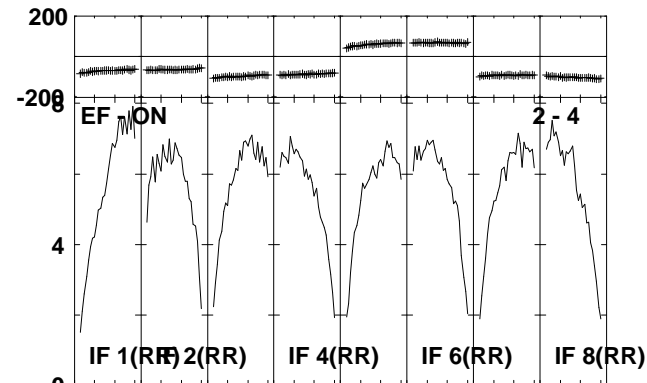
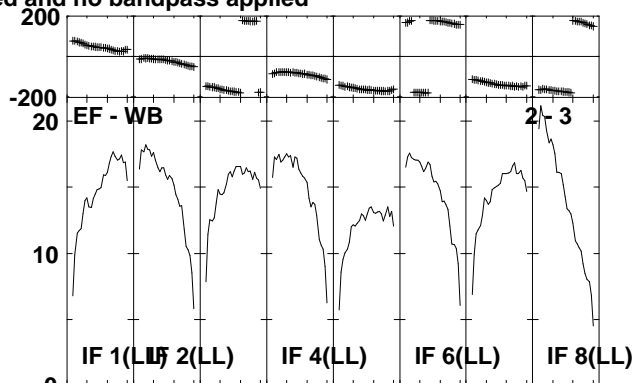
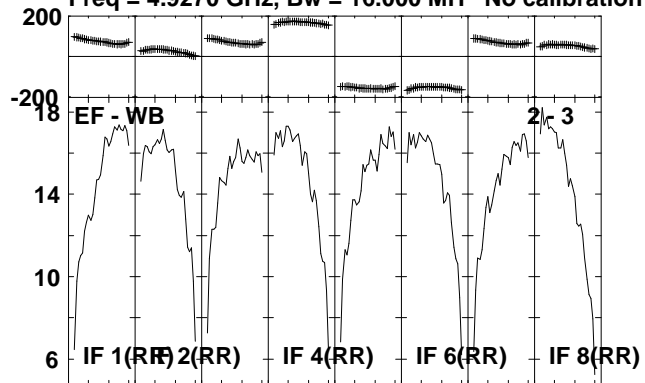

Lower frame: Milli Ampl Jy Top frame: Phas deg
Scalar averaged cross-power spectrum Several baselines displayed
Timerange: 00/15:03:11 to 00/15:04:59

Plot file version 209 created 06-JUL-2010 12:07:04

J2330+33 EP064L.UVDATA.1

Freq = 4.9270 GHz, Bw = 16.000 MH No calibration applied and no bandpass applied

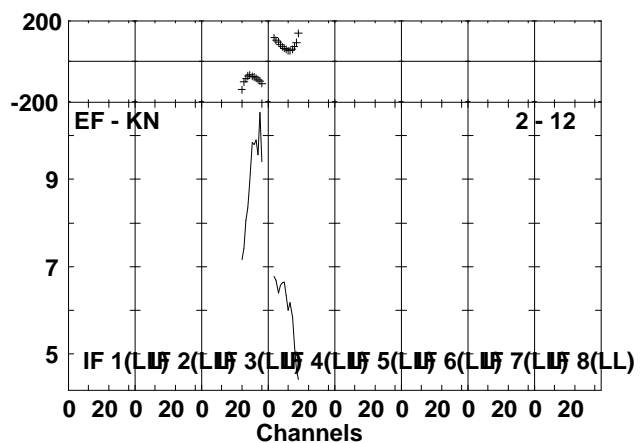
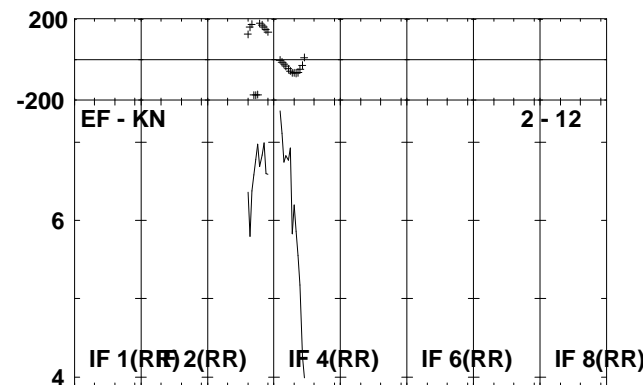
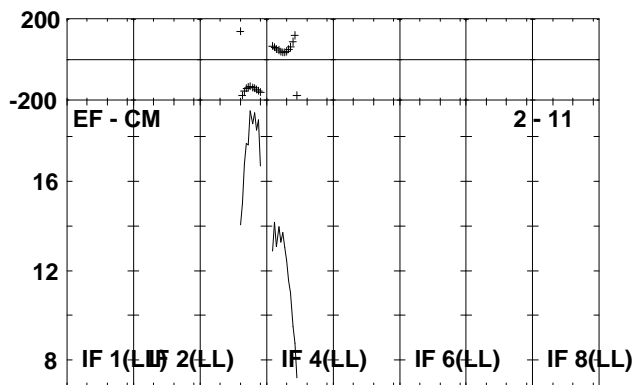
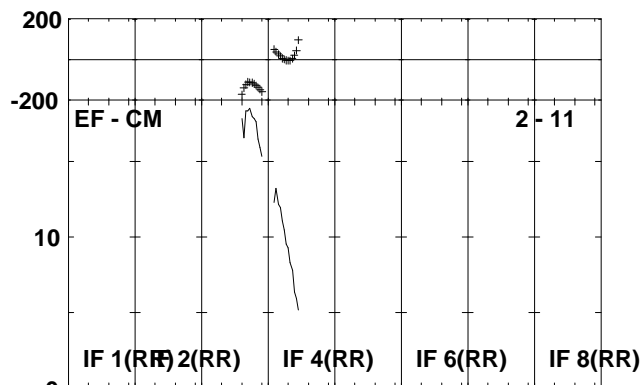
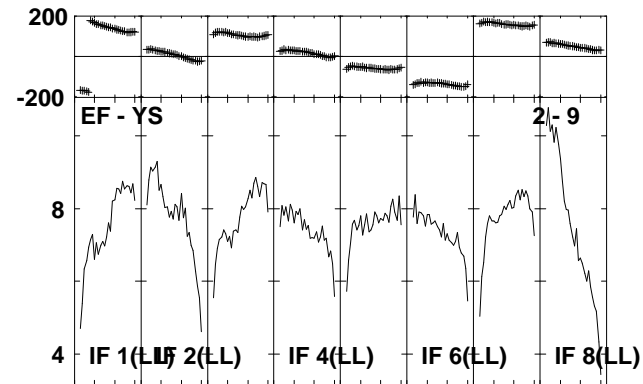
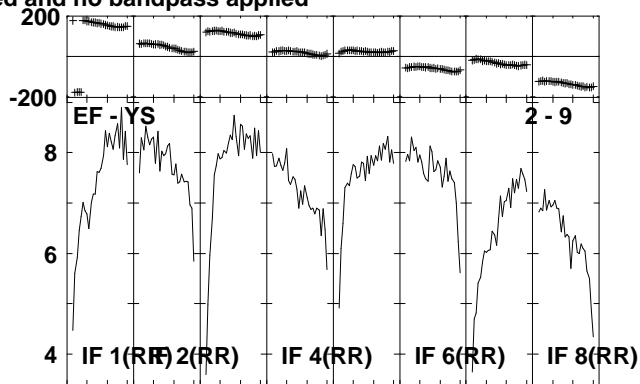
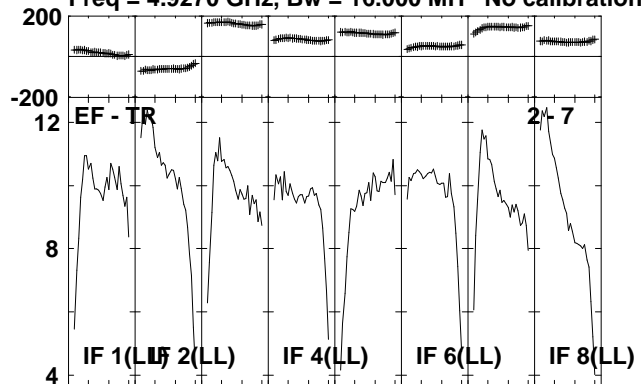

Lower frame: Milli Ampl Jy Top frame: Phas deg
Scalar averaged cross-power spectrum Several baselines displayed
Timerange: 00/15:03:11 to 00/15:04:59

Plot file version 210 created 06-JUL-2010 12:07:05

IRAS2336 EP064L.UVDATA.1

Freq = 4.9270 GHz, Bw = 16.000 MH No calibration applied and no bandpass applied

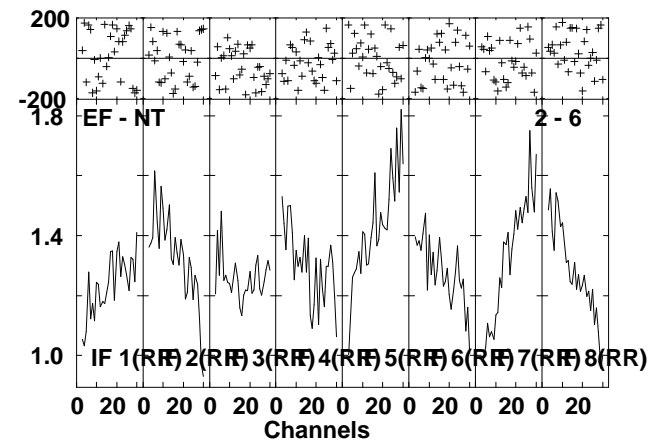
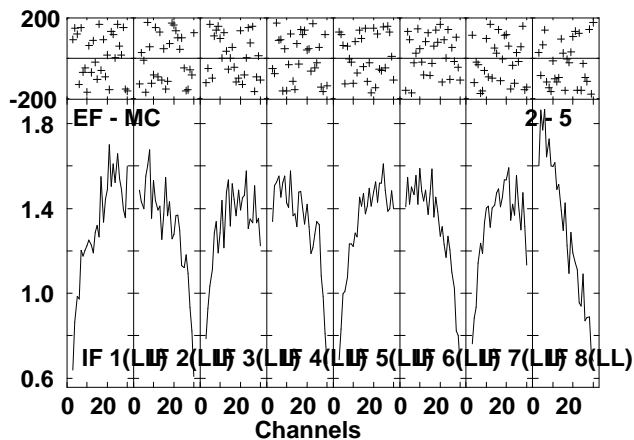
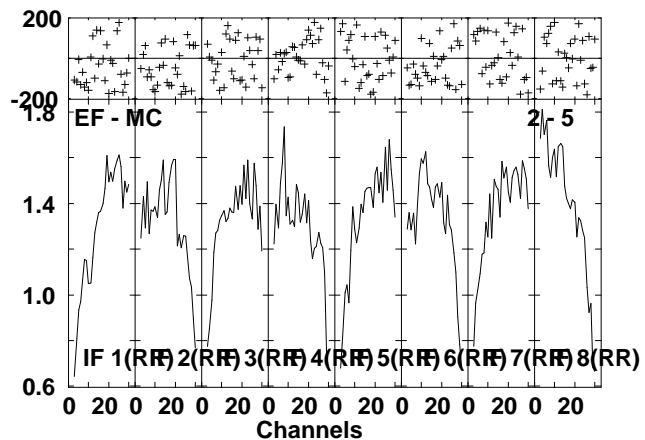
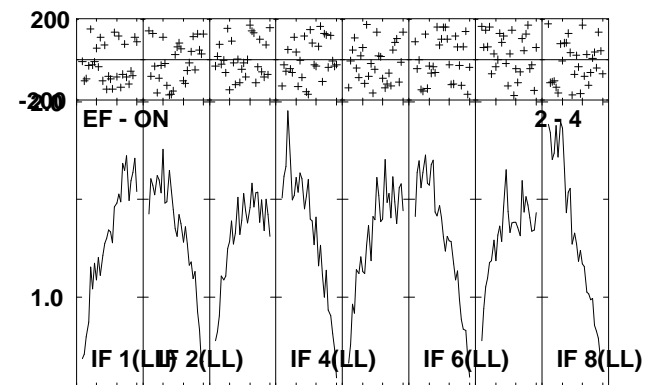
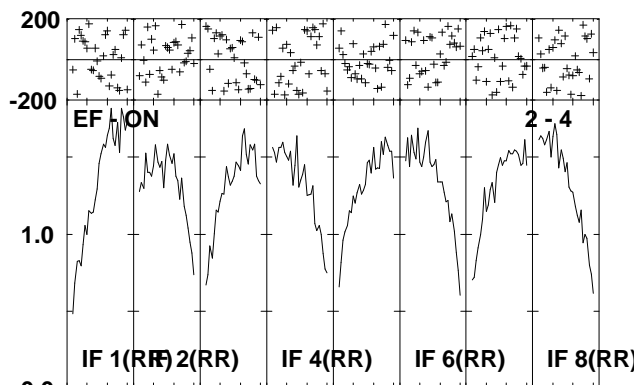
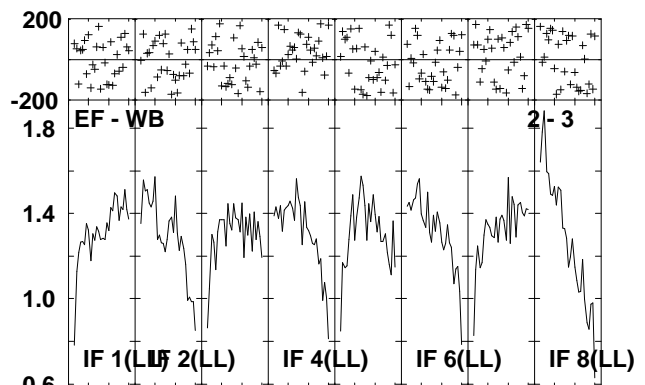
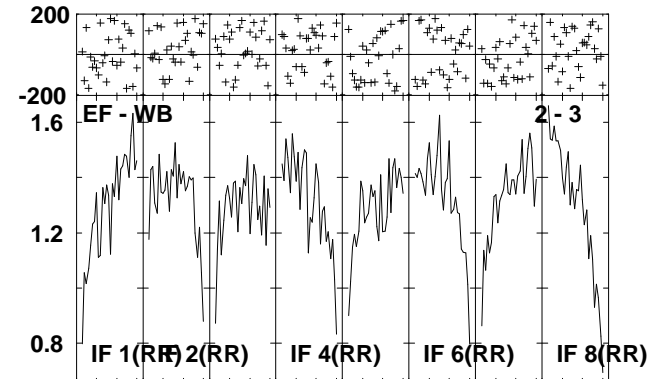
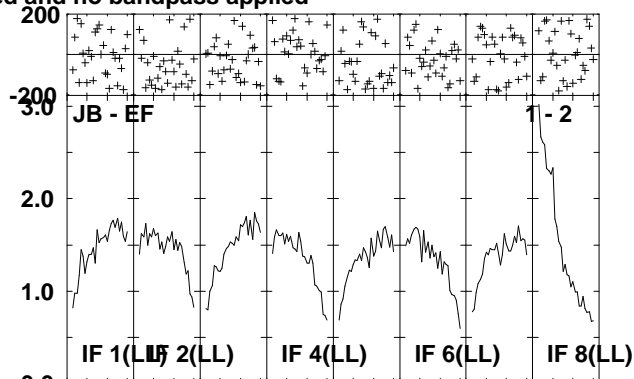
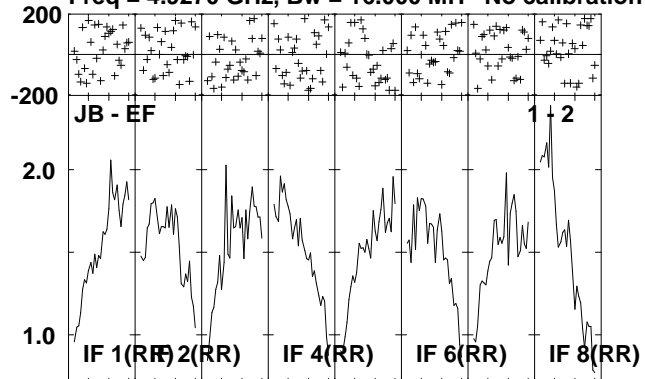

Lower frame: Milli Ampl Jy Top frame: Phas deg
Scalar averaged cross-power spectrum Several baselines displayed
Timerange: 00/15:05:01 to 00/15:08:39

Plot file version 211 created 06-JUL-2010 12:07:07

IRAS2336 EP064L.UVDATA.1

Freq = 4.9270 GHz, Bw = 16.000 MH No calibration applied and no bandpass applied

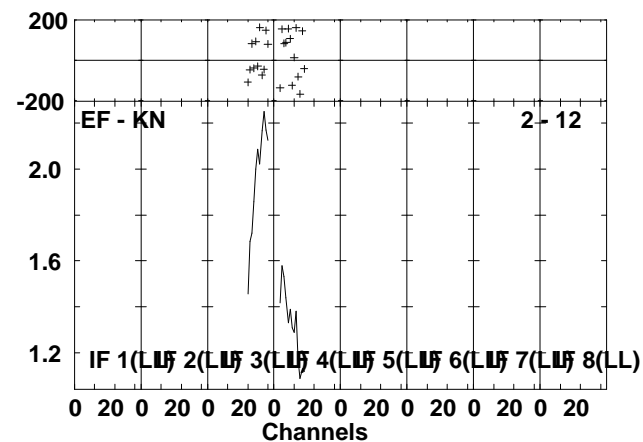
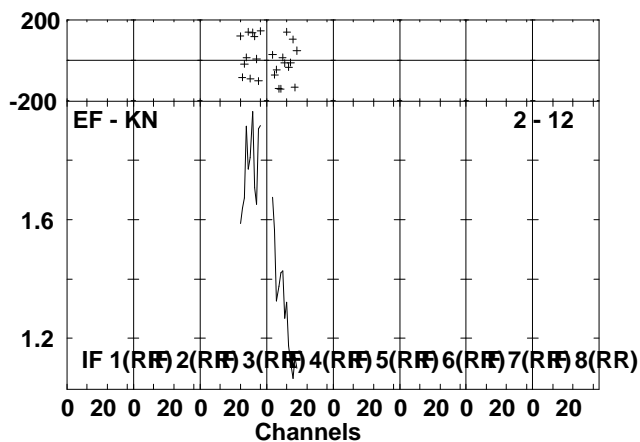
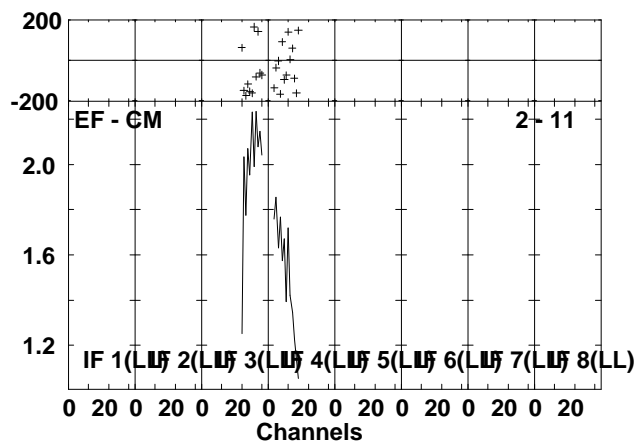
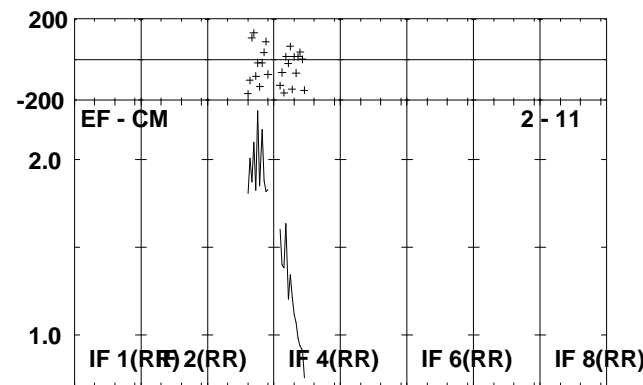
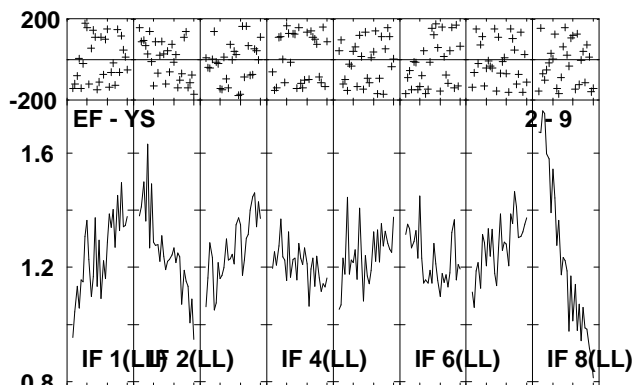
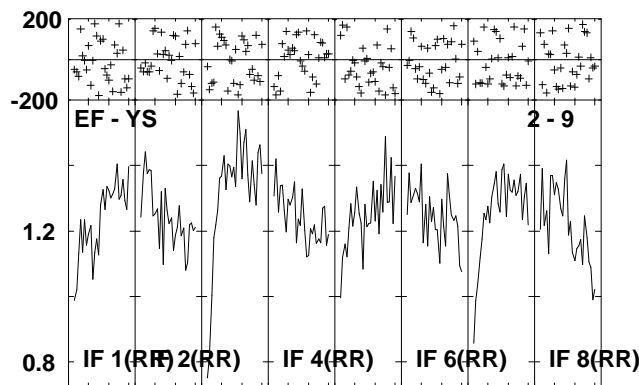
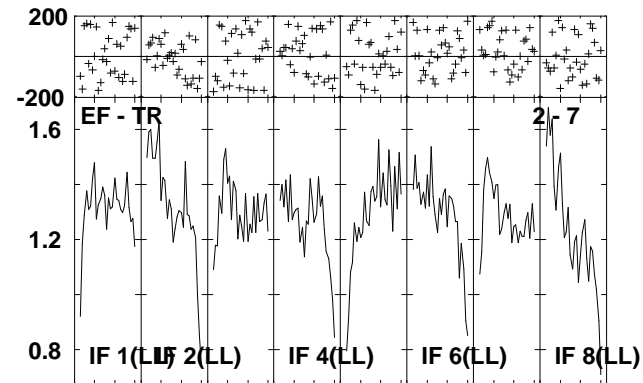
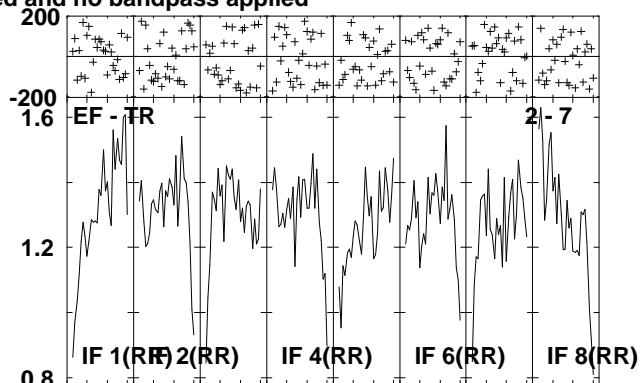
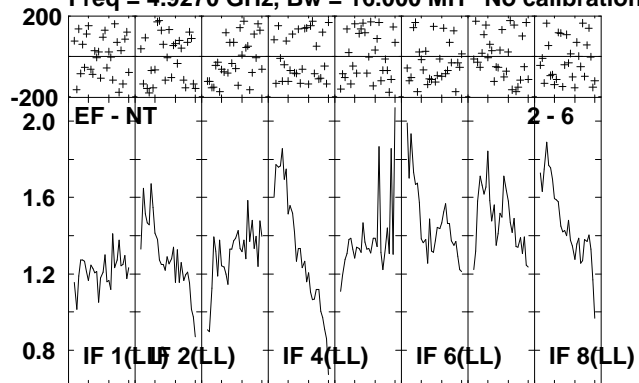

Lower frame: Milli Ampl Jy Top frame: Phas deg
Scalar averaged cross-power spectrum Several baselines displayed
Timerange: 00/15:05:01 to 00/15:08:39

Plot file version 212 created 06-JUL-2010 12:07:11

J2330+33 EP064L.UVDATA.1

Freq = 4.9270 GHz, Bw = 16.000 MH No calibration applied and no bandpass applied

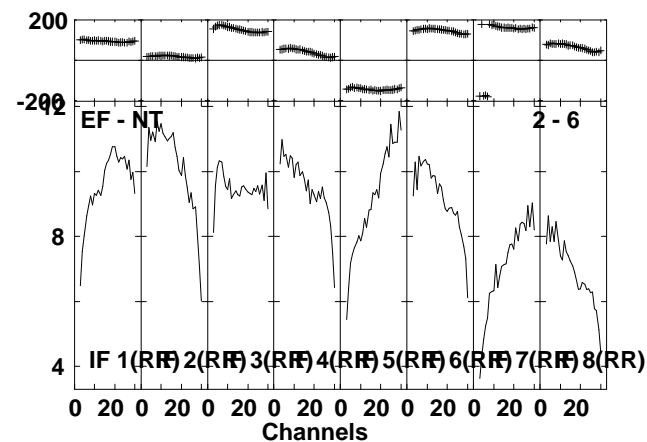
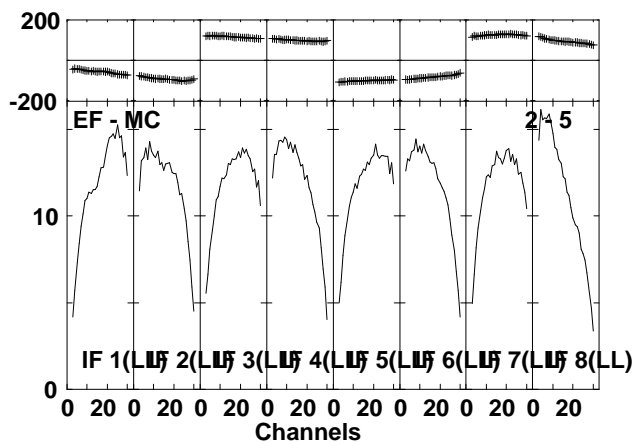
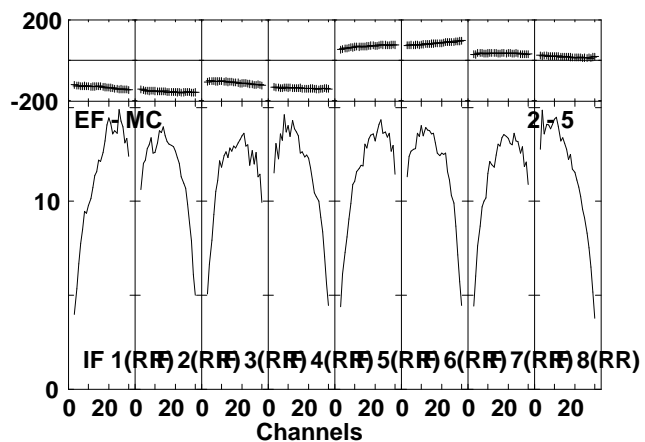
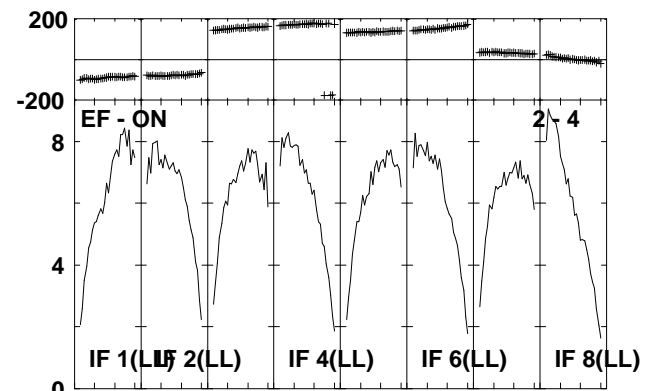
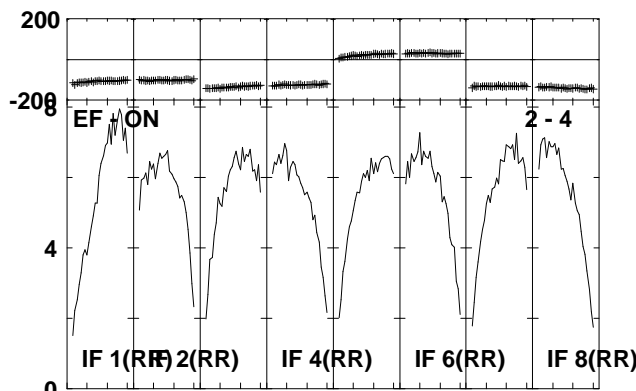
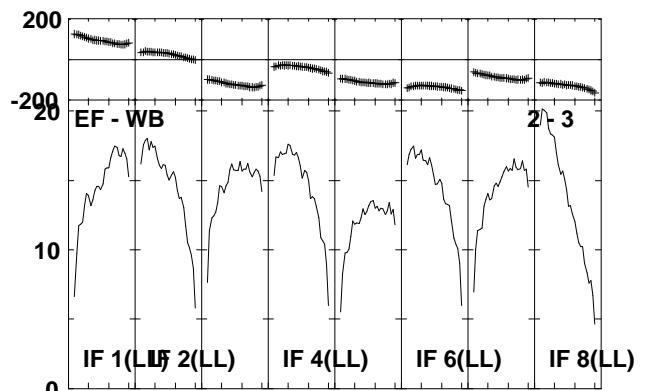
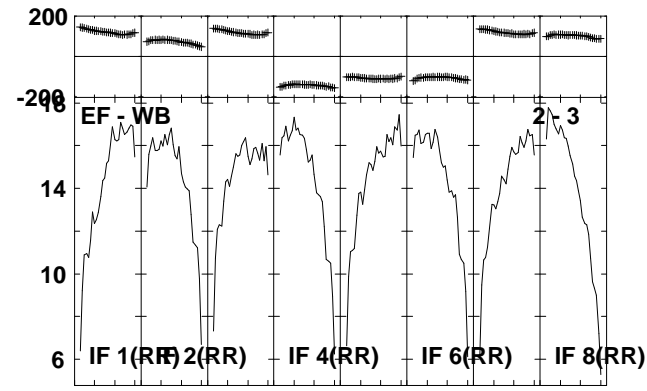
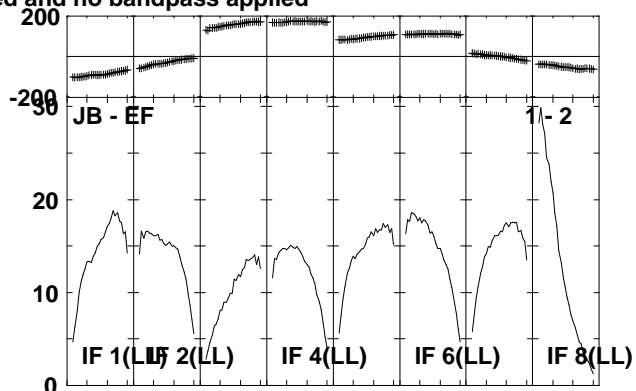
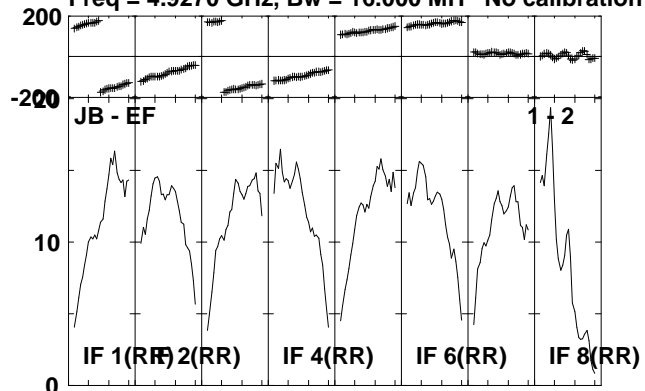

Lower frame: Milli Ampl Jy Top frame: Phas deg
Scalar averaged cross-power spectrum Several baselines displayed
Timerange: 00/15:08:41 to 00/15:10:29

Plot file version 213 created 06-JUL-2010 12:07:12

J2330+33 EP064L.UVDATA.1

Freq = 4.9270 GHz, Bw = 16.000 MH No calibration applied and no bandpass applied

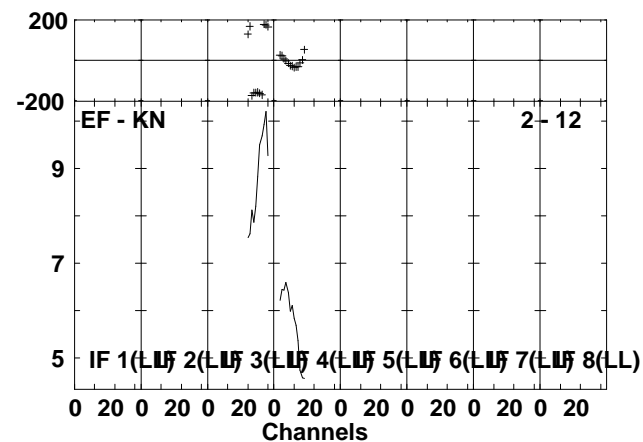
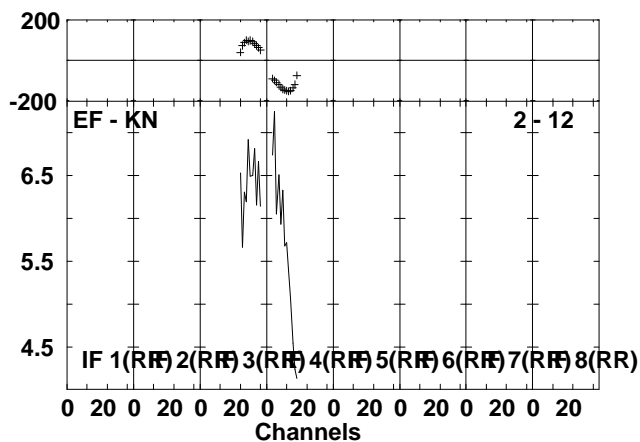
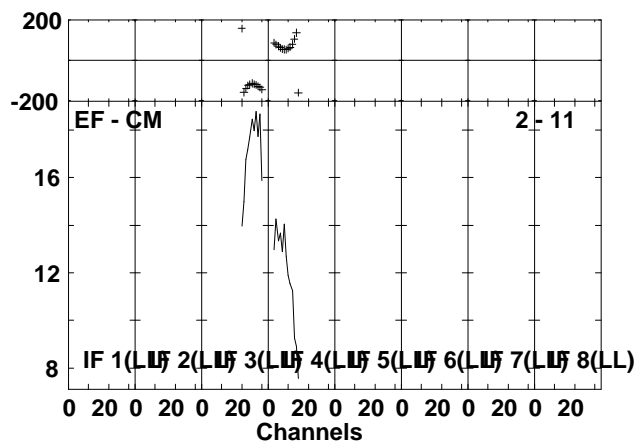
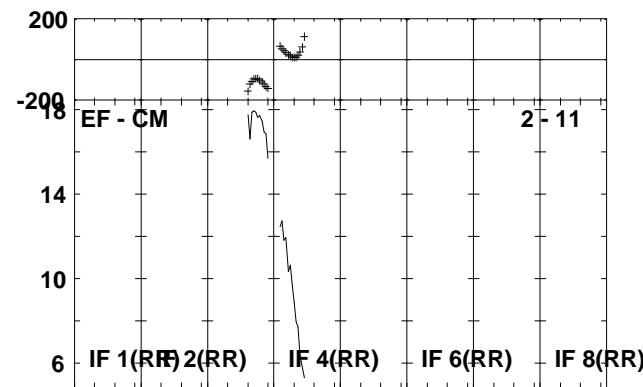
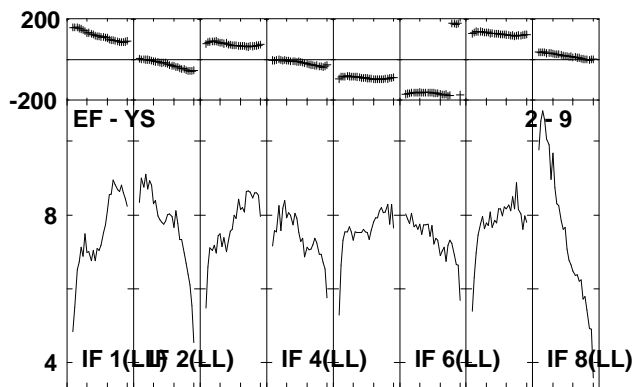
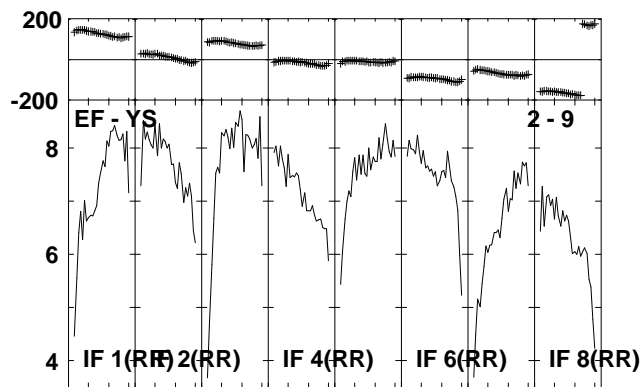
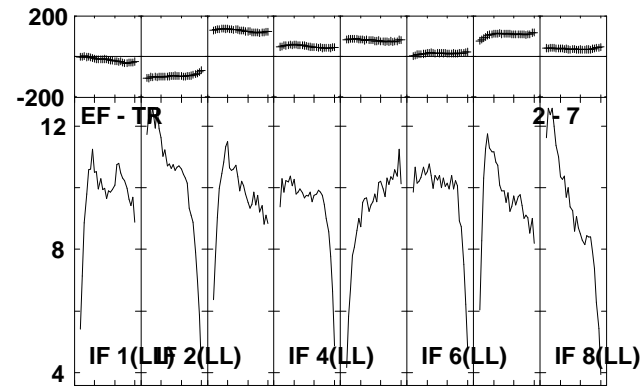
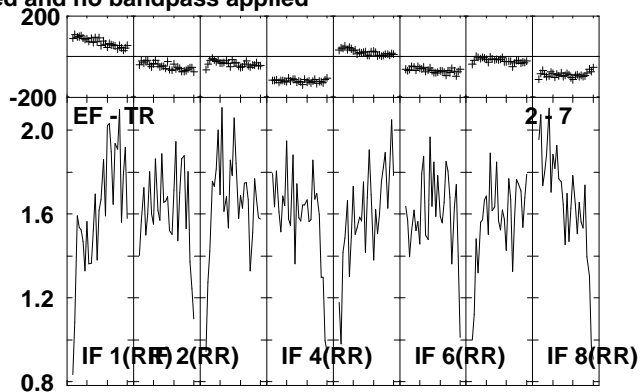
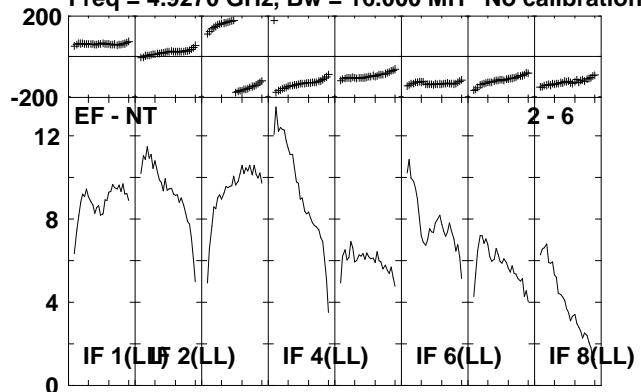

Lower frame: Milli Ampl Jy Top frame: Phas deg
Scalar averaged cross-power spectrum Several baselines displayed
Timerange: 00/15:08:41 to 00/15:10:29

Plot file version 214 created 06-JUL-2010 12:07:14

IRAS2336 EP064L.UVDATA.1

Freq = 4.9270 GHz, Bw = 16.000 MH No calibration applied and no bandpass applied

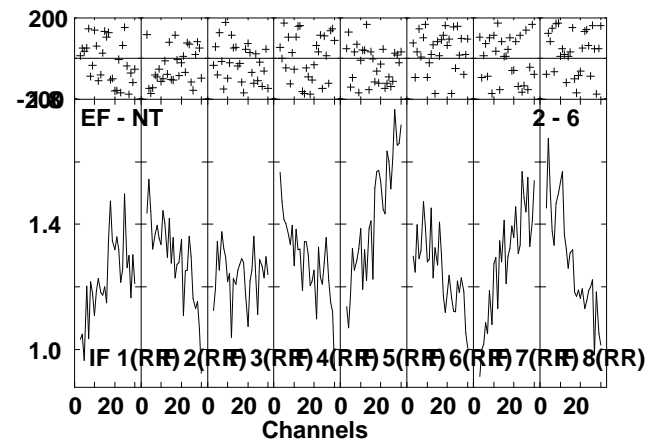
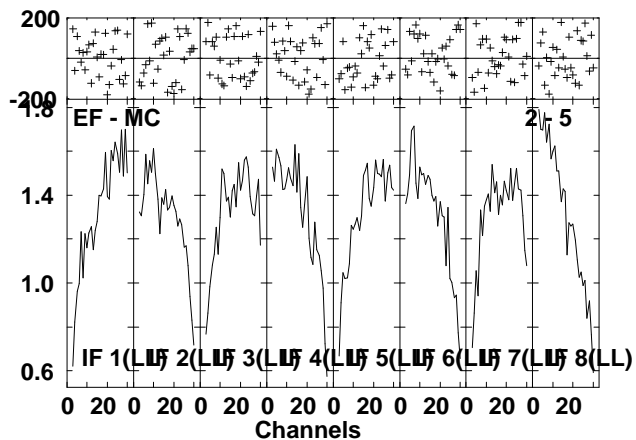
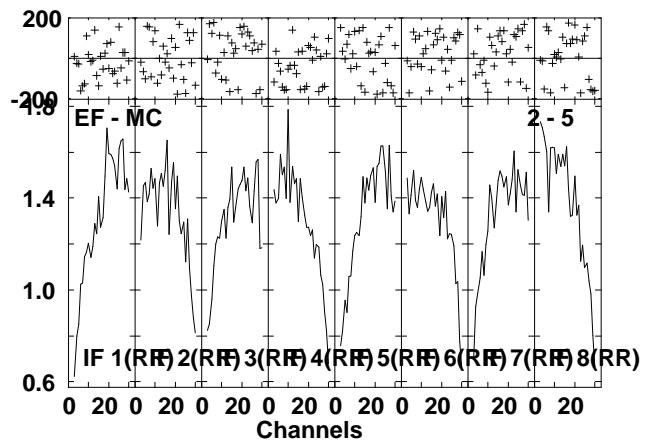
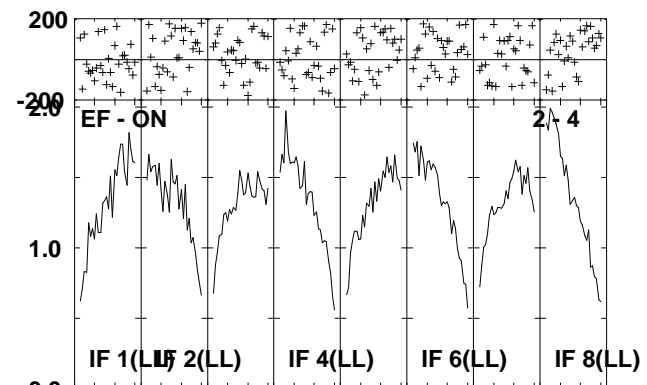
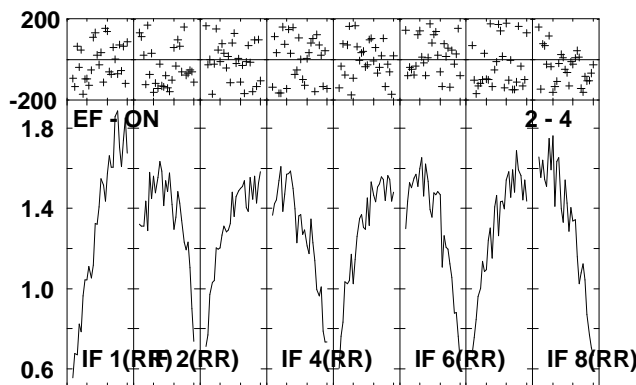
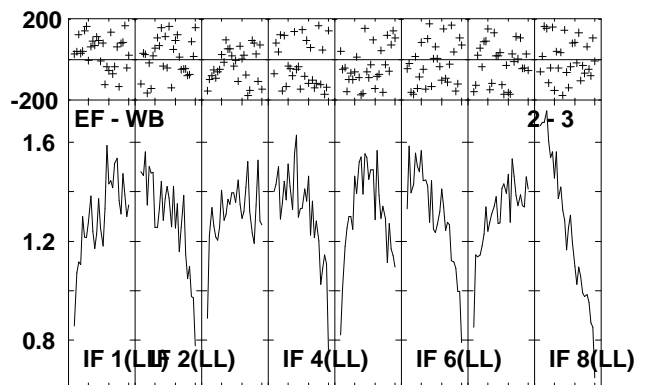
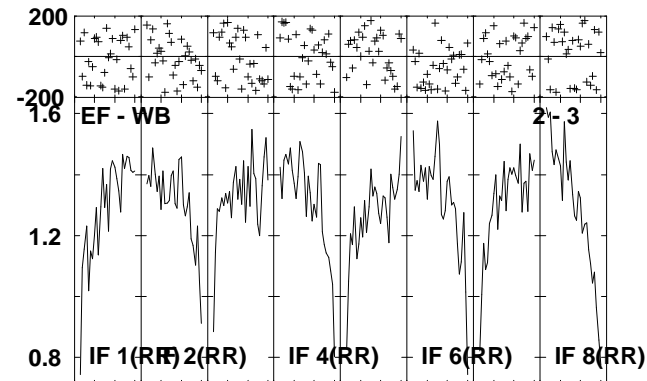
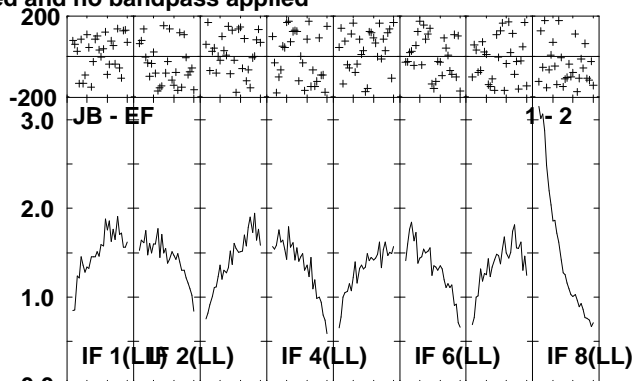
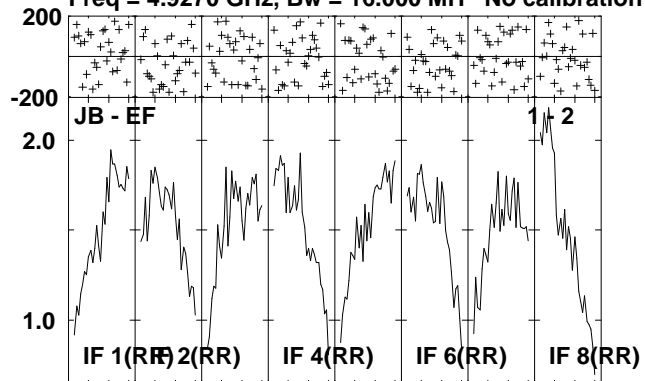

Lower frame: Milli Ampl Jy Top frame: Phas deg
Scalar averaged cross-power spectrum Several baselines displayed
Timerange: 00/15:10:31 to 00/15:14:07

Plot file version 215 created 06-JUL-2010 12:07:16

IRAS2336 EP064L.UVDATA.1

Freq = 4.9270 GHz, Bw = 16.000 MH No calibration applied and no bandpass applied

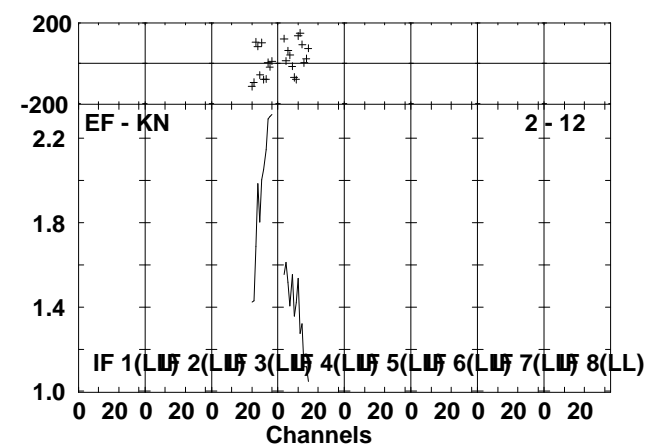
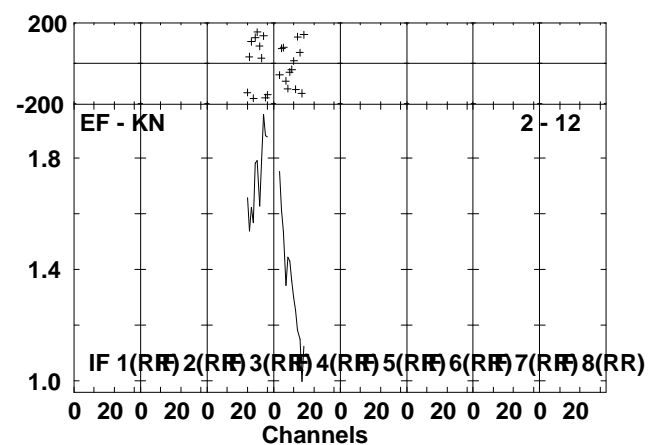
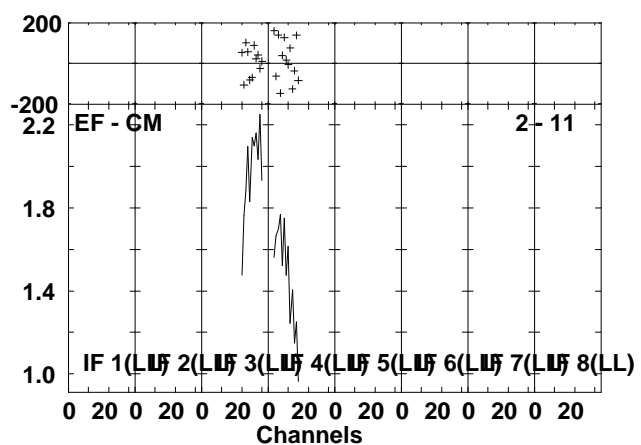
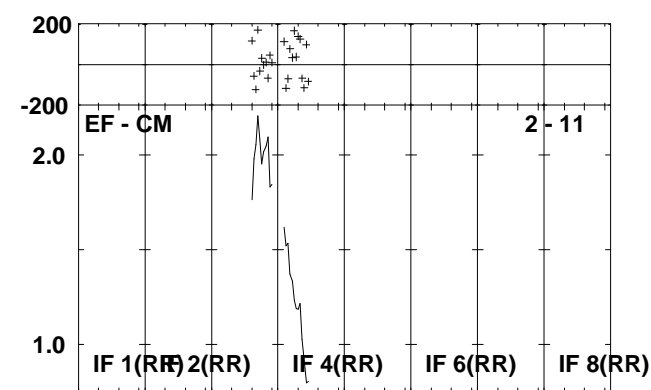
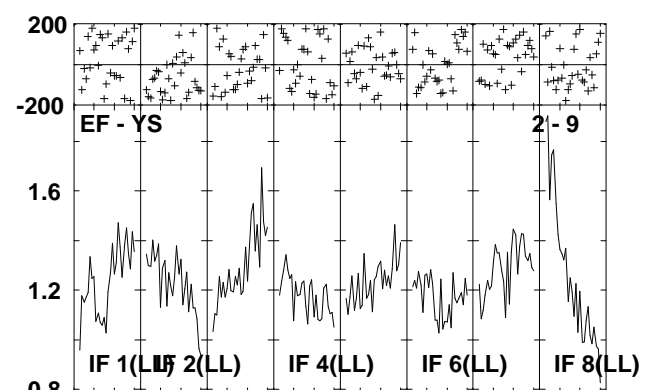
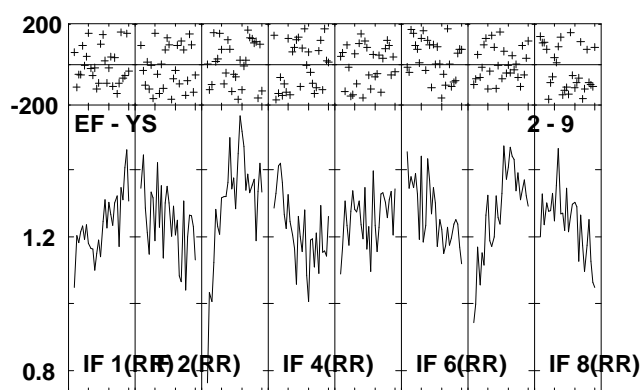
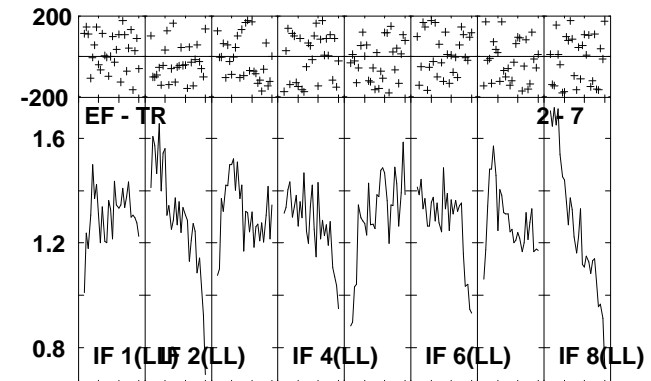
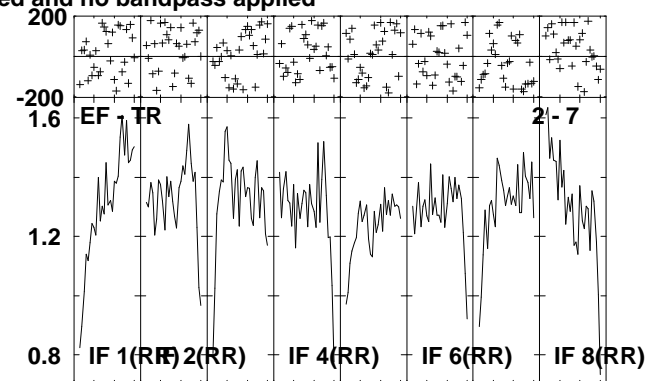
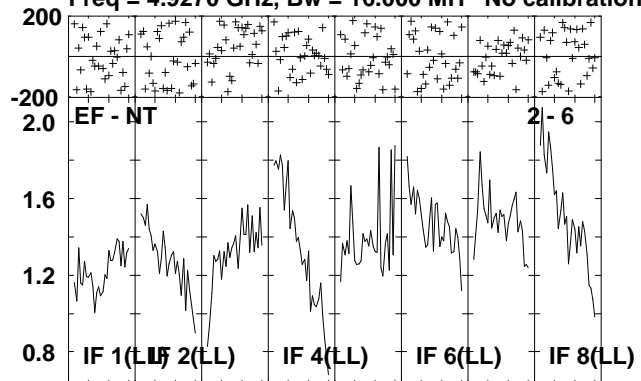

Lower frame: Milli Ampl Jy Top frame: Phas deg
Scalar averaged cross-power spectrum Several baselines displayed
Timerange: 00/15:10:31 to 00/15:14:07

Plot file version 216 created 06-JUL-2010 12:07:19

J2330+33 EP064L.UVDATA.1

Freq = 4.9270 GHz, Bw = 16.000 MH No calibration applied and no bandpass applied

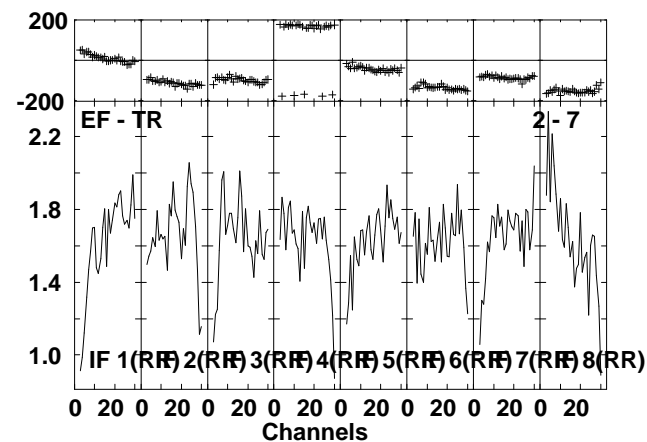
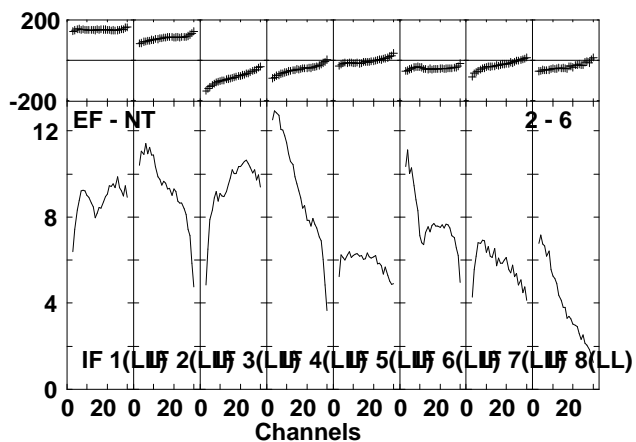
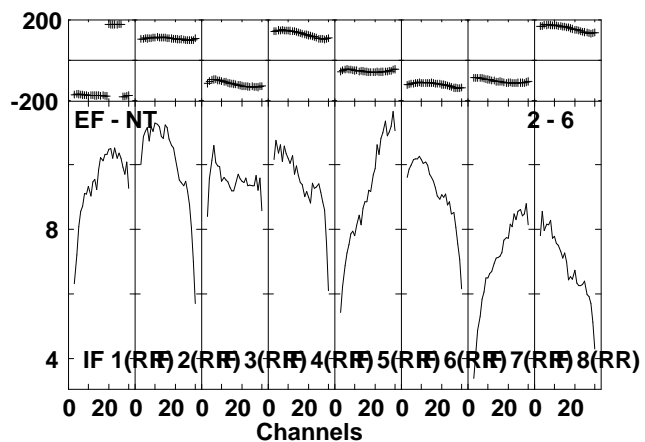
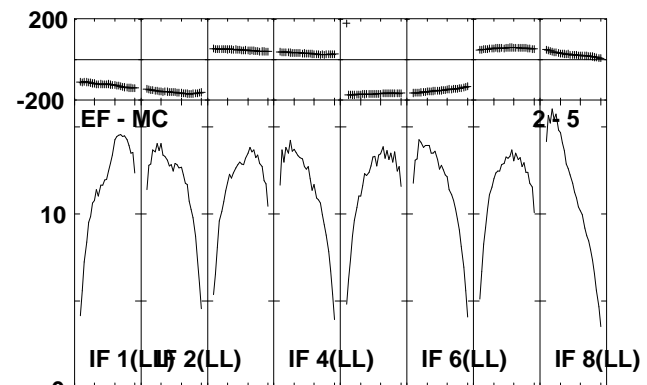
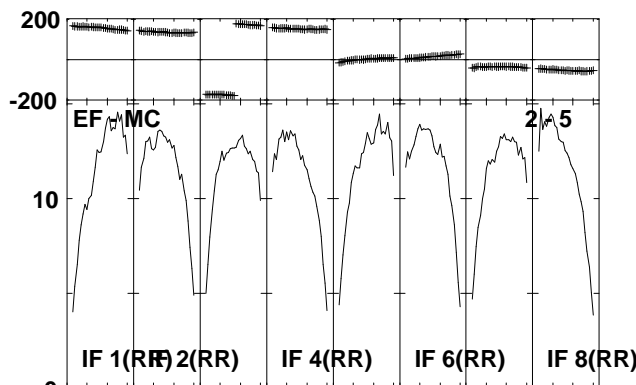
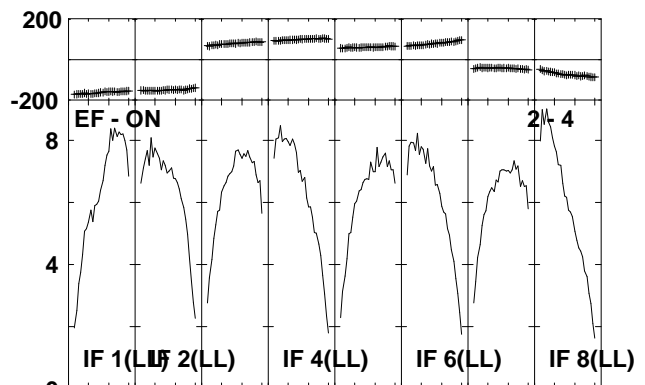
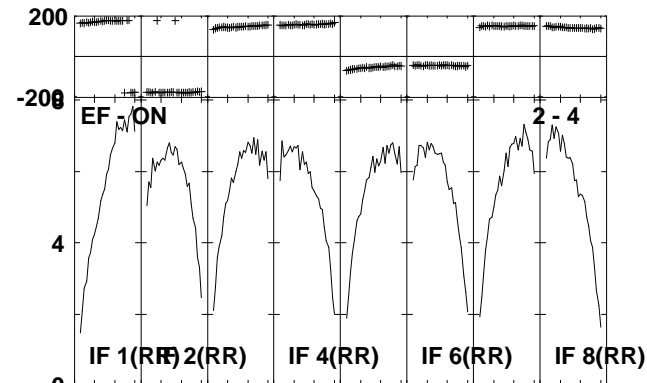
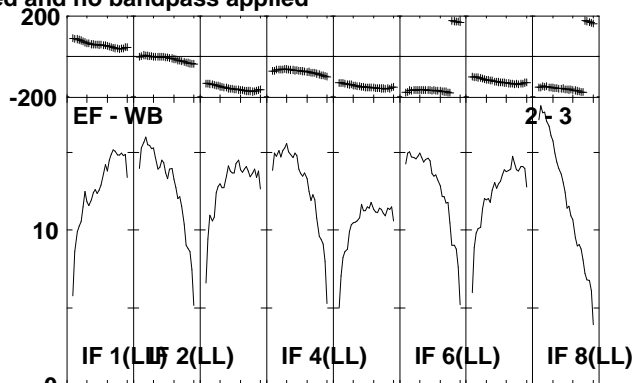
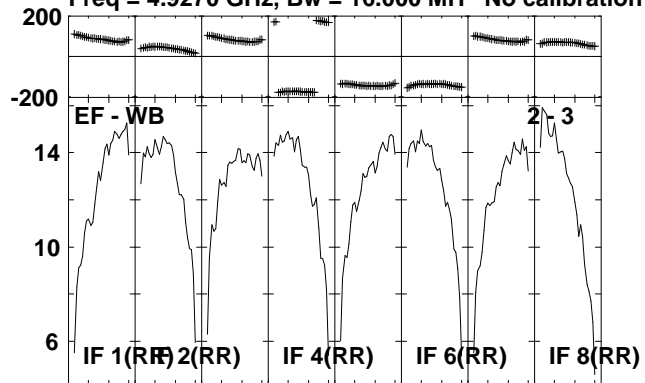

Lower frame: Milli Ampl Jy Top frame: Phas deg
Scalar averaged cross-power spectrum Several baselines displayed
Timerange: 00/15:15:11 to 00/15:16:47

Plot file version 217 created 06-JUL-2010 12:07:20

J2330+33 EP064L.UVDATA.1

Freq = 4.9270 GHz, Bw = 16.000 MH No calibration applied and no bandpass applied

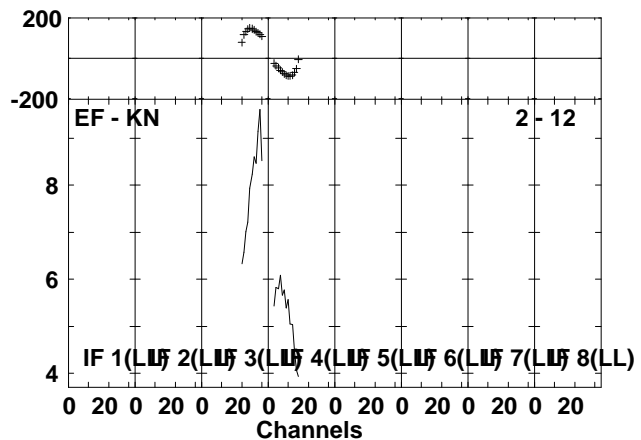
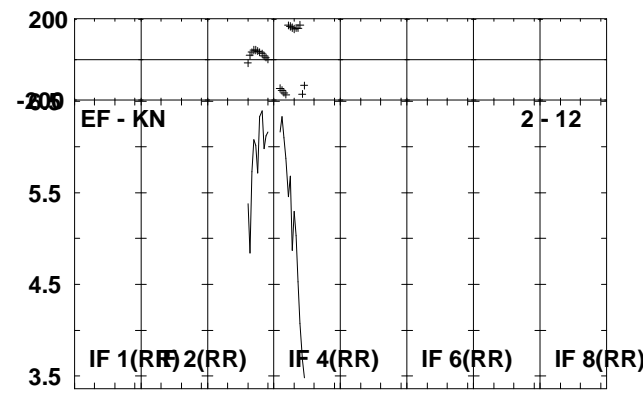
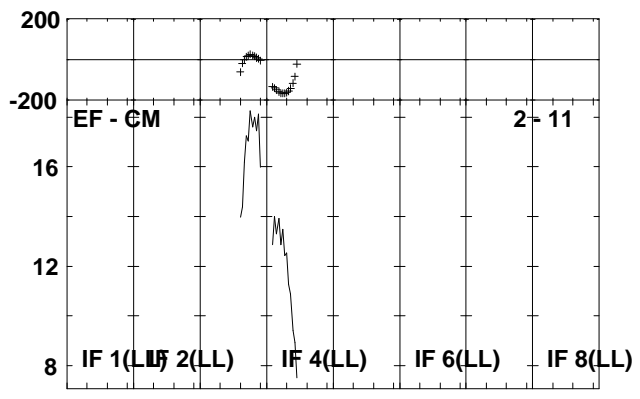
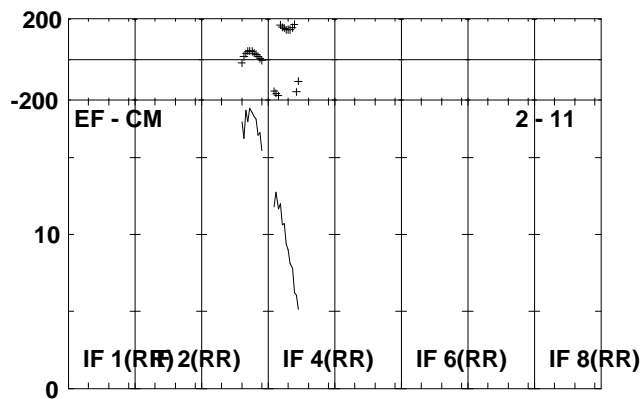
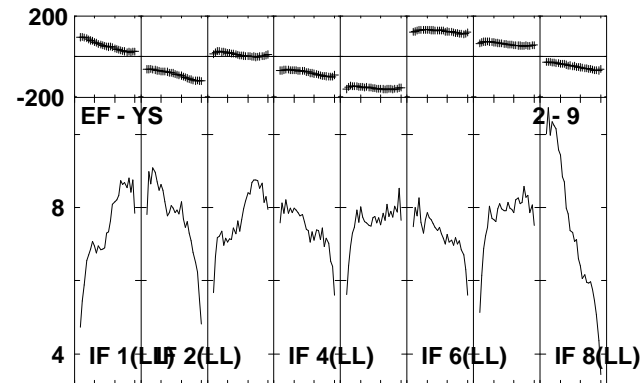
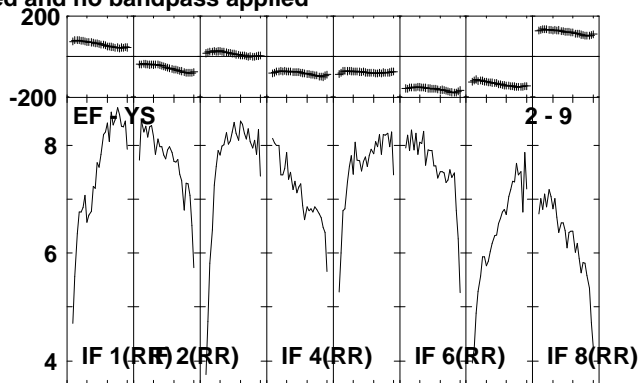
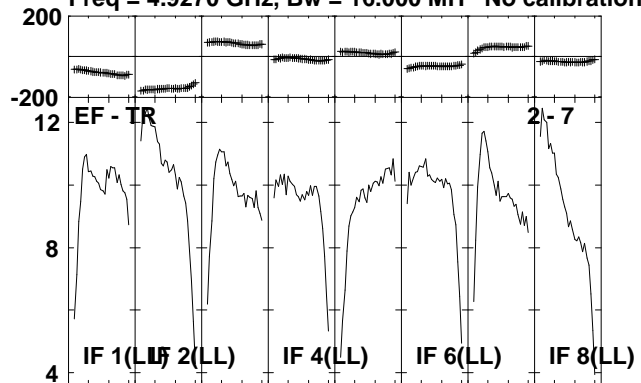

Lower frame: Milli Ampl Jy Top frame: Phas deg
Scalar averaged cross-power spectrum Several baselines displayed
Timerange: 00/15:15:11 to 00/15:16:47

Plot file version 218 created 06-JUL-2010 12:07:21

IRAS2336 EP064L.UVDATA.1

Freq = 4.9270 GHz, Bw = 16.000 MH No calibration applied and no bandpass applied

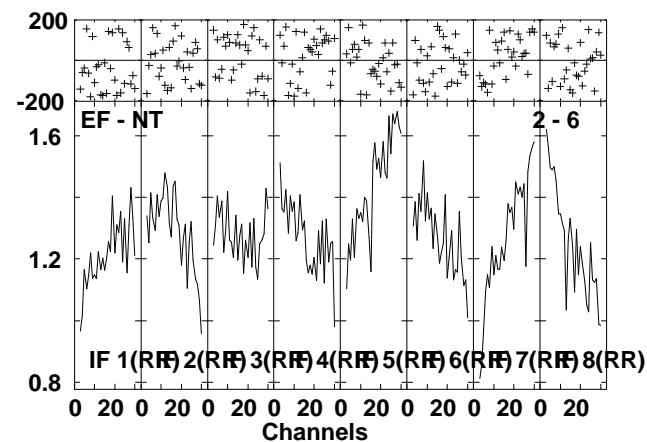
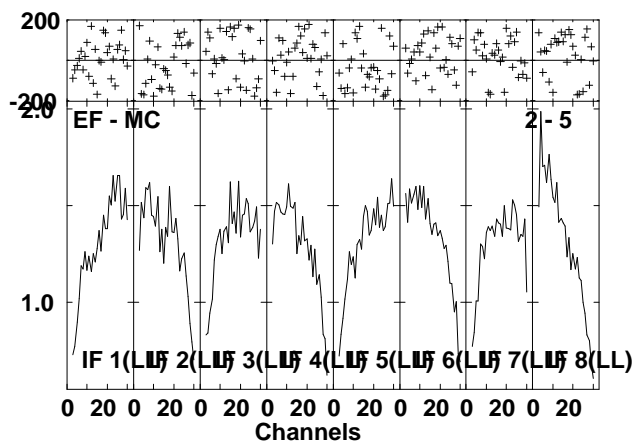
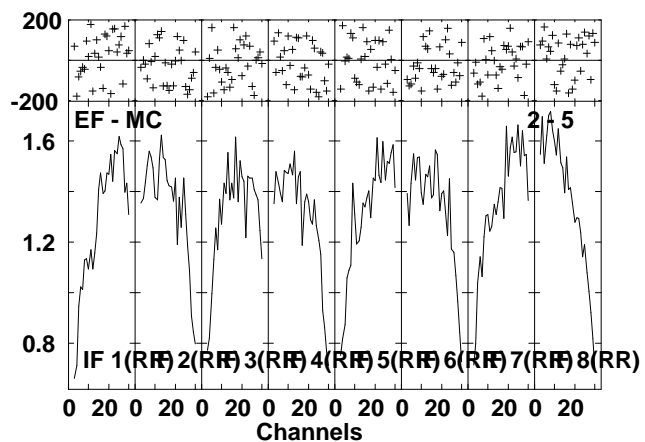
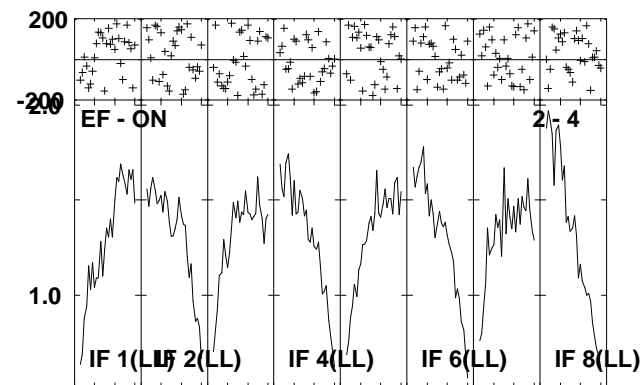
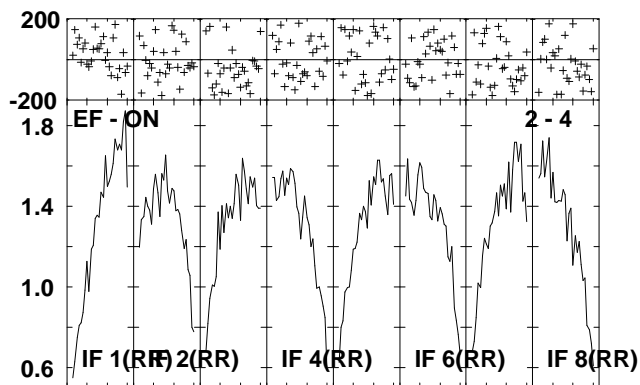
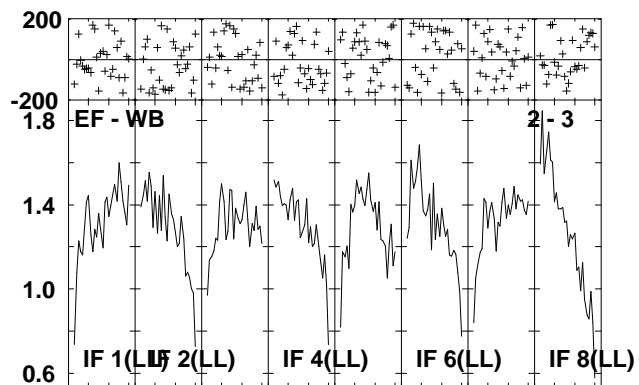
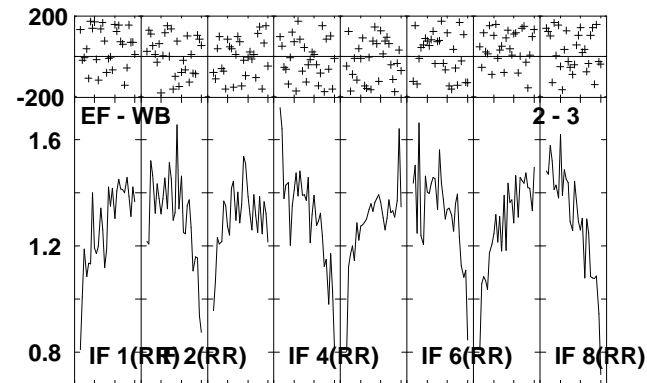
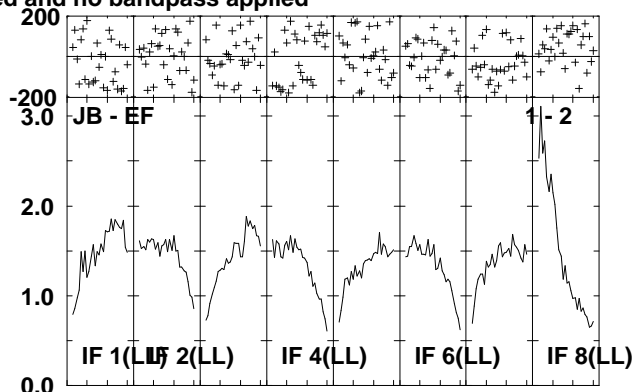
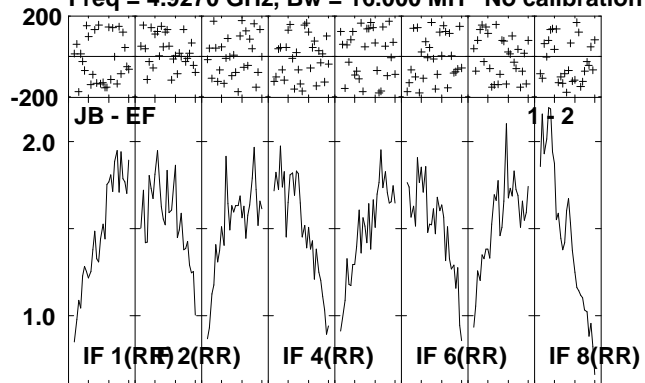

Lower frame: Milli Ampl Jy Top frame: Phas deg
Scalar averaged cross-power spectrum Several baselines displayed
Timerange: 00/15:16:51 to 00/15:20:29

Plot file version 219 created 06-JUL-2010 12:07:23

IRAS2336 EP064L.UVDATA.1

Freq = 4.9270 GHz, Bw = 16.000 MH No calibration applied and no bandpass applied

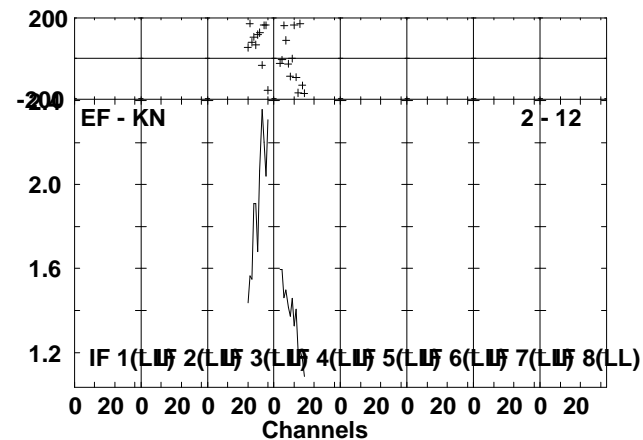
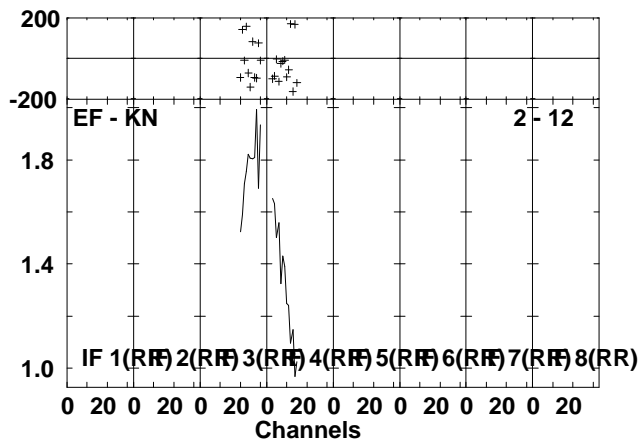
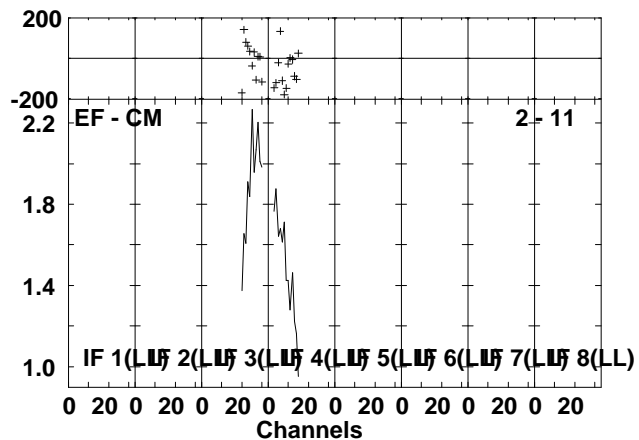
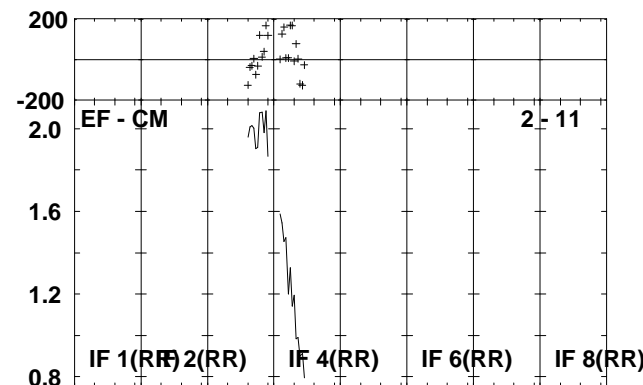
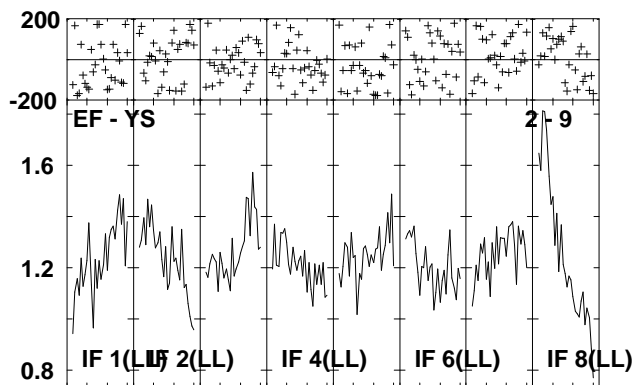
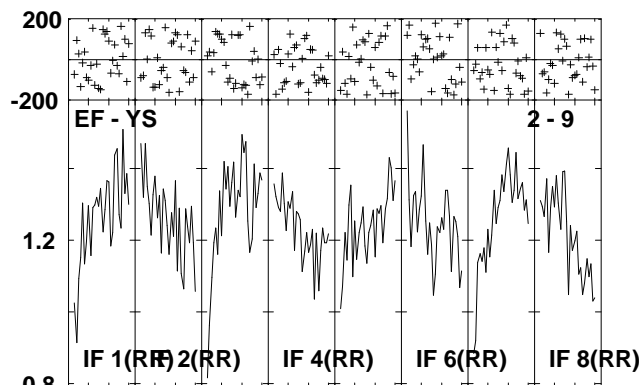
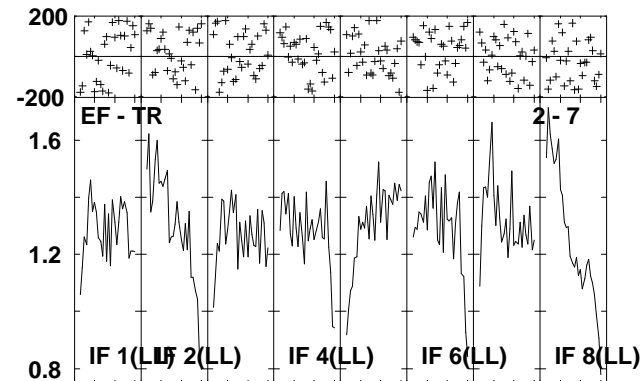
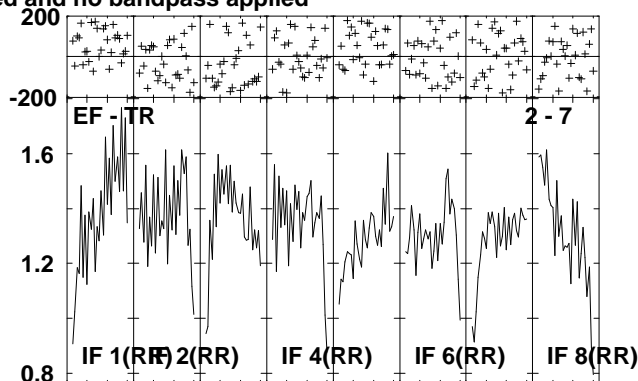
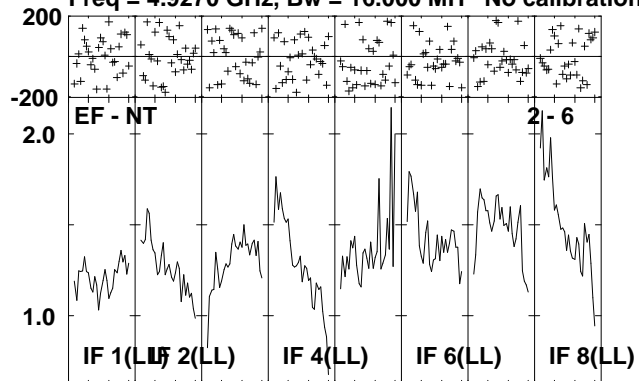

Lower frame: Milli Ampl Jy Top frame: Phas deg
Scalar averaged cross-power spectrum Several baselines displayed
Timerange: 00/15:16:51 to 00/15:20:29

Plot file version 220 created 06-JUL-2010 12:07:26

J2330+33 EP064L.UVDATA.1

Freq = 4.9270 GHz, Bw = 16.000 MH No calibration applied and no bandpass applied

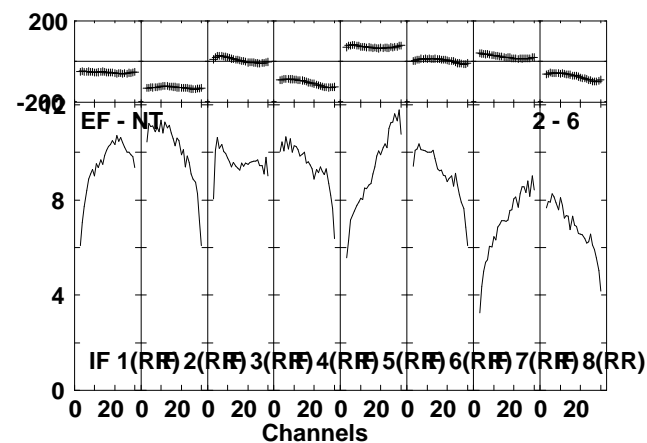
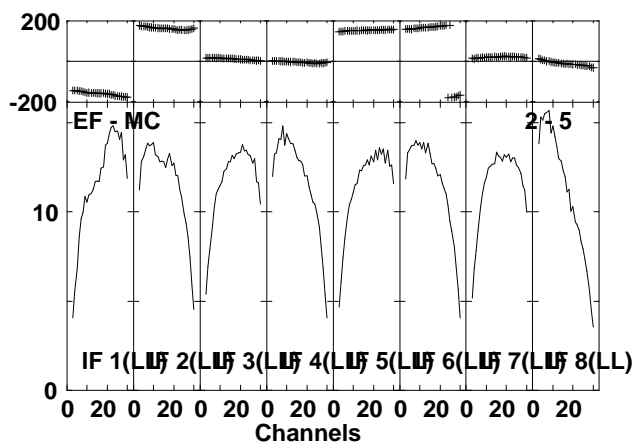
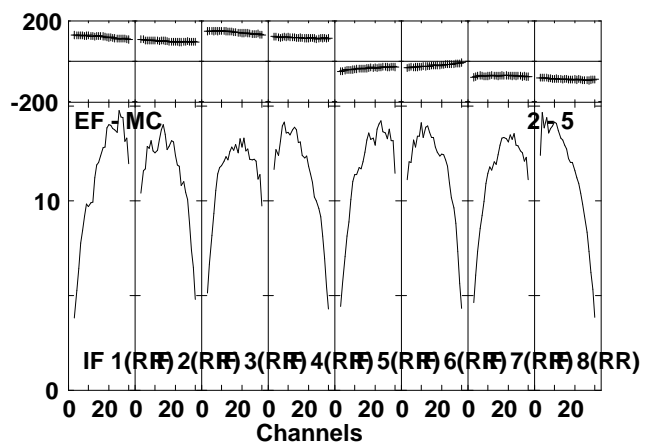
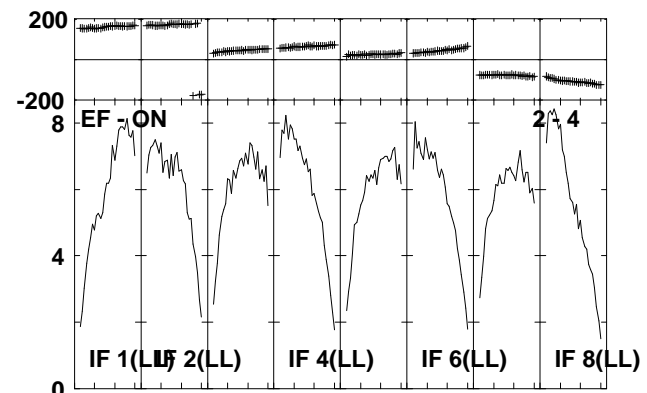
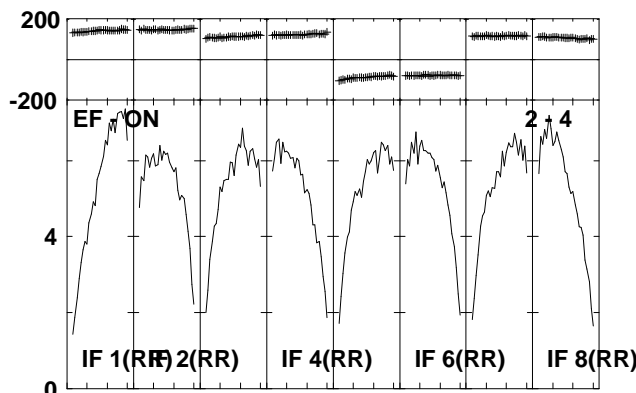
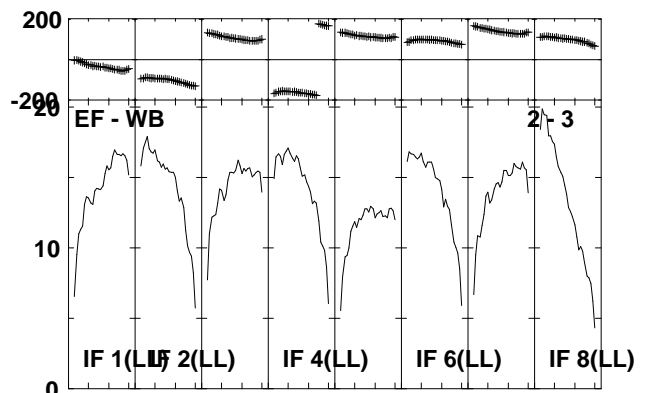
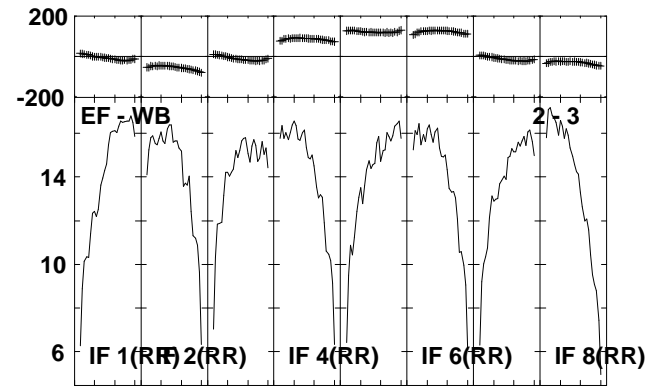
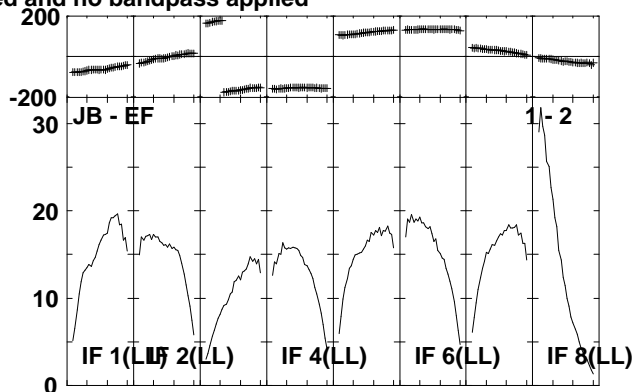
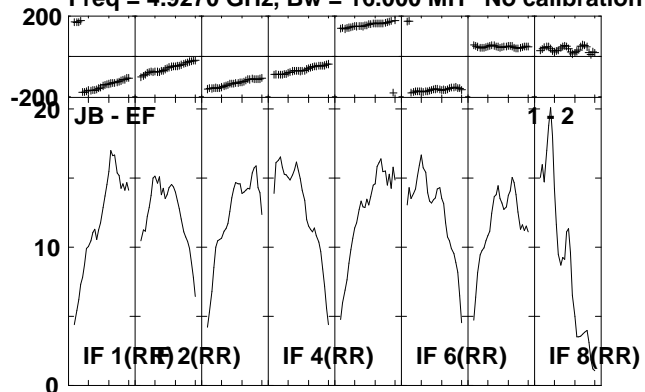

Lower frame: Milli Ampl Jy Top frame: Phas deg
Scalar averaged cross-power spectrum Several baselines displayed
Timerange: 00/15:20:31 to 00/15:22:19

Plot file version 221 created 06-JUL-2010 12:07:27

J2330+33 EP064L.UVDATA.1

Freq = 4.9270 GHz, Bw = 16.000 MH No calibration applied and no bandpass applied

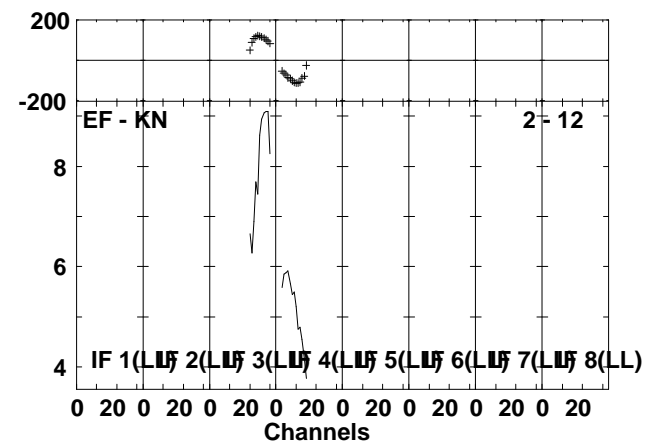
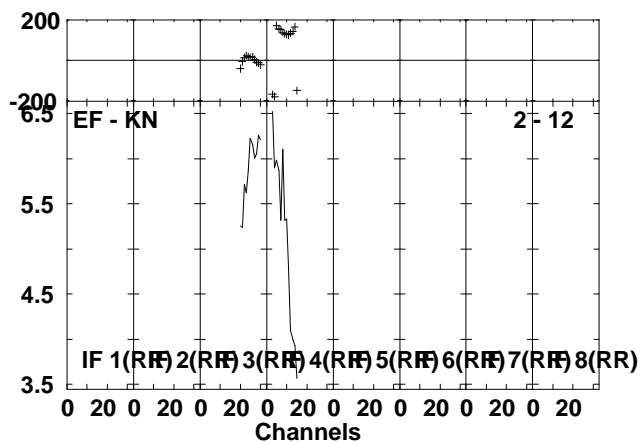
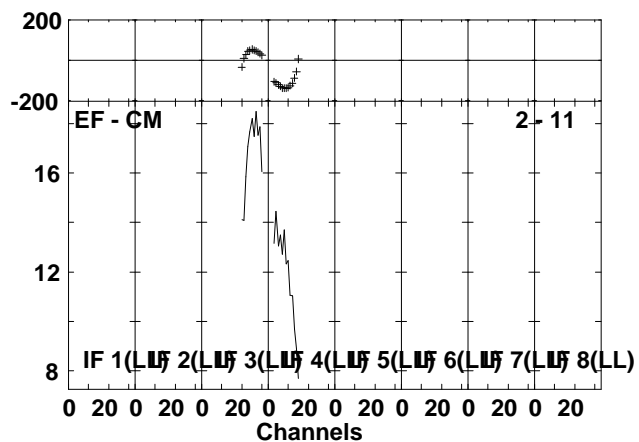
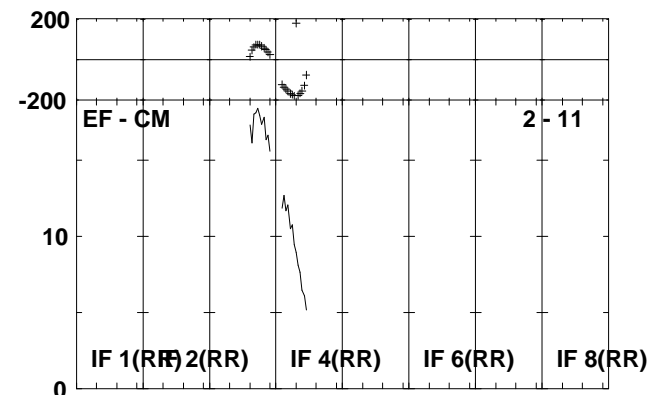
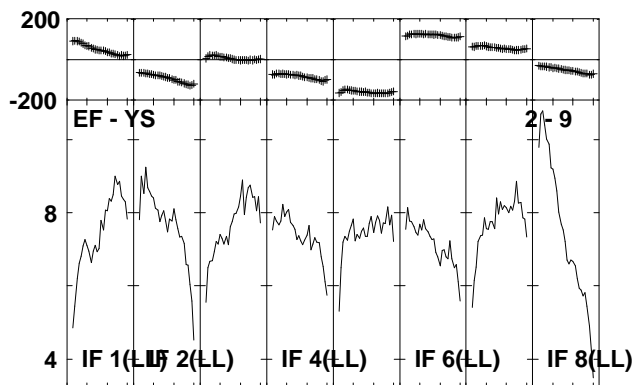
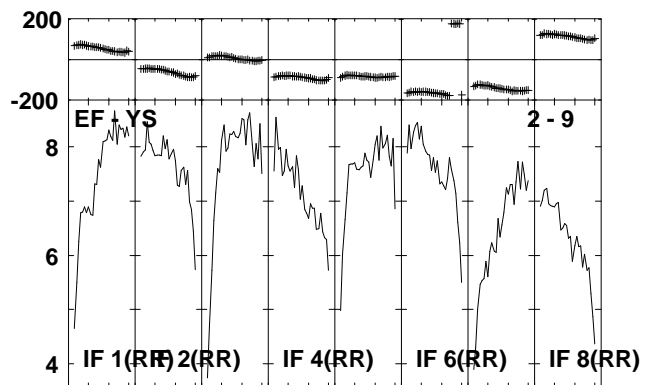
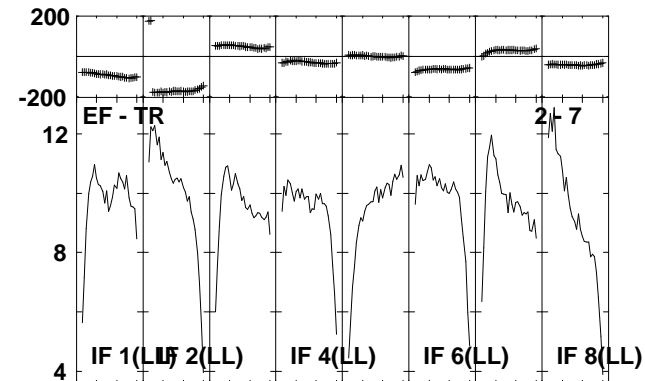
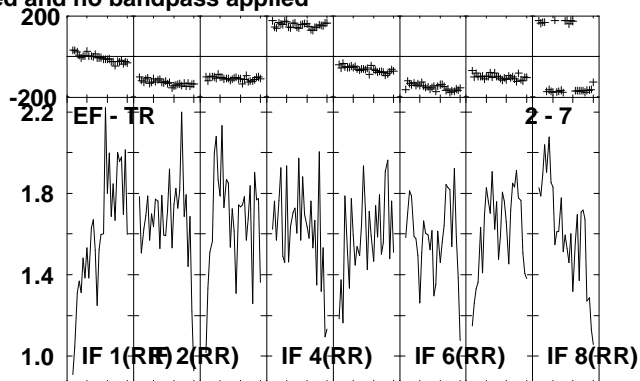
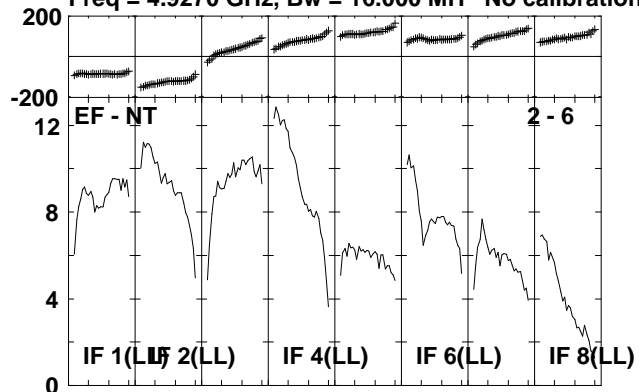

Lower frame: Milli Ampl Jy Top frame: Phas deg
Scalar averaged cross-power spectrum Several baselines displayed
Timerange: 00/15:20:31 to 00/15:22:19

Plot file version 222 created 06-JUL-2010 12:07:29

IRAS2336 EP064L.UVDATA.1

Freq = 4.9270 GHz, Bw = 16.000 MH No calibration applied and no bandpass applied

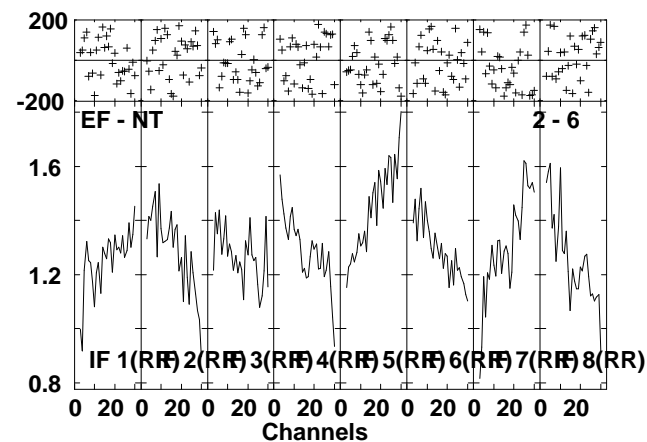
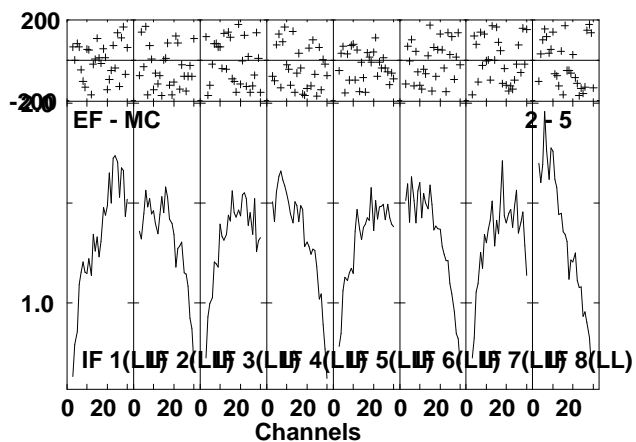
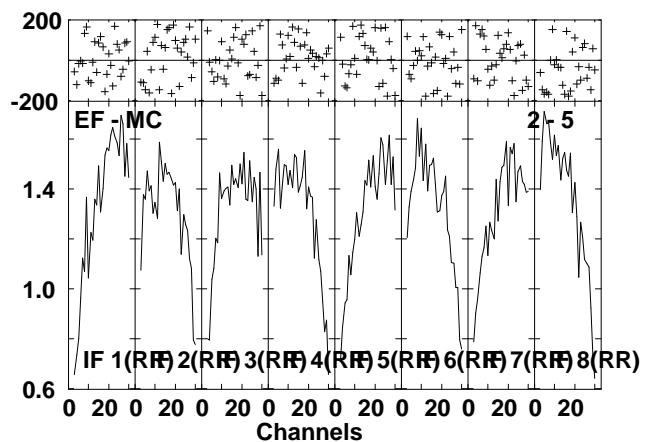
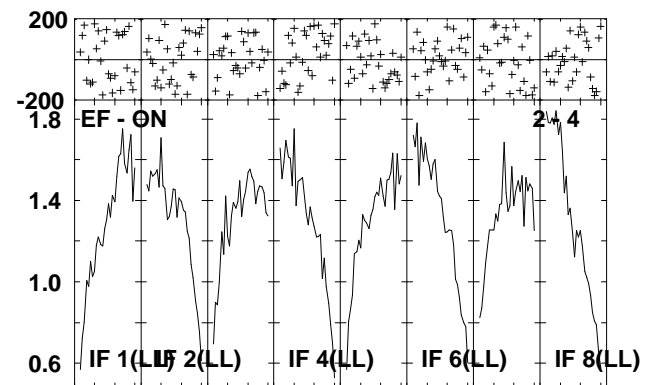
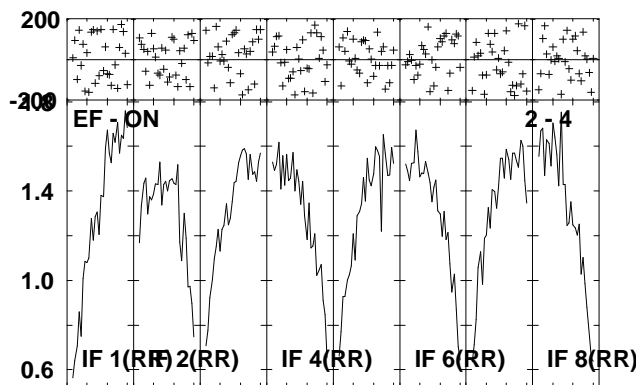
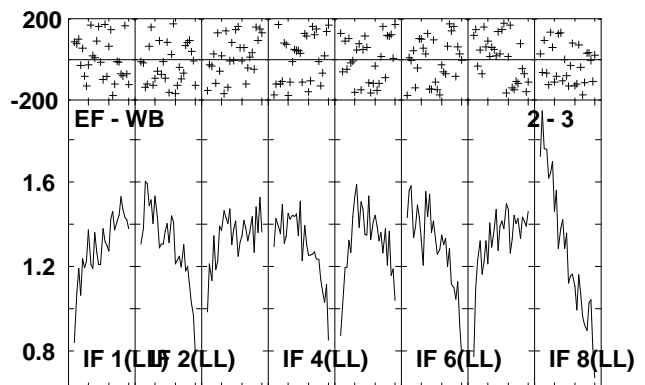
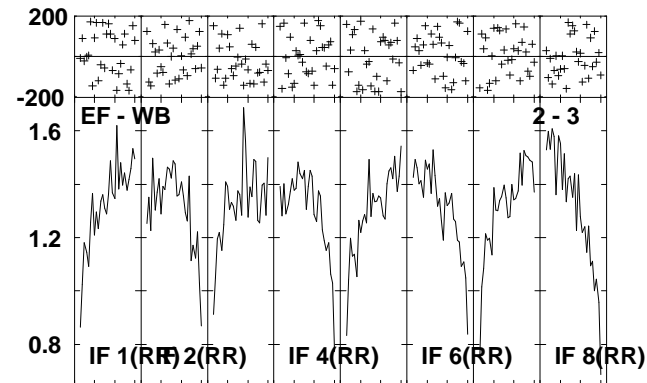
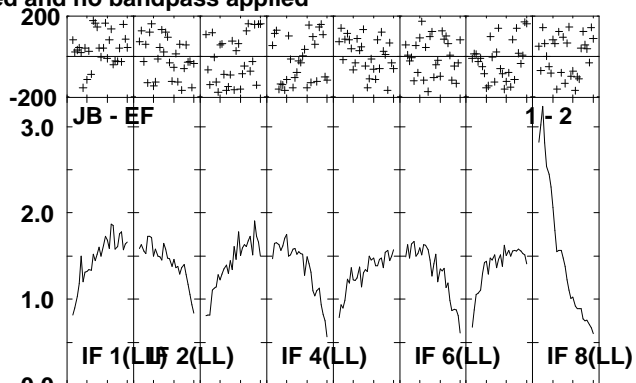
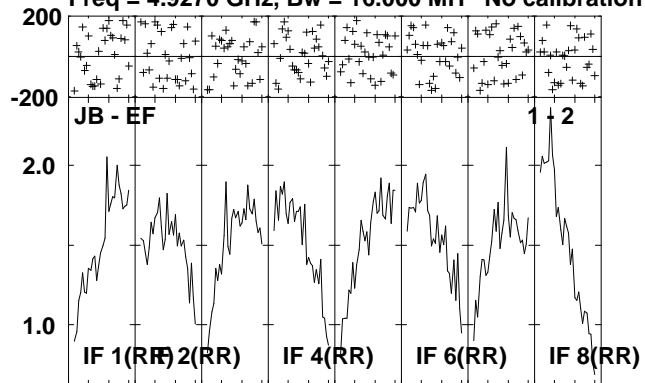

Lower frame: Milli Ampl Jy Top frame: Phas deg
Scalar averaged cross-power spectrum Several baselines displayed
Timerange: 00/15:22:27 to 00/15:25:59

Plot file version 223 created 06-JUL-2010 12:07:31

IRAS2336 EP064L.UVDATA.1

Freq = 4.9270 GHz, Bw = 16.000 MH No calibration applied and no bandpass applied

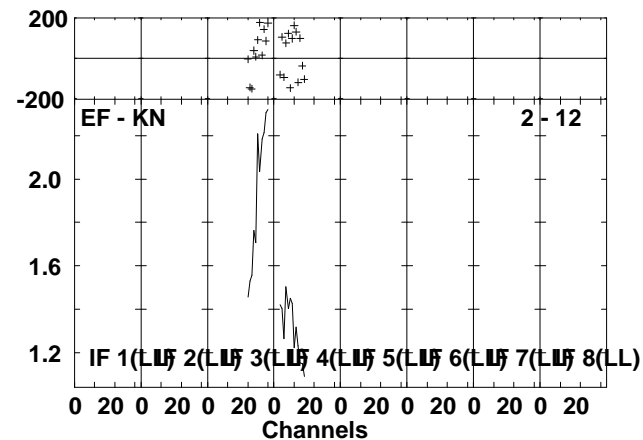
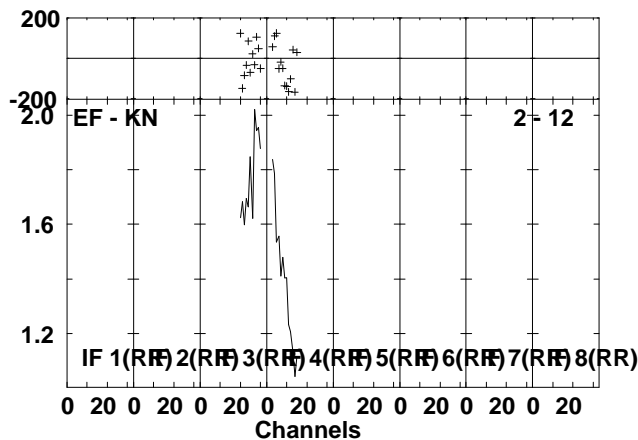
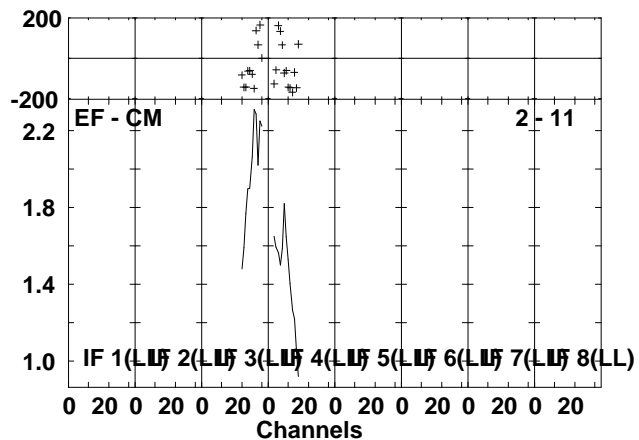
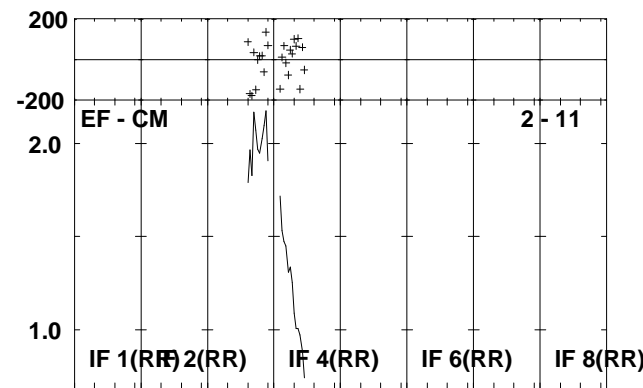
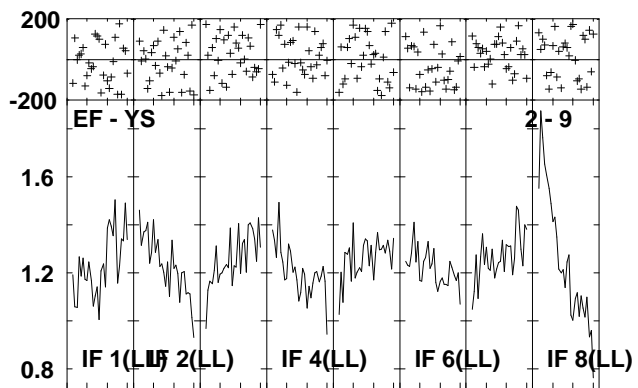
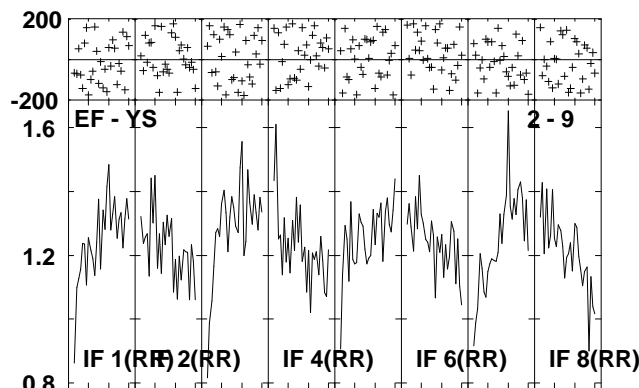
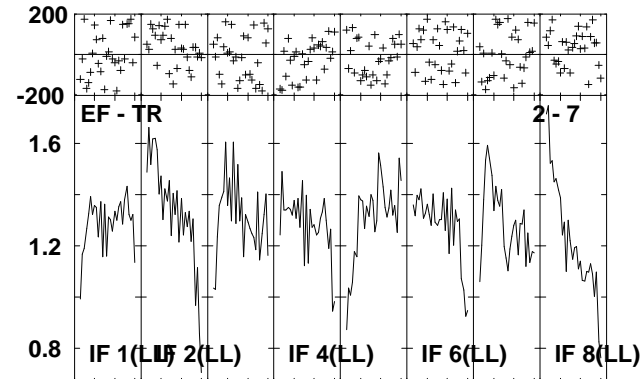
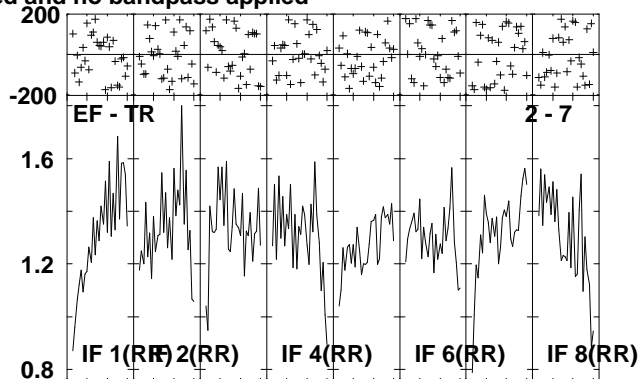
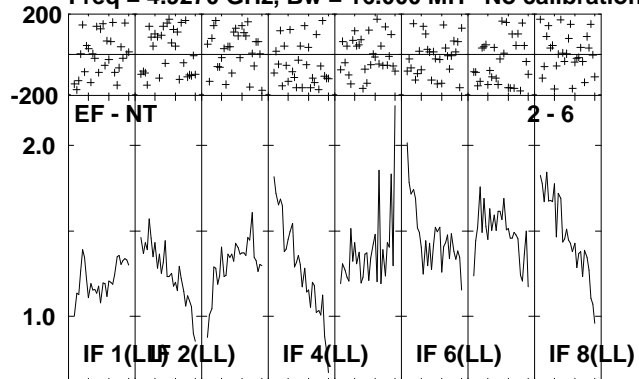

Lower frame: Milli Ampl Jy Top frame: Phas deg
Scalar averaged cross-power spectrum Several baselines displayed
Timerange: 00/15:22:27 to 00/15:25:59

Plot file version 224 created 06-JUL-2010 12:07:34

J2330+33 EP064L.UVDATA.1

Freq = 4.9270 GHz, Bw = 16.000 MH No calibration applied and no bandpass applied

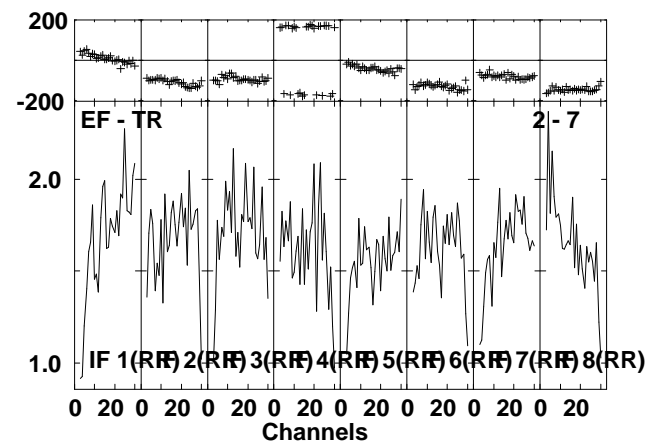
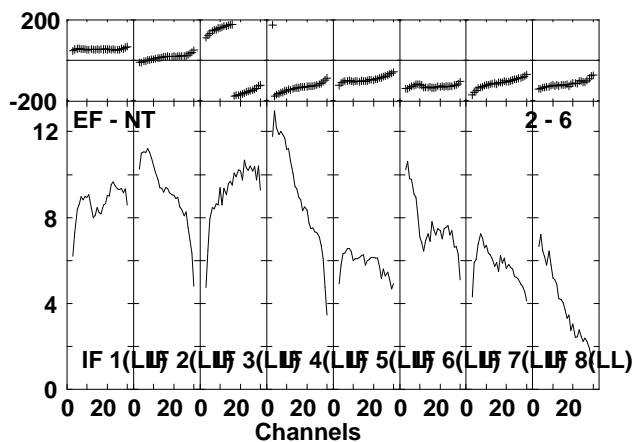
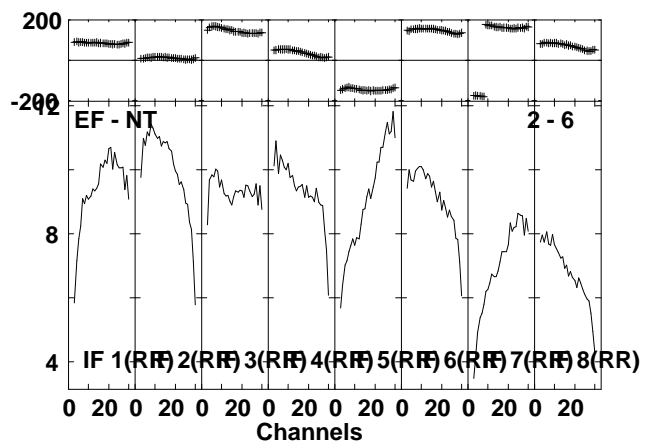
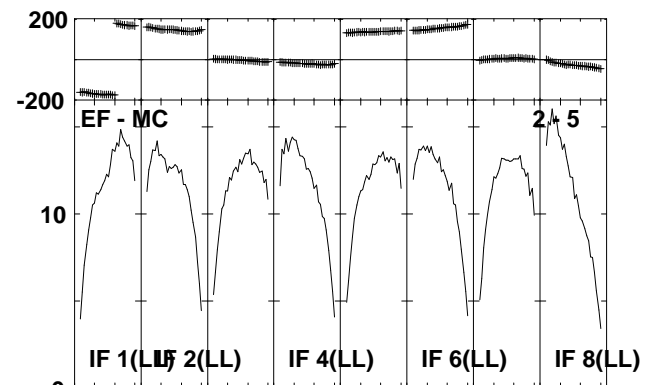
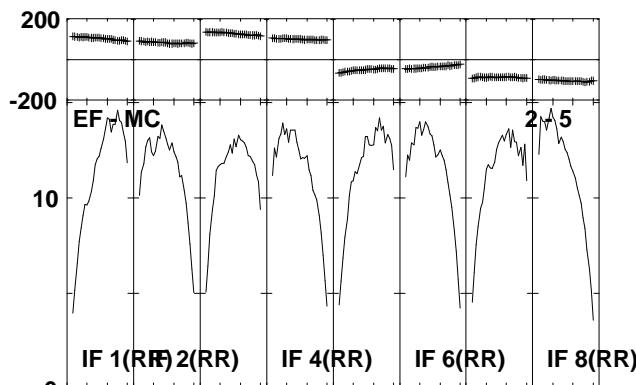
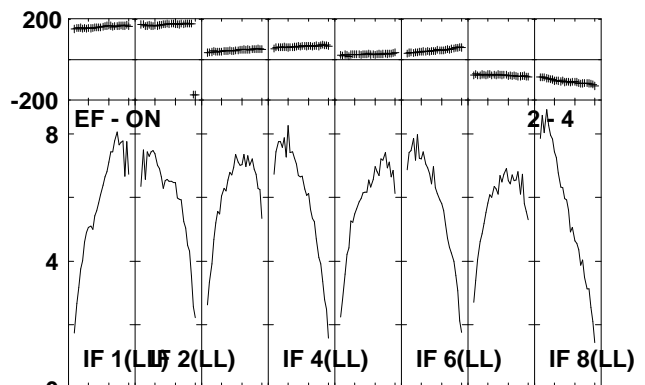
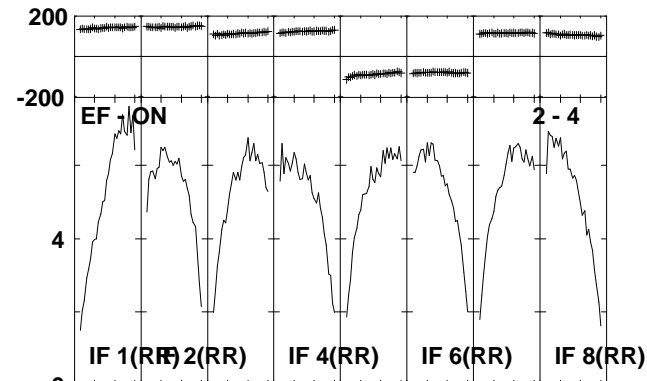
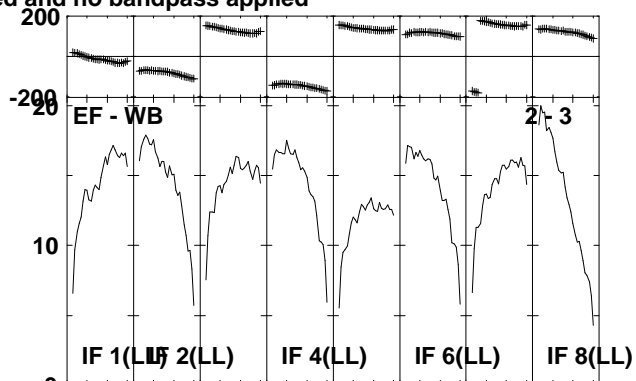
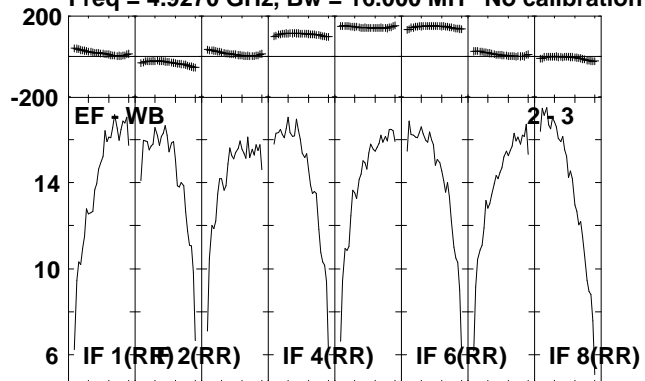

Lower frame: Milli Ampl Jy Top frame: Phas deg
Scalar averaged cross-power spectrum Several baselines displayed
Timerange: 00/15:26:01 to 00/15:27:49

Plot file version 225 created 06-JUL-2010 12:07:34

J2330+33 EP064L.UVDATA.1

Freq = 4.9270 GHz, Bw = 16.000 MH No calibration applied and no bandpass applied

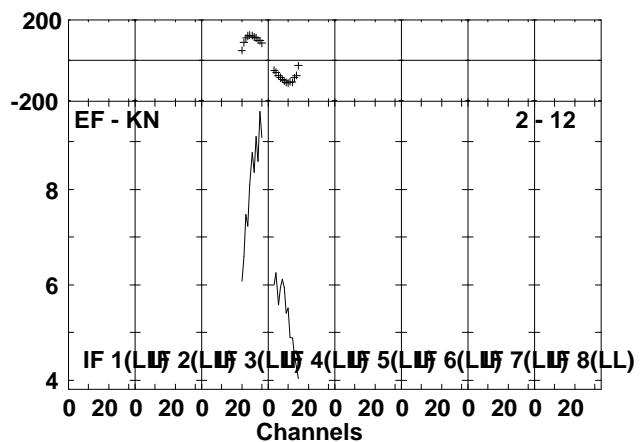
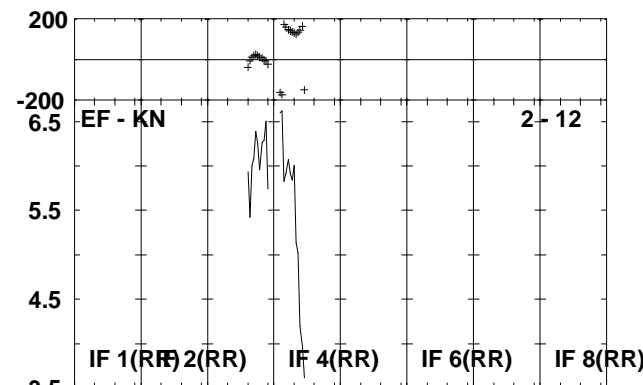
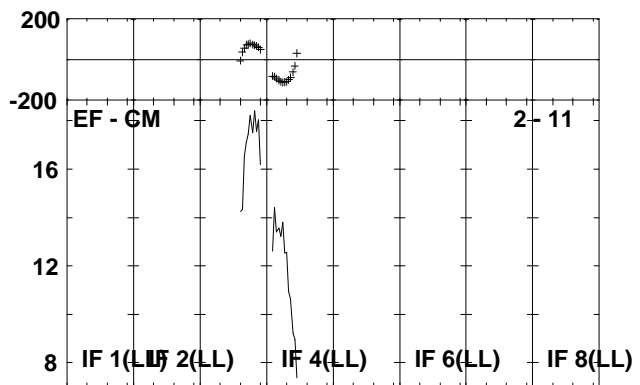
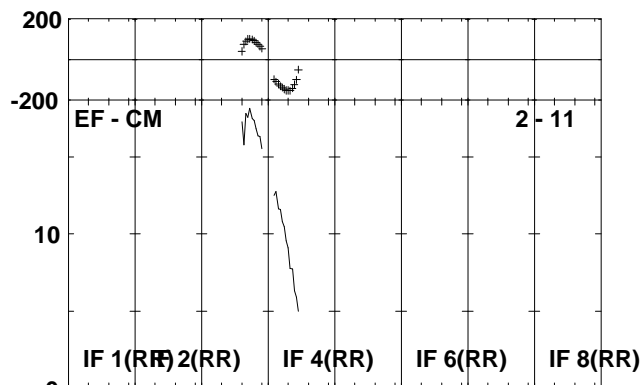
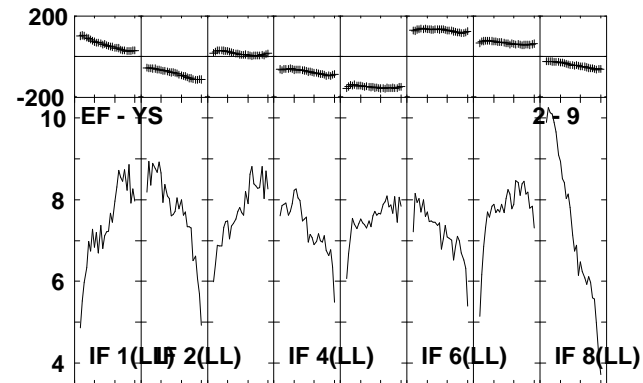
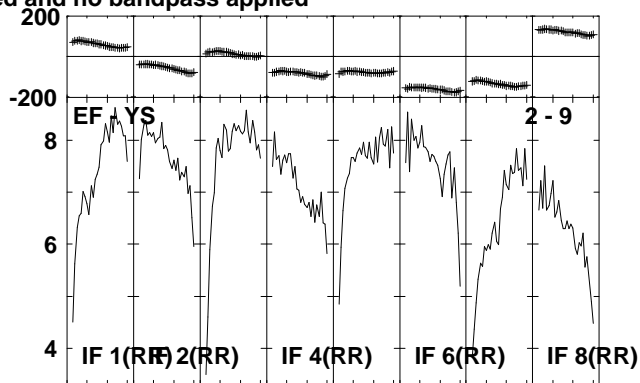
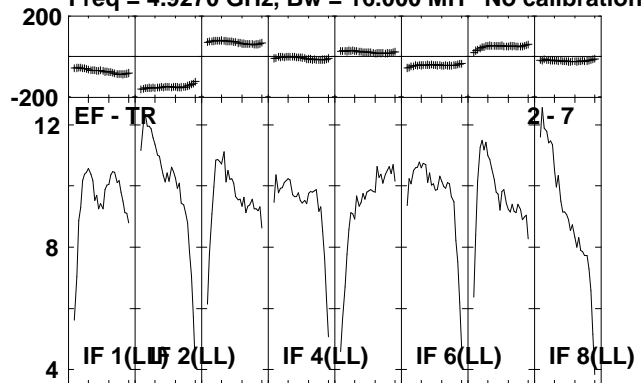

Lower frame: Milli Ampl Jy Top frame: Phas deg
Scalar averaged cross-power spectrum Several baselines displayed
Timerange: 00/15:26:01 to 00/15:27:49

Plot file version 226 created 06-JUL-2010 12:07:36

IRAS2336 EP064L.UVDATA.1

Freq = 4.9270 GHz, Bw = 16.000 MH No calibration applied and no bandpass applied

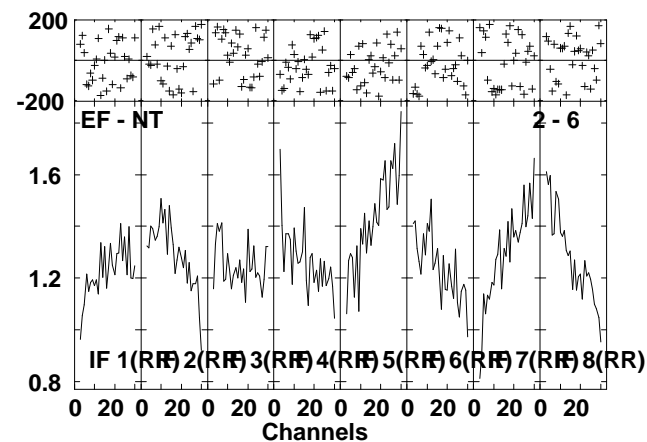
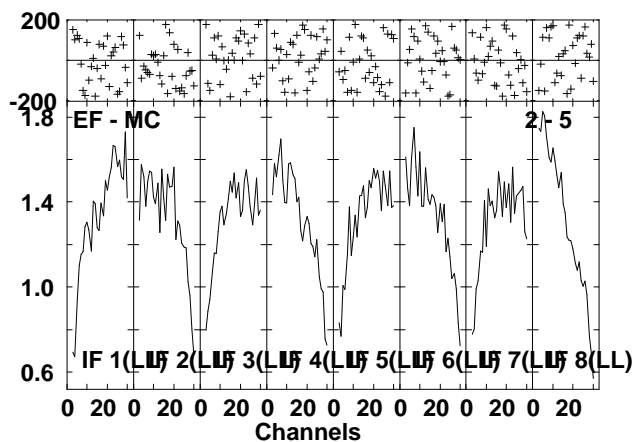
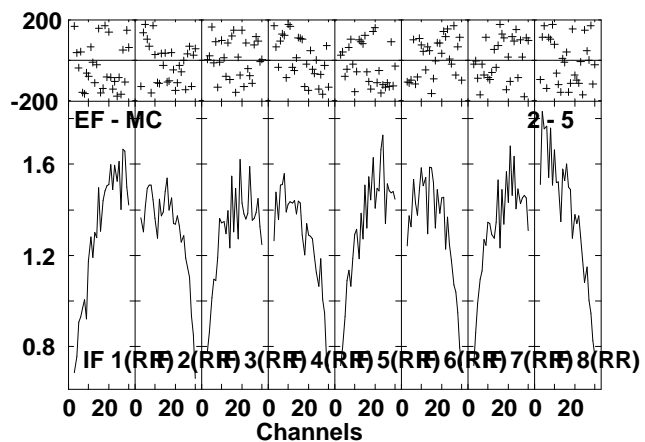
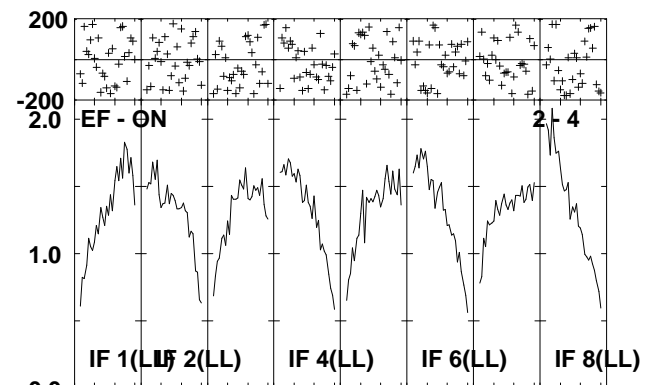
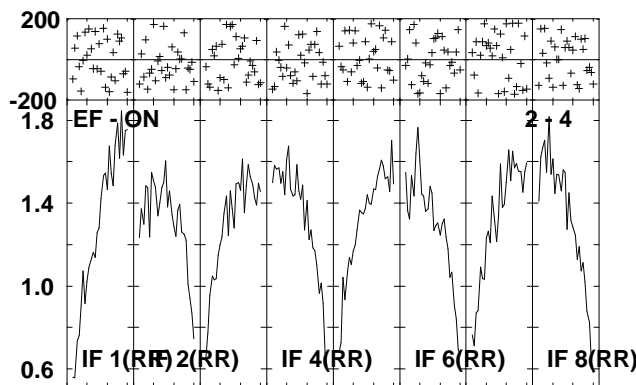
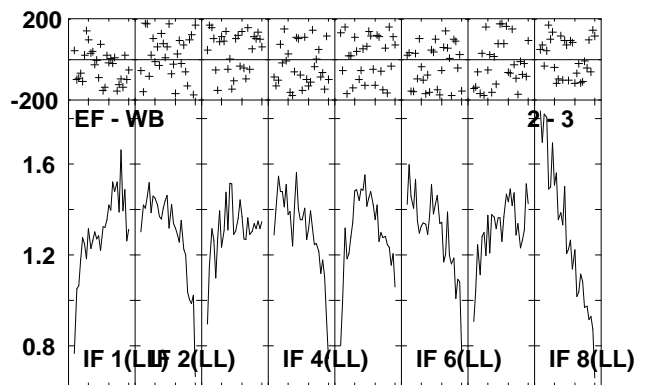
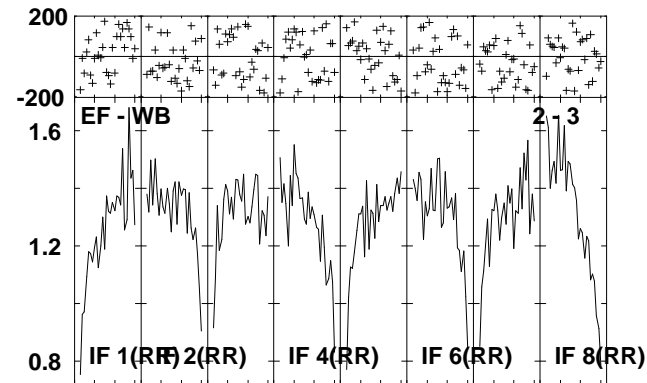
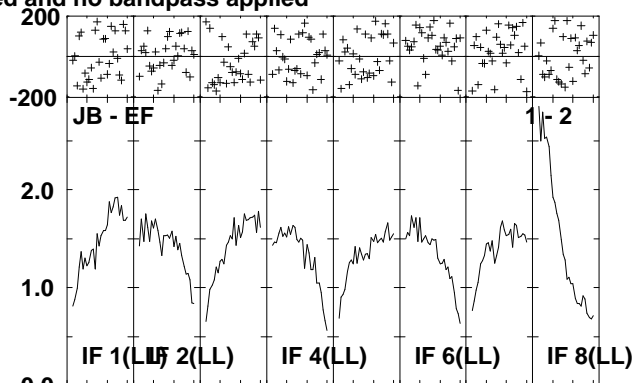
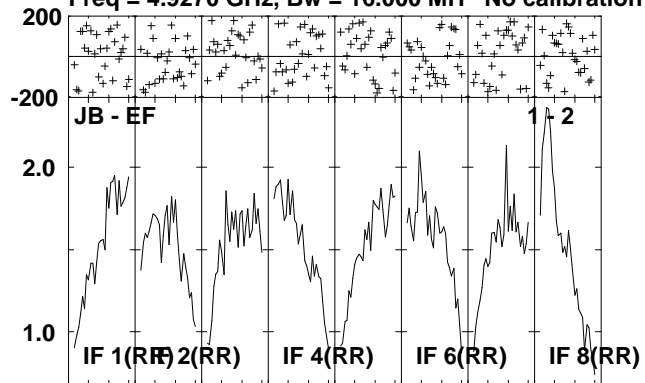

Lower frame: Milli Ampl Jy Top frame: Phas deg
Scalar averaged cross-power spectrum Several baselines displayed
Timerange: 00/15:27:51 to 00/15:31:29

Plot file version 227 created 06-JUL-2010 12:07:38

IRAS2336 EP064L.UVDATA.1

Freq = 4.9270 GHz, Bw = 16.000 MH No calibration applied and no bandpass applied

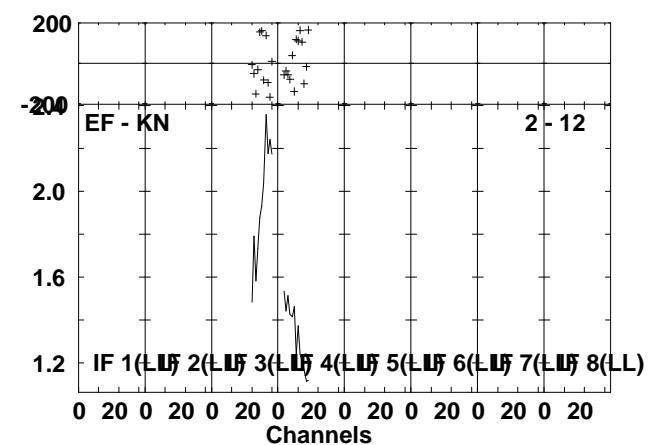
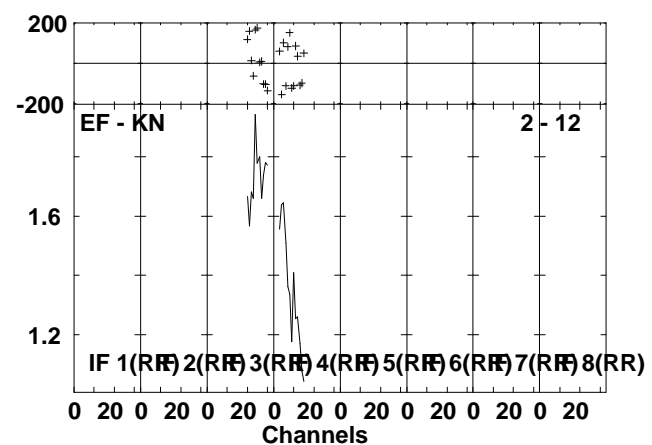
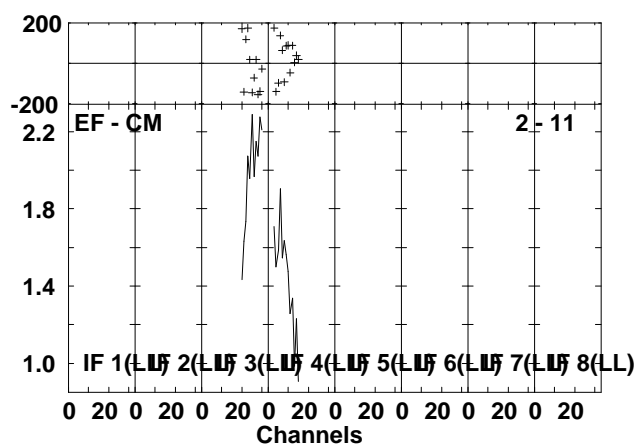
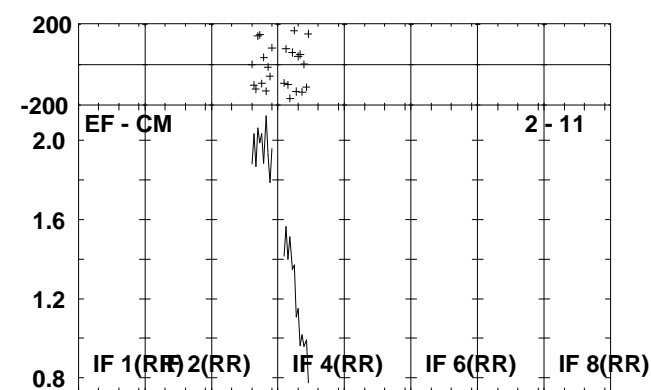
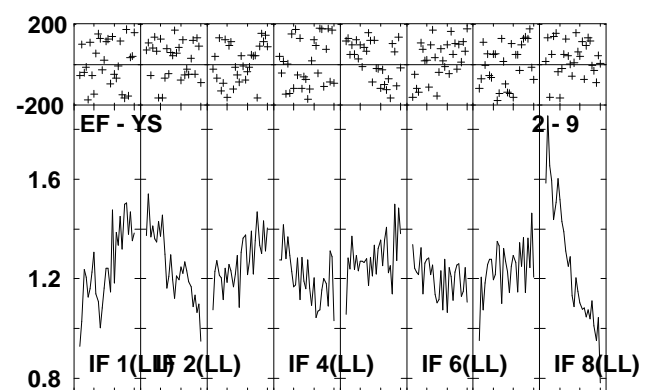
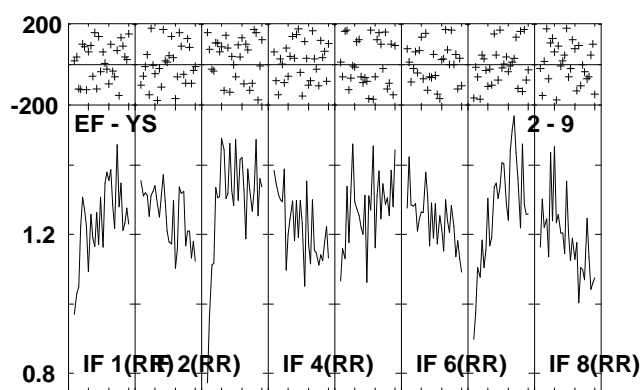
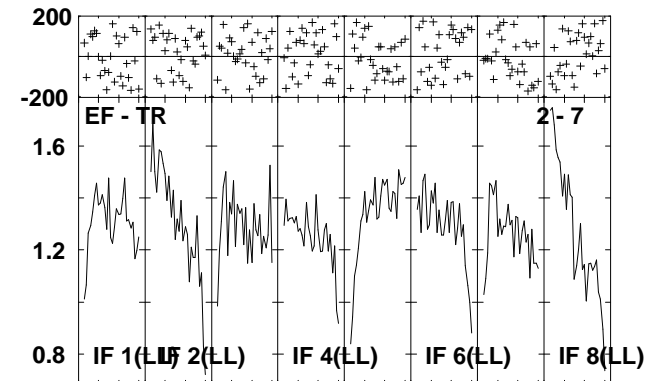
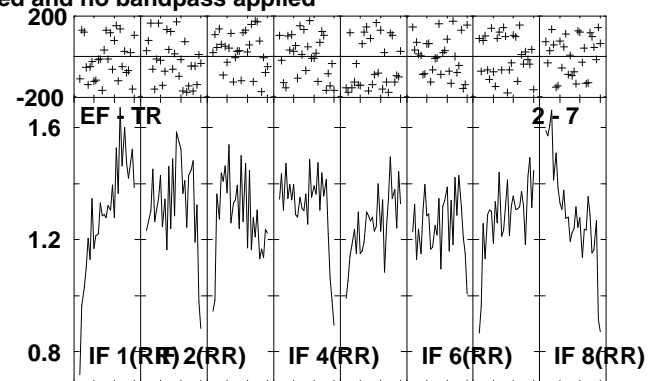
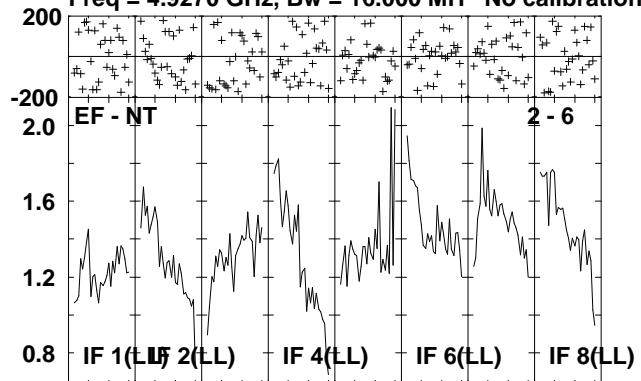

Lower frame: Milli Ampl Jy Top frame: Phas deg
Scalar averaged cross-power spectrum Several baselines displayed
Timerange: 00/15:27:51 to 00/15:31:29

Plot file version 228 created 06-JUL-2010 12:07:41

J2330+33 EP064L.UVDATA.1

Freq = 4.9270 GHz, Bw = 16.000 MH No calibration applied and no bandpass applied

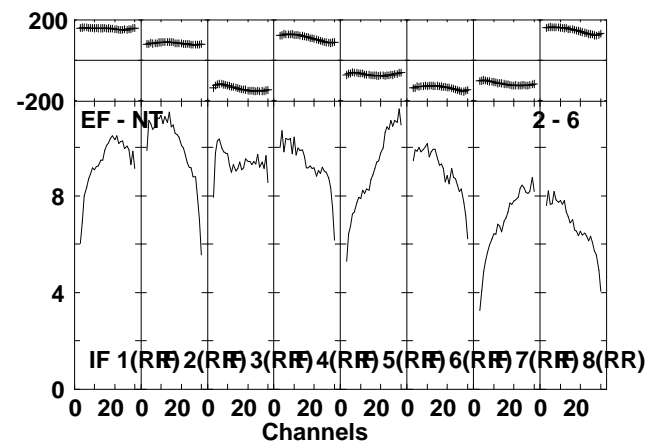
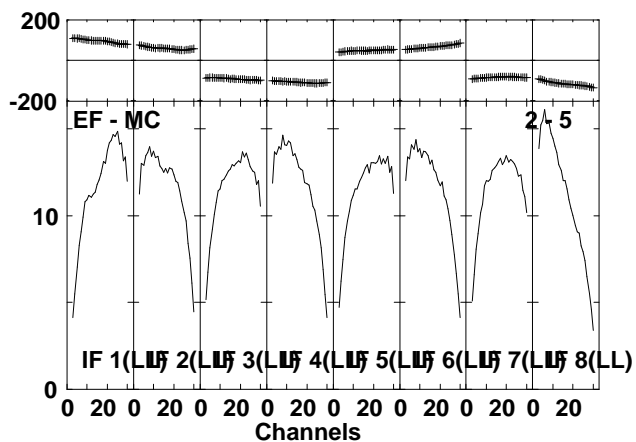
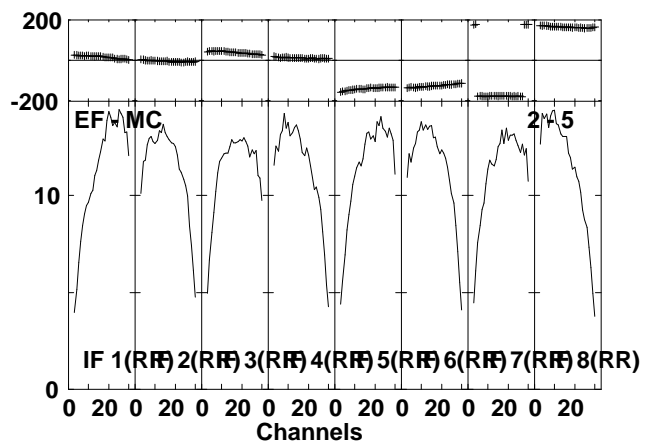
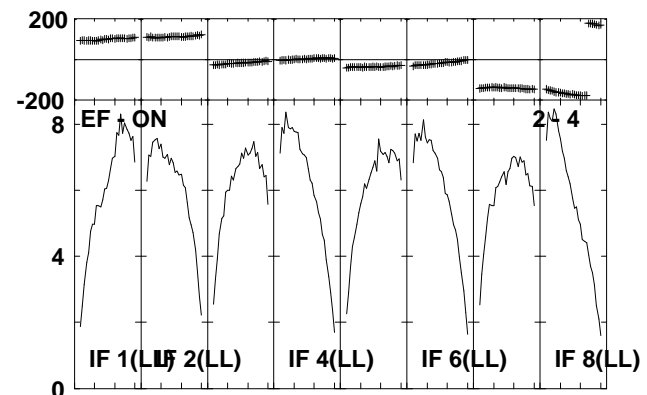
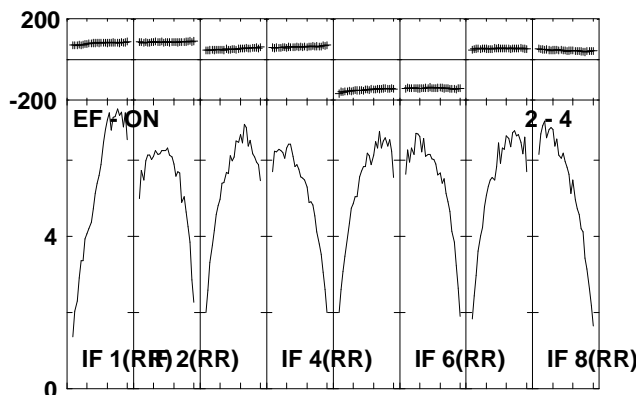
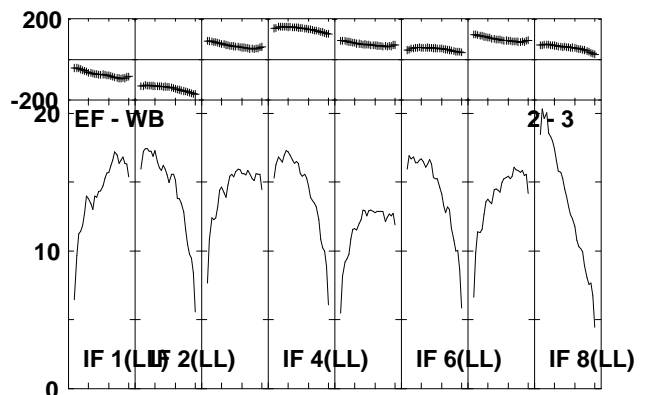
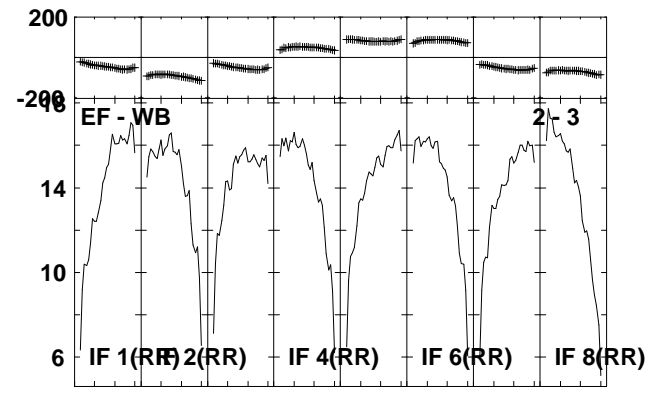
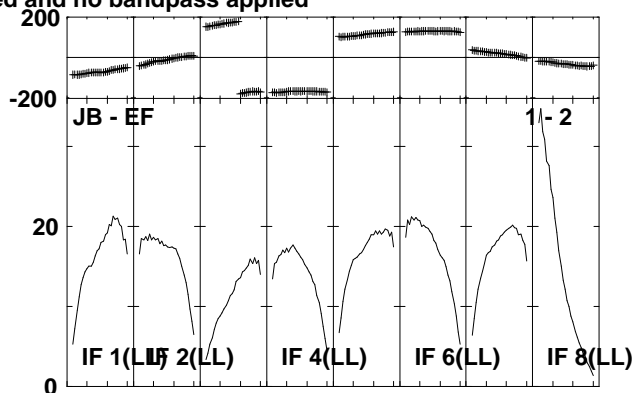
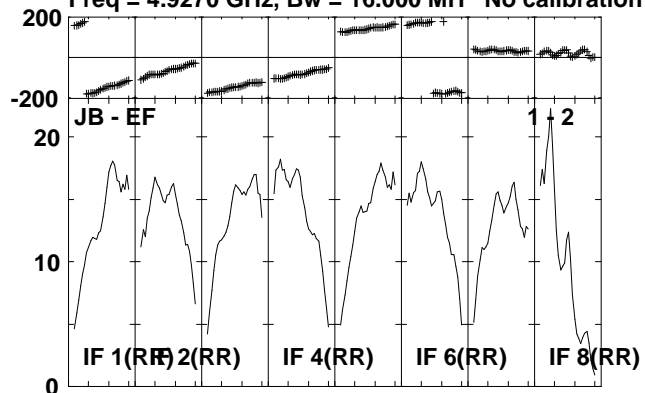

Lower frame: Milli Ampl Jy Top frame: Phas deg
Scalar averaged cross-power spectrum Several baselines displayed
Timerange: 00/15:32:31 to 00/15:34:19

Plot file version 229 created 06-JUL-2010 12:07:42

J2330+33 EP064L.UVDATA.1

Freq = 4.9270 GHz, Bw = 16.000 MH No calibration applied and no bandpass applied

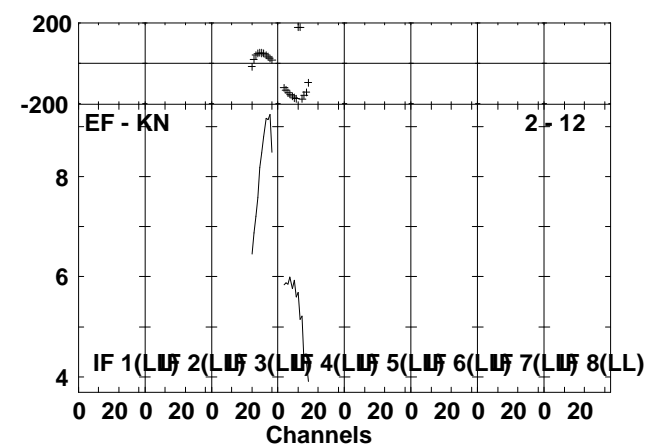
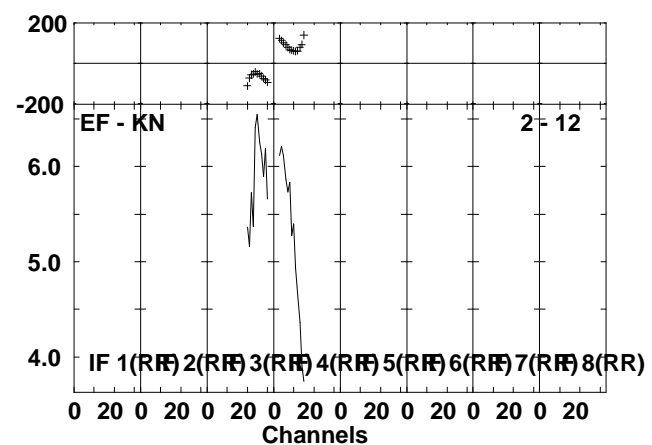
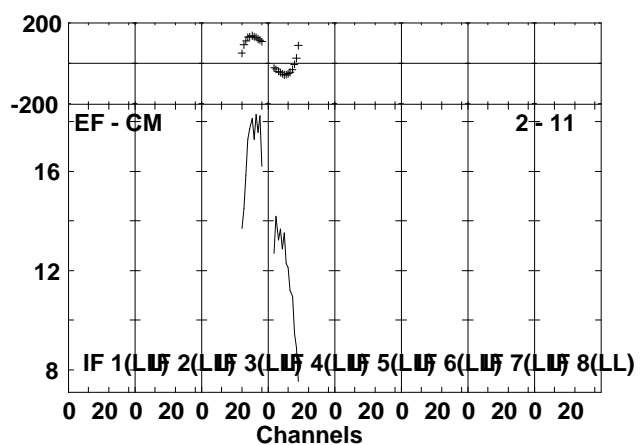
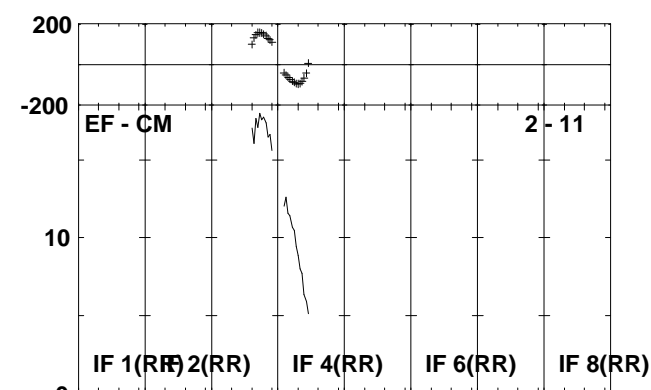
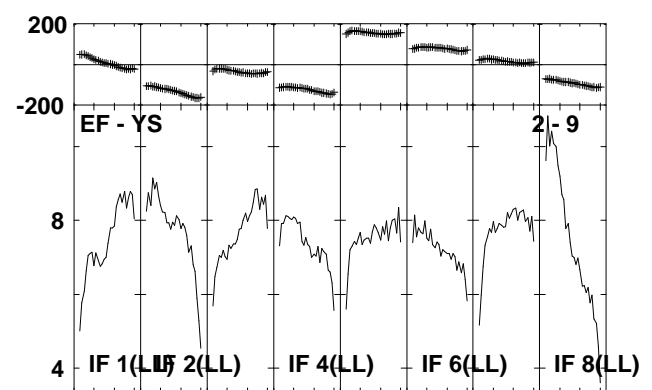
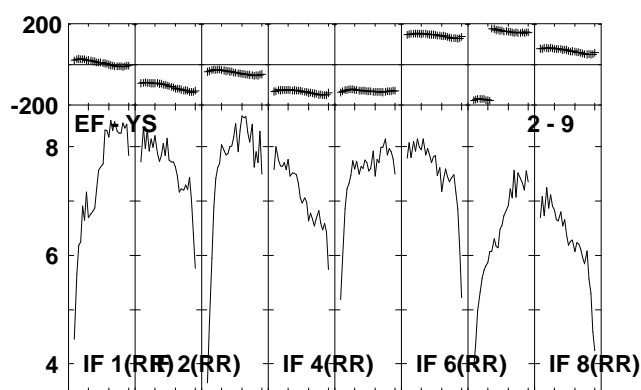
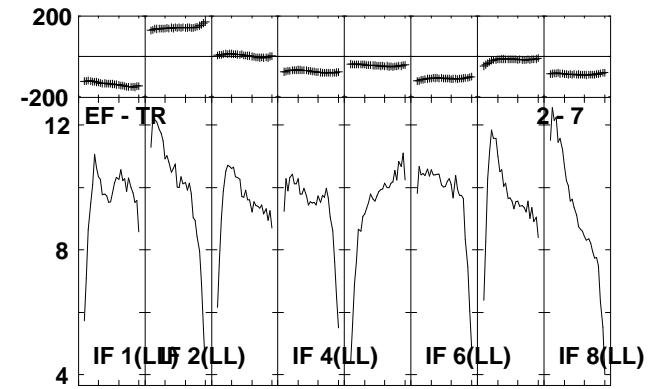
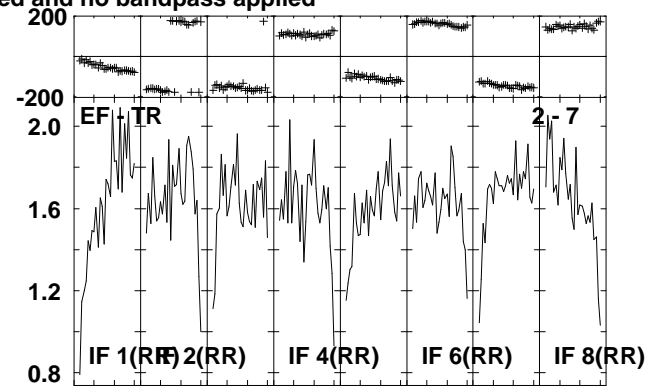
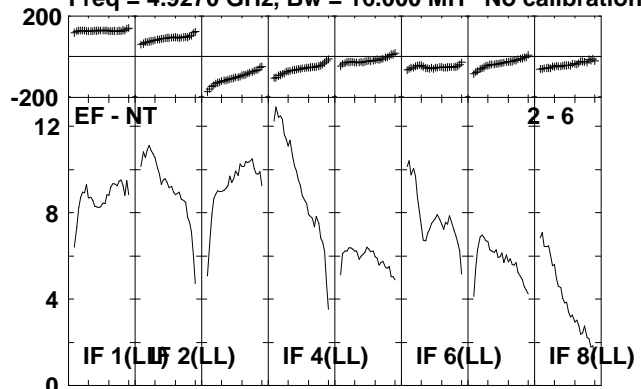

Lower frame: Milli Ampl Jy Top frame: Phas deg
Scalar averaged cross-power spectrum Several baselines displayed
Timerange: 00/15:32:31 to 00/15:34:19

Plot file version 230 created 06-JUL-2010 12:07:44

IRAS2336 EP064L.UVDATA.1

Freq = 4.9270 GHz, Bw = 16.000 MH No calibration applied and no bandpass applied

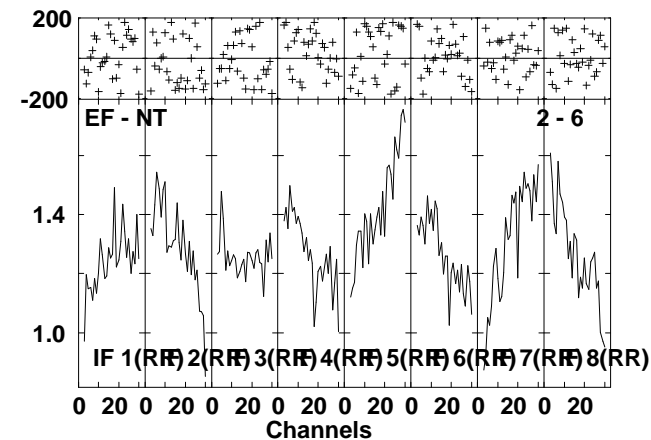
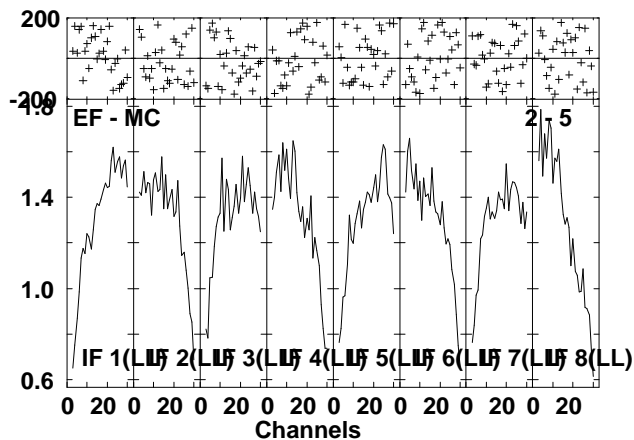
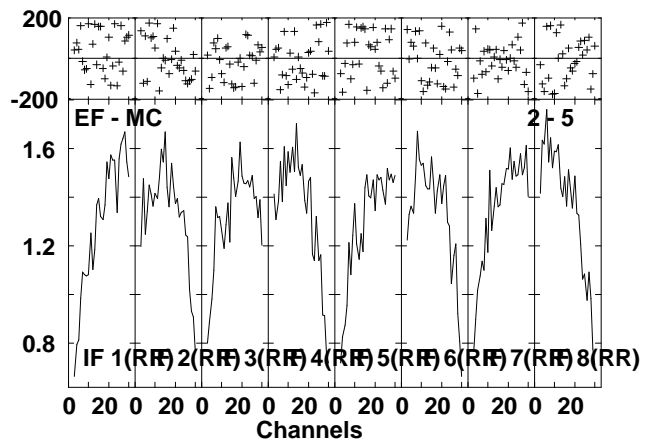
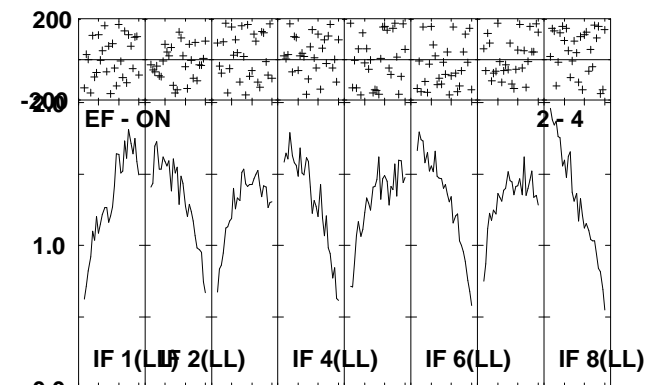
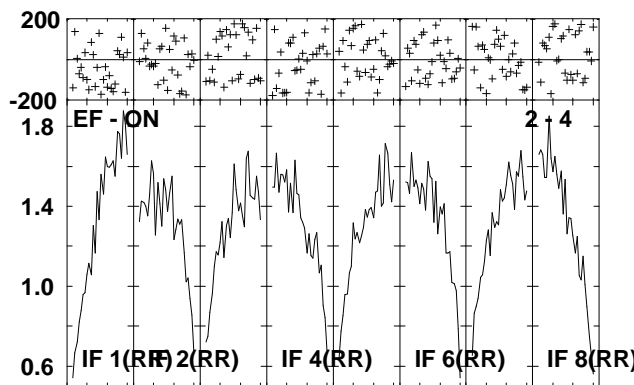
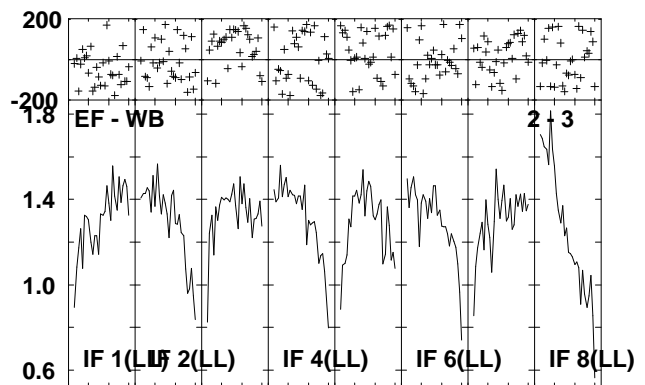
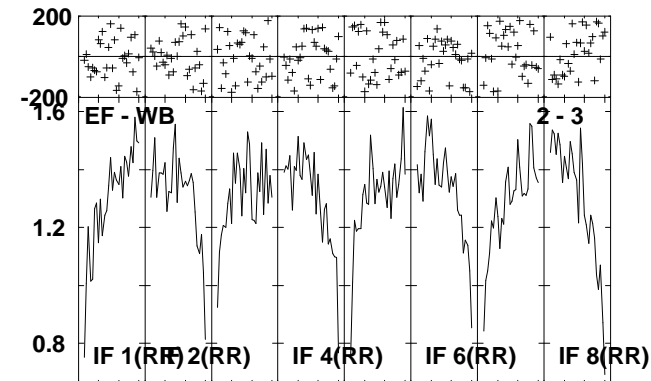
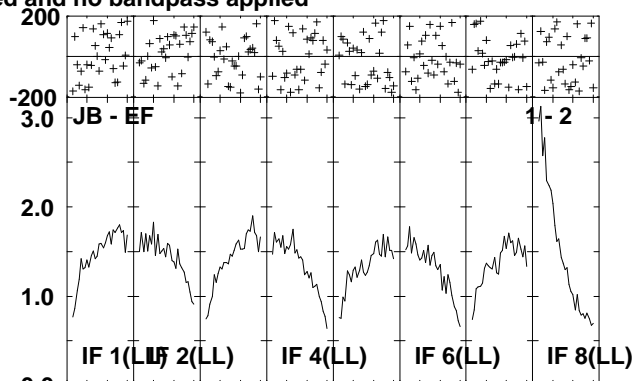
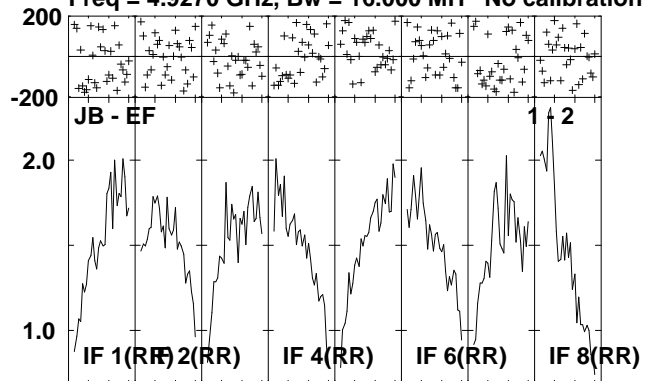

Lower frame: Milli Ampl Jy Top frame: Phas deg
Scalar averaged cross-power spectrum Several baselines displayed
Timerange: 00/15:34:21 to 00/15:37:59

Plot file version 231 created 06-JUL-2010 12:07:46

IRAS2336 EP064L.UVDATA.1

Freq = 4.9270 GHz, Bw = 16.000 MH No calibration applied and no bandpass applied

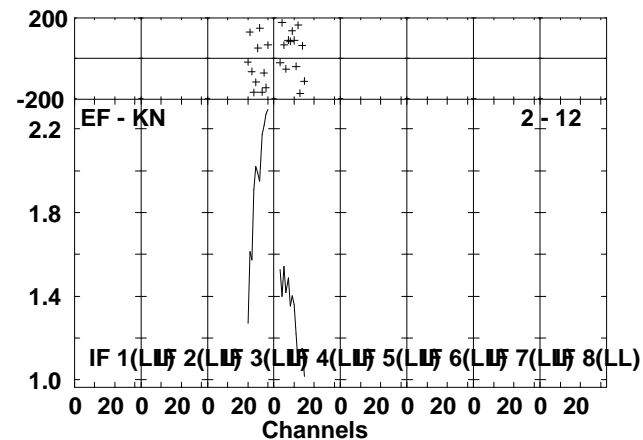
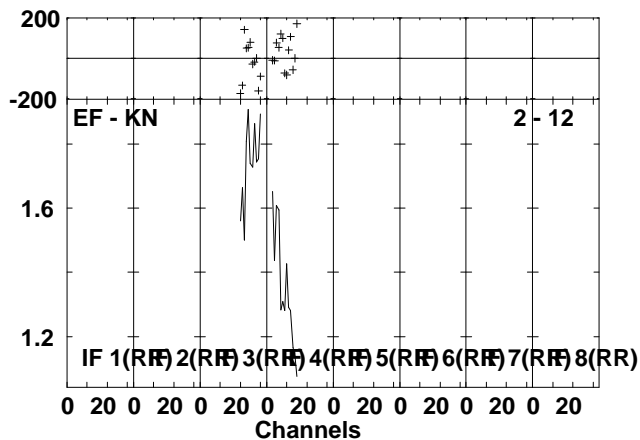
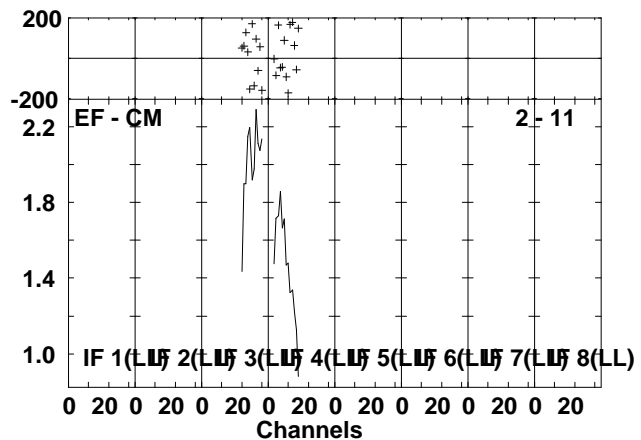
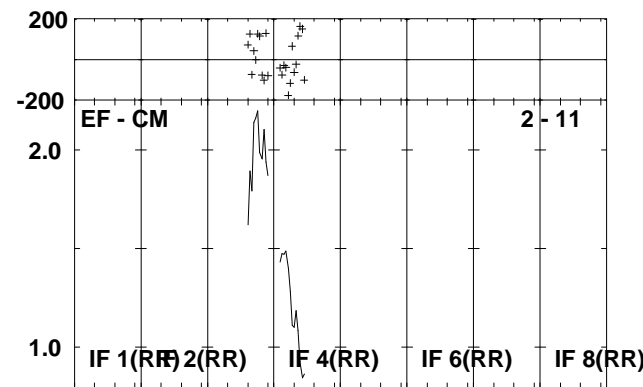
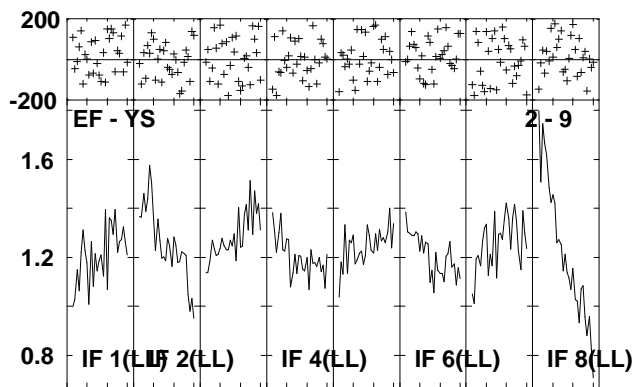
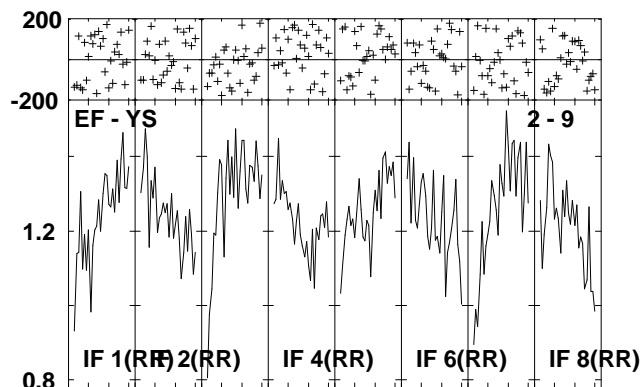
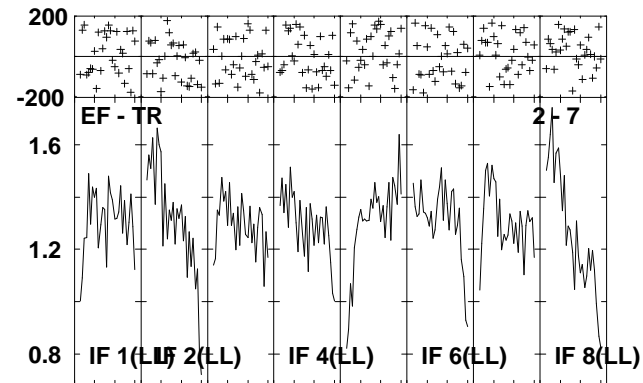
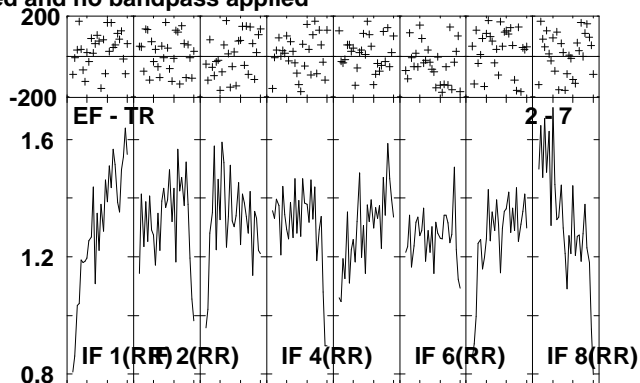
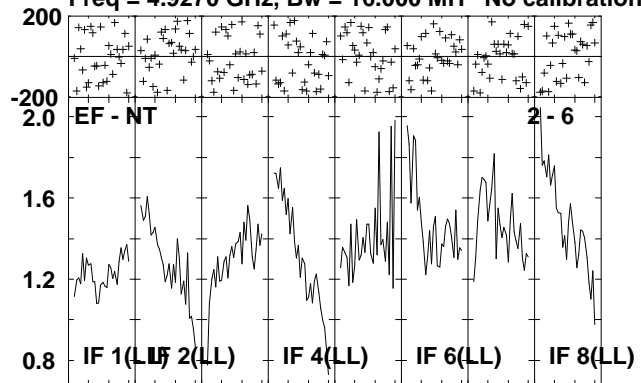

Lower frame: Milli Ampl Jy Top frame: Phas deg
Scalar averaged cross-power spectrum Several baselines displayed
Timerange: 00/15:34:21 to 00/15:37:59

Plot file version 232 created 06-JUL-2010 12:07:50

J2330+33 EP064L.UVDATA.1

Freq = 4.9270 GHz, Bw = 16.000 MH No calibration applied and no bandpass applied

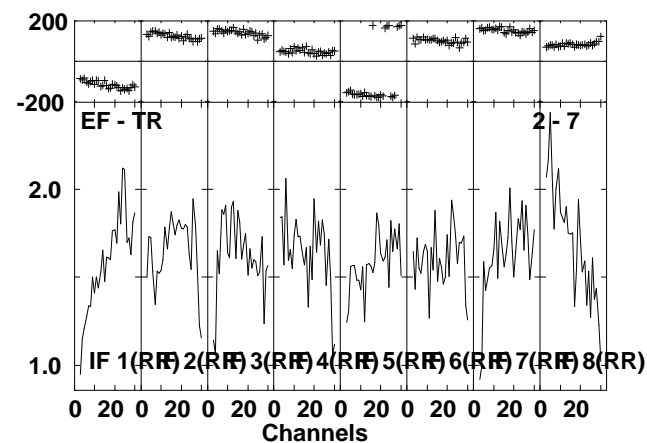
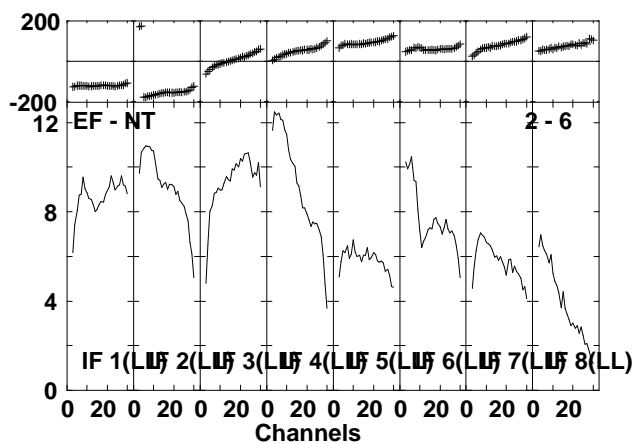
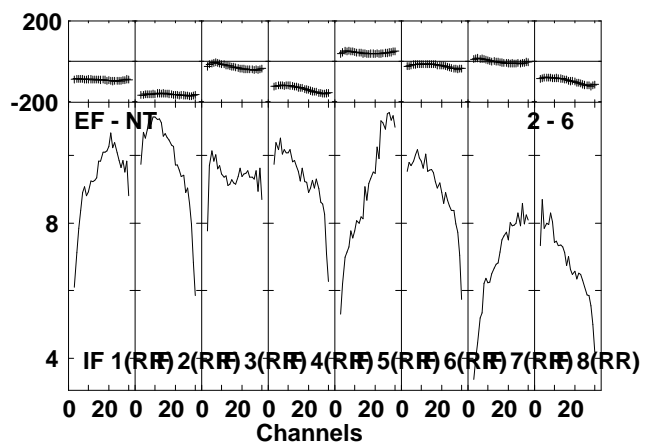
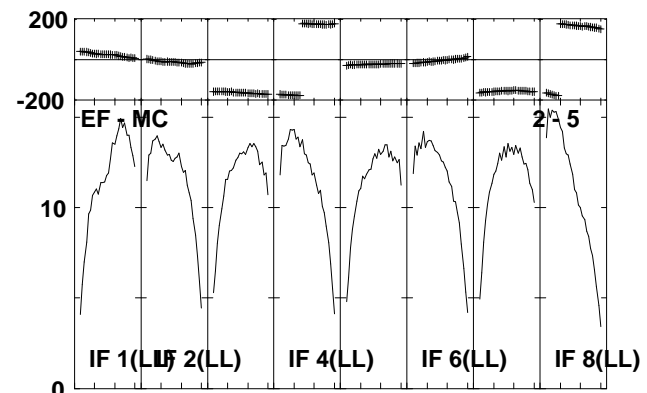
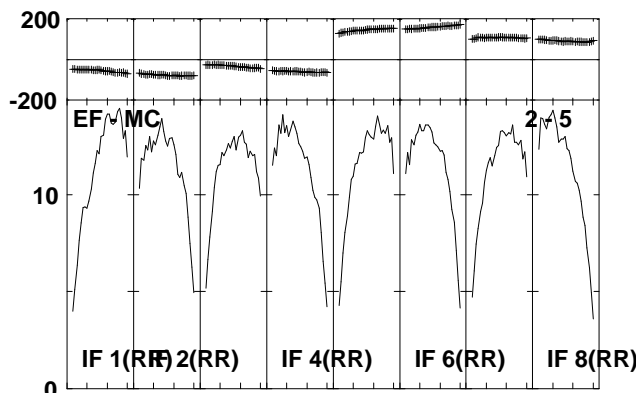
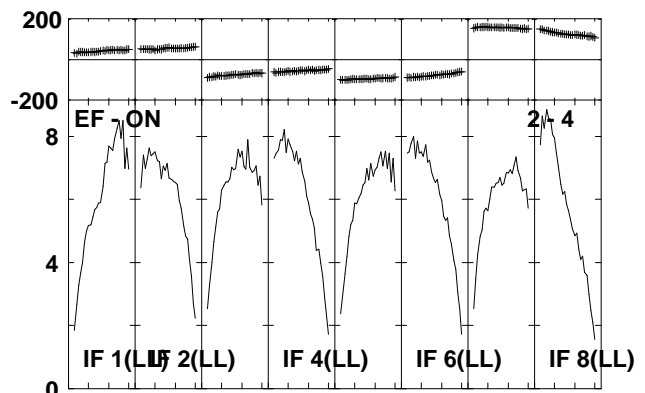
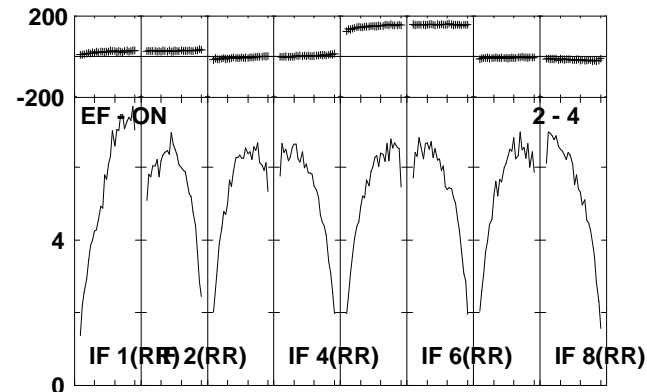
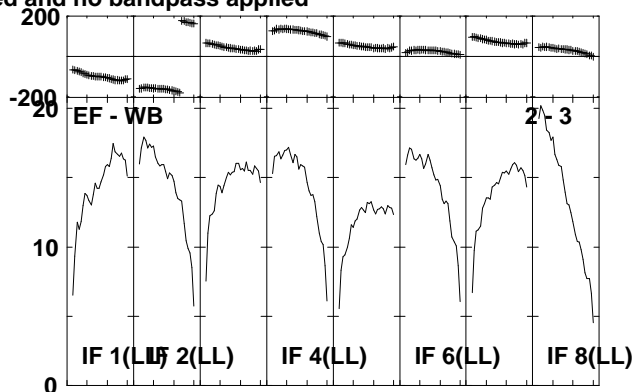
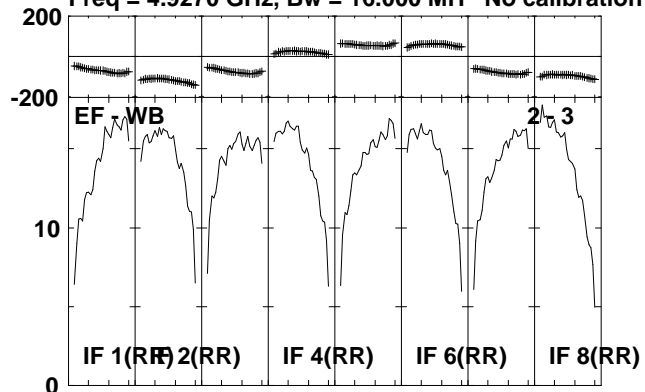

Lower frame: Milli Ampl Jy Top frame: Phas deg
Scalar averaged cross-power spectrum Several baselines displayed
Timerange: 00/15:38:01 to 00/15:39:59

Plot file version 233 created 06-JUL-2010 12:07:51

J2330+33 EP064L.UVDATA.1

Freq = 4.9270 GHz, Bw = 16.000 MH No calibration applied and no bandpass applied

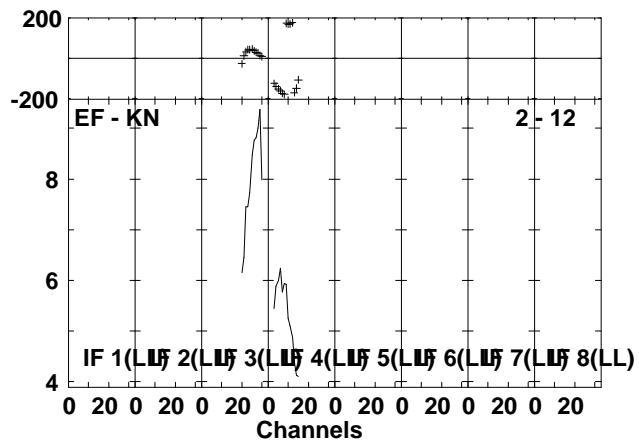
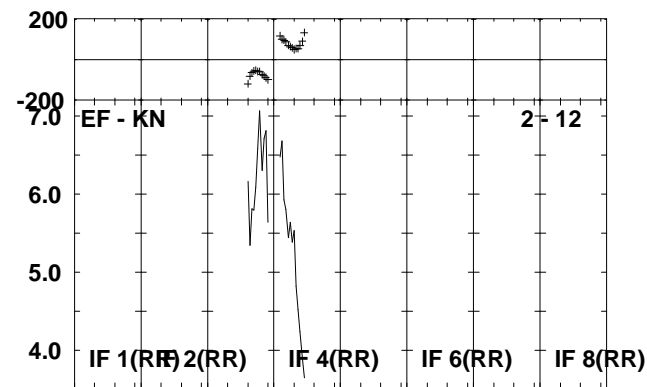
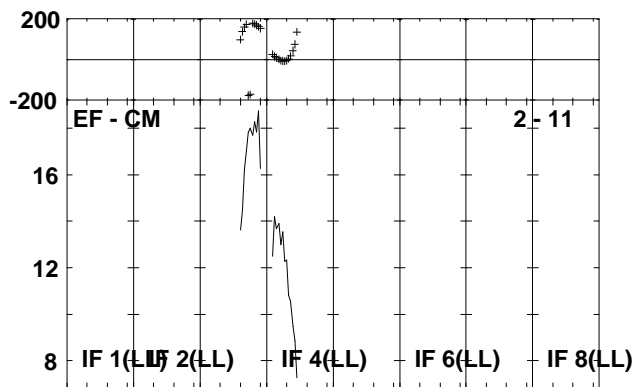
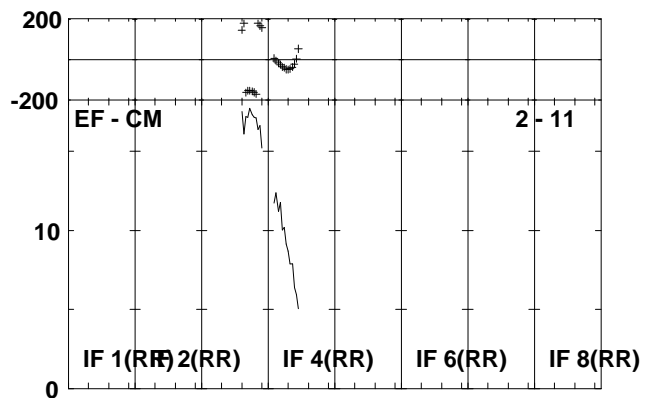
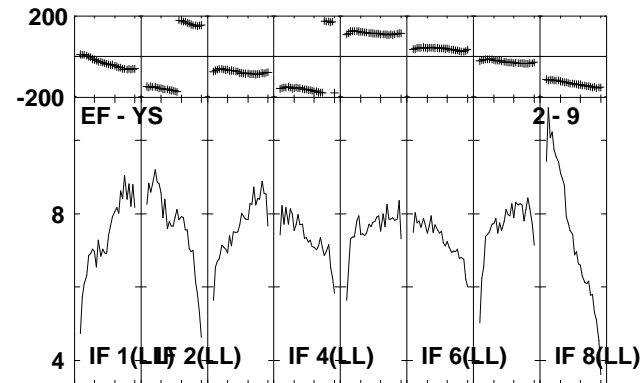
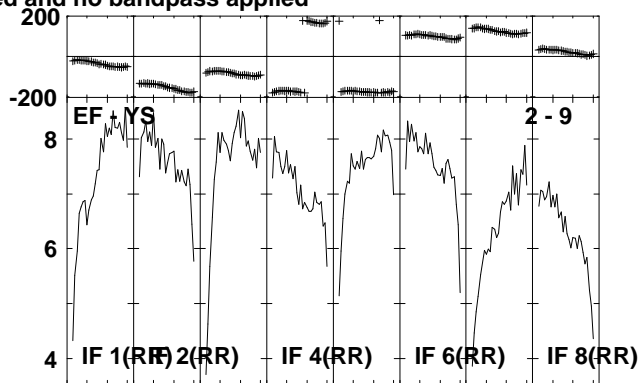
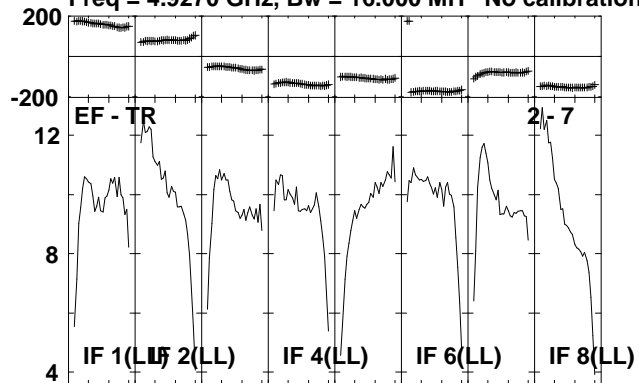

Lower frame: Milli Ampl Jy Top frame: Phas deg
Scalar averaged cross-power spectrum Several baselines displayed
Timerange: 00/15:38:01 to 00/15:39:59

Plot file version 234 created 06-JUL-2010 12:07:58

IRAS2336 EP064L.UVDATA.1

Freq = 4.9270 GHz, Bw = 16.000 MH No calibration applied and no bandpass applied

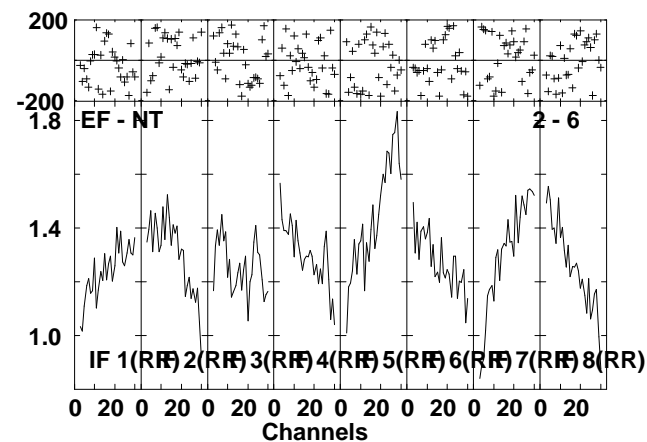
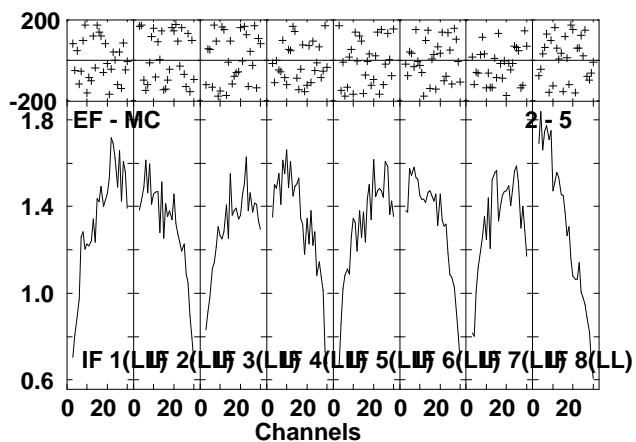
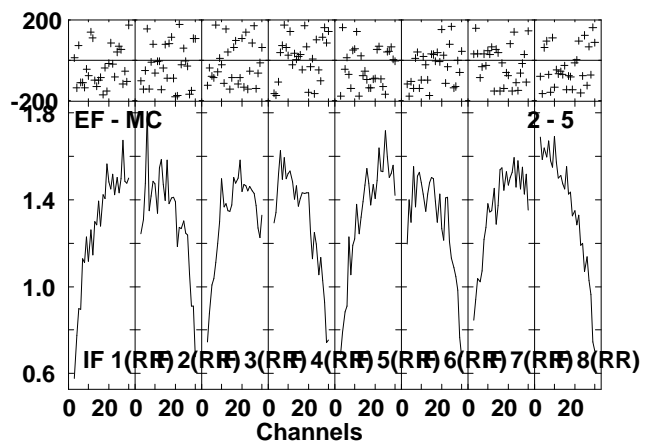
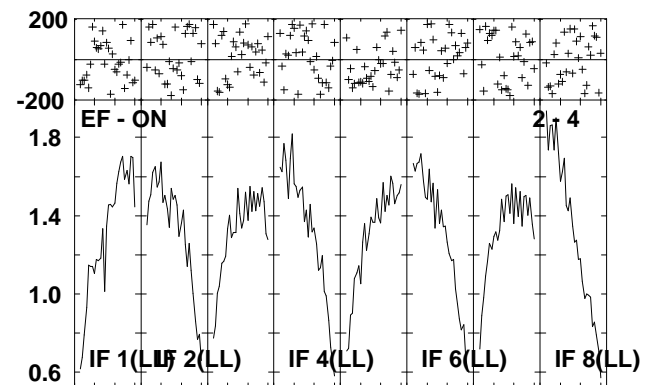
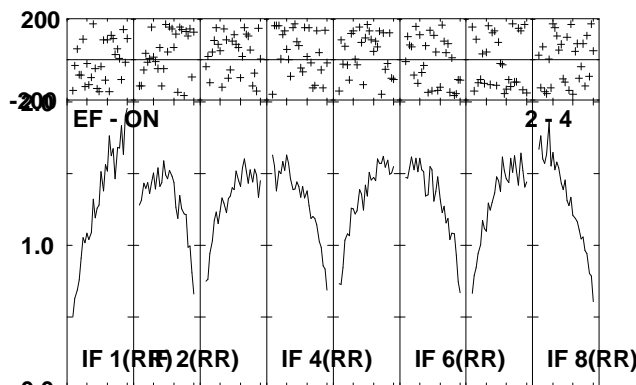
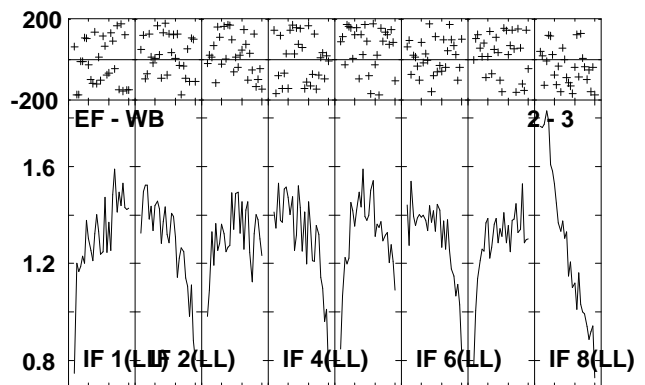
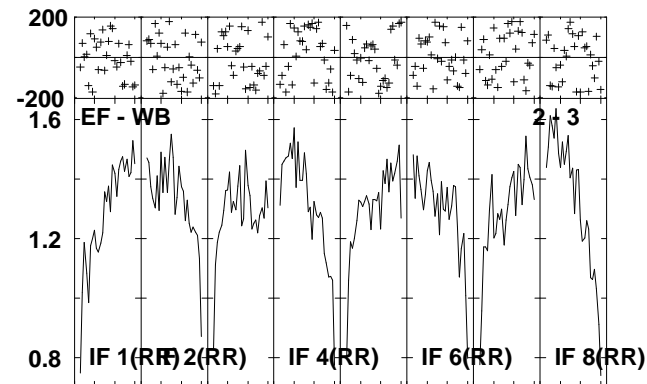
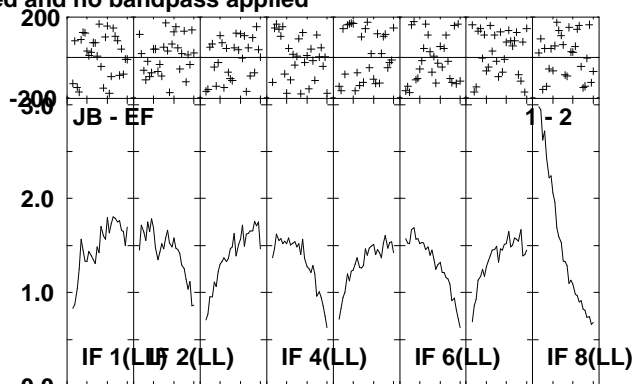
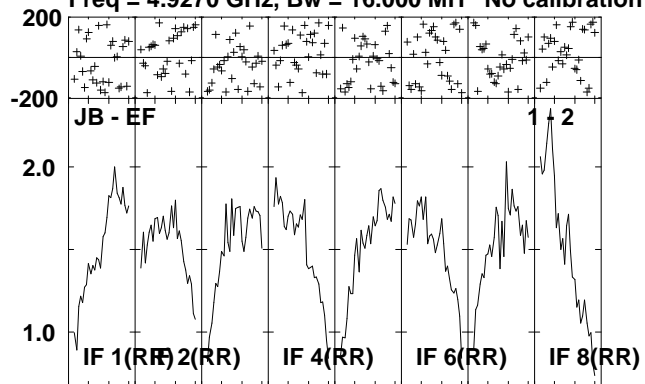

Lower frame: Milli Ampl Jy Top frame: Phas deg
Scalar averaged cross-power spectrum Several baselines displayed
Timerange: 00/15:40:01 to 00/15:44:19

Plot file version 235 created 06-JUL-2010 12:08:00

IRAS2336 EP064L.UVDATA.1

Freq = 4.9270 GHz, Bw = 16.000 MH No calibration applied and no bandpass applied

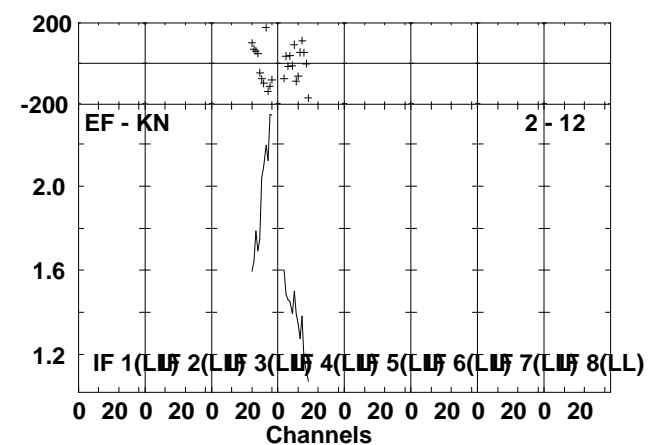
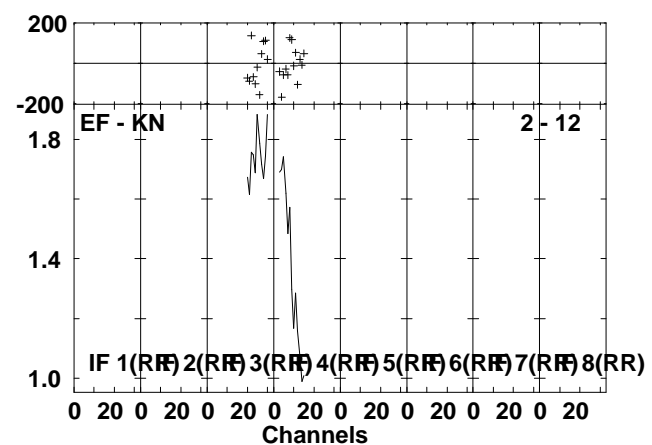
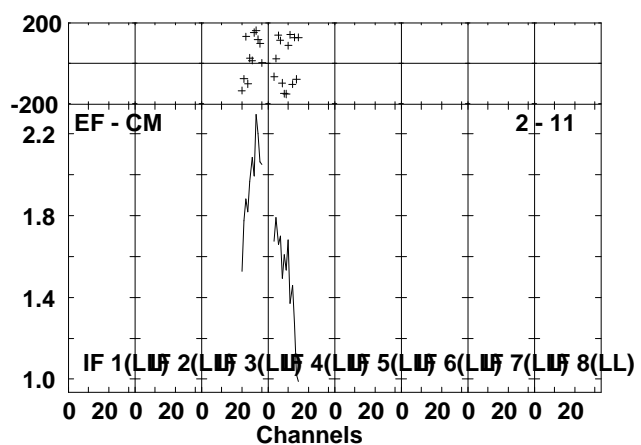
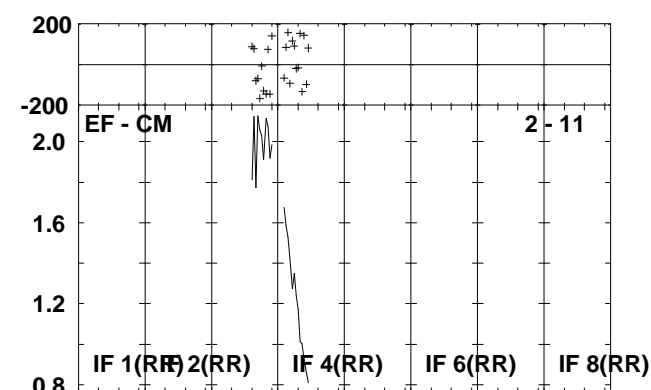
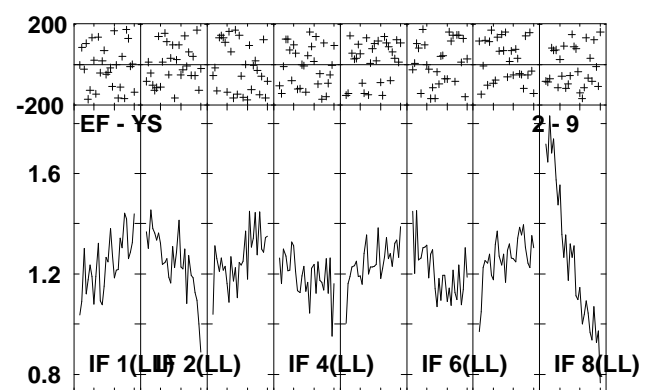
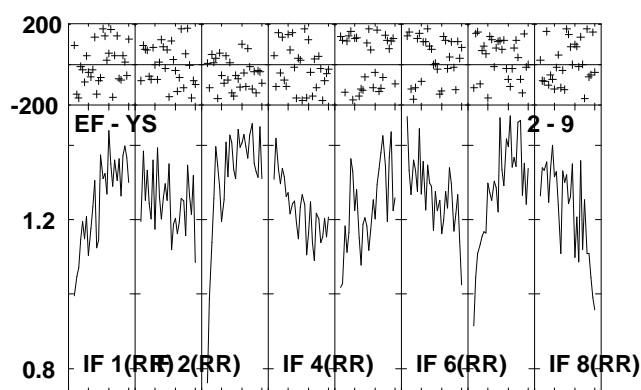
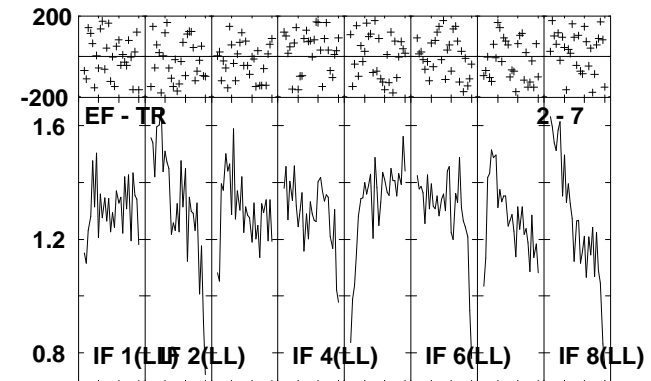
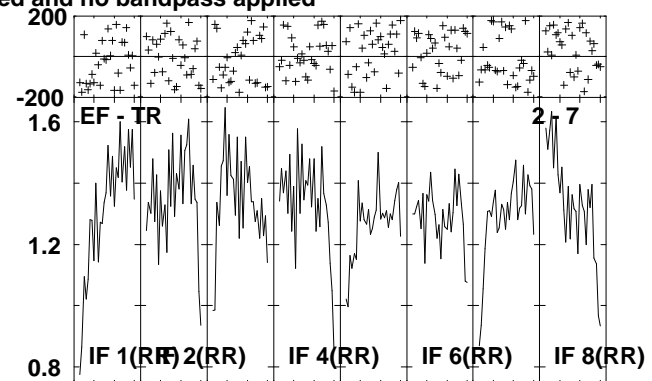
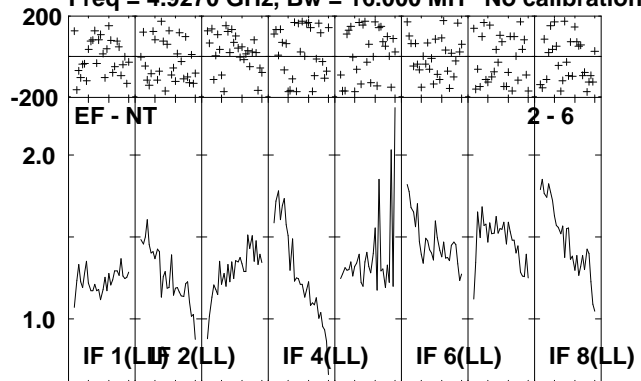

Lower frame: Milli Ampl Jy Top frame: Phas deg
Scalar averaged cross-power spectrum Several baselines displayed
Timerange: 00/15:40:01 to 00/15:44:19

Plot file version 236 created 06-JUL-2010 12:08:04

J2330+33 EP064L.UVDATA.1

Freq = 4.9270 GHz, Bw = 16.000 MH No calibration applied and no bandpass applied

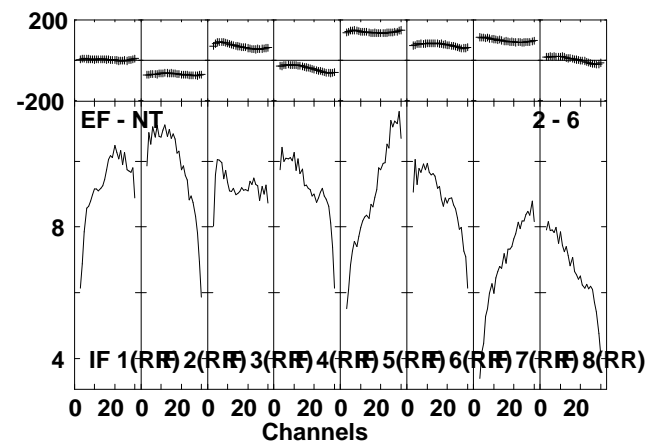
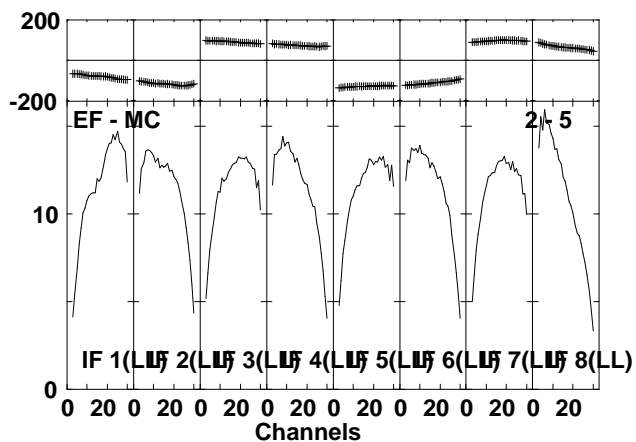
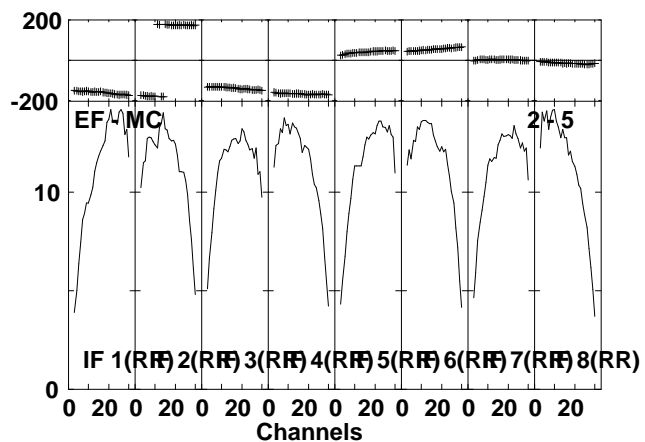
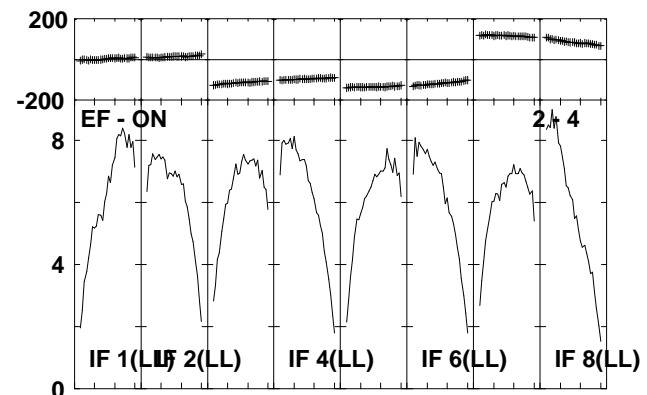
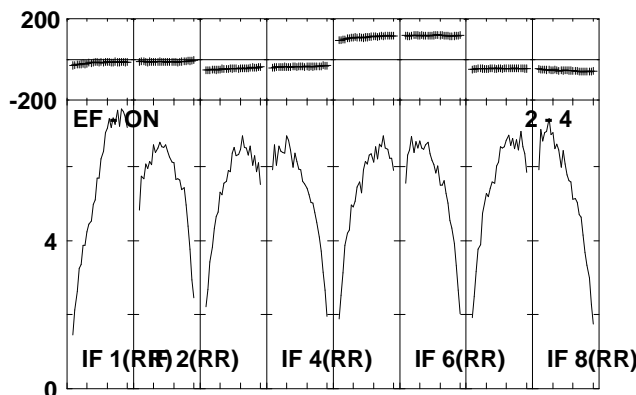
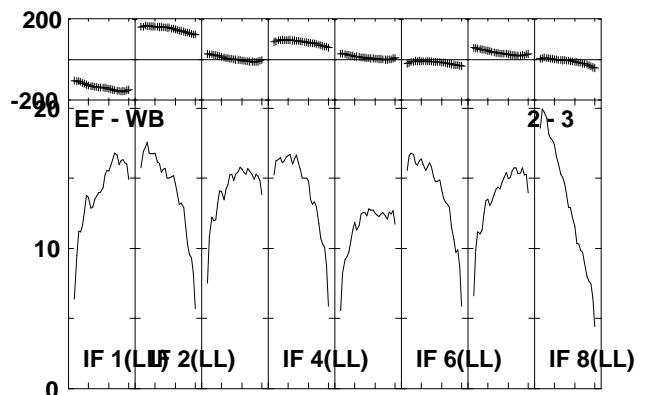
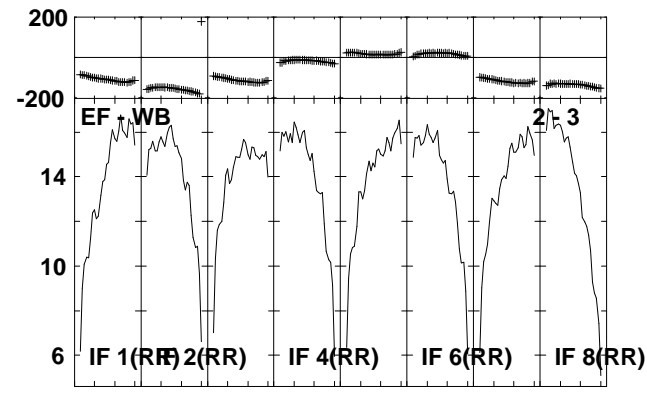
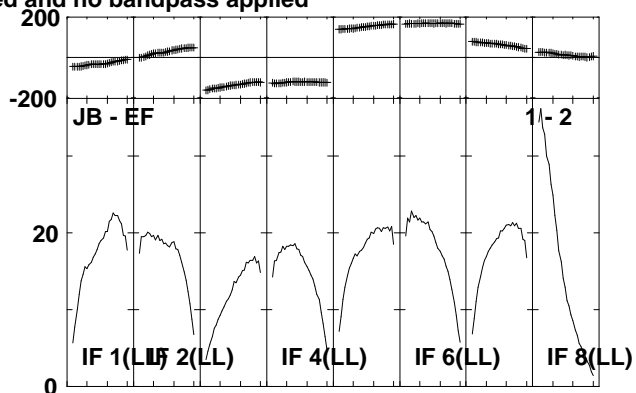
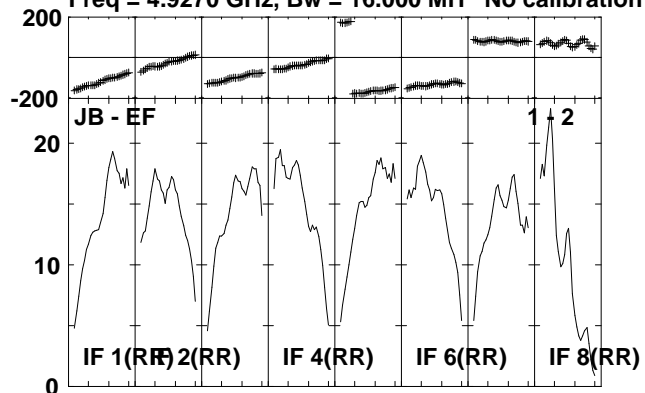

Lower frame: Milli Ampl Jy Top frame: Phas deg
Scalar averaged cross-power spectrum Several baselines displayed
Timerange: 00/15:45:21 to 00/15:47:19

Plot file version 237 created 06-JUL-2010 12:08:05

J2330+33 EP064L.UVDATA.1

Freq = 4.9270 GHz, Bw = 16.000 MH No calibration applied and no bandpass applied

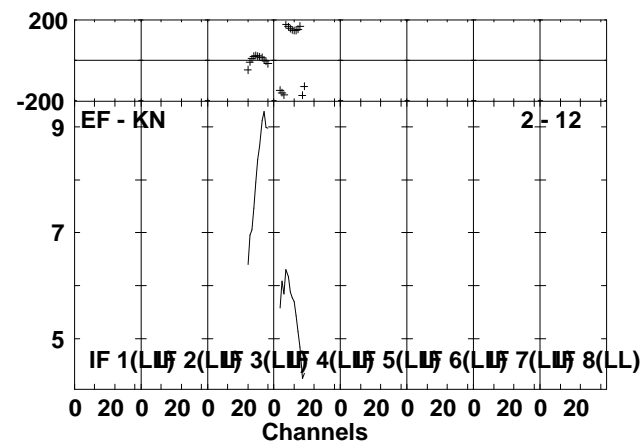
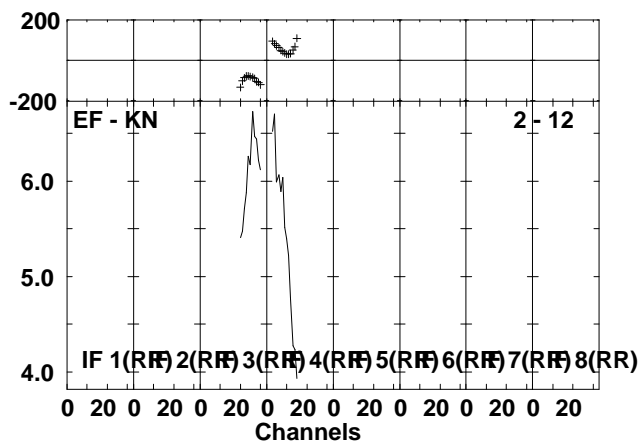
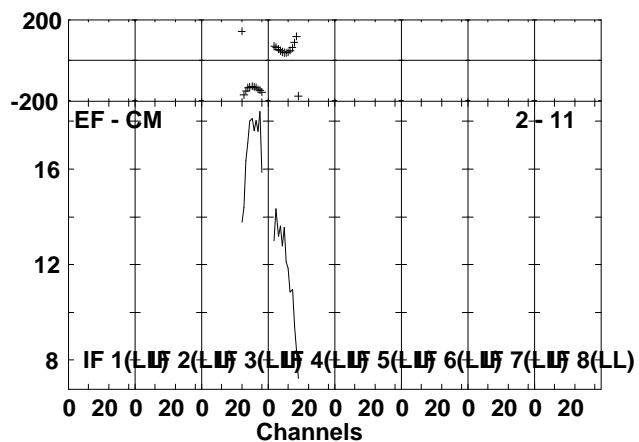
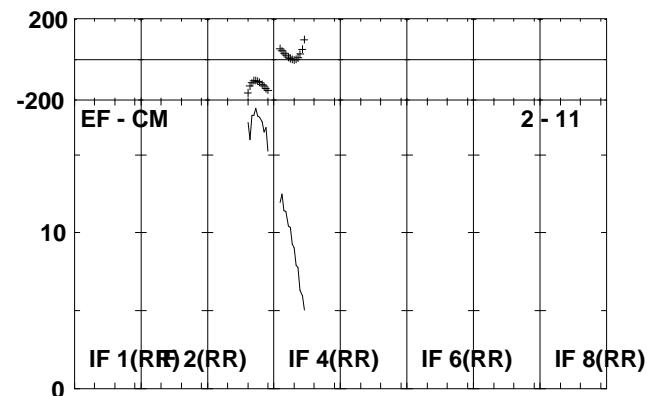
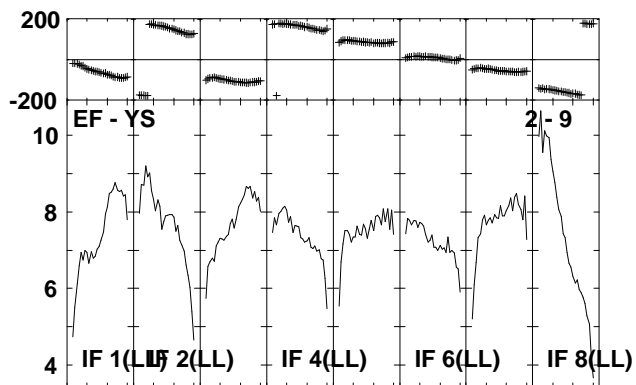
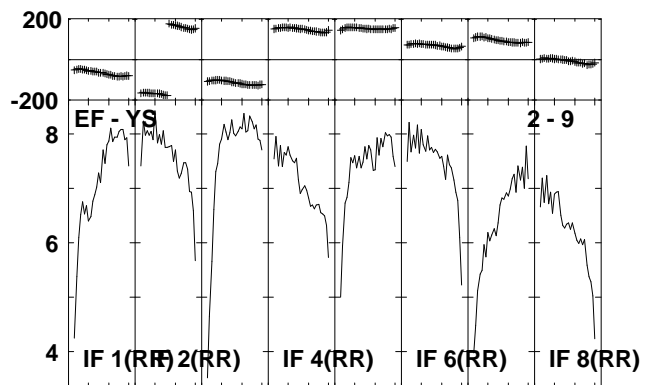
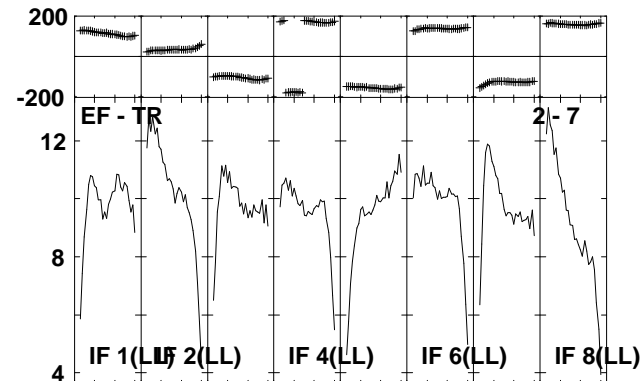
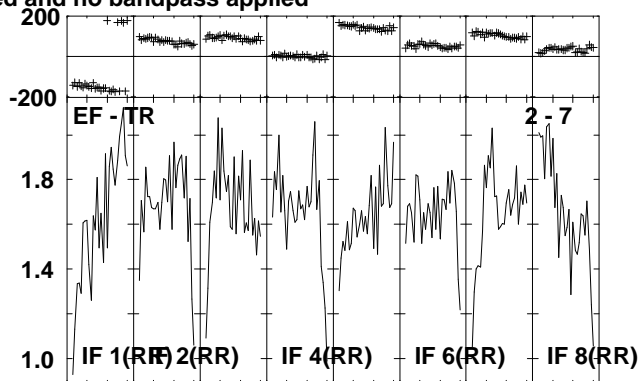
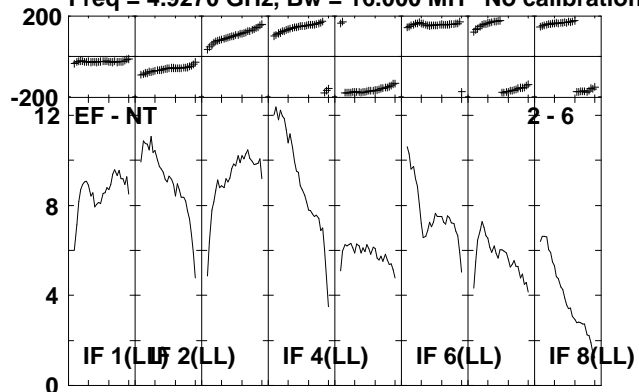

Lower frame: Milli Ampl Jy Top frame: Phas deg
Scalar averaged cross-power spectrum Several baselines displayed
Timerange: 00/15:45:21 to 00/15:47:19

Plot file version 238 created 06-JUL-2010 12:08:07

IRAS2336 EP064L.UVDATA.1

Freq = 4.9270 GHz, Bw = 16.000 MH No calibration applied and no bandpass applied

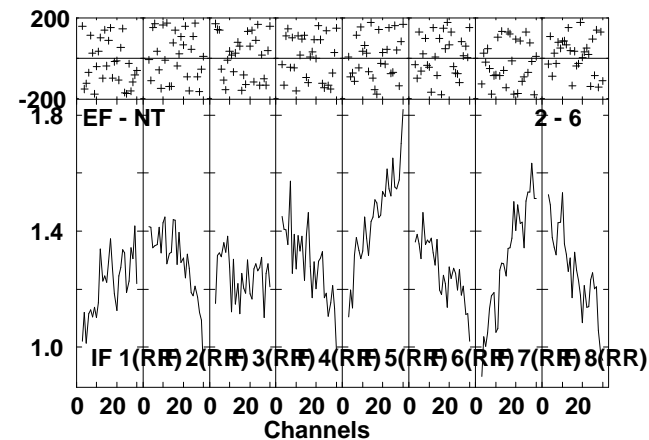
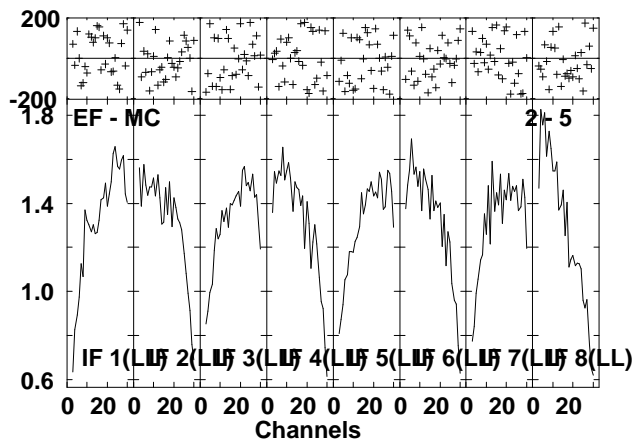
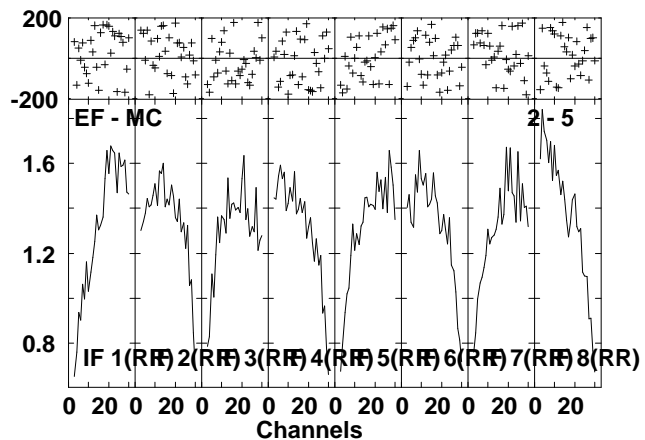
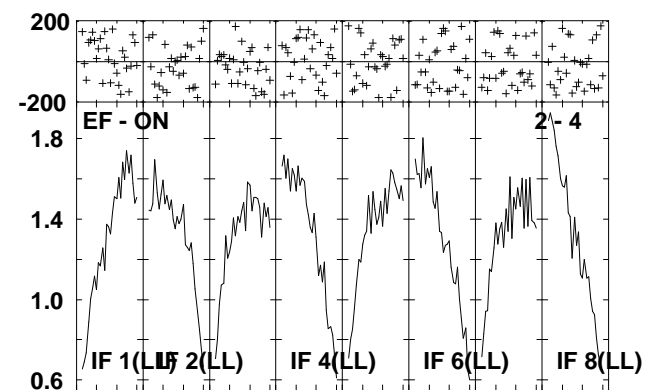
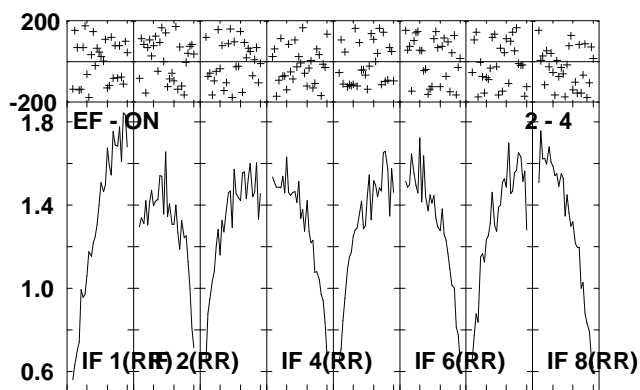
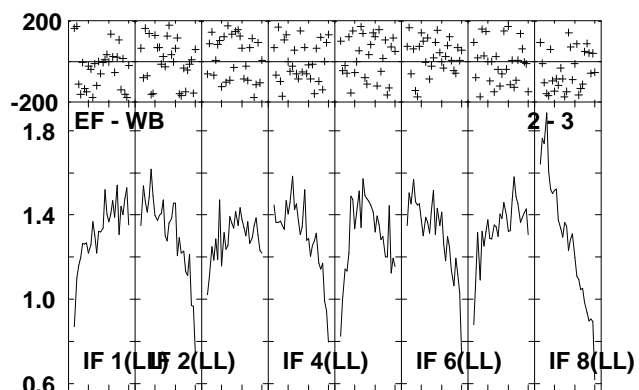
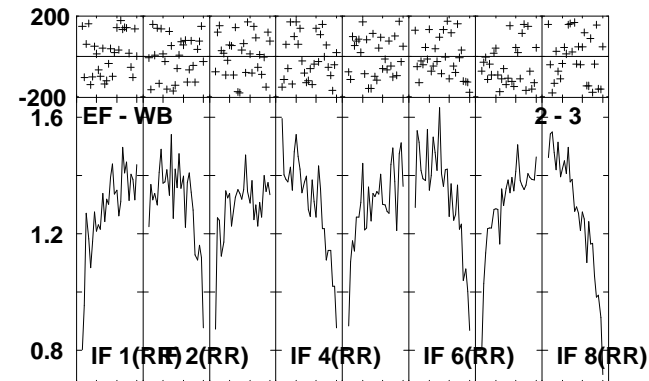
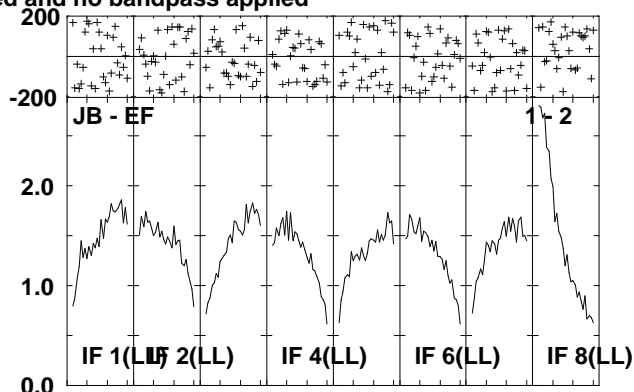
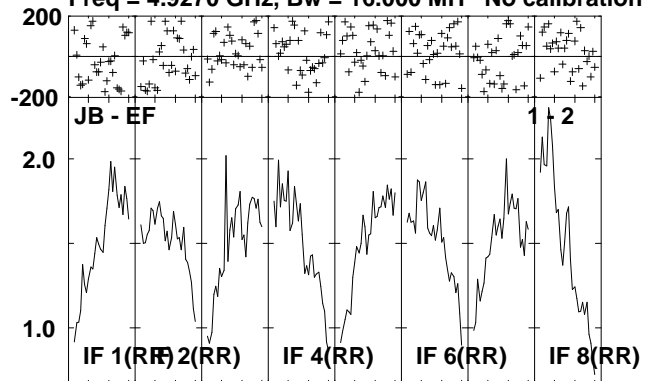

Lower frame: Milli Ampl Jy Top frame: Phas deg
Scalar averaged cross-power spectrum Several baselines displayed
Timerange: 00:15:47:21 to 00:15:51:39

Plot file version 239 created 06-JUL-2010 12:08:10

IRAS2336 EP064L.UVDATA.1

Freq = 4.9270 GHz, Bw = 16.000 MH No calibration applied and no bandpass applied

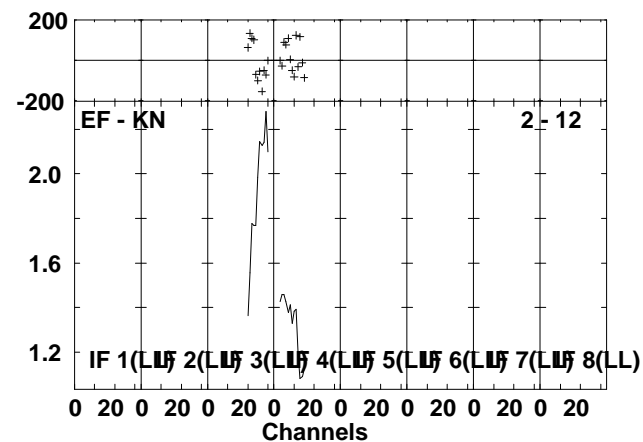
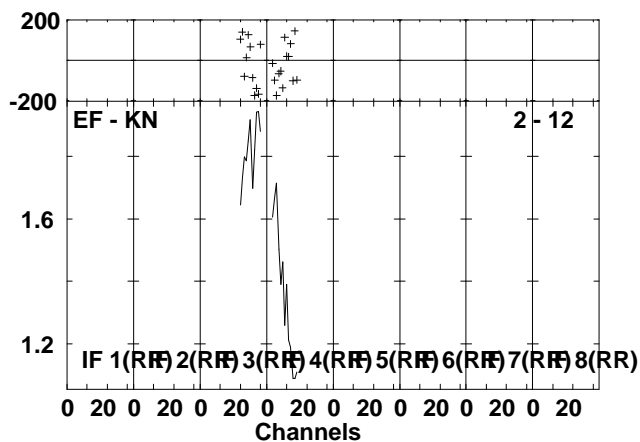
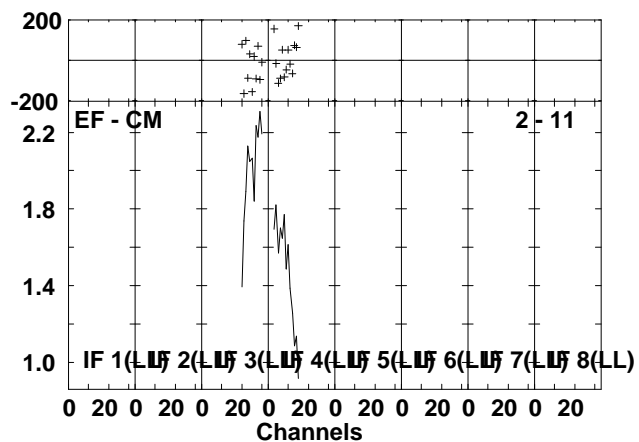
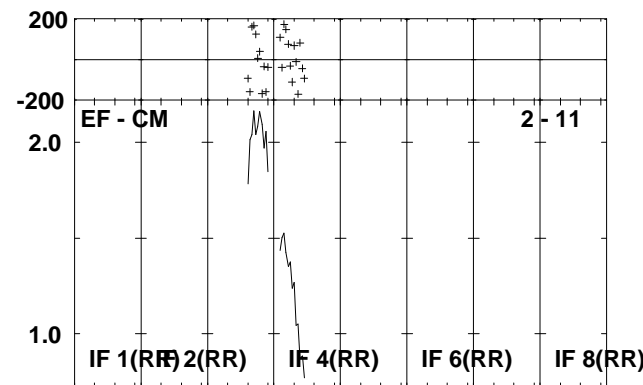
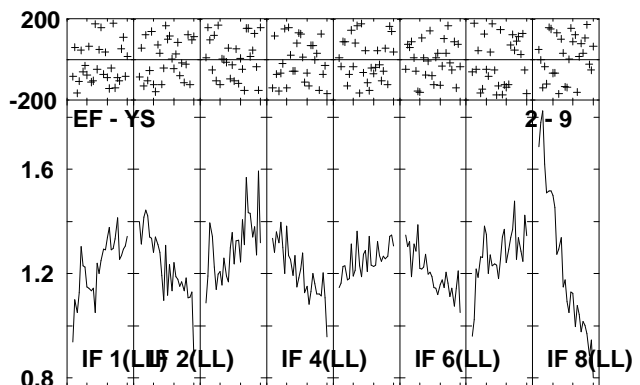
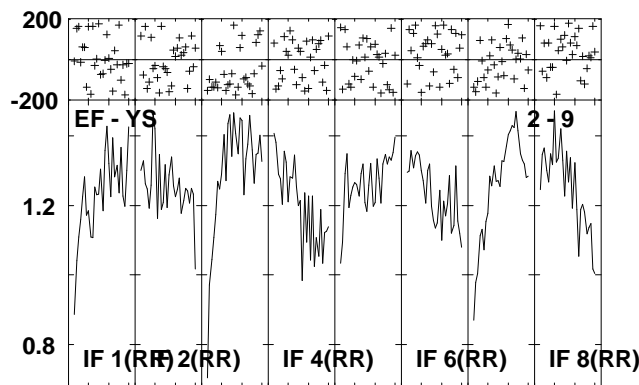
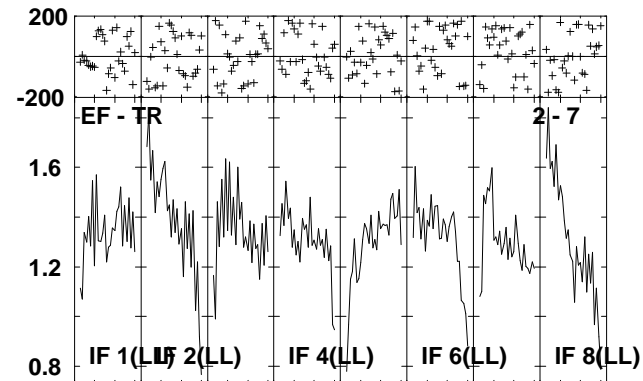
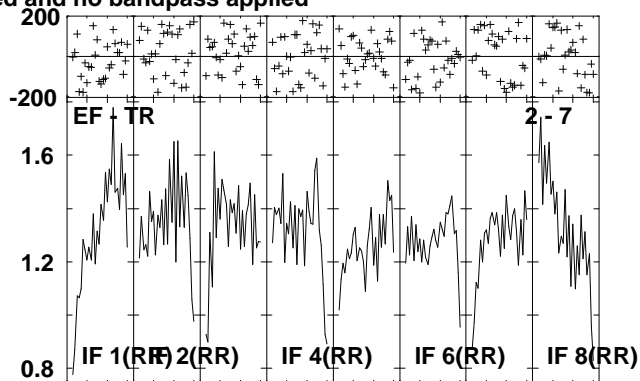
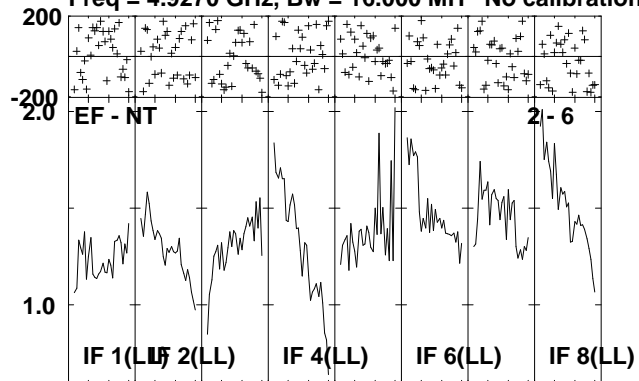

Lower frame: Milli Ampl Jy Top frame: Phas deg
Scalar averaged cross-power spectrum Several baselines displayed
Timerange: 00/15:47:21 to 00/15:51:39

Plot file version 240 created 06-JUL-2010 12:08:14

J2330+33 EP064L.UVDATA.1

Freq = 4.9270 GHz, Bw = 16.000 MH No calibration applied and no bandpass applied

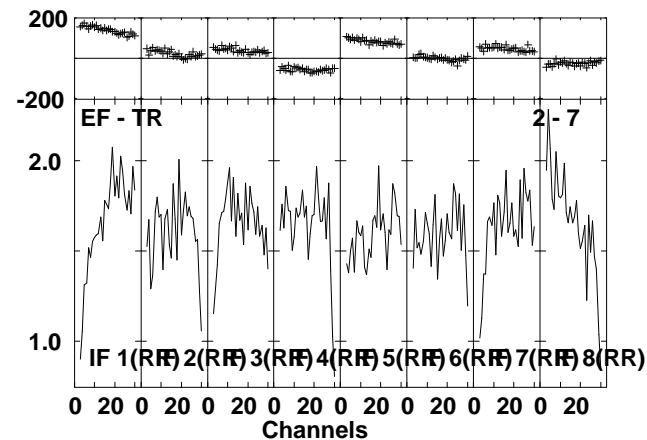
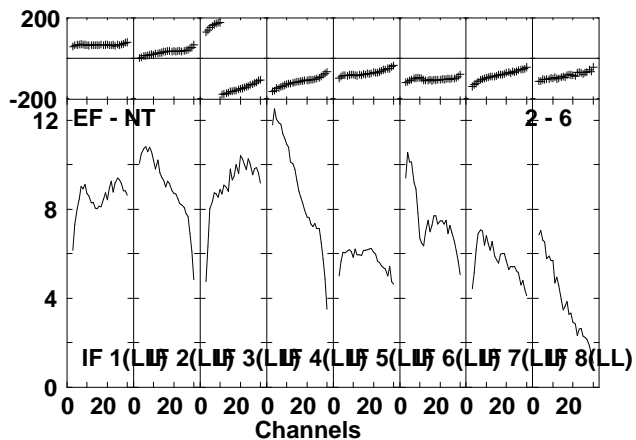
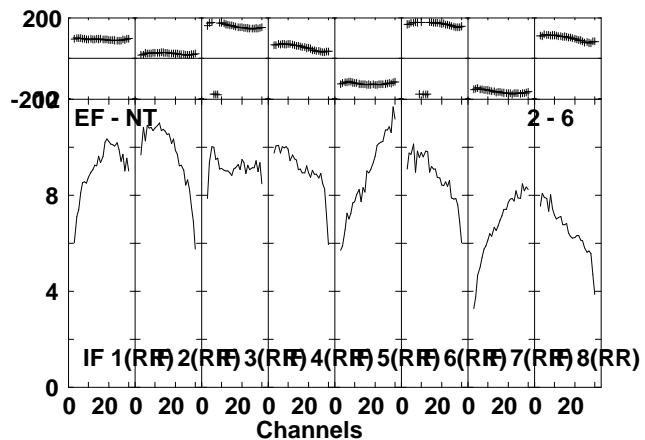
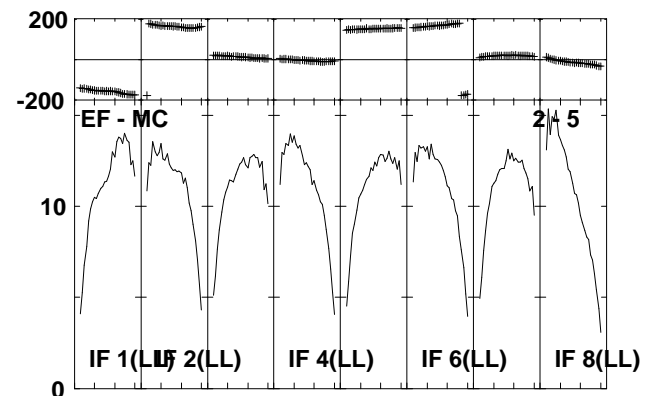
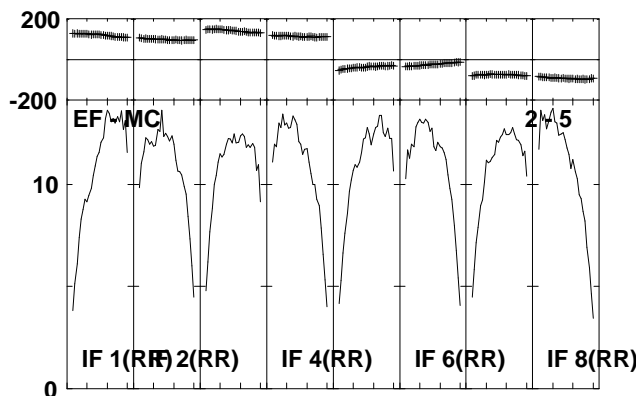
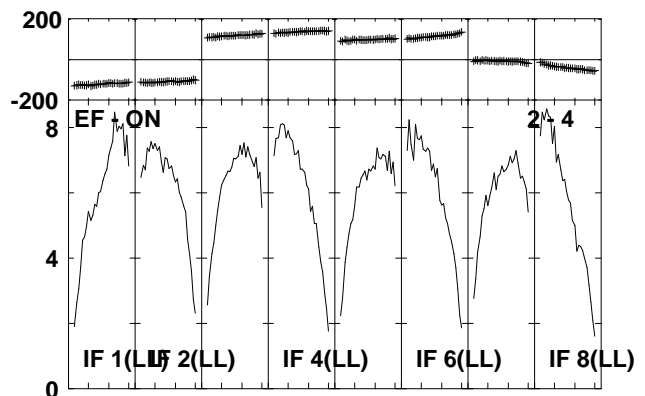
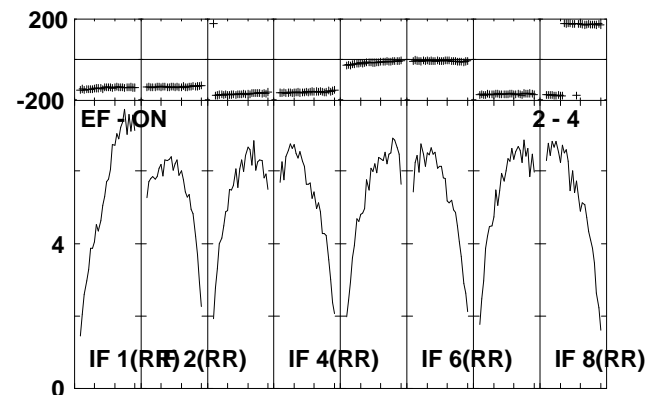
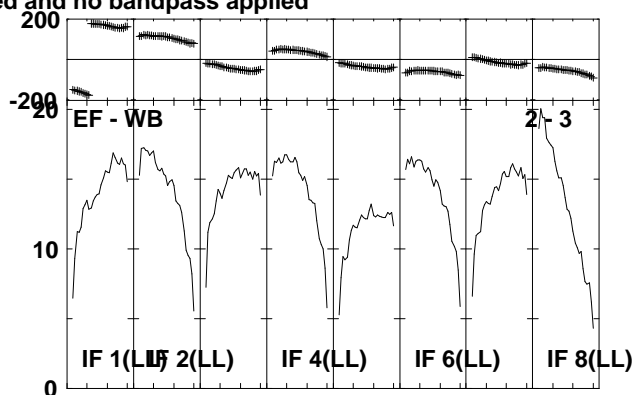
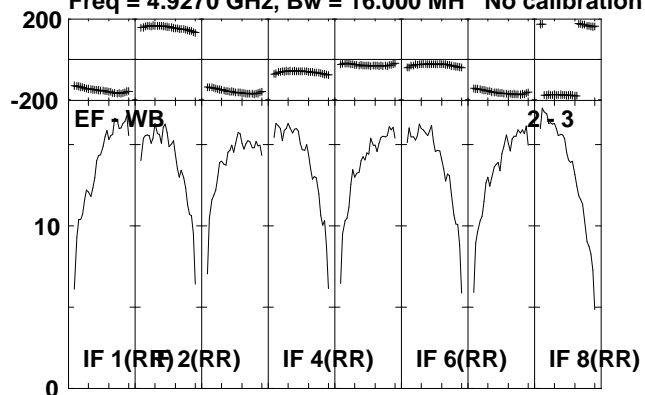

Lower frame: Milli Ampl Jy Top frame: Phas deg
Scalar averaged cross-power spectrum Several baselines displayed
Timerange: 00/15:51:41 to 00/15:53:39

Plot file version 241 created 06-JUL-2010 12:08:15

J2330+33 EP064L.UVDATA.1

Freq = 4.9270 GHz, Bw = 16.000 MH No calibration applied and no bandpass applied

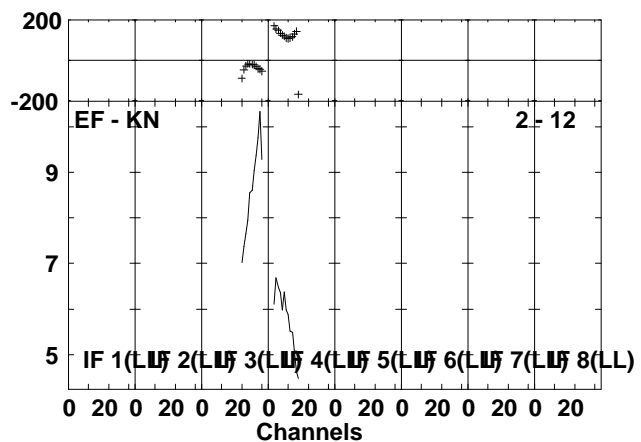
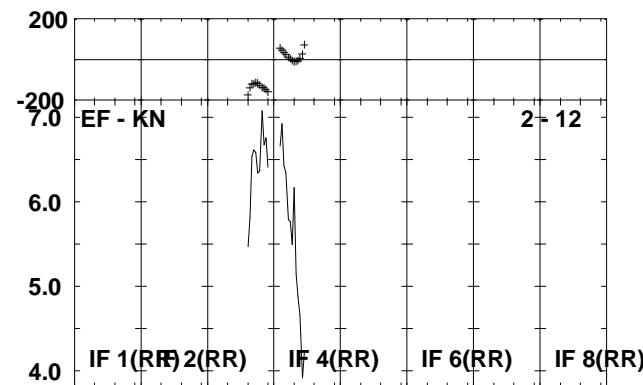
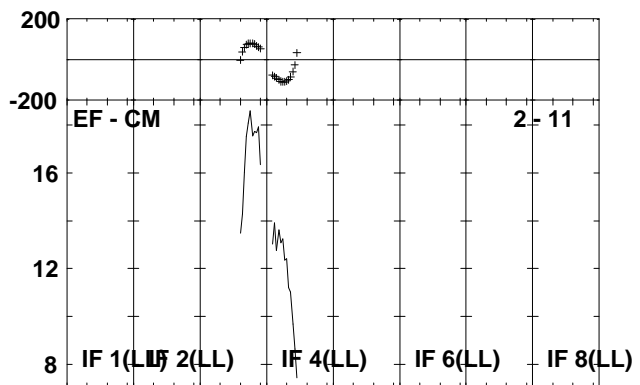
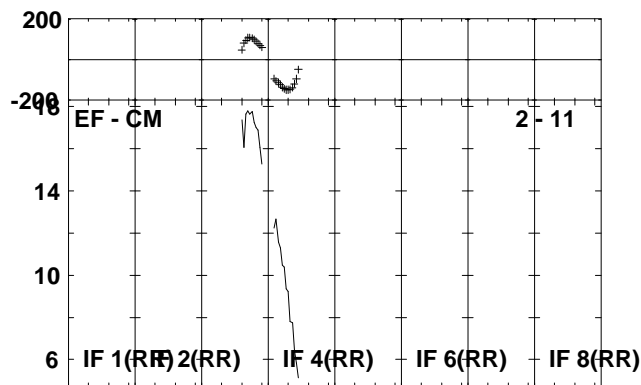
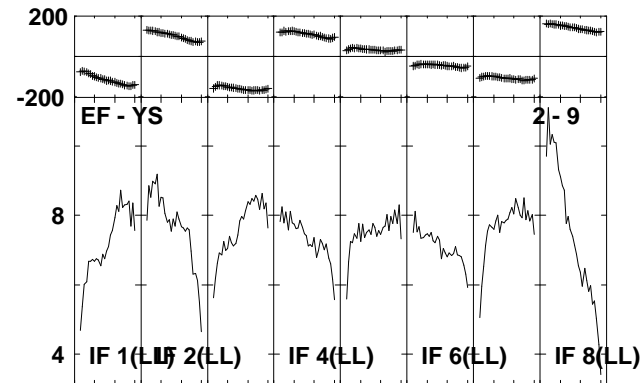
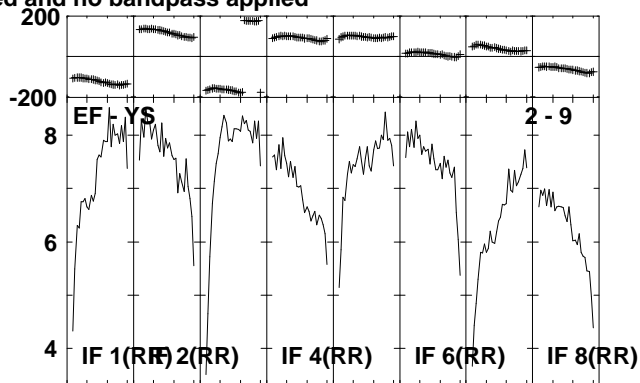
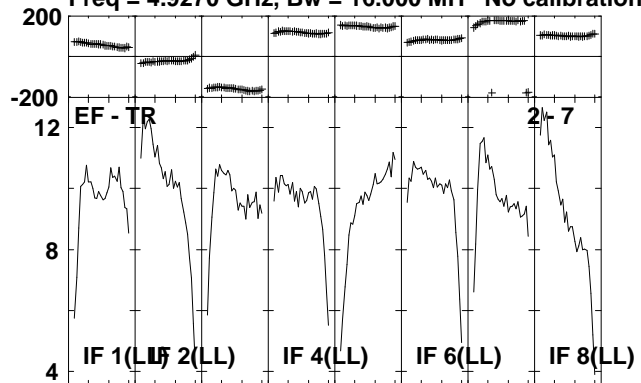

Lower frame: Milli Ampl Jy Top frame: Phas deg
Scalar averaged cross-power spectrum Several baselines displayed
Timerange: 00/15:51:41 to 00/15:53:39

Plot file version 242 created 06-JUL-2010 12:08:16

IRAS2336 EP064L.UVDATA.1

Freq = 4.9270 GHz, Bw = 16.000 MH No calibration applied and no bandpass applied

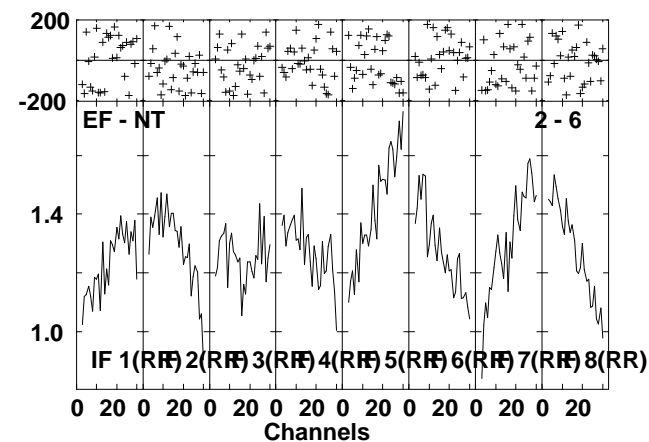
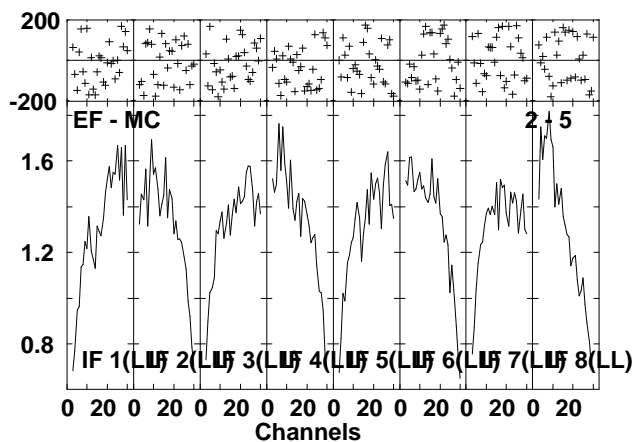
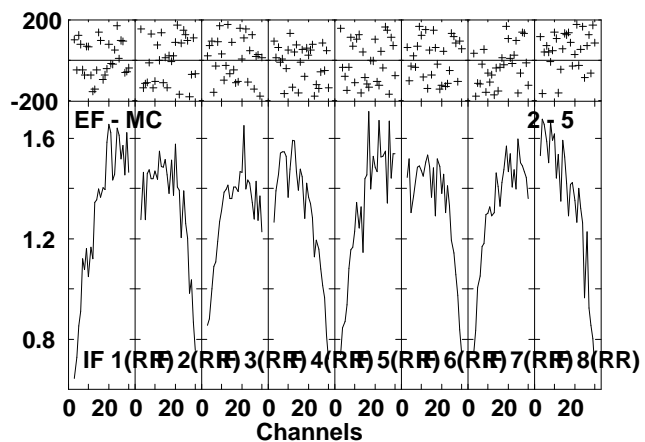
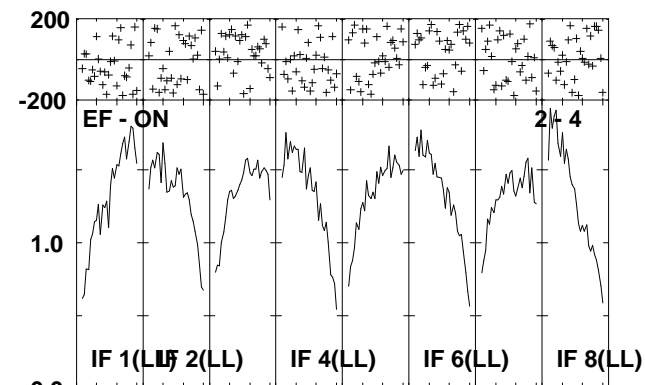
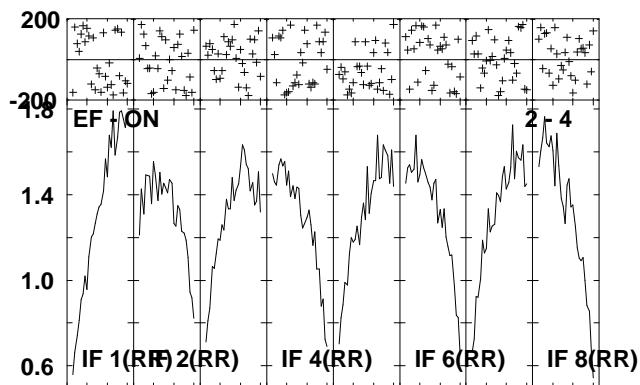
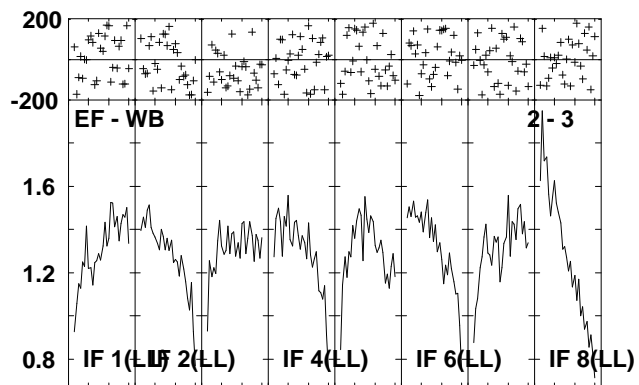
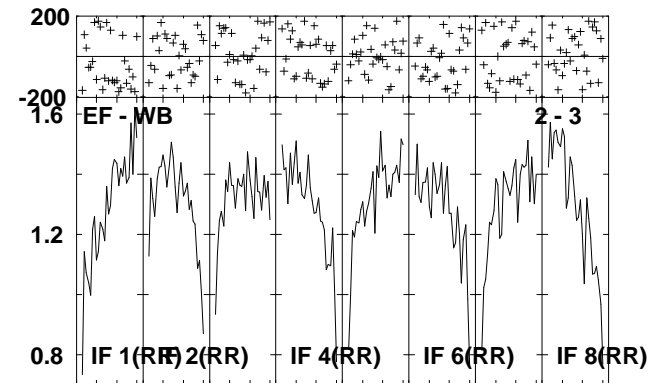
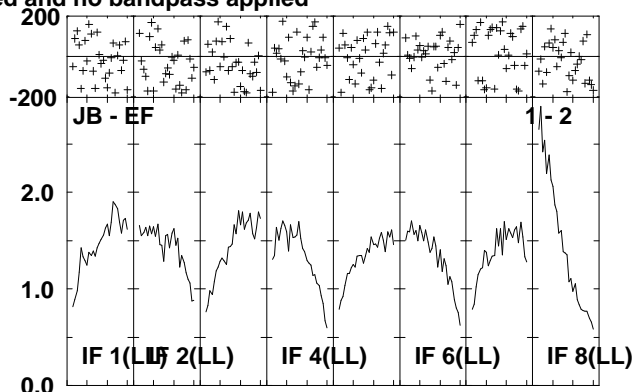
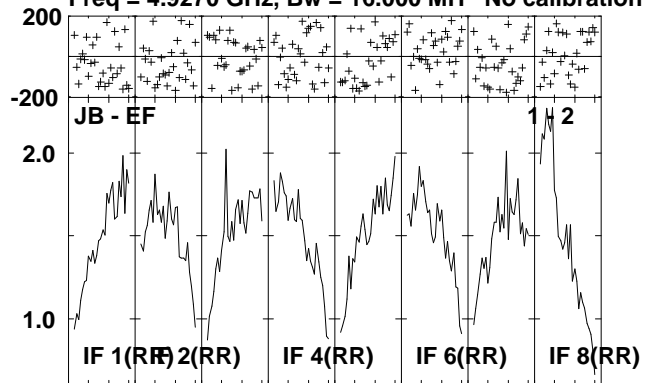

Lower frame: Milli Ampl Jy Top frame: Phas deg
Scalar averaged cross-power spectrum Several baselines displayed
Timerange: 00/15:53:41 to 00/15:57:59

Plot file version 243 created 06-JUL-2010 12:08:19

IRAS2336 EP064L.UVDATA.1

Freq = 4.9270 GHz, Bw = 16.000 MH No calibration applied and no bandpass applied

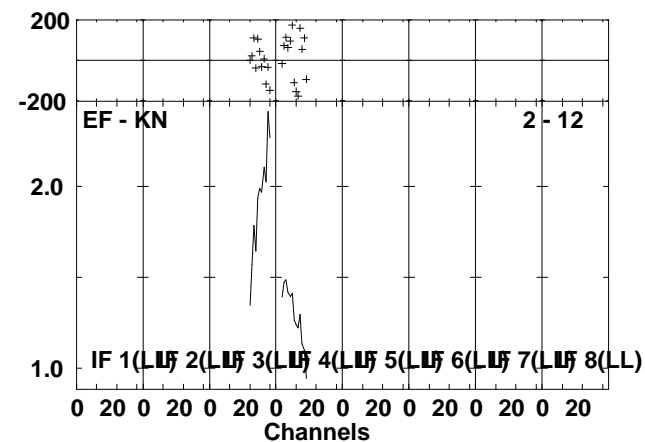
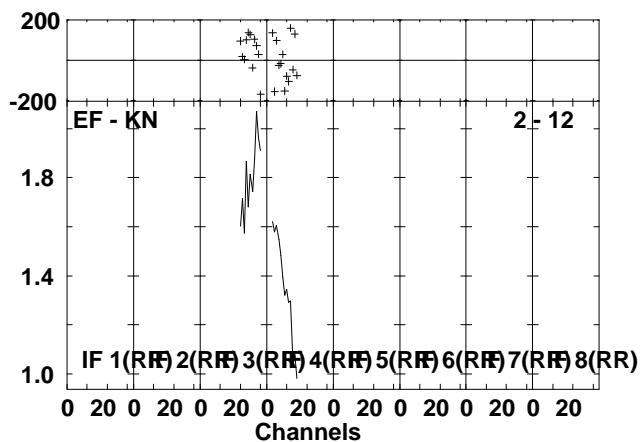
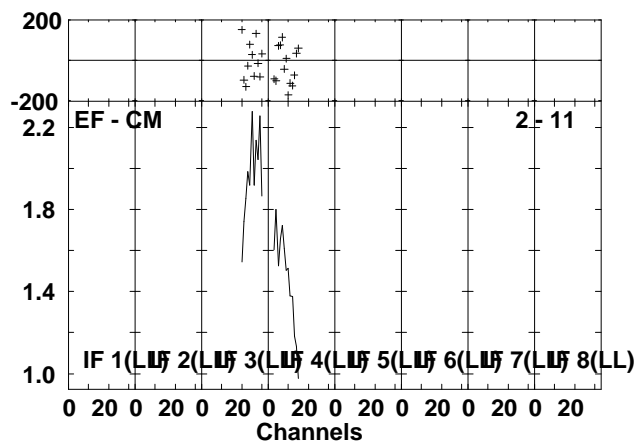
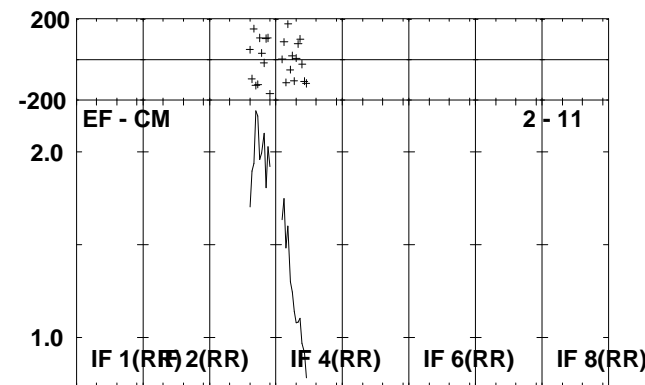
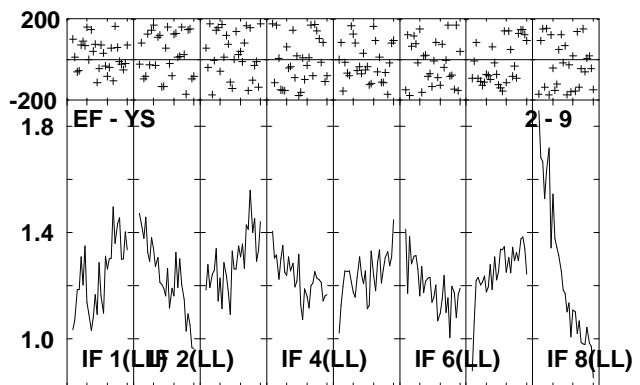
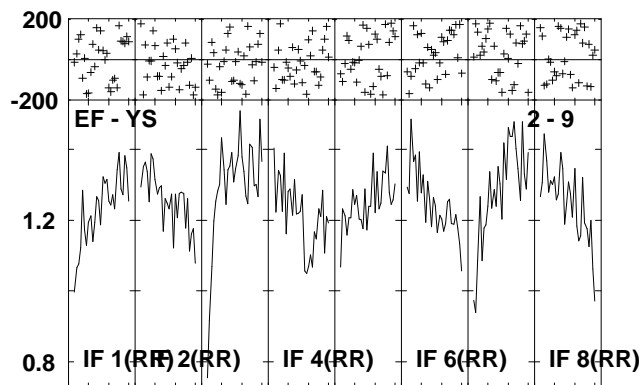
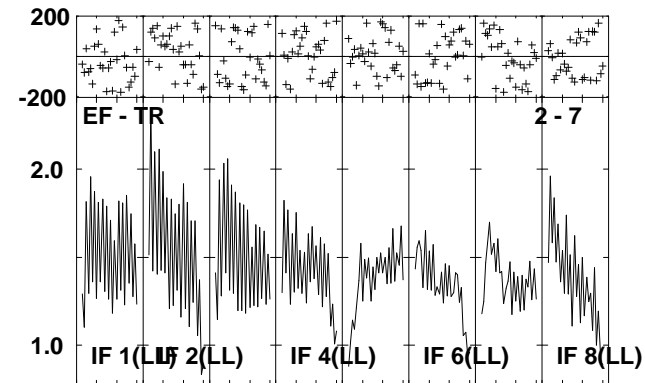
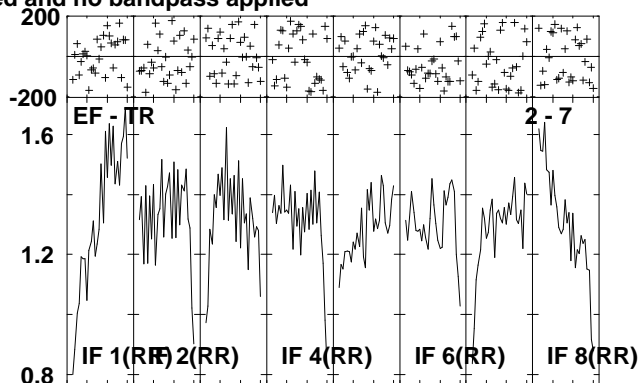
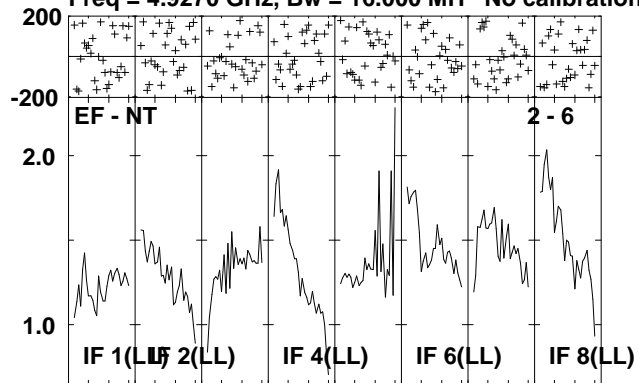

Lower frame: Milli Ampl Jy Top frame: Phas deg
Scalar averaged cross-power spectrum Several baselines displayed
Timerange: 00/15:53:41 to 00/15:57:59

Plot file version 244 created 06-JUL-2010 12:08:23

J2330+33 EP064L.UVDATA.1

Freq = 4.9270 GHz, Bw = 16.000 MH No calibration applied and no bandpass applied

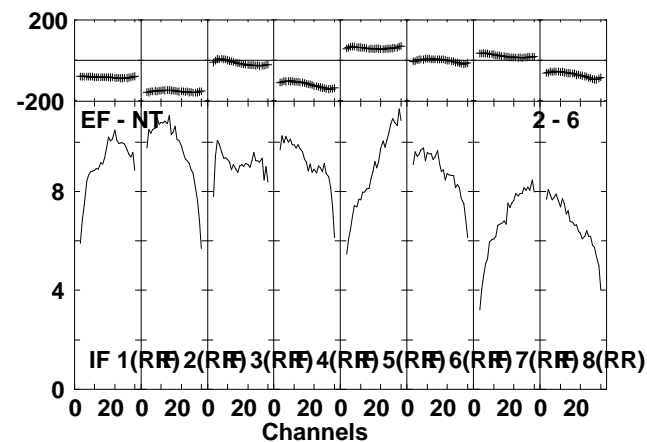
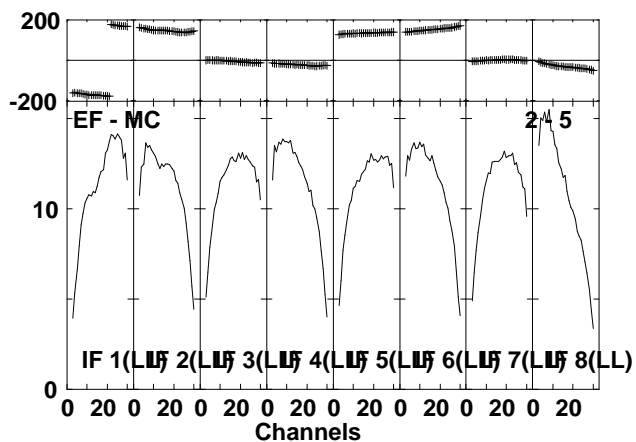
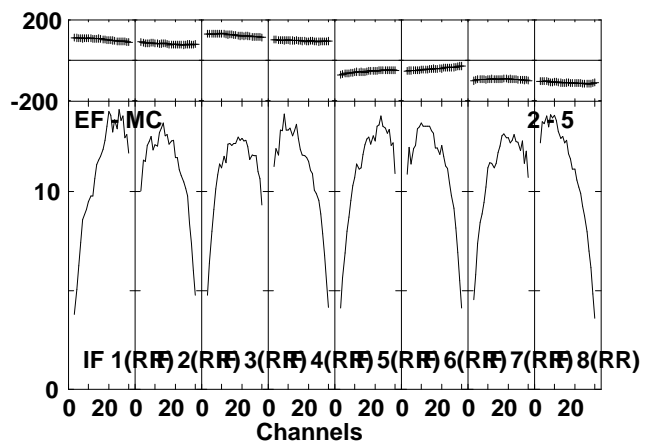
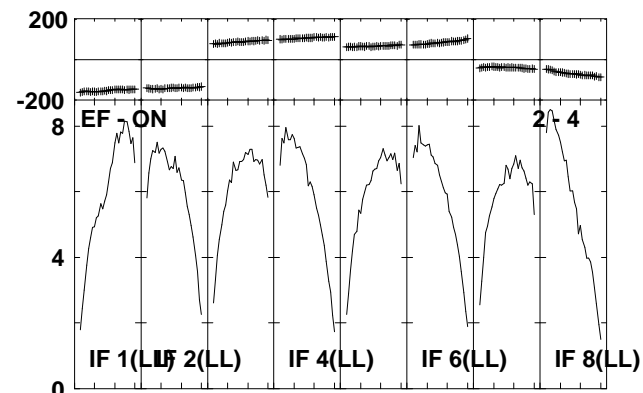
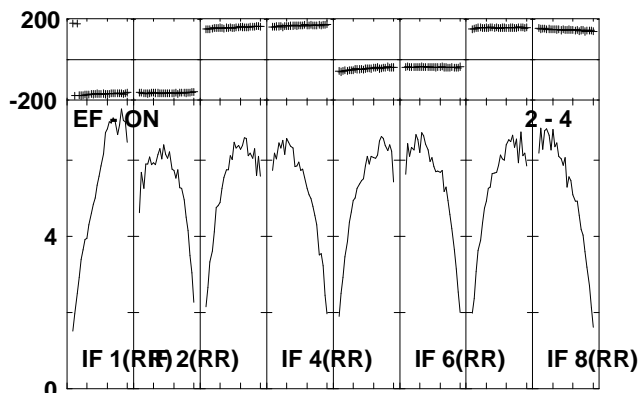
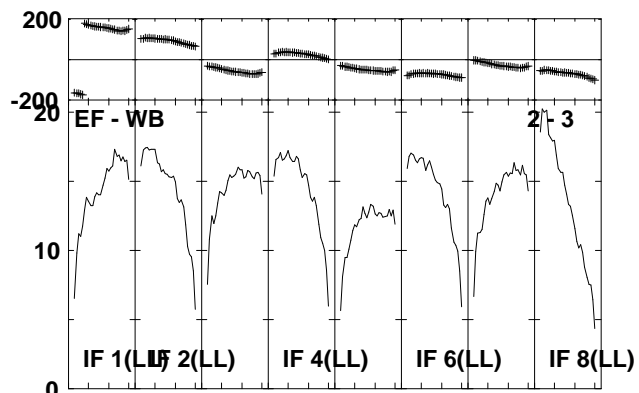
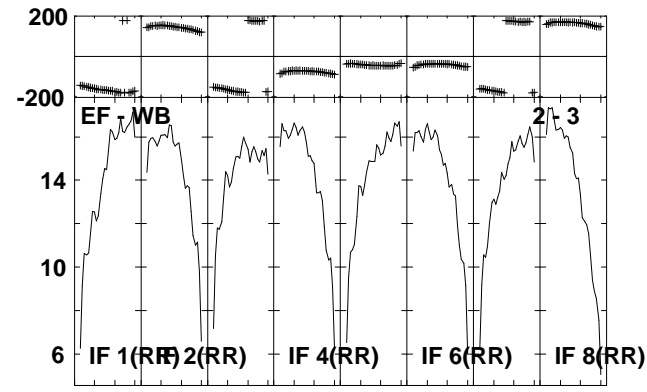
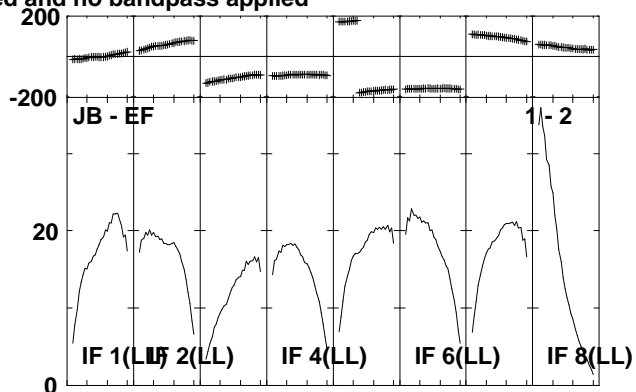
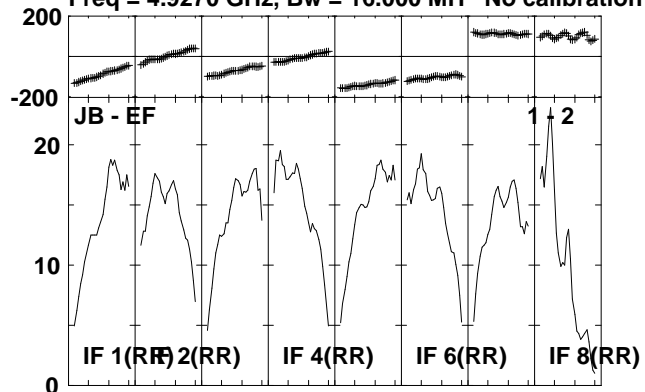

Lower frame: Milli Ampl Jy Top frame: Phas deg
Scalar averaged cross-power spectrum Several baselines displayed
Timerange: 00/15:59:01 to 00/16:00:59

Plot file version 245 created 06-JUL-2010 12:08:24

J2330+33 EP064L.UVDATA.1

Freq = 4.9270 GHz, Bw = 16.000 MH No calibration applied and no bandpass applied

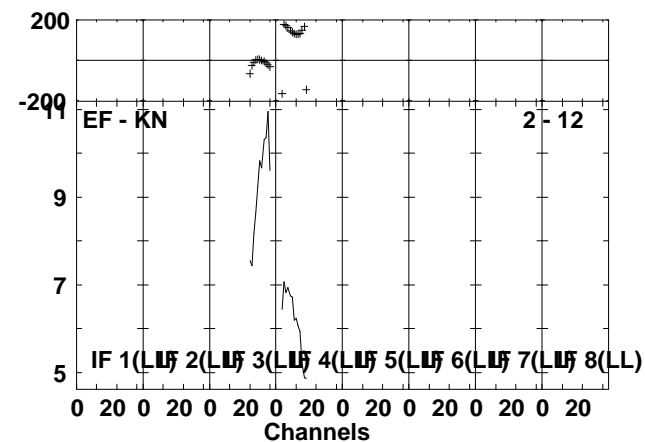
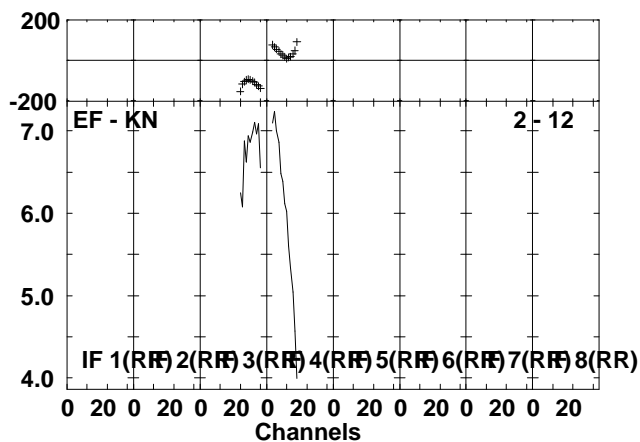
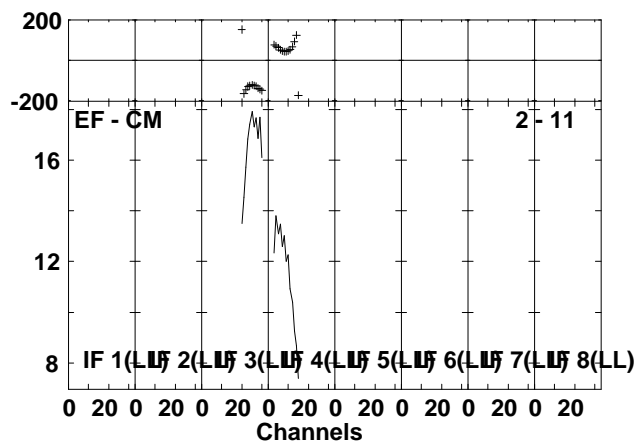
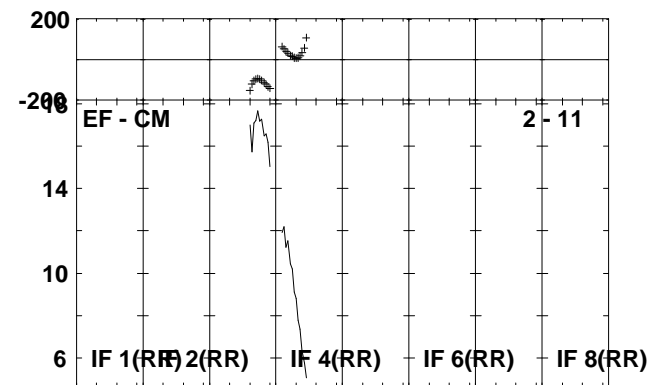
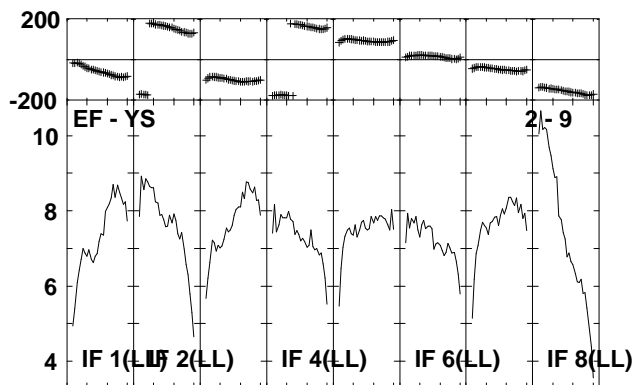
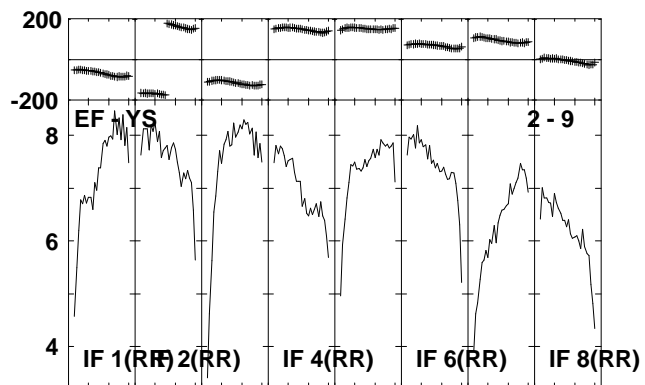
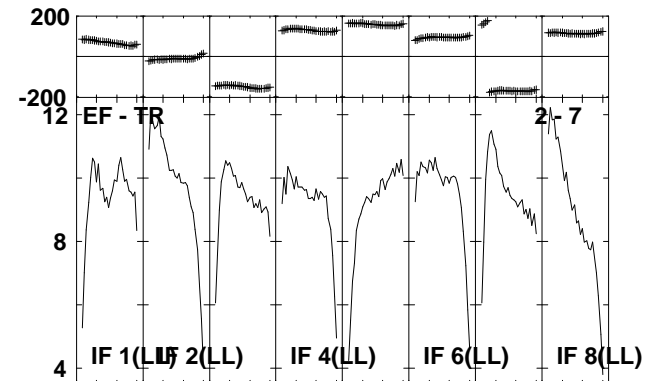
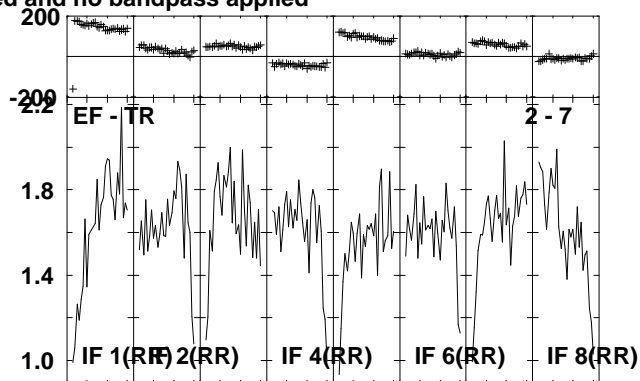
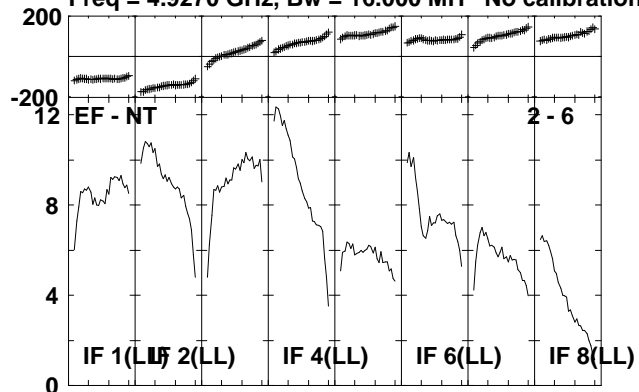

Lower frame: Milli Ampl Jy Top frame: Phas deg
Scalar averaged cross-power spectrum Several baselines displayed
Timerange: 00/15:59:01 to 00/16:00:59

Plot file version 246 created 06-JUL-2010 12:08:26

IRAS2336 EP064L.UVDATA.1

Freq = 4.9270 GHz, Bw = 16.000 MH No calibration applied and no bandpass applied

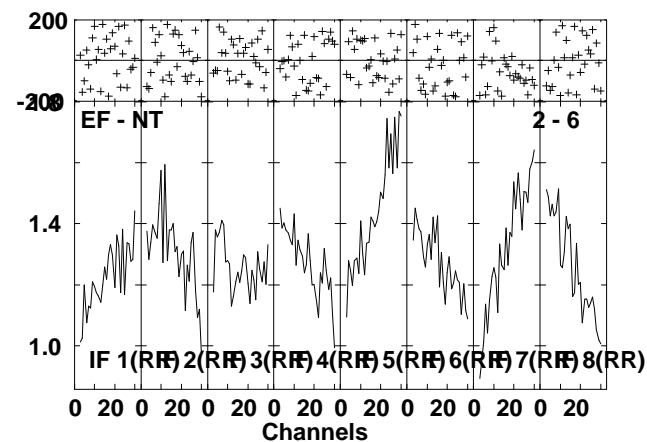
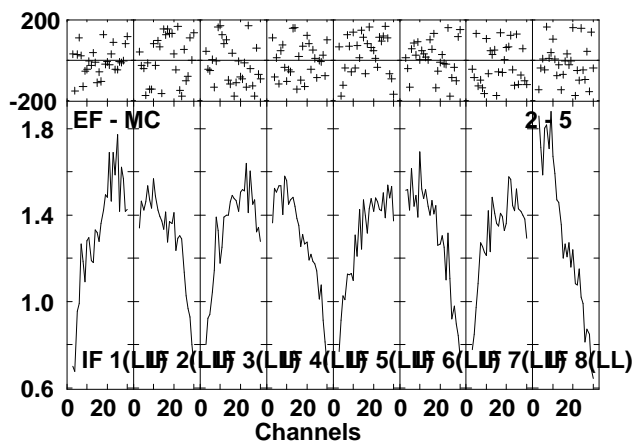
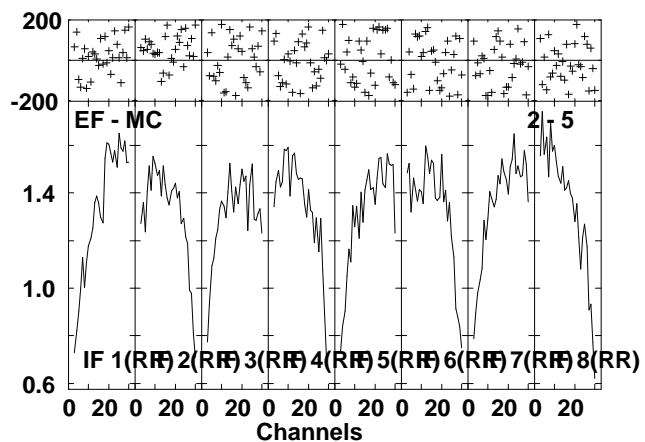
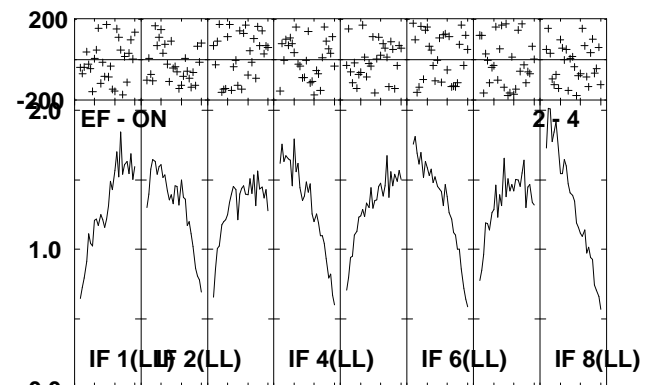
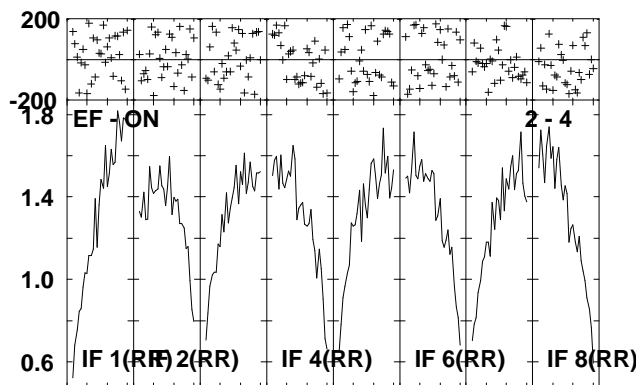
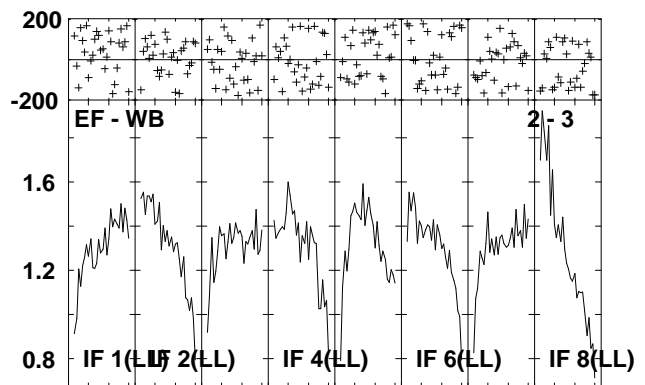
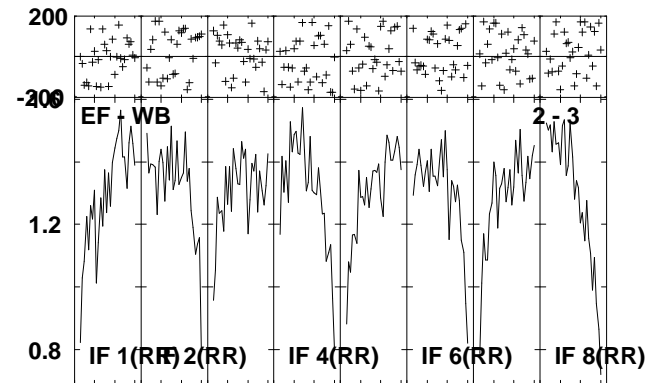
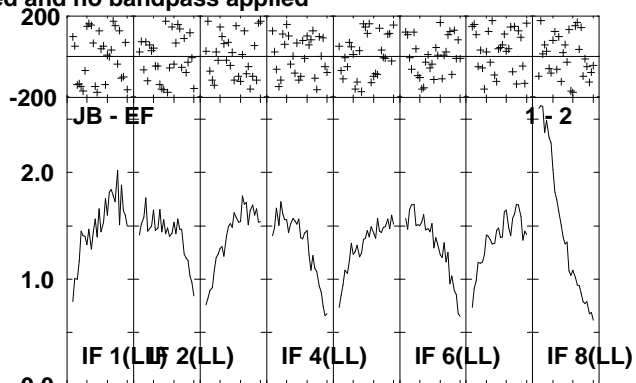
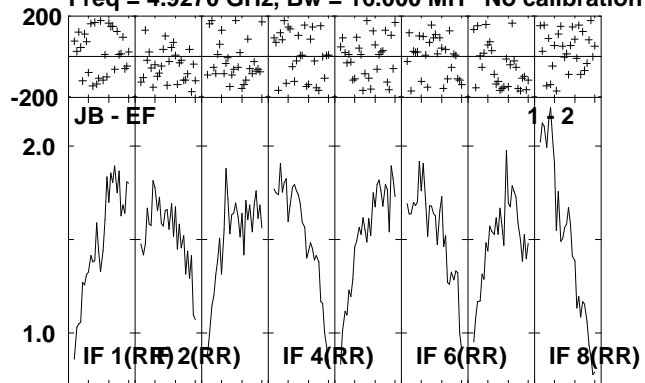

Lower frame: Milli Ampl Jy Top frame: Phas deg
Scalar averaged cross-power spectrum Several baselines displayed
Timerange: 00/16:01:01 to 00/16:05:19

Plot file version 247 created 06-JUL-2010 12:08:28

IRAS2336 EP064L.UVDATA.1

Freq = 4.9270 GHz, Bw = 16.000 MH No calibration applied and no bandpass applied

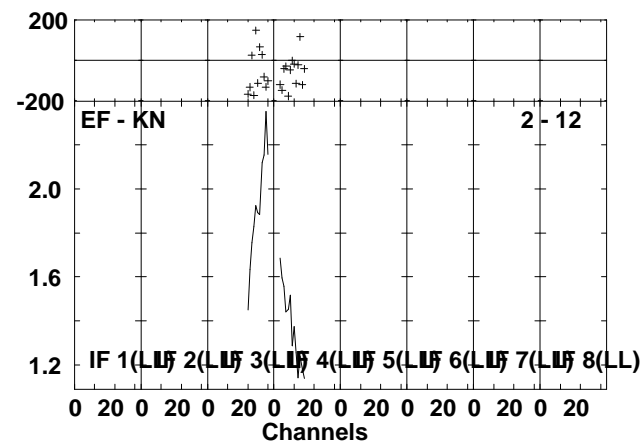
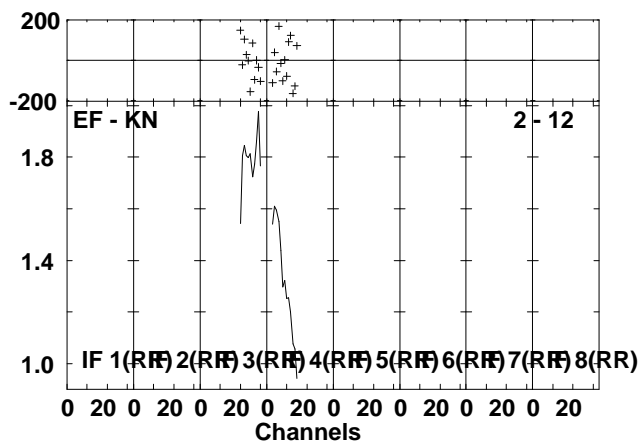
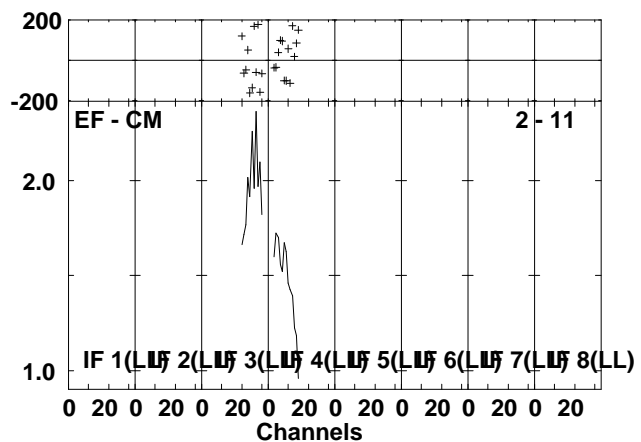
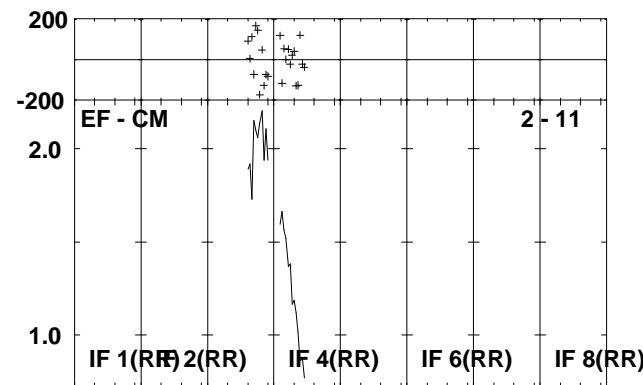
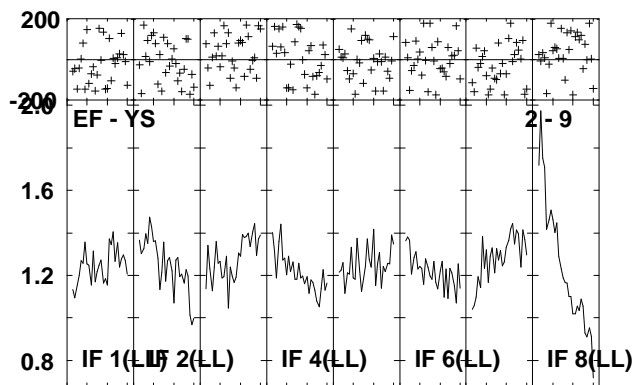
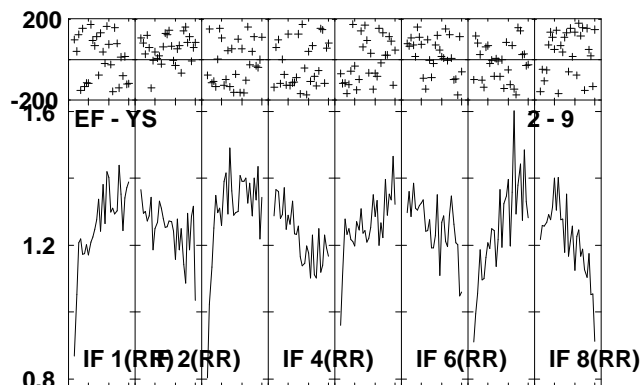
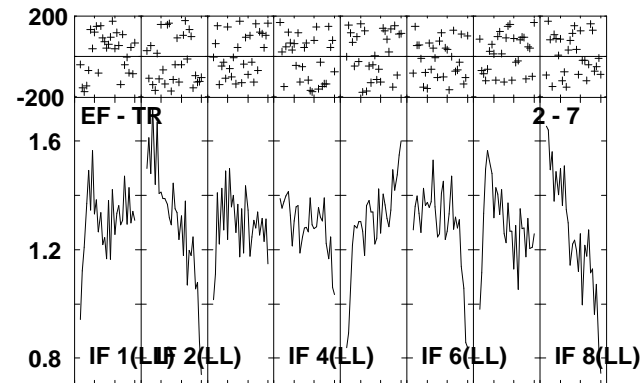
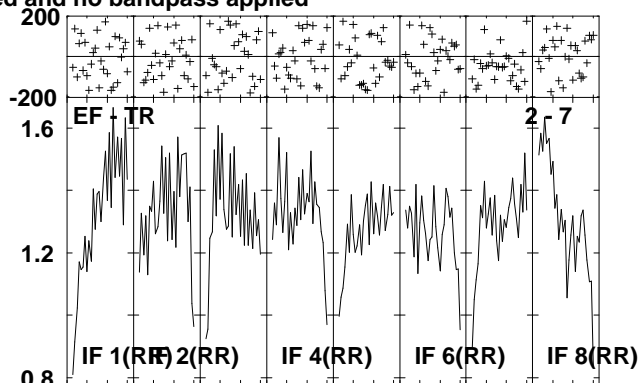
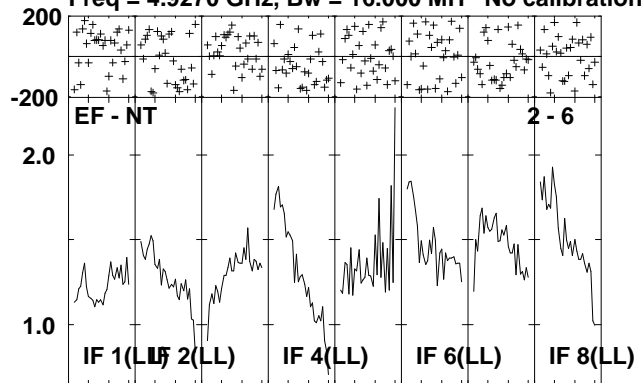

Lower frame: Milli Ampl Jy Top frame: Phas deg
Scalar averaged cross-power spectrum Several baselines displayed
Timerange: 00/16:01:01 to 00/16:05:19

Plot file version 248 created 06-JUL-2010 12:08:32

J2330+33 EP064L.UVDATA.1

Freq = 4.9270 GHz, Bw = 16.000 MH No calibration applied and no bandpass applied

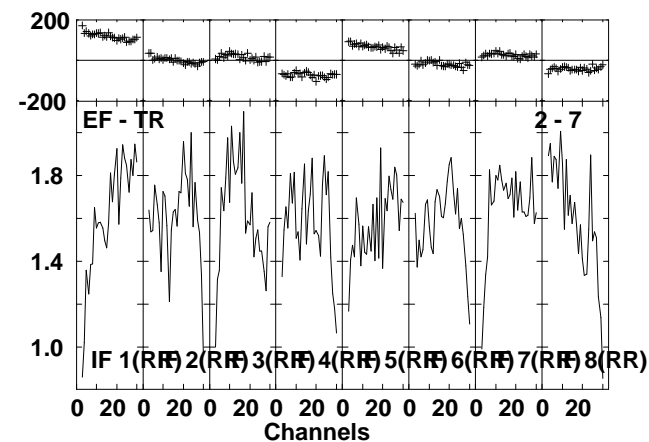
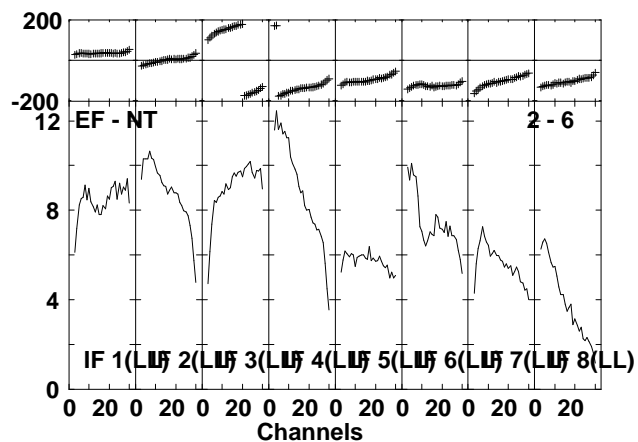
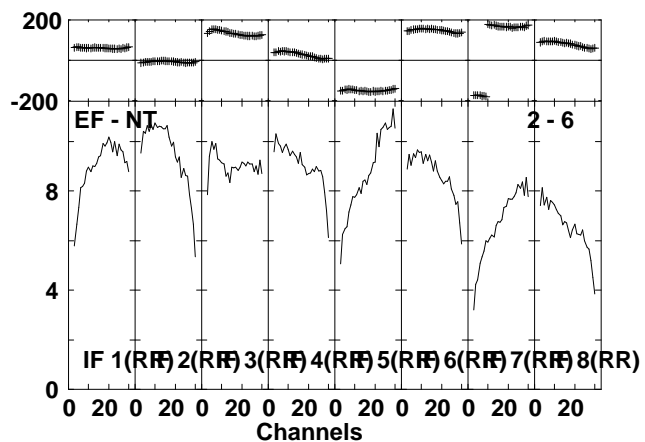
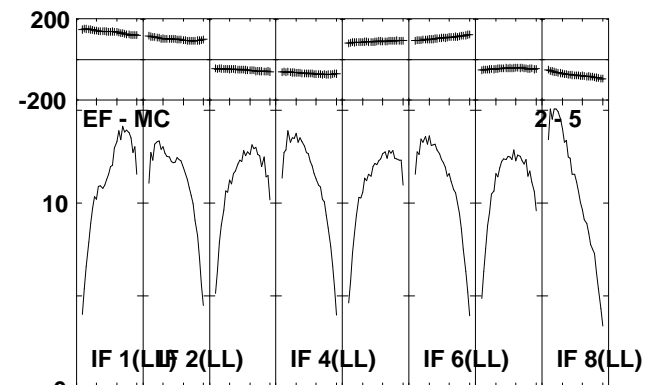
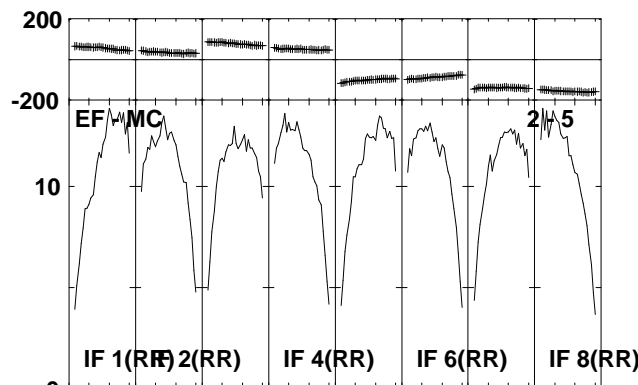
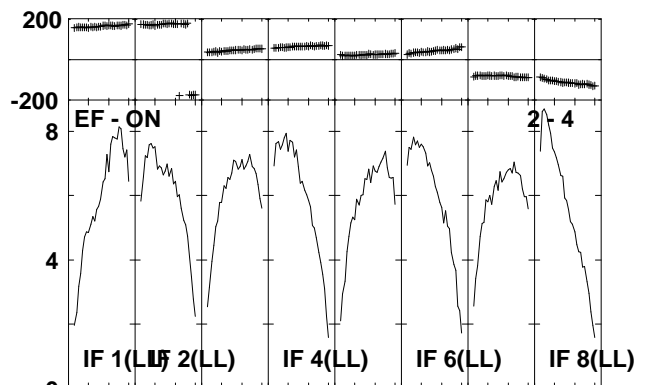
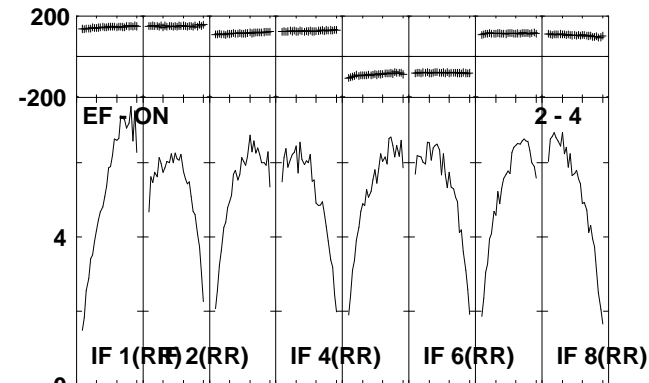
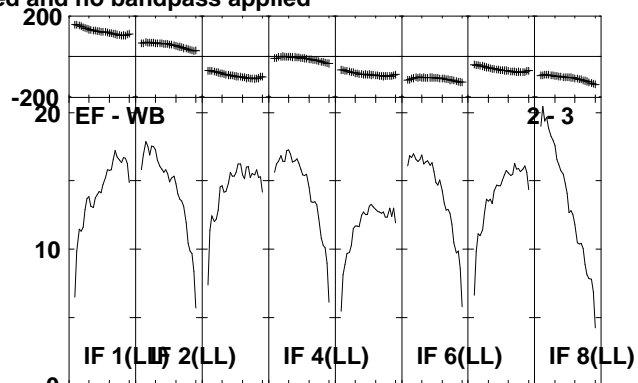
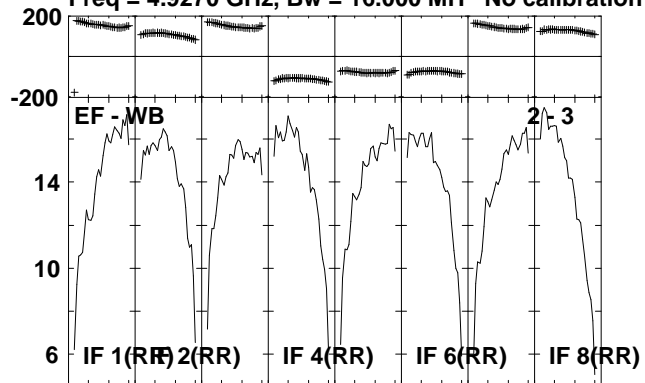

Lower frame: Milli Ampl Jy Top frame: Phas deg
Scalar averaged cross-power spectrum Several baselines displayed
Timerange: 00/16:05:21 to 00/16:07:19

Plot file version 249 created 06-JUL-2010 12:08:33

J2330+33 EP064L.UVDATA.1

Freq = 4.9270 GHz, Bw = 16.000 MH No calibration applied and no bandpass applied

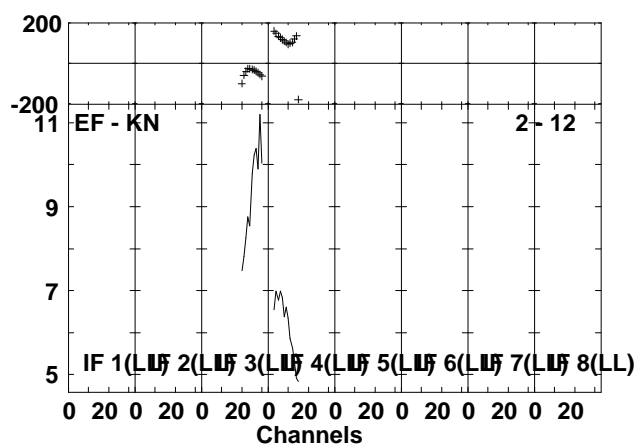
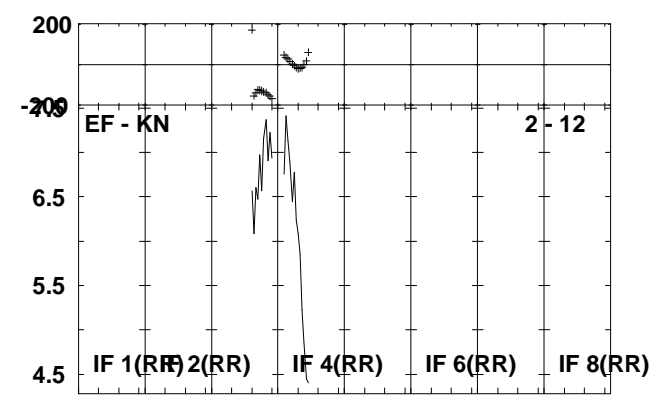
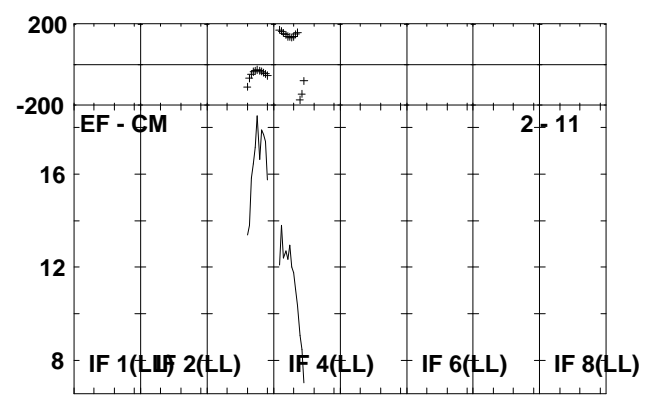
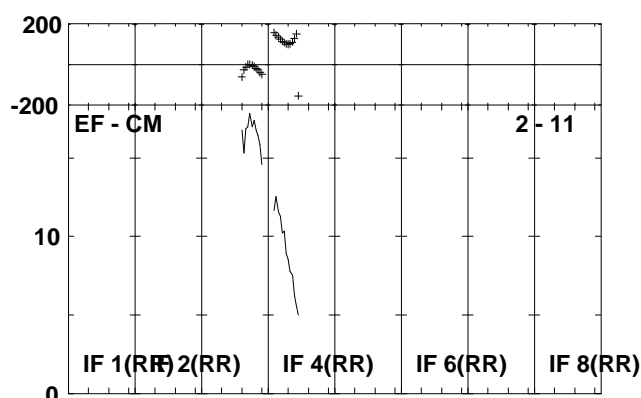
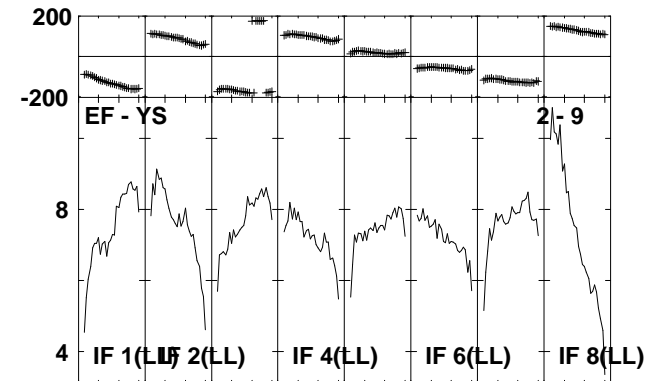
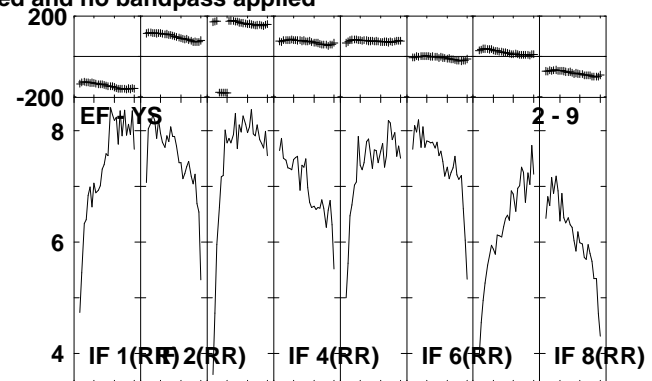
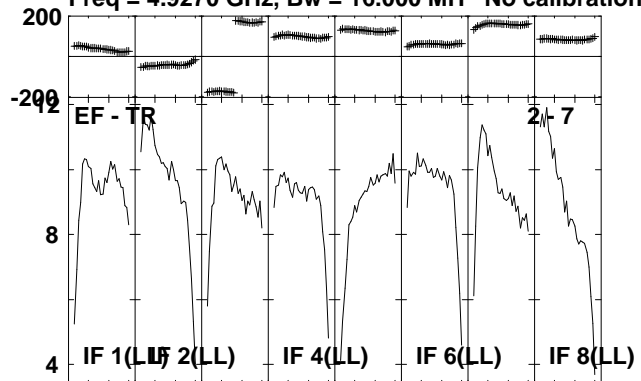

Lower frame: Milli Ampl Jy Top frame: Phas deg
Scalar averaged cross-power spectrum Several baselines displayed
Timerange: 00/16:05:21 to 00/16:07:19

Plot file version 250 created 06-JUL-2010 12:08:35

IRAS2336 EP064L.UVDATA.1

Freq = 4.9270 GHz, Bw = 16.000 MH No calibration applied and no bandpass applied

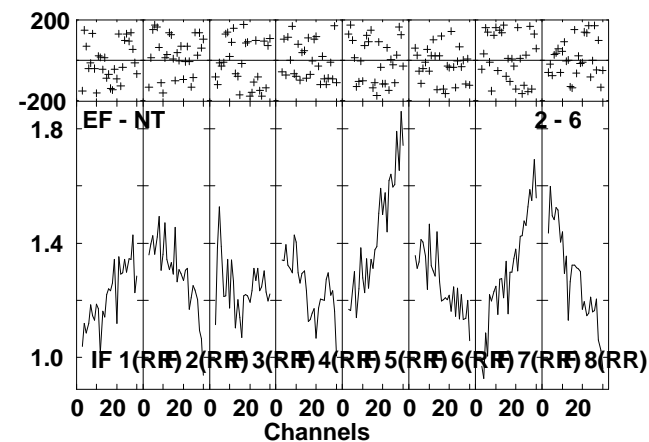
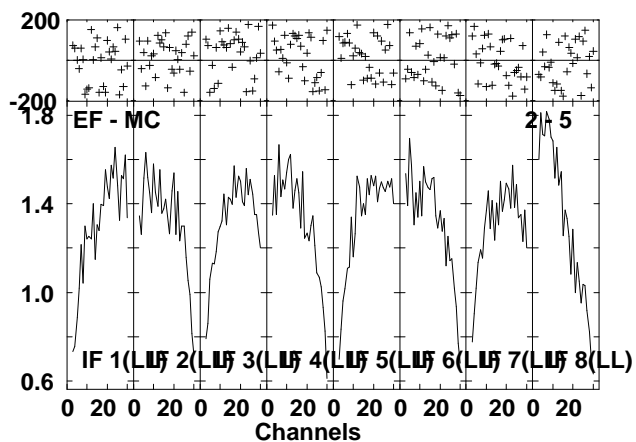
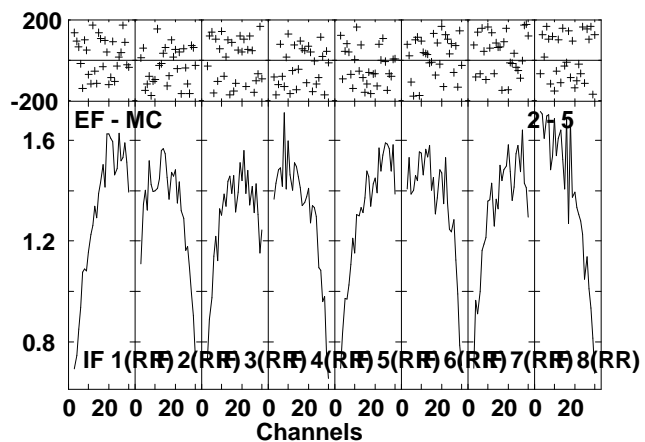
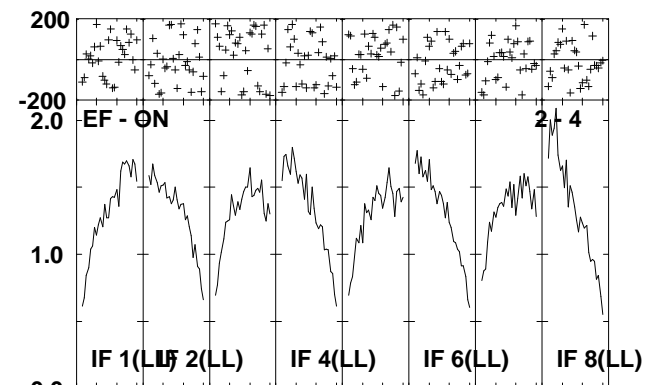
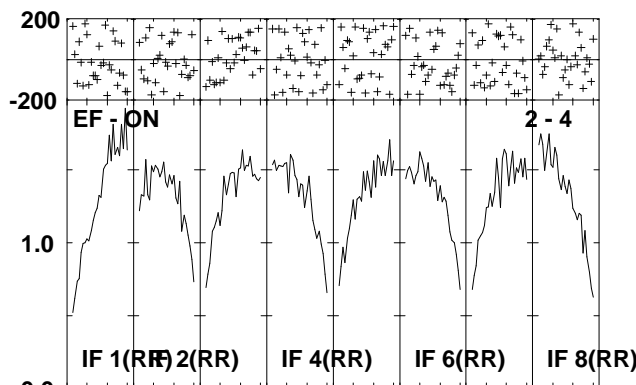
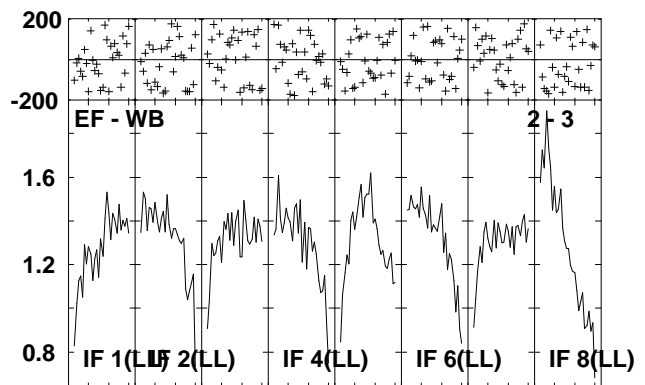
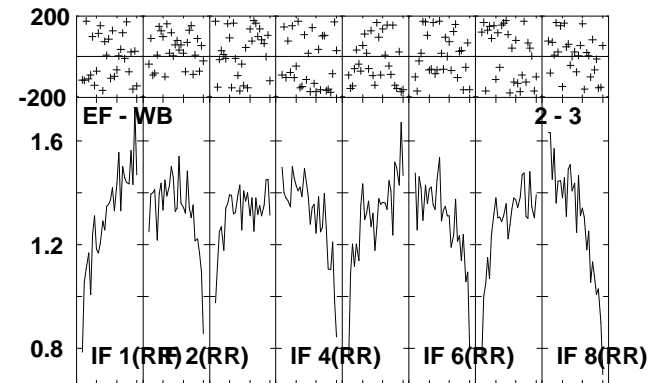
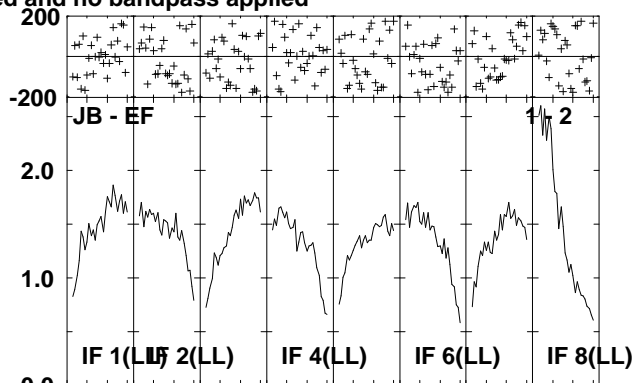
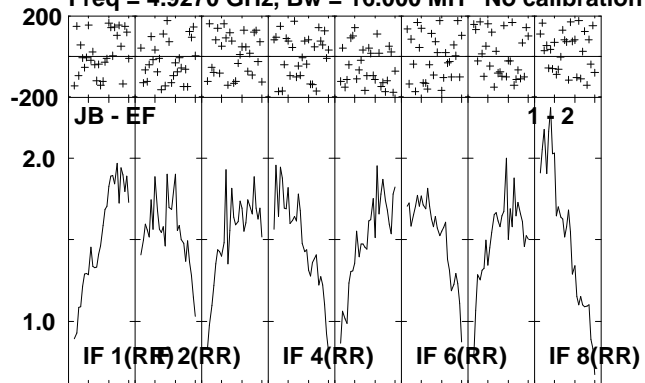

Lower frame: Milli Ampl Jy Top frame: Phas deg
Scalar averaged cross-power spectrum Several baselines displayed
Timerange: 00/16:07:21 to 00/16:11:39

Plot file version 251 created 06-JUL-2010 12:08:37

IRAS2336 EP064L.UVDATA.1

Freq = 4.9270 GHz, Bw = 16.000 MH No calibration applied and no bandpass applied

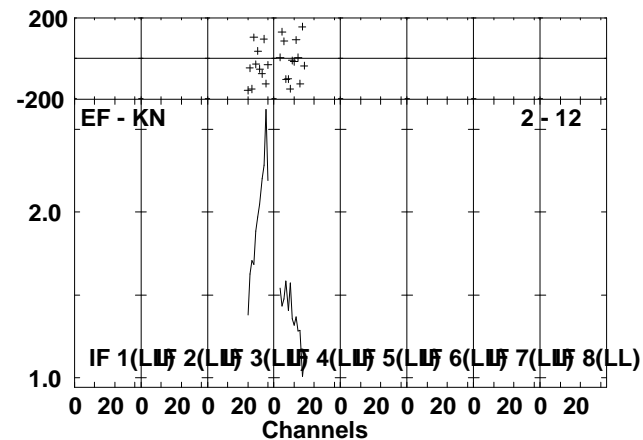
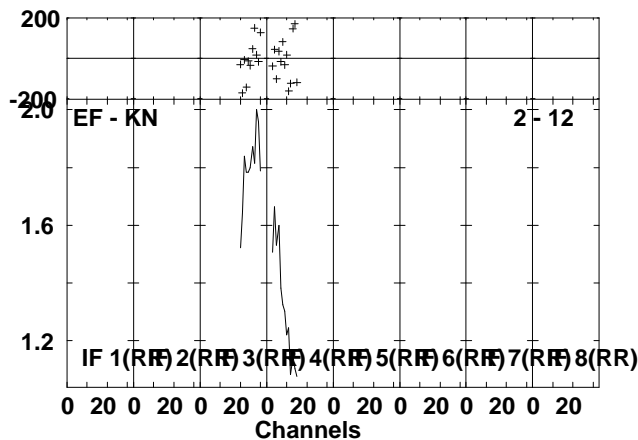
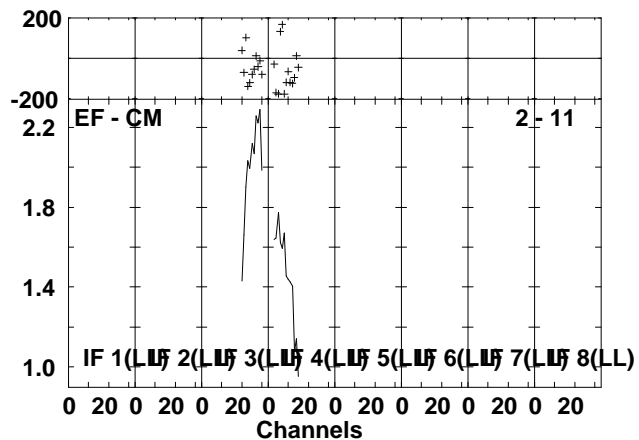
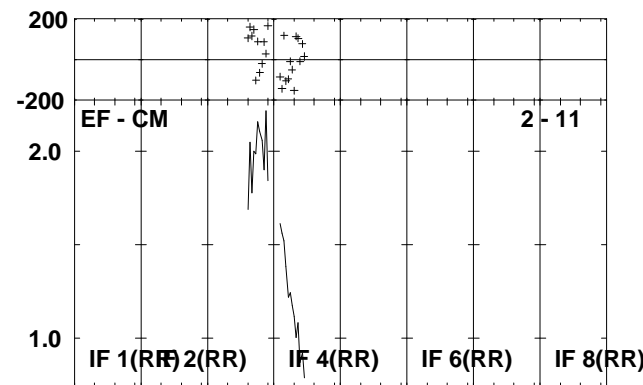
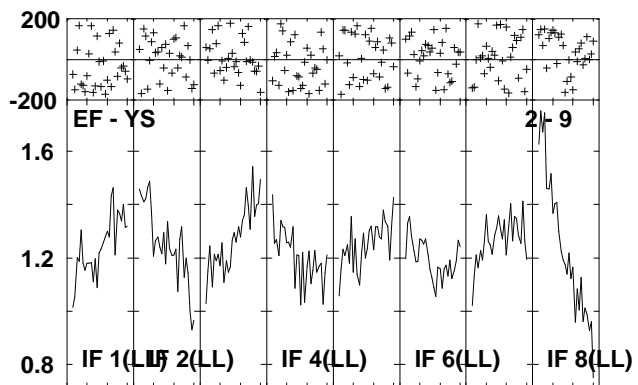
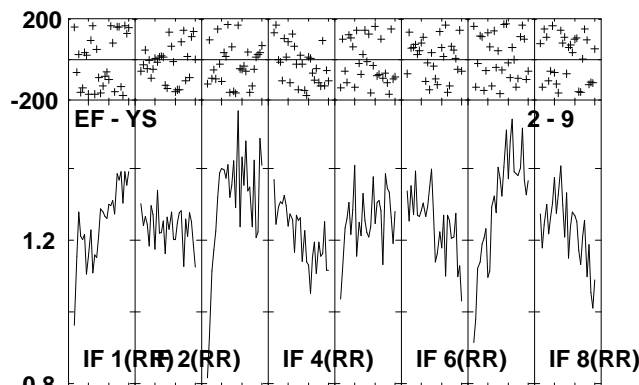
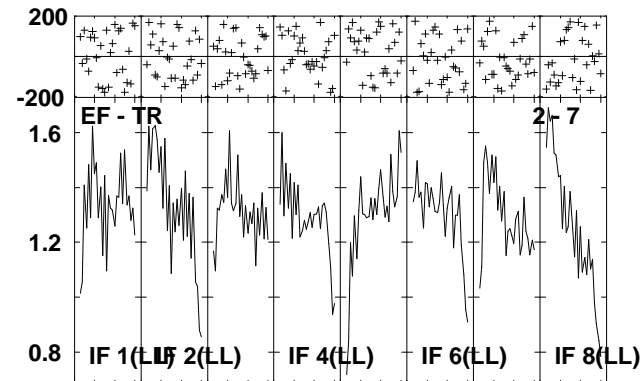
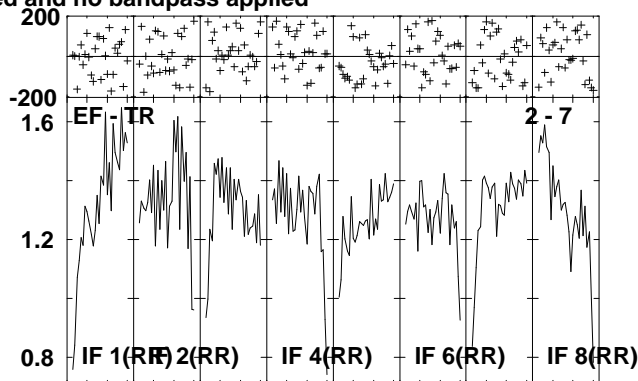
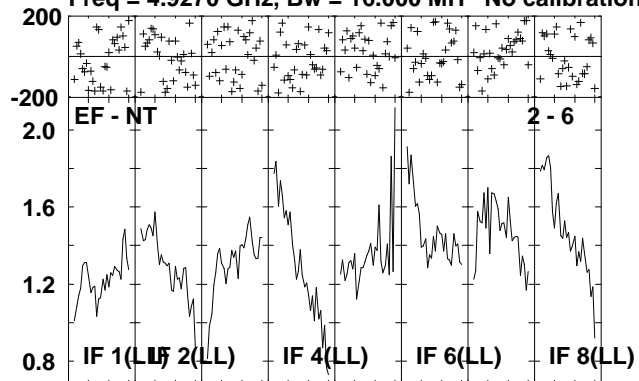

Lower frame: Milli Ampl Jy Top frame: Phas deg
Scalar averaged cross-power spectrum Several baselines displayed
Timerange: 00/16:07:21 to 00/16:11:39

Plot file version 252 created 06-JUL-2010 12:08:41

J2330+33 EP064L.UVDATA.1

Freq = 4.9270 GHz, Bw = 16.000 MH No calibration applied and no bandpass applied

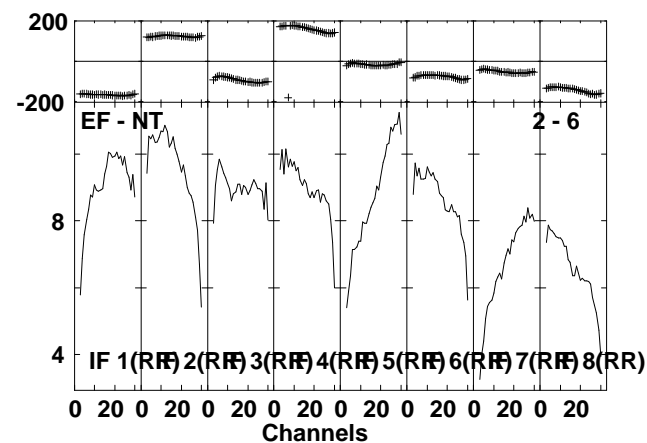
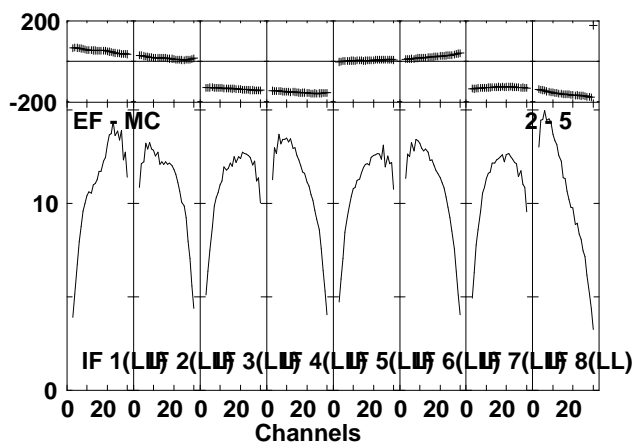
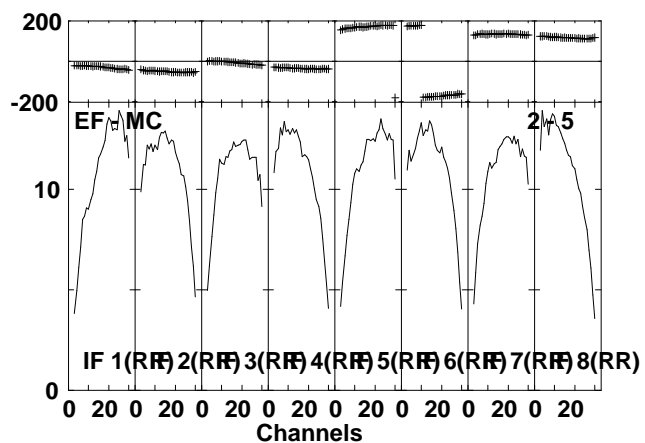
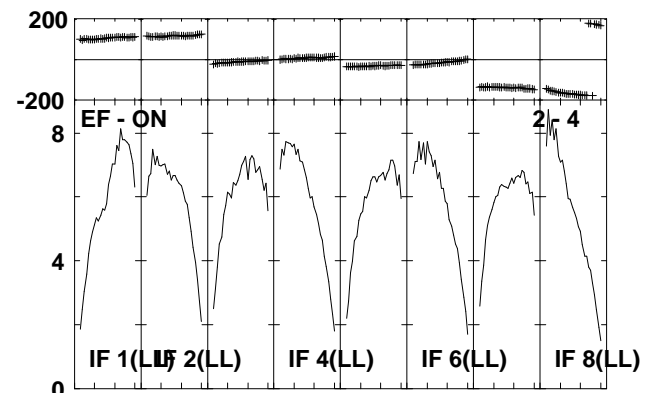
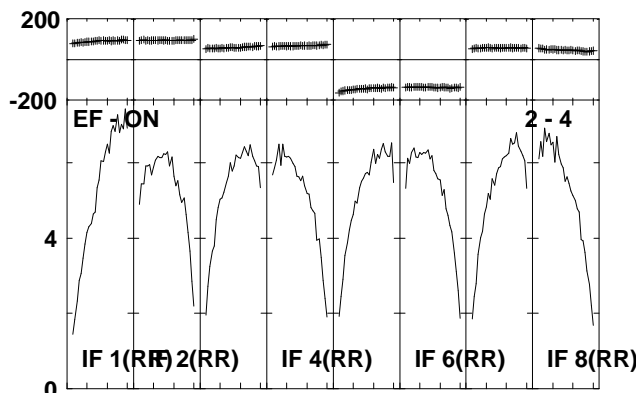
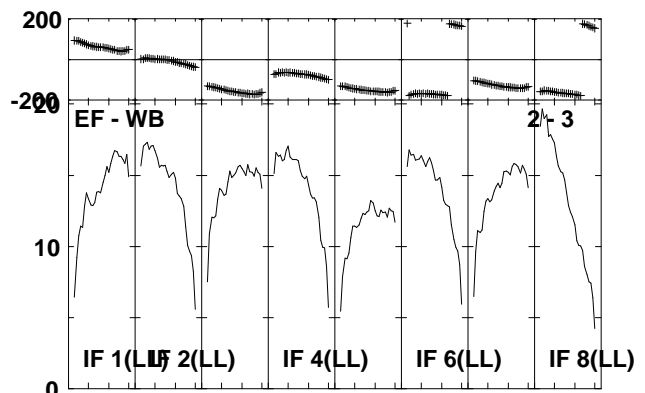
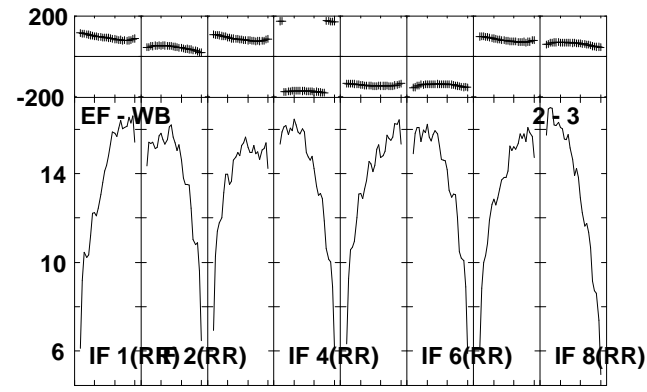
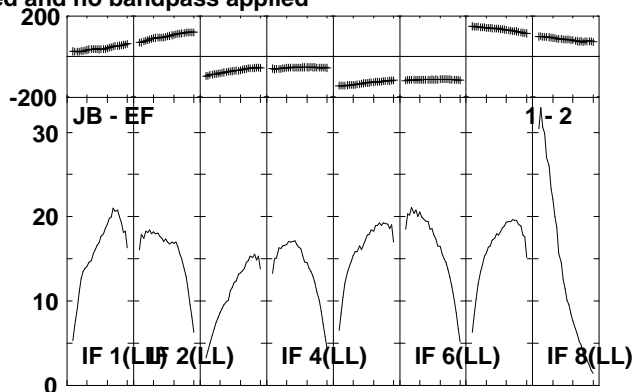
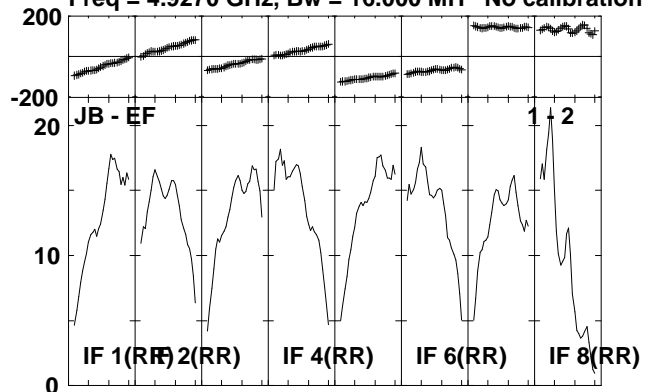

Lower frame: Milli Ampl Jy Top frame: Phas deg
Scalar averaged cross-power spectrum Several baselines displayed
Timerange: 00/16:12:41 to 00/16:14:39

Plot file version 253 created 06-JUL-2010 12:08:42

J2330+33 EP064L.UVDATA.1

Freq = 4.9270 GHz, Bw = 16.000 MH No calibration applied and no bandpass applied

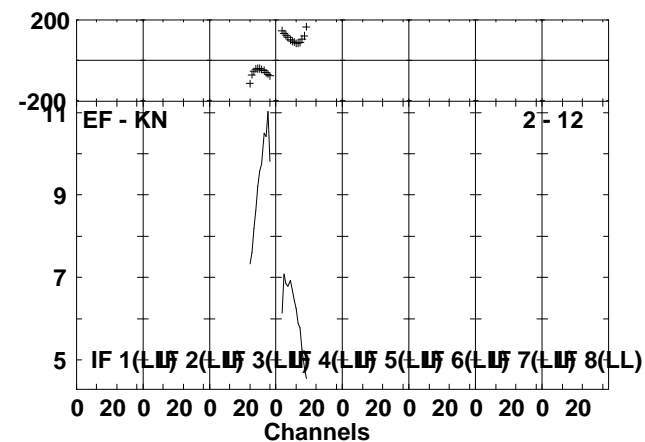
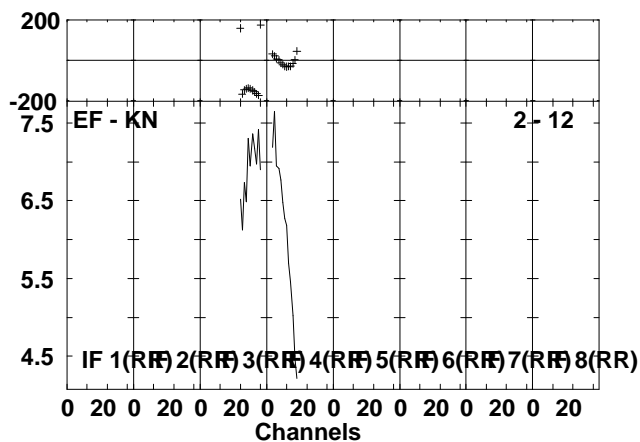
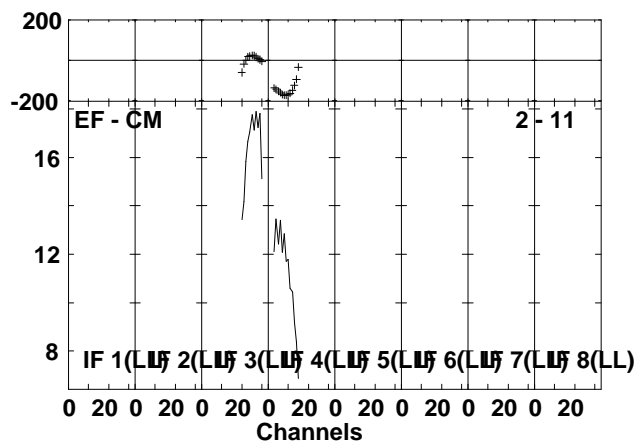
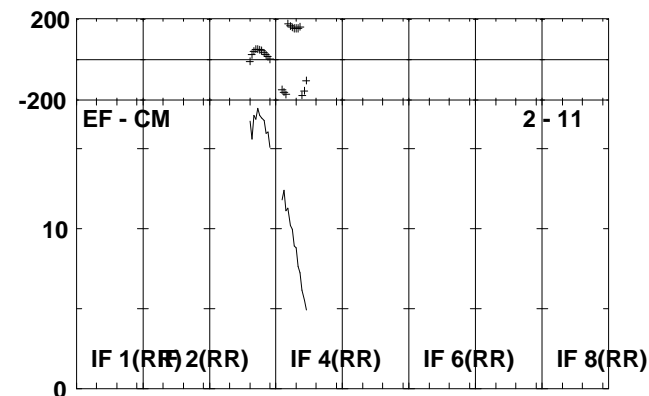
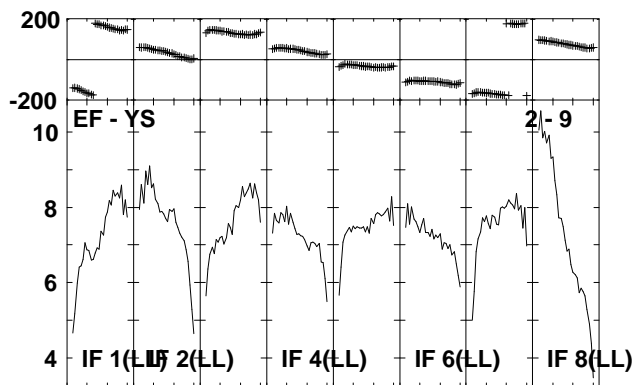
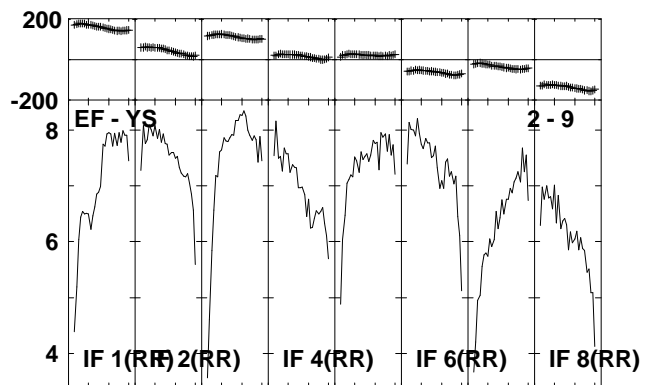
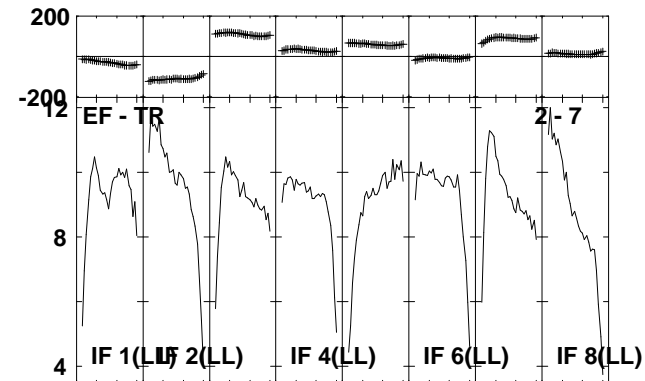
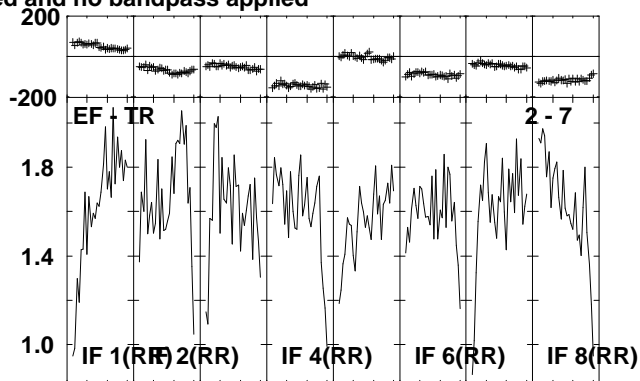
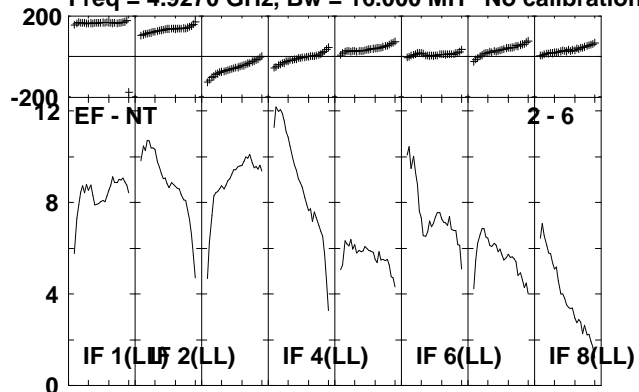

Lower frame: Milli Ampl Jy Top frame: Phas deg
Scalar averaged cross-power spectrum Several baselines displayed
Timerange: 00/16:12:41 to 00/16:14:39

Plot file version 254 created 06-JUL-2010 12:08:44

IRAS2336 EP064L.UVDATA.1

Freq = 4.9270 GHz, Bw = 16.000 MH No calibration applied and no bandpass applied

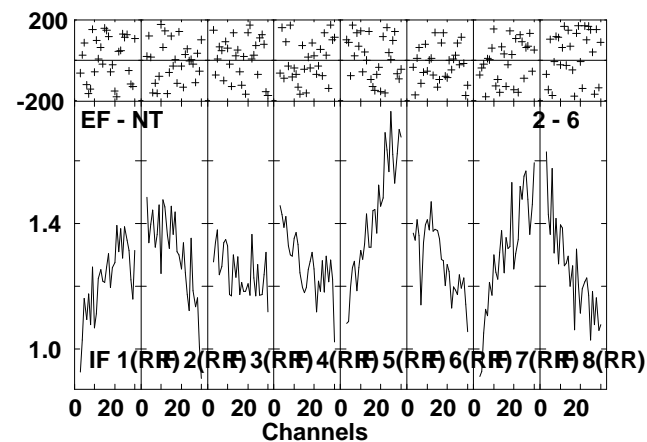
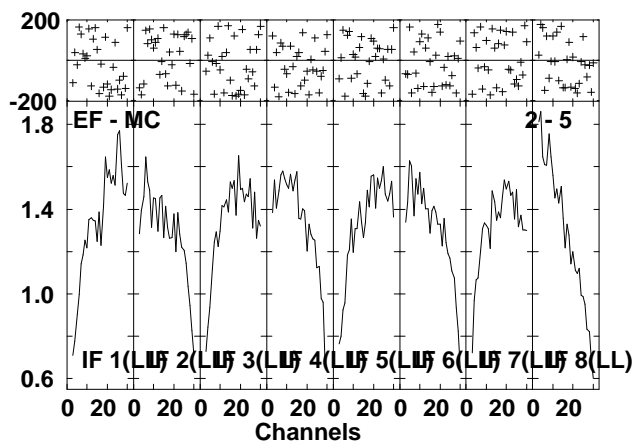
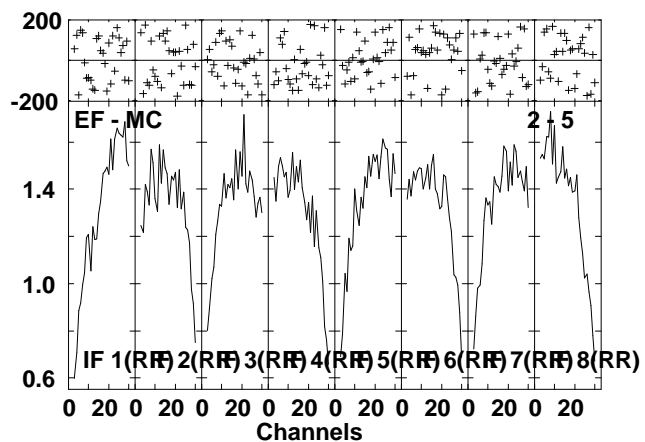
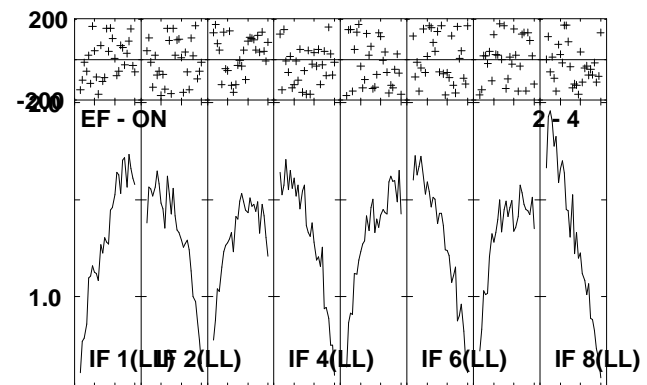
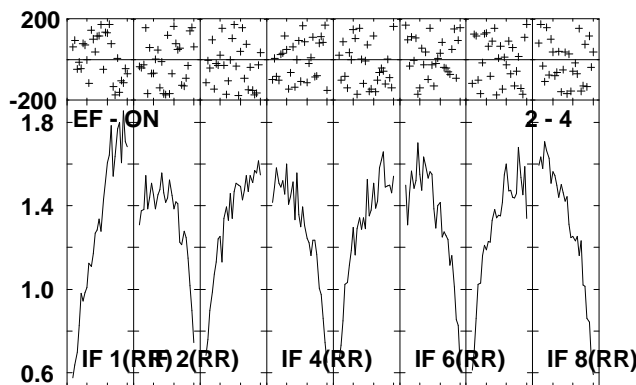
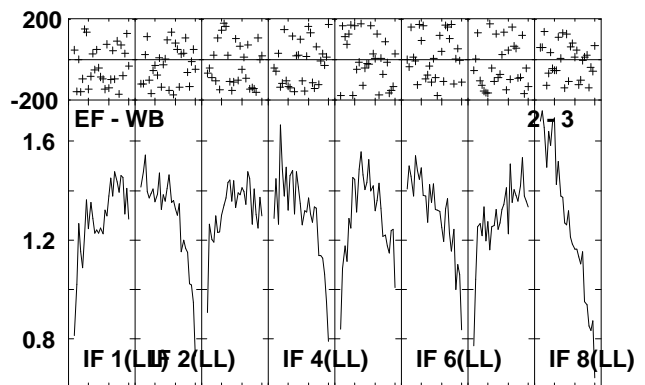
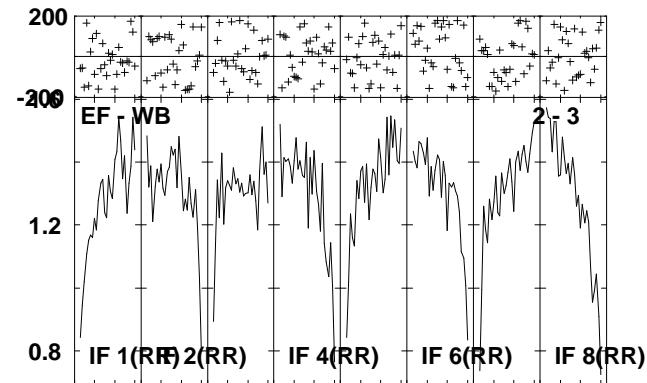
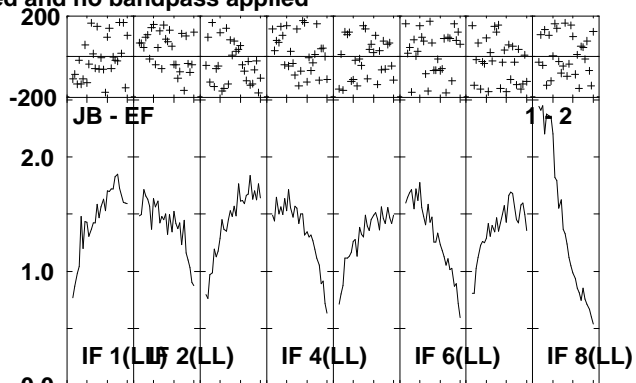
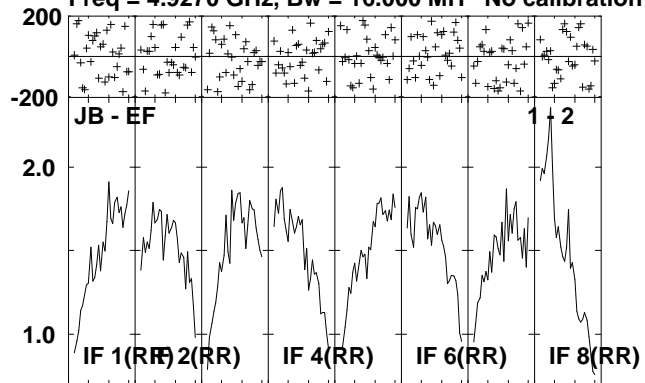

Lower frame: Milli Ampl Jy Top frame: Phas deg
Scalar averaged cross-power spectrum Several baselines displayed
Timerange: 00/16:14:41 to 00/16:18:59

Plot file version 255 created 06-JUL-2010 12:08:47

IRAS2336 EP064L.UVDATA.1

Freq = 4.9270 GHz, Bw = 16.000 MH No calibration applied and no bandpass applied

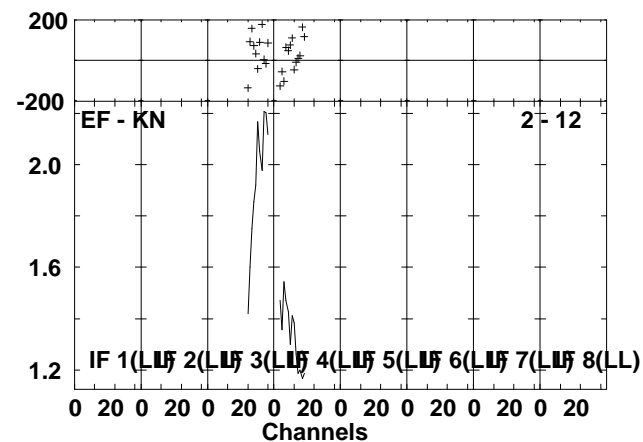
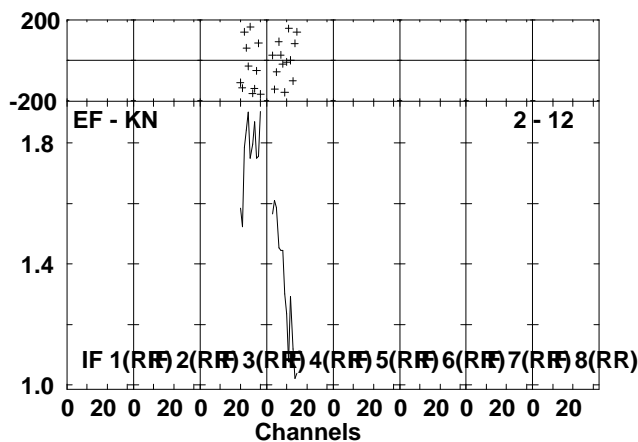
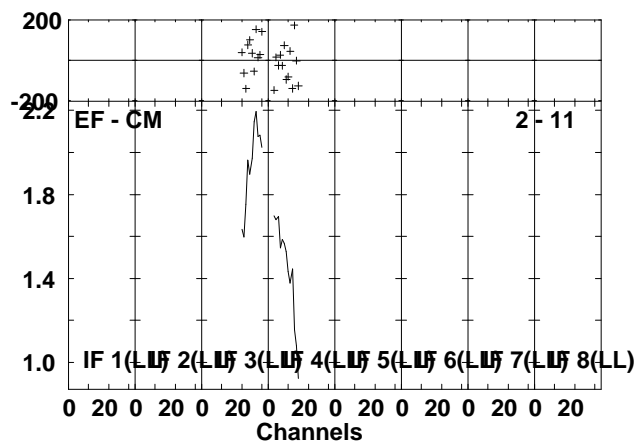
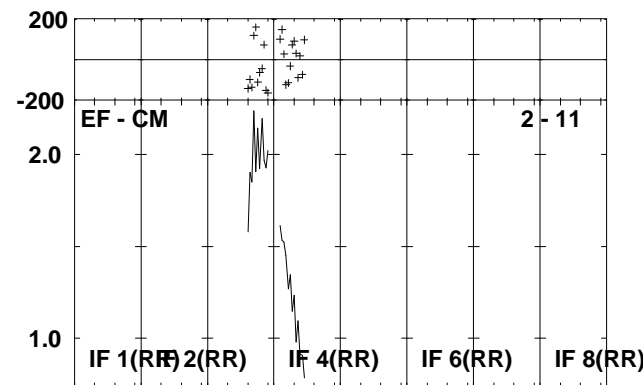
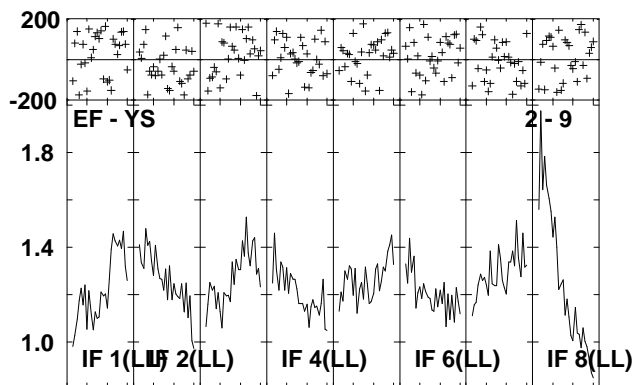
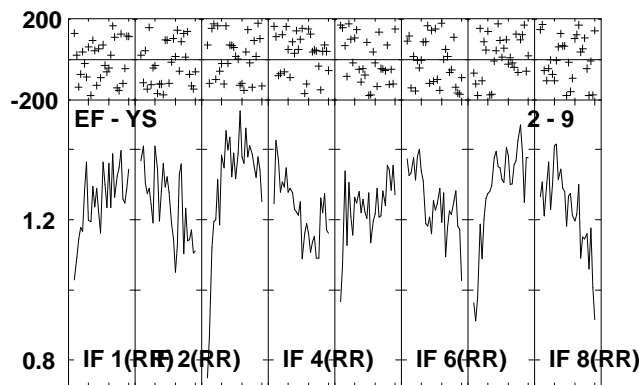
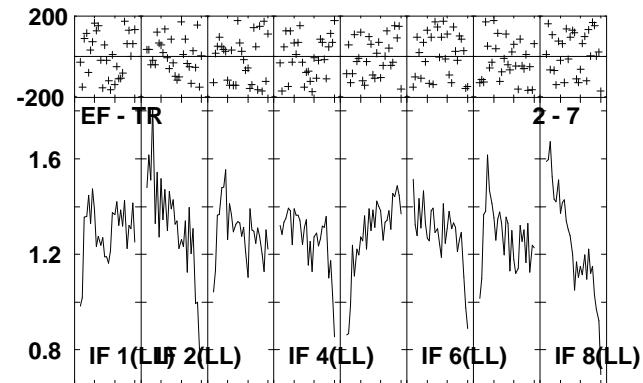
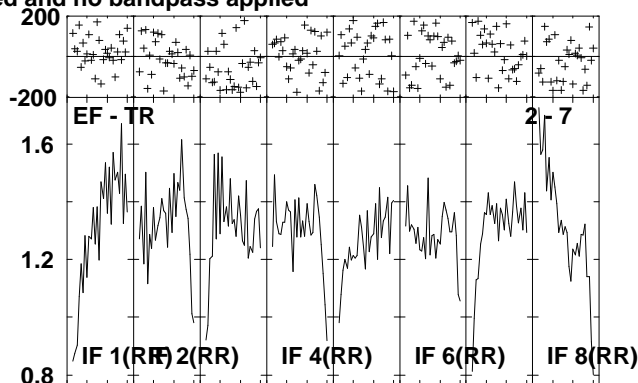
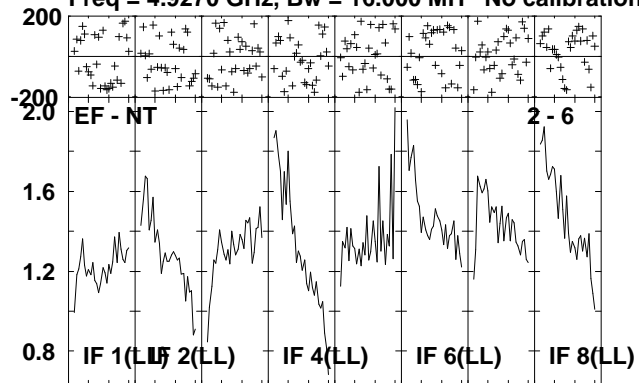

Lower frame: Milli Ampl Jy Top frame: Phas deg
Scalar averaged cross-power spectrum Several baselines displayed
Timerange: 00/16:14:41 to 00/16:18:59

Plot file version 256 created 06-JUL-2010 12:08:51

J2330+33 EP064L.UVDATA.1

Freq = 4.9270 GHz, Bw = 16.000 MH No calibration applied and no bandpass applied

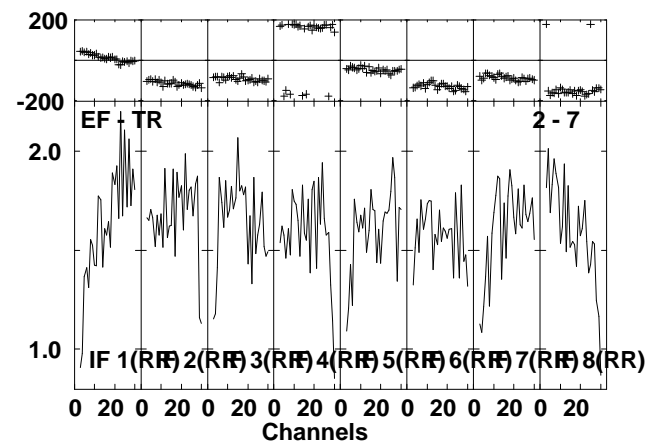
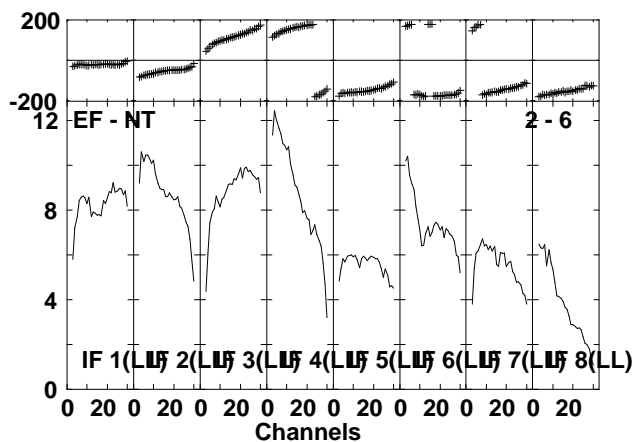
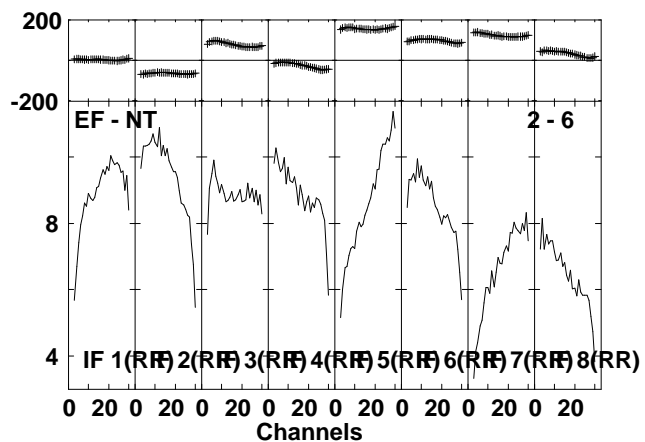
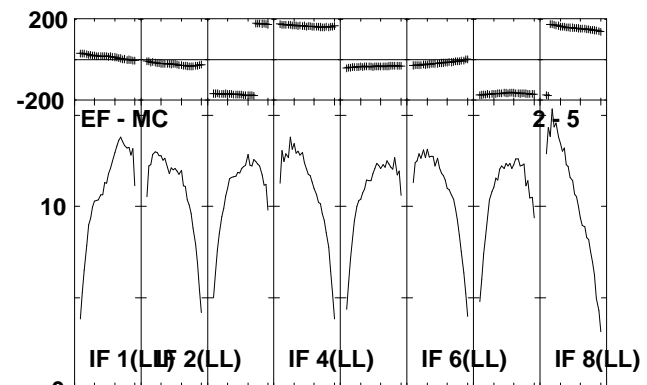
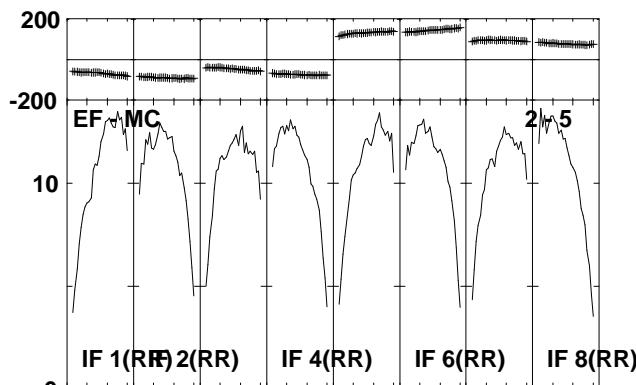
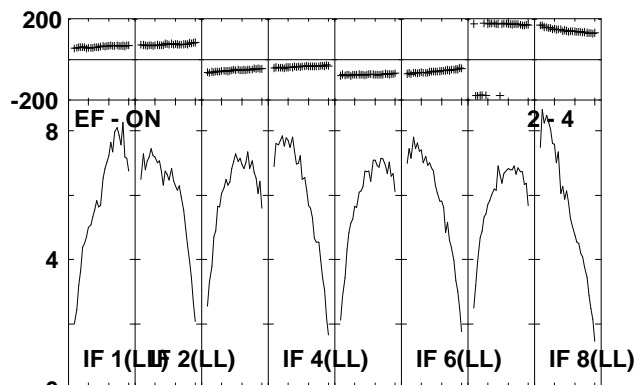
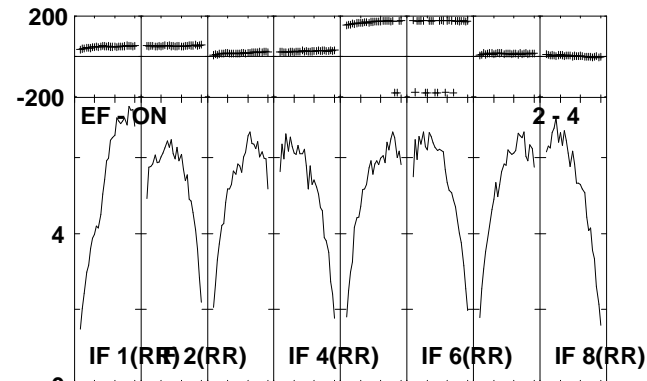
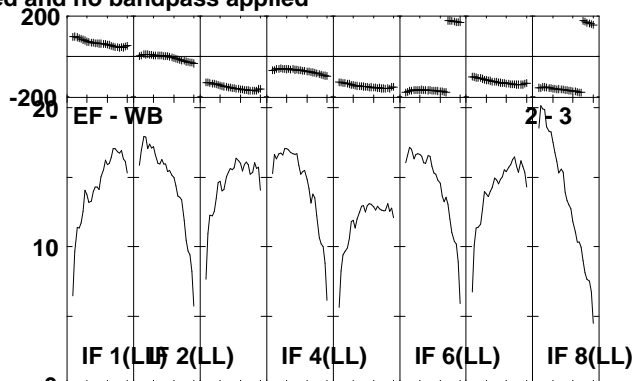
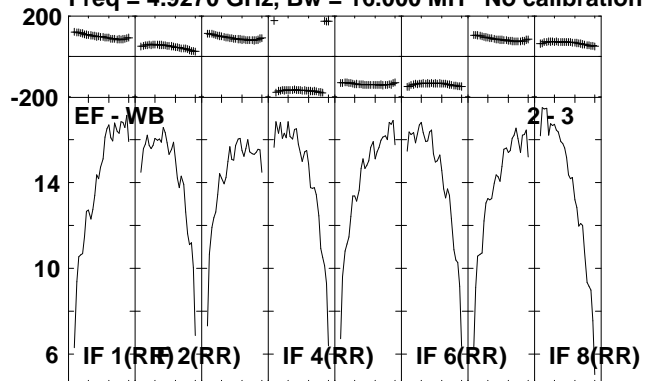

Lower frame: Milli Ampl Jy Top frame: Phas deg
Scalar averaged cross-power spectrum Several baselines displayed
Timerange: 00/16:19:01 to 00/16:20:59

Plot file version 257 created 06-JUL-2010 12:08:52

J2330+33 EP064L.UVDATA.1

Freq = 4.9270 GHz, Bw = 16.000 MH No calibration applied and no bandpass applied

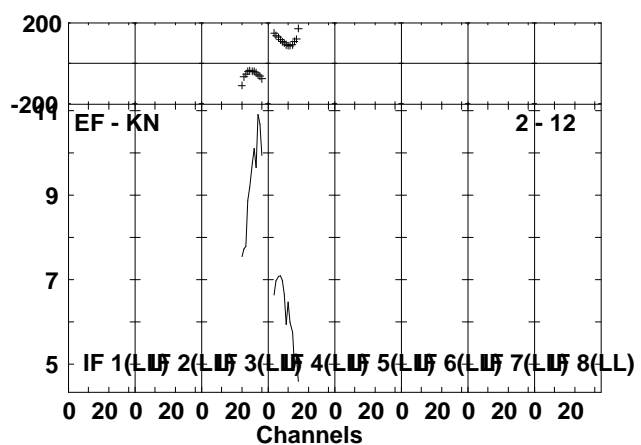
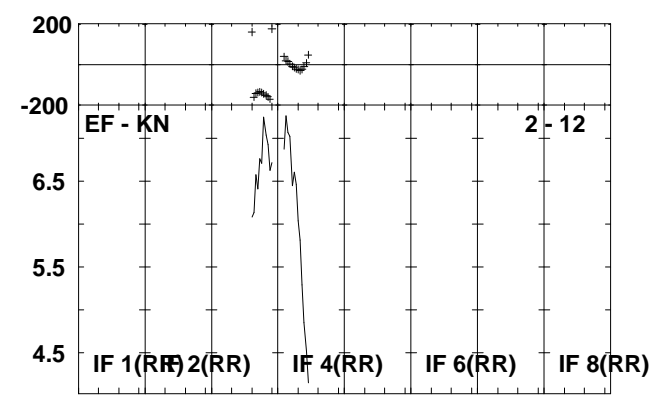
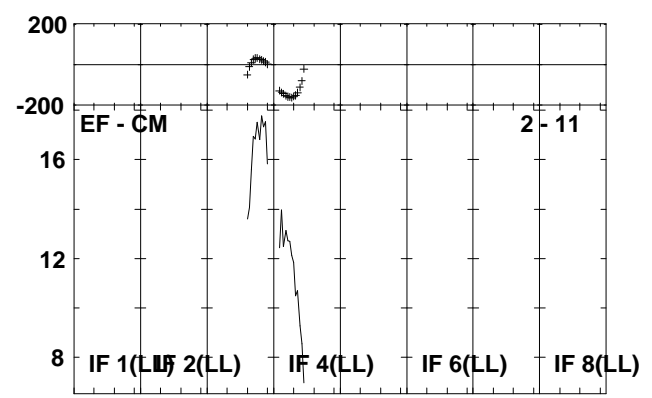
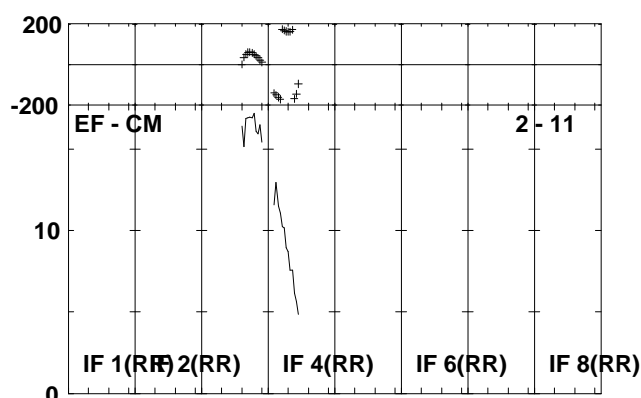
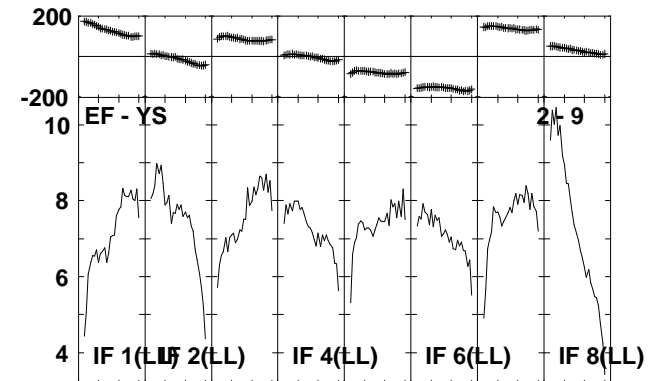
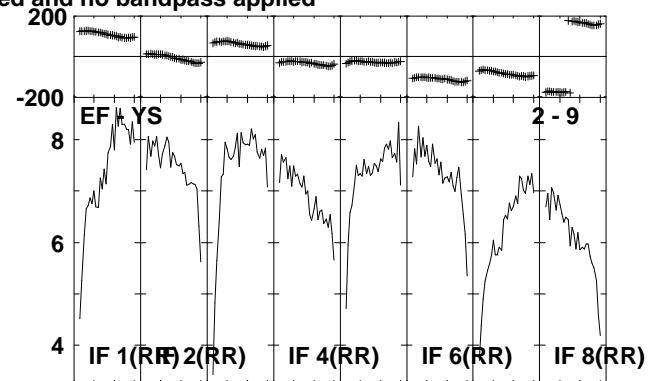
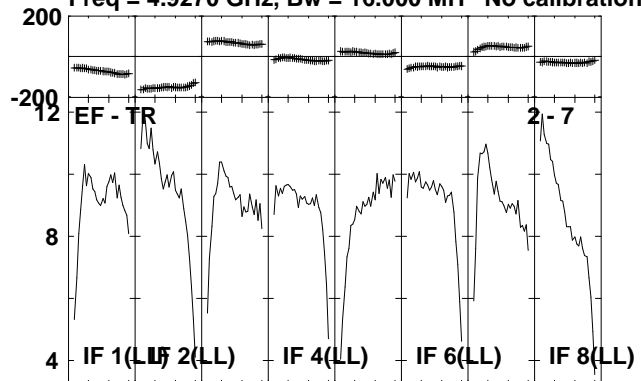

Lower frame: Milli Ampl Jy Top frame: Phas deg
Scalar averaged cross-power spectrum Several baselines displayed
Timerange: 00/16:19:01 to 00/16:20:59

Plot file version 258 created 06-JUL-2010 12:08:53

IRAS2336 EP064L.UVDATA.1

Freq = 4.9270 GHz, Bw = 16.000 MH No calibration applied and no bandpass applied

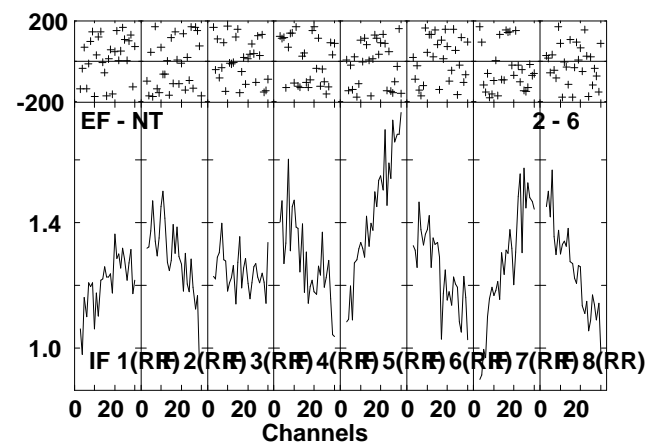
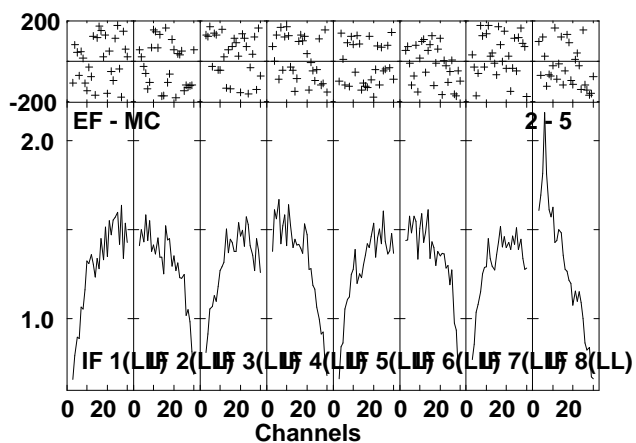
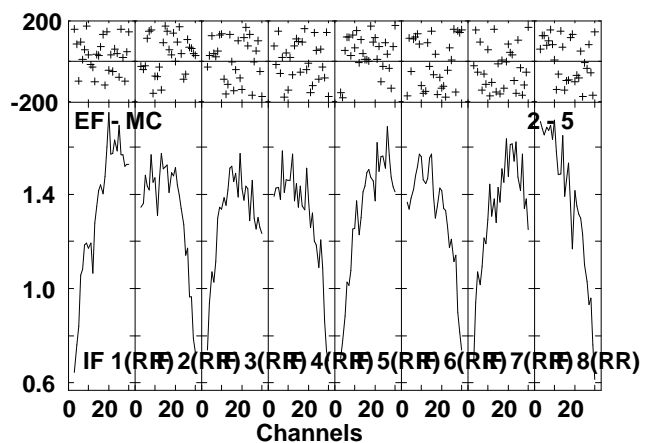
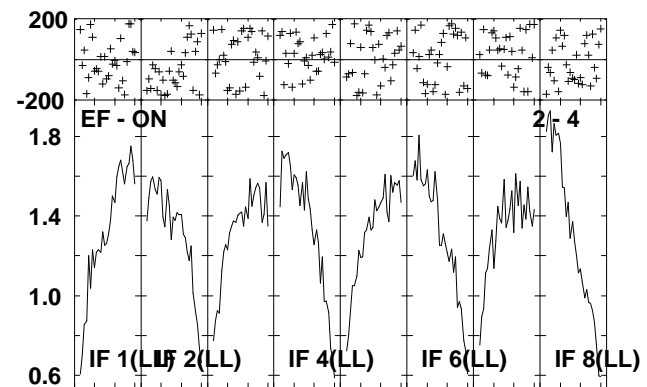
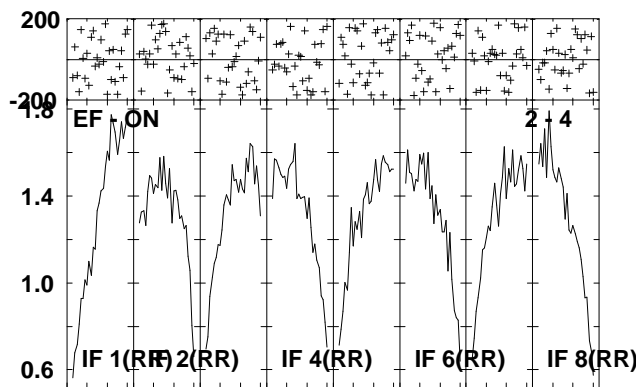
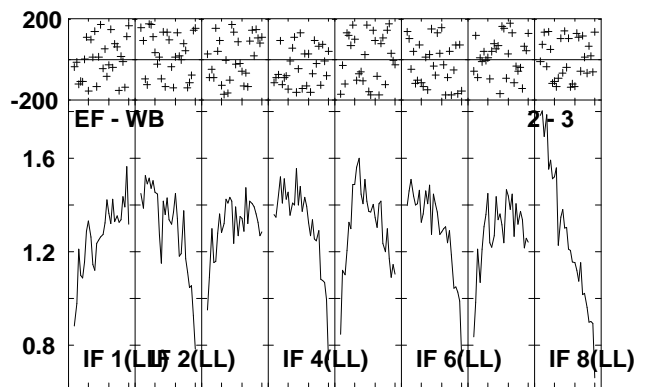
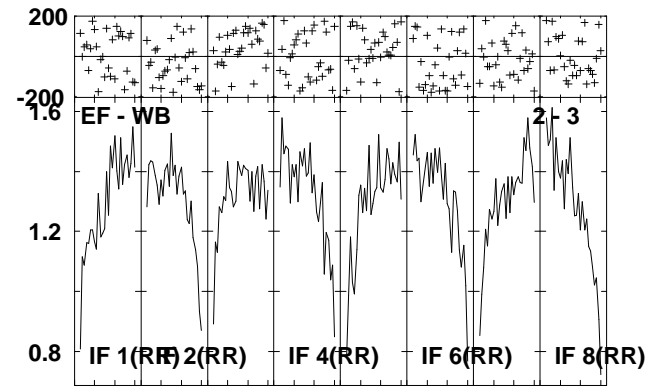
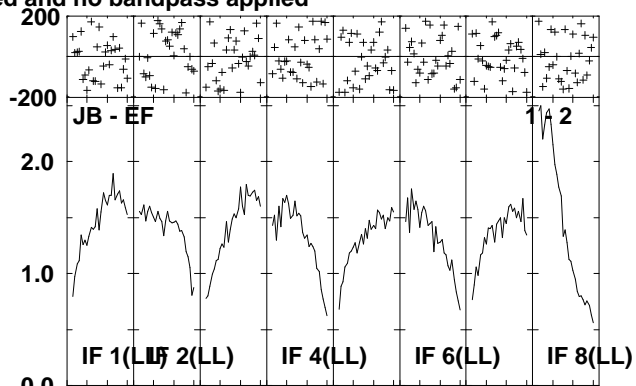
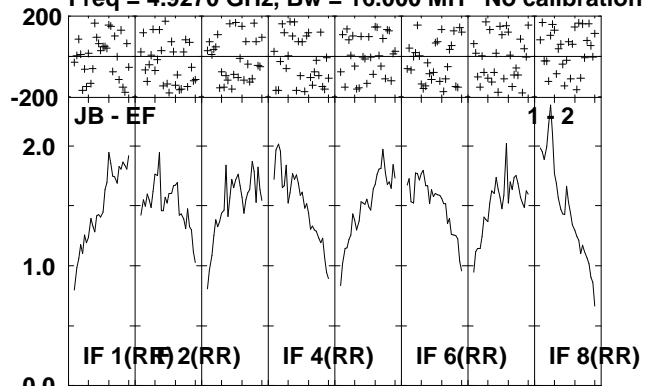

Lower frame: Milli Ampl Jy Top frame: Phas deg
Scalar averaged cross-power spectrum Several baselines displayed
Timerange: 00/16:21:01 to 00/16:25:19

Plot file version 259 created 06-JUL-2010 12:08:56

IRAS2336 EP064L.UVDATA.1

Freq = 4.9270 GHz, Bw = 16.000 MH No calibration applied and no bandpass applied

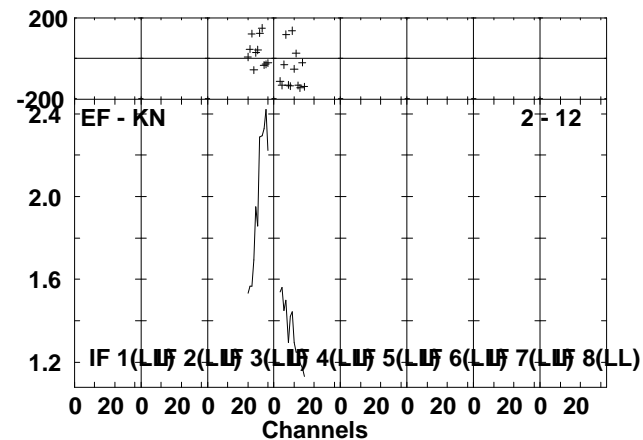
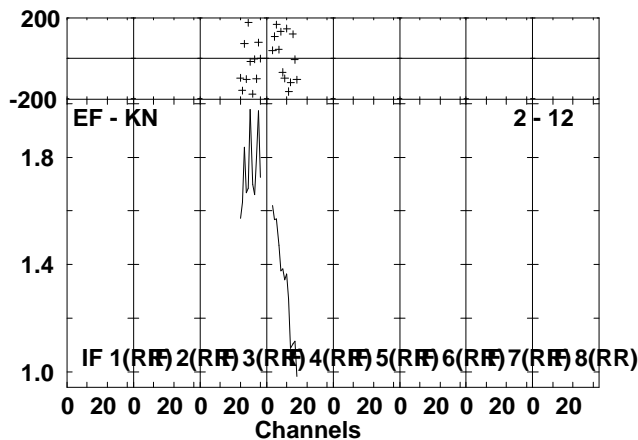
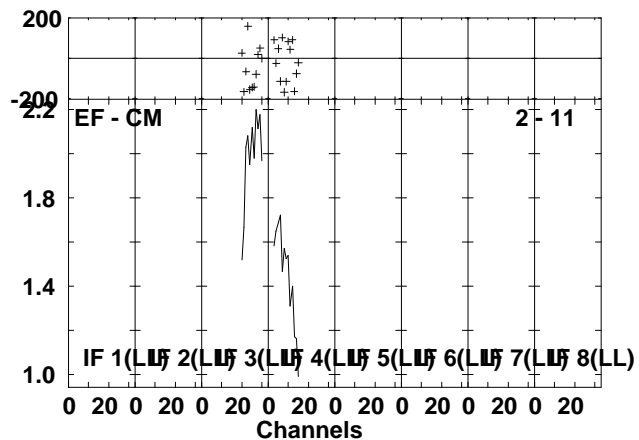
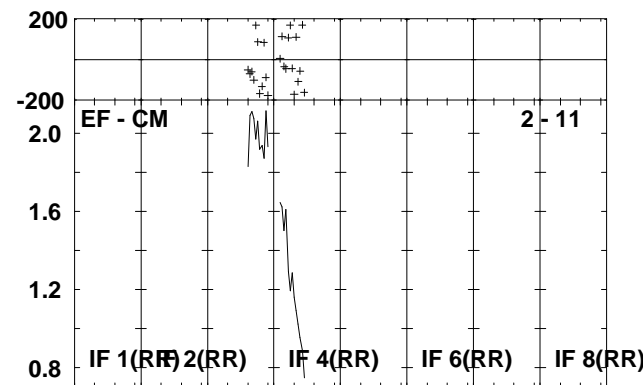
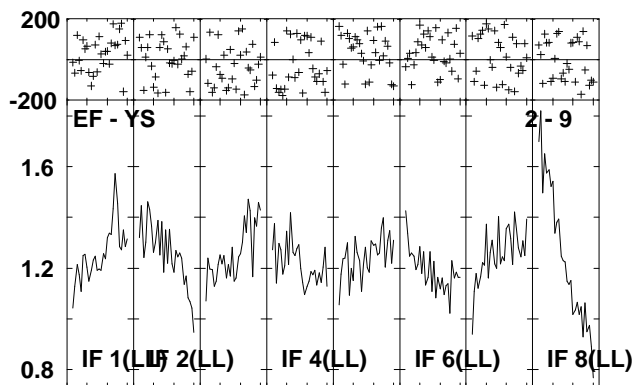
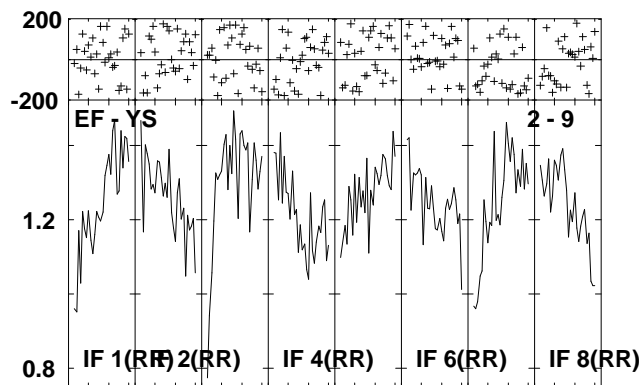
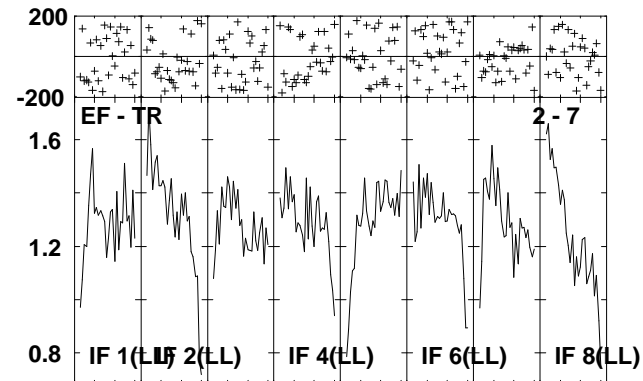
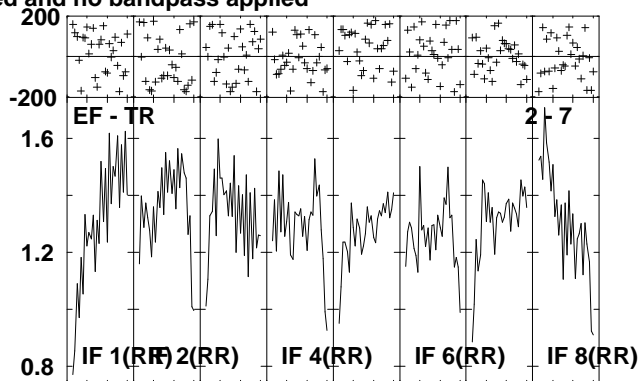
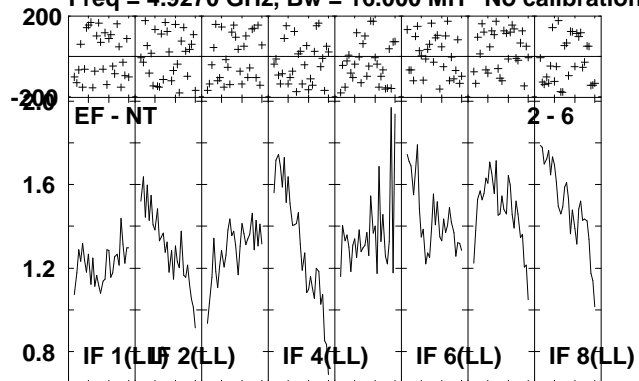

Lower frame: Milli Ampl Jy Top frame: Phas deg
Scalar averaged cross-power spectrum Several baselines displayed
Timerange: 00/16:21:01 to 00/16:25:19

Plot file version 260 created 06-JUL-2010 12:09:00

J2330+33 EP064L.UVDATA.1

Freq = 4.9270 GHz, Bw = 16.000 MH No calibration applied and no bandpass applied

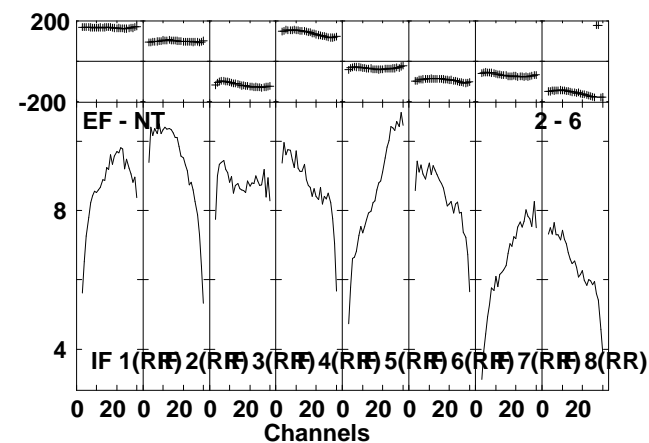
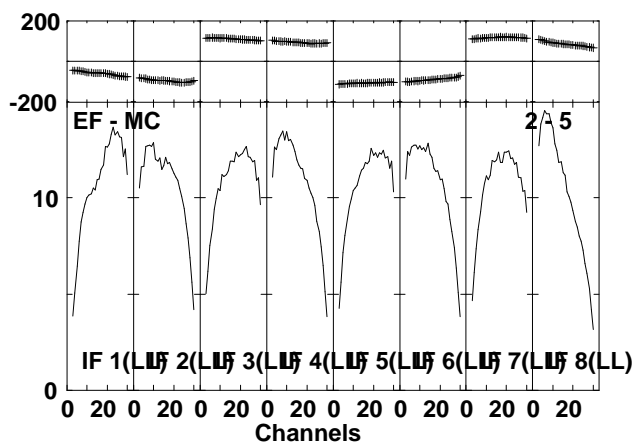
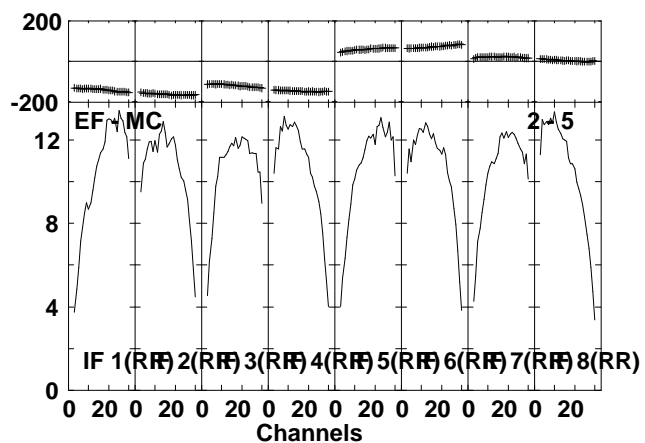
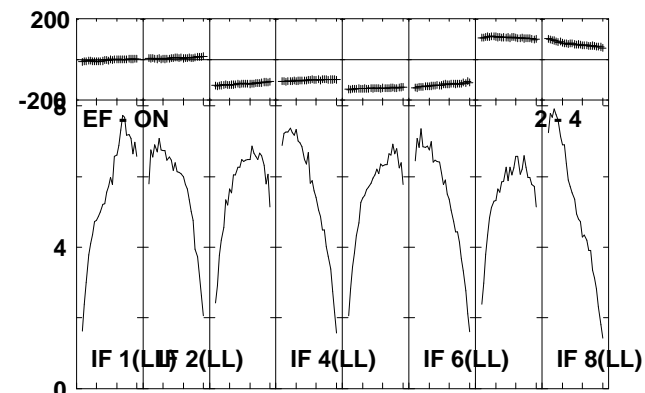
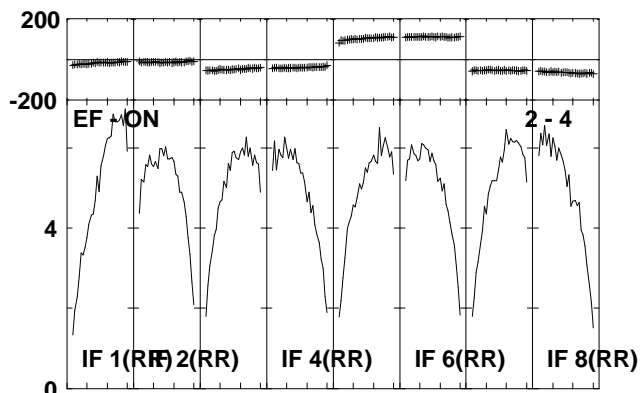
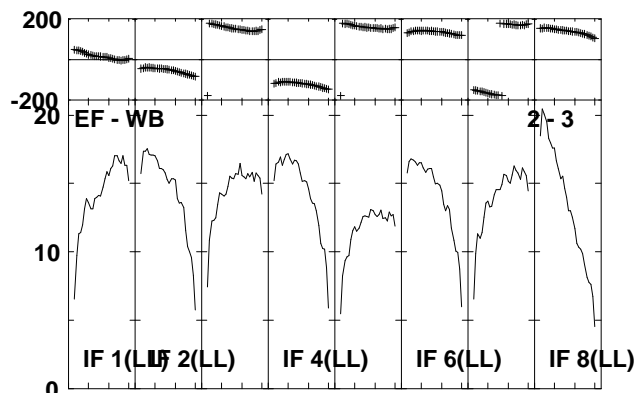
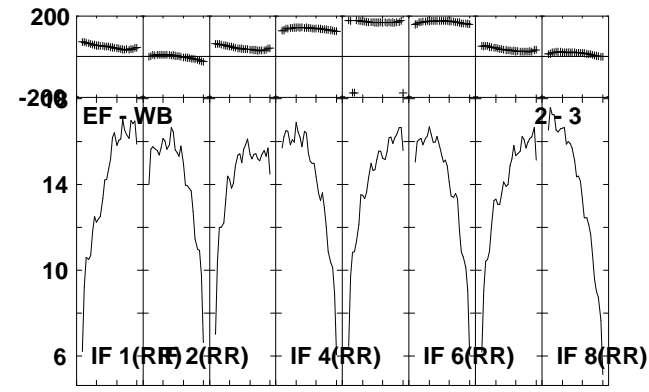
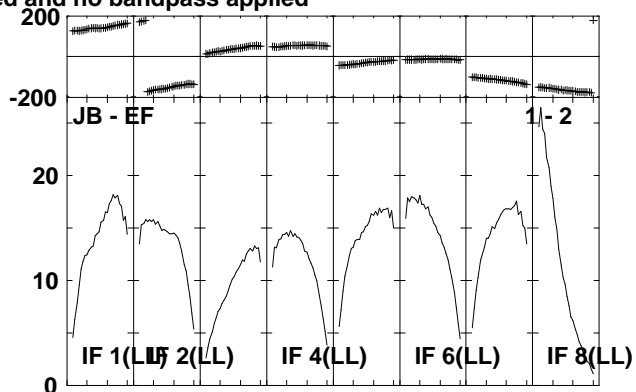
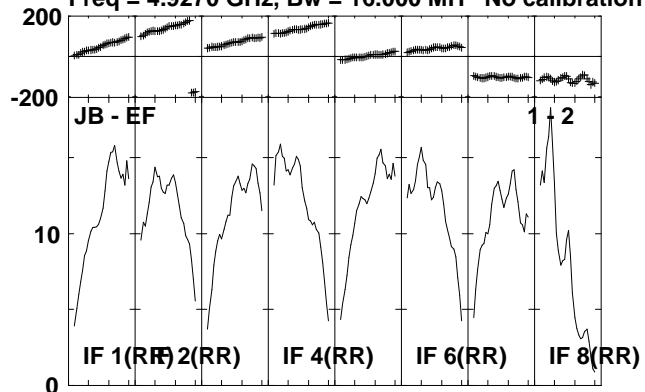

Lower frame: Milli Ampl Jy Top frame: Phas deg
Scalar averaged cross-power spectrum Several baselines displayed
Timerange: 00/16:26:21 to 00/16:28:19

Plot file version 261 created 06-JUL-2010 12:09:01

J2330+33 EP064L.UVDATA.1

Freq = 4.9270 GHz, Bw = 16.000 MH No calibration applied and no bandpass applied

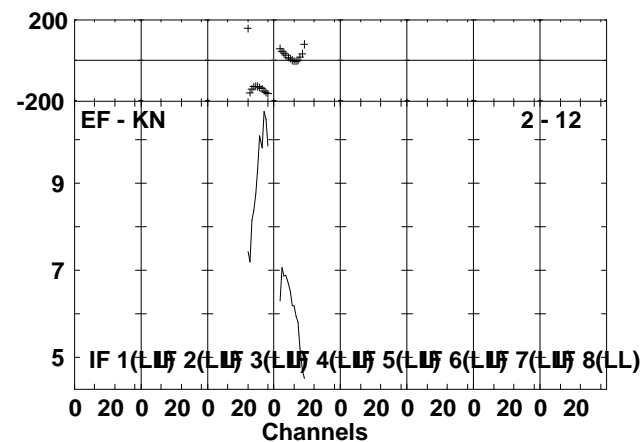
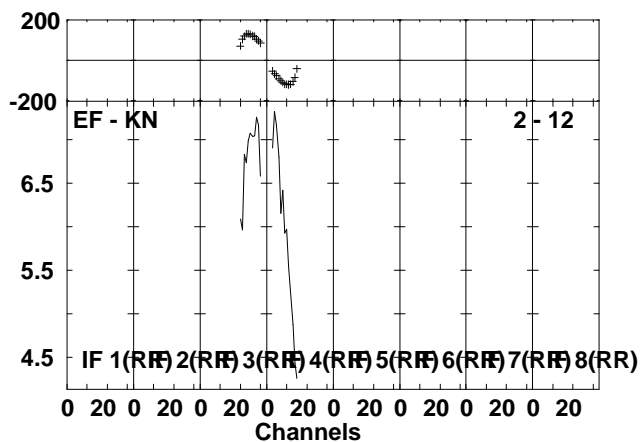
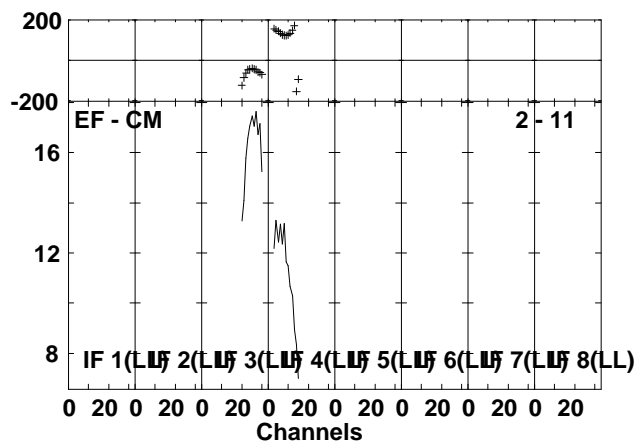
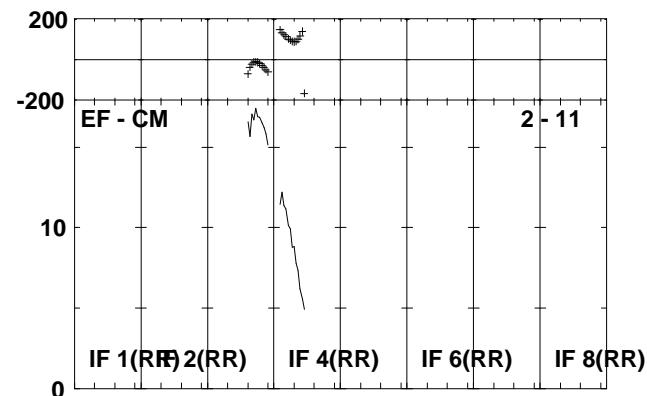
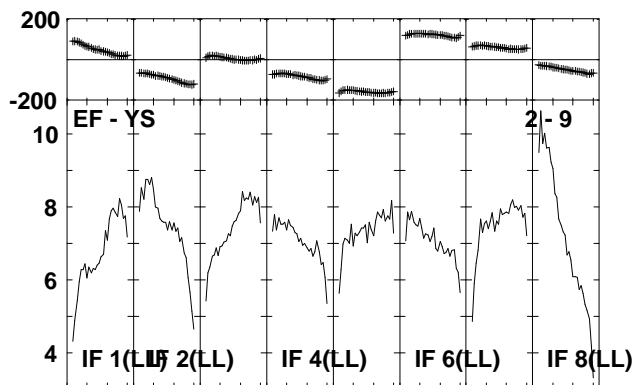
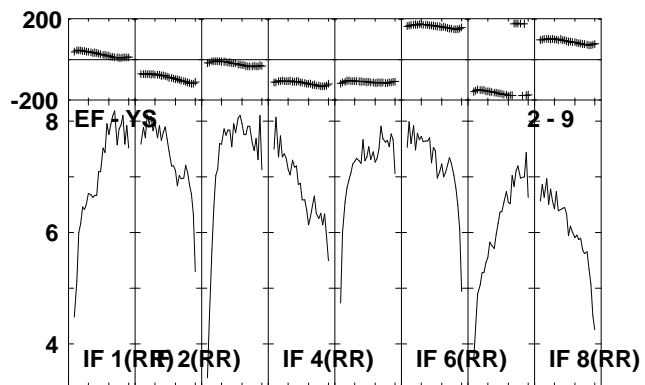
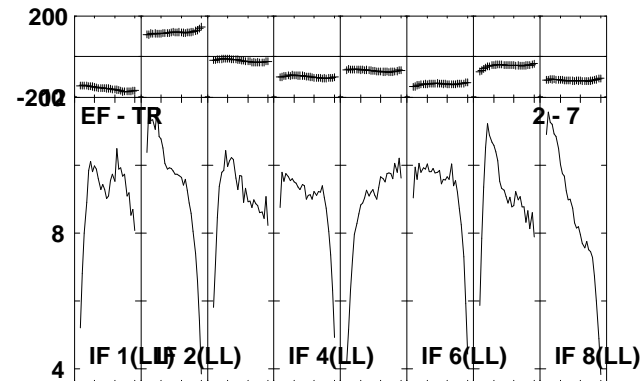
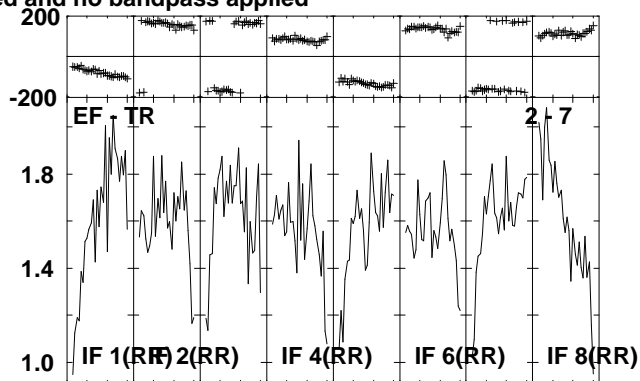
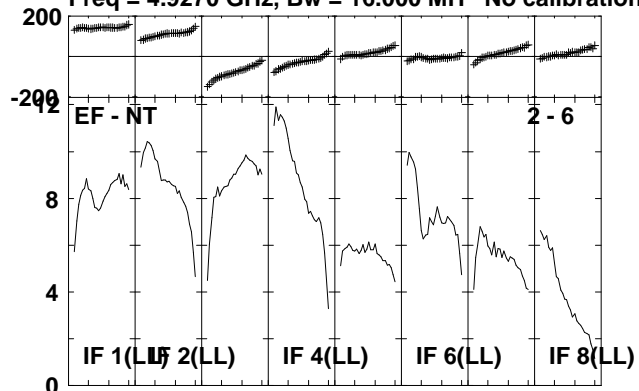

Lower frame: Milli Ampl Jy Top frame: Phas deg
Scalar averaged cross-power spectrum Several baselines displayed
Timerange: 00/16:26:21 to 00/16:28:19

Plot file version 262 created 06-JUL-2010 12:09:03

IRAS2336 EP064L.UVDATA.1

Freq = 4.9270 GHz, Bw = 16.000 MH No calibration applied and no bandpass applied

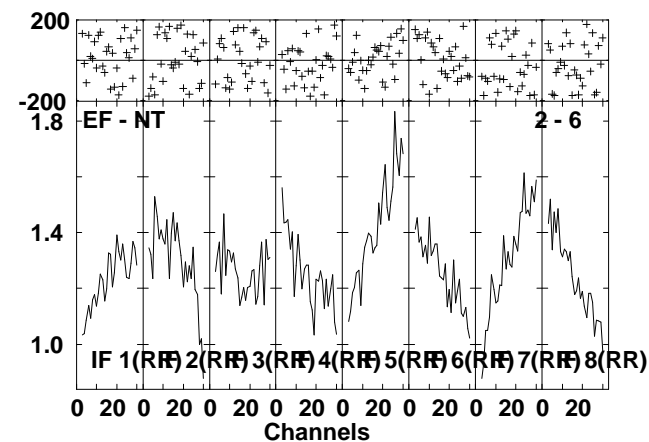
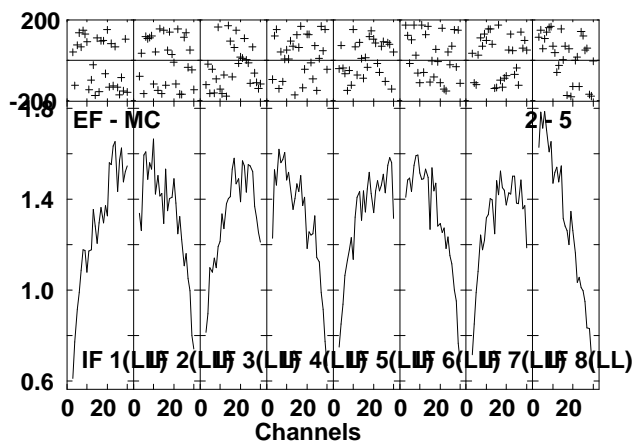
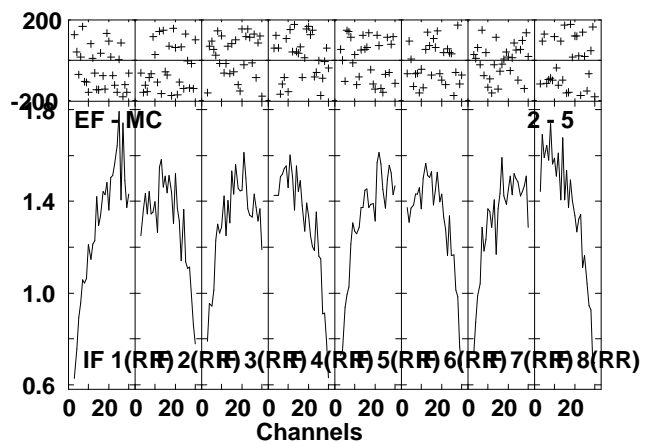
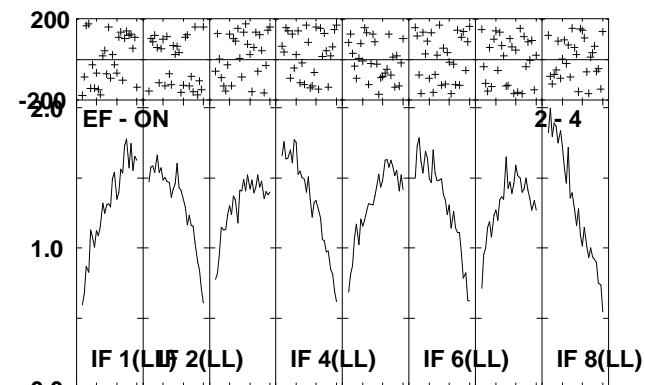
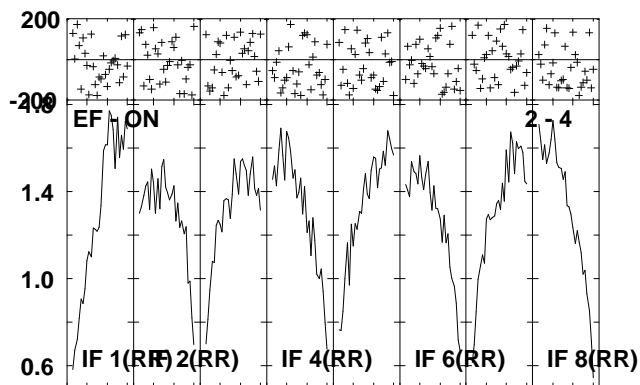
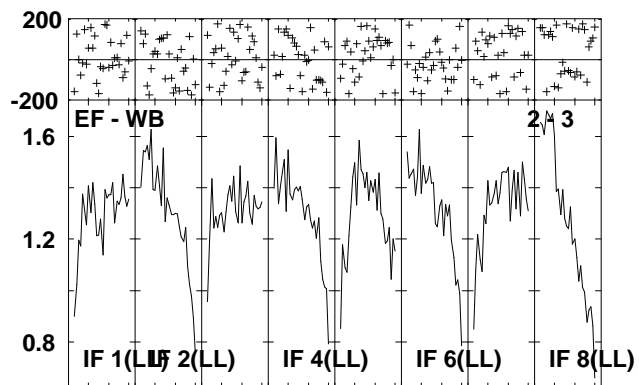
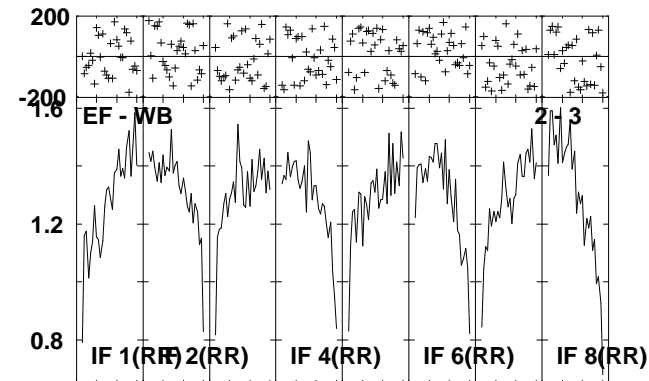
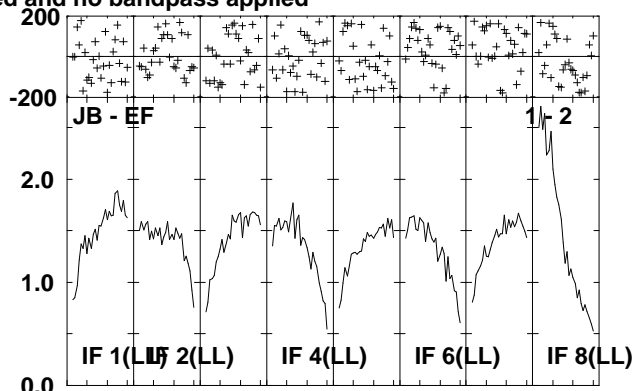
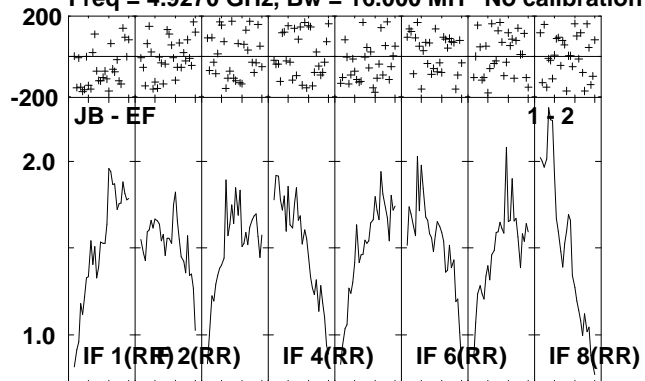

Lower frame: Milli Ampl Jy Top frame: Phas deg
Scalar averaged cross-power spectrum Several baselines displayed
Timerange: 00/16:28:21 to 00/16:32:39

Plot file version 263 created 06-JUL-2010 12:09:06

IRAS2336 EP064L.UVDATA.1

Freq = 4.9270 GHz, Bw = 16.000 MH No calibration applied and no bandpass applied

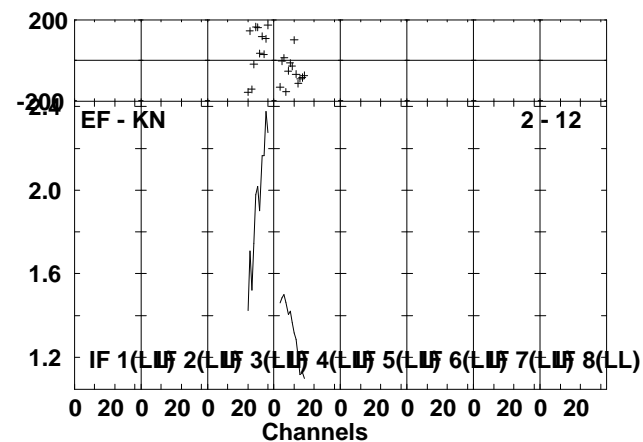
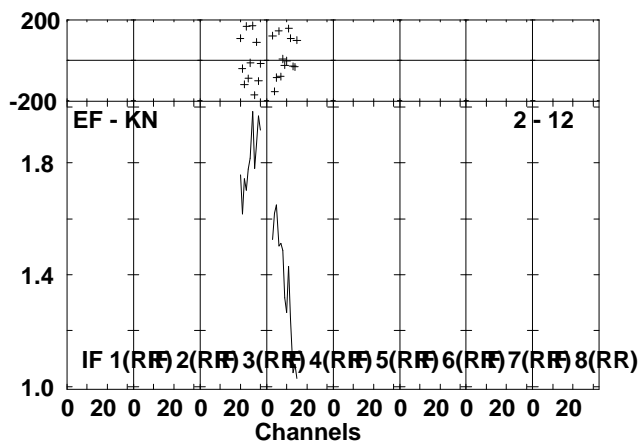
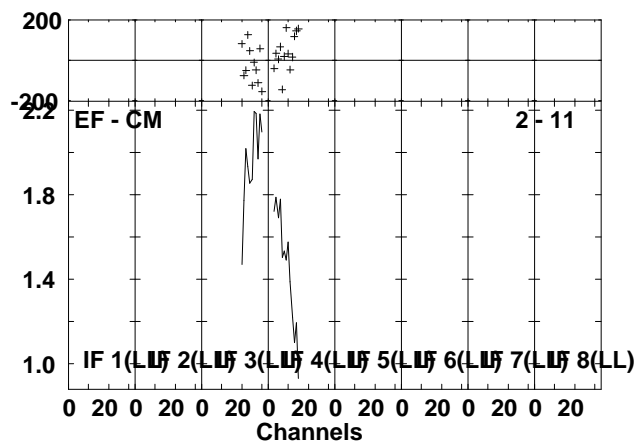
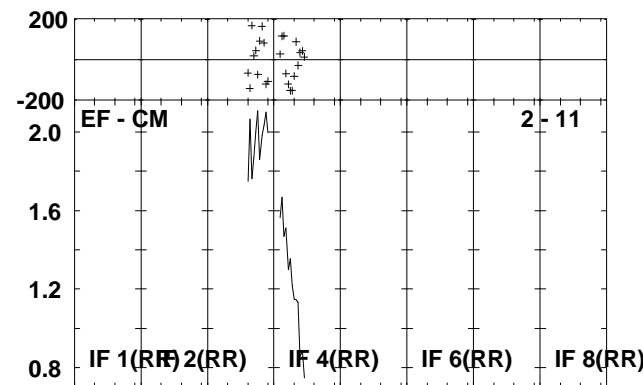
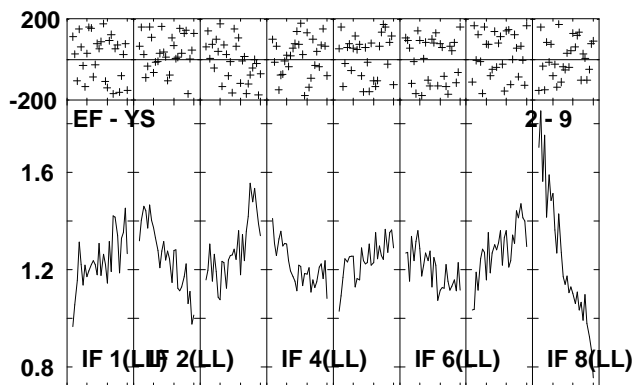
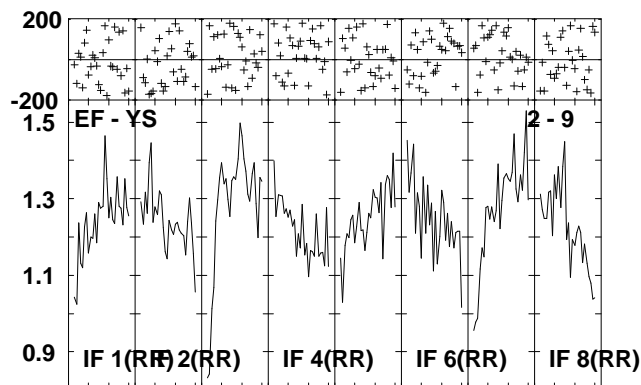
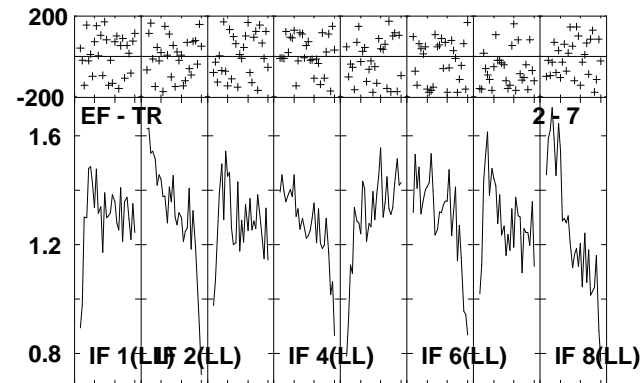
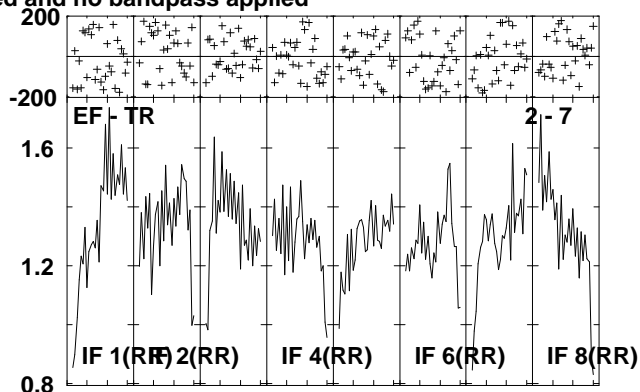
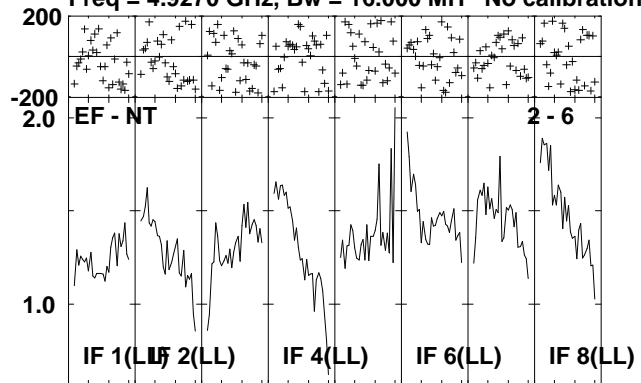

Lower frame: Milli Ampl Jy Top frame: Phas deg
Scalar averaged cross-power spectrum Several baselines displayed
Timerange: 00/16:28:21 to 00/16:32:39

Plot file version 264 created 06-JUL-2010 12:09:10

J2330+33 EP064L.UVDATA.1

Freq = 4.9270 GHz, Bw = 16.000 MH No calibration applied and no bandpass applied

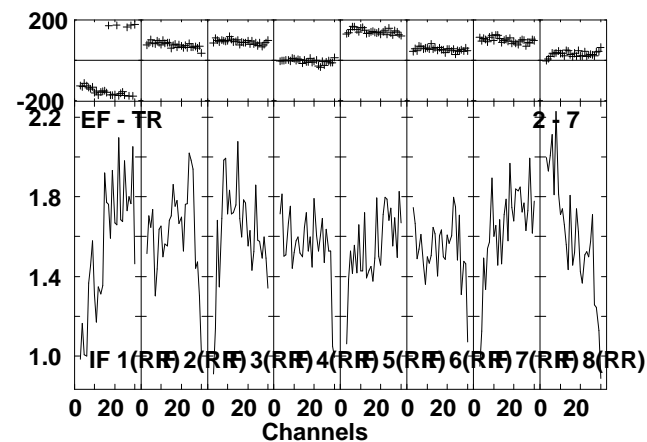
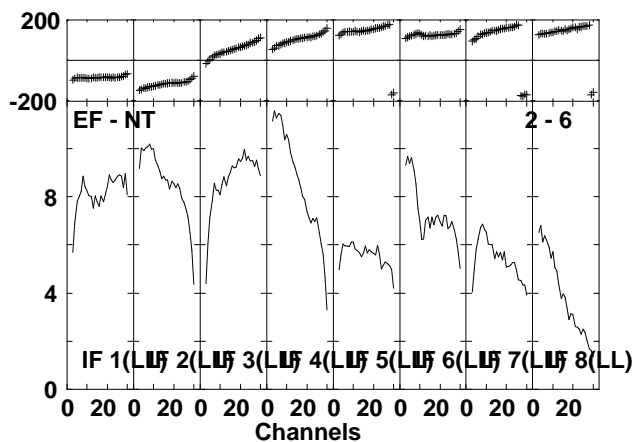
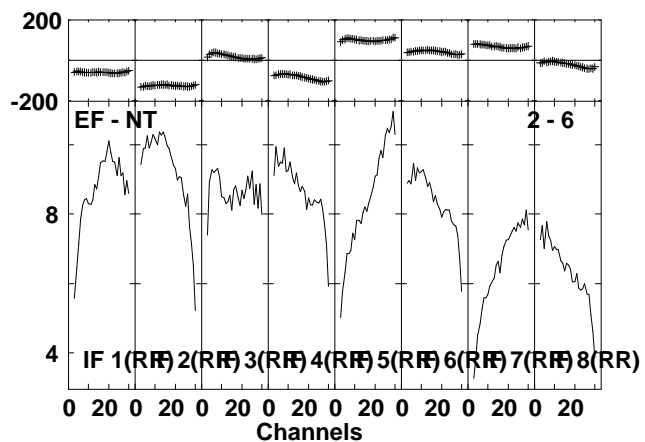
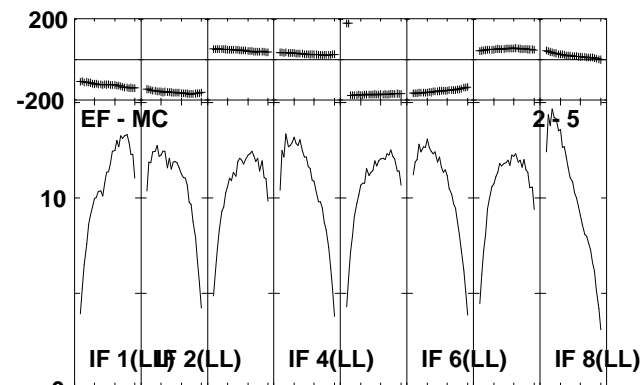
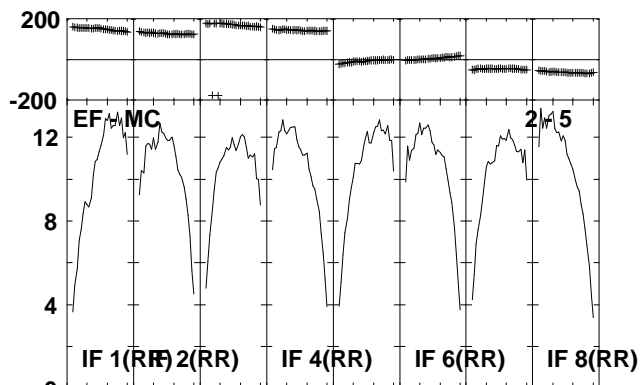
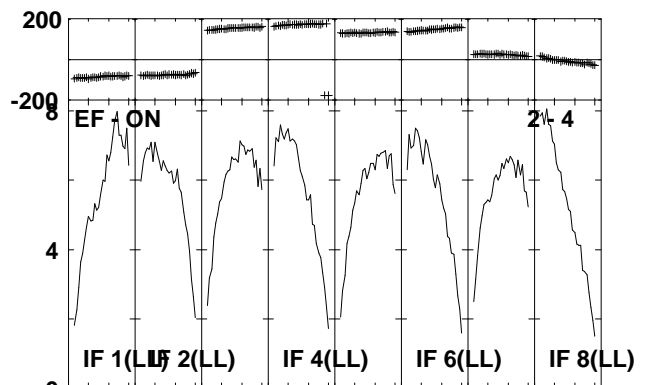
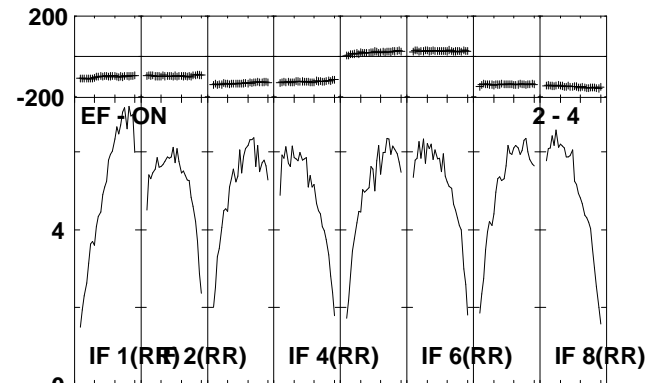
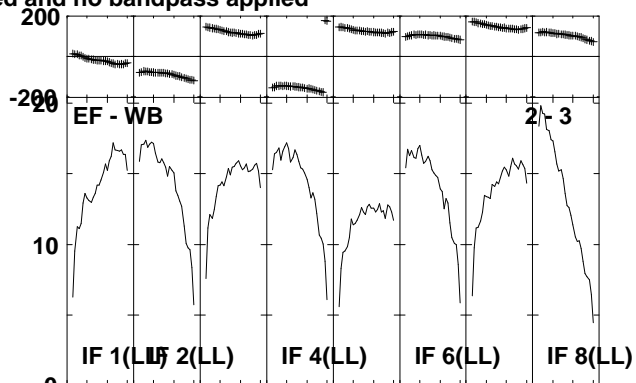
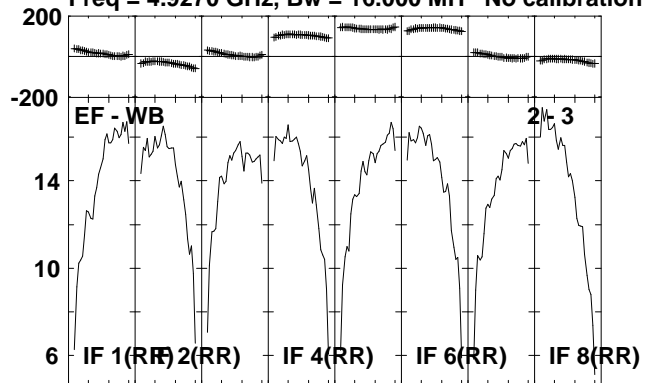

Lower frame: Milli Ampl Jy Top frame: Phas deg
Scalar averaged cross-power spectrum Several baselines displayed
Timerange: 00/16:32:41 to 00/16:34:37

Plot file version 265 created 06-JUL-2010 12:09:11

J2330+33 EP064L.UVDATA.1

Freq = 4.9270 GHz, Bw = 16.000 MH No calibration applied and no bandpass applied

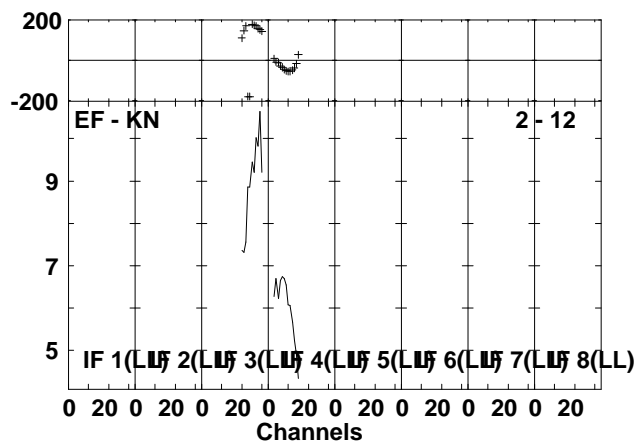
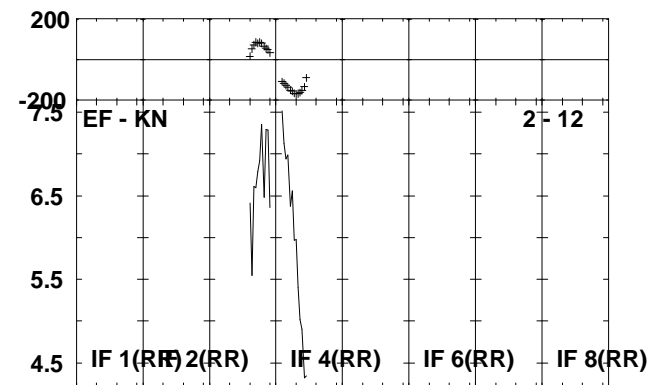
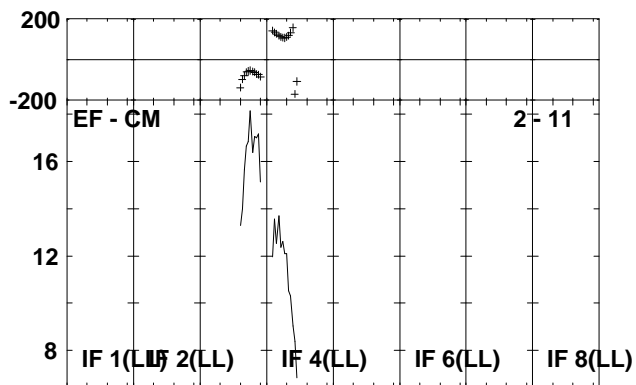
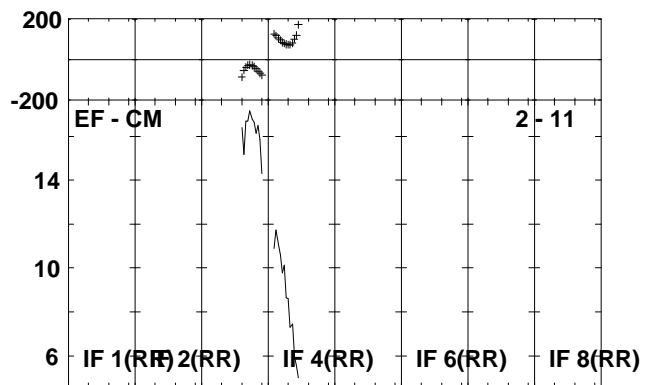
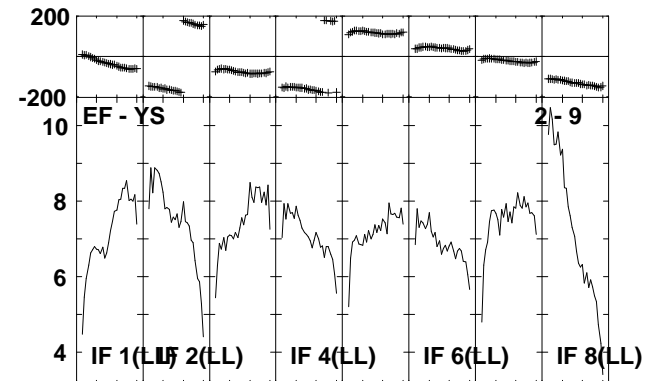
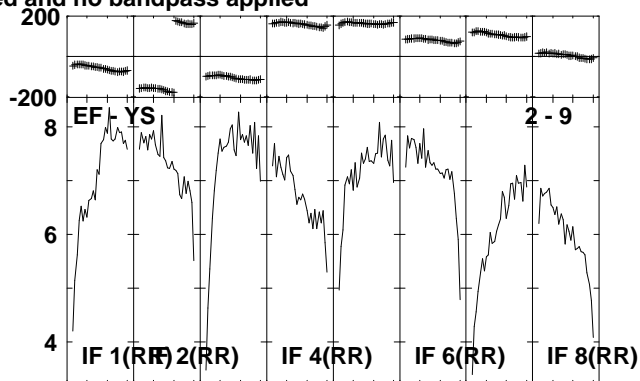
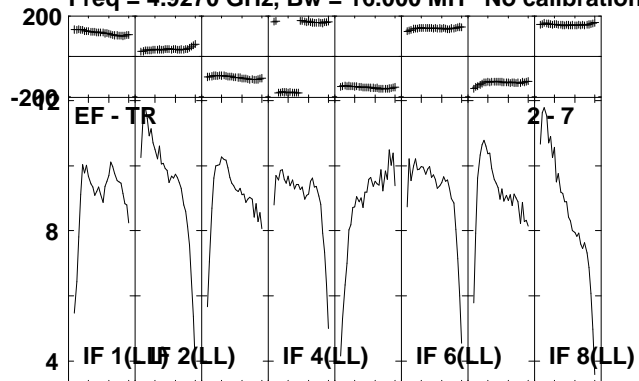

Lower frame: Milli Ampl Jy Top frame: Phas deg
Scalar averaged cross-power spectrum Several baselines displayed
Timerange: 00/16:32:41 to 00/16:34:37

Plot file version 266 created 06-JUL-2010 12:09:12

IRAS2336 EP064L.UVDATA.1

Freq = 4.9270 GHz, Bw = 16.000 MH No calibration applied and no bandpass applied

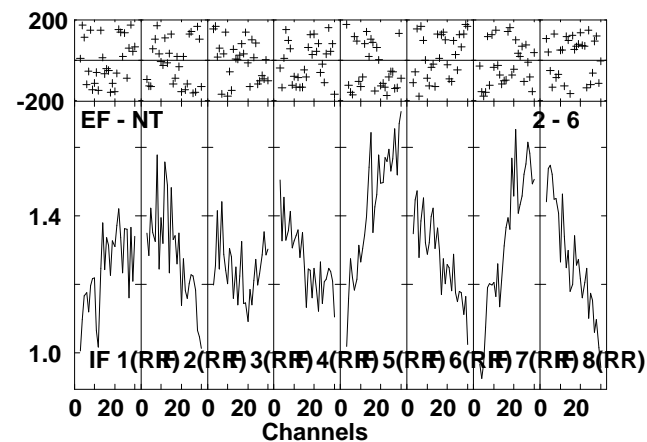
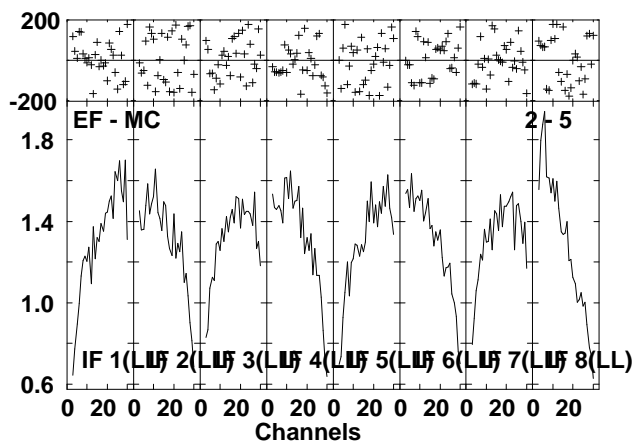
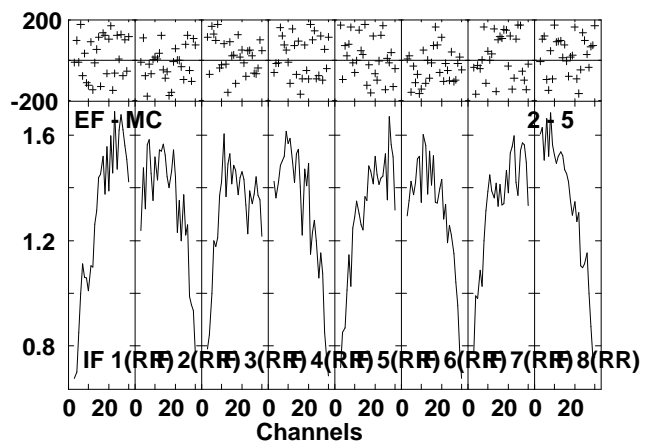
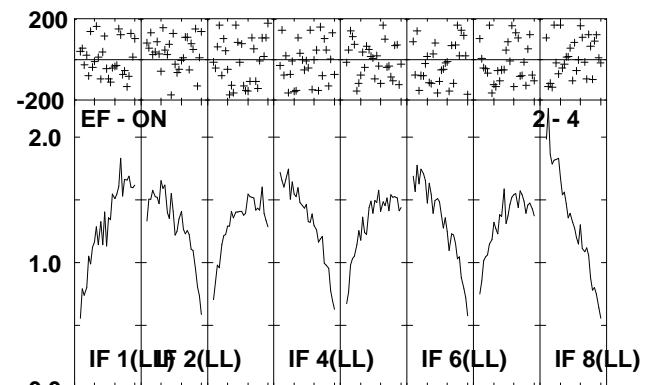
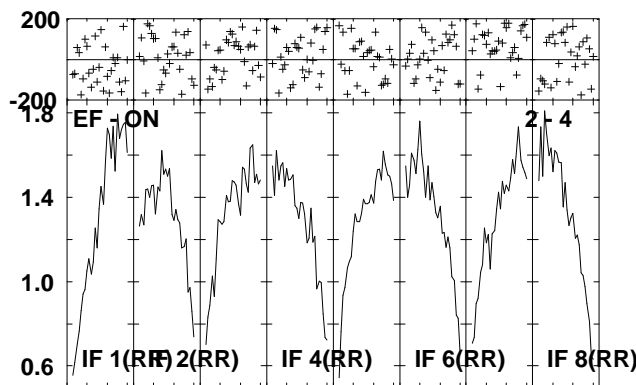
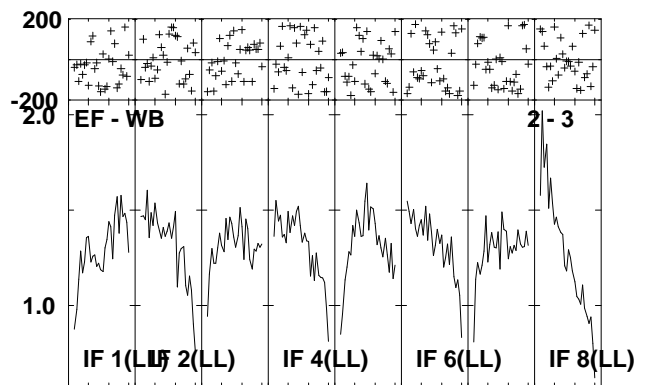
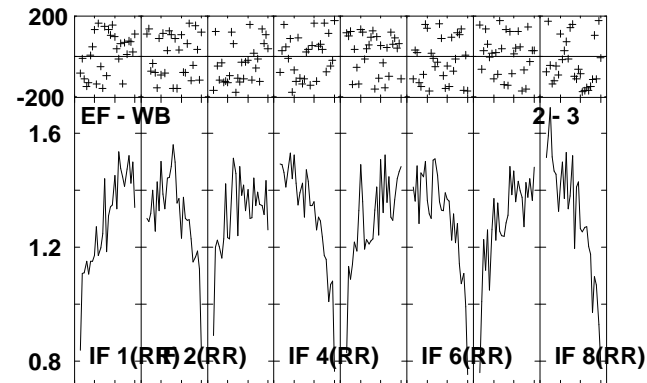
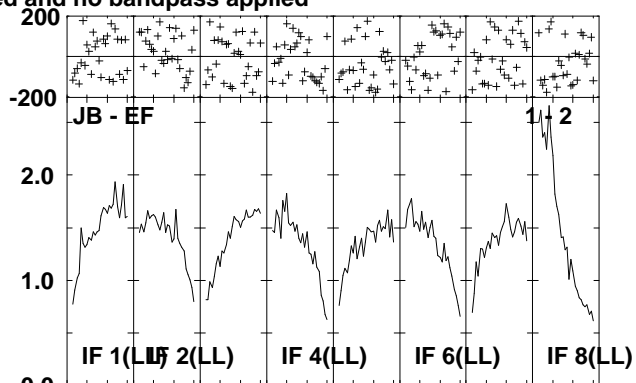
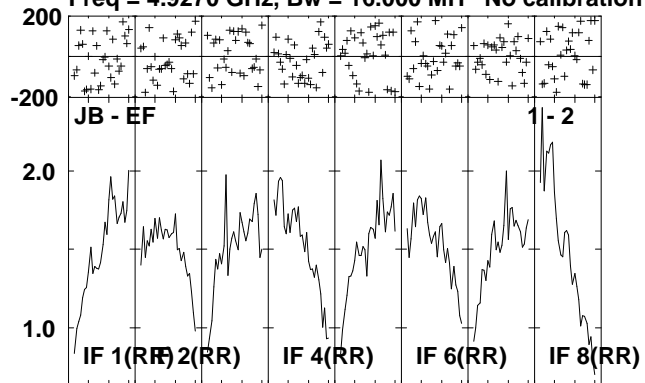

Lower frame: Milli Ampl Jy Top frame: Phas deg
Scalar averaged cross-power spectrum Several baselines displayed
Timerange: 00/16:34:41 to 00/16:38:59

Plot file version 267 created 06-JUL-2010 12:09:14

IRAS2336 EP064L.UVDATA.1

Freq = 4.9270 GHz, Bw = 16.000 MH No calibration applied and no bandpass applied

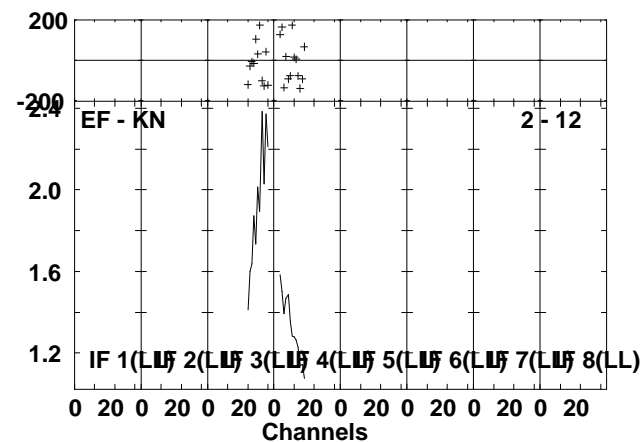
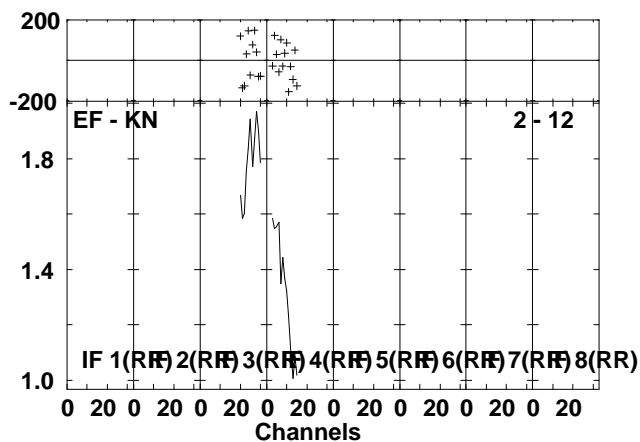
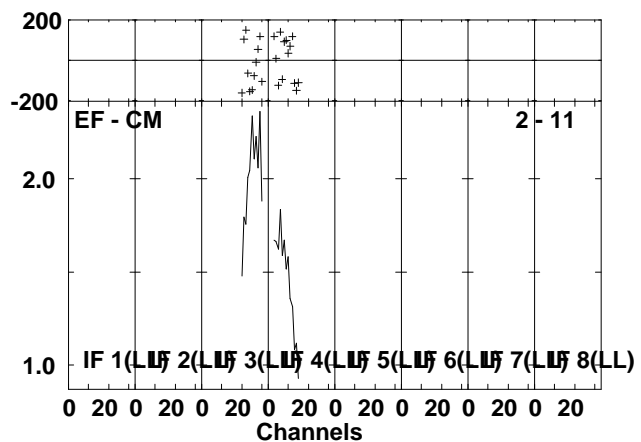
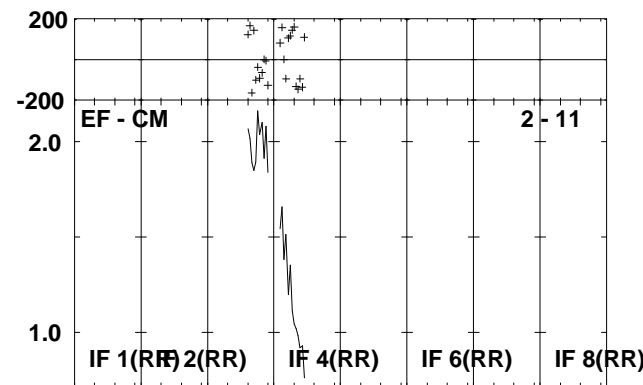
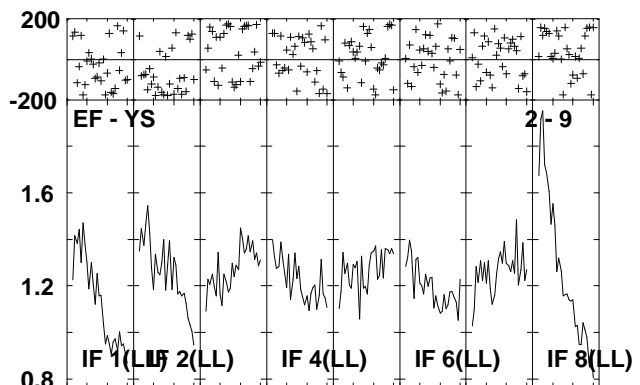
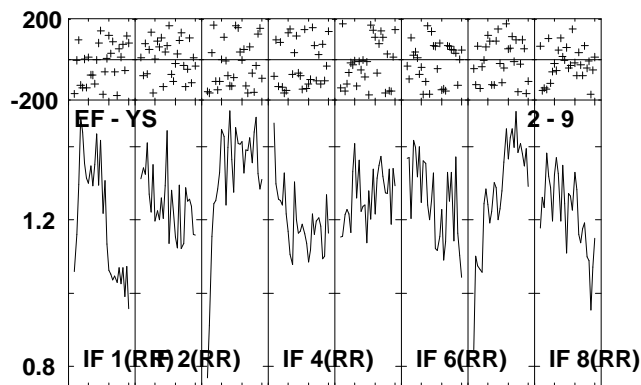
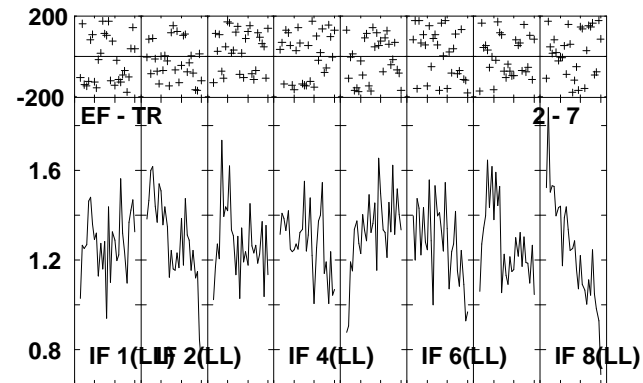
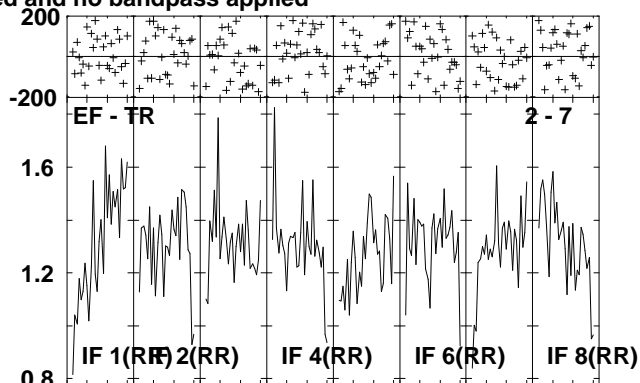
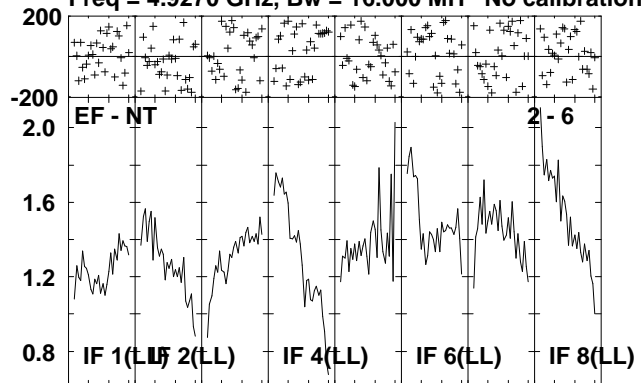

Lower frame: Milli Ampl Jy Top frame: Phas deg
Scalar averaged cross-power spectrum Several baselines displayed
Timerange: 00/16:34:41 to 00/16:38:59

Plot file version 268 created 06-JUL-2010 12:09:17

J2330+33 EP064L.UVDATA.1

Freq = 4.9270 GHz, Bw = 16.000 MH No calibration applied and no bandpass applied

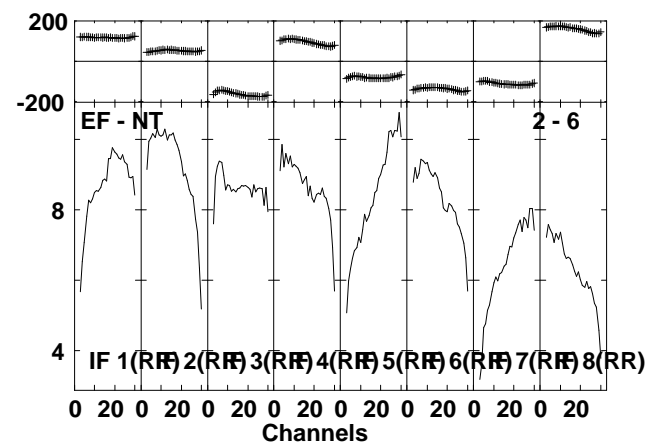
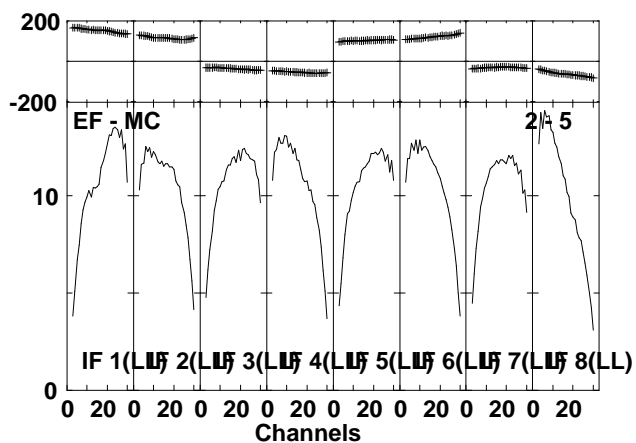
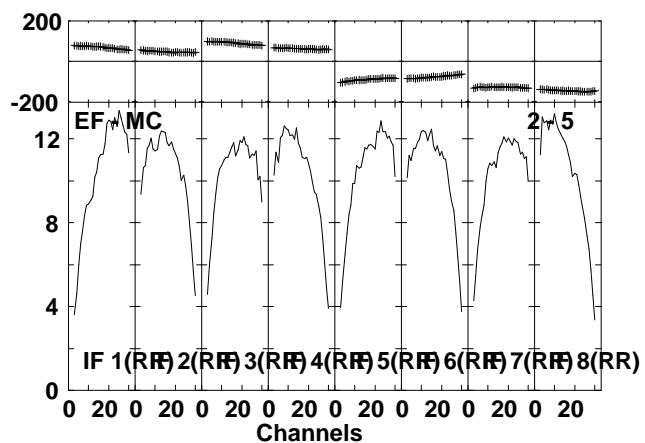
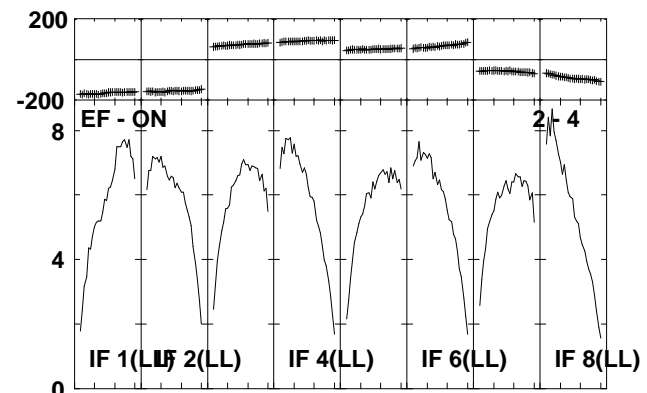
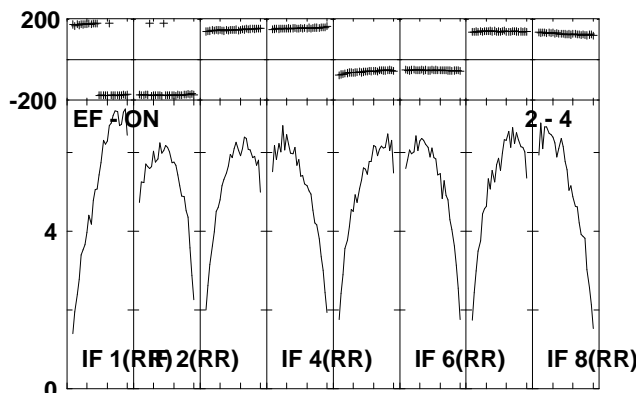
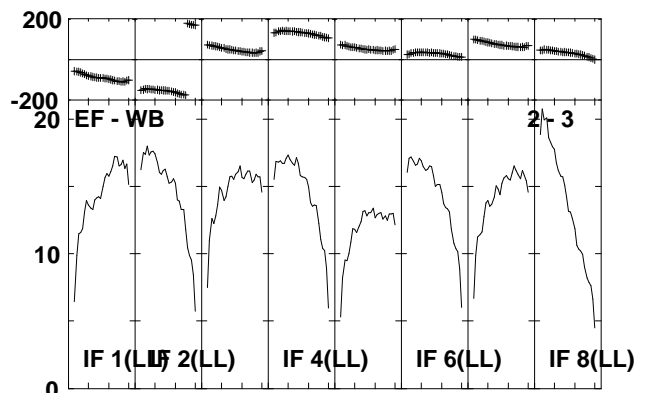
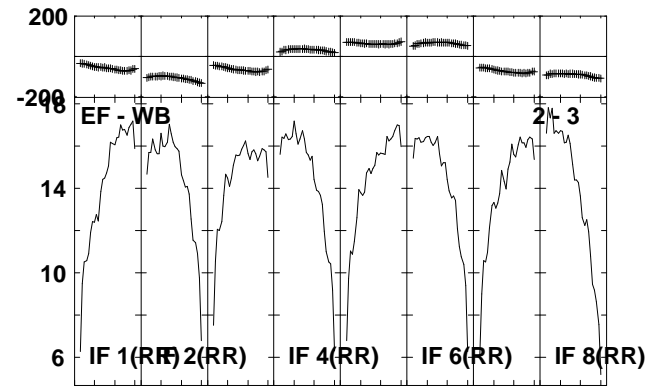
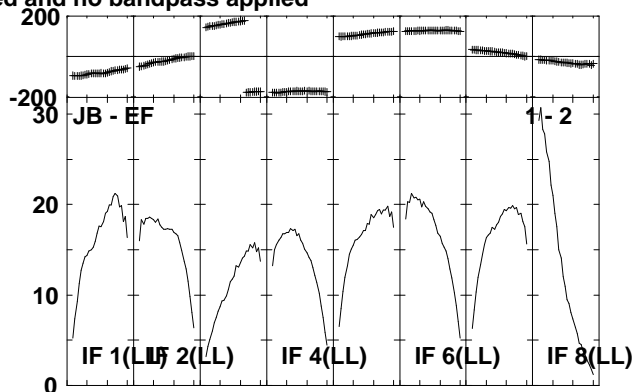
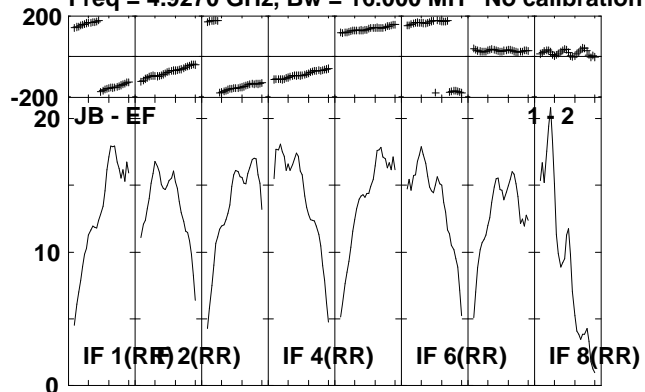

Lower frame: Milli Ampl Jy Top frame: Phas deg
Scalar averaged cross-power spectrum Several baselines displayed
Timerange: 00/16:40:01 to 00/16:41:59

Plot file version 269 created 06-JUL-2010 12:09:18

J2330+33 EP064L.UVDATA.1

Freq = 4.9270 GHz, Bw = 16.000 MH No calibration applied and no bandpass applied

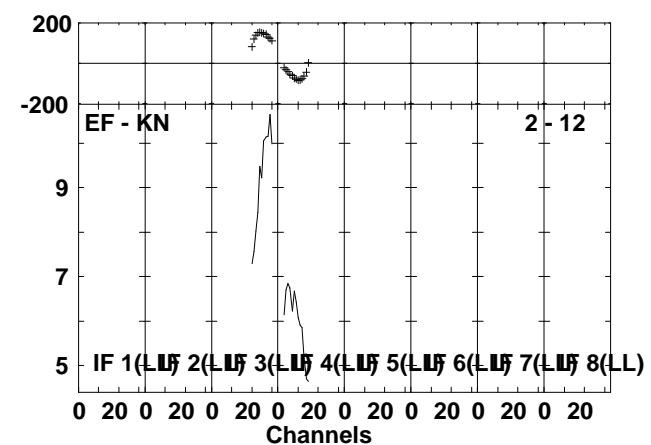
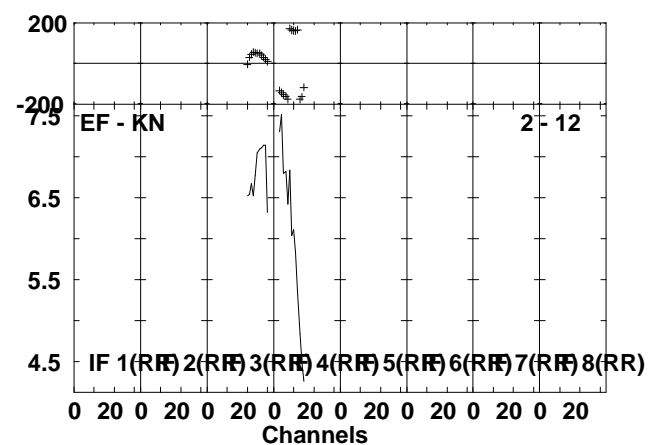
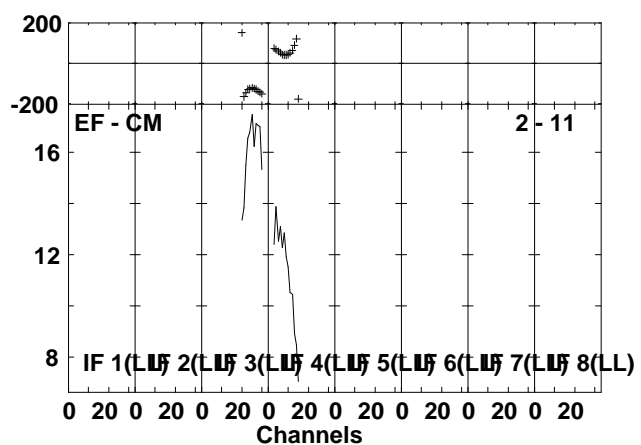
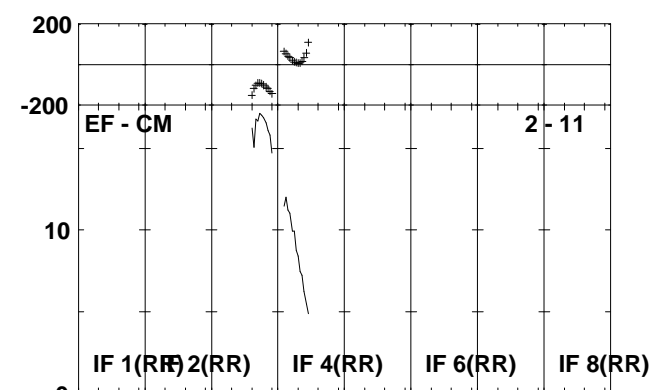
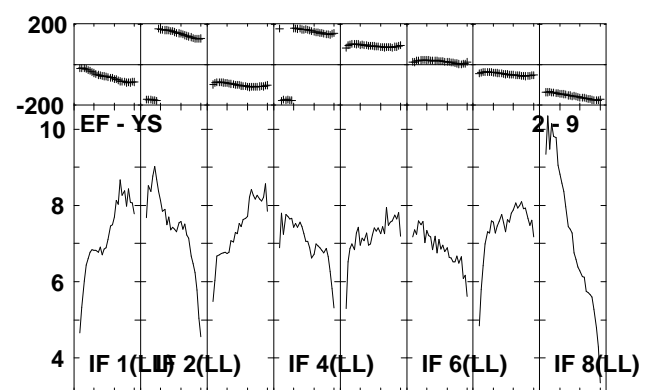
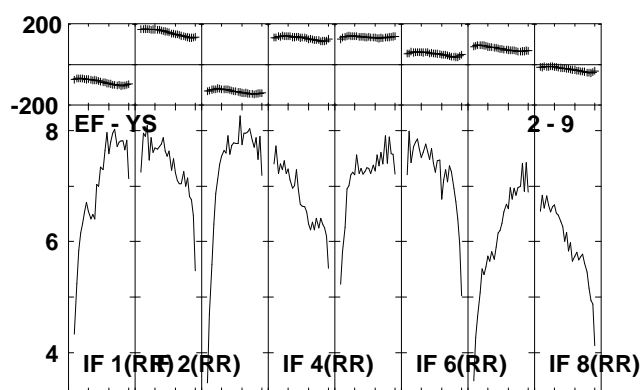
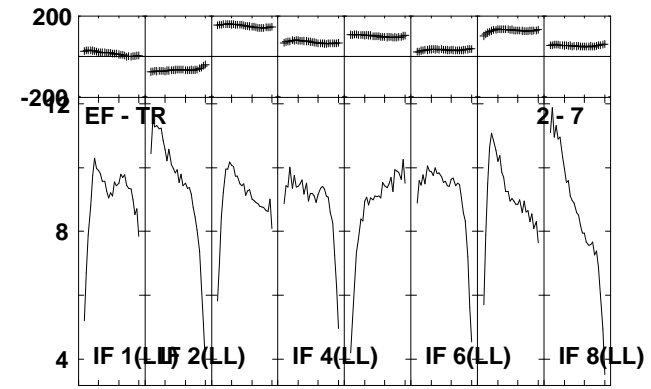
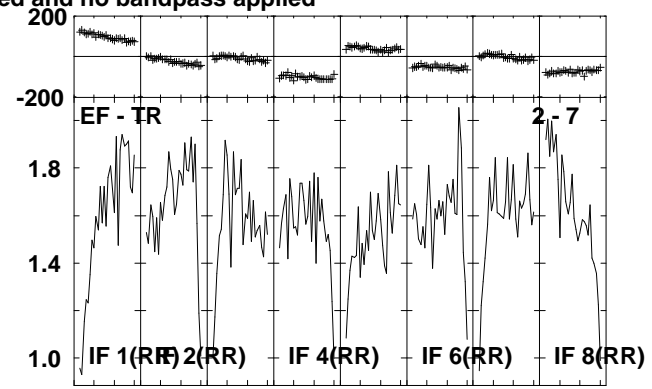
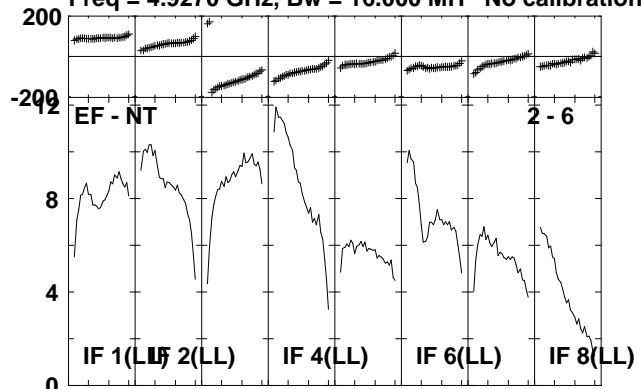

Lower frame: Milli Ampl Jy Top frame: Phas deg
Scalar averaged cross-power spectrum Several baselines displayed
Timerange: 00/16:40:01 to 00/16:41:59

Plot file version 270 created 06-JUL-2010 12:09:21

IRAS2336 EP064L.UVDATA.1

Freq = 4.9270 GHz, Bw = 16.000 MH No calibration applied and no bandpass applied

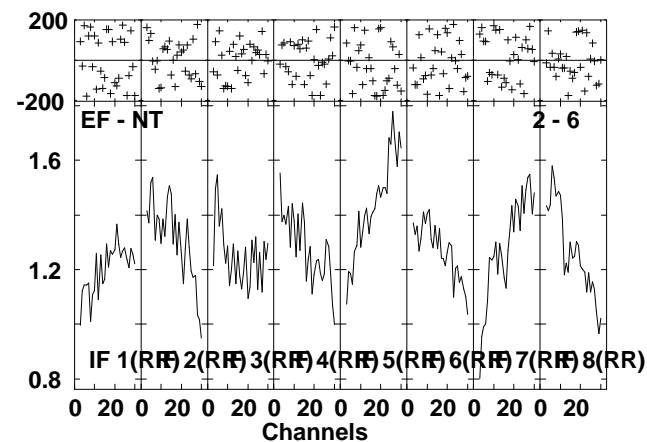
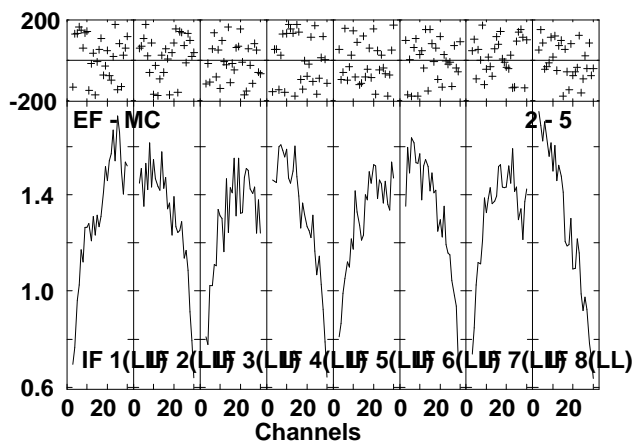
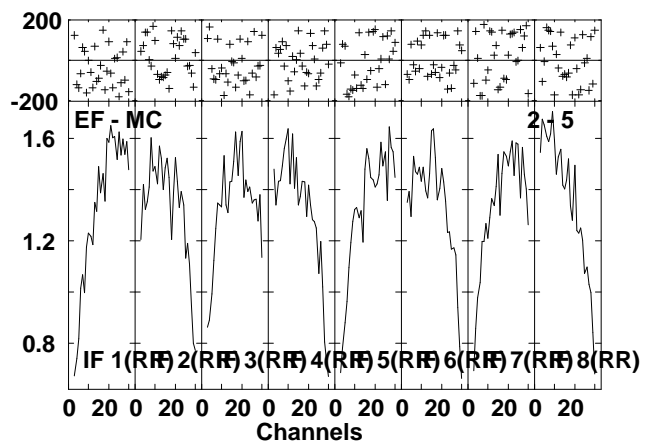
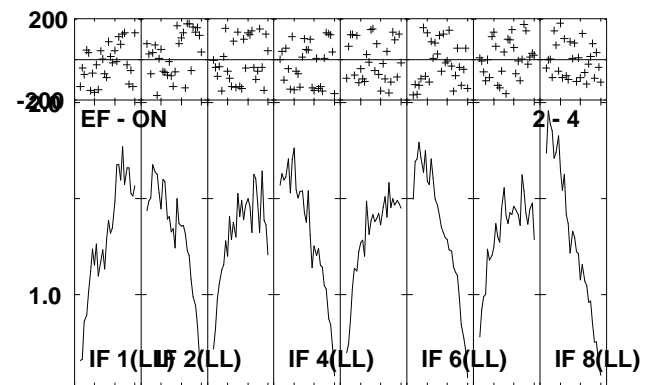
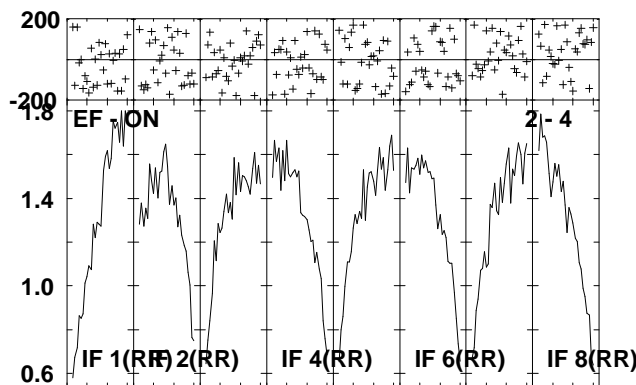
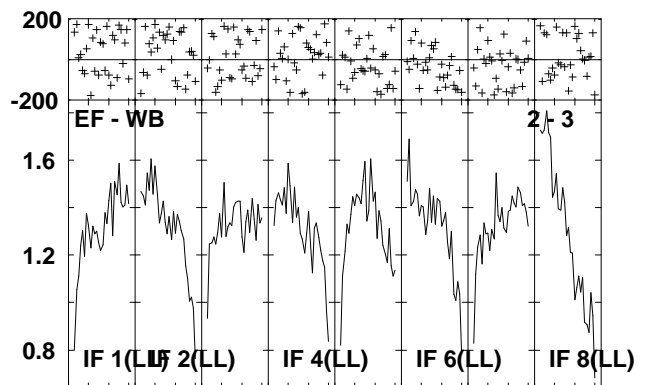
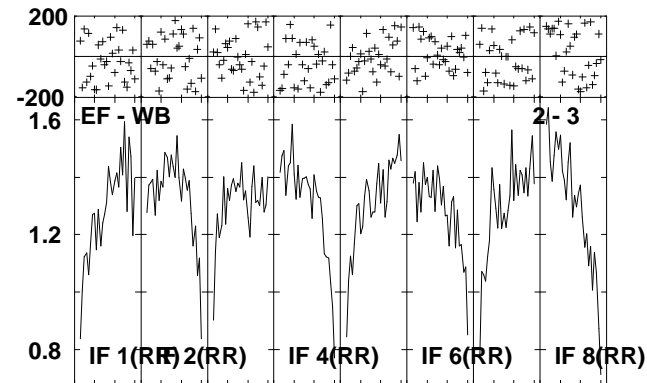
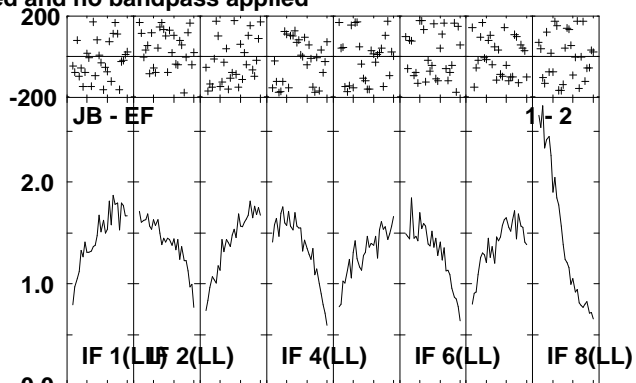
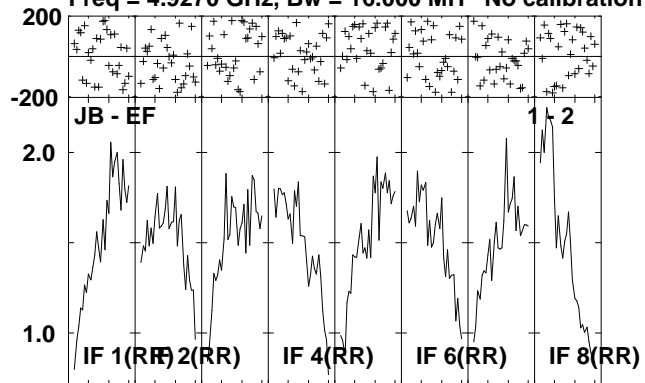

Lower frame: Milli Ampl Jy Top frame: Phas deg
Scalar averaged cross-power spectrum Several baselines displayed
Timerange: 00/16:42:09 to 00/16:46:19

Plot file version 271 created 06-JUL-2010 12:09:23

IRAS2336 EP064L.UVDATA.1

Freq = 4.9270 GHz, Bw = 16.000 MH No calibration applied and no bandpass applied

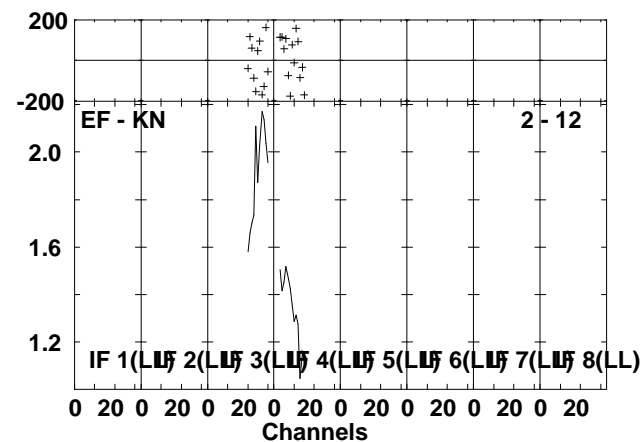
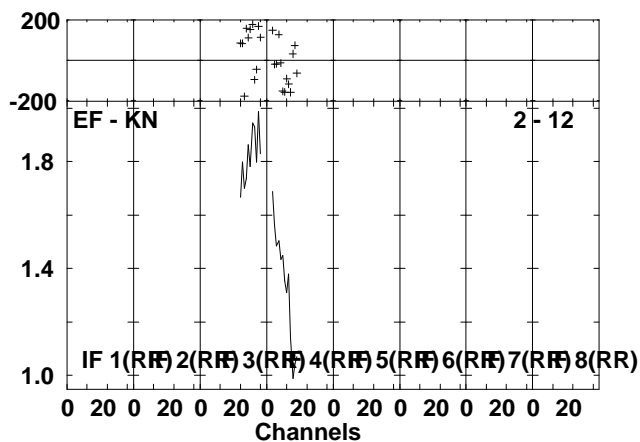
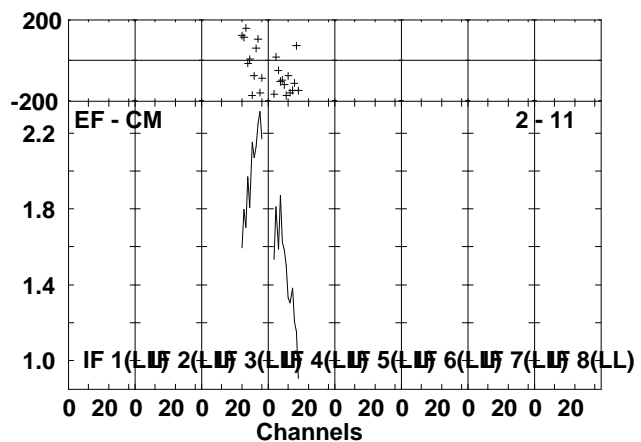
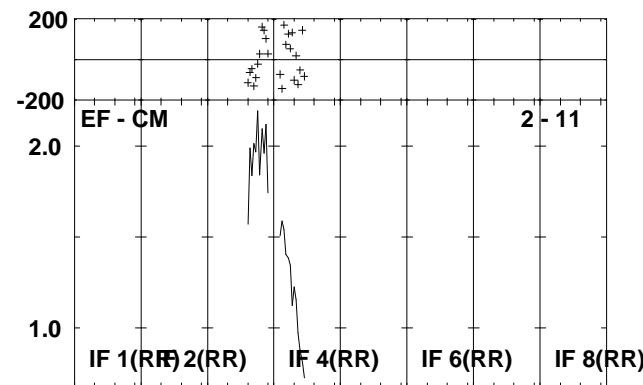
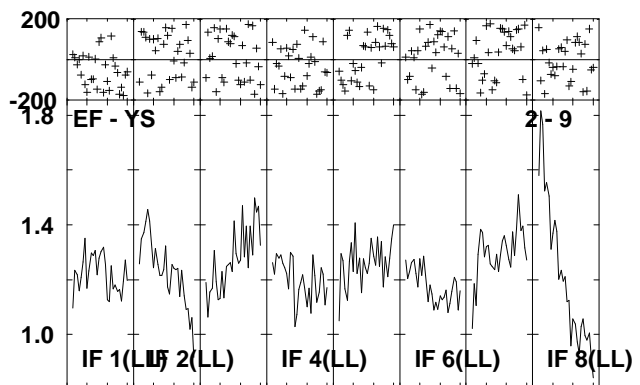
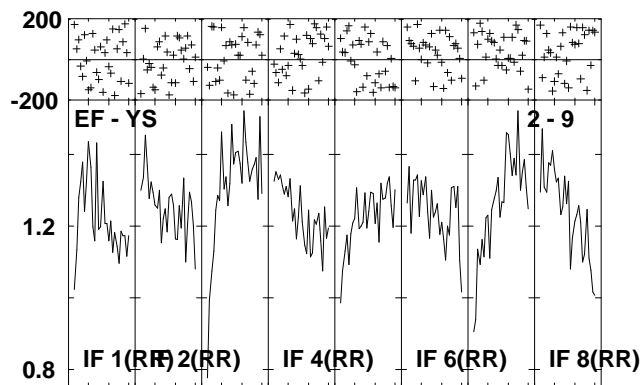
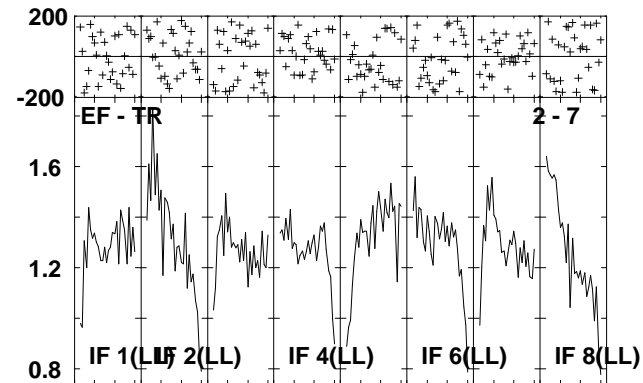
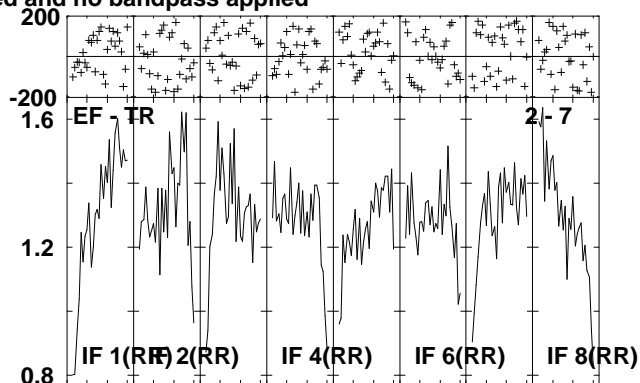
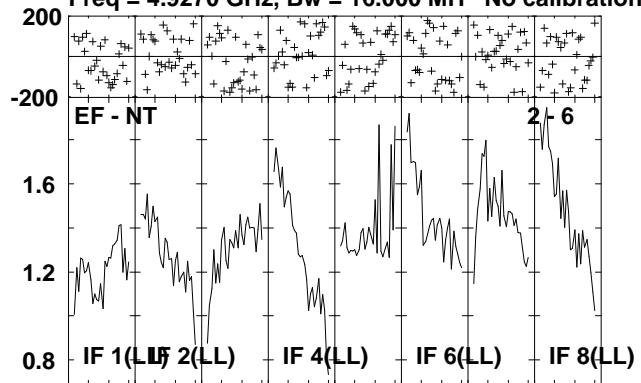

Lower frame: Milli Ampl Jy Top frame: Phas deg
Scalar averaged cross-power spectrum Several baselines displayed
Timerange: 00/16:42:09 to 00/16:46:19

Plot file version 272 created 06-JUL-2010 12:09:26

J2330+33 EP064L.UVDATA.1

Freq = 4.9270 GHz, Bw = 16.000 MH No calibration applied and no bandpass applied

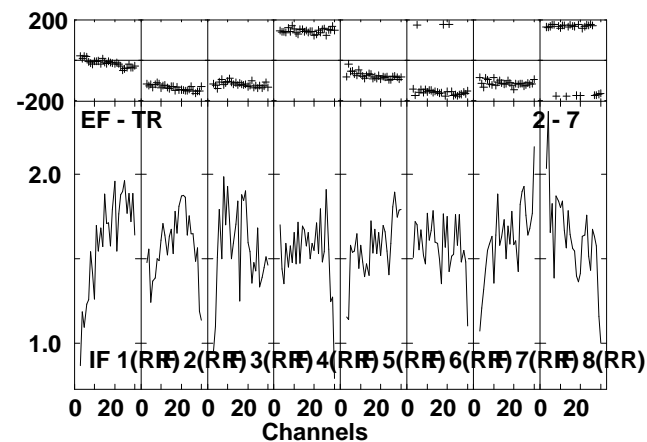
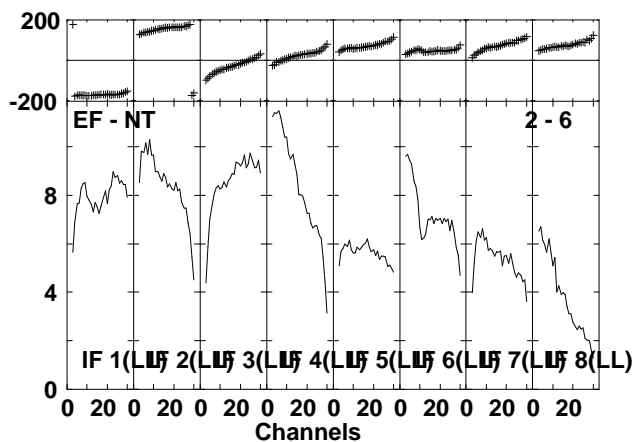
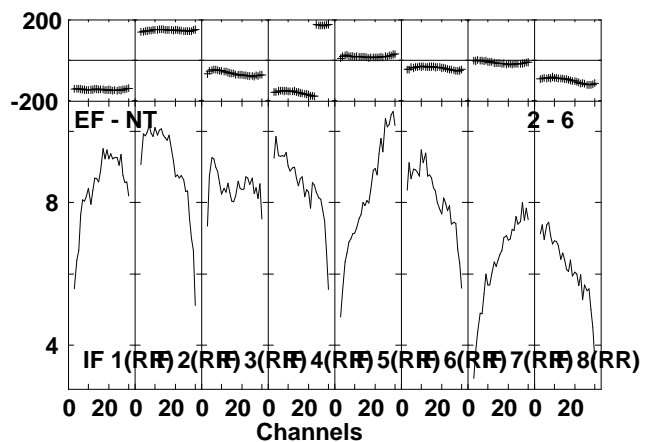
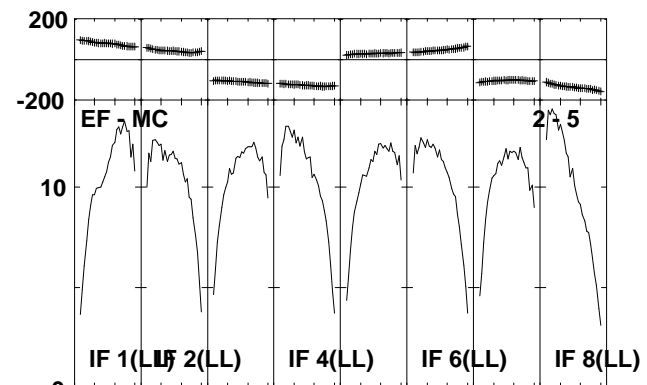
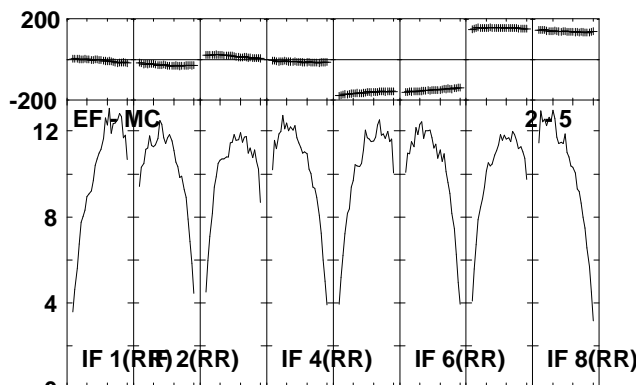
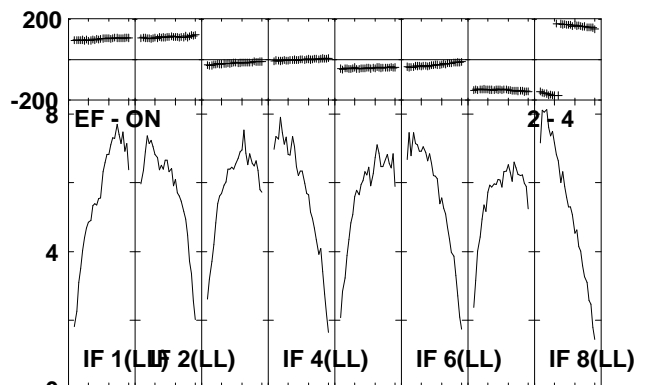
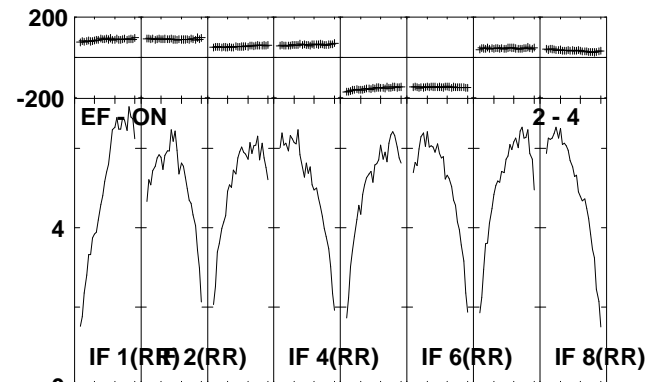
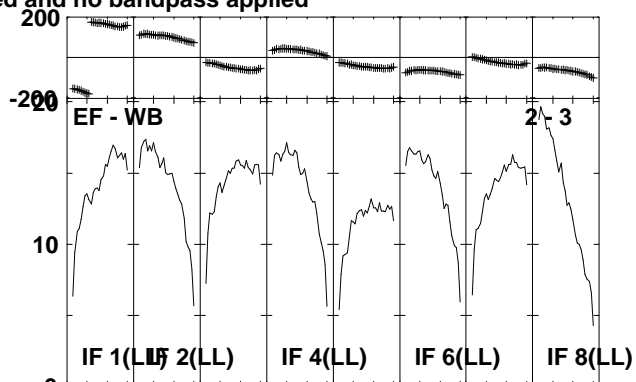
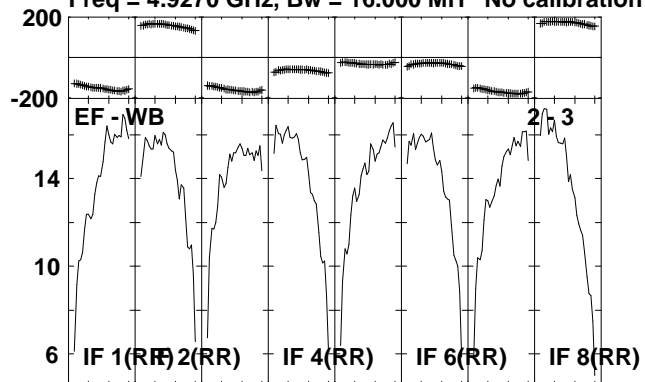

Lower frame: Milli Ampl Jy Top frame: Phas deg
Scalar averaged cross-power spectrum Several baselines displayed
Timerange: 00/16:46:21 to 00/16:48:19

Plot file version 273 created 06-JUL-2010 12:09:27

J2330+33 EP064L.UVDATA.1

Freq = 4.9270 GHz, Bw = 16.000 MH No calibration applied and no bandpass applied

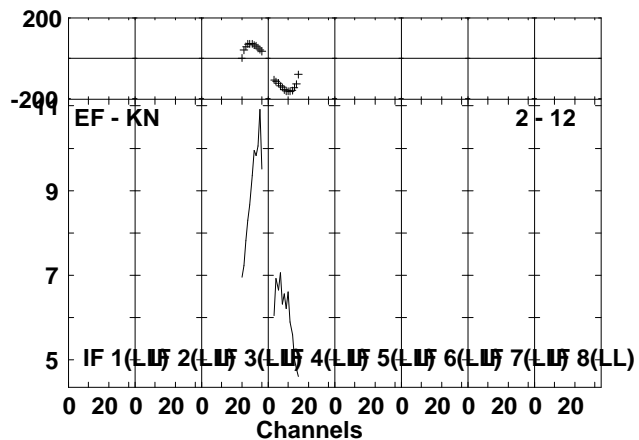
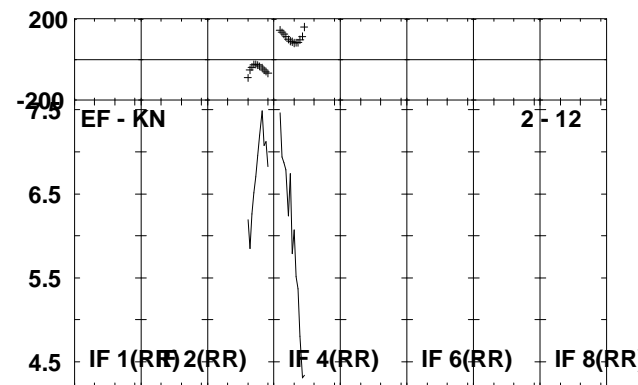
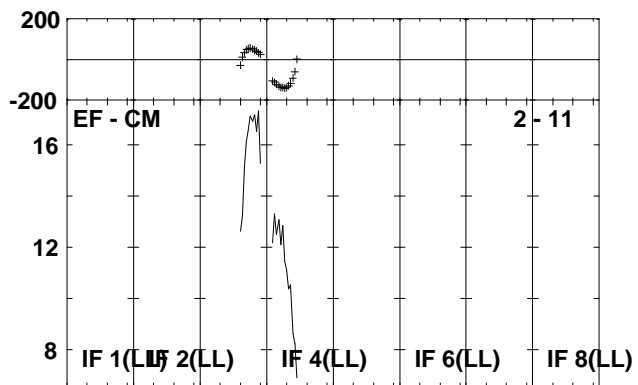
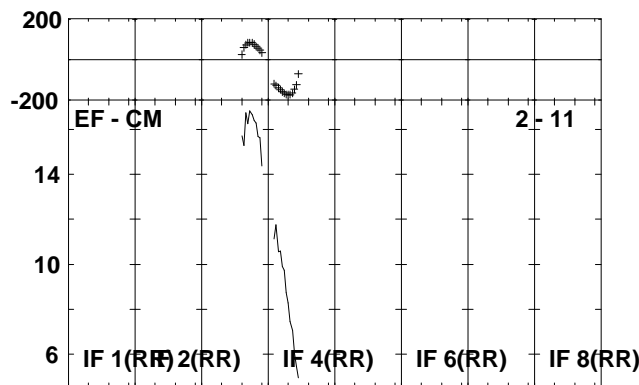
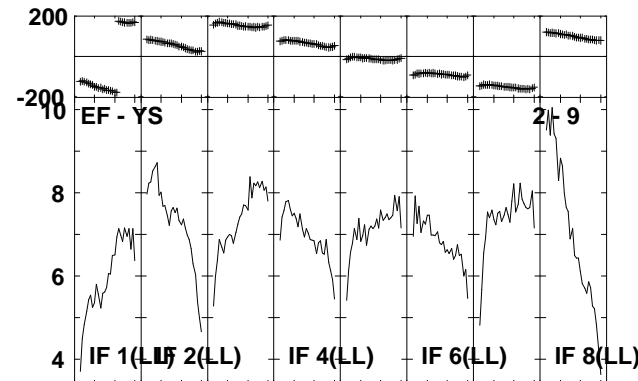
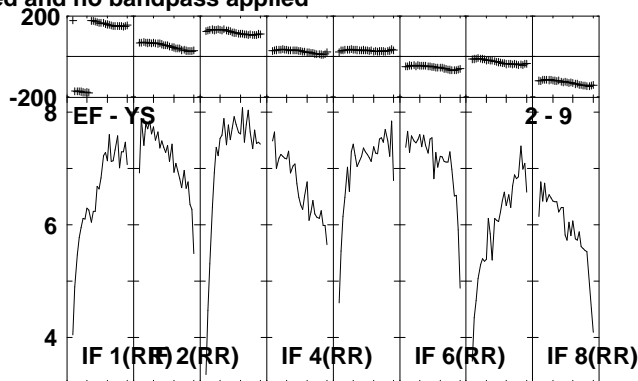
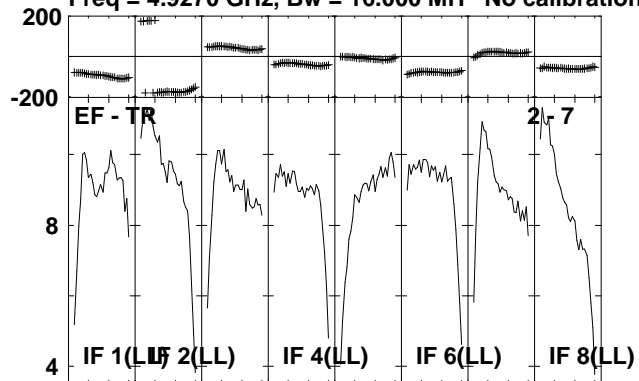

Lower frame: Milli Ampl Jy Top frame: Phas deg
Scalar averaged cross-power spectrum Several baselines displayed
Timerange: 00/16:46:21 to 00/16:48:19

Plot file version 274 created 06-JUL-2010 12:09:29

IRAS2336 EP064L.UVDATA.1

Freq = 4.9270 GHz, Bw = 16.000 MH No calibration applied and no bandpass applied

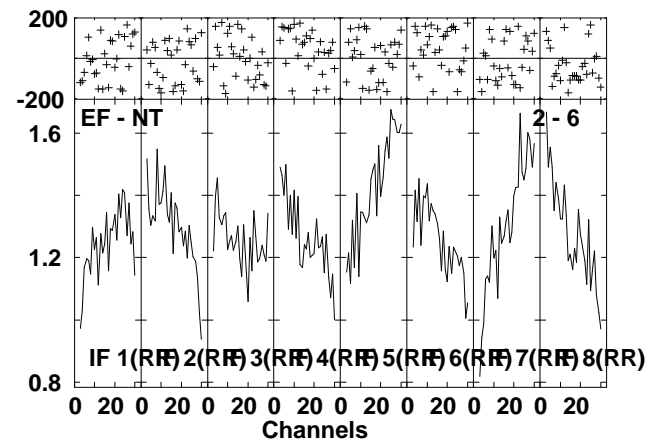
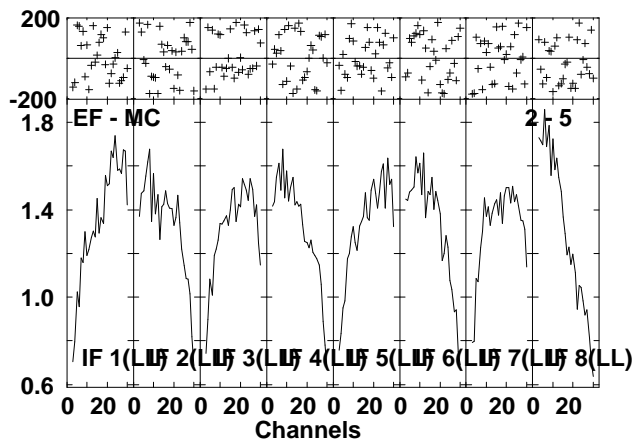
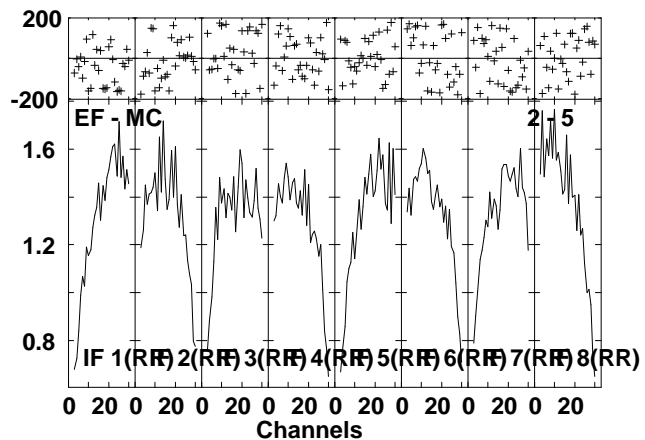
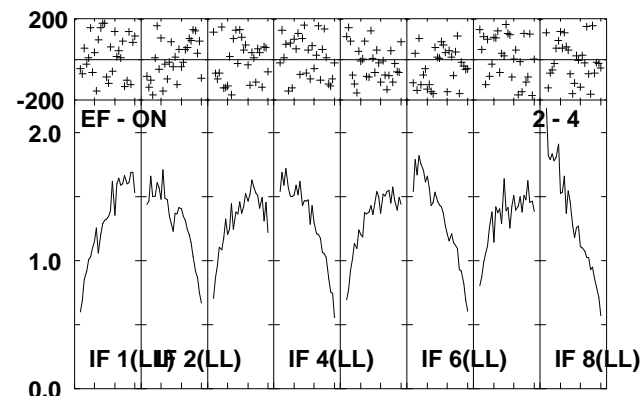
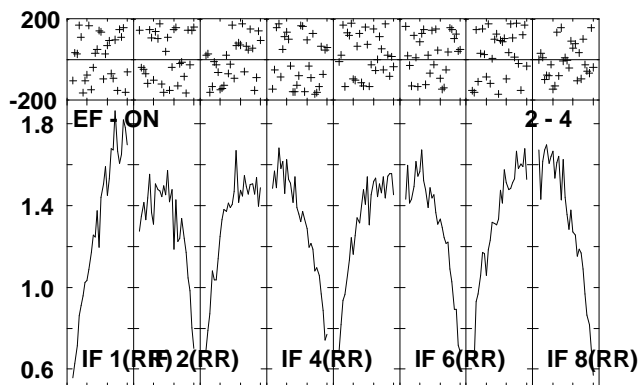
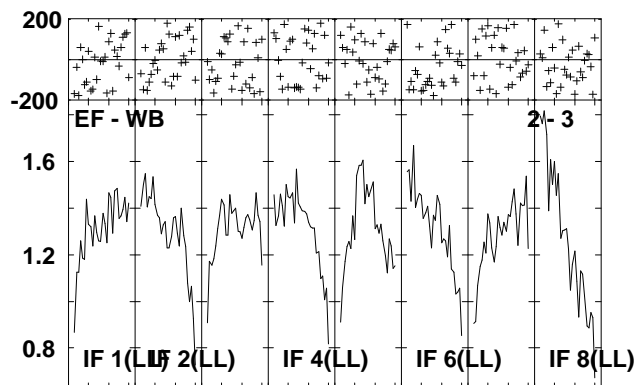
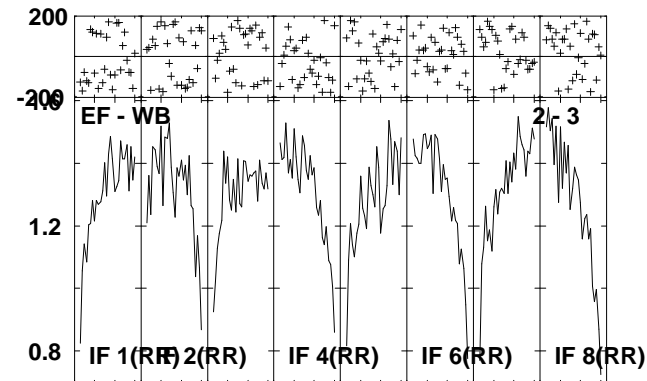
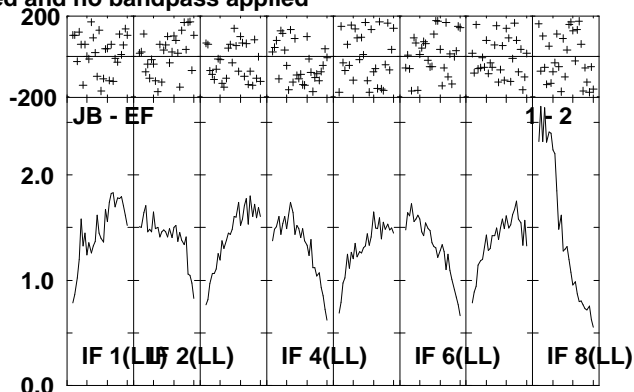
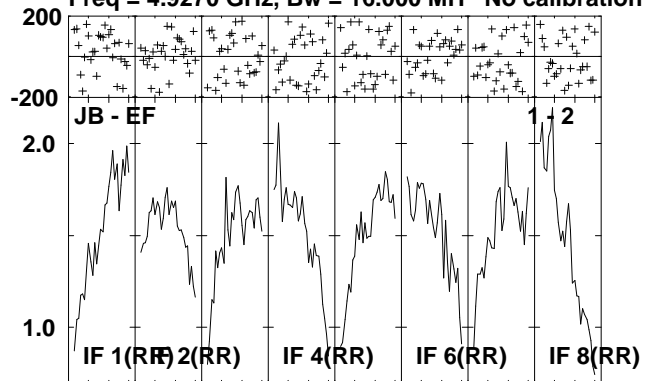

Lower frame: Milli Ampl Jy Top frame: Phas deg
Scalar averaged cross-power spectrum Several baselines displayed
Timerange: 00/16:48:21 to 00/16:52:37

Plot file version 275 created 06-JUL-2010 12:09:31

IRAS2336 EP064L.UVDATA.1

Freq = 4.9270 GHz, Bw = 16.000 MH No calibration applied and no bandpass applied

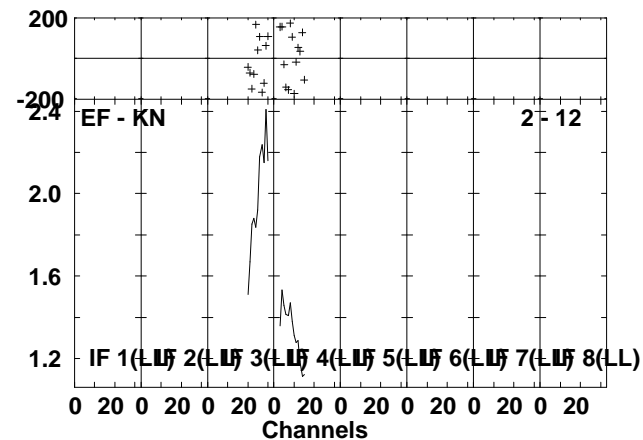
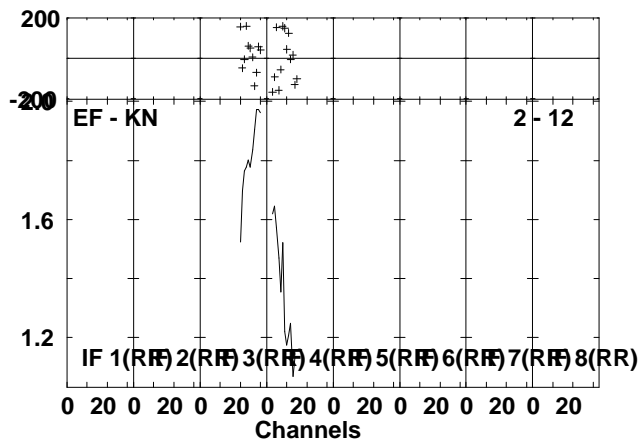
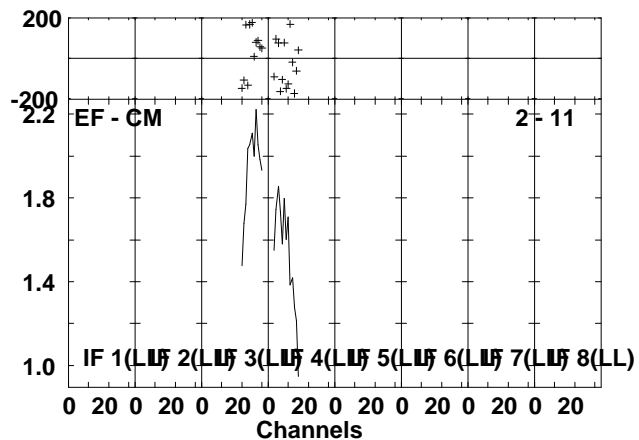
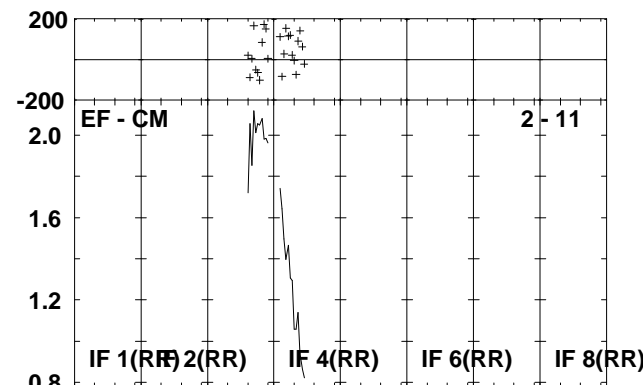
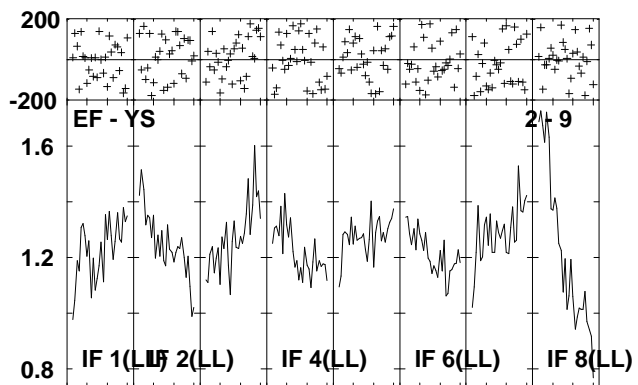
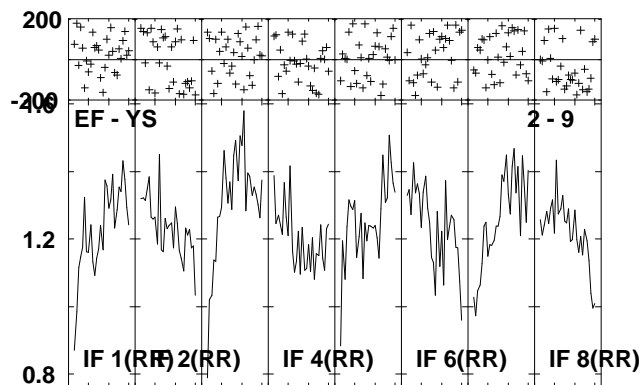
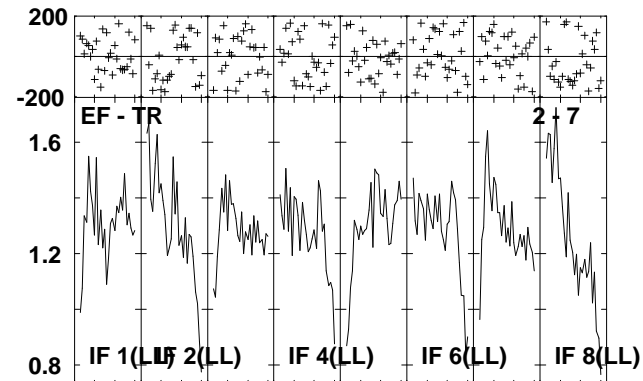
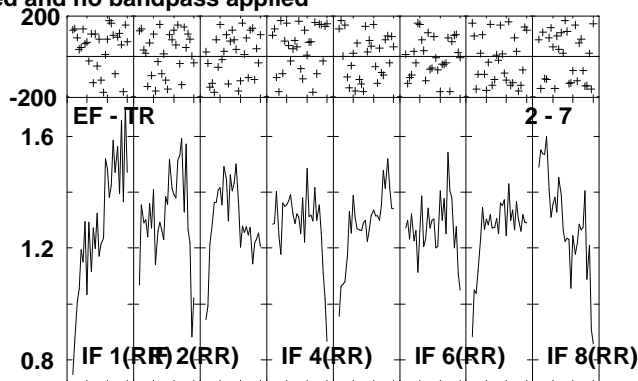
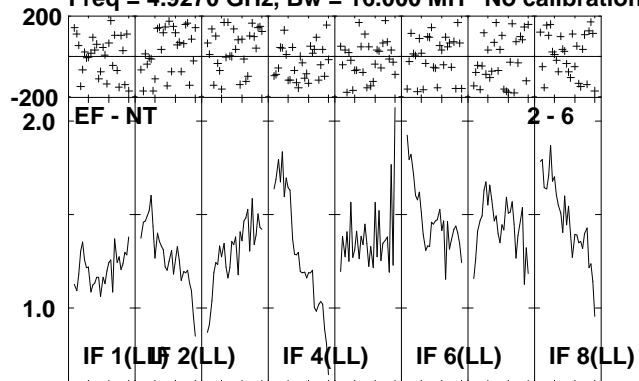

Lower frame: Milli Ampl Jy Top frame: Phas deg
Scalar averaged cross-power spectrum Several baselines displayed
Timerange: 00/16:48:21 to 00/16:52:37

Plot file version 276 created 06-JUL-2010 12:09:35

J2330+33 EP064L.UVDATA.1

Freq = 4.9270 GHz, Bw = 16.000 MH No calibration applied and no bandpass applied

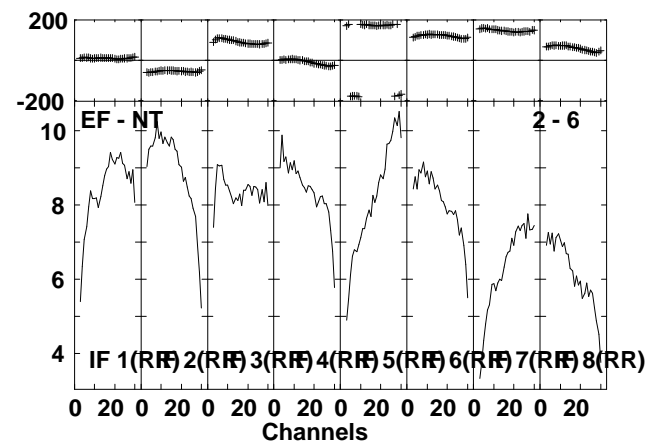
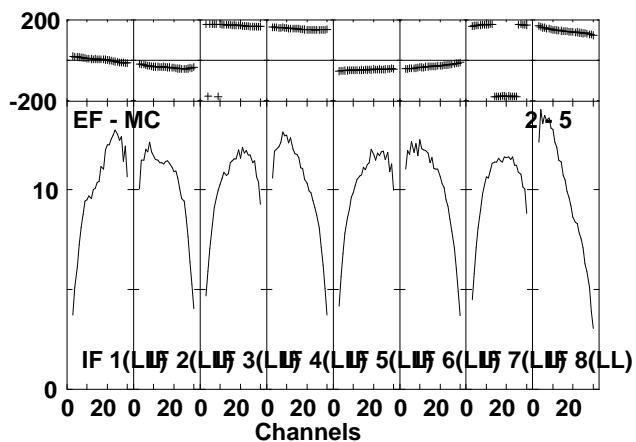
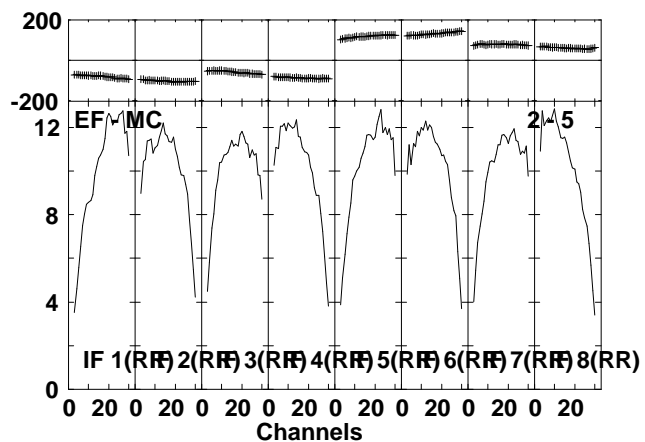
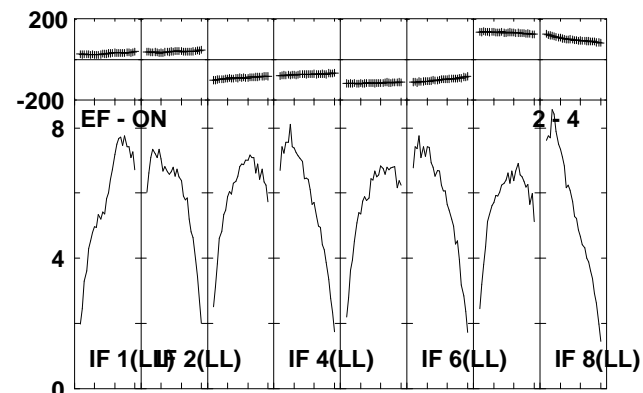
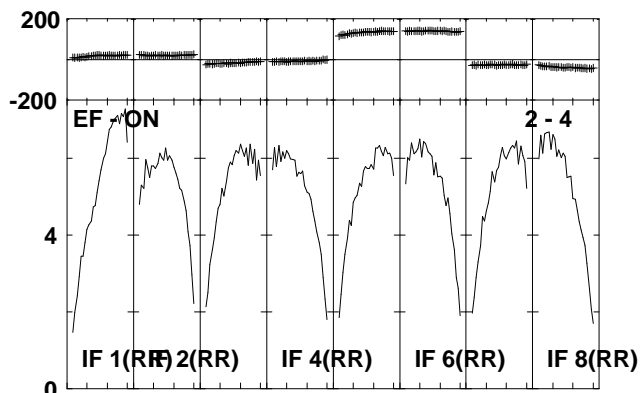
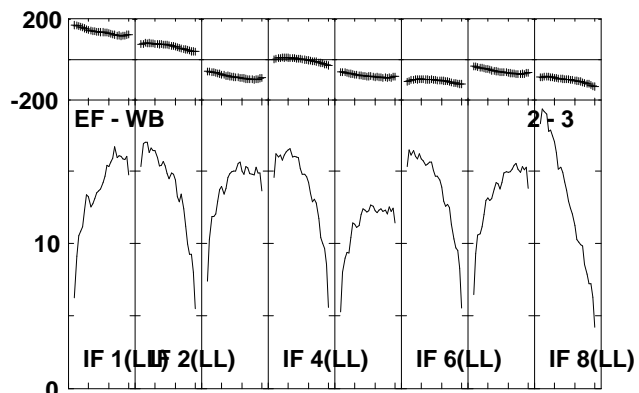
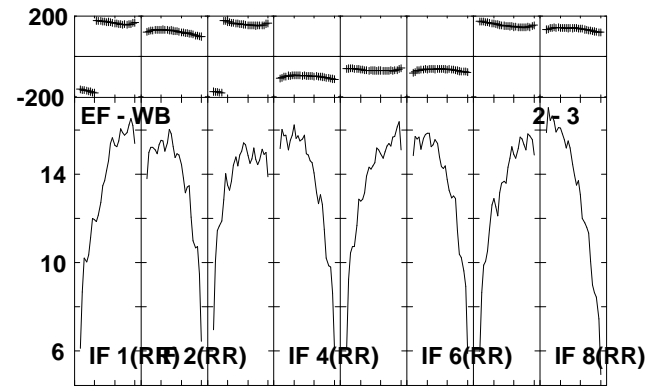
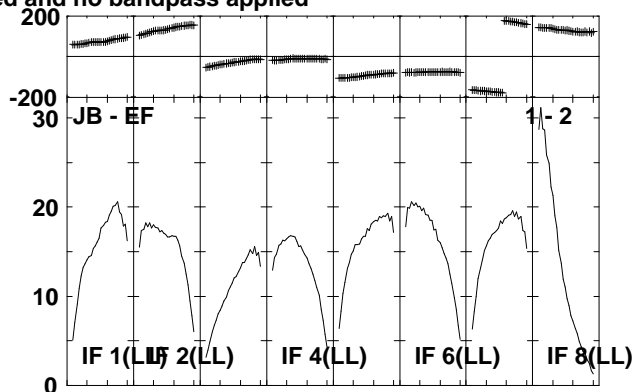
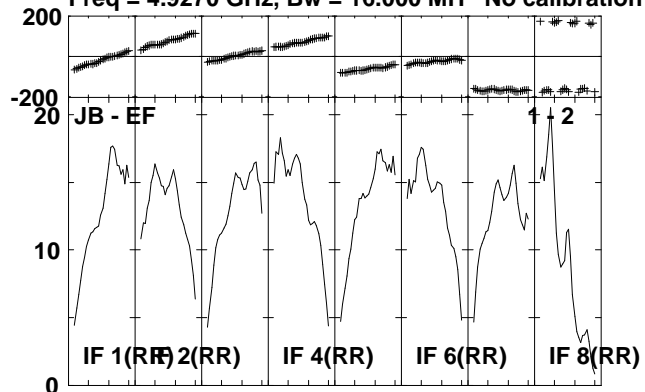

Lower frame: Milli Ampl Jy Top frame: Phas deg
Scalar averaged cross-power spectrum Several baselines displayed
Timerange: 00/16:53:41 to 00/16:55:39

Plot file version 277 created 06-JUL-2010 12:09:36

J2330+33 EP064L.UVDATA.1

Freq = 4.9270 GHz, Bw = 16.000 MH No calibration applied and no bandpass applied

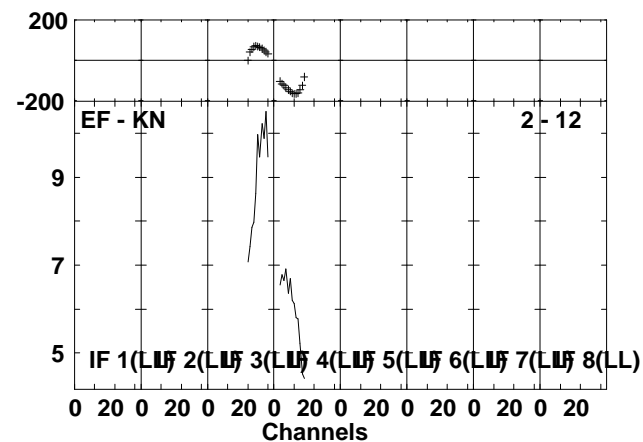
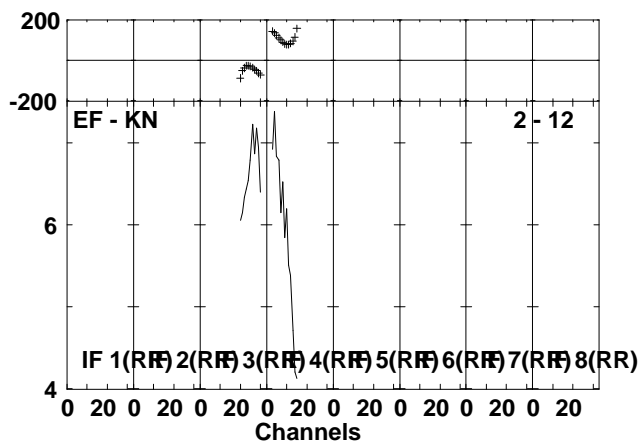
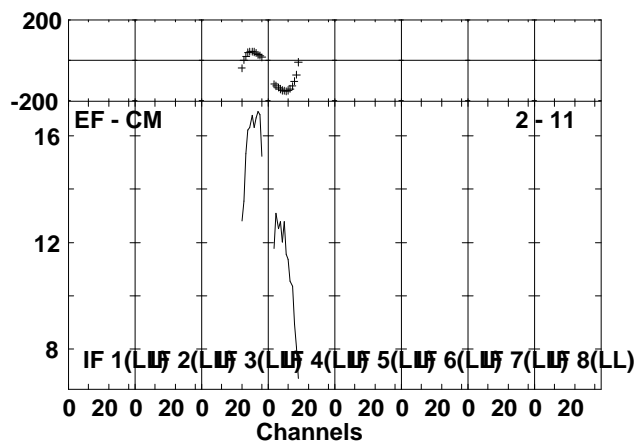
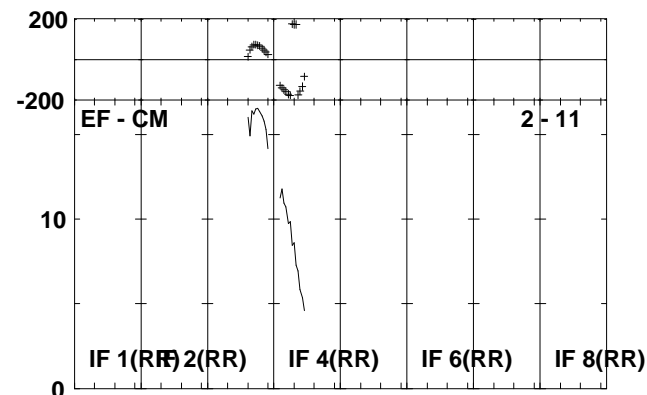
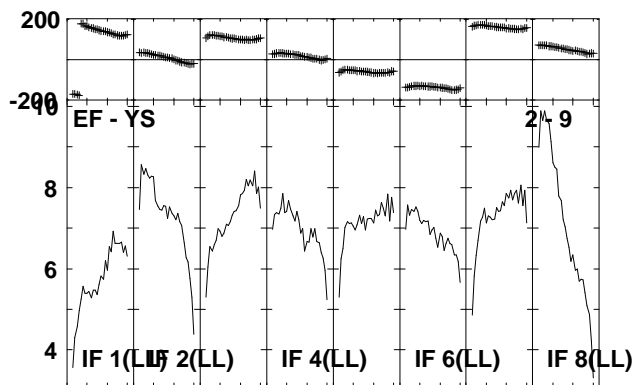
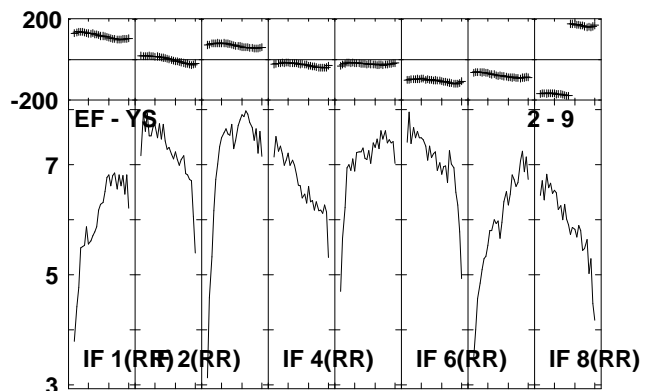
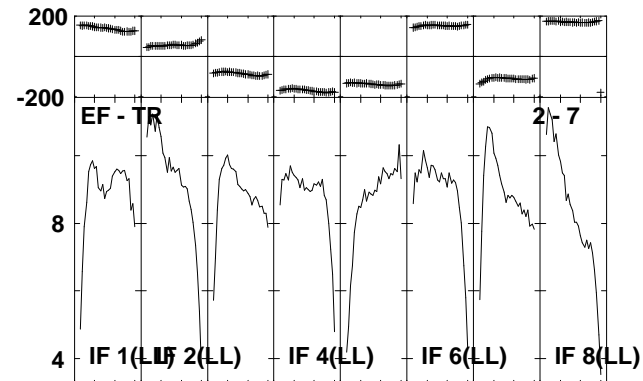
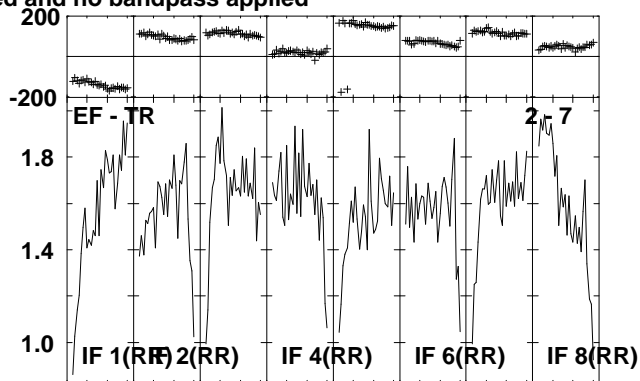
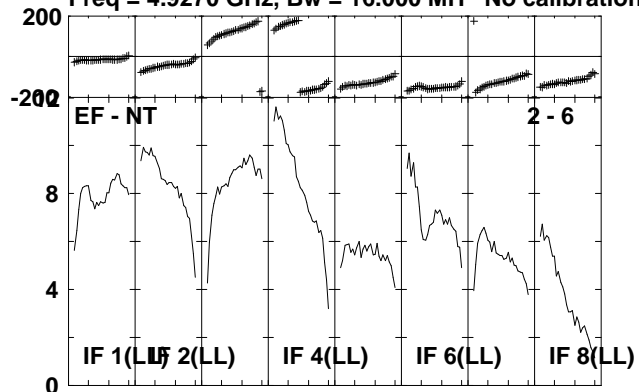

Lower frame: Milli Ampl Jy Top frame: Phas deg
Scalar averaged cross-power spectrum Several baselines displayed
Timerange: 00/16:53:41 to 00/16:55:39

Plot file version 278 created 06-JUL-2010 12:09:39

IRAS2336 EP064L.UVDATA.1

Freq = 4.9270 GHz, Bw = 16.000 MH No calibration applied and no bandpass applied

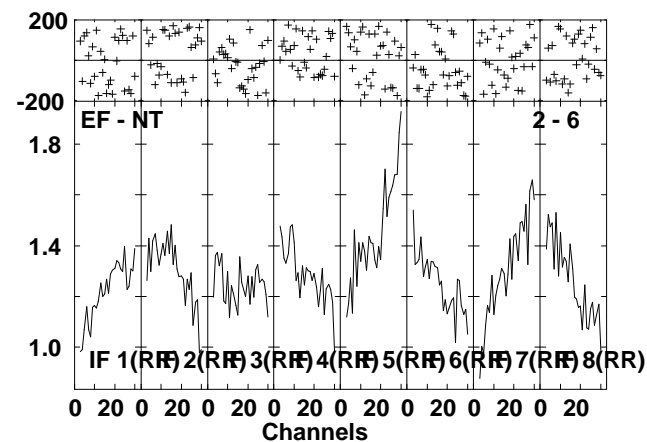
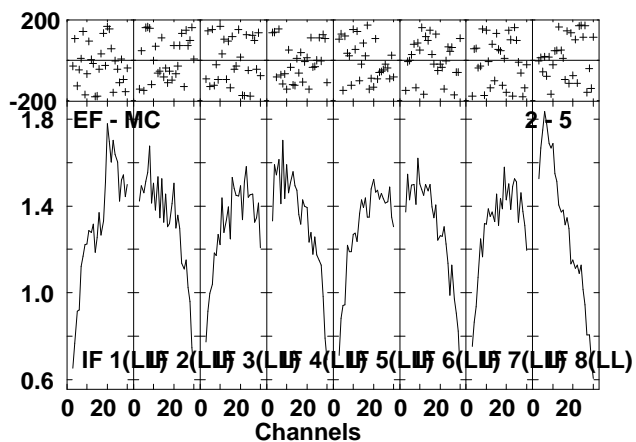
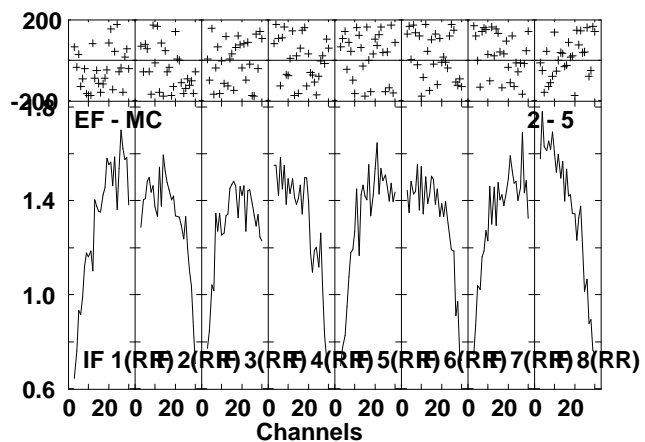
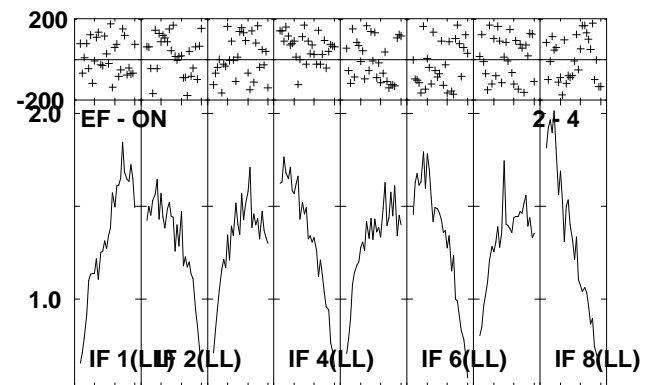
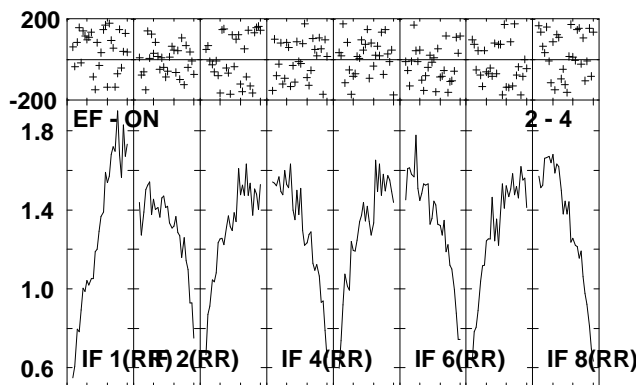
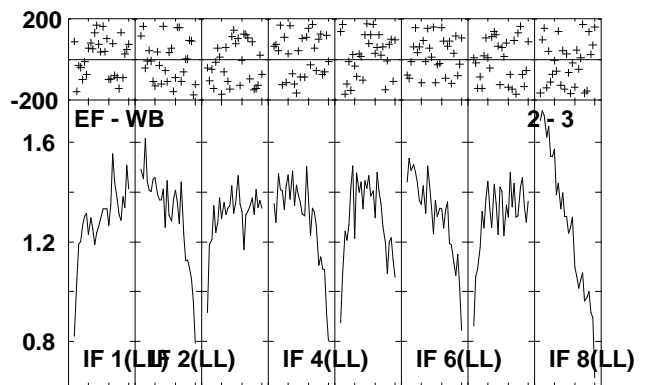
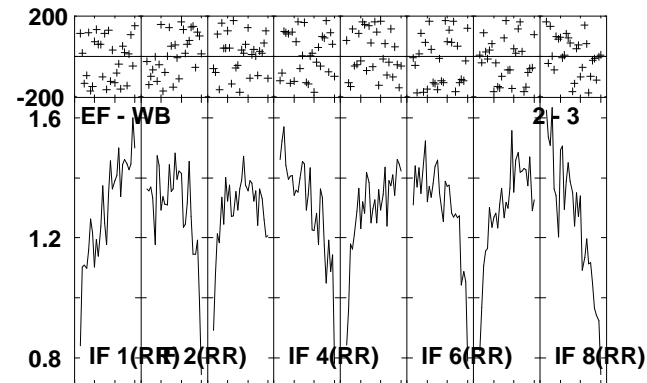
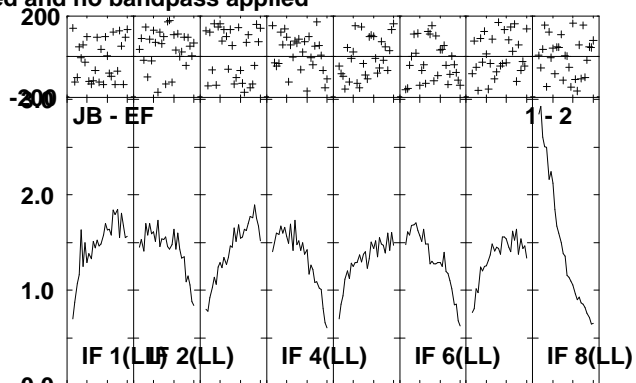
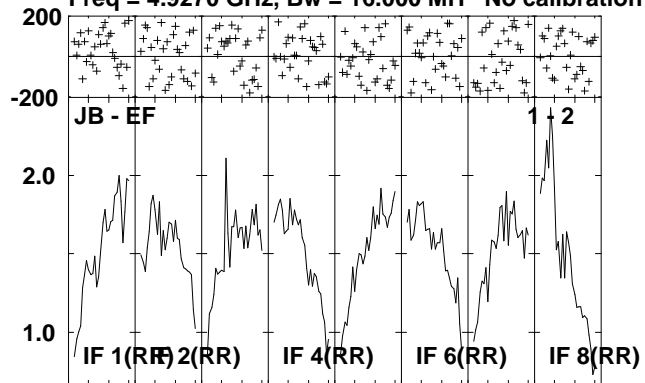

Lower frame: Milli Ampl Jy Top frame: Phas deg
Scalar averaged cross-power spectrum Several baselines displayed
Timerange: 00/16:55:41 to 00/16:59:57

Plot file version 279 created 06-JUL-2010 12:09:41

IRAS2336 EP064L.UVDATA.1

Freq = 4.9270 GHz, Bw = 16.000 MH No calibration applied and no bandpass applied

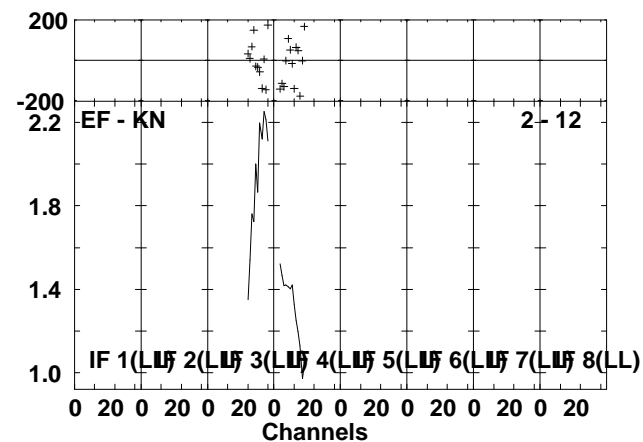
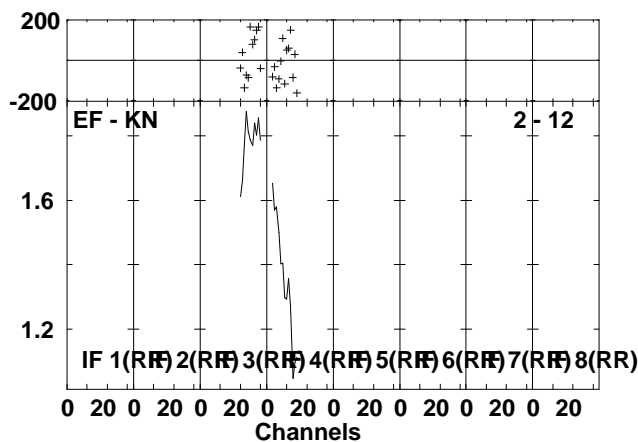
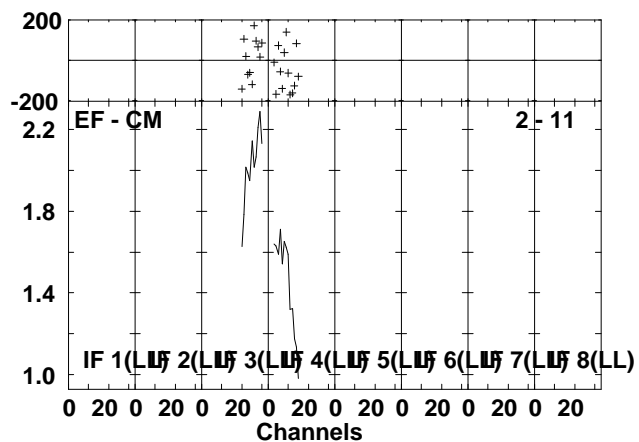
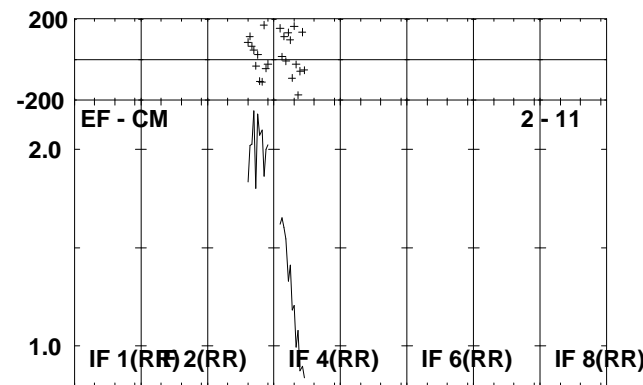
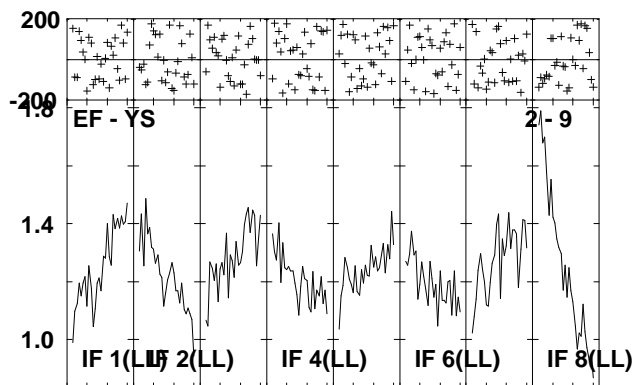
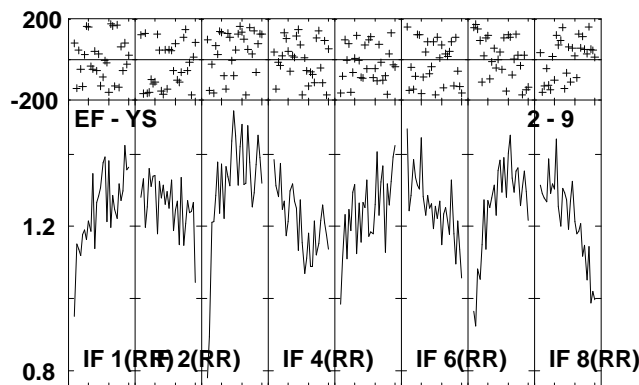
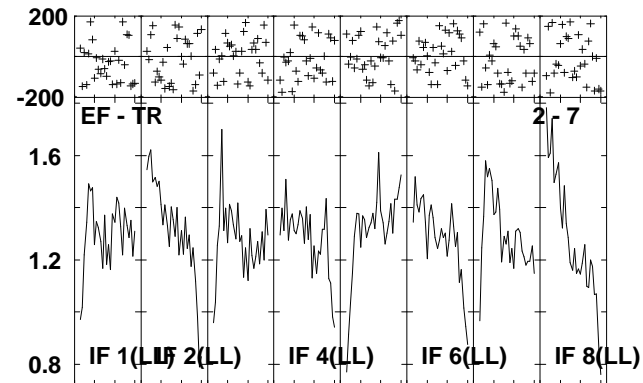
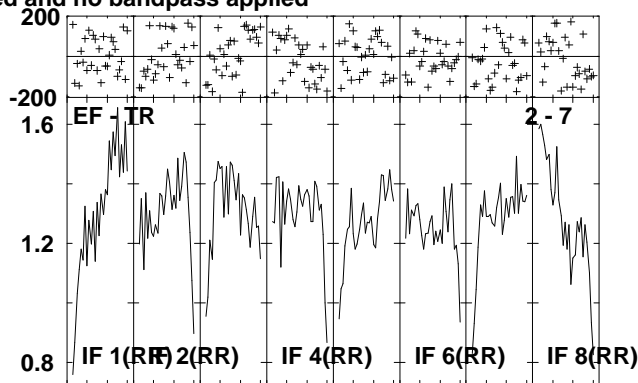
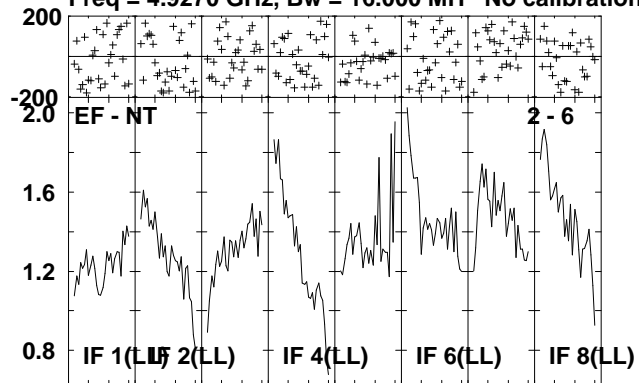

Lower frame: Milli Ampl Jy Top frame: Phas deg
Scalar averaged cross-power spectrum Several baselines displayed
Timerange: 00/16:55:41 to 00/16:59:57