

Plot file version 1 created 24-AUG-2010 08:02:11

3C286 EP064M.UVDATA.1

Freq = 4.9270 GHz, Bw = 16.000 MH No calibration applied and no bandpass applied

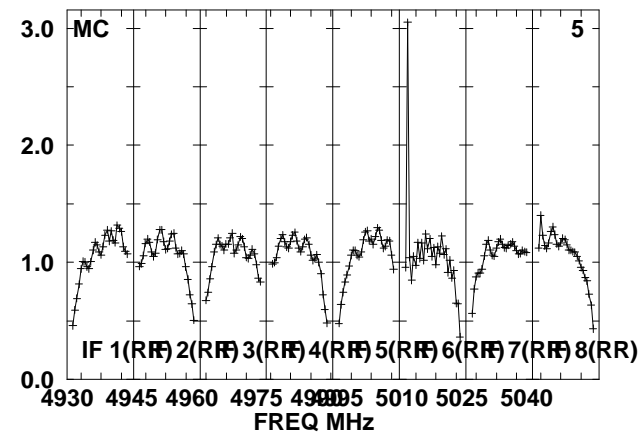
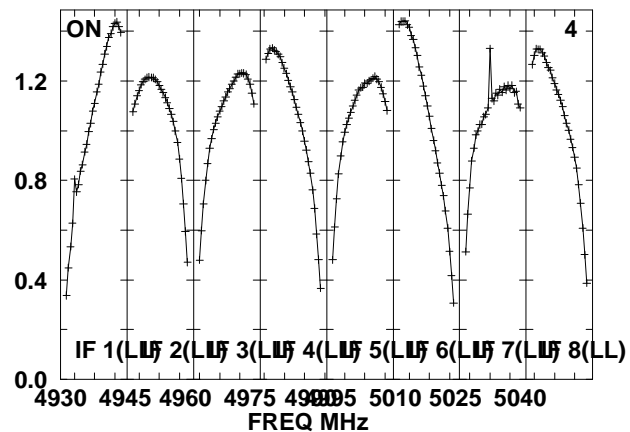
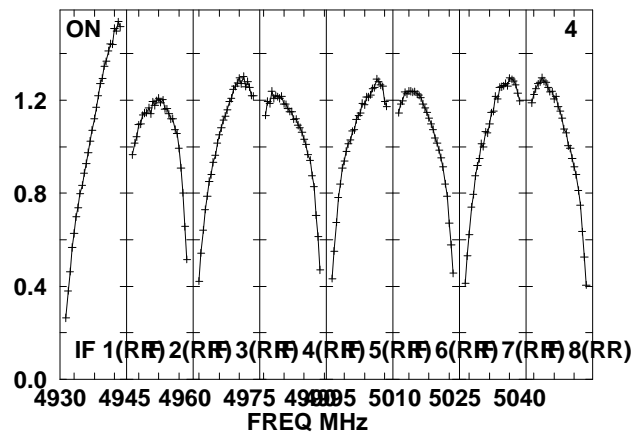
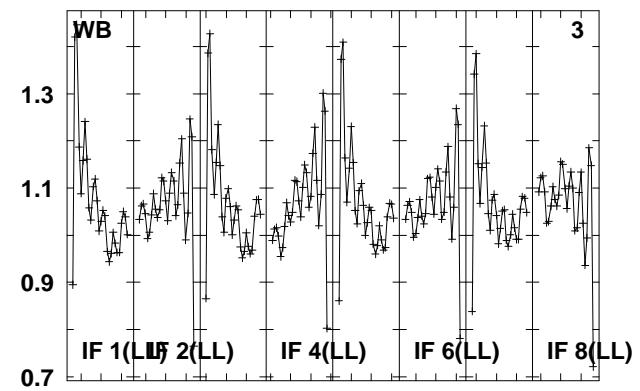
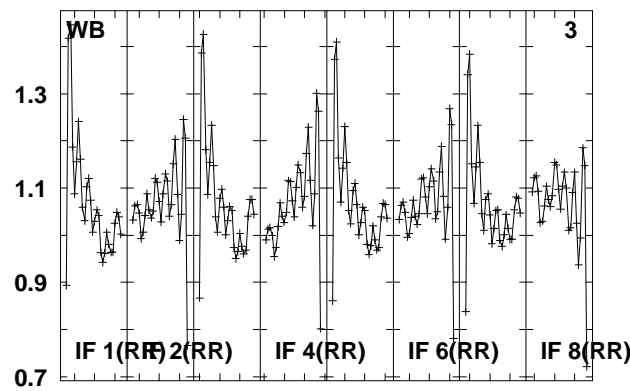
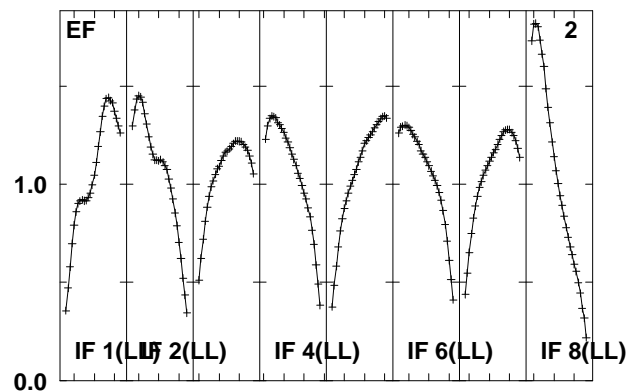
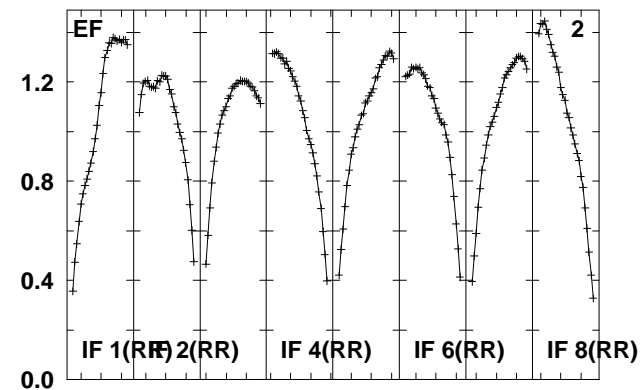
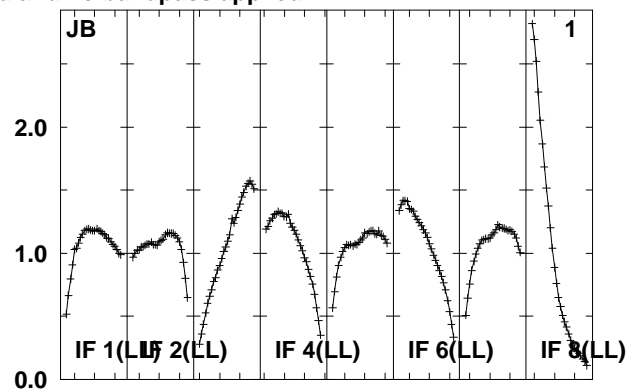
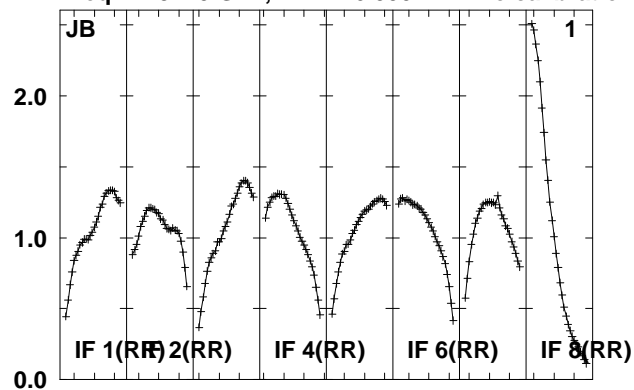

Lower frame: Real Jy
Total-power spectrum Antenna: *
Timerange: 00/22:00:01 to 00/22:04:59

Plot file version 2 created 24-AUG-2010 08:02:12

3C286 EP064M.UVDATA.1

Freq = 4.9270 GHz, Bw = 16.000 MH No calibration applied and no bandpass applied

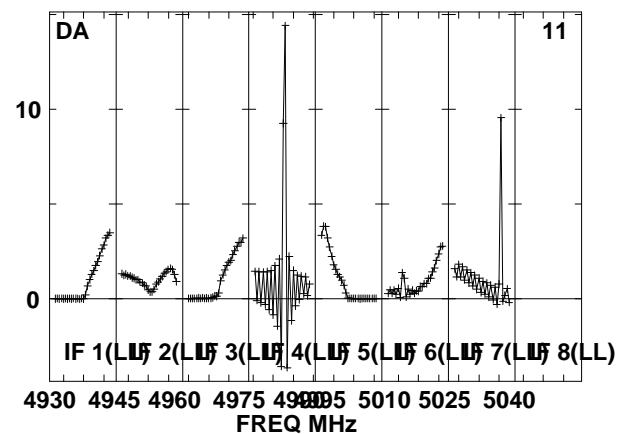
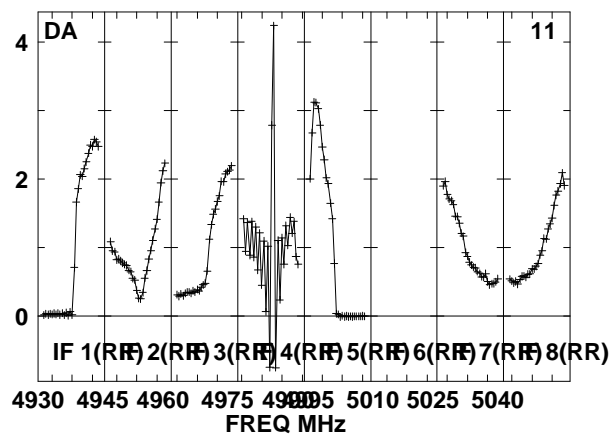
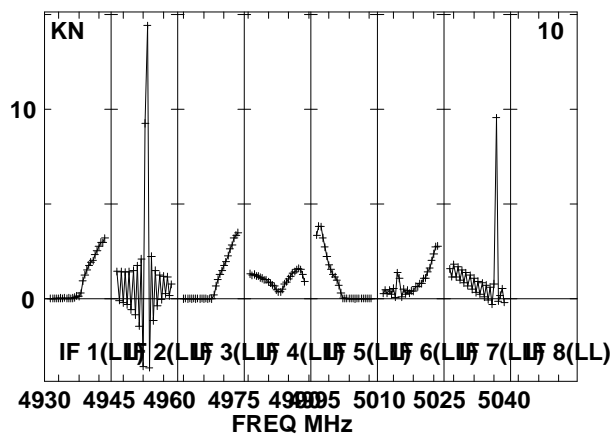
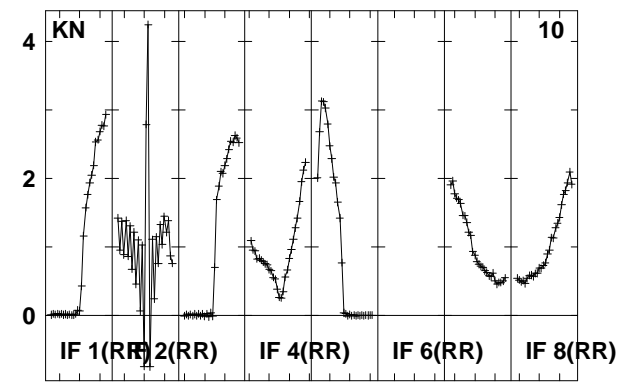
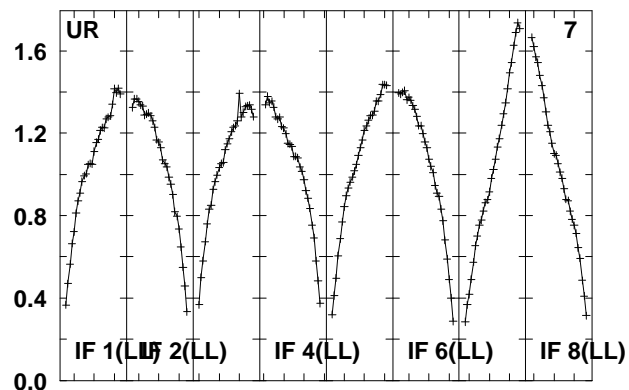
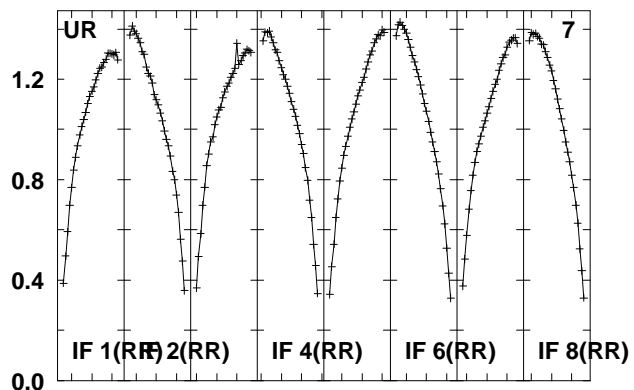
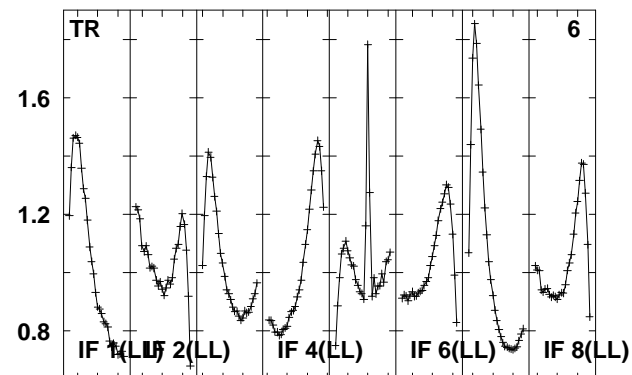
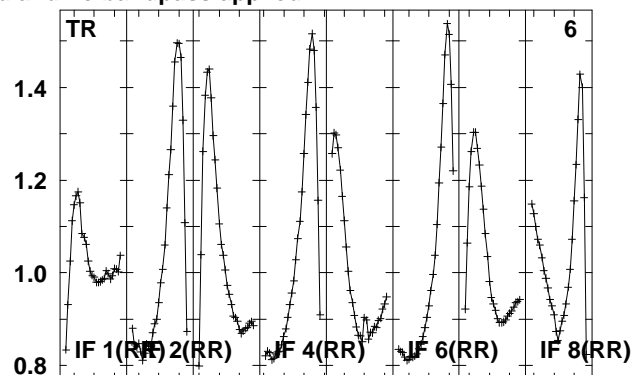
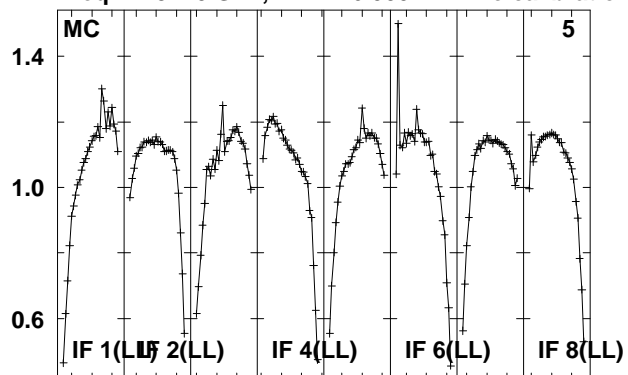

Lower frame: Real Jy

Total-power spectrum Antenna: *

Timerange: 00/22:00:01 to 00/22:04:59

Plot file version 3 created 24-AUG-2010 08:02:14

3C345 EP064M.UVDATA.1

Freq = 4.9270 GHz, Bw = 16.000 MH No calibration applied and no bandpass applied

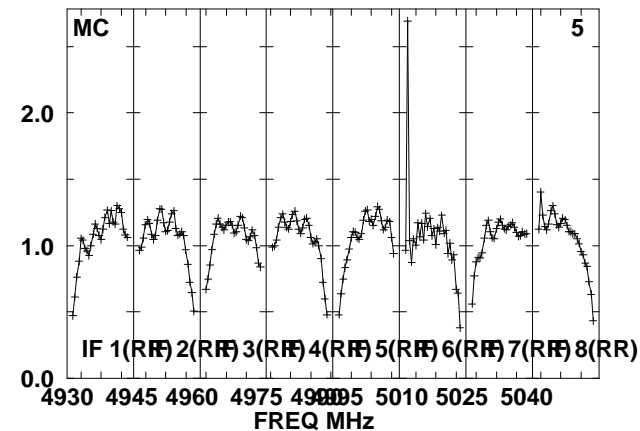
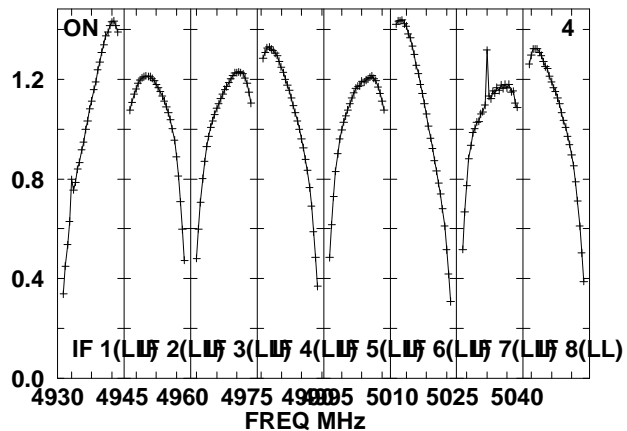
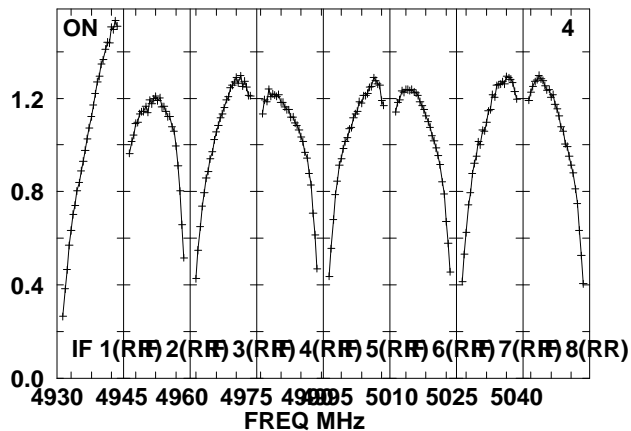
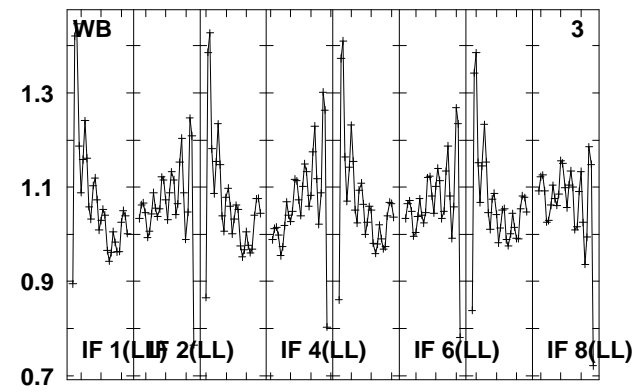
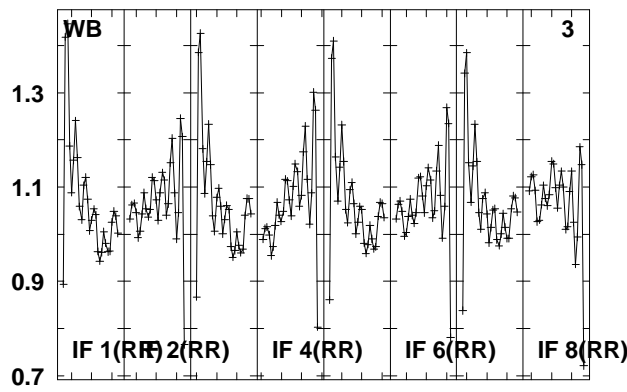
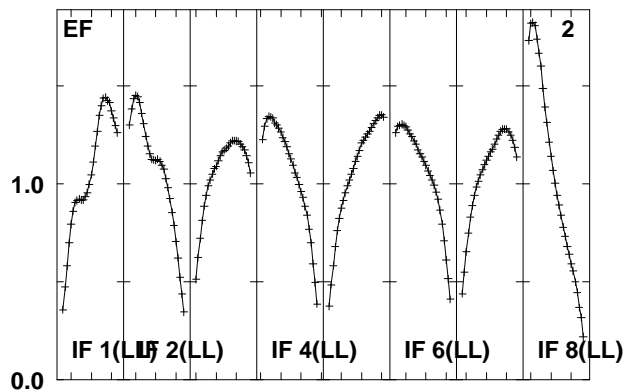
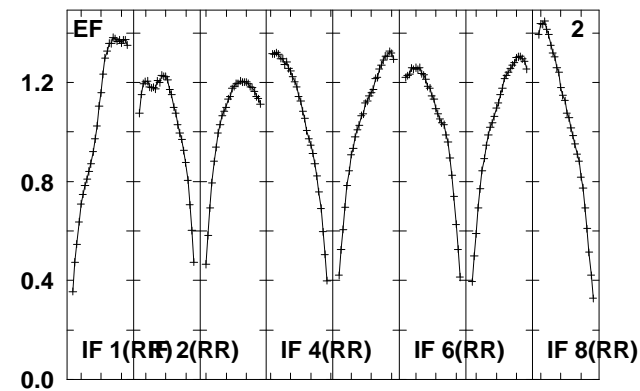
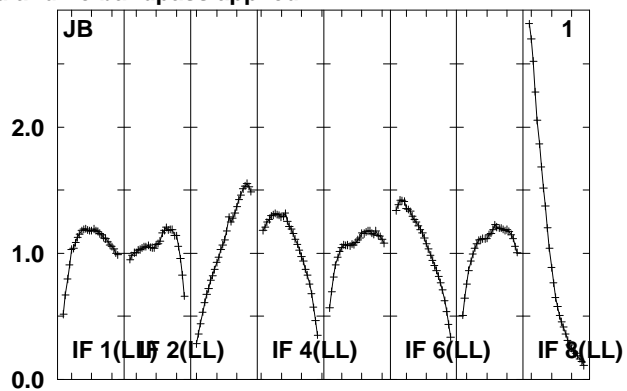
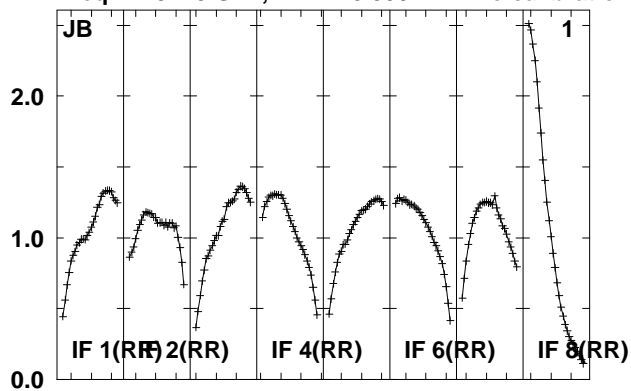

Lower frame: Real Jy
Total-power spectrum Antenna: *
Timerange: 00/22:06:01 to 00/22:19:59

Plot file version 4 created 24-AUG-2010 08:02:15

3C345 EP064M.UVDATA.1

Freq = 4.9270 GHz, Bw = 16.000 MH No calibration applied and no bandpass applied

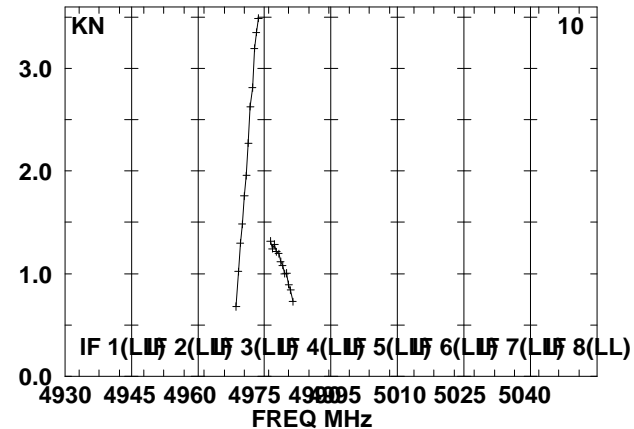
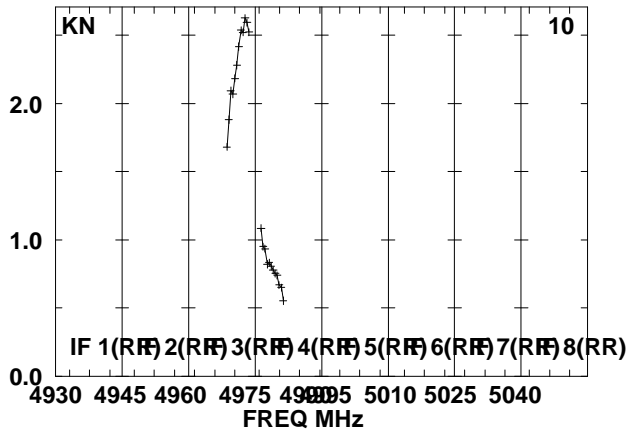
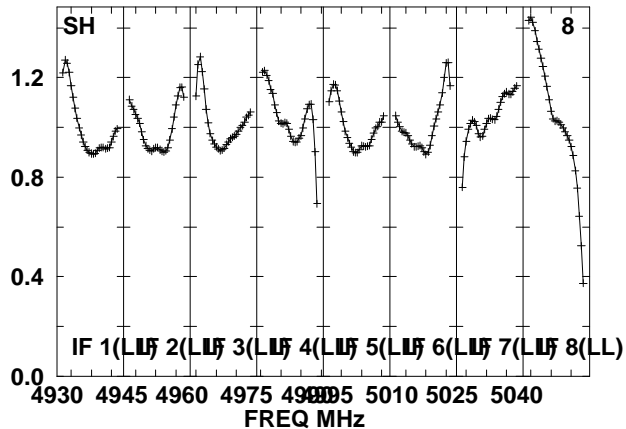
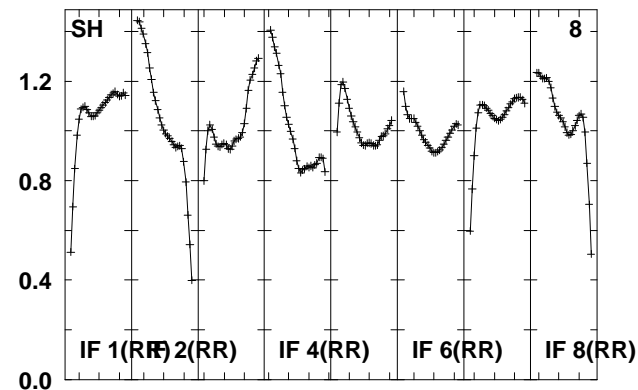
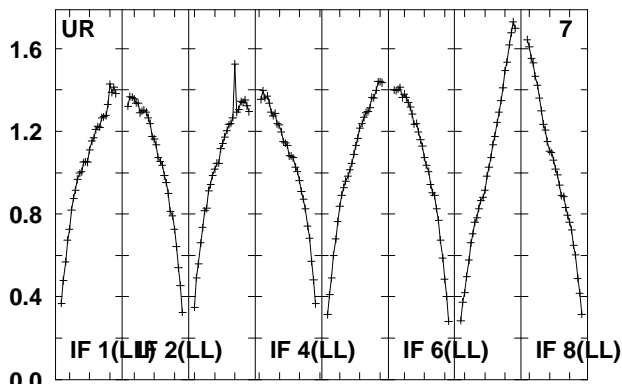
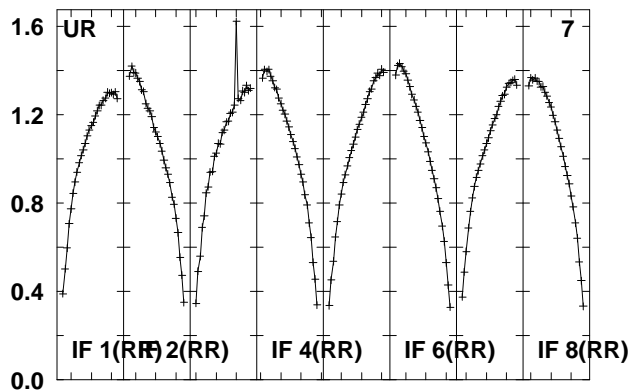
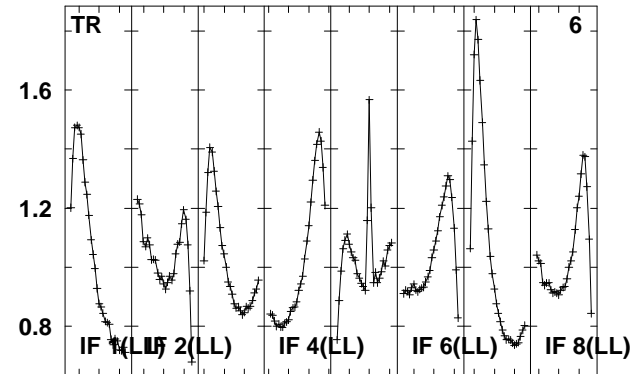
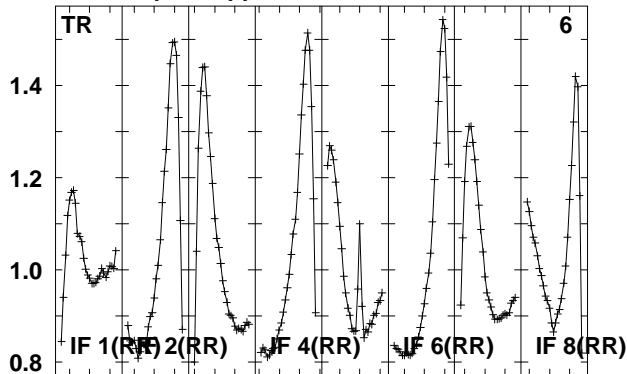
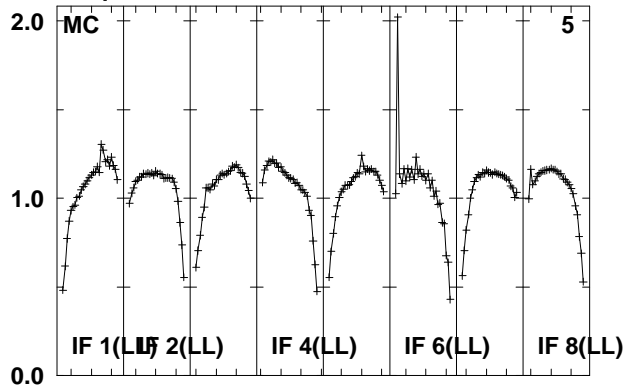

Lower frame: Real Jy
Total-power spectrum Antenna: *
Timerange: 00/22:06:01 to 00/22:19:59

Plot file version 5 created 24-AUG-2010 08:02:18

3C345 EP064M.UVDATA.1

Freq = 4.9270 GHz, Bw = 16.000 MH No calibration applied and no bandpass applied

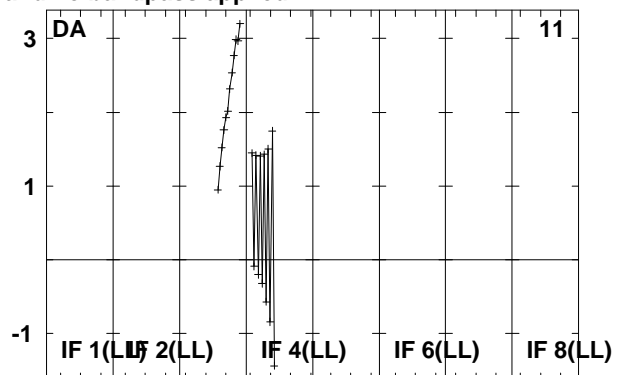
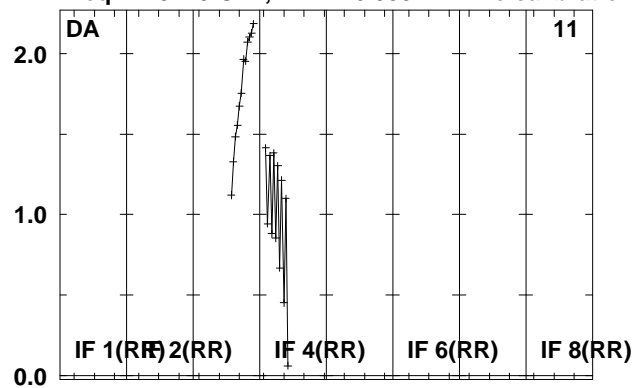

Lower frame: Real Jy
Total-power spectrum Antenna: *
Timerange: 00/22:06:01 to 00/22:19:59

Plot file version 6 created 24-AUG-2010 08:02:18

J1941-05 EP064M.UVDATA.1

Freq = 4.9270 GHz, Bw = 16.000 MH No calibration applied and no bandpass applied

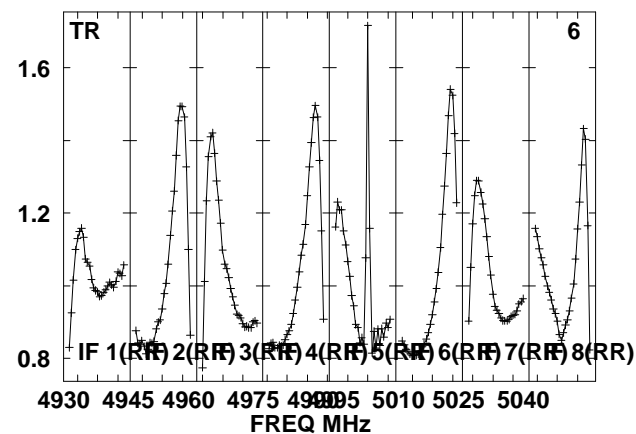
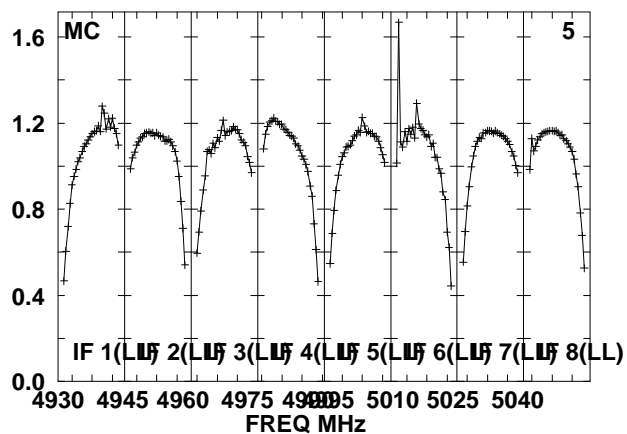
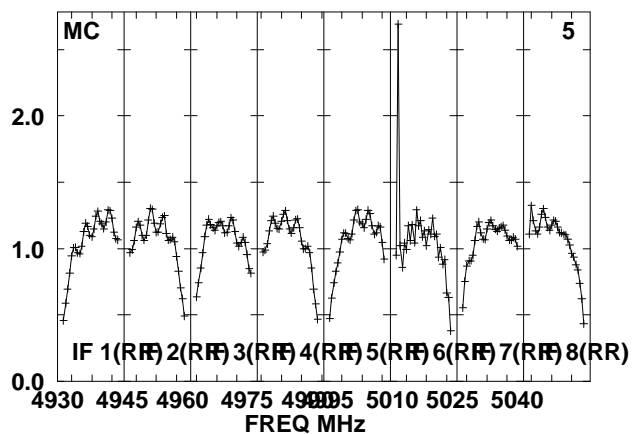
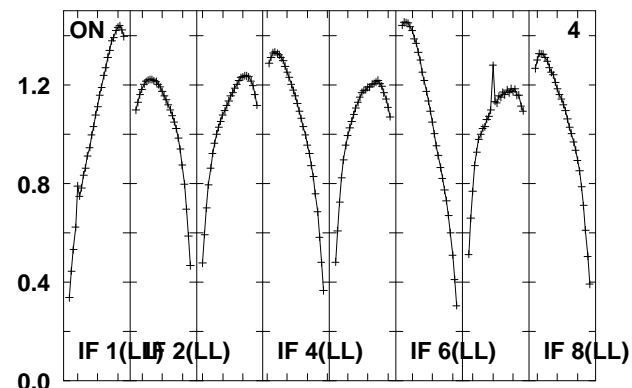
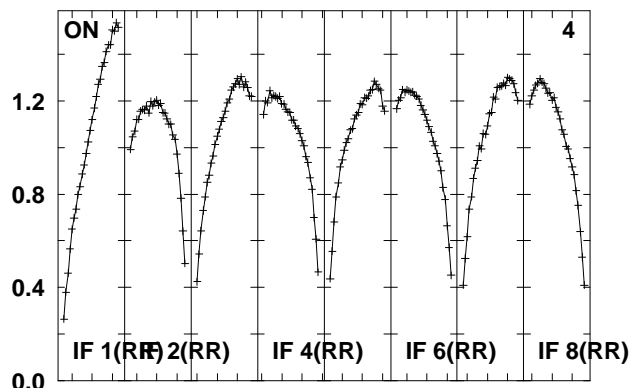
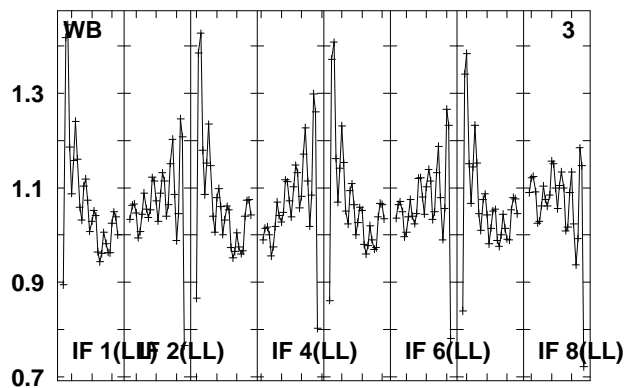
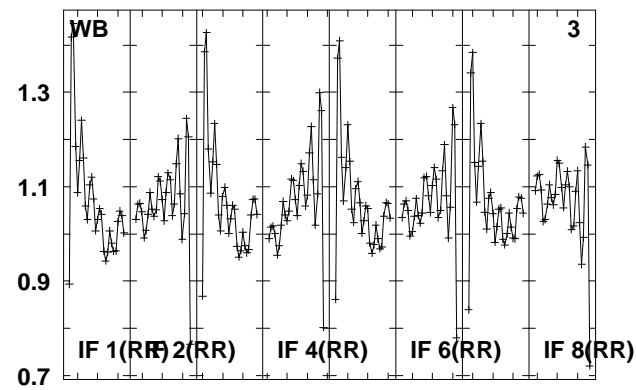
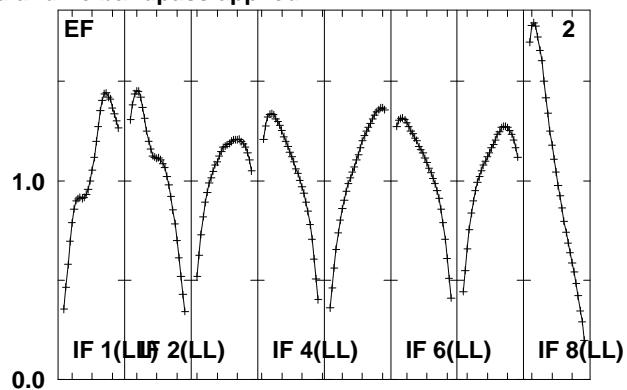
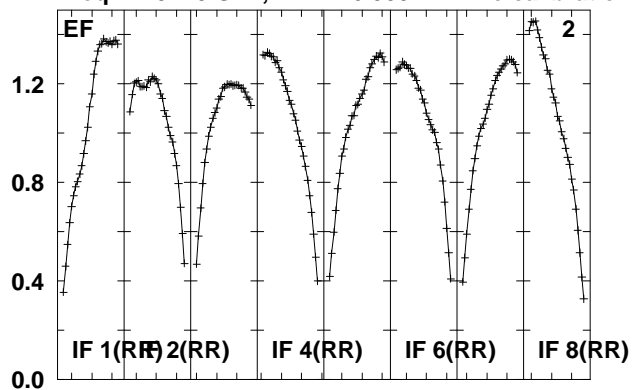

Lower frame: Real Jy
Total-power spectrum Antenna: *
Timerange: 00/22:26:01 to 00/22:27:29

Plot file version 7 created 24-AUG-2010 08:02:18

J1941-05 EP064M.UVDATA.1

Freq = 4.9270 GHz, Bw = 16.000 MH No calibration applied and no bandpass applied

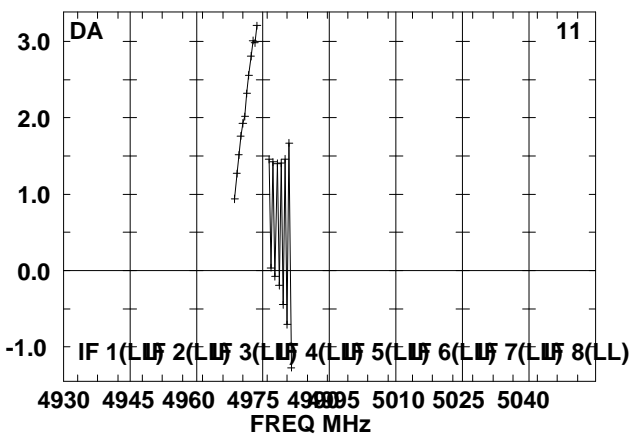
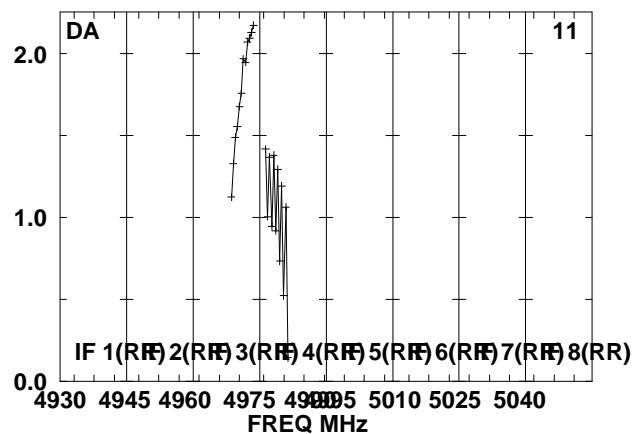
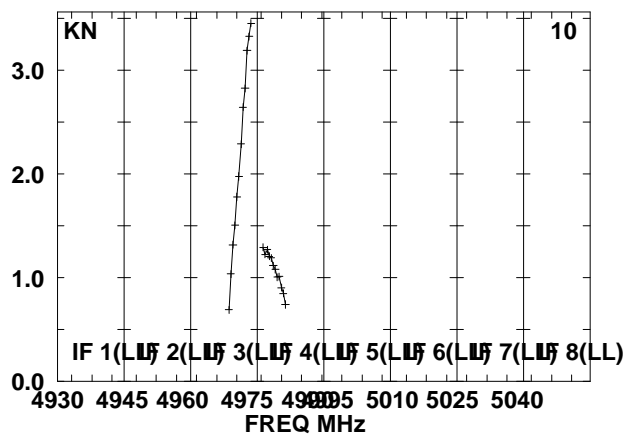
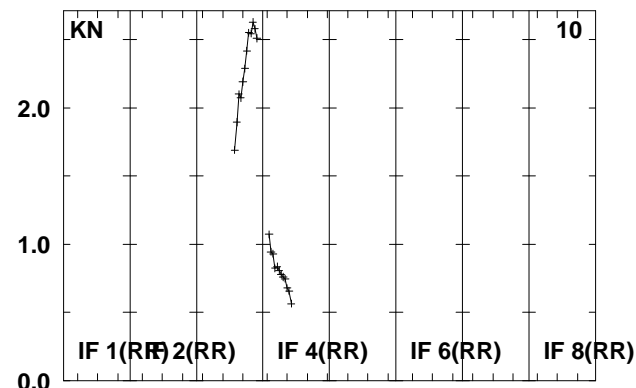
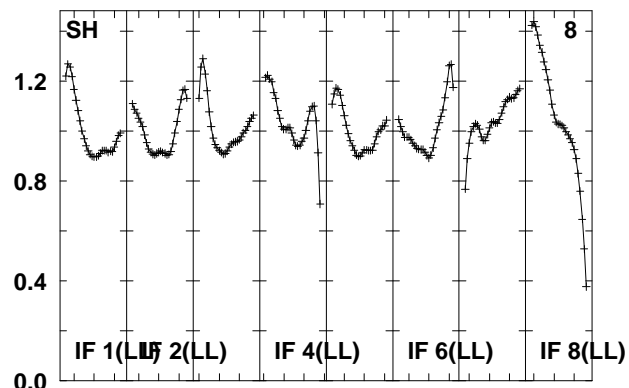
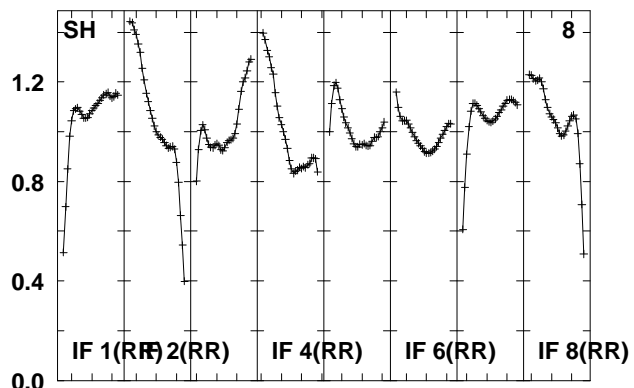
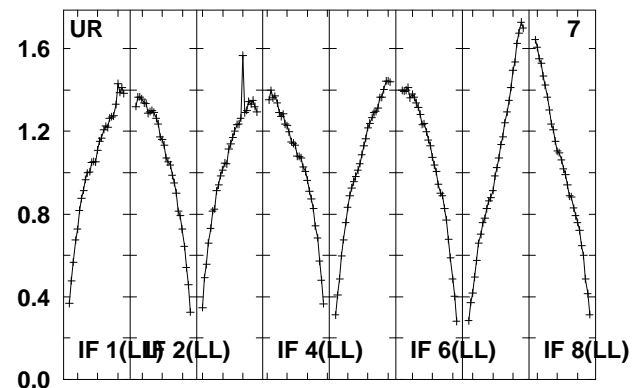
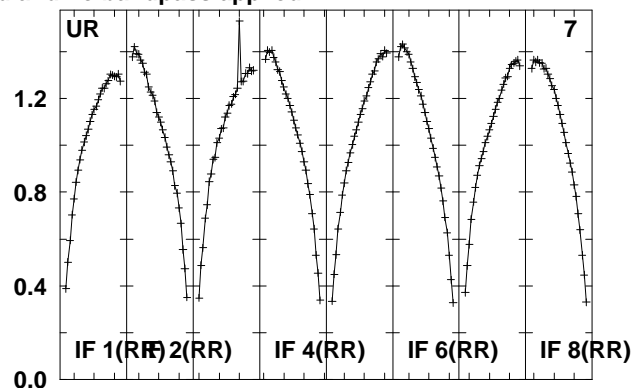
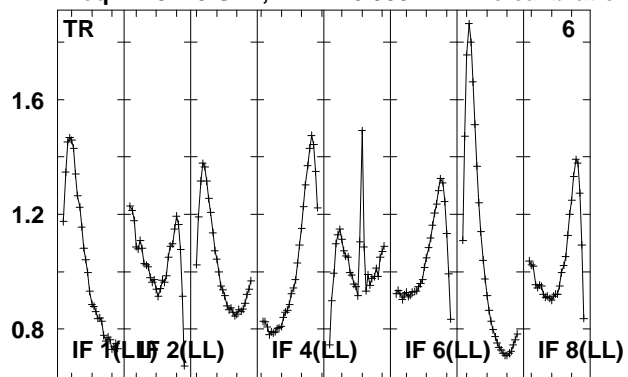

Lower frame: Real Jy
Total-power spectrum Antenna: *
Timerange: 00/22:26:01 to 00/22:27:29

Plot file version 8 created 24-AUG-2010 08:02:18

IRAS1929 EP064M.UVDATA.1

Freq = 4.9270 GHz, Bw = 16.000 MH No calibration applied and no bandpass applied

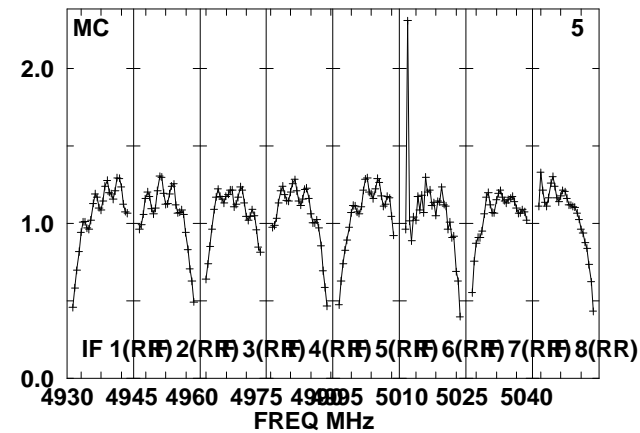
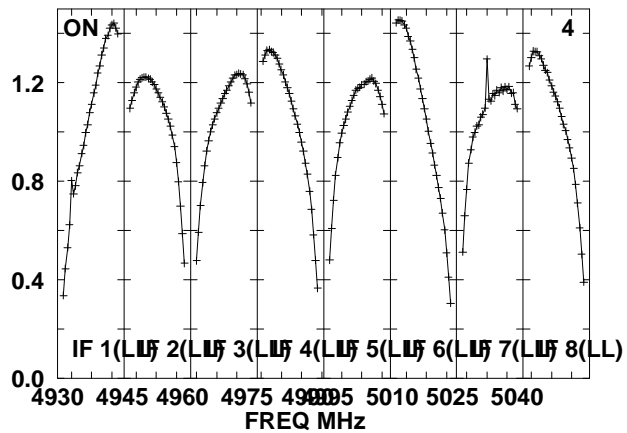
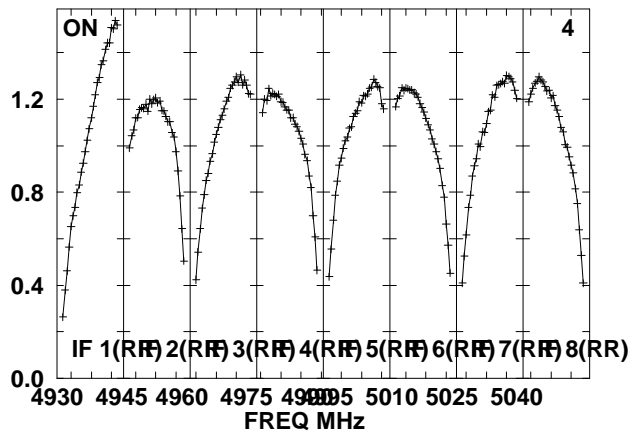
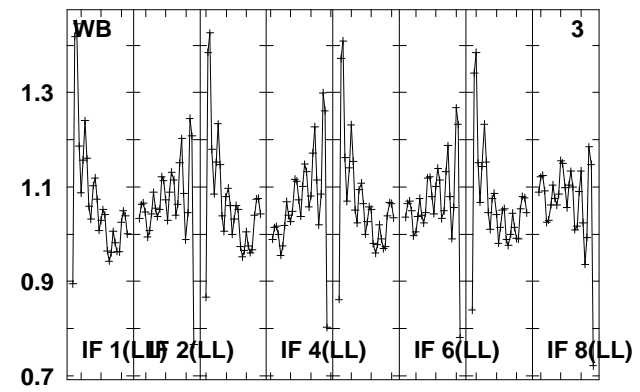
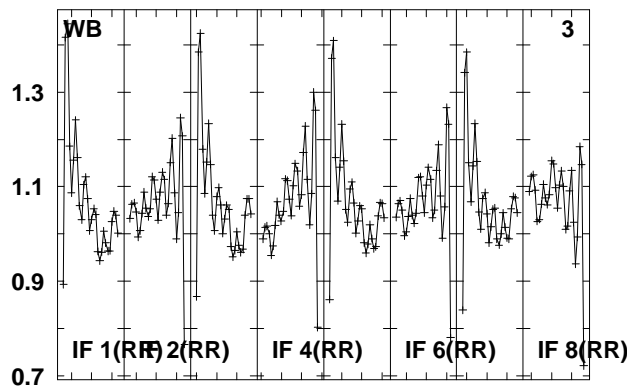
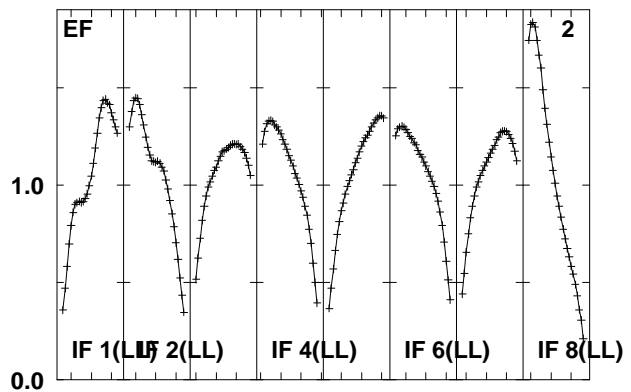
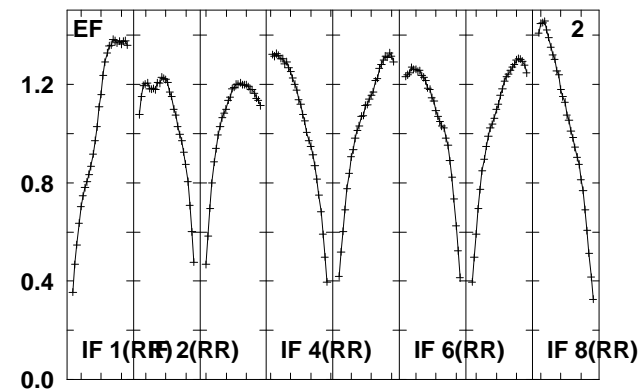
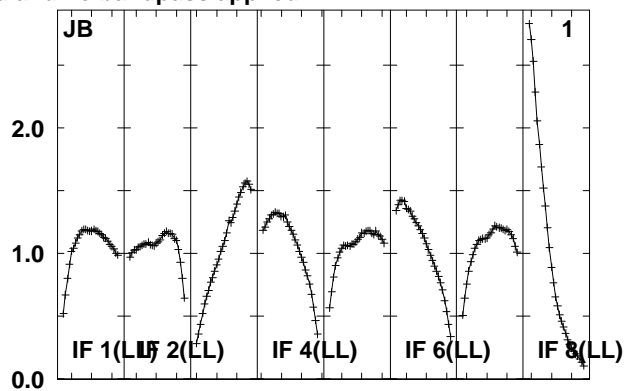
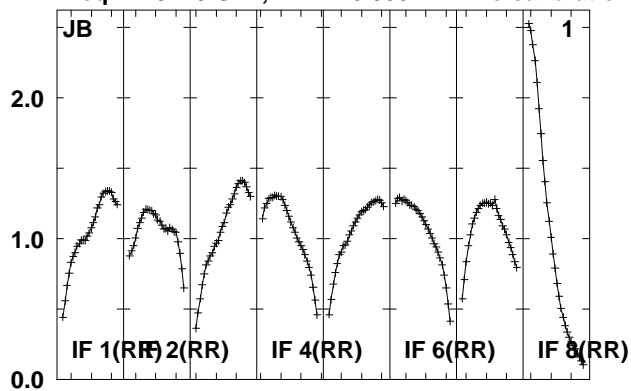

Lower frame: Real Jy
Total-power spectrum Antenna: *
Timerange: 00/22:27:31 to 00/22:30:59

Plot file version 9 created 24-AUG-2010 08:02:19

IRAS1929 EP064M.UVDATA.1

Freq = 4.9270 GHz, Bw = 16.000 MH No calibration applied and no bandpass applied

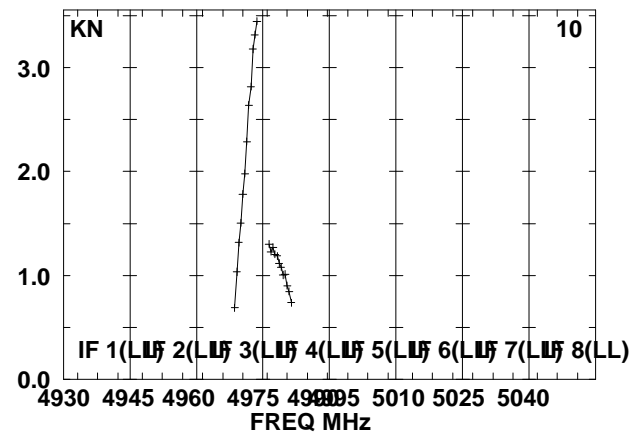
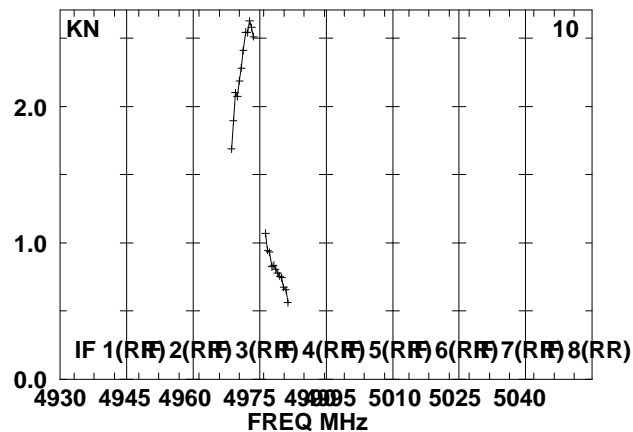
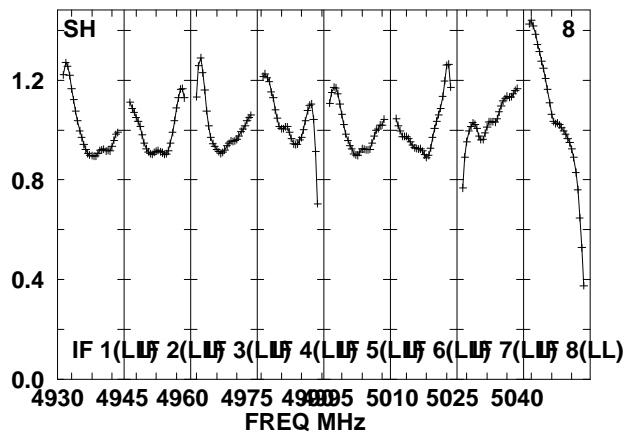
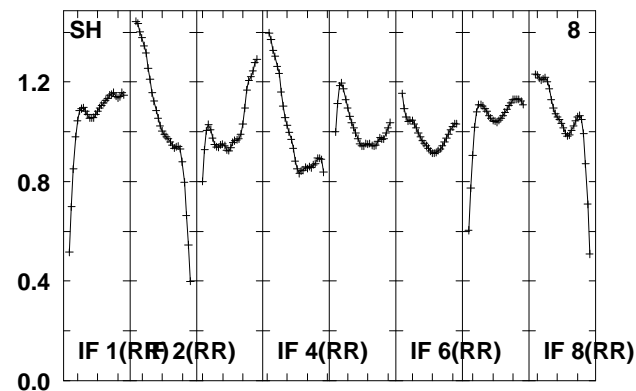
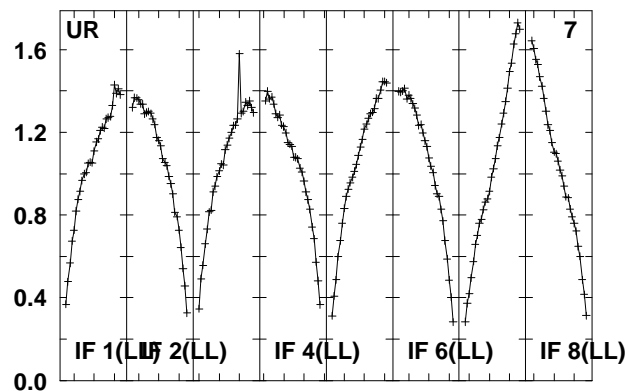
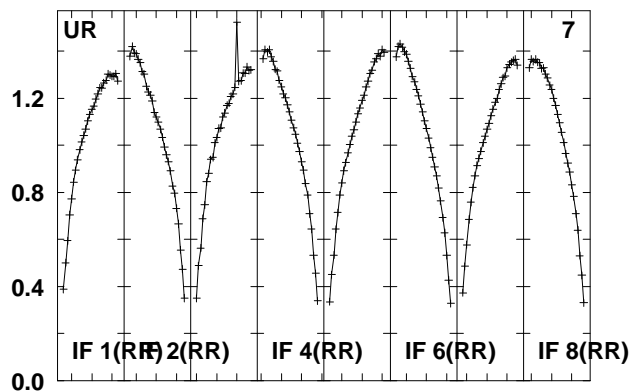
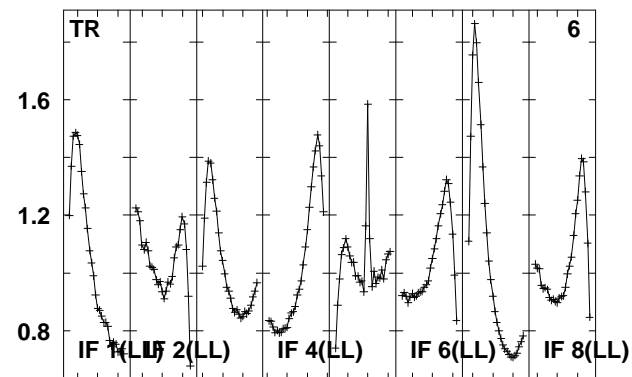
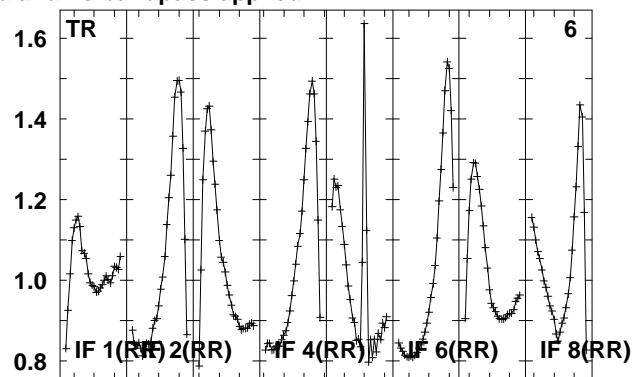
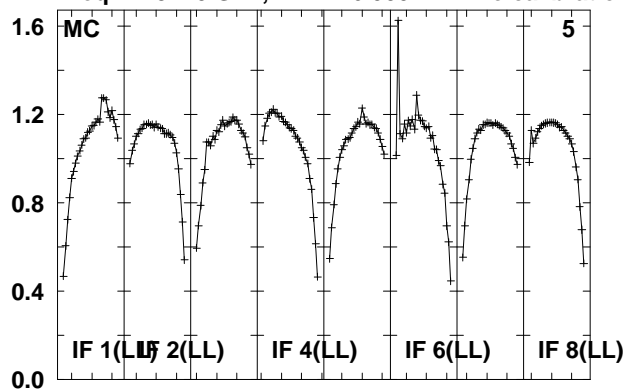

Lower frame: Real Jy
Total-power spectrum Antenna: *
Timerange: 00/22:27:31 to 00/22:30:59

Plot file version 10 created 24-AUG-2010 08:02:19

IRAS1929 EP064M.UVDATA.1

Freq = 4.9270 GHz, Bw = 16.000 MH No calibration applied and no bandpass applied

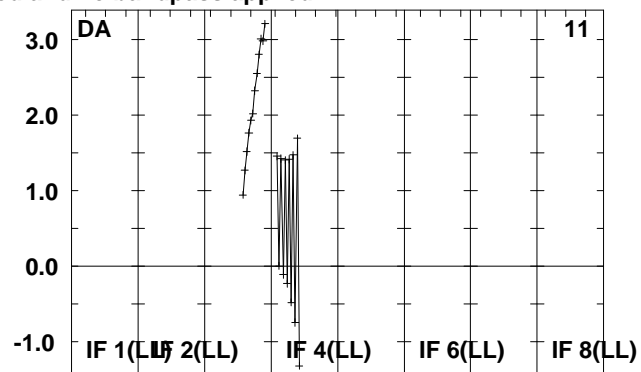
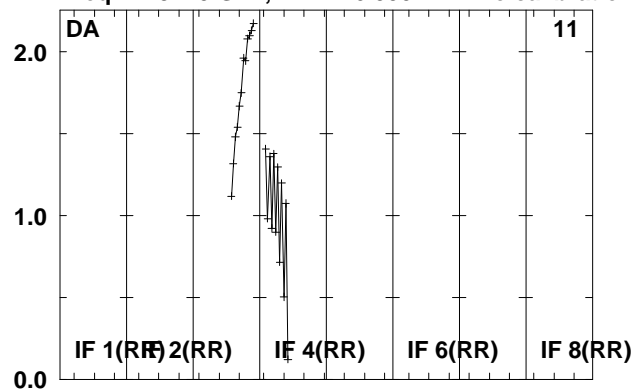

Lower frame: Real Jy
Total-power spectrum Antenna: *
Timerange: 00/22:27:31 to 00/22:30:59

Plot file version 11 created 24-AUG-2010 08:02:20

J1941-05 EP064M.UVDATA.1

Freq = 4.9270 GHz, Bw = 16.000 MH No calibration applied and no bandpass applied

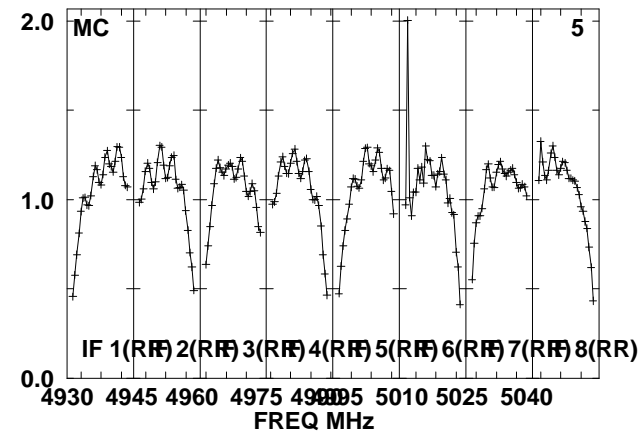
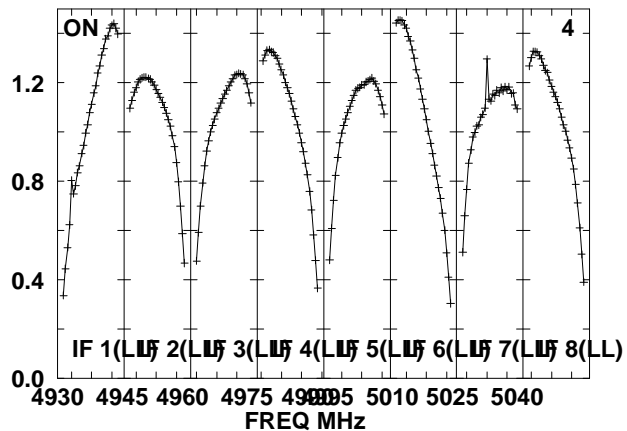
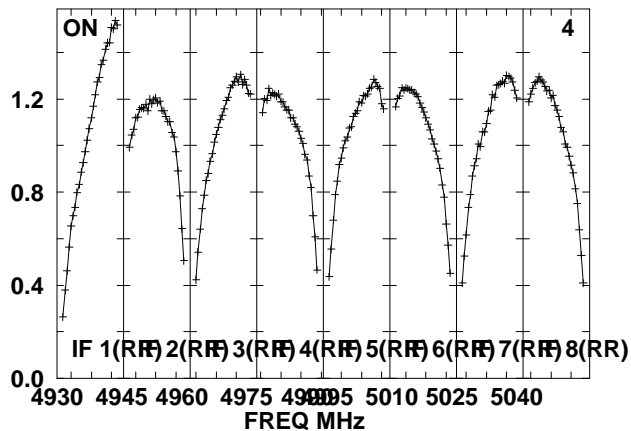
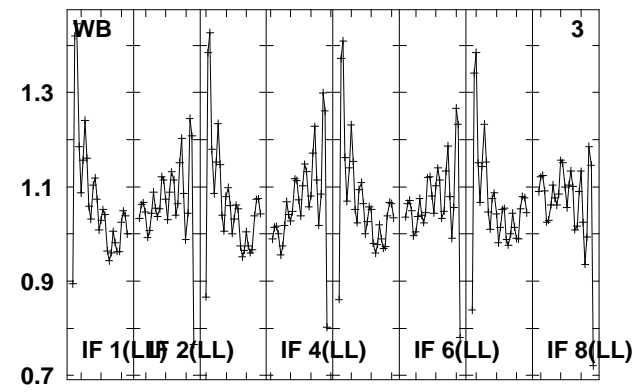
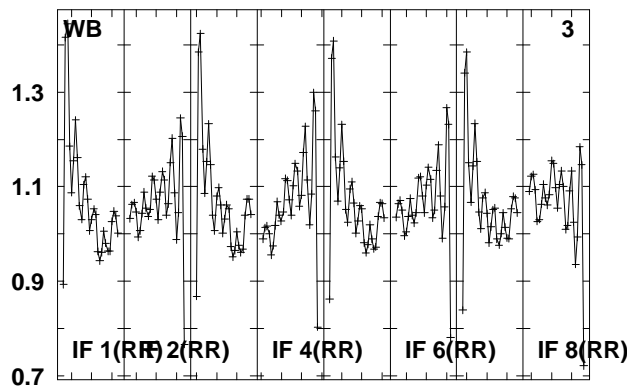
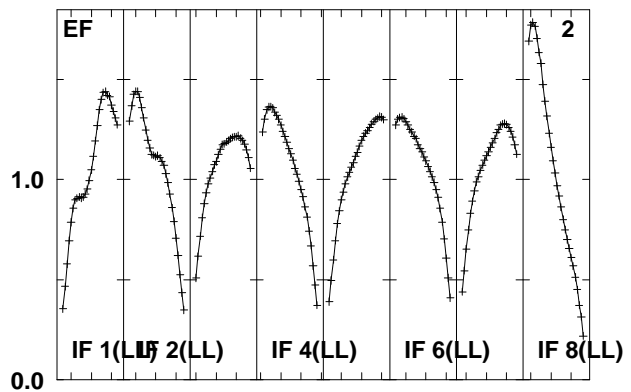
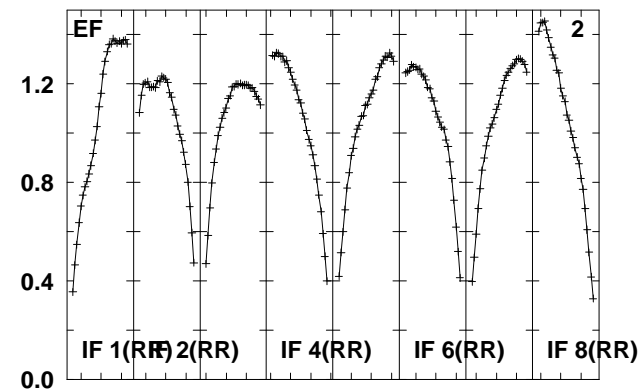
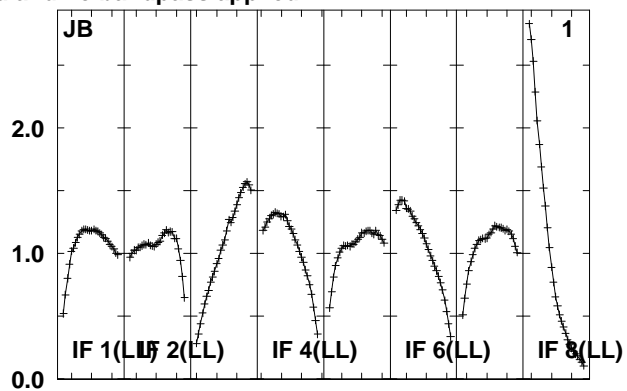
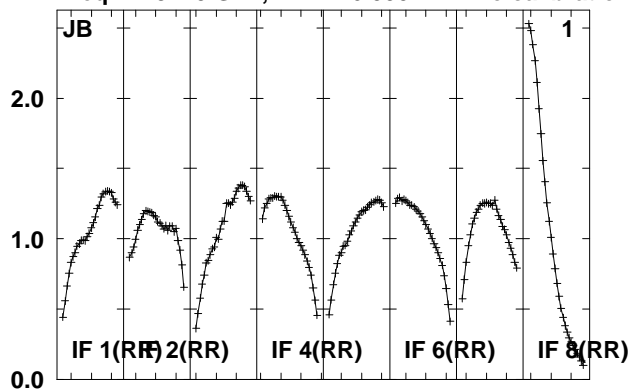

Lower frame: Real Jy
Total-power spectrum Antenna: *
Timerange: 00/22:31:01 to 00/22:32:29

Plot file version 12 created 24-AUG-2010 08:02:20

J1941-05 EP064M.UVDATA.1

Freq = 4.9270 GHz, Bw = 16.000 MH No calibration applied and no bandpass applied

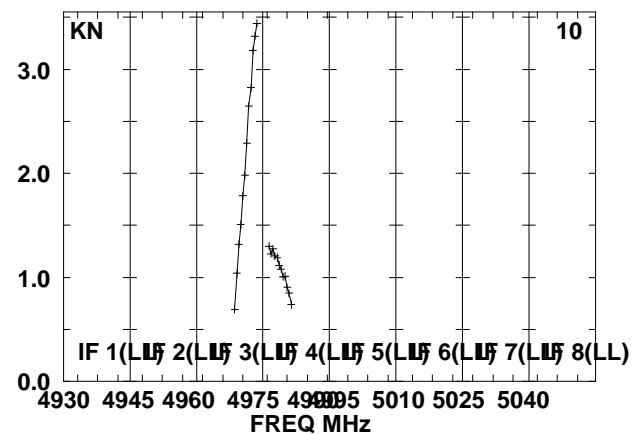
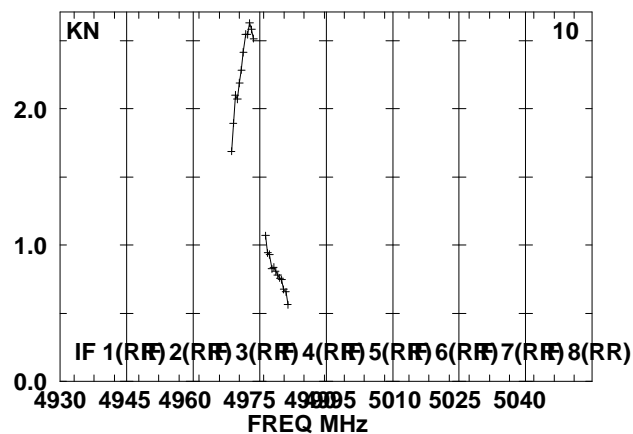
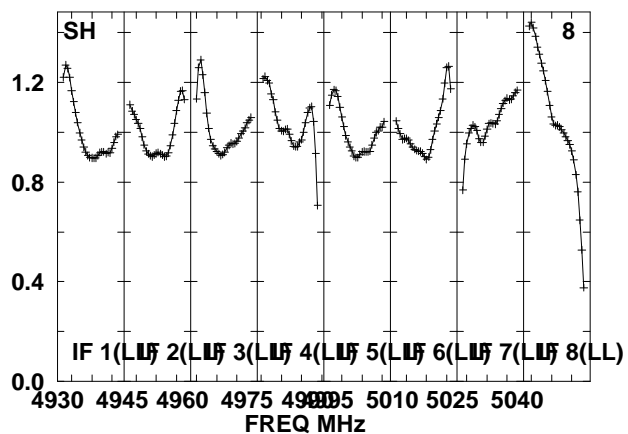
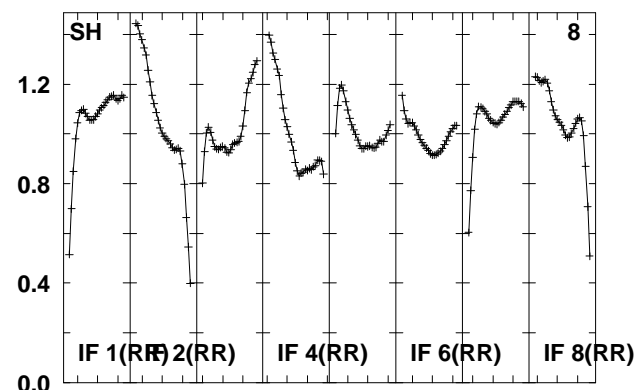
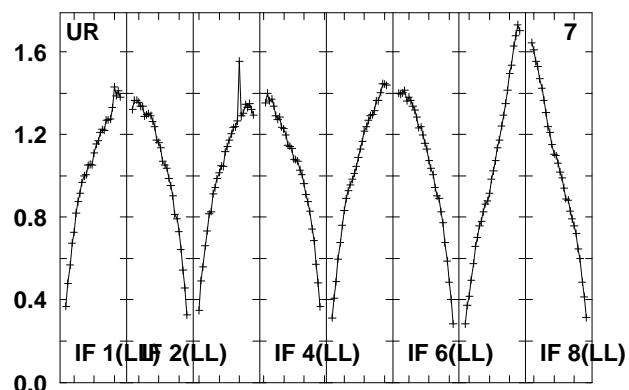
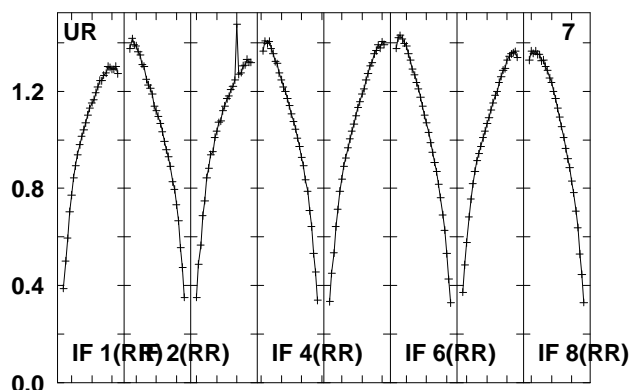
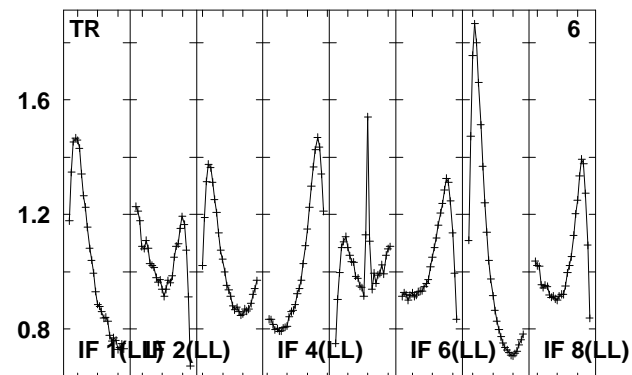
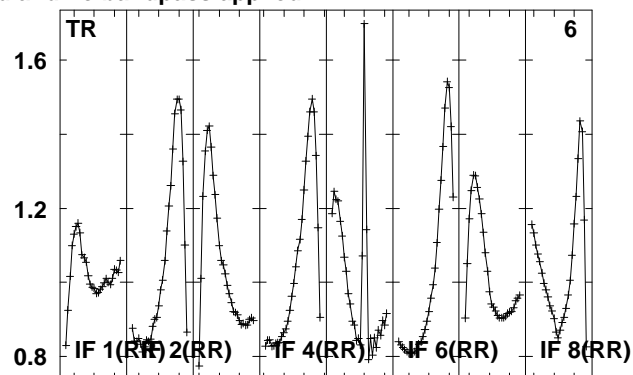
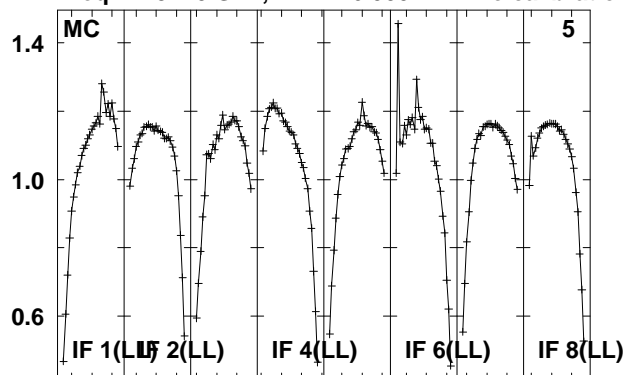

Lower frame: Real Jy
Total-power spectrum Antenna: *
Timerange: 00/22:31:01 to 00/22:32:29

Plot file version 13 created 24-AUG-2010 08:02:20

J1941-05 EP064M.UVDATA.1

Freq = 4.9270 GHz, Bw = 16.000 MH No calibration applied and no bandpass applied

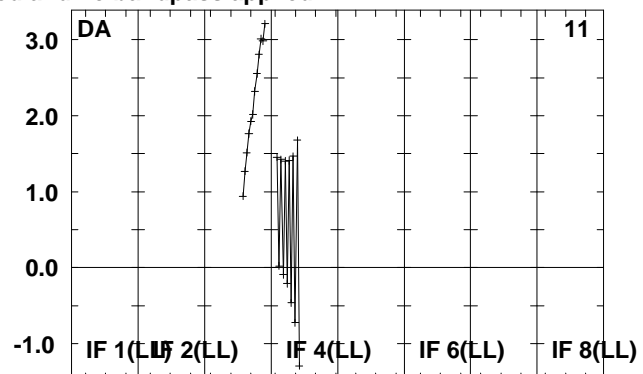
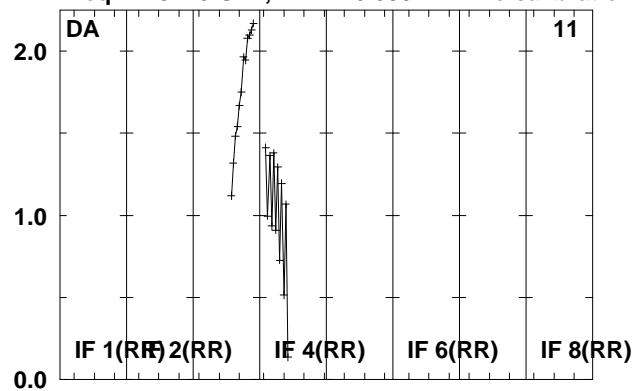

Lower frame: Real Jy
Total-power spectrum Antenna: *
Timerange: 00/22:31:01 to 00/22:32:29

Plot file version 14 created 24-AUG-2010 08:02:20

IRAS1929 EP064M.UVDATA.1

Freq = 4.9270 GHz, Bw = 16.000 MH No calibration applied and no bandpass applied

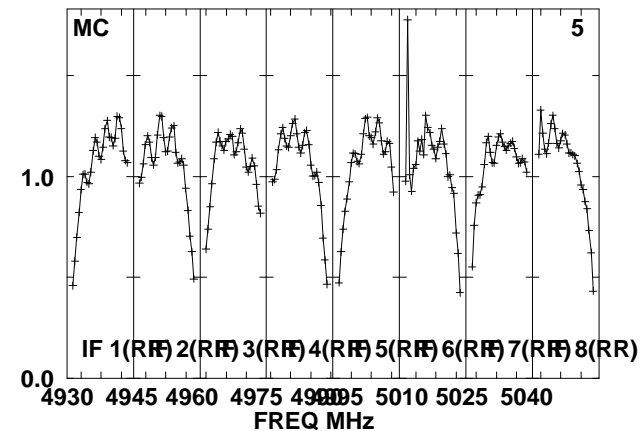
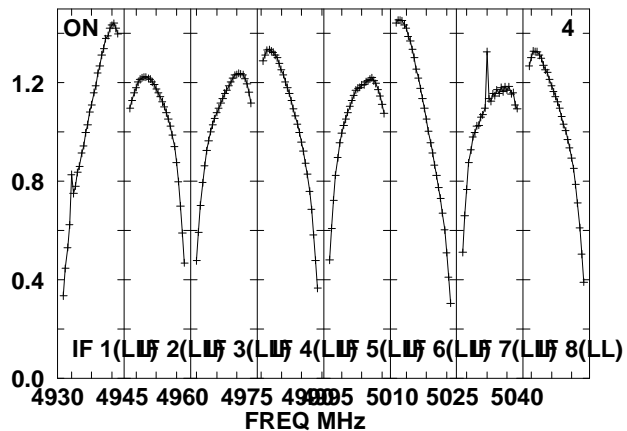
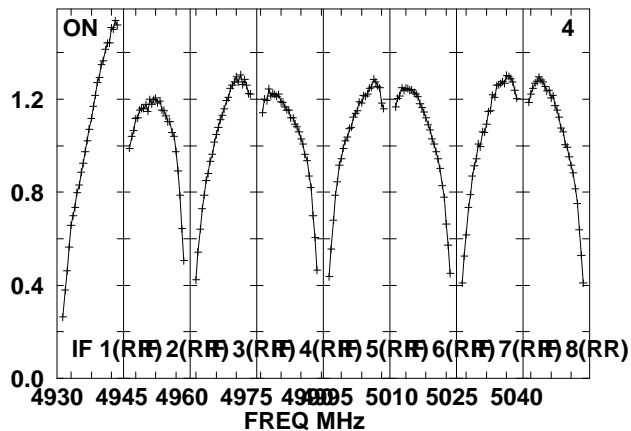
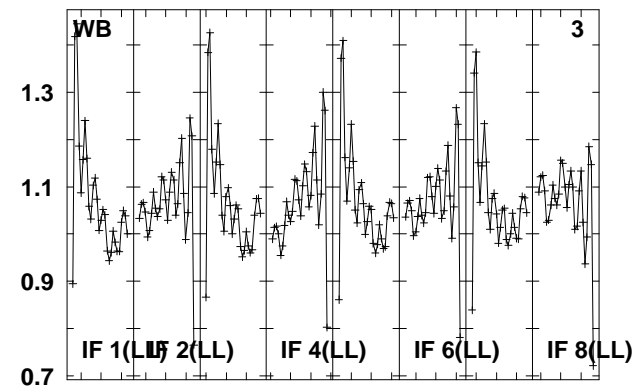
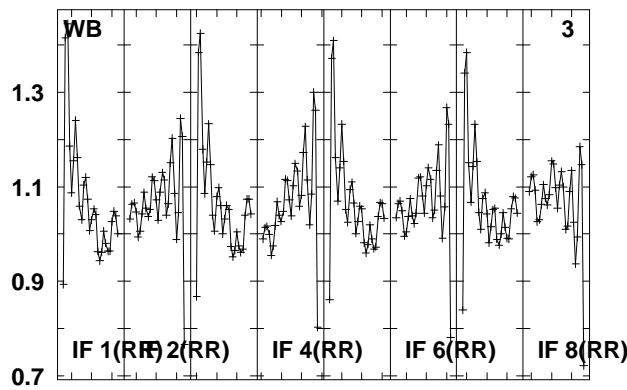
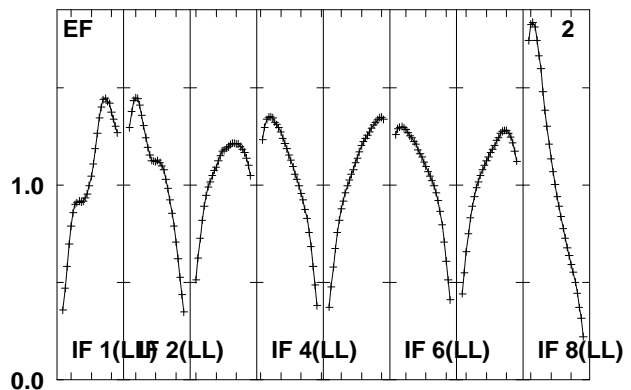
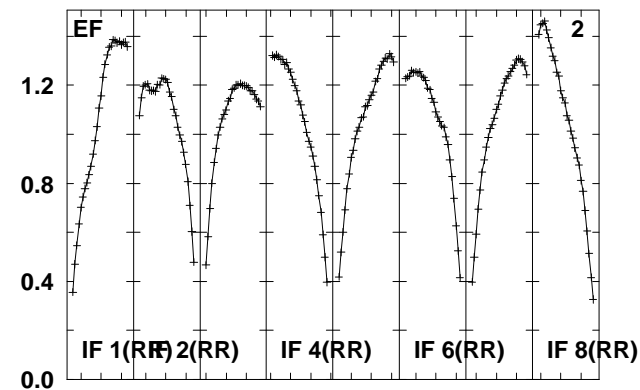
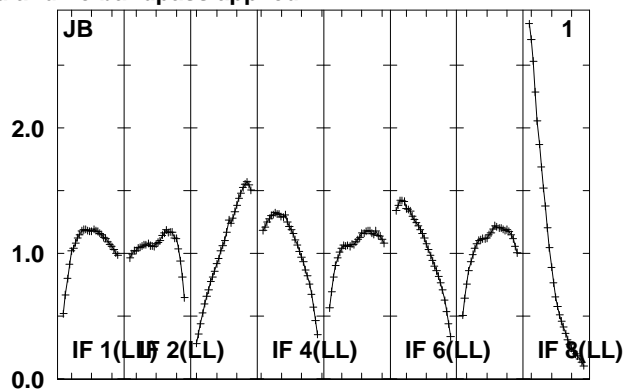
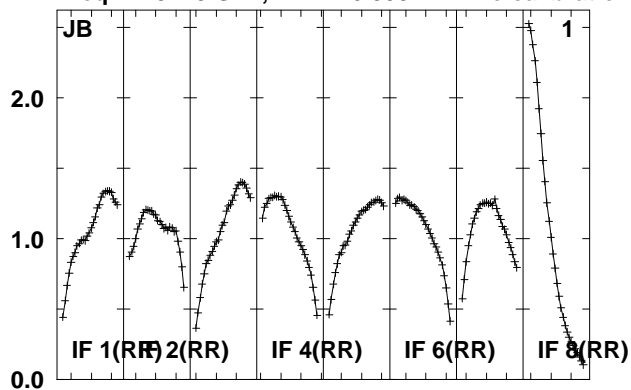

Lower frame: Real Jy
Total-power spectrum Antenna: *
Timerange: 00/22:32:31 to 00/22:35:59

Plot file version 15 created 24-AUG-2010 08:02:21

IRAS1929 EP064M.UVDATA.1

Freq = 4.9270 GHz, Bw = 16.000 MH No calibration applied and no bandpass applied

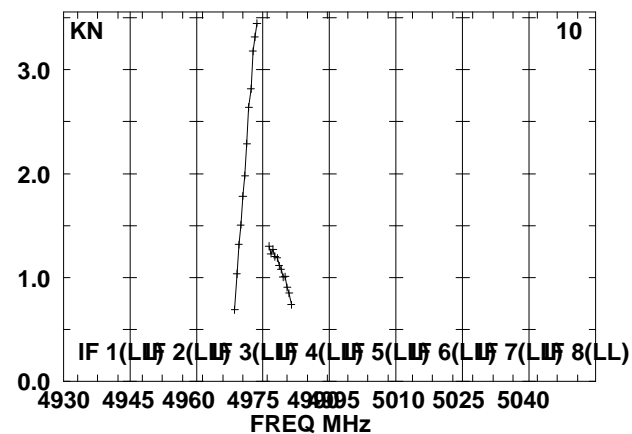
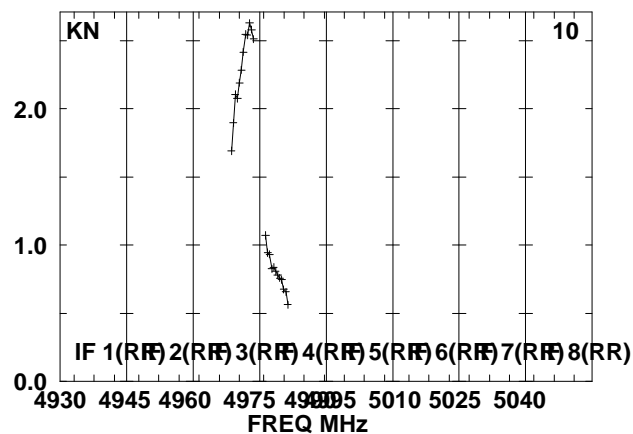
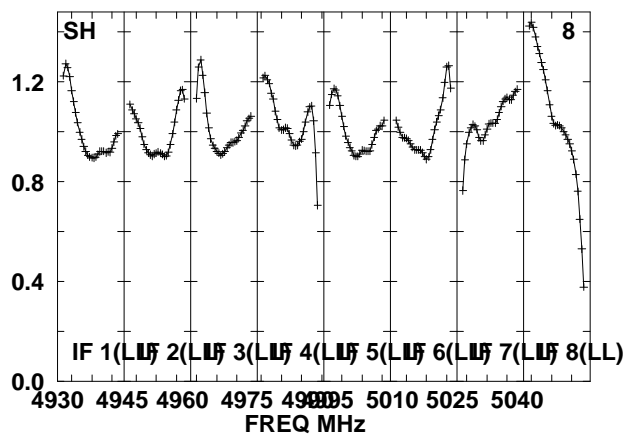
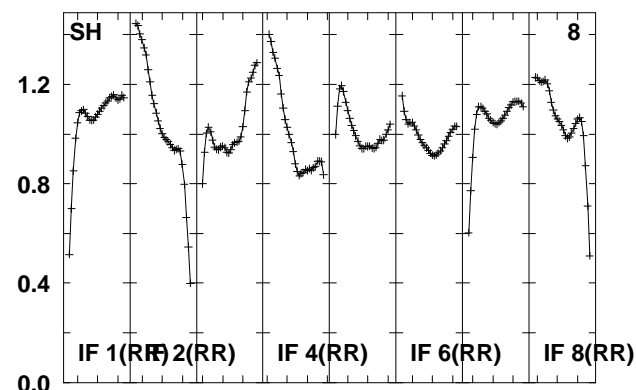
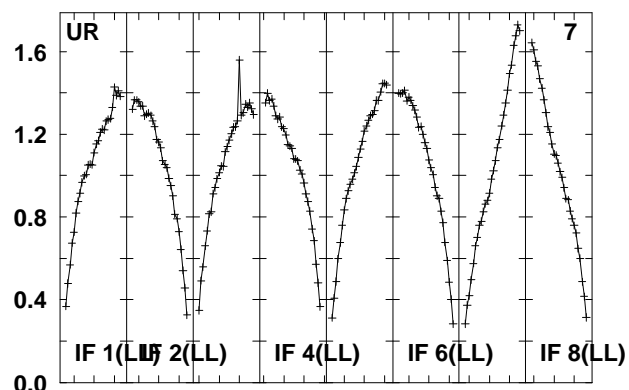
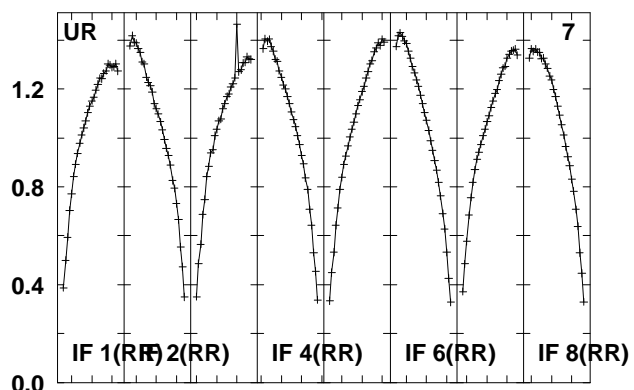
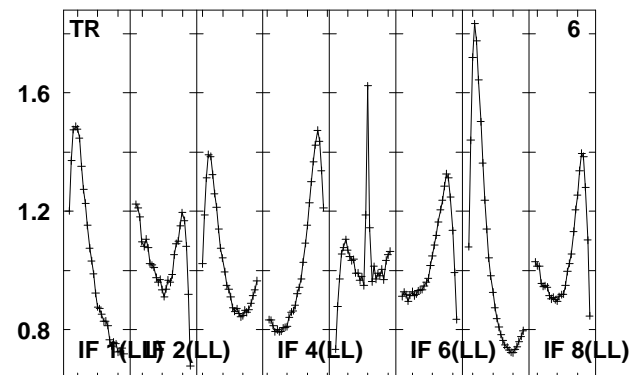
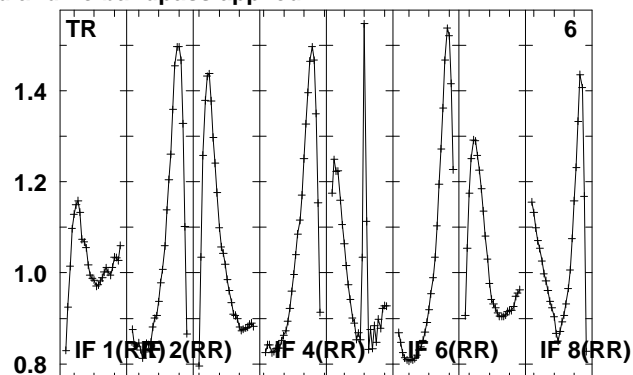
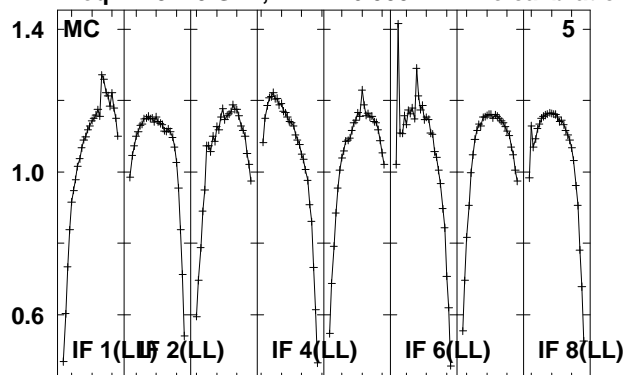

Lower frame: Real Jy

Total-power spectrum Antenna: *

Timerange: 00/22:32:31 to 00/22:35:59

Plot file version 16 created 24-AUG-2010 08:02:21

IRAS1929 EP064M.UVDATA.1

Freq = 4.9270 GHz, Bw = 16.000 MH No calibration applied and no bandpass applied

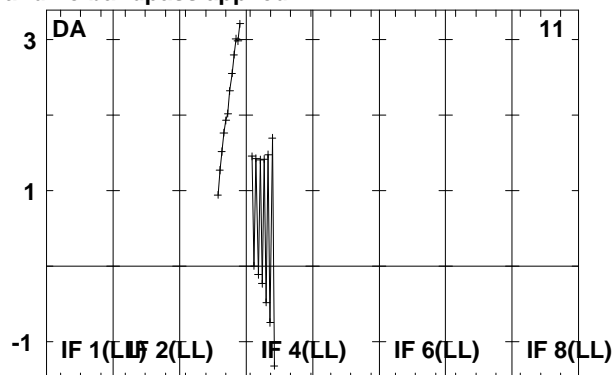
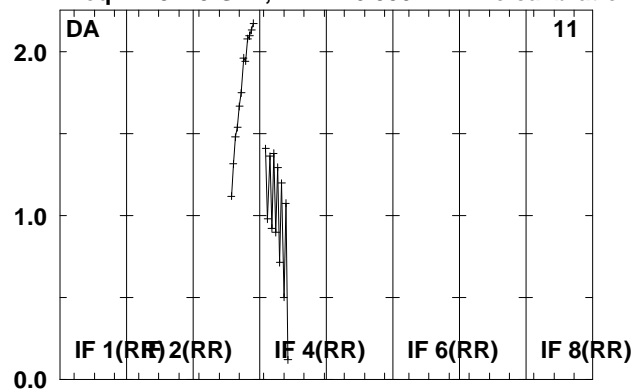

Lower frame: Real Jy
Total-power spectrum Antenna: *
Timerange: 00/22:32:31 to 00/22:35:59

Plot file version 17 created 24-AUG-2010 08:02:22

J1941-05 EP064M.UVDATA.1

Freq = 4.9270 GHz, Bw = 16.000 MH No calibration applied and no bandpass applied

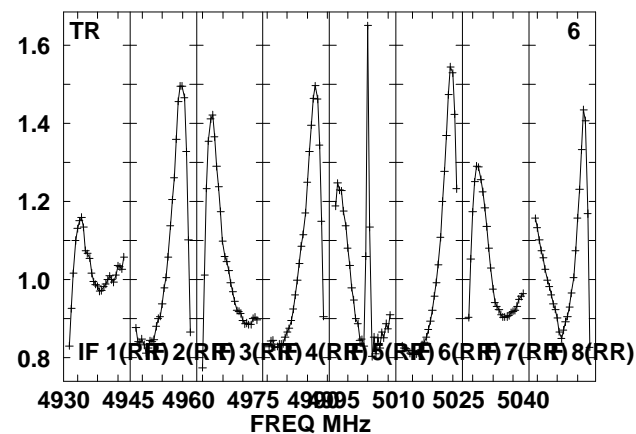
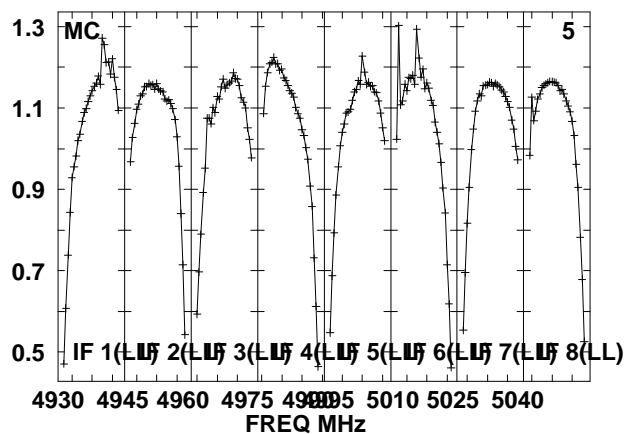
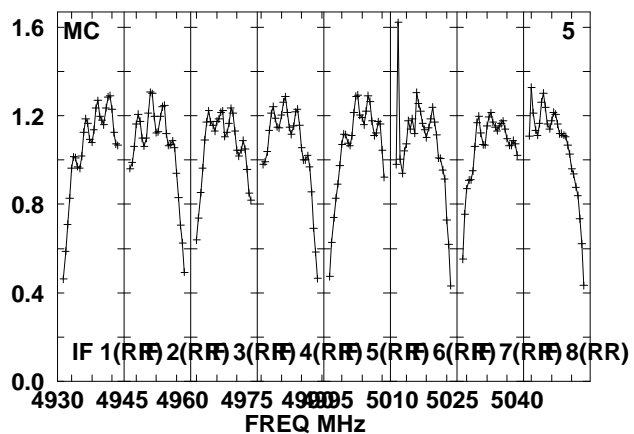
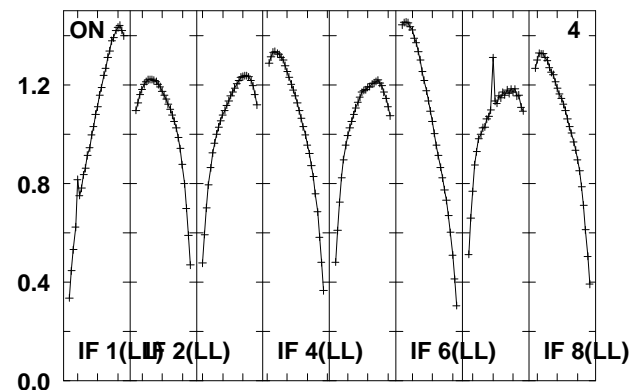
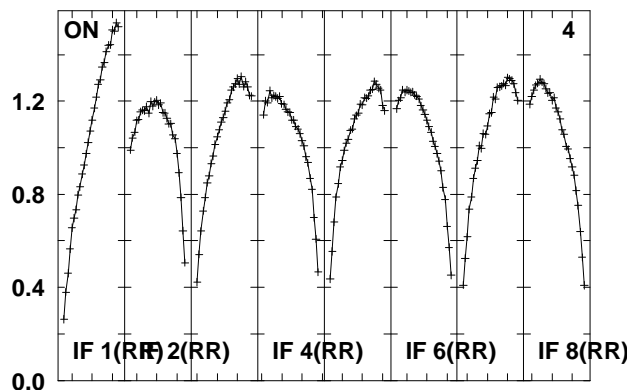
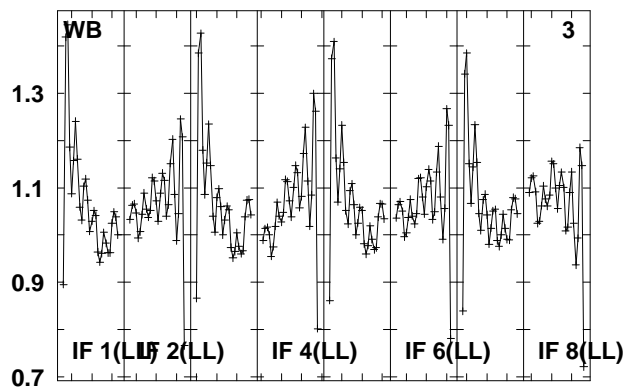
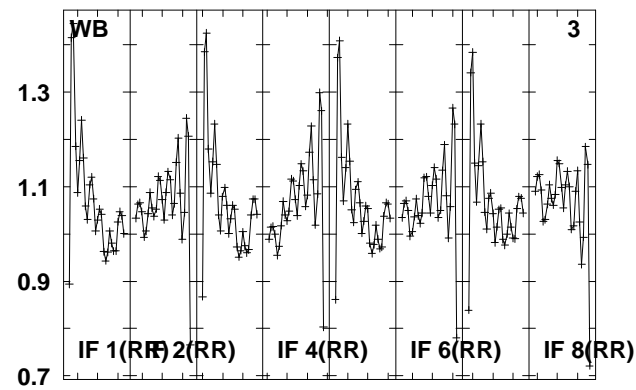
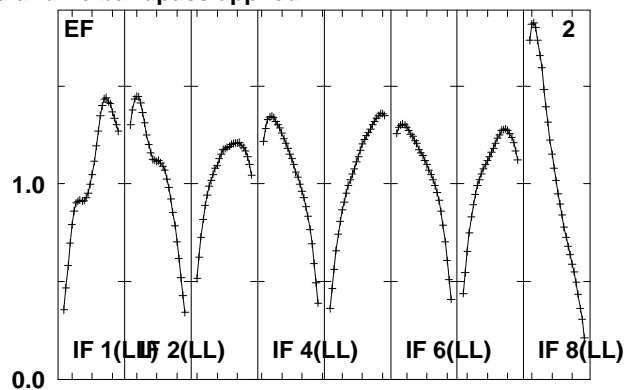
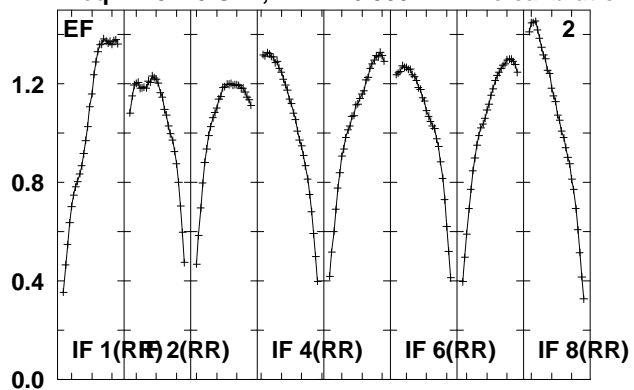

Lower frame: Real Jy
Total-power spectrum Antenna: *
Timerange: 00/22:36:01 to 00/22:37:29

Plot file version 18 created 24-AUG-2010 08:02:22

J1941-05 EP064M.UVDATA.1

Freq = 4.9270 GHz, Bw = 16.000 MH No calibration applied and no bandpass applied

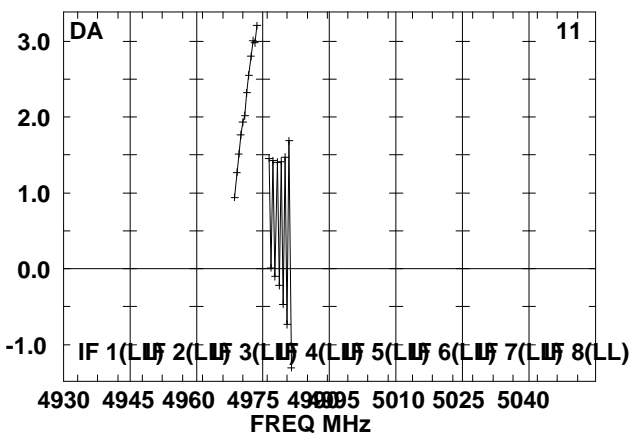
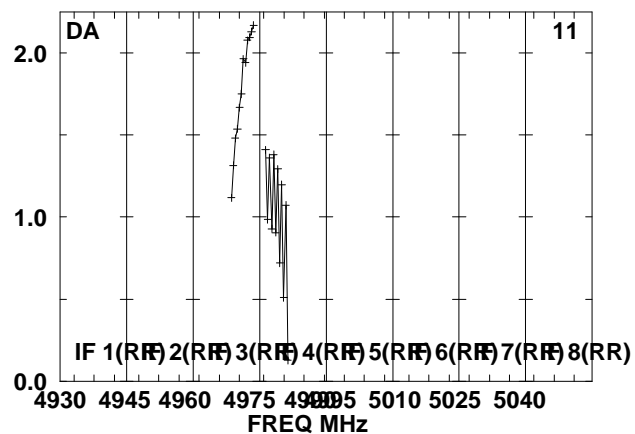
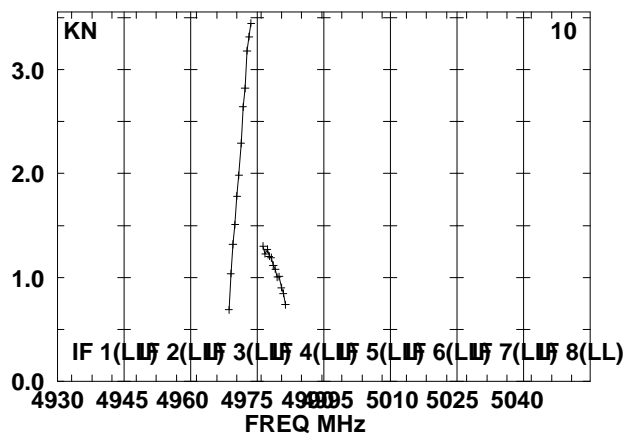
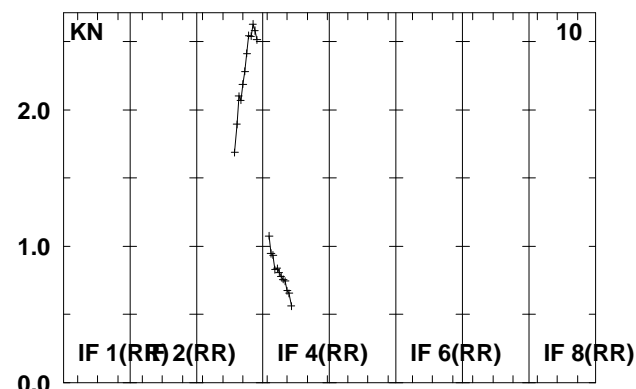
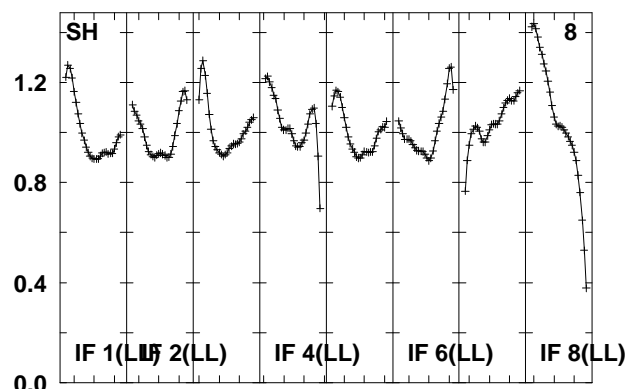
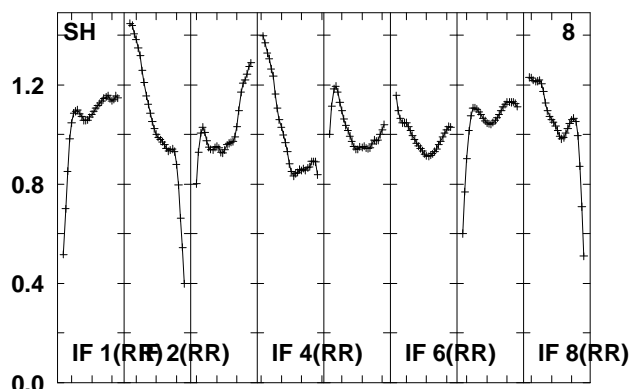
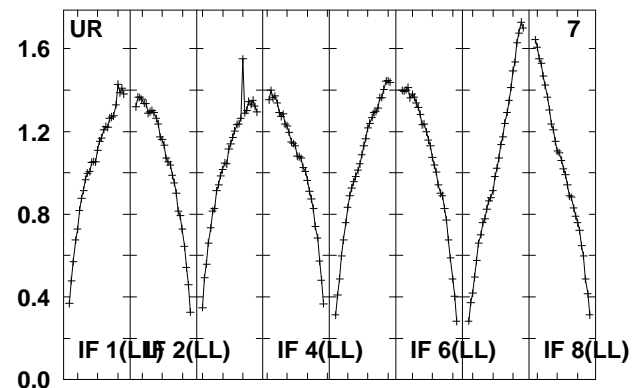
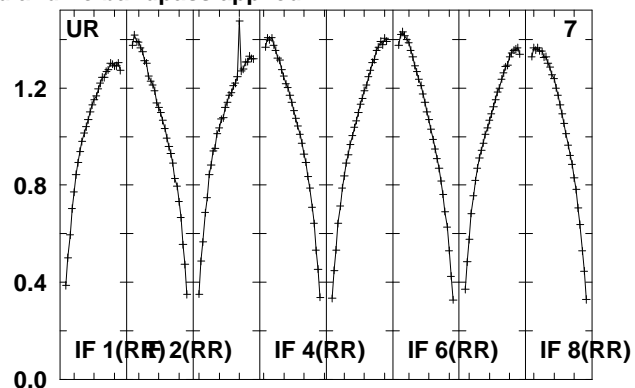
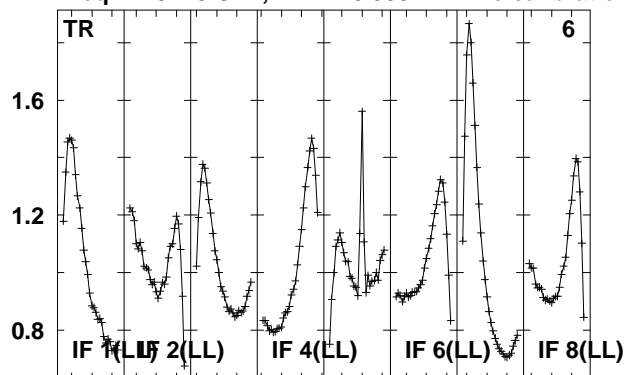

Lower frame: Real Jy

Total-power spectrum Antenna: *

Timerange: 00/22:36:01 to 00/22:37:29

Plot file version 19 created 24-AUG-2010 08:02:22

IRAS1929 EP064M.UVDATA.1

Freq = 4.9270 GHz, Bw = 16.000 MH No calibration applied and no bandpass applied

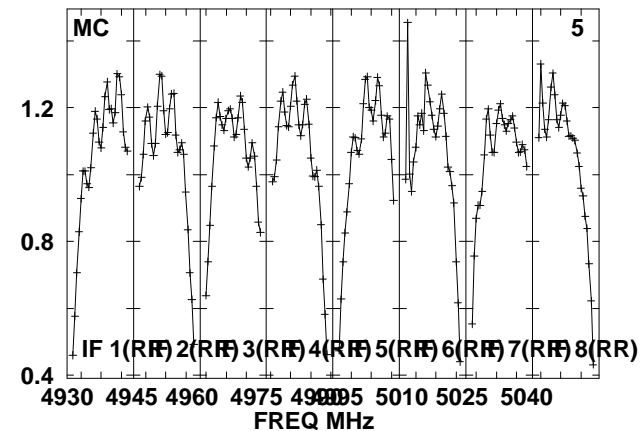
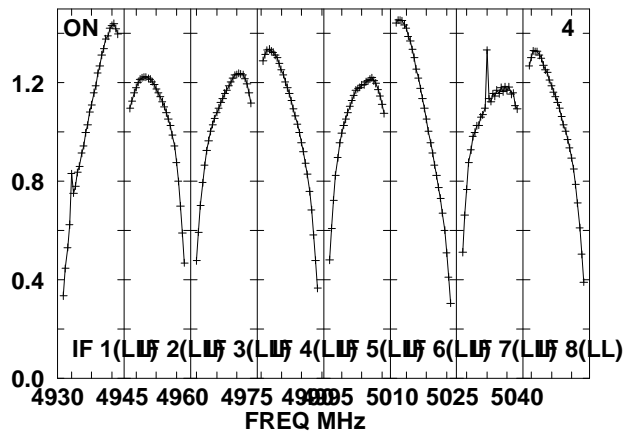
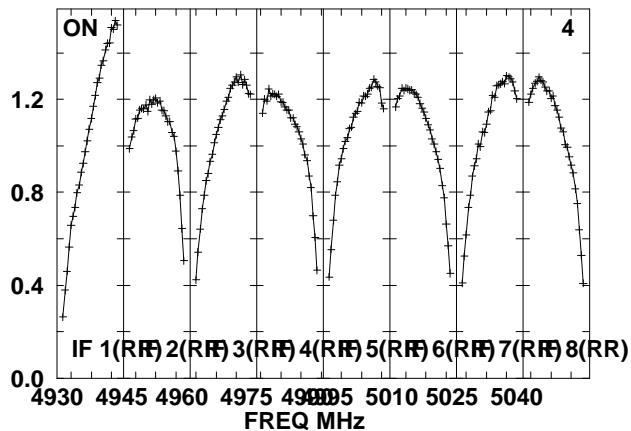
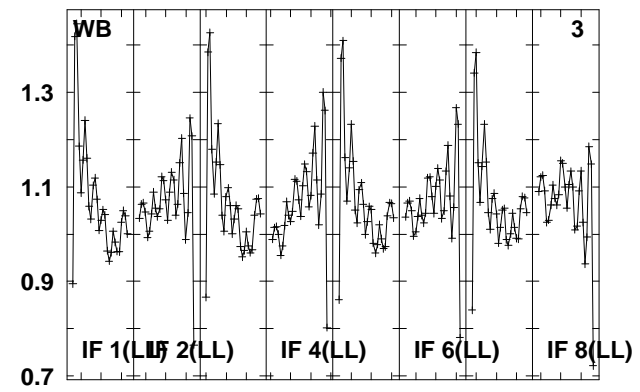
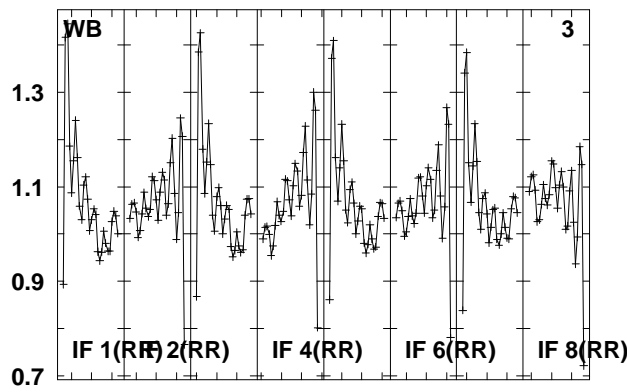
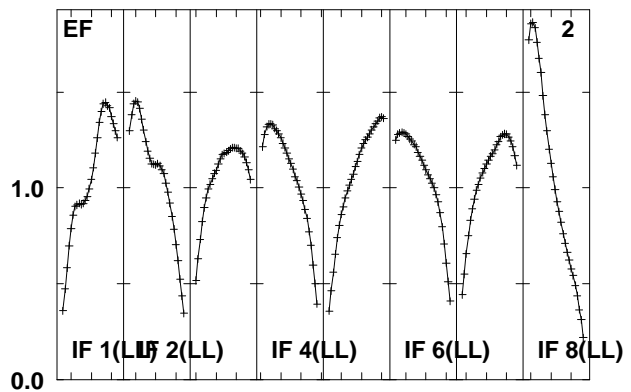
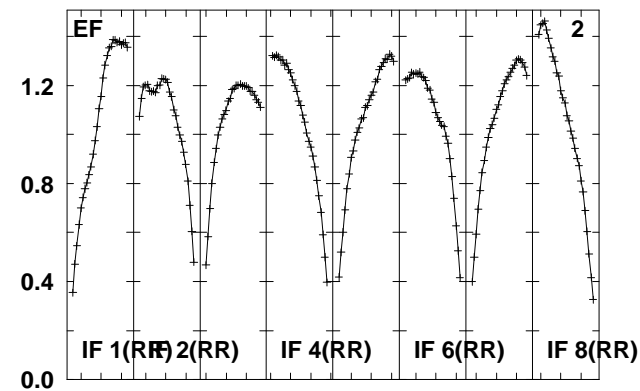
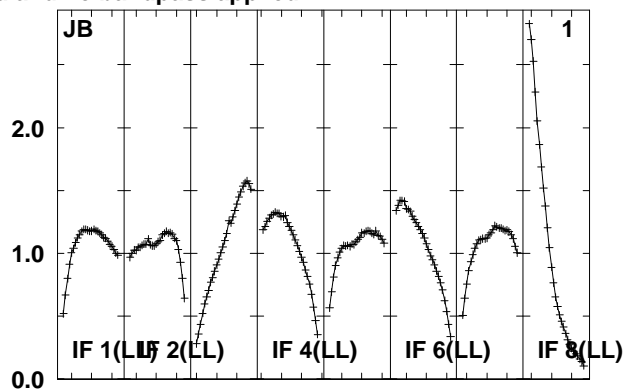
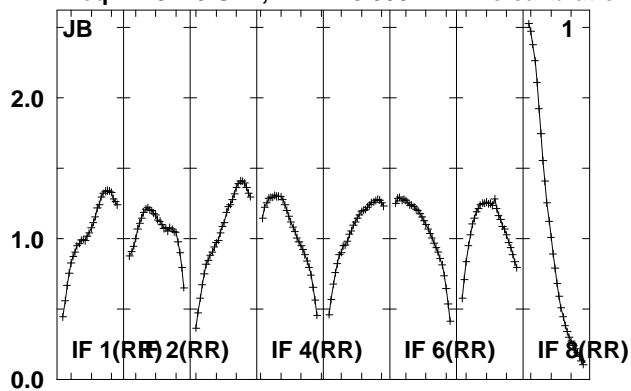

Lower frame: Real Jy
Total-power spectrum Antenna: *
Timerange: 00/22:37:31 to 00/22:40:59

Plot file version 20 created 24-AUG-2010 08:02:23

IRAS1929 EP064M.UVDATA.1

Freq = 4.9270 GHz, Bw = 16.000 MH No calibration applied and no bandpass applied

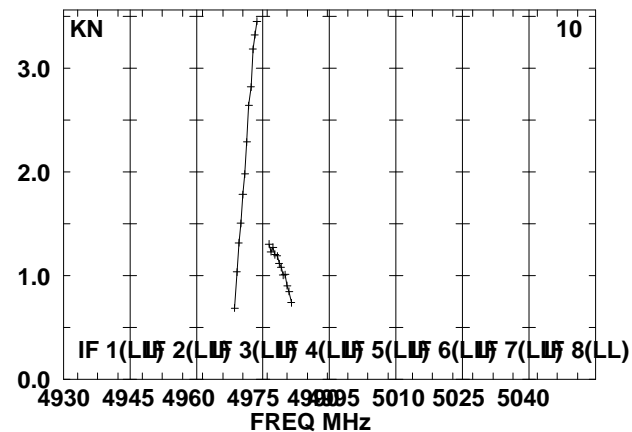
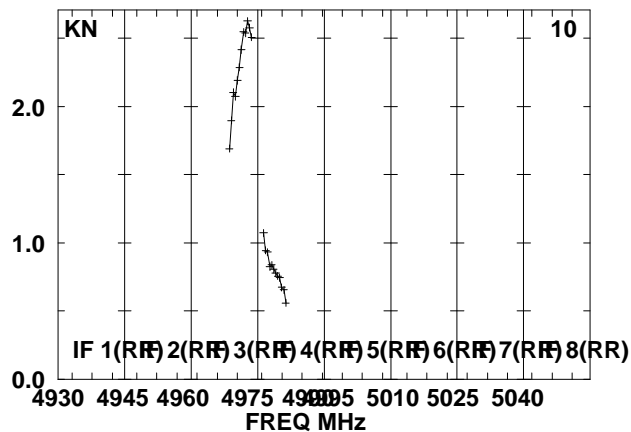
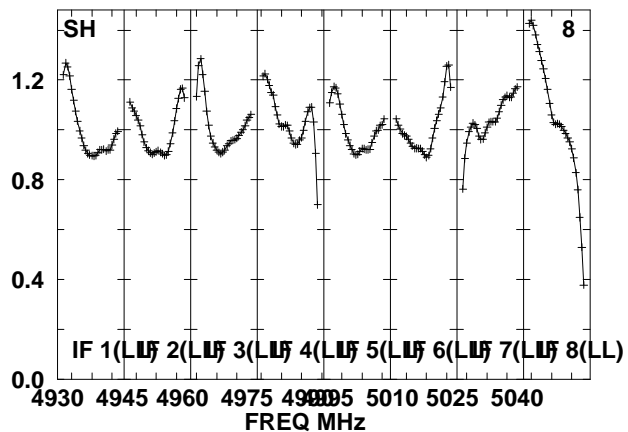
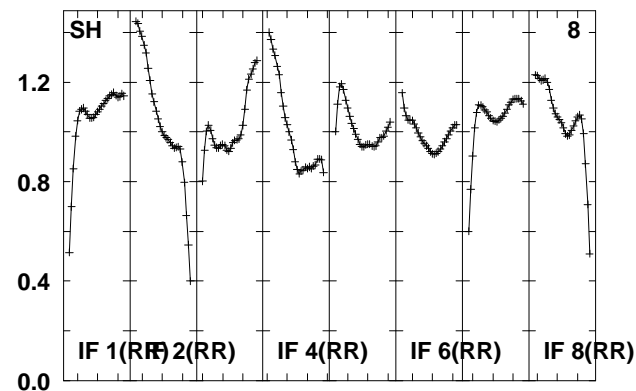
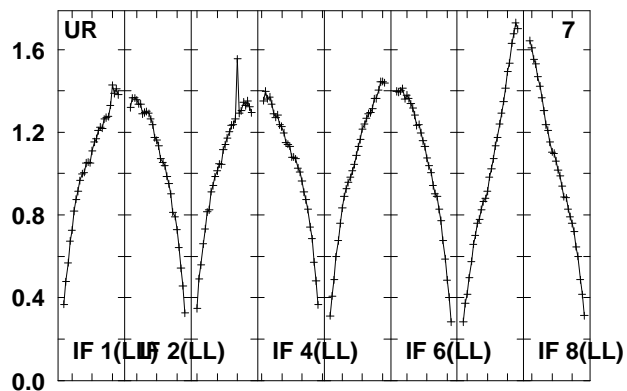
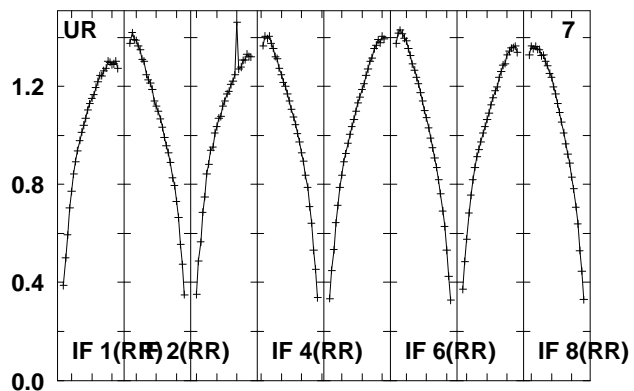
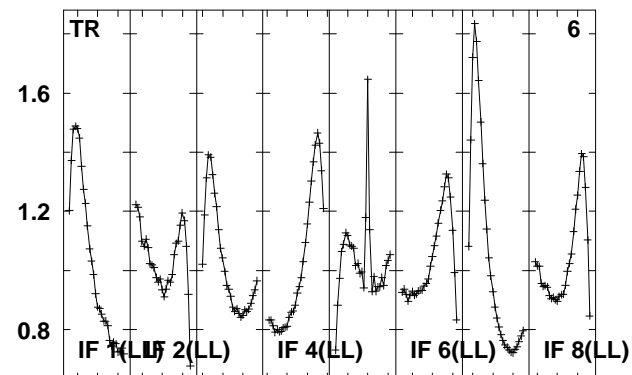
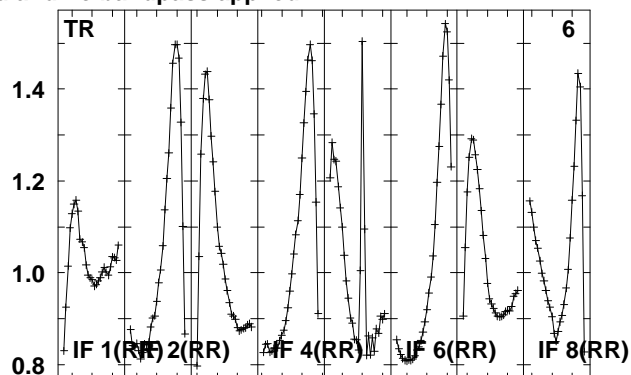
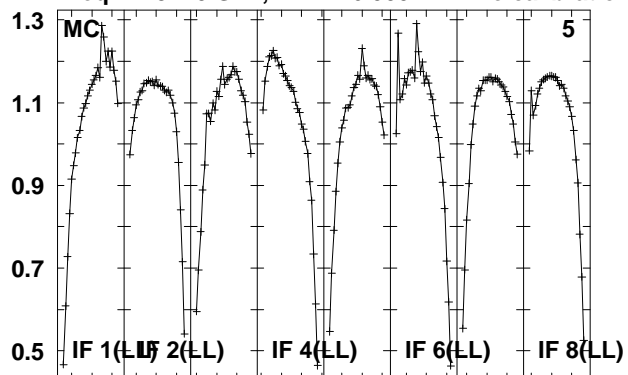

Lower frame: Real Jy

Total-power spectrum Antenna: *

Timerange: 00/22:37:31 to 00/22:40:59

Plot file version 21 created 24-AUG-2010 08:02:24

IRAS1929 EP064M.UVDATA.1

Freq = 4.9270 GHz, Bw = 16.000 MH No calibration applied and no bandpass applied

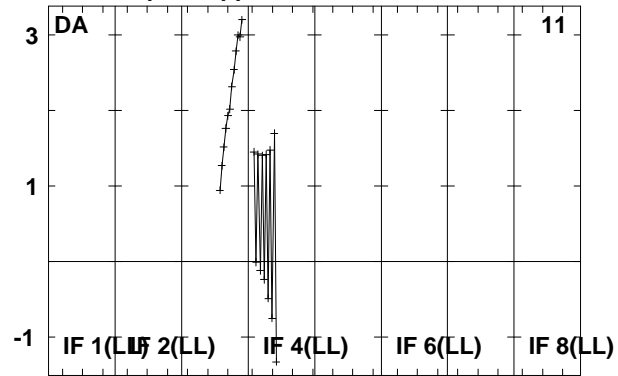
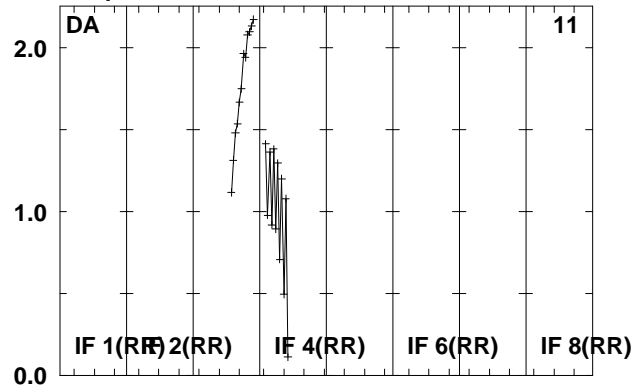

Lower frame: Real Jy
Total-power spectrum Antenna: *
Timerange: 00/22:37:31 to 00/22:40:59

Plot file version 22 created 24-AUG-2010 08:02:24

J1941-05 EP064M.UVDATA.1

Freq = 4.9270 GHz, Bw = 16.000 MH No calibration applied and no bandpass applied

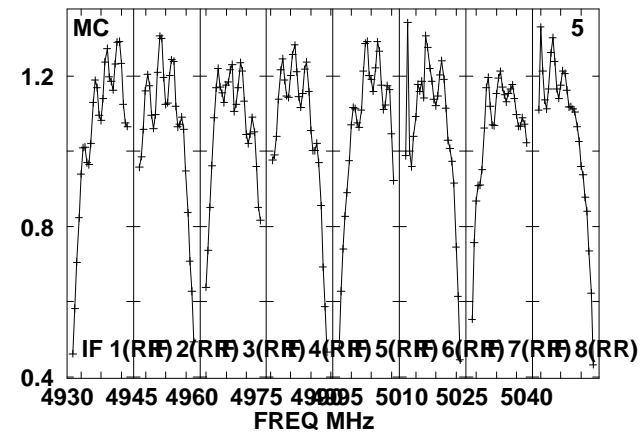
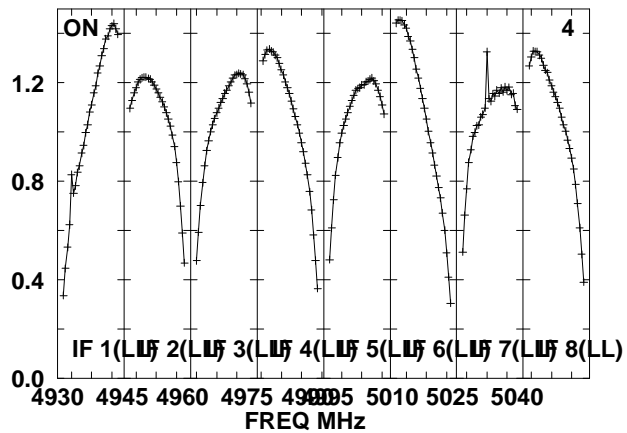
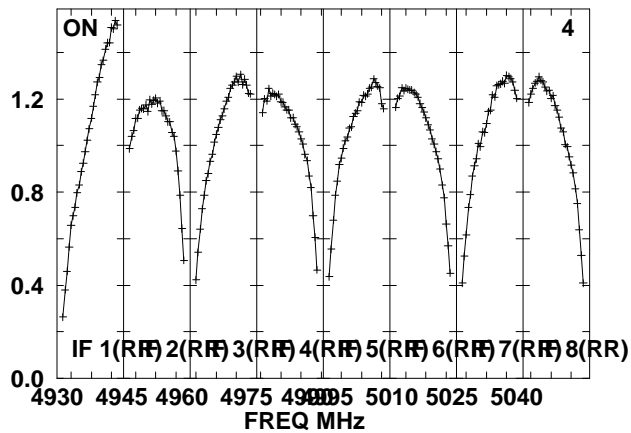
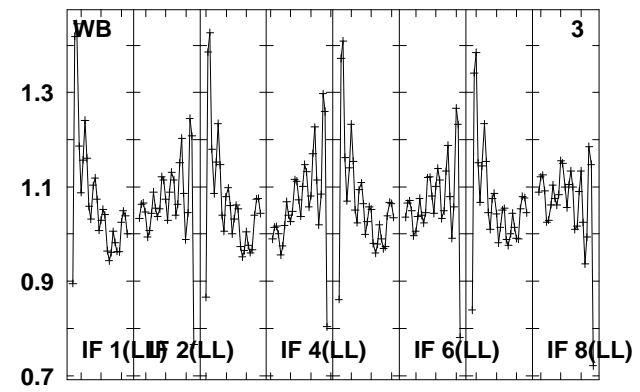
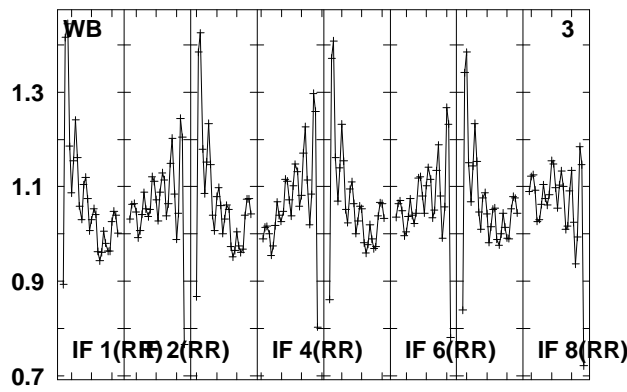
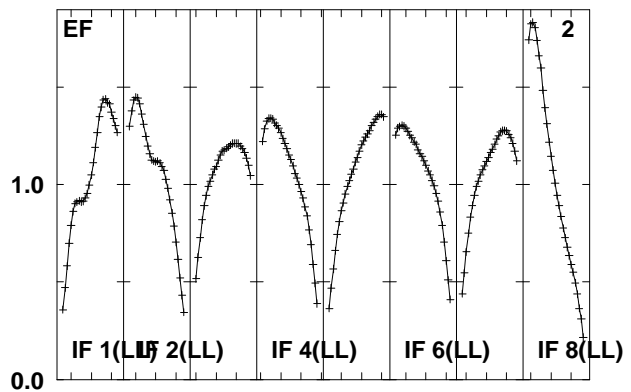
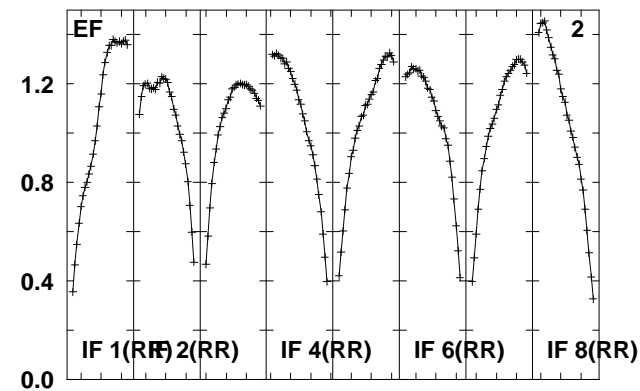
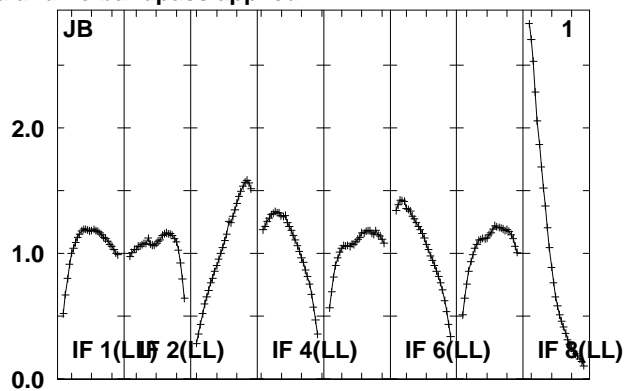
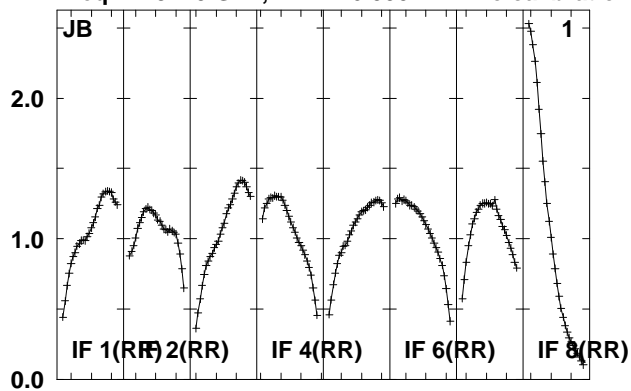

Lower frame: Real Jy
Total-power spectrum Antenna: *
Timerange: 00/22:42:01 to 00/22:43:29

Plot file version 23 created 24-AUG-2010 08:02:24

J1941-05 EP064M.UVDATA.1

Freq = 4.9270 GHz, Bw = 16.000 MH No calibration applied and no bandpass applied

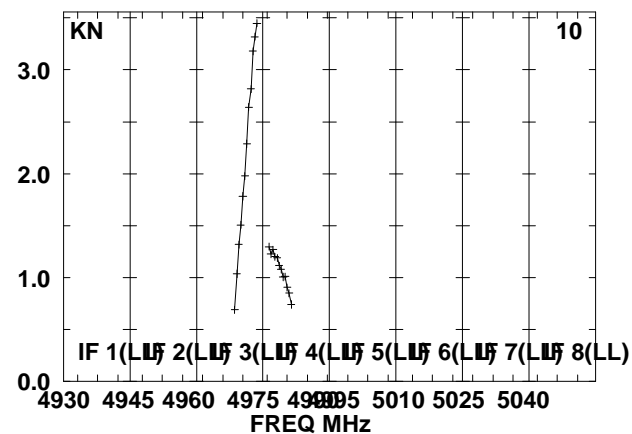
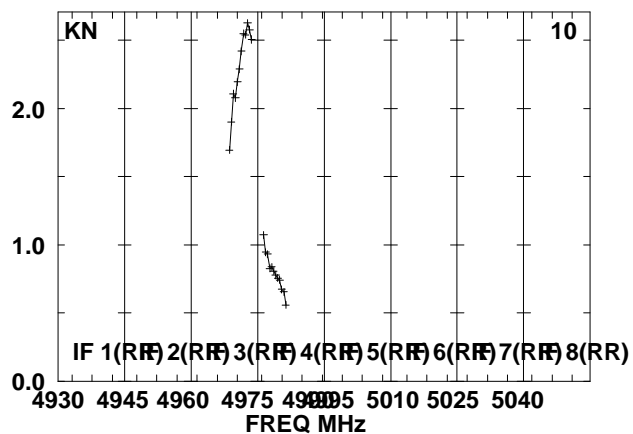
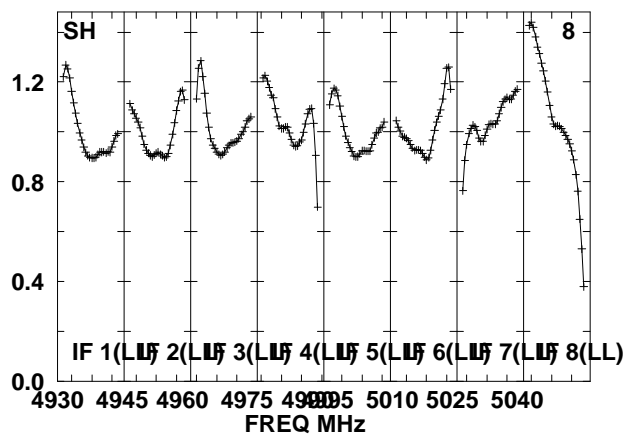
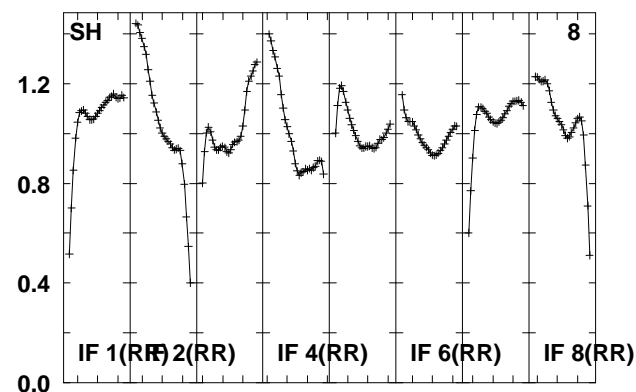
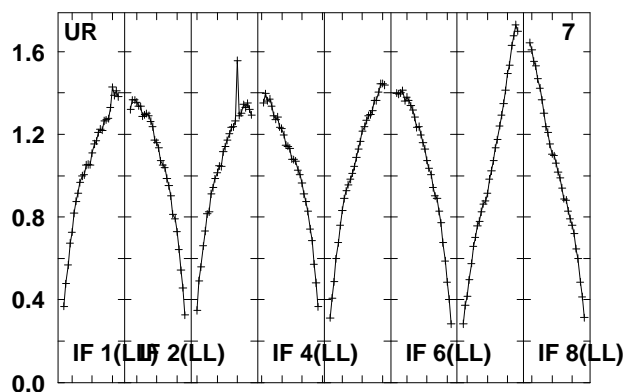
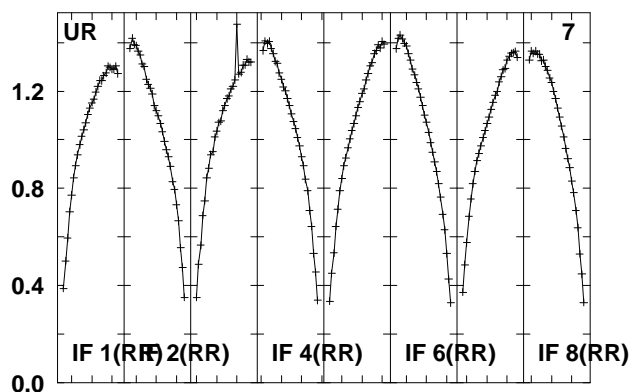
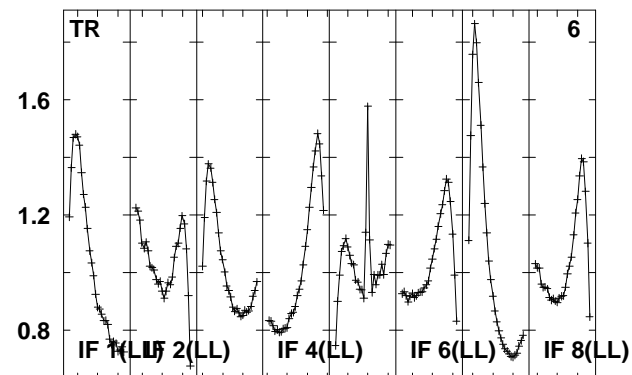
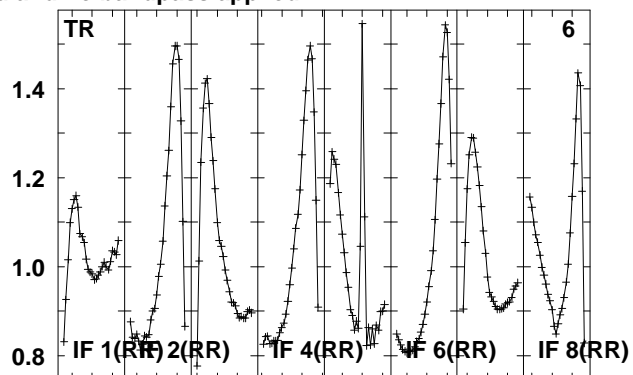
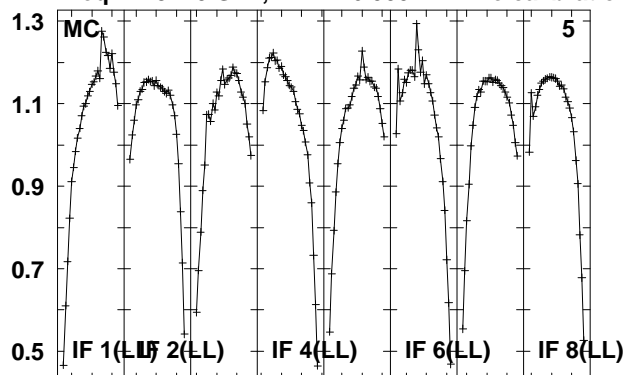

Lower frame: Real Jy

Total-power spectrum Antenna: *

Timerange: 00/22:42:01 to 00/22:43:29

Plot file version 24 created 24-AUG-2010 08:02:24

J1941-05 EP064M.UVDATA.1

Freq = 4.9270 GHz, Bw = 16.000 MH No calibration applied and no bandpass applied

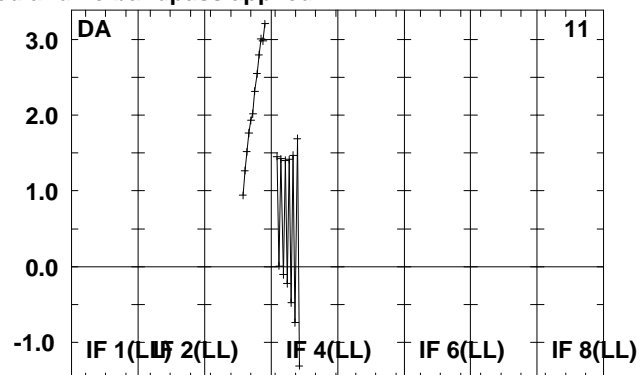
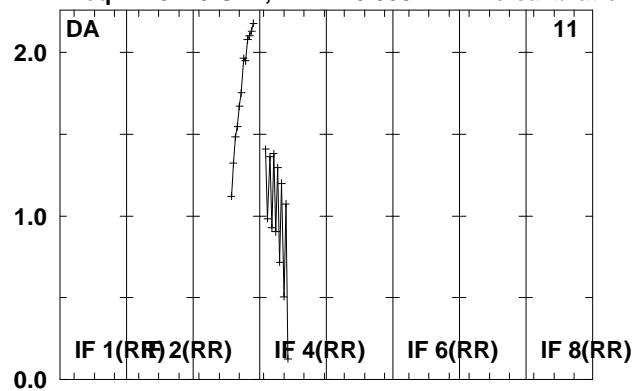

Lower frame: Real Jy
Total-power spectrum Antenna: *
Timerange: 00/22:42:01 to 00/22:43:29

Plot file version 25 created 24-AUG-2010 08:02:24

IRAS1929 EP064M.UVDATA.1

Freq = 4.9270 GHz, Bw = 16.000 MH No calibration applied and no bandpass applied

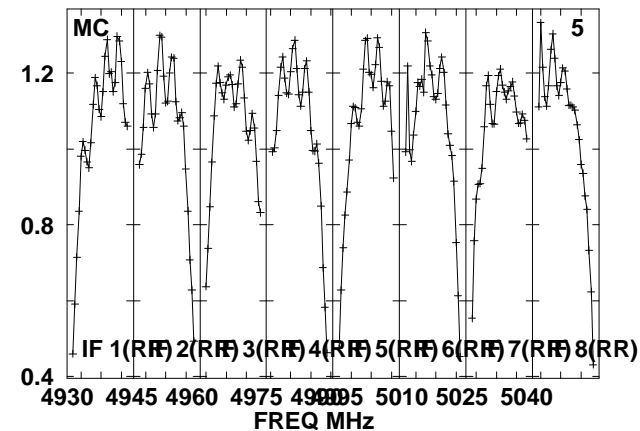
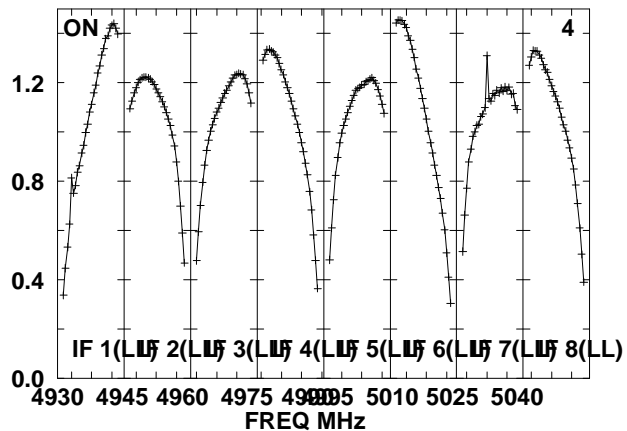
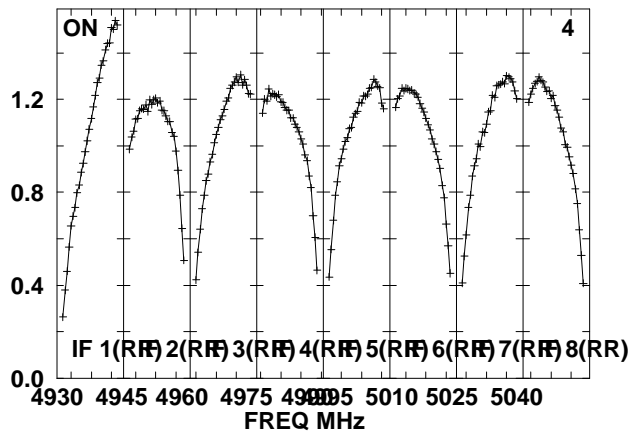
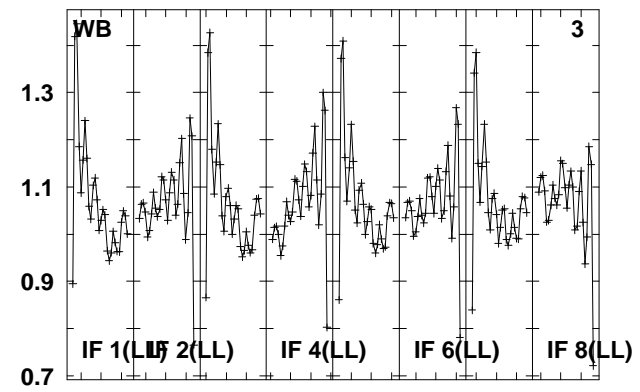
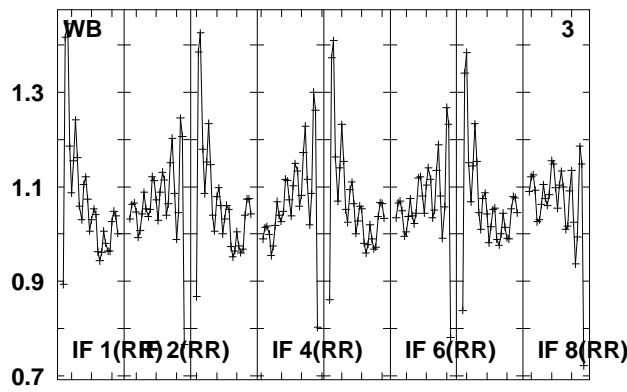
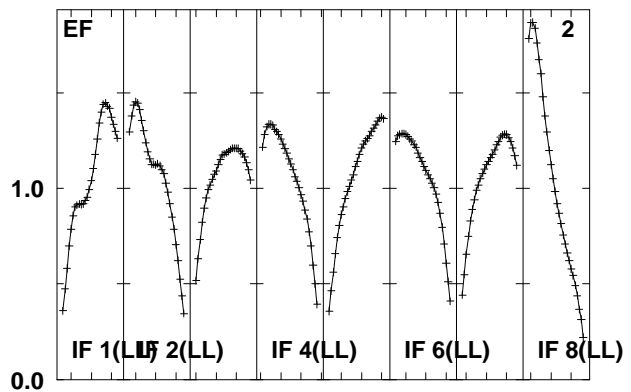
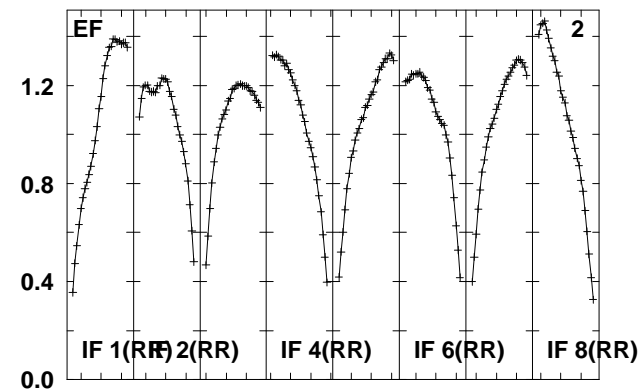
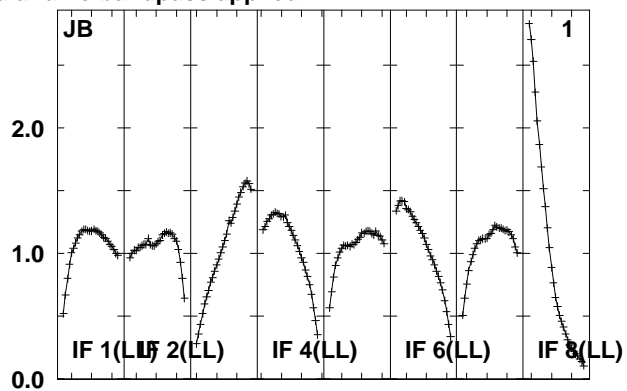
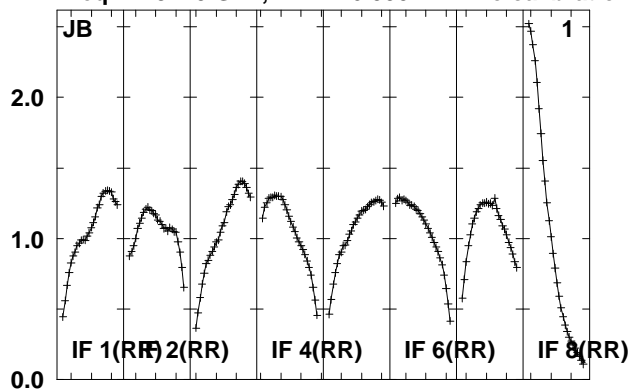

Lower frame: Real Jy
Total-power spectrum Antenna: *
Timerange: 00/22:43:31 to 00/22:46:59

Plot file version 26 created 24-AUG-2010 08:02:25

IRAS1929 EP064M.UVDATA.1

Freq = 4.9270 GHz, Bw = 16.000 MH No calibration applied and no bandpass applied

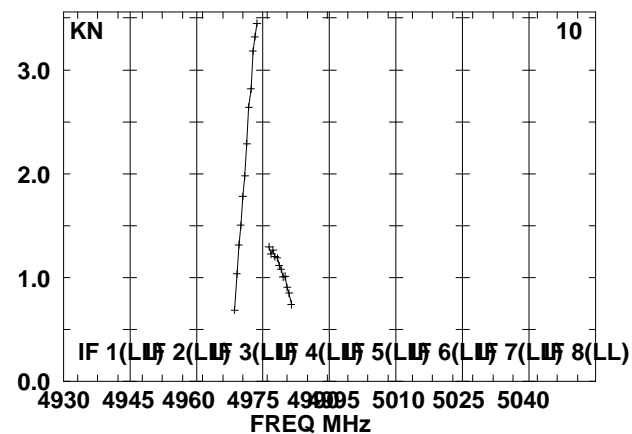
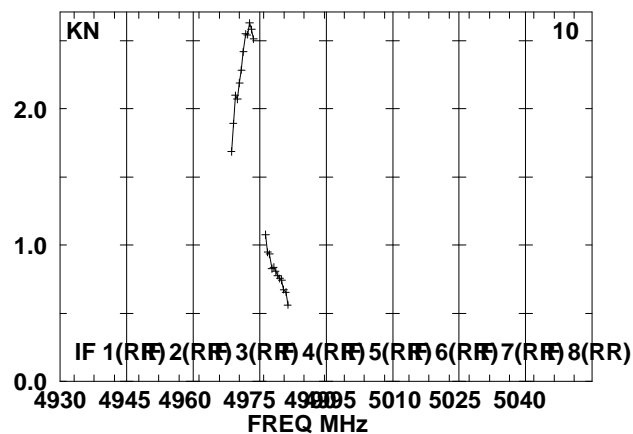
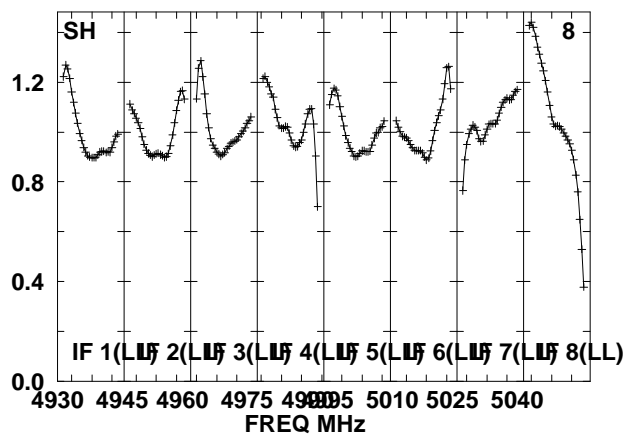
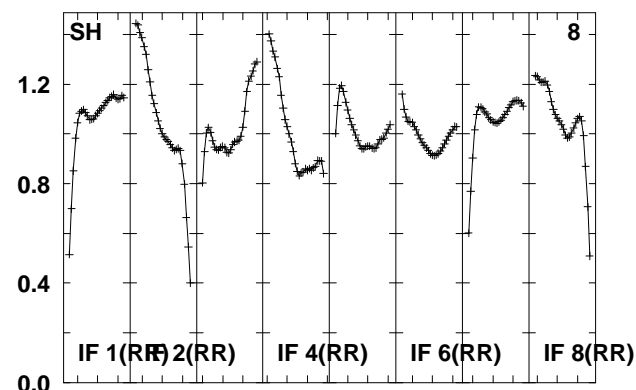
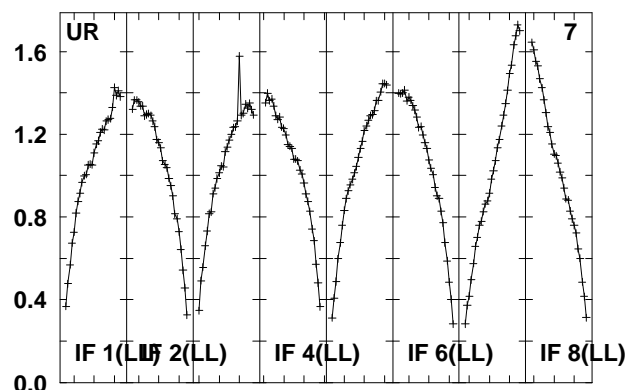
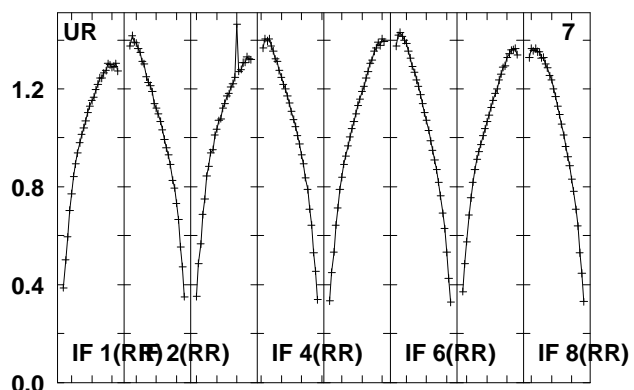
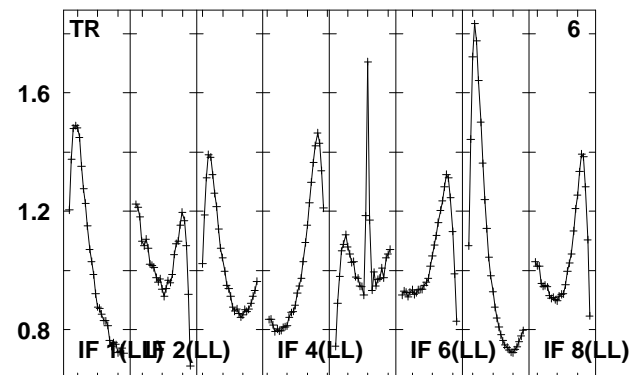
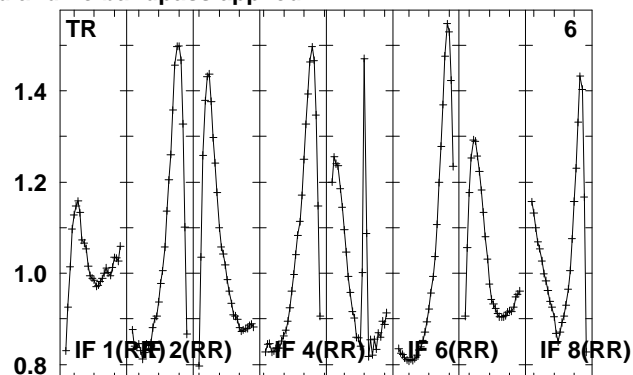
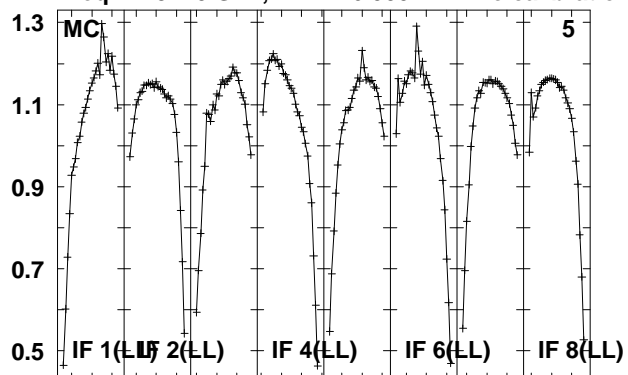

Lower frame: Real Jy

Total-power spectrum Antenna: *

Timerange: 00/22:43:31 to 00/22:46:59

Plot file version 27 created 24-AUG-2010 08:02:26

IRAS1929 EP064M.UVDATA.1

Freq = 4.9270 GHz, Bw = 16.000 MH No calibration applied and no bandpass applied

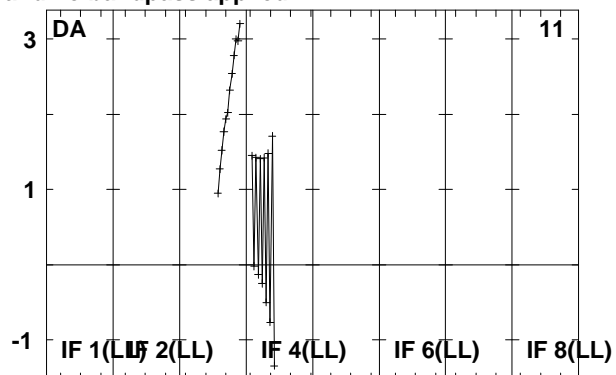
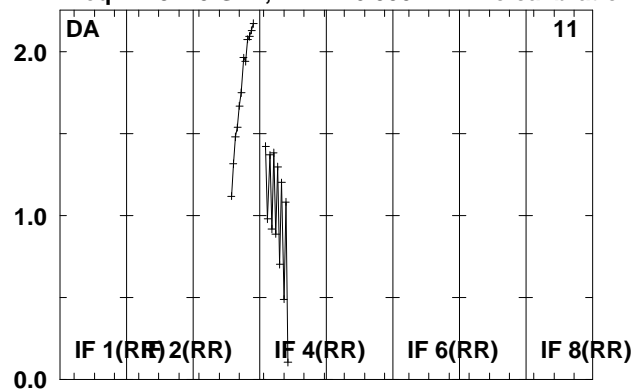

Lower frame: Real Jy
Total-power spectrum Antenna: *
Timerange: 00/22:43:31 to 00/22:46:59

Plot file version 28 created 24-AUG-2010 08:02:26

J1941-05 EP064M.UVDATA.1

Freq = 4.9270 GHz, Bw = 16.000 MH No calibration applied and no bandpass applied

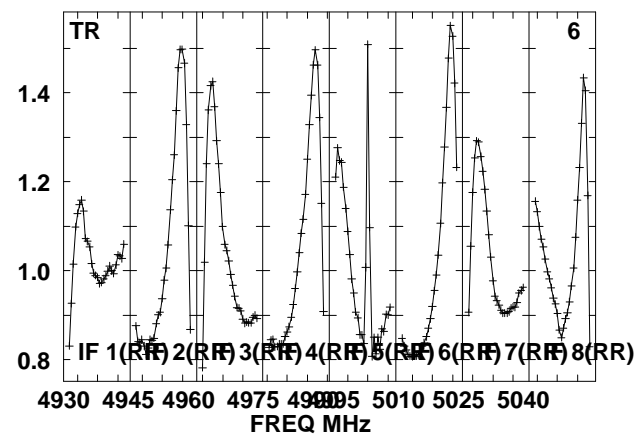
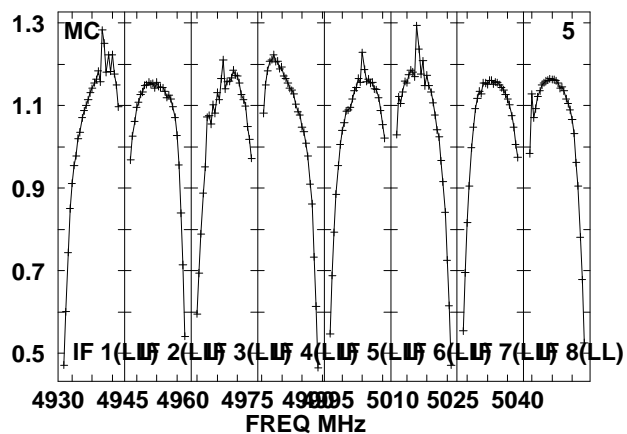
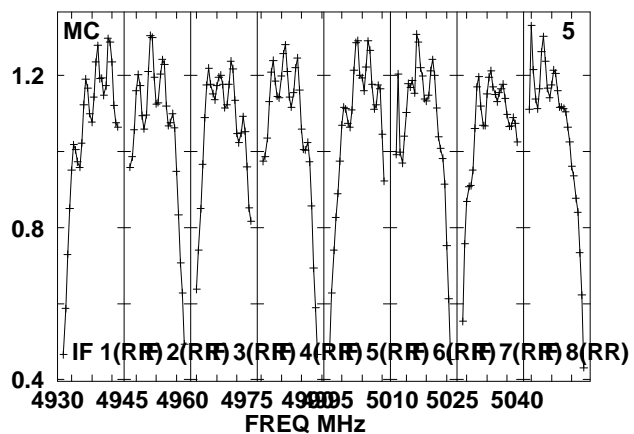
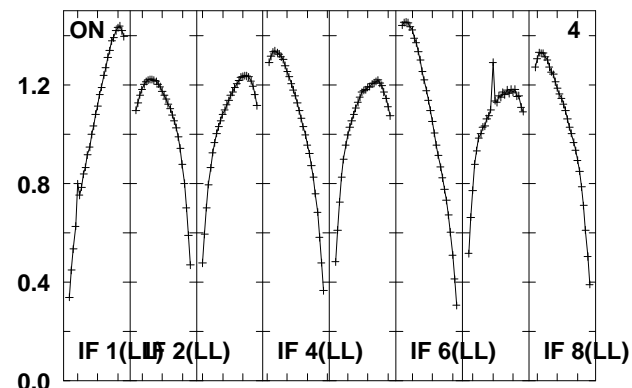
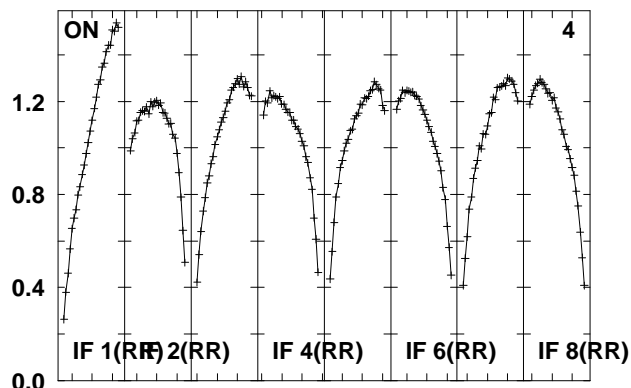
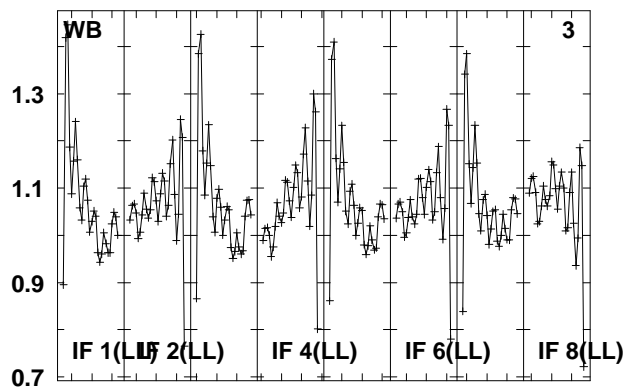
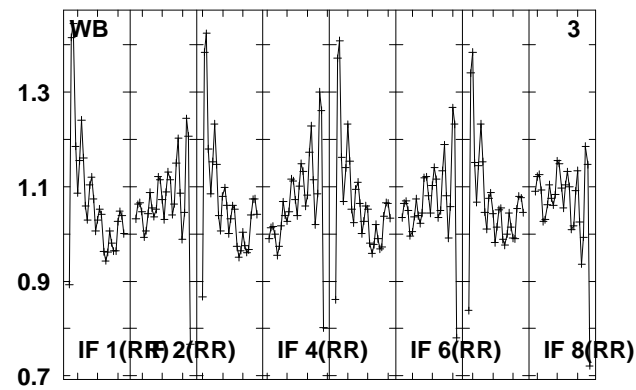
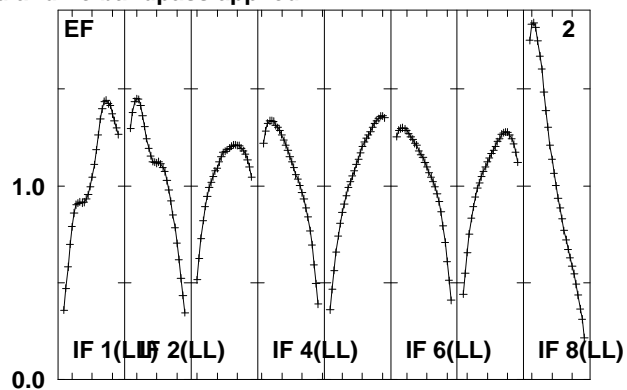
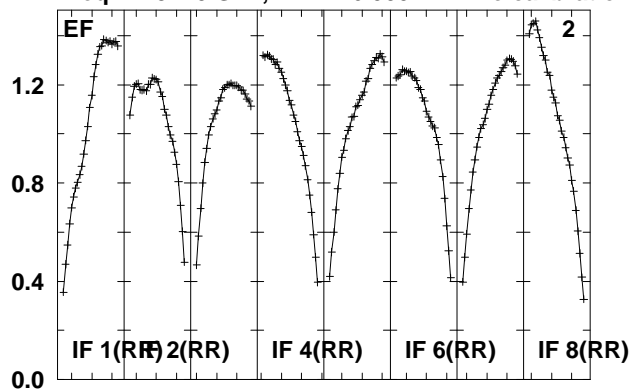

Lower frame: Real Jy

Total-power spectrum Antenna: *

Timerange: 00/22:47:01 to 00/22:48:29

Plot file version 29 created 24-AUG-2010 08:02:26

J1941-05 EP064M.UVDATA.1

Freq = 4.9270 GHz, Bw = 16.000 MH No calibration applied and no bandpass applied

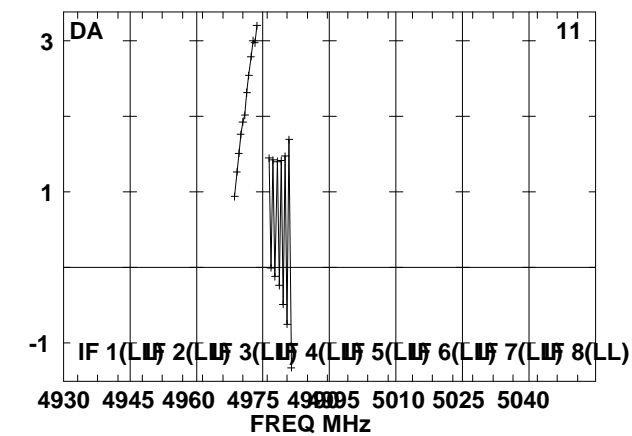
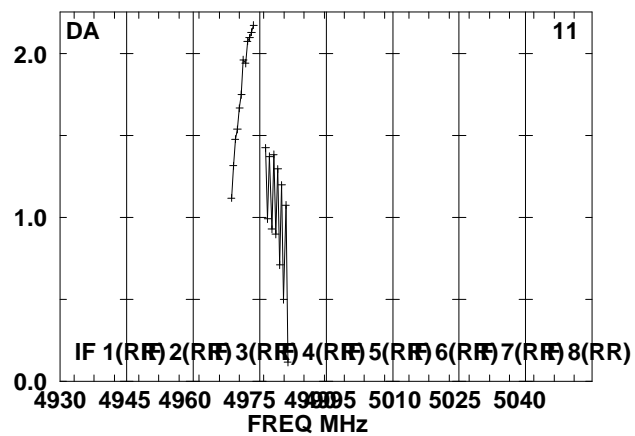
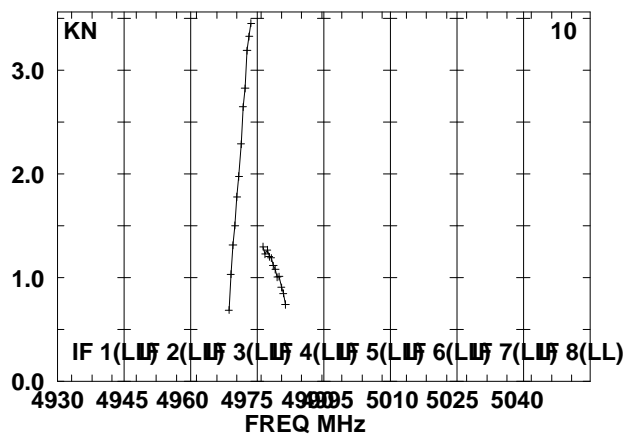
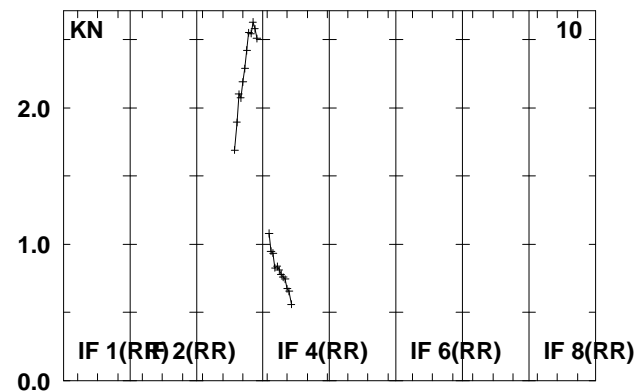
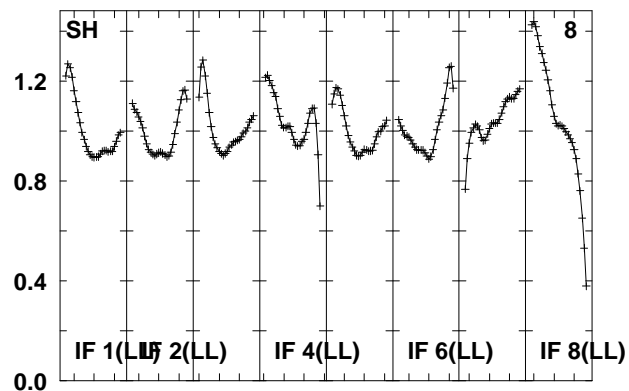
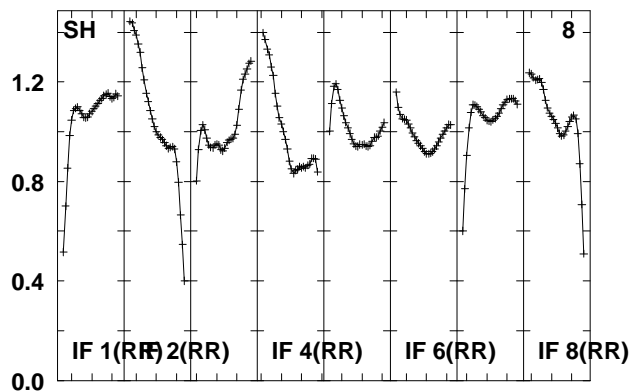
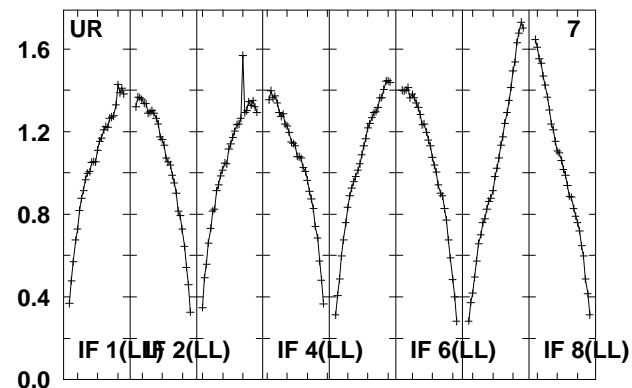
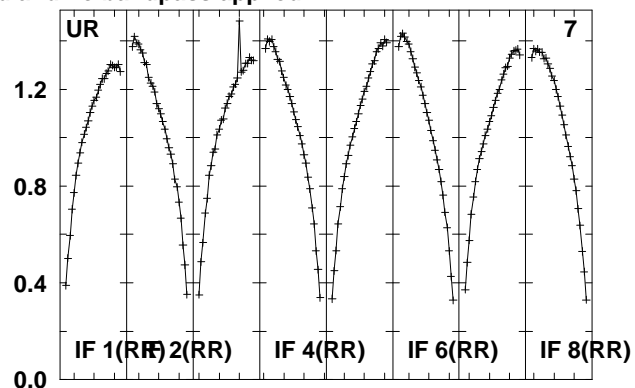
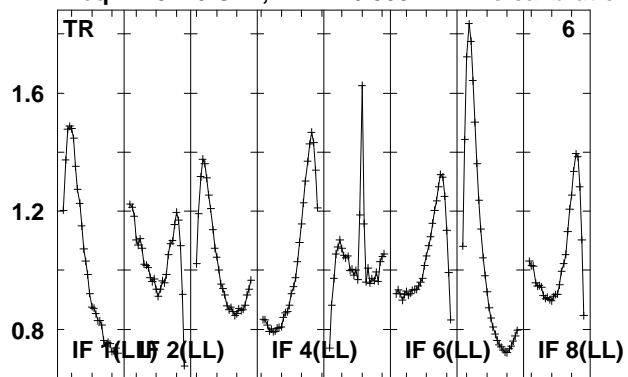

Lower frame: Real Jy
Total-power spectrum Antenna: *
Timerange: 00/22:47:01 to 00/22:48:29

Plot file version 30 created 24-AUG-2010 08:02:26

IRAS1929 EP064M.UVDATA.1

Freq = 4.9270 GHz, Bw = 16.000 MH No calibration applied and no bandpass applied

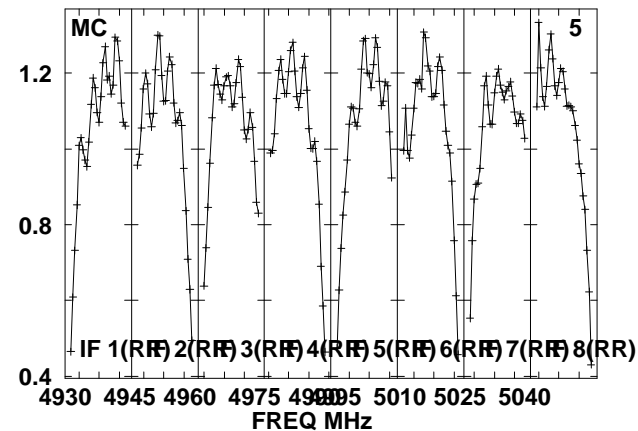
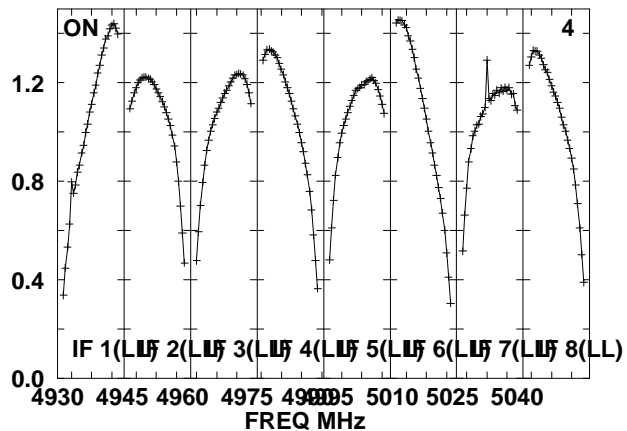
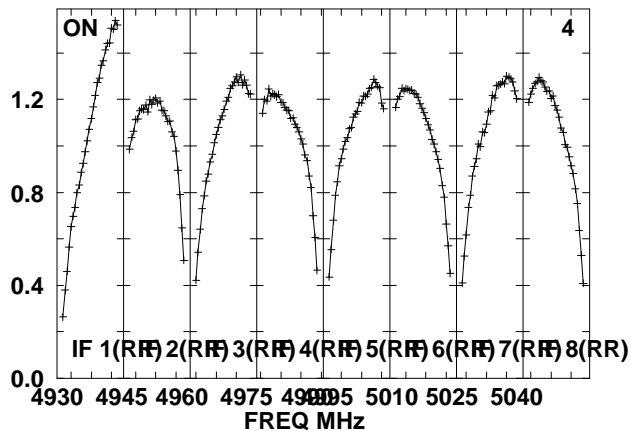
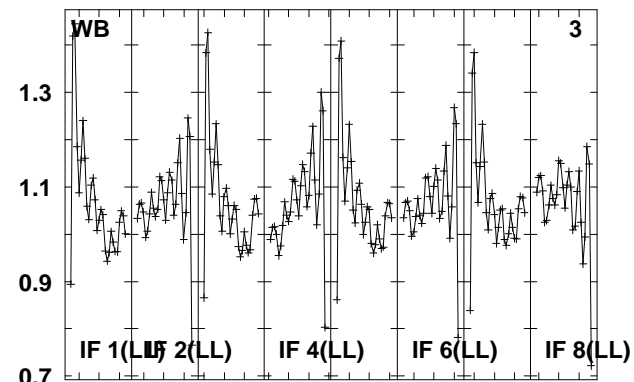
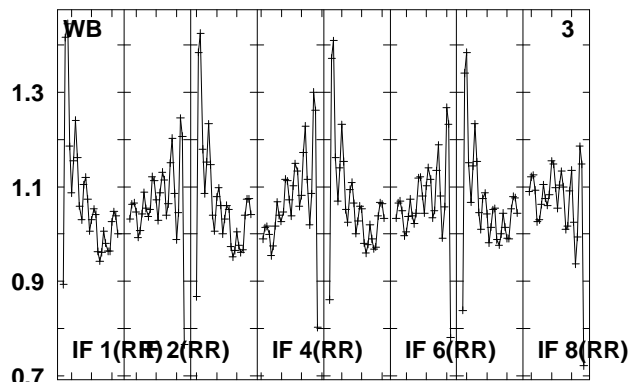
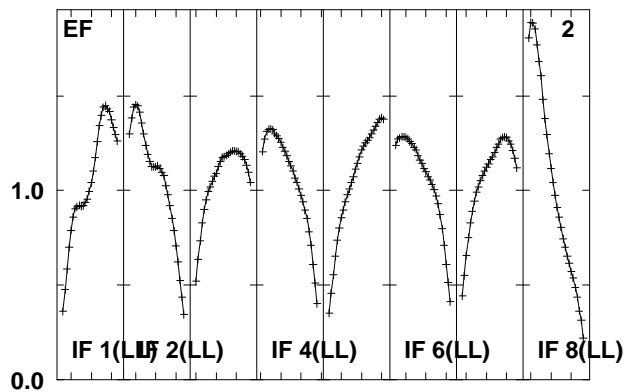
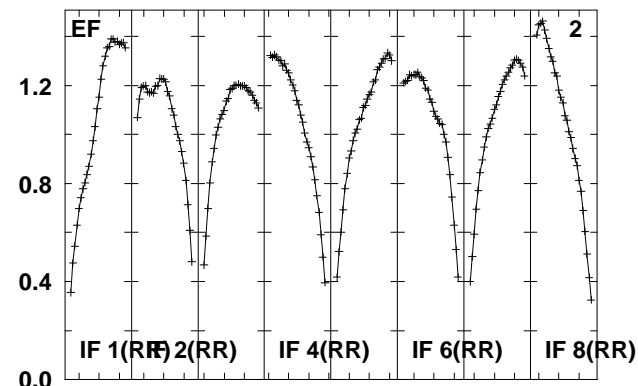
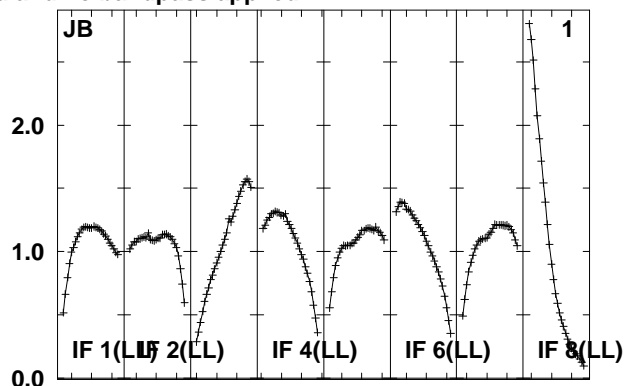
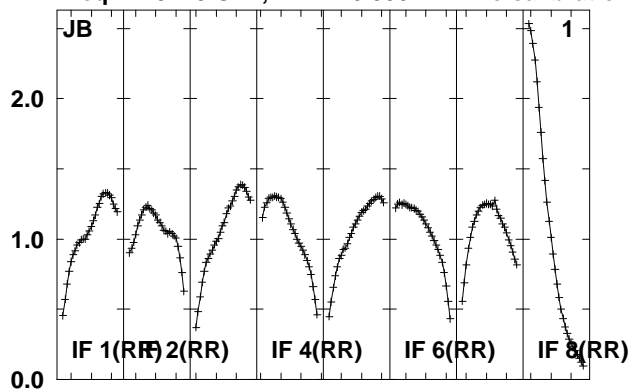

Lower frame: Real Jy

Total-power spectrum Antenna: *

Timerange: 00/22:48:31 to 00/22:51:59

Plot file version 31 created 24-AUG-2010 08:02:27

IRAS1929 EP064M.UVDATA.1

Freq = 4.9270 GHz, Bw = 16.000 MH No calibration applied and no bandpass applied

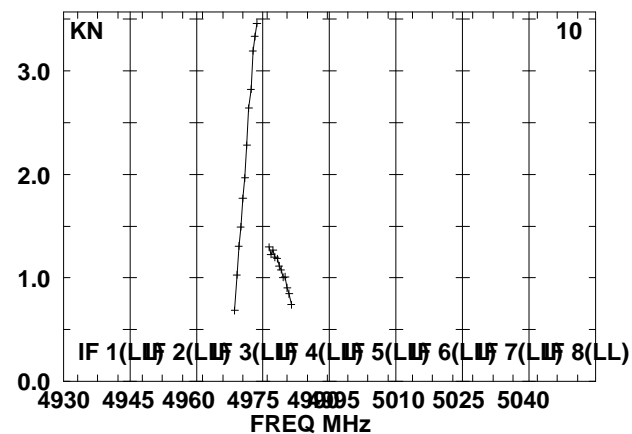
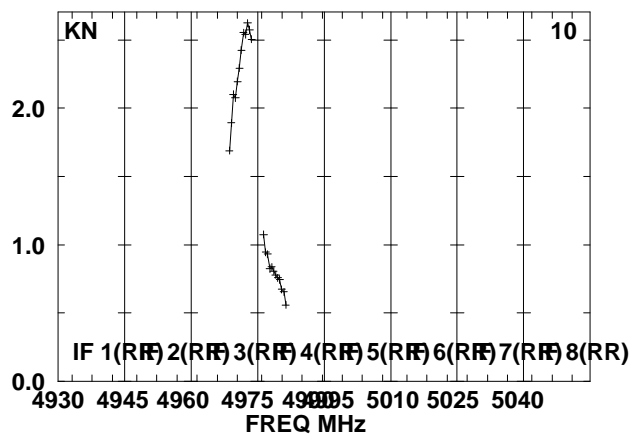
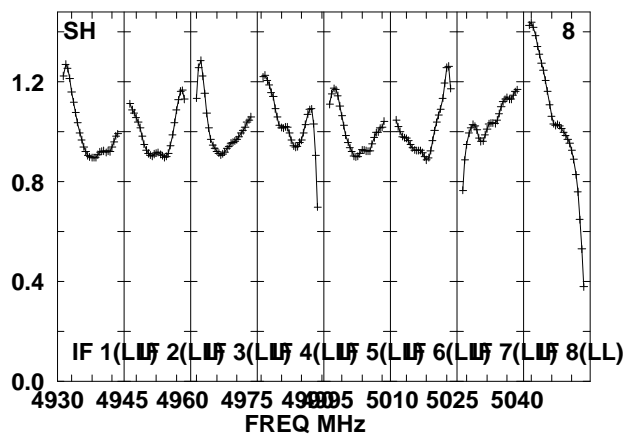
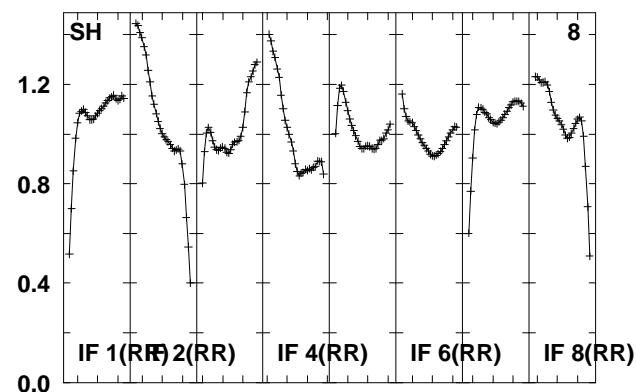
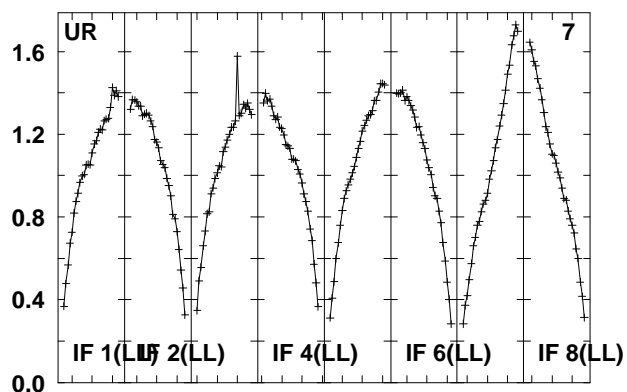
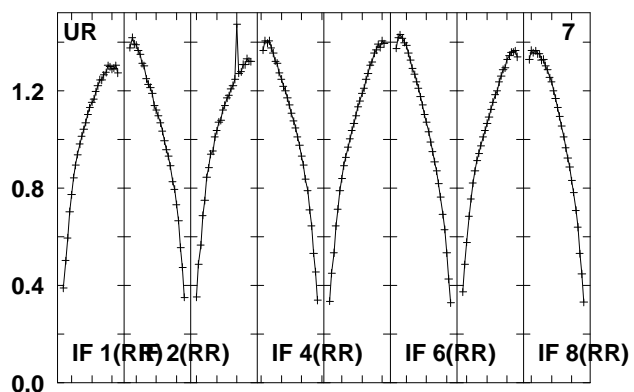
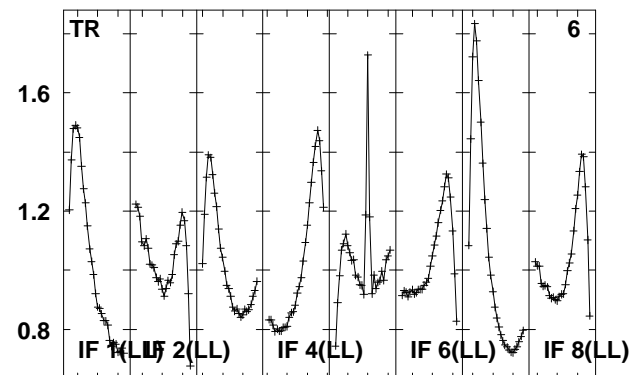
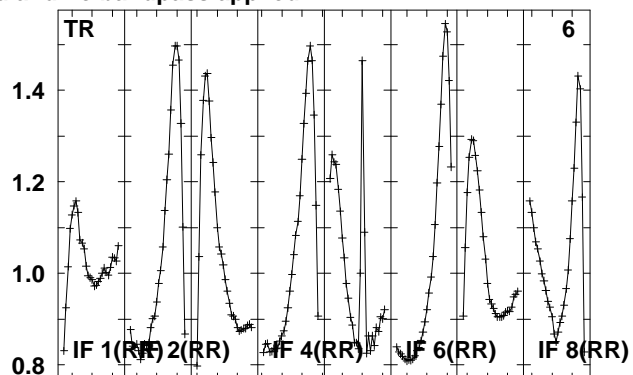
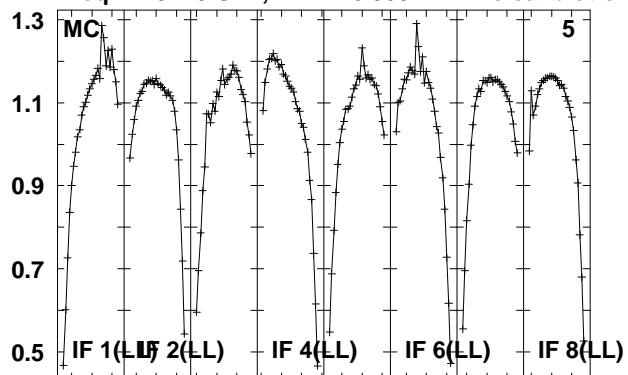

Lower frame: Real Jy
Total-power spectrum Antenna: *
Timerange: 00/22:48:31 to 00/22:51:59

Plot file version 32 created 24-AUG-2010 08:02:28

IRAS1929 EP064M.UVDATA.1

Freq = 4.9270 GHz, Bw = 16.000 MH No calibration applied and no bandpass applied

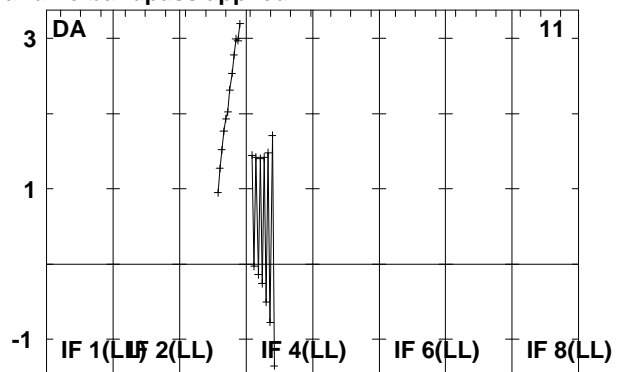
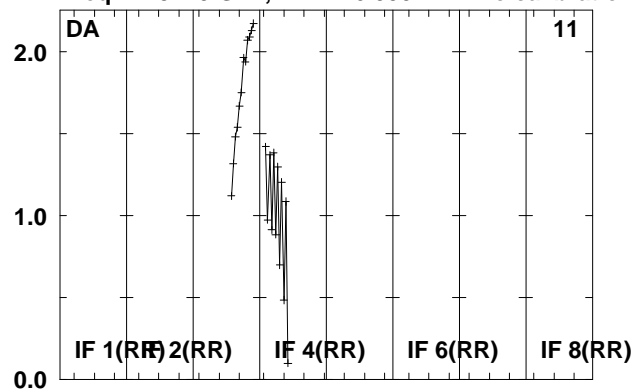

Lower frame: Real Jy
Total-power spectrum Antenna: *
Timerange: 00/22:48:31 to 00/22:51:59

Plot file version 33 created 24-AUG-2010 08:02:28

J1941-05 EP064M.UVDATA.1

Freq = 4.9270 GHz, Bw = 16.000 MH No calibration applied and no bandpass applied

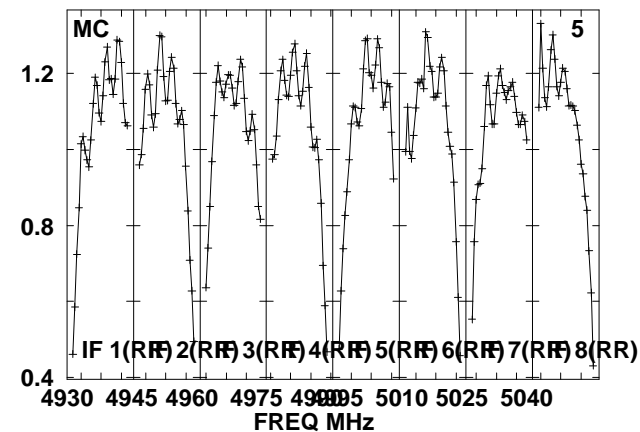
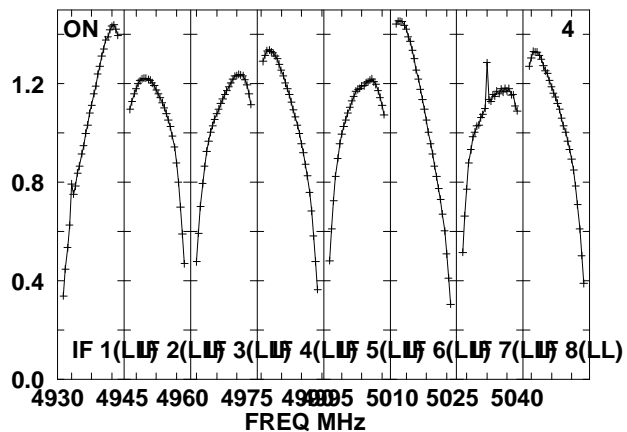
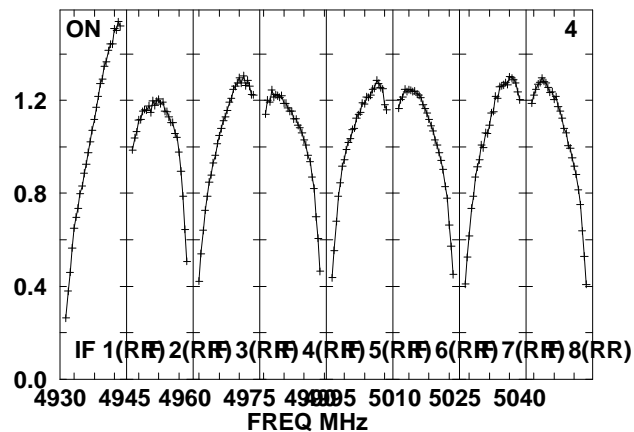
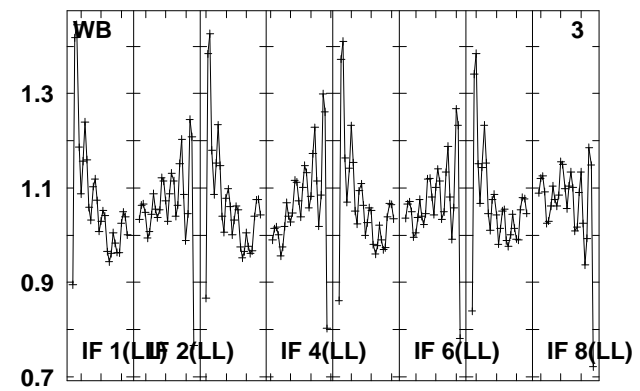
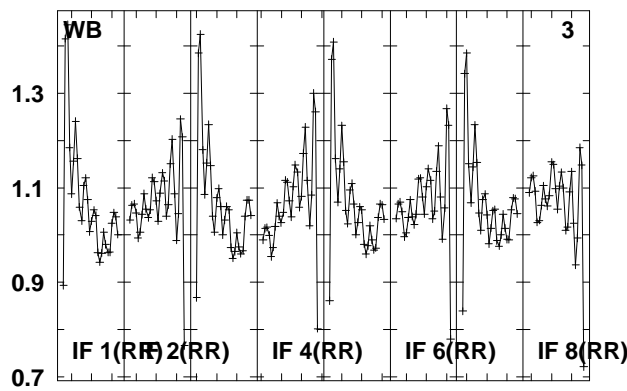
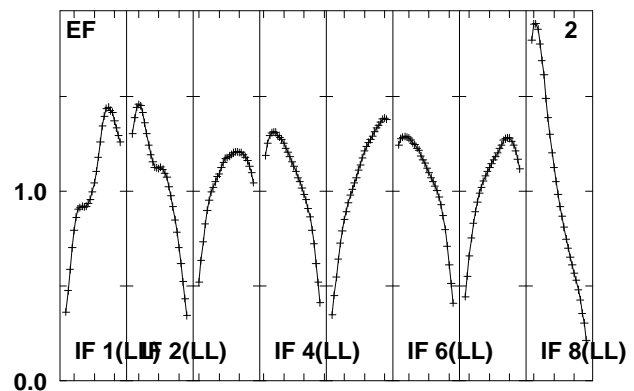
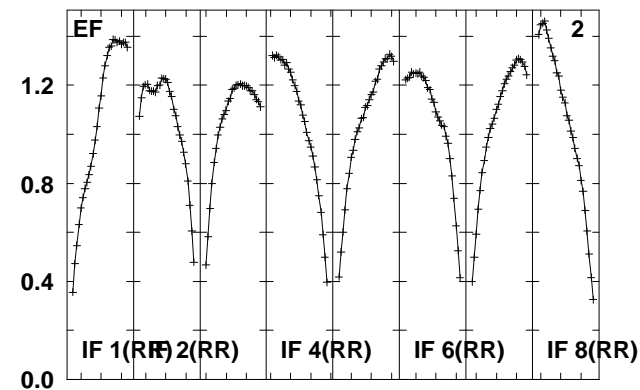
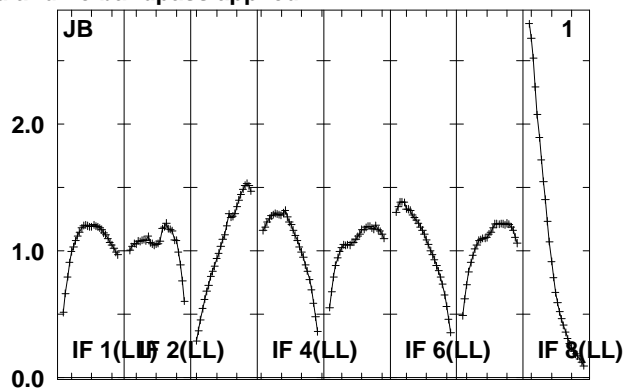
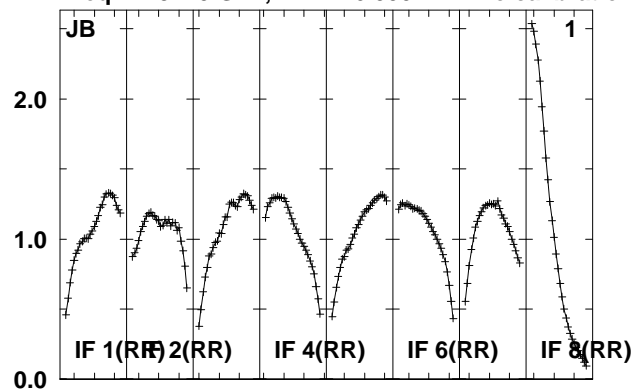

Lower frame: Real Jy
Total-power spectrum Antenna: *
Timerange: 00/22:52:01 to 00/22:53:29

Plot file version 34 created 24-AUG-2010 08:02:28

J1941-05 EP064M.UVDATA.1

Freq = 4.9270 GHz, Bw = 16.000 MH No calibration applied and no bandpass applied

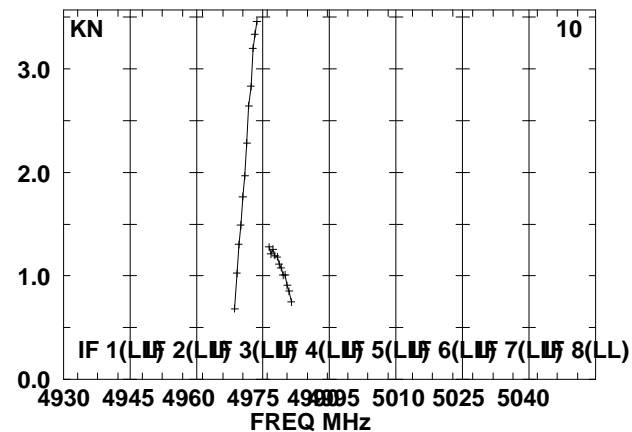
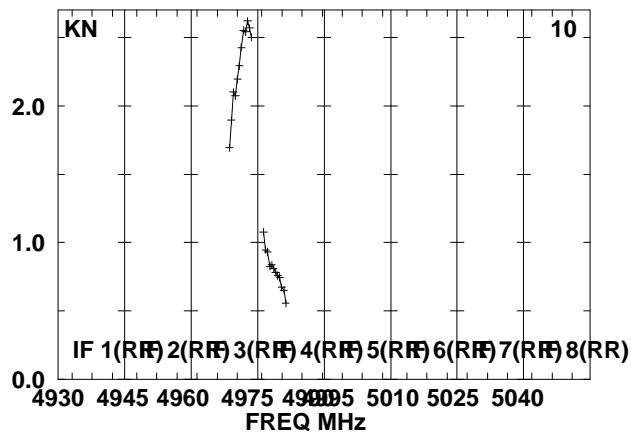
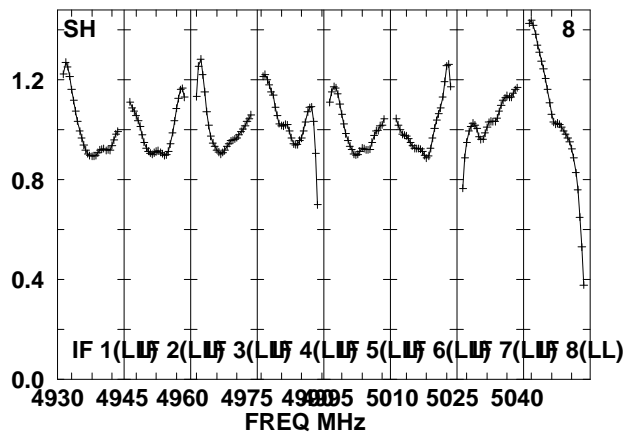
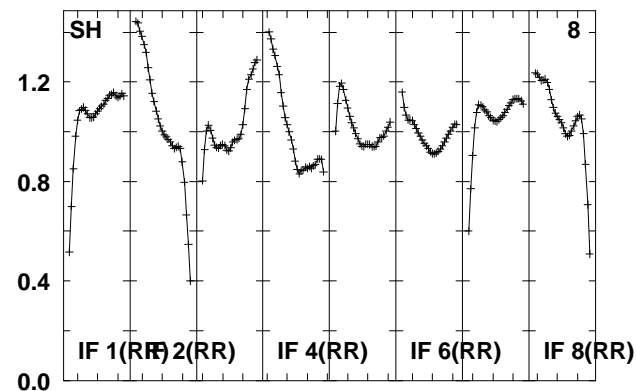
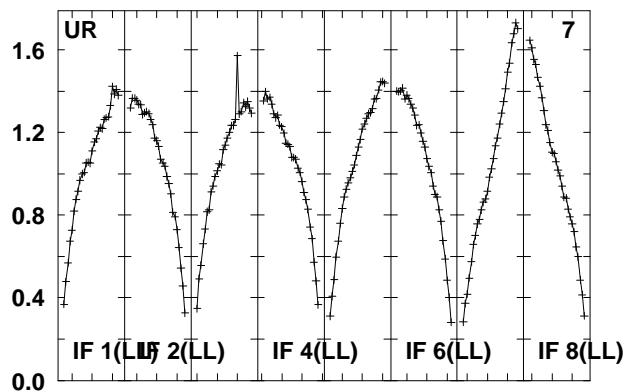
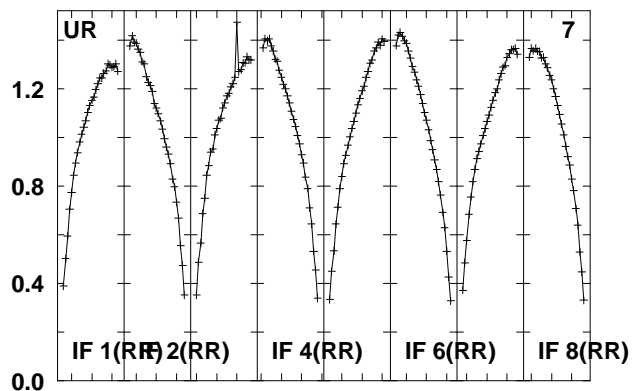
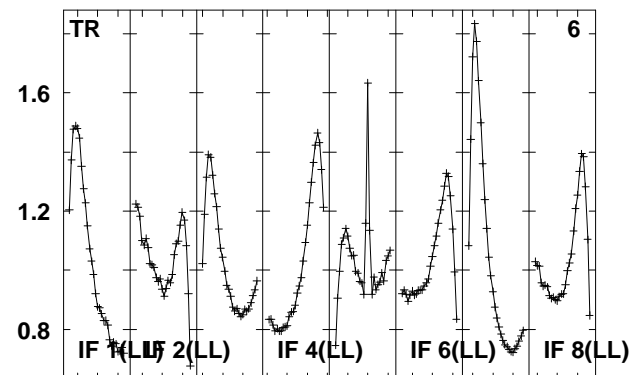
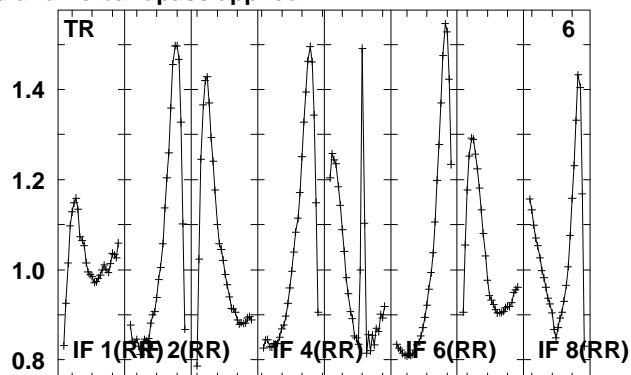
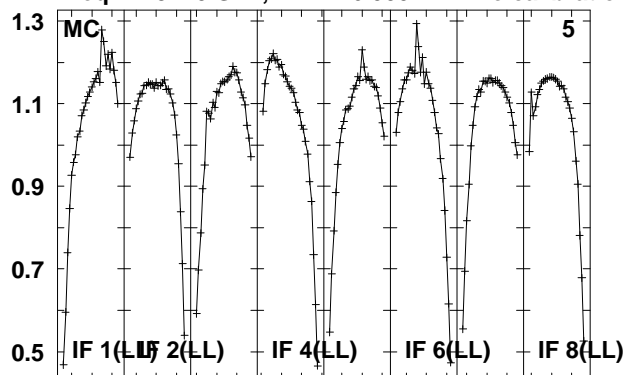

Lower frame: Real Jy
Total-power spectrum Antenna: *
Timerange: 00/22:52:01 to 00/22:53:29

Plot file version 35 created 24-AUG-2010 08:02:28

J1941-05 EP064M.UVDATA.1

Freq = 4.9270 GHz, Bw = 16.000 MH No calibration applied and no bandpass applied

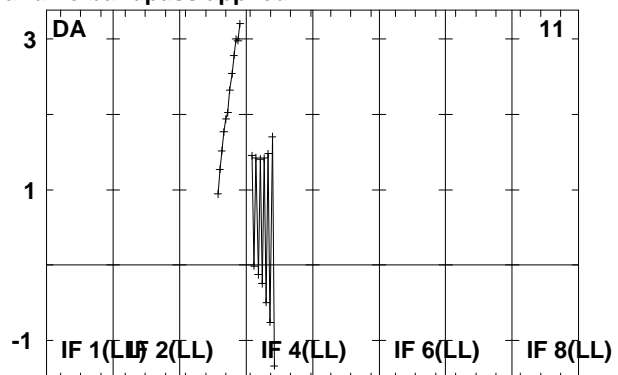
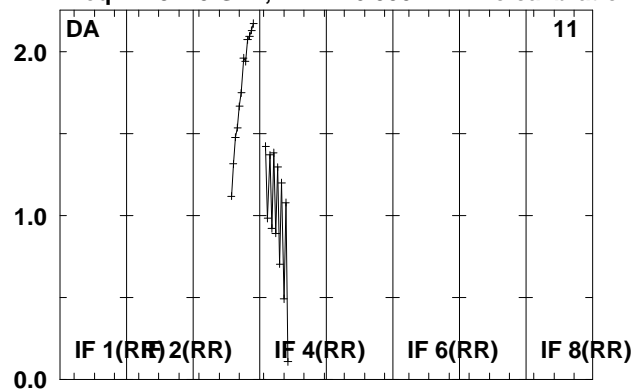

Lower frame: Real Jy
Total-power spectrum Antenna: *
Timerange: 00/22:52:01 to 00/22:53:29

Plot file version 36 created 24-AUG-2010 08:02:29

IRAS1929 EP064M.UVDATA.1

Freq = 4.9270 GHz, Bw = 16.000 MH No calibration applied and no bandpass applied

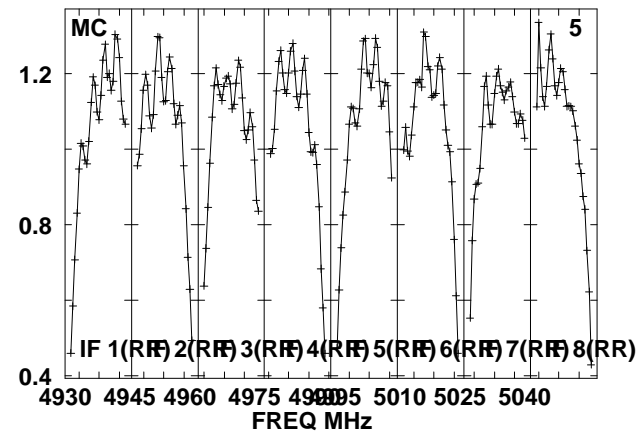
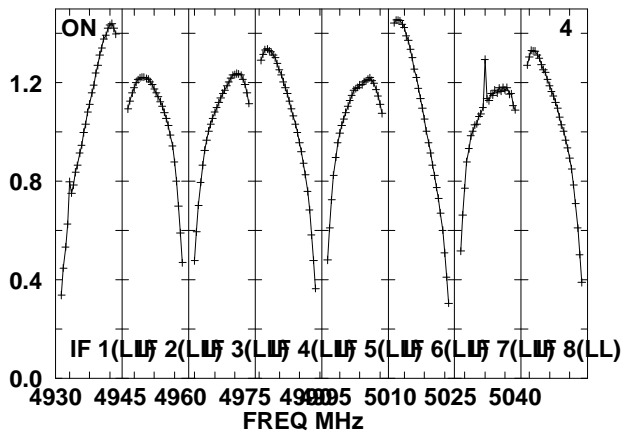
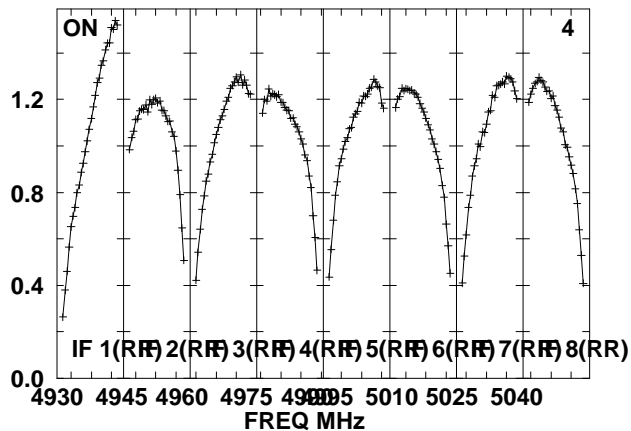
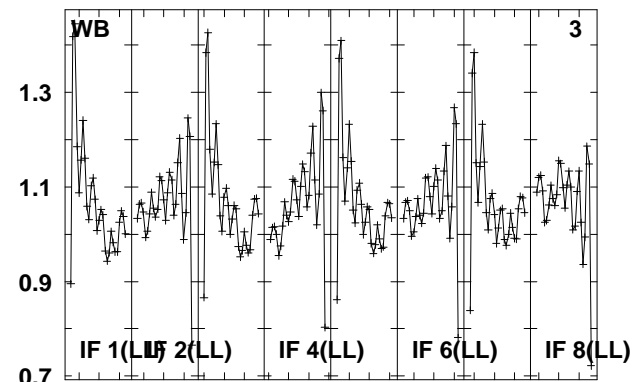
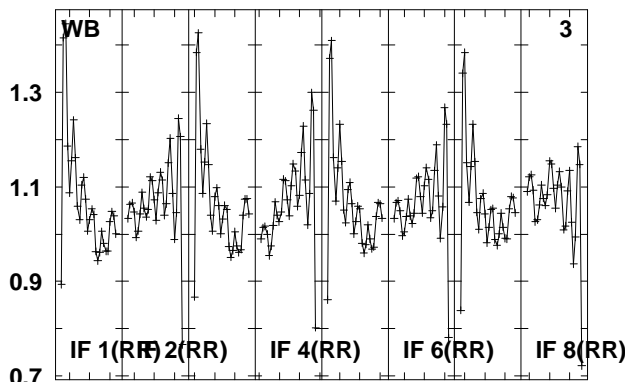
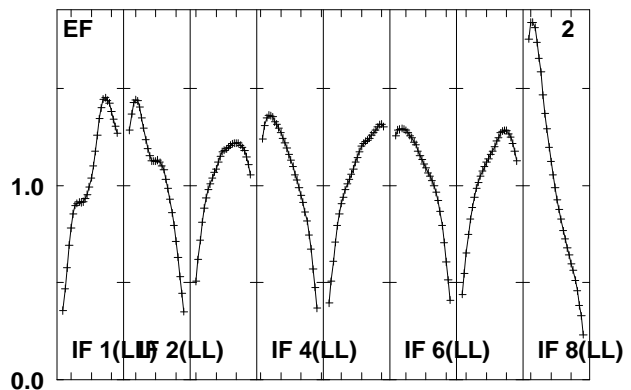
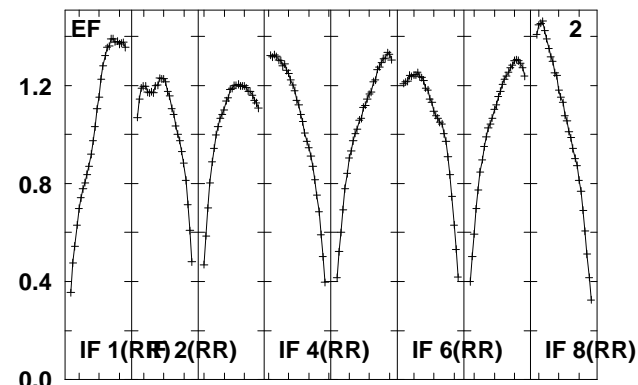
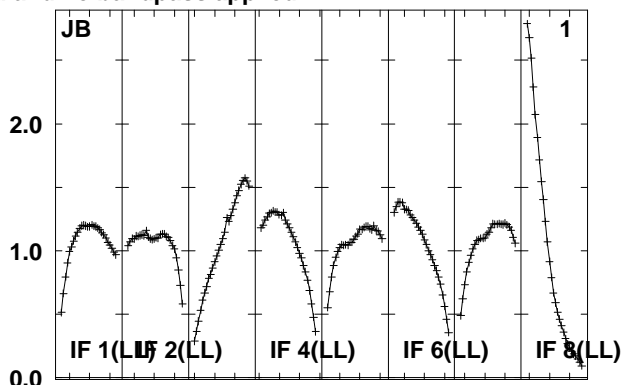
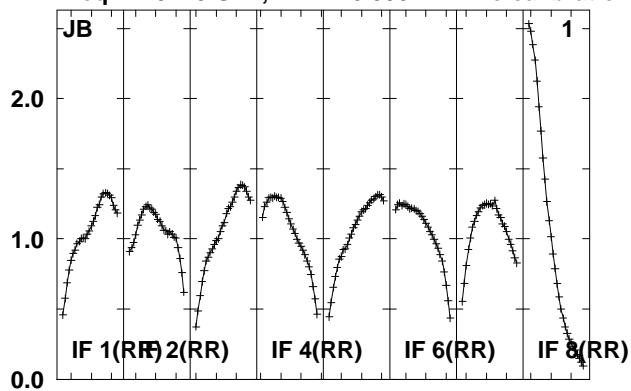

Lower frame: Real Jy
Total-power spectrum Antenna: *
Timerange: 00/22:53:31 to 00/22:56:59

Plot file version 37 created 24-AUG-2010 08:02:29

IRAS1929 EP064M.UVDATA.1

Freq = 4.9270 GHz, Bw = 16.000 MH No calibration applied and no bandpass applied

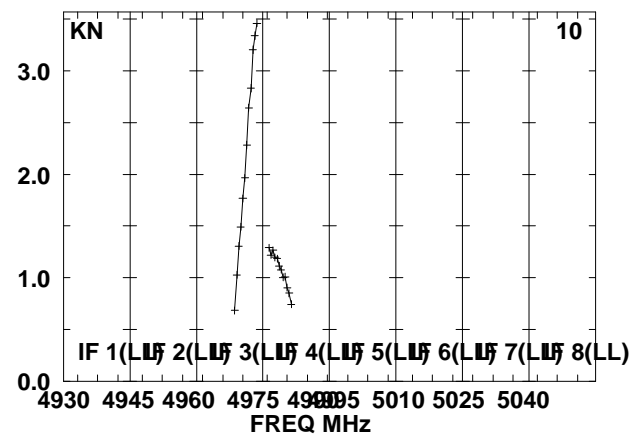
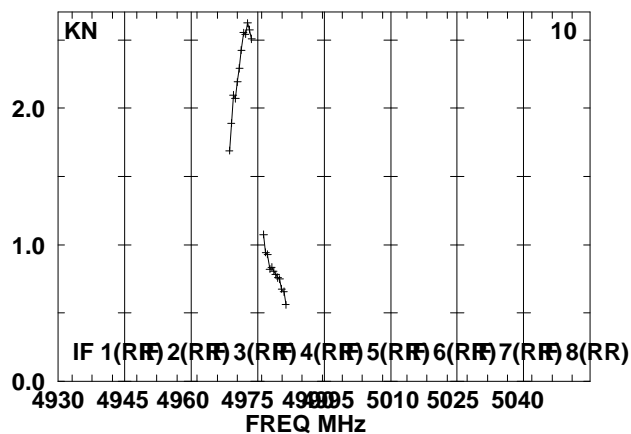
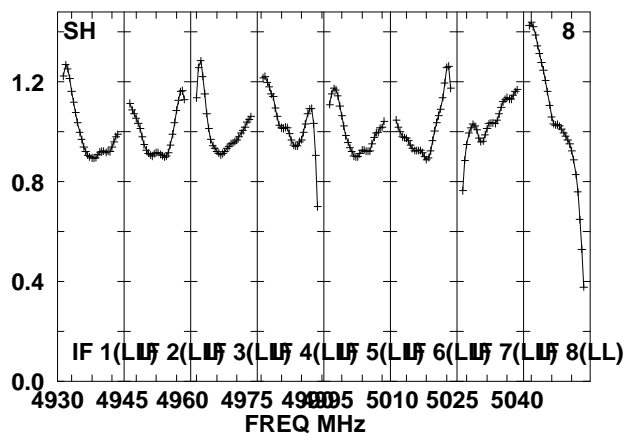
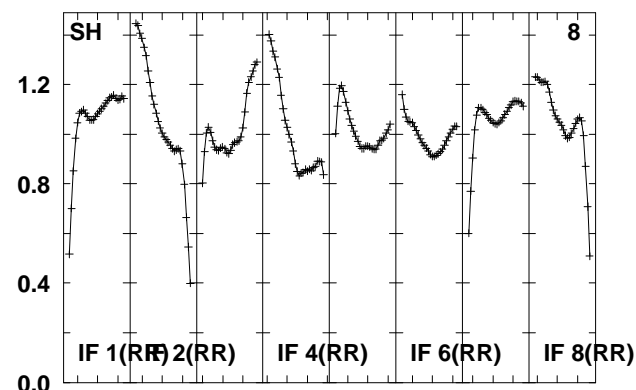
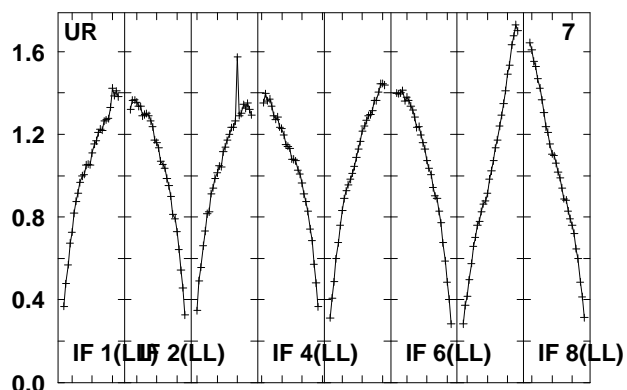
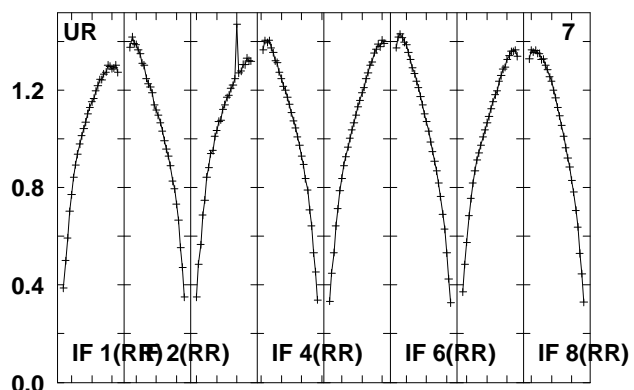
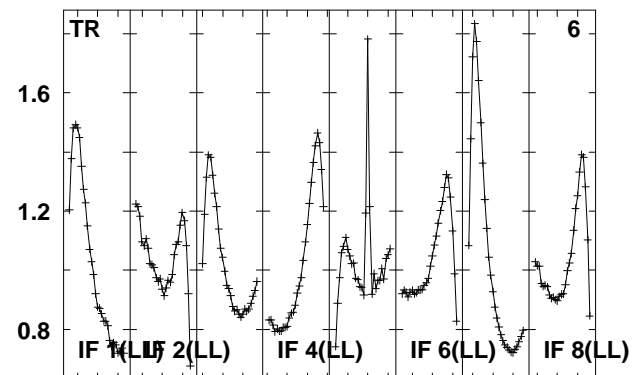
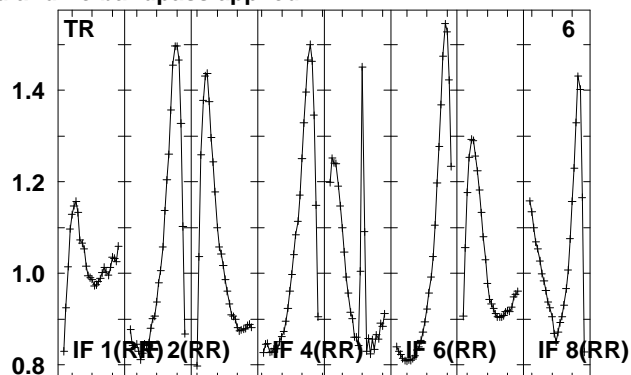
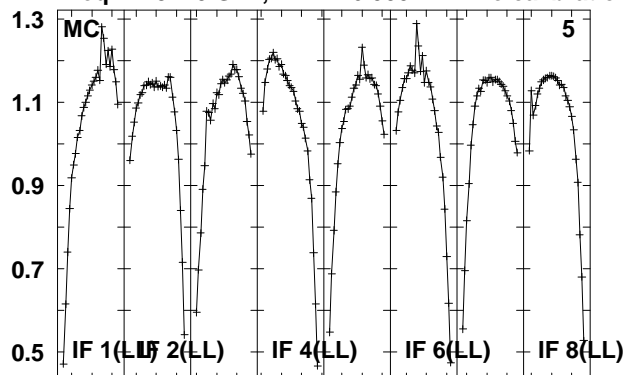

Lower frame: Real Jy

Total-power spectrum Antenna: *

Timerange: 00/22:53:31 to 00/22:56:59

Plot file version 38 created 24-AUG-2010 08:02:30

IRAS1929 EP064M.UVDATA.1

Freq = 4.9270 GHz, Bw = 16.000 MH No calibration applied and no bandpass applied

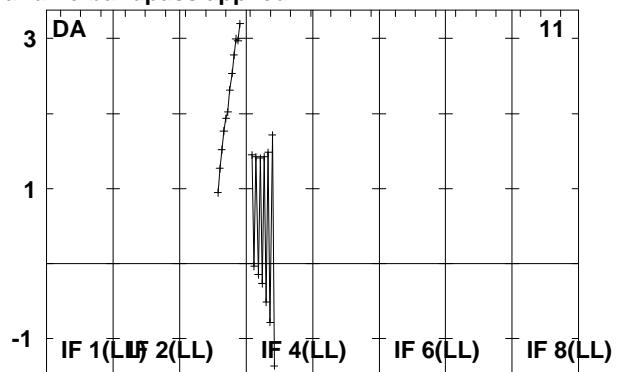
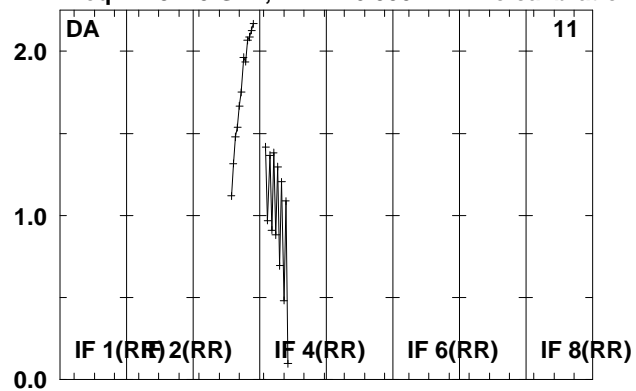

Lower frame: Real Jy
Total-power spectrum Antenna: *
Timerange: 00/22:53:31 to 00/22:56:59

Plot file version 39 created 24-AUG-2010 08:02:30

J1941-05 EP064M.UVDATA.1

Freq = 4.9270 GHz, Bw = 16.000 MH No calibration applied and no bandpass applied

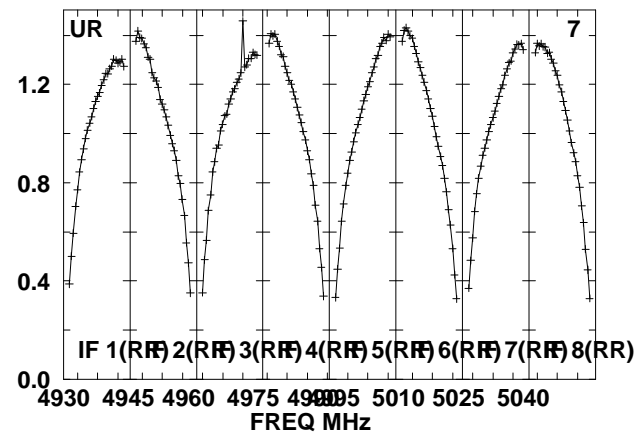
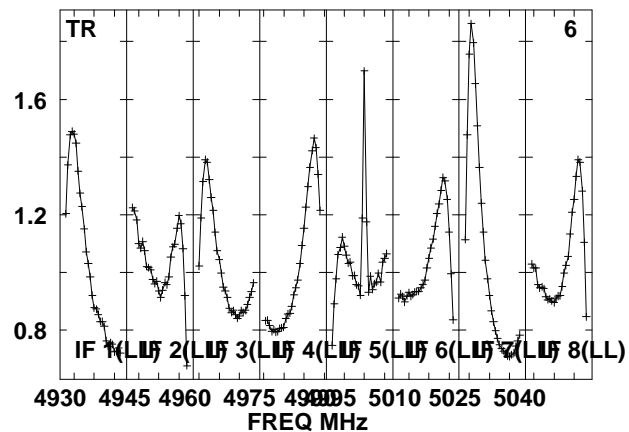
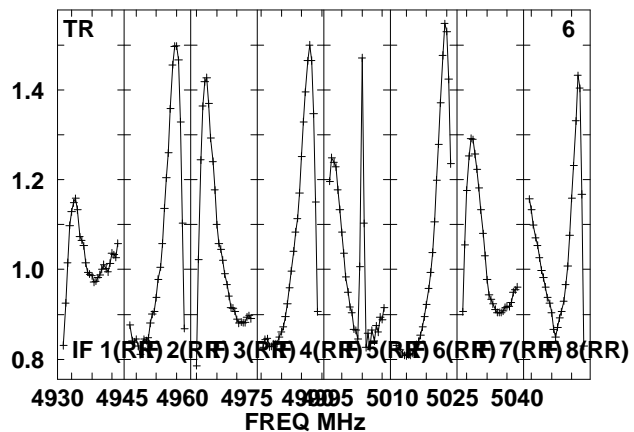
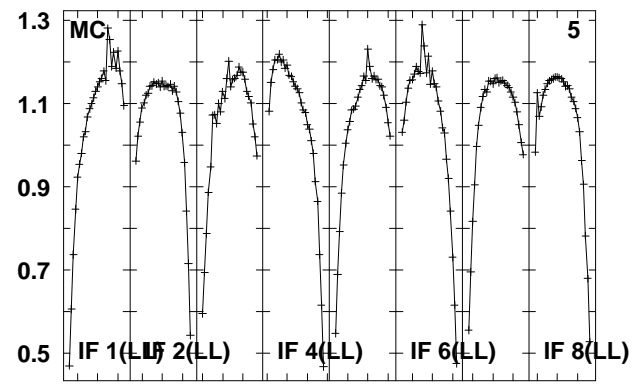
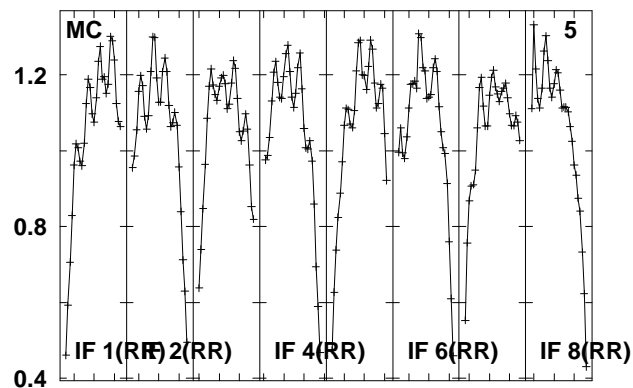
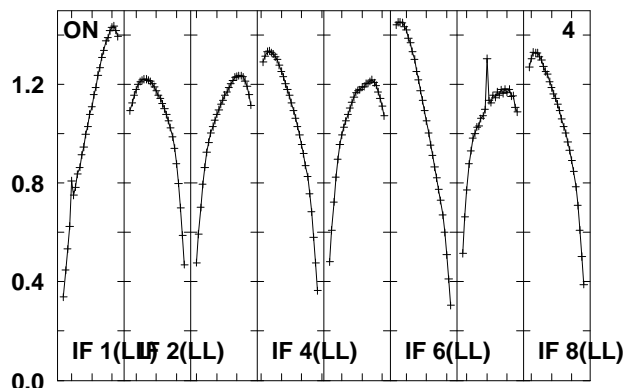
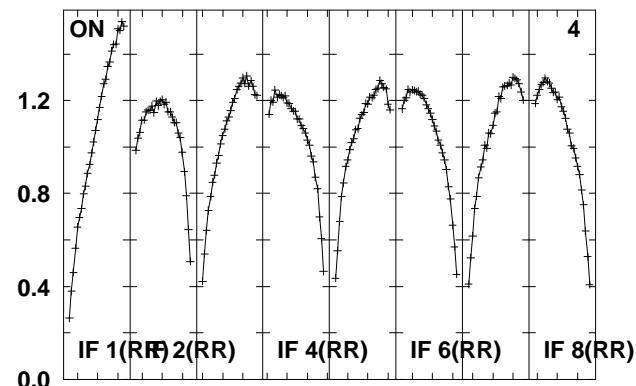
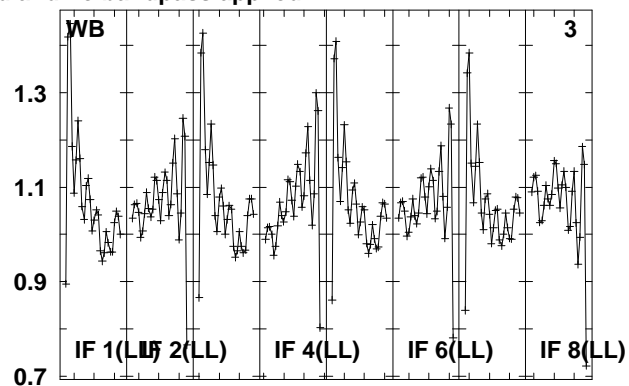
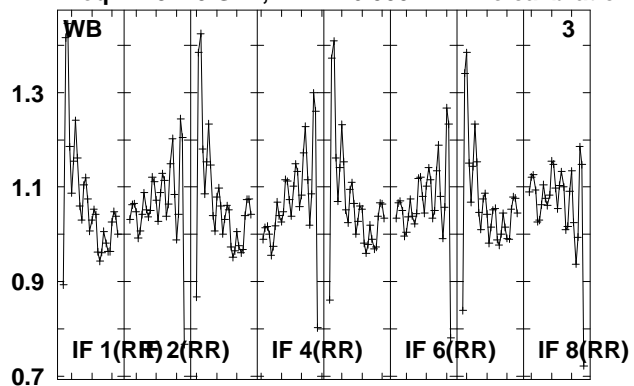

Lower frame: Real Jy
Total-power spectrum Antenna: *
Timerange: 00/22:58:01 to 00/22:59:29

Plot file version 40 created 24-AUG-2010 08:02:30

J1941-05 EP064M.UVDATA.1

Freq = 4.9270 GHz, Bw = 16.000 MH No calibration applied and no bandpass applied

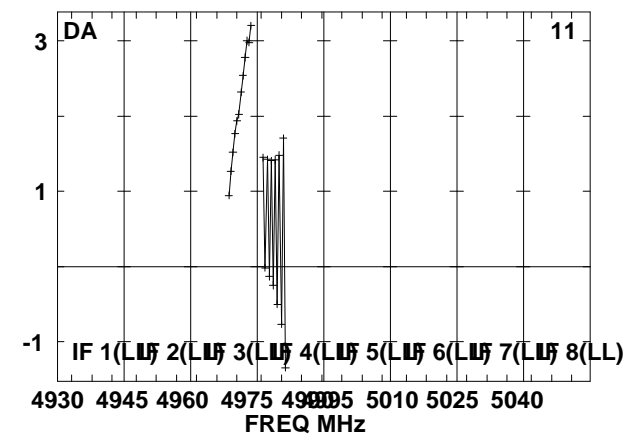
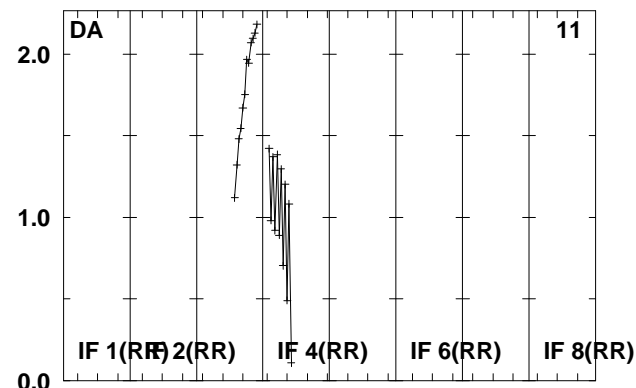
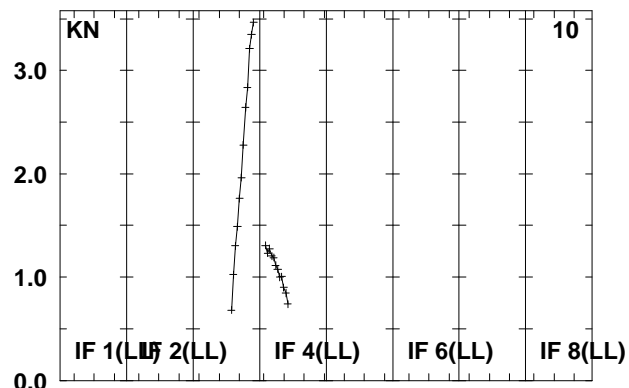
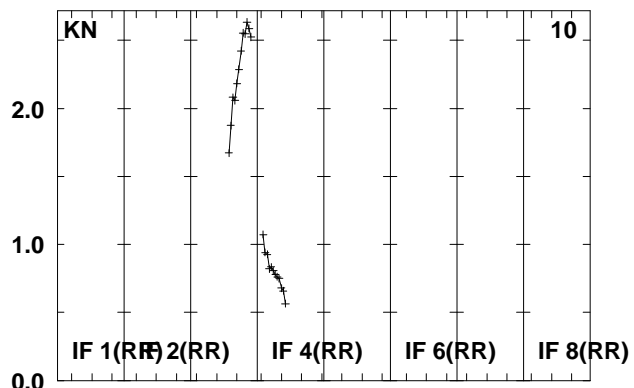
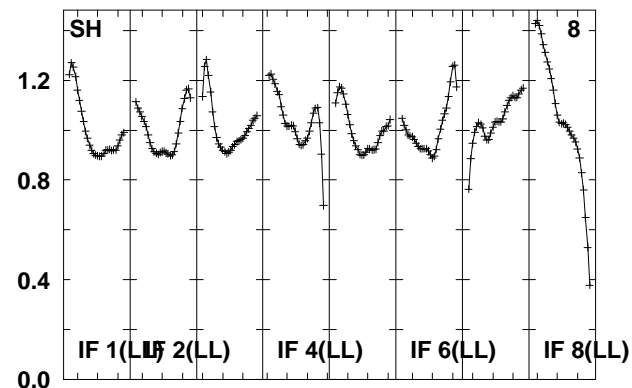
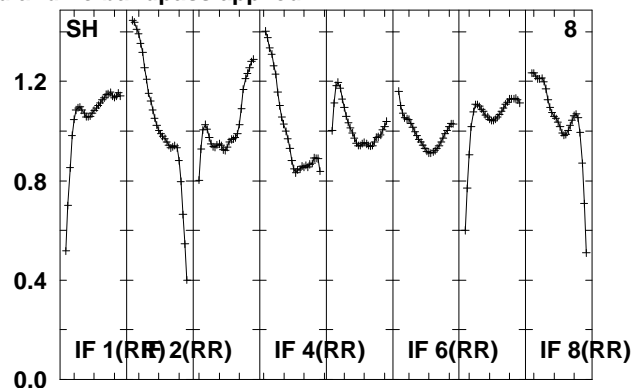
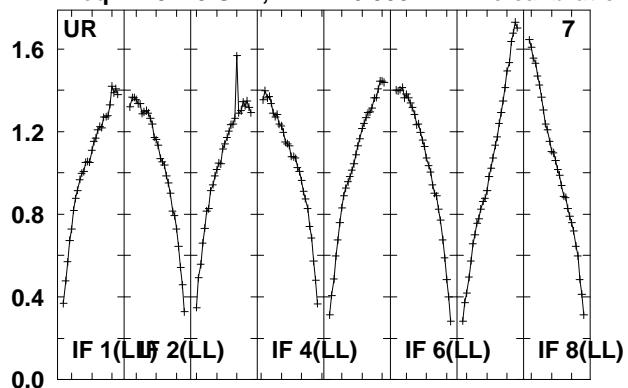

Lower frame: Real Jy

Total-power spectrum Antenna: *

Timerange: 00/22:58:01 to 00/22:59:29

Plot file version 41 created 24-AUG-2010 08:02:31

IRAS1929 EP064M.UVDATA.1

Freq = 4.9270 GHz, Bw = 16.000 MH No calibration applied and no bandpass applied

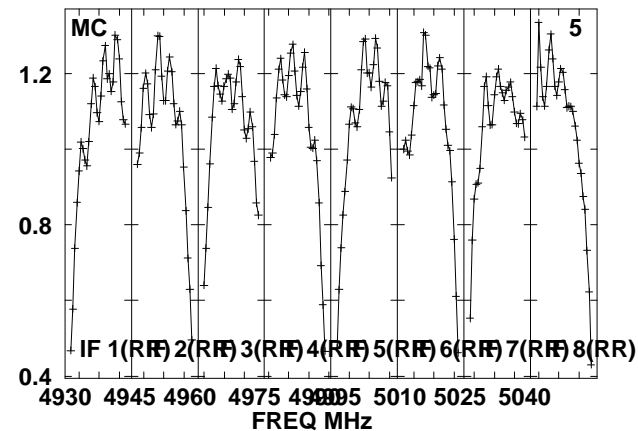
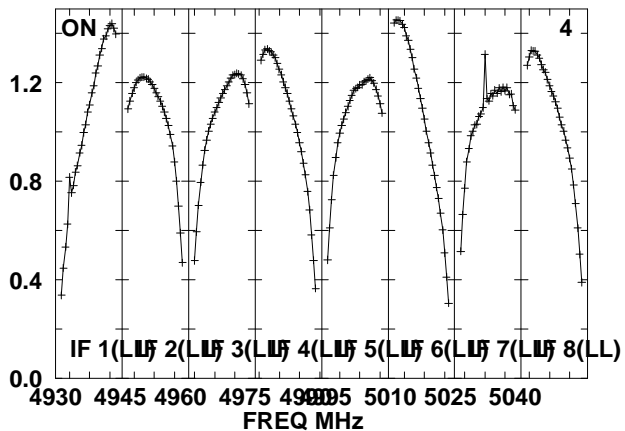
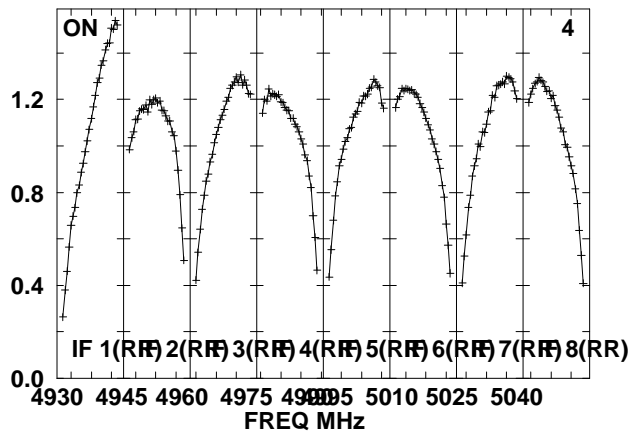
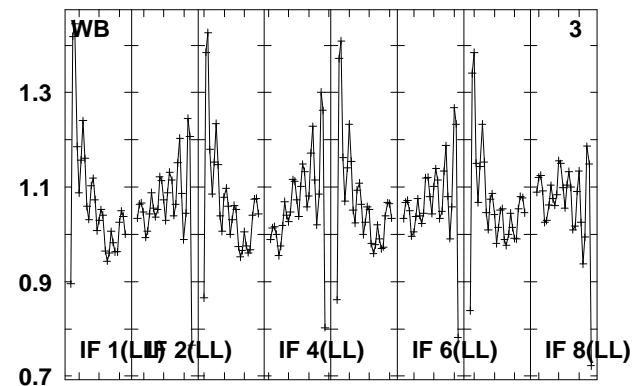
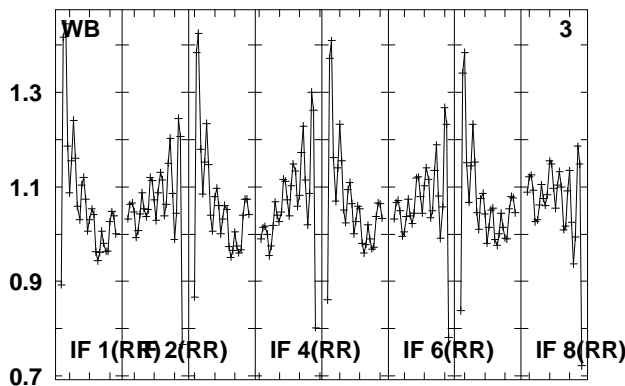
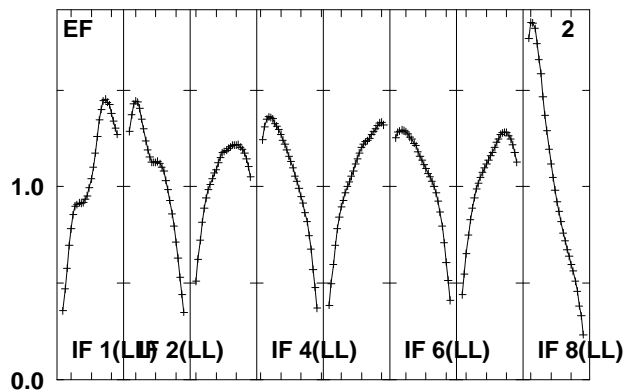
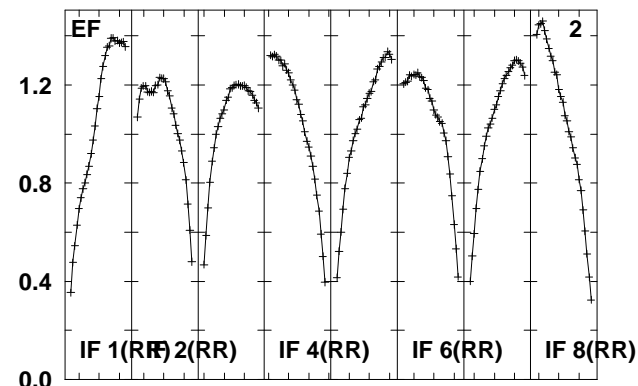
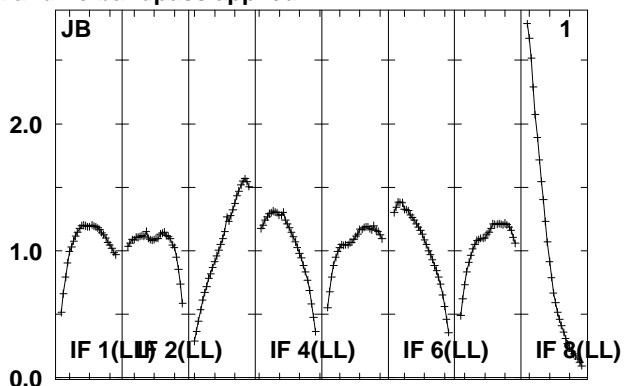
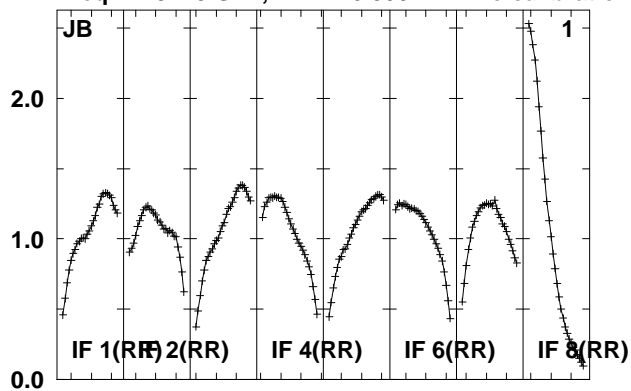

Lower frame: Real Jy

Total-power spectrum Antenna: *

Timerange: 00/22:59:31 to 00/23:02:59

Plot file version 42 created 24-AUG-2010 08:02:31

IRAS1929 EP064M.UVDATA.1

Freq = 4.9270 GHz, Bw = 16.000 MH No calibration applied and no bandpass applied

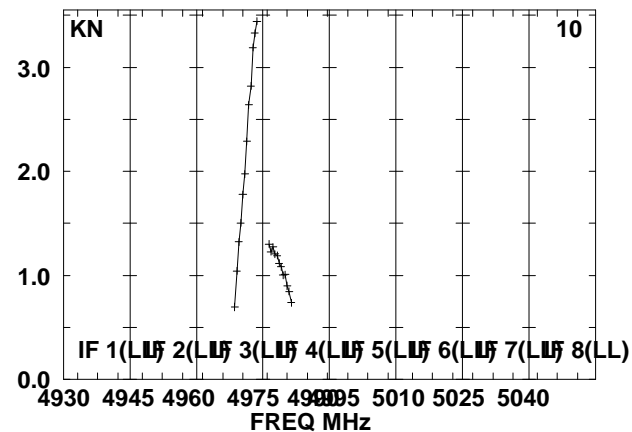
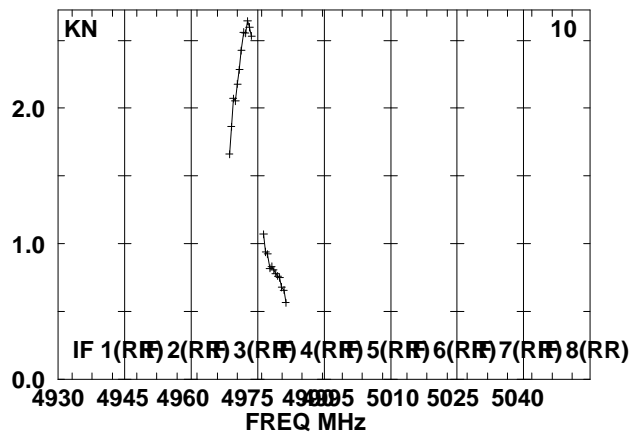
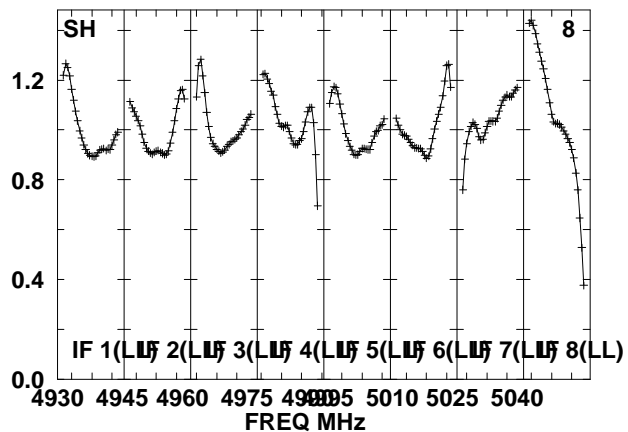
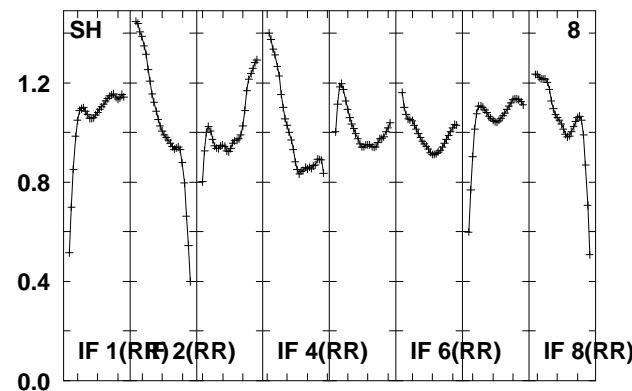
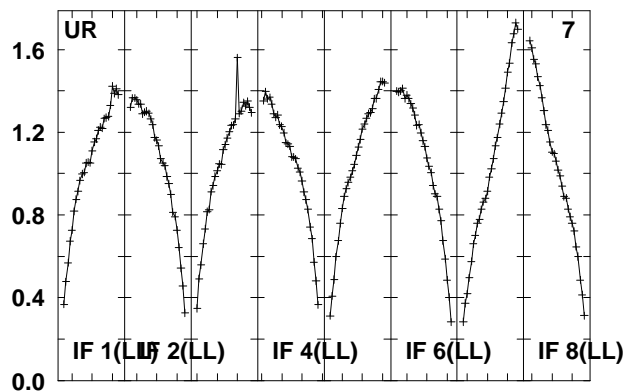
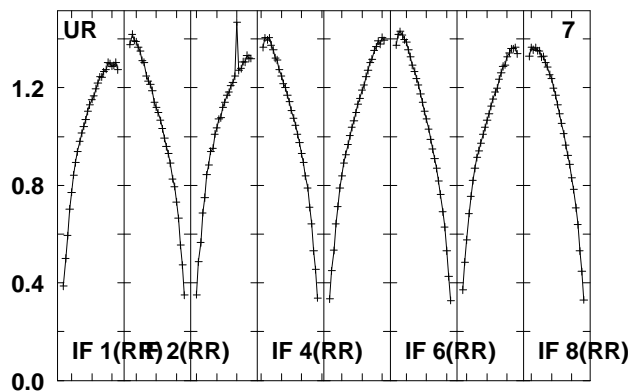
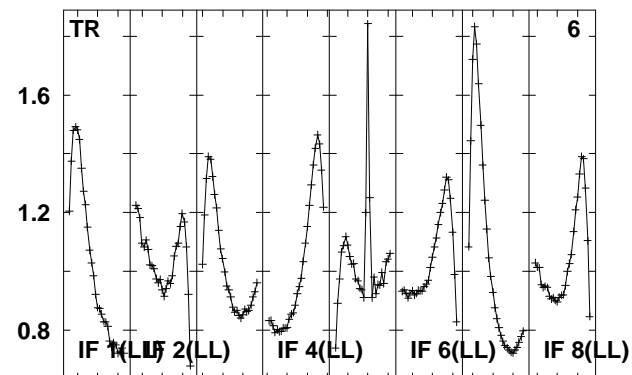
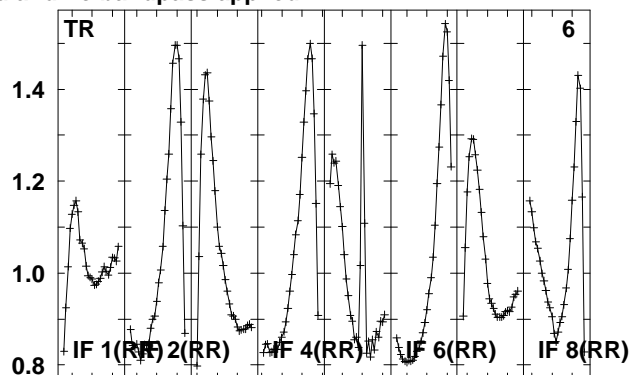
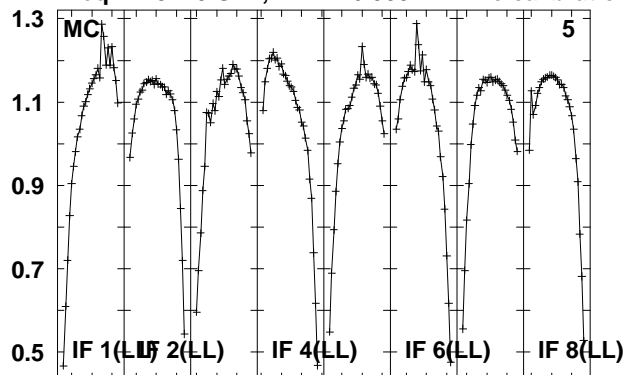

Lower frame: Real Jy
Total-power spectrum Antenna: *
Timerange: 00/22:59:31 to 00/23:02:59

Plot file version 43 created 24-AUG-2010 08:02:32

IRAS1929 EP064M.UVDATA.1

Freq = 4.9270 GHz, Bw = 16.000 MH No calibration applied and no bandpass applied

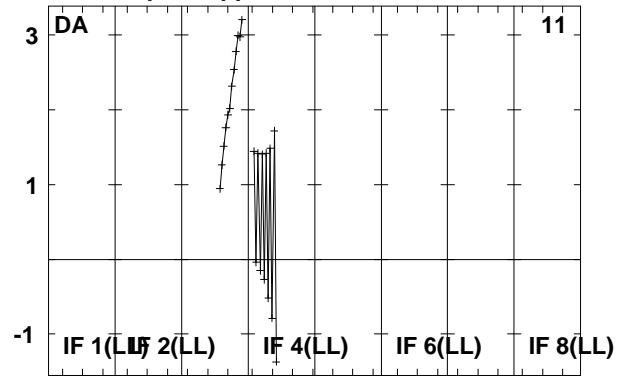
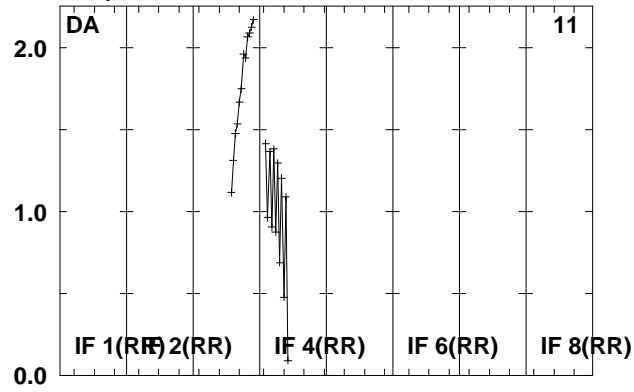

Lower frame: Real Jy
Total-power spectrum Antenna: *
Timerange: 00/22:59:31 to 00/23:02:59

Plot file version 44 created 24-AUG-2010 08:02:32

J1941-05 EP064M.UVDATA.1

Freq = 4.9270 GHz, Bw = 16.000 MH No calibration applied and no bandpass applied

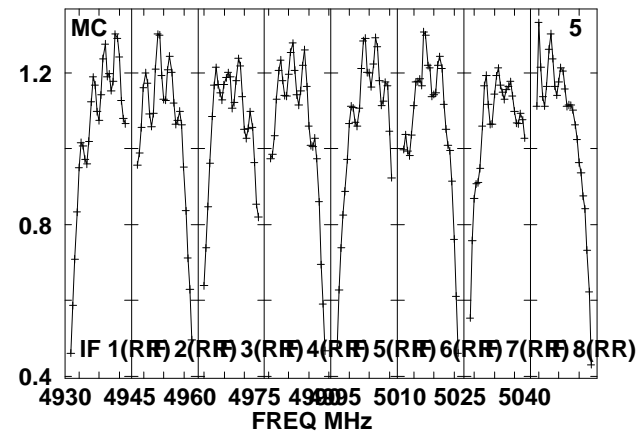
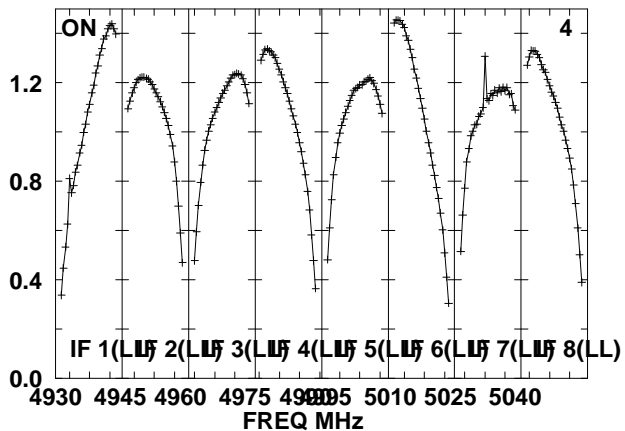
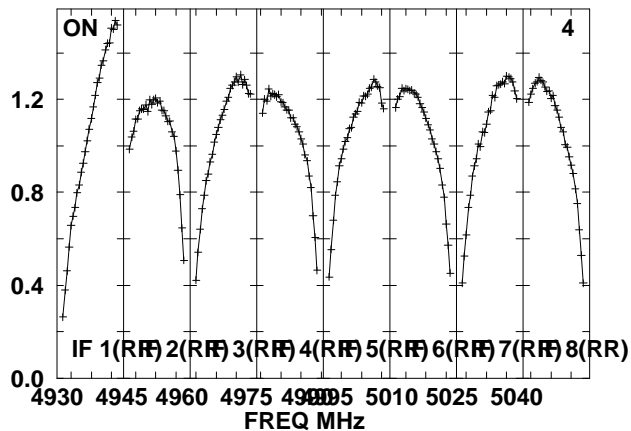
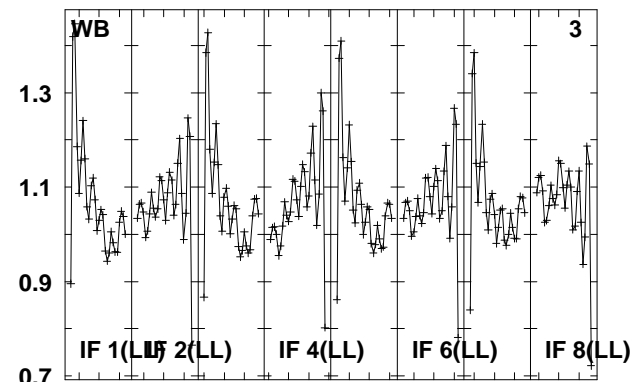
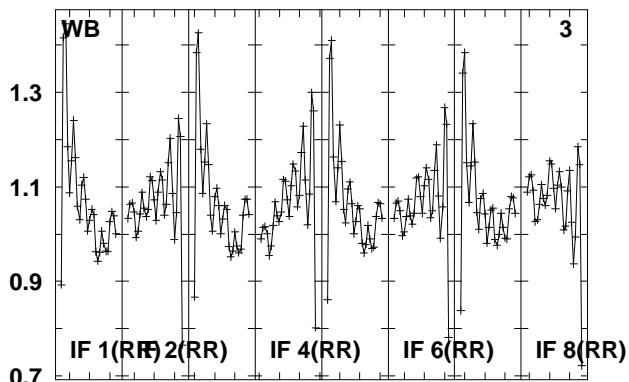
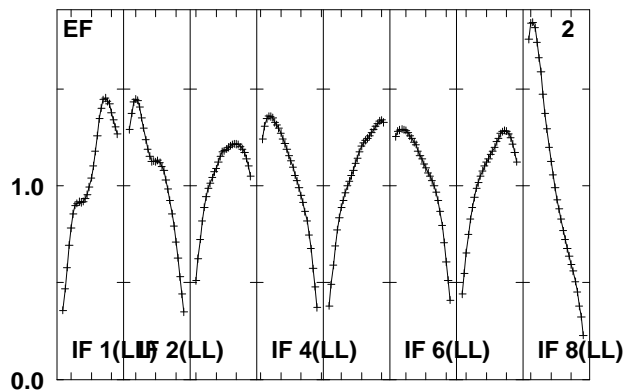
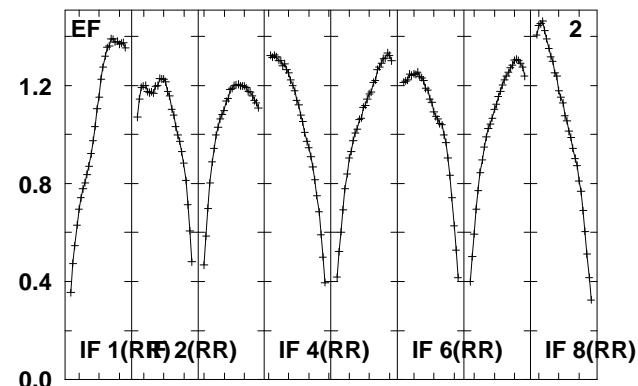
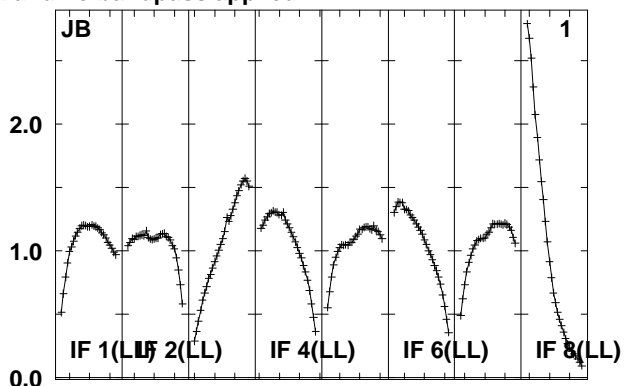
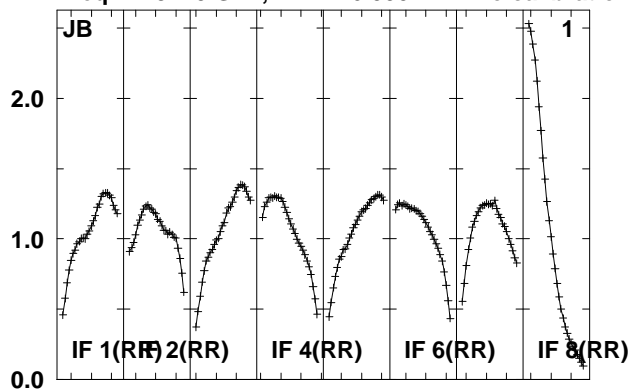

Lower frame: Real Jy
Total-power spectrum Antenna: *
Timerange: 00/23:03:01 to 00/23:04:29

Plot file version 45 created 24-AUG-2010 08:02:32

J1941-05 EP064M.UVDATA.1

Freq = 4.9270 GHz, Bw = 16.000 MH No calibration applied and no bandpass applied

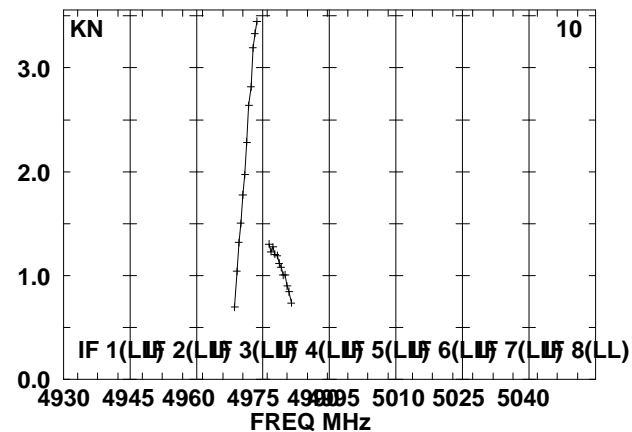
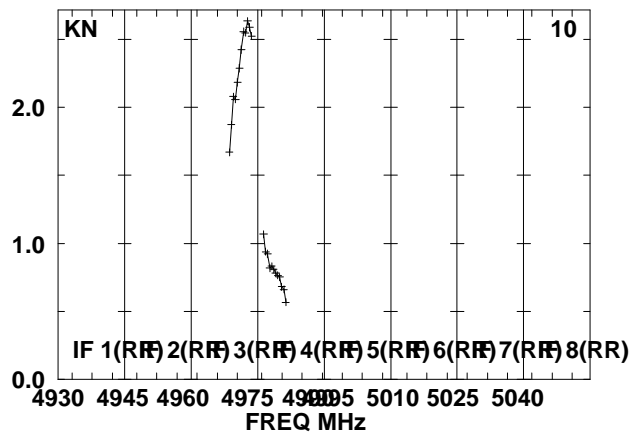
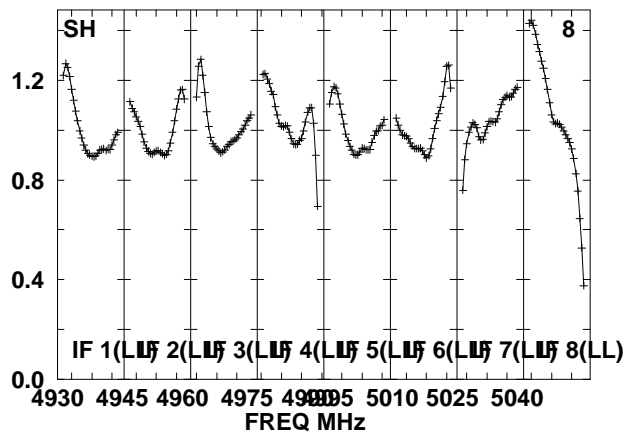
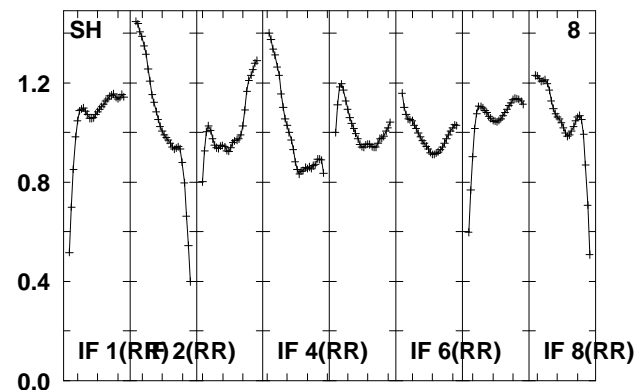
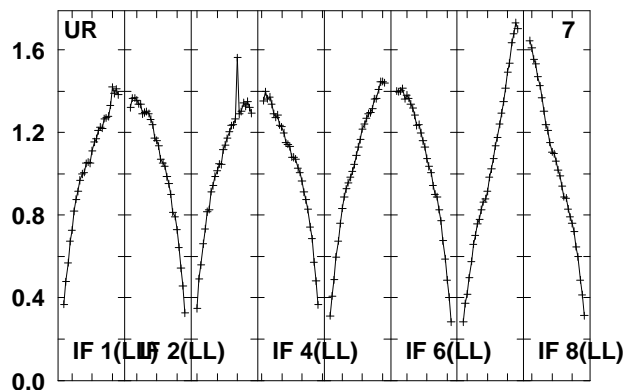
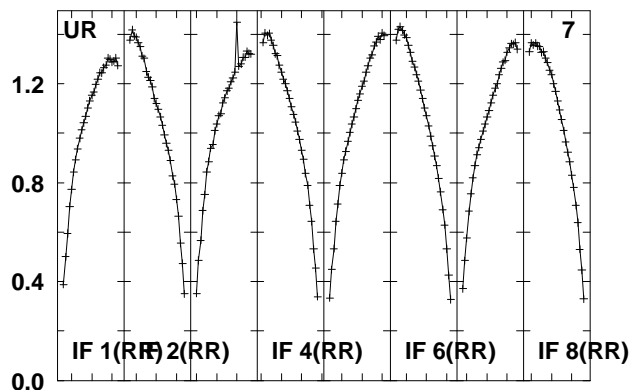
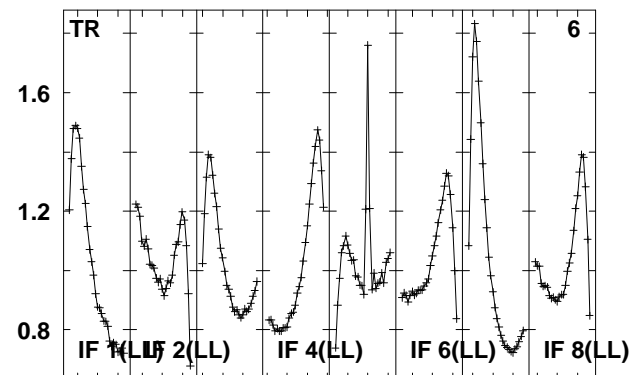
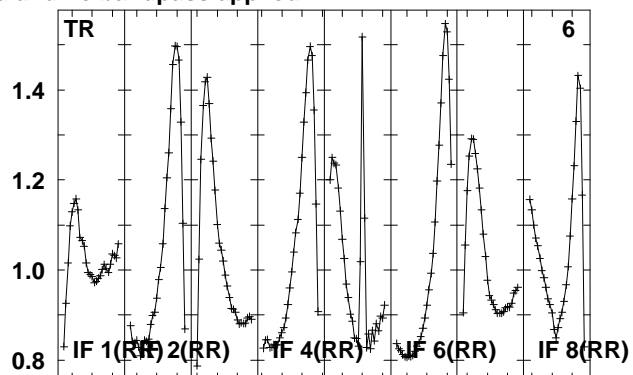
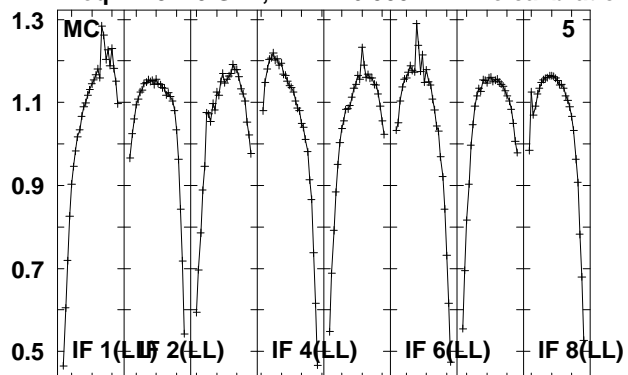

Lower frame: Real Jy
Total-power spectrum Antenna: *
Timerange: 00/23:03:01 to 00/23:04:29

Plot file version 46 created 24-AUG-2010 08:02:33

J1941-05 EP064M.UVDATA.1

Freq = 4.9270 GHz, Bw = 16.000 MH No calibration applied and no bandpass applied

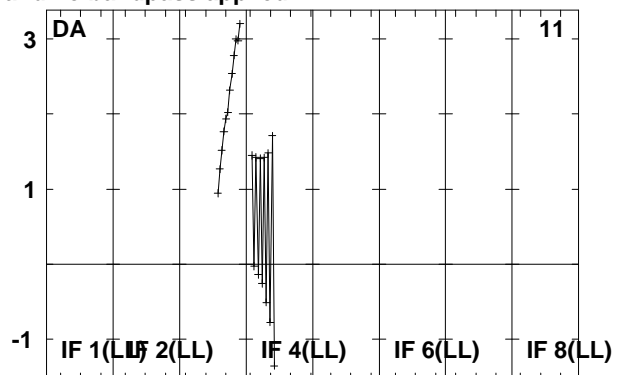
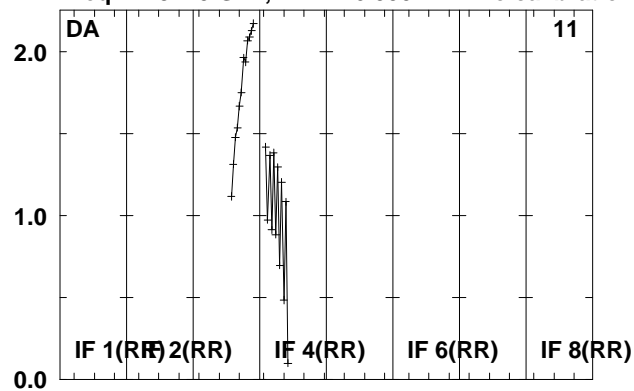

Lower frame: Real Jy
Total-power spectrum Antenna: *
Timerange: 00/23:03:01 to 00/23:04:29

Plot file version 47 created 24-AUG-2010 08:02:33

IRAS1929 EP064M.UVDATA.1

Freq = 4.9270 GHz, Bw = 16.000 MH No calibration applied and no bandpass applied

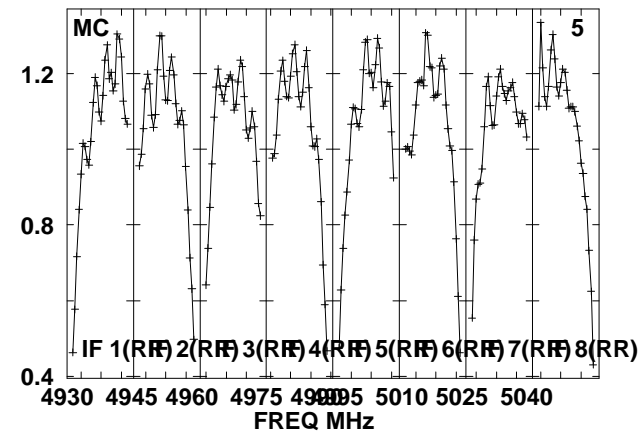
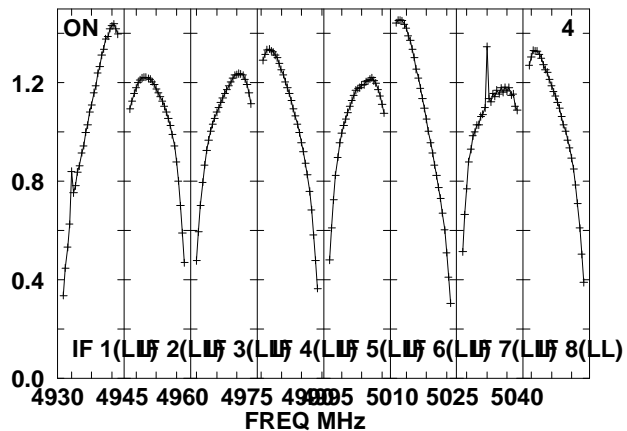
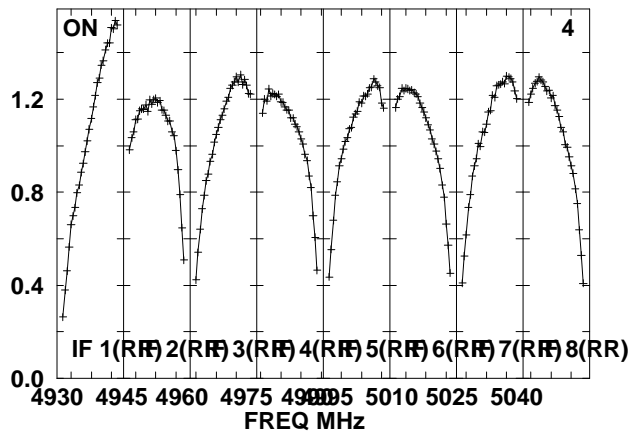
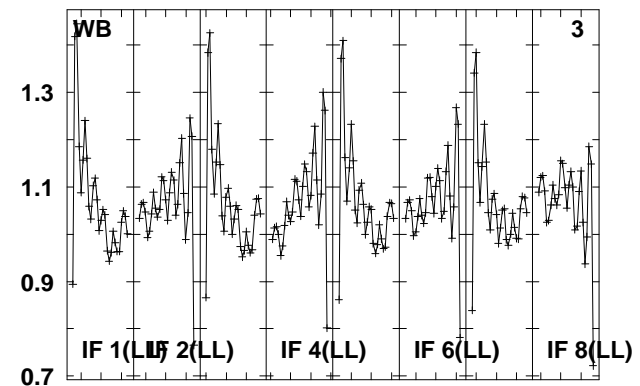
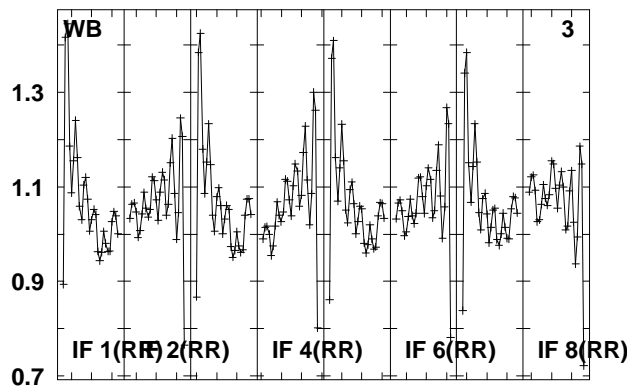
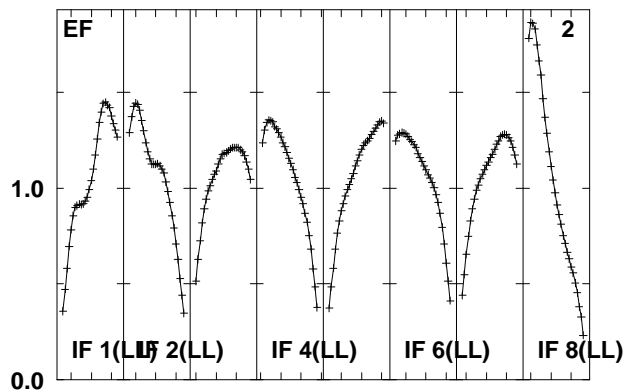
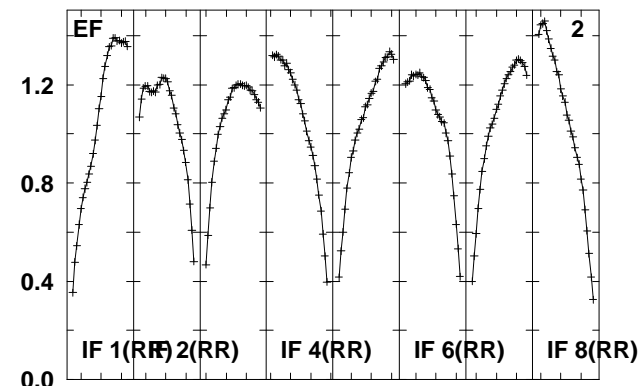
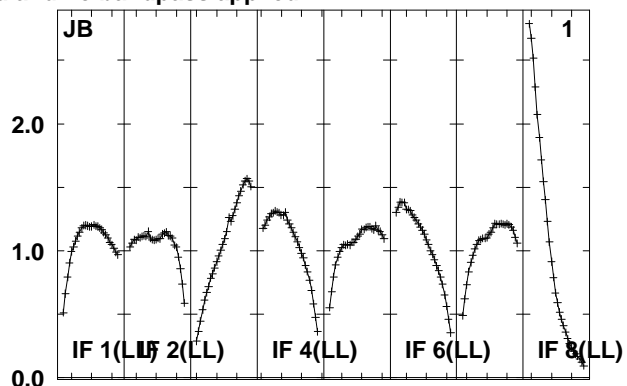
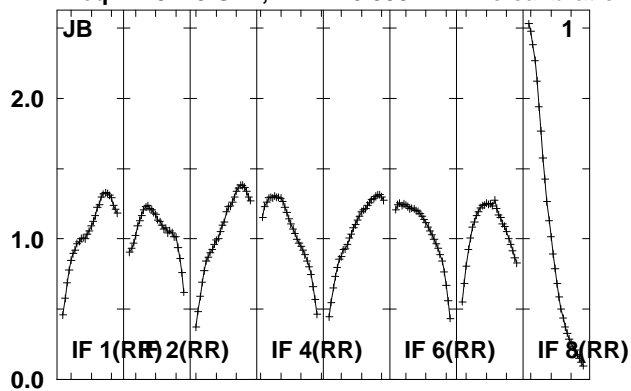

Lower frame: Real Jy
Total-power spectrum Antenna: *
Timerange: 00/23:04:31 to 00/23:07:59

Plot file version 48 created 24-AUG-2010 08:02:34

IRAS1929 EP064M.UVDATA.1

Freq = 4.9270 GHz, Bw = 16.000 MH No calibration applied and no bandpass applied

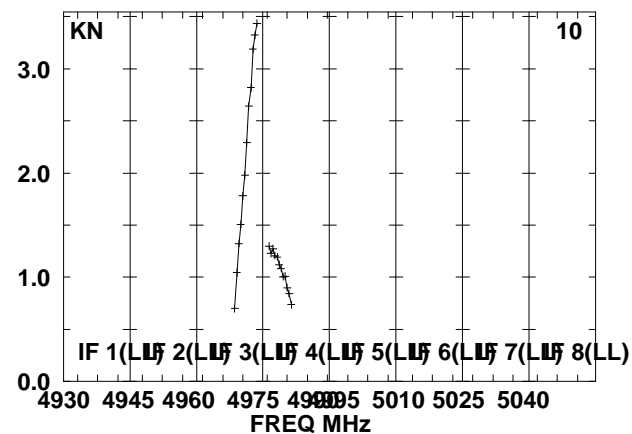
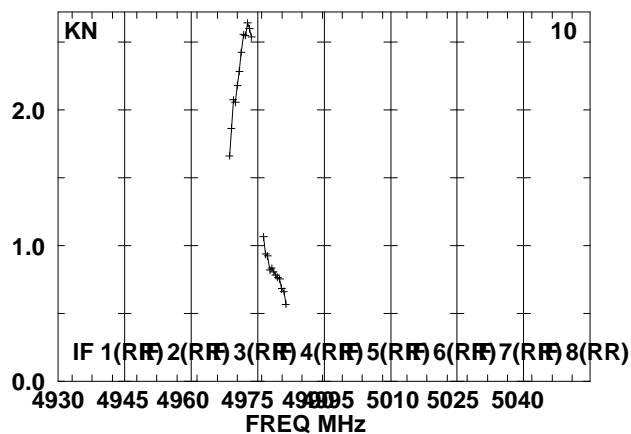
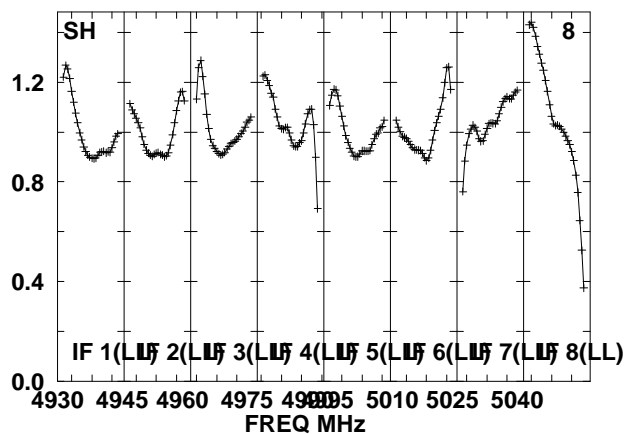
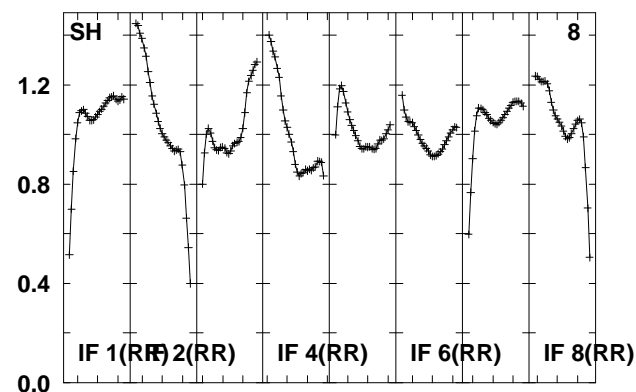
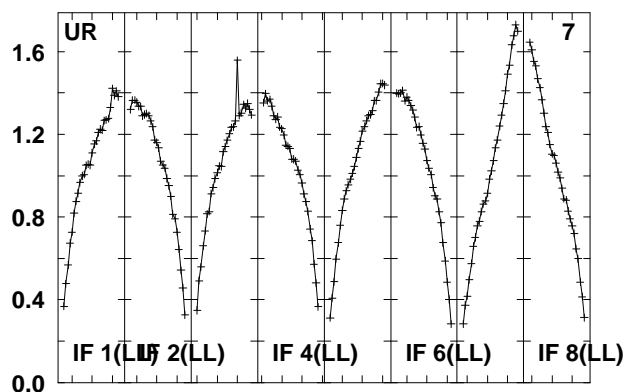
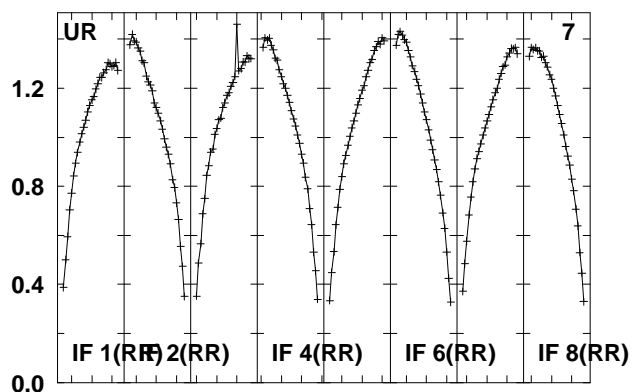
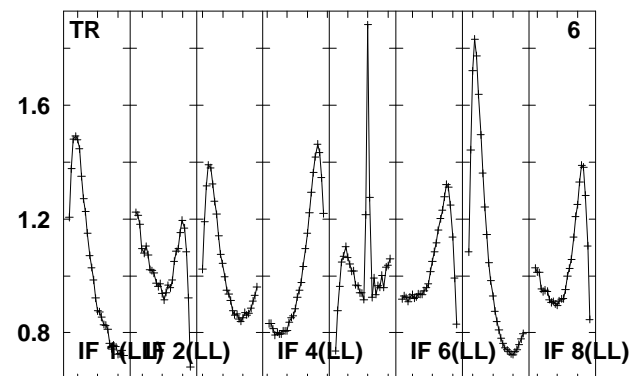
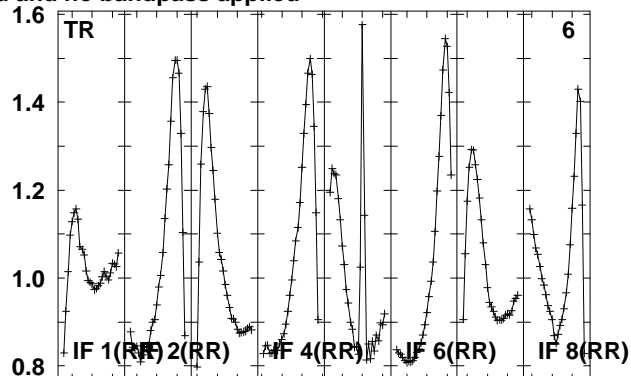
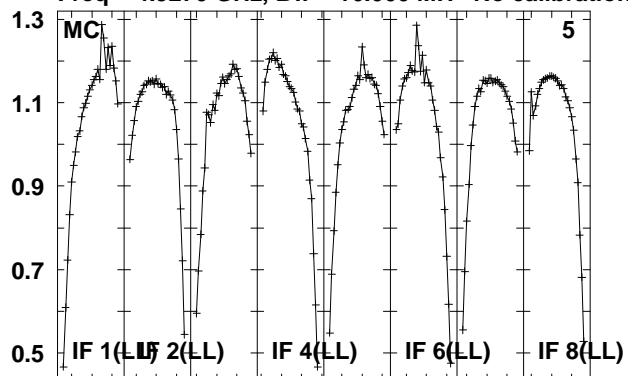

Lower frame: Real Jy
Total-power spectrum Antenna: *
Timerange: 00/23:04:31 to 00/23:07:59

Plot file version 49 created 24-AUG-2010 08:02:35

IRAS1929 EP064M.UVDATA.1

Freq = 4.9270 GHz, Bw = 16.000 MH No calibration applied and no bandpass applied

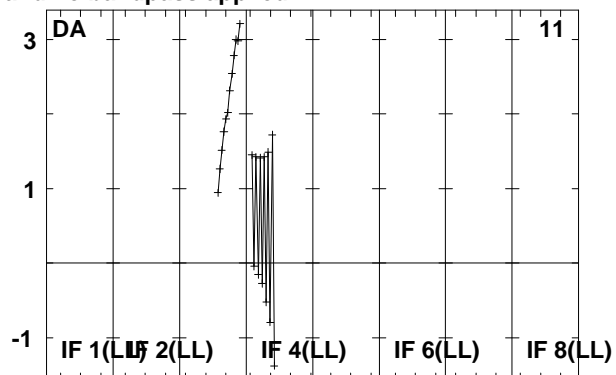
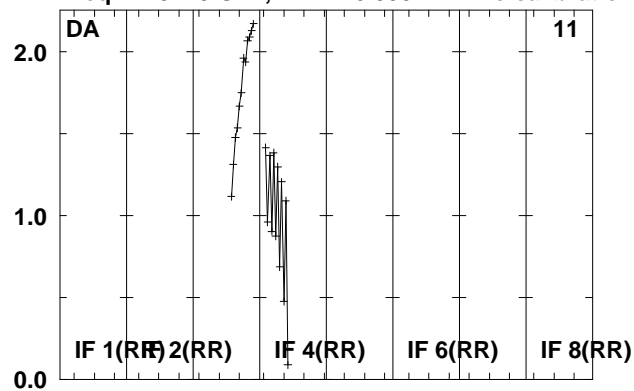

Lower frame: Real Jy
Total-power spectrum Antenna: *
Timerange: 00/23:04:31 to 00/23:07:59

Plot file version 50 created 24-AUG-2010 08:02:35

J1941-05 EP064M.UVDATA.1

Freq = 4.9270 GHz, Bw = 16.000 MH No calibration applied and no bandpass applied

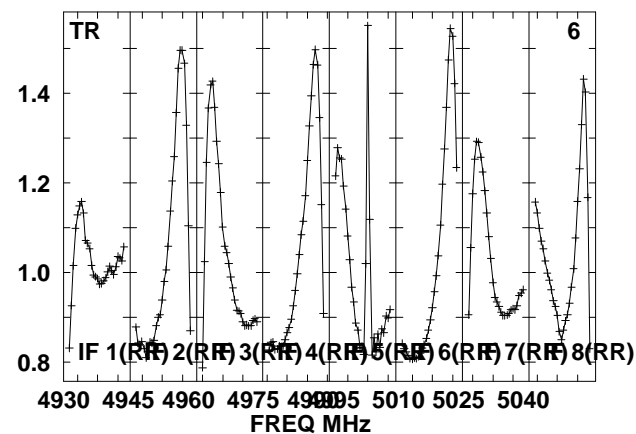
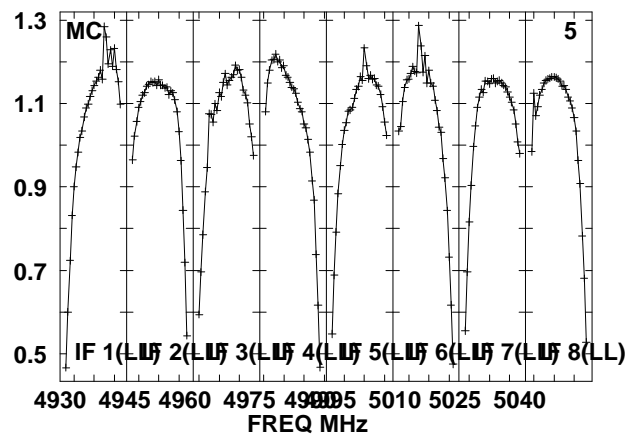
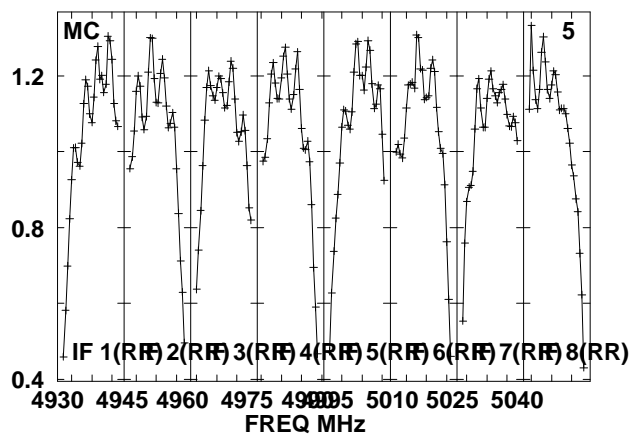
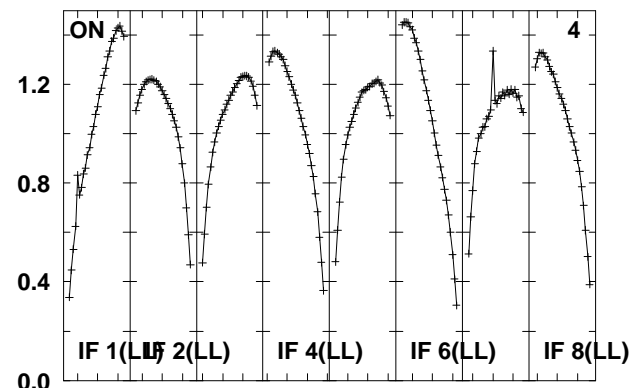
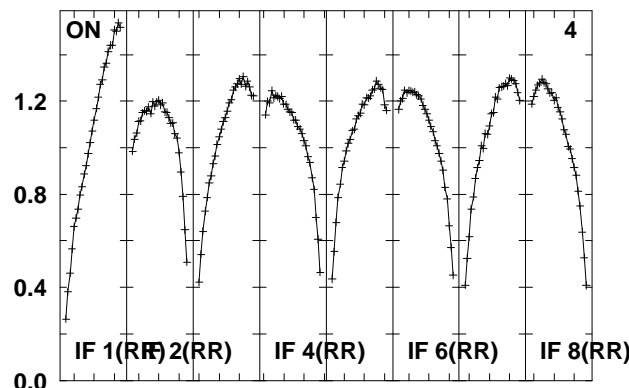
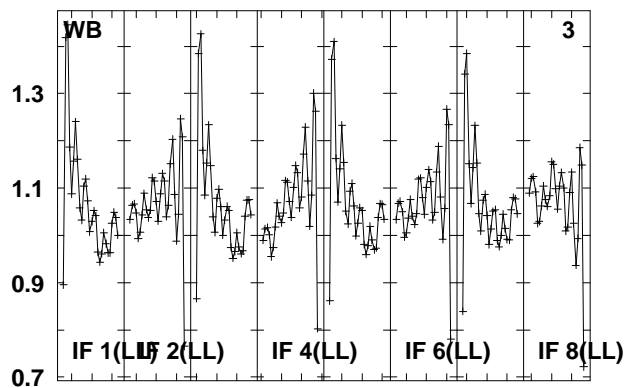
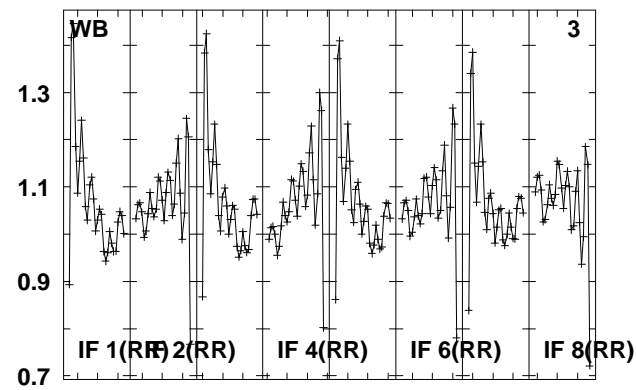
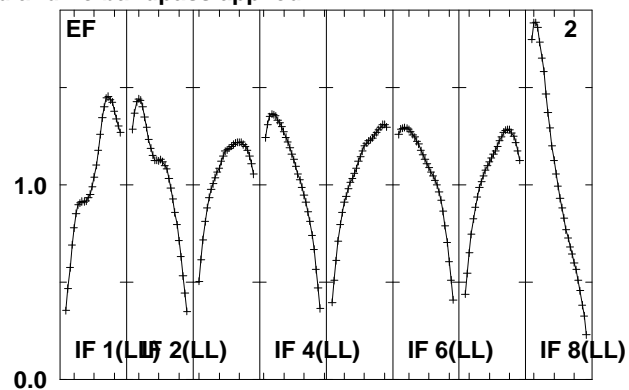
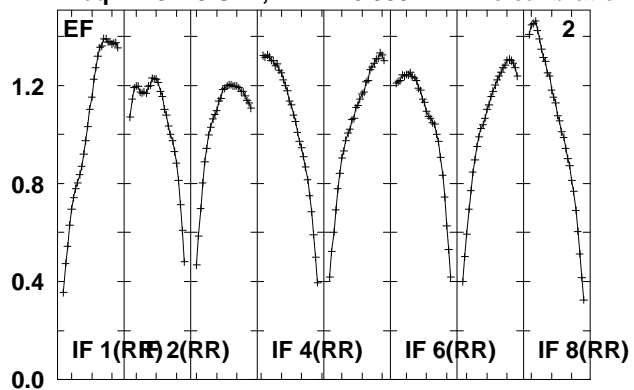

Lower frame: Real Jy
Total-power spectrum Antenna: *
Timerange: 00/23:08:01 to 00/23:09:29

Plot file version 51 created 24-AUG-2010 08:02:35

J1941-05 EP064M.UVDATA.1

Freq = 4.9270 GHz, Bw = 16.000 MH No calibration applied and no bandpass applied

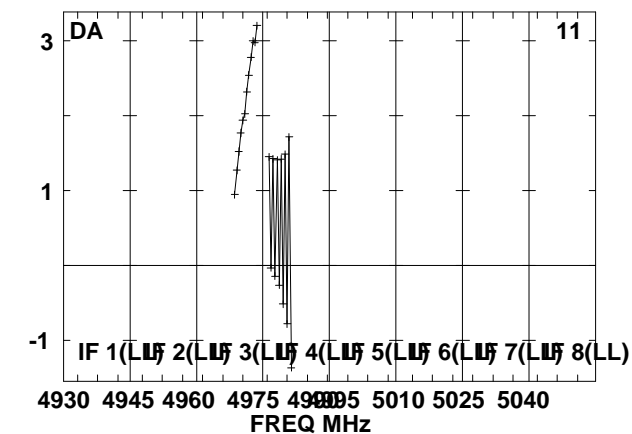
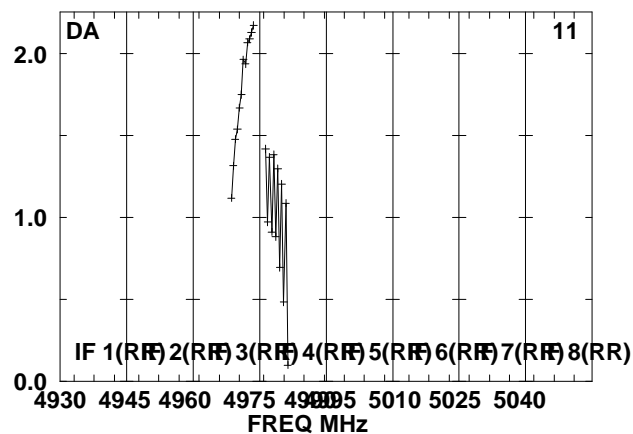
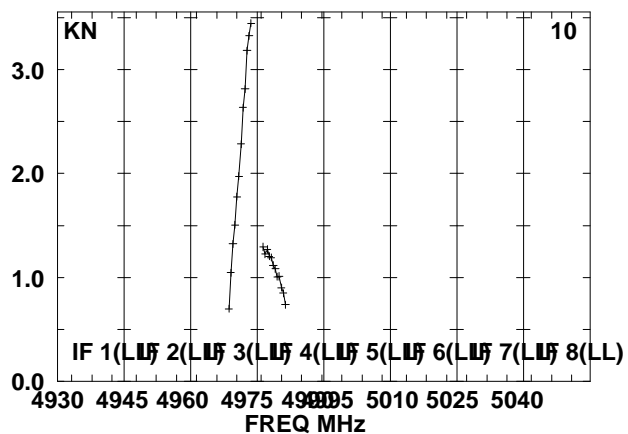
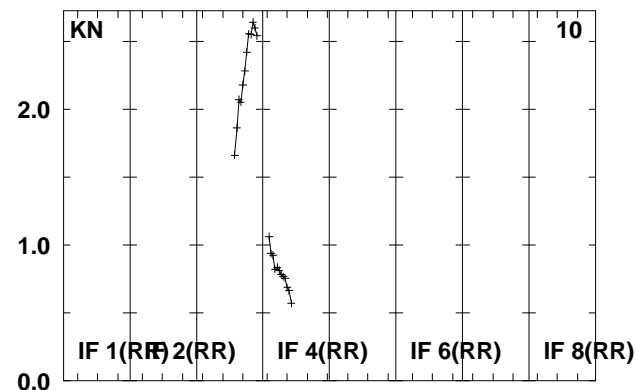
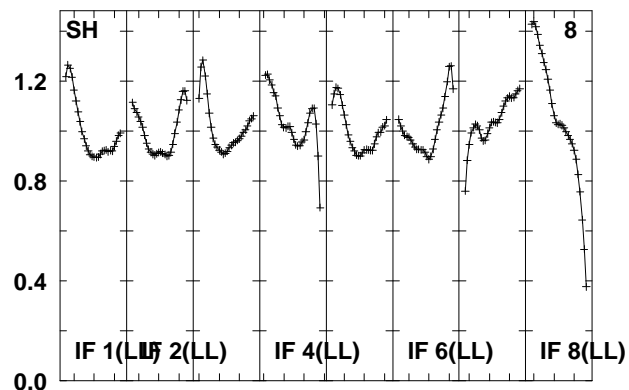
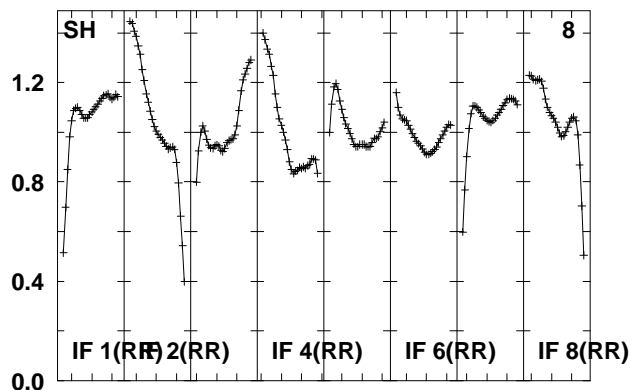
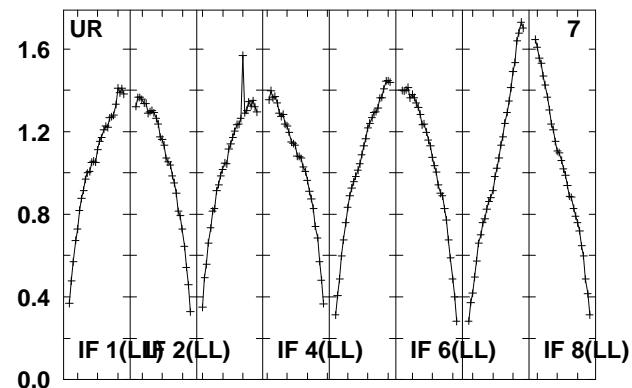
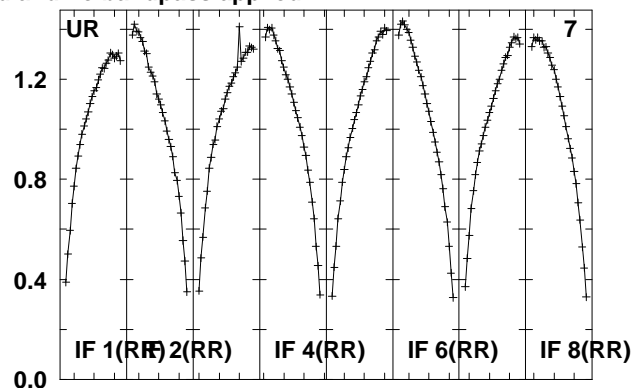
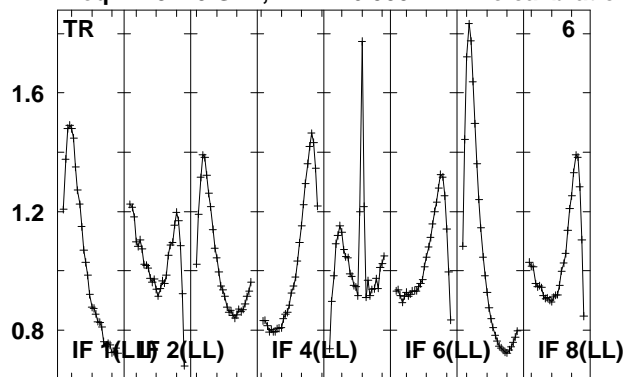

Lower frame: Real Jy
Total-power spectrum Antenna: *
Timerange: 00/23:08:01 to 00/23:09:29

Plot file version 52 created 24-AUG-2010 08:02:36

IRAS1929 EP064M.UVDATA.1

Freq = 4.9270 GHz, Bw = 16.000 MH No calibration applied and no bandpass applied

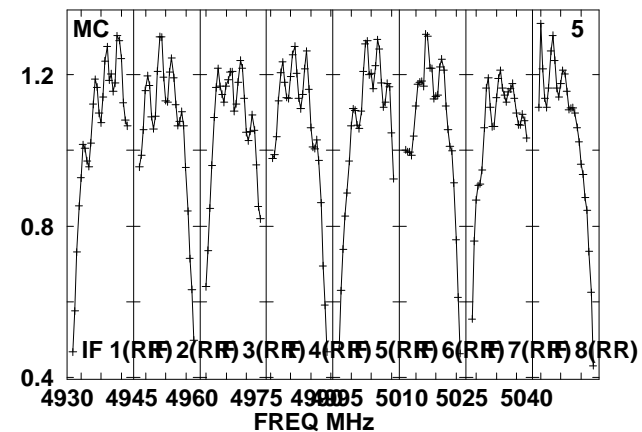
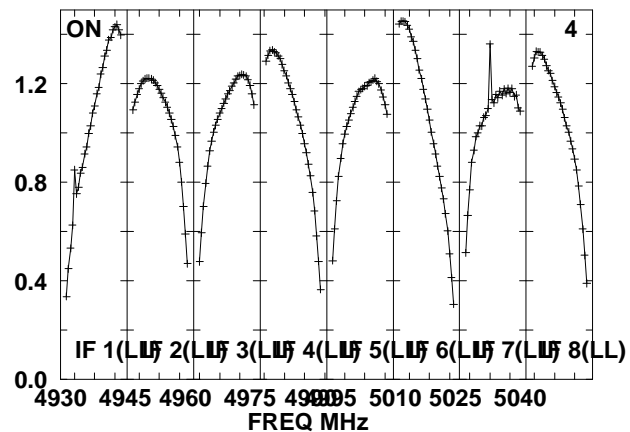
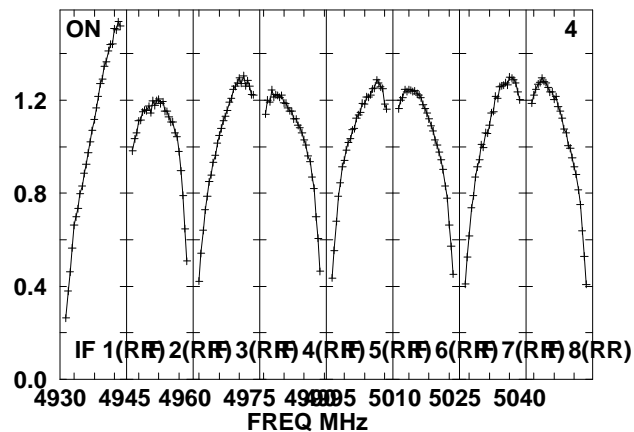
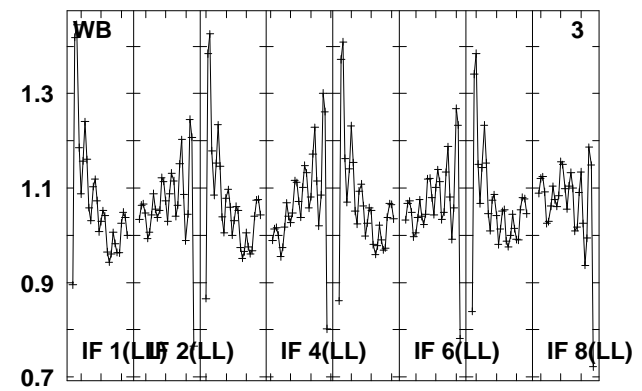
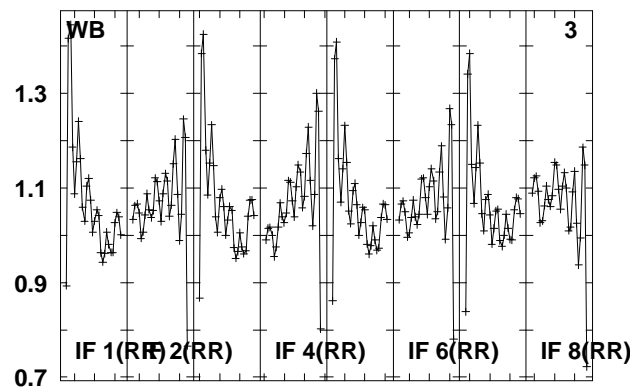
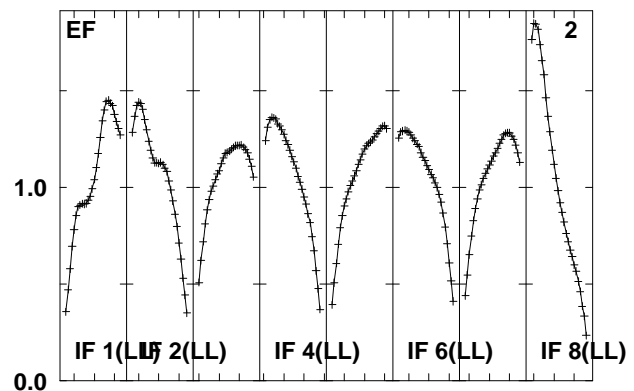
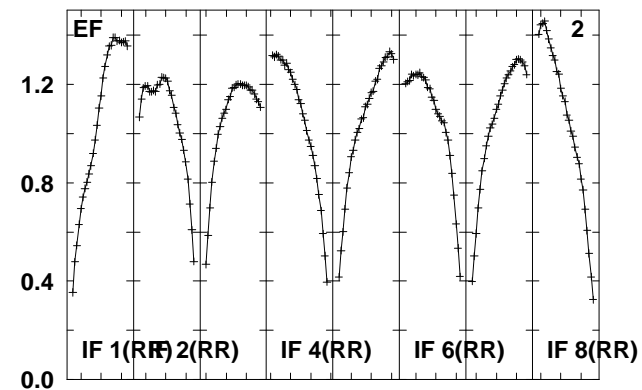
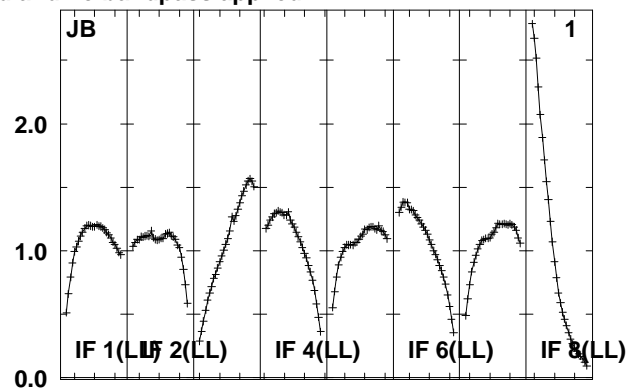
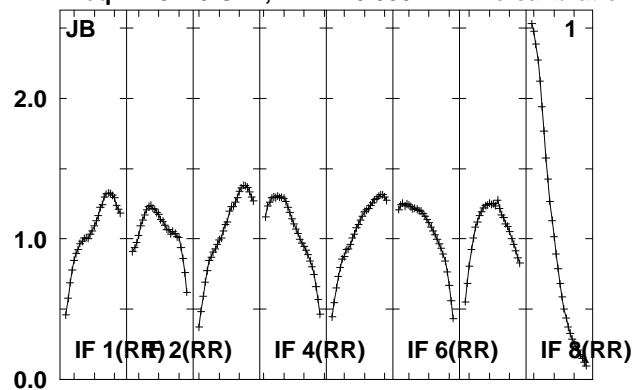

Lower frame: Real Jy
Total-power spectrum Antenna: *
Timerange: 00/23:09:31 to 00/23:12:59

Plot file version 53 created 24-AUG-2010 08:02:36

IRAS1929 EP064M.UVDATA.1

Freq = 4.9270 GHz, Bw = 16.000 MH No calibration applied and no bandpass applied

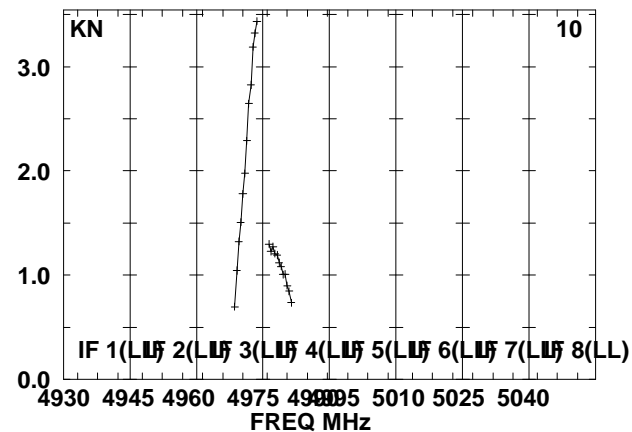
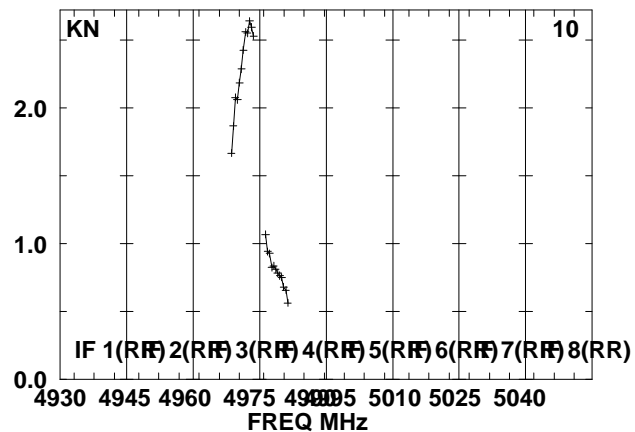
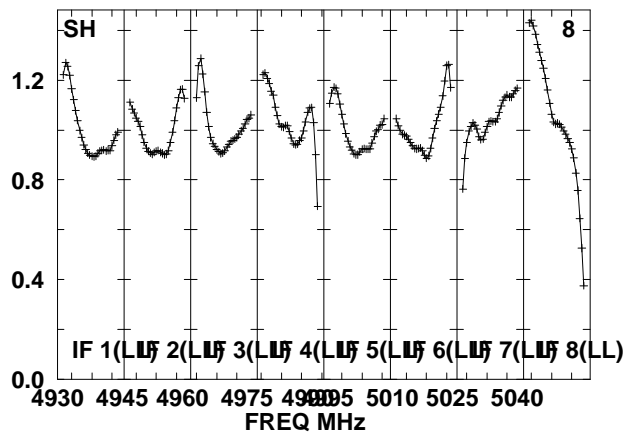
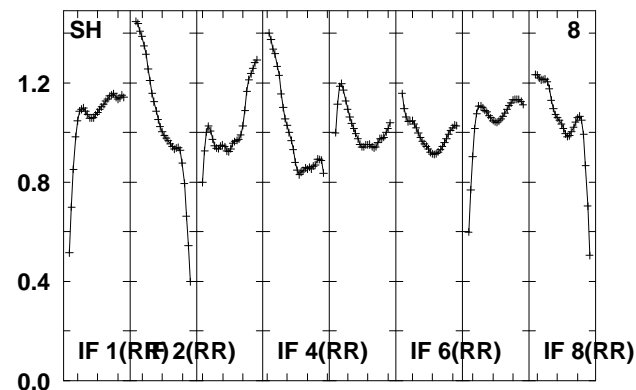
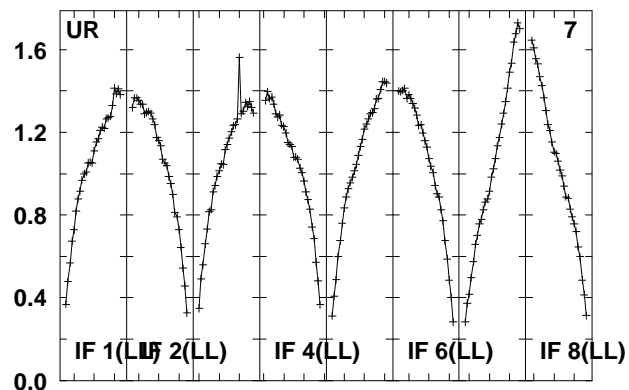
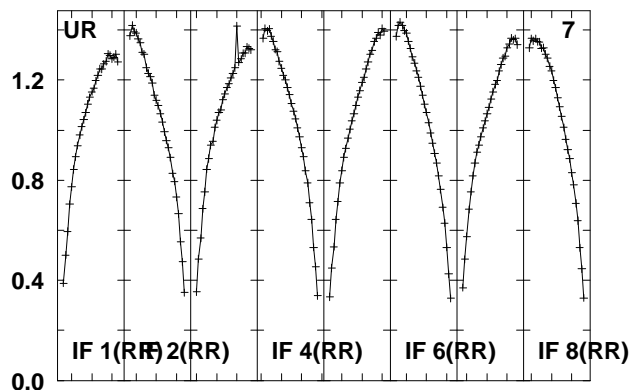
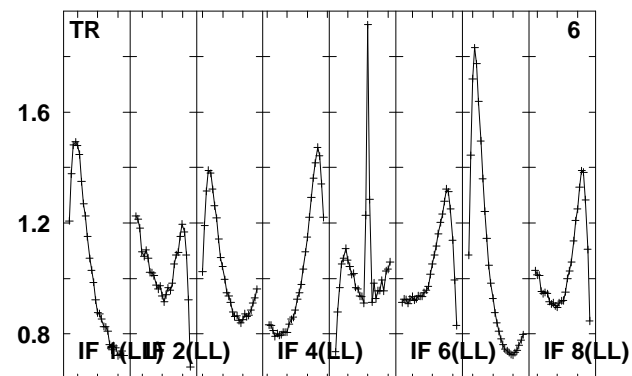
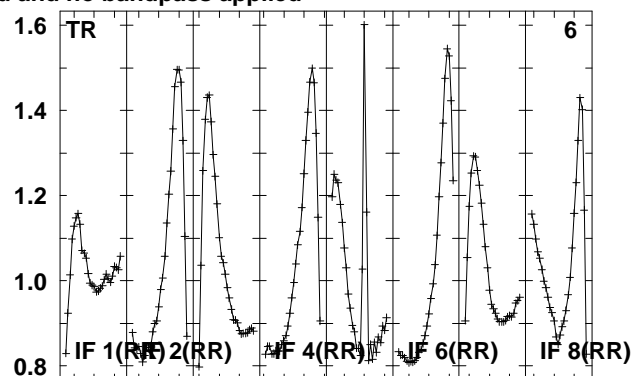
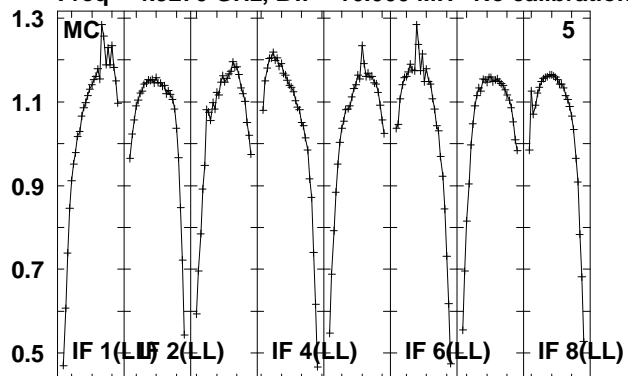

Lower frame: Real Jy

Total-power spectrum Antenna: *

Timerange: 00/23:09:31 to 00/23:12:59

Plot file version 54 created 24-AUG-2010 08:02:37

IRAS1929 EP064M.UVDATA.1

Freq = 4.9270 GHz, Bw = 16.000 MH No calibration applied and no bandpass applied

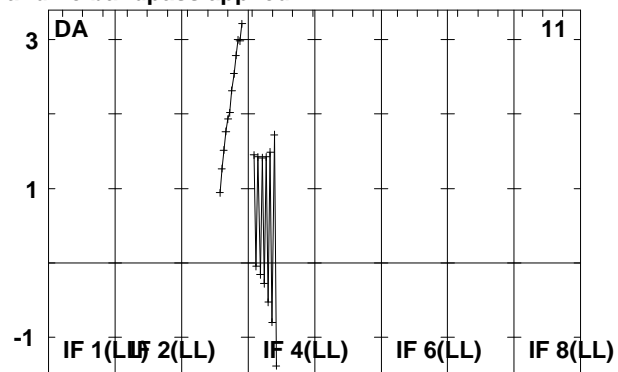
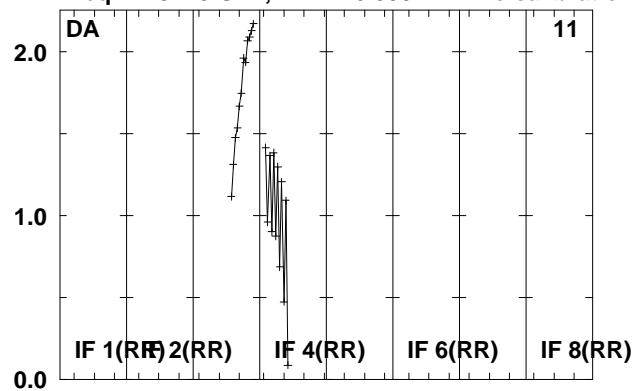

Lower frame: Real Jy
Total-power spectrum Antenna: *
Timerange: 00/23:09:31 to 00/23:12:59

Plot file version 55 created 24-AUG-2010 08:02:37

J1941-05 EP064M.UVDATA.1

Freq = 4.9270 GHz, Bw = 16.000 MH No calibration applied and no bandpass applied

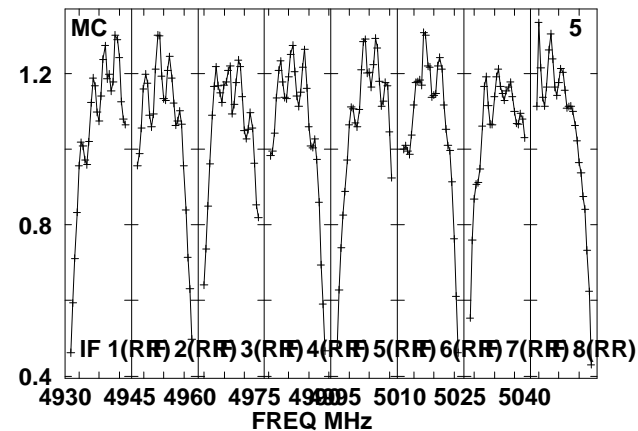
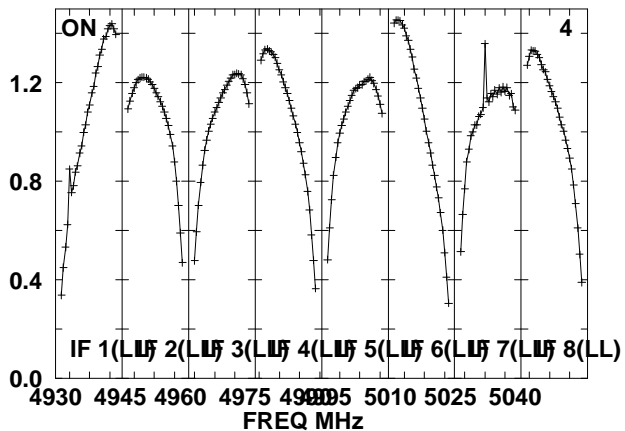
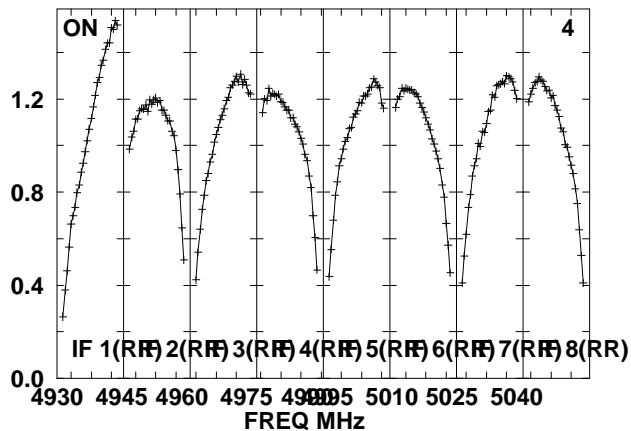
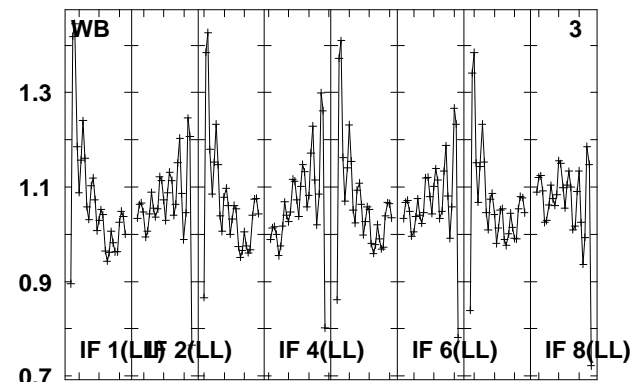
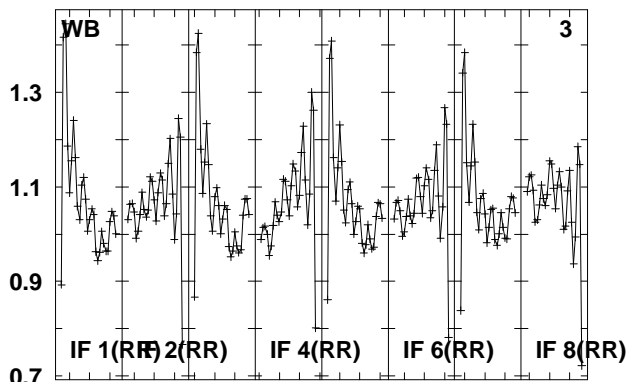
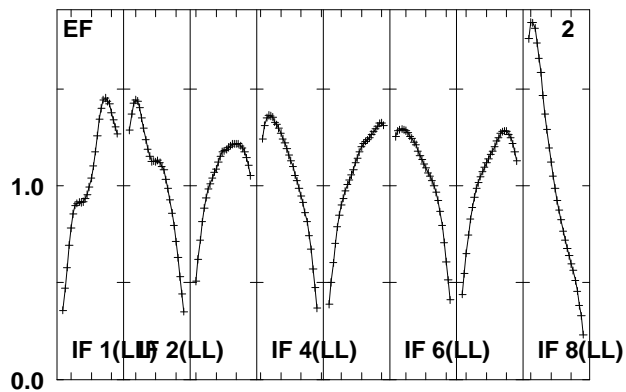
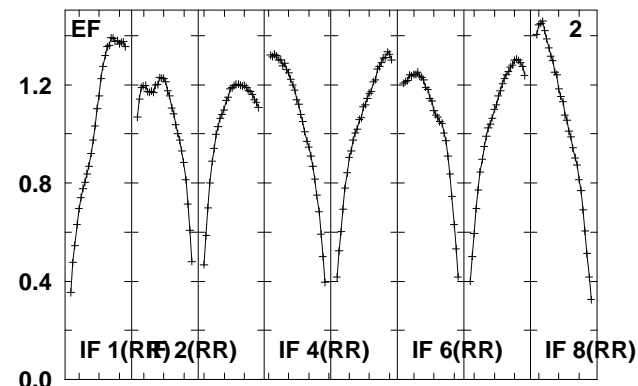
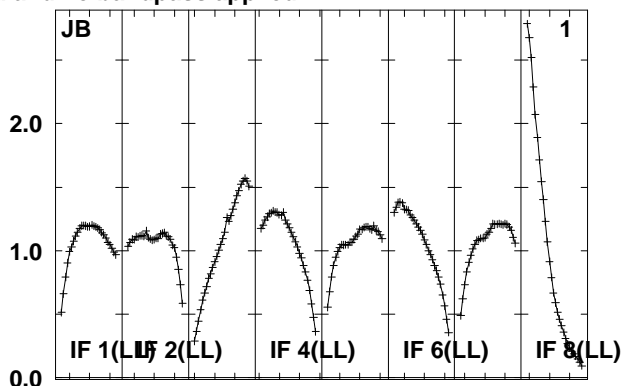
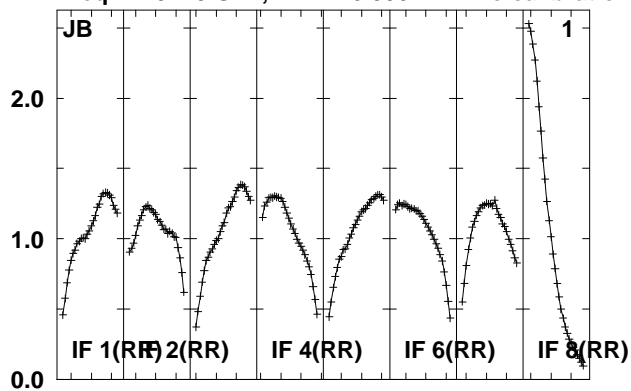

Lower frame: Real Jy
Total-power spectrum Antenna: *
Timerange: 00/23:14:01 to 00/23:15:29

Plot file version 56 created 24-AUG-2010 08:02:37

J1941-05 EP064M.UVDATA.1

Freq = 4.9270 GHz, Bw = 16.000 MH No calibration applied and no bandpass applied

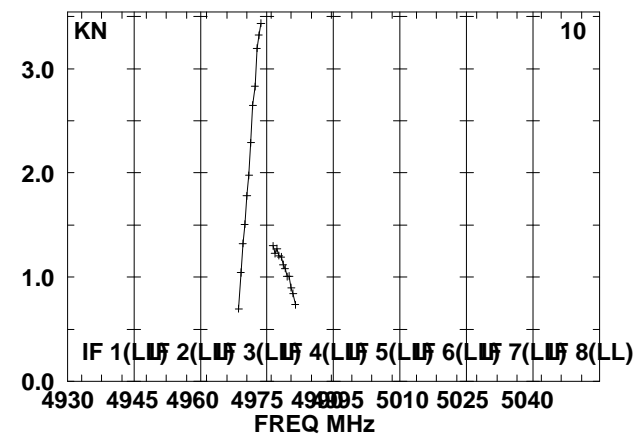
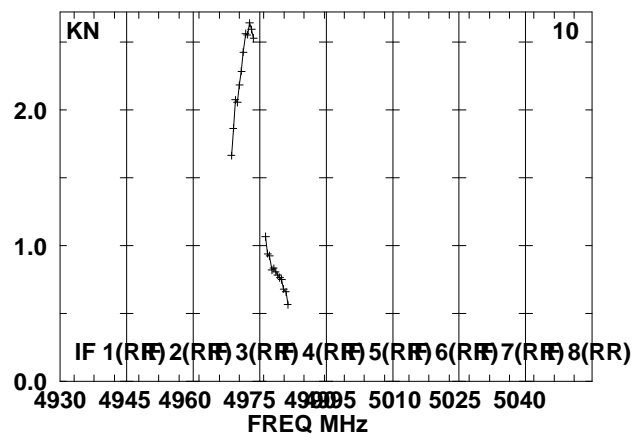
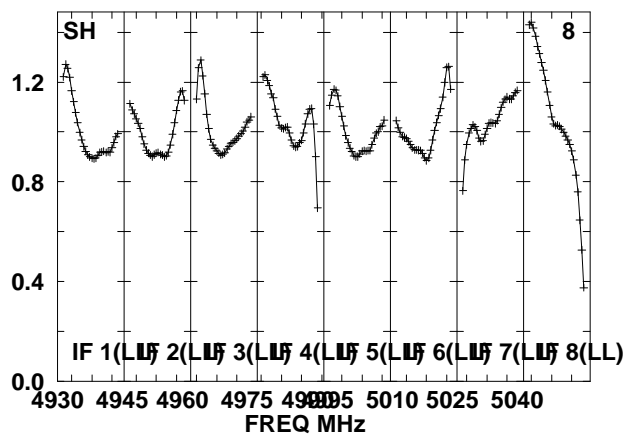
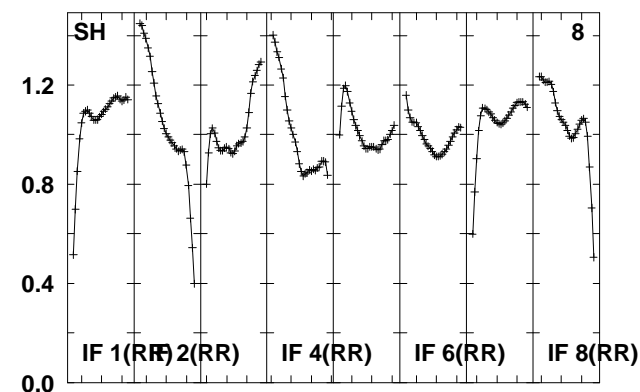
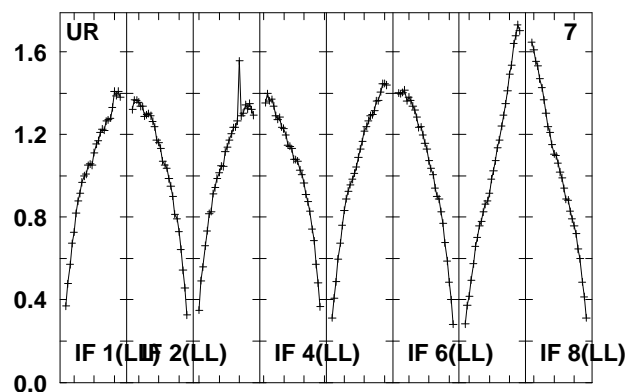
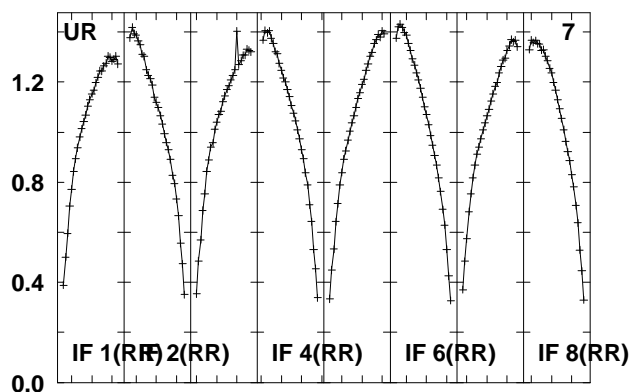
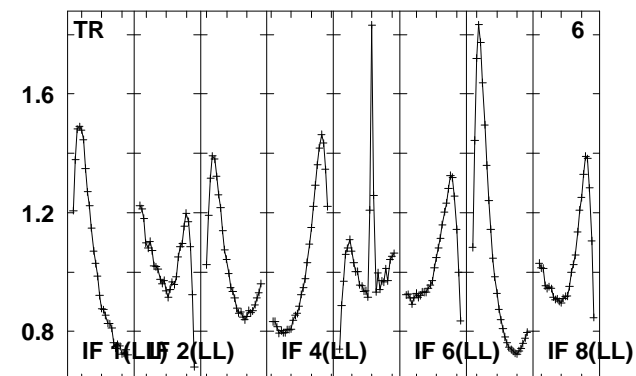
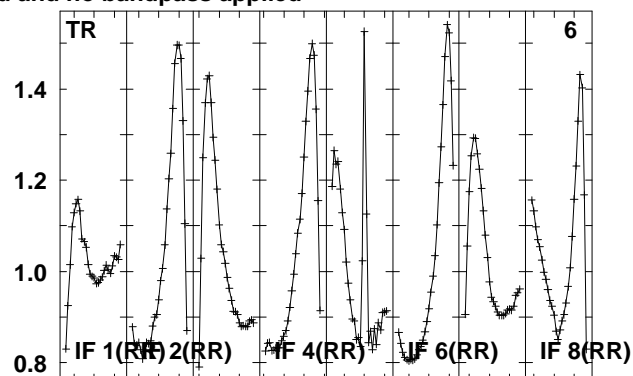
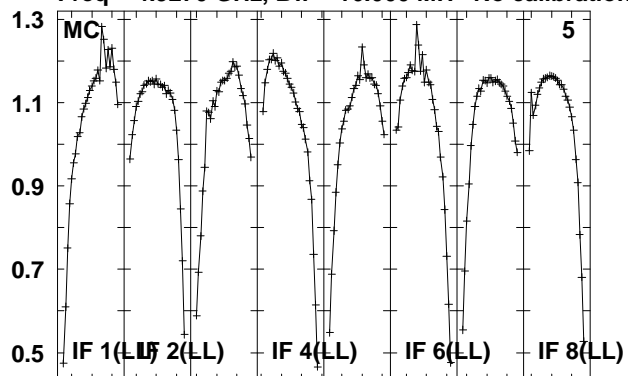

Lower frame: Real Jy
Total-power spectrum Antenna: *
Timerange: 00/23:14:01 to 00/23:15:29

Plot file version 57 created 24-AUG-2010 08:02:38

J1941-05 EP064M.UVDATA.1

Freq = 4.9270 GHz, Bw = 16.000 MH No calibration applied and no bandpass applied

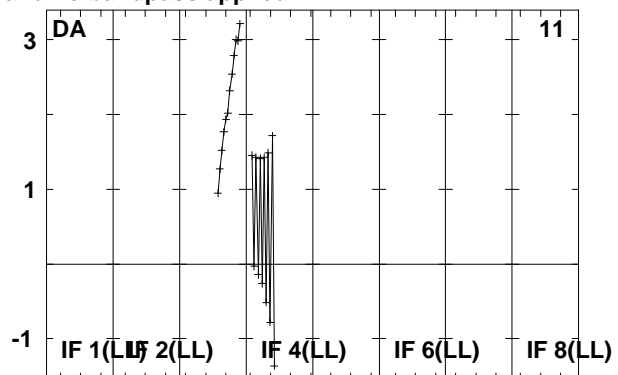
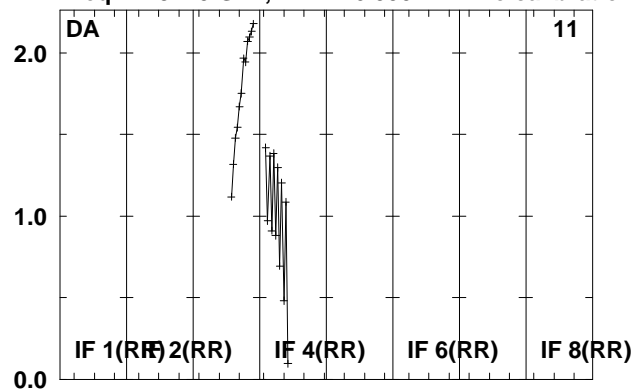

Lower frame: Real Jy
Total-power spectrum Antenna: *
Timerange: 00/23:14:01 to 00/23:15:29

Plot file version 58 created 24-AUG-2010 08:02:38

IRAS1929 EP064M.UVDATA.1

Freq = 4.9270 GHz, Bw = 16.000 MH No calibration applied and no bandpass applied

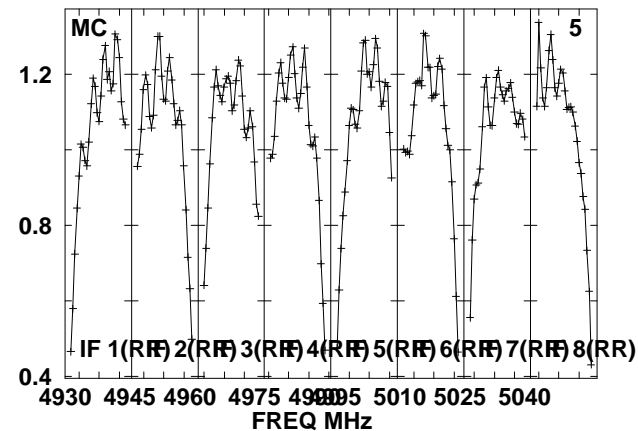
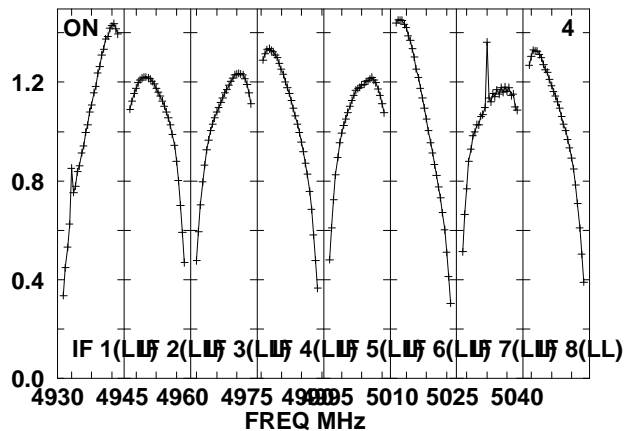
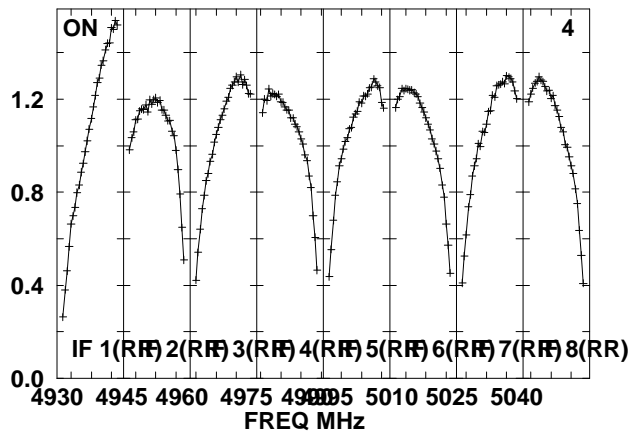
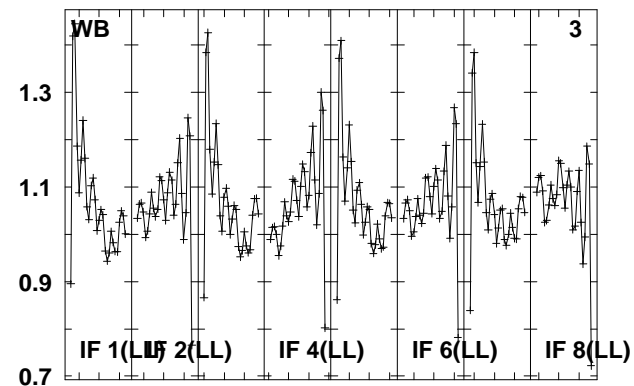
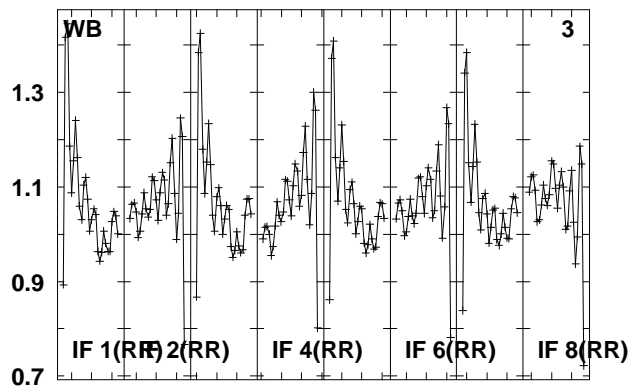
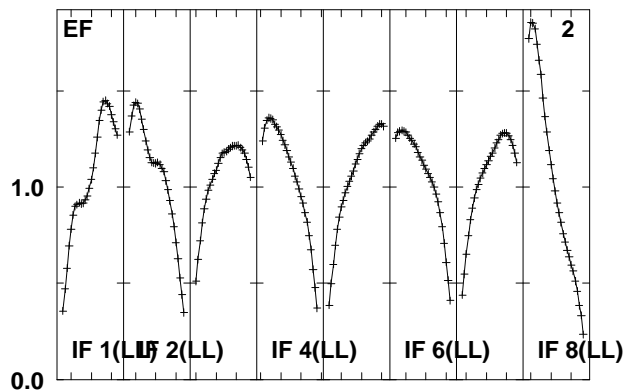
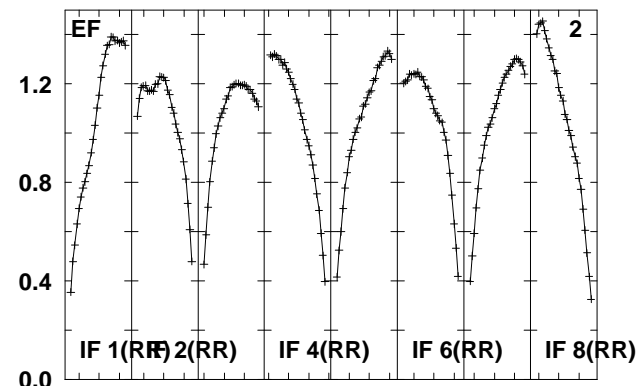
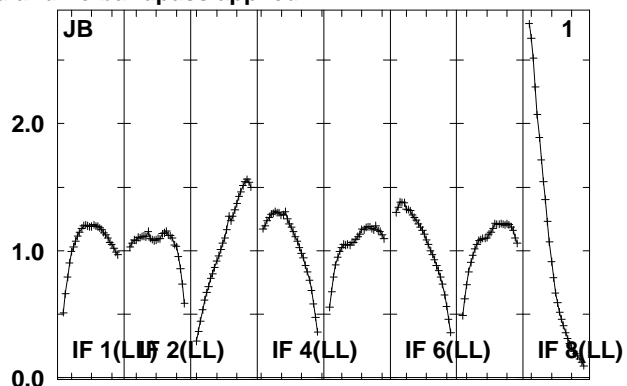
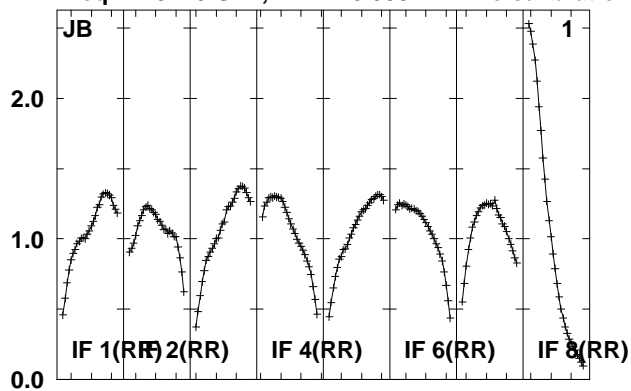

Lower frame: Real Jy
Total-power spectrum Antenna: *
Timerange: 00/23:15:31 to 00/23:18:59

Plot file version 59 created 24-AUG-2010 08:02:38

IRAS1929 EP064M.UVDATA.1

Freq = 4.9270 GHz, Bw = 16.000 MH No calibration applied and no bandpass applied

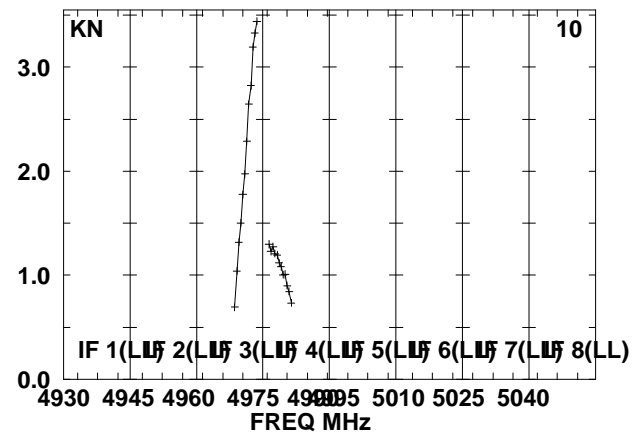
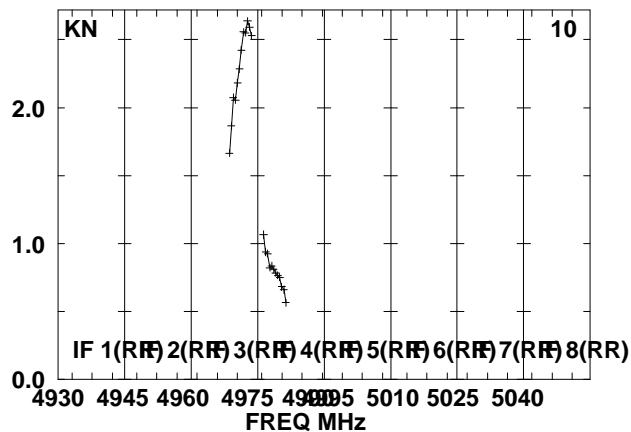
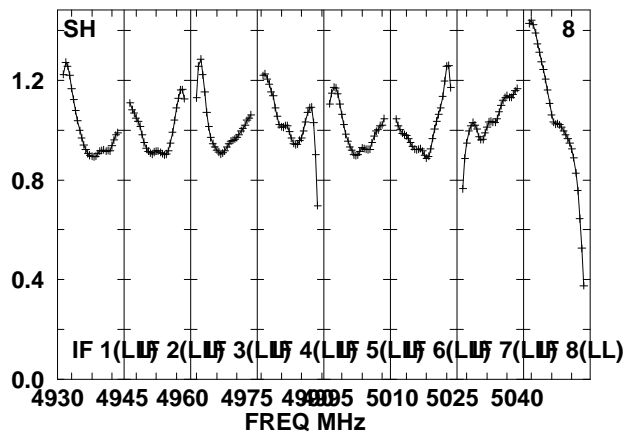
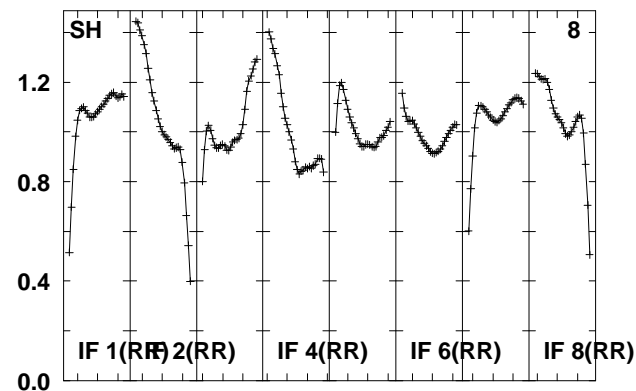
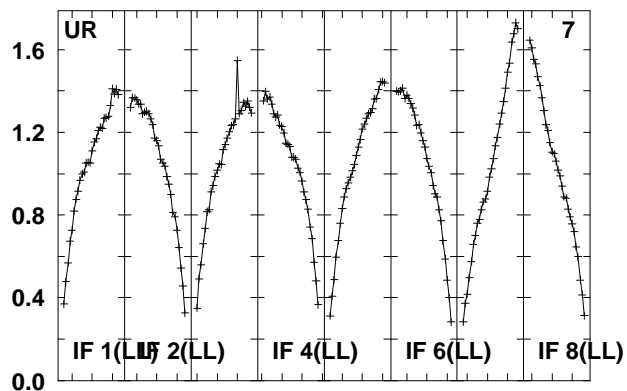
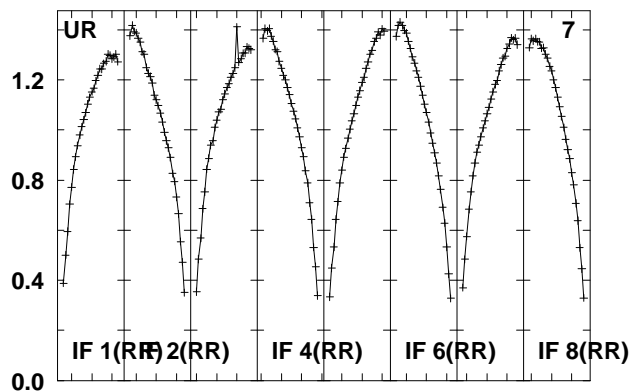
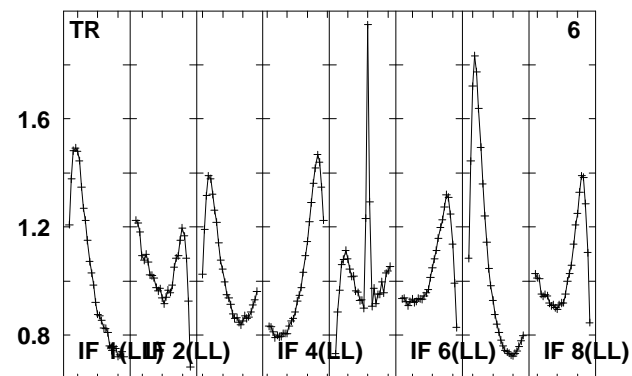
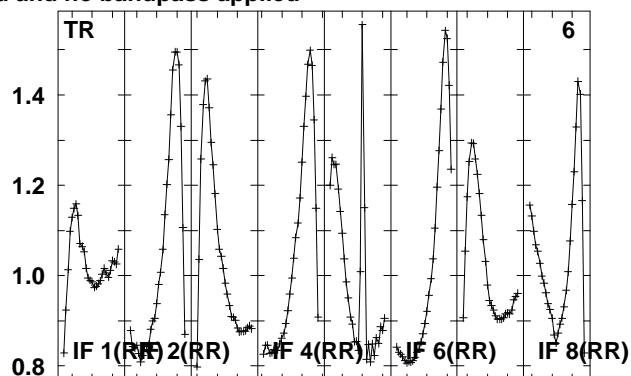
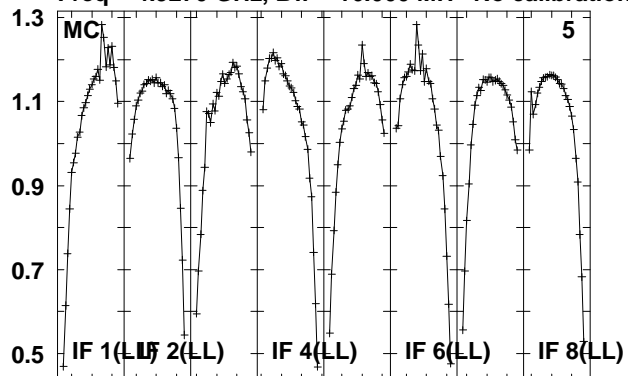

Lower frame: Real Jy
Total-power spectrum Antenna: *
Timerange: 00/23:15:31 to 00/23:18:59

Plot file version 60 created 24-AUG-2010 08:02:39

IRAS1929 EP064M.UVDATA.1

Freq = 4.9270 GHz, Bw = 16.000 MH No calibration applied and no bandpass applied

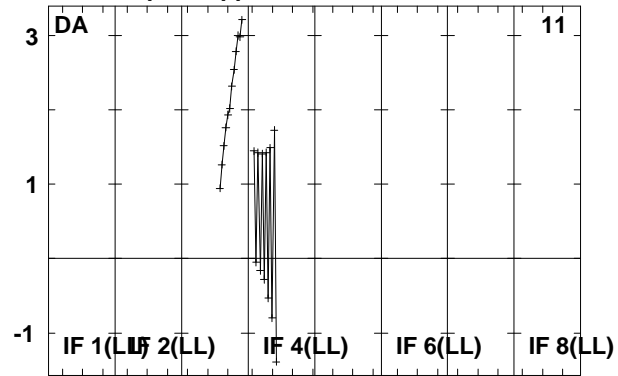
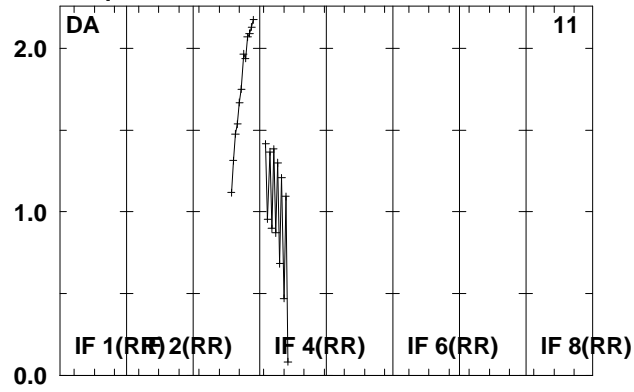

Lower frame: Real Jy
Total-power spectrum Antenna: *
Timerange: 00/23:15:31 to 00/23:18:59

Plot file version 61 created 24-AUG-2010 08:02:39

J1941-05 EP064M.UVDATA.1

Freq = 4.9270 GHz, Bw = 16.000 MH No calibration applied and no bandpass applied

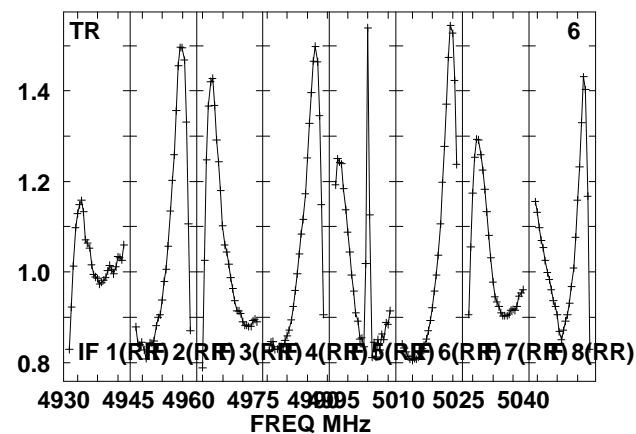
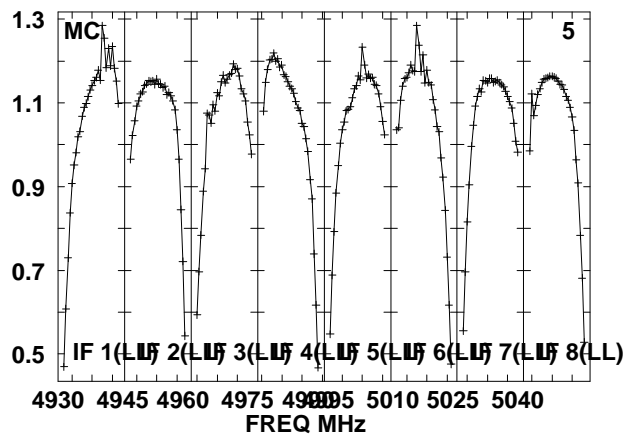
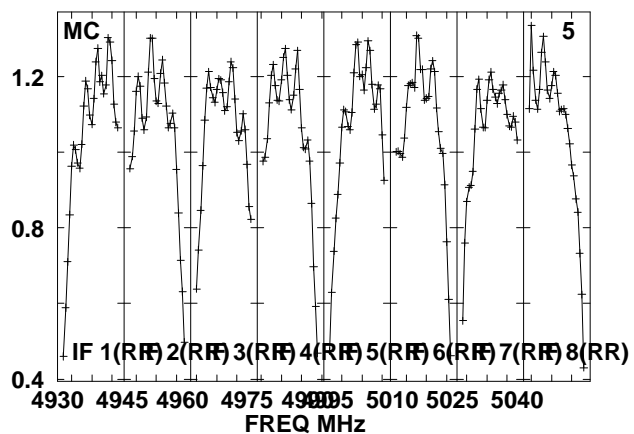
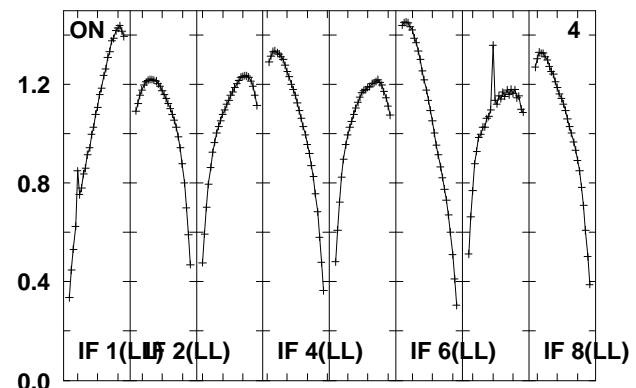
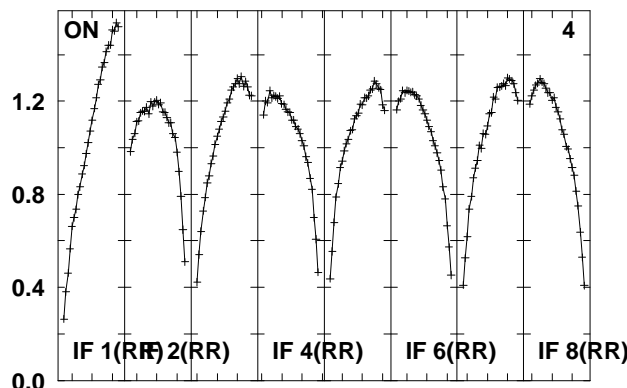
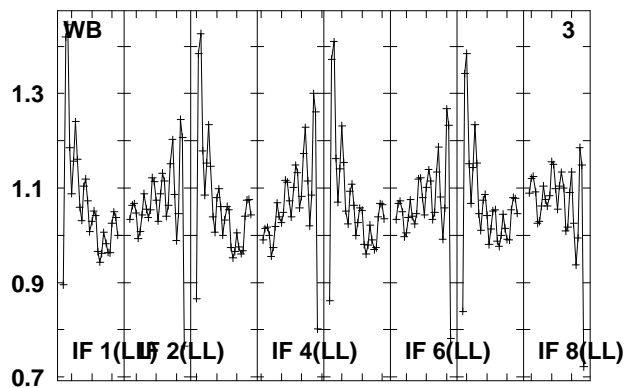
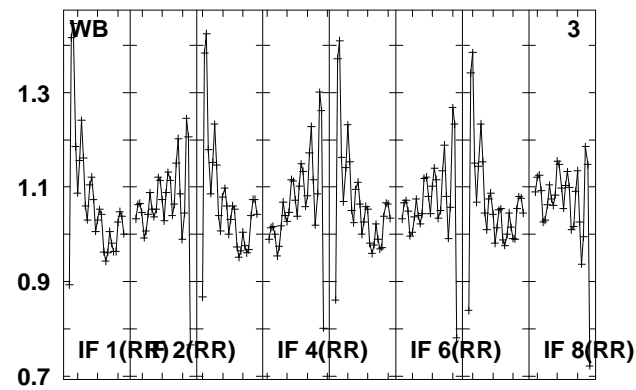
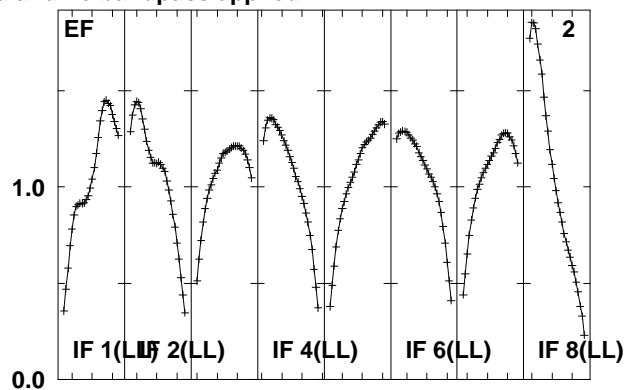
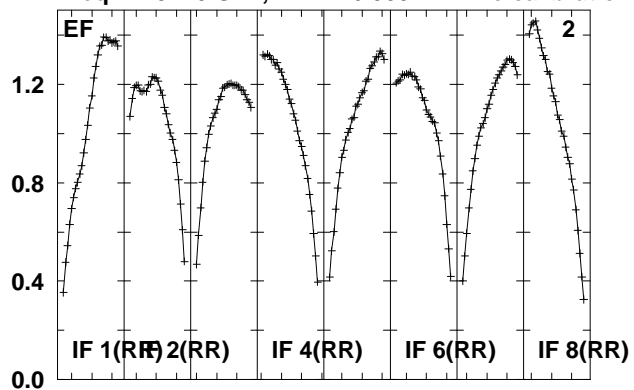

Lower frame: Real Jy
Total-power spectrum Antenna: *
Timerange: 00/23:19:01 to 00/23:20:29

Plot file version 62 created 24-AUG-2010 08:02:39

J1941-05 EP064M.UVDATA.1

Freq = 4.9270 GHz, Bw = 16.000 MH No calibration applied and no bandpass applied

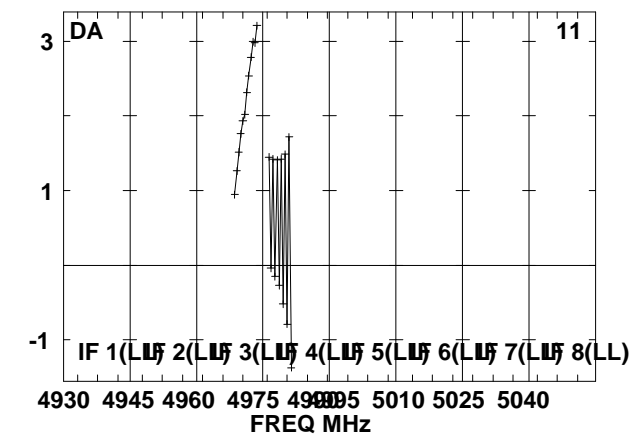
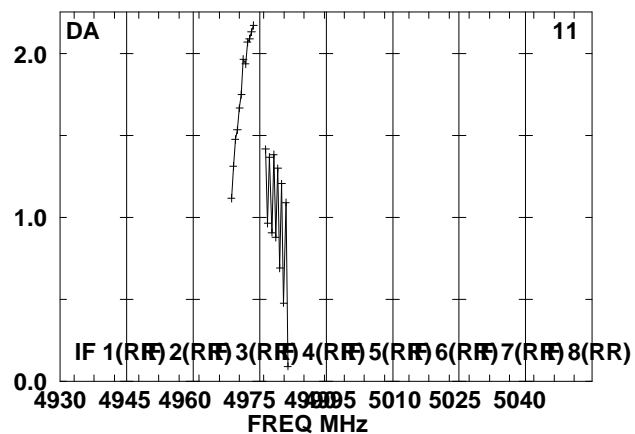
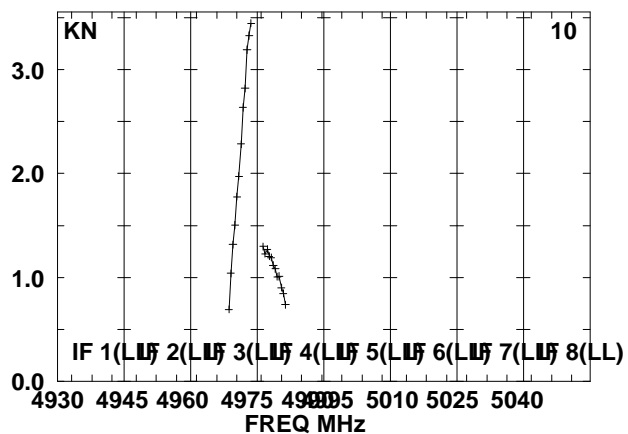
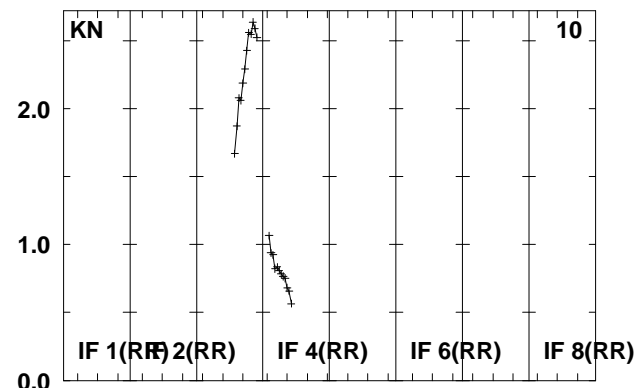
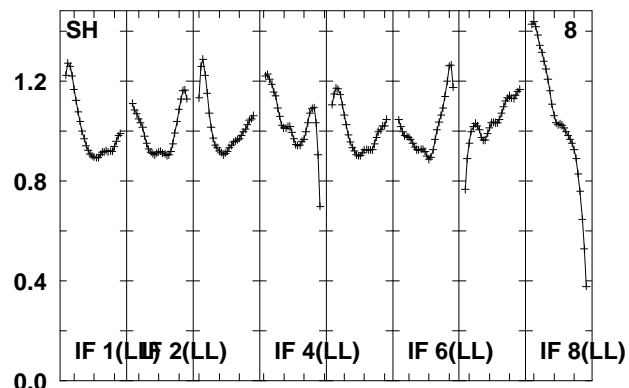
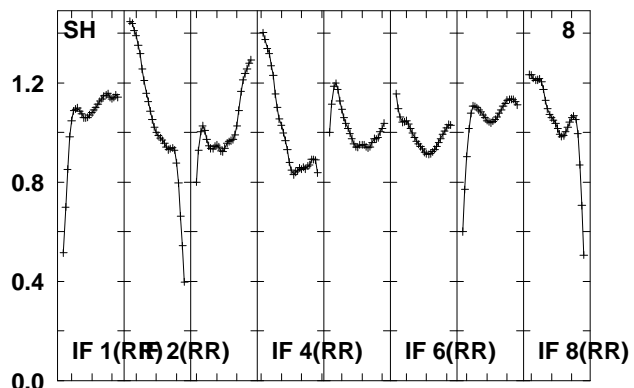
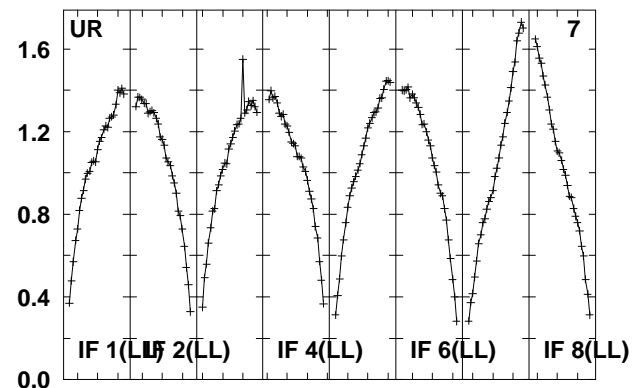
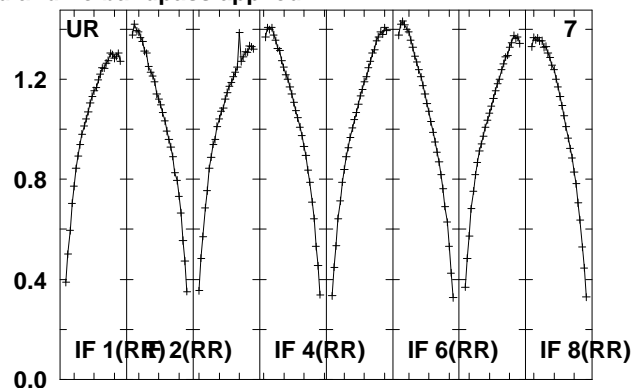
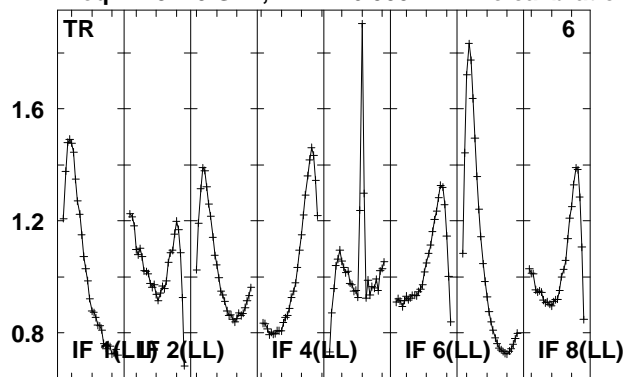

Lower frame: Real Jy
Total-power spectrum Antenna: *
Timerange: 00/23:19:01 to 00/23:20:29

Plot file version 63 created 24-AUG-2010 08:02:40

IRAS1929 EP064M.UVDATA.1

Freq = 4.9270 GHz, Bw = 16.000 MH No calibration applied and no bandpass applied

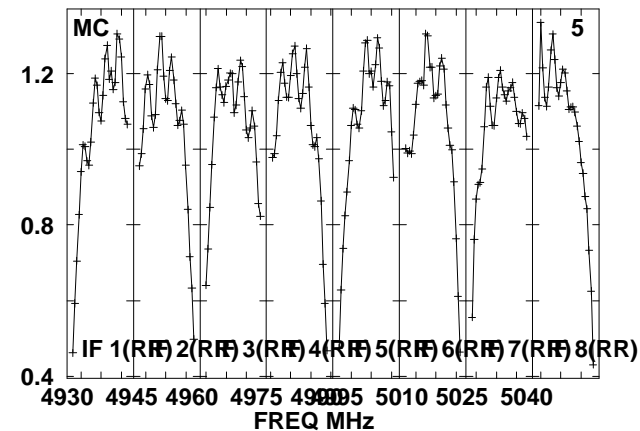
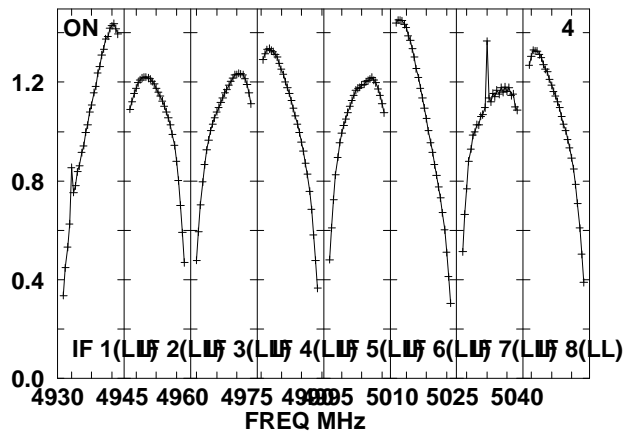
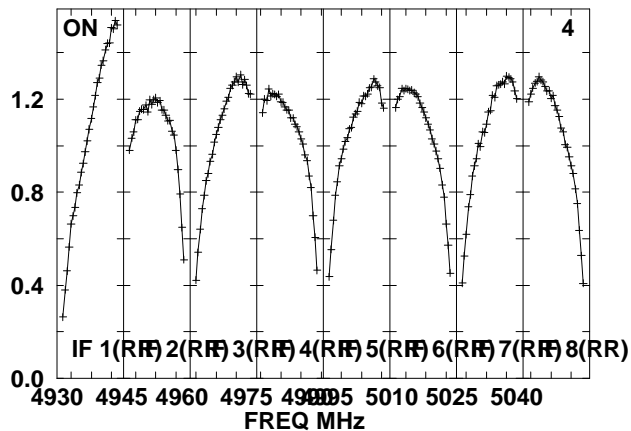
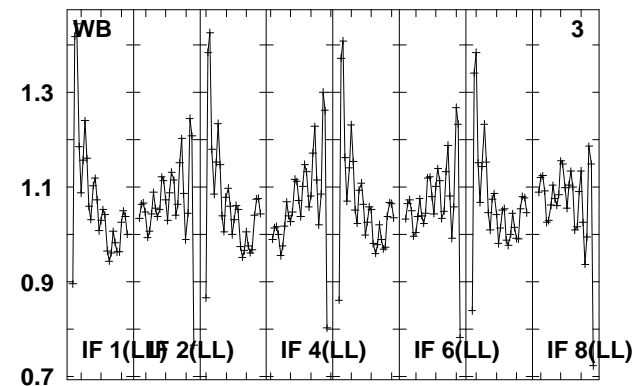
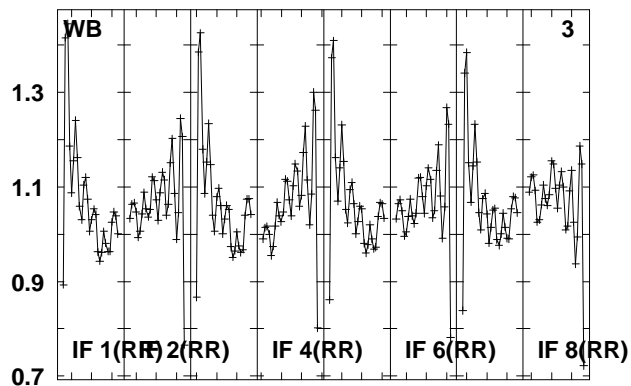
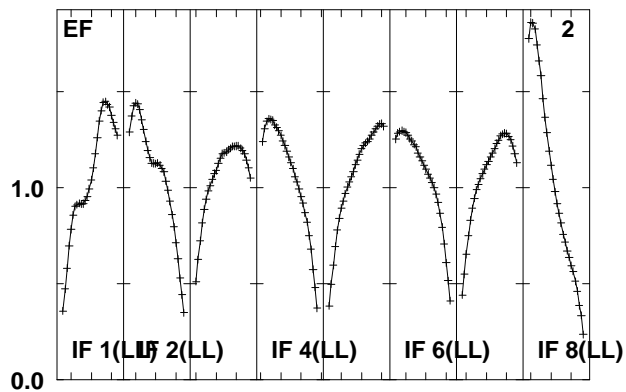
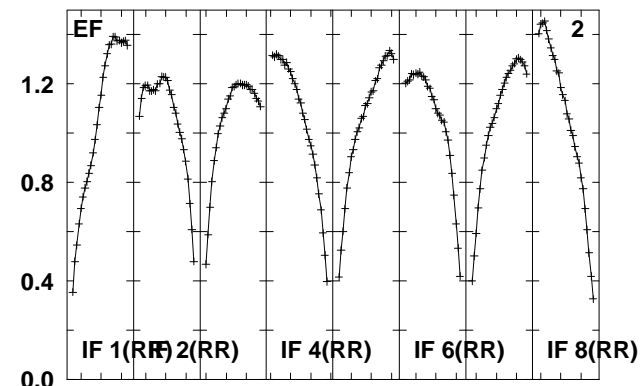
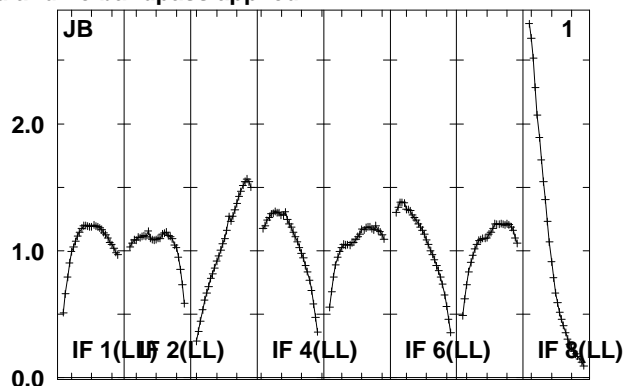
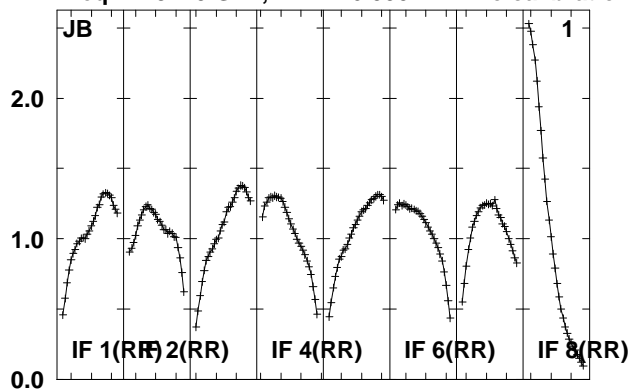

Lower frame: Real Jy

Total-power spectrum Antenna: *

Timerange: 00/23:20:31 to 00/23:23:59

Plot file version 64 created 24-AUG-2010 08:02:40

IRAS1929 EP064M.UVDATA.1

Freq = 4.9270 GHz, Bw = 16.000 MH No calibration applied and no bandpass applied

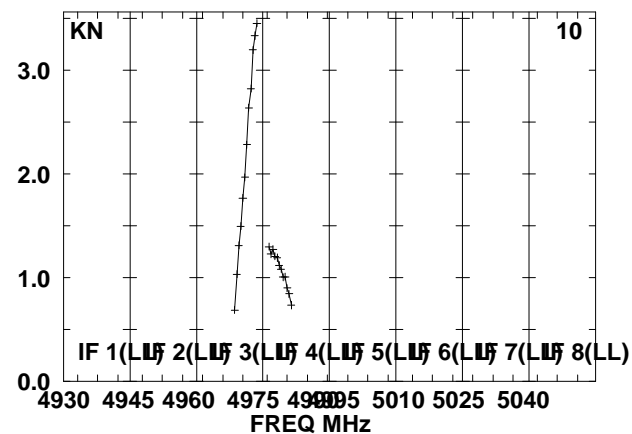
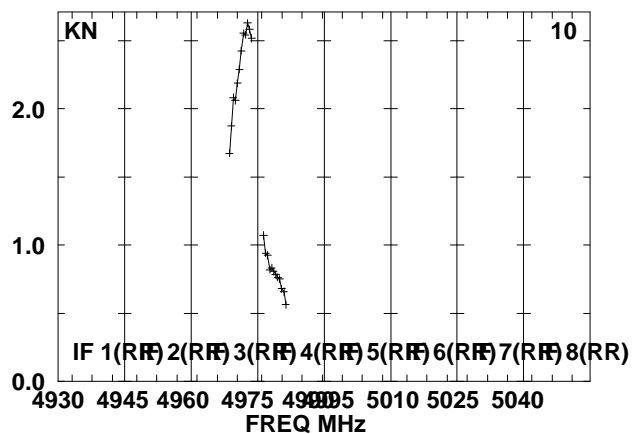
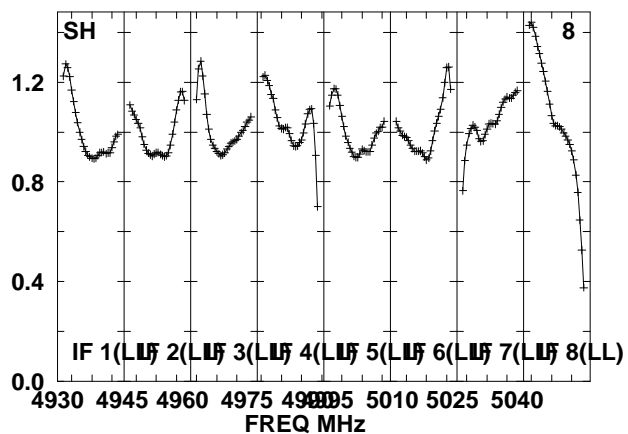
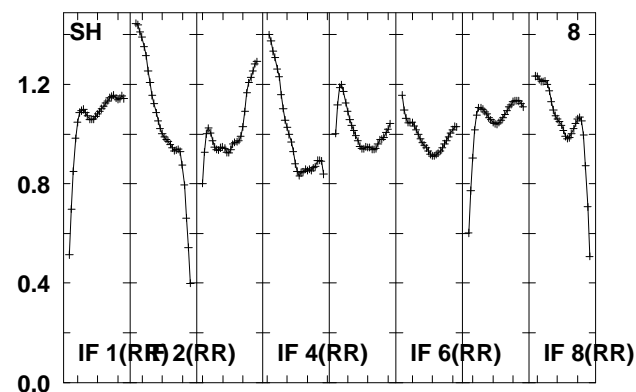
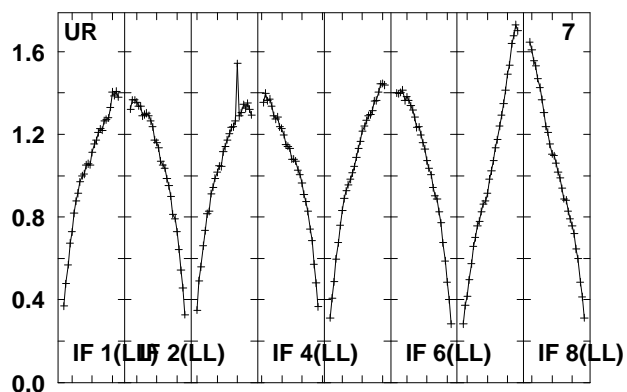
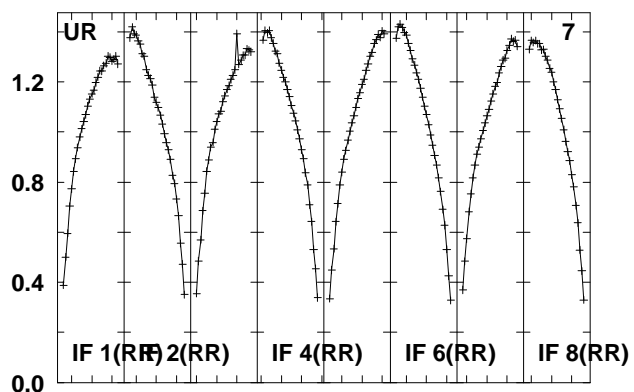
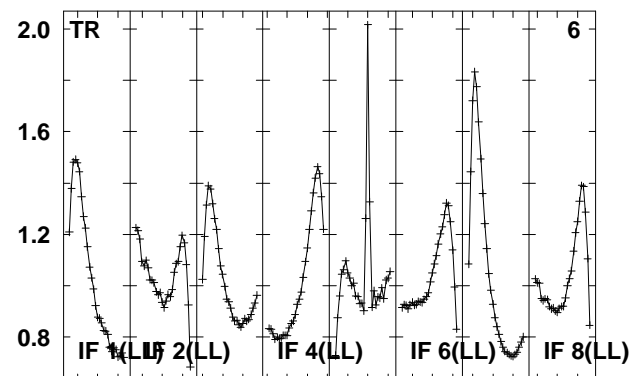
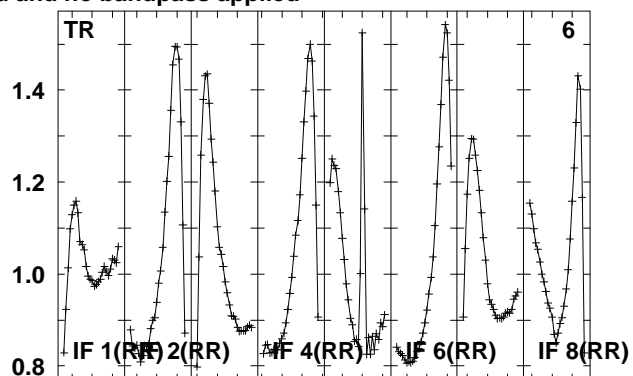
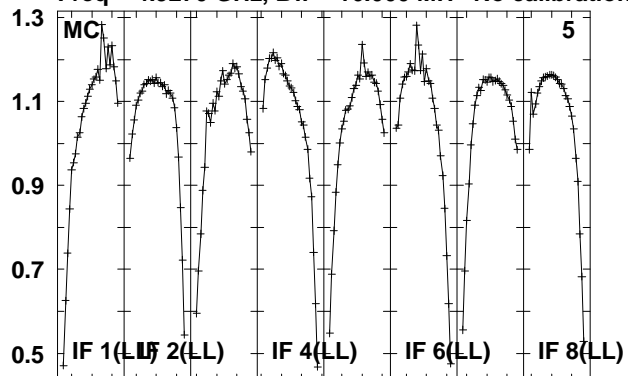

Lower frame: Real Jy

Total-power spectrum Antenna: *

Timerange: 00/23:20:31 to 00/23:23:59

Plot file version 65 created 24-AUG-2010 08:02:41

IRAS1929 EP064M.UVDATA.1

Freq = 4.9270 GHz, Bw = 16.000 MH No calibration applied and no bandpass applied

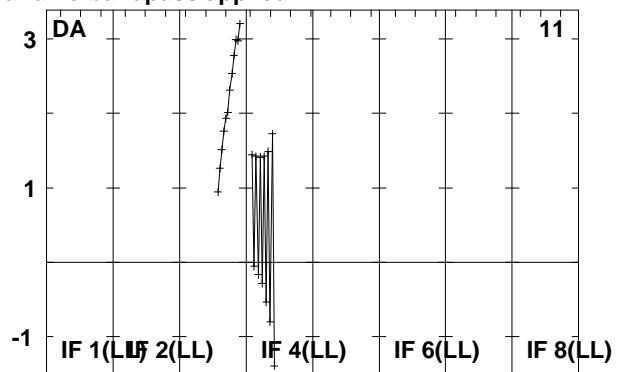
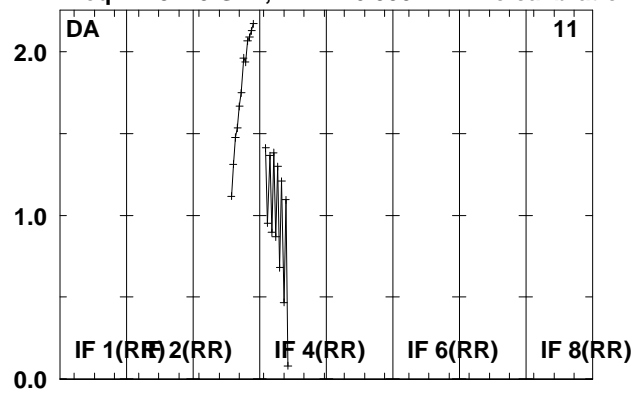

Lower frame: Real Jy
Total-power spectrum Antenna: *
Timerange: 00/23:20:31 to 00/23:23:59

Plot file version 66 created 24-AUG-2010 08:02:41

J1941-05 EP064M.UVDATA.1

Freq = 4.9270 GHz, Bw = 16.000 MH No calibration applied and no bandpass applied

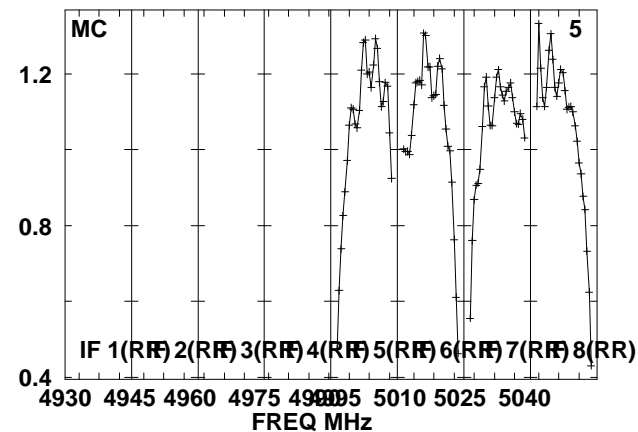
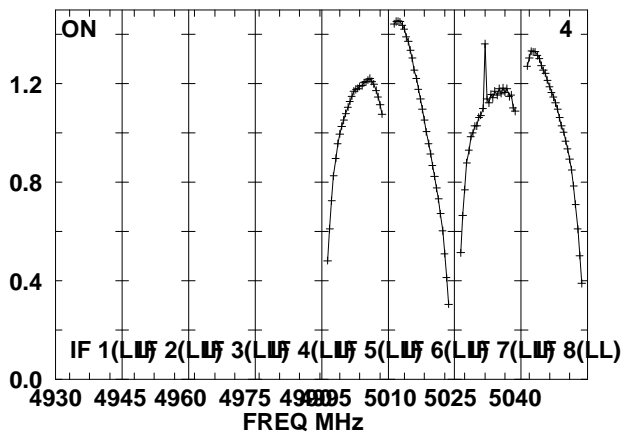
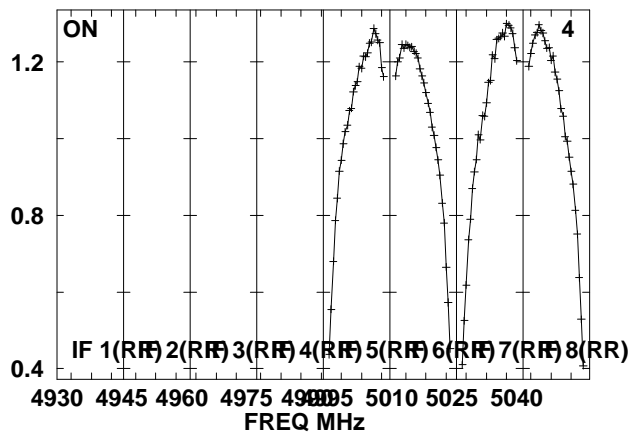
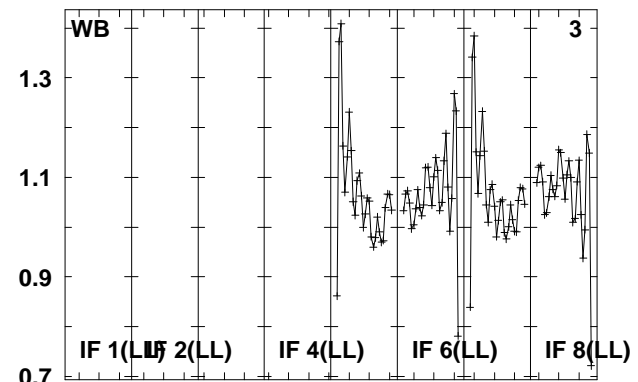
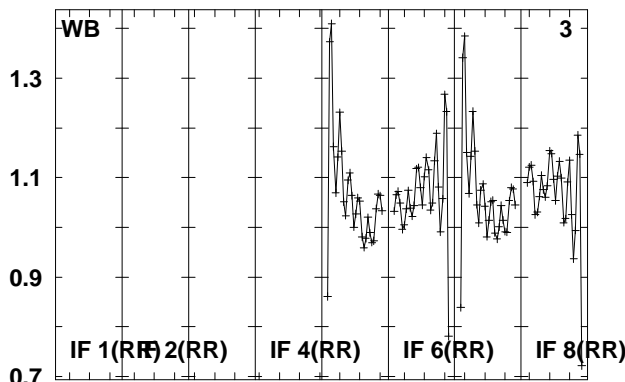
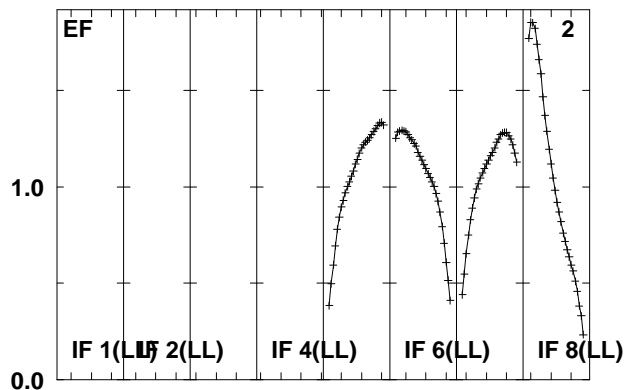
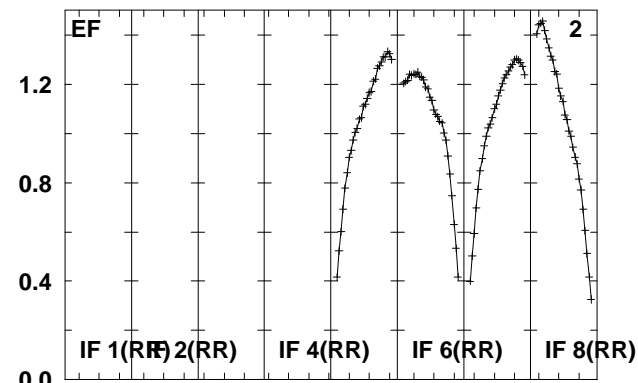
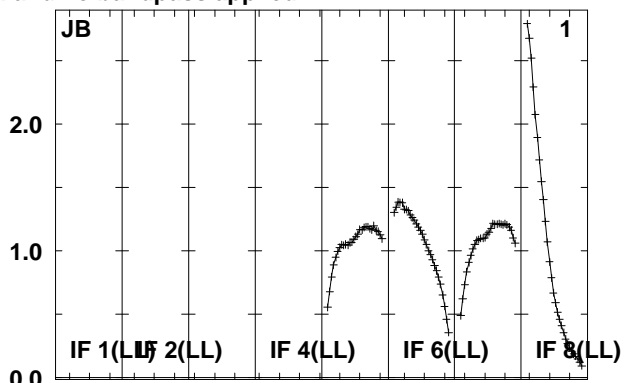
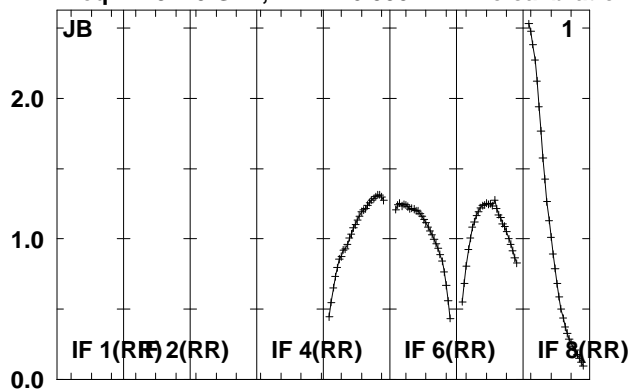

Lower frame: Real Jy
Total-power spectrum Antenna: *
Timerange: 00/23:24:03 to 00/23:25:27

Plot file version 67 created 24-AUG-2010 08:02:42

J1941-05 EP064M.UVDATA.1

Freq = 4.9270 GHz, Bw = 16.000 MH No calibration applied and no bandpass applied

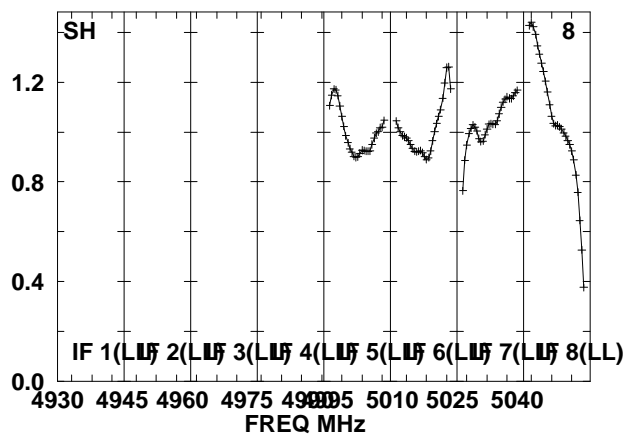
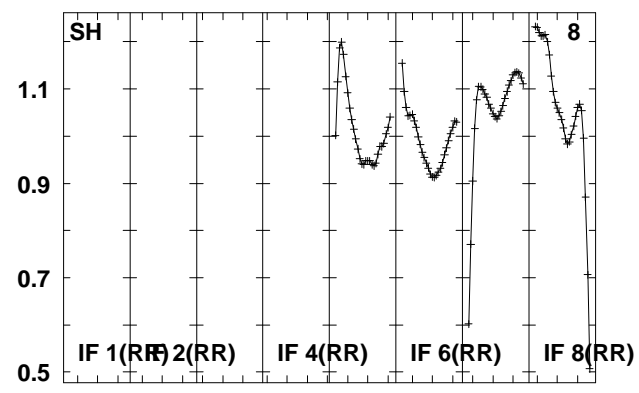
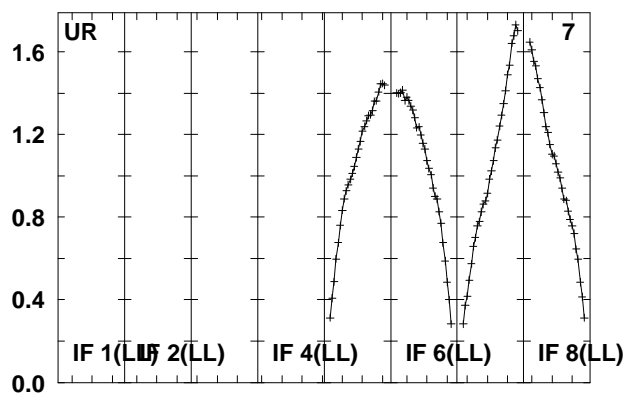
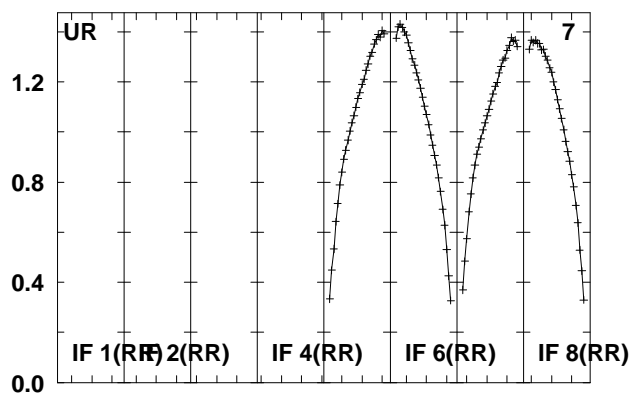
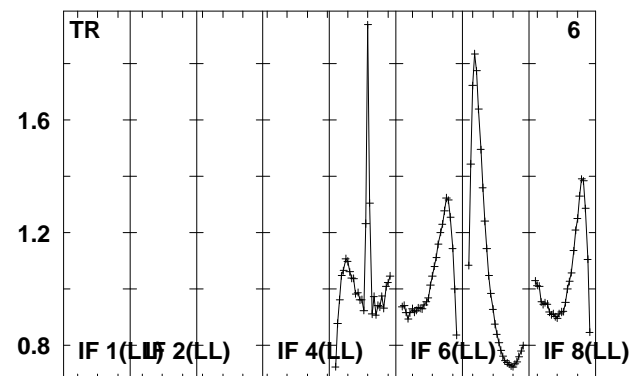
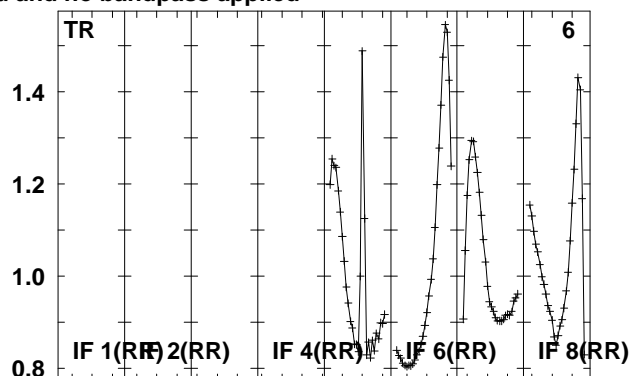
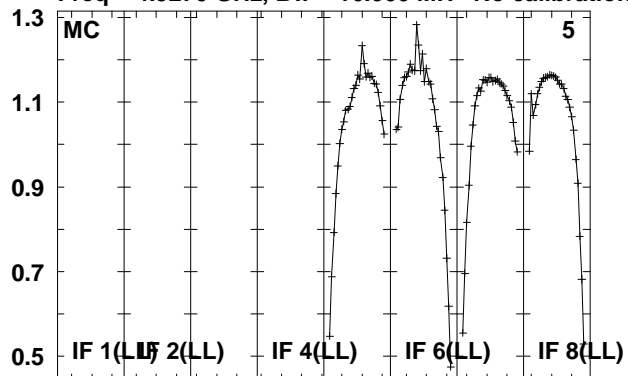

Lower frame: Real Jy

Total-power spectrum Antenna: *

Timerange: 00/23:24:03 to 00/23:25:27

Plot file version 68 created 24-AUG-2010 08:02:42

IRAS1929 EP064M.UVDATA.1

Freq = 4.9270 GHz, Bw = 16.000 MH No calibration applied and no bandpass applied

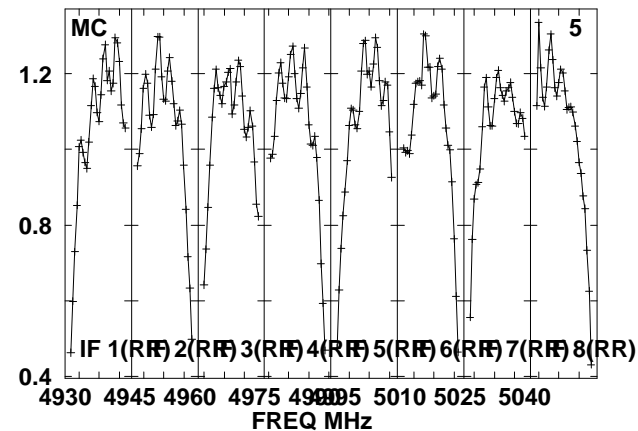
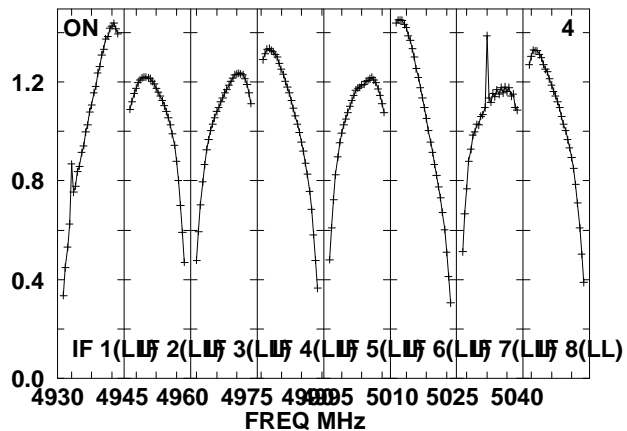
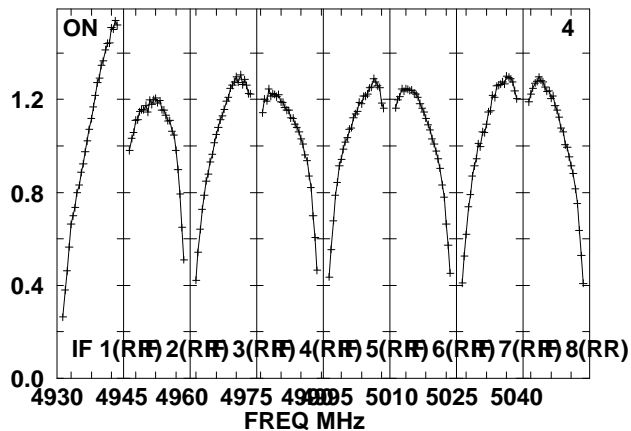
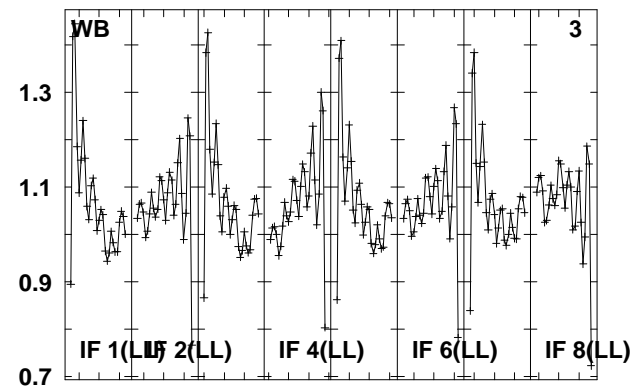
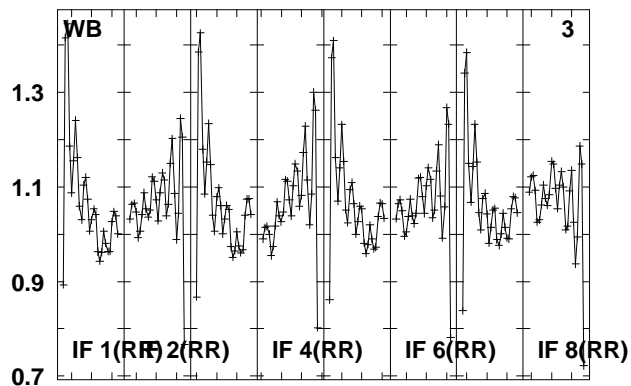
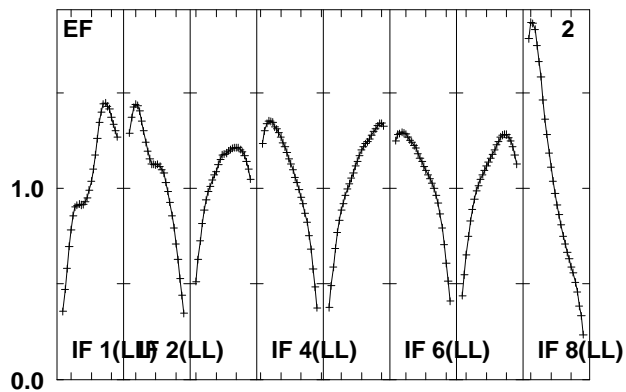
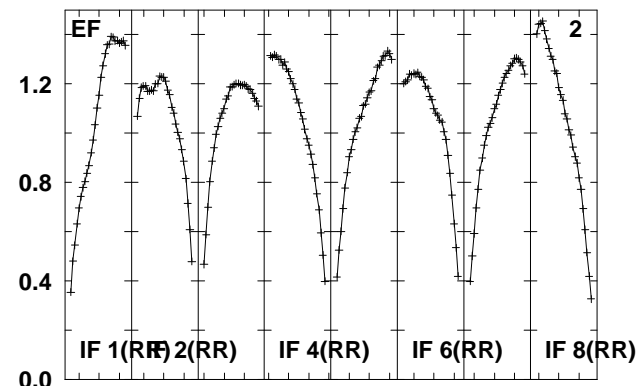
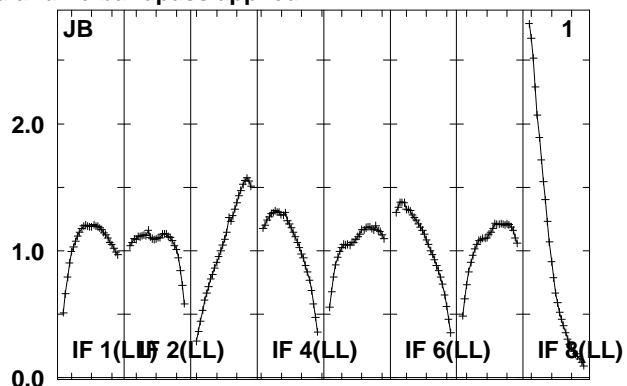
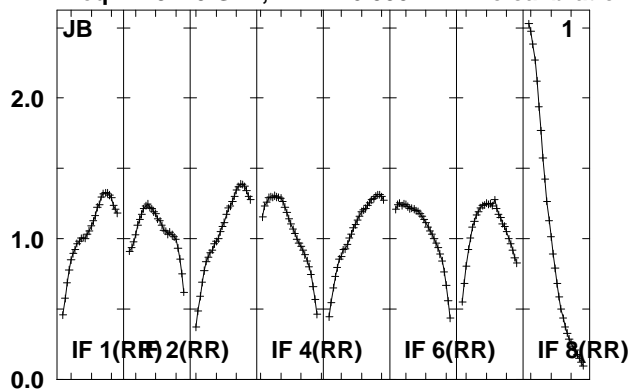

Lower frame: Real Jy

Total-power spectrum Antenna: *

Timerange: 00/23:25:33 to 00/23:28:59

Plot file version 69 created 24-AUG-2010 08:02:42

IRAS1929 EP064M.UVDATA.1

Freq = 4.9270 GHz, Bw = 16.000 MH No calibration applied and no bandpass applied

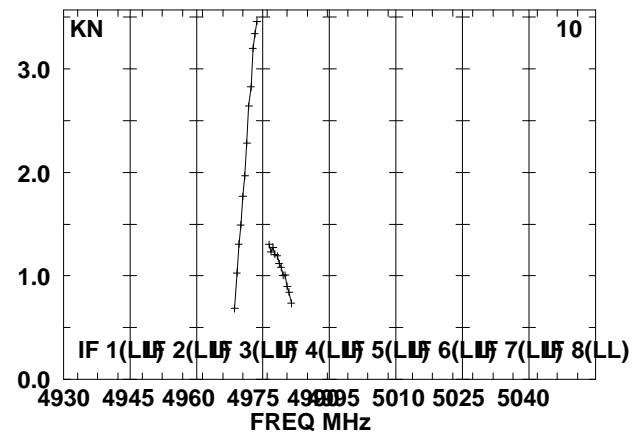
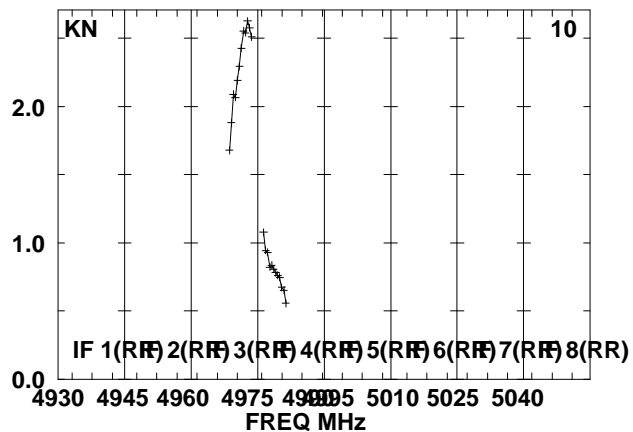
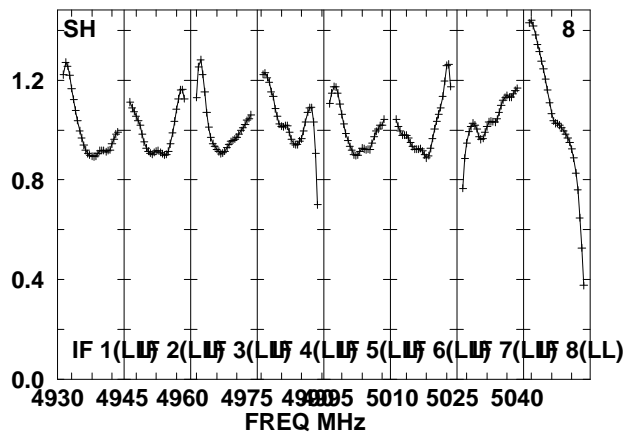
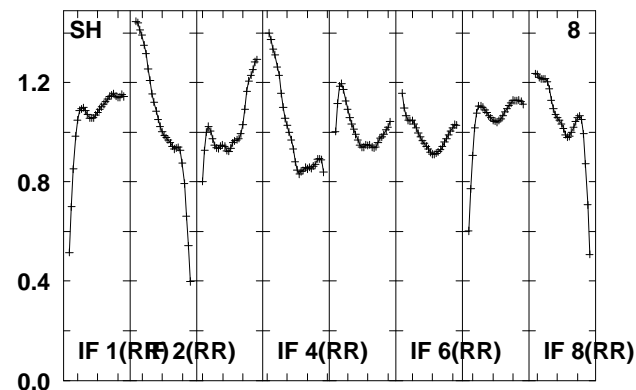
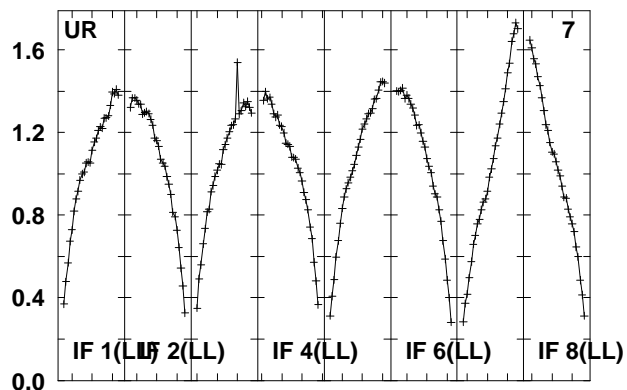
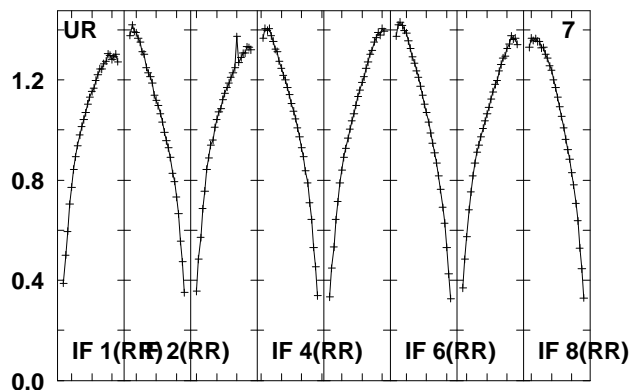
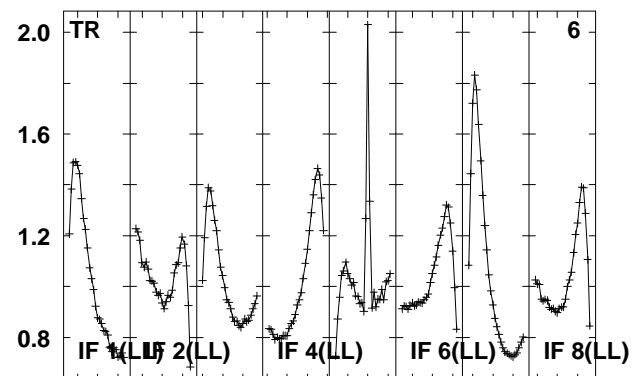
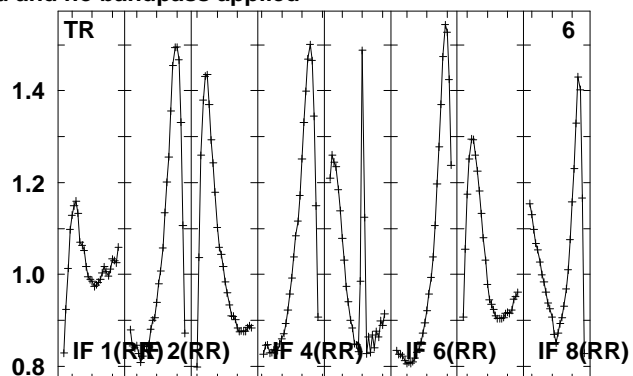
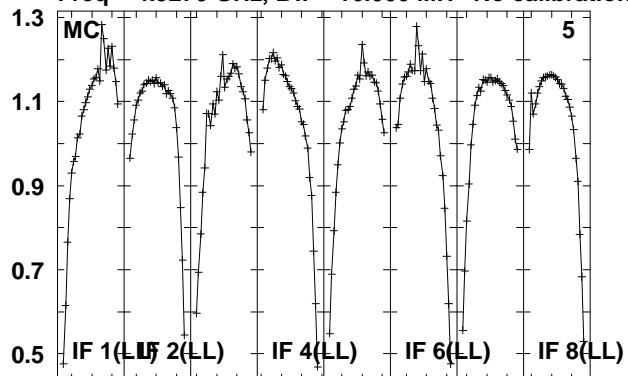

Lower frame: Real Jy

Total-power spectrum Antenna: *

Timerange: 00/23:25:33 to 00/23:28:59

Plot file version 70 created 24-AUG-2010 08:02:43

IRAS1929 EP064M.UVDATA.1

Freq = 4.9270 GHz, Bw = 16.000 MH No calibration applied and no bandpass applied

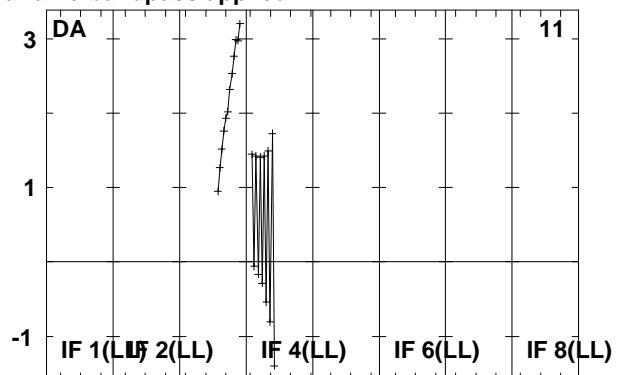
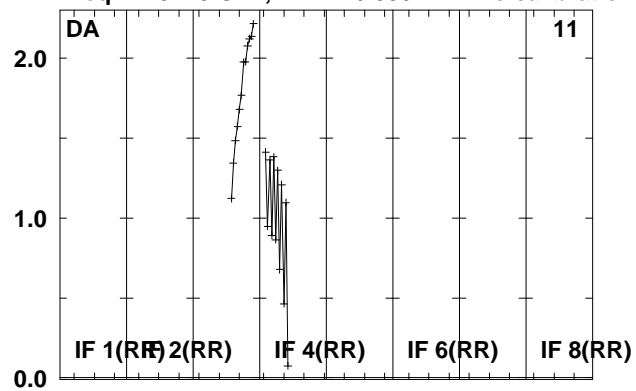

Lower frame: Real Jy
Total-power spectrum Antenna: *
Timerange: 00/23:25:33 to 00/23:28:59

Plot file version 71 created 24-AUG-2010 08:02:43

J1941-05 EP064M.UVDATA.1

Freq = 4.9270 GHz, Bw = 16.000 MH No calibration applied and no bandpass applied

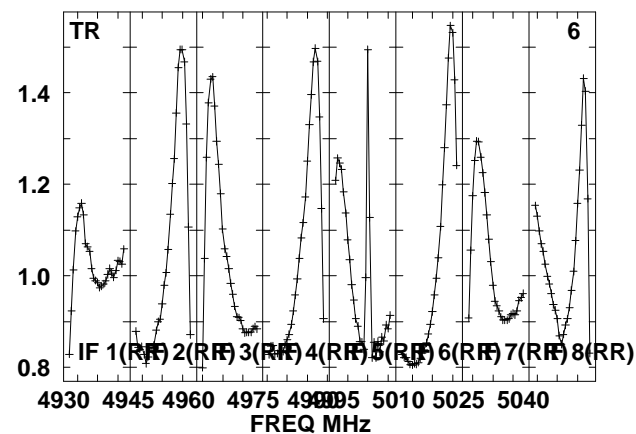
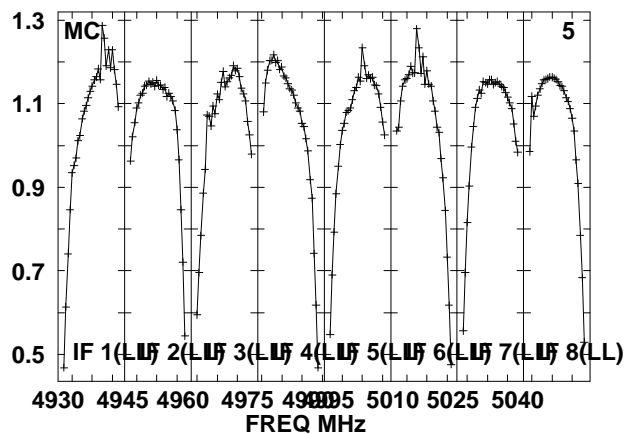
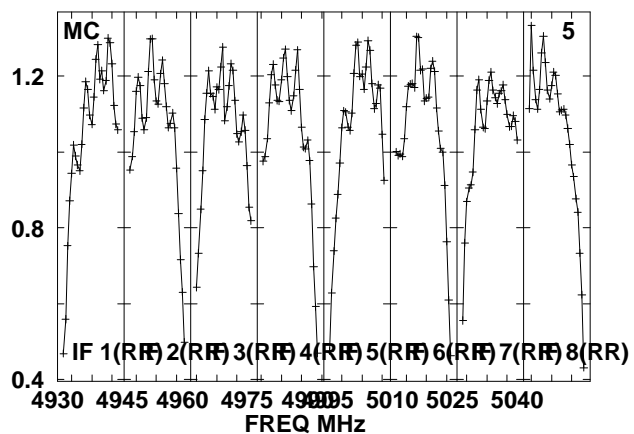
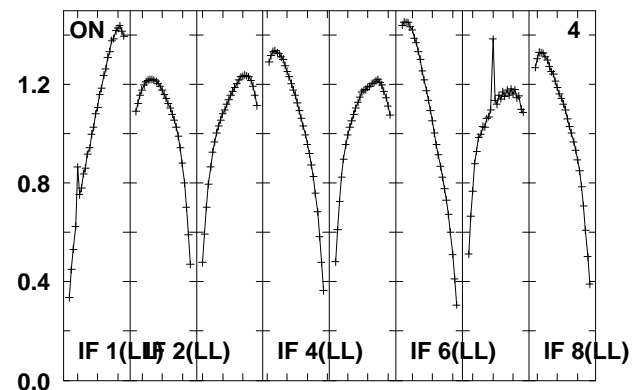
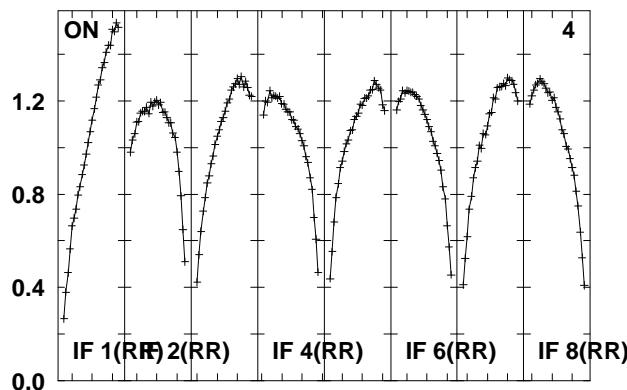
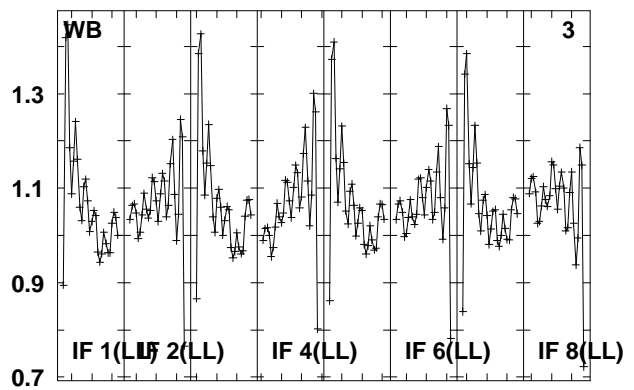
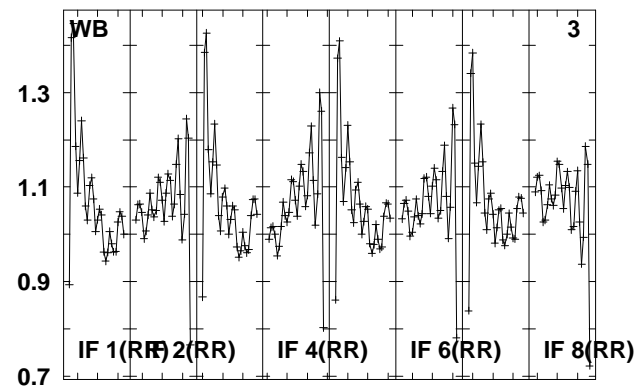
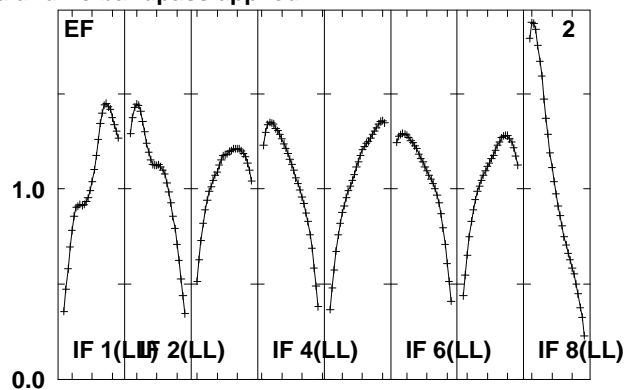
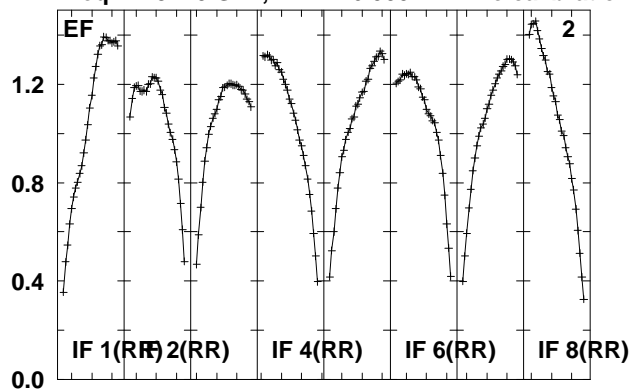

Lower frame: Real Jy
Total-power spectrum Antenna: *
Timerange: 00/23:30:01 to 00/23:31:29

Plot file version 72 created 24-AUG-2010 08:02:44

J1941-05 EP064M.UVDATA.1

Freq = 4.9270 GHz, Bw = 16.000 MH No calibration applied and no bandpass applied

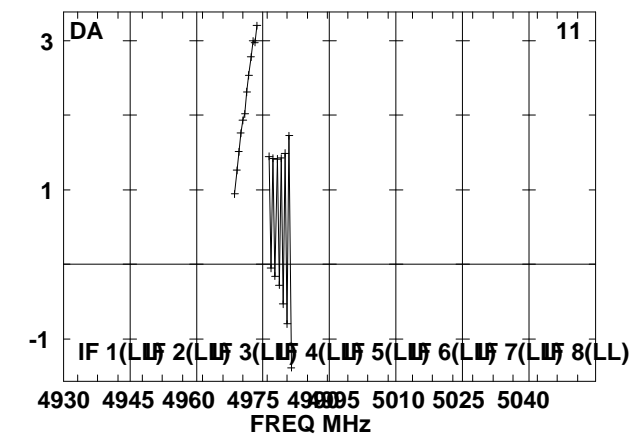
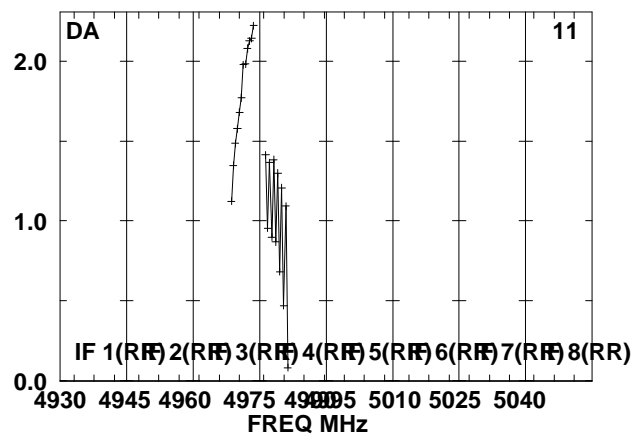
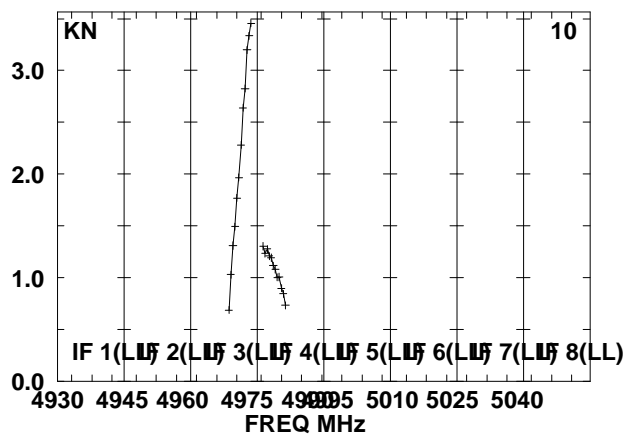
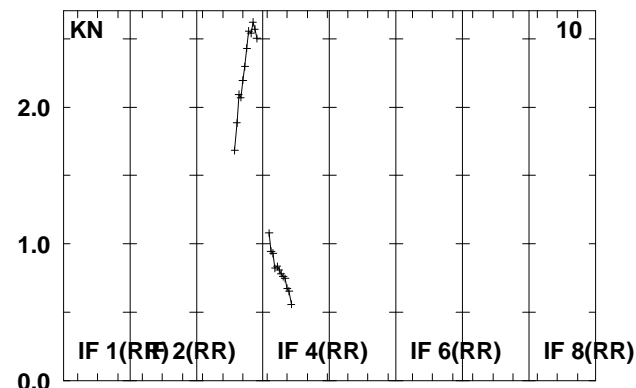
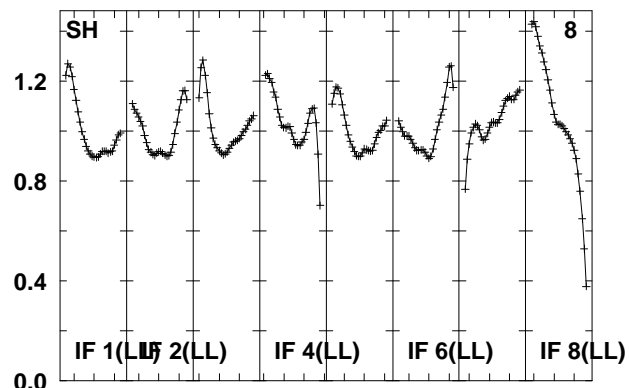
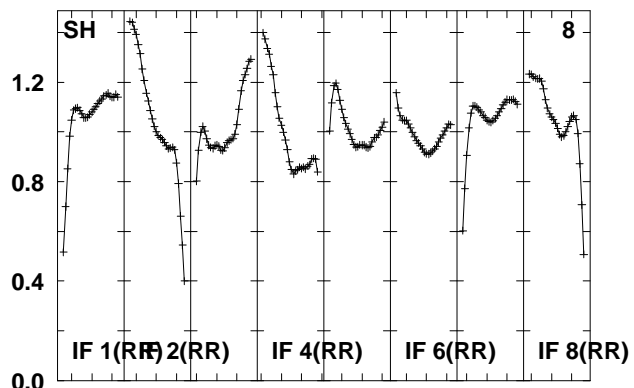
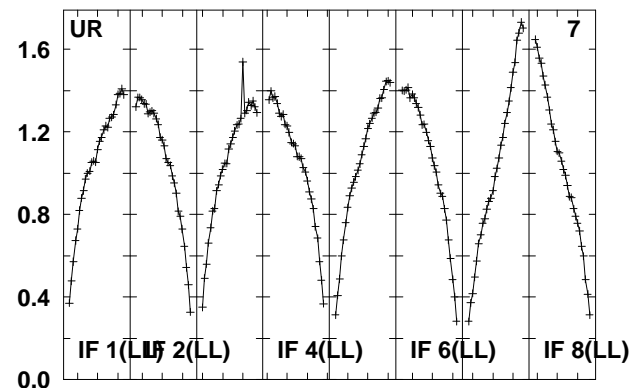
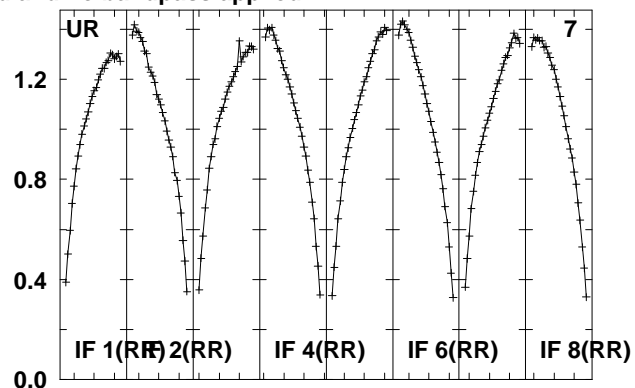
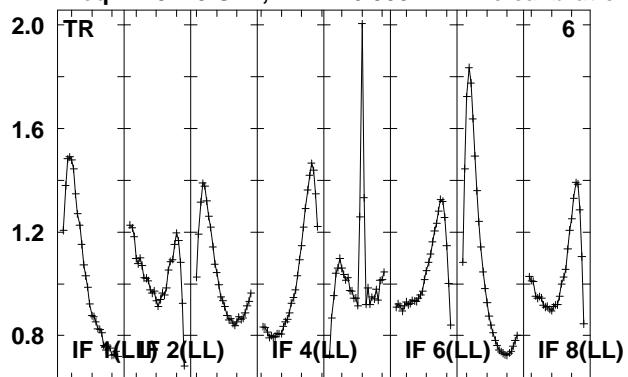

Lower frame: Real Jy
Total-power spectrum Antenna: *
Timerange: 00/23:30:01 to 00/23:31:29

Plot file version 73 created 24-AUG-2010 08:02:44

IRAS1929 EP064M.UVDATA.1

Freq = 4.9270 GHz, Bw = 16.000 MH No calibration applied and no bandpass applied

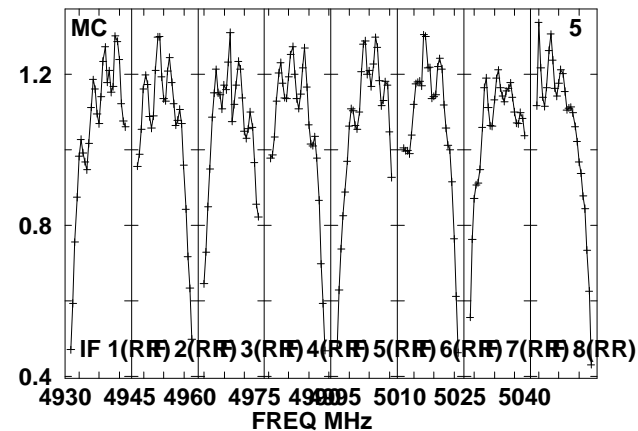
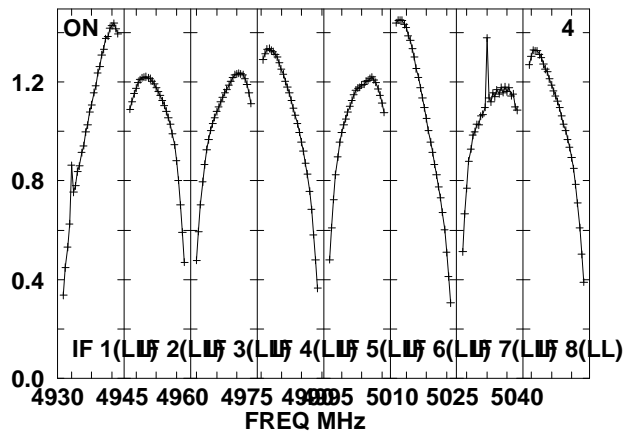
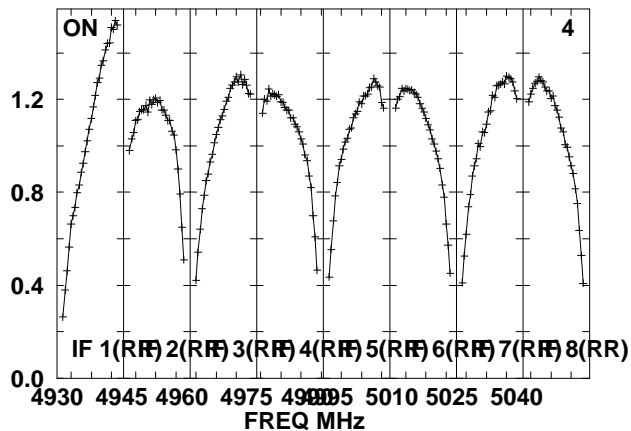
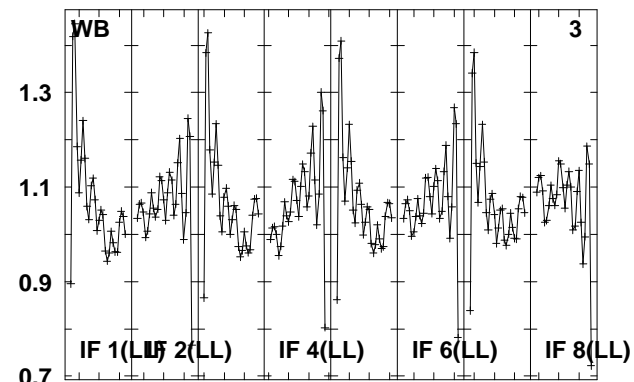
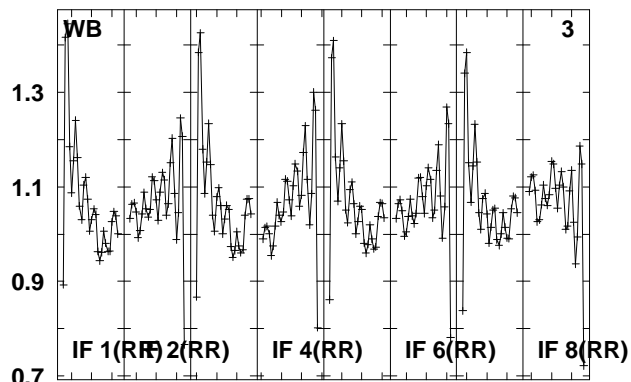
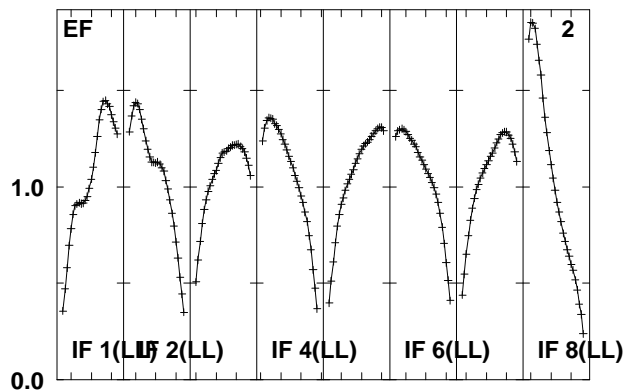
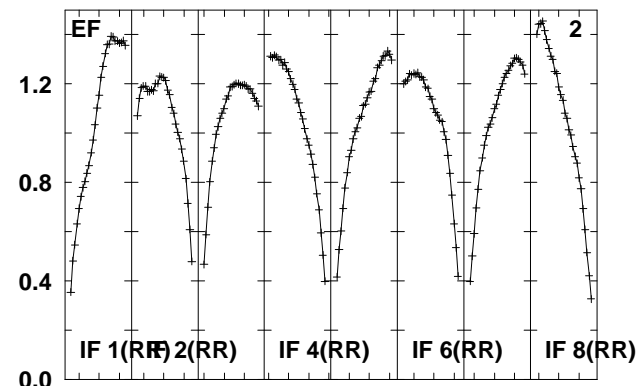
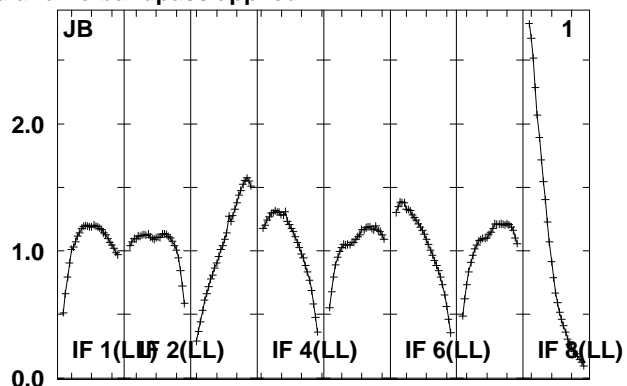
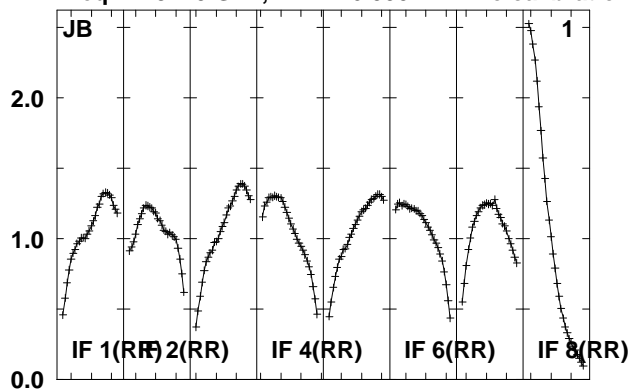

Lower frame: Real Jy
Total-power spectrum Antenna: *
Timerange: 00/23:31:31 to 00/23:34:59

Plot file version 74 created 24-AUG-2010 08:02:45

IRAS1929 EP064M.UVDATA.1

Freq = 4.9270 GHz, Bw = 16.000 MH No calibration applied and no bandpass applied

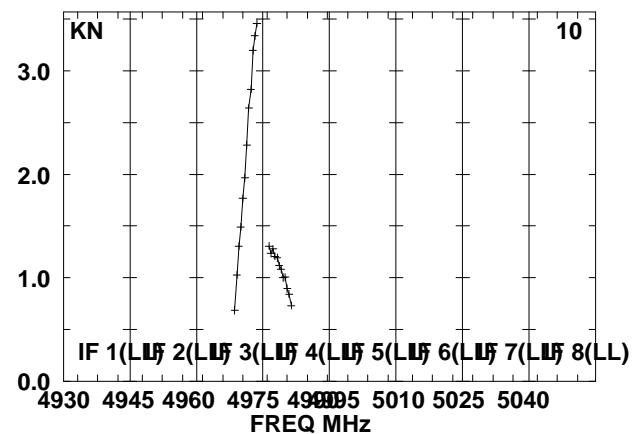
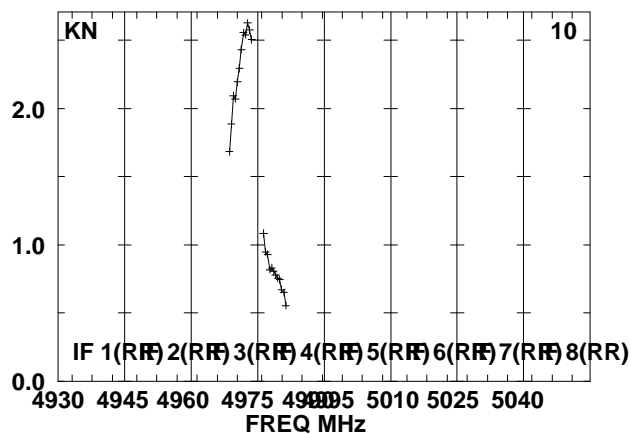
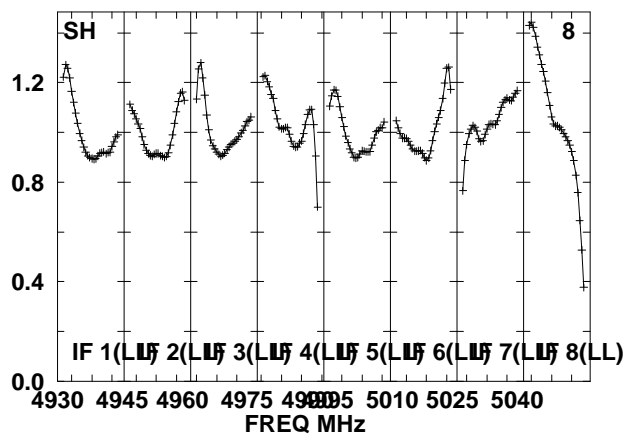
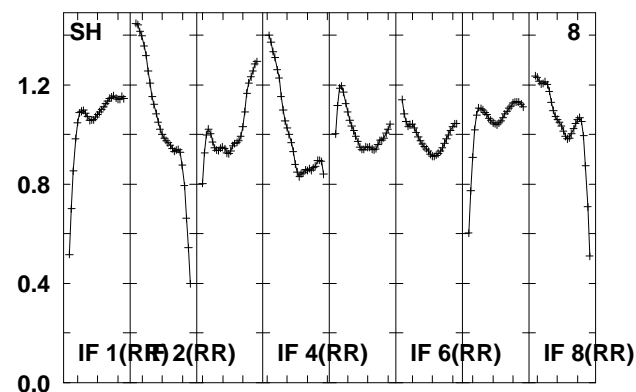
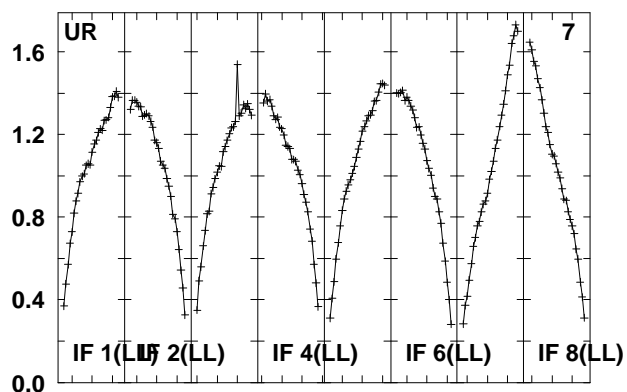
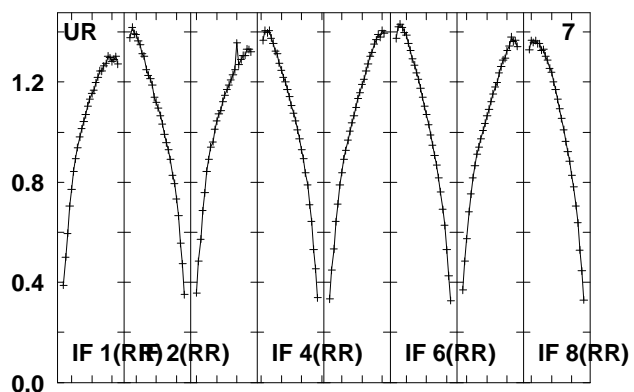
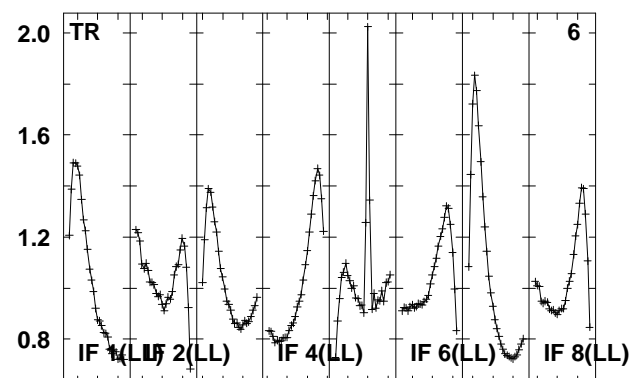
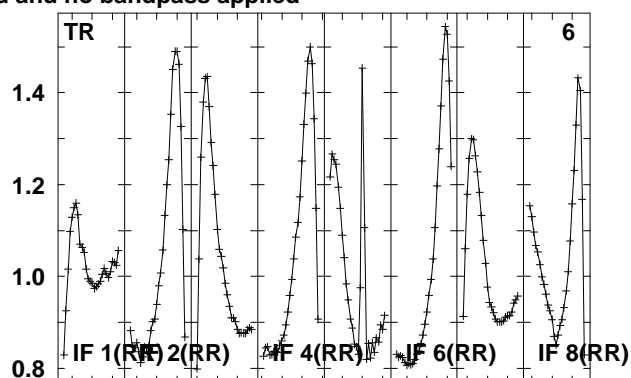
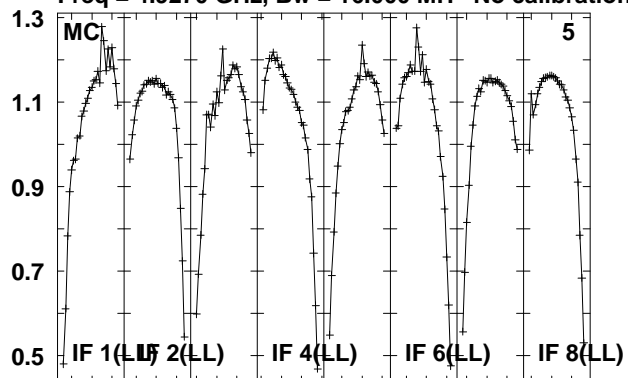

Lower frame: Real Jy

Total-power spectrum Antenna: *

Timerange: 00/23:31:31 to 00/23:34:59

Plot file version 75 created 24-AUG-2010 08:02:45

IRAS1929 EP064M.UVDATA.1

Freq = 4.9270 GHz, Bw = 16.000 MH No calibration applied and no bandpass applied

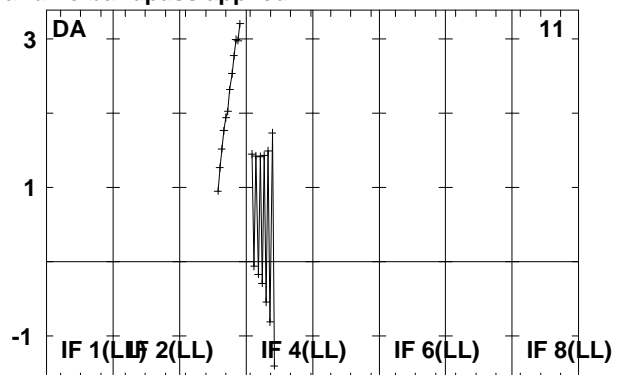
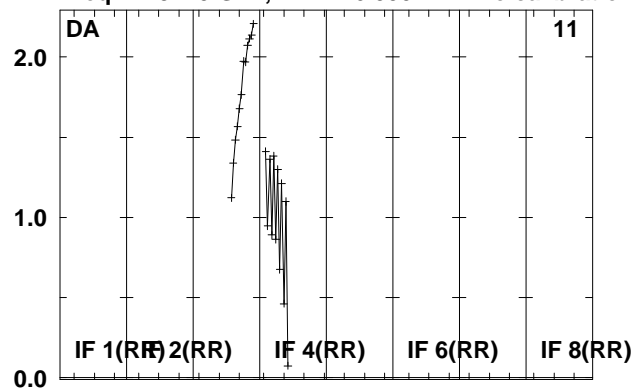

Lower frame: Real Jy
Total-power spectrum Antenna: *
Timerange: 00/23:31:31 to 00/23:34:59

Plot file version 76 created 24-AUG-2010 08:02:45

J1941-05 EP064M.UVDATA.1

Freq = 4.9270 GHz, Bw = 16.000 MH No calibration applied and no bandpass applied

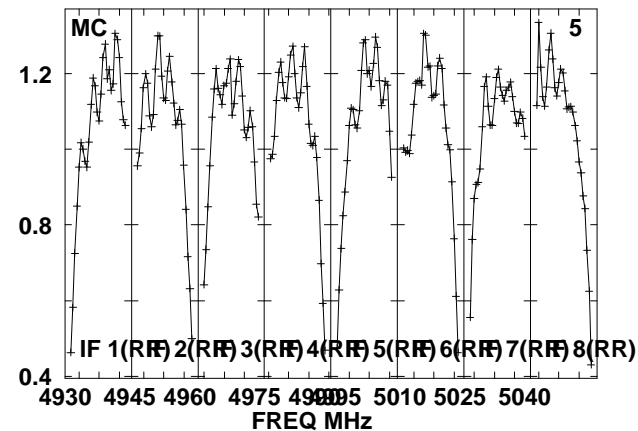
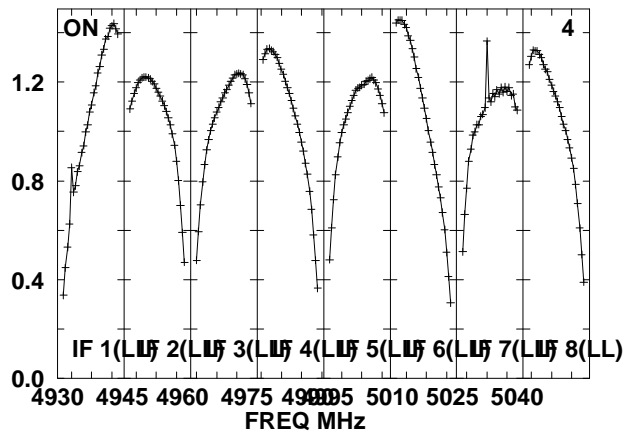
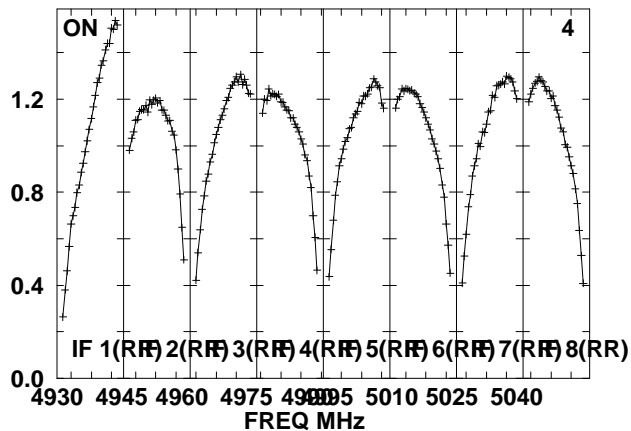
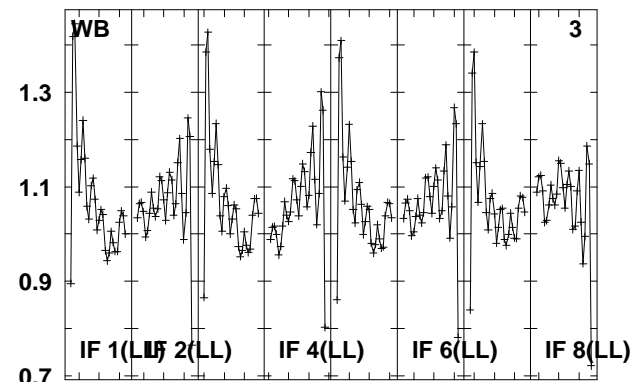
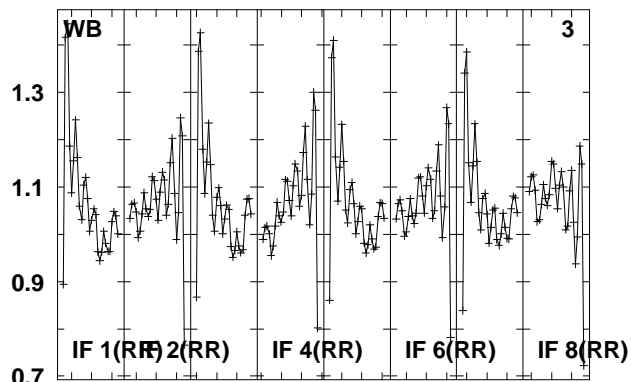
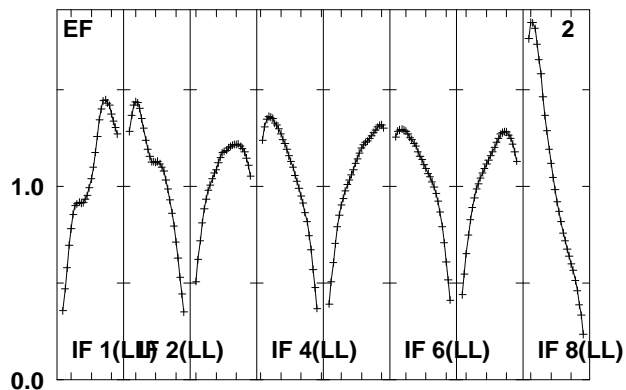
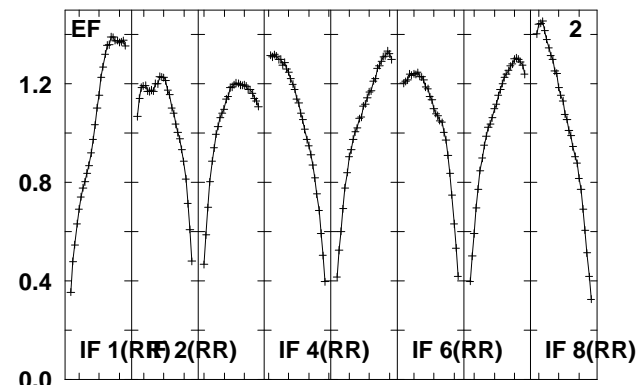
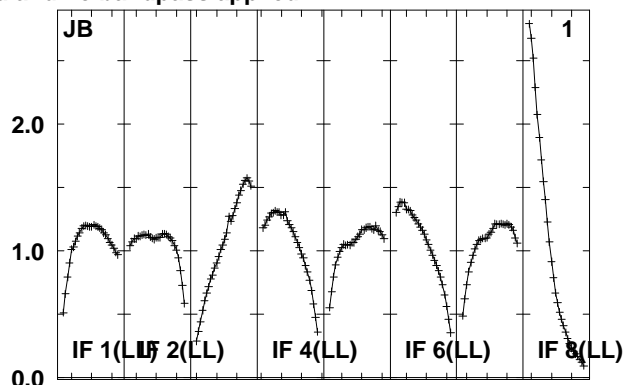
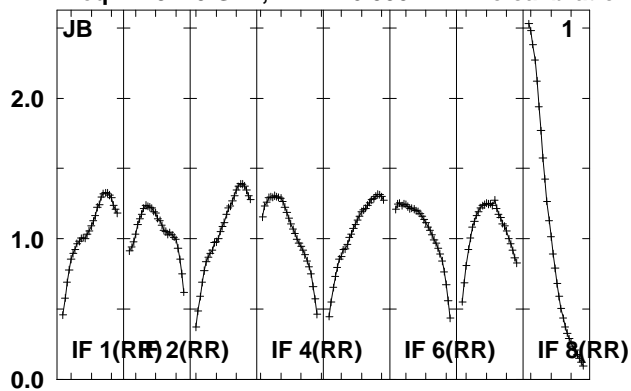

Lower frame: Real Jy
Total-power spectrum Antenna: *
Timerange: 00/23:35:01 to 00/23:36:29

Plot file version 77 created 24-AUG-2010 08:02:46
 J1941-05 EP064M.UVDATA.1
 Freq = 4.9270 GHz, Bw = 16.000 MH No calibration applied and no bandpass applied

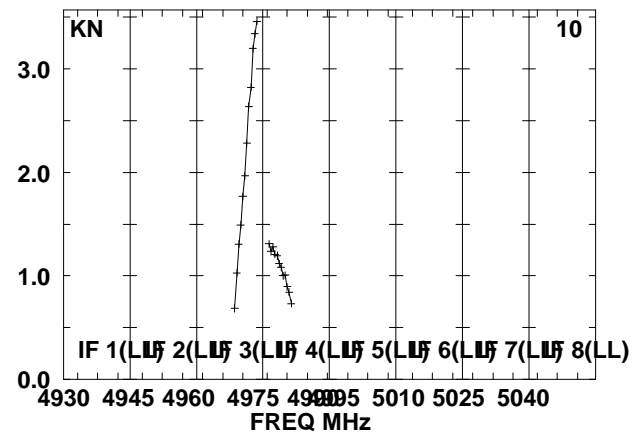
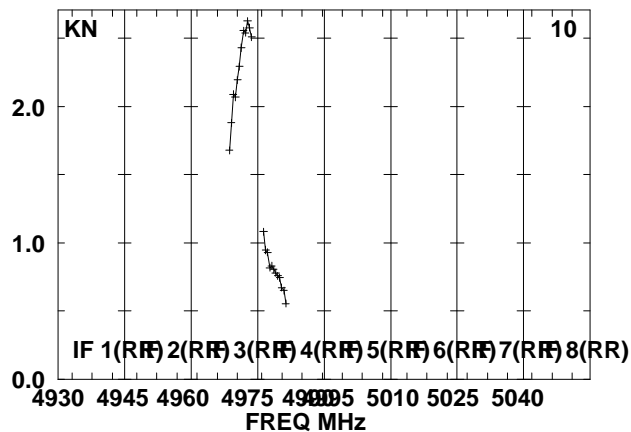
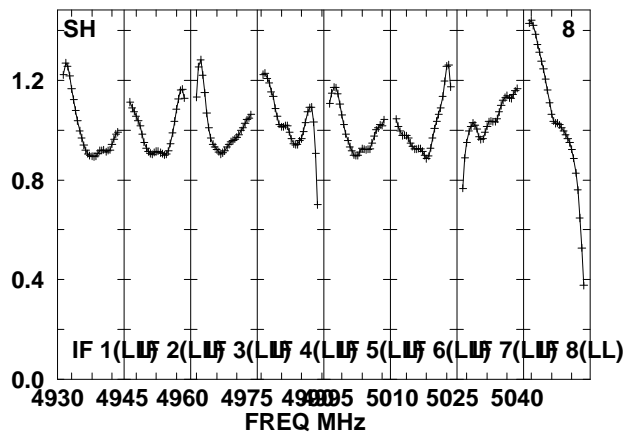
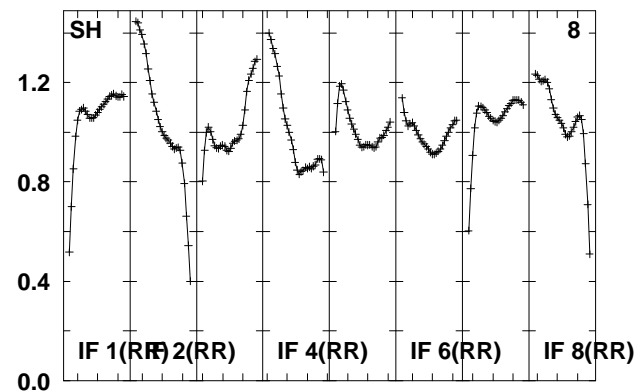
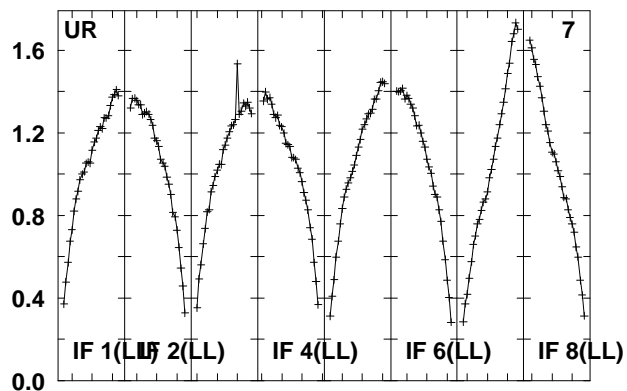
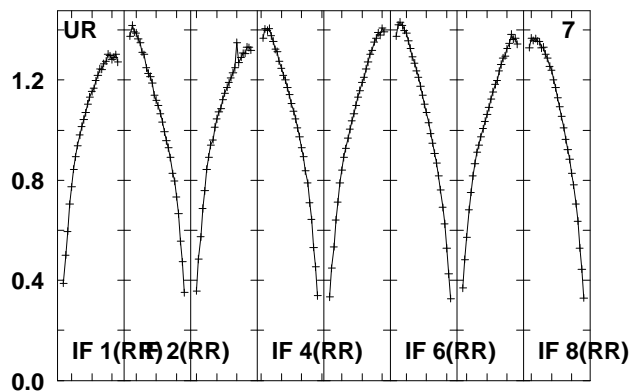
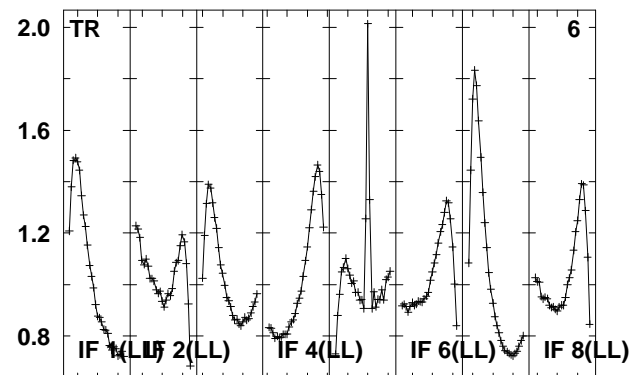
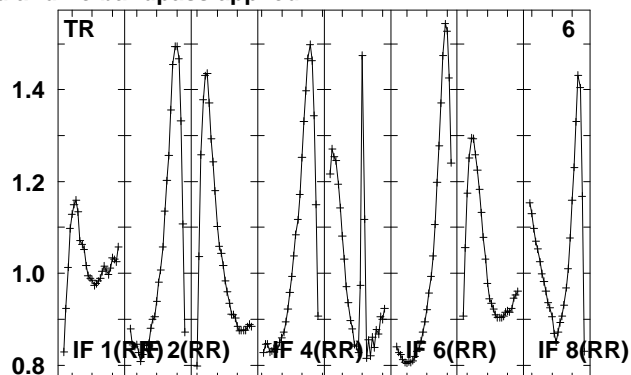
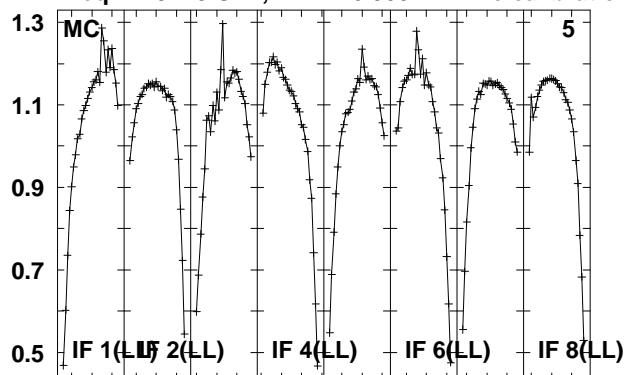

Lower frame: Real Jy
 Total-power spectrum Antenna: *
 Timerange: 00/23:35:01 to 00/23:36:29

Plot file version 78 created 24-AUG-2010 08:02:46

J1941-05 EP064M.UVDATA.1

Freq = 4.9270 GHz, Bw = 16.000 MH No calibration applied and no bandpass applied

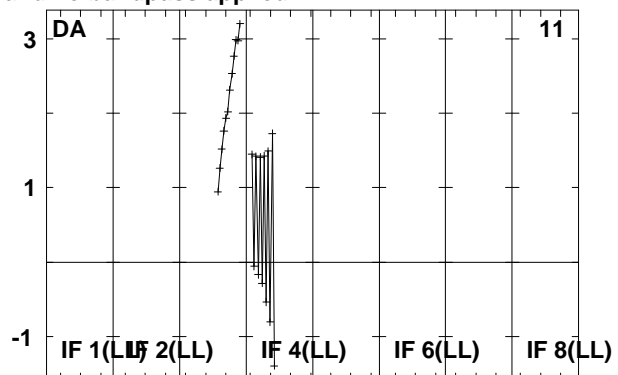
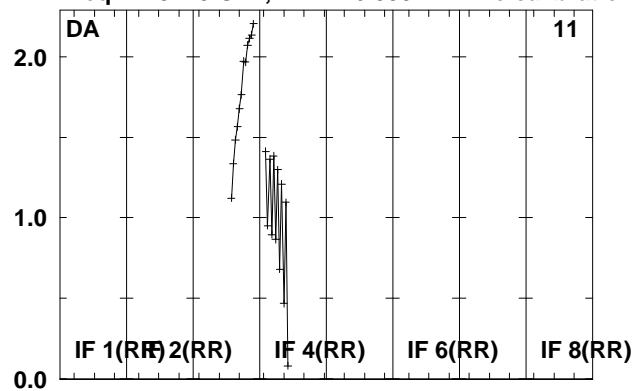

Lower frame: Real Jy
Total-power spectrum Antenna: *
Timerange: 00/23:35:01 to 00/23:36:29

Plot file version 79 created 24-AUG-2010 08:02:46

IRAS1929 EP064M.UVDATA.1

Freq = 4.9270 GHz, Bw = 16.000 MH No calibration applied and no bandpass applied

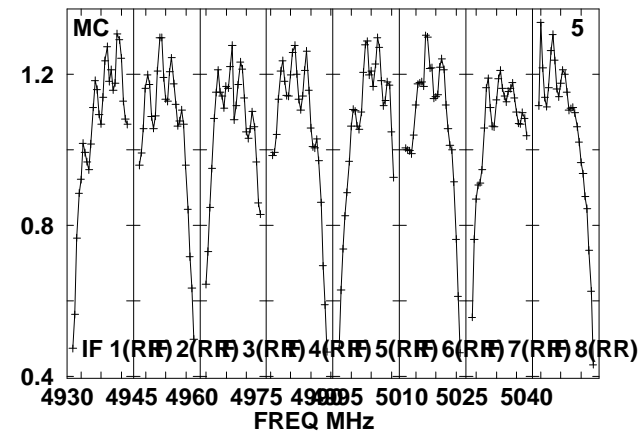
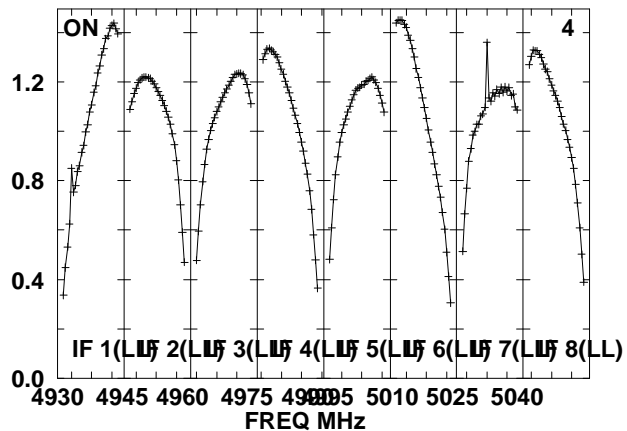
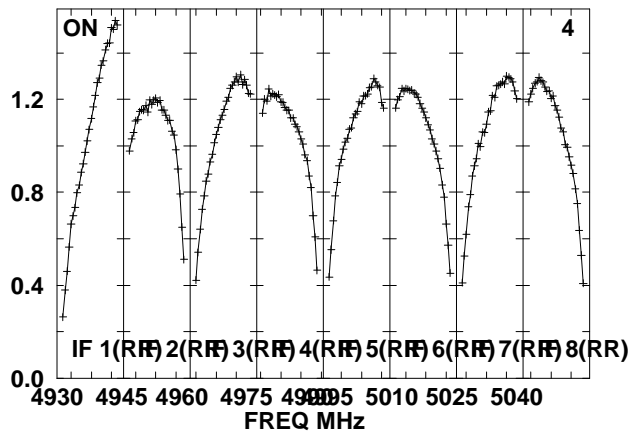
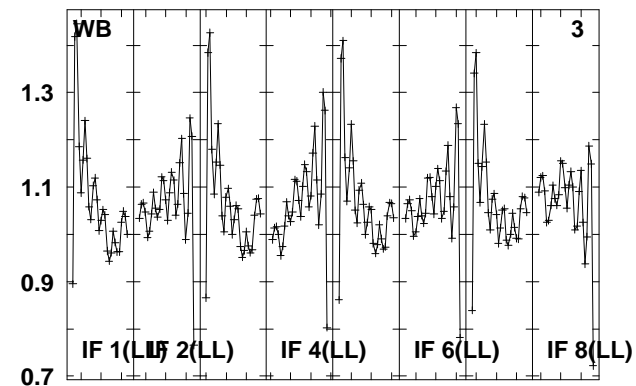
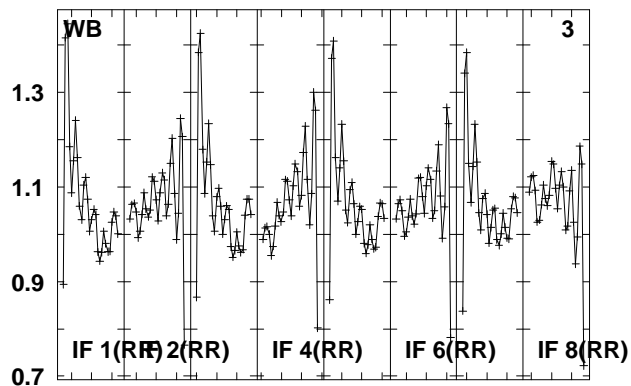
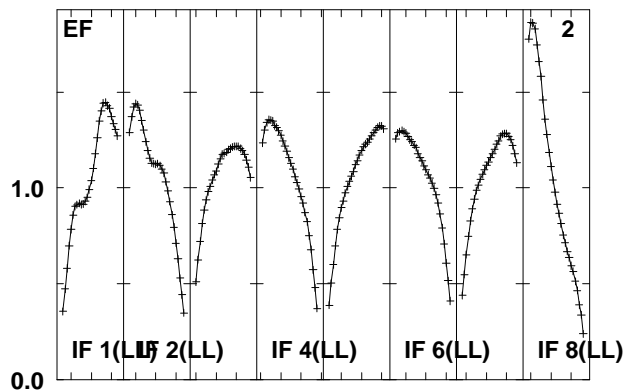
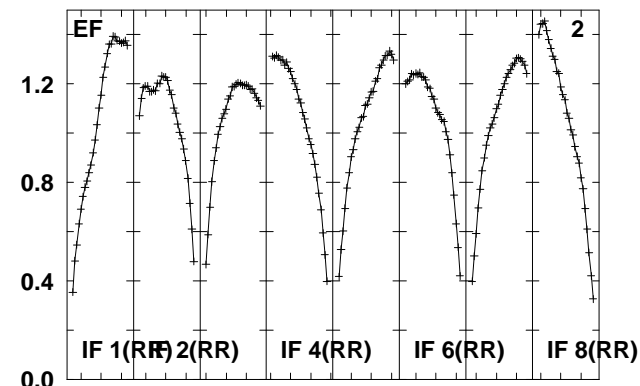
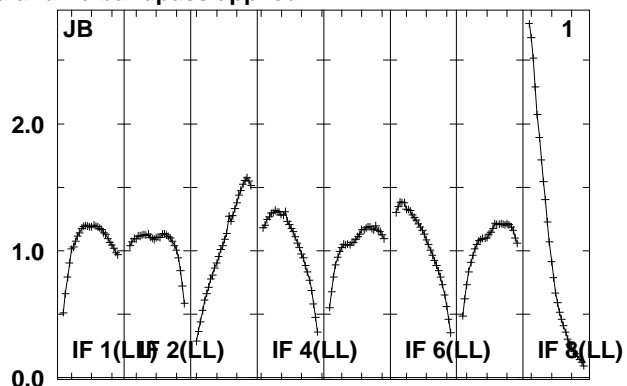
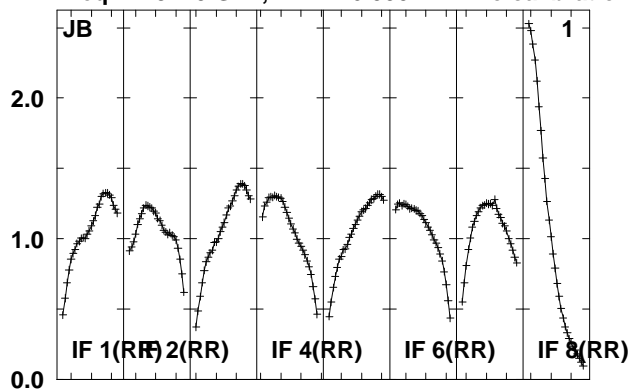

Lower frame: Real Jy

Total-power spectrum Antenna: *

Timerange: 00/23:36:31 to 00/23:39:59

Plot file version 80 created 24-AUG-2010 08:02:47

IRAS1929 EP064M.UVDATA.1

Freq = 4.9270 GHz, Bw = 16.000 MH No calibration applied and no bandpass applied

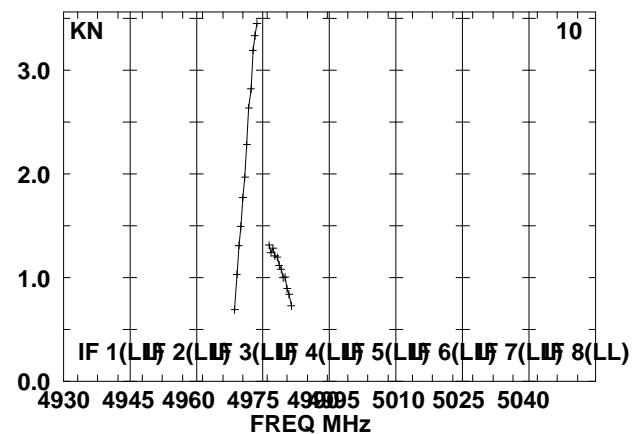
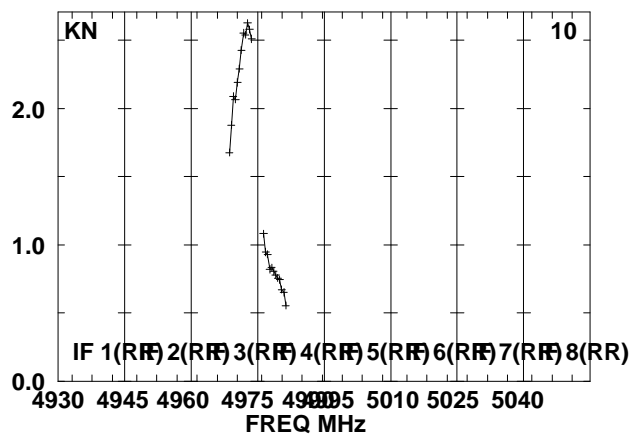
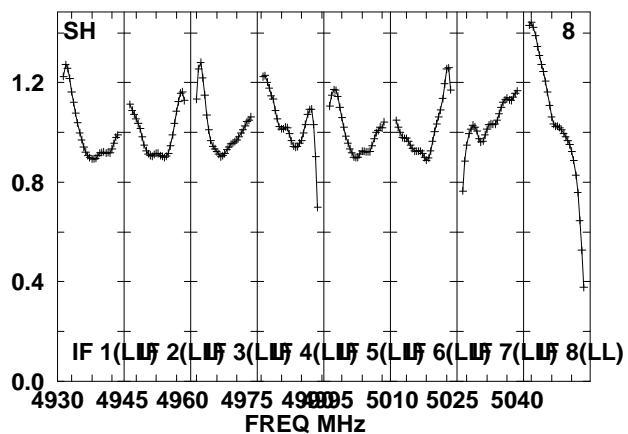
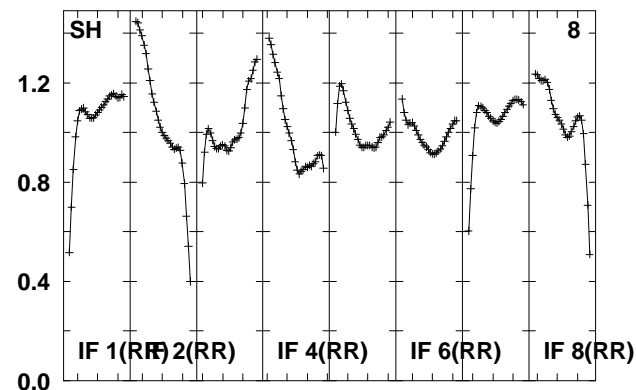
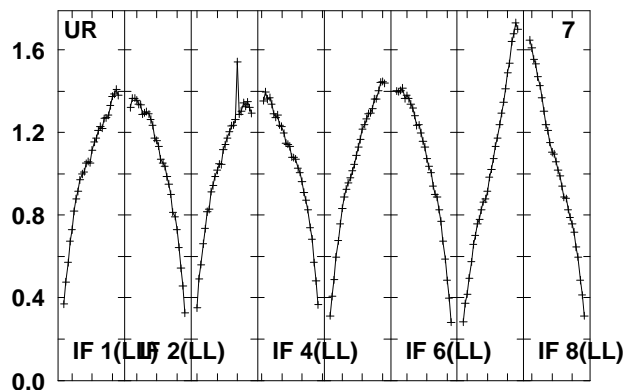
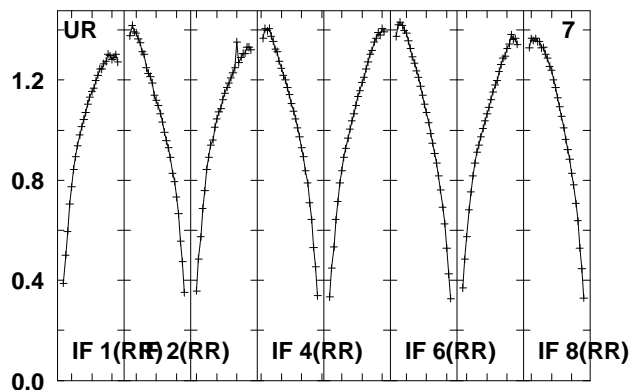
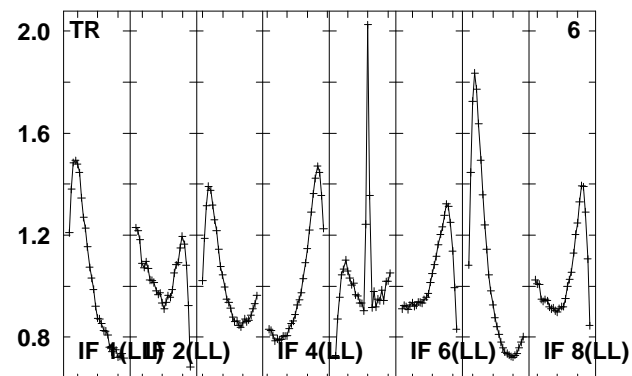
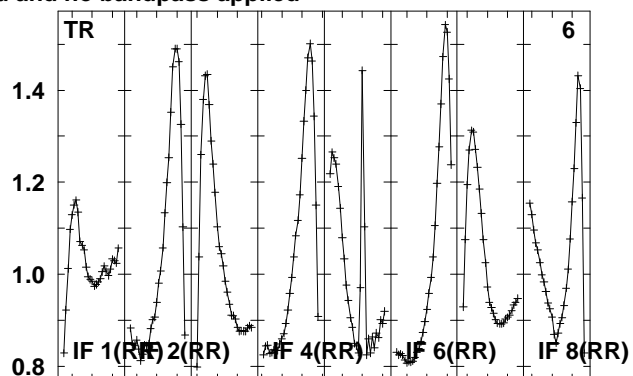
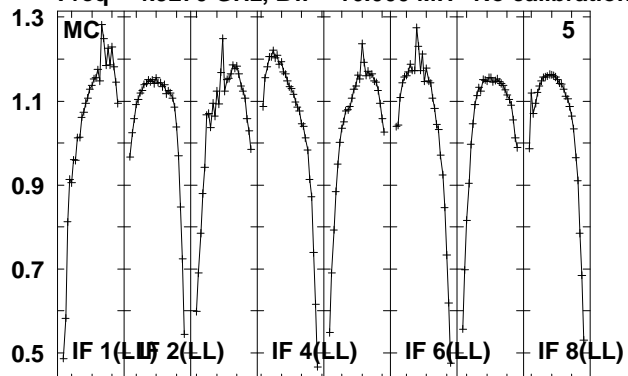

Lower frame: Real Jy

Total-power spectrum Antenna: *

Timerange: 00/23:36:31 to 00/23:39:59

Plot file version 81 created 24-AUG-2010 08:02:47

IRAS1929 EP064M.UVDATA.1

Freq = 4.9270 GHz, Bw = 16.000 MH No calibration applied and no bandpass applied

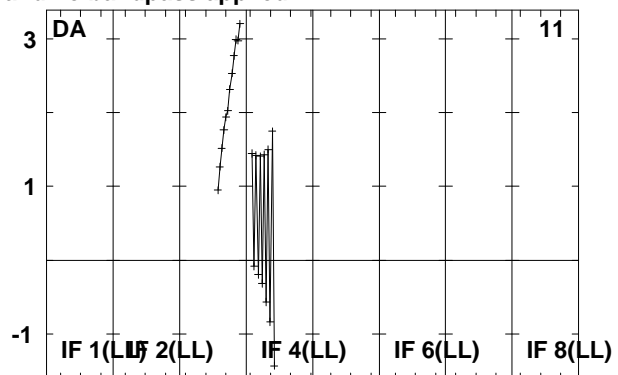
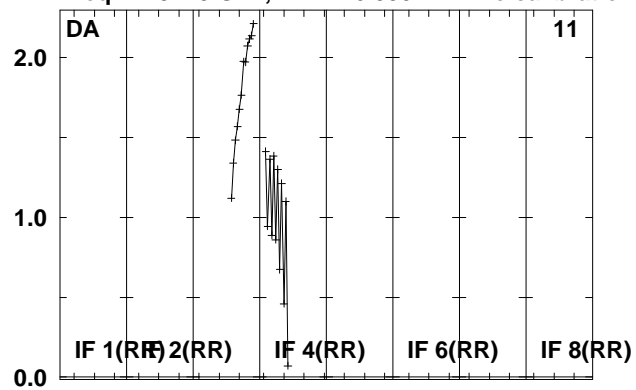

Lower frame: Real Jy
Total-power spectrum Antenna: *
Timerange: 00/23:36:31 to 00/23:39:59

Plot file version 82 created 24-AUG-2010 08:02:48
 J1941-05 EP064M.UVDATA.1
 Freq = 4.9270 GHz, Bw = 16.000 MH No calibration applied and no bandpass applied

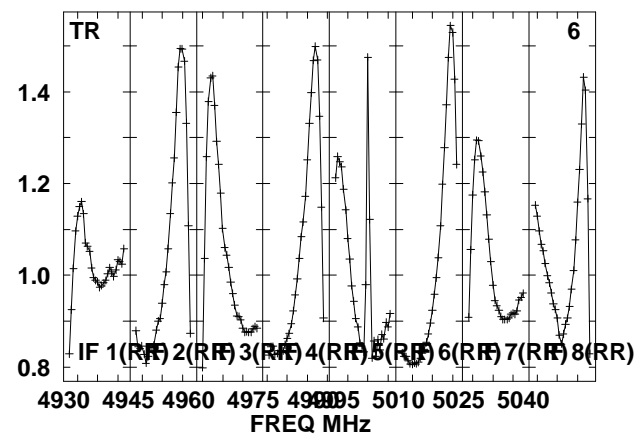
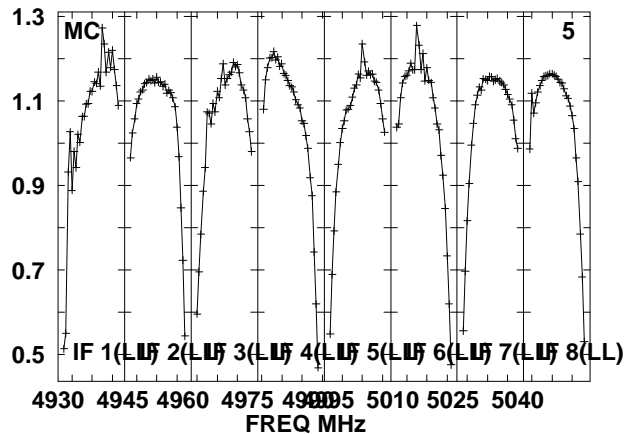
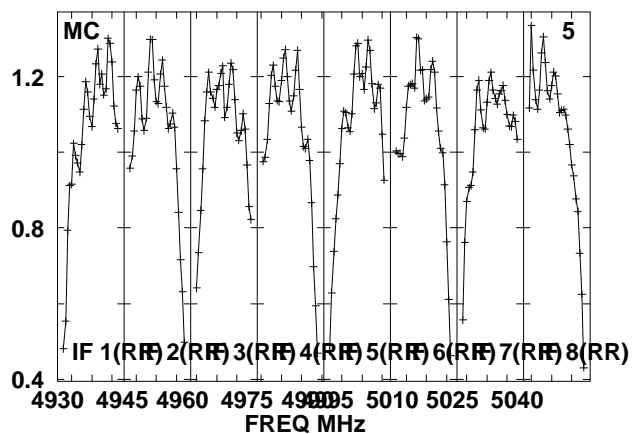
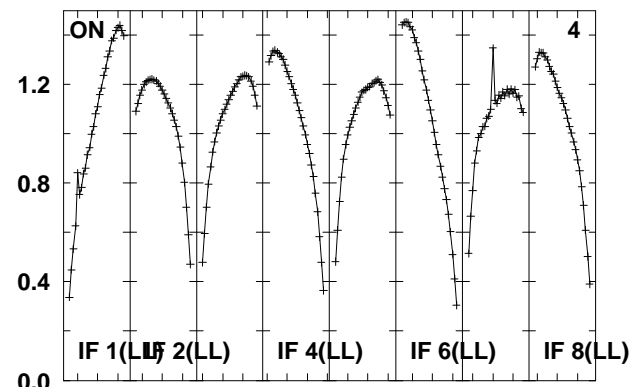
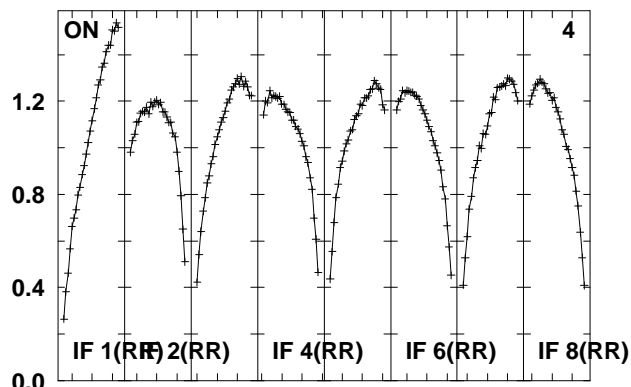
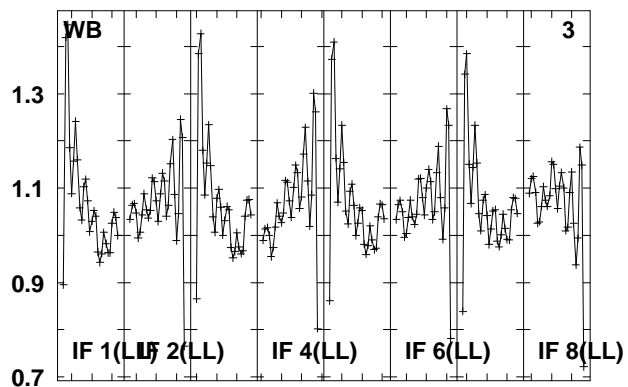
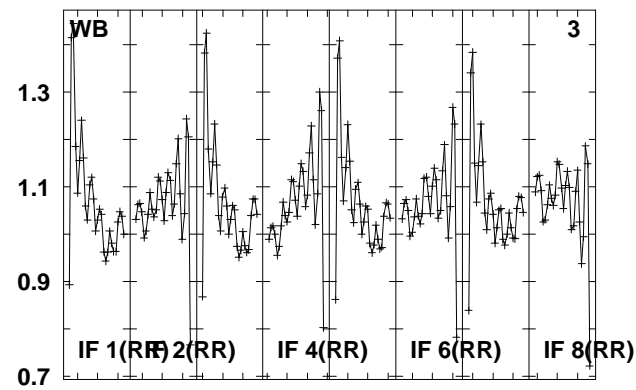
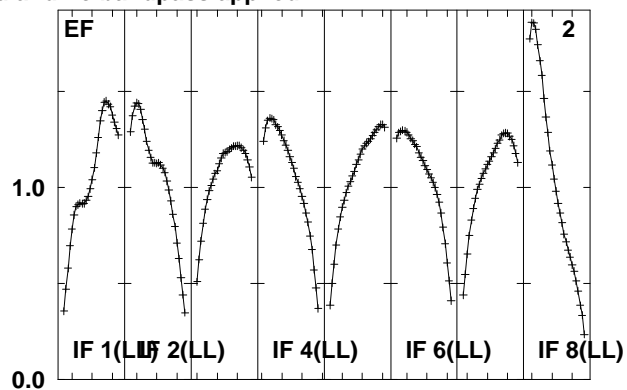
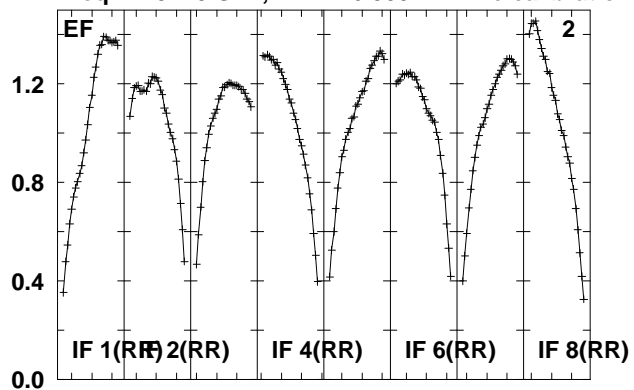

Lower frame: Real Jy
 Total-power spectrum Antenna: *
 Timerange: 00/23:40:01 to 00/23:41:27

Plot file version 83 created 24-AUG-2010 08:02:48

J1941-05 EP064M.UVDATA.1

Freq = 4.9270 GHz, Bw = 16.000 MH No calibration applied and no bandpass applied

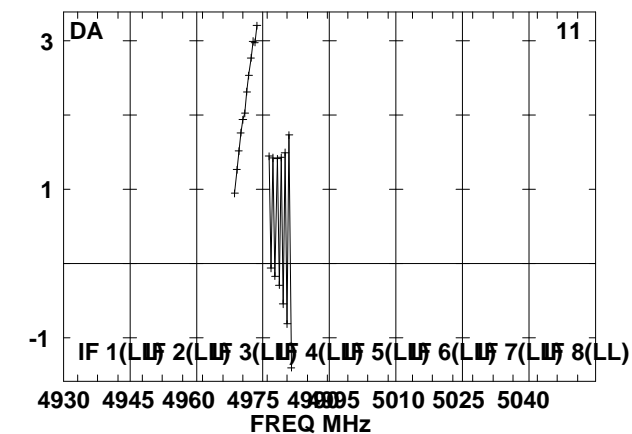
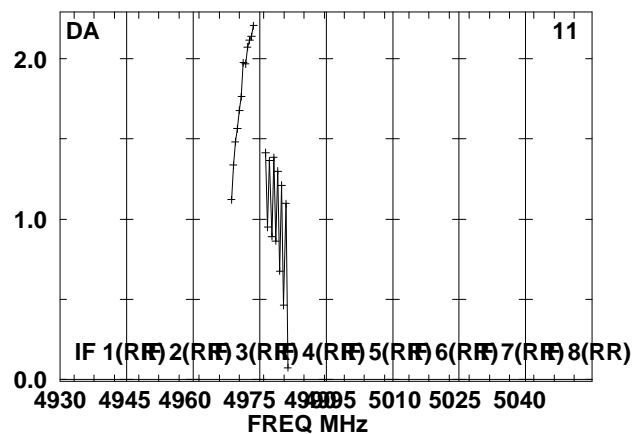
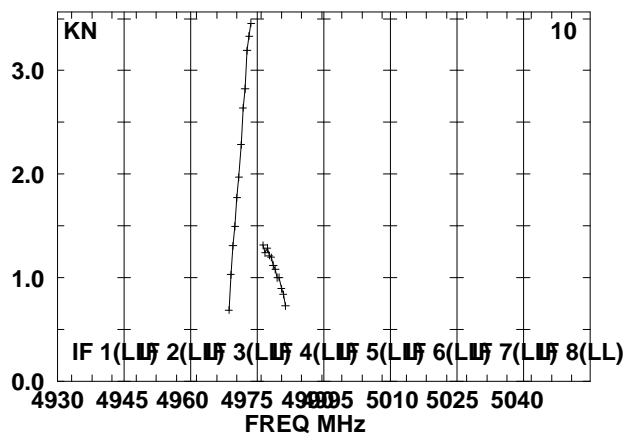
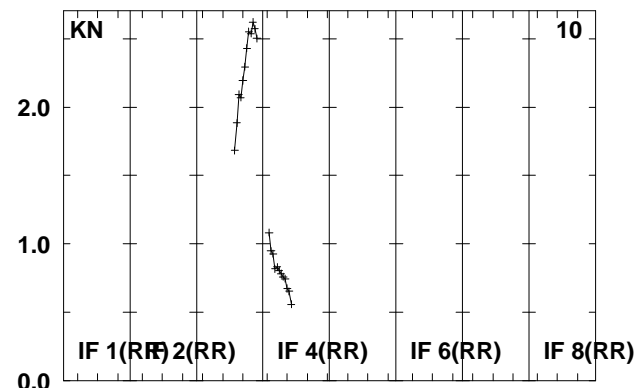
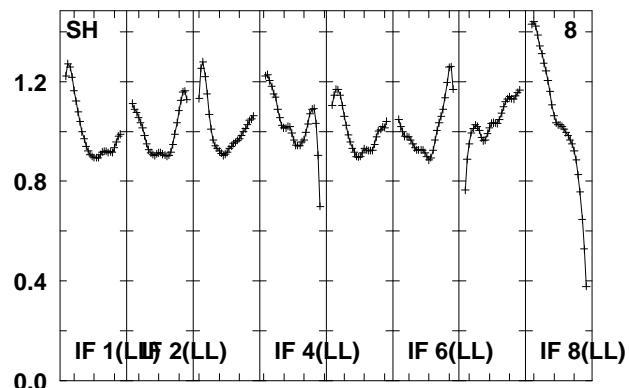
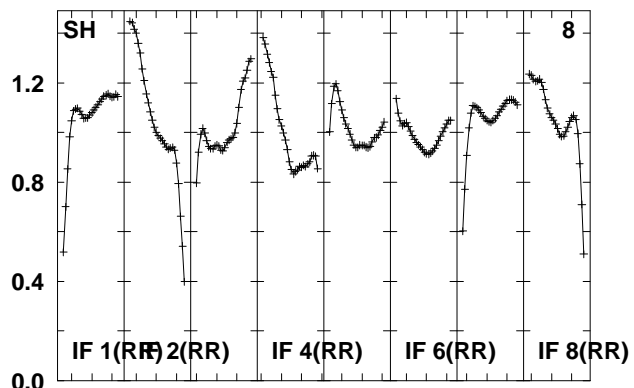
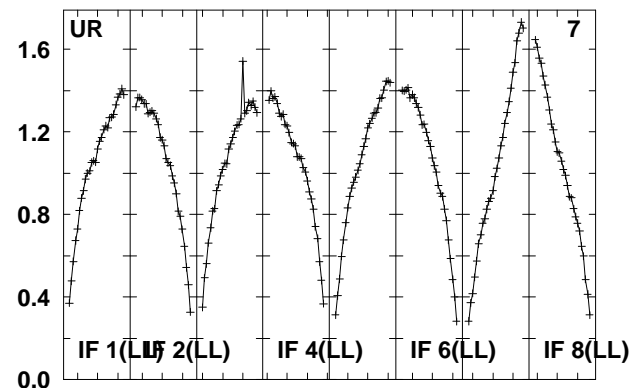
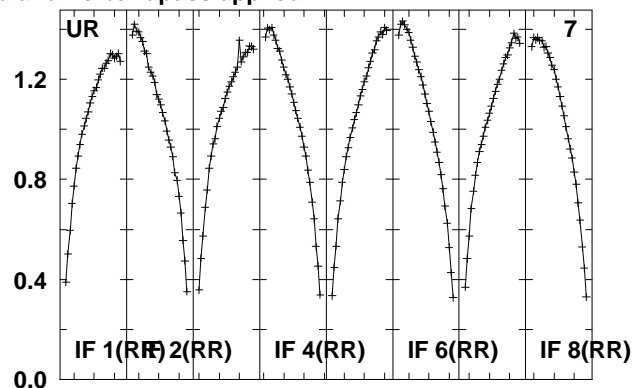
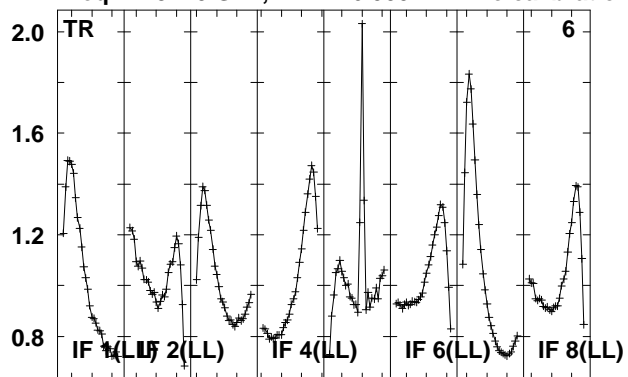

Lower frame: Real Jy
Total-power spectrum Antenna: *
Timerange: 00/23:40:01 to 00/23:41:27

Plot file version 84 created 24-AUG-2010 08:02:48

IRAS1929 EP064M.UVDATA.1

Freq = 4.9270 GHz, Bw = 16.000 MH No calibration applied and no bandpass applied

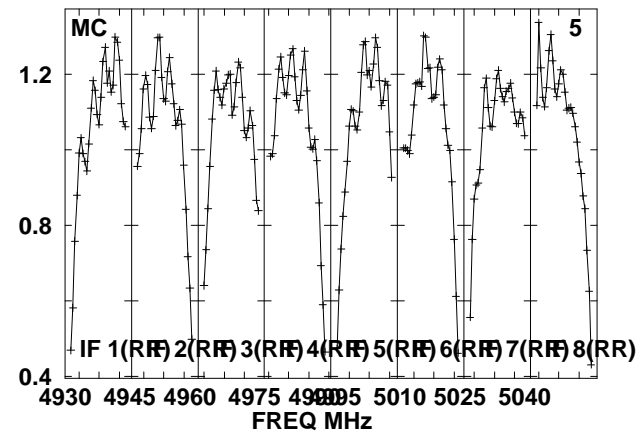
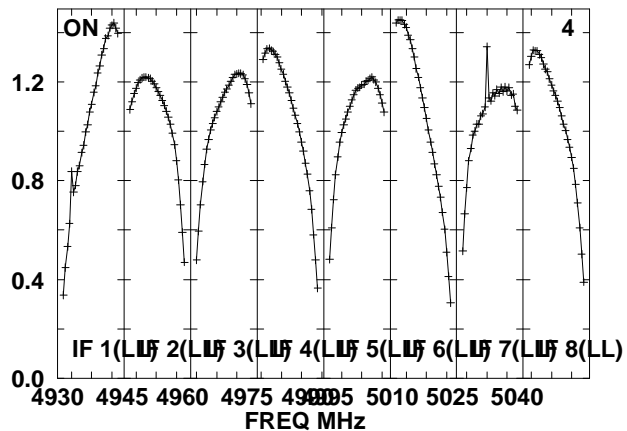
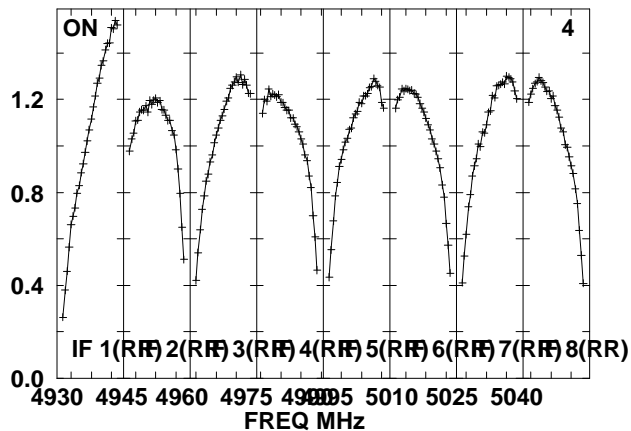
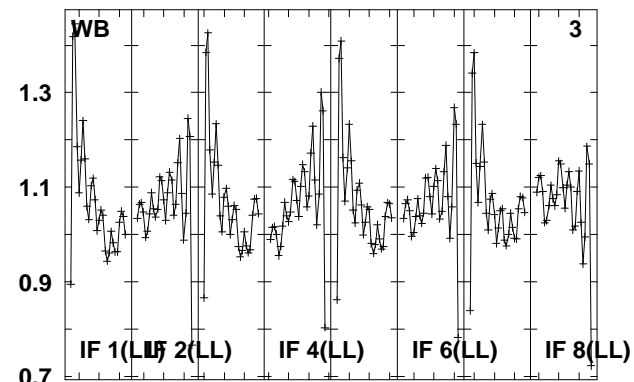
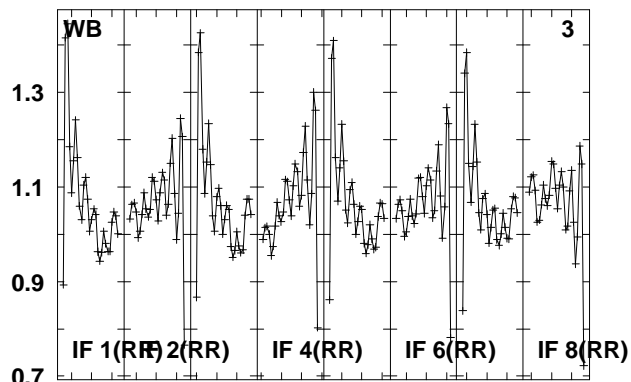
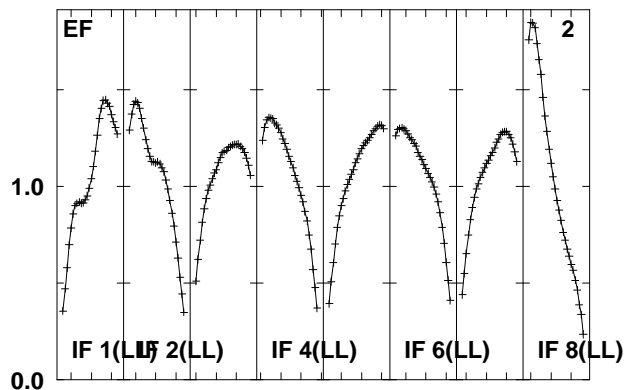
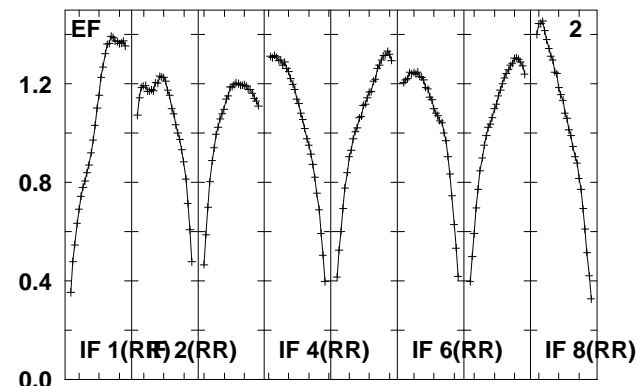
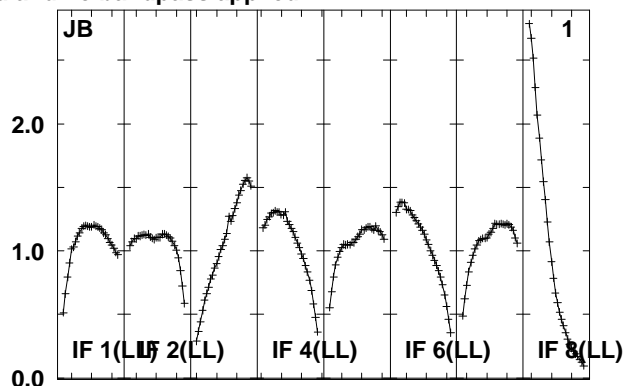
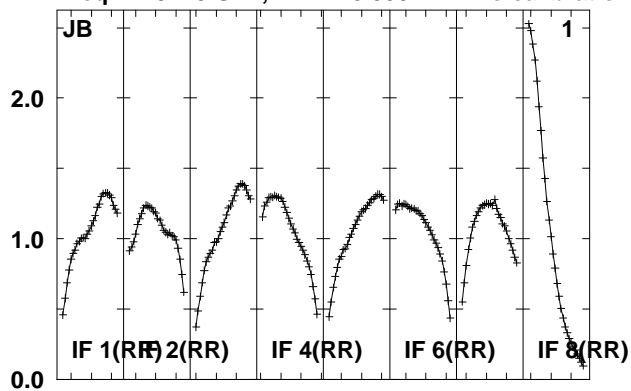

Lower frame: Real Jy

Total-power spectrum Antenna: *

Timerange: 00/23:41:31 to 00/23:44:59

Plot file version 85 created 24-AUG-2010 08:02:49

IRAS1929 EP064M.UVDATA.1

Freq = 4.9270 GHz, Bw = 16.000 MH No calibration applied and no bandpass applied

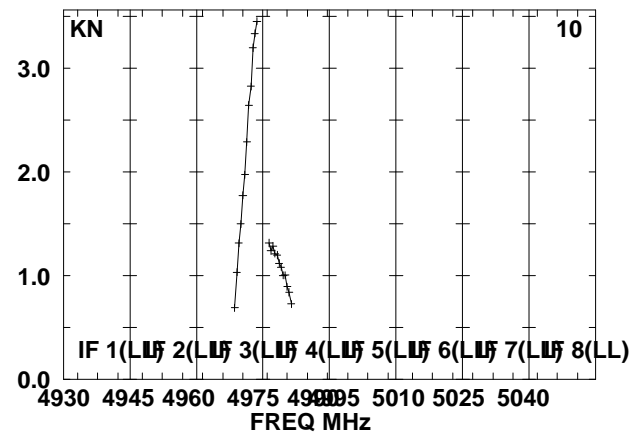
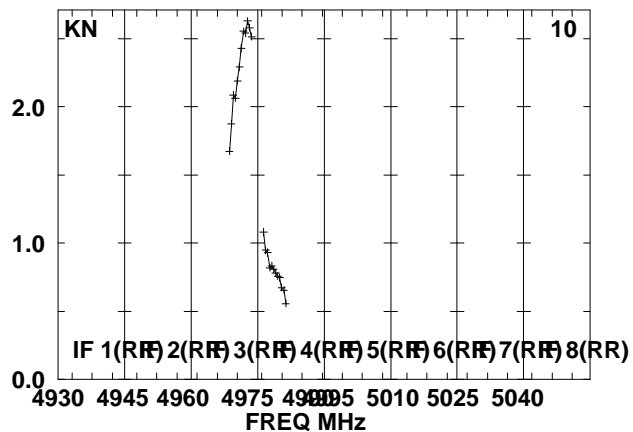
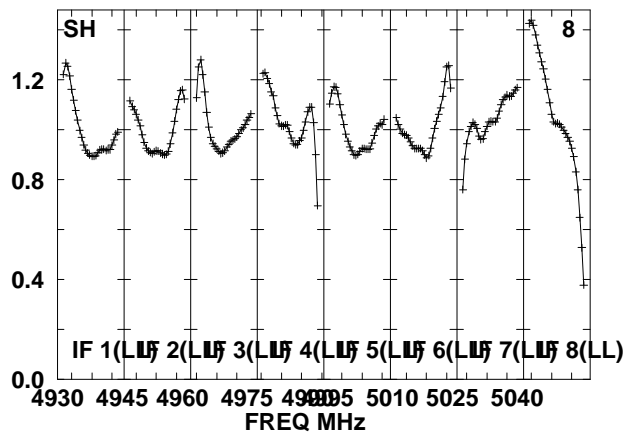
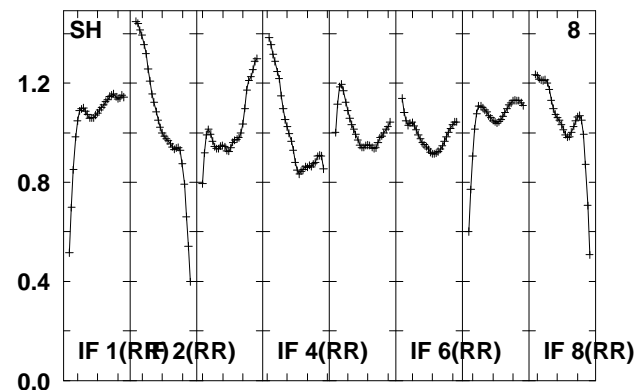
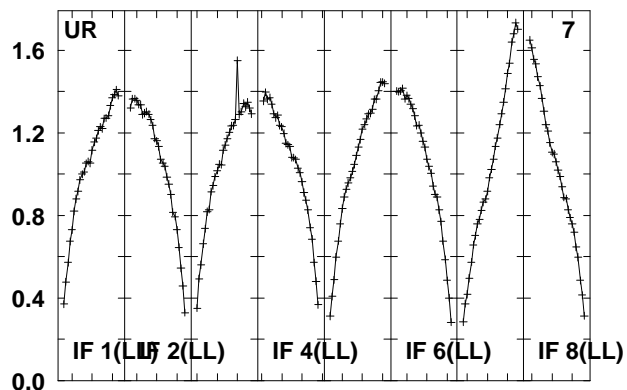
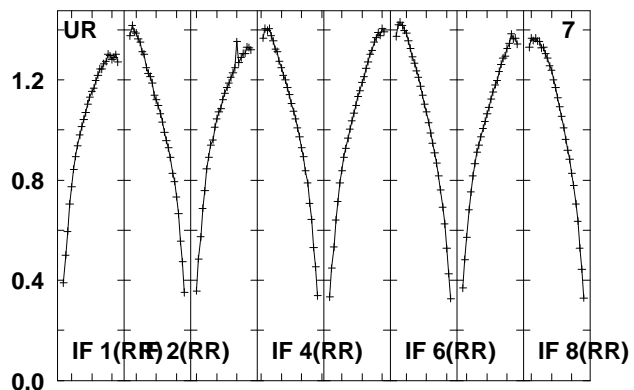
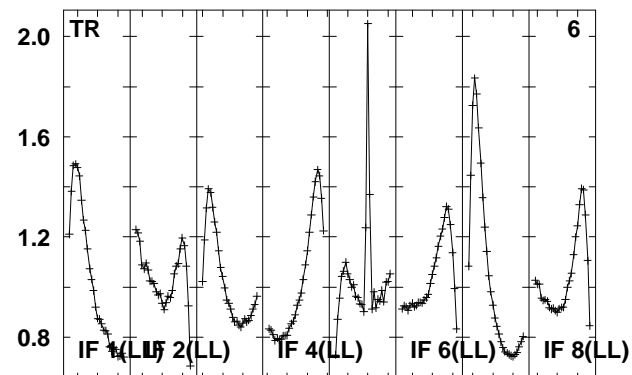
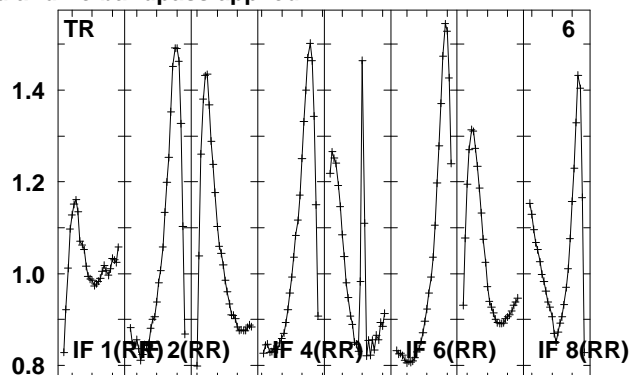
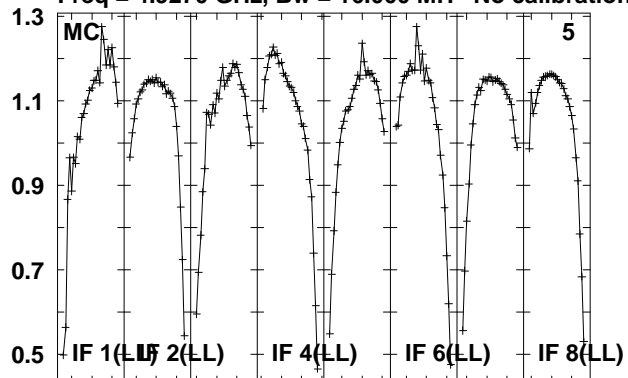

Lower frame: Real Jy

Total-power spectrum Antenna: *

Timerange: 00/23:41:31 to 00/23:44:59

Plot file version 86 created 24-AUG-2010 08:02:50

IRAS1929 EP064M.UVDATA.1

Freq = 4.9270 GHz, Bw = 16.000 MH No calibration applied and no bandpass applied

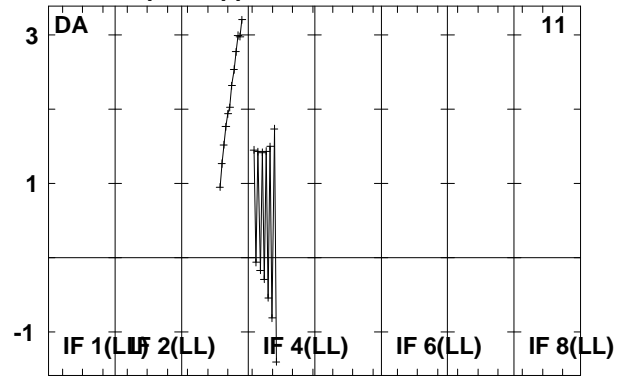
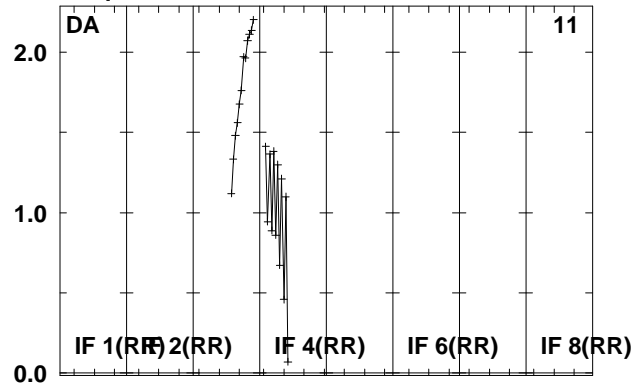

Lower frame: Real Jy
Total-power spectrum Antenna: *
Timerange: 00/23:41:31 to 00/23:44:59

Plot file version 87 created 24-AUG-2010 08:02:50

J1941-05 EP064M.UVDATA.1

Freq = 4.9270 GHz, Bw = 16.000 MH No calibration applied and no bandpass applied

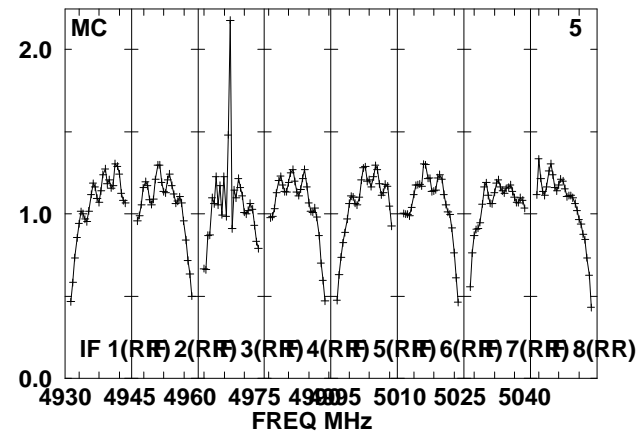
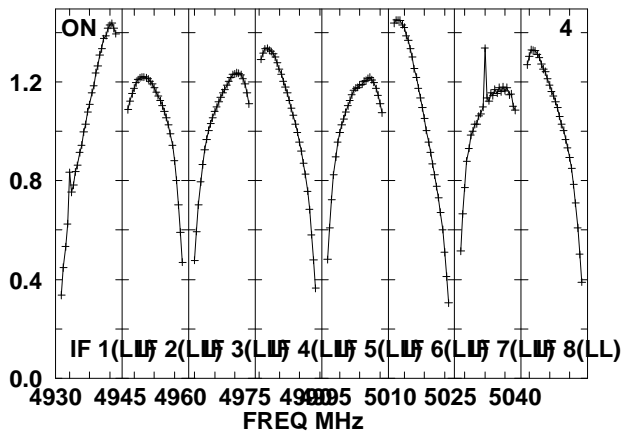
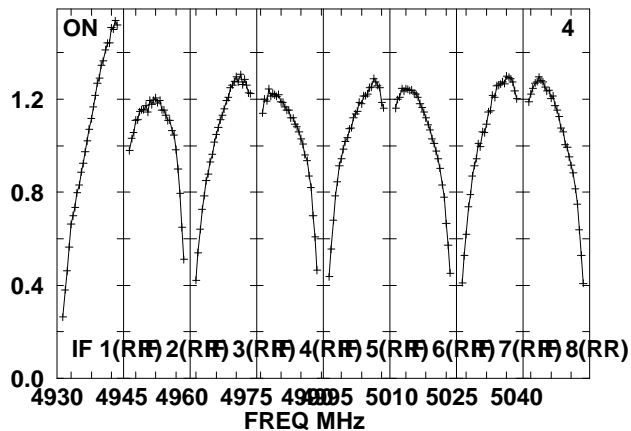
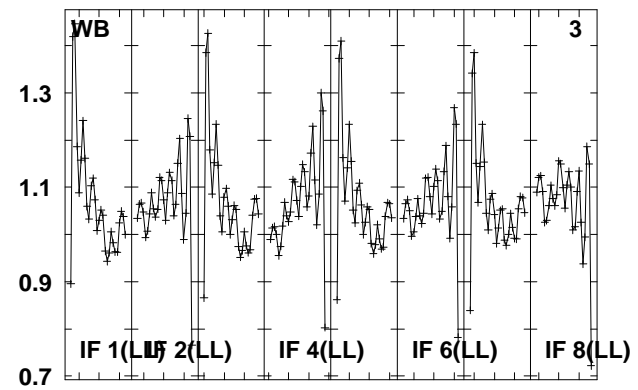
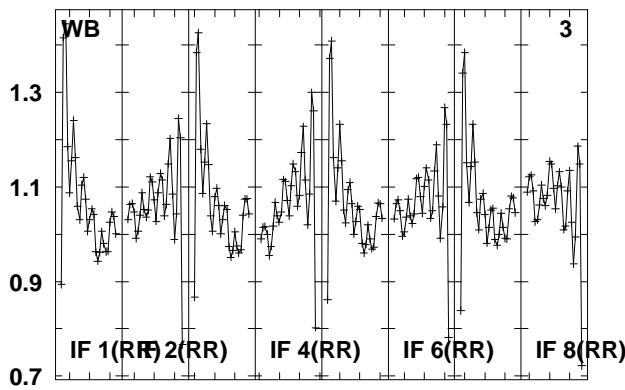
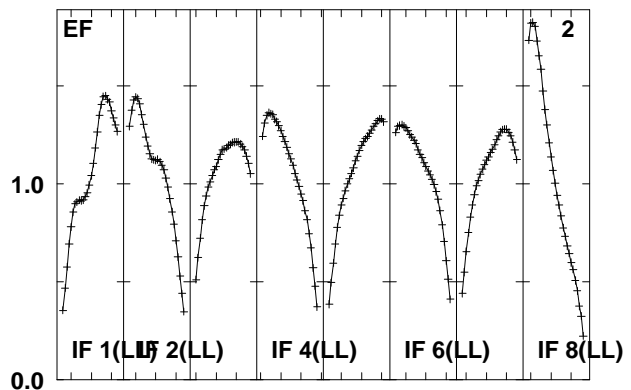
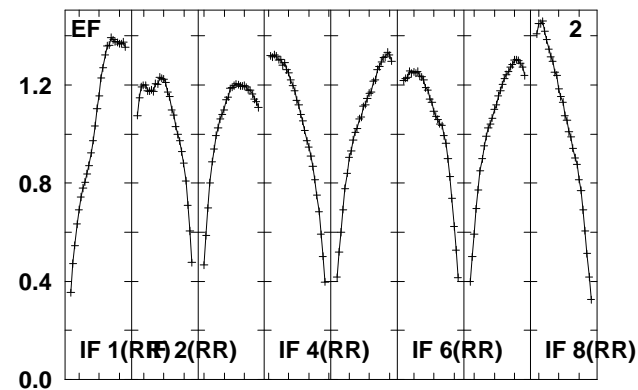
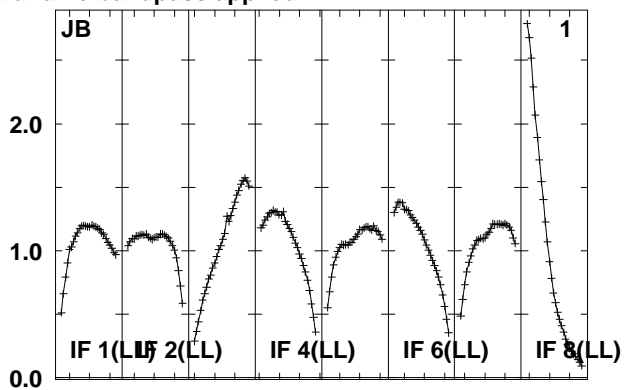
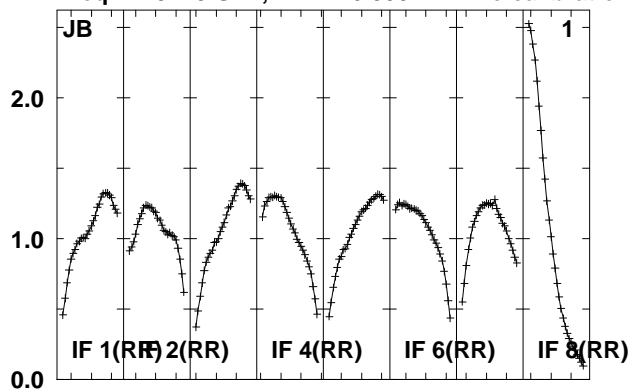

Lower frame: Real Jy
Total-power spectrum Antenna: *
Timerange: 00/23:46:01 to 00/23:47:29

Plot file version 88 created 24-AUG-2010 08:02:50

J1941-05 EP064M.UVDATA.1

Freq = 4.9270 GHz, Bw = 16.000 MH No calibration applied and no bandpass applied

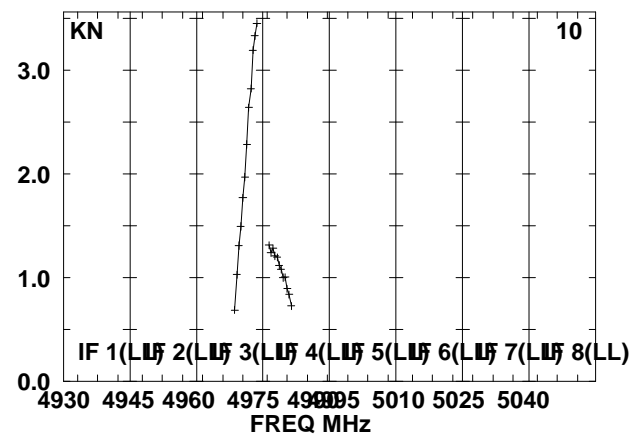
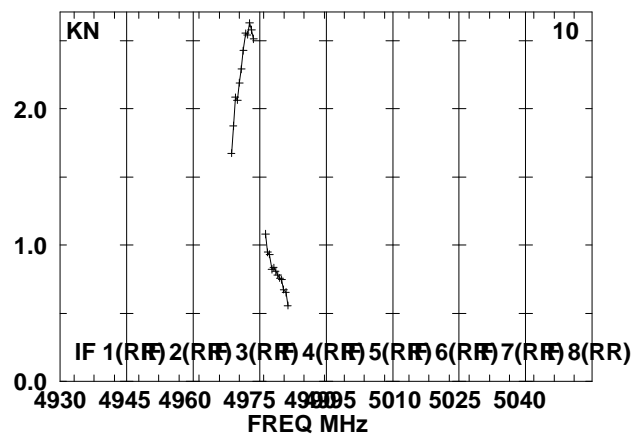
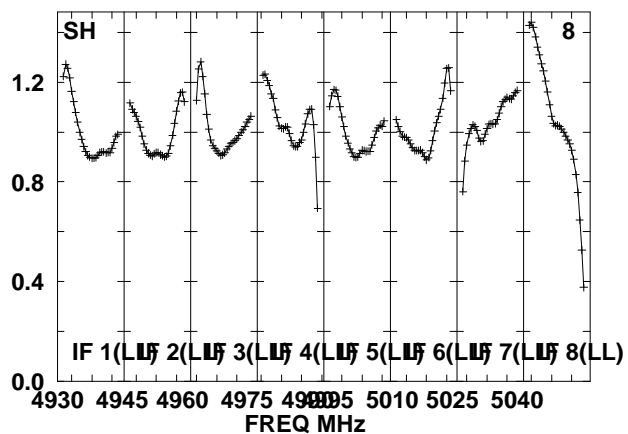
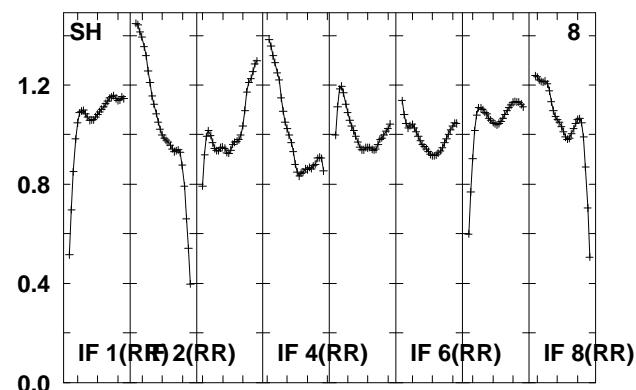
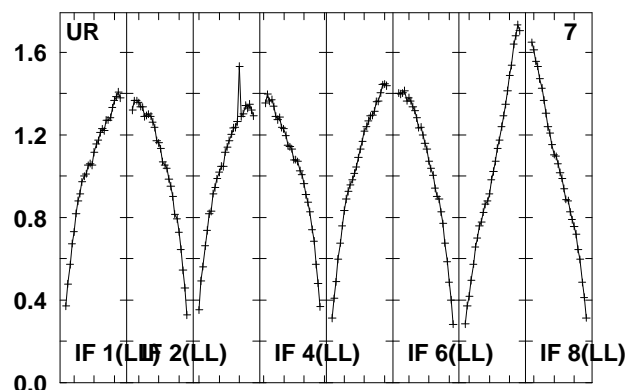
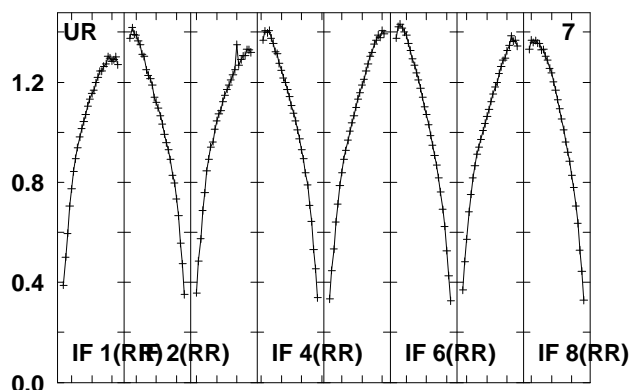
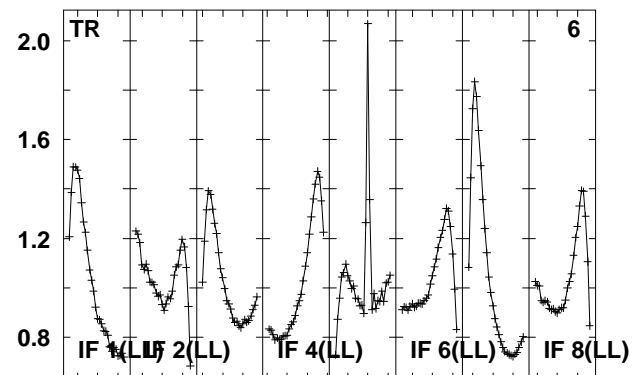
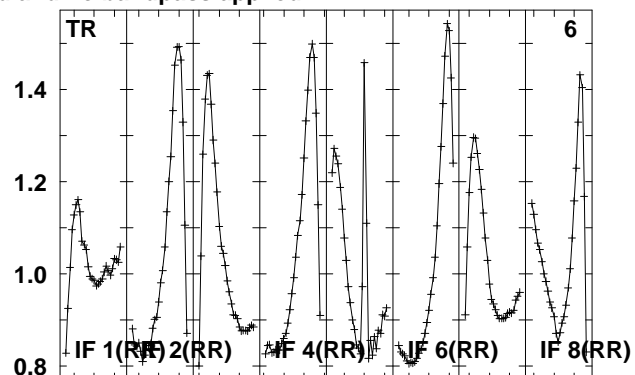
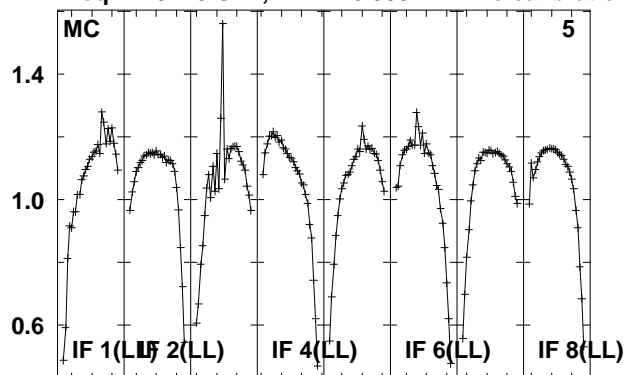

Lower frame: Real Jy

Total-power spectrum Antenna: *

Timerange: 00/23:46:01 to 00/23:47:29

Plot file version 89 created 24-AUG-2010 08:02:50

J1941-05 EP064M.UVDATA.1

Freq = 4.9270 GHz, Bw = 16.000 MH No calibration applied and no bandpass applied

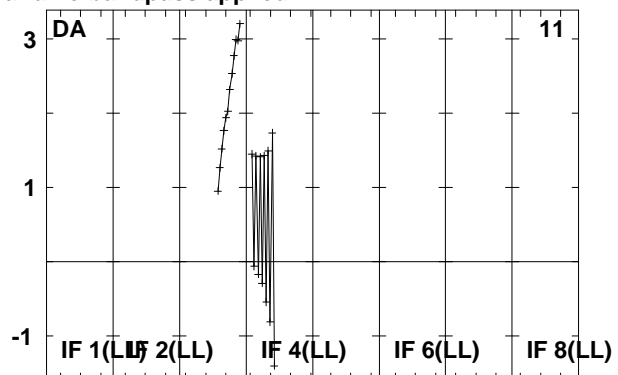
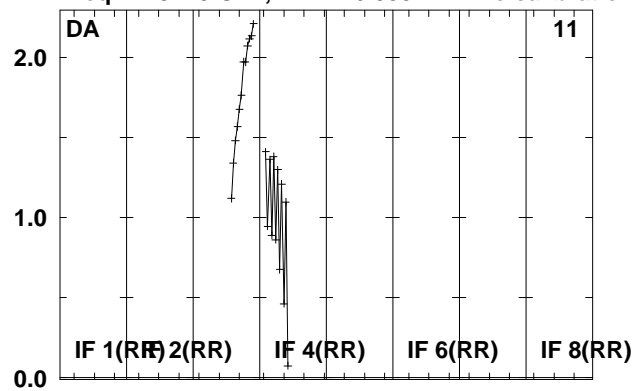

Lower frame: Real Jy
Total-power spectrum Antenna: *
Timerange: 00/23:46:01 to 00/23:47:29

Plot file version 90 created 24-AUG-2010 08:02:50

IRAS1929 EP064M.UVDATA.1

Freq = 4.9270 GHz, Bw = 16.000 MH No calibration applied and no bandpass applied

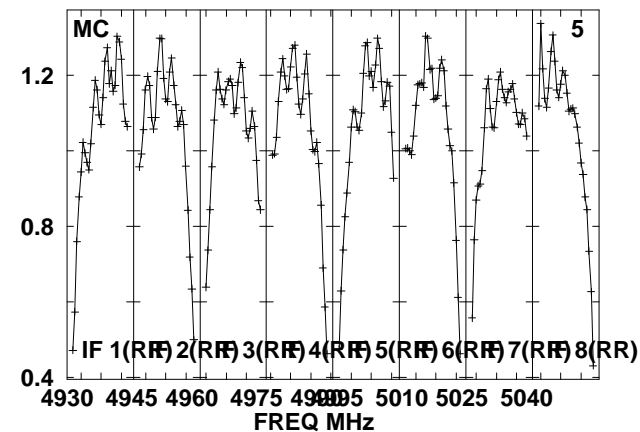
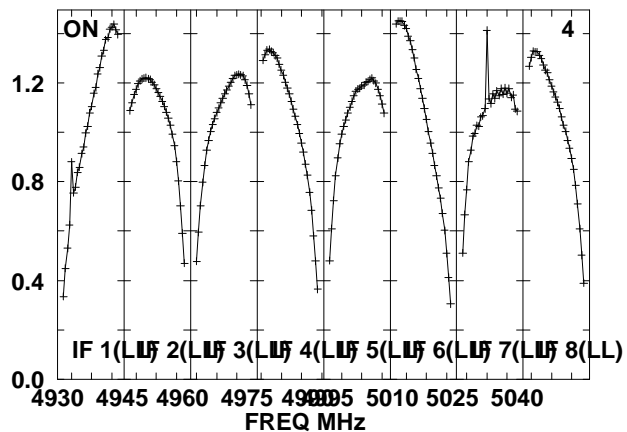
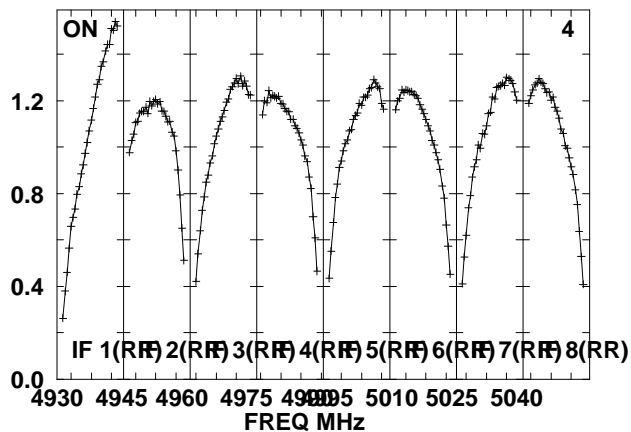
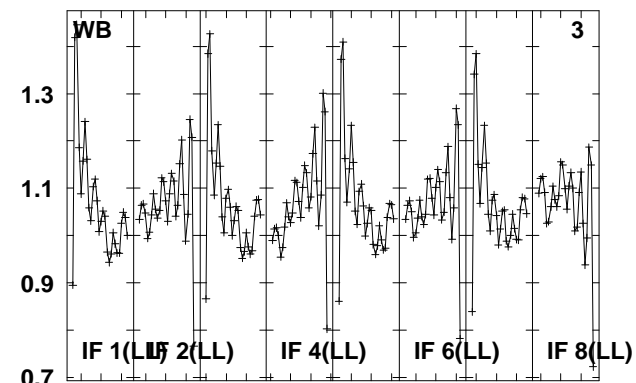
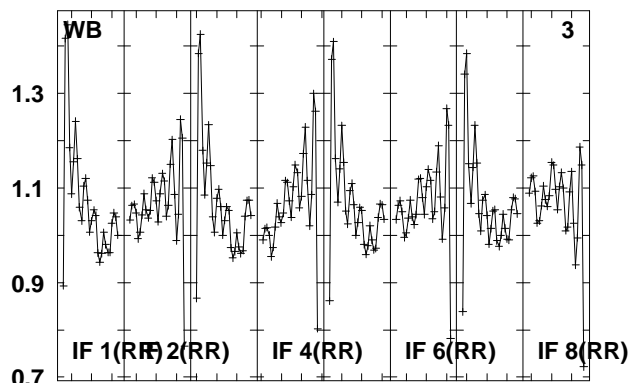
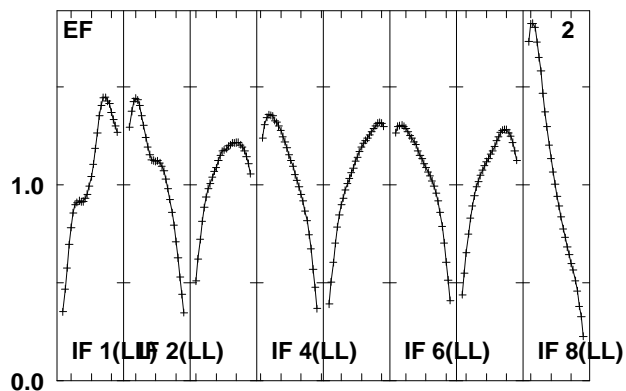
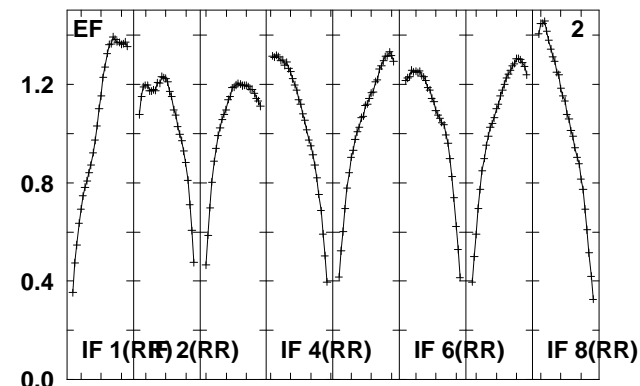
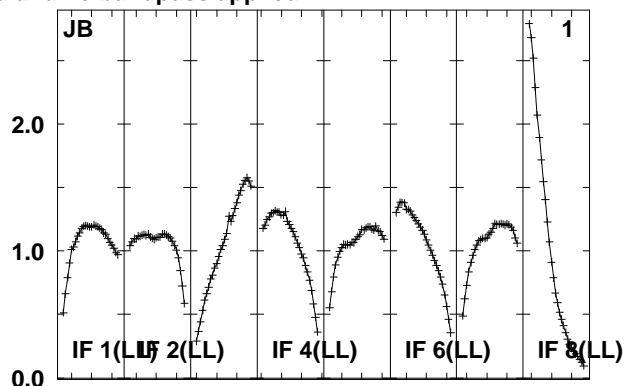
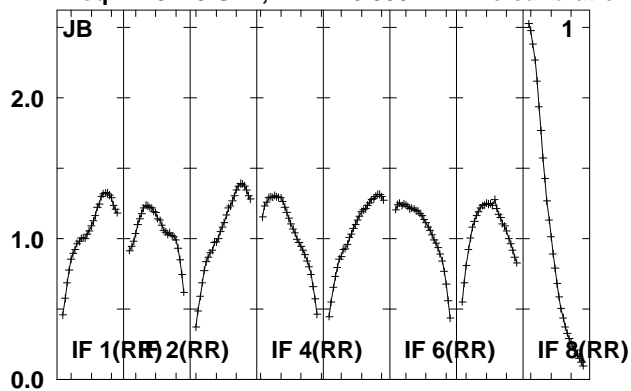

Lower frame: Real Jy
Total-power spectrum Antenna: *
Timerange: 00/23:47:31 to 00/23:50:59

Plot file version 91 created 24-AUG-2010 08:02:51

IRAS1929 EP064M.UVDATA.1

Freq = 4.9270 GHz, Bw = 16.000 MH No calibration applied and no bandpass applied

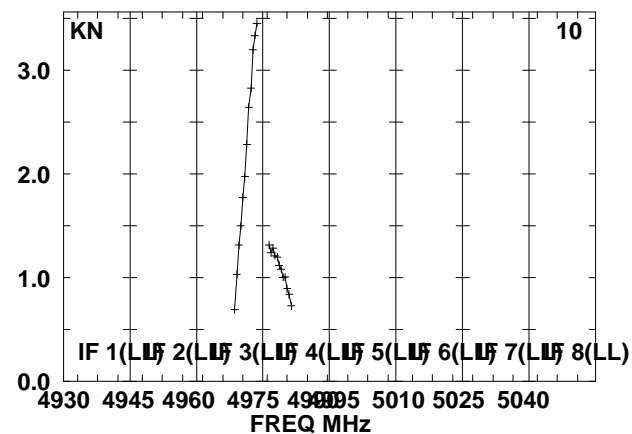
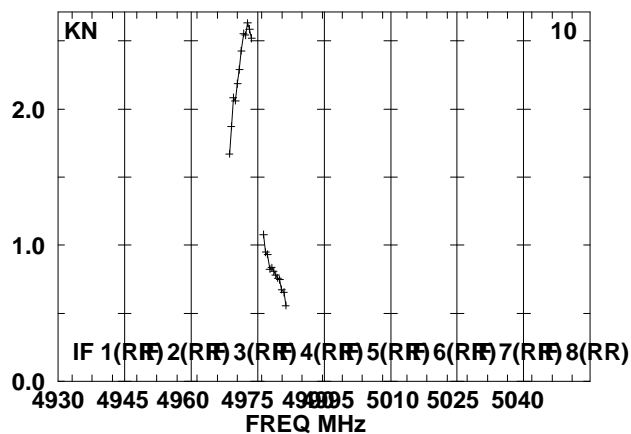
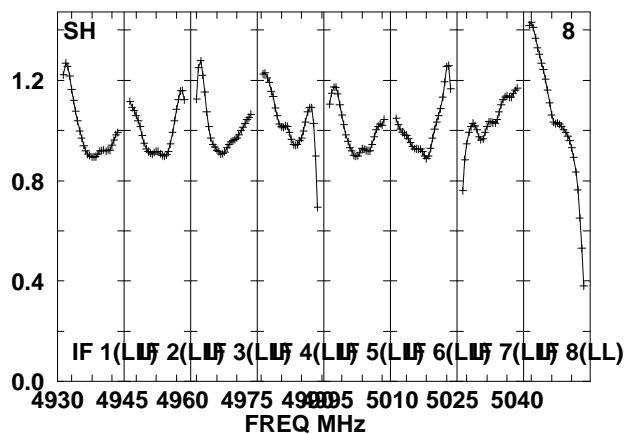
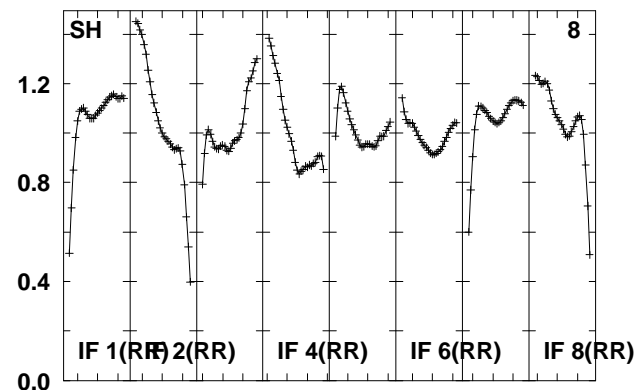
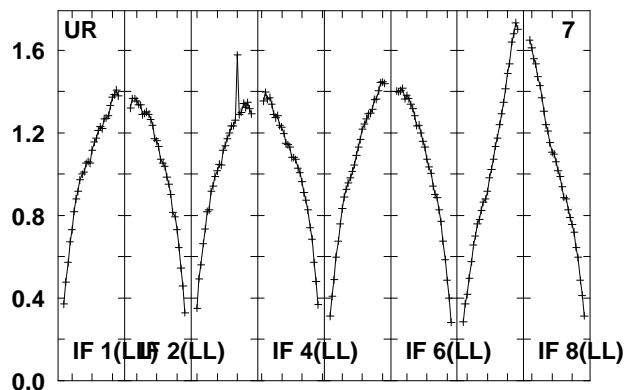
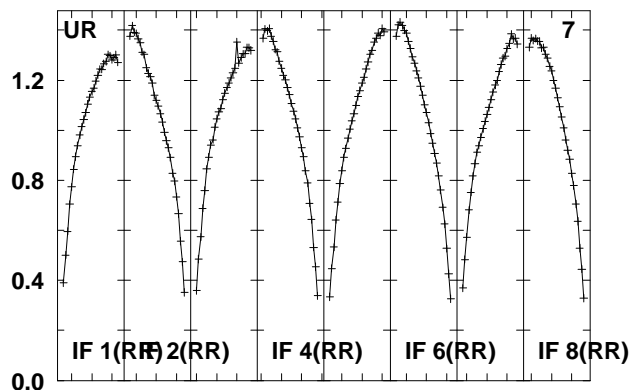
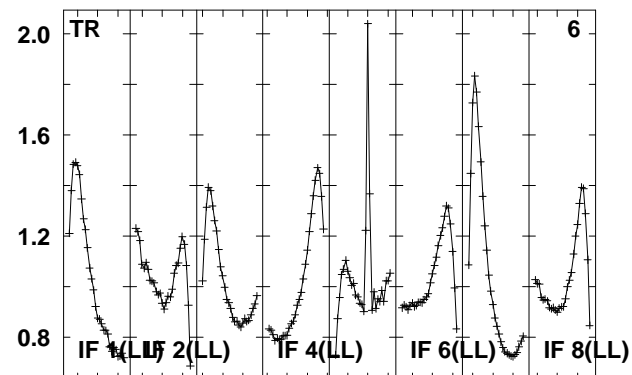
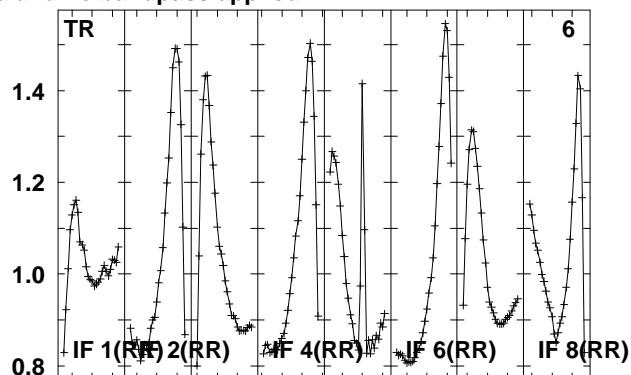
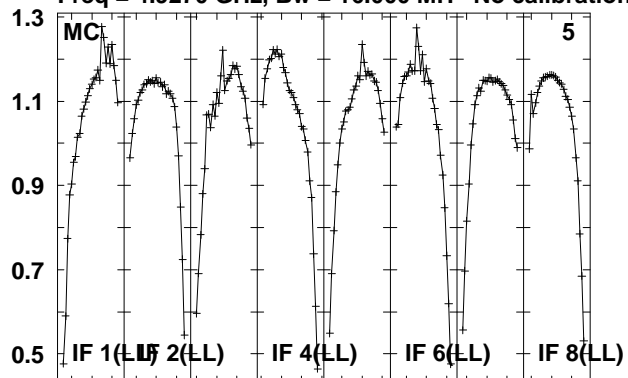

Lower frame: Real Jy
Total-power spectrum Antenna: *
Timerange: 00/23:47:31 to 00/23:50:59

Plot file version 92 created 24-AUG-2010 08:02:52

IRAS1929 EP064M.UVDATA.1

Freq = 4.9270 GHz, Bw = 16.000 MH No calibration applied and no bandpass applied

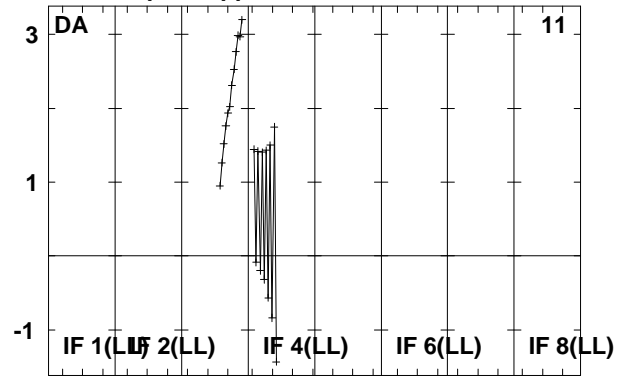
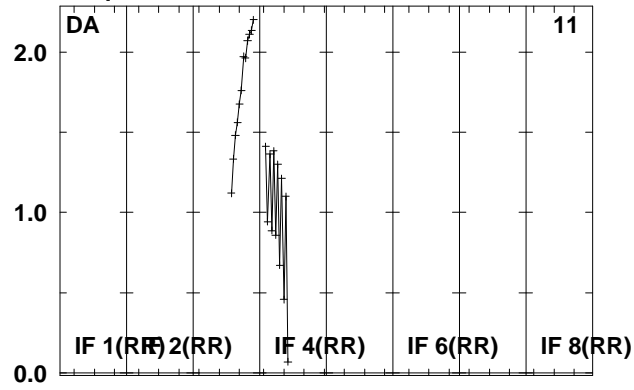

Lower frame: Real Jy
Total-power spectrum Antenna: *
Timerange: 00/23:47:31 to 00/23:50:59

Plot file version 93 created 24-AUG-2010 08:02:52

J1941-05 EP064M.UVDATA.1

Freq = 4.9270 GHz, Bw = 16.000 MH No calibration applied and no bandpass applied

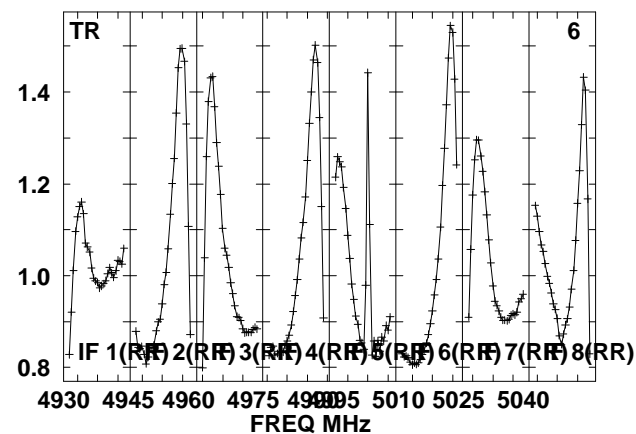
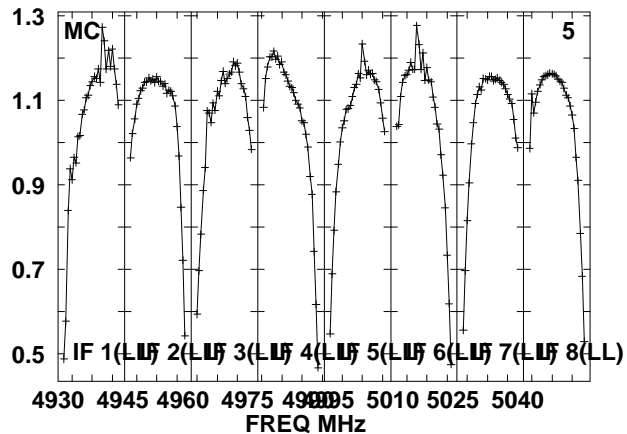
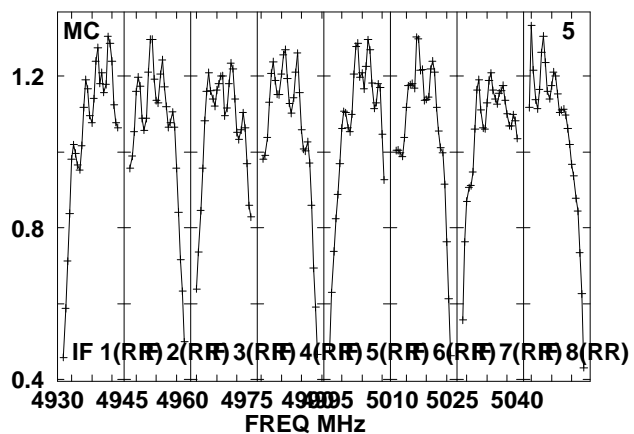
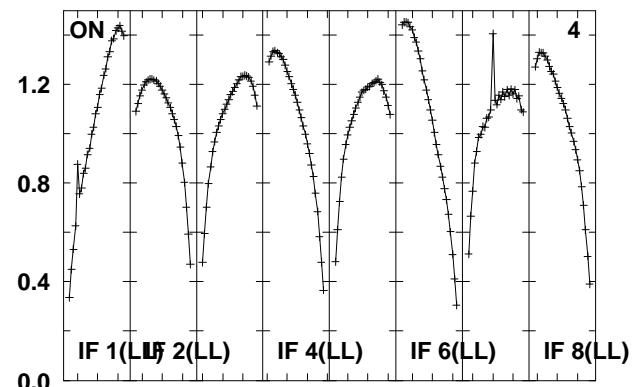
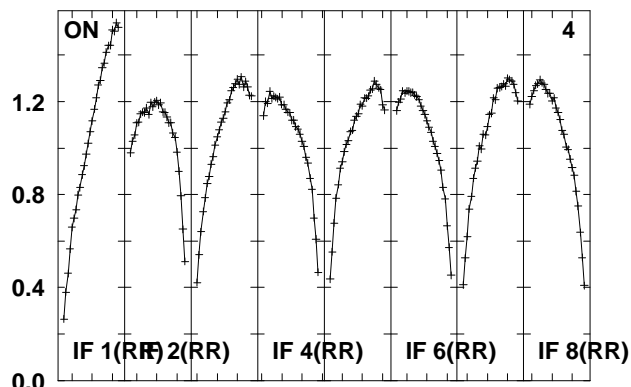
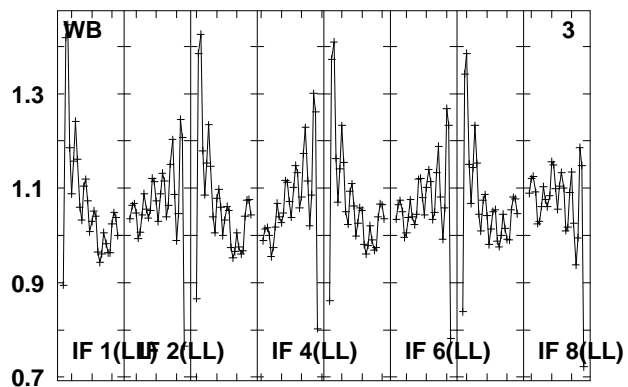
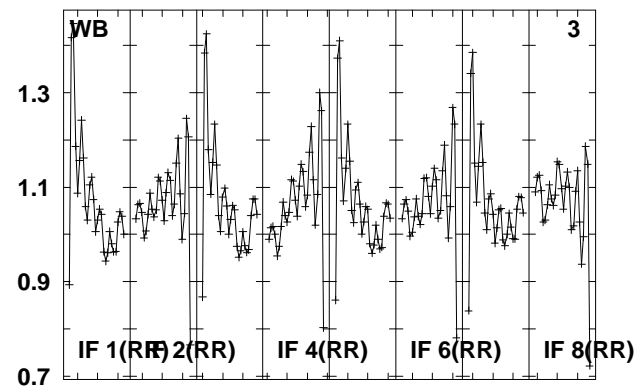
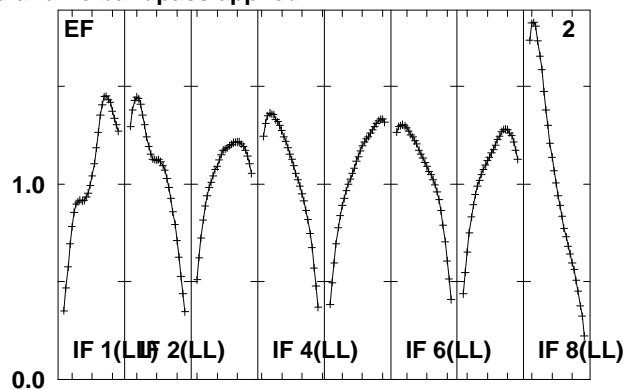
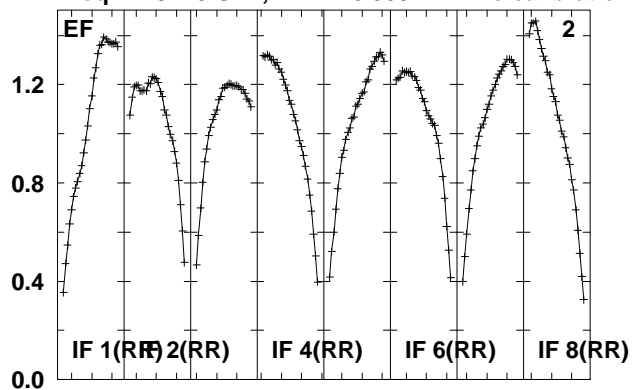

Lower frame: Real Jy

Total-power spectrum Antenna: *

Timerange: 00/23:51:01 to 00/23:52:29

Plot file version 94 created 24-AUG-2010 08:02:52

J1941-05 EP064M.UVDATA.1

Freq = 4.9270 GHz, Bw = 16.000 MH No calibration applied and no bandpass applied

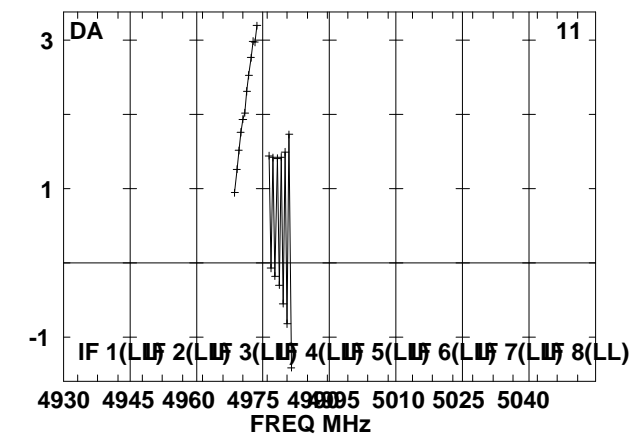
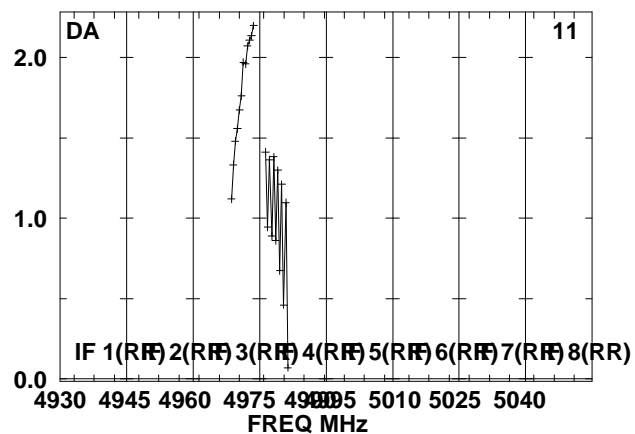
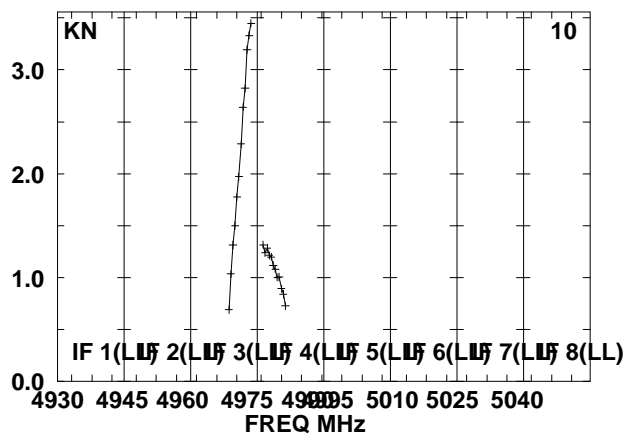
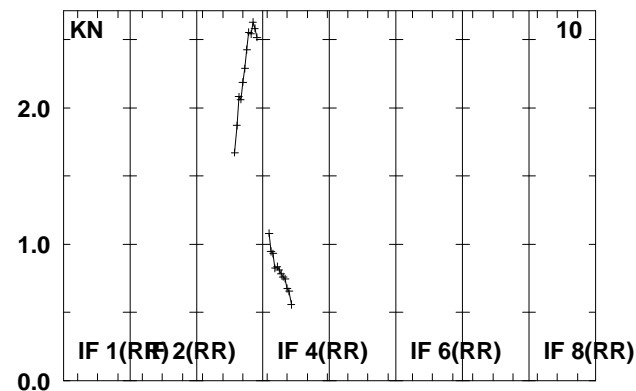
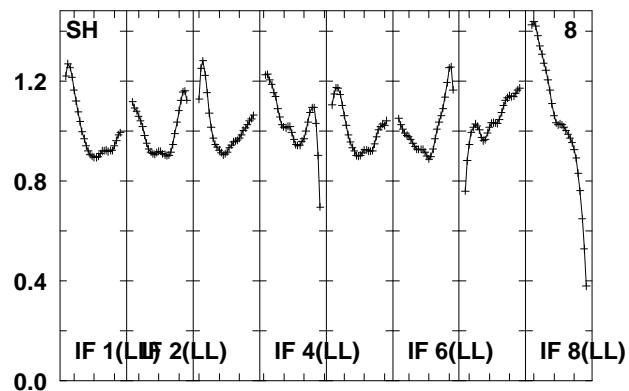
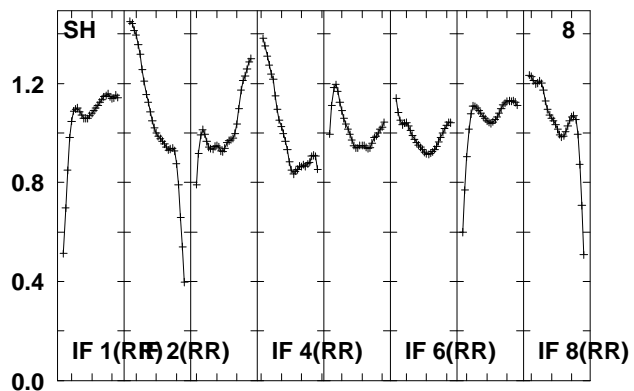
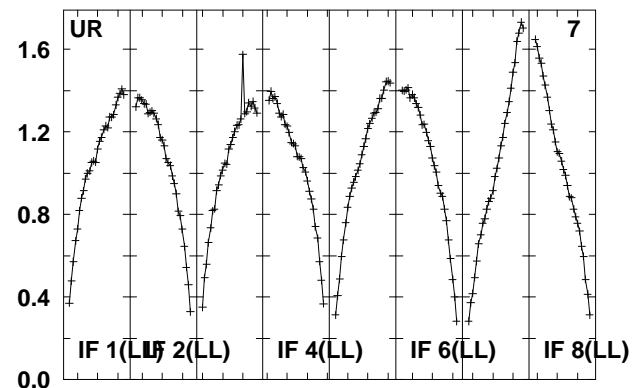
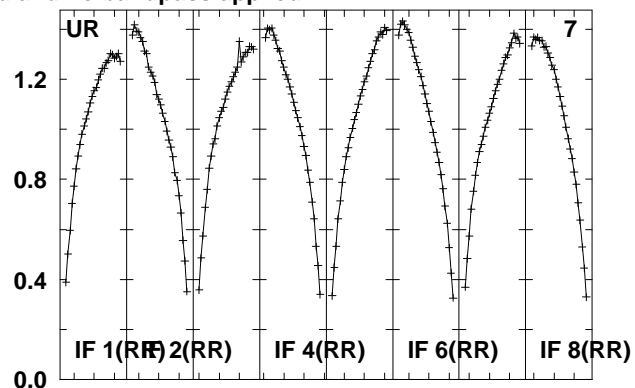
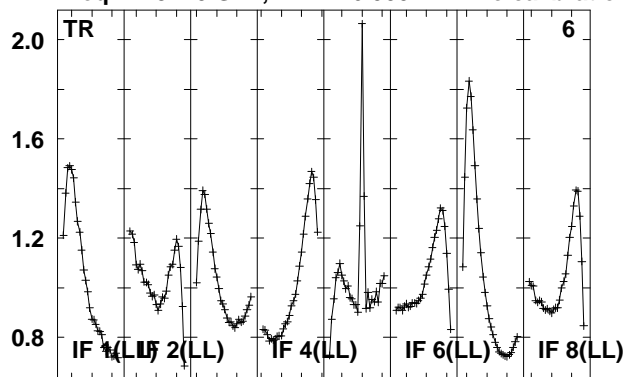

Lower frame: Real Jy
Total-power spectrum Antenna: *
Timerange: 00/23:51:01 to 00/23:52:29

Plot file version 95 created 24-AUG-2010 08:02:52

IRAS1929 EP064M.UVDATA.1

Freq = 4.9270 GHz, Bw = 16.000 MH No calibration applied and no bandpass applied

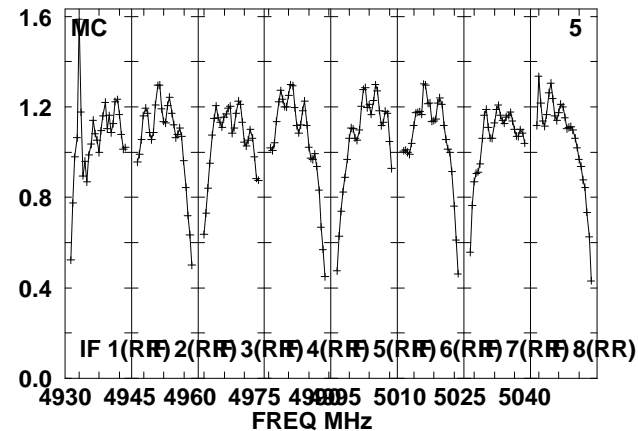
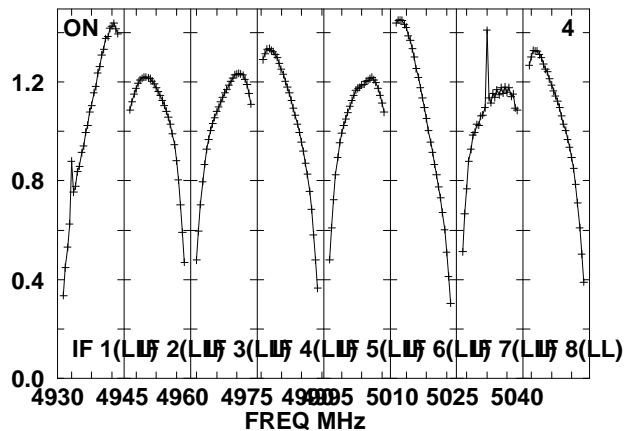
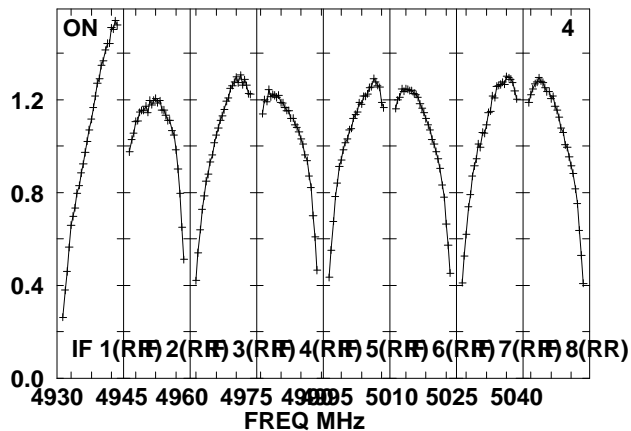
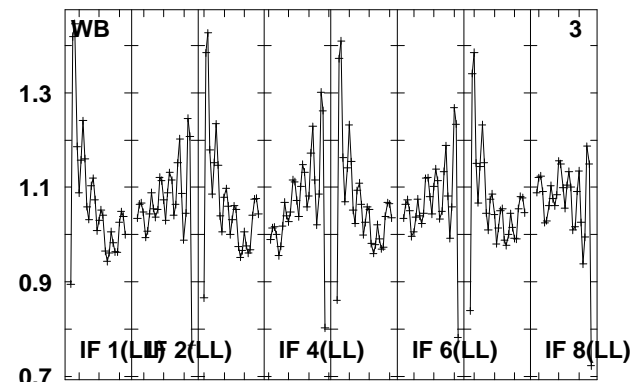
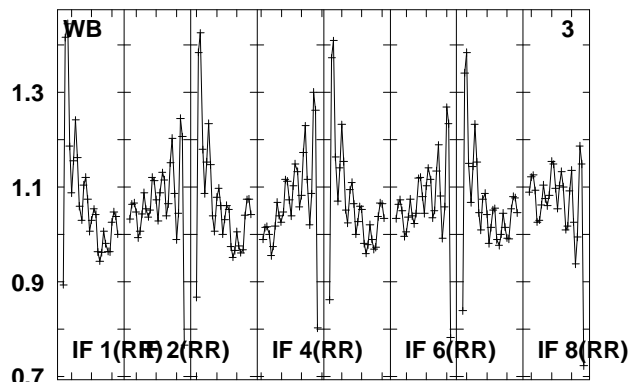
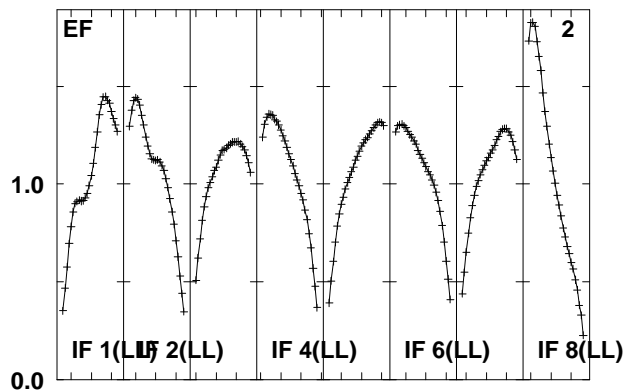
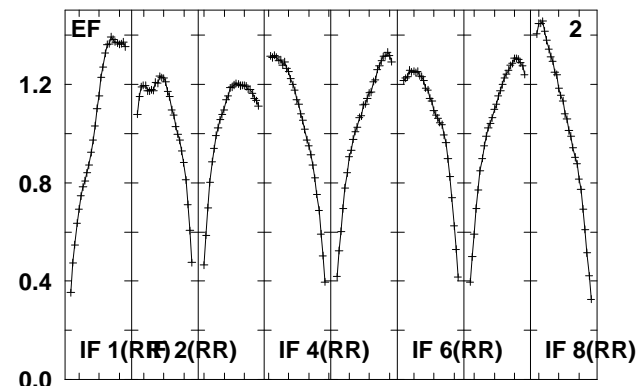
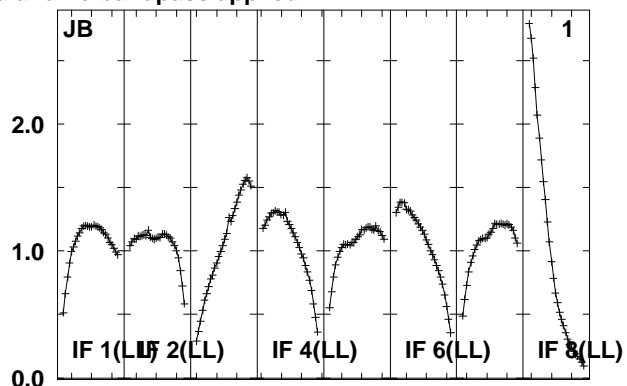
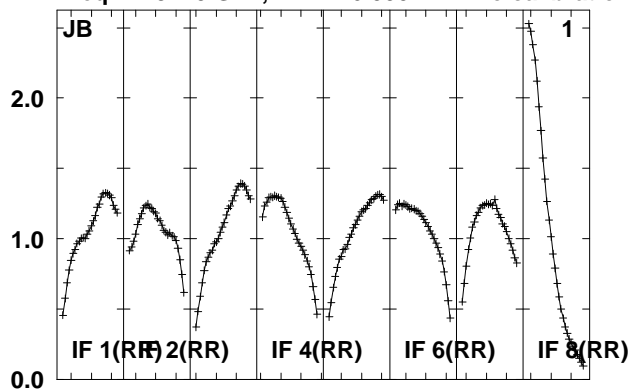

Lower frame: Real Jy
Total-power spectrum Antenna: *
Timerange: 00/23:52:31 to 00/23:55:59

Plot file version 96 created 24-AUG-2010 08:02:53

IRAS1929 EP064M.UVDATA.1

Freq = 4.9270 GHz, Bw = 16.000 MH No calibration applied and no bandpass applied

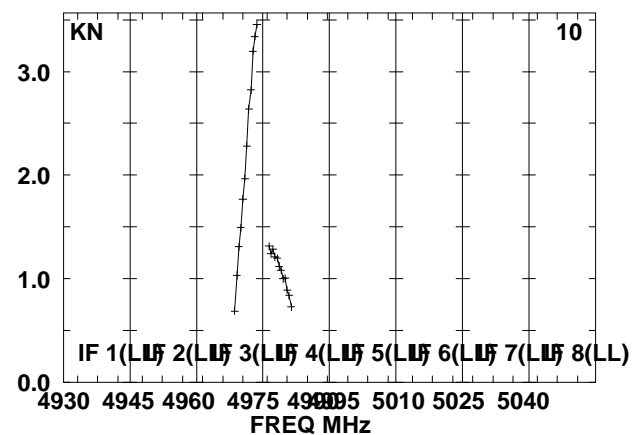
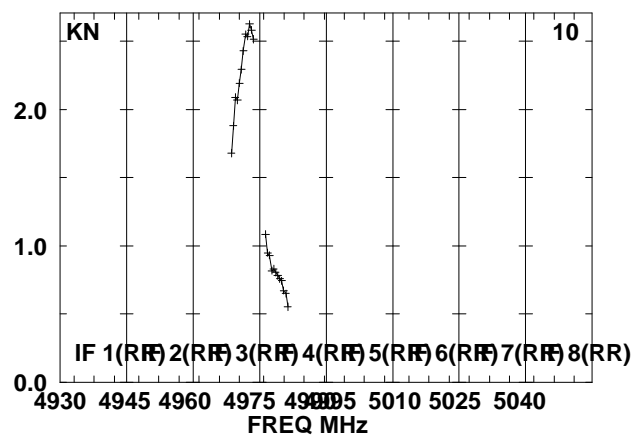
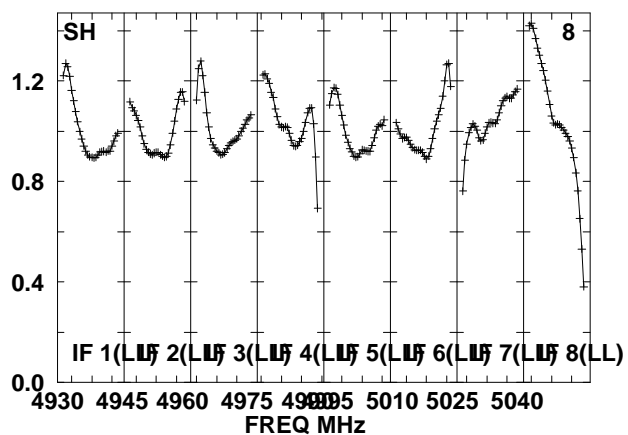
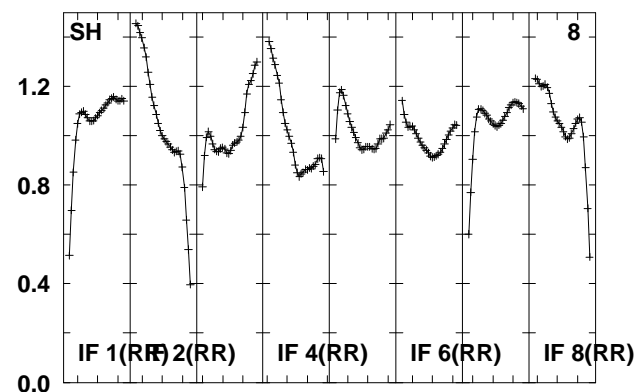
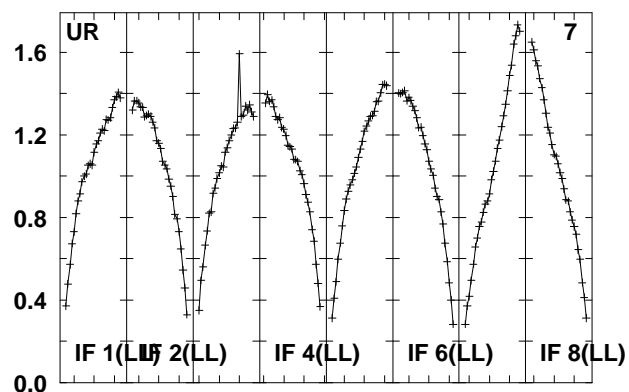
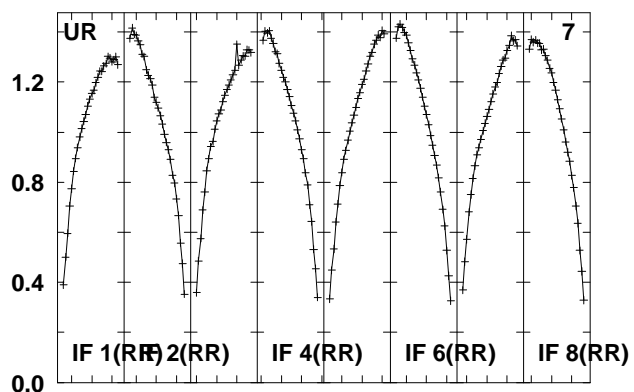
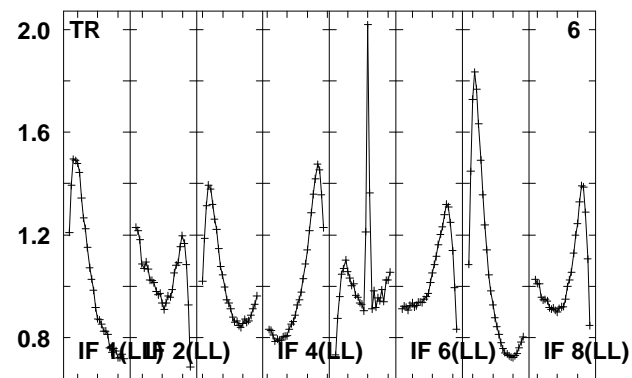
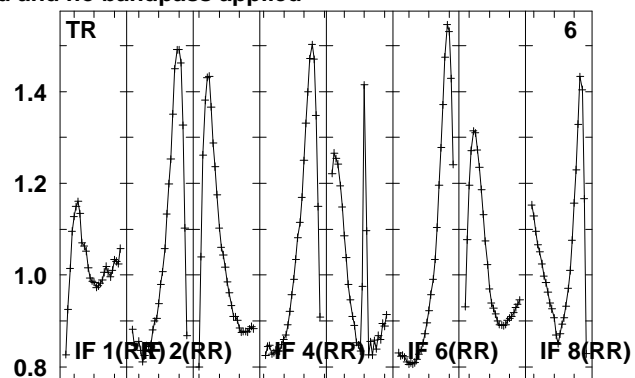
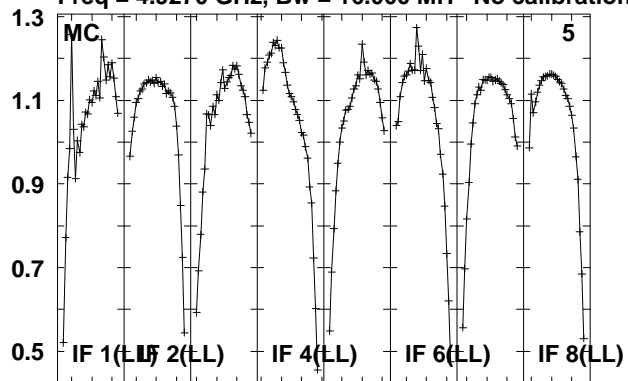

Lower frame: Real Jy

Total-power spectrum Antenna: *

Timerange: 00/23:52:31 to 00/23:55:59

Plot file version 97 created 24-AUG-2010 08:02:54

IRAS1929 EP064M.UVDATA.1

Freq = 4.9270 GHz, Bw = 16.000 MH No calibration applied and no bandpass applied

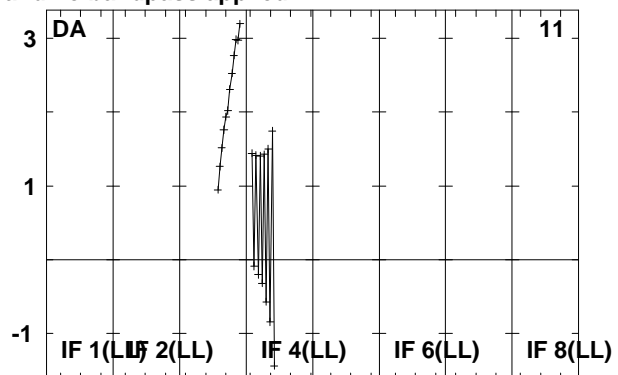
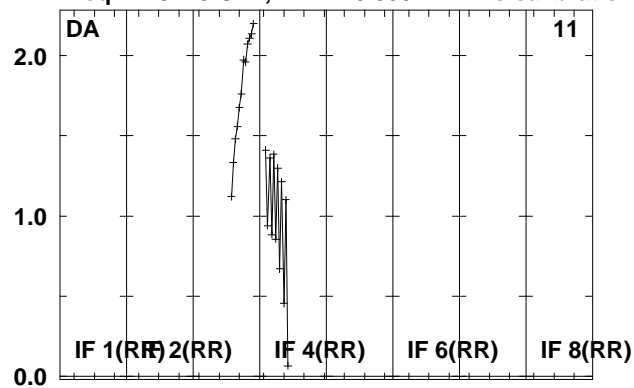

Lower frame: Real Jy
Total-power spectrum Antenna: *
Timerange: 00/23:52:31 to 00/23:55:59

Plot file version 98 created 24-AUG-2010 08:02:54

J1941-05 EP064M.UVDATA.1

Freq = 4.9270 GHz, Bw = 16.000 MH No calibration applied and no bandpass applied

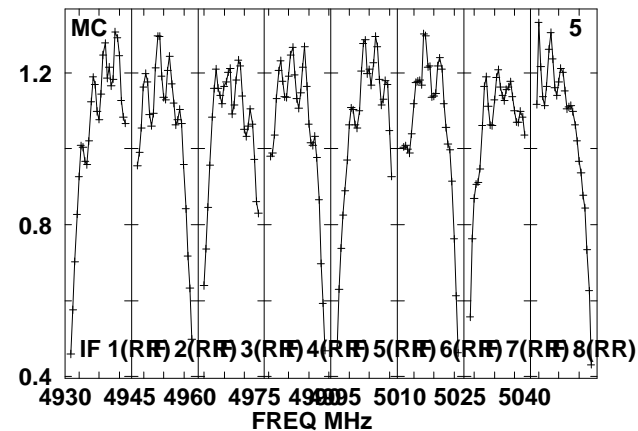
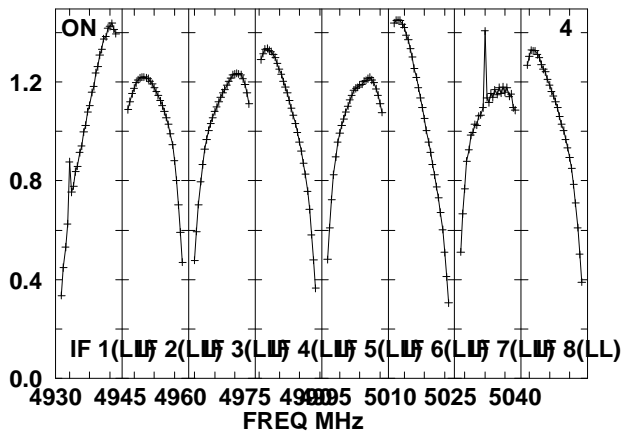
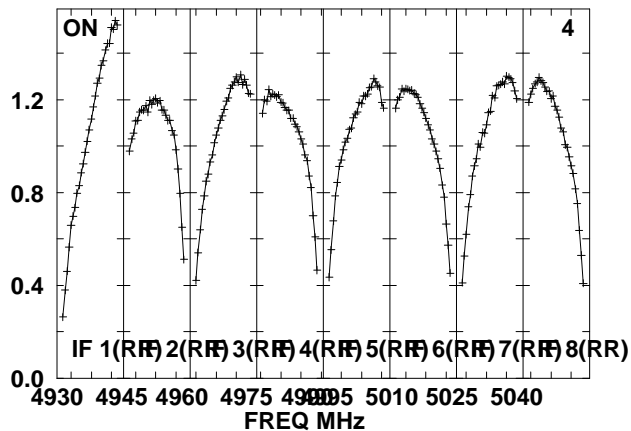
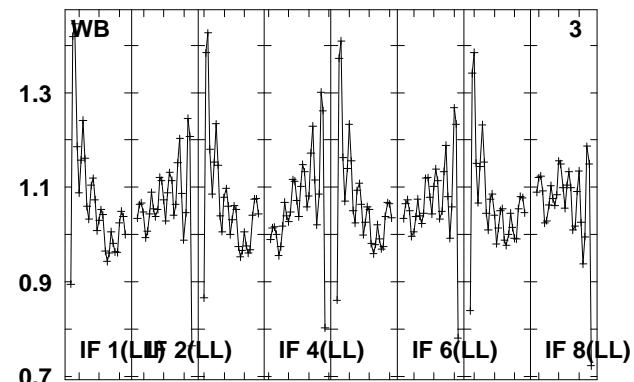
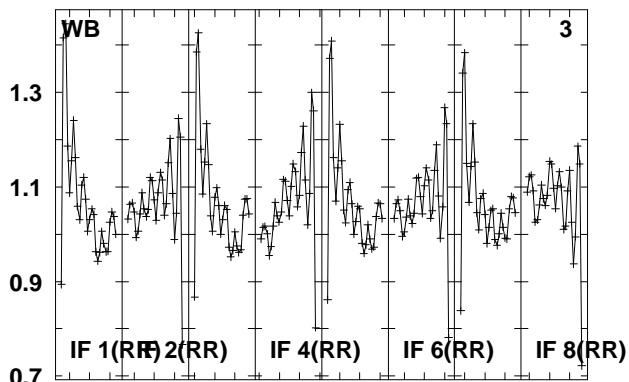
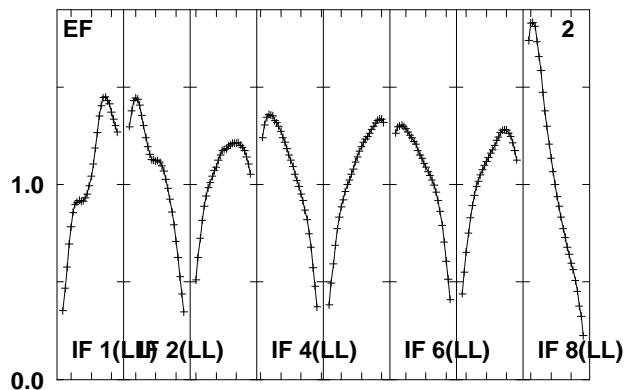
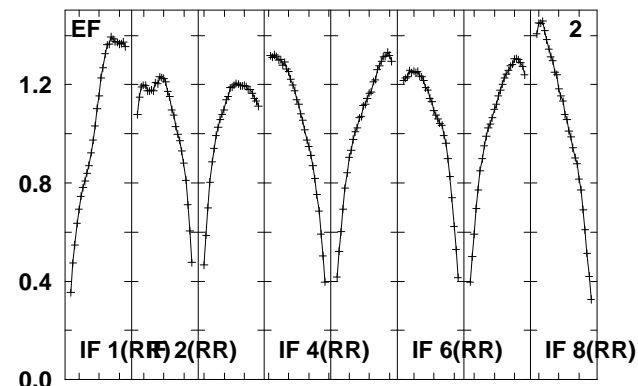
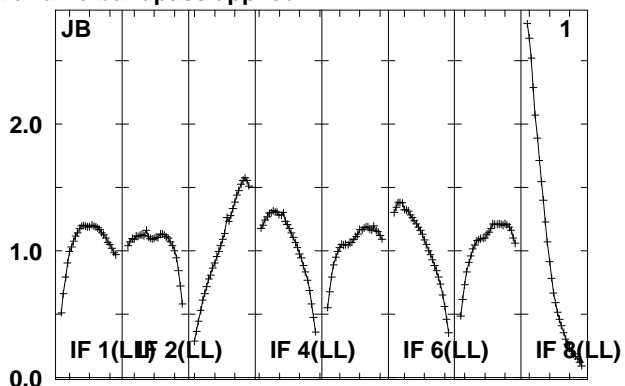
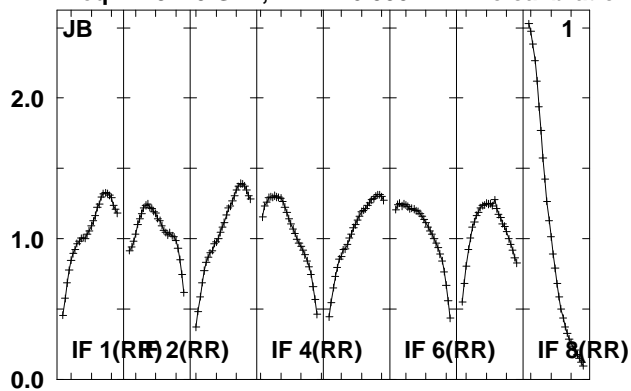

Lower frame: Real Jy
Total-power spectrum Antenna: *
Timerange: 00/23:56:01 to 00/23:57:29

Plot file version 99 created 24-AUG-2010 08:02:54
 J1941-05 EP064M.UVDATA.1
 Freq = 4.9270 GHz, Bw = 16.000 MH No calibration applied and no bandpass applied

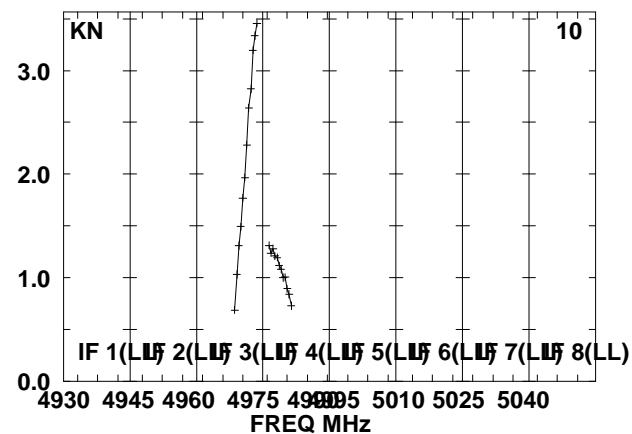
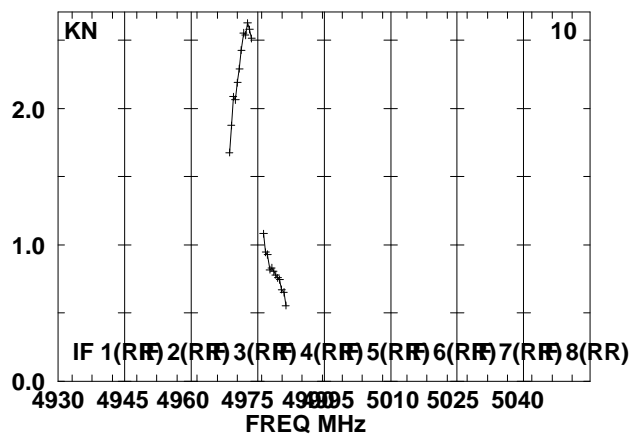
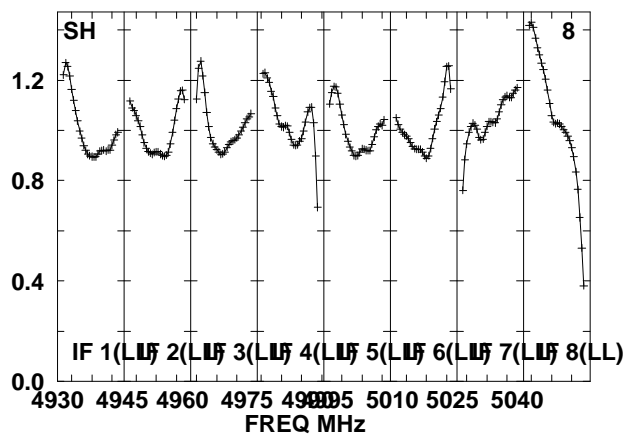
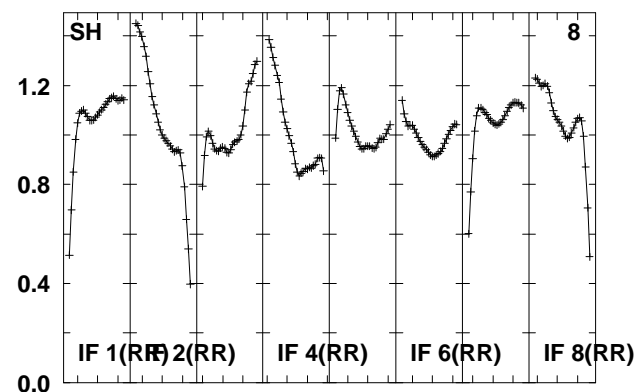
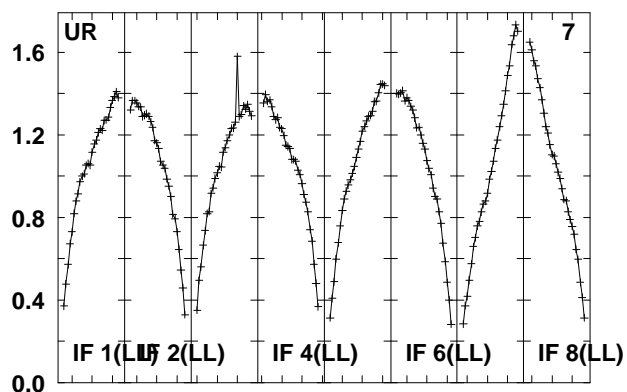
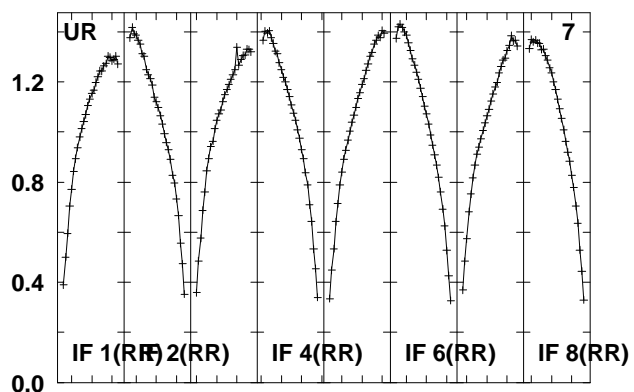
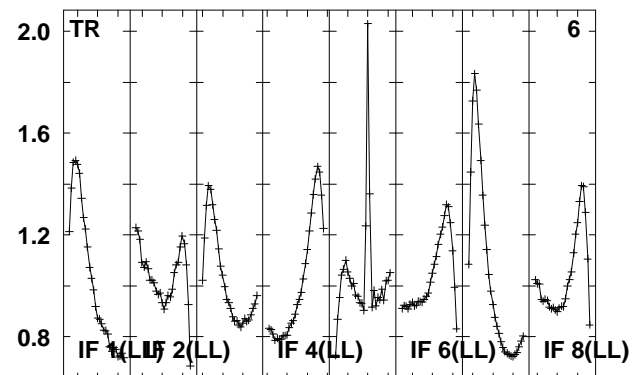
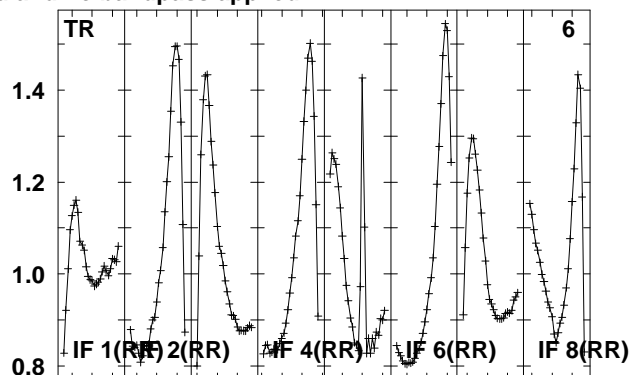
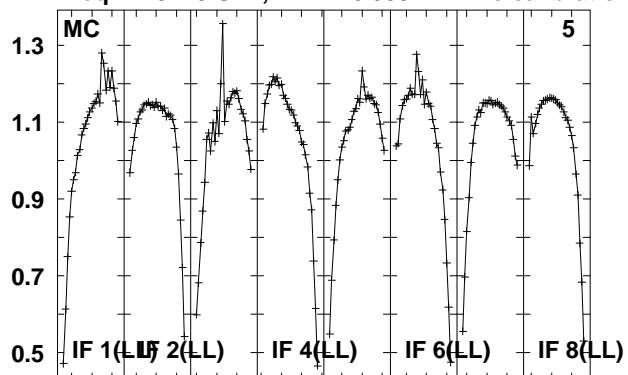

Lower frame: Real Jy
 Total-power spectrum Antenna: *
 Timerange: 00/23:56:01 to 00/23:57:29

Plot file version 100 created 24-AUG-2010 08:02:55

J1941-05 EP064M.UVDATA.1

Freq = 4.9270 GHz, Bw = 16.000 MH No calibration applied and no bandpass applied

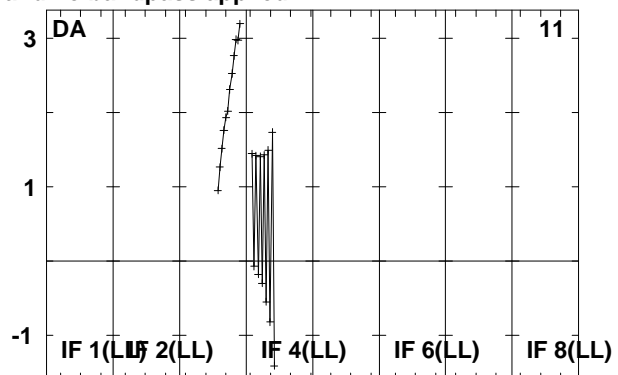
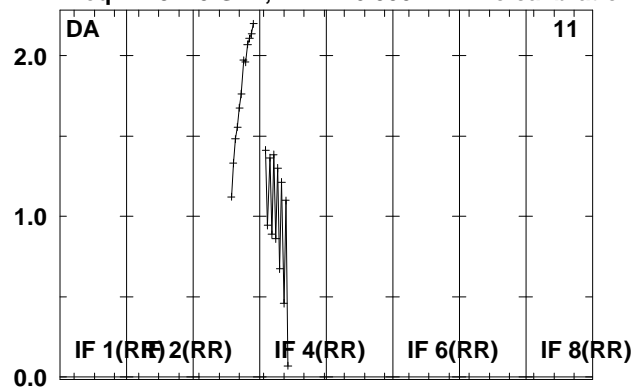

Lower frame: Real Jy
Total-power spectrum Antenna: *
Timerange: 00/23:56:01 to 00/23:57:29

Plot file version 101 created 24-AUG-2010 08:02:55

IRAS1929 EP064M.UVDATA.1

Freq = 4.9270 GHz, Bw = 16.000 MH No calibration applied and no bandpass applied

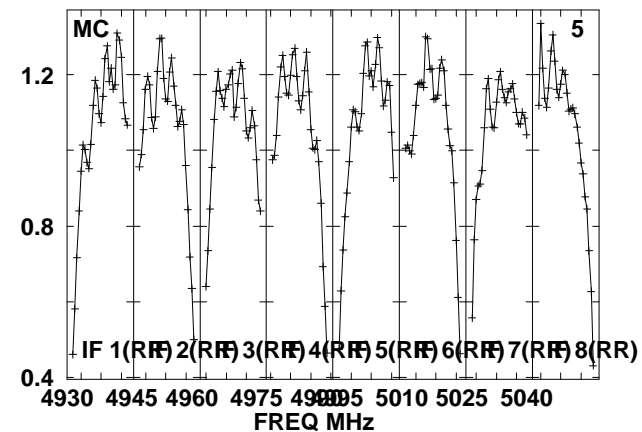
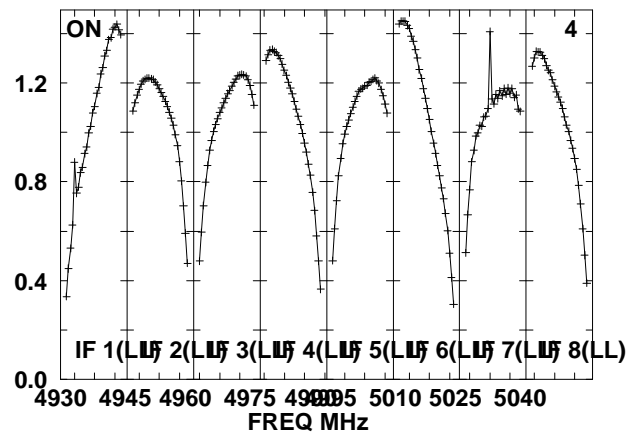
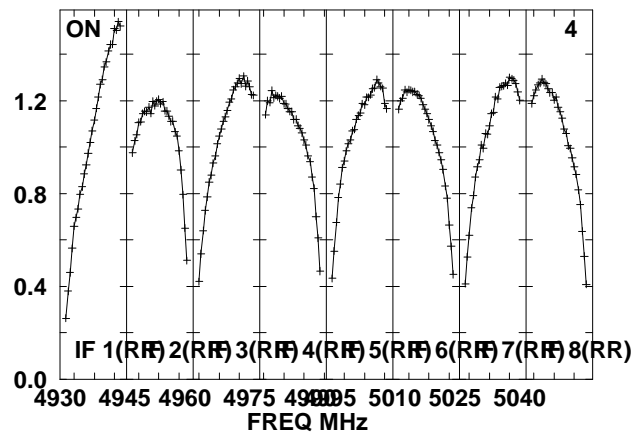
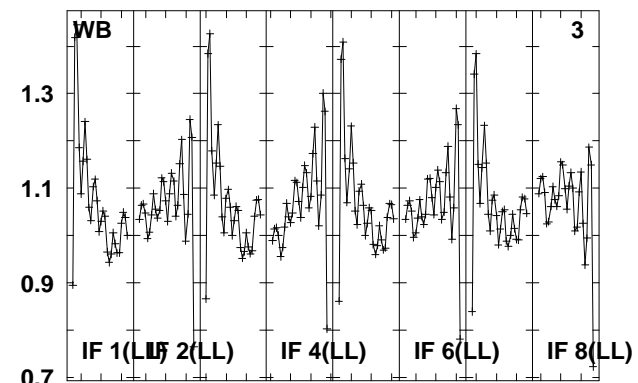
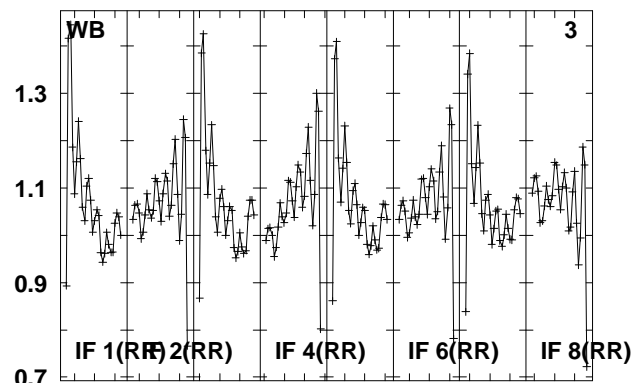
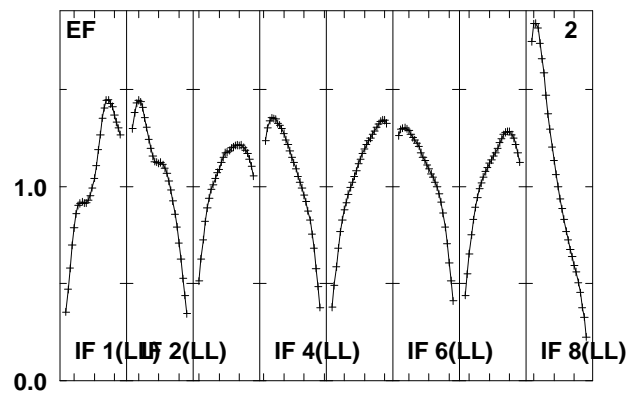
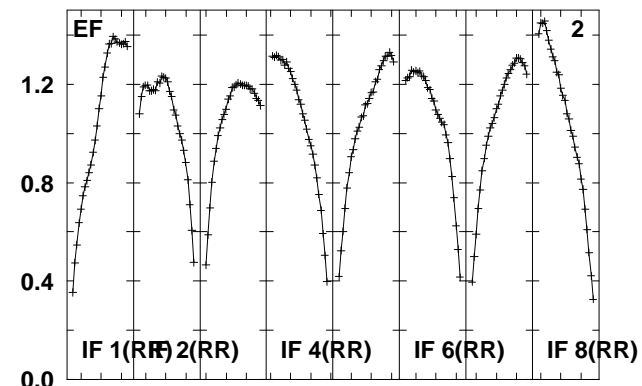
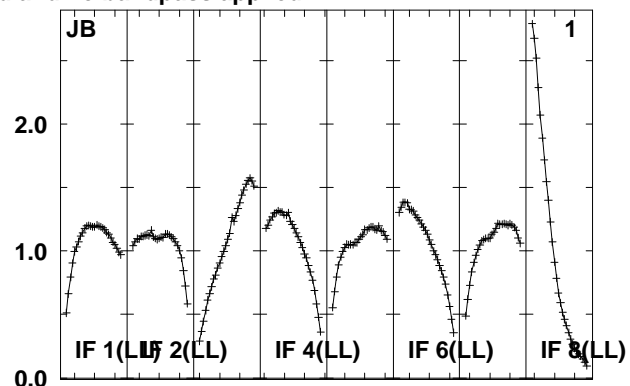
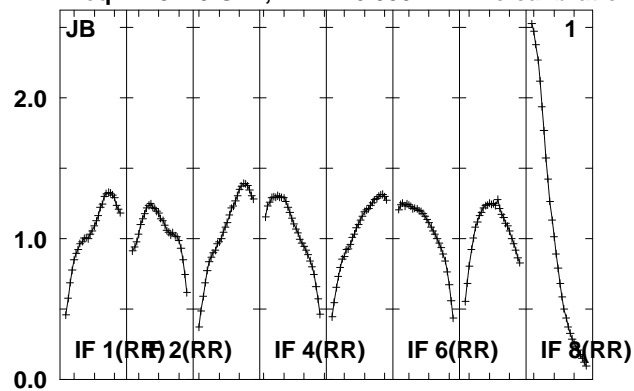

Lower frame: Real Jy
Total-power spectrum Antenna: *
Timerange: 00/23:57:31 to 01/00:00:59

Plot file version 102 created 24-AUG-2010 08:02:55

IRAS1929 EP064M.UVDATA.1

Freq = 4.9270 GHz, Bw = 16.000 MH No calibration applied and no bandpass applied

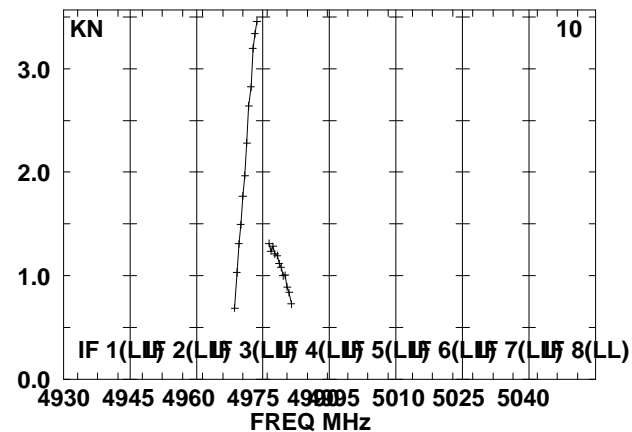
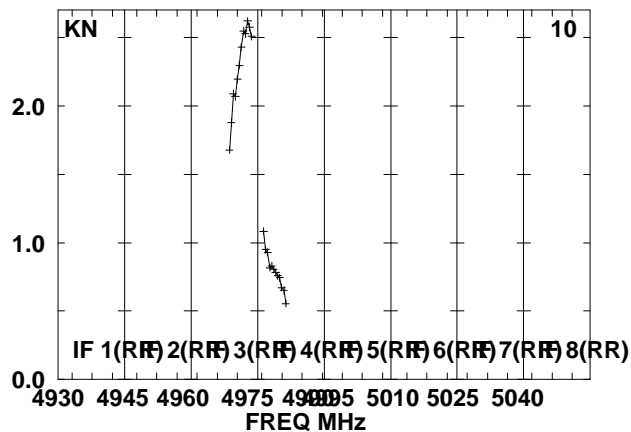
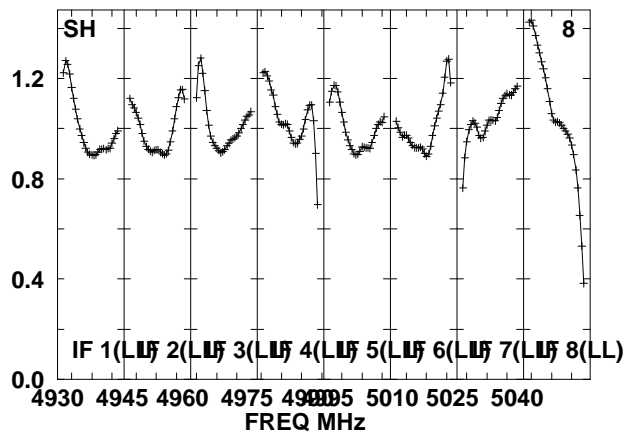
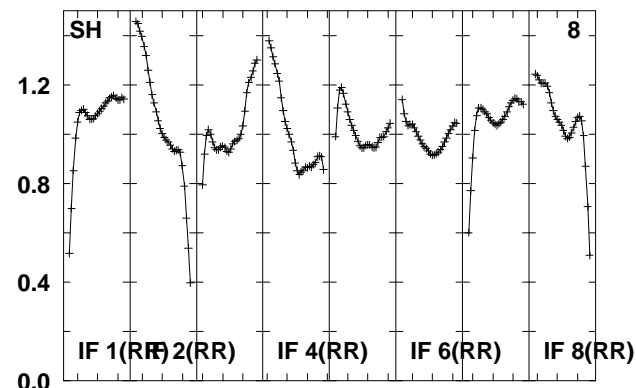
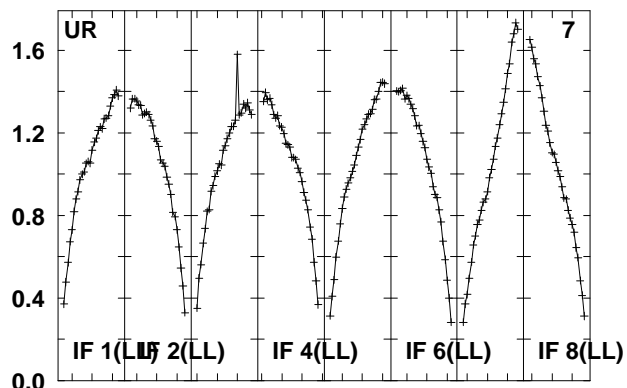
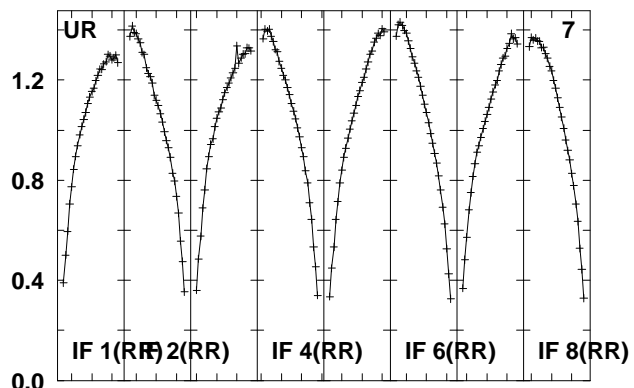
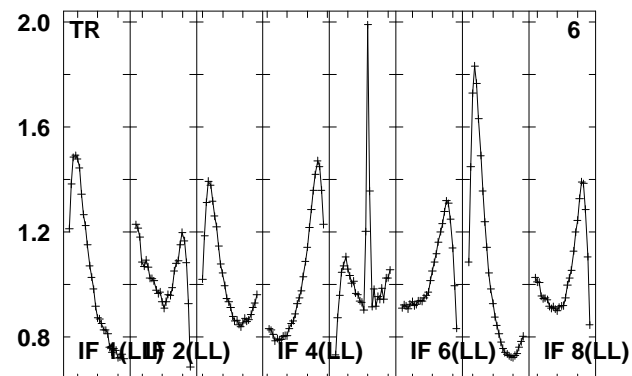
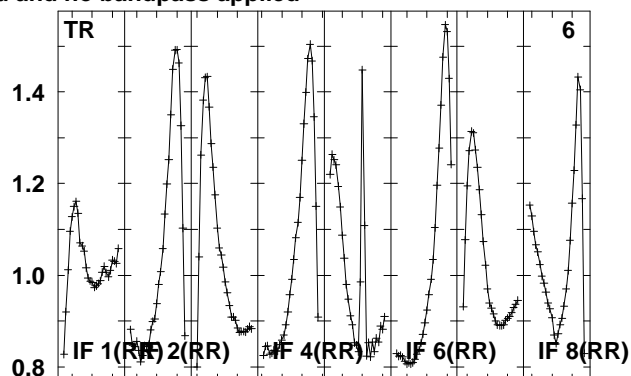
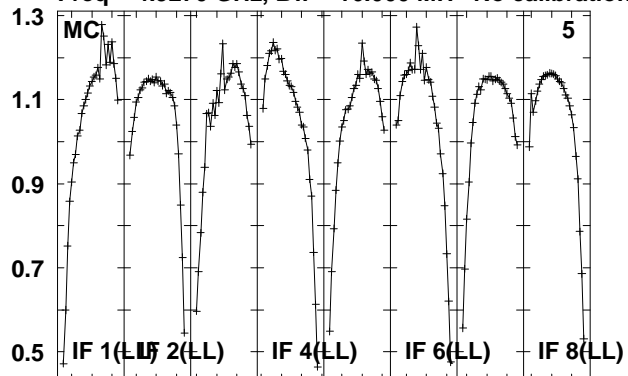

Lower frame: Real Jy

Total-power spectrum Antenna: *

Timerange: 00/23:57:31 to 01/00:00:59

Plot file version 103 created 24-AUG-2010 08:02:56

IRAS1929 EP064M.UVDATA.1

Freq = 4.9270 GHz, Bw = 16.000 MH No calibration applied and no bandpass applied

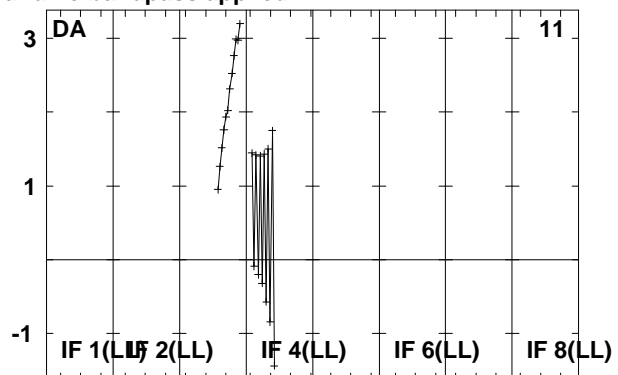
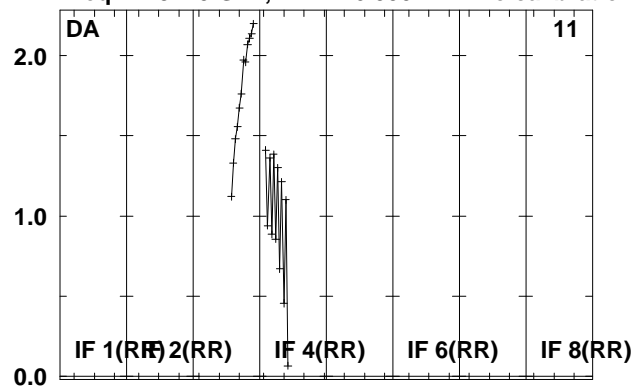

Lower frame: Real Jy
Total-power spectrum Antenna: *
Timerange: 00/23:57:31 to 01/00:00:59

Plot file version 104 created 24-AUG-2010 08:02:56

J1941-05 EP064M.UVDATA.1

Freq = 4.9270 GHz, Bw = 16.000 MH No calibration applied and no bandpass applied

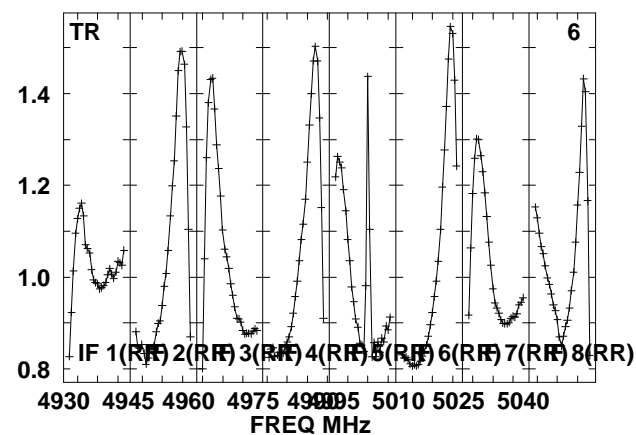
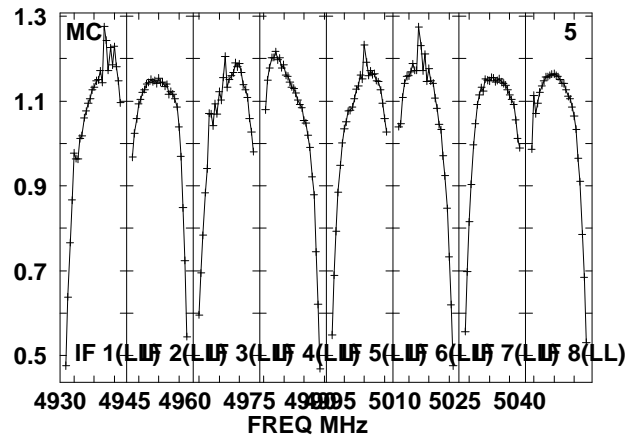
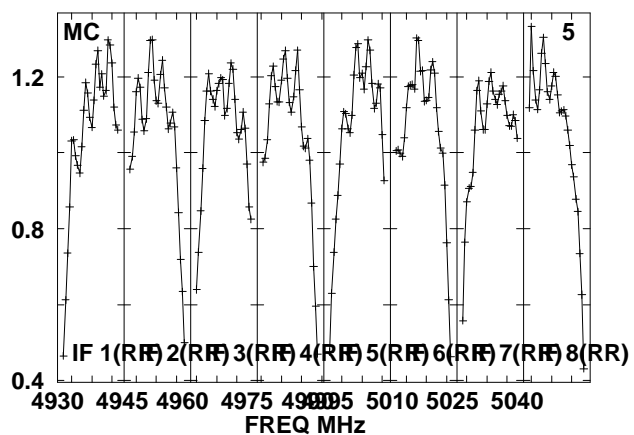
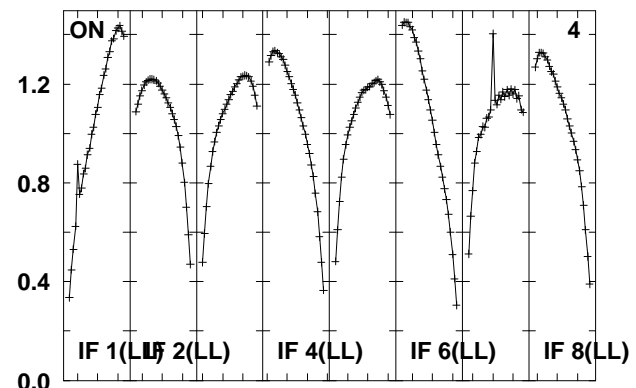
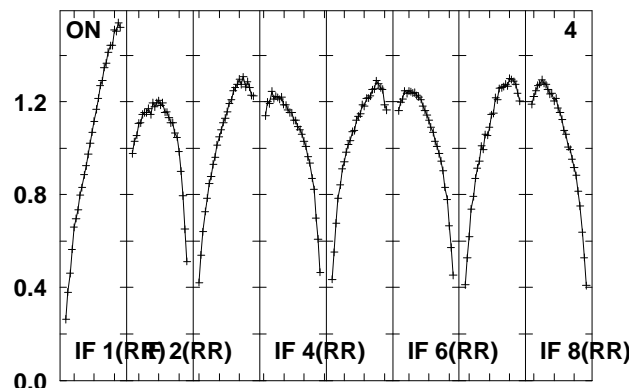
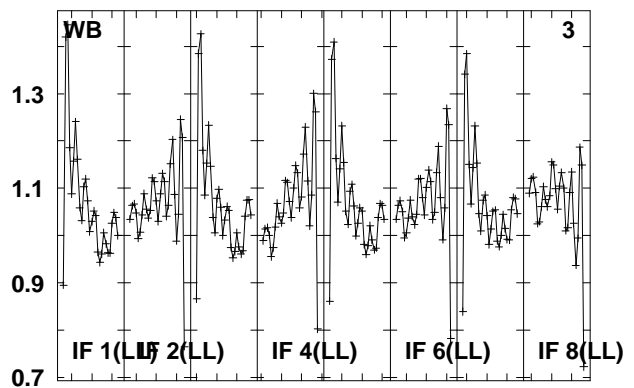
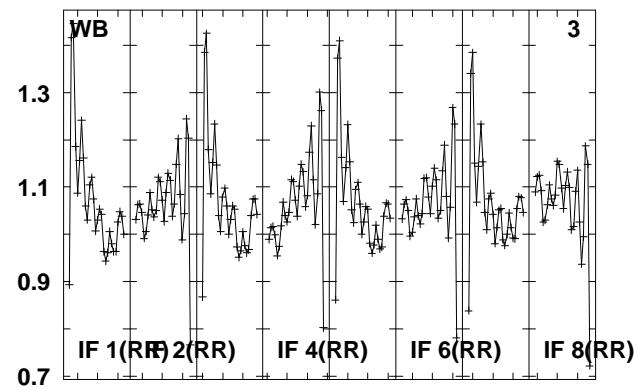
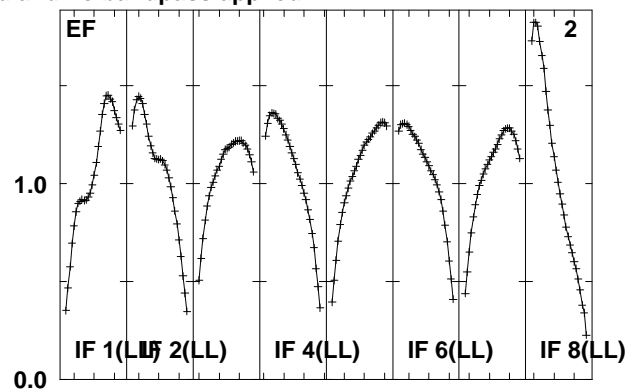
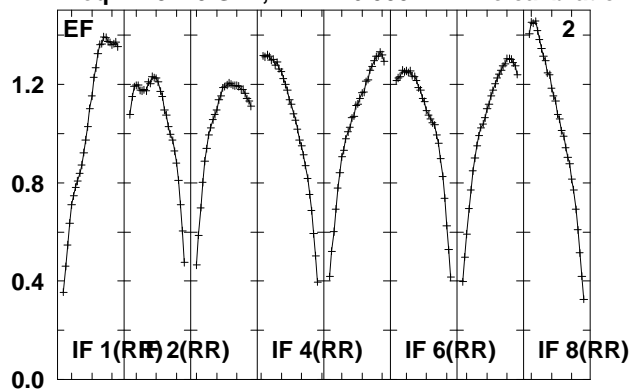

Lower frame: Real Jy
Total-power spectrum Antenna: *
Timerange: 01/00:02:01 to 01/00:03:27

Plot file version 105 created 24-AUG-2010 08:02:56

J1941-05 EP064M.UVDATA.1

Freq = 4.9270 GHz, Bw = 16.000 MH No calibration applied and no bandpass applied

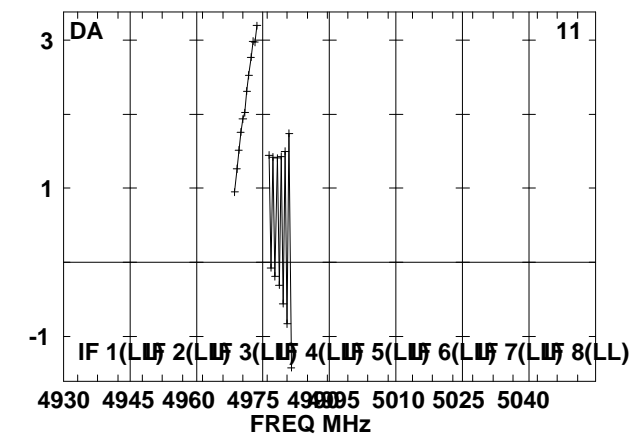
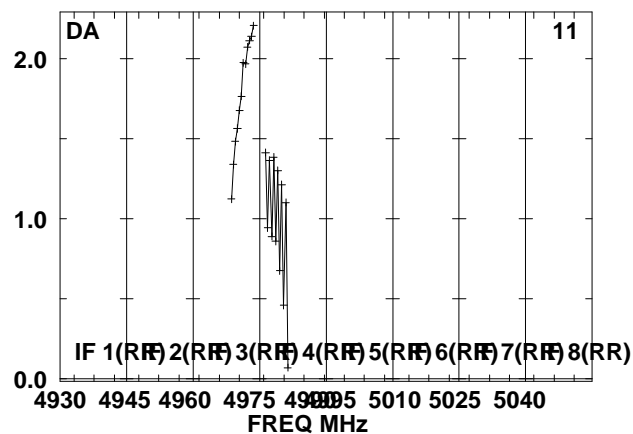
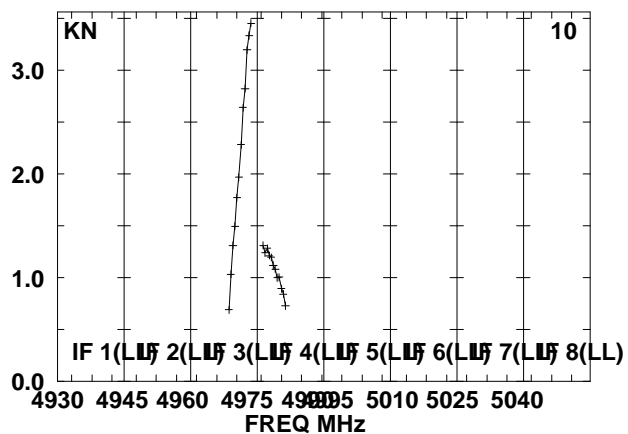
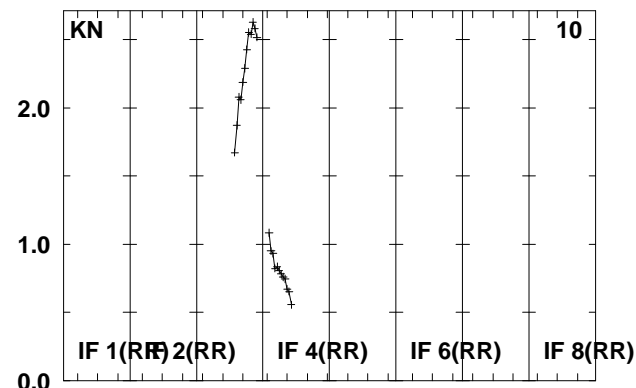
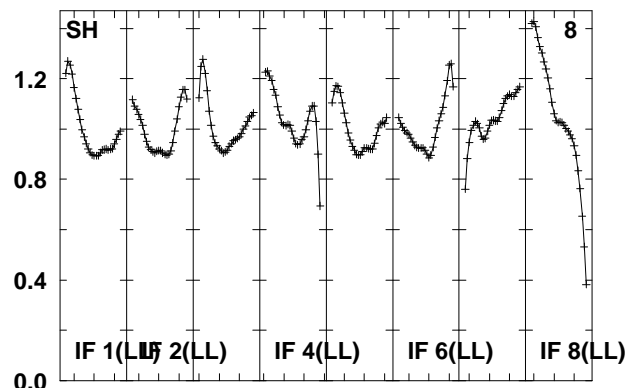
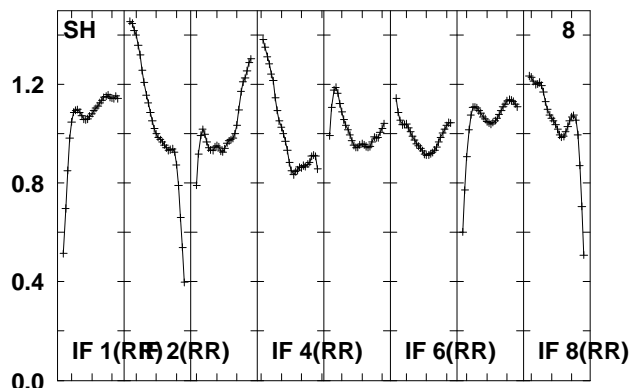
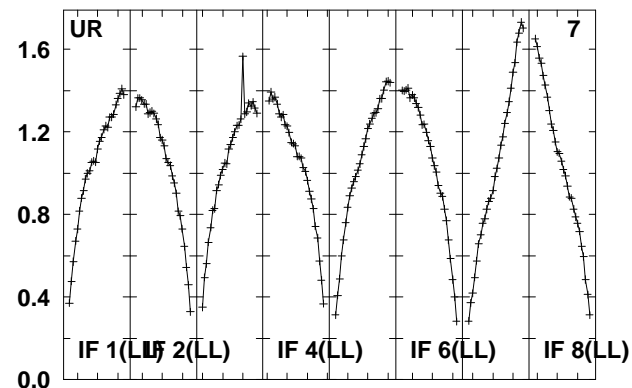
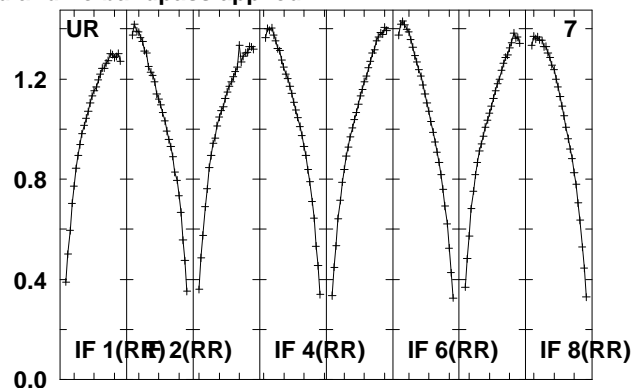
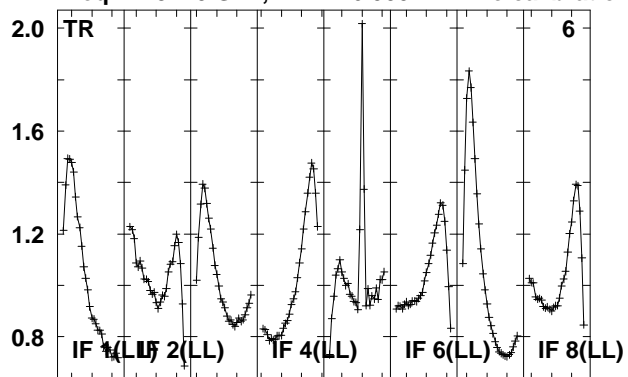

Lower frame: Real Jy
Total-power spectrum Antenna: *
Timerange: 01/00:02:01 to 01/00:03:27

Plot file version 106 created 24-AUG-2010 08:02:57

IRAS1929 EP064M.UVDATA.1

Freq = 4.9270 GHz, Bw = 16.000 MH No calibration applied and no bandpass applied

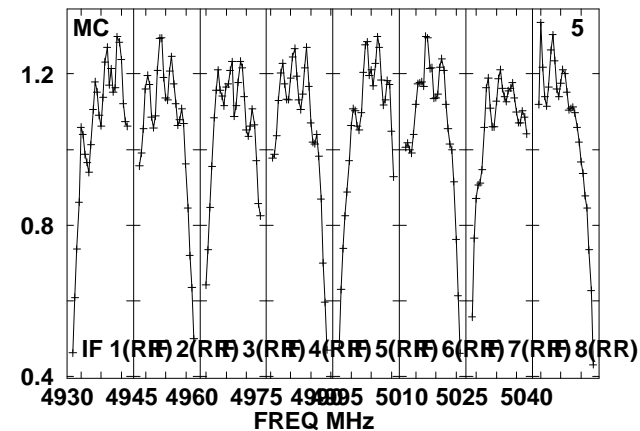
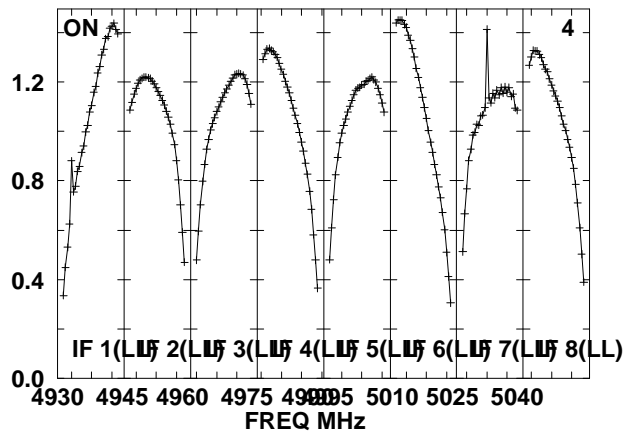
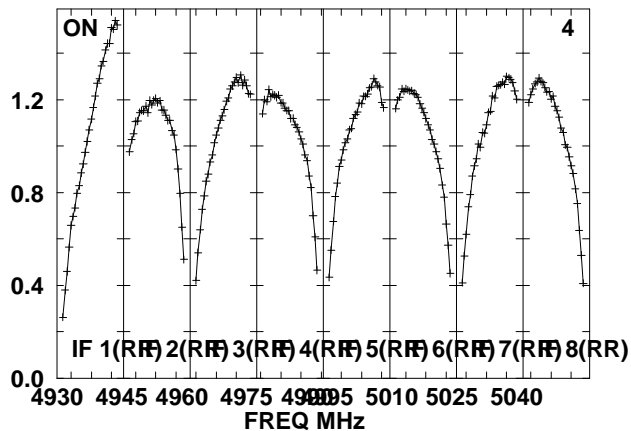
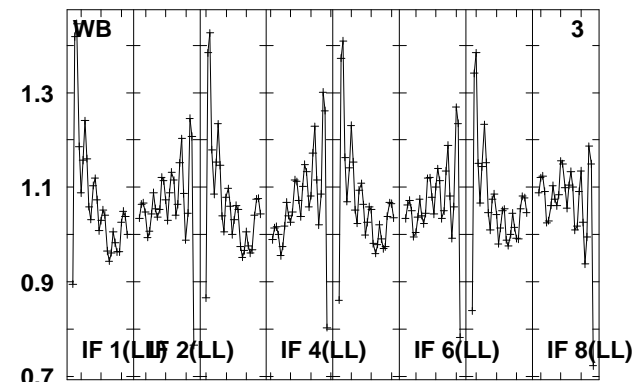
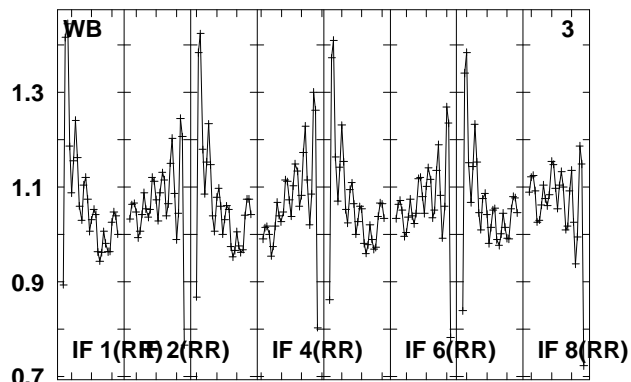
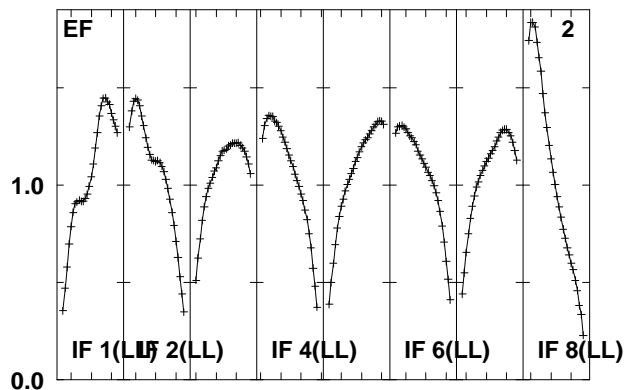
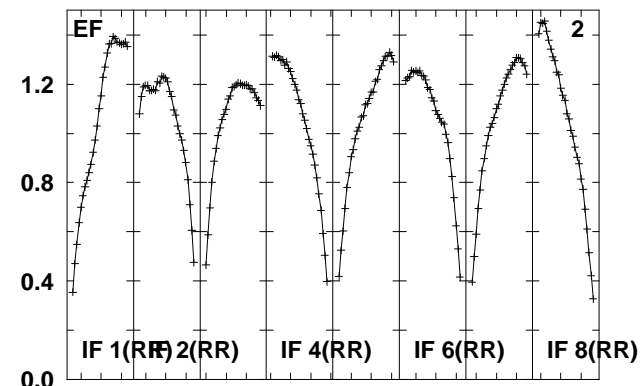
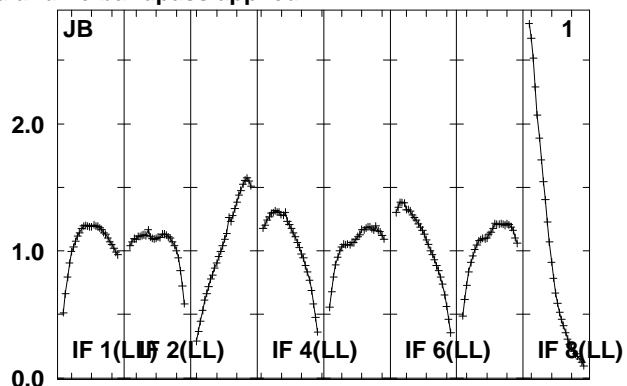
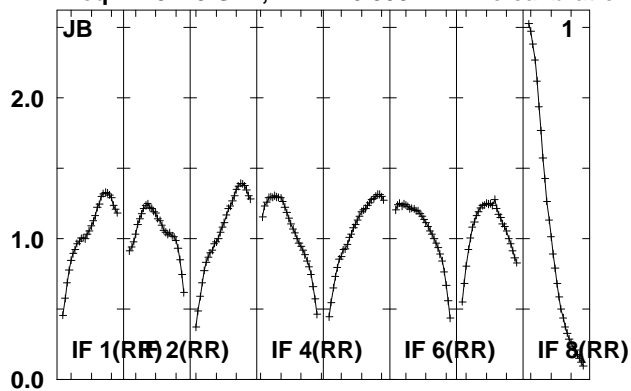

Lower frame: Real Jy
Total-power spectrum Antenna: *
Timerange: 01/00:03:31 to 01/00:06:59

Plot file version 107 created 24-AUG-2010 08:02:57

IRAS1929 EP064M.UVDATA.1

Freq = 4.9270 GHz, Bw = 16.000 MH No calibration applied and no bandpass applied

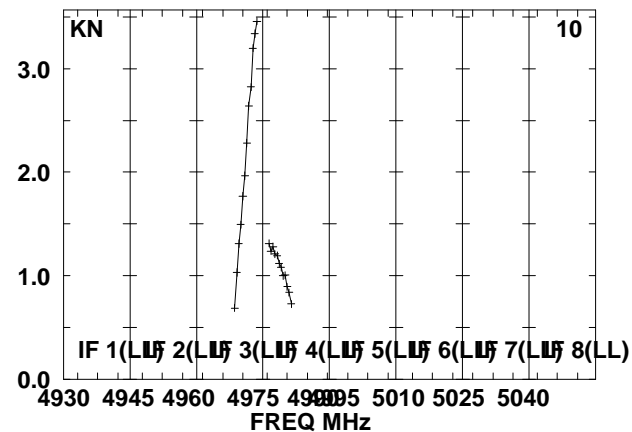
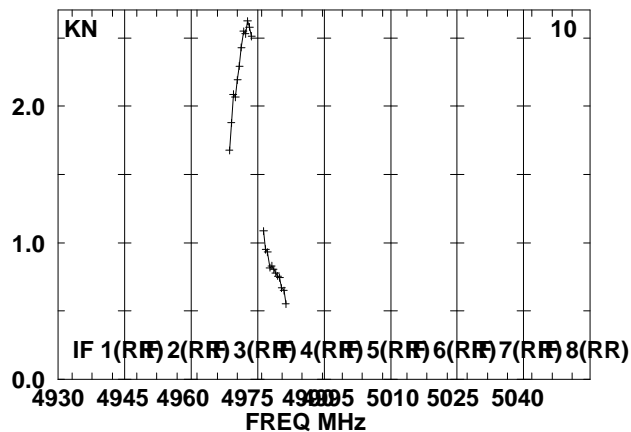
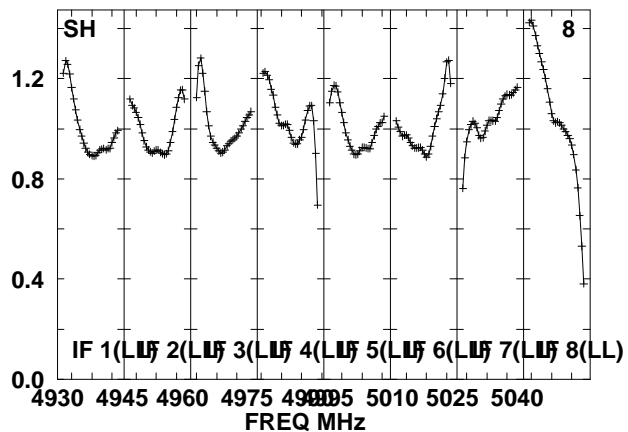
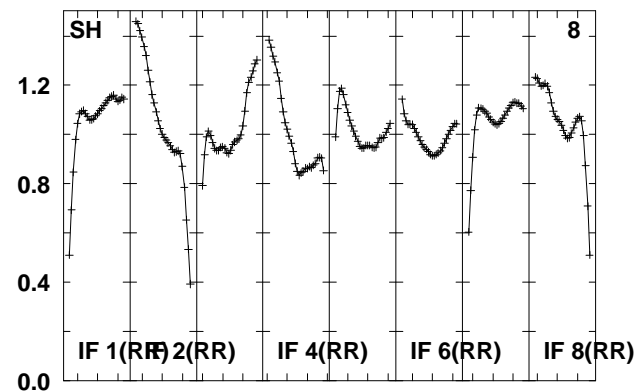
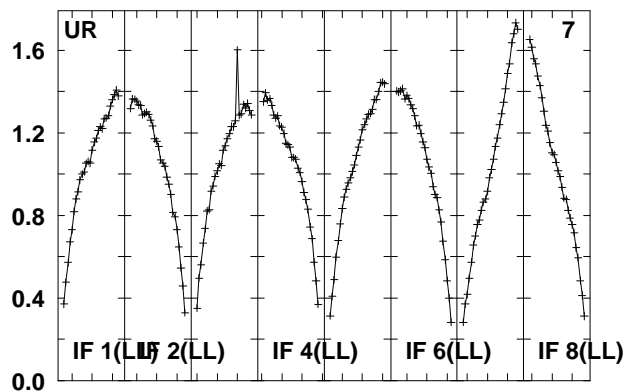
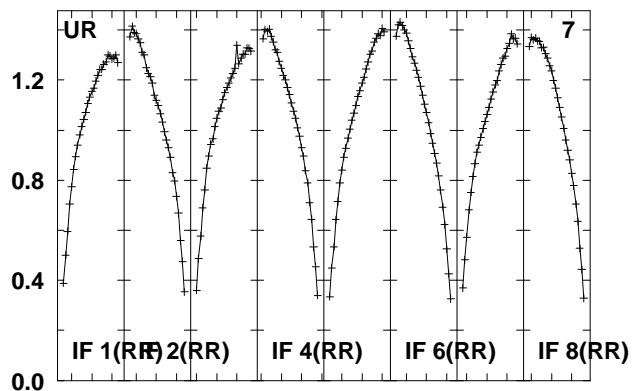
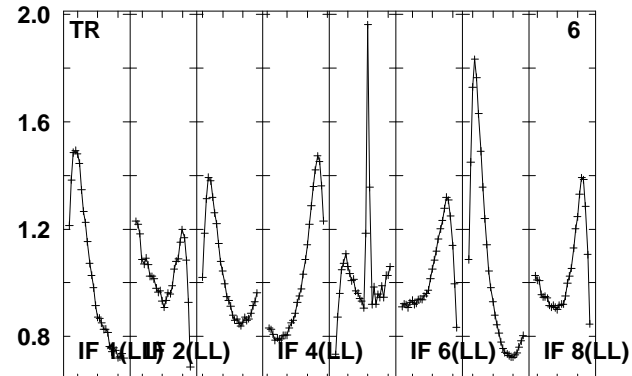
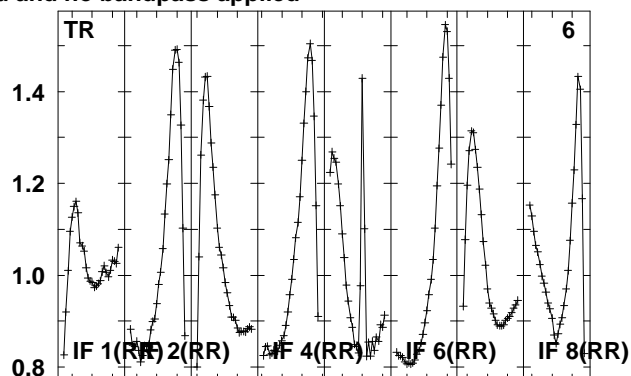
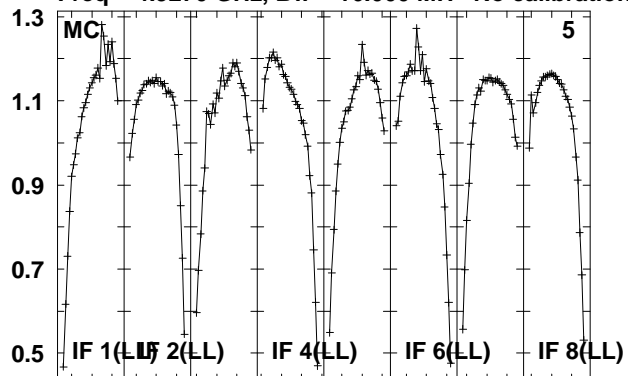

Lower frame: Real Jy

Total-power spectrum Antenna: *

Timerange: 01/00:03:31 to 01/00:06:59

Plot file version 108 created 24-AUG-2010 08:02:58

IRAS1929 EP064M.UVDATA.1

Freq = 4.9270 GHz, Bw = 16.000 MH No calibration applied and no bandpass applied

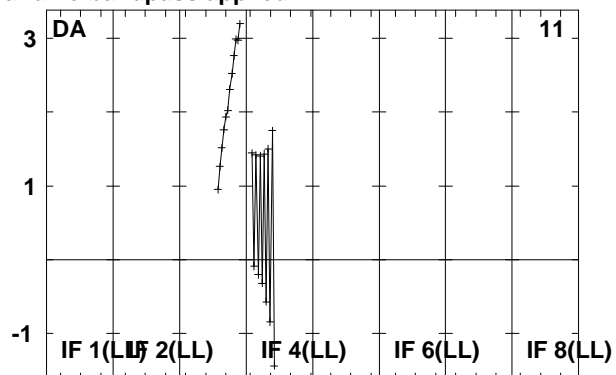
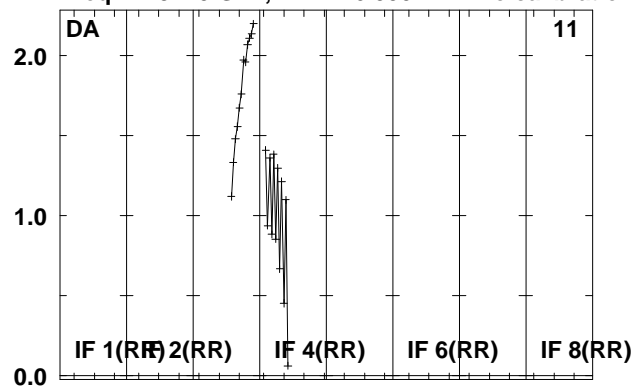

Lower frame: Real Jy
Total-power spectrum Antenna: *
Timerange: 01/00:03:31 to 01/00:06:59

Plot file version 109 created 24-AUG-2010 08:02:58

J1941-05 EP064M.UVDATA.1

Freq = 4.9270 GHz, Bw = 16.000 MH No calibration applied and no bandpass applied

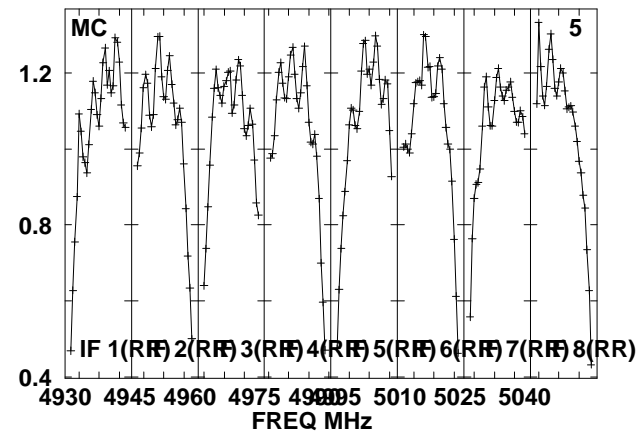
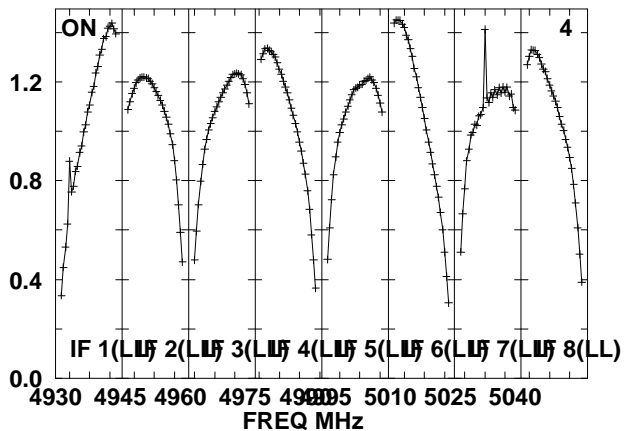
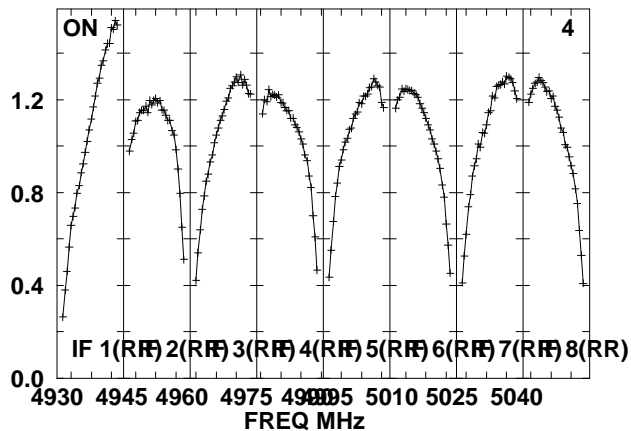
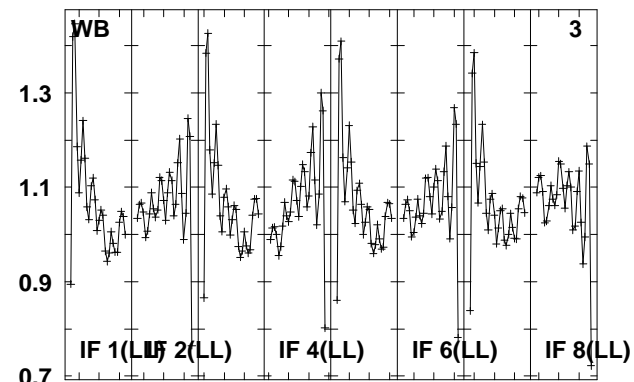
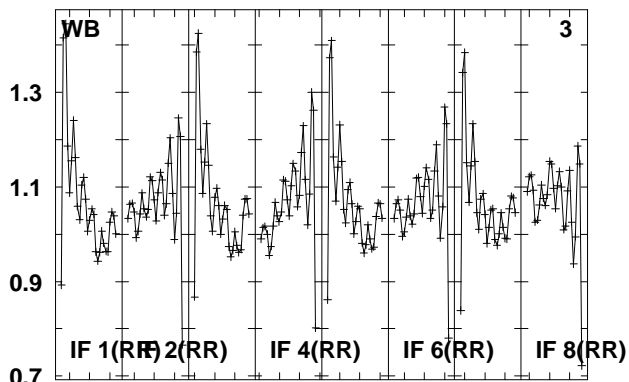
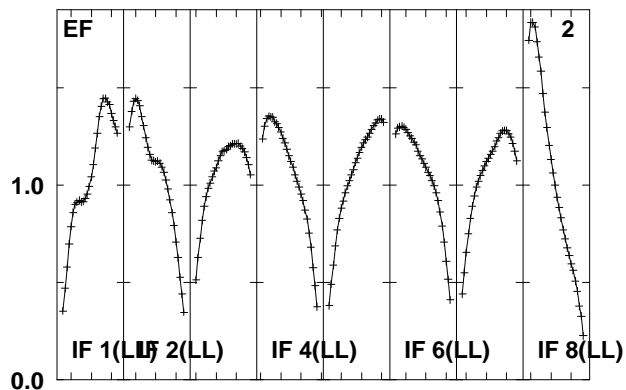
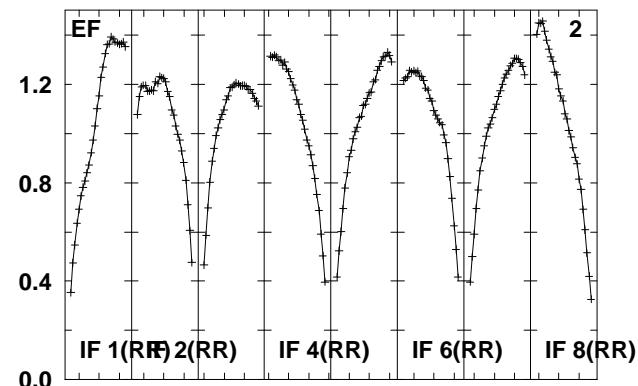
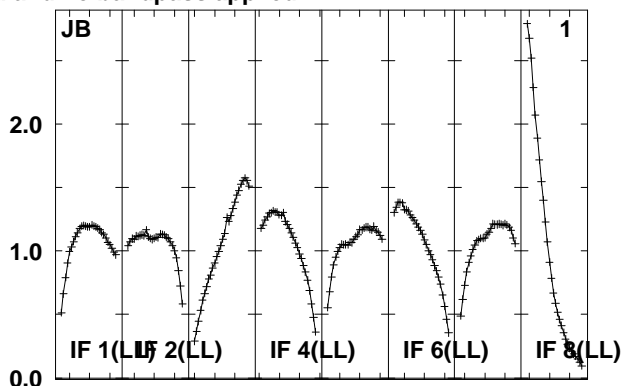
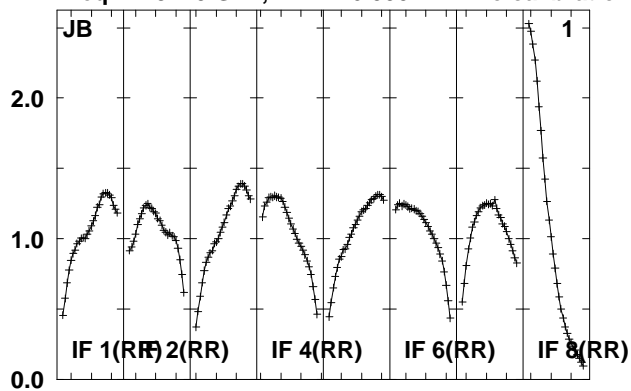

Lower frame: Real Jy
Total-power spectrum Antenna: *
Timerange: 01/00:07:01 to 01/00:08:29

Plot file version 110 created 24-AUG-2010 08:02:58

J1941-05 EP064M.UVDATA.1

Freq = 4.9270 GHz, Bw = 16.000 MH No calibration applied and no bandpass applied

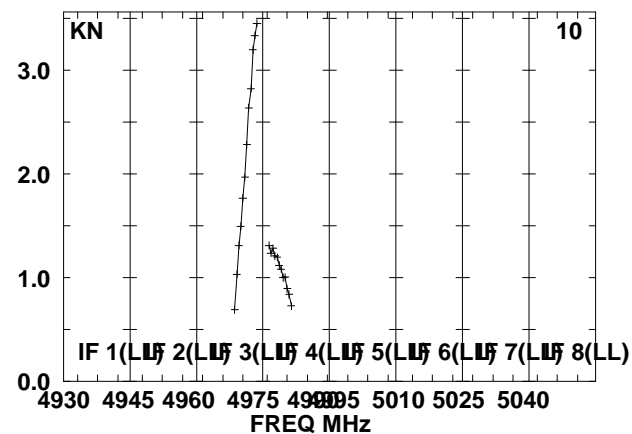
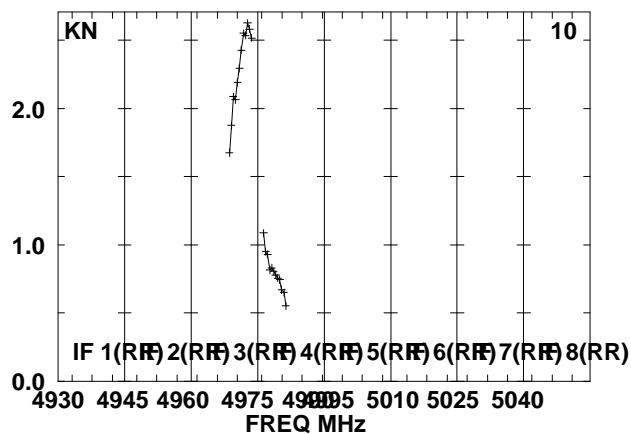
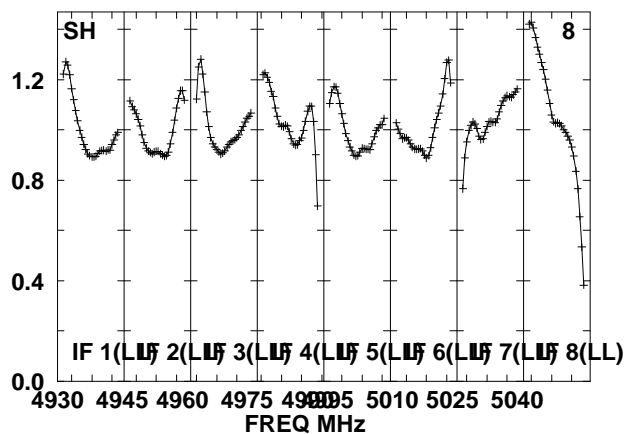
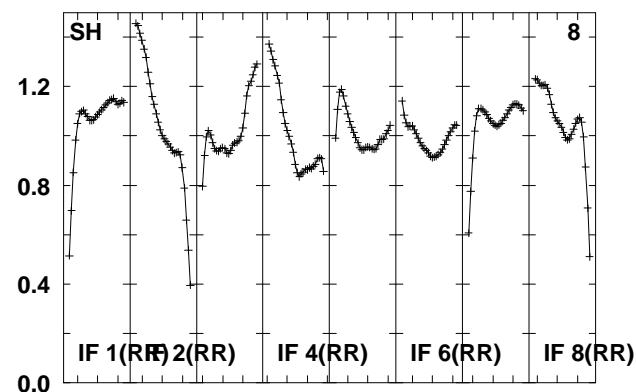
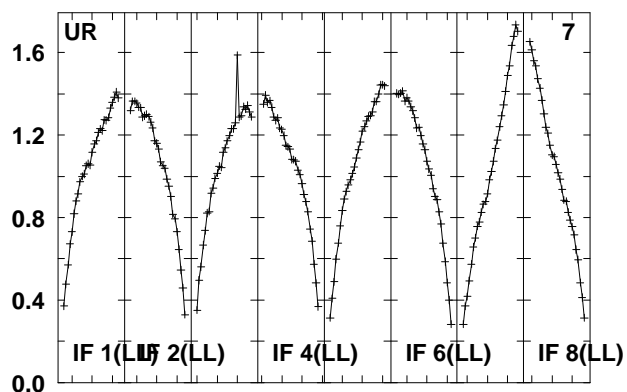
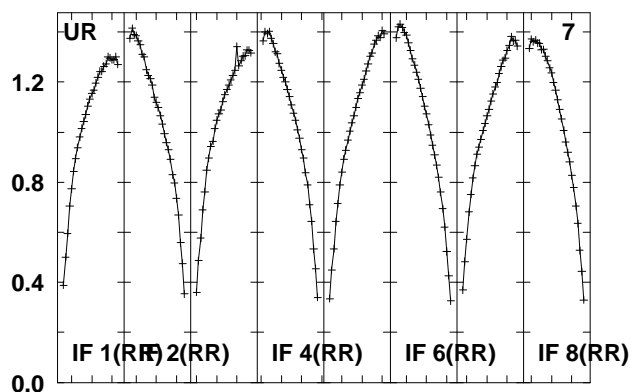
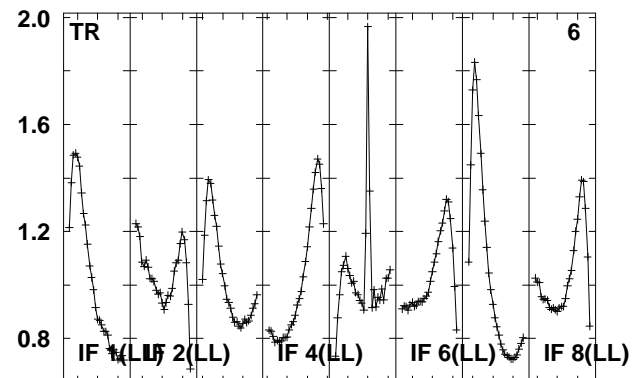
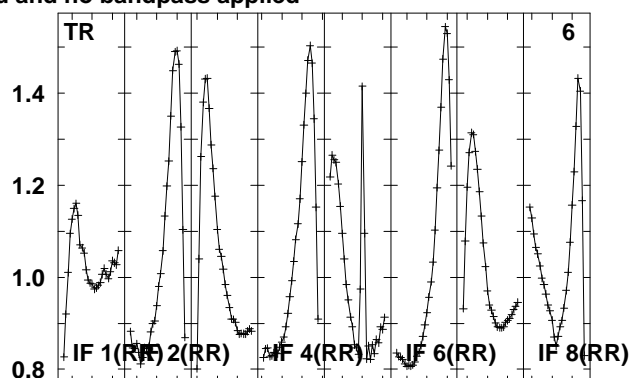
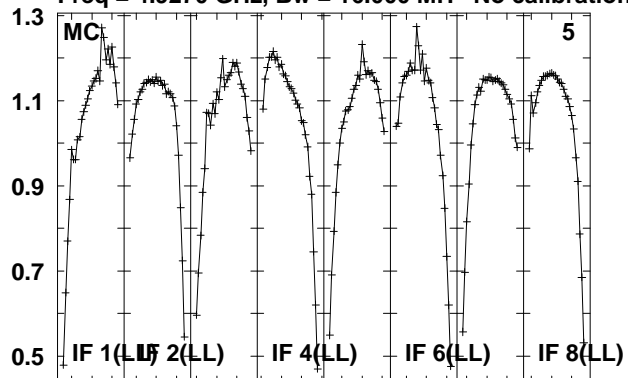

Lower frame: Real Jy

Total-power spectrum Antenna: *

Timerange: 01/00:07:01 to 01/00:08:29

Plot file version 111 created 24-AUG-2010 08:02:59

J1941-05 EP064M.UVDATA.1

Freq = 4.9270 GHz, Bw = 16.000 MH No calibration applied and no bandpass applied

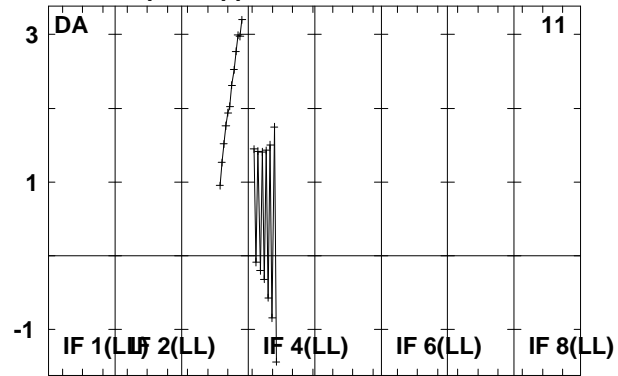
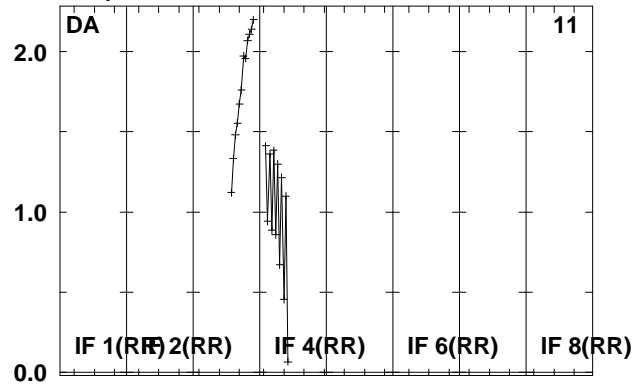

Lower frame: Real Jy
Total-power spectrum Antenna: *
Timerange: 01/00:07:01 to 01/00:08:29

Plot file version 112 created 24-AUG-2010 08:02:59

IRAS1929 EP064M.UVDATA.1

Freq = 4.9270 GHz, Bw = 16.000 MH No calibration applied and no bandpass applied

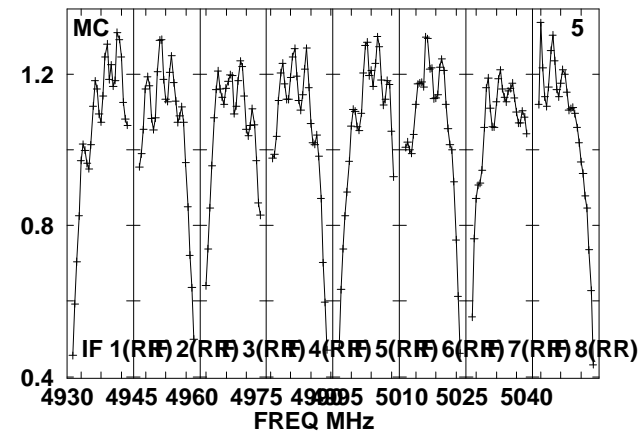
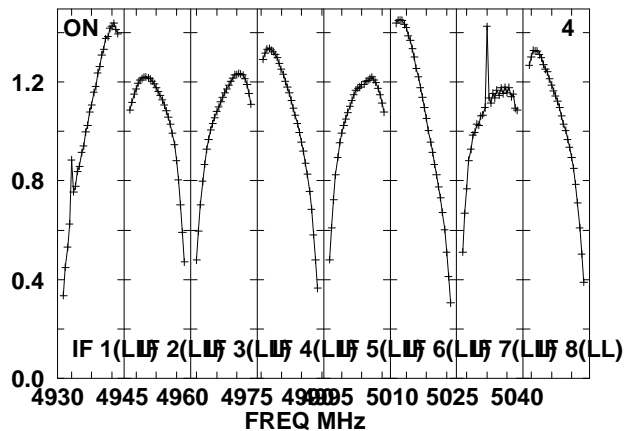
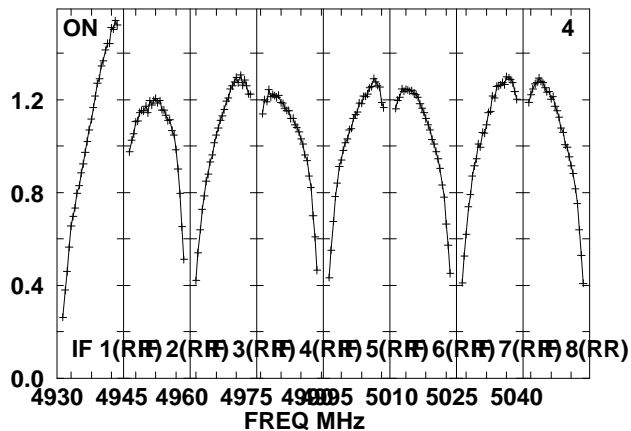
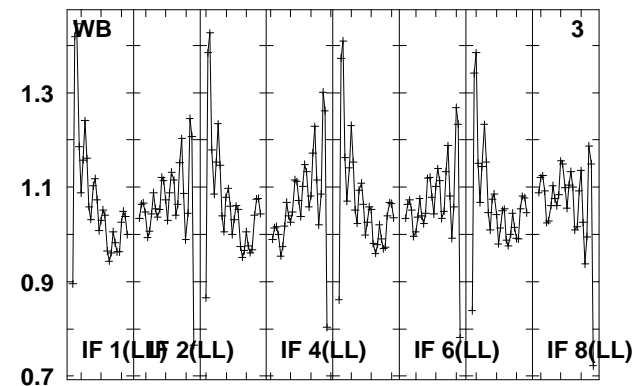
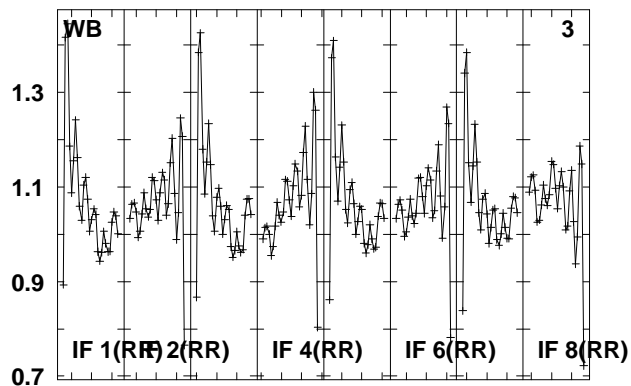
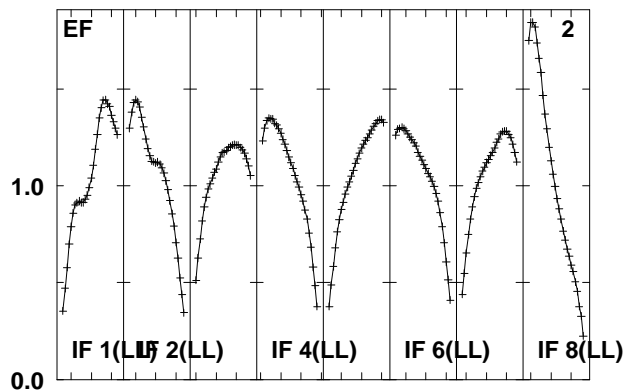
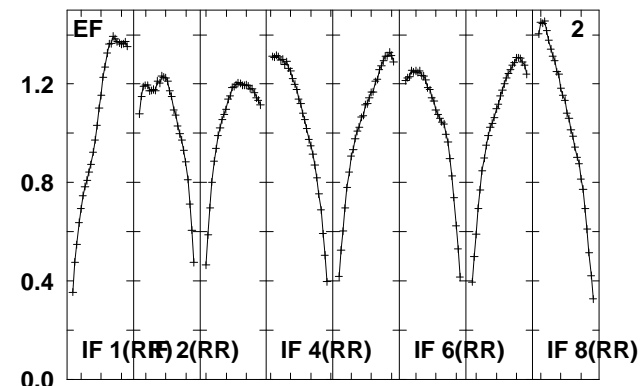
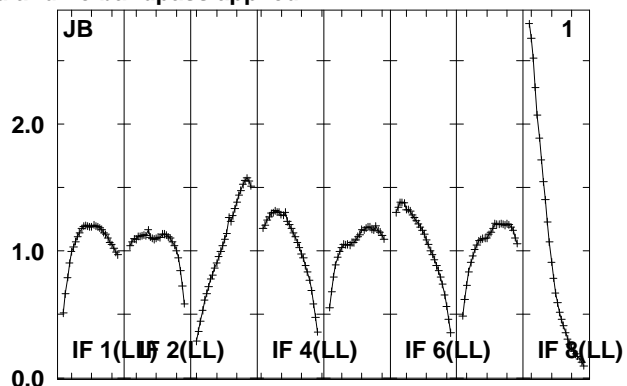
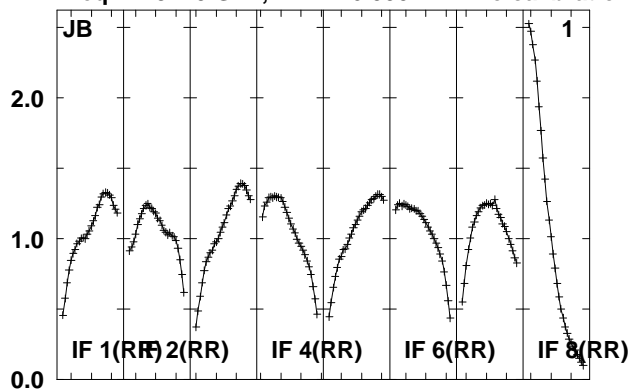

Lower frame: Real Jy
Total-power spectrum Antenna: *
Timerange: 01/00:08:31 to 01/00:11:59

Plot file version 113 created 24-AUG-2010 08:02:59

IRAS1929 EP064M.UVDATA.1

Freq = 4.9270 GHz, Bw = 16.000 MH No calibration applied and no bandpass applied

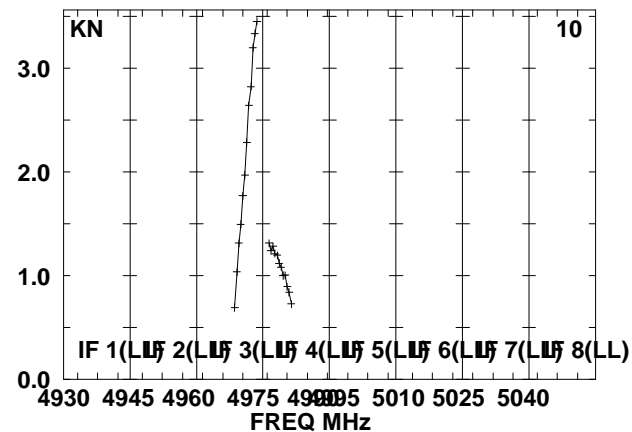
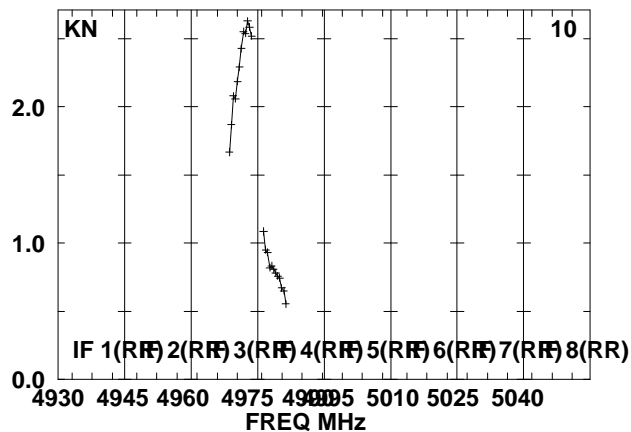
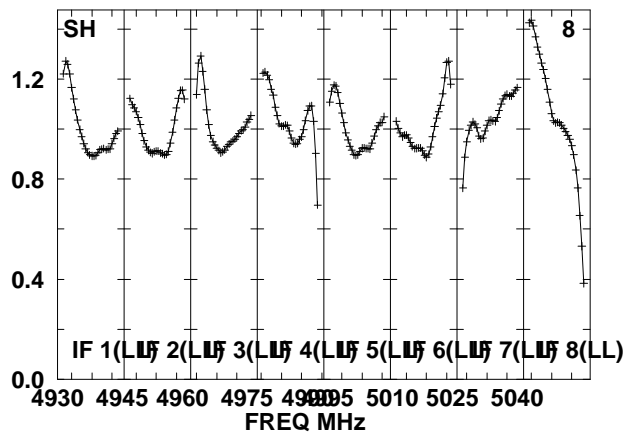
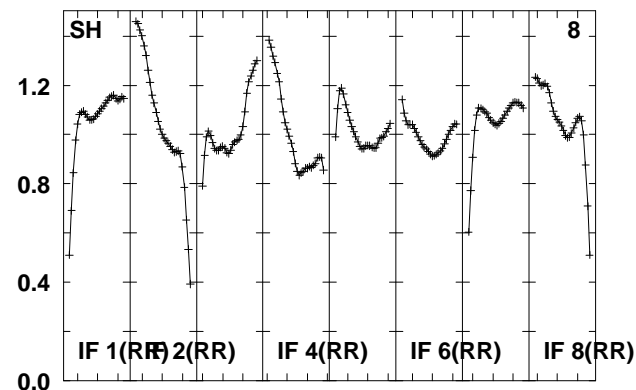
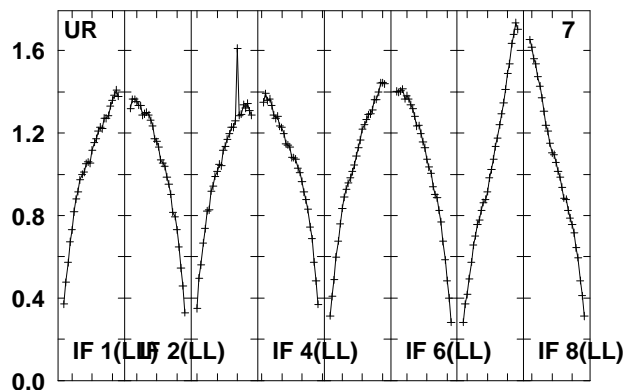
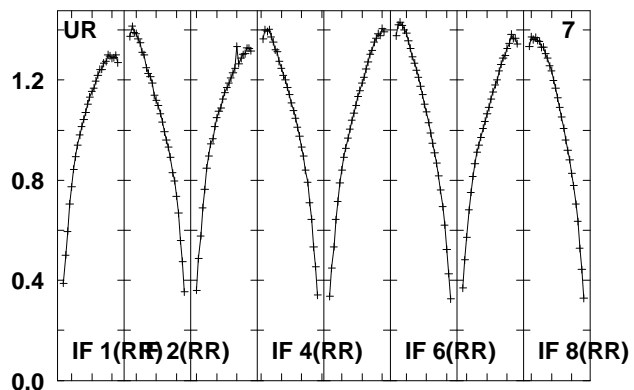
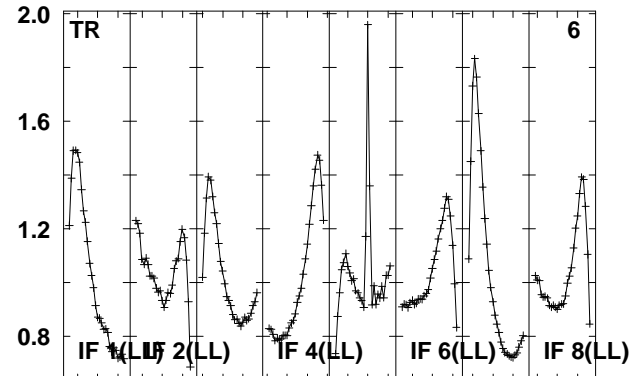
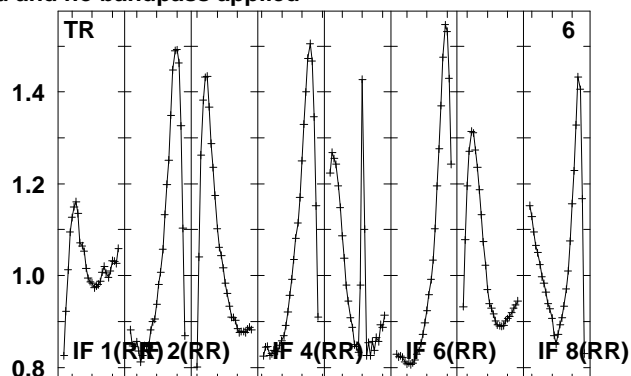
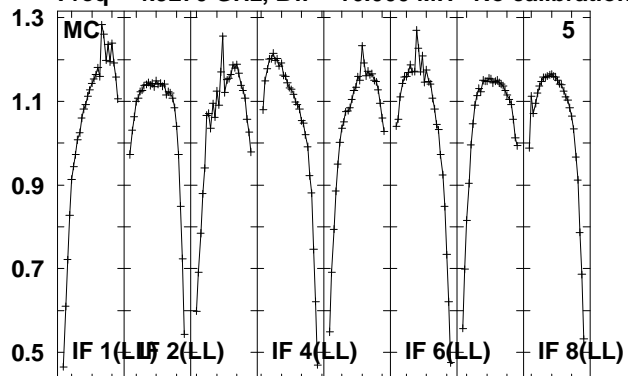

Lower frame: Real Jy

Total-power spectrum Antenna: *

Timerange: 01/00:08:31 to 01/00:11:59

Plot file version 114 created 24-AUG-2010 08:03:00

IRAS1929 EP064M.UVDATA.1

Freq = 4.9270 GHz, Bw = 16.000 MH No calibration applied and no bandpass applied

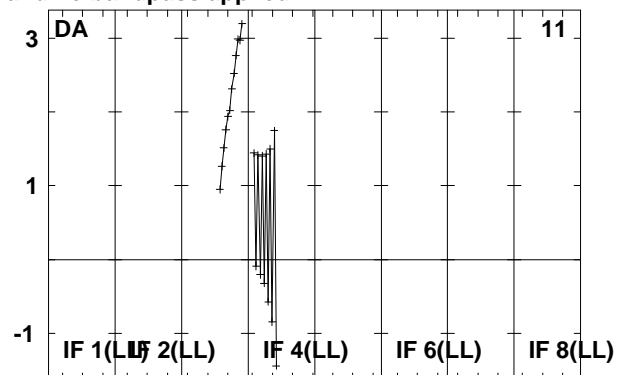
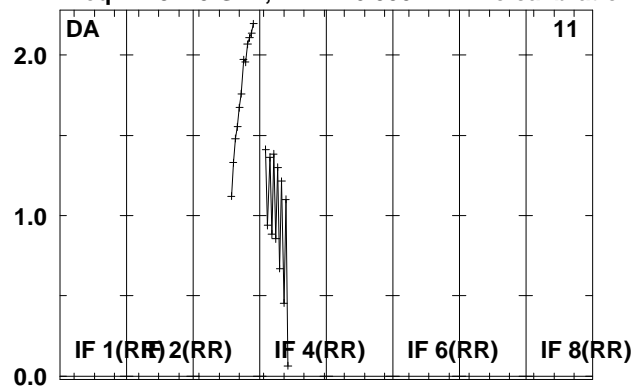

Lower frame: Real Jy
Total-power spectrum Antenna: *
Timerange: 01/00:08:31 to 01/00:11:59

Plot file version 115 created 24-AUG-2010 08:03:00

J1941-05 EP064M.UVDATA.1

Freq = 4.9270 GHz, Bw = 16.000 MH No calibration applied and no bandpass applied

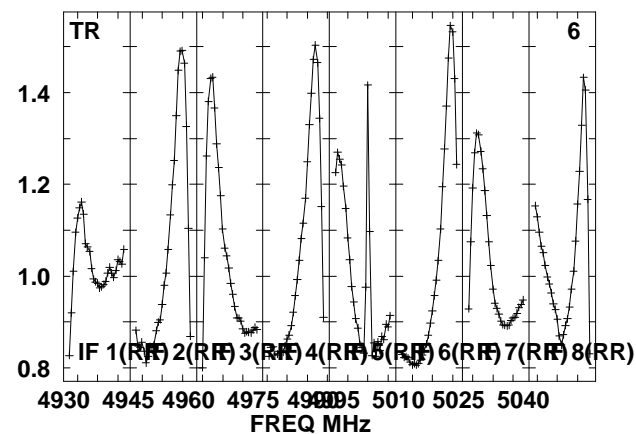
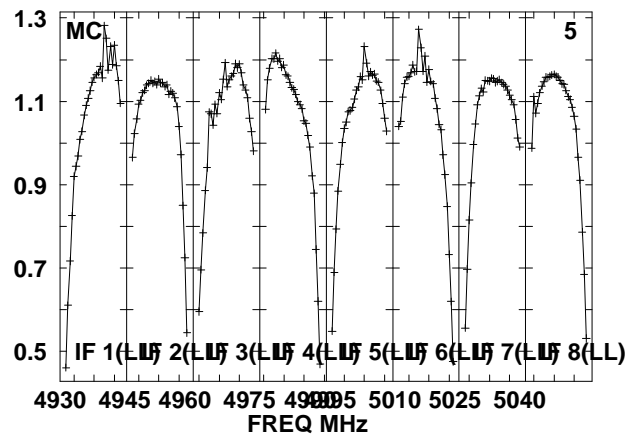
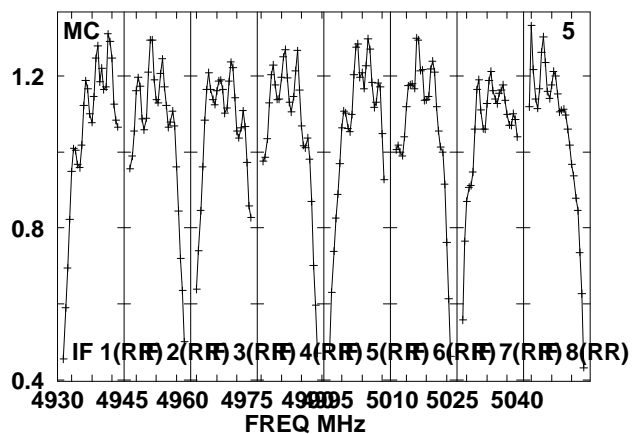
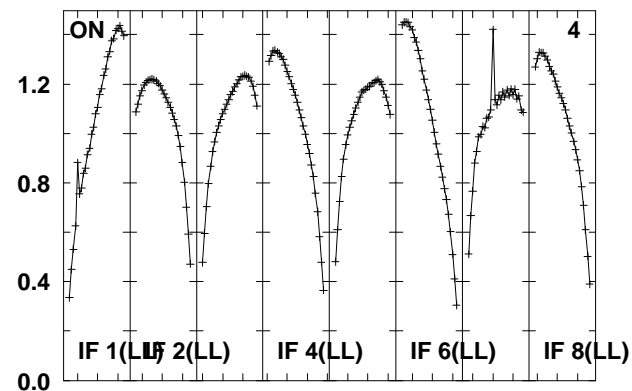
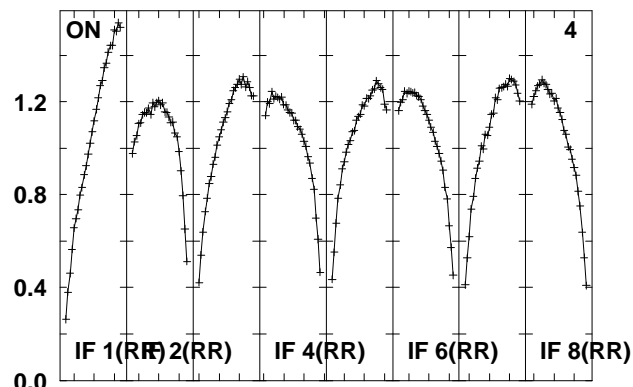
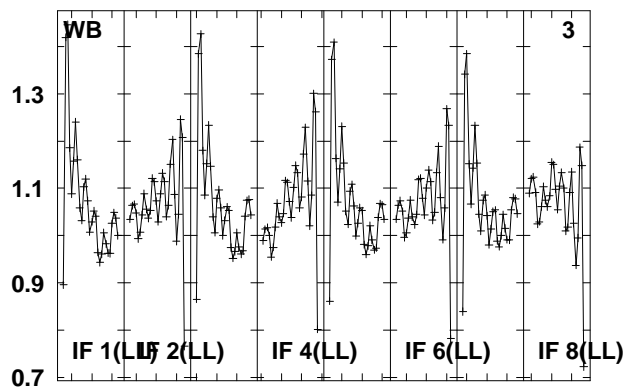
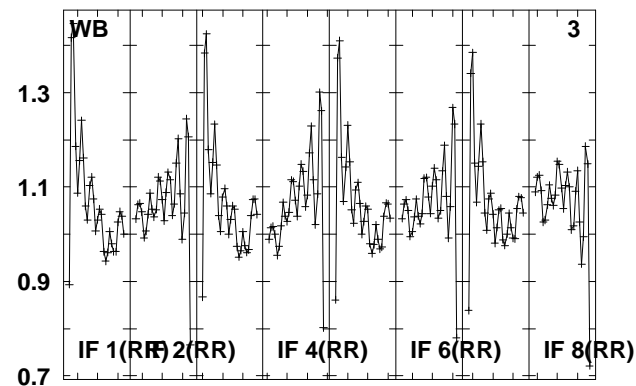
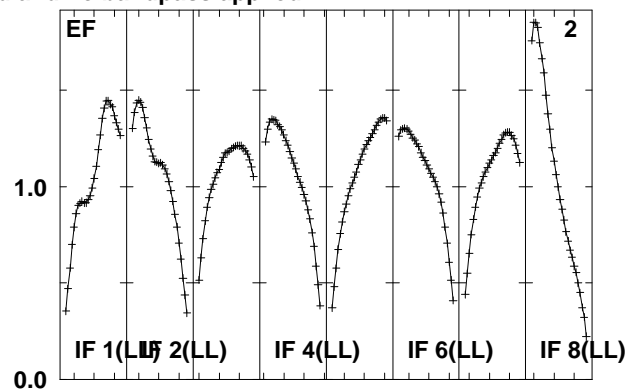
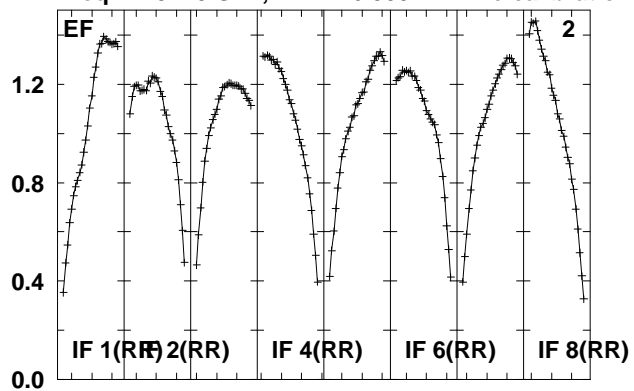

Lower frame: Real Jy
Total-power spectrum Antenna: *
Timerange: 01/00:12:01 to 01/00:13:29

Plot file version 116 created 24-AUG-2010 08:03:01

J1941-05 EP064M.UVDATA.1

Freq = 4.9270 GHz, Bw = 16.000 MH No calibration applied and no bandpass applied

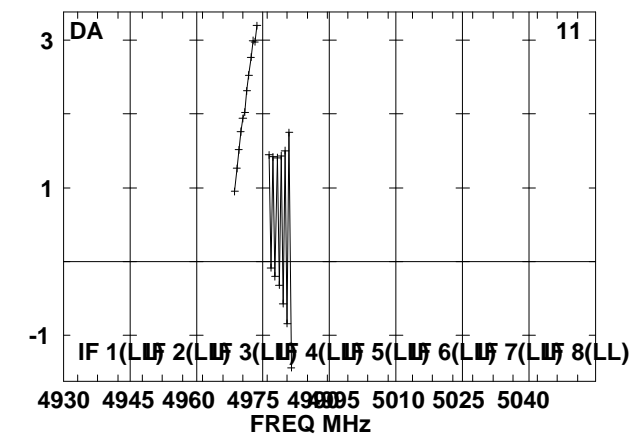
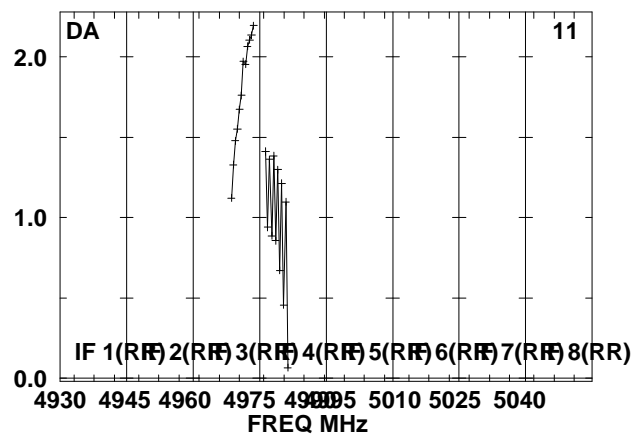
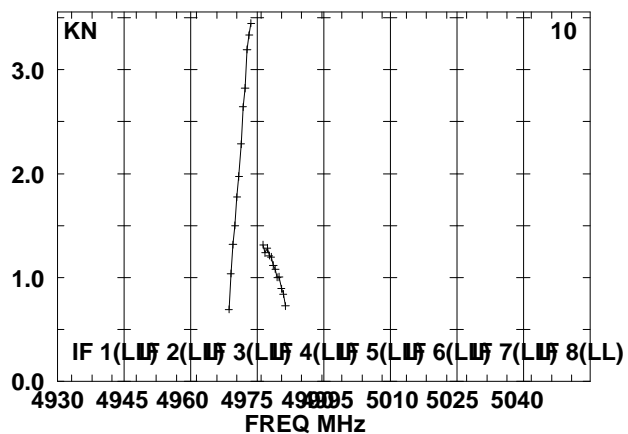
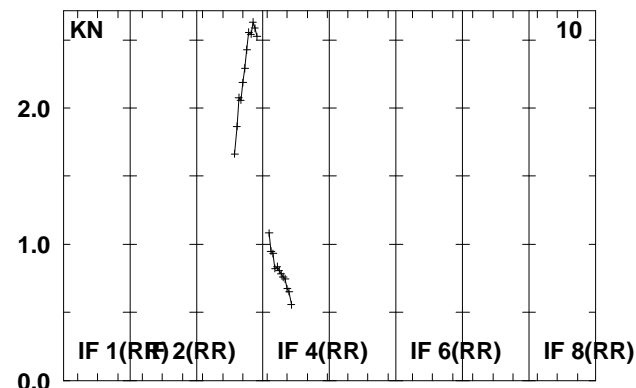
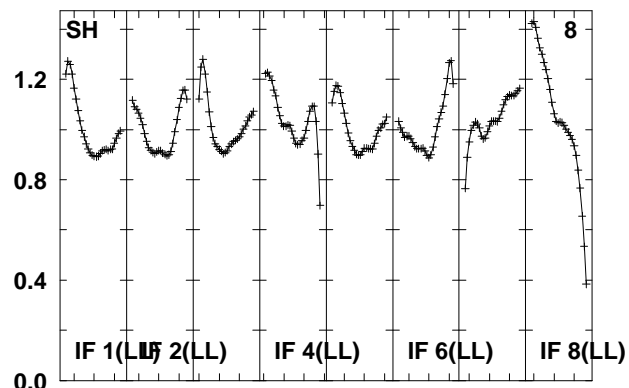
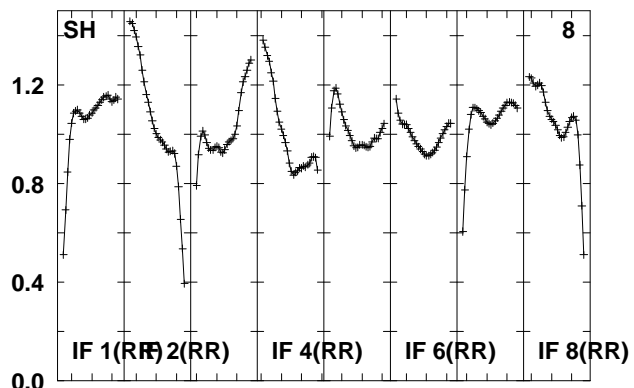
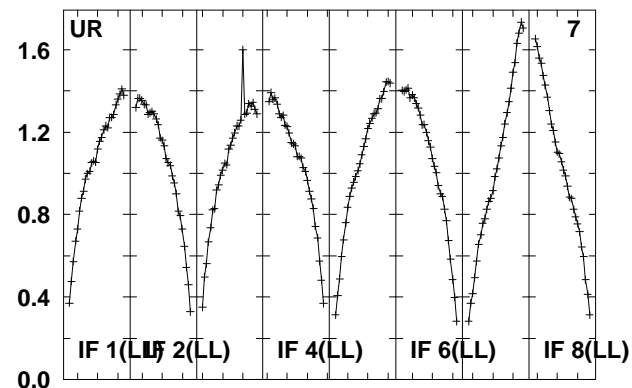
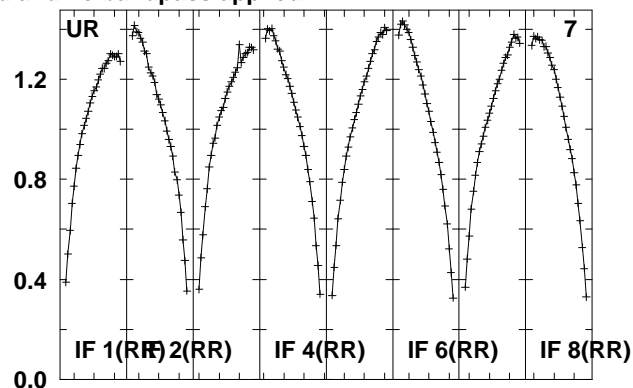
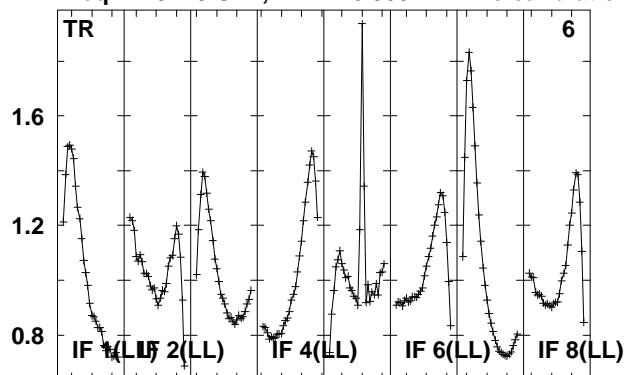

Lower frame: Real Jy
Total-power spectrum Antenna: *
Timerange: 01/00:12:01 to 01/00:13:29

Plot file version 117 created 24-AUG-2010 08:03:01

IRAS1929 EP064M.UVDATA.1

Freq = 4.9270 GHz, Bw = 16.000 MH No calibration applied and no bandpass applied

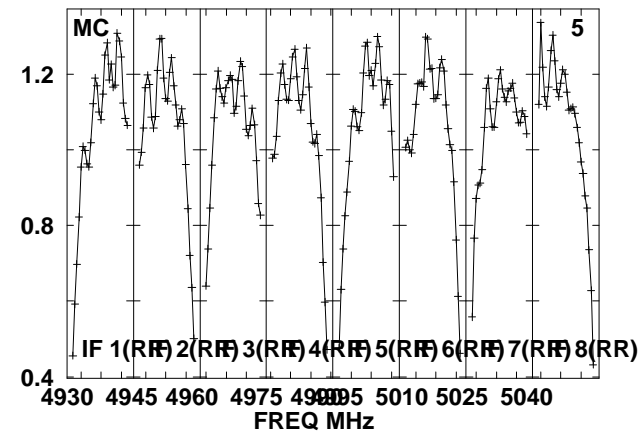
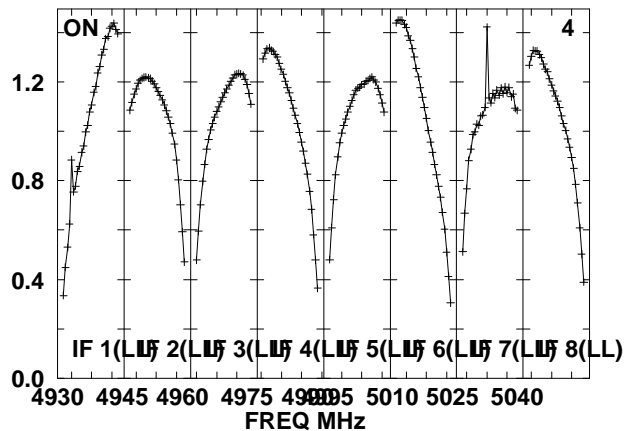
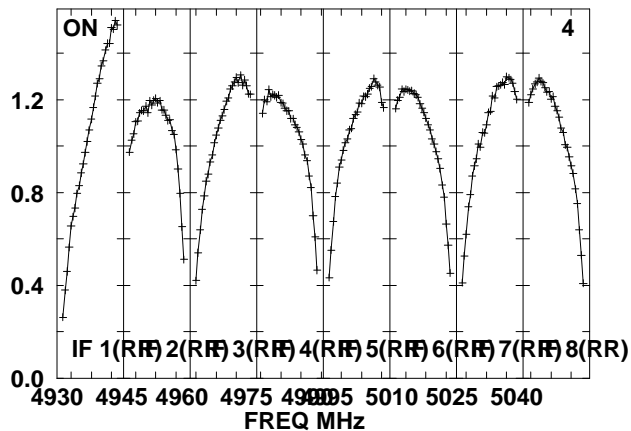
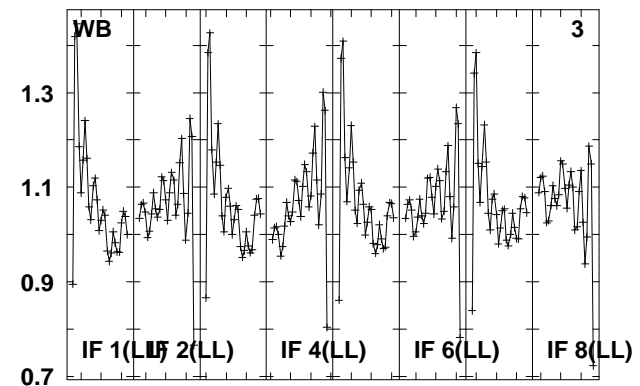
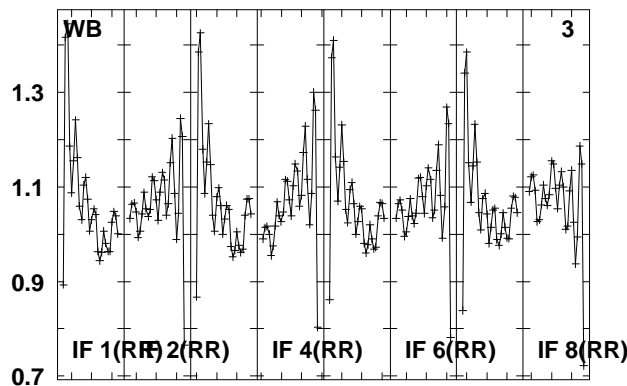
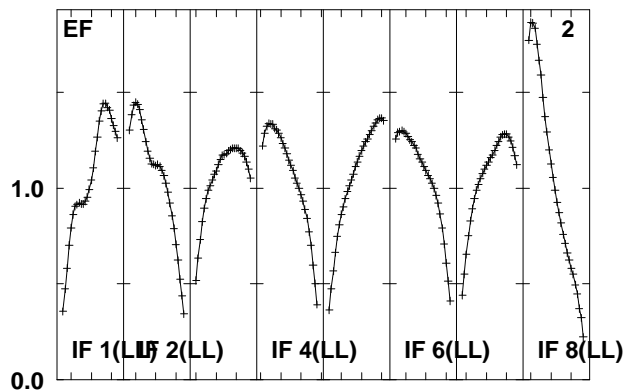
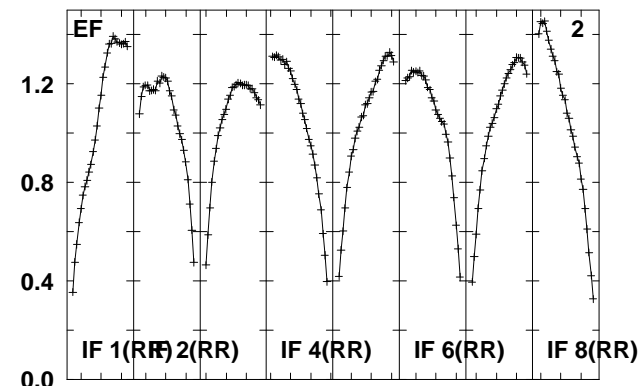
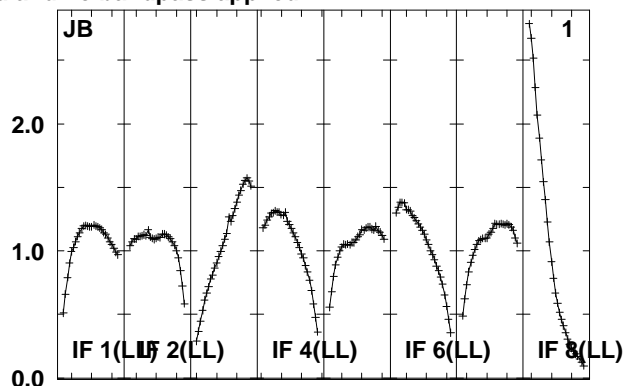
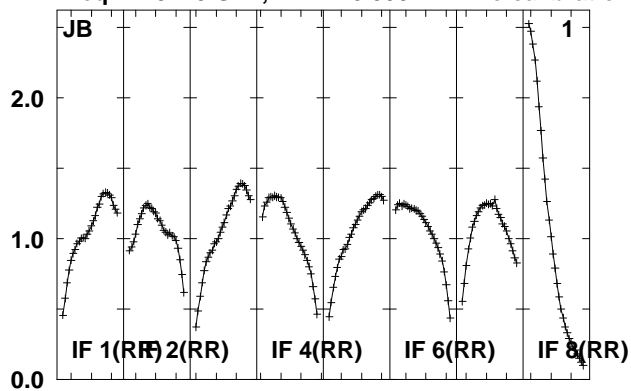

Lower frame: Real Jy
Total-power spectrum Antenna: *
Timerange: 01/00:13:31 to 01/00:16:59

Plot file version 118 created 24-AUG-2010 08:03:01

IRAS1929 EP064M.UVDATA.1

Freq = 4.9270 GHz, Bw = 16.000 MH No calibration applied and no bandpass applied

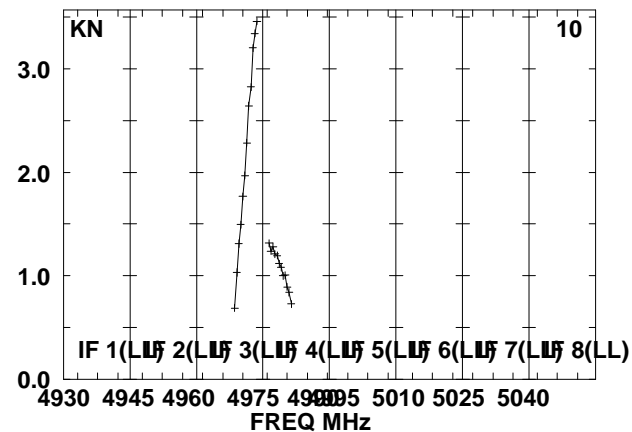
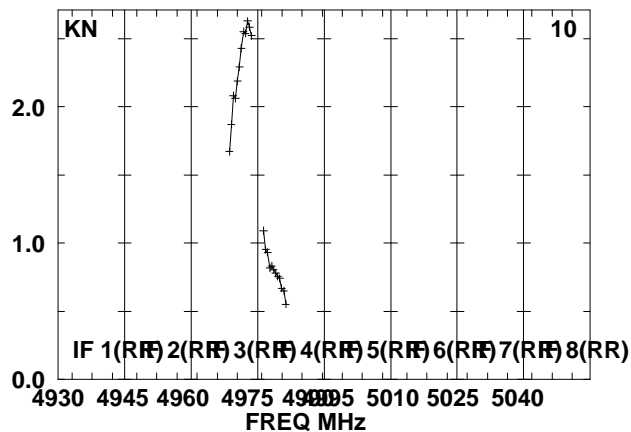
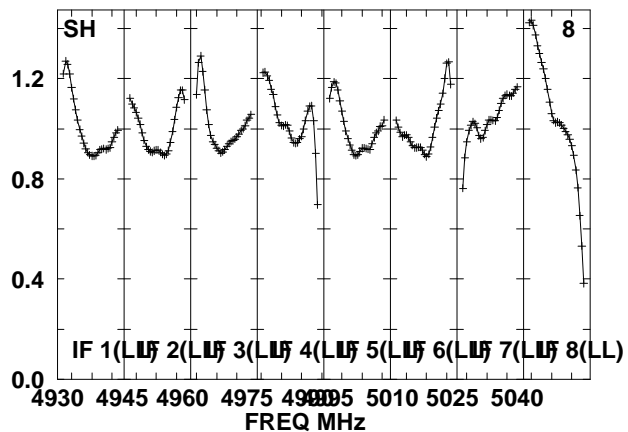
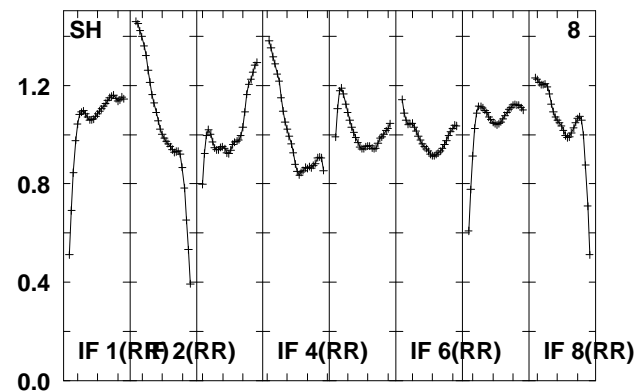
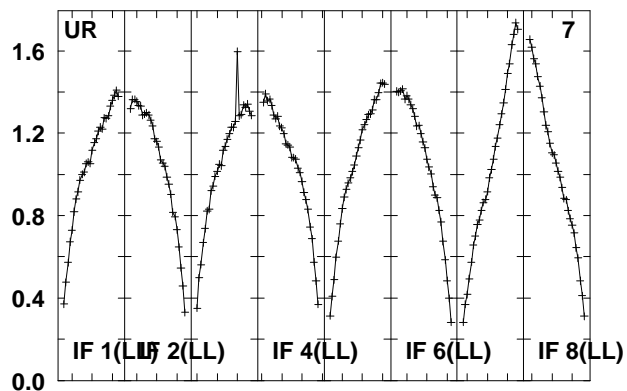
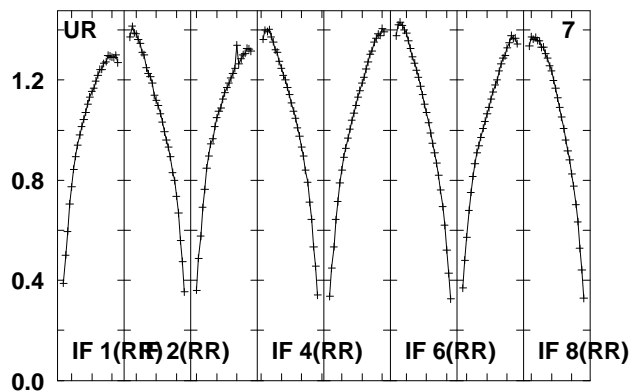
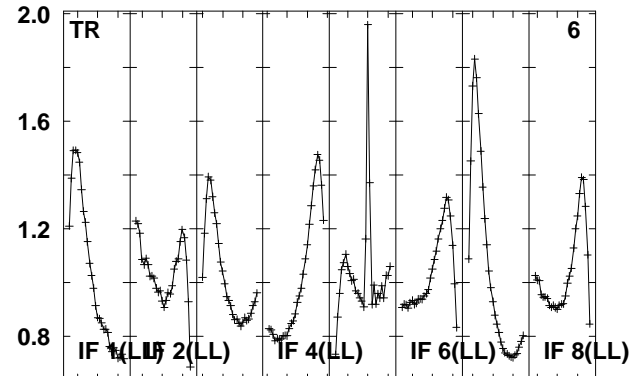
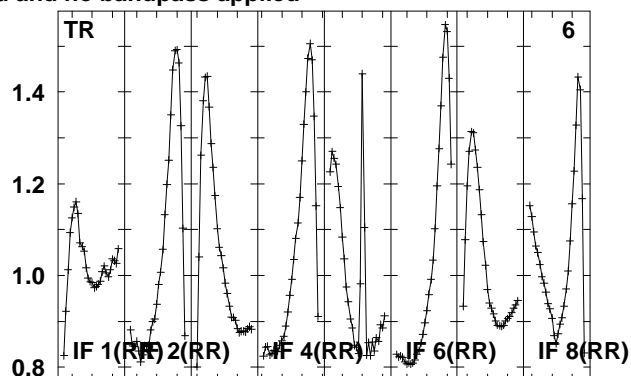
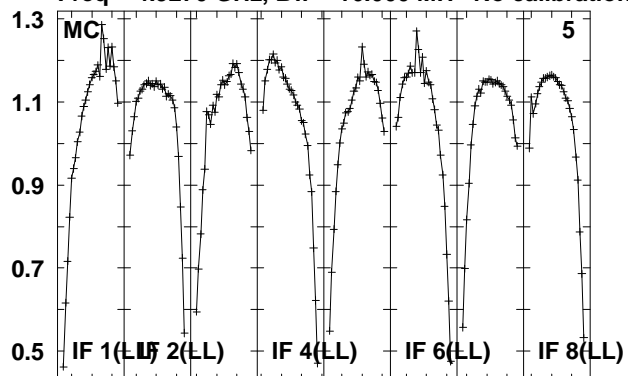

Lower frame: Real Jy

Total-power spectrum Antenna: *

Timerange: 01/00:13:31 to 01/00:16:59

Plot file version 119 created 24-AUG-2010 08:03:02

IRAS1929 EP064M.UVDATA.1

Freq = 4.9270 GHz, Bw = 16.000 MH No calibration applied and no bandpass applied

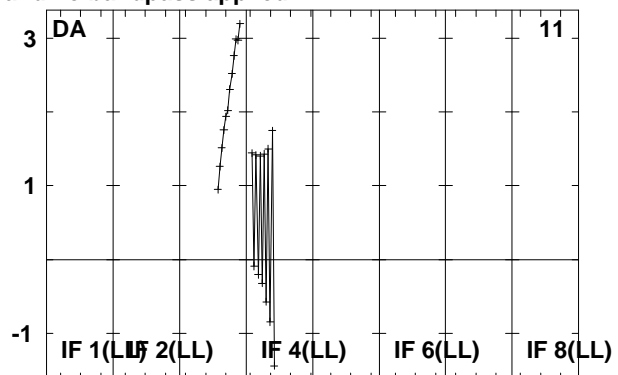
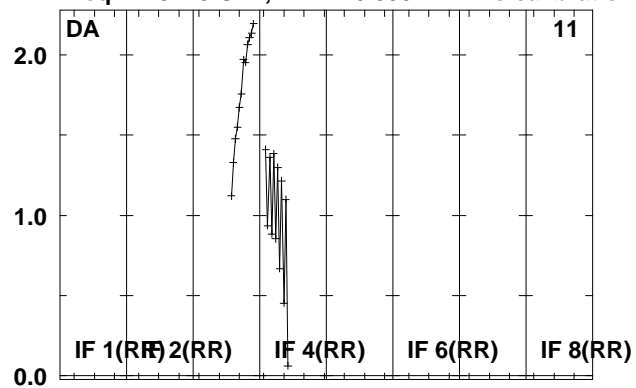

Lower frame: Real Jy
Total-power spectrum Antenna: *
Timerange: 01/00:13:31 to 01/00:16:59

Plot file version 120 created 24-AUG-2010 08:03:02

J1941-05 EP064M.UVDATA.1

Freq = 4.9270 GHz, Bw = 16.000 MH No calibration applied and no bandpass applied

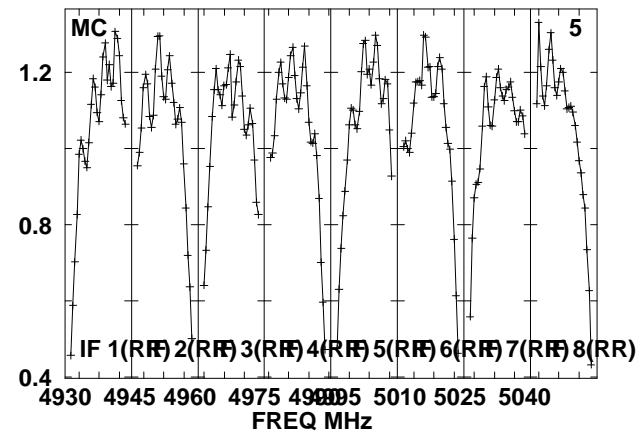
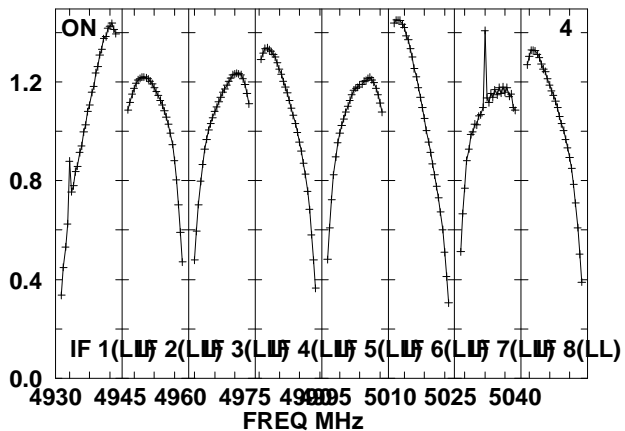
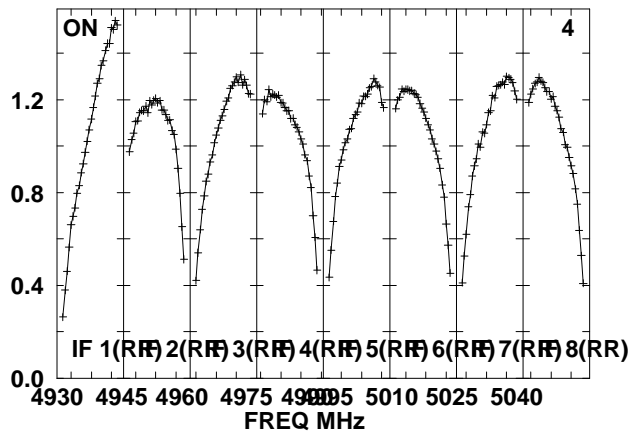
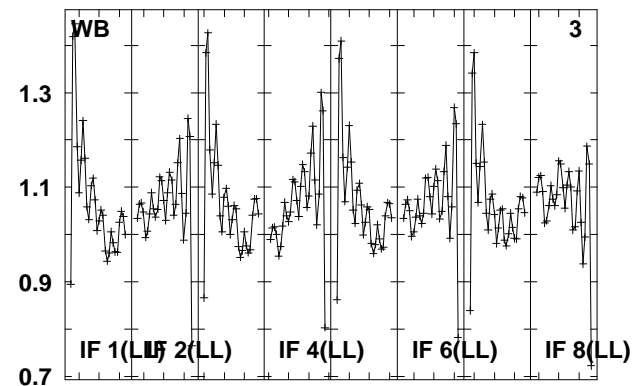
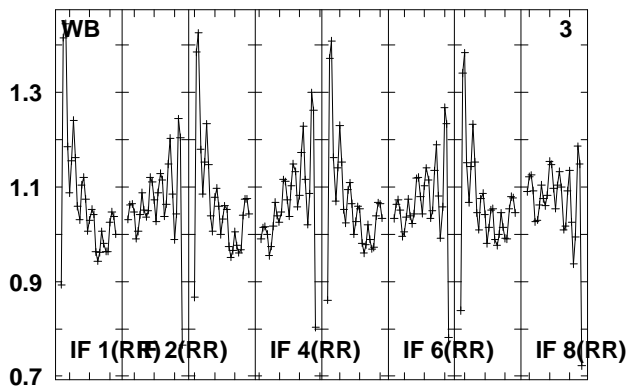
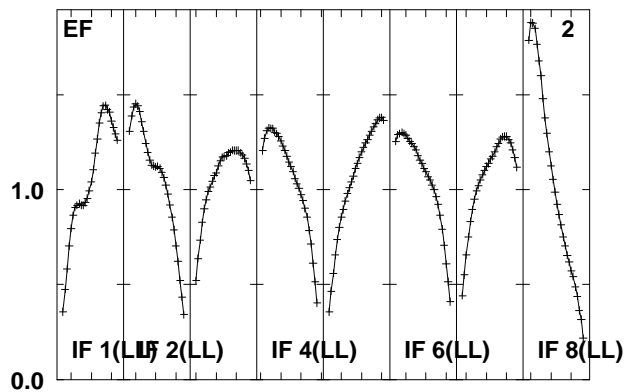
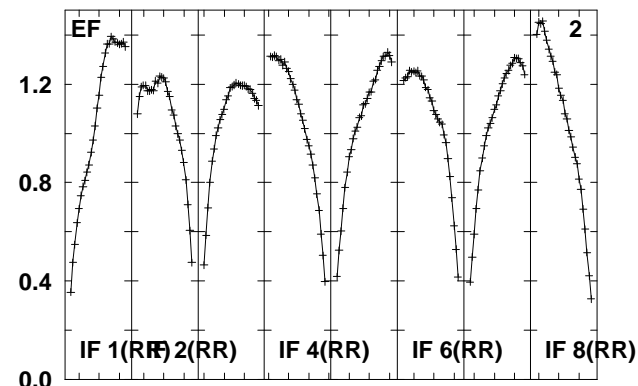
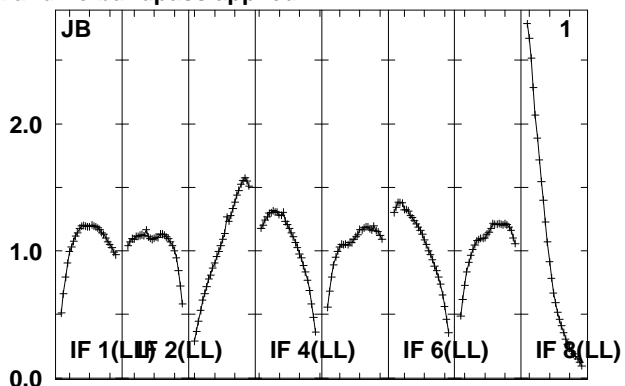
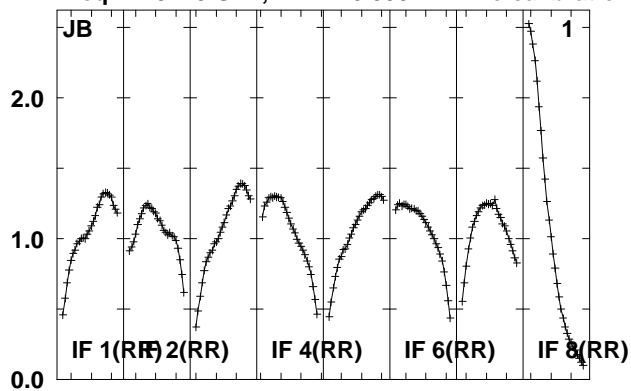

Lower frame: Real Jy
Total-power spectrum Antenna: *
Timerange: 01/00:18:01 to 01/00:19:29

Plot file version 121 created 24-AUG-2010 08:03:03

J1941-05 EP064M.UVDATA.1

Freq = 4.9270 GHz, Bw = 16.000 MH No calibration applied and no bandpass applied

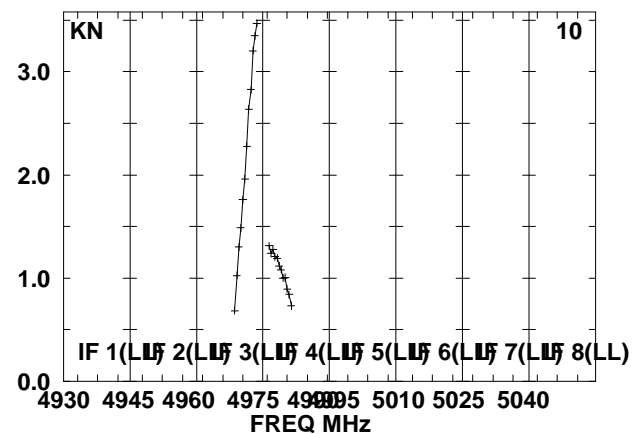
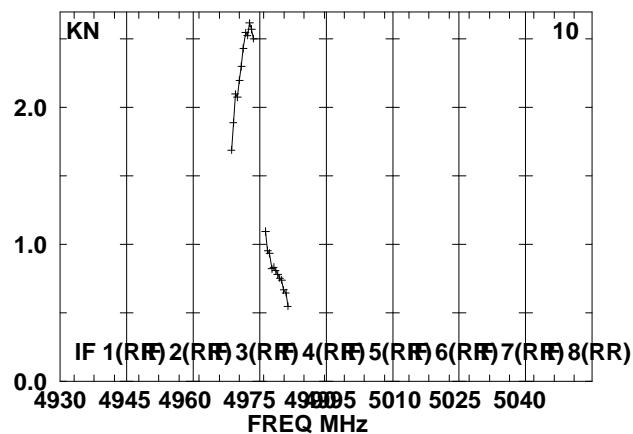
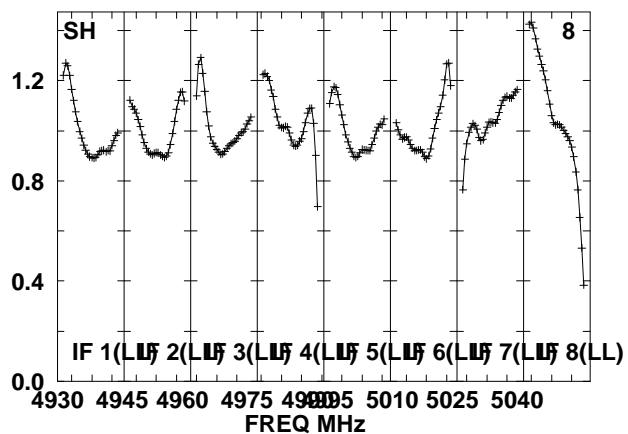
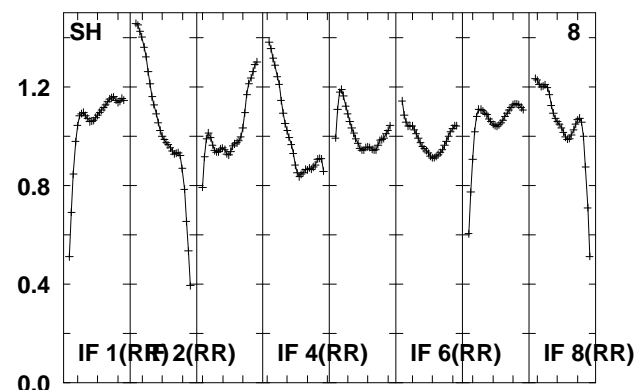
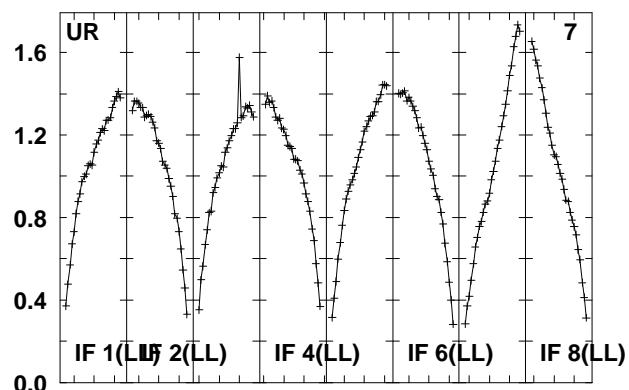
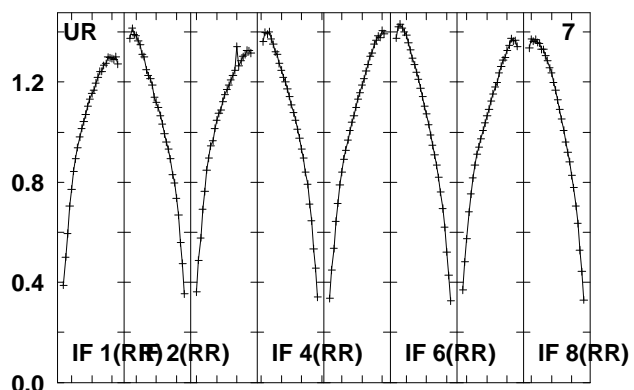
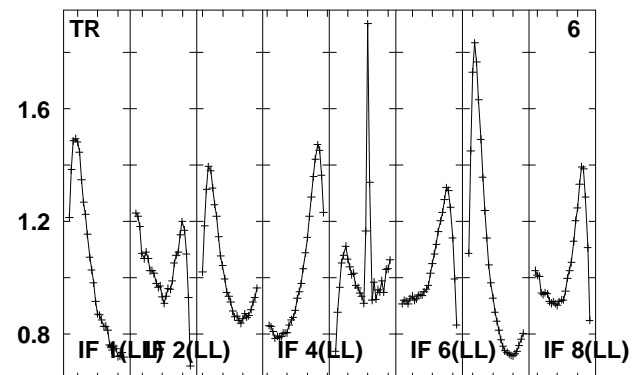
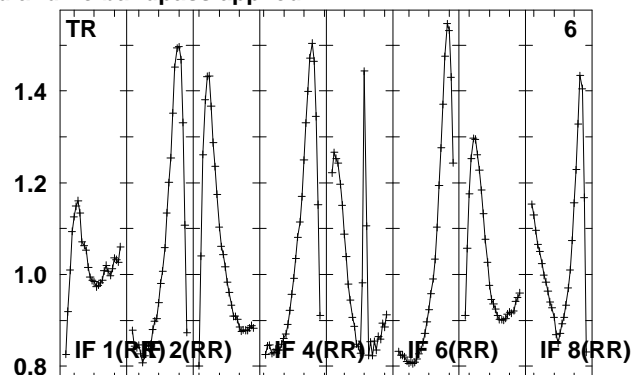
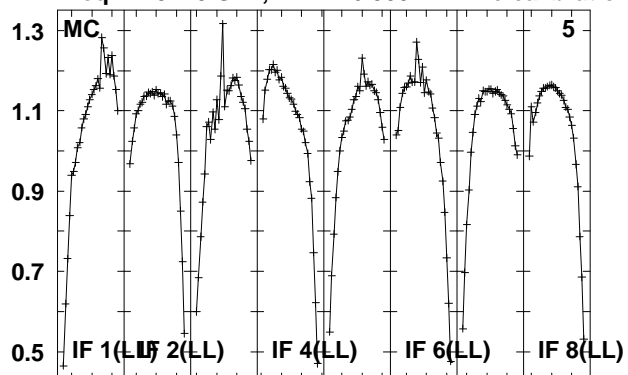

Lower frame: Real Jy

Total-power spectrum Antenna: *

Timerange: 01/00:18:01 to 01/00:19:29

Plot file version 122 created 24-AUG-2010 08:03:03

J1941-05 EP064M.UVDATA.1

Freq = 4.9270 GHz, Bw = 16.000 MH No calibration applied and no bandpass applied

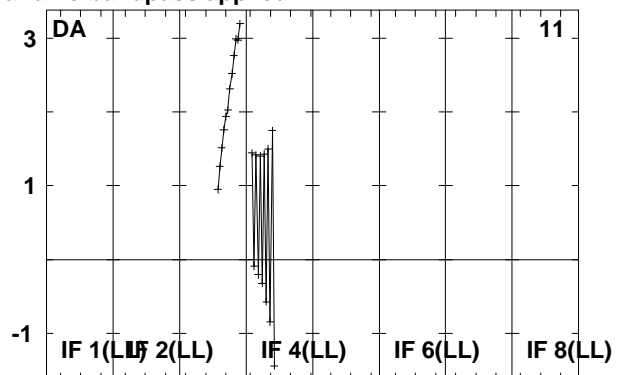
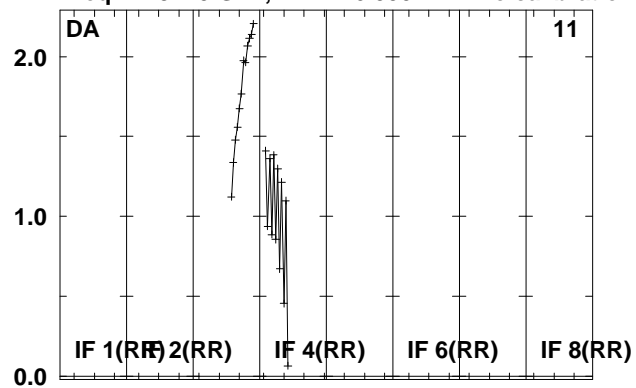

Lower frame: Real Jy
Total-power spectrum Antenna: *
Timerange: 01/00:18:01 to 01/00:19:29

Plot file version 123 created 24-AUG-2010 08:03:03

IRAS1929 EP064M.UVDATA.1

Freq = 4.9270 GHz, Bw = 16.000 MH No calibration applied and no bandpass applied

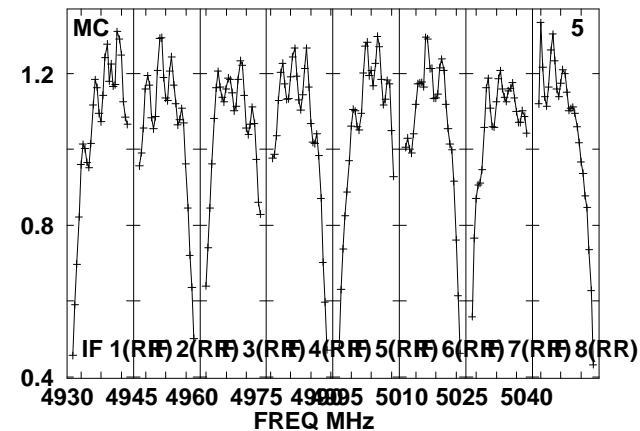
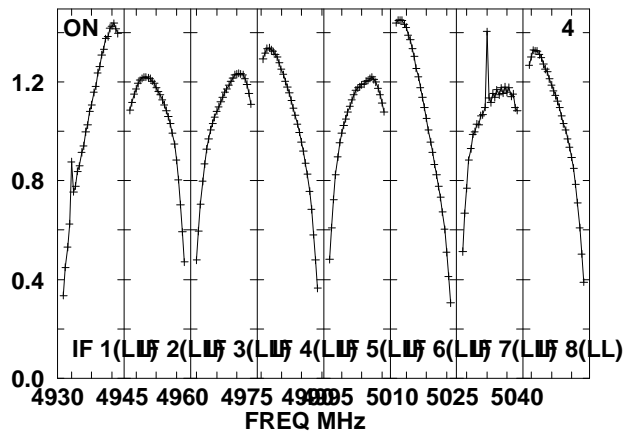
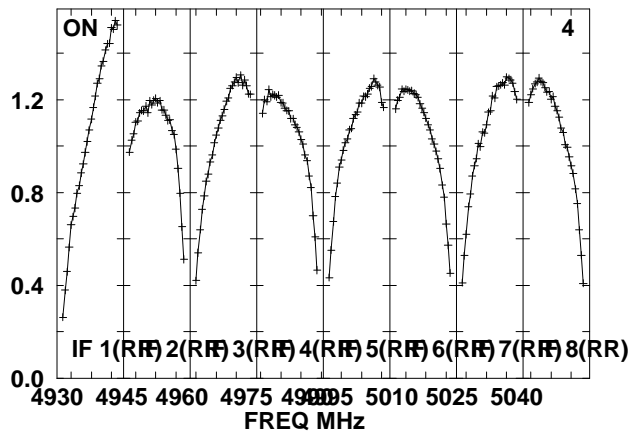
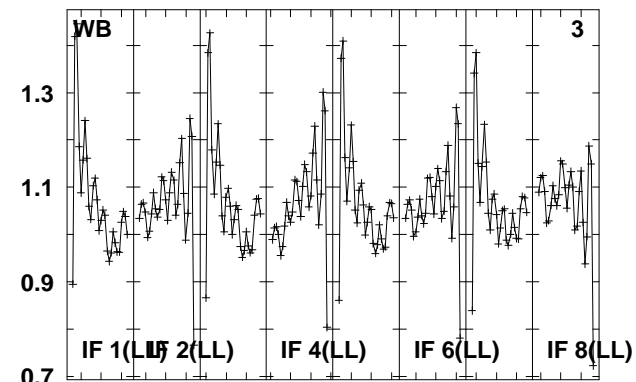
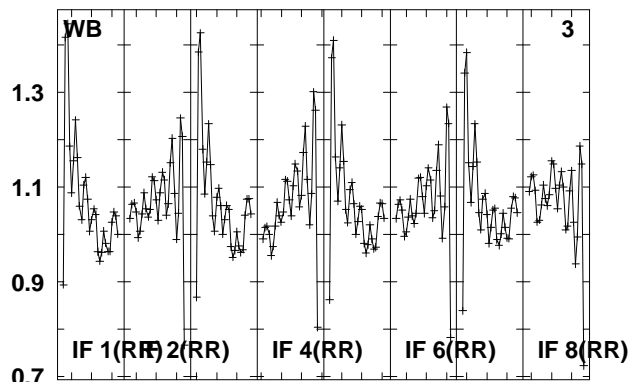
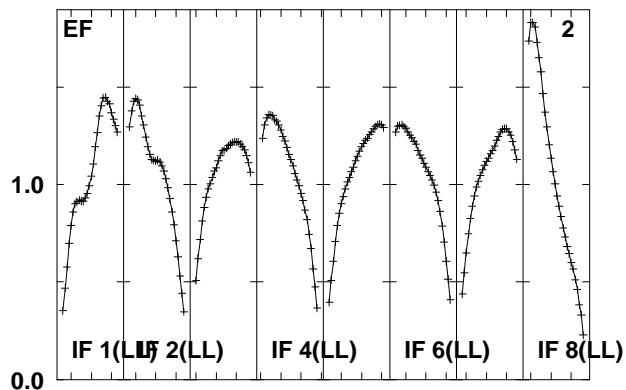
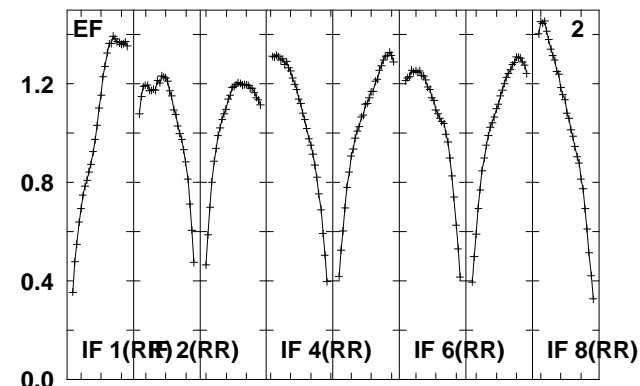
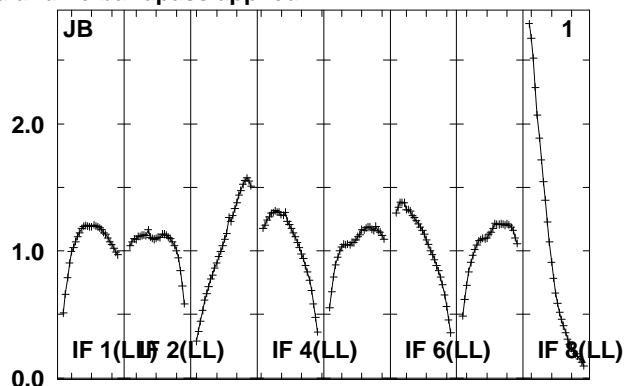
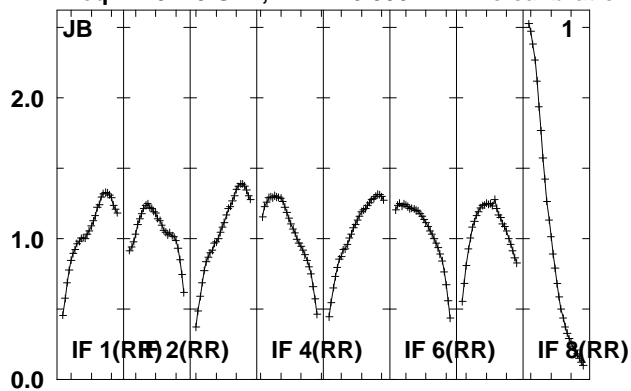

Lower frame: Real Jy
Total-power spectrum Antenna: *
Timerange: 01/00:19:31 to 01/00:22:59

Plot file version 124 created 24-AUG-2010 08:03:04

IRAS1929 EP064M.UVDATA.1

Freq = 4.9270 GHz, Bw = 16.000 MH No calibration applied and no bandpass applied

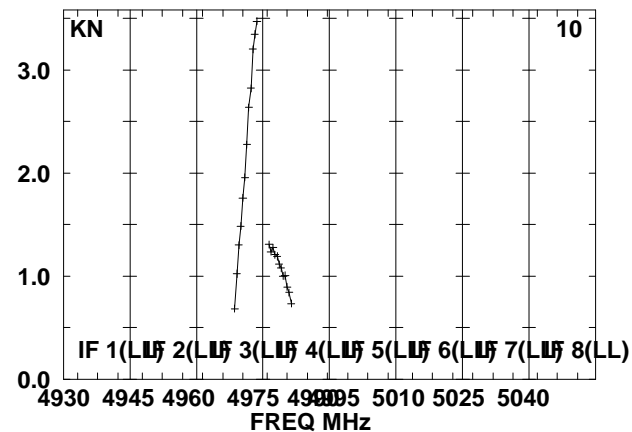
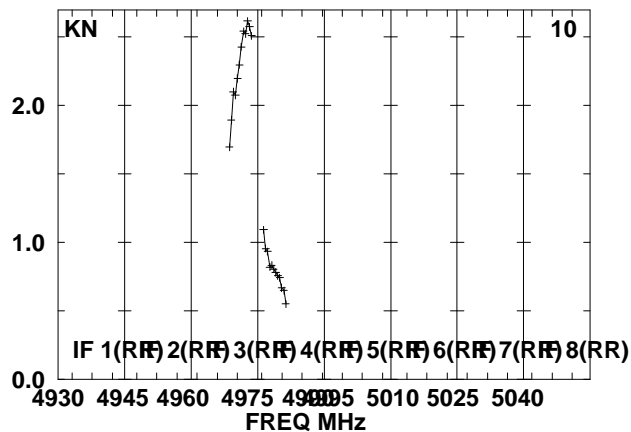
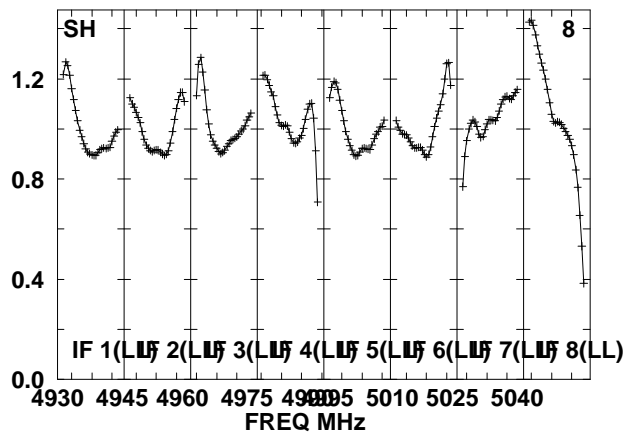
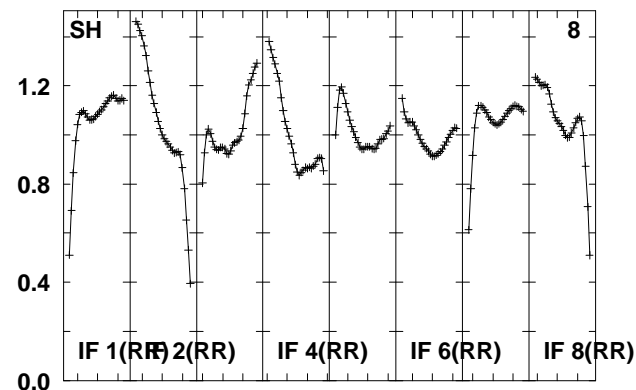
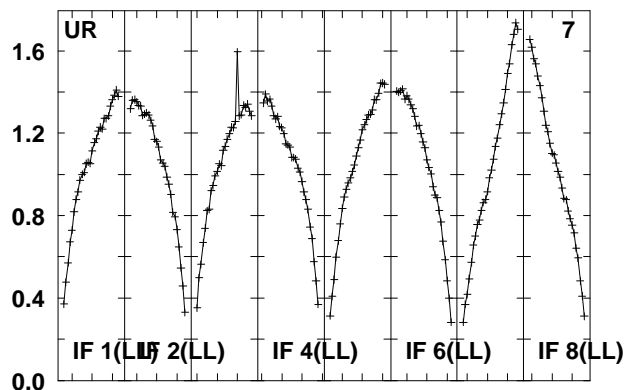
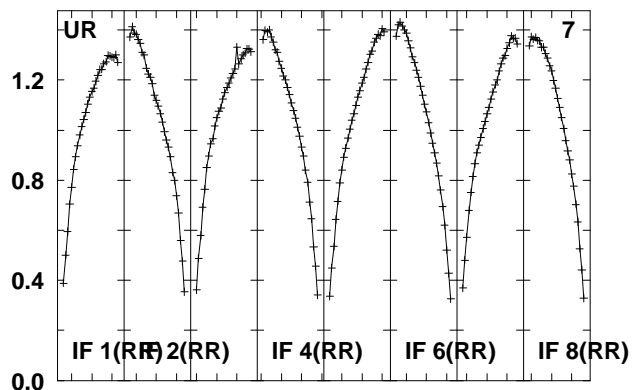
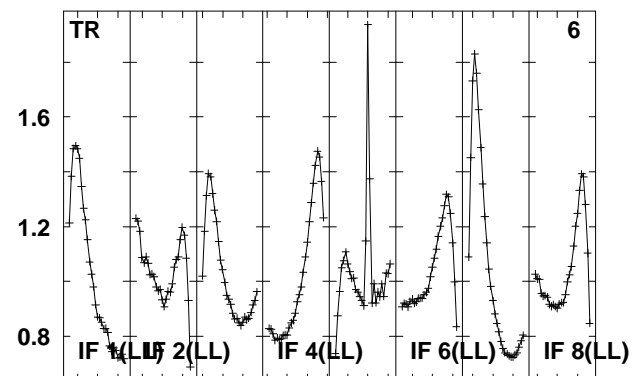
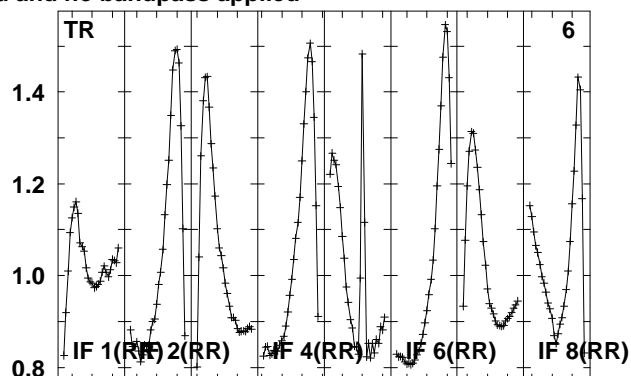
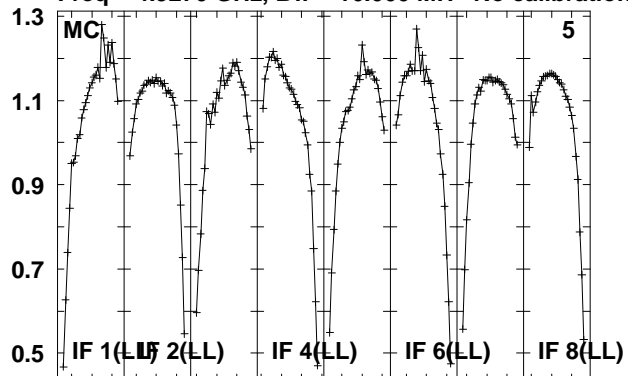

Lower frame: Real Jy

Total-power spectrum Antenna: *

Timerange: 01/00:19:31 to 01/00:22:59

Plot file version 125 created 24-AUG-2010 08:03:05

IRAS1929 EP064M.UVDATA.1

Freq = 4.9270 GHz, Bw = 16.000 MH No calibration applied and no bandpass applied

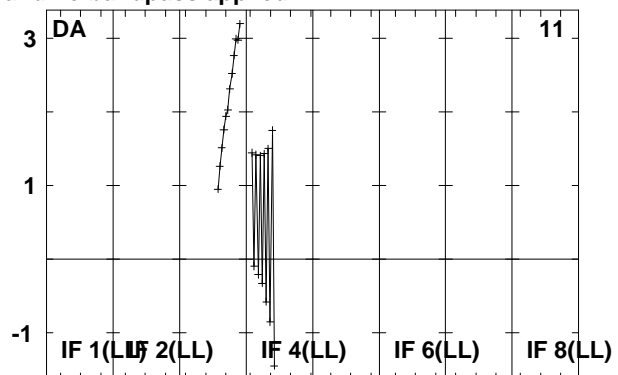
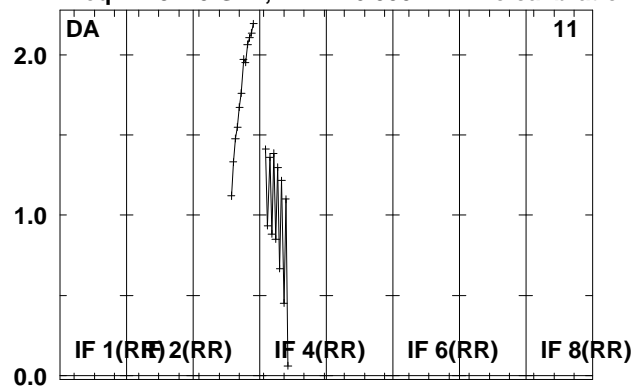

Lower frame: Real Jy
Total-power spectrum Antenna: *
Timerange: 01/00:19:31 to 01/00:22:59

Plot file version 126 created 24-AUG-2010 08:03:05

J1941-05 EP064M.UVDATA.1

Freq = 4.9270 GHz, Bw = 16.000 MH No calibration applied and no bandpass applied

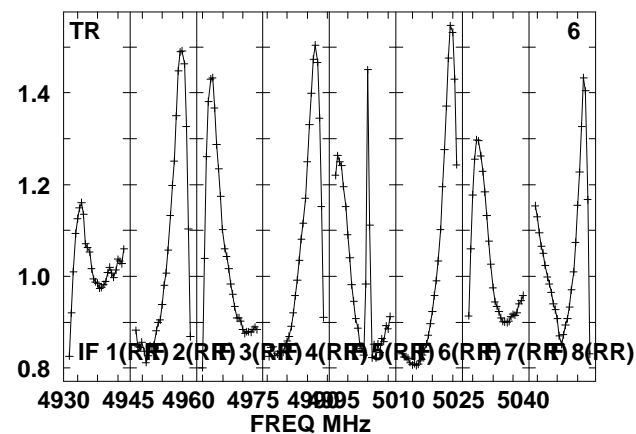
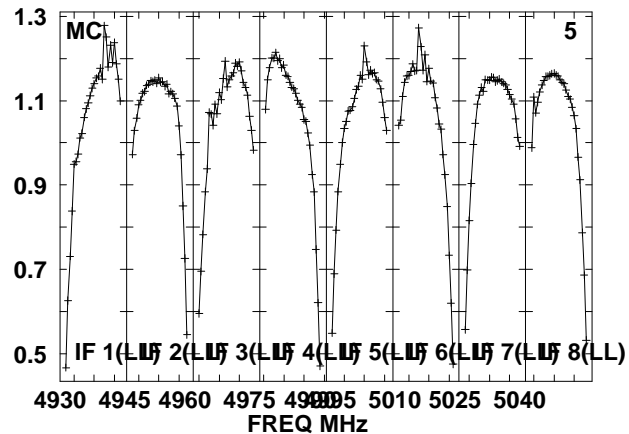
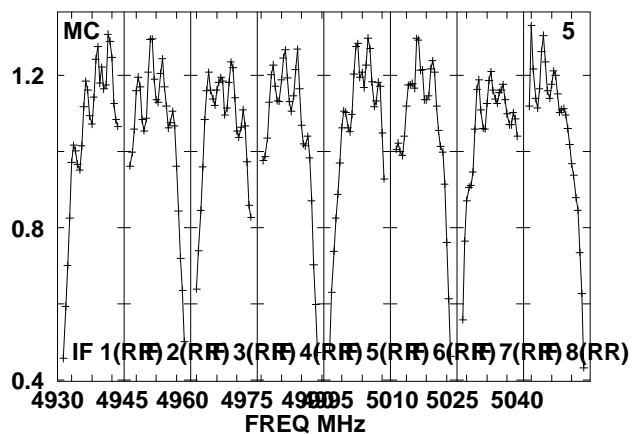
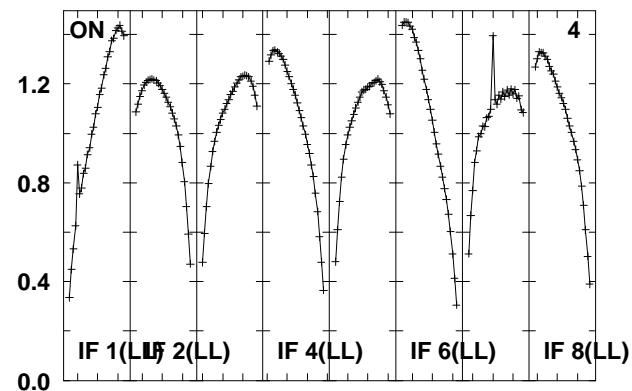
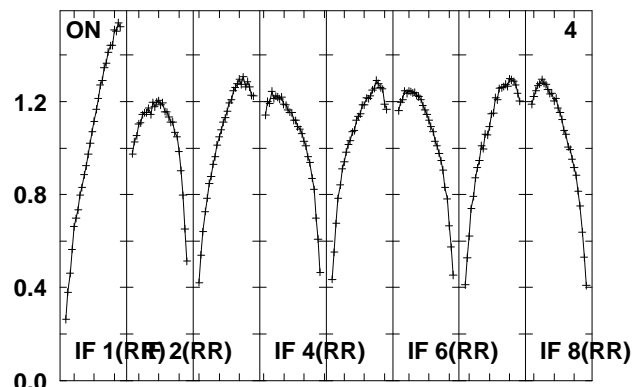
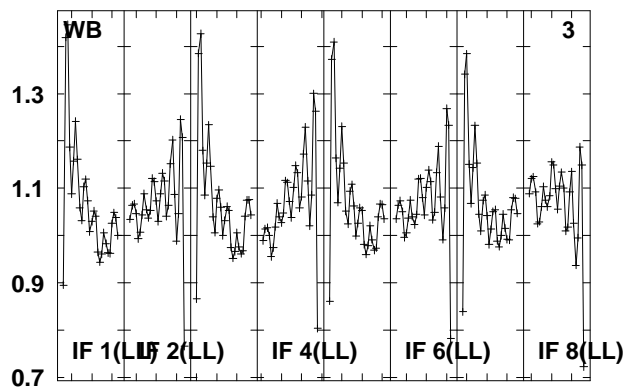
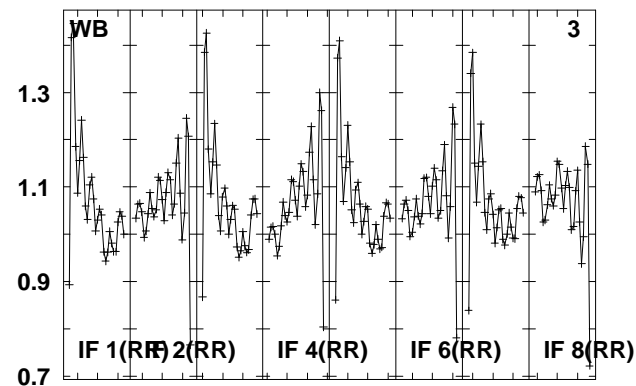
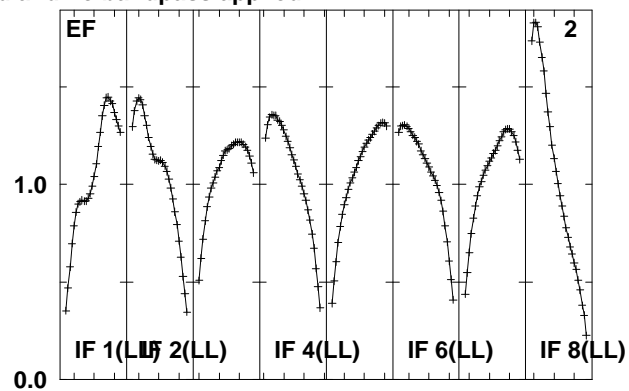
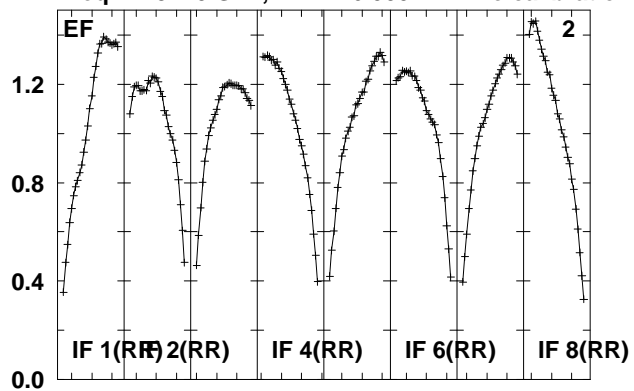

Lower frame: Real Jy
Total-power spectrum Antenna: *
Timerange: 01/00:23:01 to 01/00:24:29

Plot file version 127 created 24-AUG-2010 08:03:05

J1941-05 EP064M.UVDATA.1

Freq = 4.9270 GHz, Bw = 16.000 MH No calibration applied and no bandpass applied

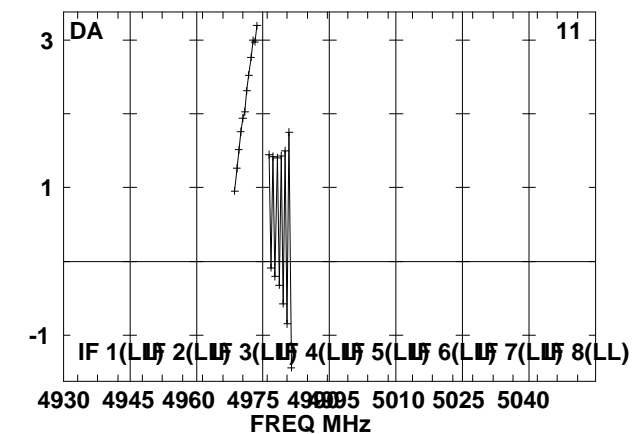
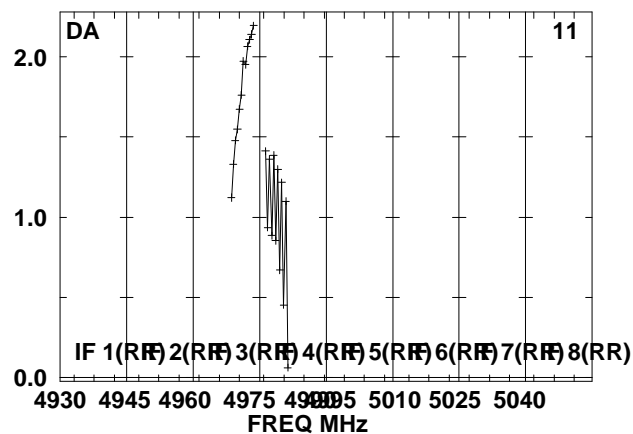
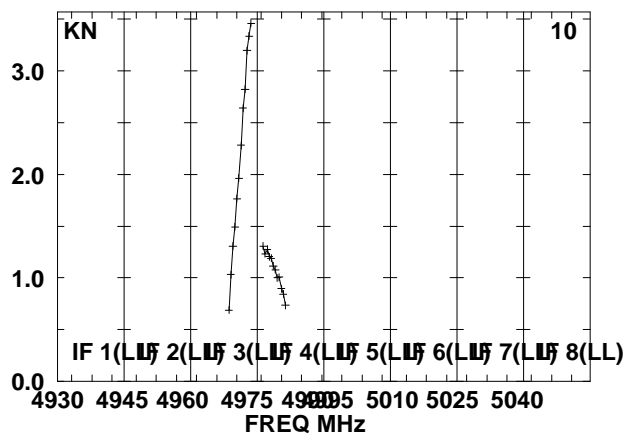
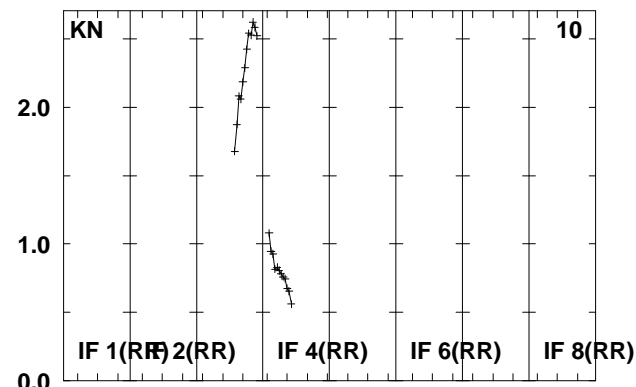
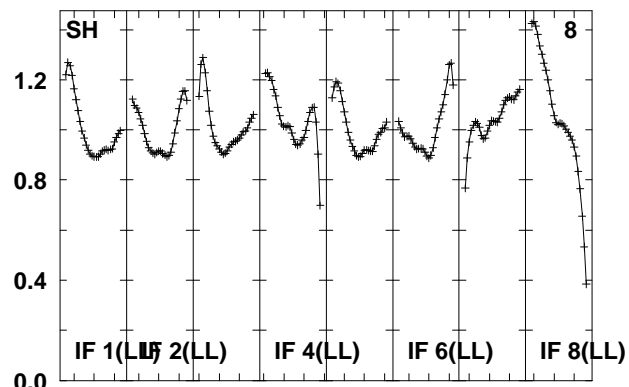
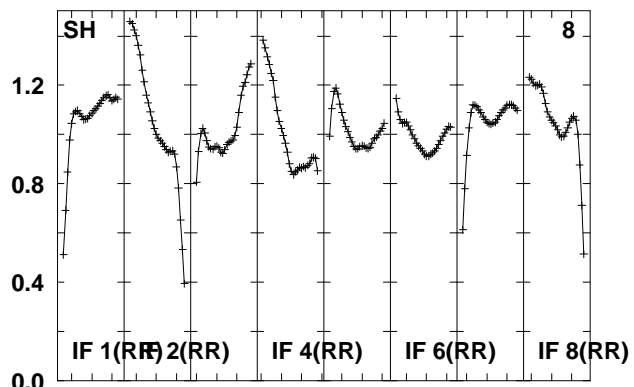
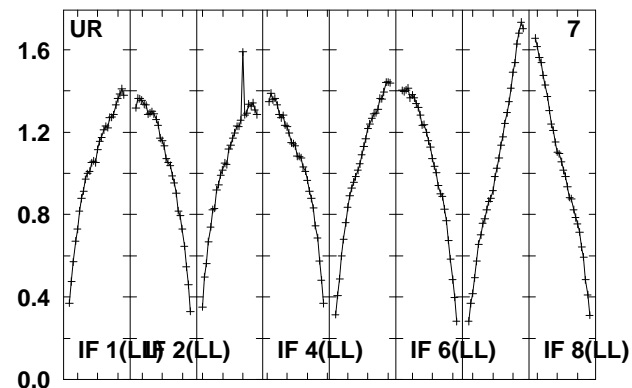
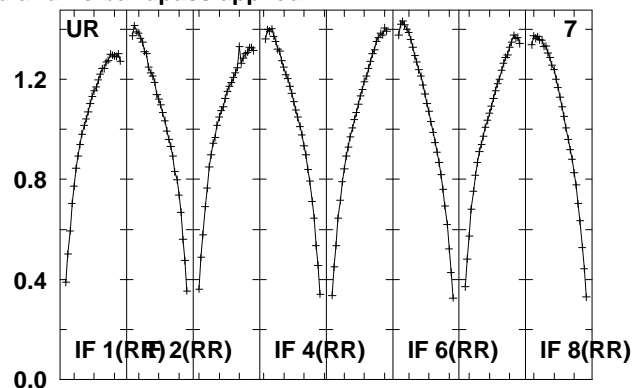
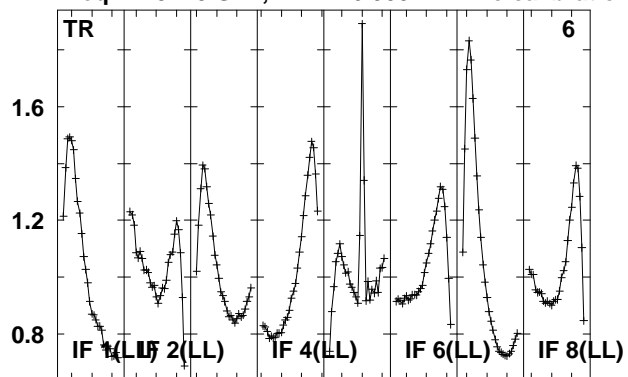

Lower frame: Real Jy
Total-power spectrum Antenna: *
Timerange: 01/00:23:01 to 01/00:24:29

Plot file version 128 created 24-AUG-2010 08:03:05

IRAS1929 EP064M.UVDATA.1

Freq = 4.9270 GHz, Bw = 16.000 MH No calibration applied and no bandpass applied

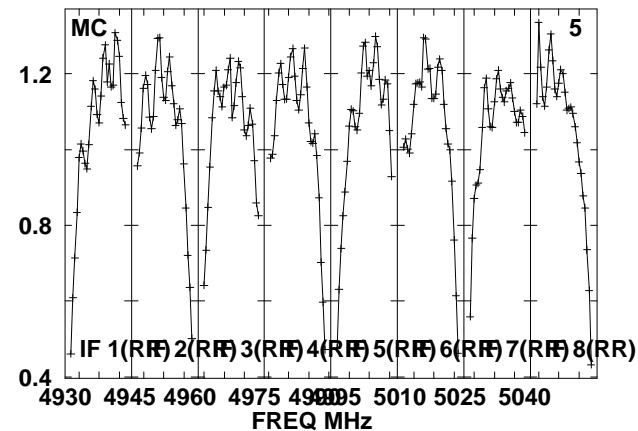
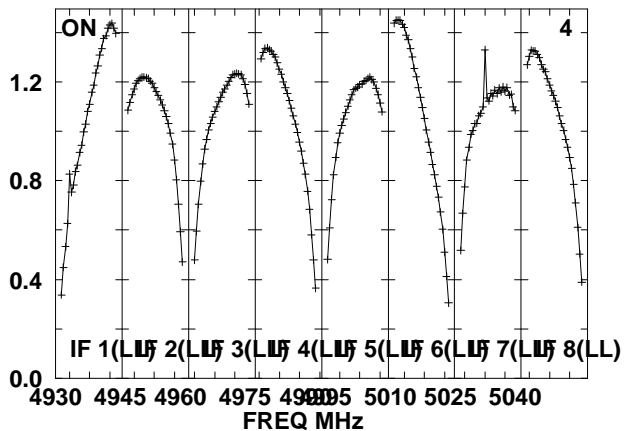
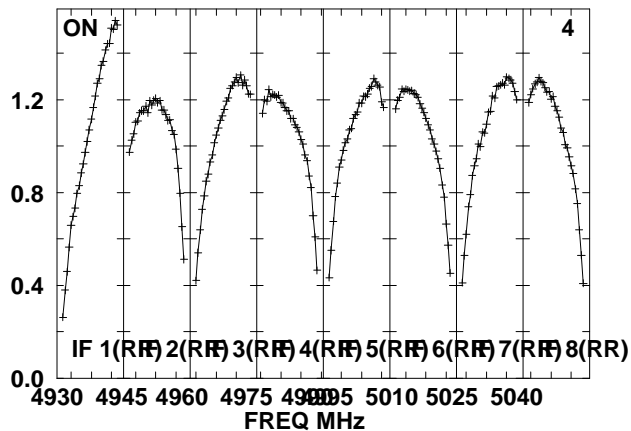
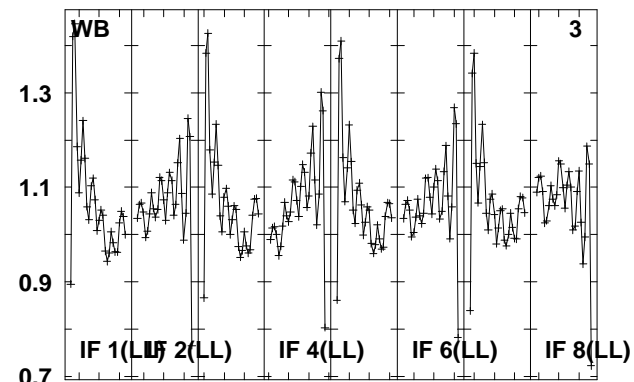
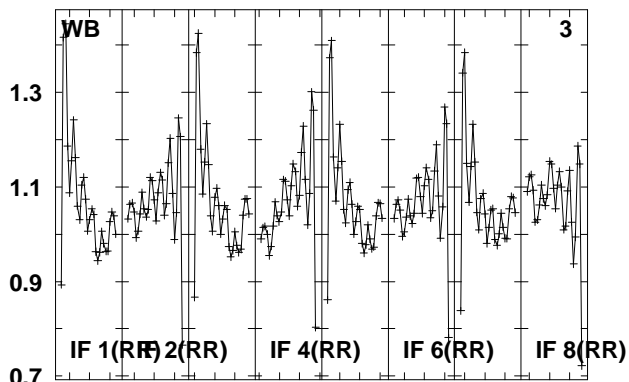
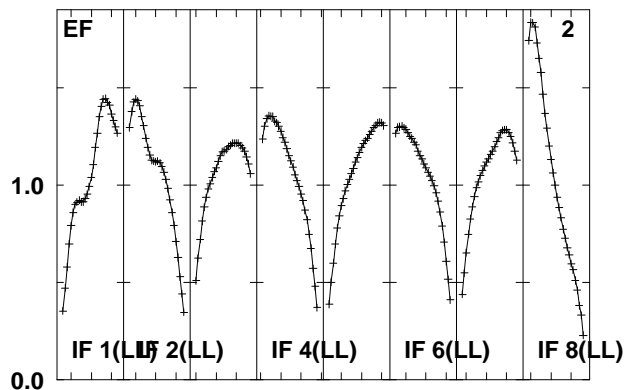
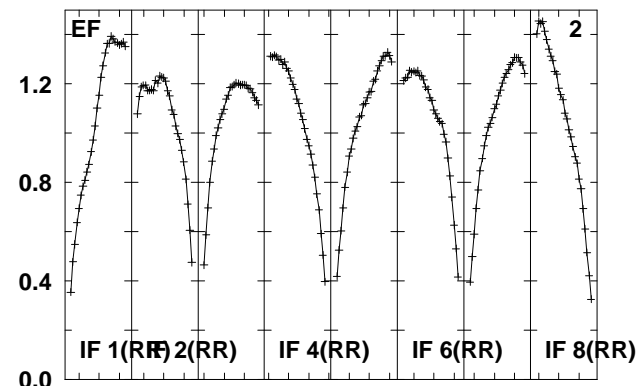
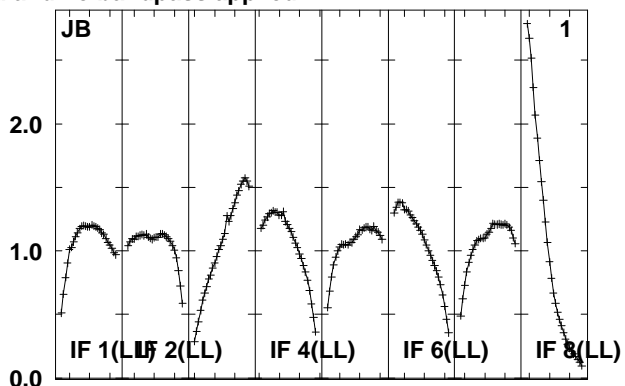
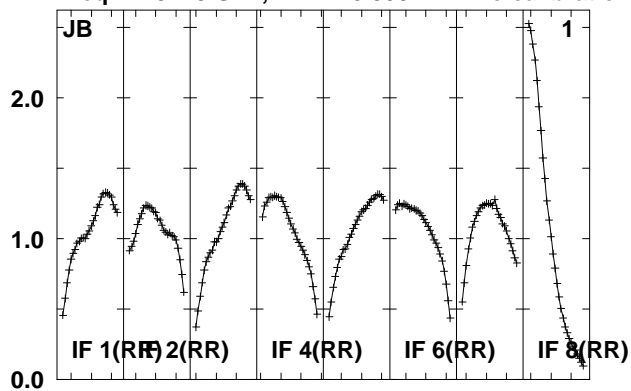

Lower frame: Real Jy

Total-power spectrum Antenna: *

Timerange: 01/00:24:31 to 01/00:27:59

Plot file version 129 created 24-AUG-2010 08:03:06

IRAS1929 EP064M.UVDATA.1

Freq = 4.9270 GHz, Bw = 16.000 MH No calibration applied and no bandpass applied

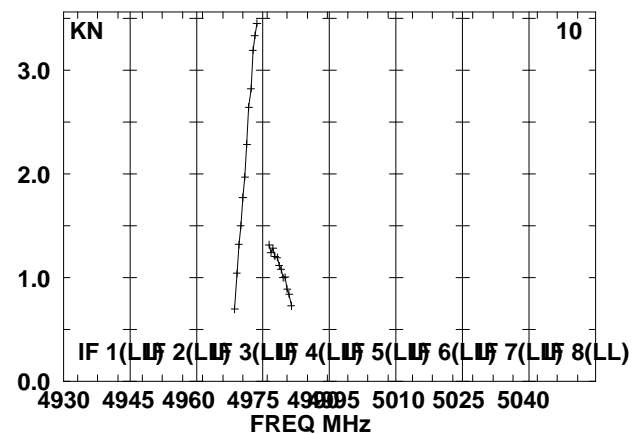
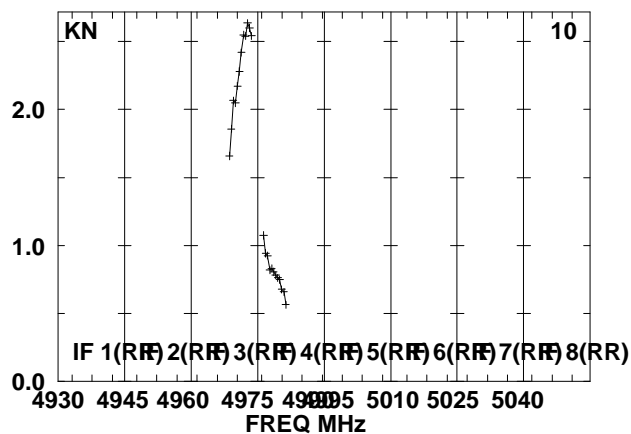
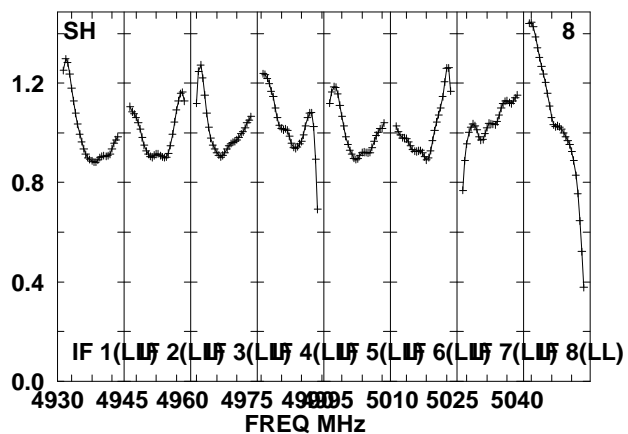
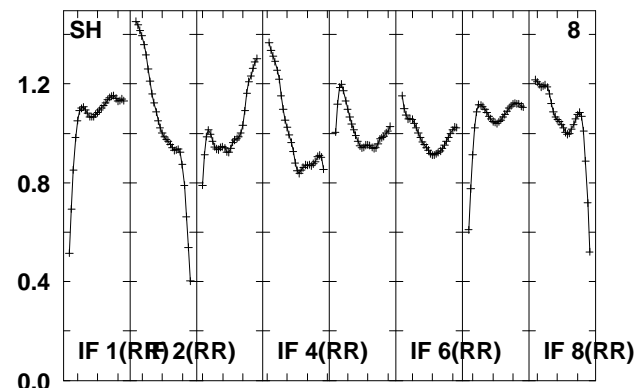
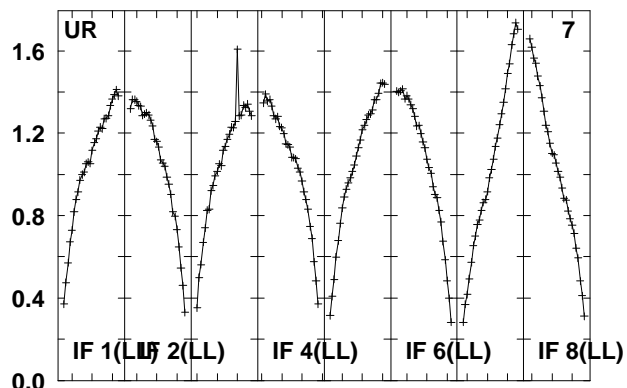
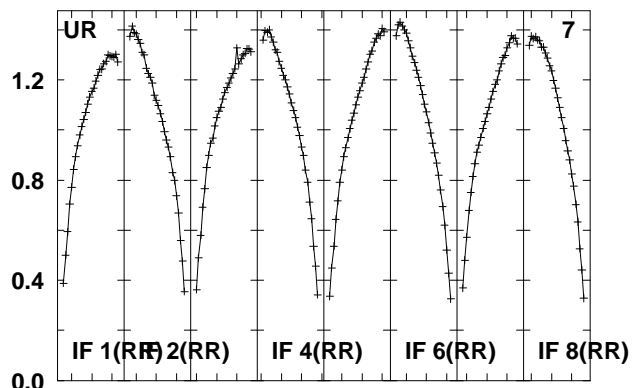
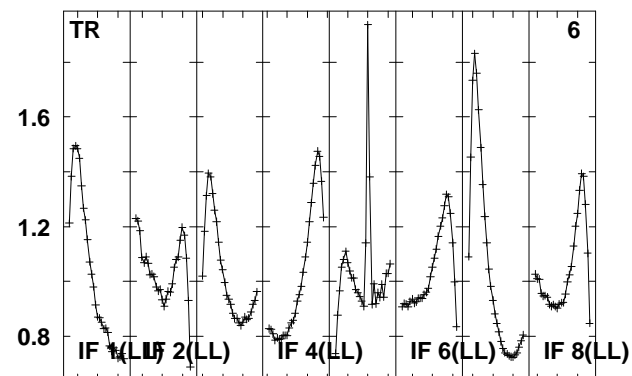
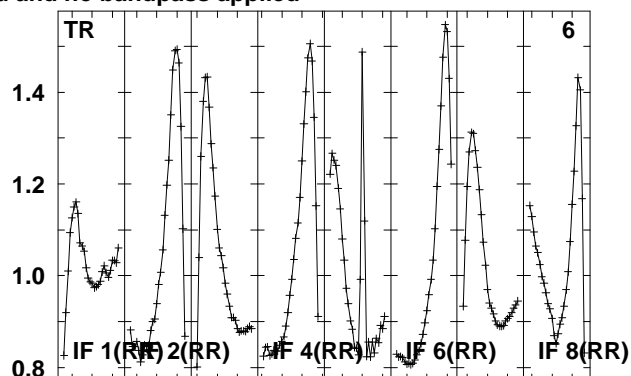
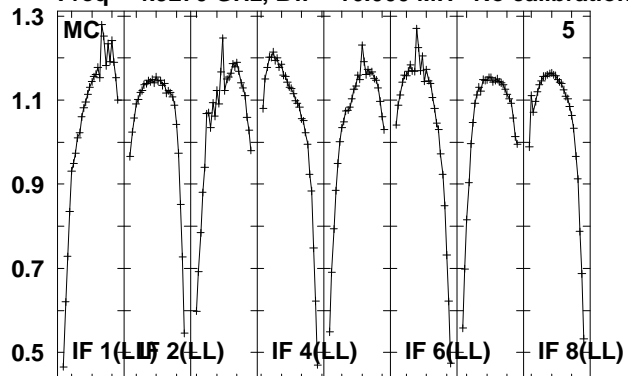

Lower frame: Real Jy

Total-power spectrum Antenna: *

Timerange: 01/00:24:31 to 01/00:27:59

Plot file version 130 created 24-AUG-2010 08:03:07

IRAS1929 EP064M.UVDATA.1

Freq = 4.9270 GHz, Bw = 16.000 MH No calibration applied and no bandpass applied

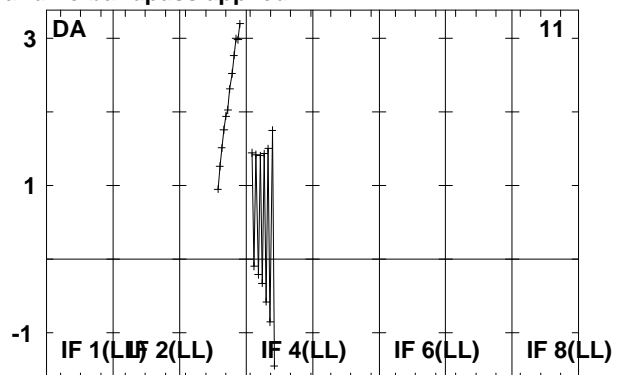
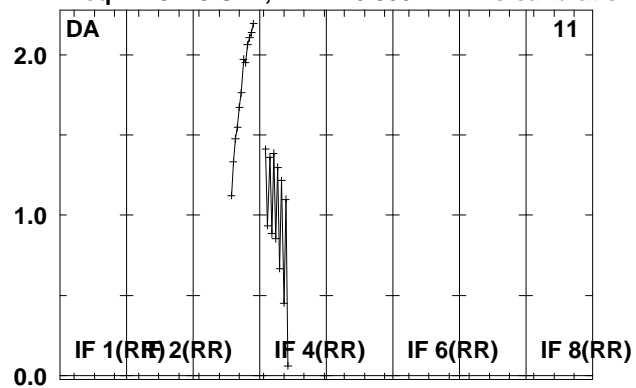

Lower frame: Real Jy
Total-power spectrum Antenna: *
Timerange: 01/00:24:31 to 01/00:27:59

Plot file version 131 created 24-AUG-2010 08:03:07

J1941-05 EP064M.UVDATA.1

Freq = 4.9270 GHz, Bw = 16.000 MH No calibration applied and no bandpass applied

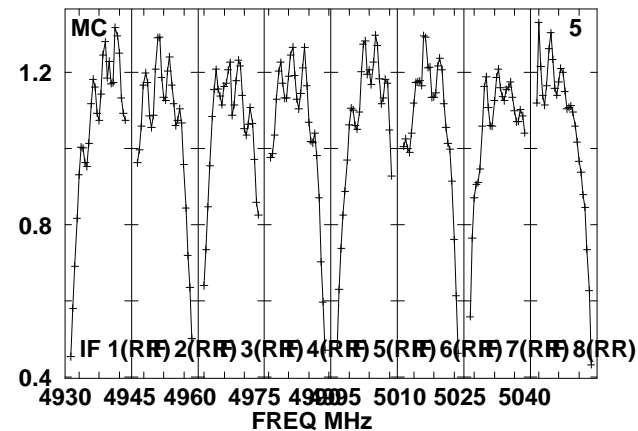
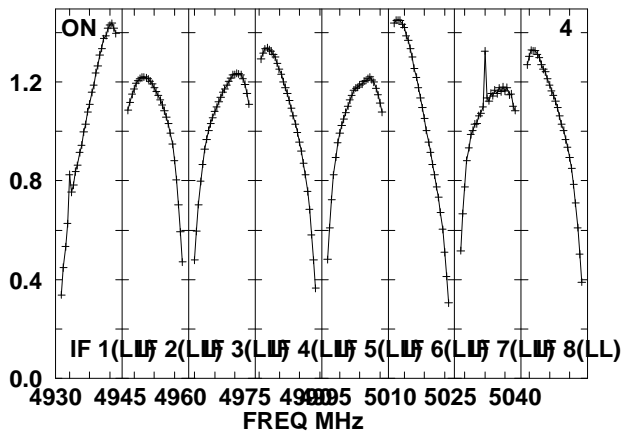
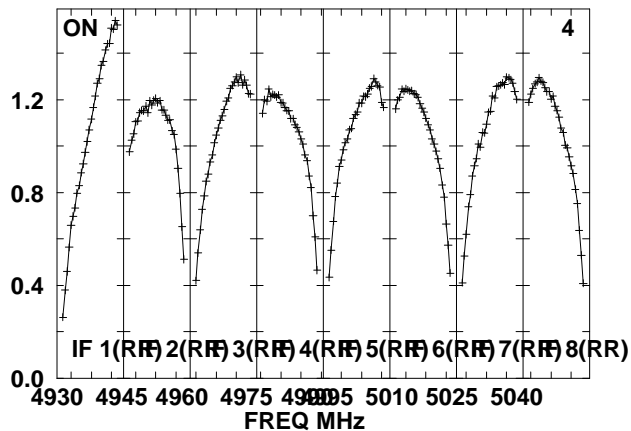
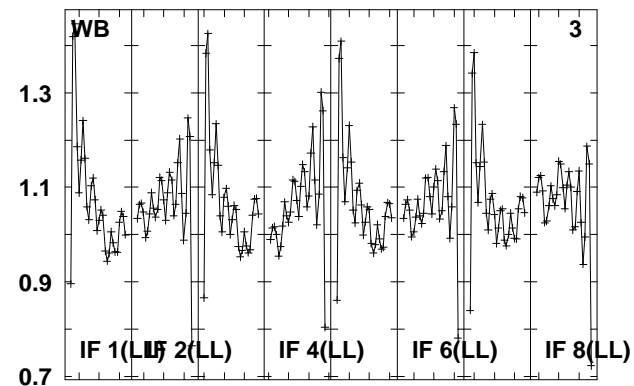
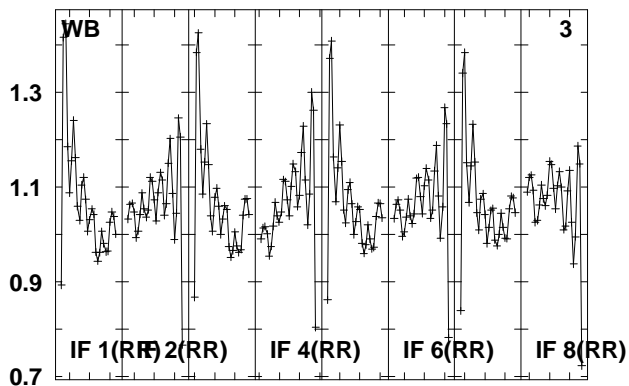
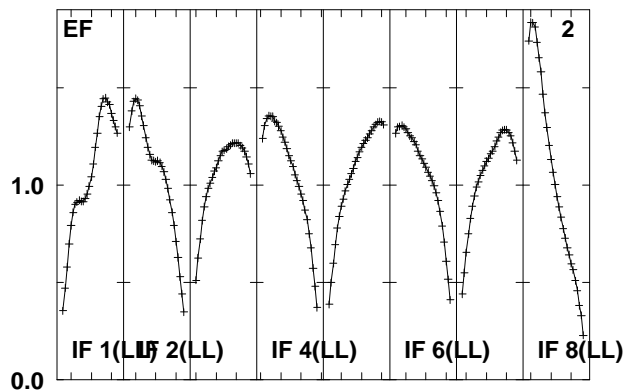
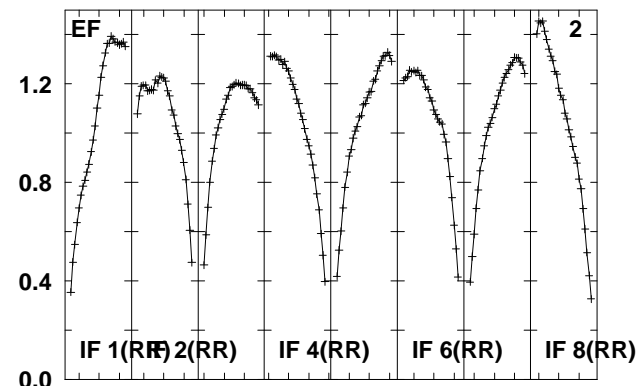
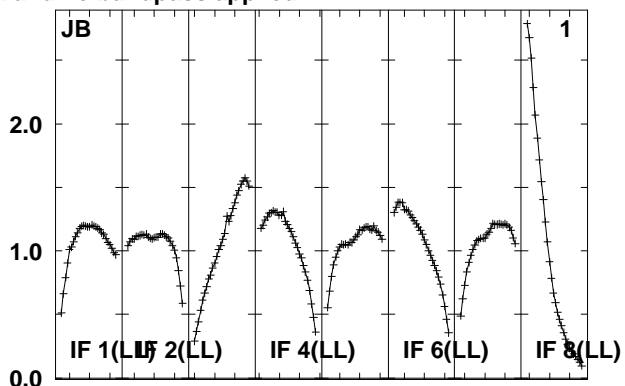
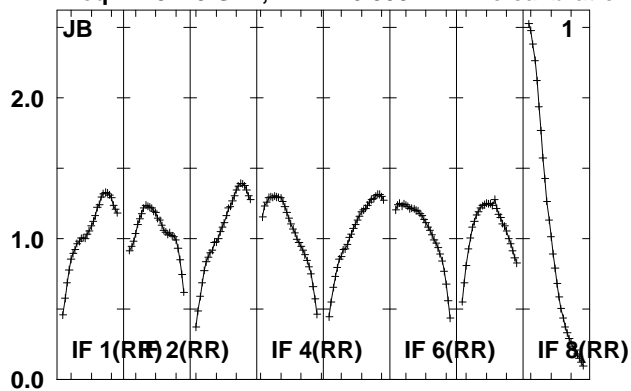

Lower frame: Real Jy

Total-power spectrum Antenna: *

Timerange: 01/00:28:01 to 01/00:29:29

Plot file version 132 created 24-AUG-2010 08:03:07

J1941-05 EP064M.UVDATA.1

Freq = 4.9270 GHz, Bw = 16.000 MH No calibration applied and no bandpass applied

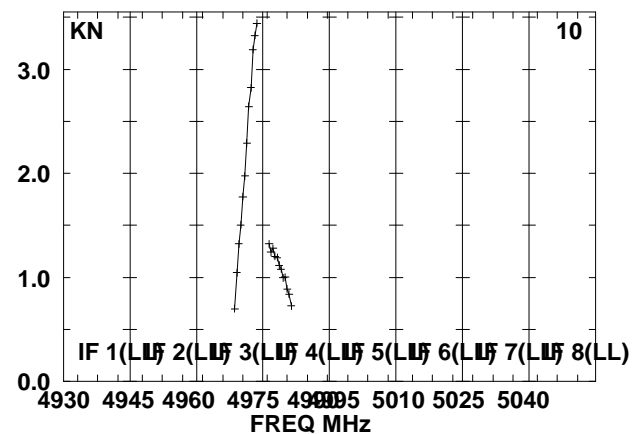
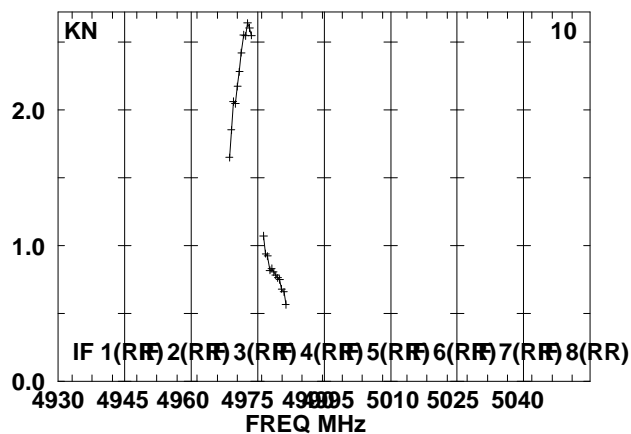
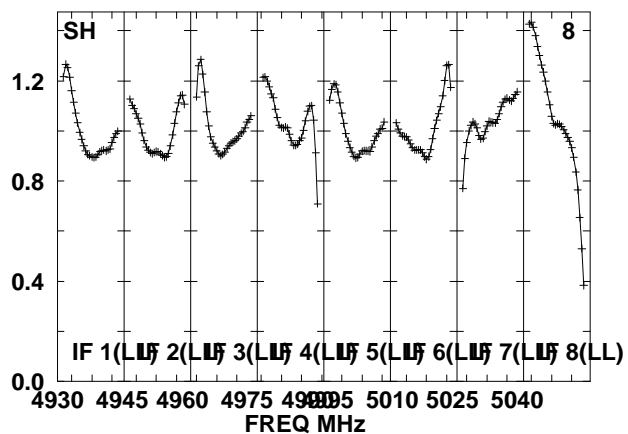
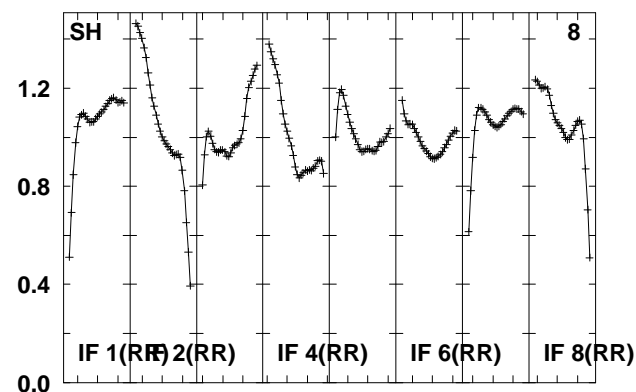
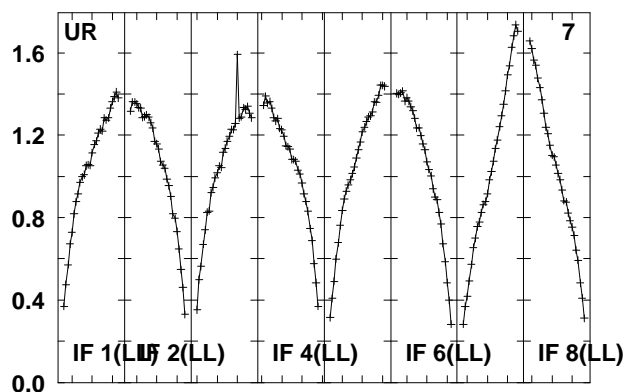
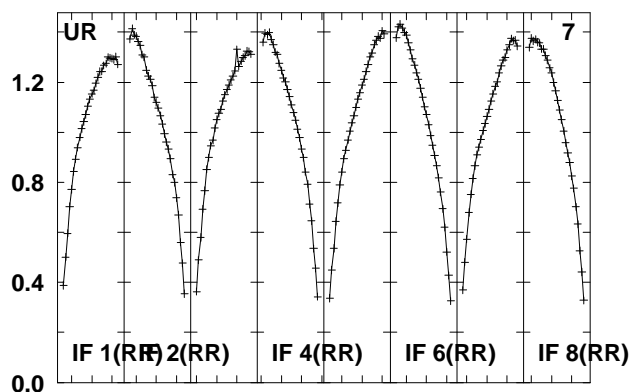
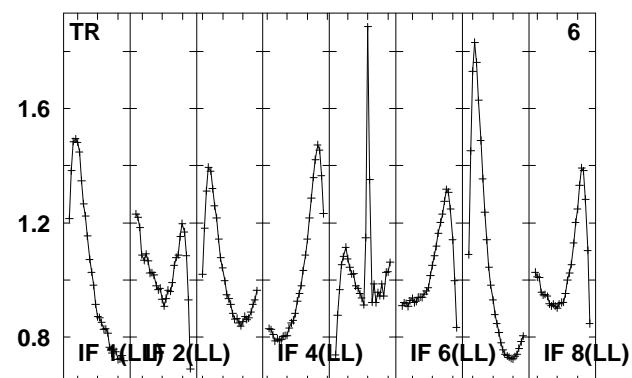
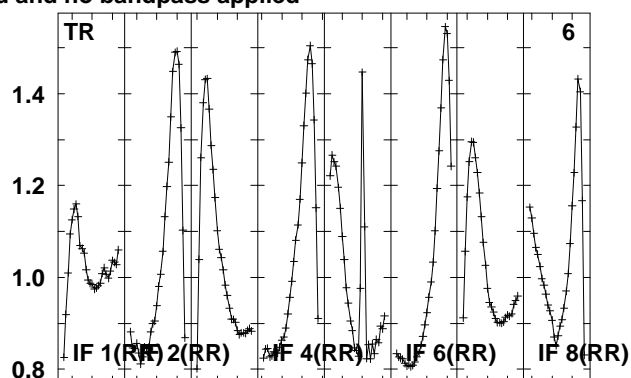
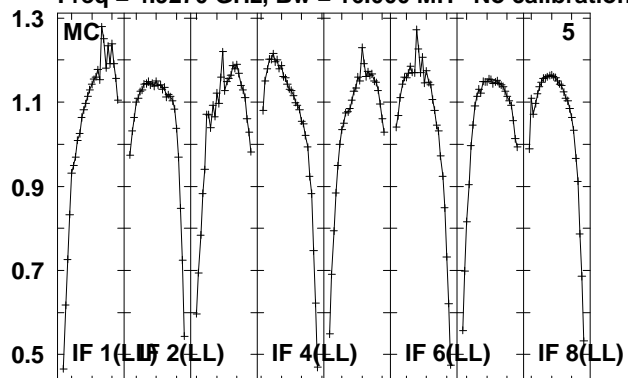

Lower frame: Real Jy
Total-power spectrum Antenna: *
Timerange: 01/00:28:01 to 01/00:29:29

Plot file version 133 created 24-AUG-2010 08:03:08

J1941-05 EP064M.UVDATA.1

Freq = 4.9270 GHz, Bw = 16.000 MH No calibration applied and no bandpass applied

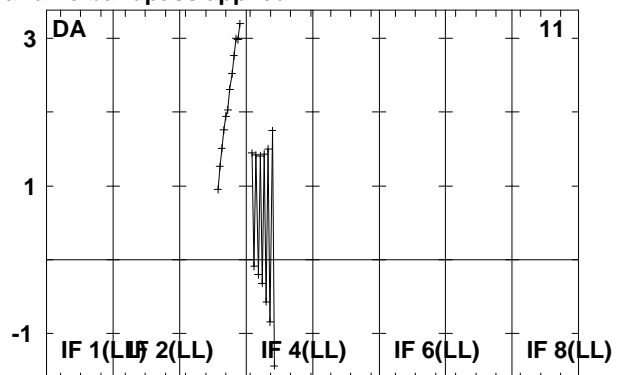
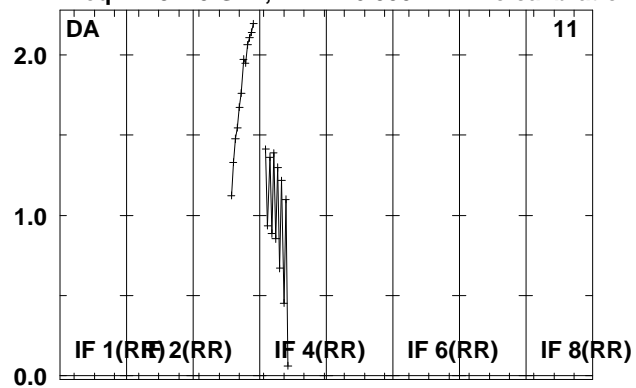

Lower frame: Real Jy
Total-power spectrum Antenna: *
Timerange: 01/00:28:01 to 01/00:29:29

Plot file version 134 created 24-AUG-2010 08:03:08

IRAS1929 EP064M.UVDATA.1

Freq = 4.9270 GHz, Bw = 16.000 MH No calibration applied and no bandpass applied

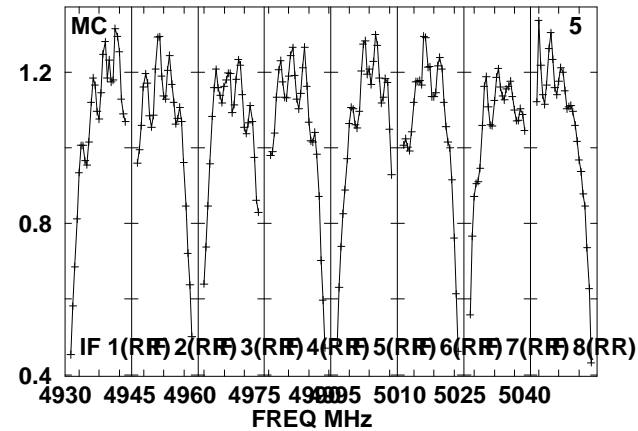
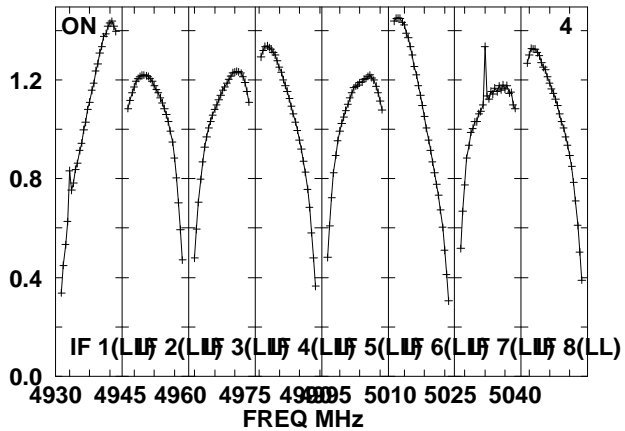
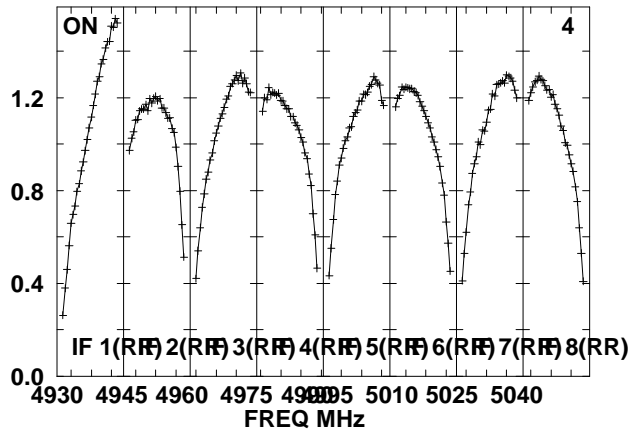
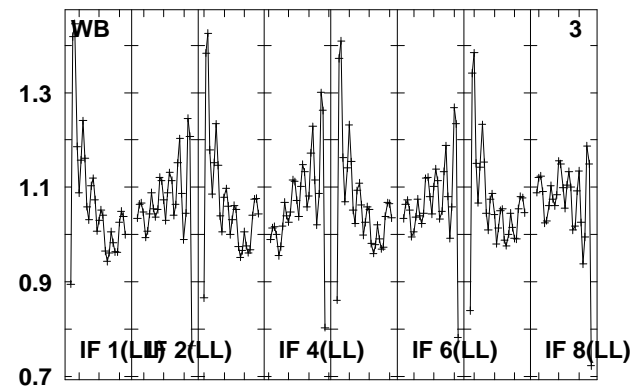
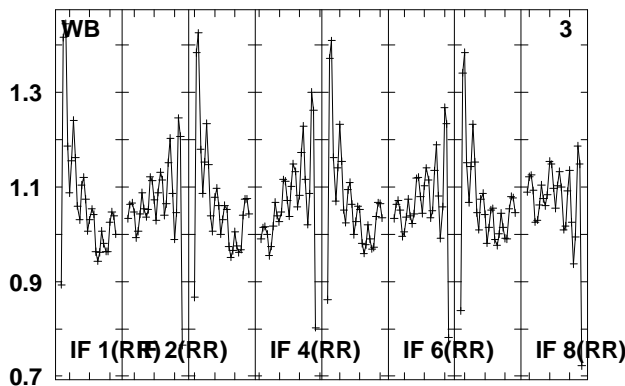
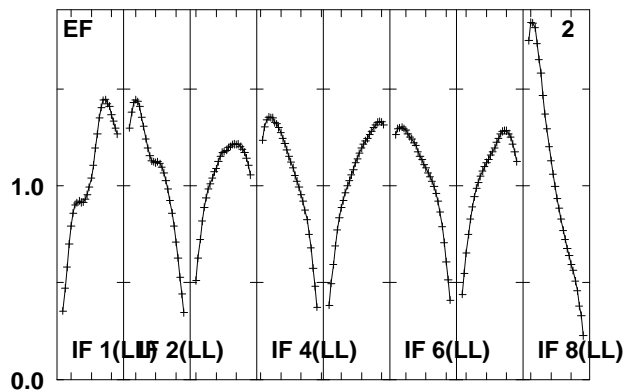
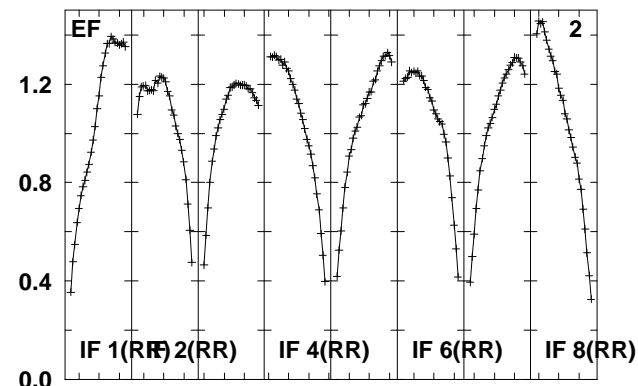
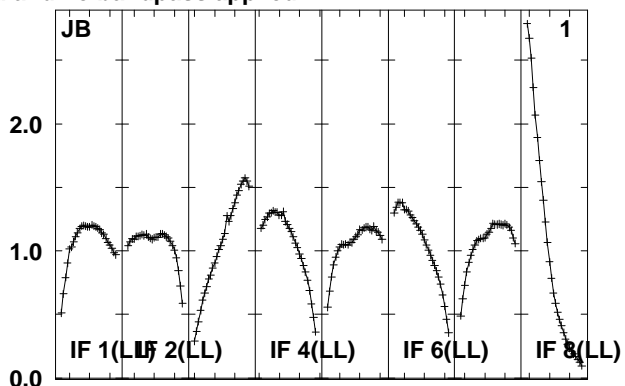
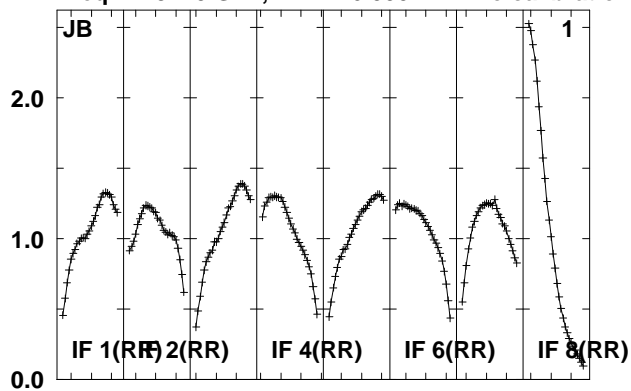

Lower frame: Real Jy
Total-power spectrum Antenna: *
Timerange: 01/00:29:31 to 01/00:32:59

Plot file version 135 created 24-AUG-2010 08:03:08

IRAS1929 EP064M.UVDATA.1

Freq = 4.9270 GHz, Bw = 16.000 MH No calibration applied and no bandpass applied

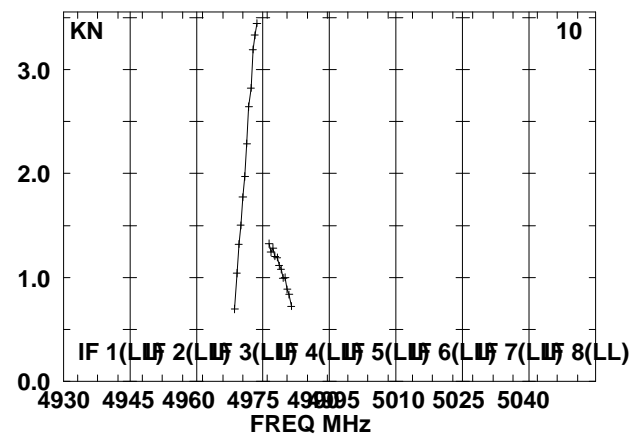
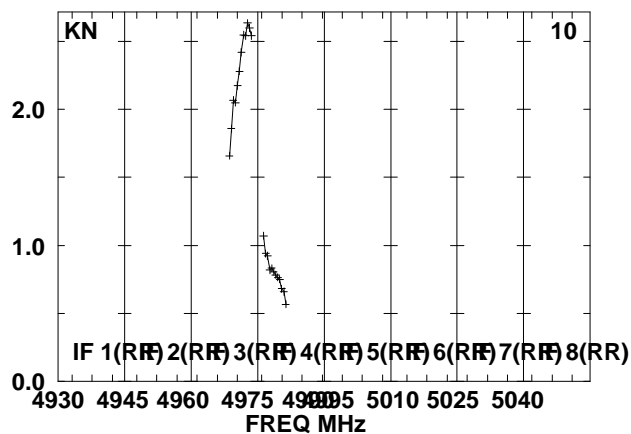
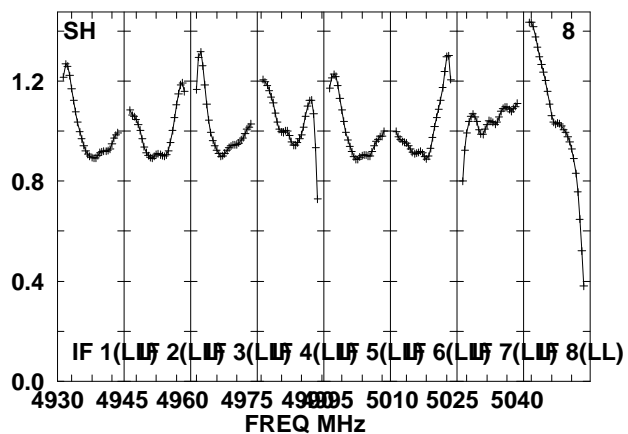
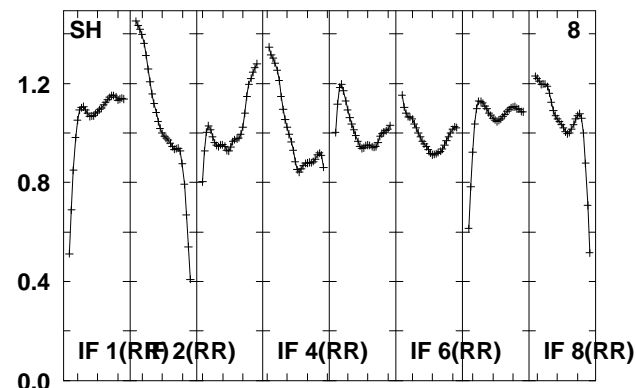
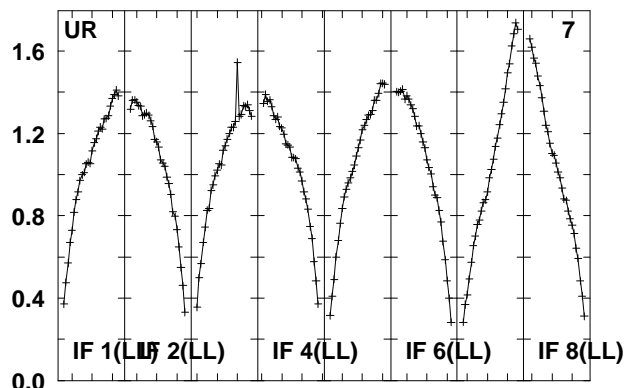
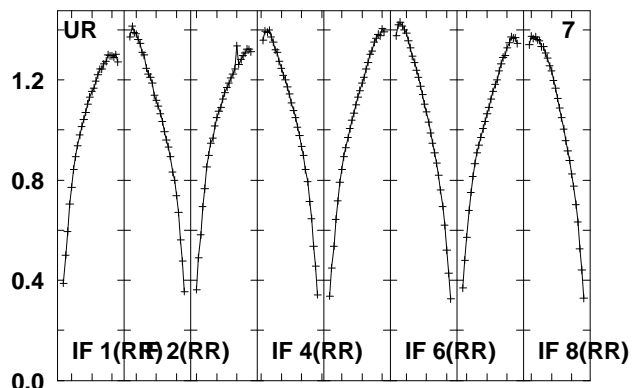
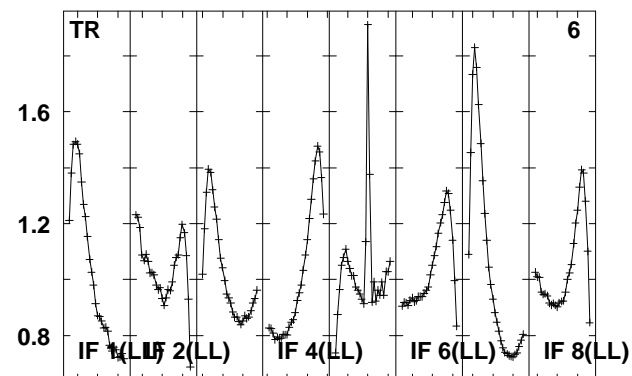
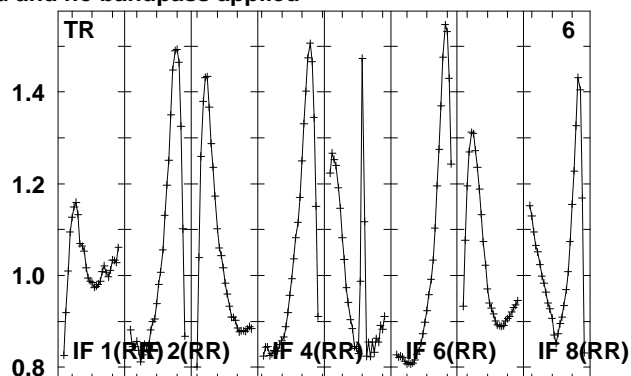
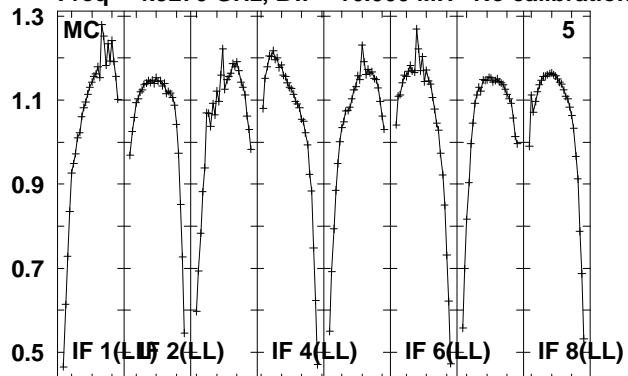

Lower frame: Real Jy

Total-power spectrum Antenna: *

Timerange: 01/00:29:31 to 01/00:32:59

Plot file version 136 created 24-AUG-2010 08:03:09

IRAS1929 EP064M.UVDATA.1

Freq = 4.9270 GHz, Bw = 16.000 MH No calibration applied and no bandpass applied

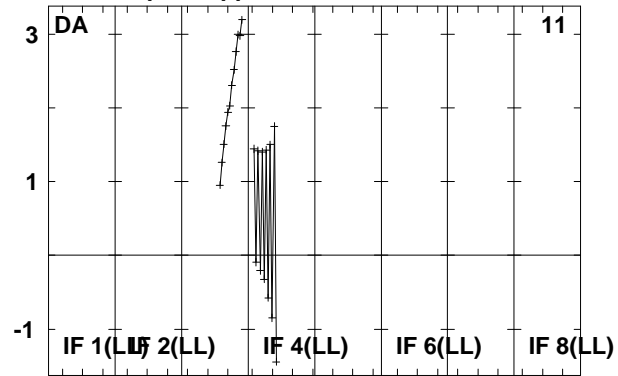
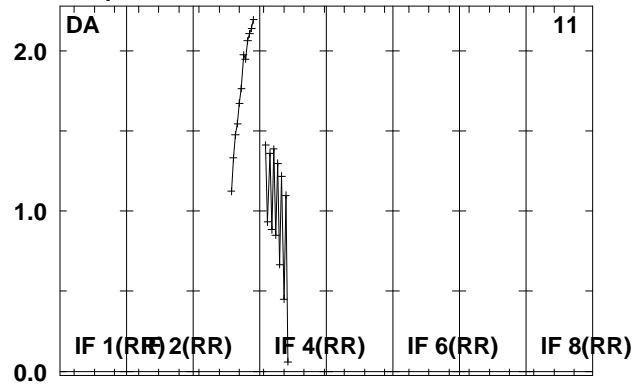

Lower frame: Real Jy
Total-power spectrum Antenna: *
Timerange: 01/00:29:31 to 01/00:32:59