

Plot file version 1 created 13-OCT-2010 18:37:55
 3C286 EP064N.UVDATA.1
 Freq = 4.9270 GHz, Bw = 16.000 MH Calibrated with CL # 3 and BP # 1 (BP mode 1)

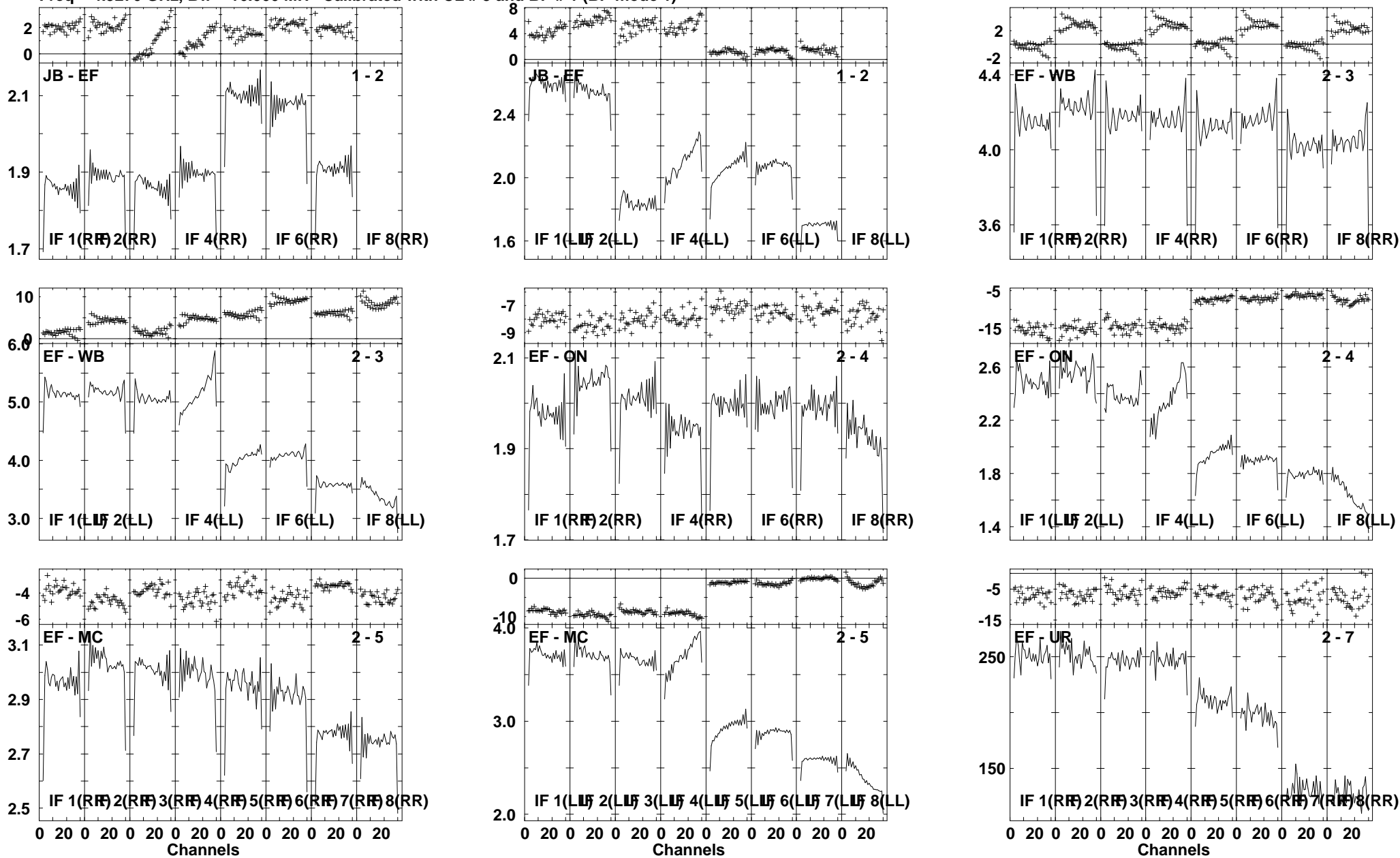

Lower frame: Ampl Jy Top frame: Phas deg
 Vector averaged cross-power spectrum Several baselines displayed
 Timerange: 00/21:30:01 to 00/21:34:59

Plot file version 2 created 13-OCT-2010 18:37:58

3C286 EP064N.UVDATA.1

Freq = 4.9270 GHz, Bw = 16.000 MH Calibrated with CL # 3 and BP # 1 (BP mode 1)

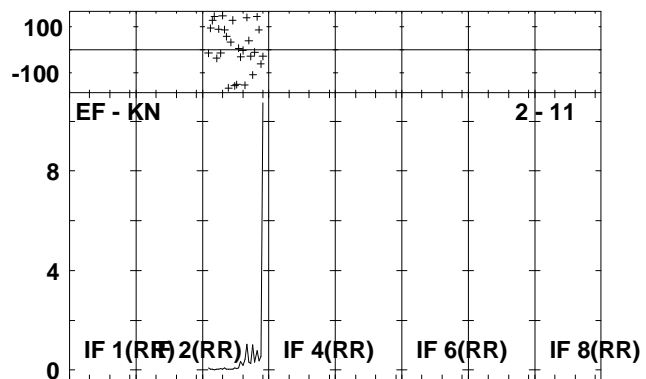
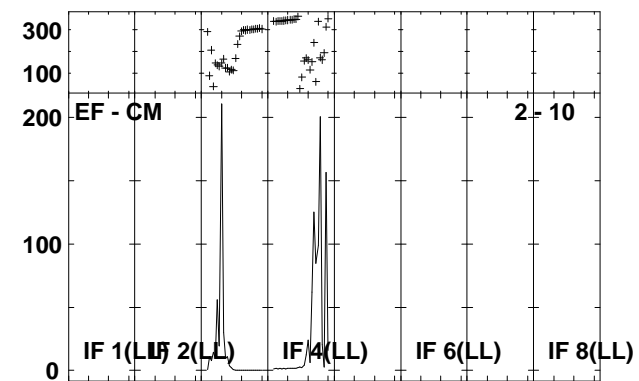
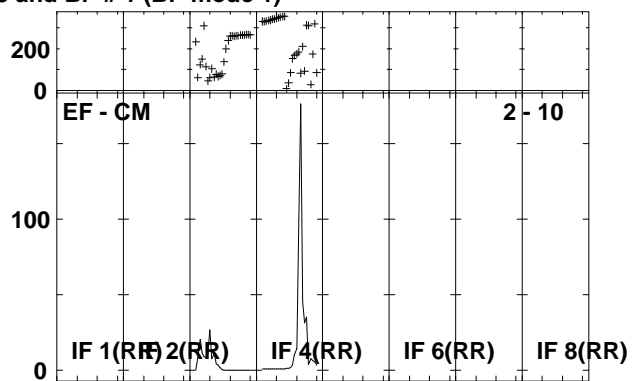
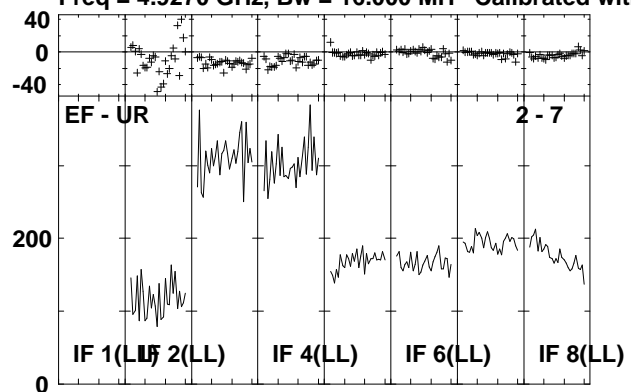

Lower frame: Milli Ampl Jy Top frame: Phas deg
Vector averaged cross-power spectrum Several baselines displayed
Timerange: 00/21:30:01 to 00/21:34:59

Plot file version 3 created 13-OCT-2010 18:38:02

J2001+10 EP064N.UVDATA.1

Freq = 4.9270 GHz, Bw = 16.000 MH Calibrated with CL # 3 and BP # 1 (BP mode 1)

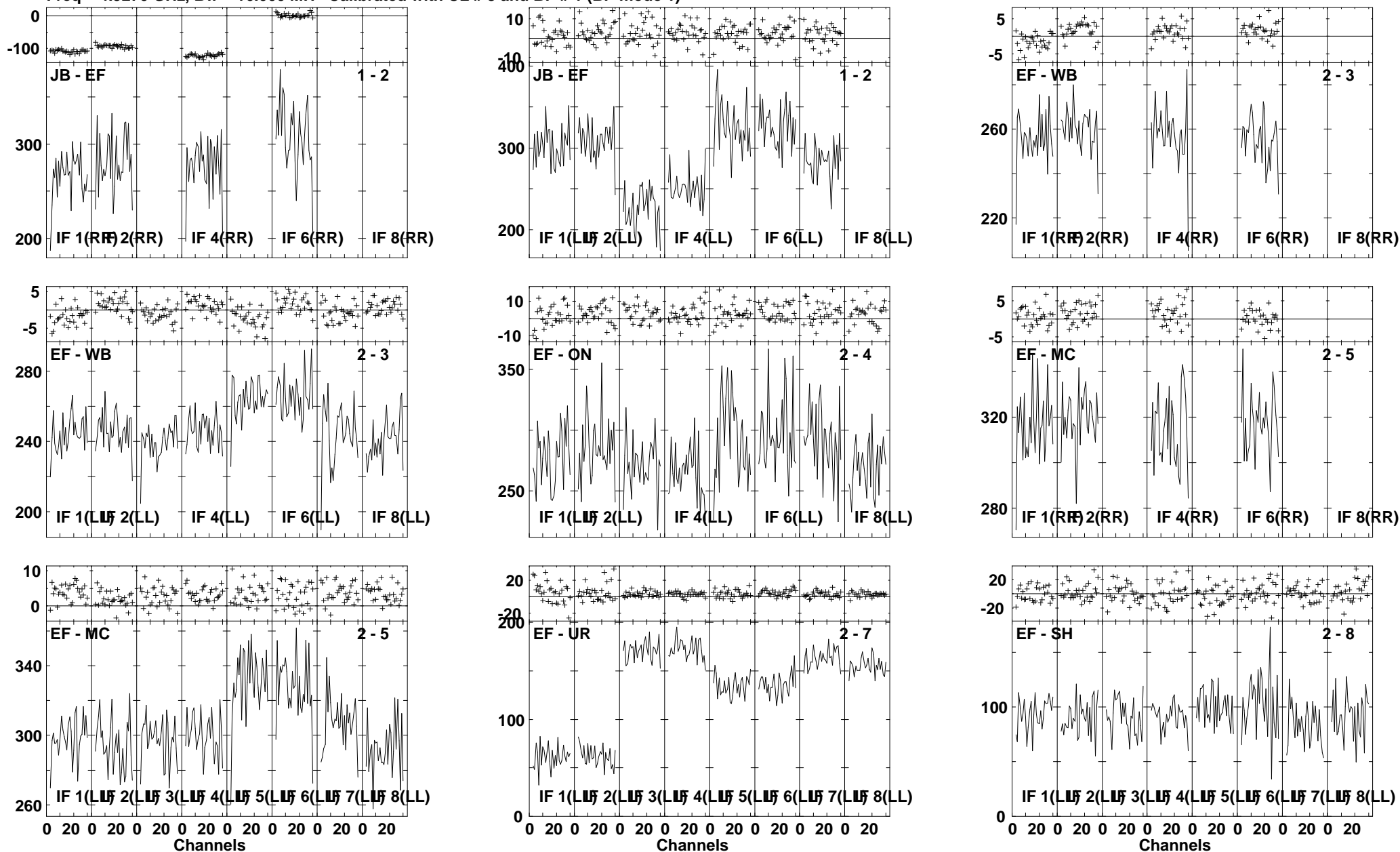

Lower frame: Milli Ampl Jy Top frame: Phas deg
Vector averaged cross-power spectrum Several baselines displayed
Timerange: 00/21:40:01 to 00/21:43:59

Plot file version 4 created 13-OCT-2010 18:38:07
J2001+10 EP064N.UVDATA.1
Freq = 4.9270 GHz, Bw = 16.000 MH Calibrated with CL # 3 and BP # 1 (BP mode 1)

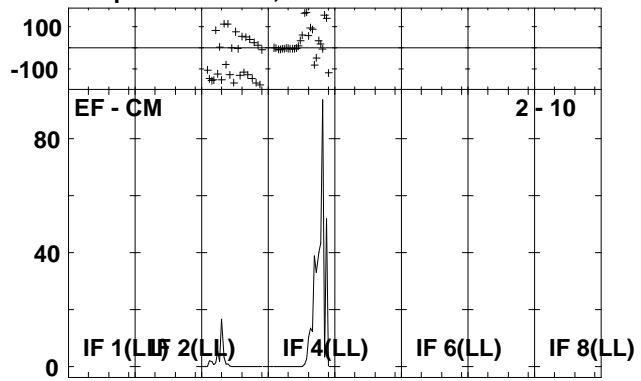

Lower frame: Ampl Jy Top frame: Phas deg
Vector averaged cross-power spectrum Several baselines displayed
Timerange: 00/21:40:01 to 00/21:43:59

Plot file version 5 created 13-OCT-2010 18:38:08

IRAS1954 EP064N.UVDATA.1

Freq = 4.9270 GHz, Bw = 16.000 MH Calibrated with CL # 3 and BP # 1 (BP mode 1)

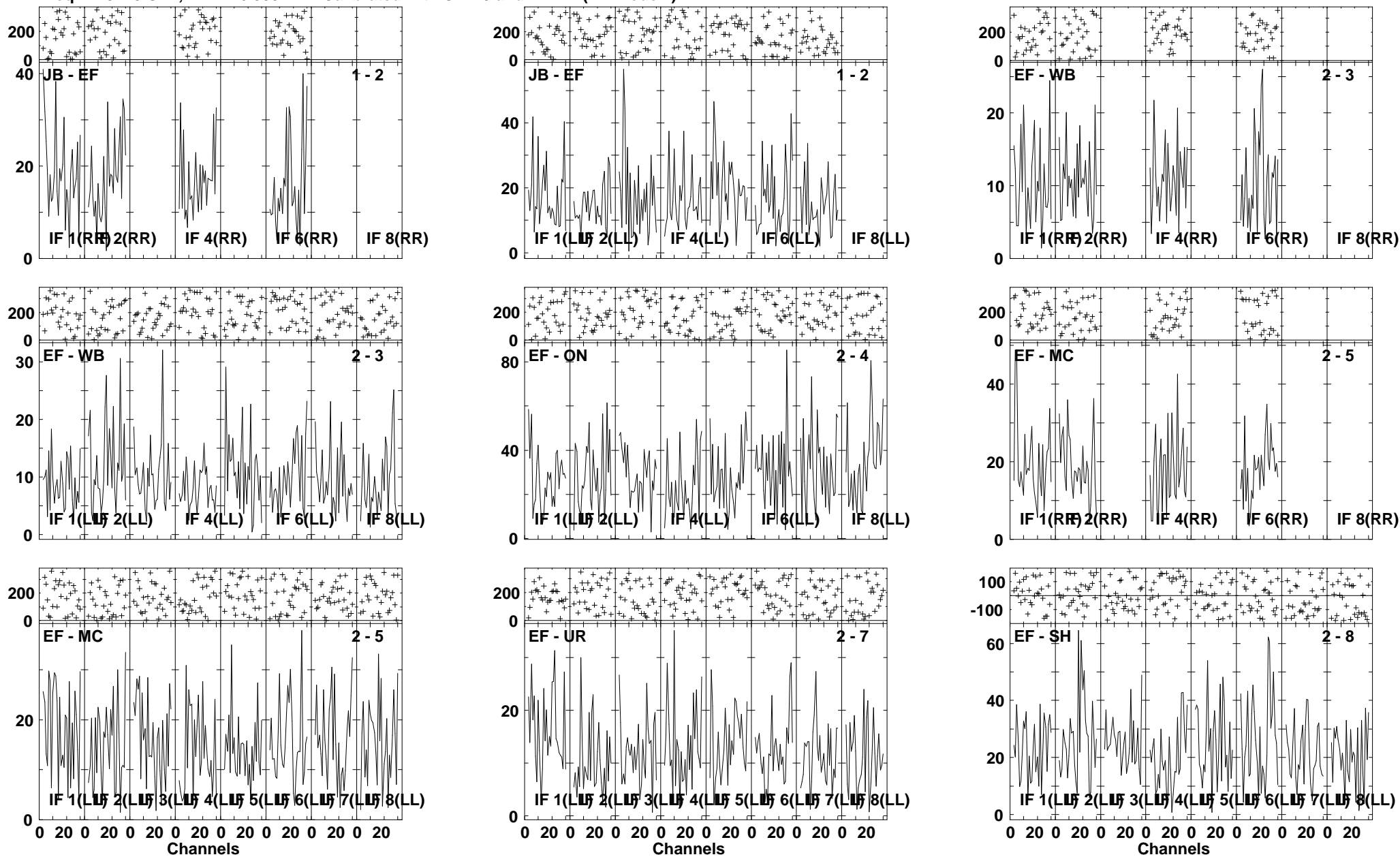

Lower frame: Milli Ampl Jy Top frame: Phas deg
Vector averaged cross-power spectrum Several baselines displayed
Timerange: 00/21:44:01 to 00/21:47:29

Plot file version 6 created 13-OCT-2010 18:38:12
IRAS1954 EP064N.UVDATA.1
Freq = 4.9270 GHz, Bw = 16.000 MH Calibrated with CL # 3 and BP # 1 (BP mode 1)

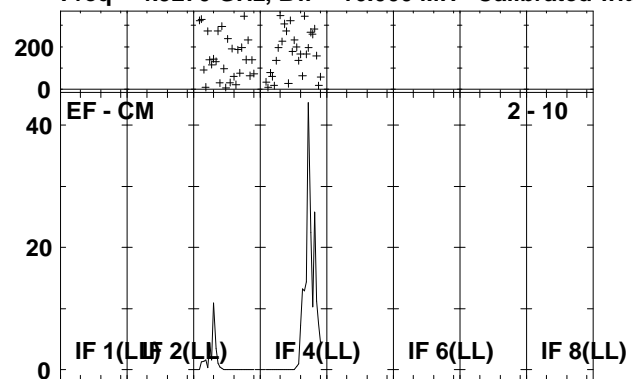

Lower frame: Ampl Jy Top frame: Phas deg
Vector averaged cross-power spectrum Several baselines displayed
Timerange: 00/21:44:01 to 00/21:47:29

Plot file version 7 created 13-OCT-2010 18:38:13

J2001+10 EP064N.UVDATA.1

Freq = 4.9270 GHz, Bw = 16.000 MH Calibrated with CL # 3 and BP # 1 (BP mode 1)

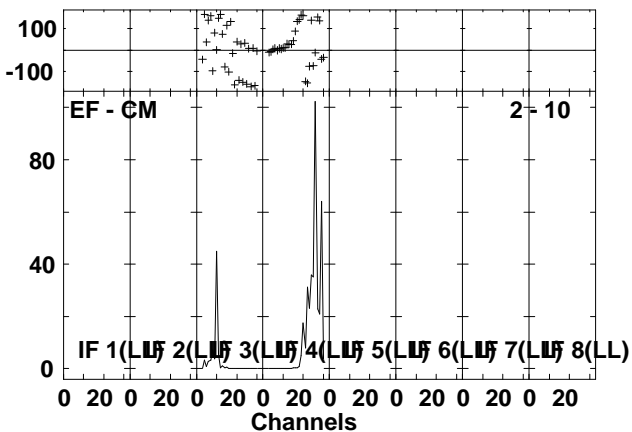
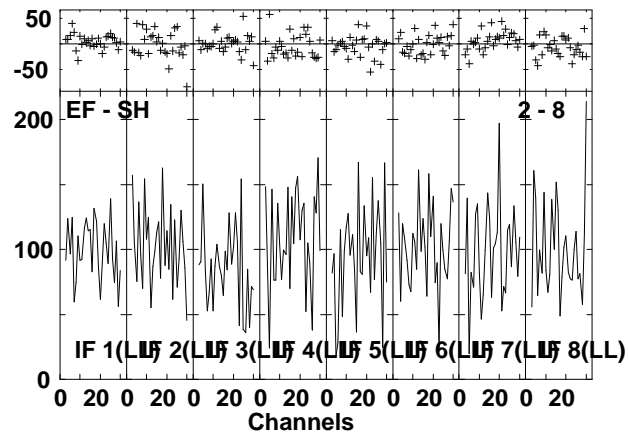
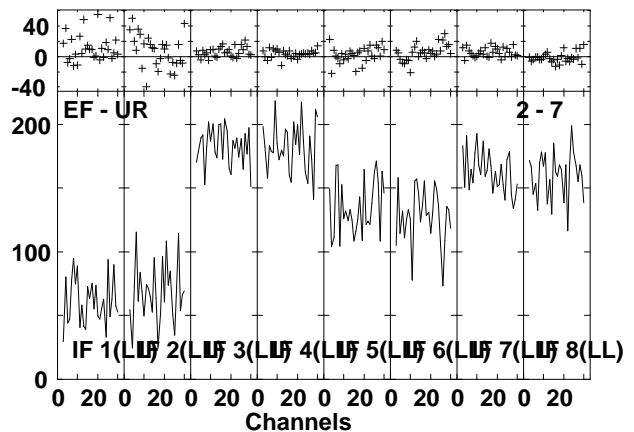
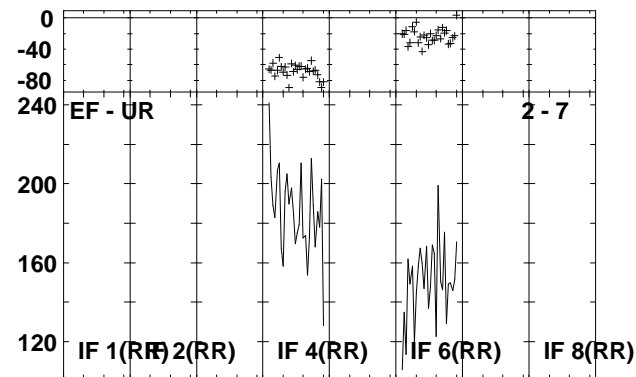
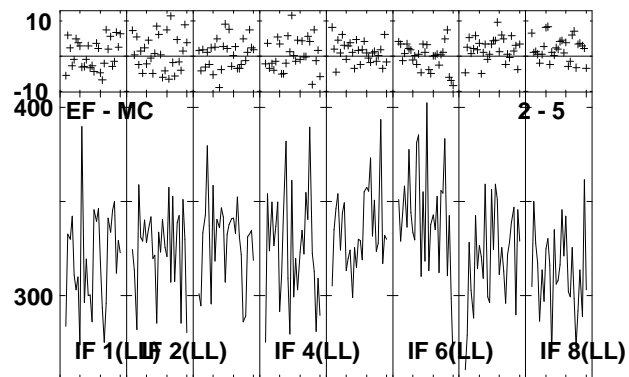
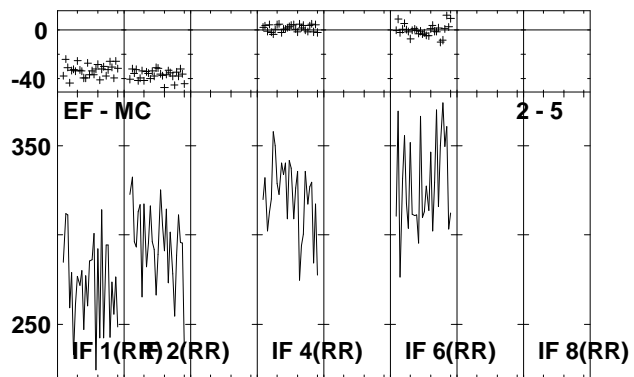
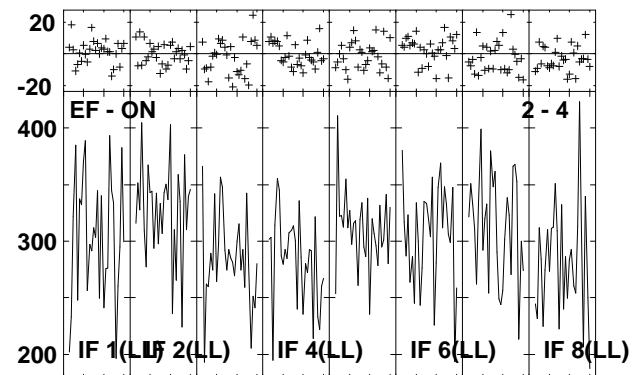
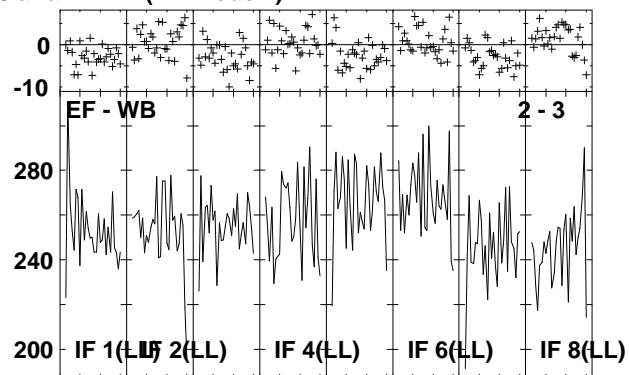
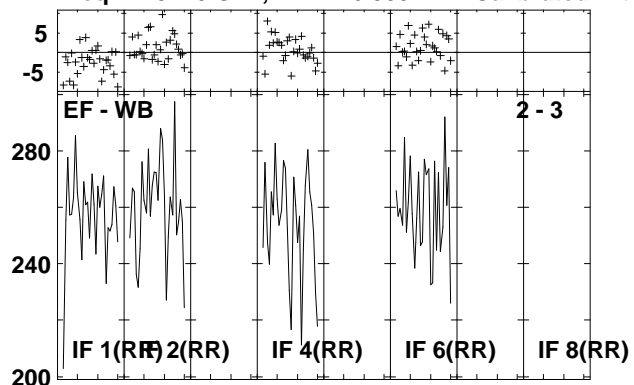

Lower frame: Milli Ampl Jy Top frame: Phas deg
Vector averaged cross-power spectrum Several baselines displayed
Timerange: 00/21:47:33 to 00/21:48:57

Plot file version 8 created 13-OCT-2010 18:38:15

IRAS1954 EP064N.UVDATA.1

Freq = 4.9270 GHz, Bw = 16.000 MH Calibrated with CL # 3 and BP # 1 (BP mode 1)

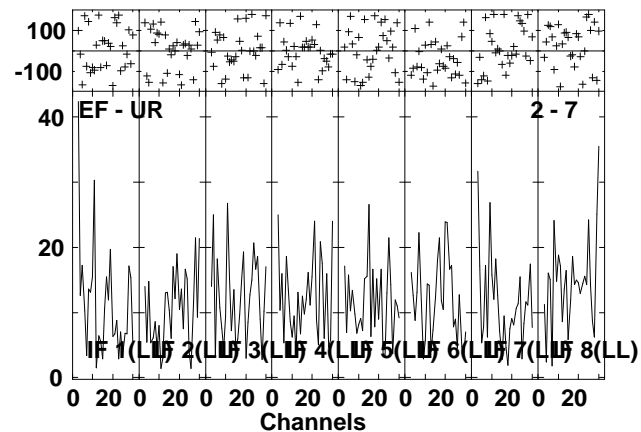
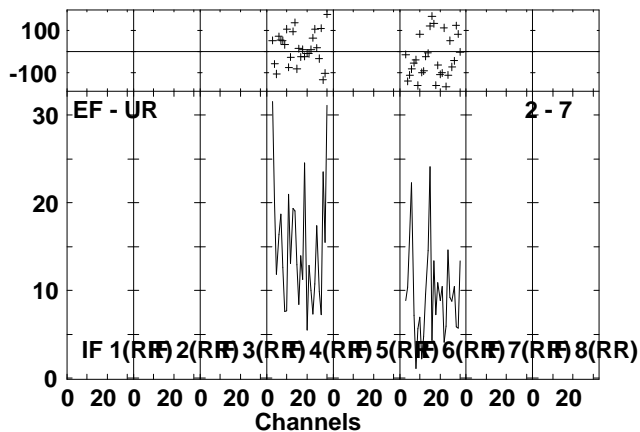
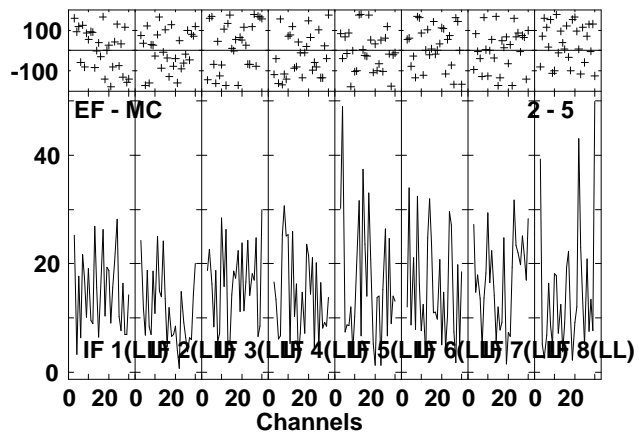
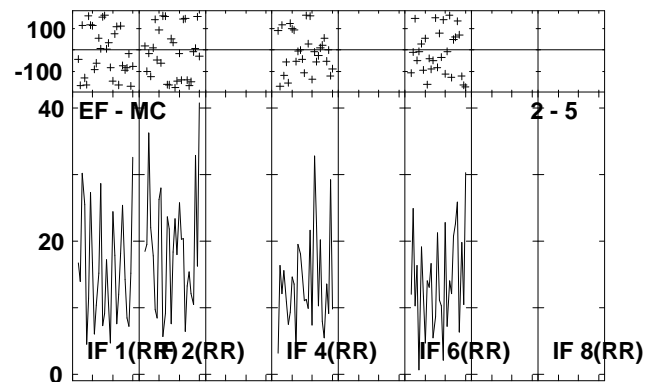
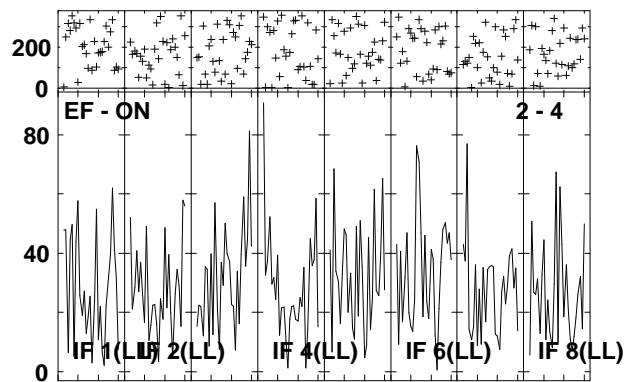
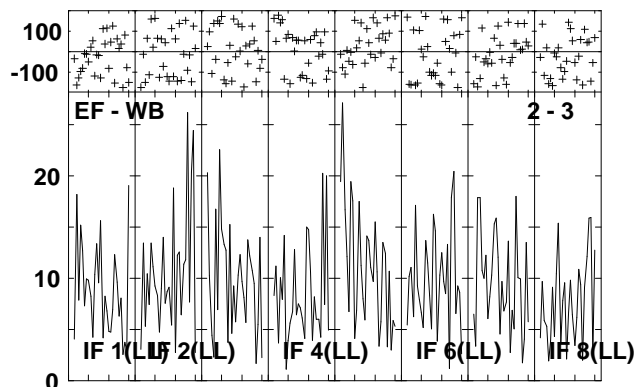
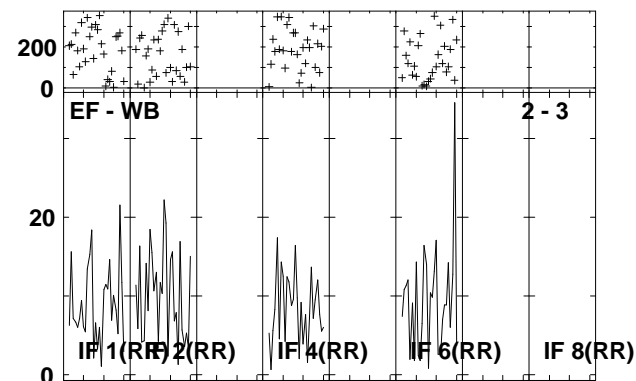
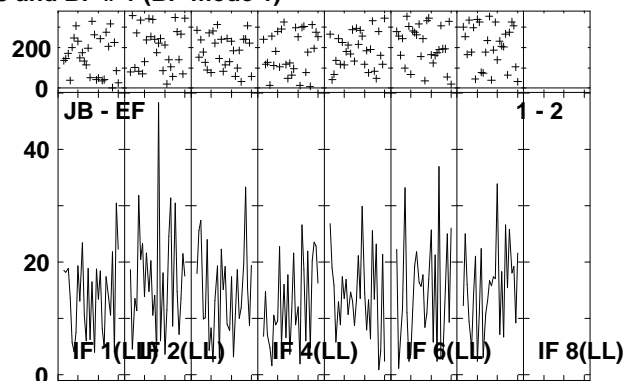
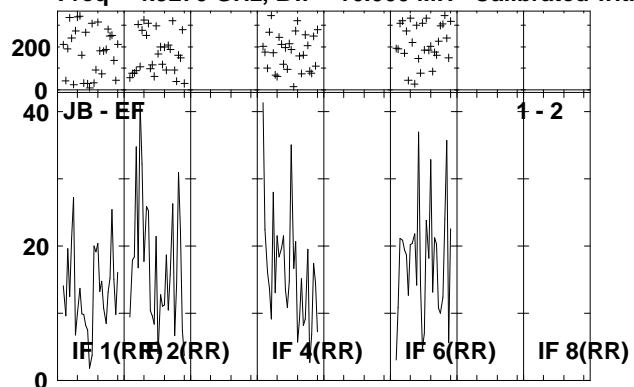

Lower frame: Milli Ampl Jy Top frame: Phas deg
Vector averaged cross-power spectrum Several baselines displayed
Timerange: 00/21:49:01 to 00/21:52:29

Plot file version 9 created 13-OCT-2010 18:38:19

IRAS1954 EP064N.UVDATA.1

Freq = 4.9270 GHz, Bw = 16.000 MH Calibrated with CL # 3 and BP # 1 (BP mode 1)

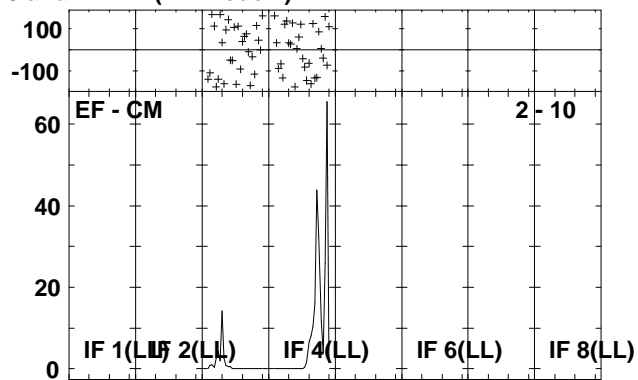
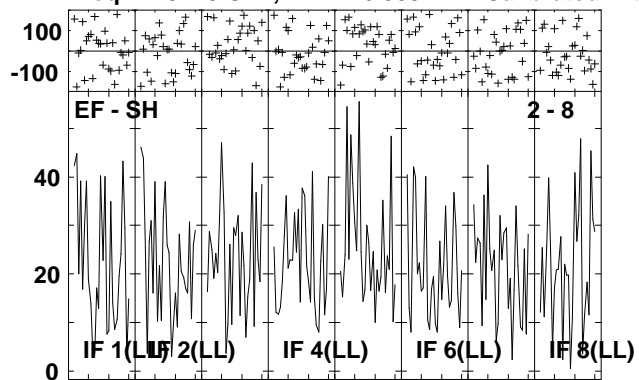

Lower frame: Milli Ampl Jy Top frame: Phas deg
Vector averaged cross-power spectrum Several baselines displayed
Timerange: 00/21:49:01 to 00/21:52:29

Plot file version 10 created 13-OCT-2010 18:38:21

J2001+10 EP064N.UVDATA.1

Freq = 4.9270 GHz, Bw = 16.000 MH Calibrated with CL # 3 and BP # 1 (BP mode 1)

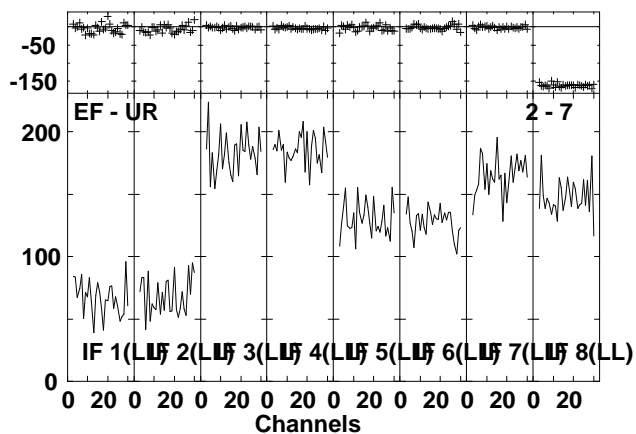
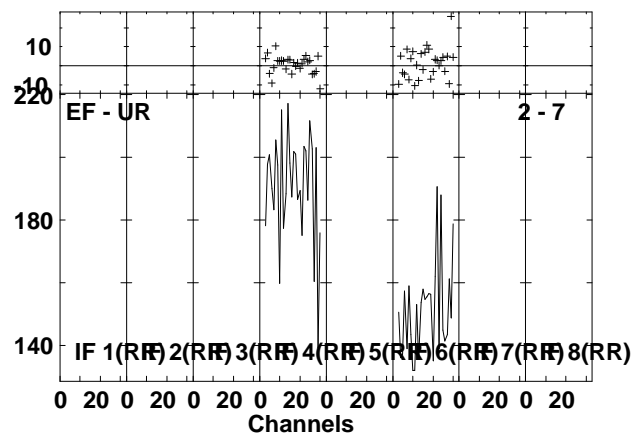
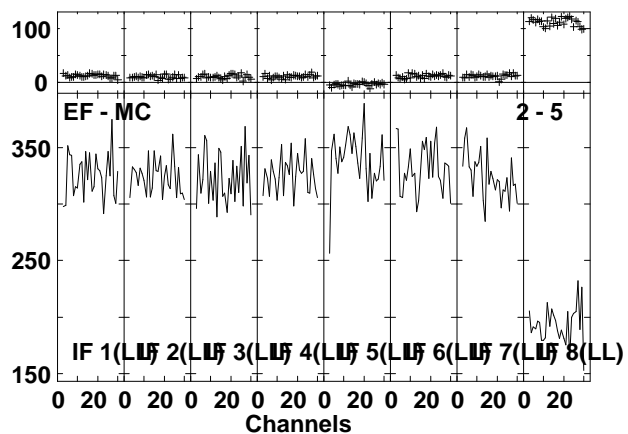
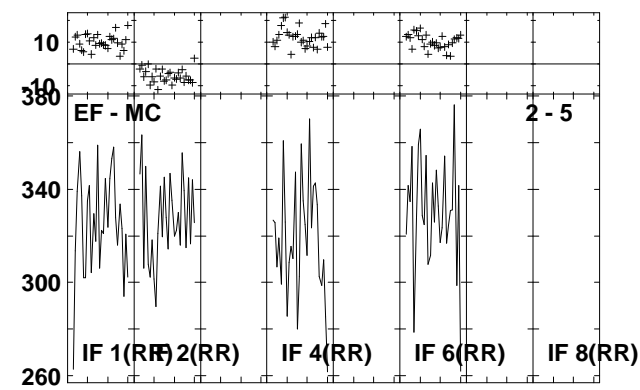
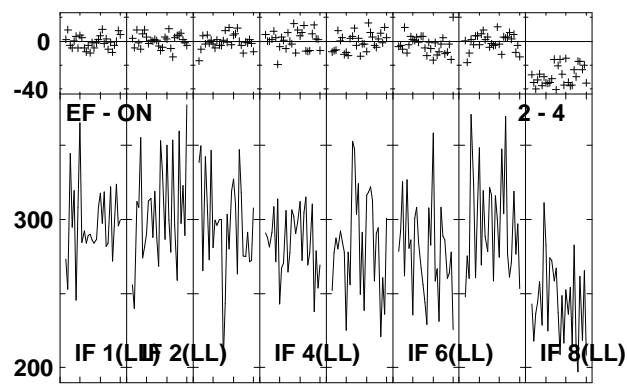
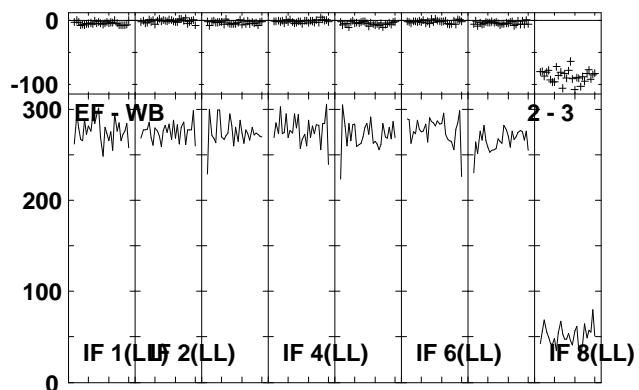
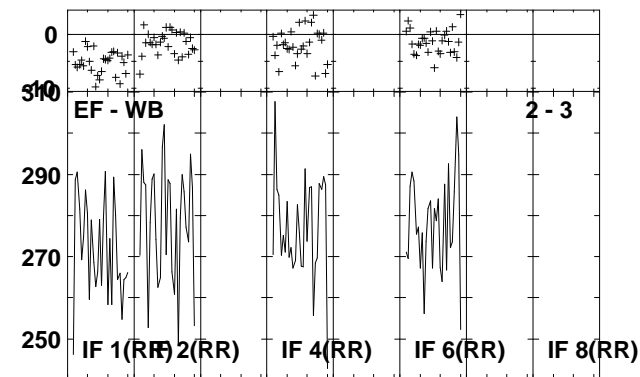
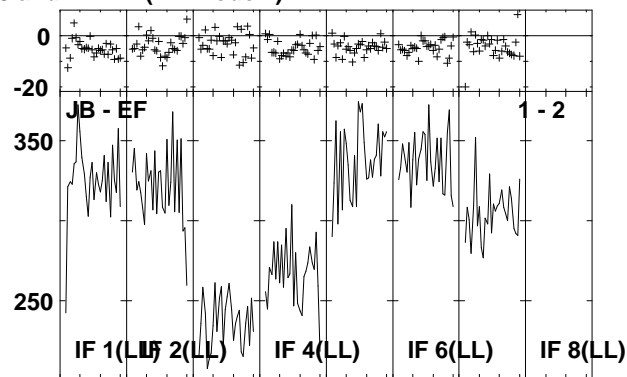
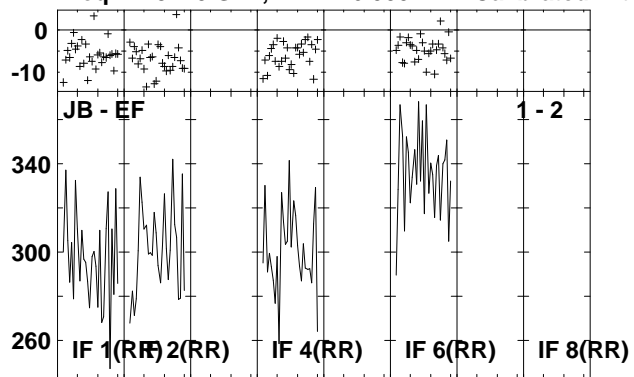

Lower frame: Milli Ampl Jy Top frame: Phas deg
Vector averaged cross-power spectrum Several baselines displayed
Timerange: 00/21:53:31 to 00/21:54:59

Plot file version 11 created 13-OCT-2010 18:38:22

J2001+10 EP064N.UVDATA.1

Freq = 4.9270 GHz, Bw = 16.000 MH Calibrated with CL # 3 and BP # 1 (BP mode 1)

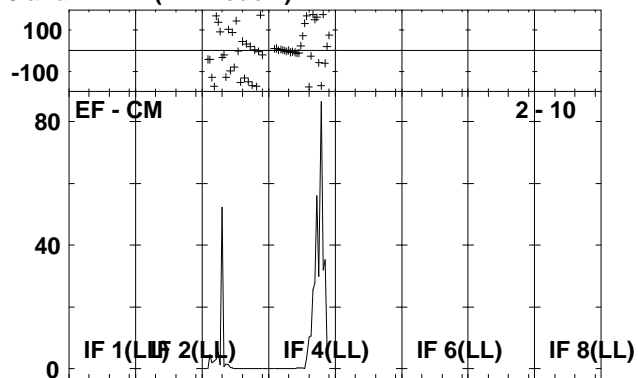
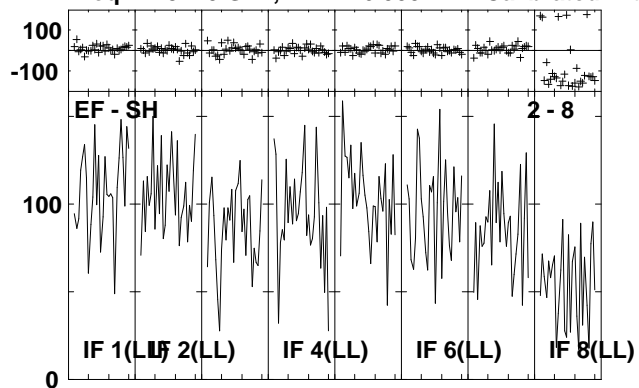

Lower frame: Milli Ampl Jy Top frame: Phas deg
Vector averaged cross-power spectrum Several baselines displayed
Timerange: 00/21:53:31 to 00/21:54:59

Plot file version 12 created 13-OCT-2010 18:38:23

IRAS1954 EP064N.UVDATA.1

Freq = 4.9270 GHz, Bw = 16.000 MH Calibrated with CL # 3 and BP # 1 (BP mode 1)

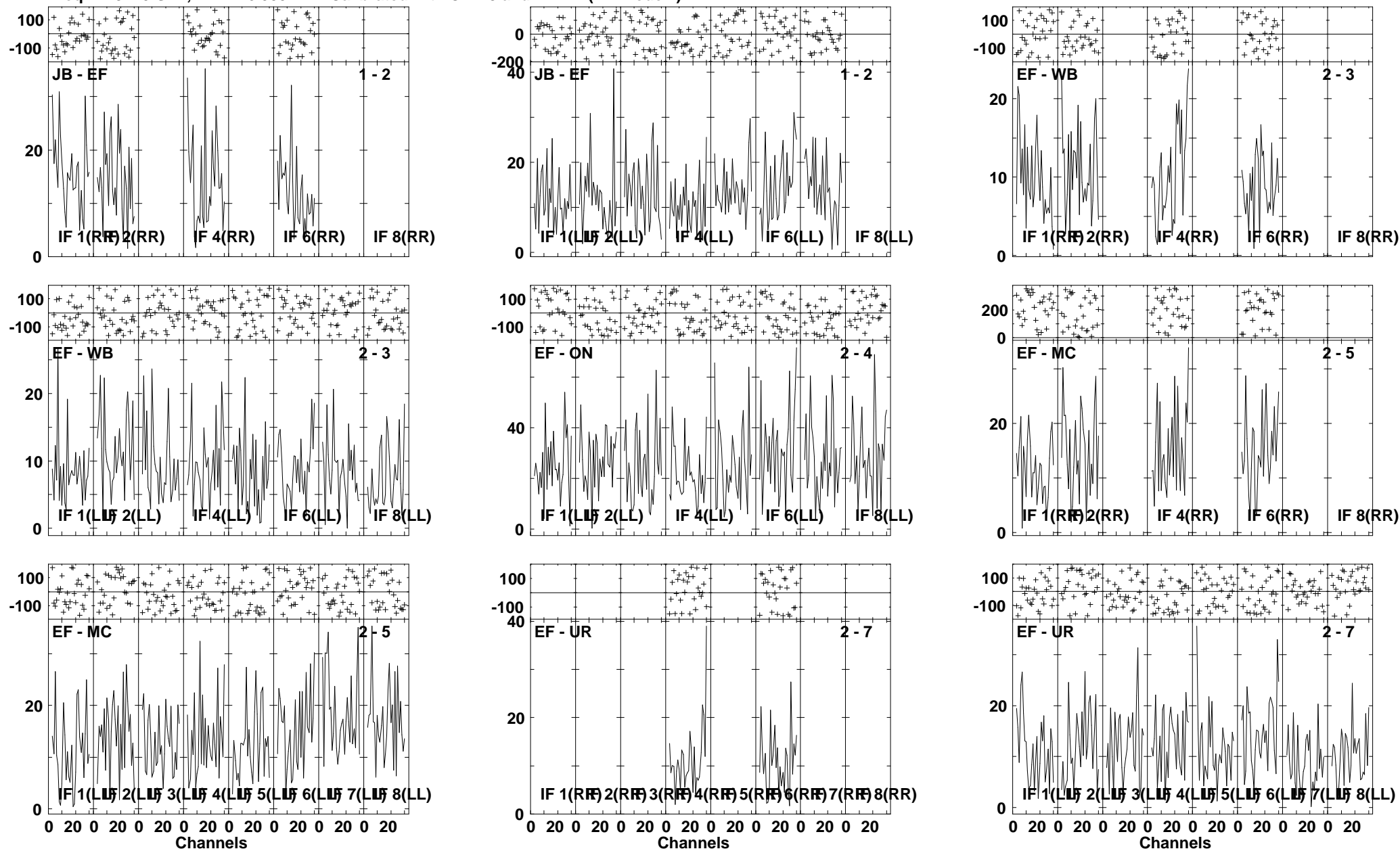

Lower frame: Milli Ampl Jy Top frame: Phas deg
Vector averaged cross-power spectrum Several baselines displayed
Timerange: 00/21:55:01 to 00/21:58:29

Plot file version 13 created 13-OCT-2010 18:38:27

IRAS1954 EP064N.UVDATA.1

Freq = 4.9270 GHz, Bw = 16.000 MH Calibrated with CL # 3 and BP # 1 (BP mode 1)

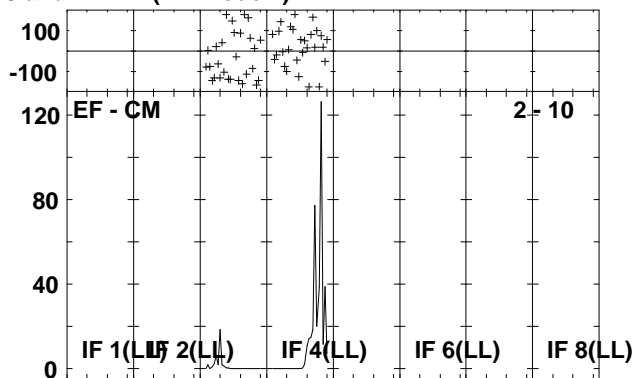
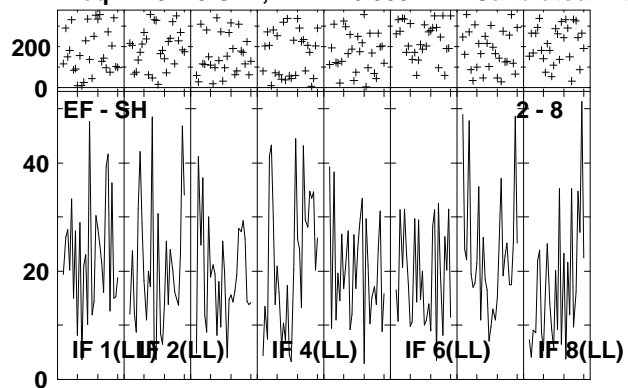

Lower frame: Milli Ampl Jy Top frame: Phas deg
Vector averaged cross-power spectrum Several baselines displayed
Timerange: 00/21:55:01 to 00/21:58:29

Plot file version 14 created 13-OCT-2010 18:38:29

J2001+10 EP064N.UVDATA.1

Freq = 4.9270 GHz, Bw = 16.000 MH Calibrated with CL # 3 and BP # 1 (BP mode 1)

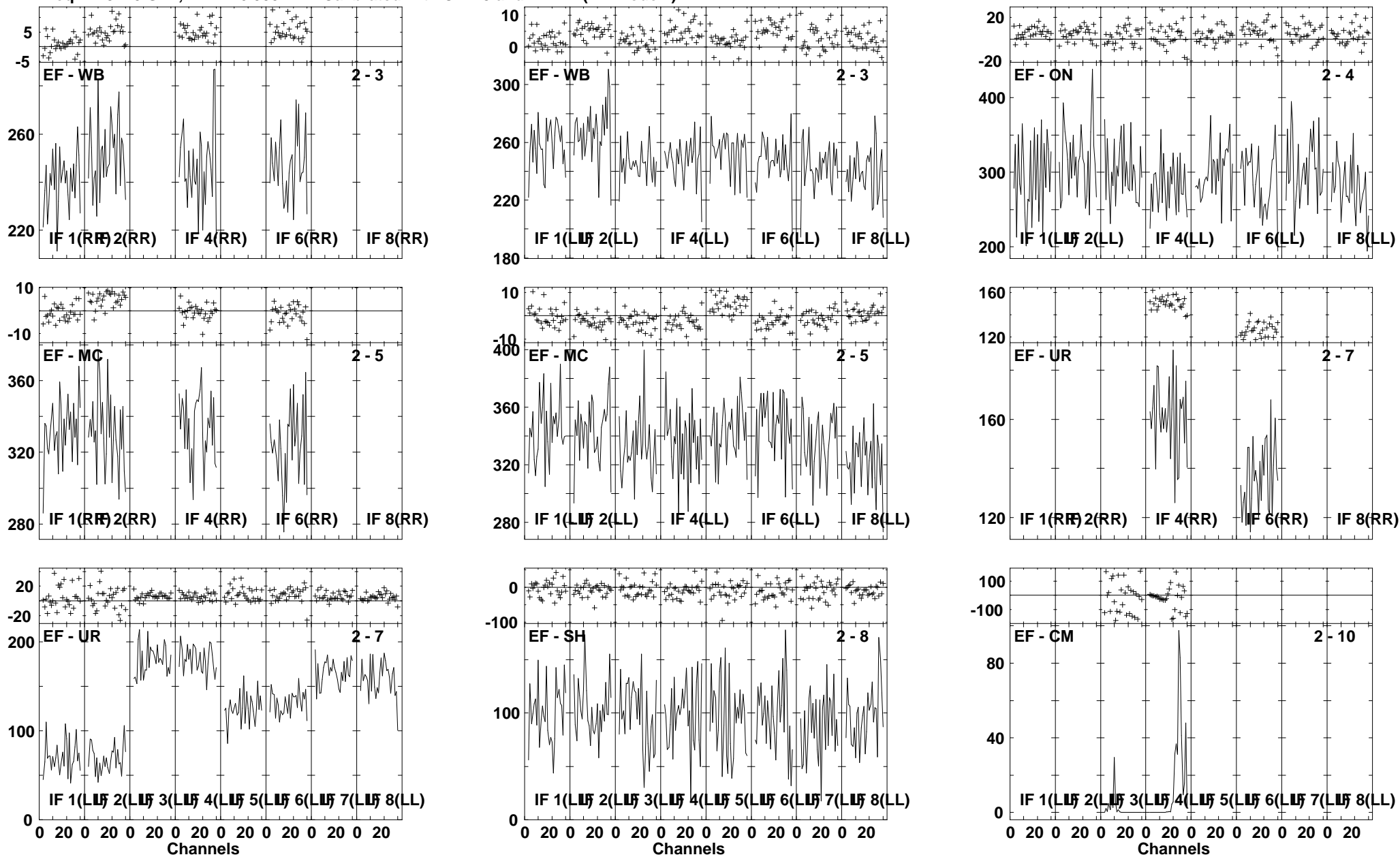

Lower frame: Milli Ampl Jy Top frame: Phas deg
Vector averaged cross-power spectrum Several baselines displayed
Timerange: 00/21:58:31 to 00/21:59:59

Plot file version 15 created 13-OCT-2010 18:38:31

IRAS1954 EP064N.UVDATA.1

Freq = 4.9270 GHz, Bw = 16.000 MH Calibrated with CL # 3 and BP # 1 (BP mode 1)

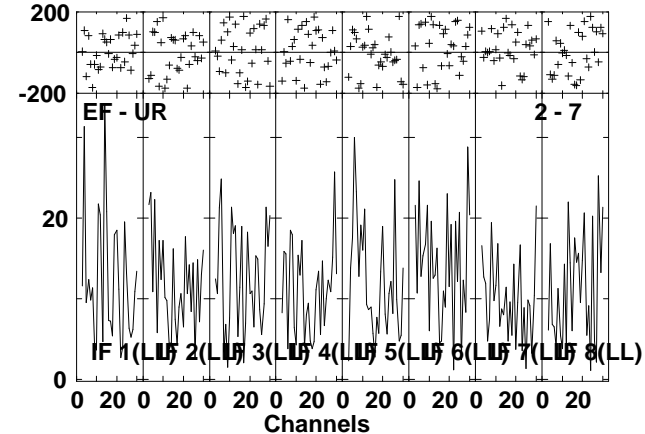
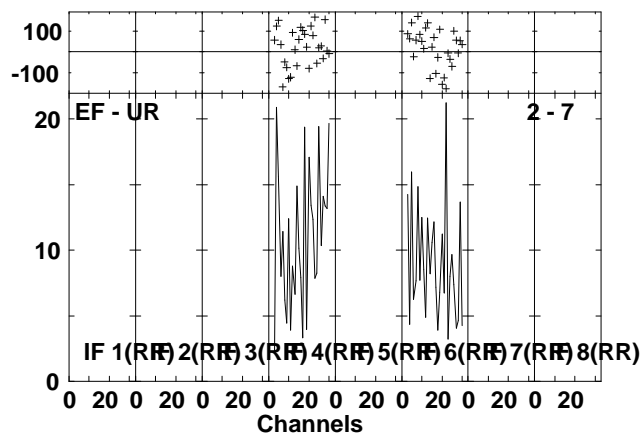
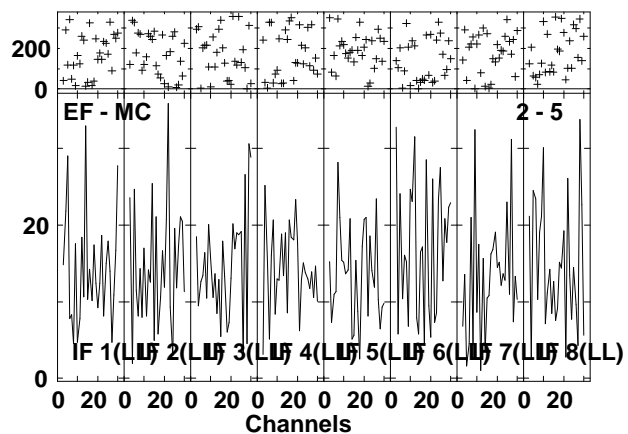
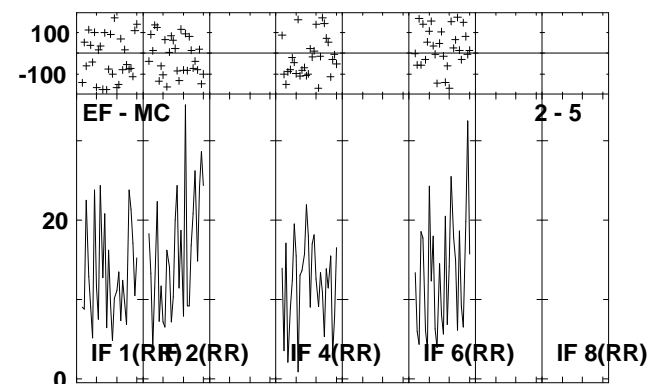
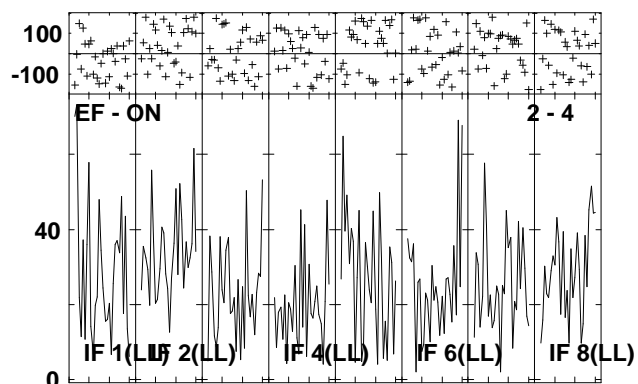
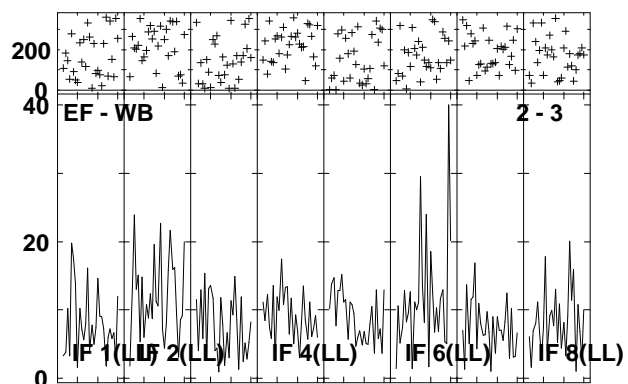
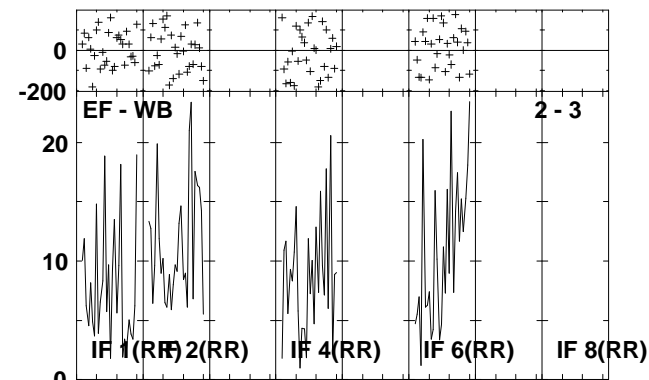
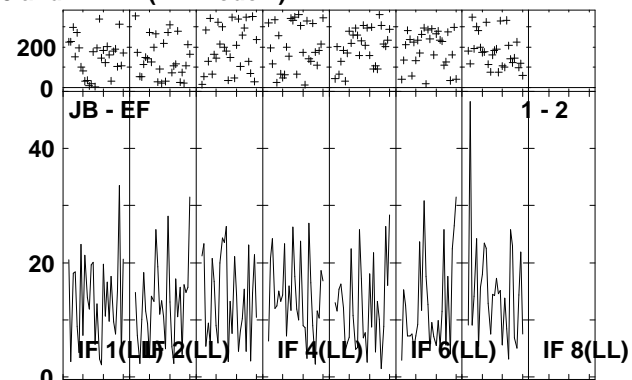
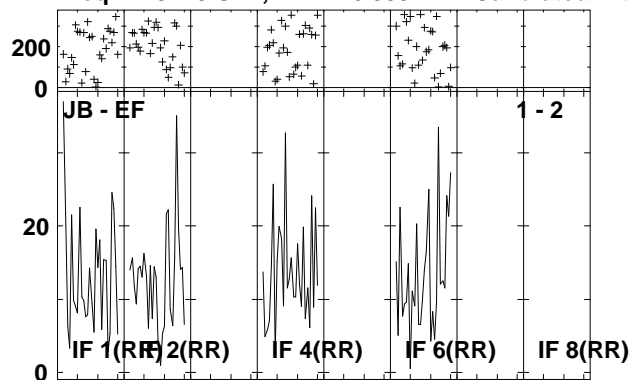

Lower frame: Milli Ampl Jy Top frame: Phas deg
Vector averaged cross-power spectrum Several baselines displayed
Timerange: 00/22:00:01 to 00/22:03:29

Plot file version 16 created 13-OCT-2010 18:38:35

IRAS1954 EP064N.UVDATA.1

Freq = 4.9270 GHz, Bw = 16.000 MH Calibrated with CL # 3 and BP # 1 (BP mode 1)

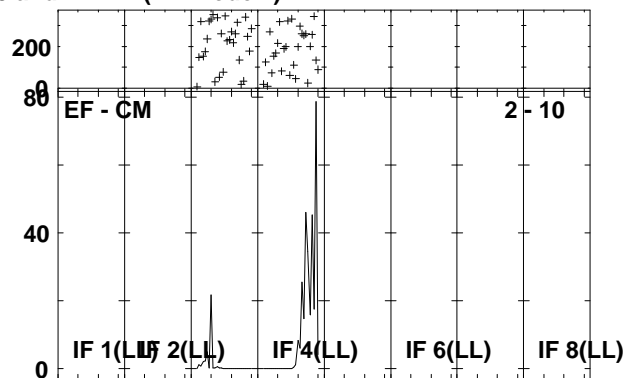
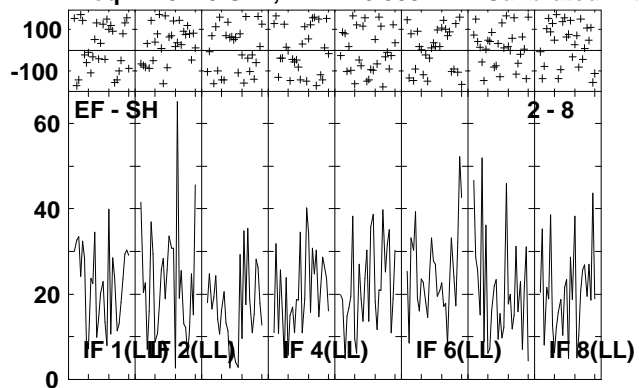

Lower frame: Milli Ampl Jy Top frame: Phas deg
Vector averaged cross-power spectrum Several baselines displayed
Timerange: 00/22:00:01 to 00/22:03:29

Plot file version 17 created 13-OCT-2010 18:38:37

J2001+10 EP064N.UVDATA.1

Freq = 4.9270 GHz, Bw = 16.000 MH Calibrated with CL # 3 and BP # 1 (BP mode 1)

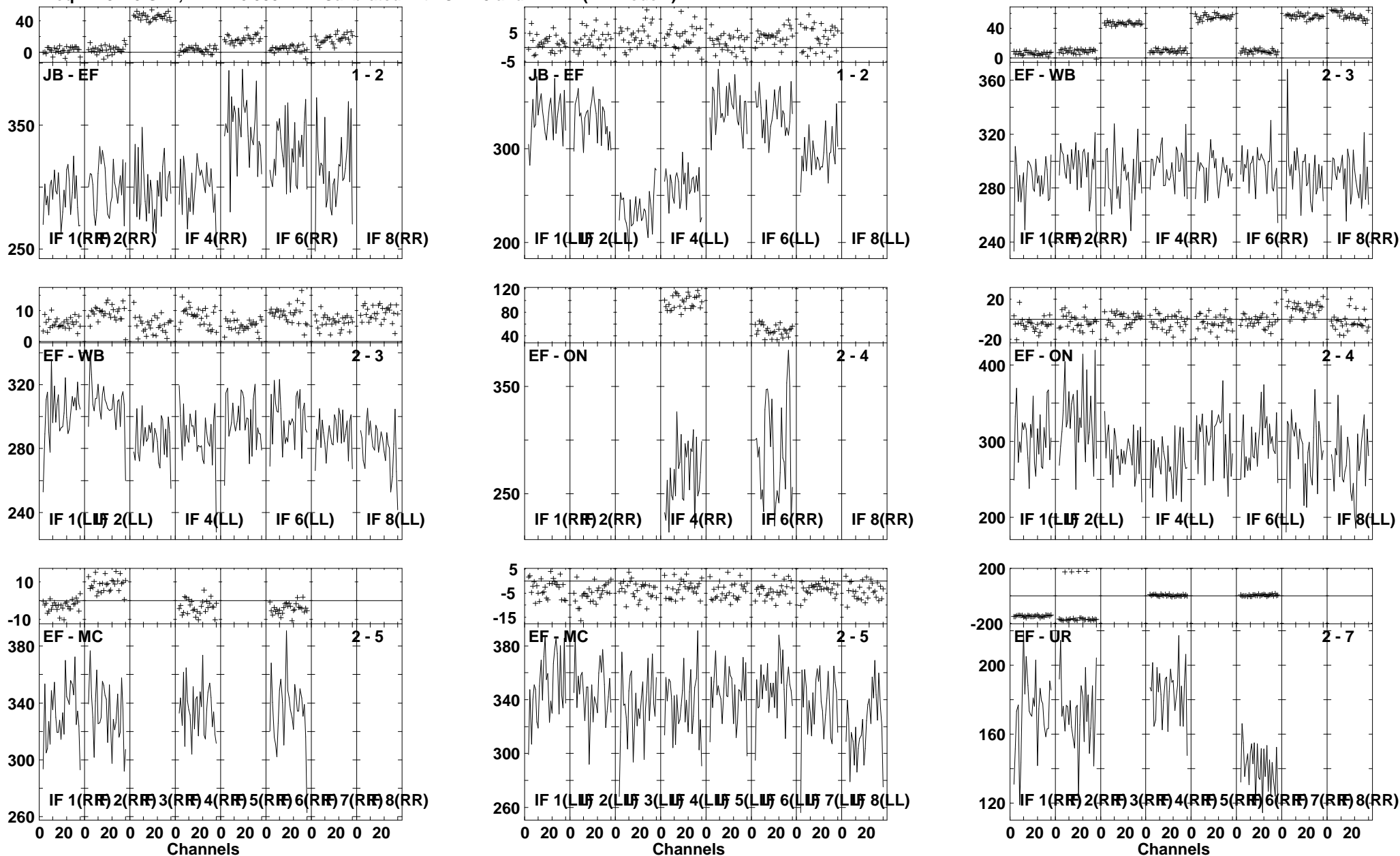

Lower frame: Milli Ampl Jy Top frame: Phas deg
Vector averaged cross-power spectrum Several baselines displayed
Timerange: 00/22:03:31 to 00/22:04:59

Plot file version 18 created 13-OCT-2010 18:38:38
J2001+10 EP064N.UVDATA.1
Freq = 4.9270 GHz, Bw = 16.000 MH Calibrated with CL # 3 and BP # 1 (BP mode 1)

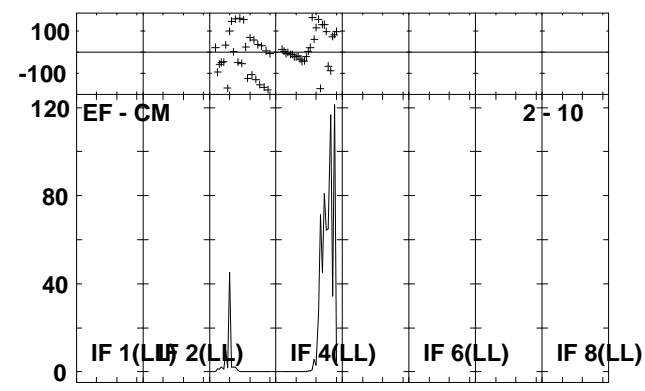
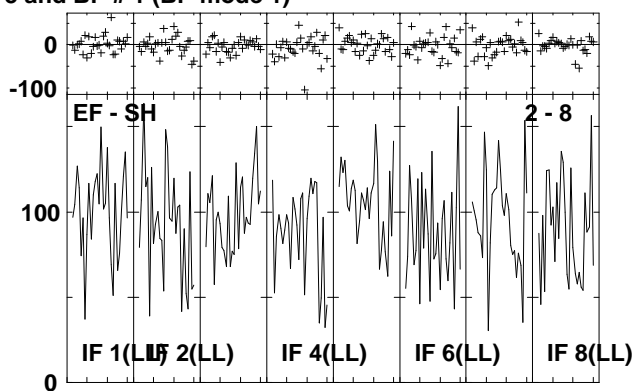
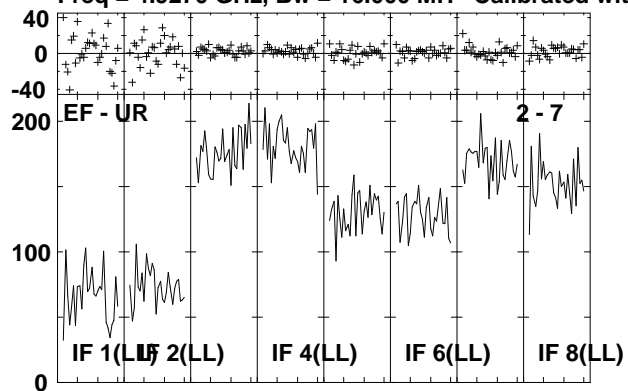

Lower frame: Milli Ampl Jy Top frame: Phas deg
Vector averaged cross-power spectrum Several baselines displayed
Timerange: 00/22:03:31 to 00/22:04:59

Plot file version 19 created 13-OCT-2010 18:38:40

IRAS1954 EP064N.UVDATA.1

Freq = 4.9270 GHz, Bw = 16.000 MH Calibrated with CL # 3 and BP # 1 (BP mode 1)

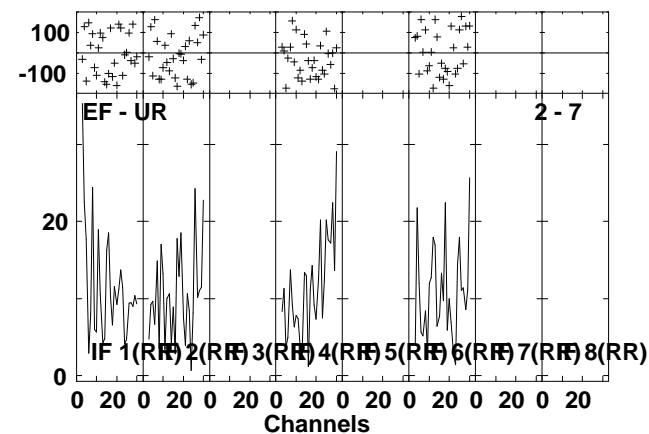
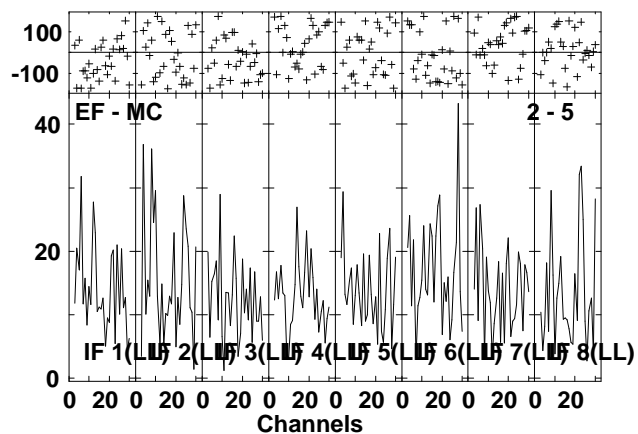
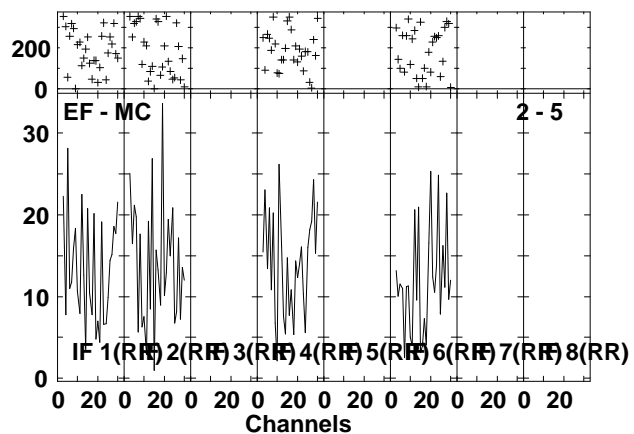
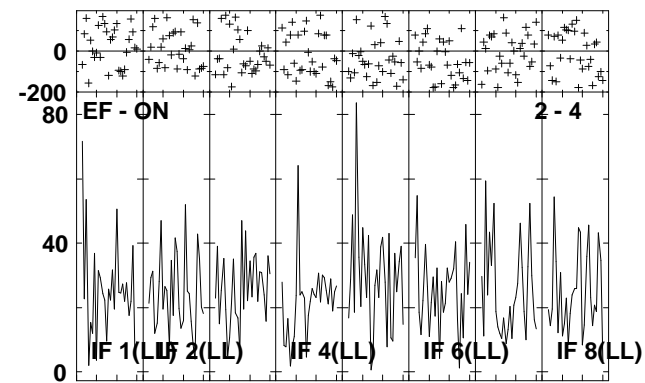
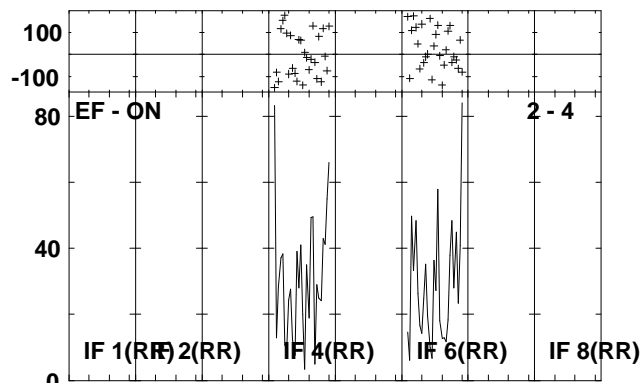
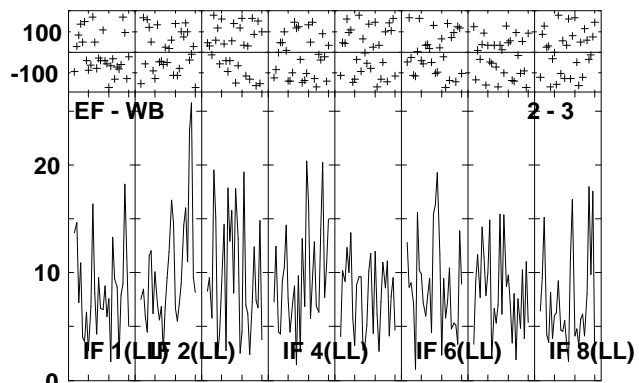
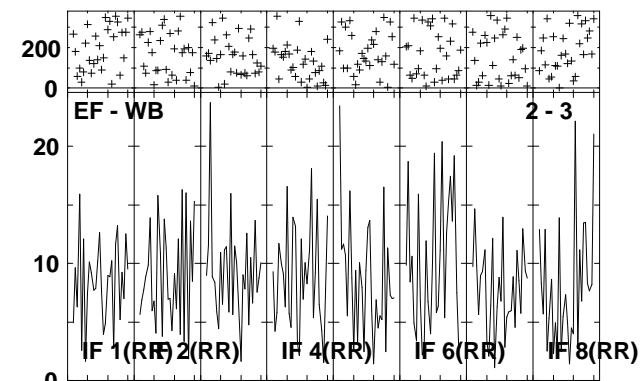
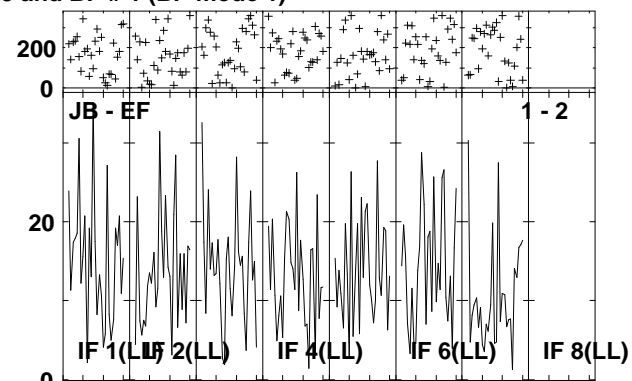
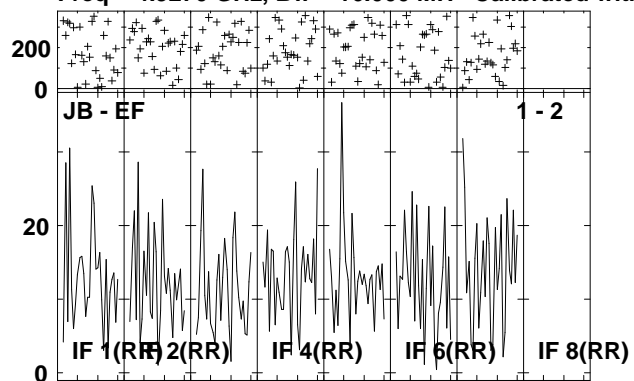

Lower frame: Milli Ampl Jy Top frame: Phas deg
Vector averaged cross-power spectrum Several baselines displayed
Timerange: 00/22:05:01 to 00/22:08:29

Plot file version 20 created 13-OCT-2010 18:38:43

IRAS1954 EP064N.UVDATA.1

Freq = 4.9270 GHz, Bw = 16.000 MH Calibrated with CL # 3 and BP # 1 (BP mode 1)

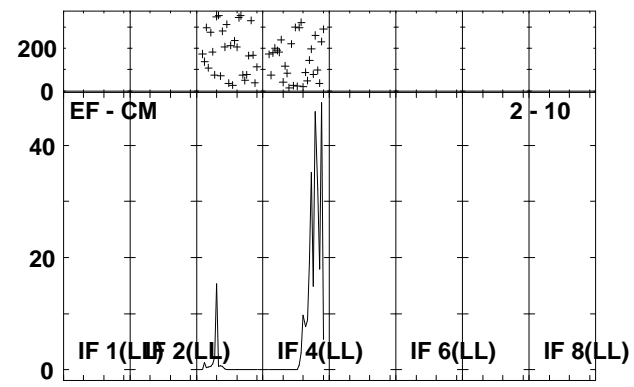
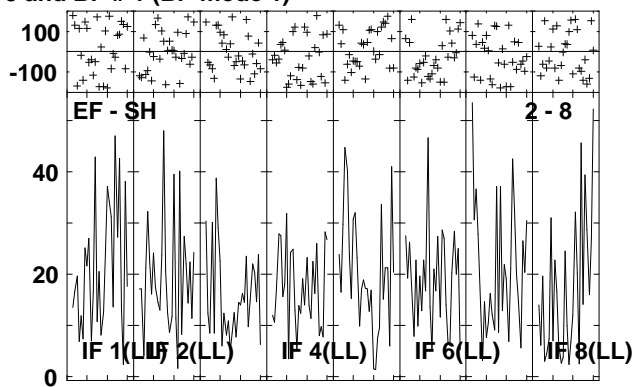
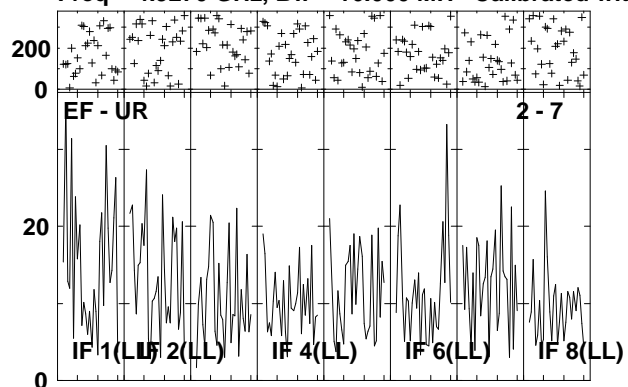

Lower frame: Milli Ampl Jy Top frame: Phas deg
Vector averaged cross-power spectrum Several baselines displayed
Timerange: 00/22:05:01 to 00/22:08:29

Plot file version 21 created 13-OCT-2010 18:38:45
 J2001+10 EP064N.UVDATA.1
 Freq = 4.9270 GHz, Bw = 16.000 MH Calibrated with CL # 3 and BP # 1 (BP mode 1)

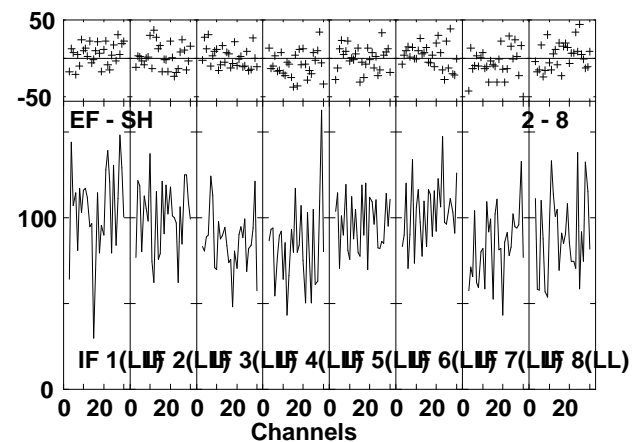
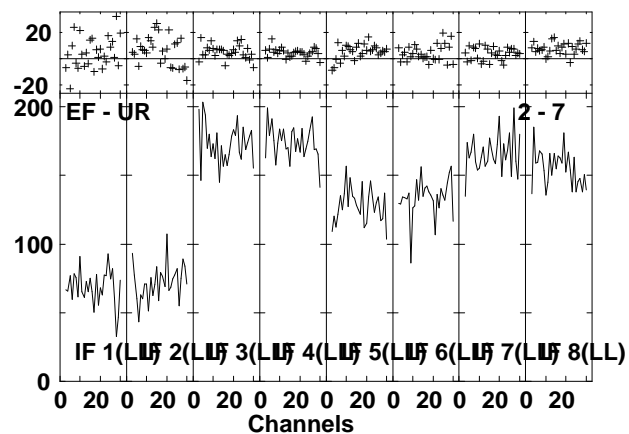
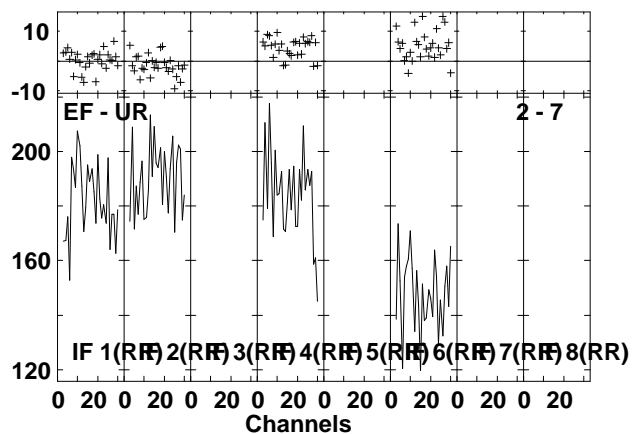
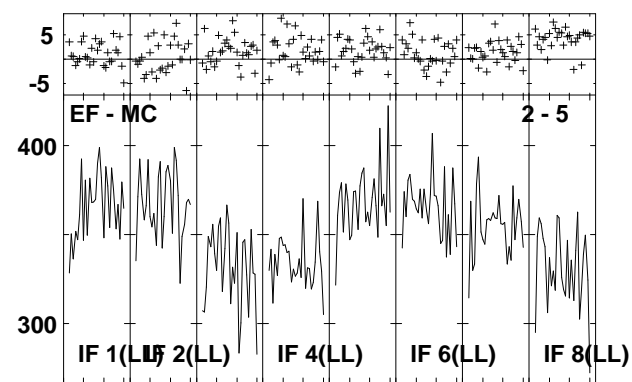
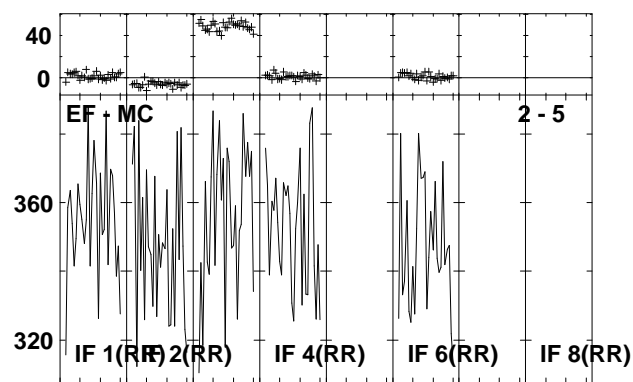
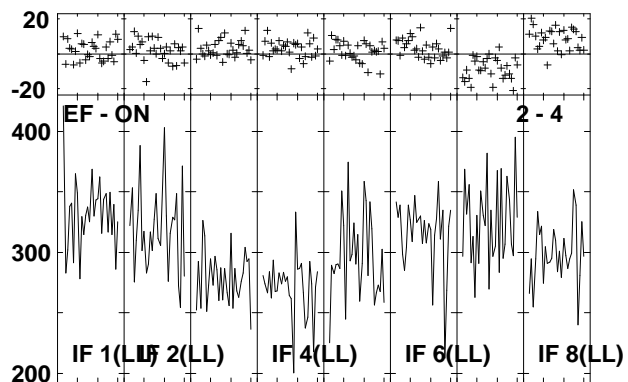
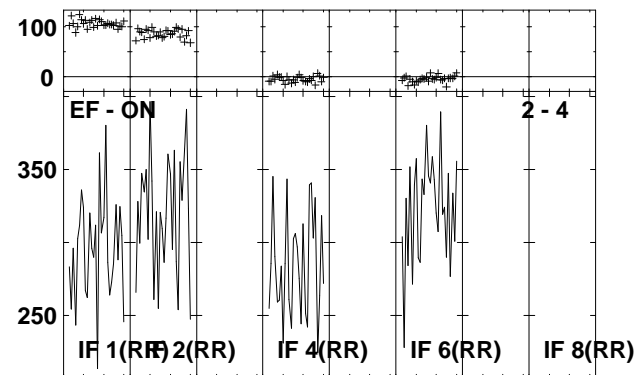
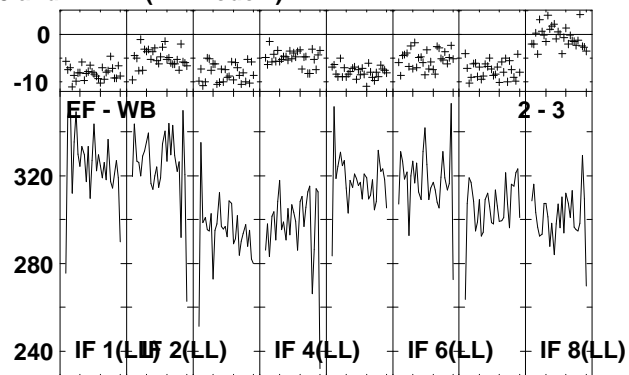
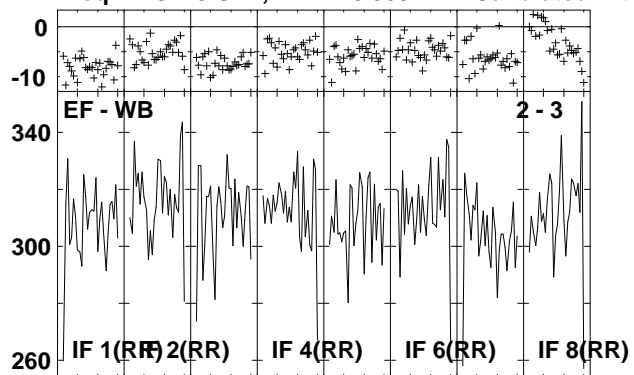

Lower frame: Milli Ampl Jy Top frame: Phas deg
 Vector averaged cross-power spectrum Several baselines displayed
 Timerange: 00/22:09:31 to 00/22:10:59

Plot file version 22 created 13-OCT-2010 18:38:47
J2001+10 EP064N.UVDATA.1
Freq = 4.9270 GHz, Bw = 16.000 MH Calibrated with CL # 3 and BP # 1 (BP mode 1)

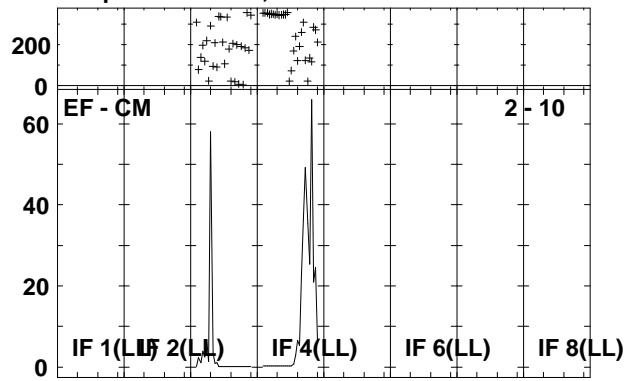

Lower frame: Ampl Jy Top frame: Phas deg
Vector averaged cross-power spectrum Several baselines displayed
Timerange: 00/22:09:31 to 00/22:10:59

Plot file version 23 created 13-OCT-2010 18:38:48

IRAS1954 EP064N.UVDATA.1

Freq = 4.9270 GHz, Bw = 16.000 MH Calibrated with CL # 3 and BP # 1 (BP mode 1)

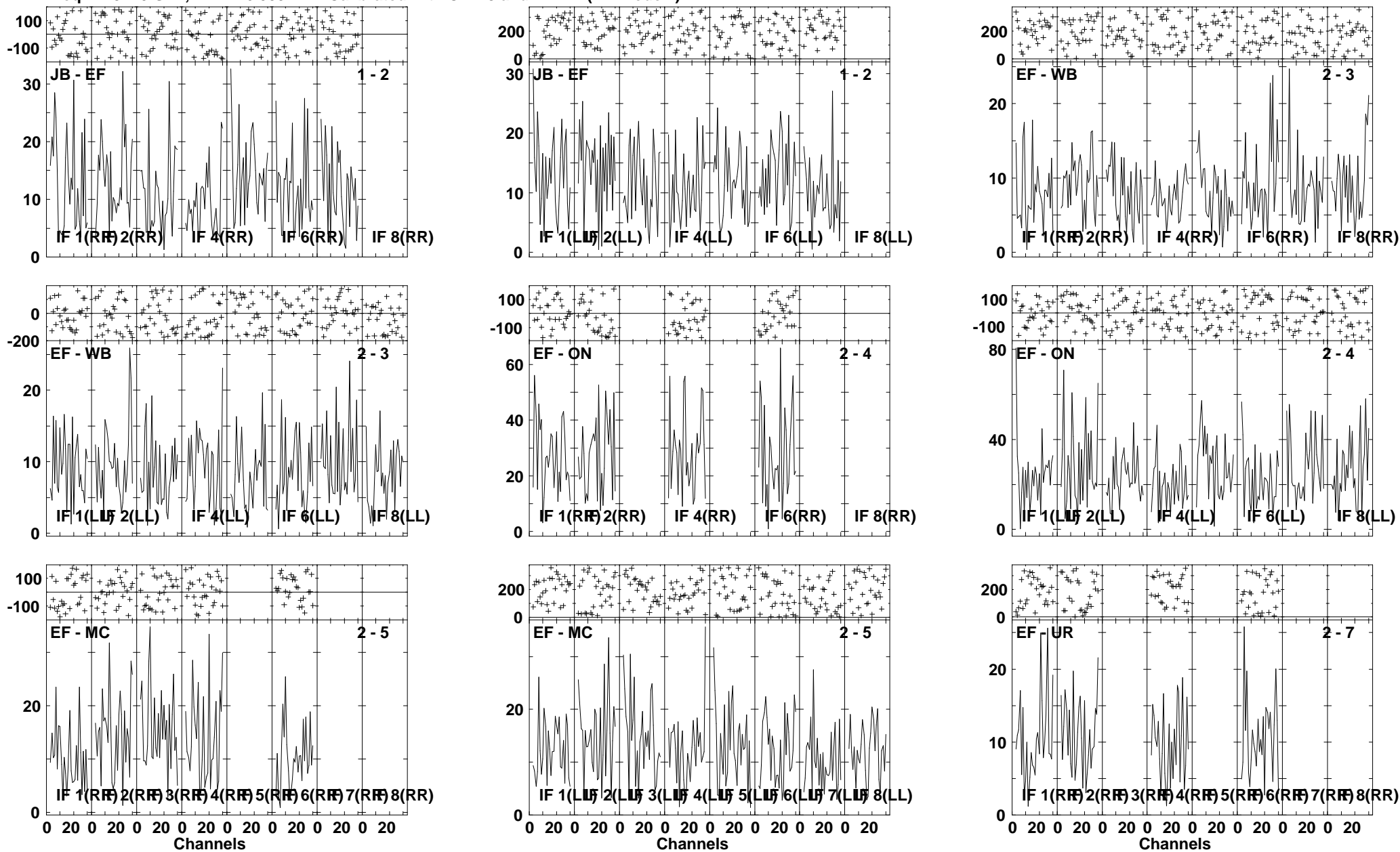

Lower frame: Milli Ampl Jy Top frame: Phas deg
Vector averaged cross-power spectrum Several baselines displayed
Timerange: 00/22:11:01 to 00/22:14:29

Plot file version 24 created 13-OCT-2010 18:38:51

IRAS1954 EP064N.UVDATA.1

Freq = 4.9270 GHz, Bw = 16.000 MH Calibrated with CL # 3 and BP # 1 (BP mode 1)

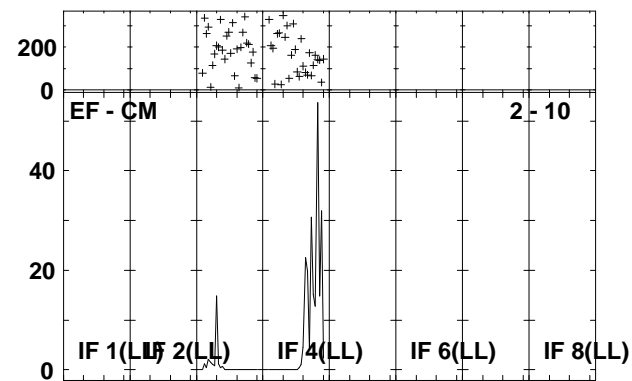
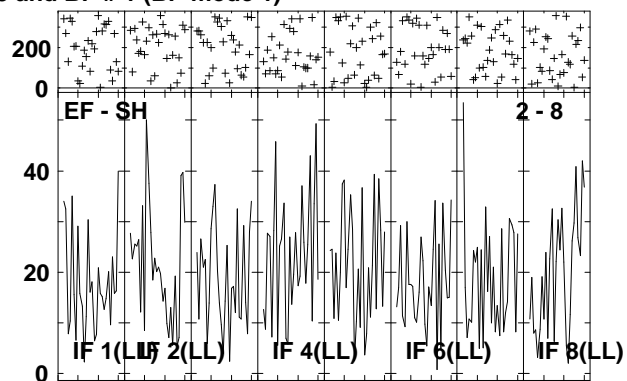
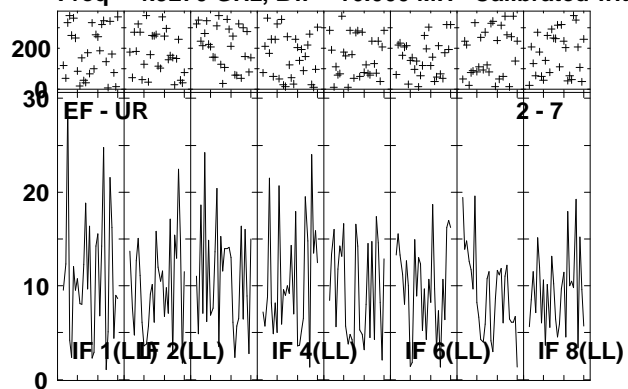

Lower frame: Milli Ampl Jy Top frame: Phas deg
Vector averaged cross-power spectrum Several baselines displayed
Timerange: 00/22:11:01 to 00/22:14:29

Plot file version 25 created 13-OCT-2010 18:38:53
 J2001+10 EP064N.UVDATA.1
 Freq = 4.9270 GHz, Bw = 16.000 MH Calibrated with CL # 3 and BP # 1 (BP mode 1)

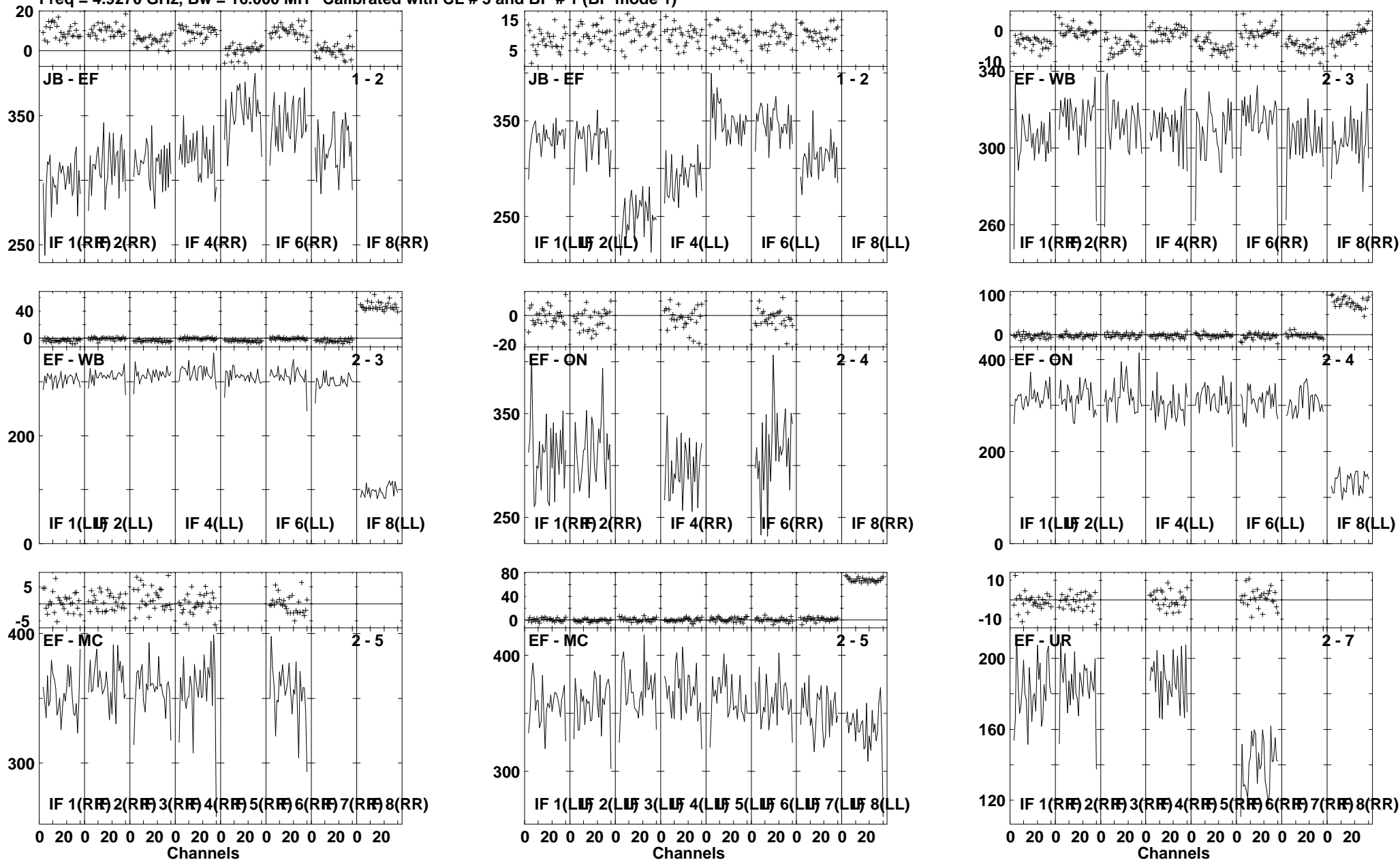

Lower frame: Milli Ampl Jy Top frame: Phas deg
 Vector averaged cross-power spectrum Several baselines displayed
 Timerange: 00/22:15:31 to 00/22:16:59

Plot file version 26 created 13-OCT-2010 18:38:55
J2001+10 EP064N.UVDATA.1
Freq = 4.9270 GHz, Bw = 16.000 MH Calibrated with CL # 3 and BP # 1 (BP mode 1)

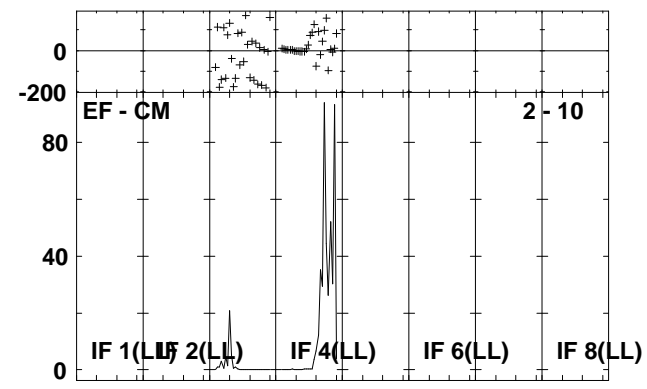
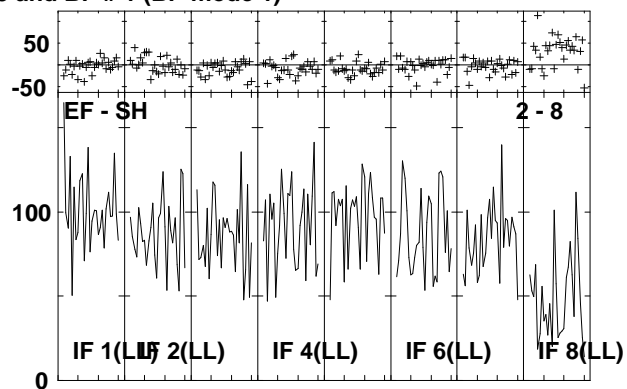
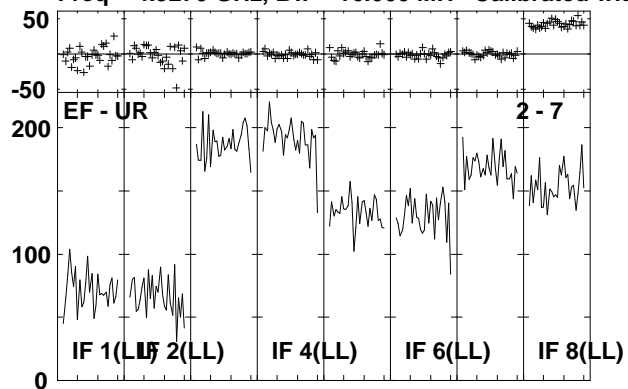

Lower frame: Milli Ampl Jy Top frame: Phas deg
Vector averaged cross-power spectrum Several baselines displayed
Timerange: 00/22:15:31 to 00/22:16:59

Plot file version 27 created 13-OCT-2010 18:38:56

IRAS1954 EP064N.UVDATA.1

Freq = 4.9270 GHz, Bw = 16.000 MH Calibrated with CL # 3 and BP # 1 (BP mode 1)

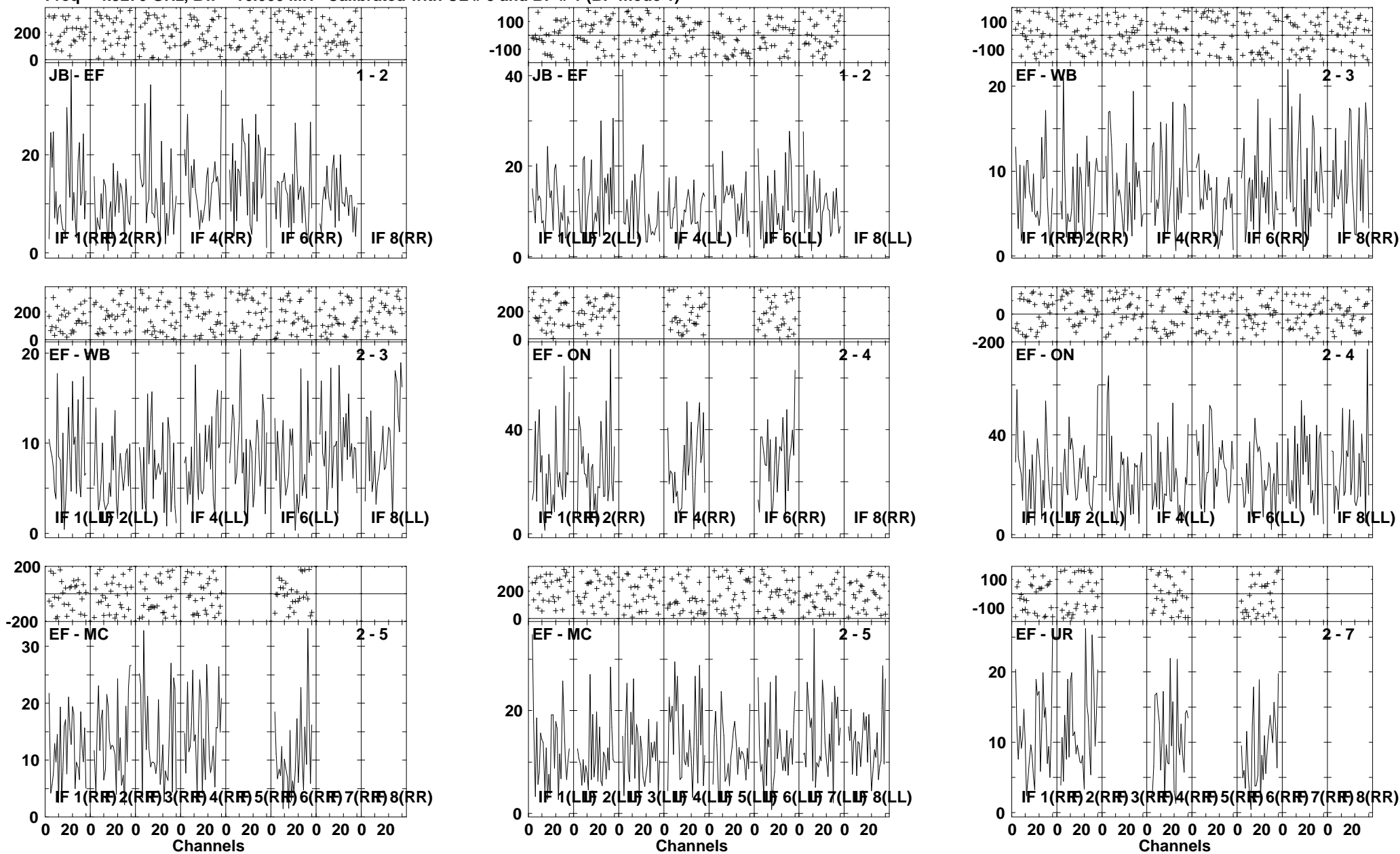

Lower frame: Milli Ampl Jy Top frame: Phas deg
Vector averaged cross-power spectrum Several baselines displayed
Timerange: 00/22:17:01 to 00/22:20:29

Plot file version 28 created 13-OCT-2010 18:38:59

IRAS1954 EP064N.UVDATA.1

Freq = 4.9270 GHz, Bw = 16.000 MH Calibrated with CL # 3 and BP # 1 (BP mode 1)

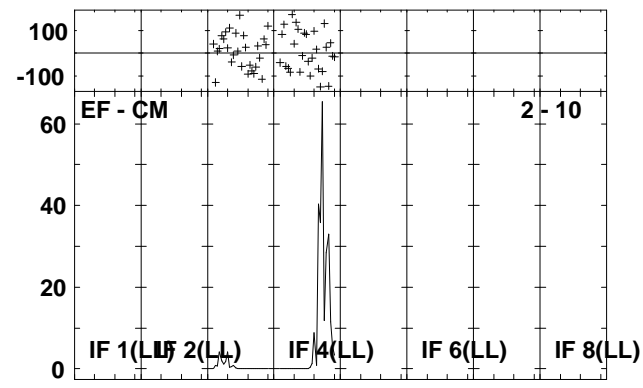
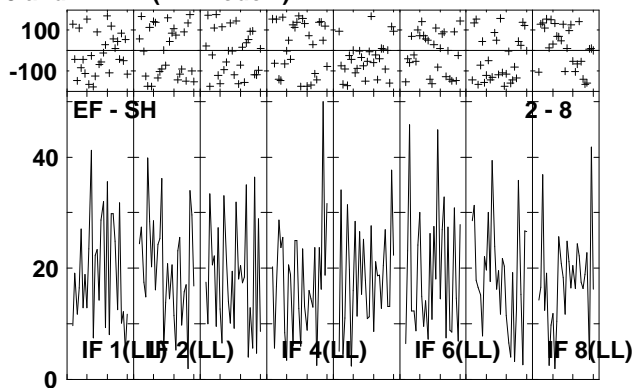
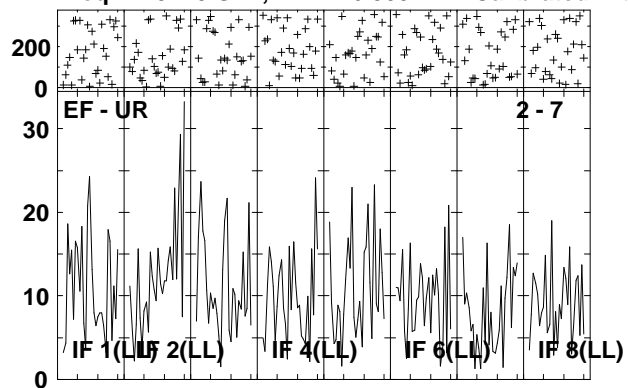

Lower frame: Milli Ampl Jy Top frame: Phas deg
Vector averaged cross-power spectrum Several baselines displayed
Timerange: 00/22:17:01 to 00/22:20:29

Plot file version 29 created 13-OCT-2010 18:39:02

J2001+10 EP064N.UVDATA.1

Freq = 4.9270 GHz, Bw = 16.000 MH Calibrated with CL # 3 and BP # 1 (BP mode 1)

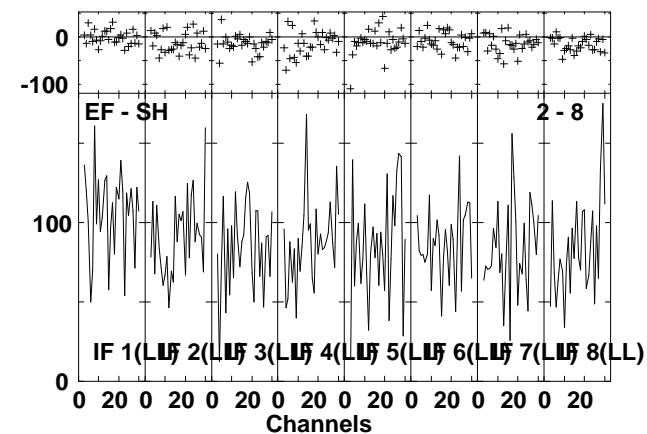
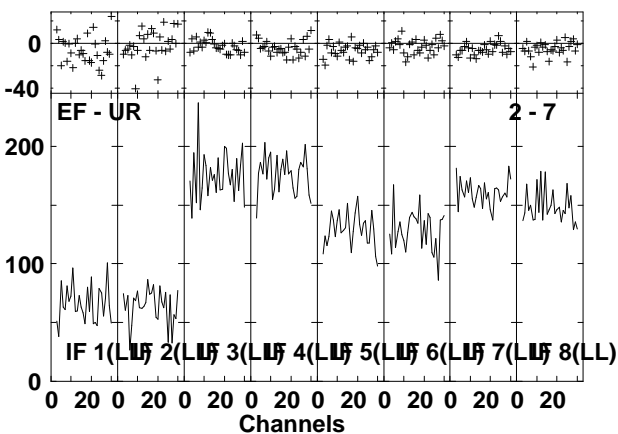
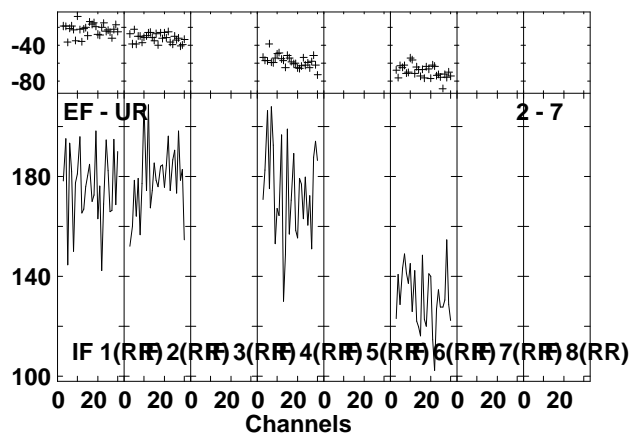
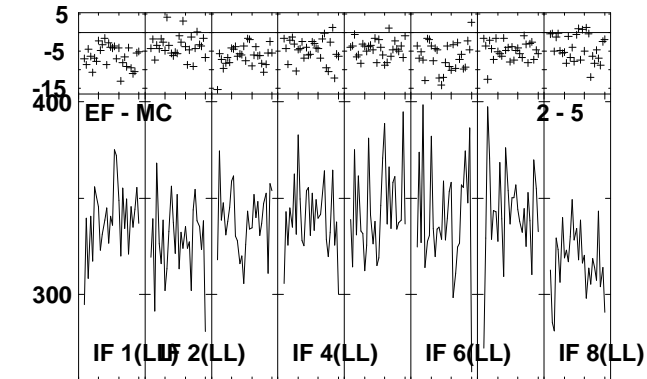
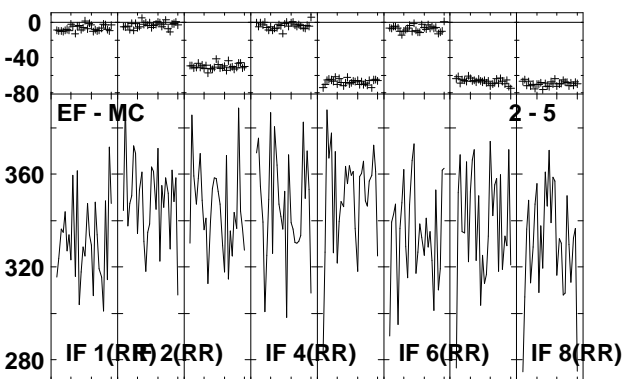
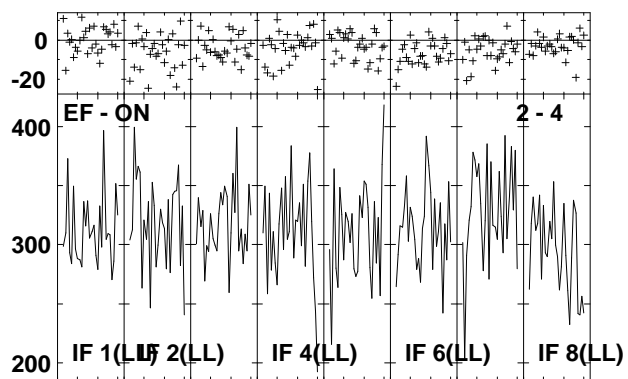
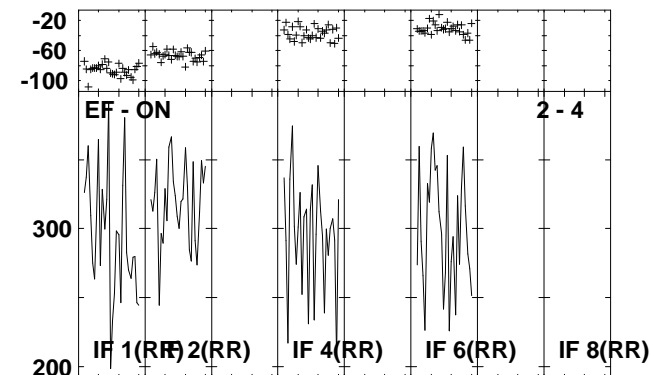
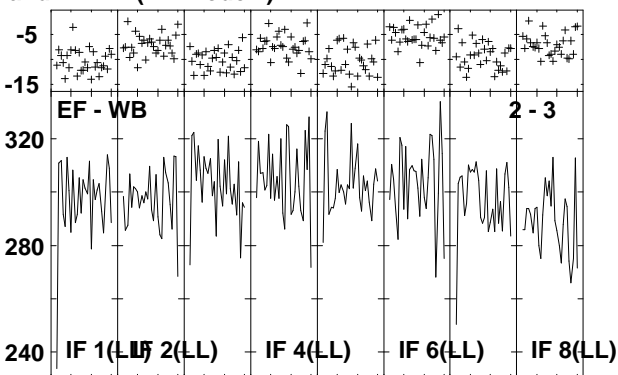
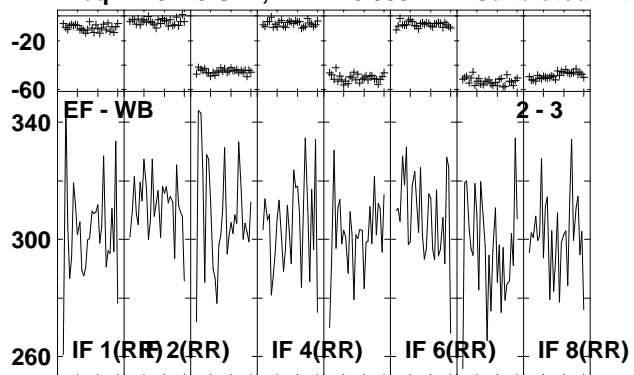

Lower frame: Milli Ampl Jy Top frame: Phas deg
Vector averaged cross-power spectrum Several baselines displayed
Timerange: 00/22:20:31 to 00/22:21:59

Plot file version 30 created 13-OCT-2010 18:39:03
J2001+10 EP064N.UVDATA.1
Freq = 4.9270 GHz, Bw = 16.000 MH Calibrated with CL # 3 and BP # 1 (BP mode 1)

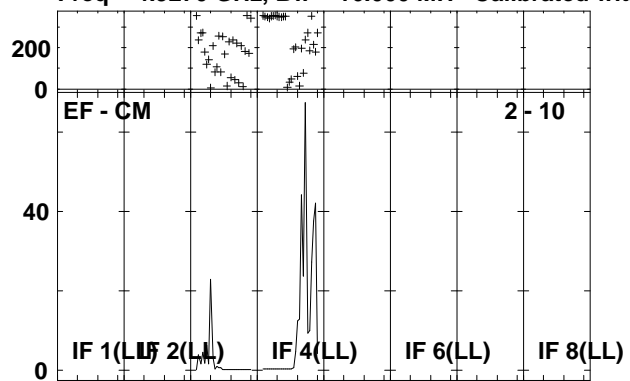

Lower frame: Ampl Jy Top frame: Phas deg
Vector averaged cross-power spectrum Several baselines displayed
Timerange: 00/22:20:31 to 00/22:21:59

Plot file version 31 created 13-OCT-2010 18:39:04

IRAS1954 EP064N.UVDATA.1

Freq = 4.9270 GHz, Bw = 16.000 MH Calibrated with CL # 3 and BP # 1 (BP mode 1)

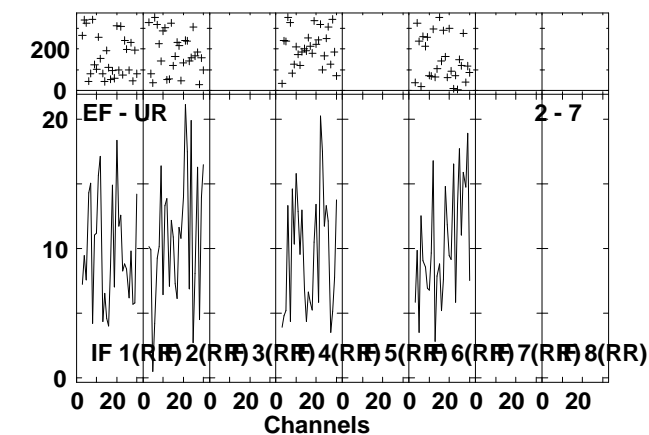
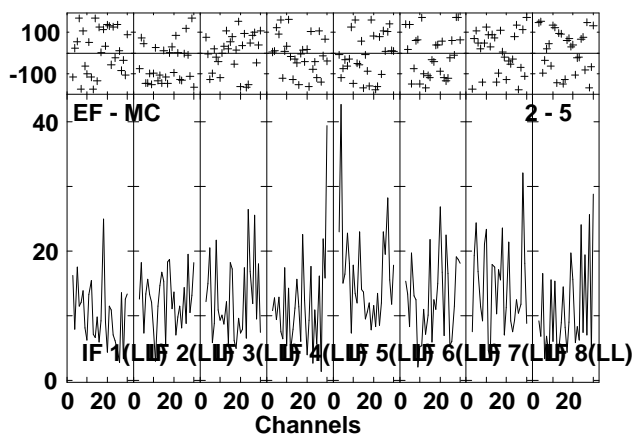
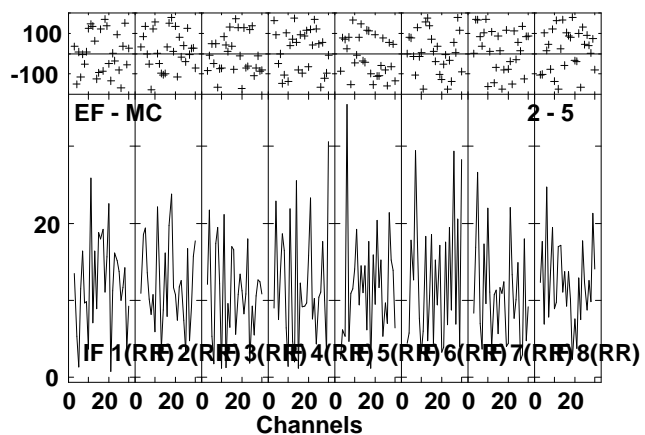
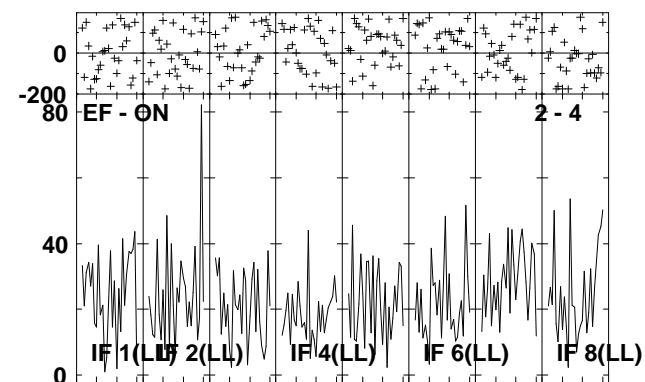
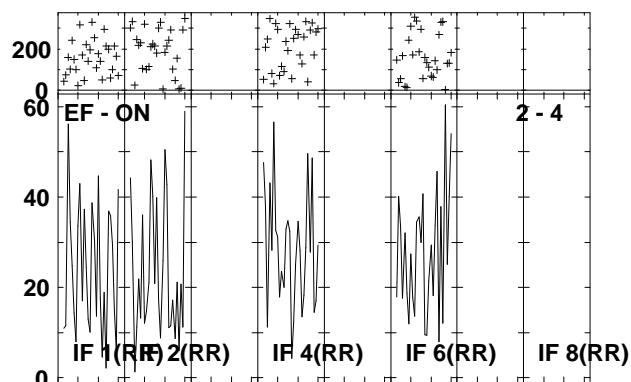
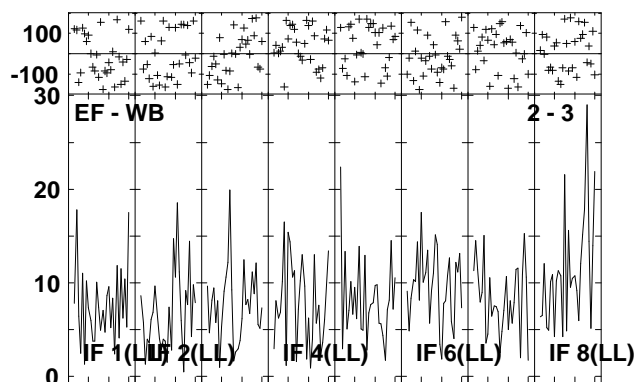
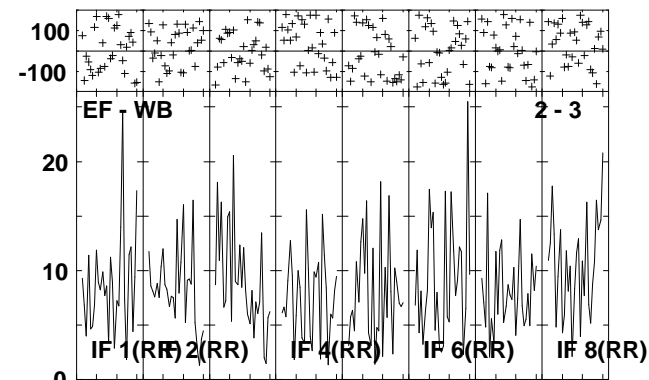
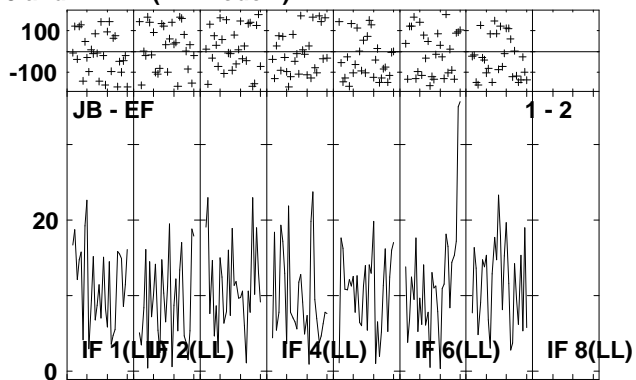
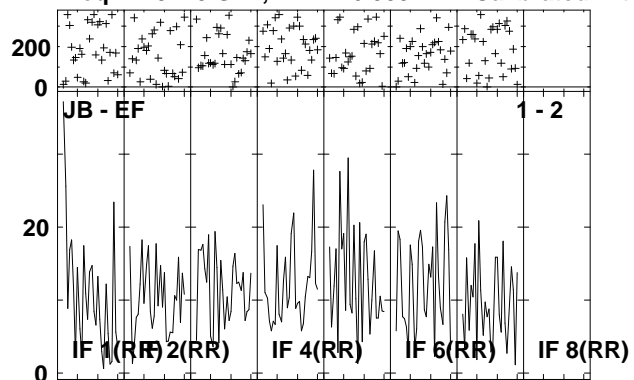

Lower frame: Milli Ampl Jy Top frame: Phas deg
Vector averaged cross-power spectrum Several baselines displayed
Timerange: 00/22:22:01 to 00/22:25:29

Plot file version 32 created 13-OCT-2010 18:39:07

IRAS1954 EP064N.UVDATA.1

Freq = 4.9270 GHz, Bw = 16.000 MH Calibrated with CL # 3 and BP # 1 (BP mode 1)

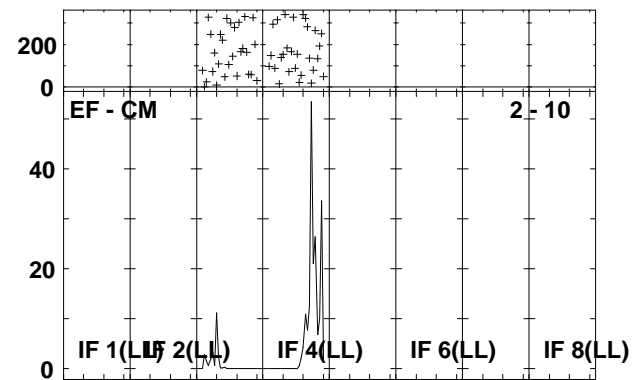
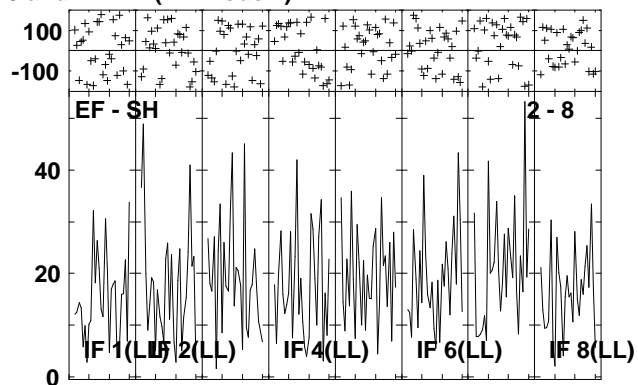
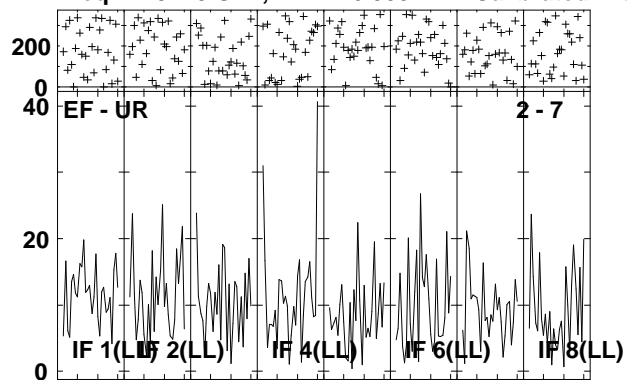

Lower frame: Milli Ampl Jy Top frame: Phas deg
Vector averaged cross-power spectrum Several baselines displayed
Timerange: 00/22:22:01 to 00/22:25:29

Plot file version 33 created 13-OCT-2010 18:39:10

J2001+10 EP064N.UVDATA.1

Freq = 4.9270 GHz, Bw = 16.000 MH Calibrated with CL # 3 and BP # 1 (BP mode 1)

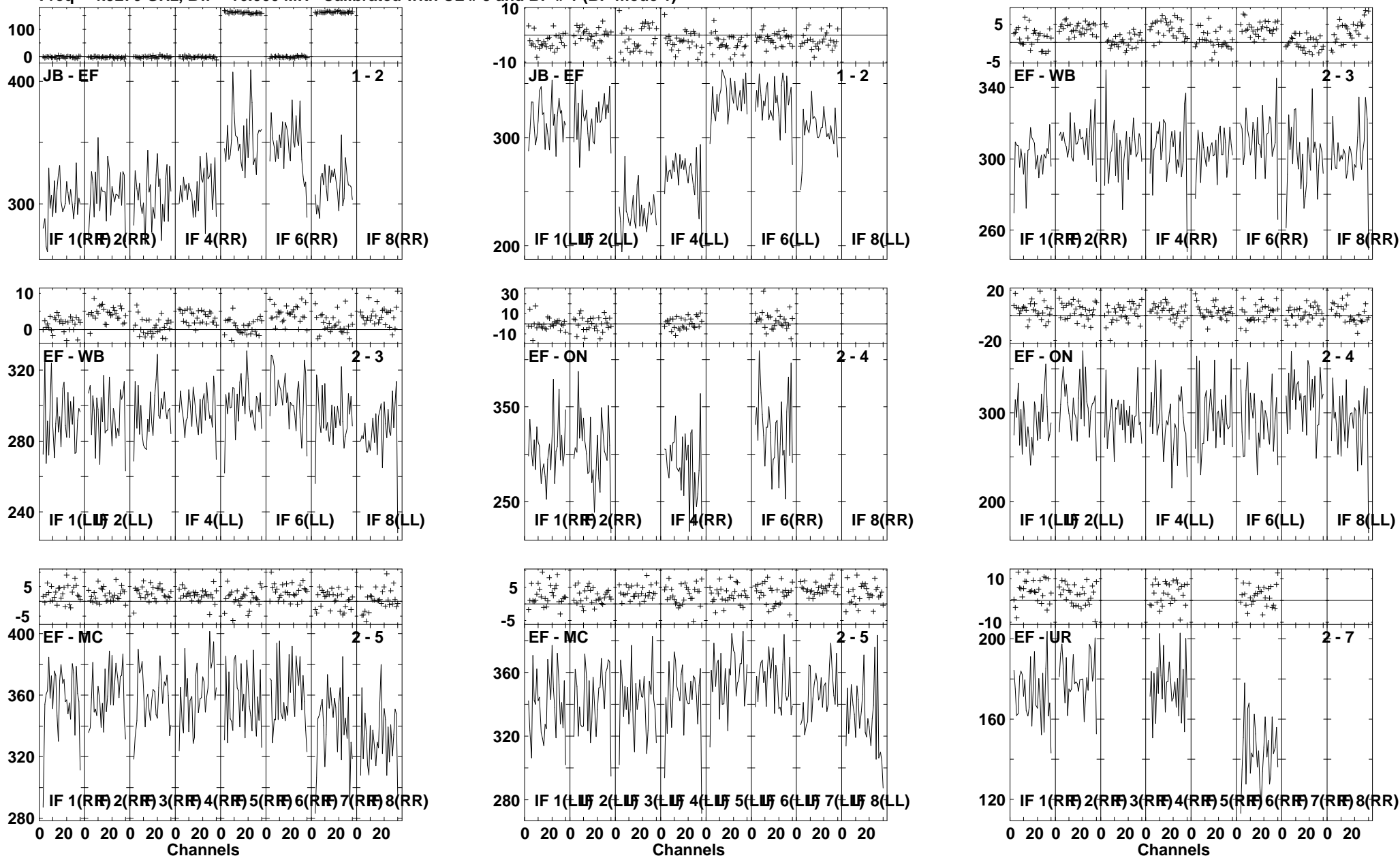

Lower frame: Milli Ampl Jy Top frame: Phas deg
Vector averaged cross-power spectrum Several baselines displayed
Timerange: 00/22:25:31 to 00/22:26:59

Plot file version 34 created 13-OCT-2010 18:39:11

J2001+10 EP064N.UVDATA.1

Freq = 4.9270 GHz, Bw = 16.000 MH Calibrated with CL # 3 and BP # 1 (BP mode 1)

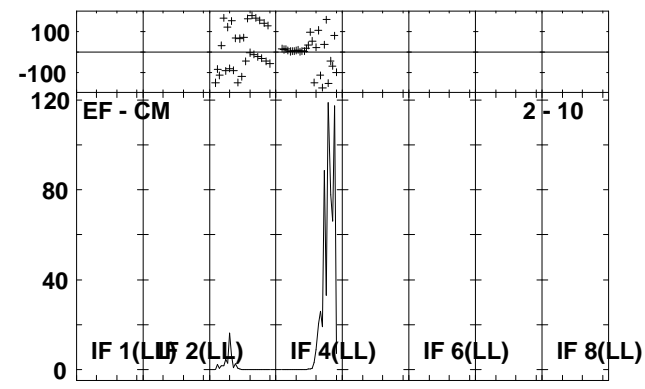
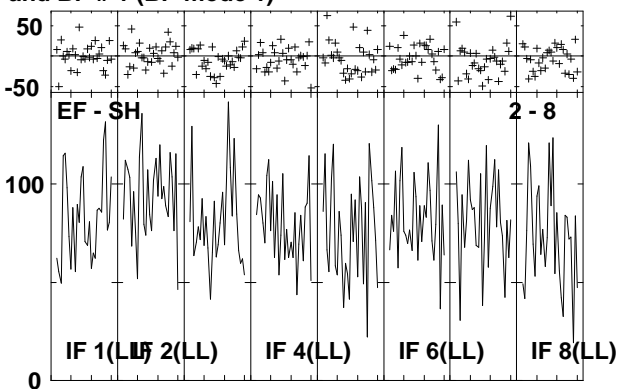
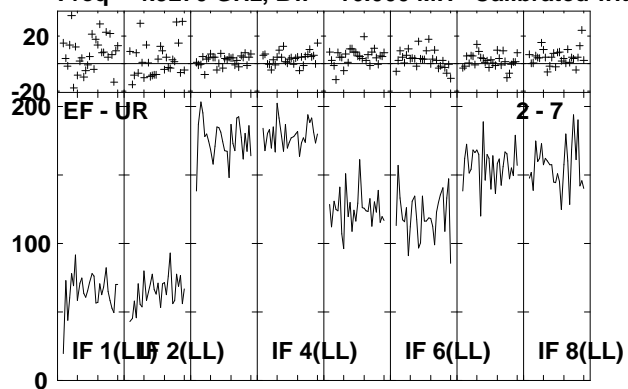

Lower frame: Milli Ampl Jy Top frame: Phas deg
Vector averaged cross-power spectrum Several baselines displayed
Timerange: 00/22:25:31 to 00/22:26:59

Plot file version 35 created 13-OCT-2010 18:39:13

IRAS1954 EP064N.UVDATA.1

Freq = 4.9270 GHz, Bw = 16.000 MH Calibrated with CL # 3 and BP # 1 (BP mode 1)

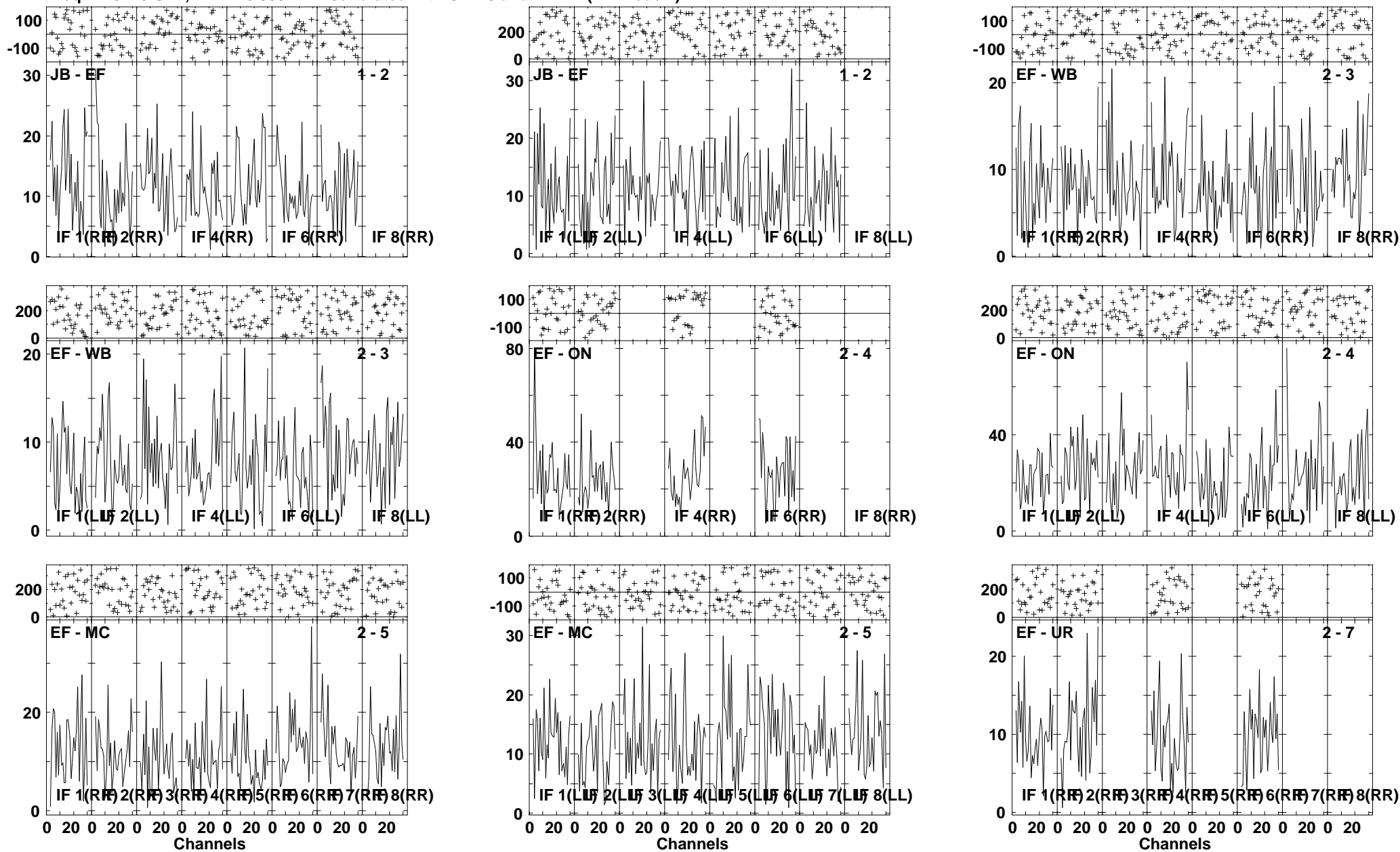

Lower frame: Milli Ampl Jy Top frame: Phas deg
Vector averaged cross-power spectrum Several baselines displayed
Timerange: 00/22:27:01 to 00/22:30:29

Plot file version 36 created 13-OCT-2010 18:39:16

IRAS1954 EP064N.UVDATA.1

Freq = 4.9270 GHz, Bw = 16.000 MH Calibrated with CL # 3 and BP # 1 (BP mode 1)

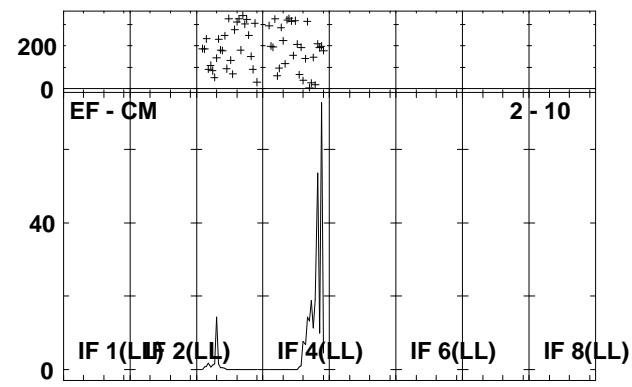
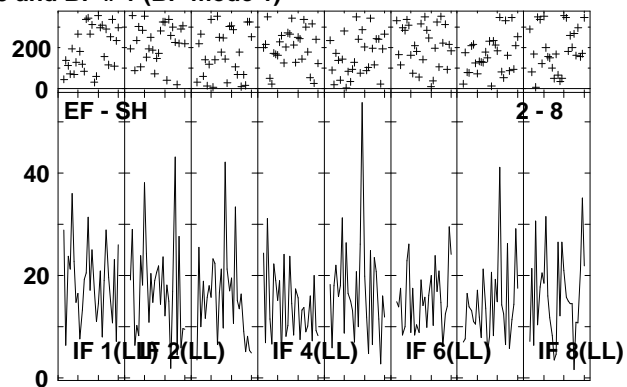
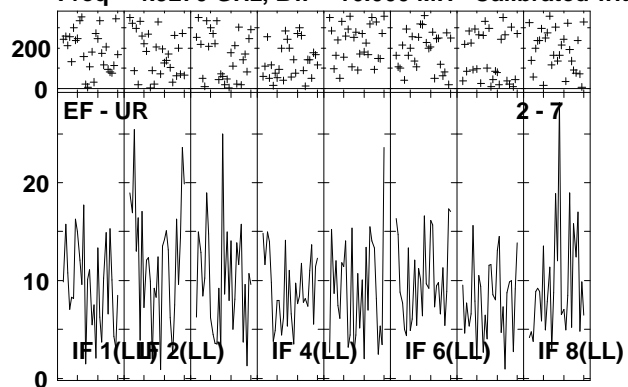

Lower frame: Milli Ampl Jy Top frame: Phas deg
Vector averaged cross-power spectrum Several baselines displayed
Timerange: 00/22:27:01 to 00/22:30:29

Plot file version 37 created 13-OCT-2010 18:39:19

J2001+10 EP064N.UVDATA.1

Freq = 4.9270 GHz, Bw = 16.000 MH Calibrated with CL # 3 and BP # 1 (BP mode 1)

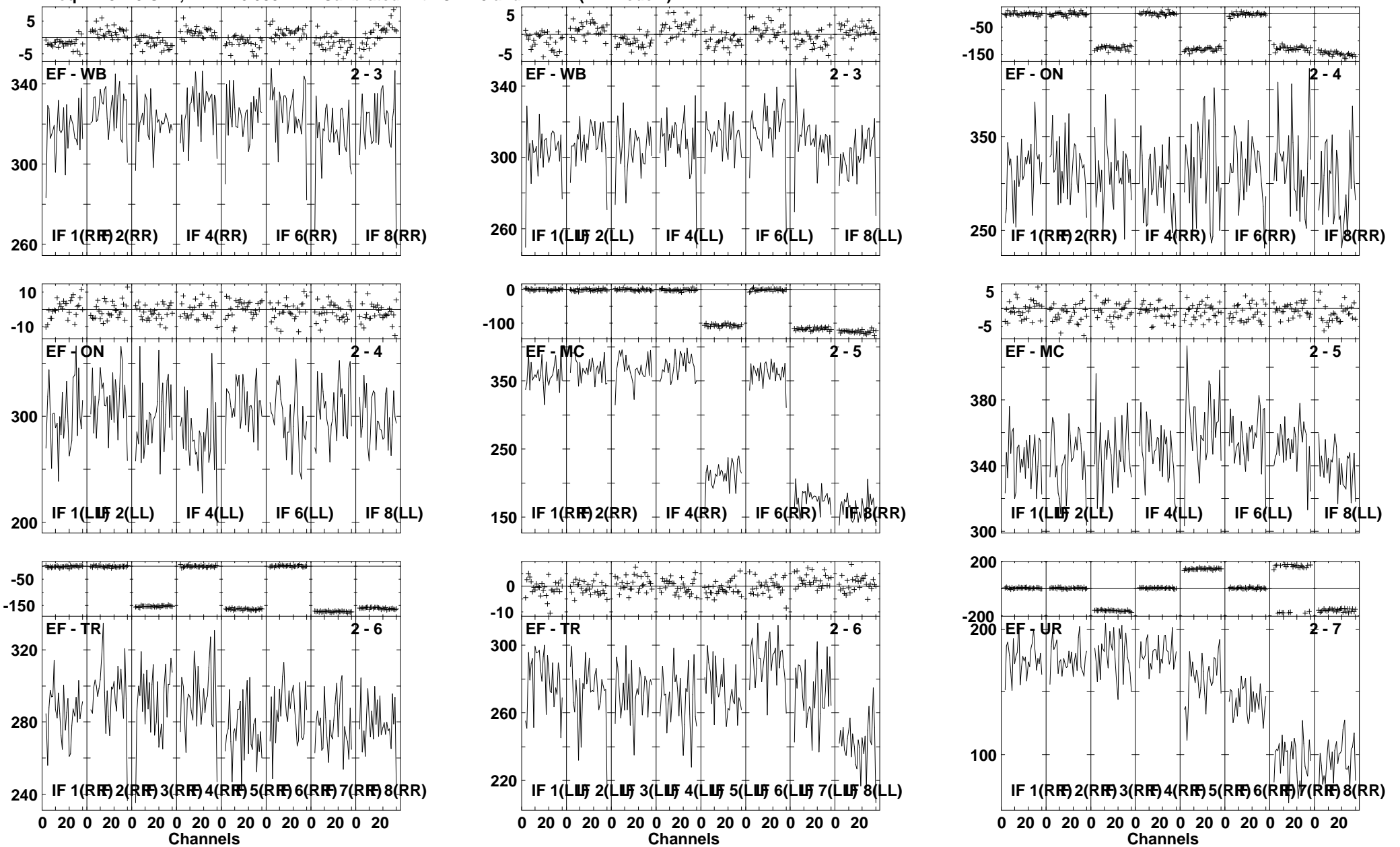

Lower frame: Milli Ampl Jy Top frame: Phas deg
Vector averaged cross-power spectrum Several baselines displayed
Timerange: 00/22:31:31 to 00/22:32:59

Plot file version 38 created 13-OCT-2010 18:39:20

J2001+10 EP064N.UVDATA.1

Freq = 4.9270 GHz, Bw = 16.000 MH Calibrated with CL # 3 and BP # 1 (BP mode 1)

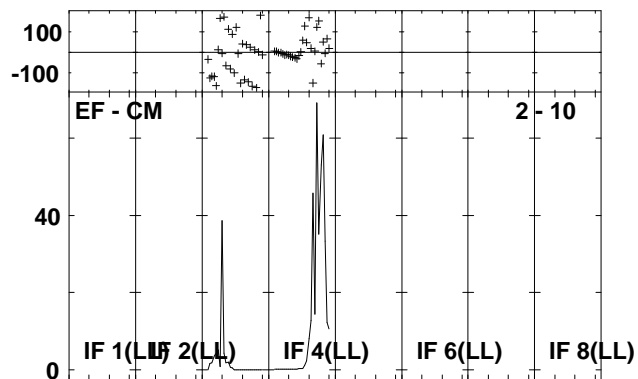
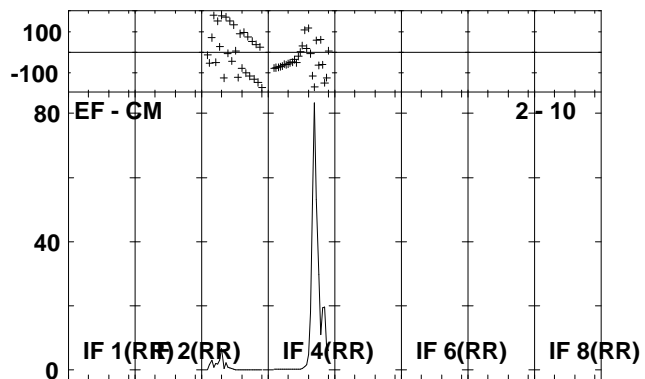
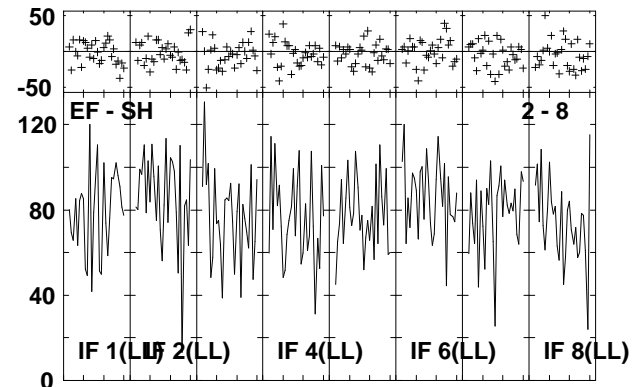
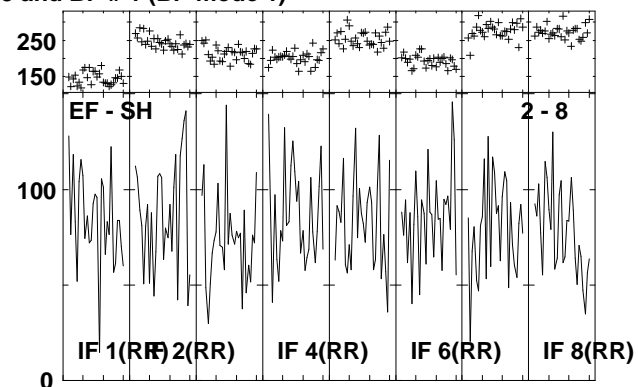
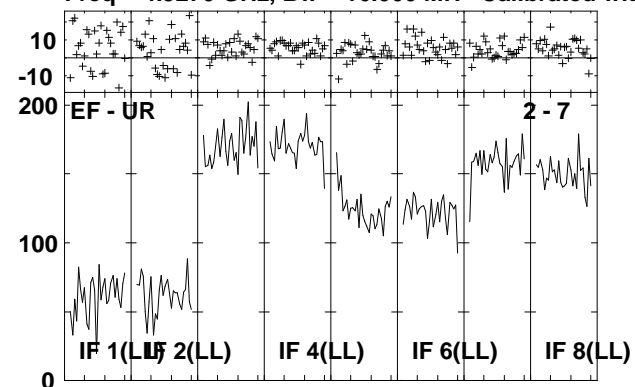

Lower frame: Milli Ampl Jy Top frame: Phas deg
Vector averaged cross-power spectrum Several baselines displayed
Timerange: 00/22:31:31 to 00/22:32:59

Plot file version 39 created 13-OCT-2010 18:39:22

IRAS1954 EP064N.UVDATA.1

Freq = 4.9270 GHz, Bw = 16.000 MH Calibrated with CL # 3 and BP # 1 (BP mode 1)

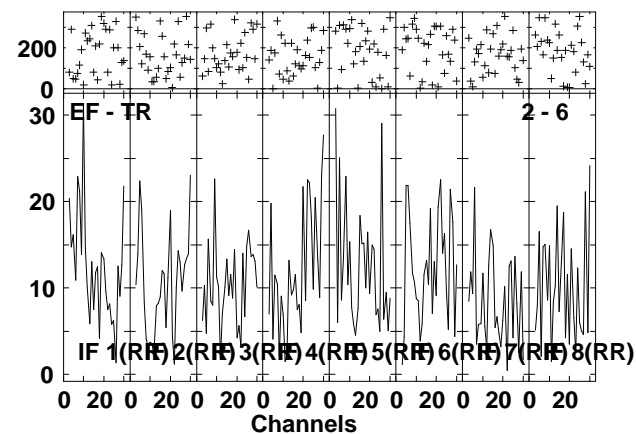
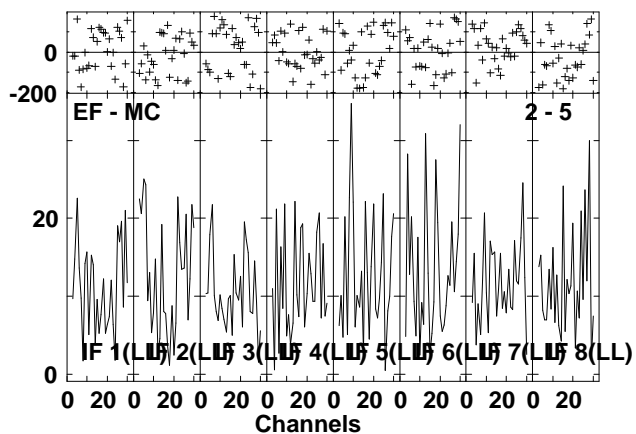
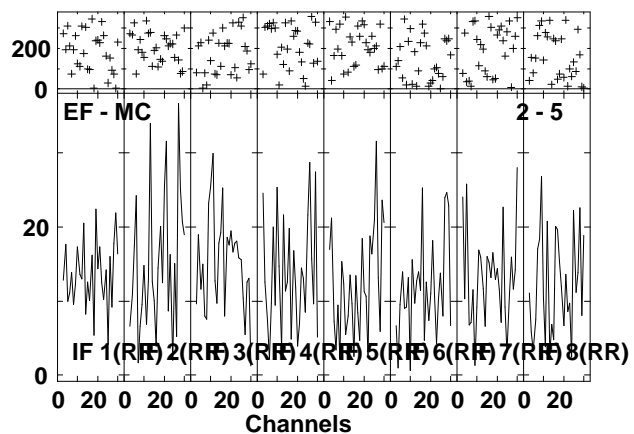
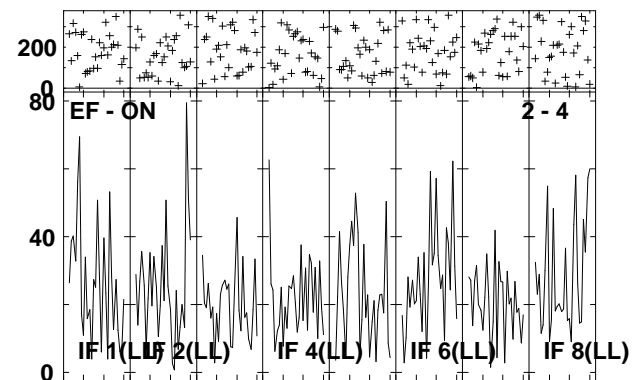
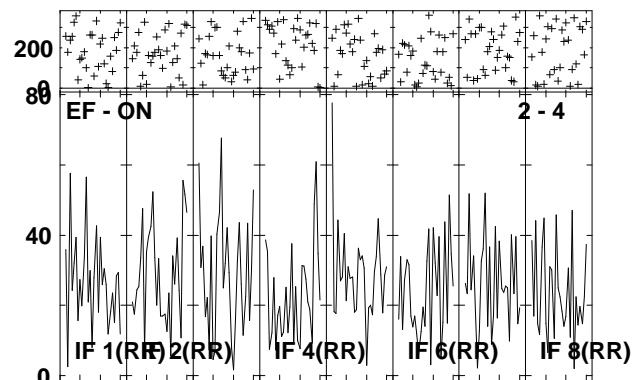
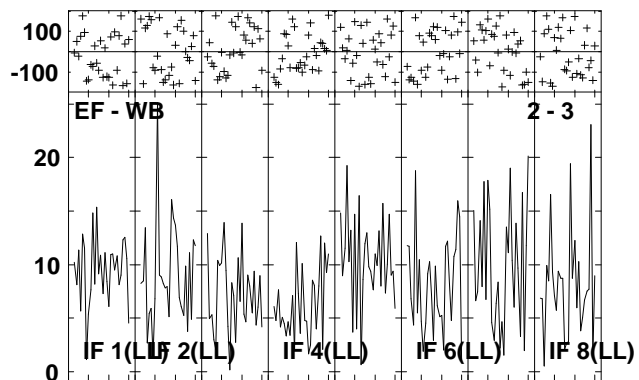
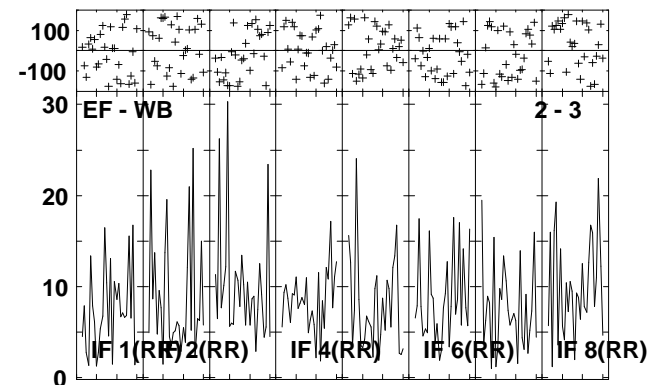
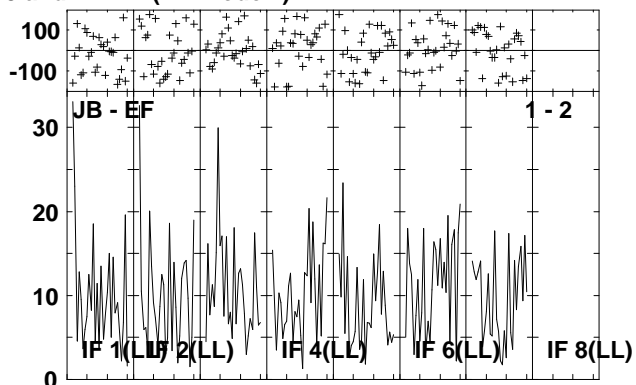
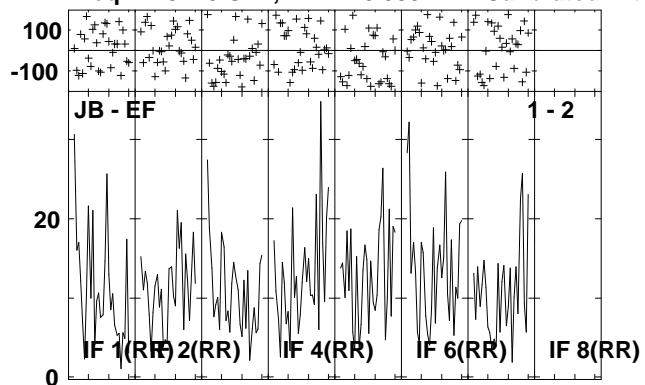

Lower frame: Milli Ampl Jy Top frame: Phas deg
Vector averaged cross-power spectrum Several baselines displayed
Timerange: 00/22:33:01 to 00/22:36:29

Plot file version 40 created 13-OCT-2010 18:39:24

IRAS1954 EP064N.UVDATA.1

Freq = 4.9270 GHz, Bw = 16.000 MH Calibrated with CL # 3 and BP # 1 (BP mode 1)

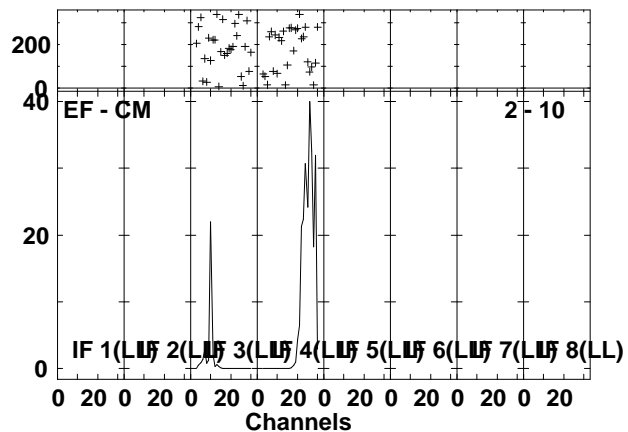
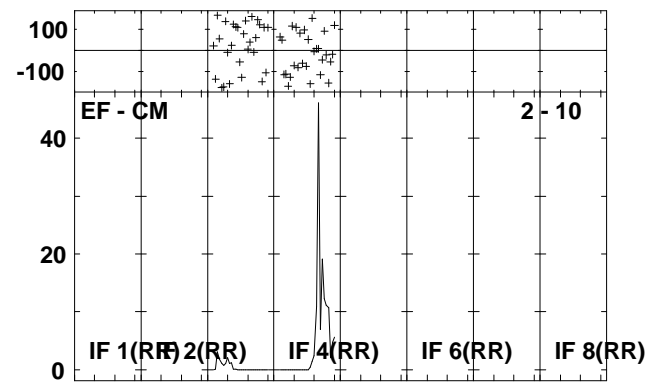
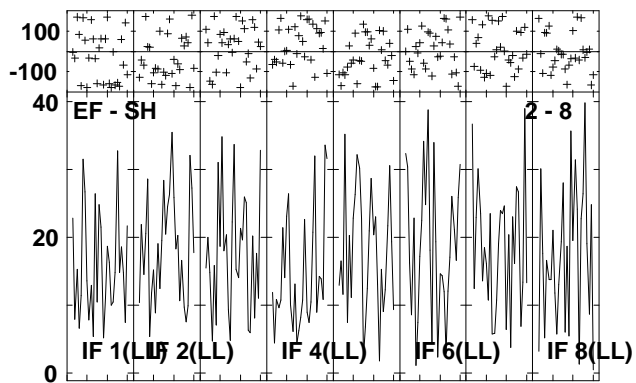
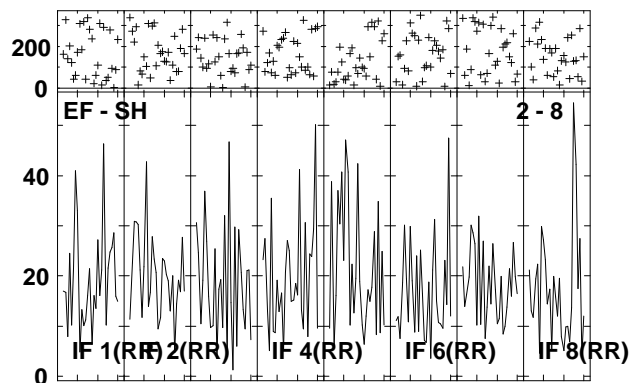
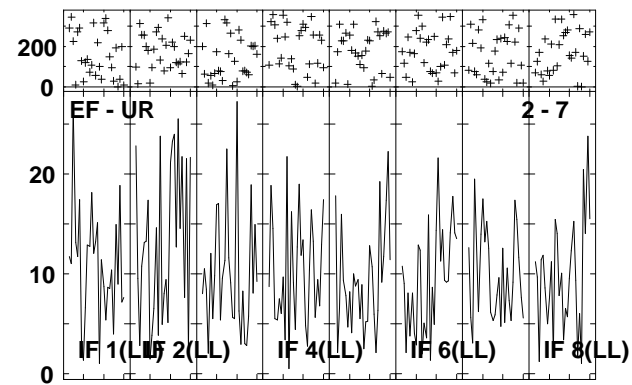
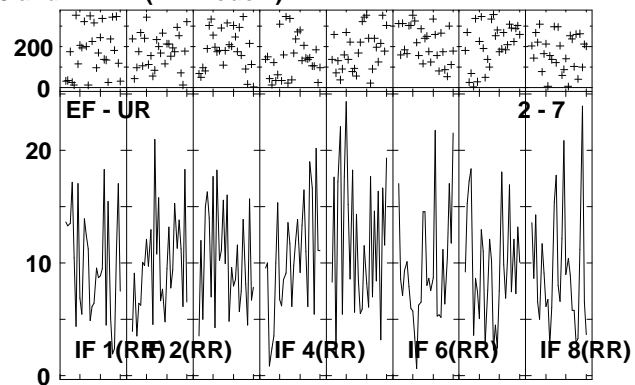
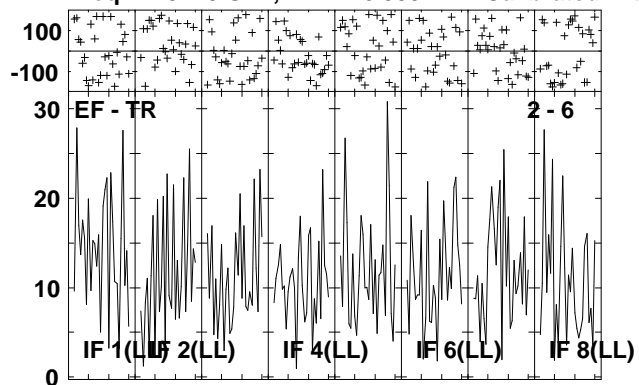

Lower frame: Milli Ampl Jy Top frame: Phas deg
Vector averaged cross-power spectrum Several baselines displayed
Timerange: 00/22:33:01 to 00/22:36:29

Plot file version 41 created 13-OCT-2010 18:39:28

J2001+10 EP064N.UVDATA.1

Freq = 4.9270 GHz, Bw = 16.000 MH Calibrated with CL # 3 and BP # 1 (BP mode 1)

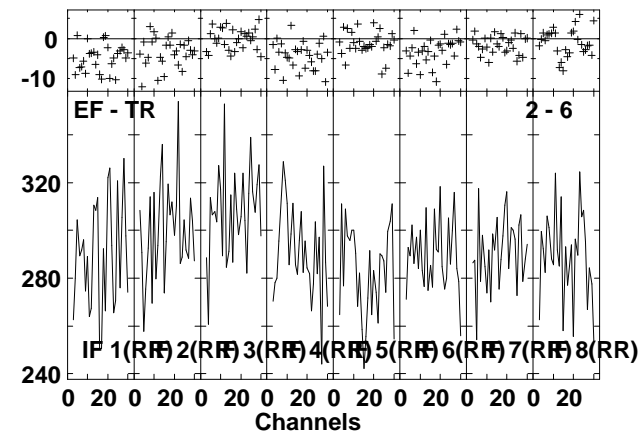
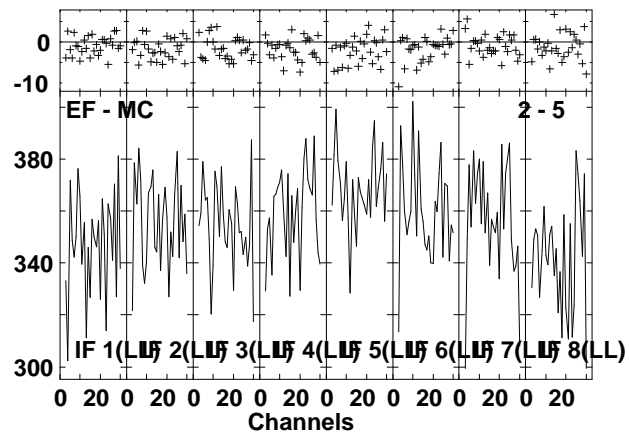
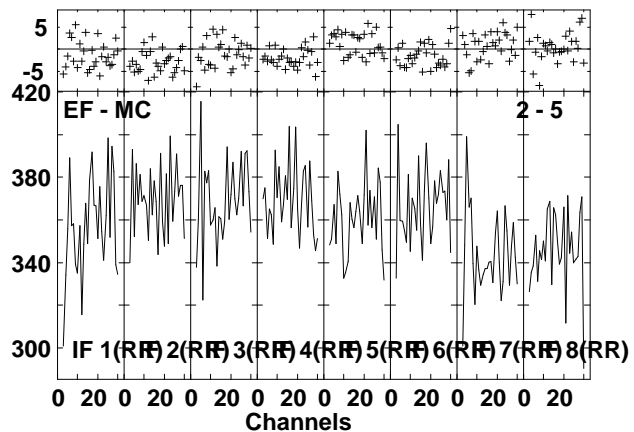
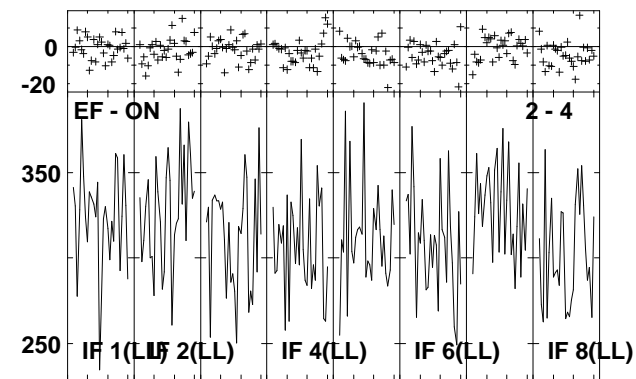
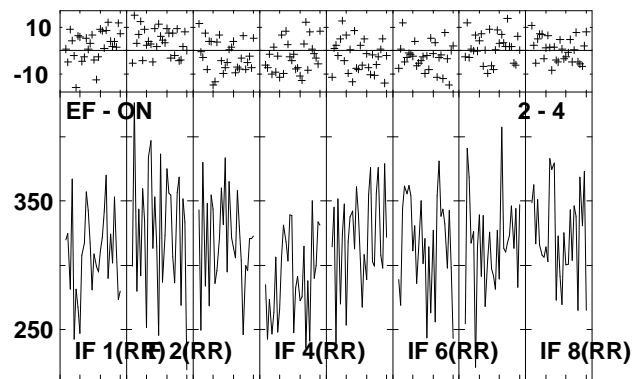
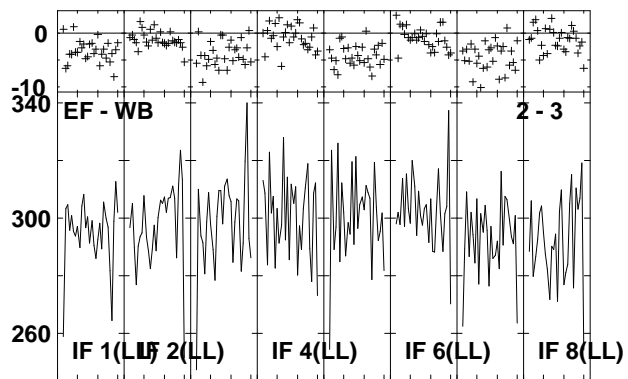
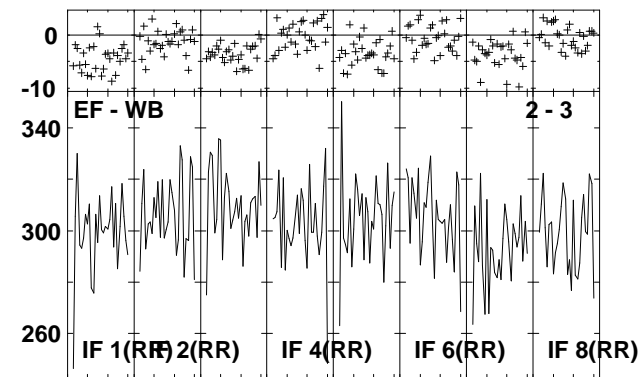
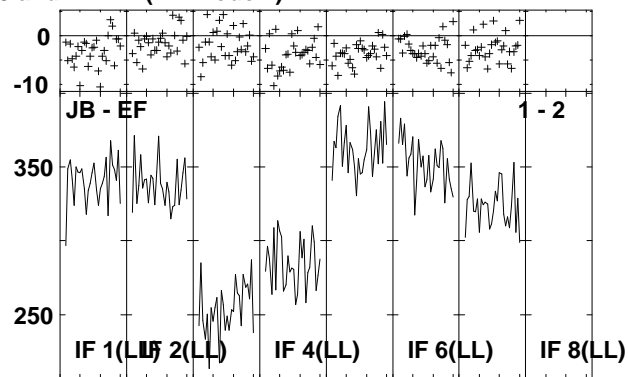
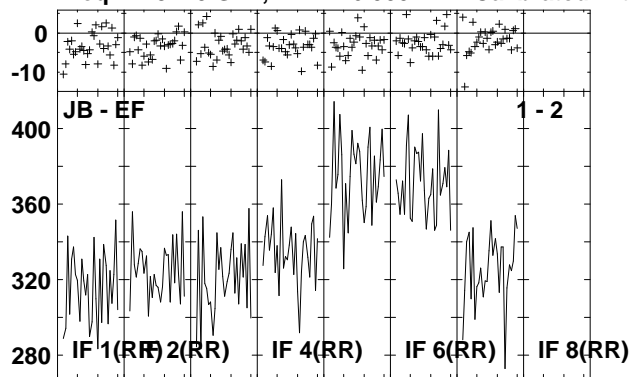

Lower frame: Milli Ampl Jy Top frame: Phas deg
Vector averaged cross-power spectrum Several baselines displayed
Timerange: 00/22:36:31 to 00/22:37:59

Plot file version 42 created 13-OCT-2010 18:39:30

J2001+10 EP064N.UVDATA.1

Freq = 4.9270 GHz, Bw = 16.000 MH Calibrated with CL # 3 and BP # 1 (BP mode 1)

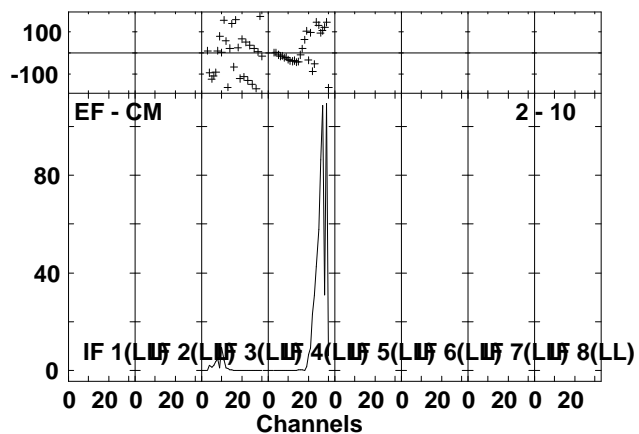
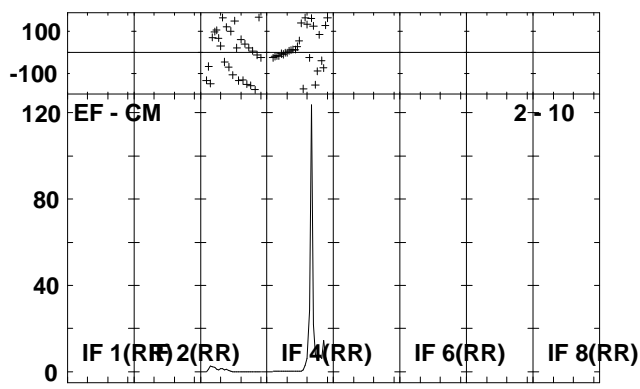
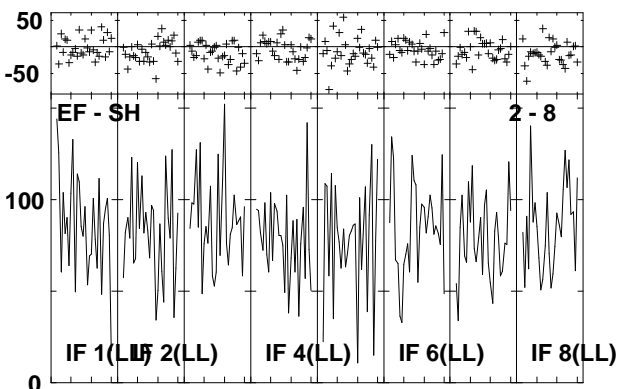
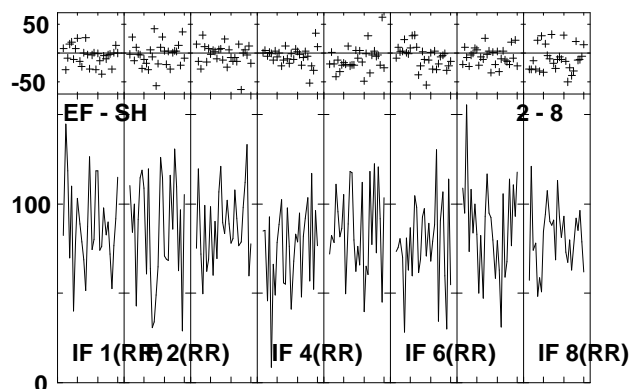
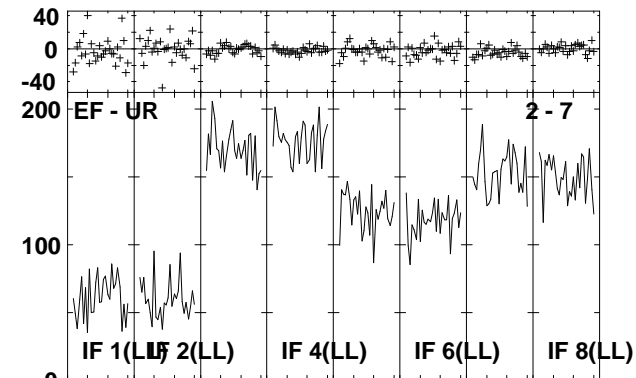
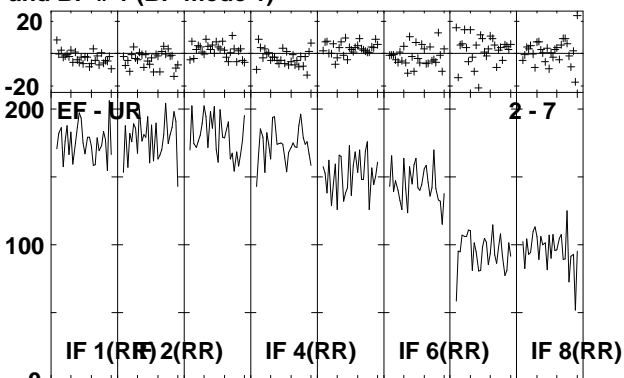
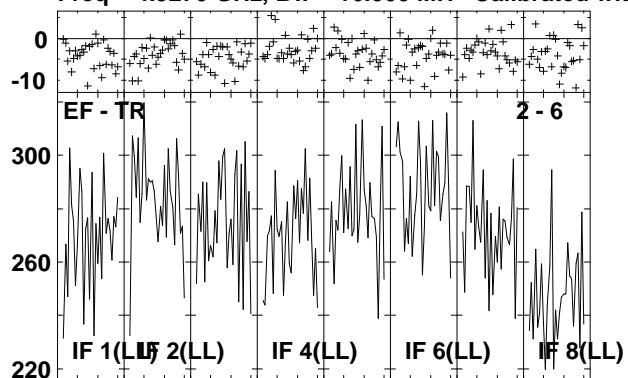

Lower frame: Milli Ampl Jy Top frame: Phas deg
Vector averaged cross-power spectrum Several baselines displayed
Timerange: 00/22:36:31 to 00/22:37:59

Plot file version 43 created 13-OCT-2010 18:39:32

IRAS1954 EP064N.UVDATA.1

Freq = 4.9270 GHz, Bw = 16.000 MH Calibrated with CL # 3 and BP # 1 (BP mode 1)

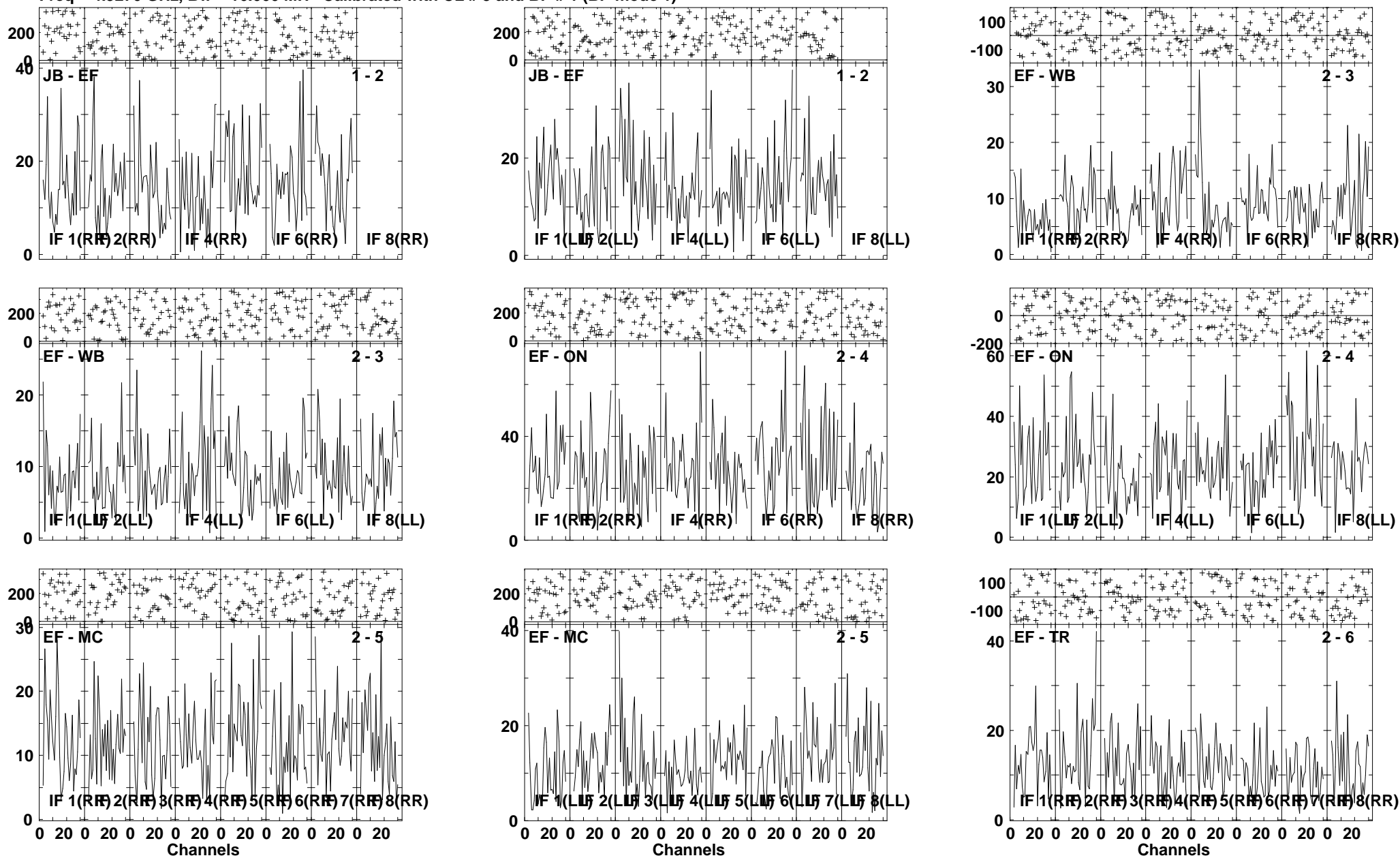

Lower frame: Milli Ampl Jy Top frame: Phas deg
Vector averaged cross-power spectrum Several baselines displayed
Timerange: 00/22:38:01 to 00/22:41:29

Plot file version 44 created 13-OCT-2010 18:39:35

IRAS1954 EP064N.UVDATA.1

Freq = 4.9270 GHz, Bw = 16.000 MH Calibrated with CL # 3 and BP # 1 (BP mode 1)

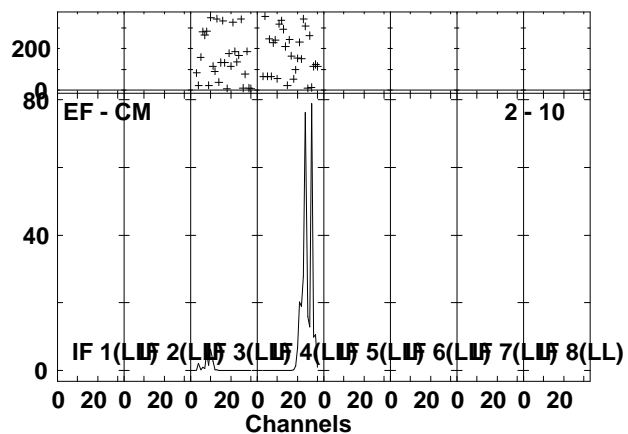
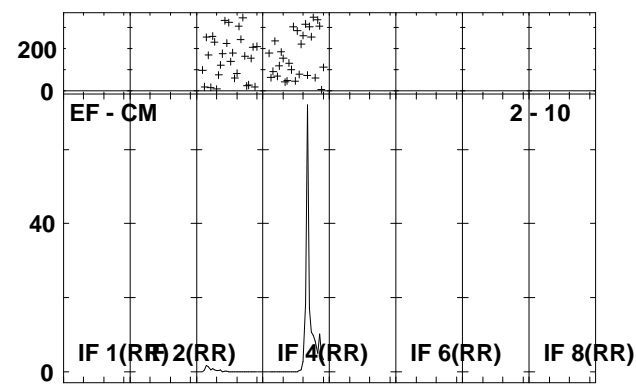
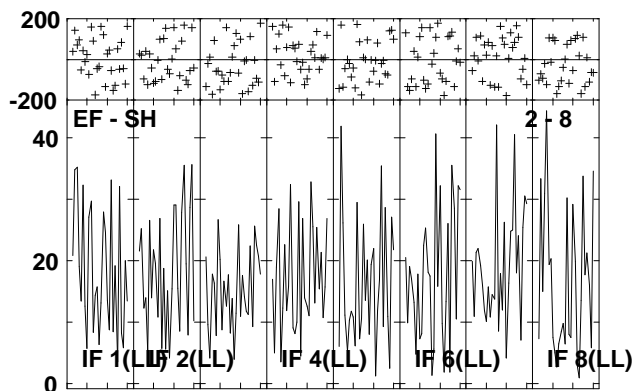
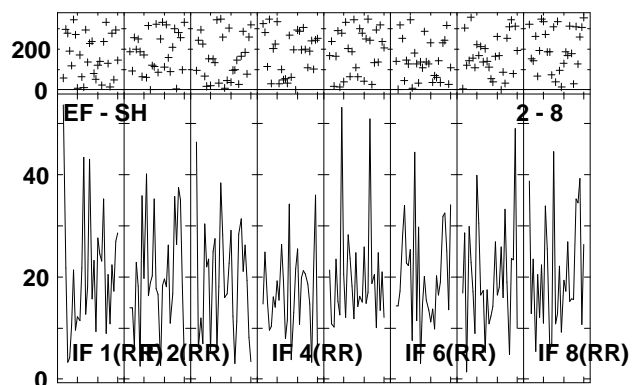
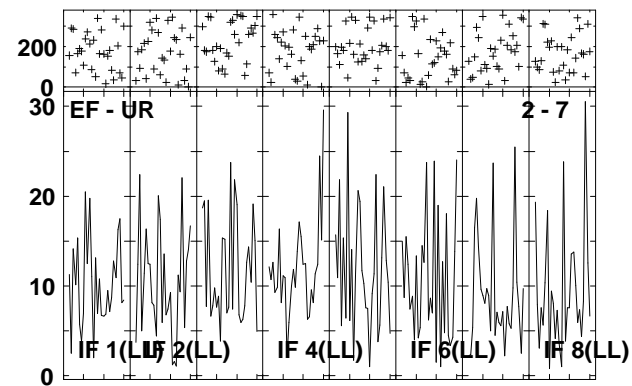
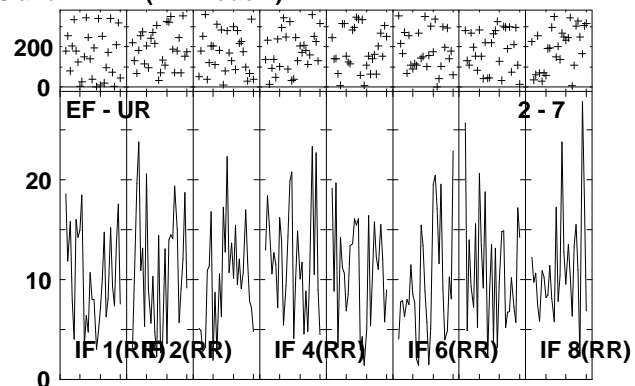
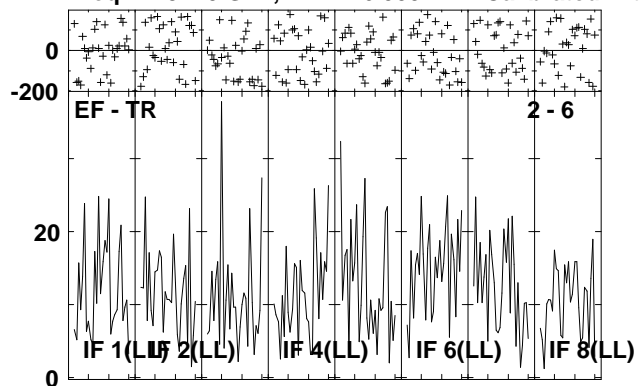

Lower frame: Milli Ampl Jy Top frame: Phas deg
Vector averaged cross-power spectrum Several baselines displayed
Timerange: 00/22:38:01 to 00/22:41:29

Plot file version 45 created 13-OCT-2010 18:39:39

J2001+10 EP064N.UVDATA.1

Freq = 4.9270 GHz, Bw = 16.000 MH Calibrated with CL # 3 and BP # 1 (BP mode 1)

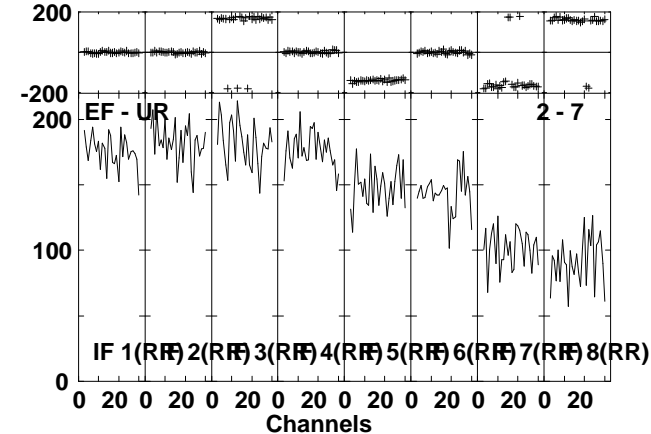
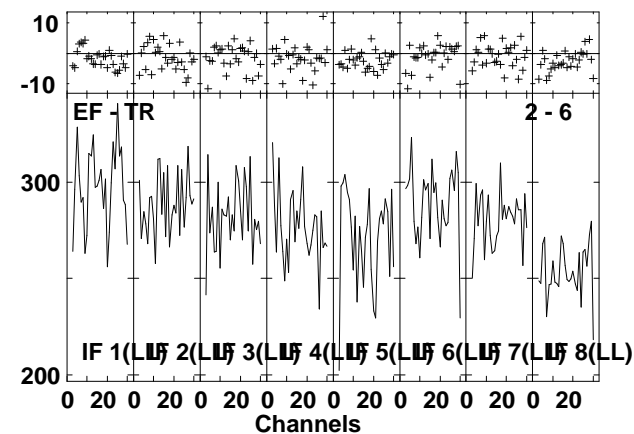
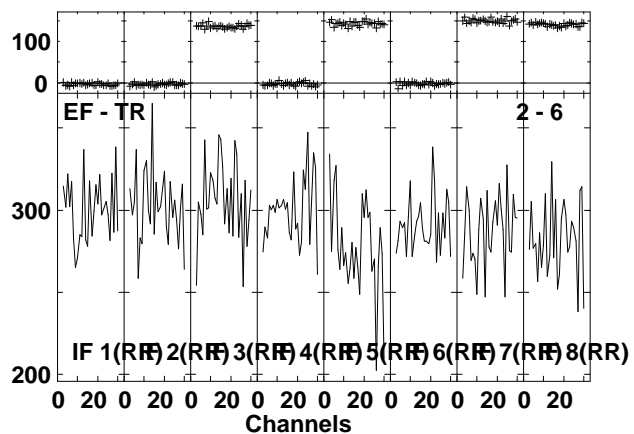
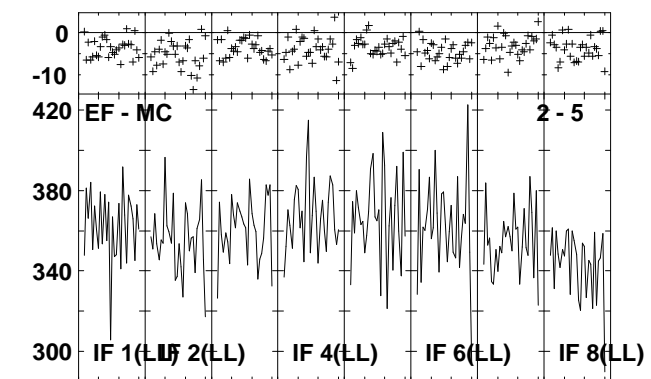
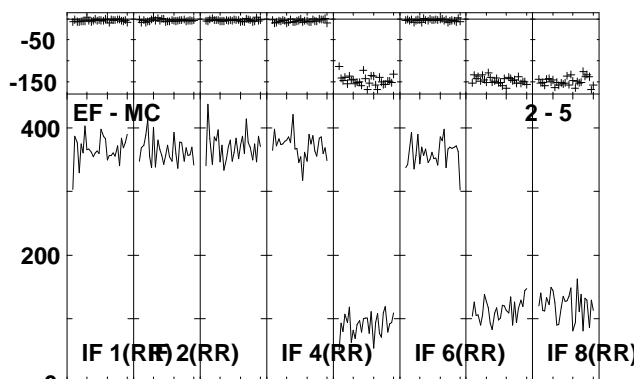
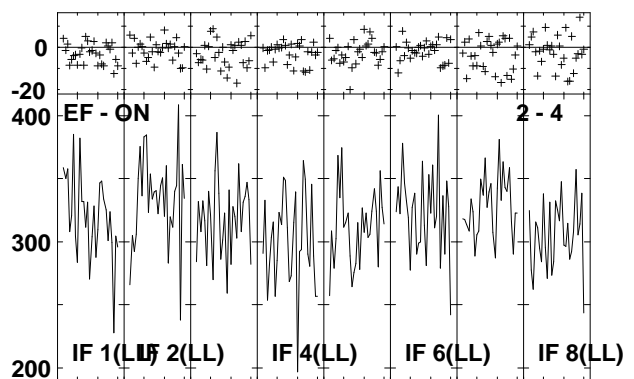
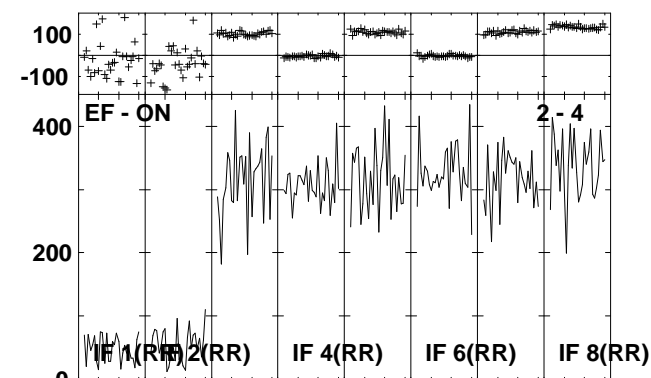
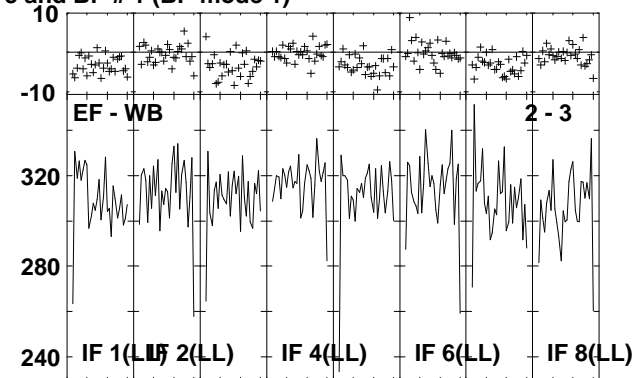
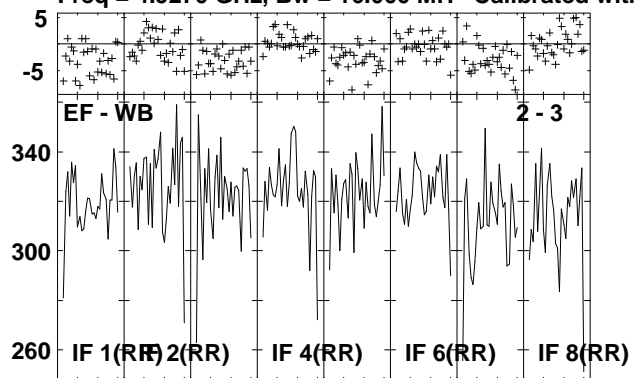

Lower frame: Milli Ampl Jy Top frame: Phas deg
Vector averaged cross-power spectrum Several baselines displayed
Timerange: 00/22:41:31 to 00/22:42:59

Plot file version 46 created 13-OCT-2010 18:39:40

J2001+10 EP064N.UVDATA.1

Freq = 4.9270 GHz, Bw = 16.000 MH Calibrated with CL # 3 and BP # 1 (BP mode 1)

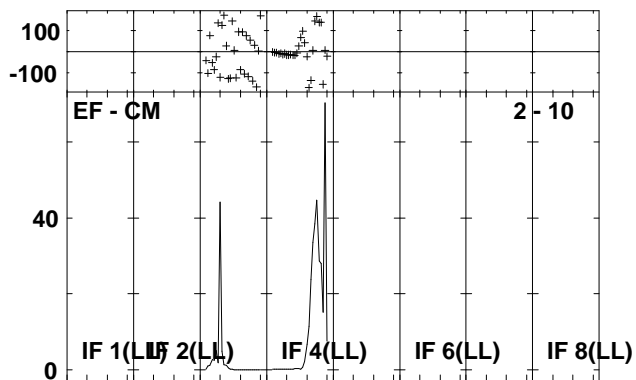
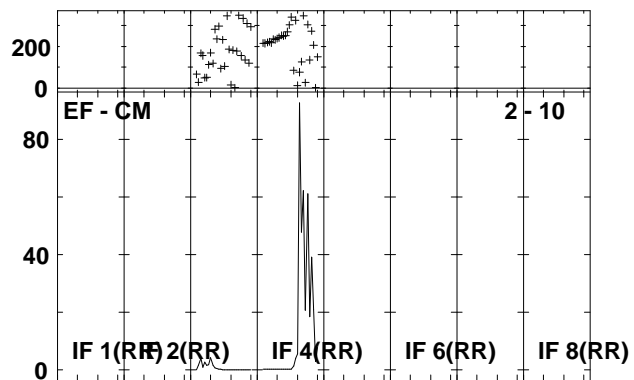
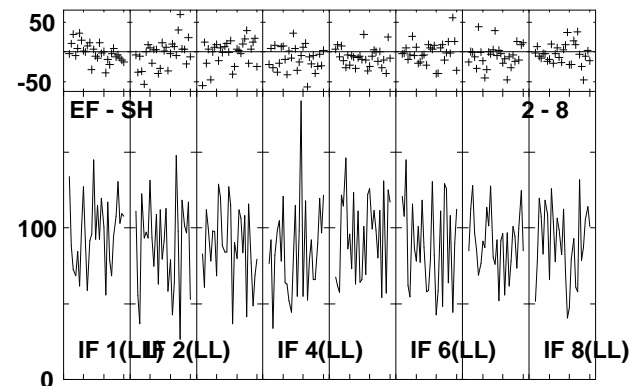
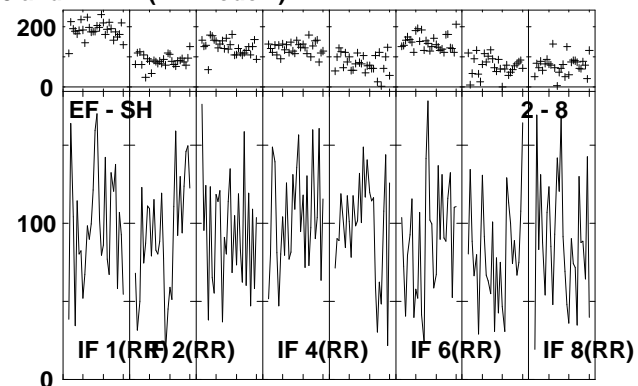
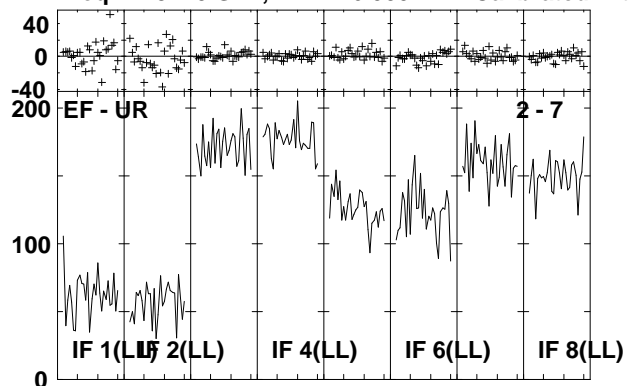

Lower frame: Milli Ampl Jy Top frame: Phas deg
Vector averaged cross-power spectrum Several baselines displayed
Timerange: 00/22:41:31 to 00/22:42:59

Plot file version 47 created 13-OCT-2010 18:39:42

IRAS1954 EP064N.UVDATA.1

Freq = 4.9270 GHz, Bw = 16.000 MH Calibrated with CL # 3 and BP # 1 (BP mode 1)

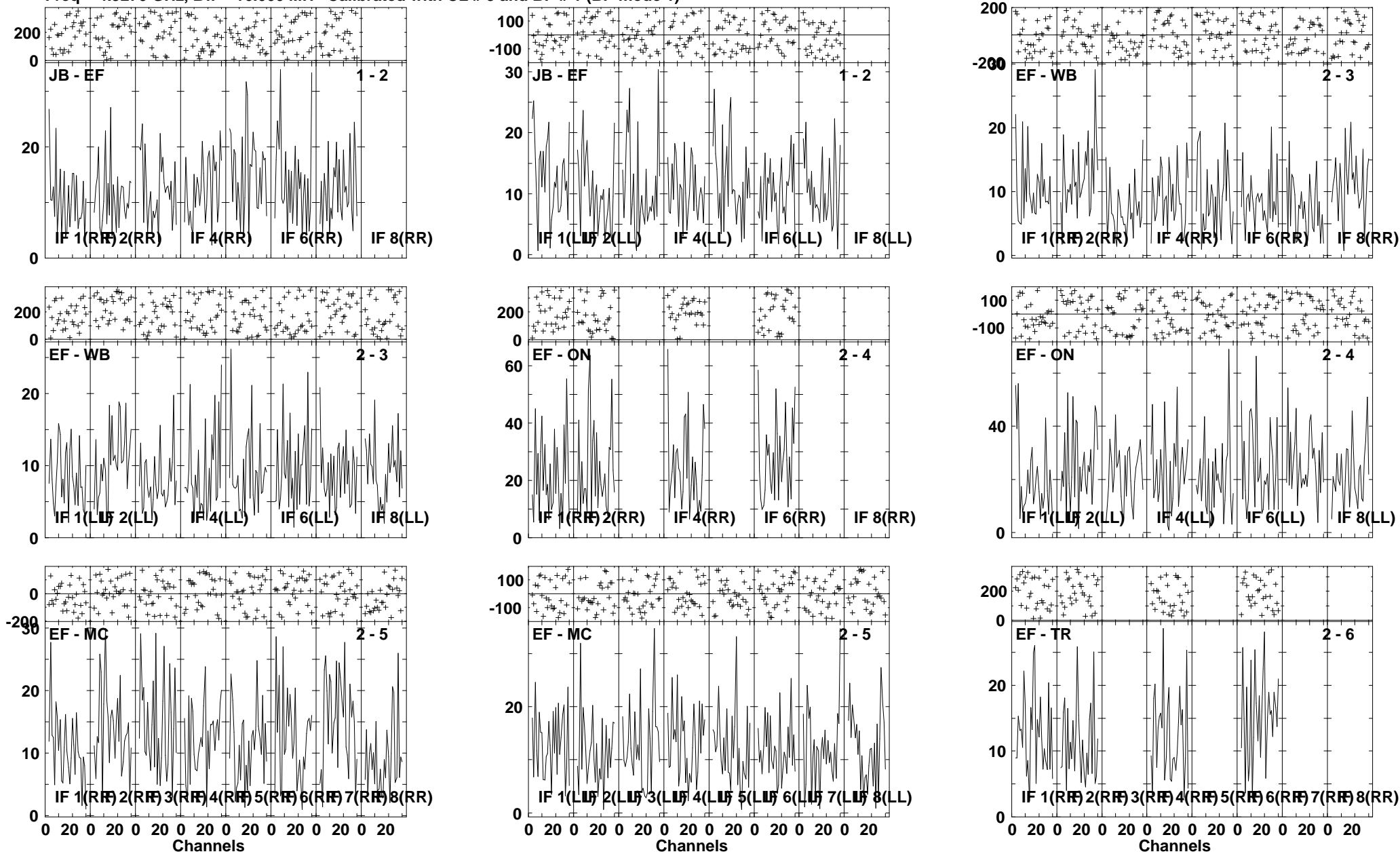

Lower frame: Milli Ampl Jy Top frame: Phas deg
Vector averaged cross-power spectrum Several baselines displayed
Timerange: 00/22:43:01 to 00/22:46:29

Plot file version 48 created 13-OCT-2010 18:39:45

IRAS1954 EP064N.UVDATA.1

Freq = 4.9270 GHz, Bw = 16.000 MH Calibrated with CL # 3 and BP # 1 (BP mode 1)

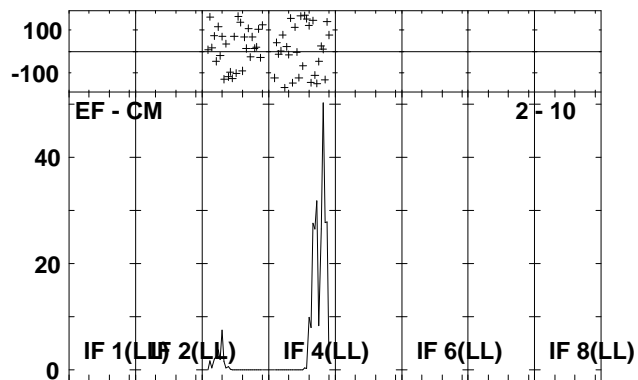
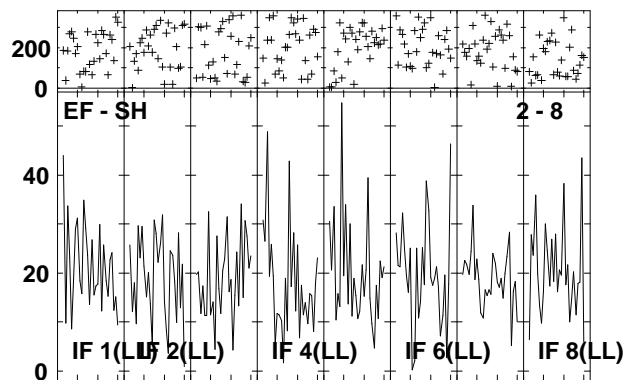
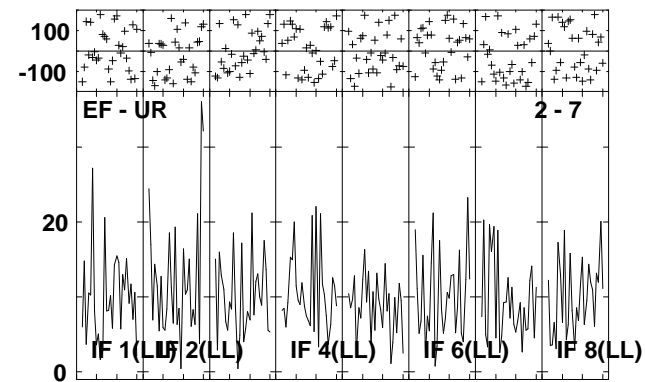
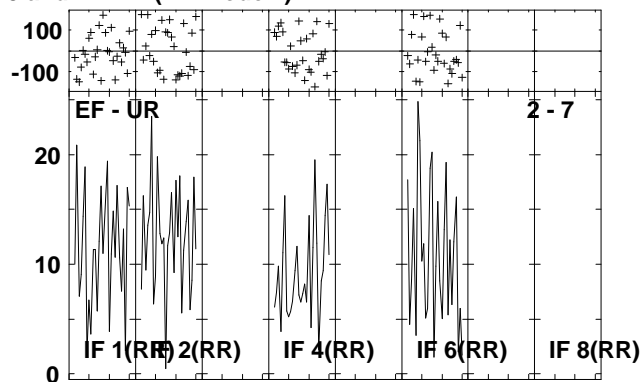
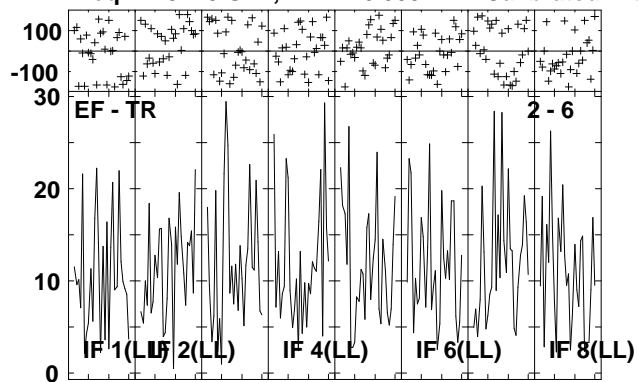

Lower frame: Milli Ampl Jy Top frame: Phas deg
Vector averaged cross-power spectrum Several baselines displayed
Timerange: 00/22:43:01 to 00/22:46:29

Plot file version 49 created 13-OCT-2010 18:39:49

J2001+10 EP064N.UVDATA.1

Freq = 4.9270 GHz, Bw = 16.000 MH Calibrated with CL # 3 and BP # 1 (BP mode 1)

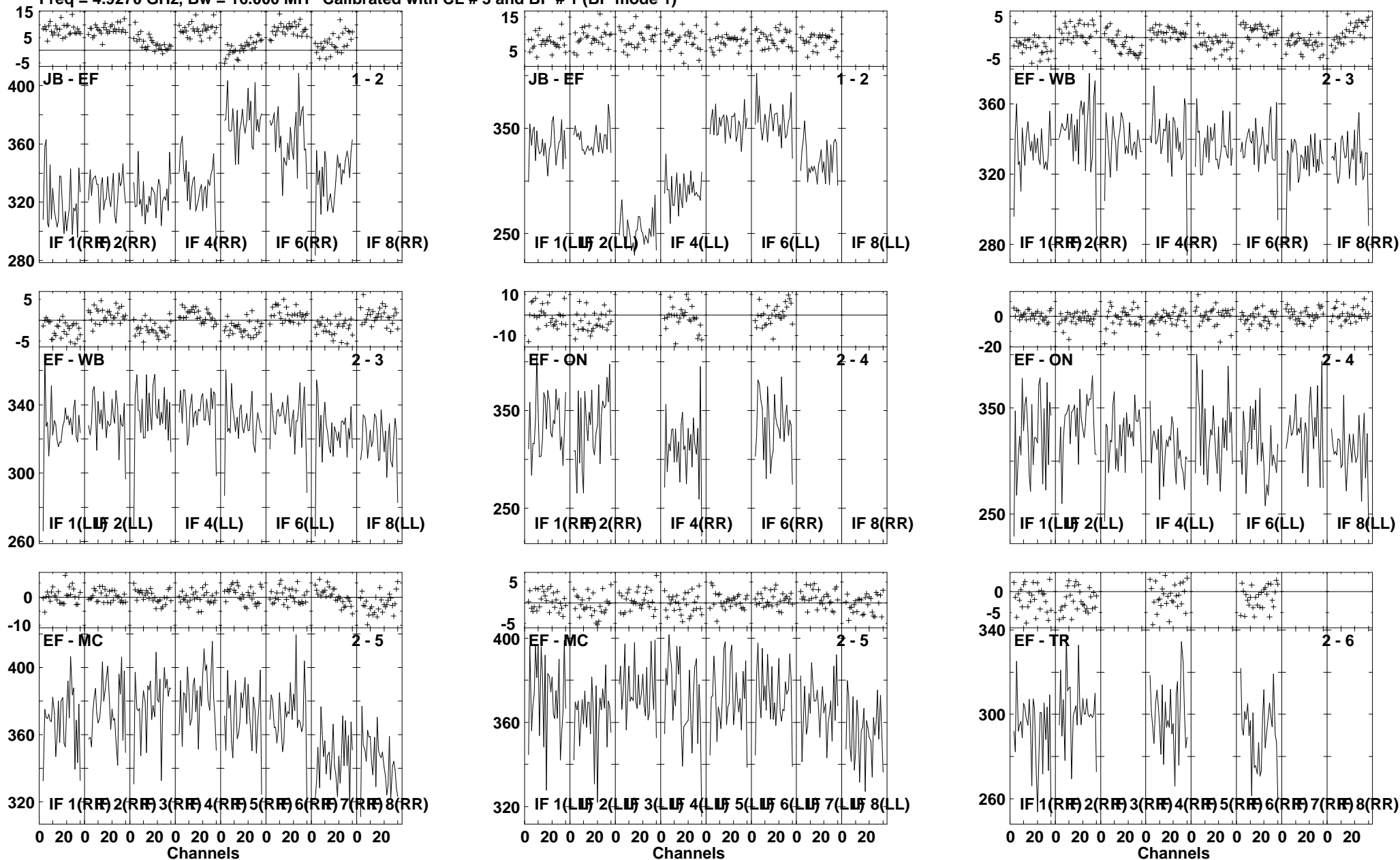

Lower frame: Milli Ampl Jy Top frame: Phas deg
Vector averaged cross-power spectrum Several baselines displayed
Timerange: 00/22:47:31 to 00/22:48:59

Plot file version 50 created 13-OCT-2010 18:39:51
 J2001+10 EP064N.UVDATA.1
 Freq = 4.9270 GHz, Bw = 16.000 MH Calibrated with CL # 3 and BP # 1 (BP mode 1)

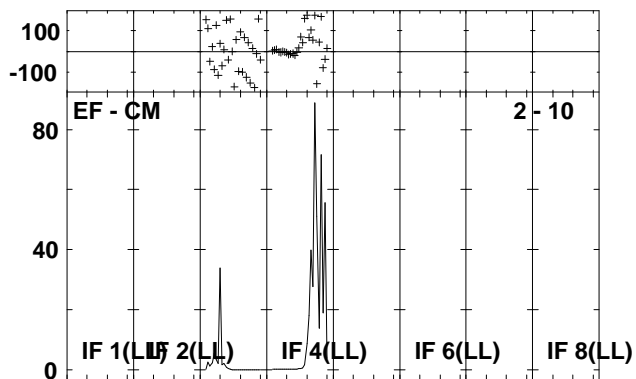
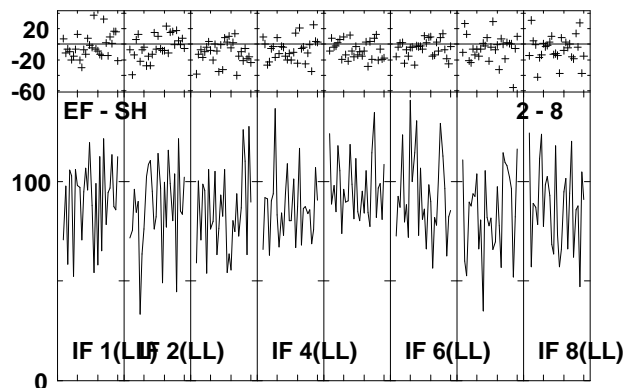
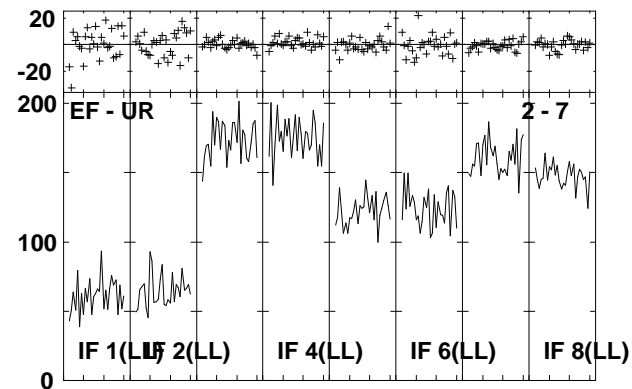
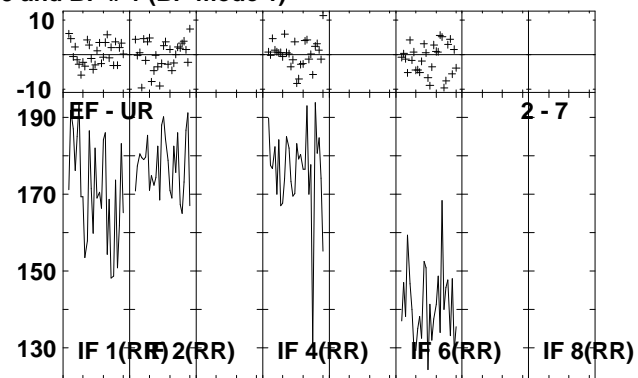
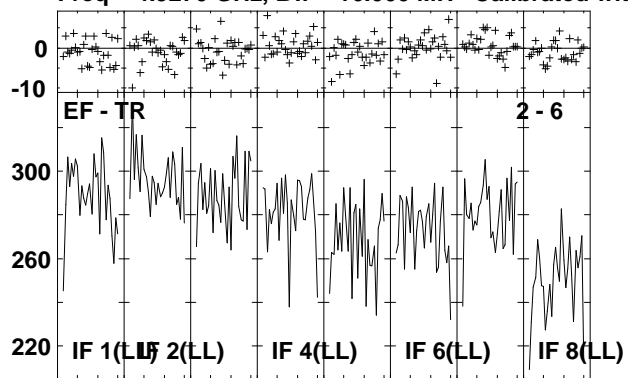

Lower frame: Milli Ampl Jy Top frame: Phas deg
 Vector averaged cross-power spectrum Several baselines displayed
 Timerange: 00/22:47:31 to 00/22:48:59

Plot file version 51 created 13-OCT-2010 18:39:53

IRAS1954 EP064N.UVDATA.1

Freq = 4.9270 GHz, Bw = 16.000 MH Calibrated with CL # 3 and BP # 1 (BP mode 1)

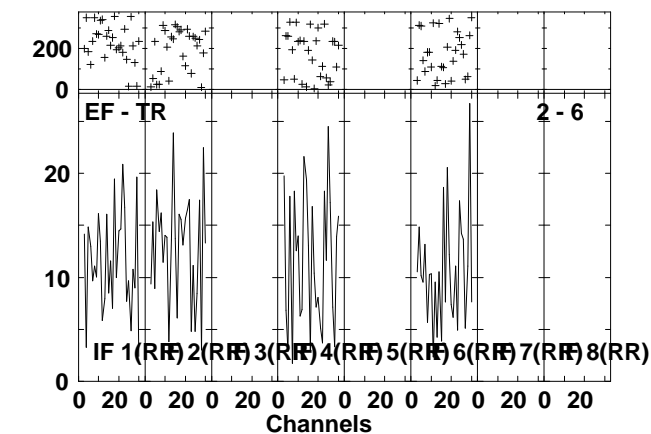
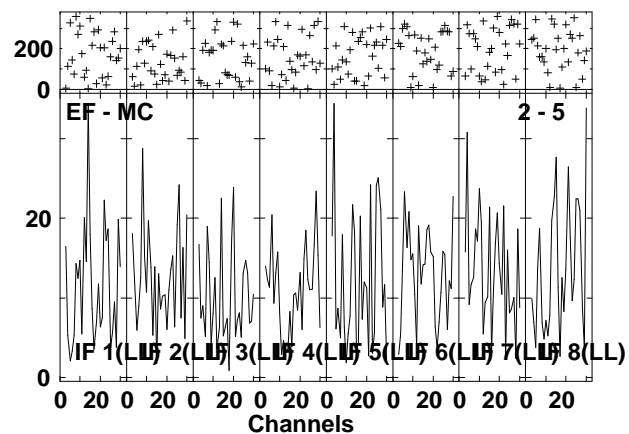
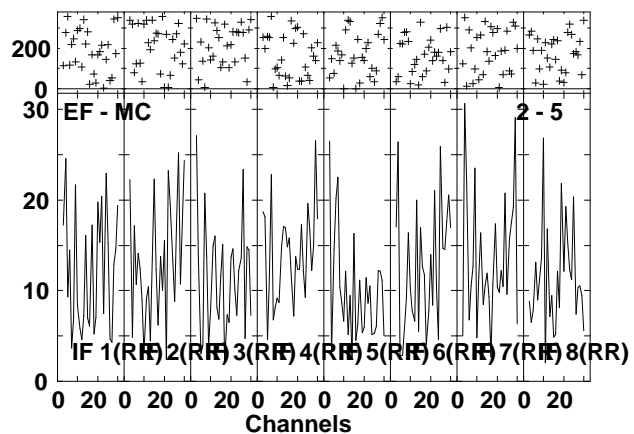
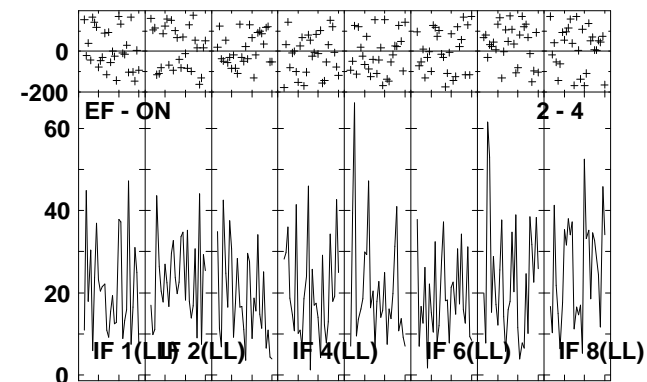
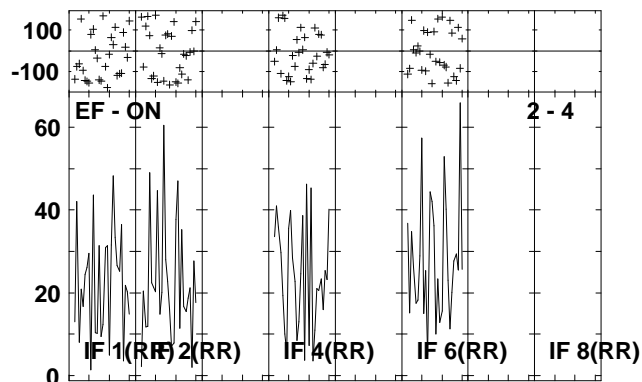
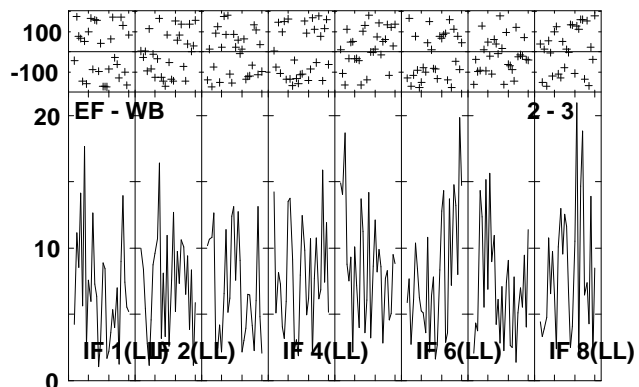
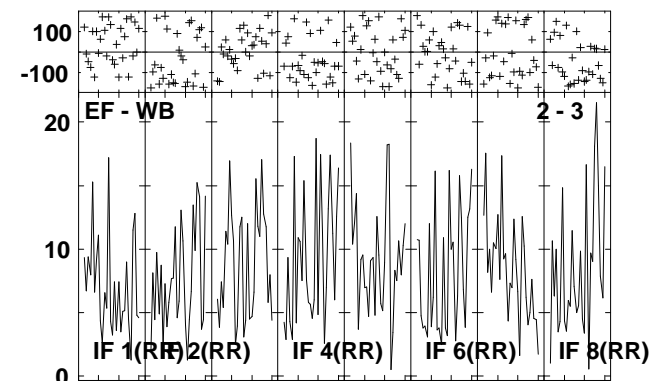
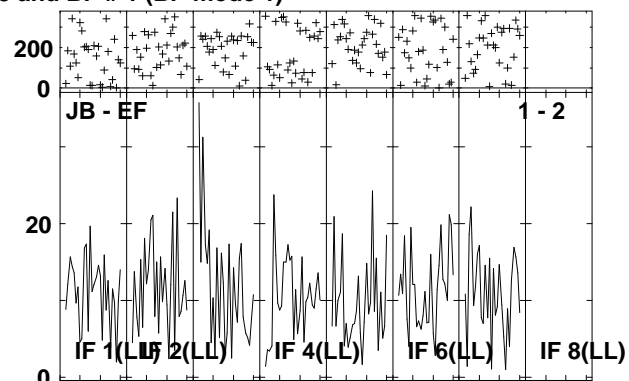
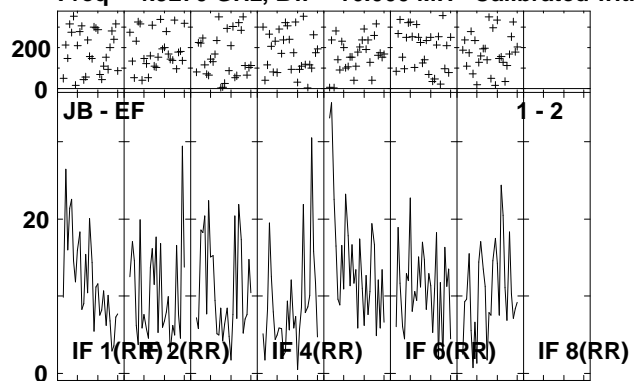

Lower frame: Milli Ampl Jy Top frame: Phas deg
Vector averaged cross-power spectrum Several baselines displayed
Timerange: 00/22:49:01 to 00/22:52:29

Plot file version 52 created 13-OCT-2010 18:39:56

IRAS1954 EP064N.UVDATA.1

Freq = 4.9270 GHz, Bw = 16.000 MH Calibrated with CL # 3 and BP # 1 (BP mode 1)

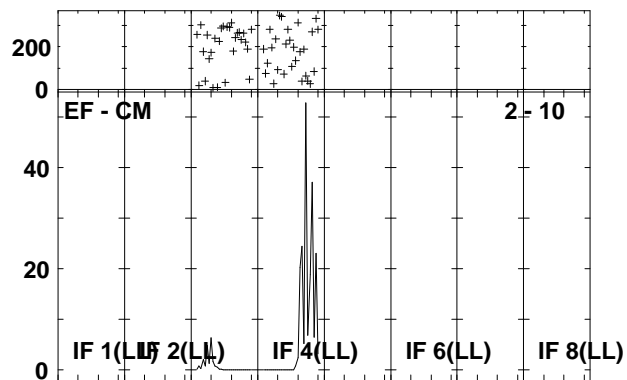
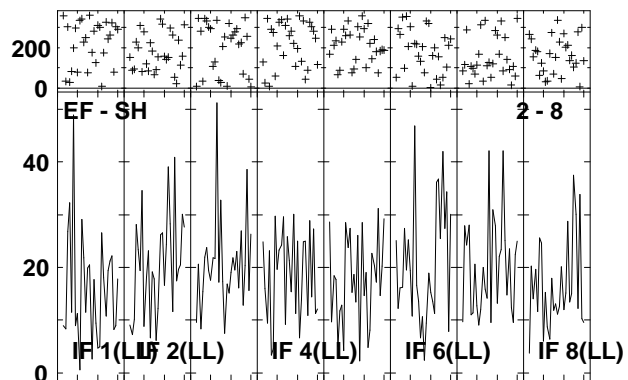
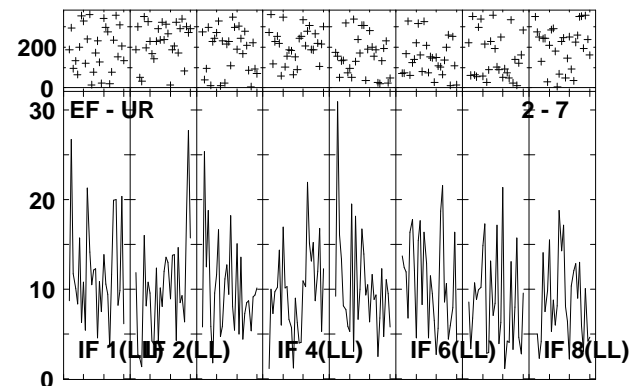
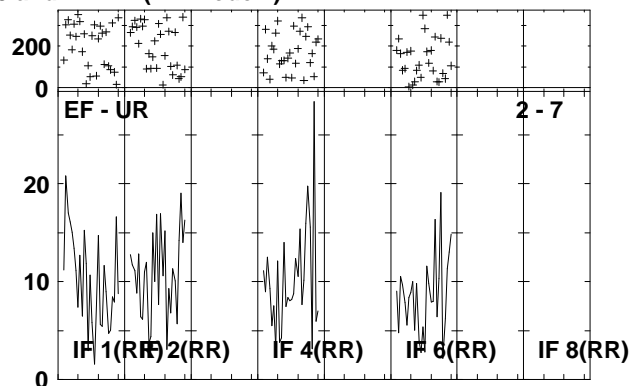
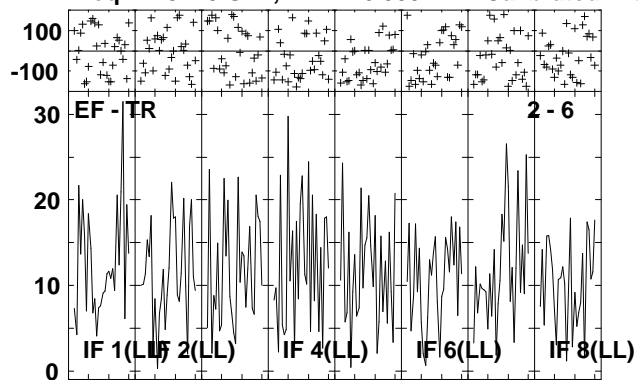

Lower frame: Milli Ampl Jy Top frame: Phas deg
Vector averaged cross-power spectrum Several baselines displayed
Timerange: 00/22:49:01 to 00/22:52:29

Plot file version 53 created 13-OCT-2010 18:40:01

J2001+10 EP064N.UVDATA.1

Freq = 4.9270 GHz, Bw = 16.000 MH Calibrated with CL # 3 and BP # 1 (BP mode 1)

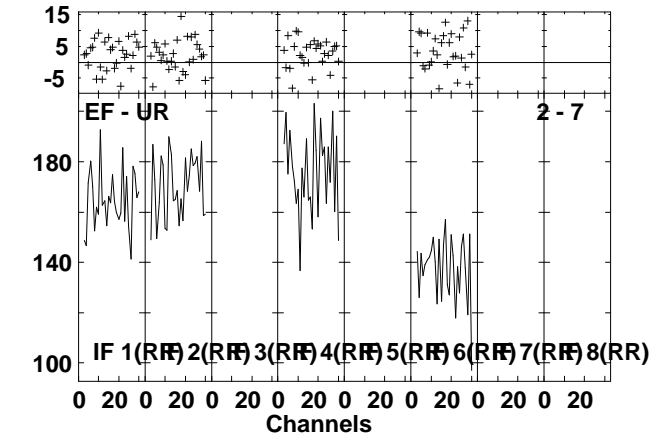
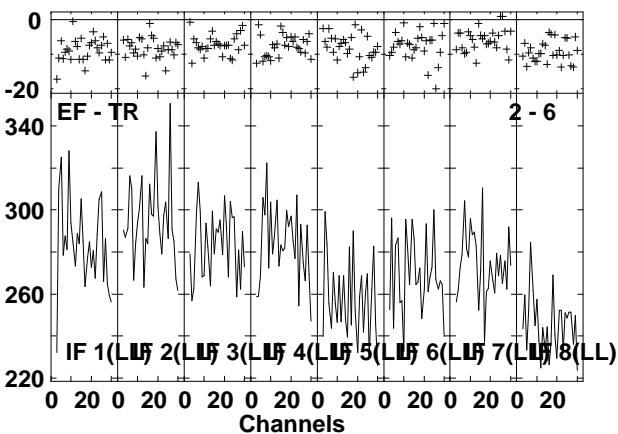
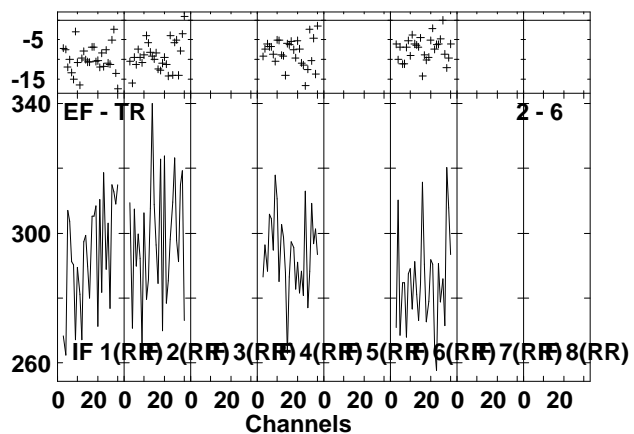
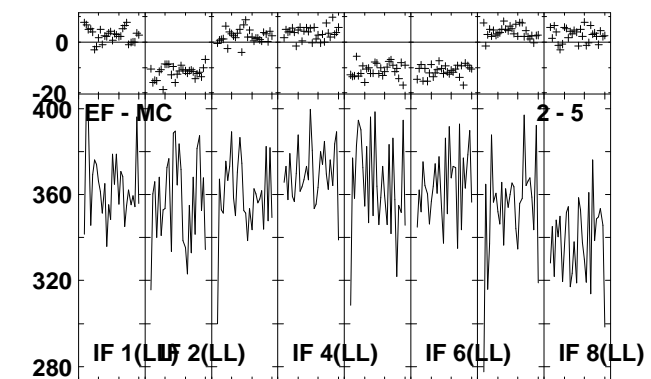
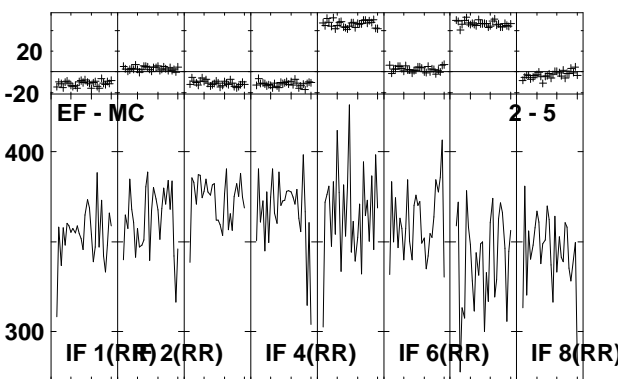
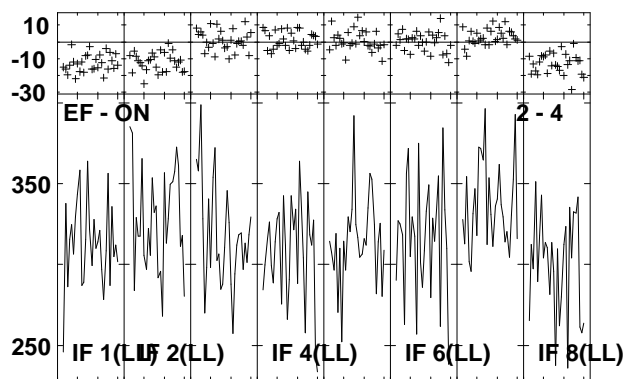
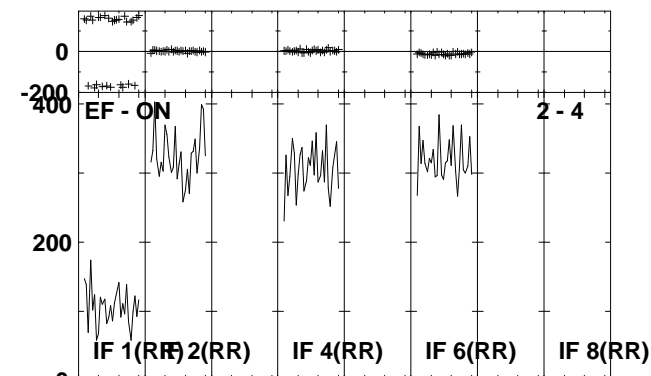
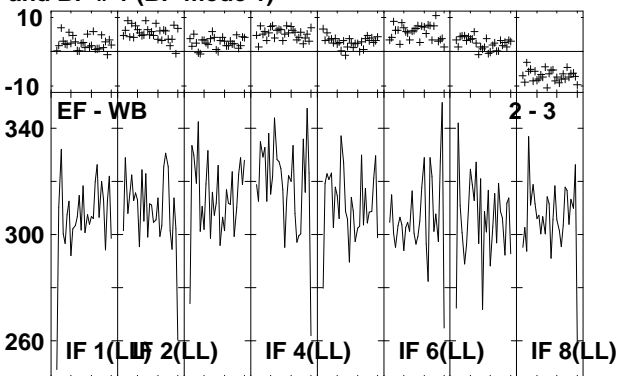
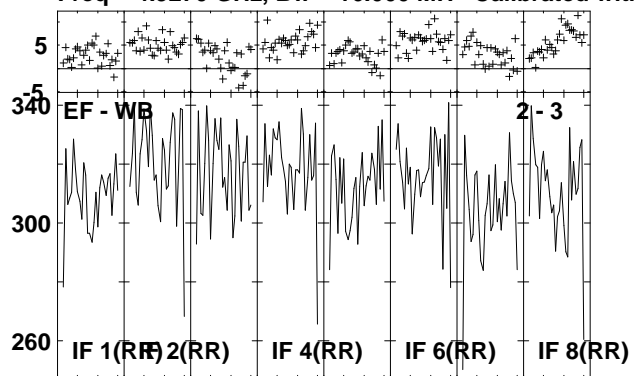

Lower frame: Milli Ampl Jy Top frame: Phas deg
Vector averaged cross-power spectrum Several baselines displayed
Timerange: 00/22:52:31 to 00/22:53:59

Plot file version 54 created 13-OCT-2010 18:40:02

J2001+10 EP064N.UVDATA.1

Freq = 4.9270 GHz, Bw = 16.000 MH Calibrated with CL # 3 and BP # 1 (BP mode 1)

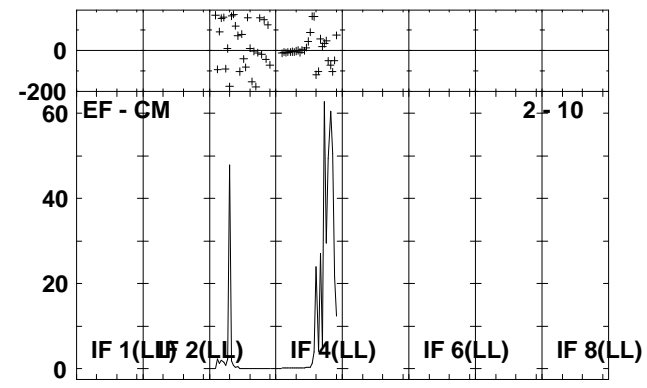
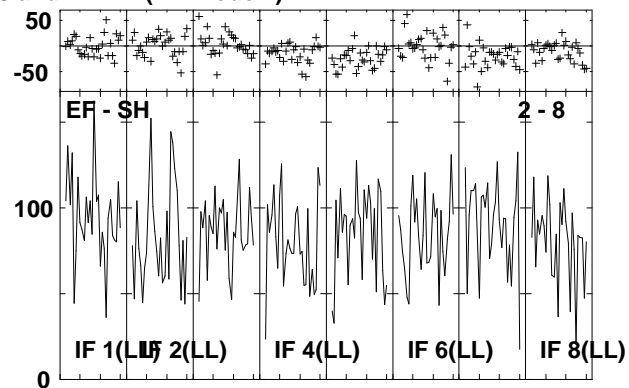
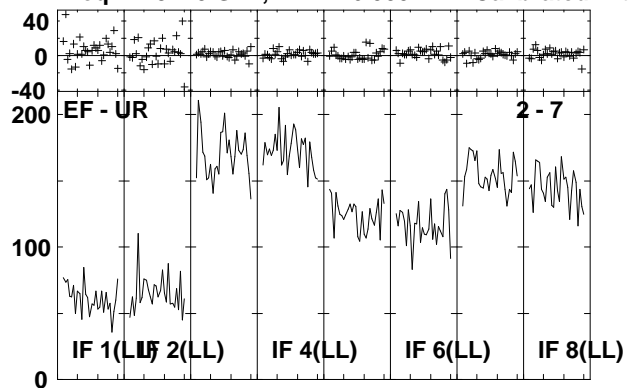

Lower frame: Milli Ampl Jy Top frame: Phas deg
Vector averaged cross-power spectrum Several baselines displayed
Timerange: 00/22:52:31 to 00/22:53:59

Plot file version 55 created 13-OCT-2010 18:40:04

IRAS1954 EP064N.UVDATA.1

Freq = 4.9270 GHz, Bw = 16.000 MH Calibrated with CL # 3 and BP # 1 (BP mode 1)

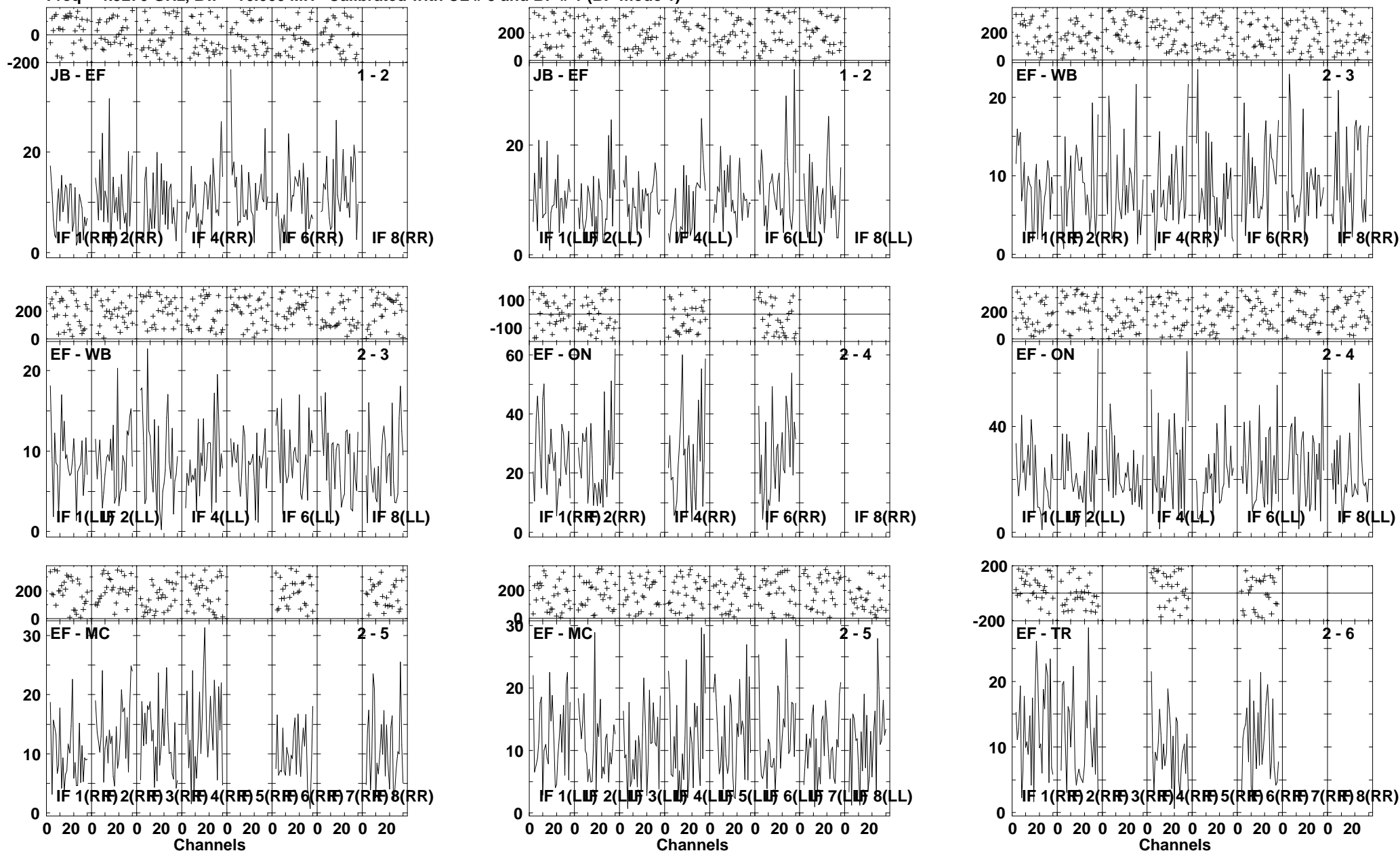

Lower frame: Milli Ampl Jy Top frame: Phas deg
Vector averaged cross-power spectrum Several baselines displayed
Timerange: 00/22:54:01 to 00/22:57:29

Plot file version 56 created 13-OCT-2010 18:40:07

IRAS1954 EP064N.UVDATA.1

Freq = 4.9270 GHz, Bw = 16.000 MH Calibrated with CL # 3 and BP # 1 (BP mode 1)

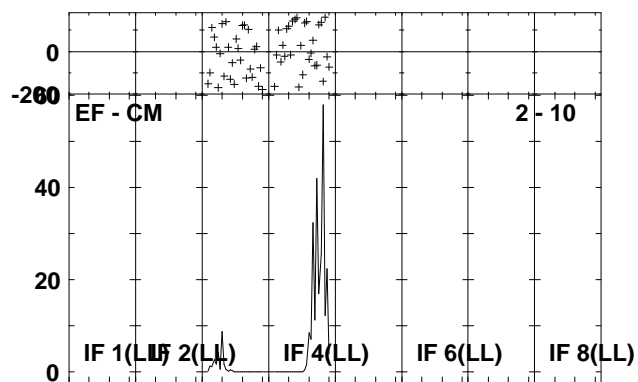
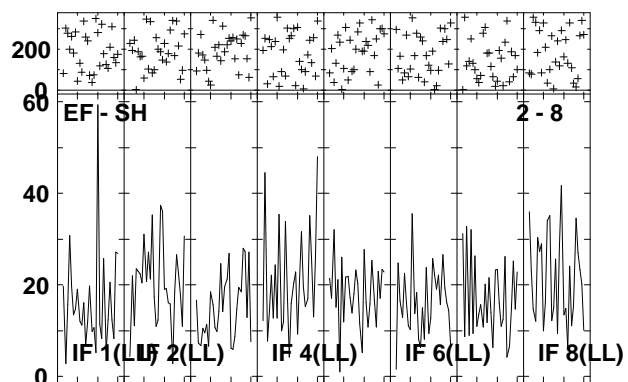
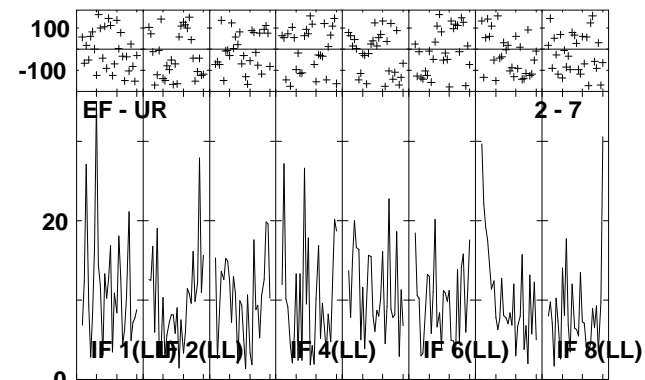
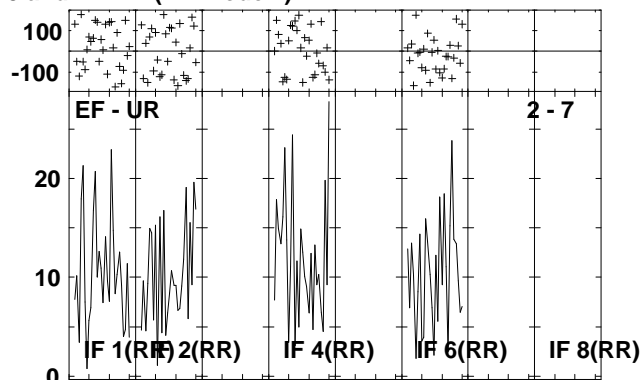
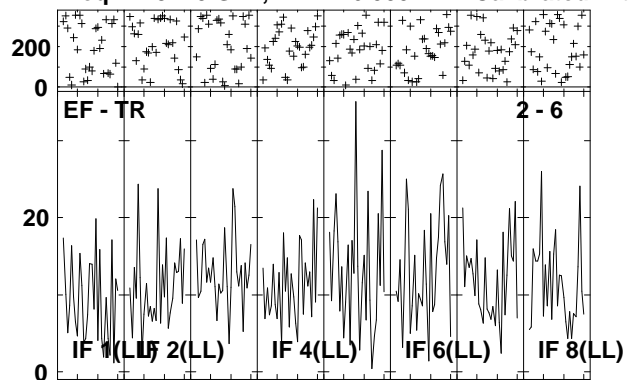

Lower frame: Milli Ampl Jy Top frame: Phas deg
Vector averaged cross-power spectrum Several baselines displayed
Timerange: 00/22:54:01 to 00/22:57:29

Plot file version 57 created 13-OCT-2010 18:40:11
 J2001+10 EP064N.UVDATA.1
 Freq = 4.9270 GHz, Bw = 16.000 MH Calibrated with CL # 3 and BP # 1 (BP mode 1)

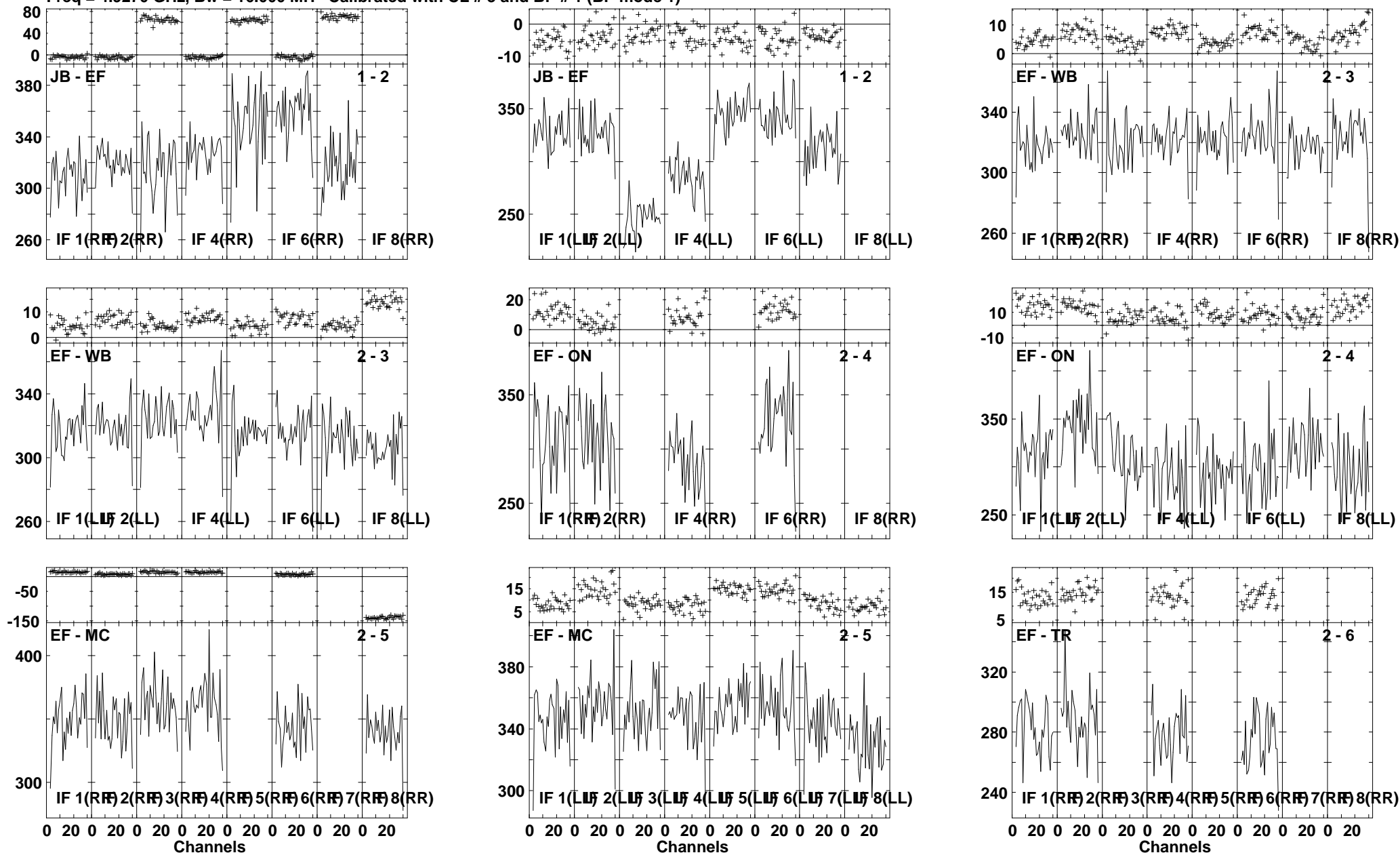

Lower frame: Milli Ampl Jy Top frame: Phas deg
 Vector averaged cross-power spectrum Several baselines displayed
 Timerange: 00/22:57:31 to 00/22:58:59

Plot file version 58 created 13-OCT-2010 18:40:12

J2001+10 EP064N.UVDATA.1

Freq = 4.9270 GHz, Bw = 16.000 MH Calibrated with CL # 3 and BP # 1 (BP mode 1)

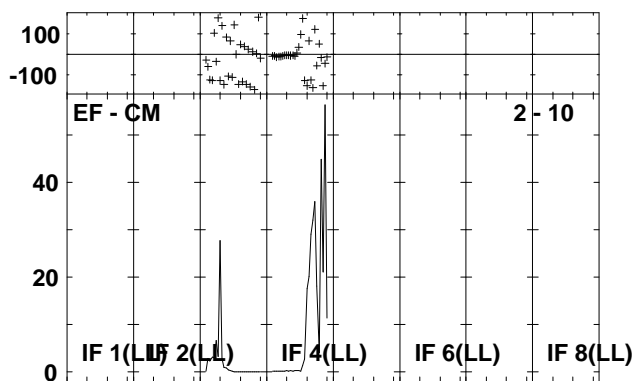
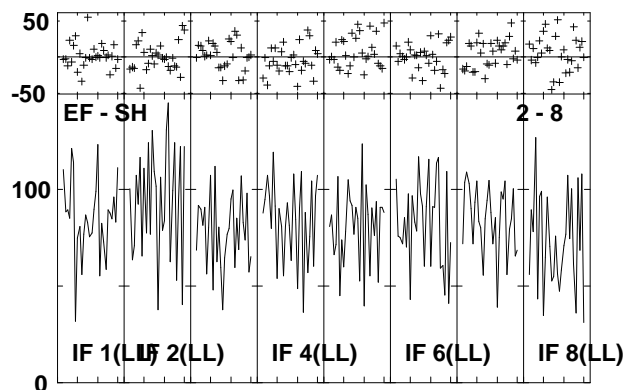
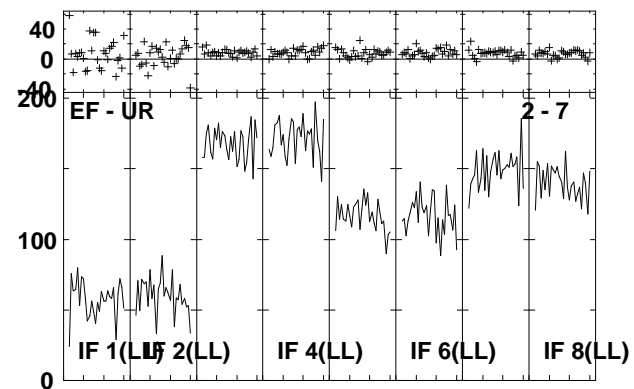
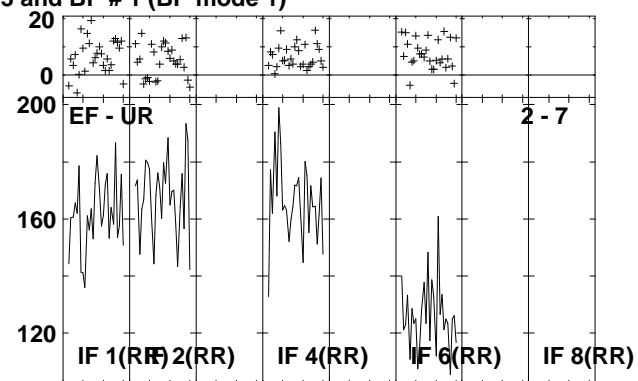
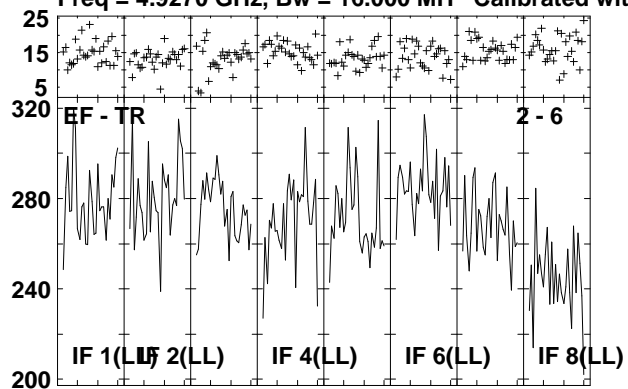

Lower frame: Milli Ampl Jy Top frame: Phas deg
Vector averaged cross-power spectrum Several baselines displayed
Timerange: 00/22:57:31 to 00/22:58:59

Plot file version 59 created 13-OCT-2010 18:40:14

IRAS1954 EP064N.UVDATA.1

Freq = 4.9270 GHz, Bw = 16.000 MH Calibrated with CL # 3 and BP # 1 (BP mode 1)

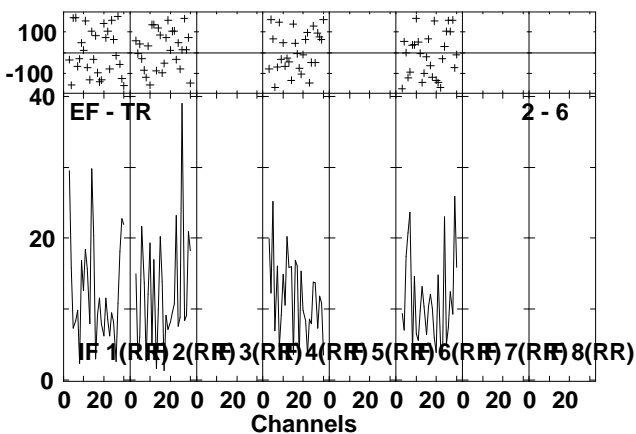
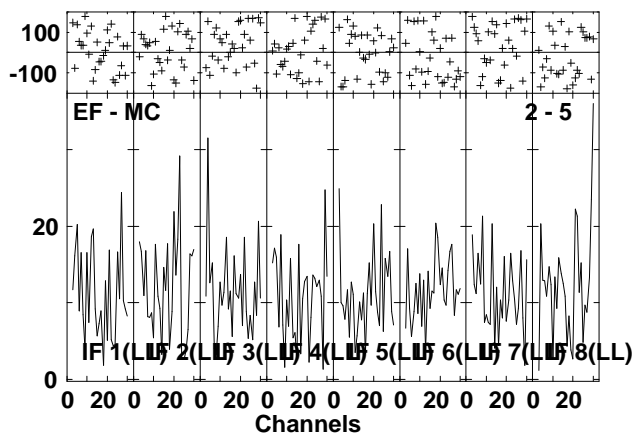
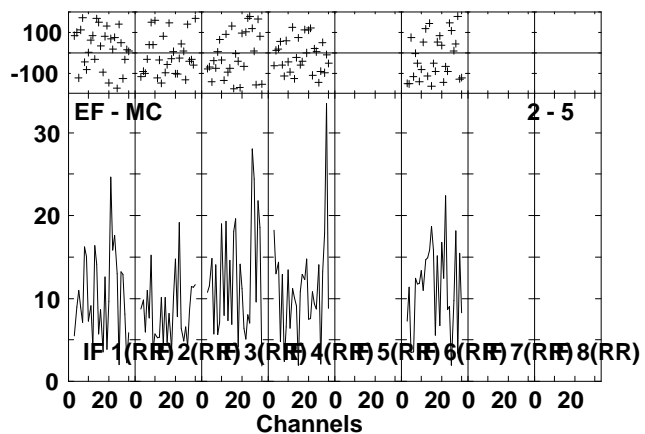
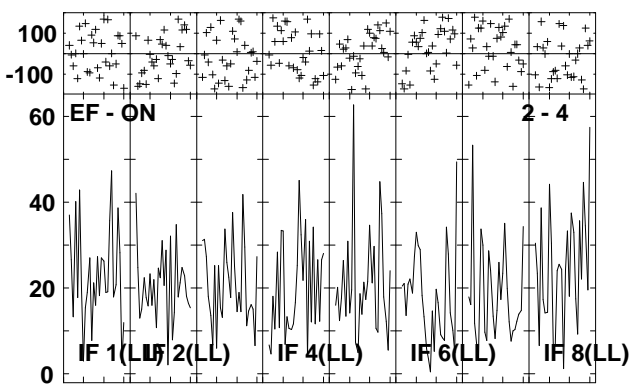
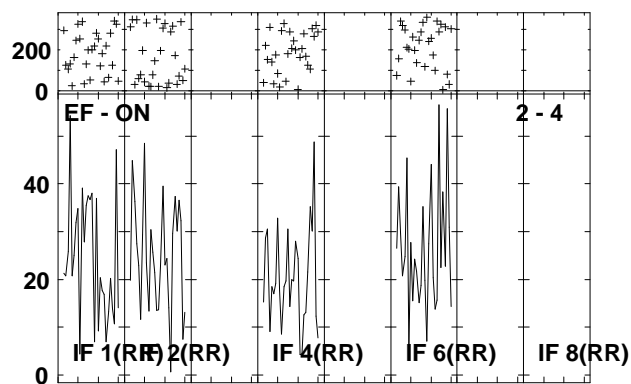
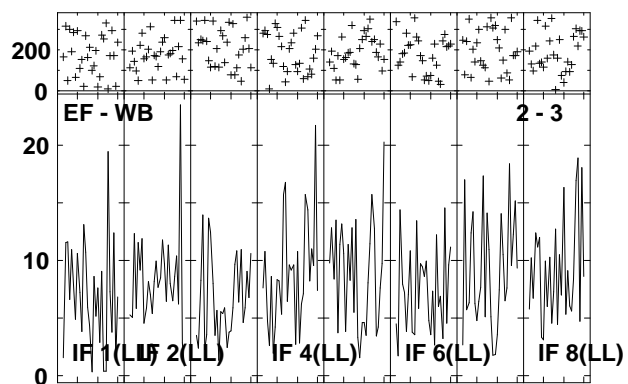
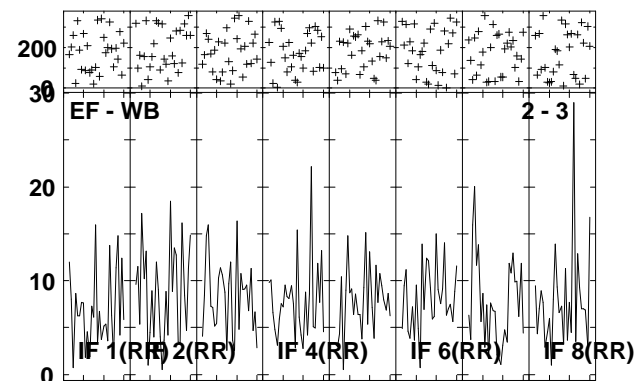
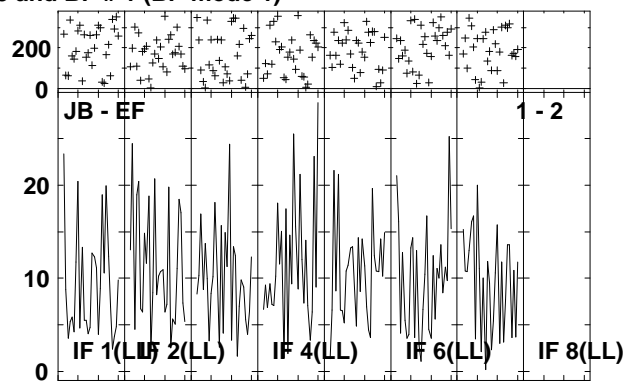
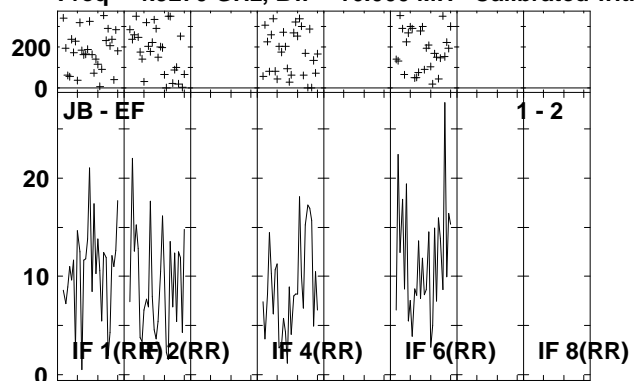

Lower frame: Milli Ampl Jy Top frame: Phas deg
Vector averaged cross-power spectrum Several baselines displayed
Timerange: 00/22:59:01 to 00/23:02:29

Plot file version 60 created 13-OCT-2010 18:40:17

IRAS1954 EP064N.UVDATA.1

Freq = 4.9270 GHz, Bw = 16.000 MH Calibrated with CL # 3 and BP # 1 (BP mode 1)

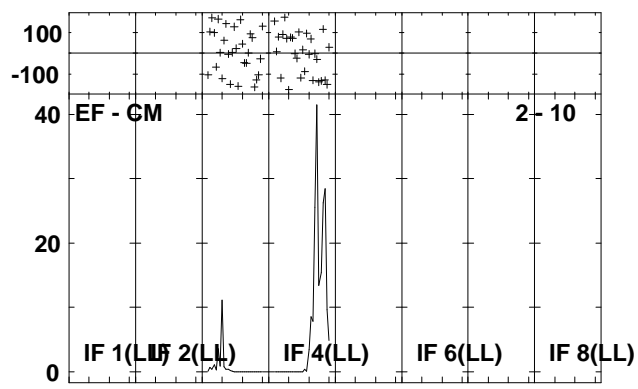
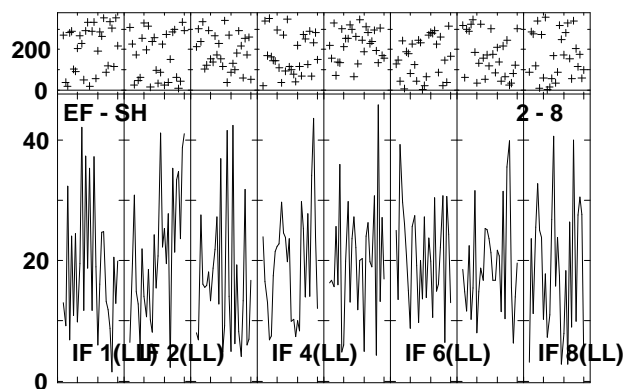
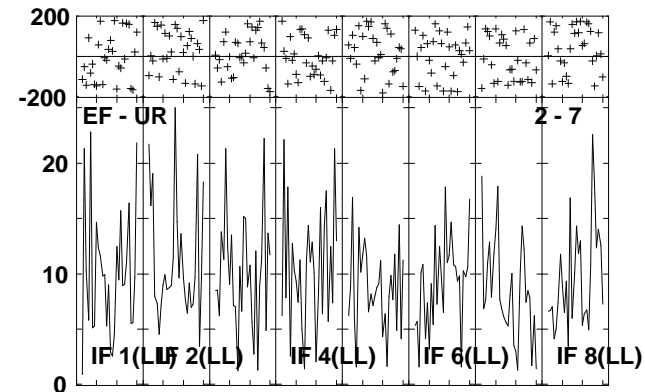
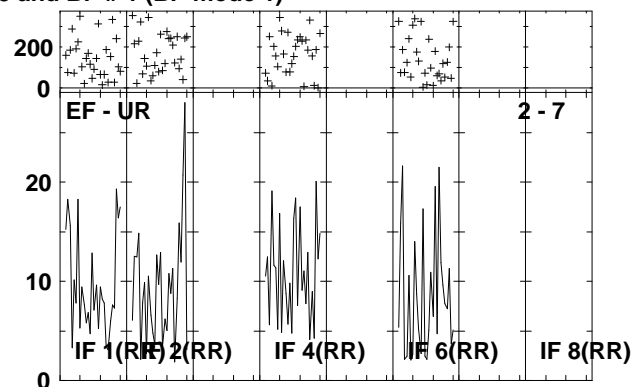
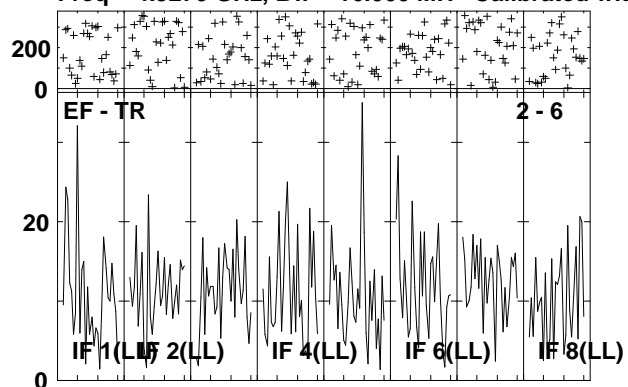

Lower frame: Milli Ampl Jy Top frame: Phas deg
Vector averaged cross-power spectrum Several baselines displayed
Timerange: 00/22:59:01 to 00/23:02:29

Plot file version 61 created 13-OCT-2010 18:40:22

J2001+10 EP064N.UVDATA.1

Freq = 4.9270 GHz, Bw = 16.000 MH Calibrated with CL # 3 and BP # 1 (BP mode 1)

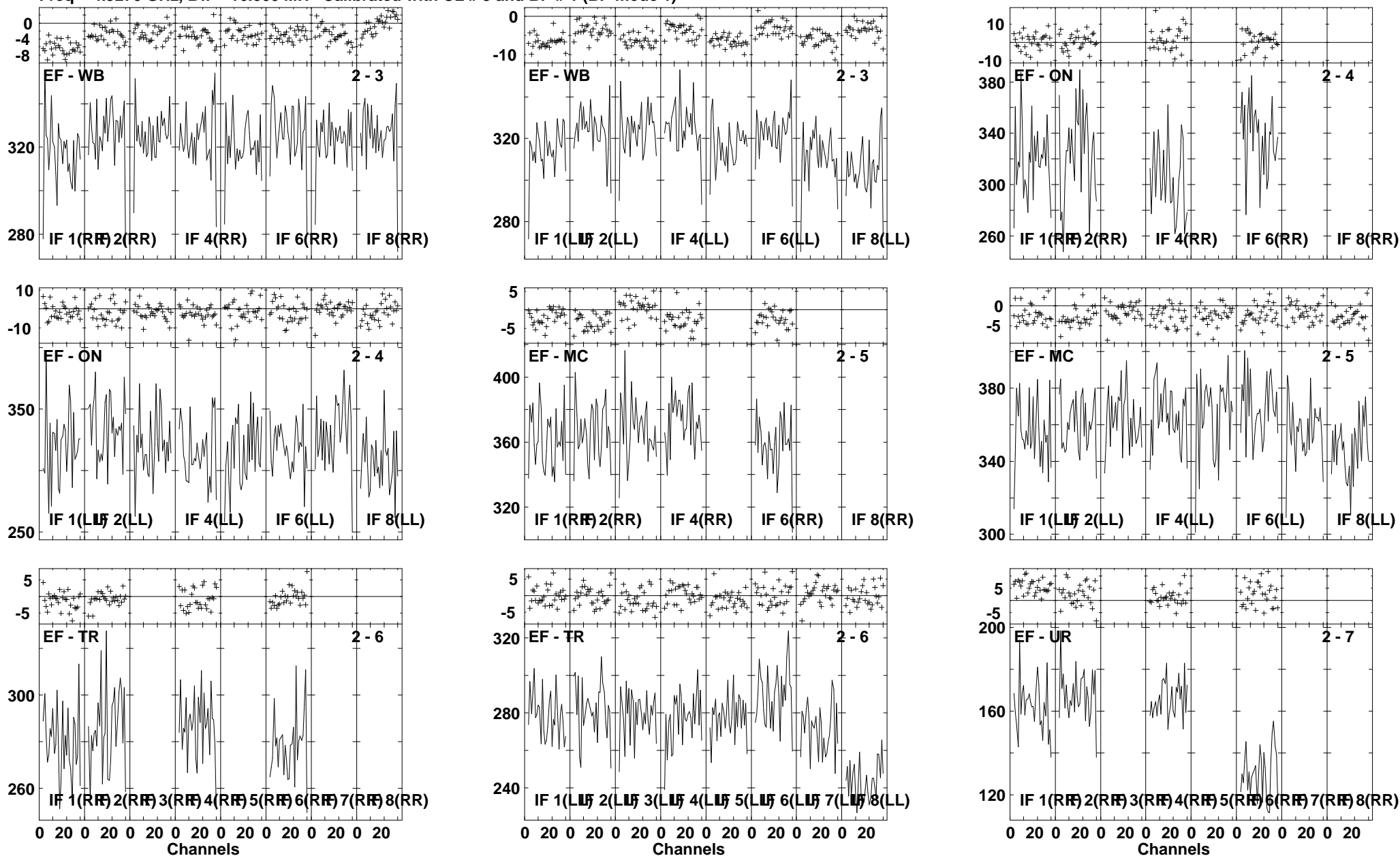

Lower frame: Milli Ampl Jy Top frame: Phas deg
Vector averaged cross-power spectrum Several baselines displayed
Timerange: 00/23:03:31 to 00/23:04:59

Plot file version 62 created 13-OCT-2010 18:40:23

J2001+10 EP064N.UVDATA.1

Freq = 4.9270 GHz, Bw = 16.000 MH Calibrated with CL # 3 and BP # 1 (BP mode 1)

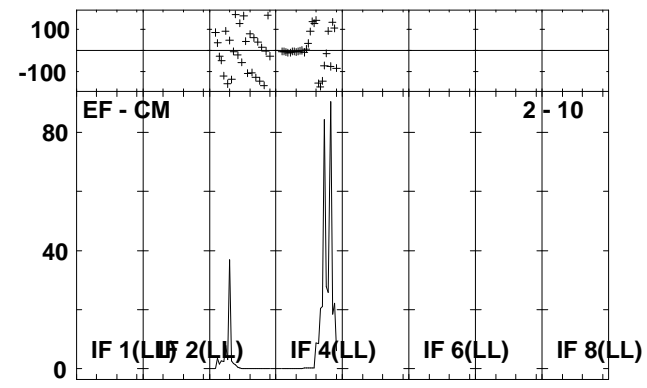
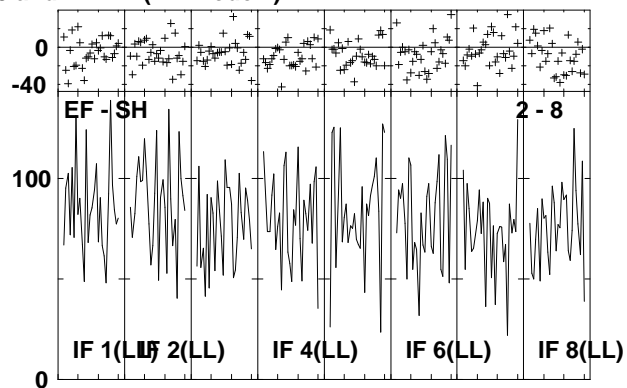
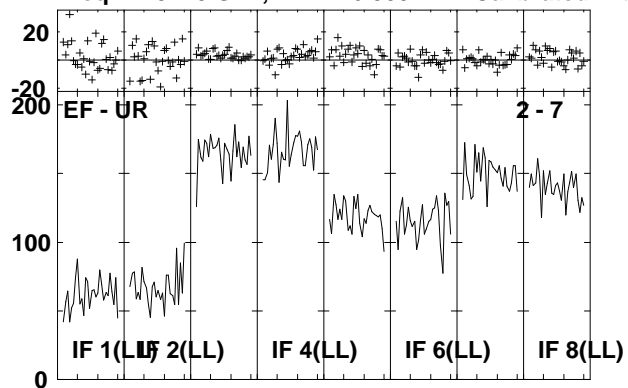

Lower frame: Milli Ampl Jy Top frame: Phas deg
Vector averaged cross-power spectrum Several baselines displayed
Timerange: 00/23:03:31 to 00/23:04:59

Plot file version 63 created 13-OCT-2010 18:40:25

IRAS1954 EP064N.UVDATA.1

Freq = 4.9270 GHz, Bw = 16.000 MH Calibrated with CL # 3 and BP # 1 (BP mode 1)

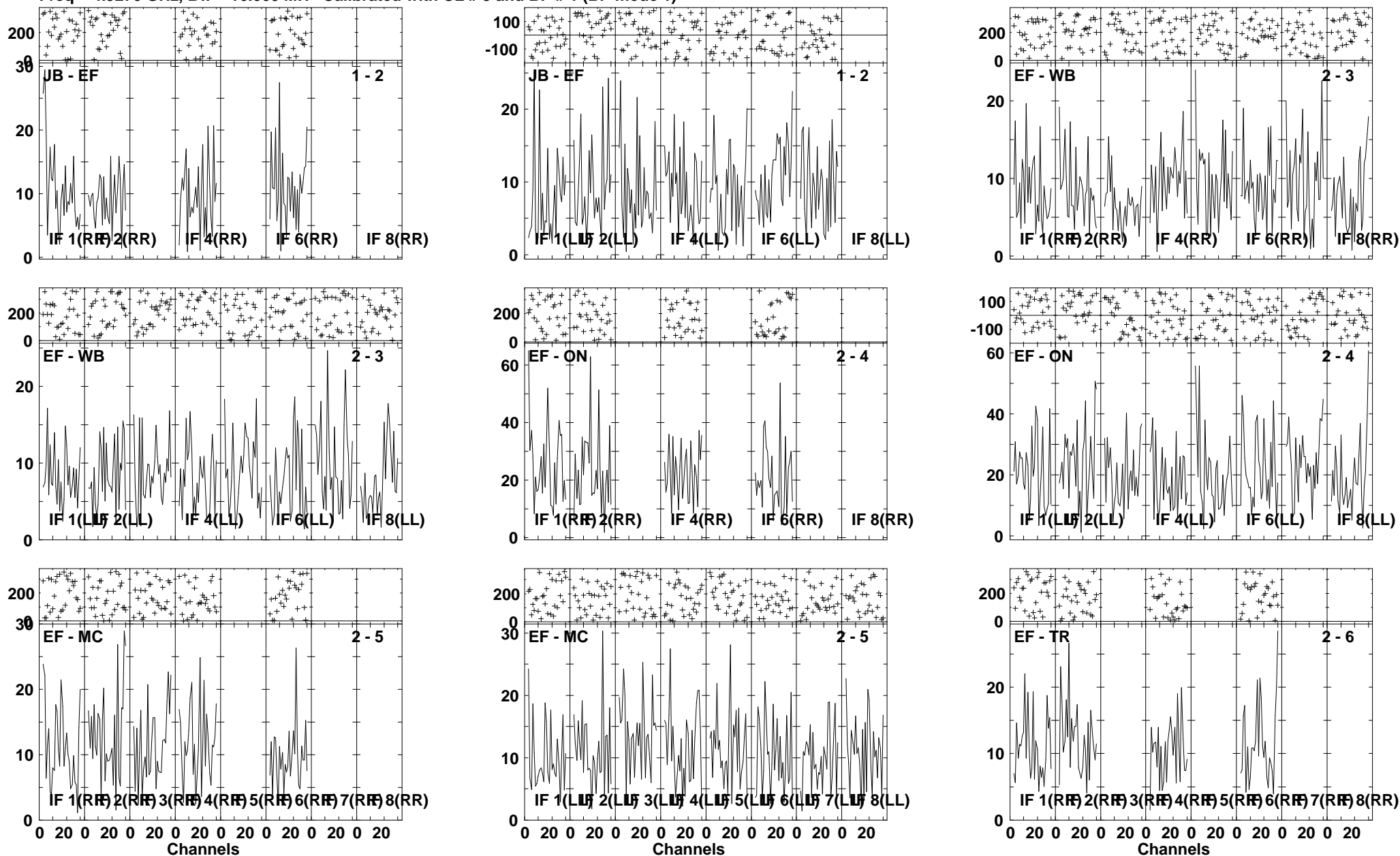

Lower frame: Milli Ampl Jy Top frame: Phas deg
Vector averaged cross-power spectrum Several baselines displayed
Timerange: 00/23:05:03 to 00/23:08:29

Plot file version 64 created 13-OCT-2010 18:40:28

IRAS1954 EP064N.UVDATA.1

Freq = 4.9270 GHz, Bw = 16.000 MH Calibrated with CL # 3 and BP # 1 (BP mode 1)

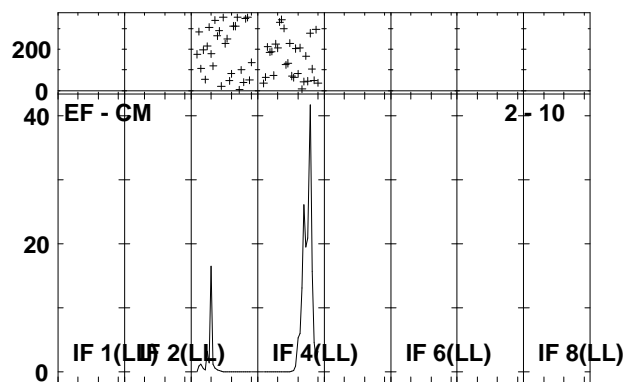
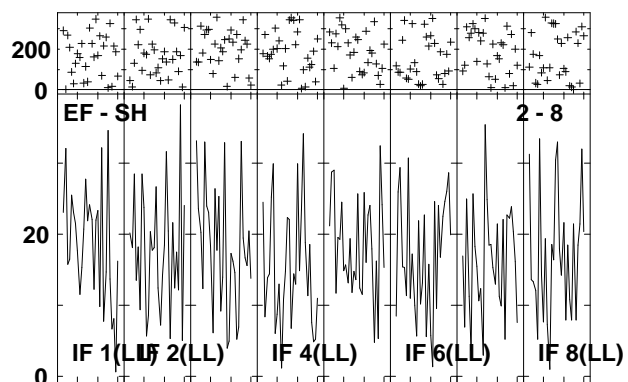
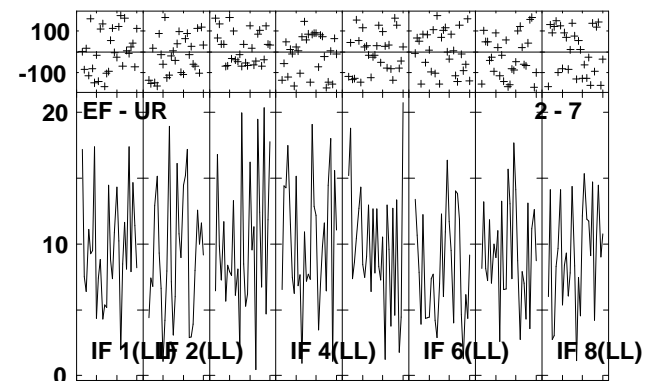
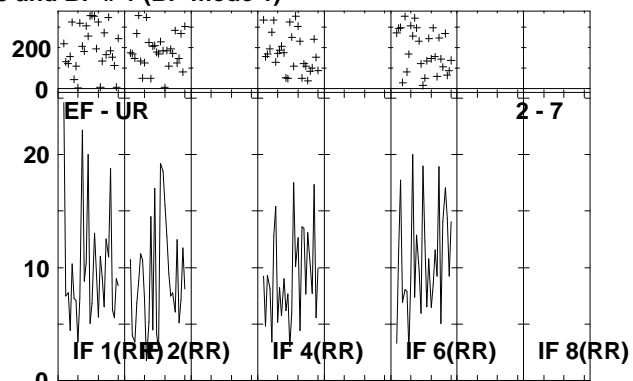
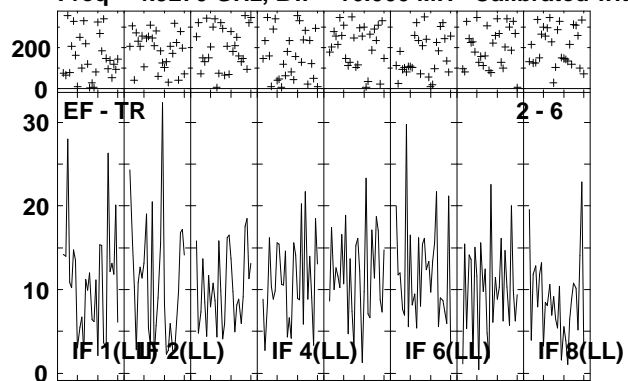

Lower frame: Milli Ampl Jy Top frame: Phas deg
Vector averaged cross-power spectrum Several baselines displayed
Timerange: 00/23:05:03 to 00/23:08:29

Plot file version 65 created 13-OCT-2010 18:40:32

J2001+10 EP064N.UVDATA.1

Freq = 4.9270 GHz, Bw = 16.000 MH Calibrated with CL # 3 and BP # 1 (BP mode 1)

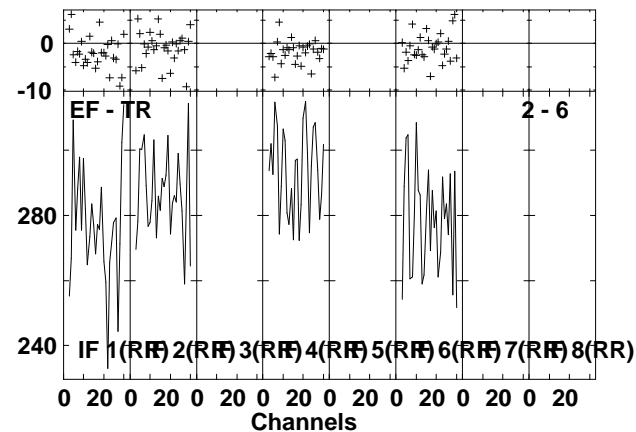
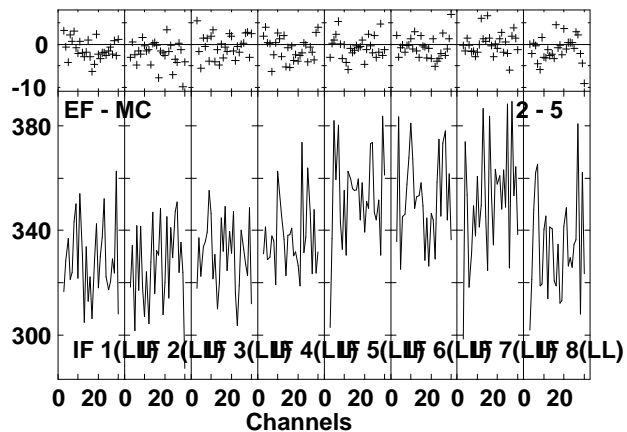
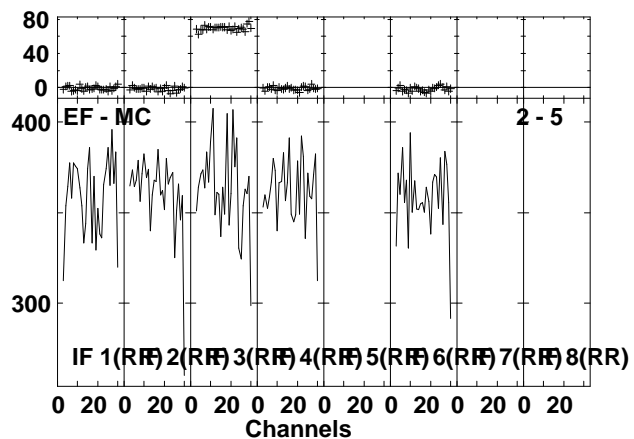
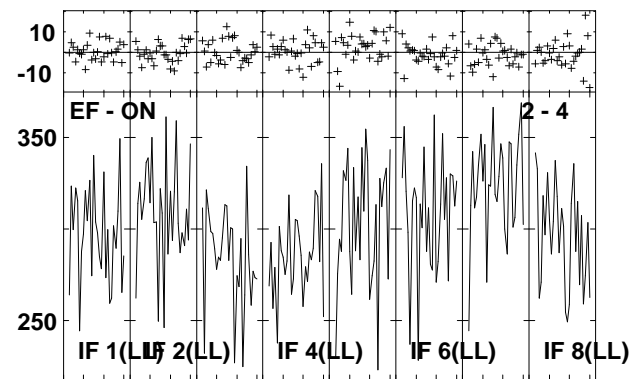
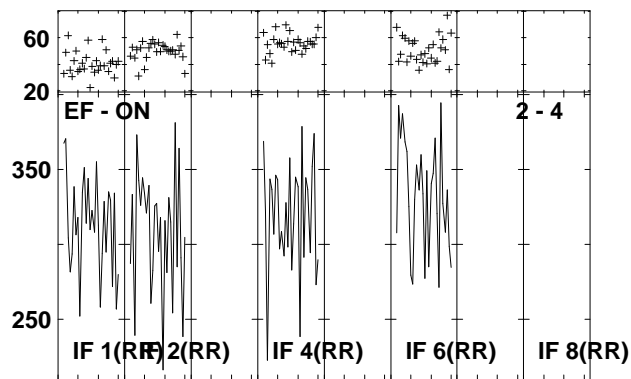
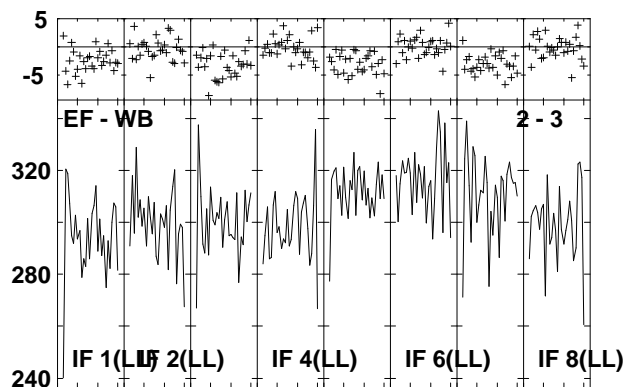
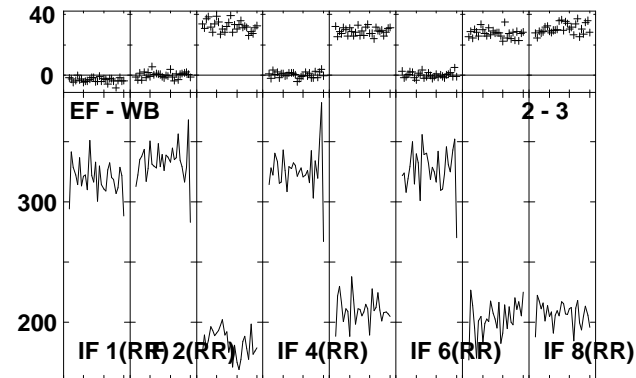
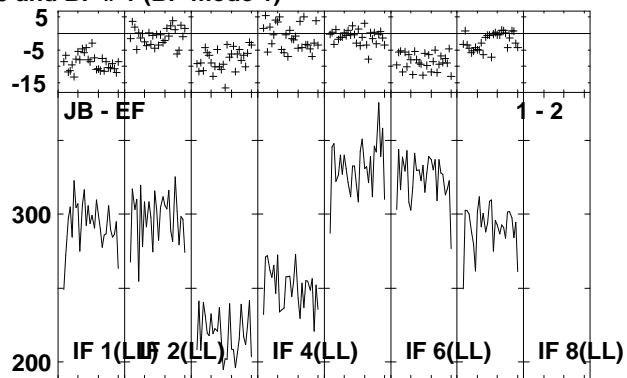
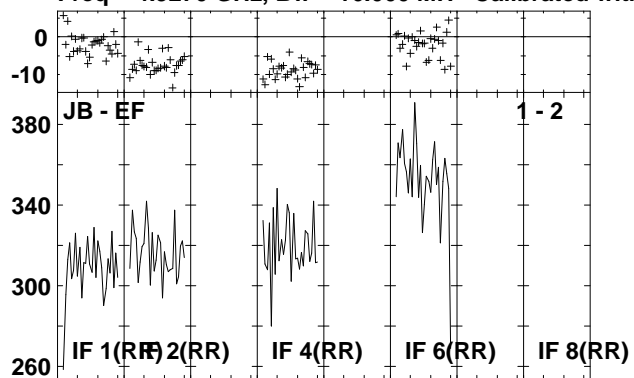

Lower frame: Milli Ampl Jy Top frame: Phas deg
Vector averaged cross-power spectrum Several baselines displayed
Timerange: 00/23:08:31 to 00/23:09:59

Plot file version 66 created 13-OCT-2010 18:40:33

J2001+10 EP064N.UVDATA.1

Freq = 4.9270 GHz, Bw = 16.000 MH Calibrated with CL # 3 and BP # 1 (BP mode 1)

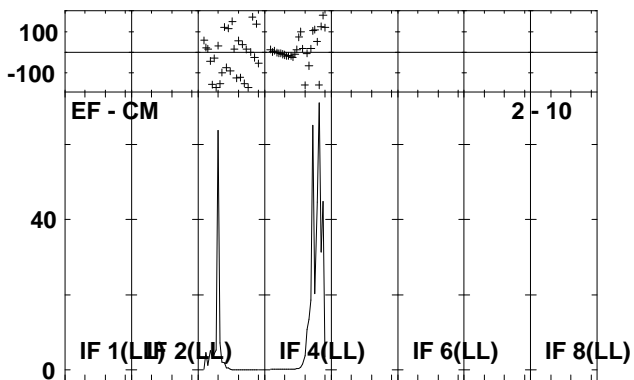
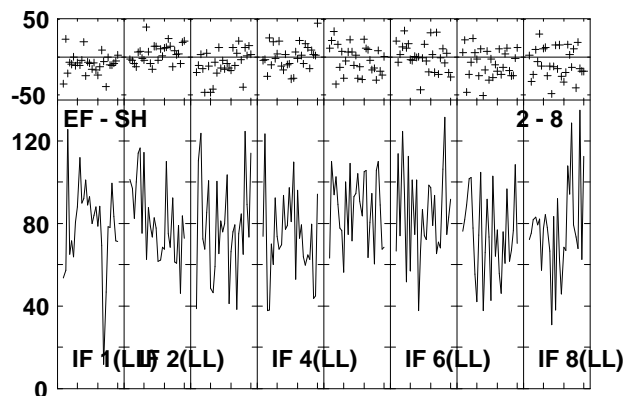
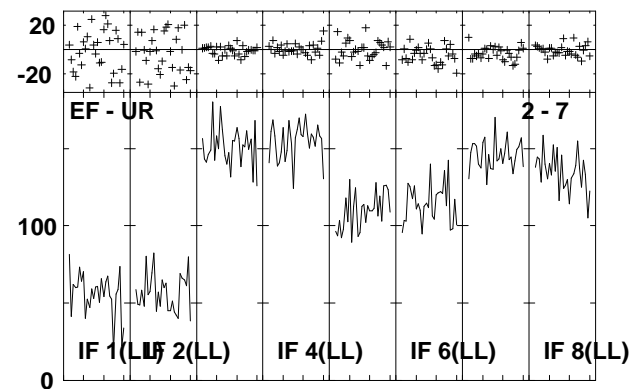
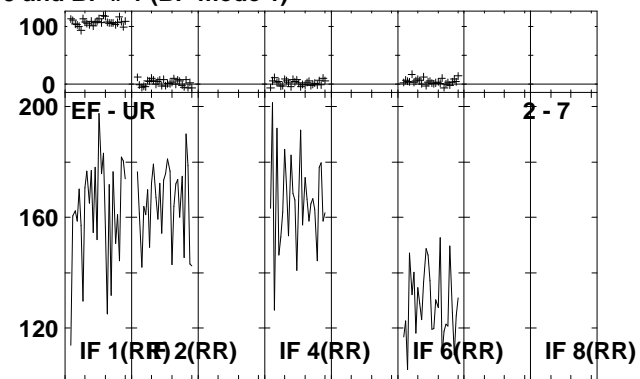
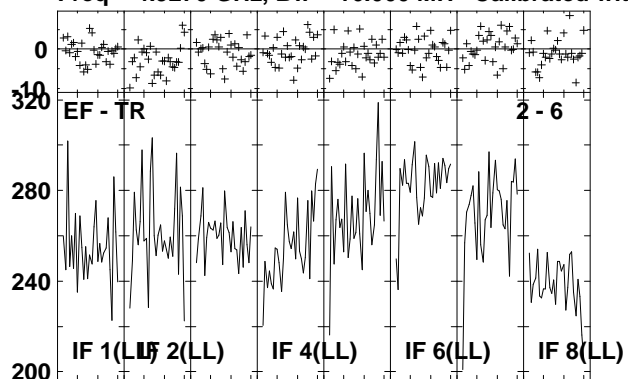

Lower frame: Milli Ampl Jy Top frame: Phas deg
Vector averaged cross-power spectrum Several baselines displayed
Timerange: 00/23:08:31 to 00/23:09:59

Plot file version 67 created 13-OCT-2010 18:40:35

IRAS1954 EP064N.UVDATA.1

Freq = 4.9270 GHz, Bw = 16.000 MH Calibrated with CL # 3 and BP # 1 (BP mode 1)

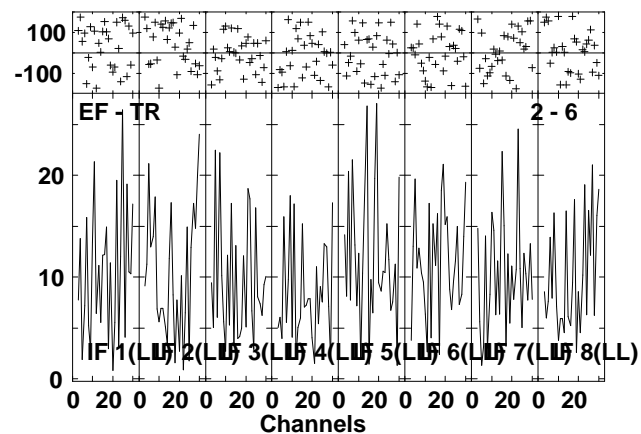
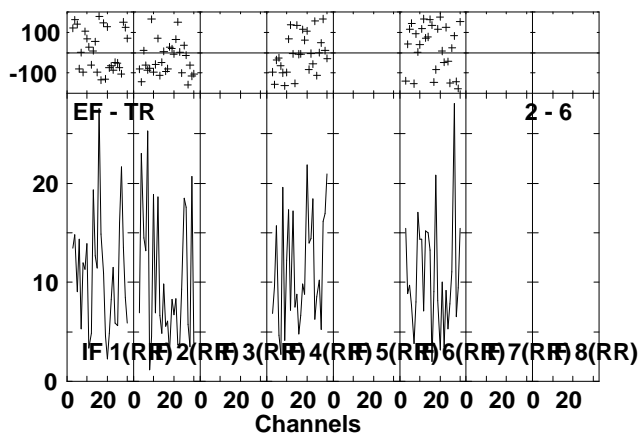
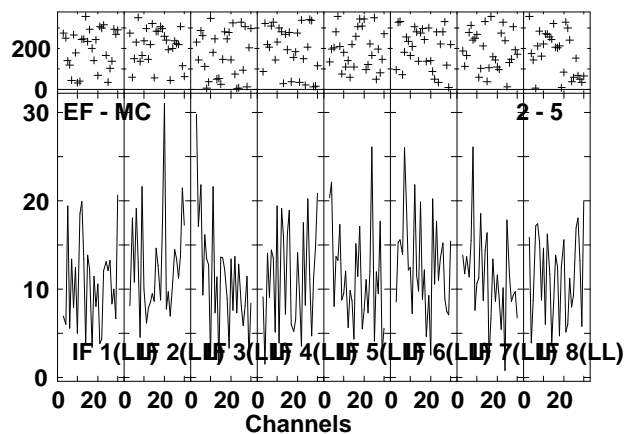
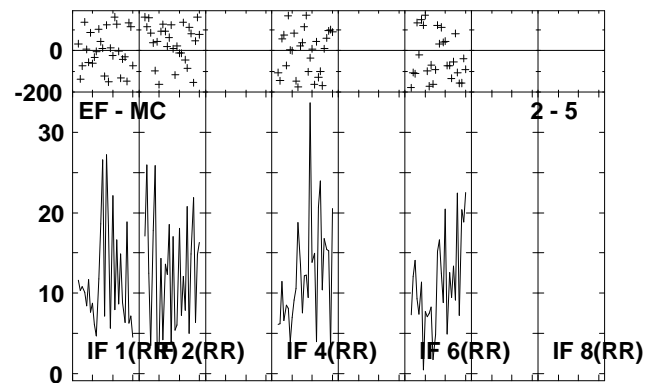
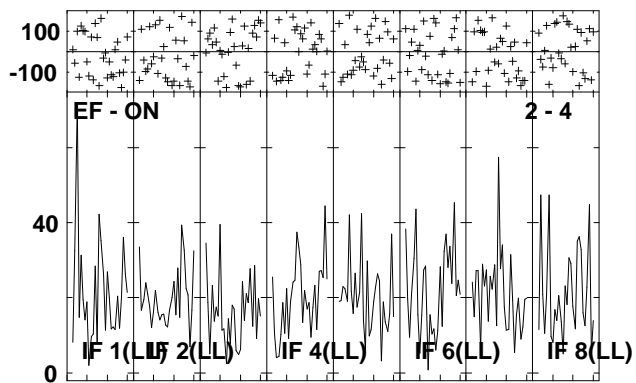
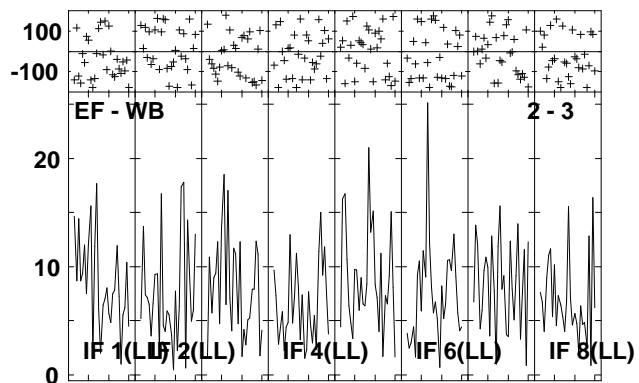
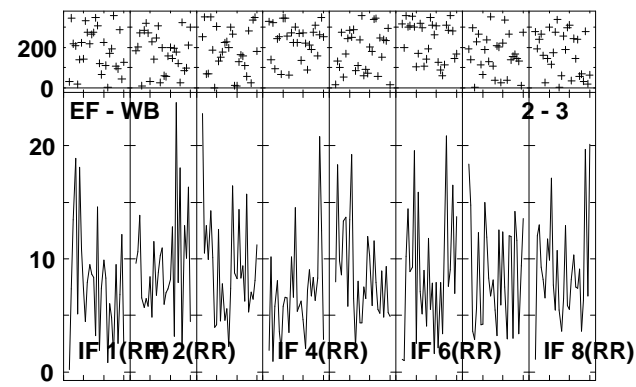
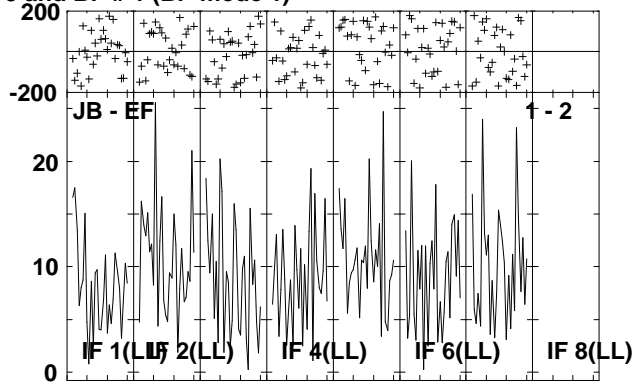
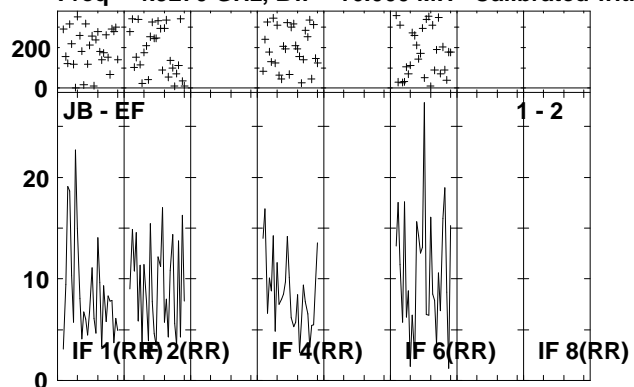

Lower frame: Milli Ampl Jy Top frame: Phas deg
Vector averaged cross-power spectrum Several baselines displayed
Timerange: 00/23:10:01 to 00/23:13:29

Plot file version 68 created 13-OCT-2010 18:40:39

IRAS1954 EP064N.UVDATA.1

Freq = 4.9270 GHz, Bw = 16.000 MH Calibrated with CL # 3 and BP # 1 (BP mode 1)

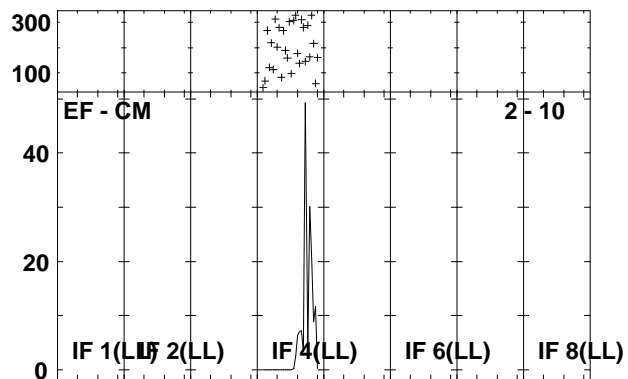
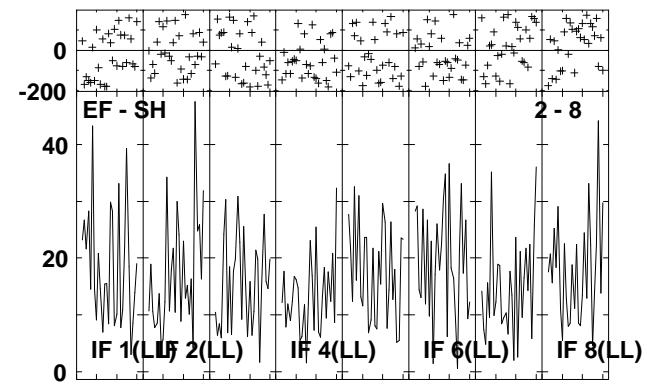
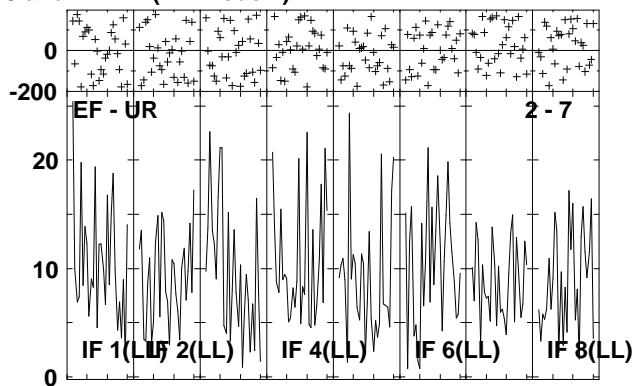
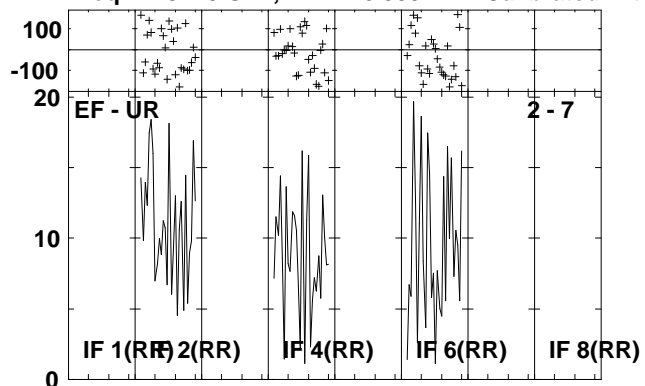

Lower frame: Milli Ampl Jy Top frame: Phas deg
Vector averaged cross-power spectrum Several baselines displayed
Timerange: 00/23:10:01 to 00/23:13:29

Plot file version 69 created 13-OCT-2010 18:40:43

J2001+10 EP064N.UVDATA.1

Freq = 4.9270 GHz, Bw = 16.000 MH Calibrated with CL # 3 and BP # 1 (BP mode 1)

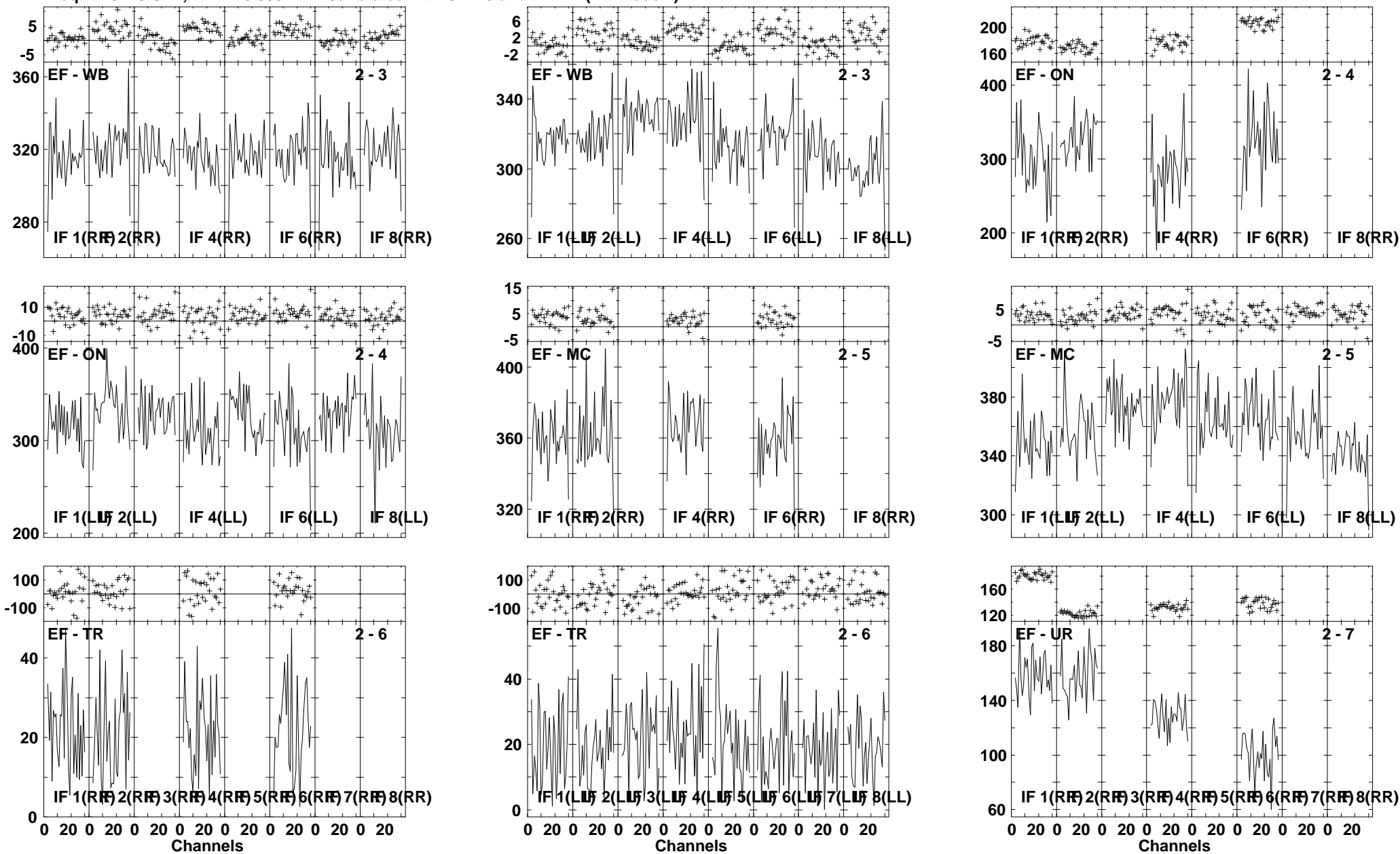

Lower frame: Milli Ampl Jy Top frame: Phas deg
Vector averaged cross-power spectrum Several baselines displayed
Timerange: 00/23:13:31 to 00/23:14:57

Plot file version 70 created 13-OCT-2010 18:40:44

J2001+10 EP064N.UVDATA.1

Freq = 4.9270 GHz, Bw = 16.000 MH Calibrated with CL # 3 and BP # 1 (BP mode 1)

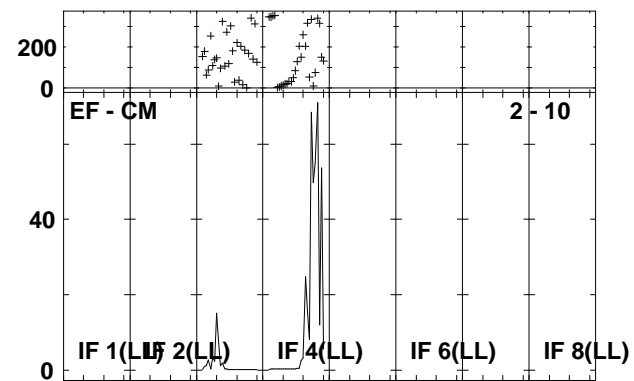
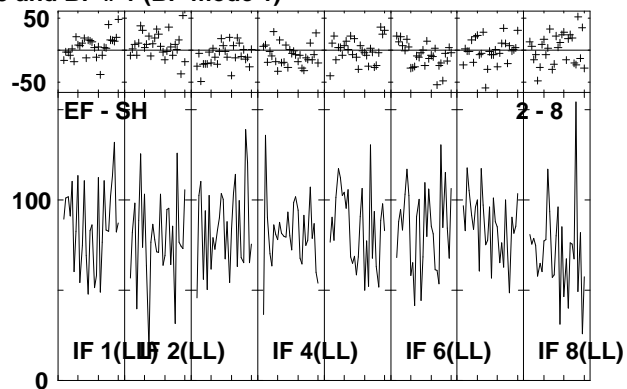
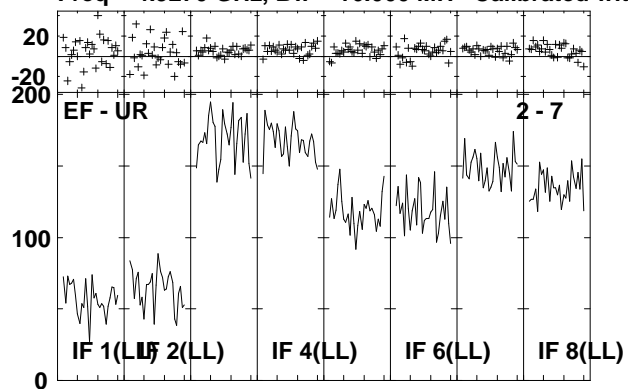

Lower frame: Milli Ampl Jy Top frame: Phas deg
Vector averaged cross-power spectrum Several baselines displayed
Timerange: 00/23:13:31 to 00/23:14:57

Plot file version 71 created 13-OCT-2010 18:40:45

IRAS1954 EP064N.UVDATA.1

Freq = 4.9270 GHz, Bw = 16.000 MH Calibrated with CL # 3 and BP # 1 (BP mode 1)

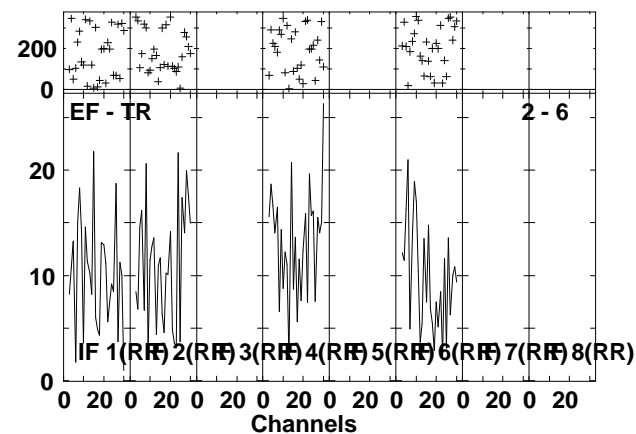
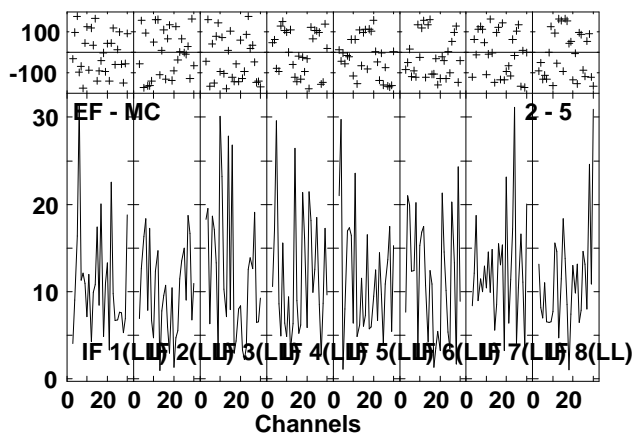
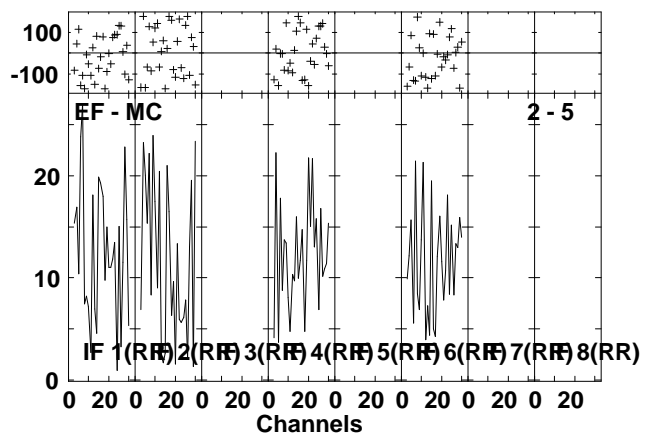
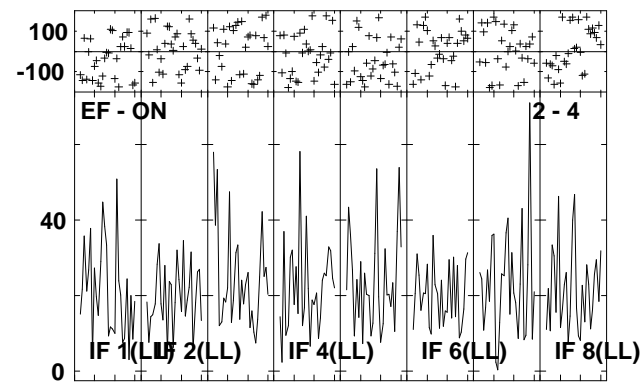
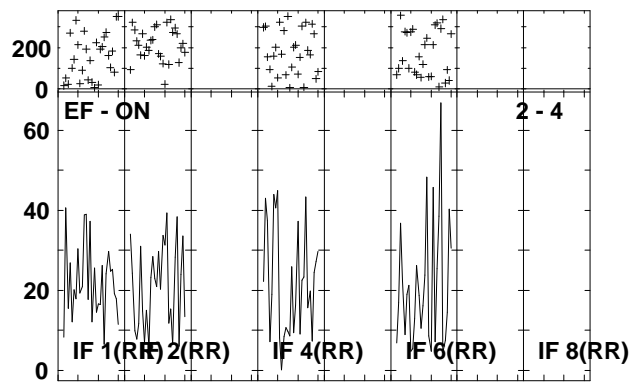
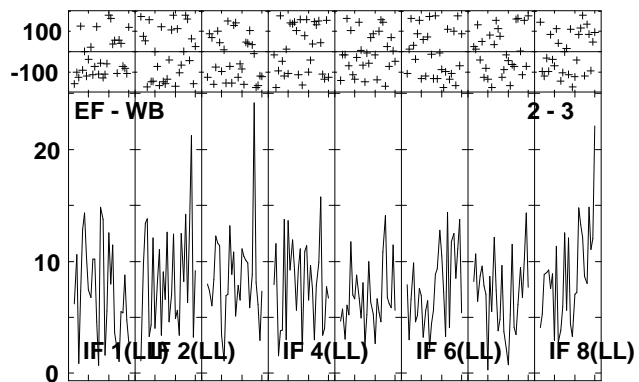
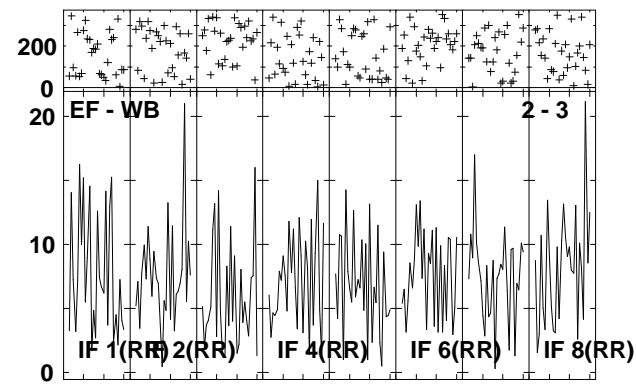
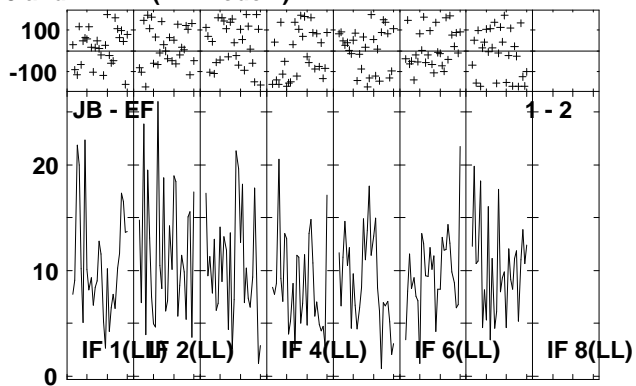
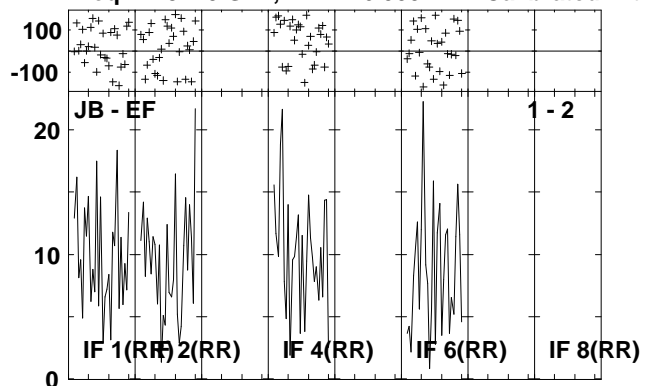

Lower frame: Milli Ampl Jy Top frame: Phas deg
Vector averaged cross-power spectrum Several baselines displayed
Timerange: 00/23:15:01 to 00/23:18:29

Plot file version 72 created 13-OCT-2010 18:40:48

IRAS1954 EP064N.UVDATA.1

Freq = 4.9270 GHz, Bw = 16.000 MH Calibrated with CL # 3 and BP # 1 (BP mode 1)

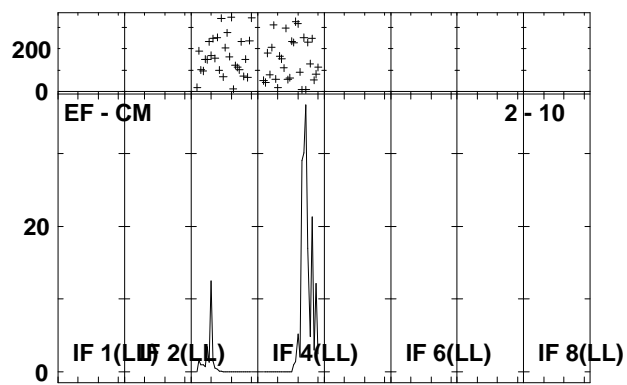
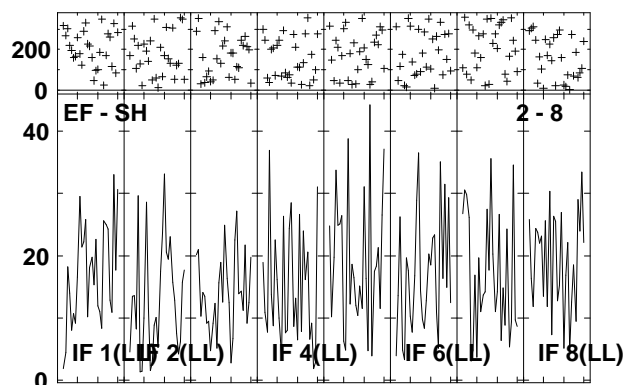
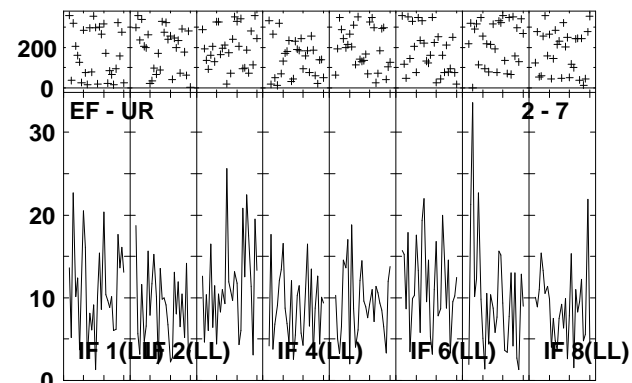
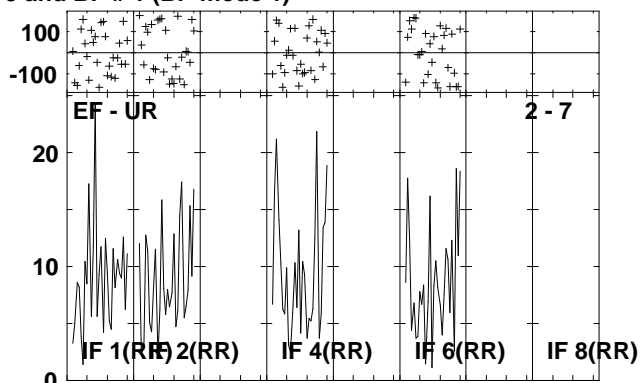
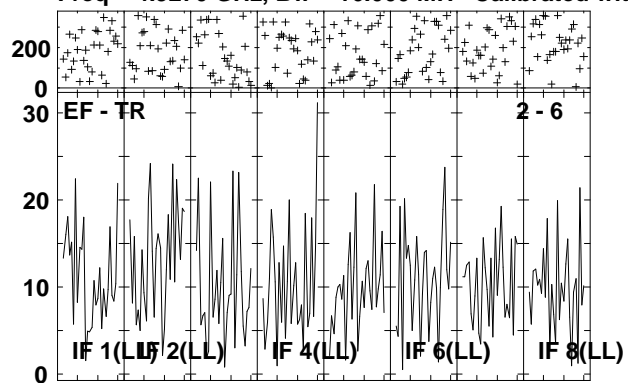

Lower frame: Milli Ampl Jy Top frame: Phas deg
Vector averaged cross-power spectrum Several baselines displayed
Timerange: 00/23:15:01 to 00/23:18:29

Plot file version 73 created 13-OCT-2010 18:40:52
 J2001+10 EP064N.UVDATA.1
 Freq = 4.9270 GHz, Bw = 16.000 MH Calibrated with CL # 3 and BP # 1 (BP mode 1)

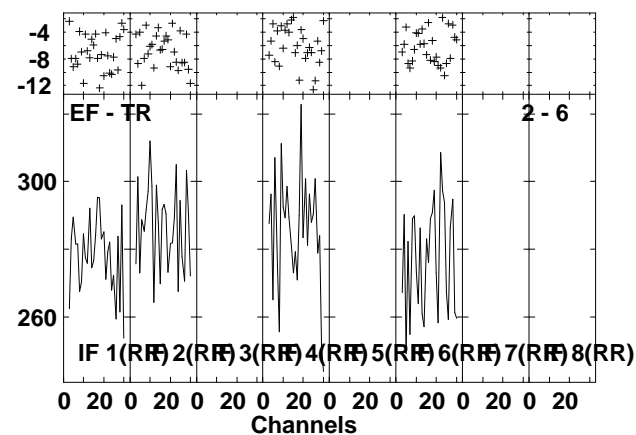
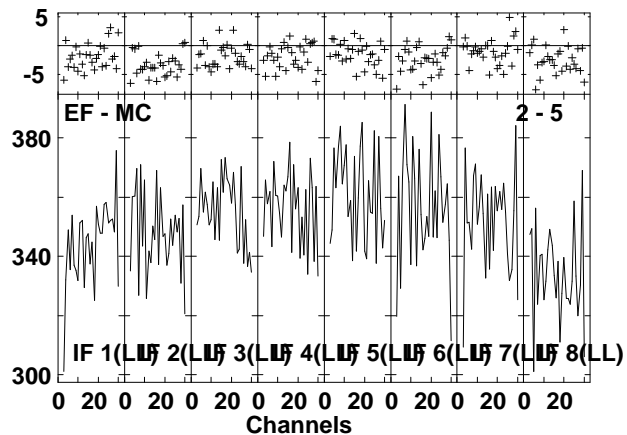
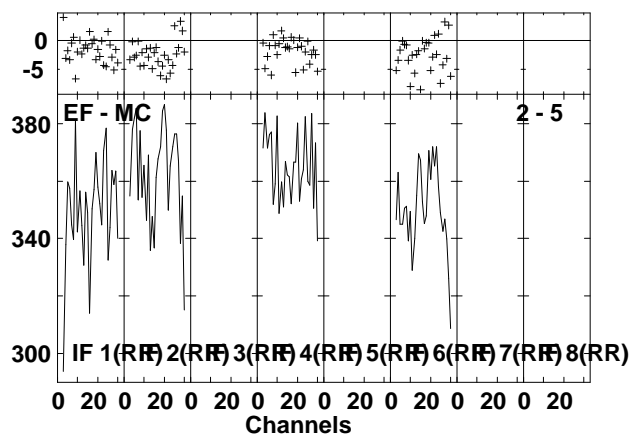
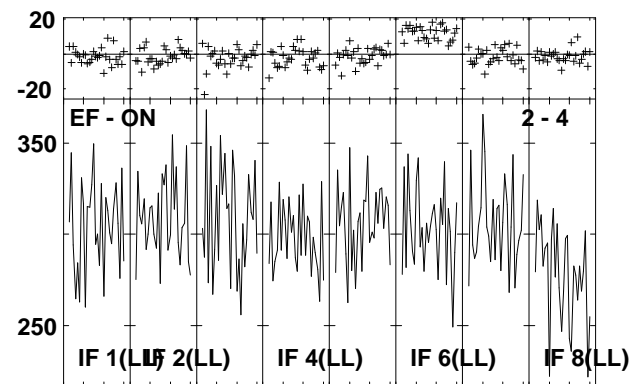
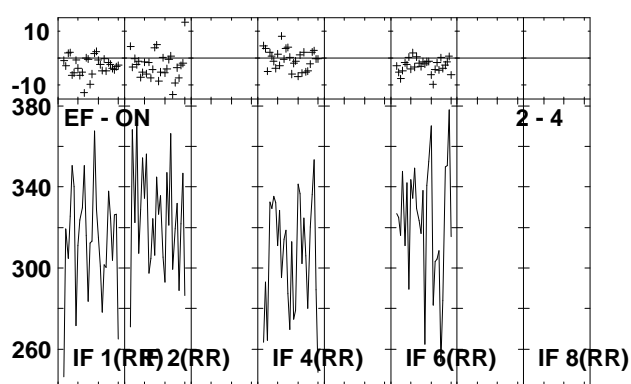
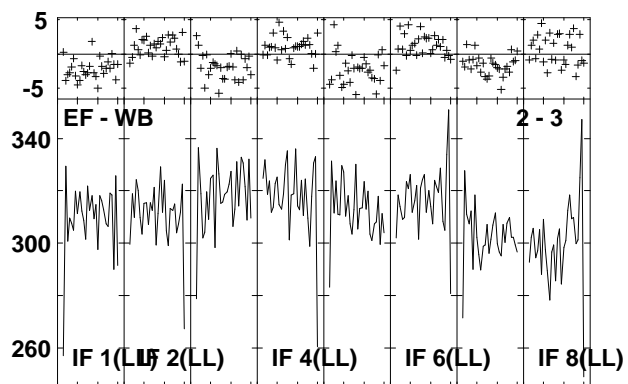
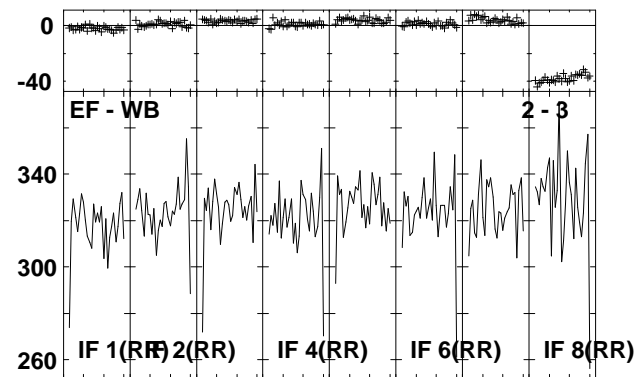
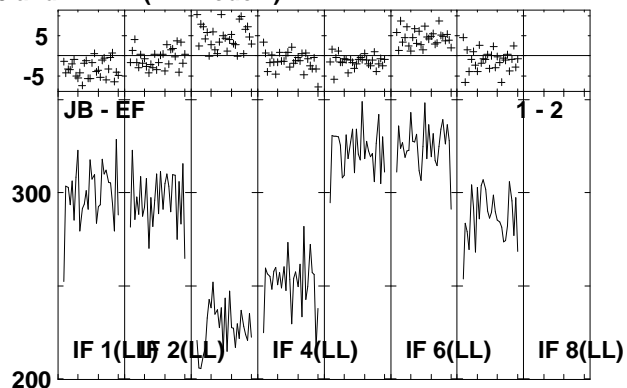
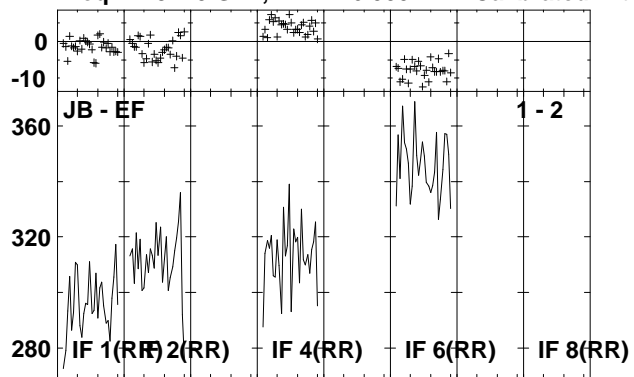

Lower frame: Milli Ampl Jy Top frame: Phas deg
 Vector averaged cross-power spectrum Several baselines displayed
 Timerange: 00/23:19:31 to 00/23:20:59

Plot file version 74 created 13-OCT-2010 18:40:54

J2001+10 EP064N.UVDATA.1

Freq = 4.9270 GHz, Bw = 16.000 MH Calibrated with CL # 3 and BP # 1 (BP mode 1)

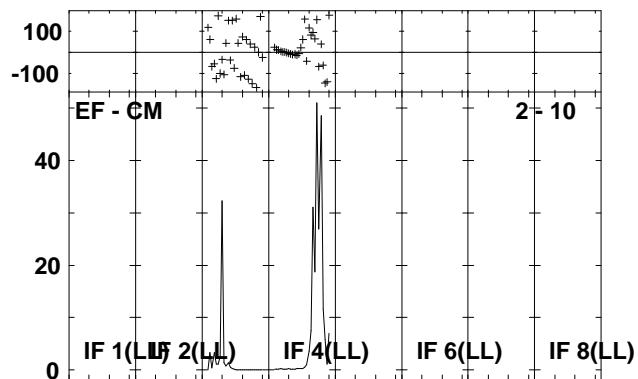
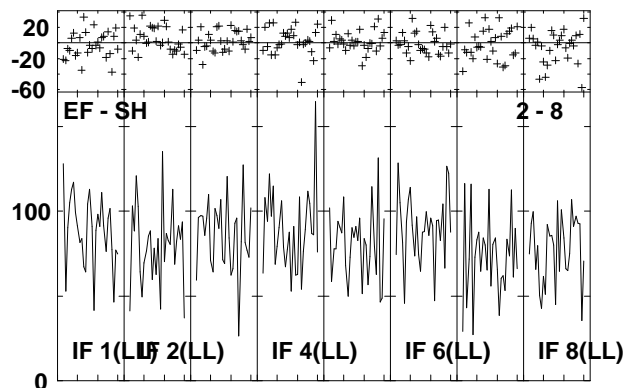
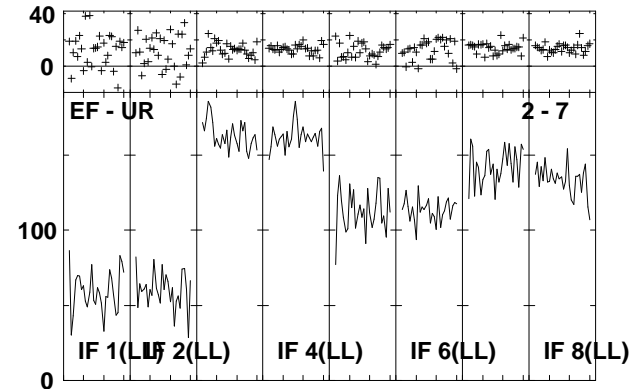
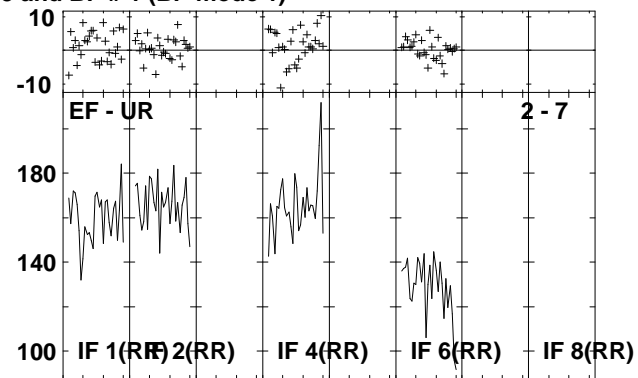
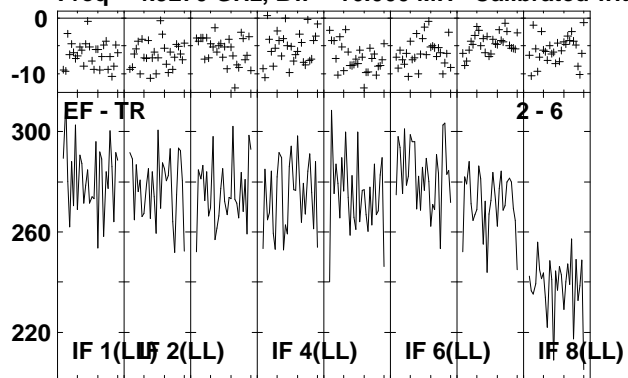

Lower frame: Milli Ampl Jy Top frame: Phas deg
Vector averaged cross-power spectrum Several baselines displayed
Timerange: 00/23:19:31 to 00/23:20:59

Plot file version 75 created 13-OCT-2010 18:40:56

IRAS1954 EP064N.UVDATA.1

Freq = 4.9270 GHz, Bw = 16.000 MH Calibrated with CL # 3 and BP # 1 (BP mode 1)

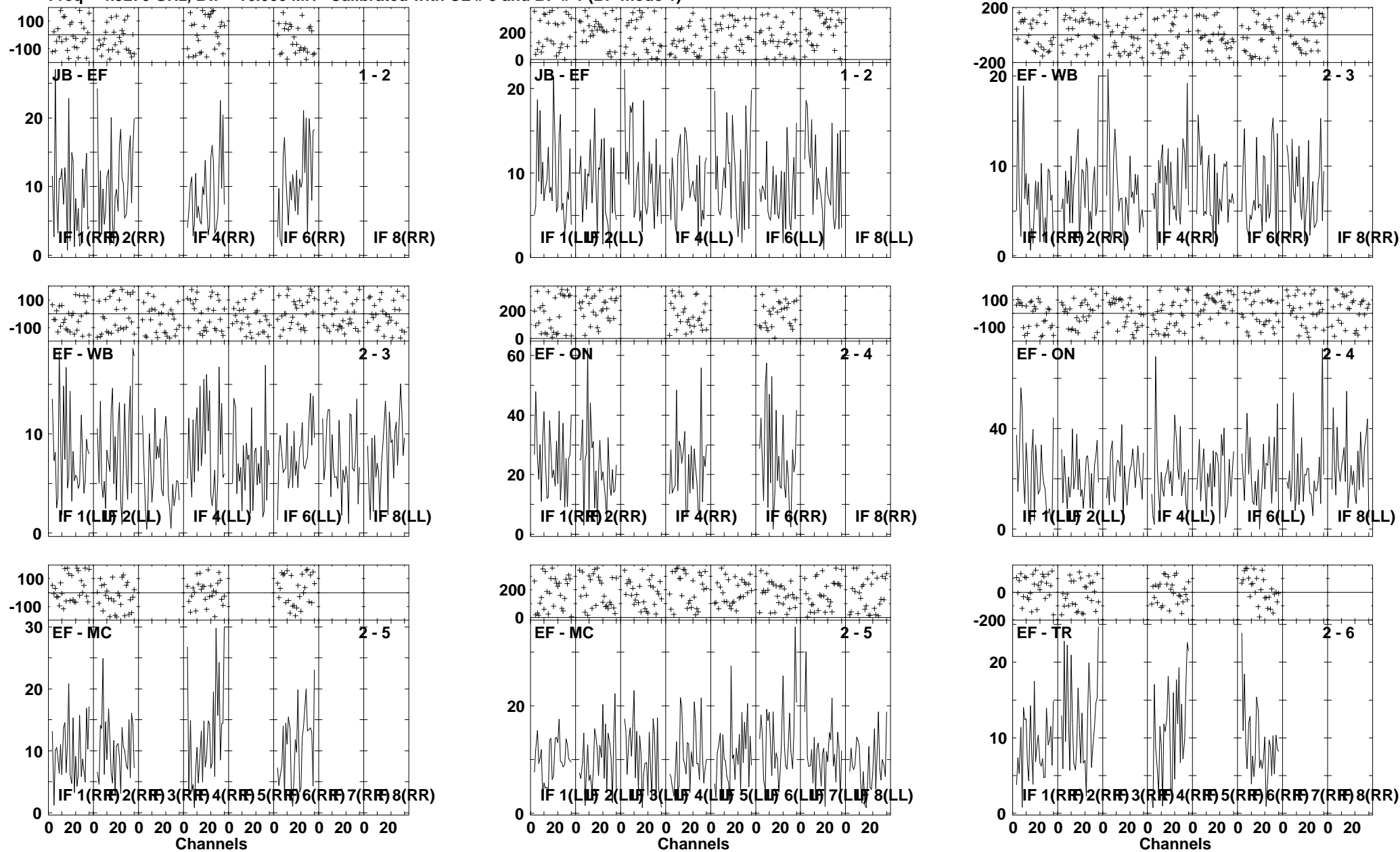

Lower frame: Milli Ampl Jy Top frame: Phas deg
Vector averaged cross-power spectrum Several baselines displayed
Timerange: 00/23:21:01 to 00/23:24:29

Plot file version 76 created 13-OCT-2010 18:40:59

IRAS1954 EP064N.UVDATA.1

Freq = 4.9270 GHz, Bw = 16.000 MH Calibrated with CL # 3 and BP # 1 (BP mode 1)

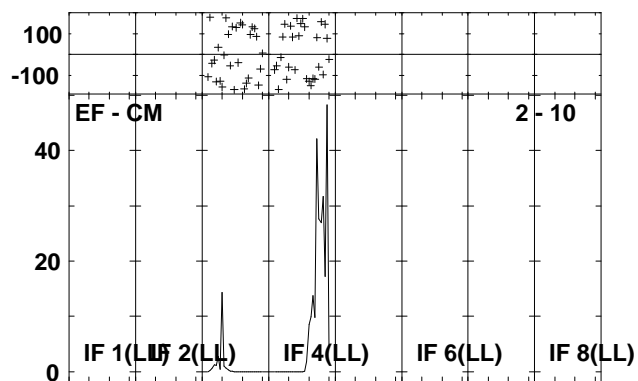
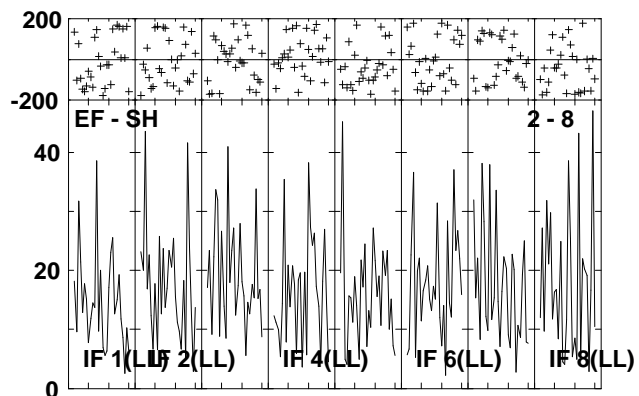
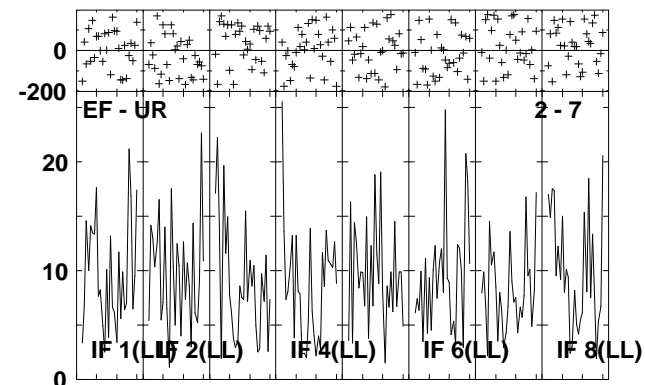
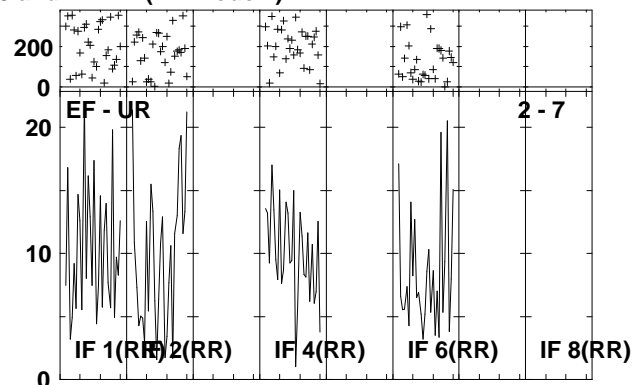
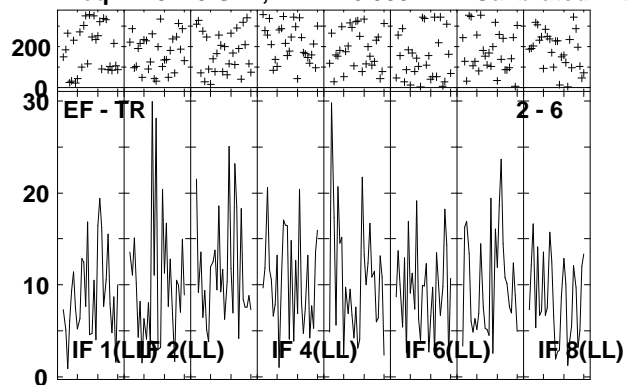

Lower frame: Milli Ampl Jy Top frame: Phas deg
Vector averaged cross-power spectrum Several baselines displayed
Timerange: 00/23:21:01 to 00/23:24:29

Plot file version 77 created 13-OCT-2010 18:41:04
 J2001+10 EP064N.UVDATA.1
 Freq = 4.9270 GHz, Bw = 16.000 MH Calibrated with CL # 3 and BP # 1 (BP mode 1)

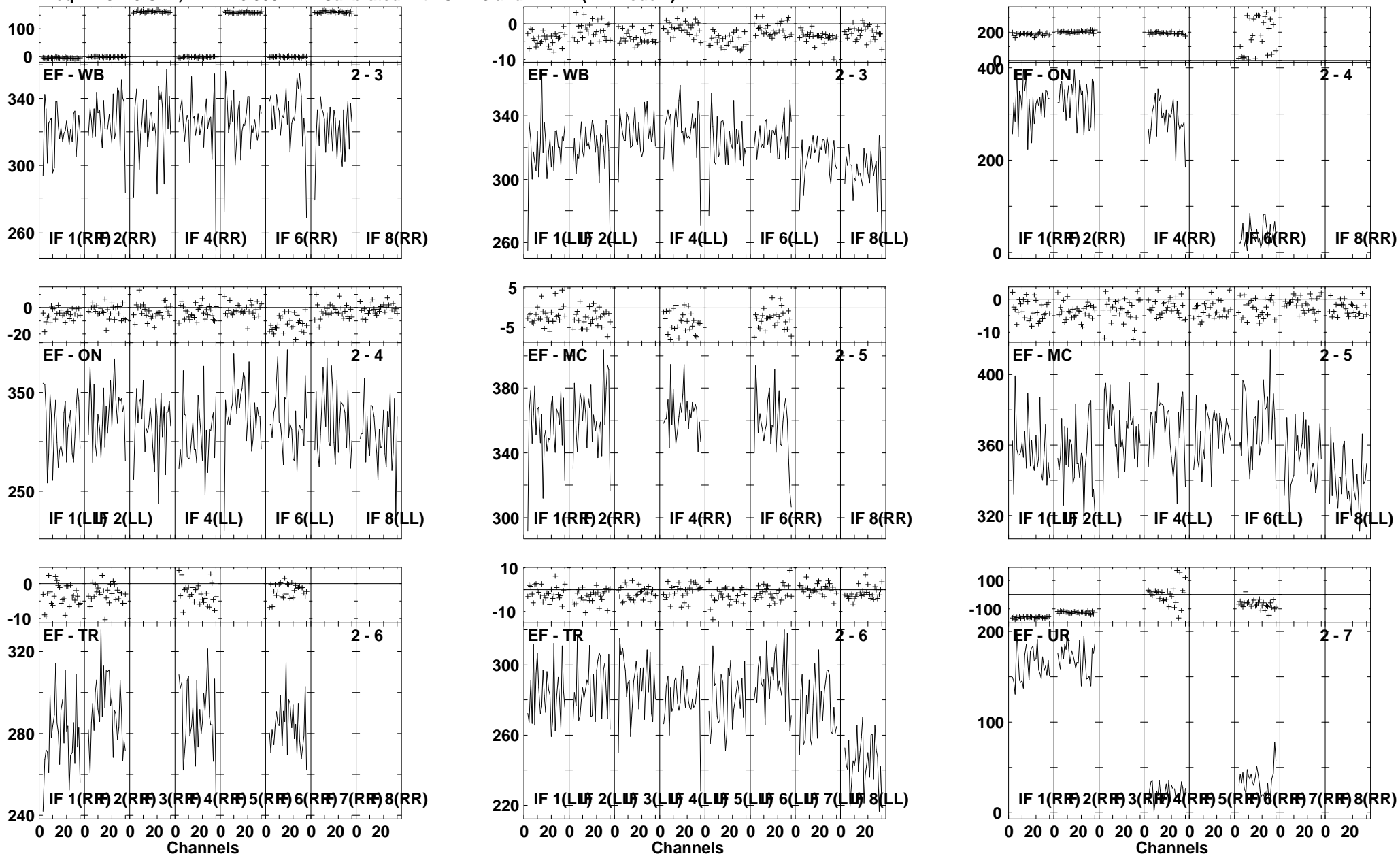

Lower frame: Milli Ampl Jy Top frame: Phas deg
 Vector averaged cross-power spectrum Several baselines displayed
 Timerange: 00/23:24:31 to 00/23:25:59

Plot file version 78 created 13-OCT-2010 18:41:05

J2001+10 EP064N.UVDATA.1

Freq = 4.9270 GHz, Bw = 16.000 MH Calibrated with CL # 3 and BP # 1 (BP mode 1)

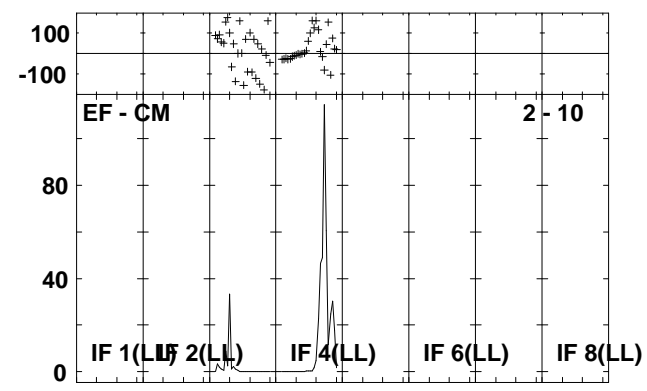
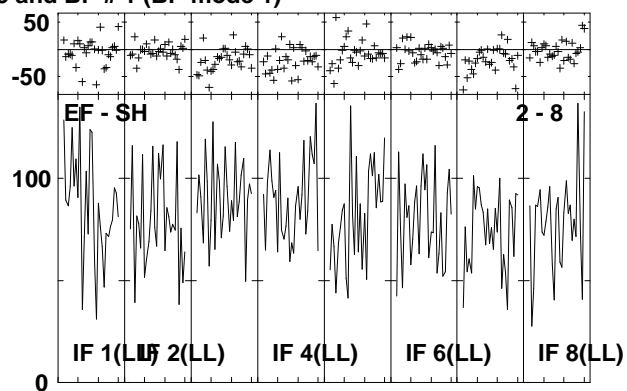
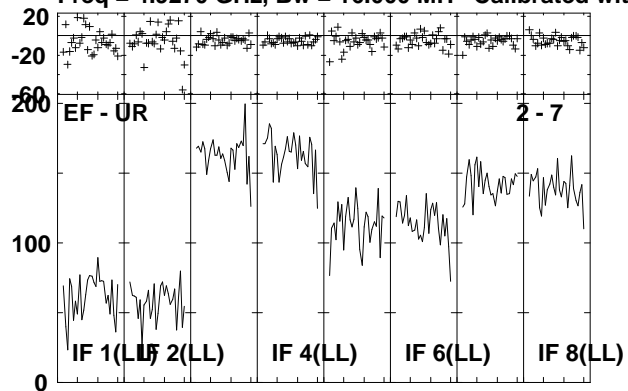

Lower frame: Milli Ampl Jy Top frame: Phas deg
Vector averaged cross-power spectrum Several baselines displayed
Timerange: 00/23:24:31 to 00/23:25:59

Plot file version 79 created 13-OCT-2010 18:41:07

IRAS1954 EP064N.UVDATA.1

Freq = 4.9270 GHz, Bw = 16.000 MH Calibrated with CL # 3 and BP # 1 (BP mode 1)

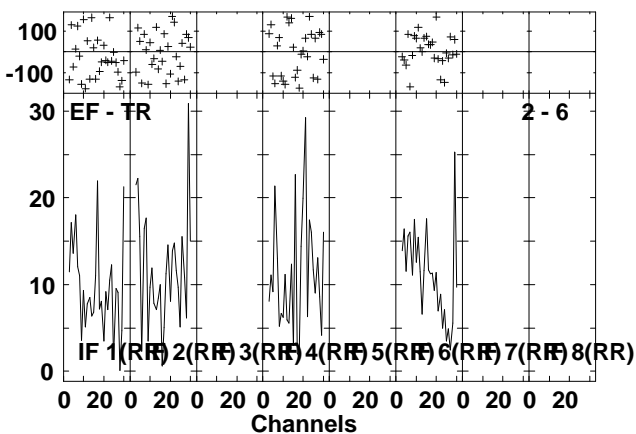
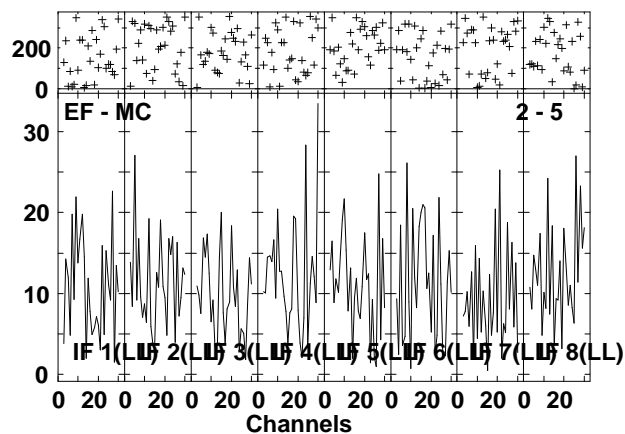
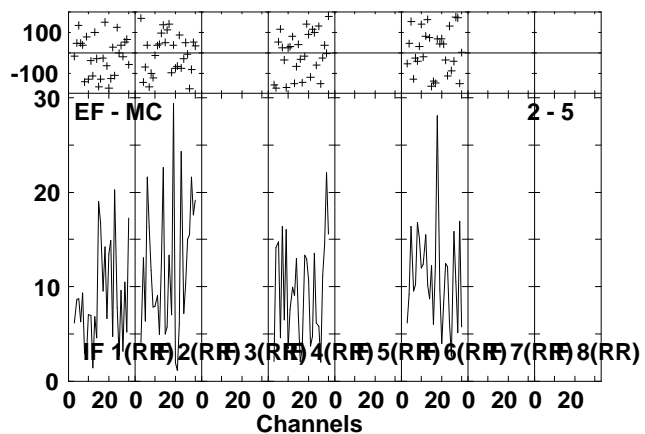
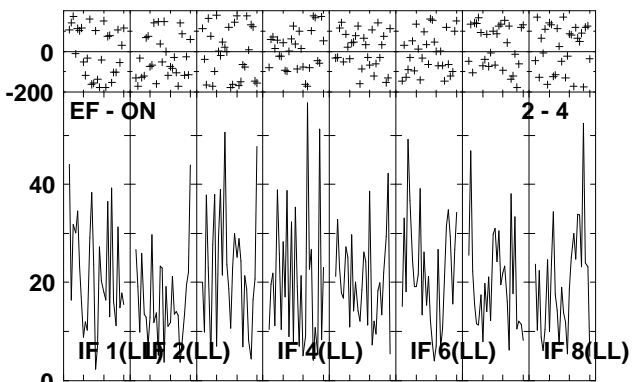
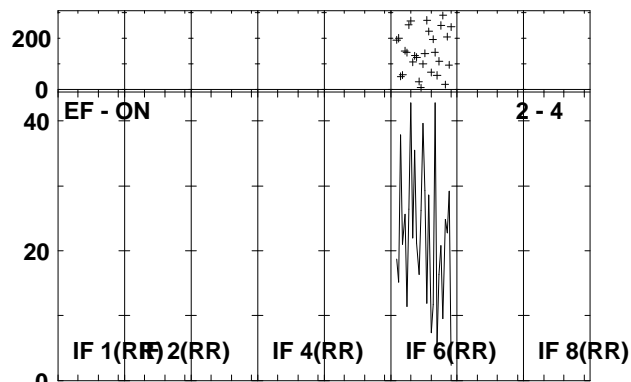
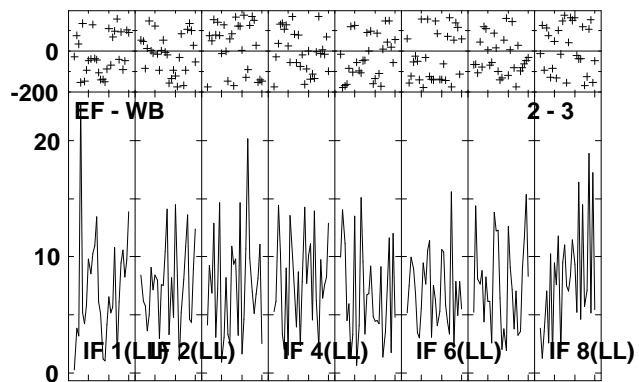
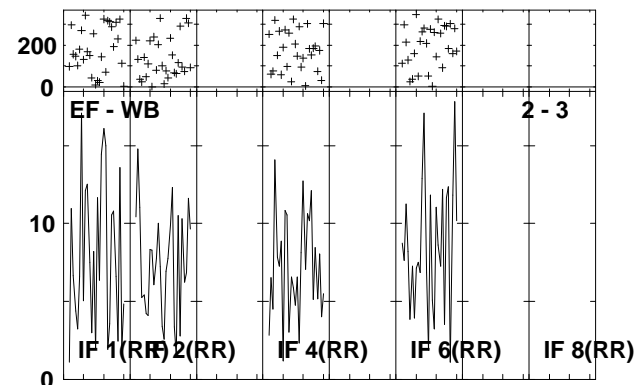
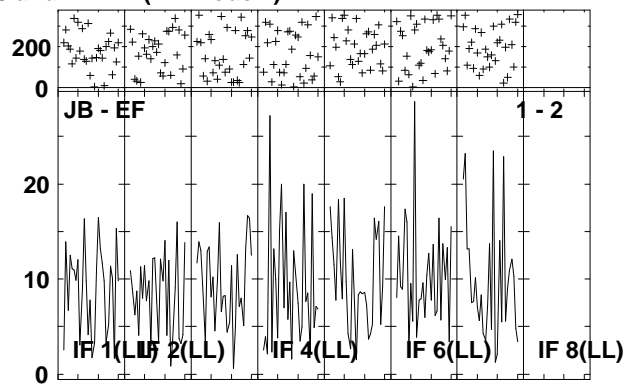
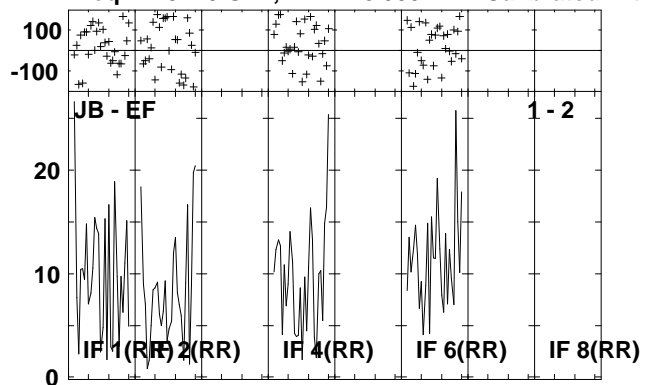

Lower frame: Milli Ampl Jy Top frame: Phas deg
Vector averaged cross-power spectrum Several baselines displayed
Timerange: 00/23:26:01 to 00/23:29:29

Plot file version 80 created 13-OCT-2010 18:41:10

IRAS1954 EP064N.UVDATA.1

Freq = 4.9270 GHz, Bw = 16.000 MH Calibrated with CL # 3 and BP # 1 (BP mode 1)

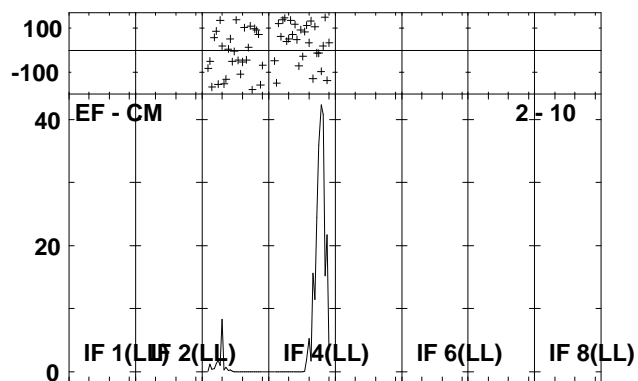
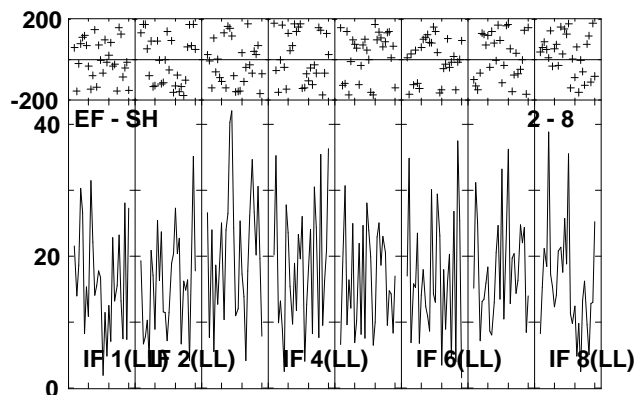
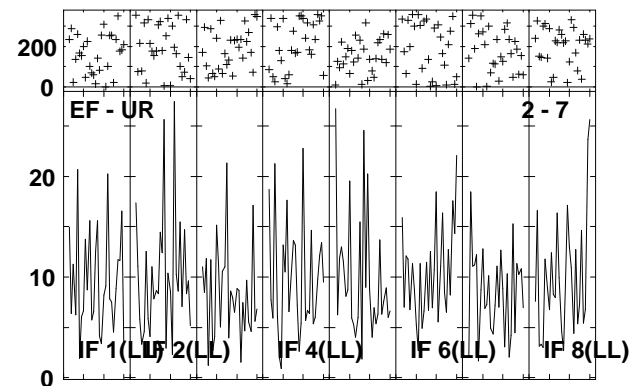
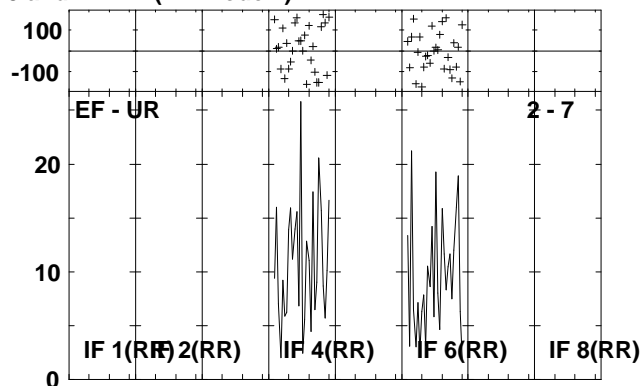
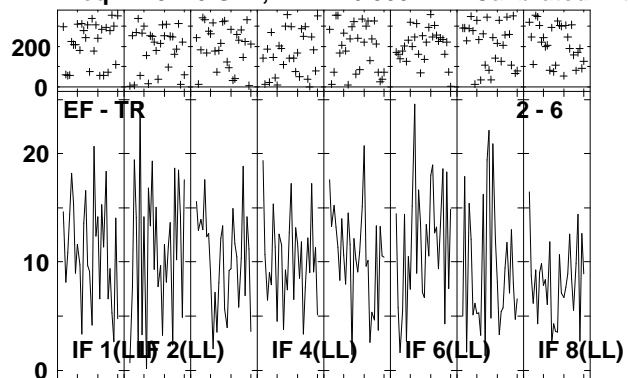

Lower frame: Milli Ampl Jy Top frame: Phas deg
Vector averaged cross-power spectrum Several baselines displayed
Timerange: 00/23:26:01 to 00/23:29:29

Plot file version 81 created 13-OCT-2010 18:41:14

J2001+10 EP064N.UVDATA.1

Freq = 4.9270 GHz, Bw = 16.000 MH Calibrated with CL # 3 and BP # 1 (BP mode 1)

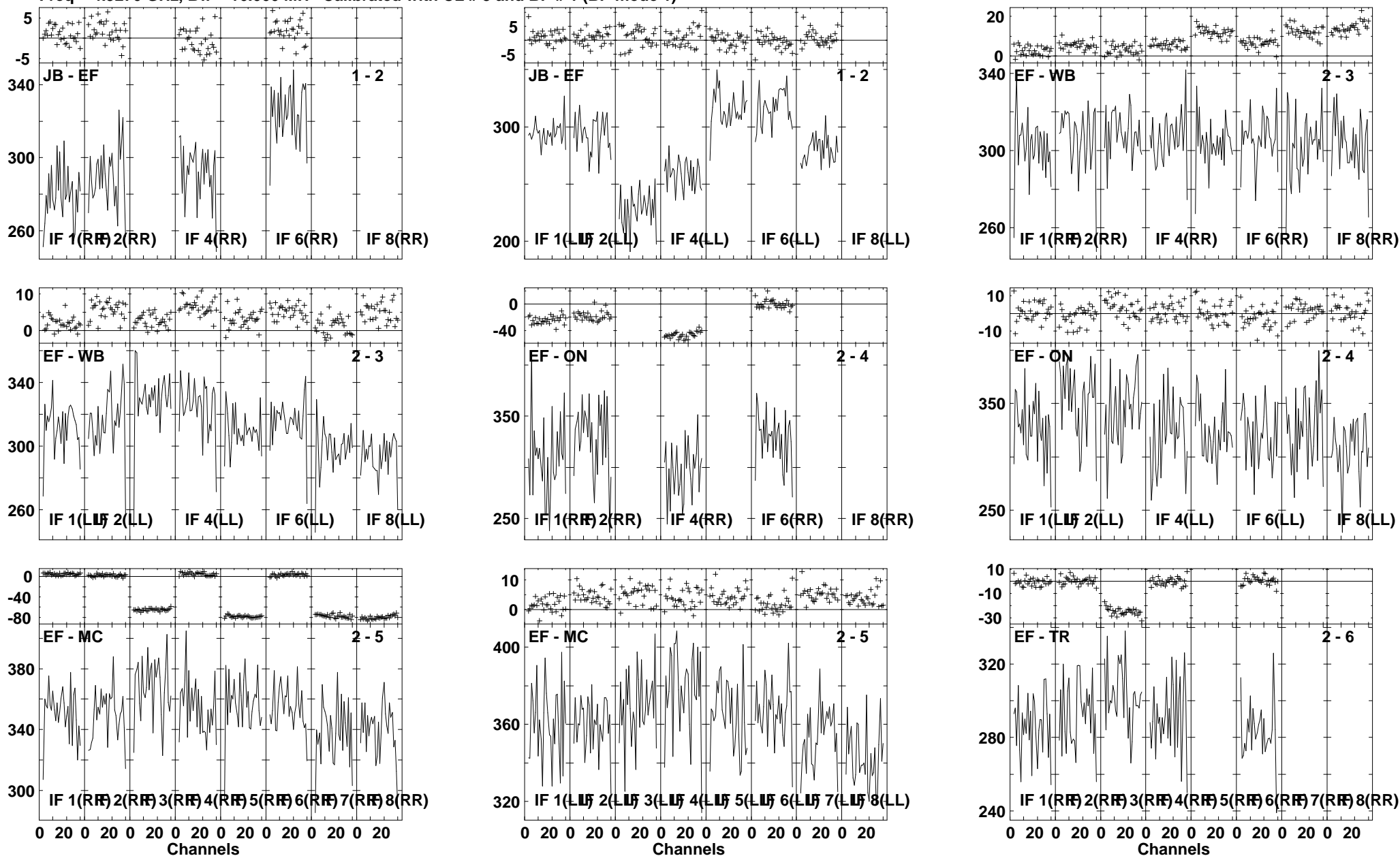

Lower frame: Milli Ampl Jy Top frame: Phas deg
Vector averaged cross-power spectrum Several baselines displayed
Timerange: 00/23:29:31 to 00/23:30:59

Plot file version 82 created 13-OCT-2010 18:41:15

J2001+10 EP064N.UVDATA.1

Freq = 4.9270 GHz, Bw = 16.000 MH Calibrated with CL # 3 and BP # 1 (BP mode 1)

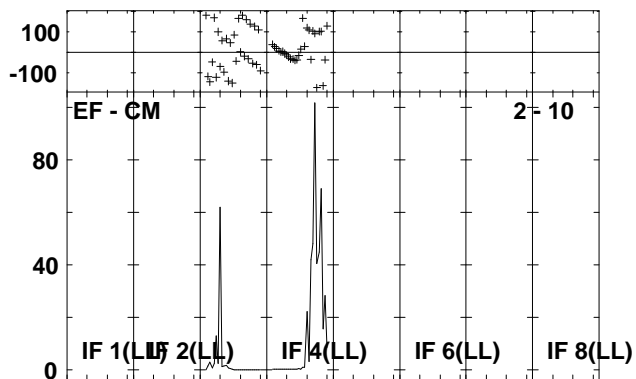
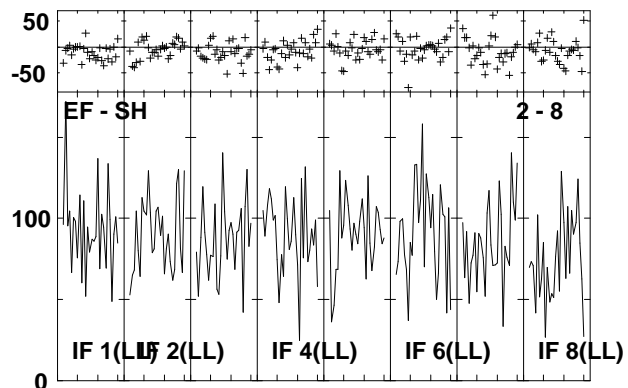
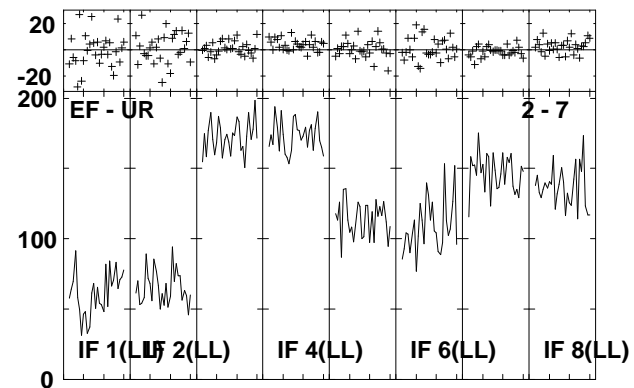
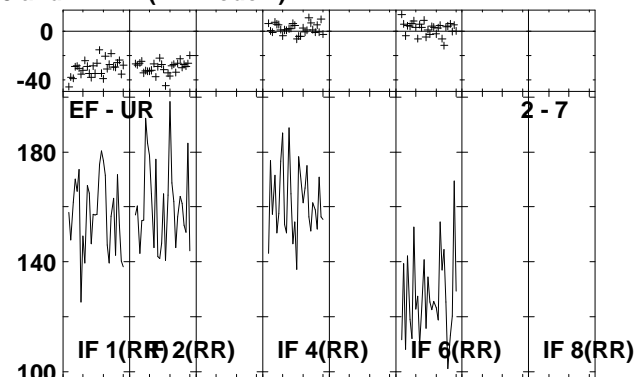
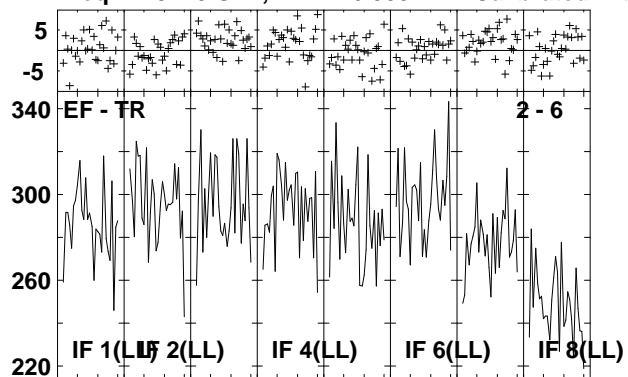

Lower frame: Milli Ampl Jy Top frame: Phas deg
Vector averaged cross-power spectrum Several baselines displayed
Timerange: 00/23:29:31 to 00/23:30:59

Plot file version 83 created 13-OCT-2010 18:41:17

IRAS1954 EP064N.UVDATA.1

Freq = 4.9270 GHz, Bw = 16.000 MH Calibrated with CL # 3 and BP # 1 (BP mode 1)

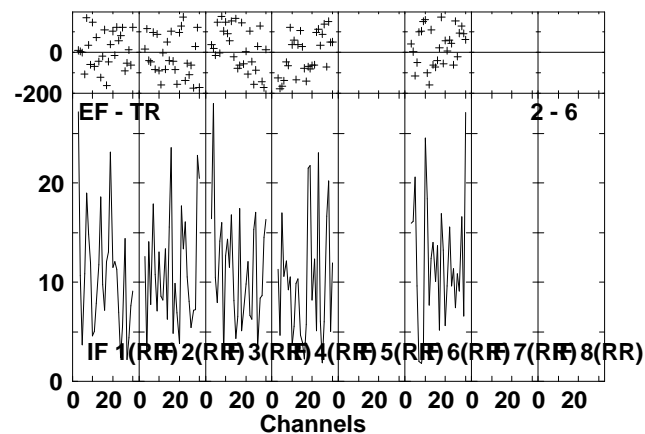
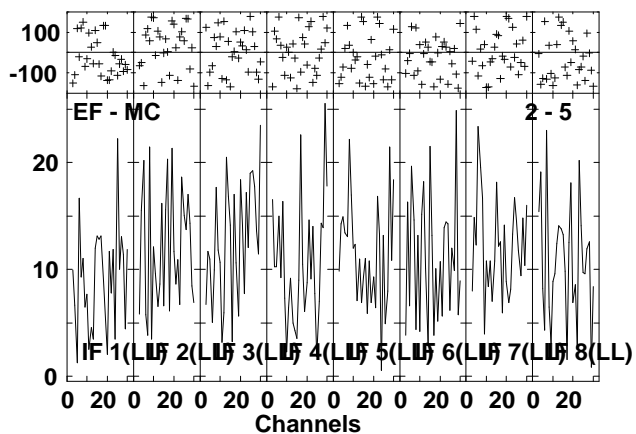
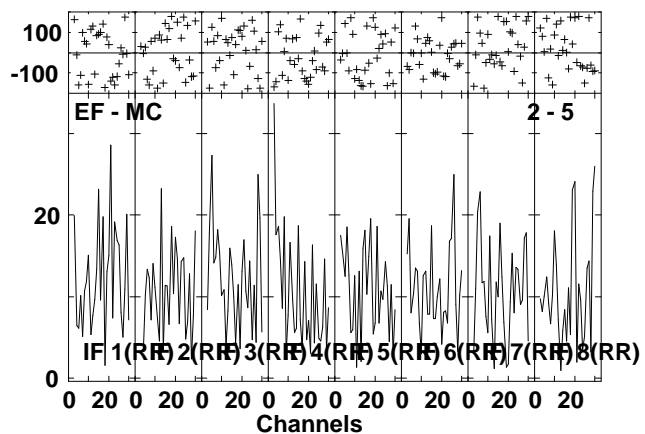
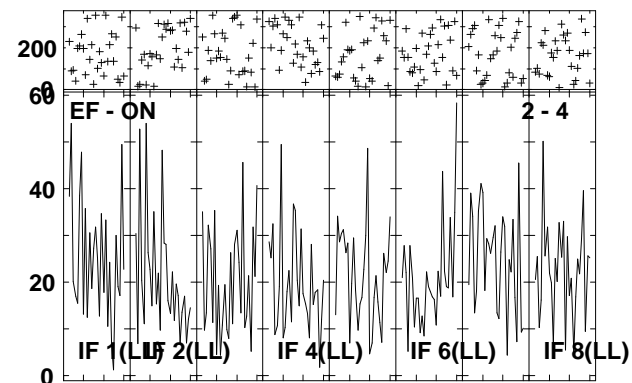
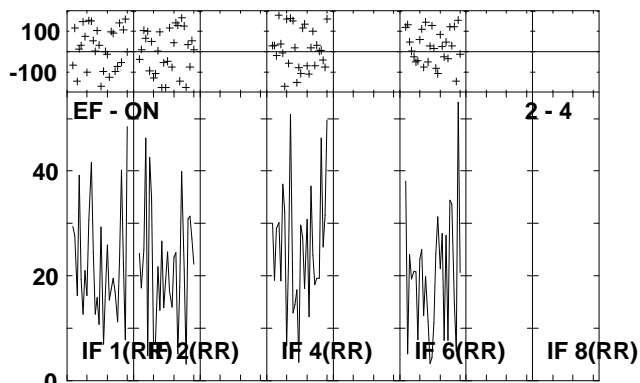
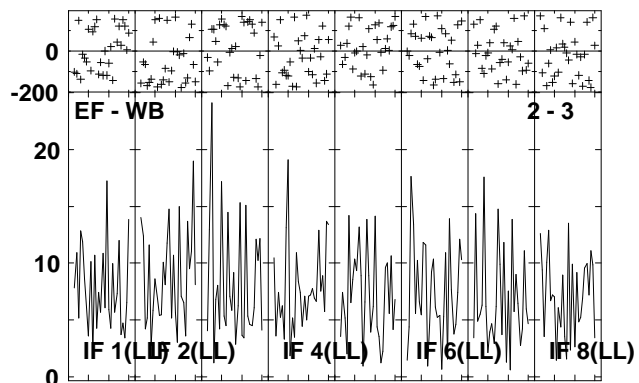
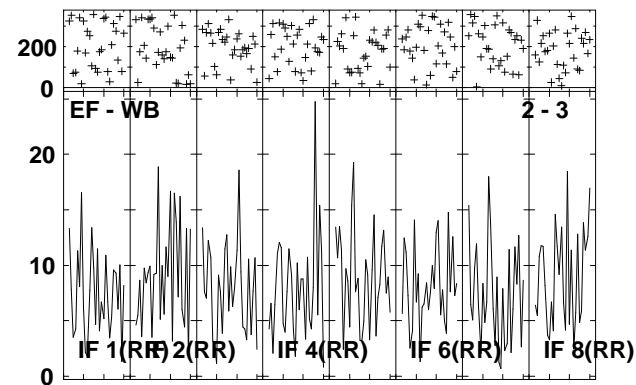
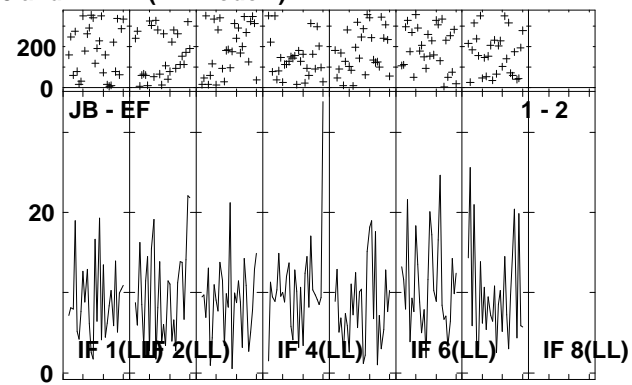
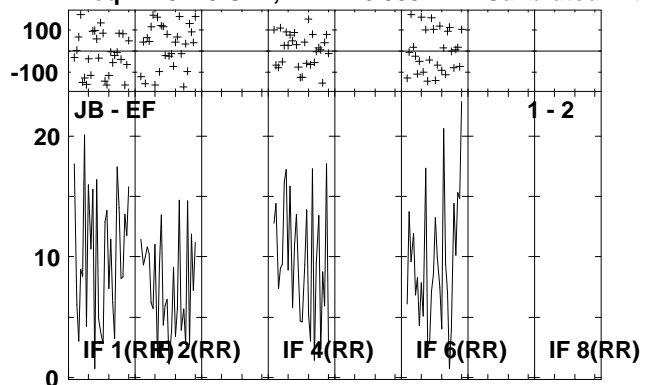

Lower frame: Milli Ampl Jy Top frame: Phas deg
Vector averaged cross-power spectrum Several baselines displayed
Timerange: 00/23:31:01 to 00/23:34:29

Plot file version 84 created 13-OCT-2010 18:41:20

IRAS1954 EP064N.UVDATA.1

Freq = 4.9270 GHz, Bw = 16.000 MH Calibrated with CL # 3 and BP # 1 (BP mode 1)

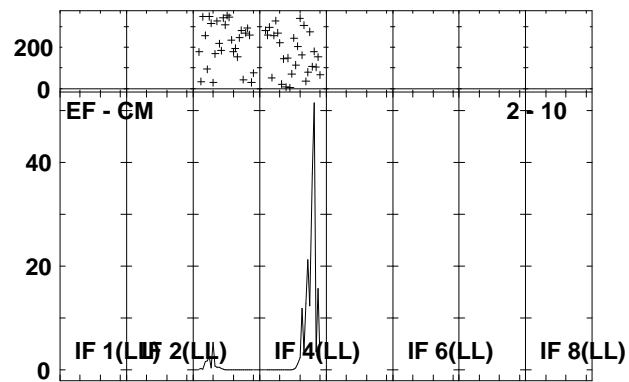
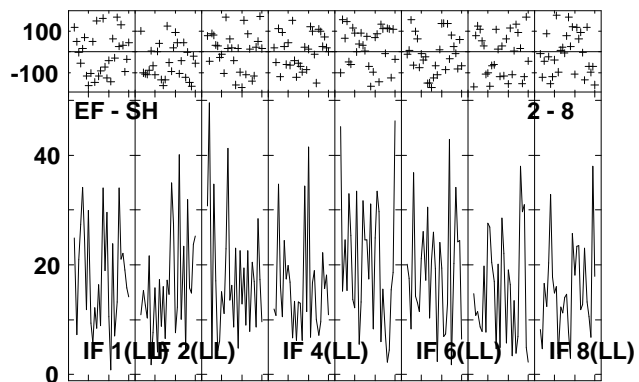
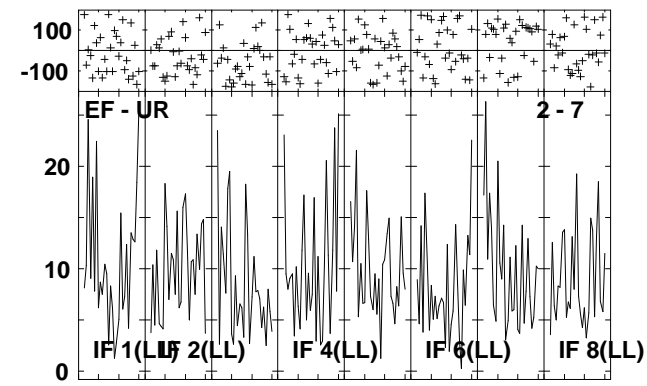
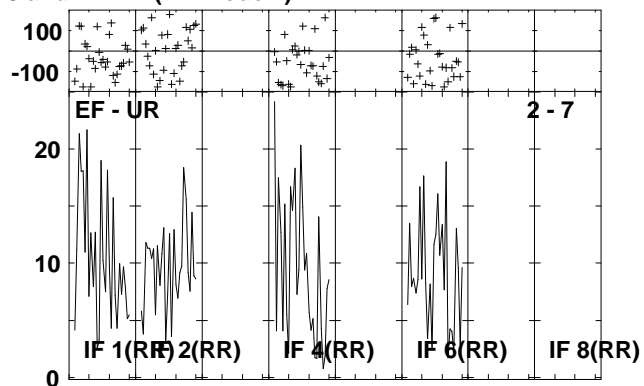
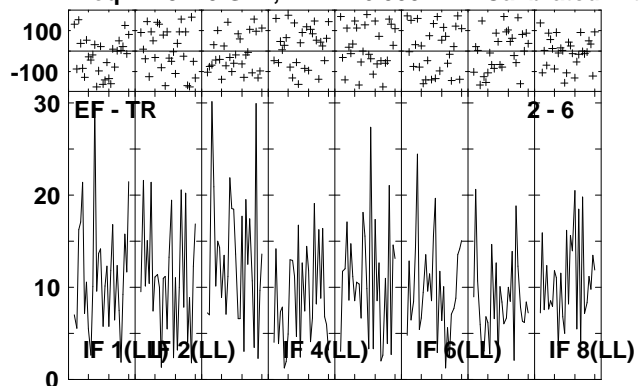

Lower frame: Milli Ampl Jy Top frame: Phas deg
Vector averaged cross-power spectrum Several baselines displayed
Timerange: 00/23:31:01 to 00/23:34:29

Plot file version 85 created 13-OCT-2010 18:41:24

J2001+10 EP064N.UVDATA.1

Freq = 4.9270 GHz, Bw = 16.000 MH Calibrated with CL # 3 and BP # 1 (BP mode 1)

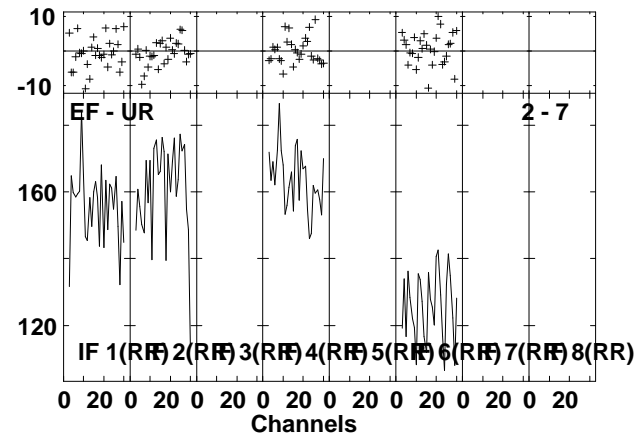
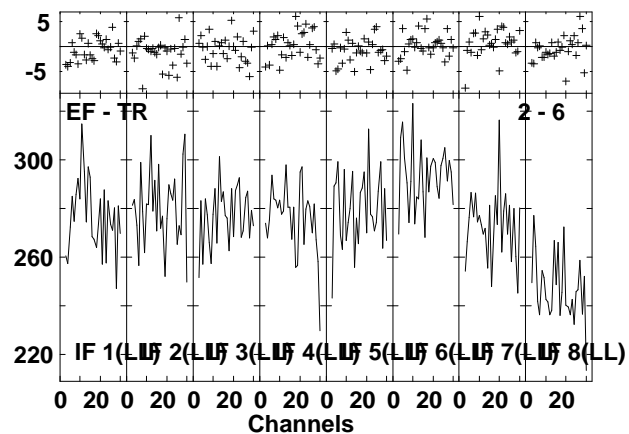
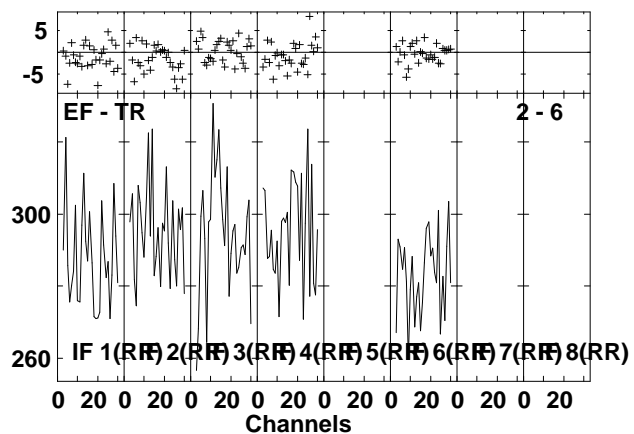
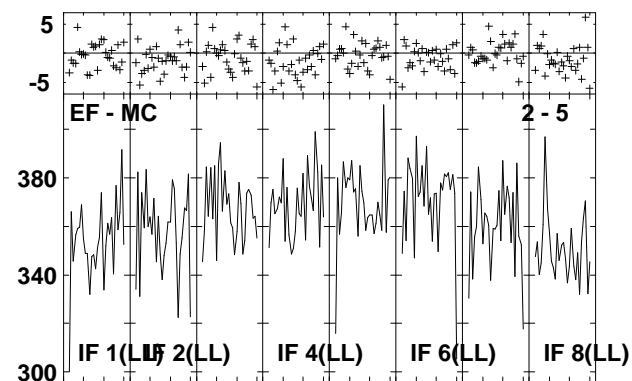
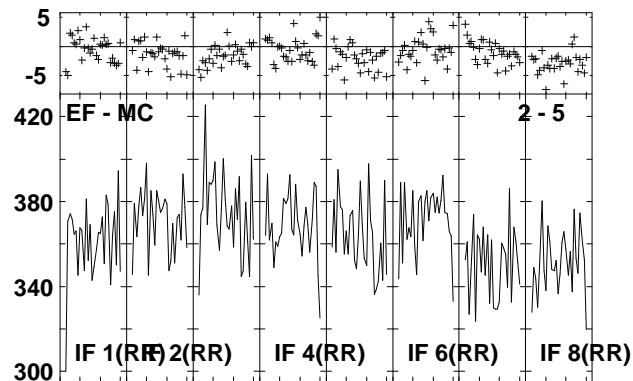
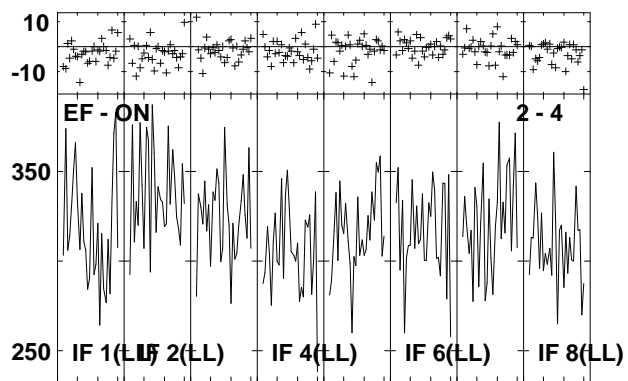
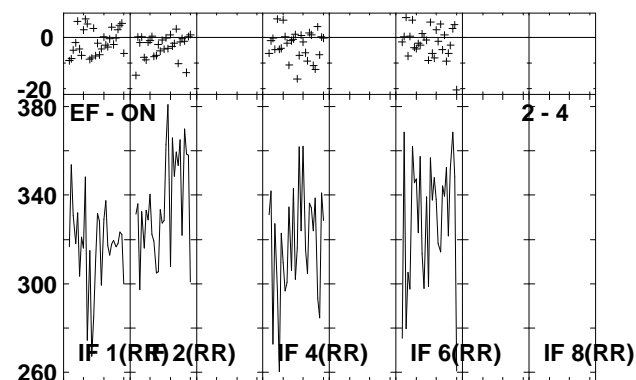
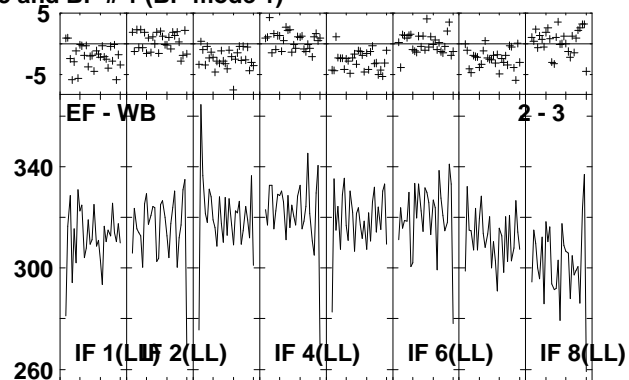
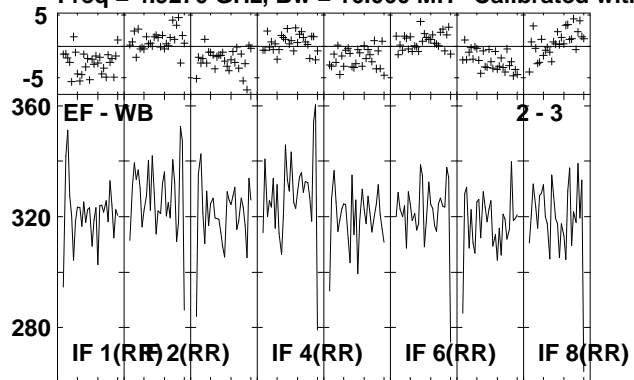

Lower frame: Milli Ampl Jy Top frame: Phas deg
Vector averaged cross-power spectrum Several baselines displayed
Timerange: 00/23:35:31 to 00/23:36:59

Plot file version 86 created 13-OCT-2010 18:41:26

J2001+10 EP064N.UVDATA.1

Freq = 4.9270 GHz, Bw = 16.000 MH Calibrated with CL # 3 and BP # 1 (BP mode 1)

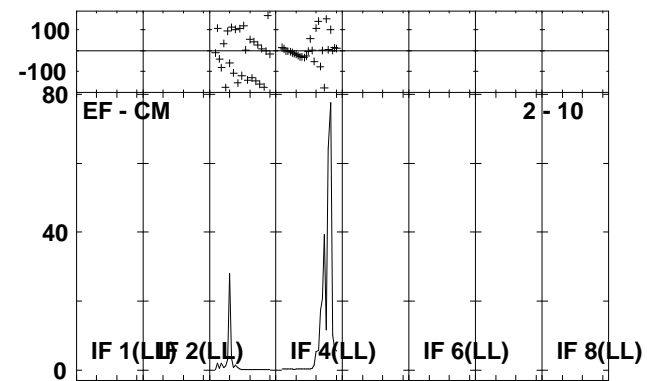
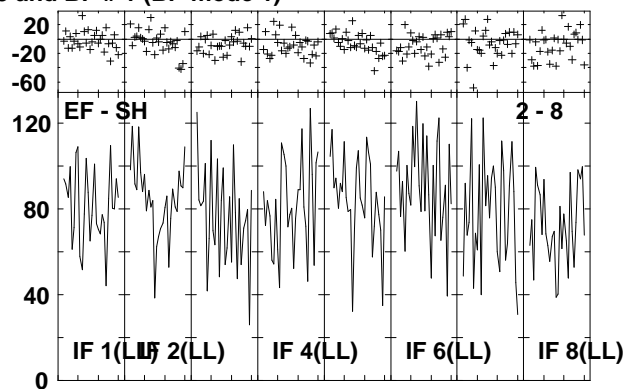
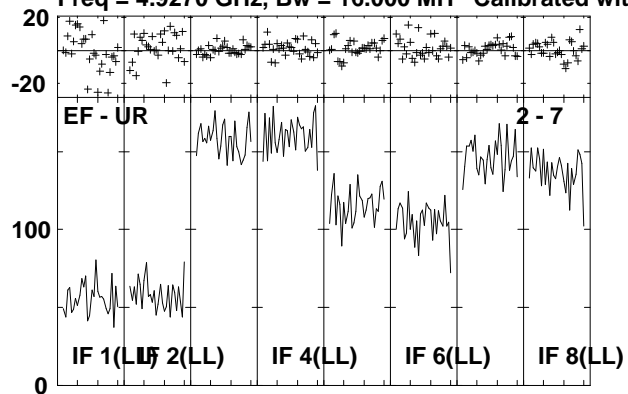

Lower frame: Milli Ampl Jy Top frame: Phas deg
Vector averaged cross-power spectrum Several baselines displayed
Timerange: 00/23:35:31 to 00/23:36:59

Plot file version 87 created 13-OCT-2010 18:41:27

IRAS1954 EP064N.UVDATA.1

Freq = 4.9270 GHz, Bw = 16.000 MH Calibrated with CL # 3 and BP # 1 (BP mode 1)

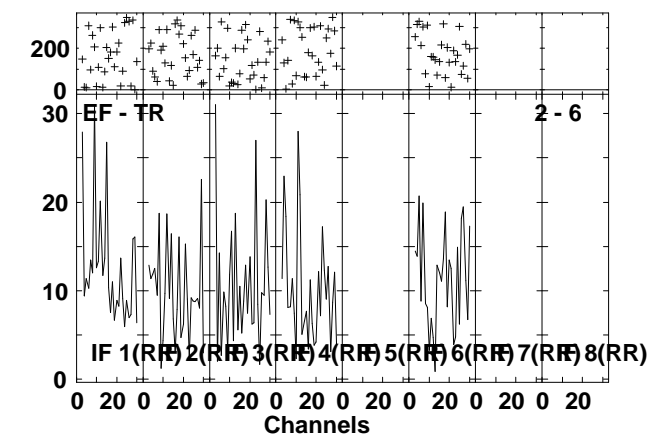
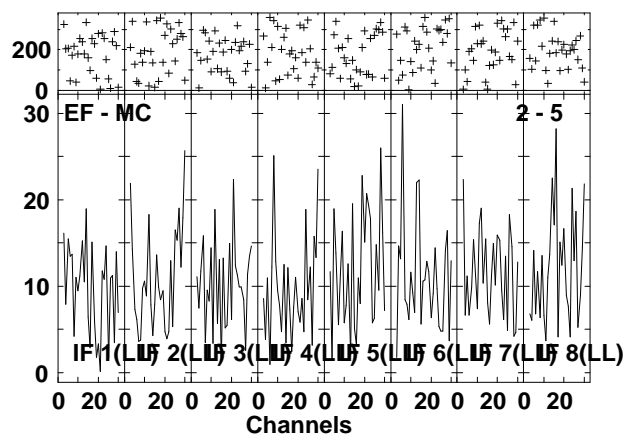
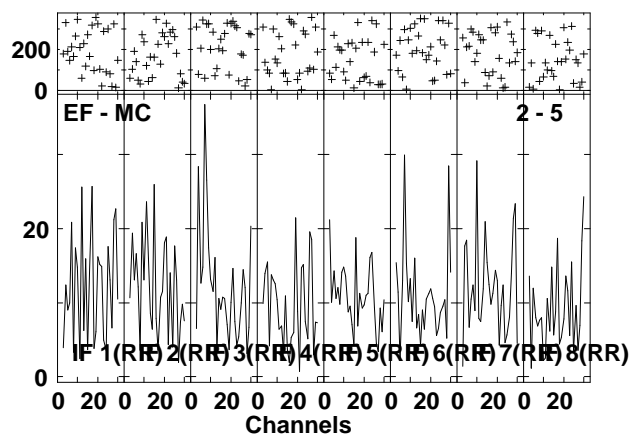
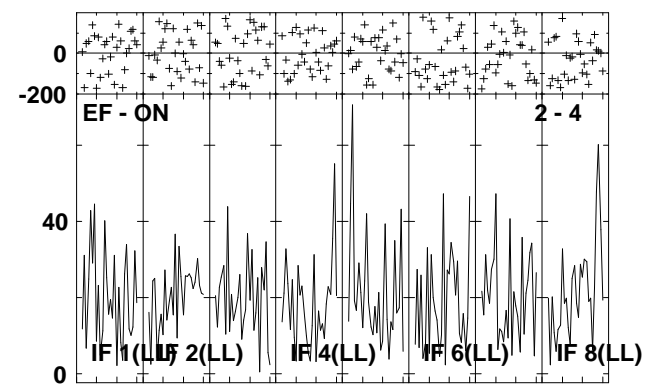
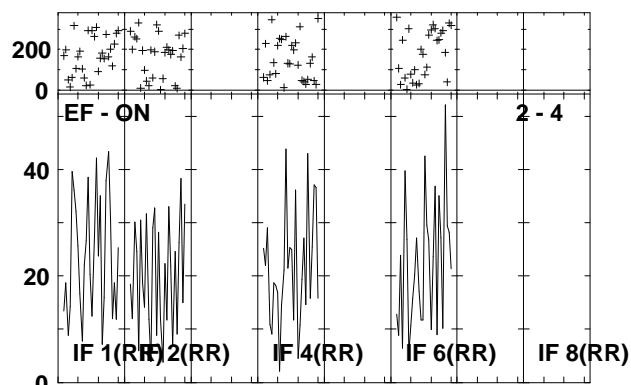
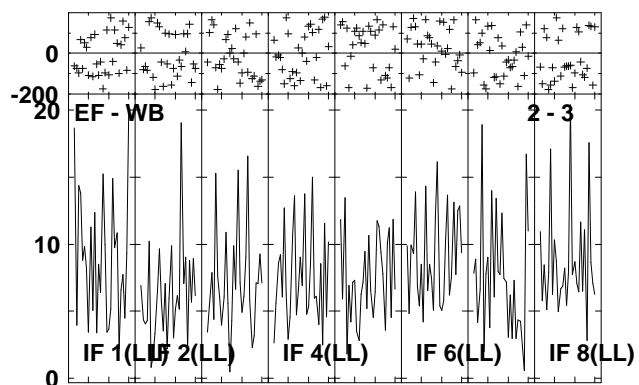
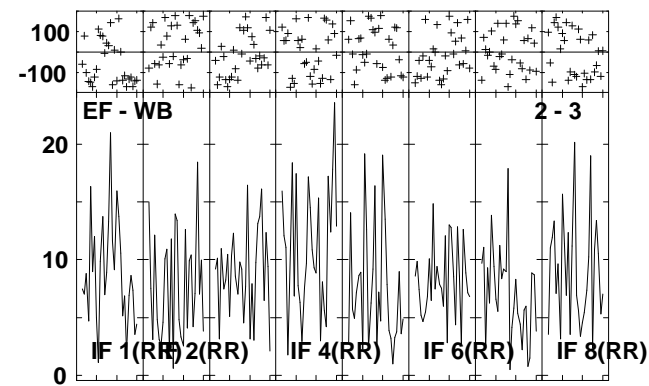
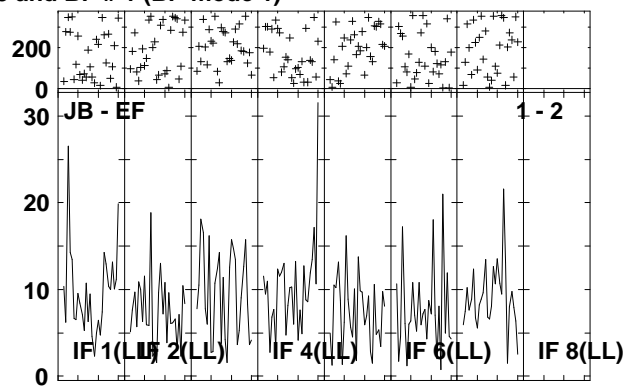
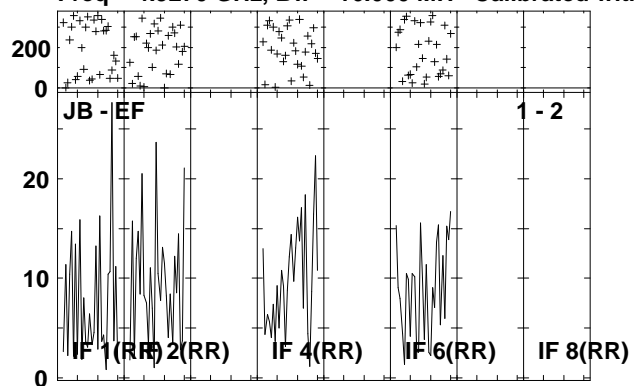

Lower frame: Milli Ampl Jy Top frame: Phas deg
Vector averaged cross-power spectrum Several baselines displayed
Timerange: 00/23:37:01 to 00/23:40:29

Plot file version 88 created 13-OCT-2010 18:41:30

IRAS1954 EP064N.UVDATA.1

Freq = 4.9270 GHz, Bw = 16.000 MH Calibrated with CL # 3 and BP # 1 (BP mode 1)

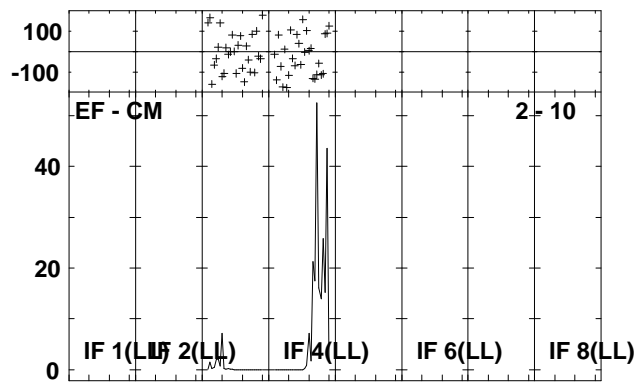
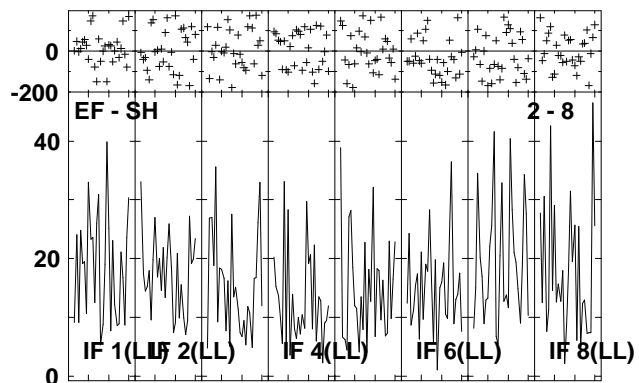
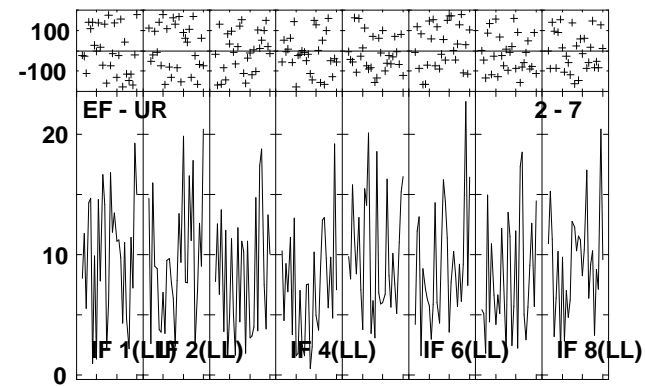
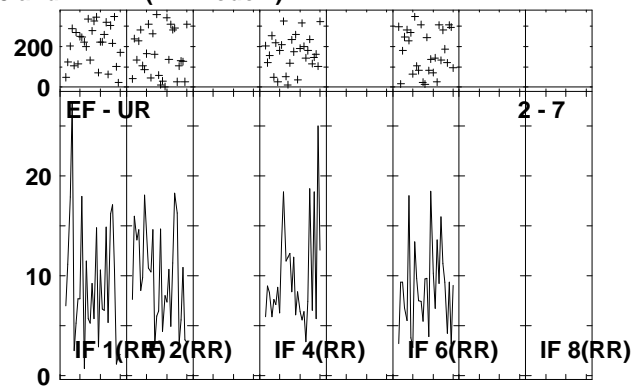
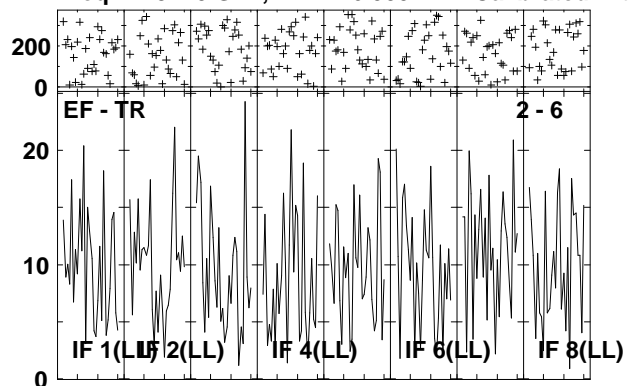

Lower frame: Milli Ampl Jy Top frame: Phas deg
Vector averaged cross-power spectrum Several baselines displayed
Timerange: 00/23:37:01 to 00/23:40:29

Plot file version 89 created 13-OCT-2010 18:41:34

J2001+10 EP064N.UVDATA.1

Freq = 4.9270 GHz, Bw = 16.000 MH Calibrated with CL # 3 and BP # 1 (BP mode 1)

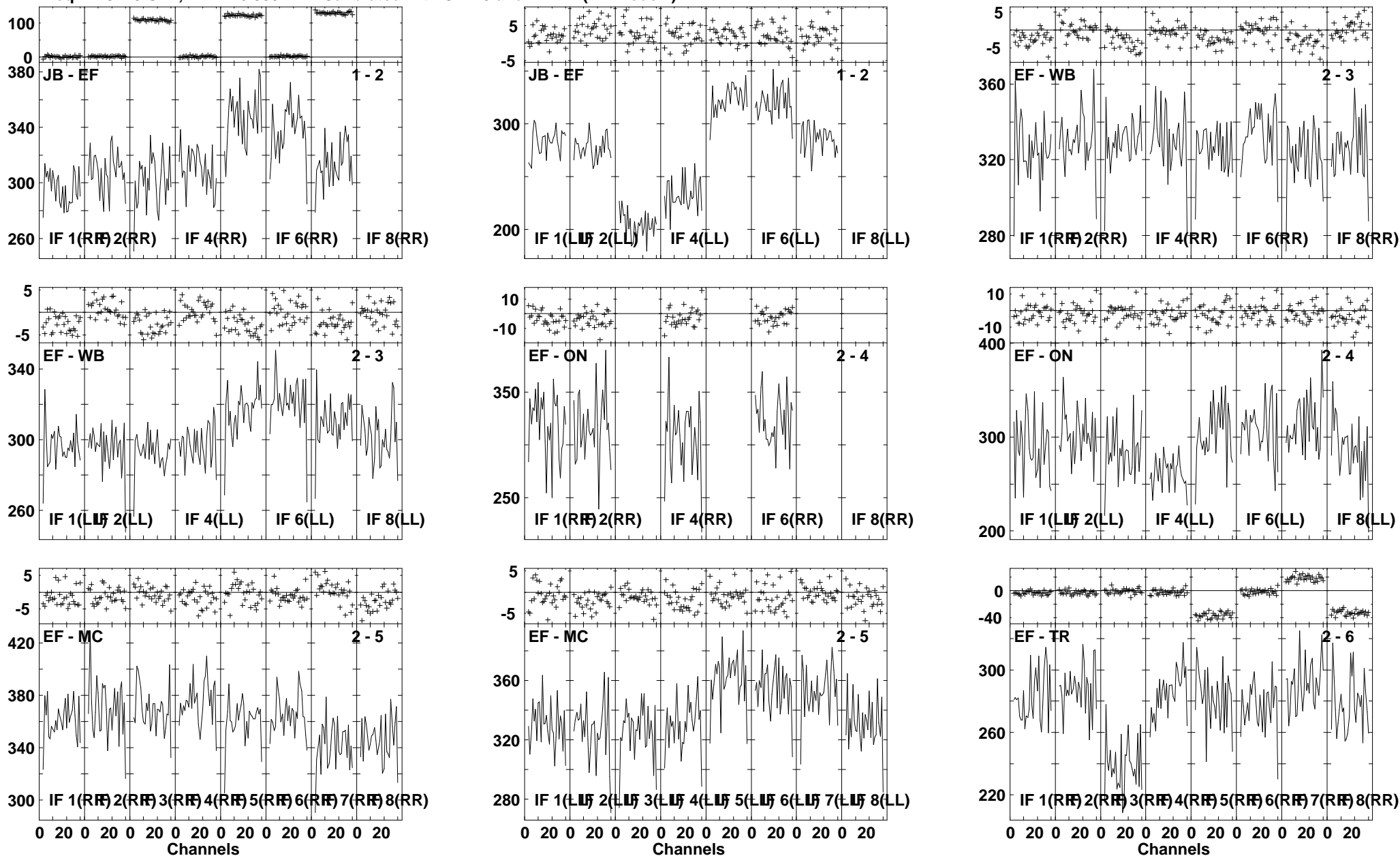

Lower frame: Milli Ampl Jy Top frame: Phas deg
Vector averaged cross-power spectrum Several baselines displayed
Timerange: 00/23:40:31 to 00/23:41:59

Plot file version 90 created 13-OCT-2010 18:41:36

J2001+10 EP064N.UVDATA.1

Freq = 4.9270 GHz, Bw = 16.000 MH Calibrated with CL # 3 and BP # 1 (BP mode 1)

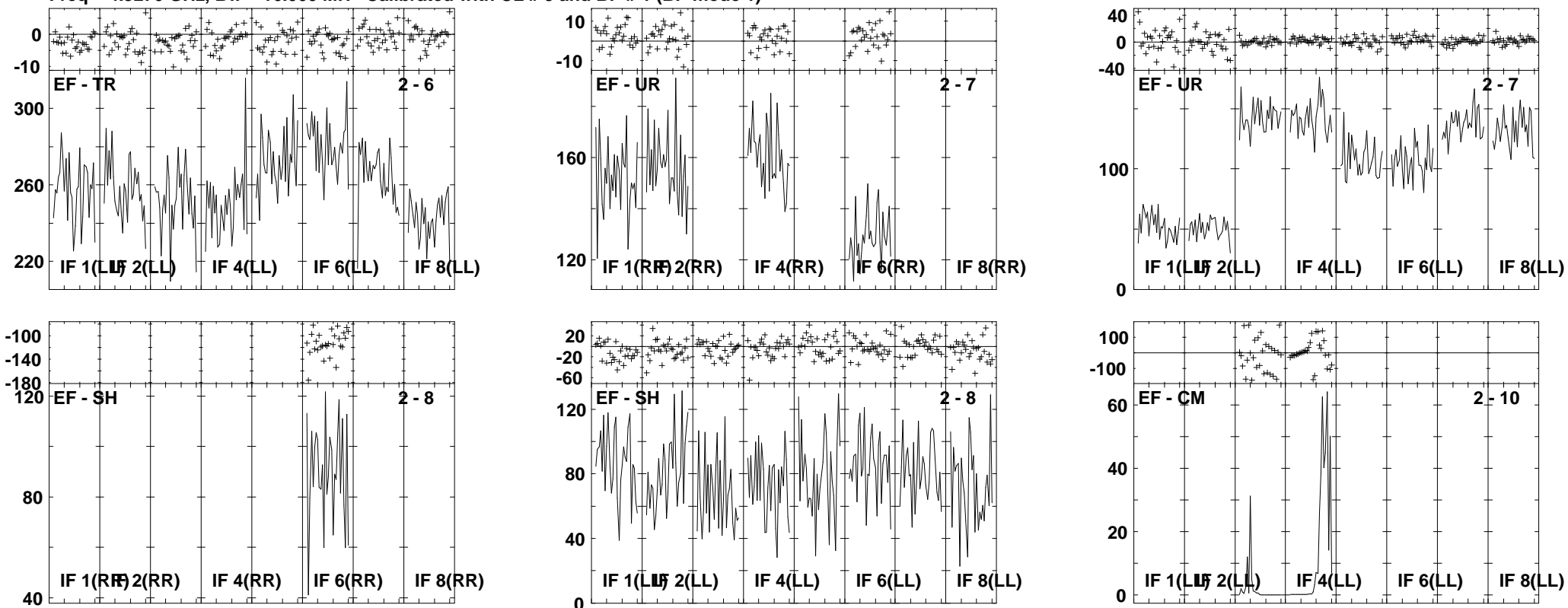

Lower frame: Milli Ampl Jy Top frame: Phas deg
Vector averaged cross-power spectrum Several baselines displayed
Timerange: 00/23:40:31 to 00/23:41:59

Plot file version 91 created 13-OCT-2010 18:41:38

IRAS1954 EP064N.UVDATA.1

Freq = 4.9270 GHz, Bw = 16.000 MH Calibrated with CL # 3 and BP # 1 (BP mode 1)

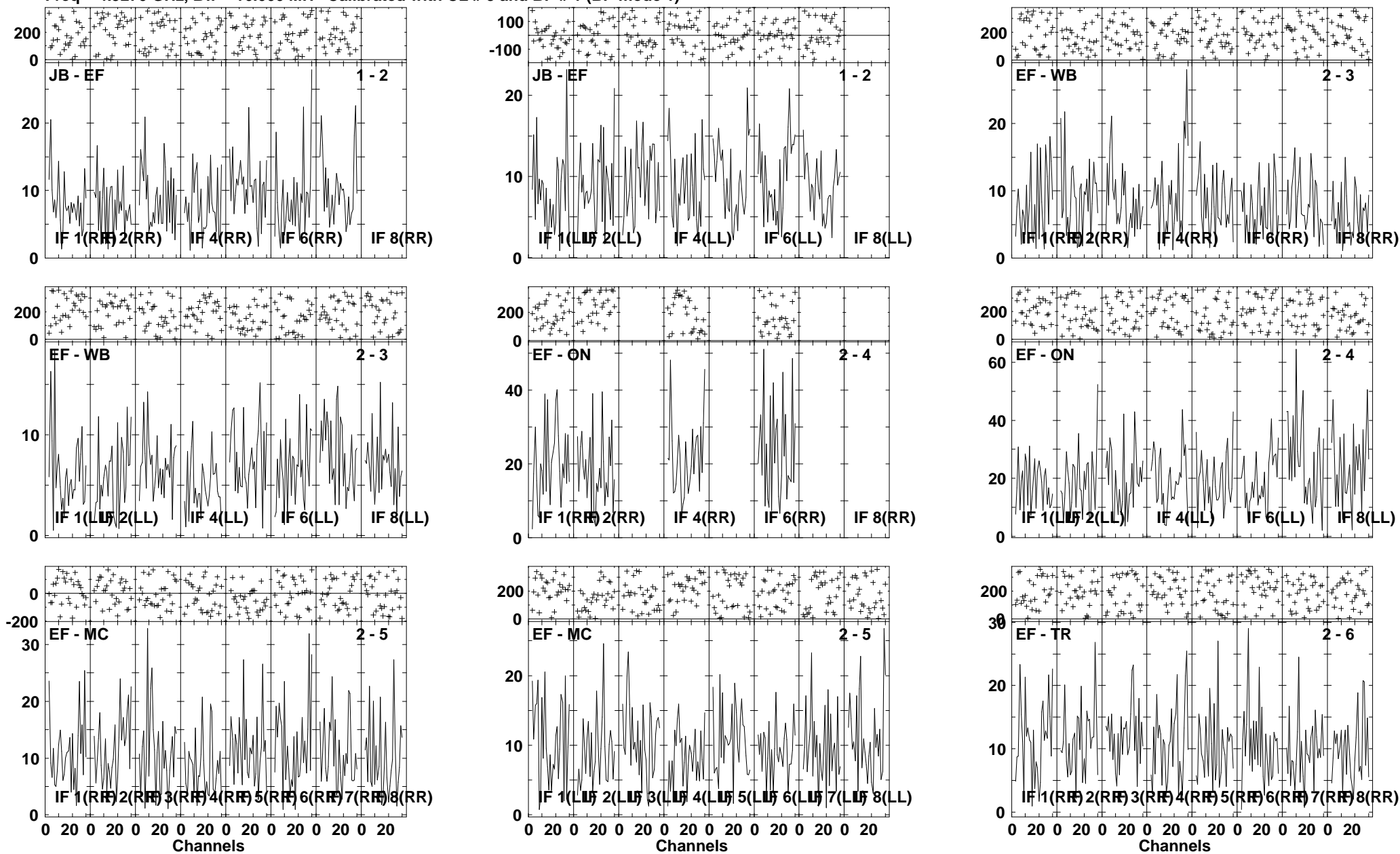

Lower frame: Milli Ampl Jy Top frame: Phas deg
Vector averaged cross-power spectrum Several baselines displayed
Timerange: 00/23:42:01 to 00/23:45:29

Plot file version 92 created 13-OCT-2010 18:41:41

IRAS1954 EP064N.UVDATA.1

Freq = 4.9270 GHz, Bw = 16.000 MH Calibrated with CL # 3 and BP # 1 (BP mode 1)

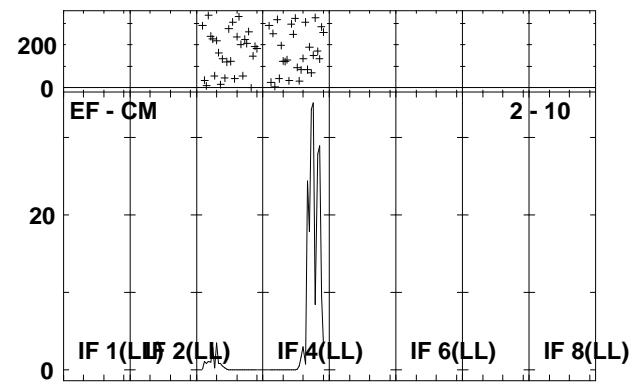
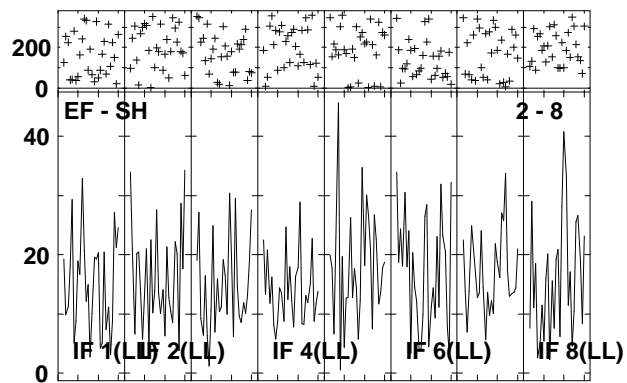
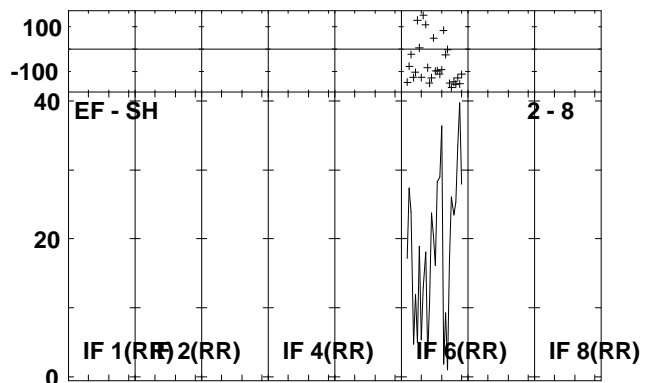
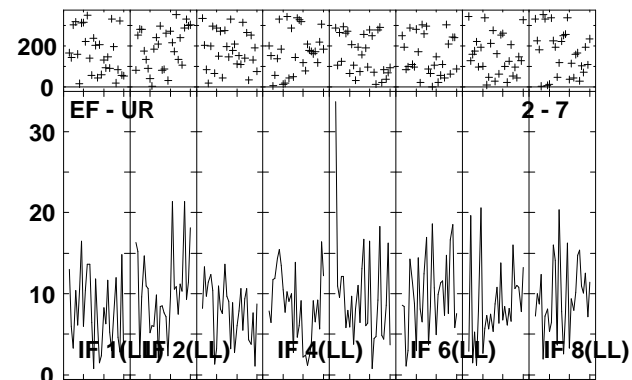
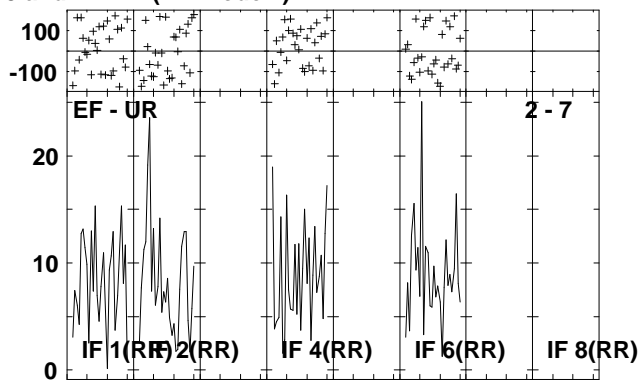
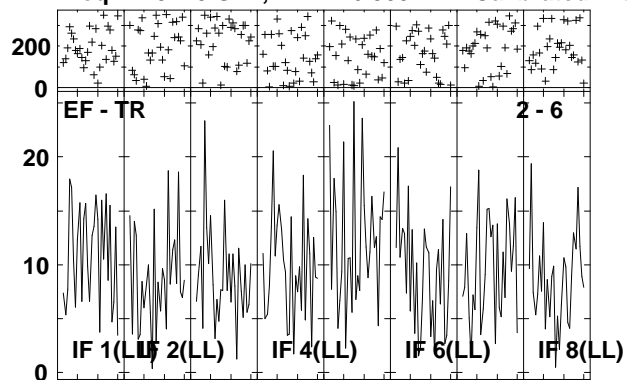

Lower frame: Milli Ampl Jy Top frame: Phas deg
Vector averaged cross-power spectrum Several baselines displayed
Timerange: 00/23:42:01 to 00/23:45:29

Plot file version 93 created 13-OCT-2010 18:41:46

J2001+10 EP064N.UVDATA.1

Freq = 4.9270 GHz, Bw = 16.000 MH Calibrated with CL # 3 and BP # 1 (BP mode 1)

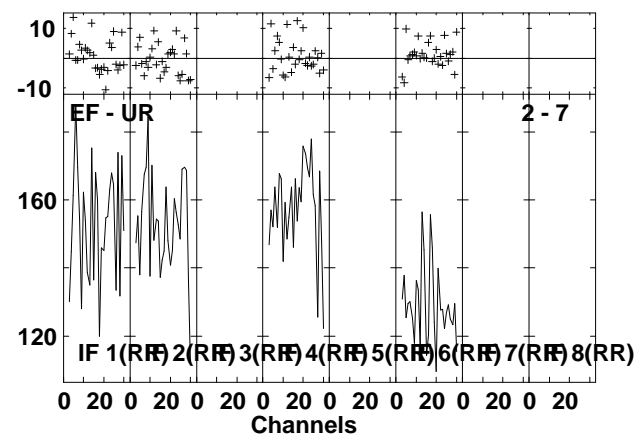
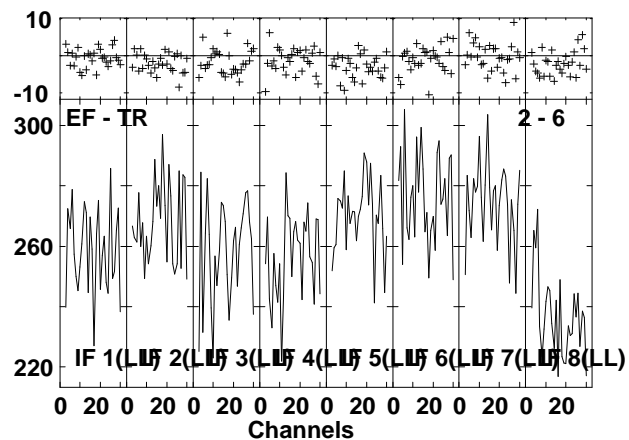
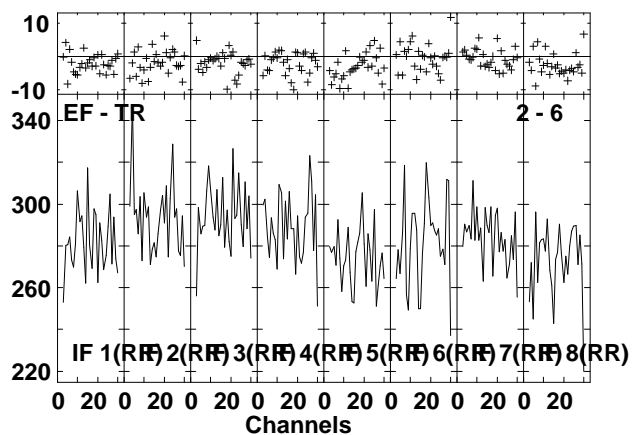
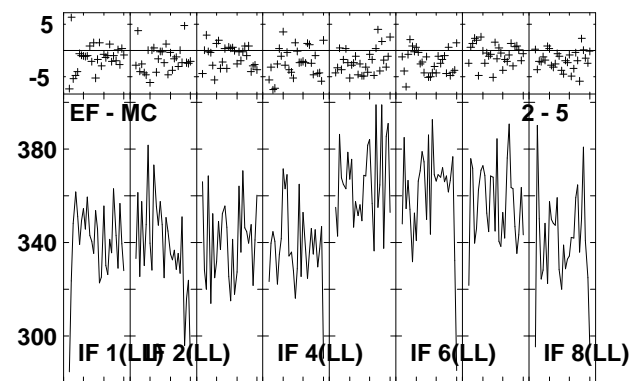
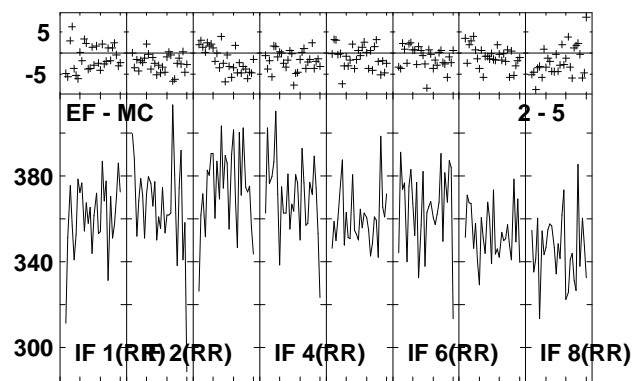
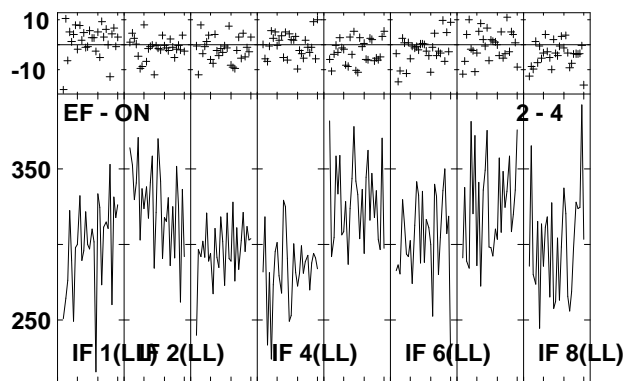
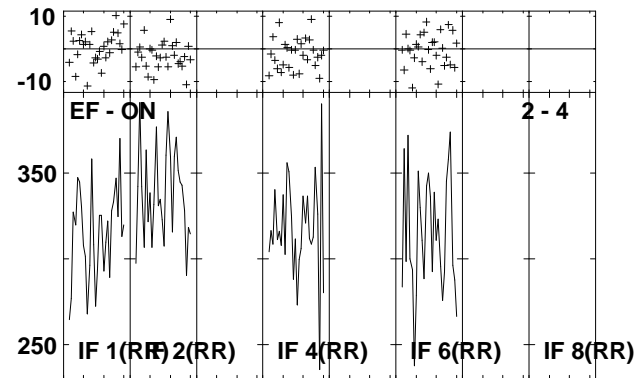
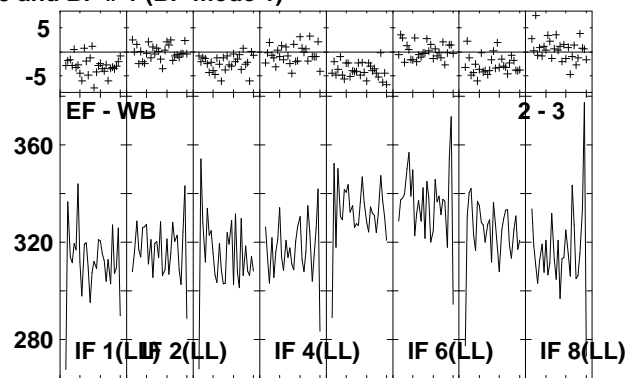
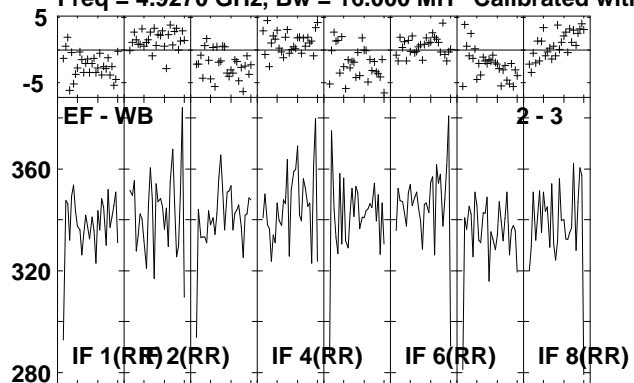

Lower frame: Milli Ampl Jy Top frame: Phas deg
Vector averaged cross-power spectrum Several baselines displayed
Timerange: 00/23:45:33 to 00/23:46:59

Plot file version 94 created 13-OCT-2010 18:41:46

J2001+10 EP064N.UVDATA.1

Freq = 4.9270 GHz, Bw = 16.000 MH Calibrated with CL # 3 and BP # 1 (BP mode 1)

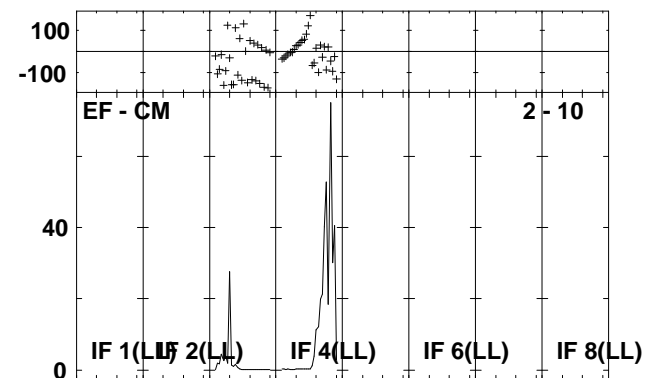
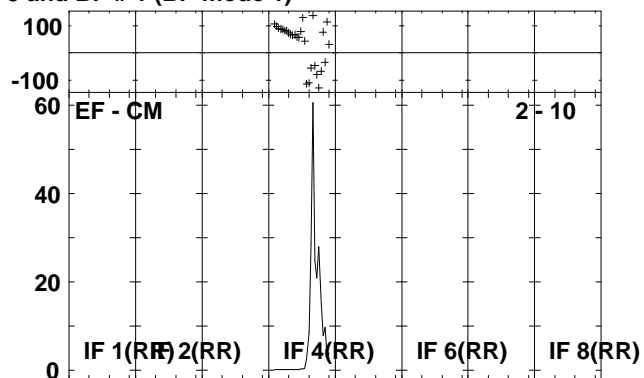
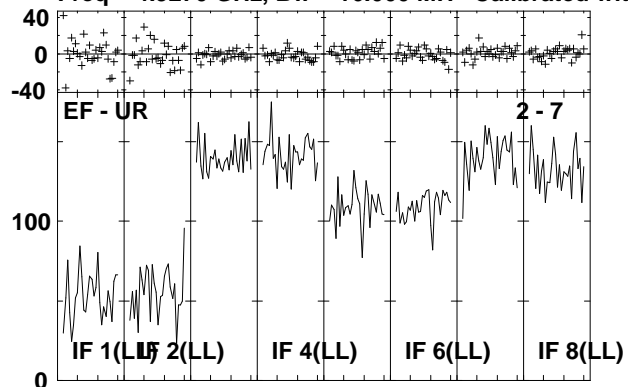

Lower frame: Milli Ampl Jy Top frame: Phas deg
Vector averaged cross-power spectrum Several baselines displayed
Timerange: 00/23:45:33 to 00/23:46:59

Plot file version 95 created 13-OCT-2010 18:41:48

IRAS1954 EP064N.UVDATA.1

Freq = 4.9270 GHz, Bw = 16.000 MH Calibrated with CL # 3 and BP # 1 (BP mode 1)

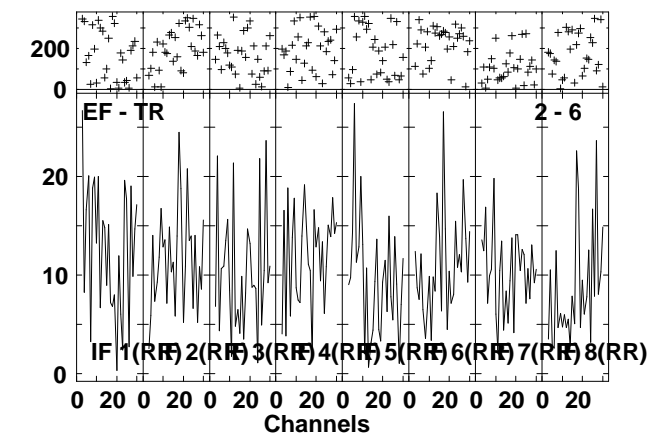
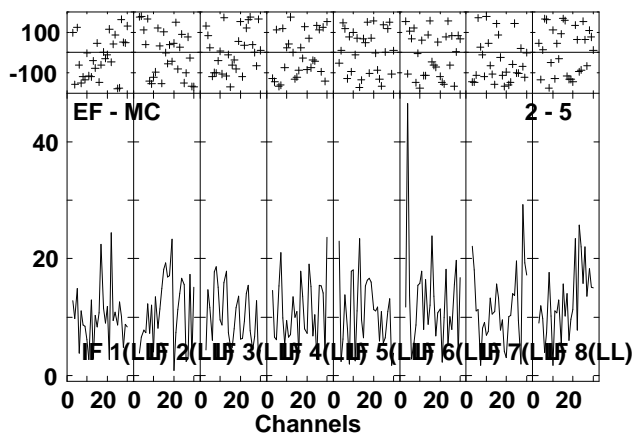
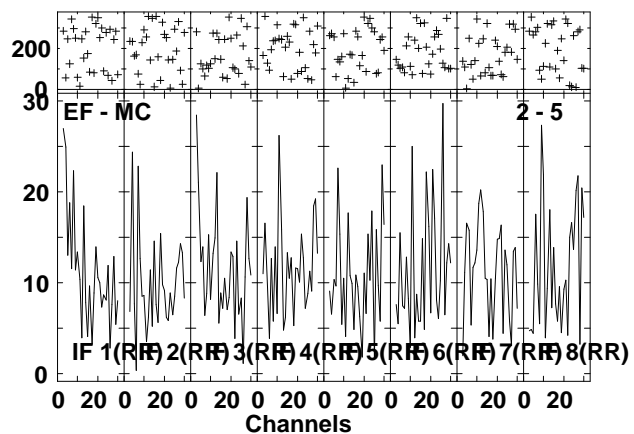
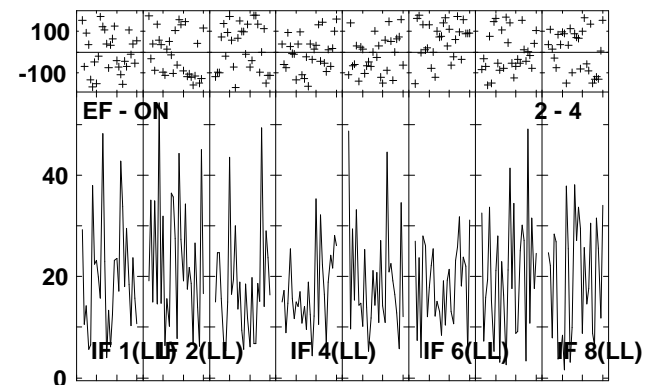
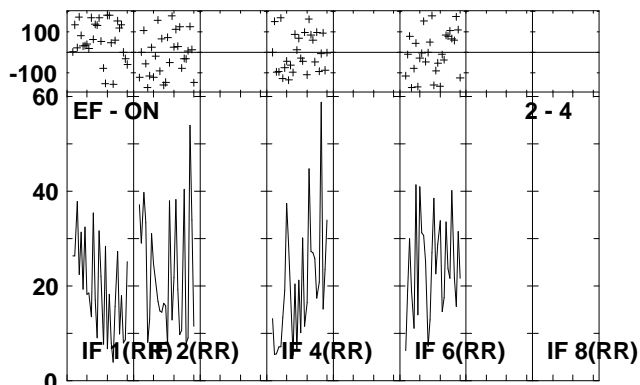
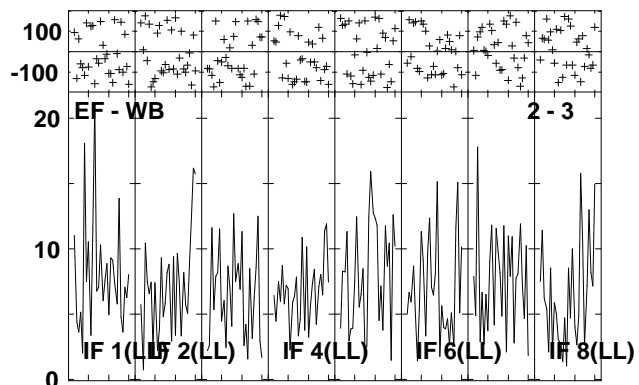
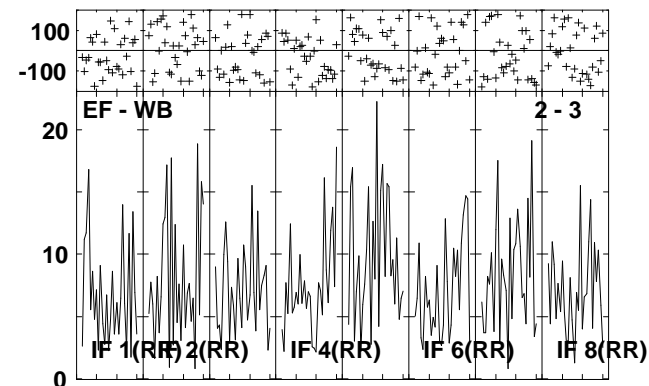
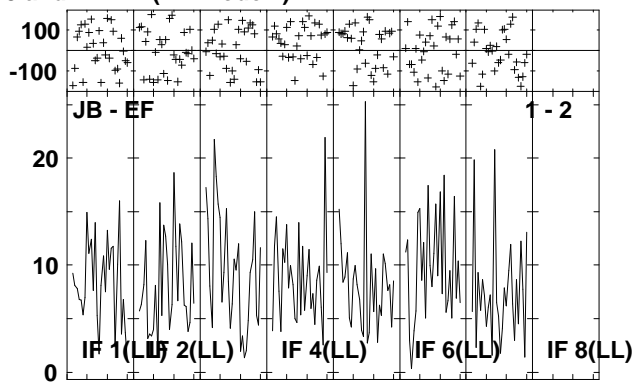
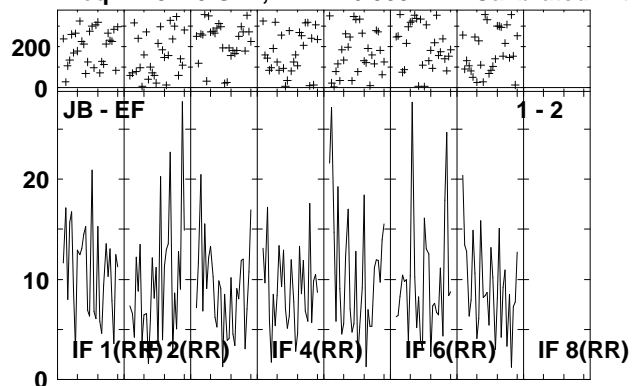

Lower frame: Milli Ampl Jy Top frame: Phas deg
Vector averaged cross-power spectrum Several baselines displayed
Timerange: 00/23:47:01 to 00/23:50:29

Plot file version 96 created 13-OCT-2010 18:41:51

IRAS1954 EP064N.UVDATA.1

Freq = 4.9270 GHz, Bw = 16.000 MH Calibrated with CL # 3 and BP # 1 (BP mode 1)

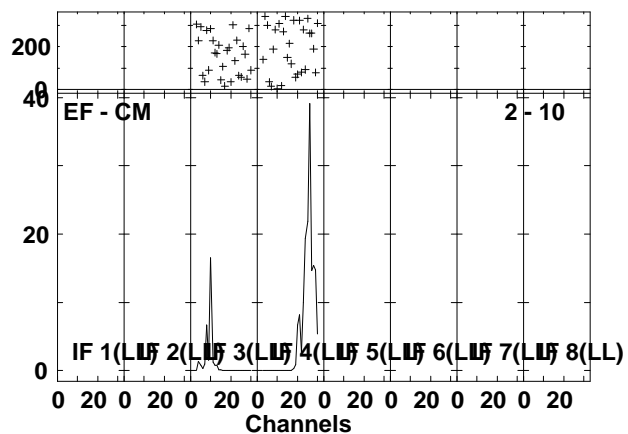
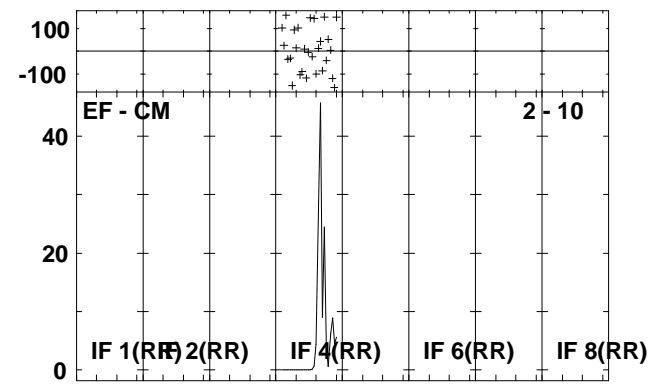
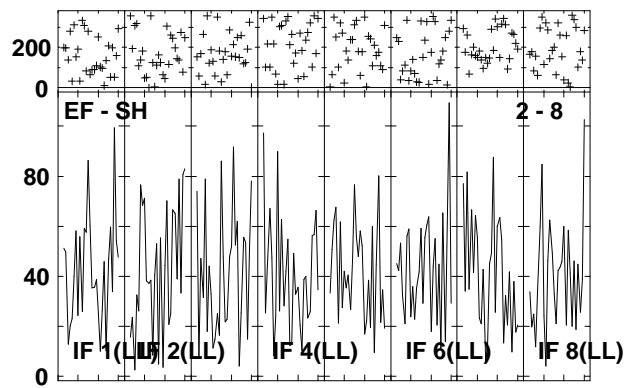
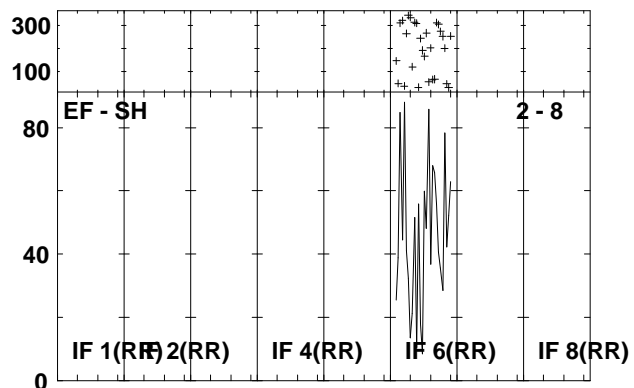
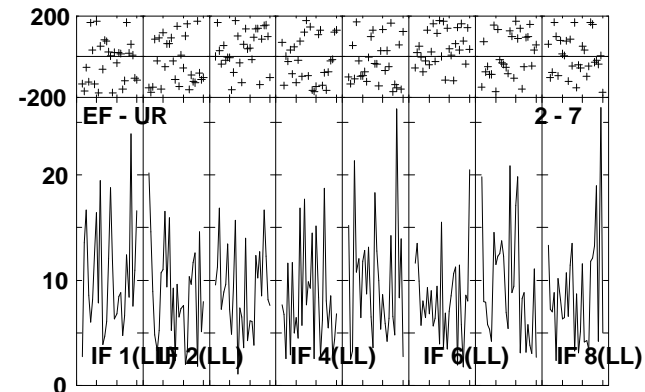
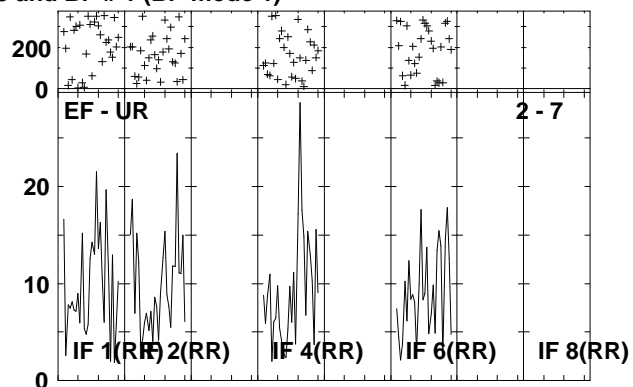
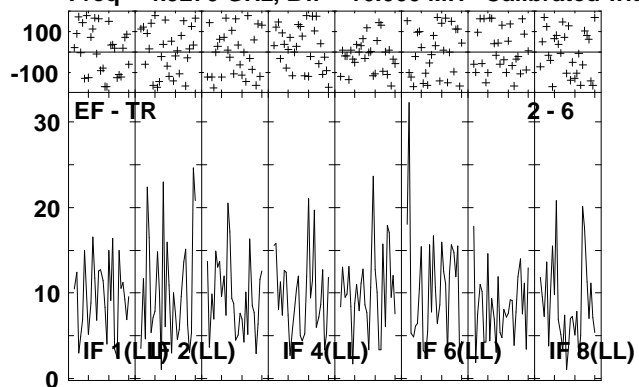

Lower frame: Milli Ampl Jy Top frame: Phas deg
Vector averaged cross-power spectrum Several baselines displayed
Timerange: 00/23:47:01 to 00/23:50:29

Plot file version 97 created 13-OCT-2010 18:41:55
 J2001+10 EP064N.UVDATA.1
 Freq = 4.9270 GHz, Bw = 16.000 MH Calibrated with CL # 3 and BP # 1 (BP mode 1)

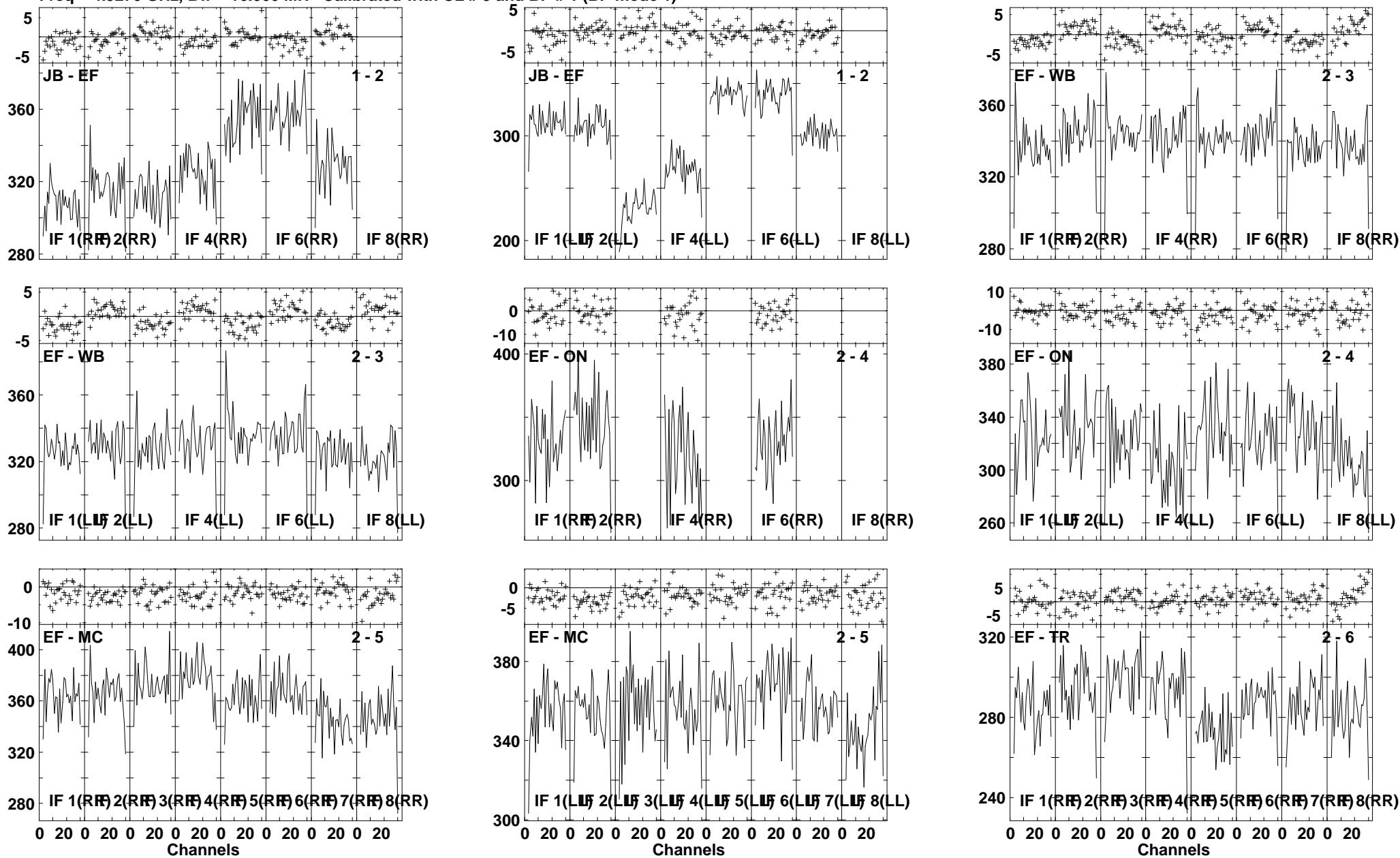

Lower frame: Milli Ampl Jy Top frame: Phas deg
 Vector averaged cross-power spectrum Several baselines displayed
 Timerange: 00/23:51:31 to 00/23:52:59

Plot file version 98 created 13-OCT-2010 18:41:56

J2001+10 EP064N.UVDATA.1

Freq = 4.9270 GHz, Bw = 16.000 MH Calibrated with CL # 3 and BP # 1 (BP mode 1)

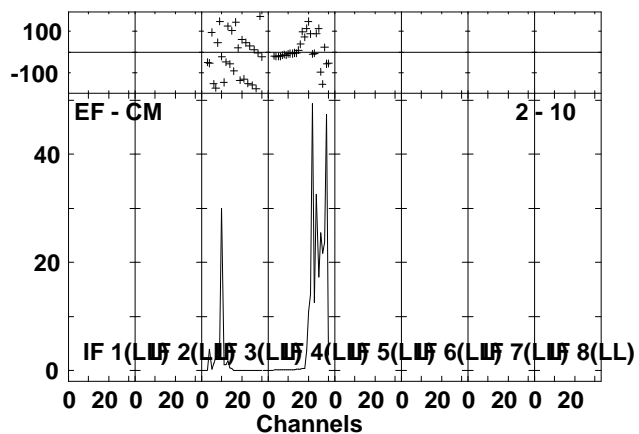
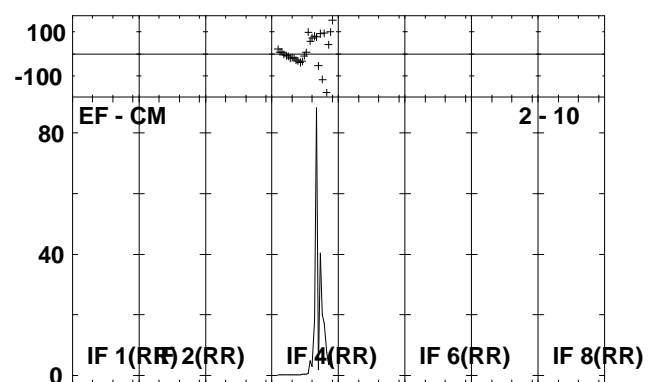
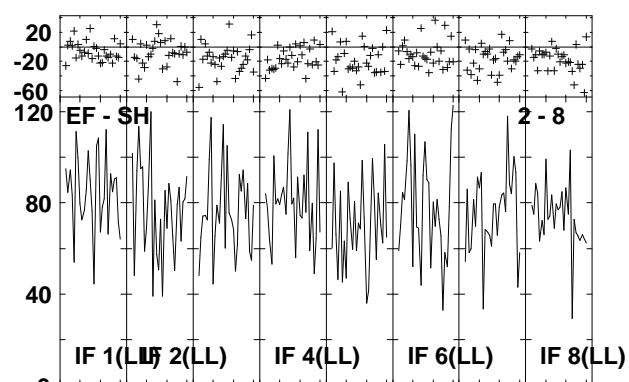
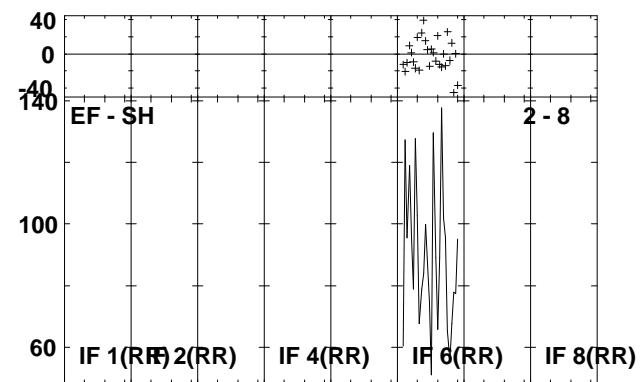
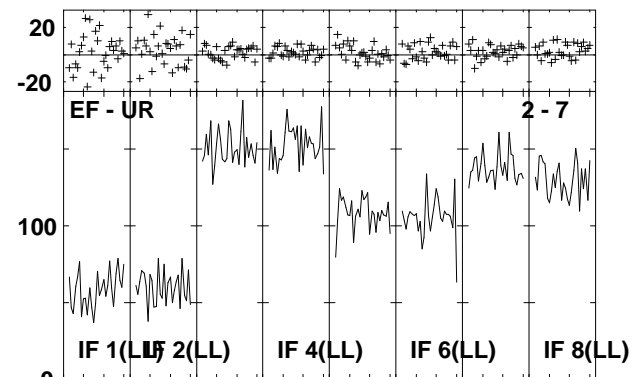
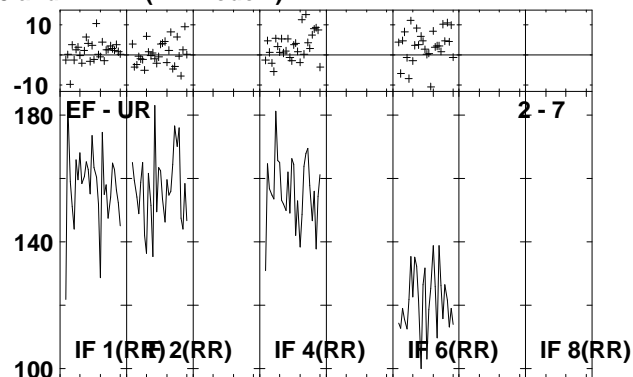
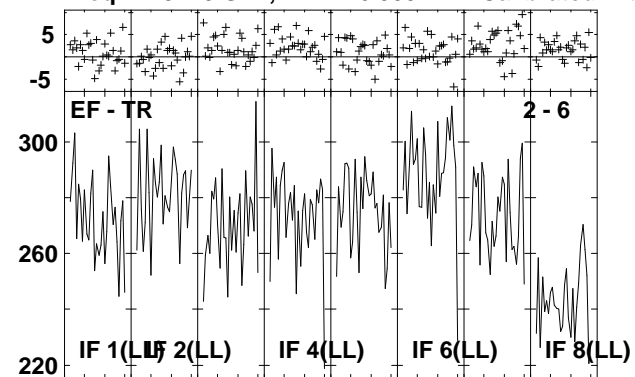

Lower frame: Milli Ampl Jy Top frame: Phas deg
Vector averaged cross-power spectrum Several baselines displayed
Timerange: 00/23:51:31 to 00/23:52:59

Plot file version 99 created 13-OCT-2010 18:41:59

IRAS1954 EP064N.UVDATA.1

Freq = 4.9270 GHz, Bw = 16.000 MH Calibrated with CL # 3 and BP # 1 (BP mode 1)

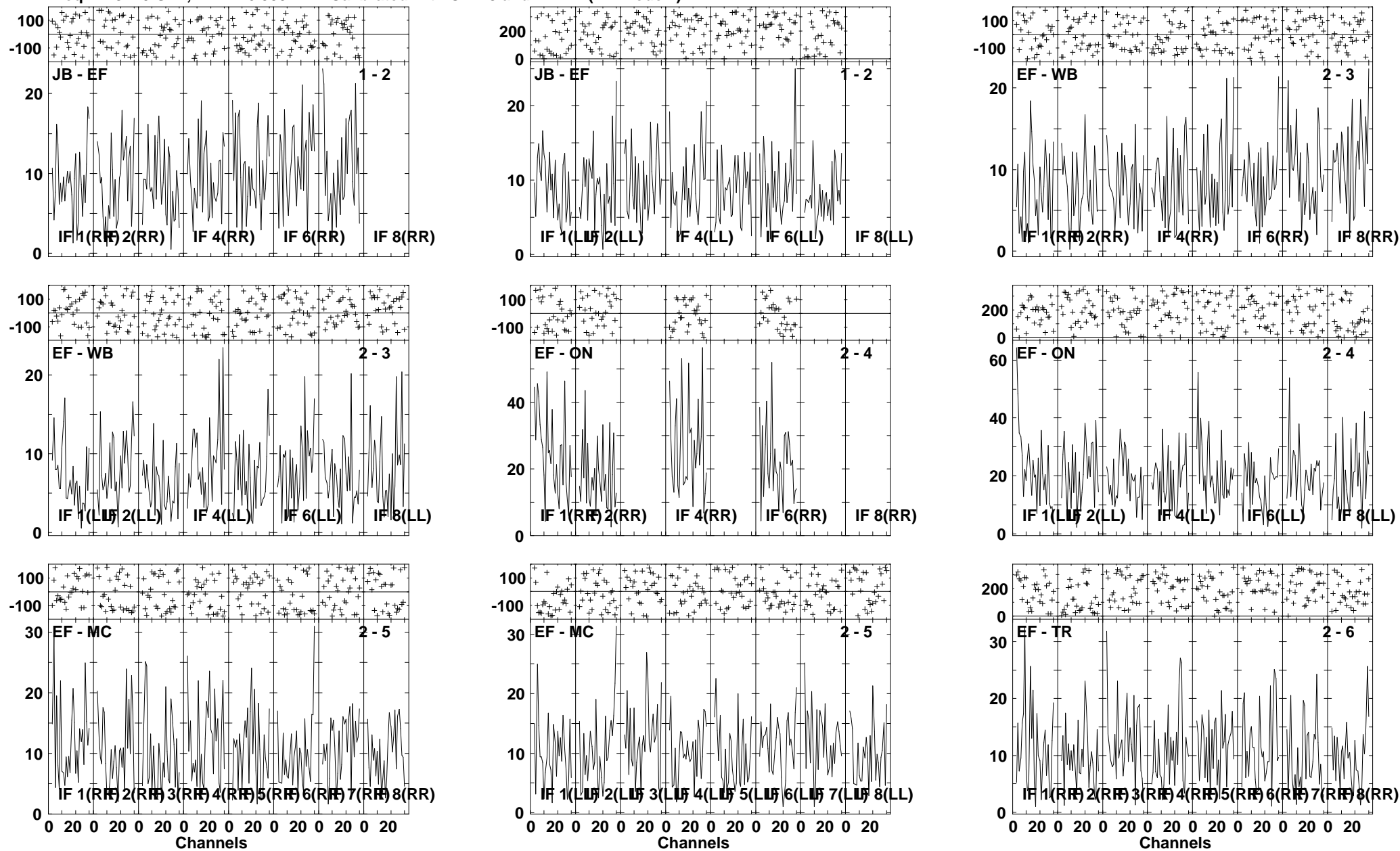

Lower frame: Milli Ampl Jy Top frame: Phas deg
Vector averaged cross-power spectrum Several baselines displayed
Timerange: 00/23:53:01 to 00/23:56:29

Plot file version 100 created 13-OCT-2010 18:42:02

IRAS1954 EP064N.UVDATA.1

Freq = 4.9270 GHz, Bw = 16.000 MH Calibrated with CL # 3 and BP # 1 (BP mode 1)

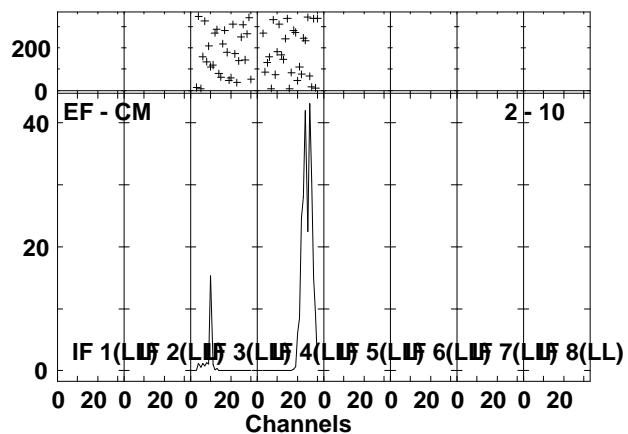
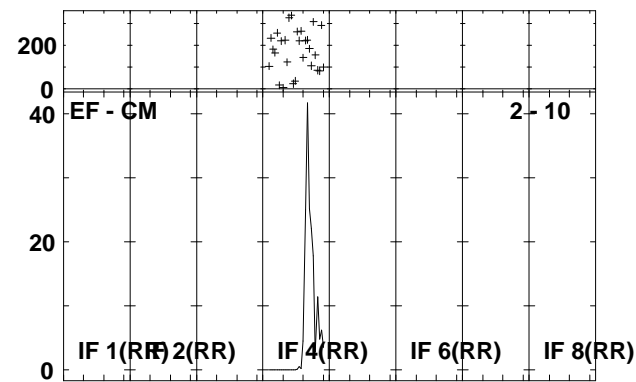
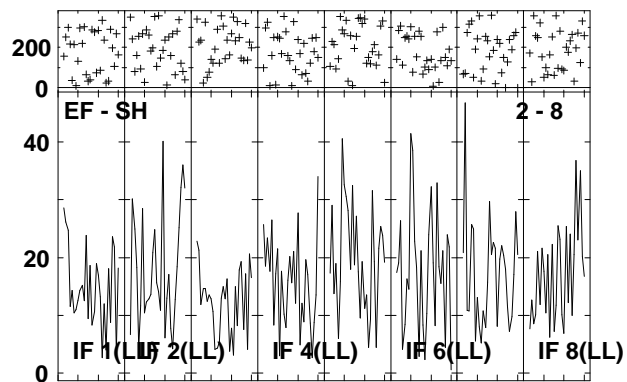
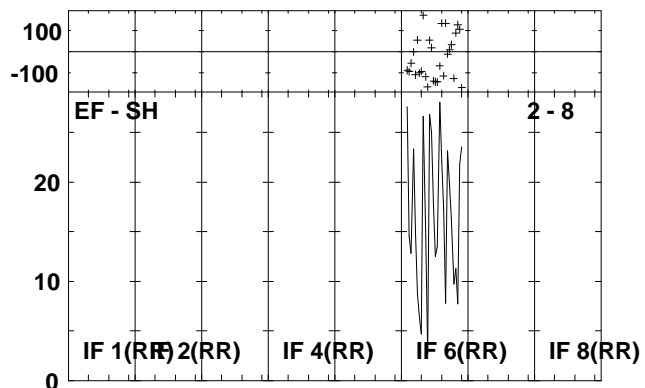
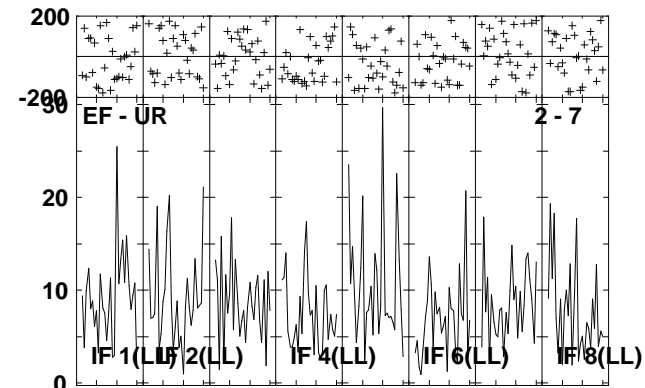
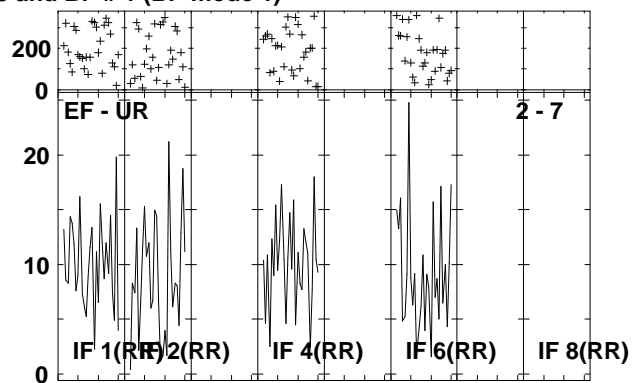
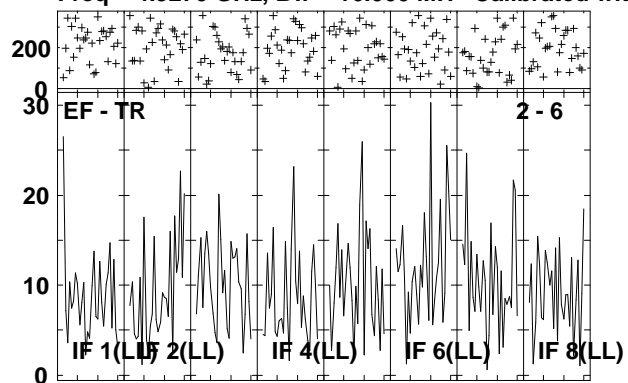

Lower frame: Milli Ampl Jy Top frame: Phas deg
Vector averaged cross-power spectrum Several baselines displayed
Timerange: 00/23:53:01 to 00/23:56:29

Plot file version 101 created 13-OCT-2010 18:42:06

J2001+10 EP064N.UVDATA.1

Freq = 4.9270 GHz, Bw = 16.000 MH Calibrated with CL # 3 and BP # 1 (BP mode 1)

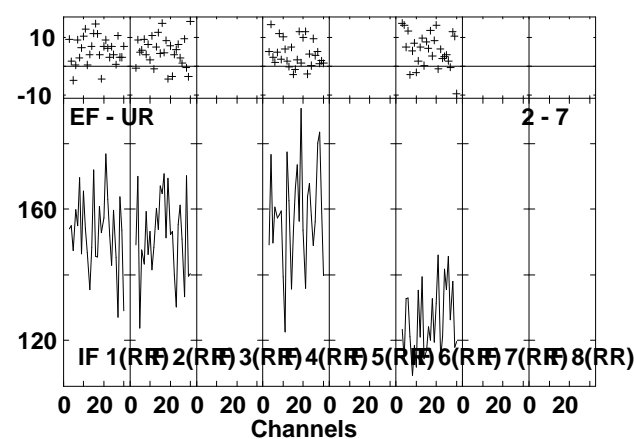
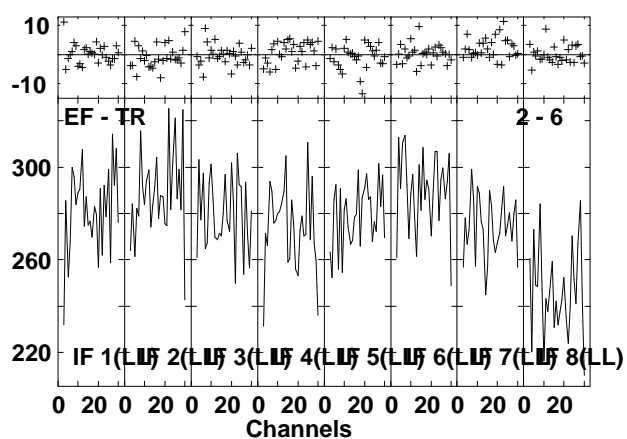
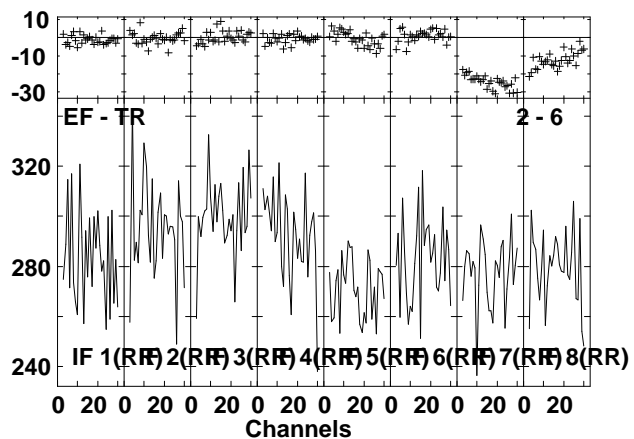
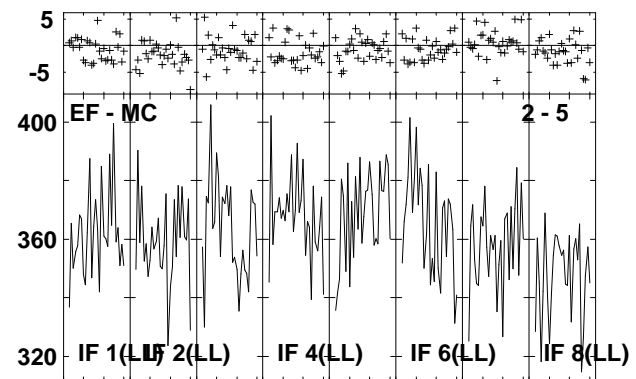
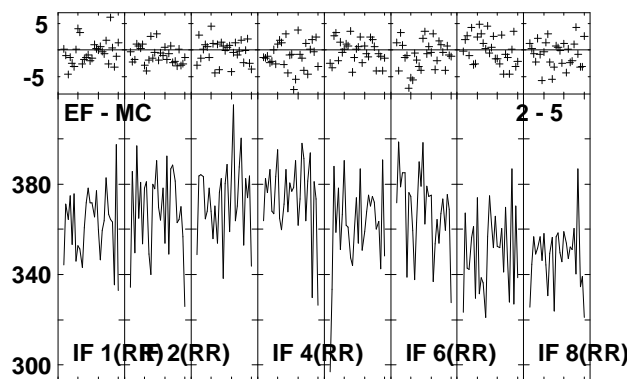
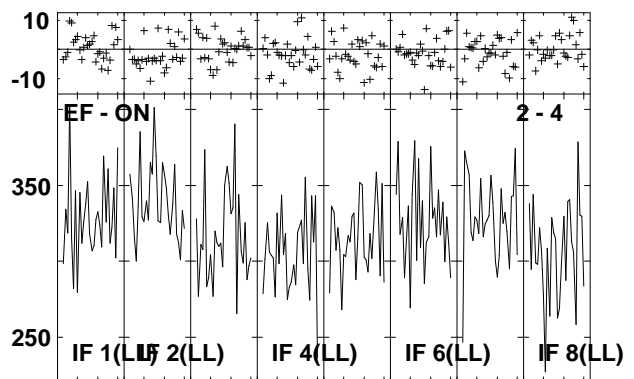
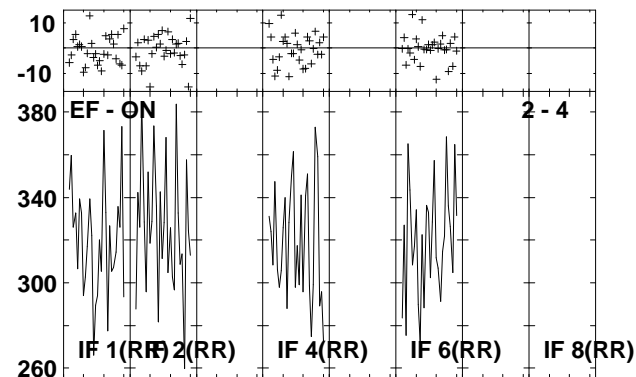
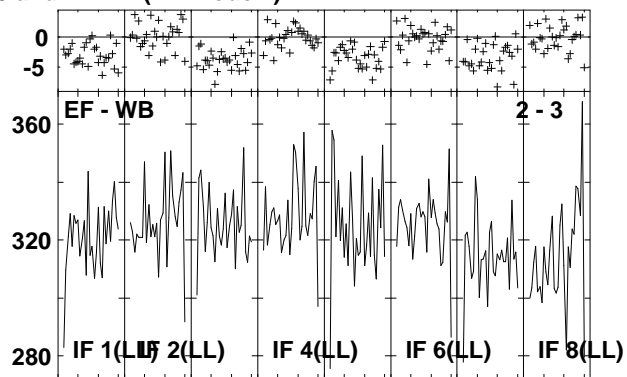
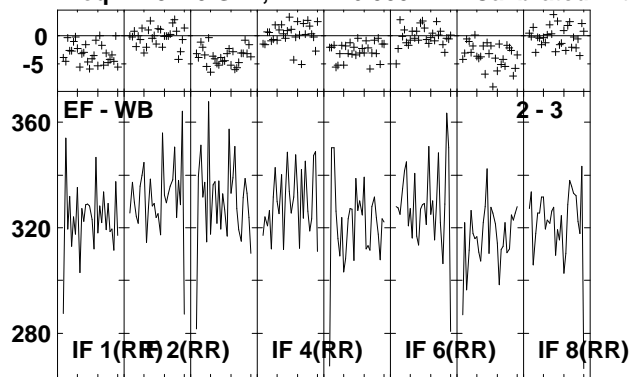

Lower frame: Milli Ampl Jy Top frame: Phas deg
Vector averaged cross-power spectrum Several baselines displayed
Timerange: 00/23:56:31 to 00/23:57:59

Plot file version 102 created 13-OCT-2010 18:42:07

J2001+10 EP064N.UVDATA.1

Freq = 4.9270 GHz, Bw = 16.000 MH Calibrated with CL # 3 and BP # 1 (BP mode 1)

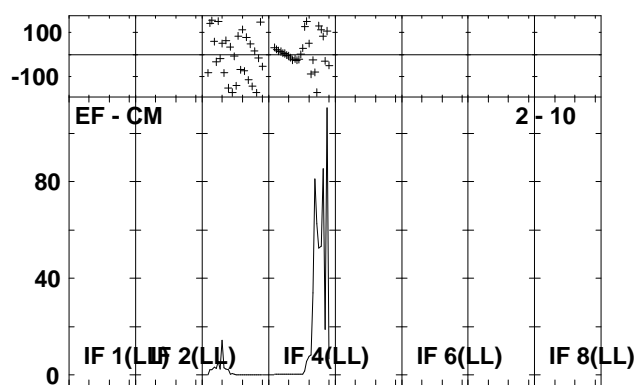
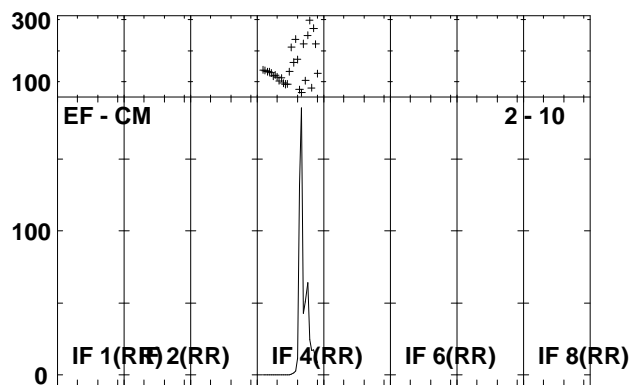
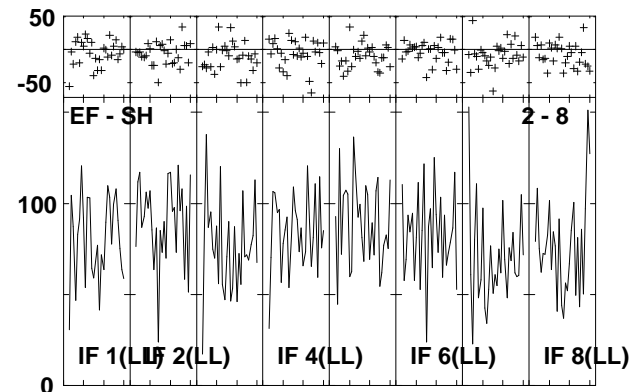
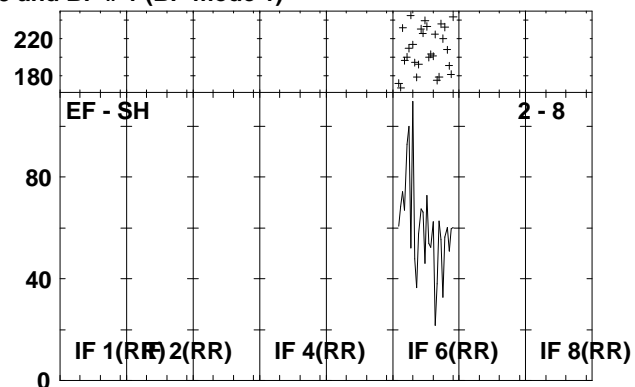
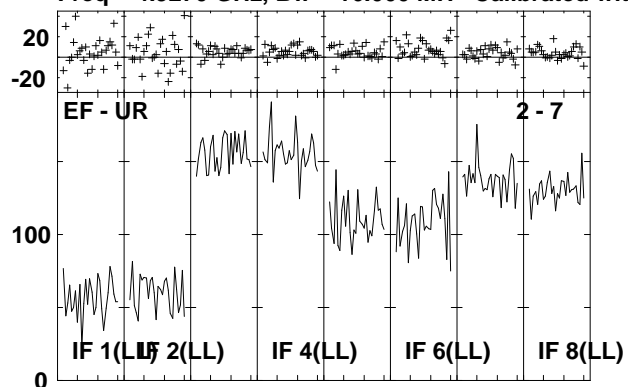

Lower frame: Milli Ampl Jy Top frame: Phas deg
Vector averaged cross-power spectrum Several baselines displayed
Timerange: 00/23:56:31 to 00/23:57:59

Plot file version 103 created 13-OCT-2010 18:42:09

IRAS1954 EP064N.UVDATA.1

Freq = 4.9270 GHz, Bw = 16.000 MH Calibrated with CL # 3 and BP # 1 (BP mode 1)

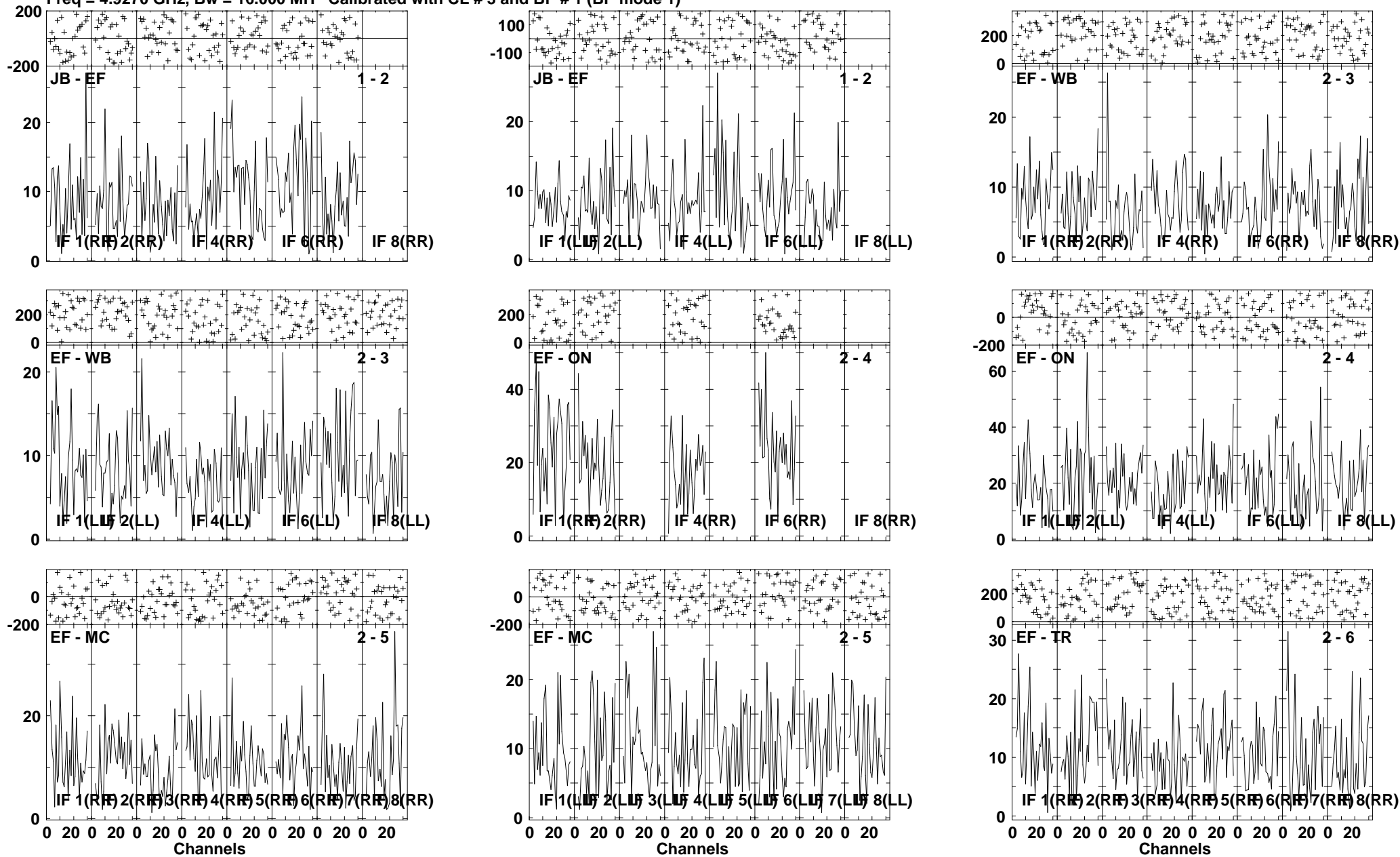

Lower frame: Milli Ampl Jy Top frame: Phas deg
Vector averaged cross-power spectrum Several baselines displayed
Timerange: 00/23:58:01 to 01/00:01:29

Plot file version 104 created 13-OCT-2010 18:42:12

IRAS1954 EP064N.UVDATA.1

Freq = 4.9270 GHz, Bw = 16.000 MH Calibrated with CL # 3 and BP # 1 (BP mode 1)

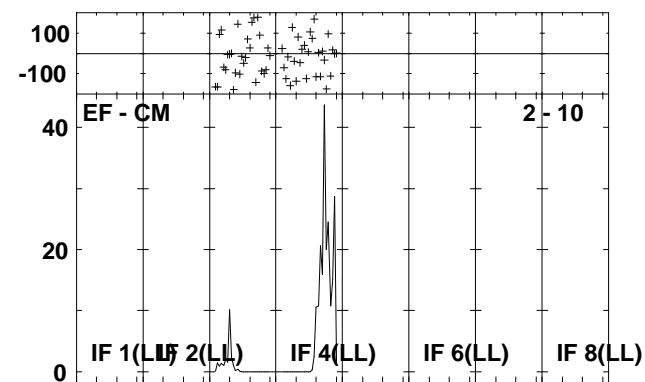
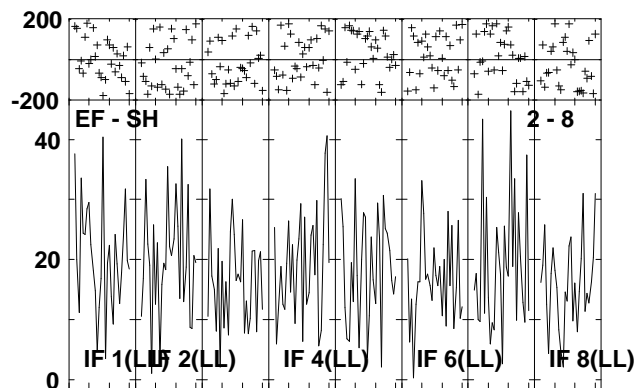
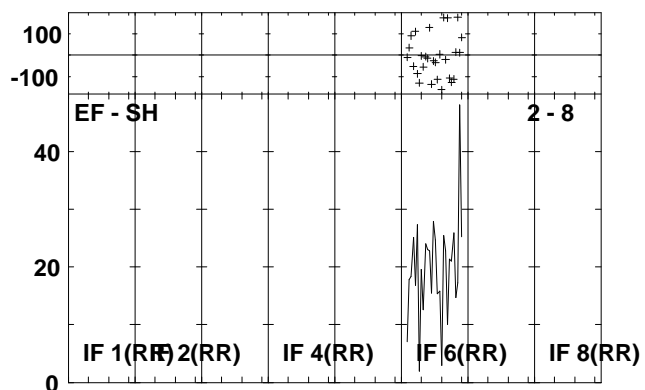
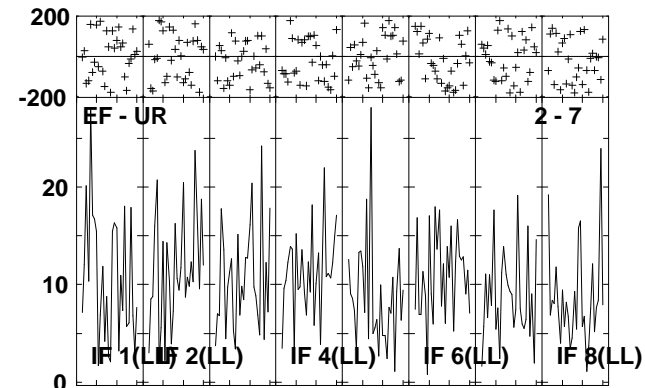
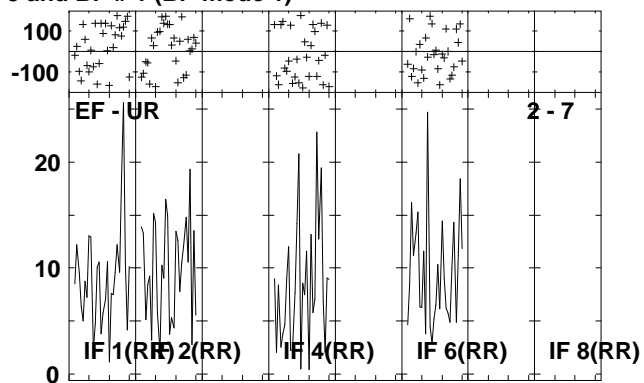
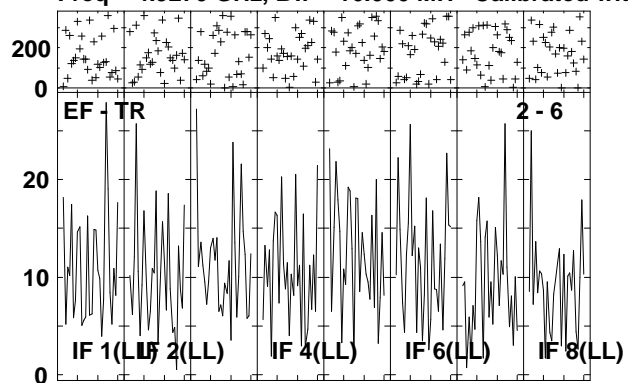

Lower frame: Milli Ampl Jy Top frame: Phas deg
Vector averaged cross-power spectrum Several baselines displayed
Timerange: 00/23:58:01 to 01/00:01:29

Plot file version 105 created 13-OCT-2010 18:42:16
 J2001+10 EP064N.UVDATA.1
 Freq = 4.9270 GHz, Bw = 16.000 MH Calibrated with CL # 3 and BP # 1 (BP mode 1)

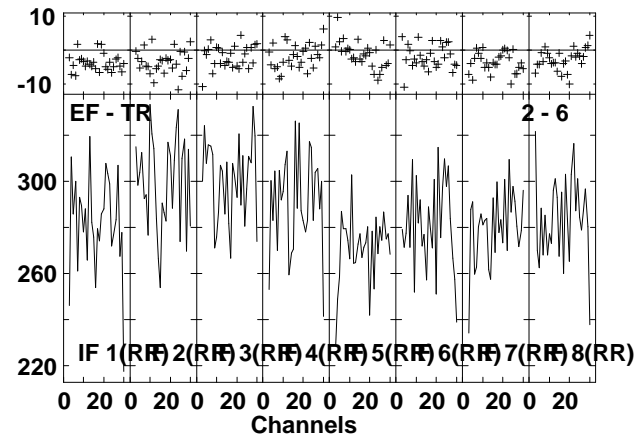
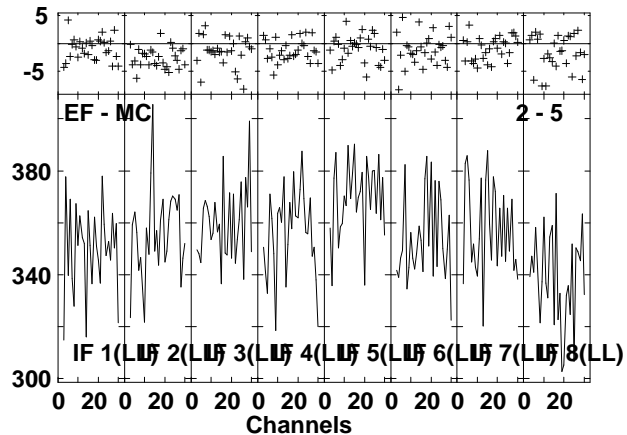
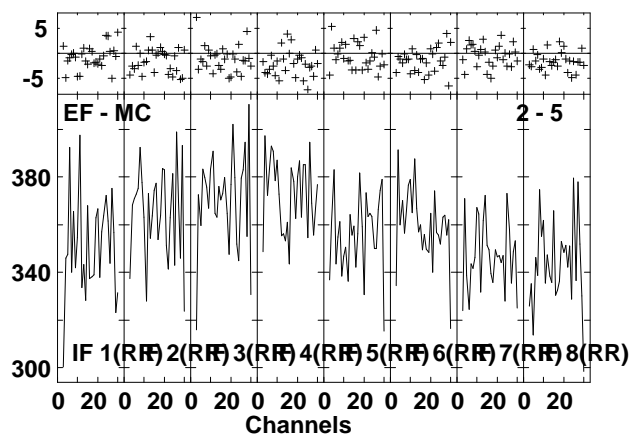
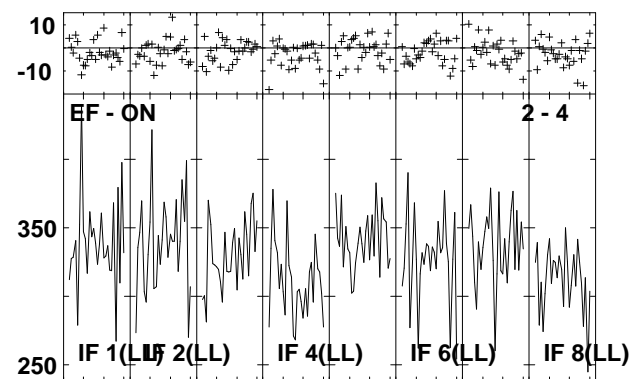
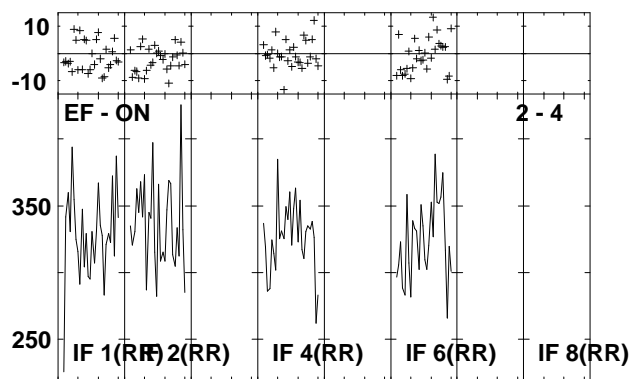
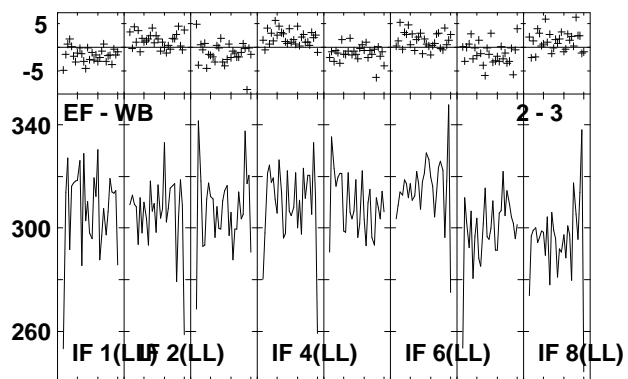
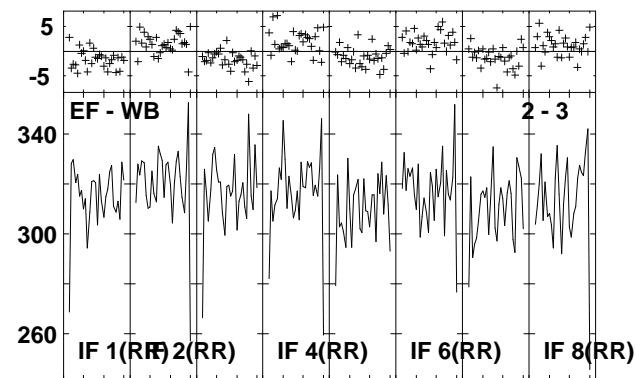
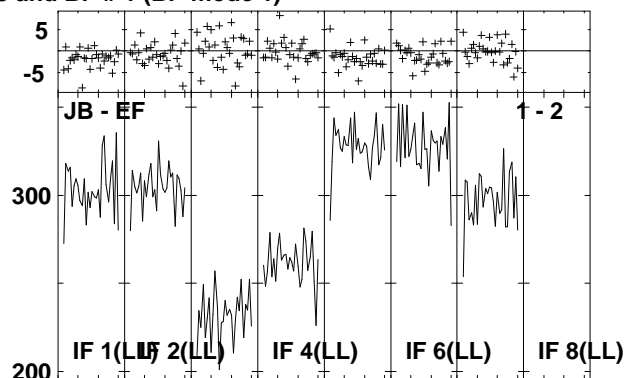
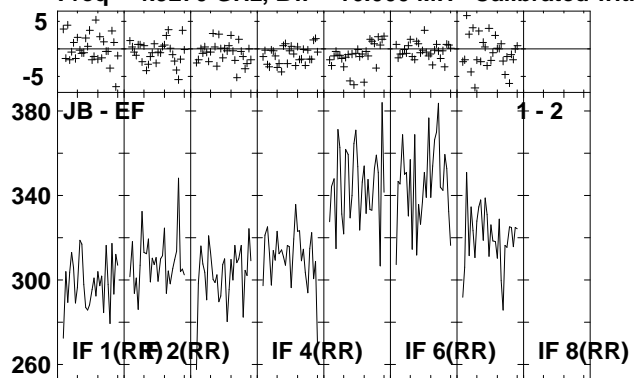

Lower frame: Milli Ampl Jy Top frame: Phas deg
 Vector averaged cross-power spectrum Several baselines displayed
 Timerange: 01/00:01:31 to 01/00:02:59

Plot file version 106 created 13-OCT-2010 18:42:18

J2001+10 EP064N.UVDATA.1

Freq = 4.9270 GHz, Bw = 16.000 MH Calibrated with CL # 3 and BP # 1 (BP mode 1)

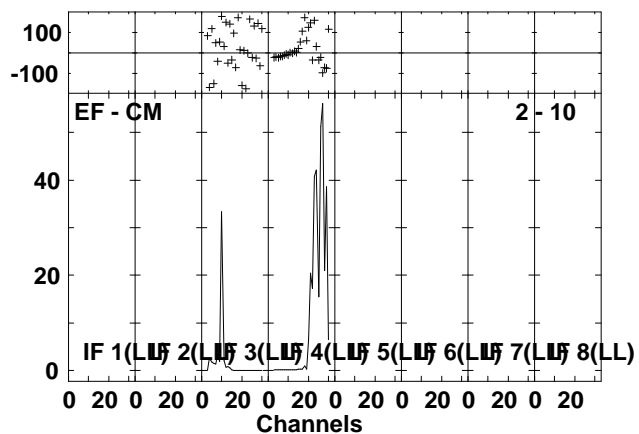
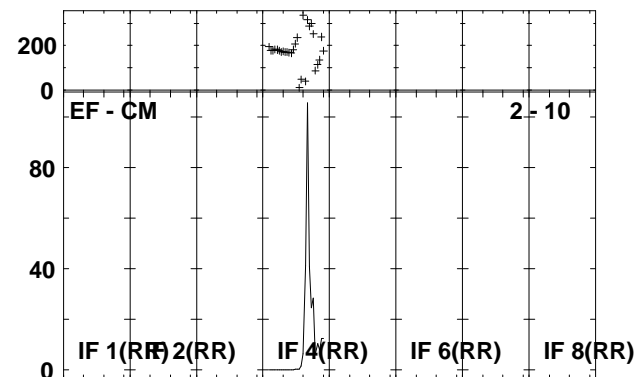
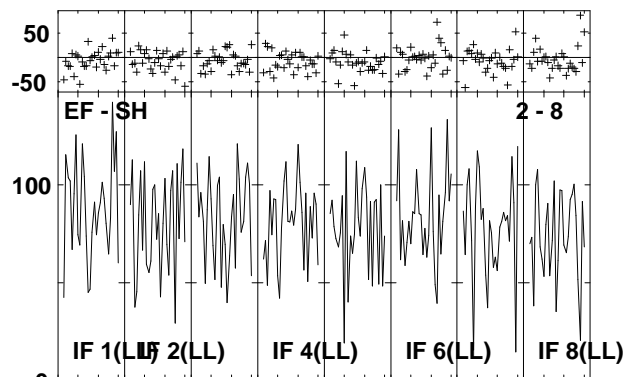
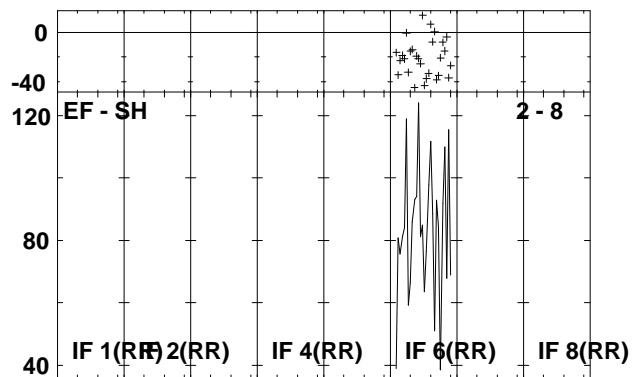
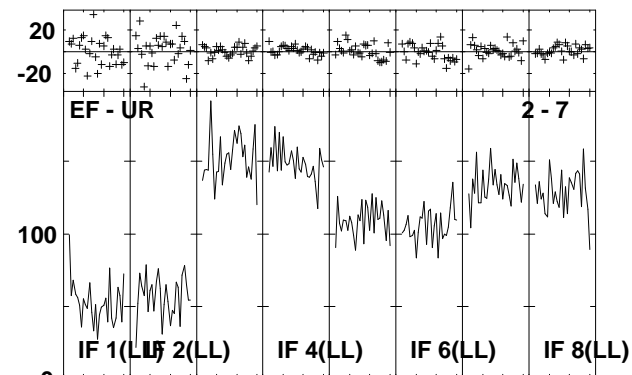
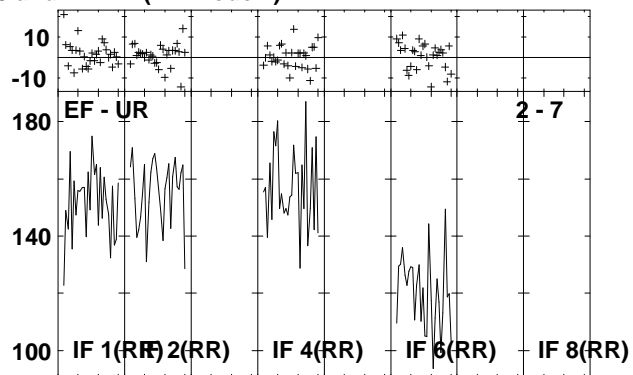
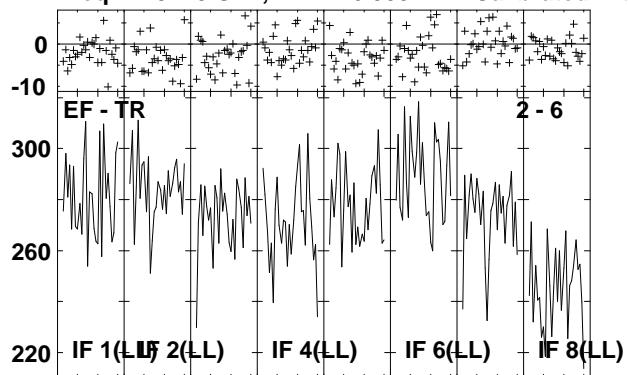

Lower frame: Milli Ampl Jy Top frame: Phas deg
Vector averaged cross-power spectrum Several baselines displayed
Timerange: 01/00:01:31 to 01/00:02:59

Plot file version 107 created 13-OCT-2010 18:42:20

IRAS1954 EP064N.UVDATA.1

Freq = 4.9270 GHz, Bw = 16.000 MH Calibrated with CL # 3 and BP # 1 (BP mode 1)

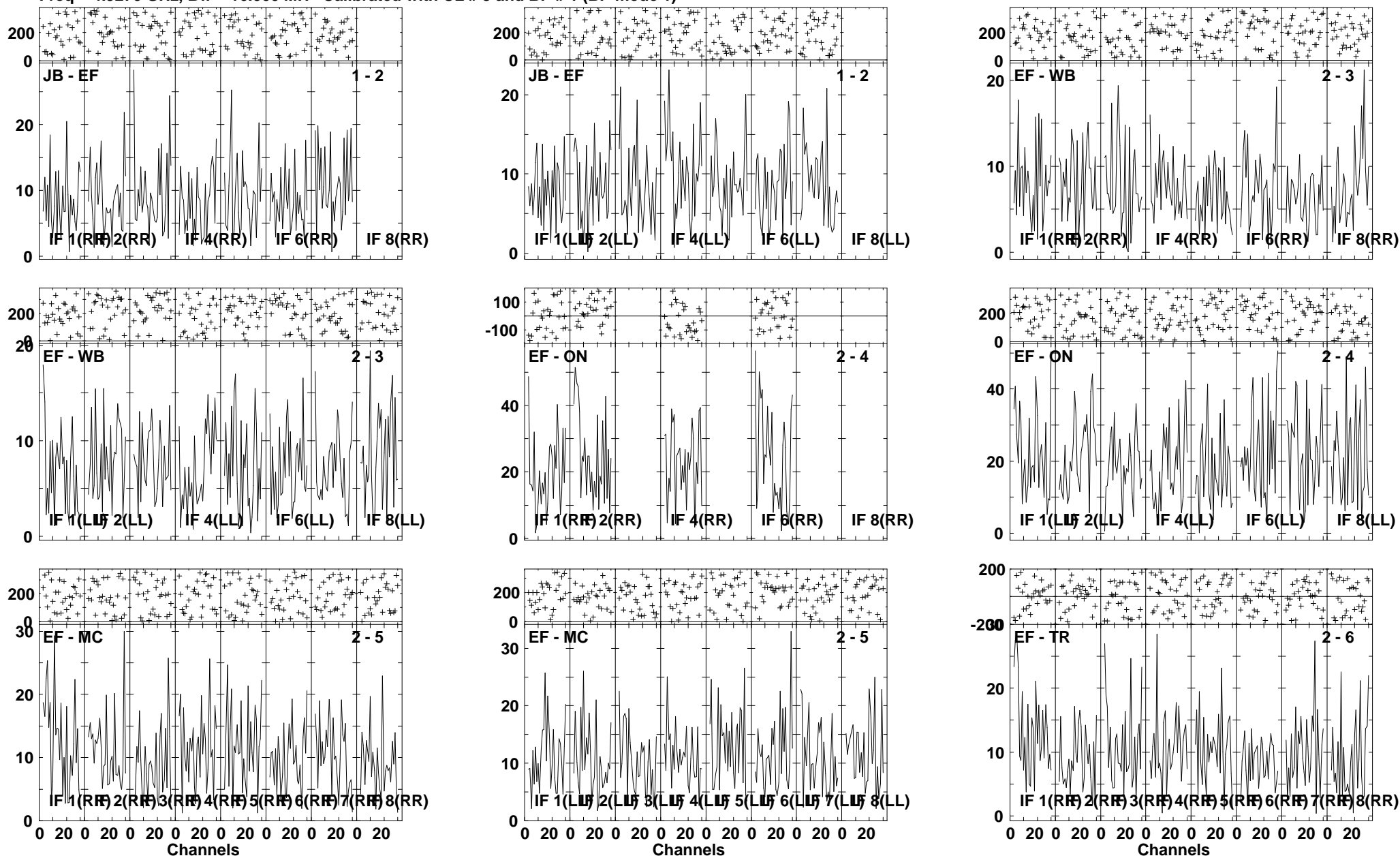

Lower frame: Milli Ampl Jy Top frame: Phas deg
Vector averaged cross-power spectrum Several baselines displayed
Timerange: 01/00:03:01 to 01/00:06:29

Plot file version 109 created 13-OCT-2010 18:42:28

J2001+10 EP064N.UVDATA.1

Freq = 4.9270 GHz, Bw = 16.000 MH Calibrated with CL # 3 and BP # 1 (BP mode 1)

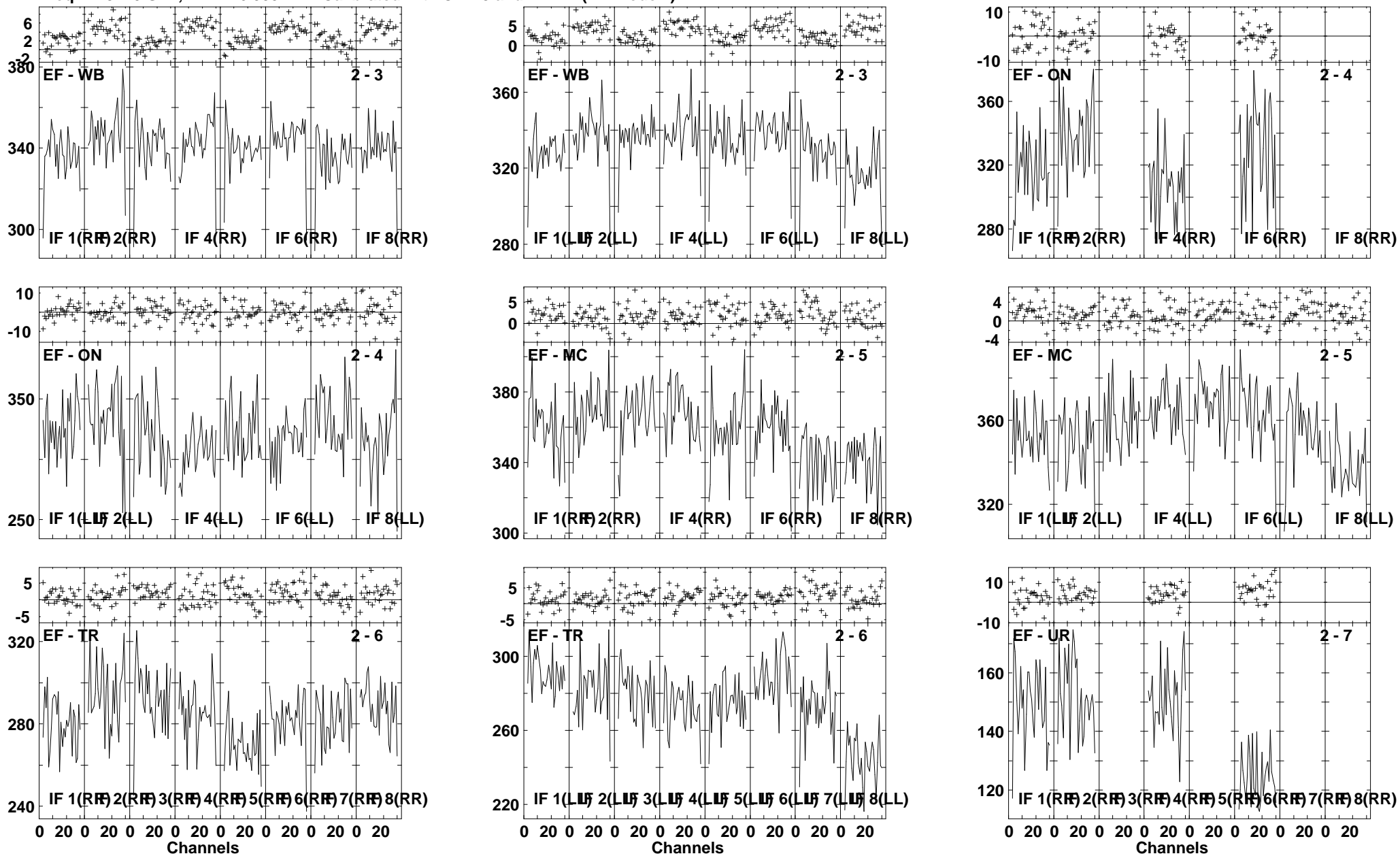

Lower frame: Milli Ampl Jy Top frame: Phas deg
Vector averaged cross-power spectrum Several baselines displayed
Timerange: 01/00:07:31 to 01/00:08:59

Plot file version 110 created 13-OCT-2010 18:42:29

J2001+10 EP064N.UVDATA.1

Freq = 4.9270 GHz, Bw = 16.000 MH Calibrated with CL # 3 and BP # 1 (BP mode 1)

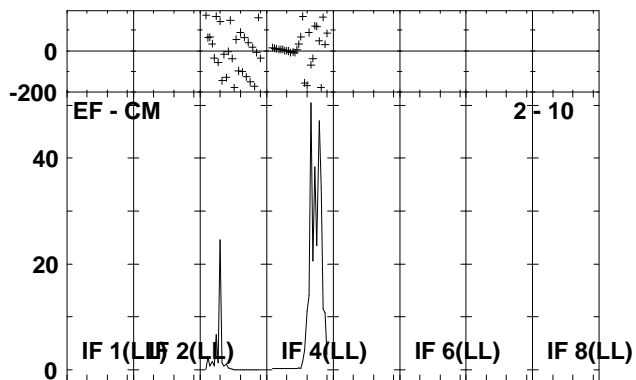
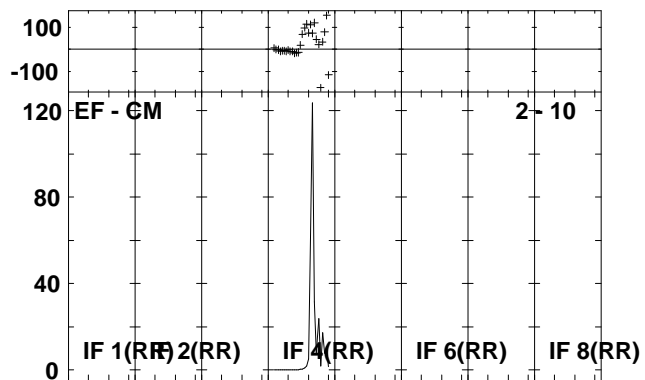
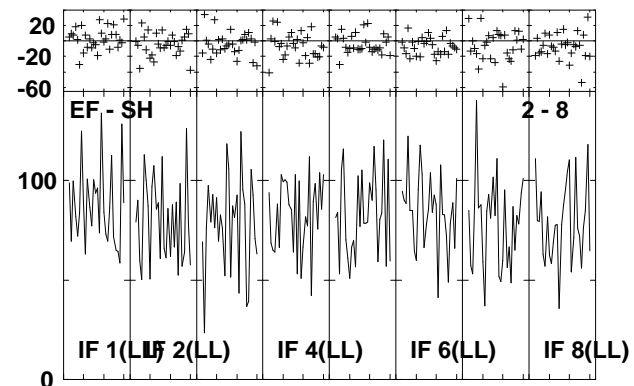
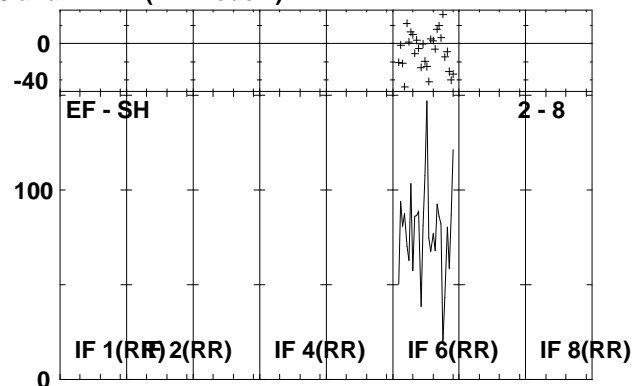
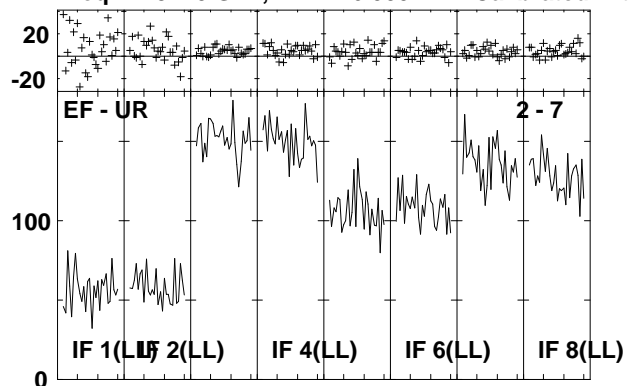

Lower frame: Milli Ampl Jy Top frame: Phas deg
Vector averaged cross-power spectrum Several baselines displayed
Timerange: 01/00:07:31 to 01/00:08:59

Plot file version 111 created 13-OCT-2010 18:42:31

IRAS1954 EP064N.UVDATA.1

Freq = 4.9270 GHz, Bw = 16.000 MH Calibrated with CL # 3 and BP # 1 (BP mode 1)

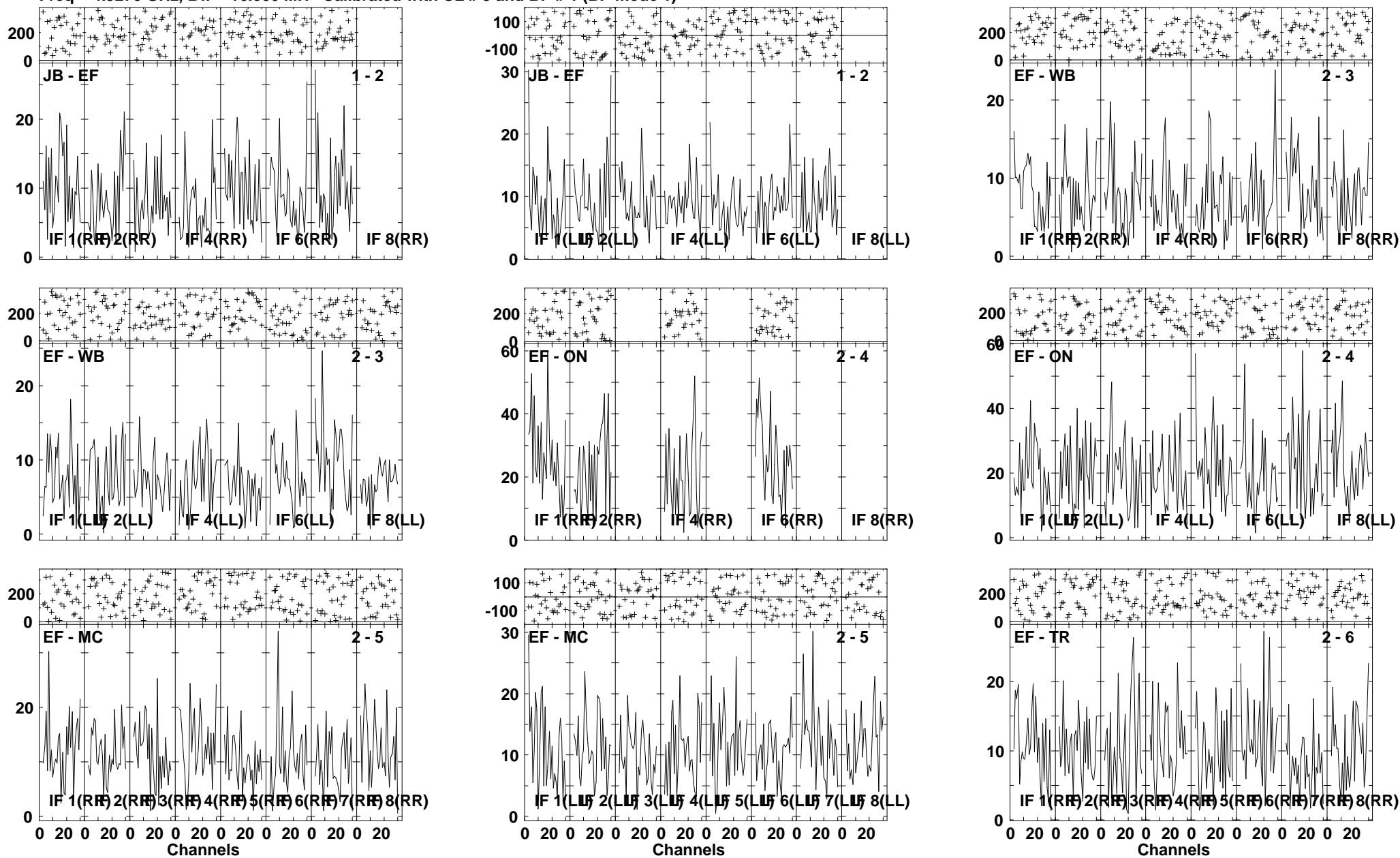

Lower frame: Milli Ampl Jy Top frame: Phas deg
Vector averaged cross-power spectrum Several baselines displayed
Timerange: 01/00:09:01 to 01/00:12:29

Plot file version 112 created 13-OCT-2010 18:42:34

IRAS1954 EP064N.UVDATA.1

Freq = 4.9270 GHz, Bw = 16.000 MH Calibrated with CL # 3 and BP # 1 (BP mode 1)

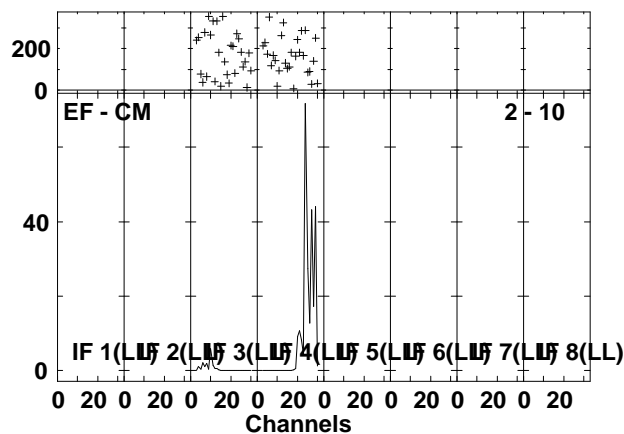
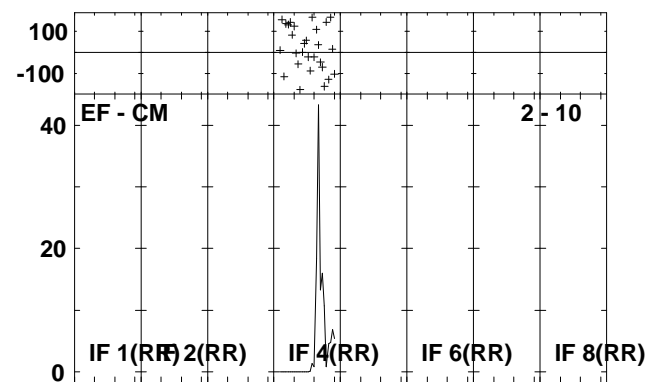
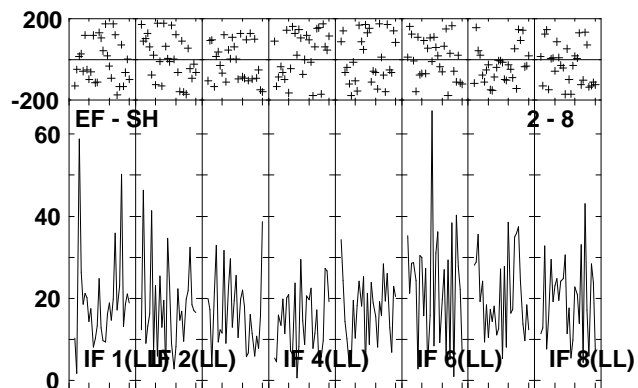
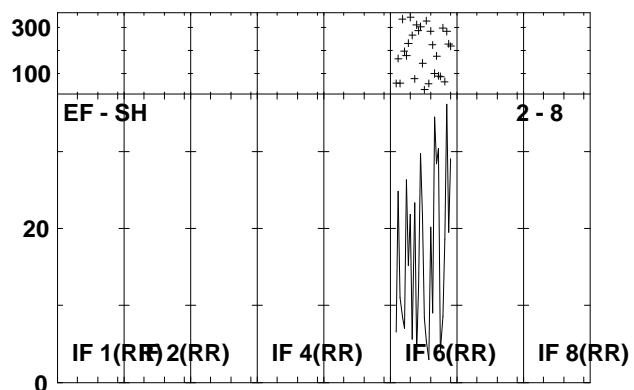
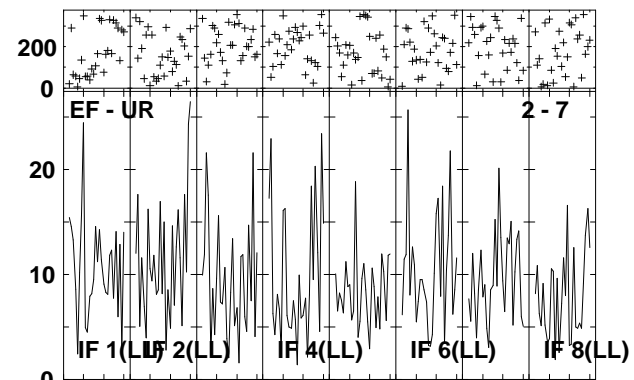
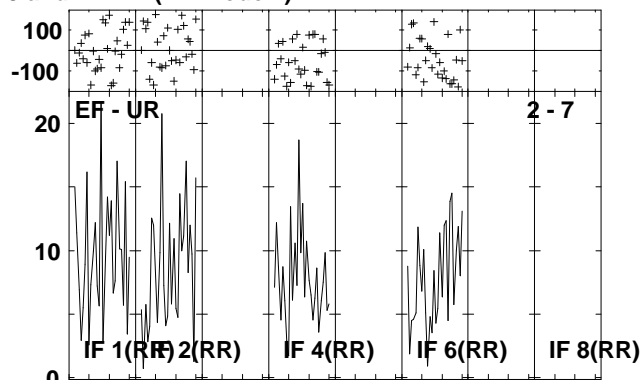
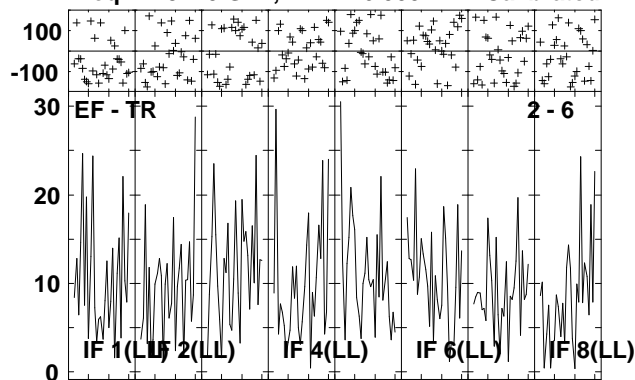

Lower frame: Milli Ampl Jy Top frame: Phas deg
Vector averaged cross-power spectrum Several baselines displayed
Timerange: 01/00:09:01 to 01/00:12:29

Plot file version 113 created 13-OCT-2010 18:42:39
 J2001+10 EP064N.UVDATA.1
 Freq = 4.9270 GHz, Bw = 16.000 MH Calibrated with CL # 3 and BP # 1 (BP mode 1)

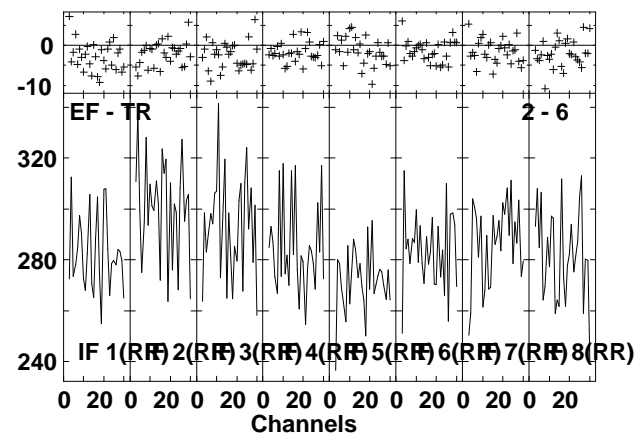
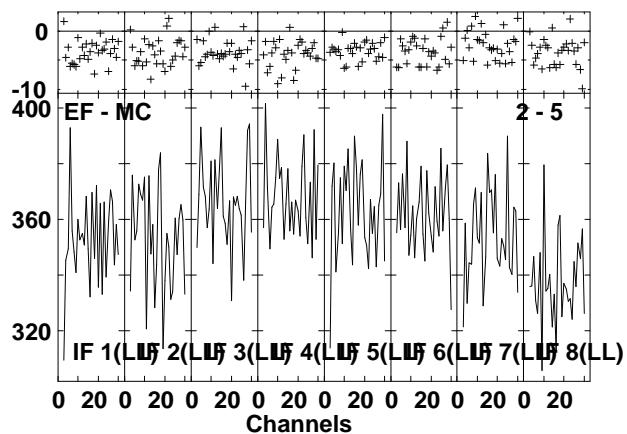
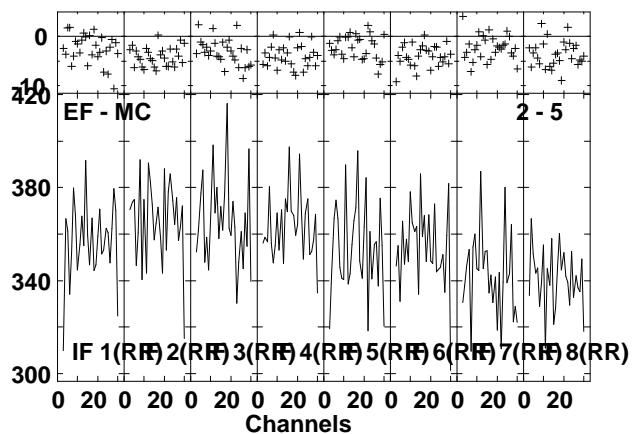
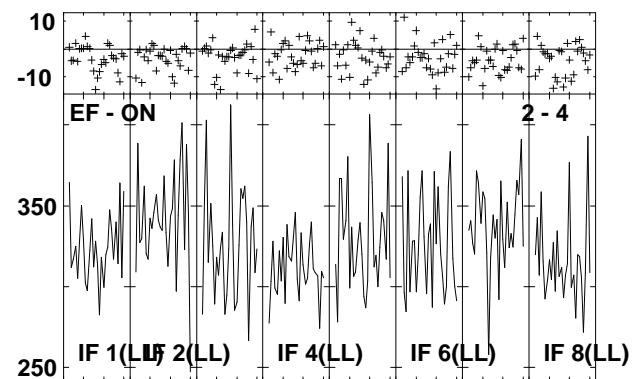
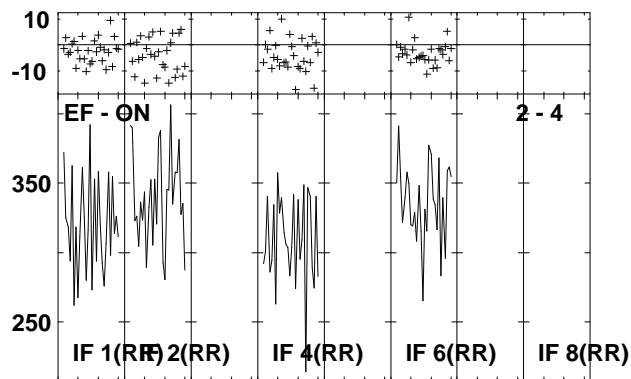
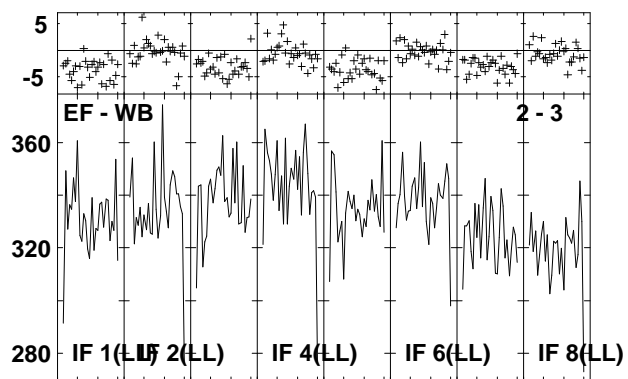
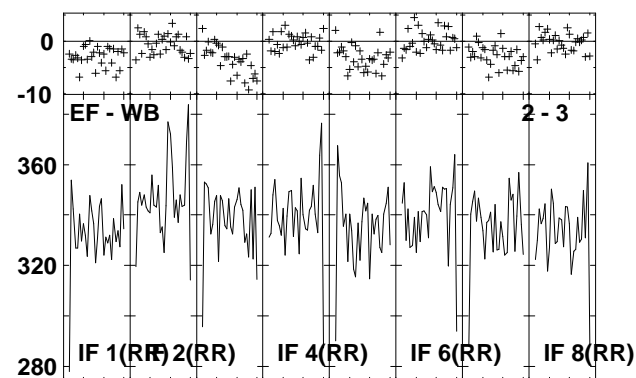
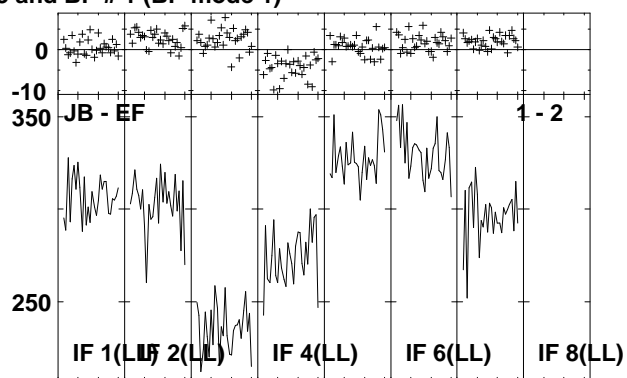
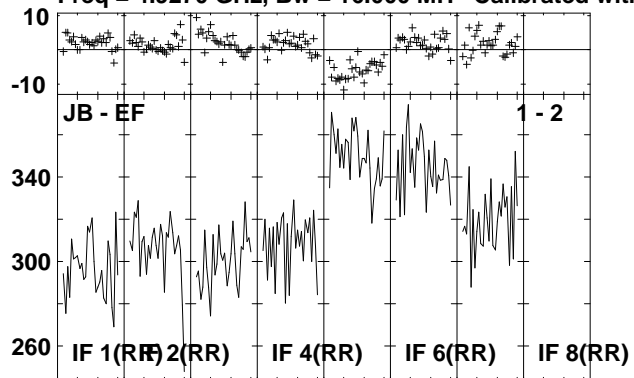

Lower frame: Milli Ampl Jy Top frame: Phas deg
 Vector averaged cross-power spectrum Several baselines displayed
 Timerange: 01/00:12:31 to 01/00:13:59

Plot file version 114 created 13-OCT-2010 18:42:40

J2001+10 EP064N.UVDATA.1

Freq = 4.9270 GHz, Bw = 16.000 MH Calibrated with CL # 3 and BP # 1 (BP mode 1)

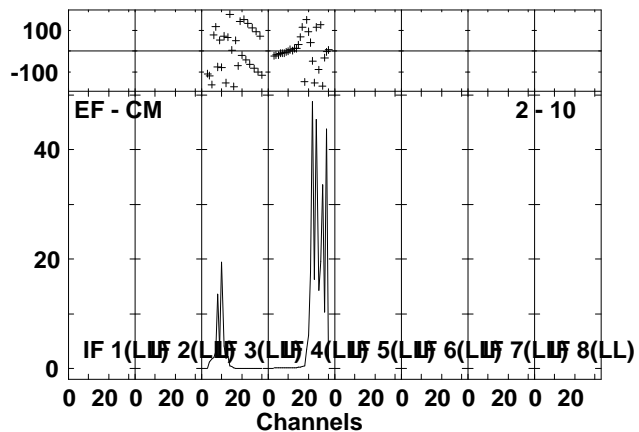
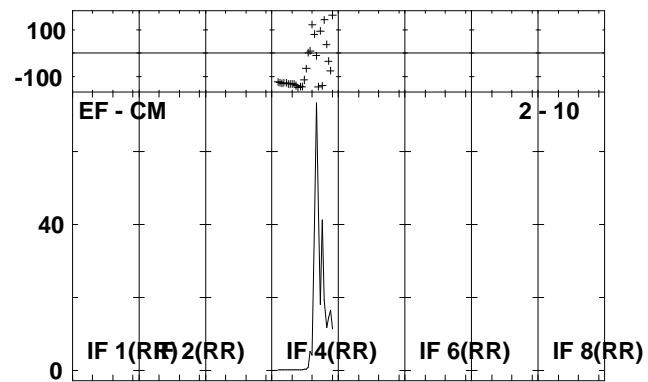
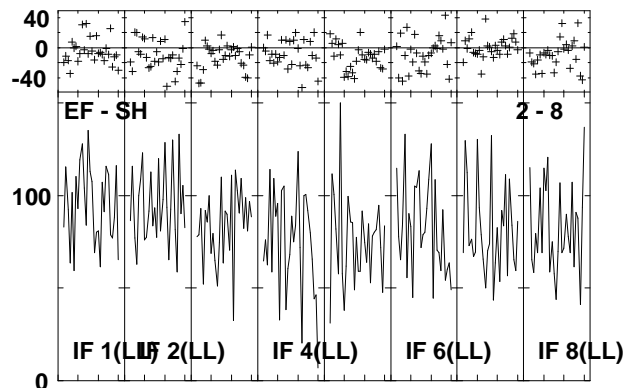
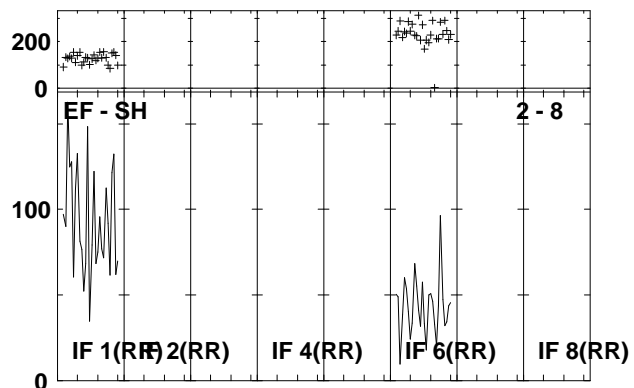
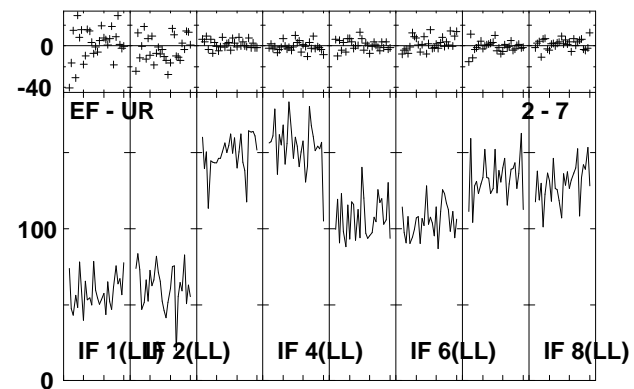
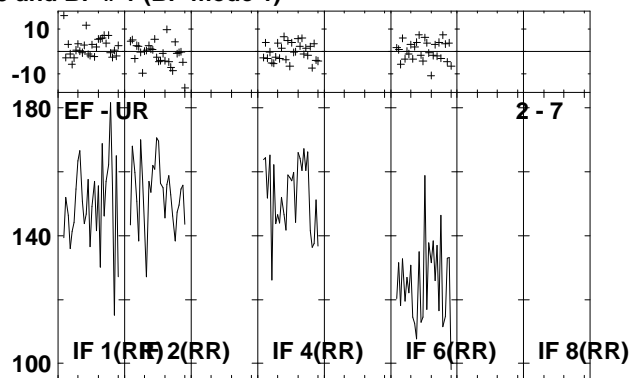
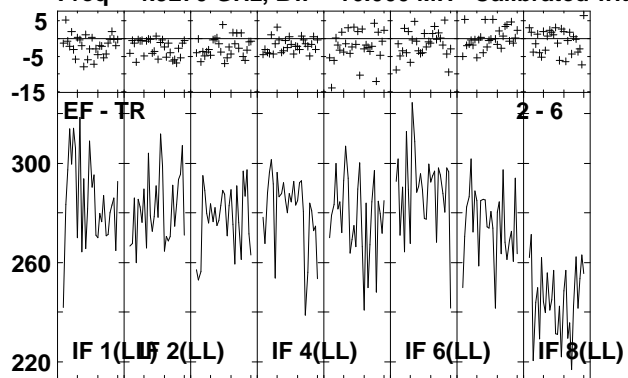

Lower frame: Milli Ampl Jy Top frame: Phas deg
Vector averaged cross-power spectrum Several baselines displayed
Timerange: 01/00:12:31 to 01/00:13:59

Plot file version 115 created 13-OCT-2010 18:42:42

IRAS1954 EP064N.UVDATA.1

Freq = 4.9270 GHz, Bw = 16.000 MH Calibrated with CL # 3 and BP # 1 (BP mode 1)

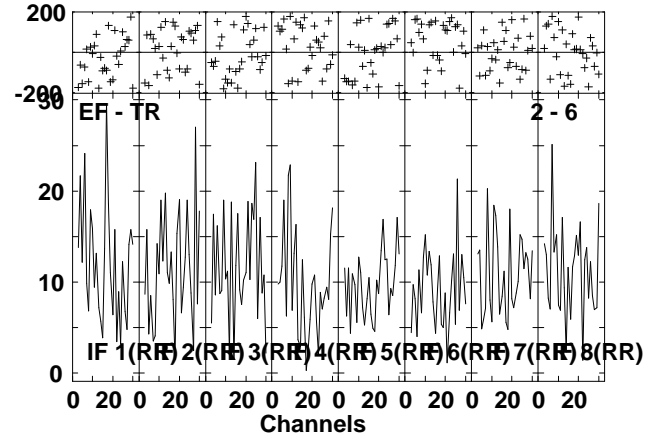
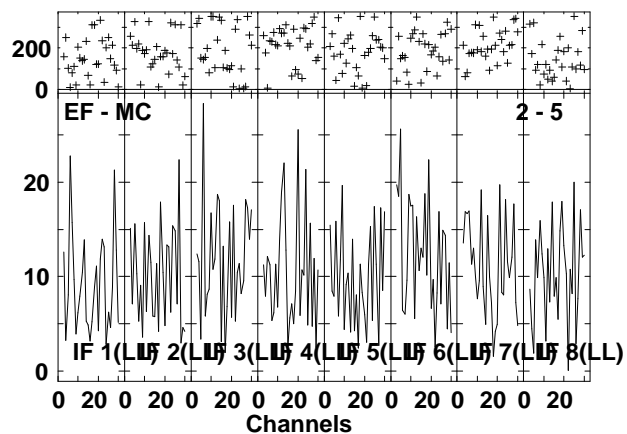
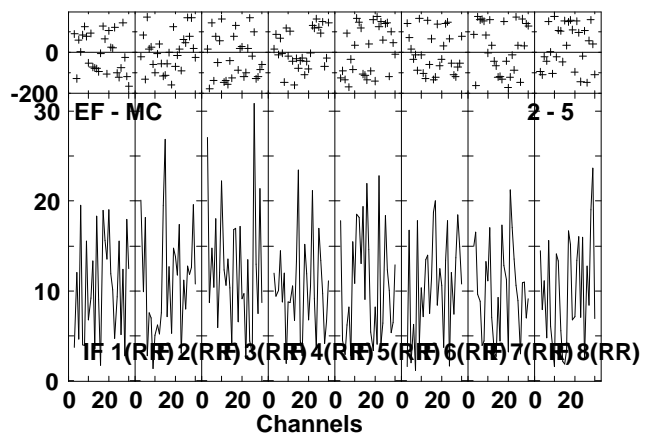
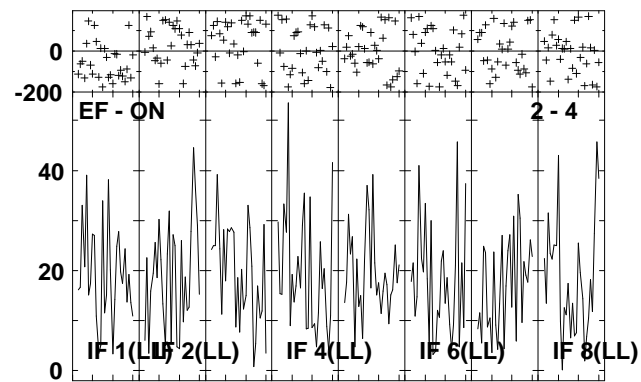
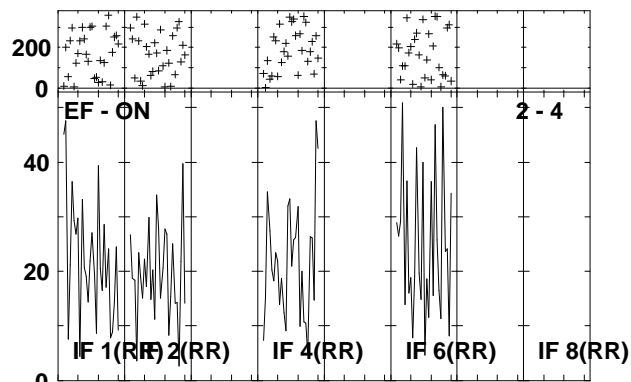
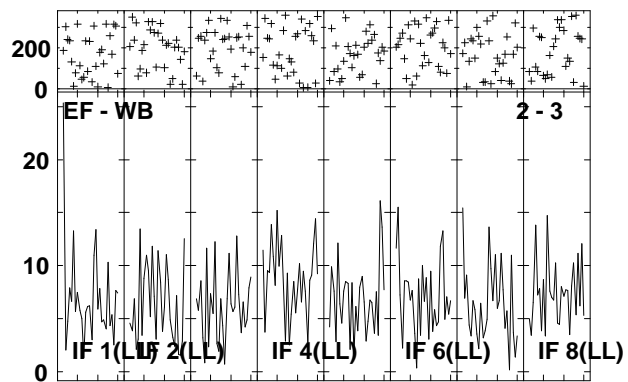
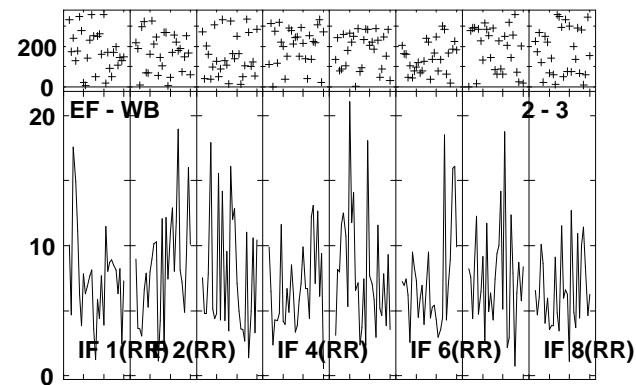
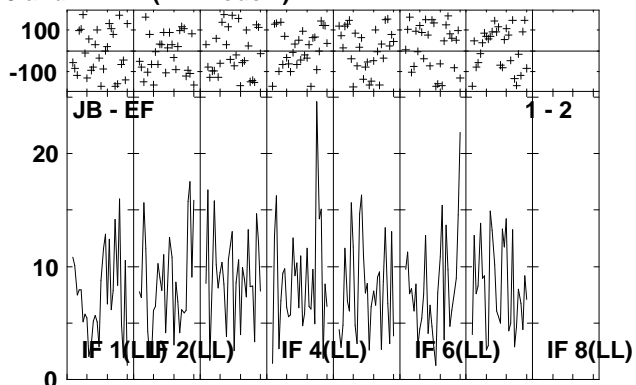
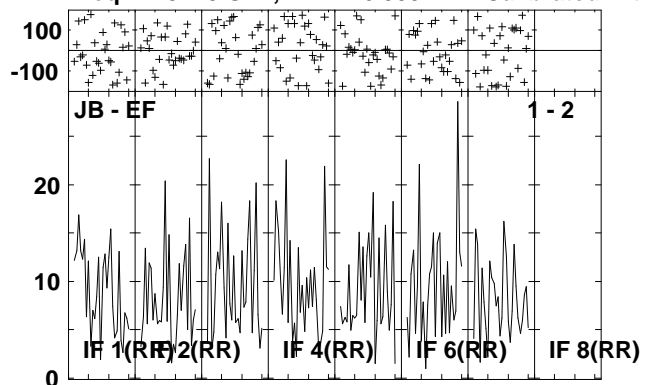

Lower frame: Milli Ampl Jy Top frame: Phas deg
Vector averaged cross-power spectrum Several baselines displayed
Timerange: 01/00:14:03 to 01/00:17:29

Plot file version 116 created 13-OCT-2010 18:42:45

IRAS1954 EP064N.UVDATA.1

Freq = 4.9270 GHz, Bw = 16.000 MH Calibrated with CL # 3 and BP # 1 (BP mode 1)

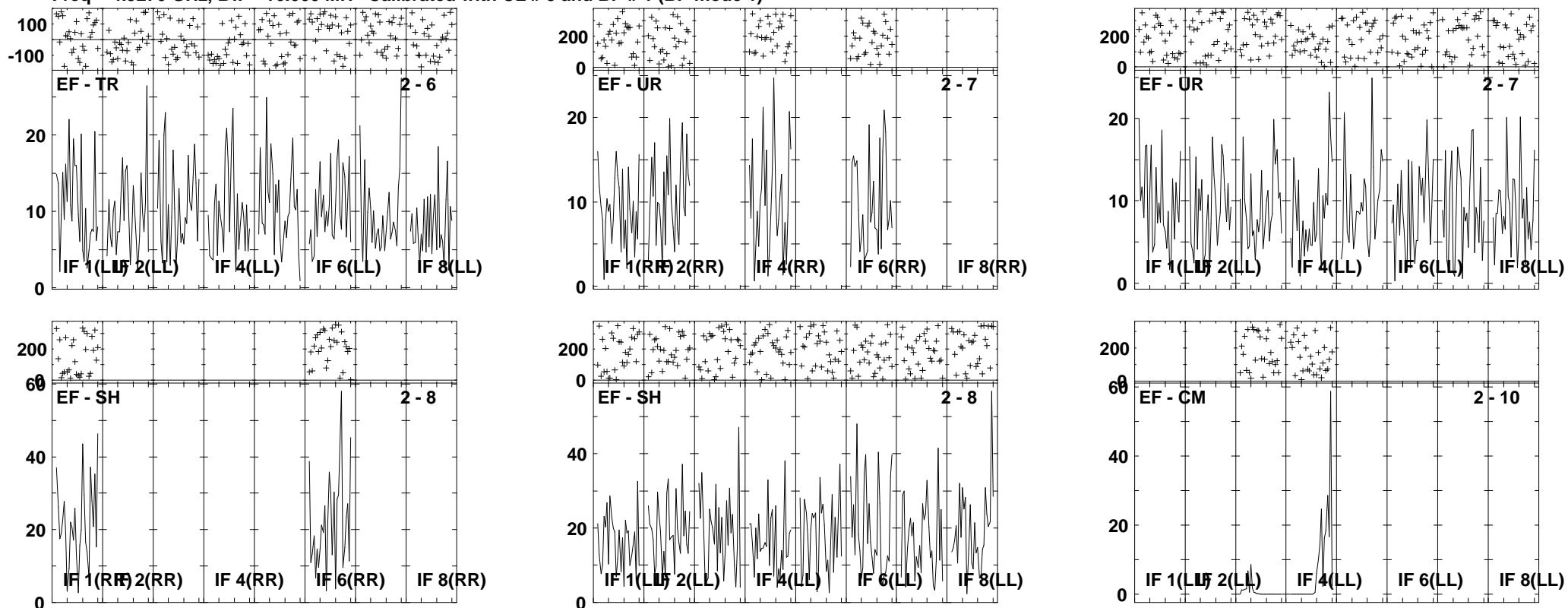

Lower frame: Milli Ampl Jy Top frame: Phas deg
Vector averaged cross-power spectrum Several baselines displayed
Timerange: 01/00:14:03 to 01/00:17:29

Plot file version 117 created 13-OCT-2010 18:42:49

J2001+10 EP064N.UVDATA.1

Freq = 4.9270 GHz, Bw = 16.000 MH Calibrated with CL # 3 and BP # 1 (BP mode 1)

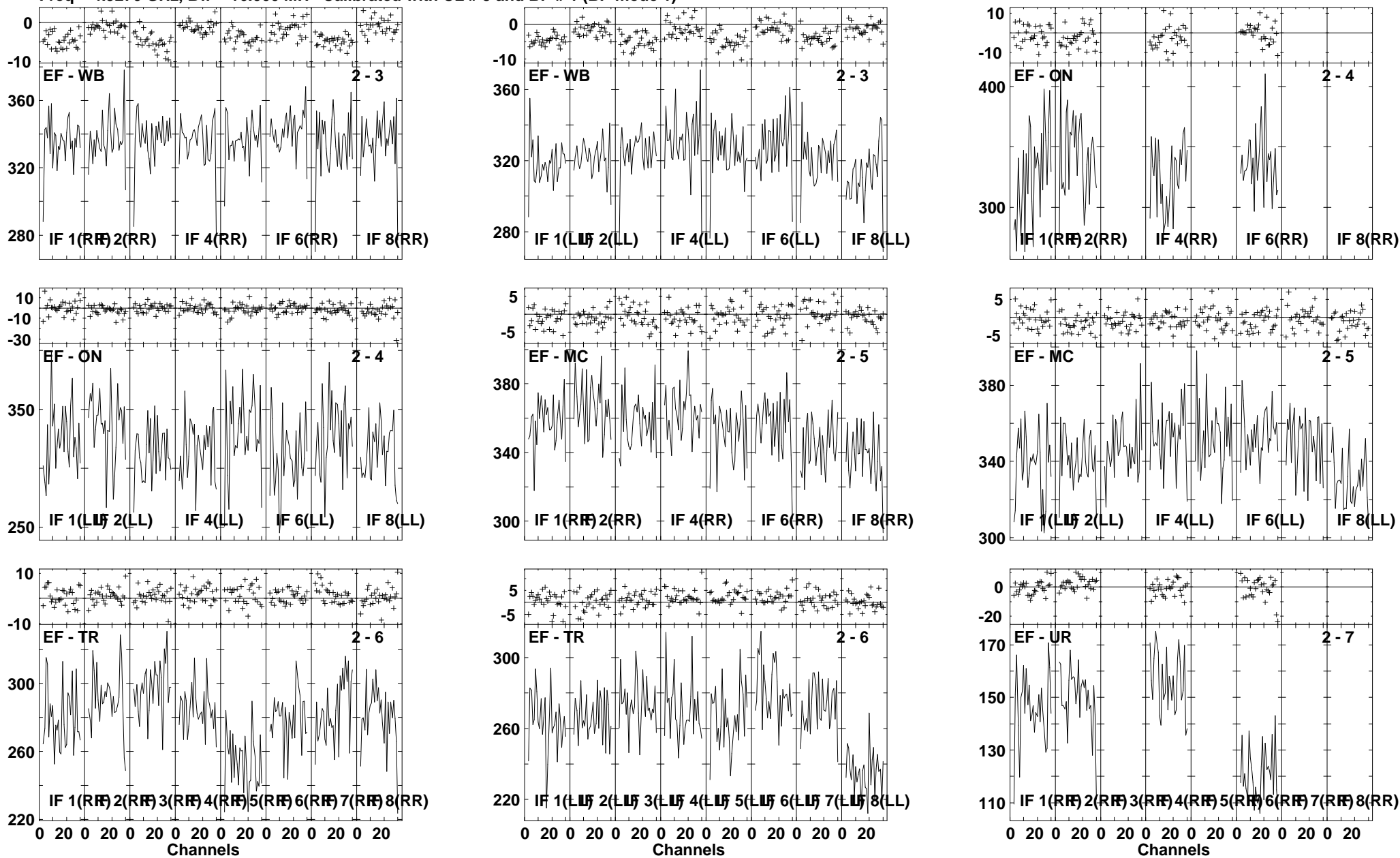

Lower frame: Milli Ampl Jy Top frame: Phas deg
Vector averaged cross-power spectrum Several baselines displayed
Timerange: 01/00:17:31 to 01/00:18:57

Plot file version 118 created 13-OCT-2010 18:42:51

J2001+10 EP064N.UVDATA.1

Freq = 4.9270 GHz, Bw = 16.000 MH Calibrated with CL # 3 and BP # 1 (BP mode 1)

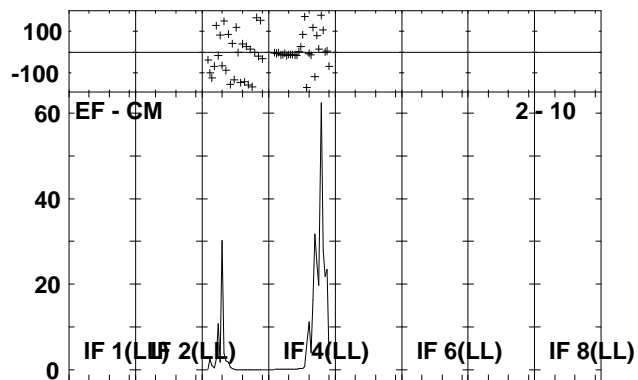
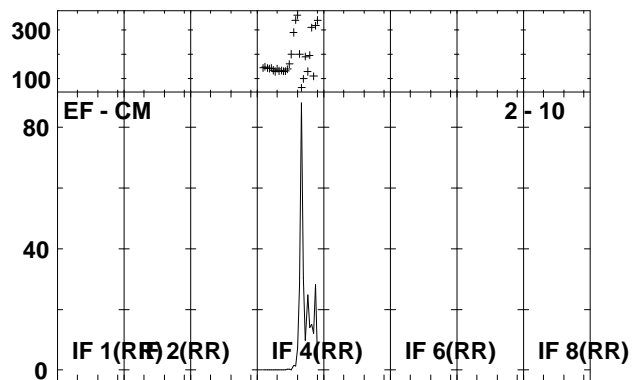
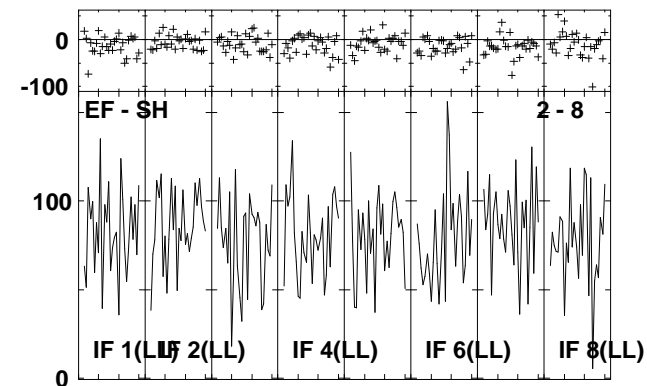
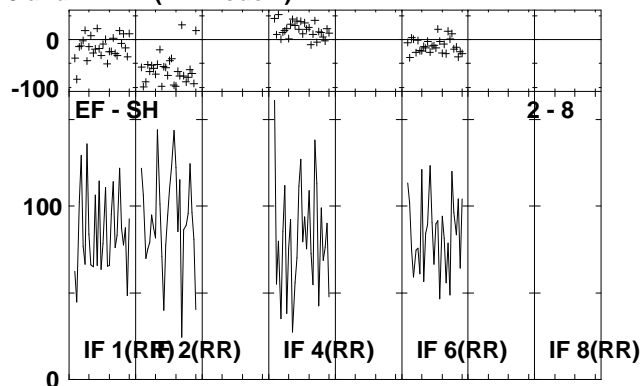
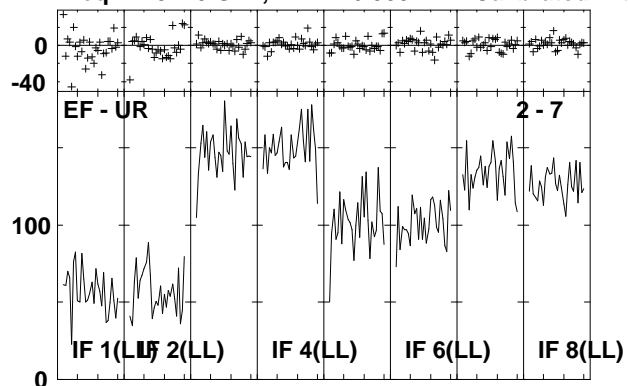

Lower frame: Milli Ampl Jy Top frame: Phas deg
Vector averaged cross-power spectrum Several baselines displayed
Timerange: 01/00:17:31 to 01/00:18:57

Plot file version 119 created 13-OCT-2010 18:42:52
 IRAS1954 EP064N.UVDATA.1
 Freq = 4.9270 GHz, Bw = 16.000 MH Calibrated with CL # 3 and BP # 1 (BP mode 1)

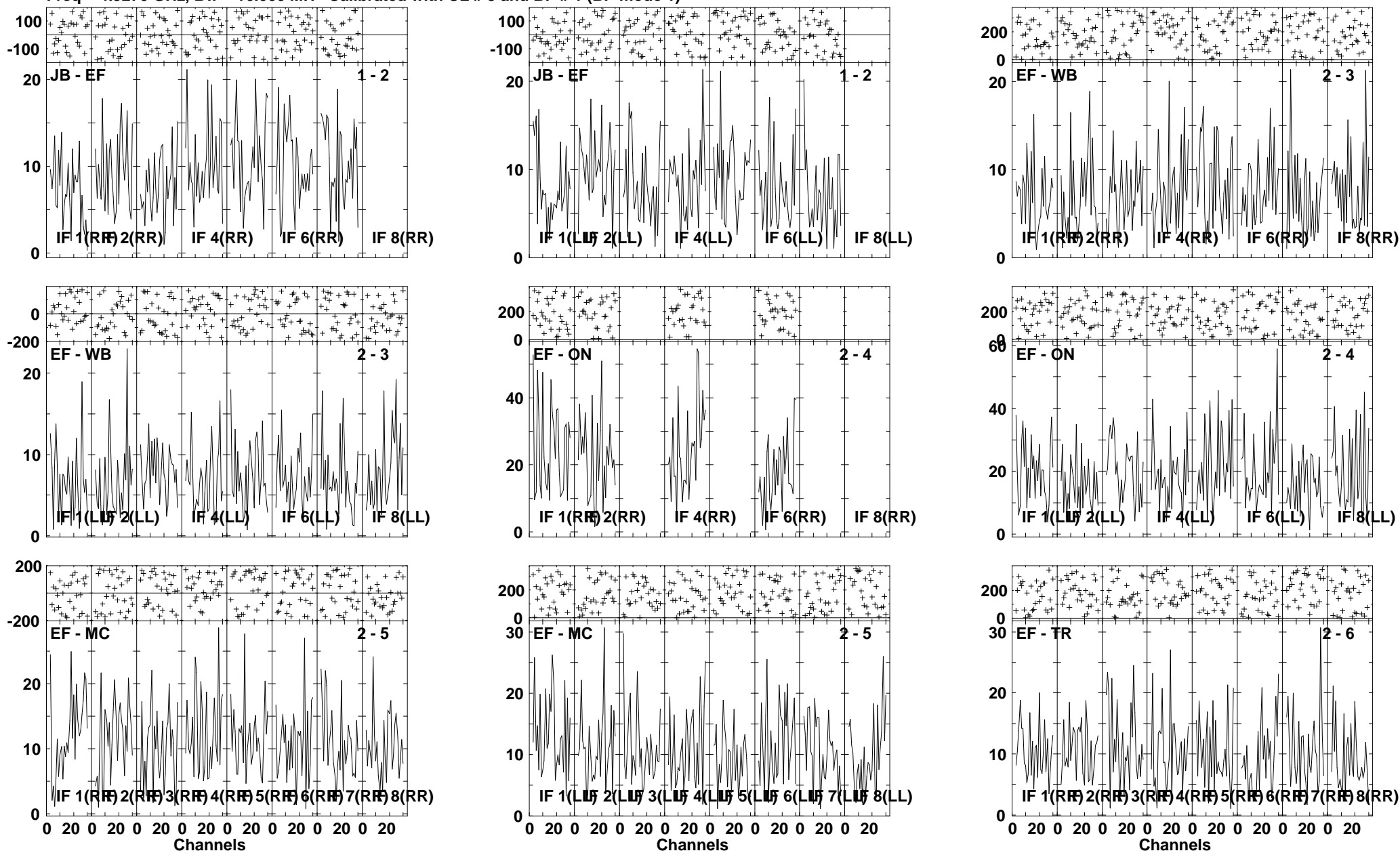

Lower frame: Milli Ampl Jy Top frame: Phas deg
 Vector averaged cross-power spectrum Several baselines displayed
 Timerange: 01/00:19:01 to 01/00:22:29

Plot file version 120 created 13-OCT-2010 18:42:55

IRAS1954 EP064N.UVDATA.1

Freq = 4.9270 GHz, Bw = 16.000 MH Calibrated with CL # 3 and BP # 1 (BP mode 1)

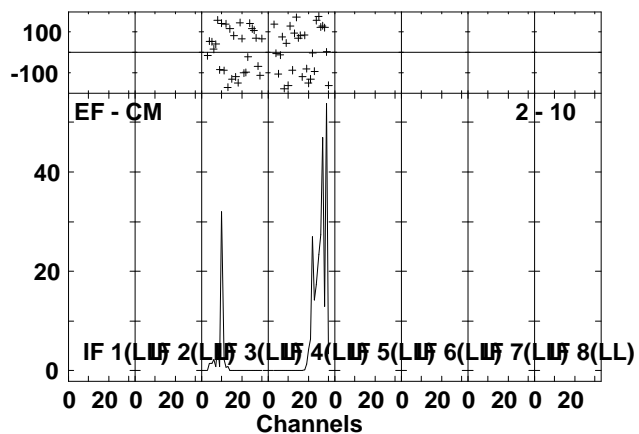
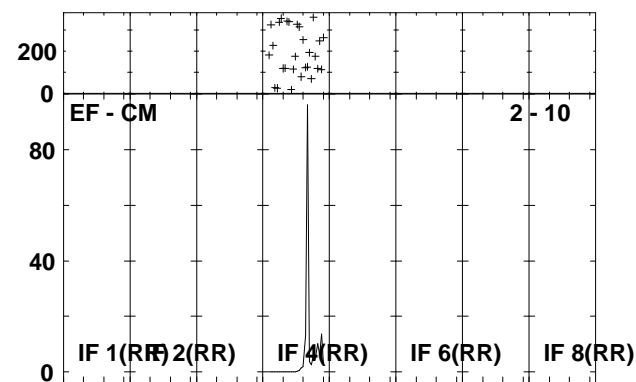
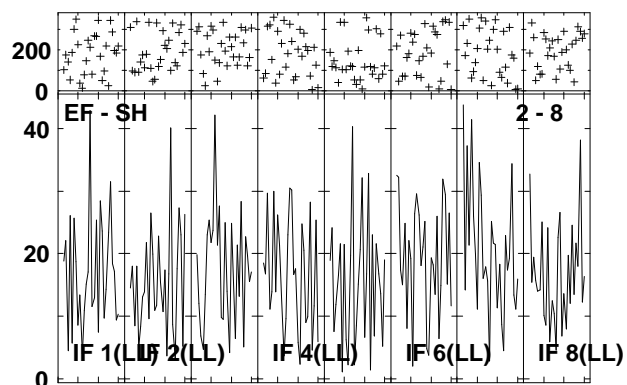
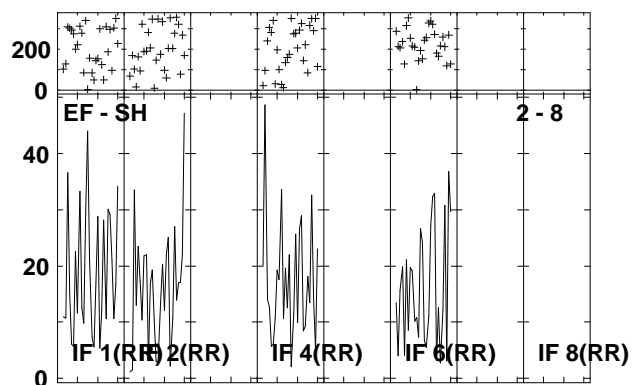
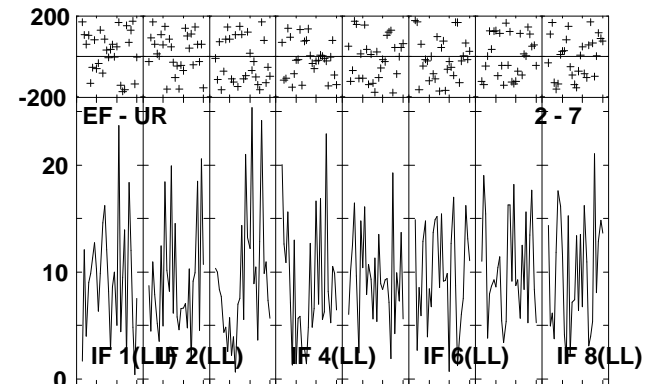
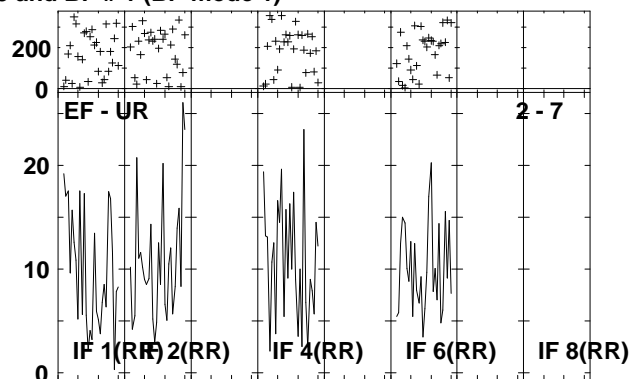
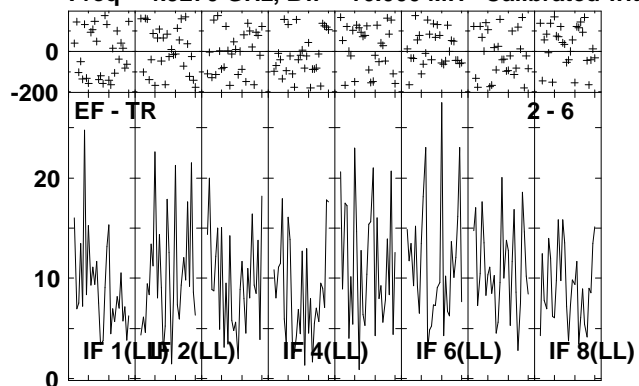

Lower frame: Milli Ampl Jy Top frame: Phas deg
Vector averaged cross-power spectrum Several baselines displayed
Timerange: 01/00:19:01 to 01/00:22:29

Plot file version 121 created 13-OCT-2010 18:42:59
 J2001+10 EP064N.UVDATA.1
 Freq = 4.9270 GHz, Bw = 16.000 MH Calibrated with CL # 3 and BP # 1 (BP mode 1)

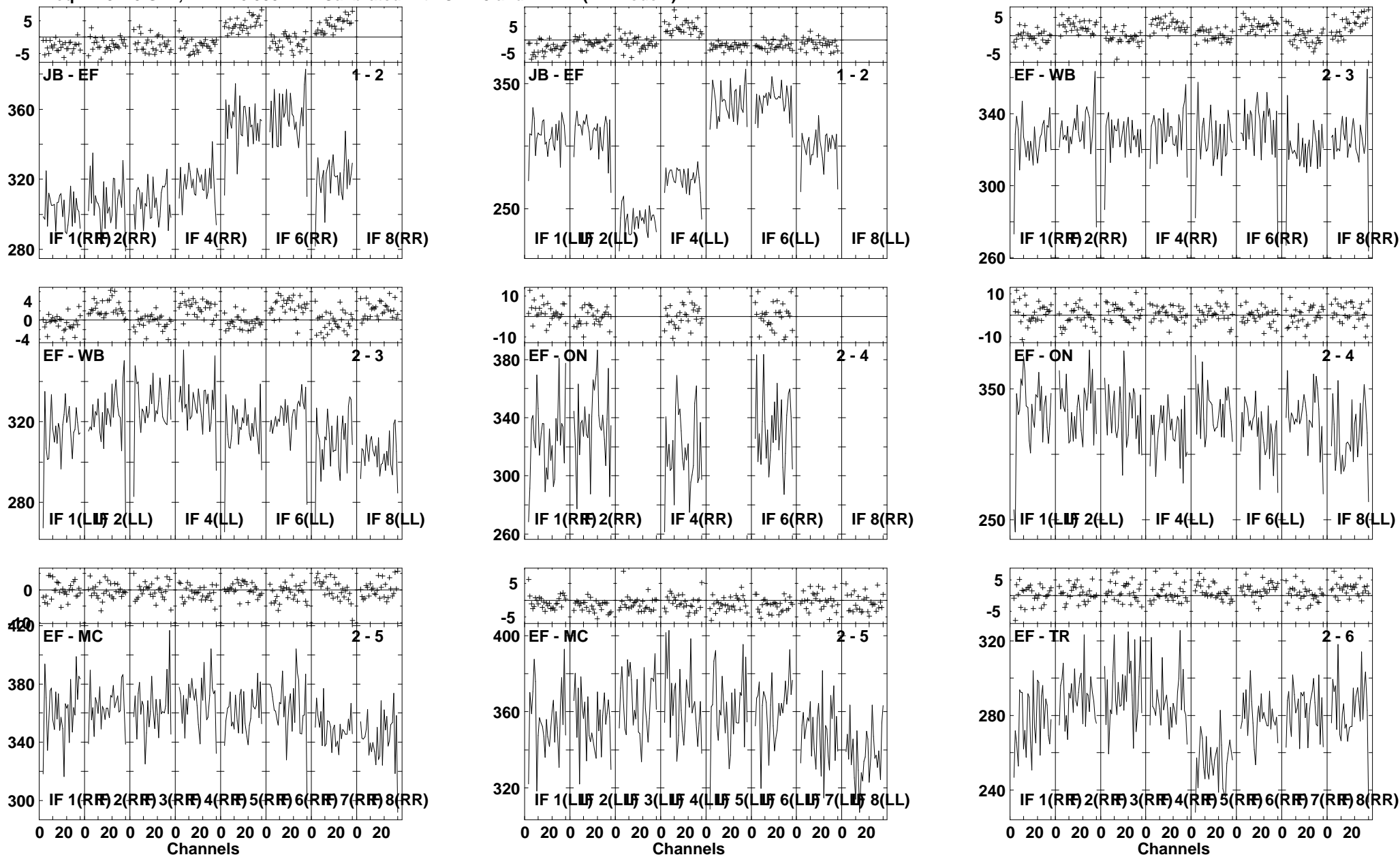

Lower frame: Milli Ampl Jy Top frame: Phas deg
 Vector averaged cross-power spectrum Several baselines displayed
 Timerange: 01/00:23:31 to 01/00:24:59

Plot file version 122 created 13-OCT-2010 18:43:01

J2001+10 EP064N.UVDATA.1

Freq = 4.9270 GHz, Bw = 16.000 MH Calibrated with CL # 3 and BP # 1 (BP mode 1)

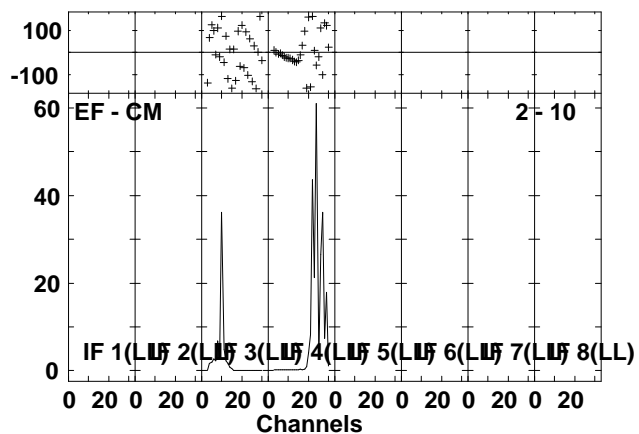
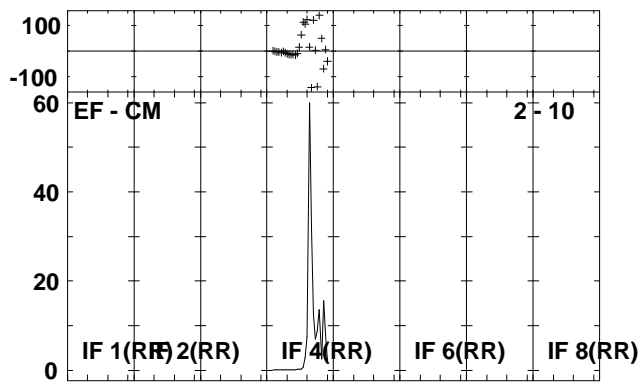
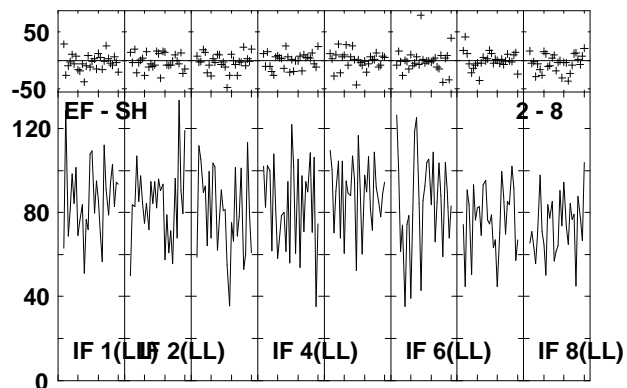
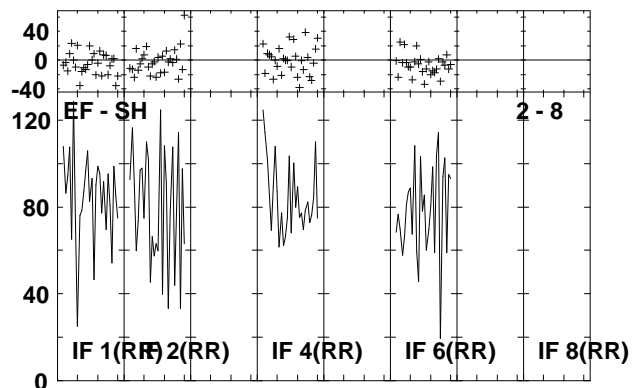
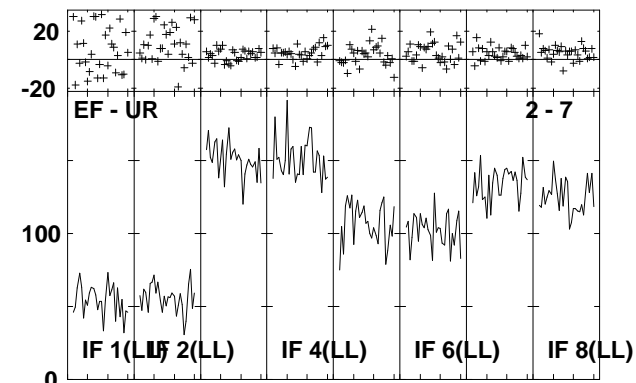
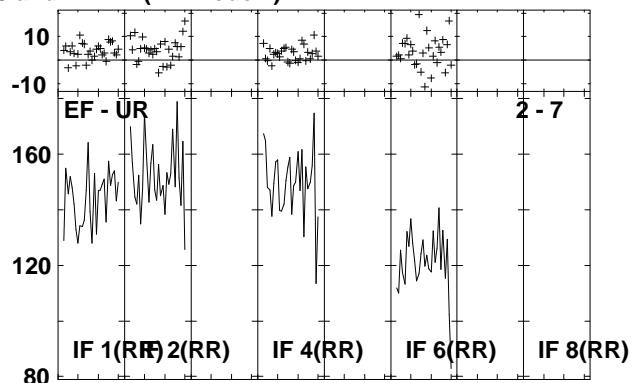
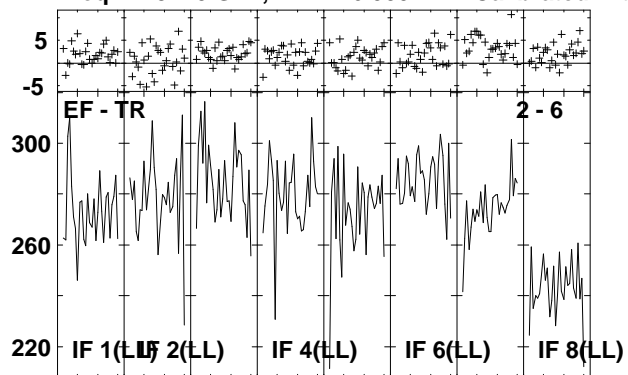

Lower frame: Milli Ampl Jy Top frame: Phas deg
Vector averaged cross-power spectrum Several baselines displayed
Timerange: 01/00:23:31 to 01/00:24:59

Plot file version 123 created 13-OCT-2010 18:43:03

IRAS1954 EP064N.UVDATA.1

Freq = 4.9270 GHz, Bw = 16.000 MH Calibrated with CL # 3 and BP # 1 (BP mode 1)

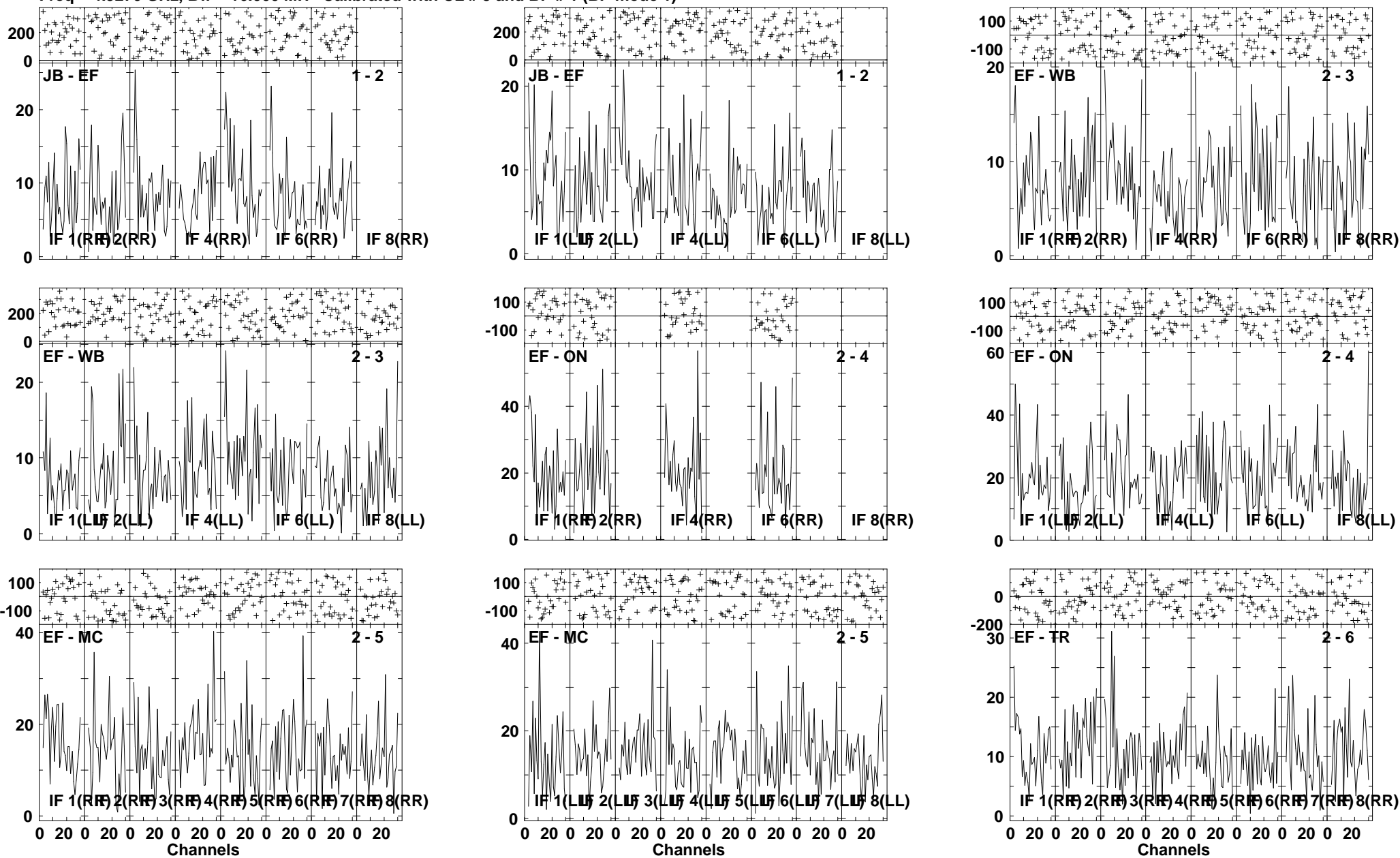

Lower frame: Milli Ampl Jy Top frame: Phas deg
Vector averaged cross-power spectrum Several baselines displayed
Timerange: 01/00:25:01 to 01/00:28:29

Plot file version 124 created 13-OCT-2010 18:43:07

IRAS1954 EP064N.UVDATA.1

Freq = 4.9270 GHz, Bw = 16.000 MH Calibrated with CL # 3 and BP # 1 (BP mode 1)

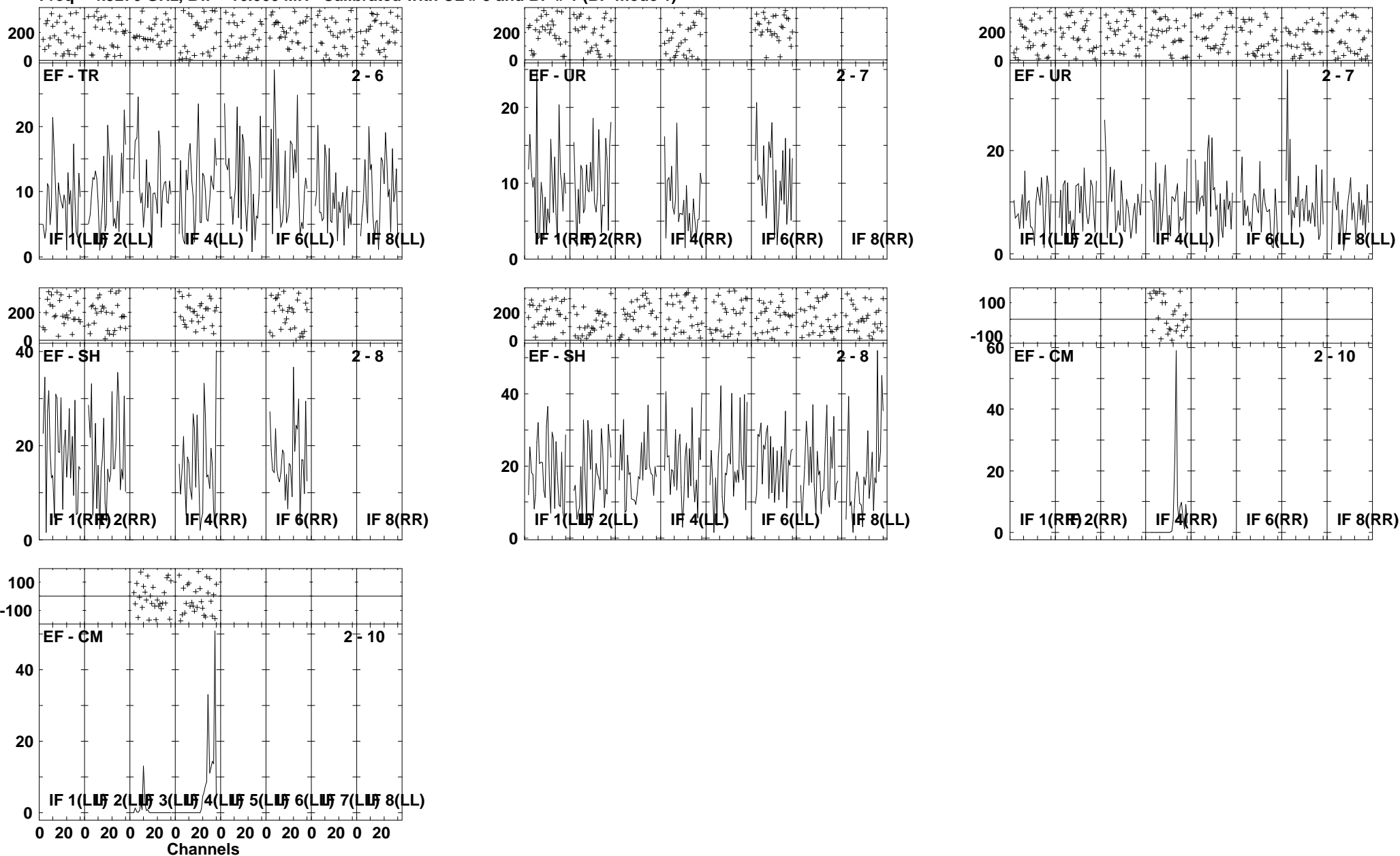

Lower frame: Milli Ampl Jy Top frame: Phas deg
Vector averaged cross-power spectrum Several baselines displayed
Timerange: 01/00:25:01 to 01/00:28:29

Plot file version 125 created 13-OCT-2010 18:43:11

J2001+10 EP064N.UVDATA.1

Freq = 4.9270 GHz, Bw = 16.000 MH Calibrated with CL # 3 and BP # 1 (BP mode 1)

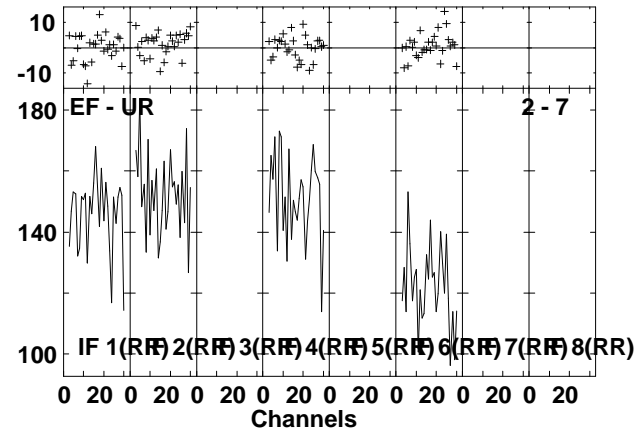
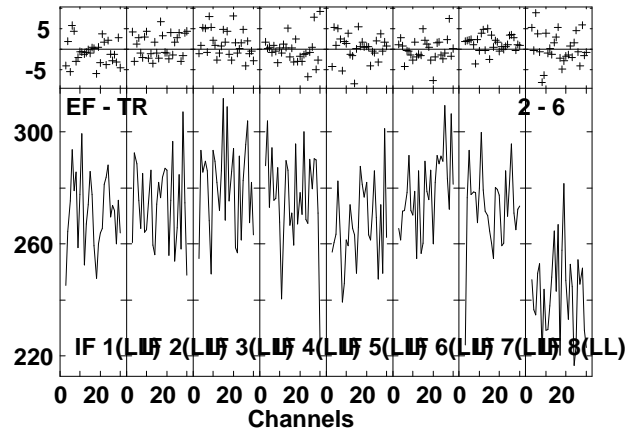
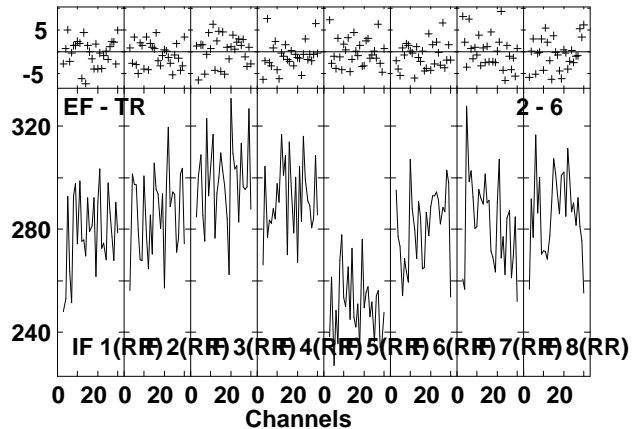
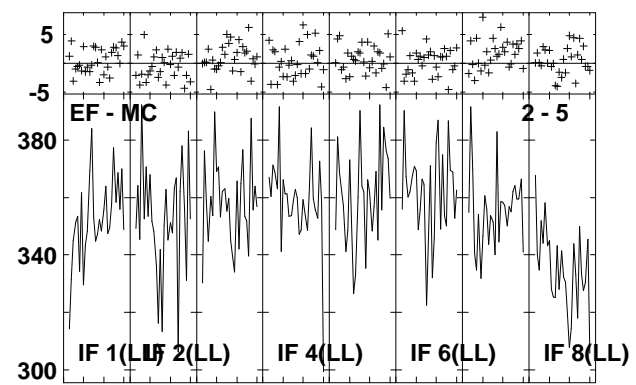
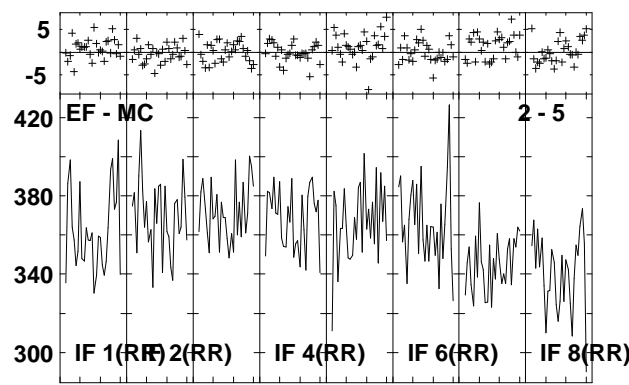
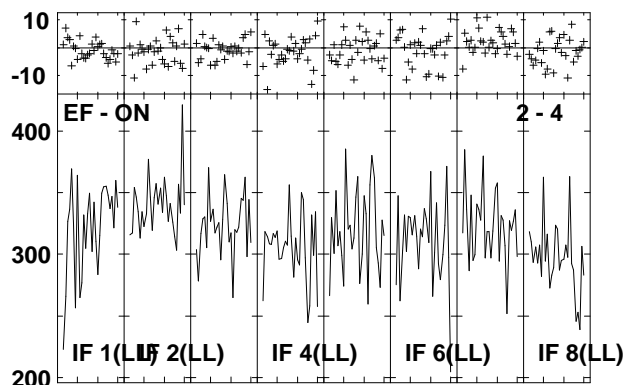
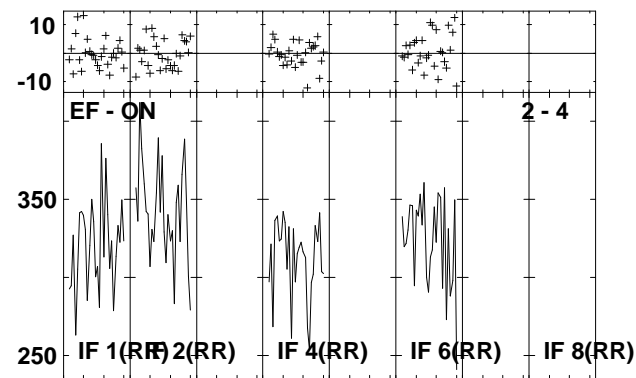
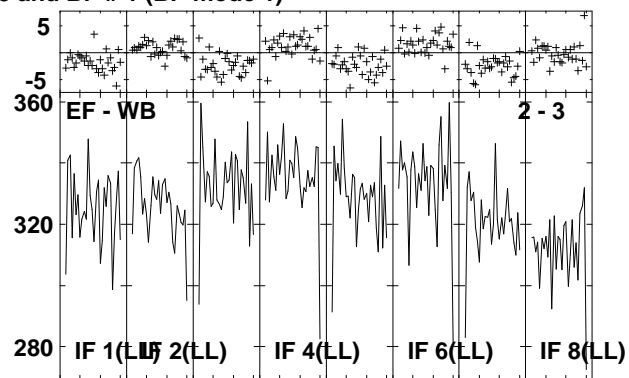
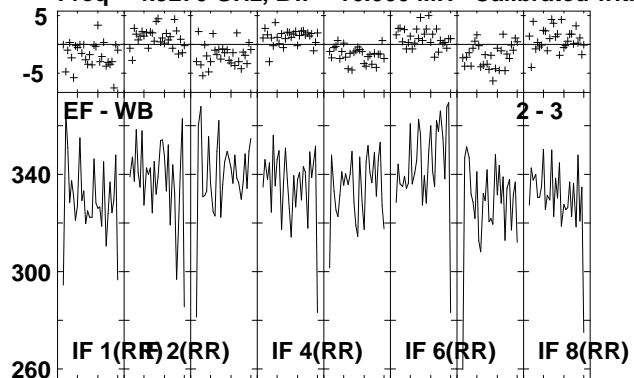

Lower frame: Milli Ampl Jy Top frame: Phas deg
Vector averaged cross-power spectrum Several baselines displayed
Timerange: 01/00:28:31 to 01/00:29:59

Plot file version 126 created 13-OCT-2010 18:43:12

J2001+10 EP064N.UVDATA.1

Freq = 4.9270 GHz, Bw = 16.000 MH Calibrated with CL # 3 and BP # 1 (BP mode 1)

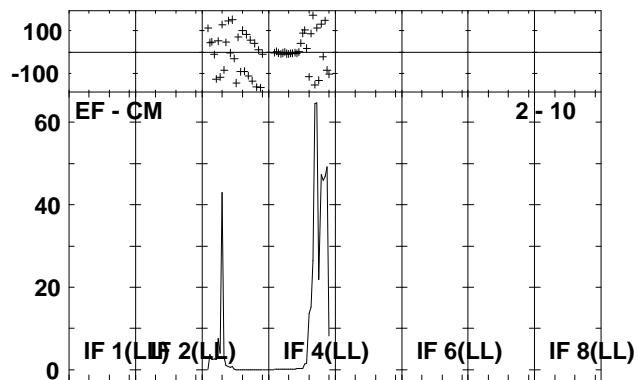
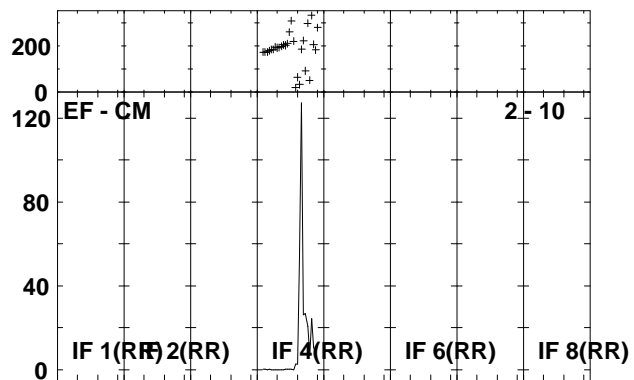
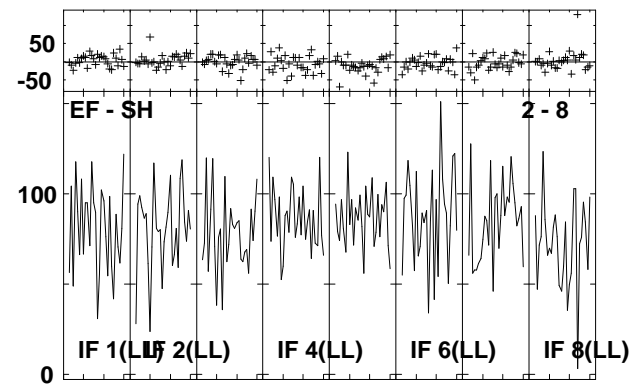
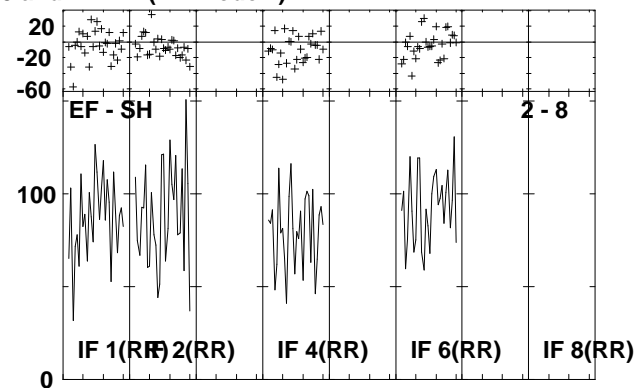
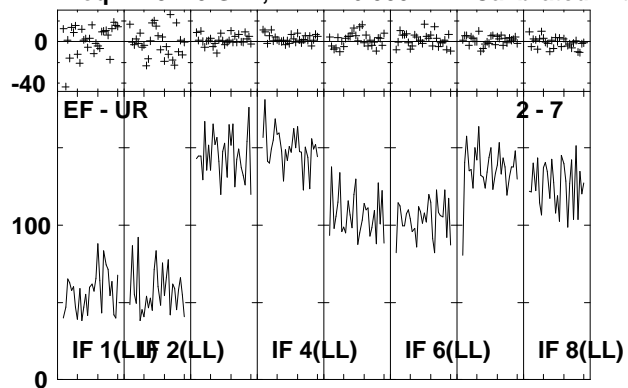

Lower frame: Milli Ampl Jy Top frame: Phas deg
Vector averaged cross-power spectrum Several baselines displayed
Timerange: 01/00:28:31 to 01/00:29:59

Plot file version 127 created 13-OCT-2010 18:43:14

IRAS1954 EP064N.UVDATA.1

Freq = 4.9270 GHz, Bw = 16.000 MH Calibrated with CL # 3 and BP # 1 (BP mode 1)

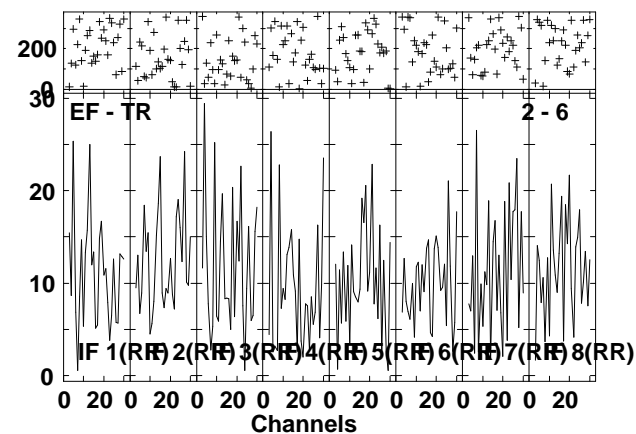
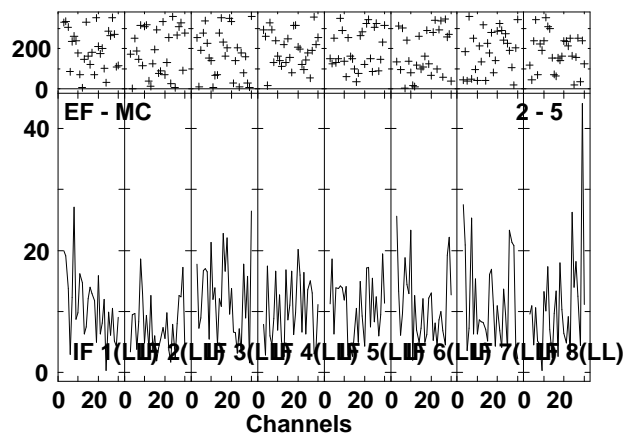
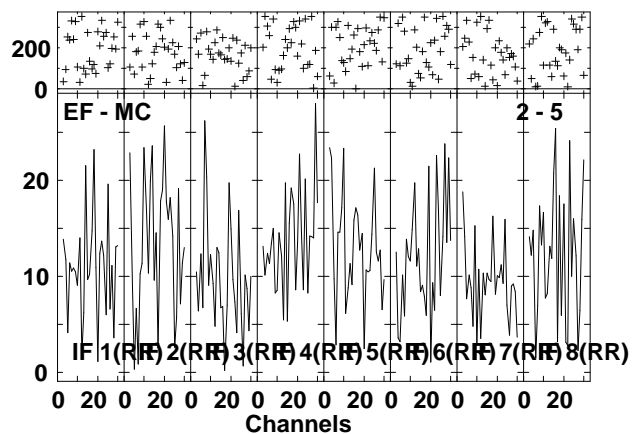
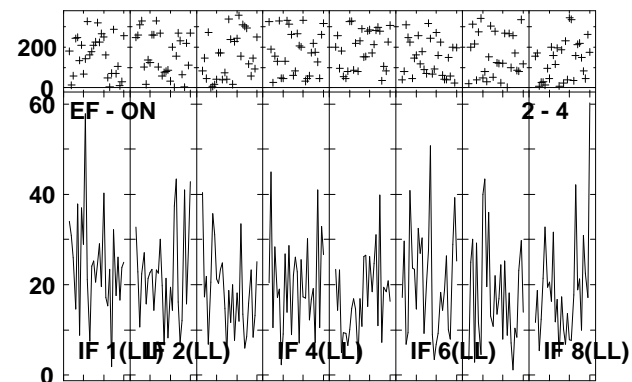
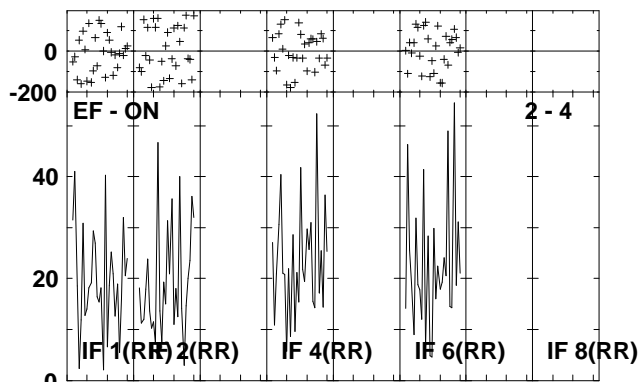
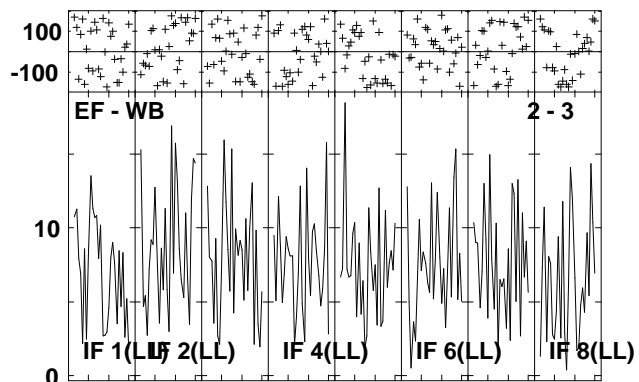
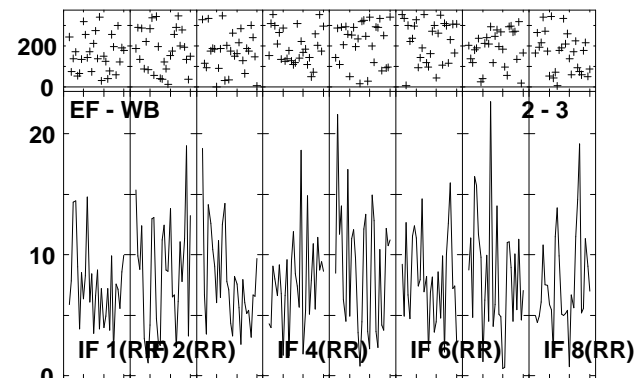
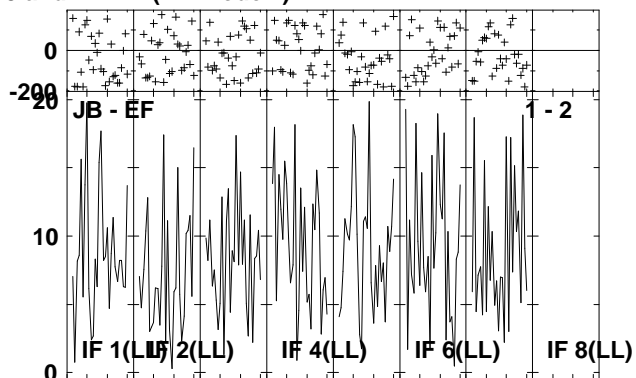
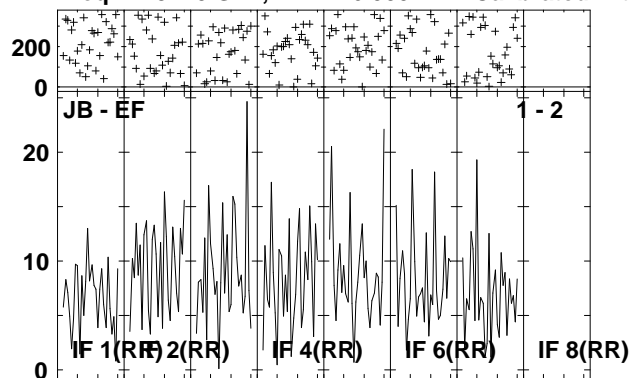

Lower frame: Milli Ampl Jy Top frame: Phas deg
Vector averaged cross-power spectrum Several baselines displayed
Timerange: 01/00:30:01 to 01/00:33:29

Plot file version 128 created 13-OCT-2010 18:43:17

IRAS1954 EP064N.UVDATA.1

Freq = 4.9270 GHz, Bw = 16.000 MH Calibrated with CL # 3 and BP # 1 (BP mode 1)

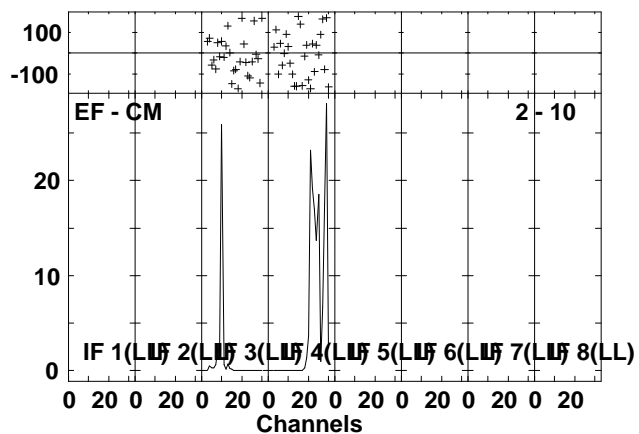
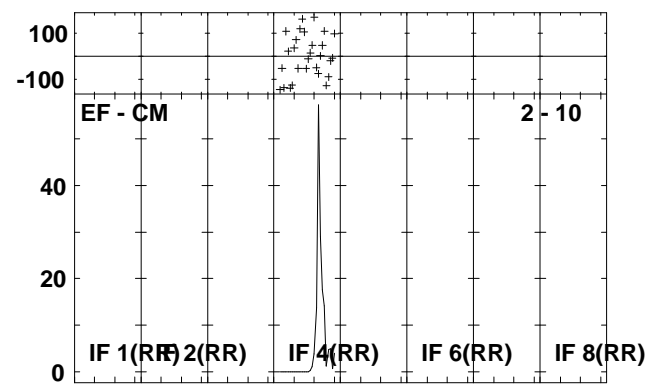
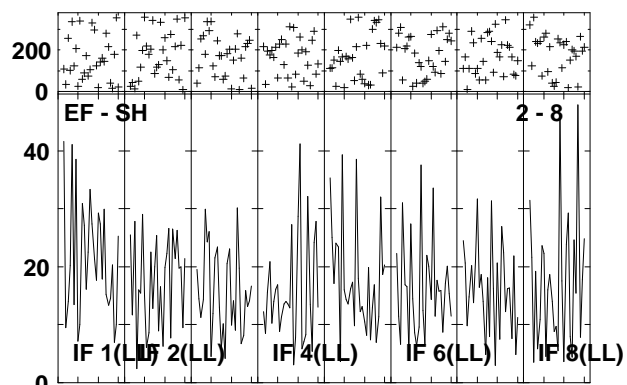
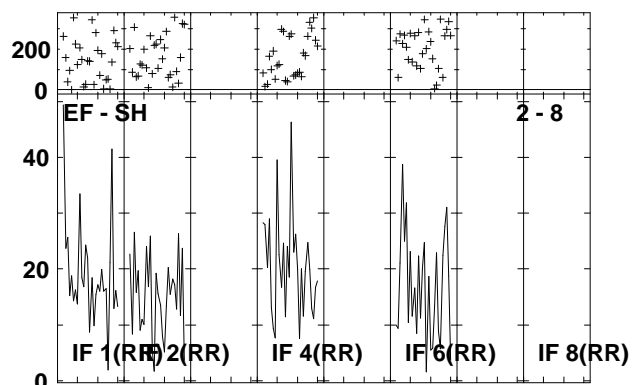
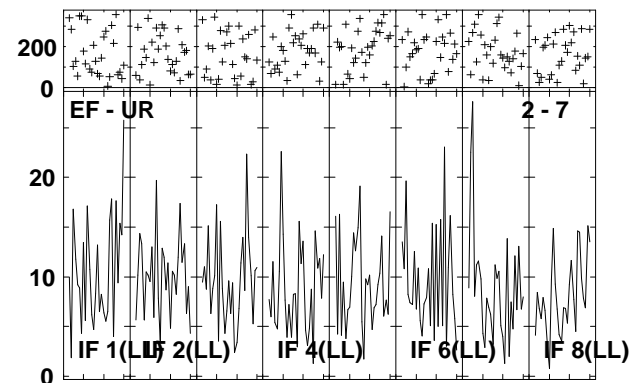
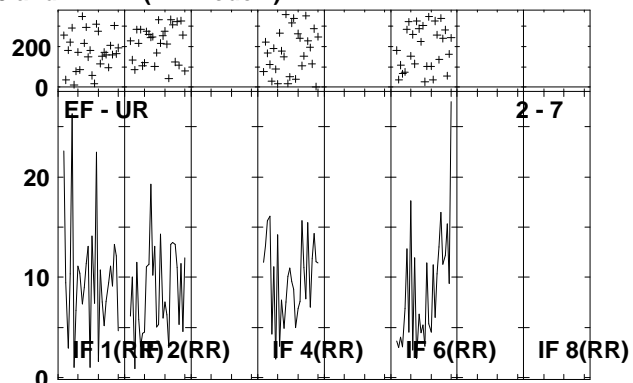
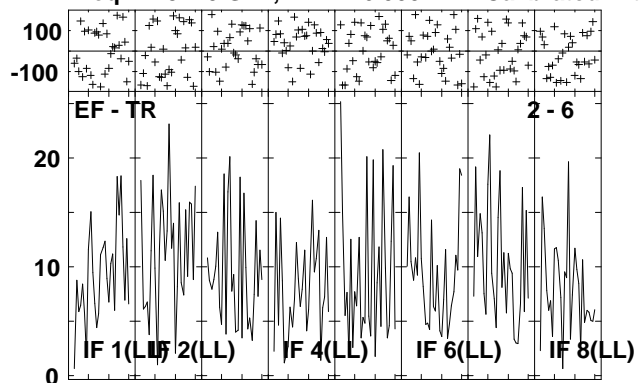

Lower frame: Milli Ampl Jy Top frame: Phas deg
Vector averaged cross-power spectrum Several baselines displayed
Timerange: 01/00:30:01 to 01/00:33:29

Plot file version 129 created 13-OCT-2010 18:43:21
 J2001+10 EP064N.UVDATA.1
 Freq = 4.9270 GHz, Bw = 16.000 MH Calibrated with CL # 3 and BP # 1 (BP mode 1)

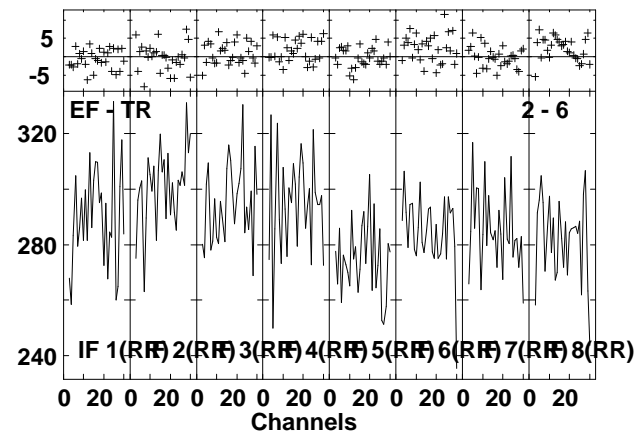
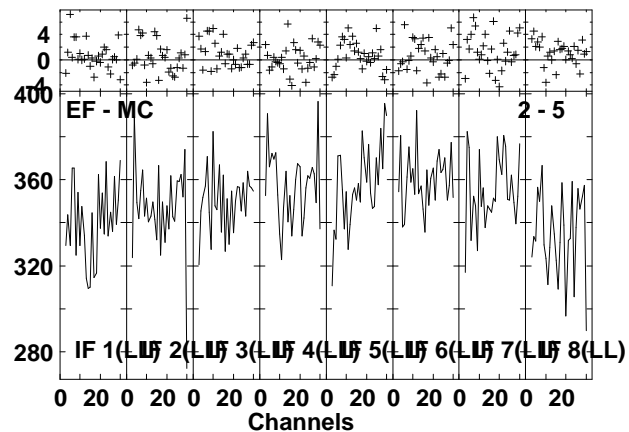
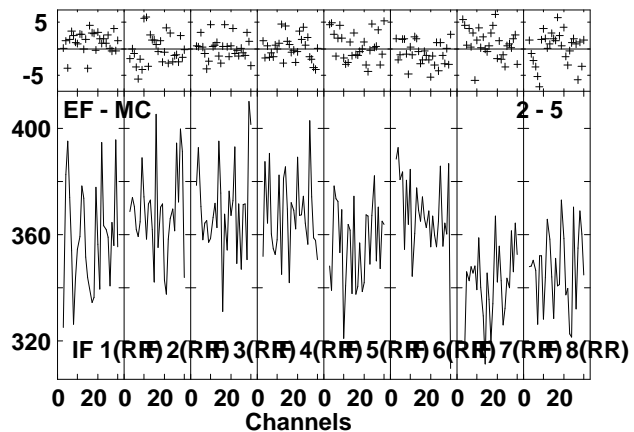
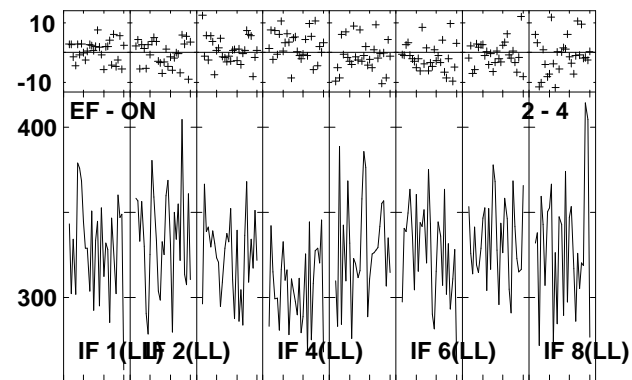
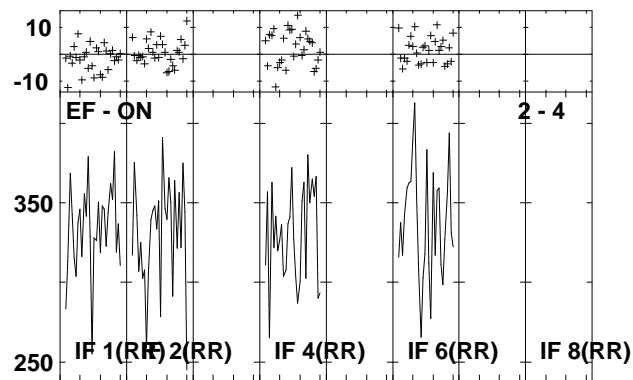
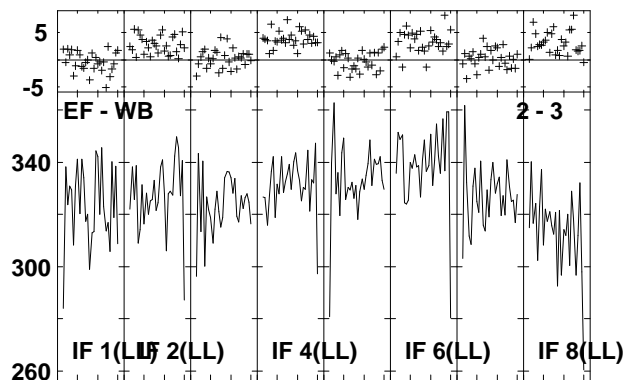
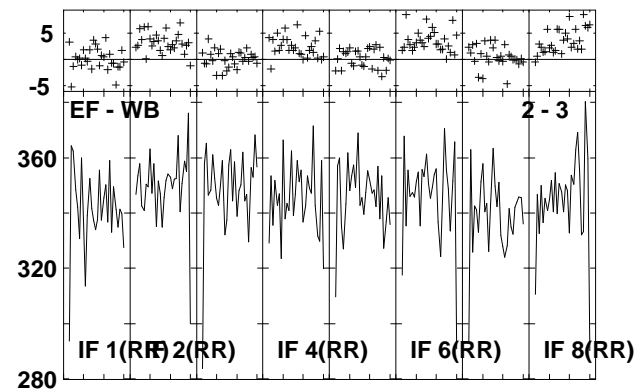
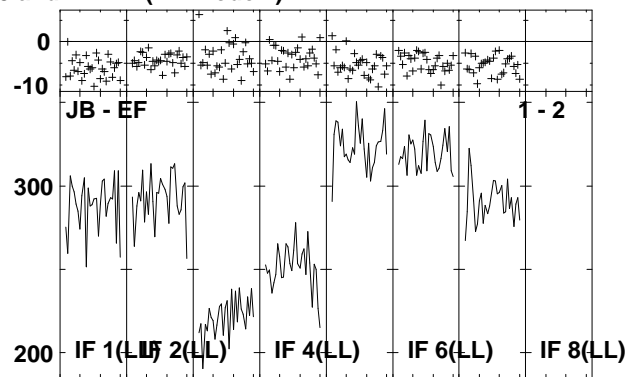
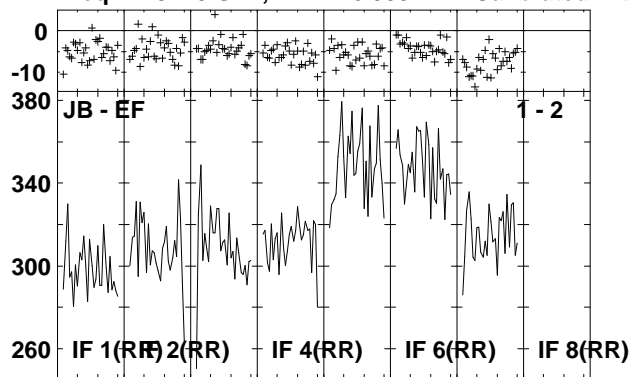

Lower frame: Milli Ampl Jy Top frame: Phas deg
 Vector averaged cross-power spectrum Several baselines displayed
 Timerange: 01/00:33:31 to 01/00:34:59

Plot file version 130 created 13-OCT-2010 18:43:23

J2001+10 EP064N.UVDATA.1

Freq = 4.9270 GHz, Bw = 16.000 MH Calibrated with CL # 3 and BP # 1 (BP mode 1)

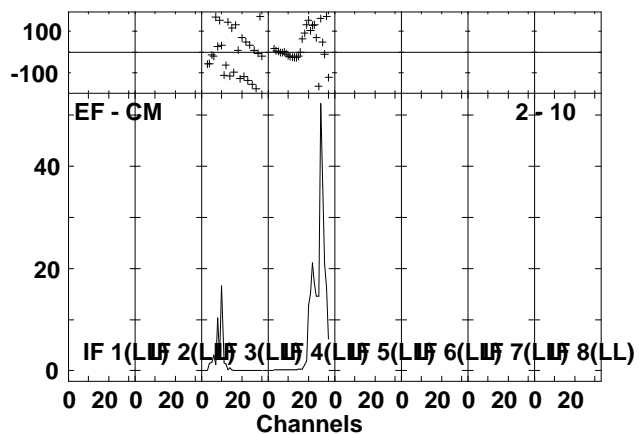
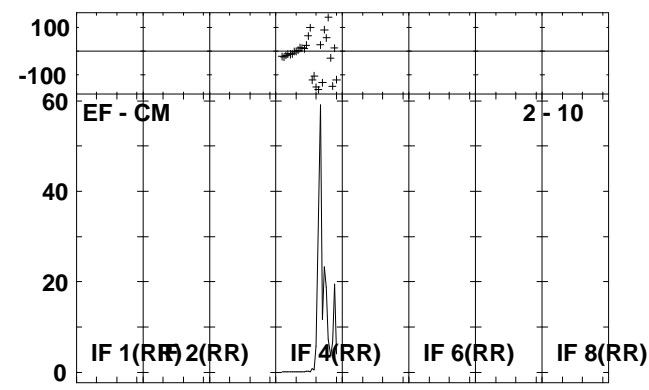
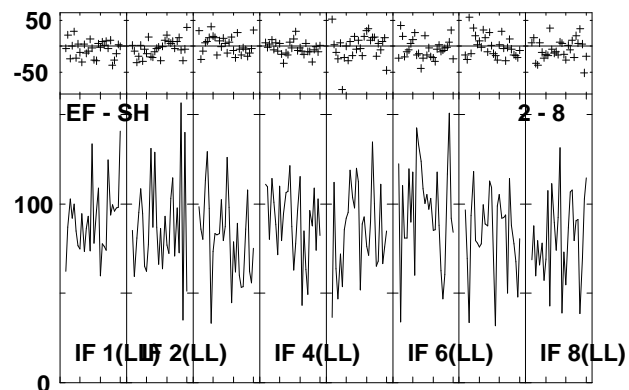
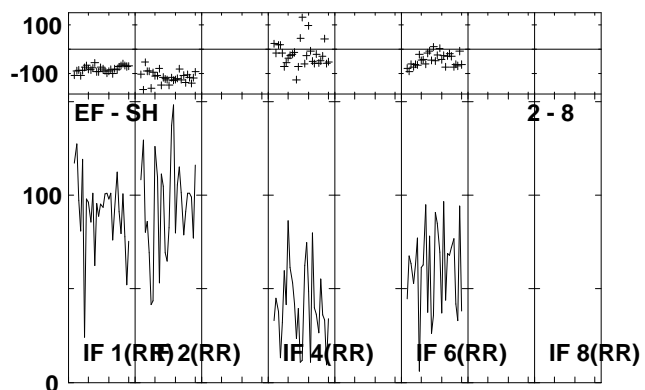
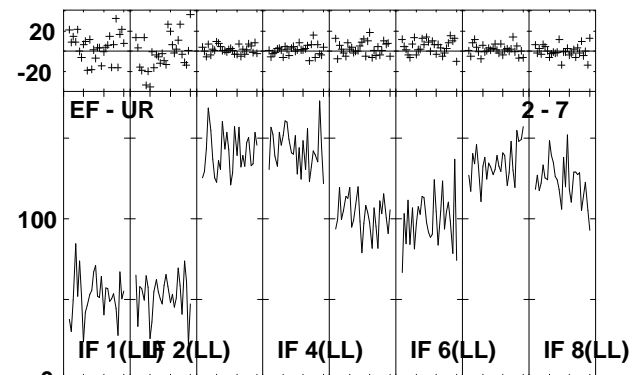
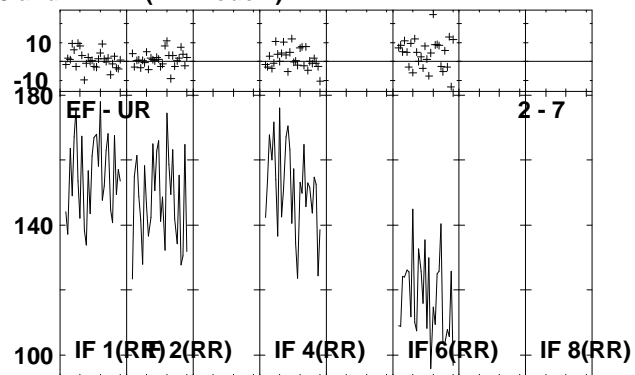
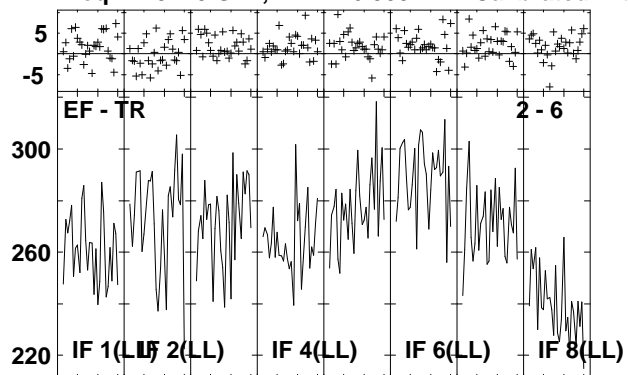

Lower frame: Milli Ampl Jy Top frame: Phas deg
Vector averaged cross-power spectrum Several baselines displayed
Timerange: 01/00:33:31 to 01/00:34:59

Plot file version 131 created 13-OCT-2010 18:43:25

IRAS1954 EP064N.UVDATA.1

Freq = 4.9270 GHz, Bw = 16.000 MH Calibrated with CL # 3 and BP # 1 (BP mode 1)

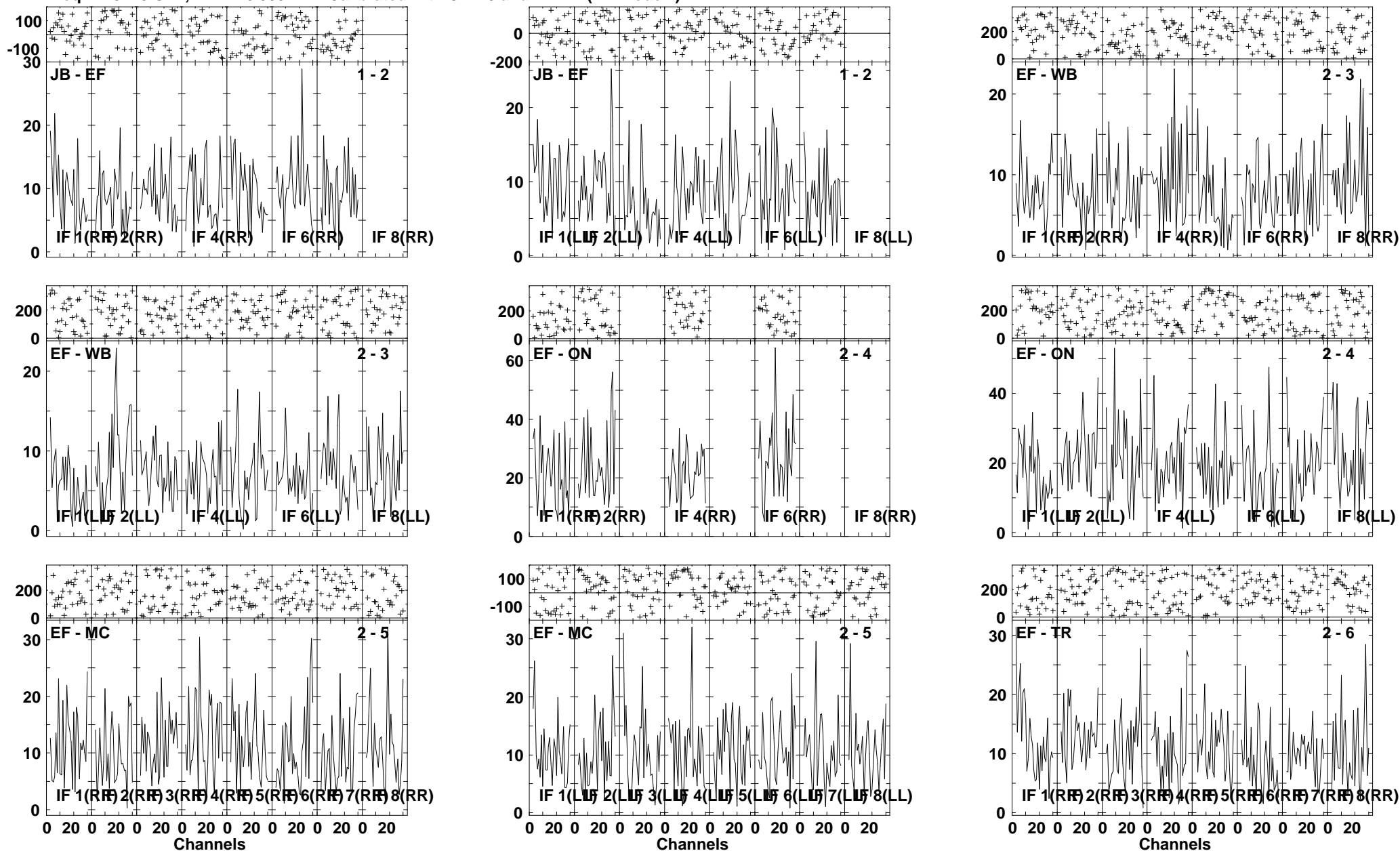

Lower frame: Milli Ampl Jy Top frame: Phas deg
Vector averaged cross-power spectrum Several baselines displayed
Timerange: 01/00:35:01 to 01/00:38:29

Plot file version 132 created 13-OCT-2010 18:43:28

IRAS1954 EP064N.UVDATA.1

Freq = 4.9270 GHz, Bw = 16.000 MH Calibrated with CL # 3 and BP # 1 (BP mode 1)

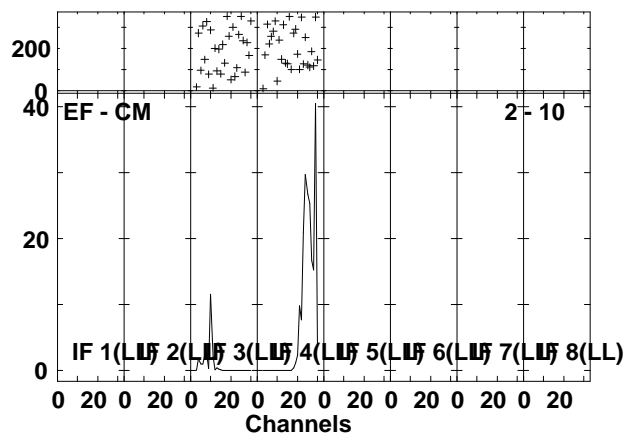
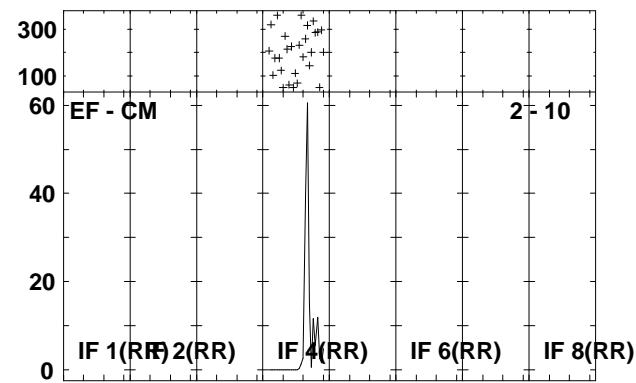
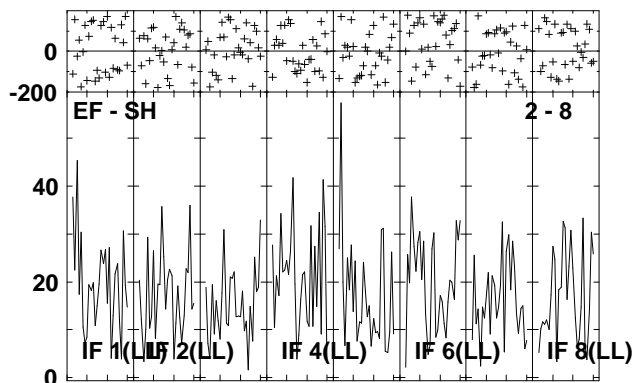
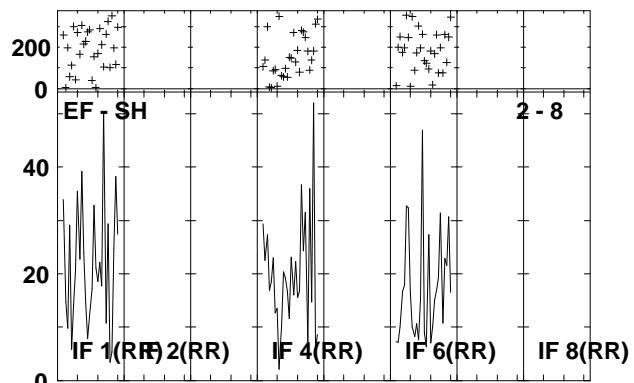
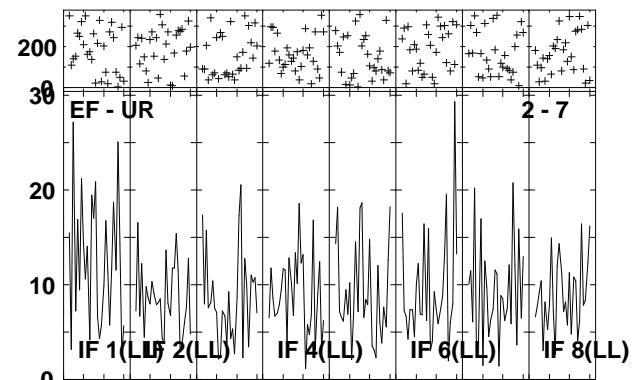
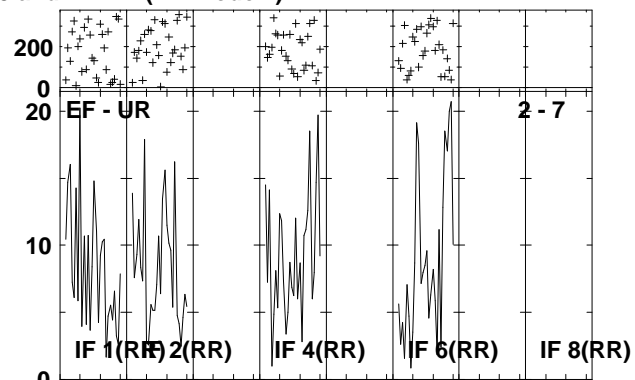
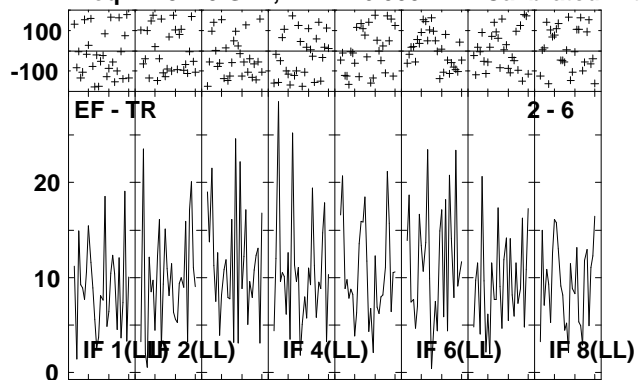

Lower frame: Milli Ampl Jy Top frame: Phas deg
Vector averaged cross-power spectrum Several baselines displayed
Timerange: 01/00:35:01 to 01/00:38:29

Plot file version 133 created 13-OCT-2010 18:43:32

J2001+10 EP064N.UVDATA.1

Freq = 4.9270 GHz, Bw = 16.000 MH Calibrated with CL # 3 and BP # 1 (BP mode 1)

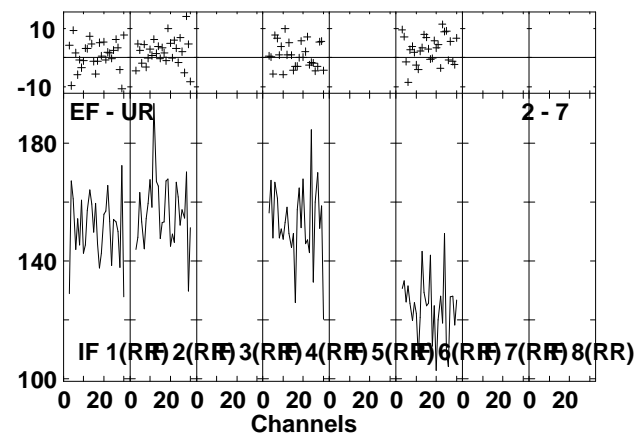
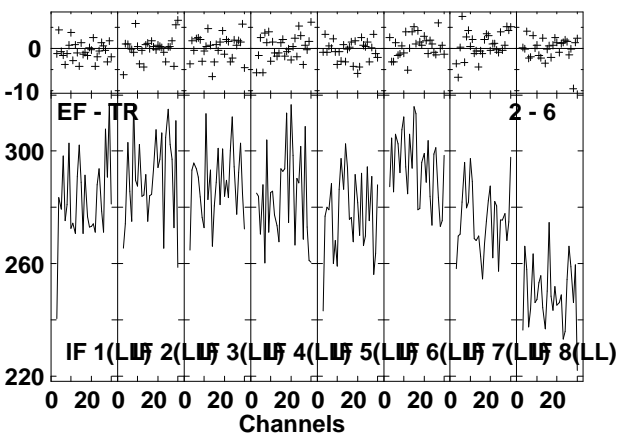
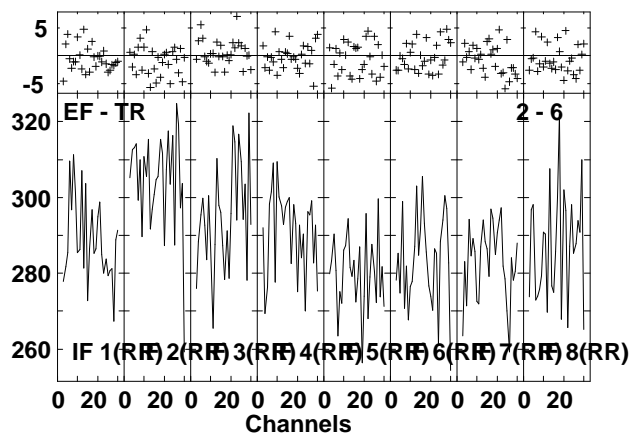
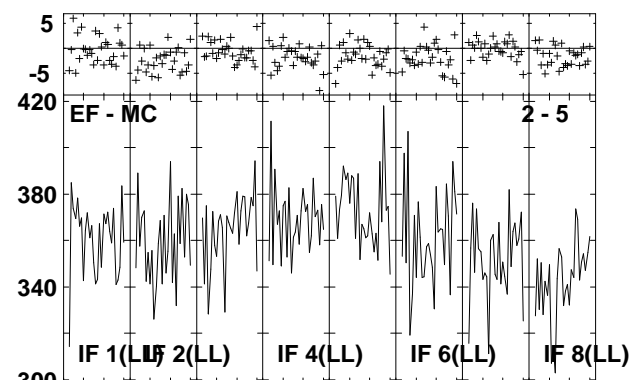
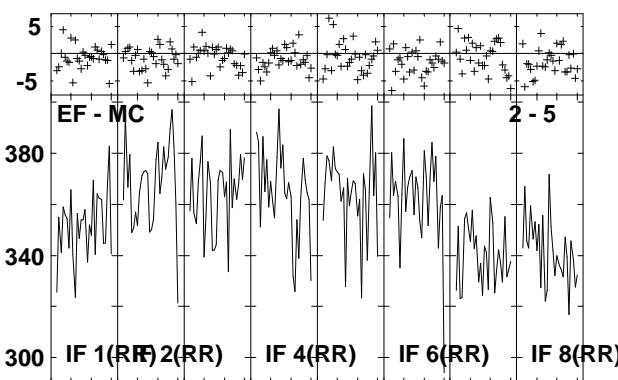
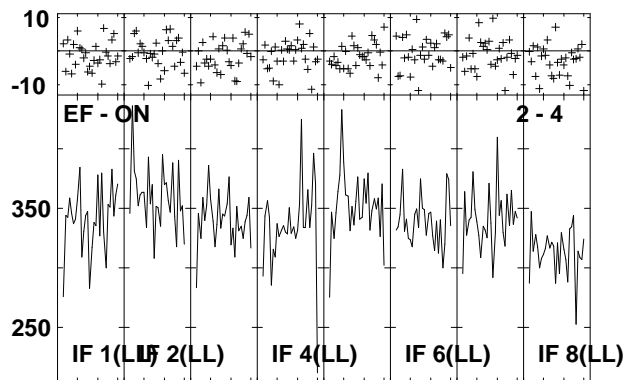
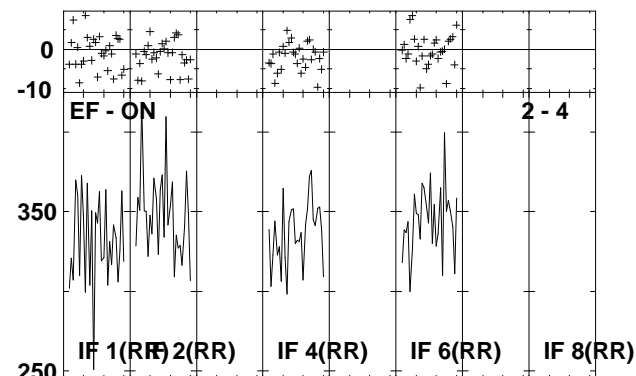
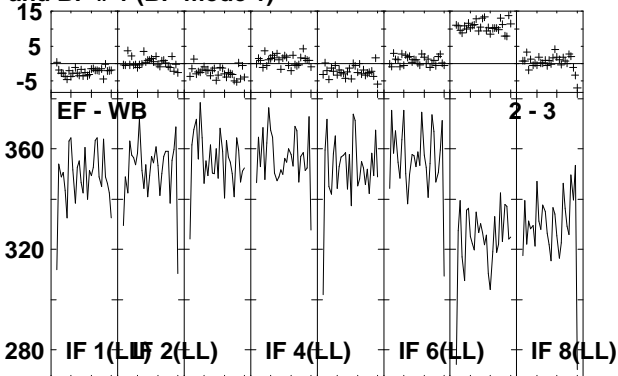
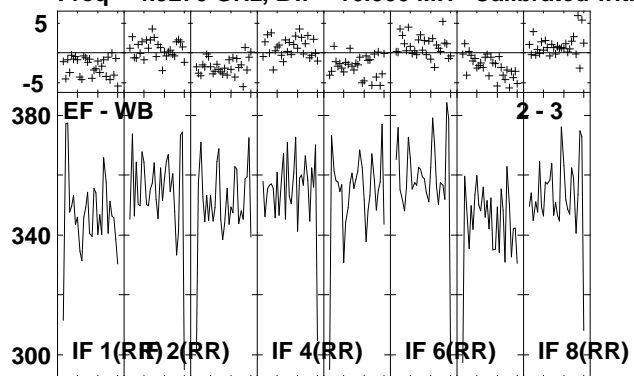

Lower frame: Milli Ampl Jy Top frame: Phas deg
Vector averaged cross-power spectrum Several baselines displayed
Timerange: 01/00:39:31 to 01/00:40:59

Plot file version 134 created 13-OCT-2010 18:43:33

J2001+10 EP064N.UVDATA.1

Freq = 4.9270 GHz, Bw = 16.000 MH Calibrated with CL # 3 and BP # 1 (BP mode 1)

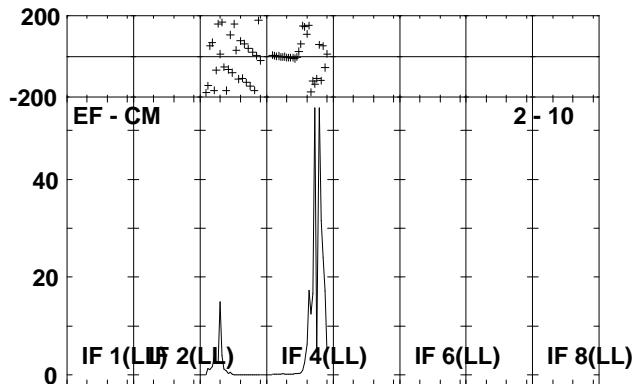
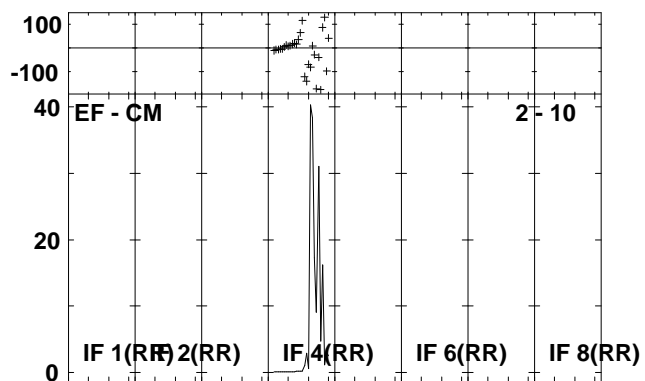
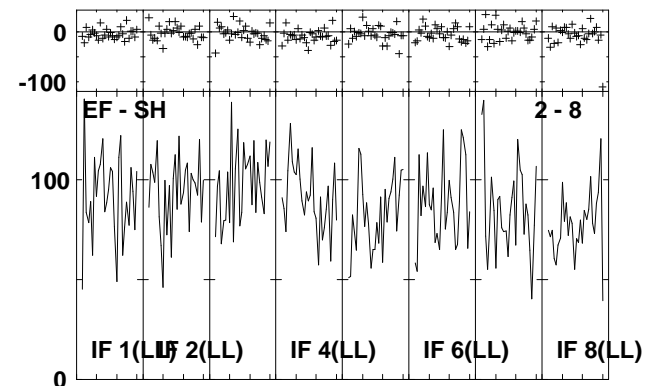
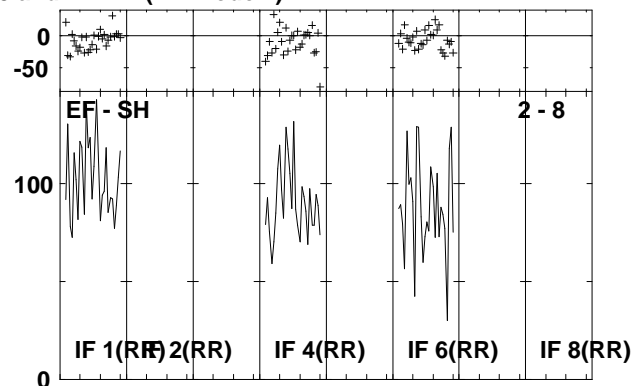
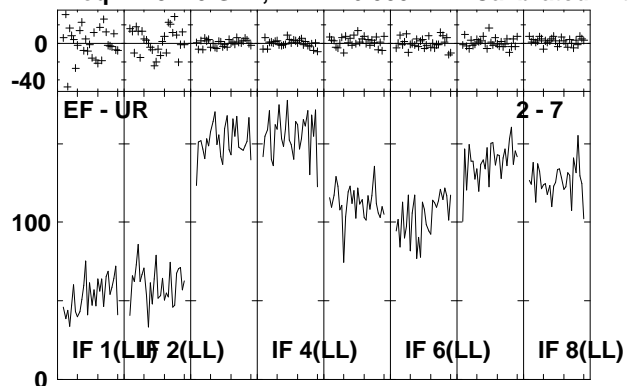

Lower frame: Milli Ampl Jy Top frame: Phas deg
Vector averaged cross-power spectrum Several baselines displayed
Timerange: 01/00:39:31 to 01/00:40:59

Plot file version 135 created 13-OCT-2010 18:43:35

IRAS1954 EP064N.UVDATA.1

Freq = 4.9270 GHz, Bw = 16.000 MH Calibrated with CL # 3 and BP # 1 (BP mode 1)

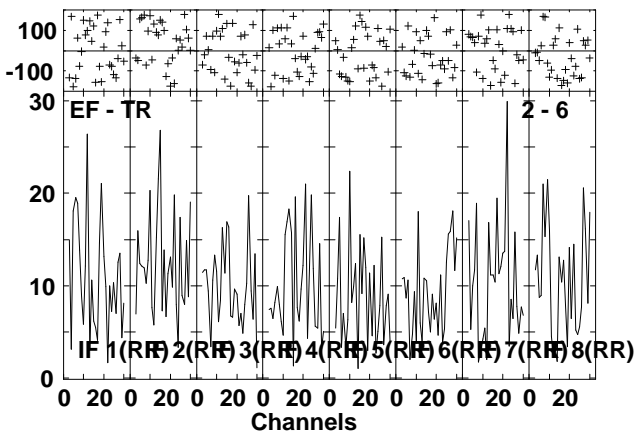
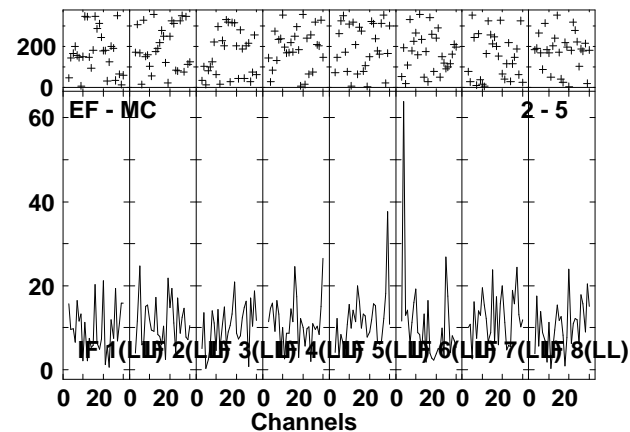
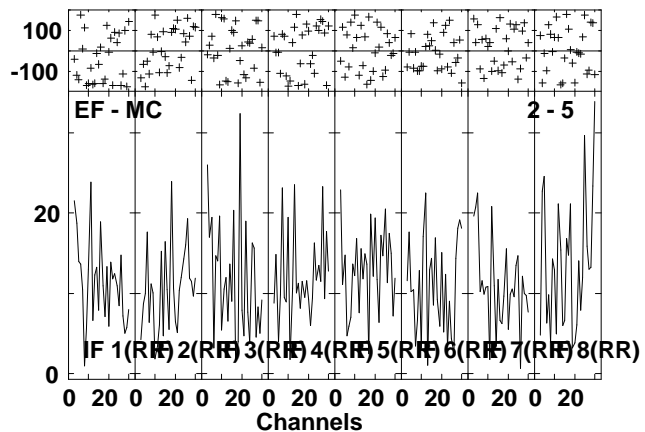
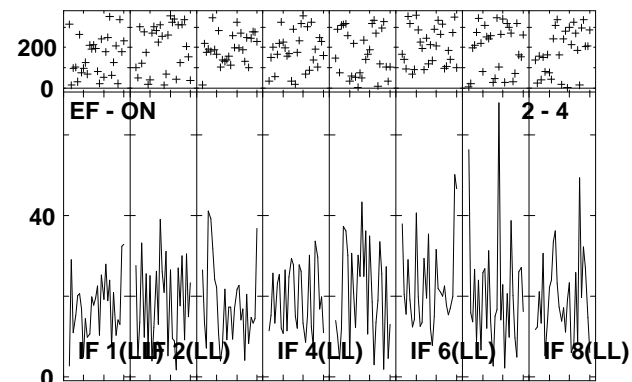
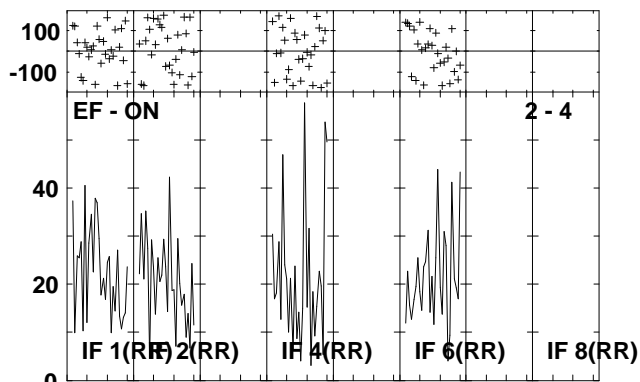
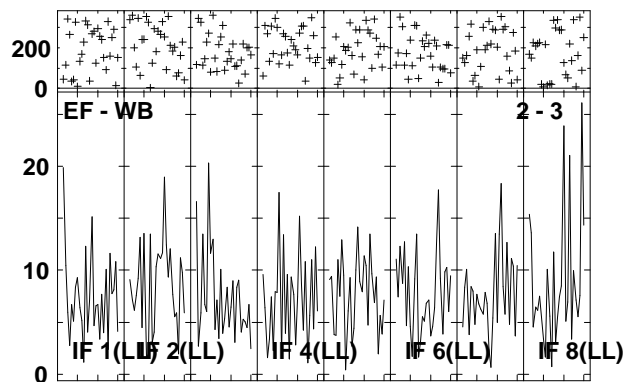
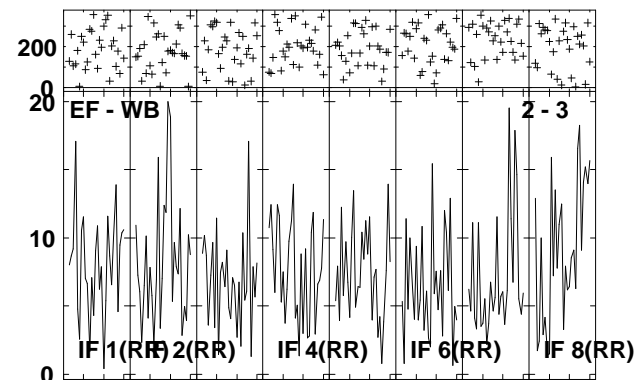
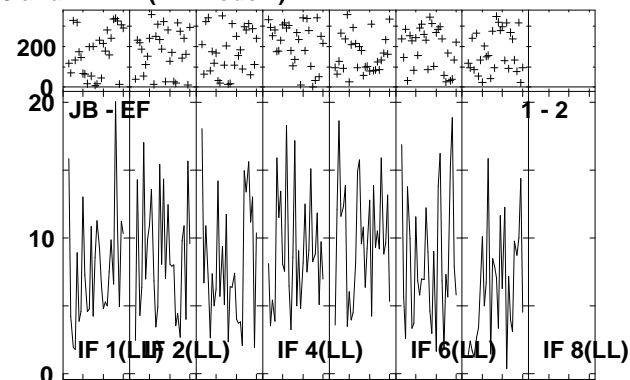
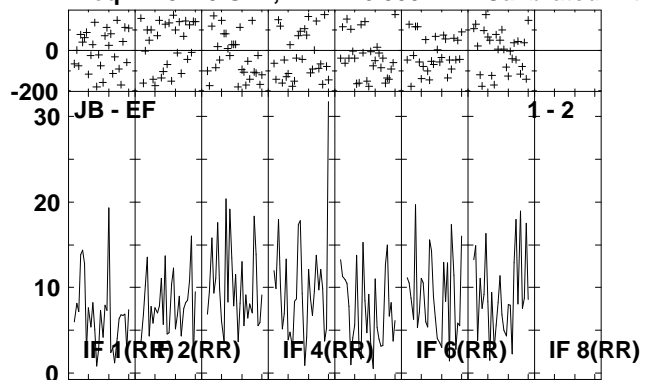

Lower frame: Milli Ampl Jy Top frame: Phas deg
Vector averaged cross-power spectrum Several baselines displayed
Timerange: 01/00:41:01 to 01/00:44:29

Plot file version 136 created 13-OCT-2010 18:43:39

IRAS1954 EP064N.UVDATA.1

Freq = 4.9270 GHz, Bw = 16.000 MH Calibrated with CL # 3 and BP # 1 (BP mode 1)

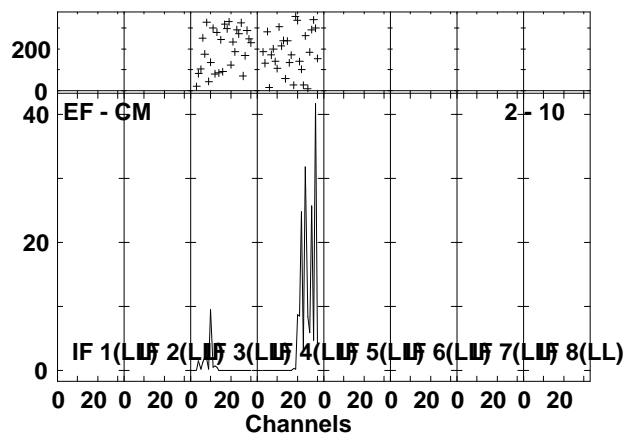
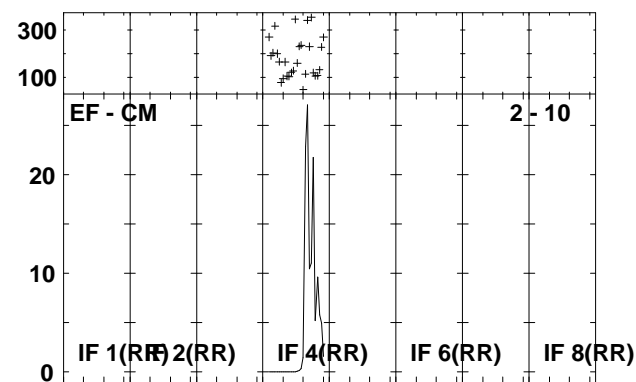
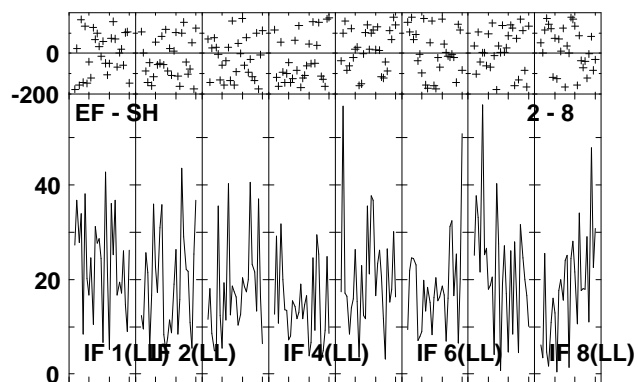
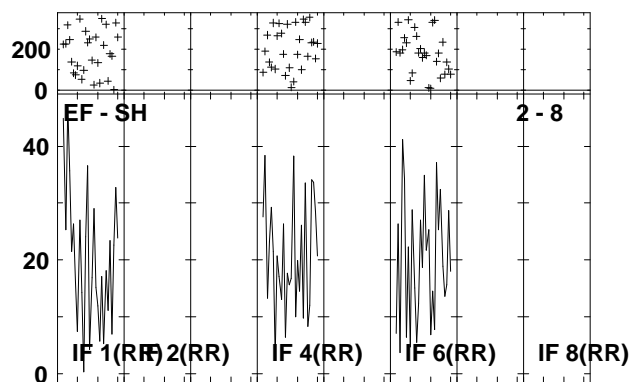
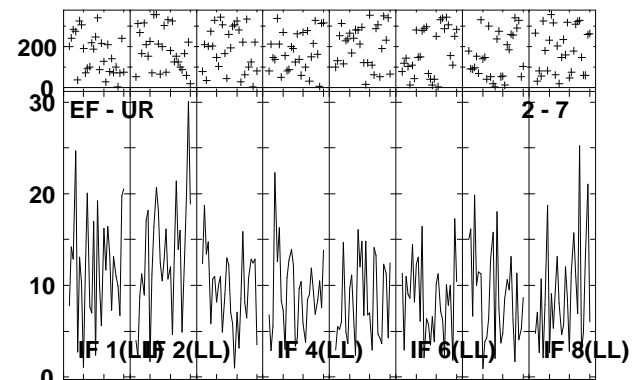
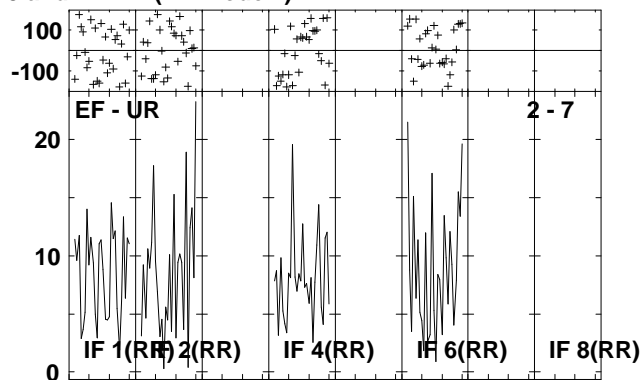
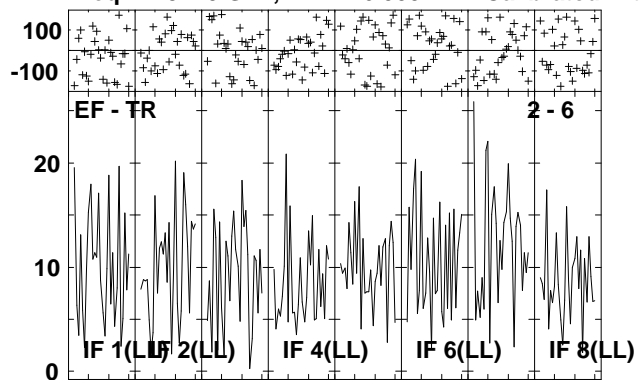

Lower frame: Milli Ampl Jy Top frame: Phas deg
Vector averaged cross-power spectrum Several baselines displayed
Timerange: 01/00:41:01 to 01/00:44:29

Plot file version 137 created 13-OCT-2010 18:43:43

J2001+10 EP064N.UVDATA.1

Freq = 4.9270 GHz, Bw = 16.000 MH Calibrated with CL # 3 and BP # 1 (BP mode 1)

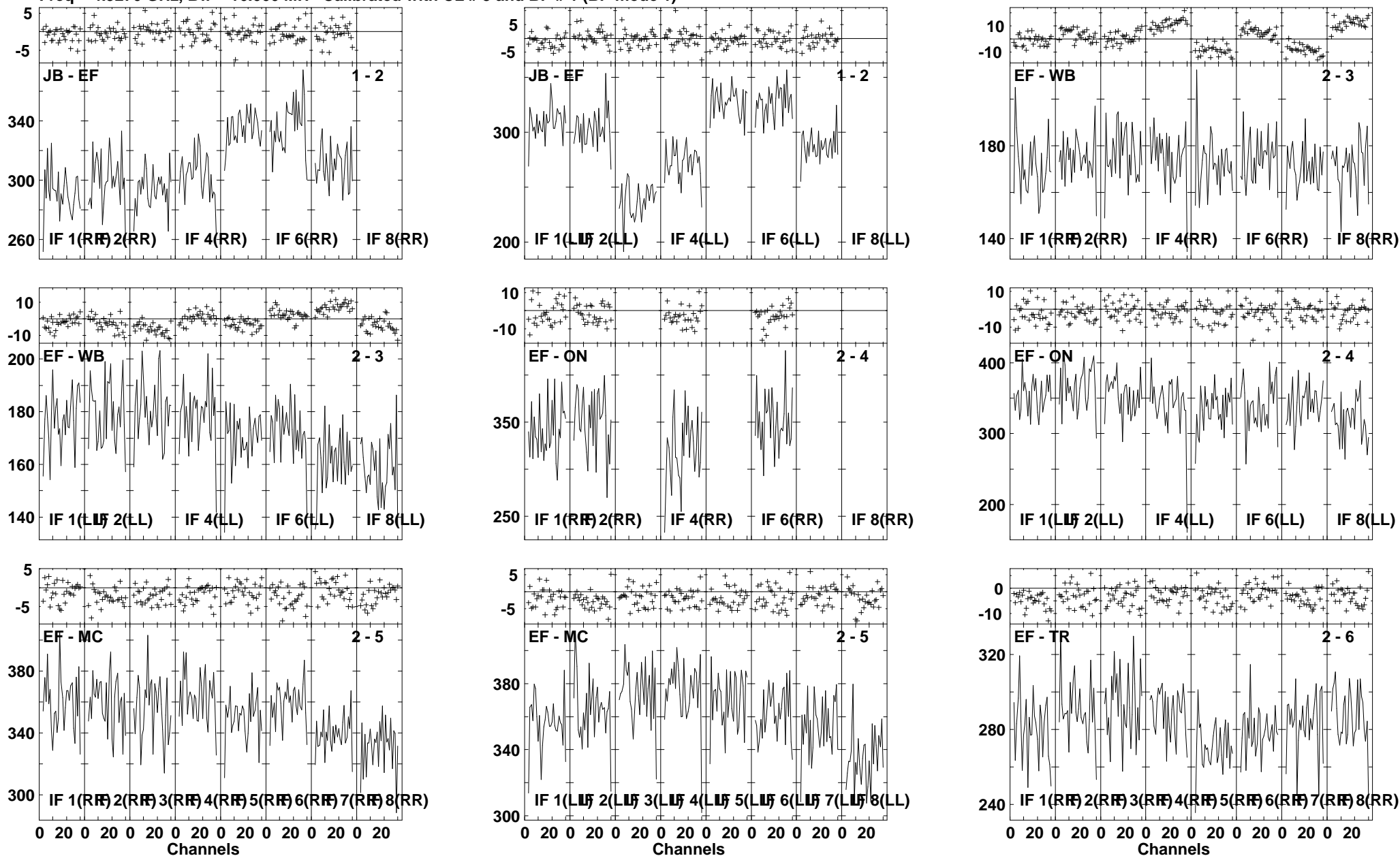

Lower frame: Milli Ampl Jy Top frame: Phas deg
Vector averaged cross-power spectrum Several baselines displayed
Timerange: 01/00:44:31 to 01/00:45:59

Plot file version 138 created 13-OCT-2010 18:43:44

J2001+10 EP064N.UVDATA.1

Freq = 4.9270 GHz, Bw = 16.000 MH Calibrated with CL # 3 and BP # 1 (BP mode 1)

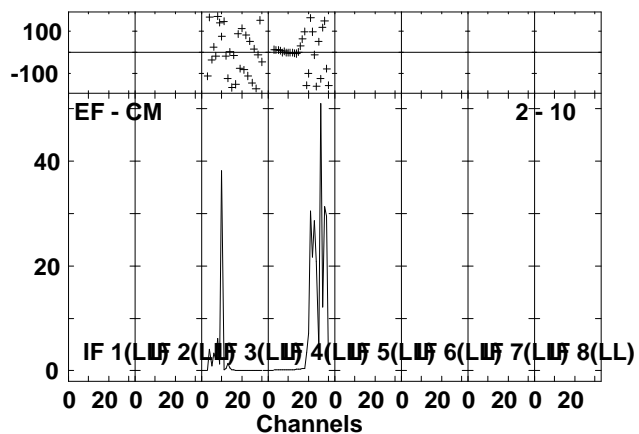
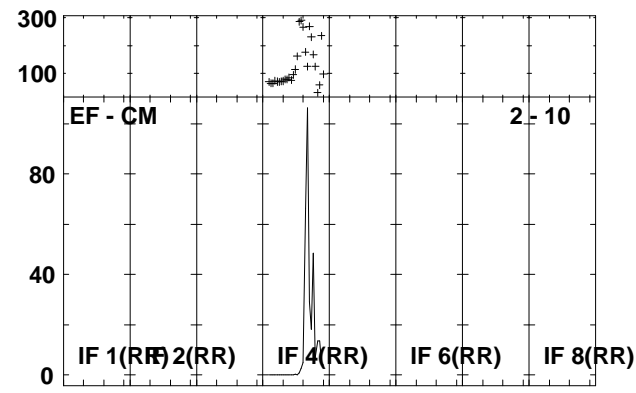
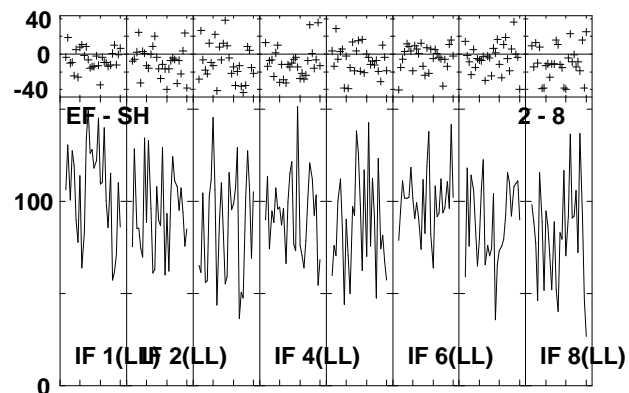
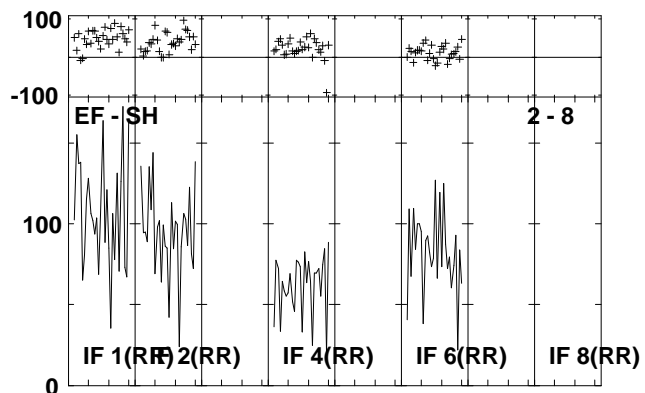
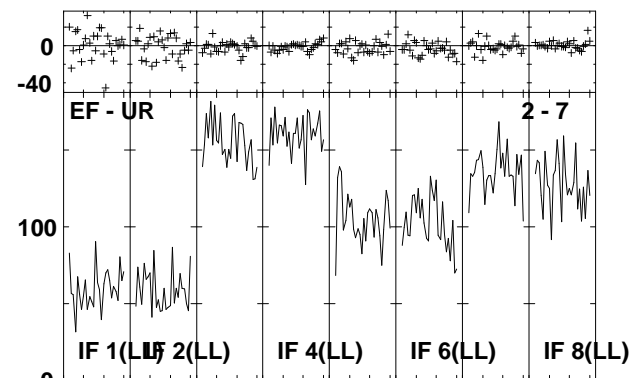
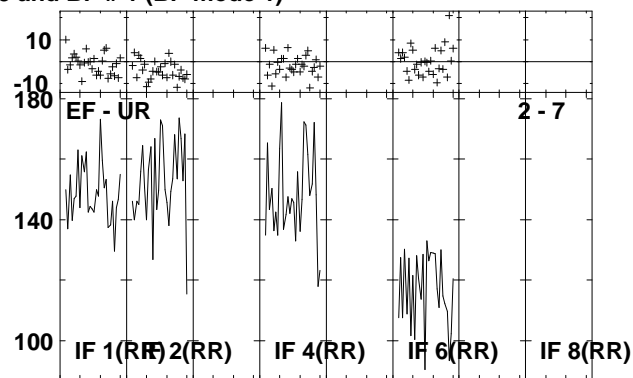
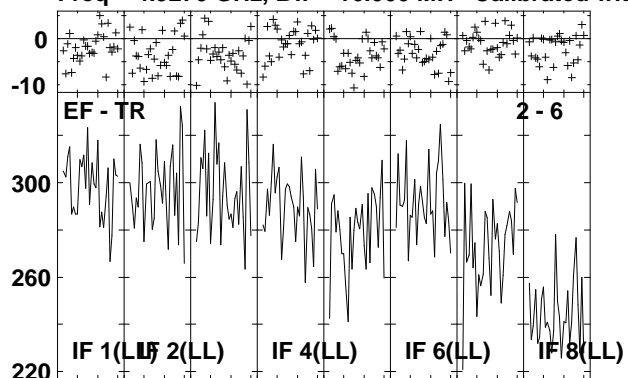

Lower frame: Milli Ampl Jy Top frame: Phas deg
Vector averaged cross-power spectrum Several baselines displayed
Timerange: 01/00:44:31 to 01/00:45:59

Plot file version 139 created 13-OCT-2010 18:43:47

IRAS1954 EP064N.UVDATA.1

Freq = 4.9270 GHz, Bw = 16.000 MH Calibrated with CL # 3 and BP # 1 (BP mode 1)

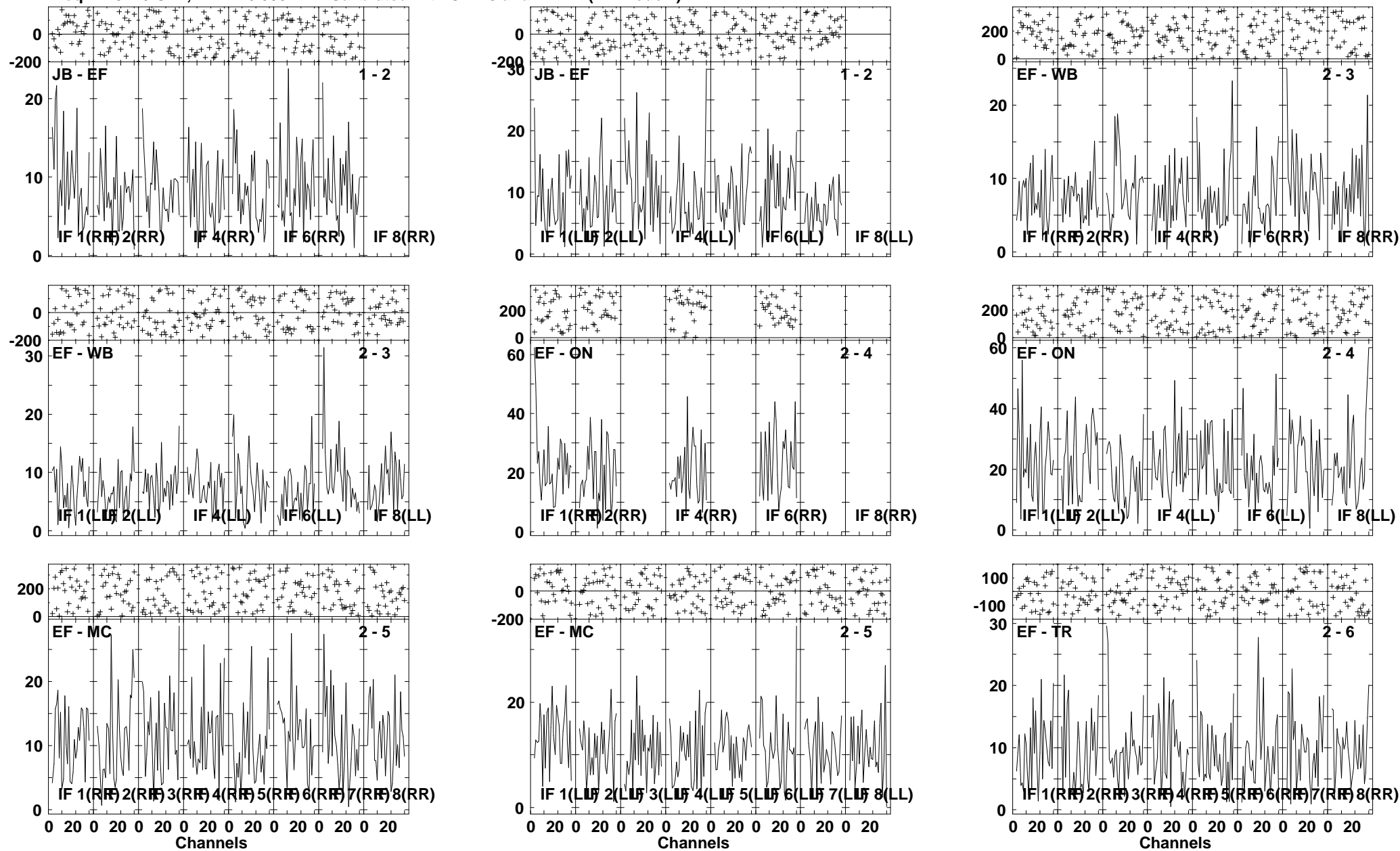

Lower frame: Milli Ampl Jy Top frame: Phas deg
Vector averaged cross-power spectrum Several baselines displayed
Timerange: 01/00:46:03 to 01/00:49:29

Plot file version 140 created 13-OCT-2010 18:43:50

IRAS1954 EP064N.UVDATA.1

Freq = 4.9270 GHz, Bw = 16.000 MH Calibrated with CL # 3 and BP # 1 (BP mode 1)

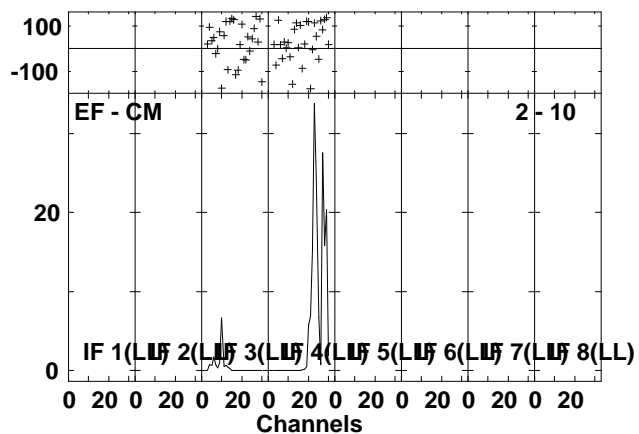
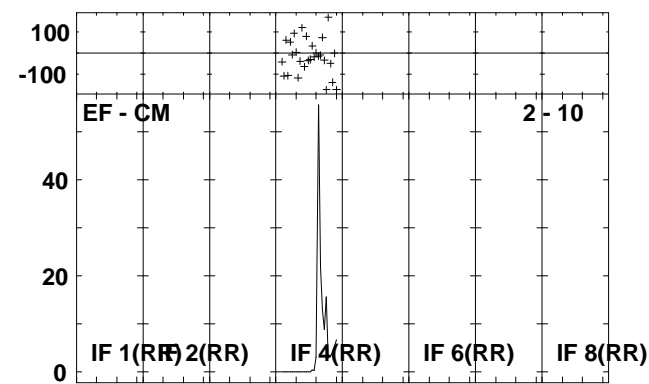
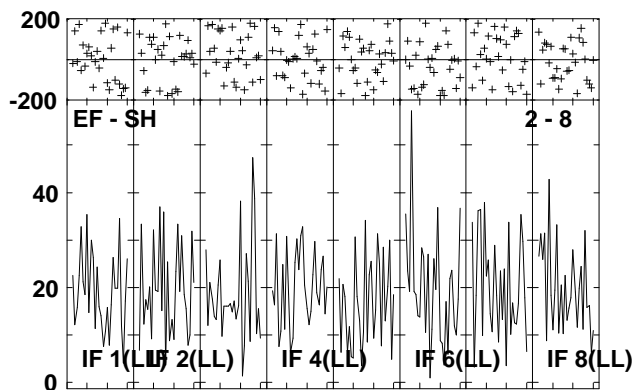
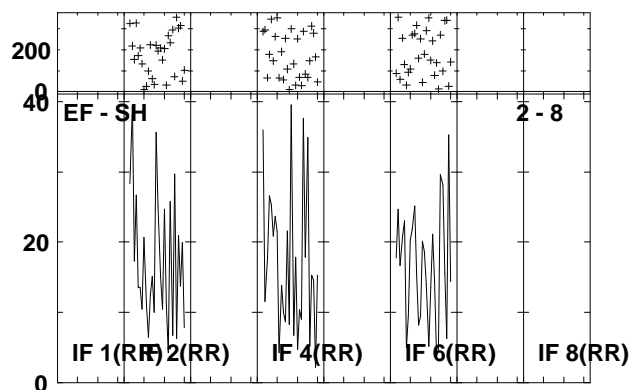
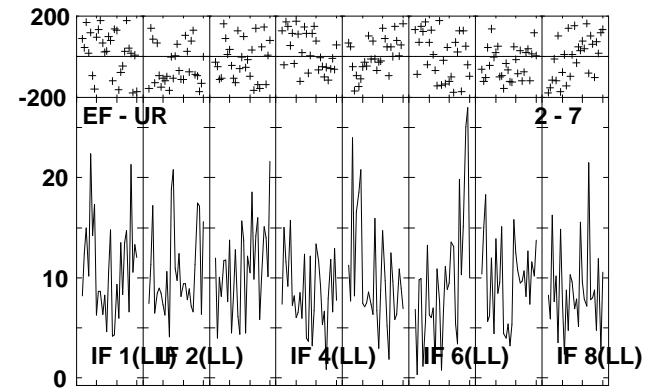
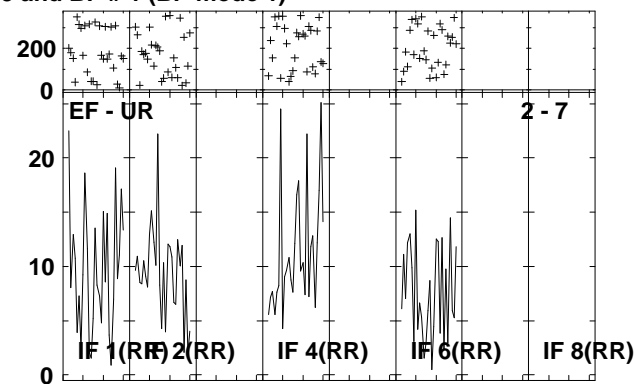
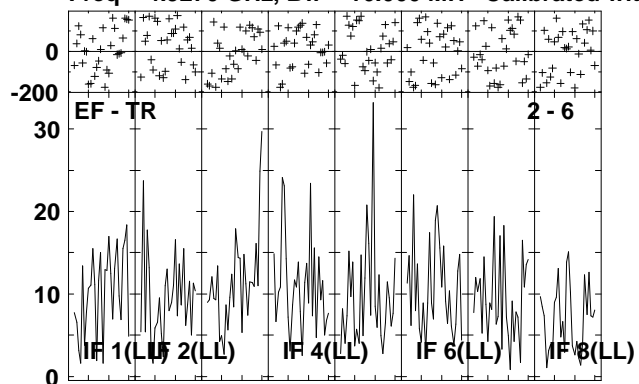

Lower frame: Milli Ampl Jy Top frame: Phas deg
Vector averaged cross-power spectrum Several baselines displayed
Timerange: 01/00:46:03 to 01/00:49:29

Plot file version 141 created 13-OCT-2010 18:43:54

J2001+10 EP064N.UVDATA.1

Freq = 4.9270 GHz, Bw = 16.000 MH Calibrated with CL # 3 and BP # 1 (BP mode 1)

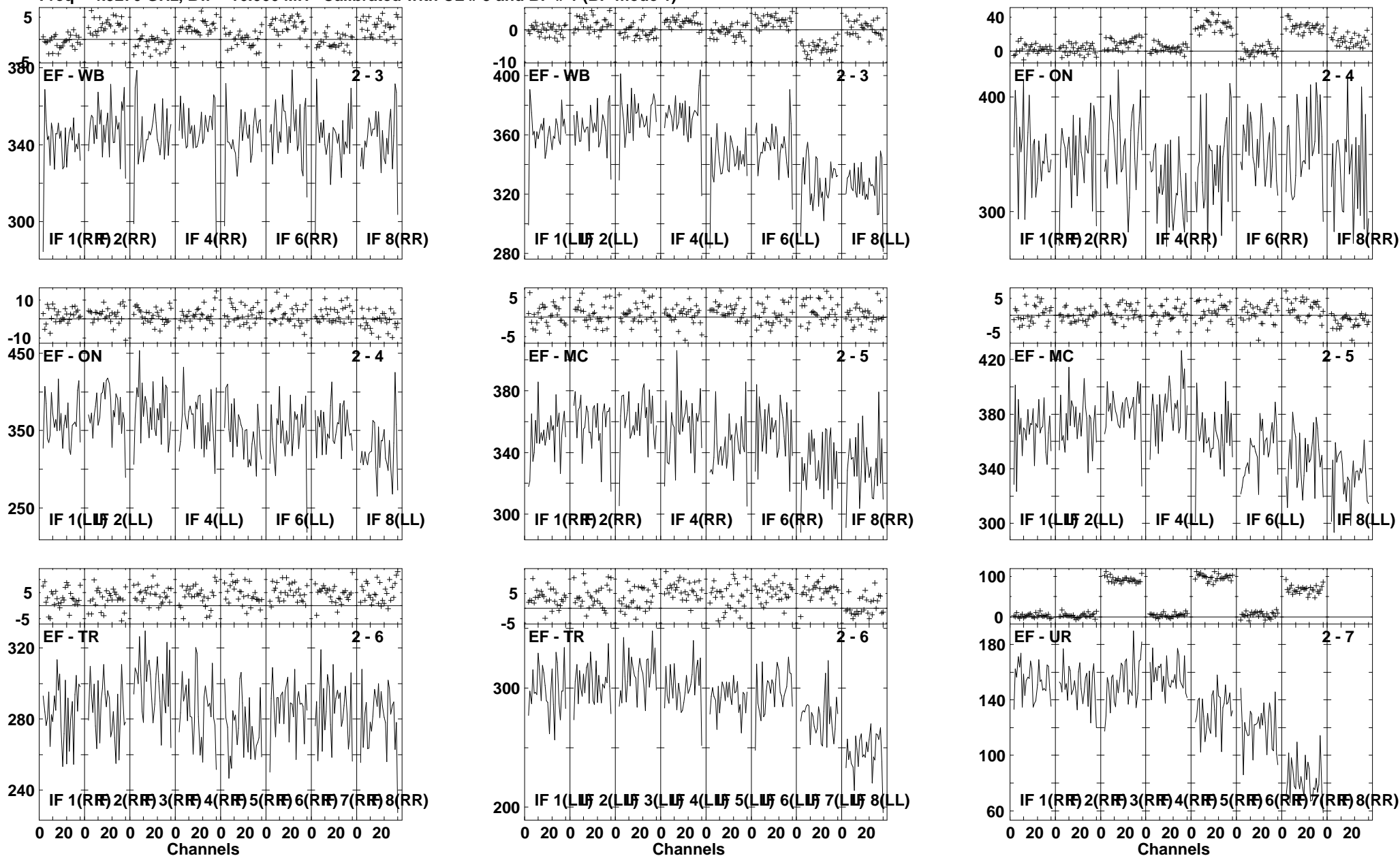

Lower frame: Milli Ampl Jy Top frame: Phas deg
Vector averaged cross-power spectrum Several baselines displayed
Timerange: 01/00:49:31 to 01/00:50:59

Plot file version 142 created 13-OCT-2010 18:43:55

J2001+10 EP064N.UVDATA.1

Freq = 4.9270 GHz, Bw = 16.000 MH Calibrated with CL # 3 and BP # 1 (BP mode 1)

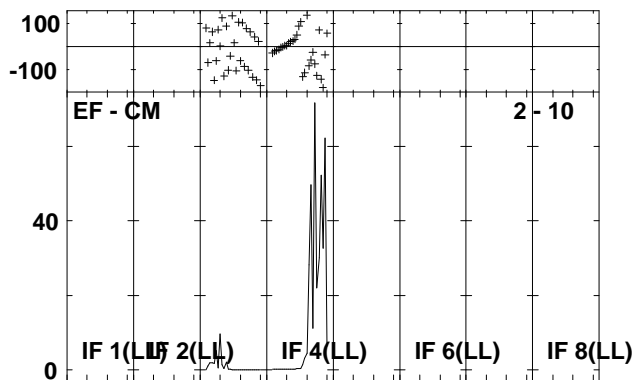
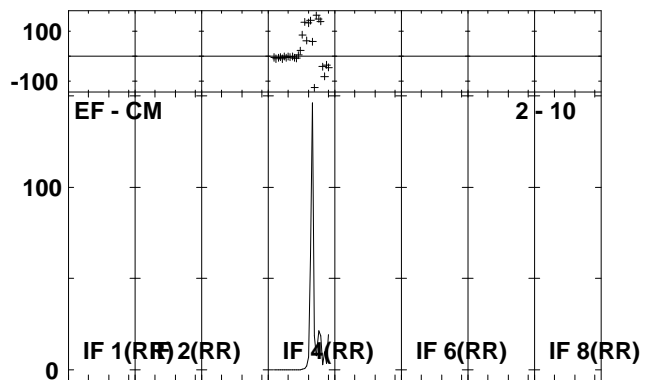
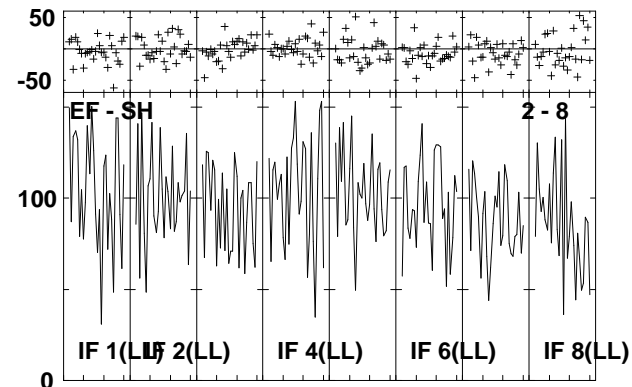
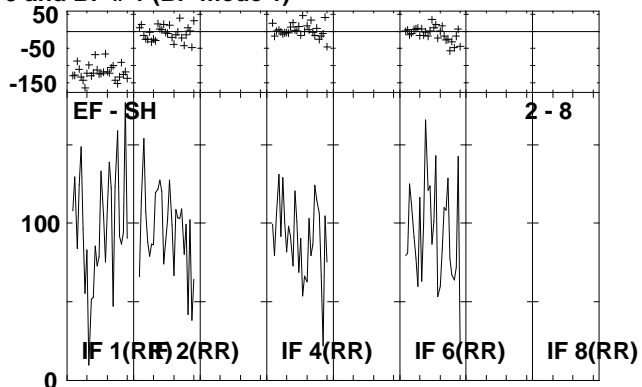
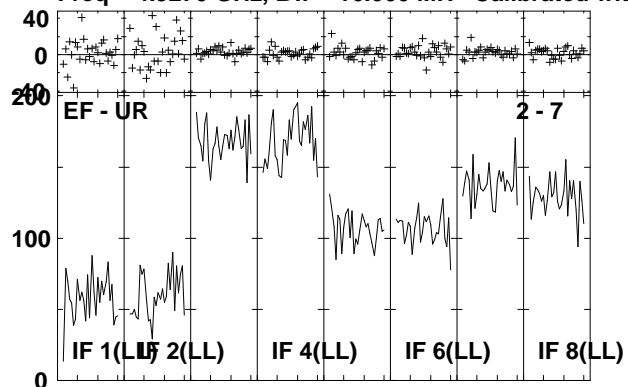

Lower frame: Milli Ampl Jy Top frame: Phas deg
Vector averaged cross-power spectrum Several baselines displayed
Timerange: 01/00:49:31 to 01/00:50:59

Plot file version 143 created 13-OCT-2010 18:43:57

IRAS1954 EP064N.UVDATA.1

Freq = 4.9270 GHz, Bw = 16.000 MH Calibrated with CL # 3 and BP # 1 (BP mode 1)

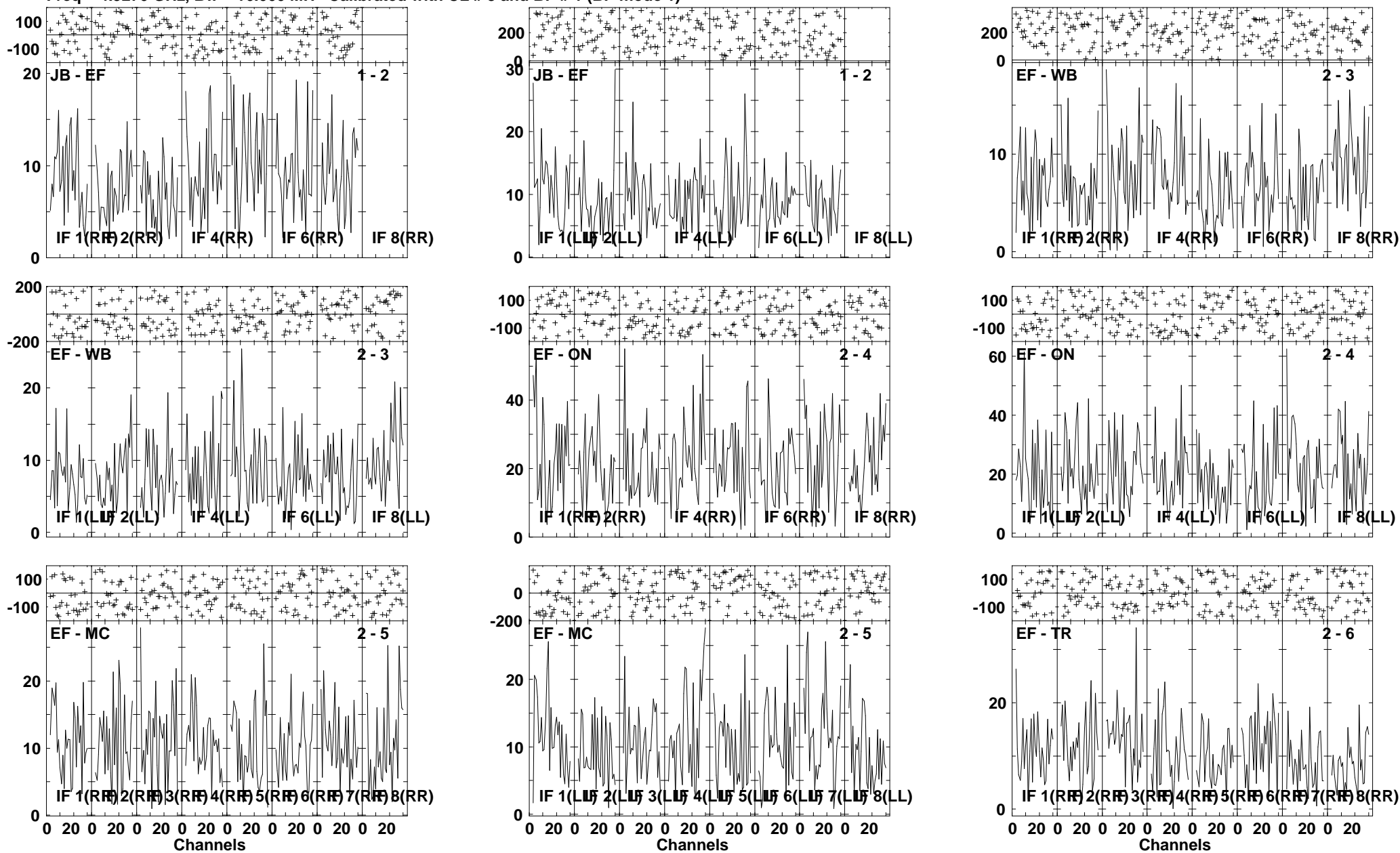

Lower frame: Milli Ampl Jy Top frame: Phas deg
Vector averaged cross-power spectrum Several baselines displayed
Timerange: 01/00:51:01 to 01/00:54:29

Plot file version 144 created 13-OCT-2010 18:44:00

IRAS1954 EP064N.UVDATA.1

Freq = 4.9270 GHz, Bw = 16.000 MH Calibrated with CL # 3 and BP # 1 (BP mode 1)

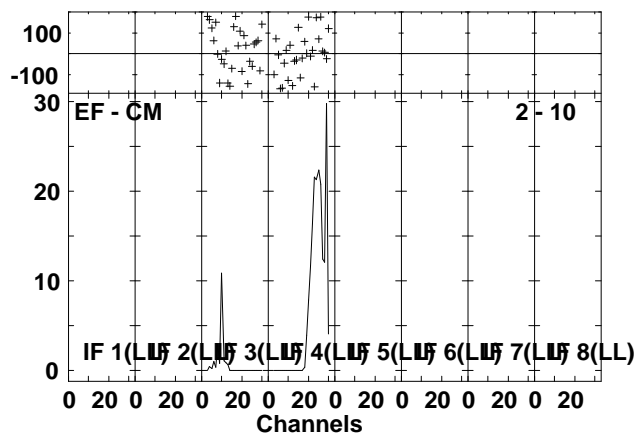
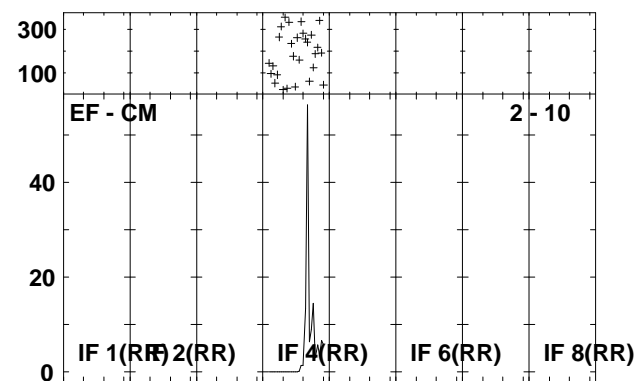
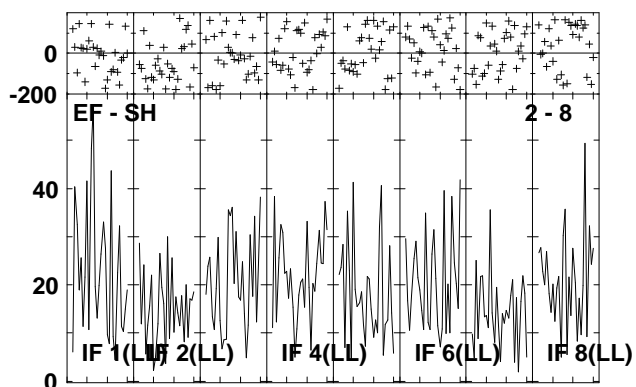
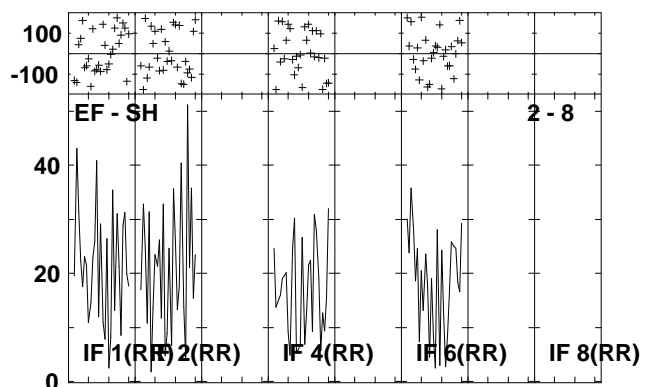
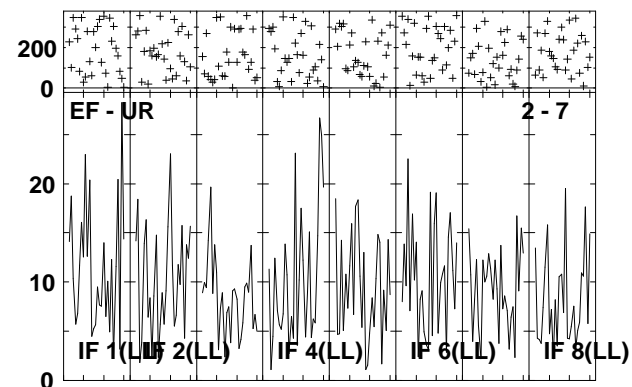
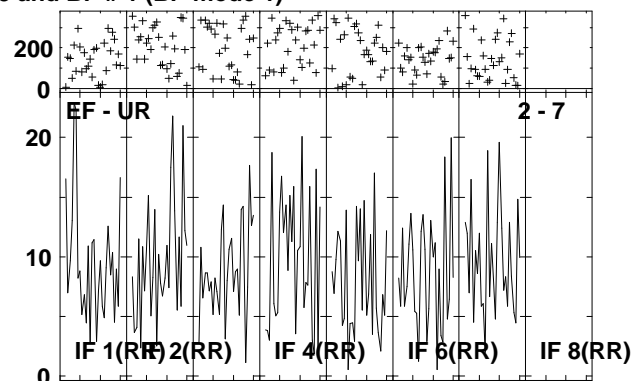
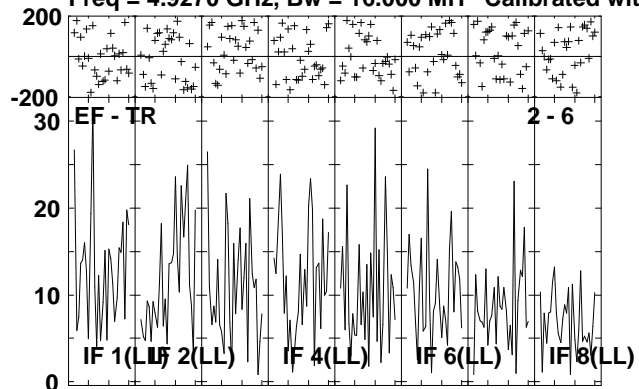

Lower frame: Milli Ampl Jy Top frame: Phas deg
Vector averaged cross-power spectrum Several baselines displayed
Timerange: 01/00:51:01 to 01/00:54:29

Plot file version 145 created 13-OCT-2010 18:44:04

J2001+10 EP064N.UVDATA.1

Freq = 4.9270 GHz, Bw = 16.000 MH Calibrated with CL # 3 and BP # 1 (BP mode 1)

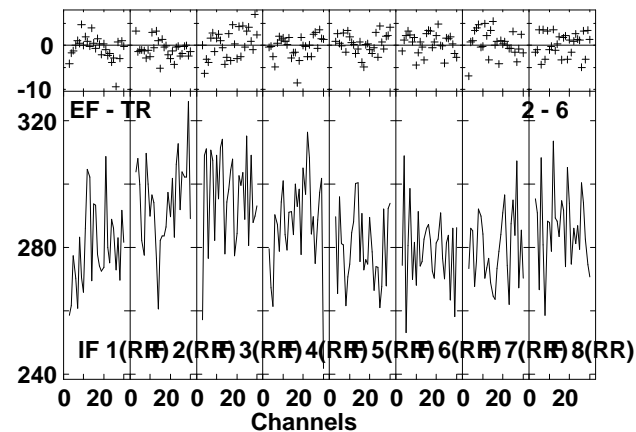
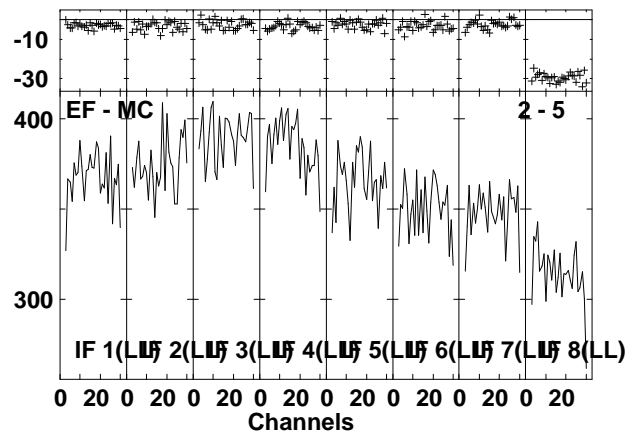
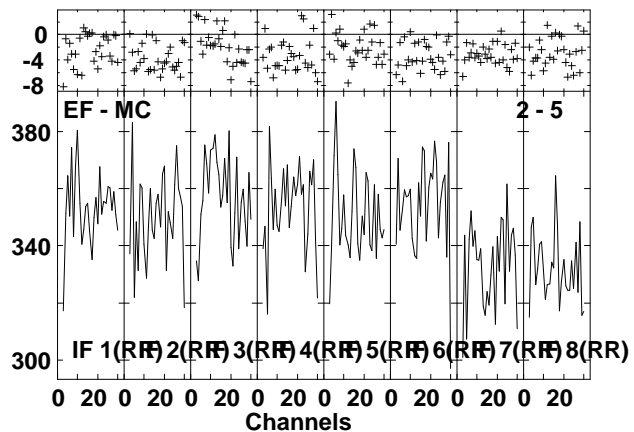
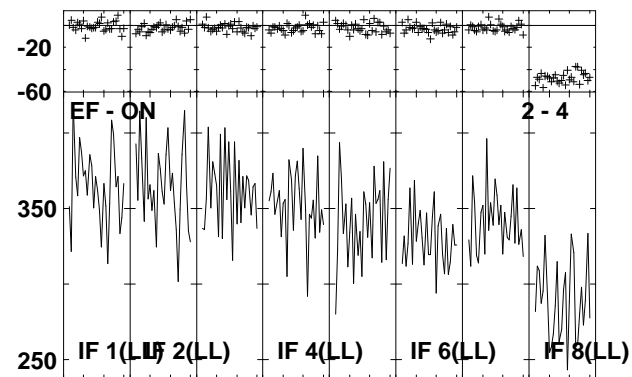
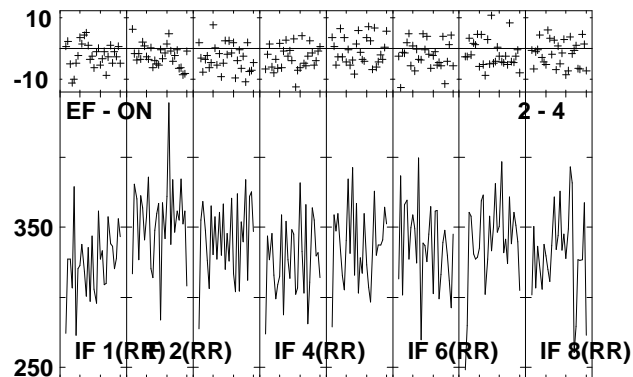
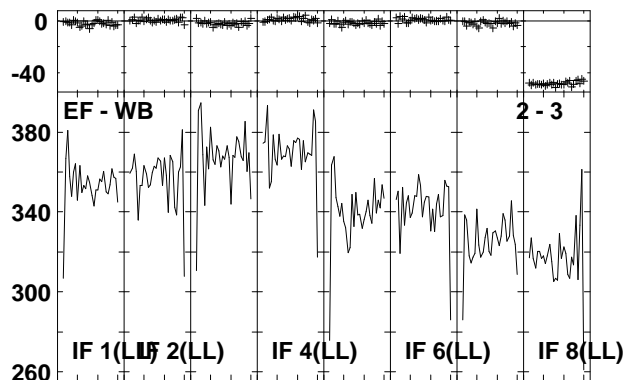
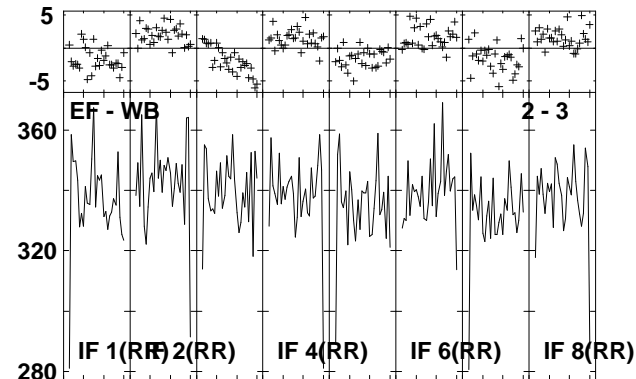
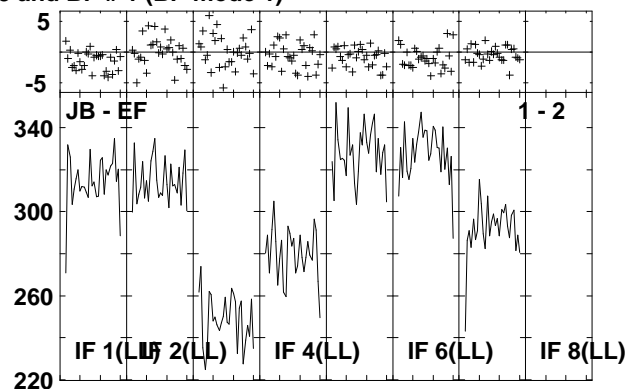
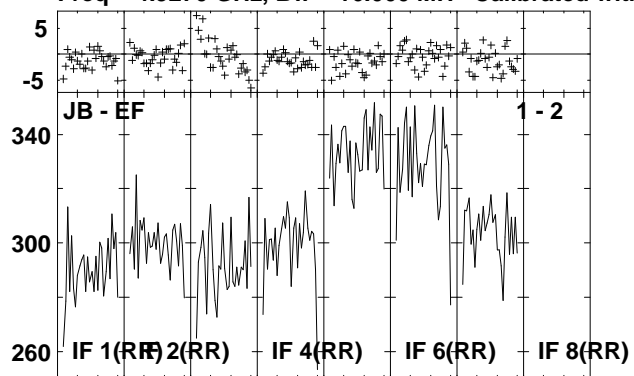

Lower frame: Milli Ampl Jy Top frame: Phas deg
Vector averaged cross-power spectrum Several baselines displayed
Timerange: 01/00:55:31 to 01/00:56:59

Plot file version 146 created 13-OCT-2010 18:44:06
 J2001+10 EP064N.UVDATA.1
 Freq = 4.9270 GHz, Bw = 16.000 MH Calibrated with CL # 3 and BP # 1 (BP mode 1)

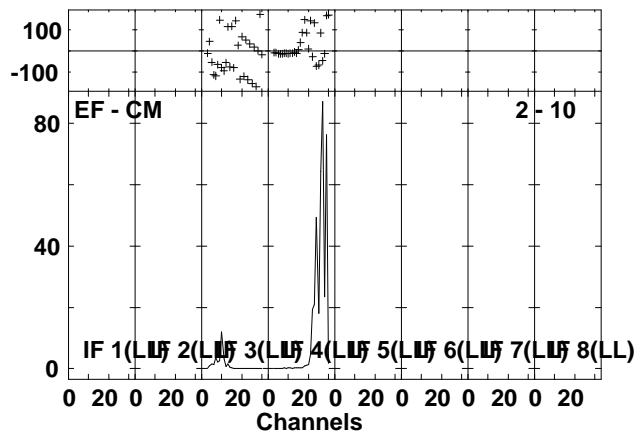
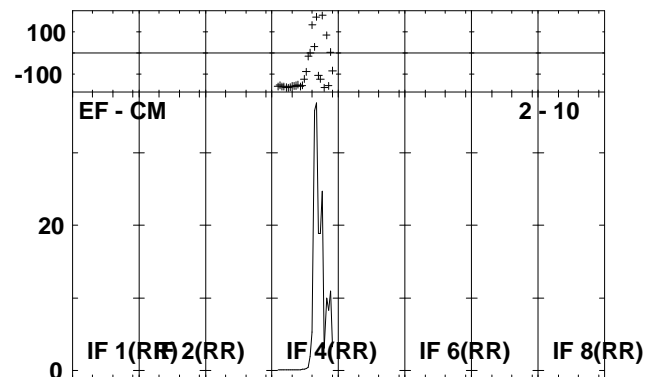
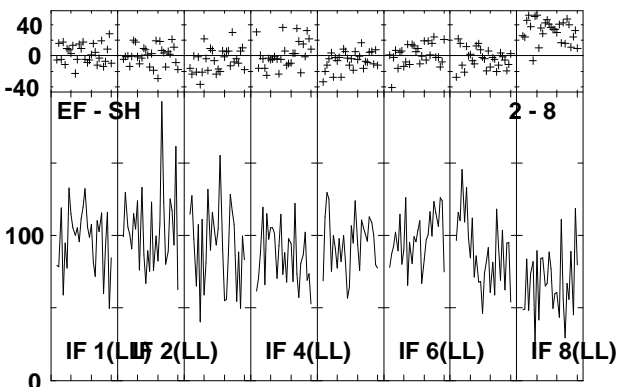
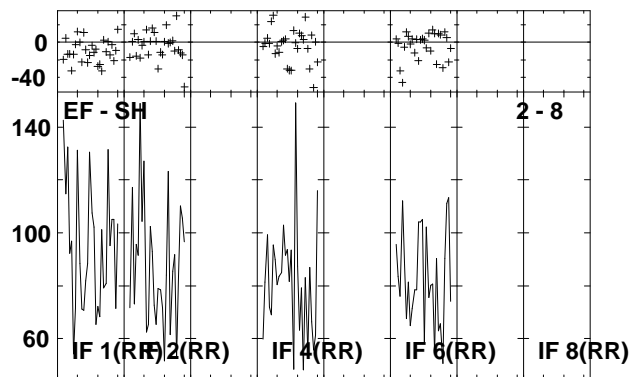
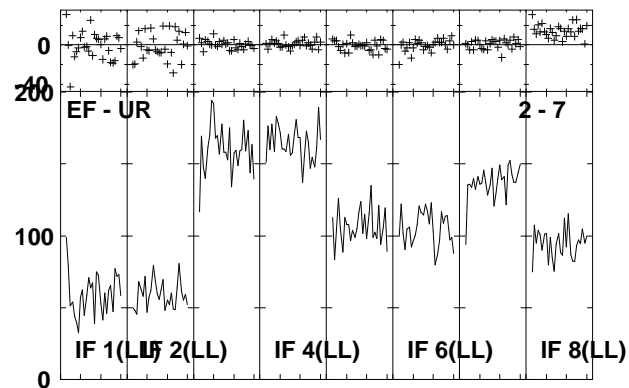
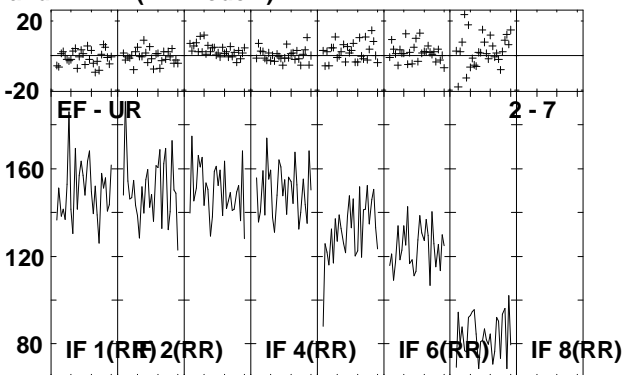
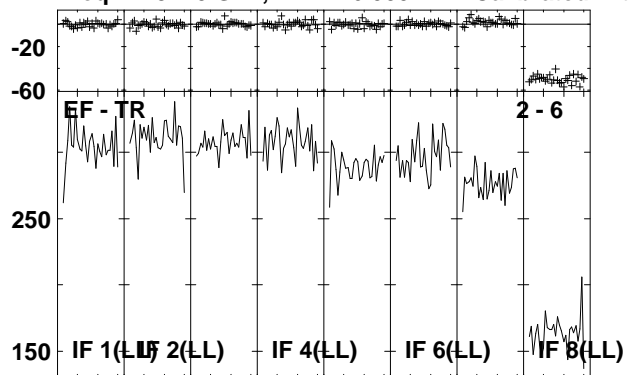

Lower frame: Milli Ampl Jy Top frame: Phas deg
 Vector averaged cross-power spectrum Several baselines displayed
 Timerange: 01/00:55:31 to 01/00:56:59

Plot file version 147 created 13-OCT-2010 18:44:08

IRAS1954 EP064N.UVDATA.1

Freq = 4.9270 GHz, Bw = 16.000 MH Calibrated with CL # 3 and BP # 1 (BP mode 1)

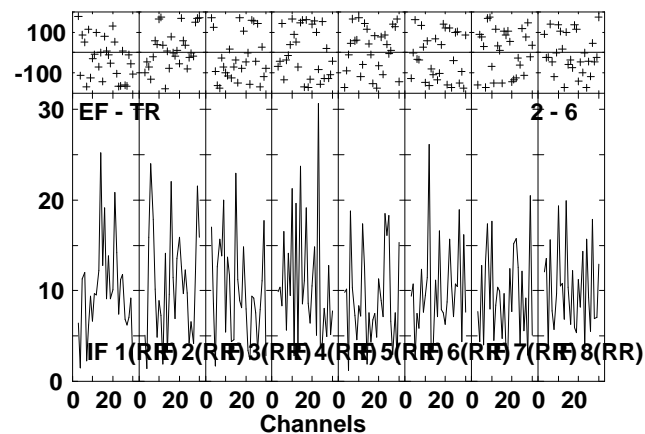
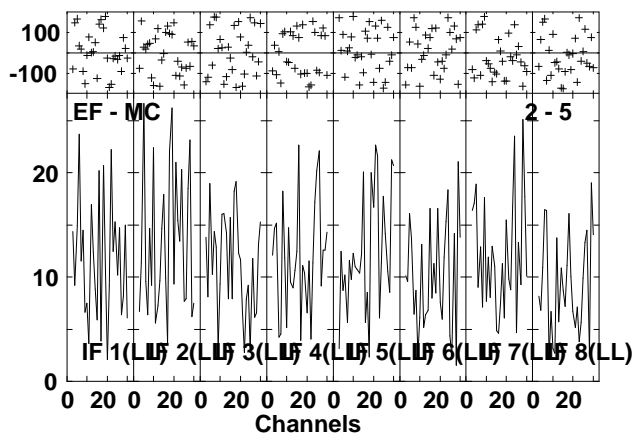
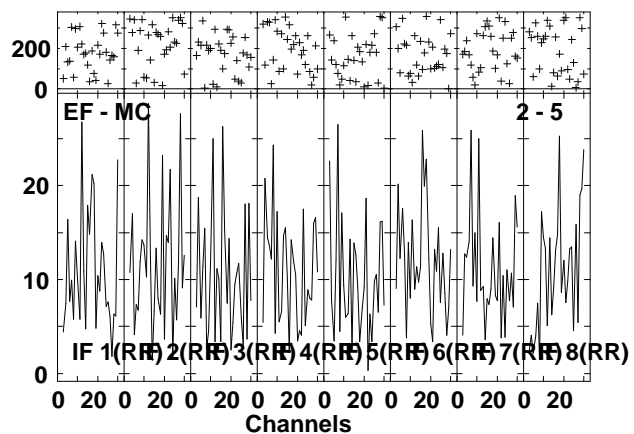
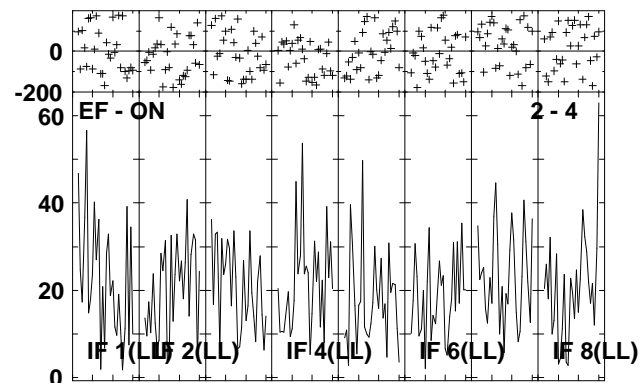
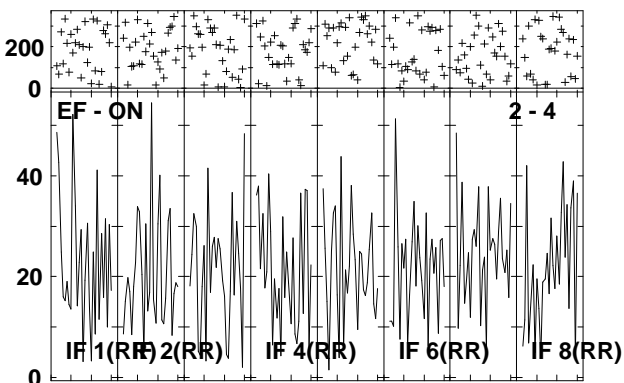
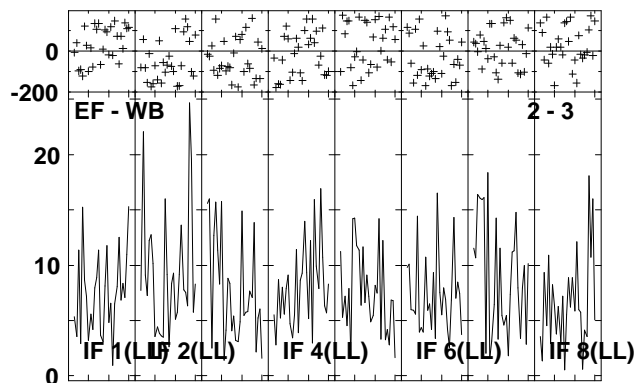
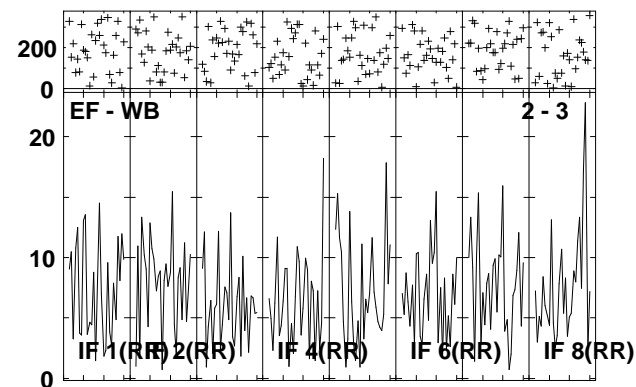
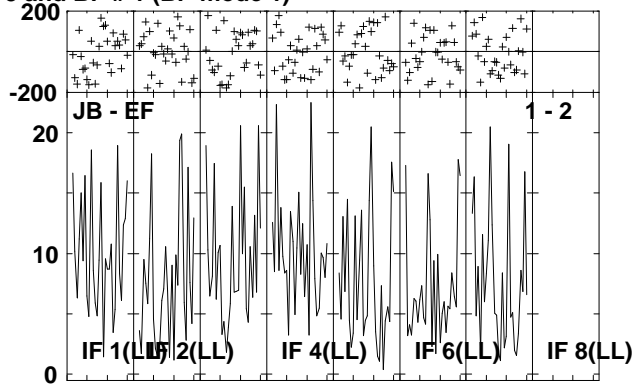
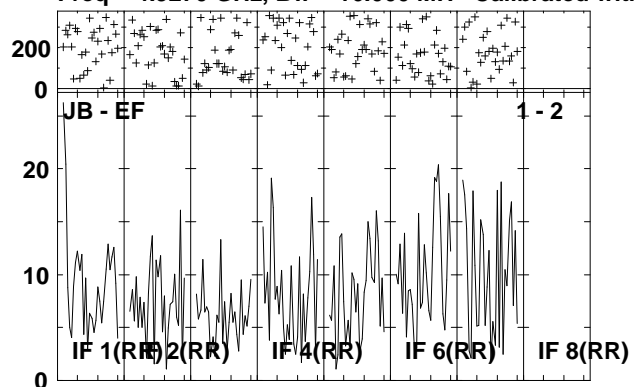

Lower frame: Milli Ampl Jy Top frame: Phas deg
Vector averaged cross-power spectrum Several baselines displayed
Timerange: 01/00:57:01 to 01/01:00:29

Plot file version 148 created 13-OCT-2010 18:44:11

IRAS1954 EP064N.UVDATA.1

Freq = 4.9270 GHz, Bw = 16.000 MH Calibrated with CL # 3 and BP # 1 (BP mode 1)

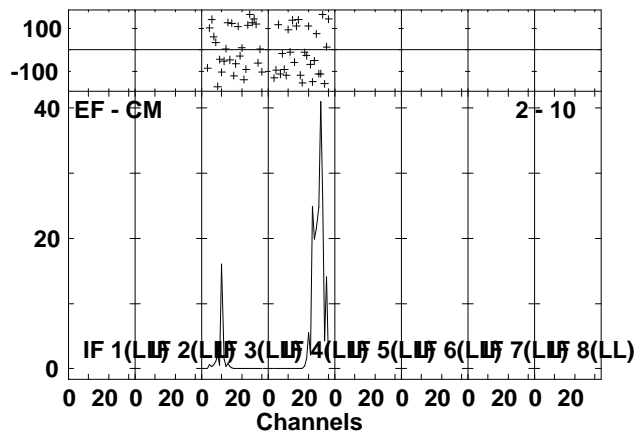
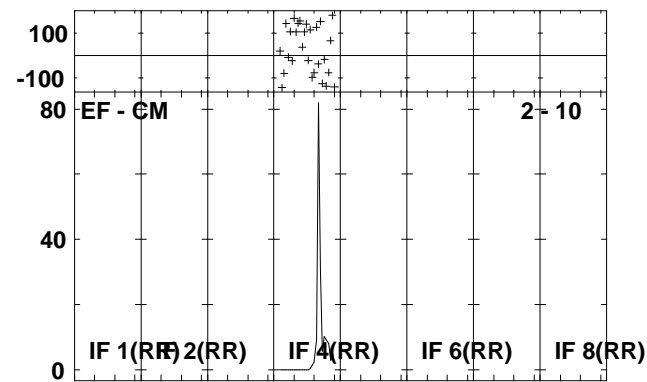
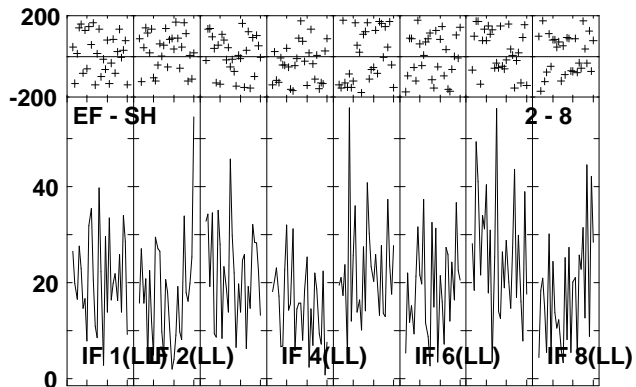
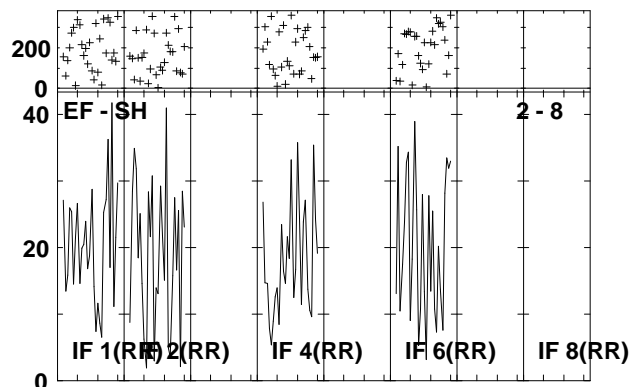
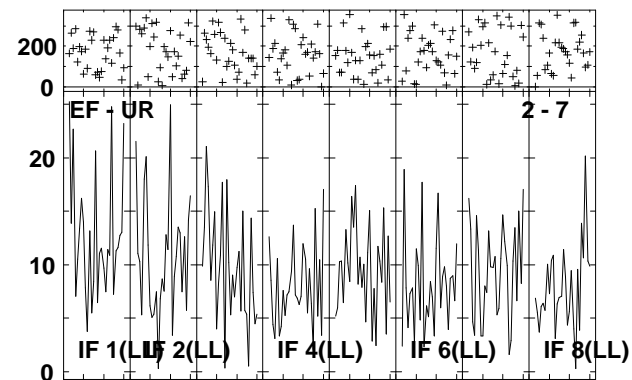
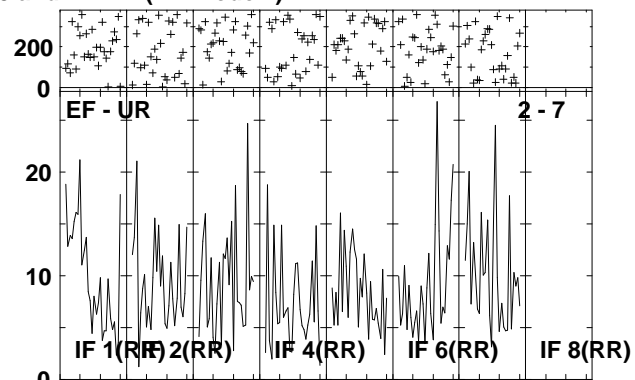
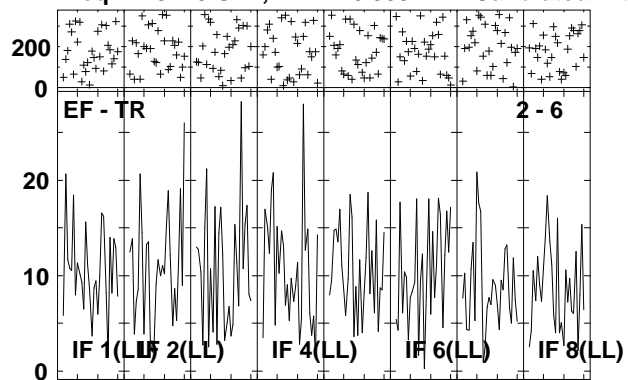

Lower frame: Milli Ampl Jy Top frame: Phas deg
Vector averaged cross-power spectrum Several baselines displayed
Timerange: 01/00:57:01 to 01/01:00:29

Plot file version 149 created 13-OCT-2010 18:44:16

J2001+10 EP064N.UVDATA.1

Freq = 4.9270 GHz, Bw = 16.000 MH Calibrated with CL # 3 and BP # 1 (BP mode 1)

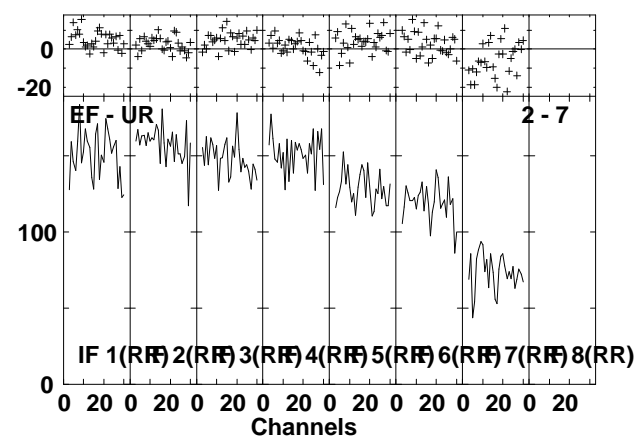
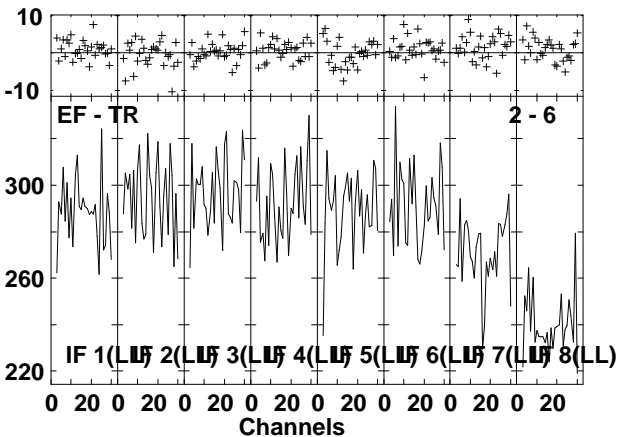
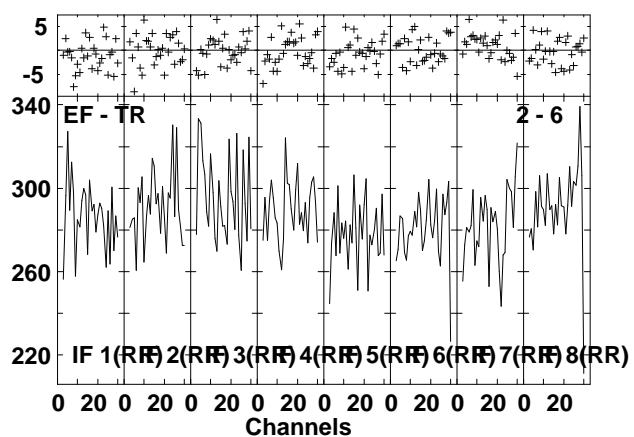
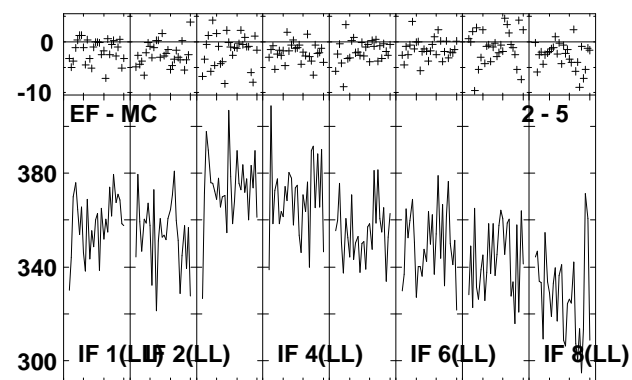
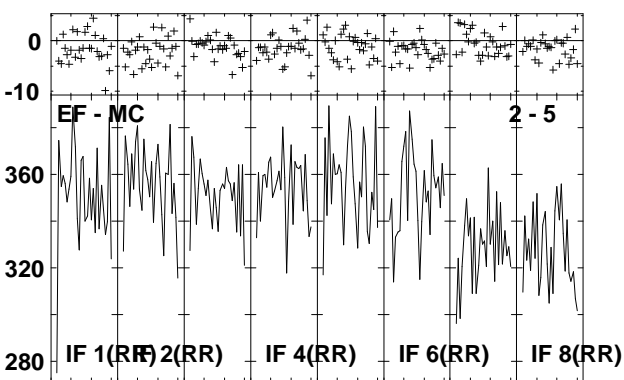
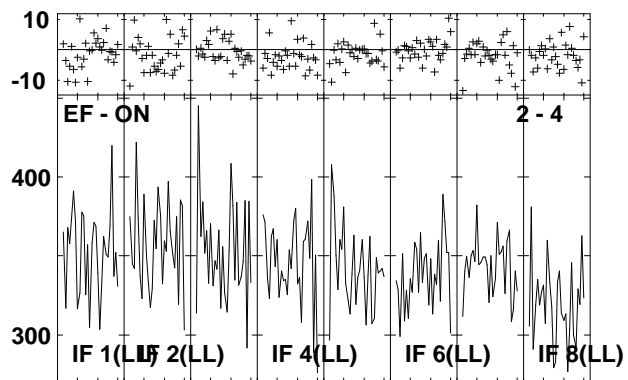
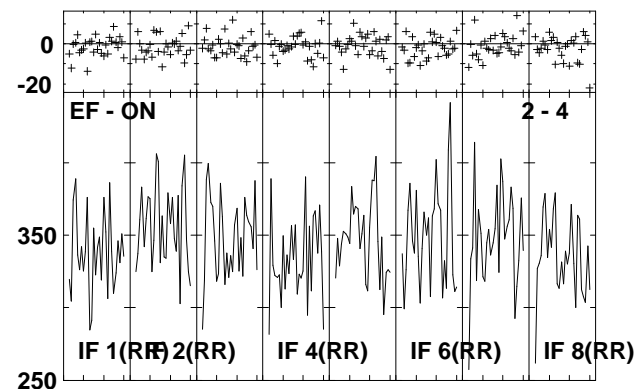
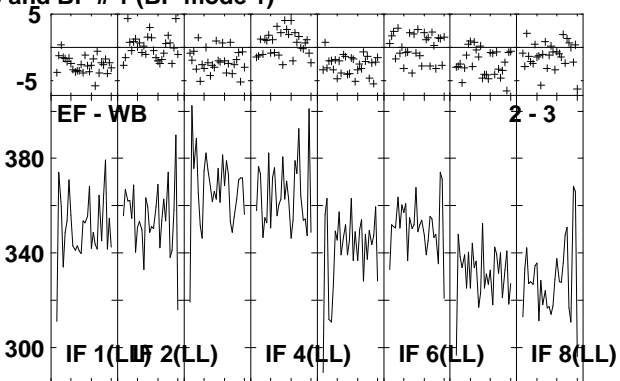
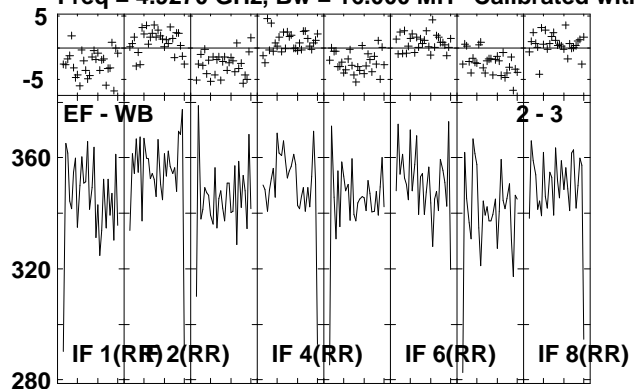

Lower frame: Milli Ampl Jy Top frame: Phas deg
Vector averaged cross-power spectrum Several baselines displayed
Timerange: 01/01:00:31 to 01/01:01:59

Plot file version 150 created 13-OCT-2010 18:44:17

J2001+10 EP064N.UVDATA.1

Freq = 4.9270 GHz, Bw = 16.000 MH Calibrated with CL # 3 and BP # 1 (BP mode 1)

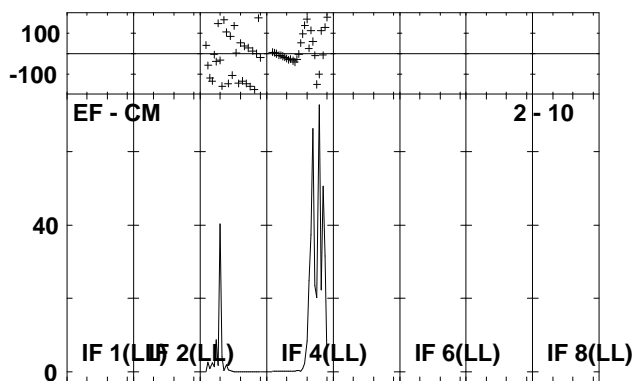
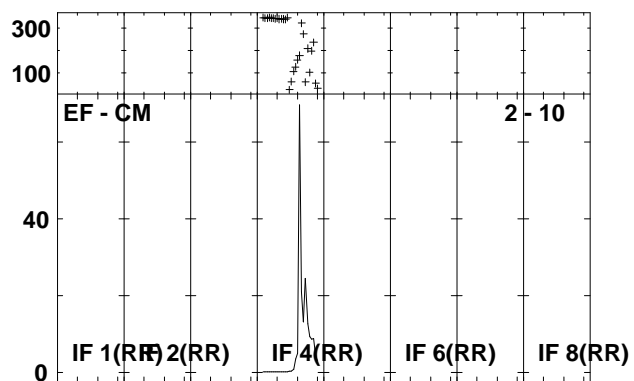
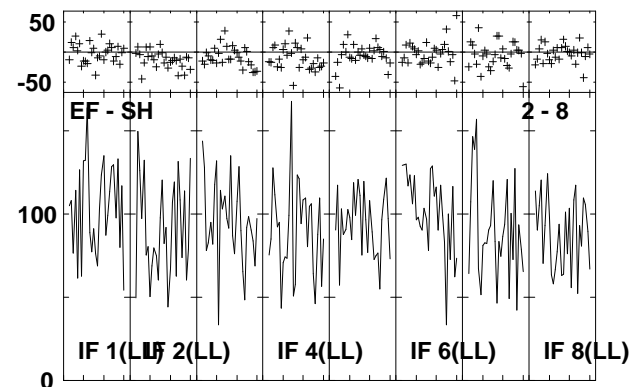
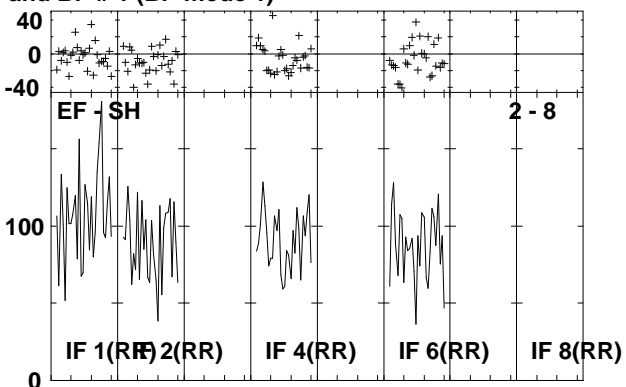
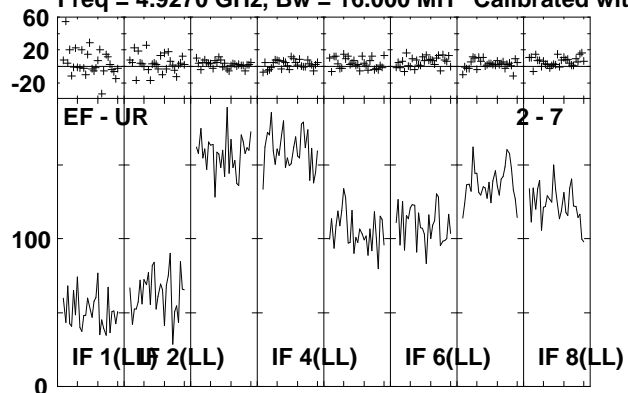

Lower frame: Milli Ampl Jy Top frame: Phas deg
Vector averaged cross-power spectrum Several baselines displayed
Timerange: 01/01:00:31 to 01/01:01:59

Plot file version 151 created 13-OCT-2010 18:44:19

IRAS1954 EP064N.UVDATA.1

Freq = 4.9270 GHz, Bw = 16.000 MH Calibrated with CL # 3 and BP # 1 (BP mode 1)

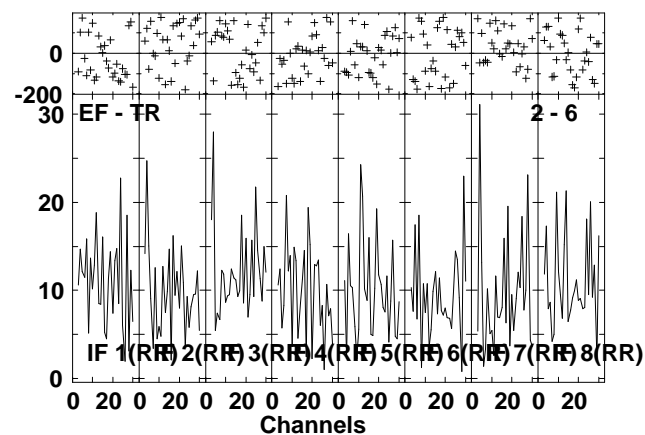
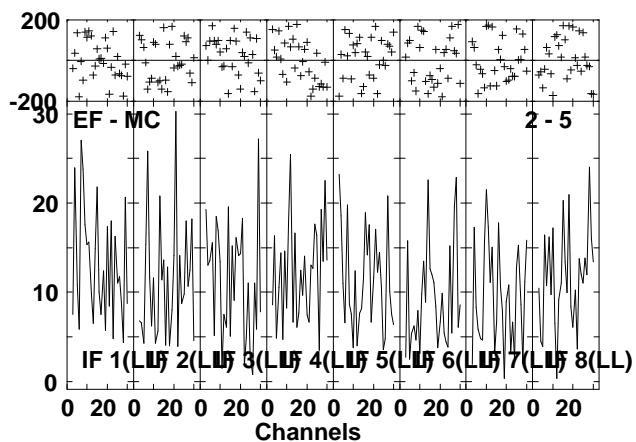
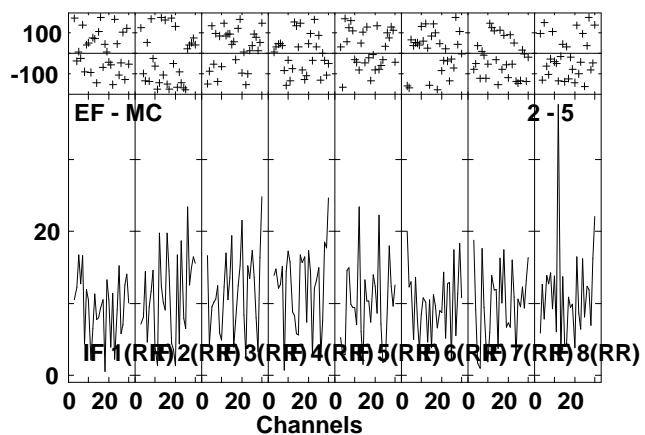
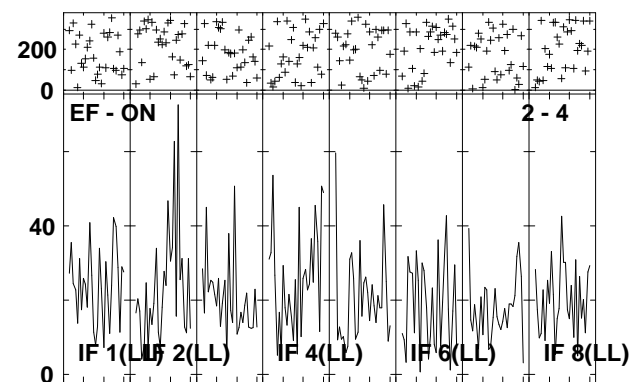
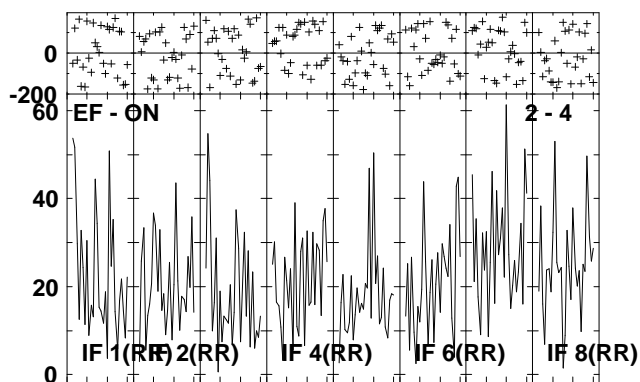
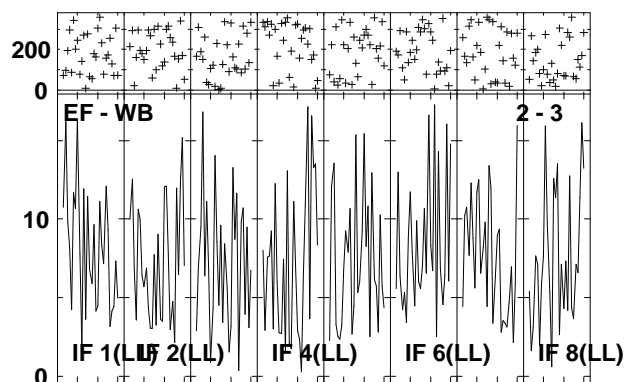
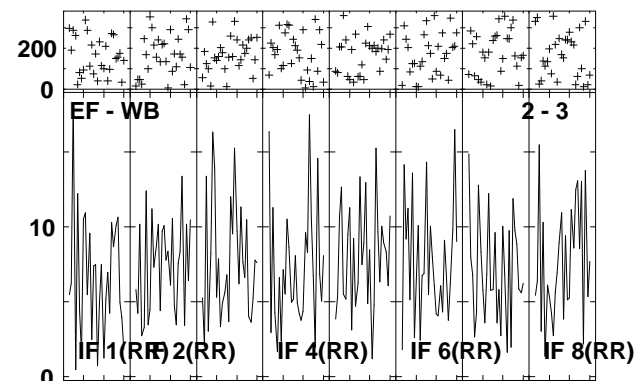
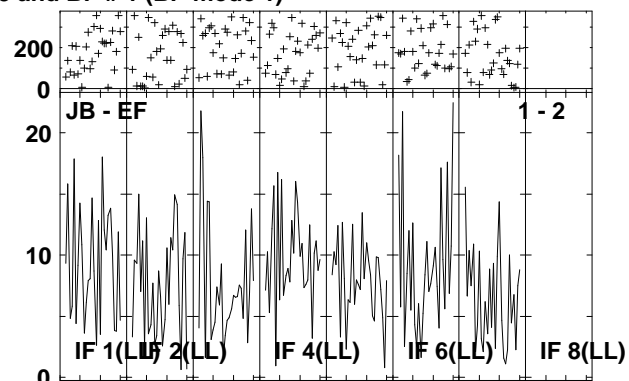
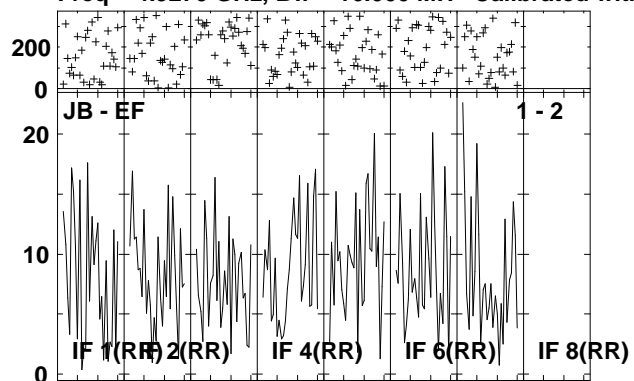

Lower frame: Milli Ampl Jy Top frame: Phas deg
Vector averaged cross-power spectrum Several baselines displayed
Timerange: 01/01:02:01 to 01/01:05:29

Plot file version 152 created 13-OCT-2010 18:44:22

IRAS1954 EP064N.UVDATA.1

Freq = 4.9270 GHz, Bw = 16.000 MH Calibrated with CL # 3 and BP # 1 (BP mode 1)

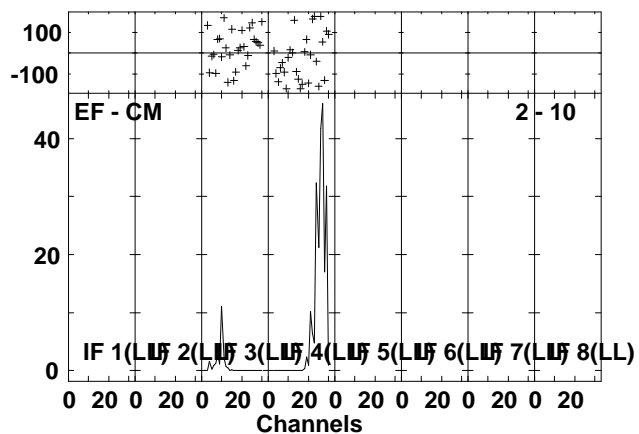
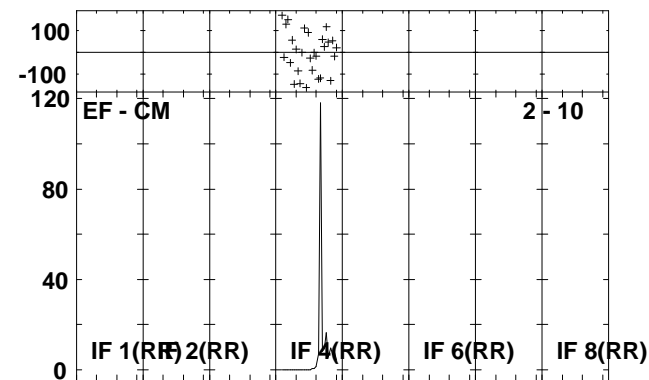
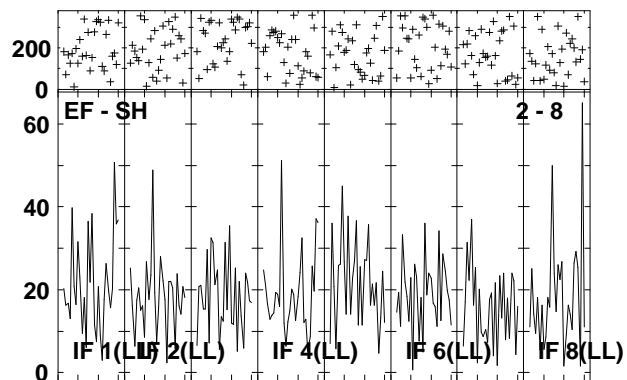
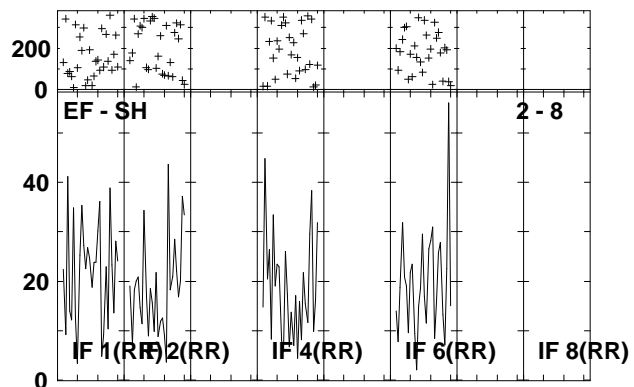
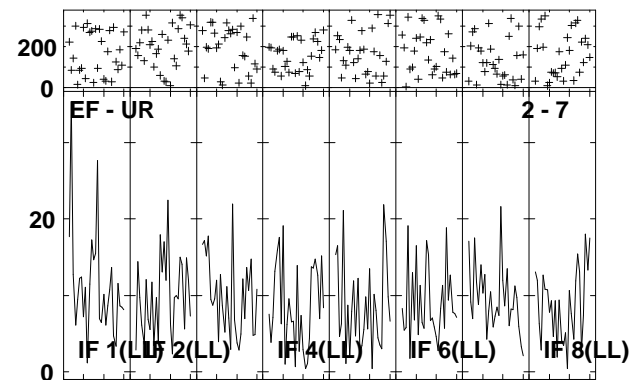
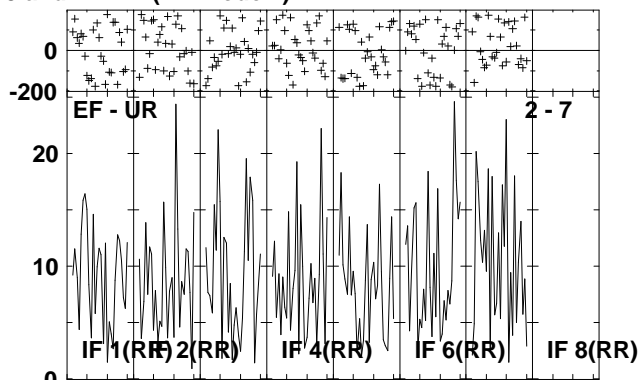
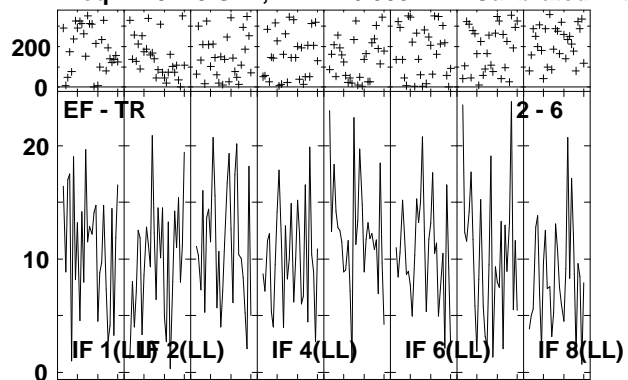

Lower frame: Milli Ampl Jy Top frame: Phas deg
Vector averaged cross-power spectrum Several baselines displayed
Timerange: 01/01:02:01 to 01/01:05:29

Plot file version 153 created 13-OCT-2010 18:44:26
 J2001+10 EP064N.UVDATA.1
 Freq = 4.9270 GHz, Bw = 16.000 MH Calibrated with CL # 3 and BP # 1 (BP mode 1)

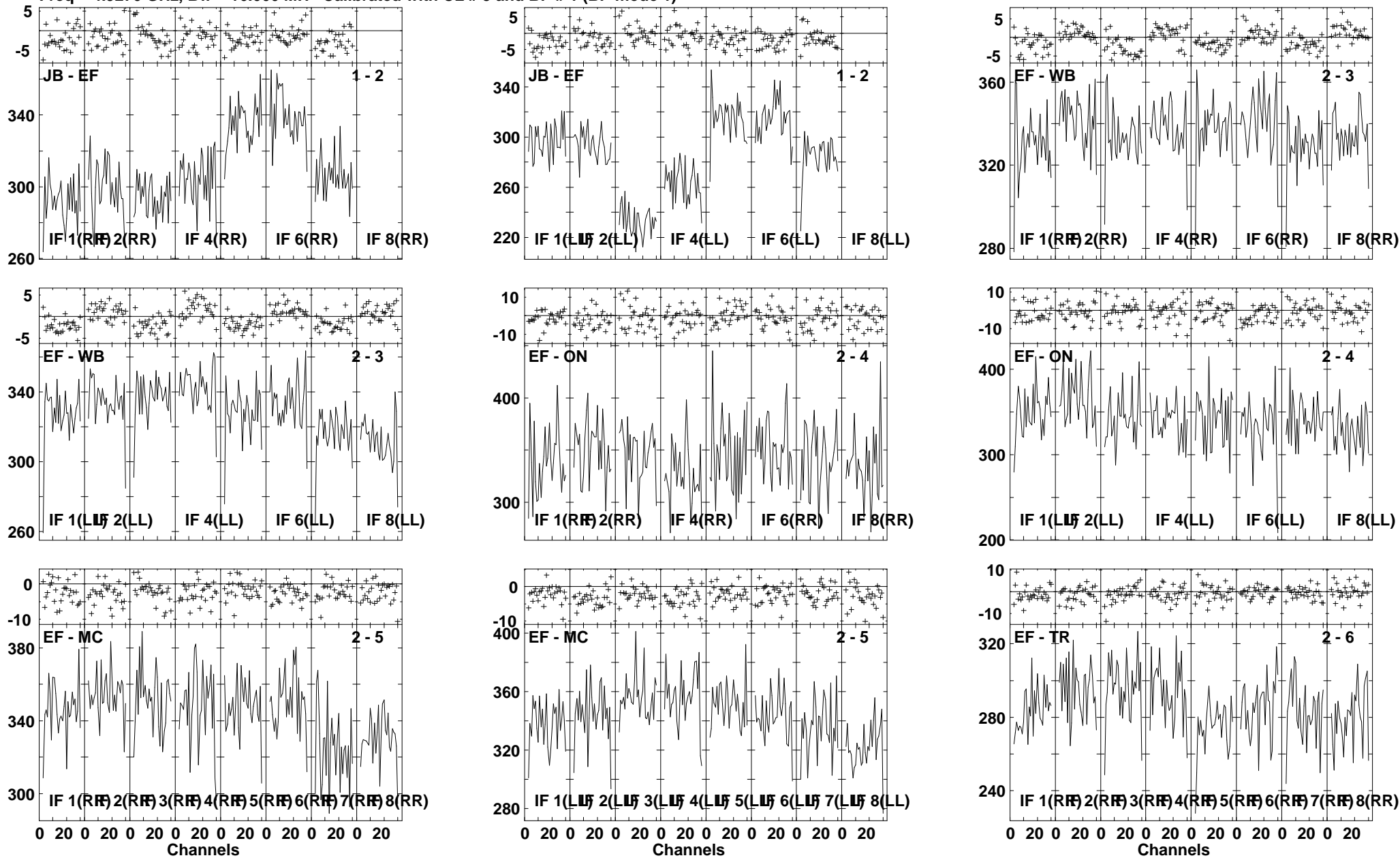

Lower frame: Milli Ampl Jy Top frame: Phas deg
 Vector averaged cross-power spectrum Several baselines displayed
 Timerange: 01/01:05:31 to 01/01:06:59

Plot file version 154 created 13-OCT-2010 18:44:28

J2001+10 EP064N.UVDATA.1

Freq = 4.9270 GHz, Bw = 16.000 MH Calibrated with CL # 3 and BP # 1 (BP mode 1)

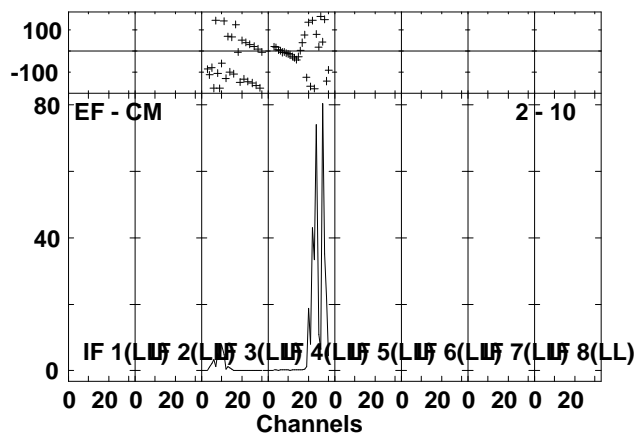
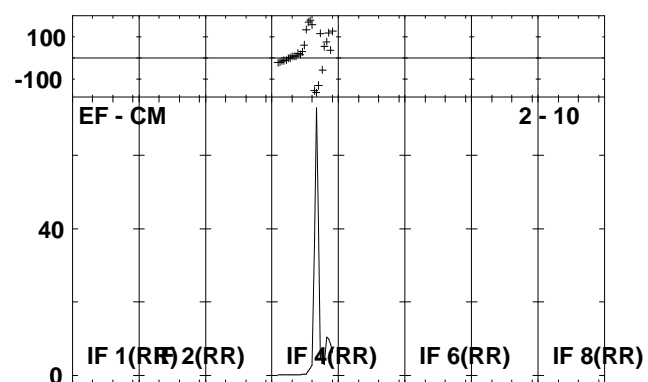
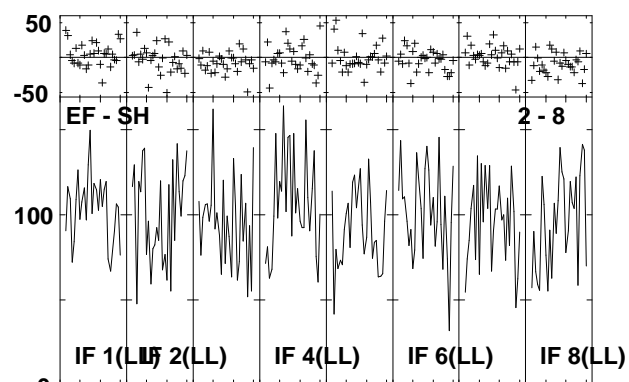
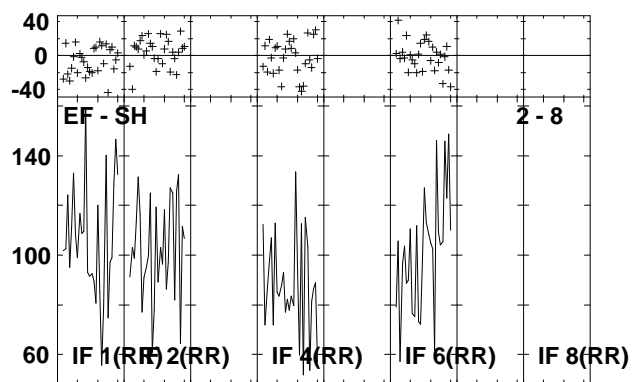
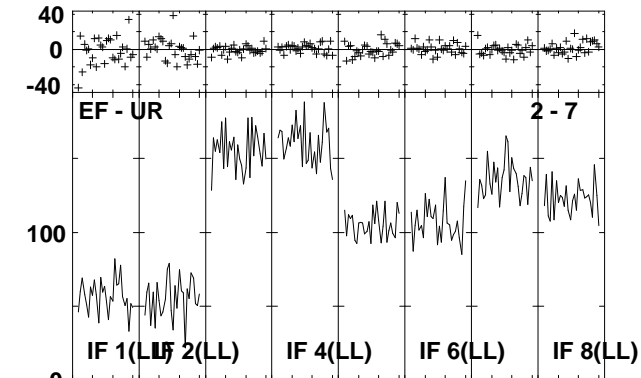
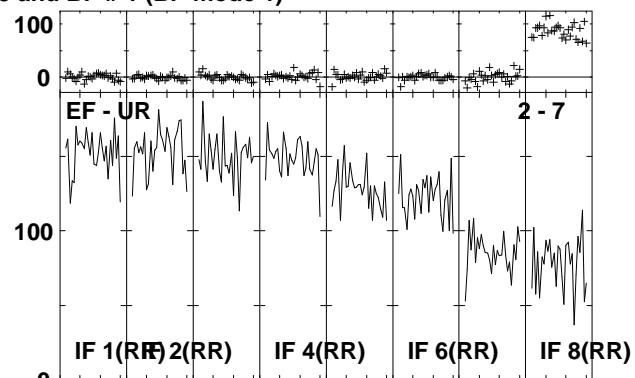
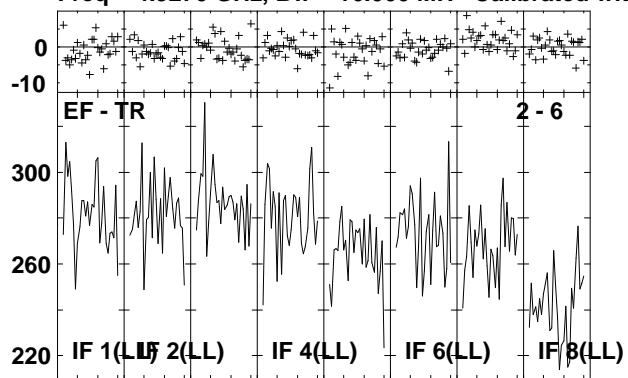

Lower frame: Milli Ampl Jy Top frame: Phas deg
Vector averaged cross-power spectrum Several baselines displayed
Timerange: 01/01:05:31 to 01/01:06:59

Plot file version 155 created 13-OCT-2010 18:44:30

IRAS1954 EP064N.UVDATA.1

Freq = 4.9270 GHz, Bw = 16.000 MH Calibrated with CL # 3 and BP # 1 (BP mode 1)

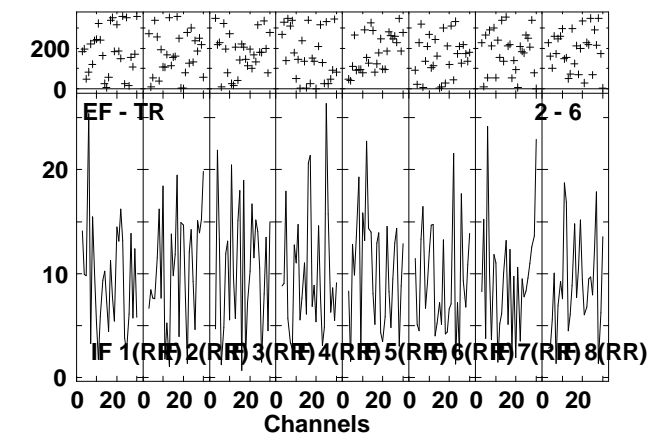
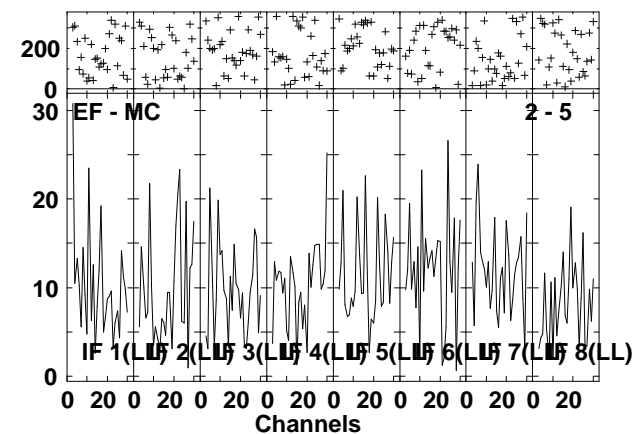
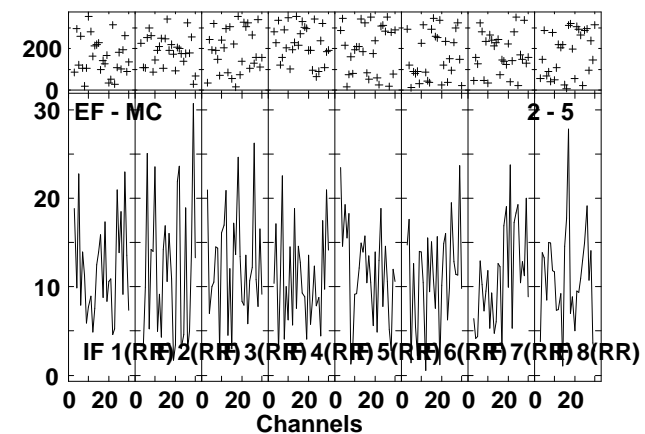
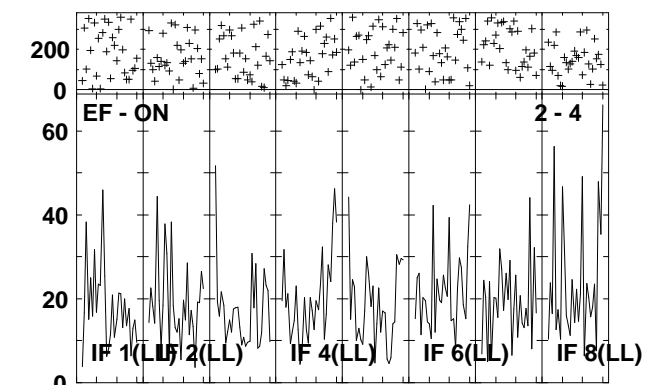
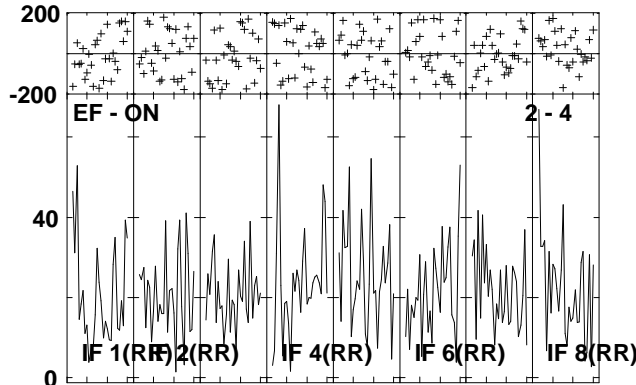
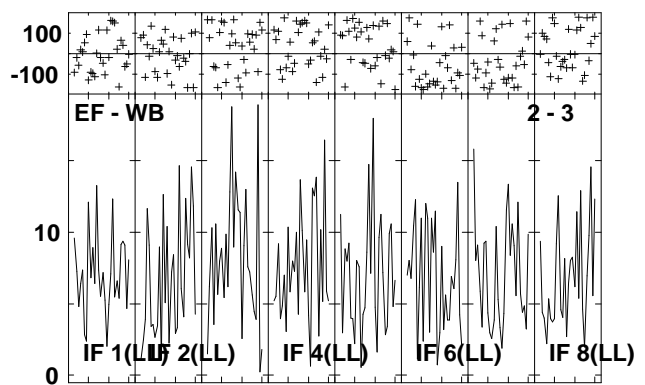
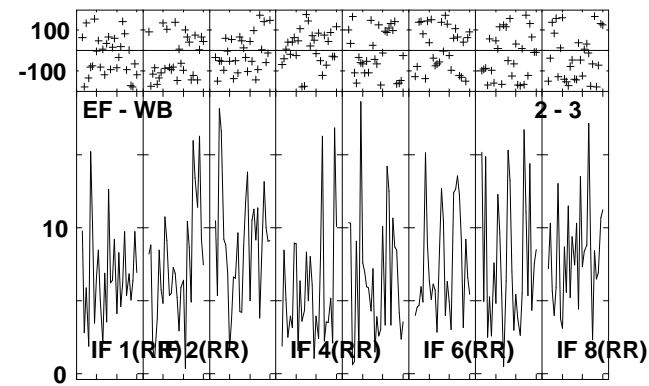
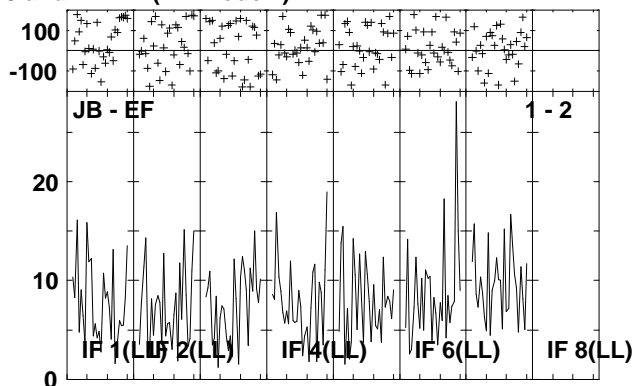
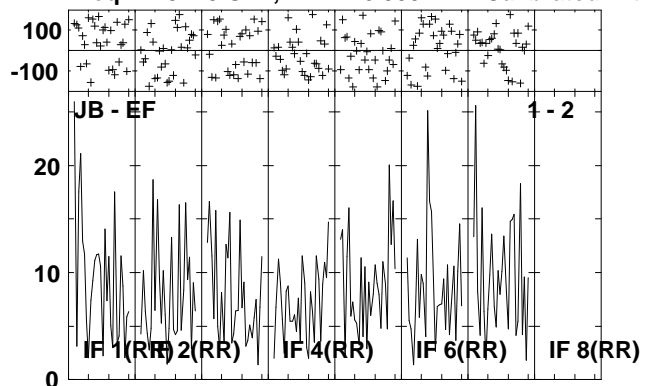

Lower frame: Milli Ampl Jy Top frame: Phas deg
Vector averaged cross-power spectrum Several baselines displayed
Timerange: 01/01:07:01 to 01/01:10:29

Plot file version 156 created 13-OCT-2010 18:44:33

IRAS1954 EP064N.UVDATA.1

Freq = 4.9270 GHz, Bw = 16.000 MH Calibrated with CL # 3 and BP # 1 (BP mode 1)

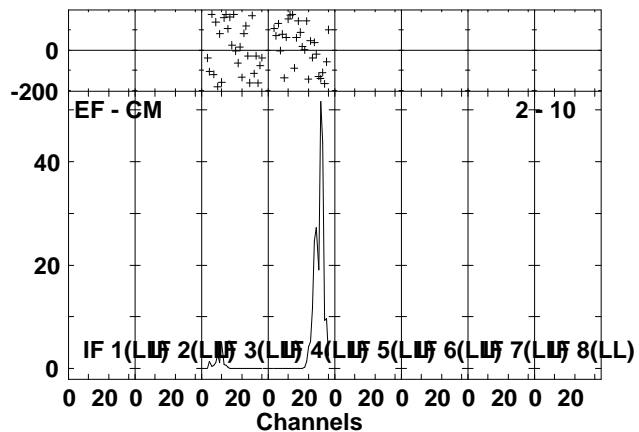
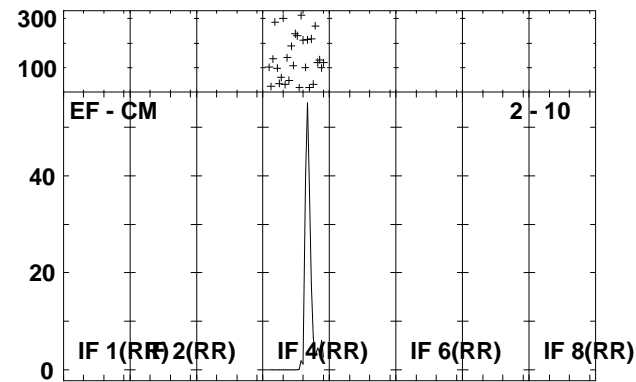
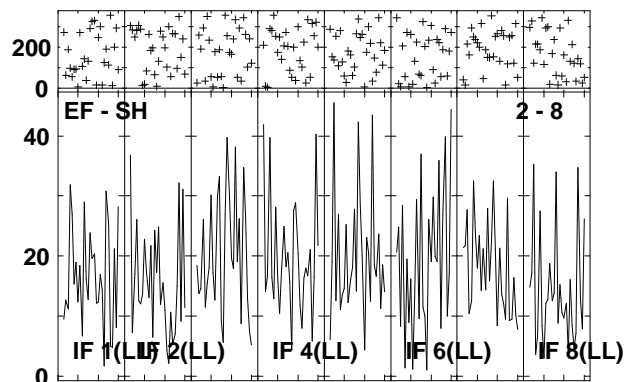
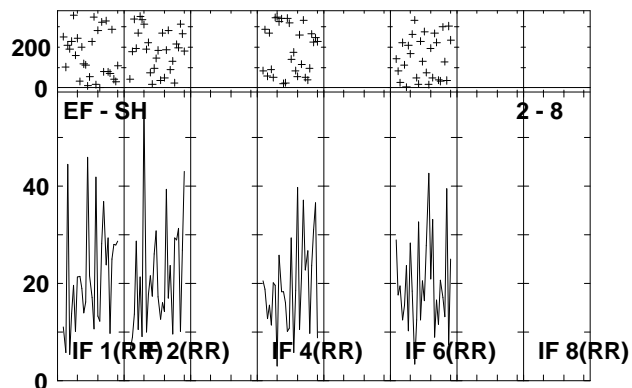
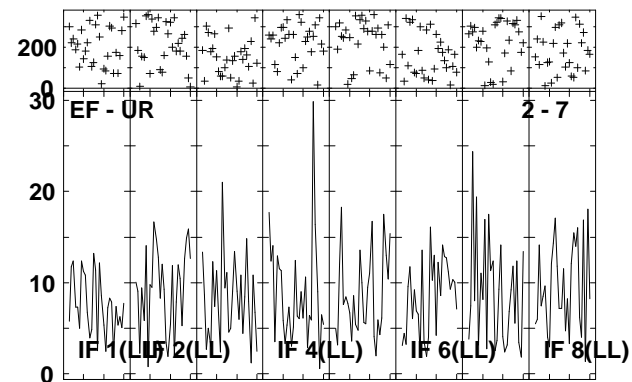
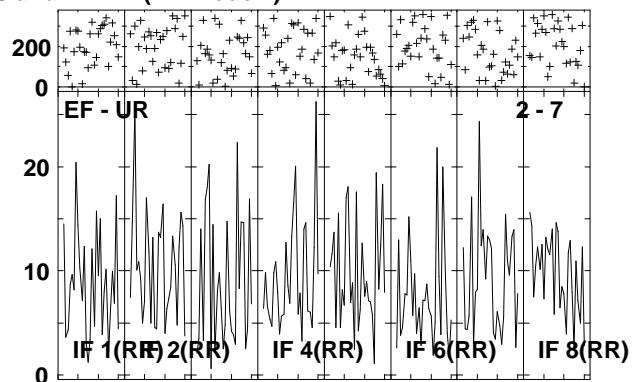
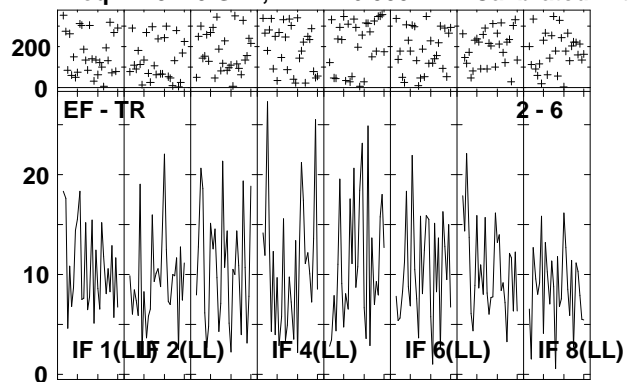

Lower frame: Milli Ampl Jy Top frame: Phas deg
Vector averaged cross-power spectrum Several baselines displayed
Timerange: 01/01:07:01 to 01/01:10:29

Plot file version 157 created 13-OCT-2010 18:44:38

J2001+10 EP064N.UVDATA.1

Freq = 4.9270 GHz, Bw = 16.000 MH Calibrated with CL # 3 and BP # 1 (BP mode 1)

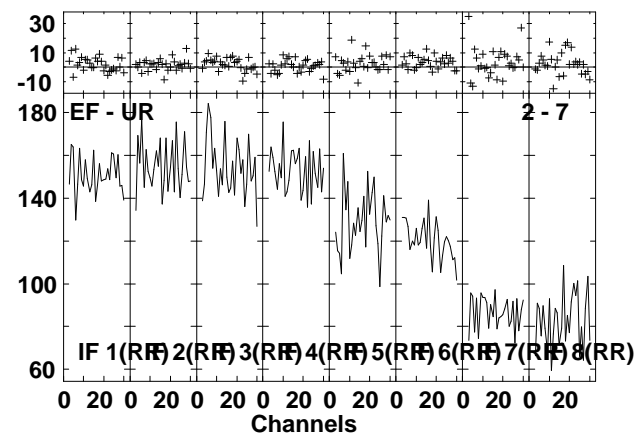
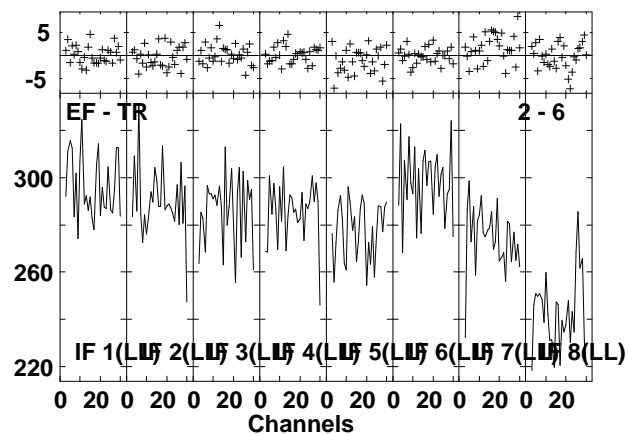
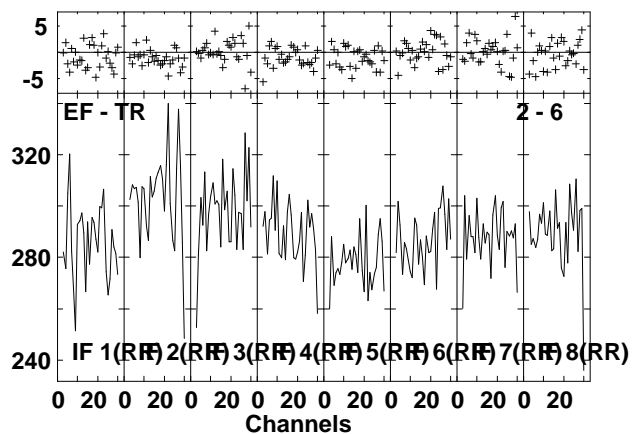
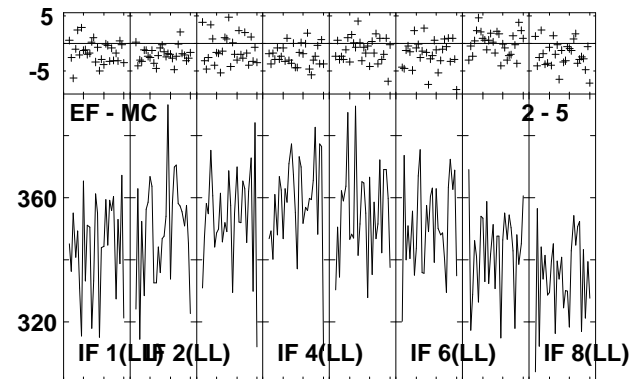
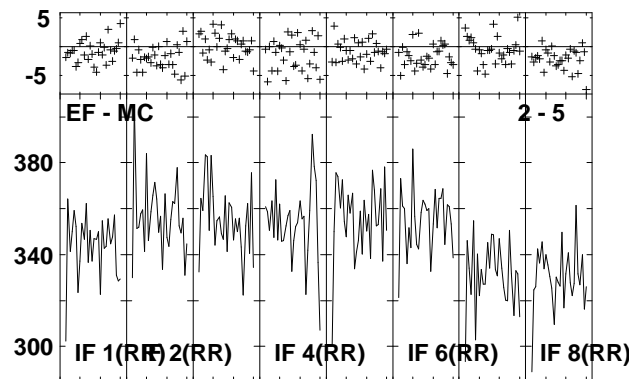
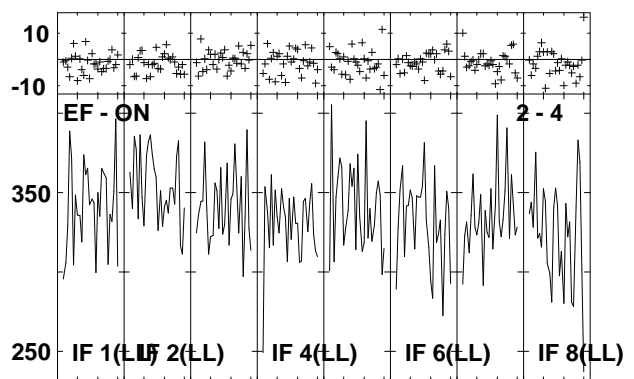
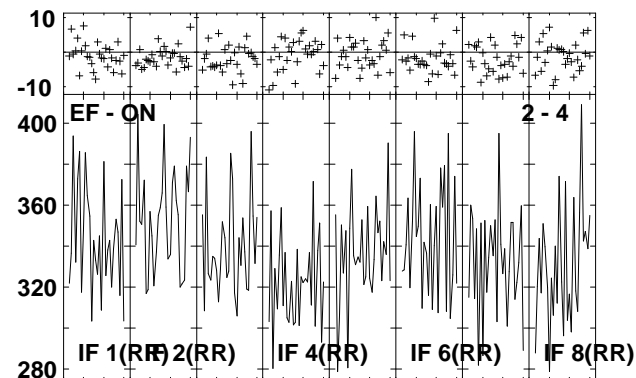
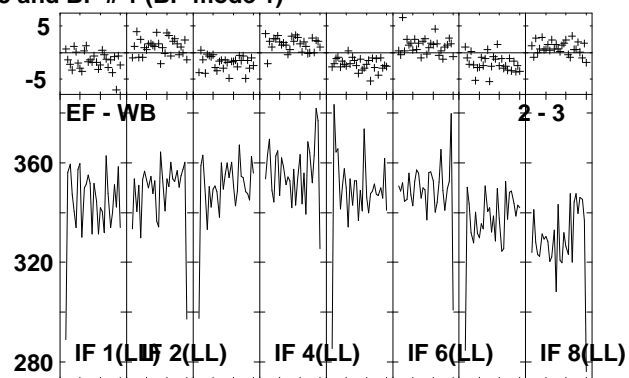
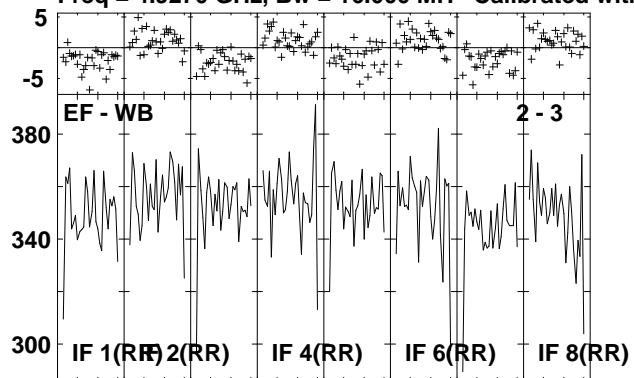

Lower frame: Milli Ampl Jy Top frame: Phas deg
Vector averaged cross-power spectrum Several baselines displayed
Timerange: 01/01:11:31 to 01/01:12:59

Plot file version 158 created 13-OCT-2010 18:44:39

J2001+10 EP064N.UVDATA.1

Freq = 4.9270 GHz, Bw = 16.000 MH Calibrated with CL # 3 and BP # 1 (BP mode 1)

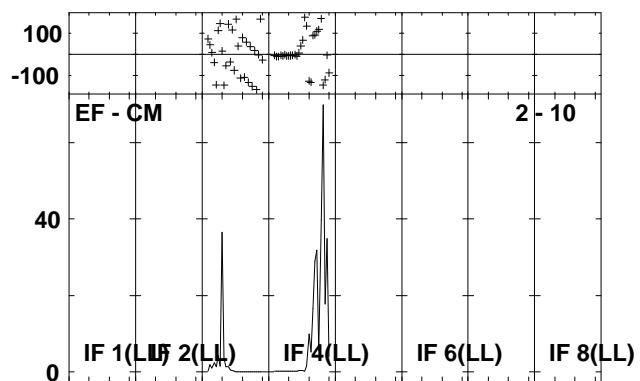
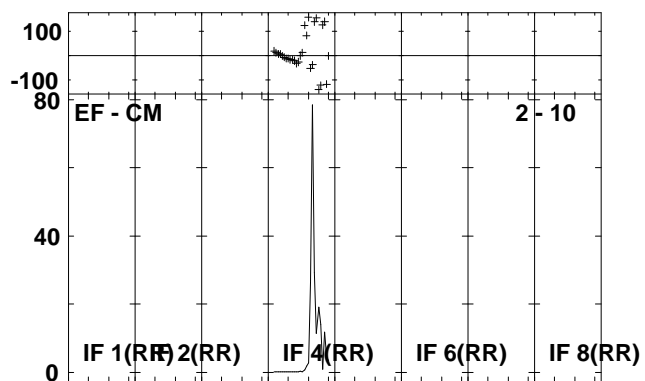
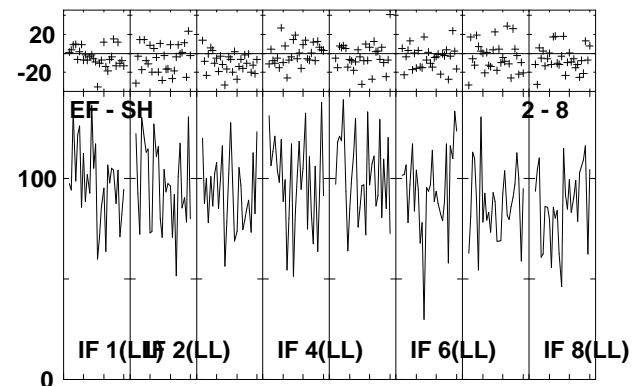
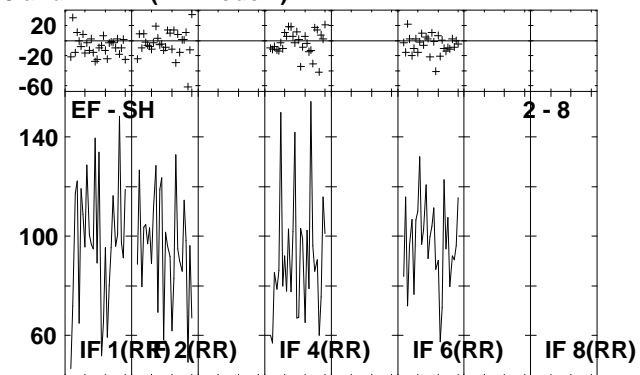
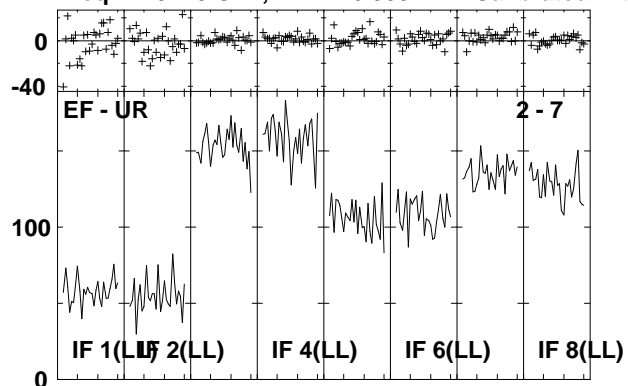

Lower frame: Milli Ampl Jy Top frame: Phas deg
Vector averaged cross-power spectrum Several baselines displayed
Timerange: 01/01:11:31 to 01/01:12:59

Plot file version 159 created 13-OCT-2010 18:44:41

IRAS1954 EP064N.UVDATA.1

Freq = 4.9270 GHz, Bw = 16.000 MH Calibrated with CL # 3 and BP # 1 (BP mode 1)

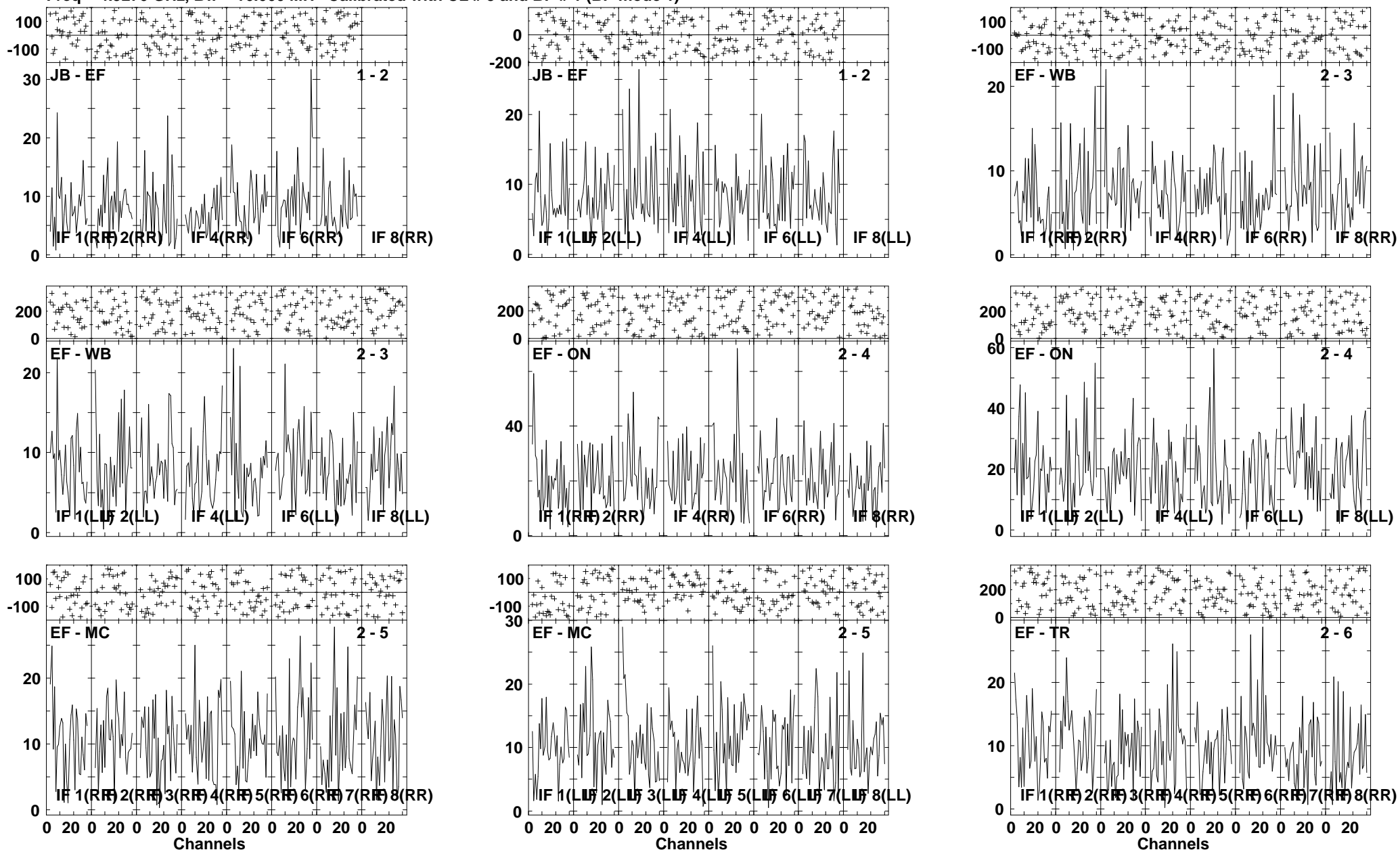

Lower frame: Milli Ampl Jy Top frame: Phas deg
Vector averaged cross-power spectrum Several baselines displayed
Timerange: 01/01:13:01 to 01/01:16:29

Plot file version 160 created 13-OCT-2010 18:44:44

IRAS1954 EP064N.UVDATA.1

Freq = 4.9270 GHz, Bw = 16.000 MH Calibrated with CL # 3 and BP # 1 (BP mode 1)

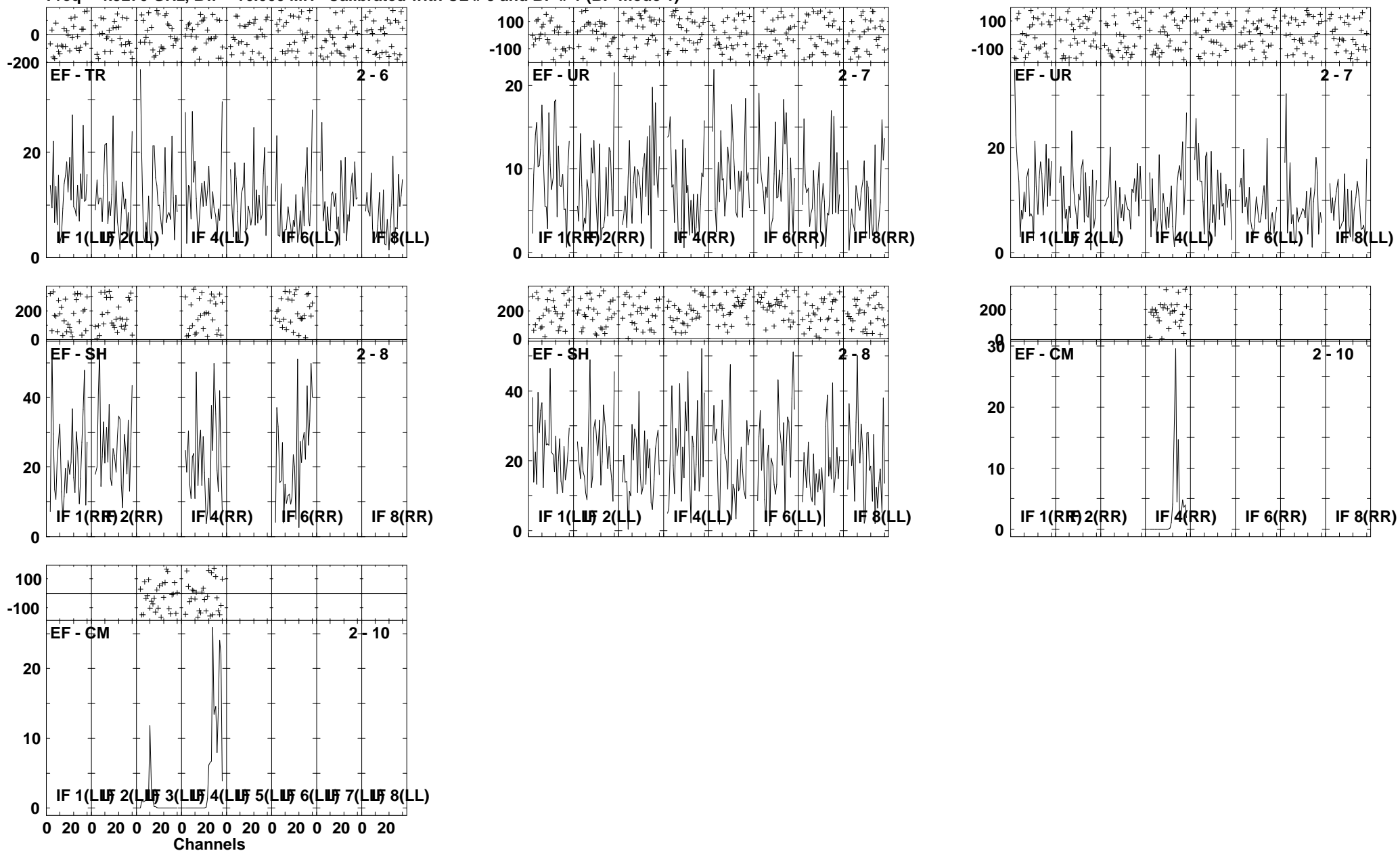

Lower frame: Milli Ampl Jy Top frame: Phas deg
Vector averaged cross-power spectrum Several baselines displayed
Timerange: 01/01:13:01 to 01/01:16:29

Plot file version 161 created 13-OCT-2010 18:44:49

J2001+10 EP064N.UVDATA.1

Freq = 4.9270 GHz, Bw = 16.000 MH Calibrated with CL # 3 and BP # 1 (BP mode 1)

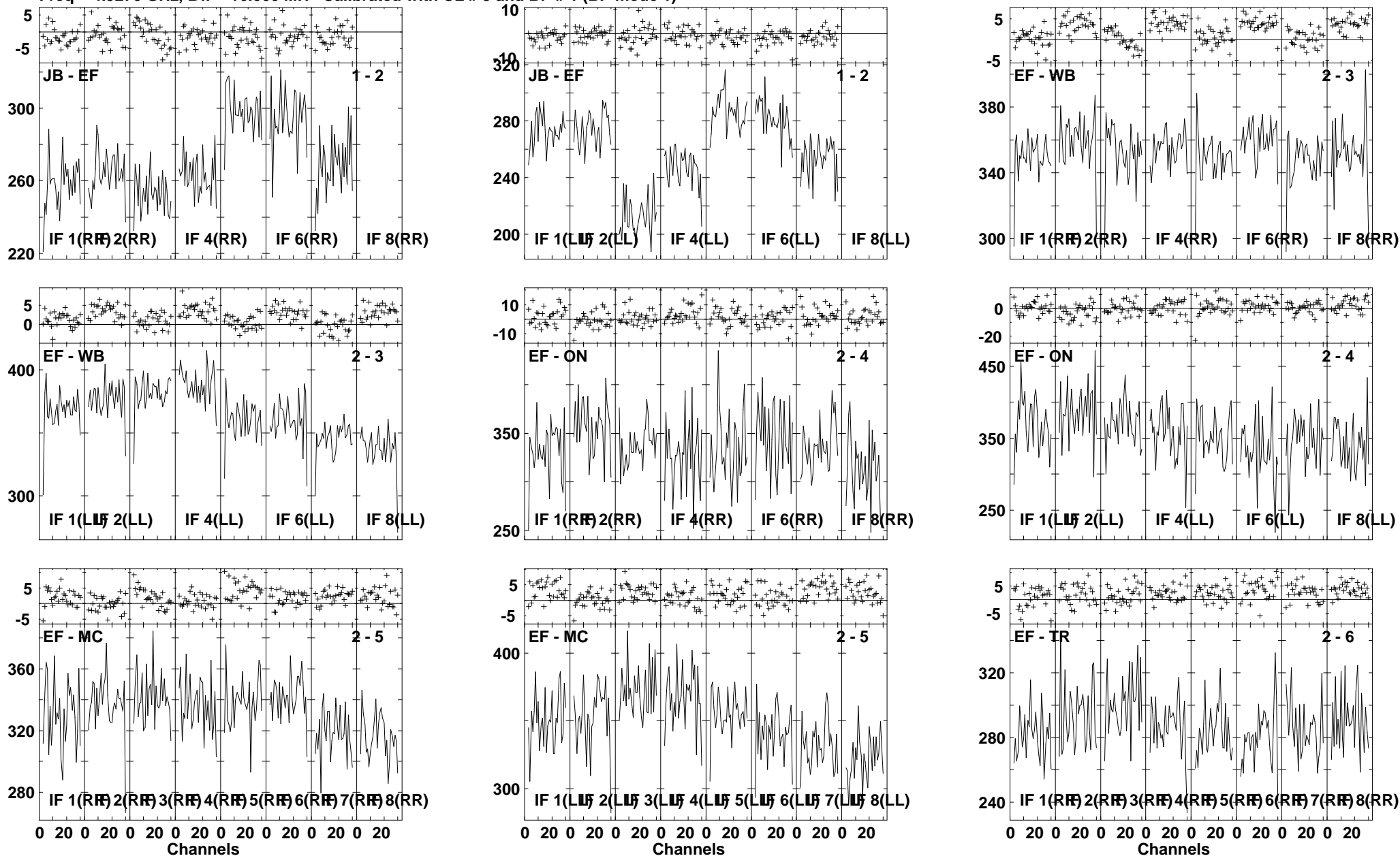

Lower frame: Milli Ampl Jy Top frame: Phas deg
Vector averaged cross-power spectrum Several baselines displayed
Timerange: 01/01:16:31 to 01/01:17:59

Plot file version 162 created 13-OCT-2010 18:44:50

J2001+10 EP064N.UVDATA.1

Freq = 4.9270 GHz, Bw = 16.000 MH Calibrated with CL # 3 and BP # 1 (BP mode 1)

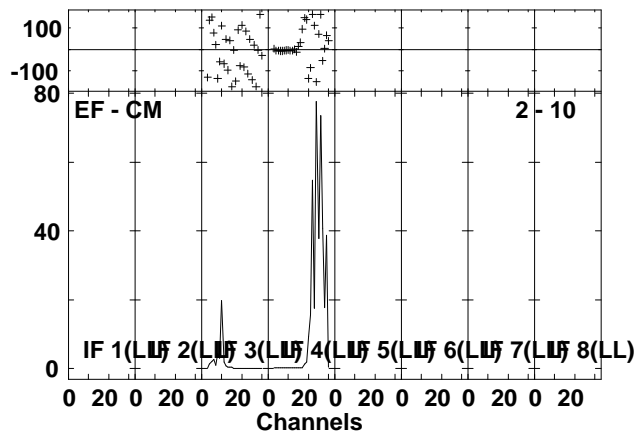
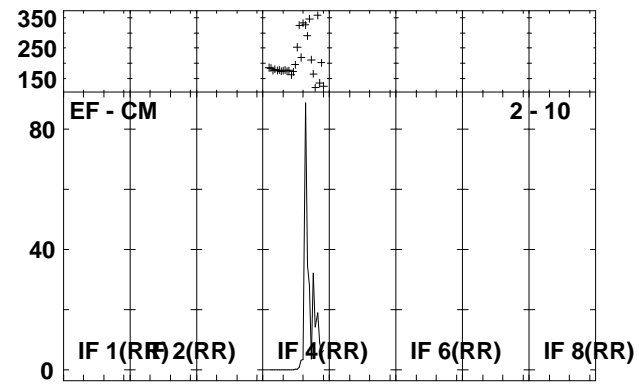
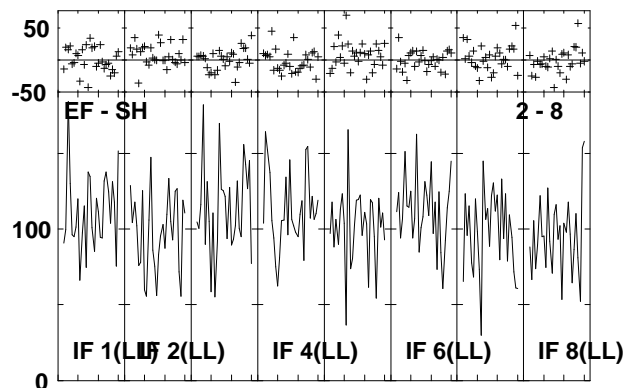
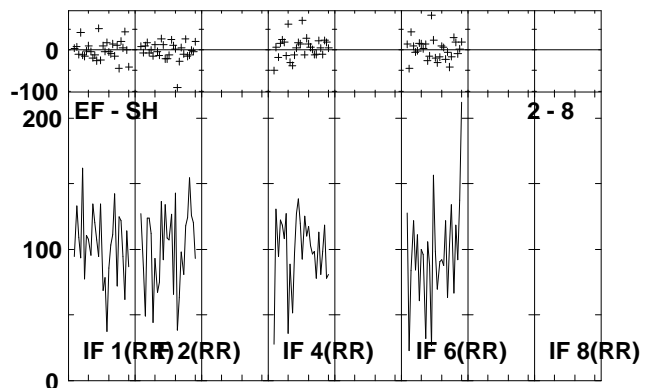
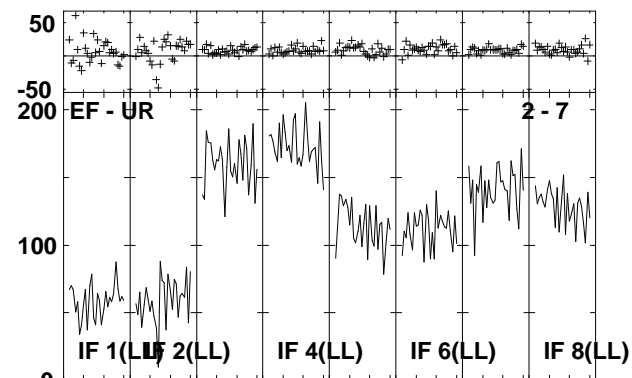
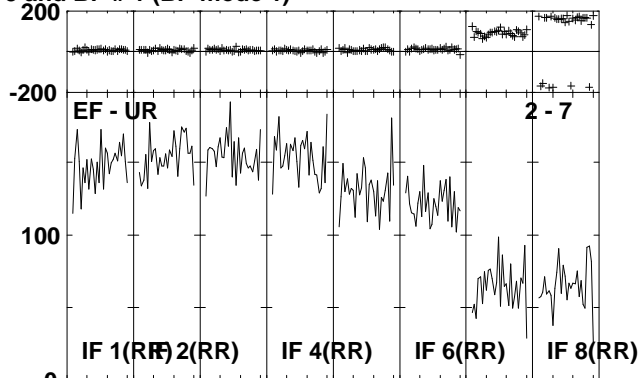
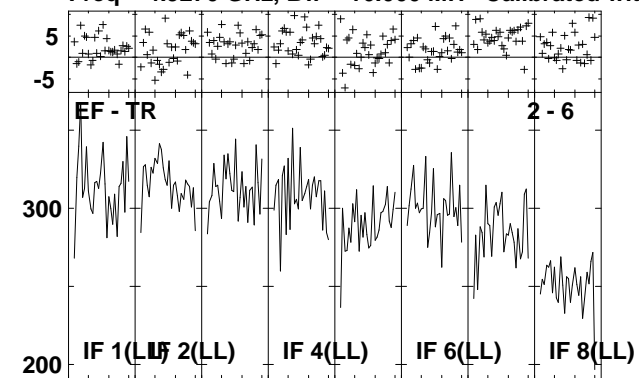

Lower frame: Milli Ampl Jy Top frame: Phas deg
Vector averaged cross-power spectrum Several baselines displayed
Timerange: 01/01:16:31 to 01/01:17:59

Plot file version 163 created 13-OCT-2010 18:44:53

IRAS1954 EP064N.UVDATA.1

Freq = 4.9270 GHz, Bw = 16.000 MH Calibrated with CL # 3 and BP # 1 (BP mode 1)

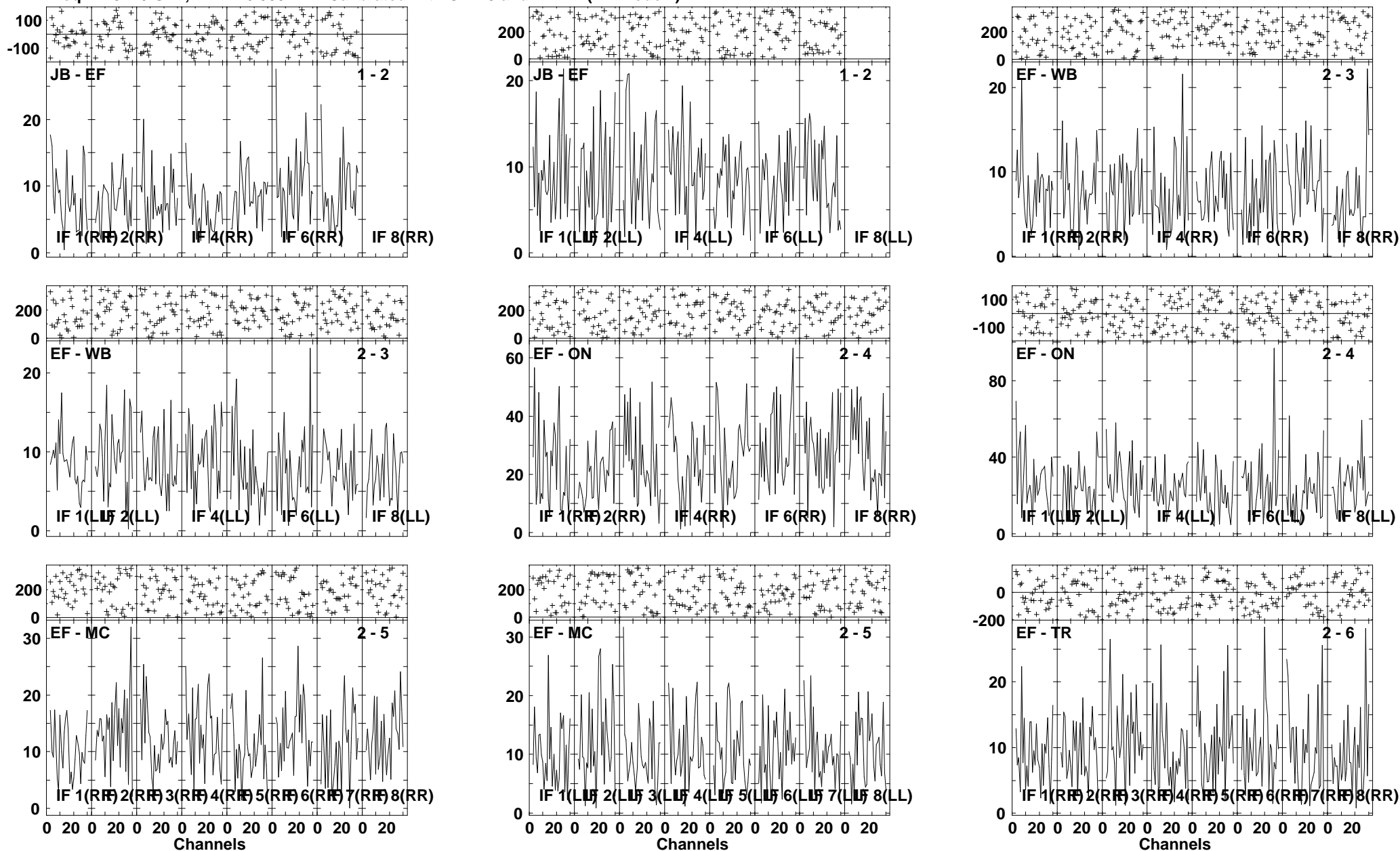

Lower frame: Milli Ampl Jy Top frame: Phas deg
Vector averaged cross-power spectrum Several baselines displayed
Timerange: 01/01:18:01 to 01/01:21:29

Plot file version 164 created 13-OCT-2010 18:44:56

IRAS1954 EP064N.UVDATA.1

Freq = 4.9270 GHz, Bw = 16.000 MH Calibrated with CL # 3 and BP # 1 (BP mode 1)

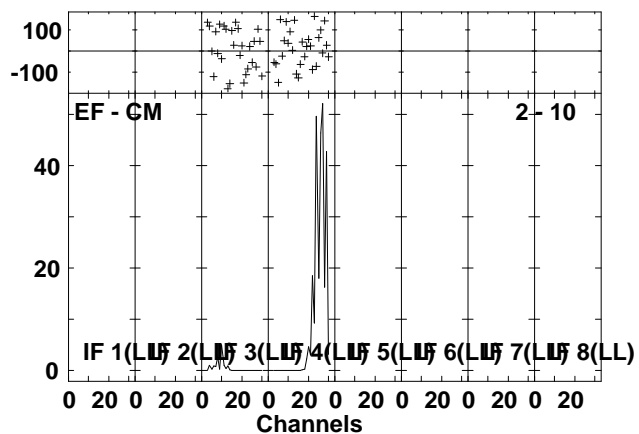
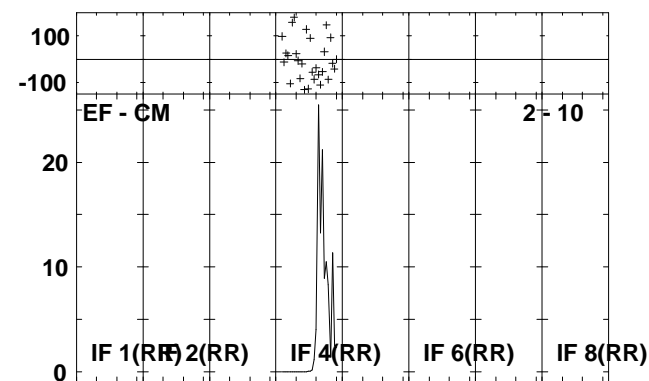
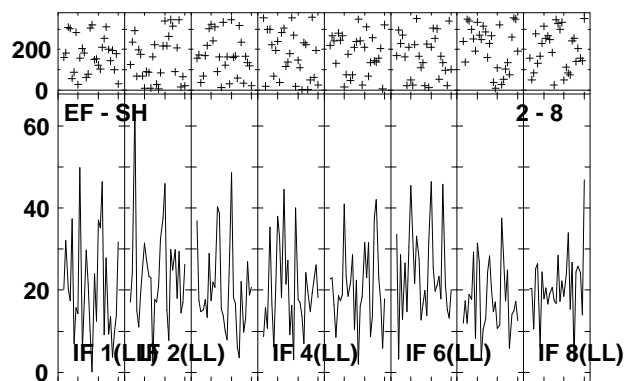
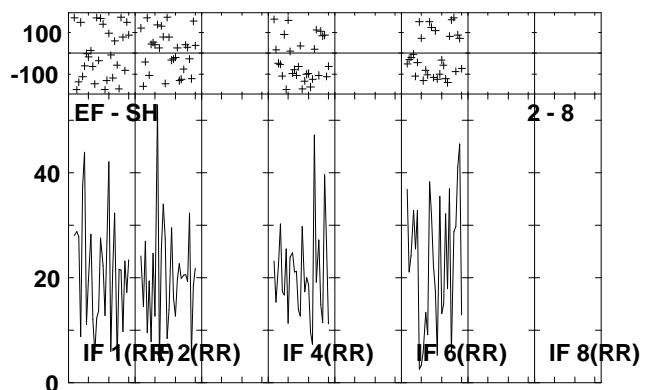
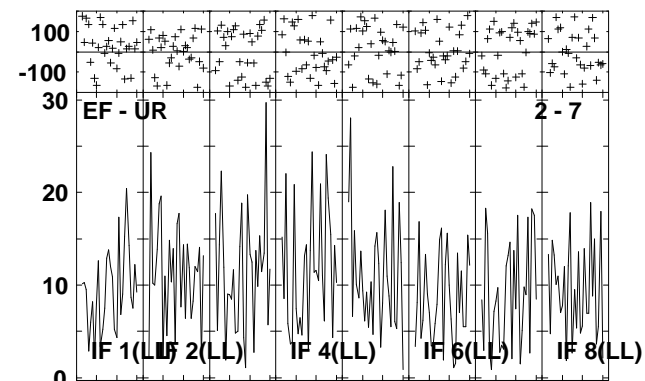
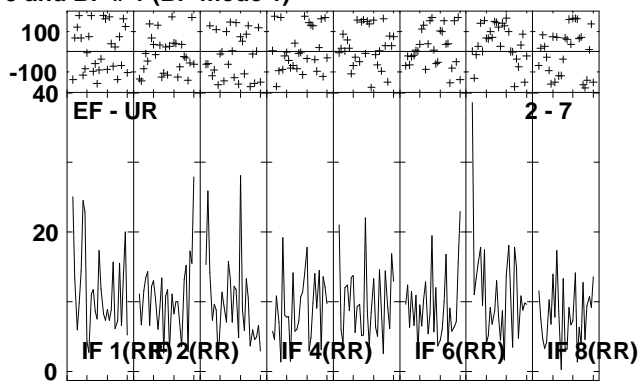
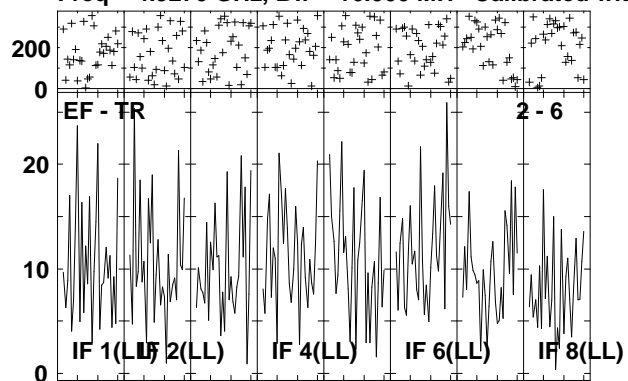

Lower frame: Milli Ampl Jy Top frame: Phas deg
Vector averaged cross-power spectrum Several baselines displayed
Timerange: 01/01:18:01 to 01/01:21:29

Plot file version 165 created 13-OCT-2010 18:45:00

J2001+10 EP064N.UVDATA.1

Freq = 4.9270 GHz, Bw = 16.000 MH Calibrated with CL # 3 and BP # 1 (BP mode 1)

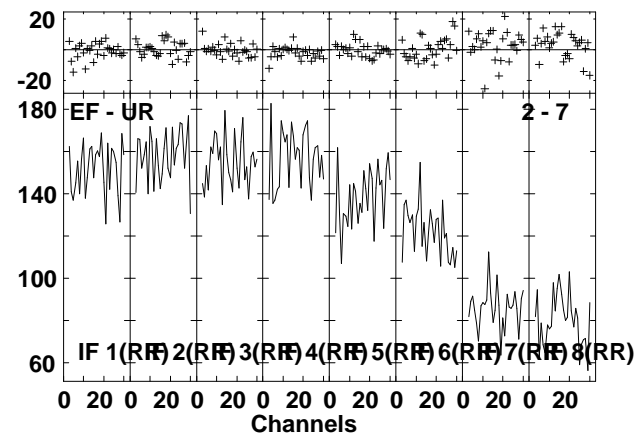
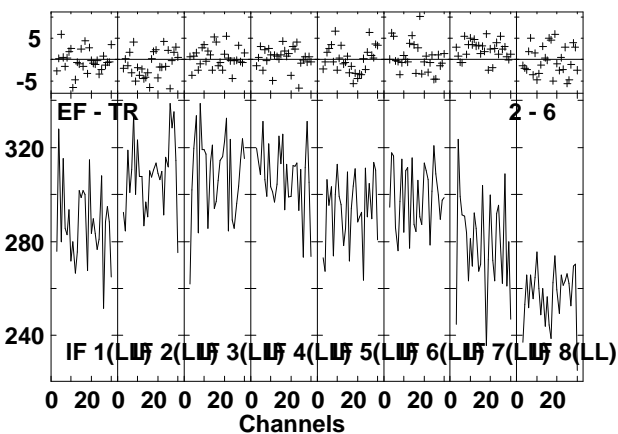
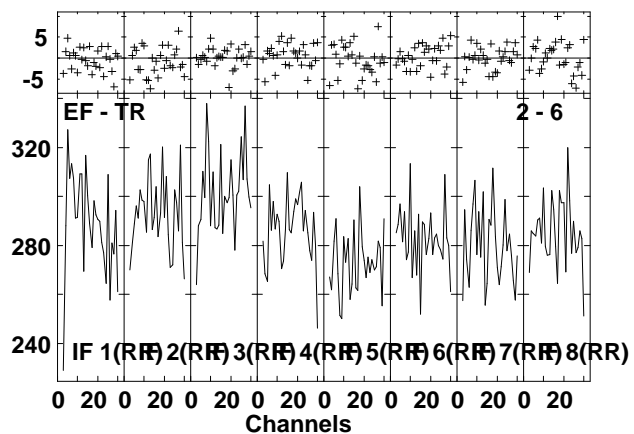
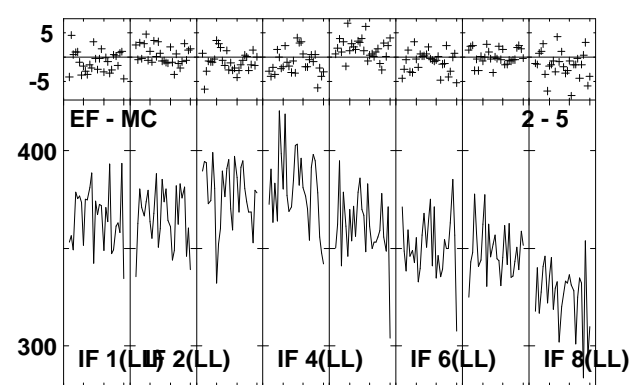
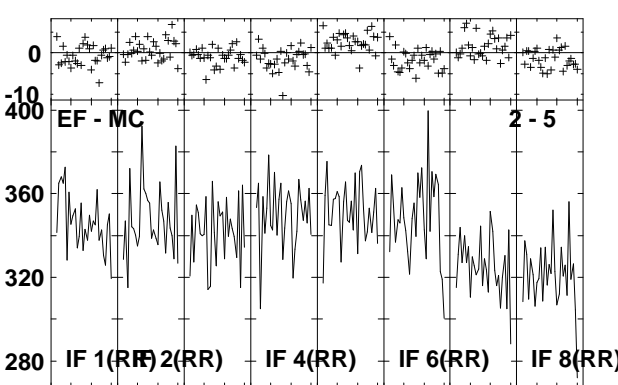
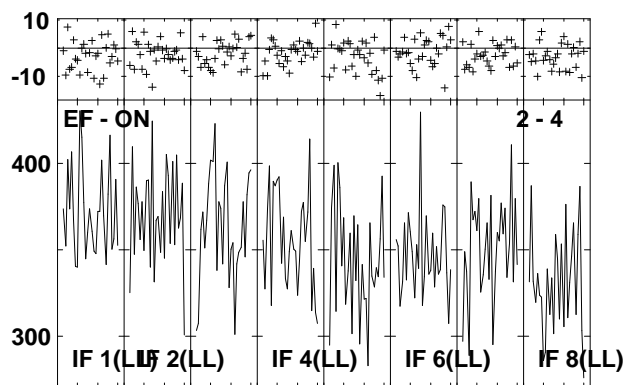
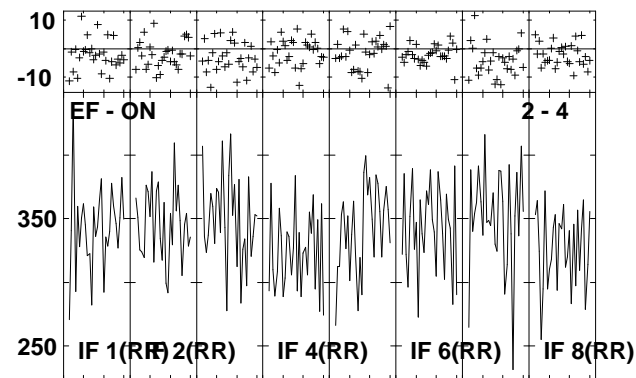
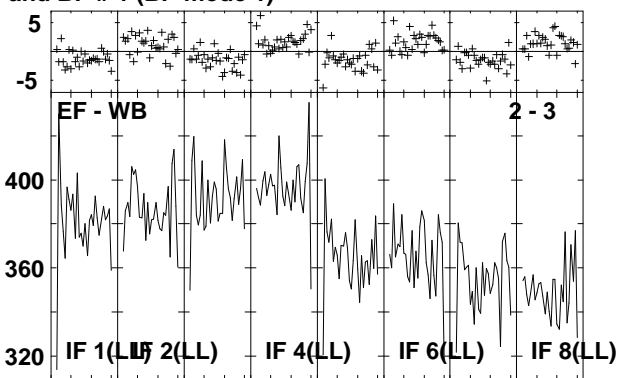
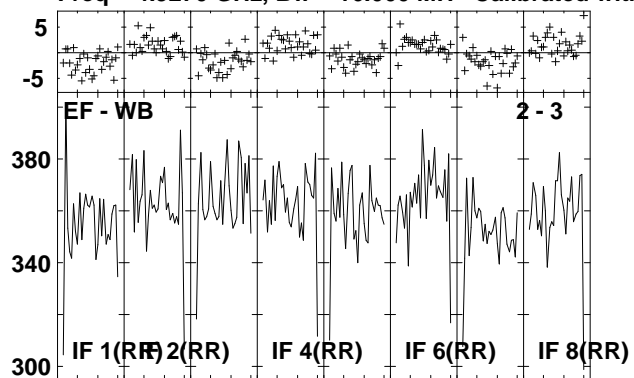

Lower frame: Milli Ampl Jy Top frame: Phas deg
Vector averaged cross-power spectrum Several baselines displayed
Timerange: 01/01:21:31 to 01/01:22:59

Plot file version 166 created 13-OCT-2010 18:45:02

J2001+10 EP064N.UVDATA.1

Freq = 4.9270 GHz, Bw = 16.000 MH Calibrated with CL # 3 and BP # 1 (BP mode 1)

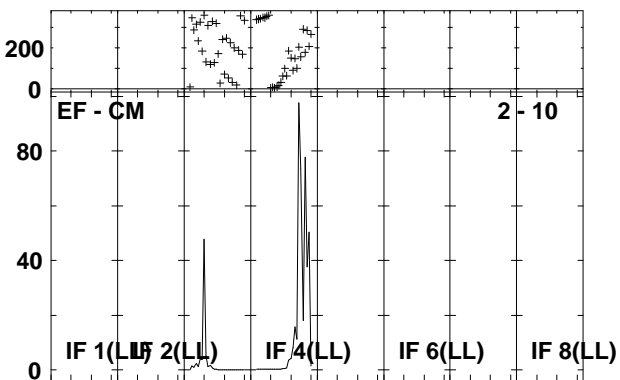
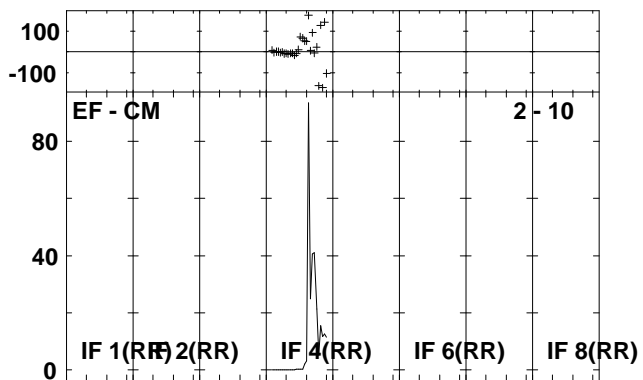
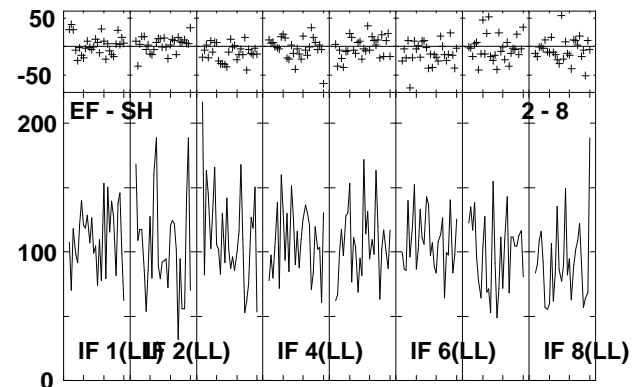
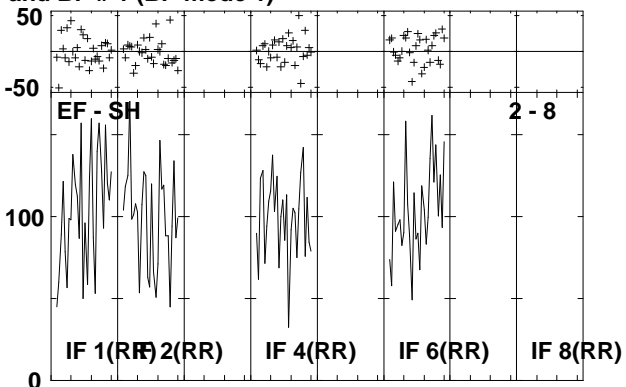
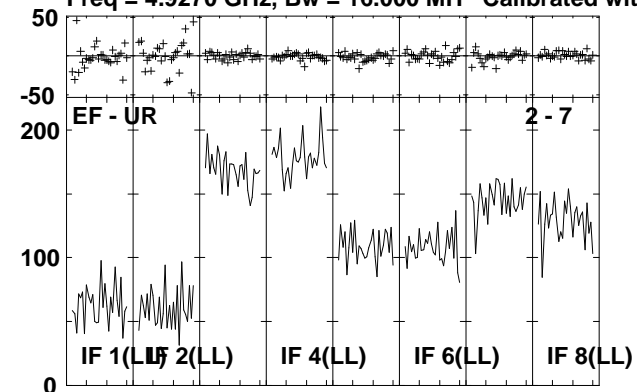

Lower frame: Milli Ampl Jy Top frame: Phas deg
Vector averaged cross-power spectrum Several baselines displayed
Timerange: 01/01:21:31 to 01/01:22:59

Plot file version 167 created 13-OCT-2010 18:45:04

IRAS1954 EP064N.UVDATA.1

Freq = 4.9270 GHz, Bw = 16.000 MH Calibrated with CL # 3 and BP # 1 (BP mode 1)

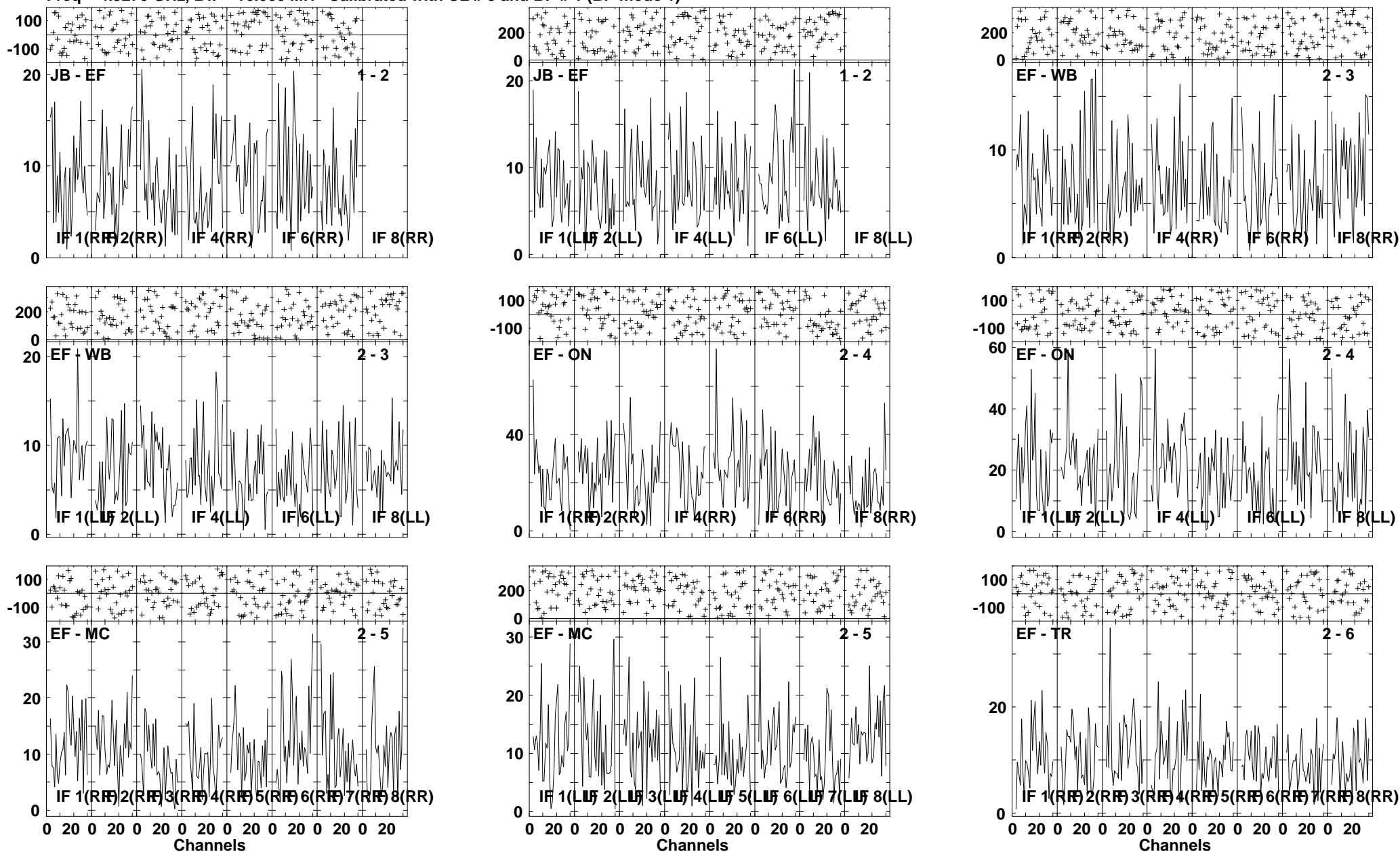

Lower frame: Milli Ampl Jy Top frame: Phas deg
Vector averaged cross-power spectrum Several baselines displayed
Timerange: 01/01:23:01 to 01/01:26:29

Plot file version 168 created 13-OCT-2010 18:45:07

IRAS1954 EP064N.UVDATA.1

Freq = 4.9270 GHz, Bw = 16.000 MH Calibrated with CL # 3 and BP # 1 (BP mode 1)

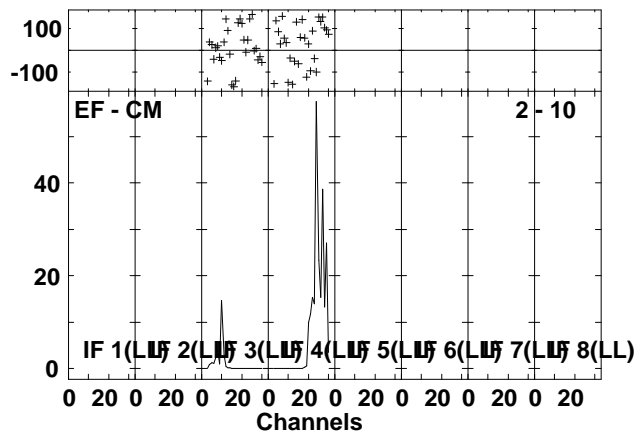
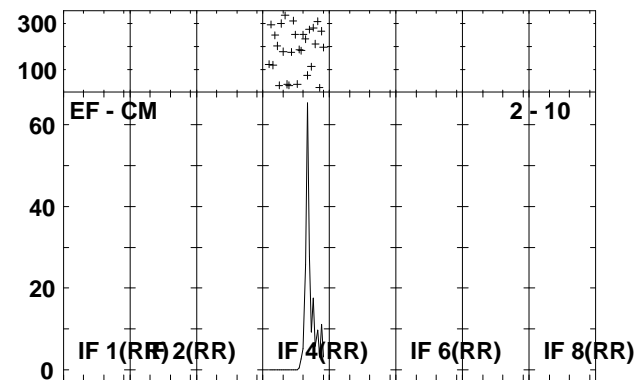
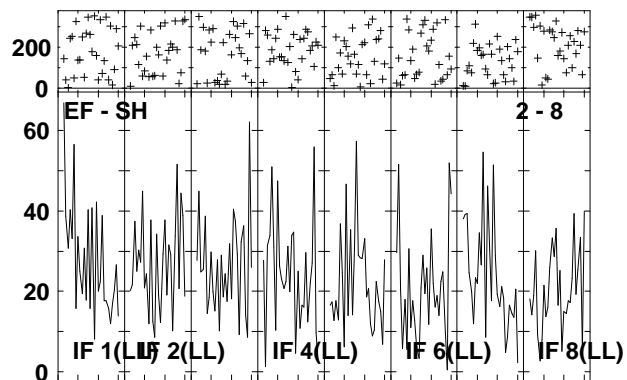
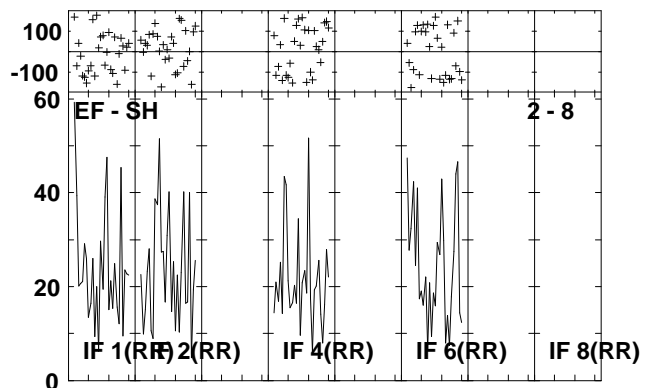
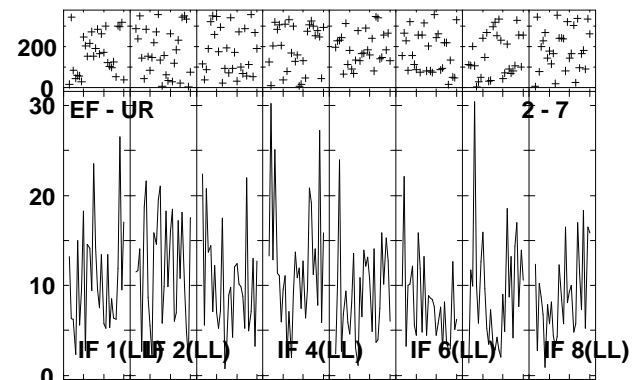
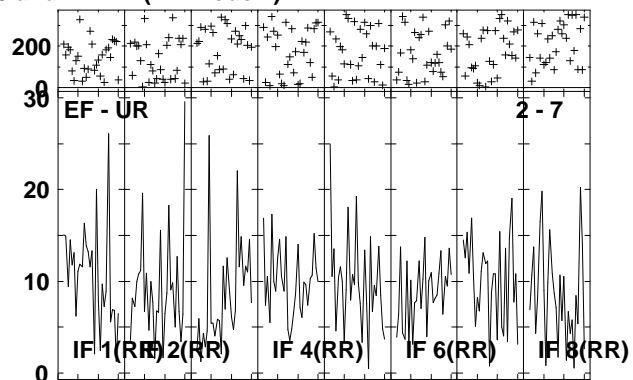
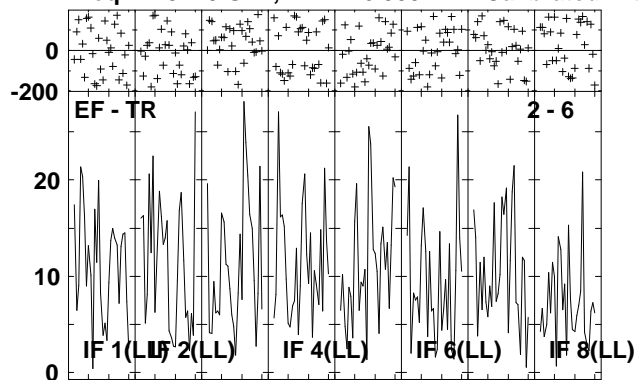

Lower frame: Milli Ampl Jy Top frame: Phas deg
Vector averaged cross-power spectrum Several baselines displayed
Timerange: 01/01:23:01 to 01/01:26:29

Plot file version 169 created 13-OCT-2010 18:45:12

2134+004 EP064N.UVDATA.1

Freq = 4.9270 GHz, Bw = 16.000 MH Calibrated with CL # 3 and BP # 1 (BP mode 1)

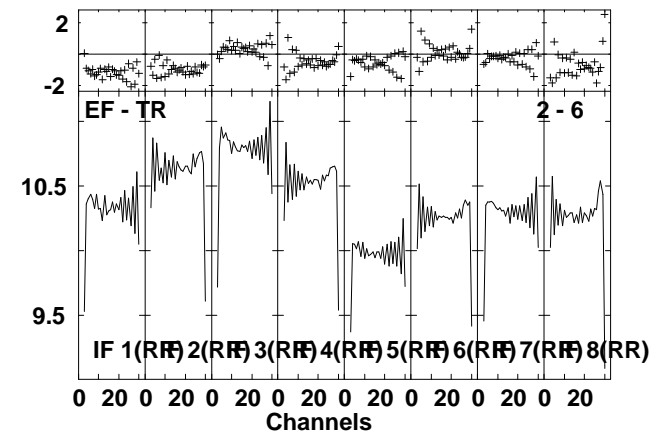
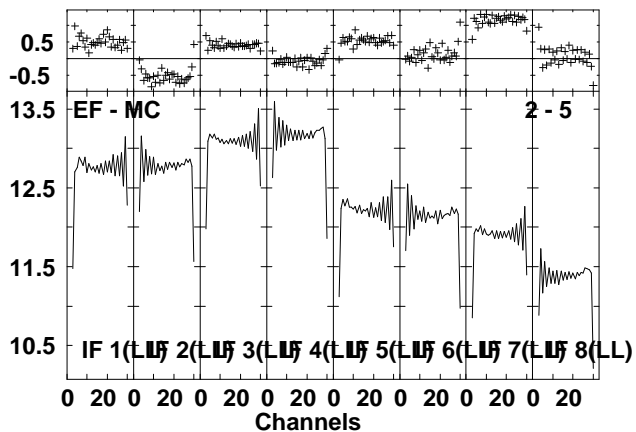
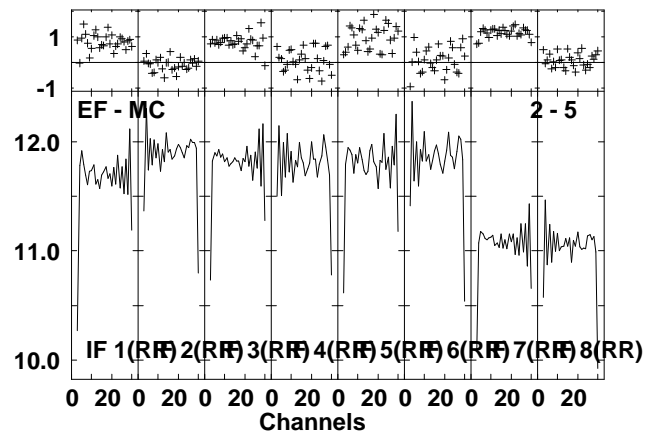
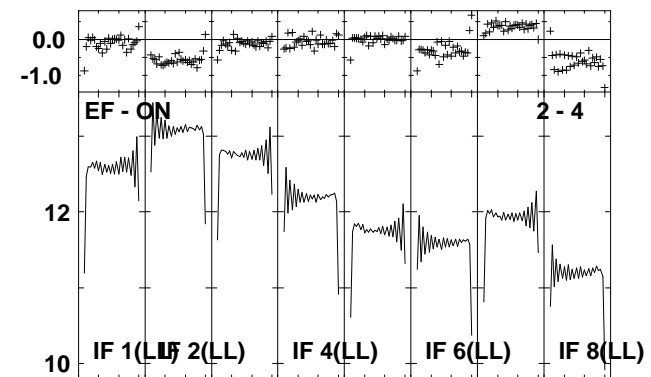
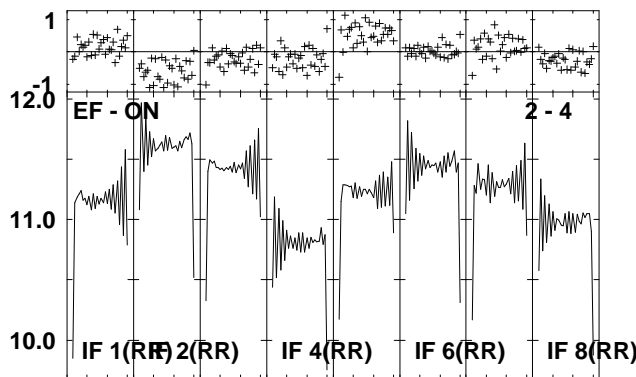
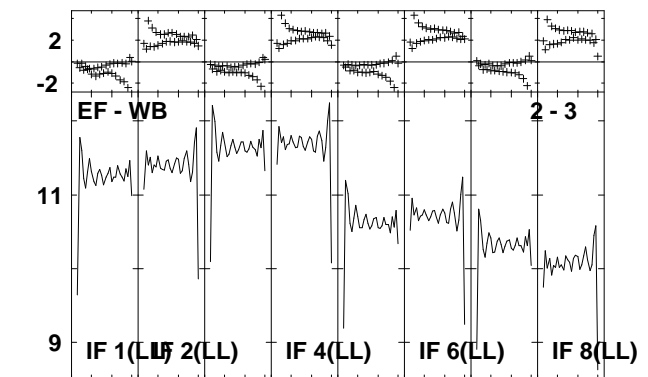
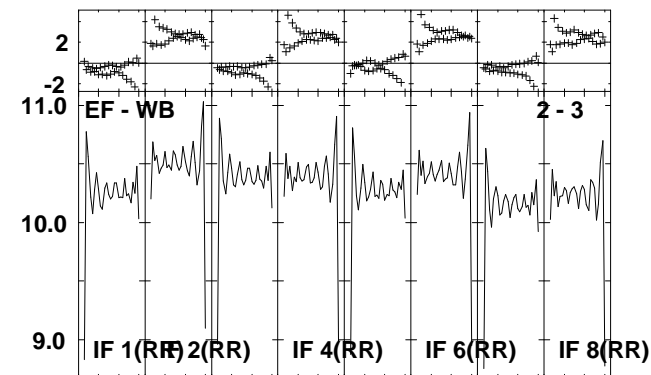
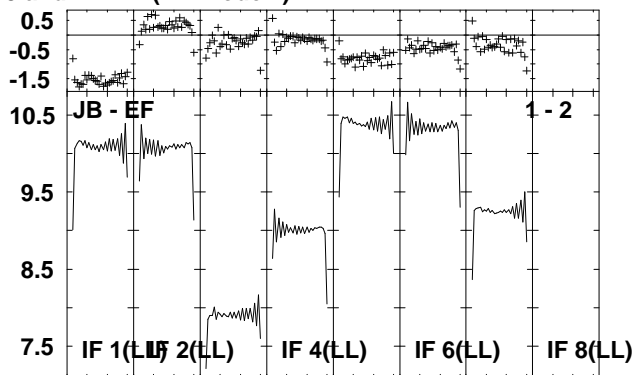
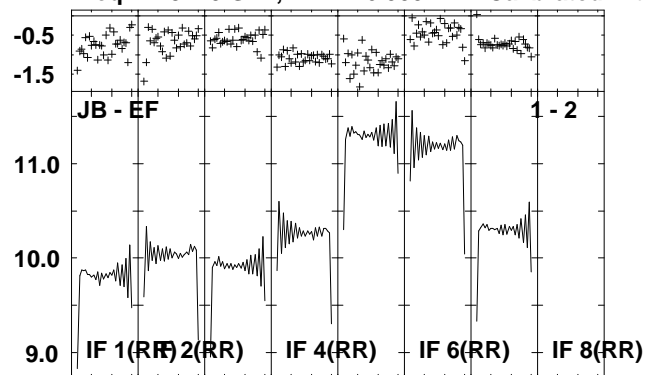

Lower frame: Ampl Jy Top frame: Phas deg
Vector averaged cross-power spectrum Several baselines displayed
Timerange: 01/01:28:31 to 01/01:34:29

Plot file version 170 created 13-OCT-2010 18:45:18

2134+004 EP064N.UVDATA.1

Freq = 4.9270 GHz, Bw = 16.000 MH Calibrated with CL # 3 and BP # 1 (BP mode 1)

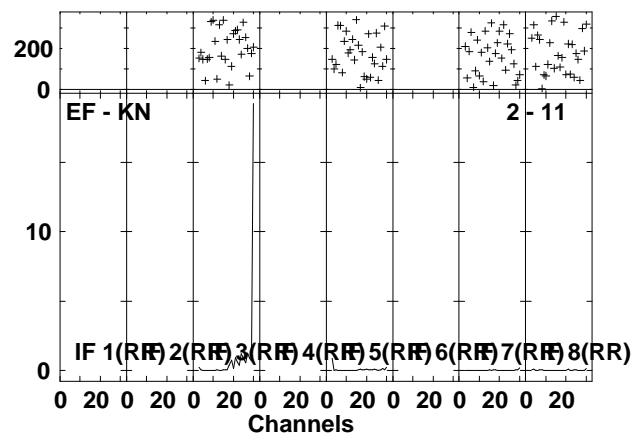
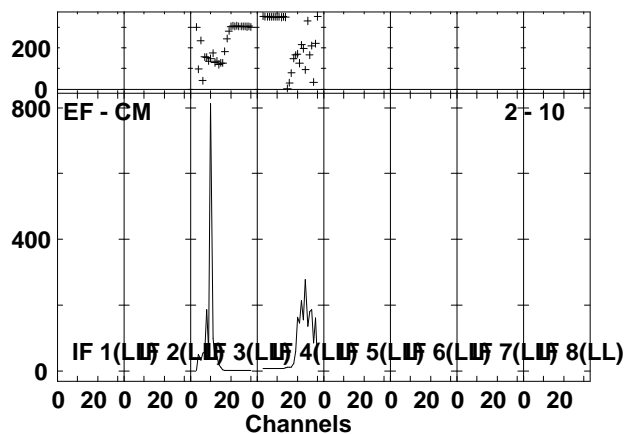
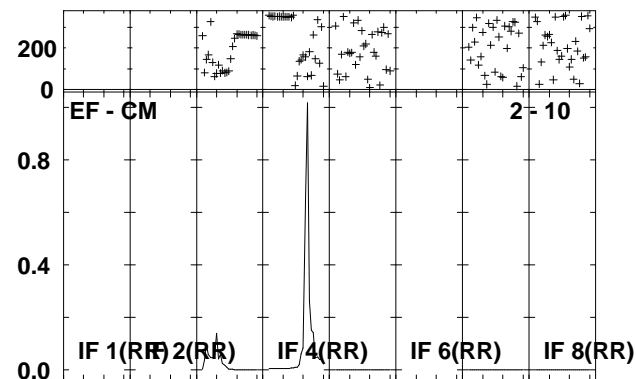
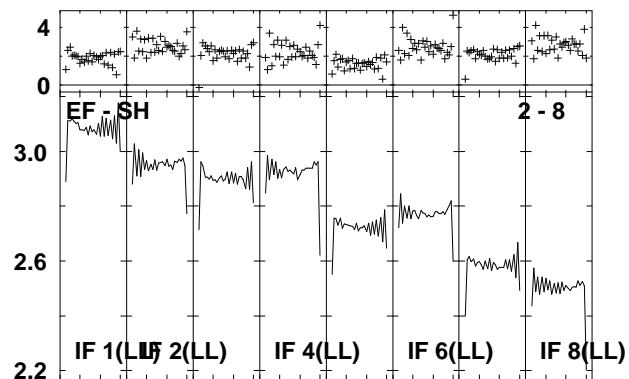
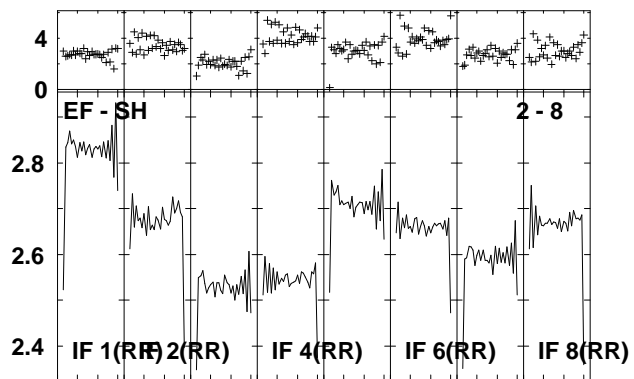
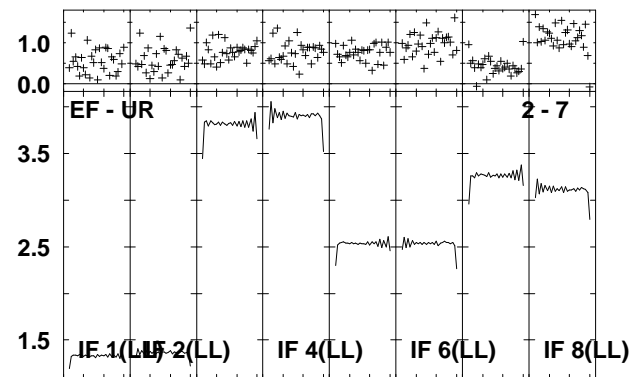
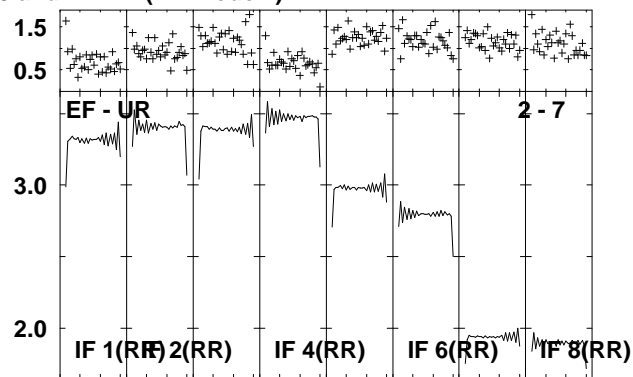
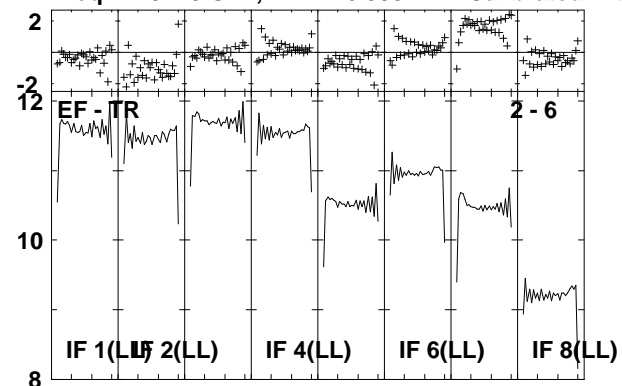

Lower frame: Ampl Jy Top frame: Phas deg
Vector averaged cross-power spectrum Several baselines displayed
Timerange: 01/01:28:31 to 01/01:34:29

Plot file version 171 created 13-OCT-2010 18:45:26

J2001+10 EP064N.UVDATA.1

Freq = 4.9270 GHz, Bw = 16.000 MH Calibrated with CL # 3 and BP # 1 (BP mode 1)

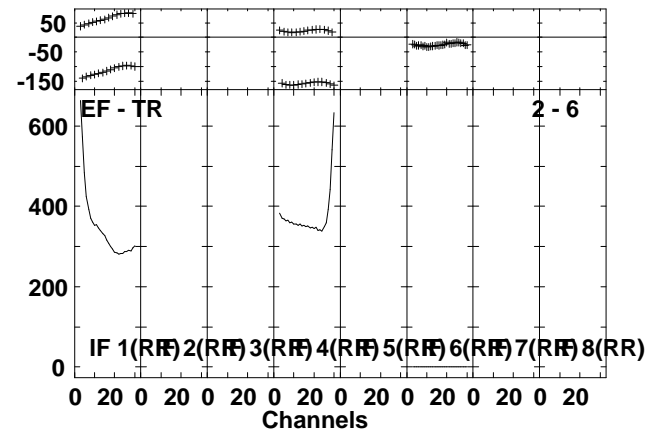
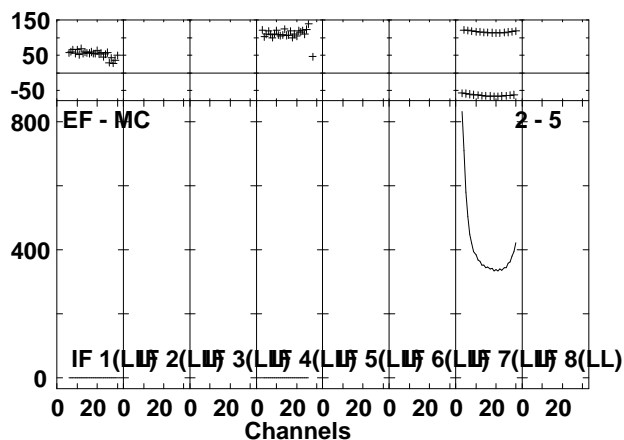
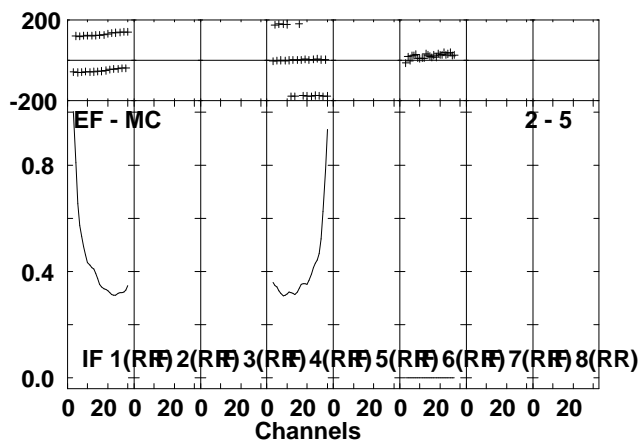
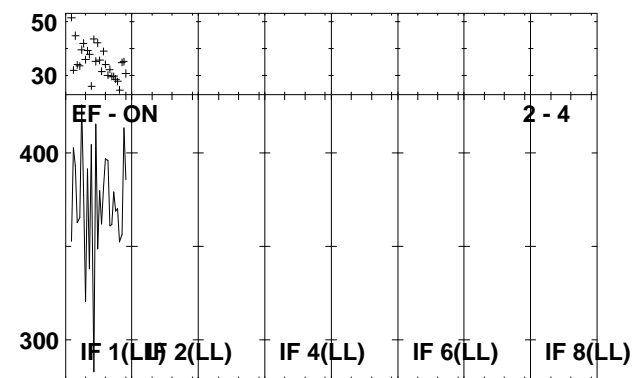
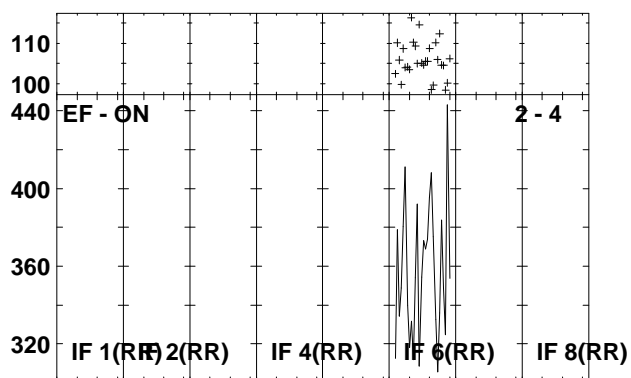
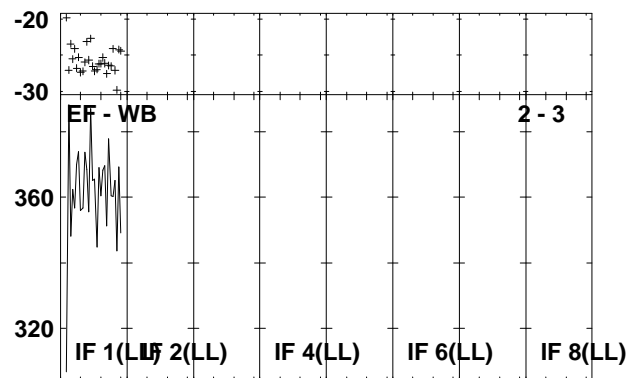
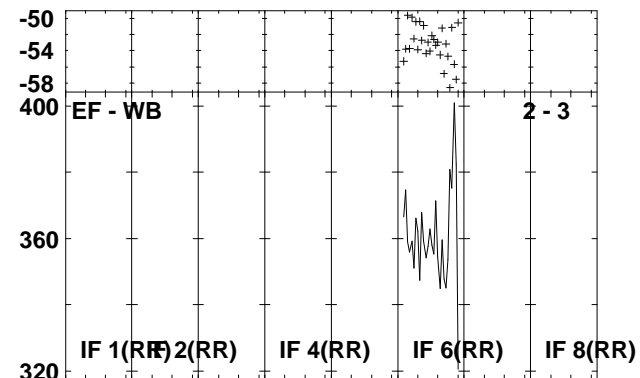
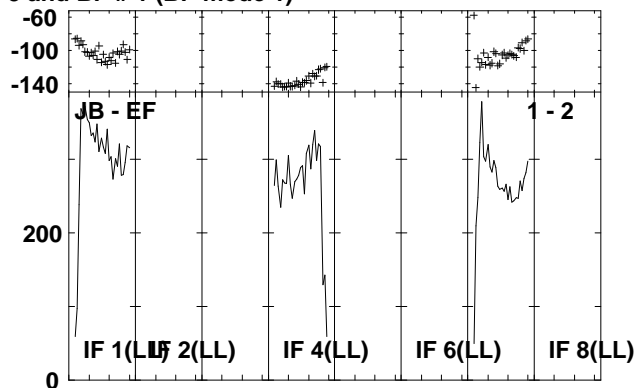
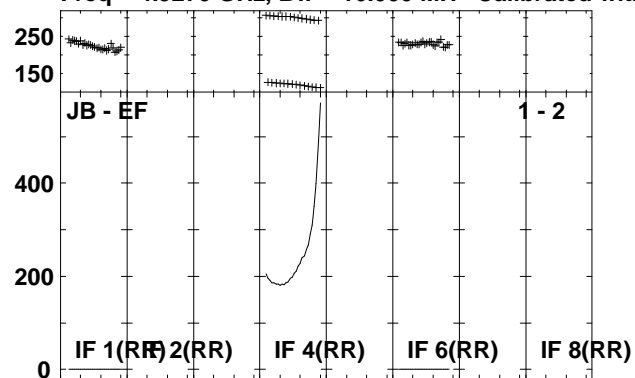

Lower frame: Ampl Jy Top frame: Phas deg
Vector averaged cross-power spectrum Several baselines displayed
Timerange: 01/01:36:31 to 01/01:37:59

Plot file version 172 created 13-OCT-2010 18:45:27

J2001+10 EP064N.UVDATA.1

Freq = 4.9270 GHz, Bw = 16.000 MH Calibrated with CL # 3 and BP # 1 (BP mode 1)

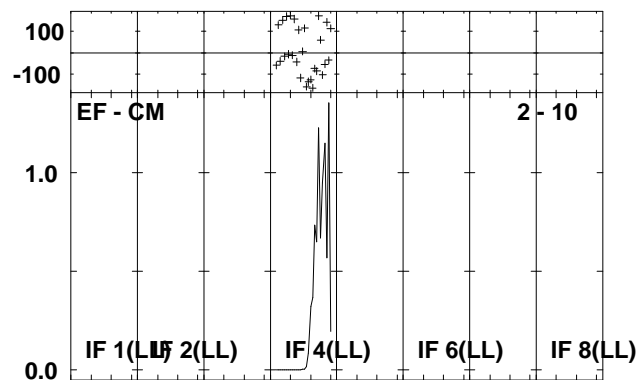
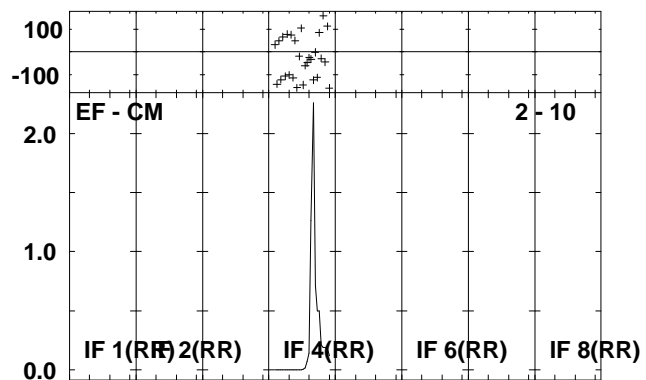
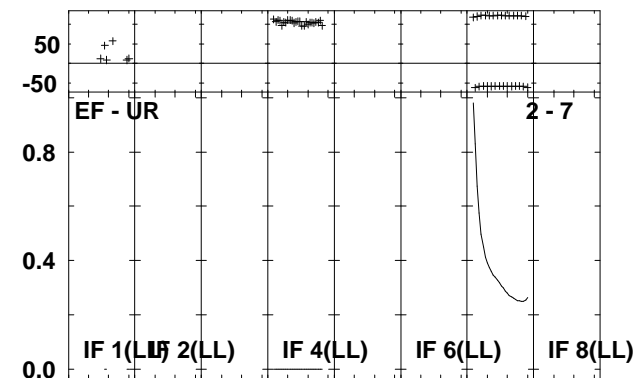
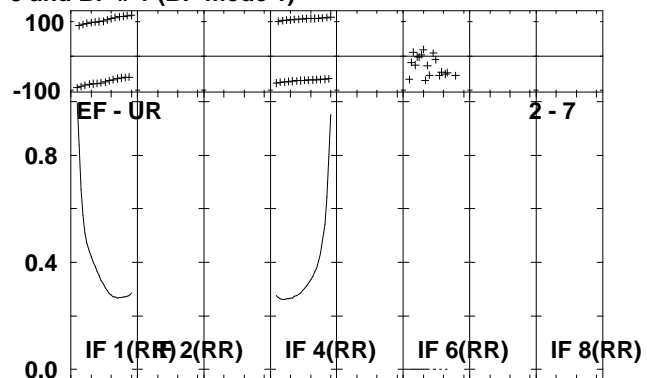
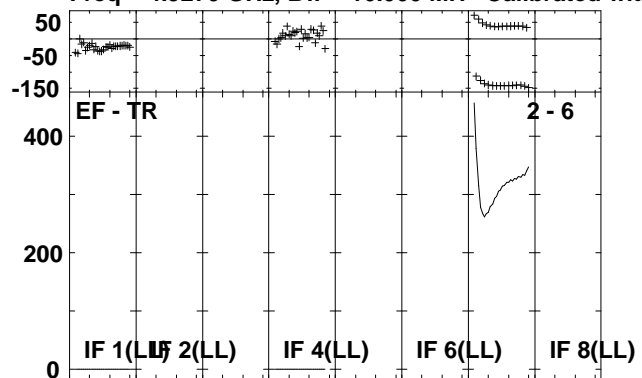

Lower frame: Ampl Jy Top frame: Phas deg
Vector averaged cross-power spectrum Several baselines displayed
Timerange: 01/01:36:31 to 01/01:37:59

Plot file version 173 created 13-OCT-2010 18:45:48

J2001+10 EP064N.UVDATA.1

Freq = 4.9270 GHz, Bw = 16.000 MH Calibrated with CL # 3 and BP # 1 (BP mode 1)

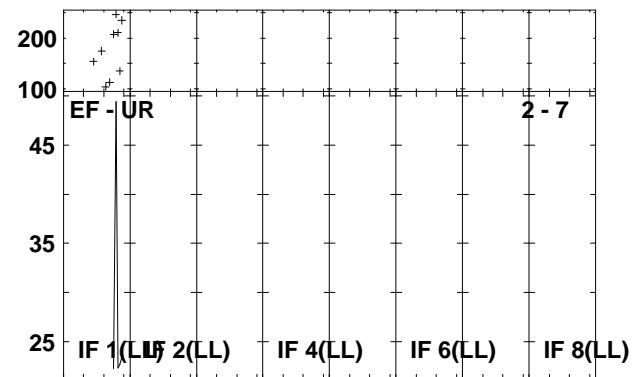
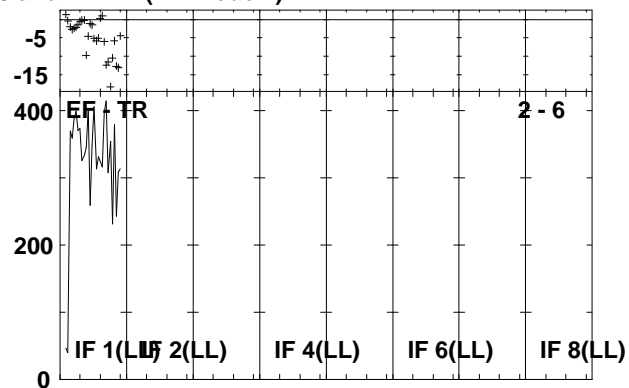
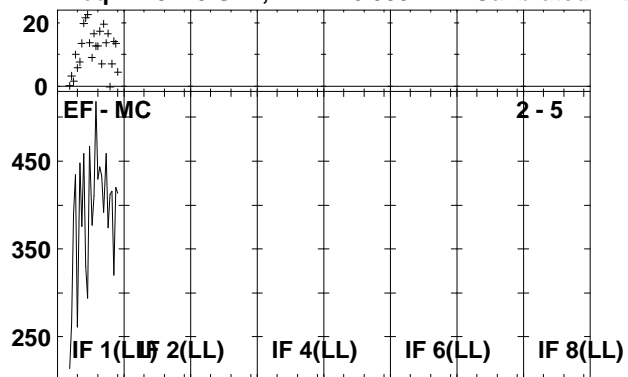

Lower frame: Milli Ampl Jy Top frame: Phas deg
Vector averaged cross-power spectrum Several baselines displayed
Timerange: 01/01:46:31 to 01/01:47:59

Plot file version 174 created 13-OCT-2010 18:45:53

IRAS1954 EP064N.UVDATA.1

Freq = 4.9270 GHz, Bw = 16.000 MH Calibrated with CL # 3 and BP # 1 (BP mode 1)

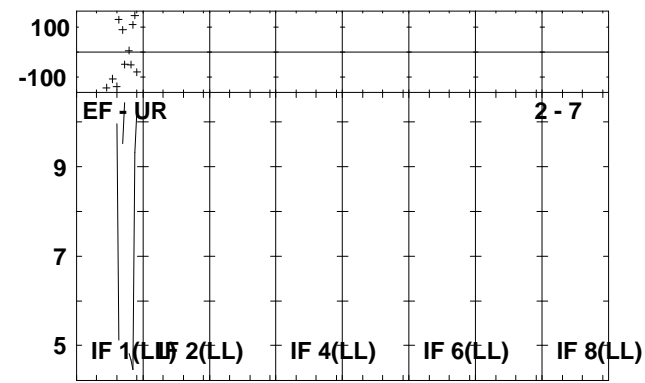
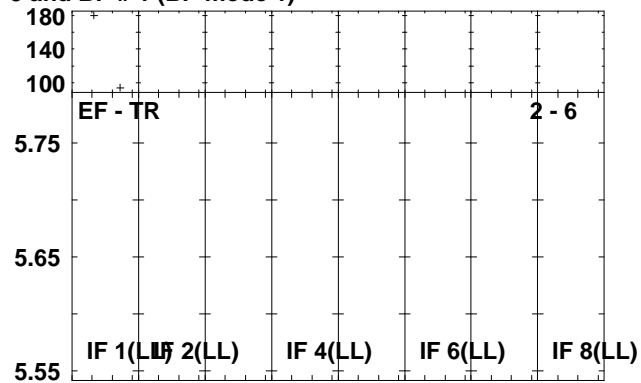
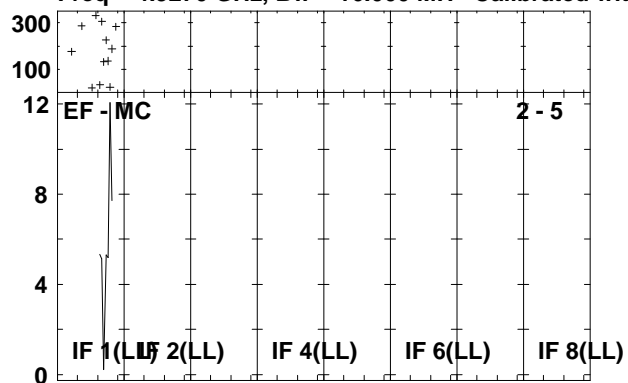

Lower frame: Milli Ampl Jy Top frame: Phas deg
Vector averaged cross-power spectrum Several baselines displayed
Timerange: 01/01:48:01 to 01/01:51:29

Plot file version 175 created 13-OCT-2010 18:45:59
J2001+10 EP064N.UVDATA.1
Freq = 4.9270 GHz, Bw = 16.000 MH Calibrated with CL # 3 and BP # 1 (BP mode 1)

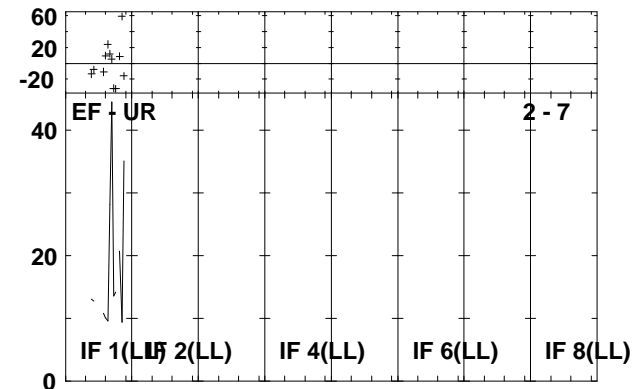
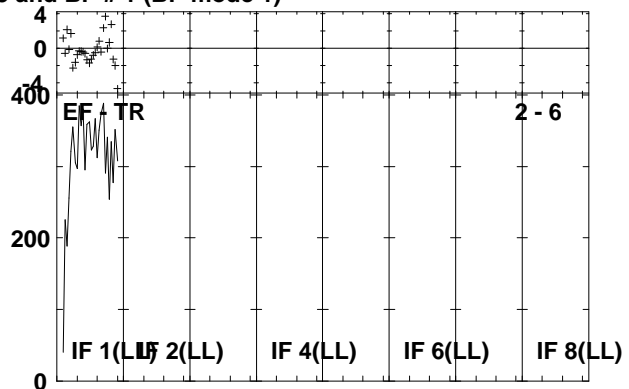
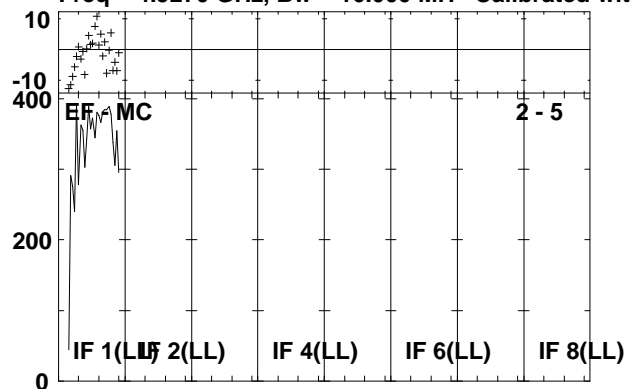

Lower frame: Milli Ampl Jy Top frame: Phas deg
Vector averaged cross-power spectrum Several baselines displayed
Timerange: 01/01:52:31 to 01/01:53:59

Plot file version 176 created 13-OCT-2010 18:46:04

IRAS1954 EP064N.UVDATA.1

Freq = 4.9270 GHz, Bw = 16.000 MH Calibrated with CL # 3 and BP # 1 (BP mode 1)

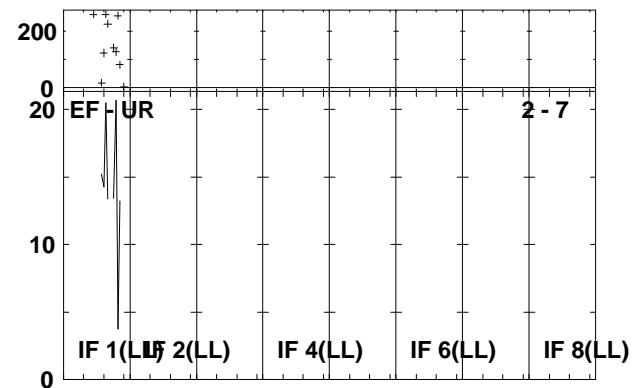
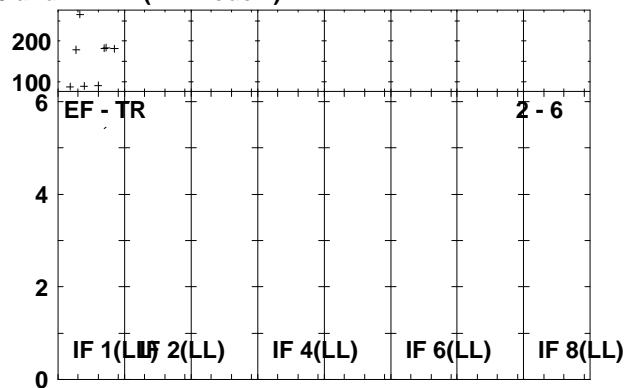
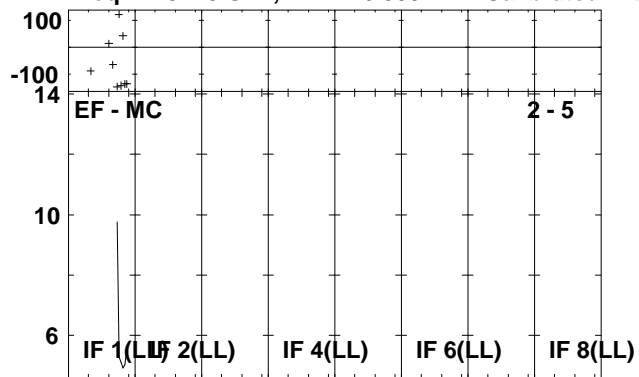

Lower frame: Milli Ampl Jy Top frame: Phas deg
Vector averaged cross-power spectrum Several baselines displayed
Timerange: 01/01:54:01 to 01/01:57:29

Plot file version 177 created 13-OCT-2010 18:46:09

J2001+10 EP064N.UVDATA.1

Freq = 4.9270 GHz, Bw = 16.000 MH Calibrated with CL # 3 and BP # 1 (BP mode 1)

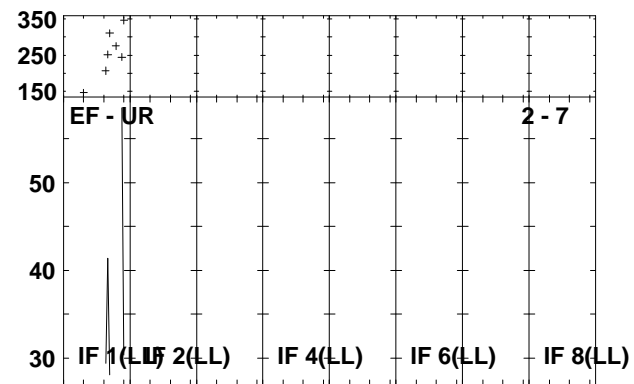
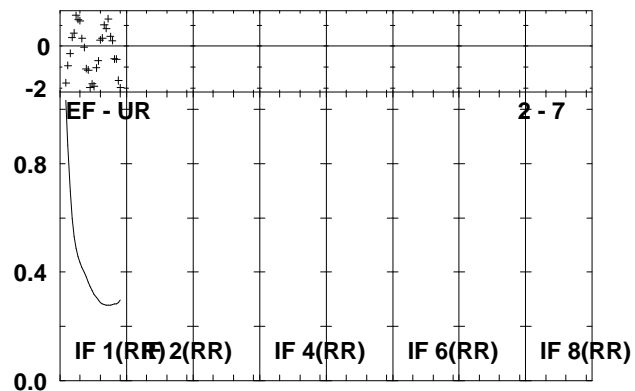
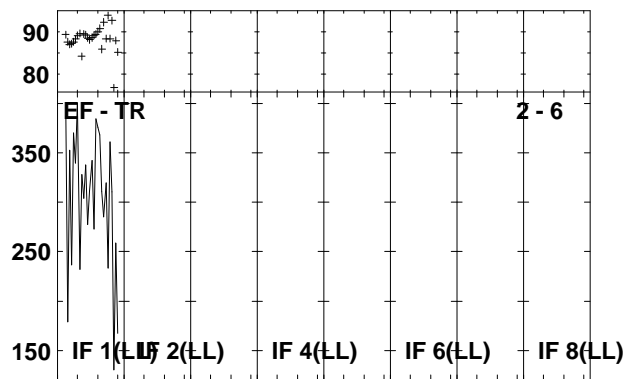
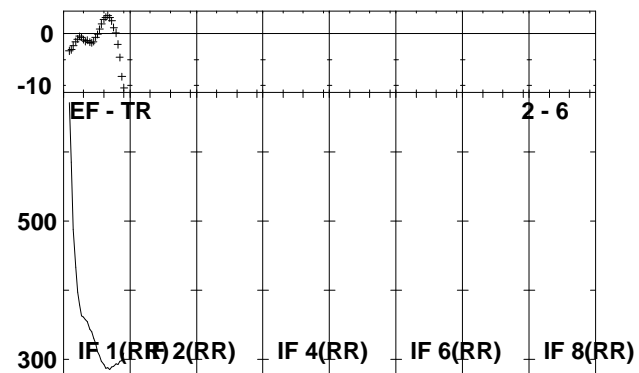
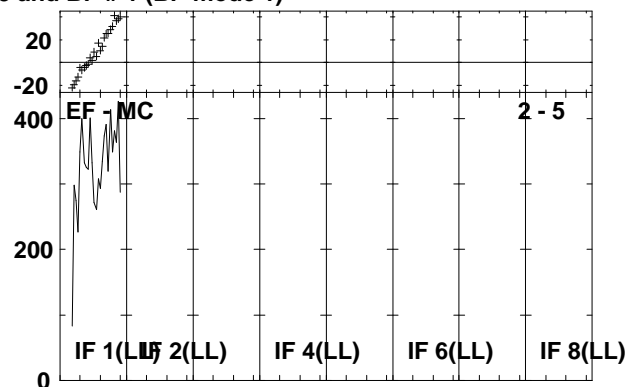
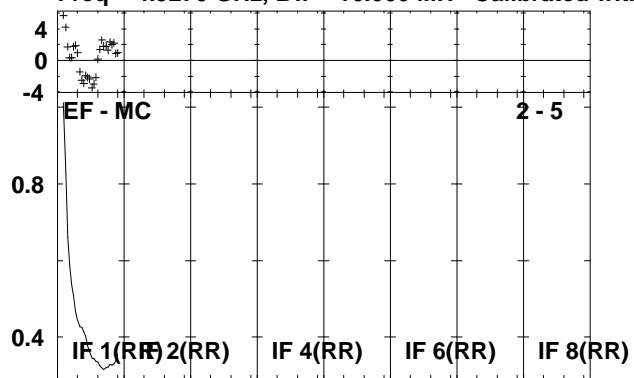

Lower frame: Kilo Ampl Jy Top frame: Phas deg
Vector averaged cross-power spectrum Several baselines displayed
Timerange: 01/01:57:31 to 01/01:58:59

Plot file version 178 created 13-OCT-2010 18:46:14

IRAS1954 EP064N.UVDATA.1

Freq = 4.9270 GHz, Bw = 16.000 MH Calibrated with CL # 3 and BP # 1 (BP mode 1)

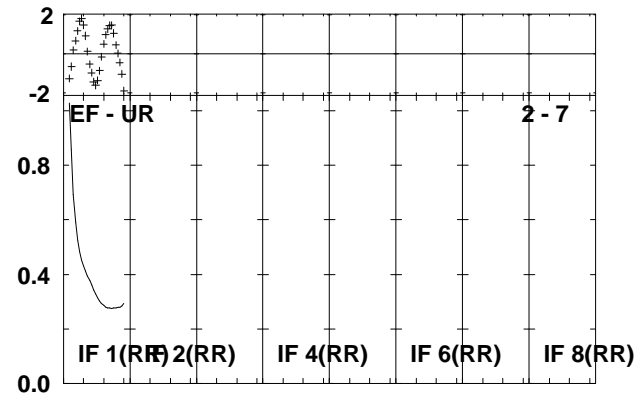
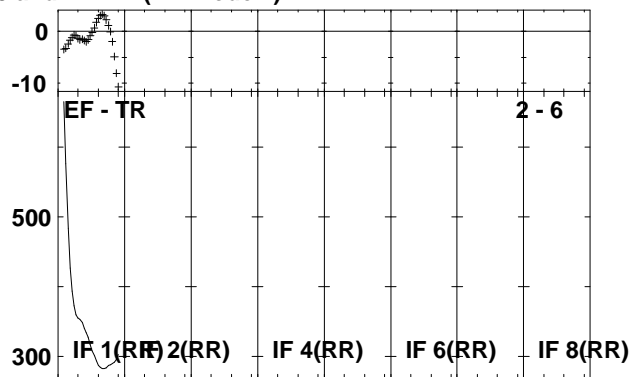
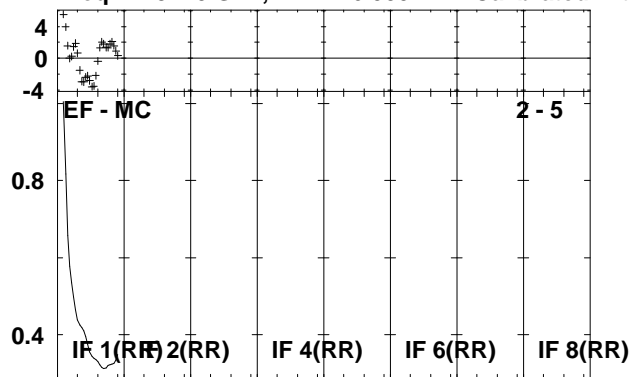

Lower frame: Kilo Ampl Jy Top frame: Phas deg
Vector averaged cross-power spectrum Several baselines displayed
Timerange: 01/01:59:01 to 01/02:02:29

Plot file version 179 created 13-OCT-2010 18:46:20

J2001+10 EP064N.UVDATA.1

Freq = 4.9270 GHz, Bw = 16.000 MH Calibrated with CL # 3 and BP # 1 (BP mode 1)

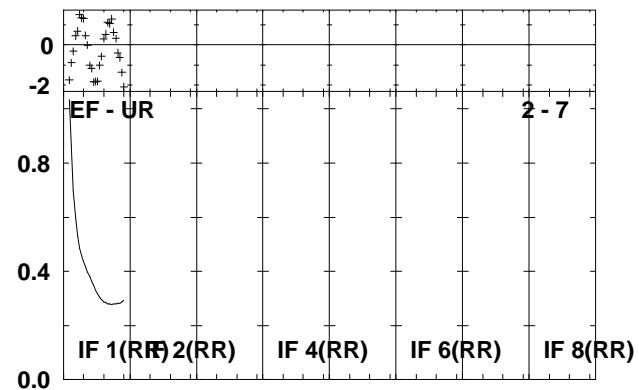
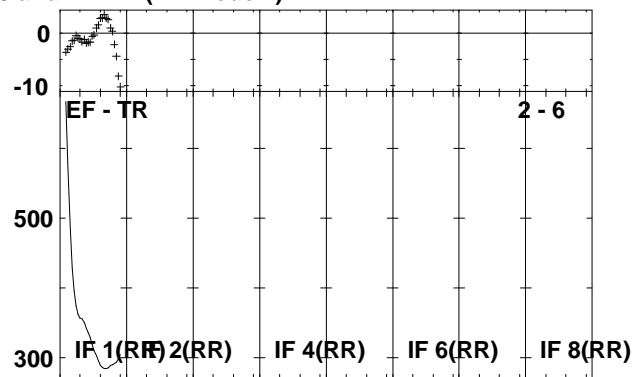
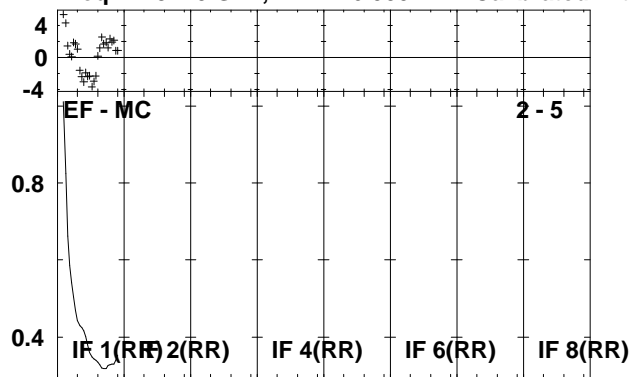

Lower frame: Kilo Ampl Jy Top frame: Phas deg
Vector averaged cross-power spectrum Several baselines displayed
Timerange: 01/02:02:31 to 01/02:03:57

Plot file version 180 created 13-OCT-2010 18:46:25

IRAS1954 EP064N.UVDATA.1

Freq = 4.9270 GHz, Bw = 16.000 MH Calibrated with CL # 3 and BP # 1 (BP mode 1)

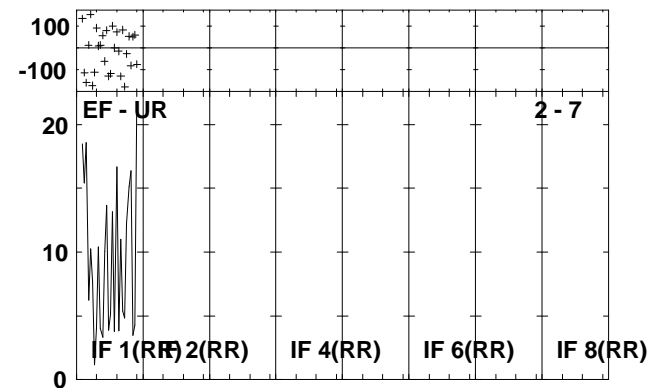
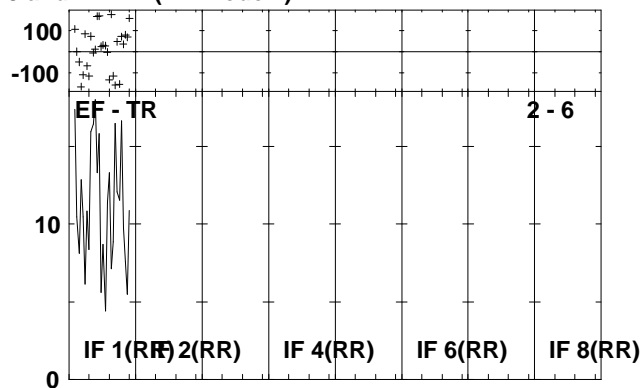
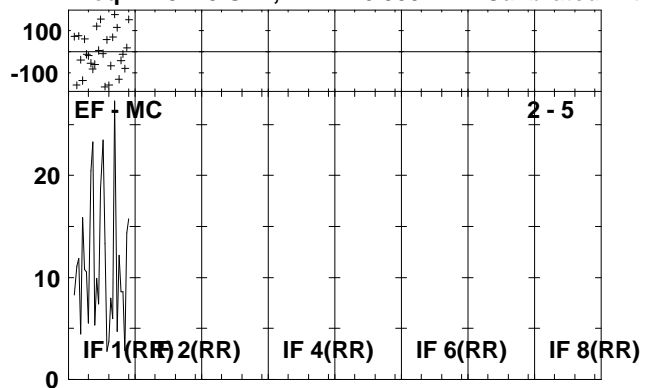

Lower frame: Milli Ampl Jy Top frame: Phas deg
Vector averaged cross-power spectrum Several baselines displayed
Timerange: 01/02:04:01 to 01/02:07:29

Plot file version 181 created 13-OCT-2010 18:46:29

J2001+10 EP064N.UVDATA.1

Freq = 4.9270 GHz, Bw = 16.000 MH Calibrated with CL # 3 and BP # 1 (BP mode 1)

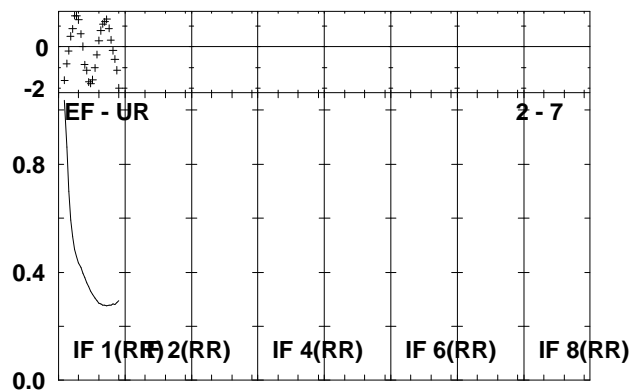
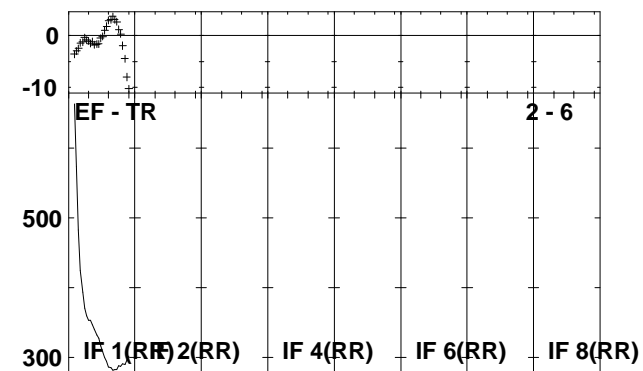
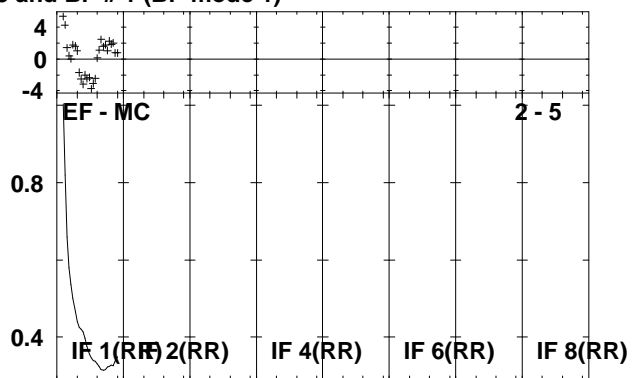
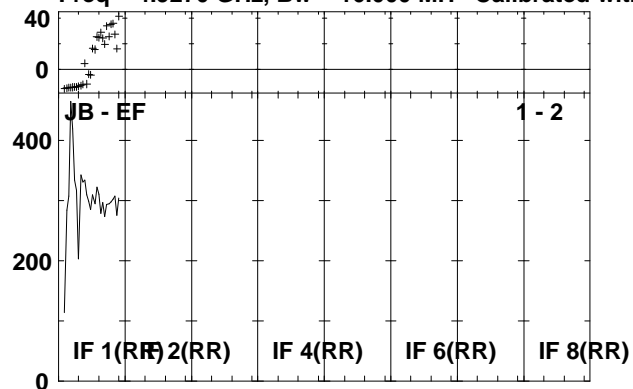

Lower frame: Milli Ampl Jy Top frame: Phas deg
Vector averaged cross-power spectrum Several baselines displayed
Timerange: 01/02:08:31 to 01/02:09:59

Plot file version 182 created 13-OCT-2010 18:46:40
J2001+10 EP064N.UVDATA.1
Freq = 4.9270 GHz, Bw = 16.000 MH Calibrated with CL # 3 and BP # 1 (BP mode 1)

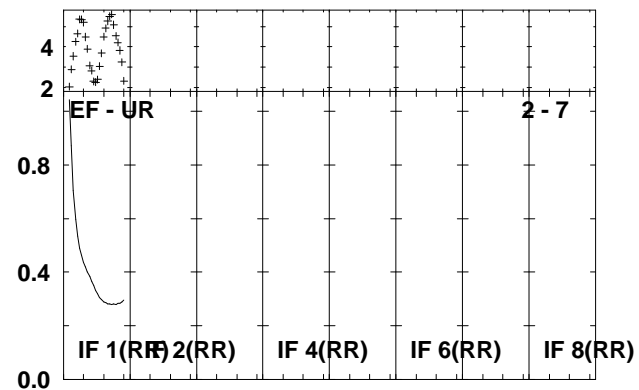
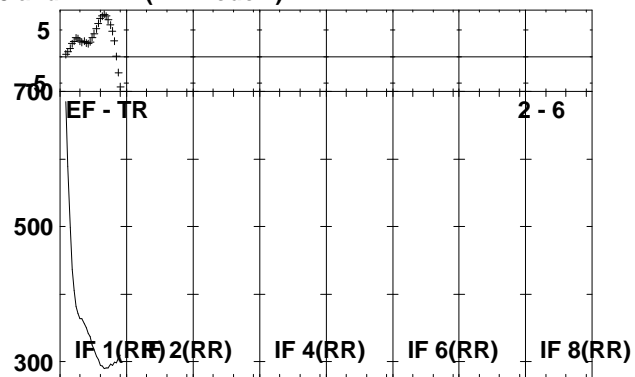
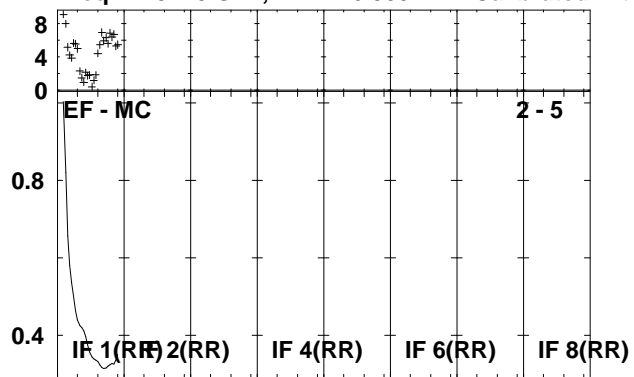

Lower frame: Kilo Ampl Jy Top frame: Phas deg
Vector averaged cross-power spectrum Several baselines displayed
Timerange: 01/02:13:31 to 01/02:14:59

Plot file version 183 created 13-OCT-2010 18:46:43

IRAS1954 EP064N.UVDATA.1

Freq = 4.9270 GHz, Bw = 16.000 MH Calibrated with CL # 3 and BP # 1 (BP mode 1)

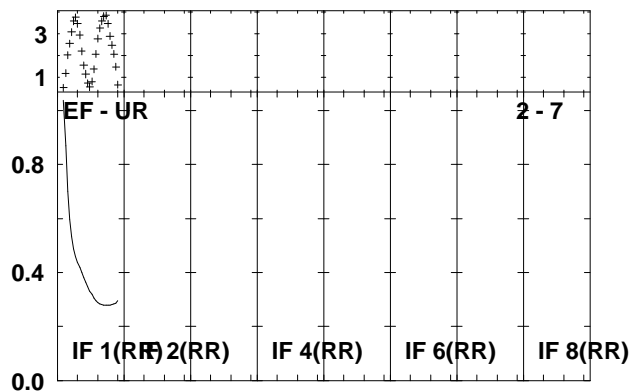
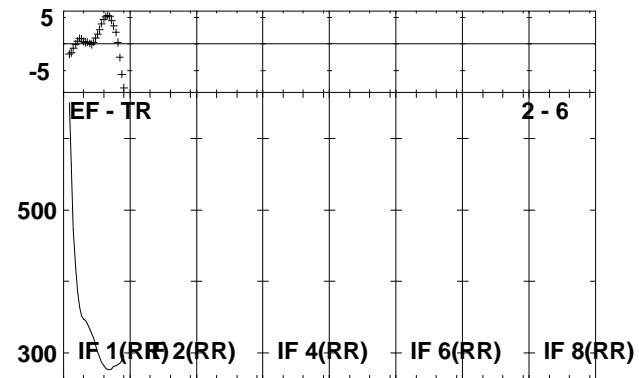
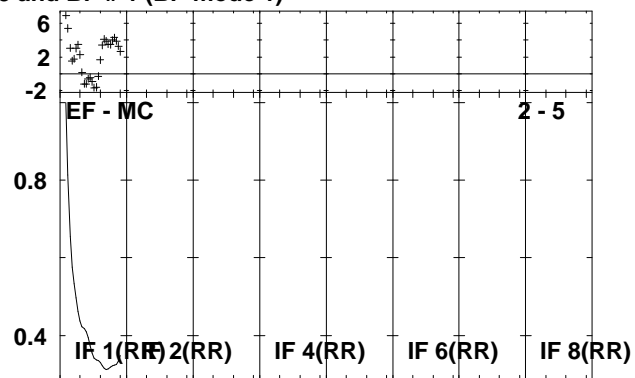
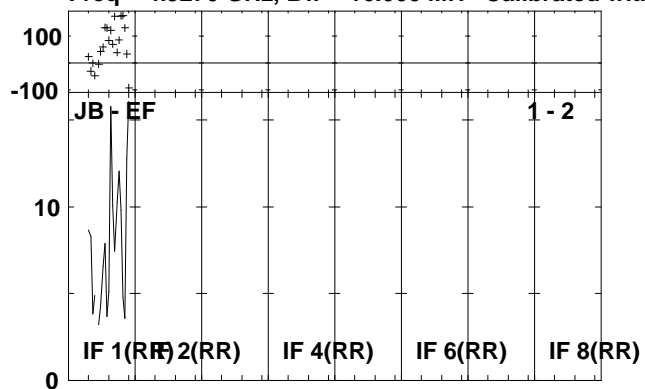

Lower frame: Milli Ampl Jy Top frame: Phas deg
Vector averaged cross-power spectrum Several baselines displayed
Timerange: 01/02:15:01 to 01/02:18:29

Plot file version 184 created 13-OCT-2010 18:46:50

J2001+10 EP064N.UVDATA.1

Freq = 4.9270 GHz, Bw = 16.000 MH Calibrated with CL # 3 and BP # 1 (BP mode 1)

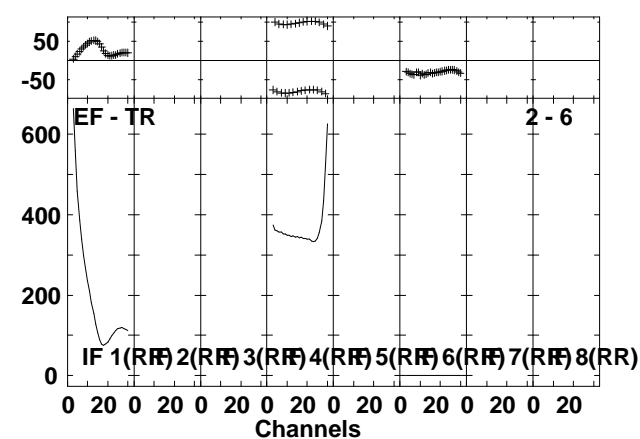
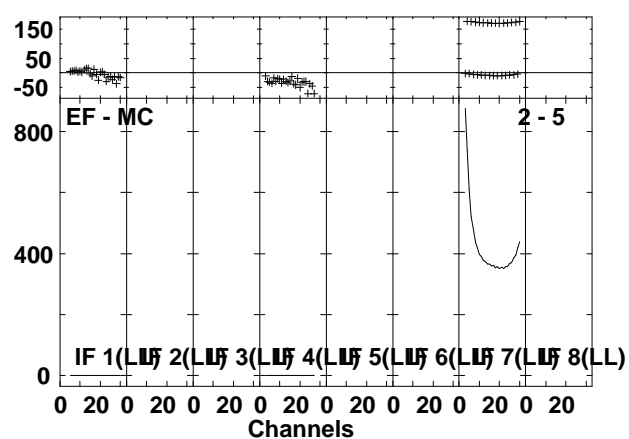
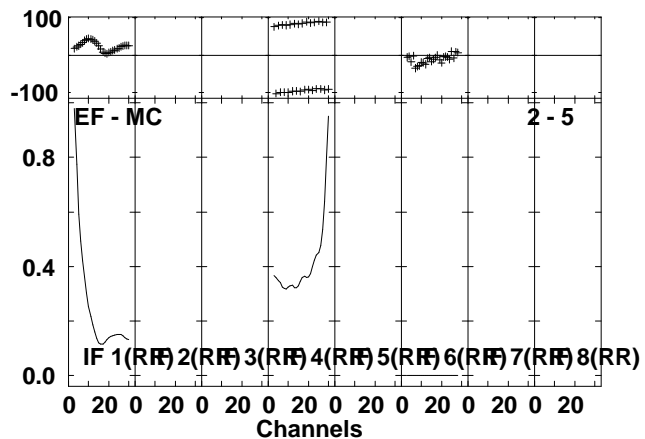
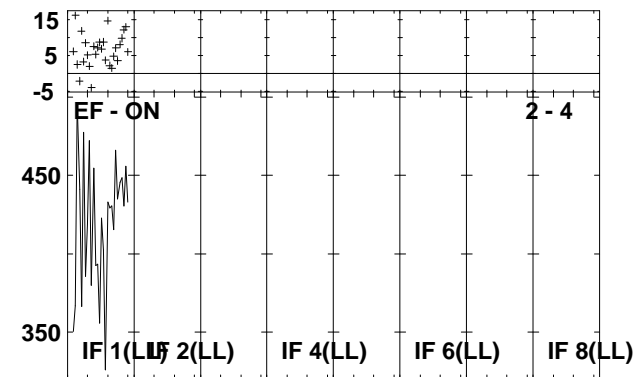
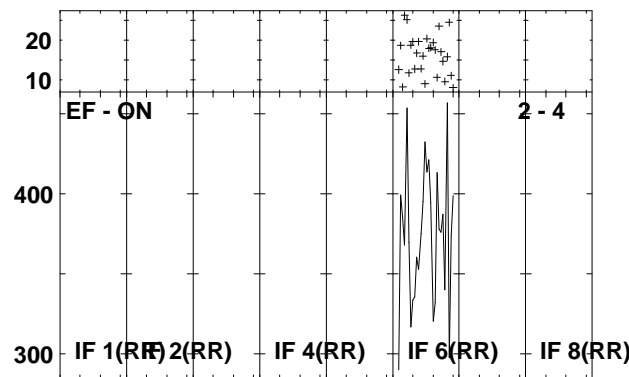
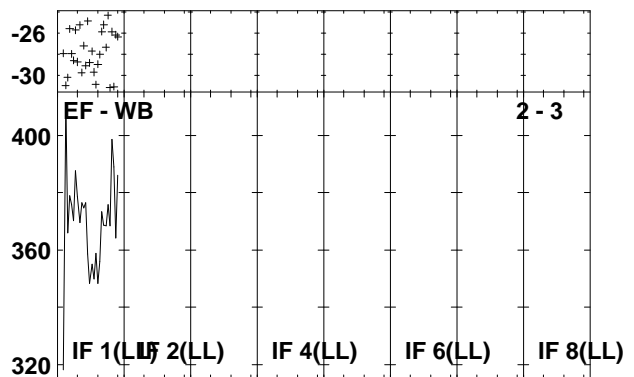
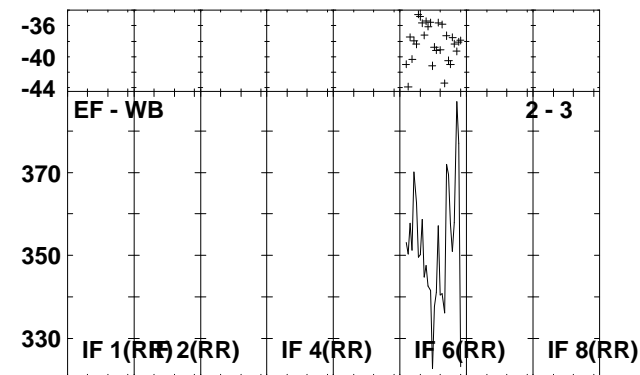
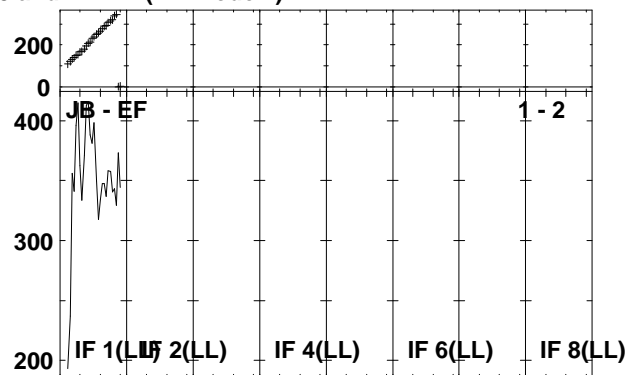
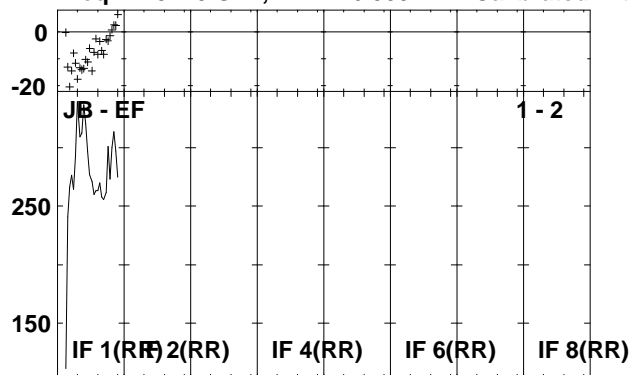

Lower frame: Milli Ampl Jy Top frame: Phas deg
Vector averaged cross-power spectrum Several baselines displayed
Timerange: 01/02:18:31 to 01/02:19:59

Plot file version 185 created 13-OCT-2010 18:46:51

J2001+10 EP064N.UVDATA.1

Freq = 4.9270 GHz, Bw = 16.000 MH Calibrated with CL # 3 and BP # 1 (BP mode 1)

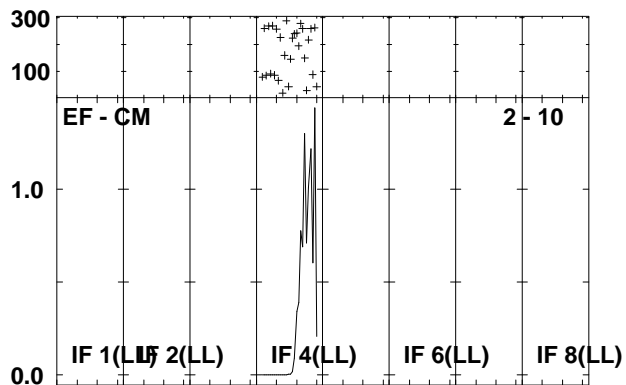
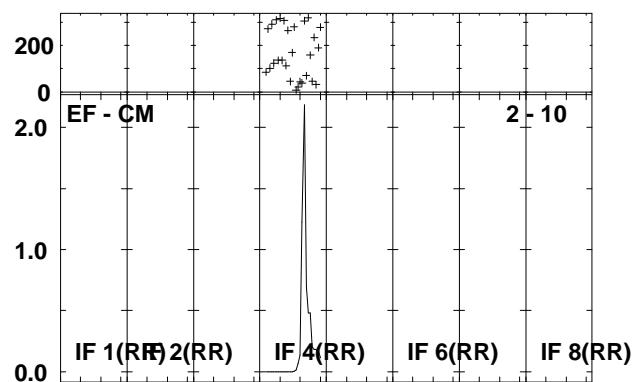
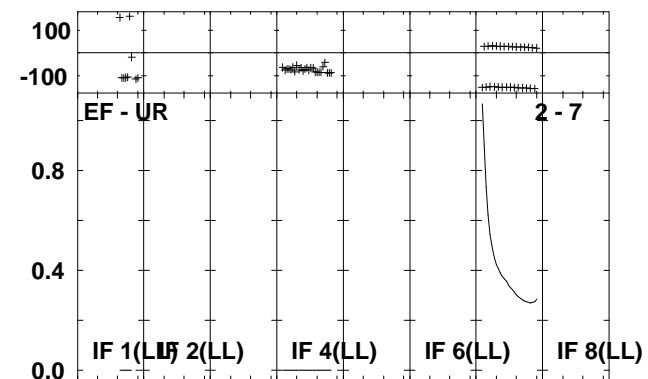
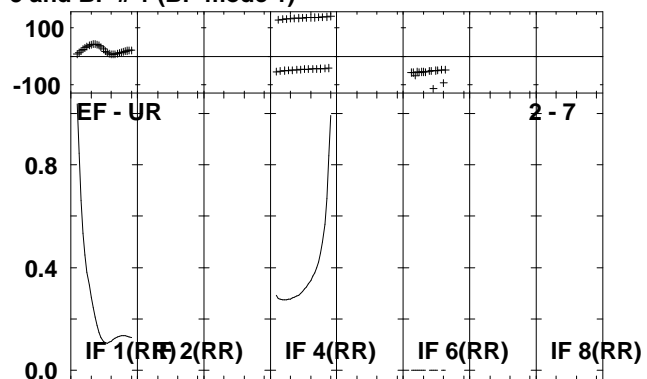
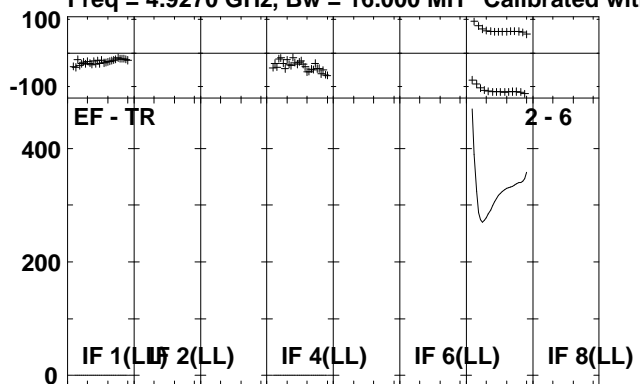

Lower frame: Ampl Jy Top frame: Phas deg
Vector averaged cross-power spectrum Several baselines displayed
Timerange: 01/02:18:31 to 01/02:19:59

Plot file version 186 created 13-OCT-2010 18:46:54

IRAS1954 EP064N.UVDATA.1

Freq = 4.9270 GHz, Bw = 16.000 MH Calibrated with CL # 3 and BP # 1 (BP mode 1)

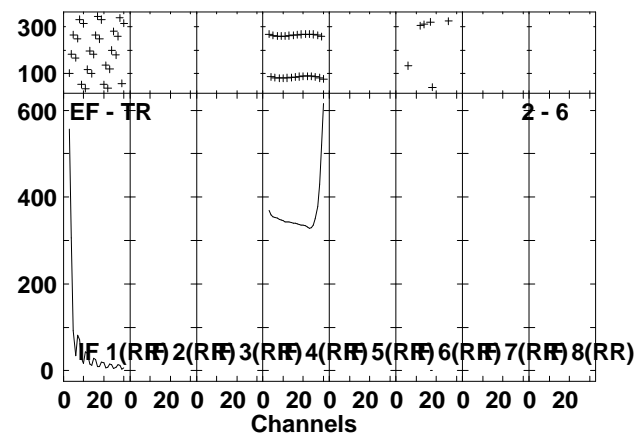
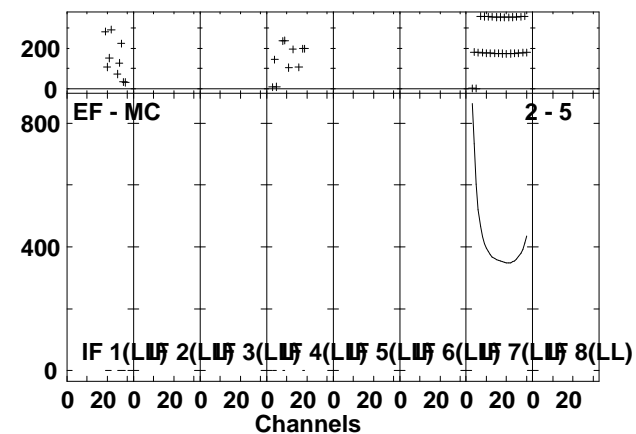
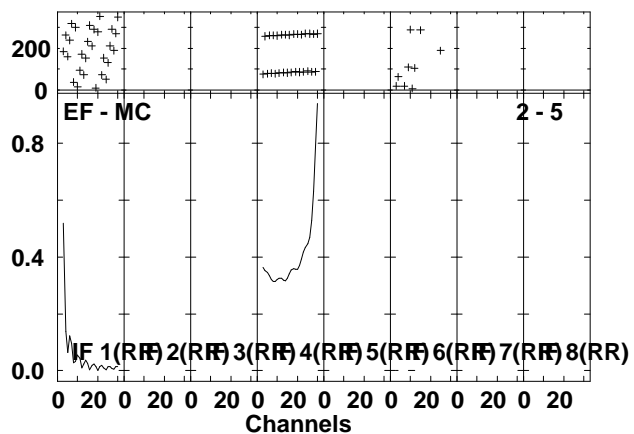
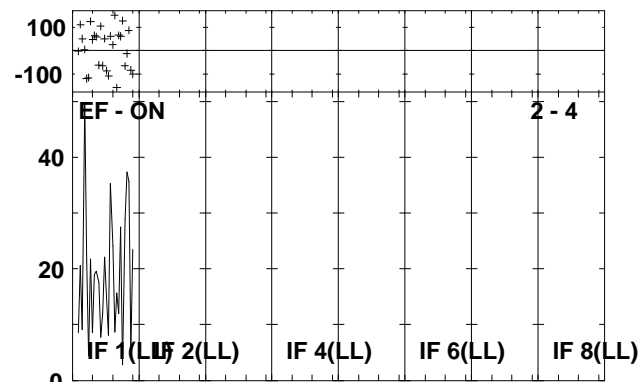
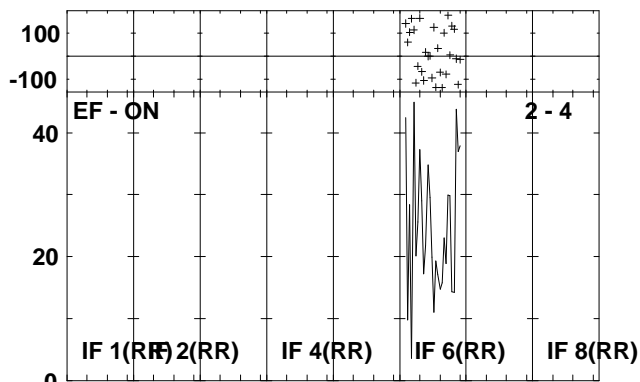
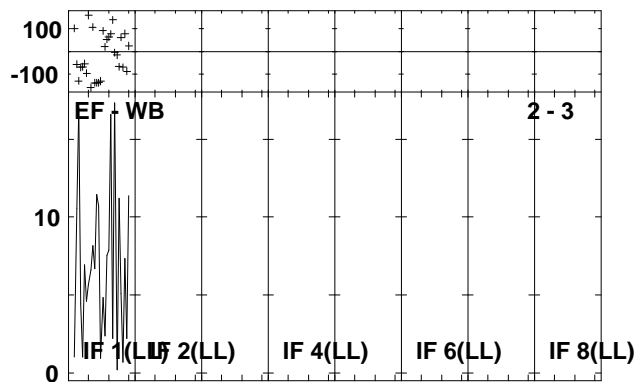
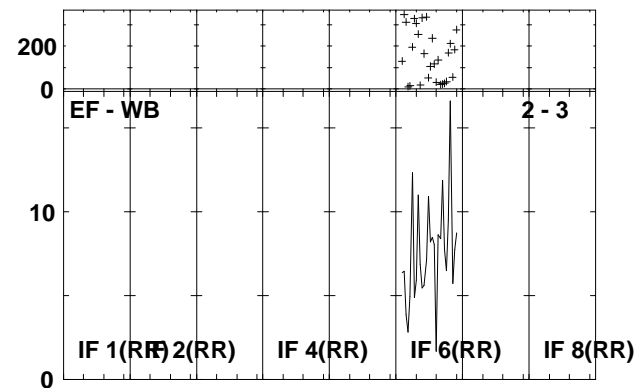
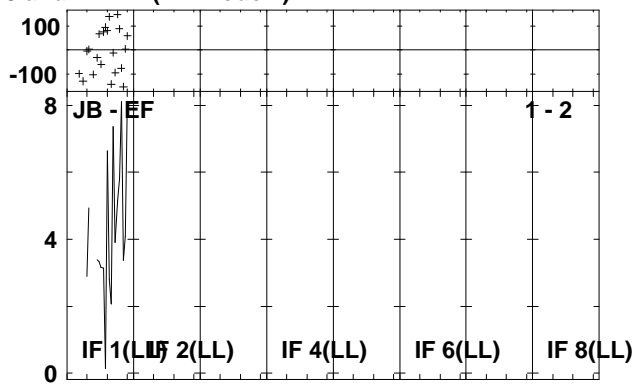
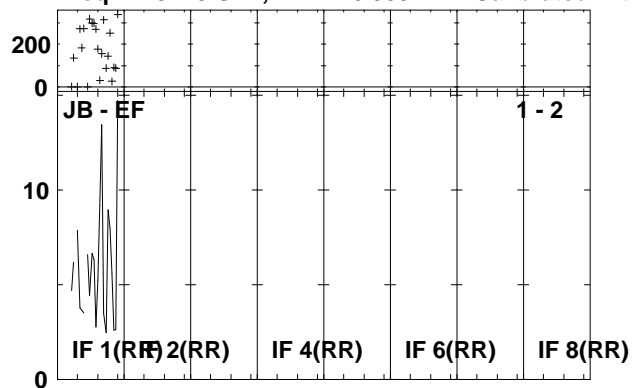

Lower frame: Milli Ampl Jy Top frame: Phas deg
Vector averaged cross-power spectrum Several baselines displayed
Timerange: 01/02:20:01 to 01/02:23:29

Plot file version 187 created 13-OCT-2010 18:46:57

IRAS1954 EP064N.UVDATA.1

Freq = 4.9270 GHz, Bw = 16.000 MH Calibrated with CL # 3 and BP # 1 (BP mode 1)

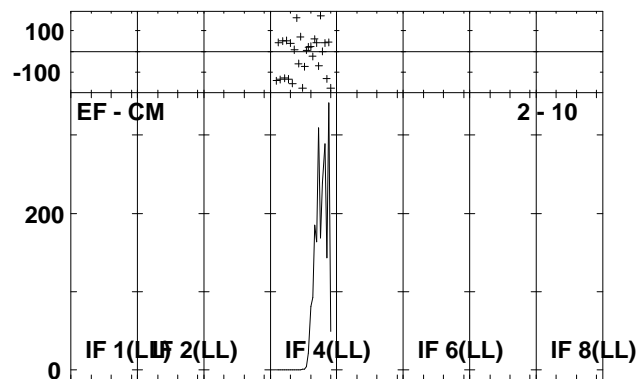
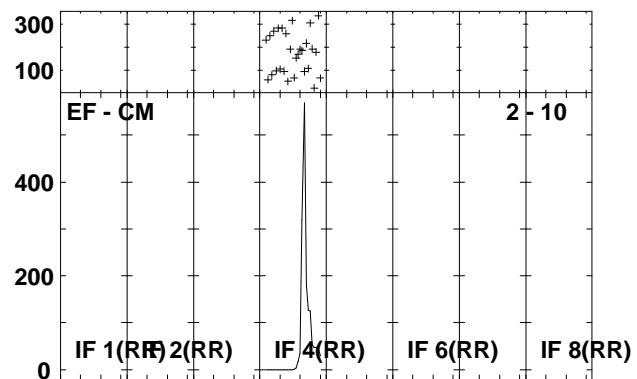
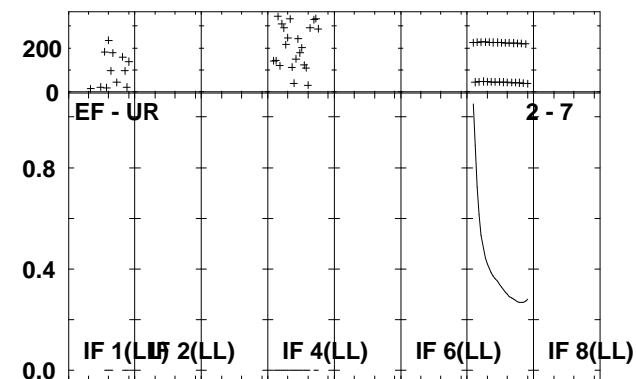
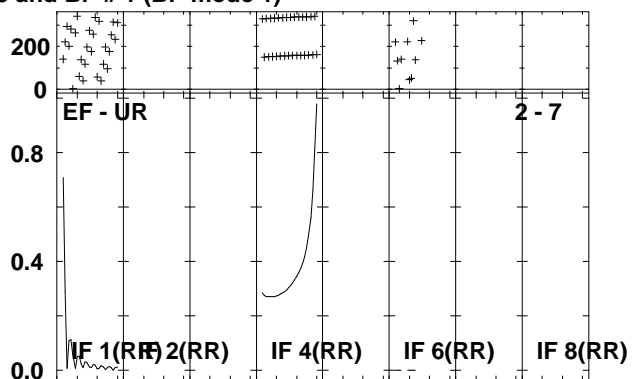
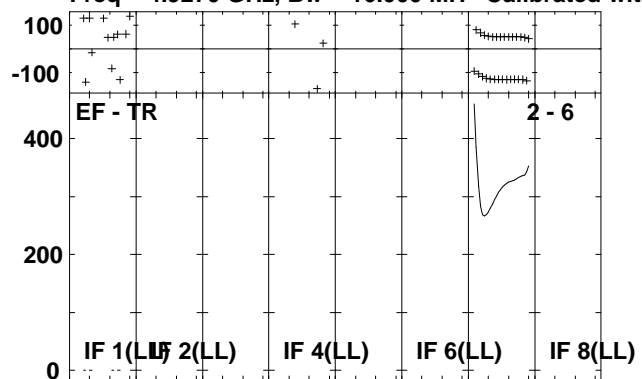

Lower frame: Ampl Jy Top frame: Phas deg
Vector averaged cross-power spectrum Several baselines displayed
Timerange: 01/02:20:01 to 01/02:23:29

Plot file version 188 created 13-OCT-2010 18:47:02

J2001+10 EP064N.UVDATA.1

Freq = 4.9270 GHz, Bw = 16.000 MH Calibrated with CL # 3 and BP # 1 (BP mode 1)

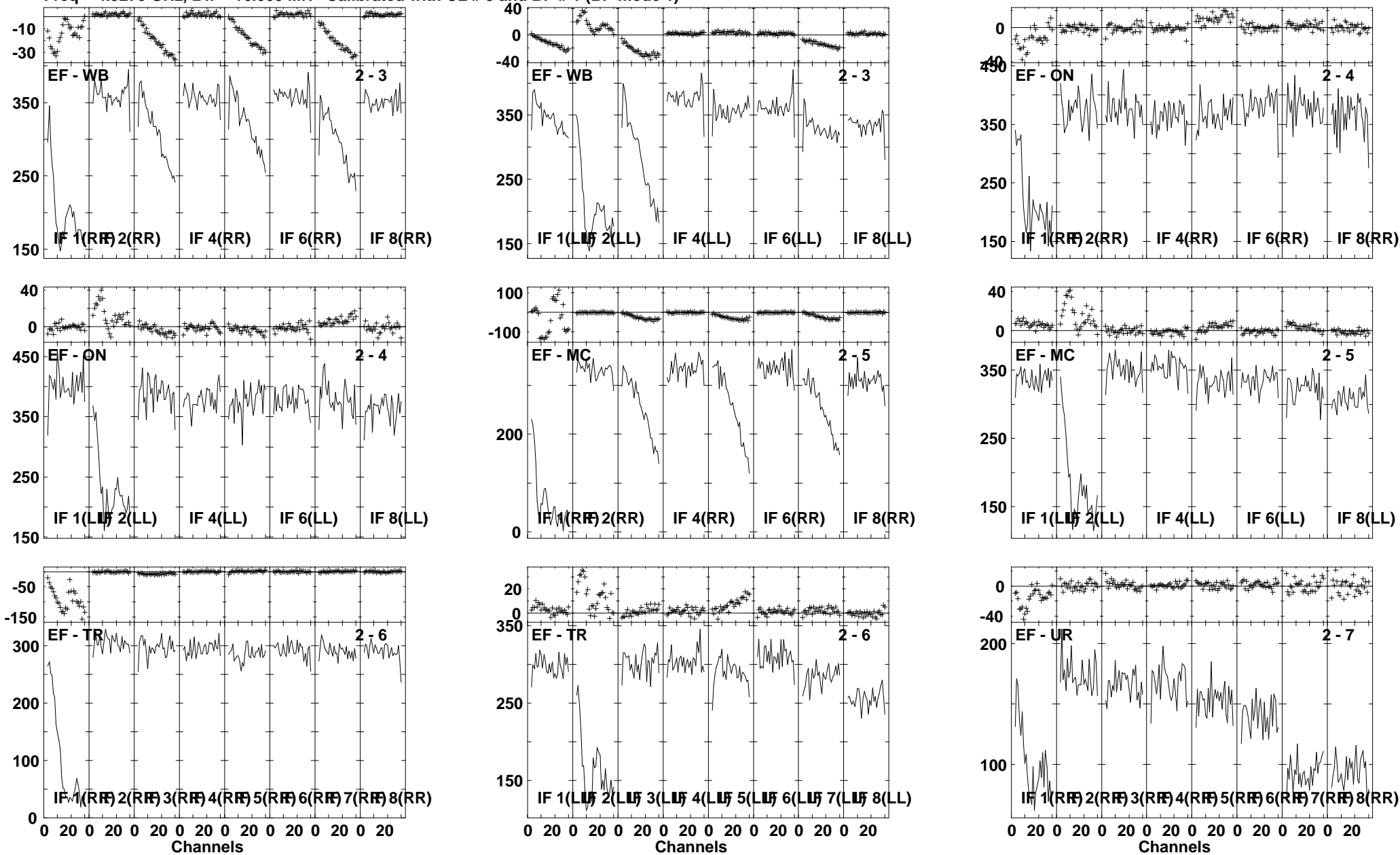

Lower frame: Milli Ampl Jy Top frame: Phas deg
Vector averaged cross-power spectrum Several baselines displayed
Timerange: 01/02:24:31 to 01/02:25:59

Plot file version 189 created 13-OCT-2010 18:47:03

J2001+10 EP064N.UVDATA.1

Freq = 4.9270 GHz, Bw = 16.000 MH Calibrated with CL # 3 and BP # 1 (BP mode 1)

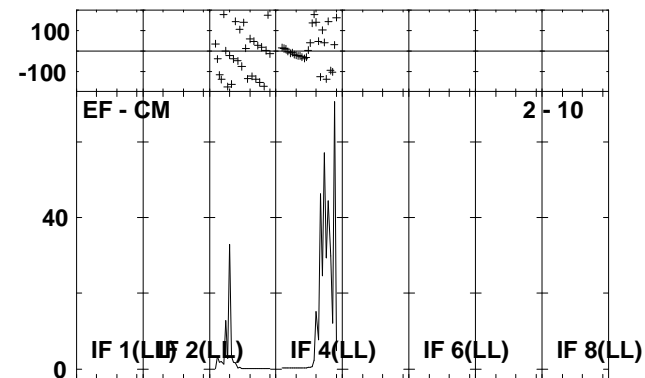
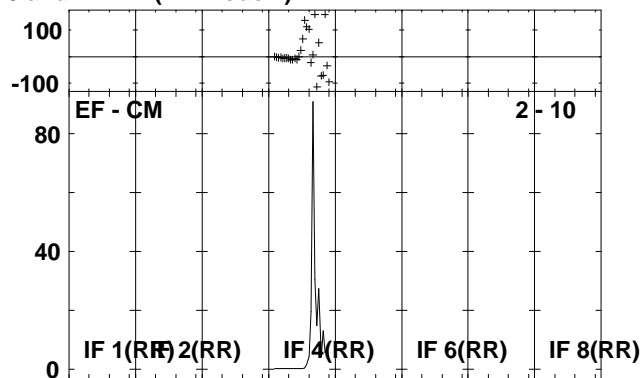
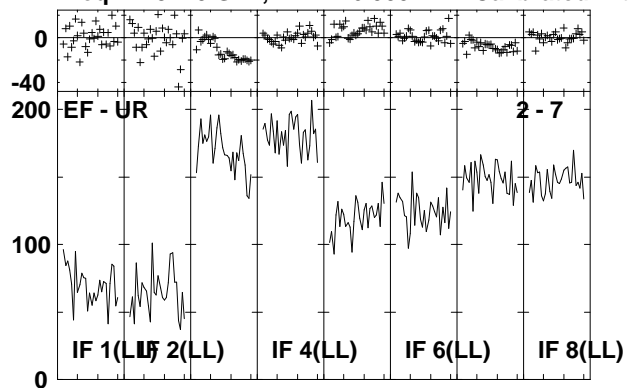

Lower frame: Milli Ampl Jy Top frame: Phas deg
Vector averaged cross-power spectrum Several baselines displayed
Timerange: 01/02:24:31 to 01/02:25:59

Plot file version 190 created 13-OCT-2010 18:47:05

IRAS1954 EP064N.UVDATA.1

Freq = 4.9270 GHz, Bw = 16.000 MH Calibrated with CL # 3 and BP # 1 (BP mode 1)

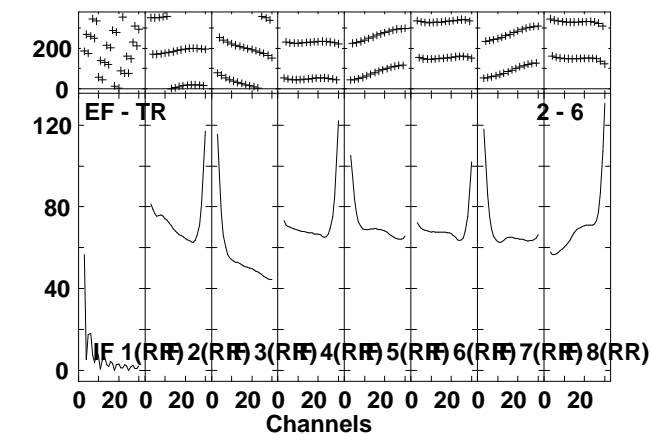
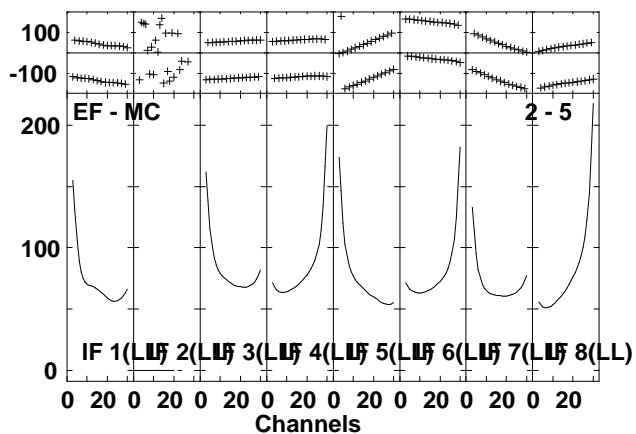
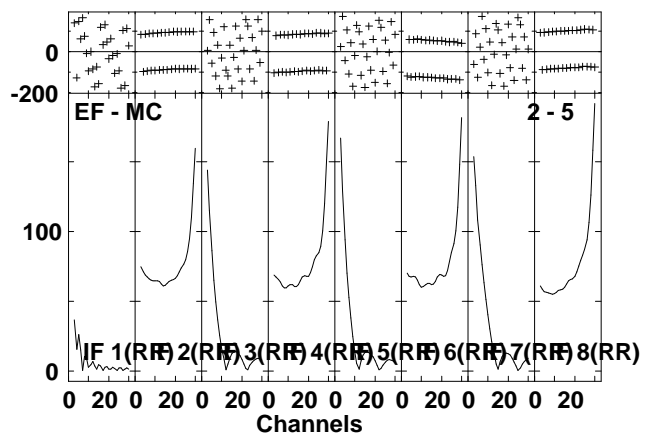
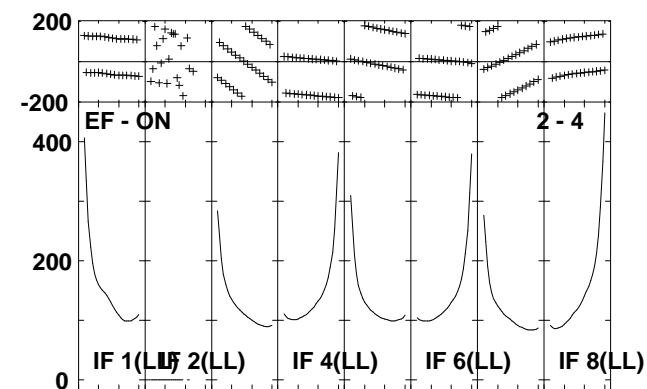
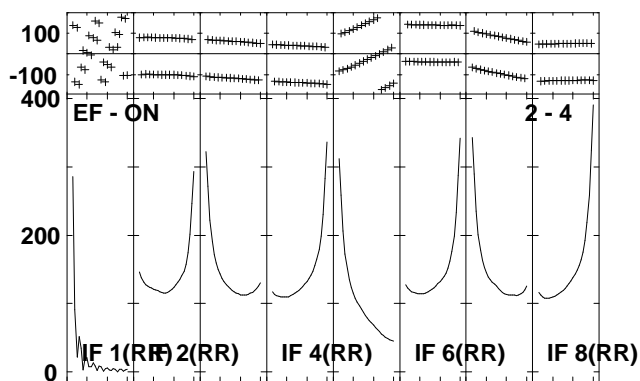
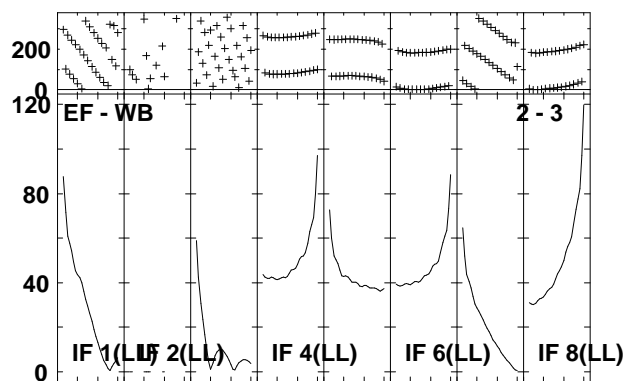
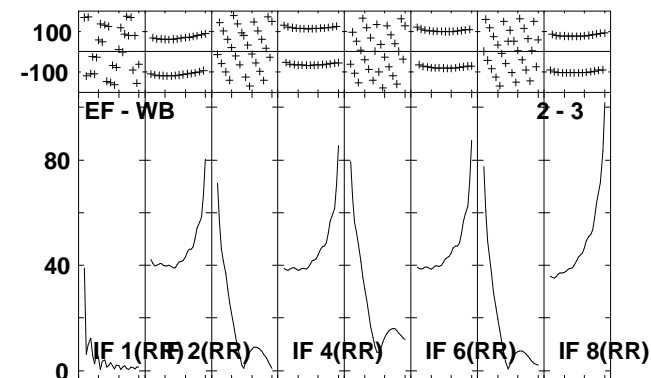
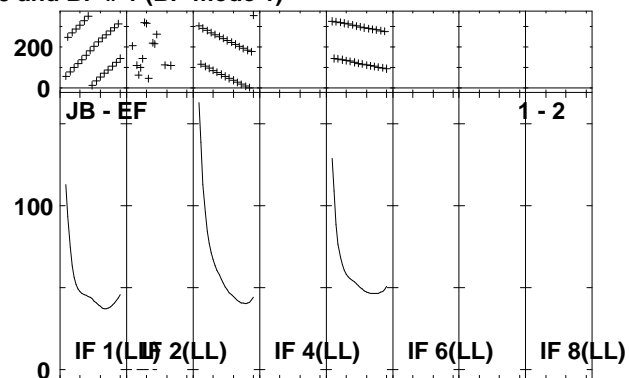
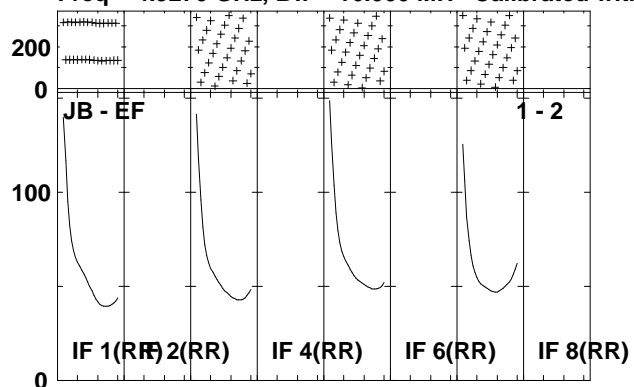

Lower frame: Ampl Jy Top frame: Phas deg
Vector averaged cross-power spectrum Several baselines displayed
Timerange: 01/02:26:01 to 01/02:29:29

Plot file version 191 created 13-OCT-2010 18:47:09

IRAS1954 EP064N.UVDATA.1

Freq = 4.9270 GHz, Bw = 16.000 MH Calibrated with CL # 3 and BP # 1 (BP mode 1)

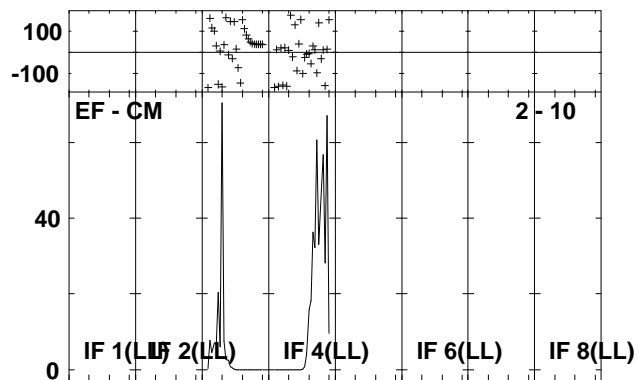
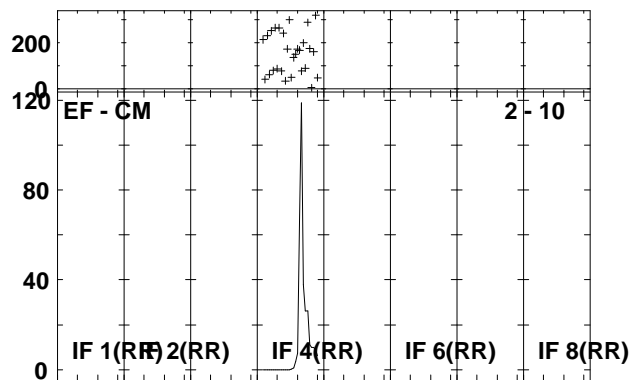
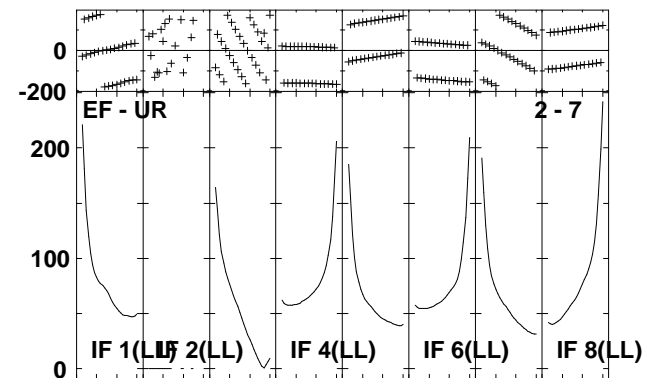
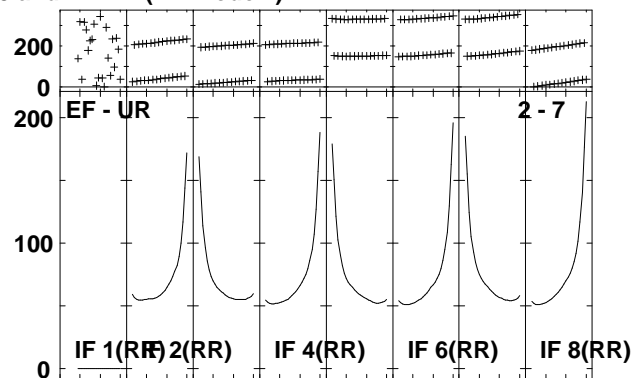
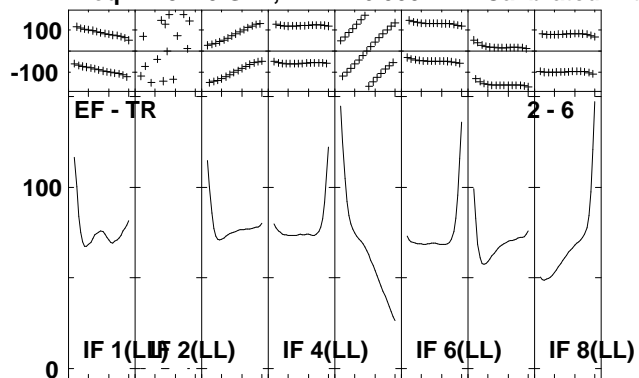

Lower frame: Ampl Jy Top frame: Phas deg
Vector averaged cross-power spectrum Several baselines displayed
Timerange: 01/02:26:01 to 01/02:29:29

Plot file version 192 created 13-OCT-2010 18:47:13

J2001+10 EP064N.UVDATA.1

Freq = 4.9270 GHz, Bw = 16.000 MH Calibrated with CL # 3 and BP # 1 (BP mode 1)

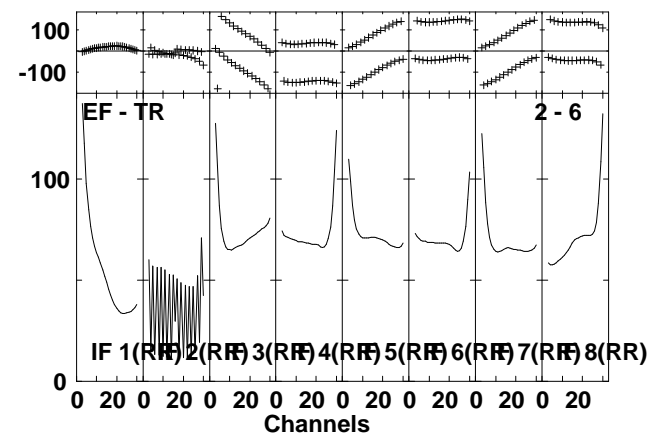
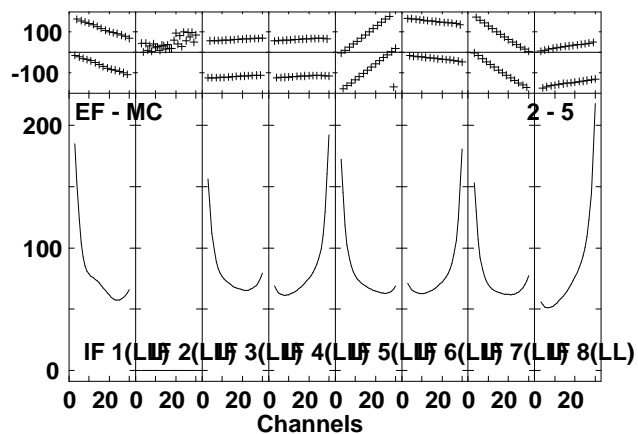
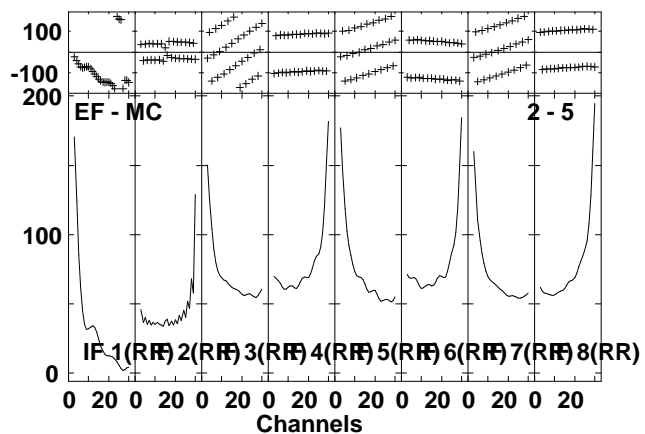
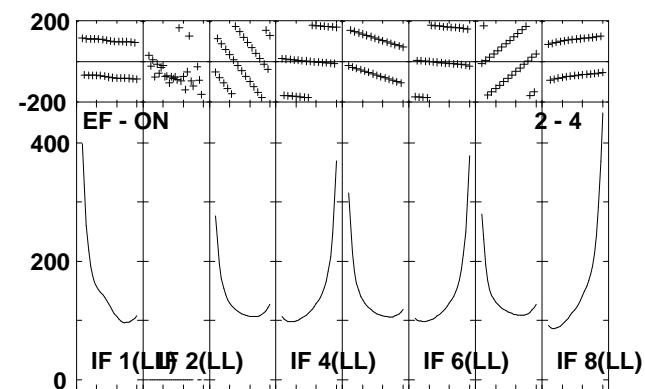
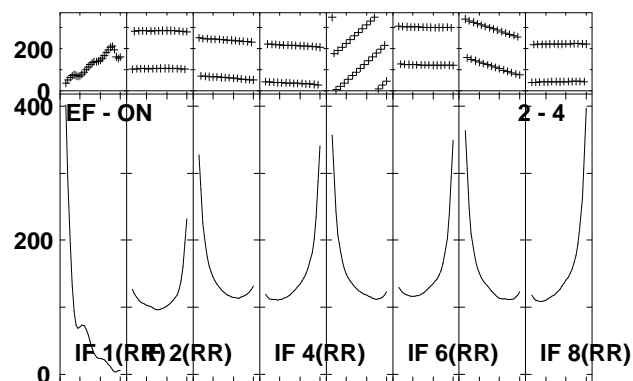
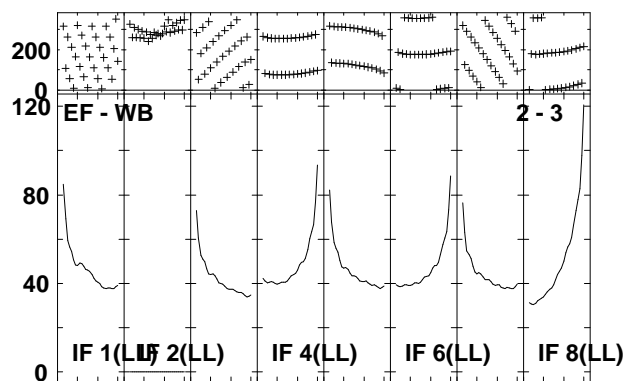
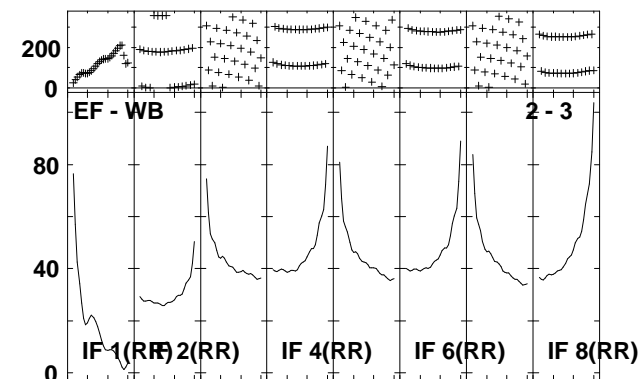
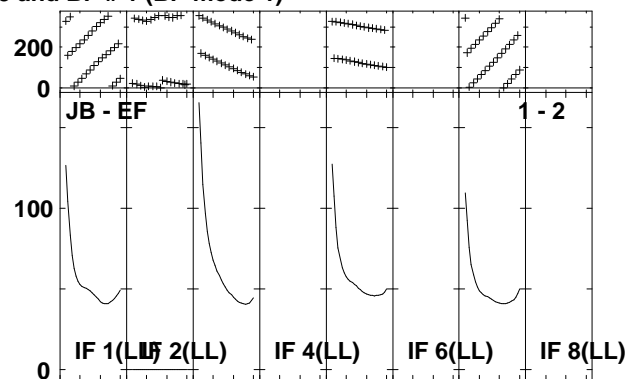
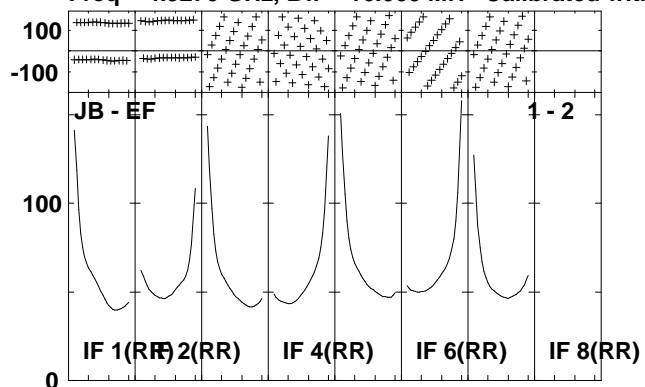

Lower frame: Ampl Jy Top frame: Phas deg
Vector averaged cross-power spectrum Several baselines displayed
Timerange: 01/02:29:31 to 01/02:30:59

Plot file version 193 created 13-OCT-2010 18:47:14

J2001+10 EP064N.UVDATA.1

Freq = 4.9270 GHz, Bw = 16.000 MH Calibrated with CL # 3 and BP # 1 (BP mode 1)

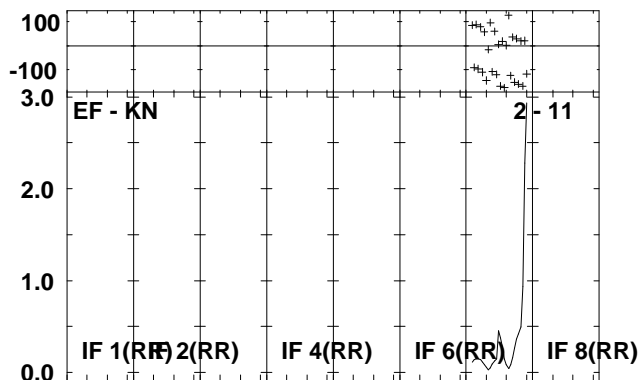
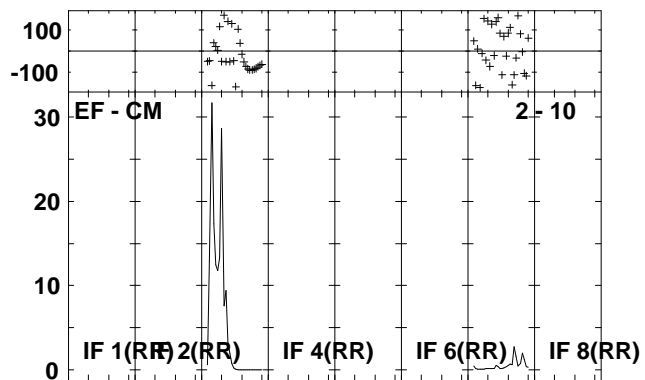
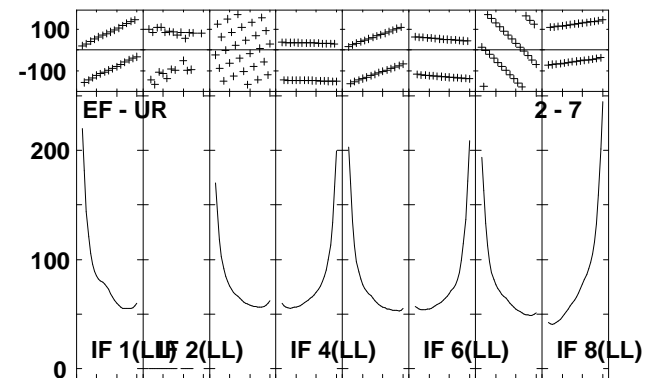
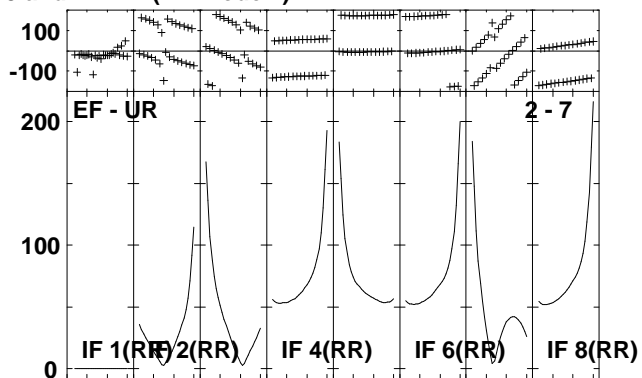
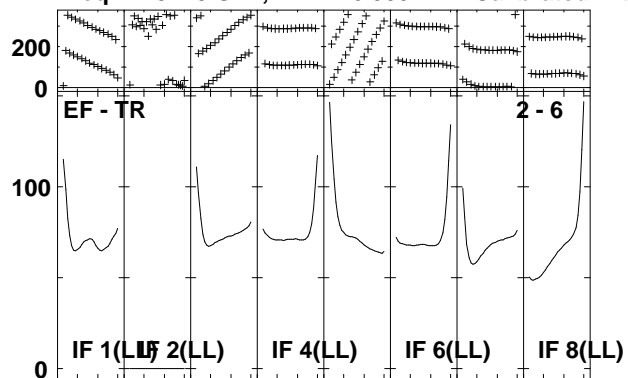

Lower frame: Ampl Jy Top frame: Phas deg
Vector averaged cross-power spectrum Several baselines displayed
Timerange: 01/02:29:31 to 01/02:30:59

Plot file version 194 created 13-OCT-2010 18:47:17

IRAS1954 EP064N.UVDATA.1

Freq = 4.9270 GHz, Bw = 16.000 MH Calibrated with CL # 3 and BP # 1 (BP mode 1)

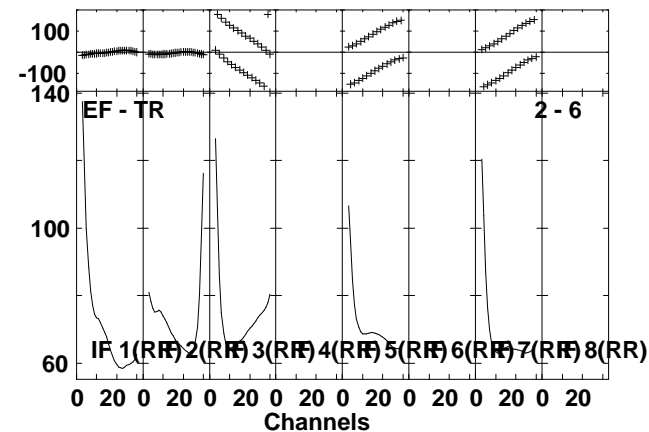
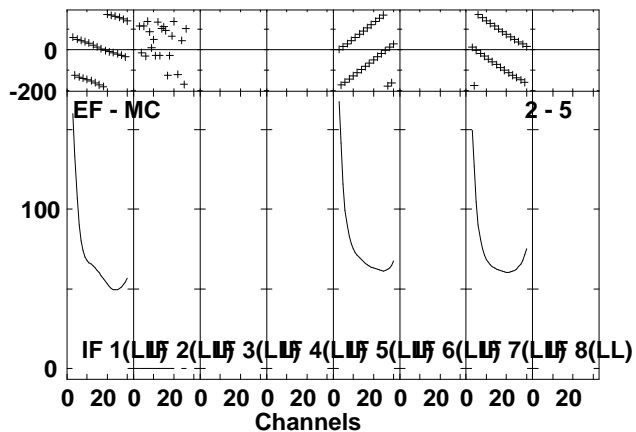
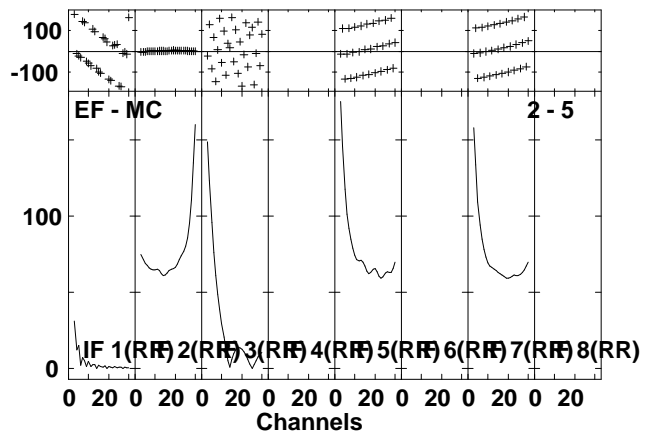
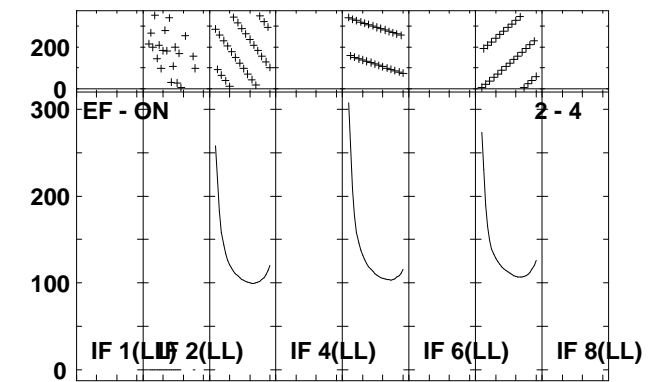
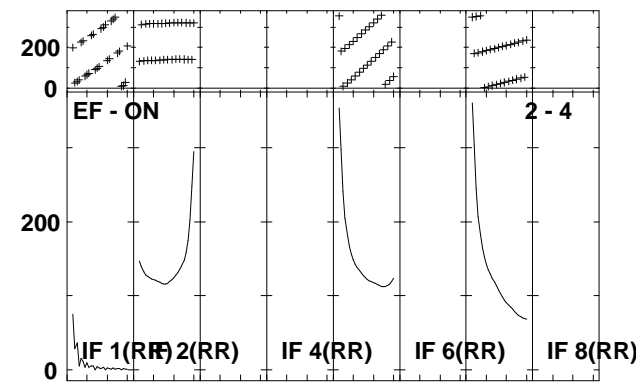
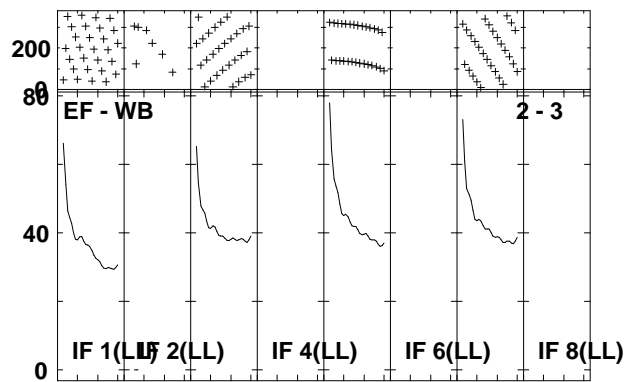
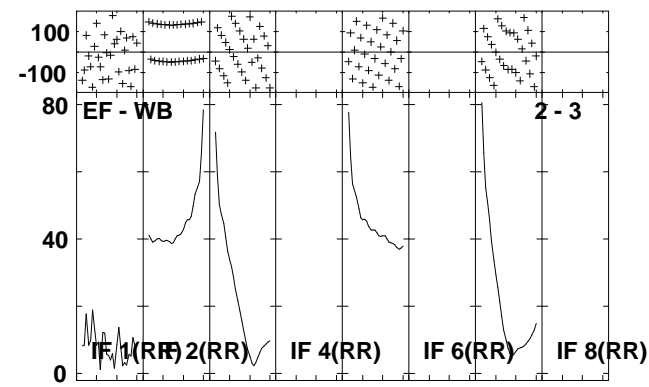
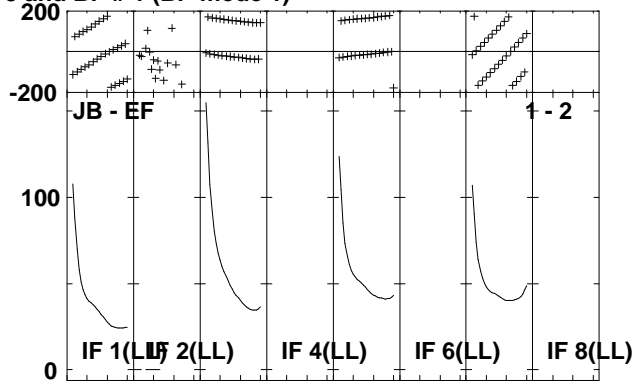
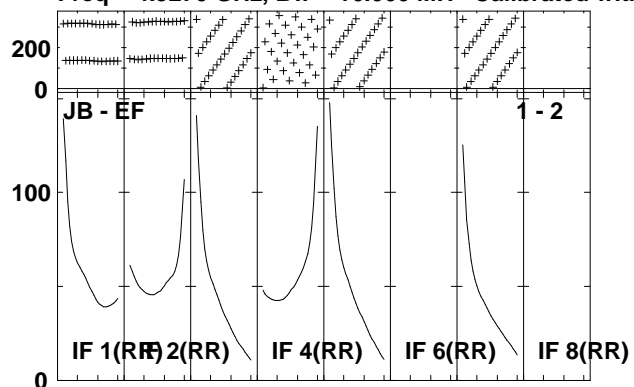

Lower frame: Ampl Jy Top frame: Phas deg
Vector averaged cross-power spectrum Several baselines displayed
Timerange: 01/02:31:01 to 01/02:34:29

Plot file version 195 created 13-OCT-2010 18:47:20

IRAS1954 EP064N.UVDATA.1

Freq = 4.9270 GHz, Bw = 16.000 MH Calibrated with CL # 3 and BP # 1 (BP mode 1)

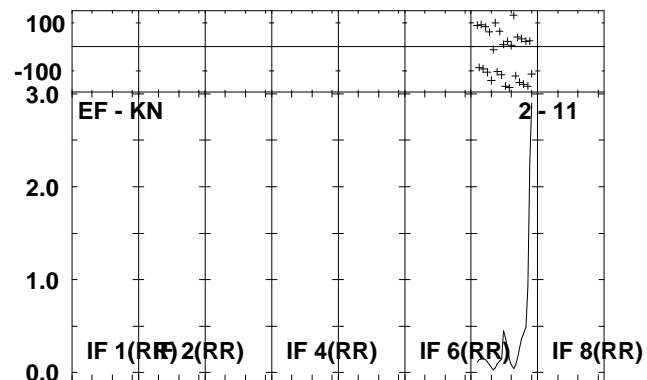
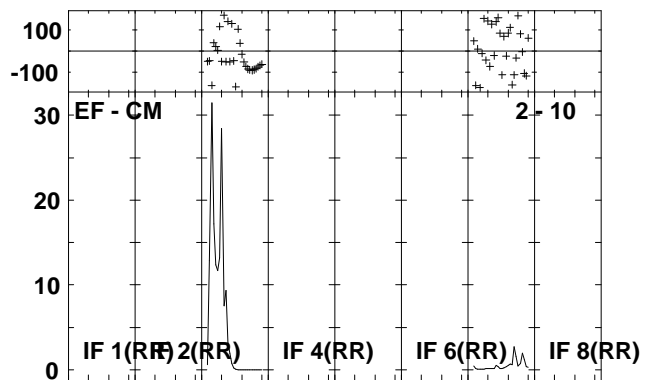
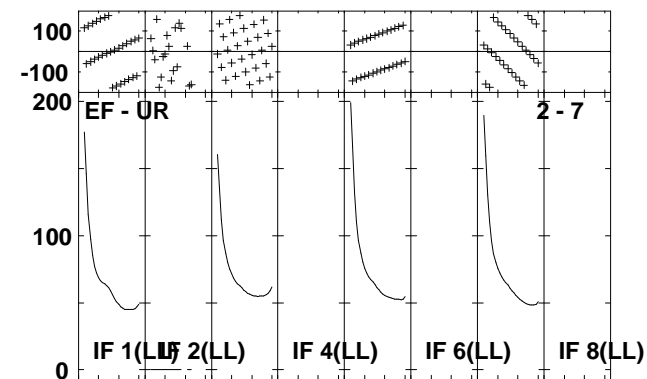
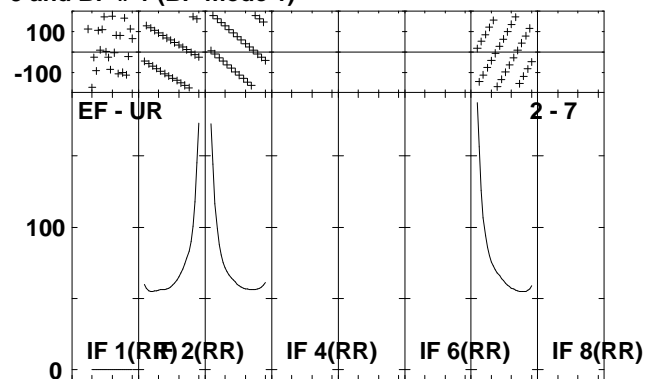
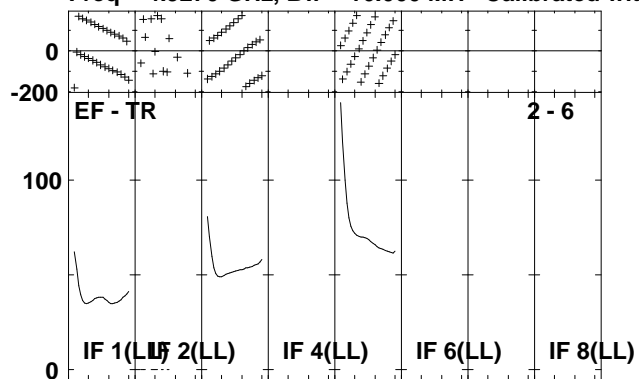

Lower frame: Ampl Jy Top frame: Phas deg
Vector averaged cross-power spectrum Several baselines displayed
Timerange: 01/02:31:01 to 01/02:34:29

Plot file version 196 created 13-OCT-2010 18:47:25

J2001+10 EP064N.UVDATA.1

Freq = 4.9270 GHz, Bw = 16.000 MH Calibrated with CL # 3 and BP # 1 (BP mode 1)

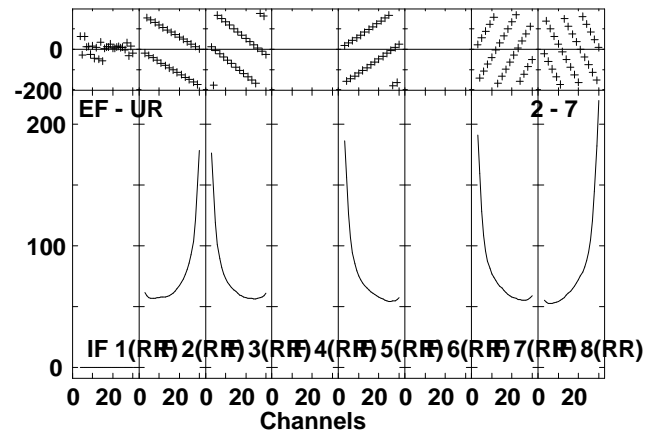
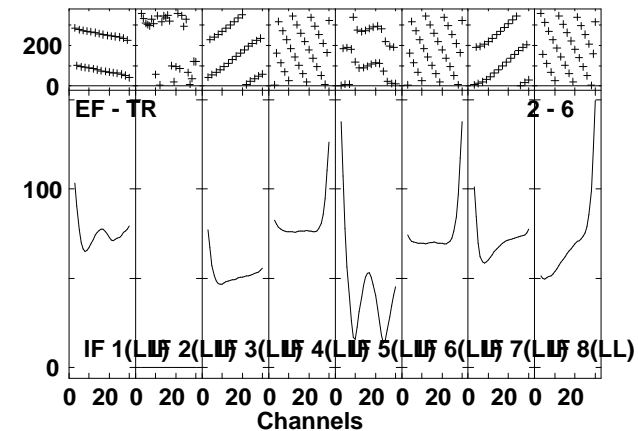
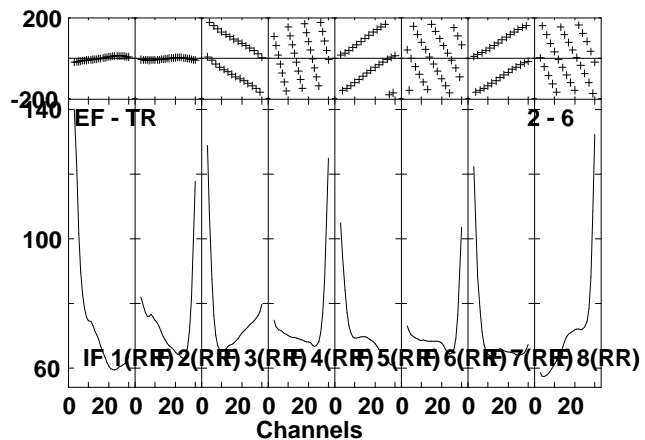
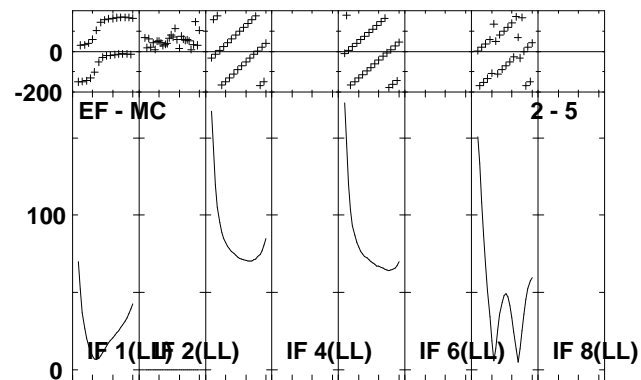
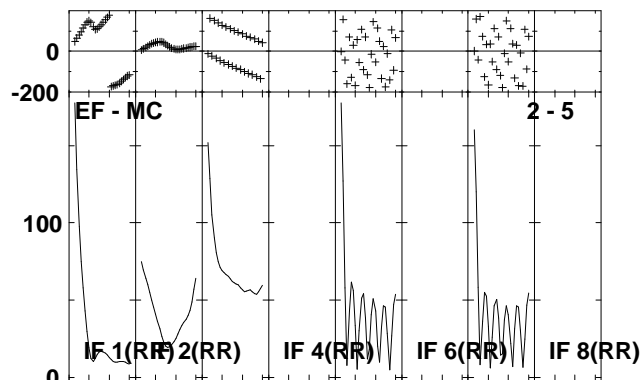
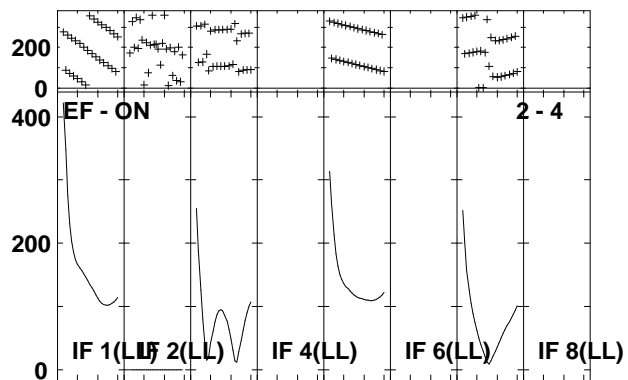
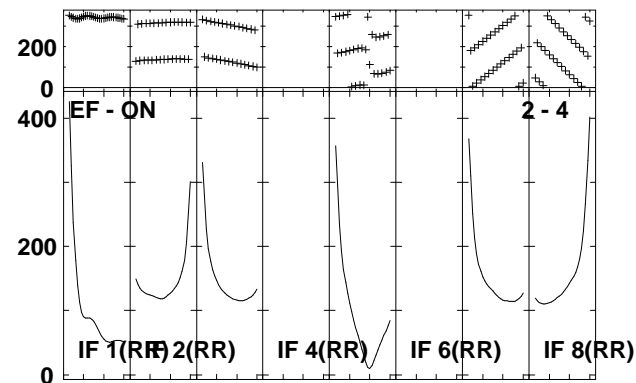
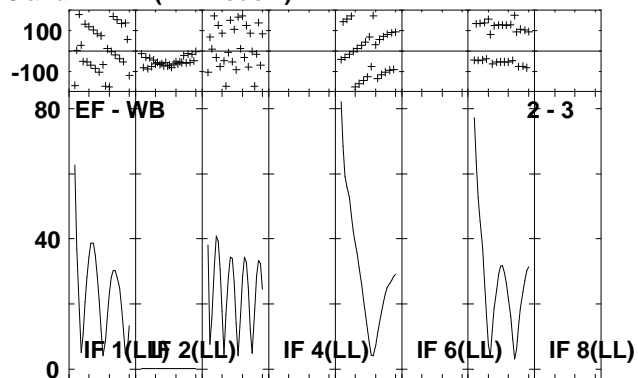
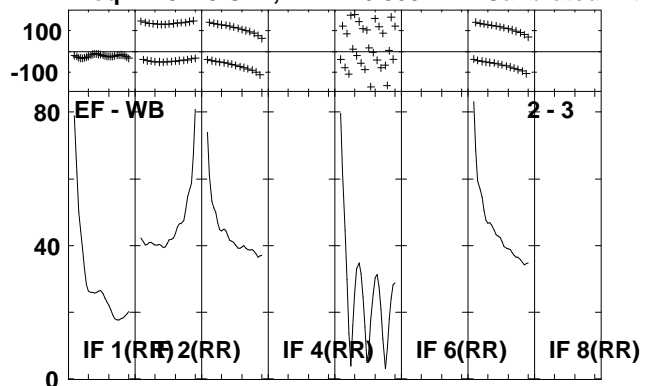

Lower frame: Ampl Jy Top frame: Phas deg
Vector averaged cross-power spectrum Several baselines displayed
Timerange: 01/02:34:31 to 01/02:35:59

Plot file version 197 created 13-OCT-2010 18:47:26

J2001+10 EP064N.UVDATA.1

Freq = 4.9270 GHz, Bw = 16.000 MH Calibrated with CL # 3 and BP # 1 (BP mode 1)

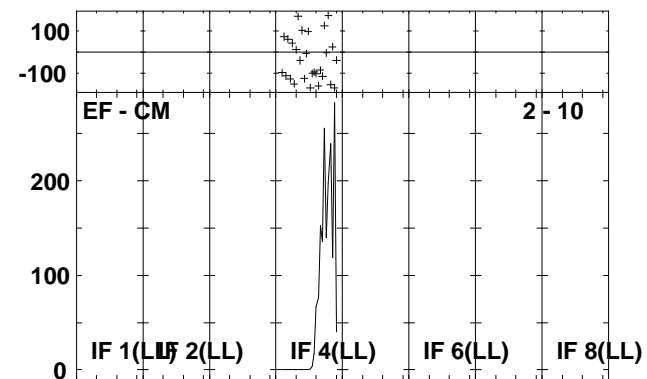
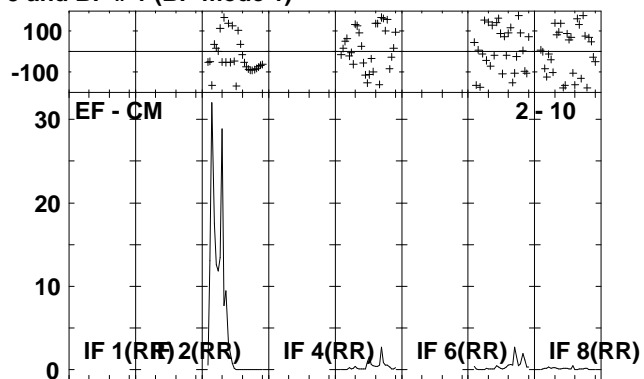
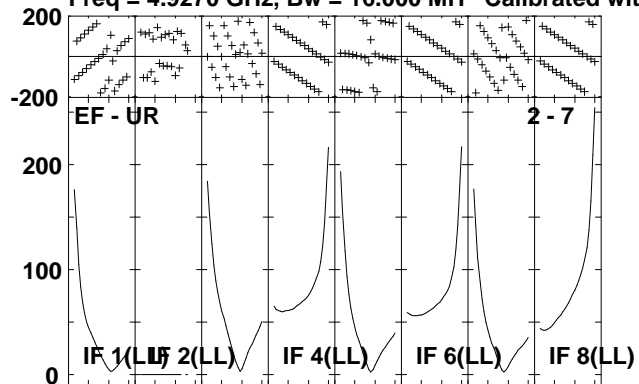

Lower frame: Ampl Jy Top frame: Phas deg
Vector averaged cross-power spectrum Several baselines displayed
Timerange: 01/02:34:31 to 01/02:35:59

Plot file version 198 created 13-OCT-2010 18:47:28

IRAS1954 EP064N.UVDATA.1

Freq = 4.9270 GHz, Bw = 16.000 MH Calibrated with CL # 3 and BP # 1 (BP mode 1)

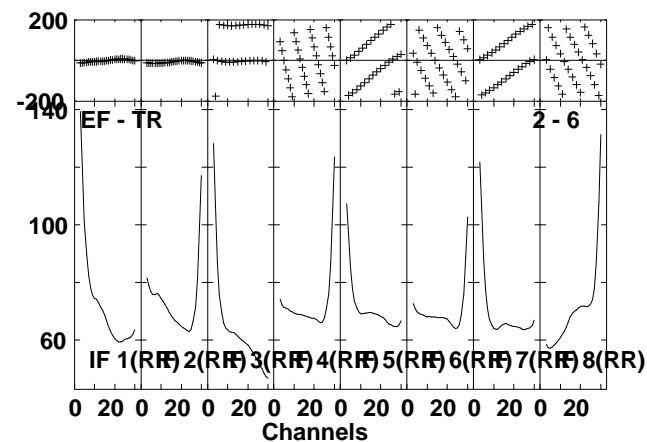
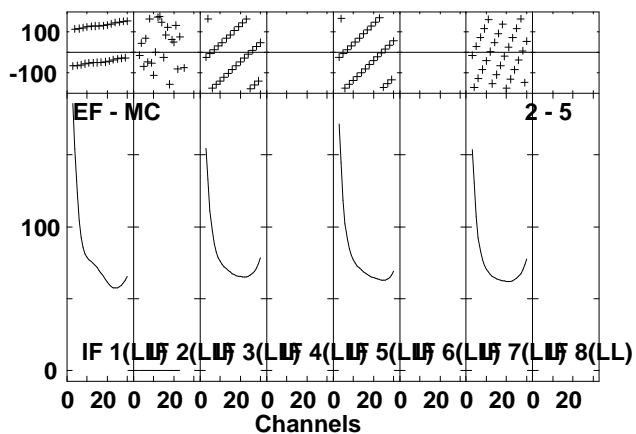
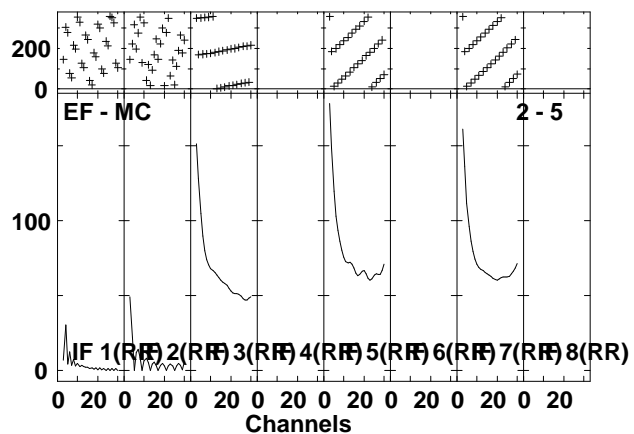
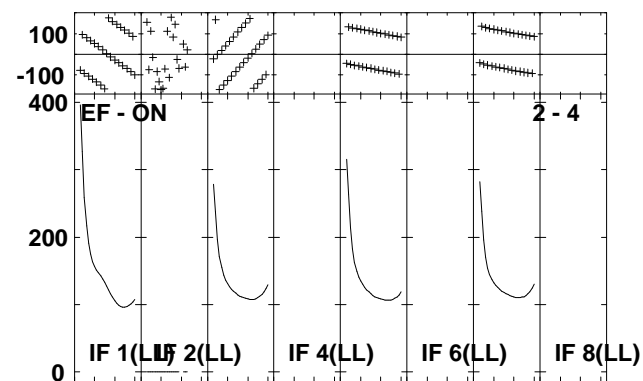
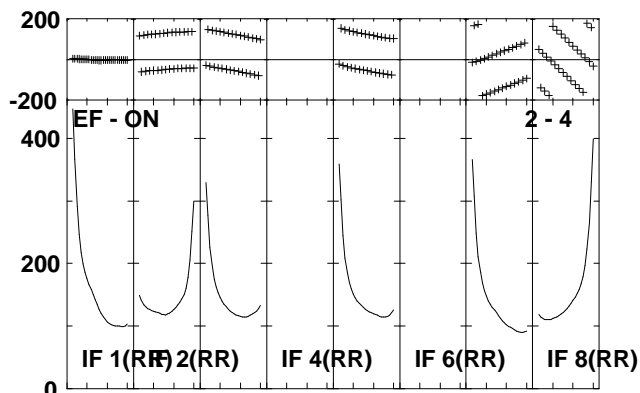
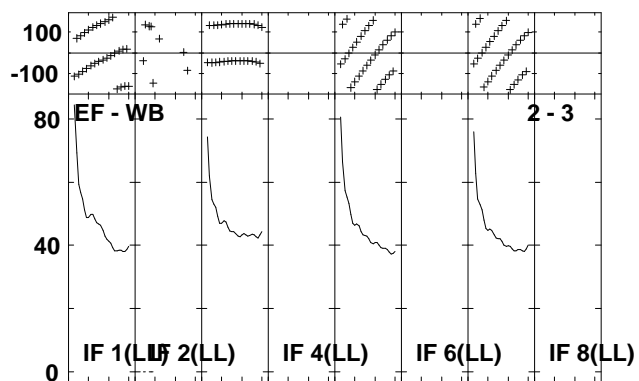
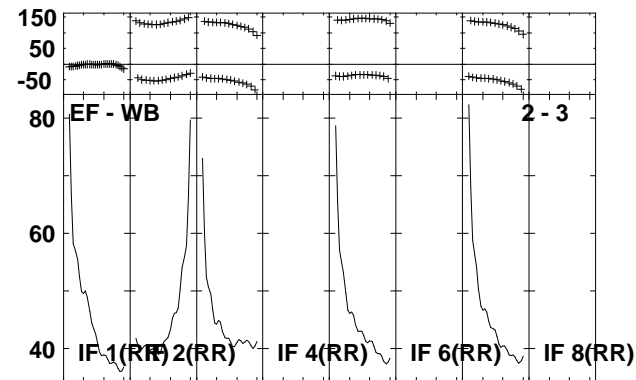
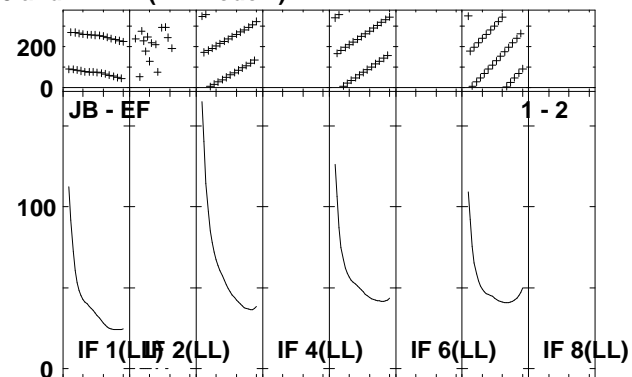
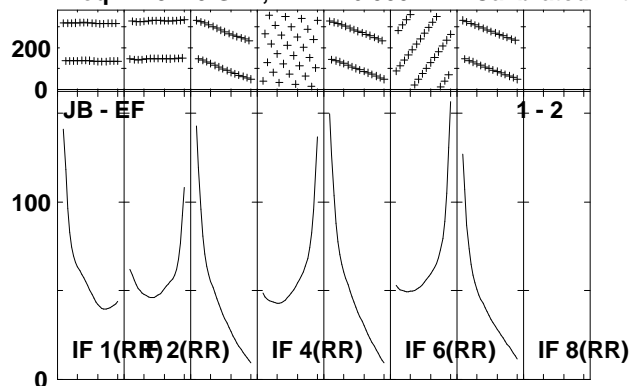

Lower frame: Ampl Jy Top frame: Phas deg
Vector averaged cross-power spectrum Several baselines displayed
Timerange: 01/02:36:01 to 01/02:39:29

Plot file version 199 created 13-OCT-2010 18:47:31

IRAS1954 EP064N.UVDATA.1

Freq = 4.9270 GHz, Bw = 16.000 MH Calibrated with CL # 3 and BP # 1 (BP mode 1)

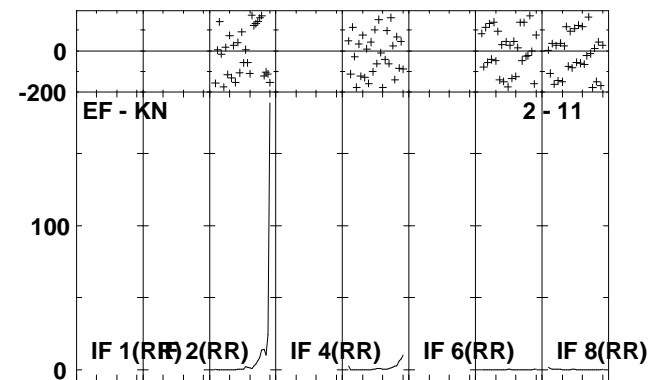
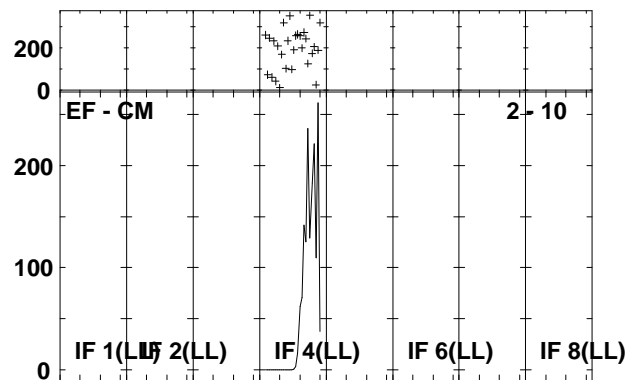
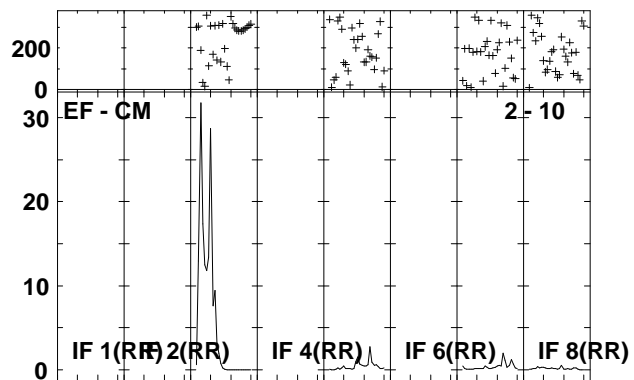
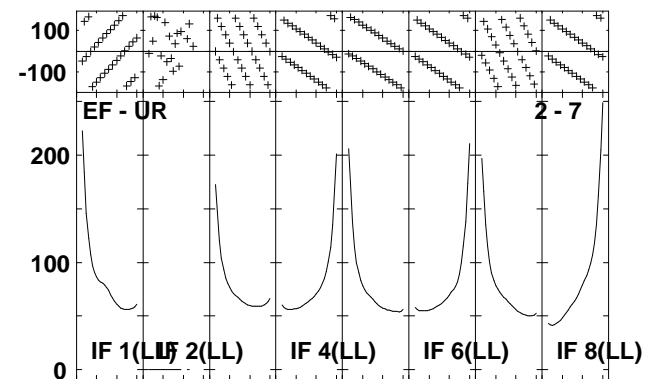
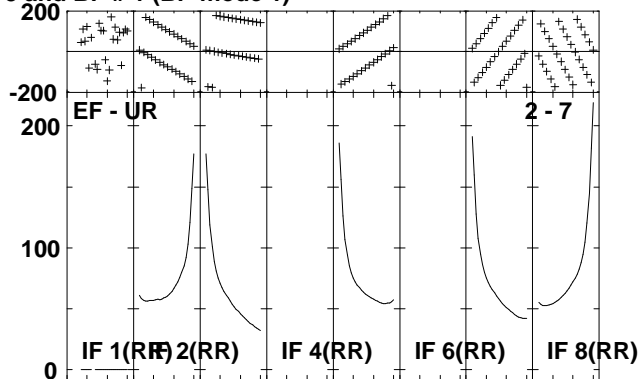
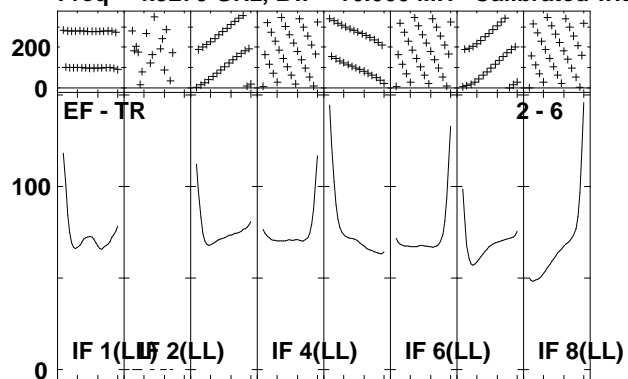

Lower frame: Ampl Jy Top frame: Phas deg
Vector averaged cross-power spectrum Several baselines displayed
Timerange: 01/02:36:01 to 01/02:39:29

Plot file version 200 created 13-OCT-2010 18:47:36

J2001+10 EP064N.UVDATA.1

Freq = 4.9270 GHz, Bw = 16.000 MH Calibrated with CL # 3 and BP # 1 (BP mode 1)

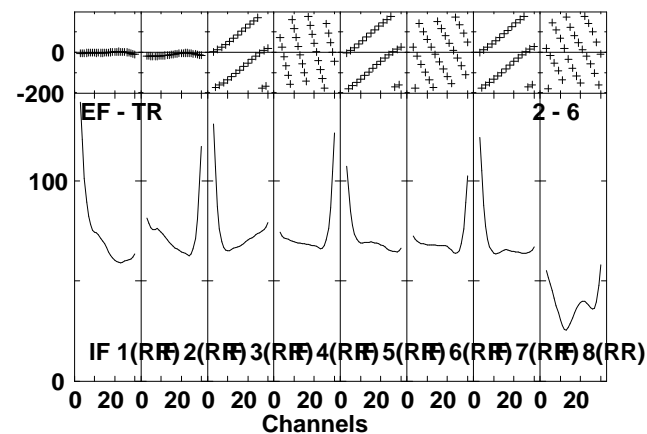
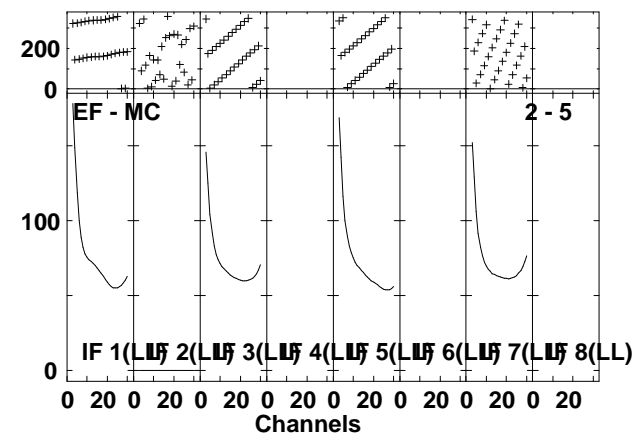
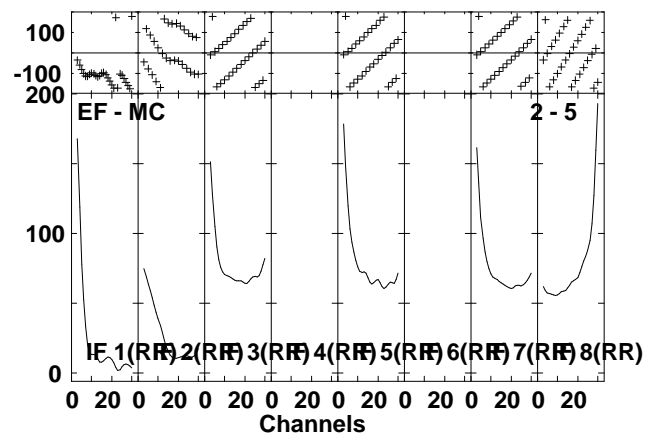
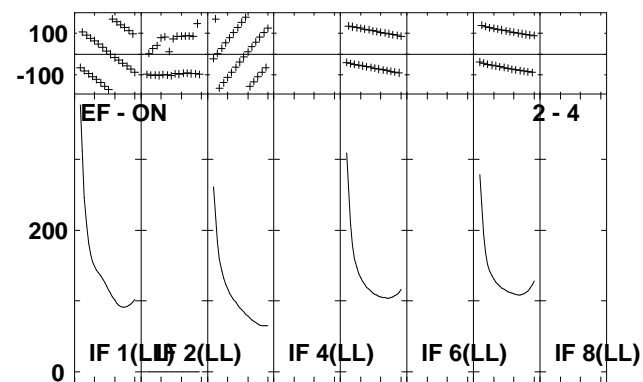
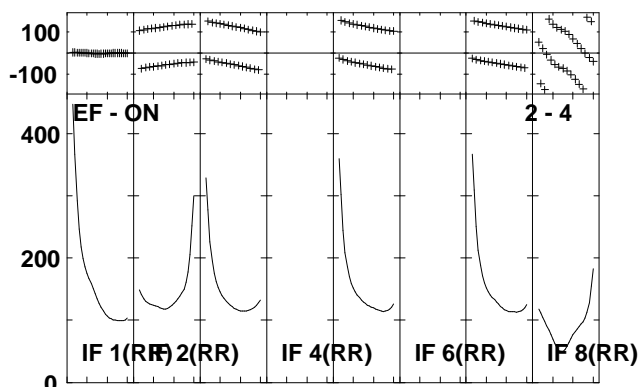
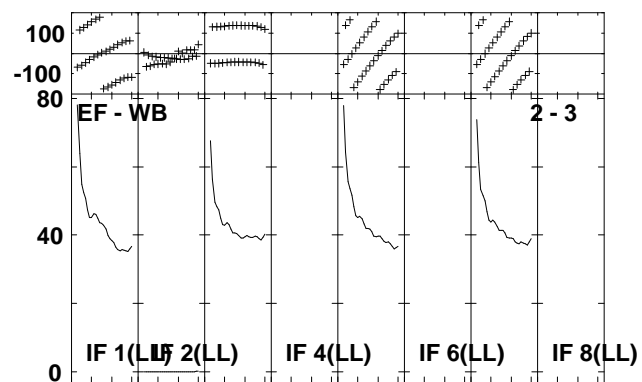
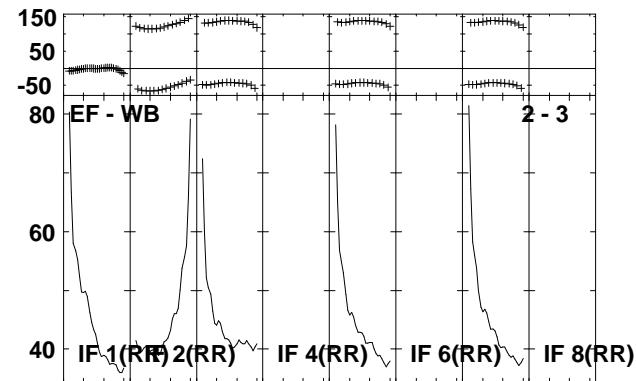
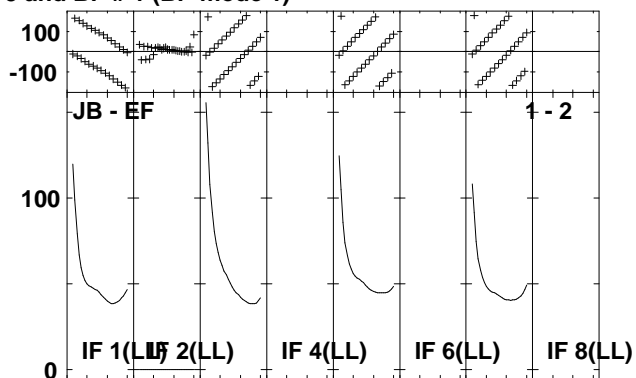
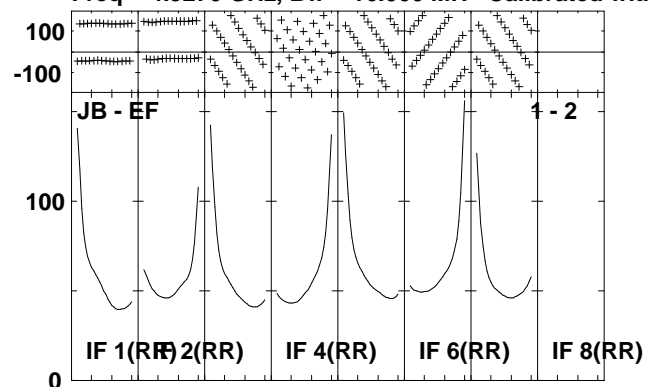

Lower frame: Ampl Jy Top frame: Phas deg
Vector averaged cross-power spectrum Several baselines displayed
Timerange: 01/02:40:31 to 01/02:41:59

Plot file version 201 created 13-OCT-2010 18:47:37

J2001+10 EP064N.UVDATA.1

Freq = 4.9270 GHz, Bw = 16.000 MH Calibrated with CL # 3 and BP # 1 (BP mode 1)

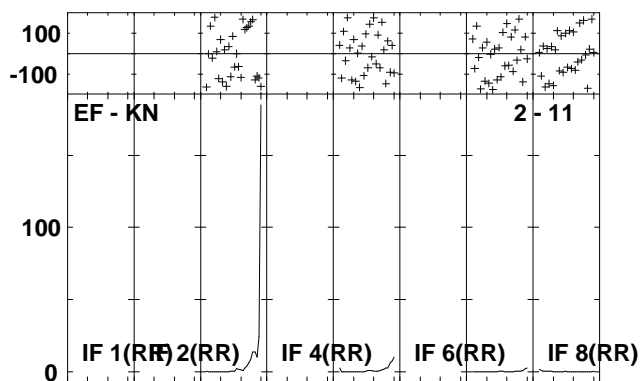
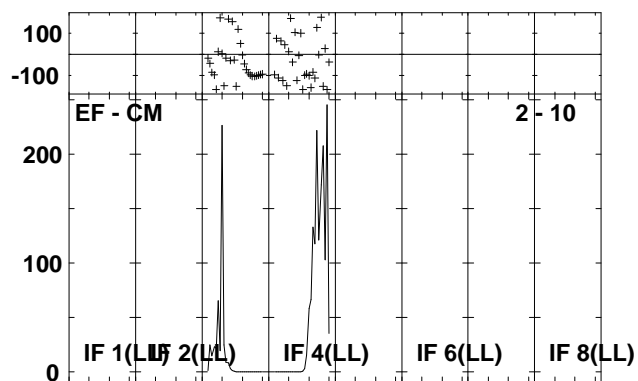
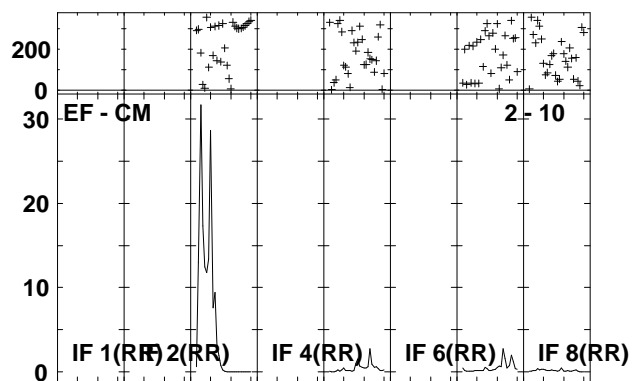
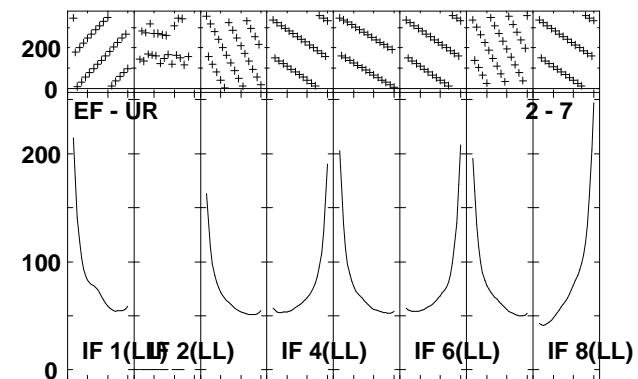
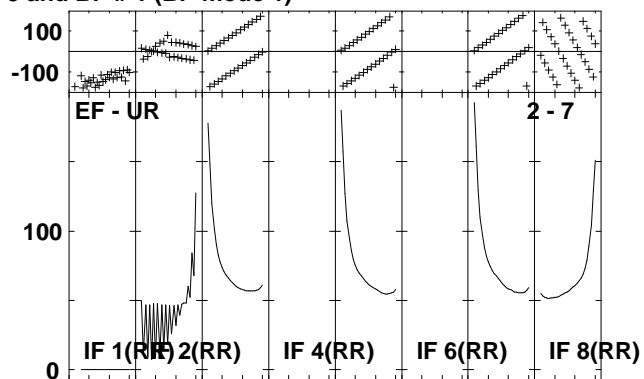
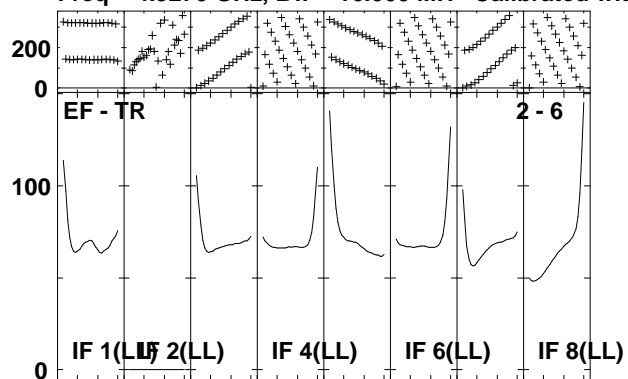

Lower frame: Ampl Jy Top frame: Phas deg
Vector averaged cross-power spectrum Several baselines displayed
Timerange: 01/02:40:31 to 01/02:41:59

Plot file version 202 created 13-OCT-2010 18:47:40

IRAS1954 EP064N.UVDATA.1

Freq = 4.9270 GHz, Bw = 16.000 MH Calibrated with CL # 3 and BP # 1 (BP mode 1)

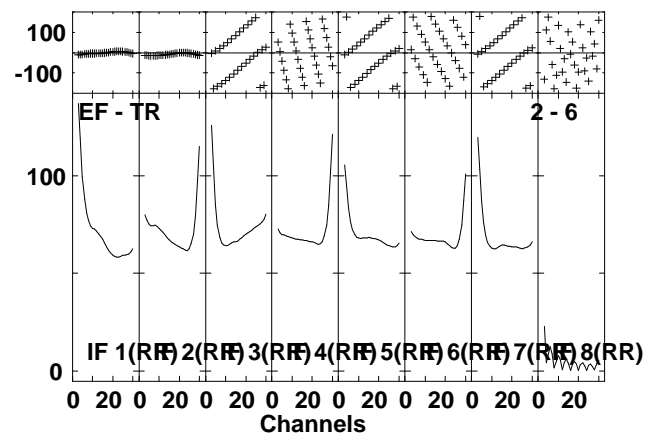
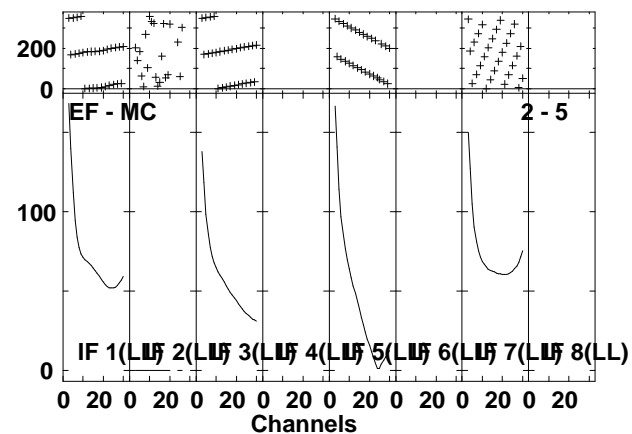
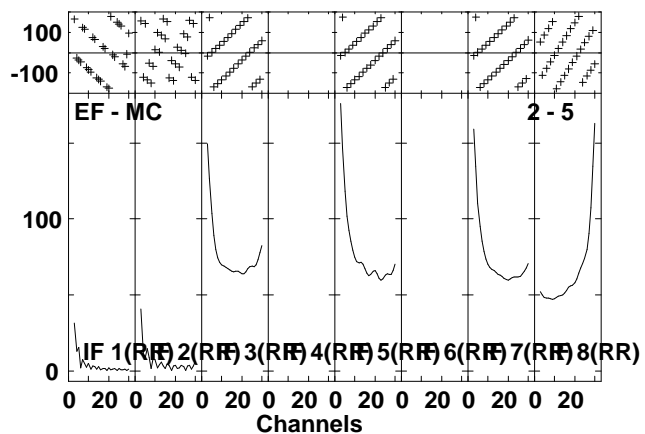
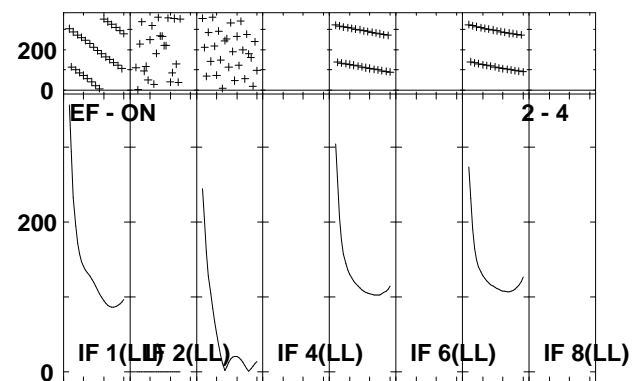
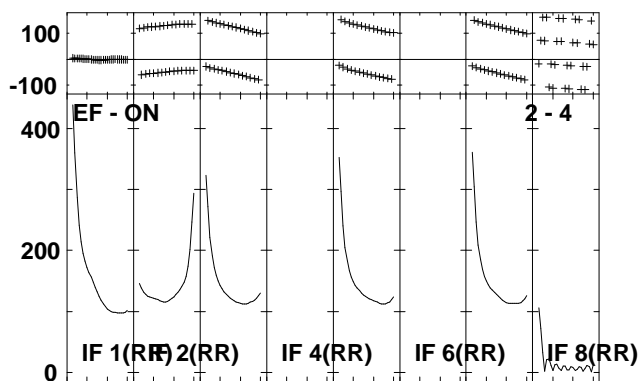
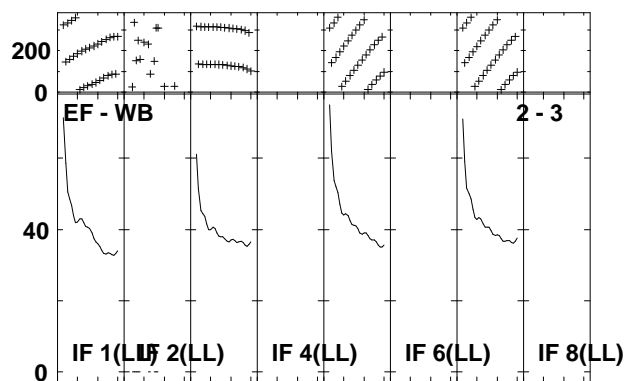
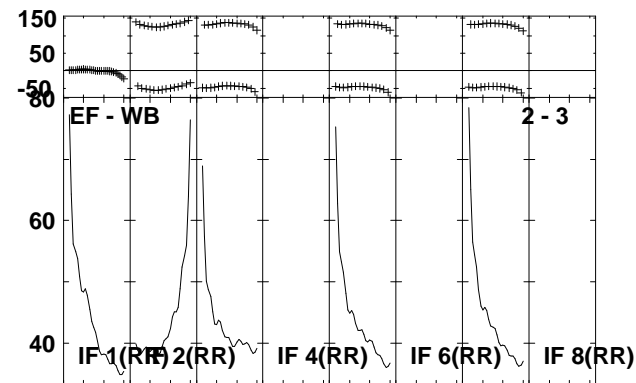
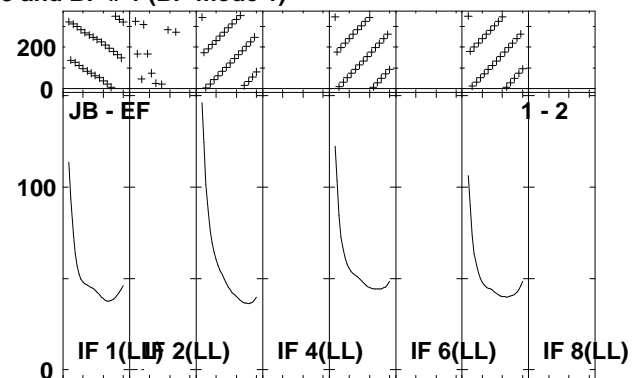
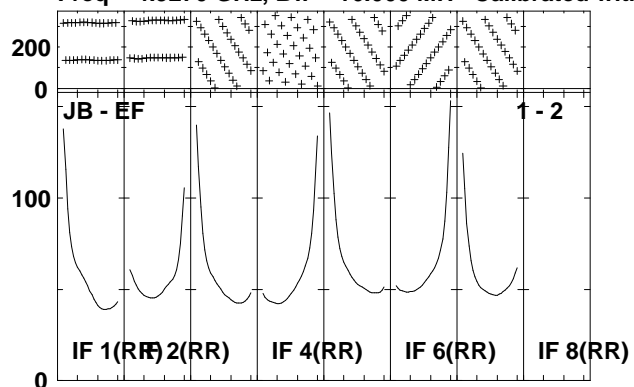

Lower frame: Ampl Jy Top frame: Phas deg
Vector averaged cross-power spectrum Several baselines displayed
Timerange: 01/02:42:01 to 01/02:45:29

Plot file version 203 created 13-OCT-2010 18:47:43

IRAS1954 EP064N.UVDATA.1

Freq = 4.9270 GHz, Bw = 16.000 MH Calibrated with CL # 3 and BP # 1 (BP mode 1)

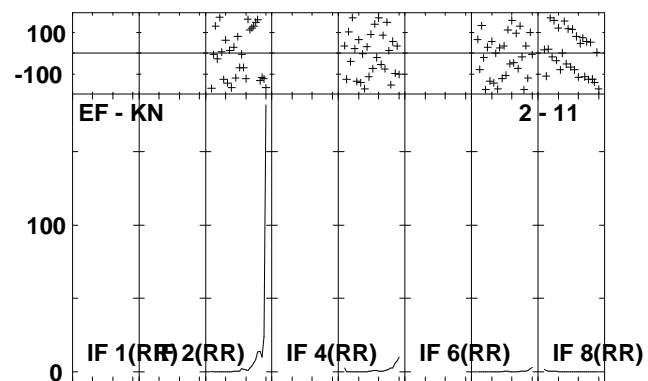
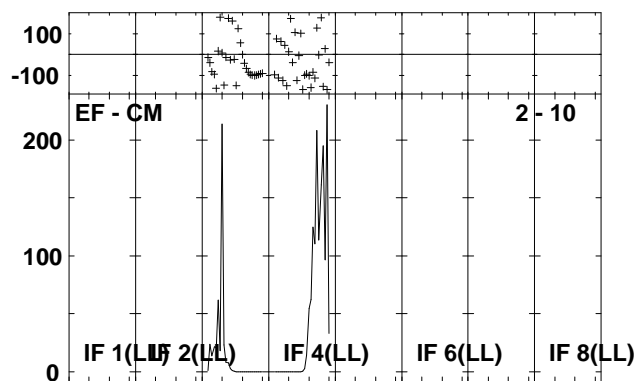
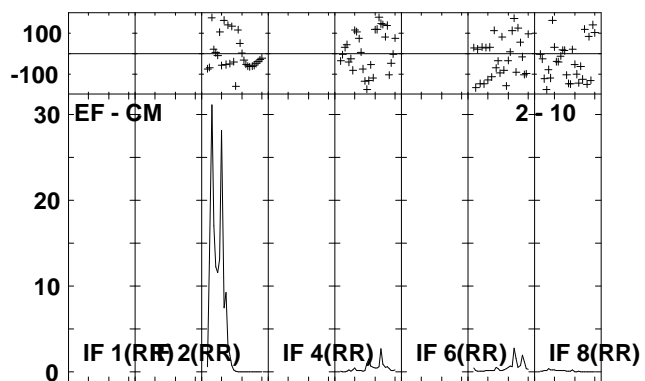
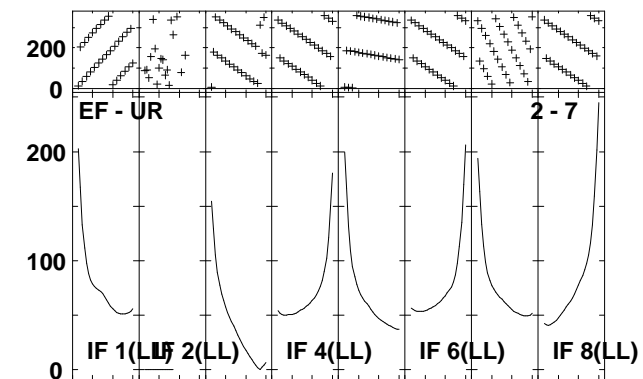
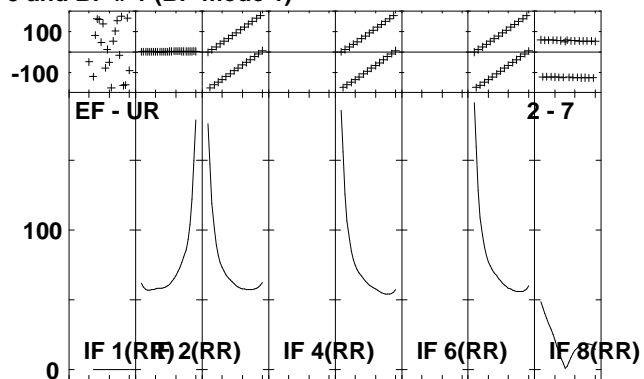
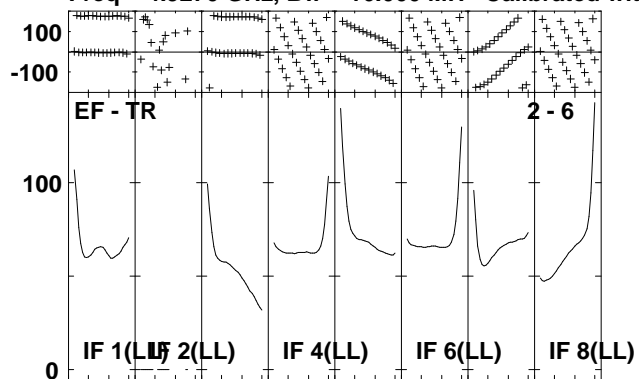

Lower frame: Ampl Jy Top frame: Phas deg
Vector averaged cross-power spectrum Several baselines displayed
Timerange: 01/02:42:01 to 01/02:45:29

Plot file version 204 created 13-OCT-2010 18:47:48

J2001+10 EP064N.UVDATA.1

Freq = 4.9270 GHz, Bw = 16.000 MH Calibrated with CL # 3 and BP # 1 (BP mode 1)

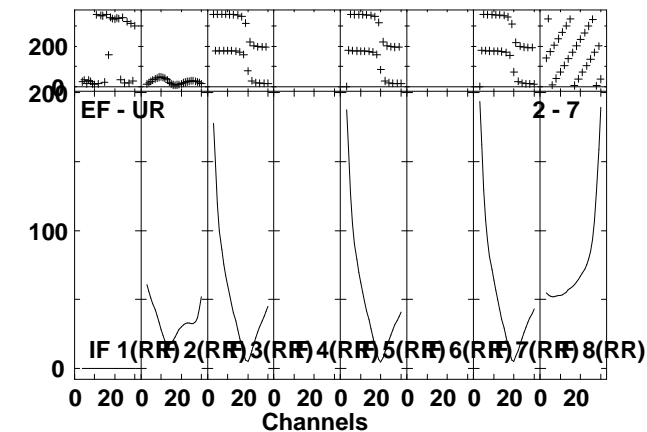
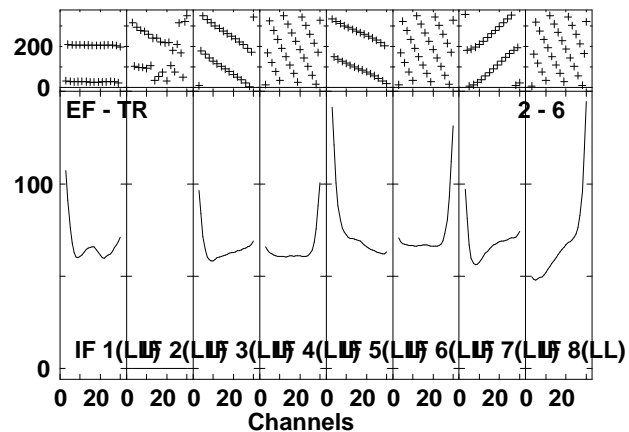
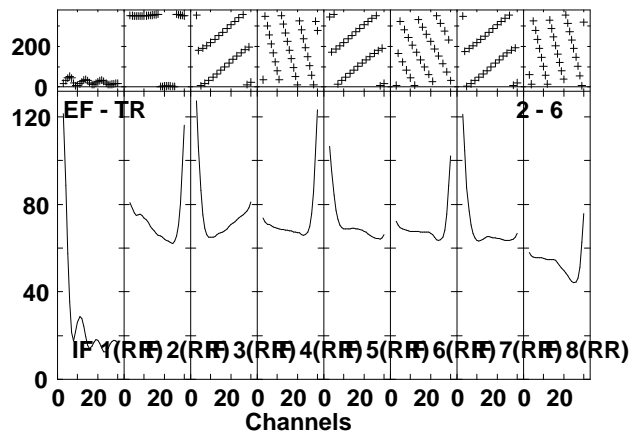
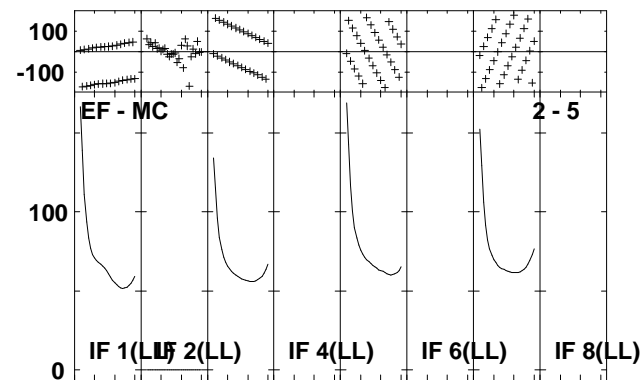
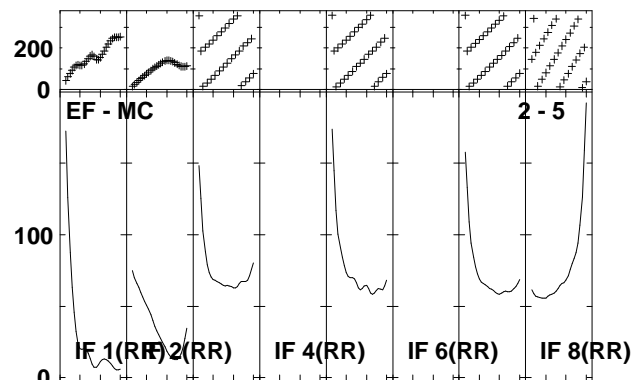
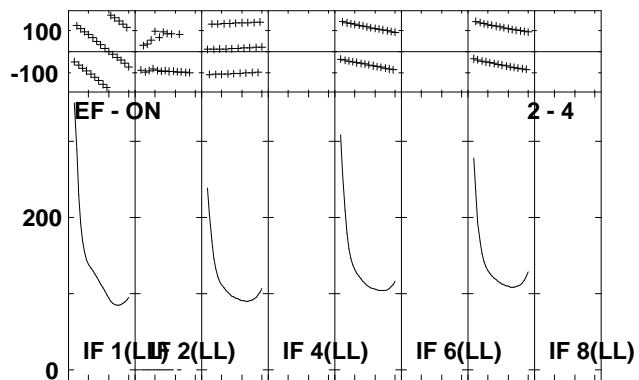
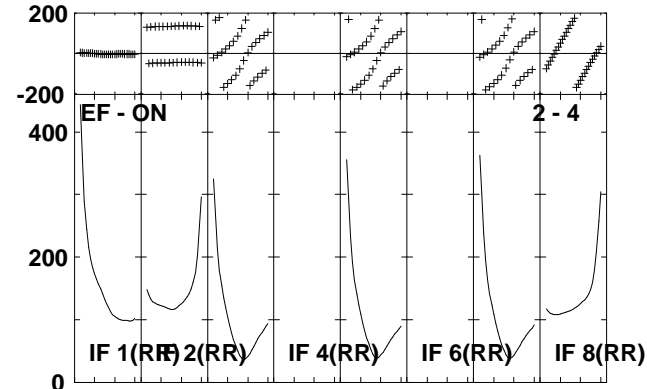
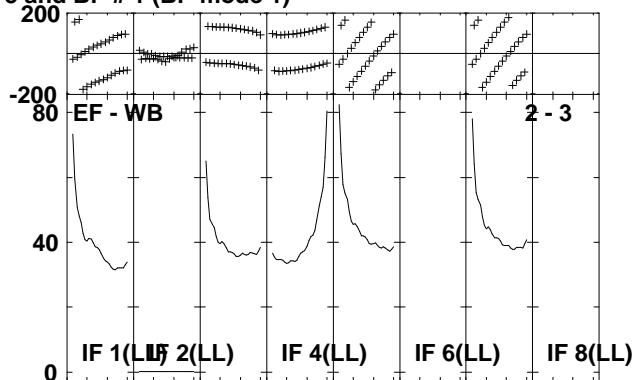
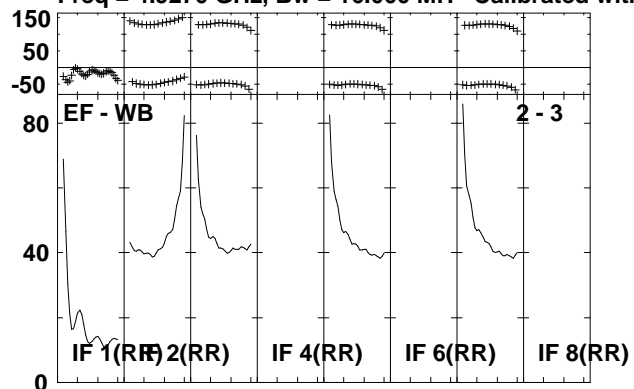

Lower frame: Ampl Jy Top frame: Phas deg
Vector averaged cross-power spectrum Several baselines displayed
Timerange: 01/02:45:31 to 01/02:46:59

Plot file version 205 created 13-OCT-2010 18:47:49

J2001+10 EP064N.UVDATA.1

Freq = 4.9270 GHz, Bw = 16.000 MH Calibrated with CL # 3 and BP # 1 (BP mode 1)

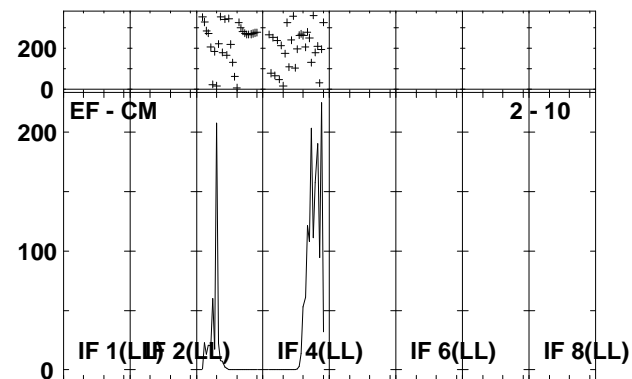
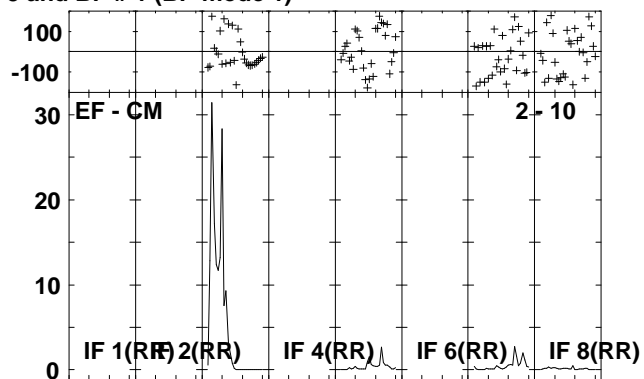
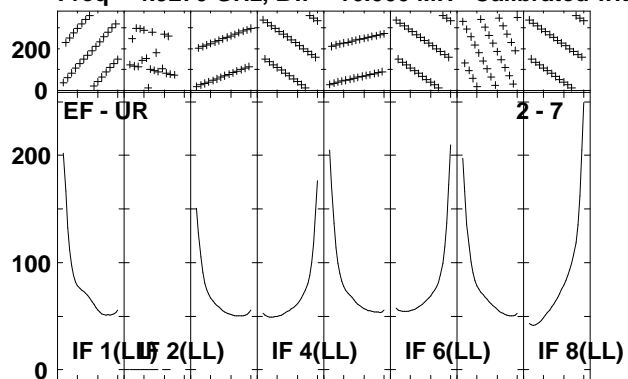

Lower frame: Ampl Jy Top frame: Phas deg
Vector averaged cross-power spectrum Several baselines displayed
Timerange: 01/02:45:31 to 01/02:46:59

Plot file version 206 created 13-OCT-2010 18:47:51

IRAS1954 EP064N.UVDATA.1

Freq = 4.9270 GHz, Bw = 16.000 MH Calibrated with CL # 3 and BP # 1 (BP mode 1)

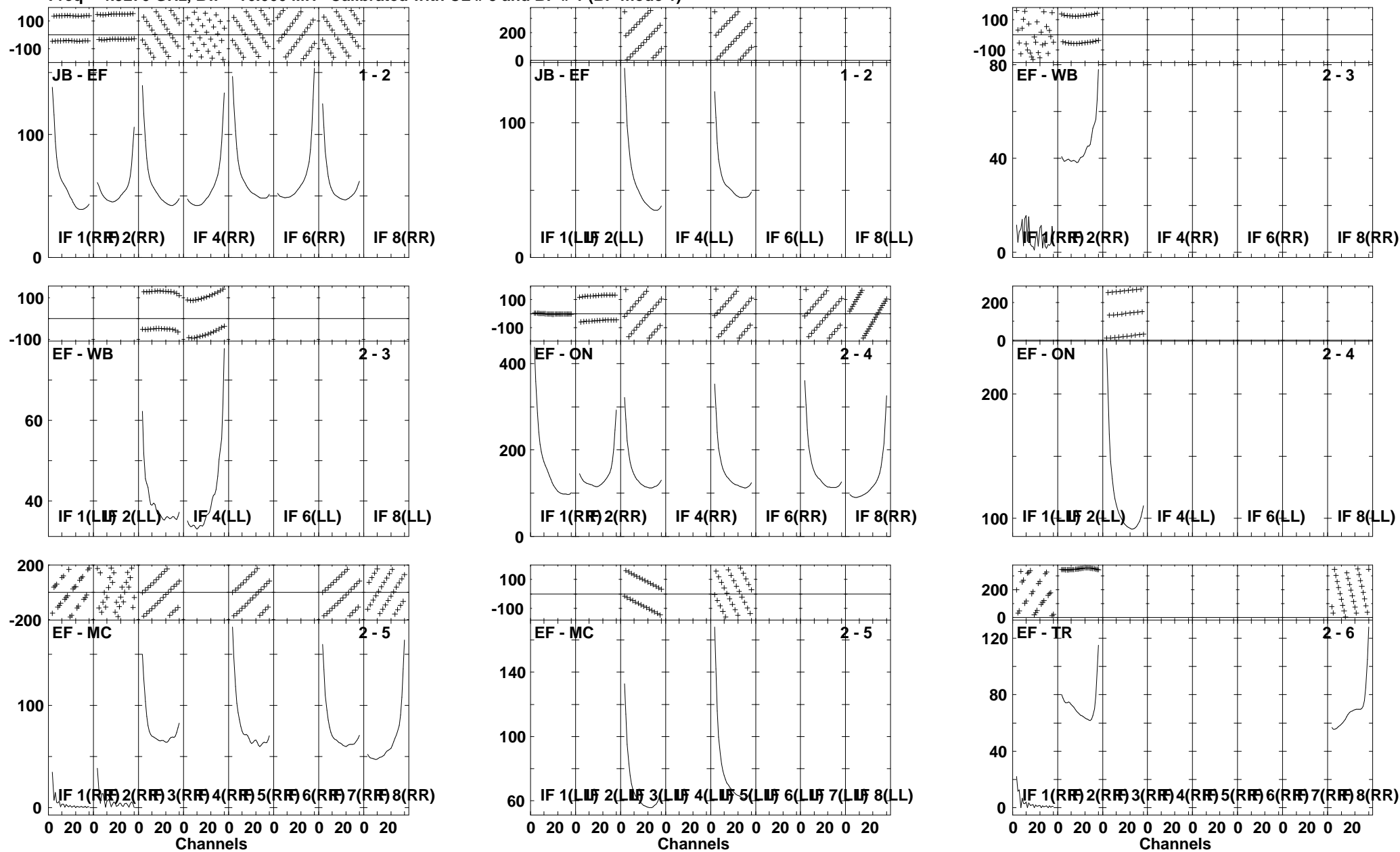

Lower frame: Ampl Jy Top frame: Phas deg
Vector averaged cross-power spectrum Several baselines displayed
Timerange: 01/02:47:01 to 01/02:50:29

Plot file version 207 created 13-OCT-2010 18:47:54

IRAS1954 EP064N.UVDATA.1

Freq = 4.9270 GHz, Bw = 16.000 MH Calibrated with CL # 3 and BP # 1 (BP mode 1)

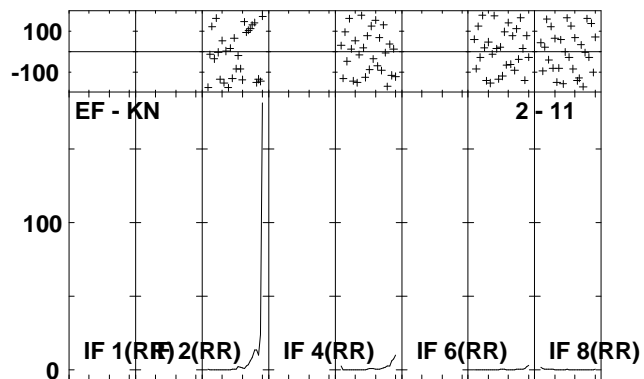
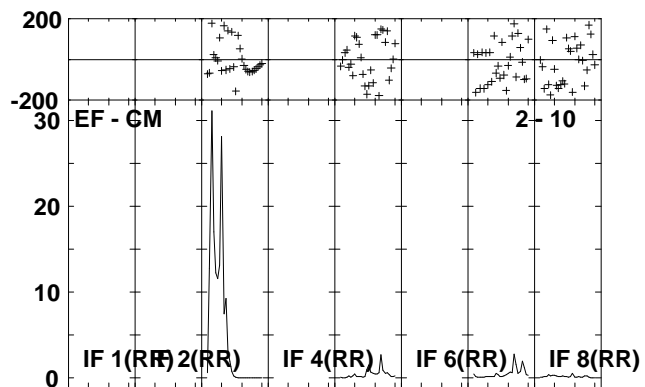
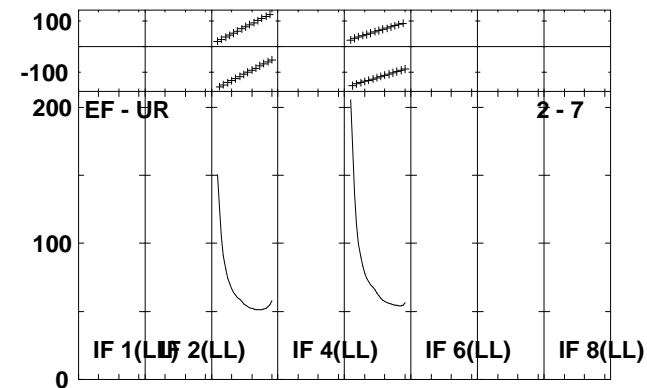
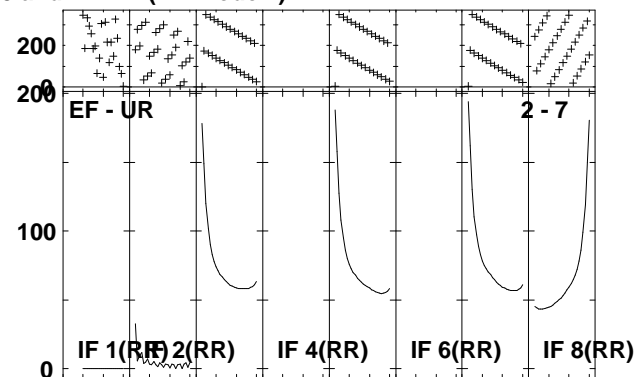
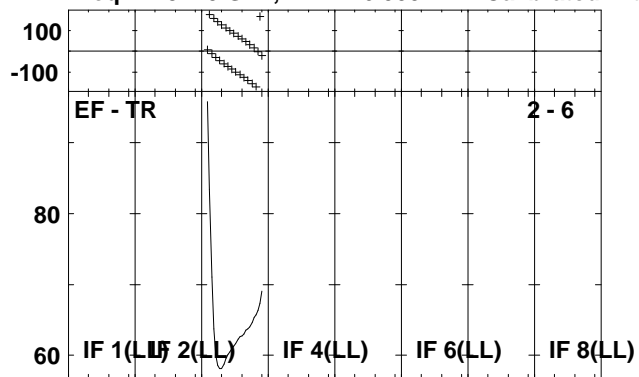

Lower frame: Ampl Jy Top frame: Phas deg

Vector averaged cross-power spectrum Several baselines displayed

Timerange: 01/02:47:01 to 01/02:50:29

Plot file version 208 created 13-OCT-2010 18:47:58

J2001+10 EP064N.UVDATA.1

Freq = 4.9270 GHz, Bw = 16.000 MH Calibrated with CL # 3 and BP # 1 (BP mode 1)

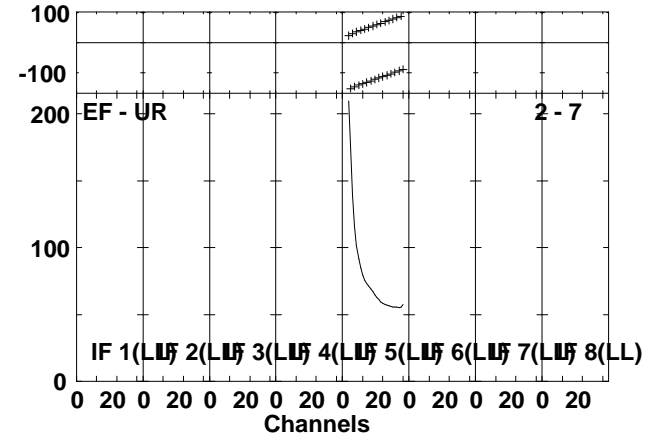
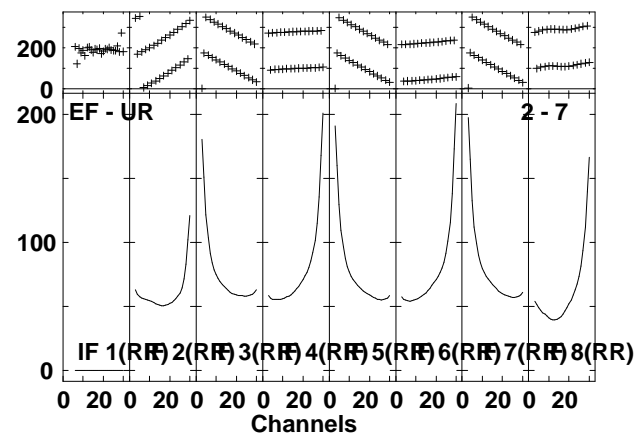
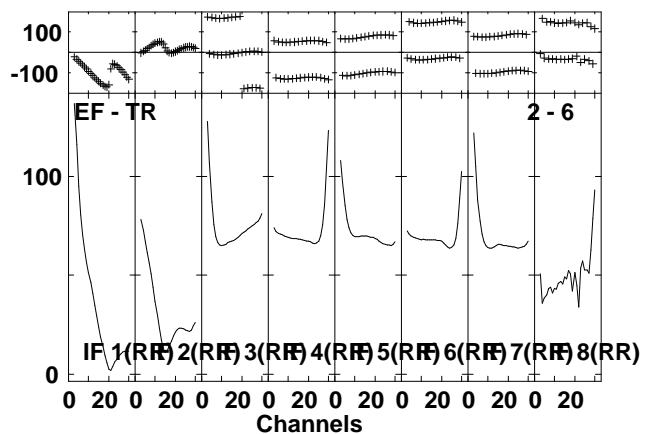
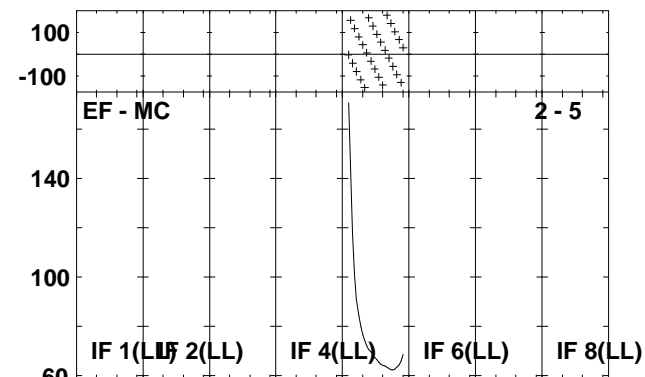
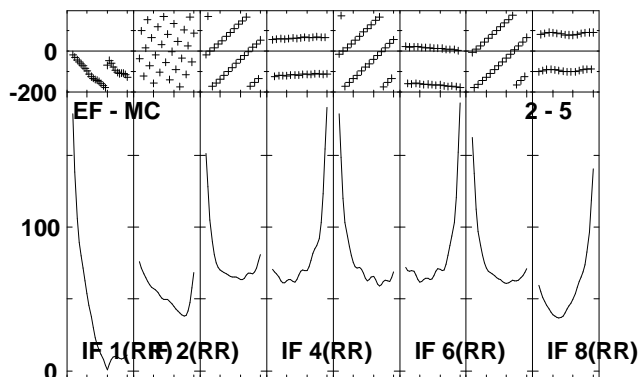
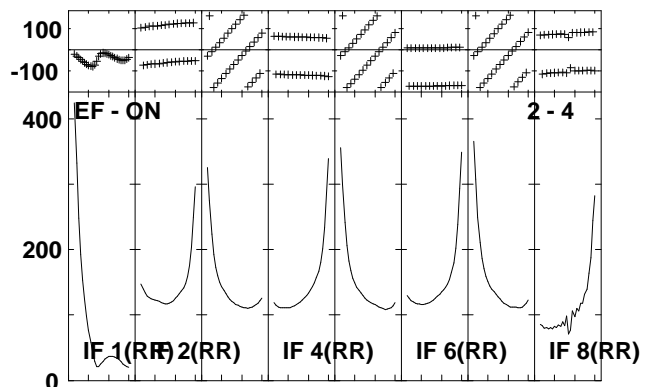
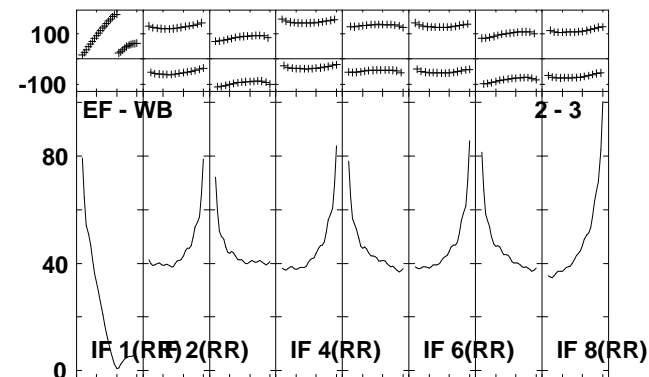
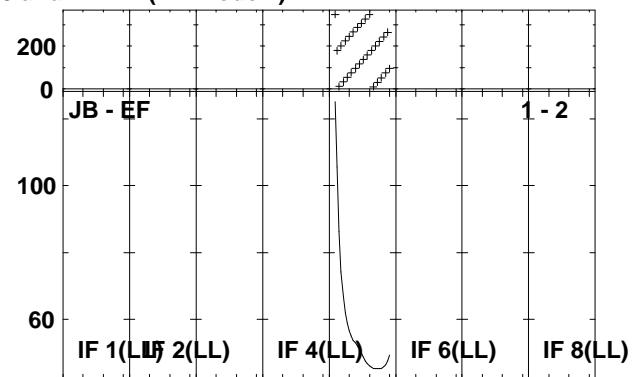
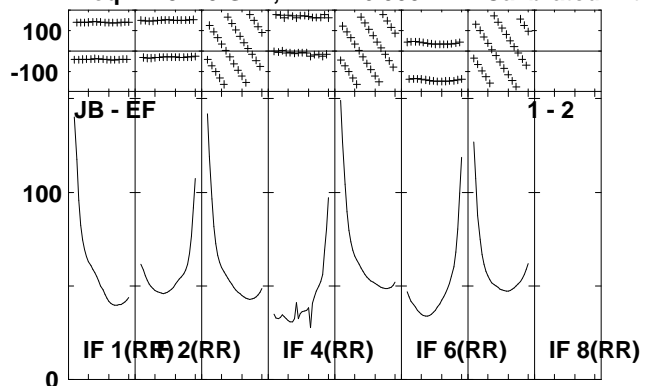

Lower frame: Ampl Jy Top frame: Phas deg
Vector averaged cross-power spectrum Several baselines displayed
Timerange: 01/02:50:31 to 01/02:51:59

Plot file version 209 created 13-OCT-2010 18:48:01

J2001+10 EP064N.UVDATA.1

Freq = 4.9270 GHz, Bw = 16.000 MH Calibrated with CL # 3 and BP # 1 (BP mode 1)

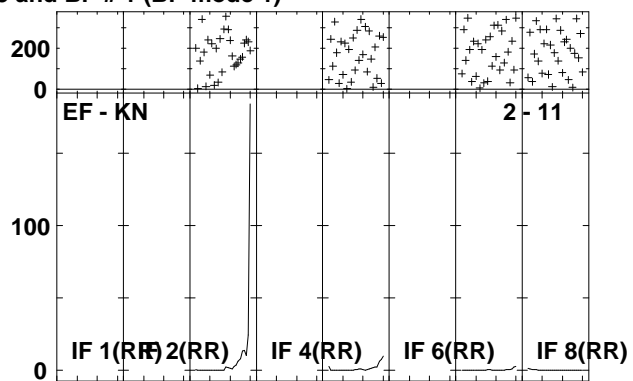
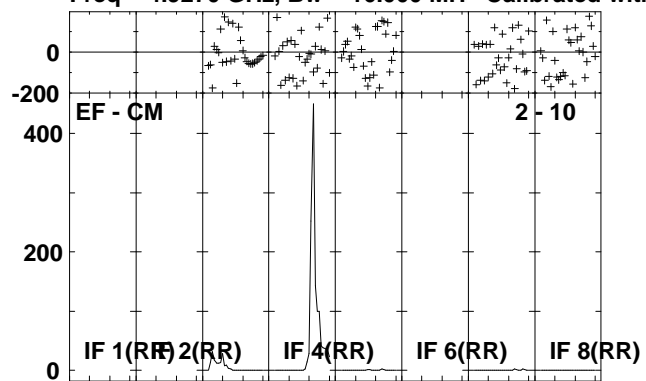

Lower frame: Kilo Ampl Jy Top frame: Phas deg
Vector averaged cross-power spectrum Several baselines displayed
Timerange: 01/02:50:31 to 01/02:51:59

Plot file version 210 created 13-OCT-2010 18:48:02

IRAS1954 EP064N.UVDATA.1

Freq = 4.9270 GHz, Bw = 16.000 MH Calibrated with CL # 3 and BP # 1 (BP mode 1)

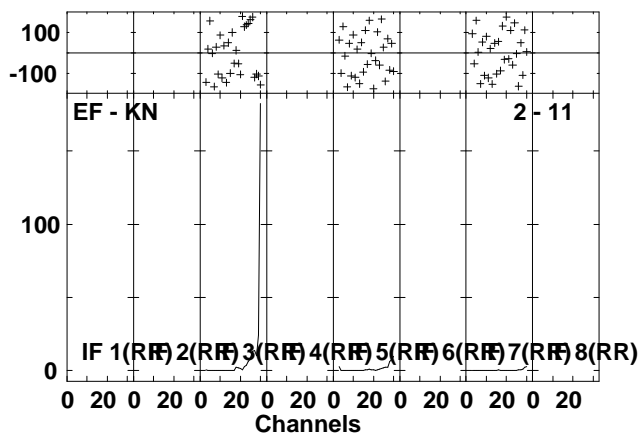
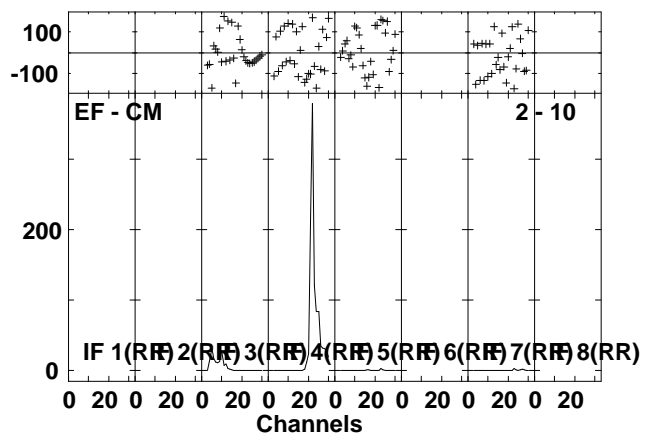
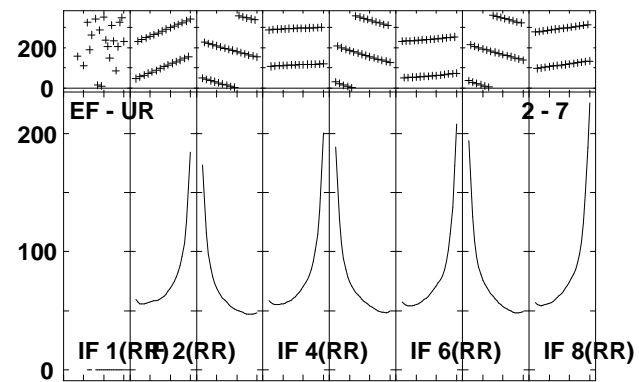
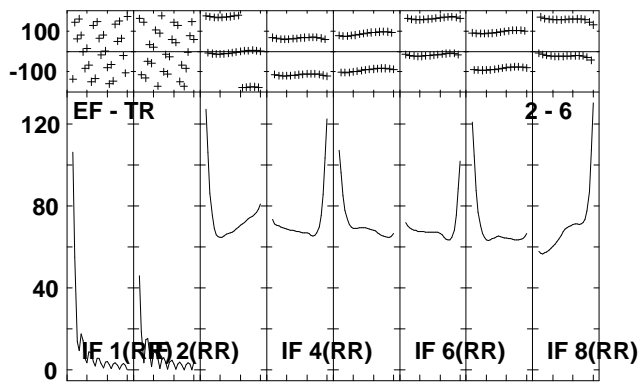
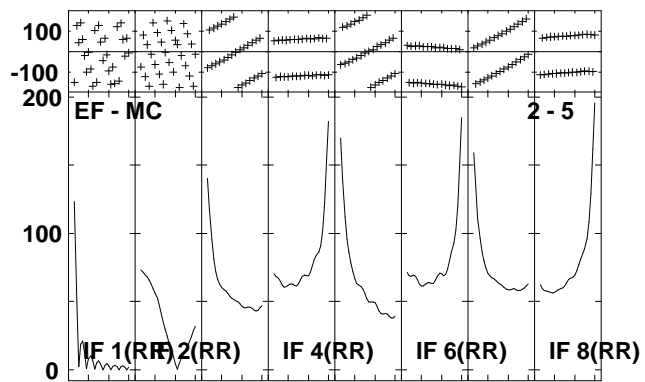
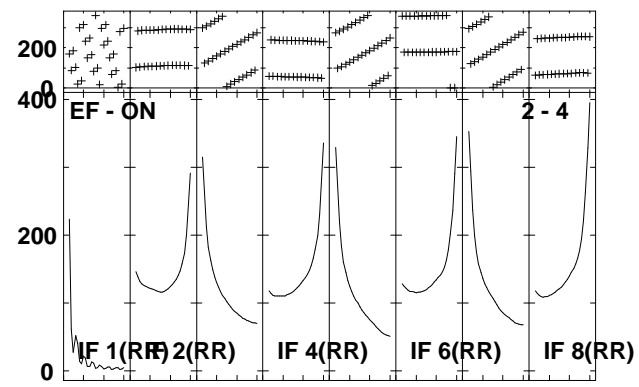
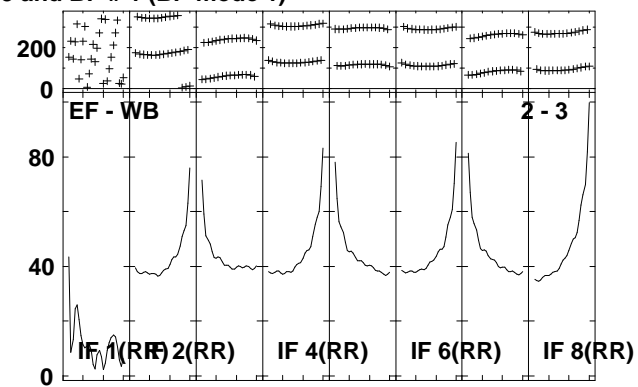
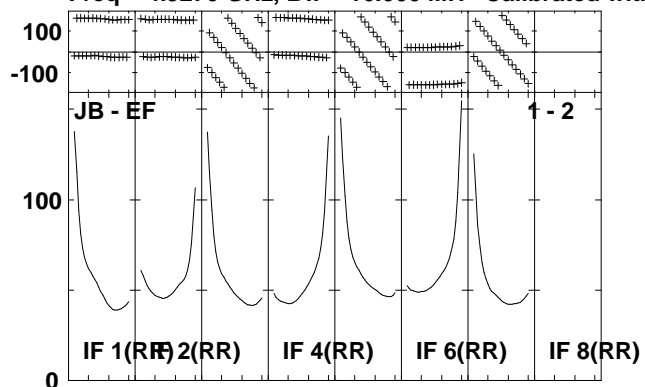

Lower frame: Ampl Jy Top frame: Phas deg
Vector averaged cross-power spectrum Several baselines displayed
Timerange: 01/02:52:01 to 01/02:55:29

Plot file version 211 created 13-OCT-2010 18:48:10

J2001+10 EP064N.UVDATA.1

Freq = 4.9270 GHz, Bw = 16.000 MH Calibrated with CL # 3 and BP # 1 (BP mode 1)

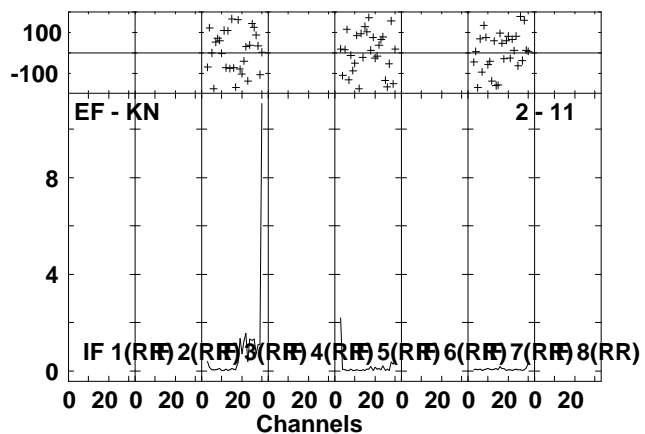
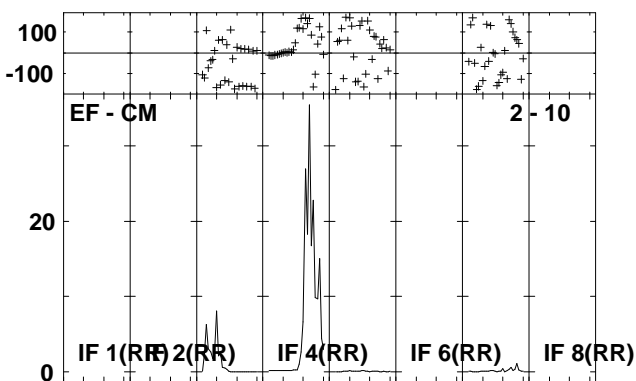
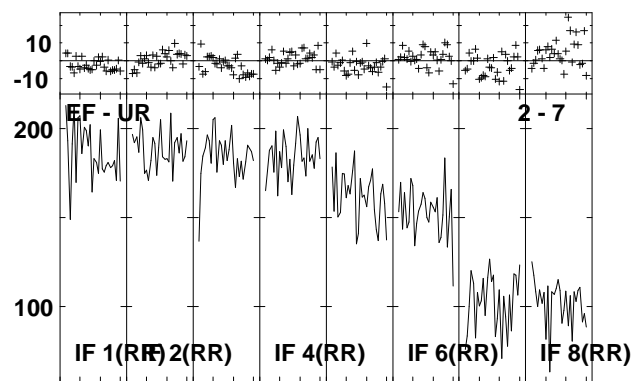
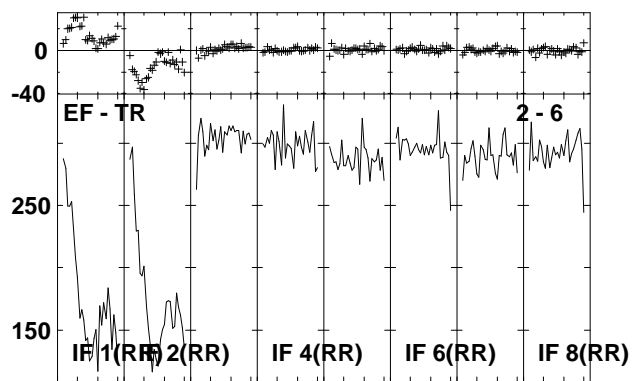
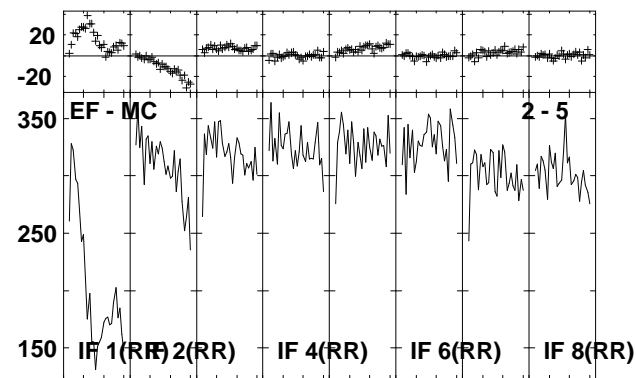
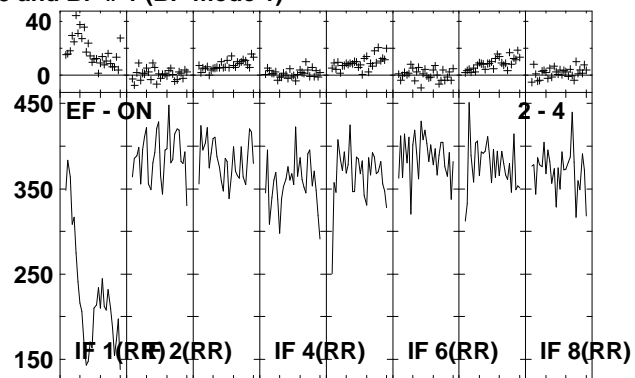
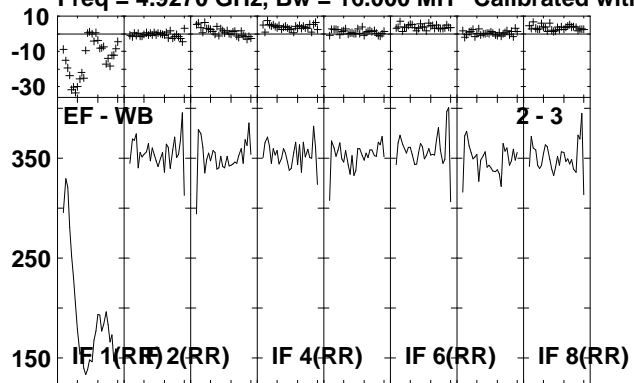

Lower frame: Milli Ampl Jy Top frame: Phas deg
Vector averaged cross-power spectrum Several baselines displayed
Timerange: 01/02:56:31 to 01/02:57:59

Plot file version 212 created 13-OCT-2010 18:48:13

IRAS1954 EP064N.UVDATA.1

Freq = 4.9270 GHz, Bw = 16.000 MH Calibrated with CL # 3 and BP # 1 (BP mode 1)

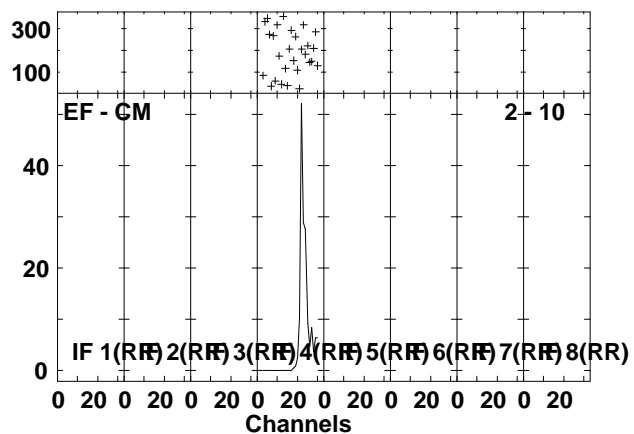
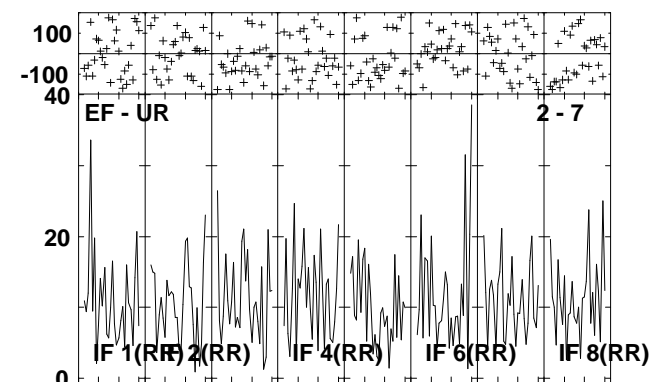
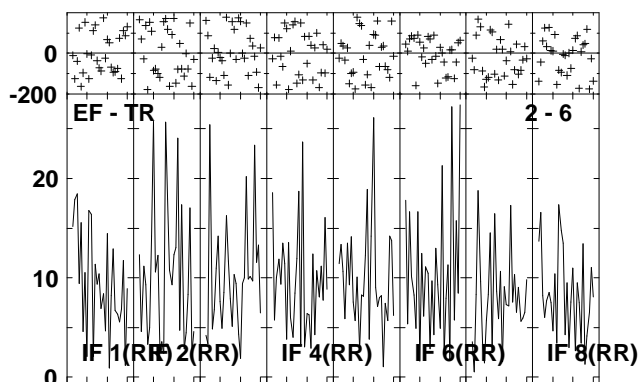
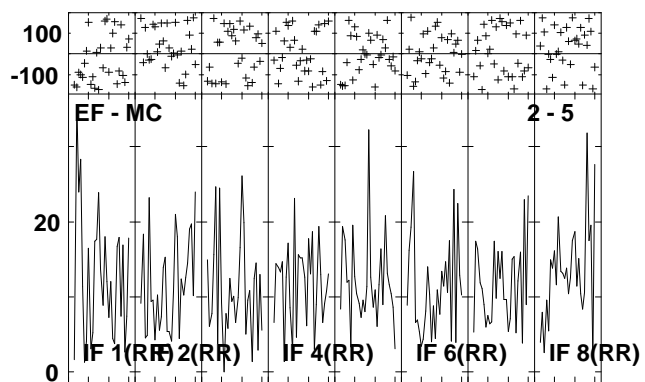
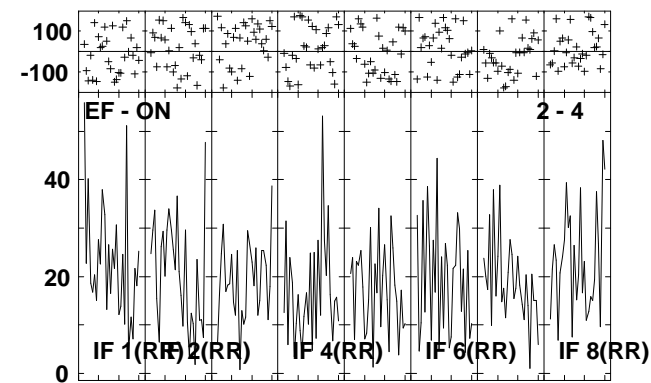
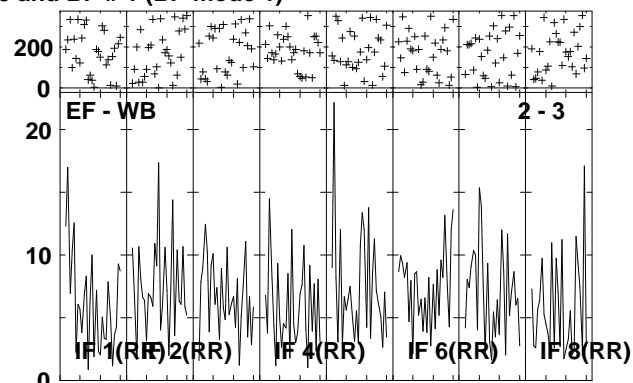
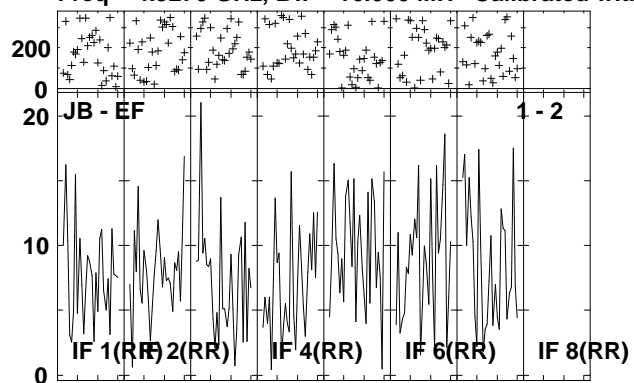

Lower frame: Milli Ampl Jy Top frame: Phas deg
Vector averaged cross-power spectrum Several baselines displayed
Timerange: 01/02:58:01 to 01/03:01:29

Plot file version 213 created 13-OCT-2010 18:48:20
 J2001+10 EP064N.UVDATA.1
 Freq = 4.9270 GHz, Bw = 16.000 MH Calibrated with CL # 3 and BP # 1 (BP mode 1)

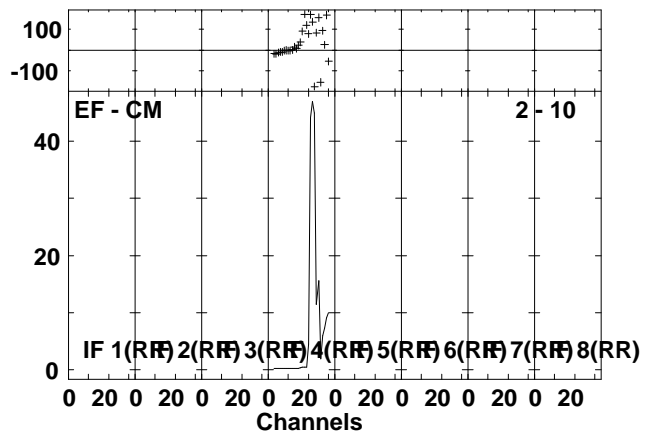
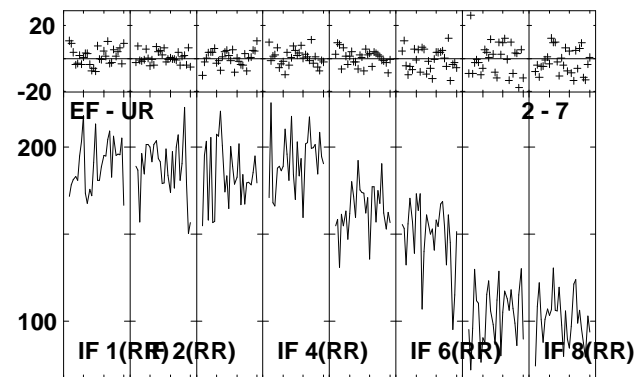
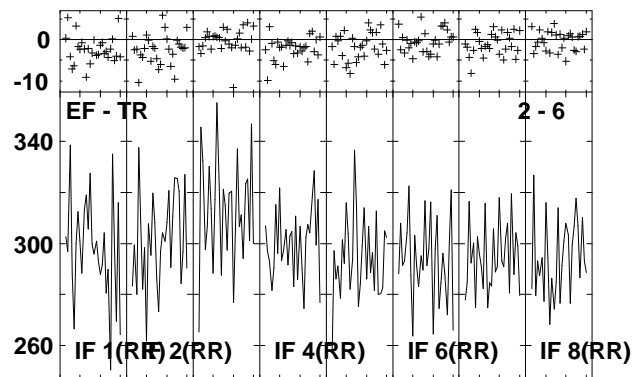
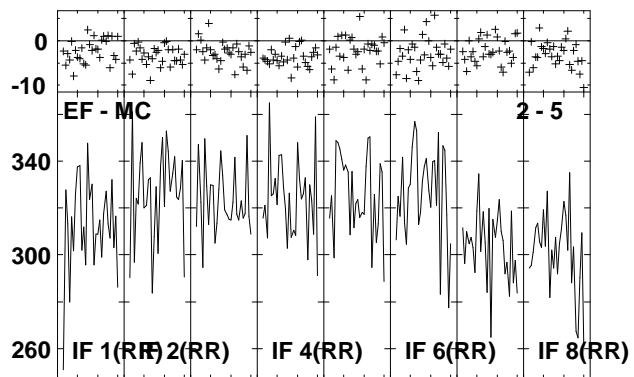
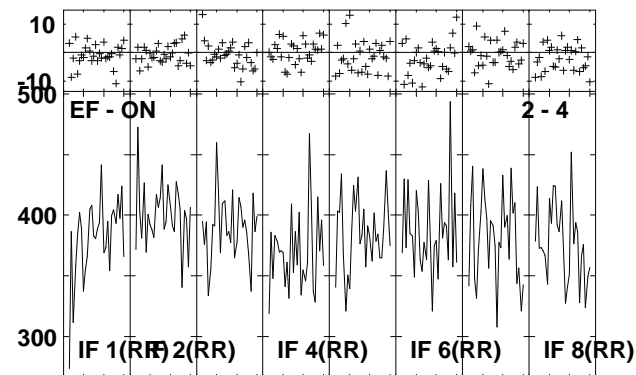
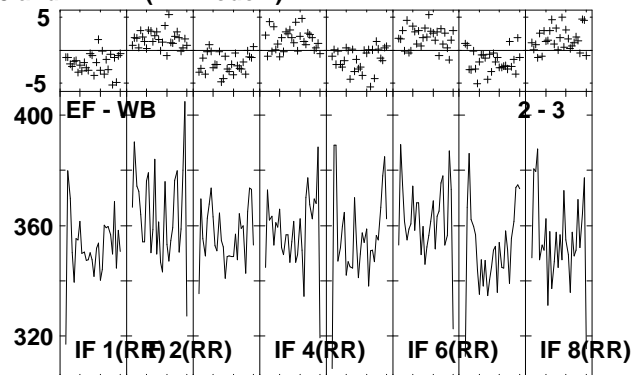
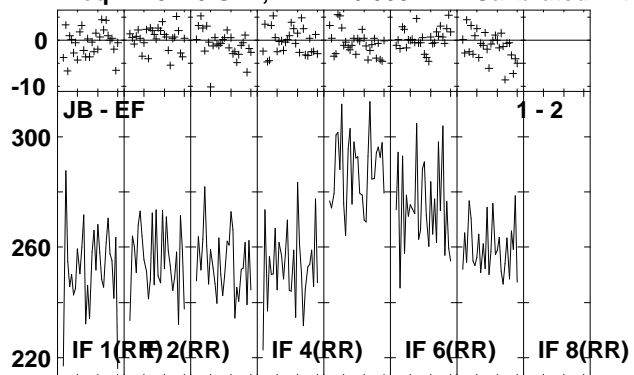

Lower frame: Milli Ampl Jy Top frame: Phas deg
 Vector averaged cross-power spectrum Several baselines displayed
 Timerange: 01/03:01:31 to 01/03:02:59

Plot file version 214 created 13-OCT-2010 18:48:24

IRAS1954 EP064N.UVDATA.1

Freq = 4.9270 GHz, Bw = 16.000 MH Calibrated with CL # 3 and BP # 1 (BP mode 1)

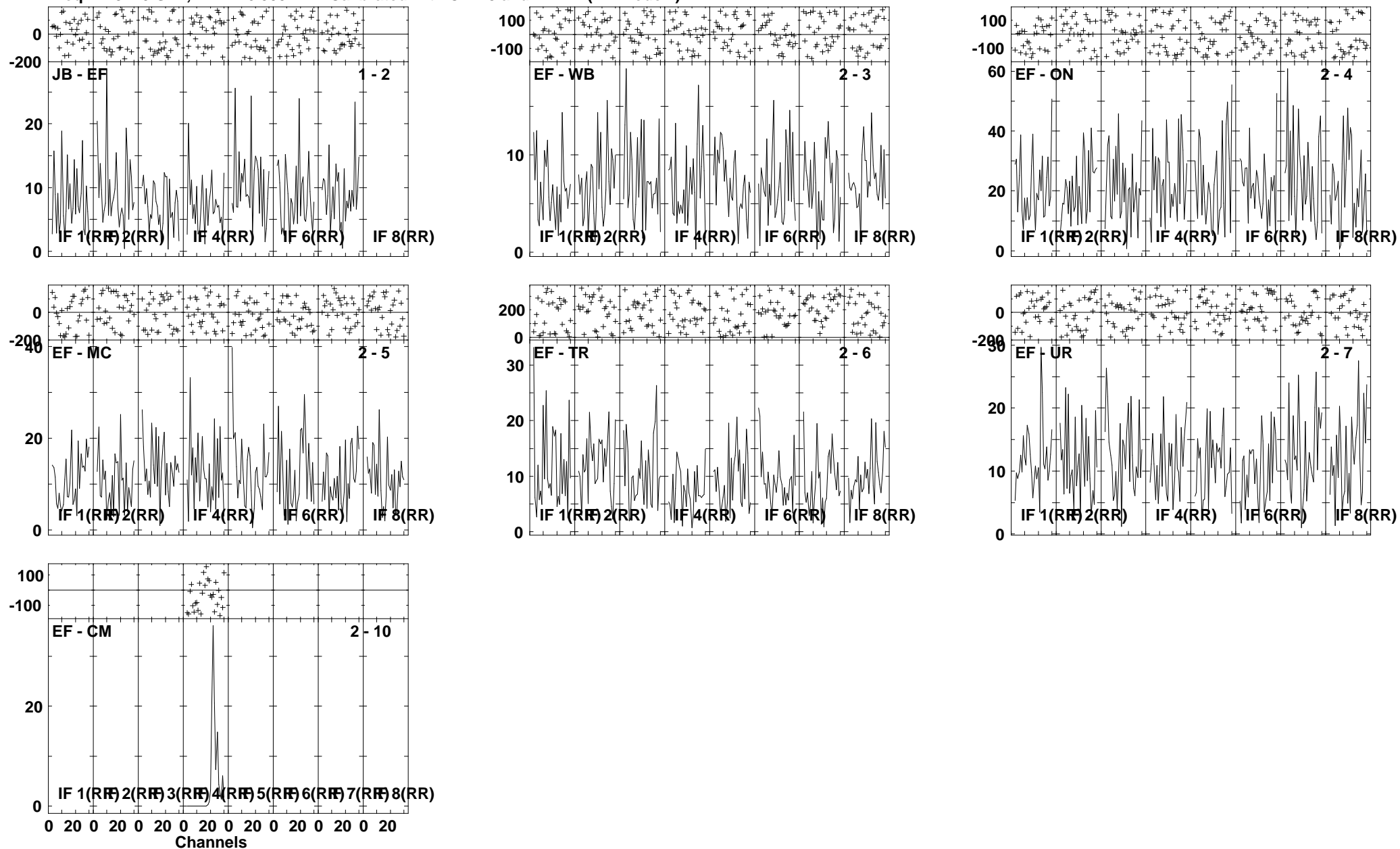

Lower frame: Milli Ampl Jy Top frame: Phas deg
Vector averaged cross-power spectrum Several baselines displayed
Timerange: 01/03:03:01 to 01/03:06:29

Plot file version 215 created 13-OCT-2010 18:48:30

J2001+10 EP064N.UVDATA.1

Freq = 4.9270 GHz, Bw = 16.000 MH Calibrated with CL # 3 and BP # 1 (BP mode 1)

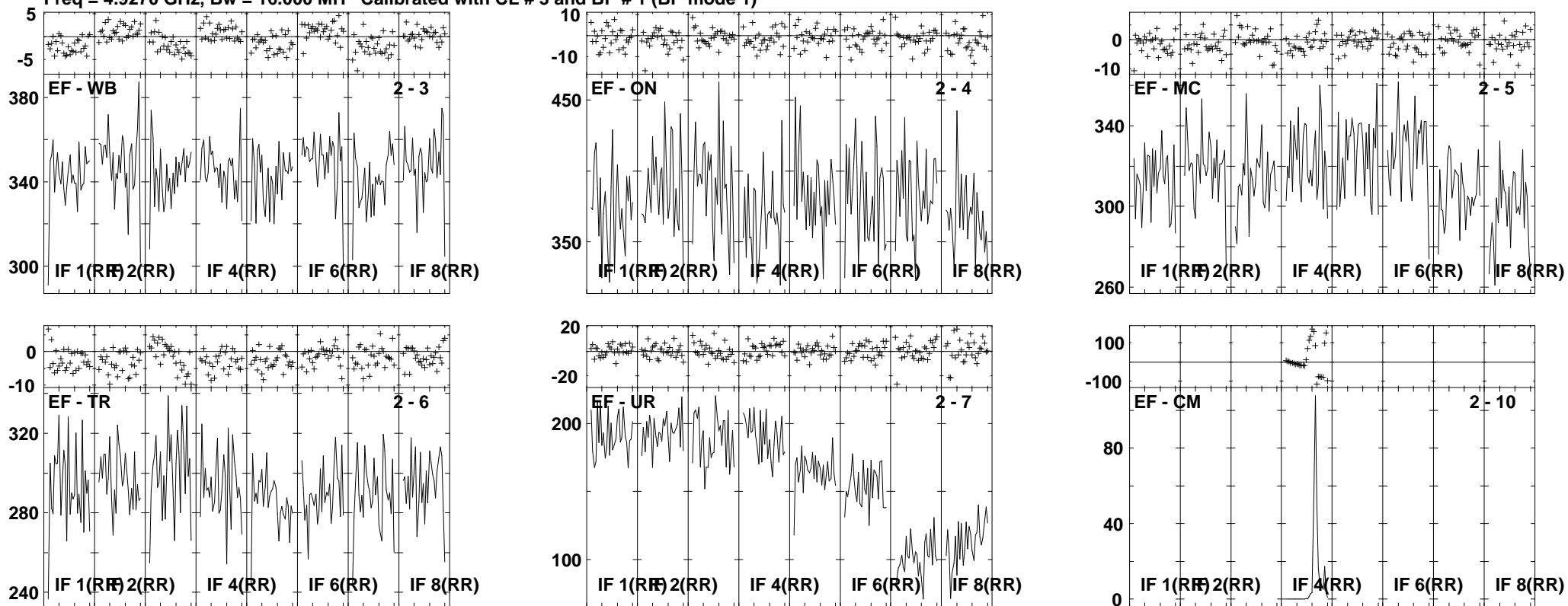

Lower frame: Milli Ampl Jy Top frame: Phas deg
Vector averaged cross-power spectrum Several baselines displayed
Timerange: 01/03:06:31 to 01/03:07:59

Plot file version 216 created 13-OCT-2010 18:48:33

IRAS1954 EP064N.UVDATA.1

Freq = 4.9270 GHz, Bw = 16.000 MH Calibrated with CL # 3 and BP # 1 (BP mode 1)

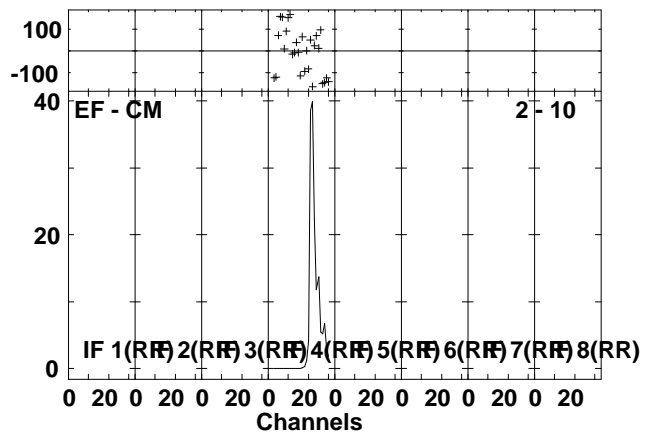
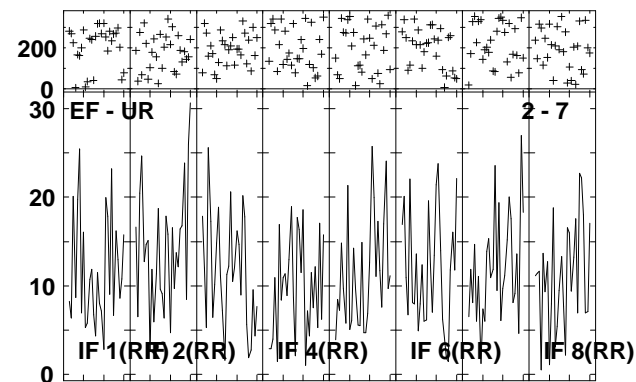
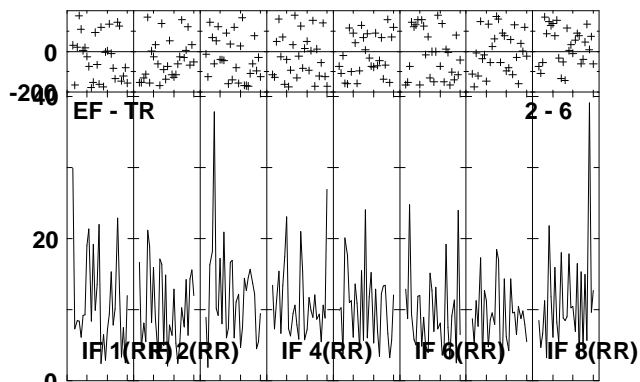
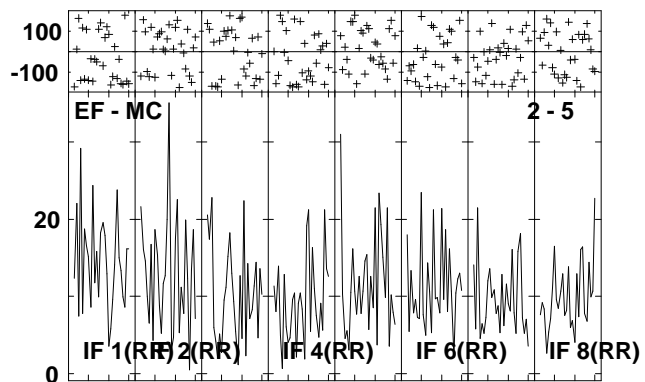
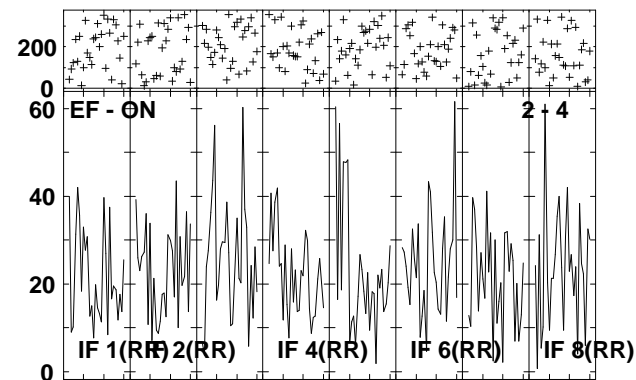
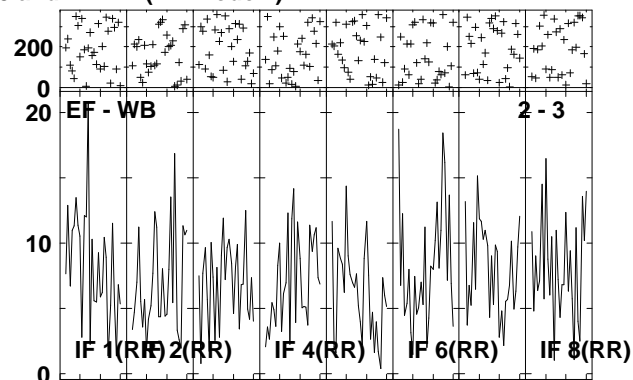
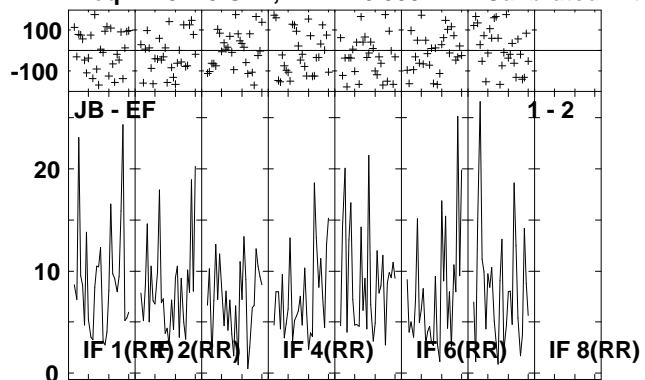

Lower frame: Milli Ampl Jy Top frame: Phas deg
Vector averaged cross-power spectrum Several baselines displayed
Timerange: 01/03:08:01 to 01/03:11:29

Plot file version 217 created 13-OCT-2010 18:48:40

J2001+10 EP064N.UVDATA.1

Freq = 4.9270 GHz, Bw = 16.000 MH Calibrated with CL # 3 and BP # 1 (BP mode 1)

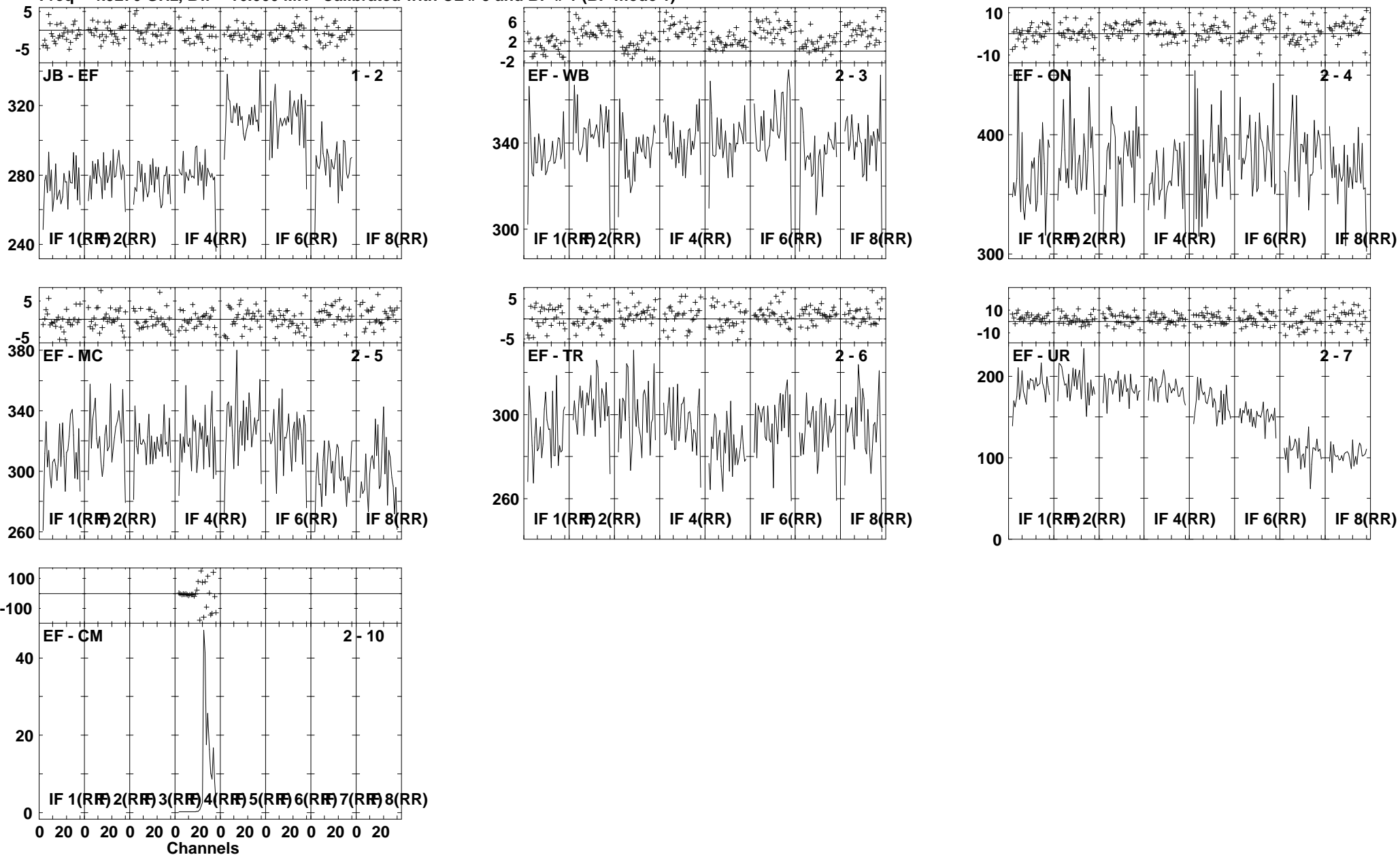

Lower frame: Milli Ampl Jy Top frame: Phas deg
Vector averaged cross-power spectrum Several baselines displayed
Timerange: 01/03:12:31 to 01/03:13:59

Plot file version 218 created 13-OCT-2010 18:48:44

IRAS1954 EP064N.UVDATA.1

Freq = 4.9270 GHz, Bw = 16.000 MH Calibrated with CL # 3 and BP # 1 (BP mode 1)

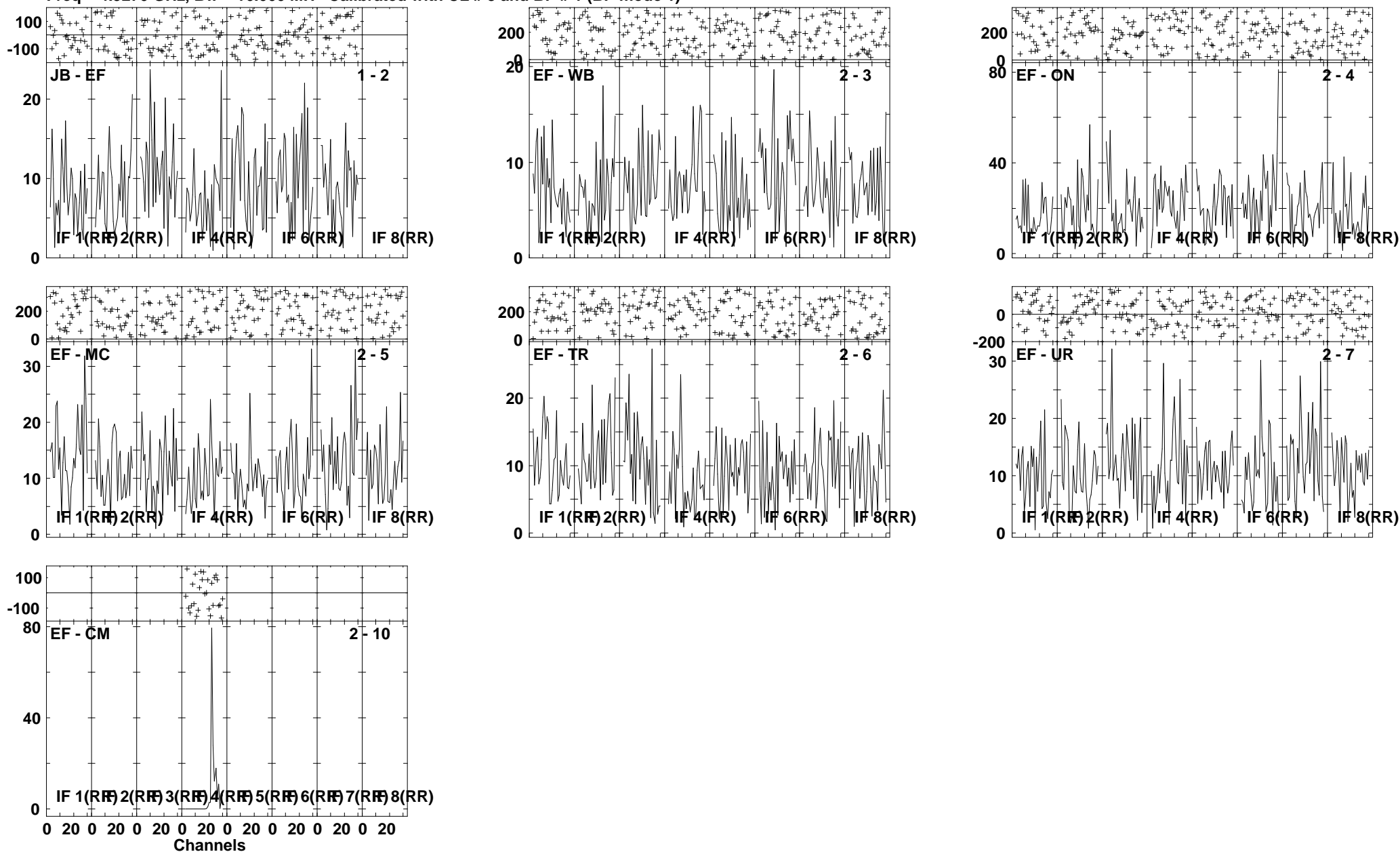

Lower frame: Milli Ampl Jy Top frame: Phas deg
 Vector averaged cross-power spectrum Several baselines displayed
 Timerange: 01/03:14:01 to 01/03:17:29

Plot file version 219 created 13-OCT-2010 18:48:51
 J2001+10 EP064N.UVDATA.1
 Freq = 4.9270 GHz, Bw = 16.000 MH Calibrated with CL # 3 and BP # 1 (BP mode 1)

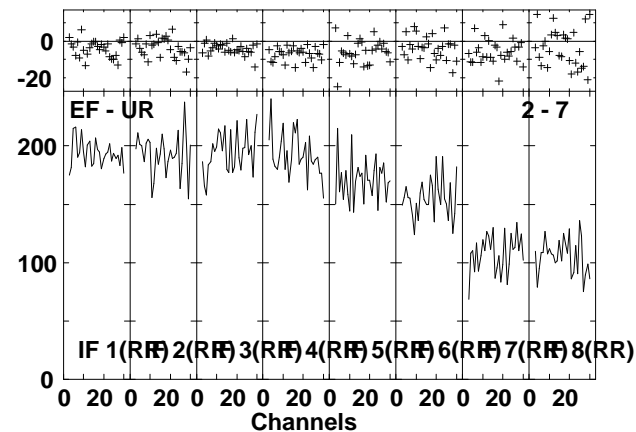
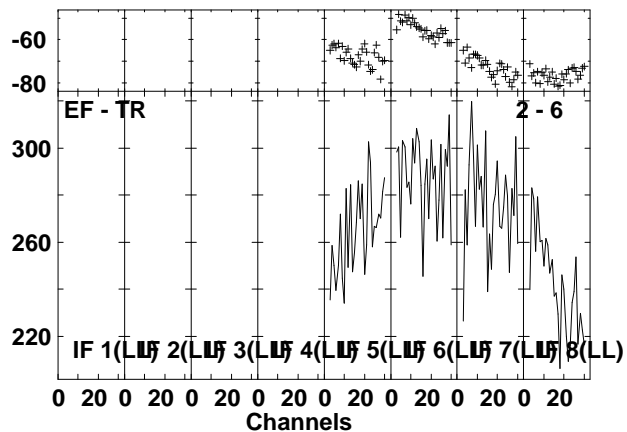
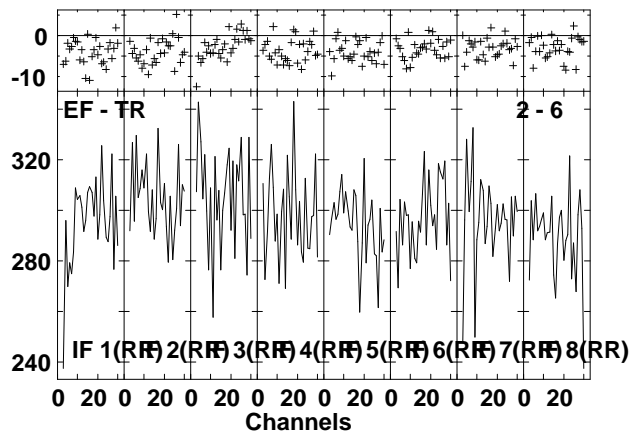
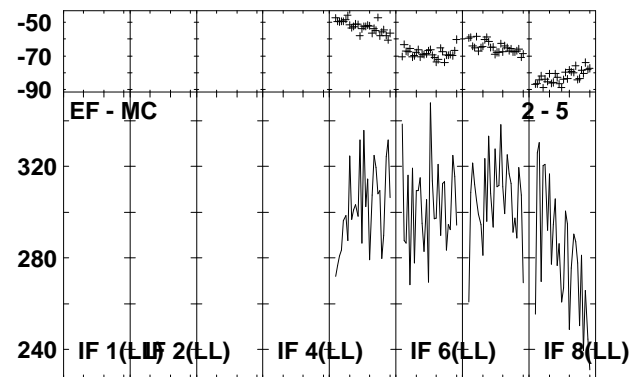
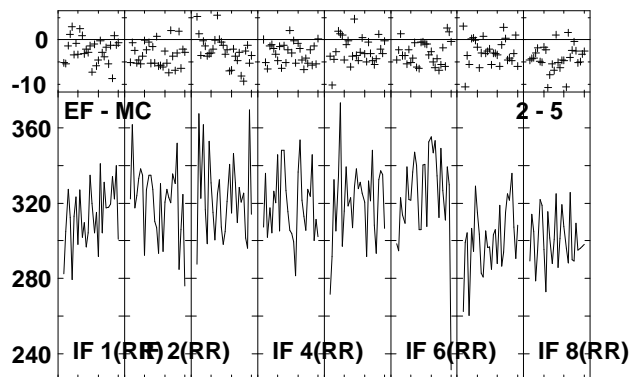
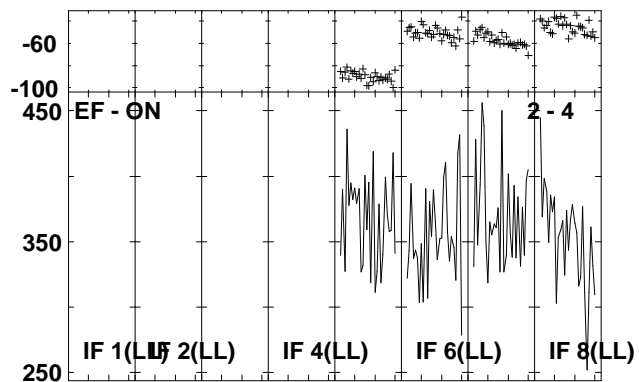
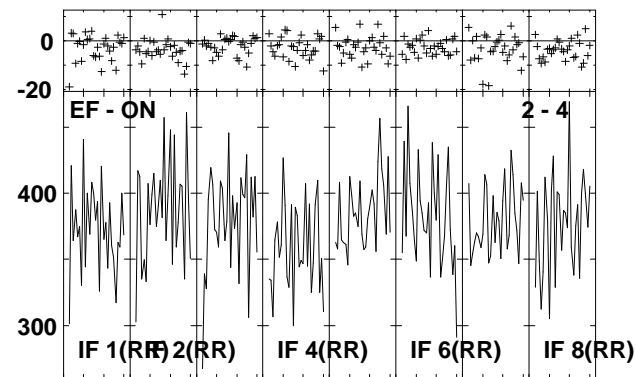
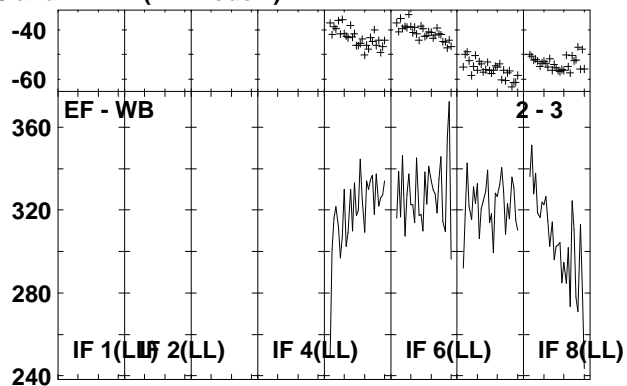
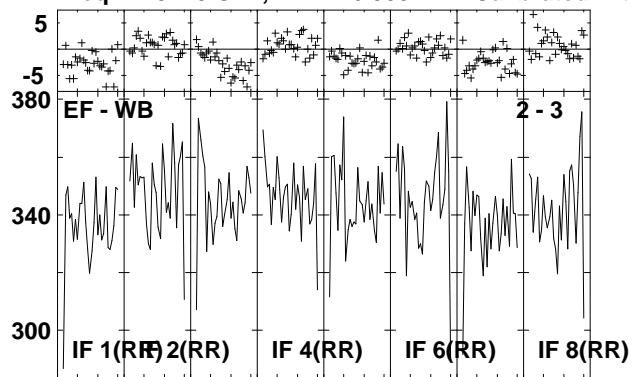

Lower frame: Milli Ampl Jy Top frame: Phas deg
 Vector averaged cross-power spectrum Several baselines displayed
 Timerange: 01/03:17:31 to 01/03:18:59

Plot file version 220 created 13-OCT-2010 18:48:52

J2001+10 EP064N.UVDATA.1

Freq = 4.9270 GHz, Bw = 16.000 MH Calibrated with CL # 3 and BP # 1 (BP mode 1)

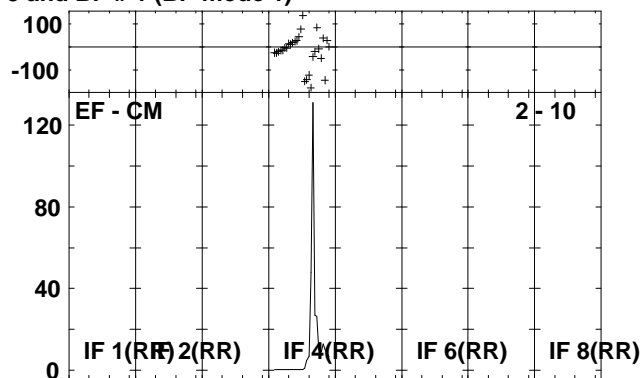
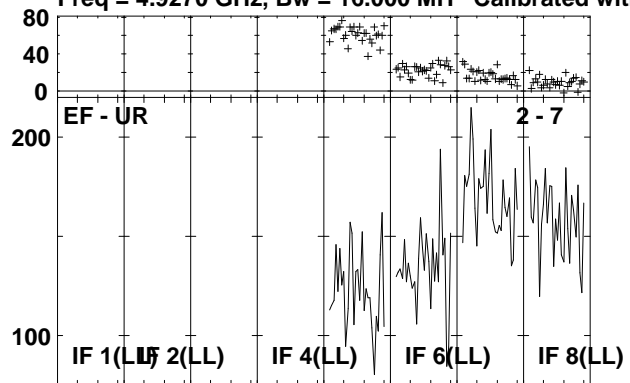

Lower frame: Milli Ampl Jy Top frame: Phas deg
Vector averaged cross-power spectrum Several baselines displayed
Timerange: 01/03:17:31 to 01/03:18:59

Plot file version 221 created 13-OCT-2010 18:48:54

IRAS1954 EP064N.UVDATA.1

Freq = 4.9270 GHz, Bw = 16.000 MH Calibrated with CL # 3 and BP # 1 (BP mode 1)

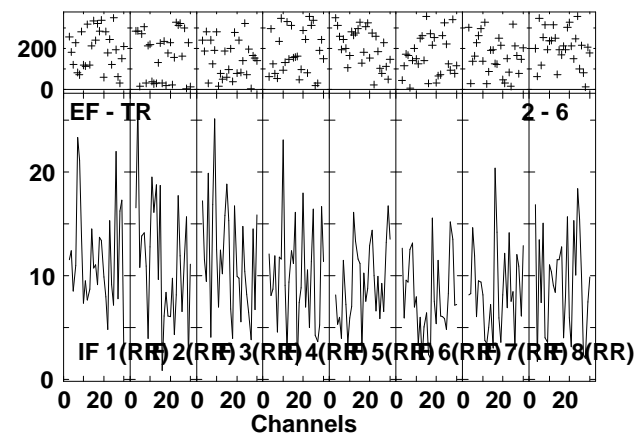
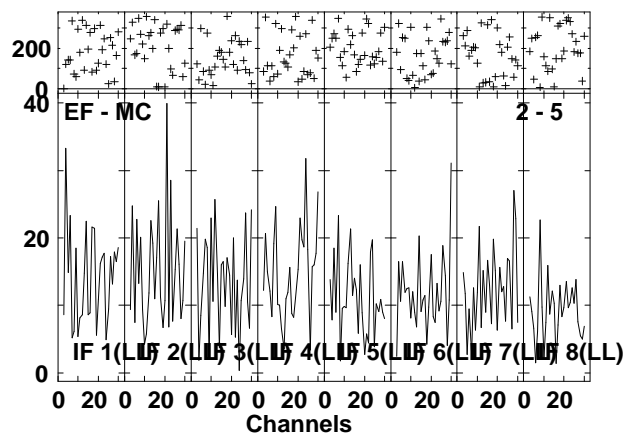
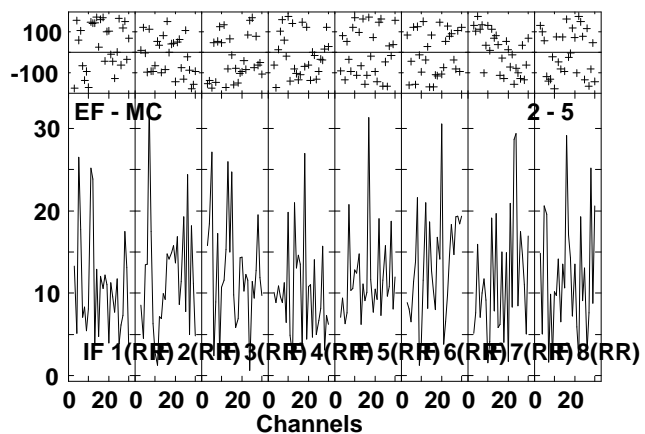
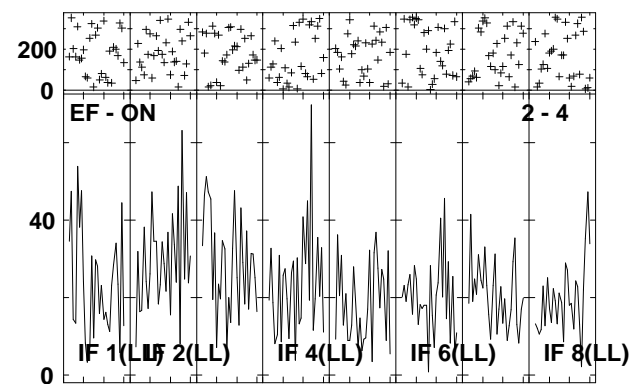
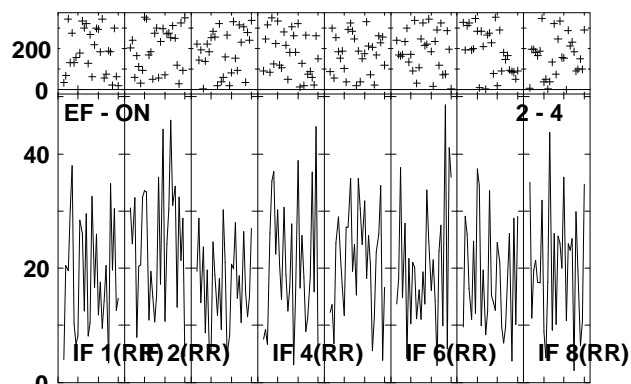
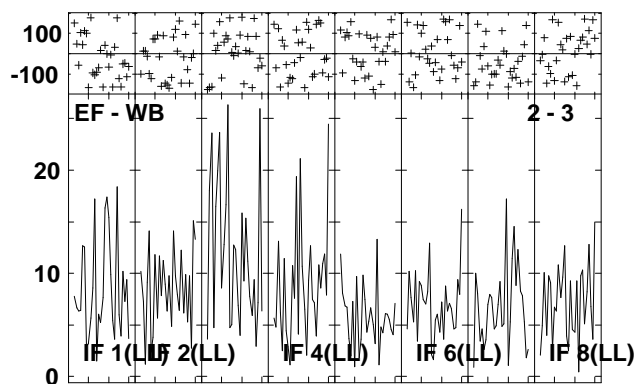
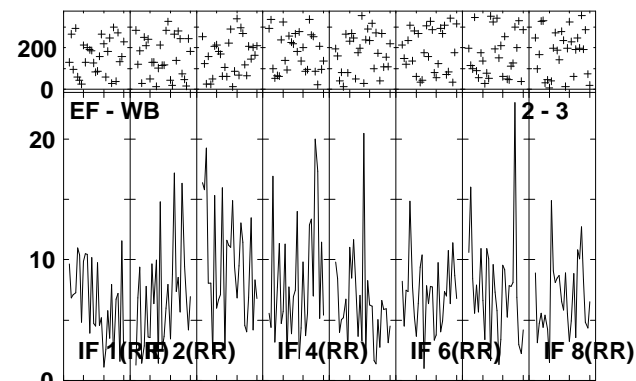
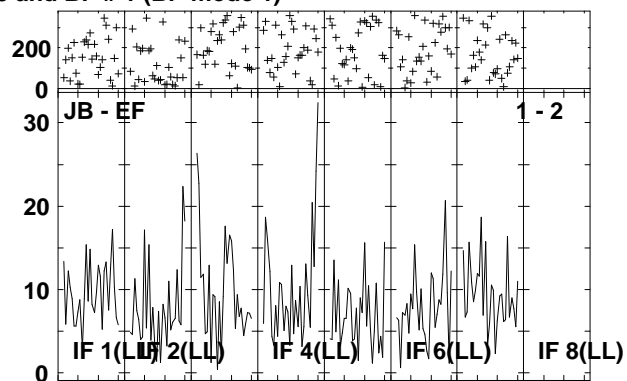
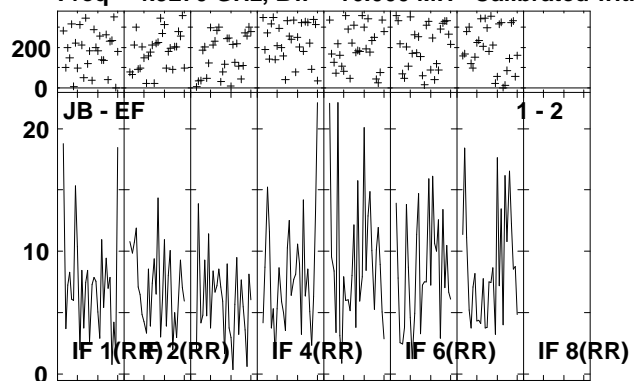

Lower frame: Milli Ampl Jy Top frame: Phas deg
Vector averaged cross-power spectrum Several baselines displayed
Timerange: 01/03:19:01 to 01/03:22:29

Plot file version 222 created 13-OCT-2010 18:48:56

IRAS1954 EP064N.UVDATA.1

Freq = 4.9270 GHz, Bw = 16.000 MH Calibrated with CL # 3 and BP # 1 (BP mode 1)

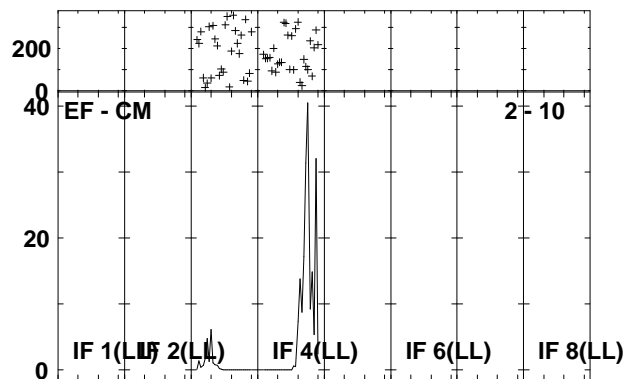
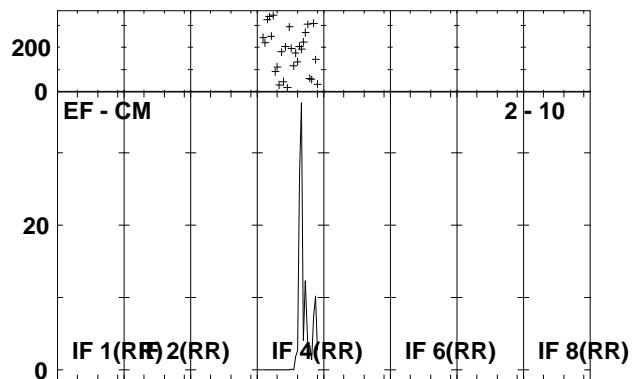
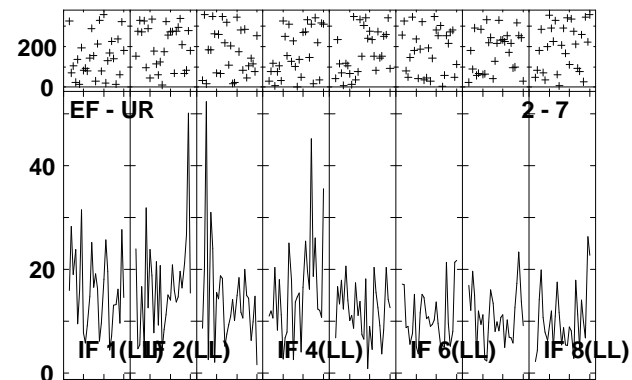
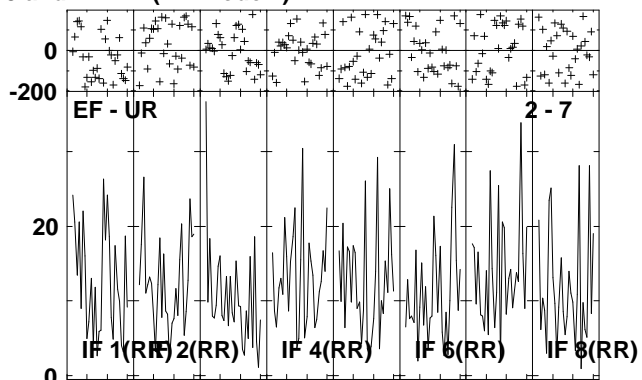
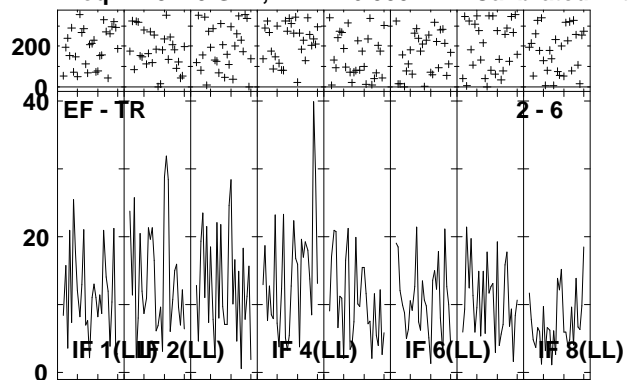

Lower frame: Milli Ampl Jy Top frame: Phas deg
Vector averaged cross-power spectrum Several baselines displayed
Timerange: 01/03:19:01 to 01/03:22:29

Plot file version 223 created 13-OCT-2010 18:49:00

J2001+10 EP064N.UVDATA.1

Freq = 4.9270 GHz, Bw = 16.000 MH Calibrated with CL # 3 and BP # 1 (BP mode 1)

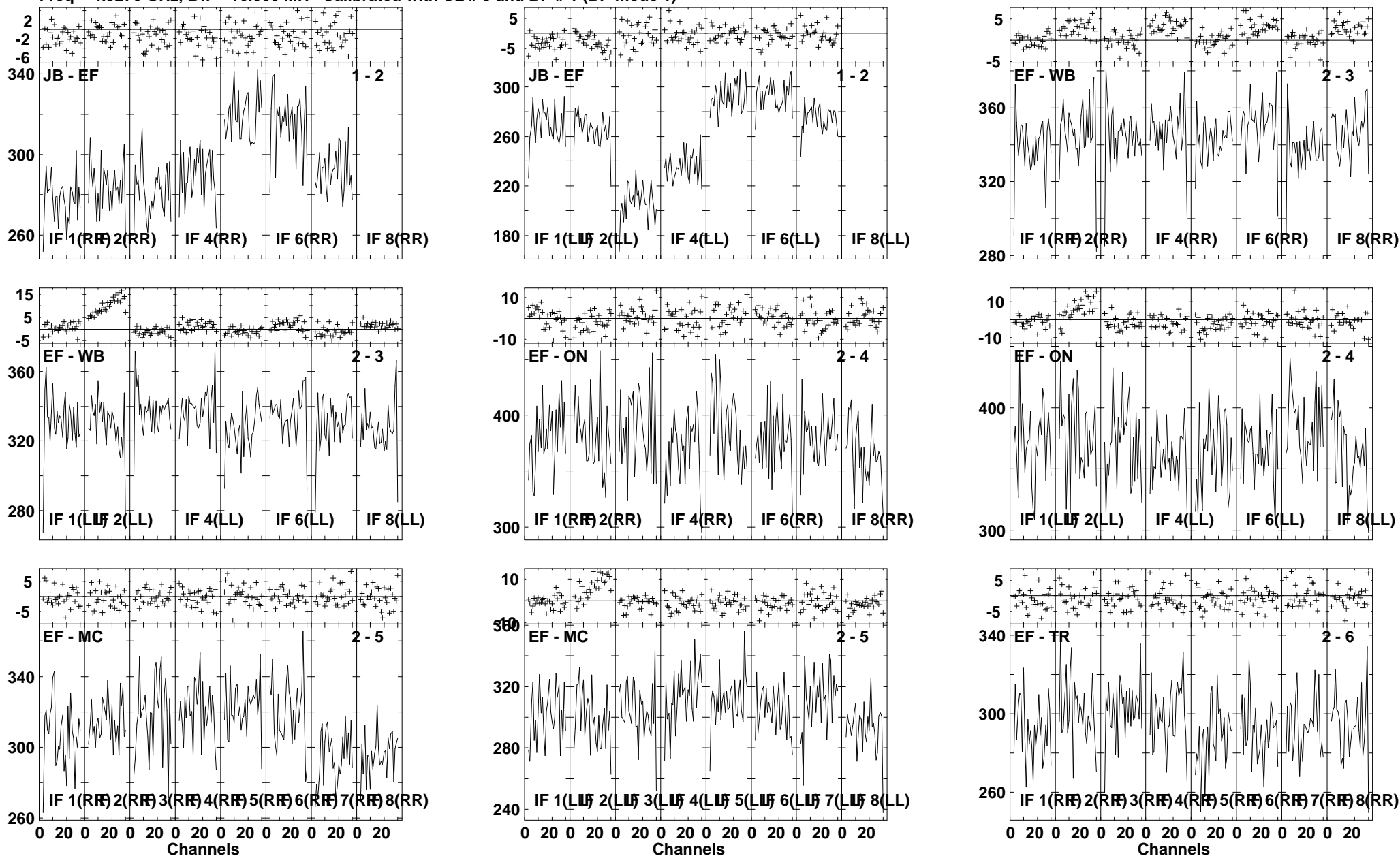

Lower frame: Milli Ampl Jy Top frame: Phas deg
Vector averaged cross-power spectrum Several baselines displayed
Timerange: 01/03:22:31 to 01/03:23:59

Plot file version 224 created 13-OCT-2010 18:49:01

J2001+10 EP064N.UVDATA.1

Freq = 4.9270 GHz, Bw = 16.000 MH Calibrated with CL # 3 and BP # 1 (BP mode 1)

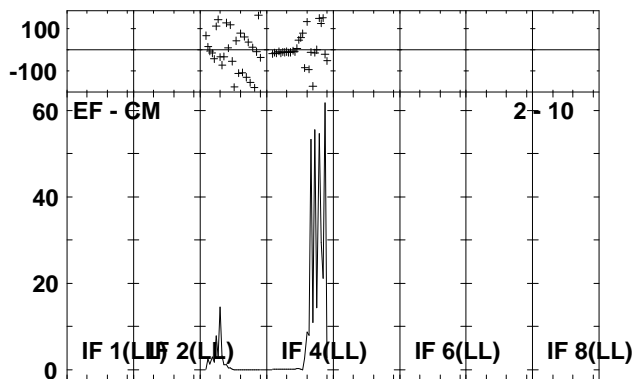
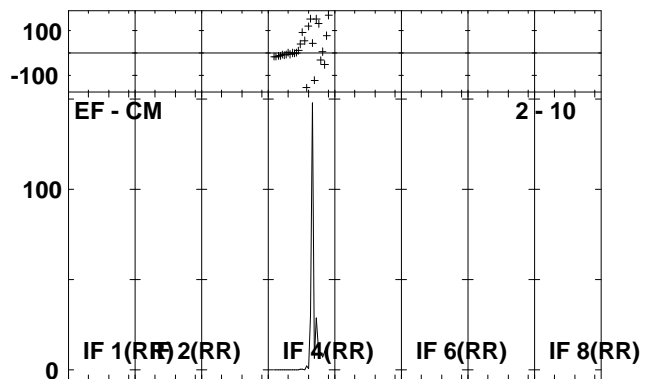
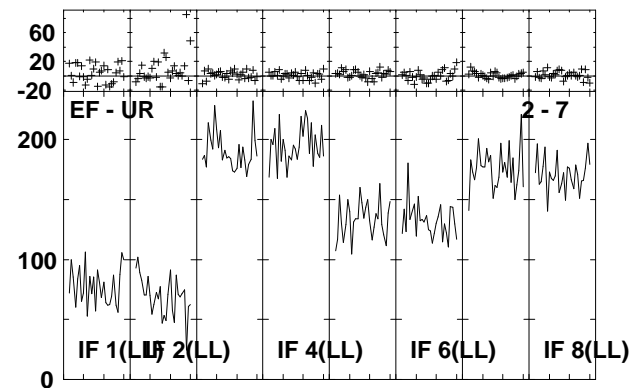
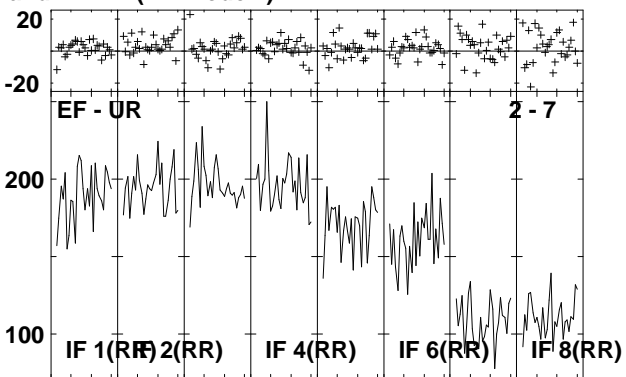
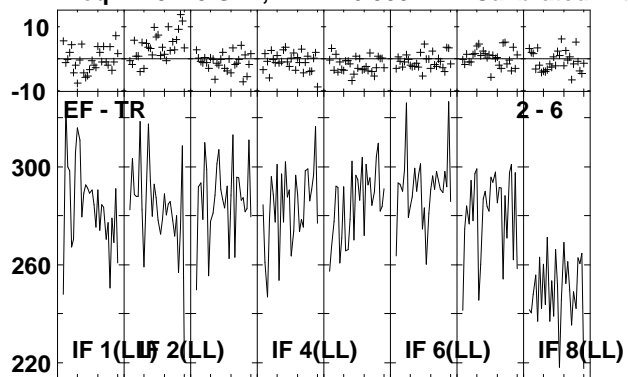

Lower frame: Milli Ampl Jy Top frame: Phas deg
Vector averaged cross-power spectrum Several baselines displayed
Timerange: 01/03:22:31 to 01/03:23:59

Plot file version 225 created 13-OCT-2010 18:49:04

IRAS1954 EP064N.UVDATA.1

Freq = 4.9270 GHz, Bw = 16.000 MH Calibrated with CL # 3 and BP # 1 (BP mode 1)

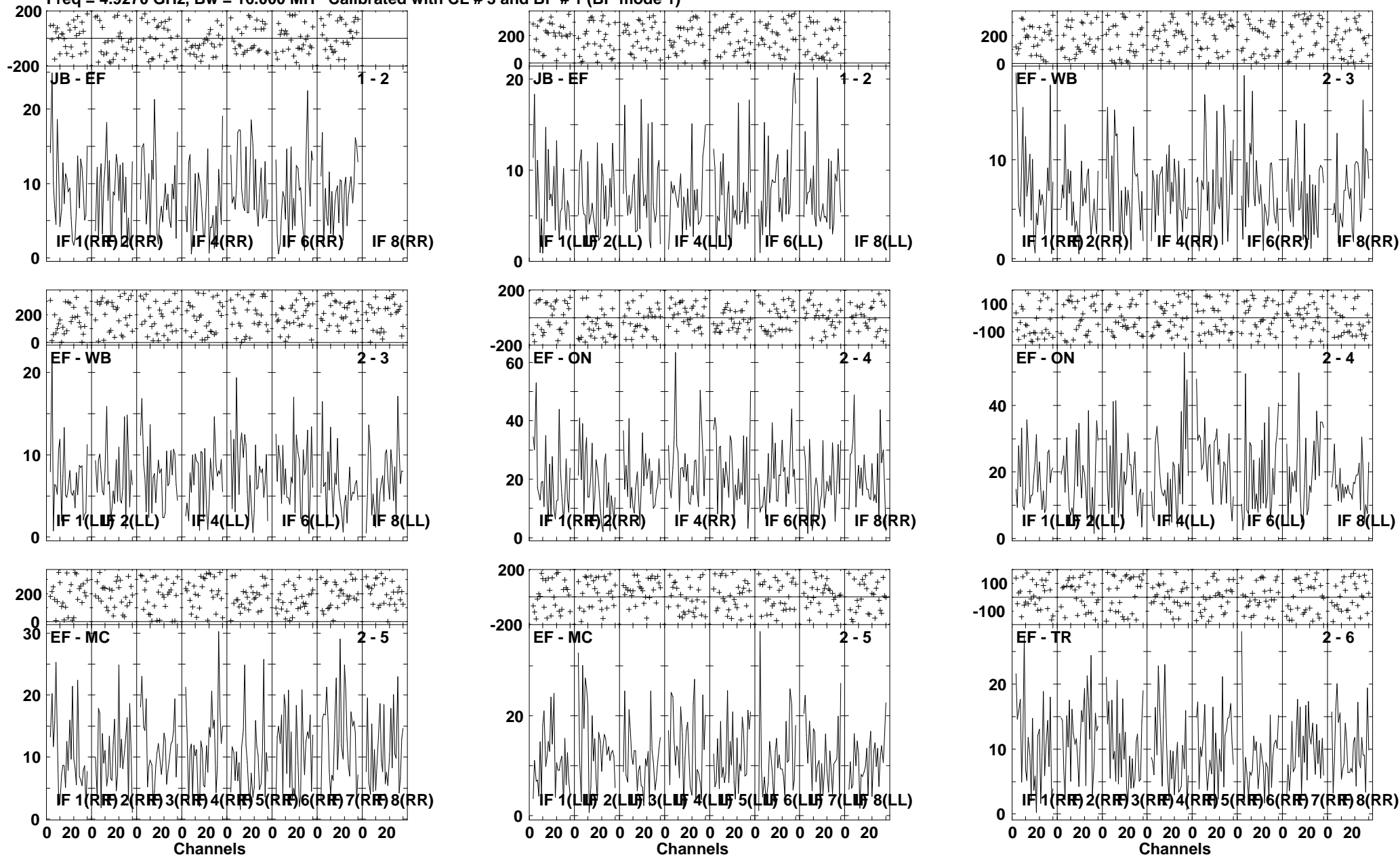

Lower frame: Milli Ampl Jy Top frame: Phas deg
Vector averaged cross-power spectrum Several baselines displayed
Timerange: 01/03:24:03 to 01/03:27:29

Plot file version 226 created 13-OCT-2010 18:49:06

IRAS1954 EP064N.UVDATA.1

Freq = 4.9270 GHz, Bw = 16.000 MH Calibrated with CL # 3 and BP # 1 (BP mode 1)

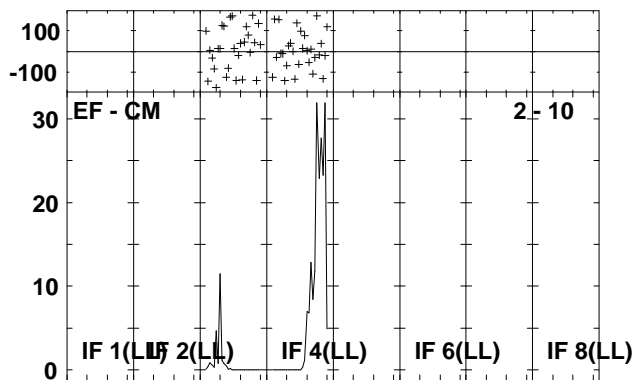
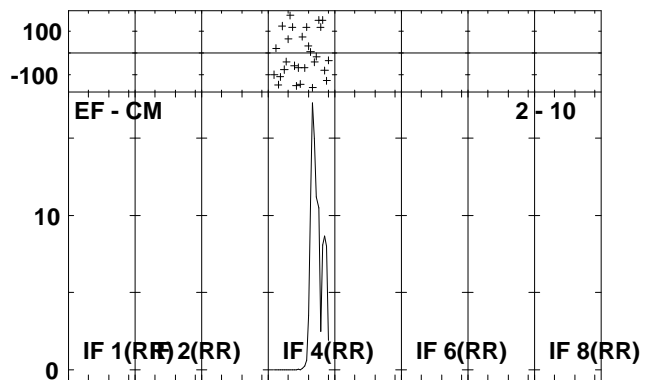
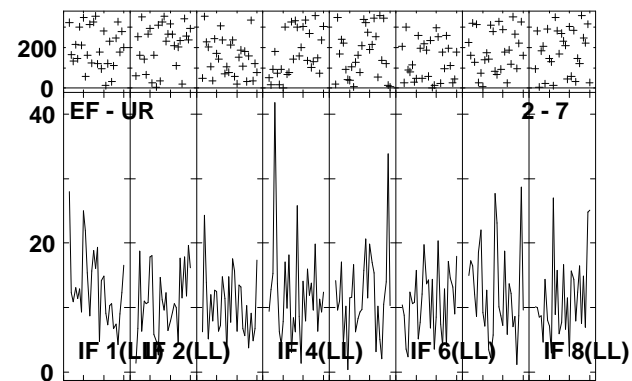
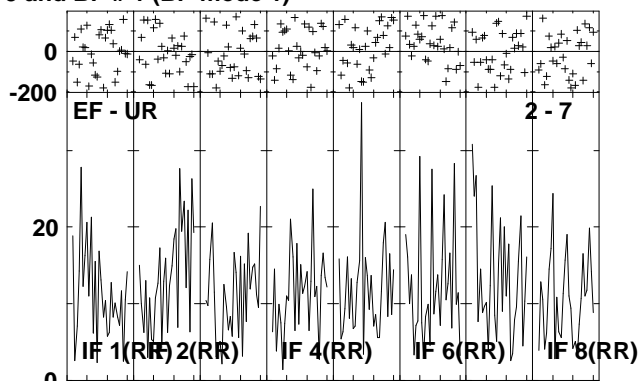
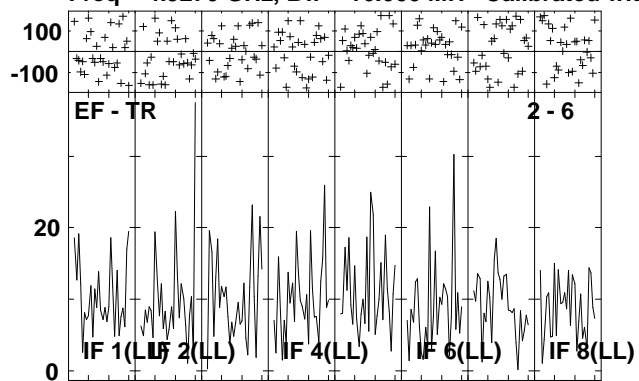

Lower frame: Milli Ampl Jy Top frame: Phas deg
Vector averaged cross-power spectrum Several baselines displayed
Timerange: 01/03:24:03 to 01/03:27:29

Plot file version 227 created 13-OCT-2010 18:49:10
 J2001+10 EP064N.UVDATA.1
 Freq = 4.9270 GHz, Bw = 16.000 MH Calibrated with CL # 3 and BP # 1 (BP mode 1)

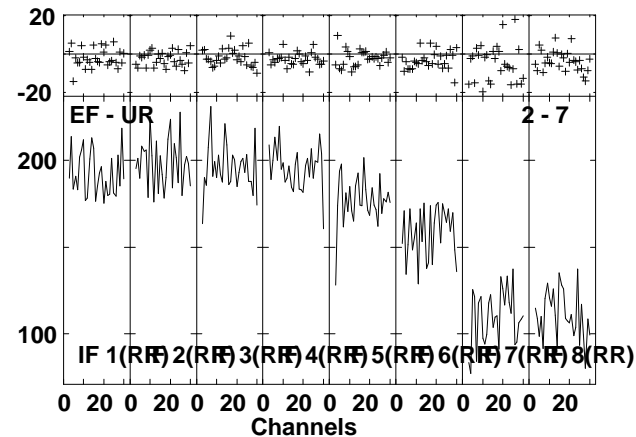
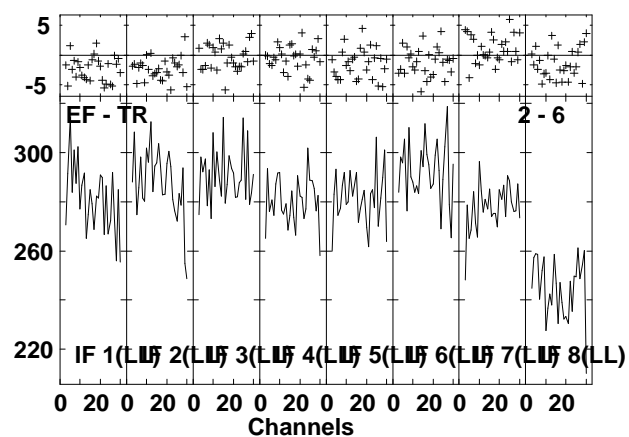
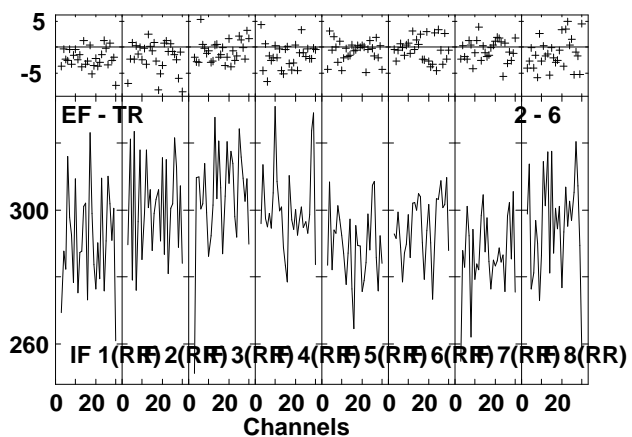
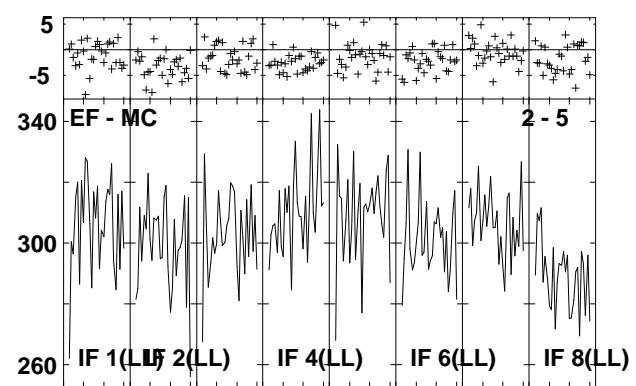
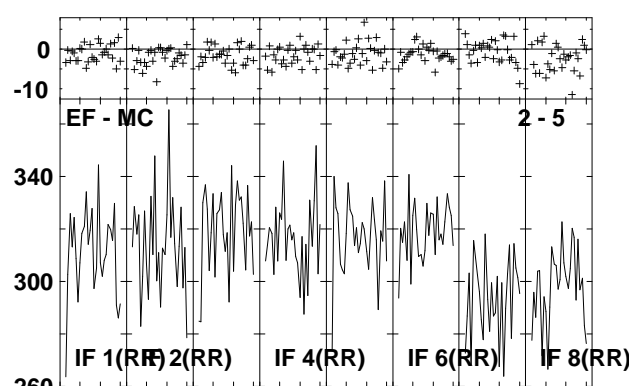
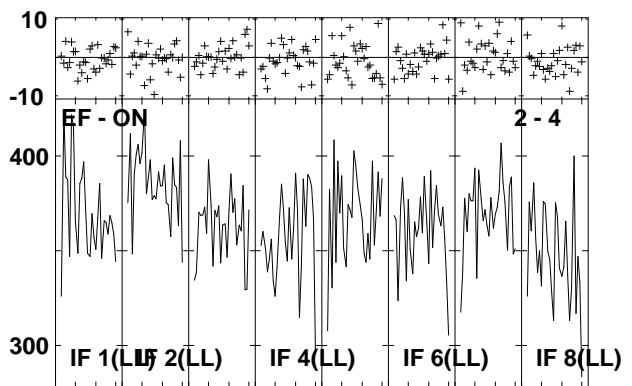
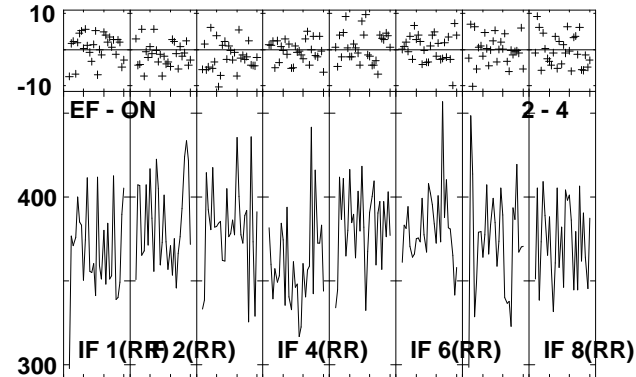
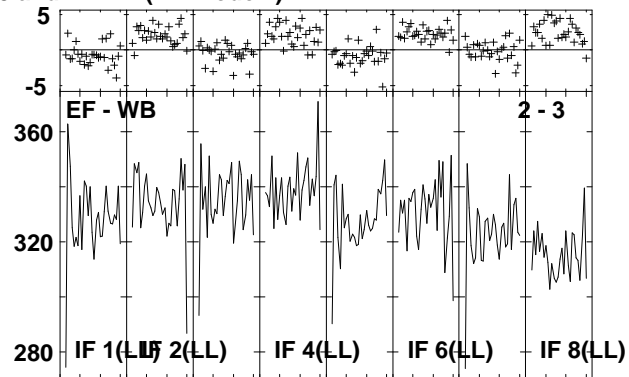
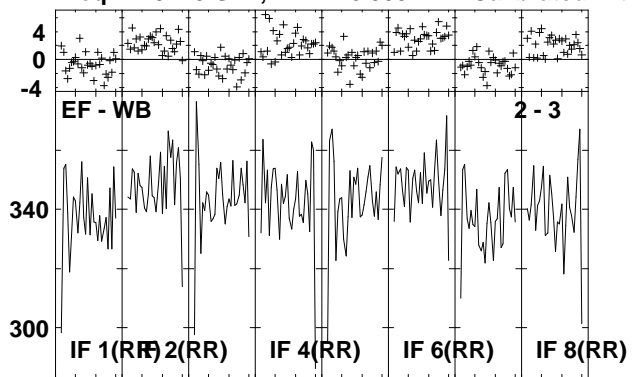

Lower frame: Milli Ampl Jy Top frame: Phas deg
 Vector averaged cross-power spectrum Several baselines displayed
 Timerange: 01/03:28:31 to 01/03:29:59

Plot file version 228 created 13-OCT-2010 18:49:11

J2001+10 EP064N.UVDATA.1

Freq = 4.9270 GHz, Bw = 16.000 MH Calibrated with CL # 3 and BP # 1 (BP mode 1)

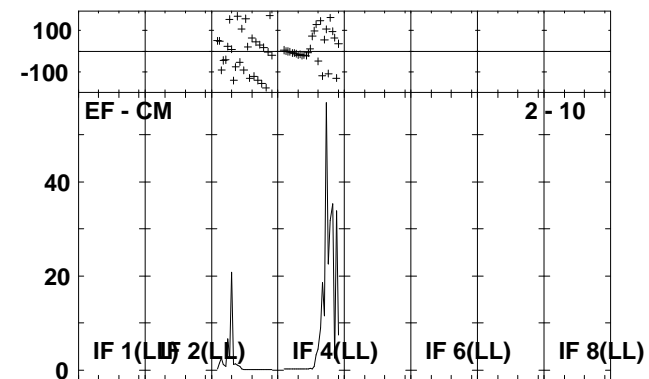
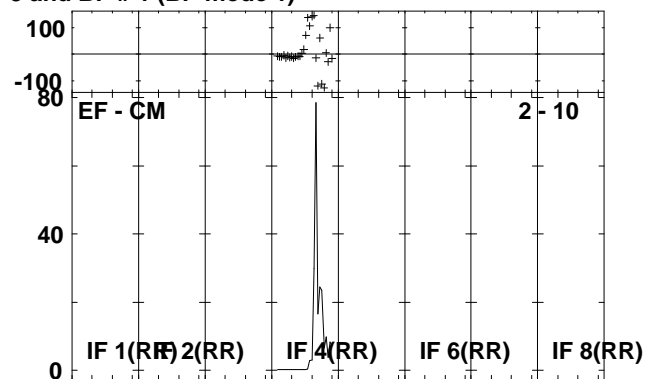
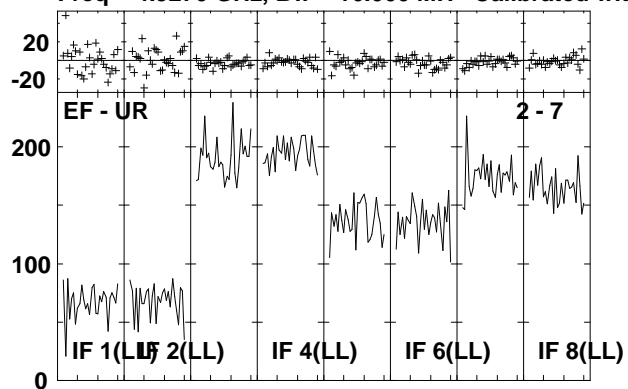

Lower frame: Milli Ampl Jy Top frame: Phas deg
Vector averaged cross-power spectrum Several baselines displayed
Timerange: 01/03:28:31 to 01/03:29:59