

Plot file version 1 created 23-AUG-2010 12:32:19

3C286 EP064P.UVDATA.1

Freq = 1.5950 GHz, Bw = 16.000 MH No calibration applied and no bandpass applied

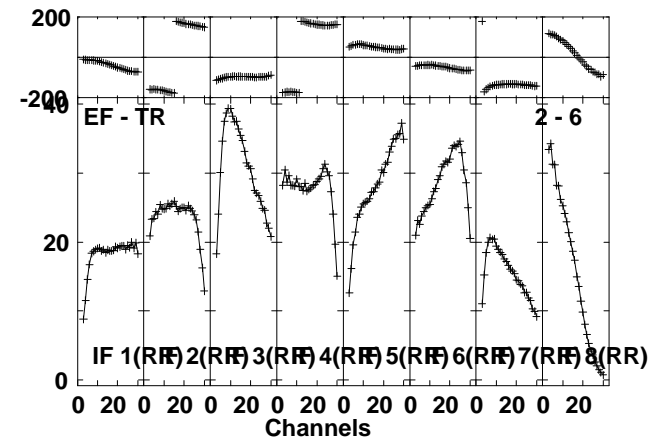
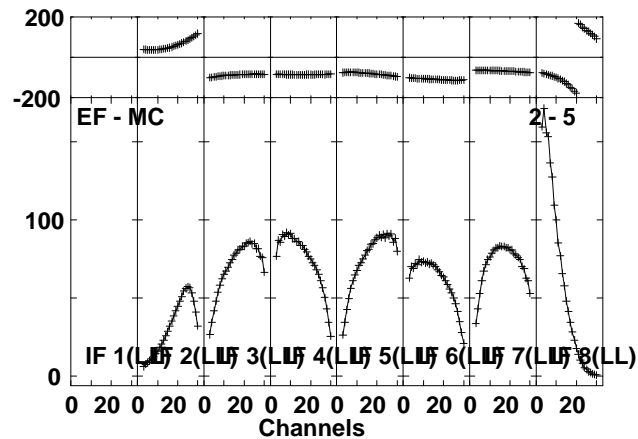
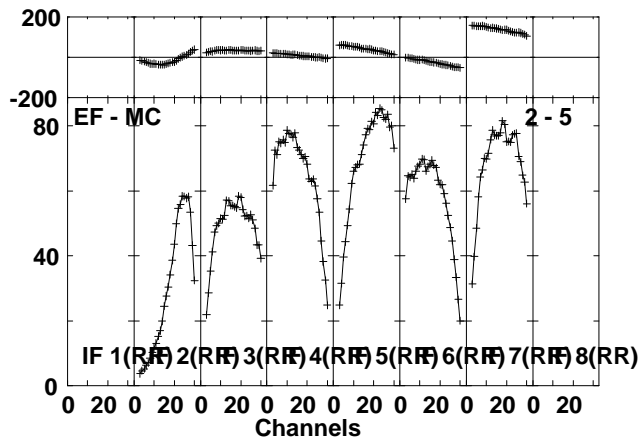
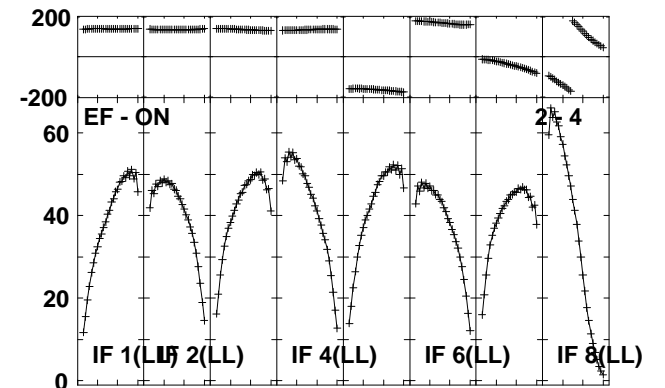
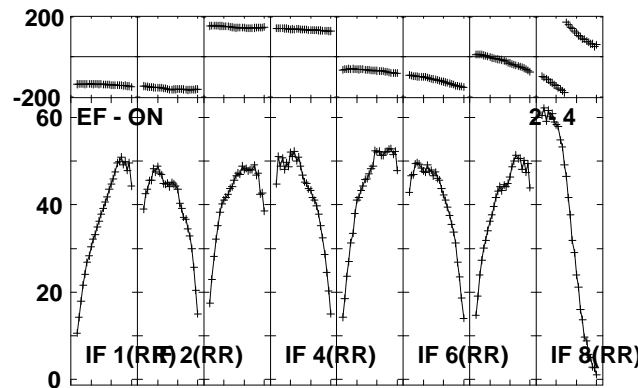
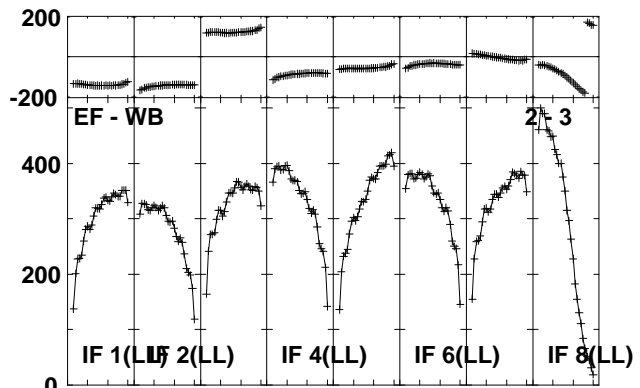
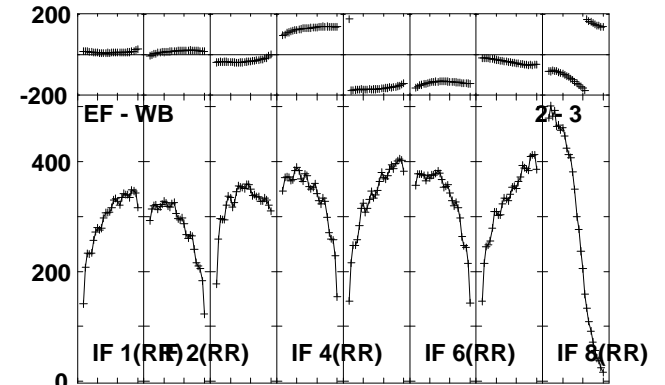
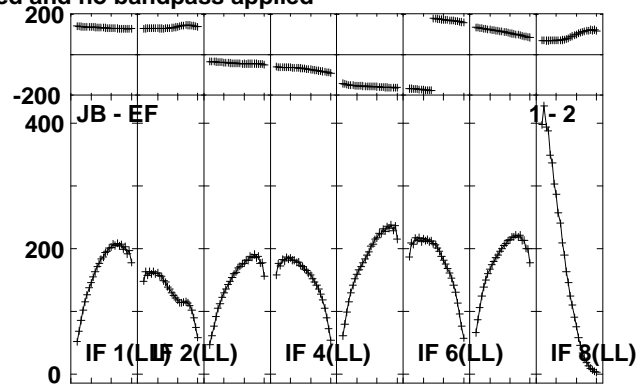
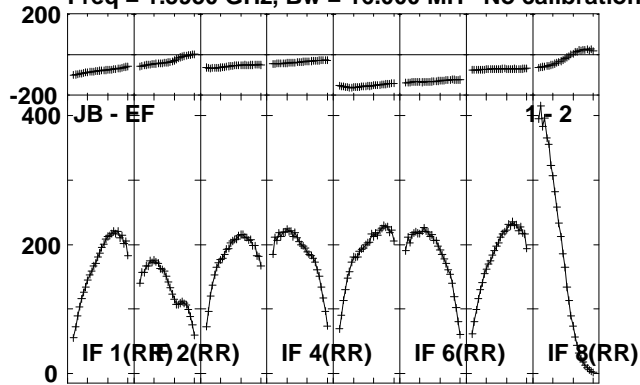

Lower frame: Milli Ampl Jy Top frame: Phas deg
Scalar averaged cross-power spectrum Several baselines displayed
Timerange: 00/21:30:01 to 00/21:34:59

Plot file version 2 created 23-AUG-2010 12:32:24
 3C286 EP064P.UVDATA.1

Freq = 1.5950 GHz, Bw = 16.000 MH No calibration applied and no bandpass applied

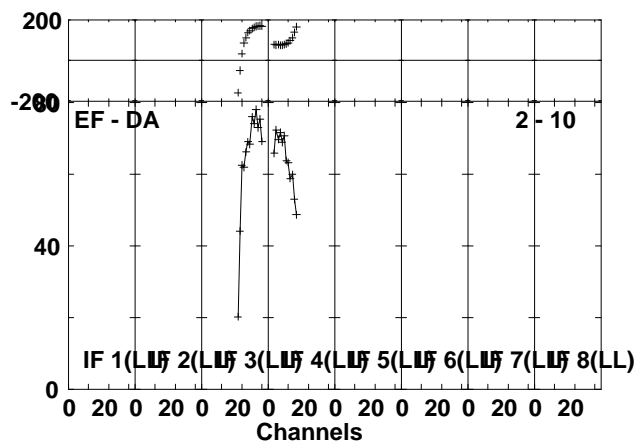
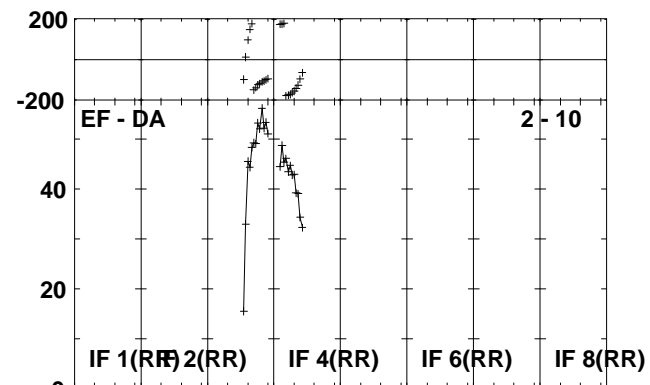
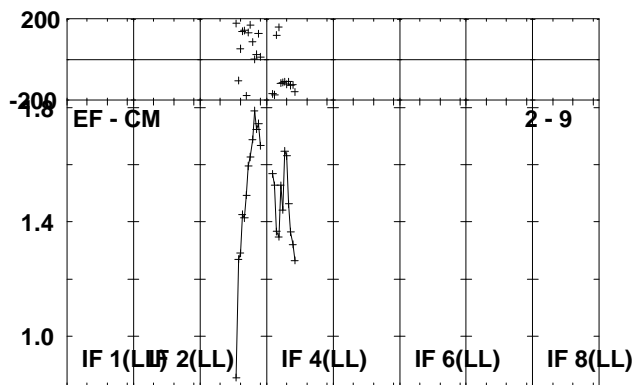
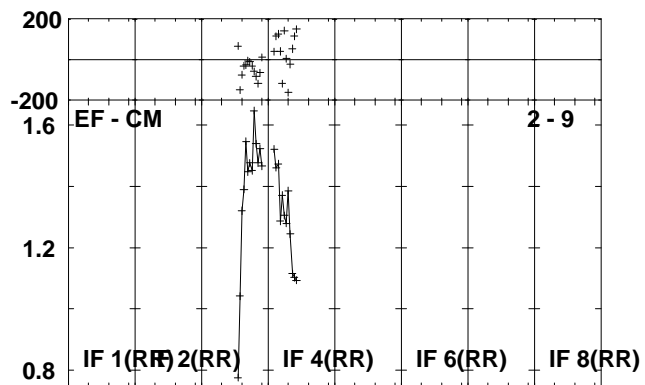
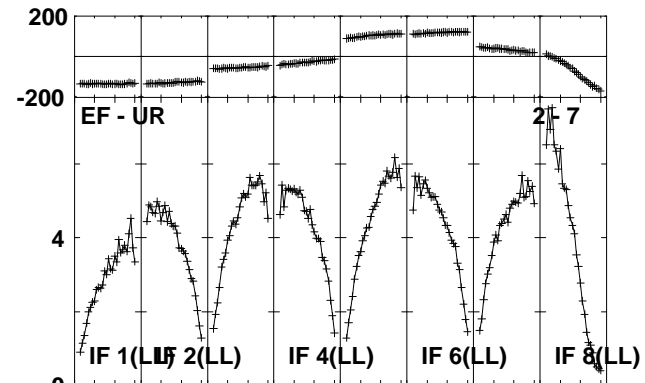
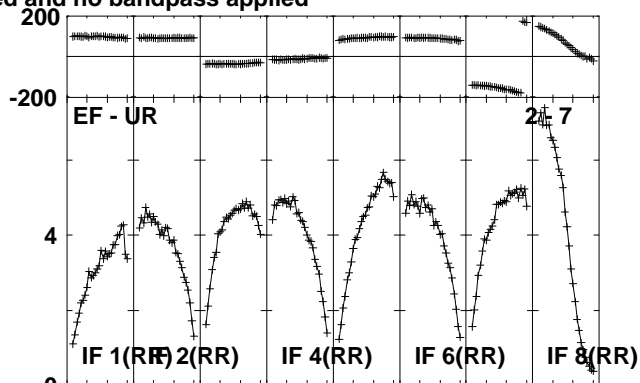
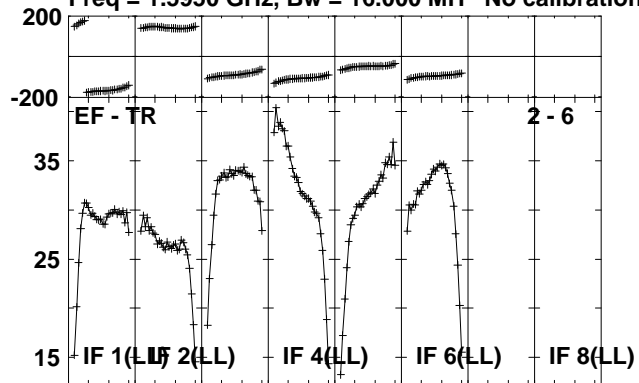

Lower frame: Milli Ampl Jy Top frame: Phas deg
 Scalar averaged cross-power spectrum Several baselines displayed
 Timerange: 00/21:30:01 to 00/21:34:59

Plot file version 3 created 23-AUG-2010 12:32:31

3C345 EP064P.UVDATA.1

Freq = 1.5950 GHz, Bw = 16.000 MH No calibration applied and no bandpass applied

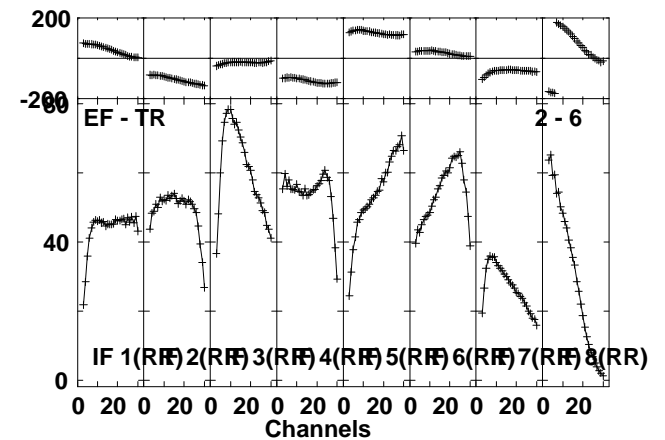
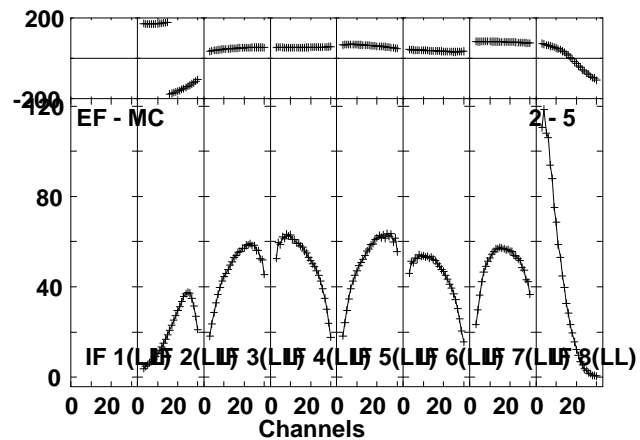
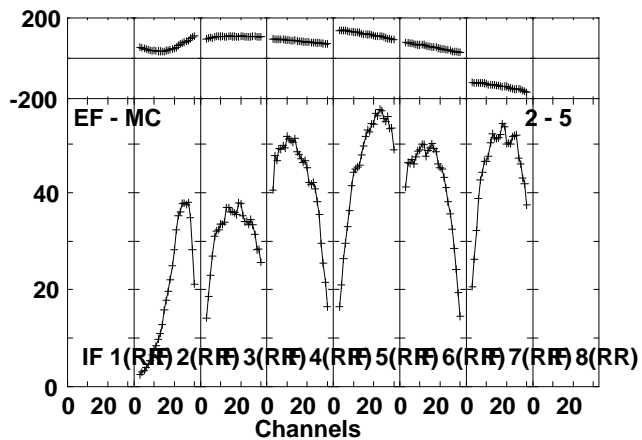
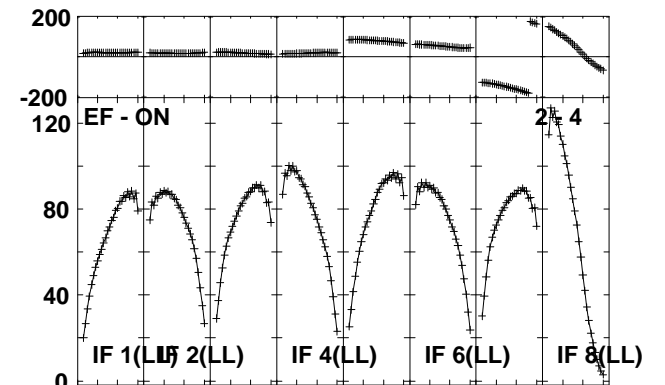
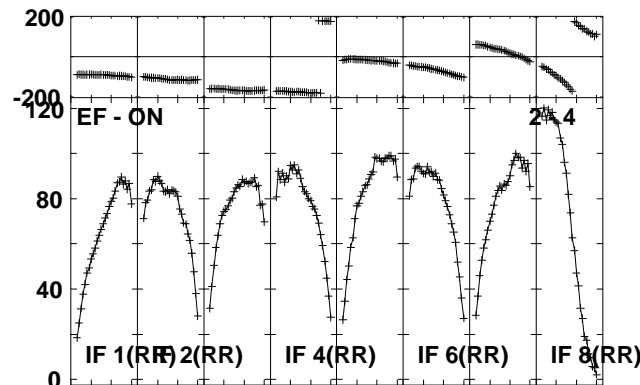
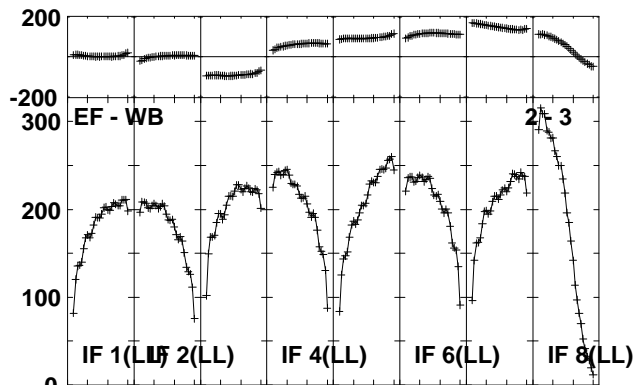
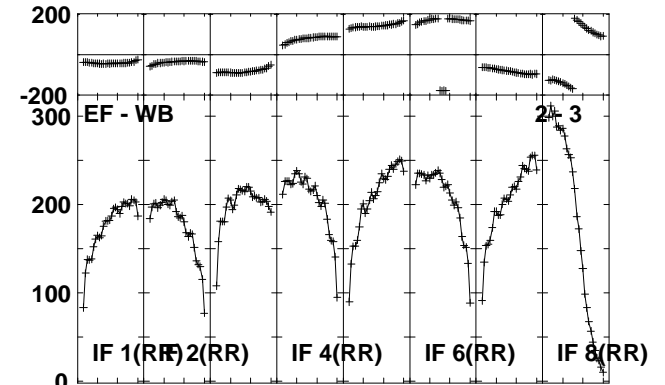
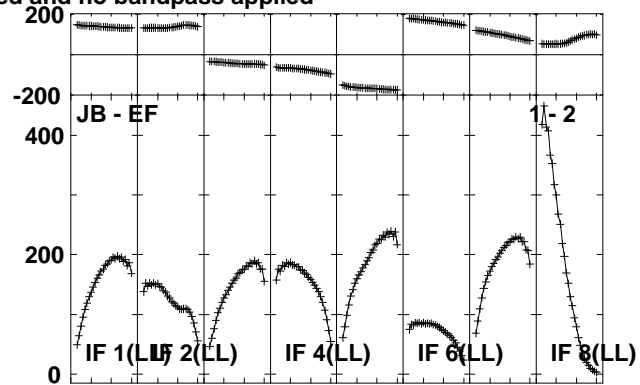
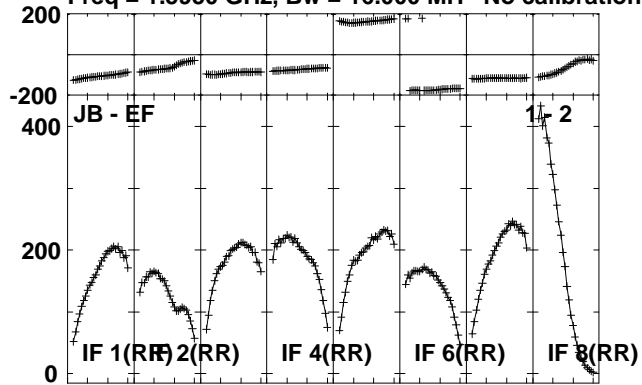

Lower frame: Milli Ampl Jy Top frame: Phas deg
Scalar averaged cross-power spectrum Several baselines displayed
Timerange: 00/21:36:01 to 00/21:49:59

Plot file version 4 created 23-AUG-2010 12:32:38

3C345 EP064P.UVDATA.1

Freq = 1.5950 GHz, Bw = 16.000 MH No calibration applied and no bandpass applied

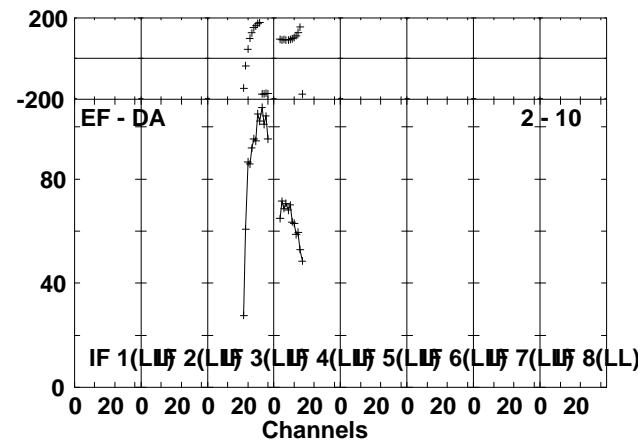
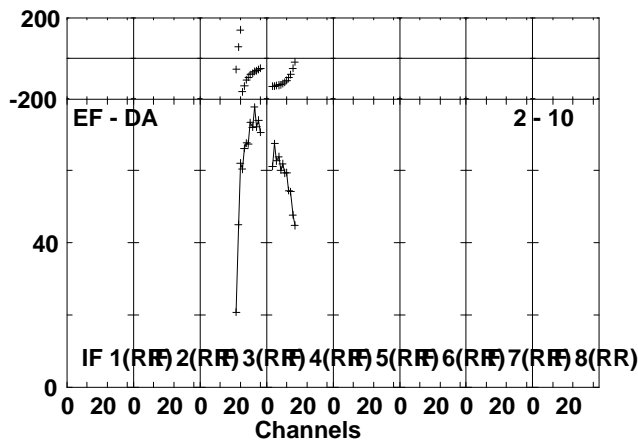
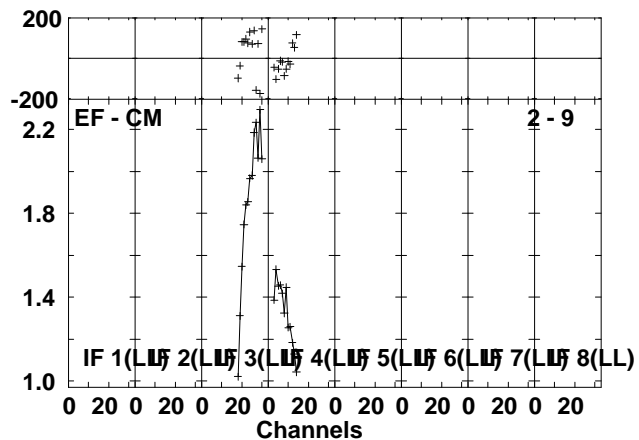
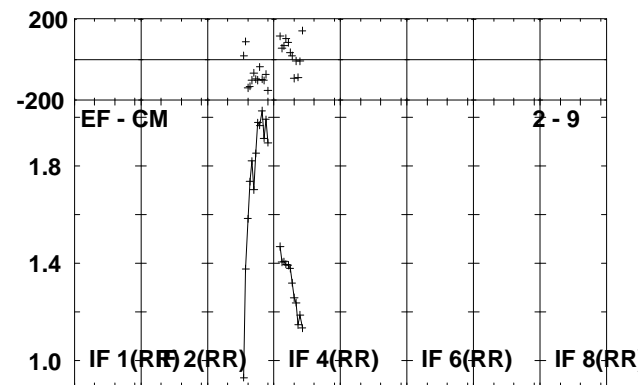
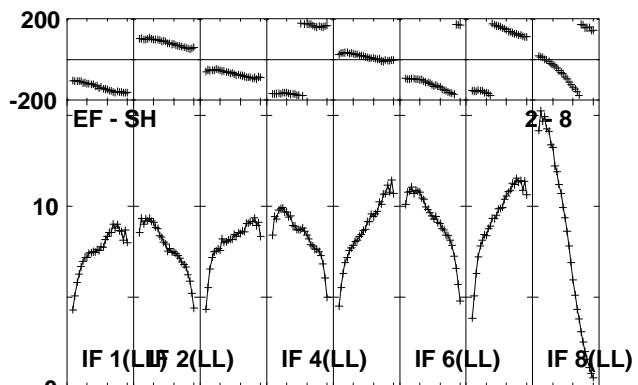
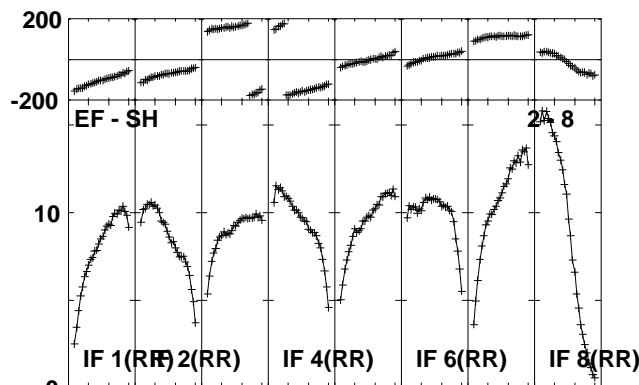
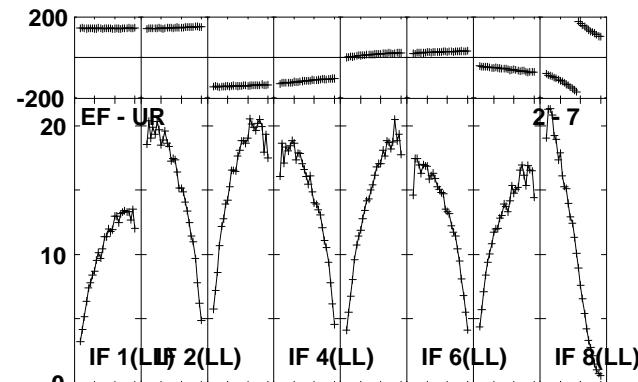
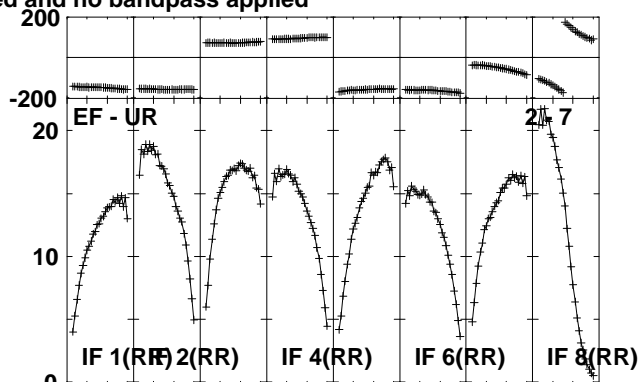
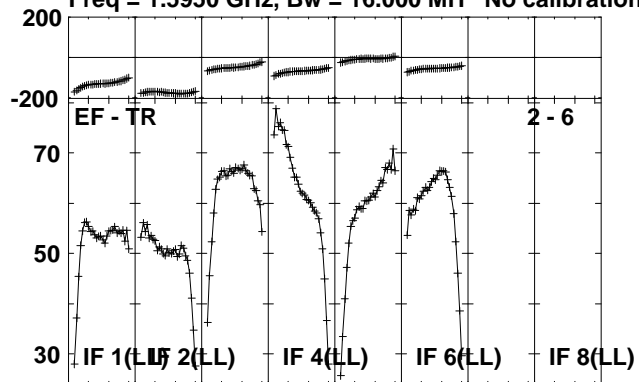

Lower frame: Milli Ampl Jy Top frame: Phas deg
Scalar averaged cross-power spectrum Several baselines displayed
Timerange: 00/21:36:01 to 00/21:49:59

Plot file version 5 created 23-AUG-2010 12:32:45
 J1941-05 EP064P.UVDATA.1

Freq = 1.5950 GHz, Bw = 16.000 MH No calibration applied and no bandpass applied

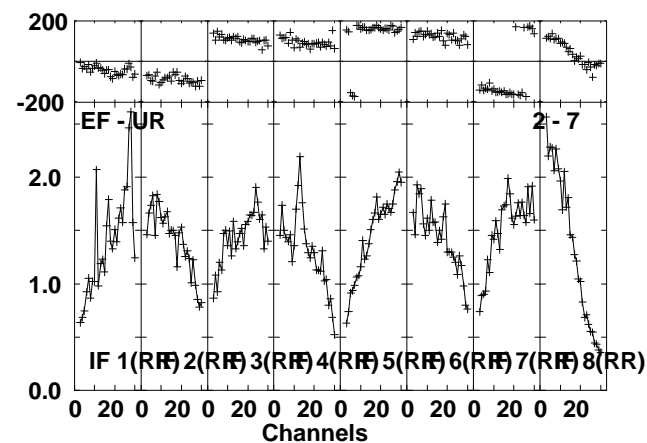
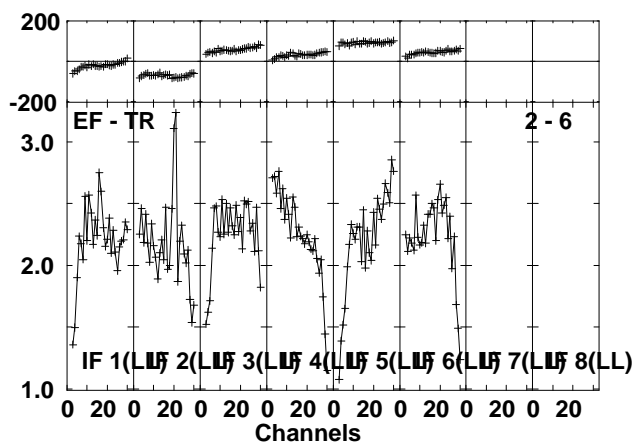
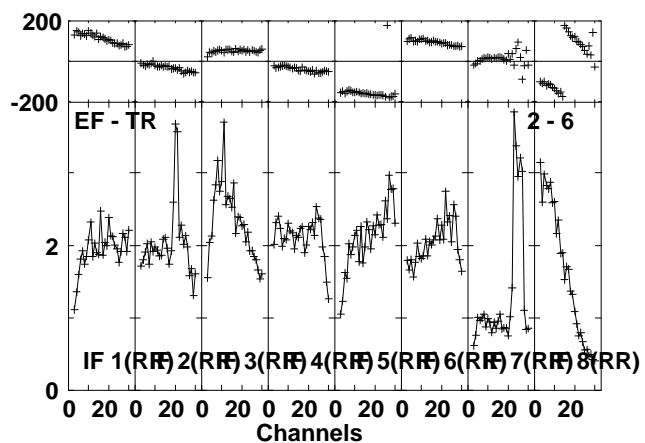
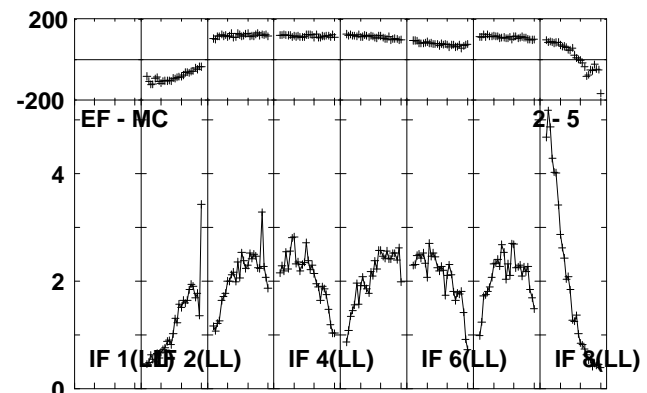
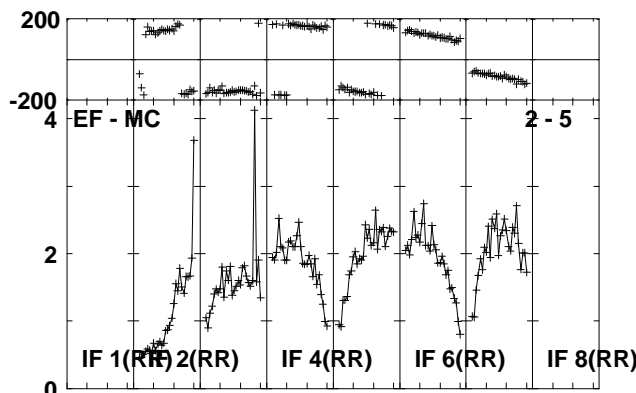
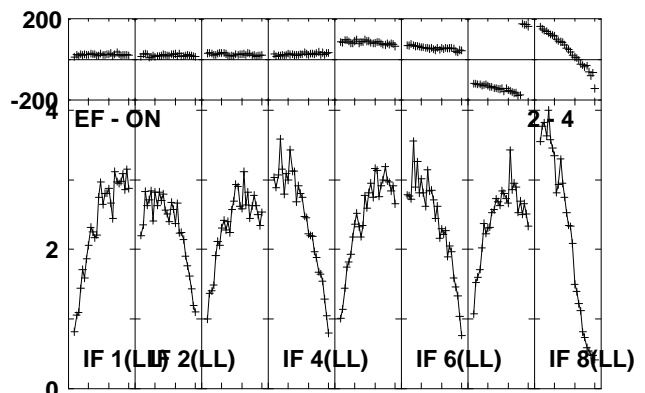
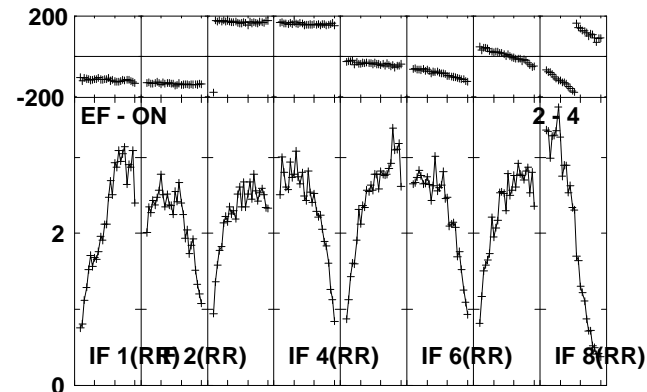
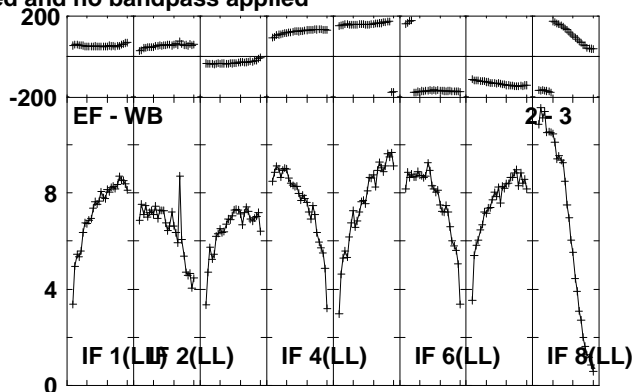
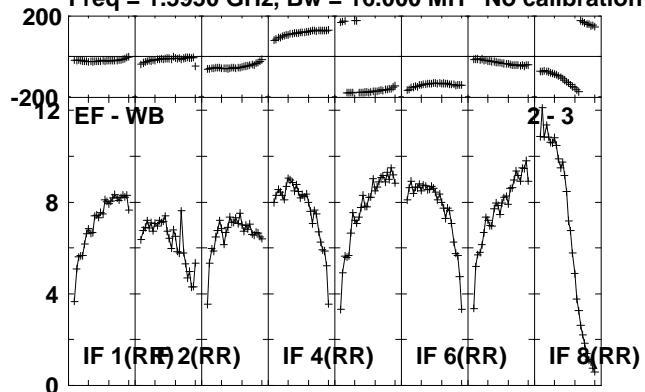

Lower frame: Milli Ampl Jy Top frame: Phas deg
 Scalar averaged cross-power spectrum Several baselines displayed
 Timerange: 00/21:56:01 to 00/21:57:27

Plot file version 6 created 23-AUG-2010 12:32:45

J1941-05 EP064P.UVDATA.1

Freq = 1.5950 GHz, Bw = 16.000 MH No calibration applied and no bandpass applied

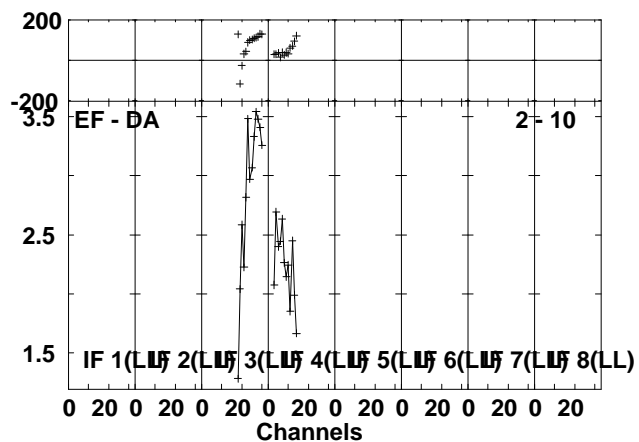
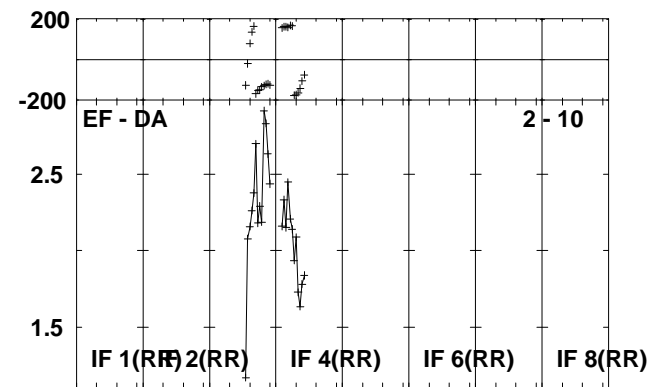
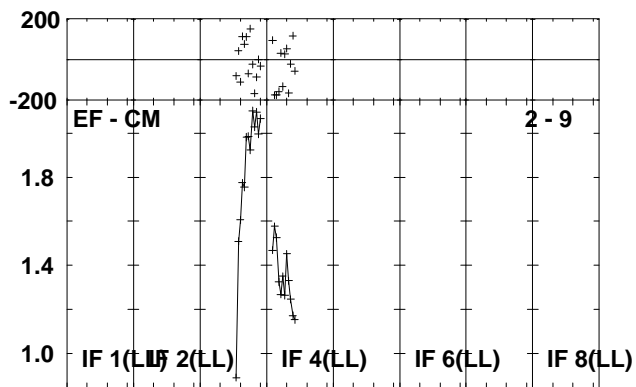
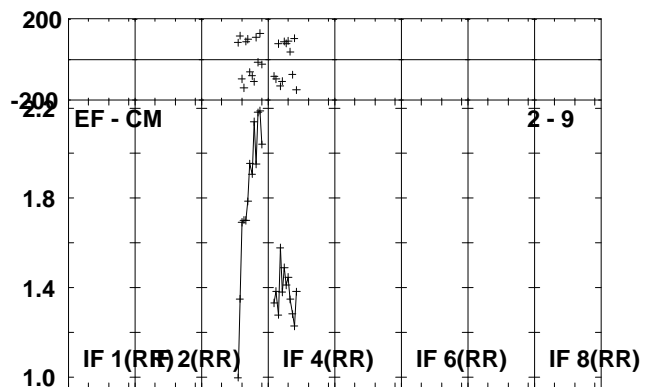
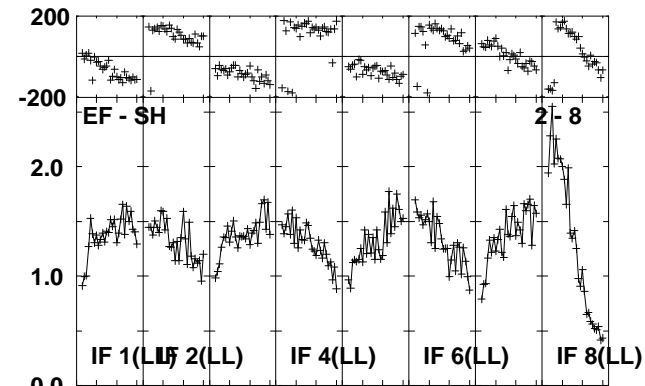
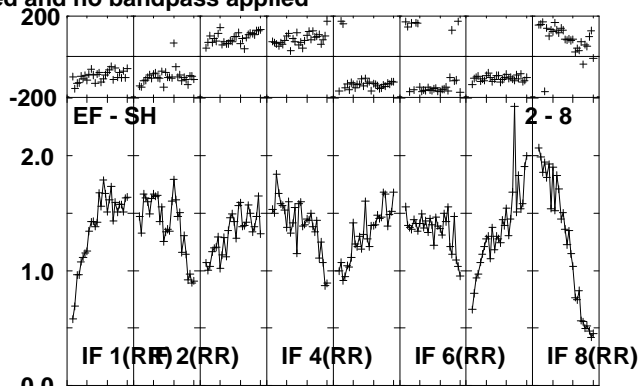
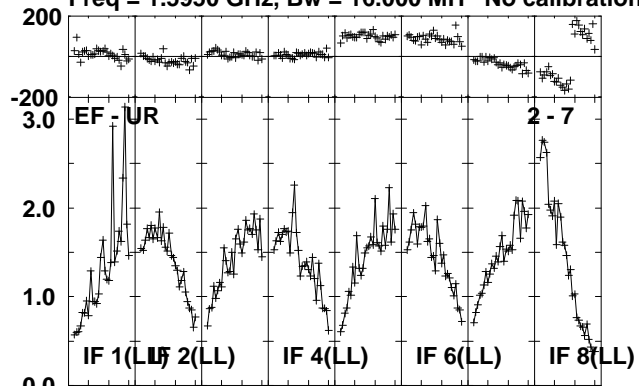

Lower frame: Milli Ampl Jy Top frame: Phas deg
Scalar averaged cross-power spectrum Several baselines displayed
Timerange: 00/21:56:01 to 00/21:57:27

Plot file version 7 created 23-AUG-2010 12:32:47

IRAS1929 EP064P.UVDATA.1

Freq = 1.5950 GHz, Bw = 16.000 MH No calibration applied and no bandpass applied

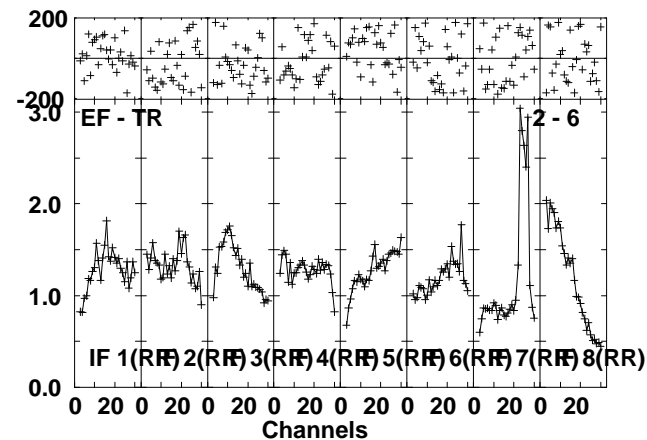
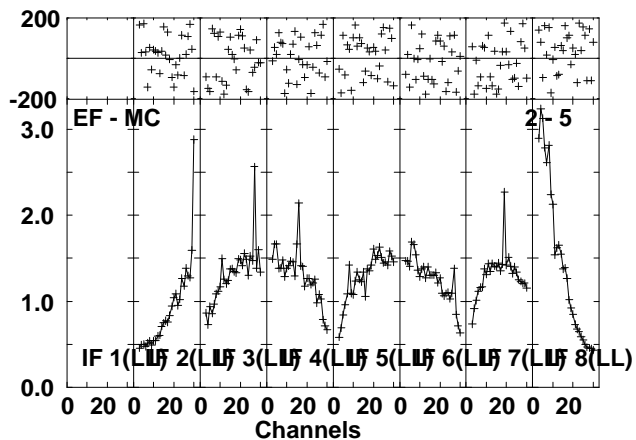
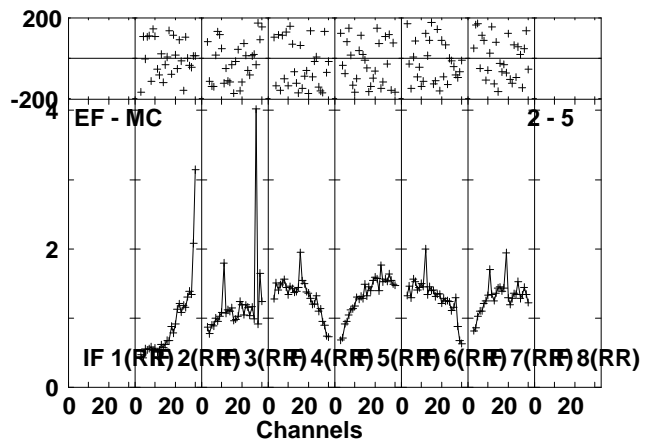
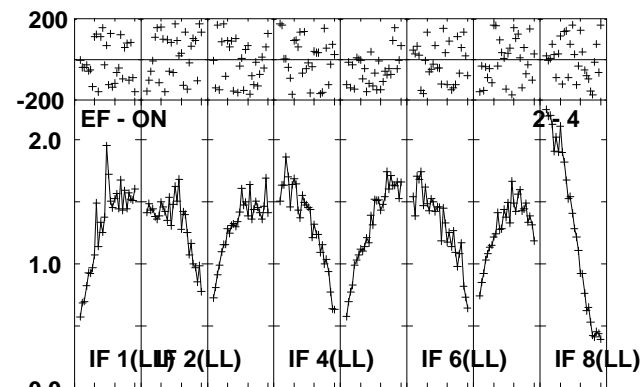
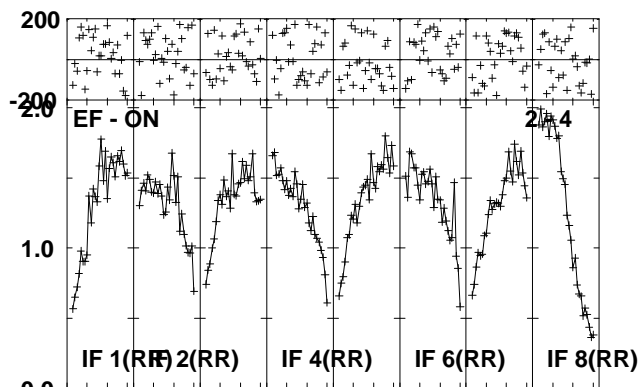
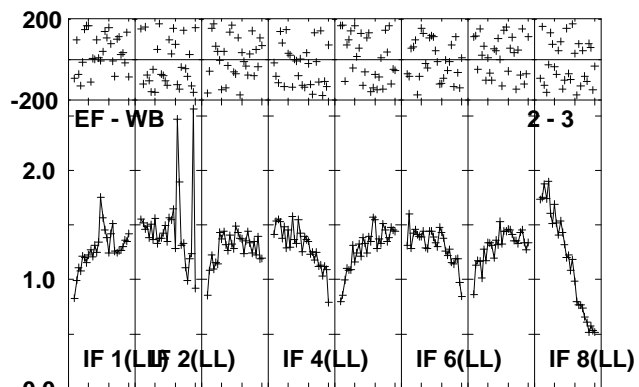
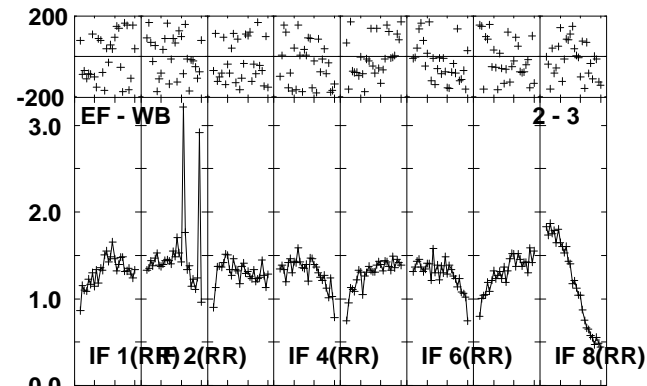
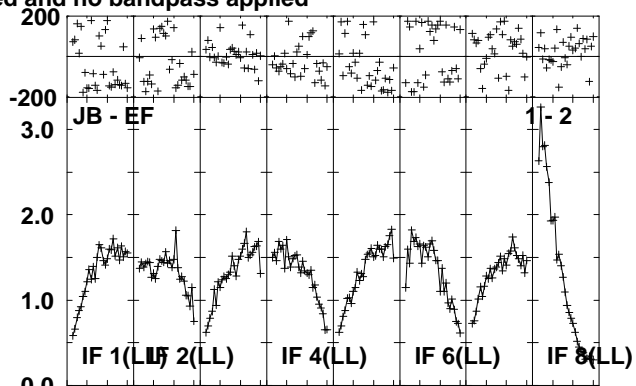
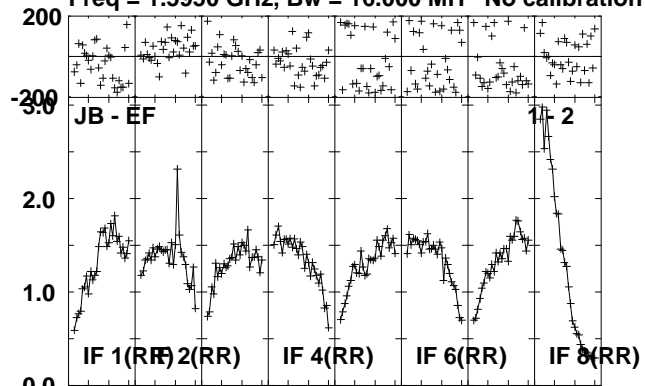

Lower frame: Milli Ampl Jy Top frame: Phas deg
Scalar averaged cross-power spectrum Several baselines displayed
Timerange: 00/21:57:31 to 00/22:00:59

Plot file version 8 created 23-AUG-2010 12:32:48

IRAS1929 EP064P.UVDATA.1

Freq = 1.5950 GHz, Bw = 16.000 MH No calibration applied and no bandpass applied

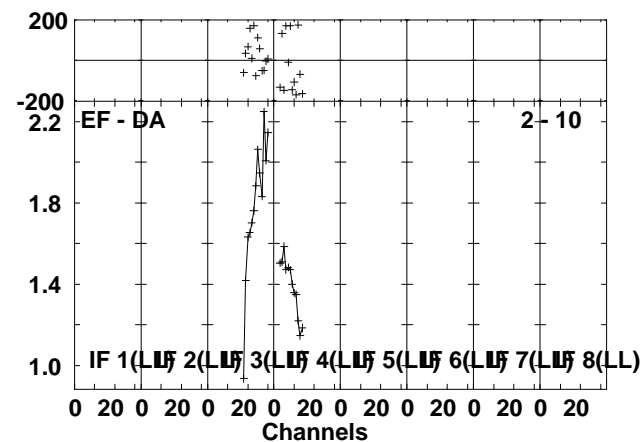
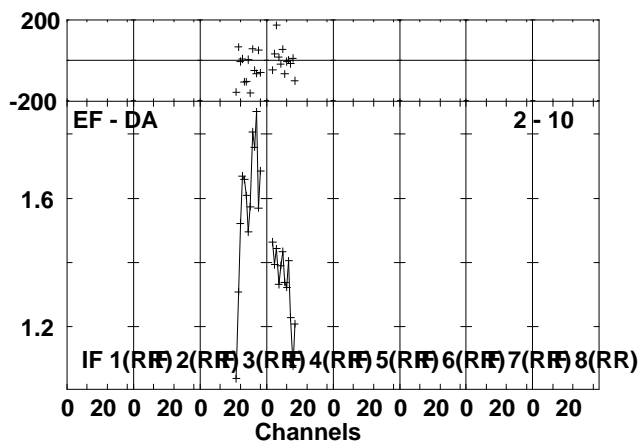
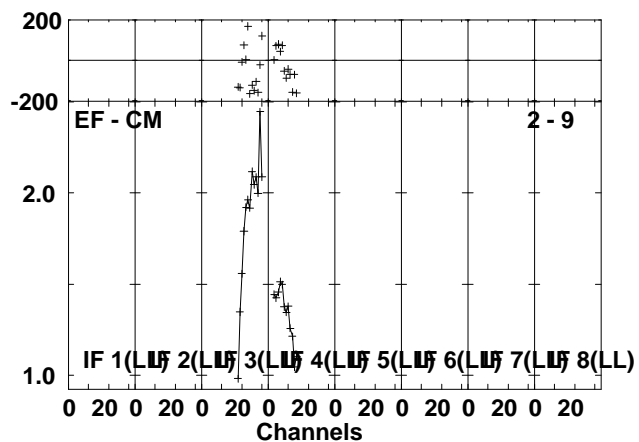
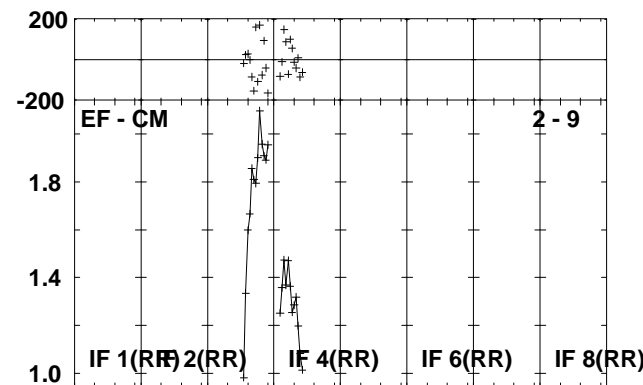
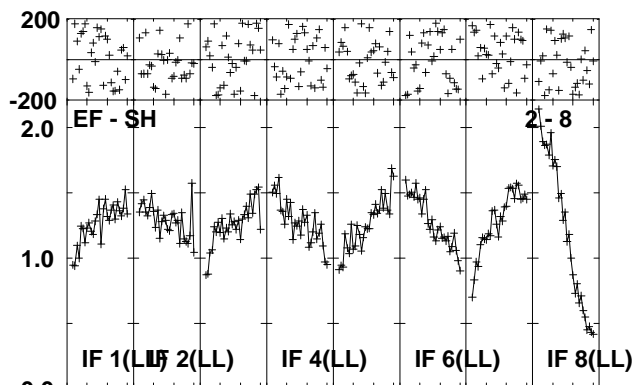
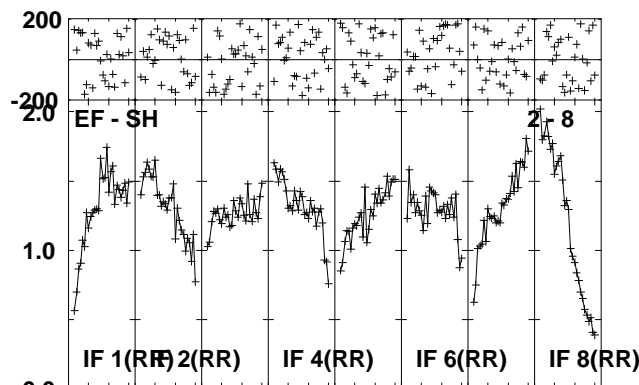
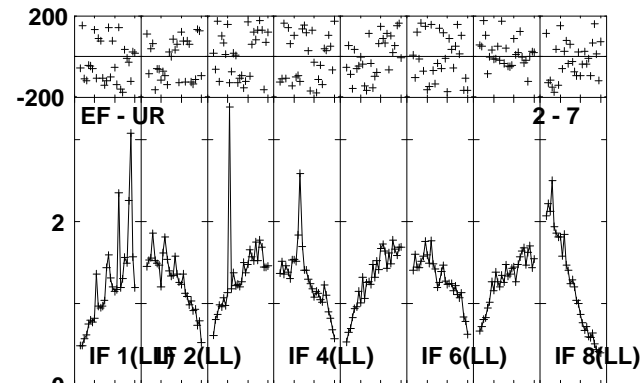
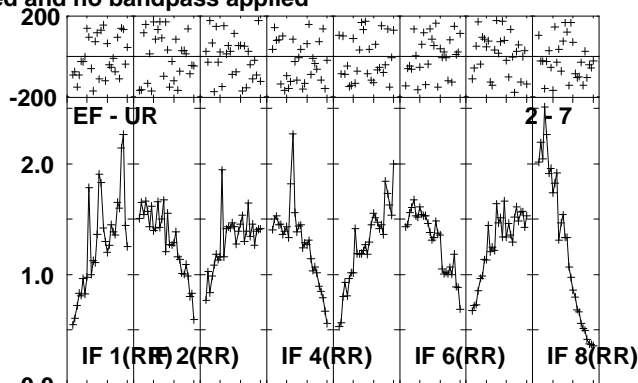
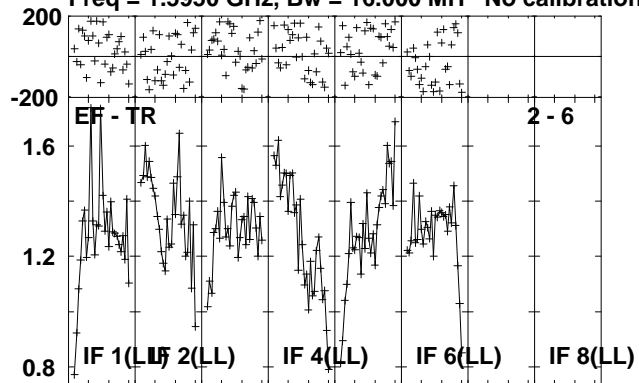

Lower frame: Milli Ampl Jy Top frame: Phas deg
Scalar averaged cross-power spectrum Several baselines displayed
Timerange: 00/21:57:31 to 00/22:00:59

Plot file version 9 created 23-AUG-2010 12:32:50
 J1941-05 EP064P.UVDATA.1

Freq = 1.5950 GHz, Bw = 16.000 MH No calibration applied and no bandpass applied

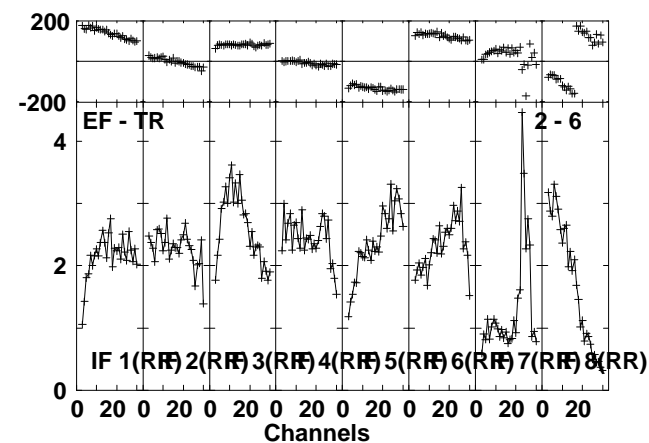
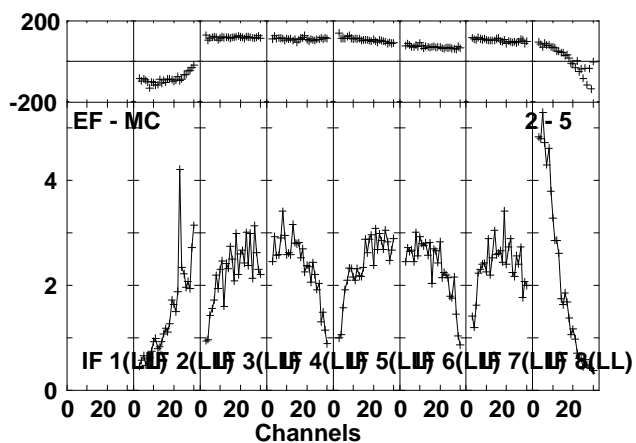
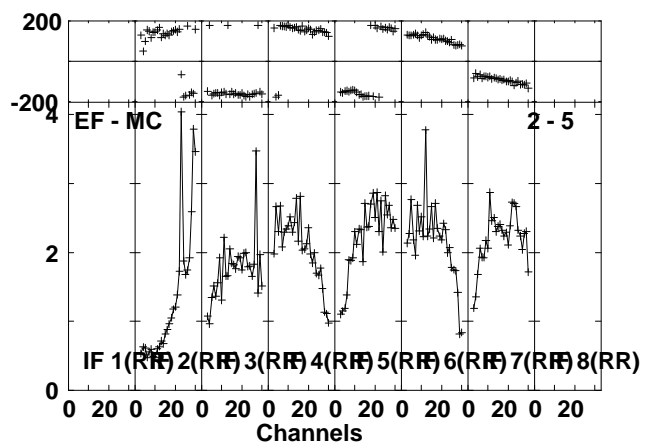
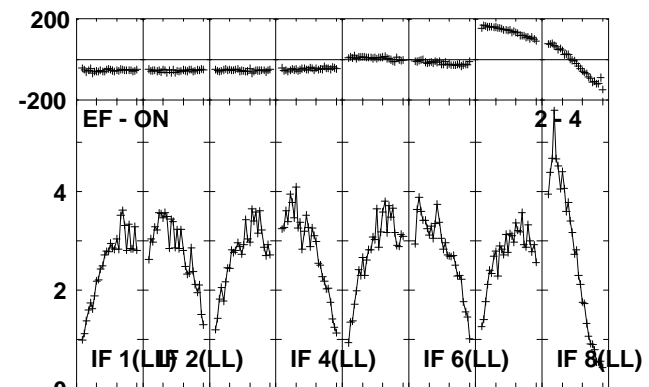
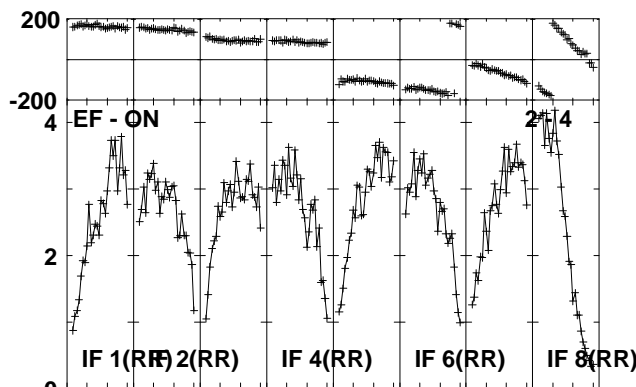
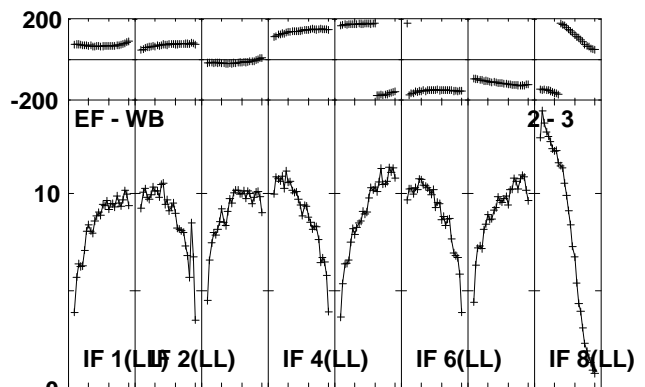
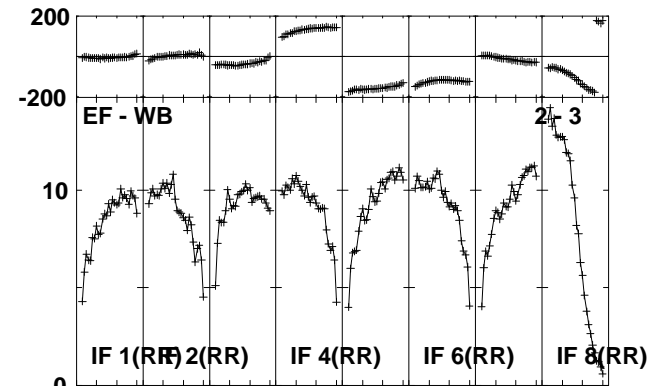
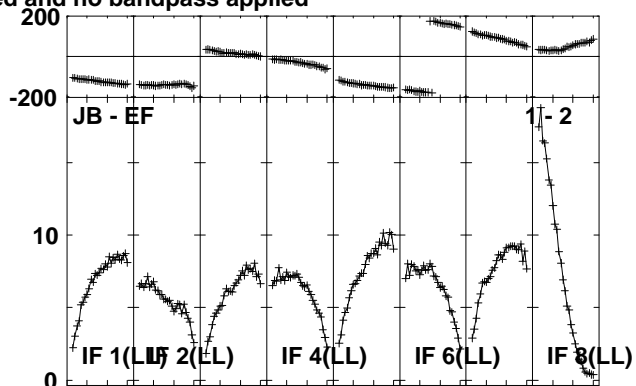
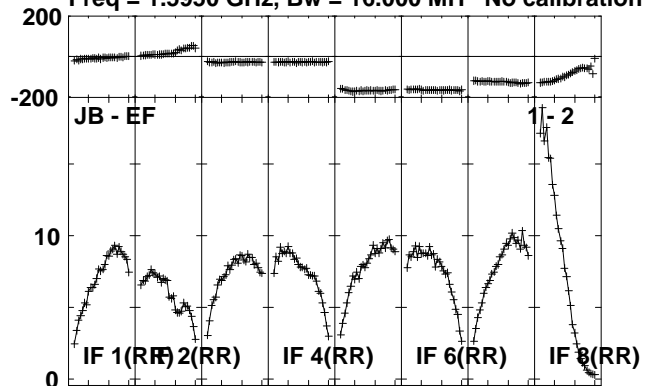

Lower frame: Milli Ampl Jy Top frame: Phas deg
 Scalar averaged cross-power spectrum Several baselines displayed
 Timerange: 00/22:01:01 to 00/22:02:29

Plot file version 10 created 23-AUG-2010 12:32:51

J1941-05 EP064P.UVDATA.1

Freq = 1.5950 GHz, Bw = 16.000 MH No calibration applied and no bandpass applied

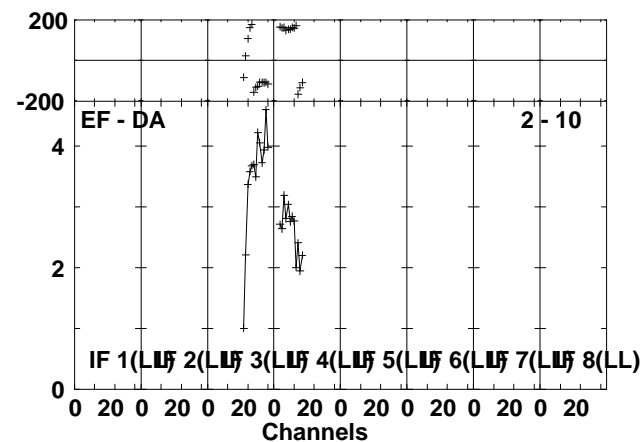
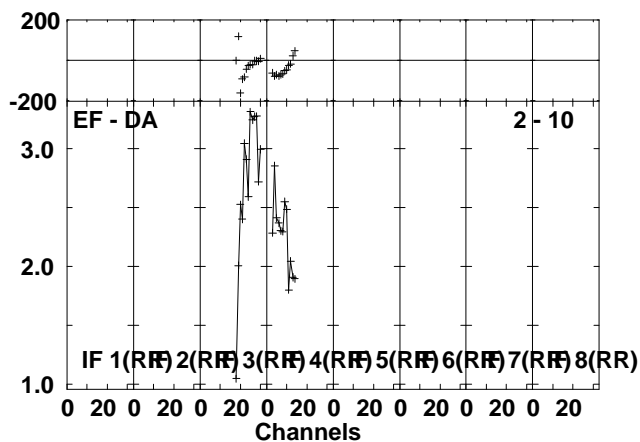
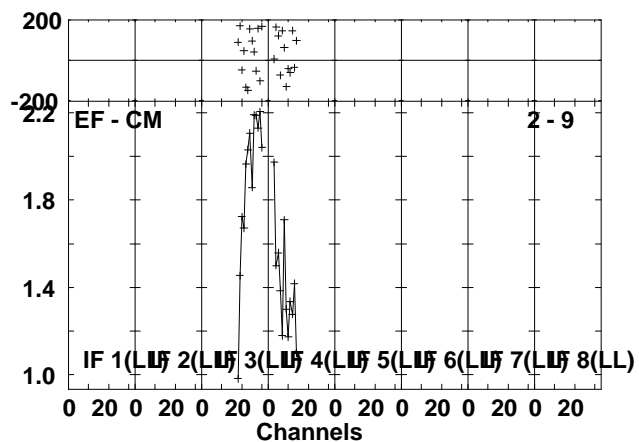
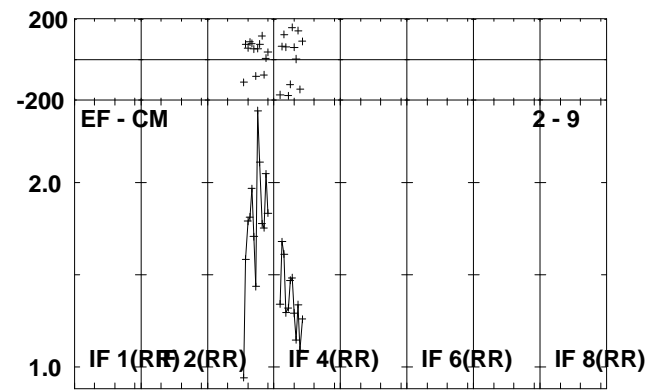
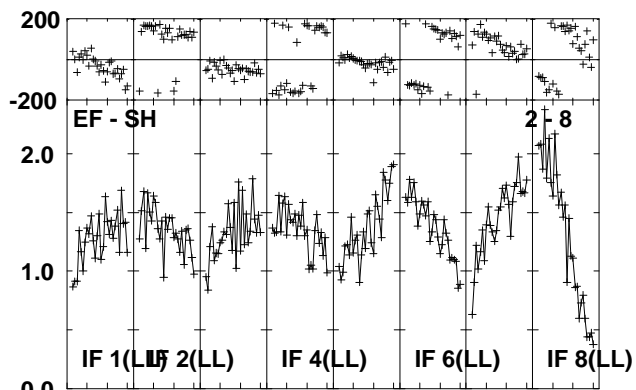
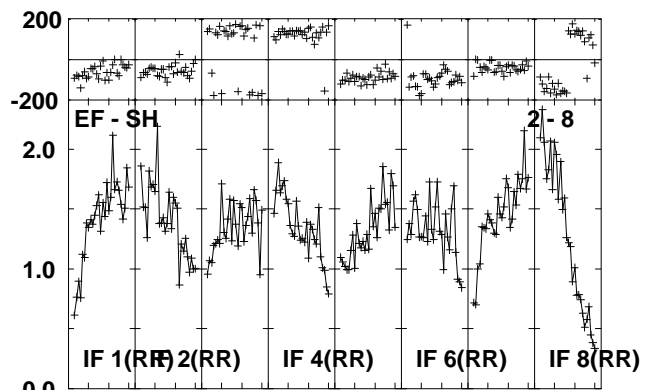
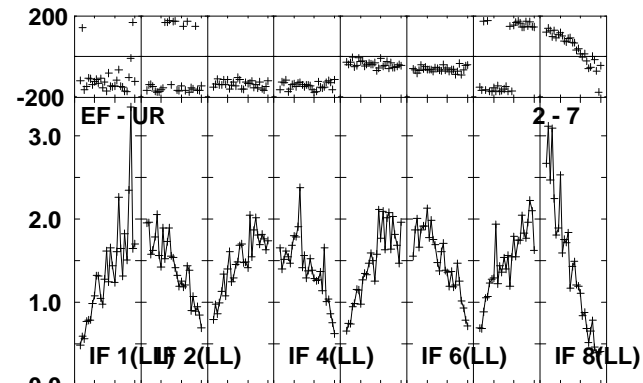
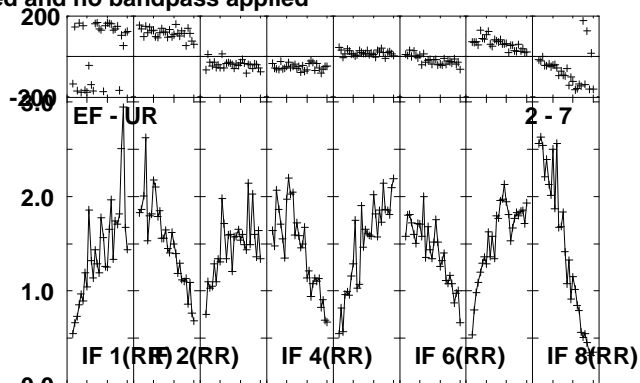
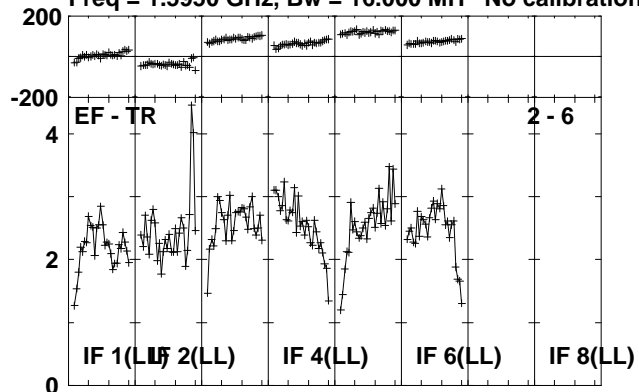

Lower frame: Milli Ampl Jy Top frame: Phas deg
Scalar averaged cross-power spectrum Several baselines displayed
Timerange: 00/22:01:01 to 00/22:02:29

Plot file version 11 created 23-AUG-2010 12:32:53

IRAS1929 EP064P.UVDATA.1

Freq = 1.5950 GHz, Bw = 16.000 MH No calibration applied and no bandpass applied

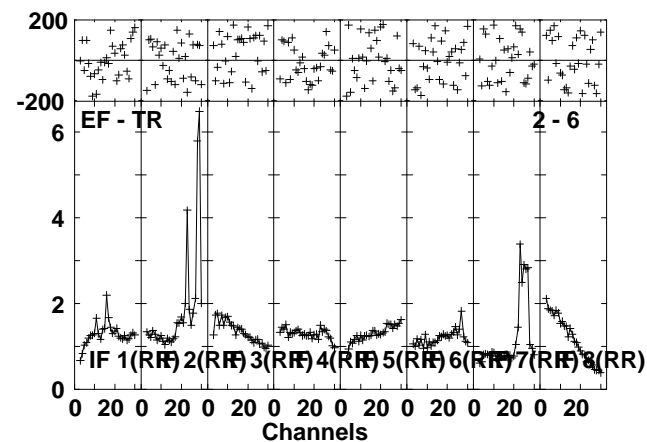
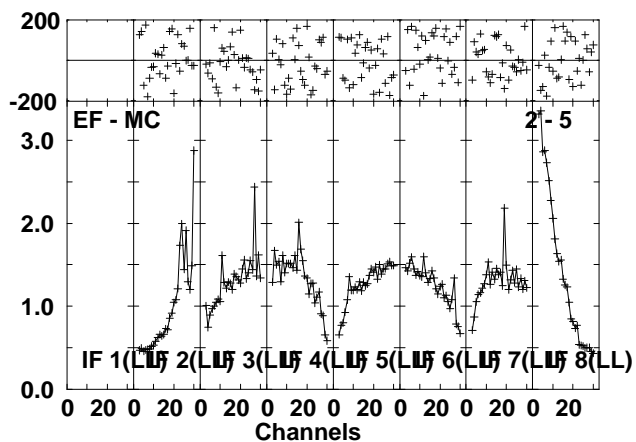
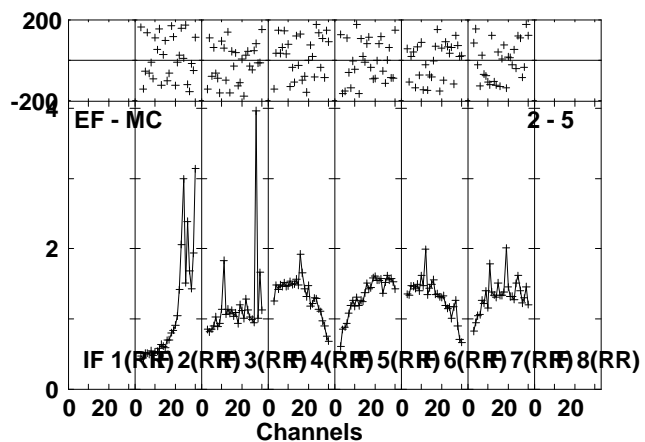
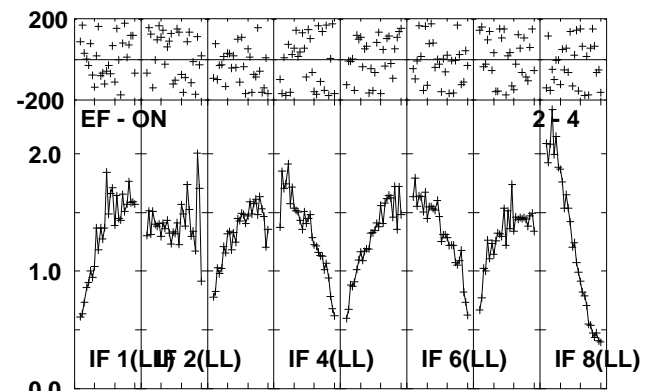
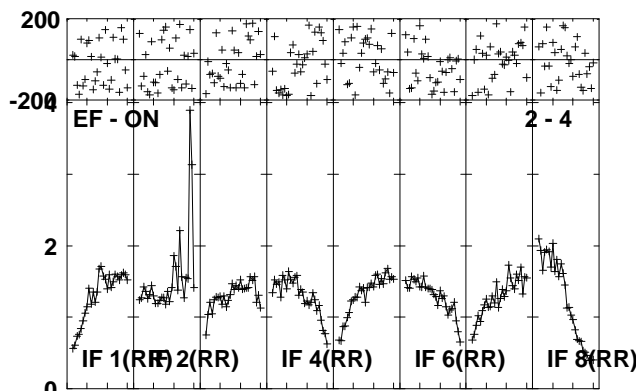
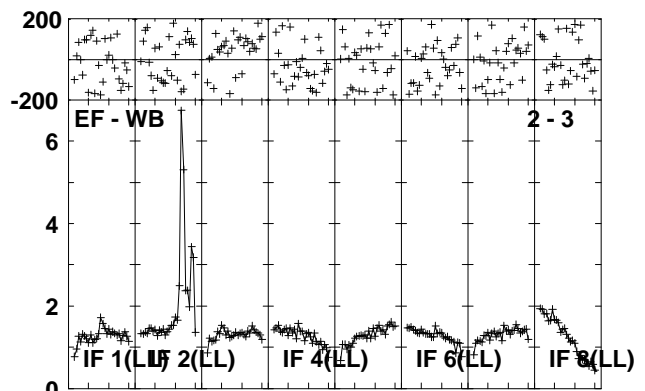
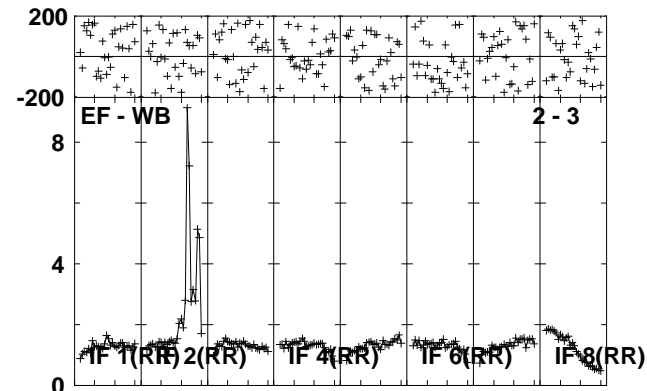
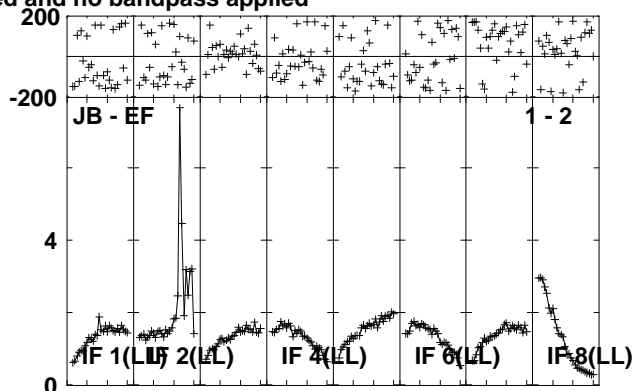
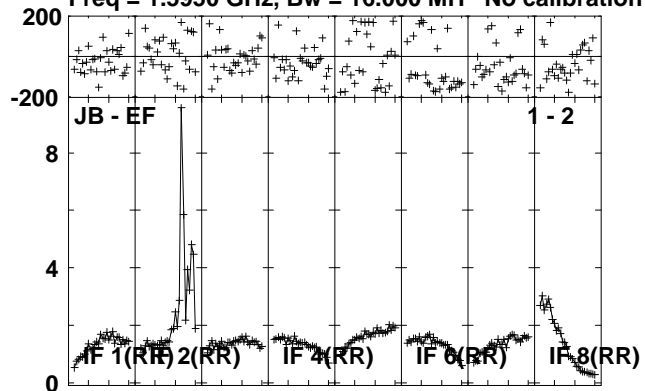

Lower frame: Milli Ampl Jy Top frame: Phas deg
Scalar averaged cross-power spectrum Several baselines displayed
Timerange: 00/22:02:31 to 00/22:05:59

Plot file version 12 created 23-AUG-2010 12:32:55

IRAS1929 EP064P.UVDATA.1

Freq = 1.5950 GHz, Bw = 16.000 MH No calibration applied and no bandpass applied

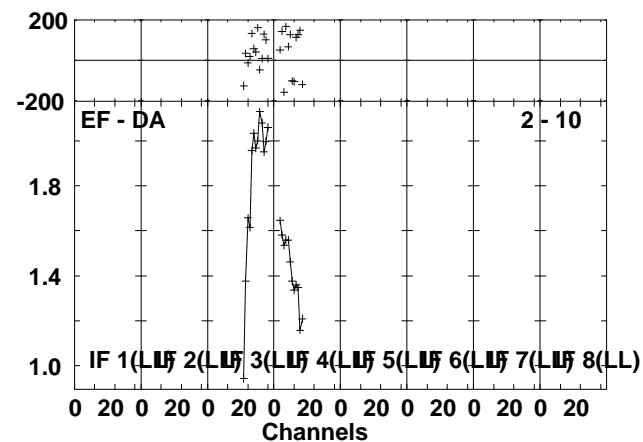
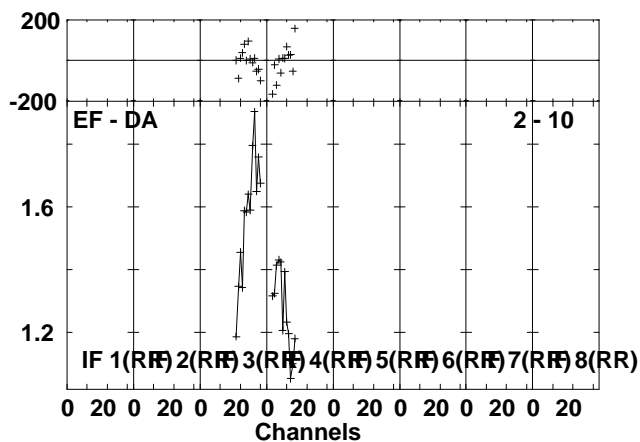
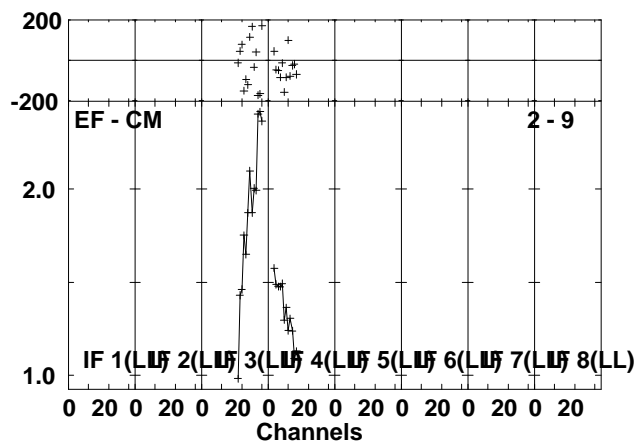
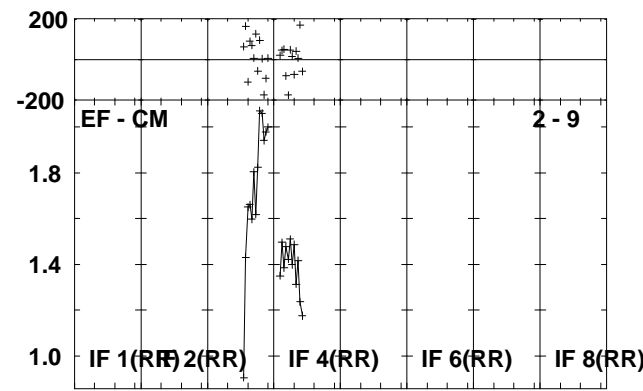
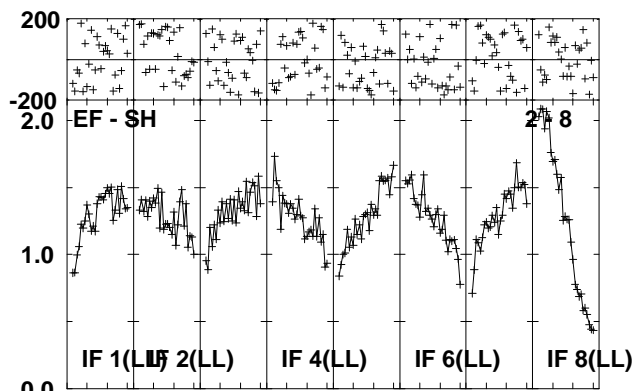
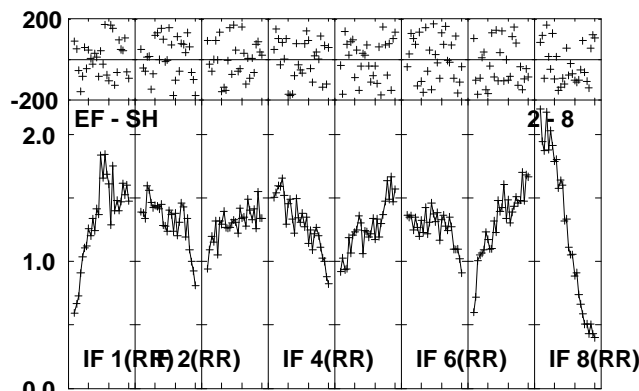
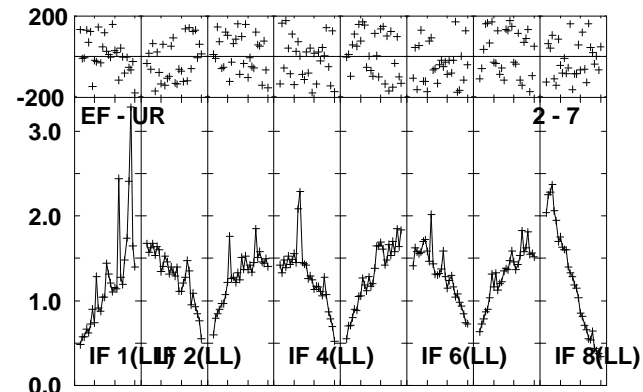
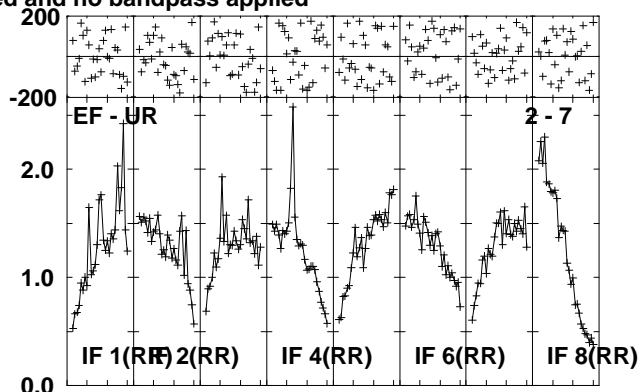
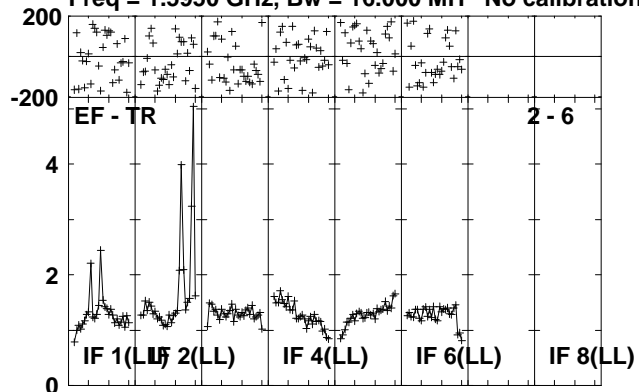

Lower frame: Milli Ampl Jy Top frame: Phas deg
Scalar averaged cross-power spectrum Several baselines displayed
Timerange: 00/22:02:31 to 00/22:05:59

Plot file version 13 created 23-AUG-2010 12:32:57

J1941-05 EP064P.UVDATA.1

Freq = 1.5950 GHz, Bw = 16.000 MH No calibration applied and no bandpass applied

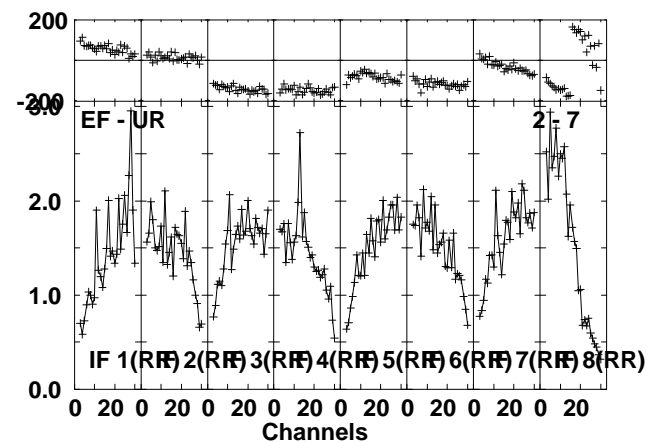
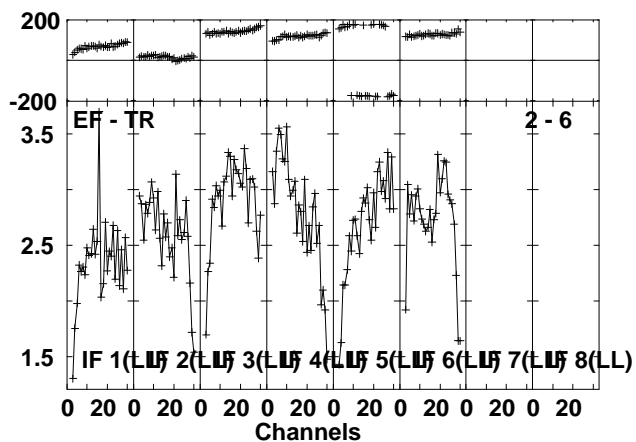
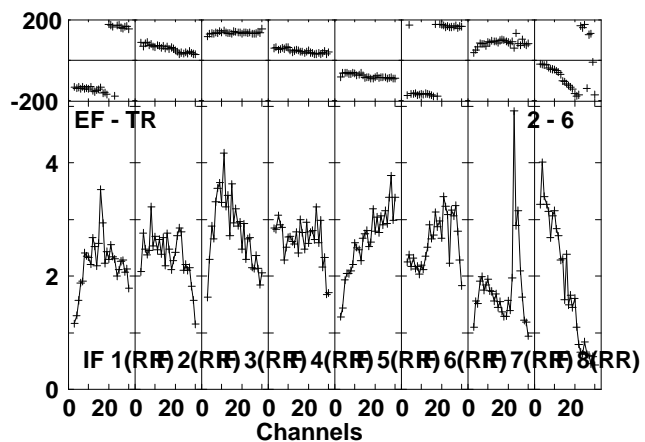
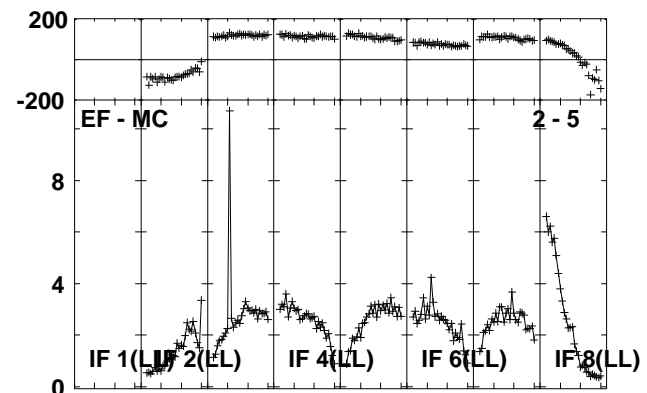
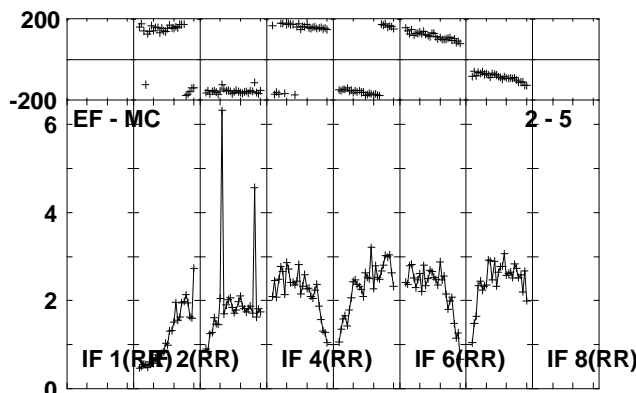
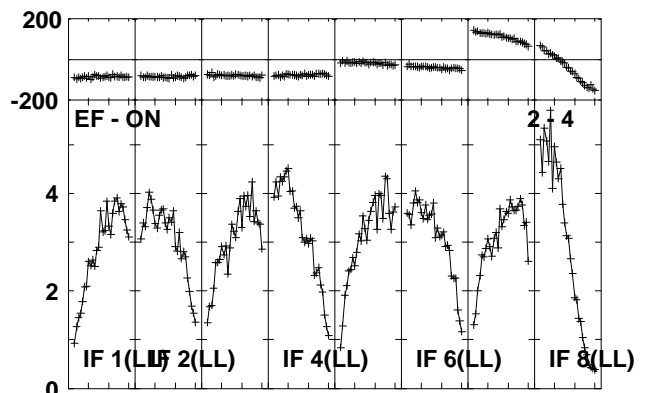
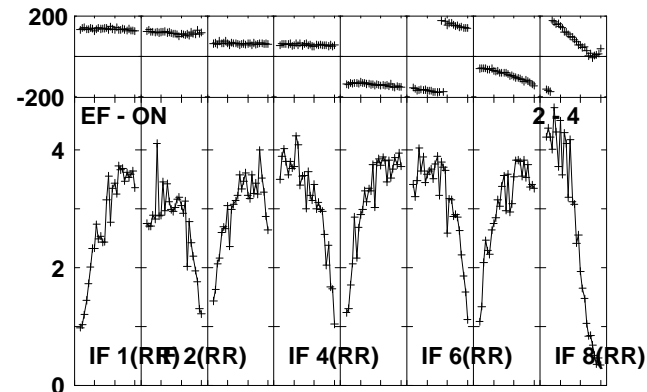
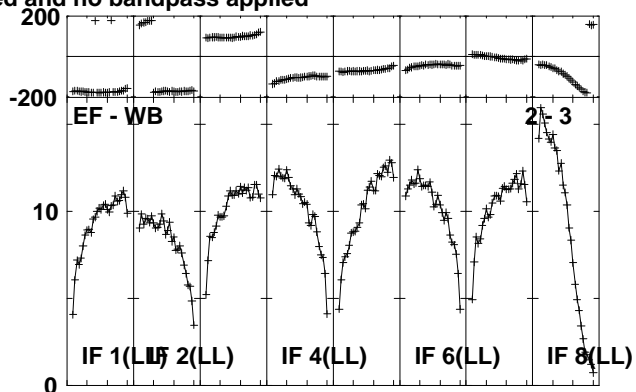
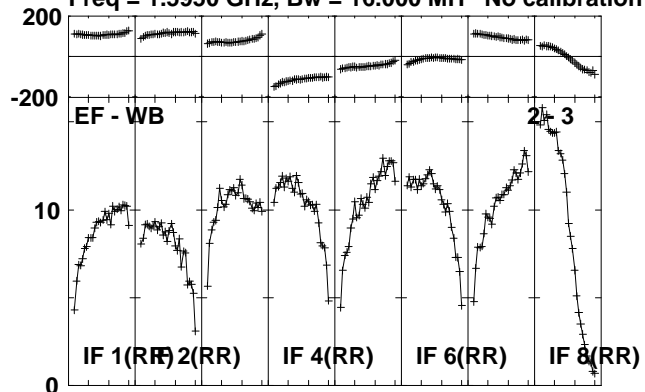

Lower frame: Milli Ampl Jy Top frame: Phas deg
Scalar averaged cross-power spectrum Several baselines displayed
Timerange: 00/22:06:01 to 00/22:07:29

Plot file version 14 created 23-AUG-2010 12:32:58

J1941-05 EP064P.UVDATA.1

Freq = 1.5950 GHz, Bw = 16.000 MH No calibration applied and no bandpass applied

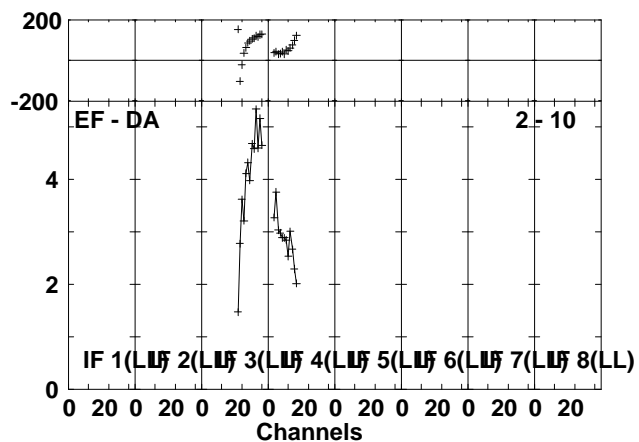
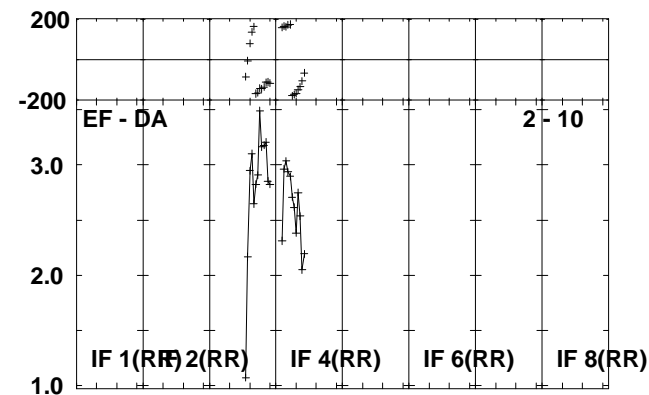
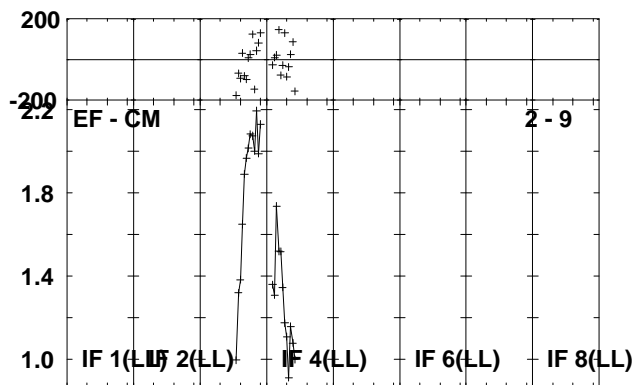
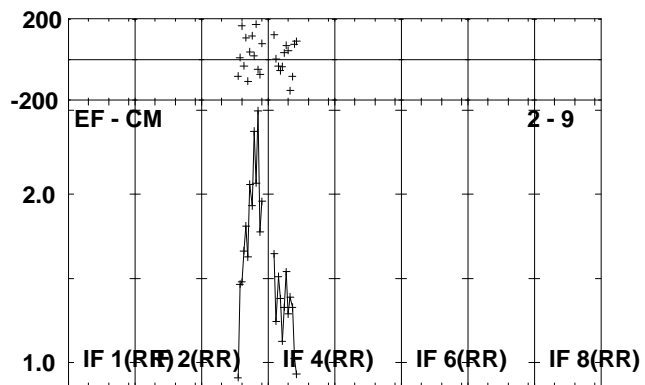
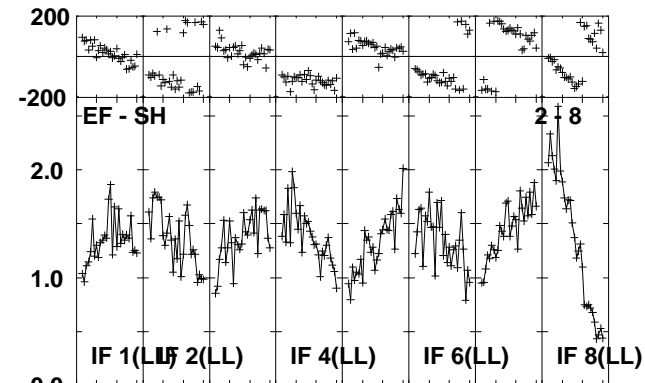
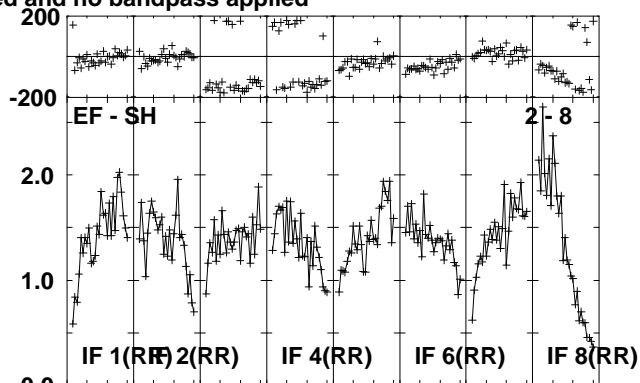
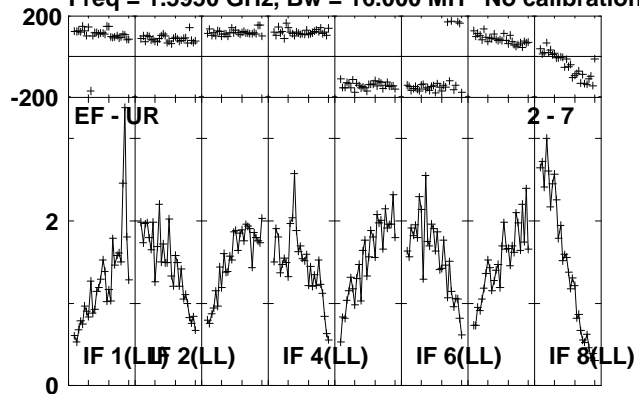

Lower frame: Milli Ampl Jy Top frame: Phas deg
Scalar averaged cross-power spectrum Several baselines displayed
Timerange: 00/22:06:01 to 00/22:07:29

Plot file version 15 created 23-AUG-2010 12:32:59

IRAS1929 EP064P.UVDATA.1

Freq = 1.5950 GHz, Bw = 16.000 MH No calibration applied and no bandpass applied

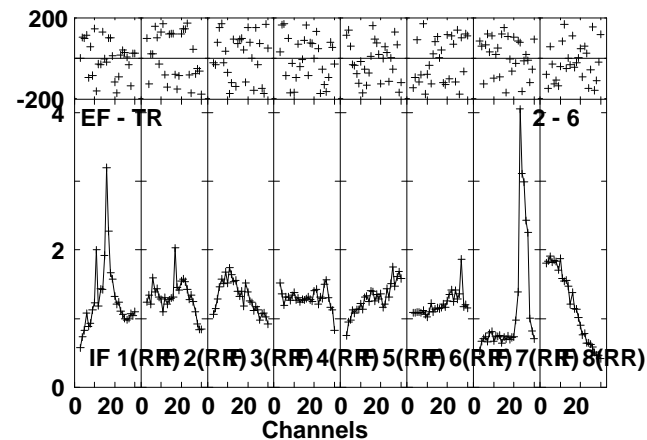
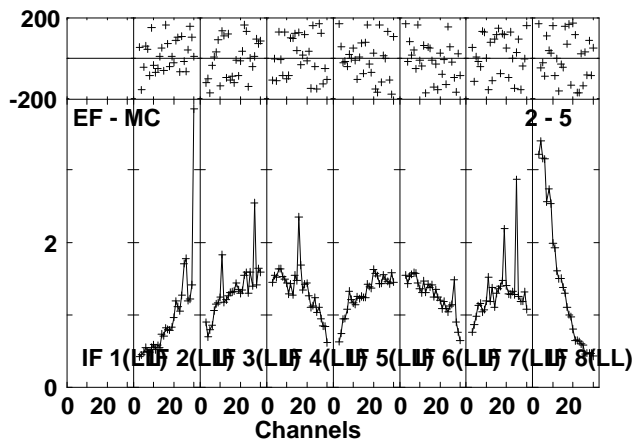
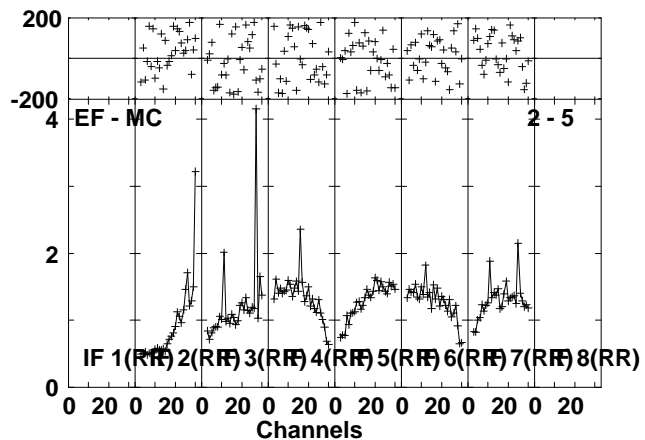
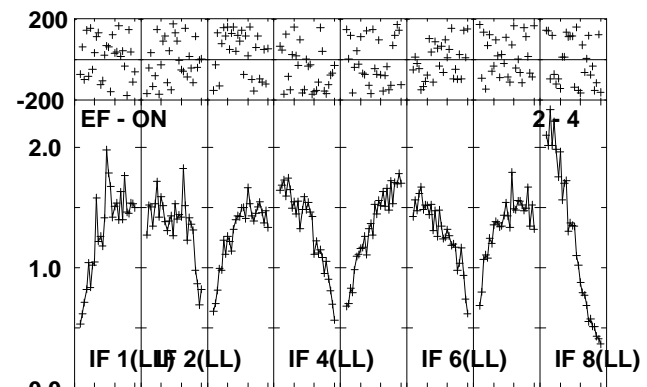
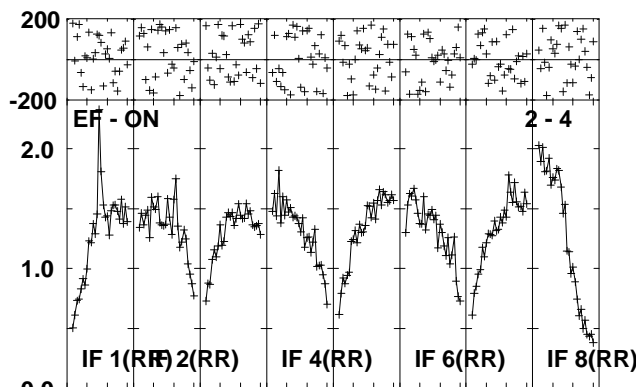
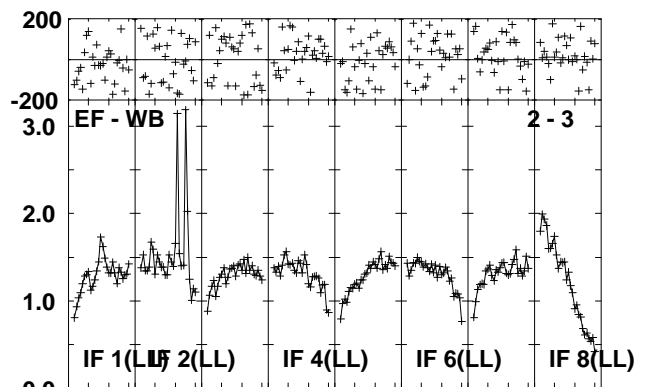
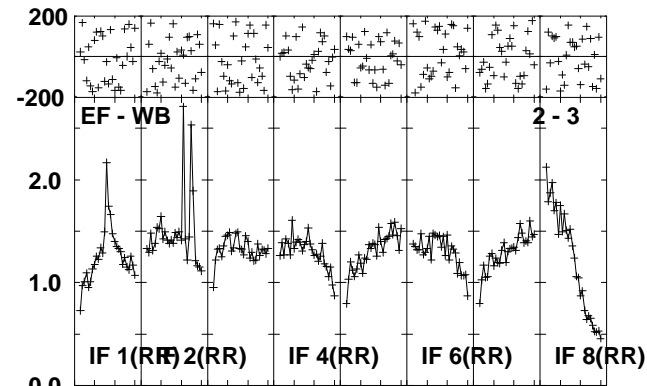
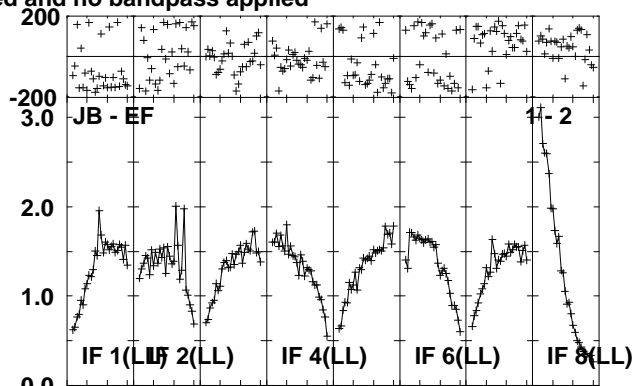
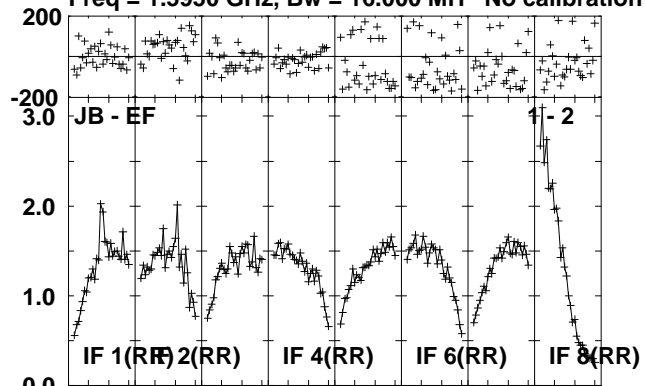

Lower frame: Milli Ampl Jy Top frame: Phas deg
Scalar averaged cross-power spectrum Several baselines displayed
Timerange: 00/22:07:31 to 00/22:10:59

Plot file version 16 created 23-AUG-2010 12:33:01

IRAS1929 EP064P.UVDATA.1

Freq = 1.5950 GHz, Bw = 16.000 MH No calibration applied and no bandpass applied

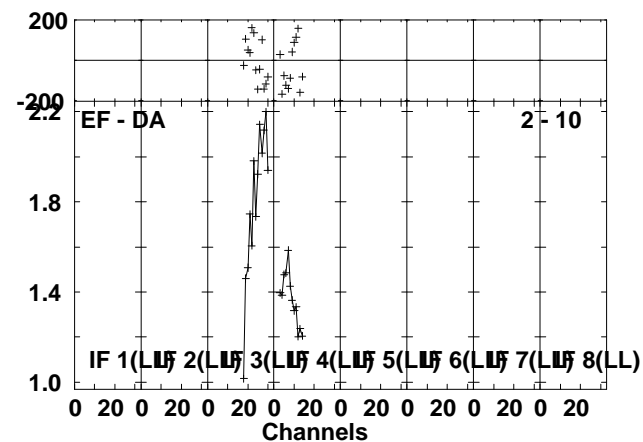
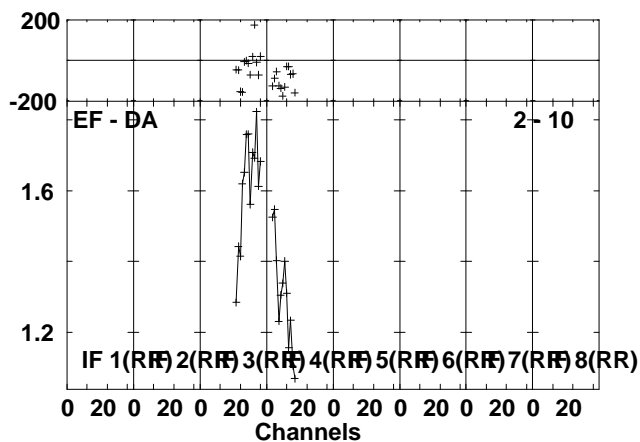
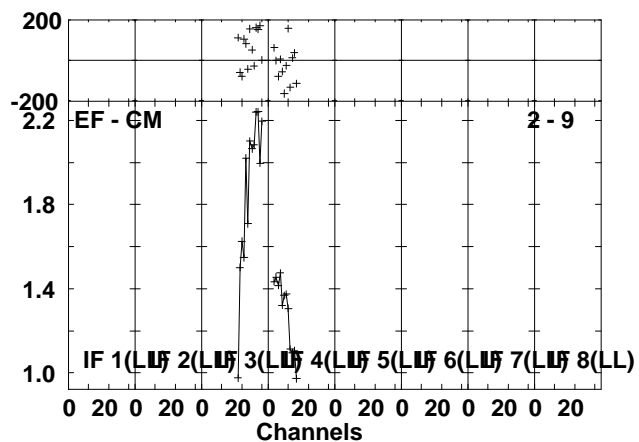
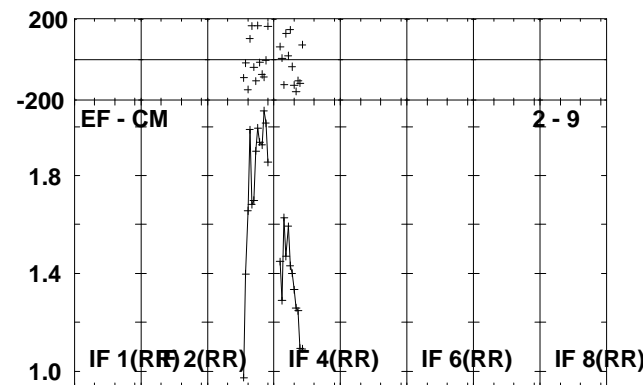
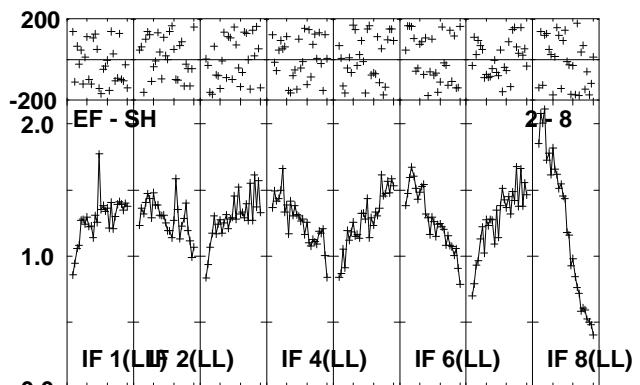
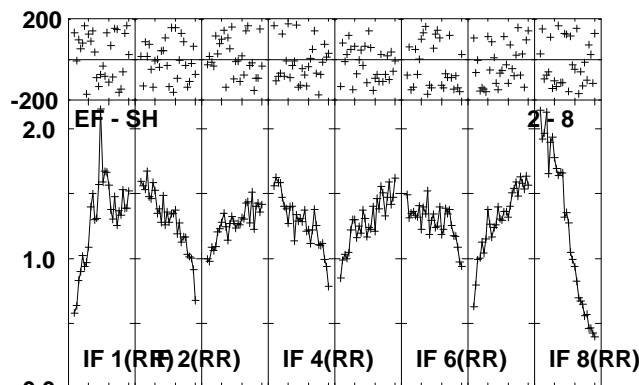
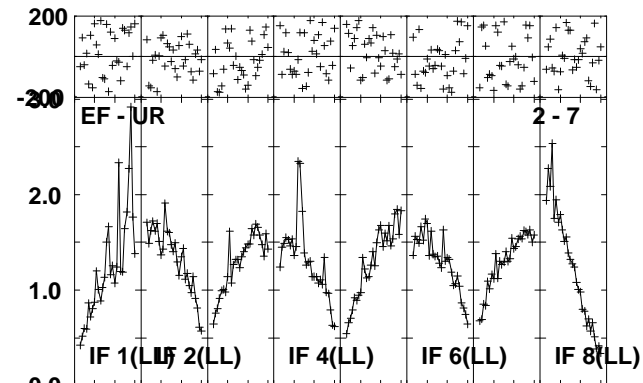
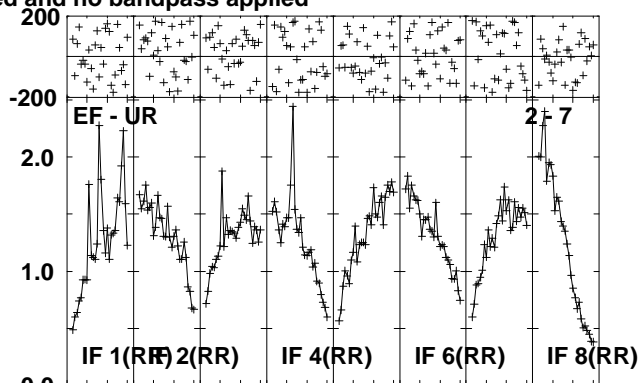
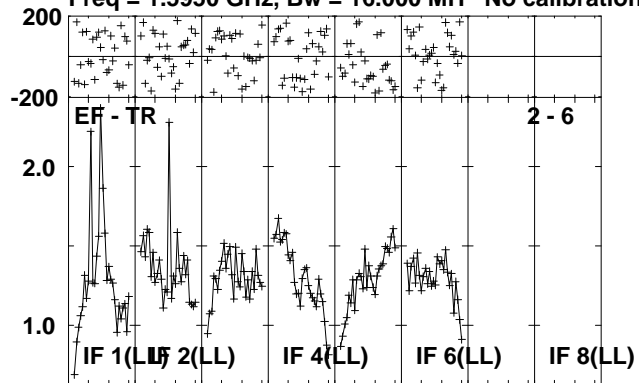

Lower frame: Milli Ampl Jy Top frame: Phas deg
Scalar averaged cross-power spectrum Several baselines displayed
Timerange: 00/22:07:31 to 00/22:10:59

Plot file version 17 created 23-AUG-2010 12:33:03

J1941-05 EP064P.UVDATA.1

Freq = 1.5950 GHz, Bw = 16.000 MH No calibration applied and no bandpass applied

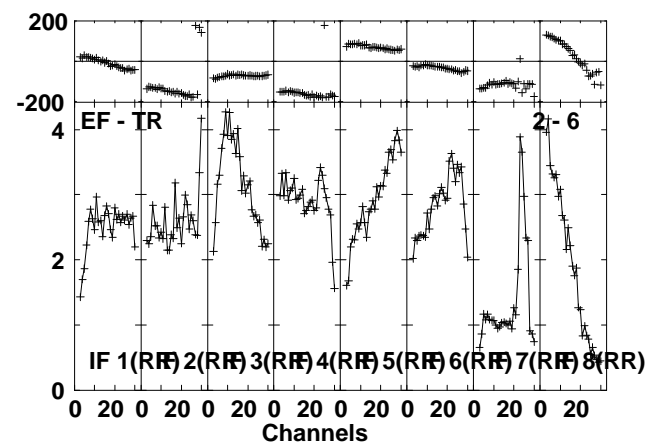
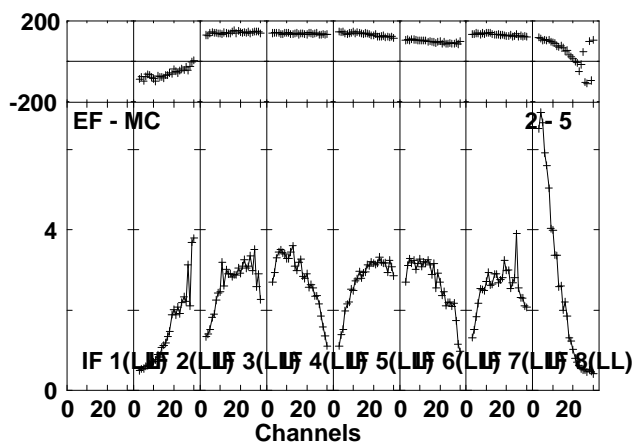
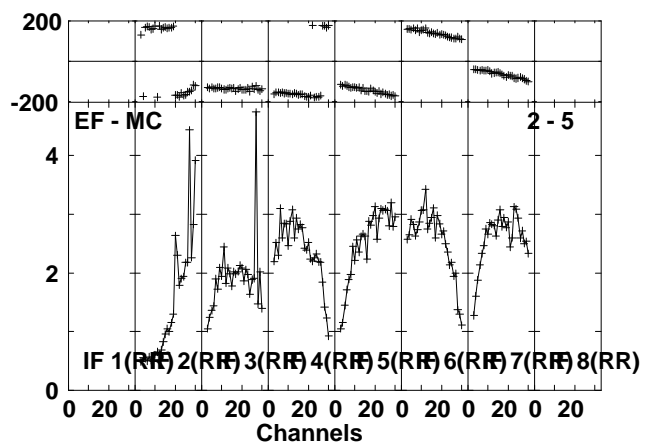
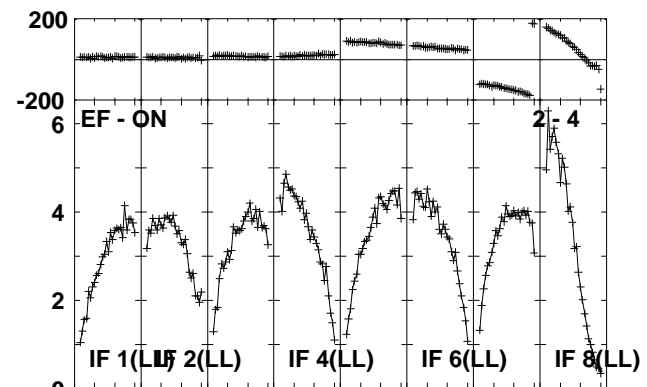
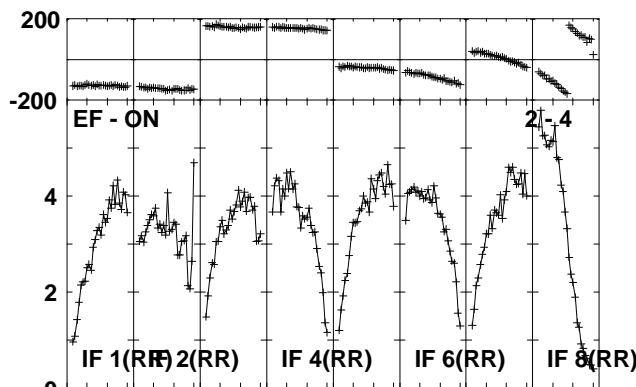
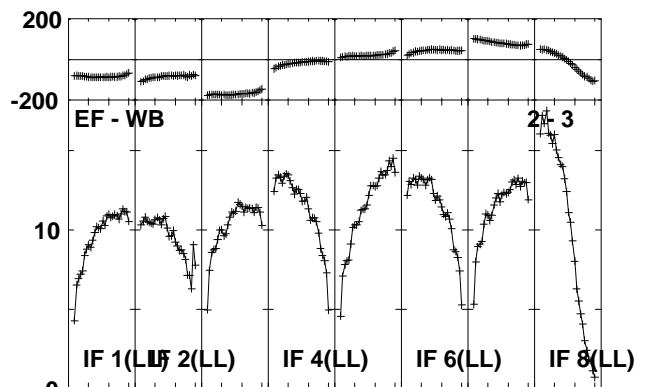
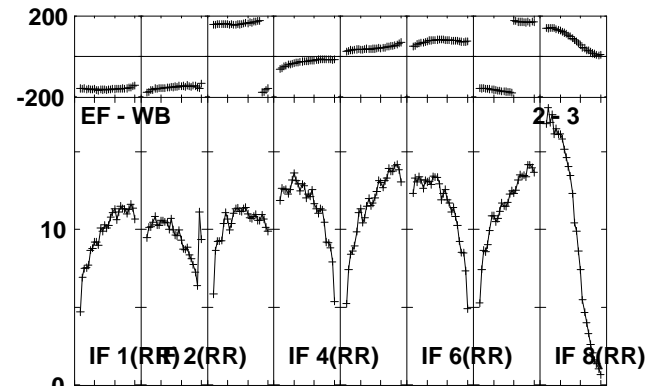
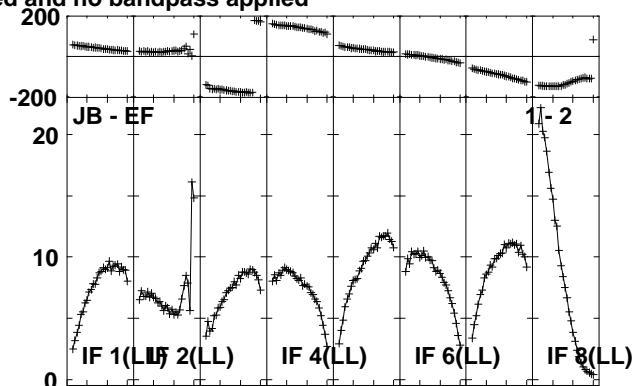
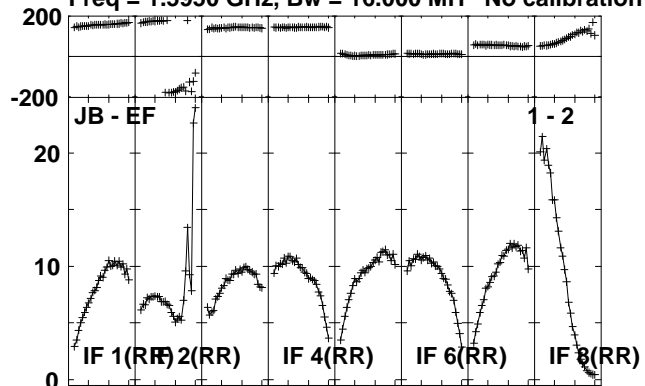

Lower frame: Milli Ampl Jy Top frame: Phas deg
Scalar averaged cross-power spectrum Several baselines displayed
Timerange: 00/22:12:01 to 00/22:13:29

Plot file version 18 created 23-AUG-2010 12:33:04

J1941-05 EP064P.UVDATA.1

Freq = 1.5950 GHz, Bw = 16.000 MH No calibration applied and no bandpass applied

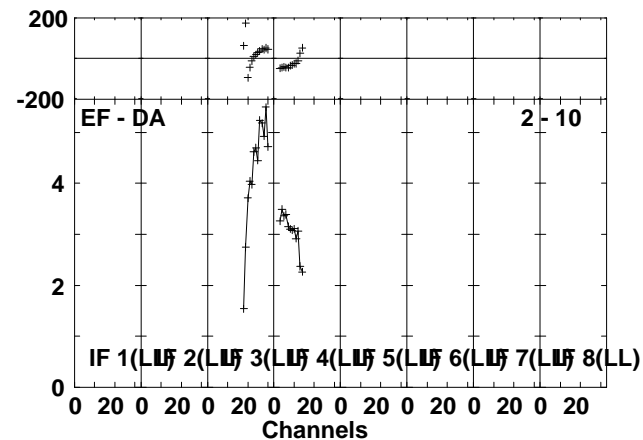
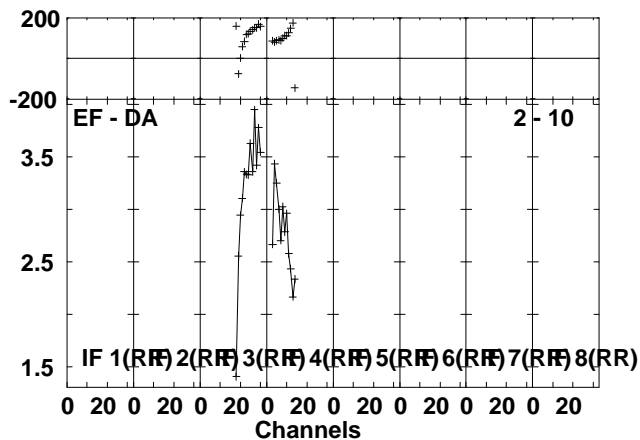
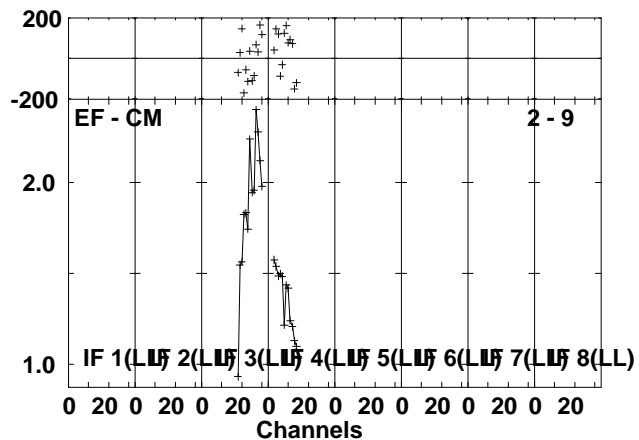
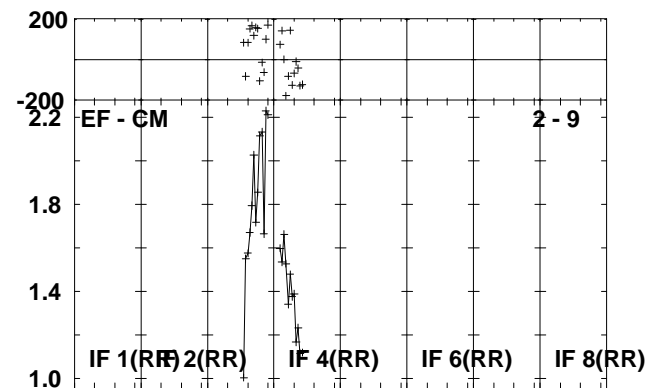
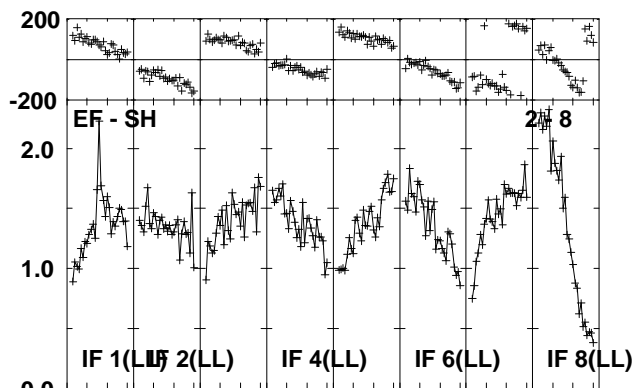
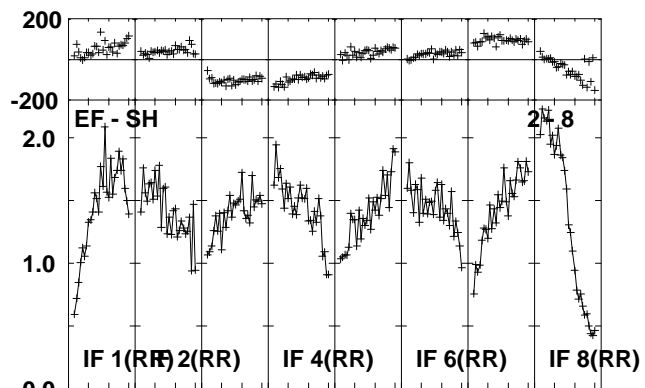
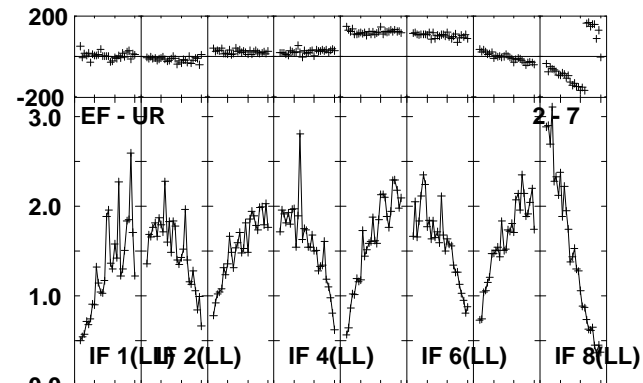
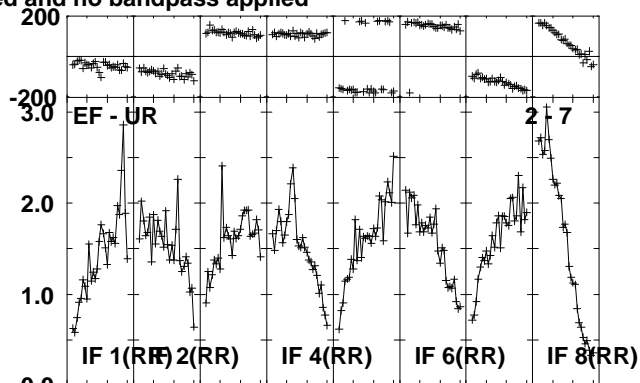
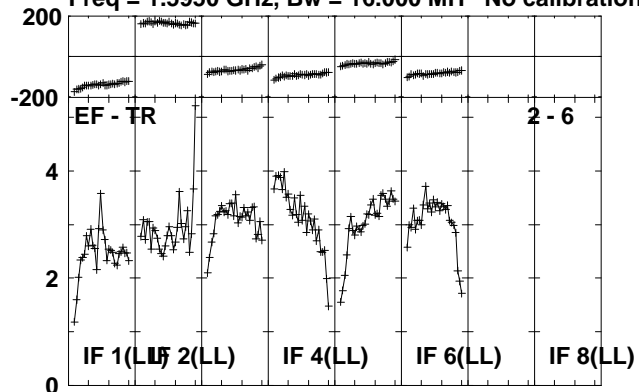

Lower frame: Milli Ampl Jy Top frame: Phas deg
Scalar averaged cross-power spectrum Several baselines displayed
Timerange: 00/22:12:01 to 00/22:13:29

Plot file version 19 created 23-AUG-2010 12:33:06

IRAS1929 EP064P.UVDATA.1

Freq = 1.5950 GHz, Bw = 16.000 MH No calibration applied and no bandpass applied

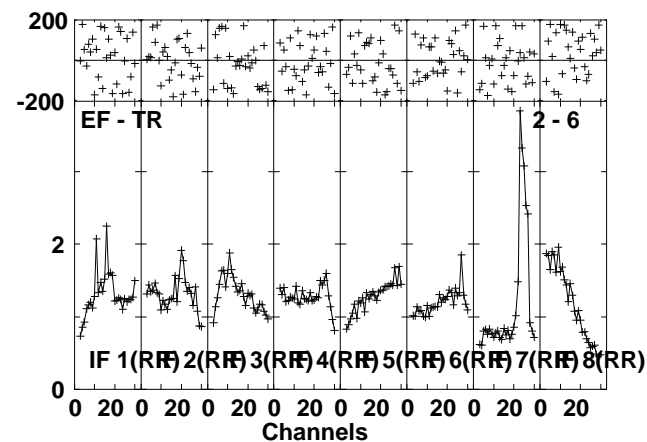
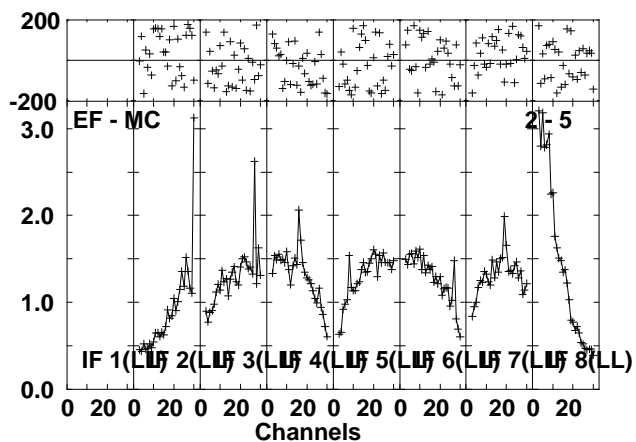
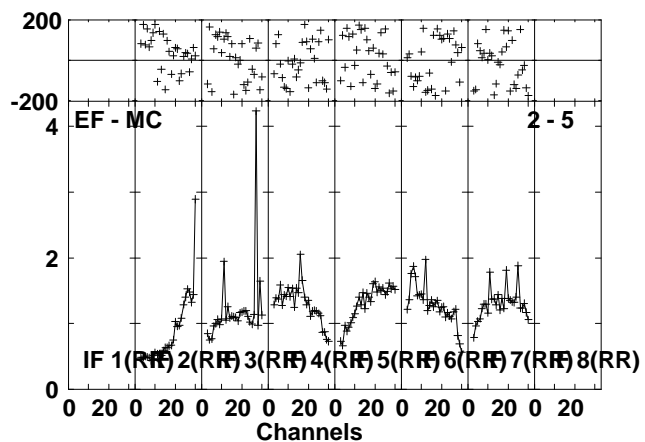
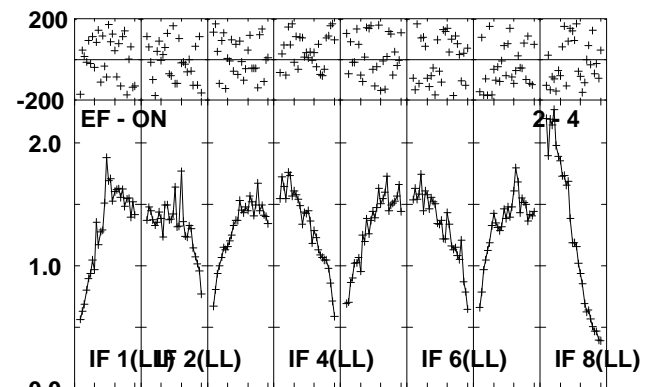
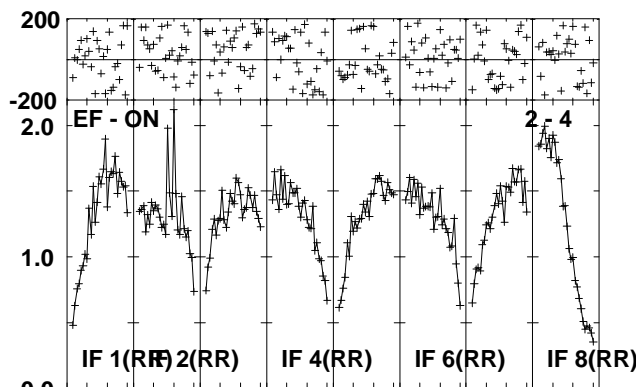
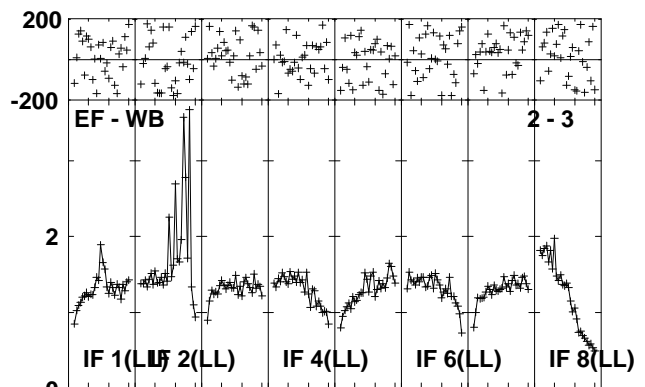
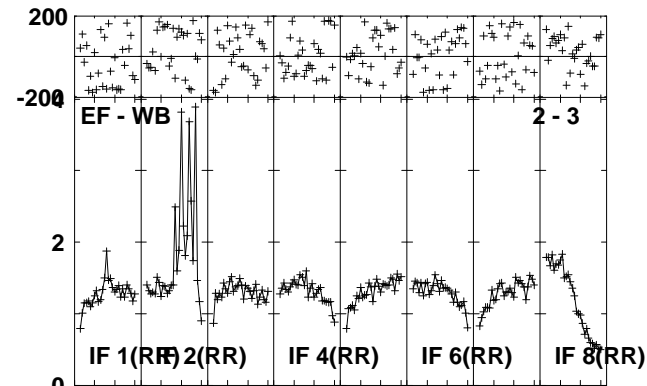
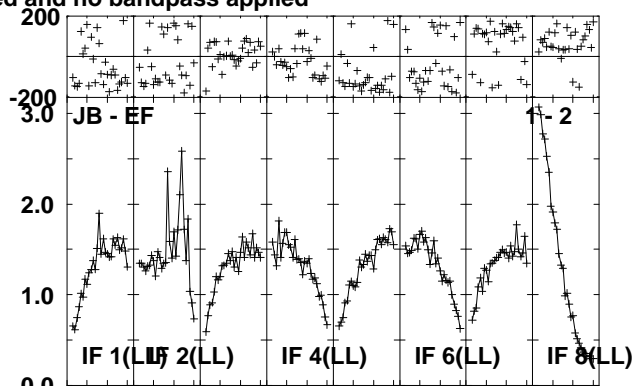
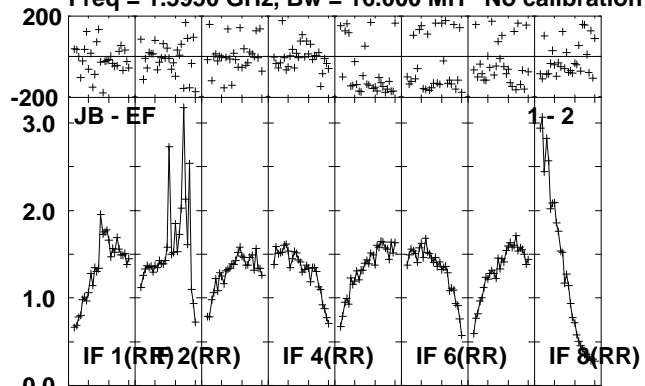

Lower frame: Milli Ampl Jy Top frame: Phas deg
Scalar averaged cross-power spectrum Several baselines displayed
Timerange: 00/22:13:31 to 00/22:16:59

Plot file version 20 created 23-AUG-2010 12:33:08

IRAS1929 EP064P.UVDATA.1

Freq = 1.5950 GHz, Bw = 16.000 MH No calibration applied and no bandpass applied

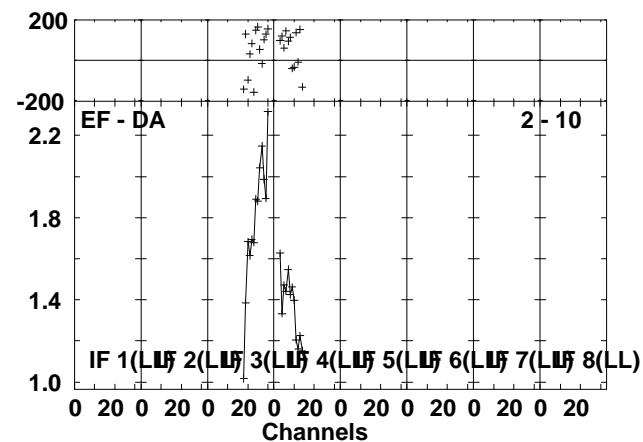
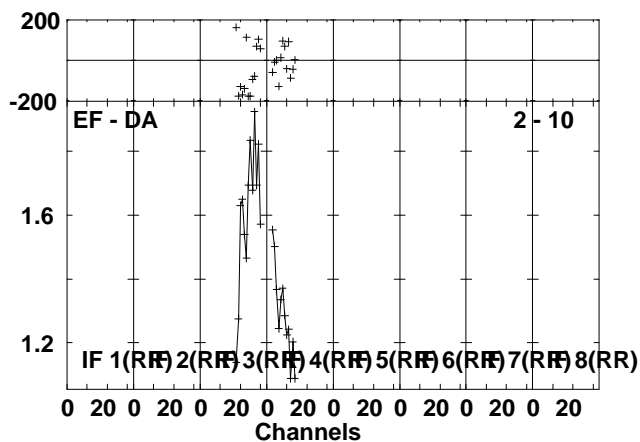
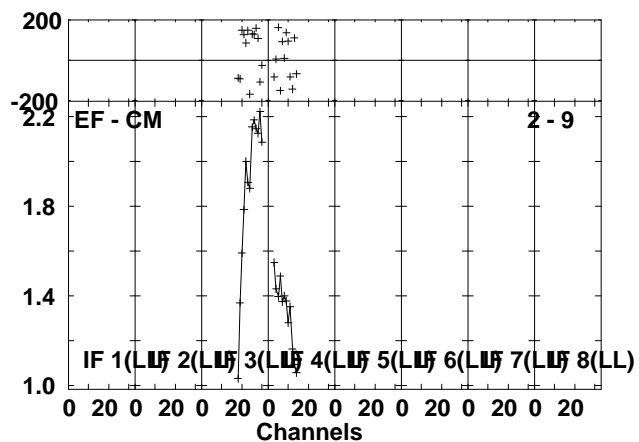
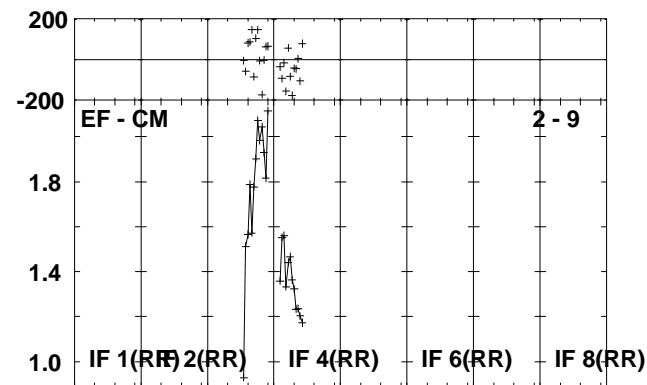
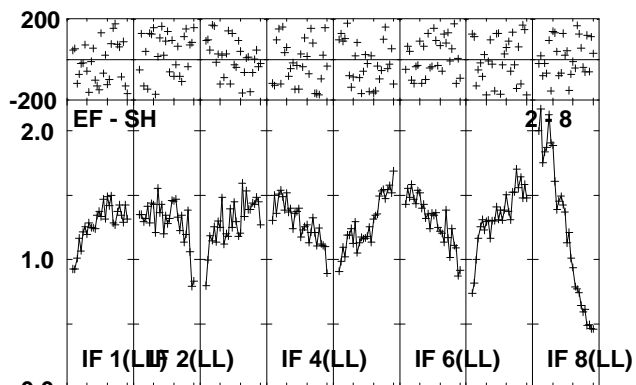
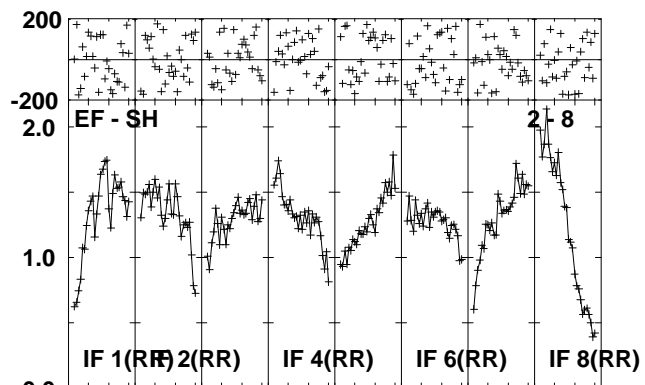
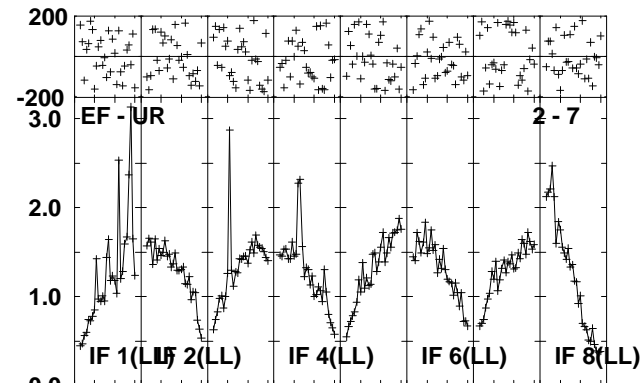
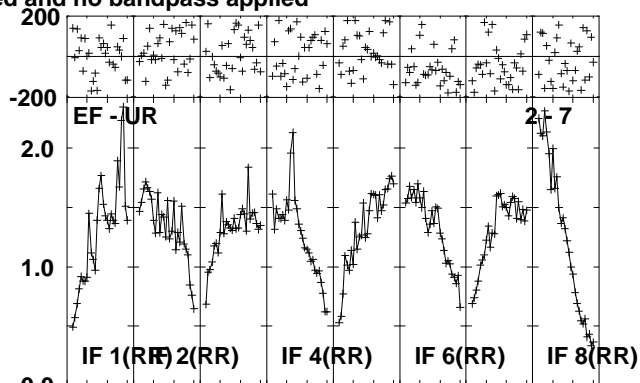
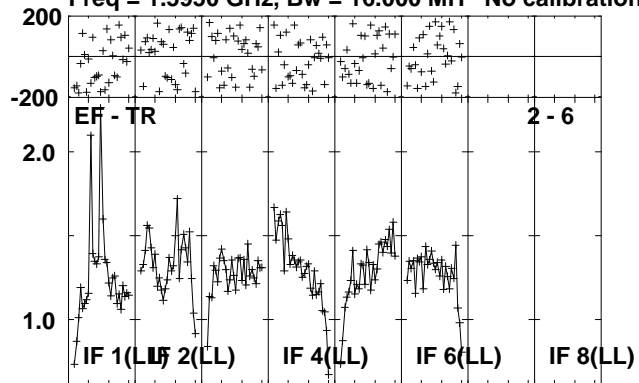

Lower frame: Milli Ampl Jy Top frame: Phas deg
Scalar averaged cross-power spectrum Several baselines displayed
Timerange: 00/22:13:31 to 00/22:16:59

Plot file version 21 created 23-AUG-2010 12:33:10

J1941-05 EP064P.UVDATA.1

Freq = 1.5950 GHz, Bw = 16.000 MH No calibration applied and no bandpass applied

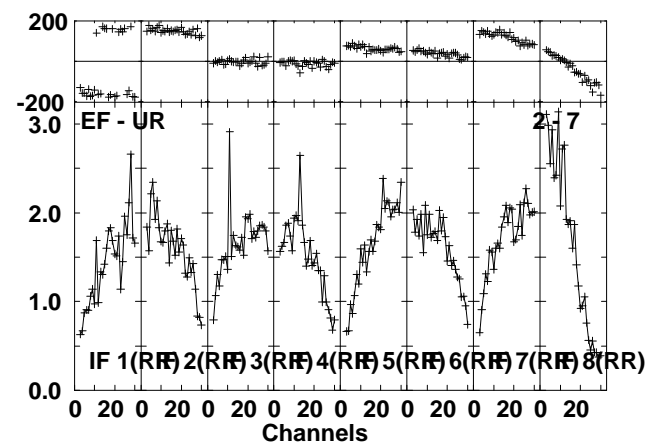
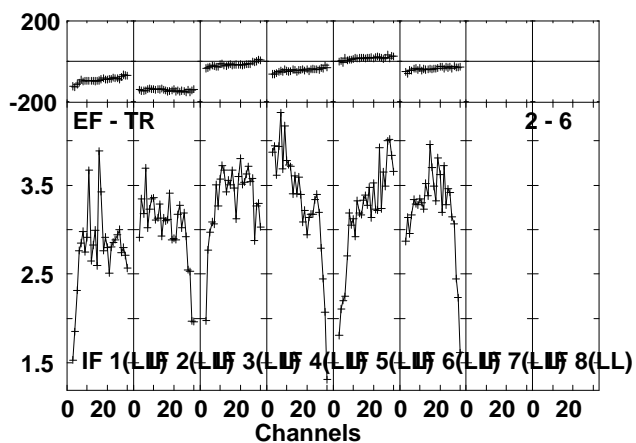
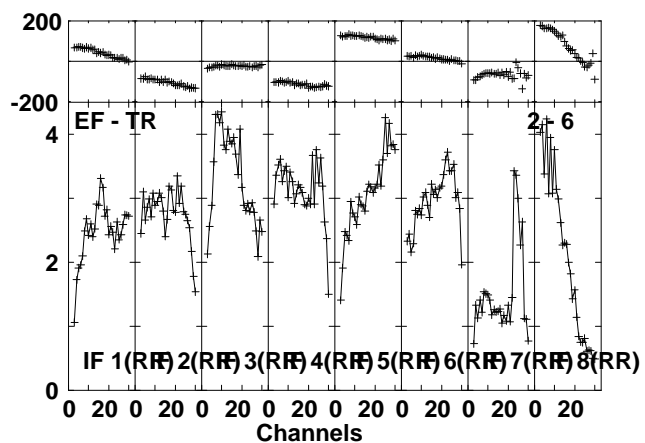
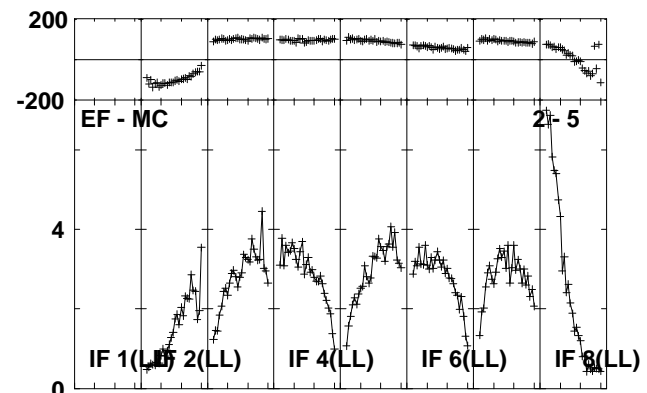
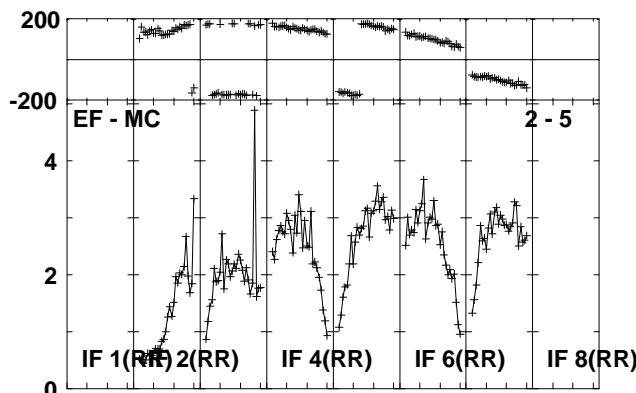
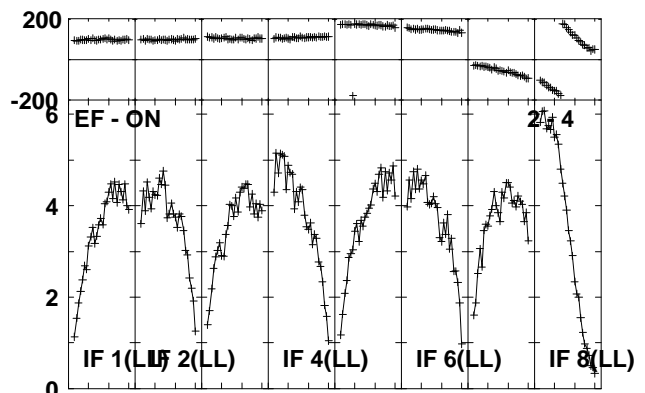
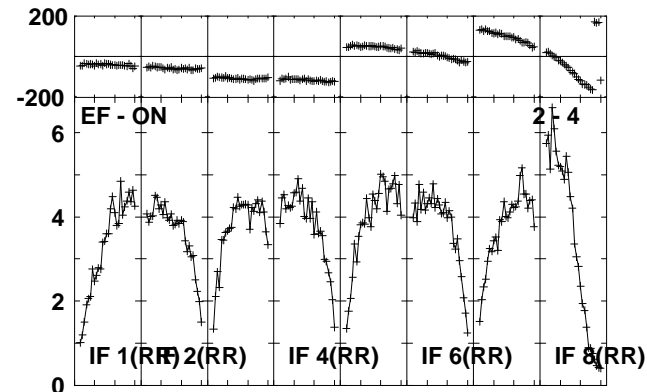
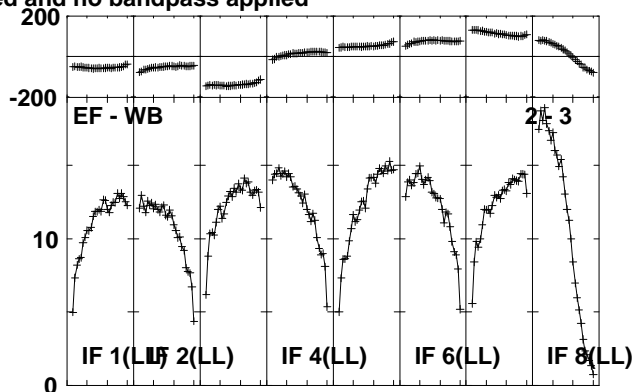
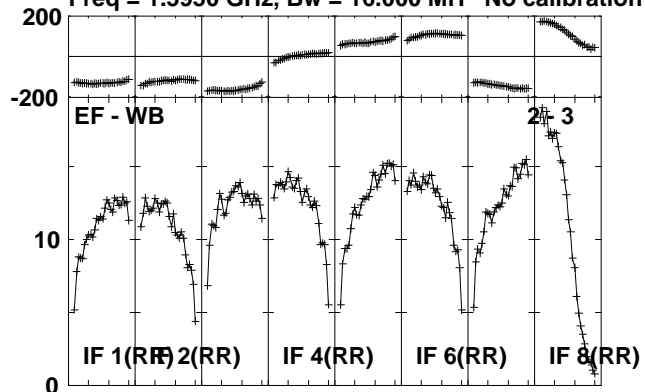

Lower frame: Milli Ampl Jy Top frame: Phas deg
Scalar averaged cross-power spectrum Several baselines displayed
Timerange: 00/22:17:01 to 00/22:18:29

Plot file version 22 created 23-AUG-2010 12:33:11

J1941-05 EP064P.UVDATA.1

Freq = 1.5950 GHz, Bw = 16.000 MH No calibration applied and no bandpass applied

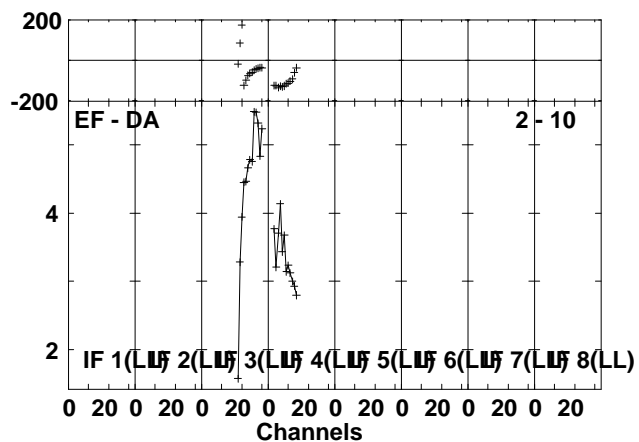
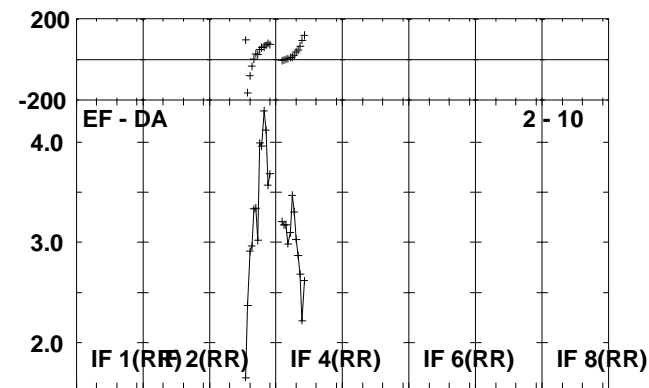
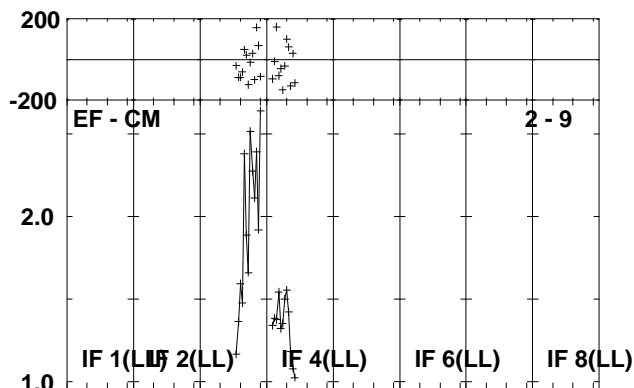
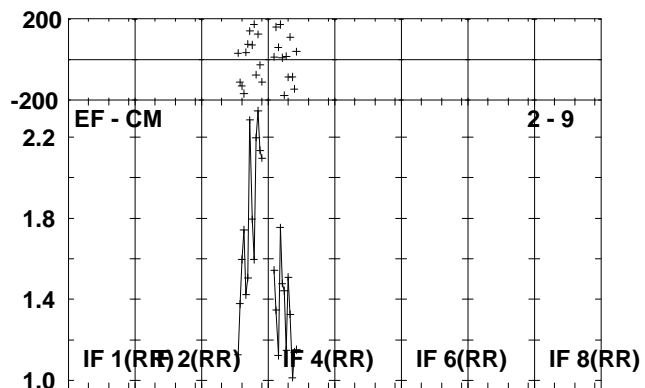
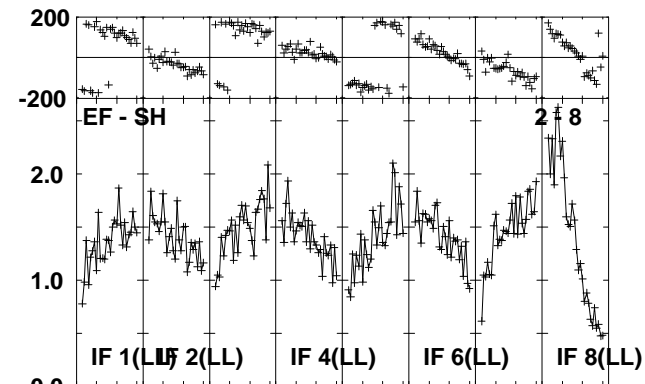
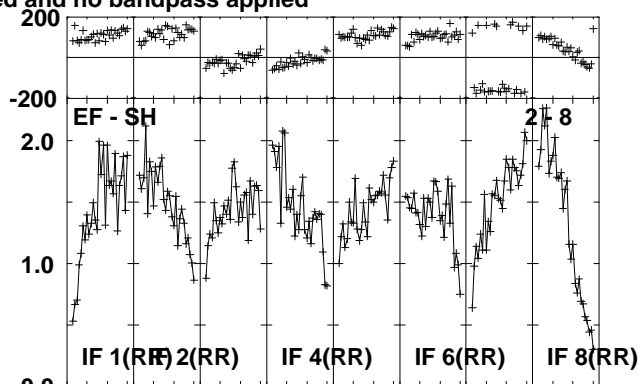
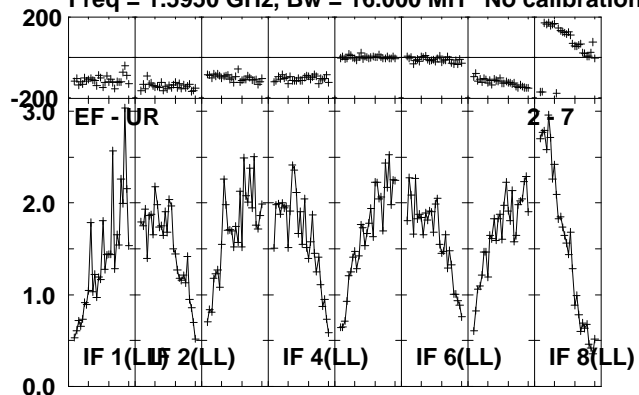

Lower frame: Milli Ampl Jy Top frame: Phas deg
Scalar averaged cross-power spectrum Several baselines displayed
Timerange: 00/22:17:01 to 00/22:18:29

Plot file version 23 created 23-AUG-2010 12:33:12

IRAS1929 EP064P.UVDATA.1

Freq = 1.5950 GHz, Bw = 16.000 MH No calibration applied and no bandpass applied

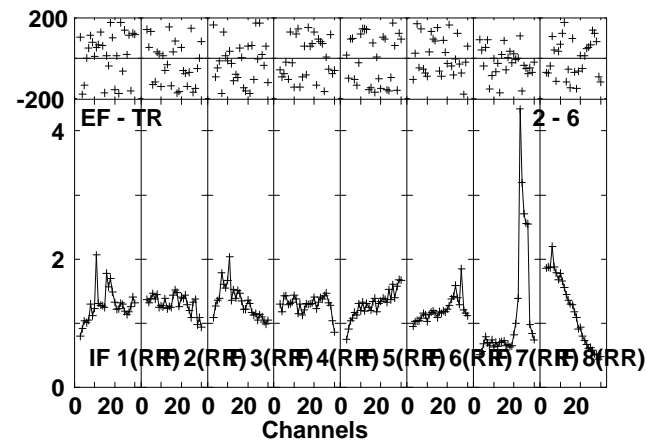
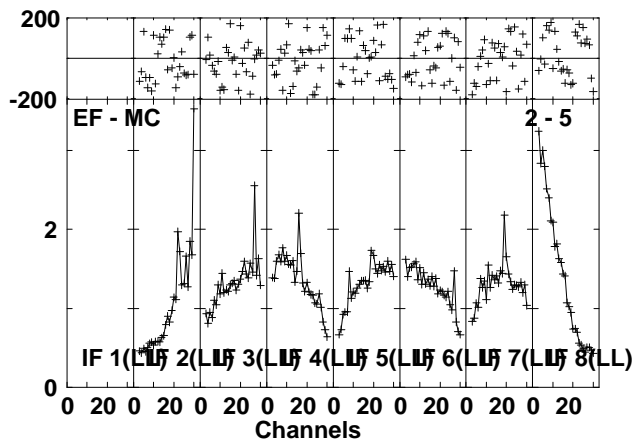
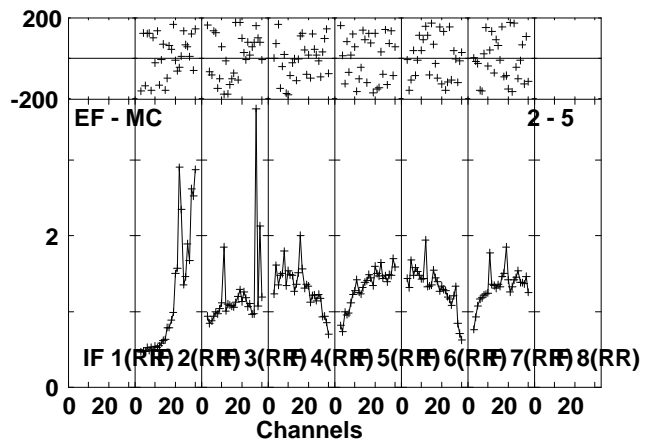
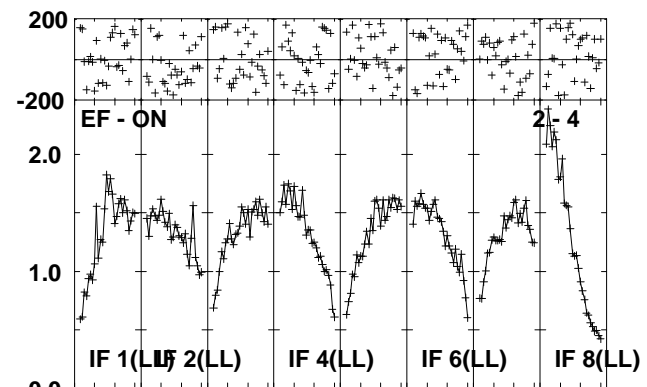
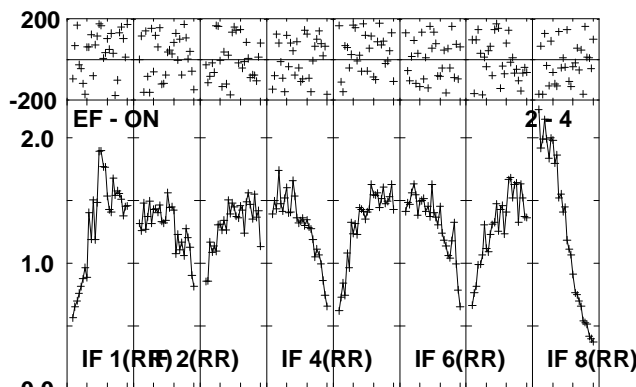
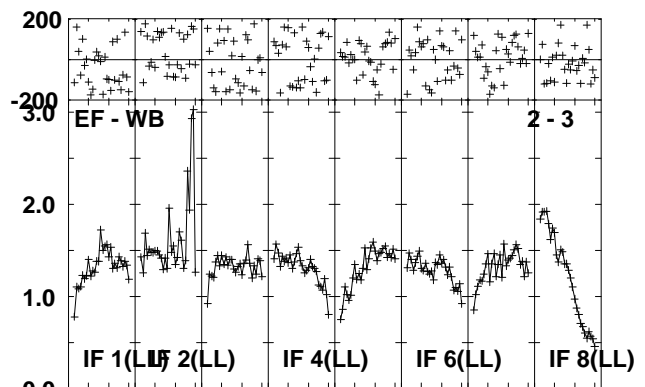
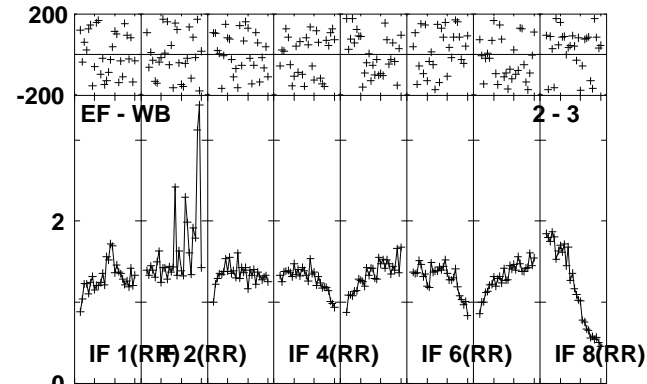
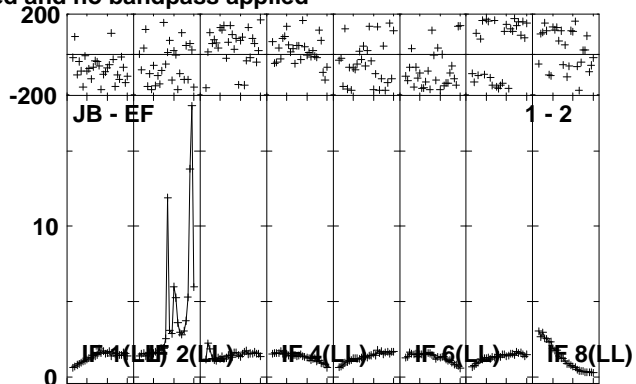
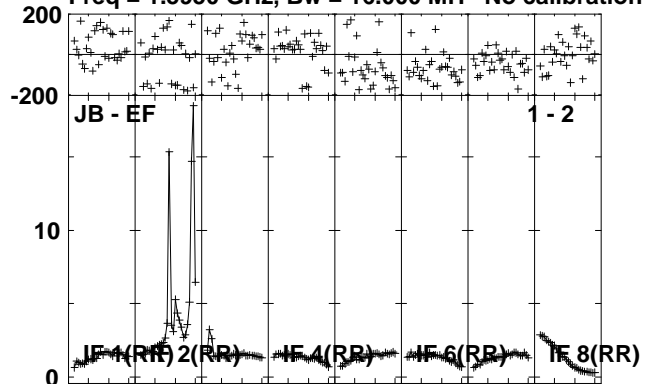

Lower frame: Milli Ampl Jy Top frame: Phas deg
Scalar averaged cross-power spectrum Several baselines displayed
Timerange: 00/22:18:31 to 00/22:21:59

Plot file version 24 created 23-AUG-2010 12:33:14

IRAS1929 EP064P.UVDATA.1

Freq = 1.5950 GHz, Bw = 16.000 MH No calibration applied and no bandpass applied

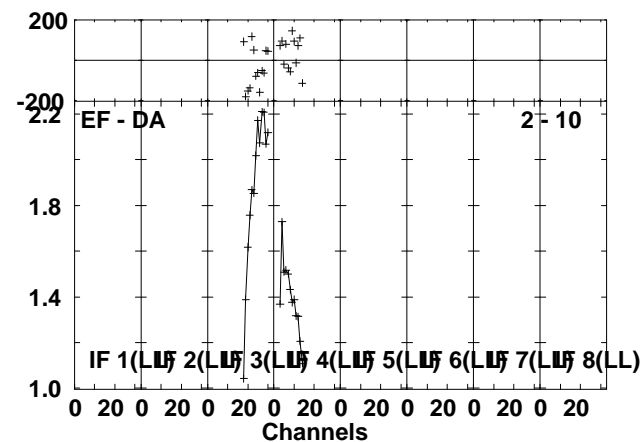
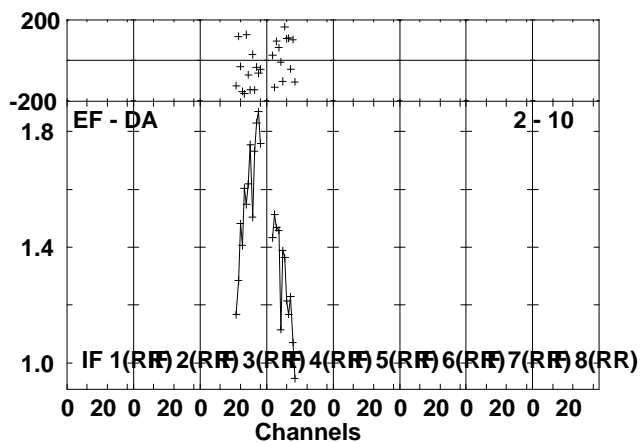
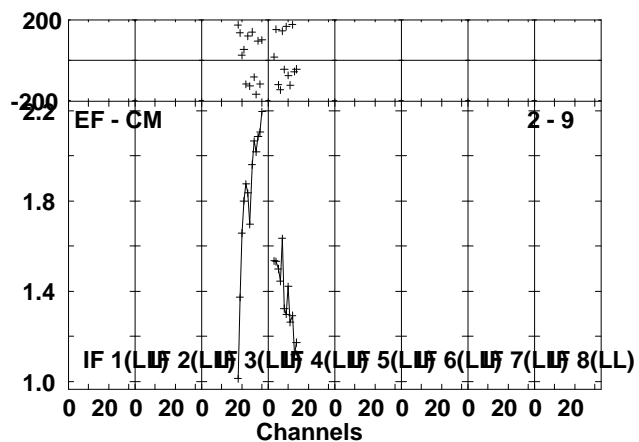
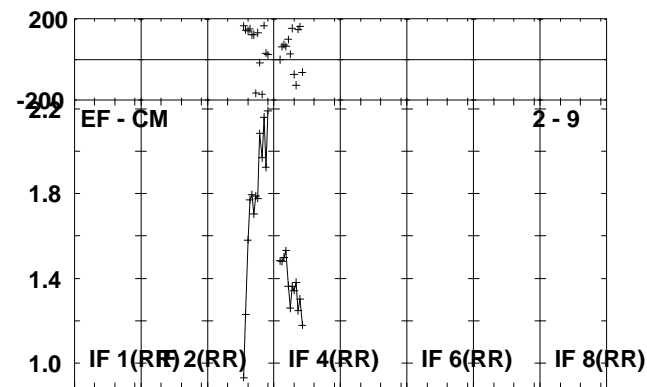
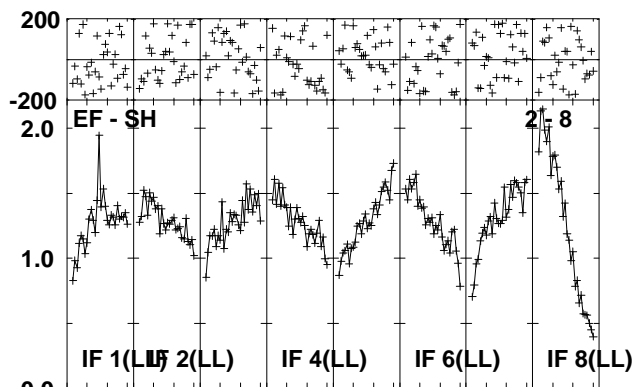
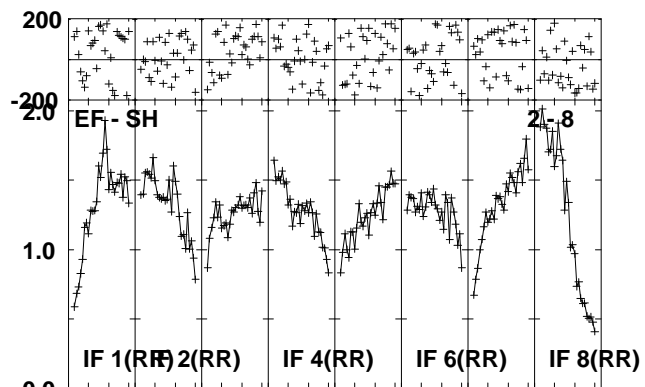
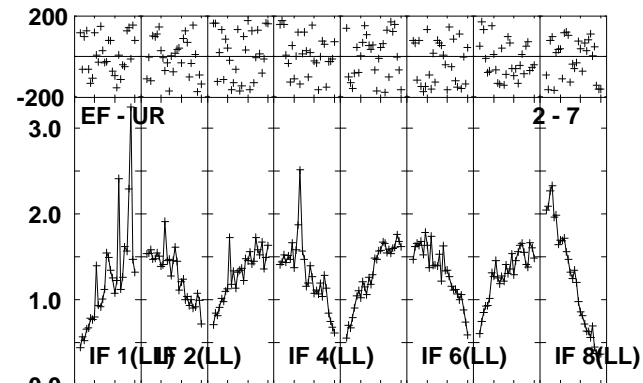
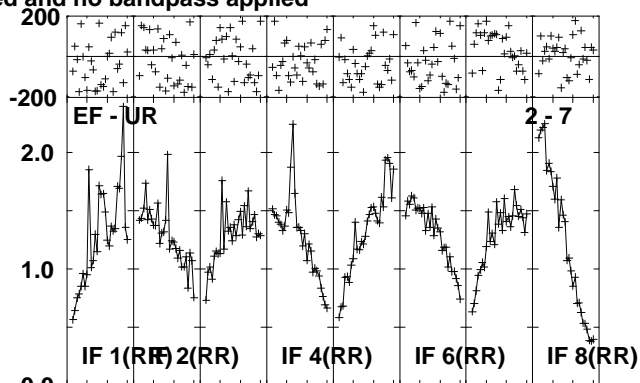
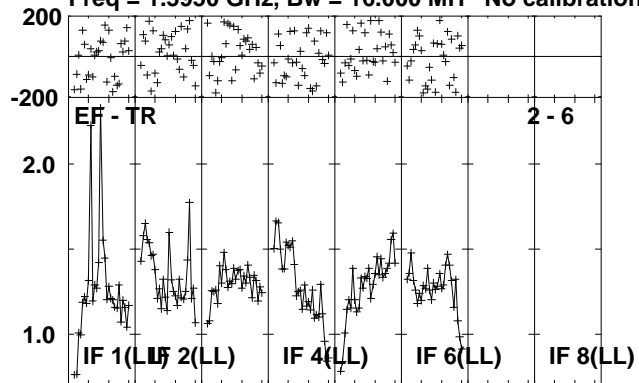

Lower frame: Milli Ampl Jy Top frame: Phas deg
Scalar averaged cross-power spectrum Several baselines displayed
Timerange: 00/22:18:31 to 00/22:21:59

Plot file version 25 created 23-AUG-2010 12:33:16

J1941-05 EP064P.UVDATA.1

Freq = 1.5950 GHz, Bw = 16.000 MH No calibration applied and no bandpass applied

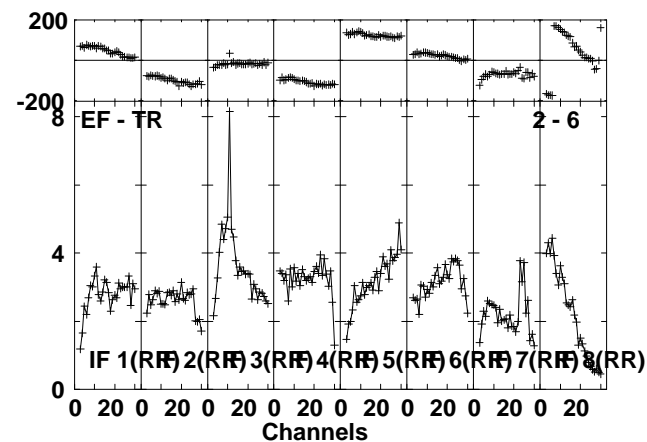
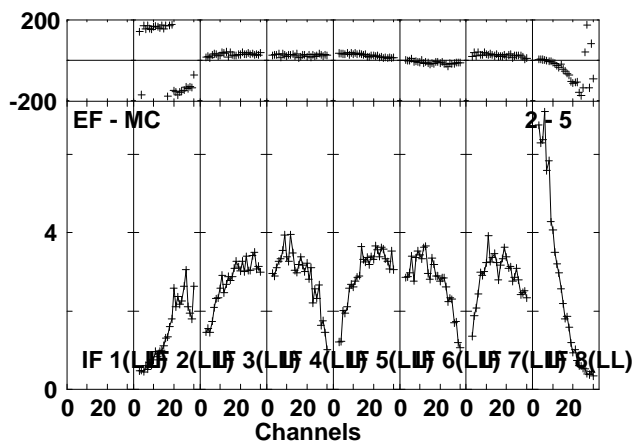
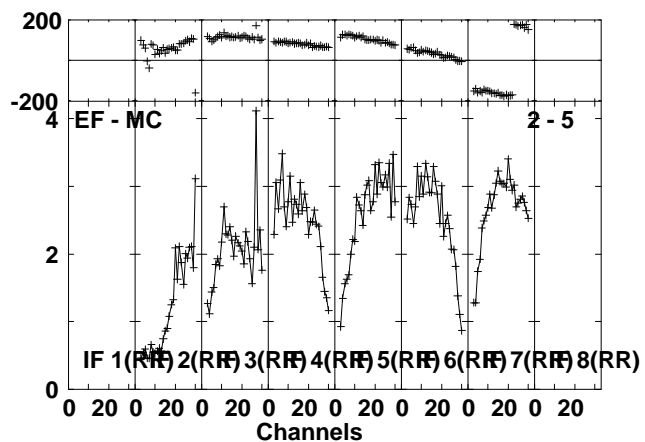
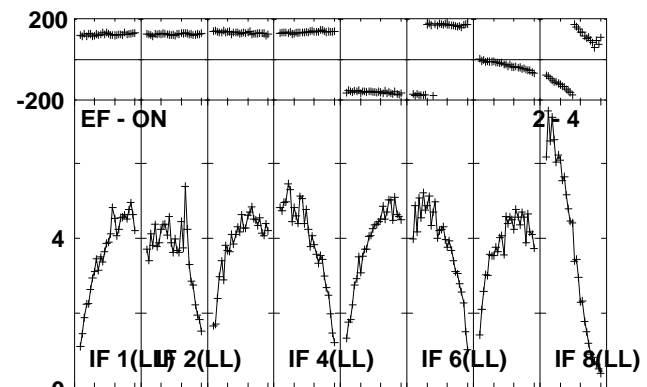
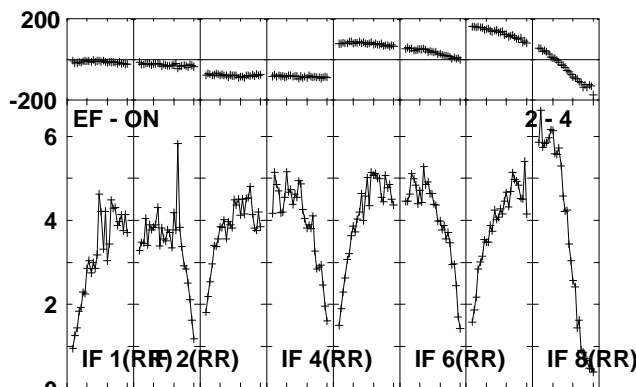
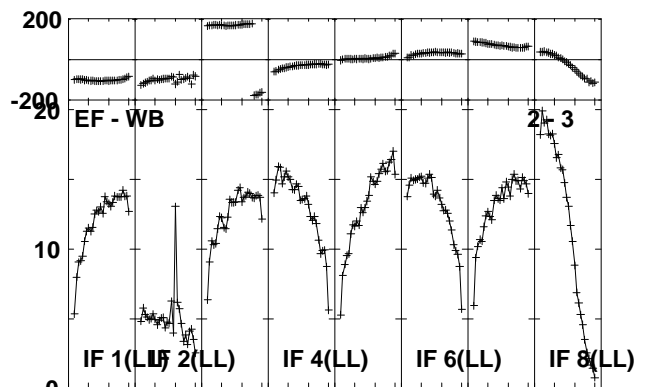
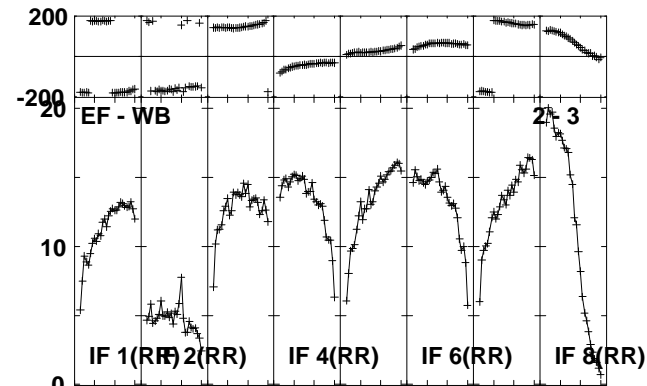
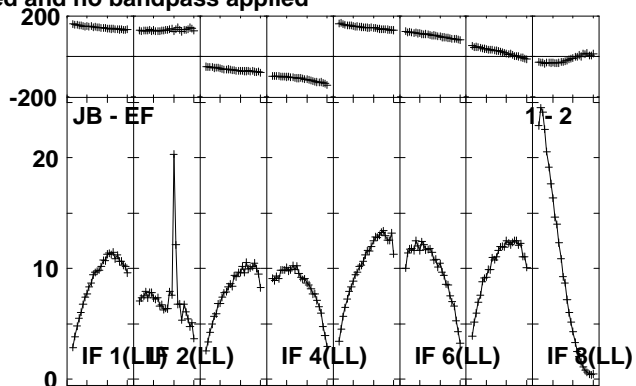
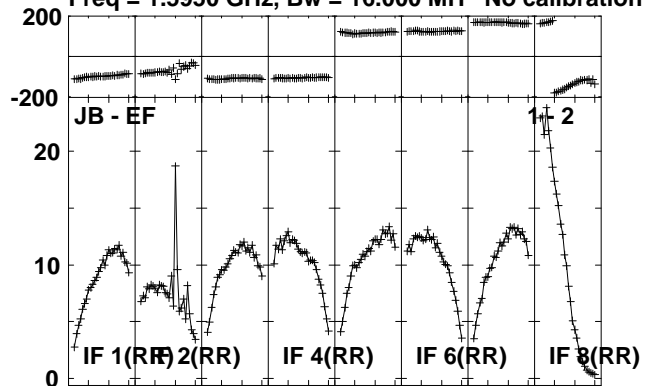

Lower frame: Milli Ampl Jy Top frame: Phas deg
Scalar averaged cross-power spectrum Several baselines displayed
Timerange: 00/22:22:01 to 00/22:23:29

Plot file version 26 created 23-AUG-2010 12:33:17

J1941-05 EP064P.UVDATA.1

Freq = 1.5950 GHz, Bw = 16.000 MH No calibration applied and no bandpass applied

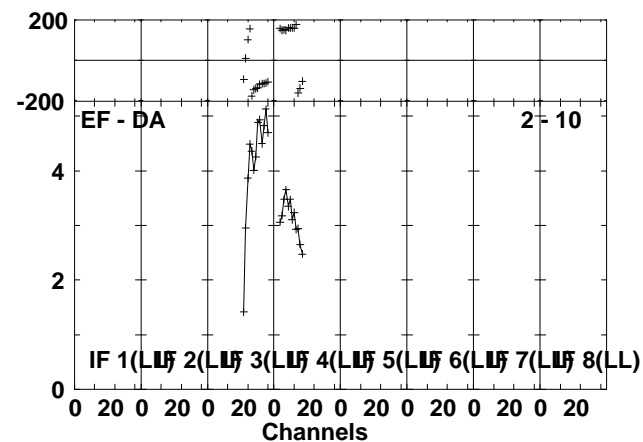
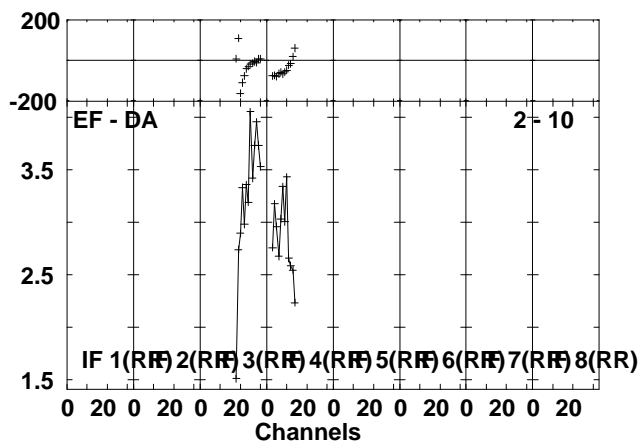
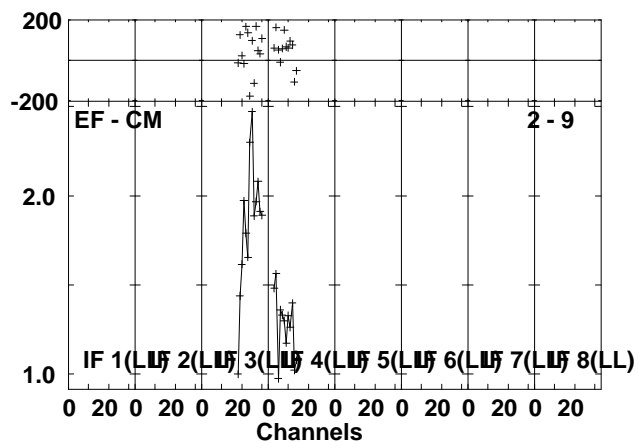
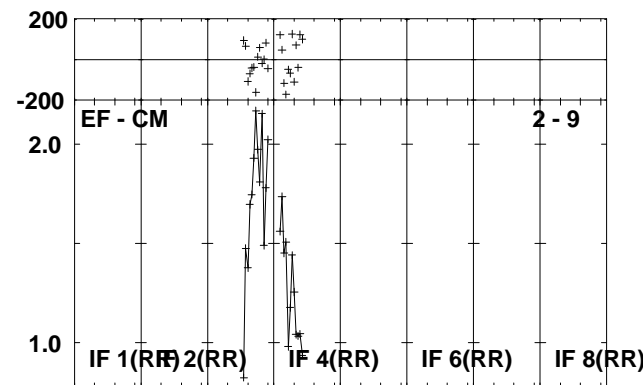
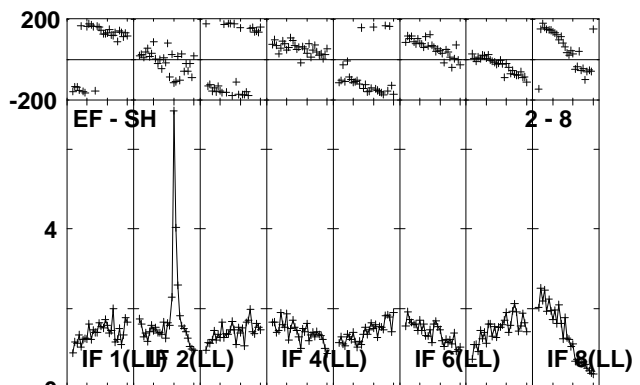
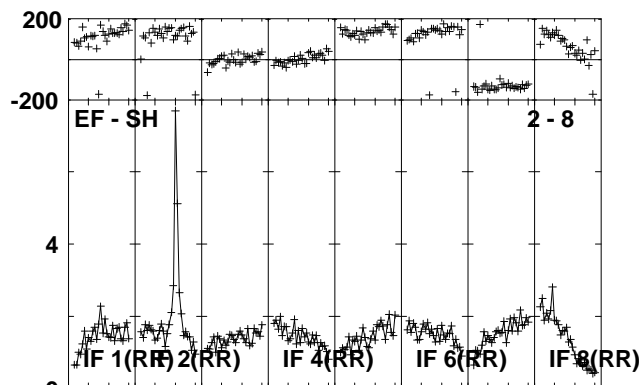
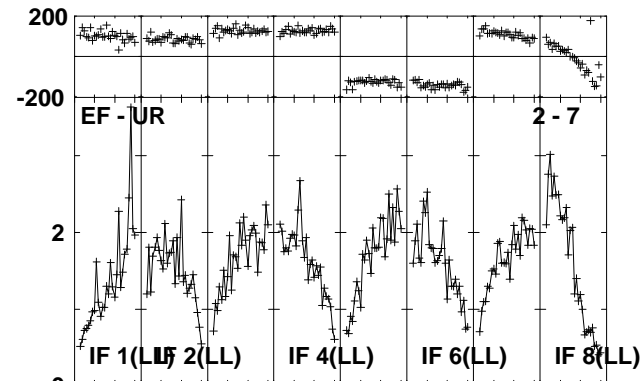
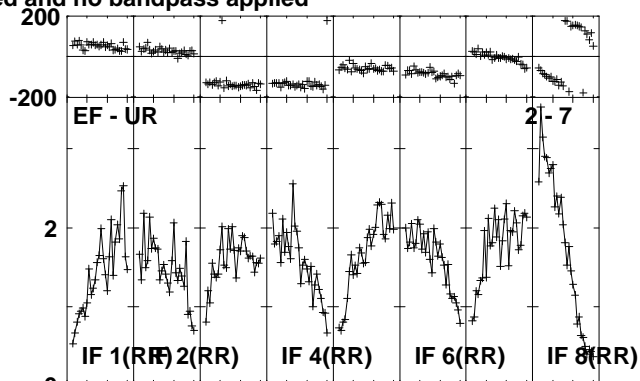
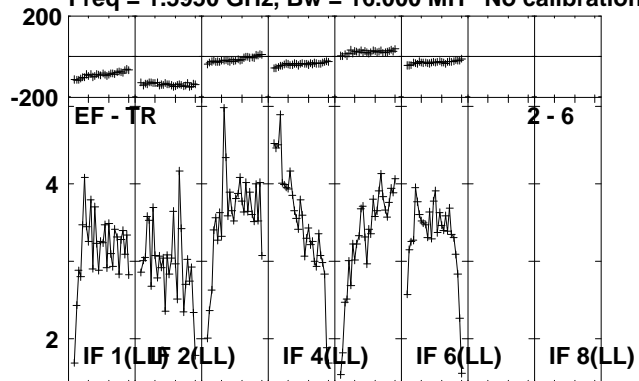

Lower frame: Milli Ampl Jy Top frame: Phas deg
Scalar averaged cross-power spectrum Several baselines displayed
Timerange: 00/22:22:01 to 00/22:23:29

Plot file version 27 created 23-AUG-2010 12:33:18

IRAS1929 EP064P.UVDATA.1

Freq = 1.5950 GHz, Bw = 16.000 MH No calibration applied and no bandpass applied

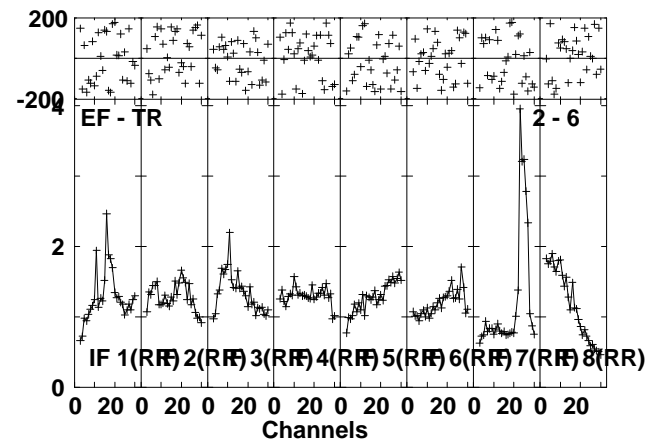
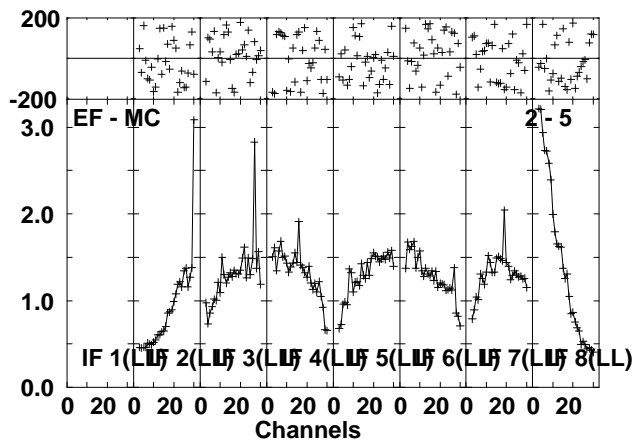
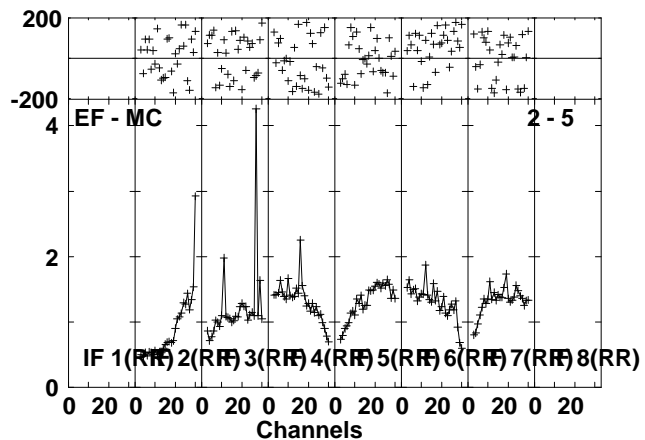
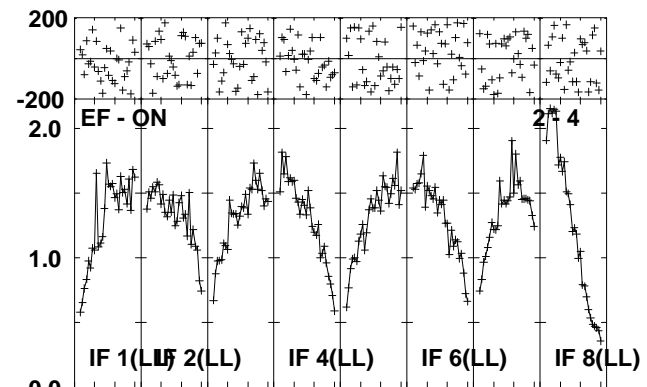
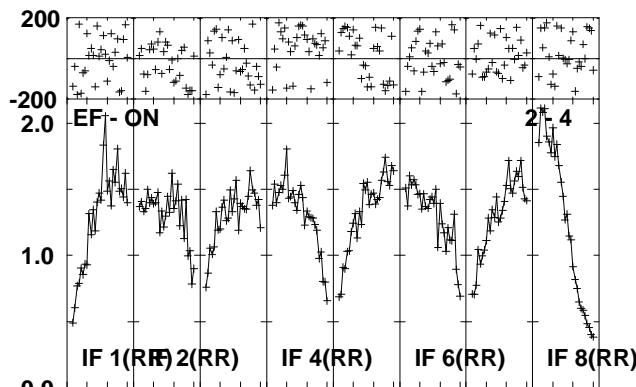
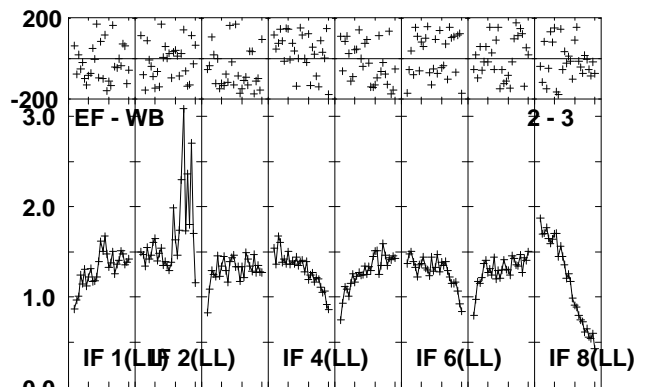
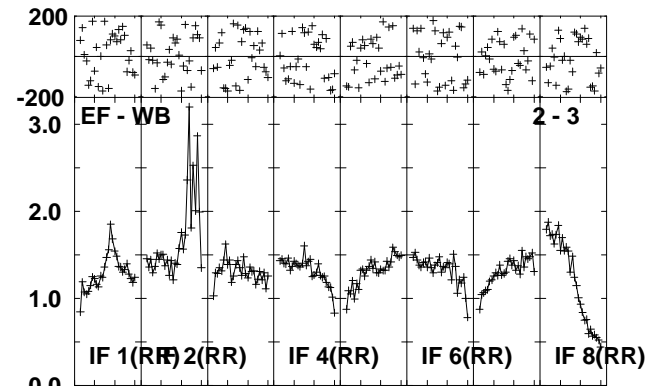
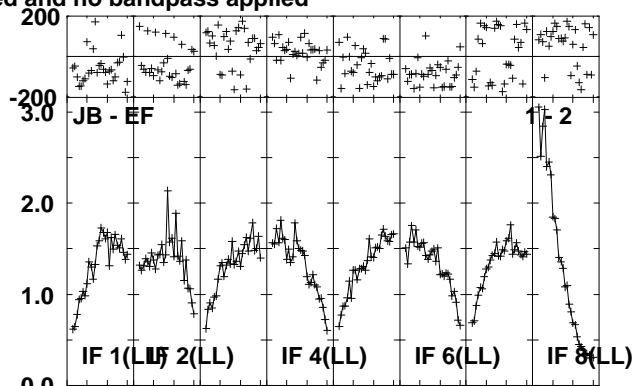
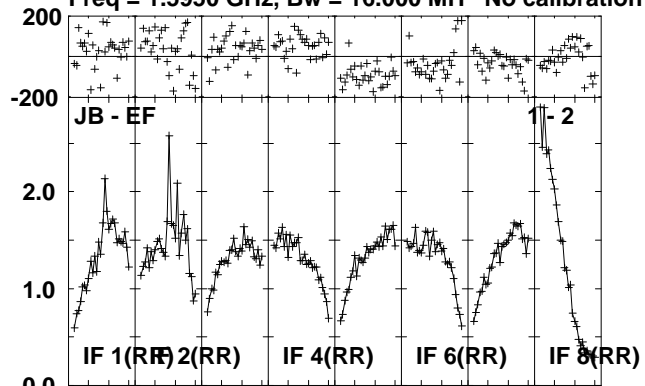

Lower frame: Milli Ampl Jy Top frame: Phas deg
Scalar averaged cross-power spectrum Several baselines displayed
Timerange: 00/22:23:31 to 00/22:26:59

Plot file version 28 created 23-AUG-2010 12:33:20

IRAS1929 EP064P.UVDATA.1

Freq = 1.5950 GHz, Bw = 16.000 MH No calibration applied and no bandpass applied

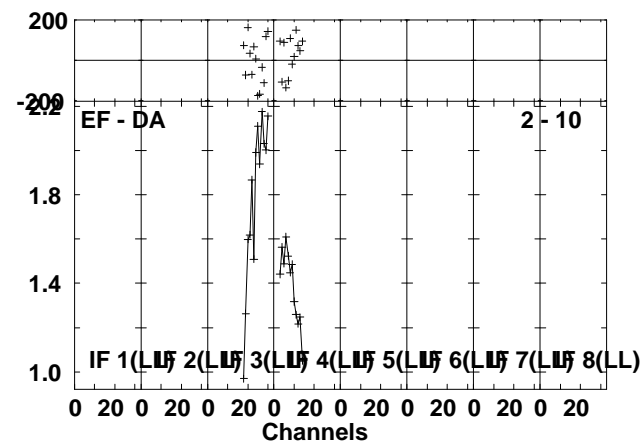
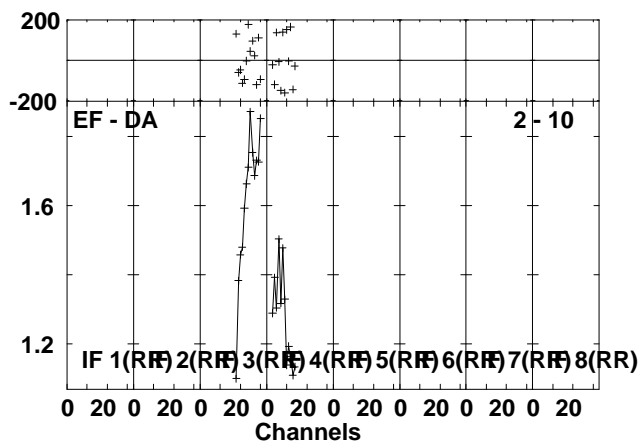
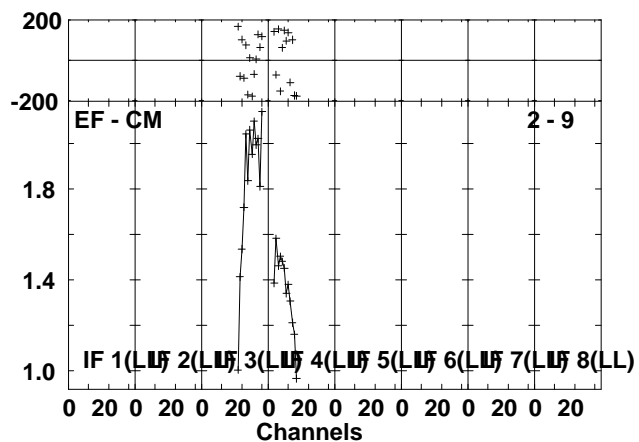
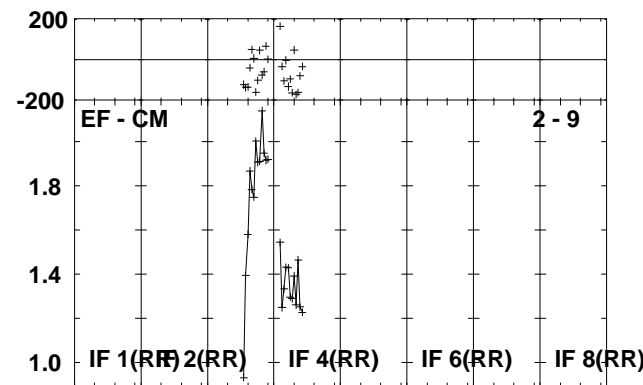
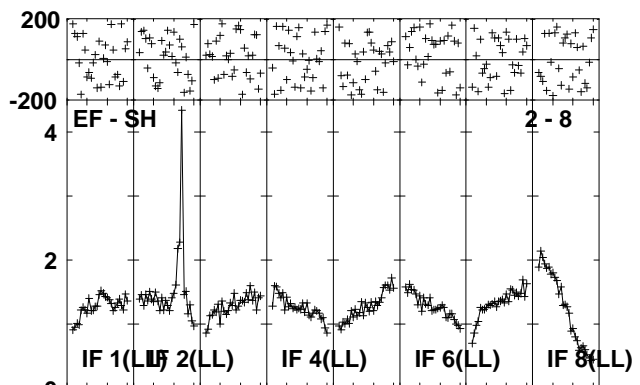
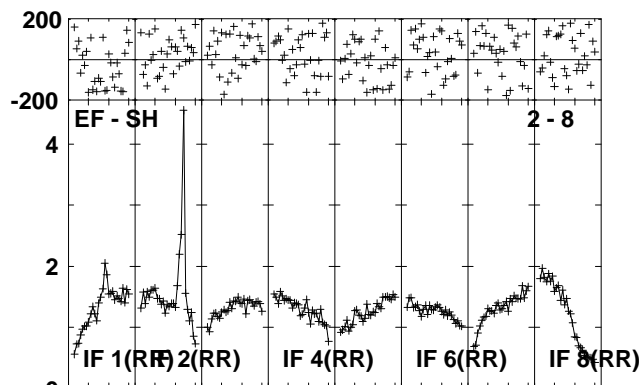
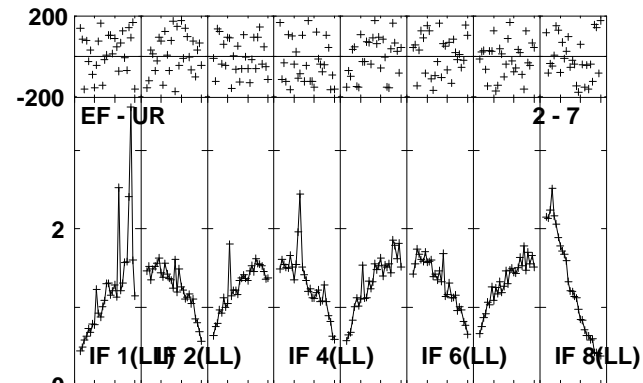
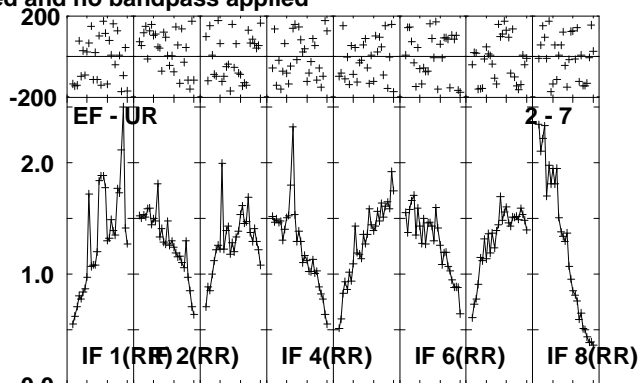
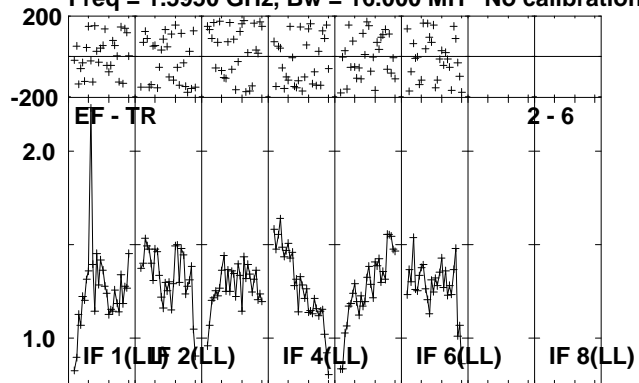

Lower frame: Milli Ampl Jy Top frame: Phas deg
Scalar averaged cross-power spectrum Several baselines displayed
Timerange: 00/22:23:31 to 00/22:26:59

Plot file version 29 created 23-AUG-2010 12:33:22

J1941-05 EP064P.UVDATA.1

Freq = 1.5950 GHz, Bw = 16.000 MH No calibration applied and no bandpass applied

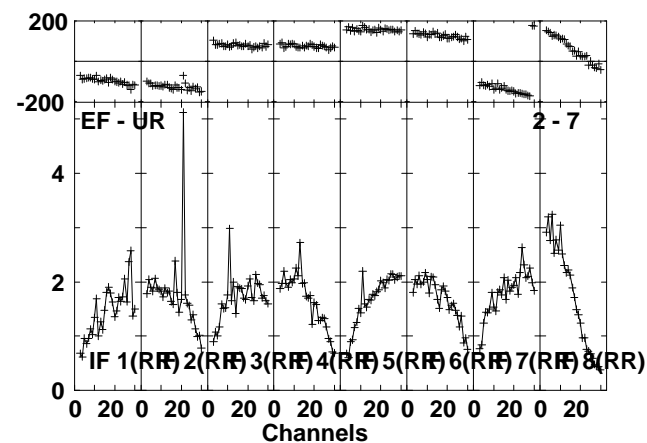
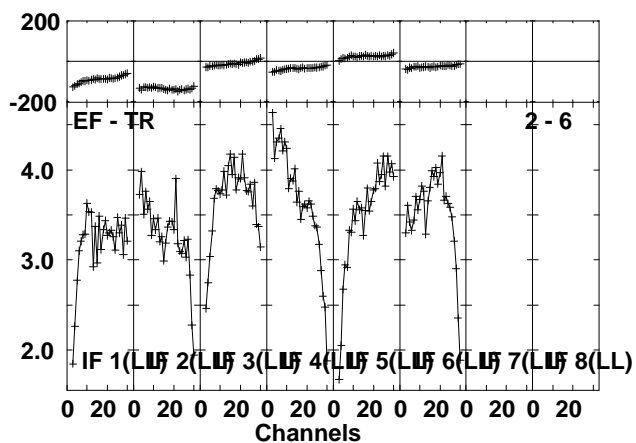
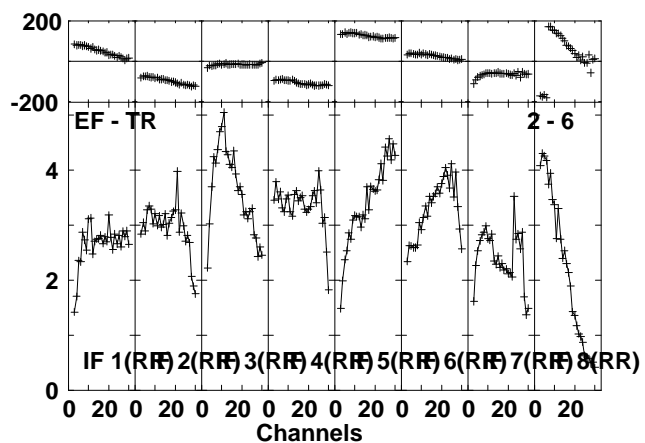
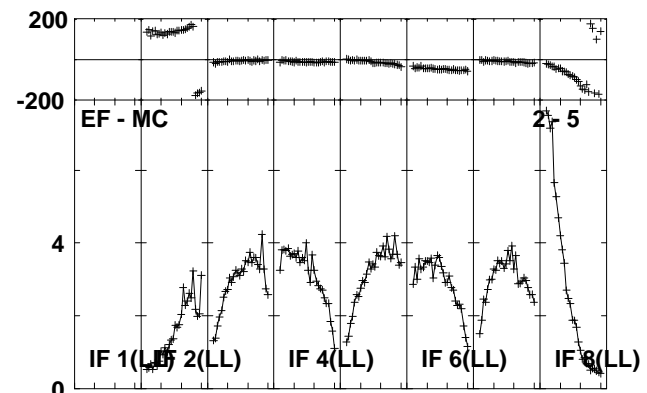
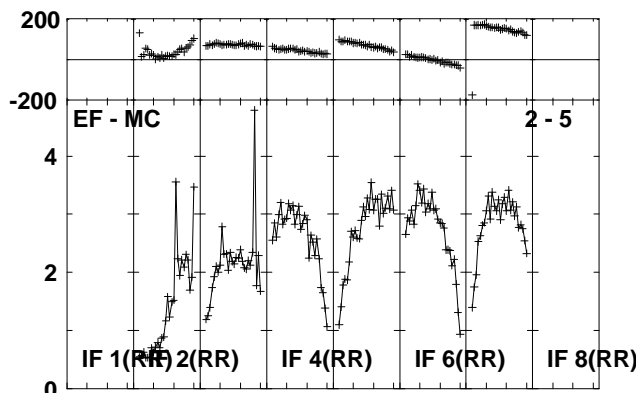
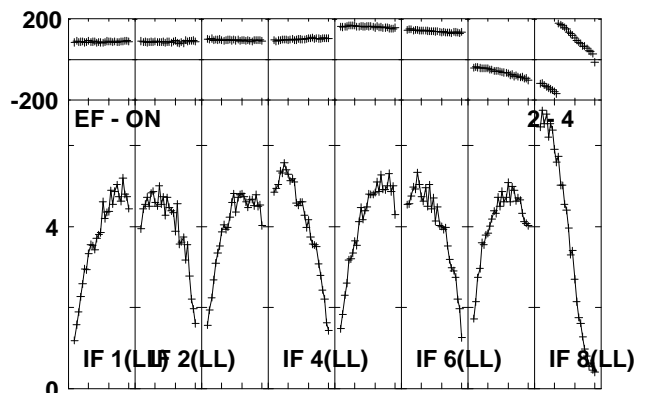
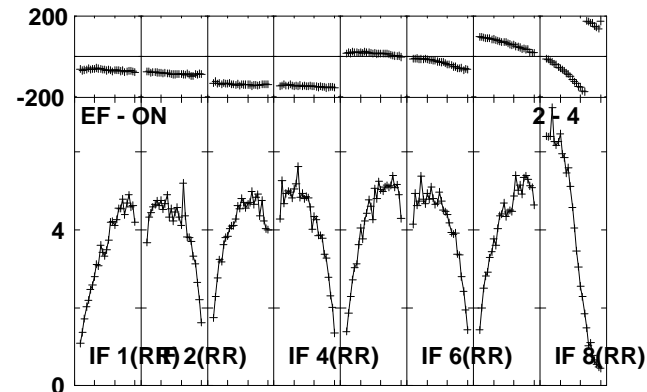
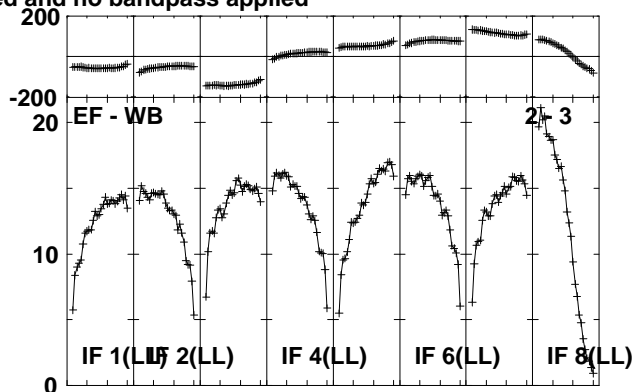
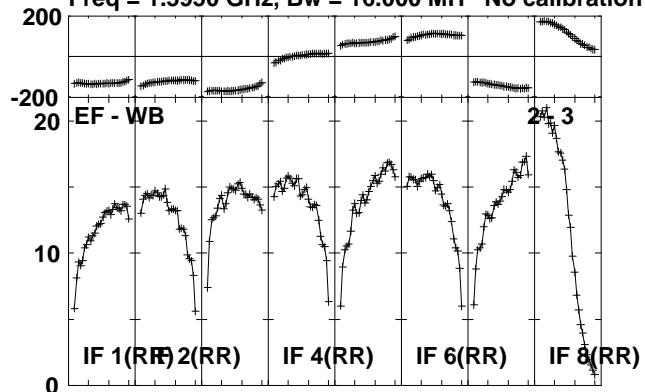

Lower frame: Milli Ampl Jy Top frame: Phas deg
Scalar averaged cross-power spectrum Several baselines displayed
Timerange: 00/22:28:01 to 00/22:29:27

Plot file version 30 created 23-AUG-2010 12:33:23

J1941-05 EP064P.UVDATA.1

Freq = 1.5950 GHz, Bw = 16.000 MH No calibration applied and no bandpass applied

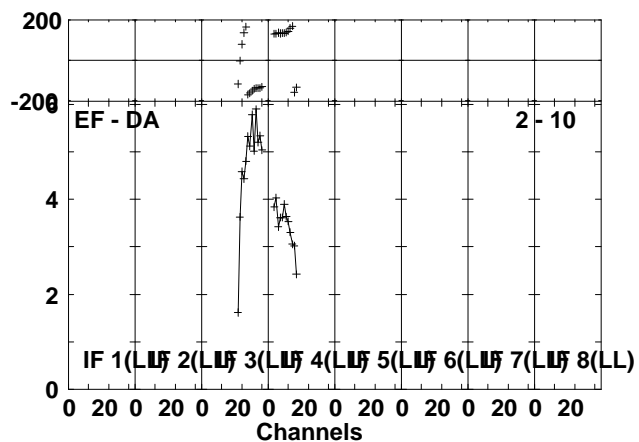
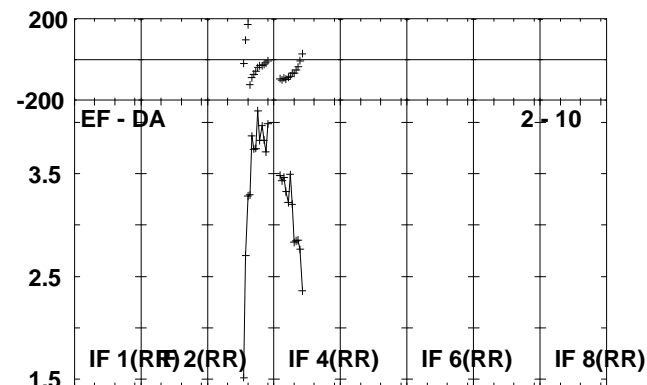
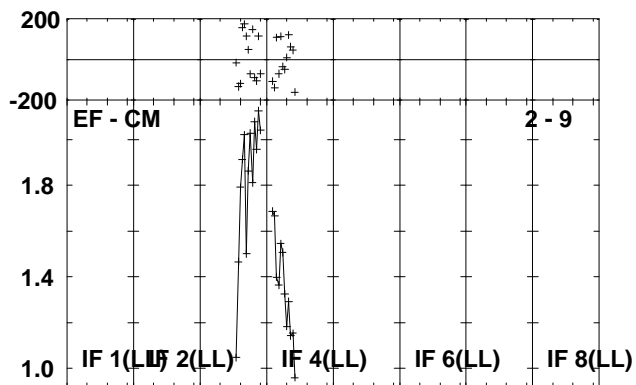
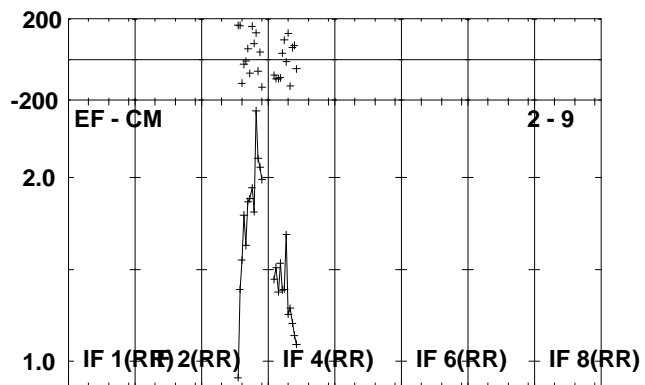
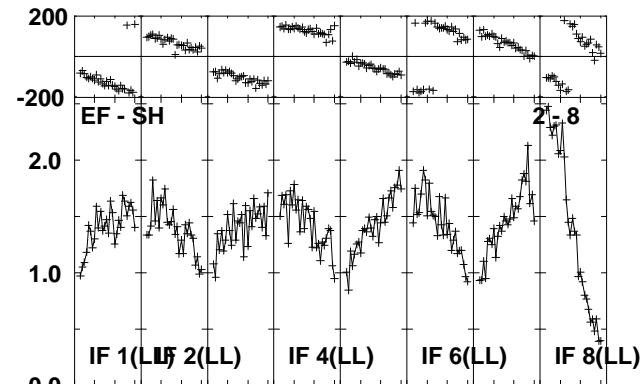
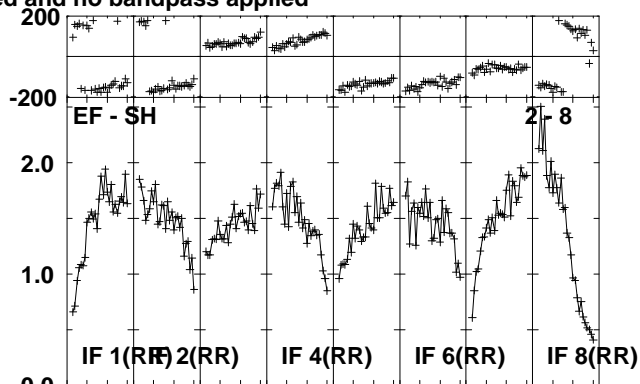
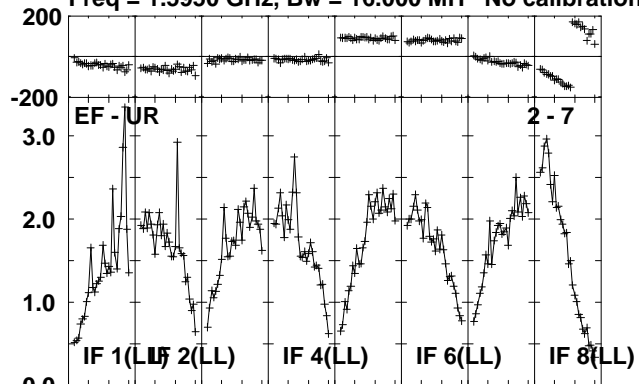

Lower frame: Milli Ampl Jy Top frame: Phas deg
Scalar averaged cross-power spectrum Several baselines displayed
Timerange: 00/22:28:01 to 00/22:29:27

Plot file version 31 created 23-AUG-2010 12:33:24

IRAS1929 EP064P.UVDATA.1

Freq = 1.5950 GHz, Bw = 16.000 MH No calibration applied and no bandpass applied

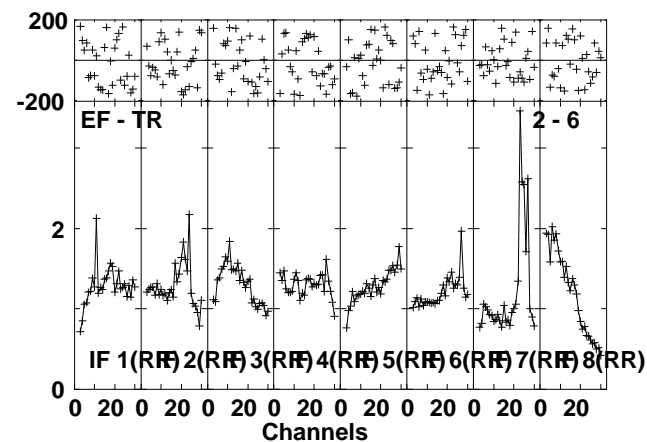
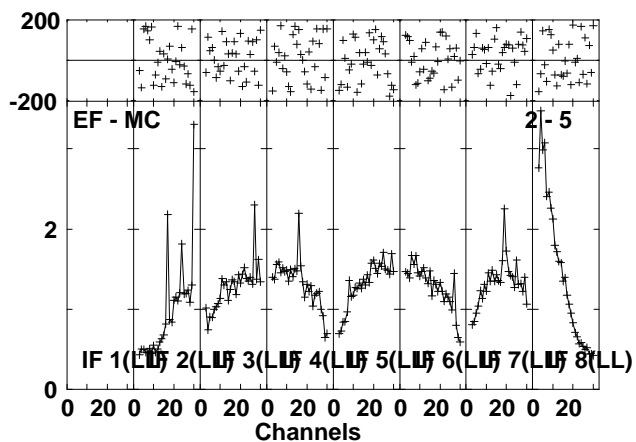
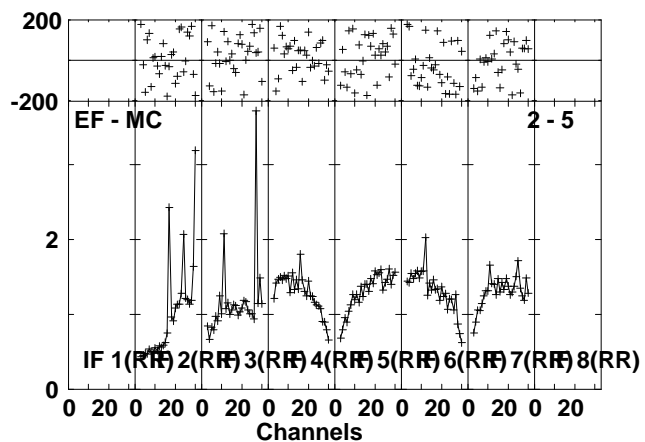
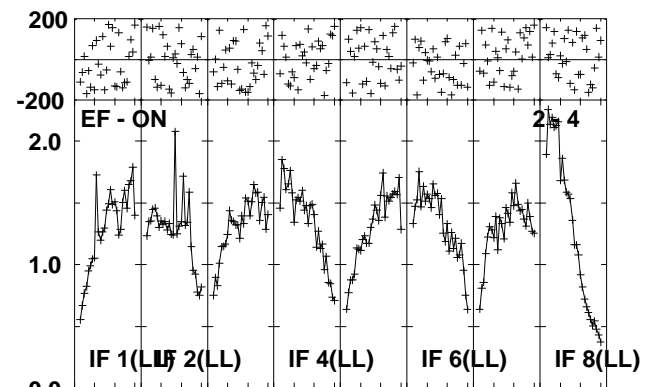
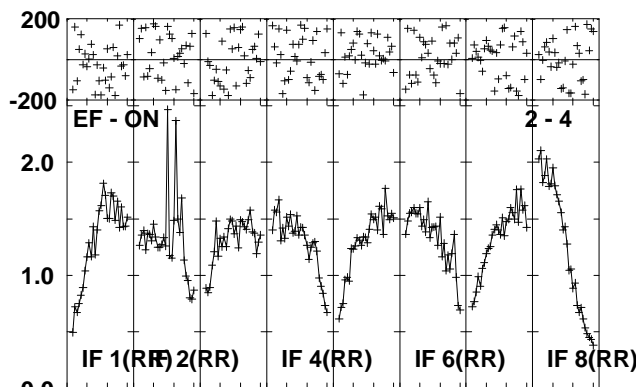
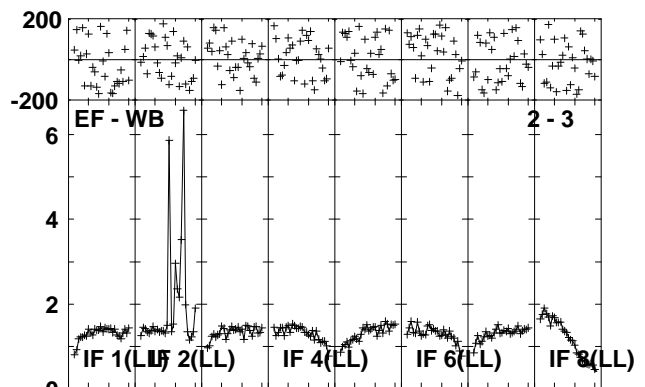
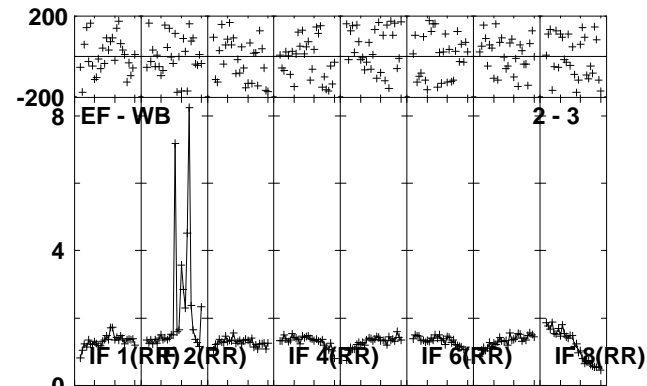
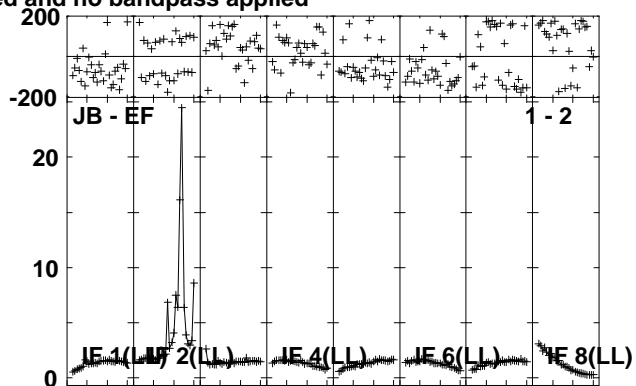
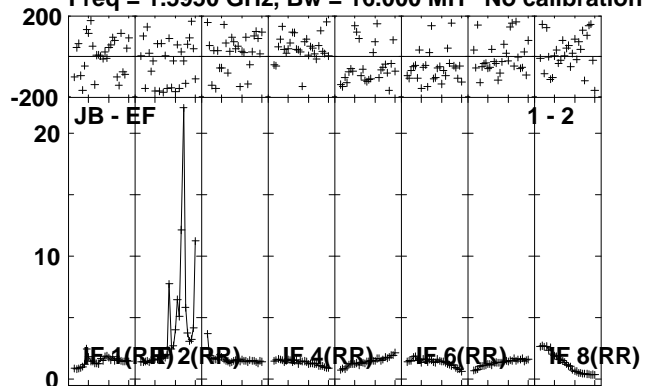

Lower frame: Milli Ampl Jy Top frame: Phas deg
Scalar averaged cross-power spectrum Several baselines displayed
Timerange: 00/22:29:31 to 00/22:32:59

Plot file version 32 created 23-AUG-2010 12:33:26

IRAS1929 EP064P.UVDATA.1

Freq = 1.5950 GHz, Bw = 16.000 MH No calibration applied and no bandpass applied

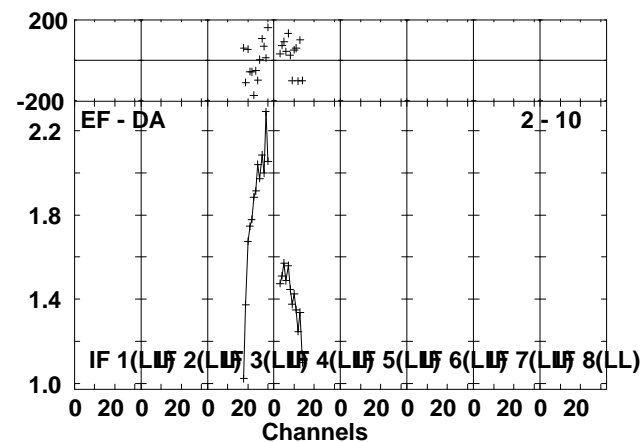
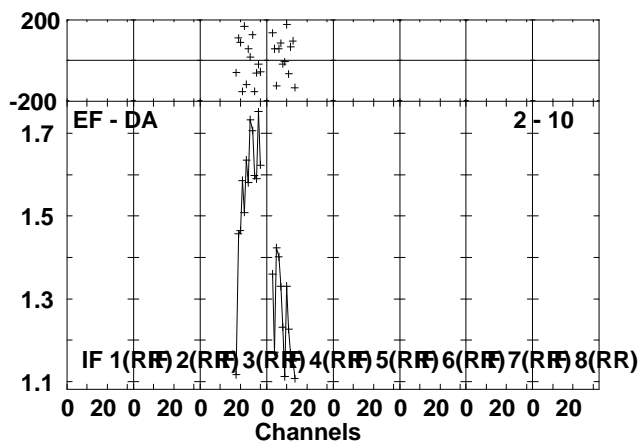
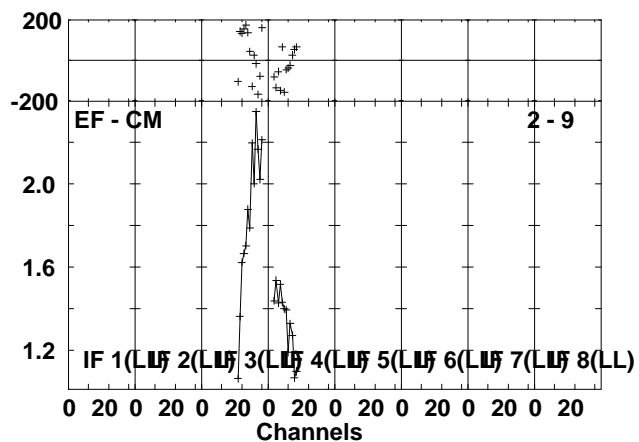
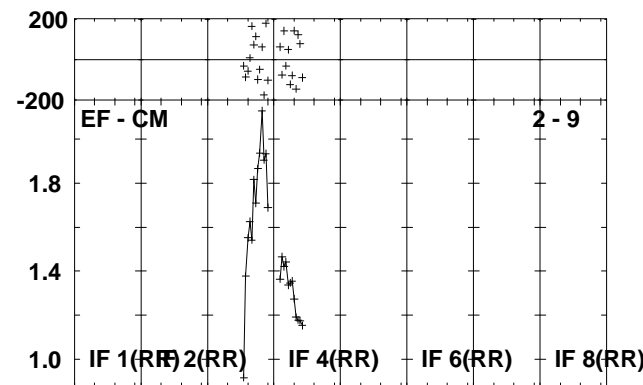
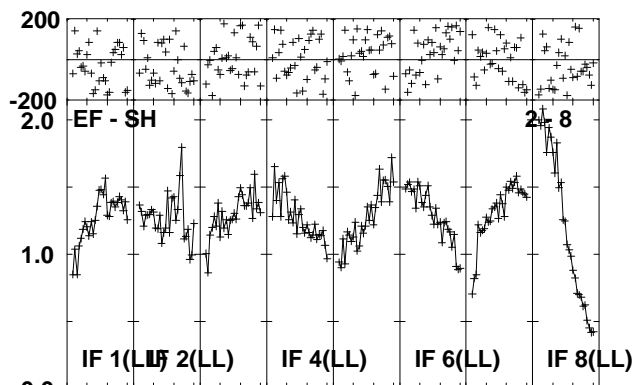
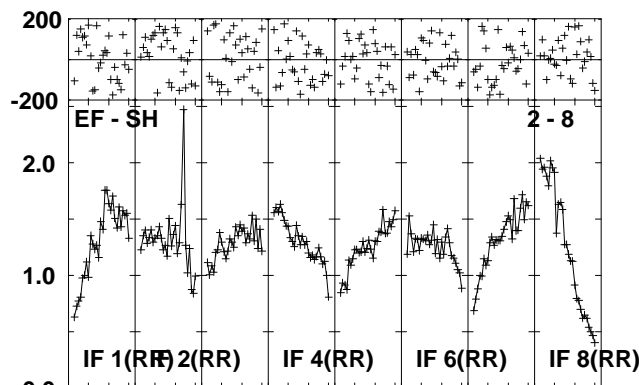
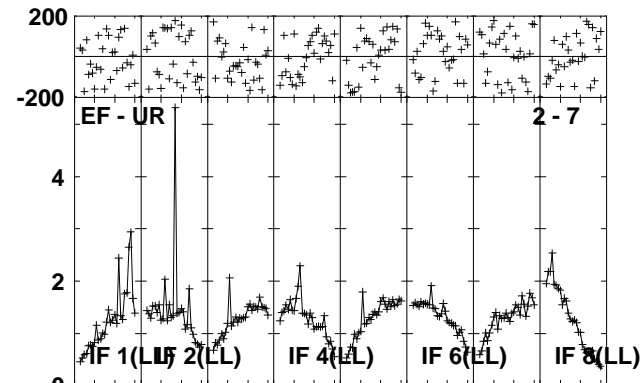
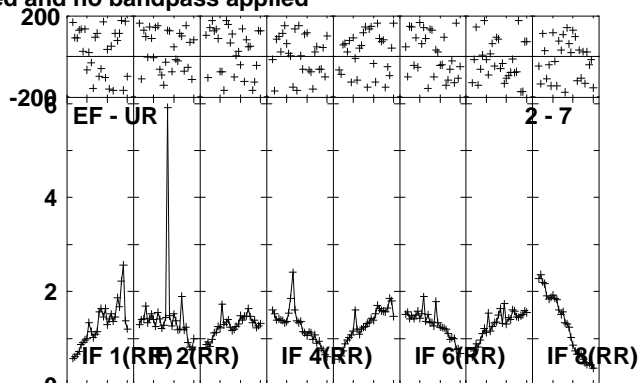
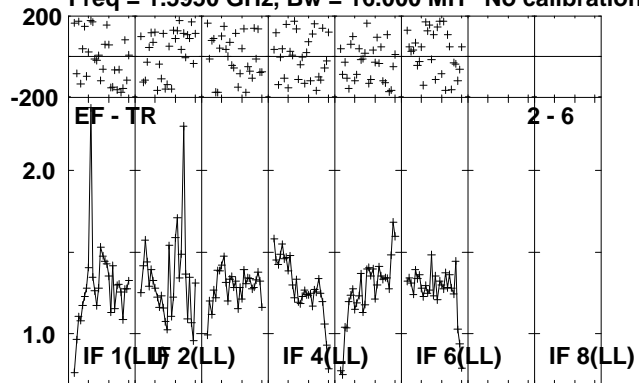

Lower frame: Milli Ampl Jy Top frame: Phas deg
Scalar averaged cross-power spectrum Several baselines displayed
Timerange: 00/22:29:31 to 00/22:32:59

Plot file version 33 created 23-AUG-2010 12:33:28

J1941-05 EP064P.UVDATA.1

Freq = 1.5950 GHz, Bw = 16.000 MH No calibration applied and no bandpass applied

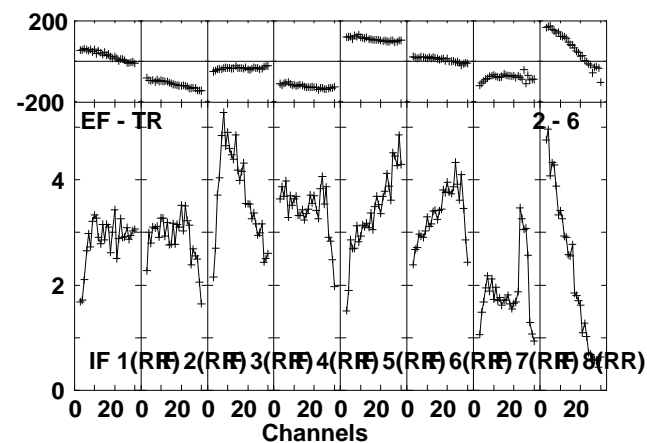
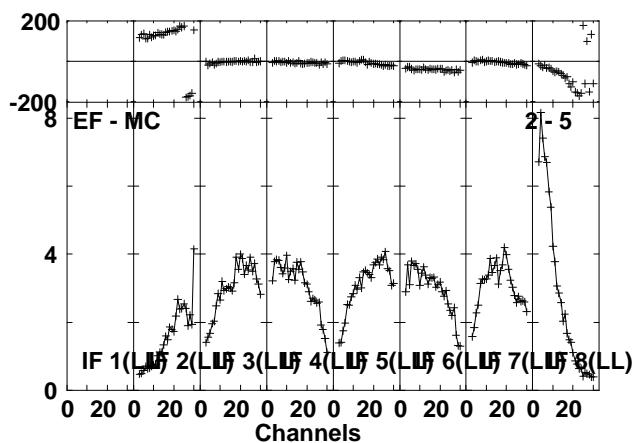
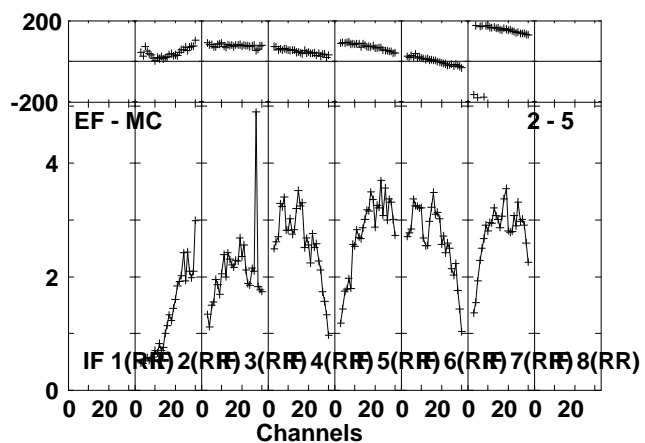
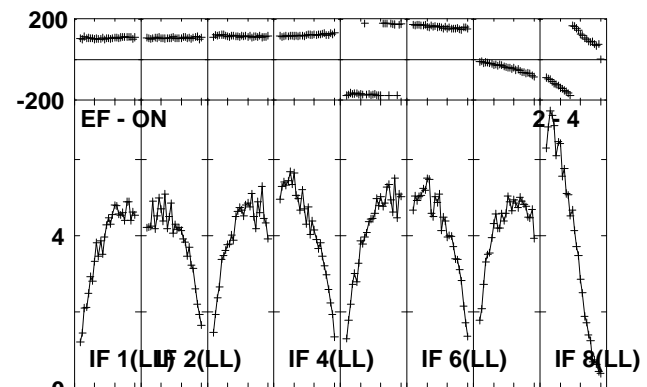
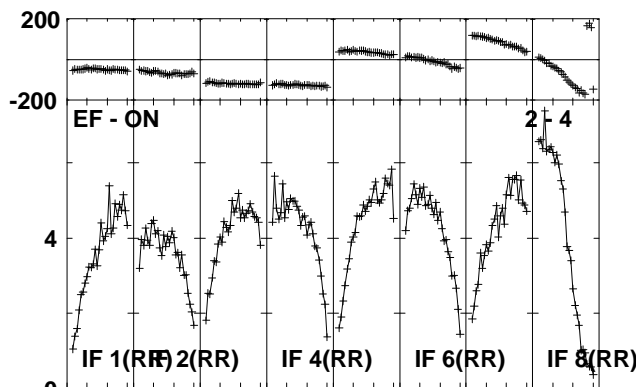
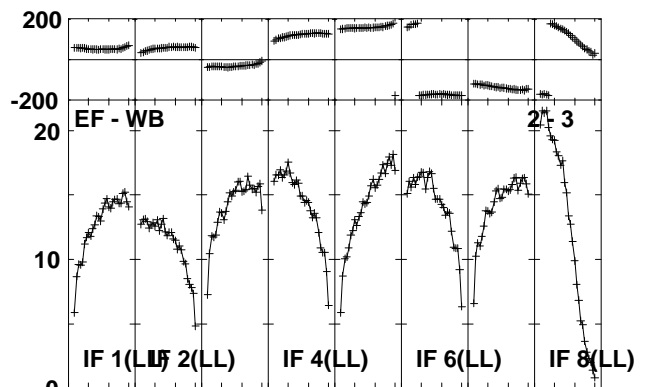
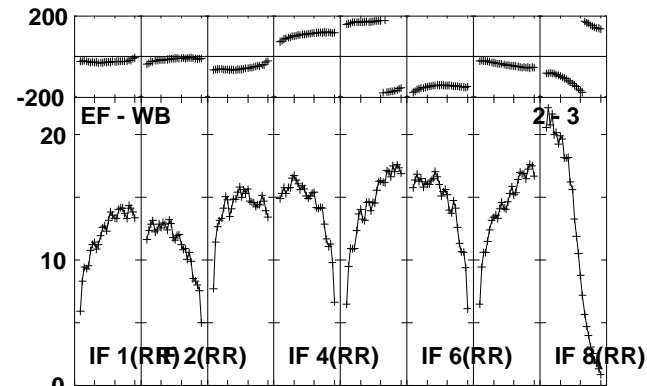
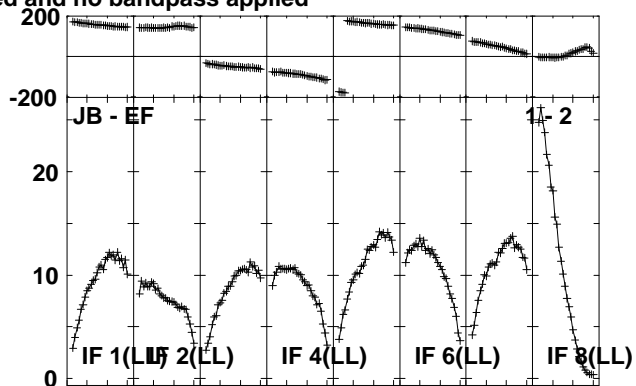
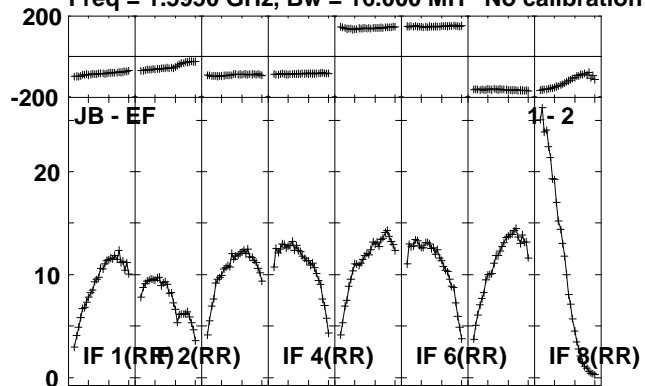

Lower frame: Milli Ampl Jy Top frame: Phas deg
Scalar averaged cross-power spectrum Several baselines displayed
Timerange: 00/22:33:01 to 00/22:34:29

Plot file version 34 created 23-AUG-2010 12:33:29

J1941-05 EP064P.UVDATA.1

Freq = 1.5950 GHz, Bw = 16.000 MH No calibration applied and no bandpass applied

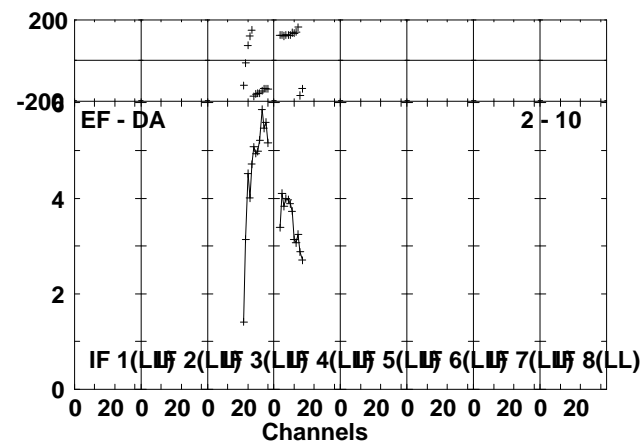
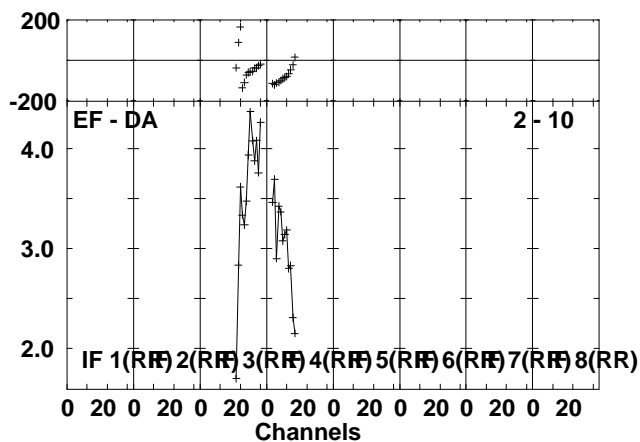
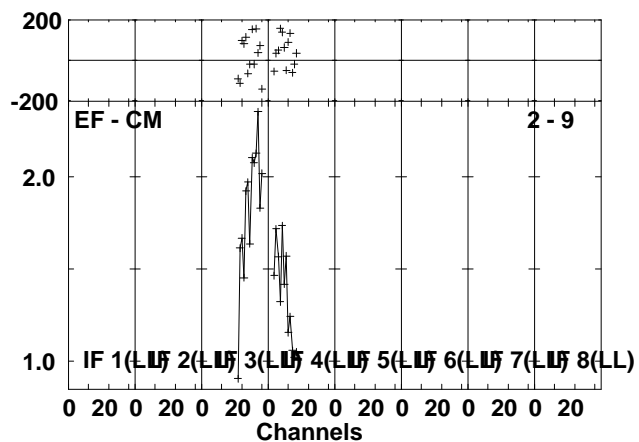
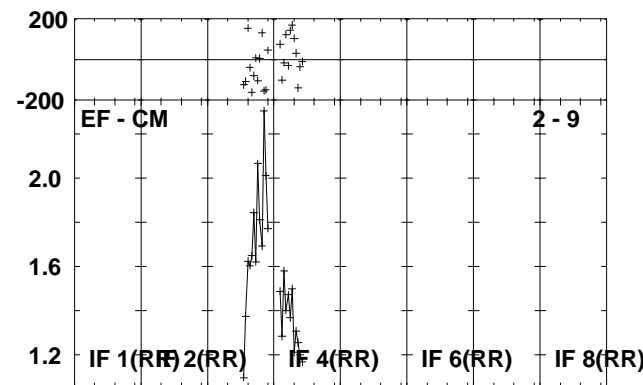
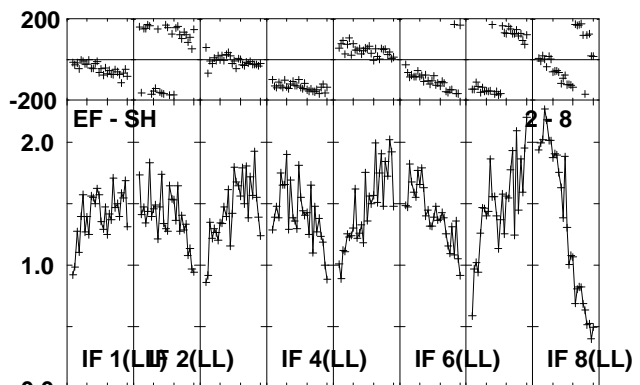
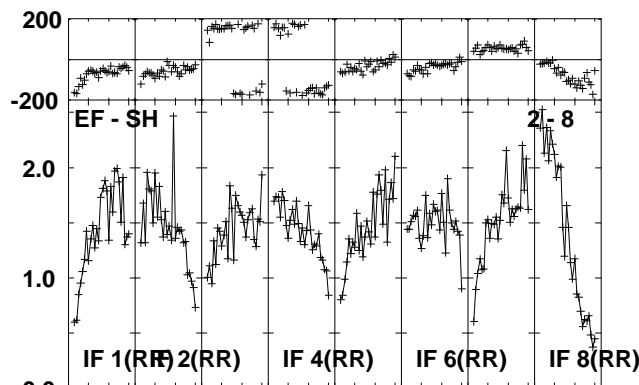
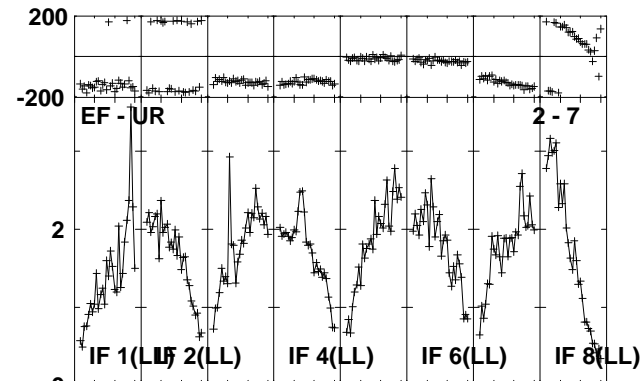
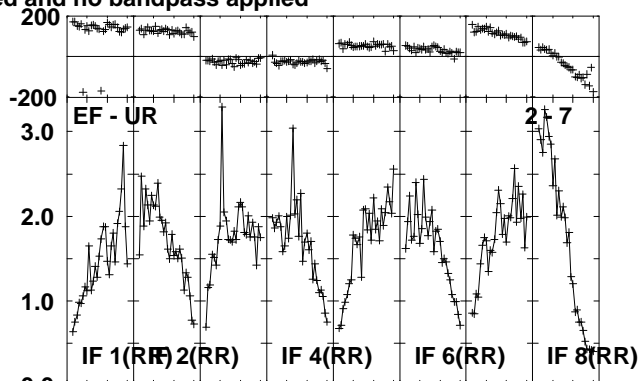
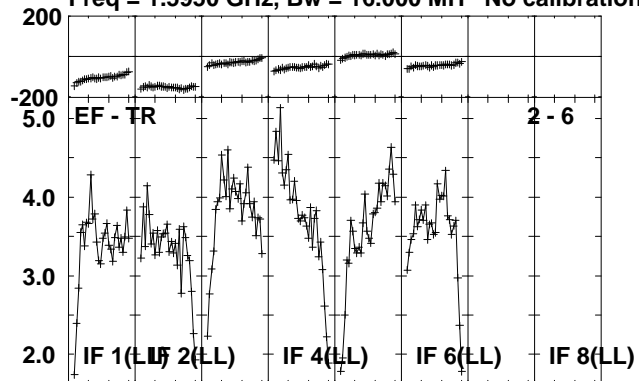

Lower frame: Milli Ampl Jy Top frame: Phas deg
Scalar averaged cross-power spectrum Several baselines displayed
Timerange: 00/22:33:01 to 00/22:34:29

Plot file version 35 created 23-AUG-2010 12:33:30

IRAS1929 EP064P.UVDATA.1

Freq = 1.5950 GHz, Bw = 16.000 MH No calibration applied and no bandpass applied

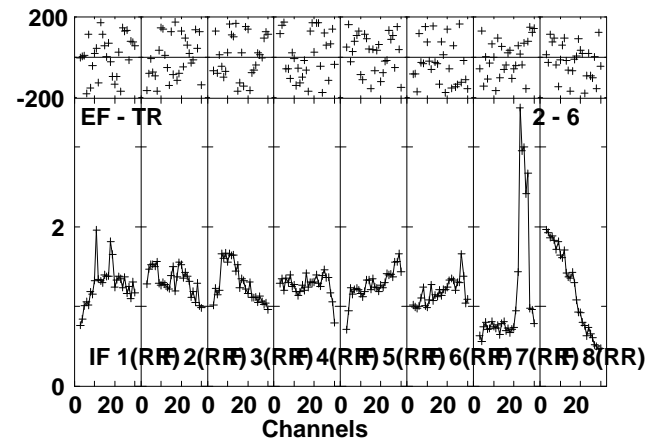
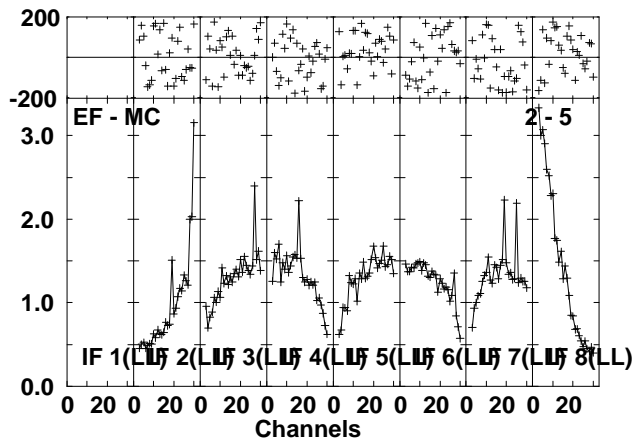
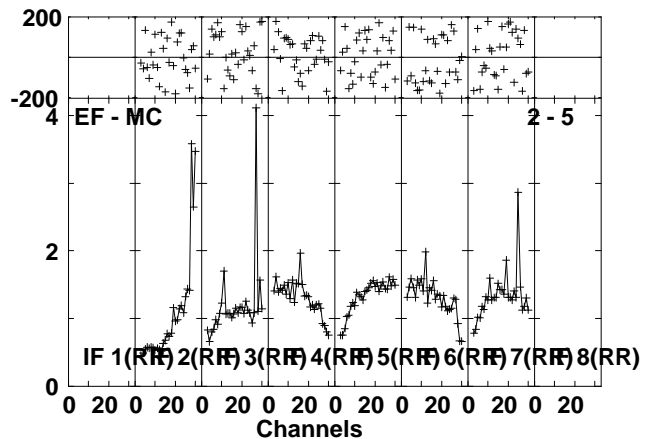
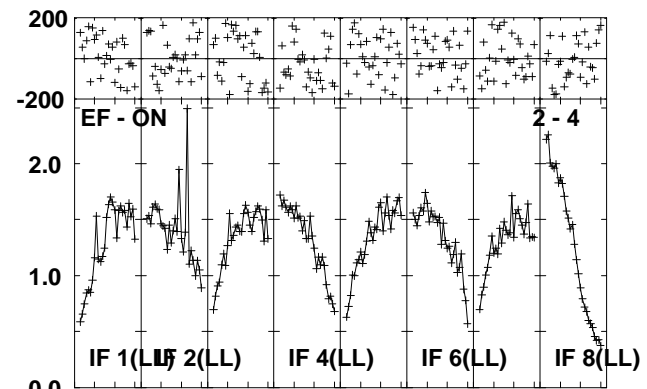
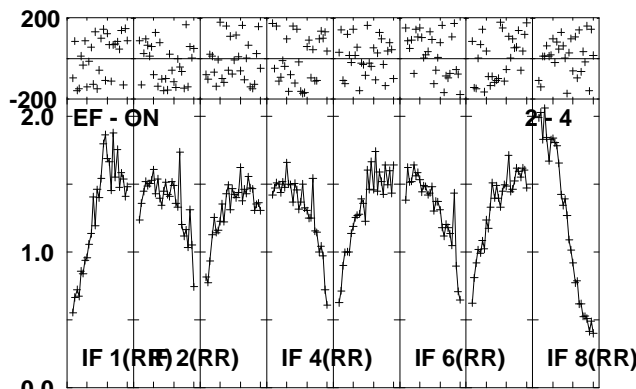
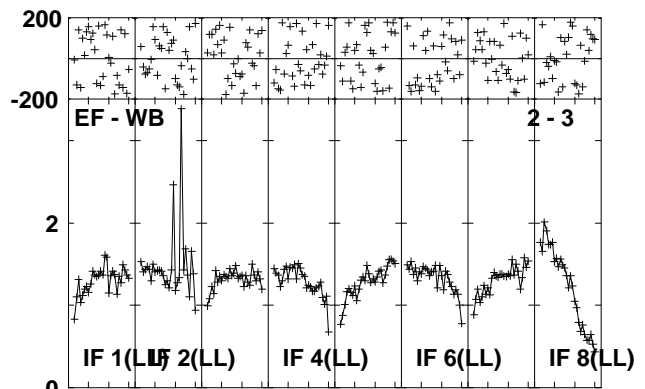
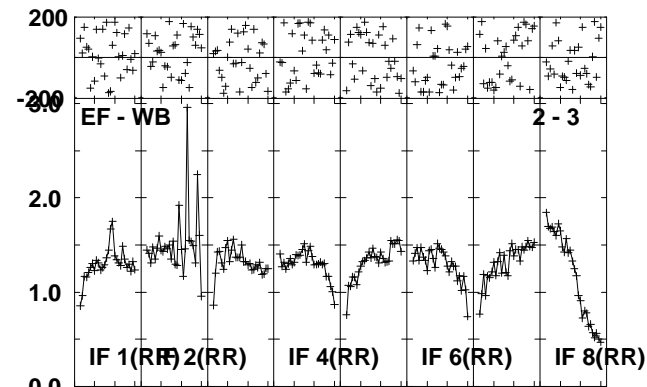
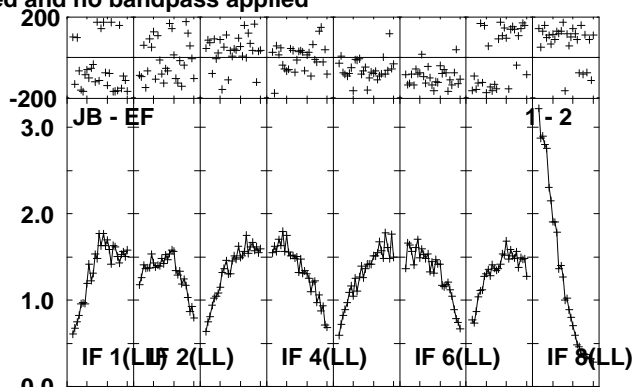
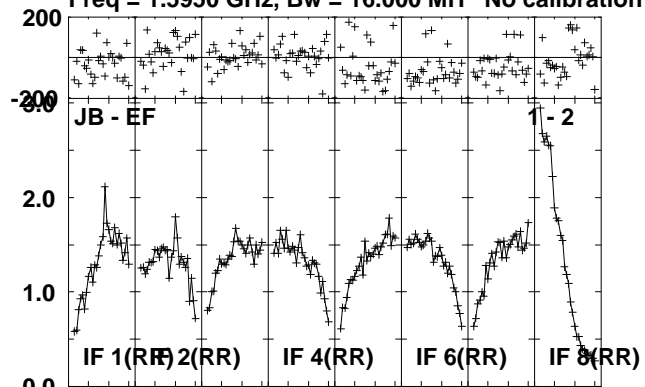

Lower frame: Milli Ampl Jy Top frame: Phas deg
Scalar averaged cross-power spectrum Several baselines displayed
Timerange: 00/22:34:31 to 00/22:37:59

Plot file version 36 created 23-AUG-2010 12:33:32

IRAS1929 EP064P.UVDATA.1

Freq = 1.5950 GHz, Bw = 16.000 MH No calibration applied and no bandpass applied

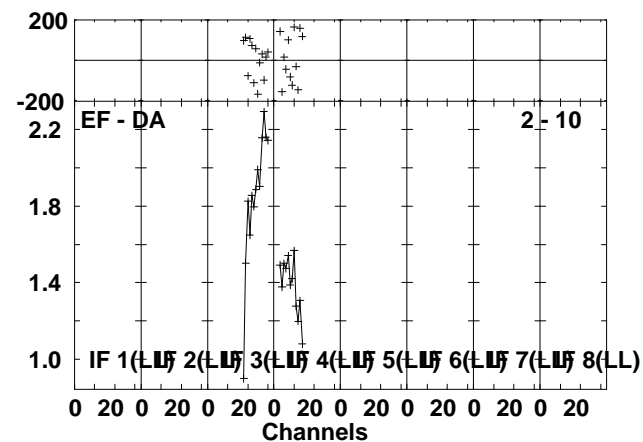
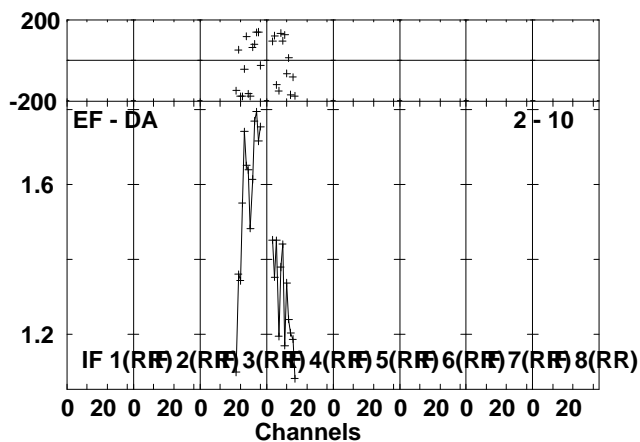
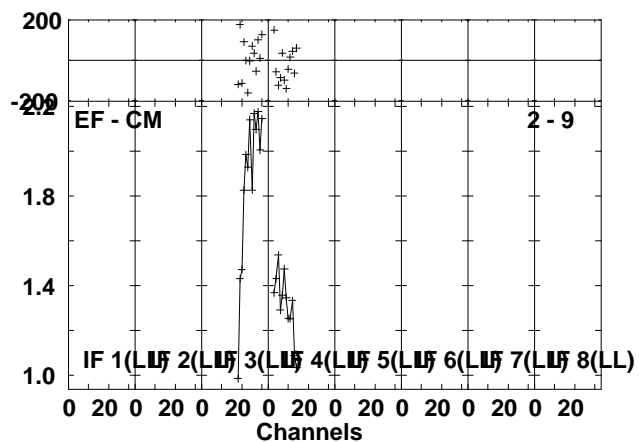
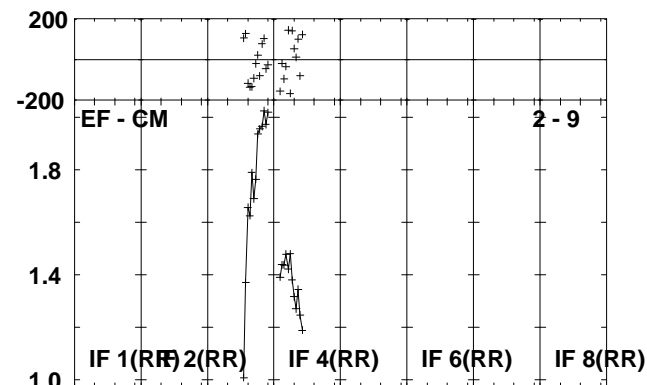
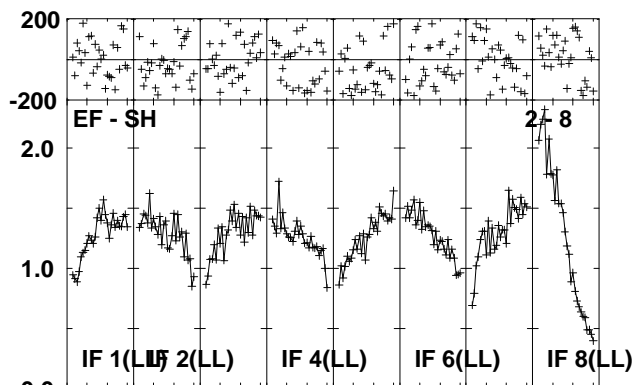
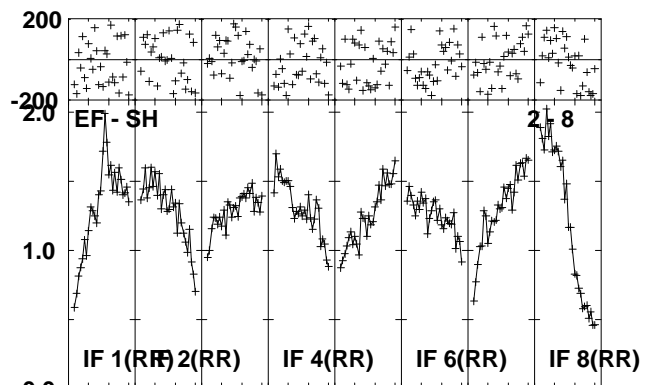
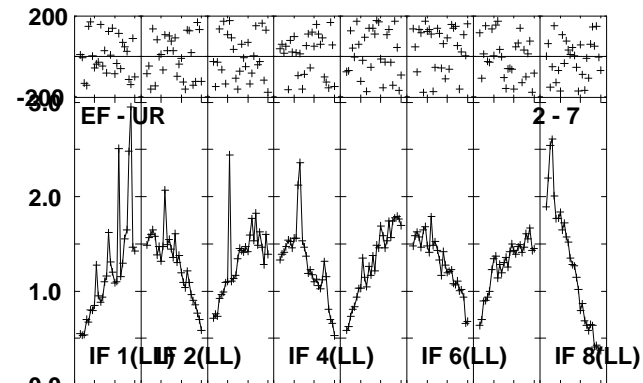
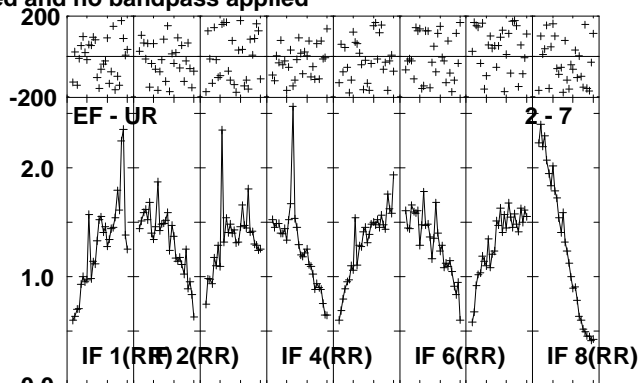
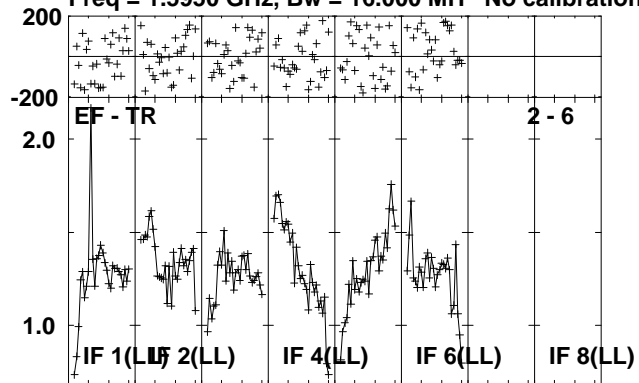

Lower frame: Milli Ampl Jy Top frame: Phas deg
Scalar averaged cross-power spectrum Several baselines displayed
Timerange: 00/22:34:31 to 00/22:37:59

Plot file version 37 created 23-AUG-2010 12:33:34

J1941-05 EP064P.UVDATA.1

Freq = 1.5950 GHz, Bw = 16.000 MH No calibration applied and no bandpass applied

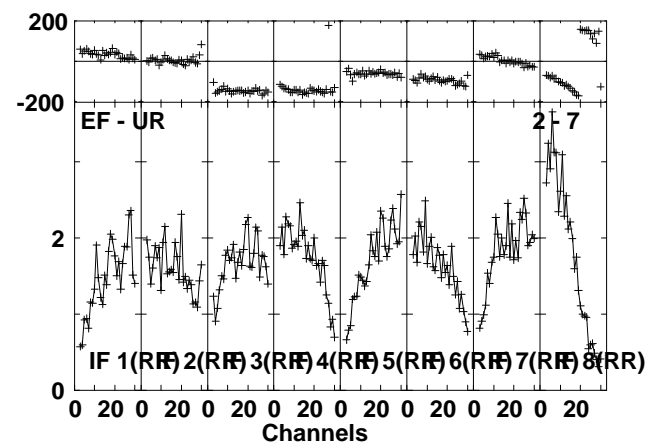
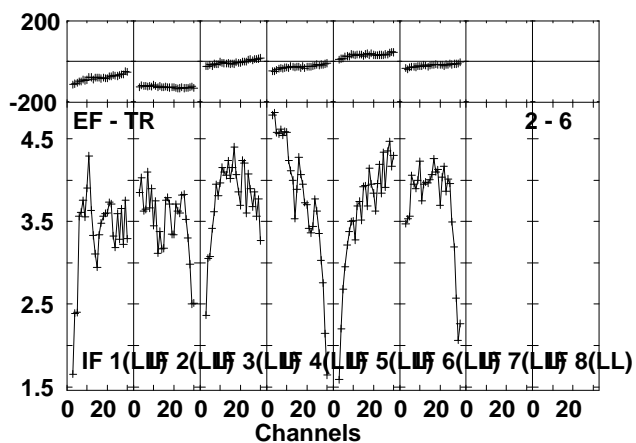
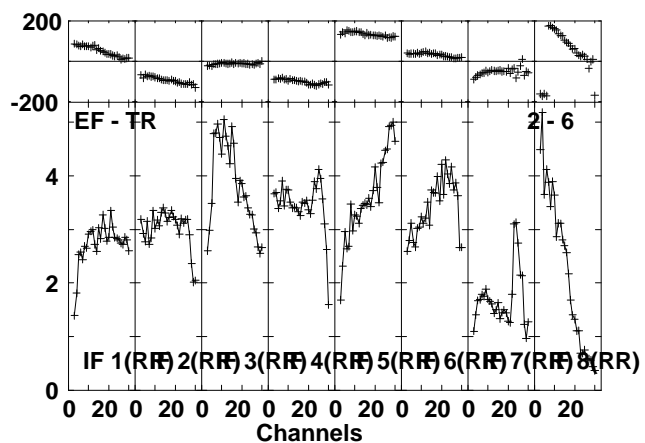
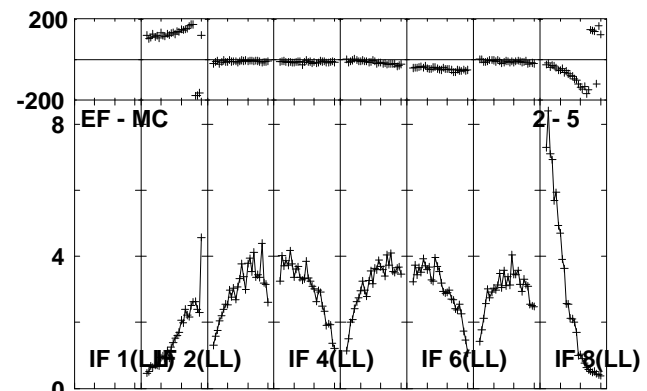
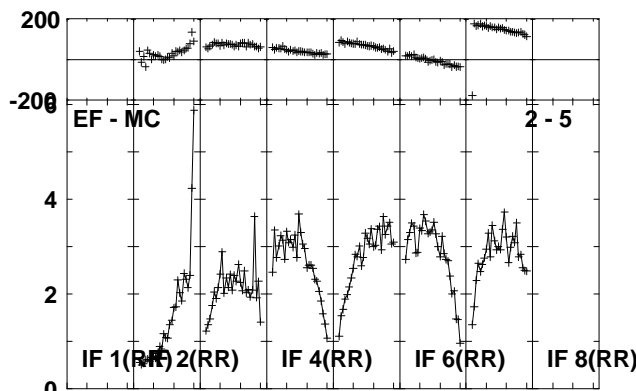
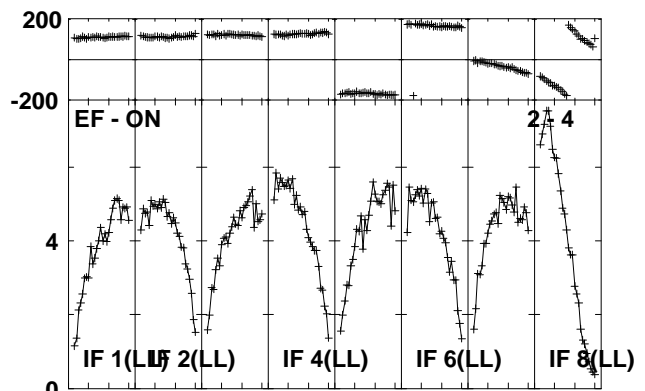
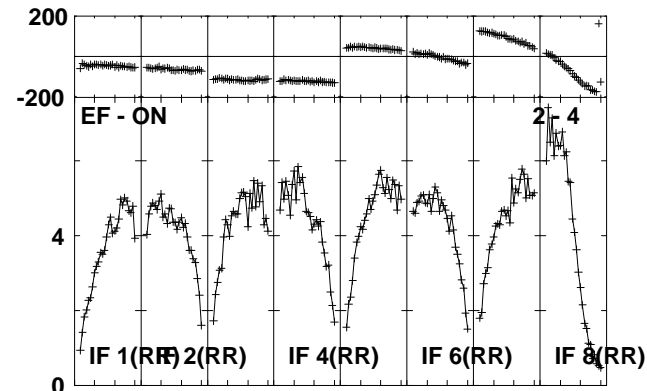
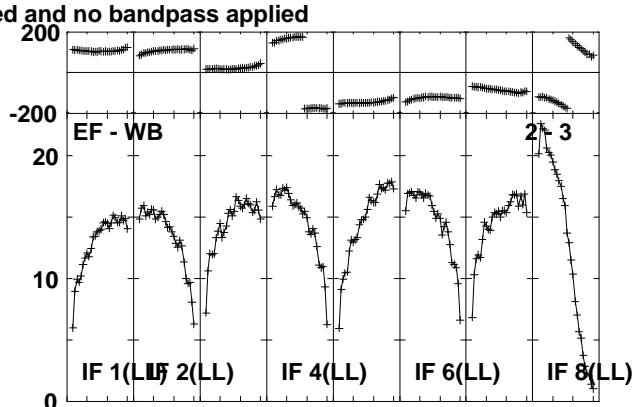
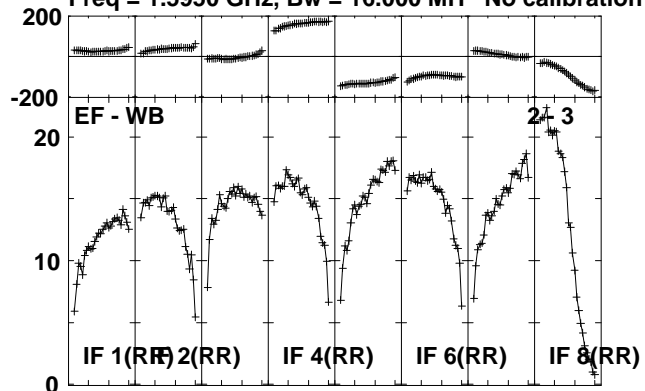

Lower frame: Milli Ampl Jy Top frame: Phas deg
Scalar averaged cross-power spectrum Several baselines displayed
Timerange: 00/22:38:01 to 00/22:39:29

Plot file version 38 created 23-AUG-2010 12:33:35

J1941-05 EP064P.UVDATA.1

Freq = 1.5950 GHz, Bw = 16.000 MH No calibration applied and no bandpass applied

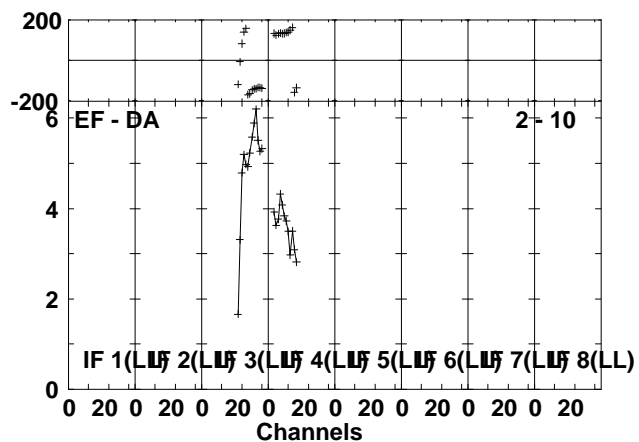
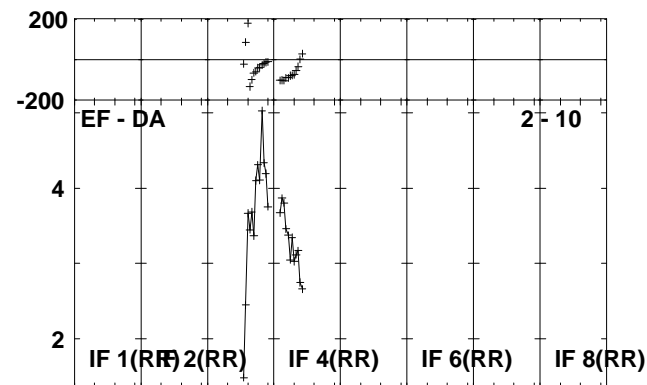
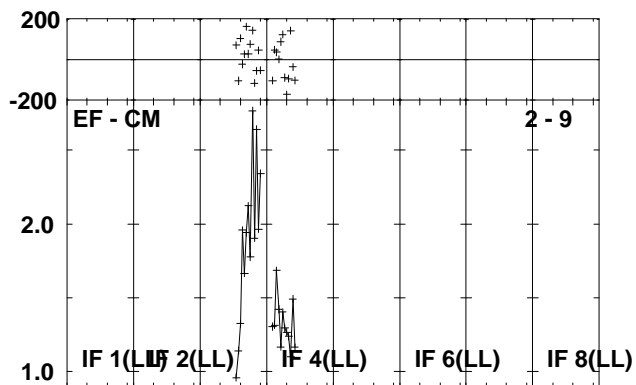
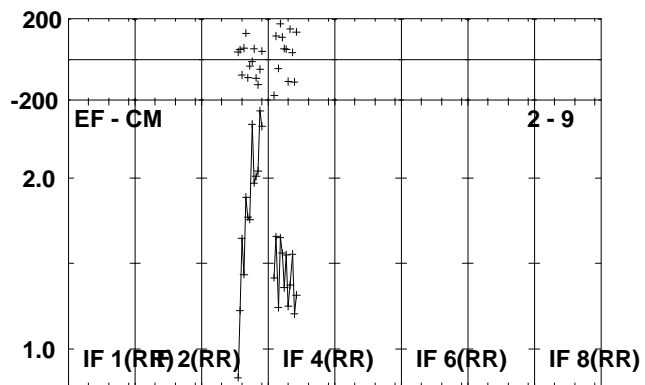
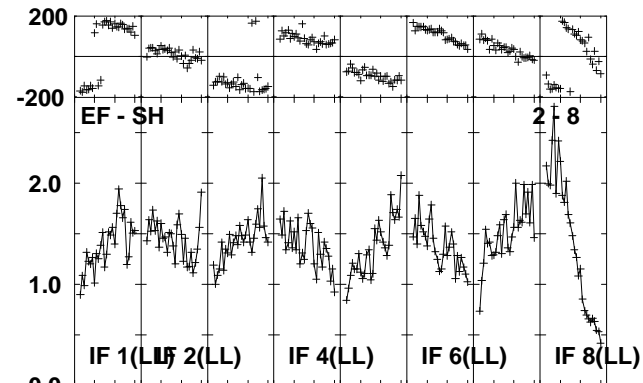
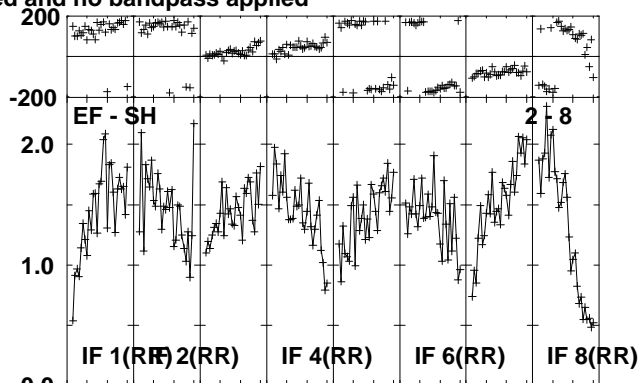
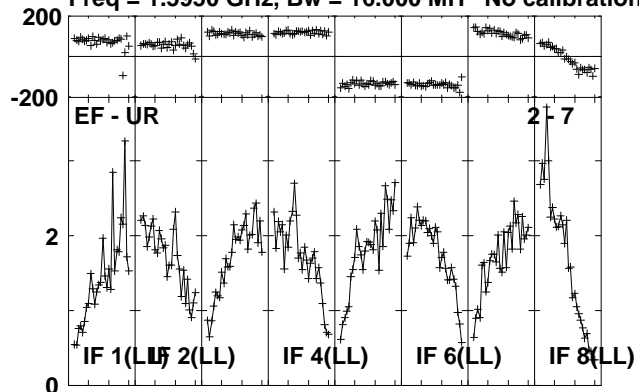

Lower frame: Milli Ampl Jy Top frame: Phas deg
Scalar averaged cross-power spectrum Several baselines displayed
Timerange: 00/22:38:01 to 00/22:39:29

Plot file version 39 created 23-AUG-2010 12:33:36

IRAS1929 EP064P.UVDATA.1

Freq = 1.5950 GHz, Bw = 16.000 MH No calibration applied and no bandpass applied

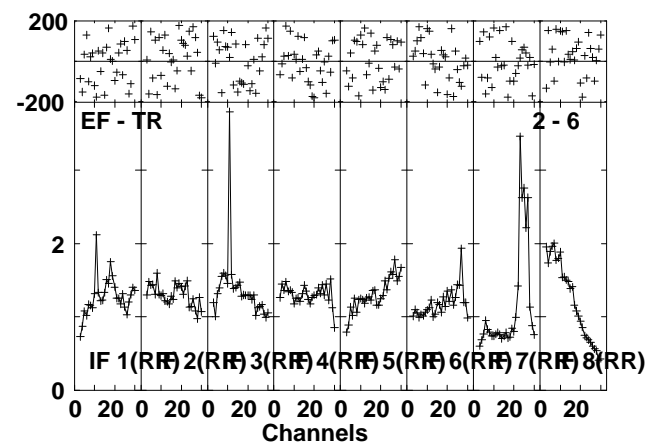
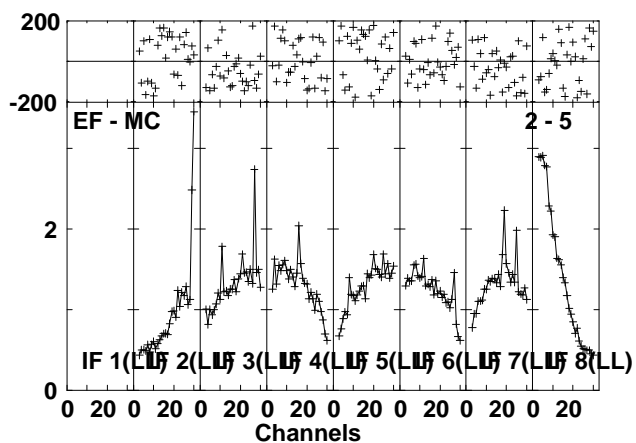
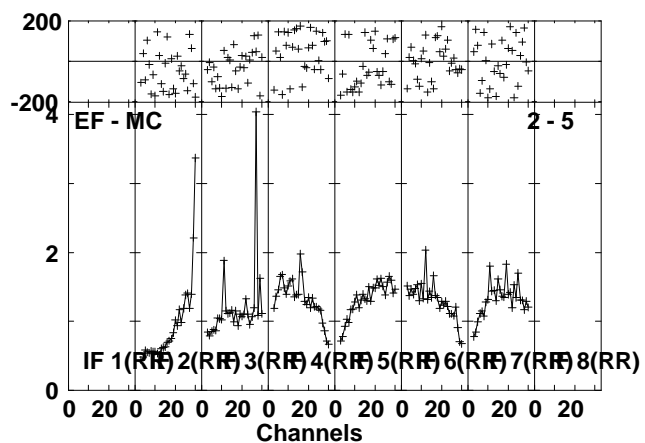
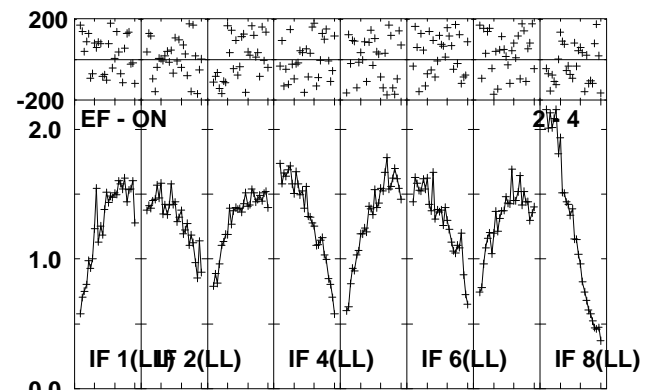
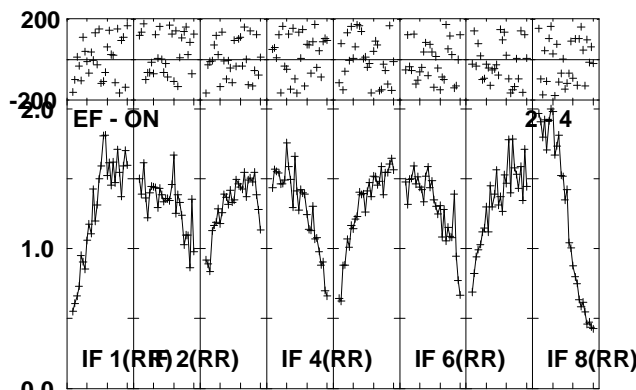
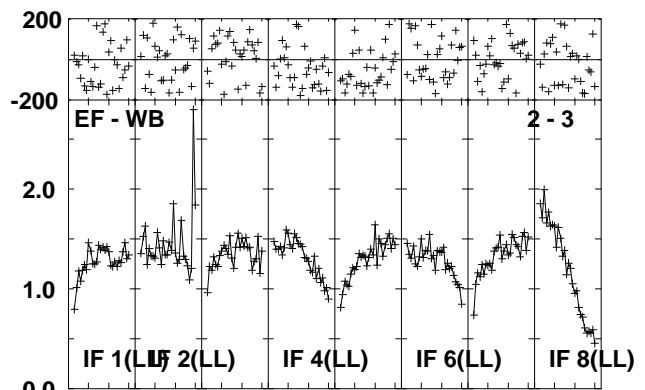
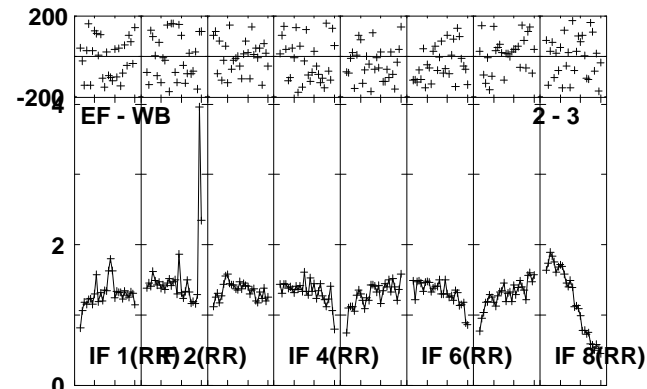
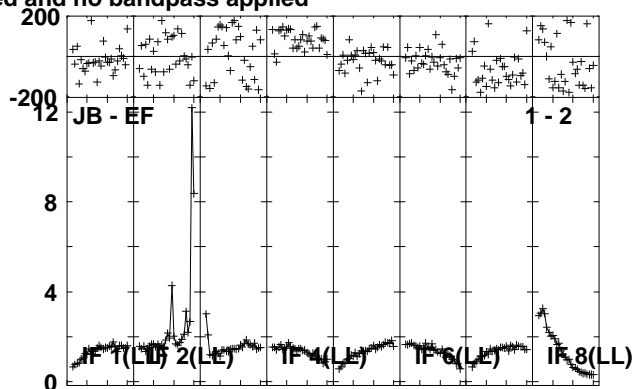
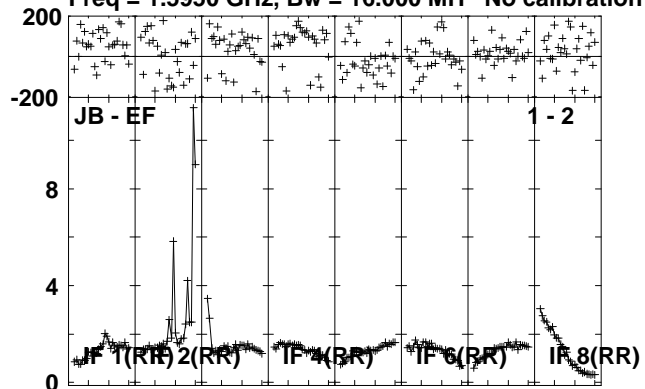

Lower frame: Milli Ampl Jy Top frame: Phas deg
Scalar averaged cross-power spectrum Several baselines displayed
Timerange: 00/22:39:31 to 00/22:42:59

Plot file version 40 created 23-AUG-2010 12:33:38

IRAS1929 EP064P.UVDATA.1

Freq = 1.5950 GHz, Bw = 16.000 MH No calibration applied and no bandpass applied

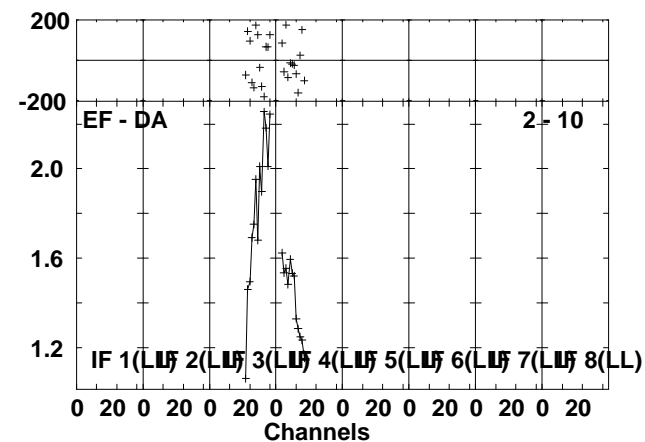
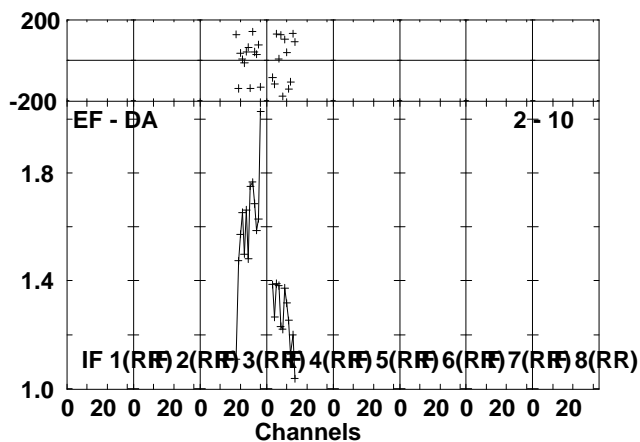
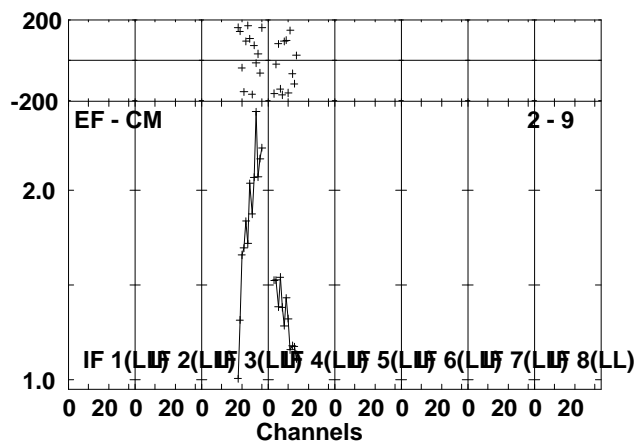
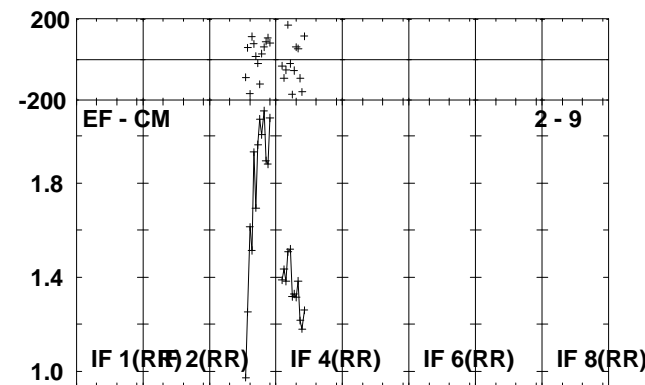
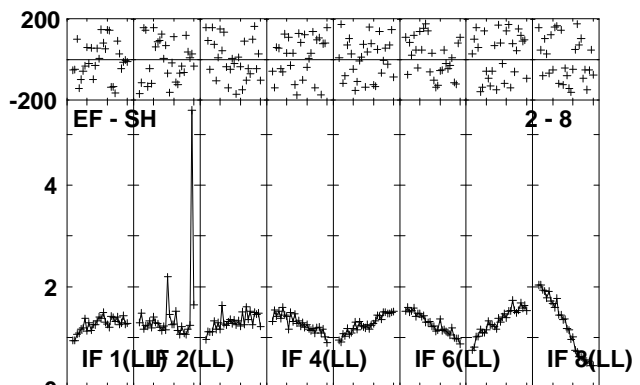
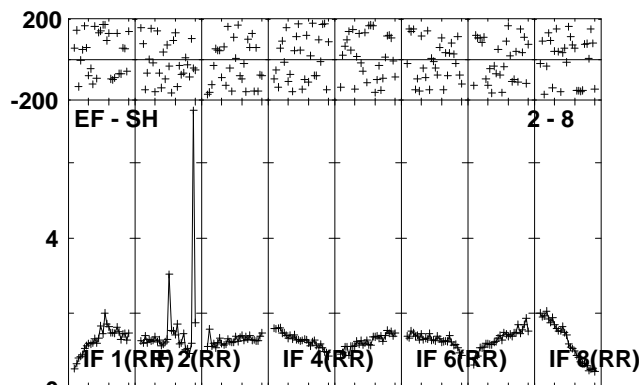
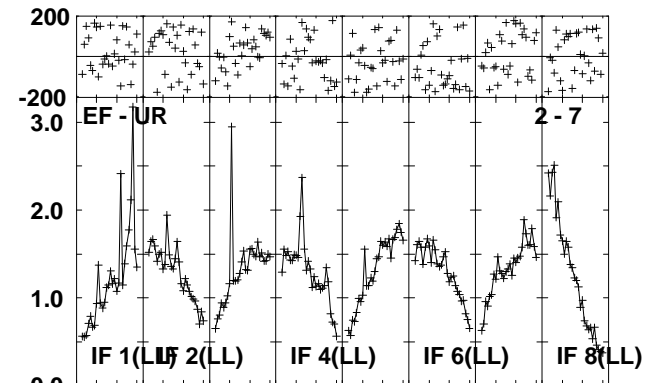
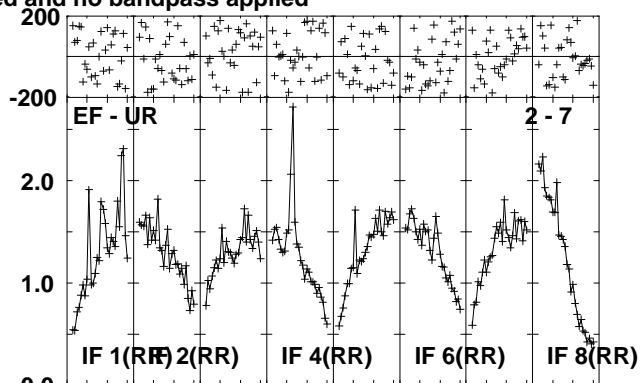
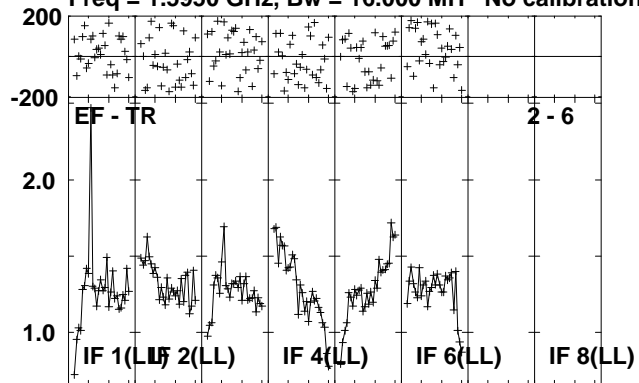

Lower frame: Milli Ampl Jy Top frame: Phas deg
Scalar averaged cross-power spectrum Several baselines displayed
Timerange: 00/22:39:31 to 00/22:42:59

Plot file version 41 created 23-AUG-2010 12:33:40

J1941-05 EP064P.UVDATA.1

Freq = 1.5950 GHz, Bw = 16.000 MH No calibration applied and no bandpass applied

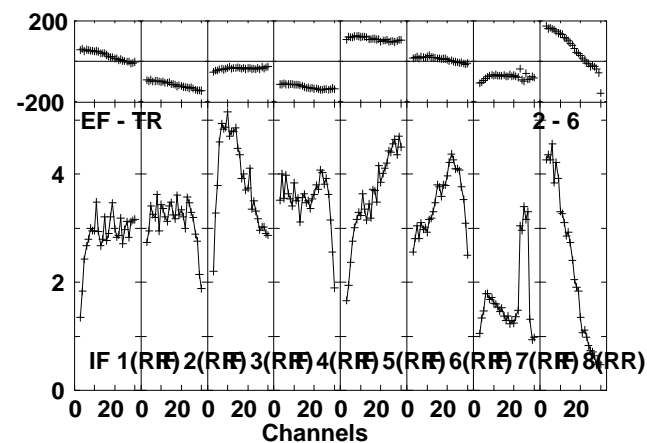
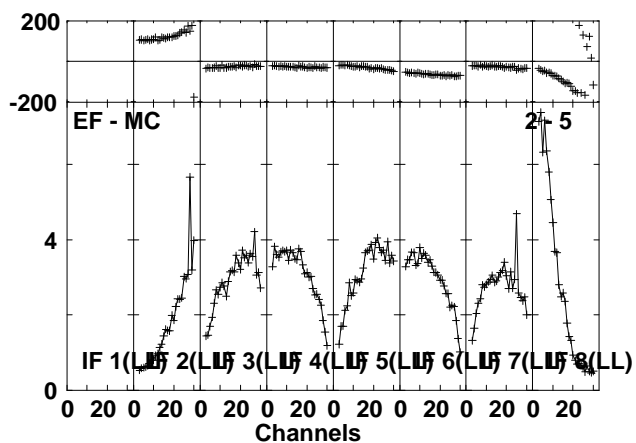
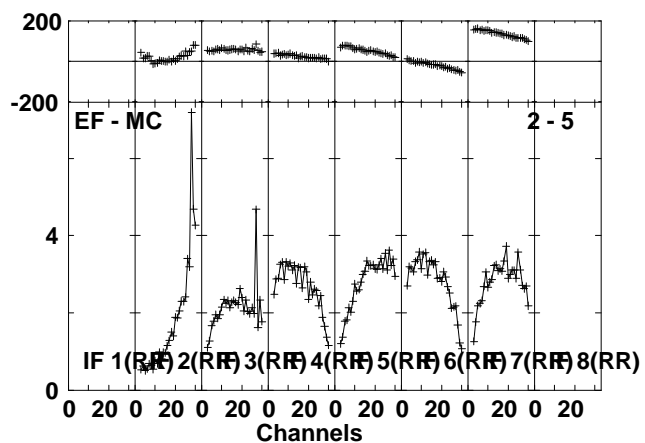
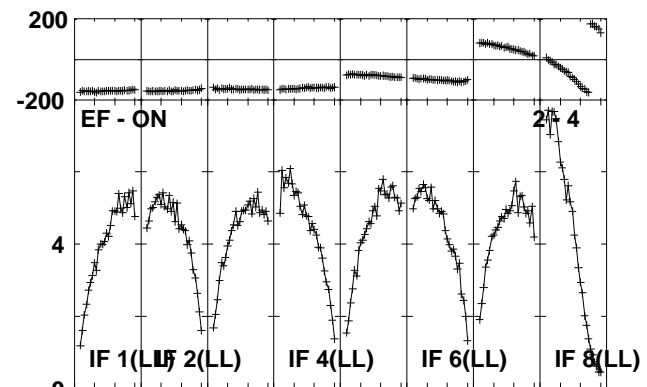
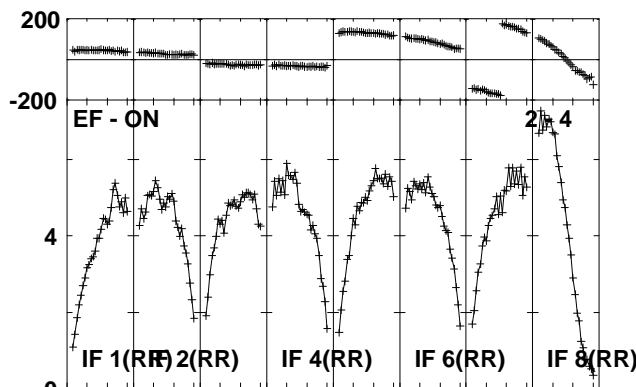
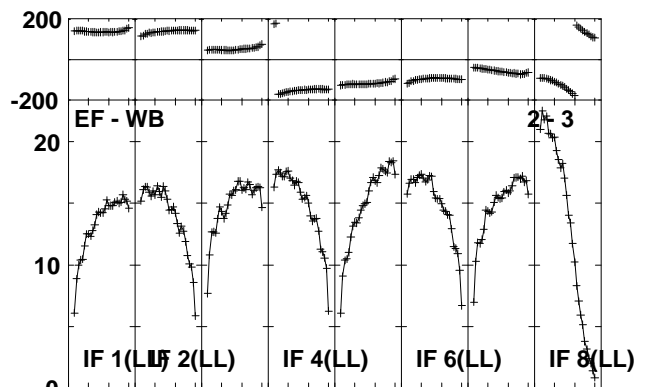
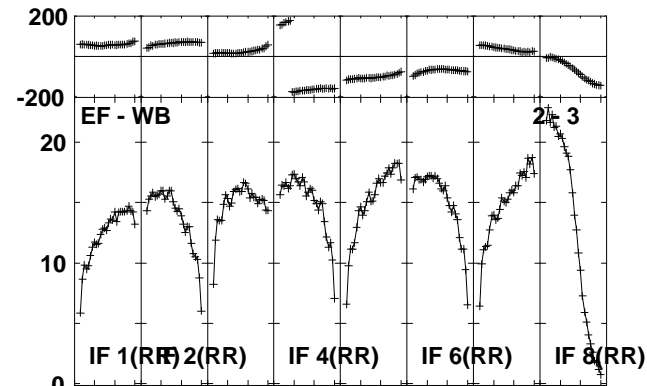
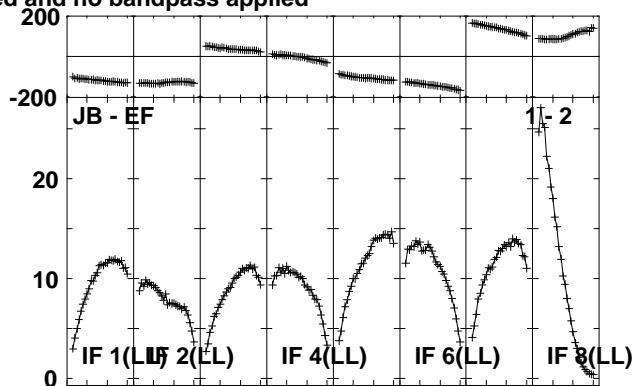
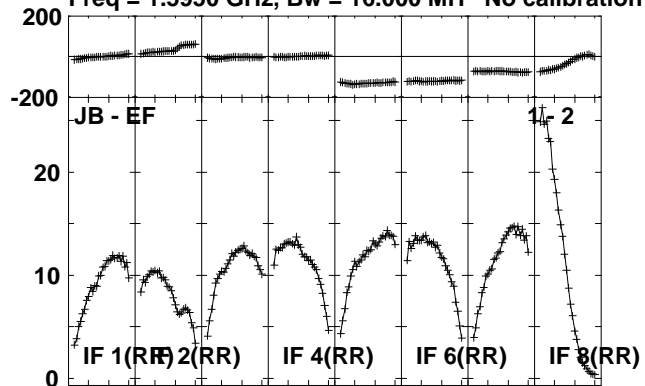

Lower frame: Milli Ampl Jy Top frame: Phas deg
Scalar averaged cross-power spectrum Several baselines displayed
Timerange: 00/22:44:01 to 00/22:45:29

Plot file version 42 created 23-AUG-2010 12:33:41

J1941-05 EP064P.UVDATA.1

Freq = 1.5950 GHz, Bw = 16.000 MH No calibration applied and no bandpass applied

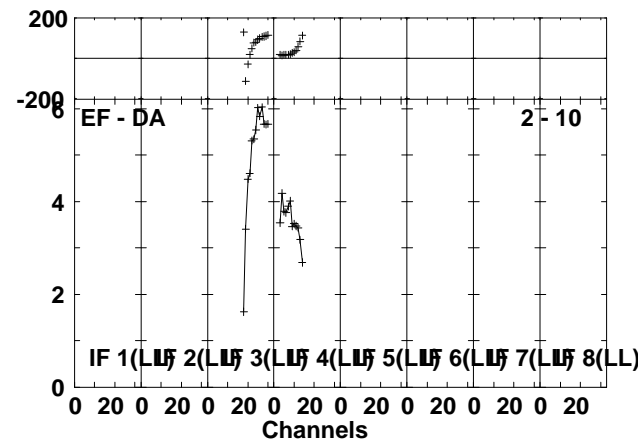
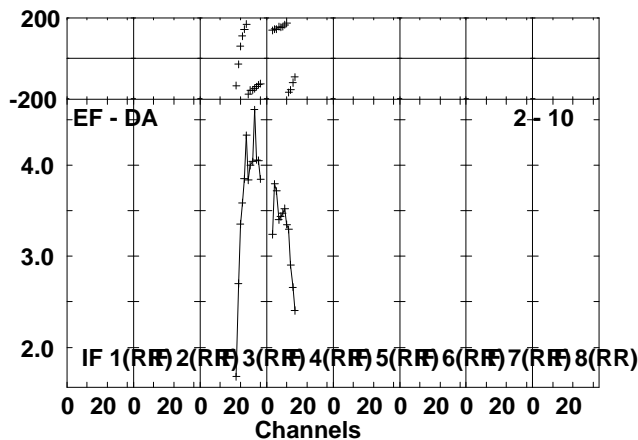
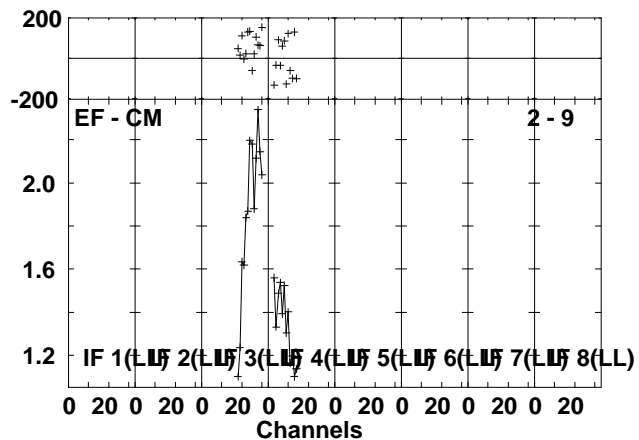
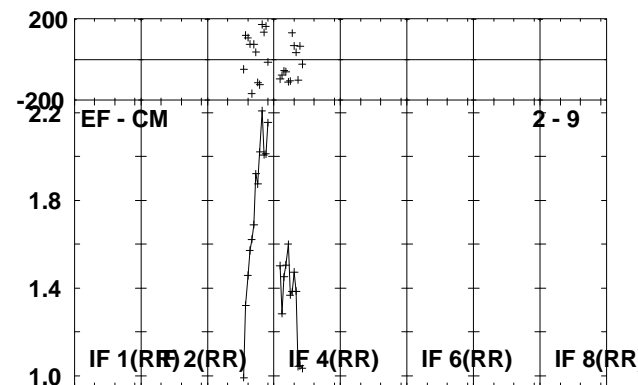
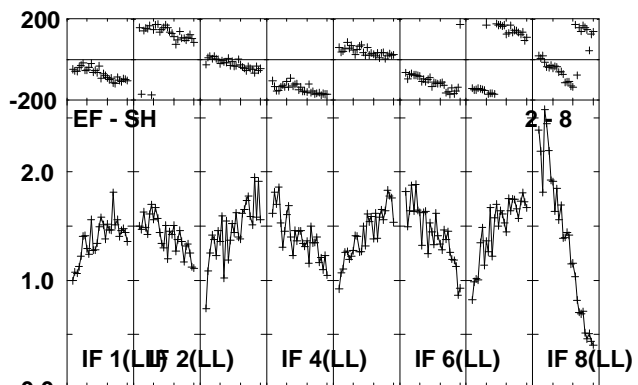
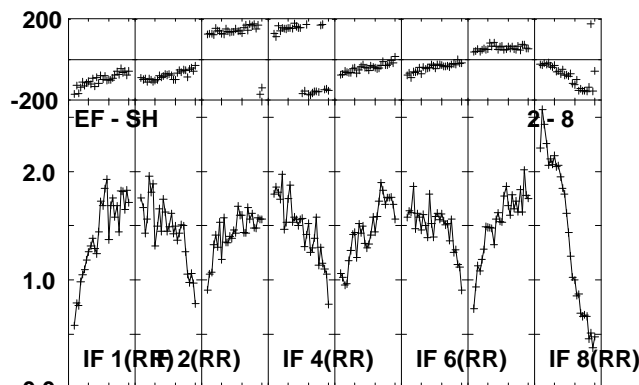
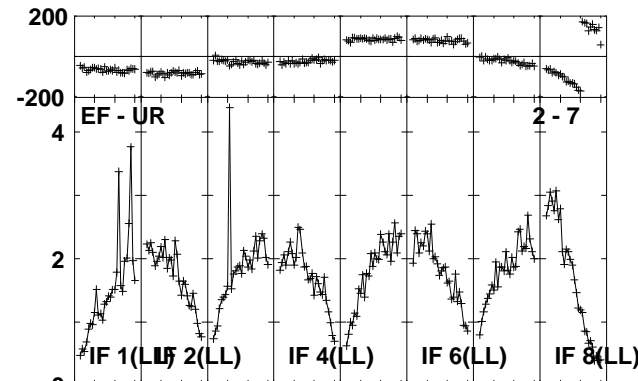
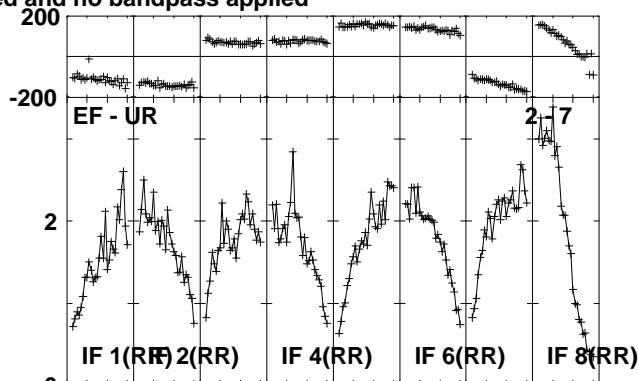
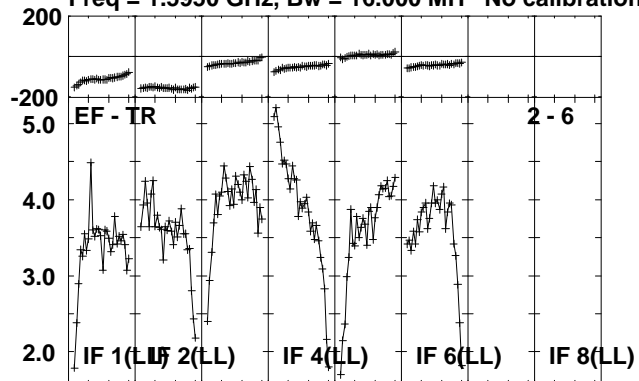

Lower frame: Milli Ampl Jy Top frame: Phas deg
Scalar averaged cross-power spectrum Several baselines displayed
Timerange: 00/22:44:01 to 00/22:45:29

Plot file version 43 created 23-AUG-2010 12:33:43

IRAS1929 EP064P.UVDATA.1

Freq = 1.5950 GHz, Bw = 16.000 MH No calibration applied and no bandpass applied

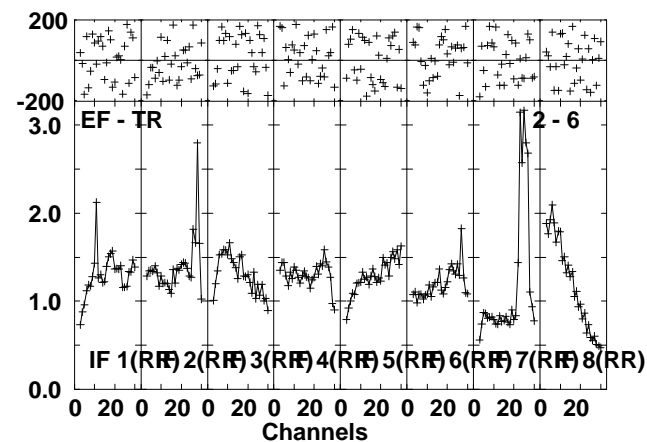
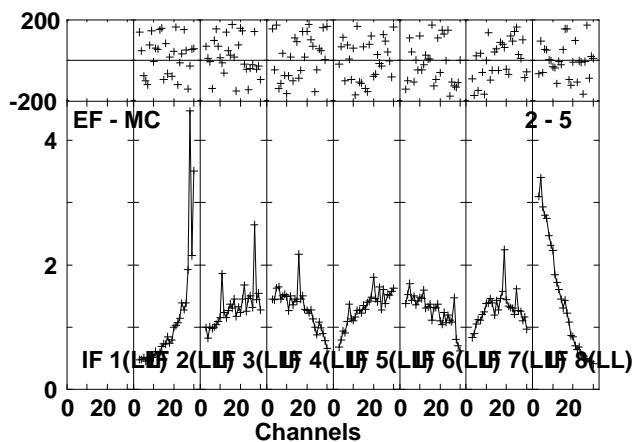
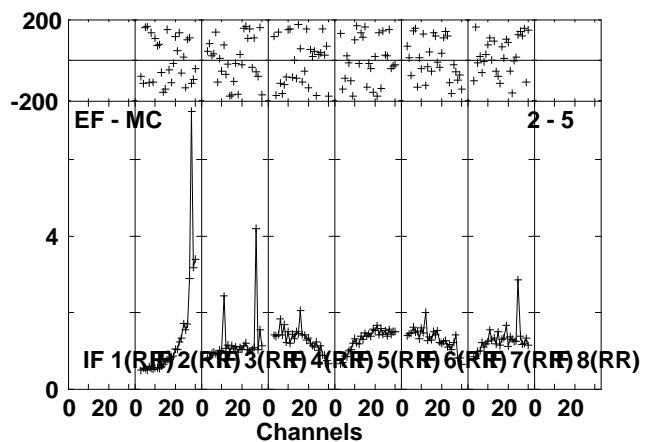
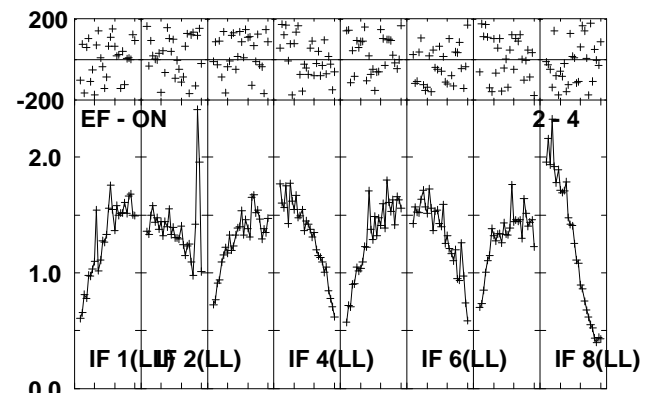
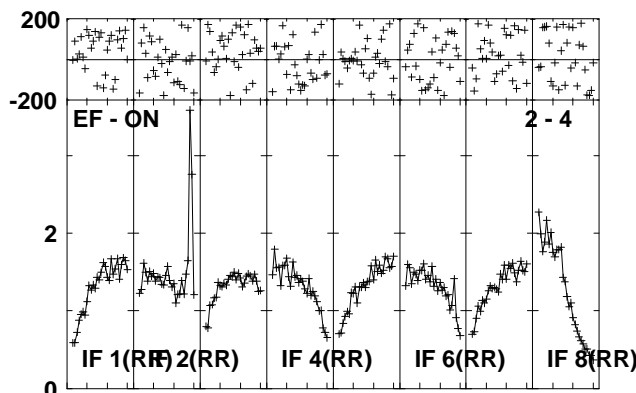
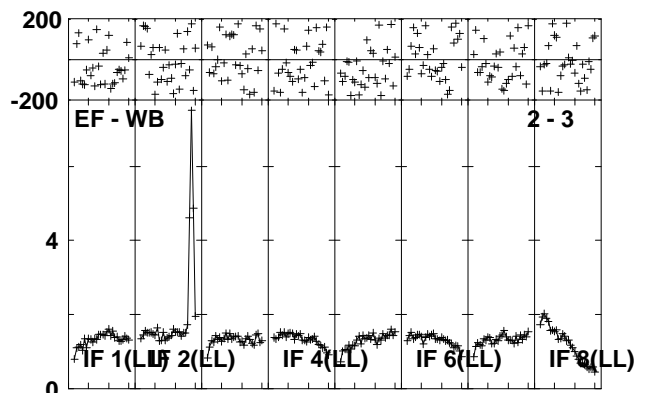
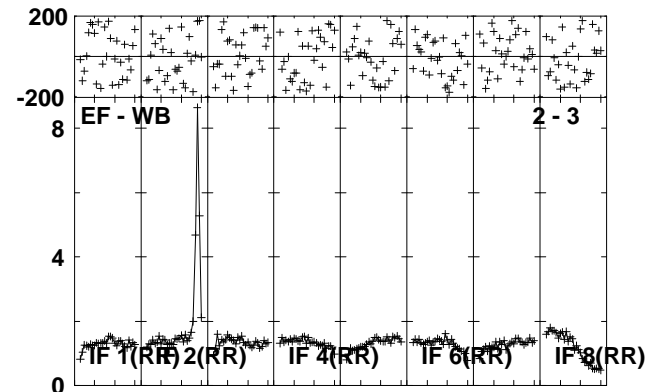
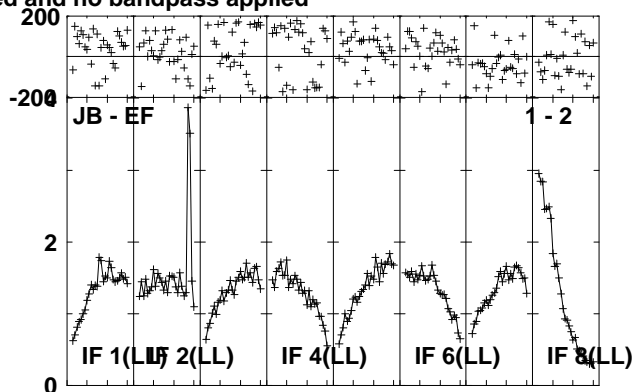
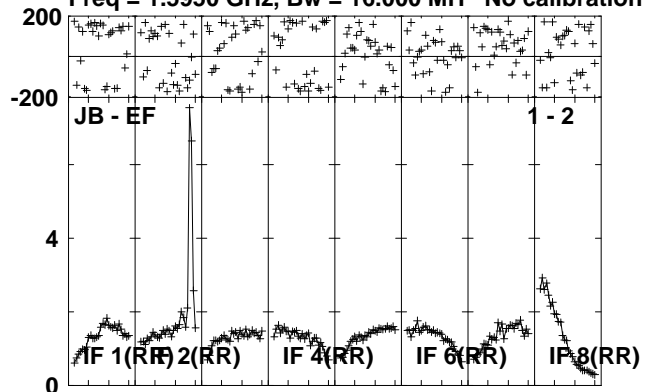

Lower frame: Milli Ampl Jy Top frame: Phas deg
Scalar averaged cross-power spectrum Several baselines displayed
Timerange: 00/22:45:31 to 00/22:48:59

Plot file version 44 created 23-AUG-2010 12:33:45

IRAS1929 EP064P.UVDATA.1

Freq = 1.5950 GHz, Bw = 16.000 MH No calibration applied and no bandpass applied

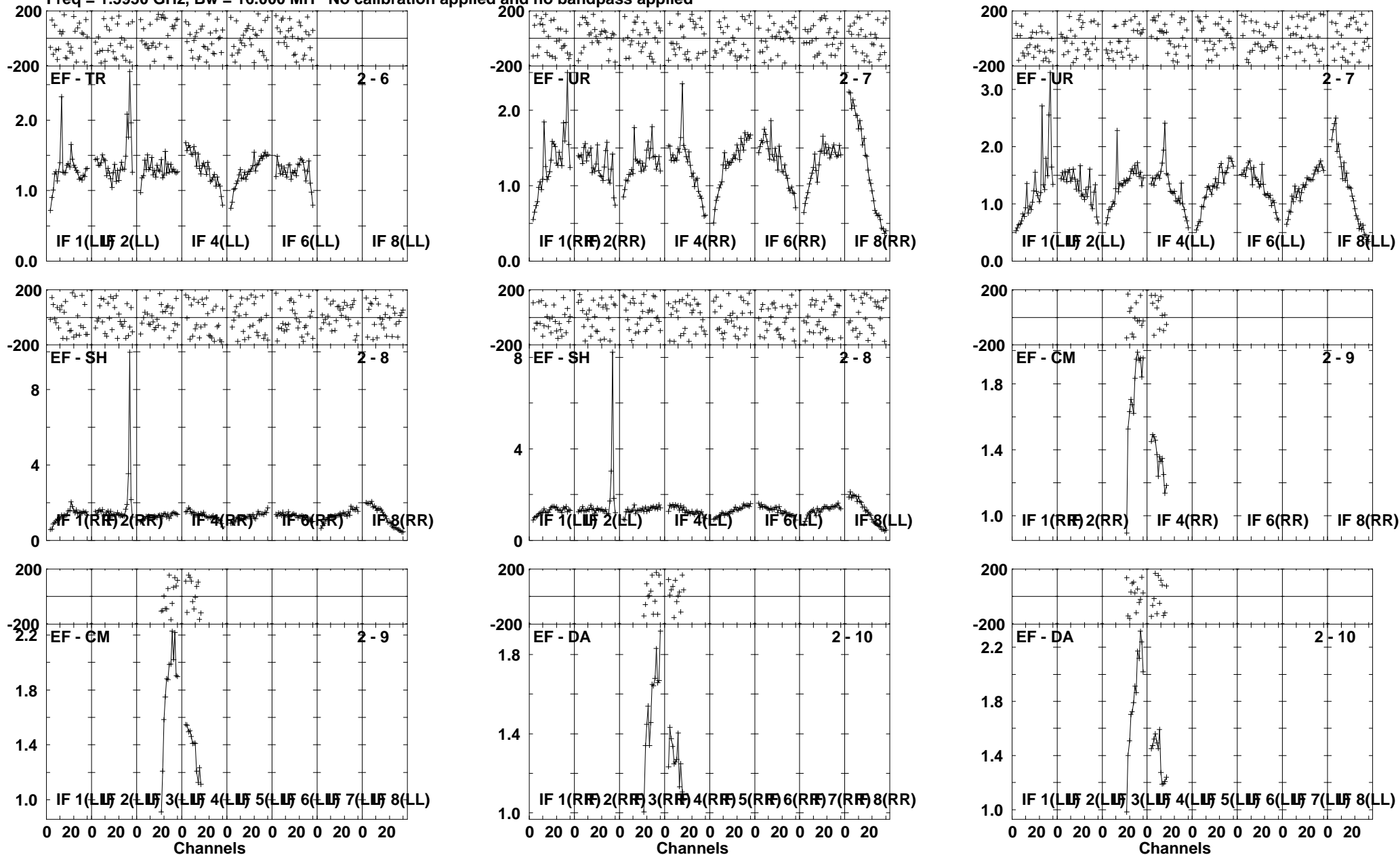

Lower frame: Milli Ampl Jy Top frame: Phas deg
Scalar averaged cross-power spectrum Several baselines displayed
Timerange: 00/22:45:31 to 00/22:48:59

Plot file version 45 created 23-AUG-2010 12:33:47

J1941-05 EP064P.UVDATA.1

Freq = 1.5950 GHz, Bw = 16.000 MH No calibration applied and no bandpass applied

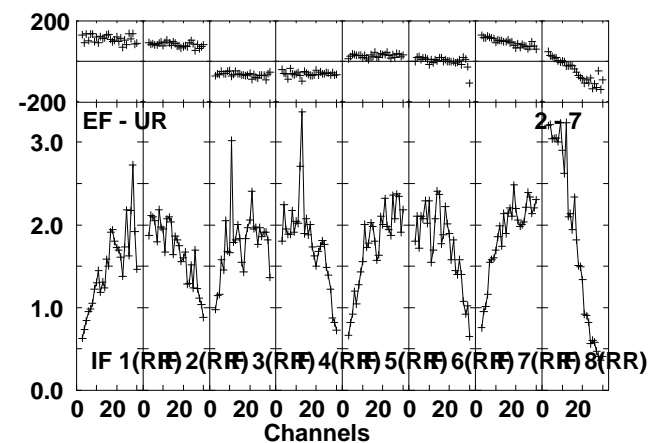
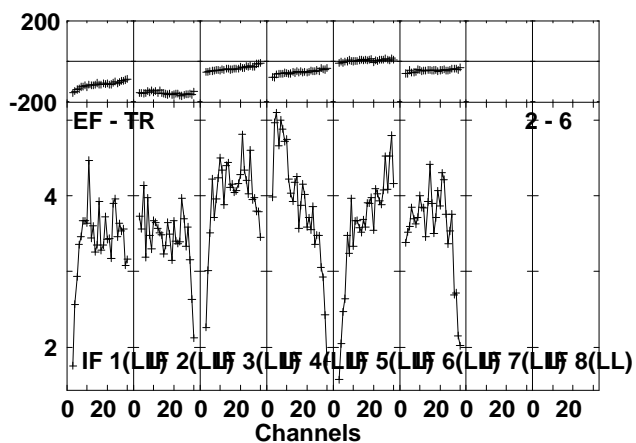
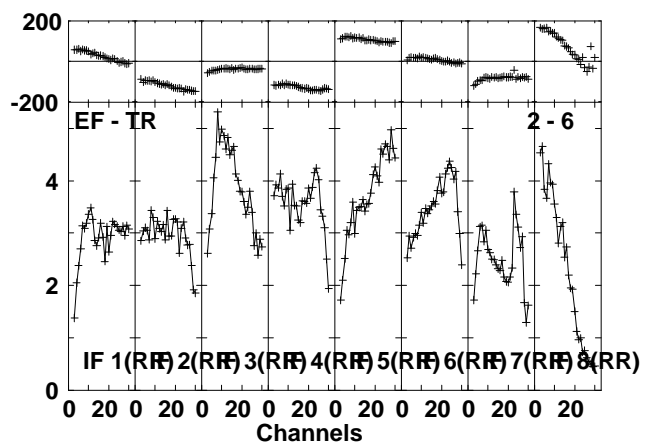
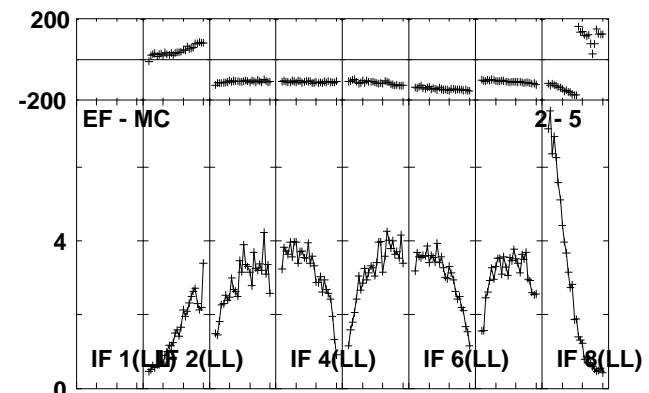
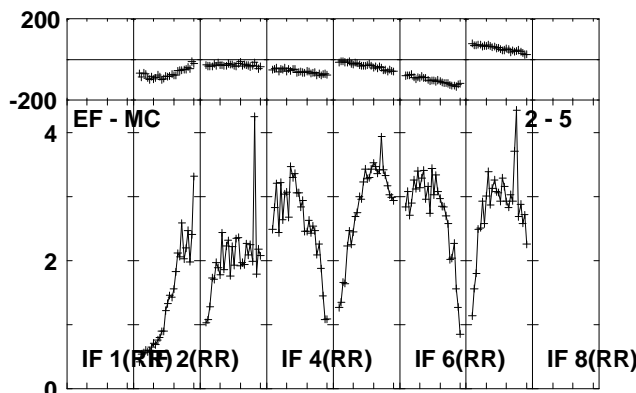
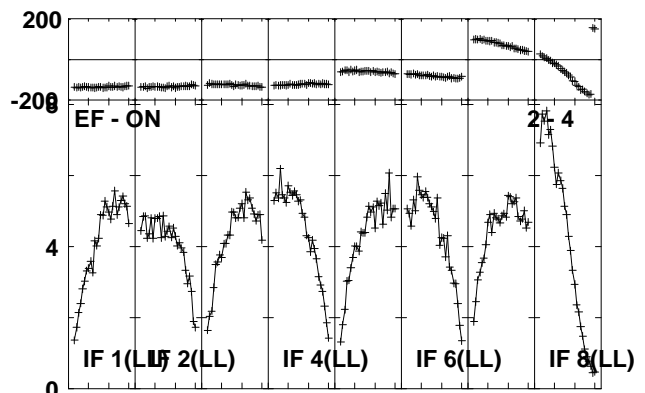
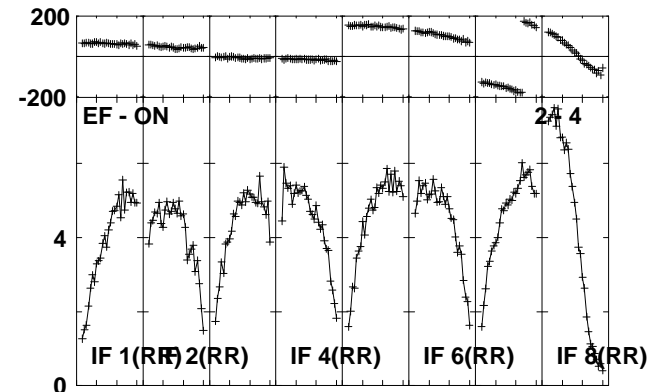
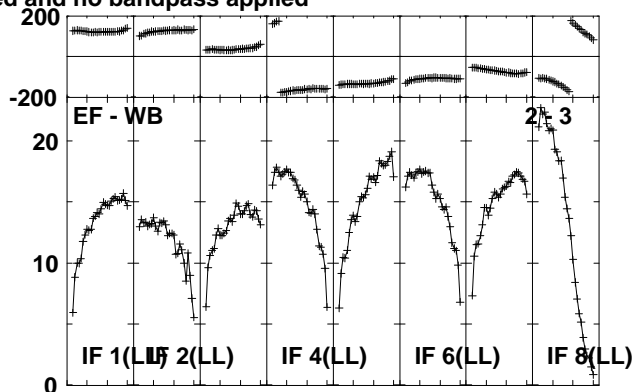
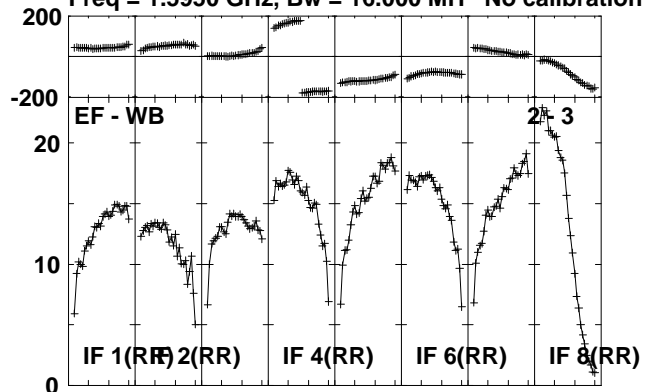

Lower frame: Milli Ampl Jy Top frame: Phas deg
Scalar averaged cross-power spectrum Several baselines displayed
Timerange: 00/22:49:01 to 00/22:50:29

Plot file version 46 created 23-AUG-2010 12:33:48

J1941-05 EP064P.UVDATA.1

Freq = 1.5950 GHz, Bw = 16.000 MH No calibration applied and no bandpass applied

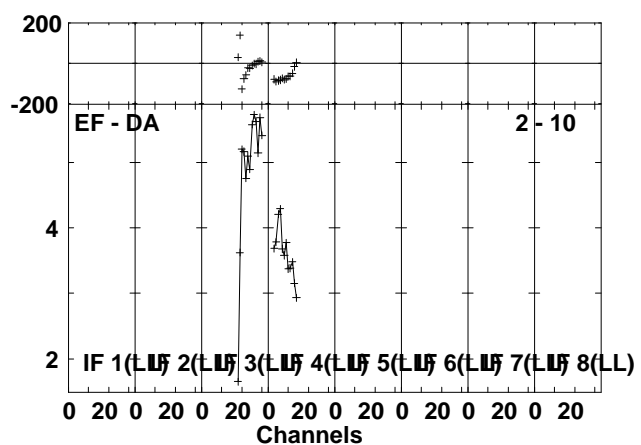
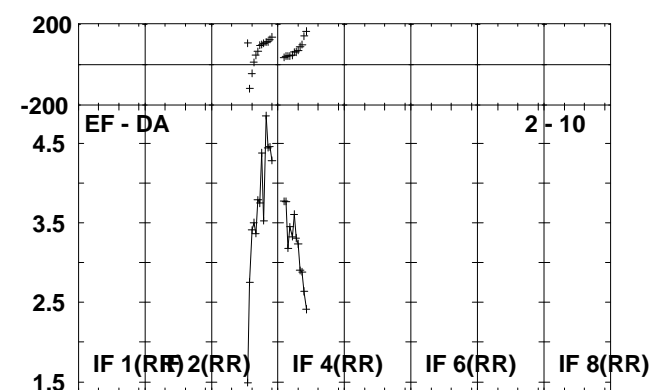
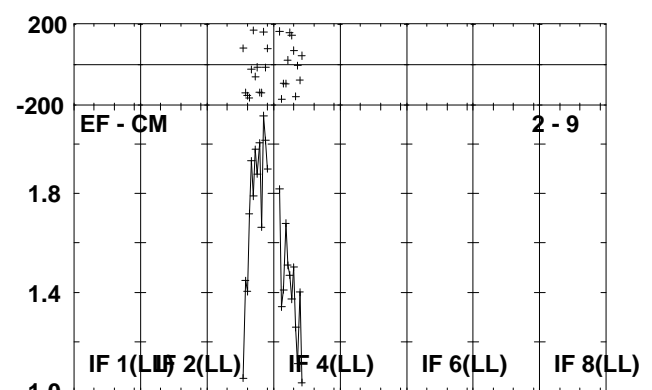
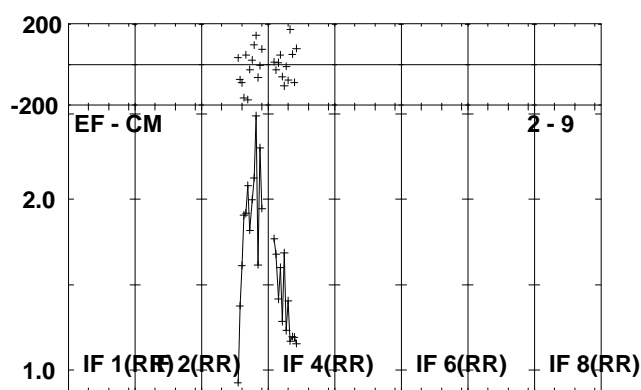
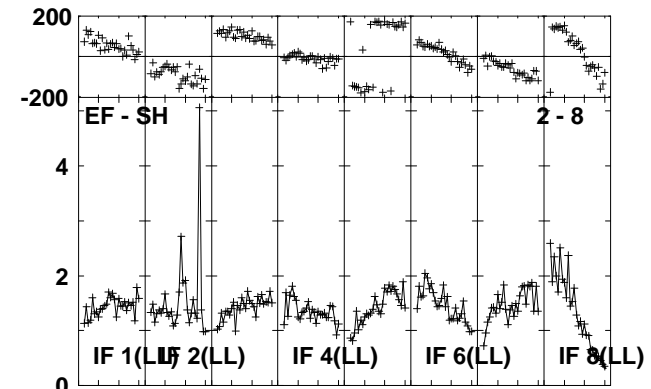
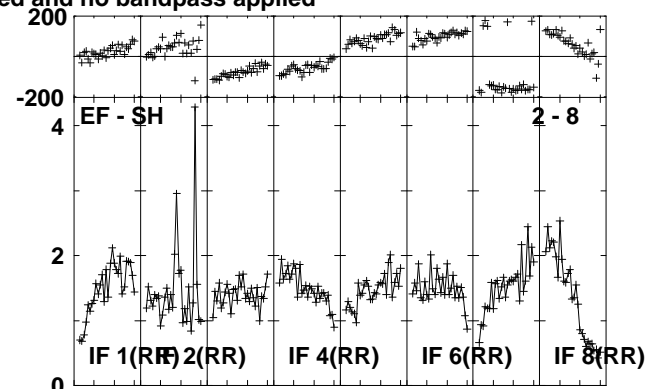
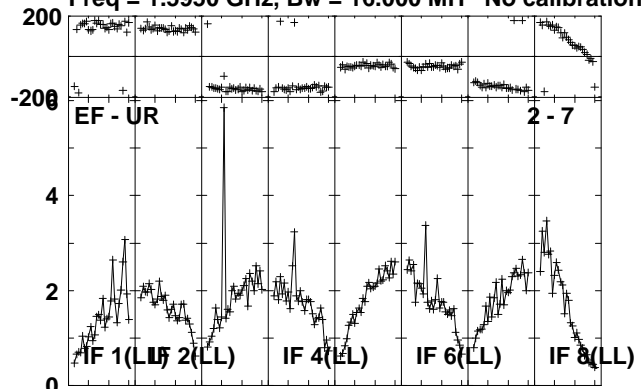

Lower frame: Milli Ampl Jy Top frame: Phas deg
Scalar averaged cross-power spectrum Several baselines displayed
Timerange: 00/22:49:01 to 00/22:50:29

Plot file version 47 created 23-AUG-2010 12:33:49

IRAS1929 EP064P.UVDATA.1

Freq = 1.5950 GHz, Bw = 16.000 MH No calibration applied and no bandpass applied

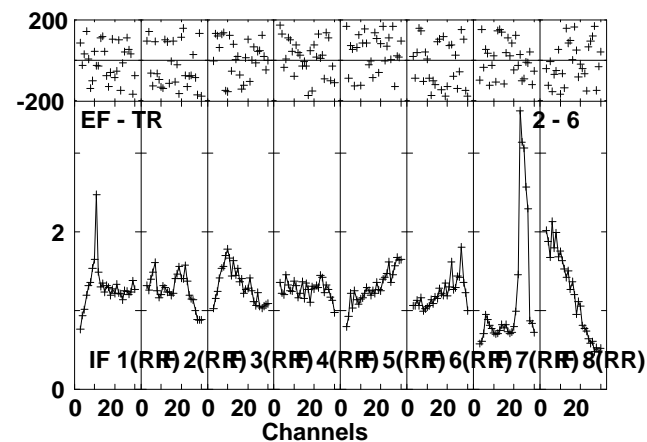
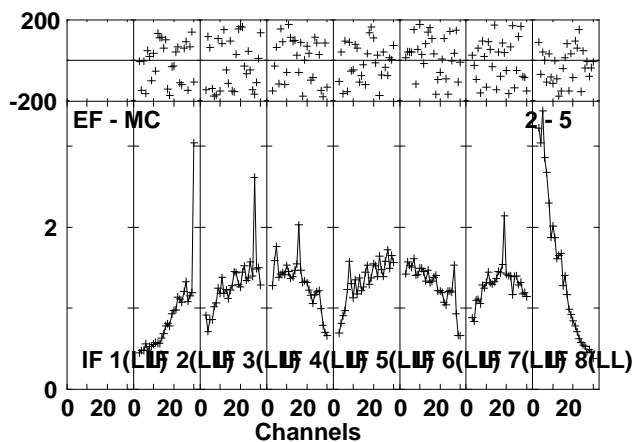
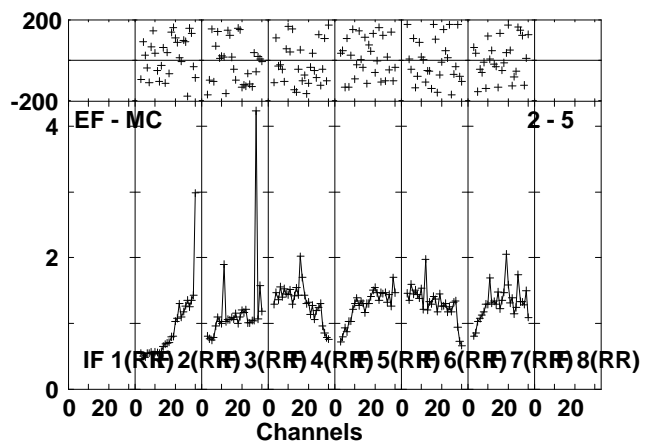
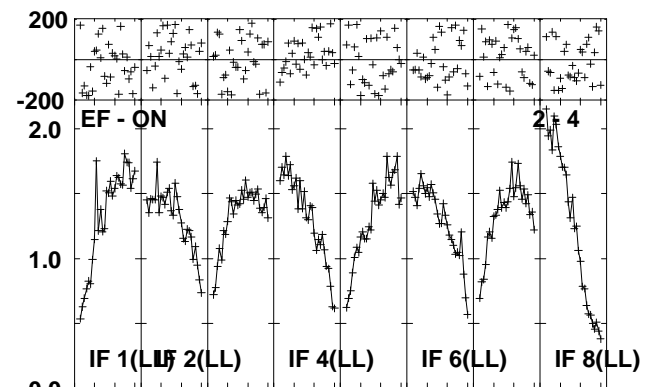
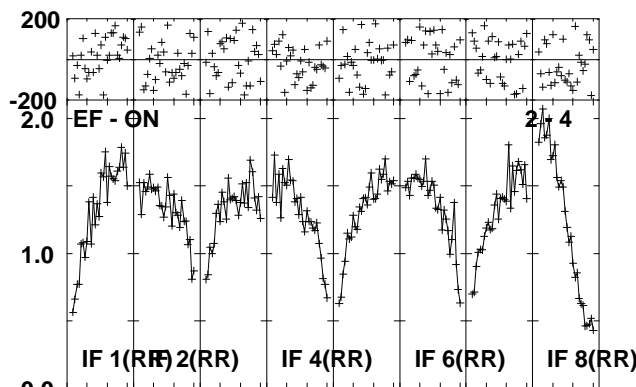
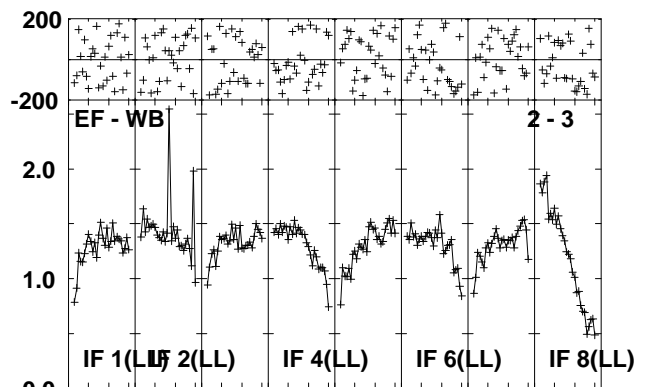
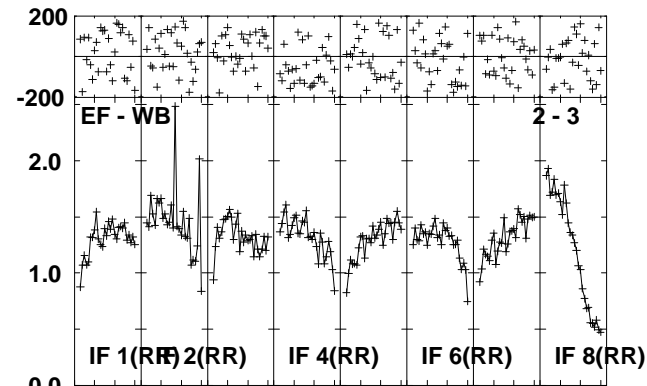
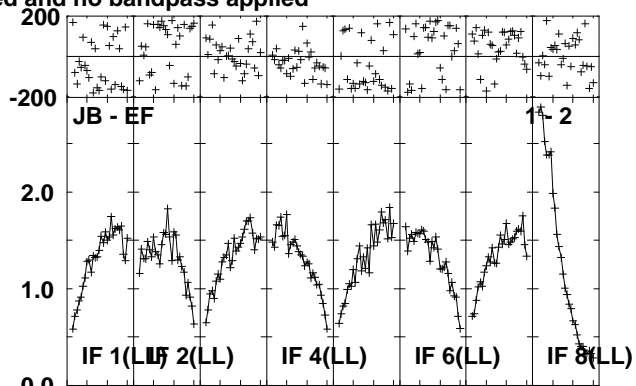
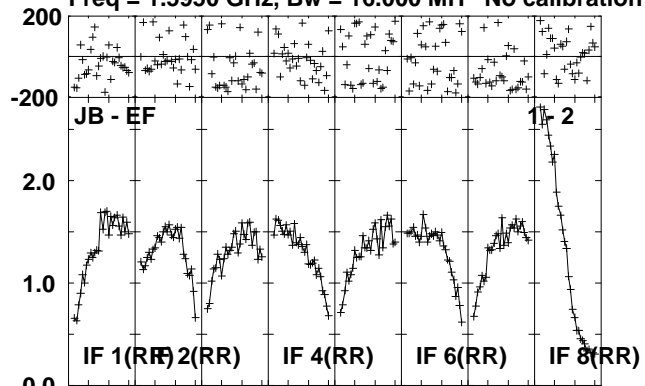

Lower frame: Milli Ampl Jy Top frame: Phas deg
Scalar averaged cross-power spectrum Several baselines displayed
Timerange: 00/22:50:31 to 00/22:53:59

Plot file version 48 created 23-AUG-2010 12:33:51

IRAS1929 EP064P.UVDATA.1

Freq = 1.5950 GHz, Bw = 16.000 MH No calibration applied and no bandpass applied

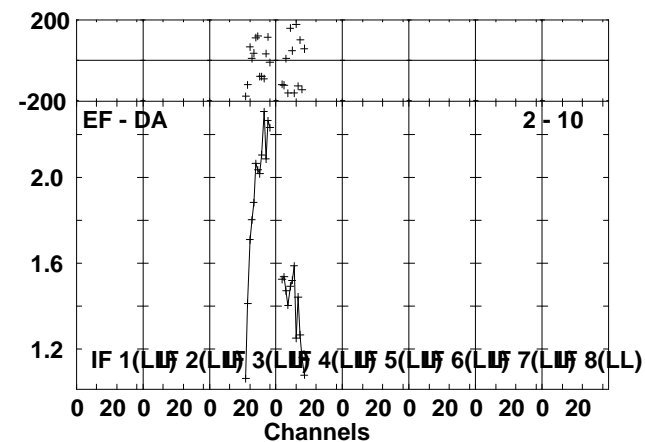
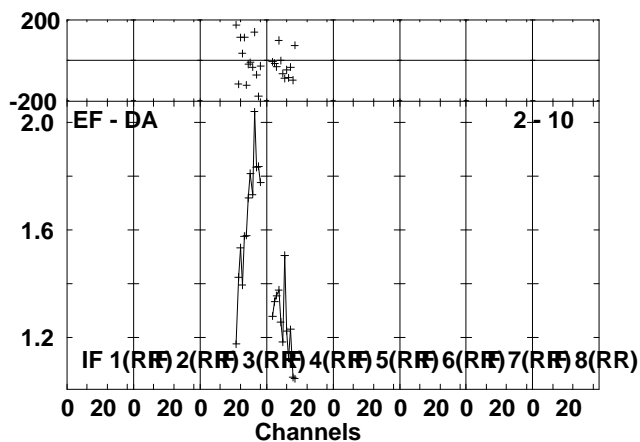
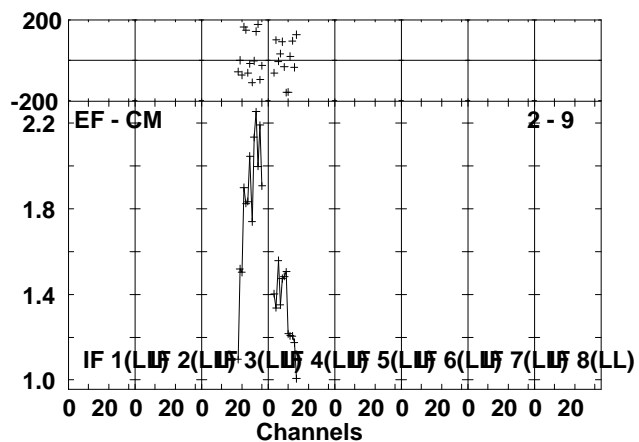
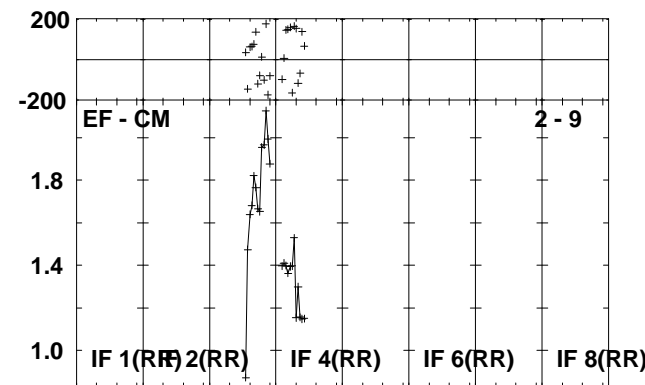
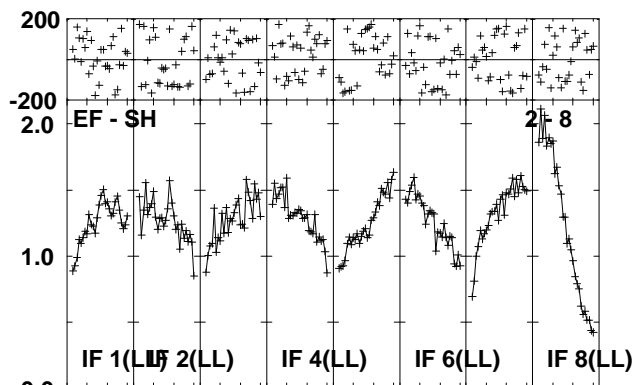
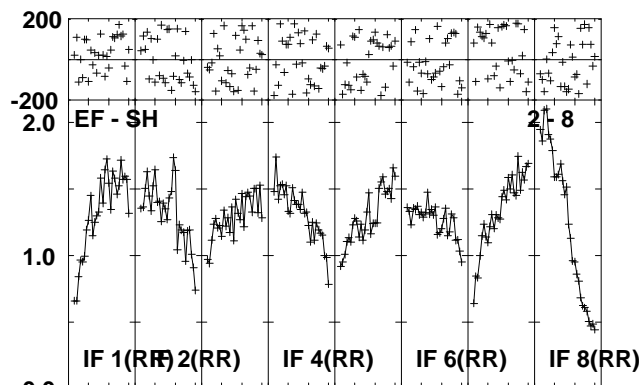
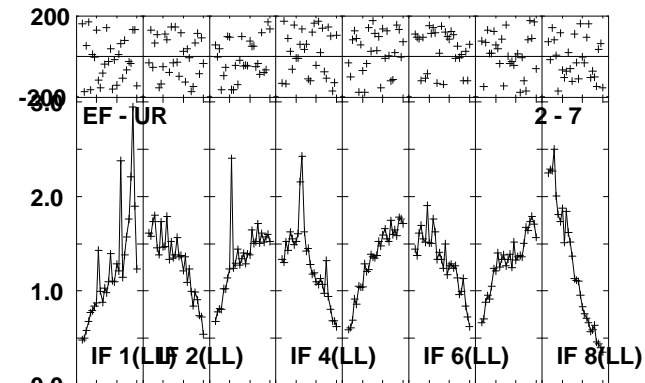
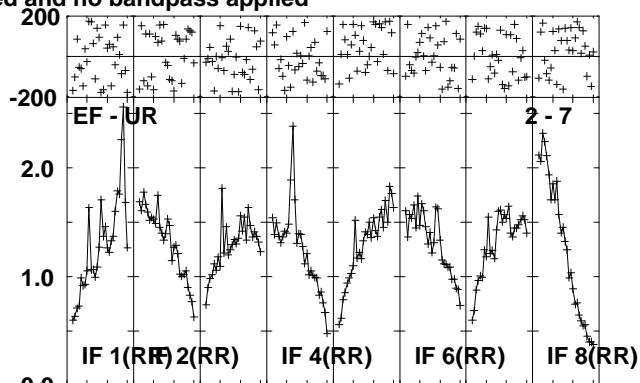
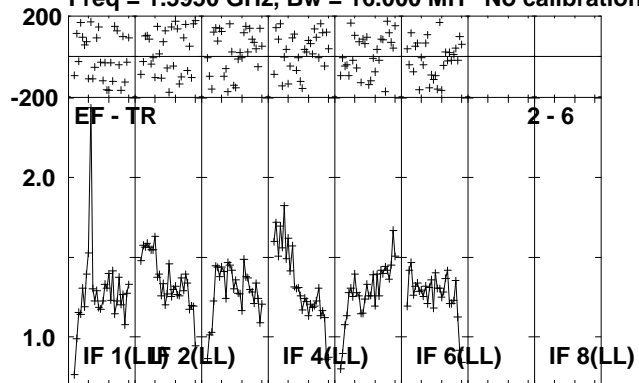

Lower frame: Milli Ampl Jy Top frame: Phas deg
Scalar averaged cross-power spectrum Several baselines displayed
Timerange: 00/22:50:31 to 00/22:53:59

Plot file version 49 created 23-AUG-2010 12:33:53

J1941-05 EP064P.UVDATA.1

Freq = 1.5950 GHz, Bw = 16.000 MH No calibration applied and no bandpass applied

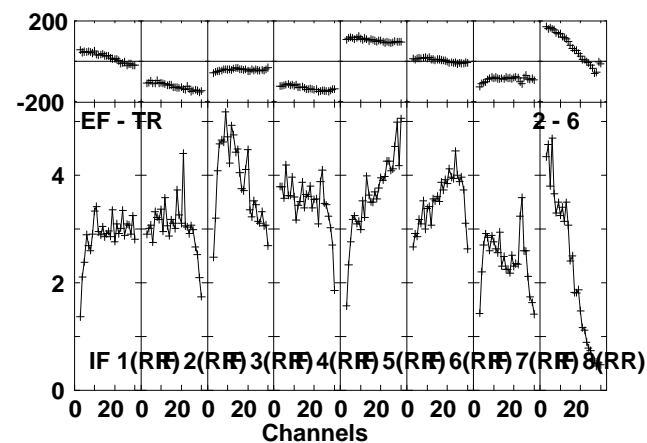
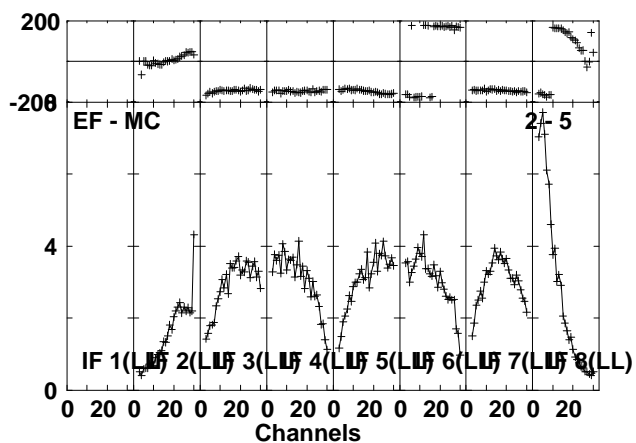
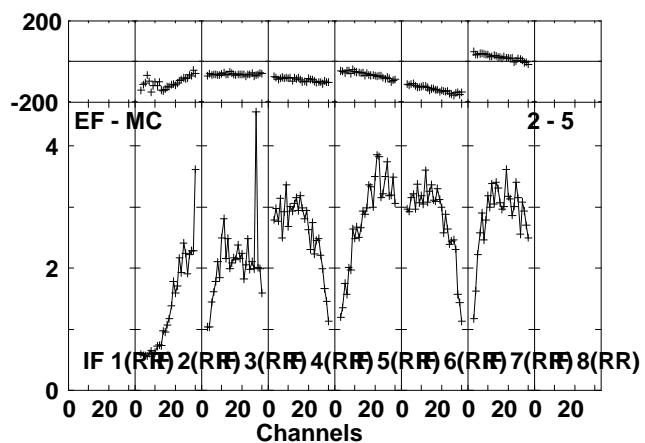
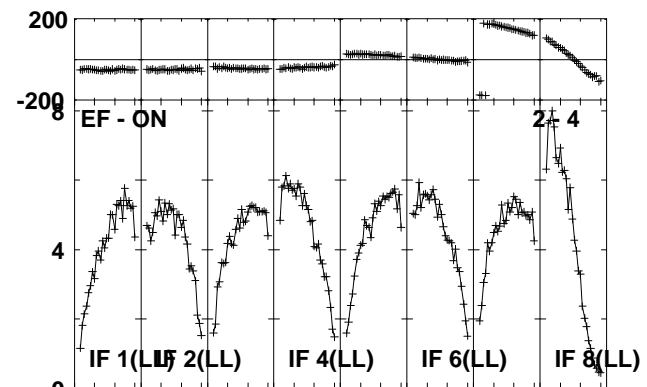
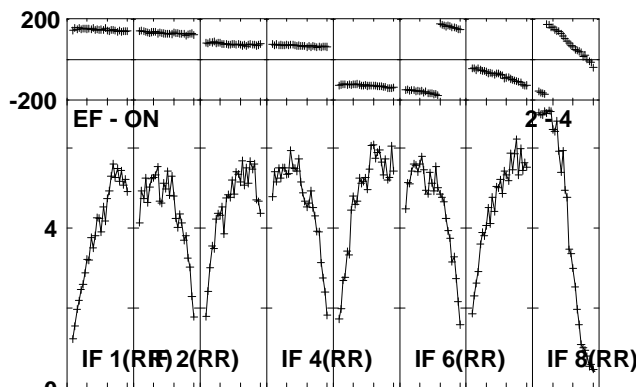
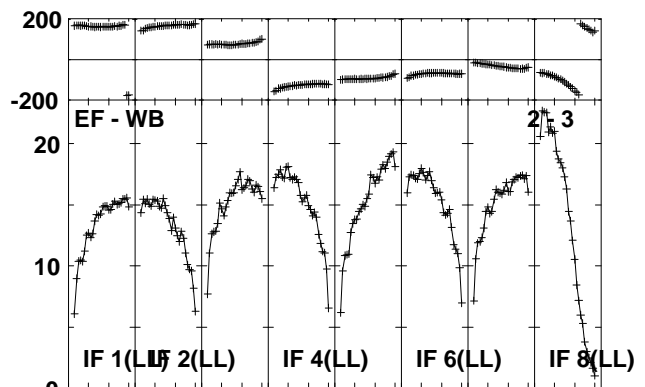
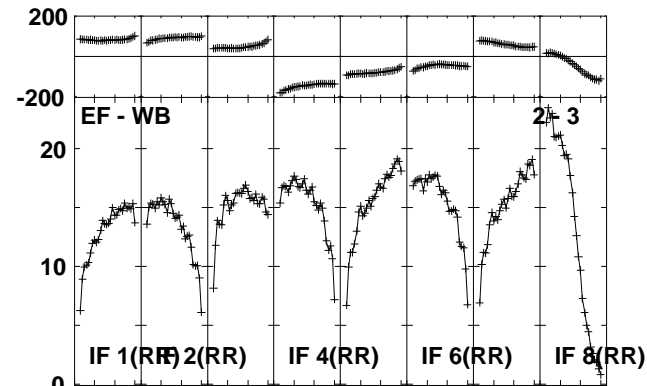
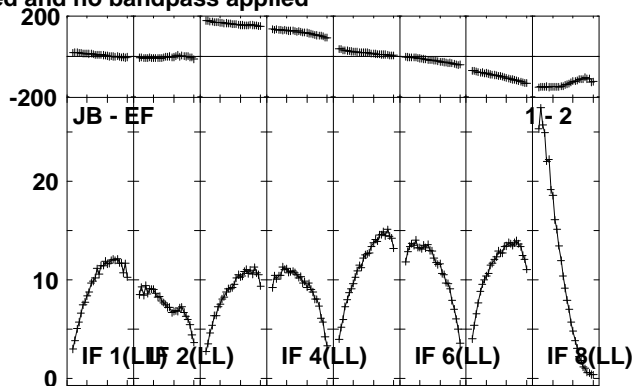
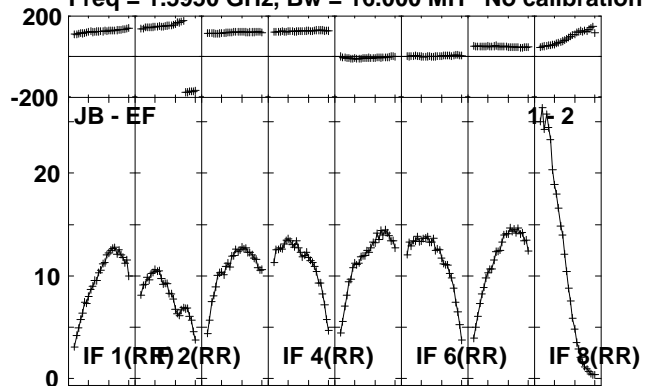

Lower frame: Milli Ampl Jy Top frame: Phas deg
Scalar averaged cross-power spectrum Several baselines displayed
Timerange: 00/22:54:01 to 00/22:55:29

Plot file version 50 created 23-AUG-2010 12:33:54

J1941-05 EP064P.UVDATA.1

Freq = 1.5950 GHz, Bw = 16.000 MH No calibration applied and no bandpass applied

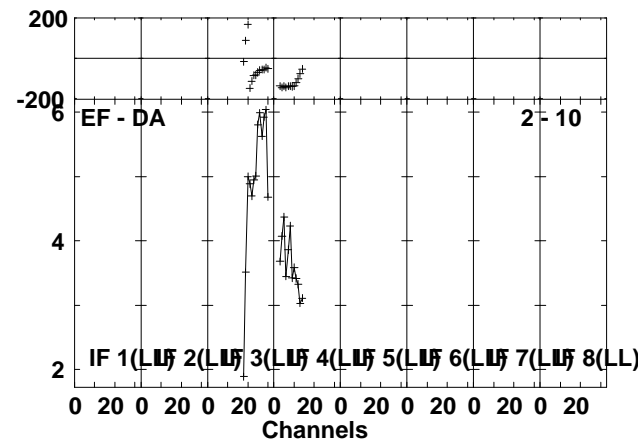
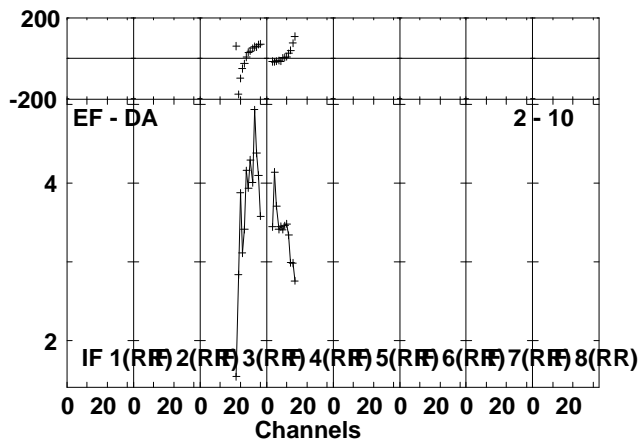
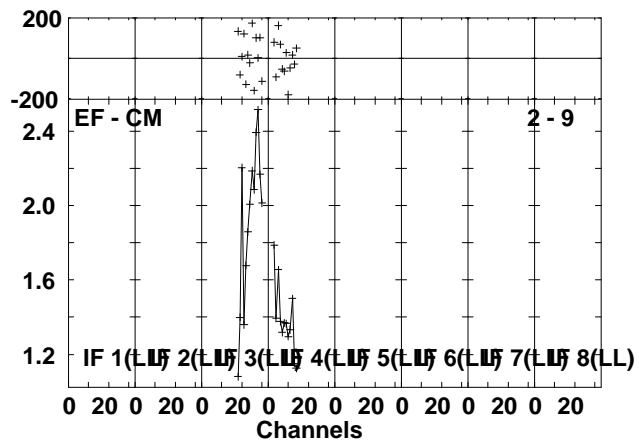
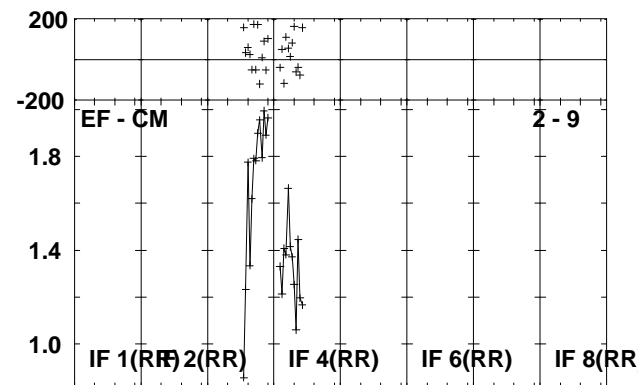
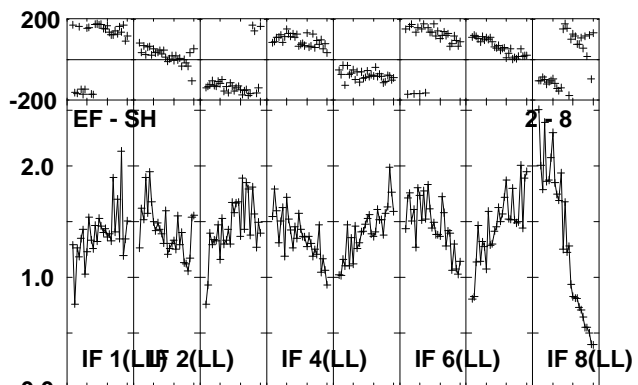
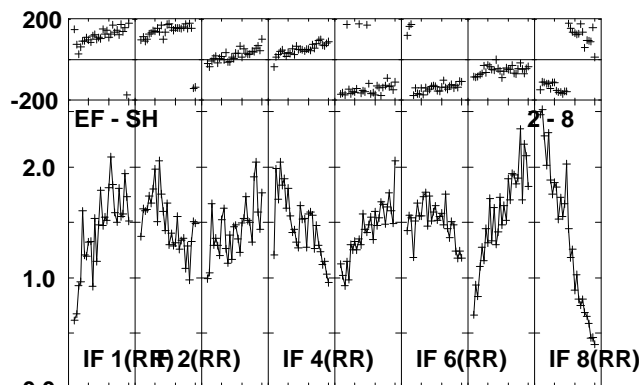
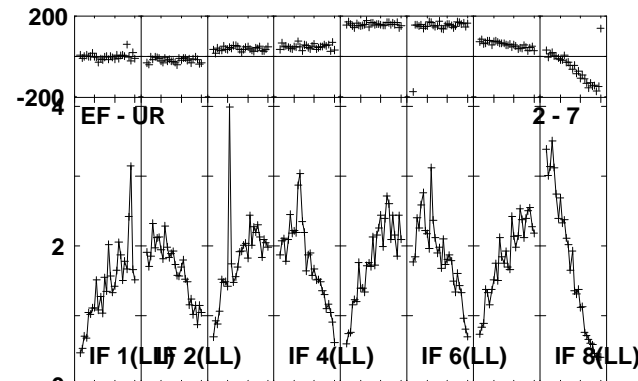
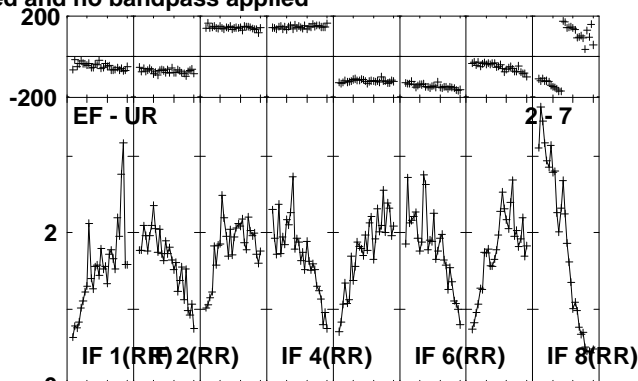
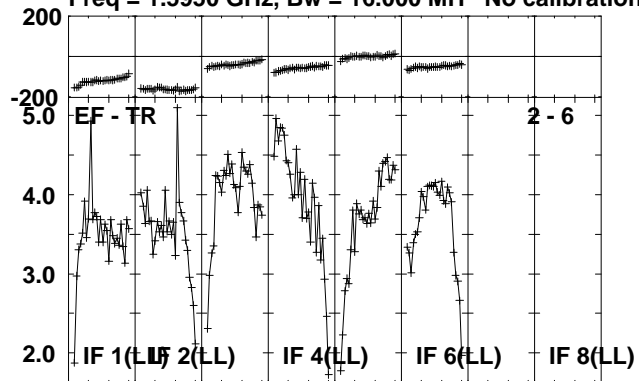

Lower frame: Milli Ampl Jy Top frame: Phas deg
Scalar averaged cross-power spectrum Several baselines displayed
Timerange: 00/22:54:01 to 00/22:55:29

Plot file version 51 created 23-AUG-2010 12:33:55

IRAS1929 EP064P.UVDATA.1

Freq = 1.5950 GHz, Bw = 16.000 MH No calibration applied and no bandpass applied

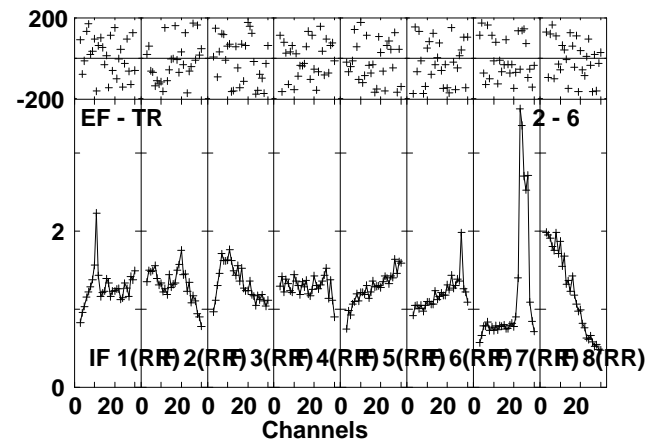
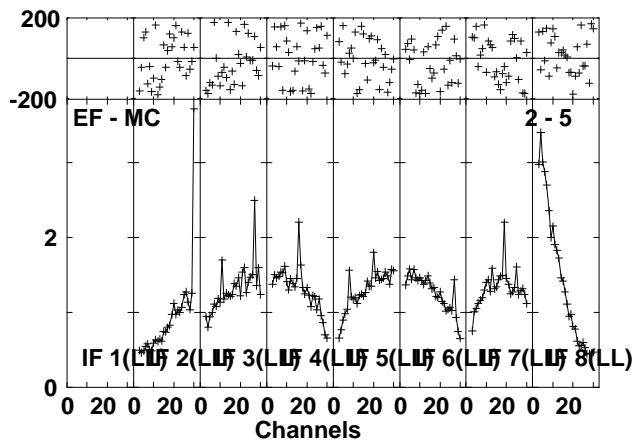
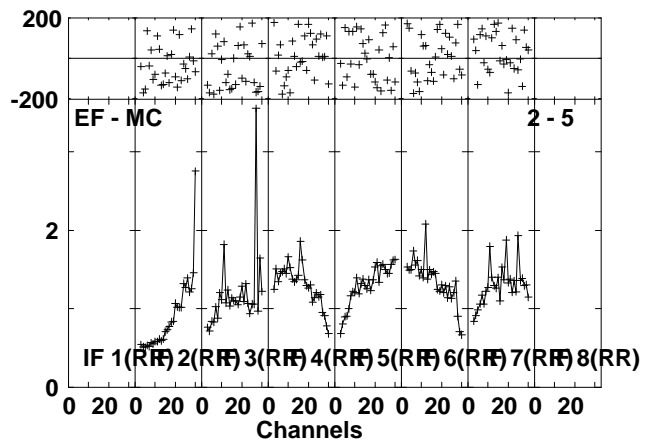
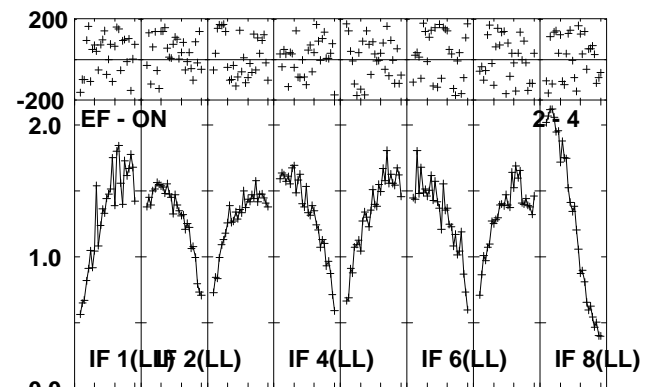
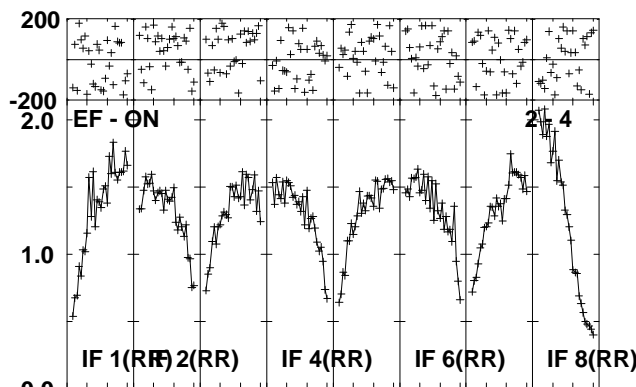
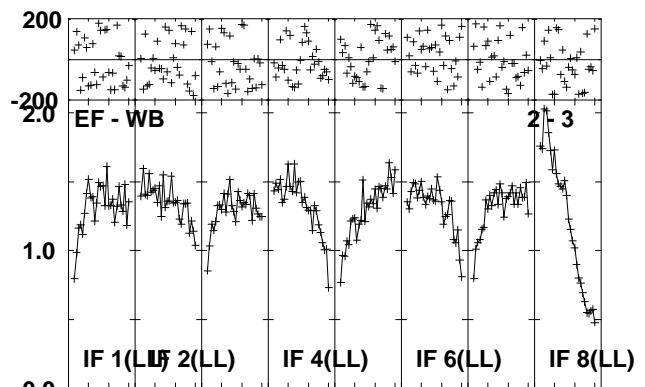
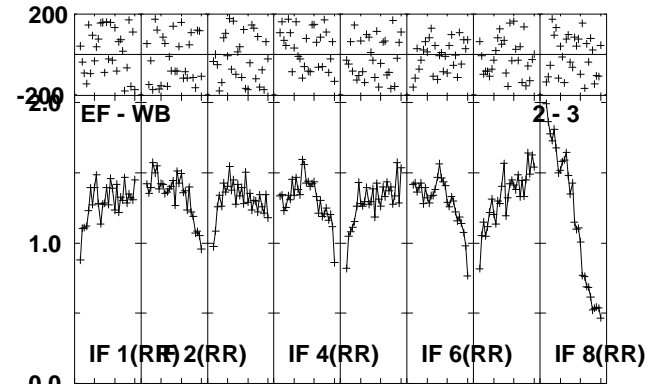
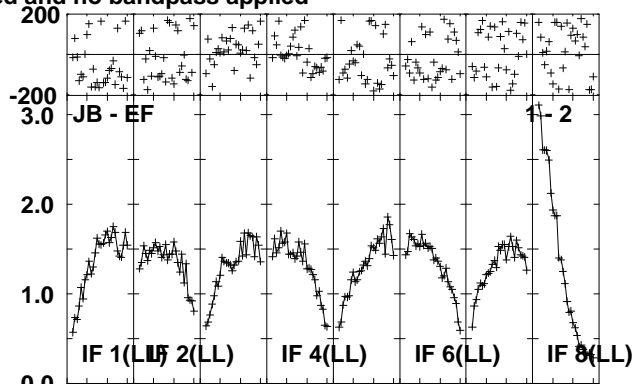
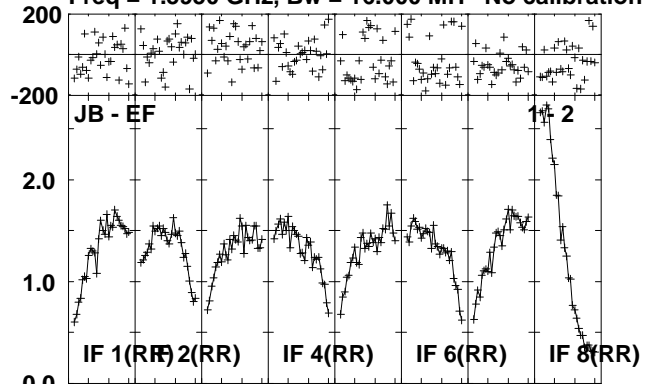

Lower frame: Milli Ampl Jy Top frame: Phas deg
Scalar averaged cross-power spectrum Several baselines displayed
Timerange: 00/22:55:31 to 00/22:58:59

Plot file version 52 created 23-AUG-2010 12:33:57

IRAS1929 EP064P.UVDATA.1

Freq = 1.5950 GHz, Bw = 16.000 MH No calibration applied and no bandpass applied

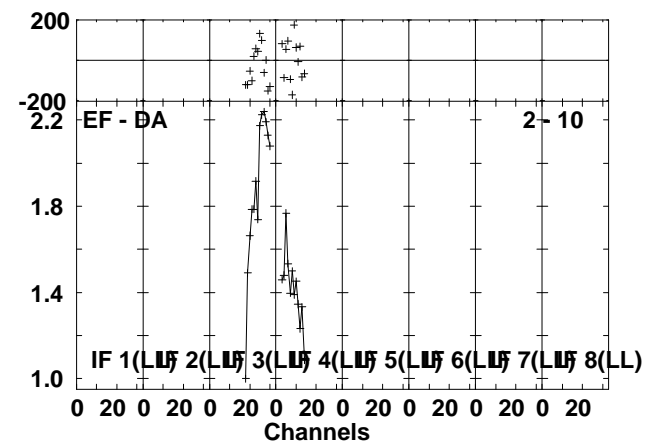
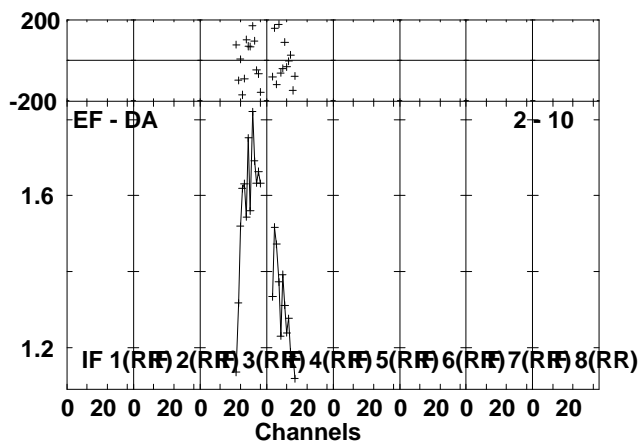
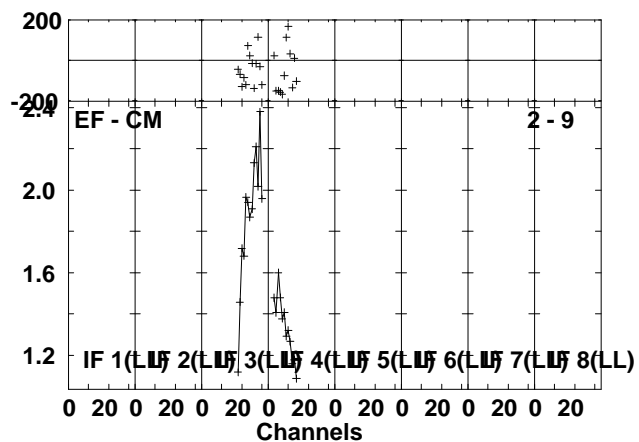
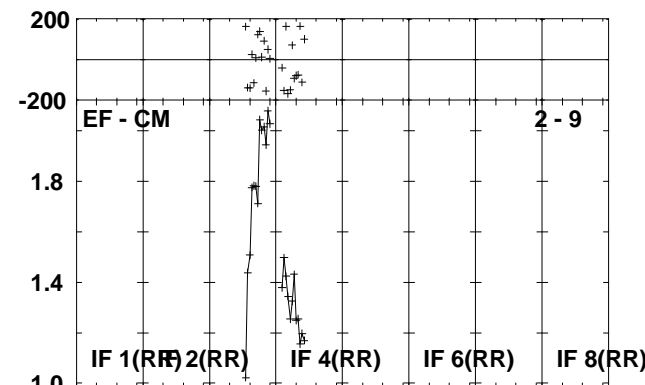
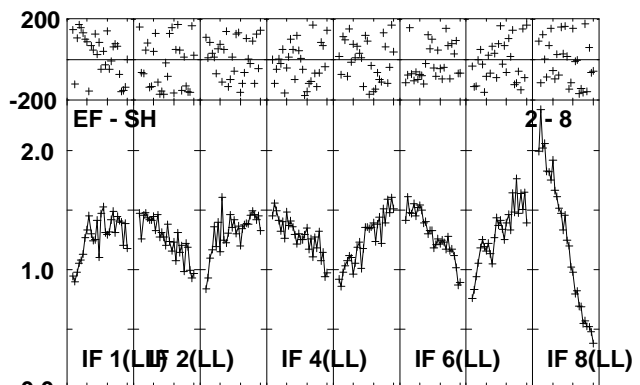
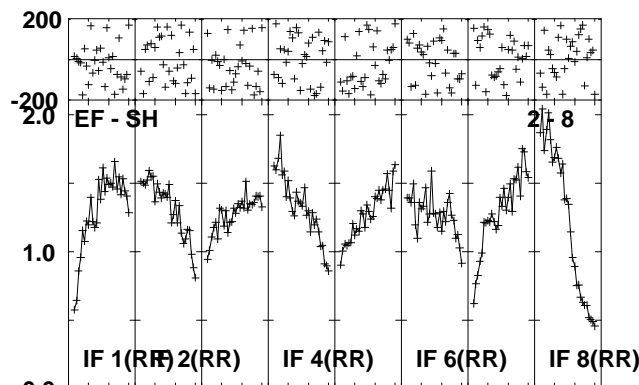
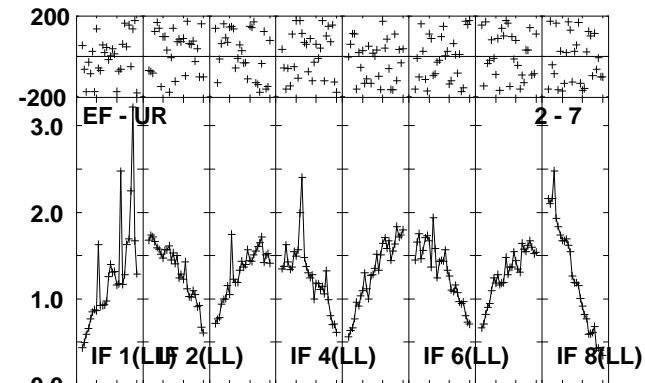
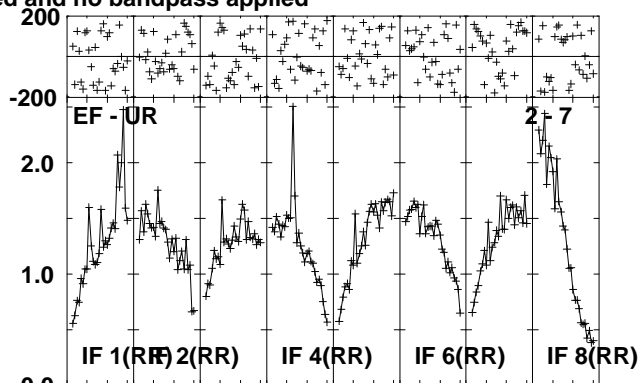
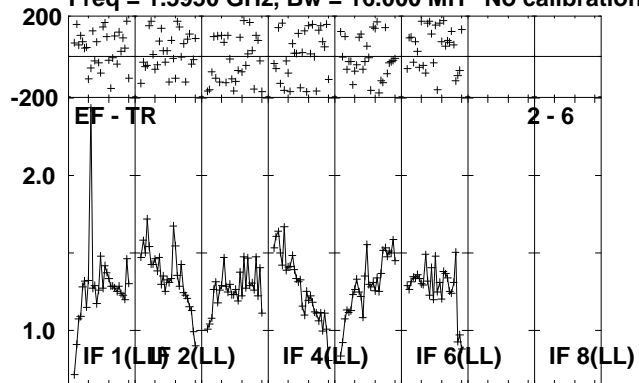

Lower frame: Milli Ampl Jy Top frame: Phas deg
Scalar averaged cross-power spectrum Several baselines displayed
Timerange: 00/22:55:31 to 00/22:58:59

Plot file version 53 created 23-AUG-2010 12:34:00

J1941-05 EP064P.UVDATA.1

Freq = 1.5950 GHz, Bw = 16.000 MH No calibration applied and no bandpass applied

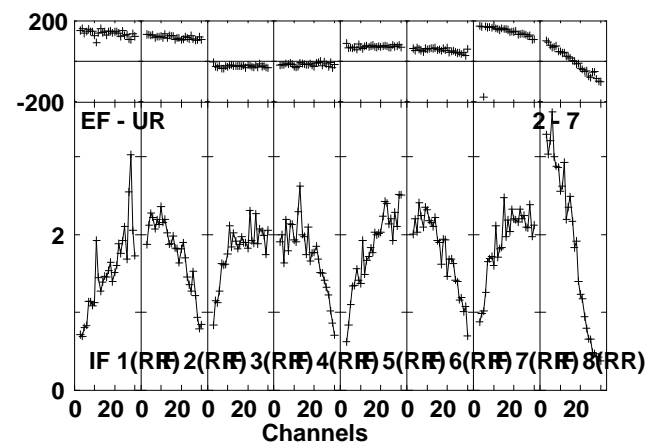
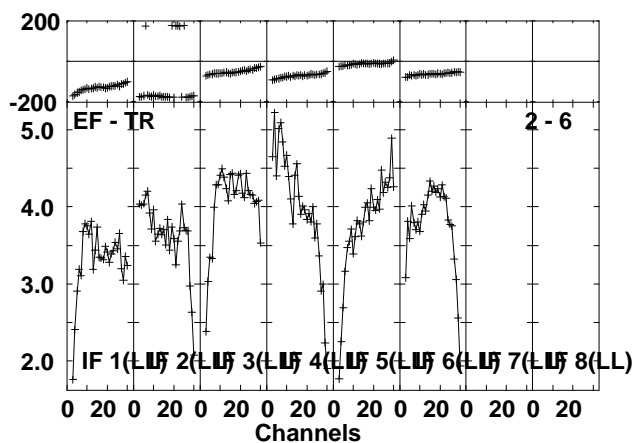
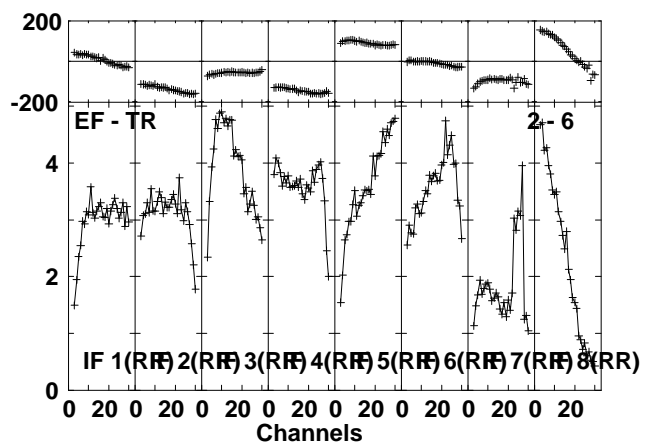
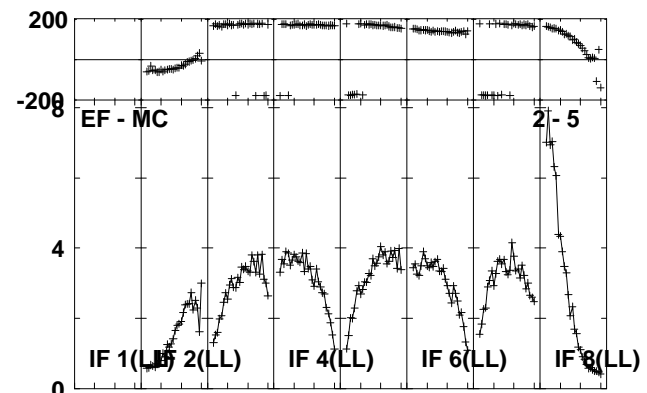
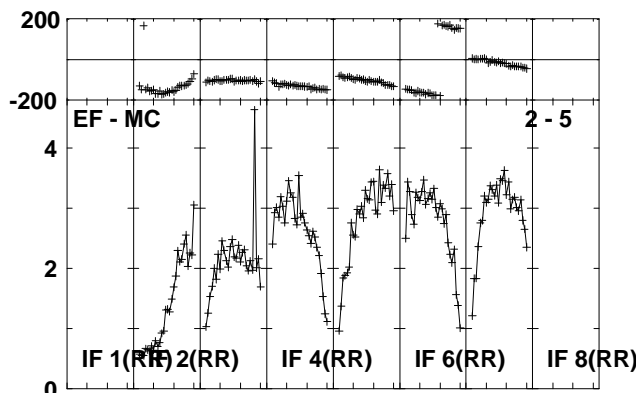
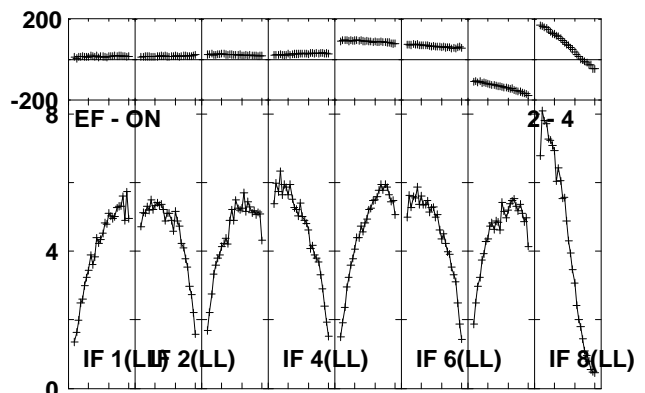
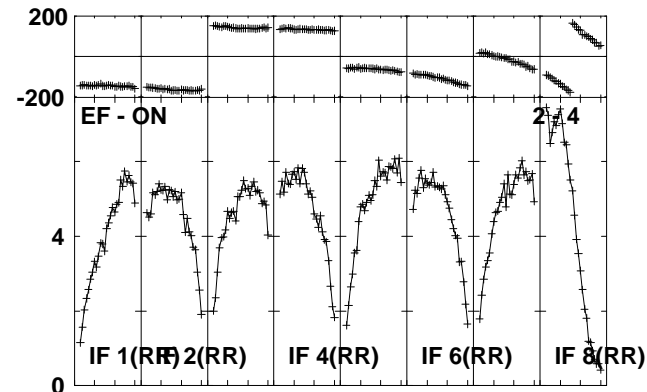
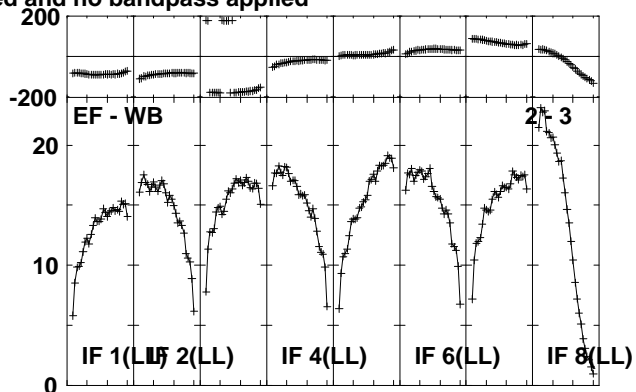
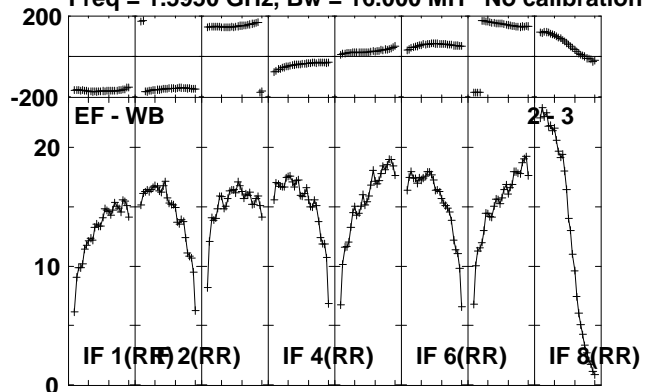

Lower frame: Milli Ampl Jy Top frame: Phas deg
Scalar averaged cross-power spectrum Several baselines displayed
Timerange: 00/23:00:01 to 00/23:01:27

Plot file version 54 created 23-AUG-2010 12:34:00

J1941-05 EP064P.UVDATA.1

Freq = 1.5950 GHz, Bw = 16.000 MH No calibration applied and no bandpass applied

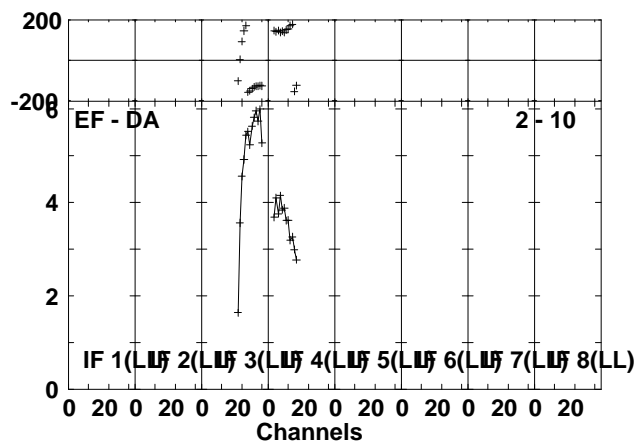
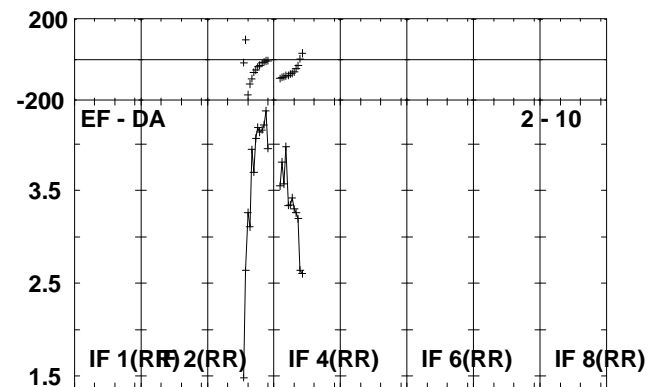
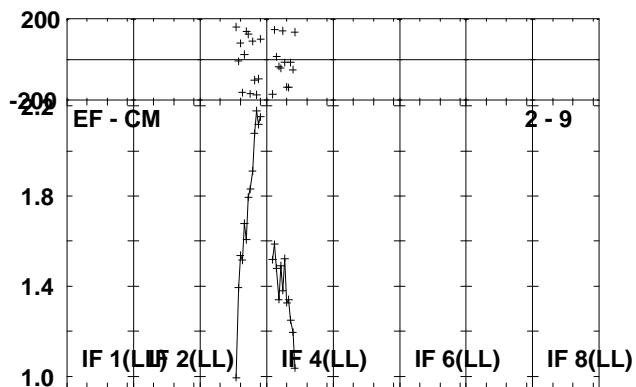
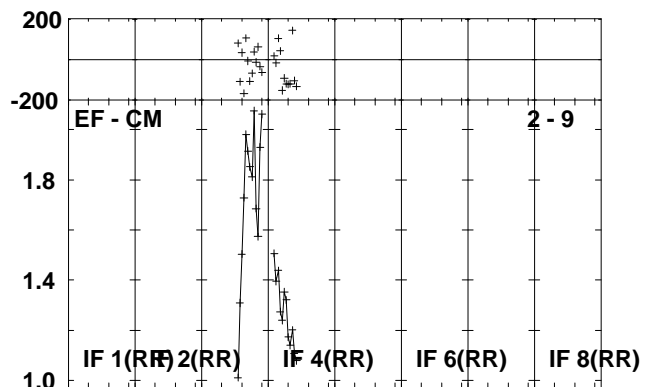
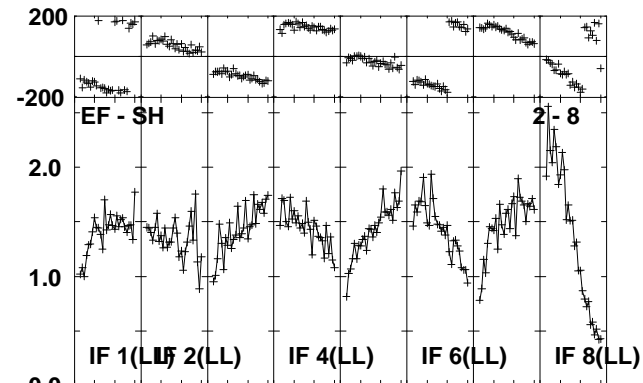
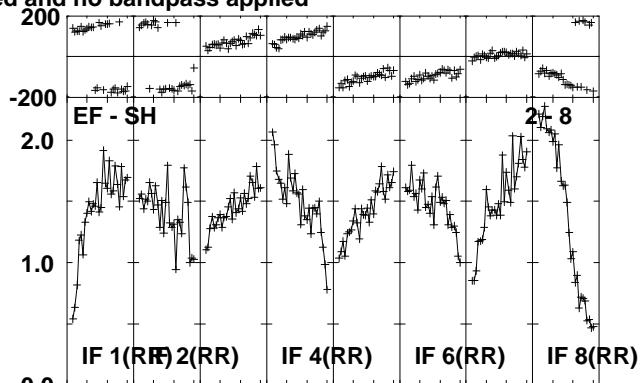
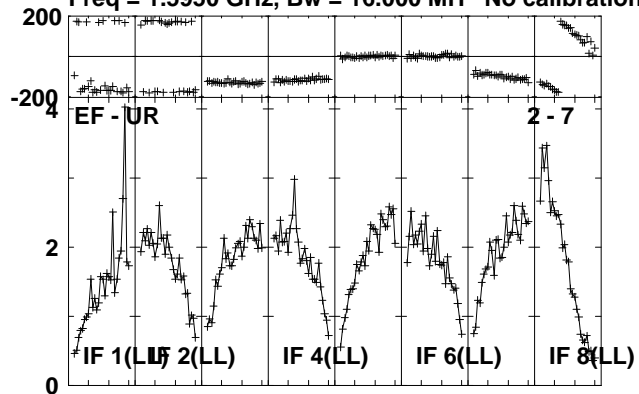

Lower frame: Milli Ampl Jy Top frame: Phas deg
Scalar averaged cross-power spectrum Several baselines displayed
Timerange: 00/23:00:01 to 00/23:01:27

Plot file version 55 created 23-AUG-2010 12:34:01

IRAS1929 EP064P.UVDATA.1

Freq = 1.5950 GHz, Bw = 16.000 MH No calibration applied and no bandpass applied

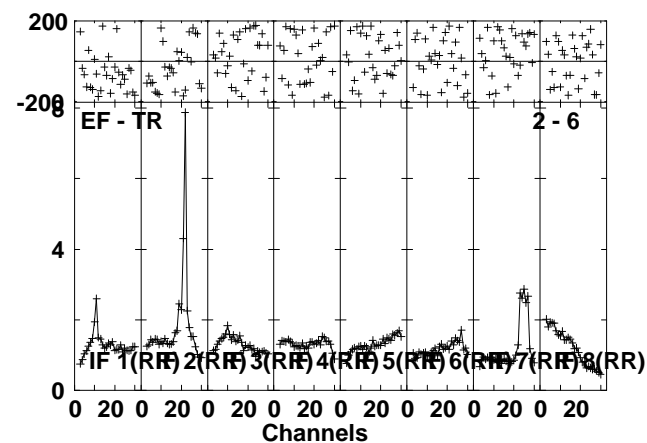
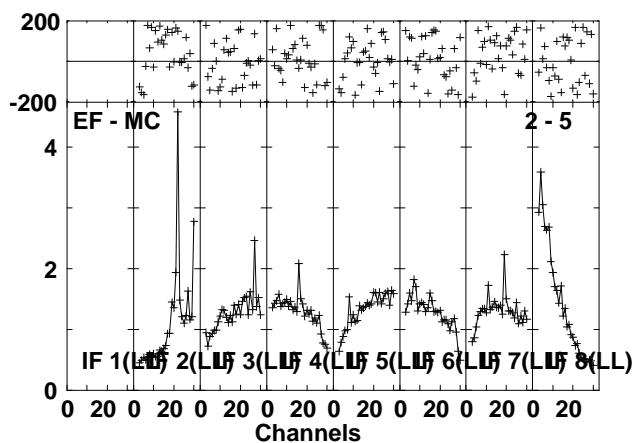
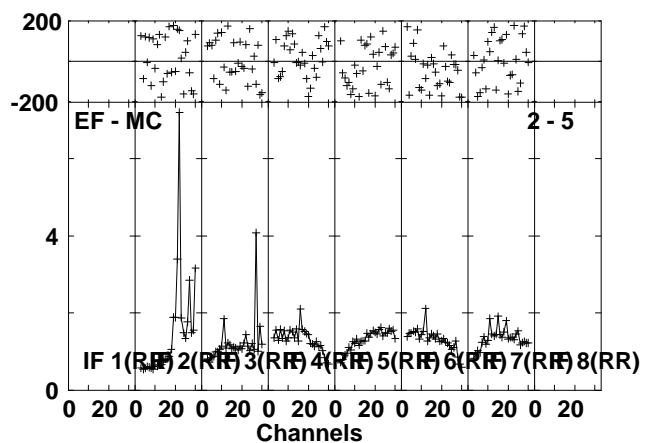
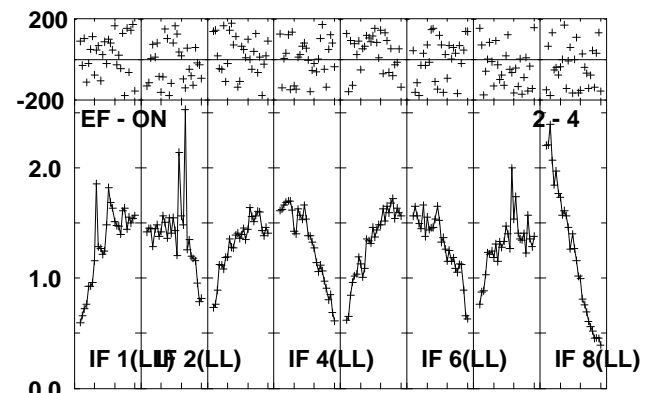
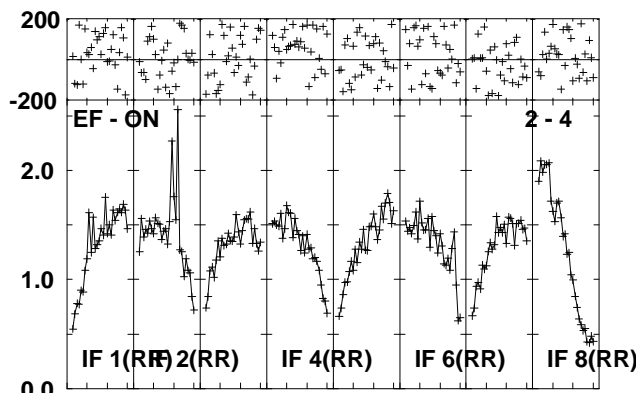
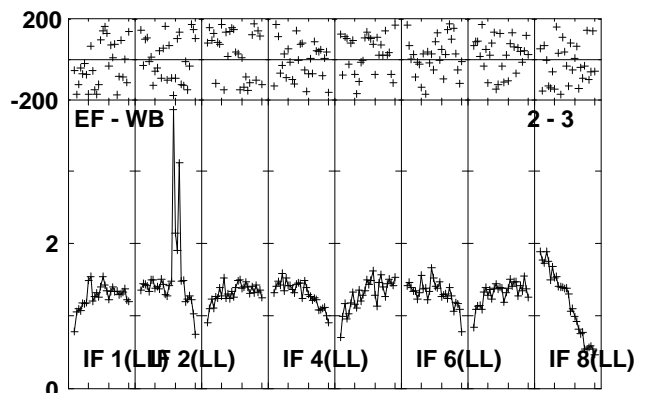
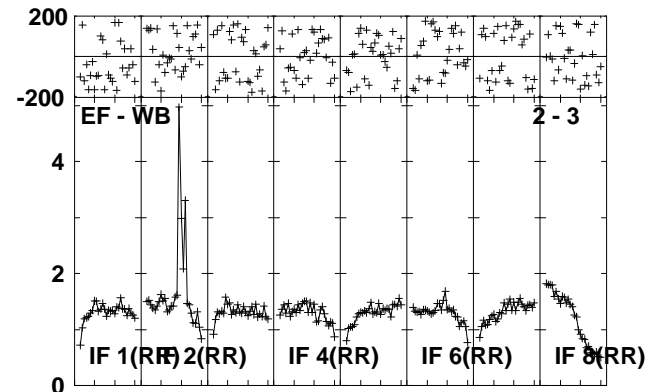
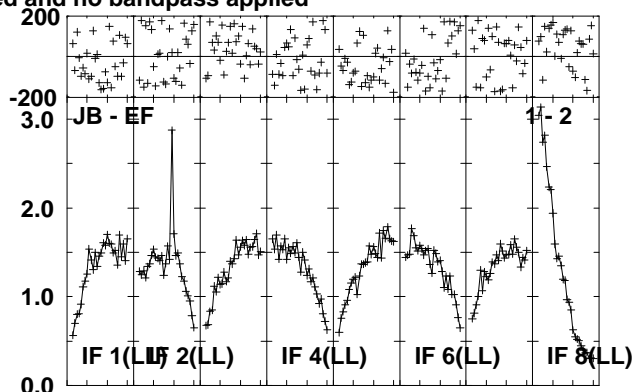
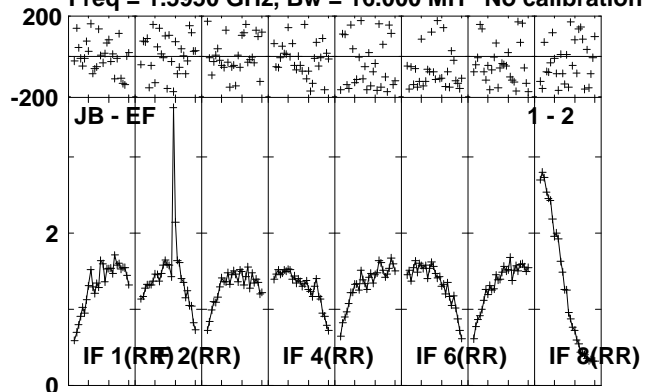

Lower frame: Milli Ampl Jy Top frame: Phas deg
Scalar averaged cross-power spectrum Several baselines displayed
Timerange: 00/23:01:31 to 00/23:04:59

Plot file version 56 created 23-AUG-2010 12:34:03

IRAS1929 EP064P.UVDATA.1

Freq = 1.5950 GHz, Bw = 16.000 MH No calibration applied and no bandpass applied

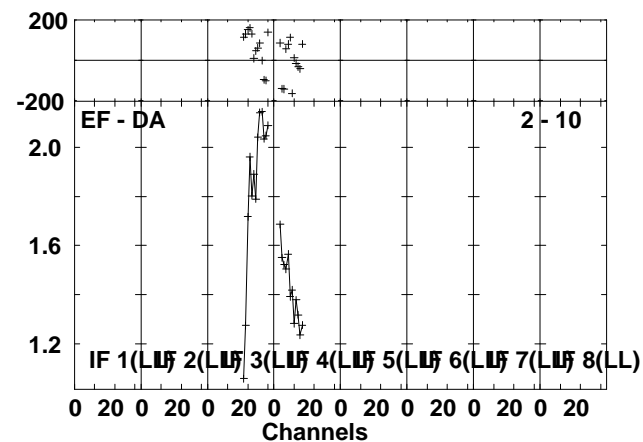
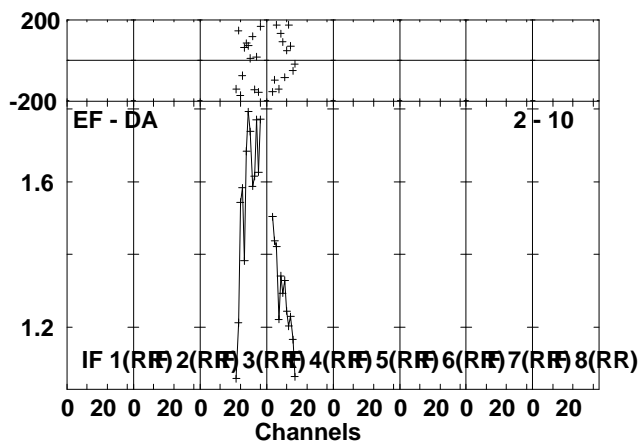
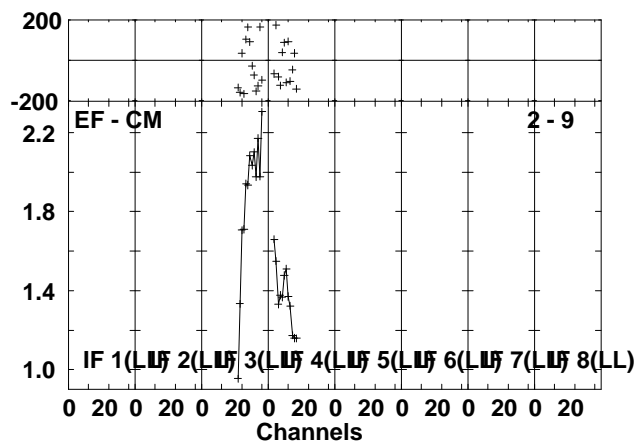
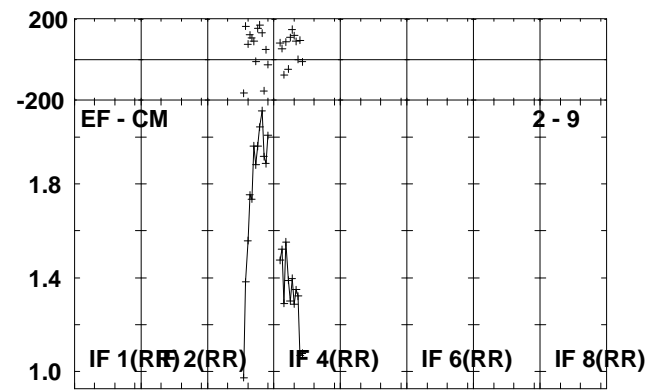
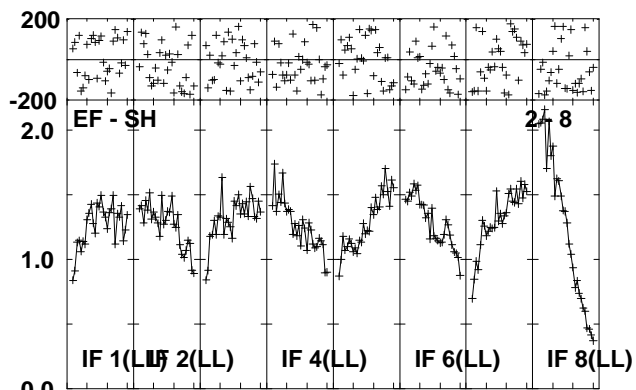
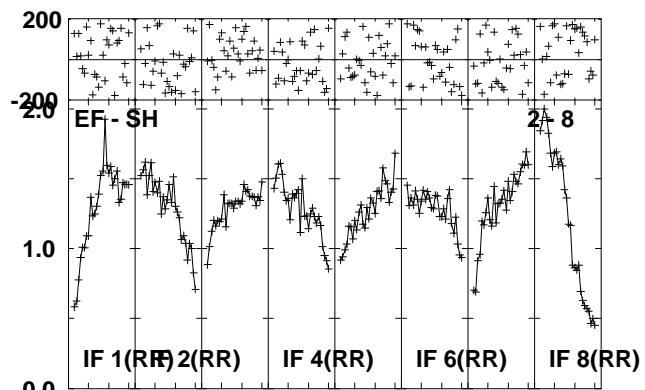
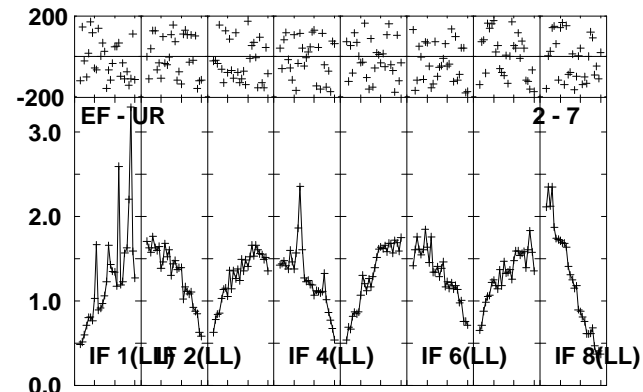
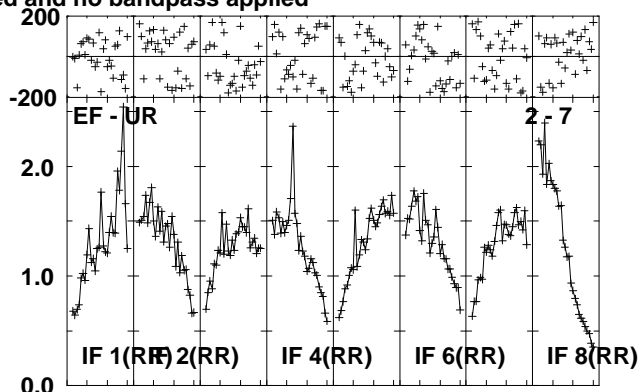
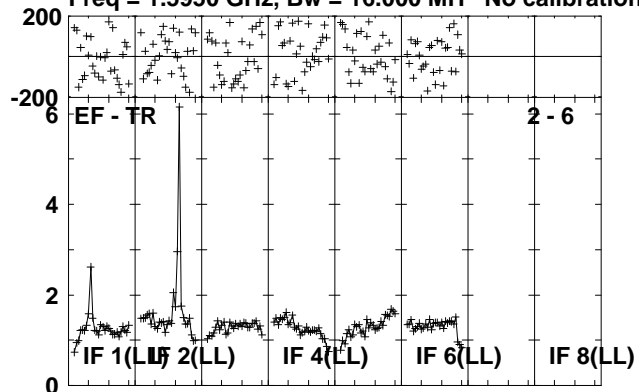

Lower frame: Milli Ampl Jy Top frame: Phas deg
Scalar averaged cross-power spectrum Several baselines displayed
Timerange: 00/23:01:31 to 00/23:04:59

Plot file version 57 created 23-AUG-2010 12:34:05

J1941-05 EP064P.UVDATA.1

Freq = 1.5950 GHz, Bw = 16.000 MH No calibration applied and no bandpass applied

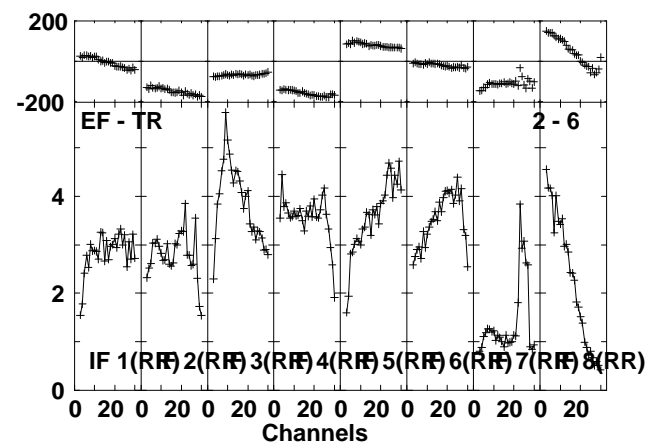
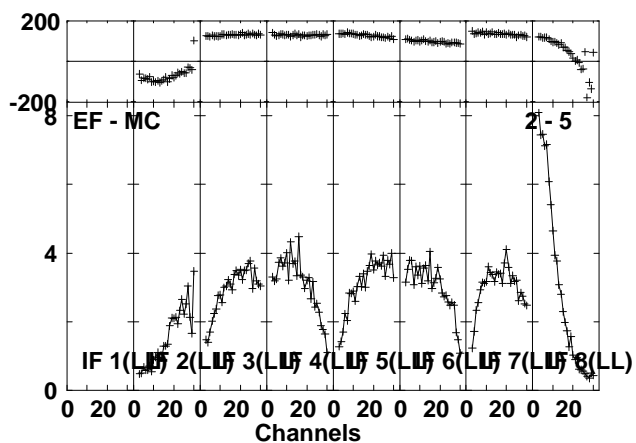
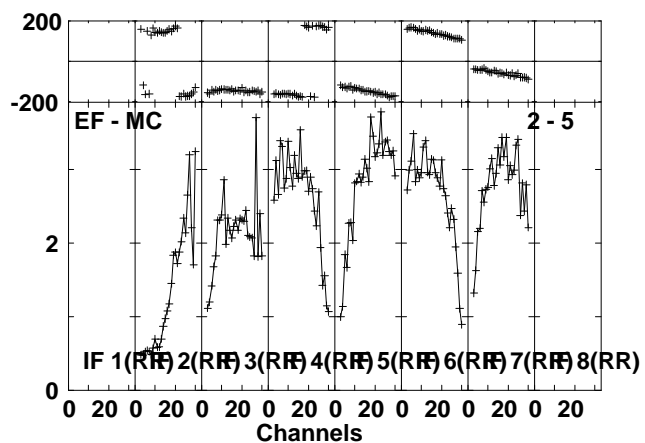
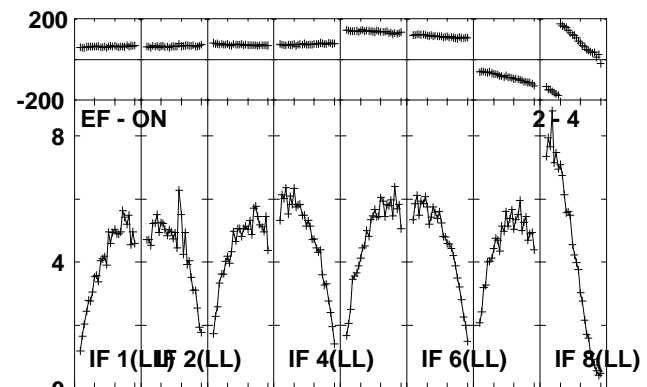
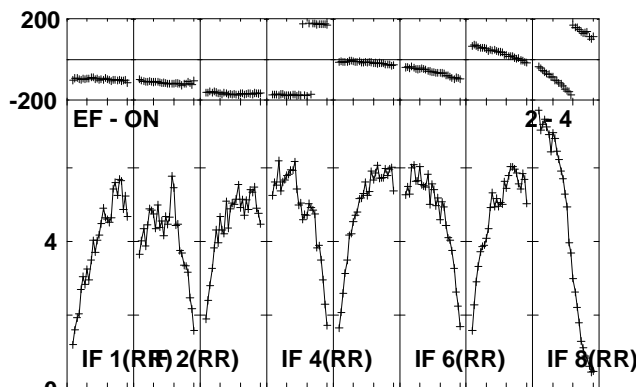
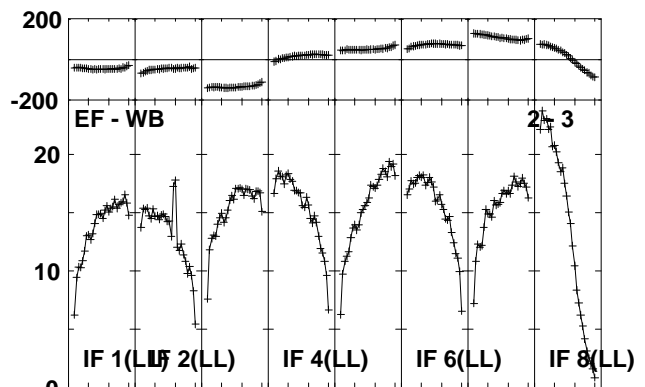
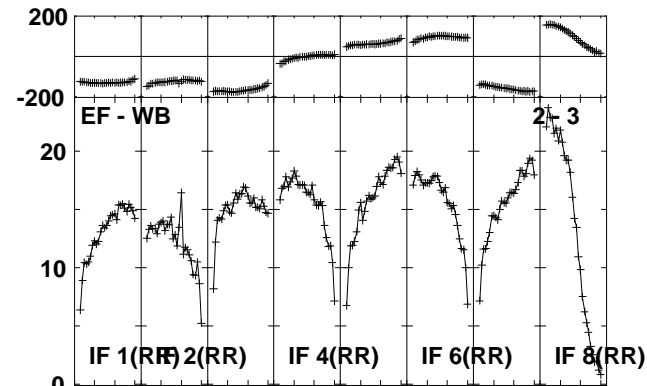
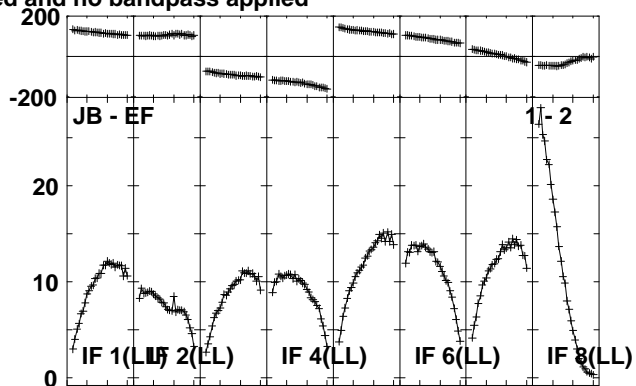
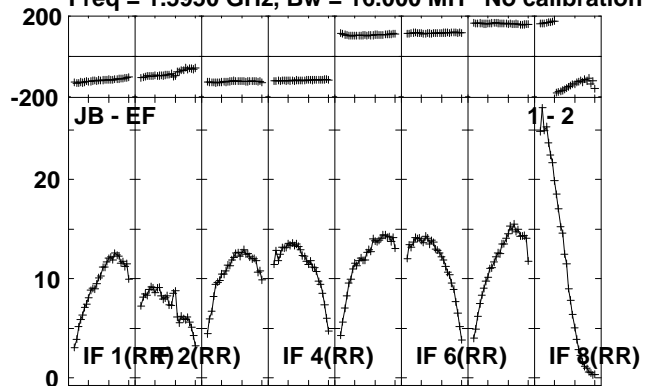

Lower frame: Milli Ampl Jy Top frame: Phas deg
Scalar averaged cross-power spectrum Several baselines displayed
Timerange: 00/23:05:01 to 00/23:06:29

Plot file version 58 created 23-AUG-2010 12:34:06

J1941-05 EP064P.UVDATA.1

Freq = 1.5950 GHz, Bw = 16.000 MH No calibration applied and no bandpass applied

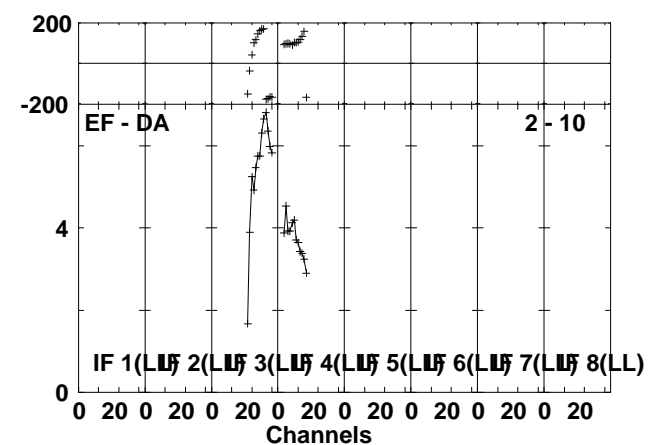
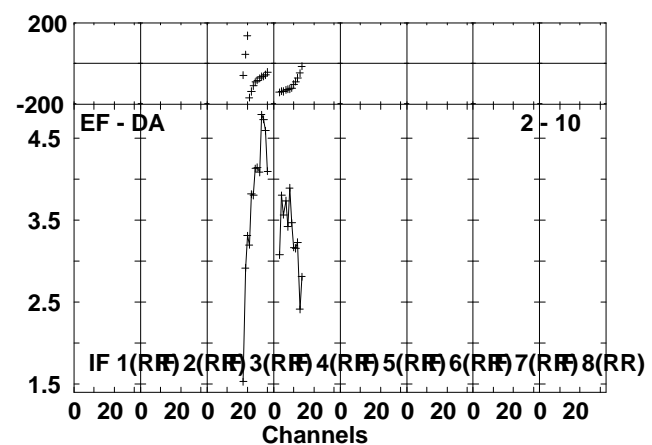
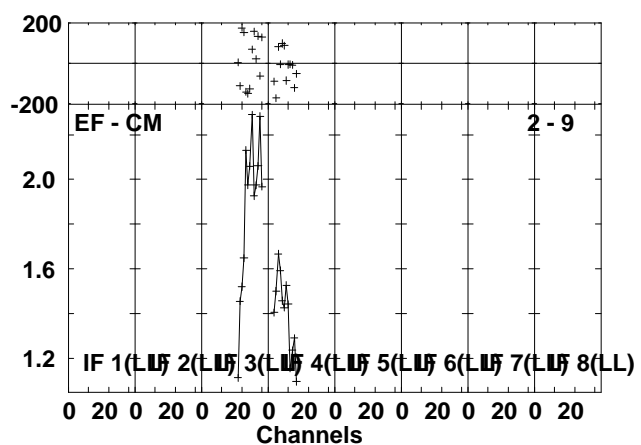
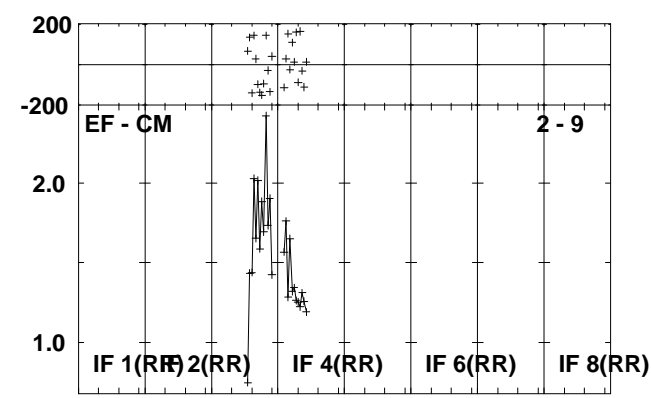
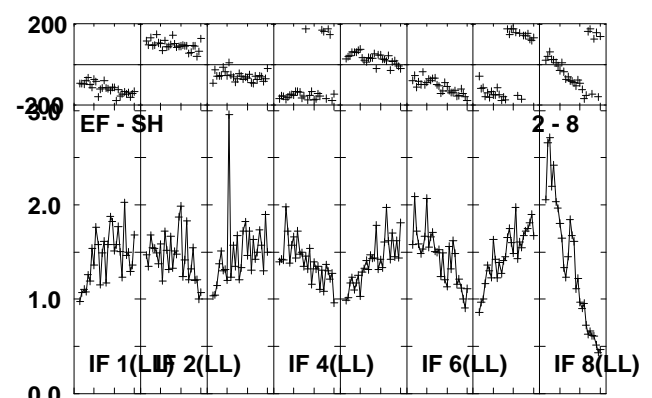
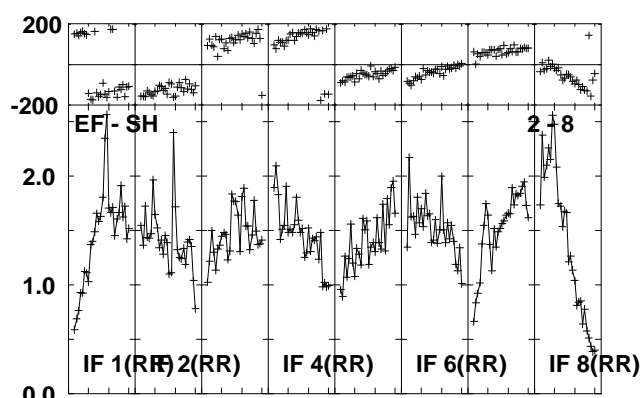
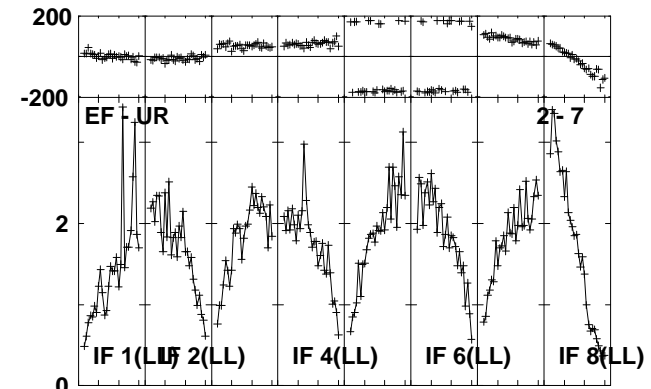
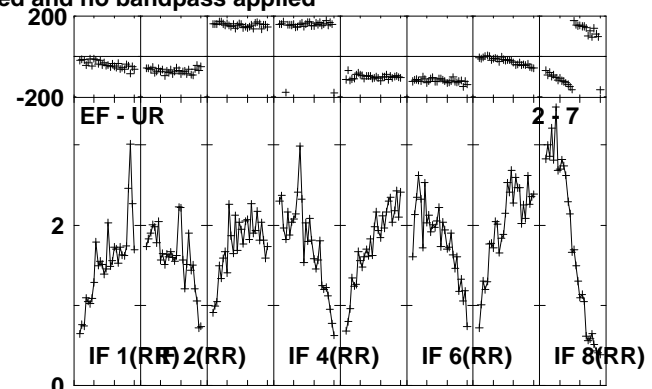
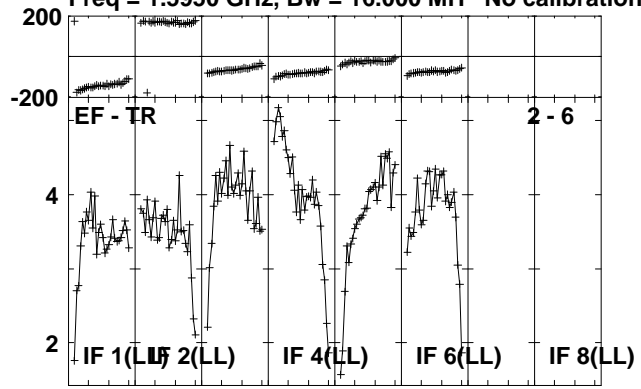

Lower frame: Milli Ampl Jy Top frame: Phas deg
Scalar averaged cross-power spectrum Several baselines displayed
Timerange: 00/23:05:01 to 00/23:06:29

Plot file version 59 created 23-AUG-2010 12:34:08

IRAS1929 EP064P.UVDATA.1

Freq = 1.5950 GHz, Bw = 16.000 MH No calibration applied and no bandpass applied

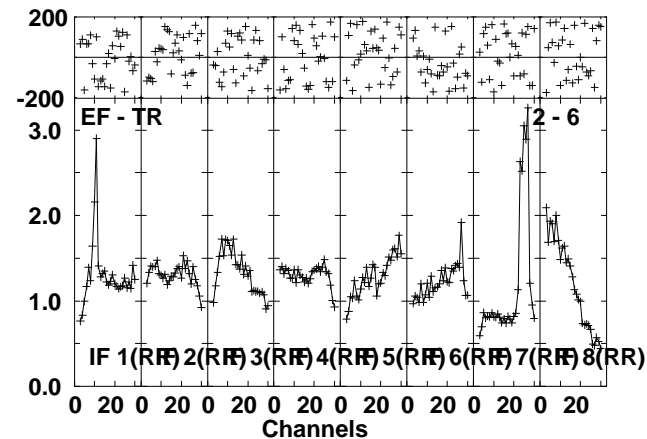
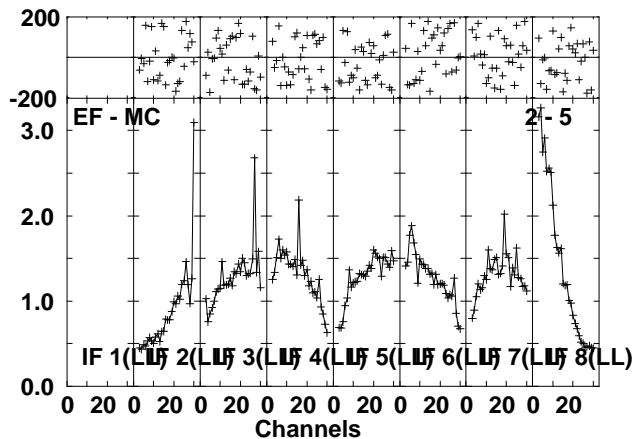
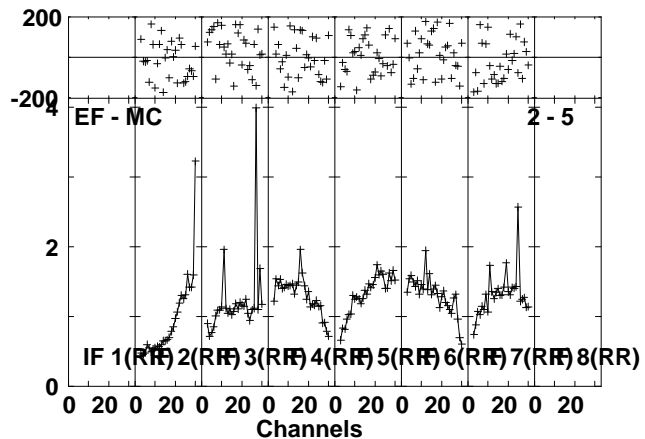
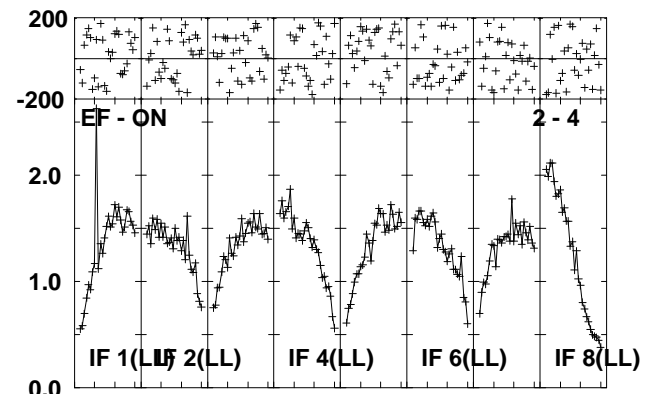
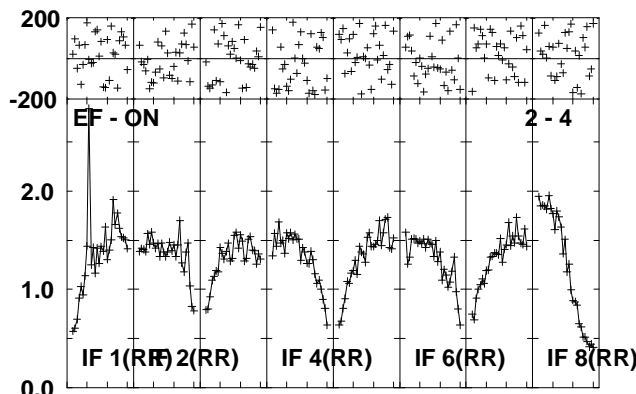
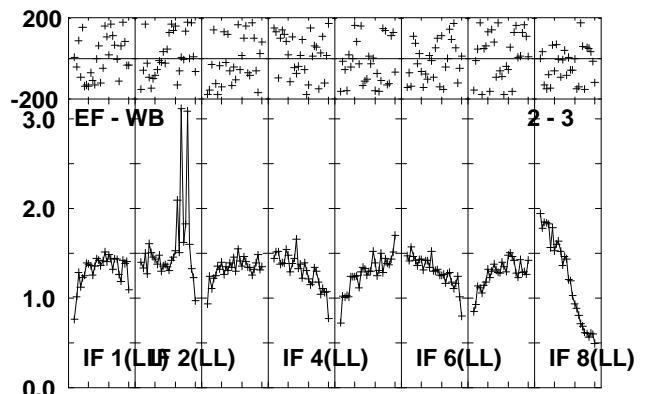
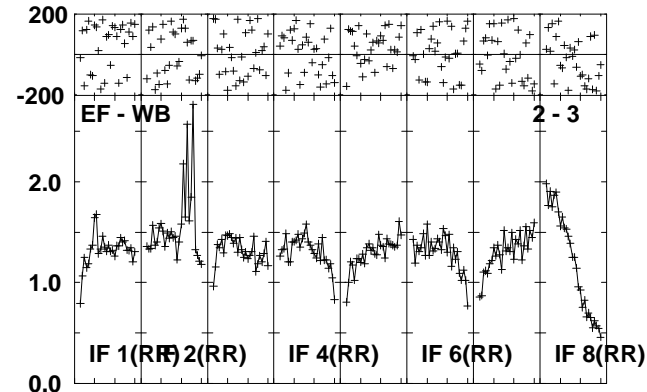
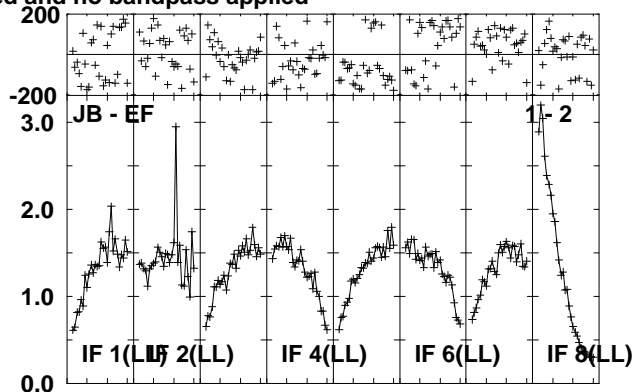
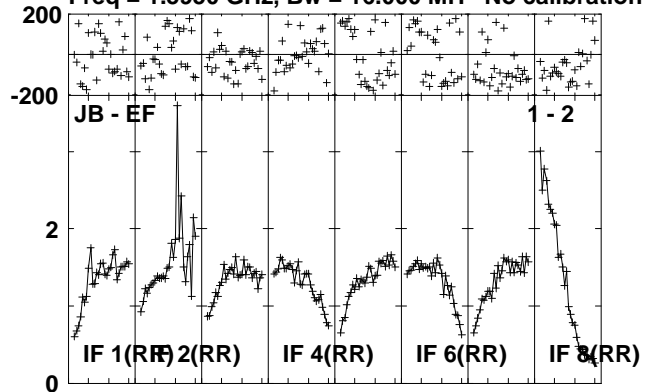

Lower frame: Milli Ampl Jy Top frame: Phas deg
Scalar averaged cross-power spectrum Several baselines displayed
Timerange: 00/23:06:31 to 00/23:09:59

Plot file version 60 created 23-AUG-2010 12:34:10

IRAS1929 EP064P.UVDATA.1

Freq = 1.5950 GHz, Bw = 16.000 MH No calibration applied and no bandpass applied

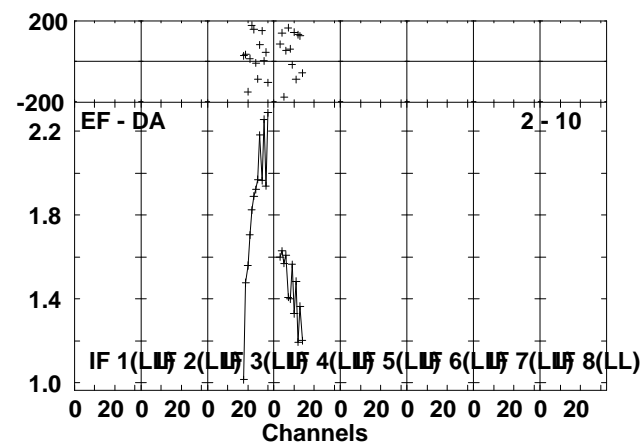
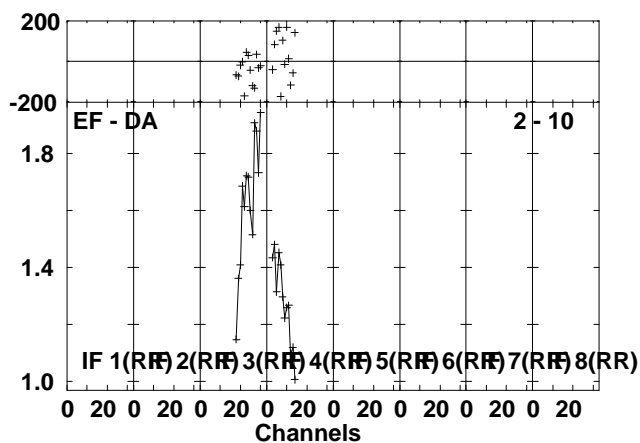
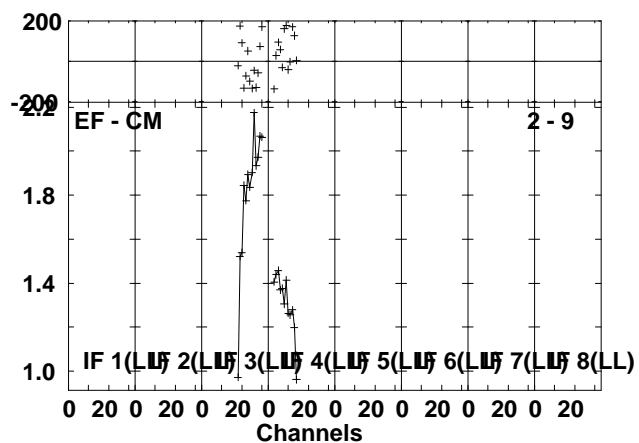
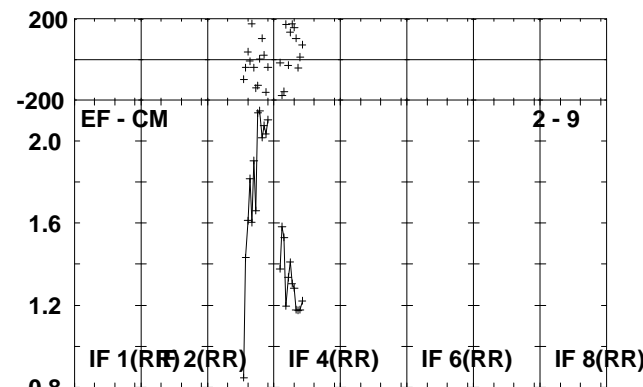
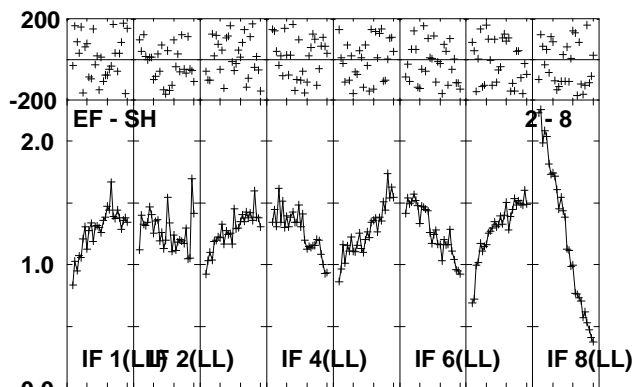
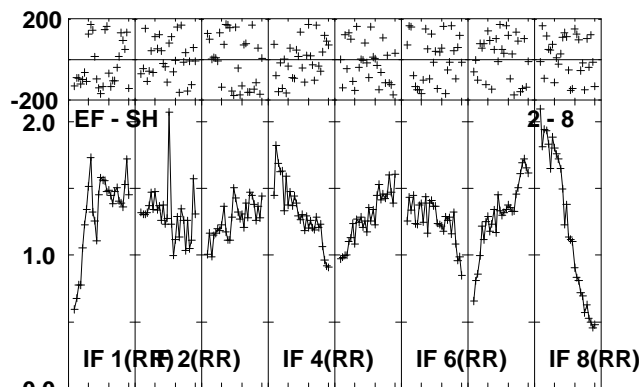
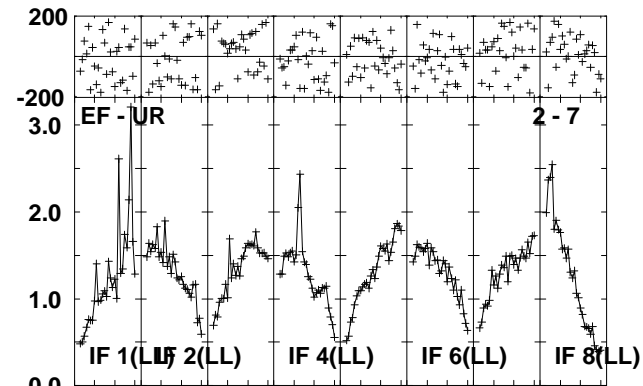
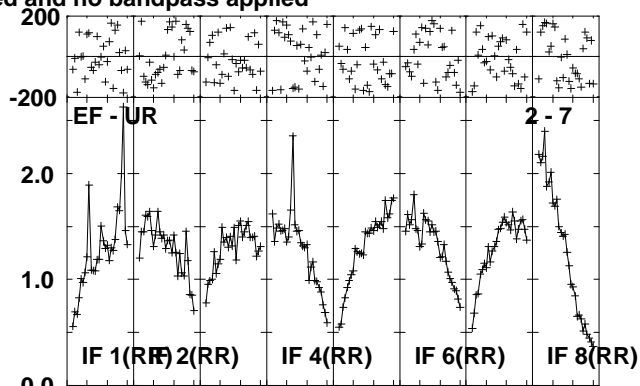
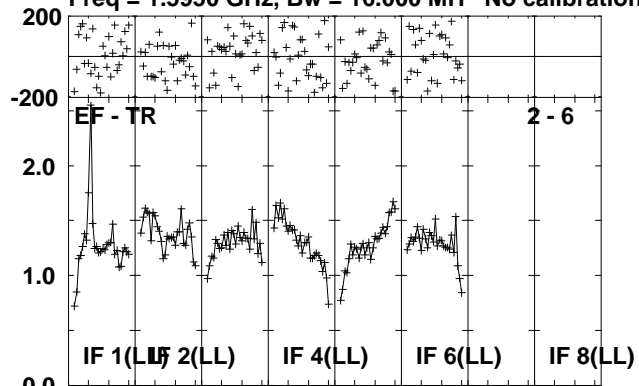

Lower frame: Milli Ampl Jy Top frame: Phas deg
Scalar averaged cross-power spectrum Several baselines displayed
Timerange: 00/23:06:31 to 00/23:09:59

Plot file version 61 created 23-AUG-2010 12:34:12

J1941-05 EP064P.UVDATA.1

Freq = 1.5950 GHz, Bw = 16.000 MH No calibration applied and no bandpass applied

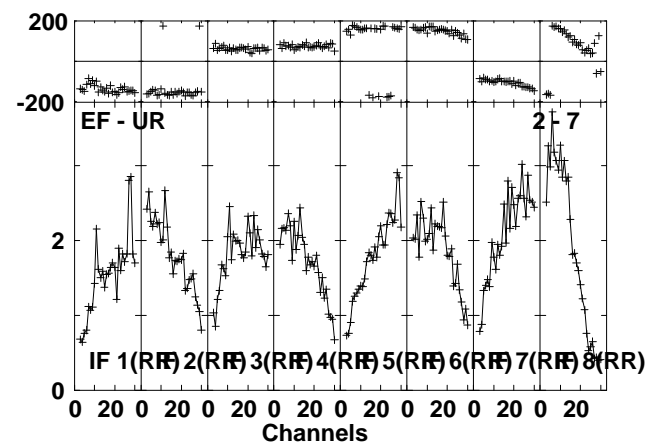
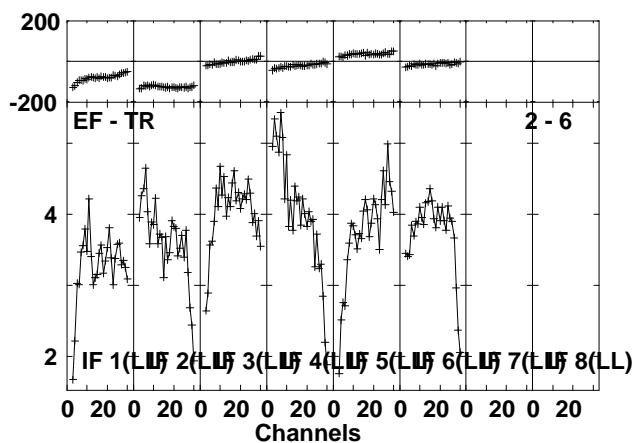
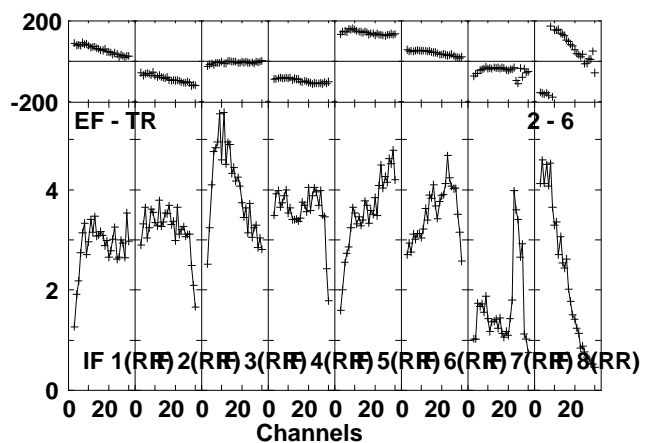
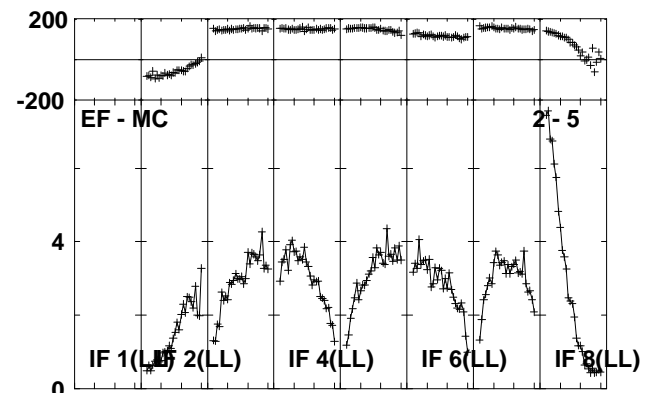
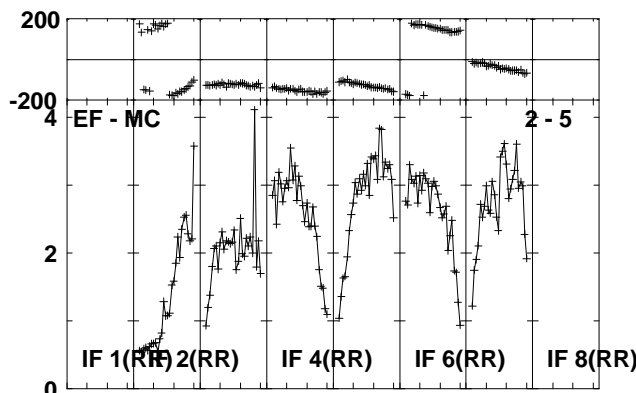
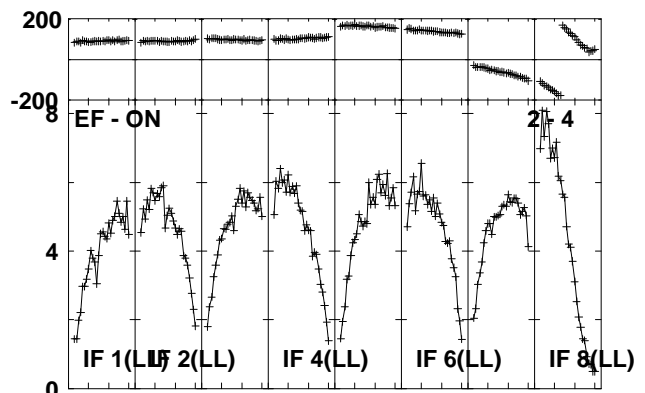
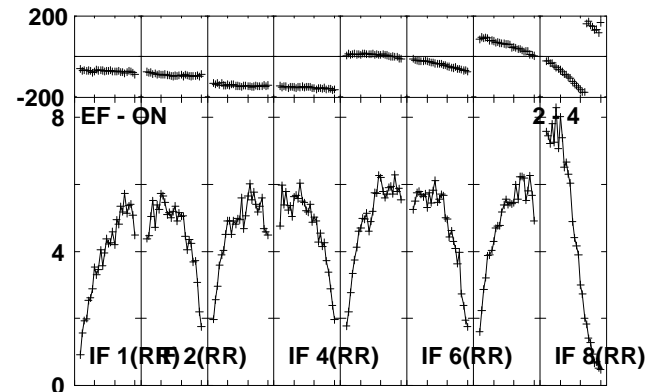
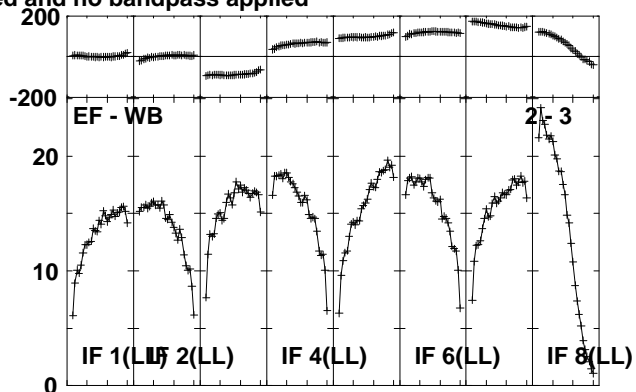
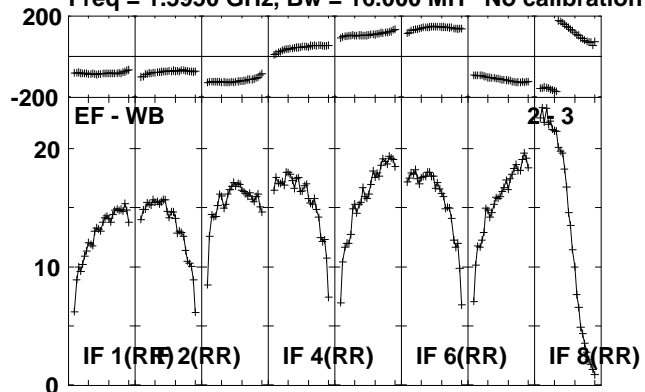

Lower frame: Milli Ampl Jy Top frame: Phas deg
Scalar averaged cross-power spectrum Several baselines displayed
Timerange: 00/23:10:01 to 00/23:11:29

Plot file version 62 created 23-AUG-2010 12:34:13

J1941-05 EP064P.UVDATA.1

Freq = 1.5950 GHz, Bw = 16.000 MH No calibration applied and no bandpass applied

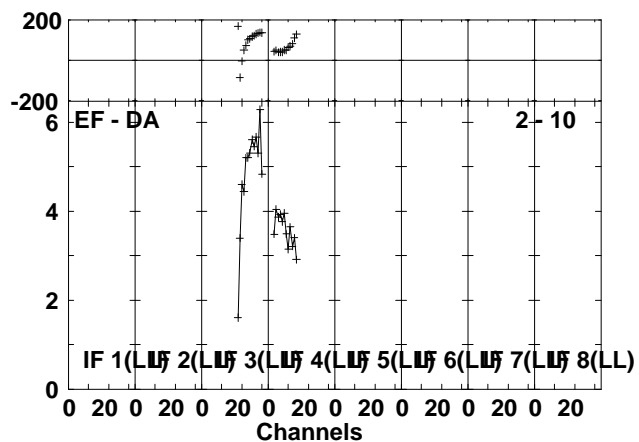
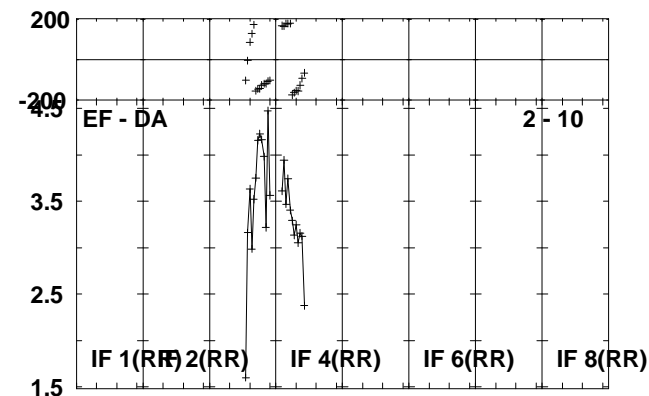
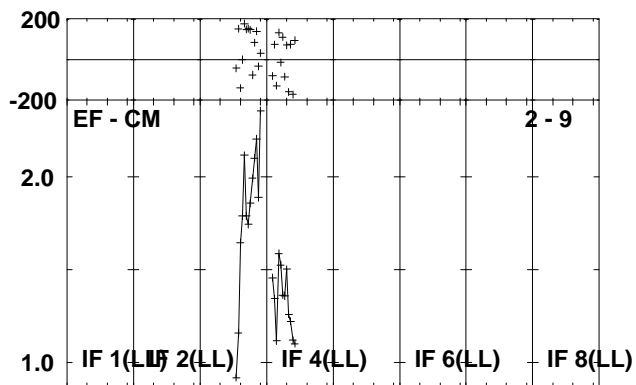
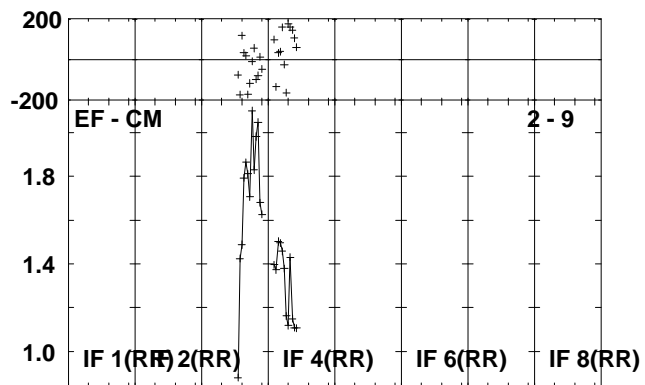
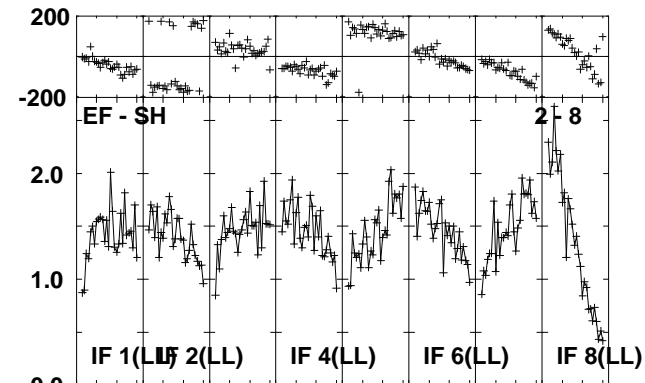
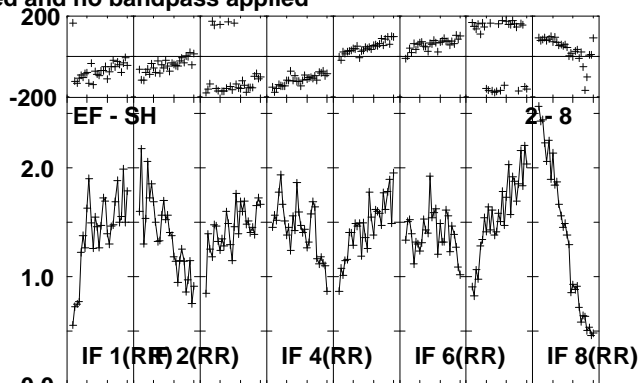
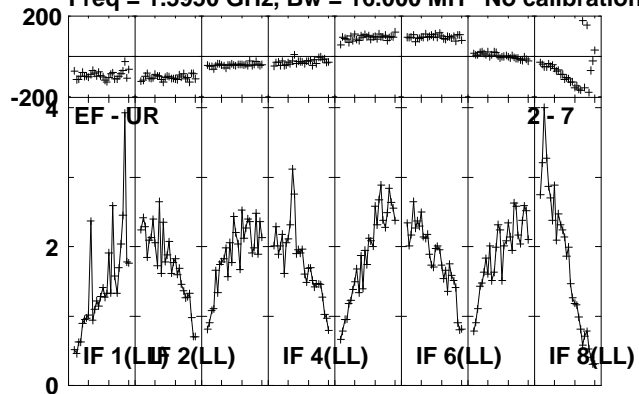

Lower frame: Milli Ampl Jy Top frame: Phas deg
Scalar averaged cross-power spectrum Several baselines displayed
Timerange: 00/23:10:01 to 00/23:11:29

Plot file version 63 created 23-AUG-2010 12:34:14

IRAS1929 EP064P.UVDATA.1

Freq = 1.5950 GHz, Bw = 16.000 MH No calibration applied and no bandpass applied

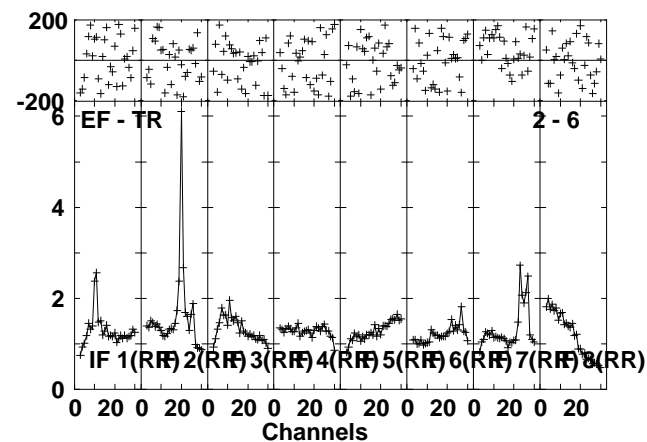
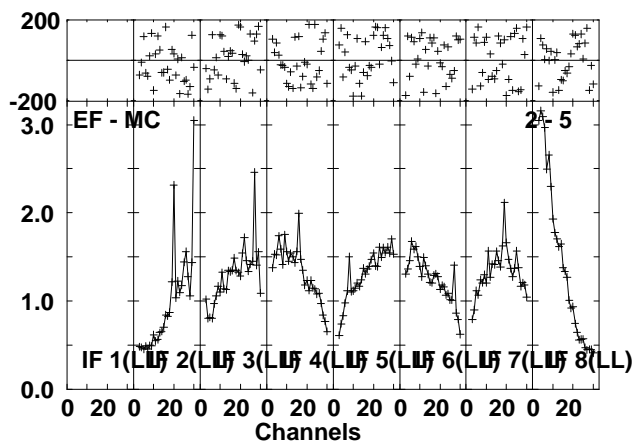
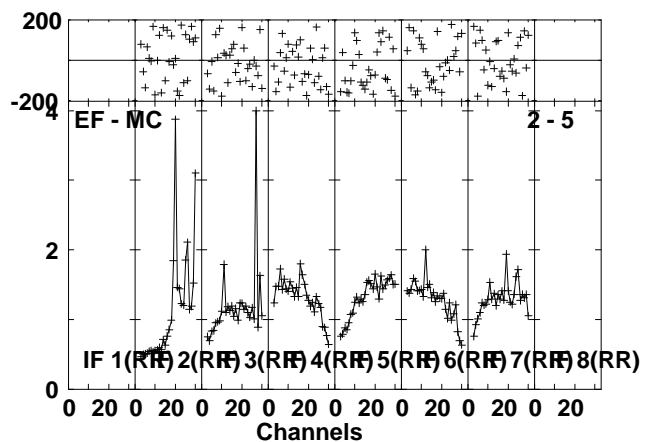
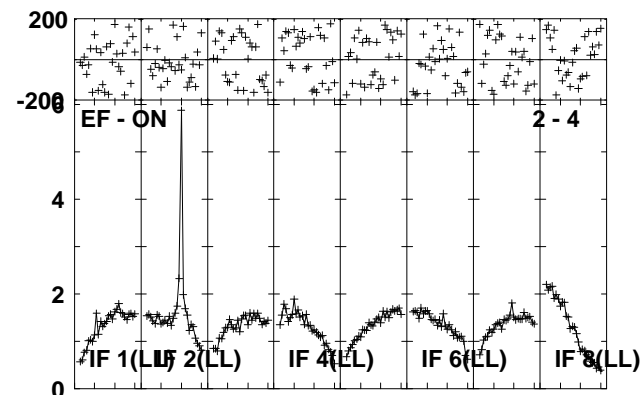
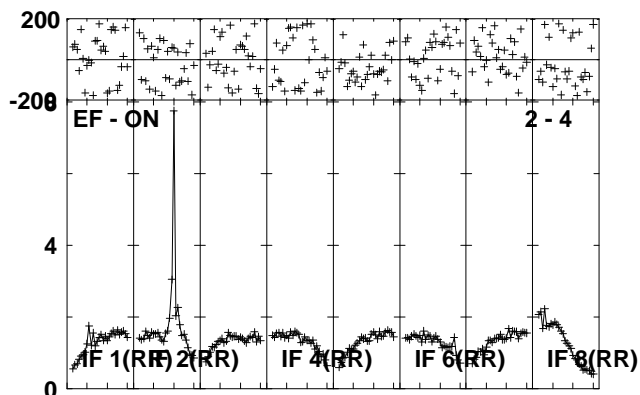
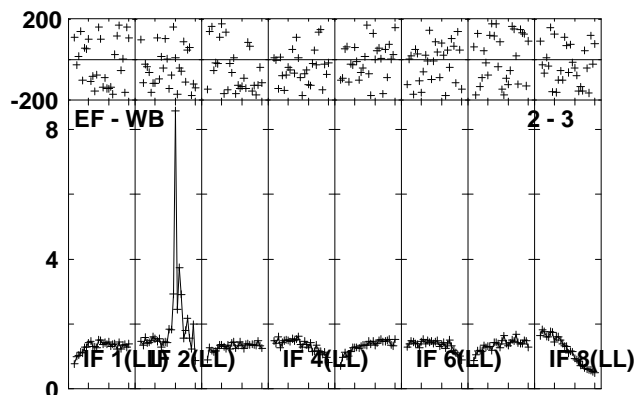
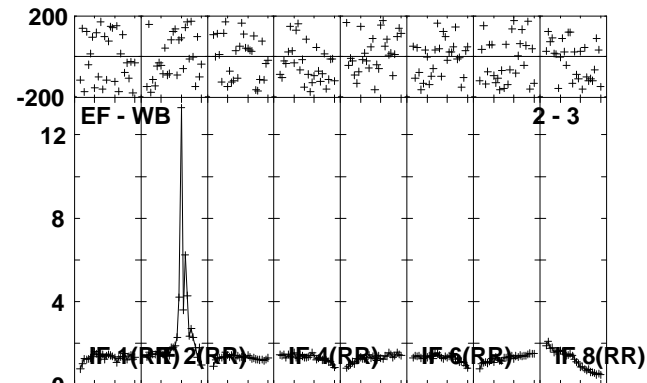
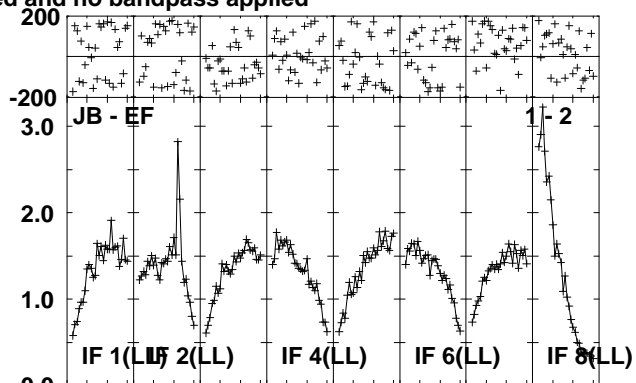
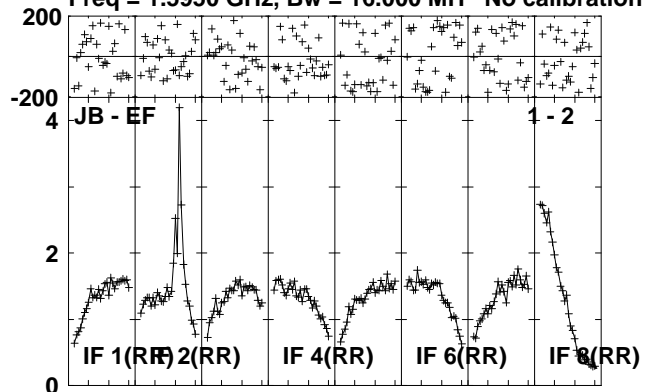

Lower frame: Milli Ampl Jy Top frame: Phas deg
Scalar averaged cross-power spectrum Several baselines displayed
Timerange: 00/23:11:31 to 00/23:14:59

Plot file version 64 created 23-AUG-2010 12:34:16

IRAS1929 EP064P.UVDATA.1

Freq = 1.5950 GHz, Bw = 16.000 MH No calibration applied and no bandpass applied

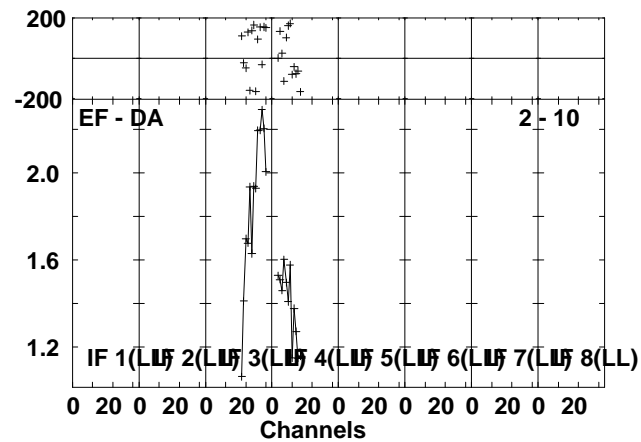
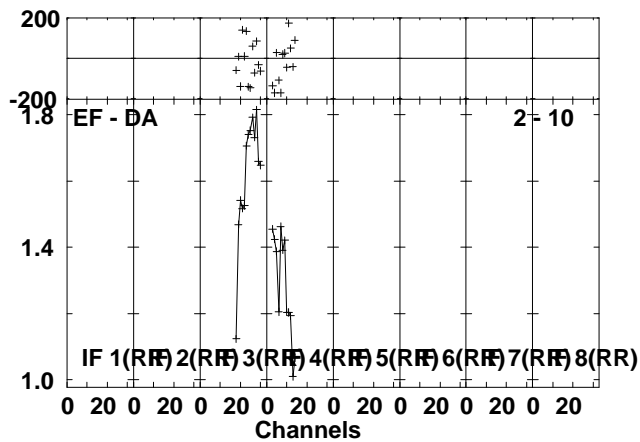
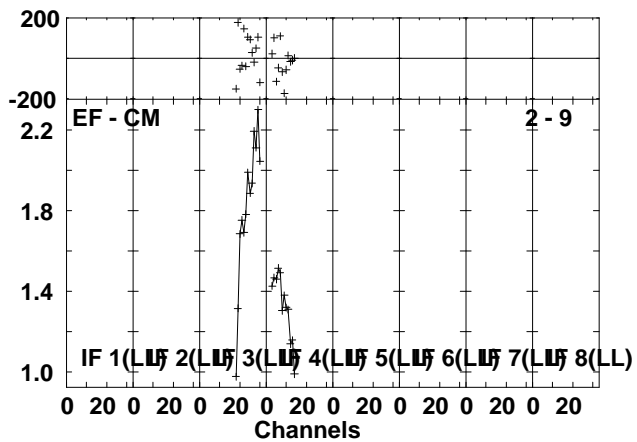
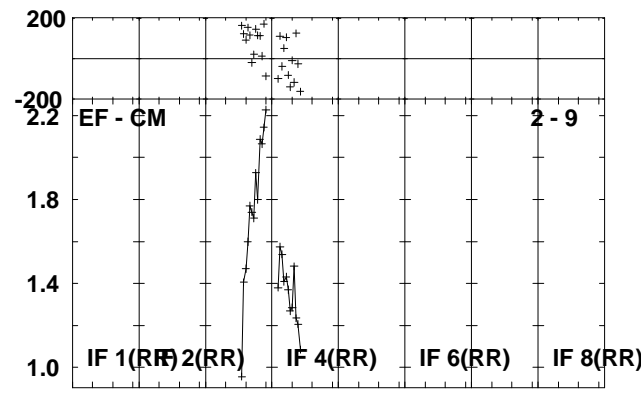
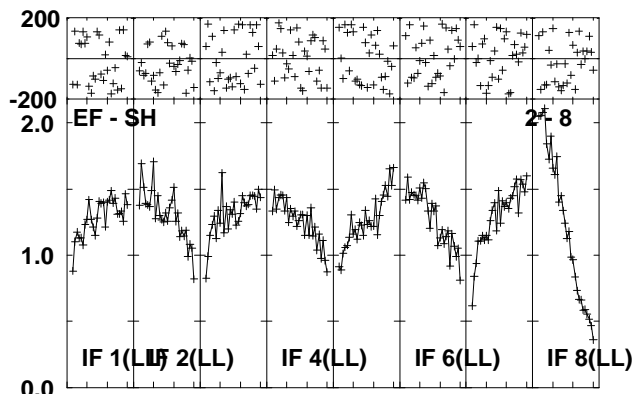
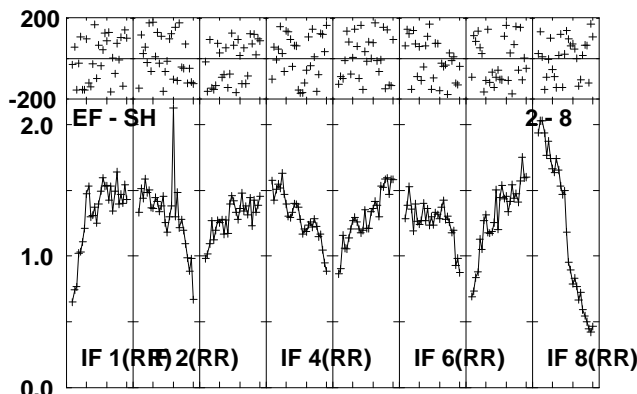
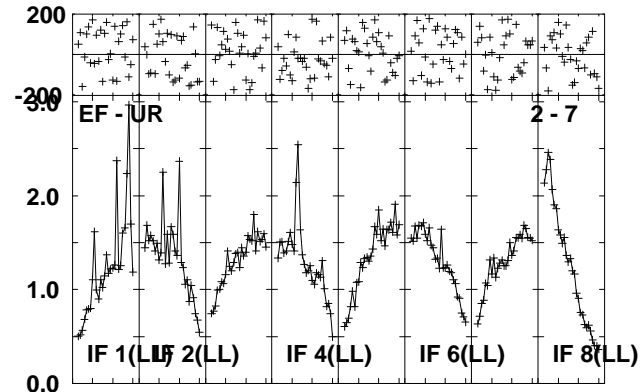
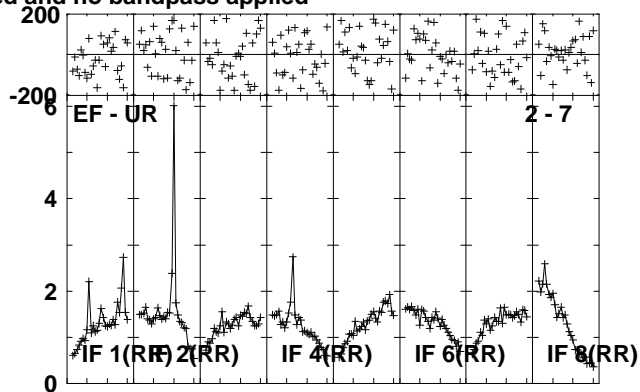
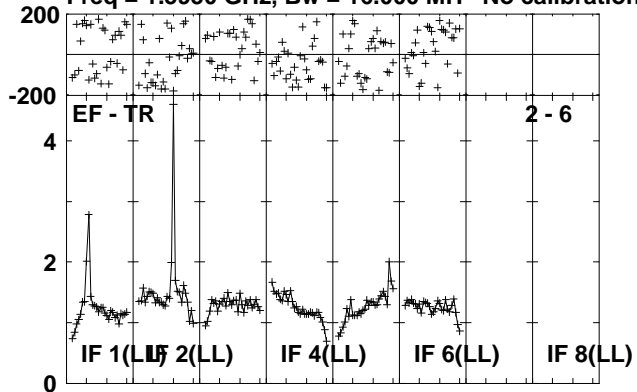

Lower frame: Milli Ampl Jy Top frame: Phas deg
Scalar averaged cross-power spectrum Several baselines displayed
Timerange: 00/23:11:31 to 00/23:14:59

Plot file version 65 created 23-AUG-2010 12:34:18

J1941-05 EP064P.UVDATA.1

Freq = 1.5950 GHz, Bw = 16.000 MH No calibration applied and no bandpass applied

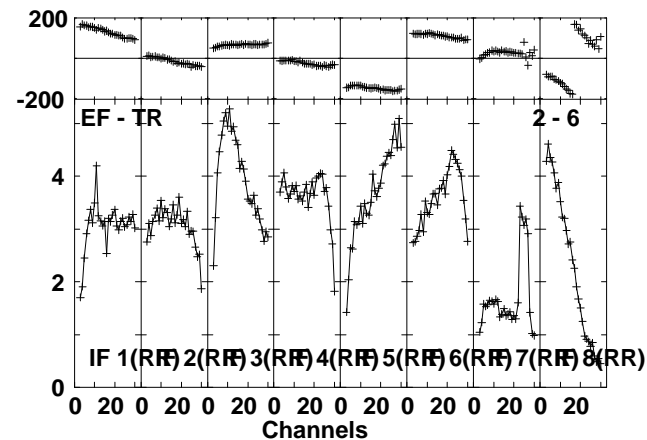
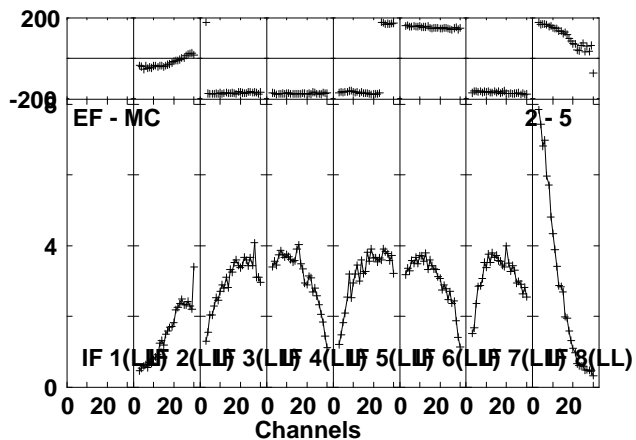
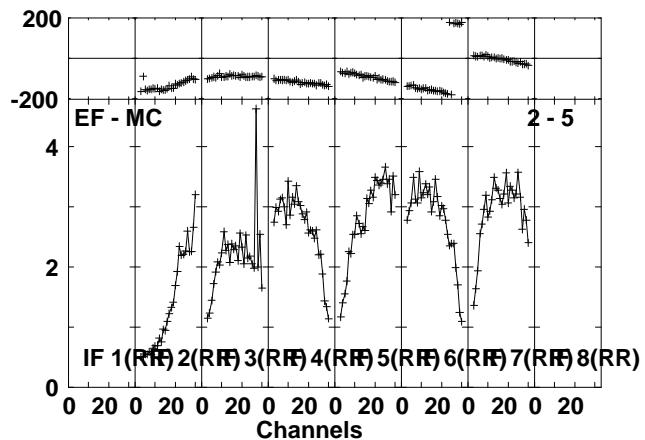
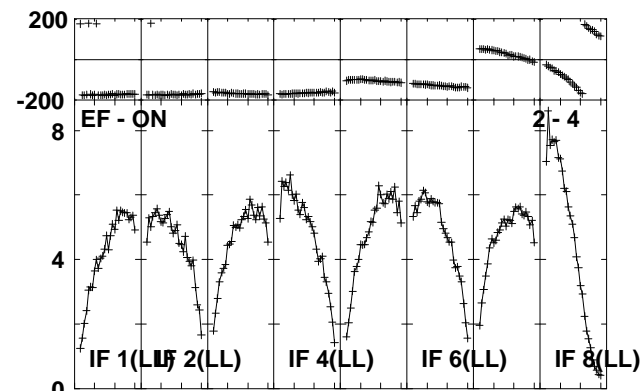
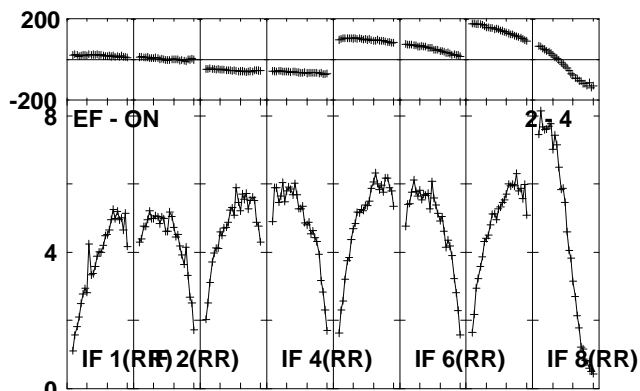
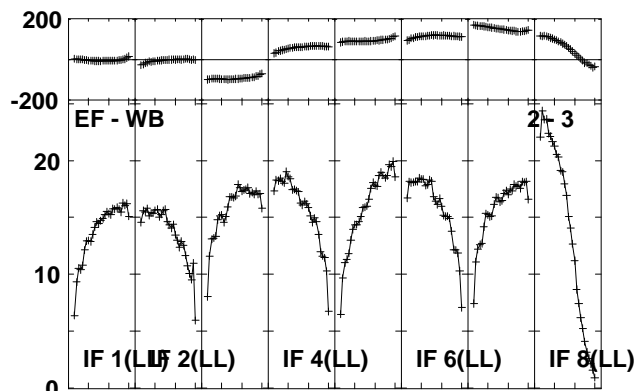
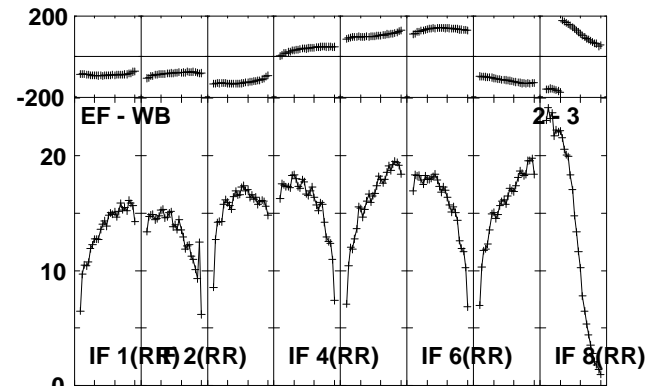
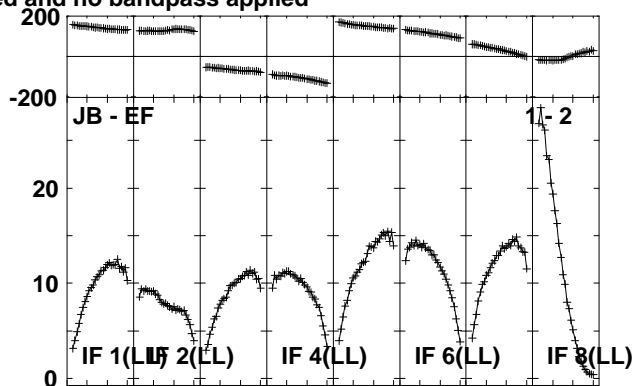
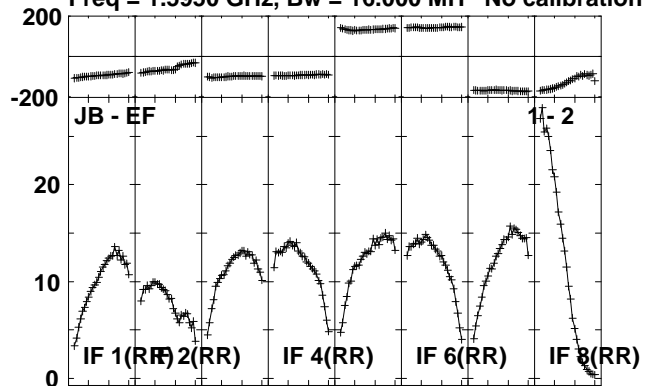

Lower frame: Milli Ampl Jy Top frame: Phas deg
Scalar averaged cross-power spectrum Several baselines displayed
Timerange: 00/23:16:01 to 00/23:17:29

Plot file version 66 created 23-AUG-2010 12:34:19

J1941-05 EP064P.UVDATA.1

Freq = 1.5950 GHz, Bw = 16.000 MH No calibration applied and no bandpass applied

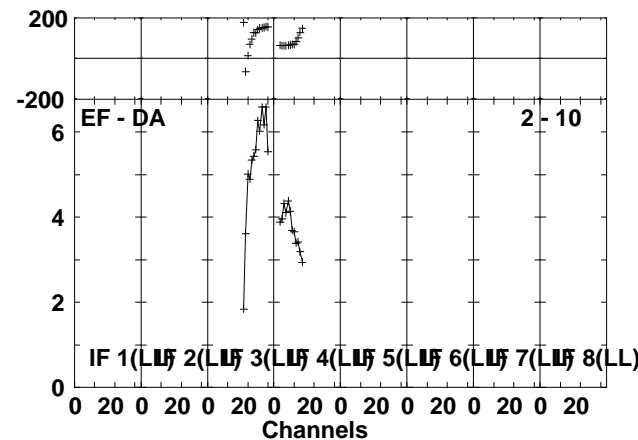
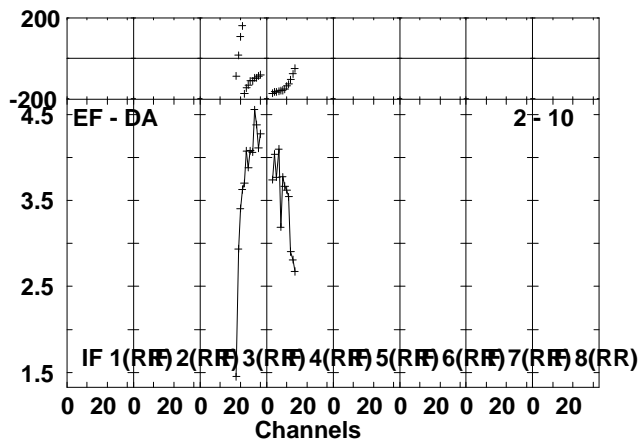
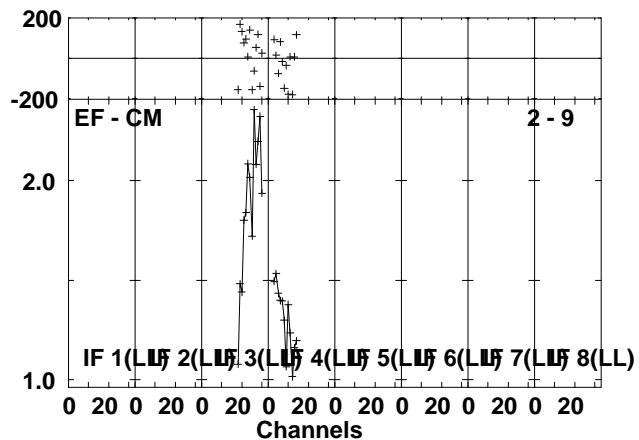
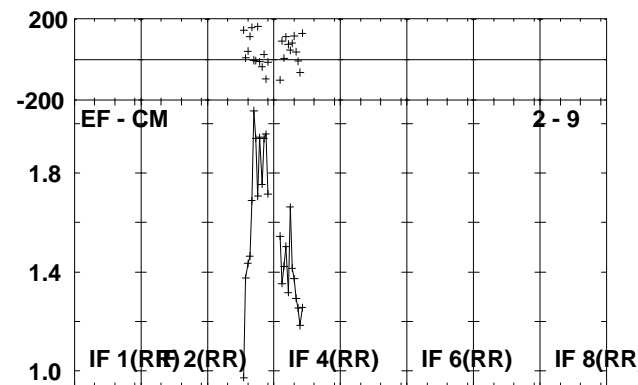
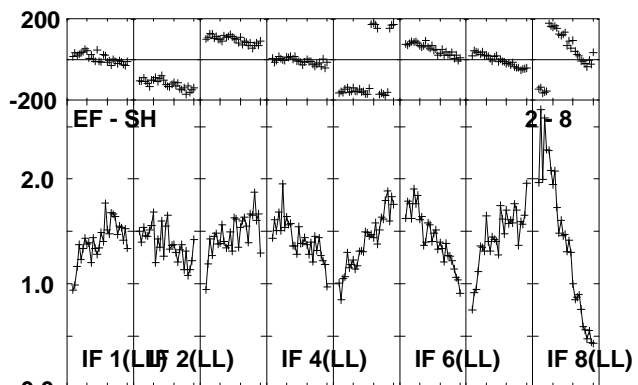
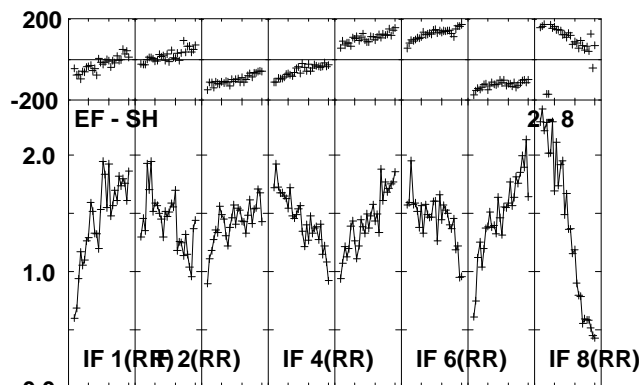
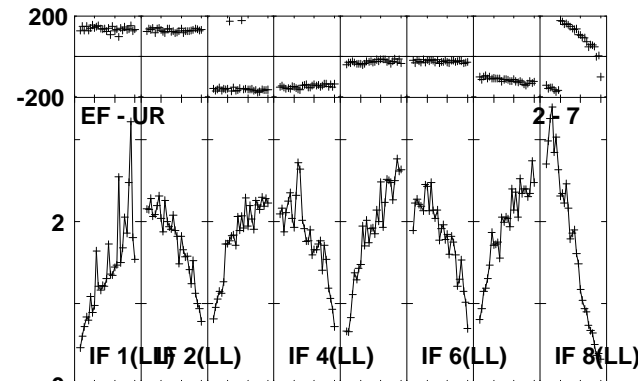
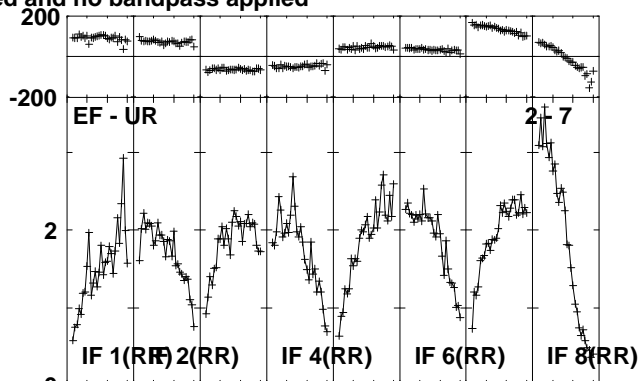
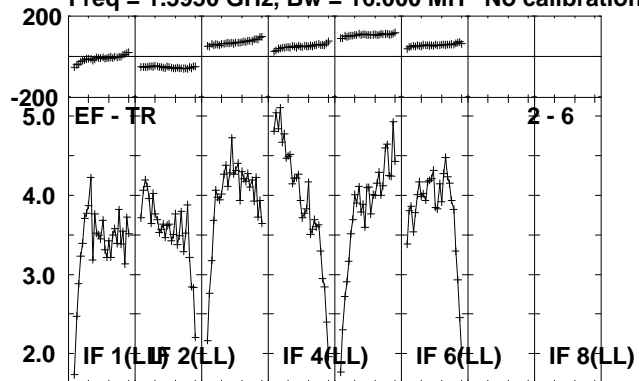

Lower frame: Milli Ampl Jy Top frame: Phas deg
Scalar averaged cross-power spectrum Several baselines displayed
Timerange: 00/23:16:01 to 00/23:17:29

Plot file version 67 created 23-AUG-2010 12:34:20

IRAS1929 EP064P.UVDATA.1

Freq = 1.5950 GHz, Bw = 16.000 MH No calibration applied and no bandpass applied

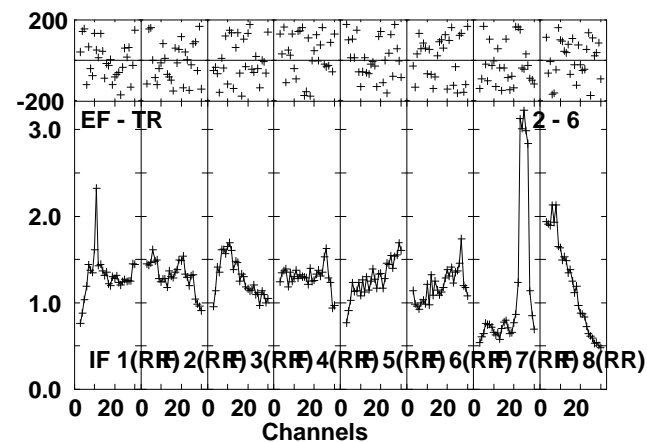
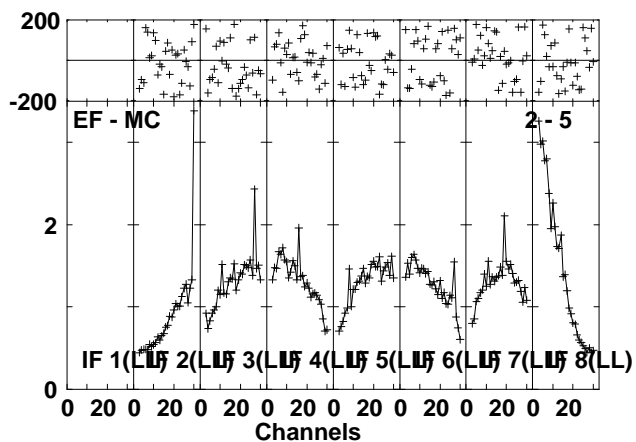
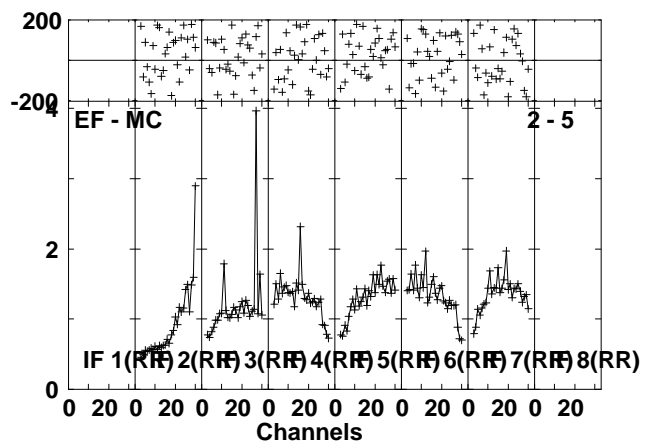
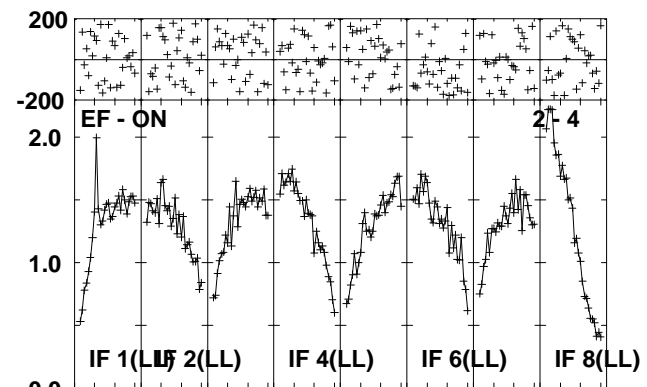
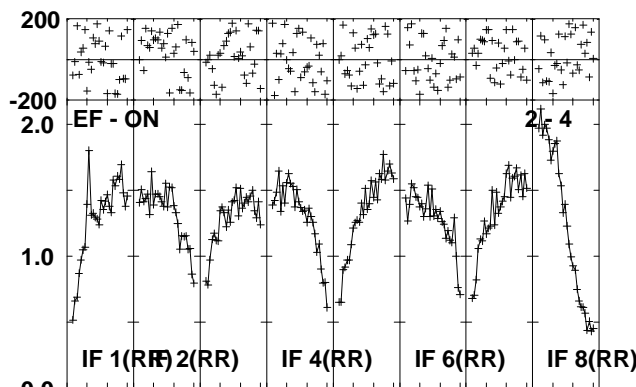
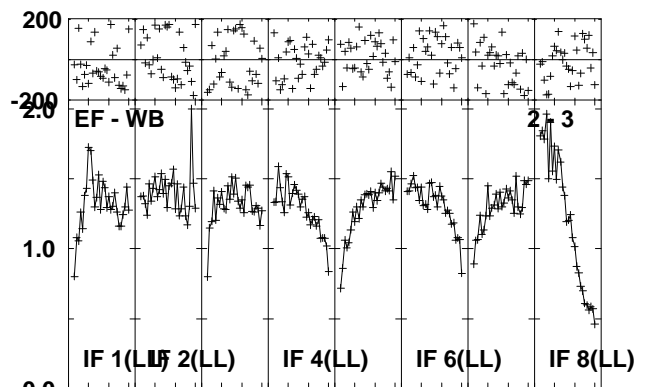
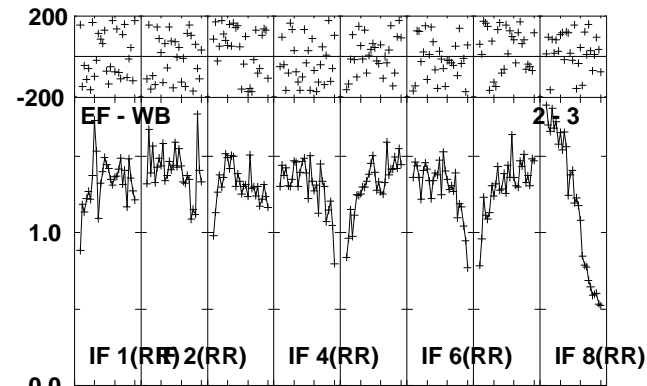
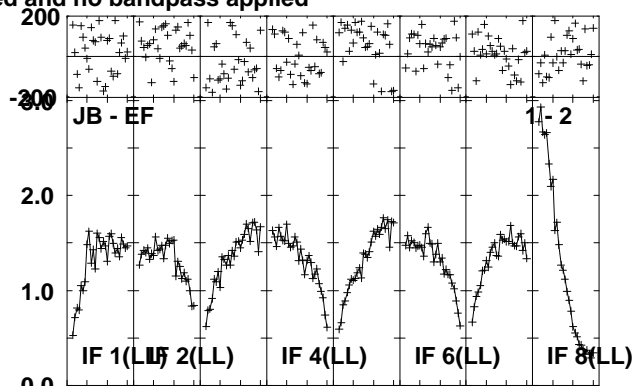
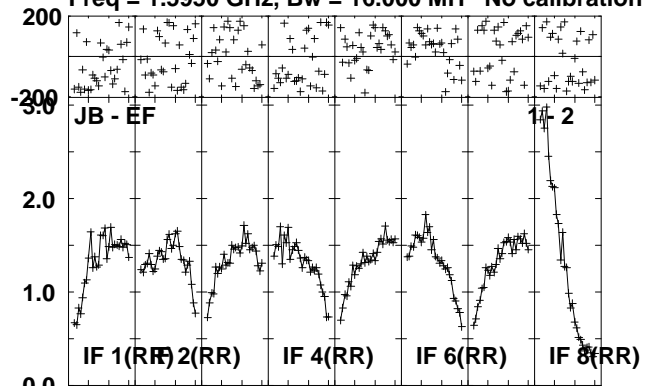

Lower frame: Milli Ampl Jy Top frame: Phas deg
Scalar averaged cross-power spectrum Several baselines displayed
Timerange: 00/23:17:31 to 00/23:20:59

Plot file version 68 created 23-AUG-2010 12:34:23

IRAS1929 EP064P.UVDATA.1

Freq = 1.5950 GHz, Bw = 16.000 MH No calibration applied and no bandpass applied

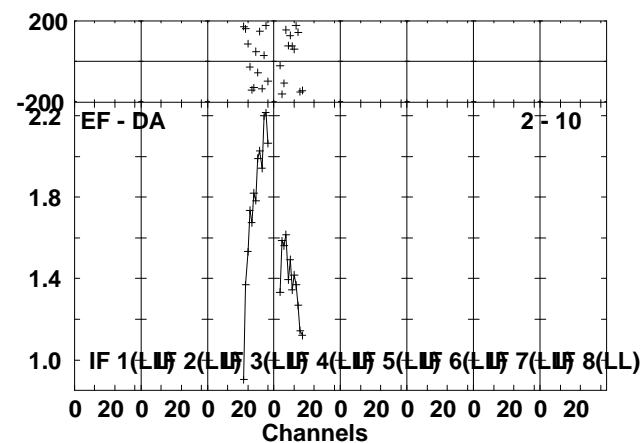
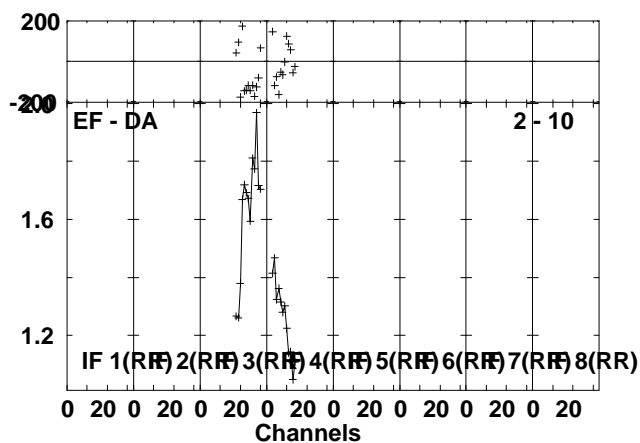
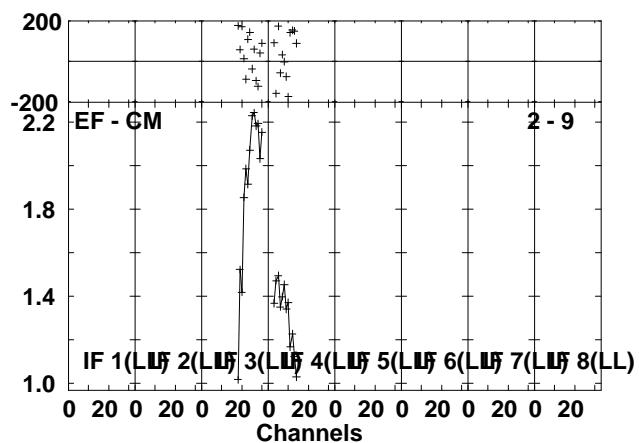
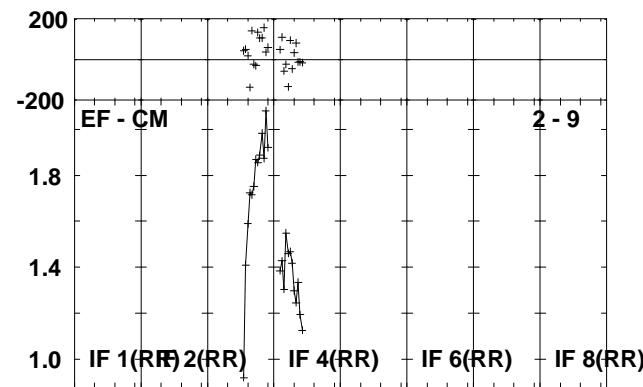
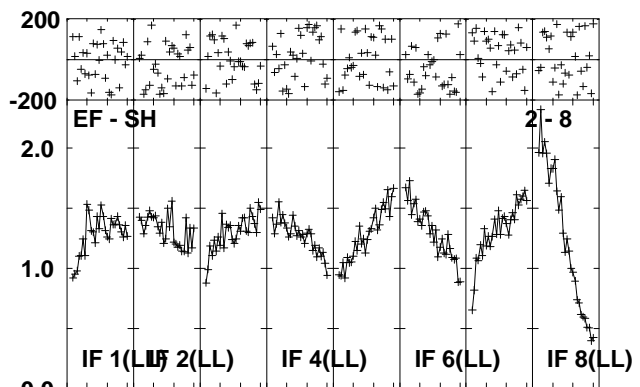
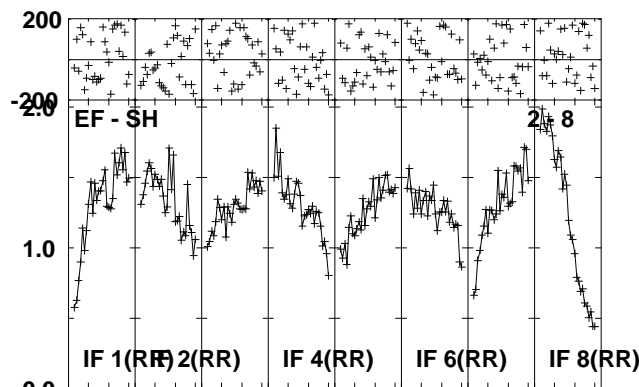
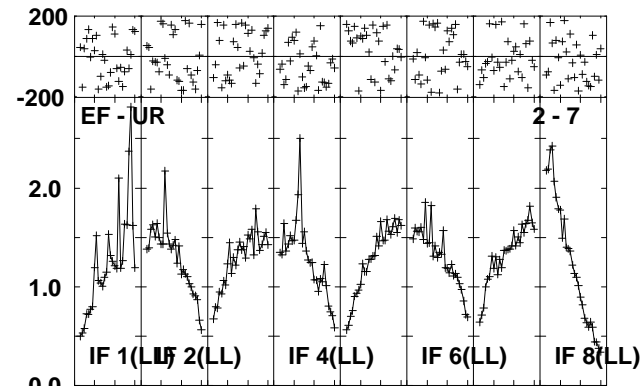
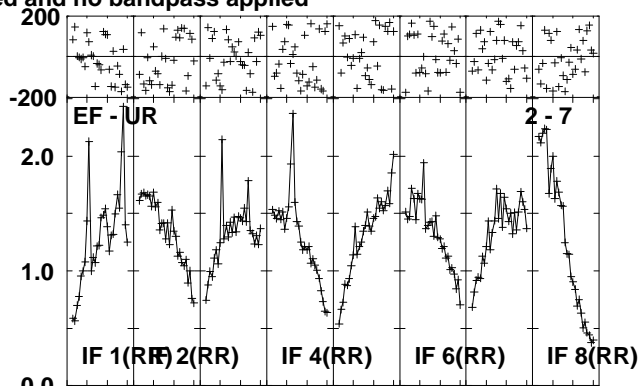
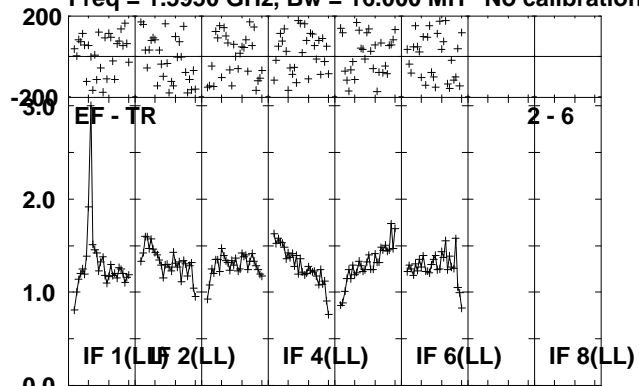

Lower frame: Milli Ampl Jy Top frame: Phas deg
Scalar averaged cross-power spectrum Several baselines displayed
Timerange: 00/23:17:31 to 00/23:20:59

Plot file version 69 created 23-AUG-2010 12:34:25

J1941-05 EP064P.UVDATA.1

Freq = 1.5950 GHz, Bw = 16.000 MH No calibration applied and no bandpass applied

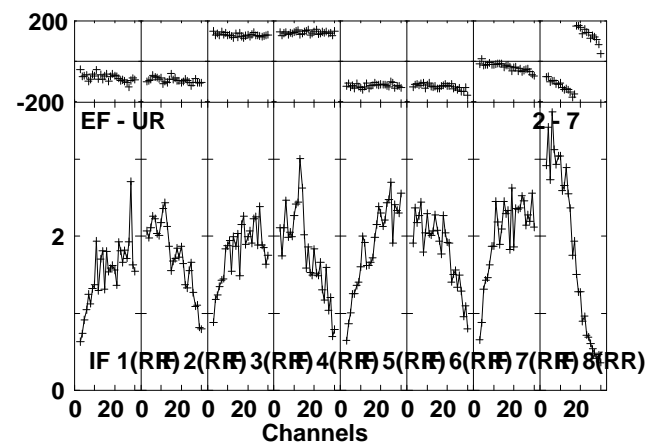
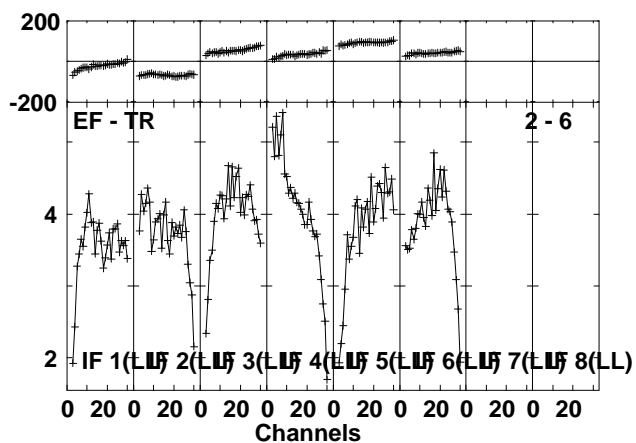
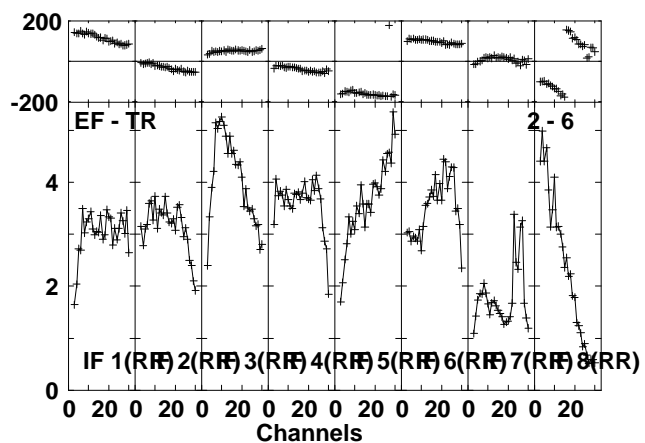
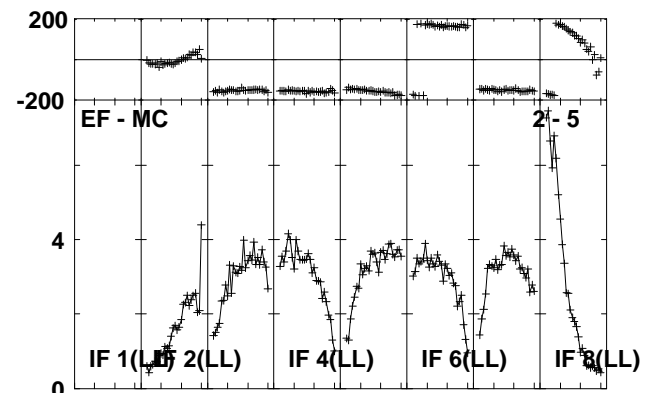
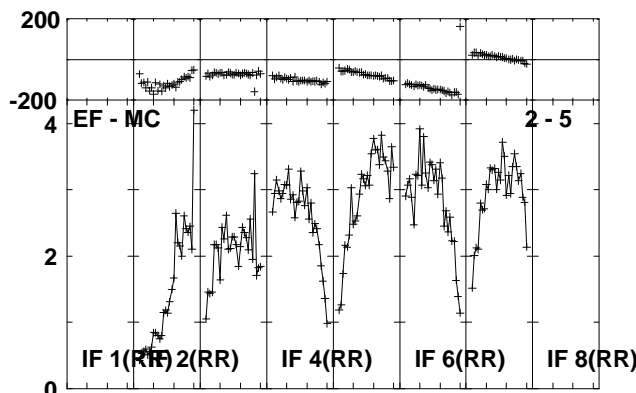
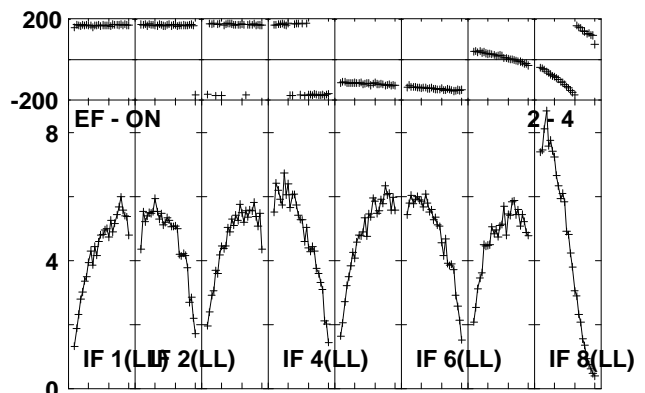
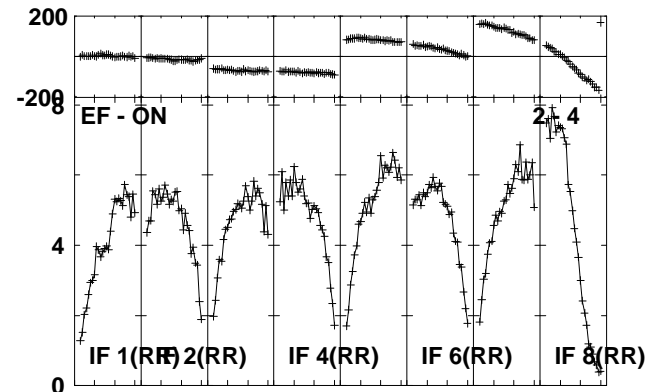
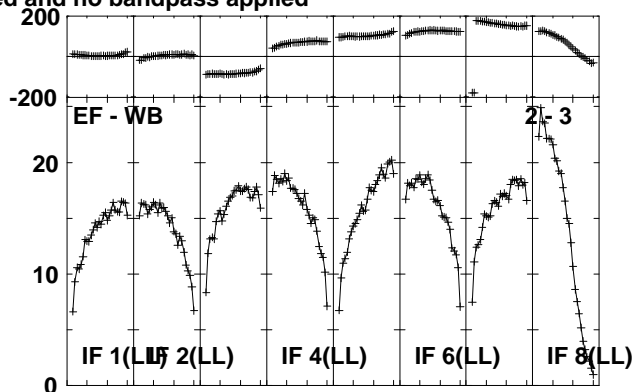
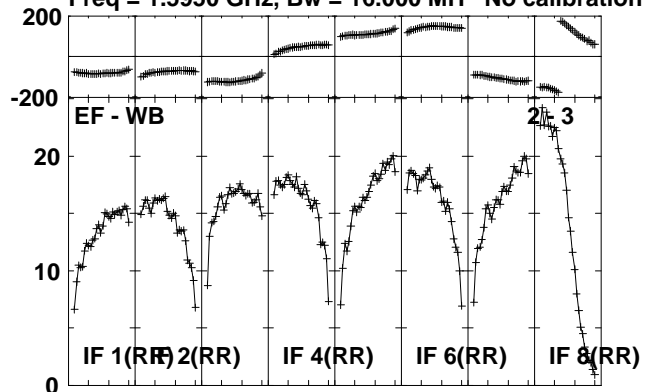

Lower frame: Milli Ampl Jy Top frame: Phas deg
Scalar averaged cross-power spectrum Several baselines displayed
Timerange: 00/23:21:01 to 00/23:22:29

Plot file version 70 created 23-AUG-2010 12:34:26

J1941-05 EP064P.UVDATA.1

Freq = 1.5950 GHz, Bw = 16.000 MH No calibration applied and no bandpass applied

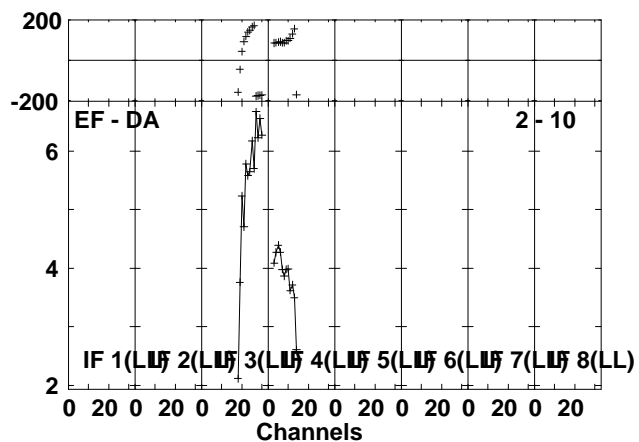
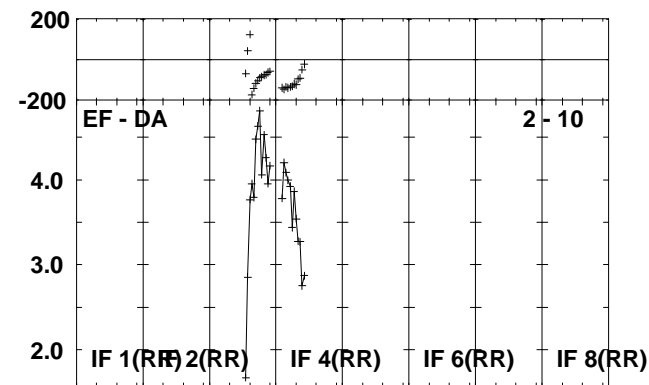
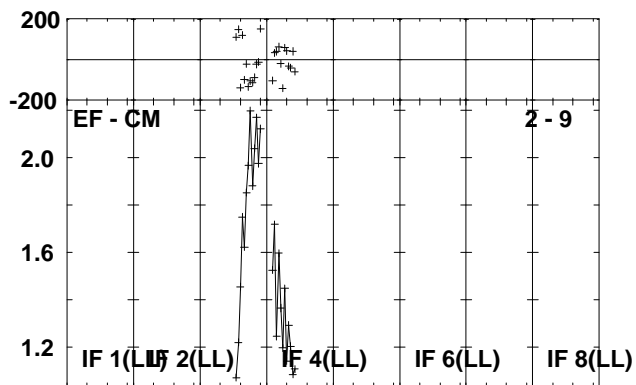
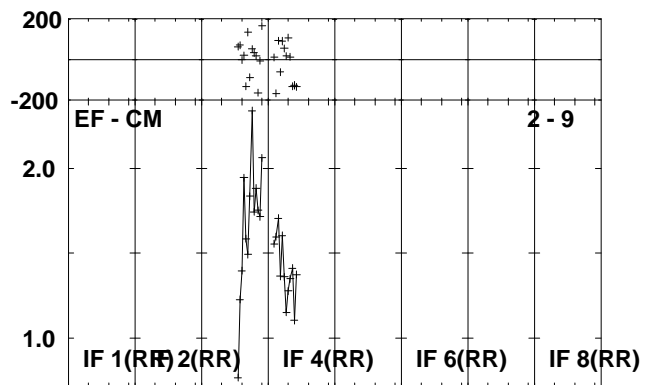
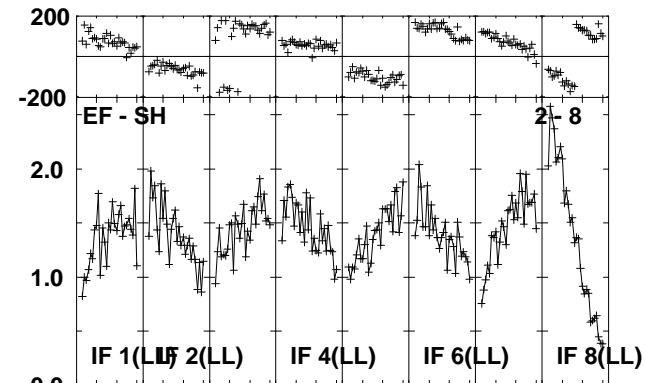
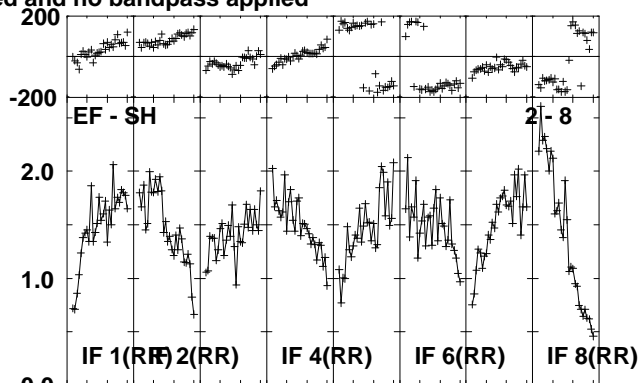
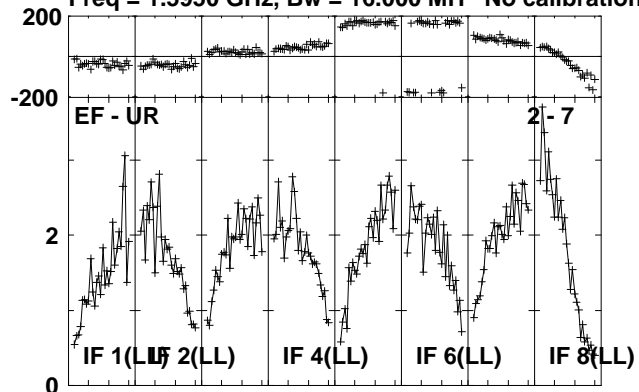

Lower frame: Milli Ampl Jy Top frame: Phas deg
Scalar averaged cross-power spectrum Several baselines displayed
Timerange: 00/23:21:01 to 00/23:22:29

Plot file version 71 created 23-AUG-2010 12:34:27

IRAS1929 EP064P.UVDATA.1

Freq = 1.5950 GHz, Bw = 16.000 MH No calibration applied and no bandpass applied

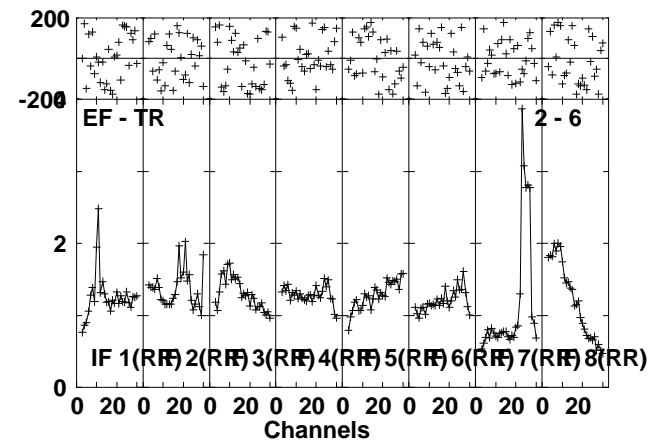
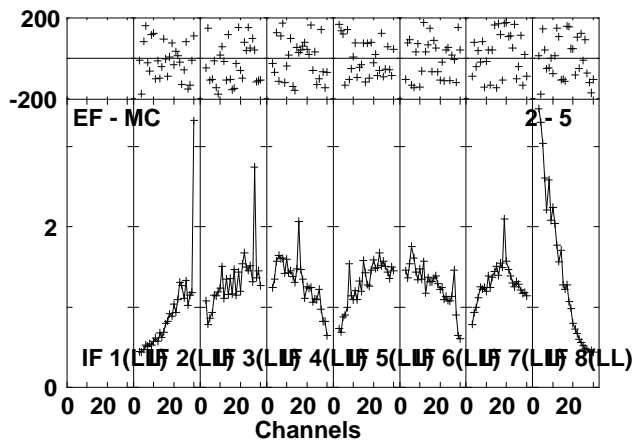
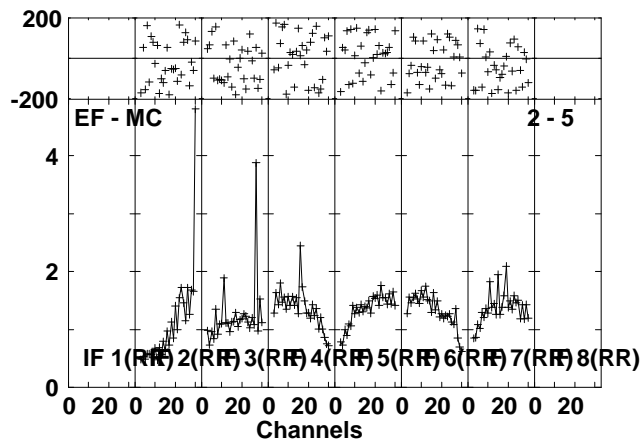
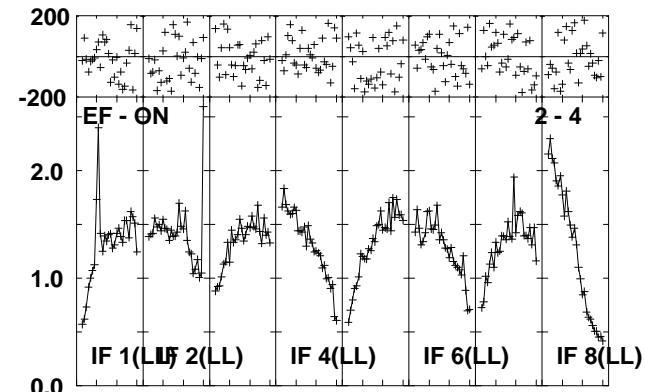
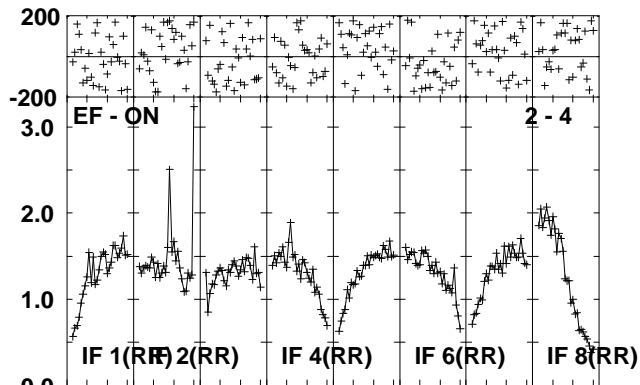
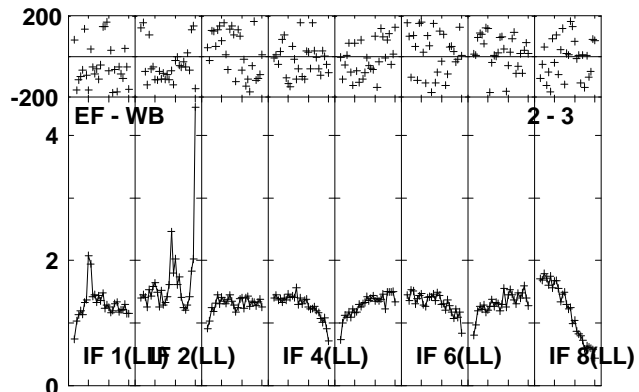
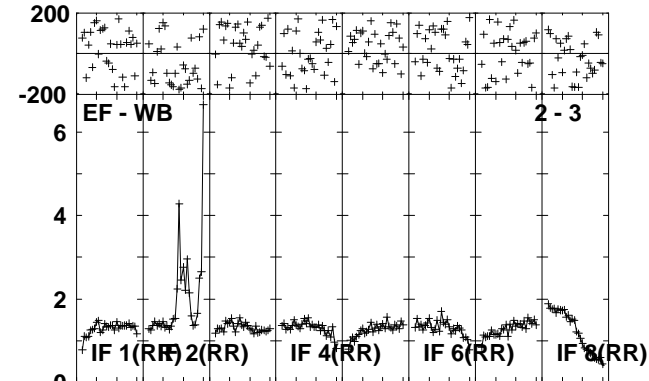
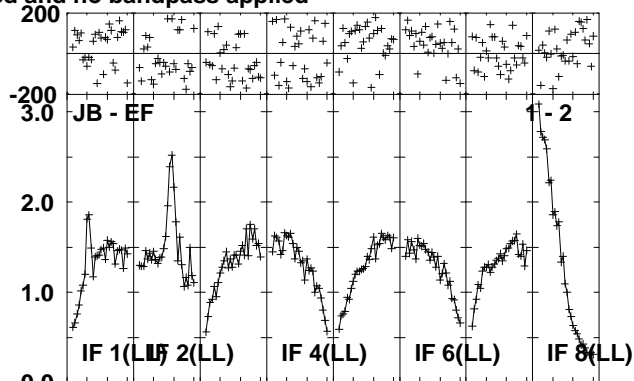
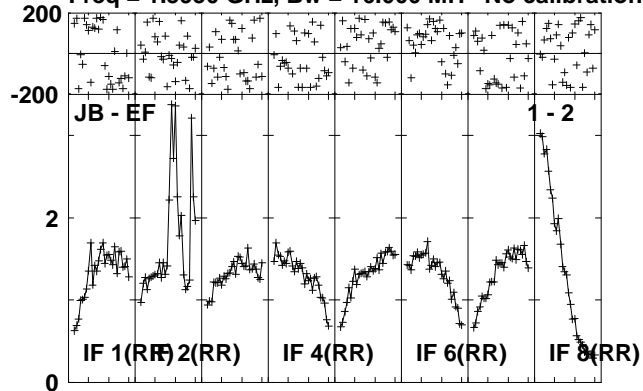

Lower frame: Milli Ampl Jy Top frame: Phas deg
 Scalar averaged cross-power spectrum Several baselines displayed
 Timerange: 00/23:22:31 to 00/23:25:59

Plot file version 72 created 23-AUG-2010 12:34:29

IRAS1929 EP064P.UVDATA.1

Freq = 1.5950 GHz, Bw = 16.000 MH No calibration applied and no bandpass applied

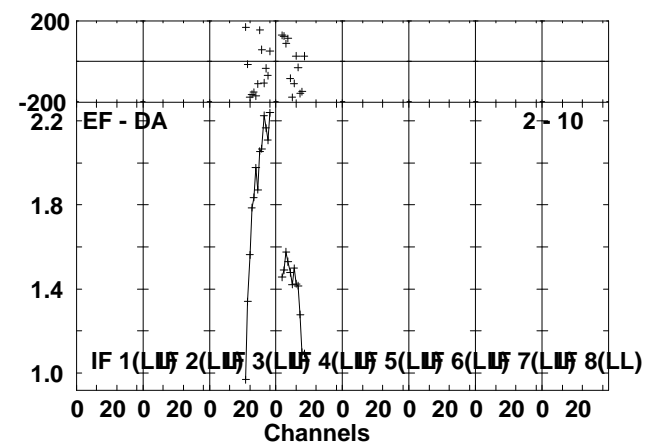
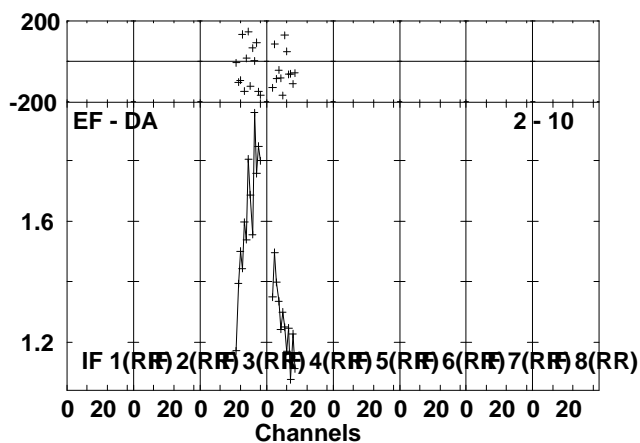
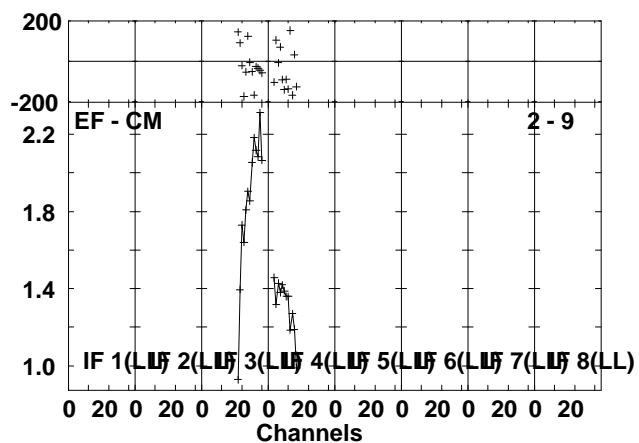
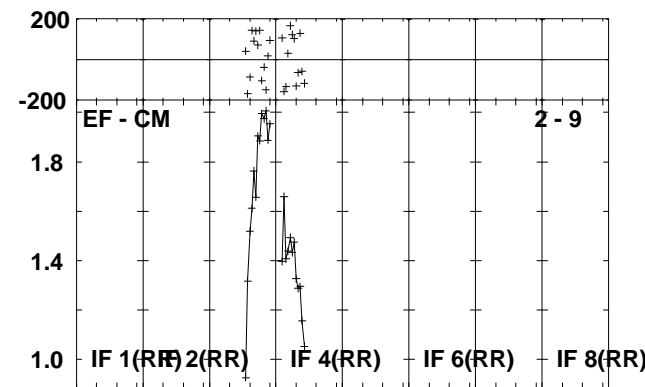
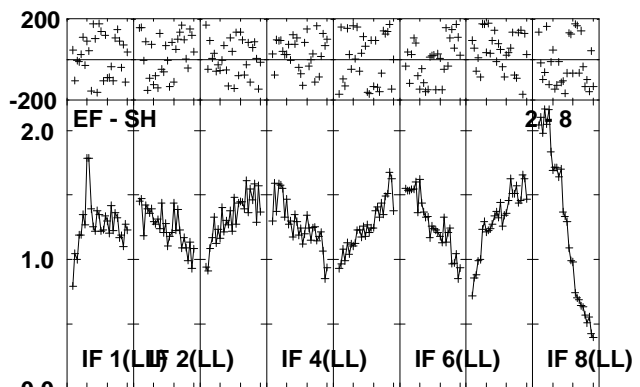
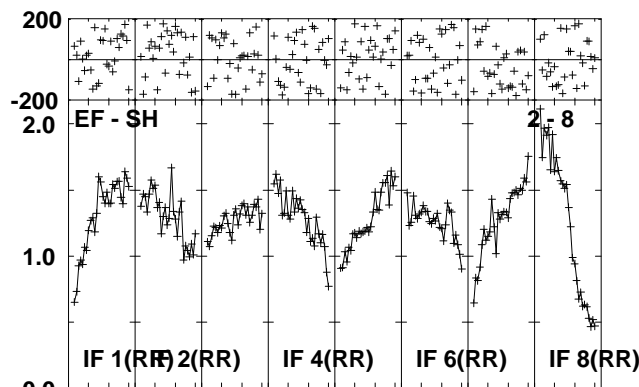
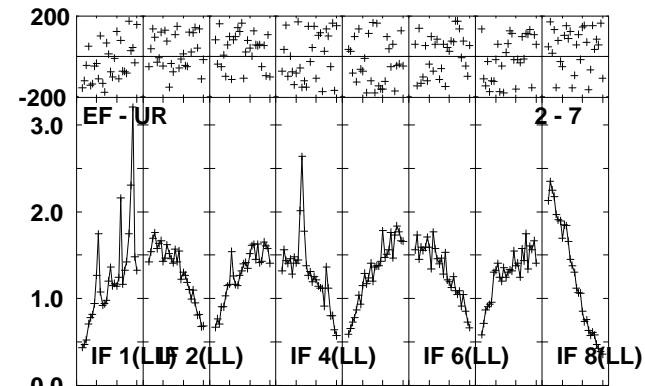
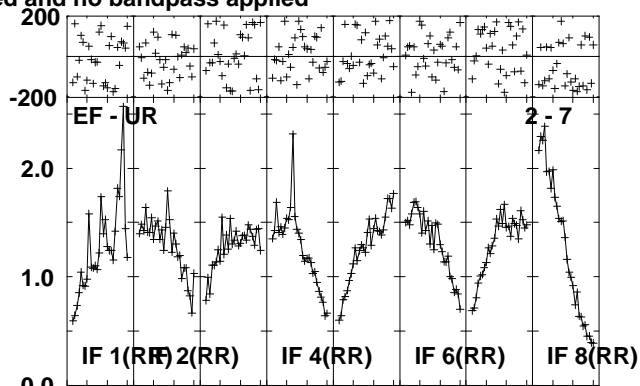
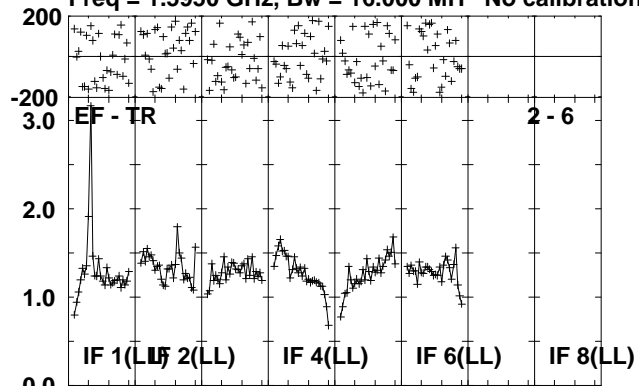

Lower frame: Milli Ampl Jy Top frame: Phas deg
Scalar averaged cross-power spectrum Several baselines displayed
Timerange: 00/23:22:31 to 00/23:25:59

Plot file version 73 created 23-AUG-2010 12:34:31

J1941-05 EP064P.UVDATA.1

Freq = 1.5950 GHz, Bw = 16.000 MH No calibration applied and no bandpass applied

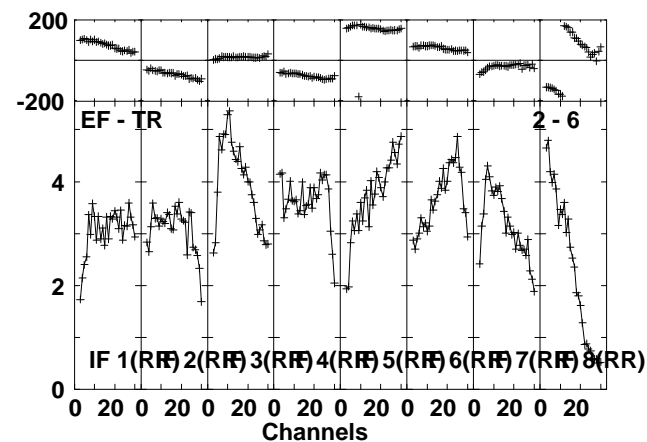
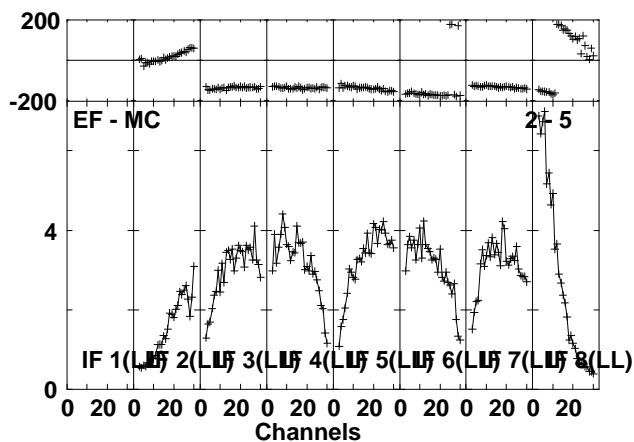
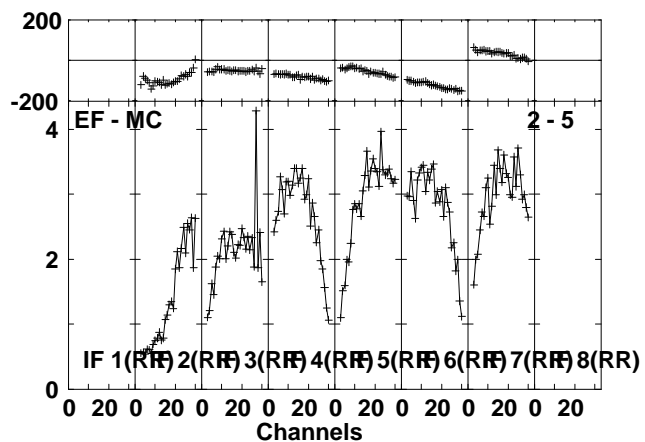
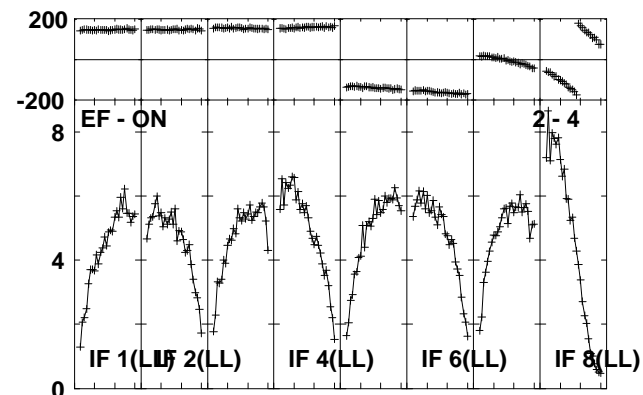
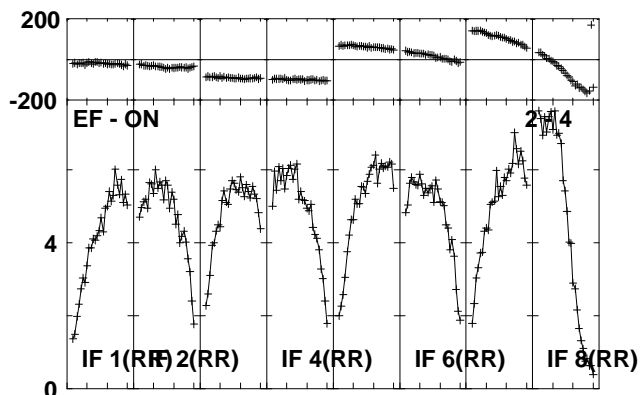
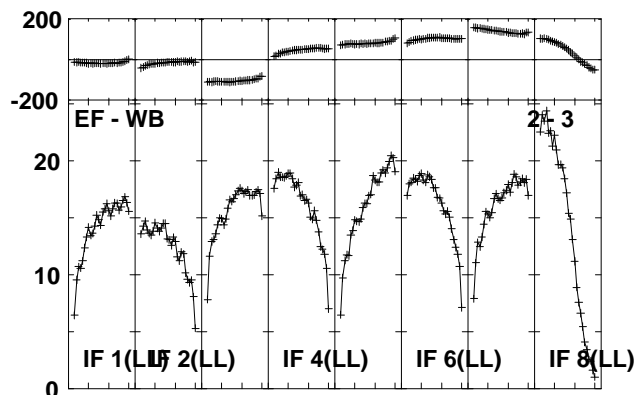
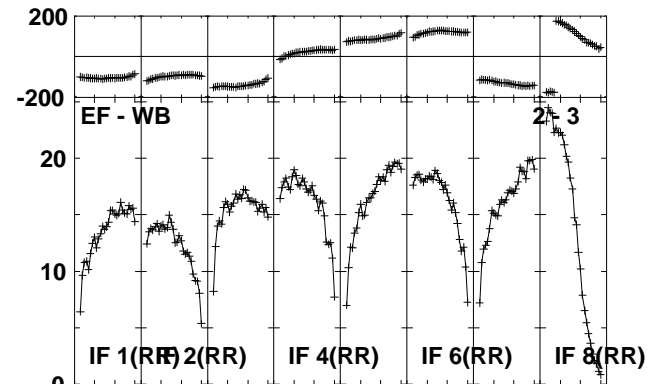
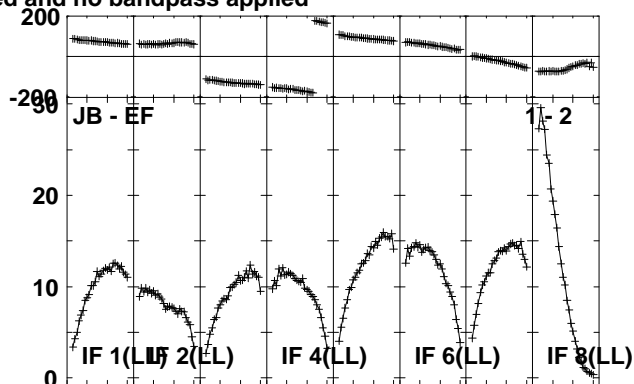
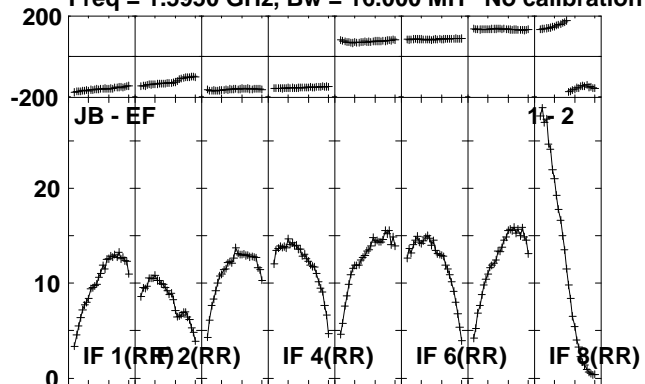

Lower frame: Milli Ampl Jy Top frame: Phas deg
Scalar averaged cross-power spectrum Several baselines displayed
Timerange: 00/23:26:01 to 00/23:27:29

Plot file version 74 created 23-AUG-2010 12:34:32

J1941-05 EP064P.UVDATA.1

Freq = 1.5950 GHz, Bw = 16.000 MH No calibration applied and no bandpass applied

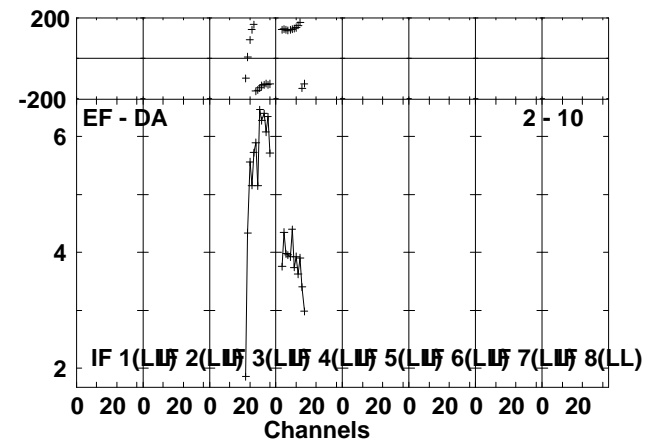
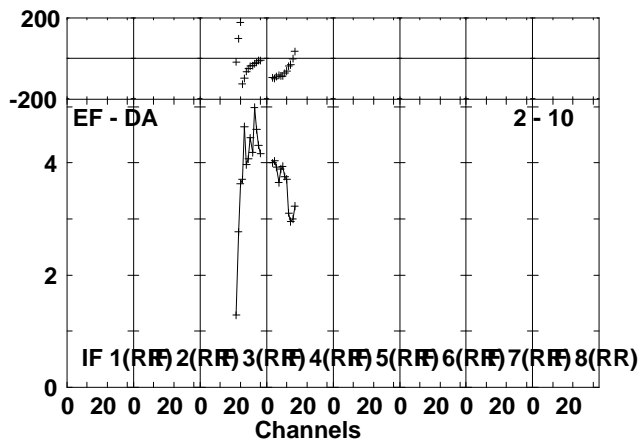
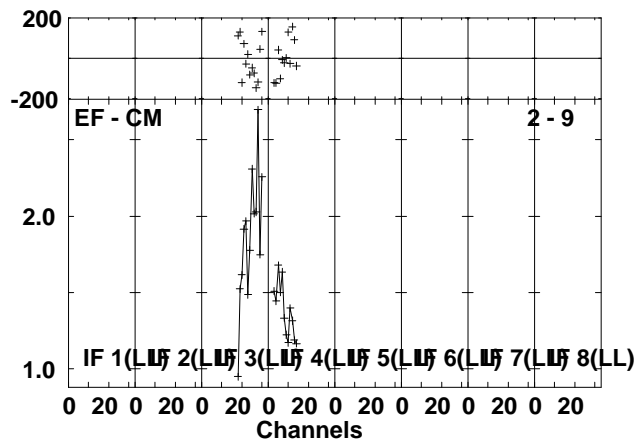
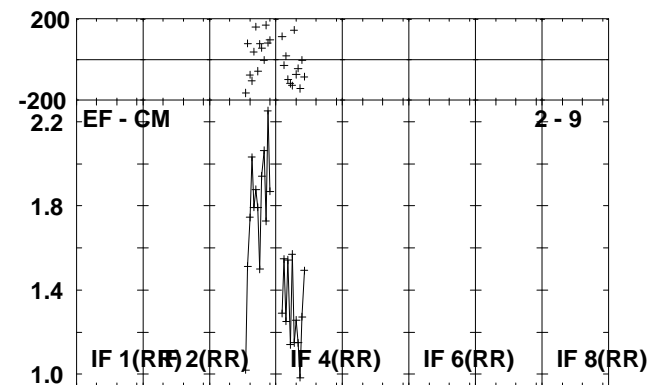
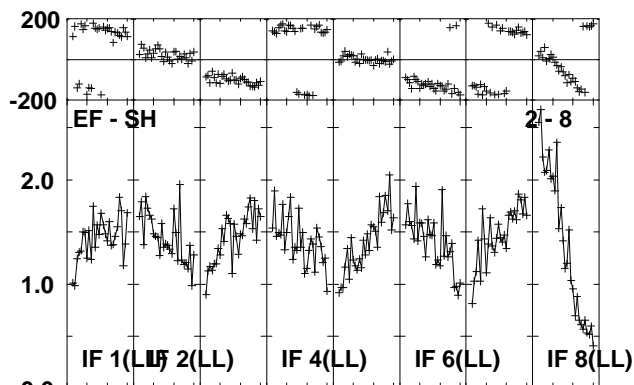
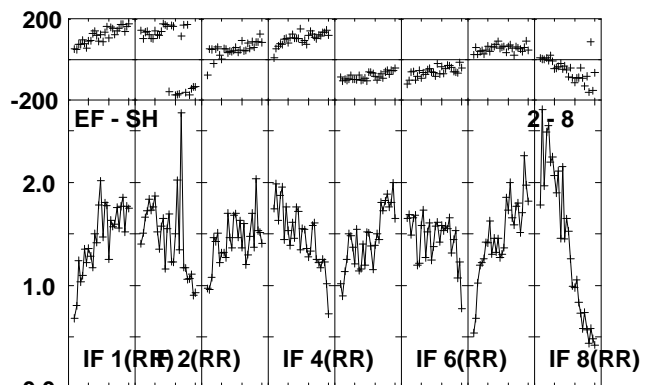
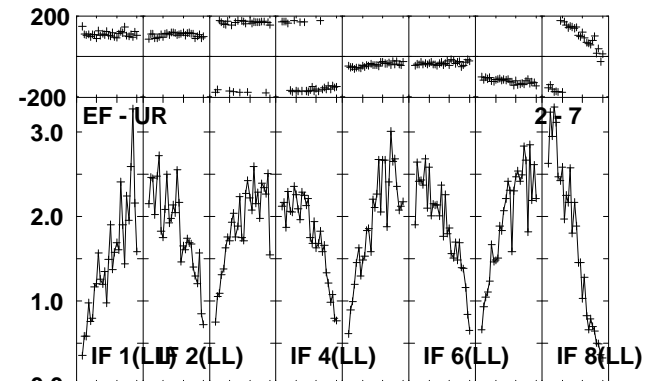
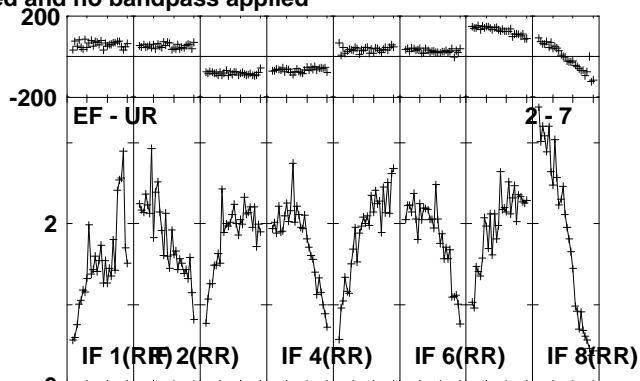
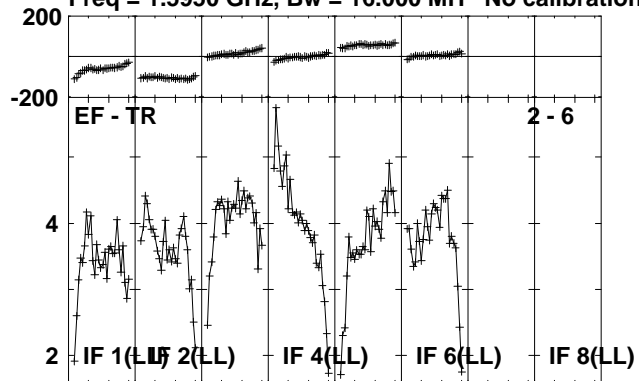

Lower frame: Milli Ampl Jy Top frame: Phas deg
Scalar averaged cross-power spectrum Several baselines displayed
Timerange: 00/23:26:01 to 00/23:27:29

Plot file version 75 created 23-AUG-2010 12:34:33

IRAS1929 EP064P.UVDATA.1

Freq = 1.5950 GHz, Bw = 16.000 MH No calibration applied and no bandpass applied

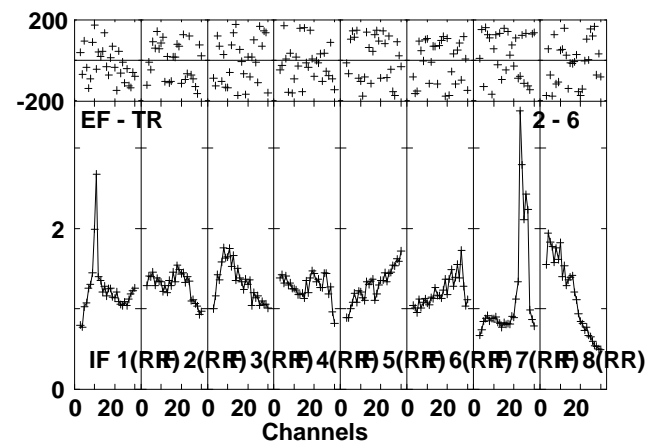
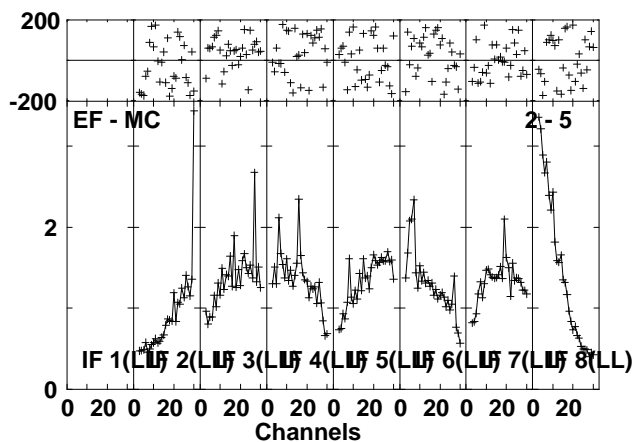
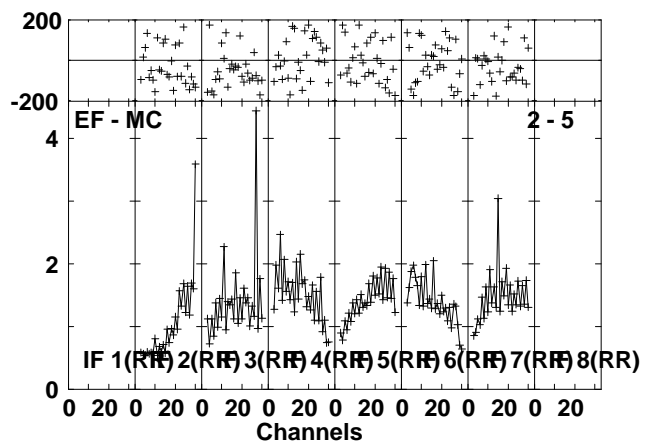
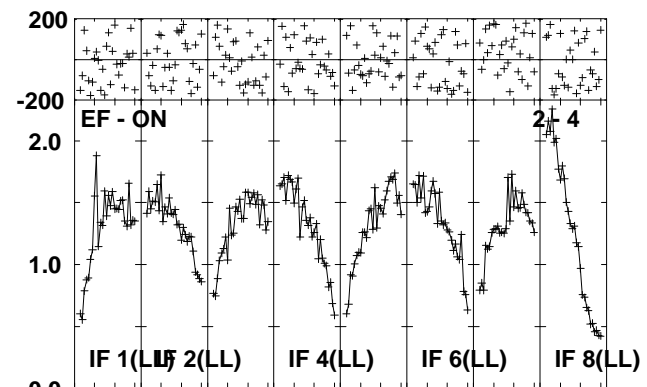
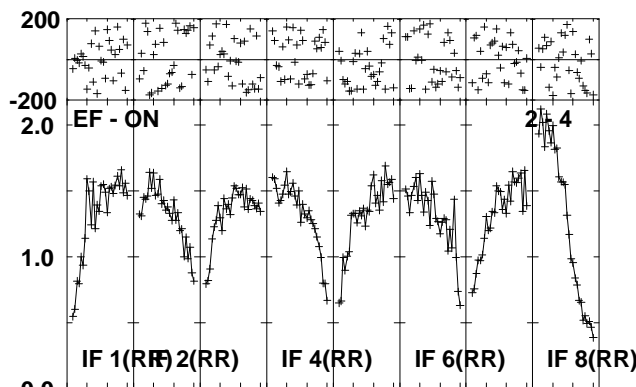
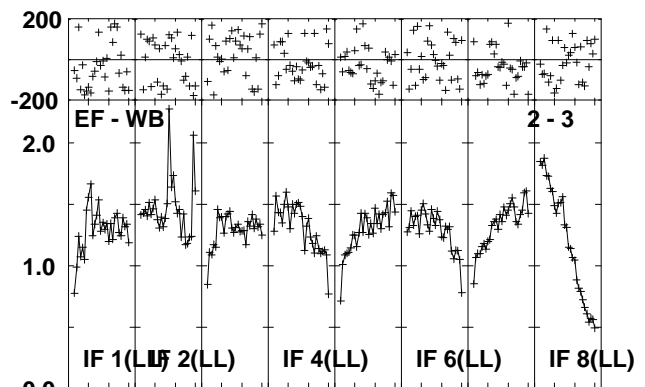
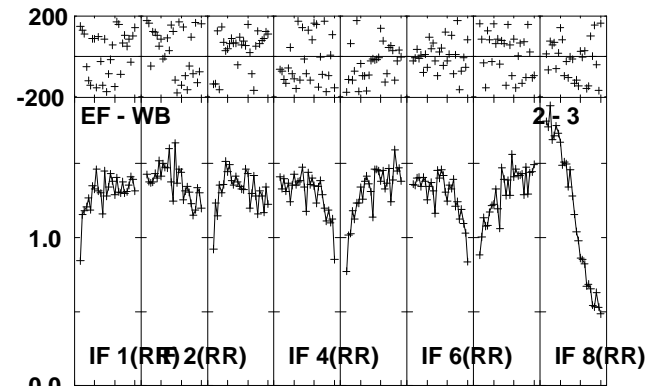
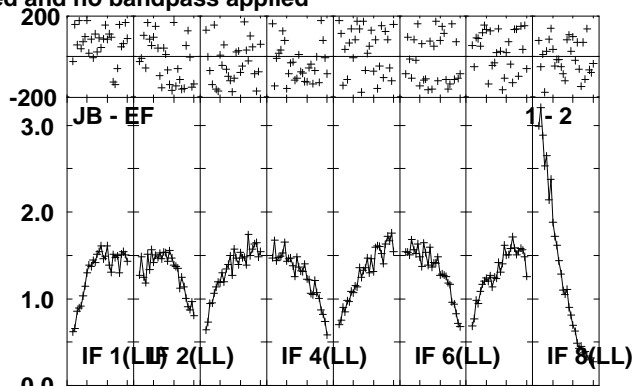
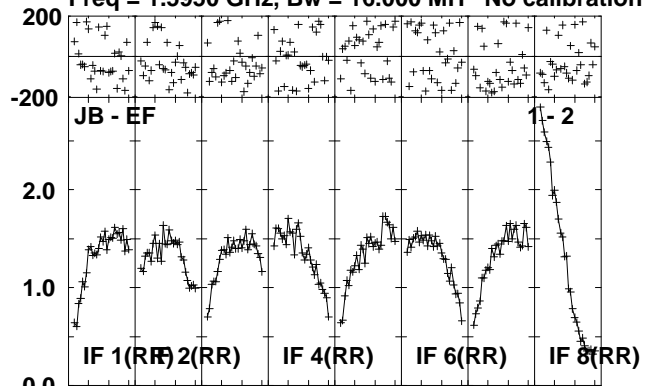

Lower frame: Milli Ampl Jy Top frame: Phas deg
Scalar averaged cross-power spectrum Several baselines displayed
Timerange: 00/23:27:31 to 00/23:30:59

Plot file version 76 created 23-AUG-2010 12:34:35

IRAS1929 EP064P.UVDATA.1

Freq = 1.5950 GHz, Bw = 16.000 MH No calibration applied and no bandpass applied

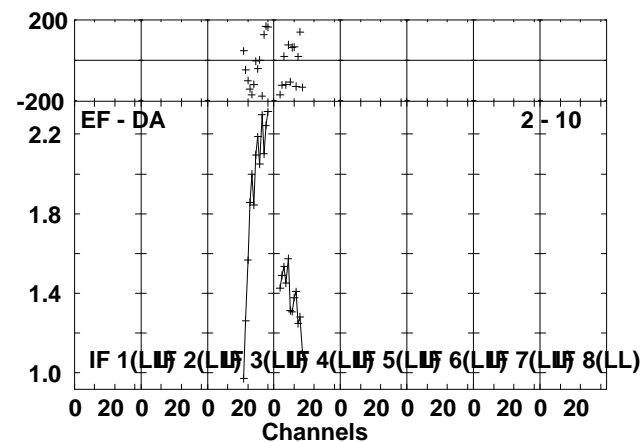
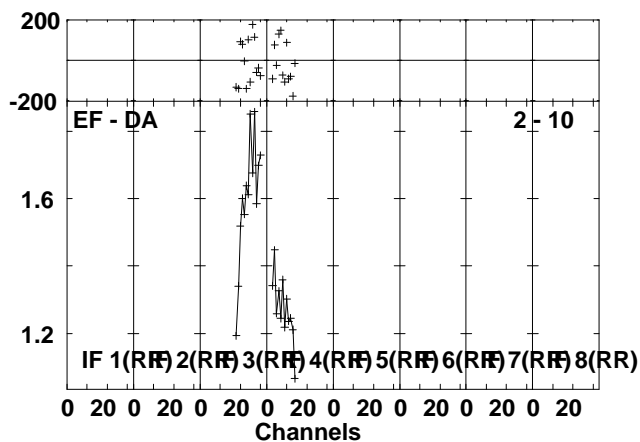
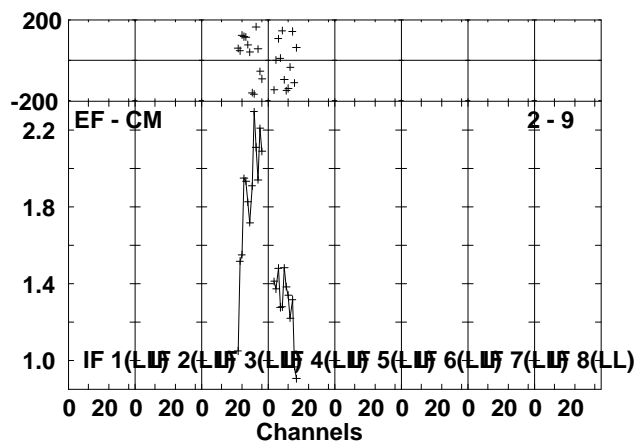
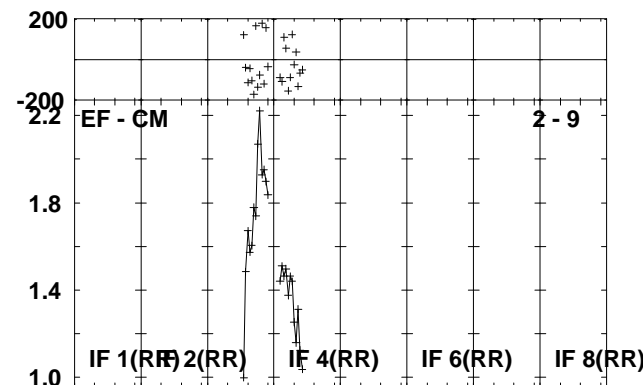
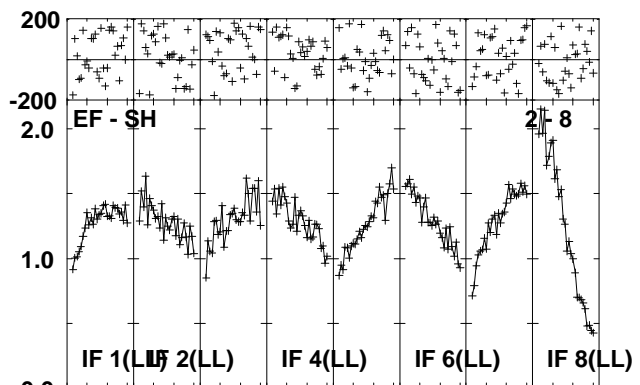
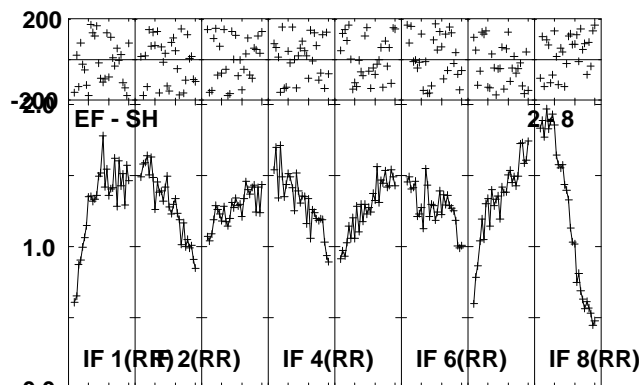
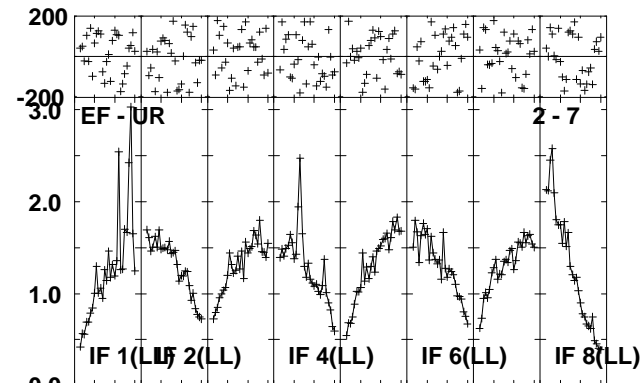
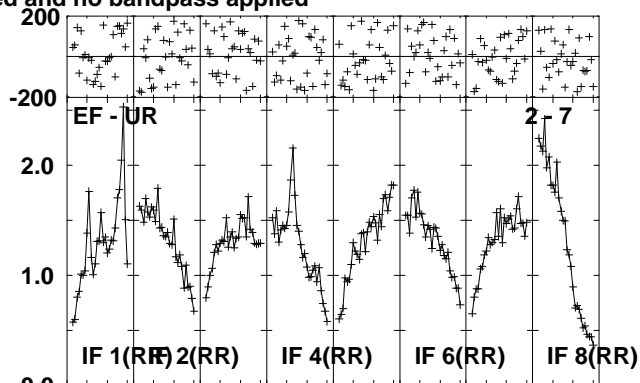
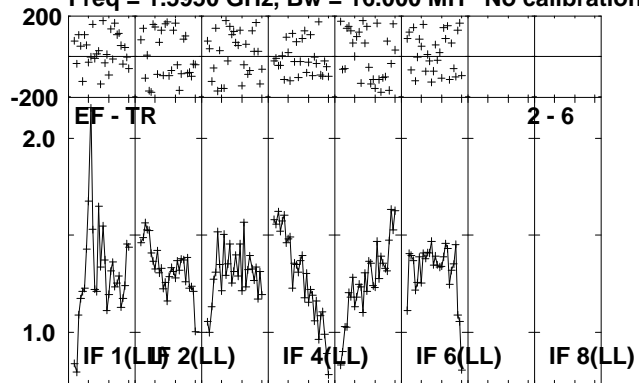

Lower frame: Milli Ampl Jy Top frame: Phas deg
Scalar averaged cross-power spectrum Several baselines displayed
Timerange: 00/23:27:31 to 00/23:30:59

Plot file version 77 created 23-AUG-2010 12:34:38

J1941-05 EP064P.UVDATA.1

Freq = 1.5950 GHz, Bw = 16.000 MH No calibration applied and no bandpass applied

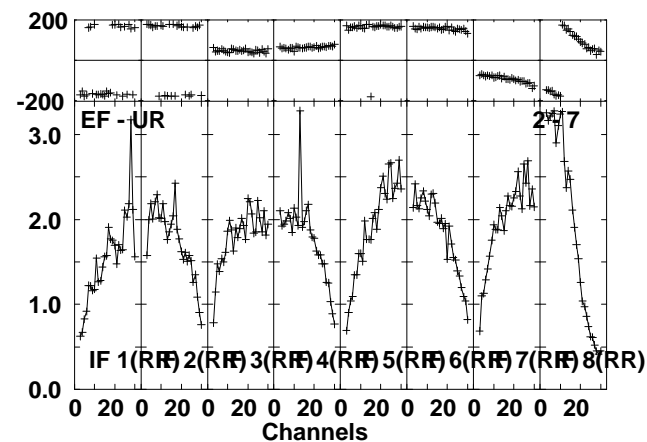
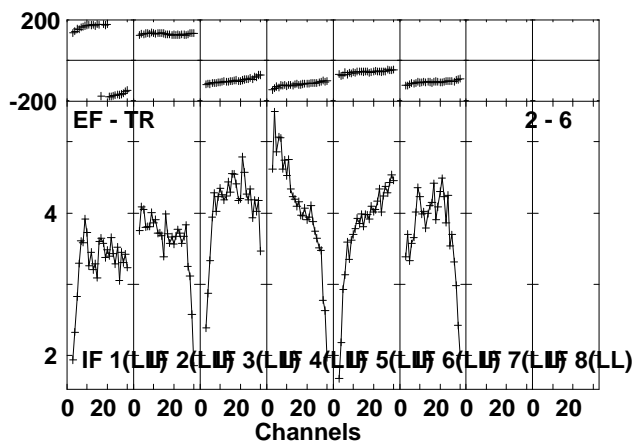
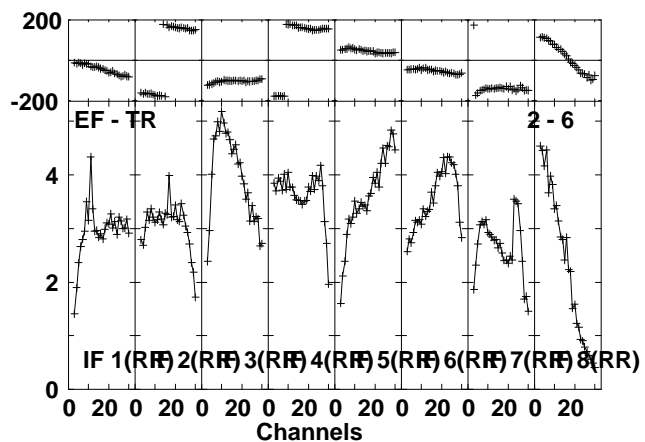
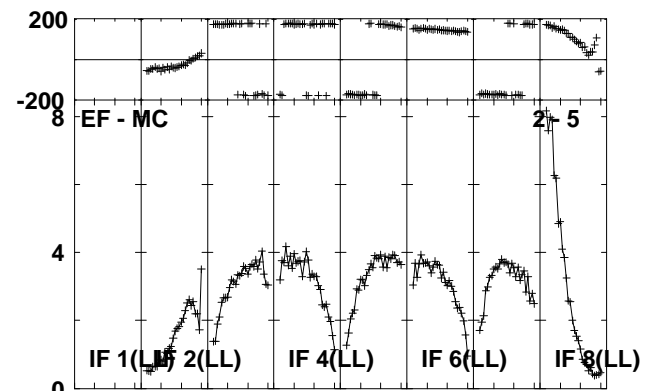
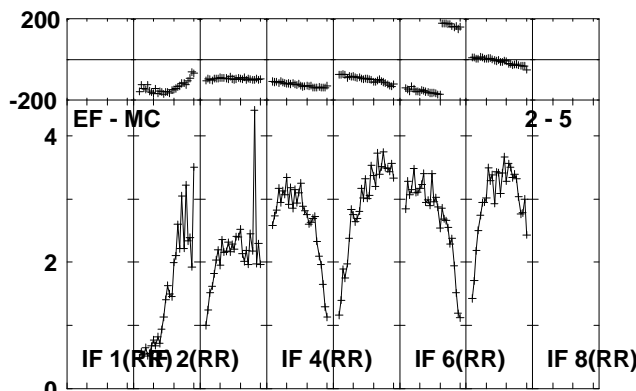
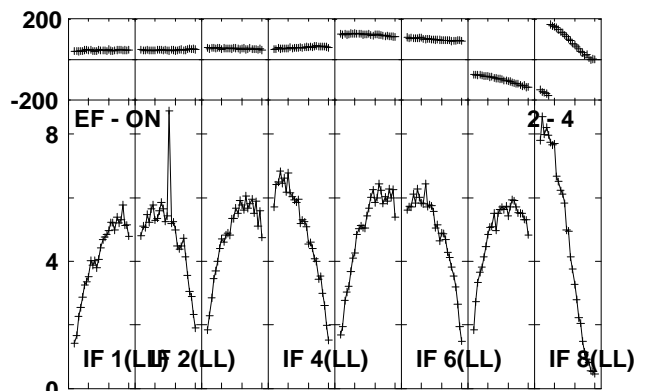
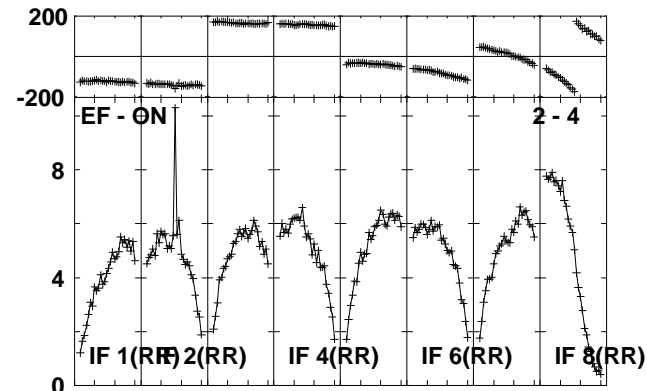
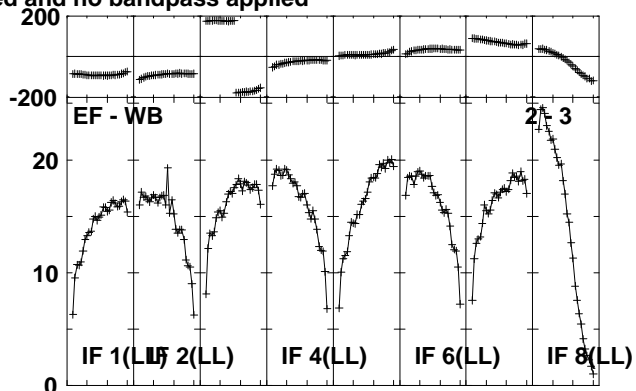
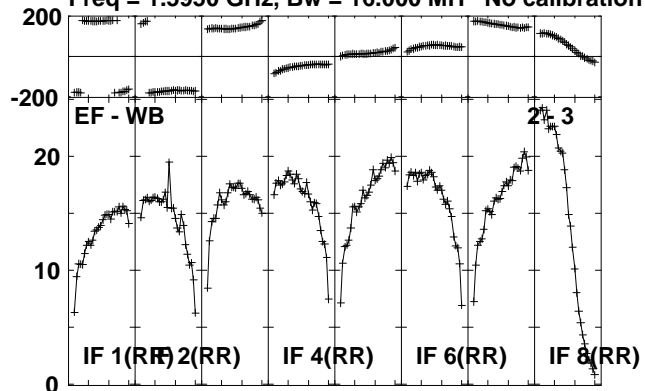

Lower frame: Milli Ampl Jy Top frame: Phas deg
Scalar averaged cross-power spectrum Several baselines displayed
Timerange: 00/23:32:01 to 00/23:33:29

Plot file version 78 created 23-AUG-2010 12:34:38

J1941-05 EP064P.UVDATA.1

Freq = 1.5950 GHz, Bw = 16.000 MH No calibration applied and no bandpass applied

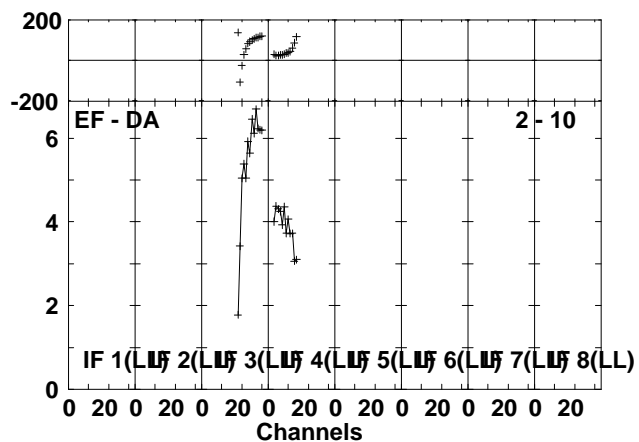
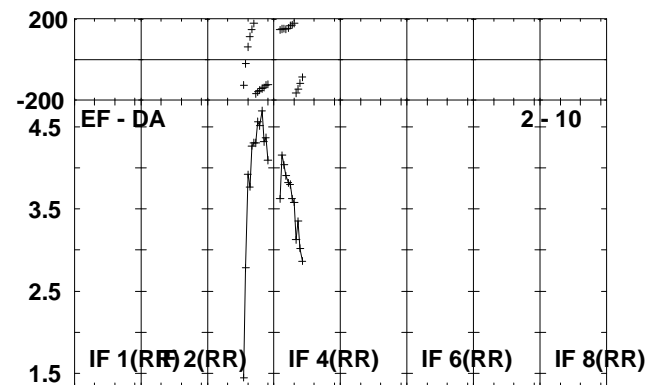
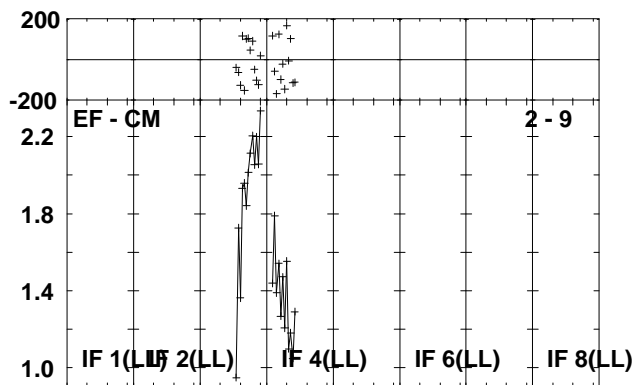
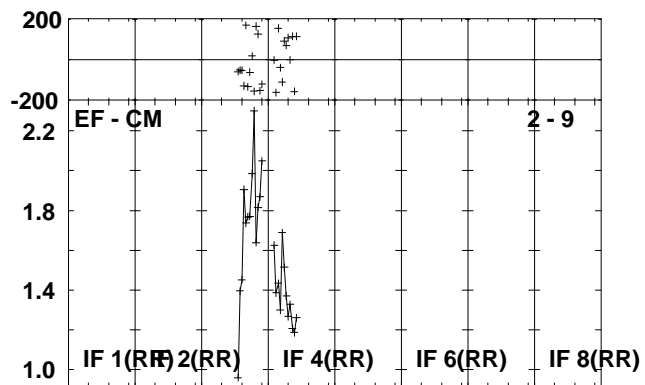
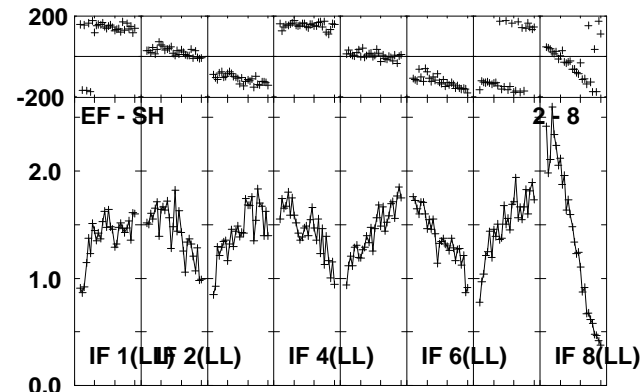
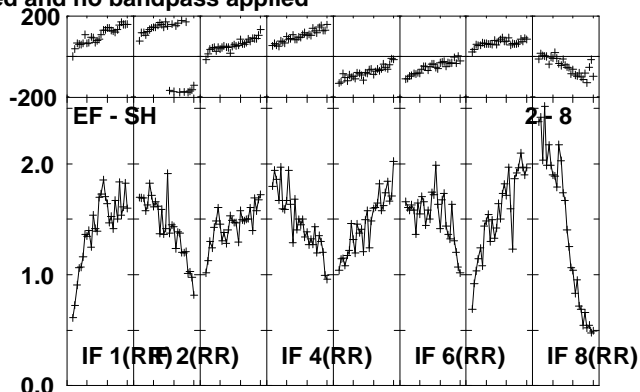
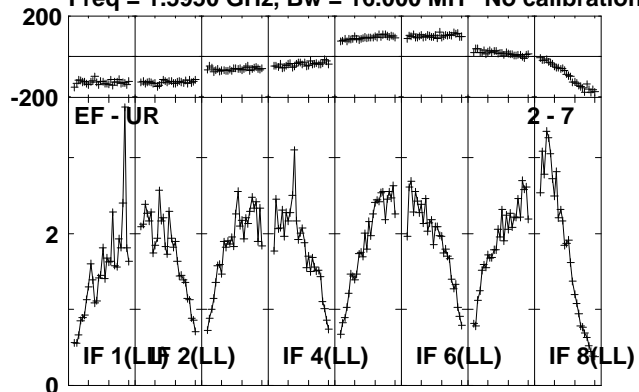

Lower frame: Milli Ampl Jy Top frame: Phas deg
Scalar averaged cross-power spectrum Several baselines displayed
Timerange: 00/23:32:01 to 00/23:33:29

Plot file version 79 created 23-AUG-2010 12:34:39

IRAS1929 EP064P.UVDATA.1

Freq = 1.5950 GHz, Bw = 16.000 MH No calibration applied and no bandpass applied

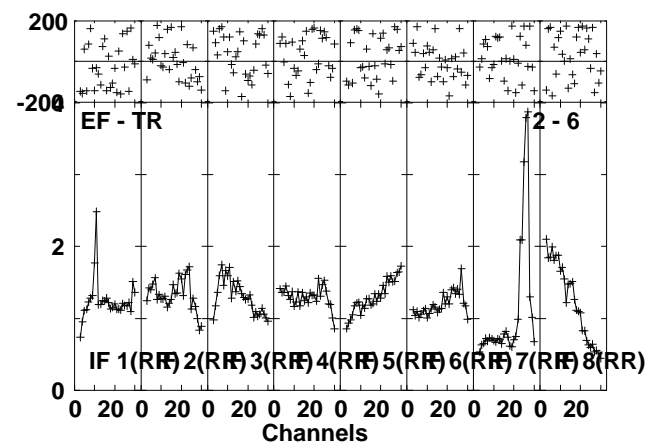
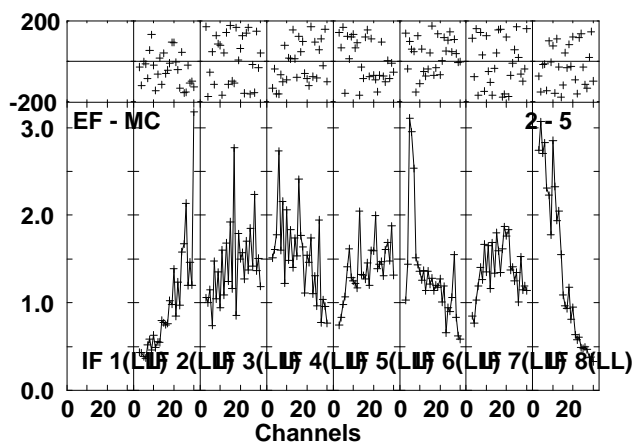
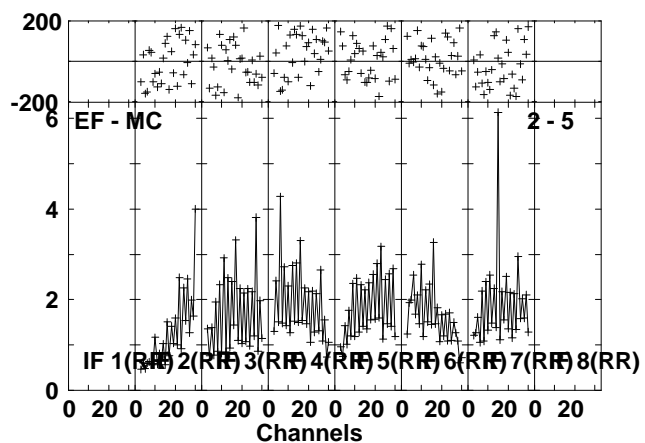
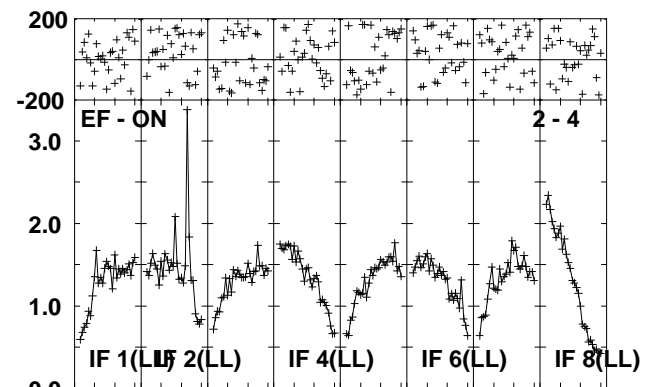
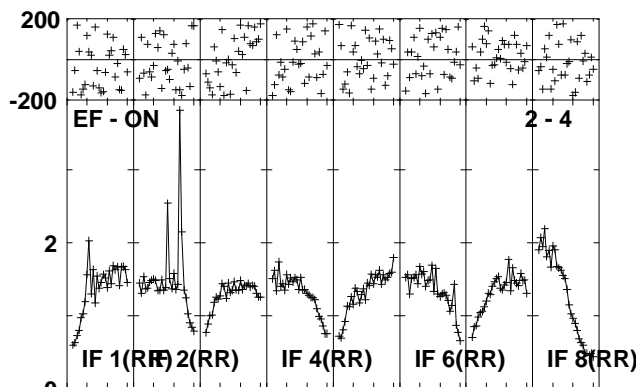
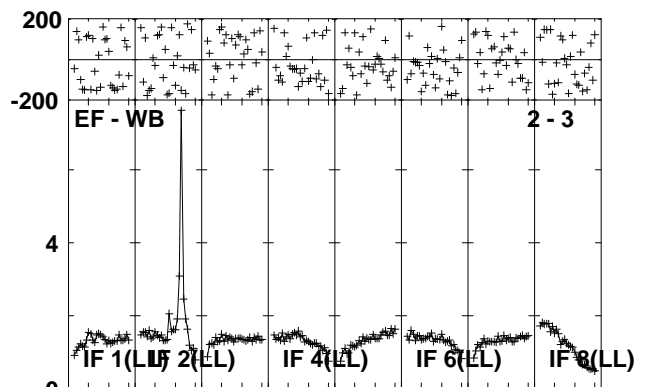
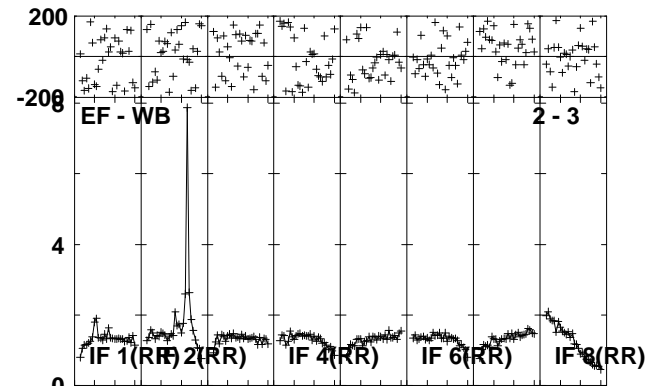
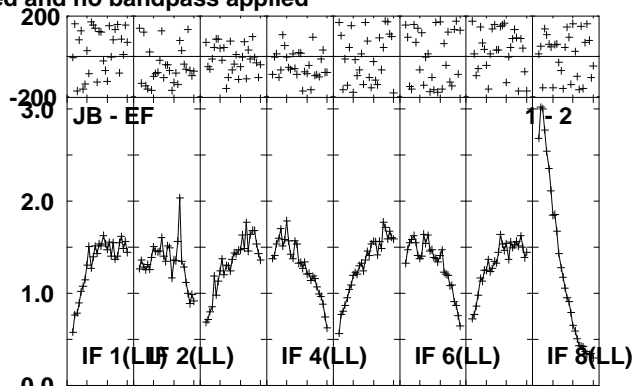
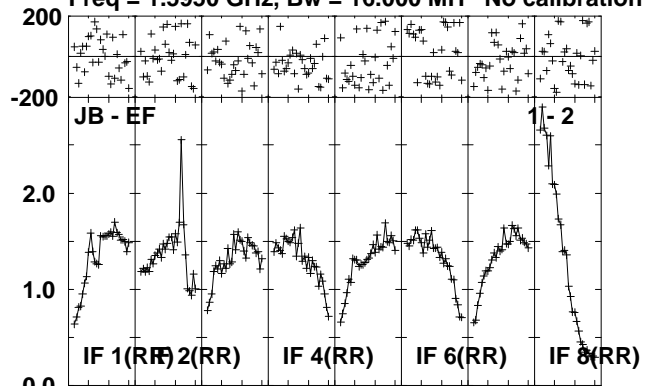

Lower frame: Milli Ampl Jy Top frame: Phas deg
Scalar averaged cross-power spectrum Several baselines displayed
Timerange: 00/23:33:31 to 00/23:36:59

Plot file version 80 created 23-AUG-2010 12:34:41

IRAS1929 EP064P.UVDATA.1

Freq = 1.5950 GHz, Bw = 16.000 MH No calibration applied and no bandpass applied

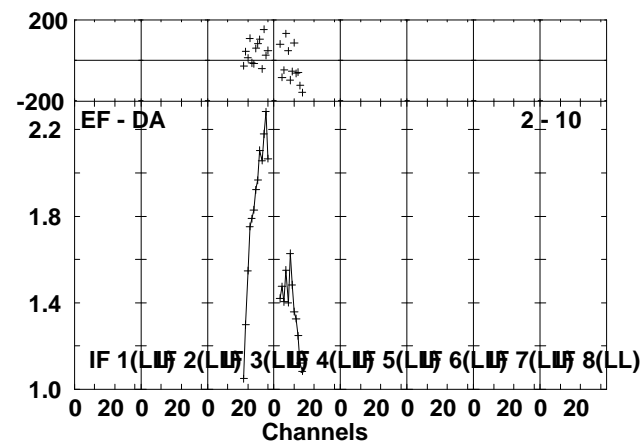
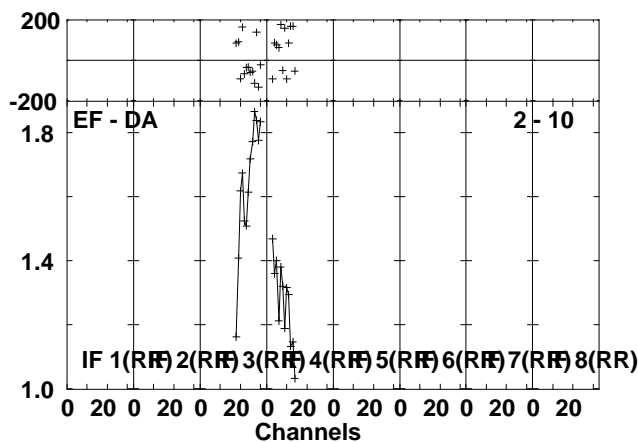
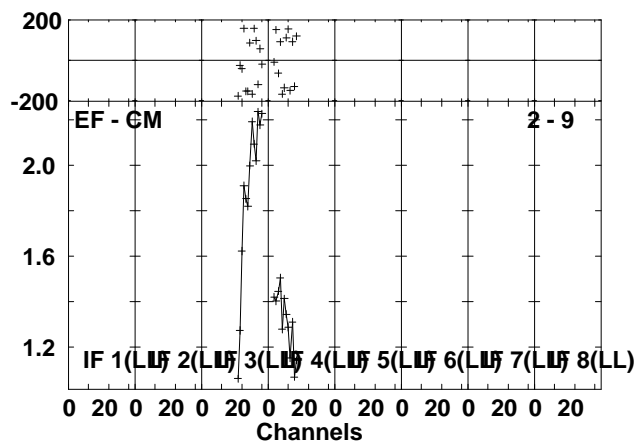
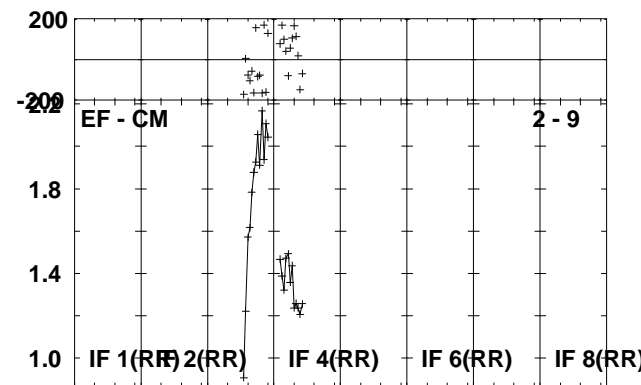
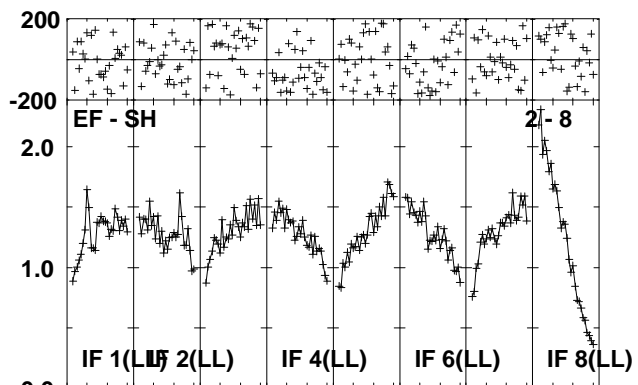
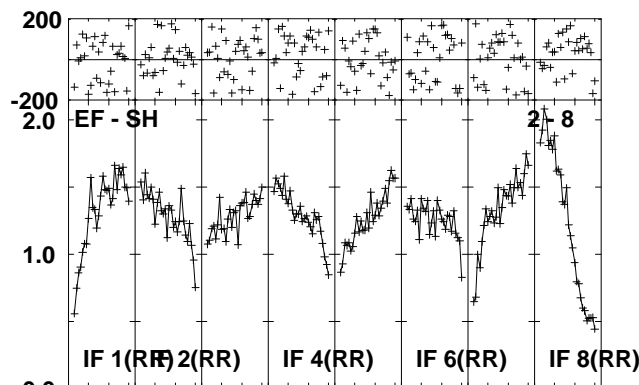
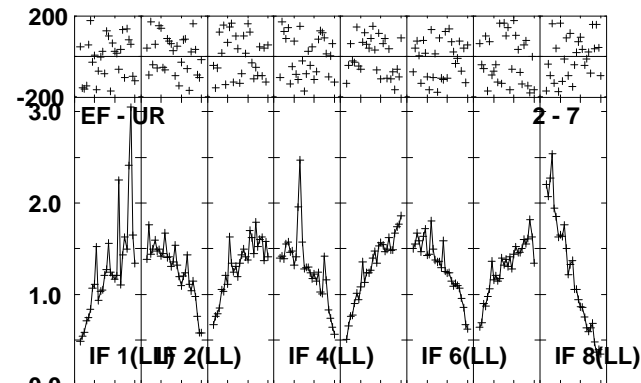
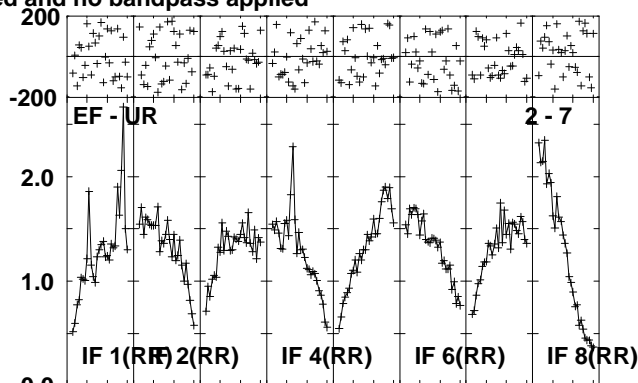
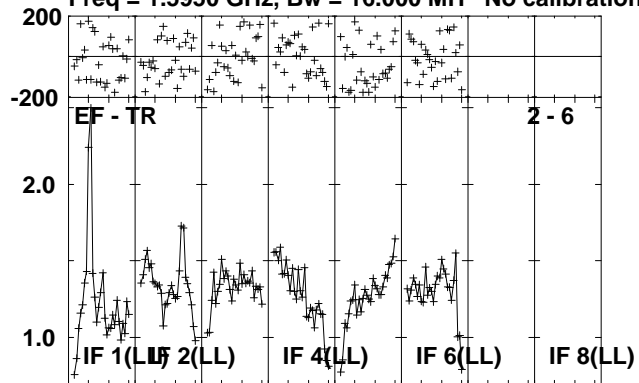

Lower frame: Milli Ampl Jy Top frame: Phas deg
Scalar averaged cross-power spectrum Several baselines displayed
Timerange: 00/23:33:31 to 00/23:36:59

Plot file version 81 created 23-AUG-2010 12:34:44

J1941-05 EP064P.UVDATA.1

Freq = 1.5950 GHz, Bw = 16.000 MH No calibration applied and no bandpass applied

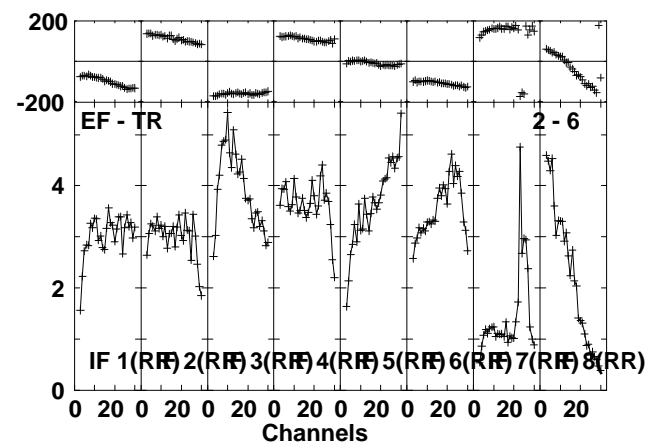
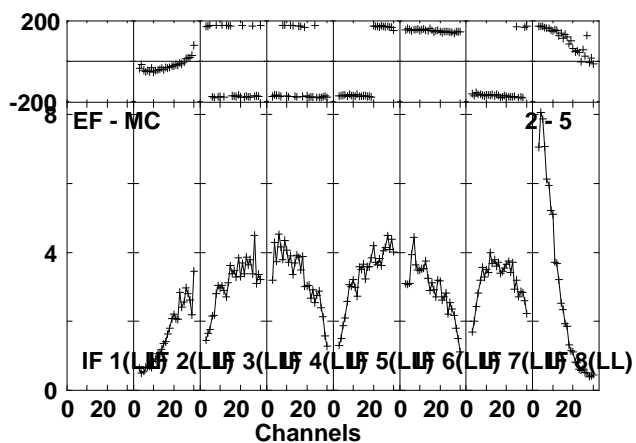
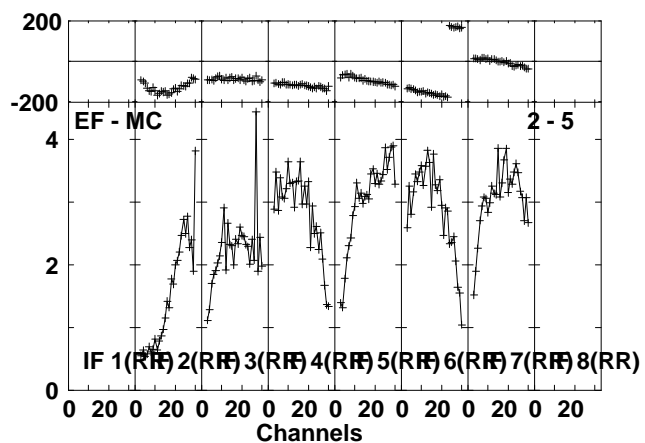
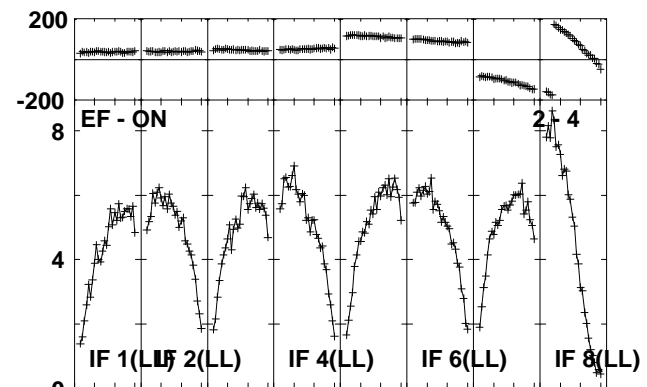
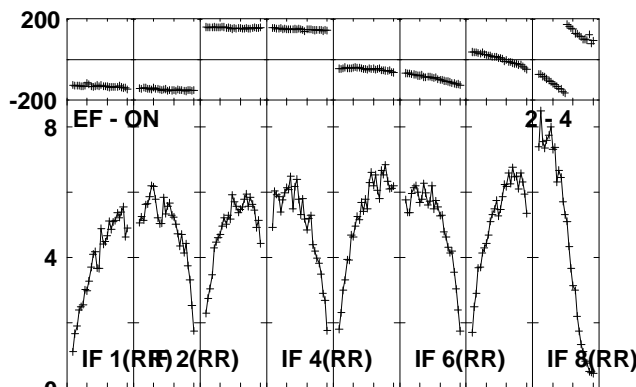
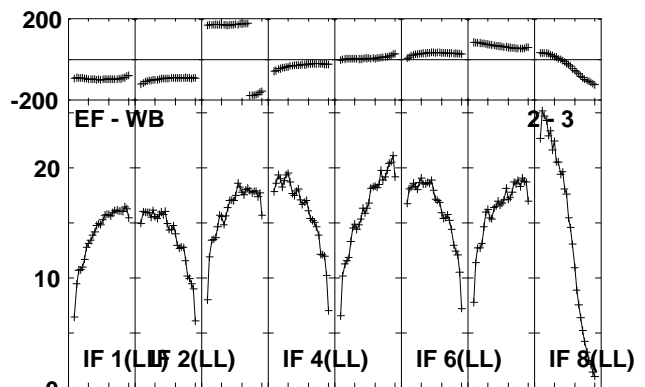
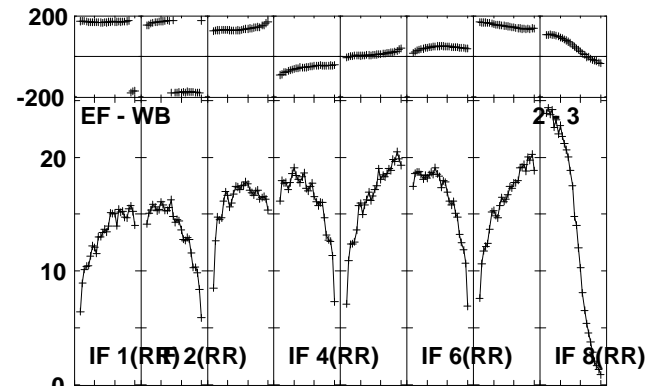
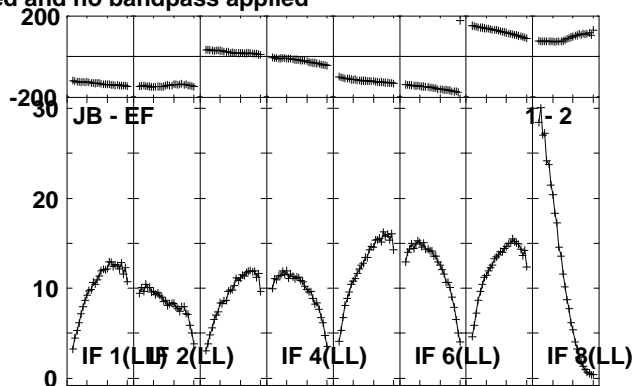
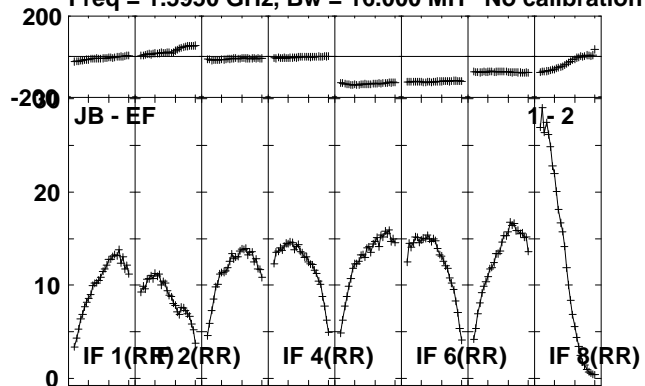

Lower frame: Milli Ampl Jy Top frame: Phas deg
Scalar averaged cross-power spectrum Several baselines displayed
Timerange: 00/23:37:01 to 00/23:38:29

Plot file version 82 created 23-AUG-2010 12:34:45

J1941-05 EP064P.UVDATA.1

Freq = 1.5950 GHz, Bw = 16.000 MH No calibration applied and no bandpass applied

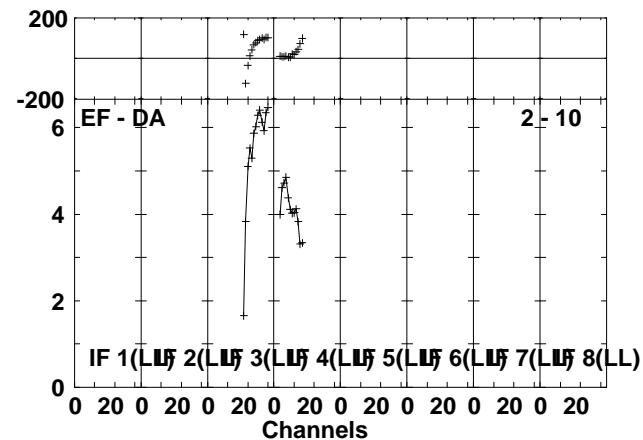
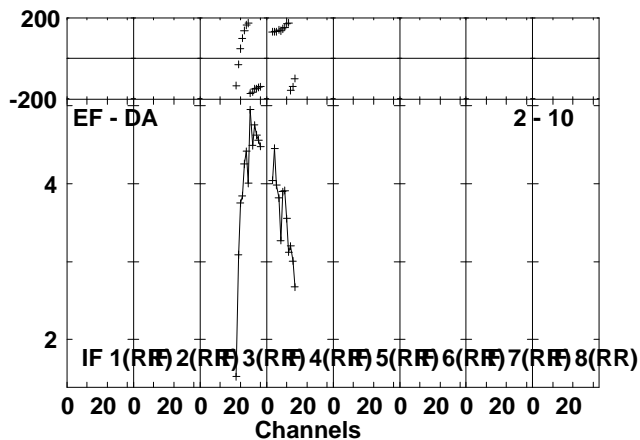
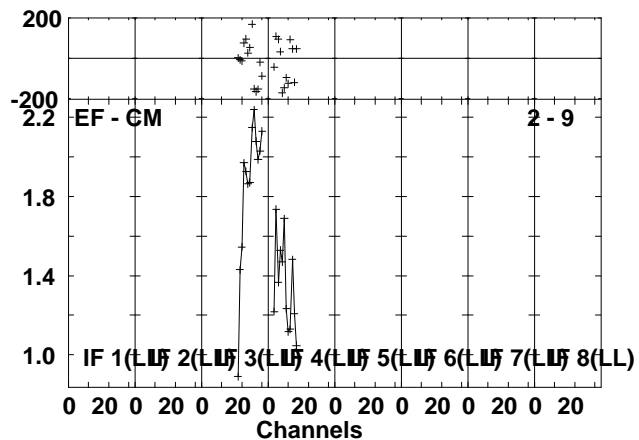
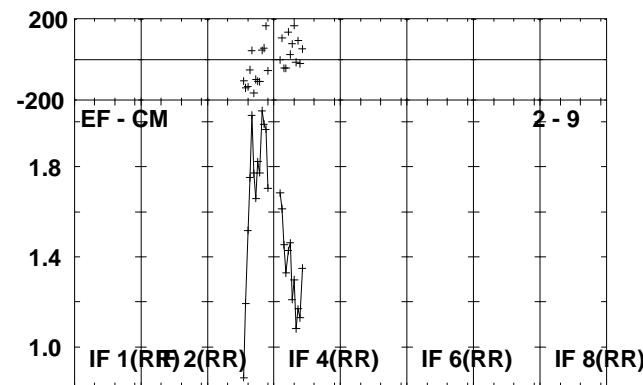
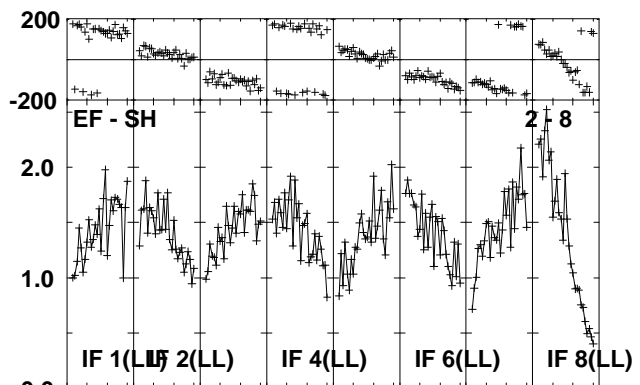
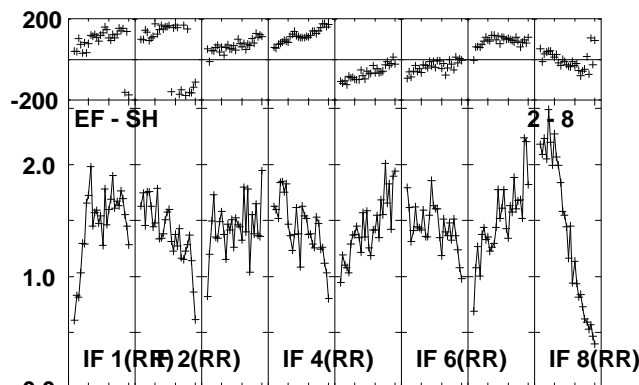
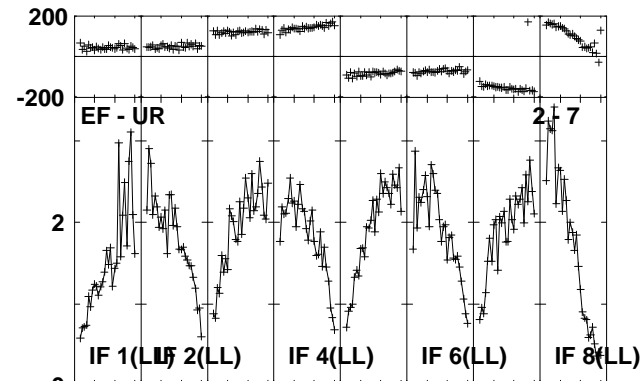
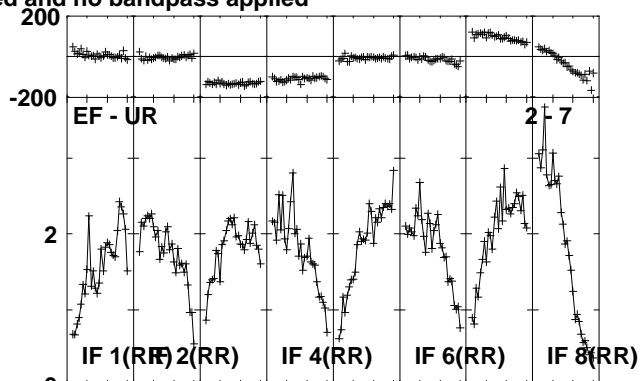
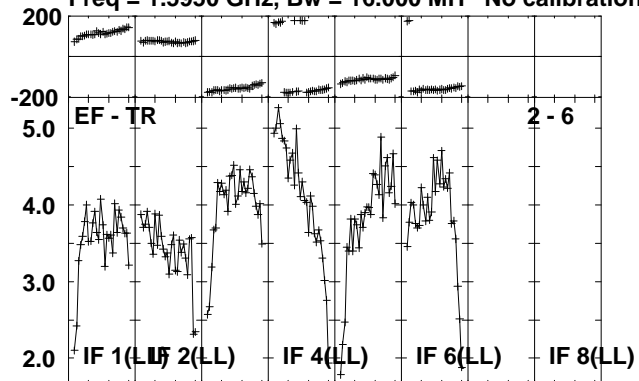

Lower frame: Milli Ampl Jy Top frame: Phas deg
Scalar averaged cross-power spectrum Several baselines displayed
Timerange: 00/23:37:01 to 00/23:38:29

Plot file version 83 created 23-AUG-2010 12:34:46

IRAS1929 EP064P.UVDATA.1

Freq = 1.5950 GHz, Bw = 16.000 MH No calibration applied and no bandpass applied

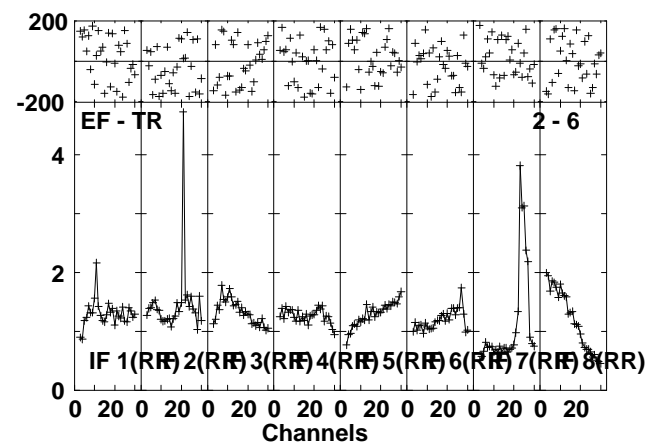
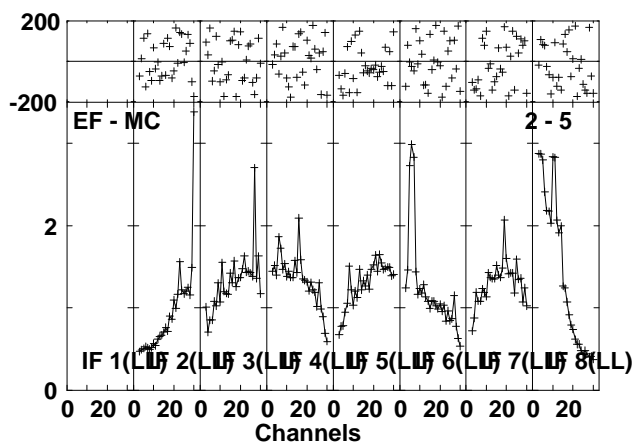
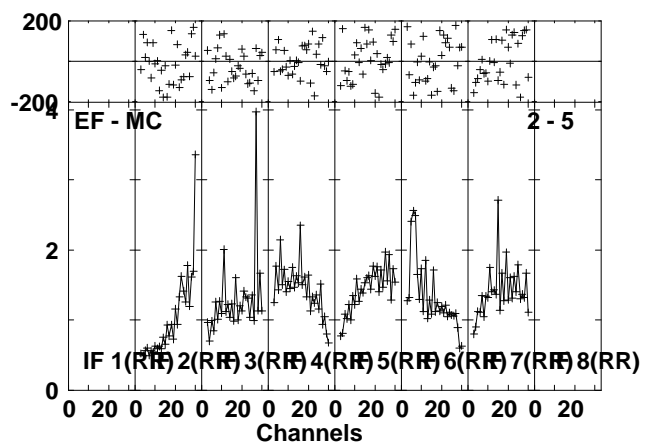
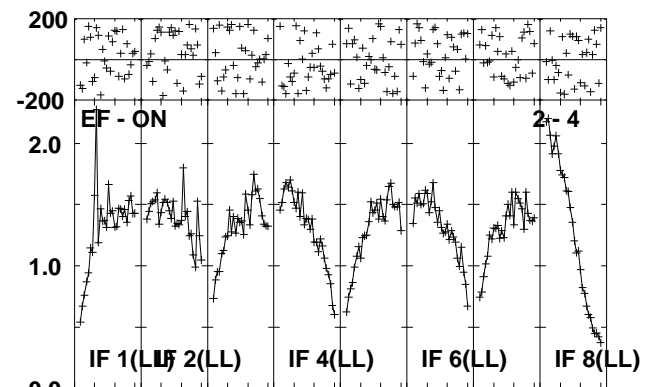
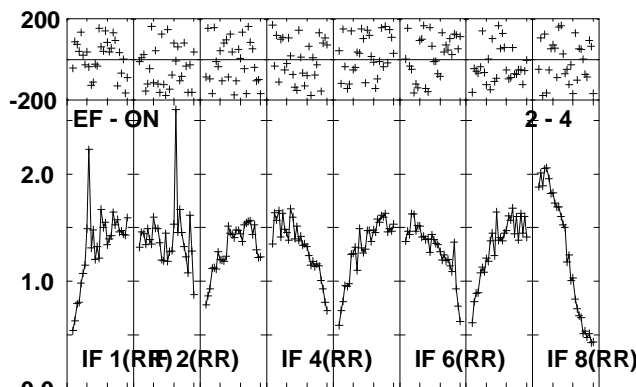
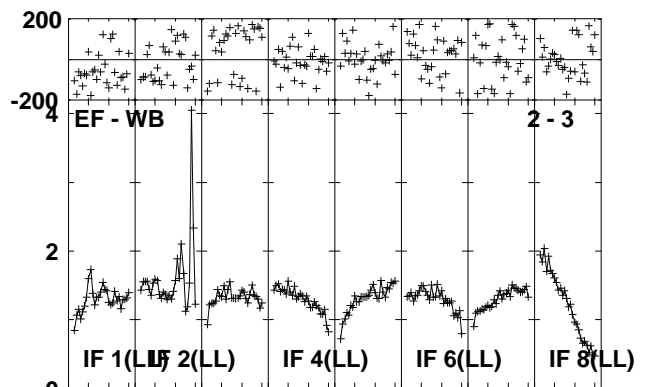
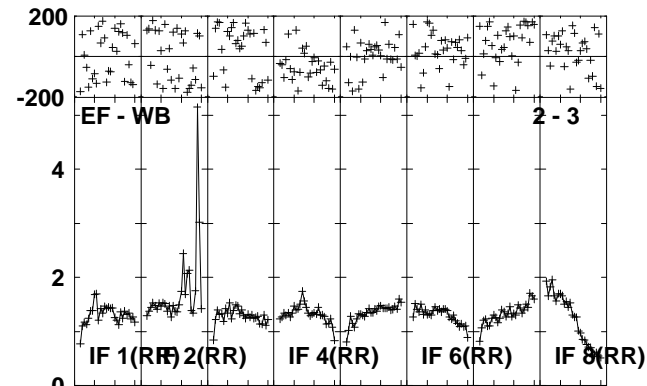
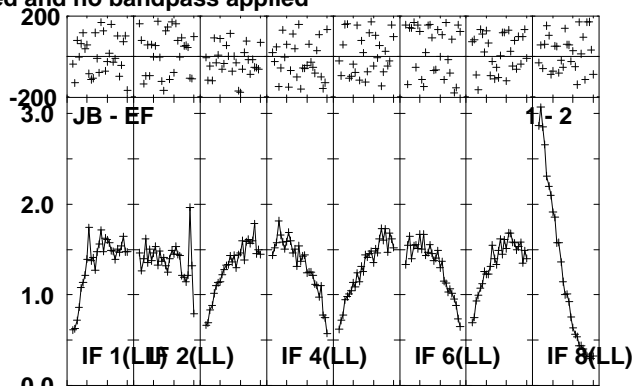
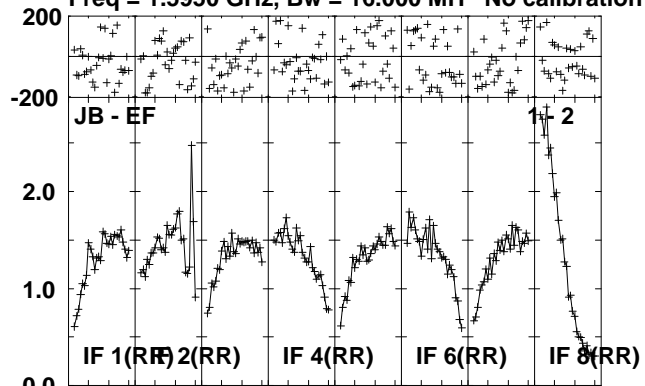

Lower frame: Milli Ampl Jy Top frame: Phas deg
Scalar averaged cross-power spectrum Several baselines displayed
Timerange: 00/23:38:31 to 00/23:41:59

Plot file version 84 created 23-AUG-2010 12:34:48

IRAS1929 EP064P.UVDATA.1

Freq = 1.5950 GHz, Bw = 16.000 MH No calibration applied and no bandpass applied

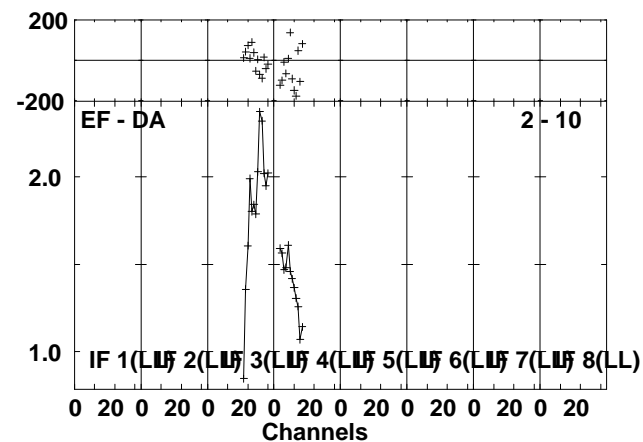
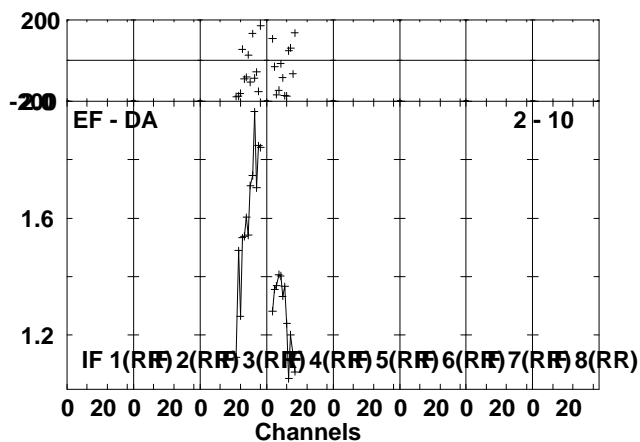
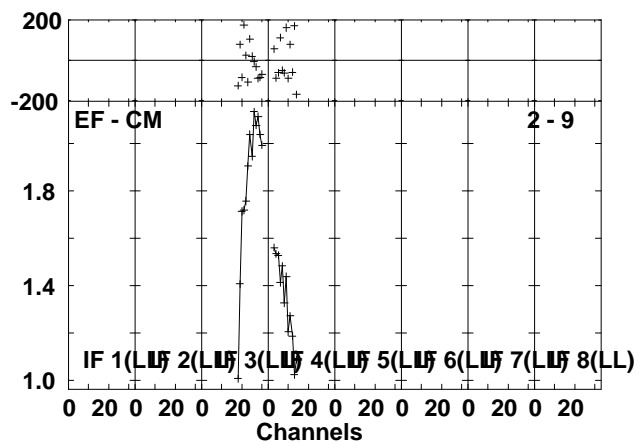
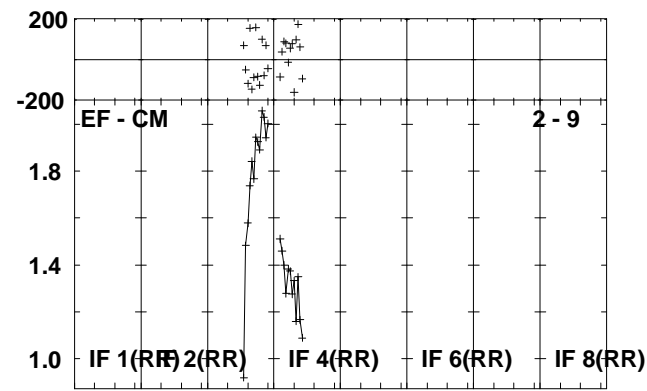
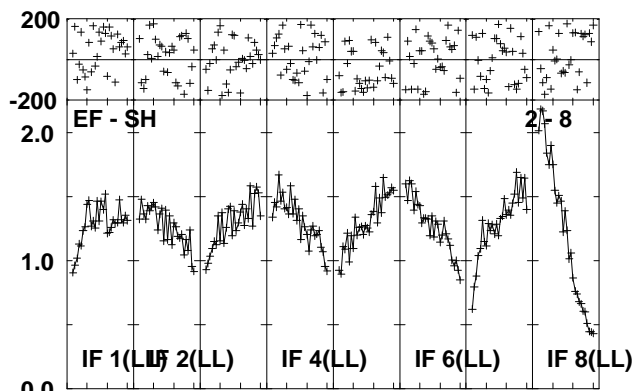
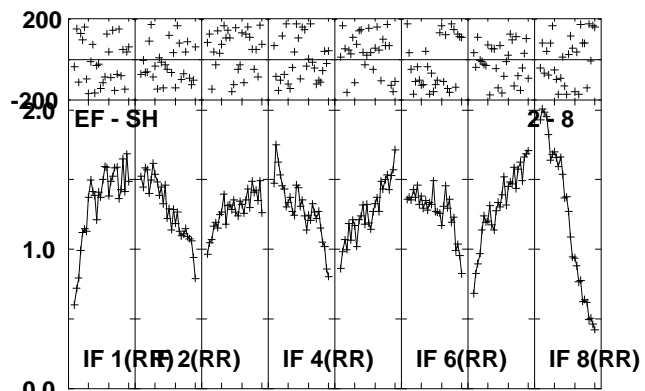
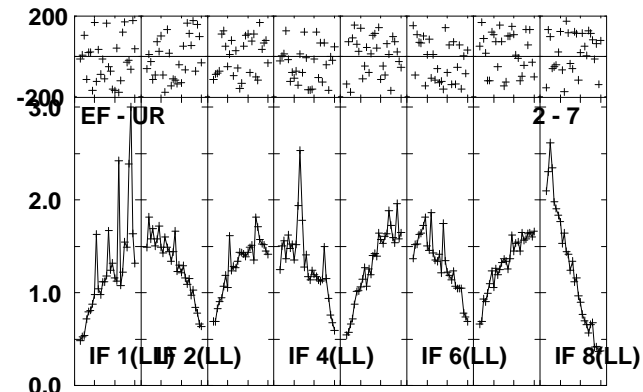
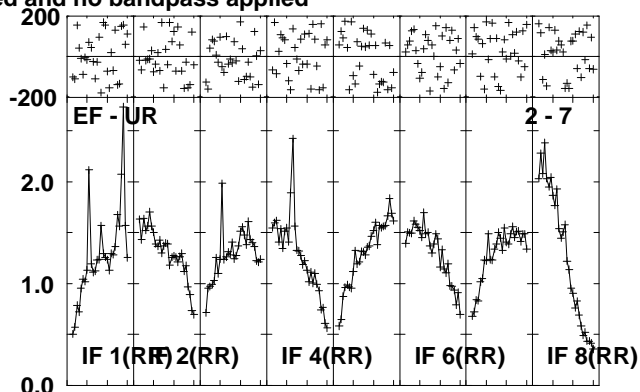
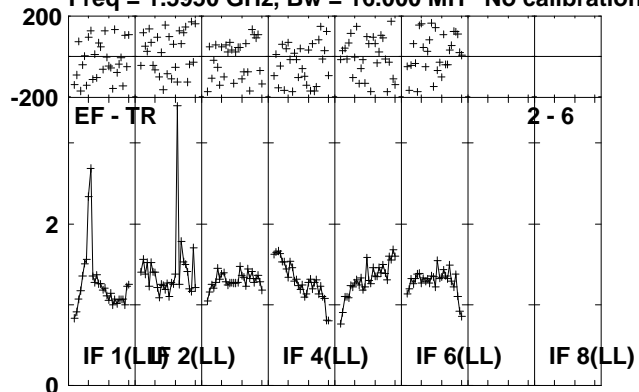

Lower frame: Milli Ampl Jy Top frame: Phas deg
Scalar averaged cross-power spectrum Several baselines displayed
Timerange: 00/23:38:31 to 00/23:41:59

Plot file version 85 created 23-AUG-2010 12:34:50

J1941-05 EP064P.UVDATA.1

Freq = 1.5950 GHz, Bw = 16.000 MH No calibration applied and no bandpass applied

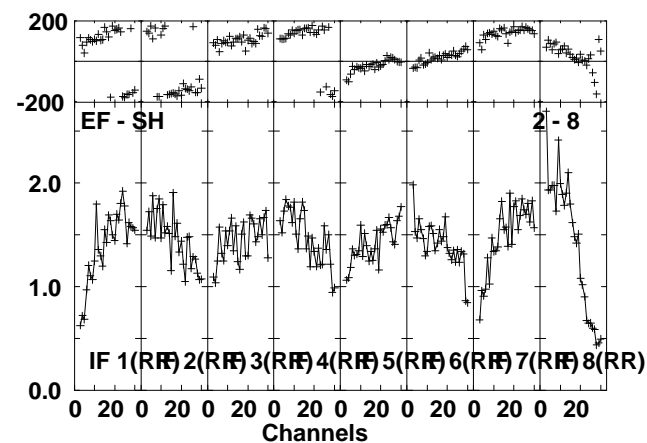
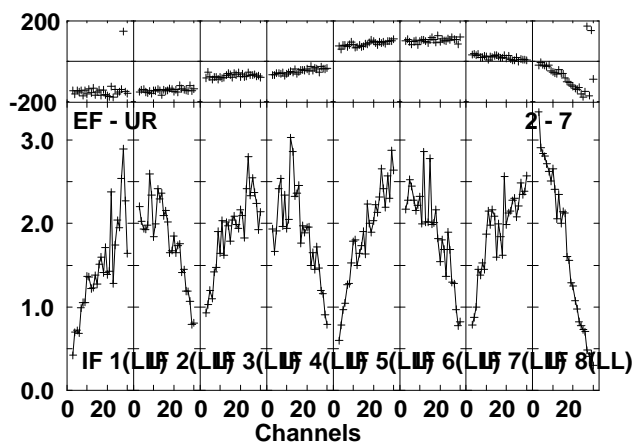
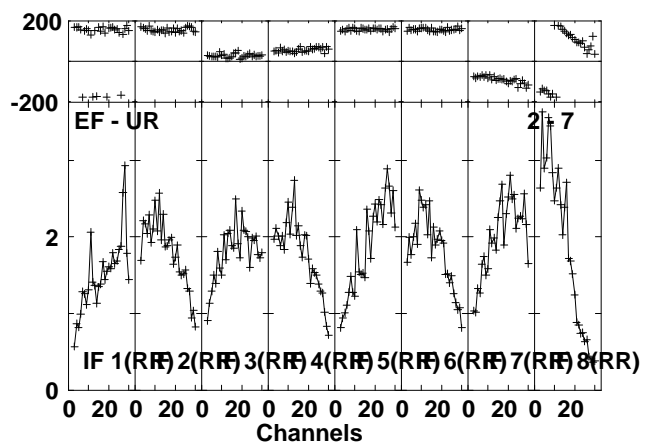
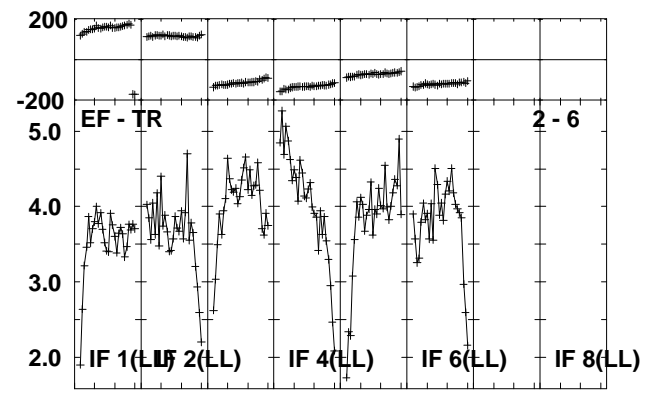
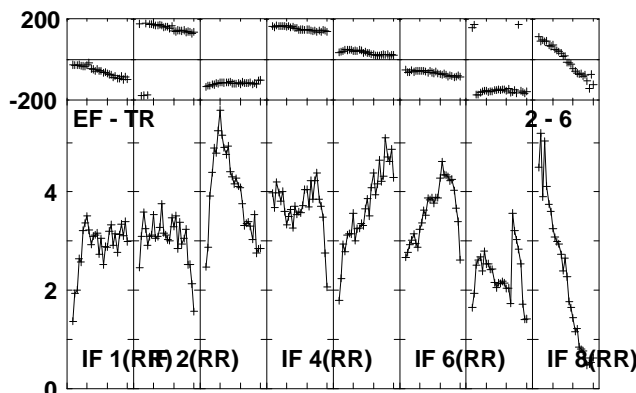
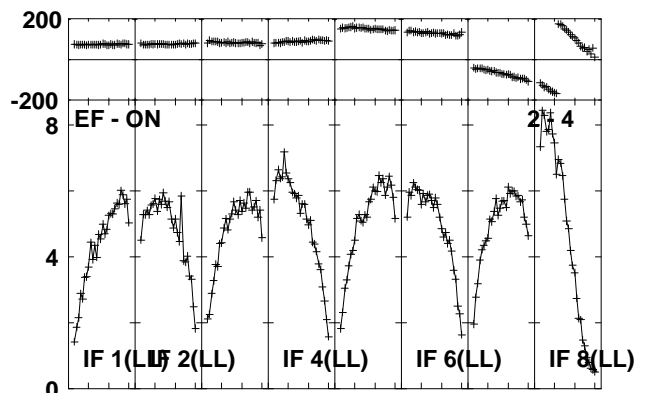
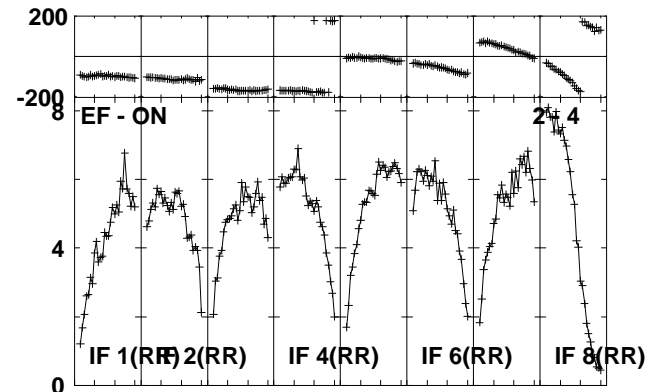
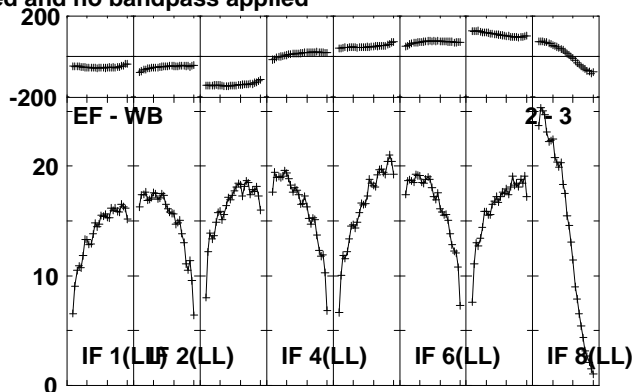
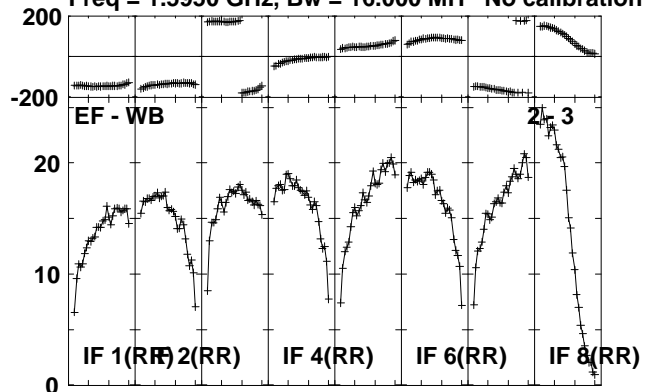

Lower frame: Milli Ampl Jy Top frame: Phas deg
Scalar averaged cross-power spectrum Several baselines displayed
Timerange: 00/23:42:01 to 00/23:43:29

Plot file version 86 created 23-AUG-2010 12:34:51

J1941-05 EP064P.UVDATA.1

Freq = 1.5950 GHz, Bw = 16.000 MH No calibration applied and no bandpass applied

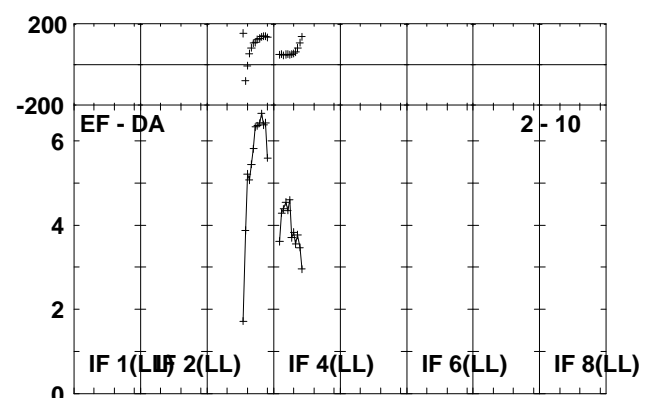
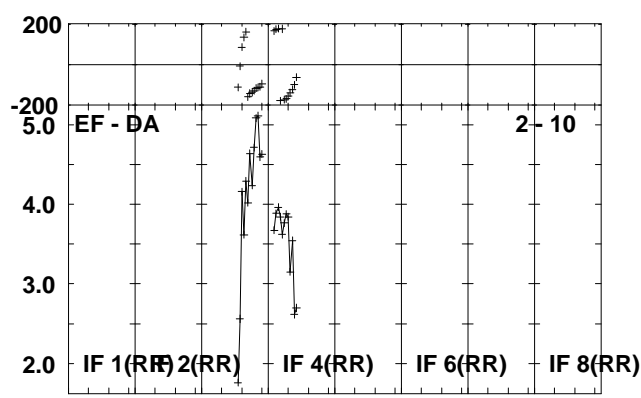
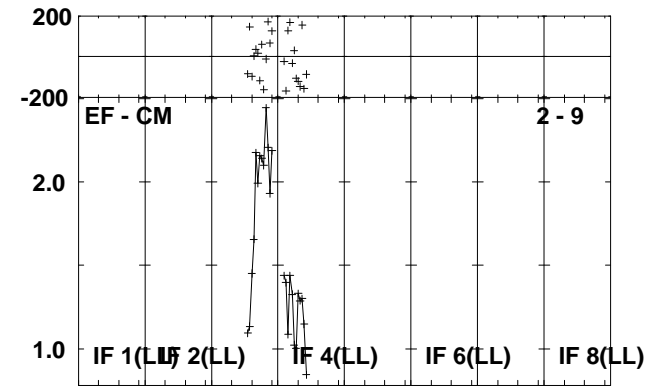
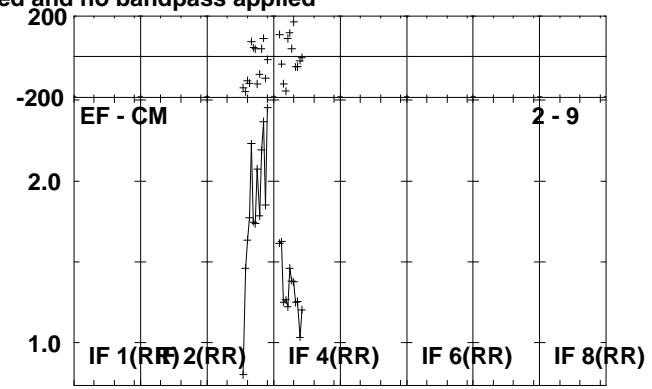
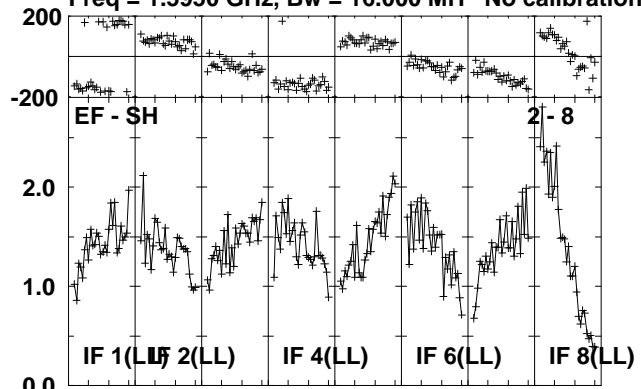

Lower frame: Milli Ampl Jy Top frame: Phas deg
Scalar averaged cross-power spectrum Several baselines displayed
Timerange: 00/23:42:01 to 00/23:43:29

Plot file version 87 created 23-AUG-2010 12:34:52

IRAS1929 EP064P.UVDATA.1

Freq = 1.5950 GHz, Bw = 16.000 MH No calibration applied and no bandpass applied

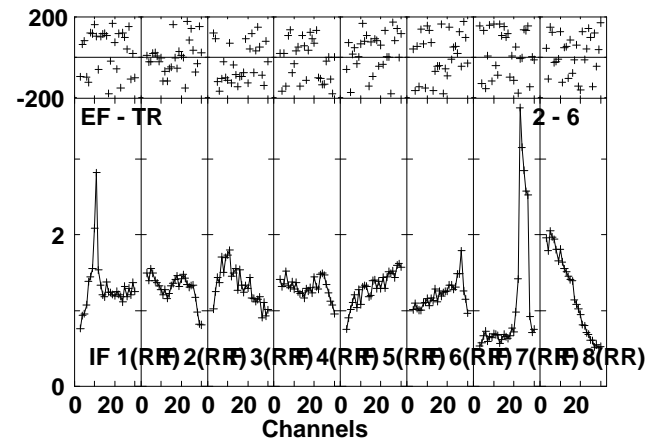
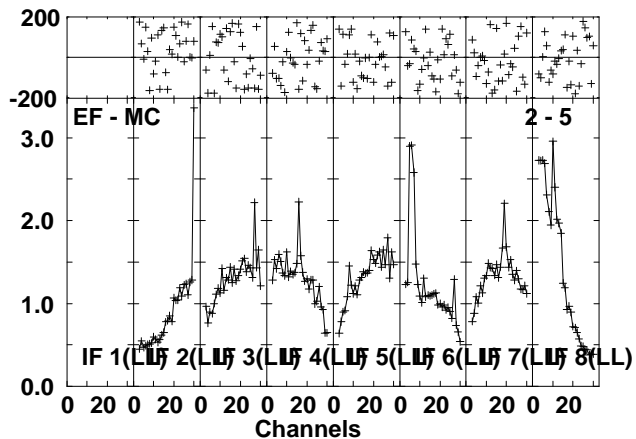
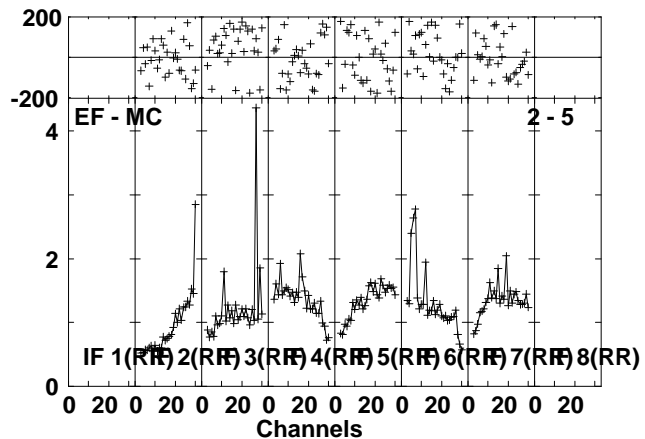
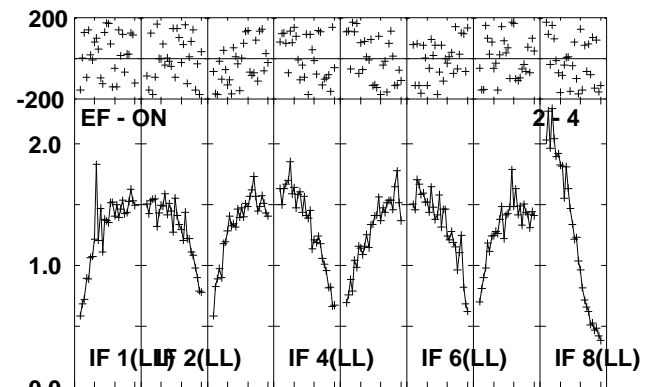
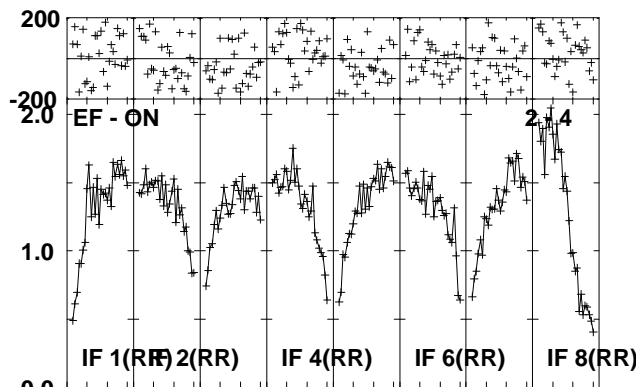
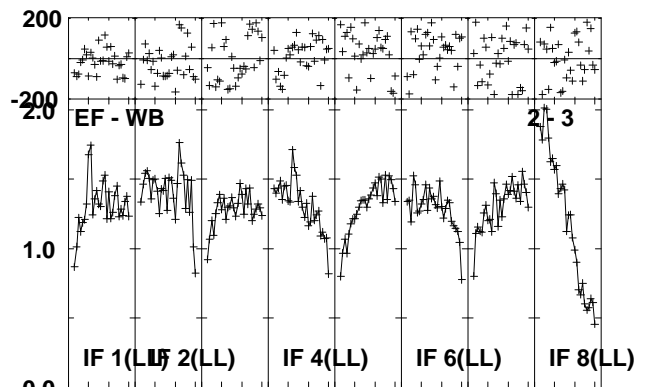
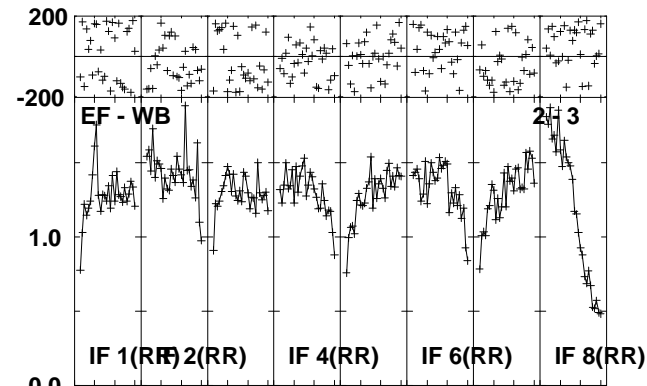
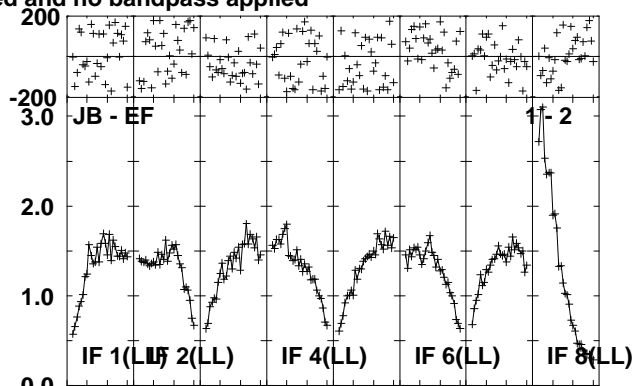
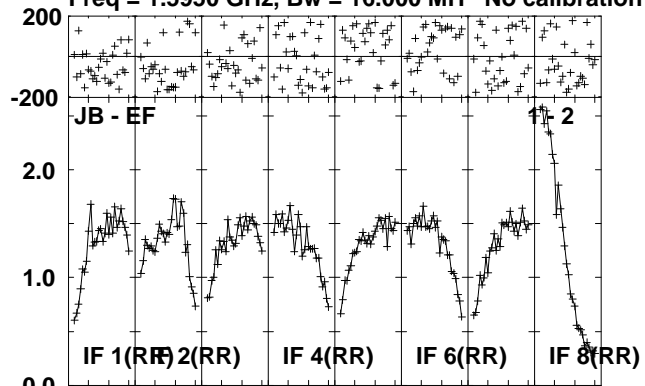

Lower frame: Milli Ampl Jy Top frame: Phas deg
Scalar averaged cross-power spectrum Several baselines displayed
Timerange: 00/23:43:31 to 00/23:46:59

Plot file version 88 created 23-AUG-2010 12:34:54

IRAS1929 EP064P.UVDATA.1

Freq = 1.5950 GHz, Bw = 16.000 MH No calibration applied and no bandpass applied

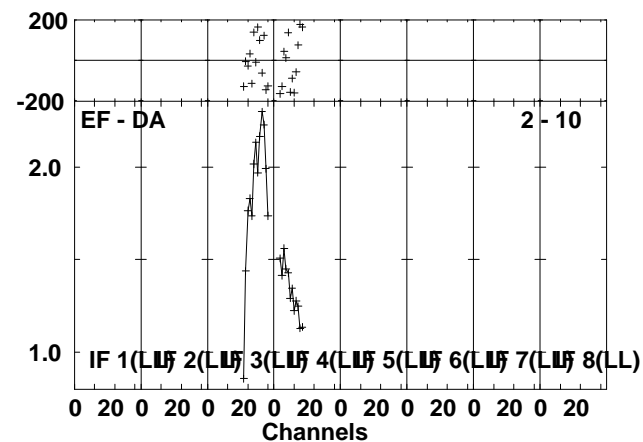
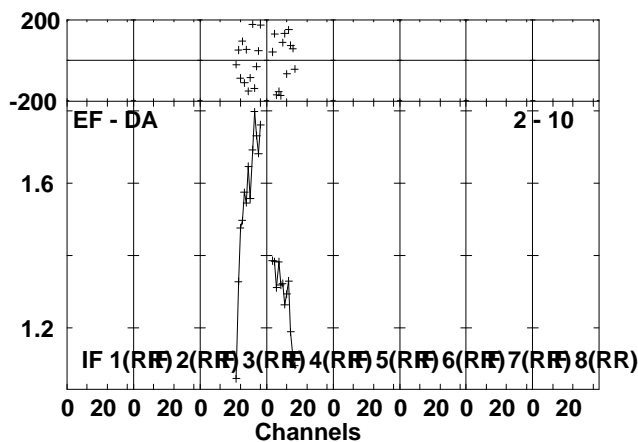
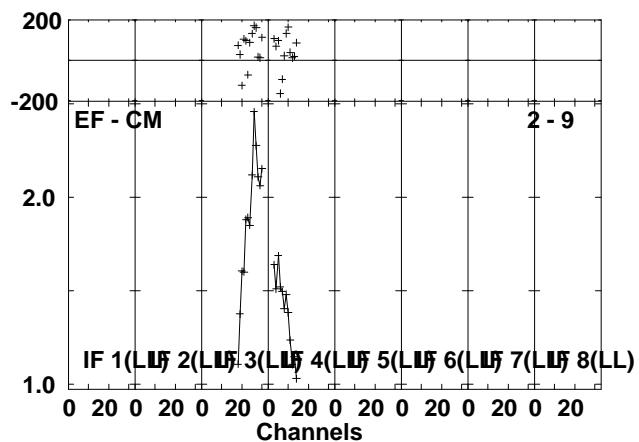
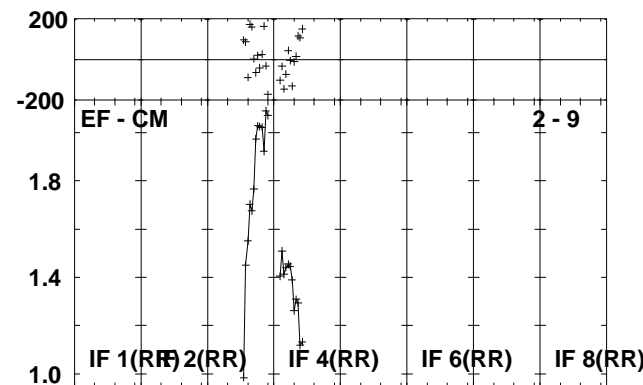
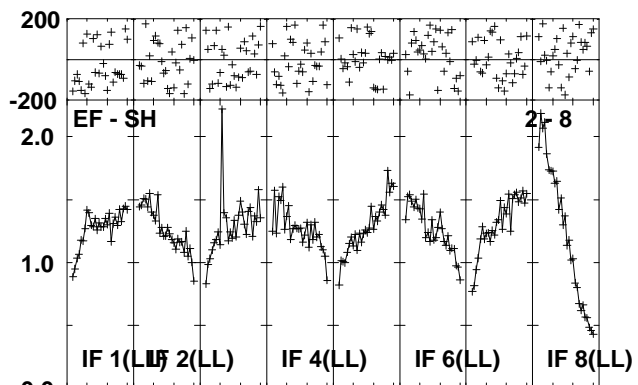
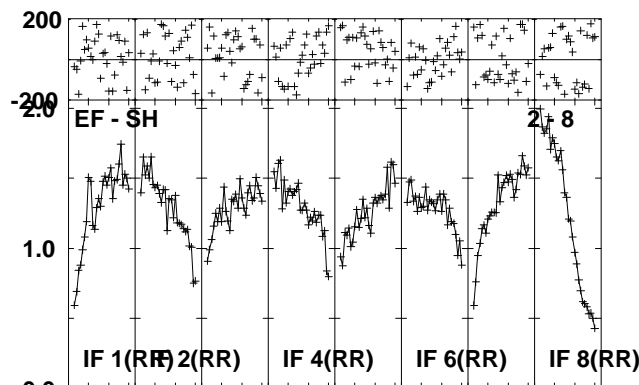
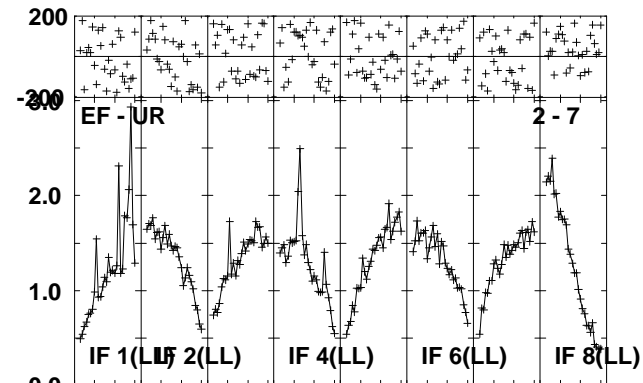
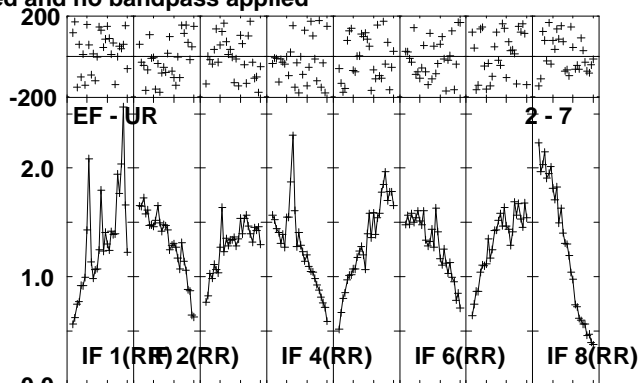
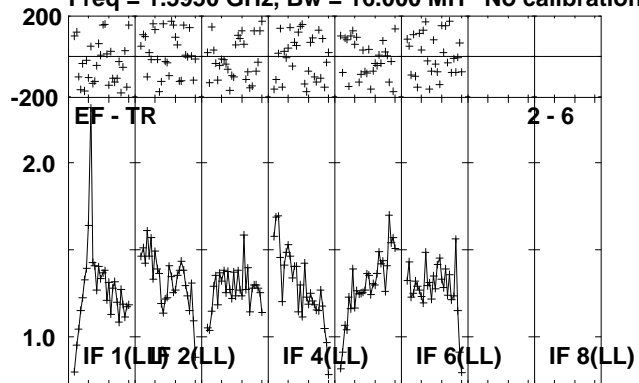

Lower frame: Milli Ampl Jy Top frame: Phas deg
Scalar averaged cross-power spectrum Several baselines displayed
Timerange: 00/23:43:31 to 00/23:46:59

Plot file version 89 created 23-AUG-2010 12:34:56

J1941-05 EP064P.UVDATA.1

Freq = 1.5950 GHz, Bw = 16.000 MH No calibration applied and no bandpass applied

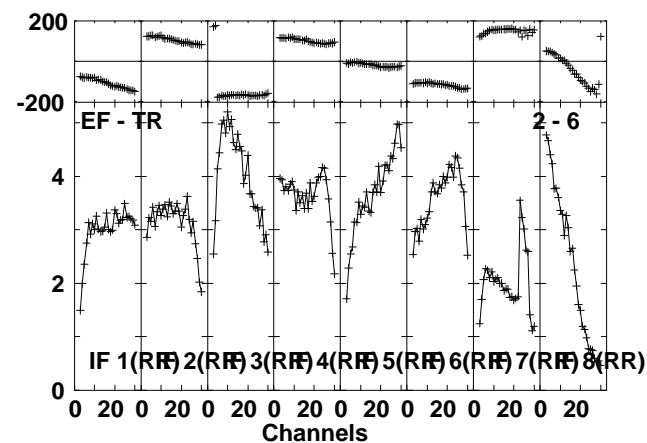
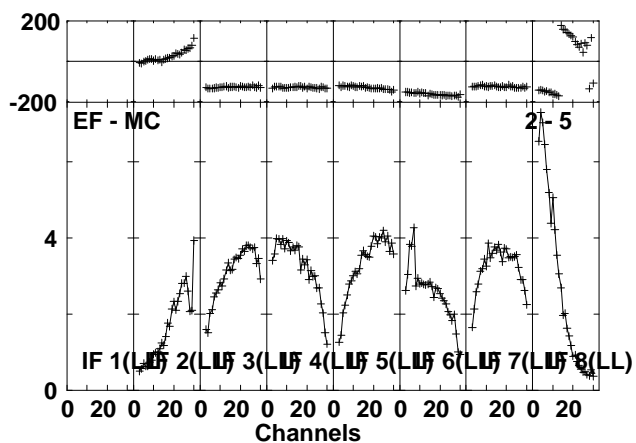
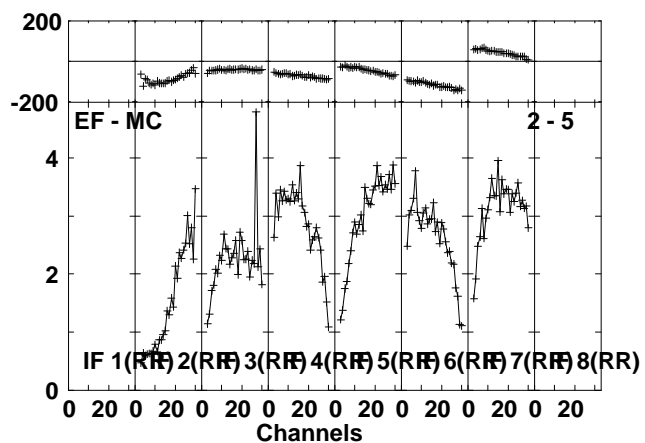
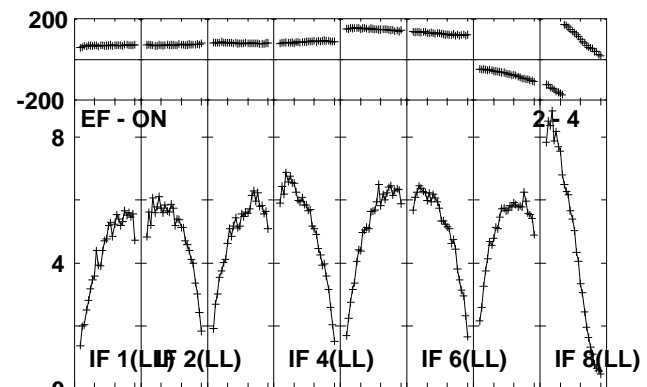
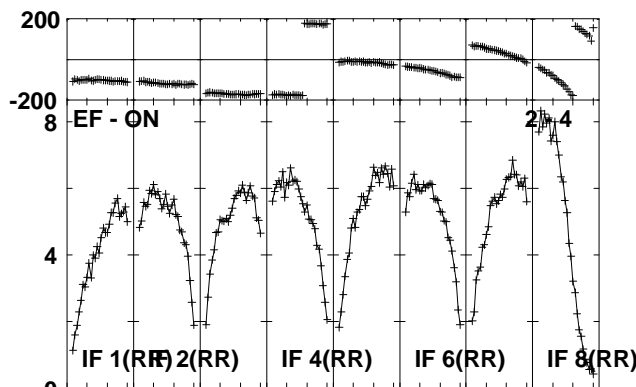
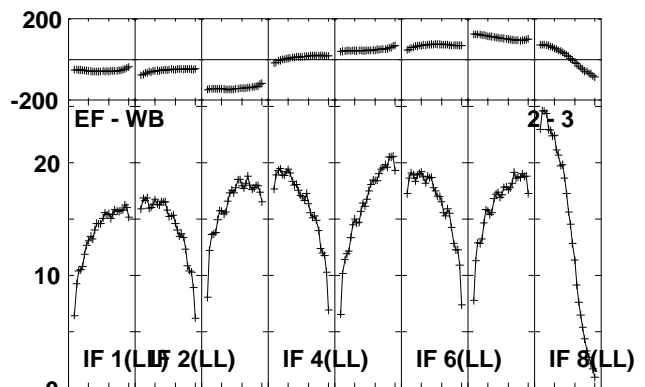
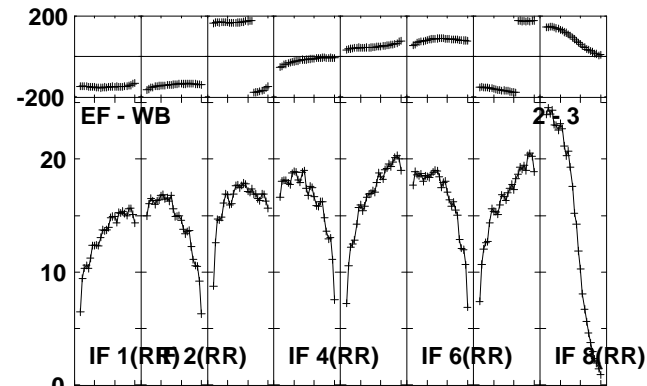
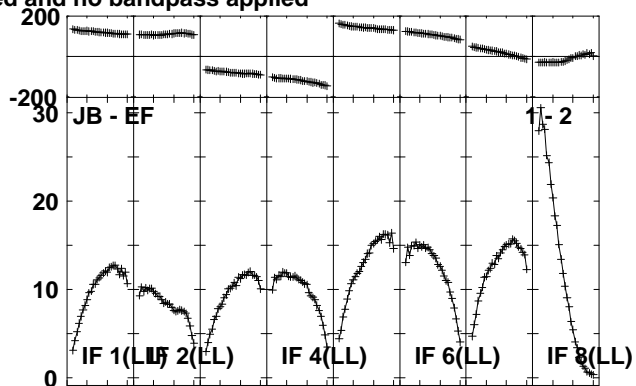
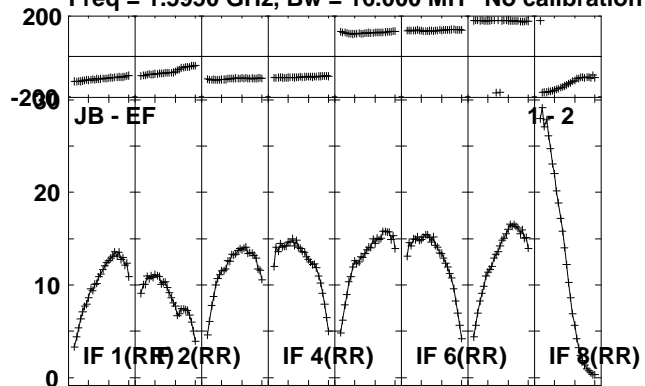

Lower frame: Milli Ampl Jy Top frame: Phas deg
Scalar averaged cross-power spectrum Several baselines displayed
Timerange: 00/23:48:01 to 00/23:49:29

Plot file version 90 created 23-AUG-2010 12:34:57

J1941-05 EP064P.UVDATA.1

Freq = 1.5950 GHz, Bw = 16.000 MH No calibration applied and no bandpass applied

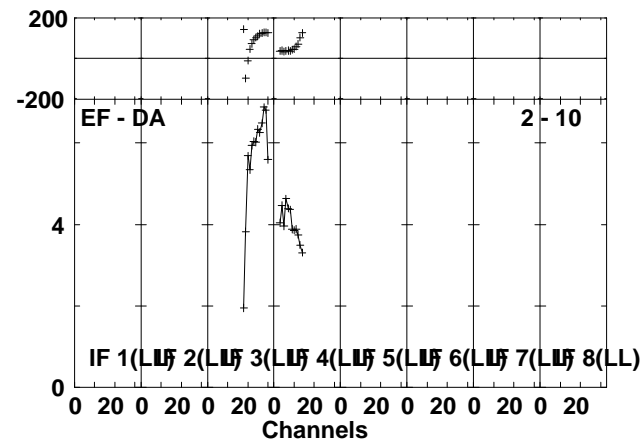
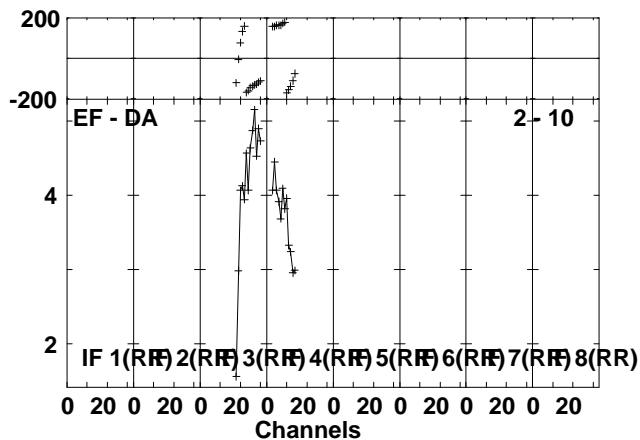
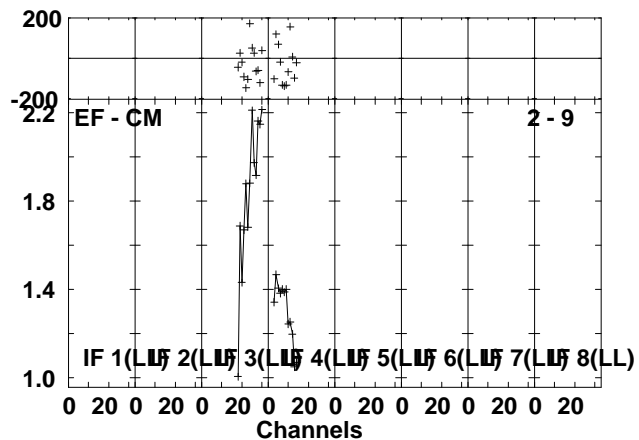
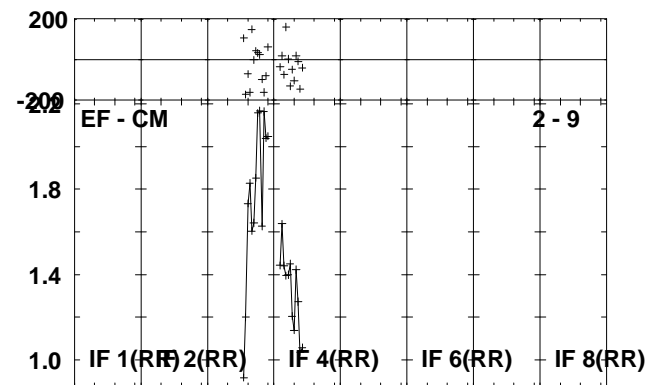
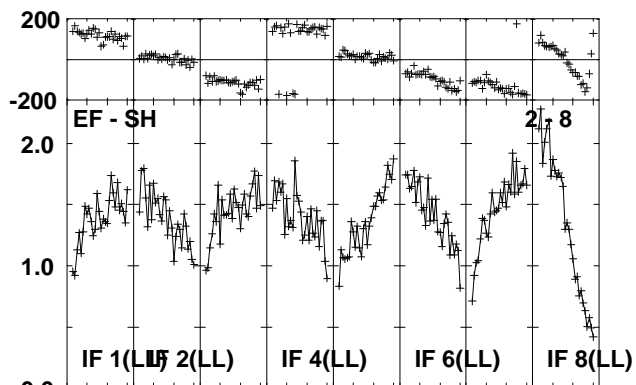
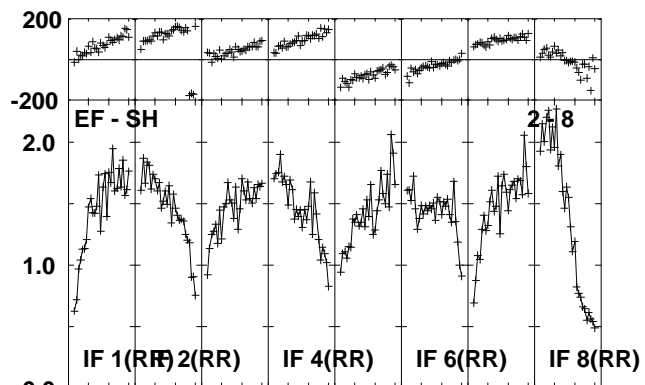
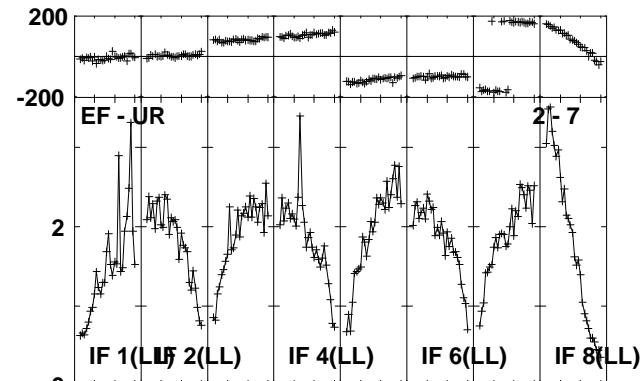
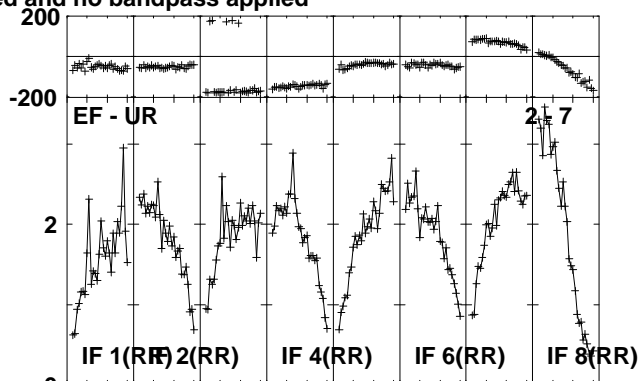
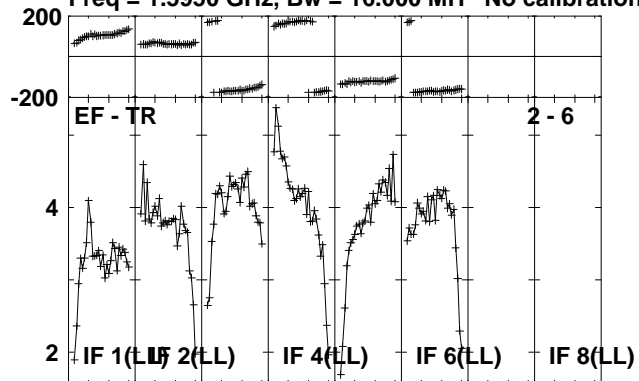

Lower frame: Milli Ampl Jy Top frame: Phas deg
Scalar averaged cross-power spectrum Several baselines displayed
Timerange: 00/23:48:01 to 00/23:49:29

Plot file version 91 created 23-AUG-2010 12:34:59

IRAS1929 EP064P.UVDATA.1

Freq = 1.5950 GHz, Bw = 16.000 MH No calibration applied and no bandpass applied

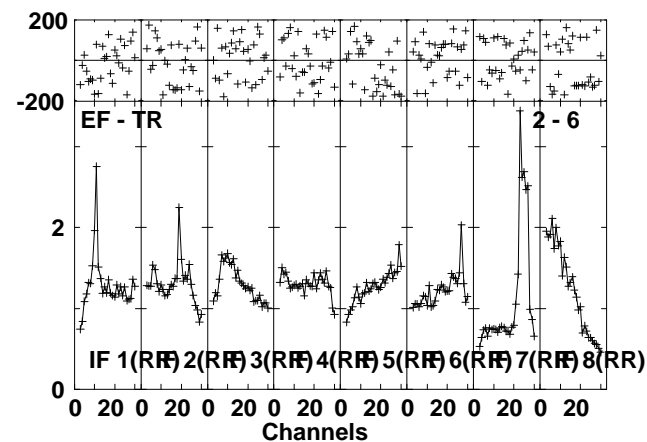
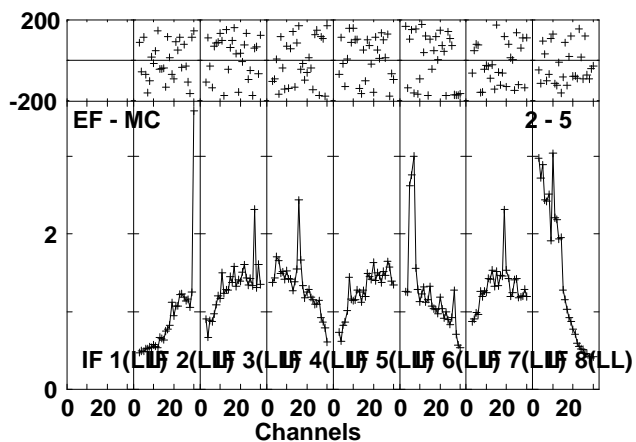
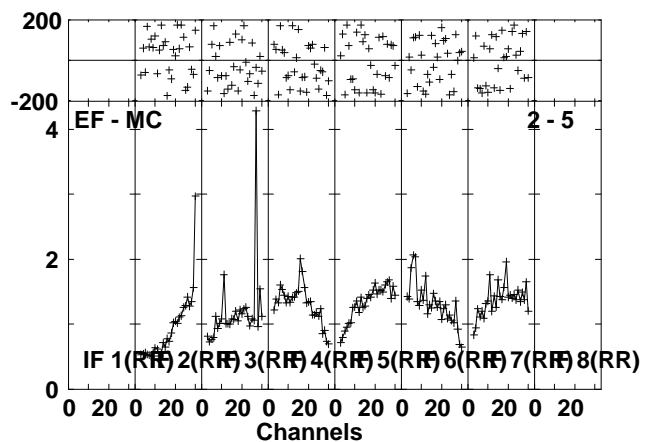
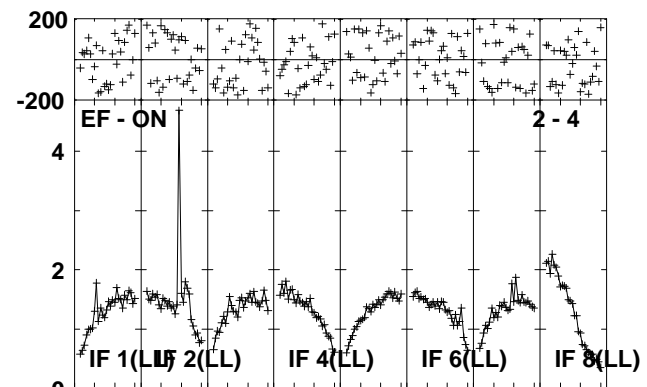
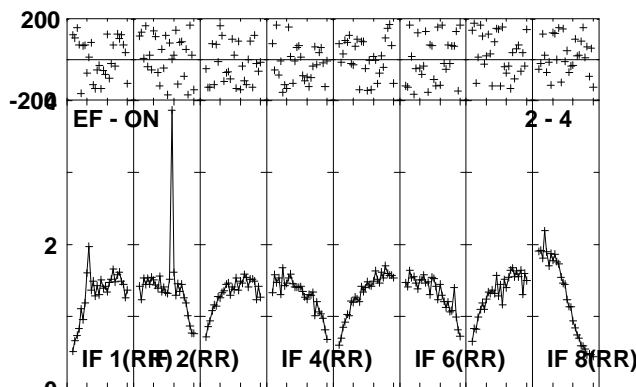
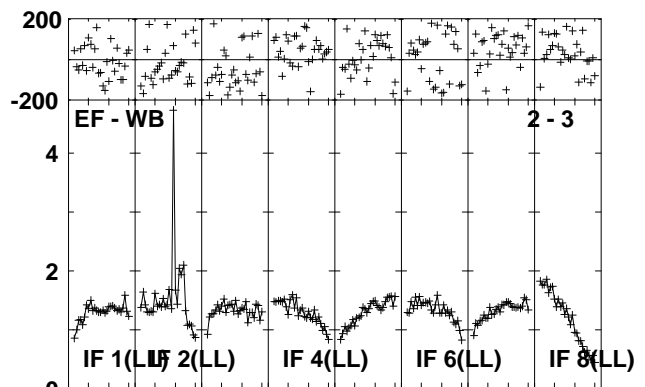
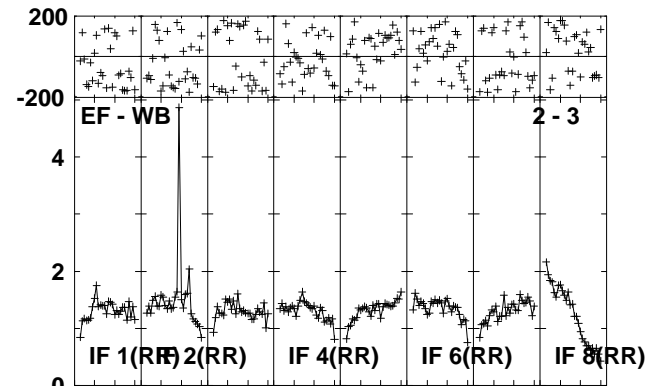
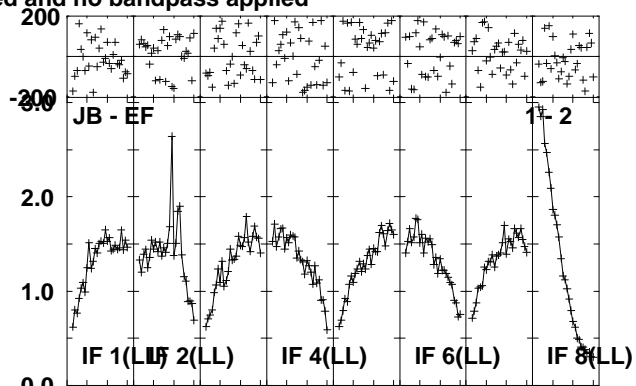
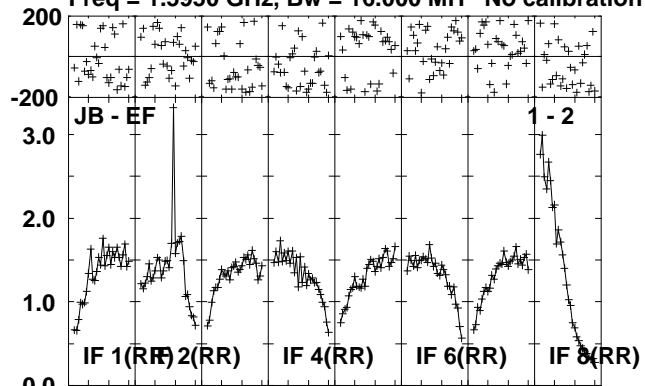

Lower frame: Milli Ampl Jy Top frame: Phas deg
Scalar averaged cross-power spectrum Several baselines displayed
Timerange: 00/23:49:31 to 00/23:52:59

Plot file version 92 created 23-AUG-2010 12:35:01

IRAS1929 EP064P.UVDATA.1

Freq = 1.5950 GHz, Bw = 16.000 MH No calibration applied and no bandpass applied

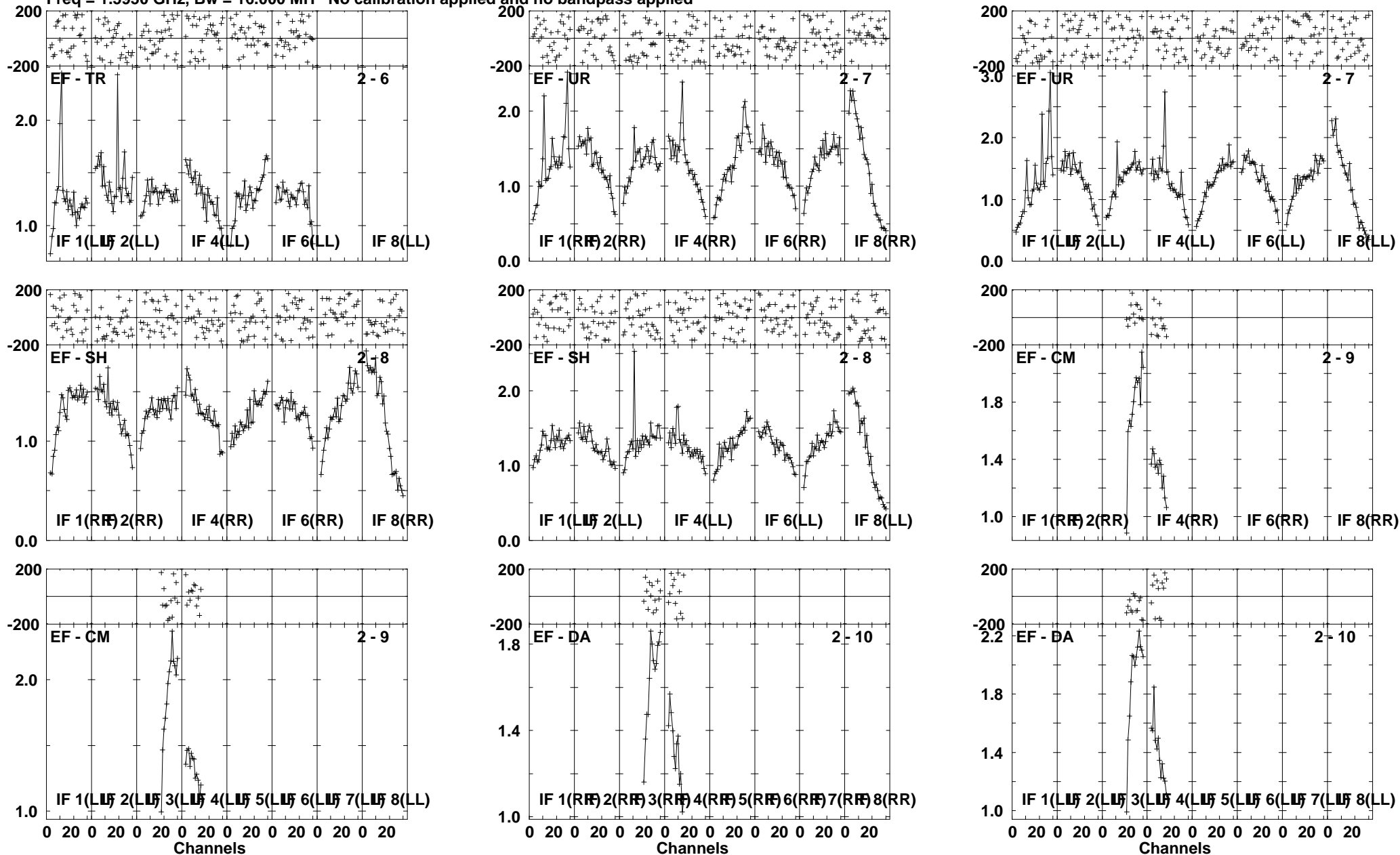

Lower frame: Milli Ampl Jy Top frame: Phas deg
Scalar averaged cross-power spectrum Several baselines displayed
Timerange: 00/23:49:31 to 00/23:52:59

Plot file version 93 created 23-AUG-2010 12:35:03

J1941-05 EP064P.UVDATA.1

Freq = 1.5950 GHz, Bw = 16.000 MH No calibration applied and no bandpass applied

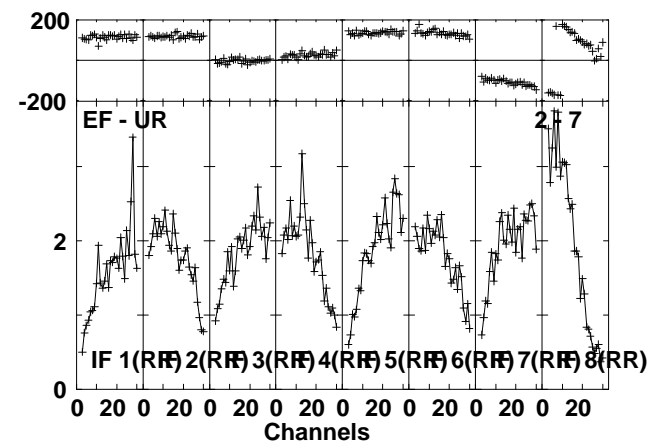
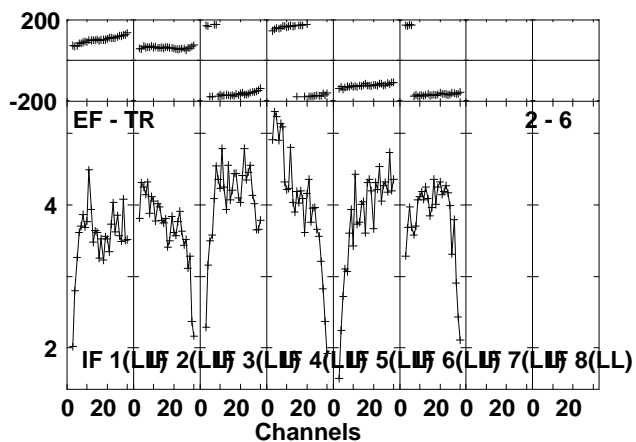
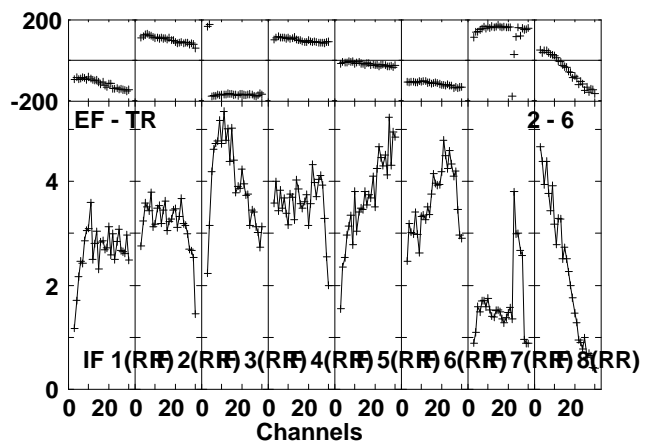
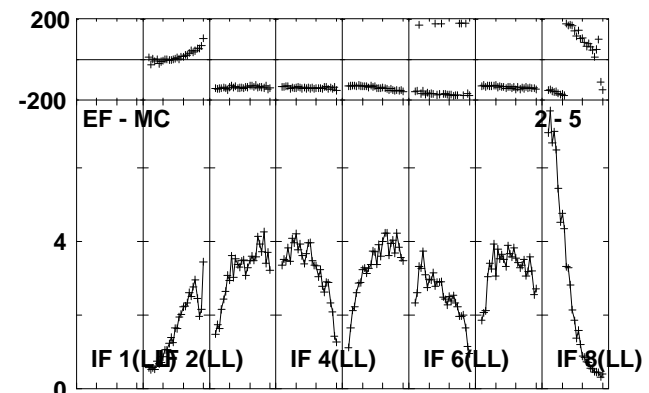
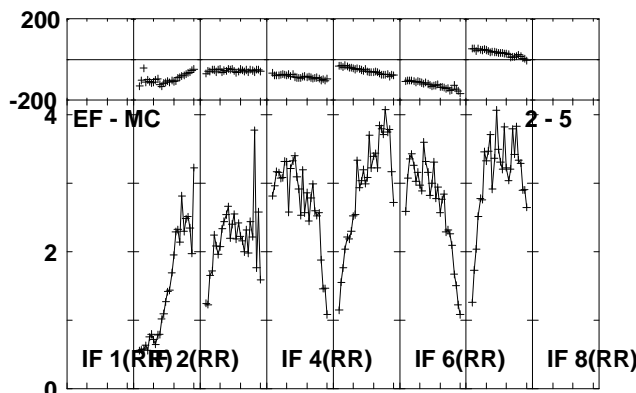
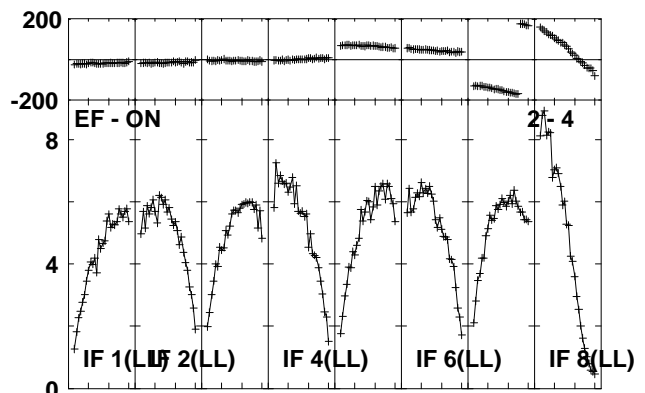
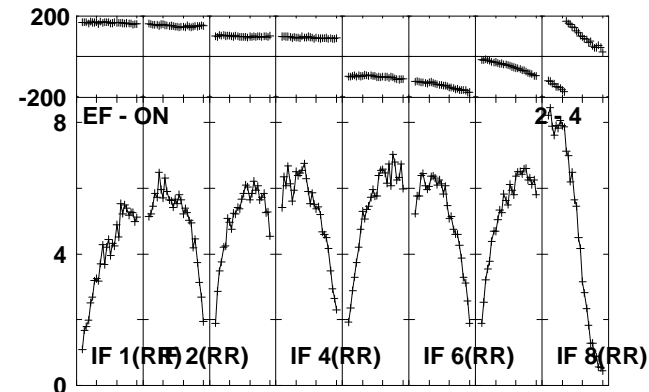
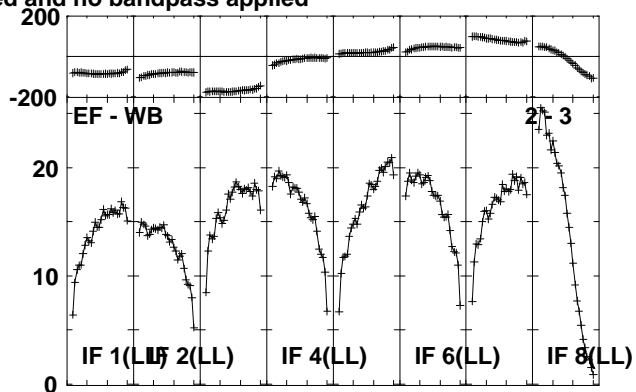
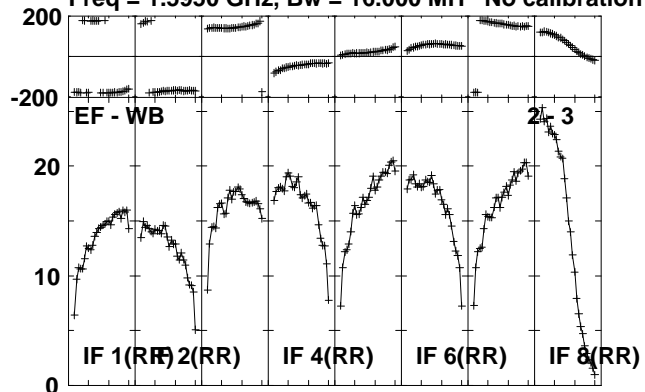

Lower frame: Milli Ampl Jy Top frame: Phas deg
Scalar averaged cross-power spectrum Several baselines displayed
Timerange: 00/23:53:01 to 00/23:54:29

Plot file version 94 created 23-AUG-2010 12:35:04

J1941-05 EP064P.UVDATA.1

Freq = 1.5950 GHz, Bw = 16.000 MH No calibration applied and no bandpass applied

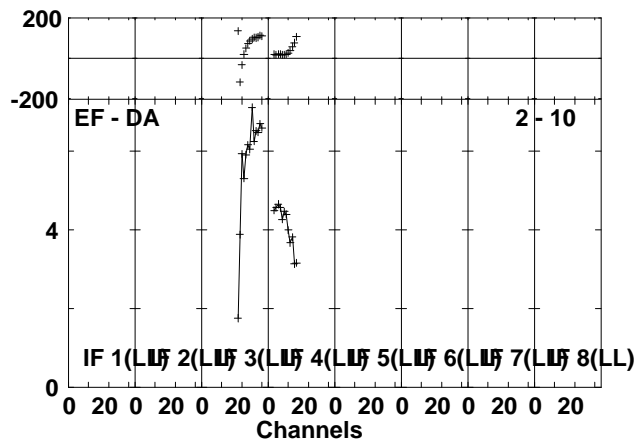
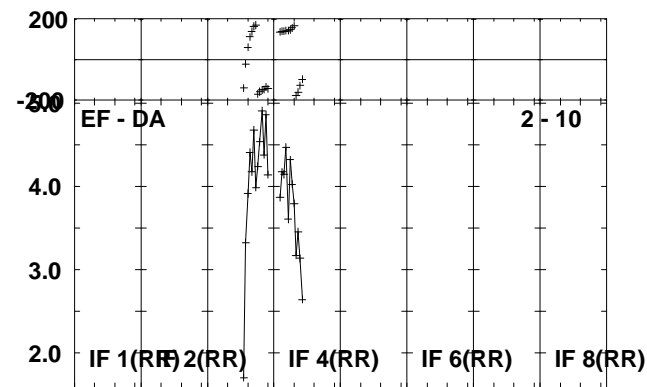
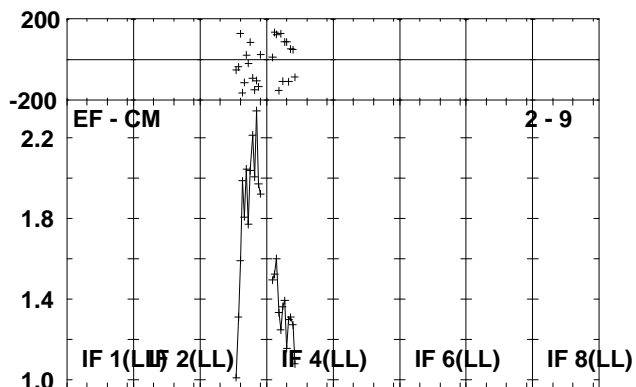
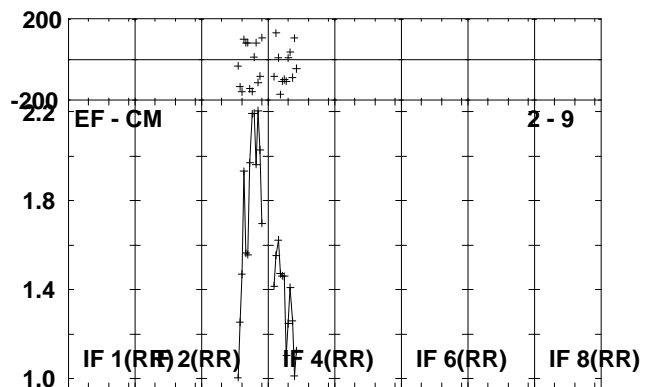
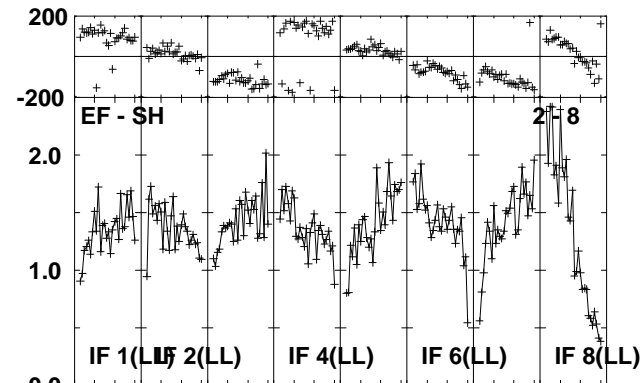
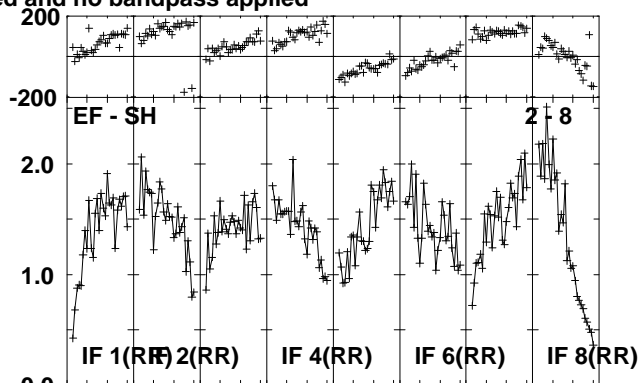
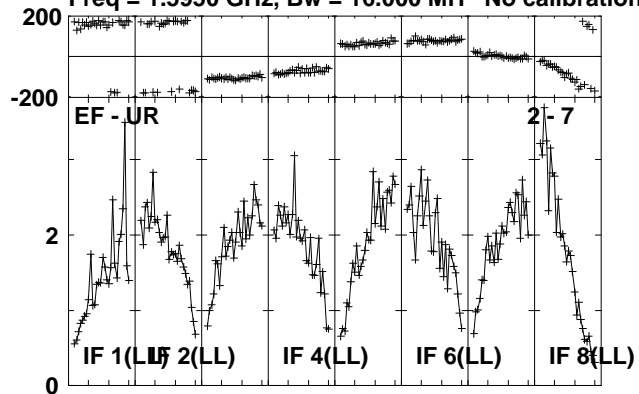

Lower frame: Milli Ampl Jy Top frame: Phas deg
Scalar averaged cross-power spectrum Several baselines displayed
Timerange: 00/23:53:01 to 00/23:54:29

Plot file version 95 created 23-AUG-2010 12:35:05

IRAS1929 EP064P.UVDATA.1

Freq = 1.5950 GHz, Bw = 16.000 MH No calibration applied and no bandpass applied

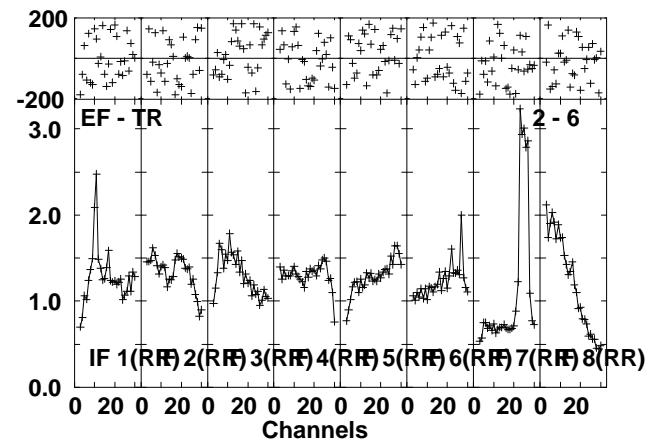
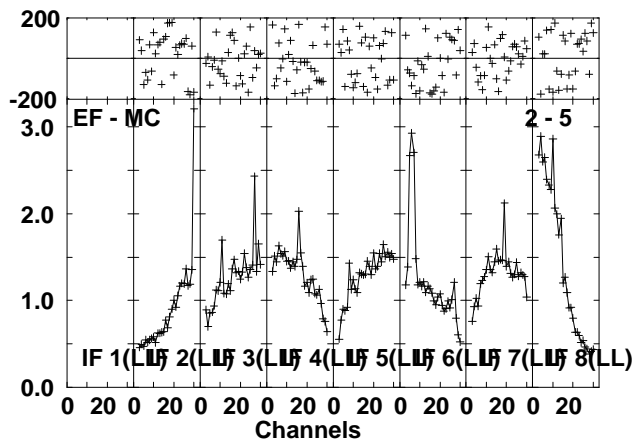
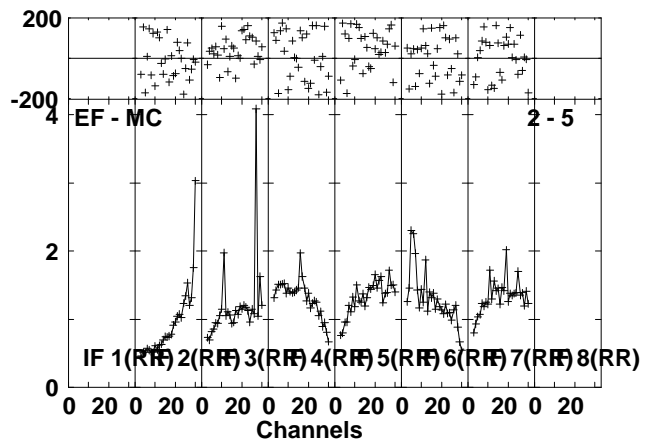
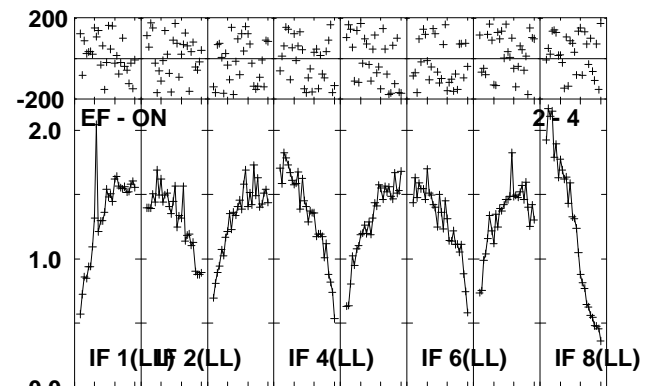
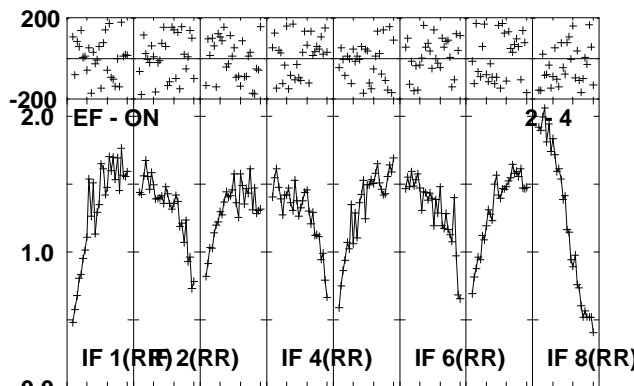
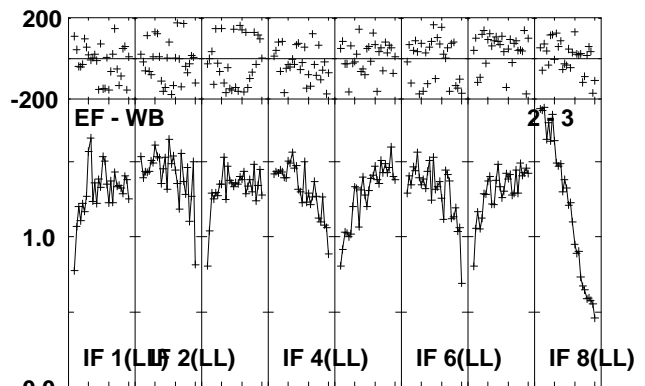
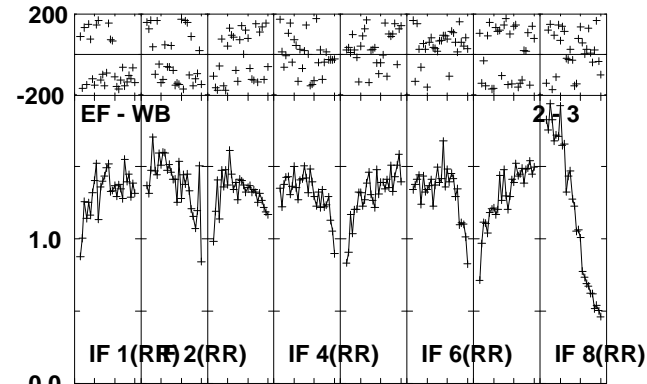
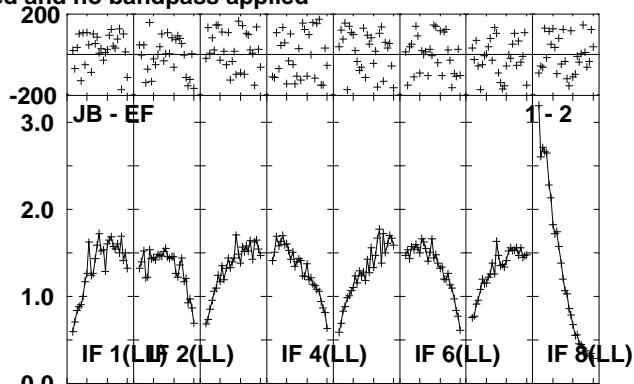
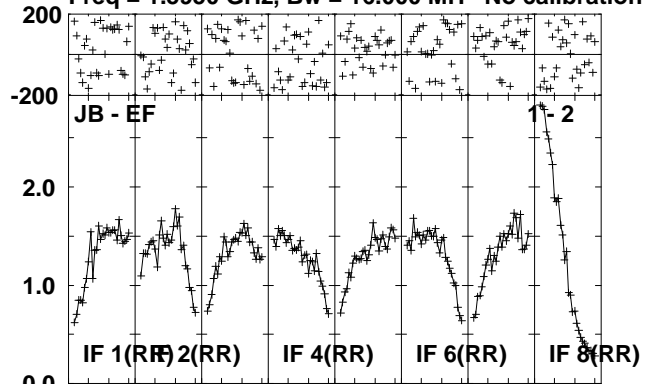

Lower frame: Milli Ampl Jy Top frame: Phas deg
Scalar averaged cross-power spectrum Several baselines displayed
Timerange: 00/23:54:31 to 00/23:57:59

Plot file version 96 created 23-AUG-2010 12:35:07

IRAS1929 EP064P.UVDATA.1

Freq = 1.5950 GHz, Bw = 16.000 MH No calibration applied and no bandpass applied

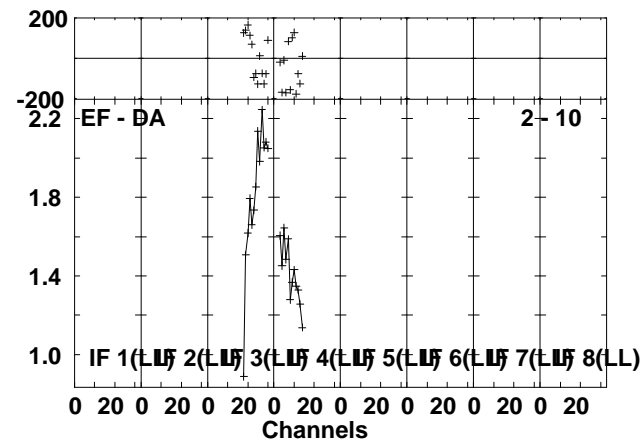
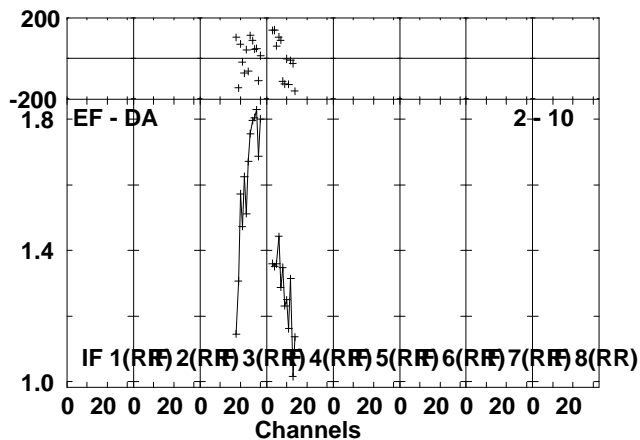
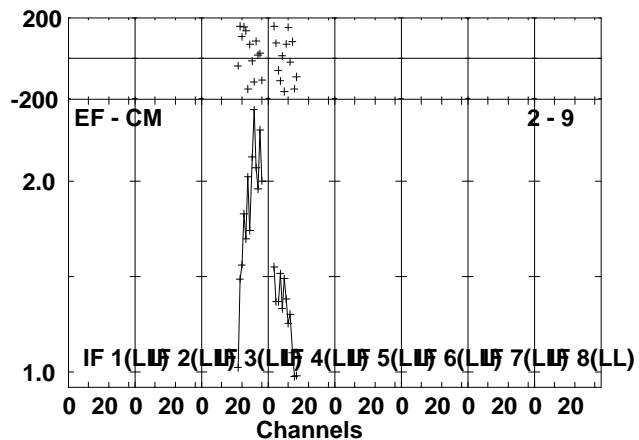
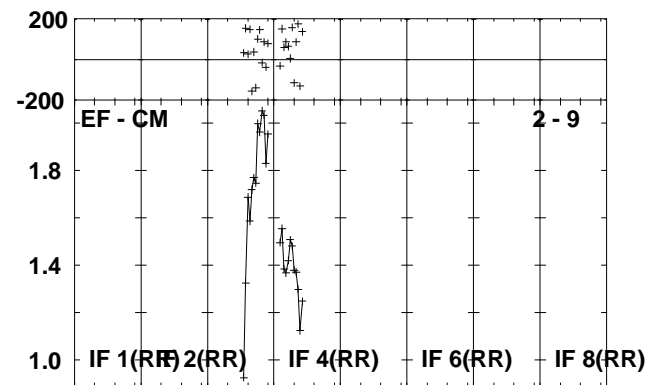
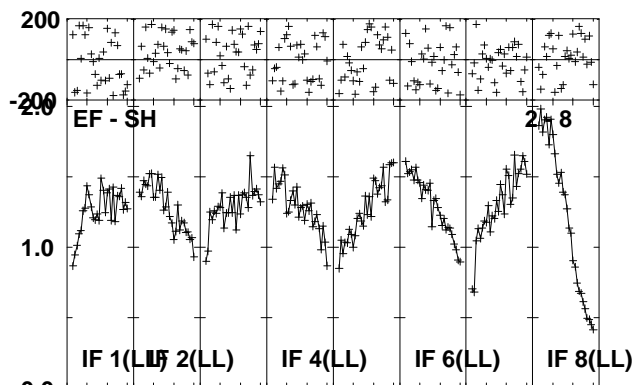
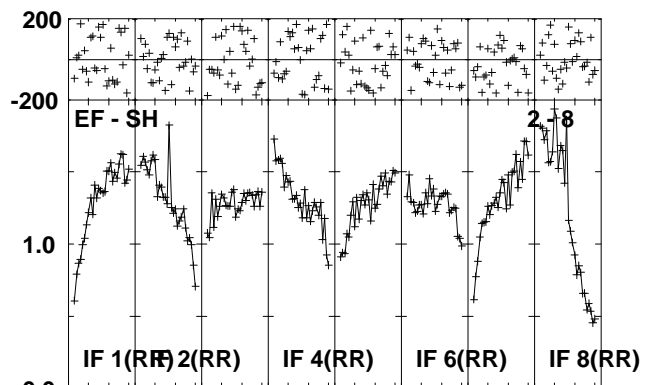
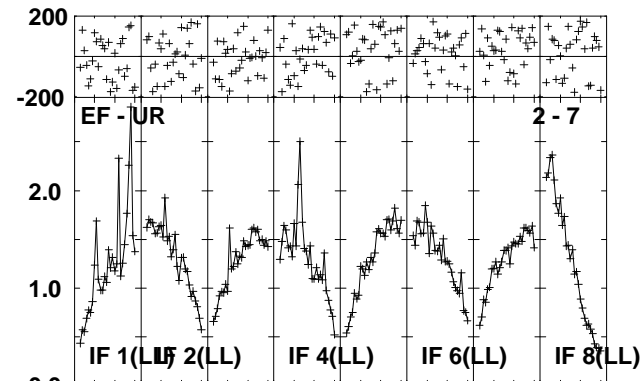
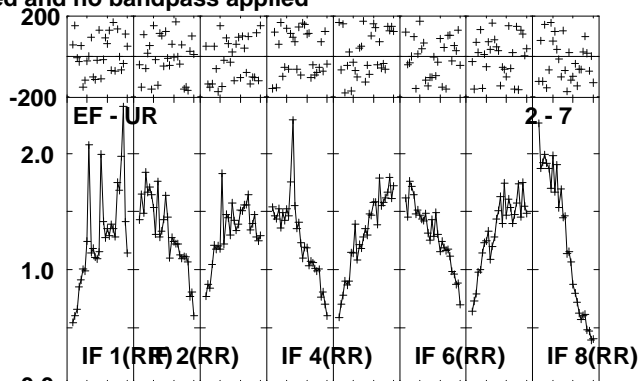
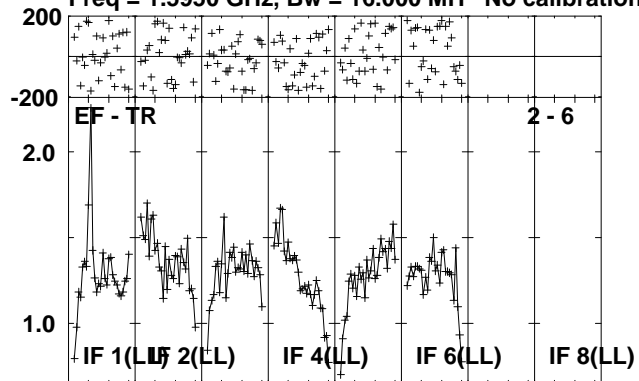

Lower frame: Milli Ampl Jy Top frame: Phas deg
Scalar averaged cross-power spectrum Several baselines displayed
Timerange: 00/23:54:31 to 00/23:57:59

Plot file version 97 created 23-AUG-2010 12:35:09

J1941-05 EP064P.UVDATA.1

Freq = 1.5950 GHz, Bw = 16.000 MH No calibration applied and no bandpass applied

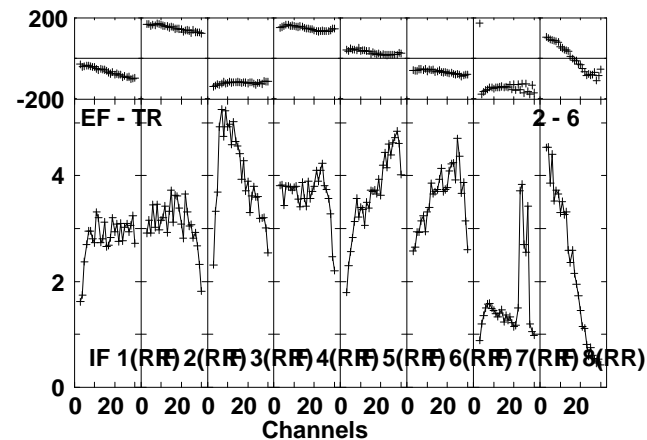
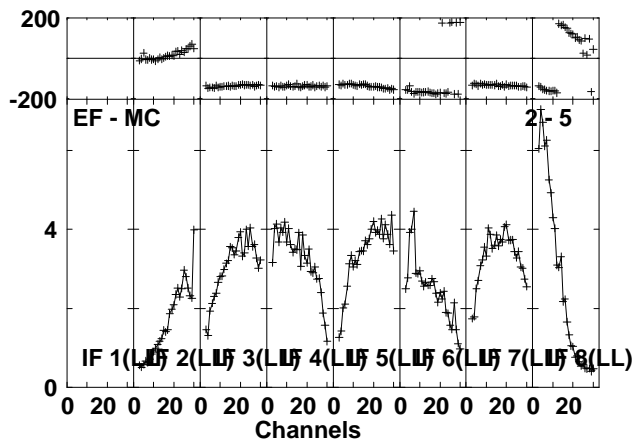
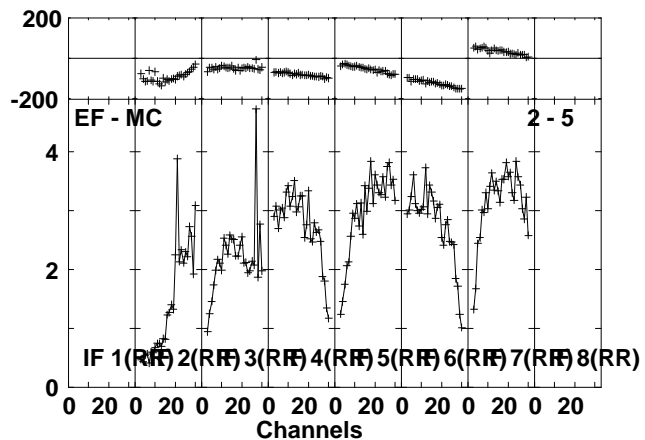
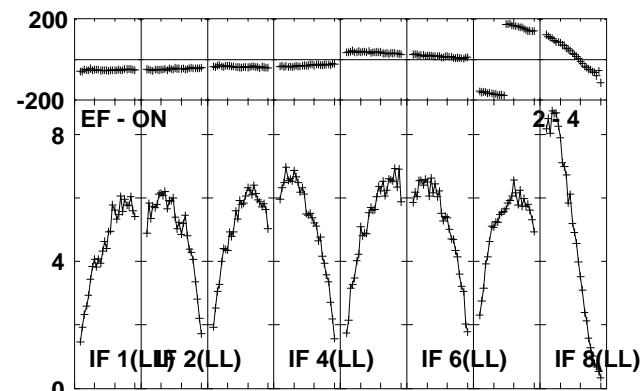
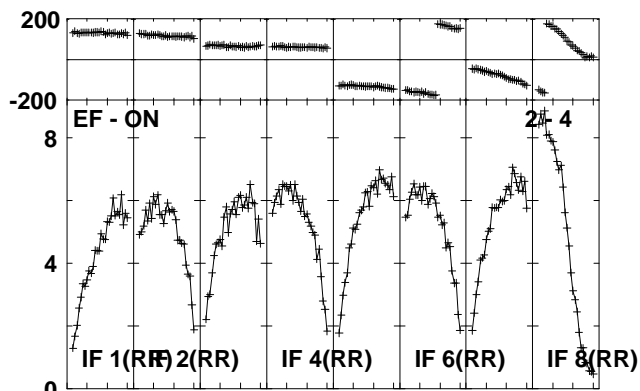
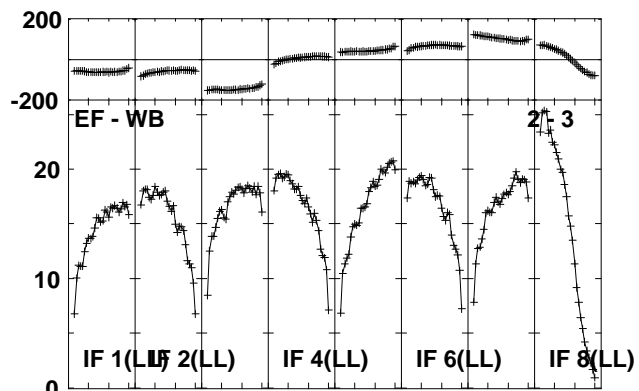
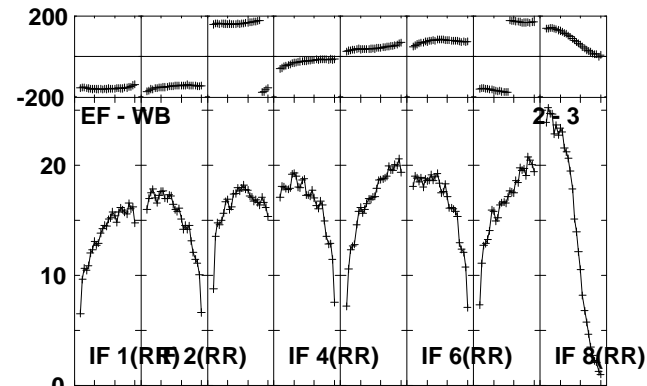
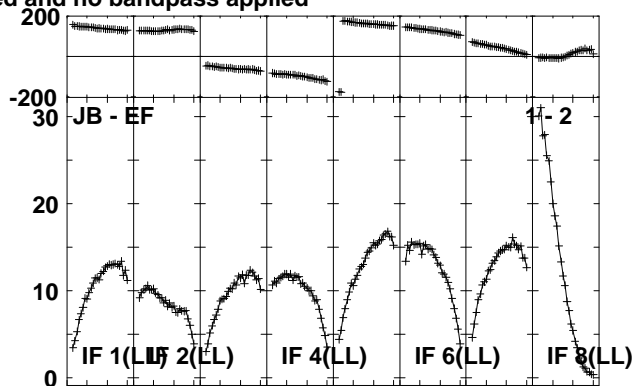
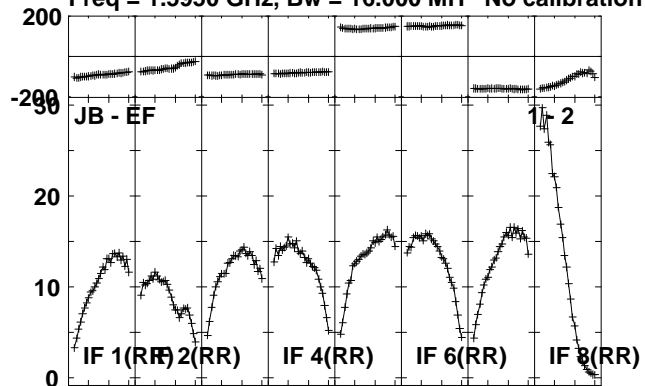

Lower frame: Milli Ampl Jy Top frame: Phas deg
Scalar averaged cross-power spectrum Several baselines displayed
Timerange: 00/23:58:01 to 00/23:59:29

Plot file version 98 created 23-AUG-2010 12:35:10

J1941-05 EP064P.UVDATA.1

Freq = 1.5950 GHz, Bw = 16.000 MH No calibration applied and no bandpass applied

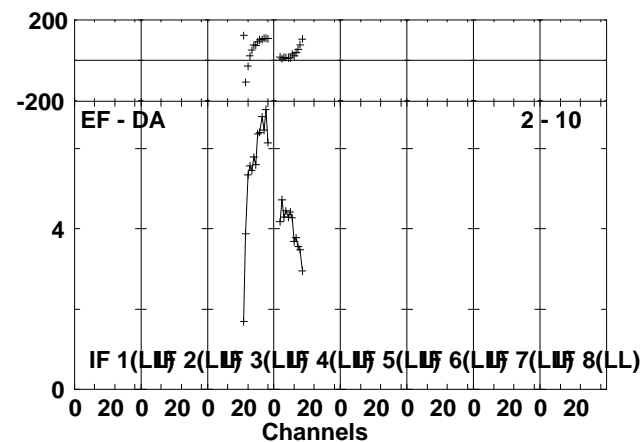
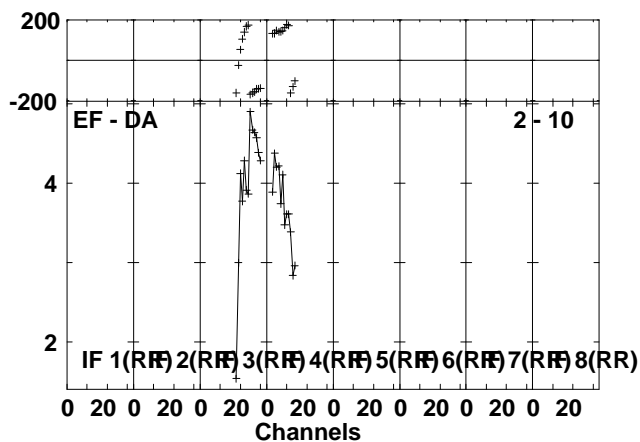
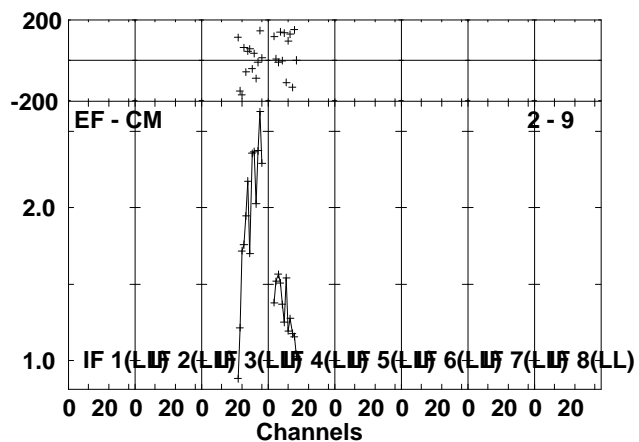
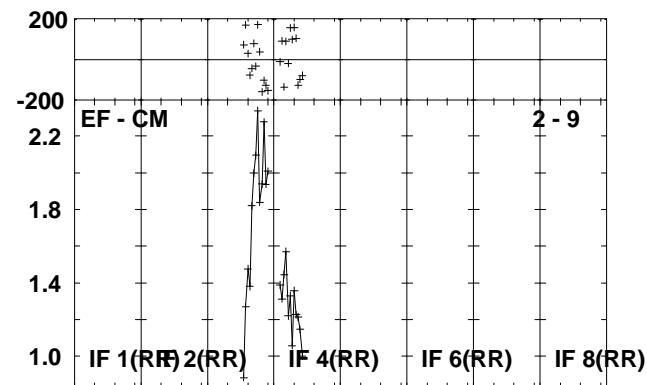
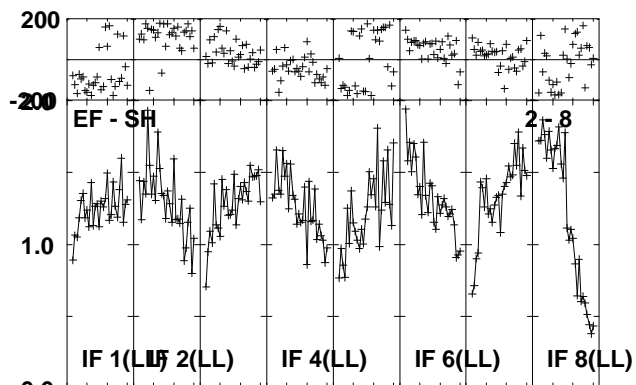
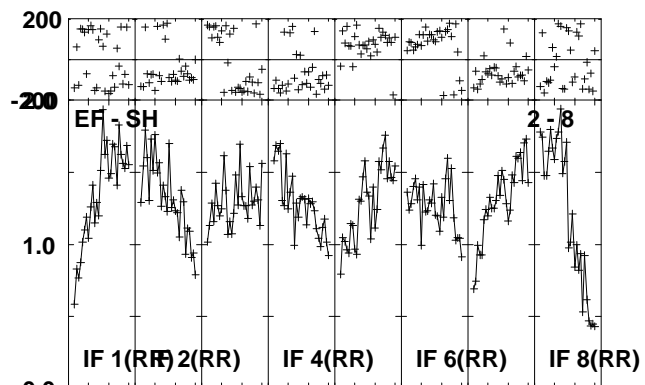
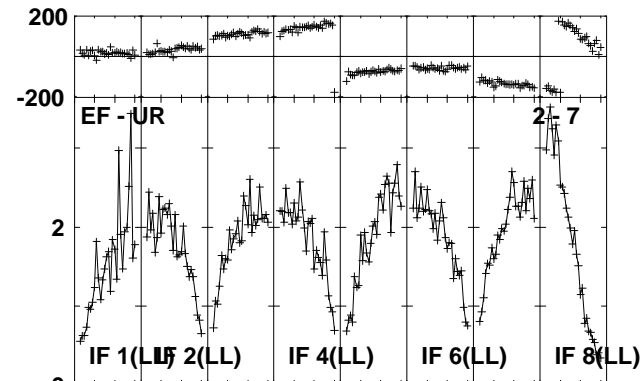
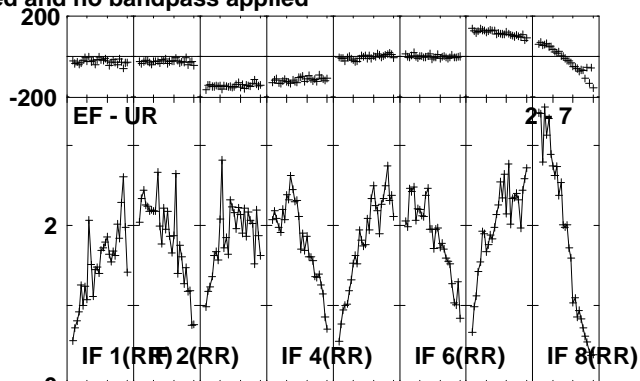
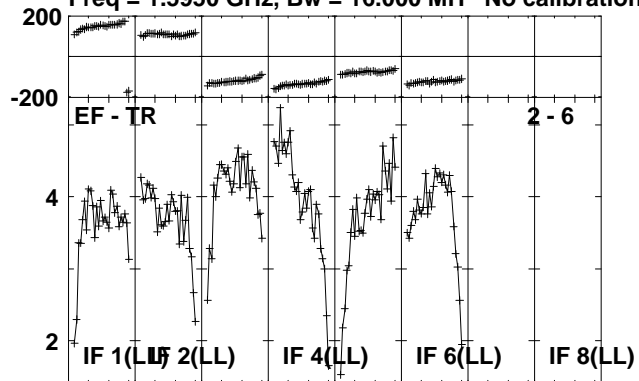

Lower frame: Milli Ampl Jy Top frame: Phas deg
Scalar averaged cross-power spectrum Several baselines displayed
Timerange: 00/23:58:01 to 00/23:59:29

Plot file version 99 created 23-AUG-2010 12:35:11

IRAS1929 EP064P.UVDATA.1

Freq = 1.5950 GHz, Bw = 16.000 MH No calibration applied and no bandpass applied

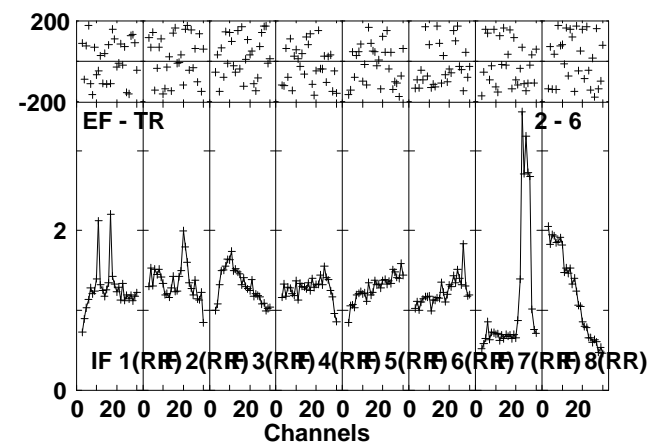
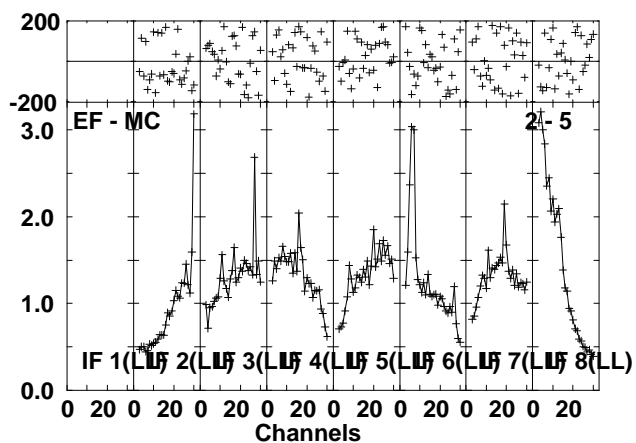
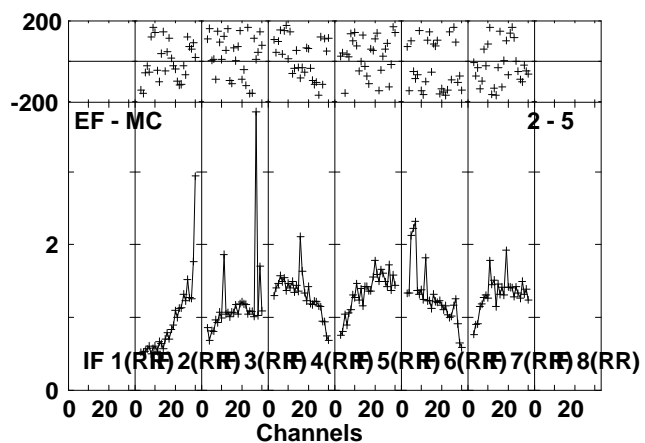
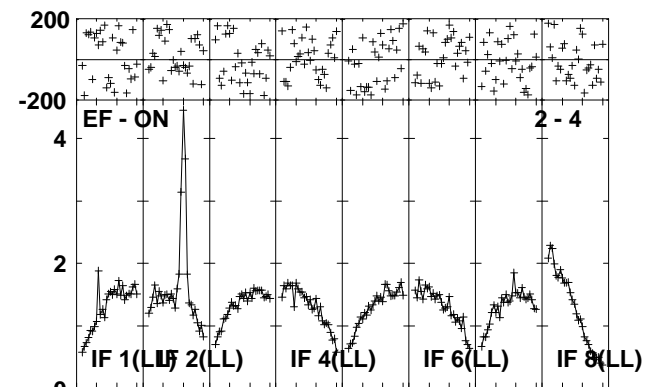
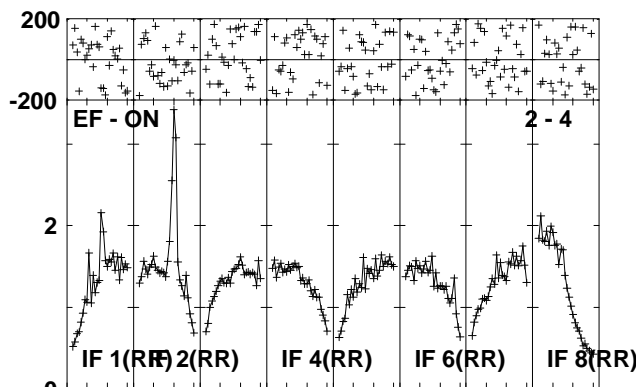
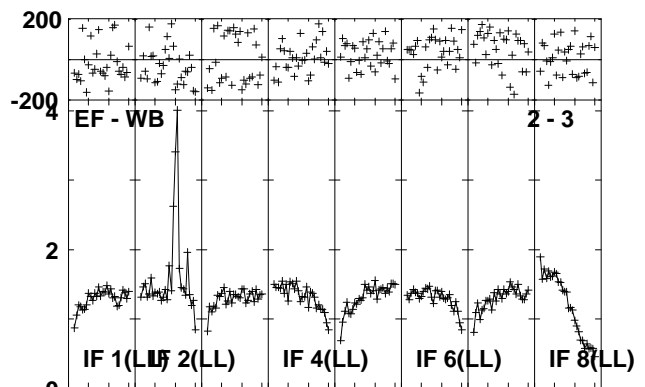
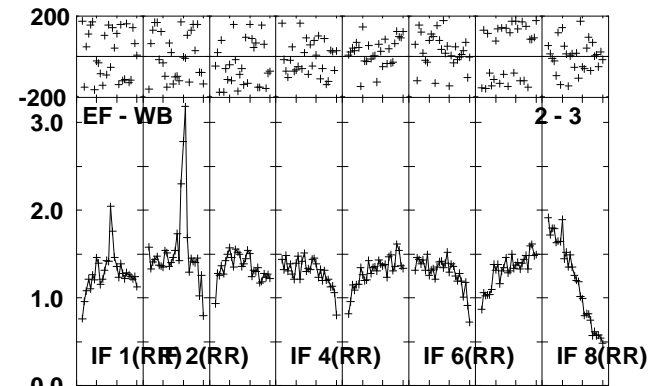
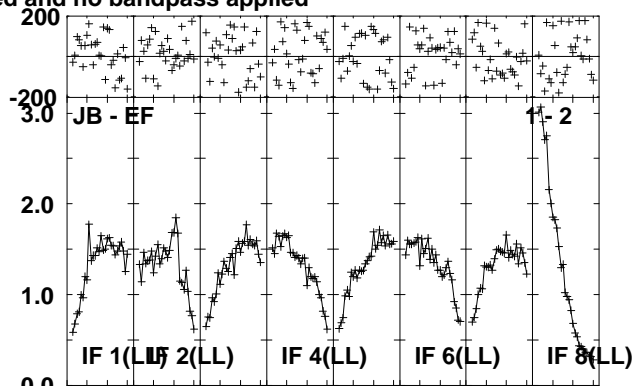
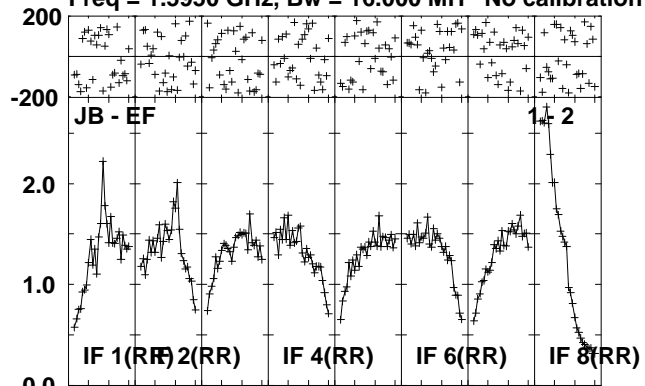

Lower frame: Milli Ampl Jy Top frame: Phas deg
Scalar averaged cross-power spectrum Several baselines displayed
Timerange: 00/23:59:31 to 01/00:02:59

Plot file version 100 created 23-AUG-2010 12:35:13

IRAS1929 EP064P.UVDATA.1

Freq = 1.5950 GHz, Bw = 16.000 MH No calibration applied and no bandpass applied

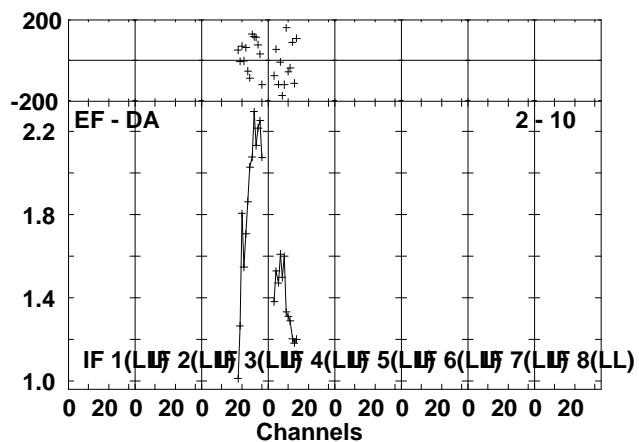
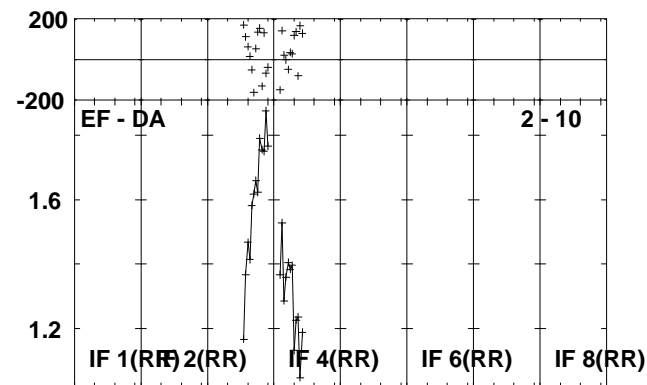
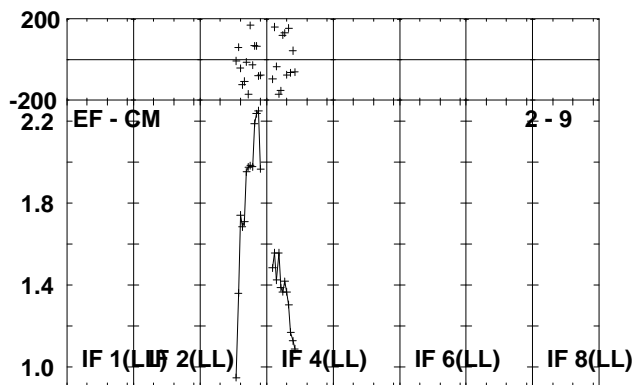
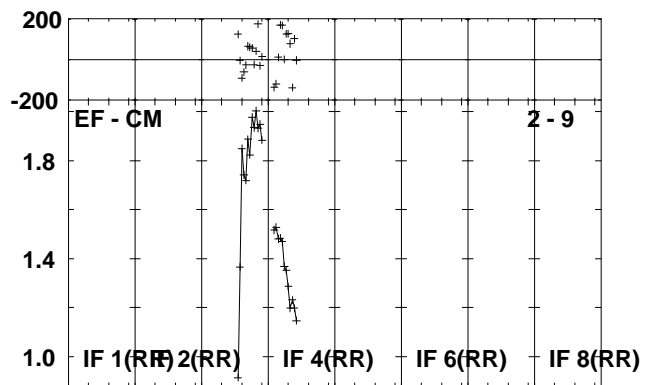
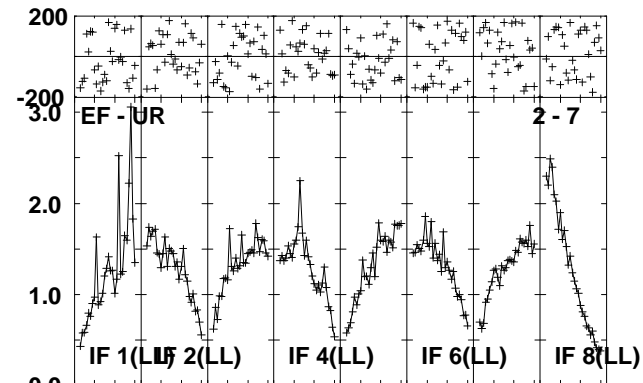
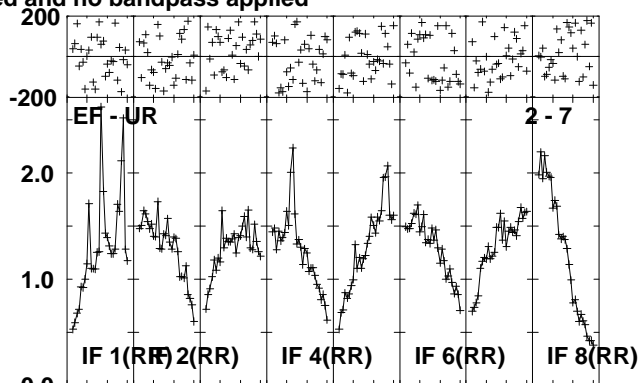
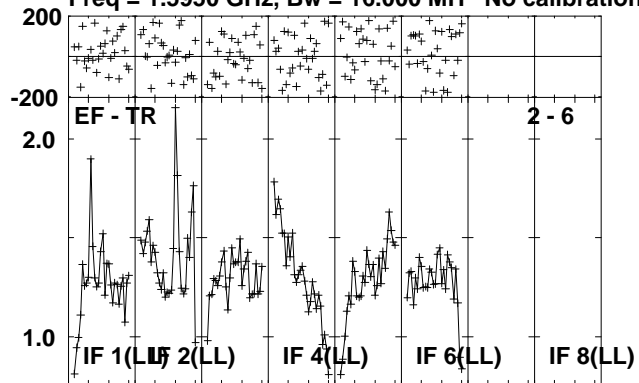

Lower frame: Milli Ampl Jy Top frame: Phas deg
Scalar averaged cross-power spectrum Several baselines displayed
Timerange: 00/23:59:31 to 01/00:02:59

Plot file version 101 created 23-AUG-2010 12:35:15

J1941-05 EP064P.UVDATA.1

Freq = 1.5950 GHz, Bw = 16.000 MH No calibration applied and no bandpass applied

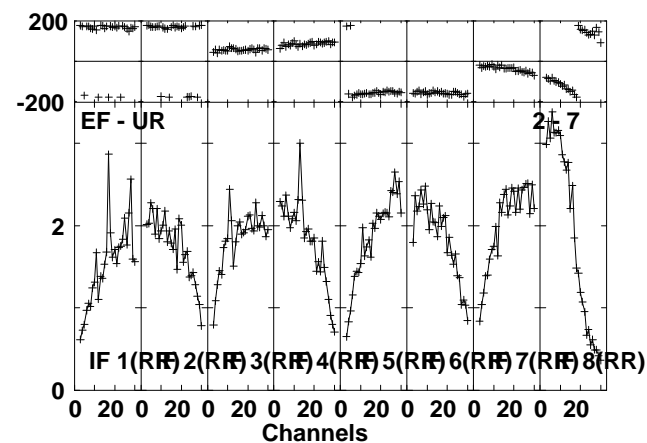
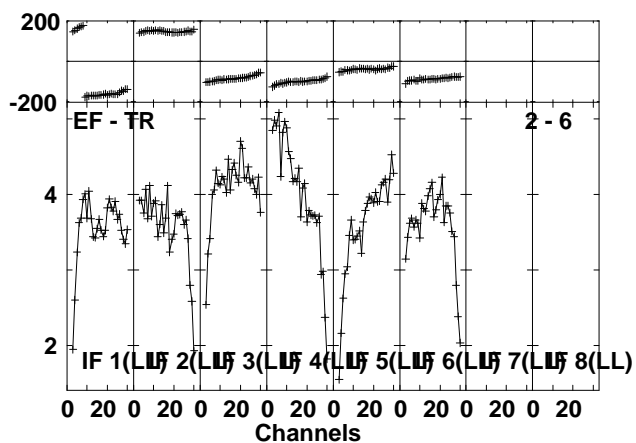
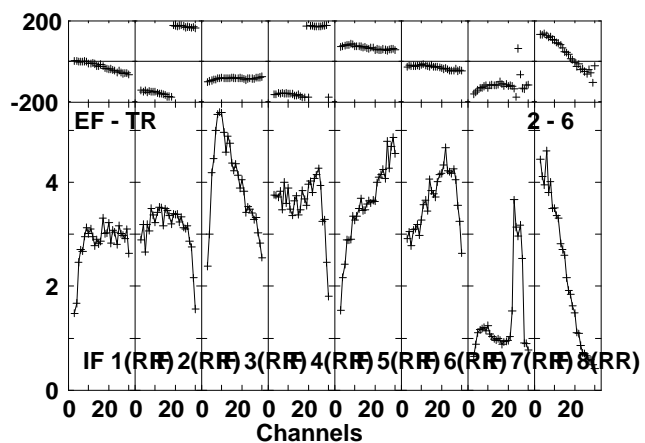
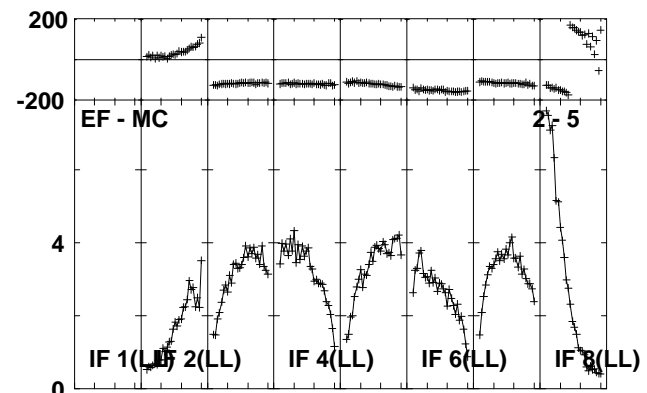
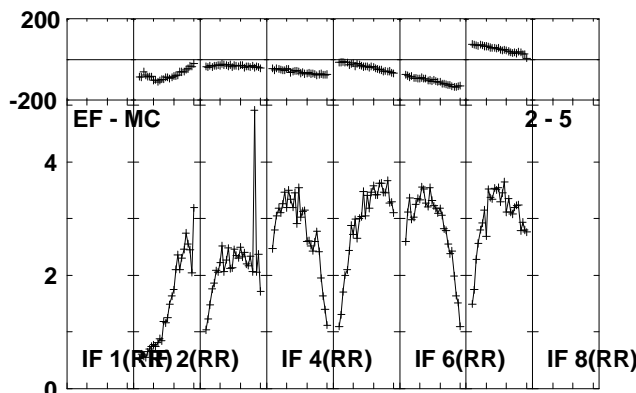
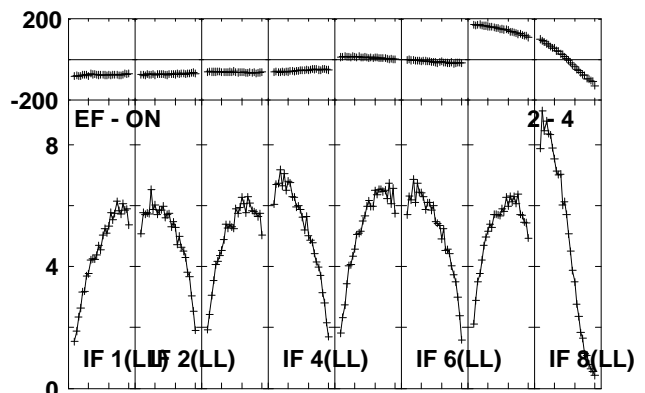
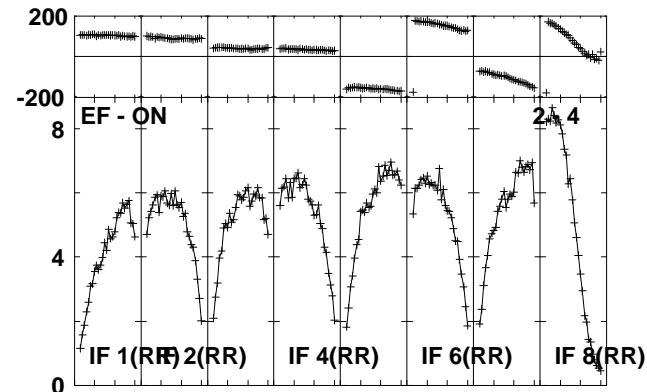
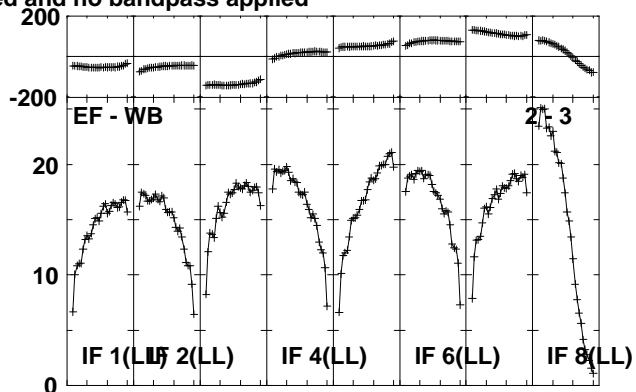
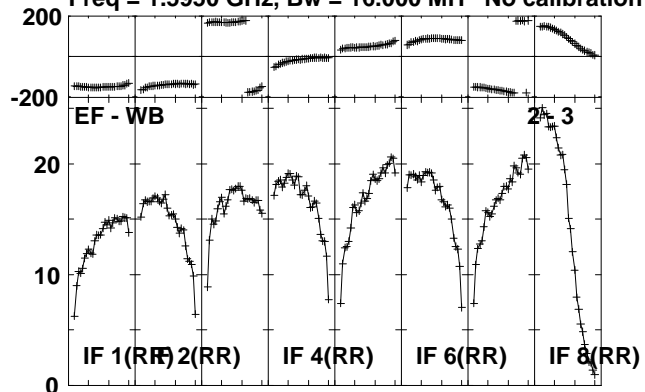

Lower frame: Milli Ampl Jy Top frame: Phas deg
Scalar averaged cross-power spectrum Several baselines displayed
Timerange: 01/00:04:01 to 01/00:05:27

Plot file version 102 created 23-AUG-2010 12:35:15
 J1941-05 EP064P.UVDATA.1

Freq = 1.5950 GHz, Bw = 16.000 MH No calibration applied and no bandpass applied

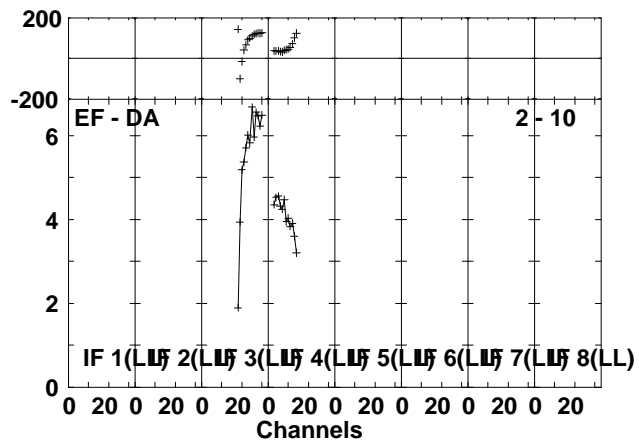
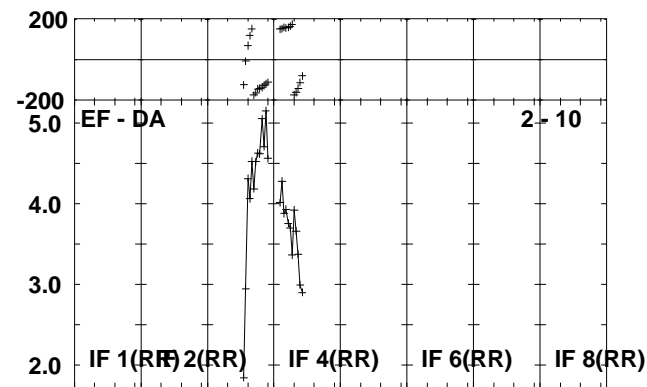
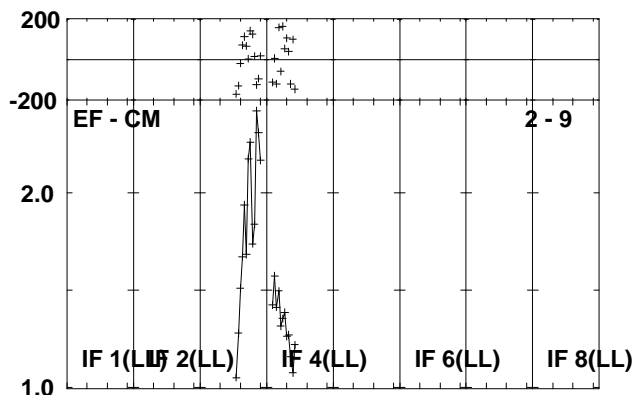
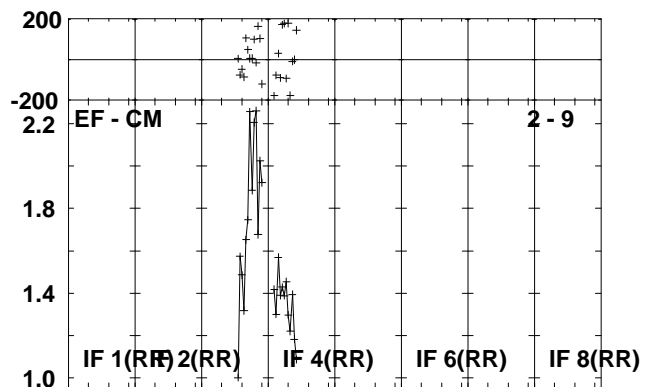
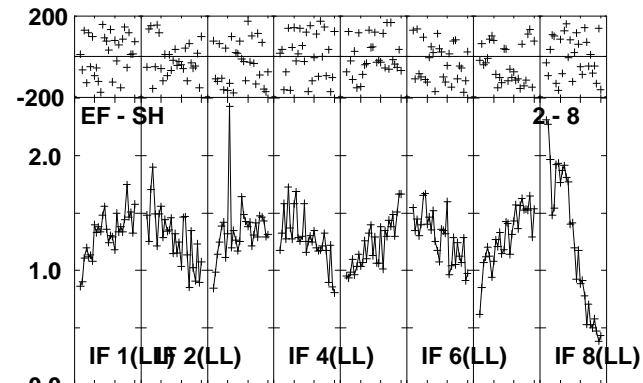
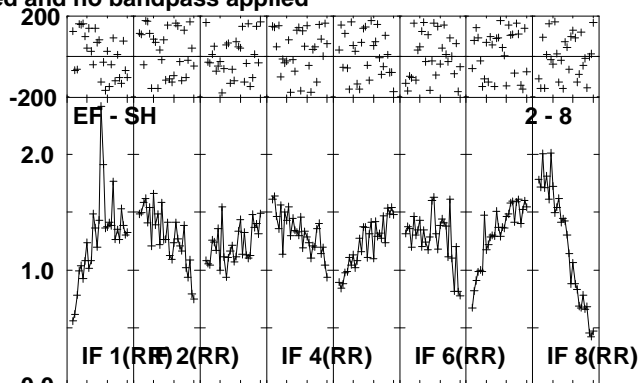
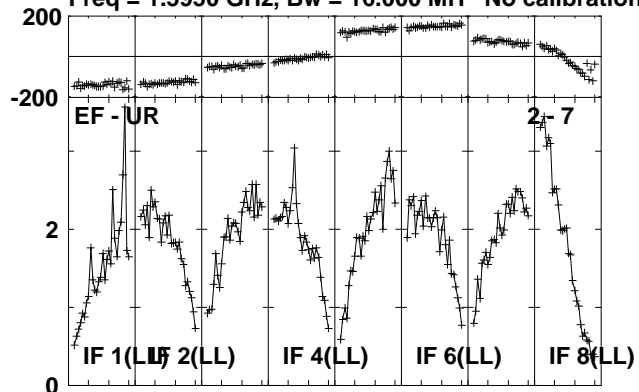

Lower frame: Milli Ampl Jy Top frame: Phas deg
 Scalar averaged cross-power spectrum Several baselines displayed
 Timerange: 01/00:04:01 to 01/00:05:27

Plot file version 103 created 23-AUG-2010 12:35:16

IRAS1929 EP064P.UVDATA.1

Freq = 1.5950 GHz, Bw = 16.000 MH No calibration applied and no bandpass applied

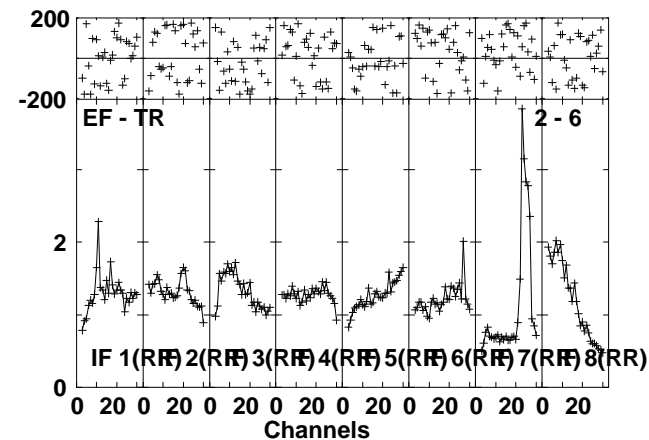
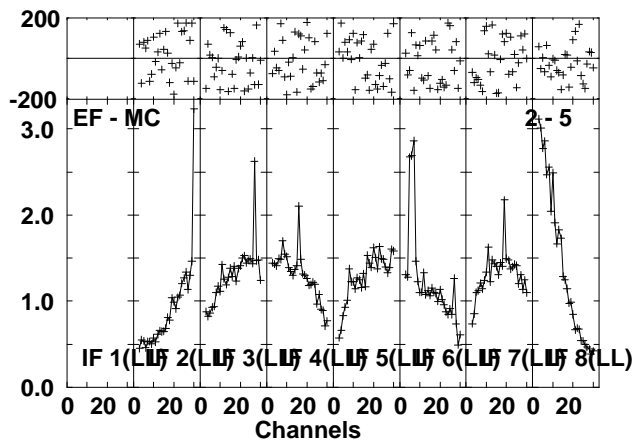
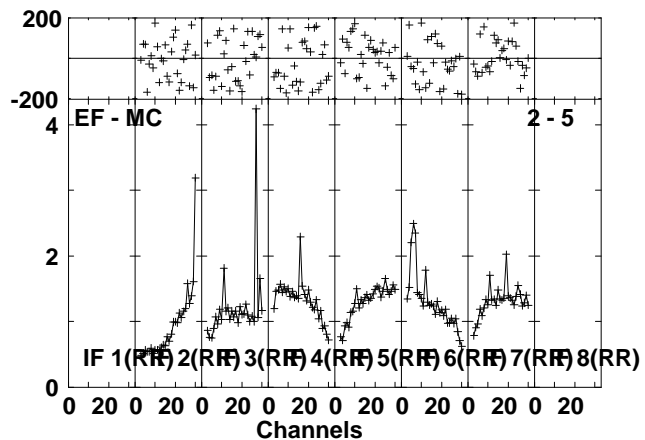
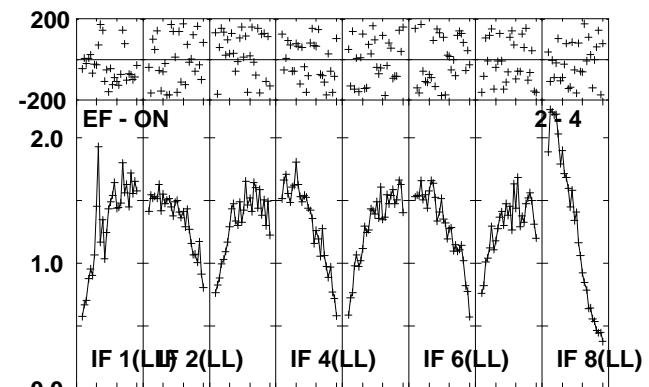
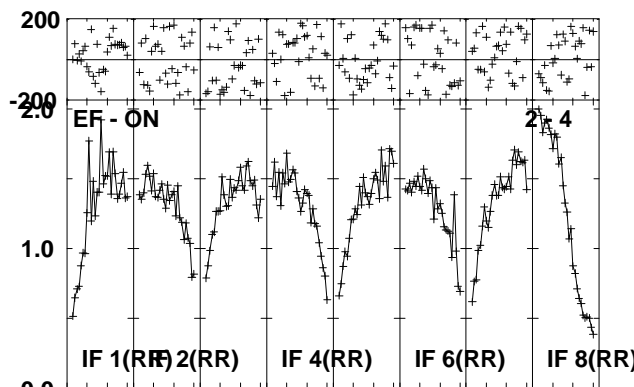
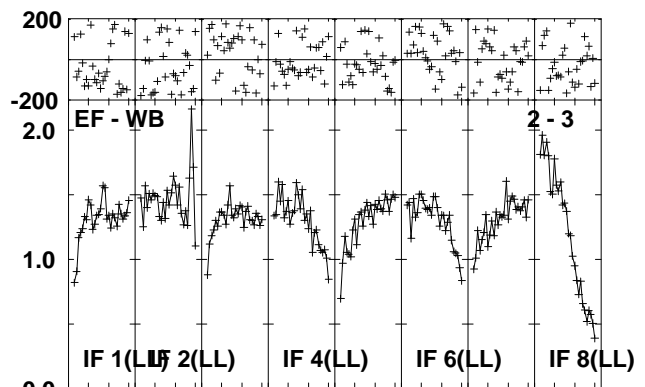
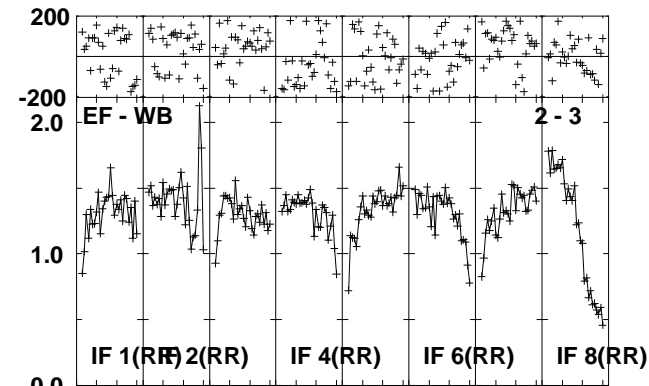
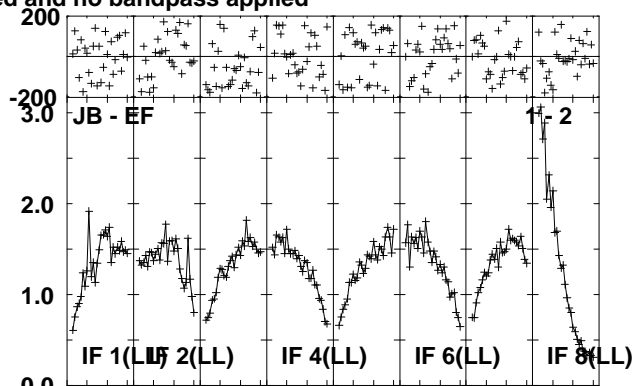
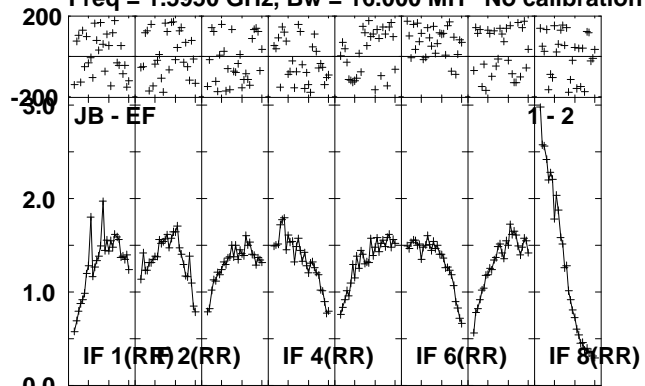

Lower frame: Milli Ampl Jy Top frame: Phas deg
Scalar averaged cross-power spectrum Several baselines displayed
Timerange: 01/00:05:31 to 01/00:08:59

Plot file version 104 created 23-AUG-2010 12:35:18

IRAS1929 EP064P.UVDATA.1

Freq = 1.5950 GHz, Bw = 16.000 MH No calibration applied and no bandpass applied

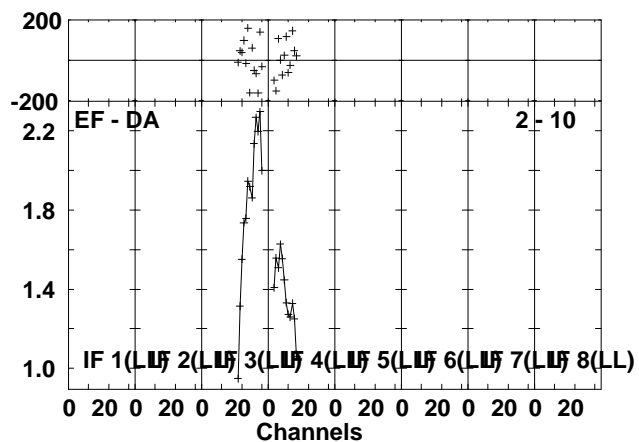
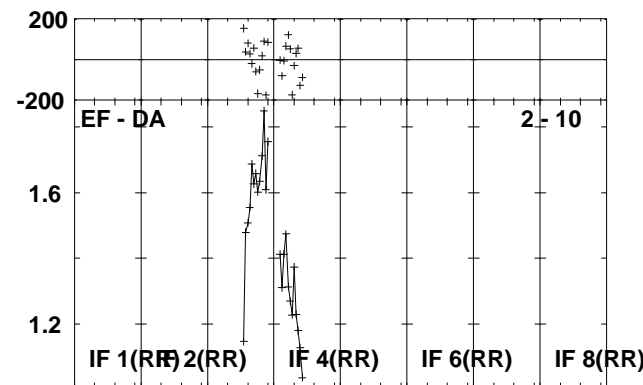
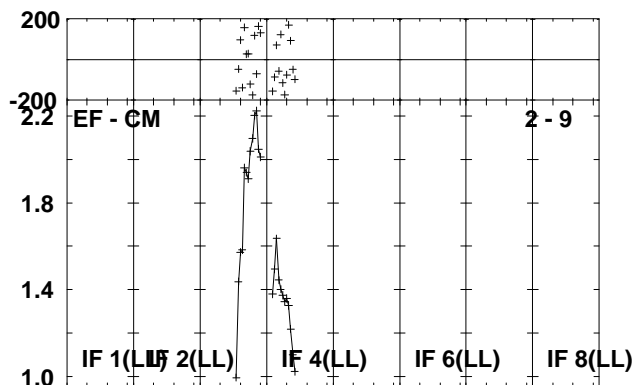
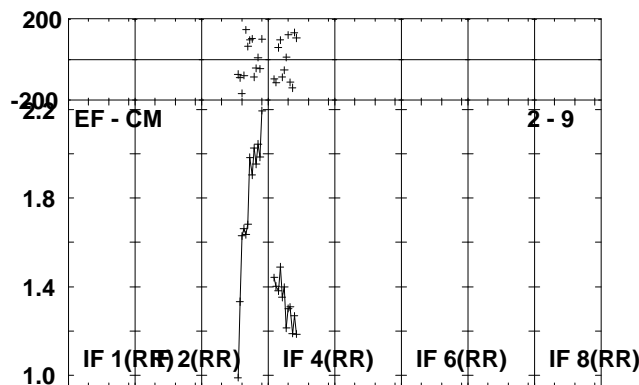
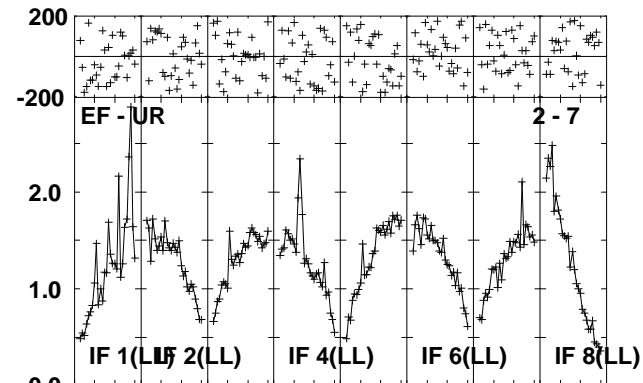
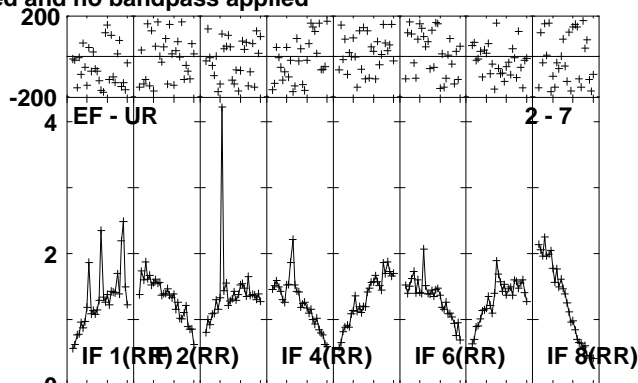
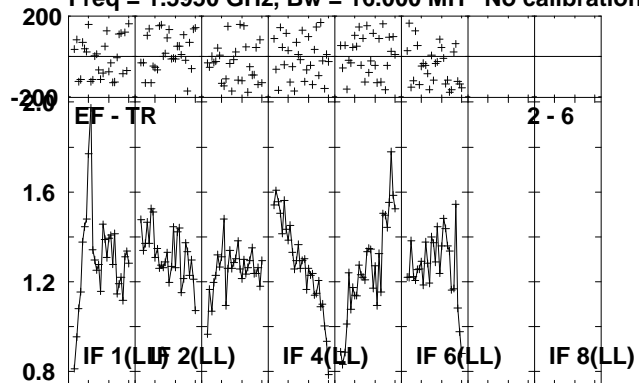

Lower frame: Milli Ampl Jy Top frame: Phas deg
Scalar averaged cross-power spectrum Several baselines displayed
Timerange: 01/00:05:31 to 01/00:08:59

Plot file version 105 created 23-AUG-2010 12:35:19

J1941-05 EP064P.UVDATA.1

Freq = 1.5950 GHz, Bw = 16.000 MH No calibration applied and no bandpass applied

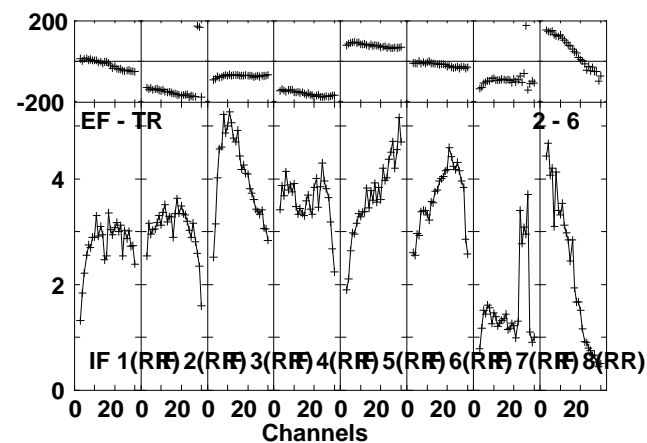
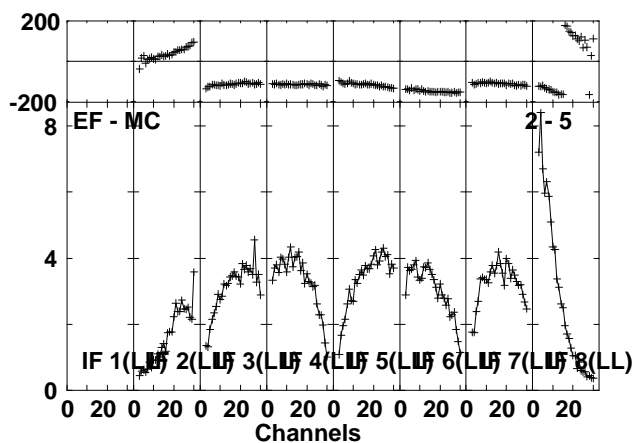
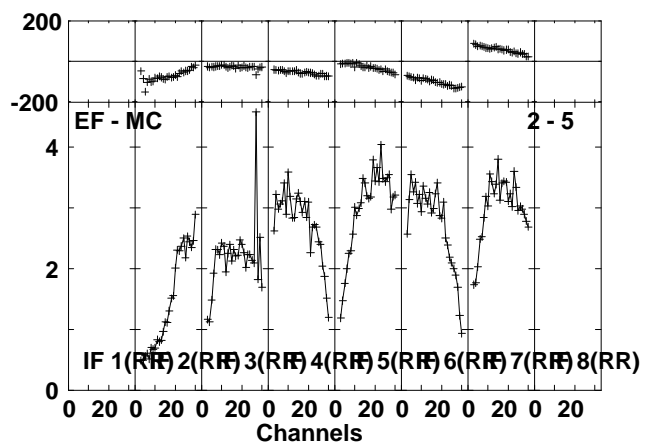
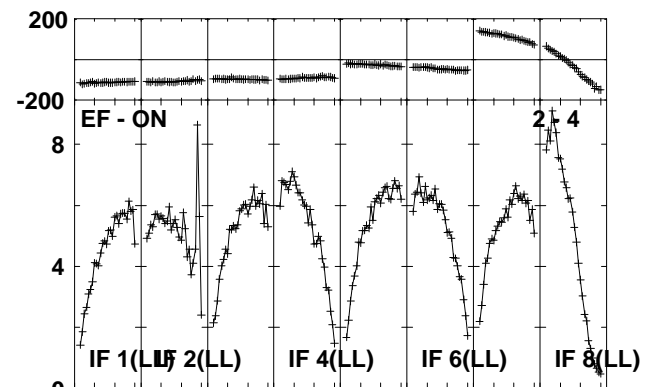
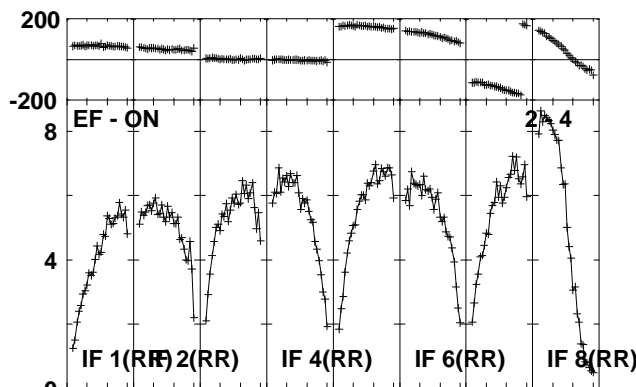
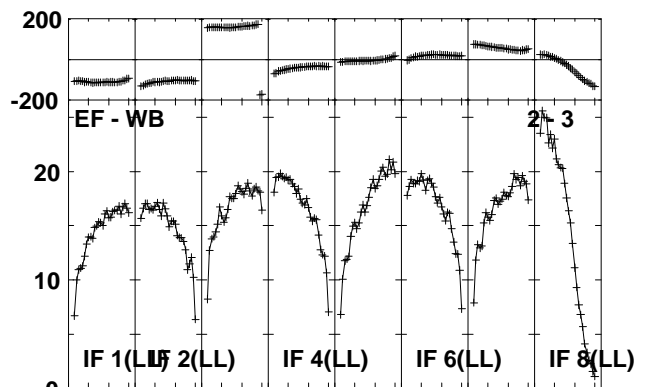
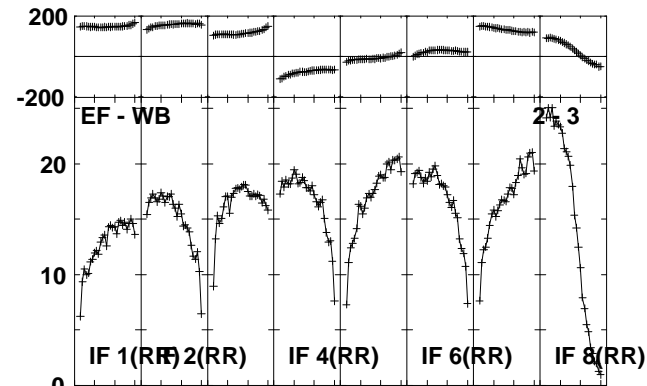
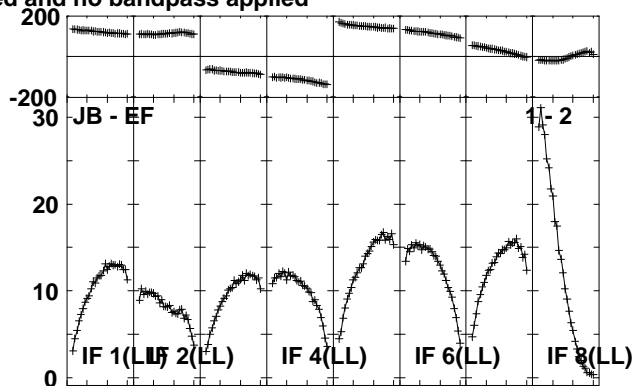
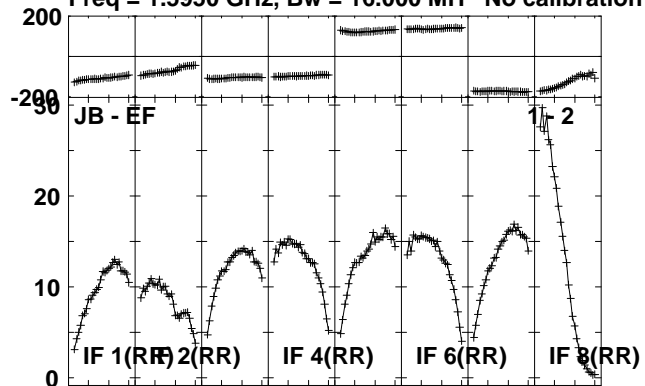

Lower frame: Milli Ampl Jy Top frame: Phas deg
Scalar averaged cross-power spectrum Several baselines displayed
Timerange: 01/00:09:01 to 01/00:10:29

Plot file version 106 created 23-AUG-2010 12:35:20

J1941-05 EP064P.UVDATA.1

Freq = 1.5950 GHz, Bw = 16.000 MH No calibration applied and no bandpass applied

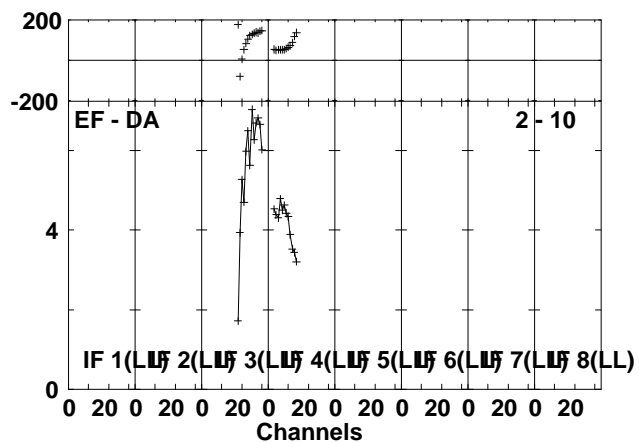
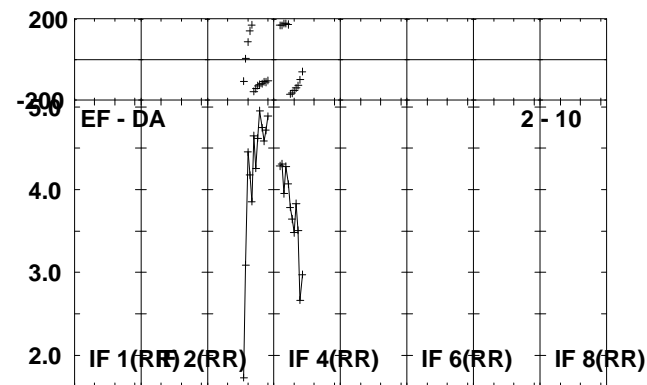
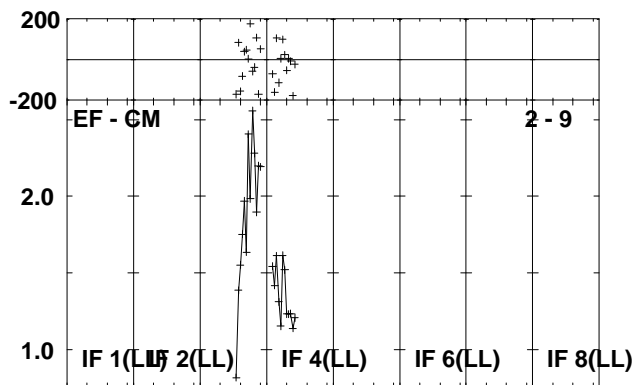
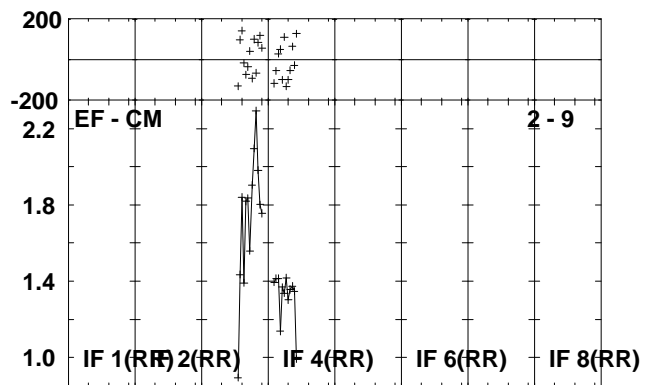
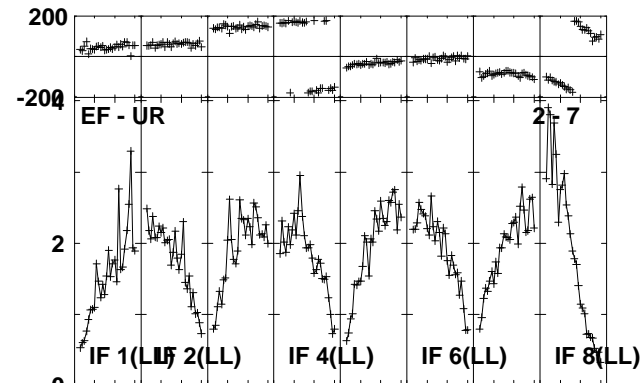
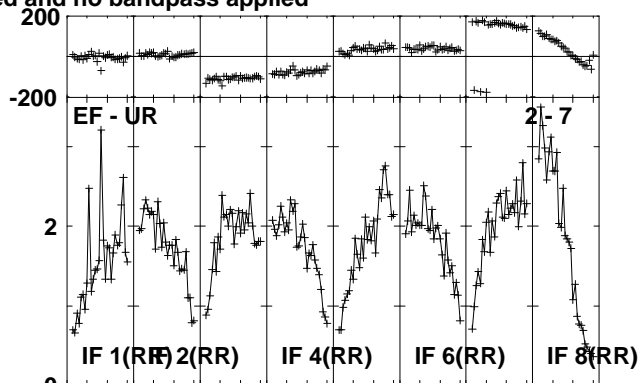
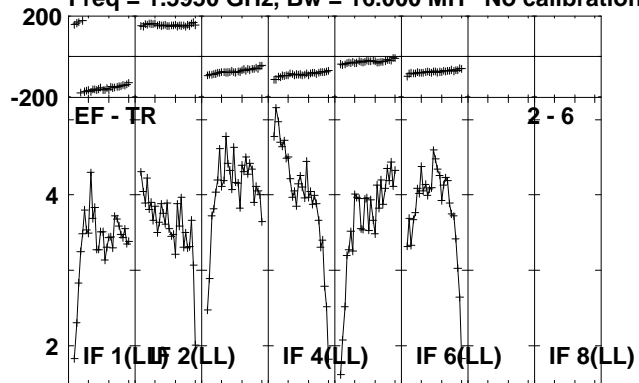

Lower frame: Milli Ampl Jy Top frame: Phas deg
Scalar averaged cross-power spectrum Several baselines displayed
Timerange: 01/00:09:01 to 01/00:10:29

Plot file version 107 created 23-AUG-2010 12:35:21

IRAS1929 EP064P.UVDATA.1

Freq = 1.5950 GHz, Bw = 16.000 MH No calibration applied and no bandpass applied

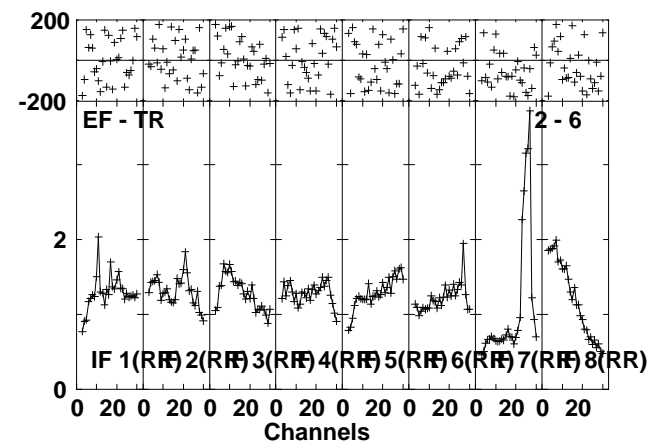
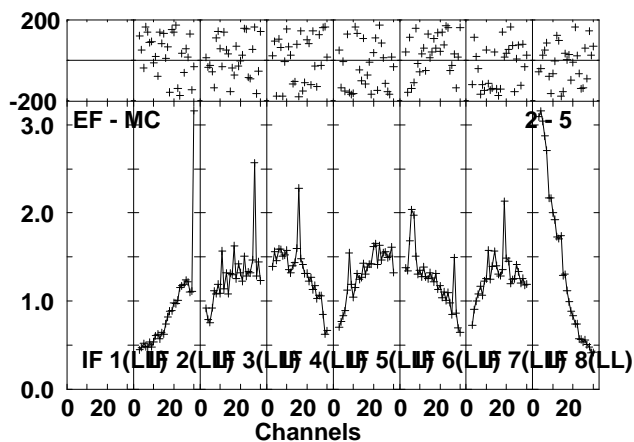
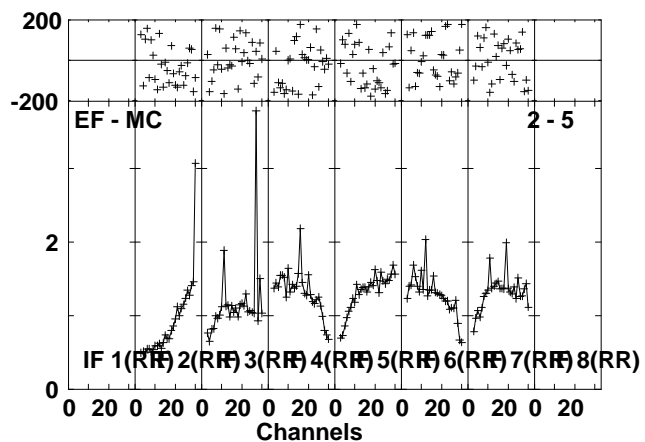
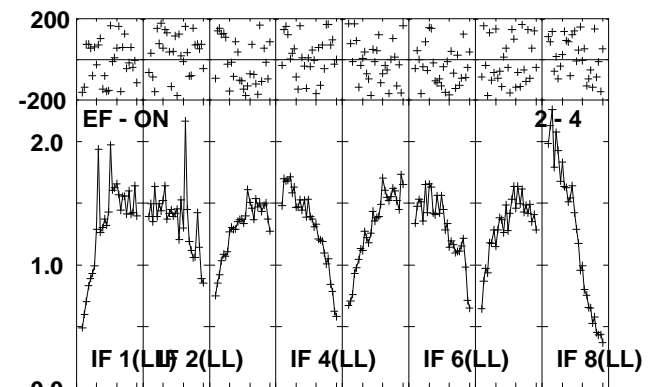
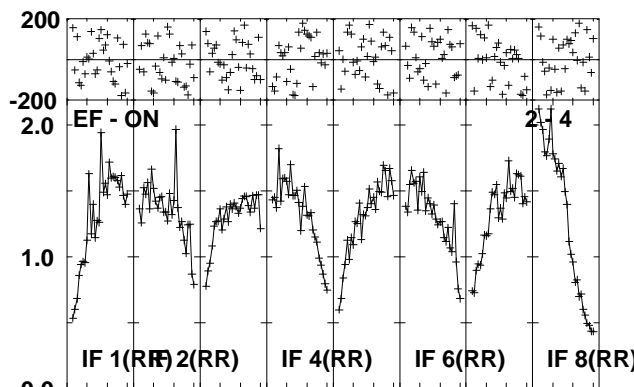
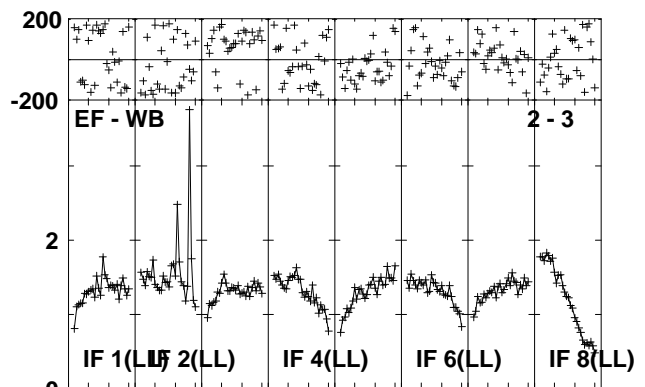
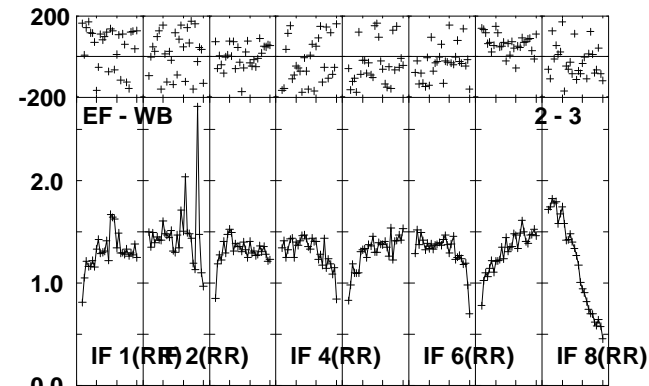
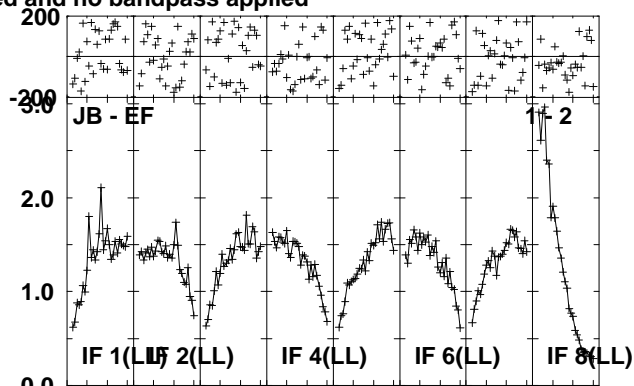
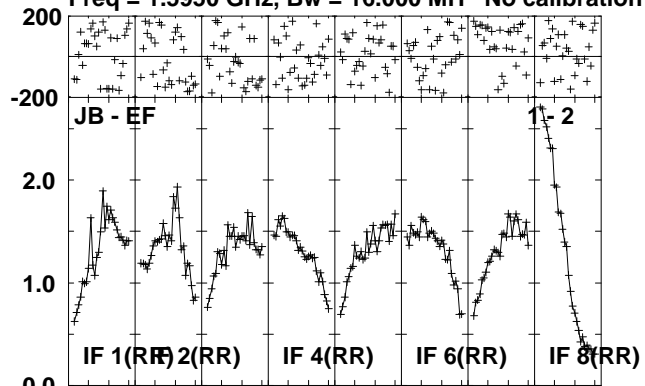

Lower frame: Milli Ampl Jy Top frame: Phas deg
Scalar averaged cross-power spectrum Several baselines displayed
Timerange: 01/00:10:31 to 01/00:13:59

Plot file version 108 created 23-AUG-2010 12:35:23

IRAS1929 EP064P.UVDATA.1

Freq = 1.5950 GHz, Bw = 16.000 MH No calibration applied and no bandpass applied

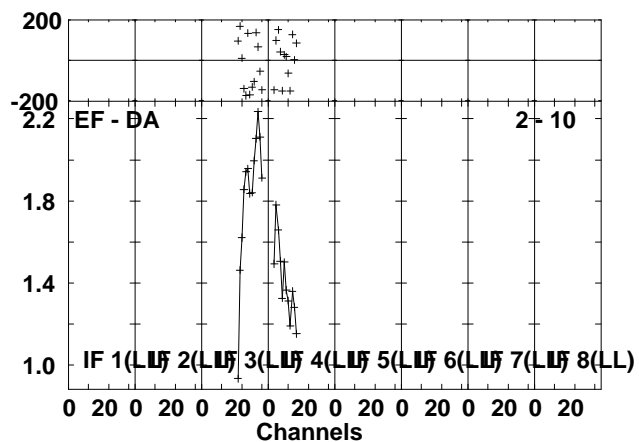
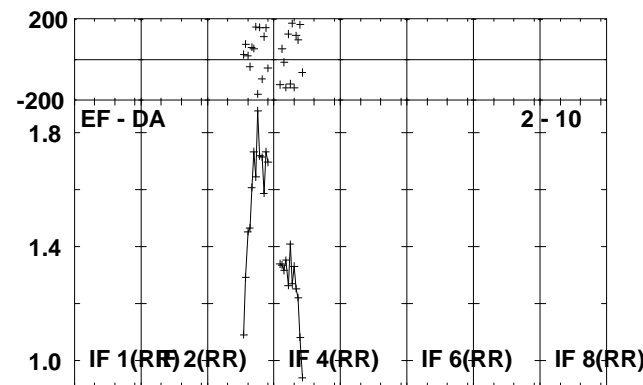
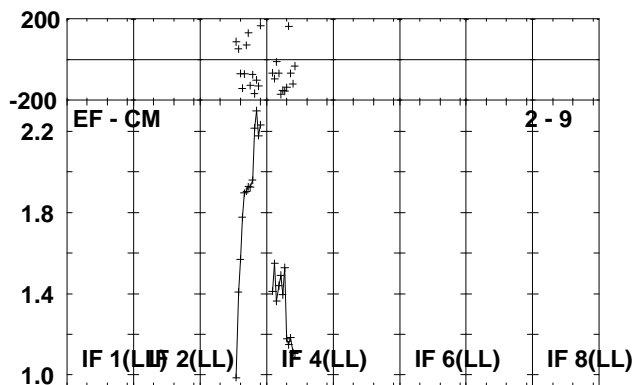
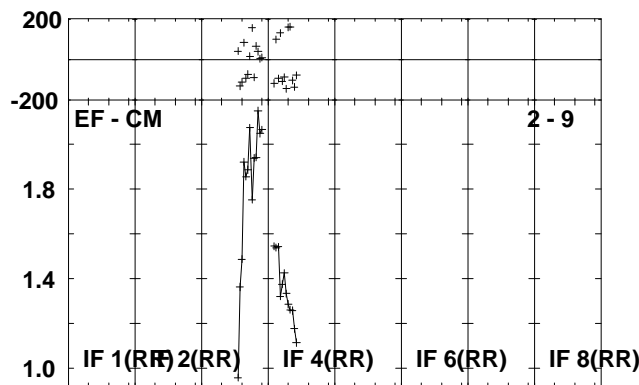
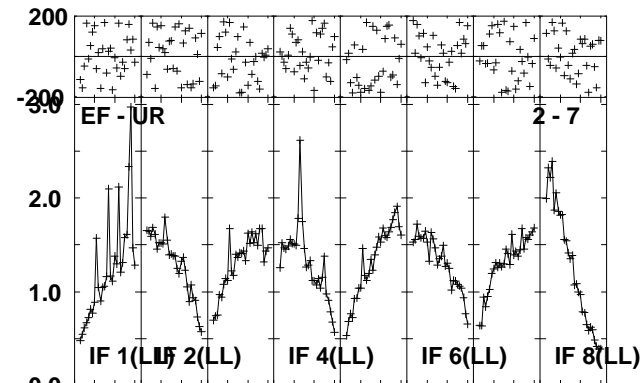
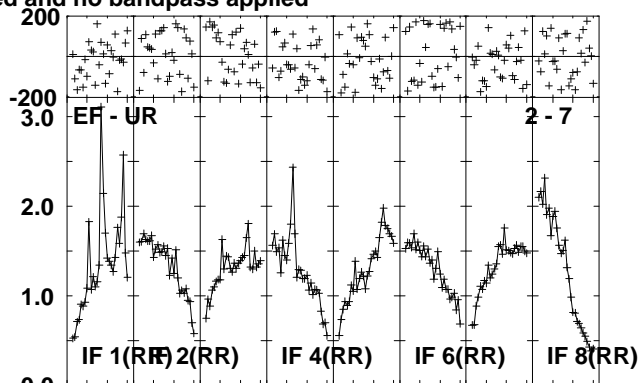
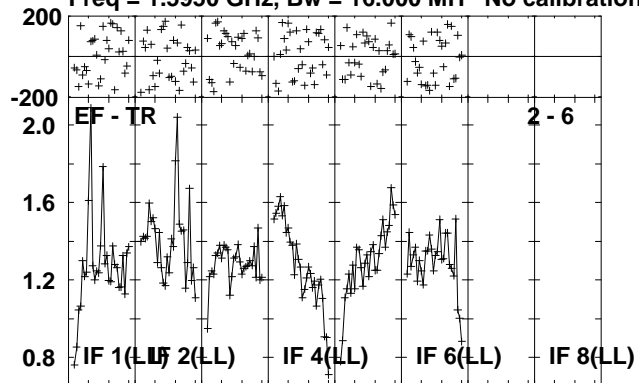

Lower frame: Milli Ampl Jy Top frame: Phas deg
Scalar averaged cross-power spectrum Several baselines displayed
Timerange: 01/00:10:31 to 01/00:13:59

Plot file version 109 created 23-AUG-2010 12:35:25

J1941-05 EP064P.UVDATA.1

Freq = 1.5950 GHz, Bw = 16.000 MH No calibration applied and no bandpass applied

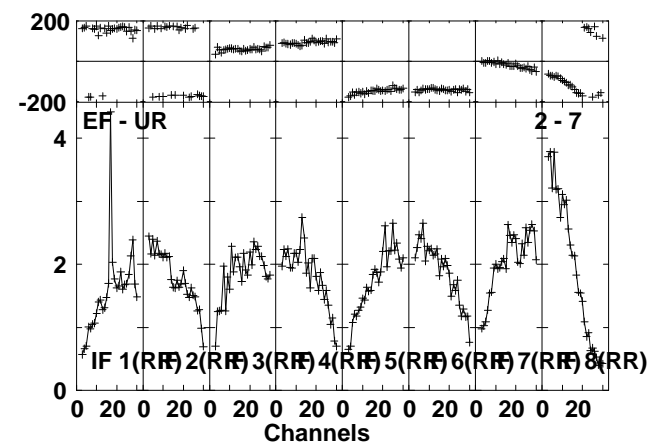
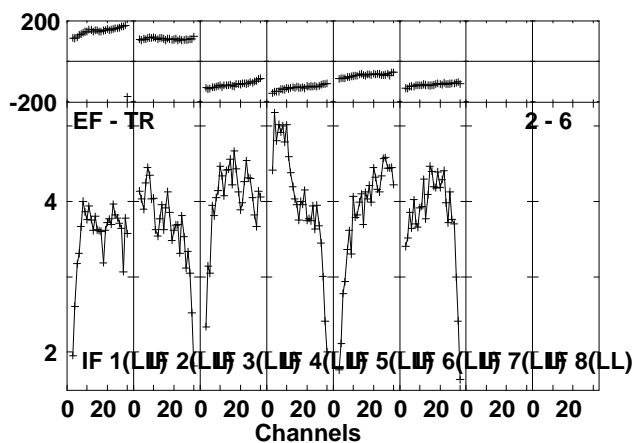
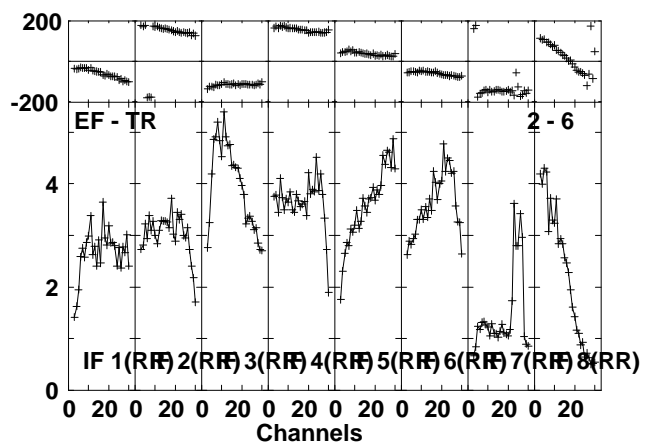
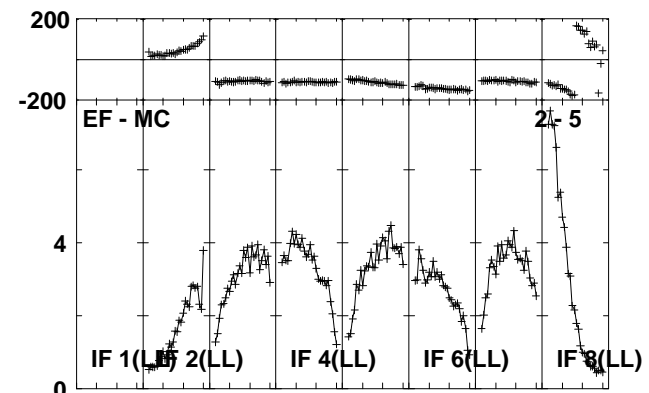
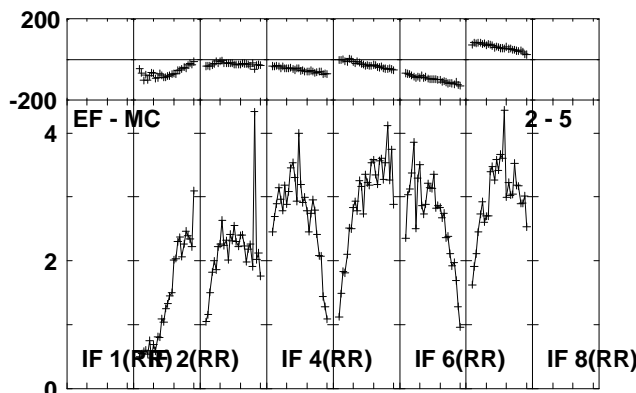
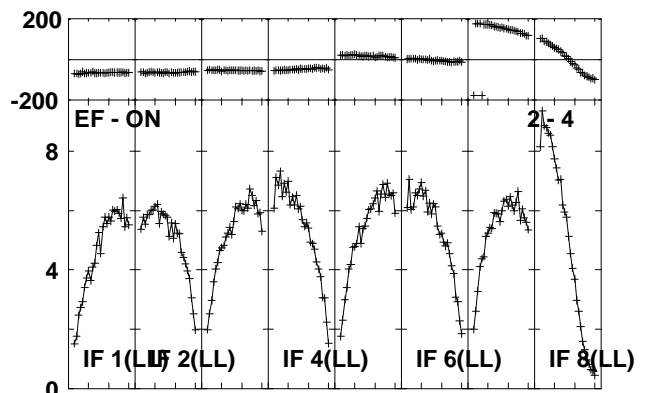
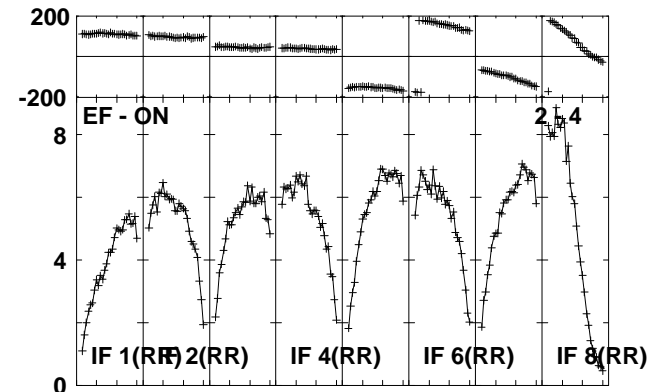
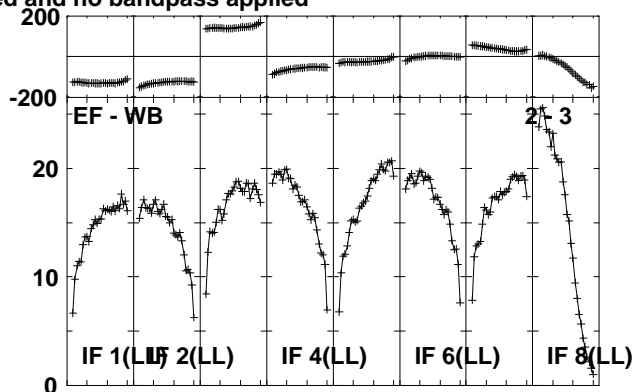
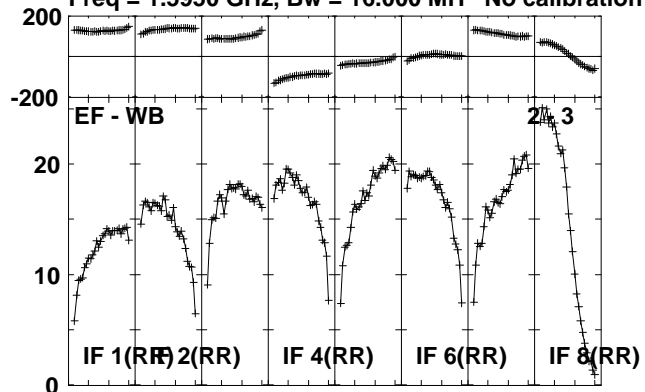

Lower frame: Milli Ampl Jy Top frame: Phas deg
Scalar averaged cross-power spectrum Several baselines displayed
Timerange: 01/00:14:01 to 01/00:15:29

Plot file version 110 created 23-AUG-2010 12:35:25
J1941-05 EP064P.UVDATA.1

Freq = 1.5950 GHz, Bw = 16.000 MH No calibration applied and no bandpass applied

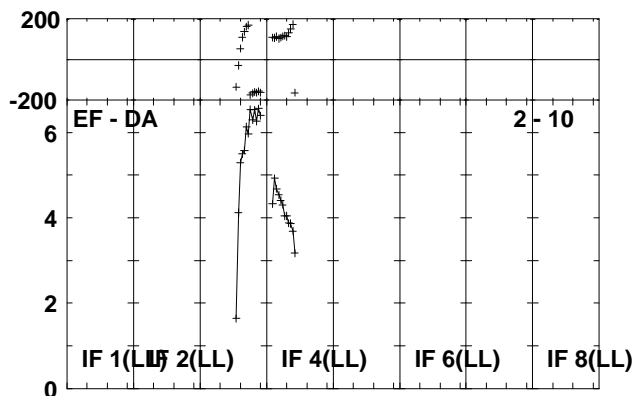
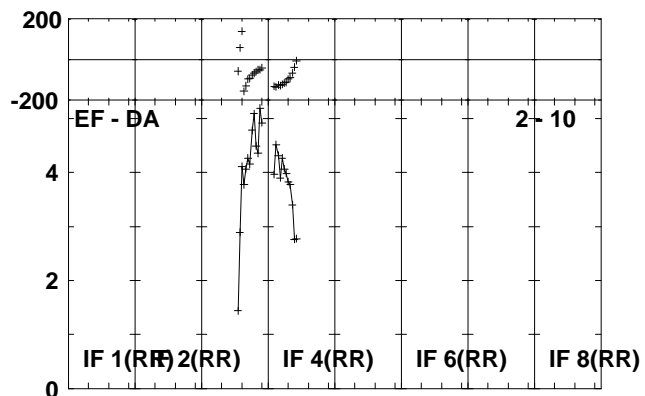
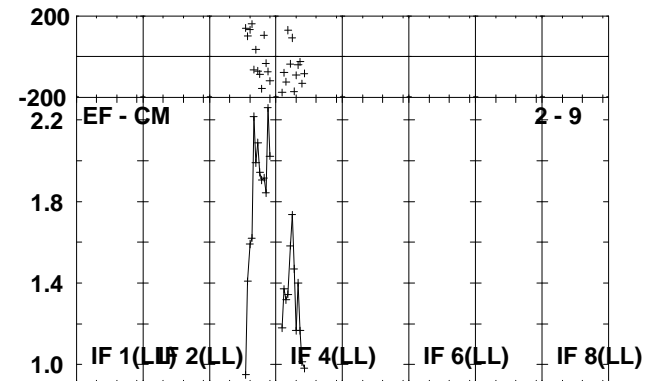
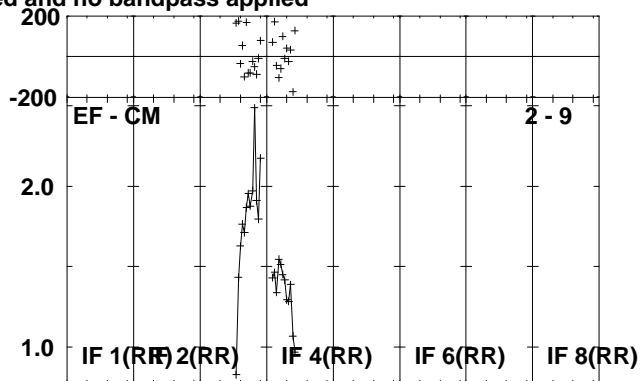
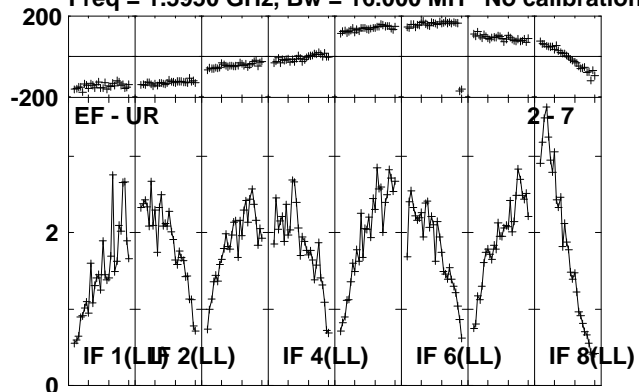

Lower frame: Milli Ampl Jy Top frame: Phas deg
Scalar averaged cross-power spectrum Several baselines displayed
Timerange: 01/00:14:01 to 01/00:15:29

Plot file version 111 created 23-AUG-2010 12:35:26

IRAS1929 EP064P.UVDATA.1

Freq = 1.5950 GHz, Bw = 16.000 MH No calibration applied and no bandpass applied

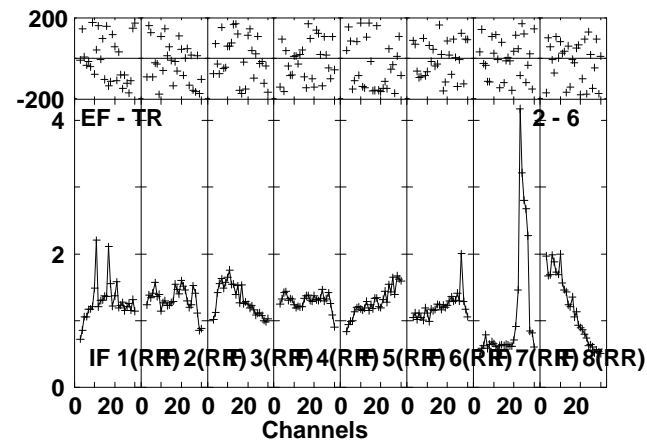
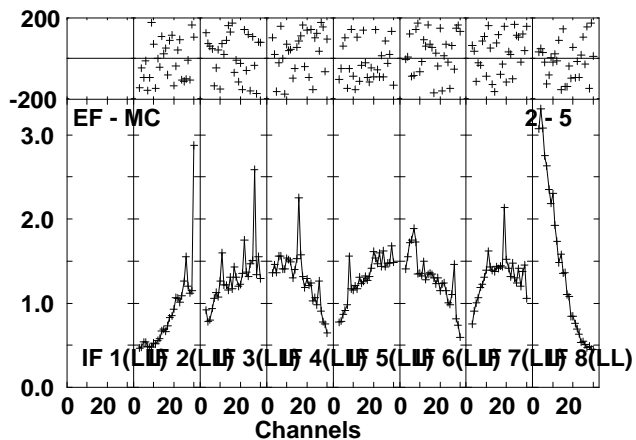
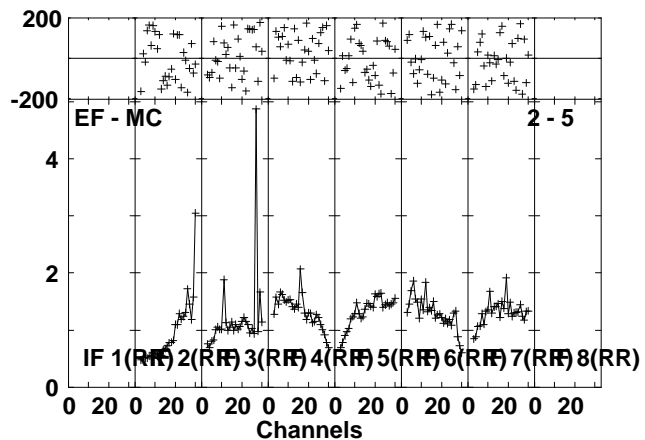
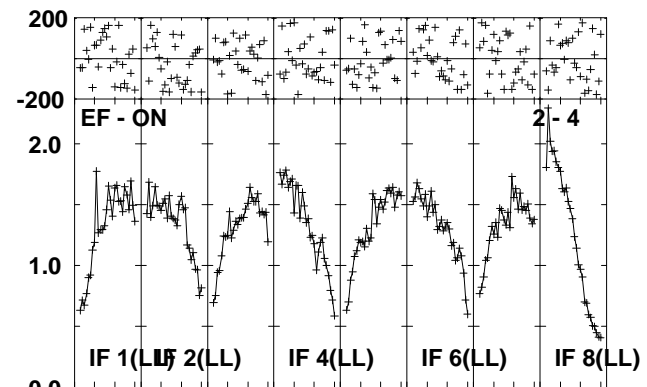
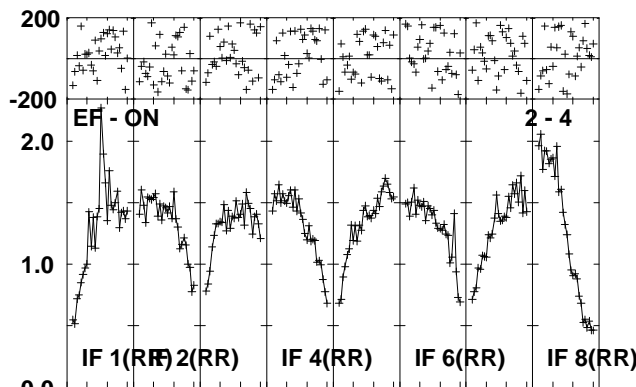
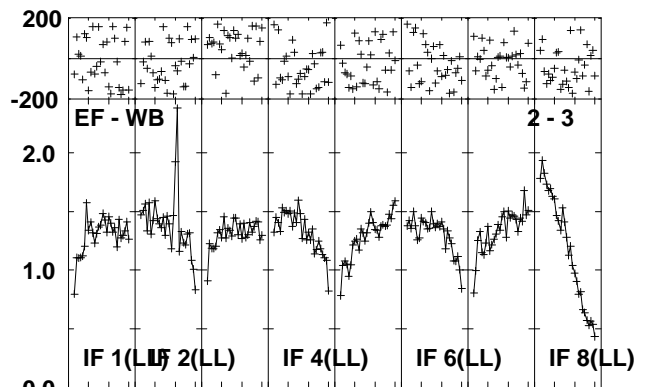
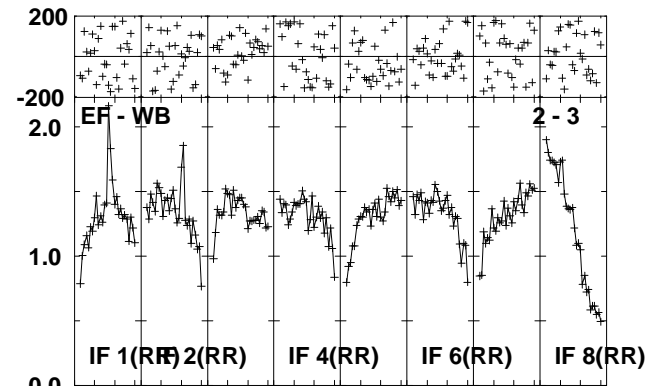
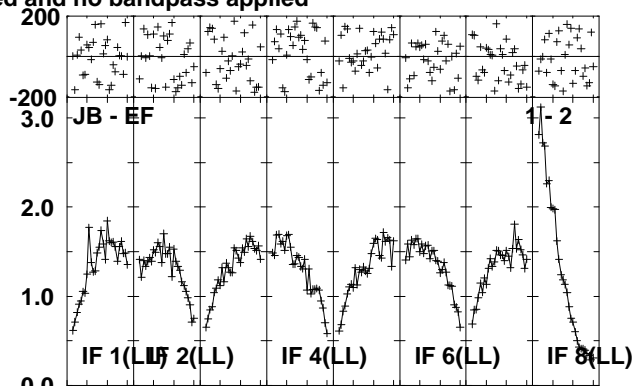
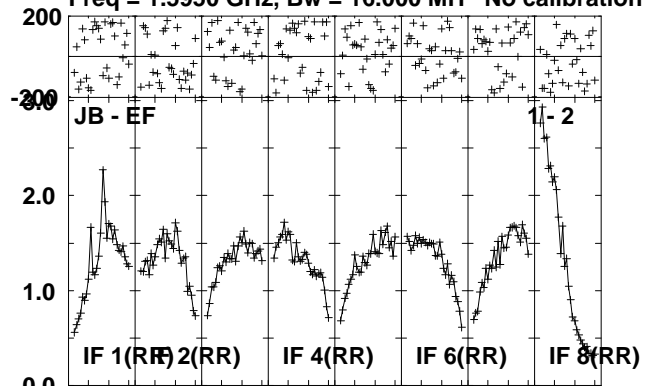

Lower frame: Milli Ampl Jy Top frame: Phas deg
Scalar averaged cross-power spectrum Several baselines displayed
Timerange: 01/00:15:31 to 01/00:18:59

Plot file version 112 created 23-AUG-2010 12:35:28

IRAS1929 EP064P.UVDATA.1

Freq = 1.5950 GHz, Bw = 16.000 MH No calibration applied and no bandpass applied

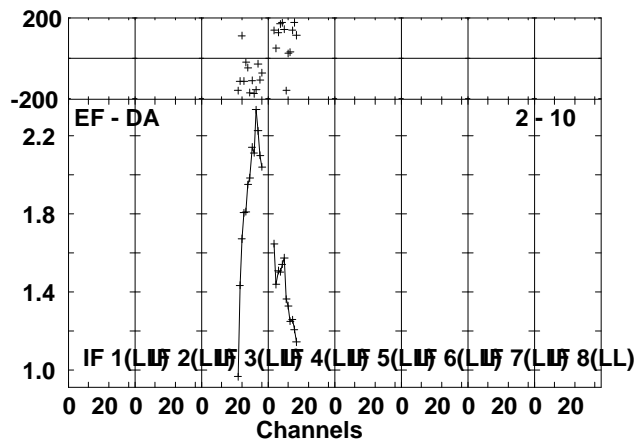
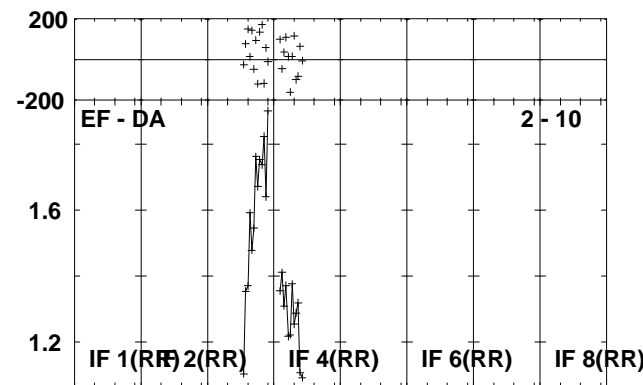
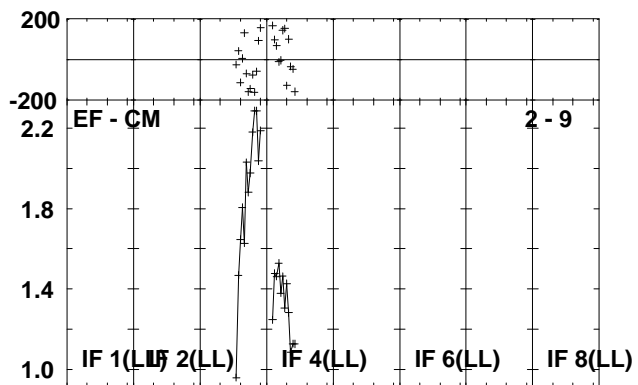
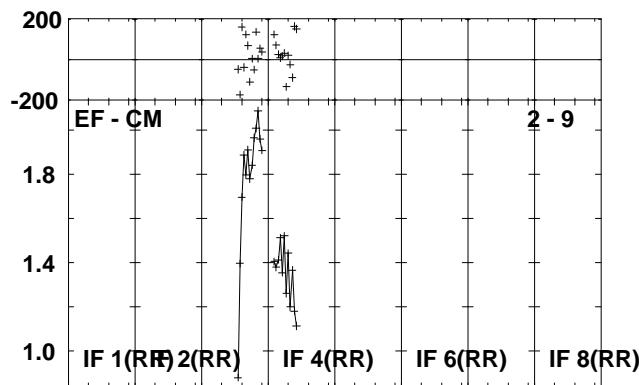
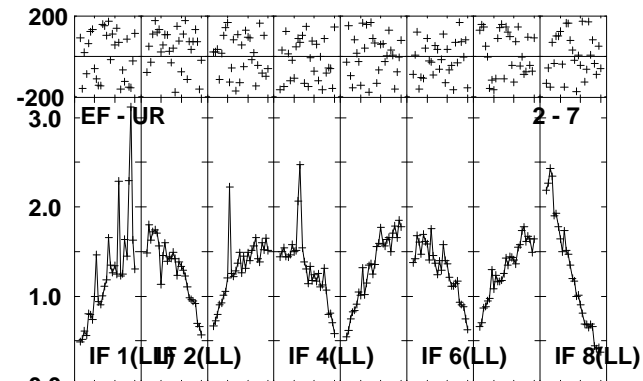
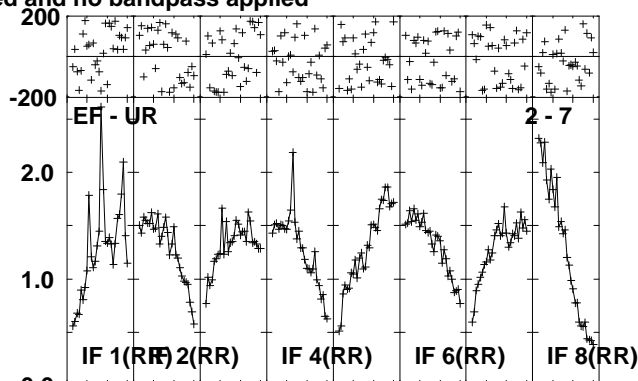
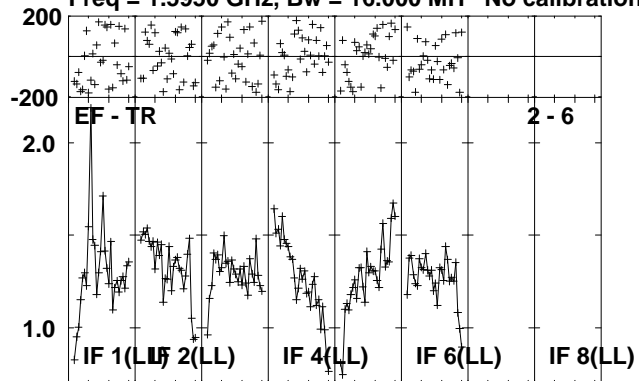

Lower frame: Milli Ampl Jy Top frame: Phas deg
Scalar averaged cross-power spectrum Several baselines displayed
Timerange: 01/00:15:31 to 01/00:18:59

Plot file version 113 created 23-AUG-2010 12:35:30

J1941-05 EP064P.UVDATA.1

Freq = 1.5950 GHz, Bw = 16.000 MH No calibration applied and no bandpass applied

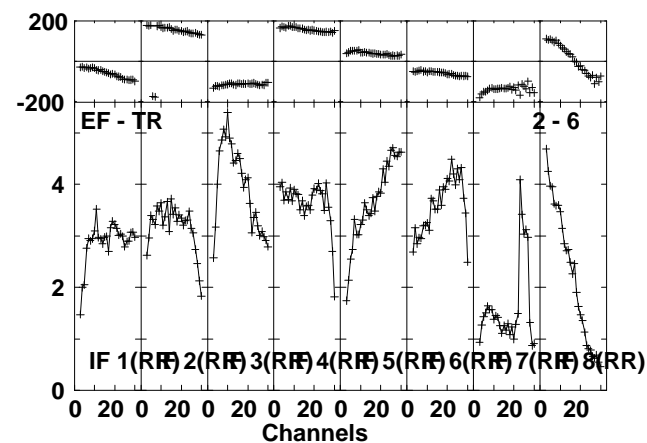
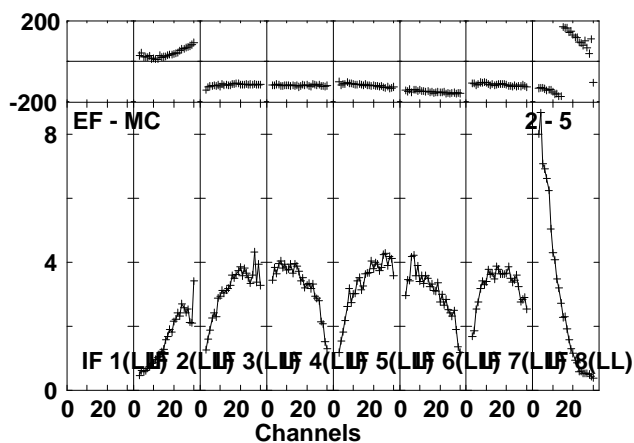
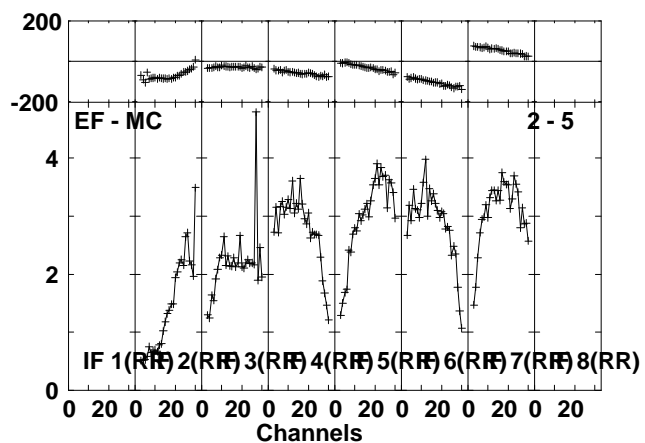
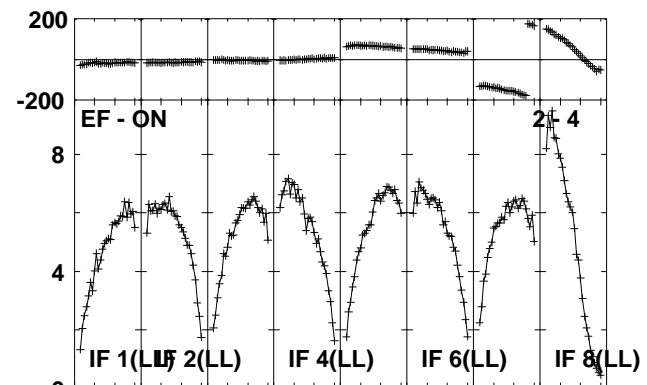
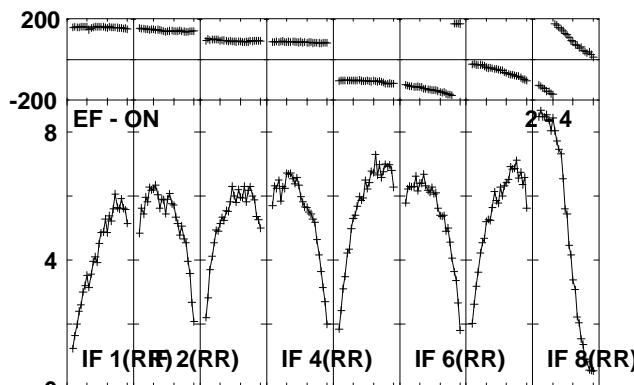
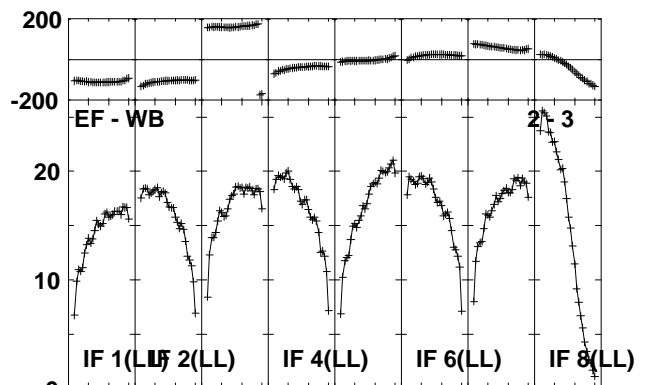
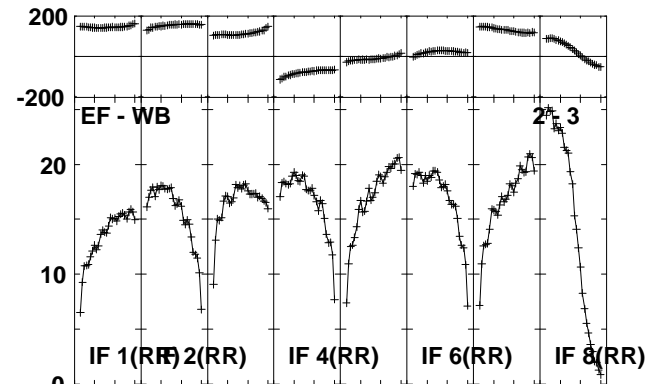
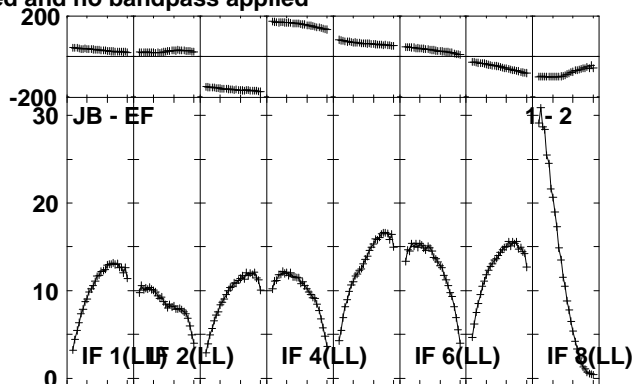
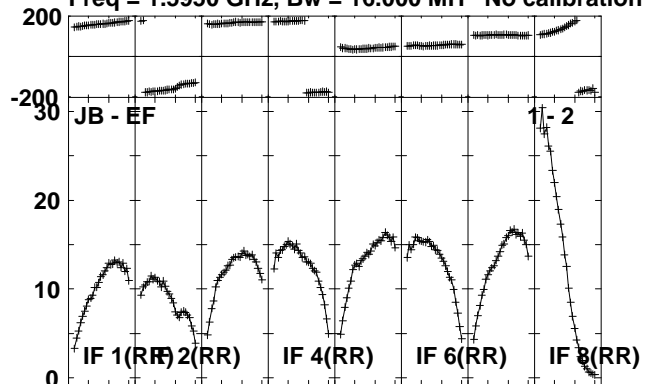

Lower frame: Milli Ampl Jy Top frame: Phas deg
Scalar averaged cross-power spectrum Several baselines displayed
Timerange: 01/00:20:01 to 01/00:21:29

Plot file version 114 created 23-AUG-2010 12:35:30

J1941-05 EP064P.UVDATA.1

Freq = 1.5950 GHz, Bw = 16.000 MH No calibration applied and no bandpass applied

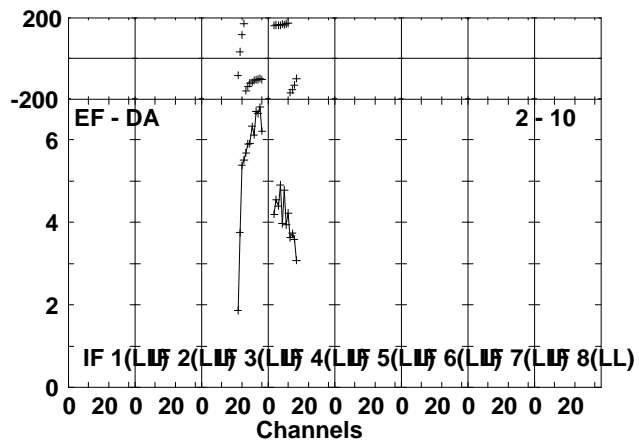
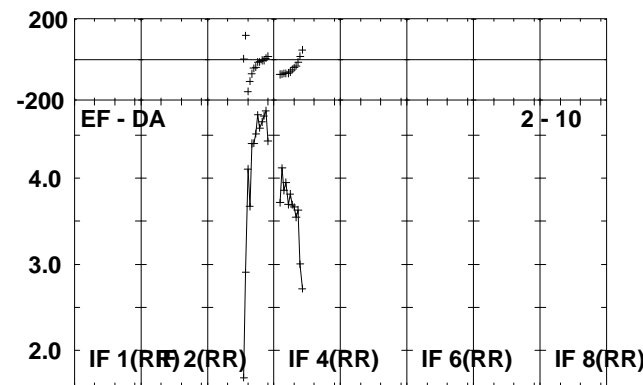
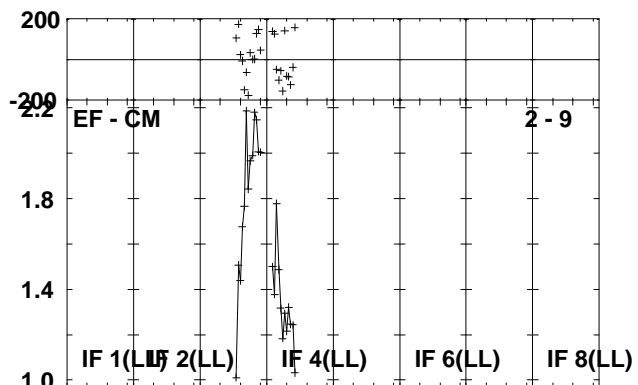
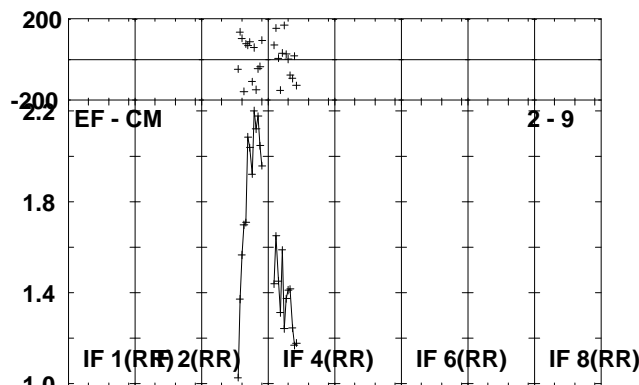
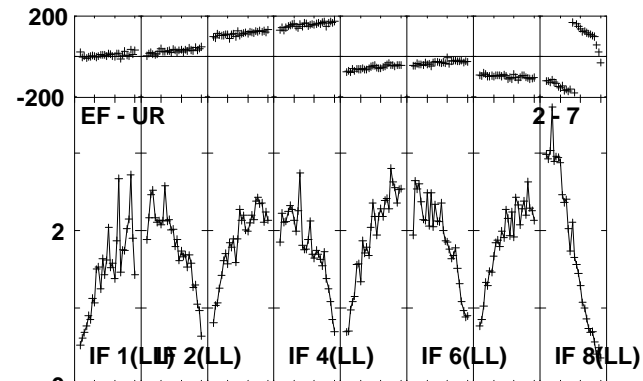
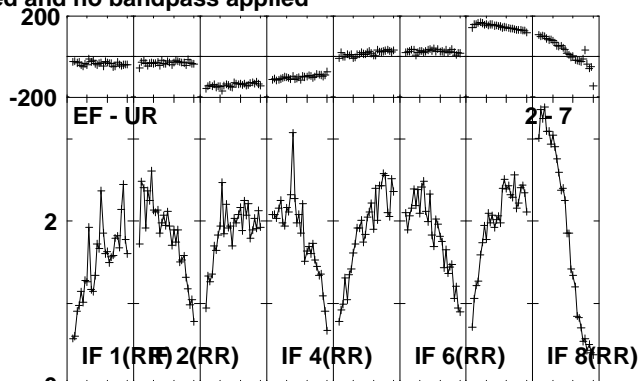
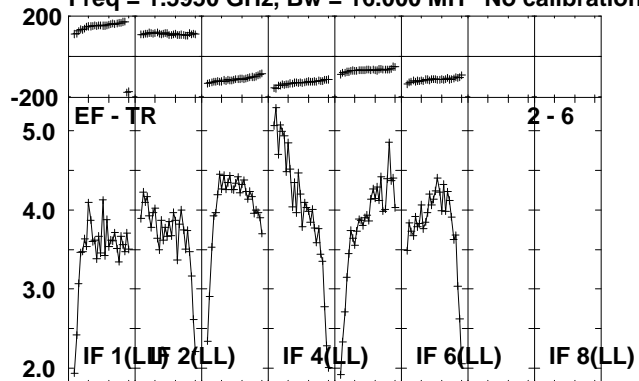

Lower frame: Milli Ampl Jy Top frame: Phas deg
Scalar averaged cross-power spectrum Several baselines displayed
Timerange: 01/00:20:01 to 01/00:21:29

Plot file version 115 created 23-AUG-2010 12:35:31

IRAS1929 EP064P.UVDATA.1

Freq = 1.5950 GHz, Bw = 16.000 MH No calibration applied and no bandpass applied

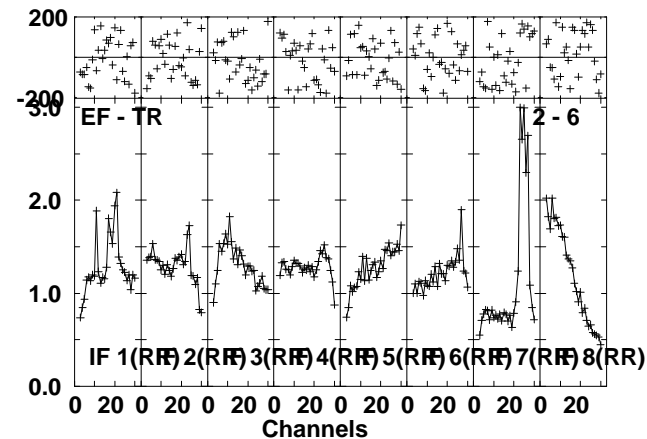
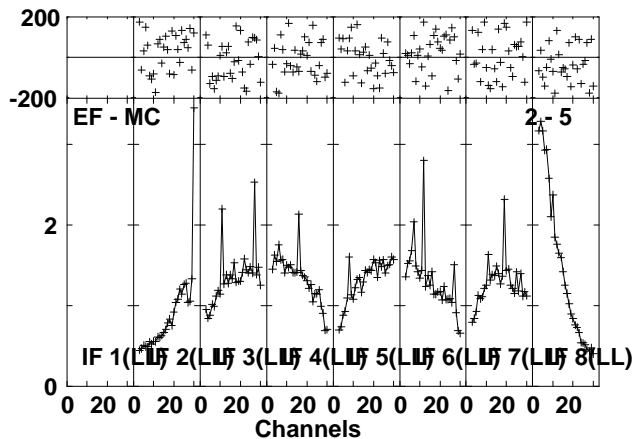
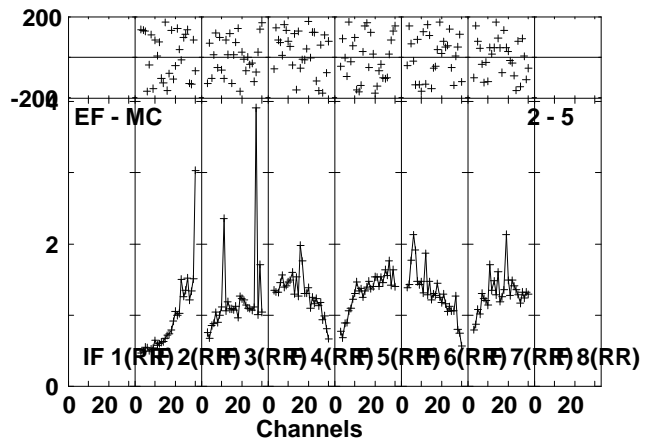
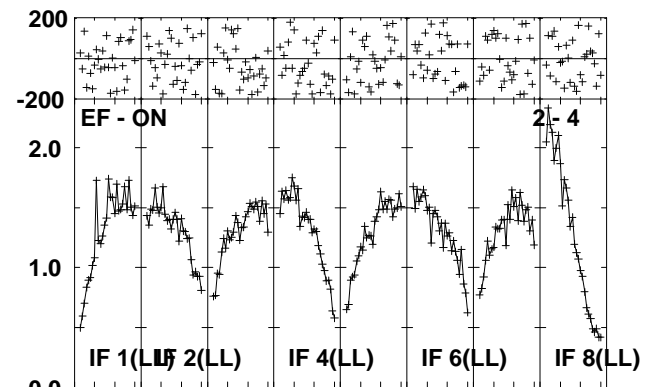
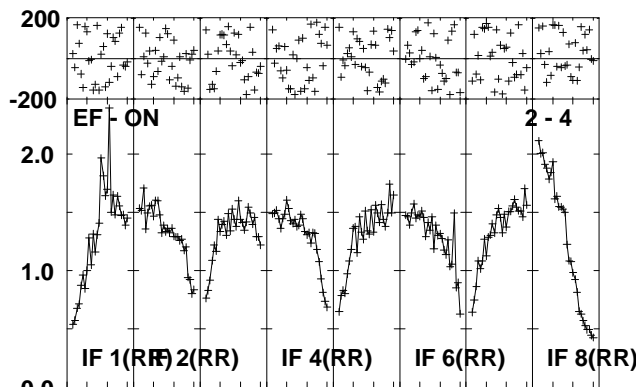
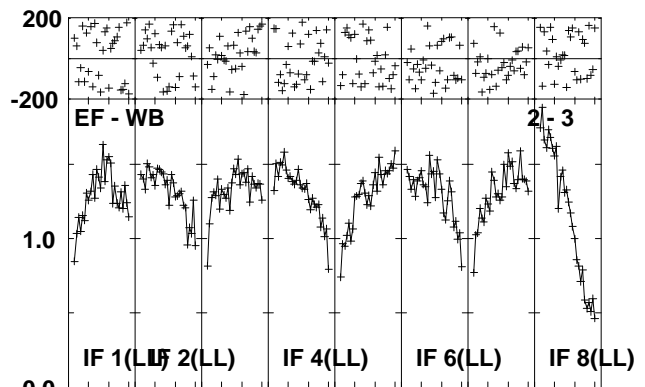
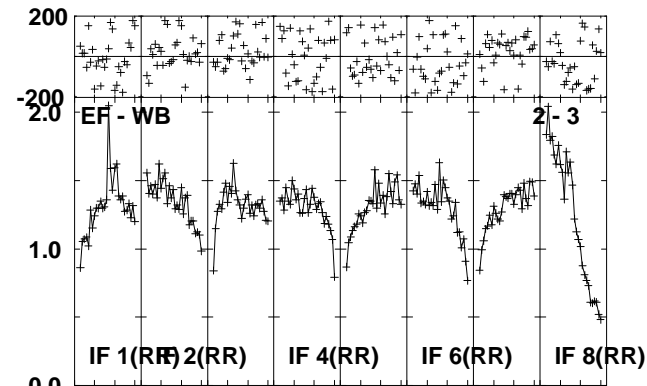
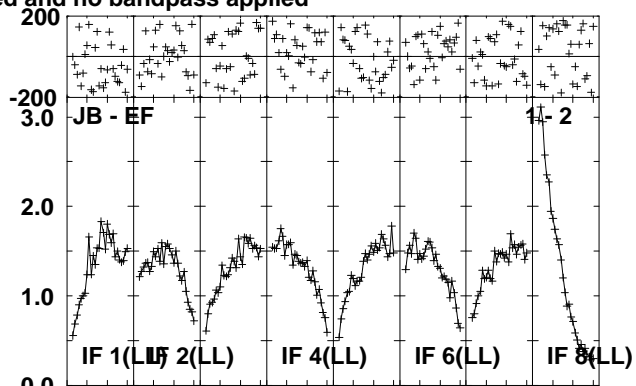
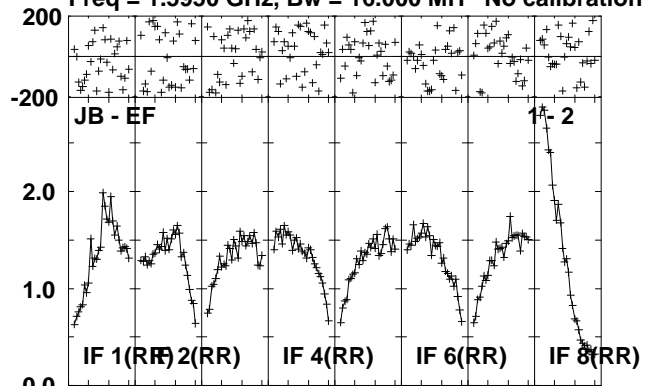

Lower frame: Milli Ampl Jy Top frame: Phas deg
Scalar averaged cross-power spectrum Several baselines displayed
Timerange: 01/00:21:31 to 01/00:24:59

Plot file version 116 created 23-AUG-2010 12:35:33

IRAS1929 EP064P.UVDATA.1

Freq = 1.5950 GHz, Bw = 16.000 MH No calibration applied and no bandpass applied

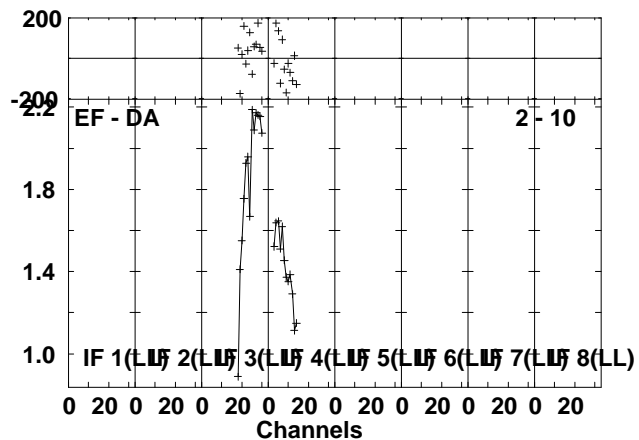
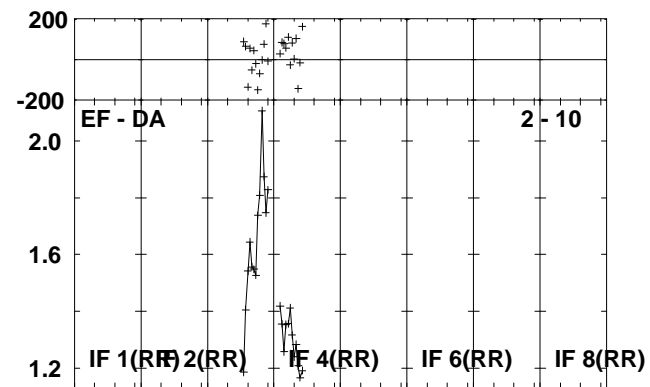
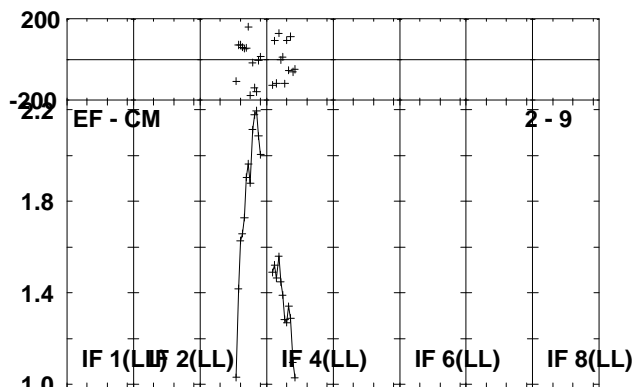
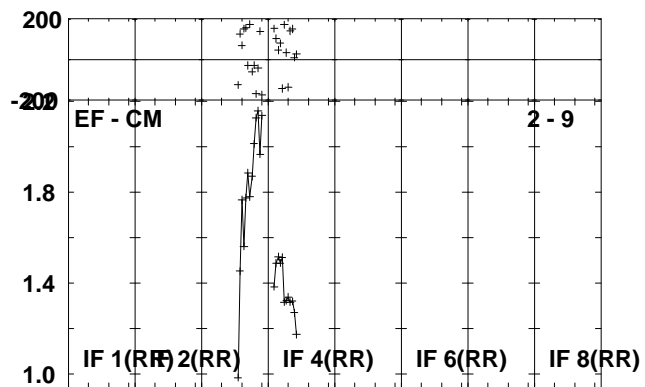
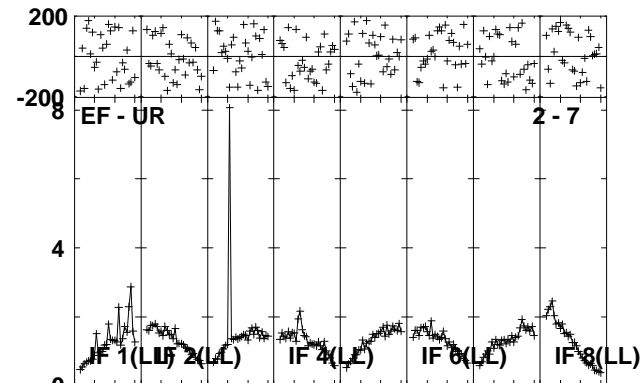
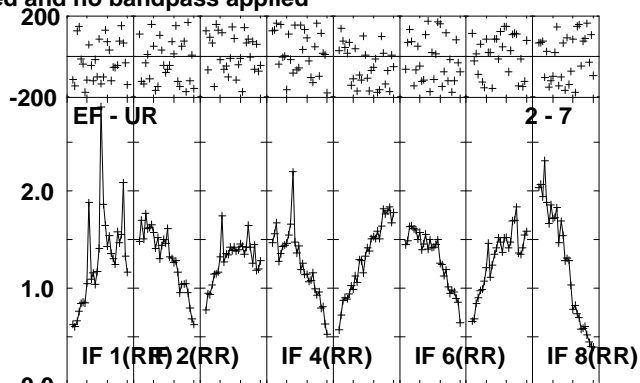
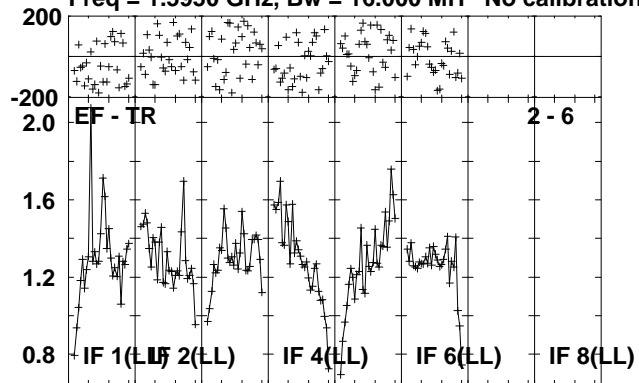

Lower frame: Milli Ampl Jy Top frame: Phas deg
Scalar averaged cross-power spectrum Several baselines displayed
Timerange: 01/00:21:31 to 01/00:24:59

Plot file version 117 created 23-AUG-2010 12:35:35

J1941-05 EP064P.UVDATA.1

Freq = 1.5950 GHz, Bw = 16.000 MH No calibration applied and no bandpass applied

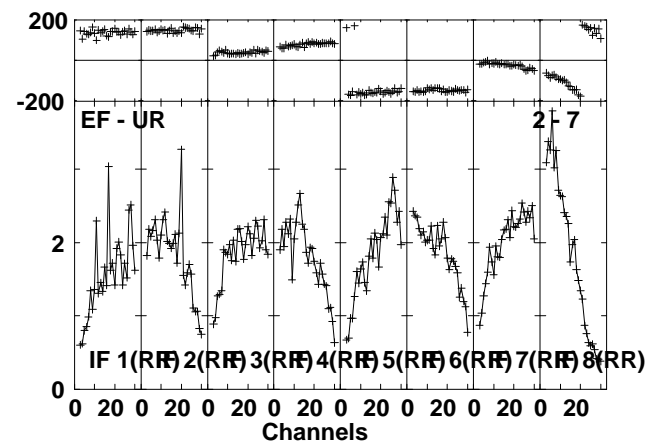
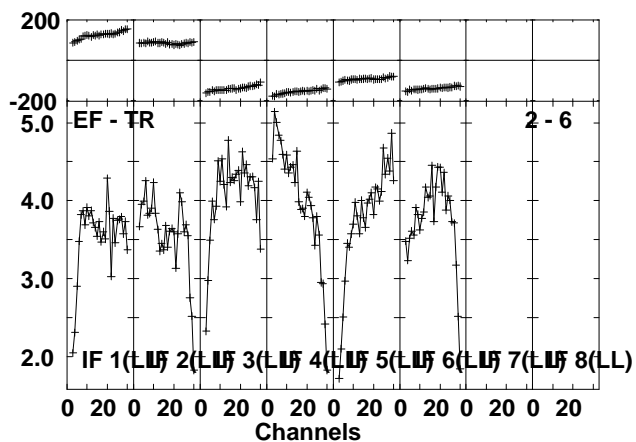
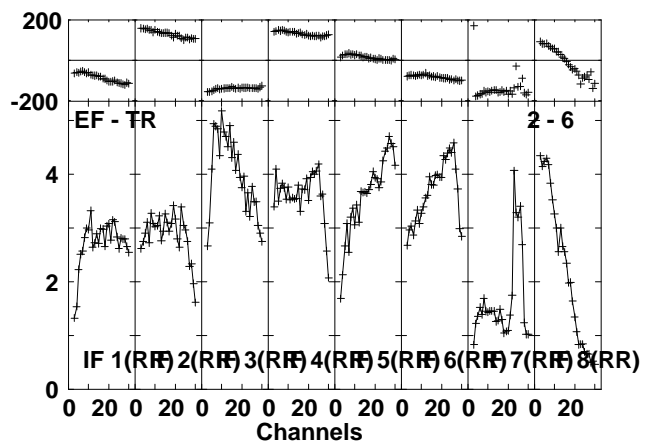
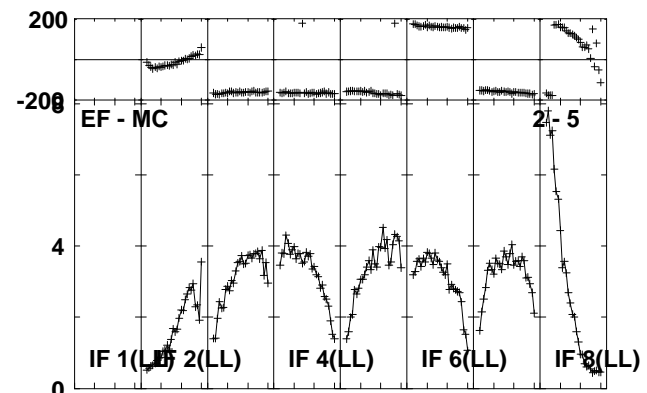
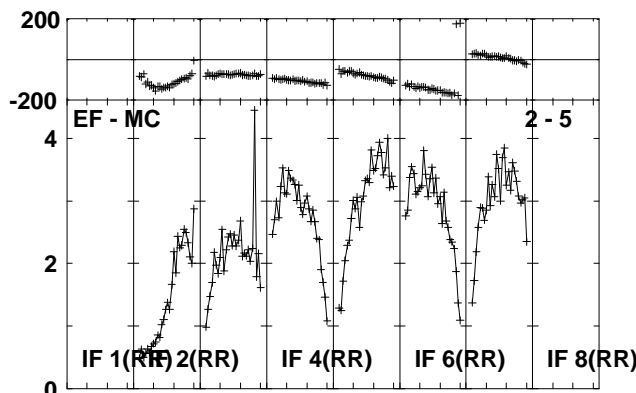
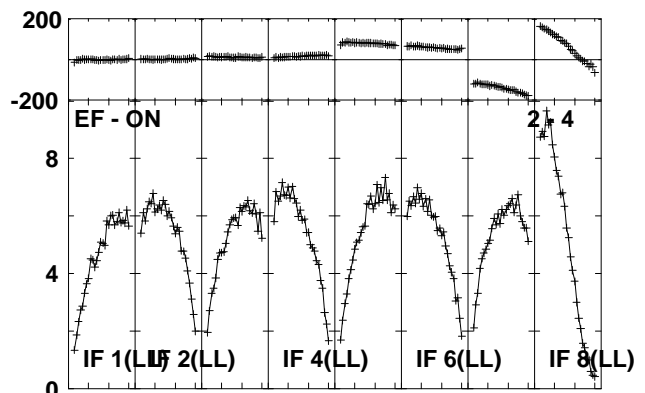
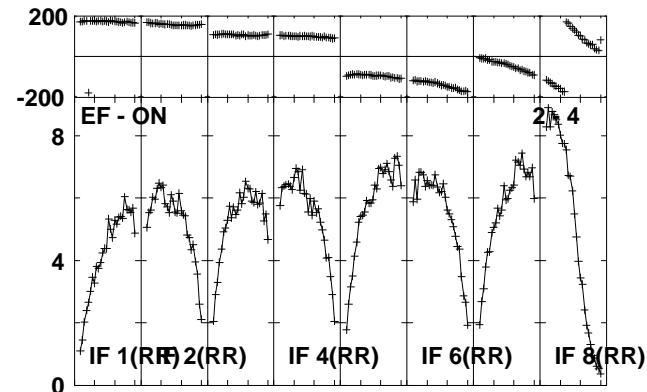
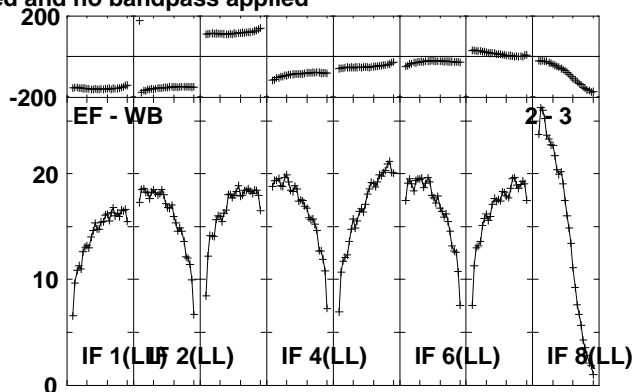
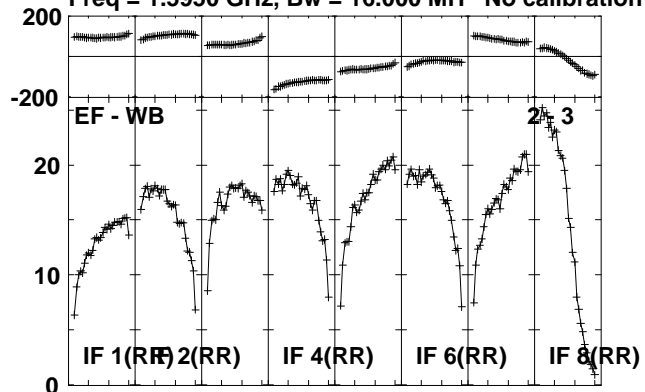

Lower frame: Milli Ampl Jy Top frame: Phas deg
Scalar averaged cross-power spectrum Several baselines displayed
Timerange: 01/00:25:01 to 01/00:26:29

Plot file version 118 created 23-AUG-2010 12:35:36

J1941-05 EP064P.UVDATA.1

Freq = 1.5950 GHz, Bw = 16.000 MH No calibration applied and no bandpass applied

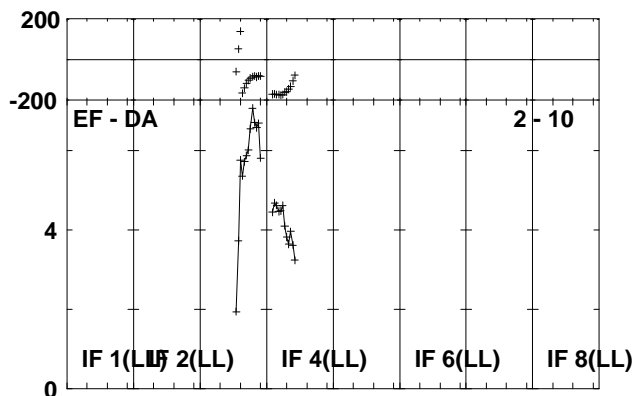
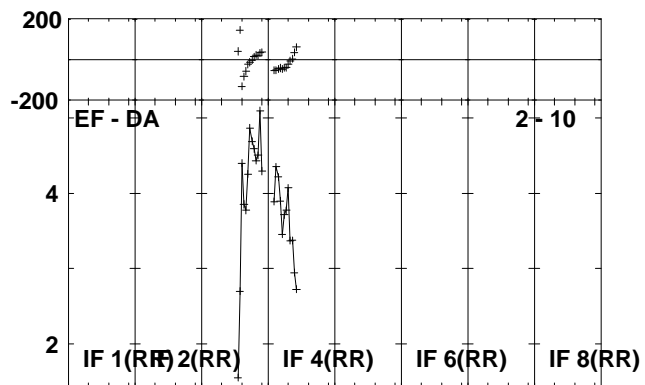
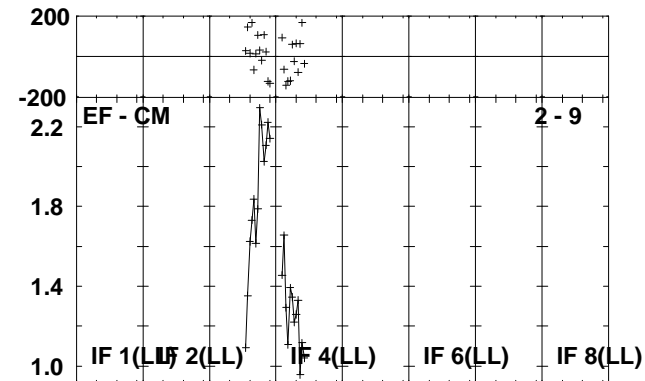
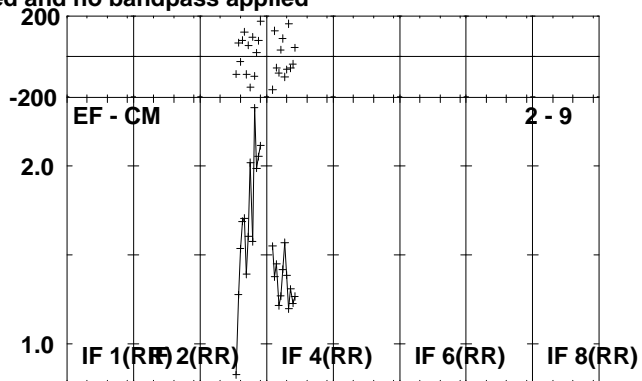
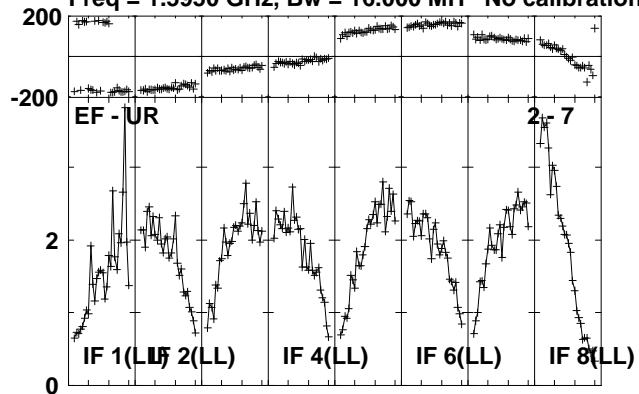

Lower frame: Milli Ampl Jy Top frame: Phas deg
Scalar averaged cross-power spectrum Several baselines displayed
Timerange: 01/00:25:01 to 01/00:26:29

Plot file version 119 created 23-AUG-2010 12:35:36

IRAS1929 EP064P.UVDATA.1

Freq = 1.5950 GHz, Bw = 16.000 MH No calibration applied and no bandpass applied

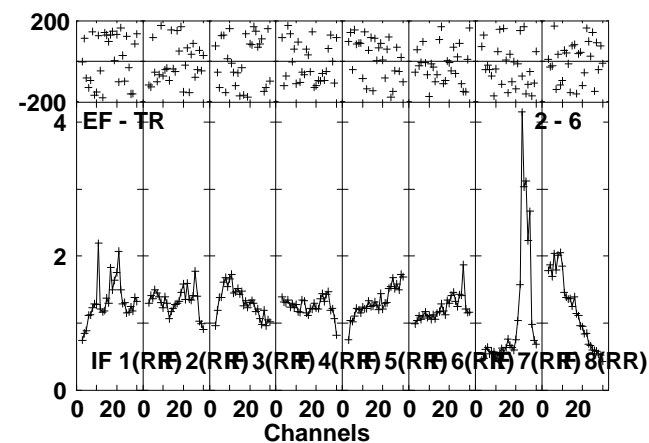
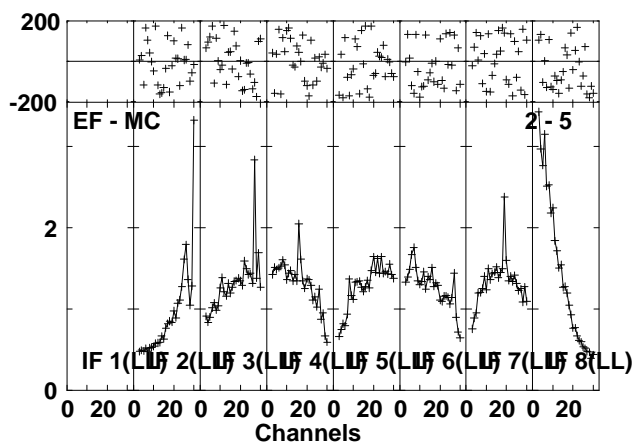
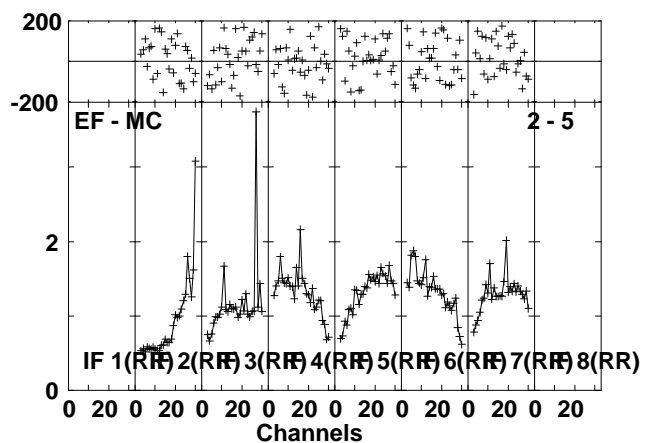
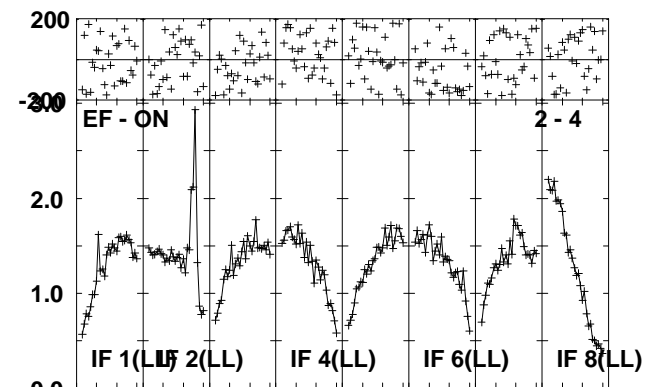
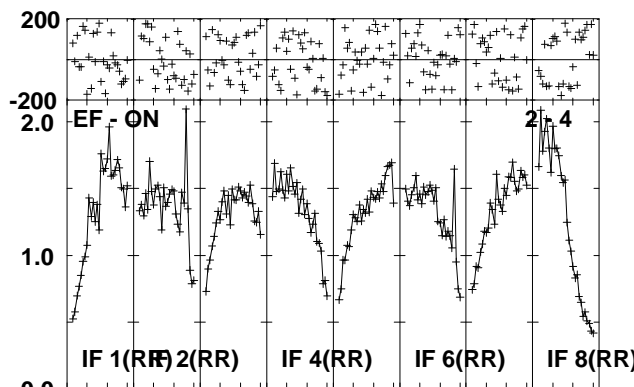
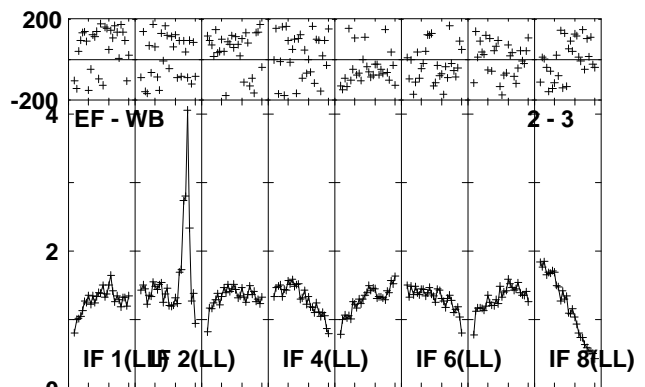
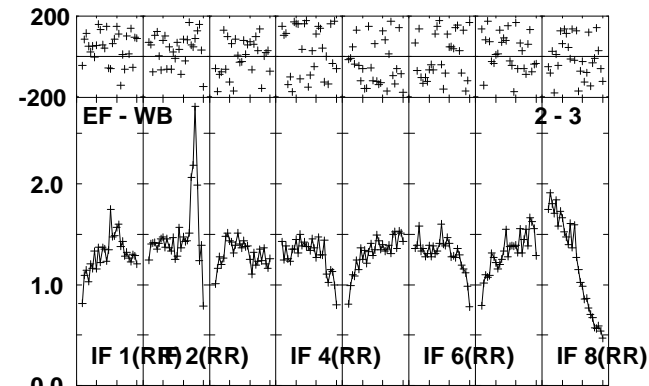
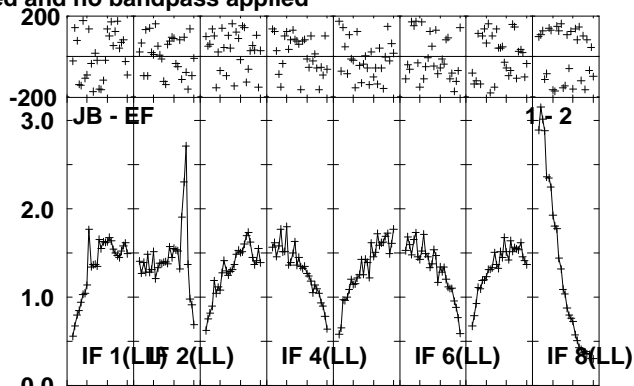
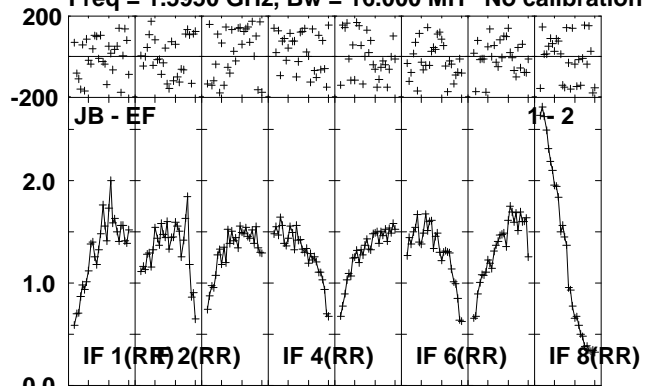

Lower frame: Milli Ampl Jy Top frame: Phas deg
Scalar averaged cross-power spectrum Several baselines displayed
Timerange: 01/00:26:31 to 01/00:29:59

Plot file version 120 created 23-AUG-2010 12:35:38

IRAS1929 EP064P.UVDATA.1

Freq = 1.5950 GHz, Bw = 16.000 MH No calibration applied and no bandpass applied

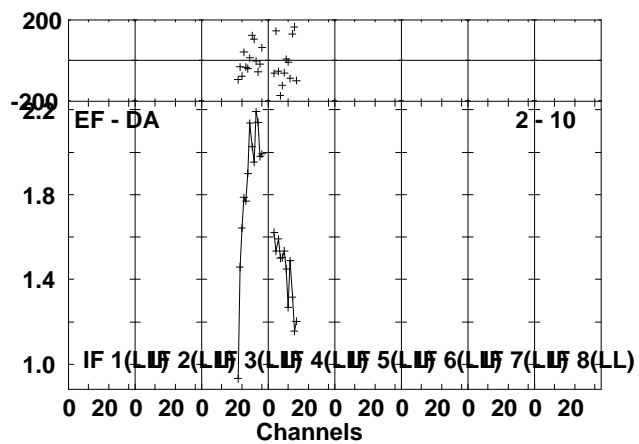
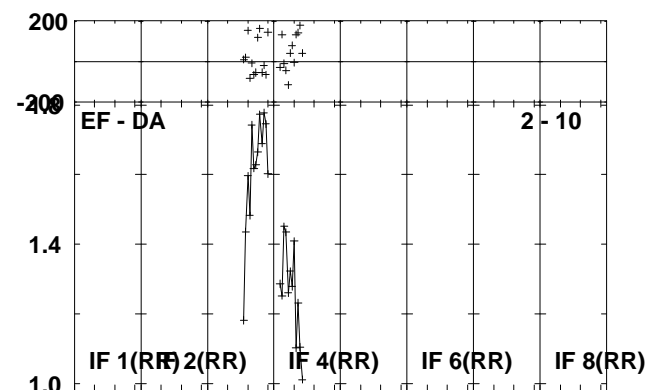
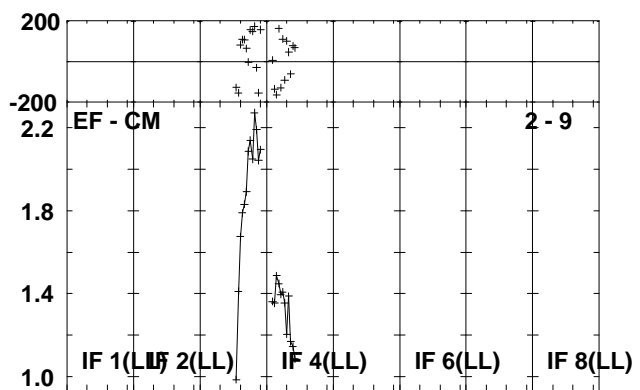
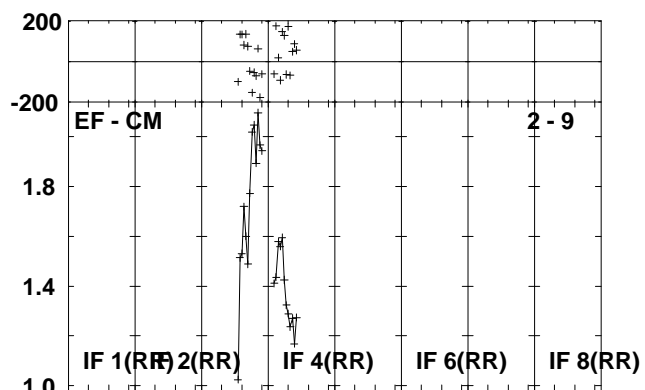
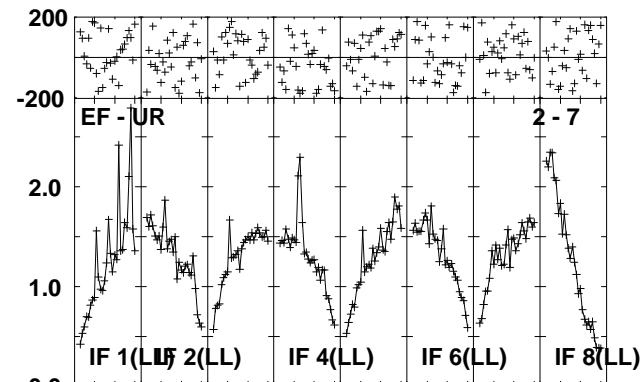
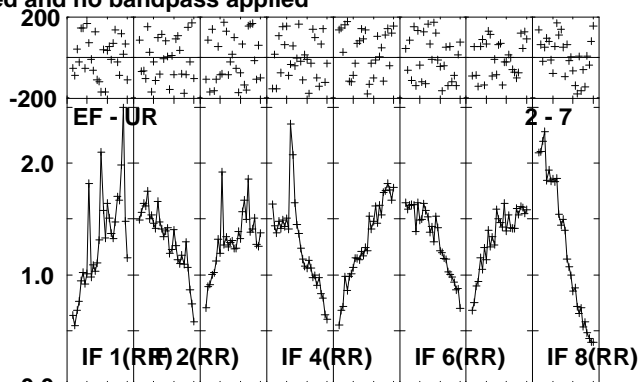
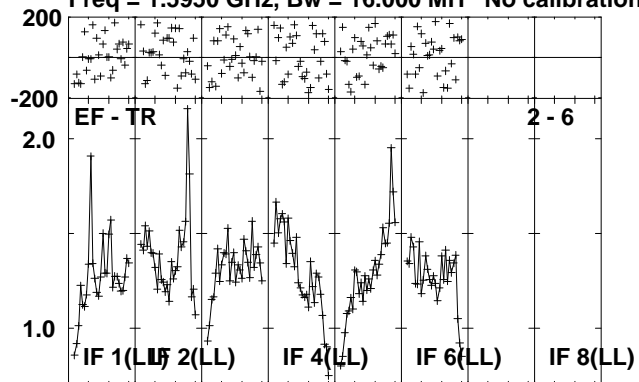

Lower frame: Milli Ampl Jy Top frame: Phas deg
 Scalar averaged cross-power spectrum Several baselines displayed
 Timerange: 01/00:26:31 to 01/00:29:59

Plot file version 121 created 23-AUG-2010 12:35:40

J1941-05 EP064P.UVDATA.1

Freq = 1.5950 GHz, Bw = 16.000 MH No calibration applied and no bandpass applied

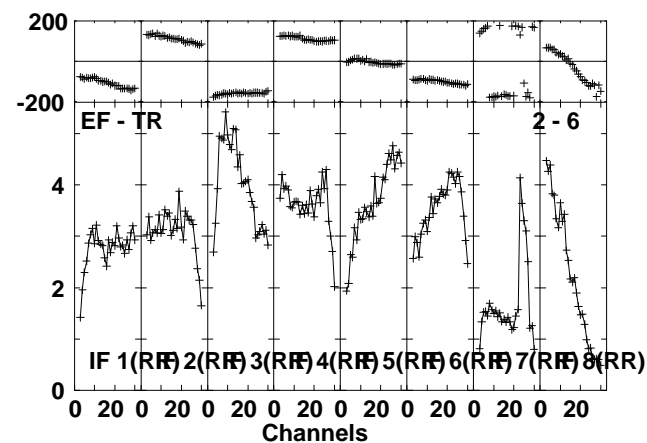
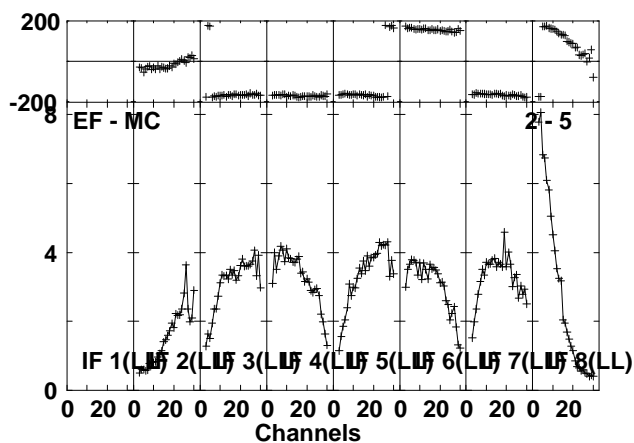
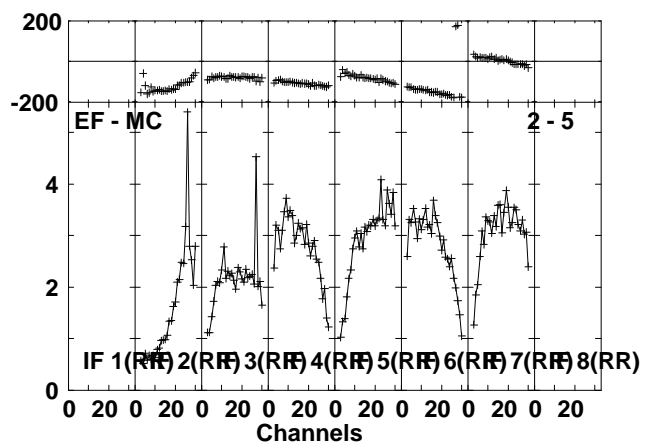
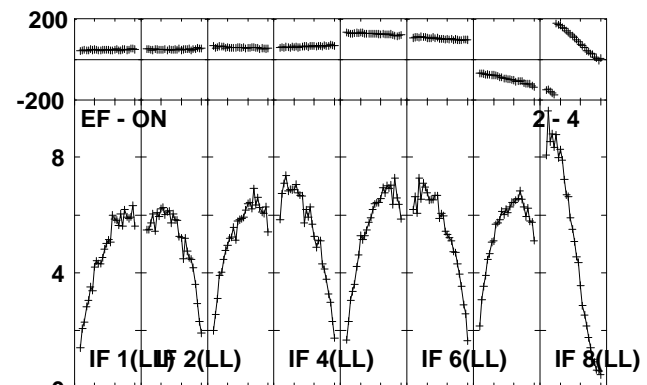
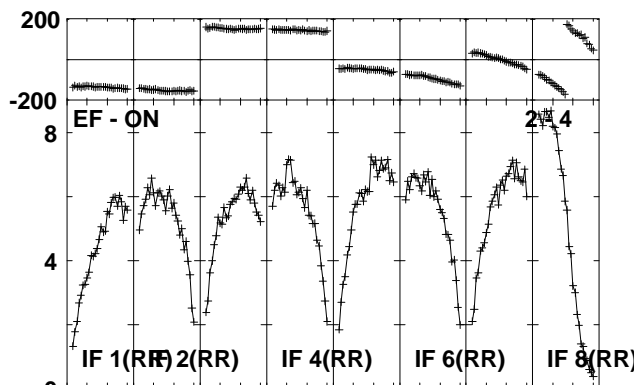
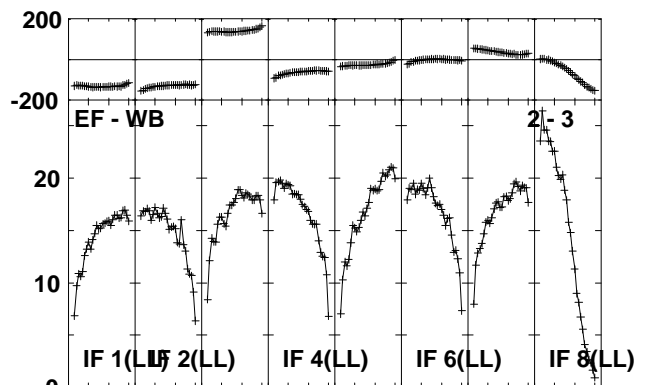
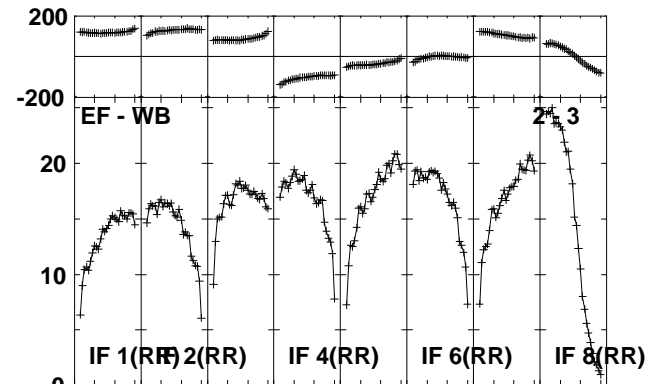
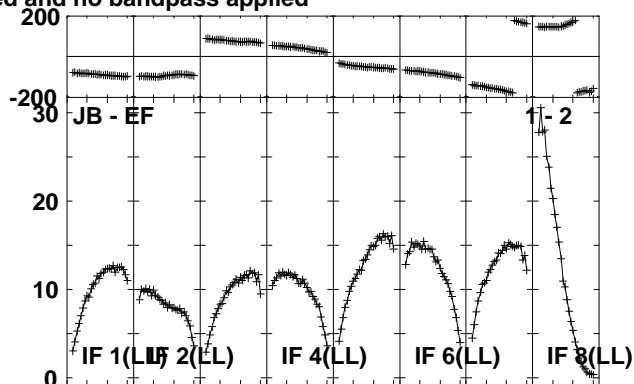
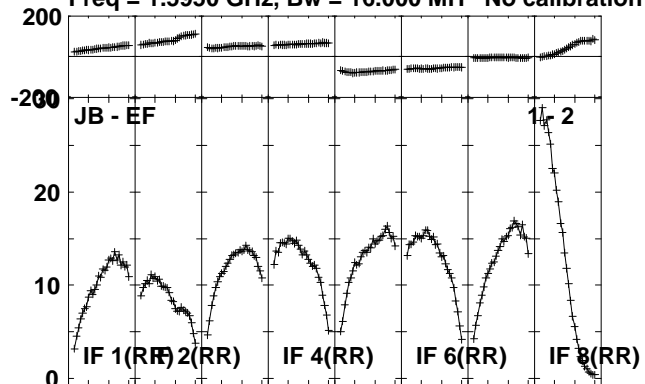

Lower frame: Milli Ampl Jy Top frame: Phas deg
Scalar averaged cross-power spectrum Several baselines displayed
Timerange: 01/00:30:01 to 01/00:31:29

Plot file version 122 created 23-AUG-2010 12:35:41
 J1941-05 EP064P.UVDATA.1

Freq = 1.5950 GHz, Bw = 16.000 MH No calibration applied and no bandpass applied

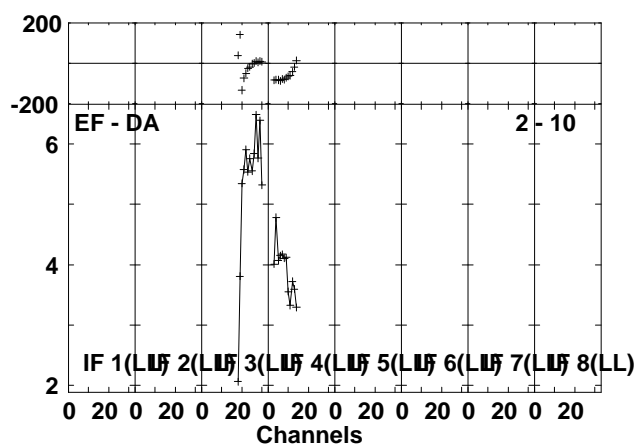
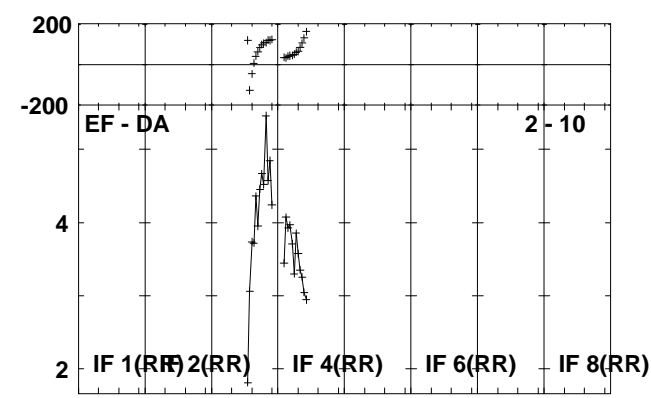
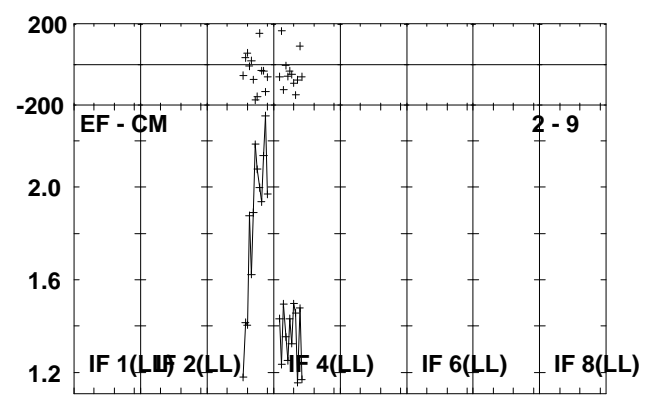
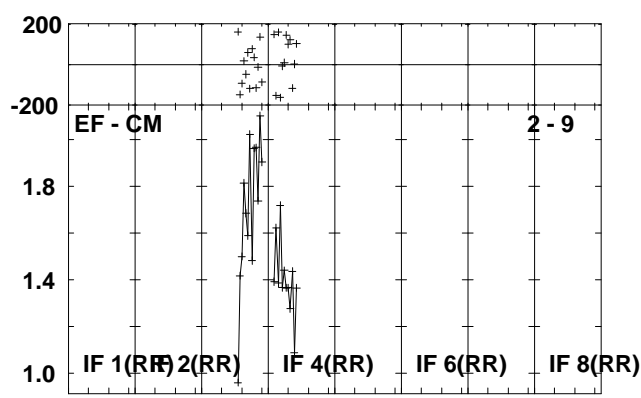
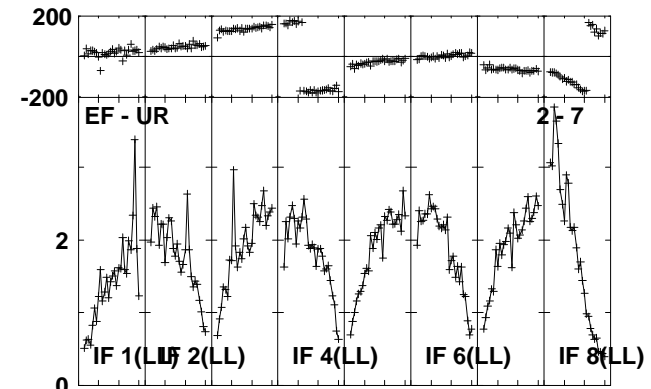
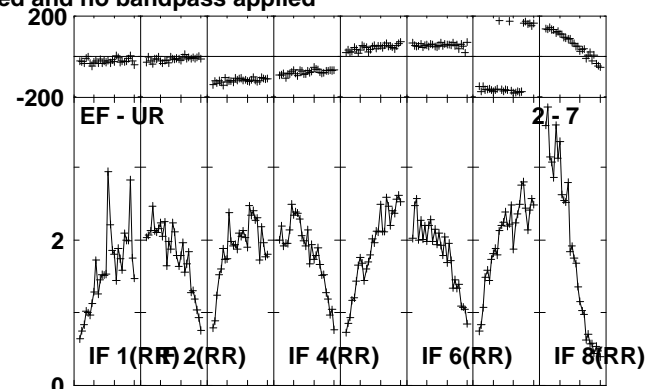
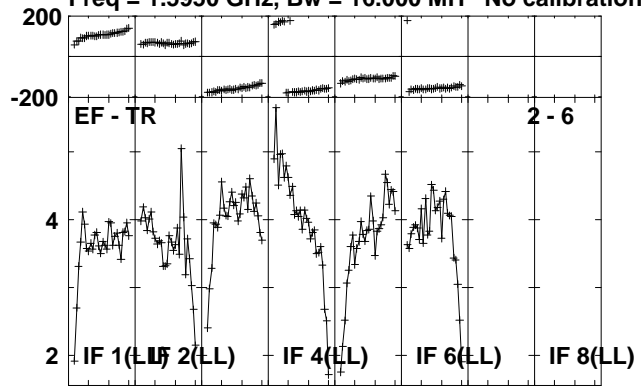

Lower frame: Milli Ampl Jy Top frame: Phas deg
 Scalar averaged cross-power spectrum Several baselines displayed
 Timerange: 01/00:30:01 to 01/00:31:29

Plot file version 123 created 23-AUG-2010 12:35:42

IRAS1929 EP064P.UVDATA.1

Freq = 1.5950 GHz, Bw = 16.000 MH No calibration applied and no bandpass applied

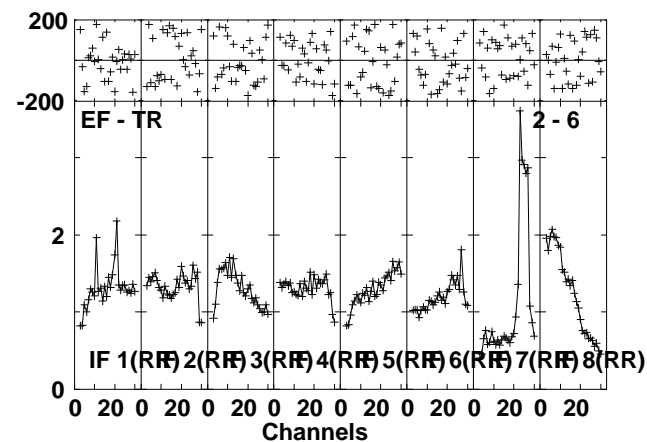
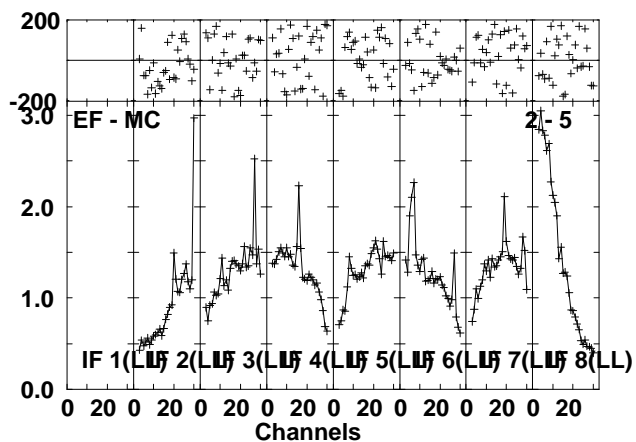
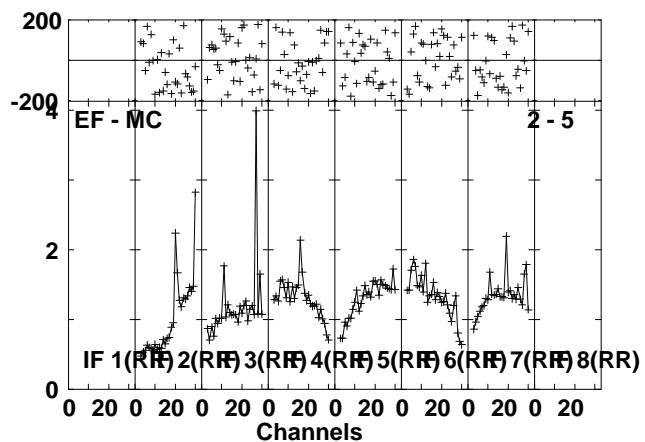
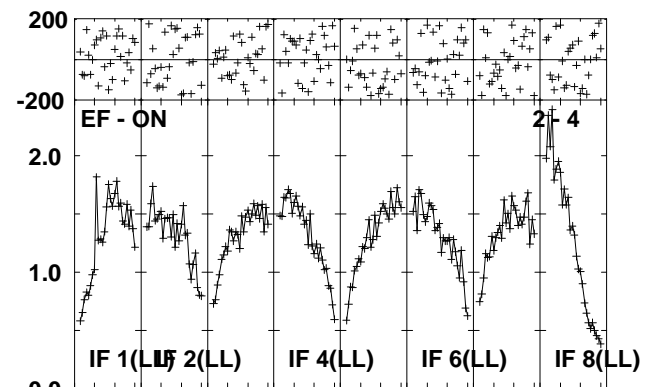
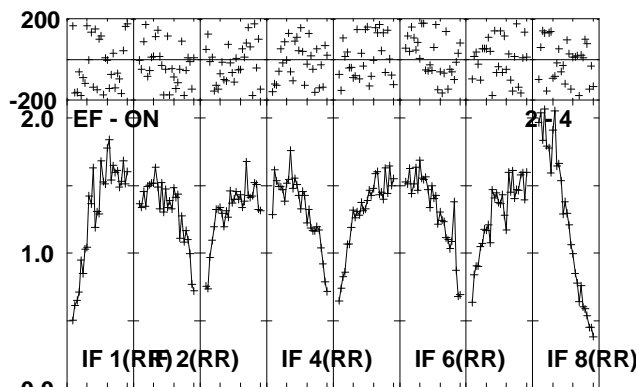
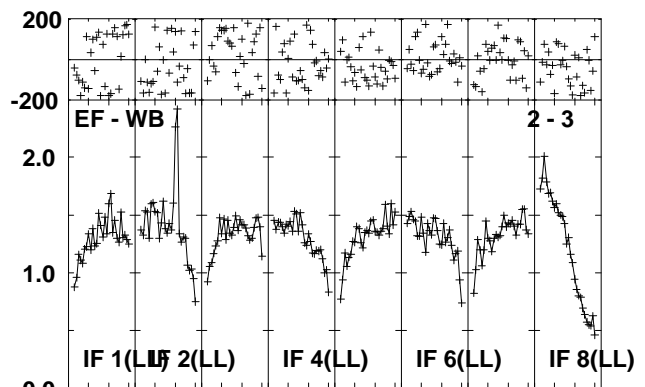
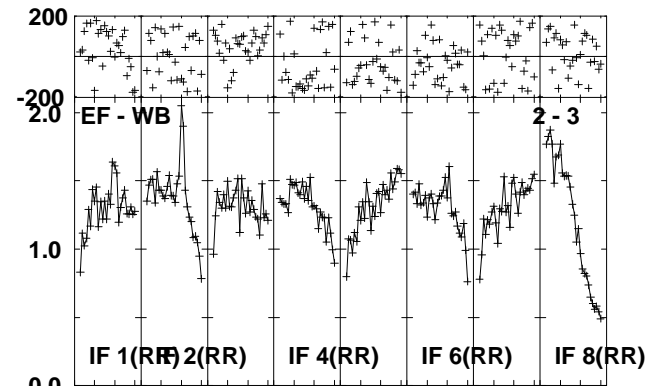
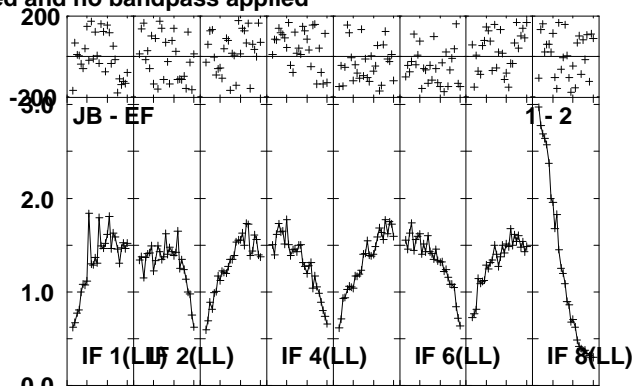
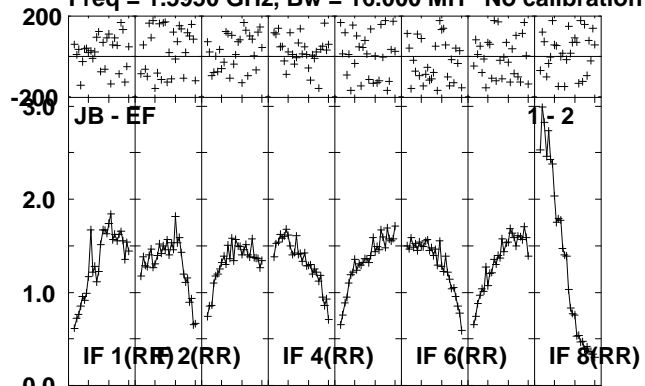

Lower frame: Milli Ampl Jy Top frame: Phas deg
Scalar averaged cross-power spectrum Several baselines displayed
Timerange: 01/00:31:31 to 01/00:34:59

Plot file version 124 created 23-AUG-2010 12:35:43

IRAS1929 EP064P.UVDATA.1

Freq = 1.5950 GHz, Bw = 16.000 MH No calibration applied and no bandpass applied

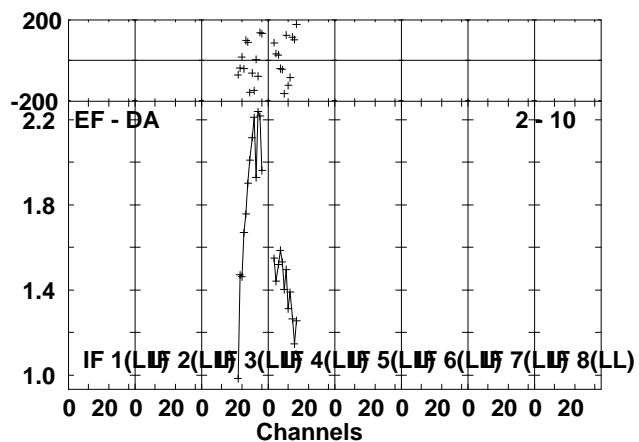
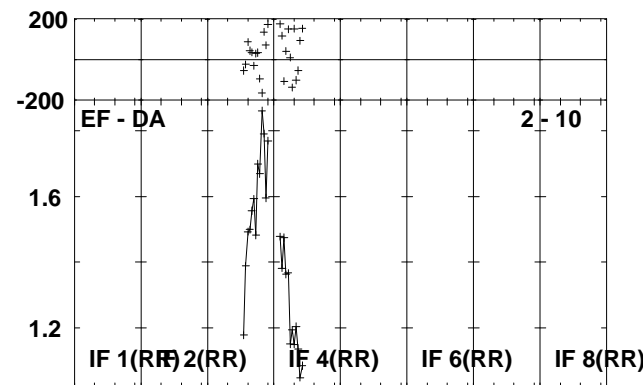
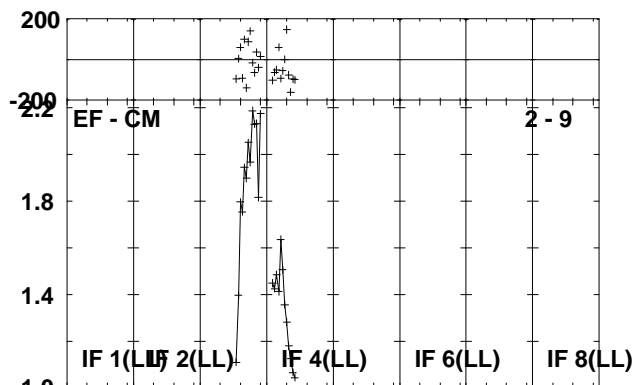
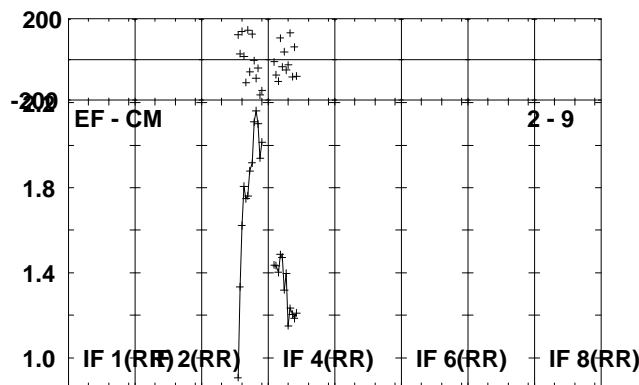
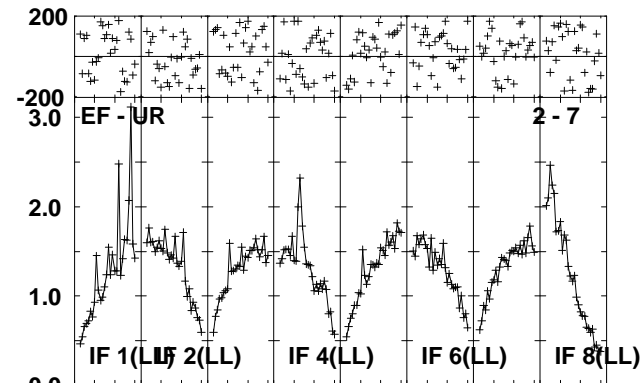
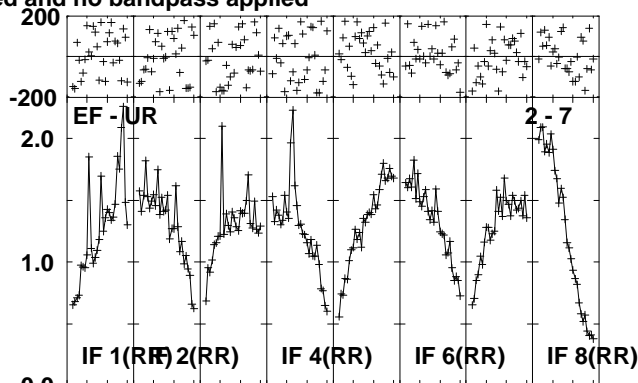
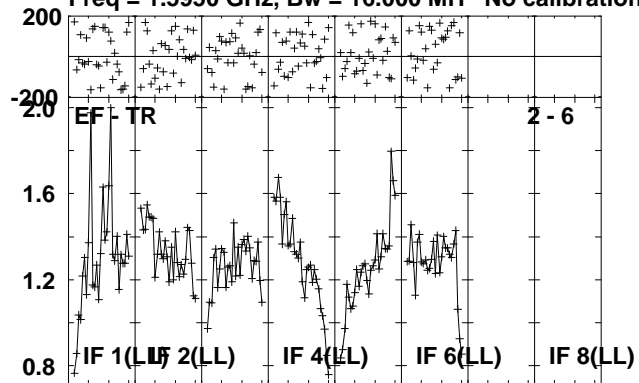

Lower frame: Milli Ampl Jy Top frame: Phas deg
Scalar averaged cross-power spectrum Several baselines displayed
Timerange: 01/00:31:31 to 01/00:34:59

Plot file version 125 created 23-AUG-2010 12:35:45

J1941-05 EP064P.UVDATA.1

Freq = 1.5950 GHz, Bw = 16.000 MH No calibration applied and no bandpass applied

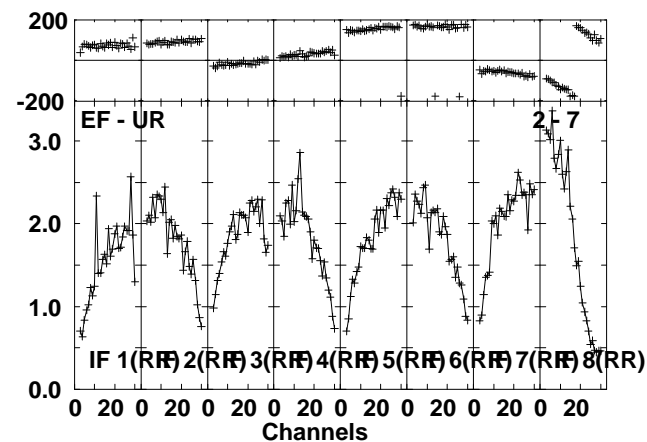
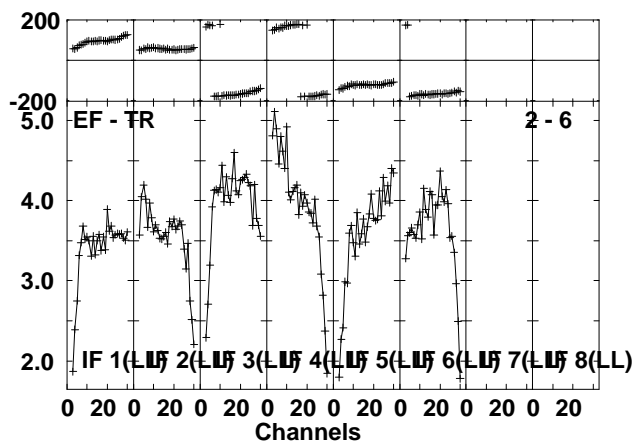
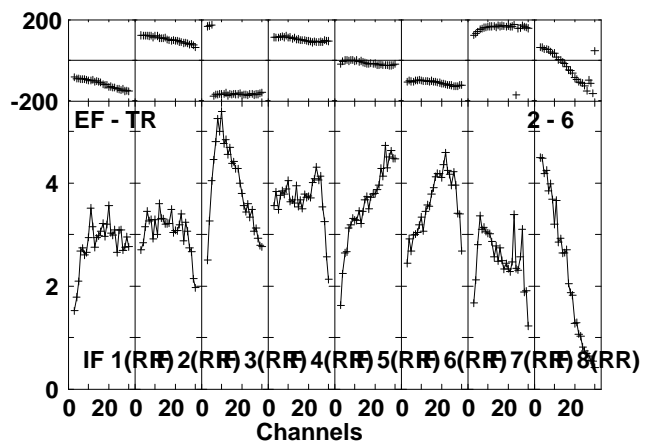
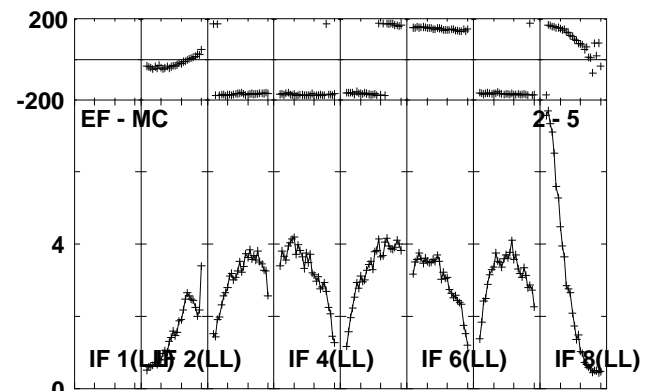
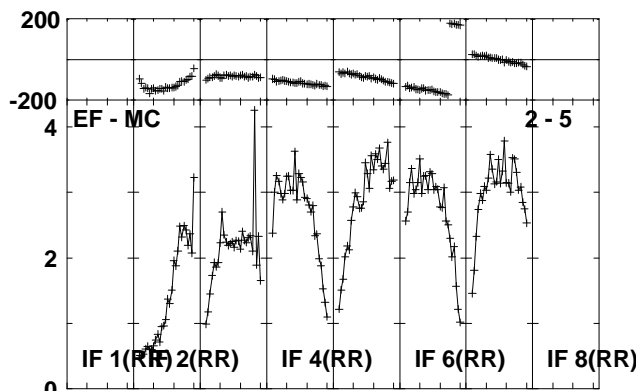
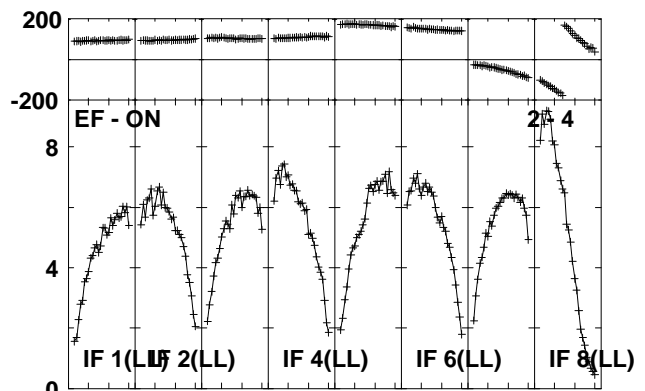
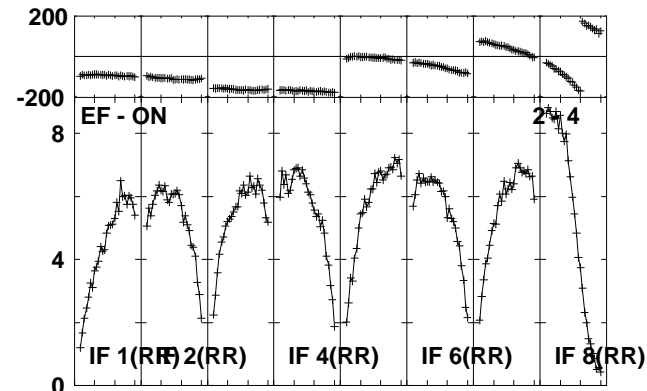
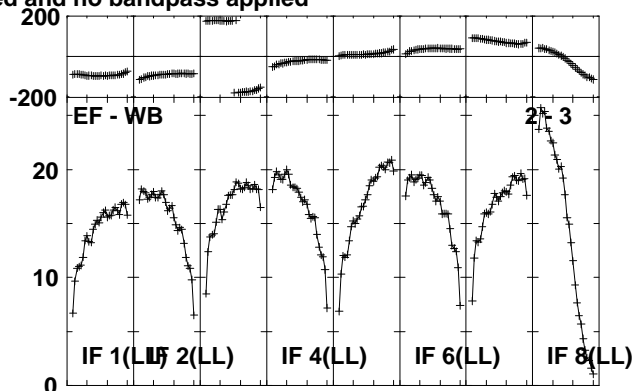
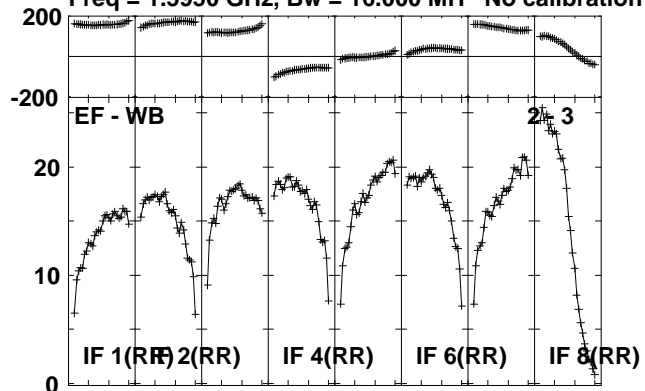

Lower frame: Milli Ampl Jy Top frame: Phas deg
Scalar averaged cross-power spectrum Several baselines displayed
Timerange: 01/00:36:01 to 01/00:37:29

Plot file version 126 created 23-AUG-2010 12:35:46
J1941-05 EP064P.UVDATA.1

Freq = 1.5950 GHz, Bw = 16.000 MH No calibration applied and no bandpass applied

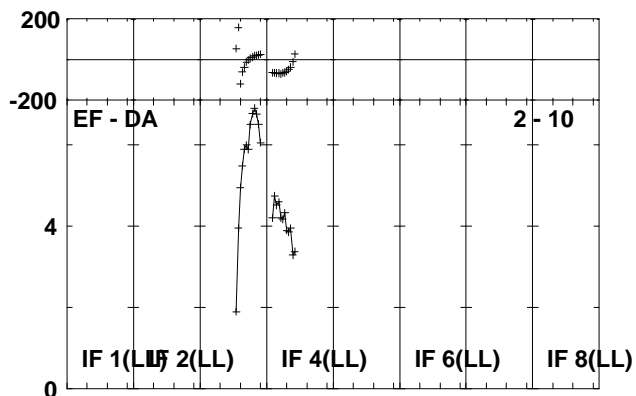
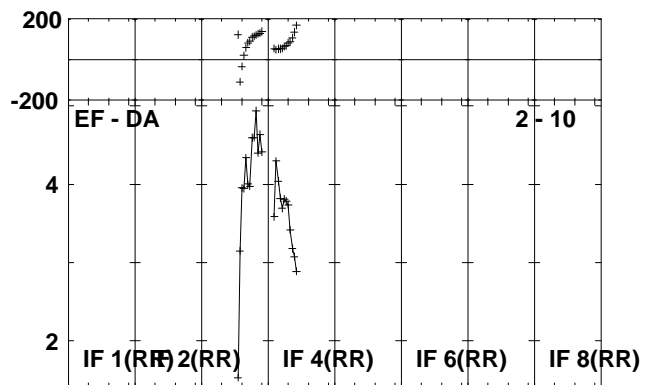
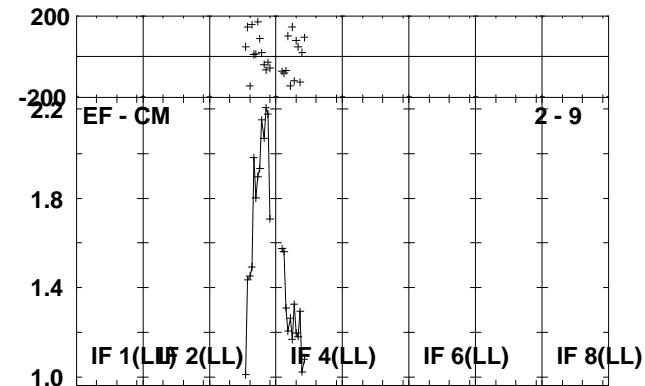
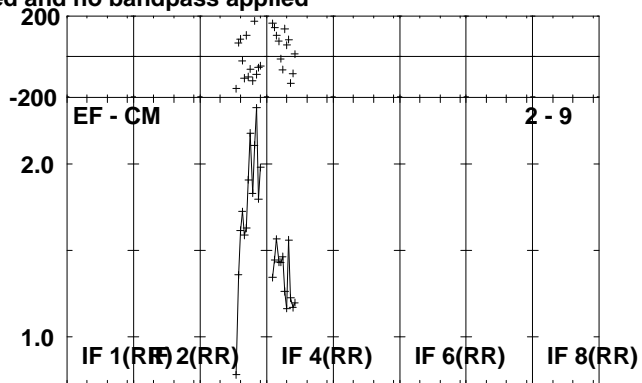
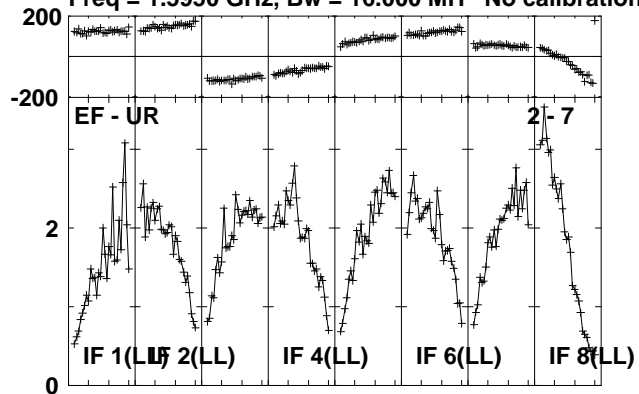

Lower frame: Milli Ampl Jy Top frame: Phas deg
Scalar averaged cross-power spectrum Several baselines displayed
Timerange: 01/00:36:01 to 01/00:37:29

Plot file version 127 created 23-AUG-2010 12:35:47

IRAS1929 EP064P.UVDATA.1

Freq = 1.5950 GHz, Bw = 16.000 MH No calibration applied and no bandpass applied

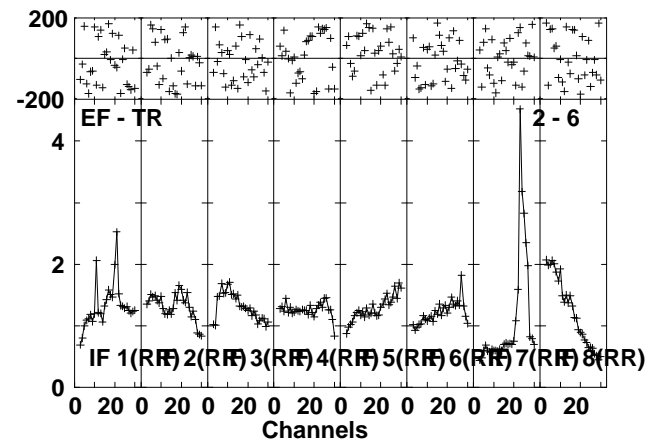
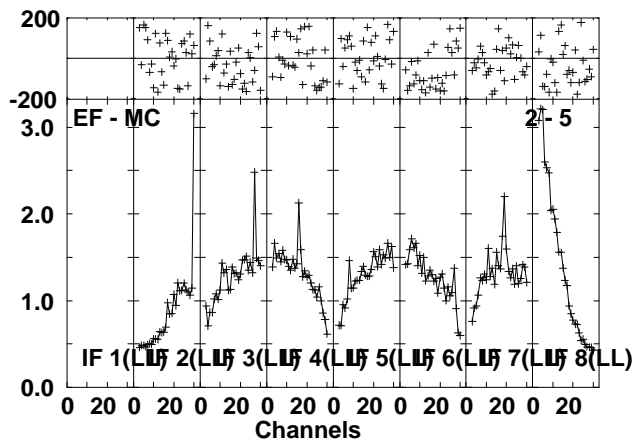
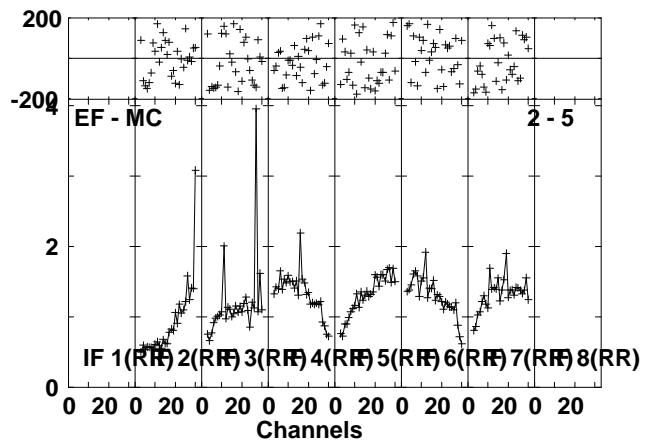
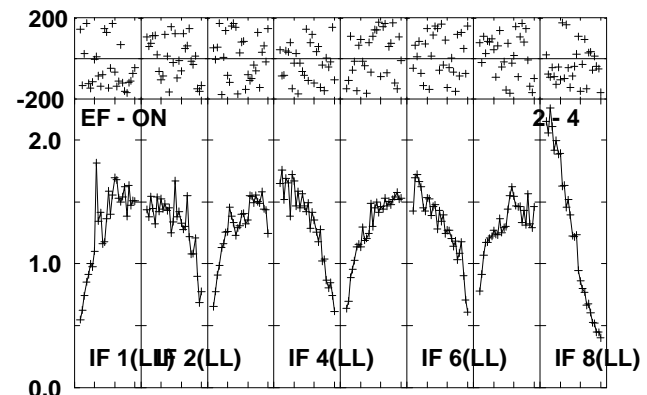
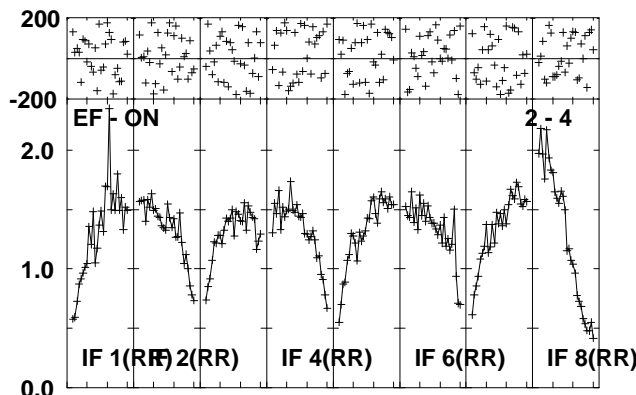
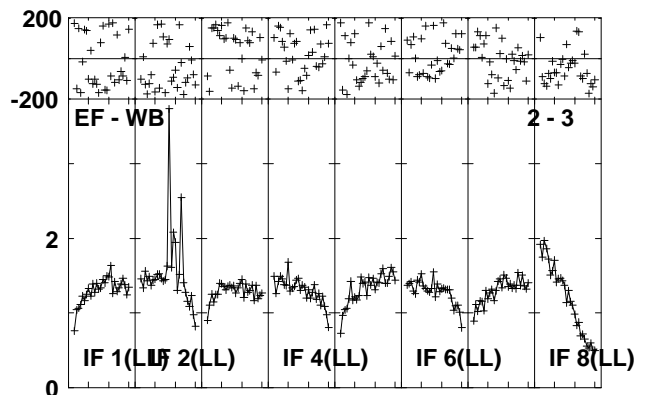
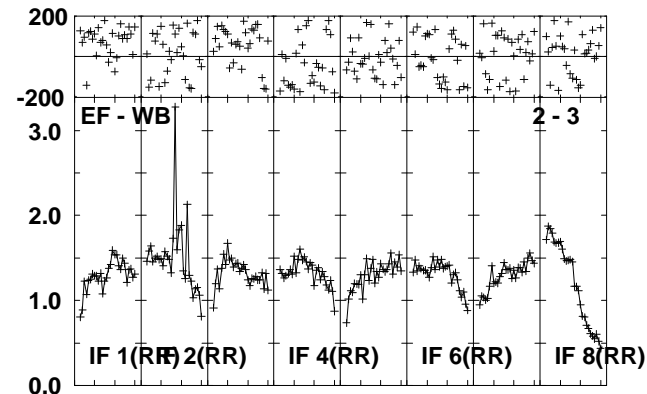
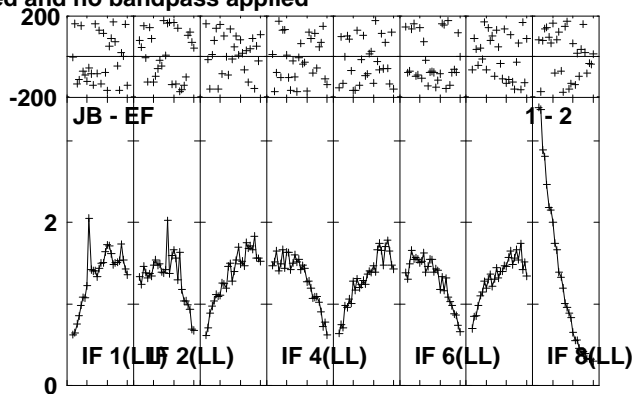
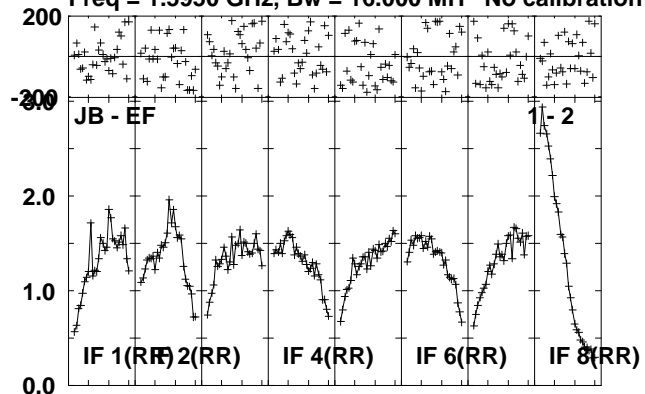

Lower frame: Milli Ampl Jy Top frame: Phas deg
Scalar averaged cross-power spectrum Several baselines displayed
Timerange: 01/00:37:33 to 01/00:40:59

Plot file version 128 created 23-AUG-2010 12:35:48

IRAS1929 EP064P.UVDATA.1

Freq = 1.5950 GHz, Bw = 16.000 MH No calibration applied and no bandpass applied

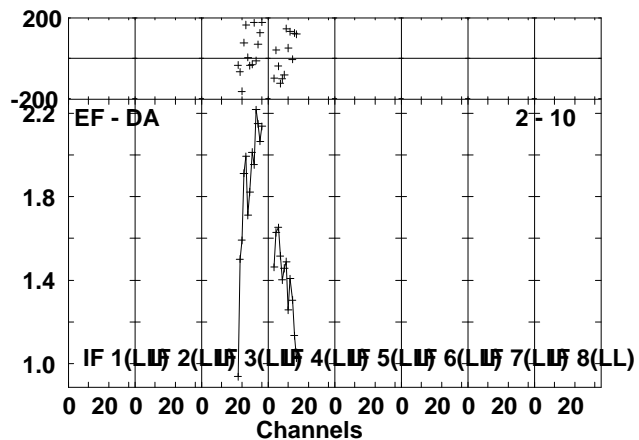
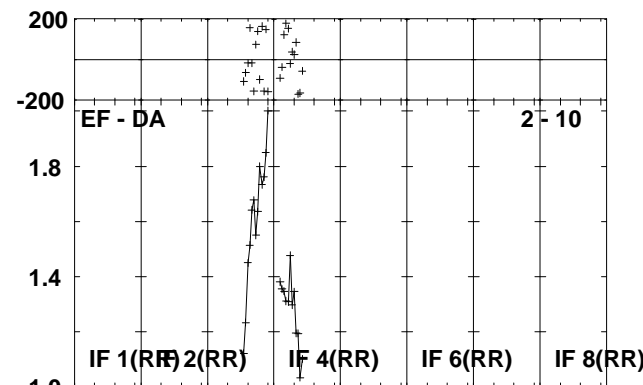
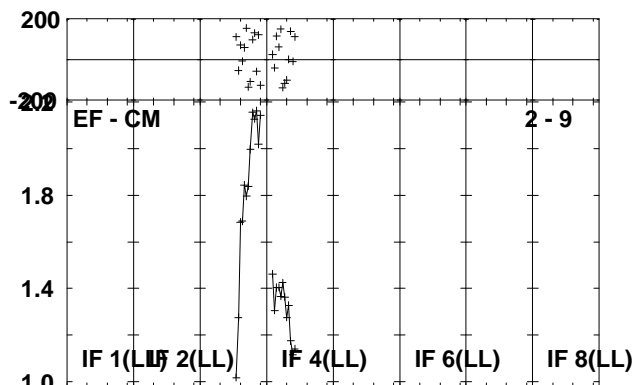
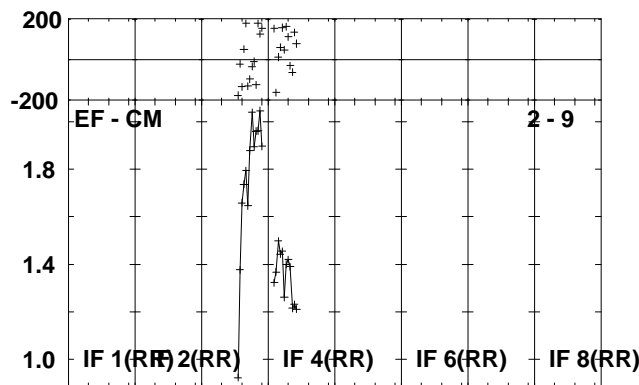
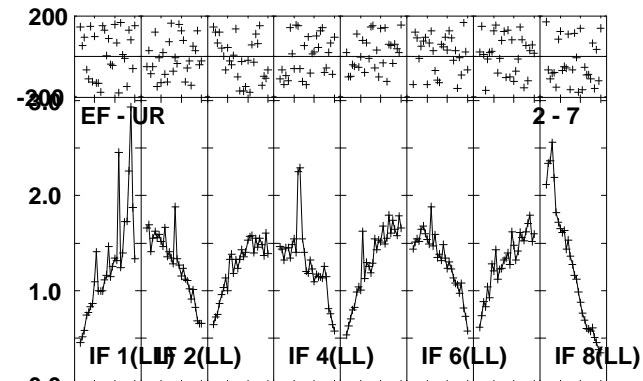
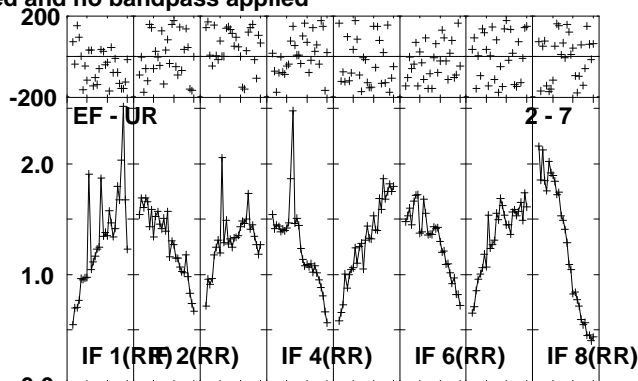
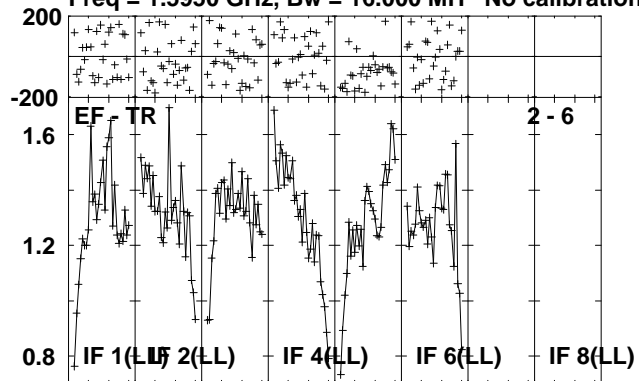

Lower frame: Milli Ampl Jy Top frame: Phas deg
Scalar averaged cross-power spectrum Several baselines displayed
Timerange: 01/00:37:33 to 01/00:40:59

Plot file version 129 created 23-AUG-2010 12:35:50

J1941-05 EP064P.UVDATA.1

Freq = 1.5950 GHz, Bw = 16.000 MH No calibration applied and no bandpass applied

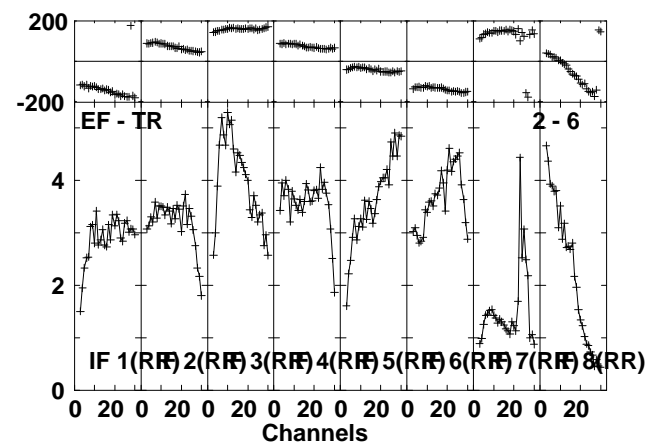
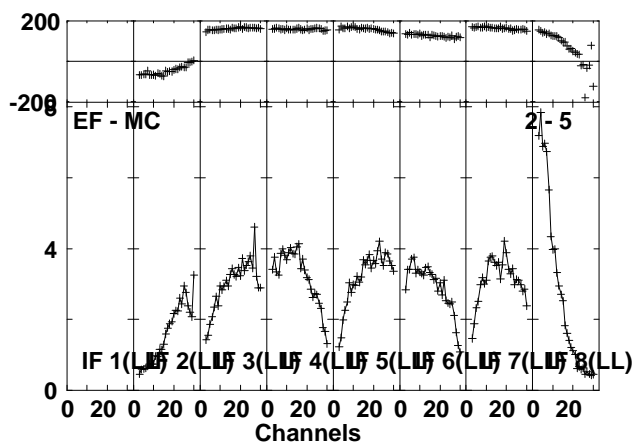
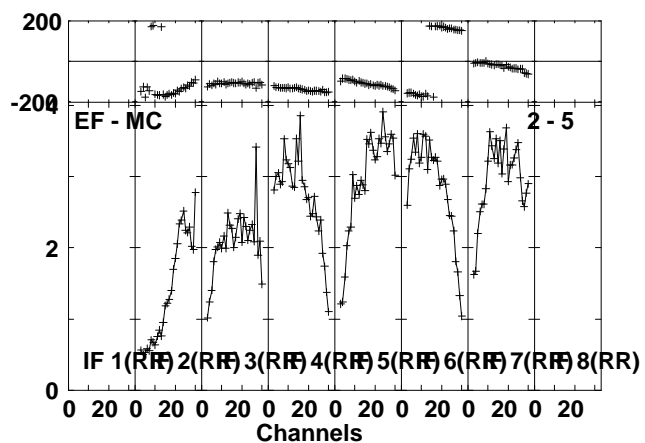
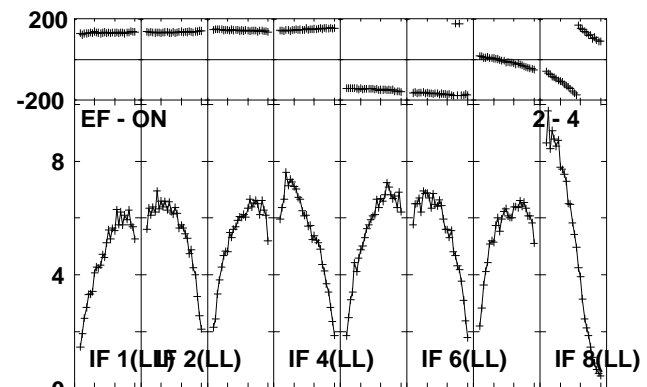
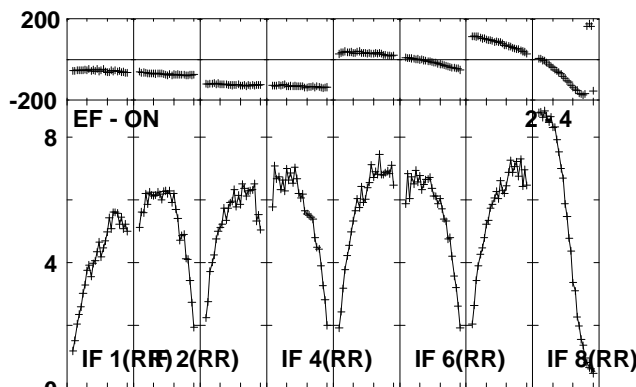
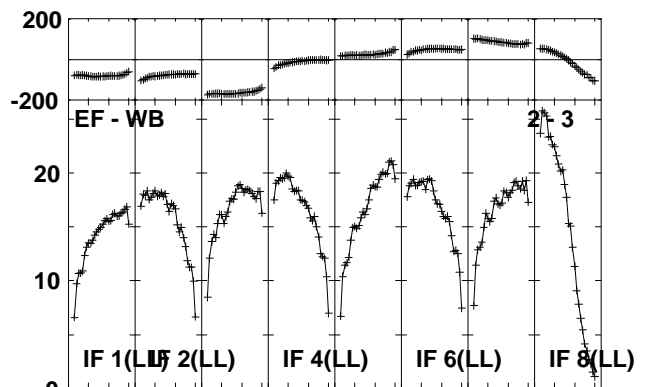
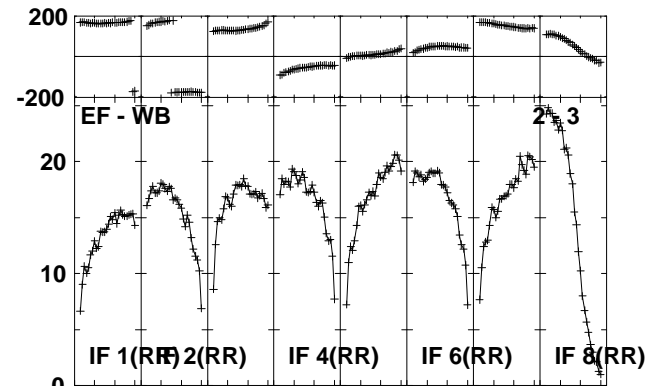
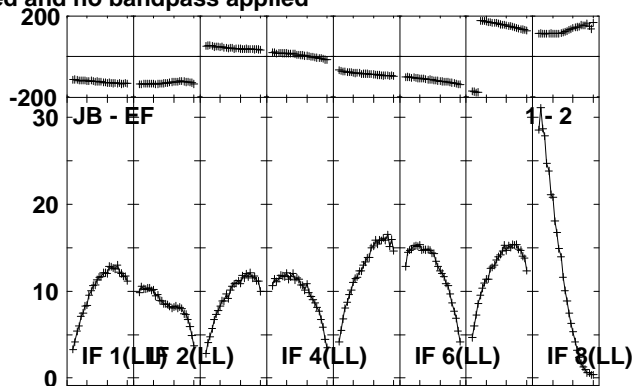
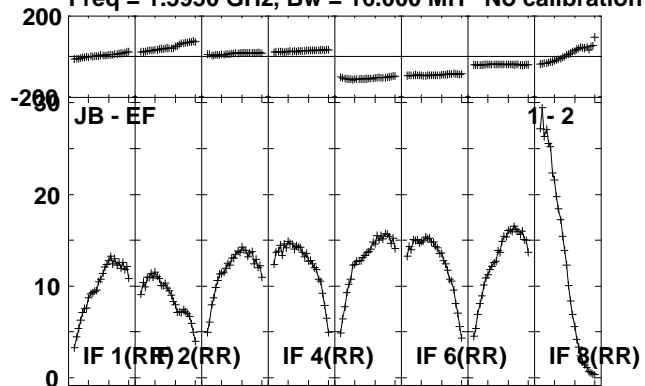

Lower frame: Milli Ampl Jy Top frame: Phas deg
Scalar averaged cross-power spectrum Several baselines displayed
Timerange: 01/00:41:01 to 01/00:42:29

Plot file version 130 created 23-AUG-2010 12:35:51
 J1941-05 EP064P.UVDATA.1

Freq = 1.5950 GHz, Bw = 16.000 MH No calibration applied and no bandpass applied

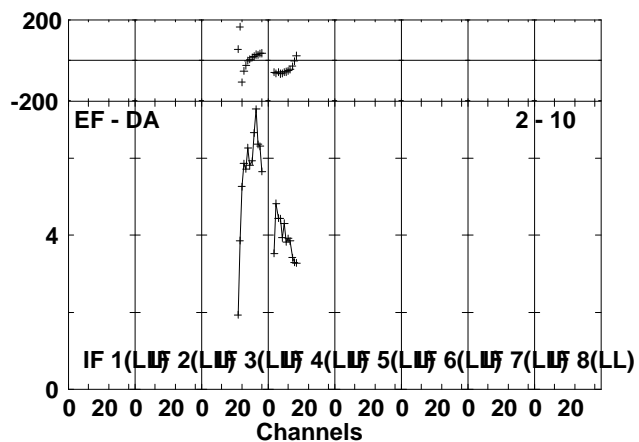
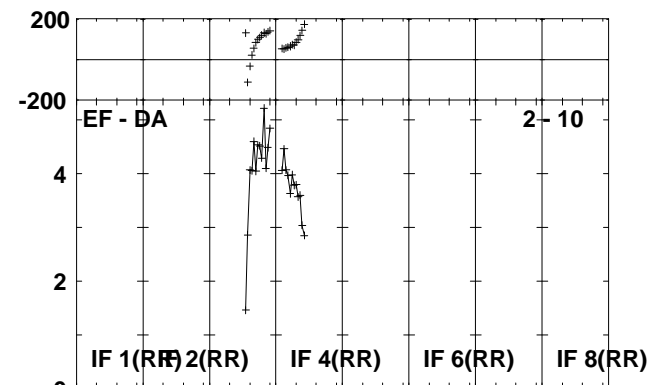
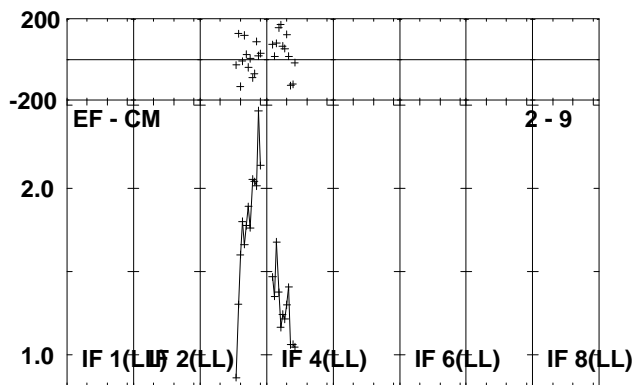
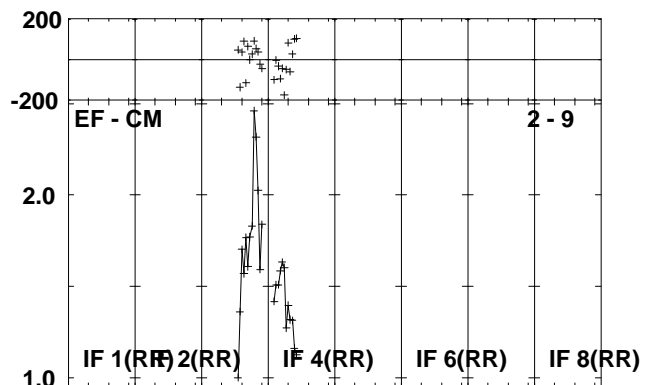
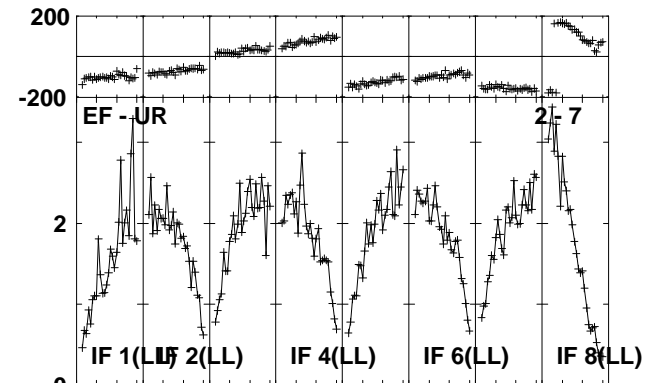
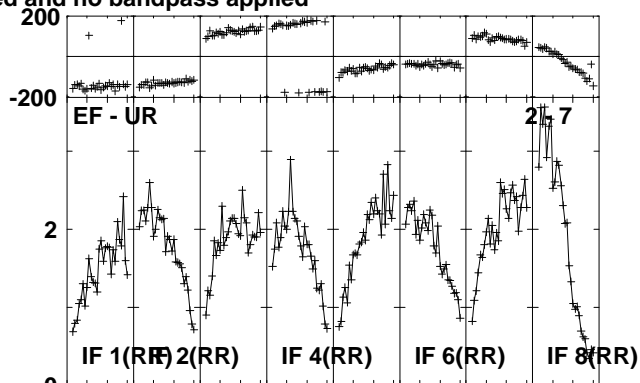
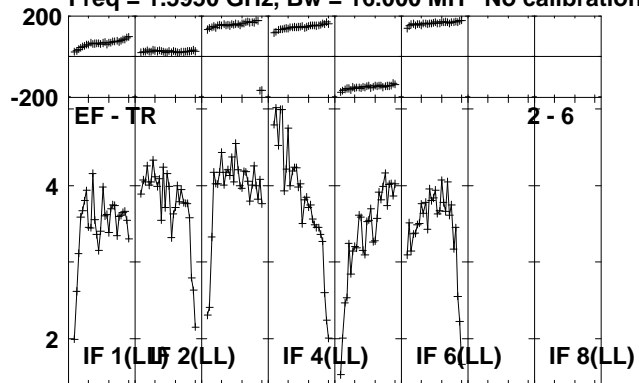

Lower frame: Milli Ampl Jy Top frame: Phas deg
 Scalar averaged cross-power spectrum Several baselines displayed
 Timerange: 01/00:41:01 to 01/00:42:29

Plot file version 131 created 23-AUG-2010 12:35:52

IRAS1929 EP064P.UVDATA.1

Freq = 1.5950 GHz, Bw = 16.000 MH No calibration applied and no bandpass applied

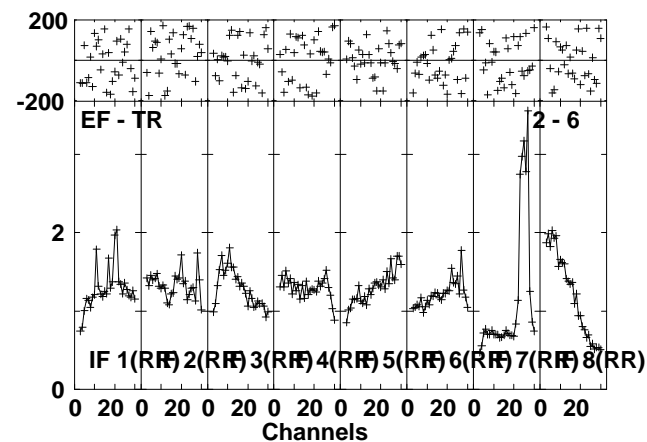
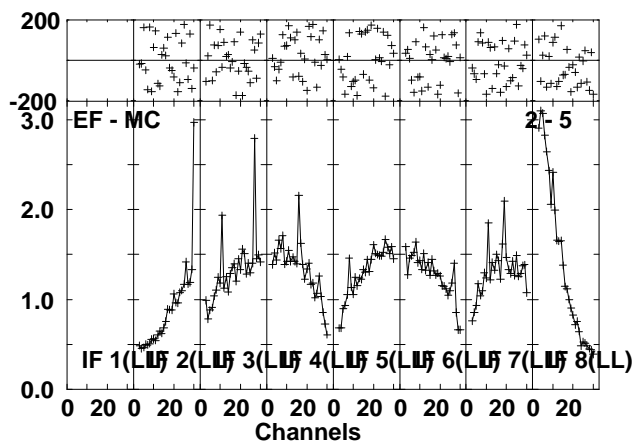
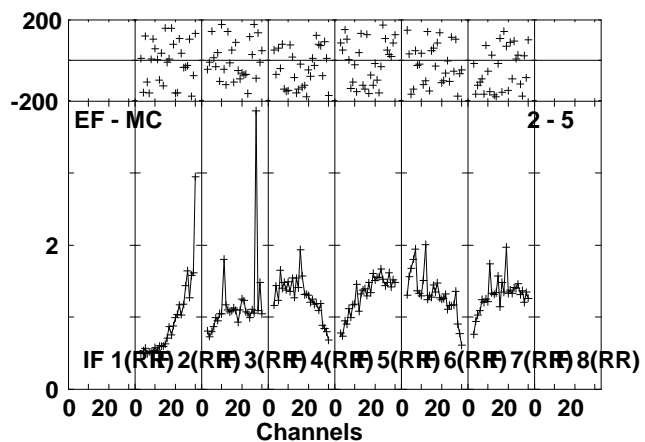
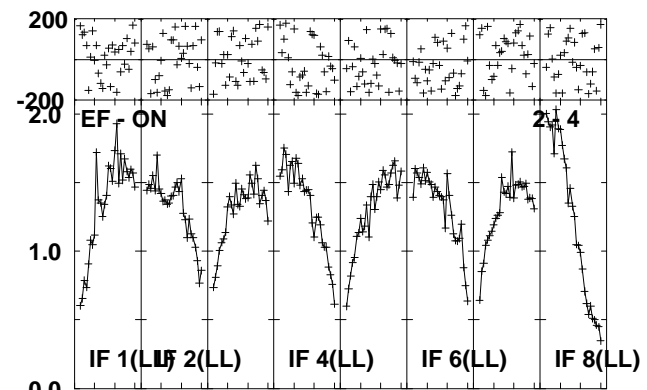
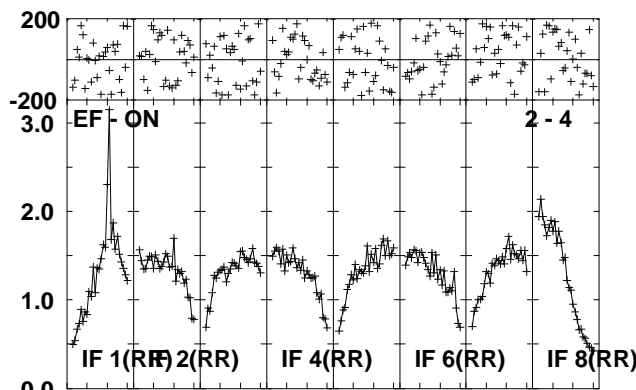
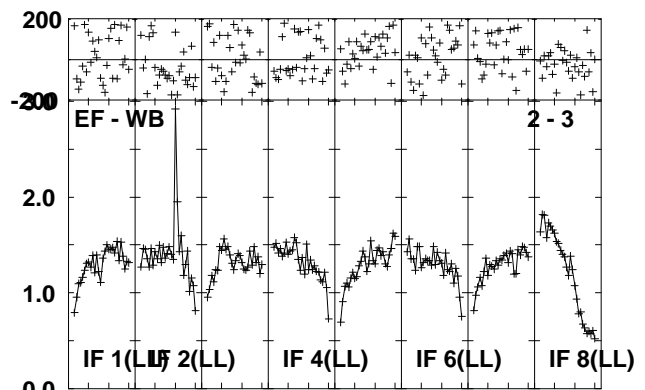
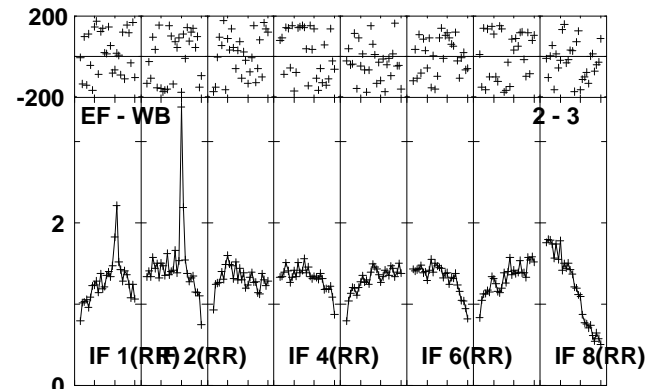
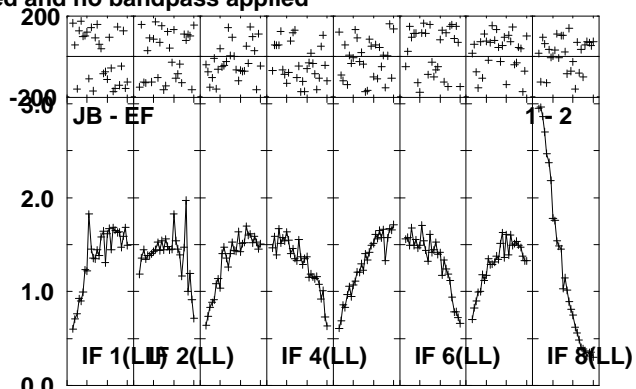
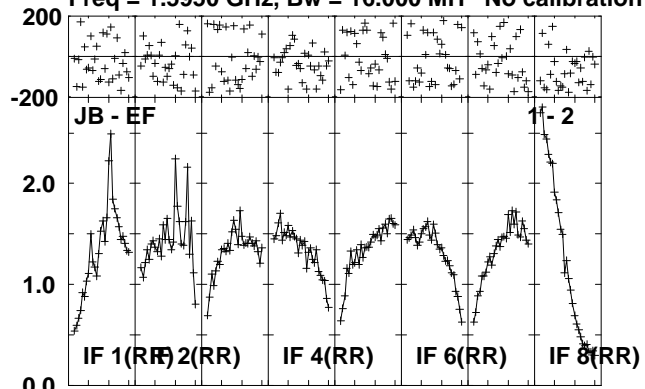

Lower frame: Milli Ampl Jy Top frame: Phas deg
Scalar averaged cross-power spectrum Several baselines displayed
Timerange: 01/00:42:31 to 01/00:45:59

Plot file version 132 created 23-AUG-2010 12:35:54

IRAS1929 EP064P.UVDATA.1

Freq = 1.5950 GHz, Bw = 16.000 MH No calibration applied and no bandpass applied

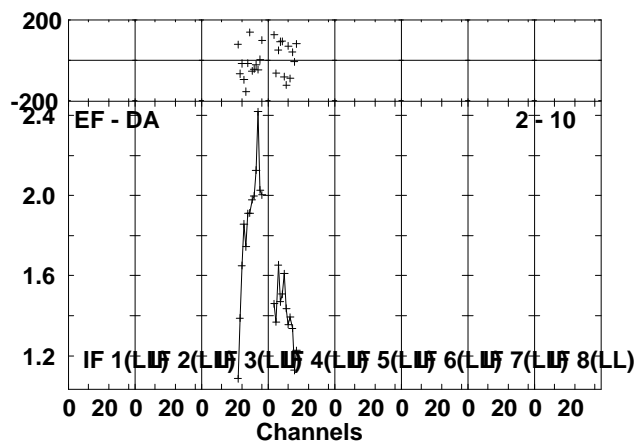
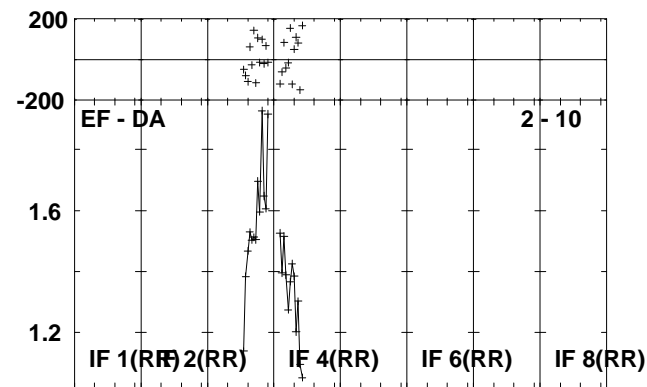
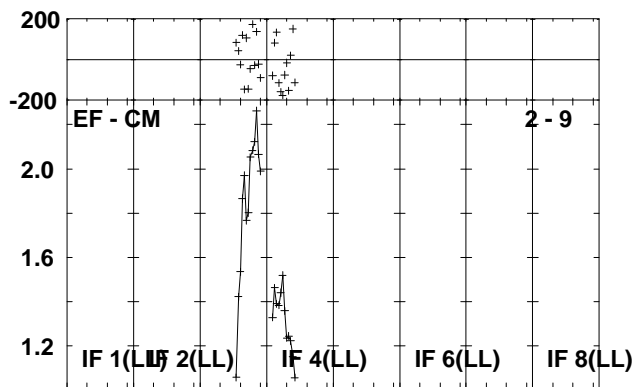
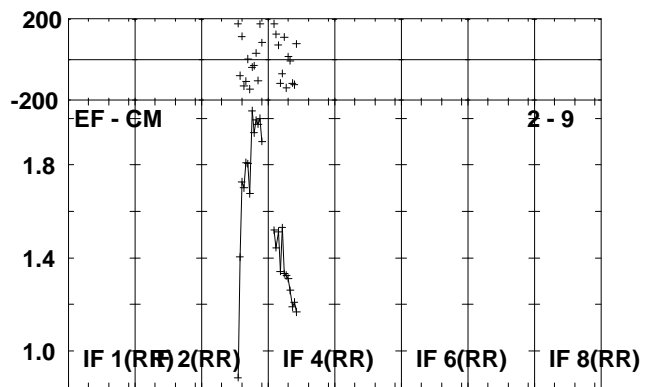
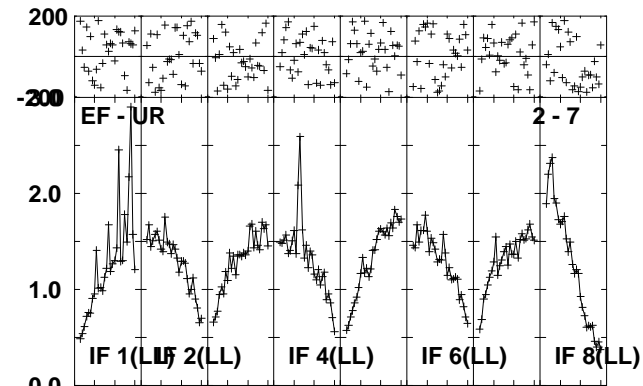
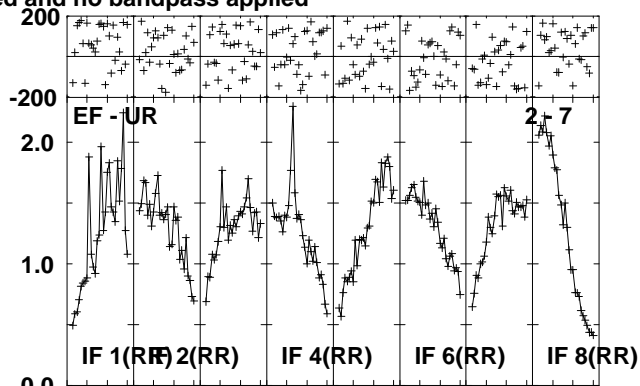
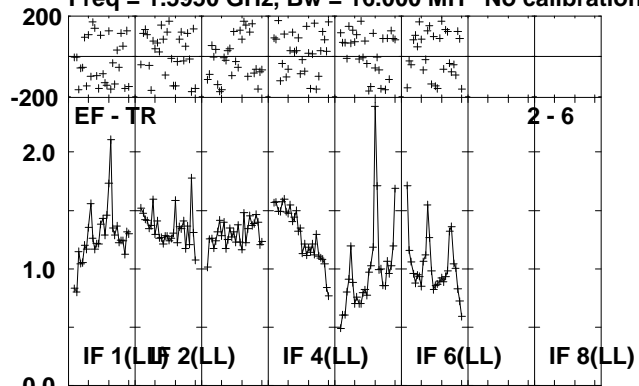

Lower frame: Milli Ampl Jy Top frame: Phas deg
Scalar averaged cross-power spectrum Several baselines displayed
Timerange: 01/00:42:31 to 01/00:45:59

Plot file version 133 created 23-AUG-2010 12:35:55

J1941-05 EP064P.UVDATA.1

Freq = 1.5950 GHz, Bw = 16.000 MH No calibration applied and no bandpass applied

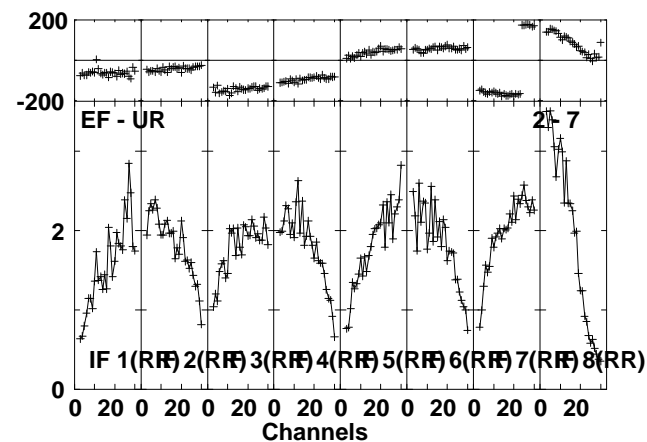
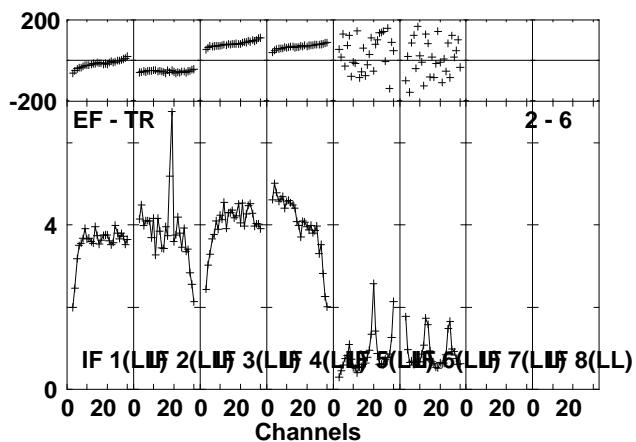
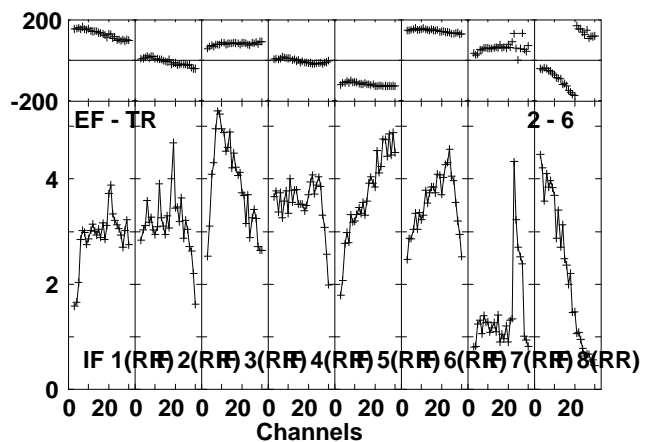
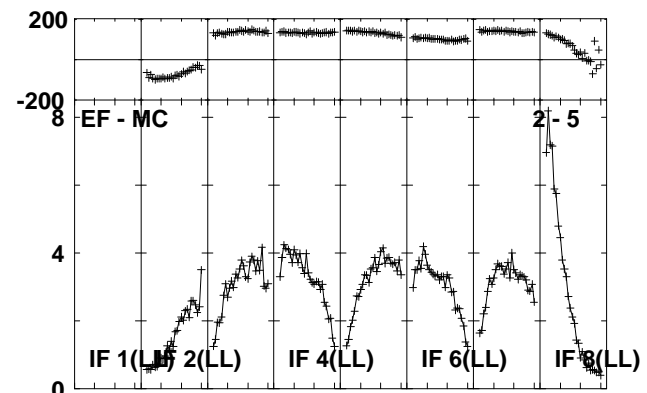
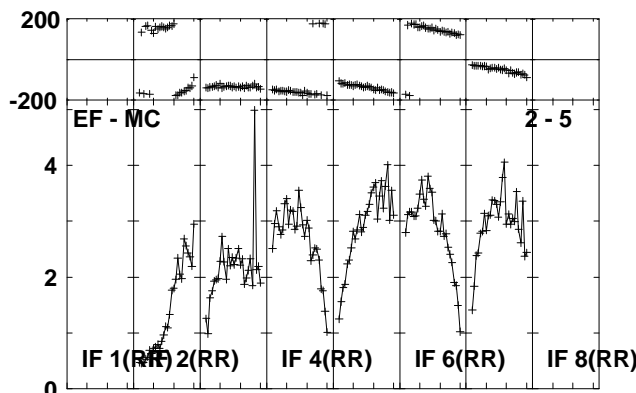
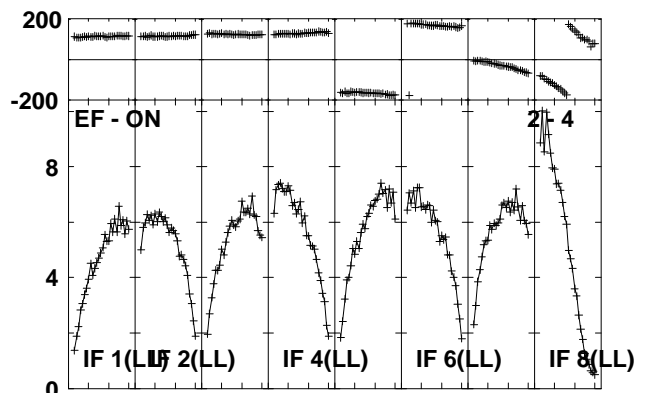
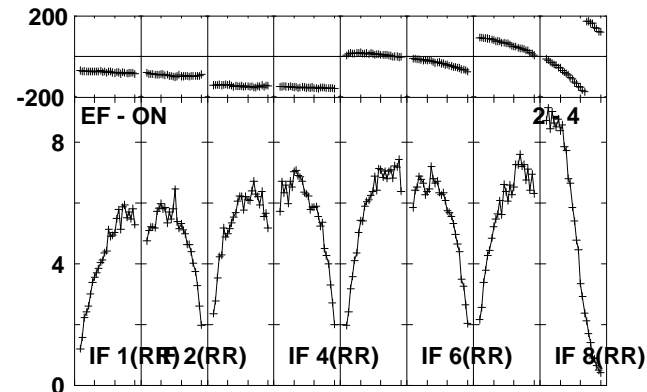
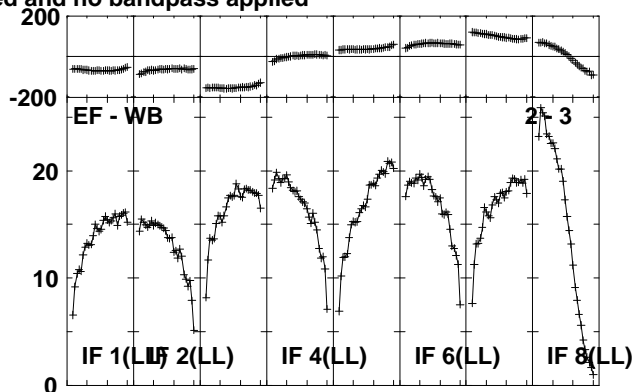
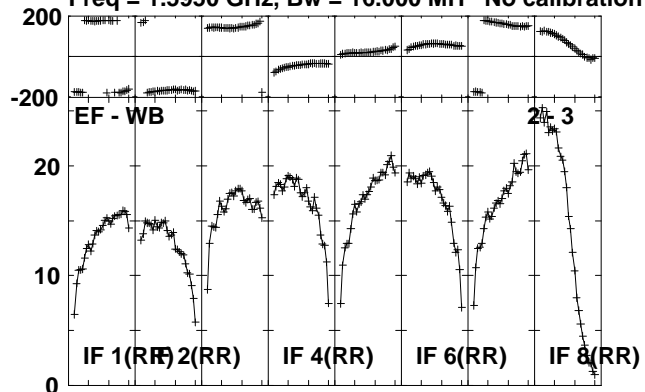

Lower frame: Milli Ampl Jy Top frame: Phas deg
Scalar averaged cross-power spectrum Several baselines displayed
Timerange: 01/00:46:01 to 01/00:47:29

Plot file version 134 created 23-AUG-2010 12:35:56

J1941-05 EP064P.UVDATA.1

Freq = 1.5950 GHz, Bw = 16.000 MH No calibration applied and no bandpass applied

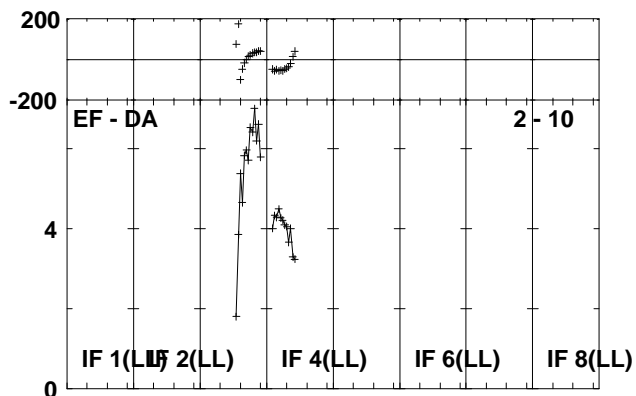
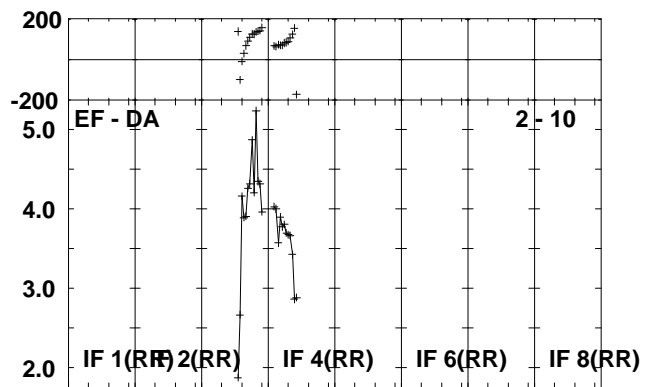
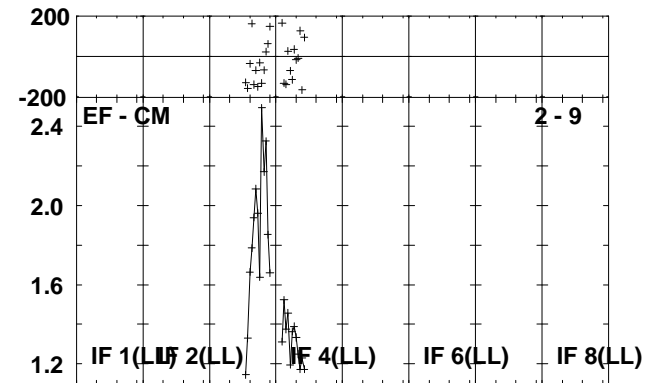
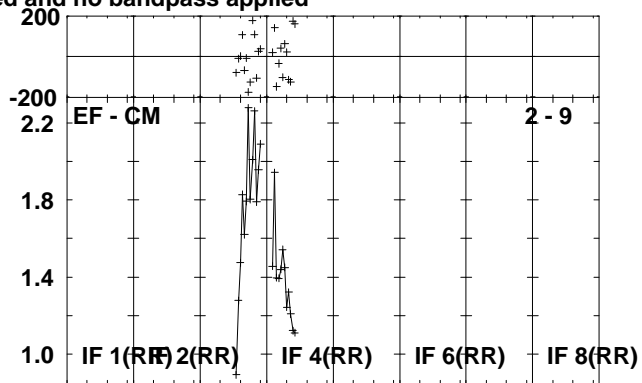
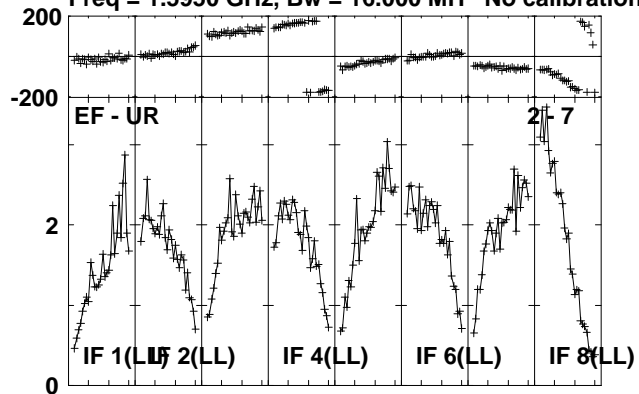

Lower frame: Milli Ampl Jy Top frame: Phas deg
Scalar averaged cross-power spectrum Several baselines displayed
Timerange: 01/00:46:01 to 01/00:47:29

Plot file version 135 created 23-AUG-2010 12:35:57

IRAS1929 EP064P.UVDATA.1

Freq = 1.5950 GHz, Bw = 16.000 MH No calibration applied and no bandpass applied

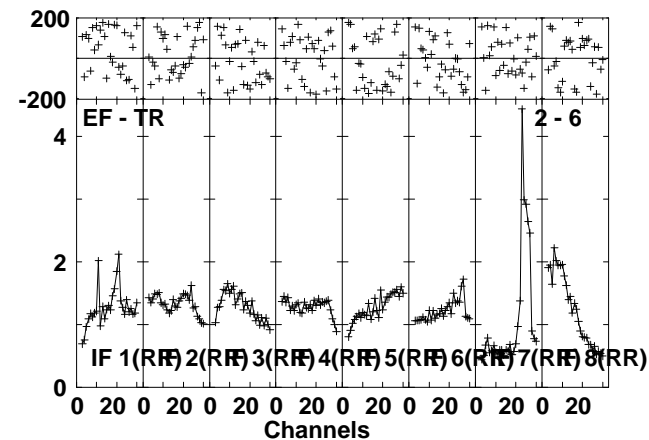
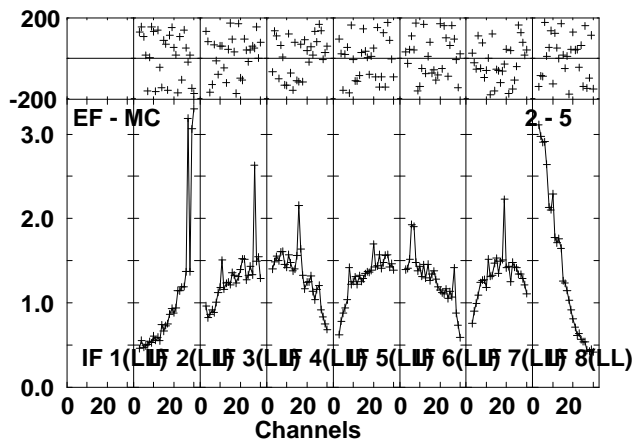
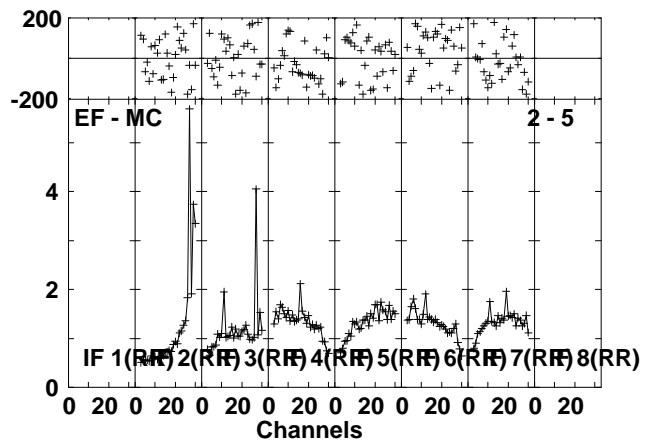
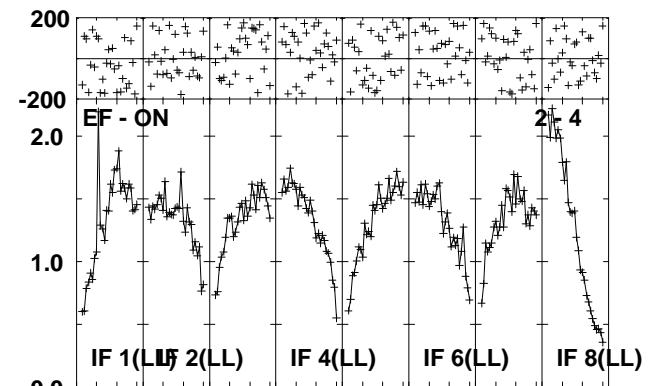
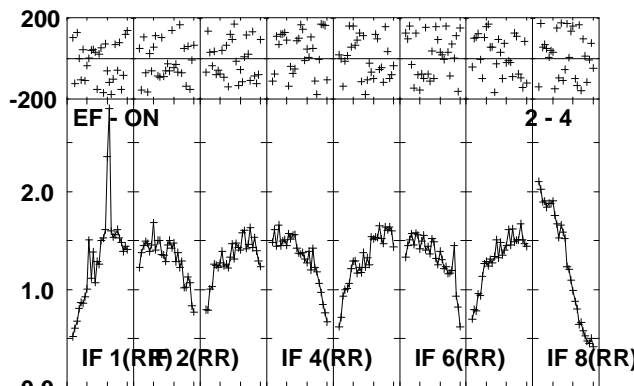
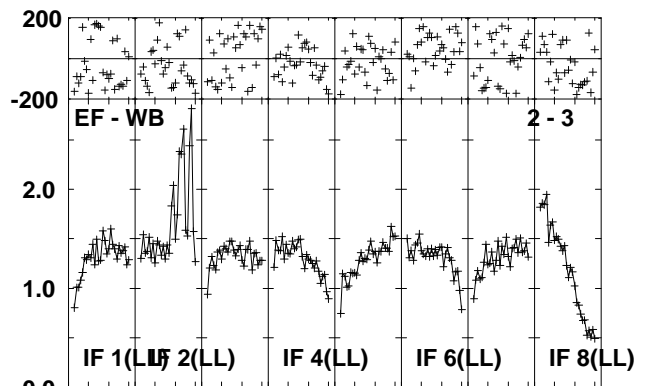
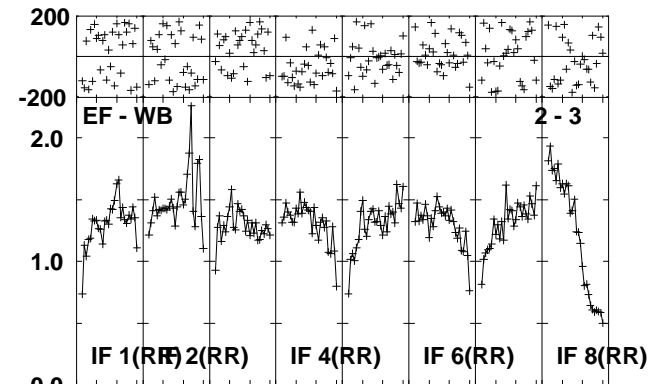
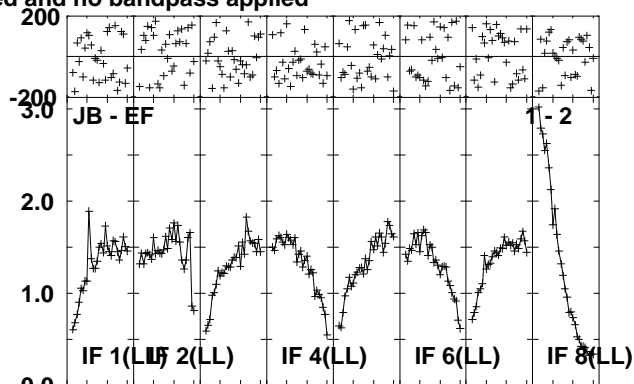
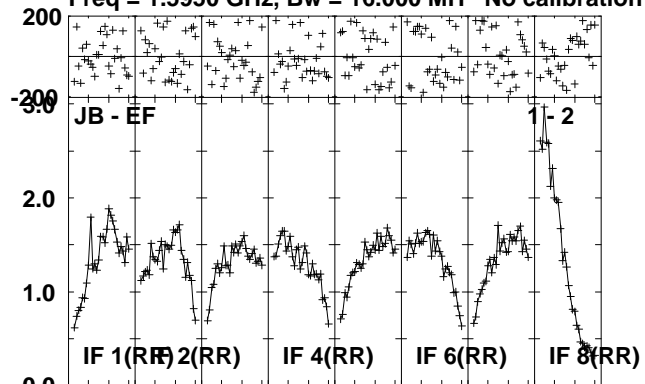

Lower frame: Milli Ampl Jy Top frame: Phas deg
Scalar averaged cross-power spectrum Several baselines displayed
Timerange: 01/00:47:31 to 01/00:50:59

Plot file version 136 created 23-AUG-2010 12:35:59

IRAS1929 EP064P.UVDATA.1

Freq = 1.5950 GHz, Bw = 16.000 MH No calibration applied and no bandpass applied

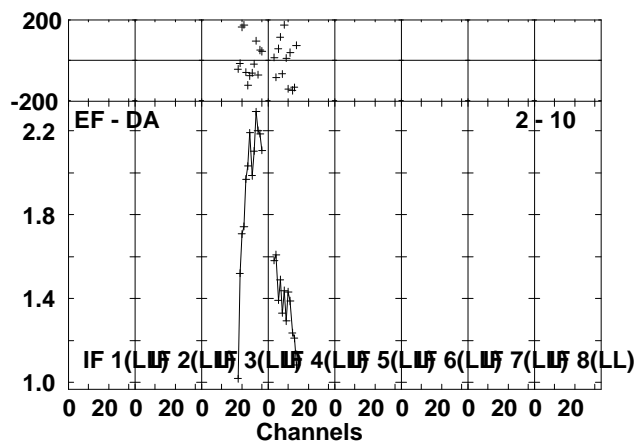
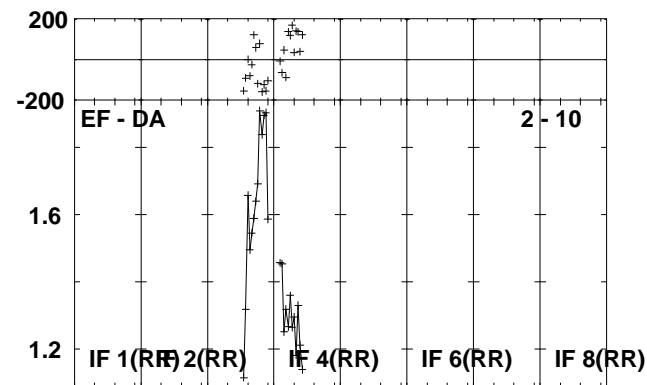
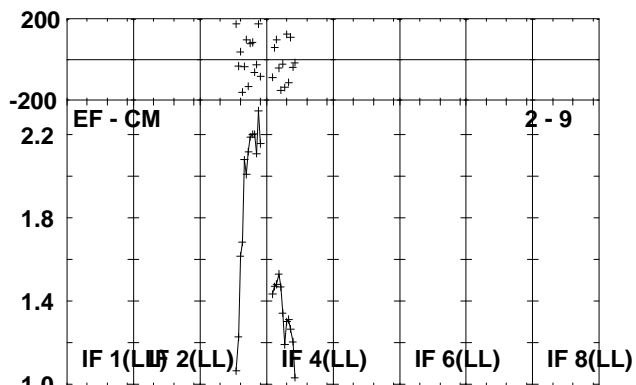
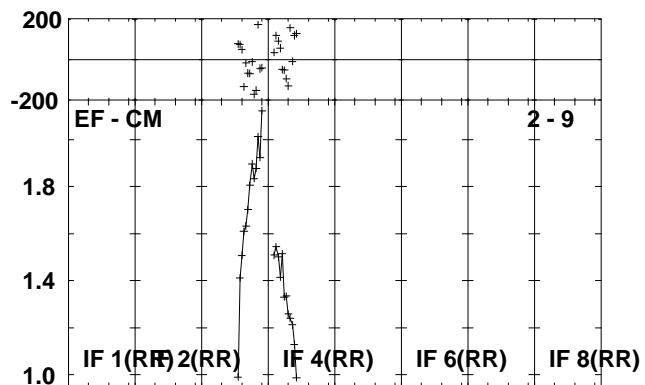
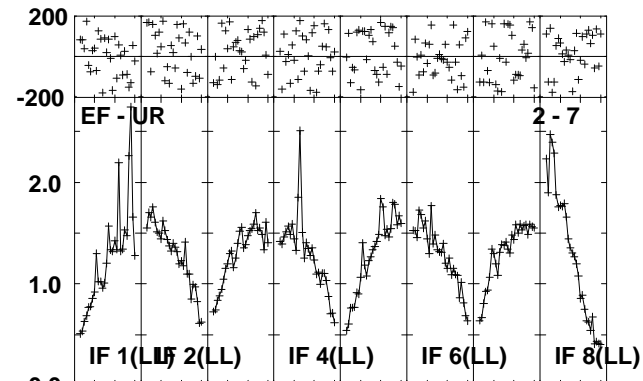
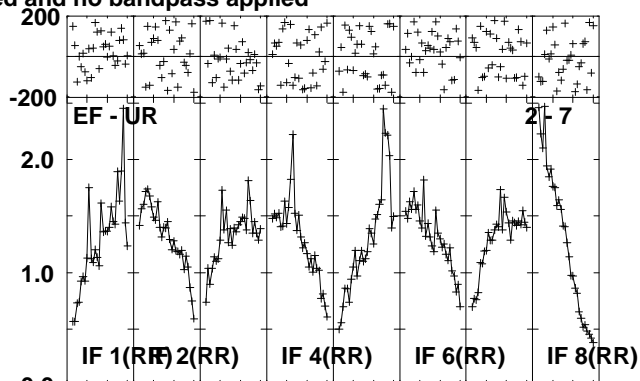
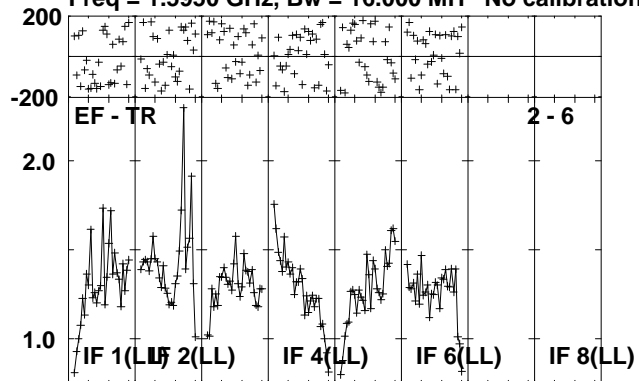

Lower frame: Milli Ampl Jy Top frame: Phas deg
Scalar averaged cross-power spectrum Several baselines displayed
Timerange: 01/00:47:31 to 01/00:50:59

Plot file version 137 created 23-AUG-2010 12:36:01

2134+004 EP064P.UVDATA.1

Freq = 1.5950 GHz, Bw = 16.000 MH No calibration applied and no bandpass applied

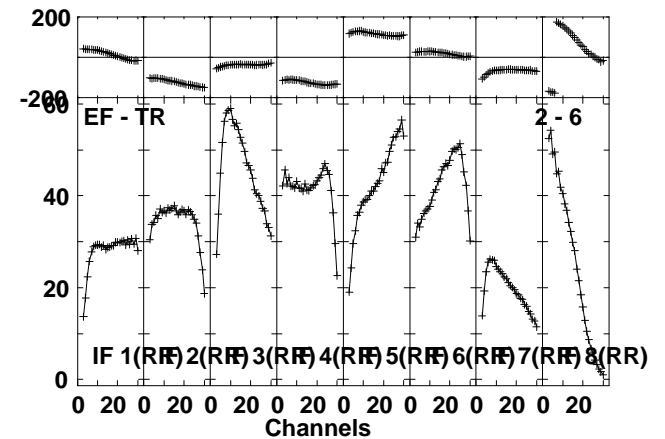
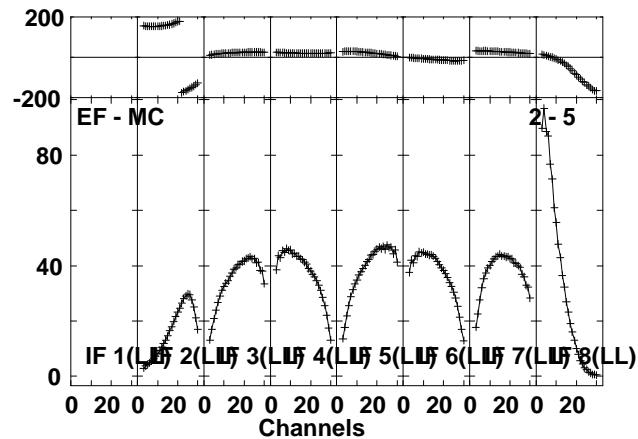
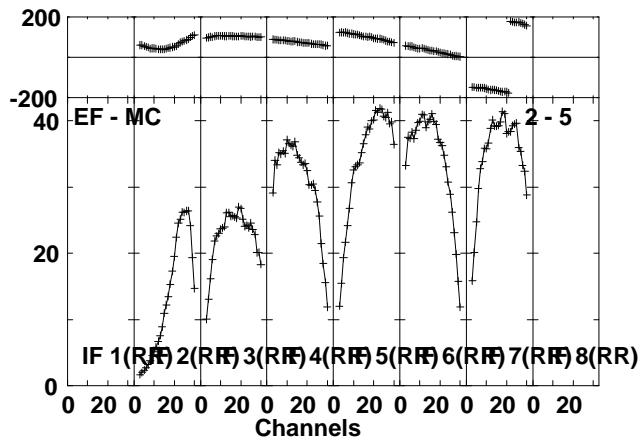
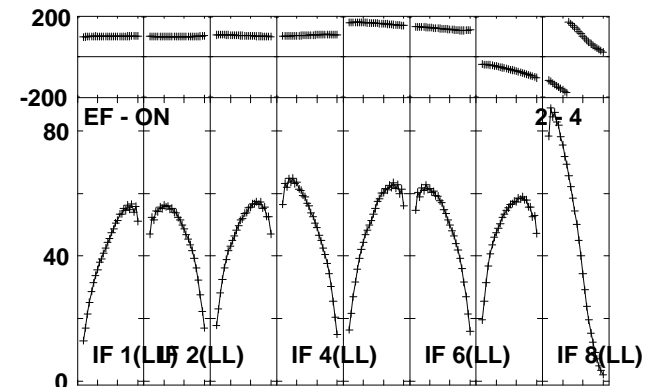
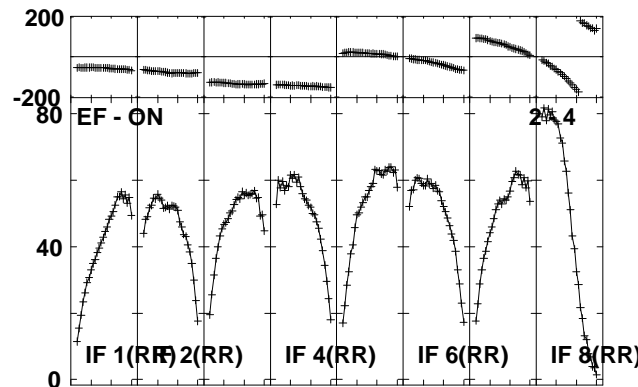
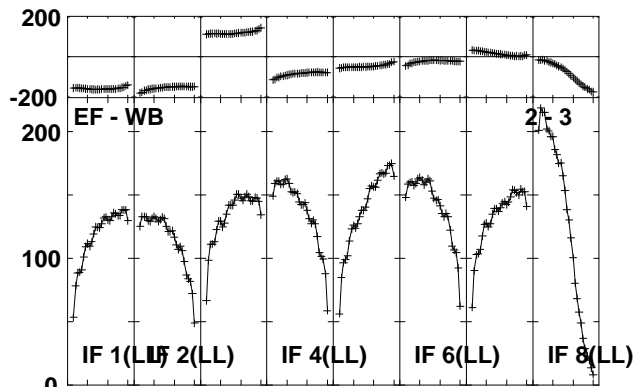
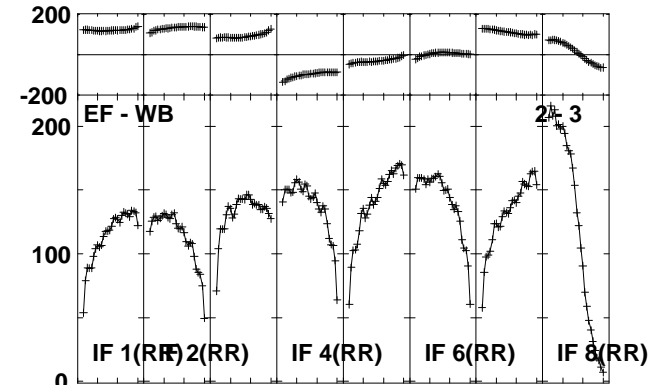
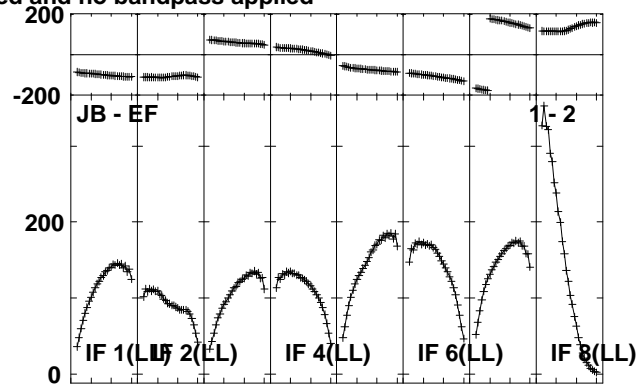
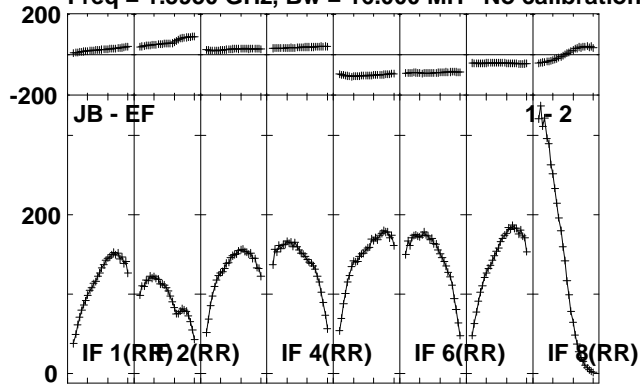

Lower frame: Milli Ampl Jy Top frame: Phas deg
Scalar averaged cross-power spectrum Several baselines displayed
Timerange: 01/00:52:01 to 01/00:57:59

Plot file version 138 created 23-AUG-2010 12:36:04

2134+004 EP064P.UVDATA.1

Freq = 1.5950 GHz, Bw = 16.000 MH No calibration applied and no bandpass applied

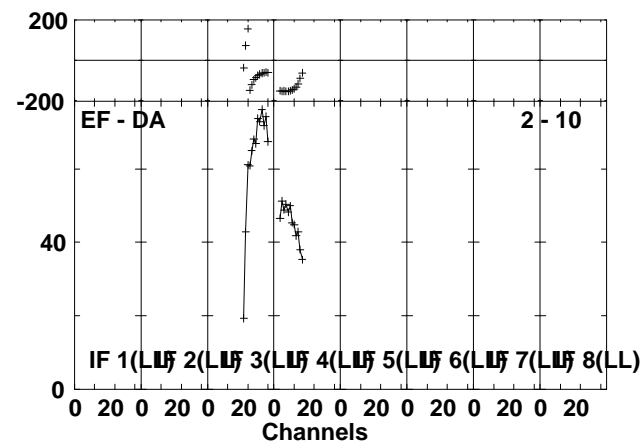
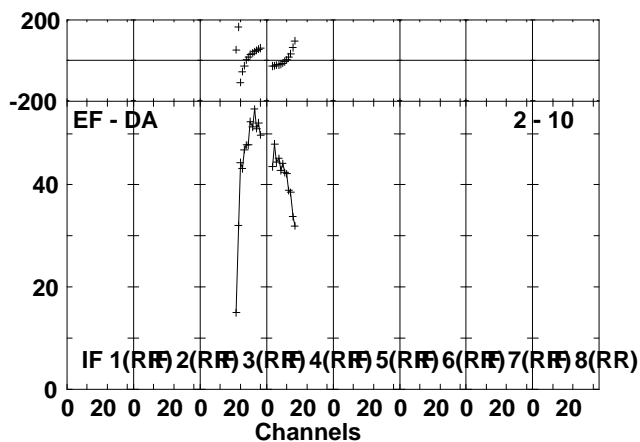
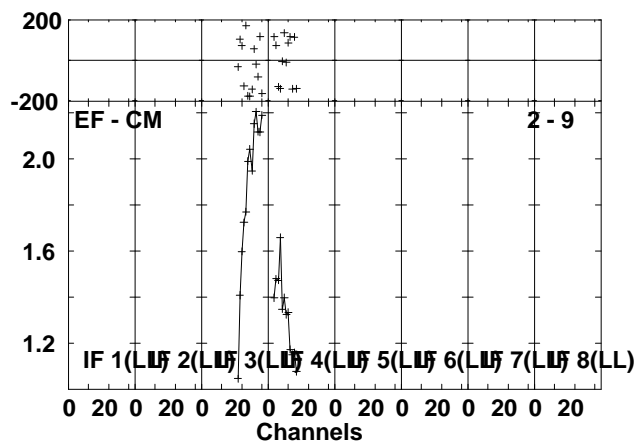
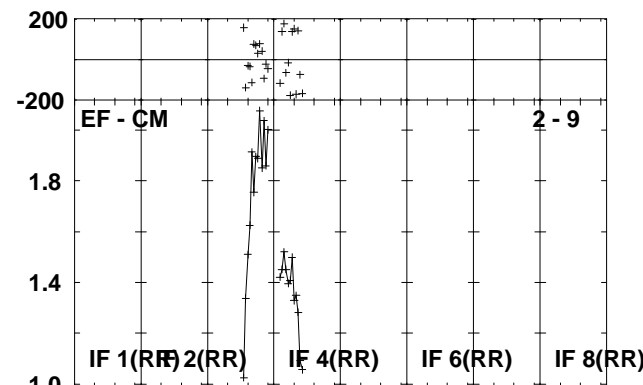
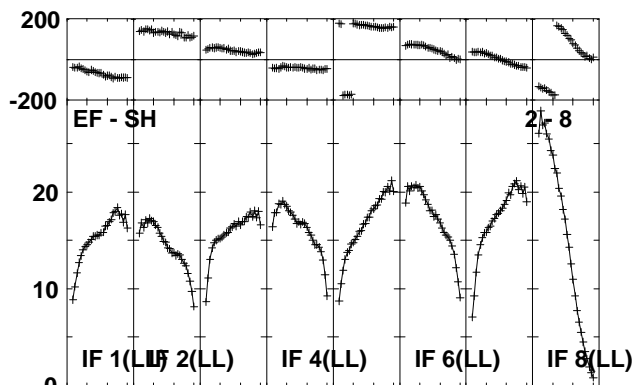
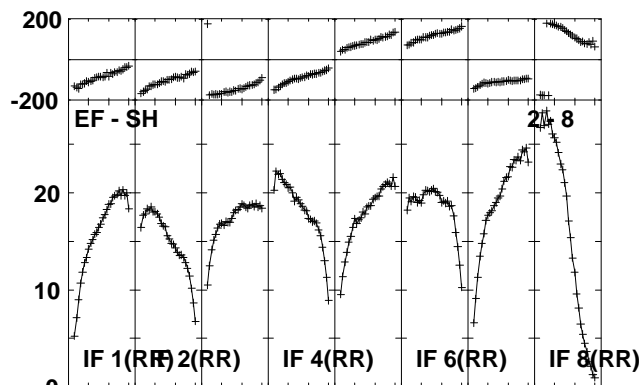
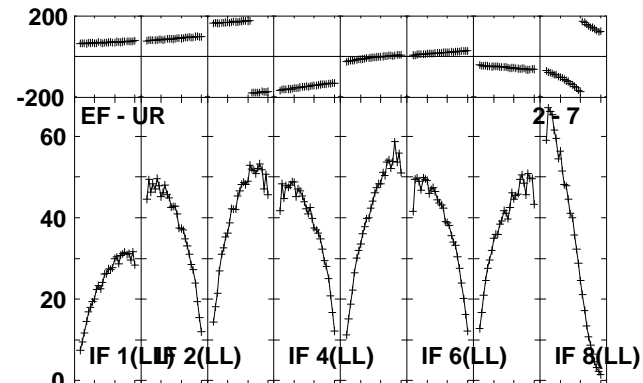
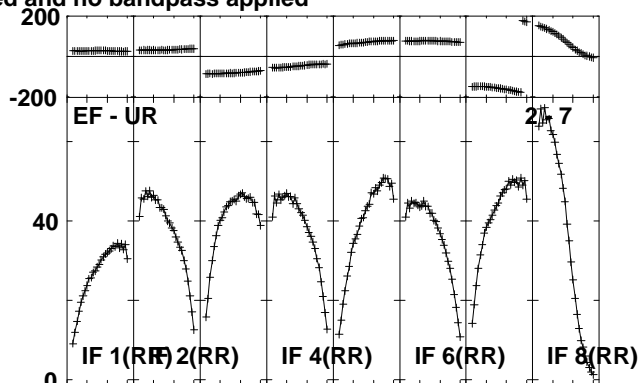
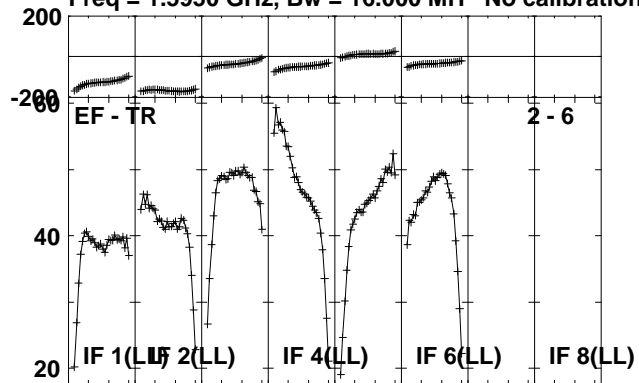

Lower frame: Milli Ampl Jy Top frame: Phas deg
Scalar averaged cross-power spectrum Several baselines displayed
Timerange: 01/00:52:01 to 01/00:57:59

Plot file version 139 created 23-AUG-2010 12:36:07

J1941-05 EP064P.UVDATA.1

Freq = 1.5950 GHz, Bw = 16.000 MH No calibration applied and no bandpass applied

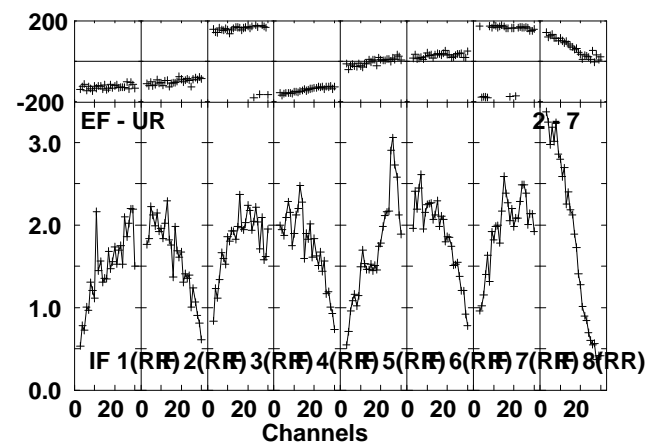
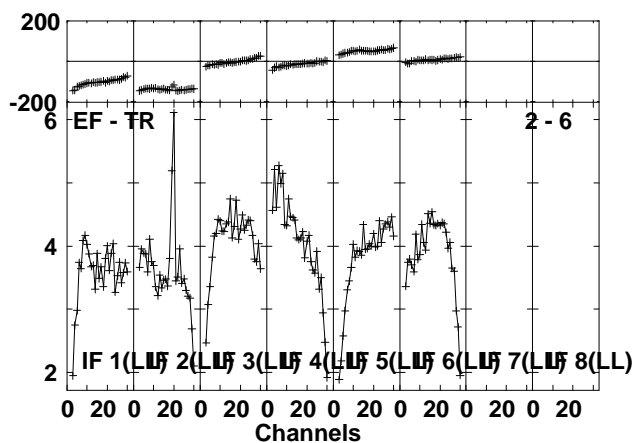
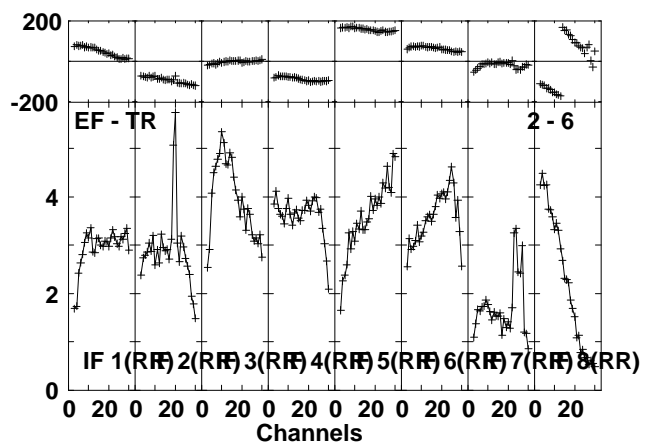
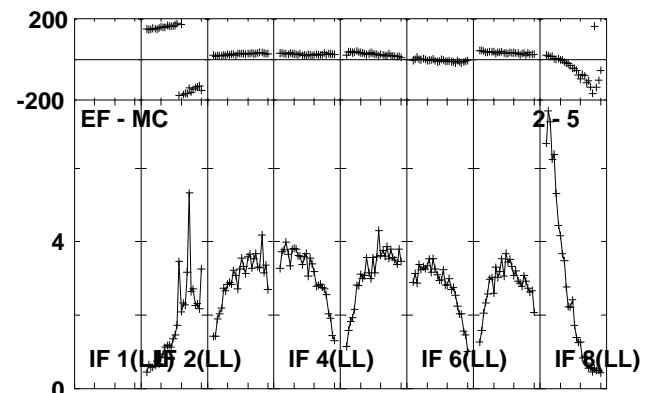
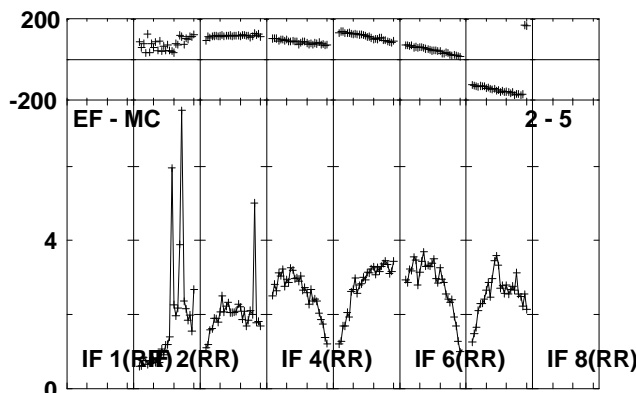
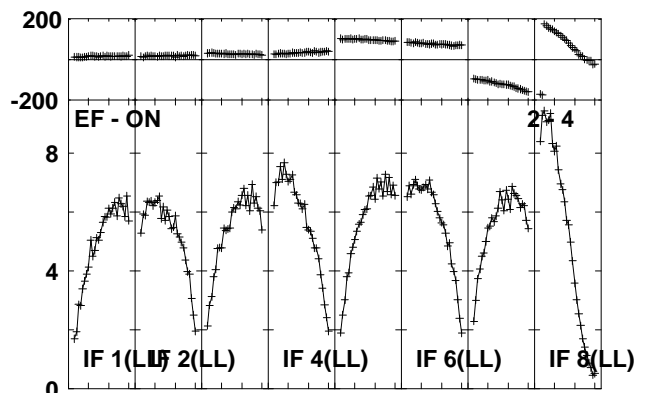
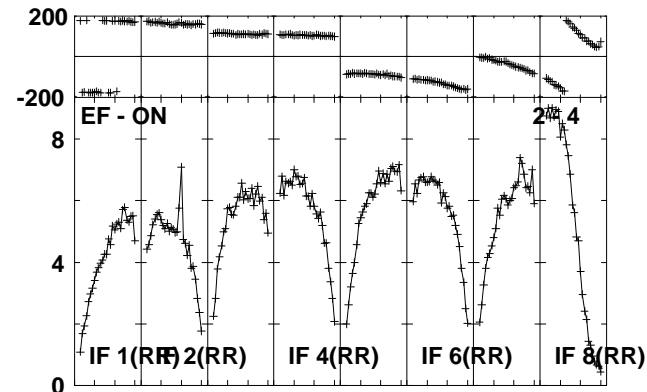
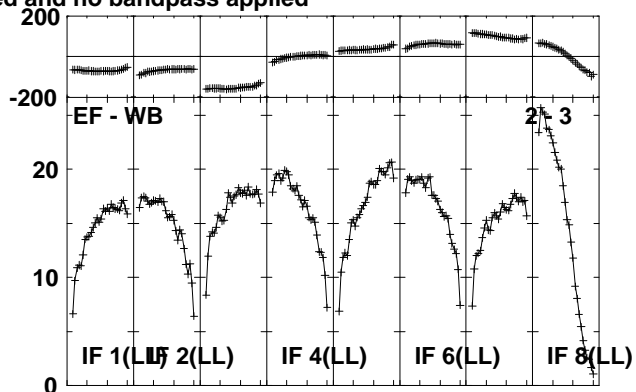
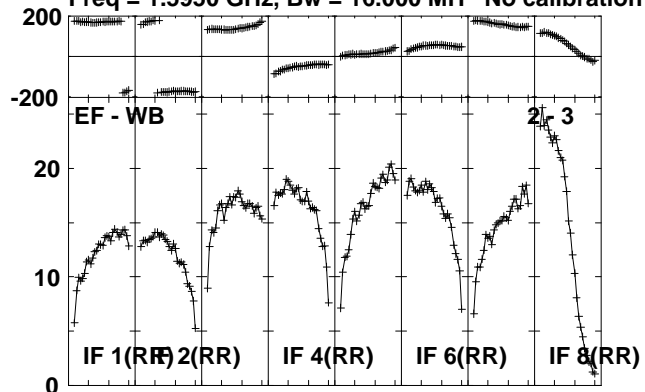

Lower frame: Milli Ampl Jy Top frame: Phas deg
Scalar averaged cross-power spectrum Several baselines displayed
Timerange: 01/00:59:31 to 01/01:00:59

Plot file version 140 created 23-AUG-2010 12:36:08
J1941-05 EP064P.UVDATA.1

Freq = 1.5950 GHz, Bw = 16.000 MH No calibration applied and no bandpass applied

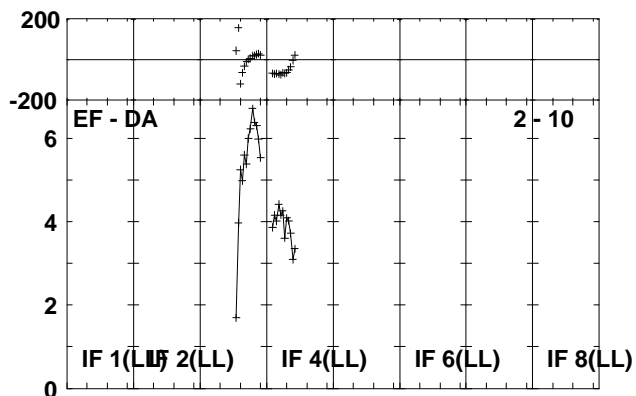
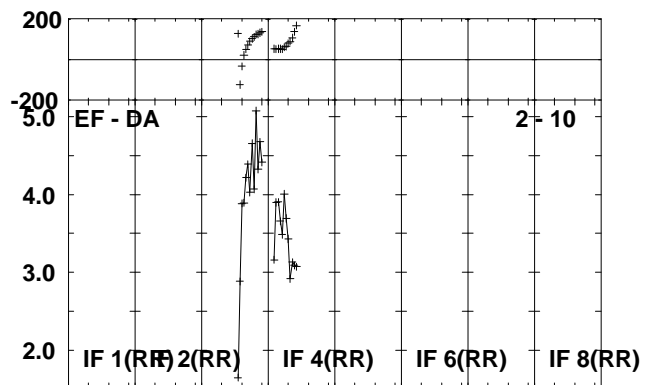
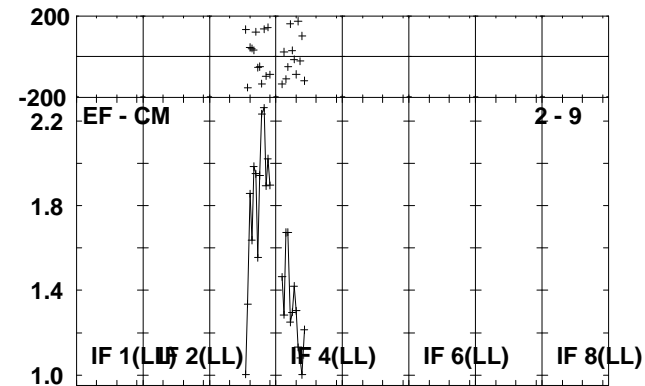
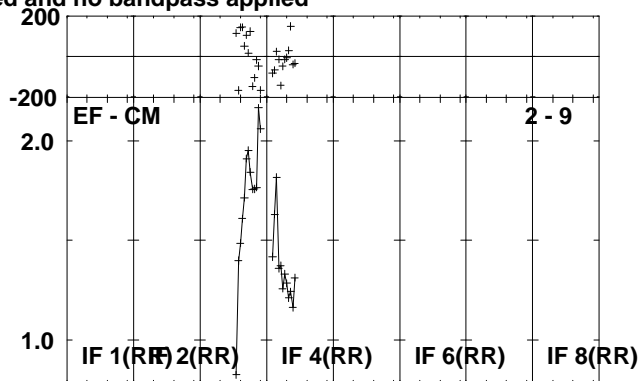
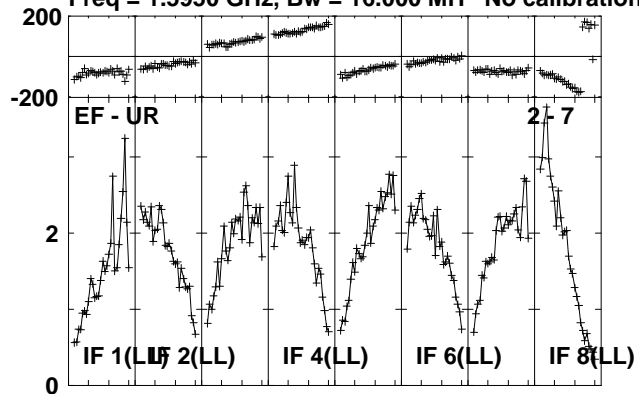

Lower frame: Milli Ampl Jy Top frame: Phas deg
Scalar averaged cross-power spectrum Several baselines displayed
Timerange: 01/00:59:31 to 01/01:00:59

Plot file version 141 created 23-AUG-2010 12:36:09

IRAS1929 EP064P.UVDATA.1

Freq = 1.5950 GHz, Bw = 16.000 MH No calibration applied and no bandpass applied

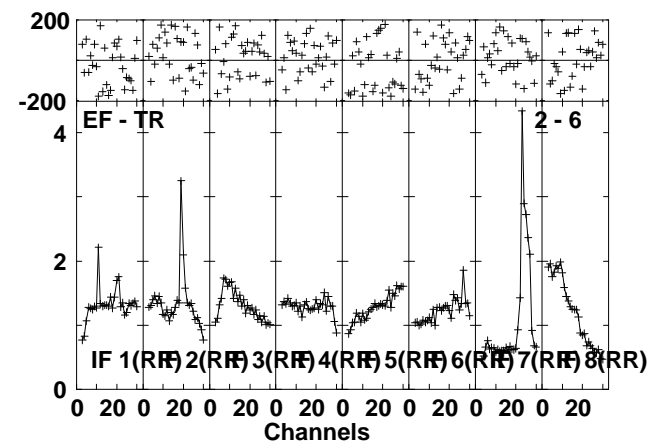
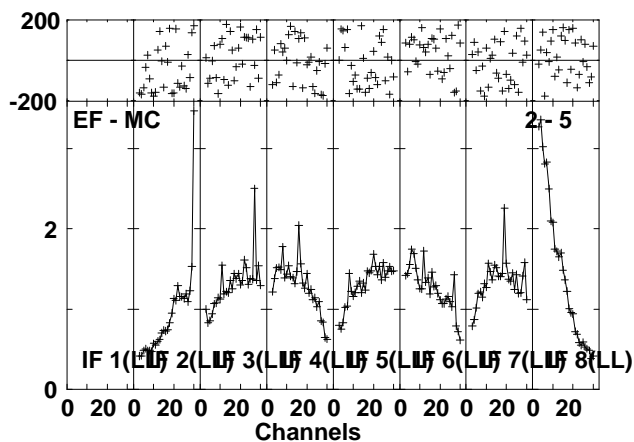
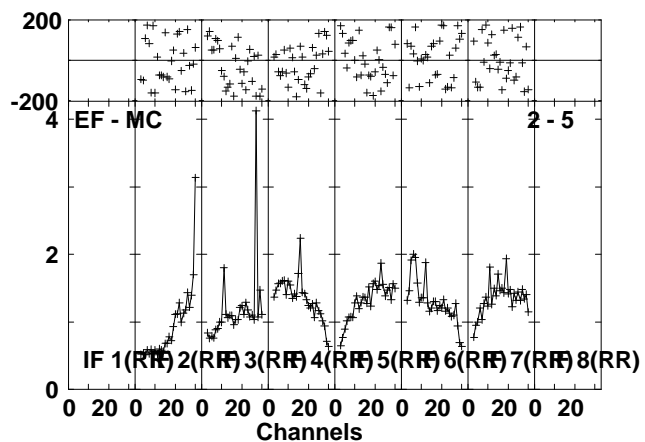
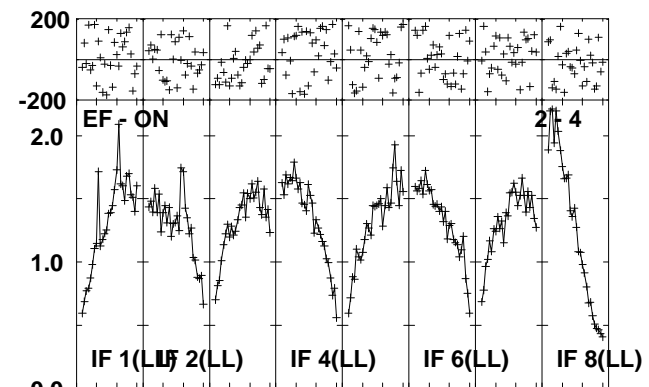
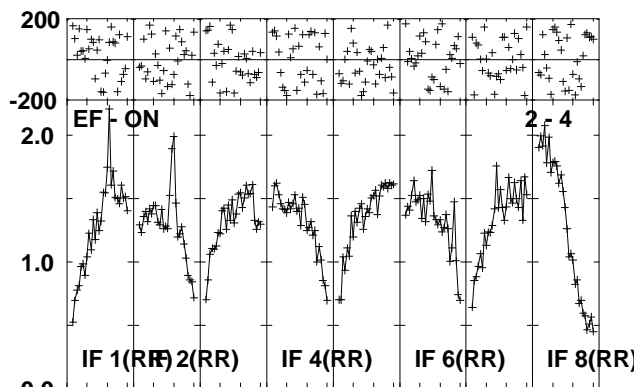
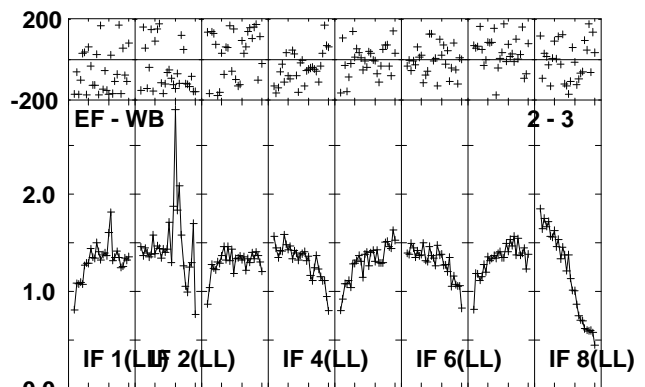
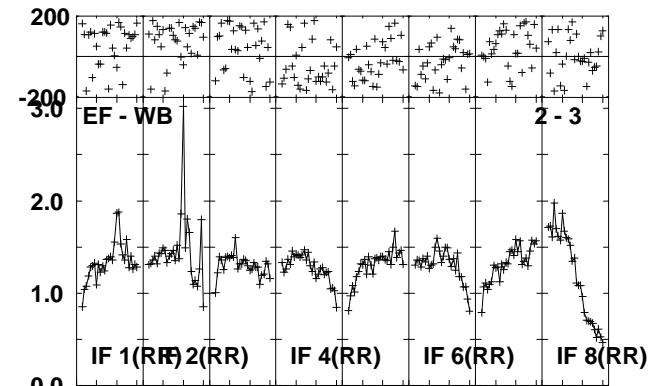
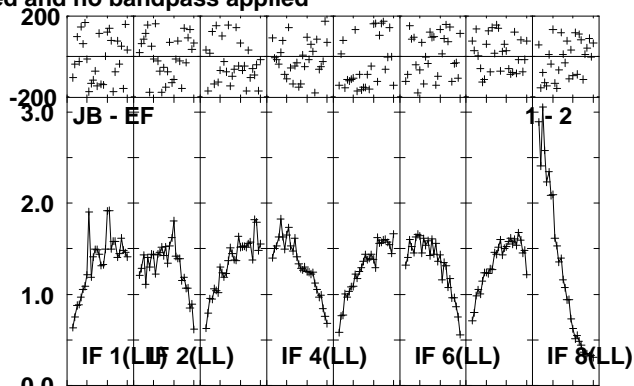
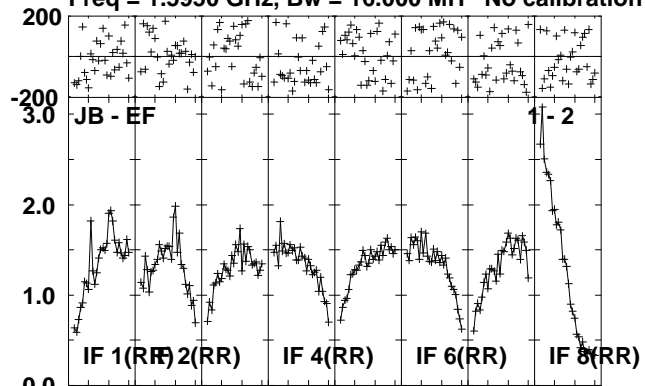

Lower frame: Milli Ampl Jy Top frame: Phas deg
Scalar averaged cross-power spectrum Several baselines displayed
Timerange: 01/01:01:01 to 01/01:04:29

Plot file version 142 created 23-AUG-2010 12:36:10

IRAS1929 EP064P.UVDATA.1

Freq = 1.5950 GHz, Bw = 16.000 MH No calibration applied and no bandpass applied

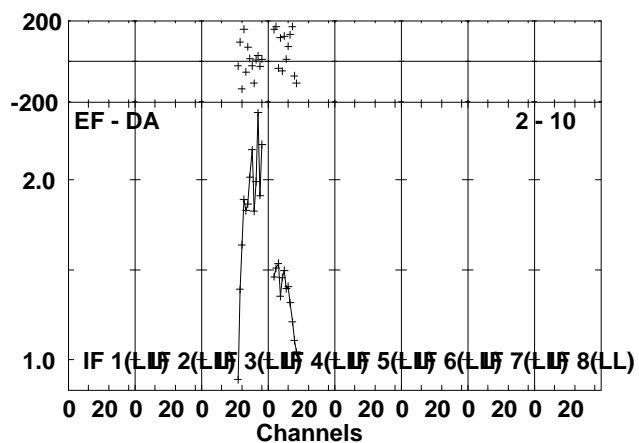
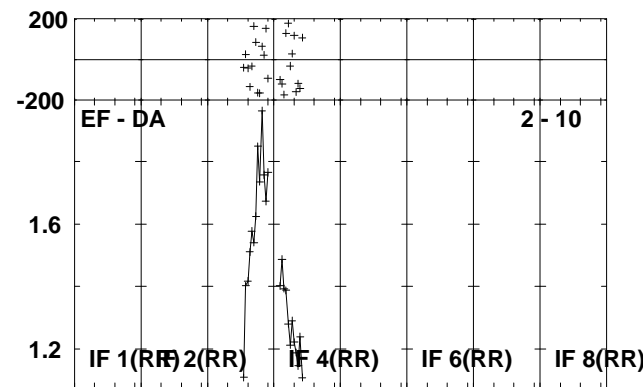
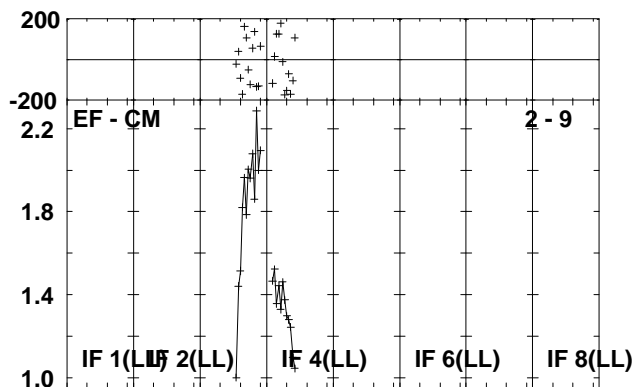
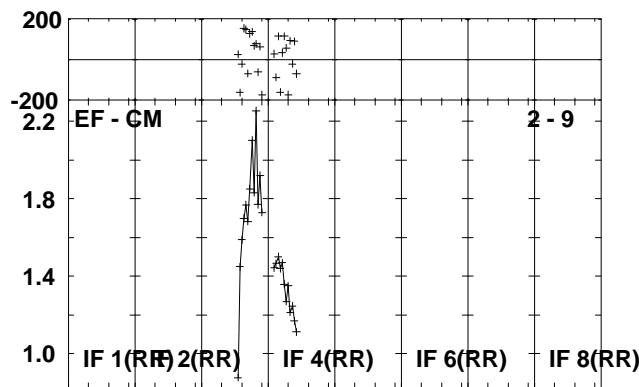
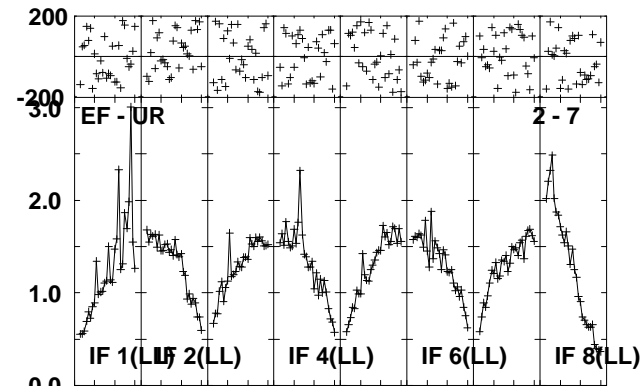
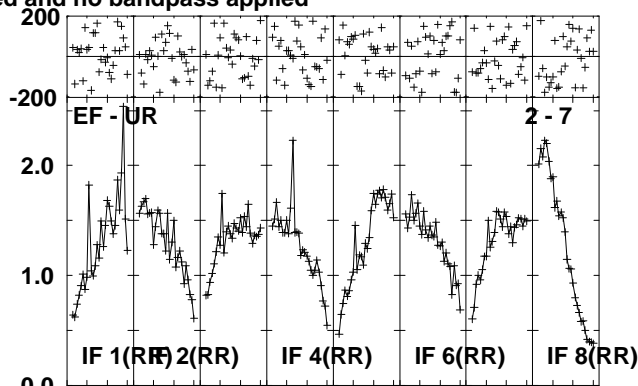
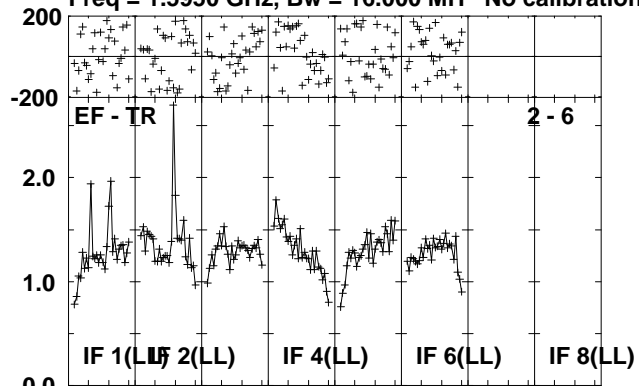

Lower frame: Milli Ampl Jy Top frame: Phas deg
Scalar averaged cross-power spectrum Several baselines displayed
Timerange: 01/01:01:01 to 01/01:04:29

Plot file version 143 created 23-AUG-2010 12:36:12

J1941-05 EP064P.UVDATA.1

Freq = 1.5950 GHz, Bw = 16.000 MH No calibration applied and no bandpass applied

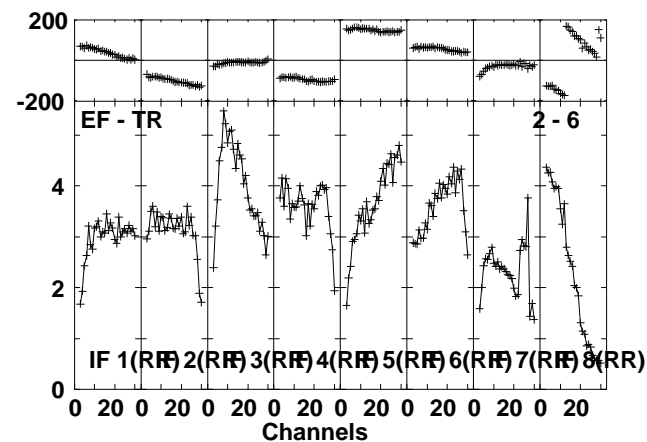
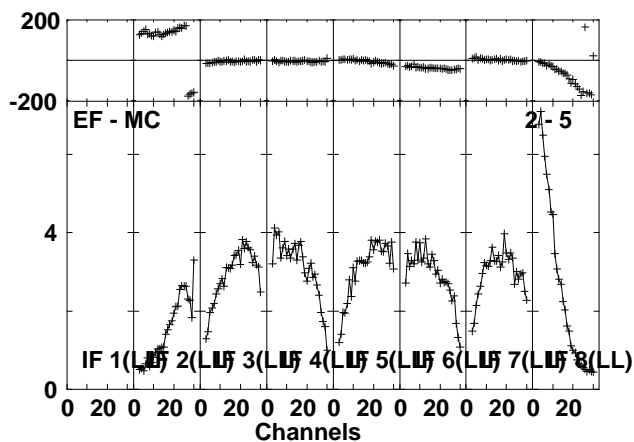
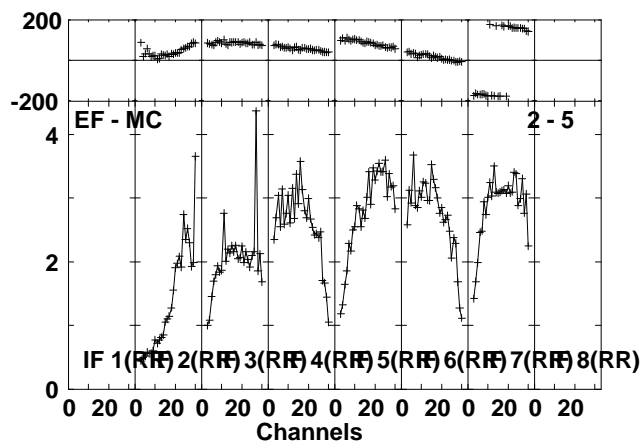
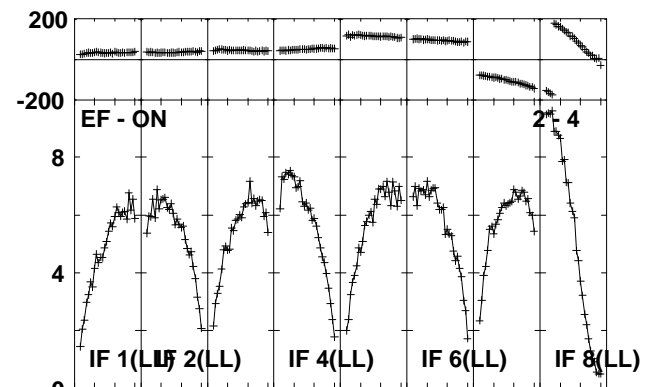
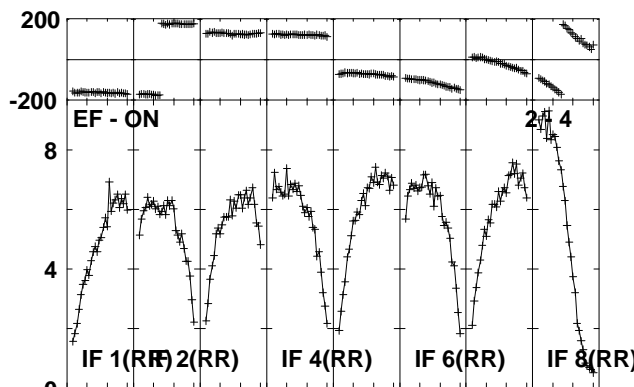
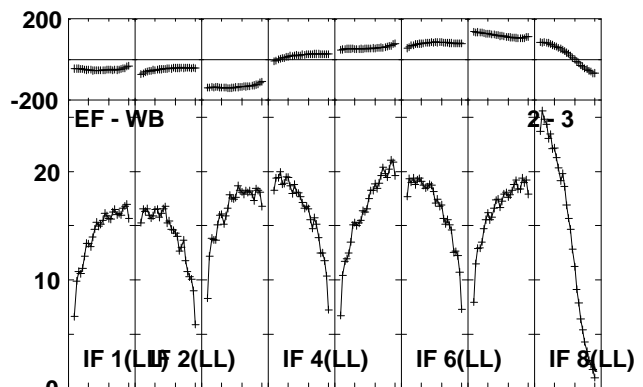
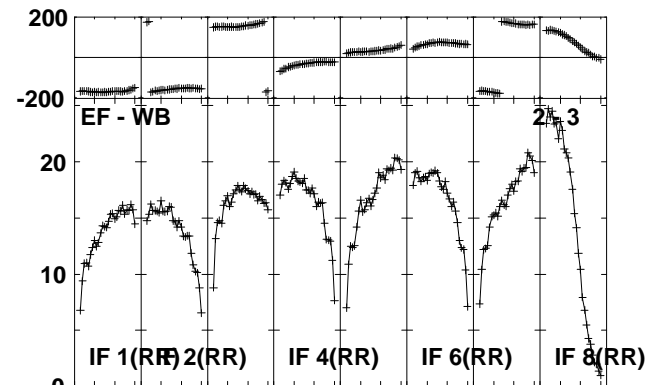
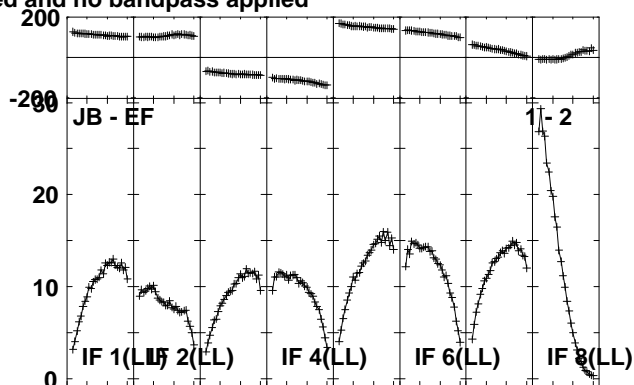
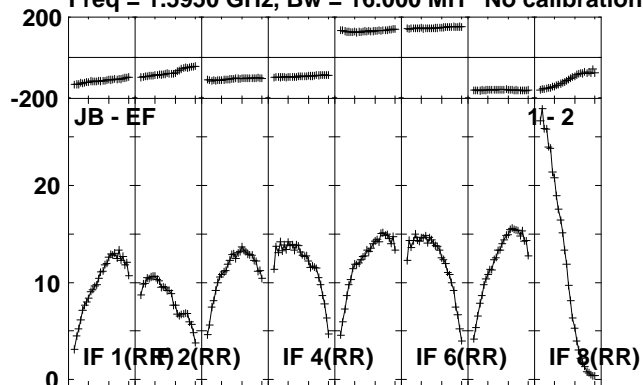

Lower frame: Milli Ampl Jy Top frame: Phas deg
Scalar averaged cross-power spectrum Several baselines displayed
Timerange: 01/01:04:31 to 01/01:05:59

Plot file version 144 created 23-AUG-2010 12:36:13
J1941-05 EP064P.UVDATA.1

Freq = 1.5950 GHz, Bw = 16.000 MH No calibration applied and no bandpass applied

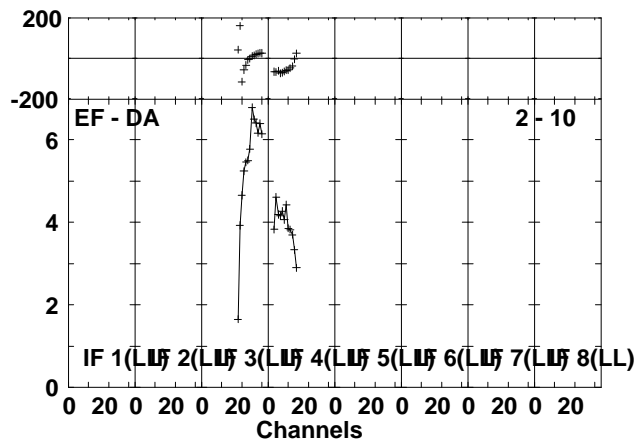
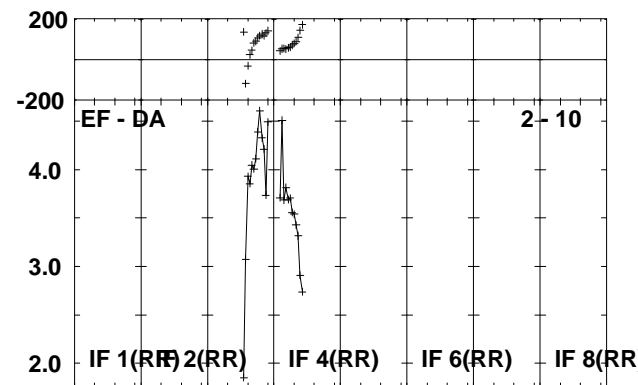
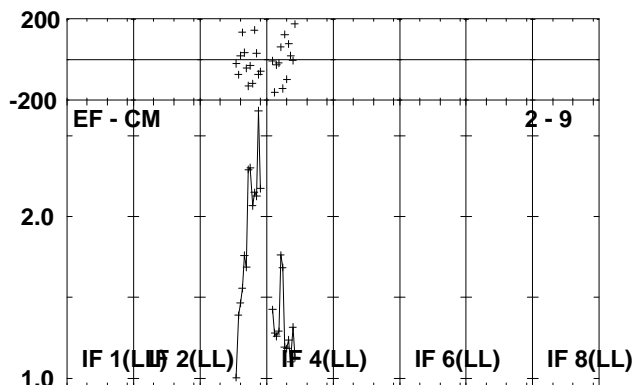
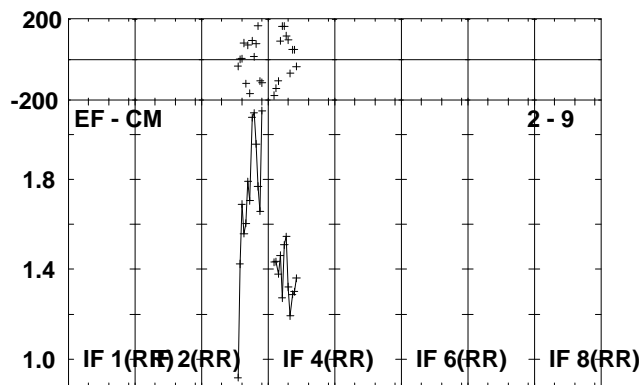
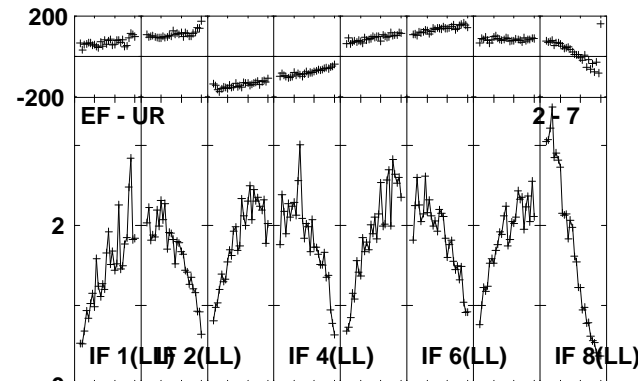
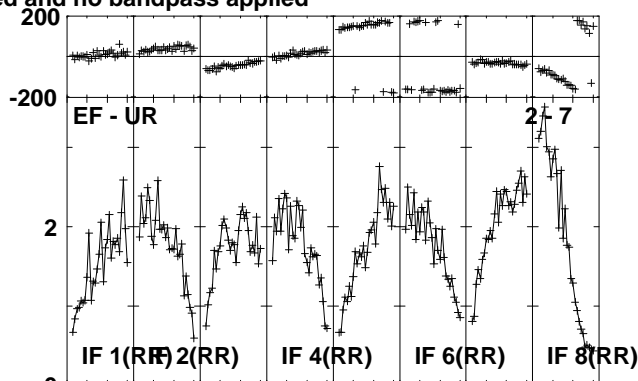
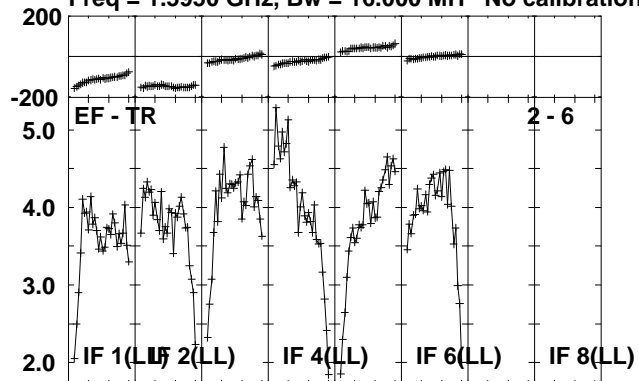

Lower frame: Milli Ampl Jy Top frame: Phas deg
Scalar averaged cross-power spectrum Several baselines displayed
Timerange: 01/01:04:31 to 01/01:05:59

Plot file version 145 created 23-AUG-2010 12:36:14

IRAS1929 EP064P.UVDATA.1

Freq = 1.5950 GHz, Bw = 16.000 MH No calibration applied and no bandpass applied

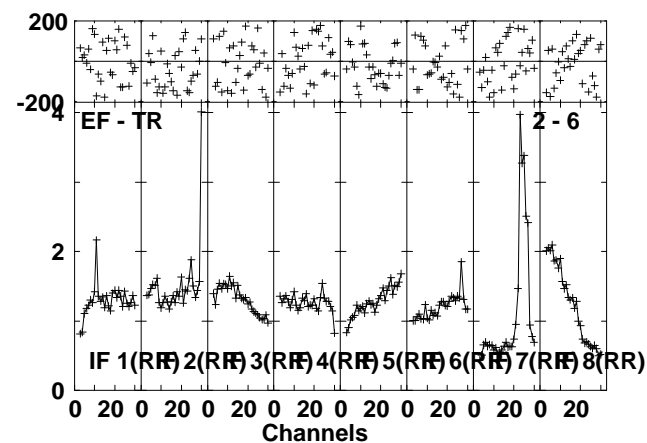
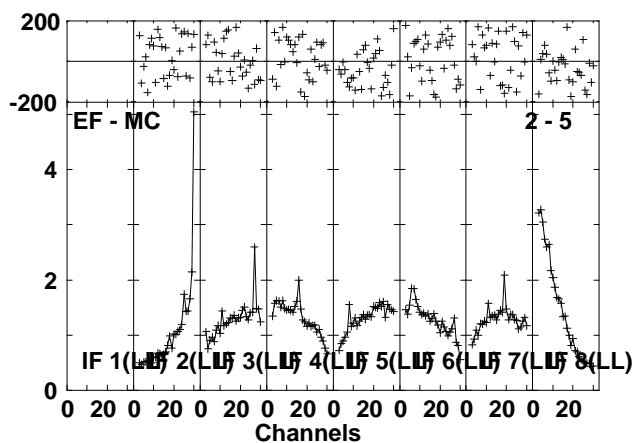
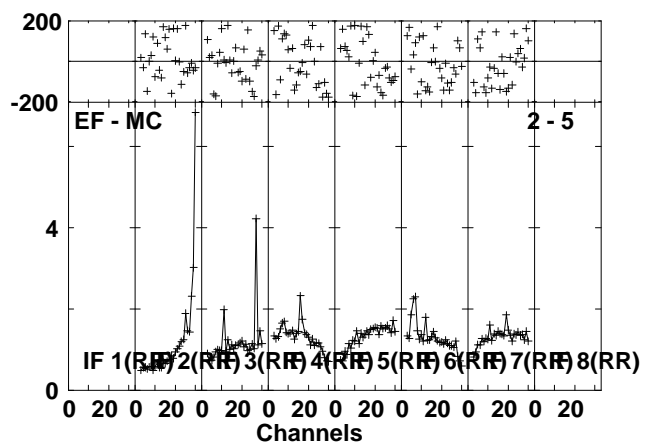
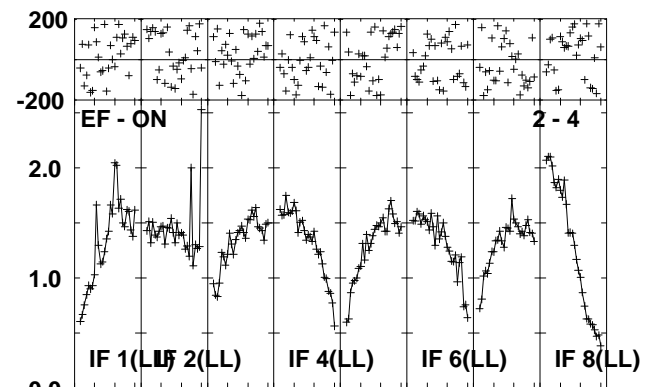
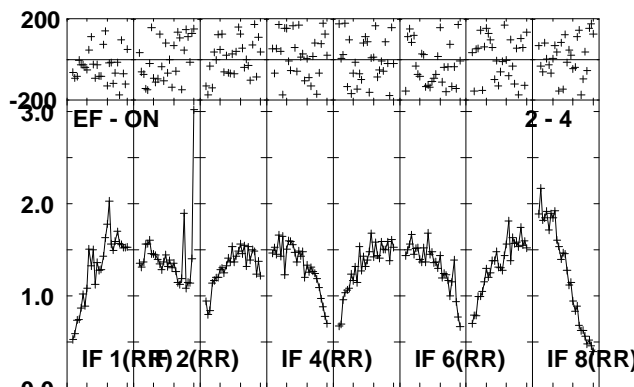
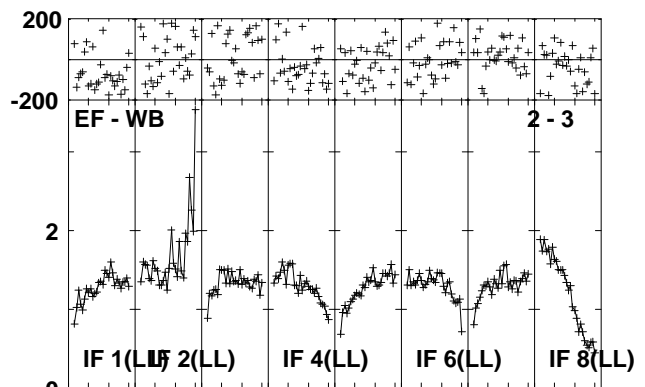
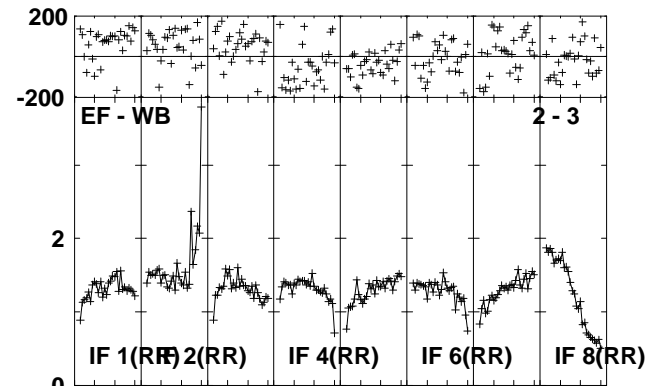
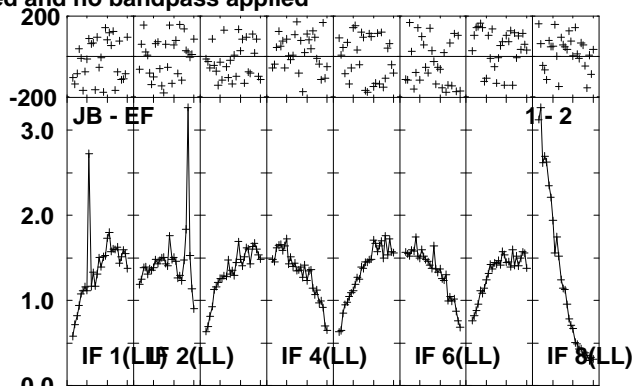
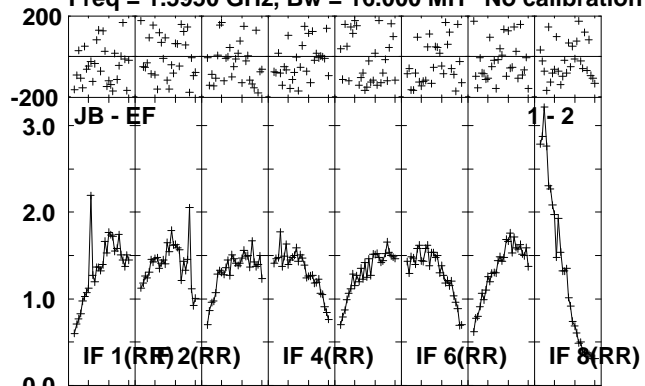

Lower frame: Milli Ampl Jy Top frame: Phas deg
Scalar averaged cross-power spectrum Several baselines displayed
Timerange: 01/01:06:01 to 01/01:09:29

Plot file version 146 created 23-AUG-2010 12:36:15

IRAS1929 EP064P.UVDATA.1

Freq = 1.5950 GHz, Bw = 16.000 MH No calibration applied and no bandpass applied

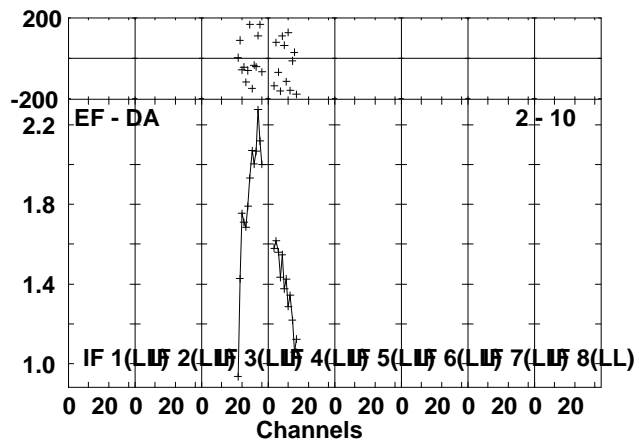
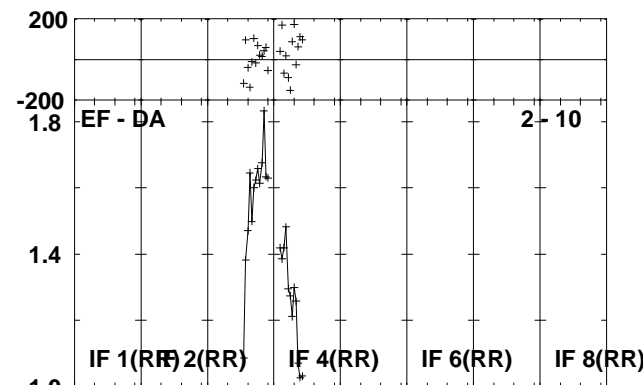
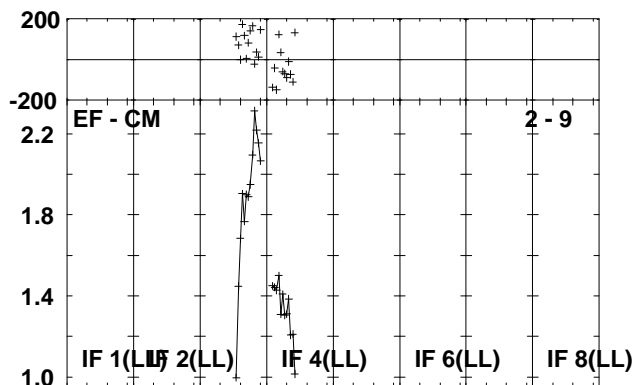
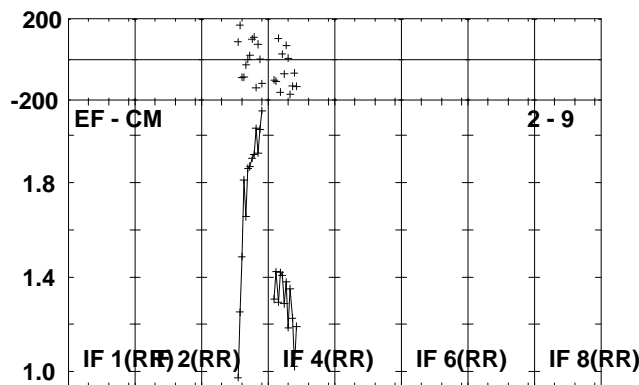
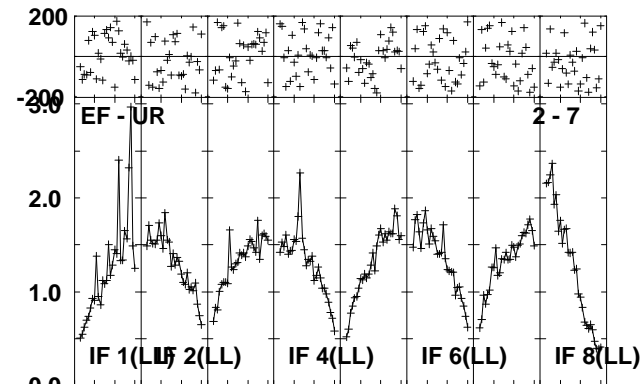
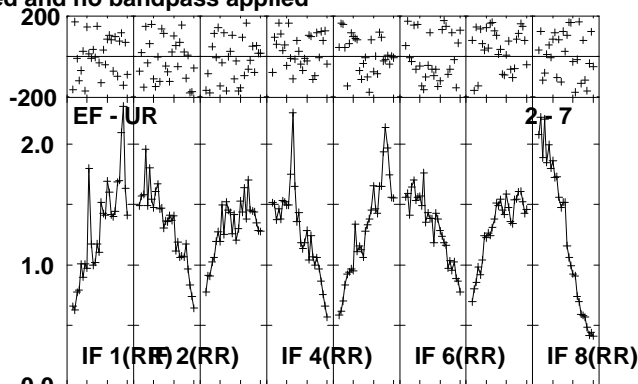
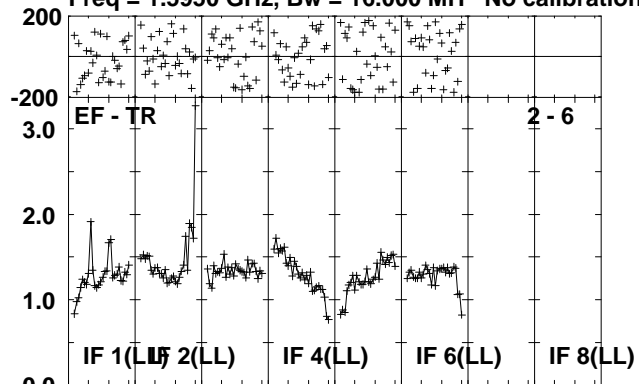

Lower frame: Milli Ampl Jy Top frame: Phas deg
Scalar averaged cross-power spectrum Several baselines displayed
Timerange: 01/01:06:01 to 01/01:09:29

Plot file version 147 created 23-AUG-2010 12:36:17

J1941-05 EP064P.UVDATA.1

Freq = 1.5950 GHz, Bw = 16.000 MH No calibration applied and no bandpass applied

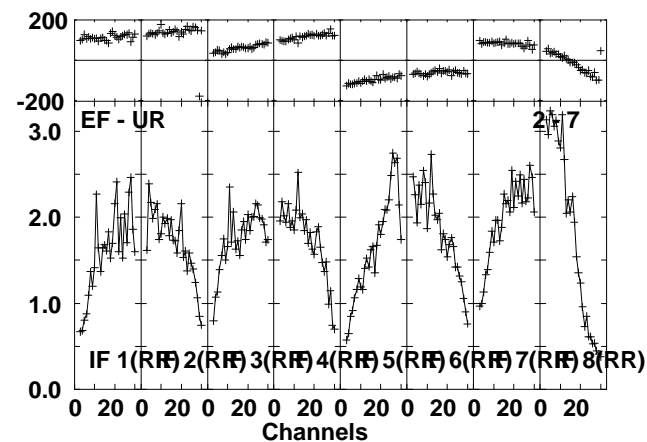
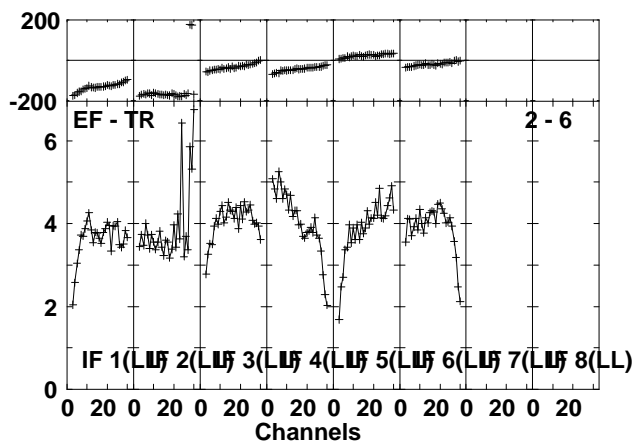
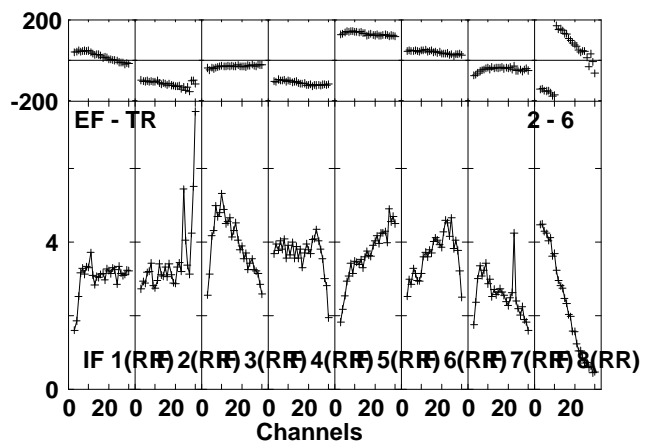
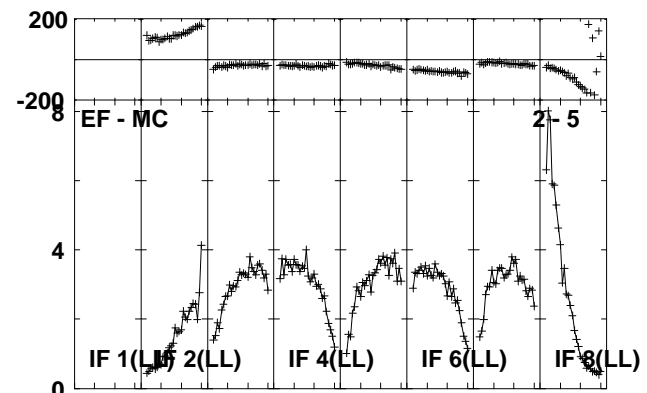
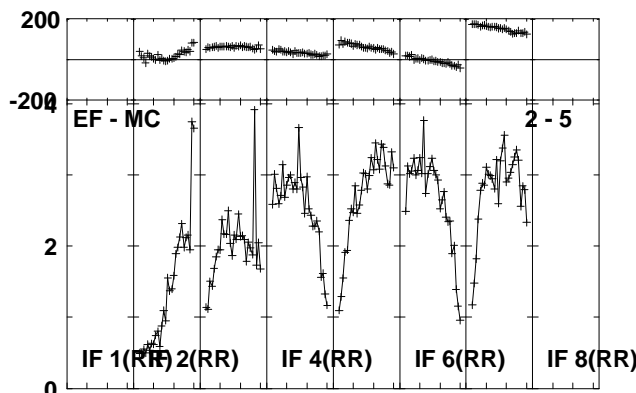
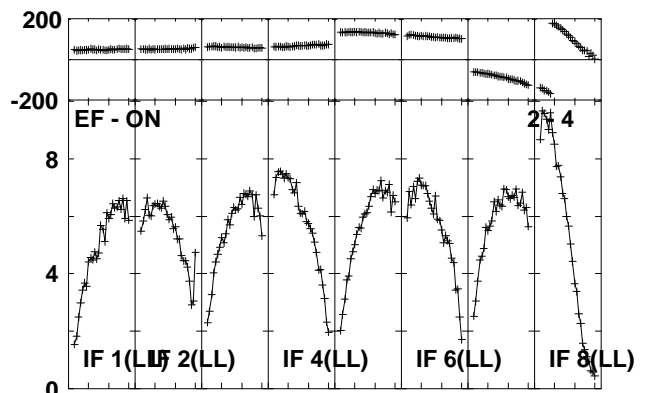
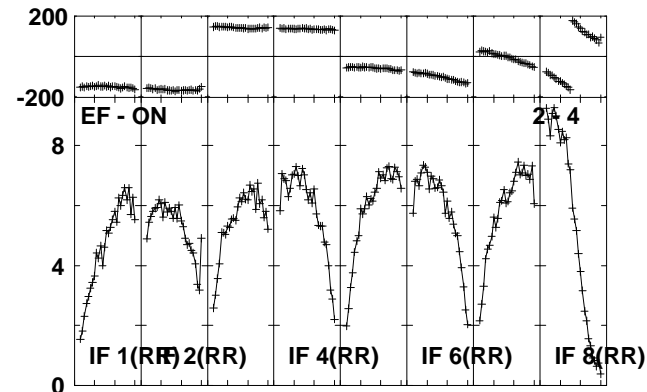
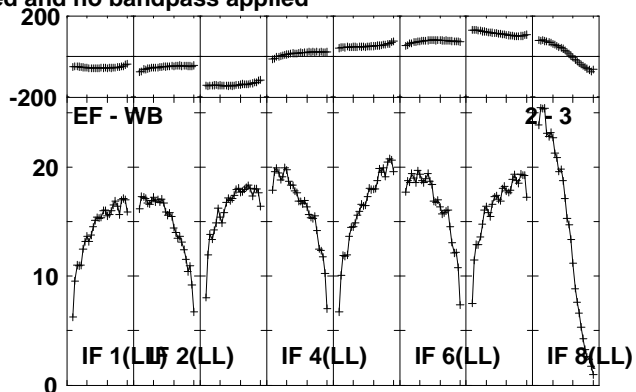
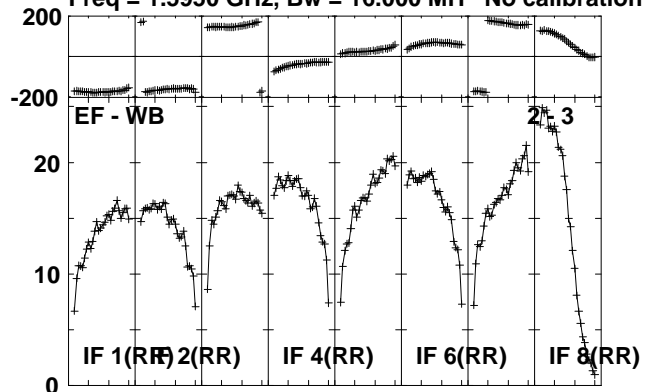

Lower frame: Milli Ampl Jy Top frame: Phas deg
Scalar averaged cross-power spectrum Several baselines displayed
Timerange: 01/01:09:31 to 01/01:10:59

Plot file version 148 created 23-AUG-2010 12:36:18

J1941-05 EP064P.UVDATA.1

Freq = 1.5950 GHz, Bw = 16.000 MH No calibration applied and no bandpass applied

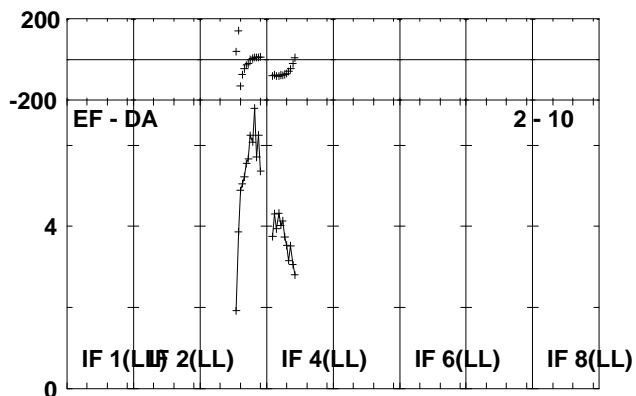
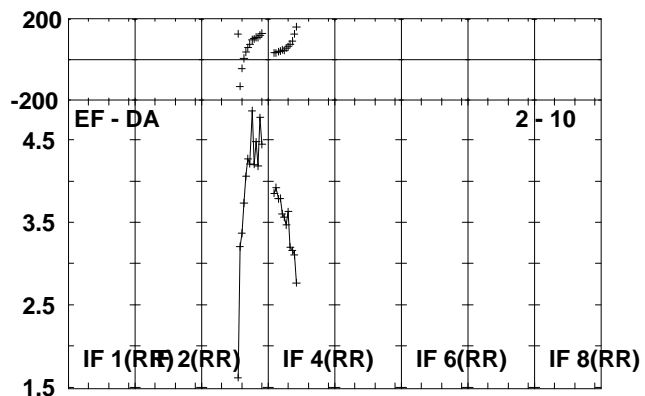
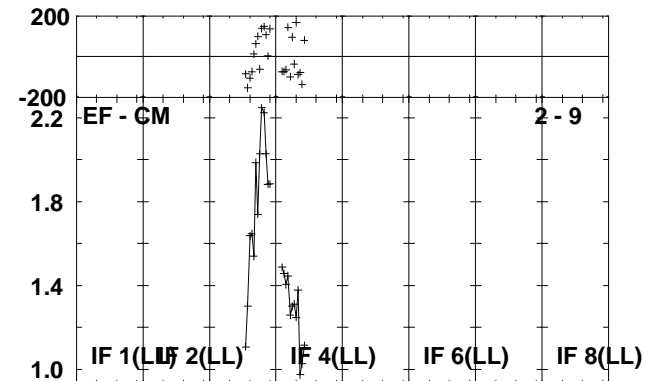
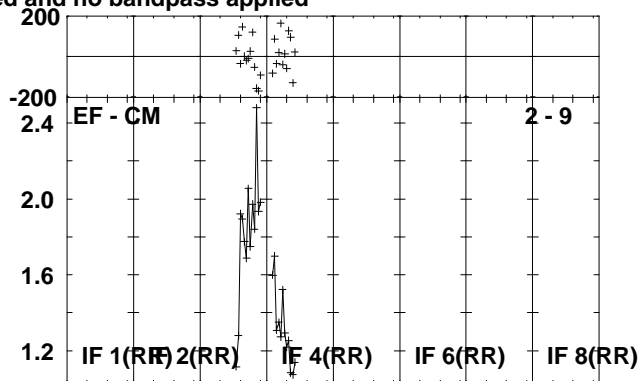
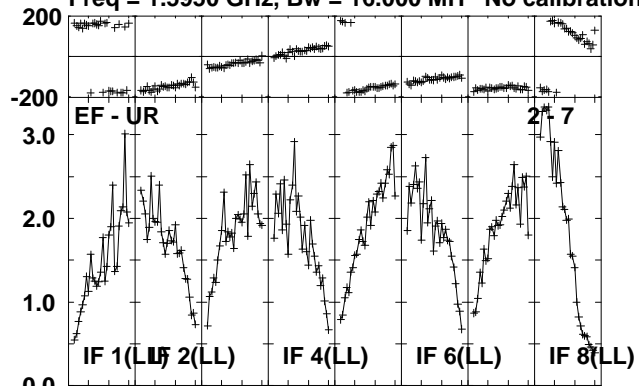

Lower frame: Milli Ampl Jy Top frame: Phas deg
Scalar averaged cross-power spectrum Several baselines displayed
Timerange: 01/01:09:31 to 01/01:10:59

Plot file version 149 created 23-AUG-2010 12:36:19

IRAS1929 EP064P.UVDATA.1

Freq = 1.5950 GHz, Bw = 16.000 MH No calibration applied and no bandpass applied

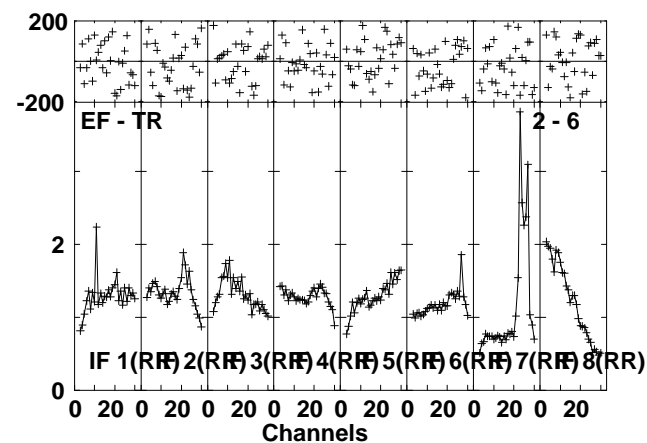
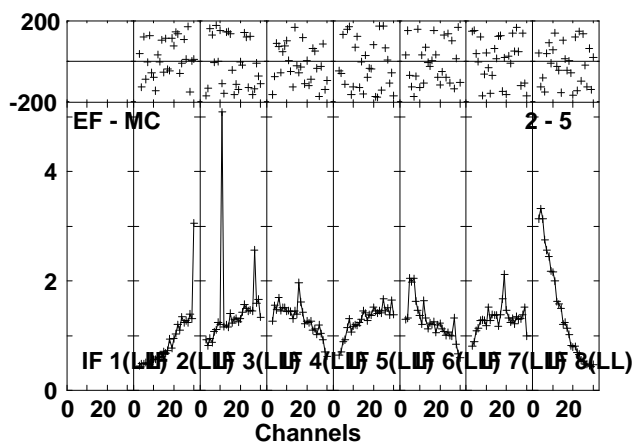
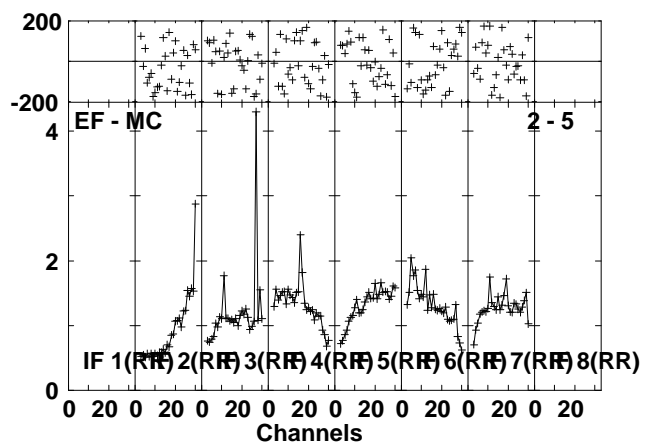
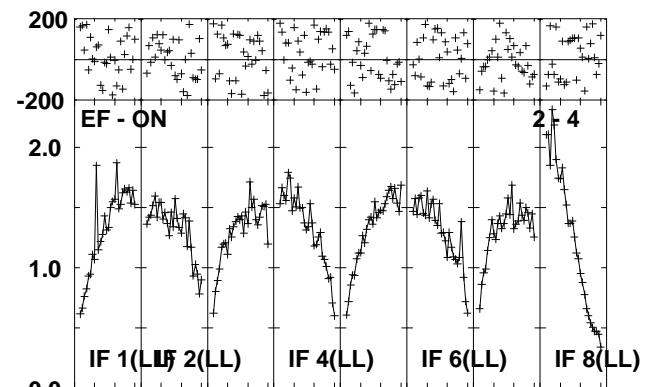
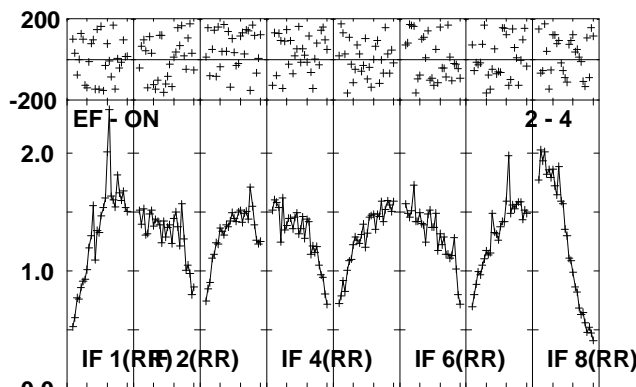
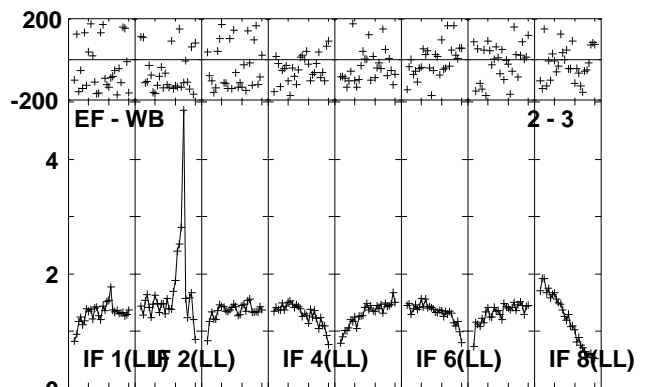
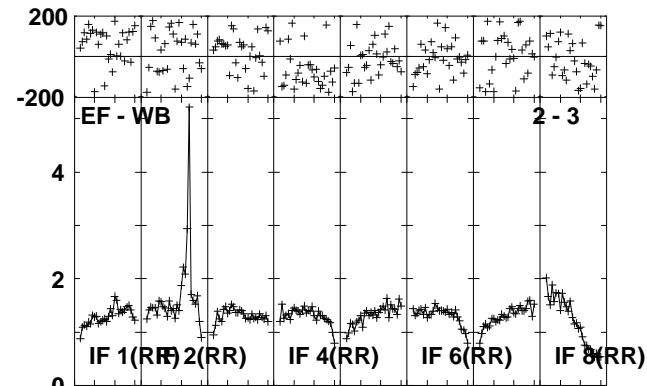
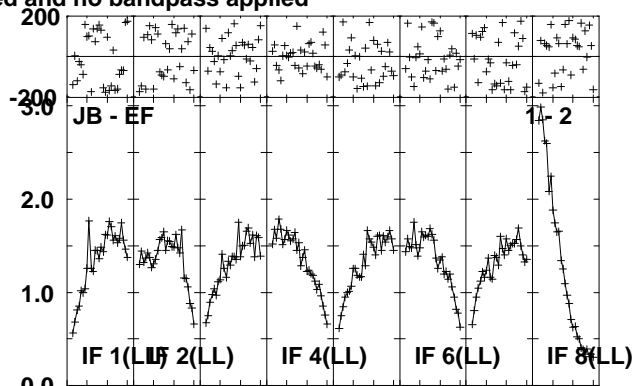
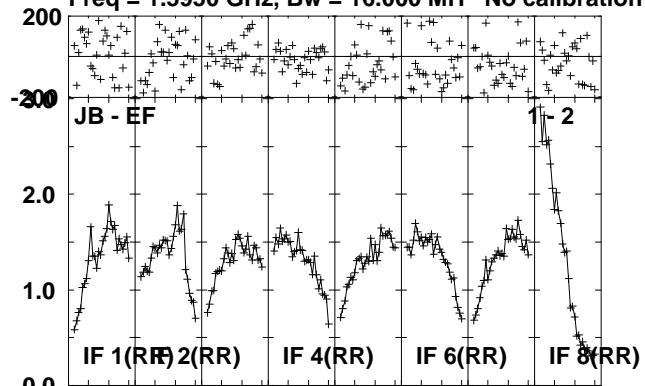

Lower frame: Milli Ampl Jy Top frame: Phas deg
Scalar averaged cross-power spectrum Several baselines displayed
Timerange: 01/01:11:01 to 01/01:14:29

Plot file version 150 created 23-AUG-2010 12:36:20

IRAS1929 EP064P.UVDATA.1

Freq = 1.5950 GHz, Bw = 16.000 MH No calibration applied and no bandpass applied

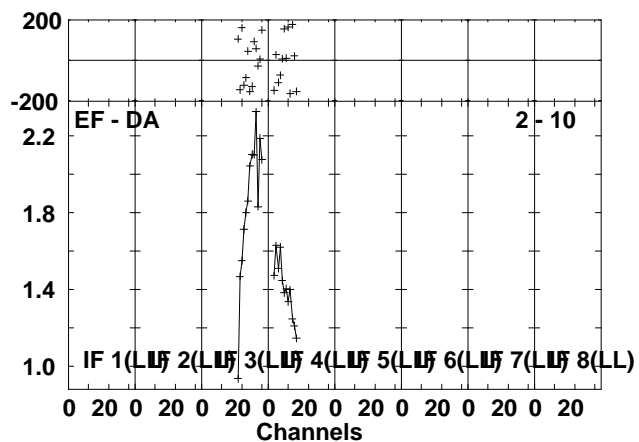
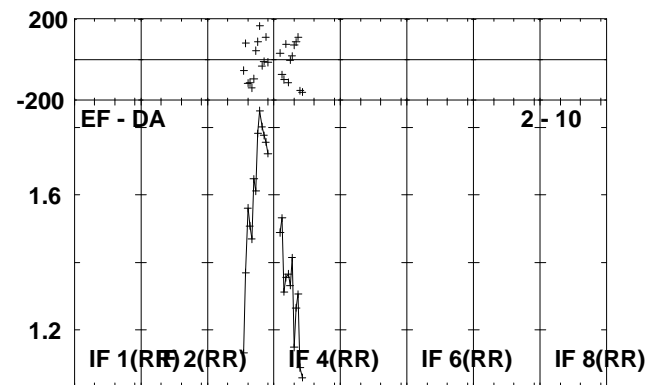
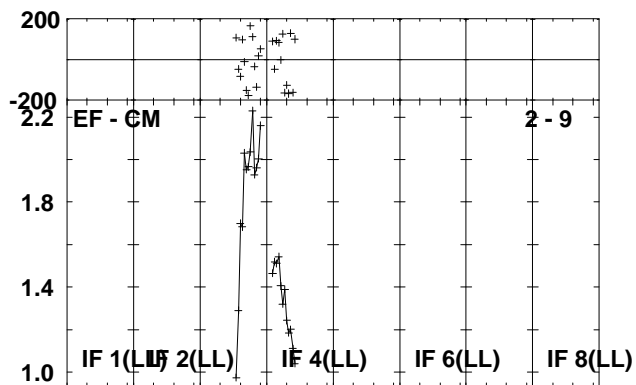
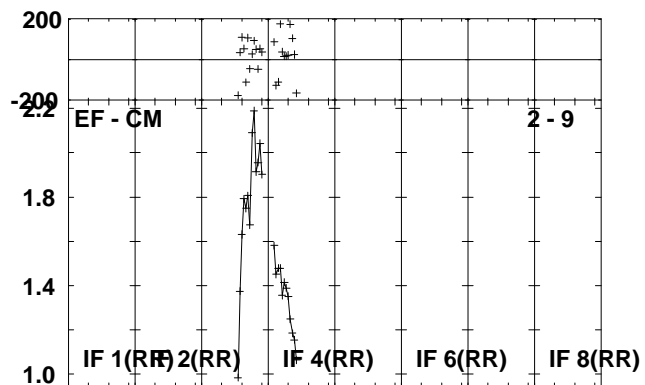
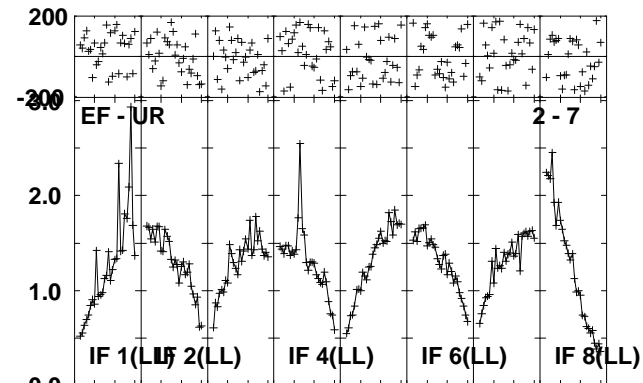
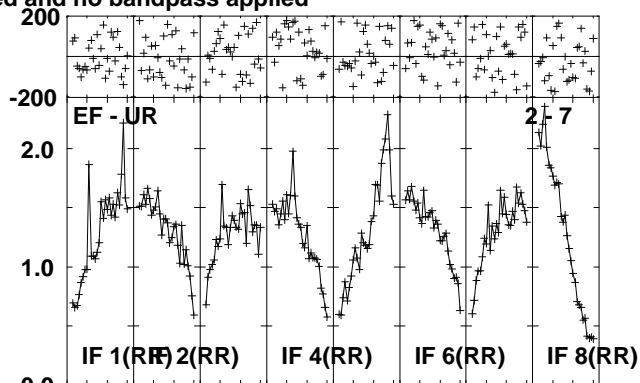
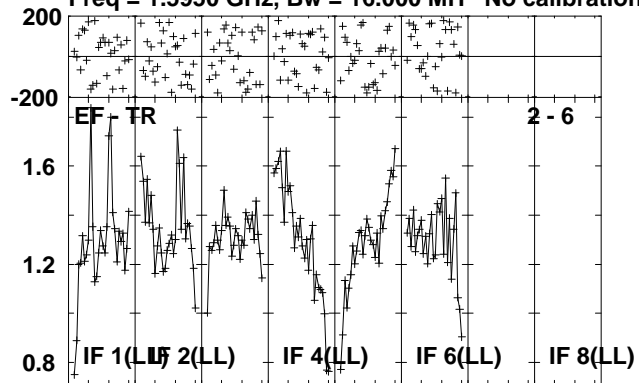

Lower frame: Milli Ampl Jy Top frame: Phas deg
Scalar averaged cross-power spectrum Several baselines displayed
Timerange: 01/01:11:01 to 01/01:14:29

Plot file version 151 created 23-AUG-2010 12:36:22

J1941-05 EP064P.UVDATA.1

Freq = 1.5950 GHz, Bw = 16.000 MH No calibration applied and no bandpass applied

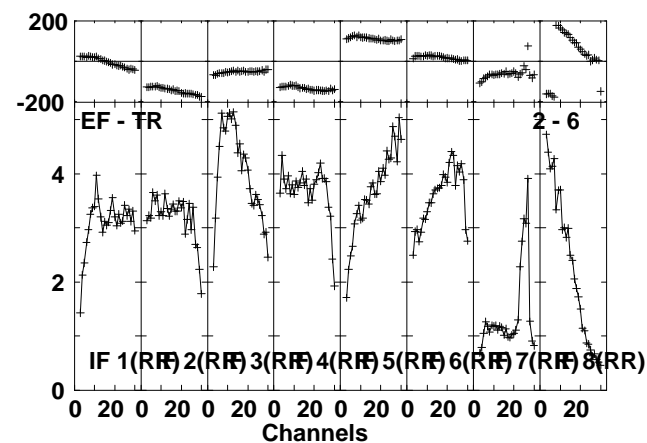
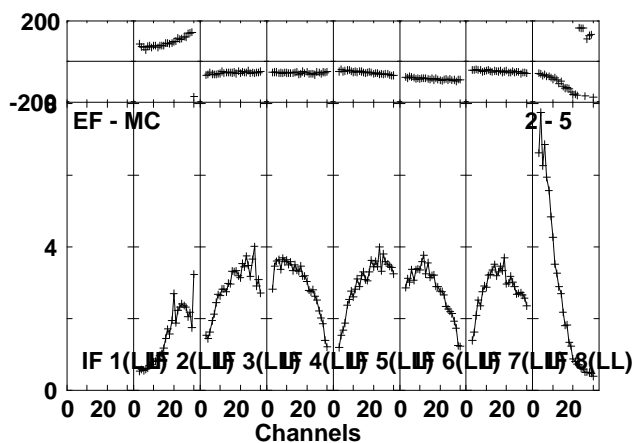
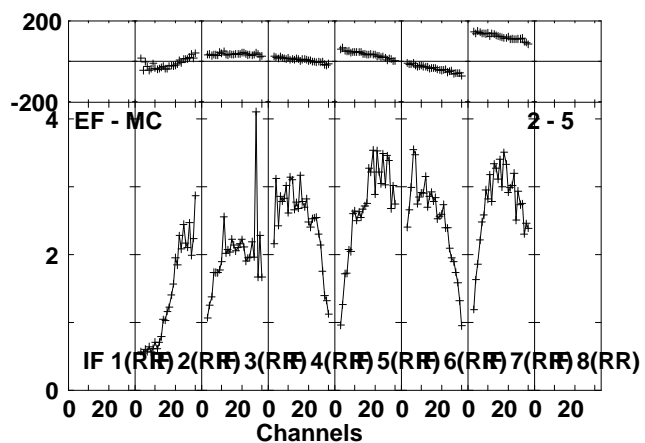
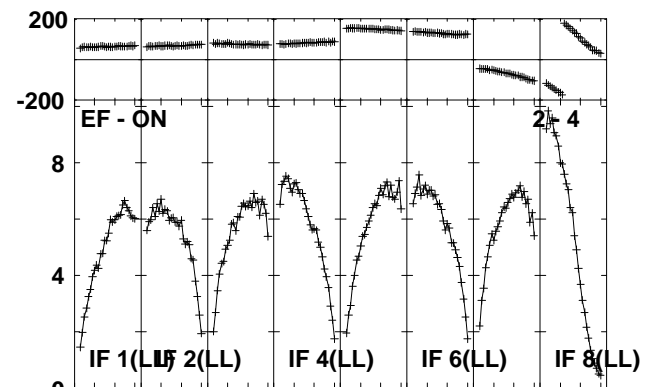
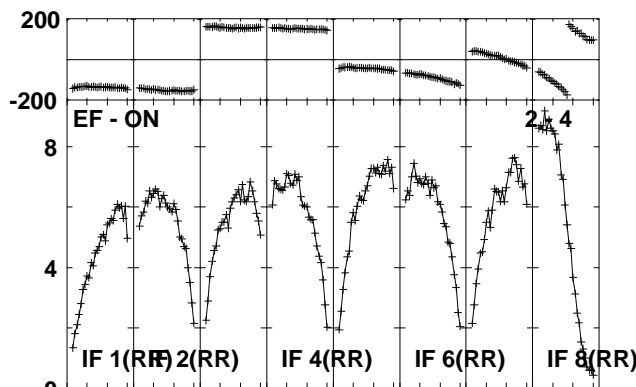
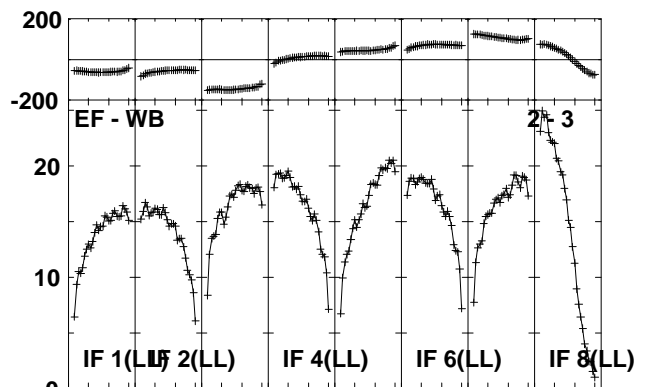
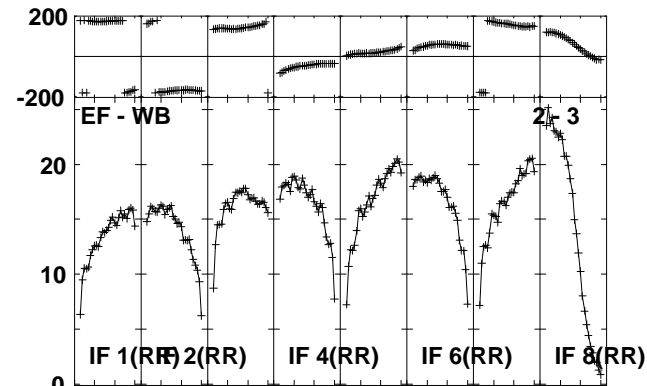
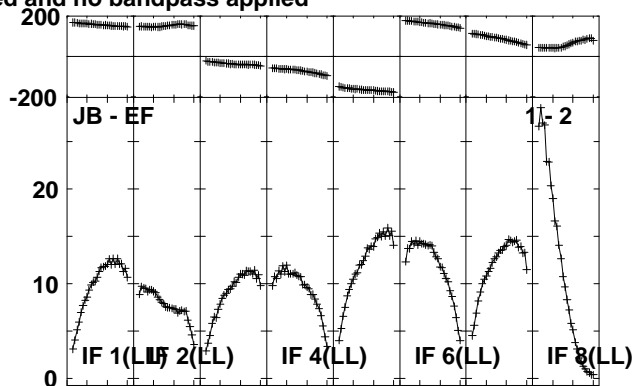
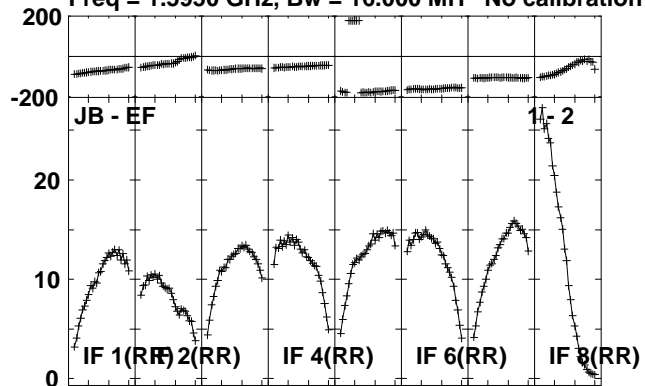

Lower frame: Milli Ampl Jy Top frame: Phas deg
Scalar averaged cross-power spectrum Several baselines displayed
Timerange: 01/01:15:31 to 01/01:16:59

Plot file version 152 created 23-AUG-2010 12:36:23

J1941-05 EP064P.UVDATA.1

Freq = 1.5950 GHz, Bw = 16.000 MH No calibration applied and no bandpass applied

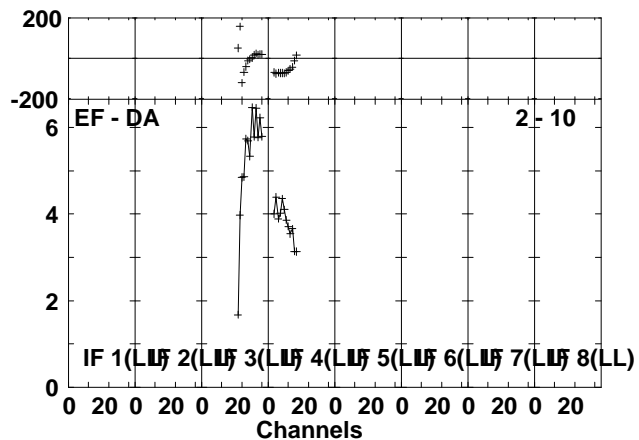
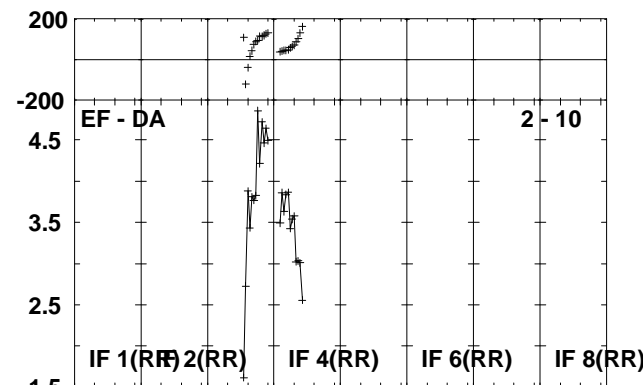
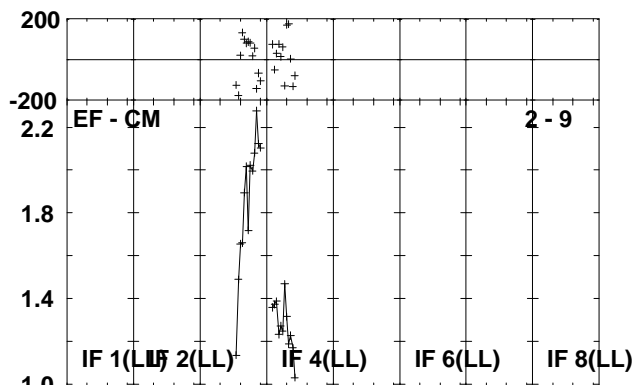
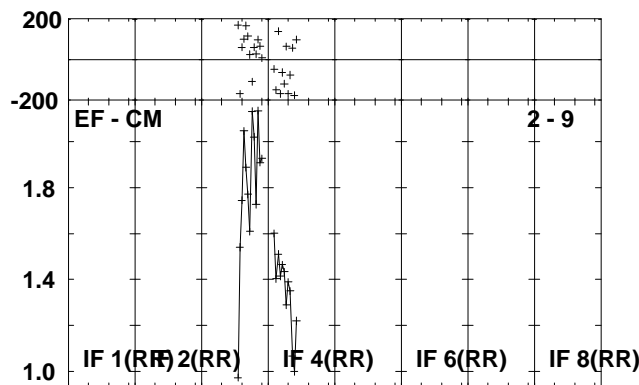
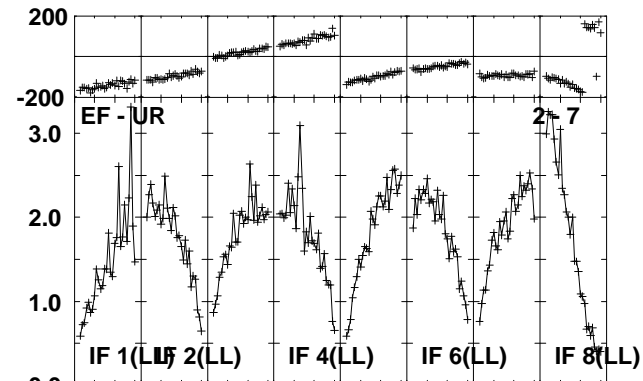
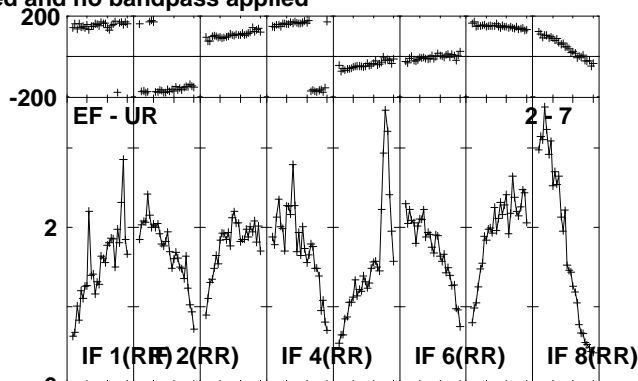
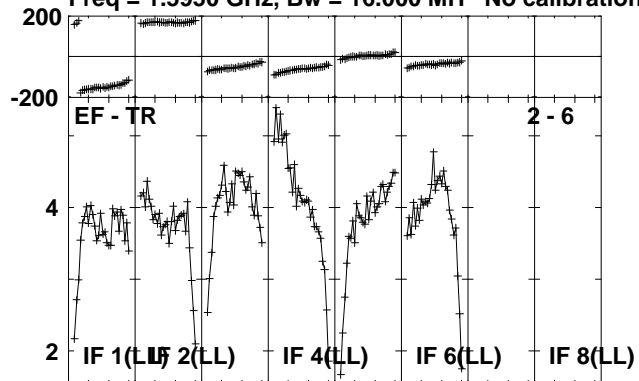

Lower frame: Milli Ampl Jy Top frame: Phas deg
Scalar averaged cross-power spectrum Several baselines displayed
Timerange: 01/01:15:31 to 01/01:16:59

Plot file version 153 created 23-AUG-2010 12:36:24

IRAS1929 EP064P.UVDATA.1

Freq = 1.5950 GHz, Bw = 16.000 MH No calibration applied and no bandpass applied

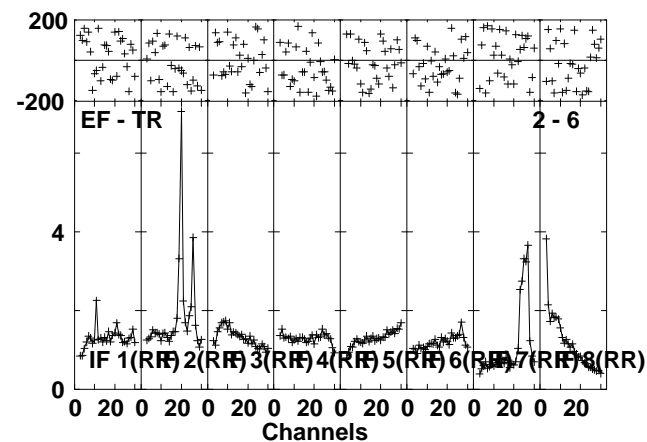
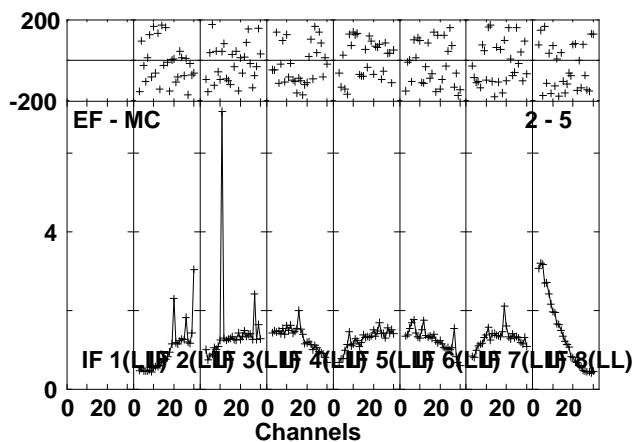
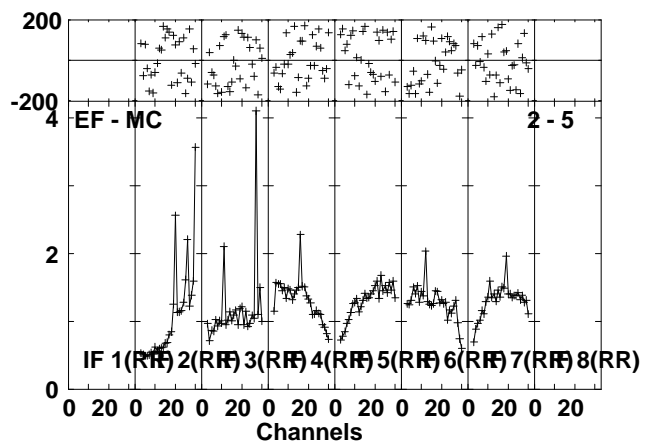
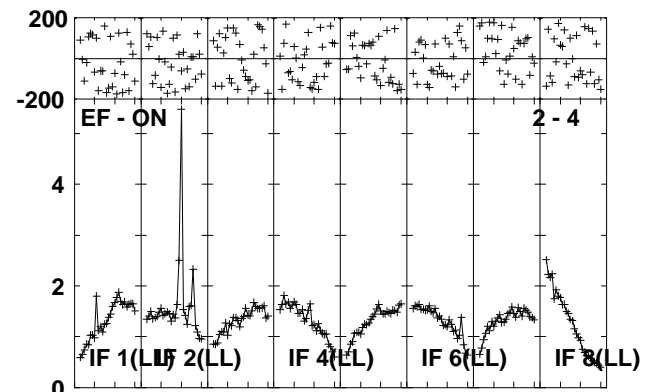
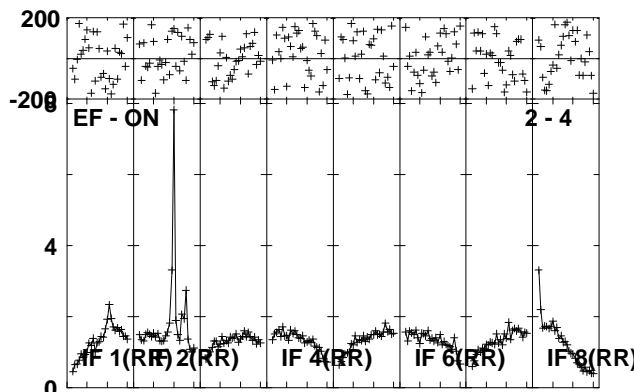
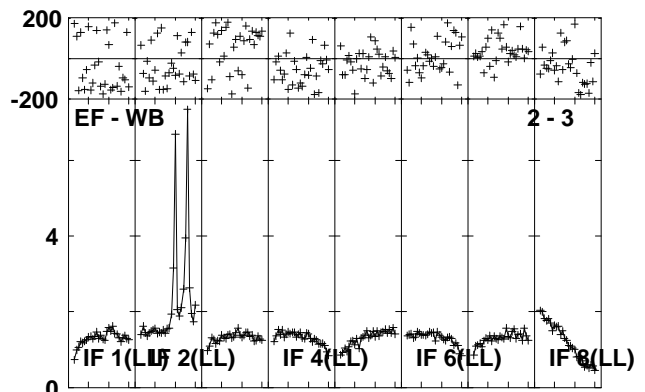
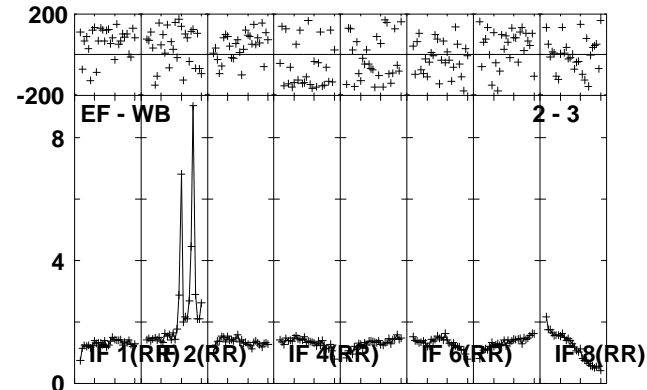
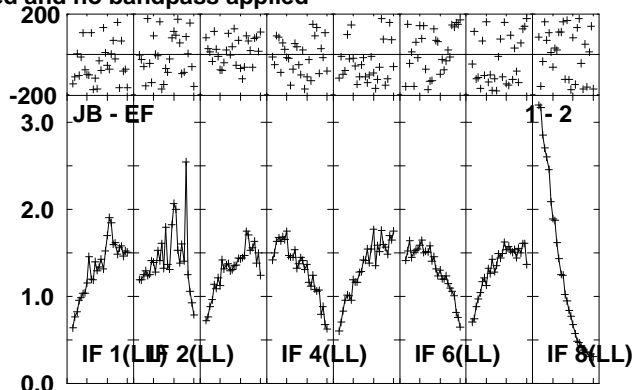
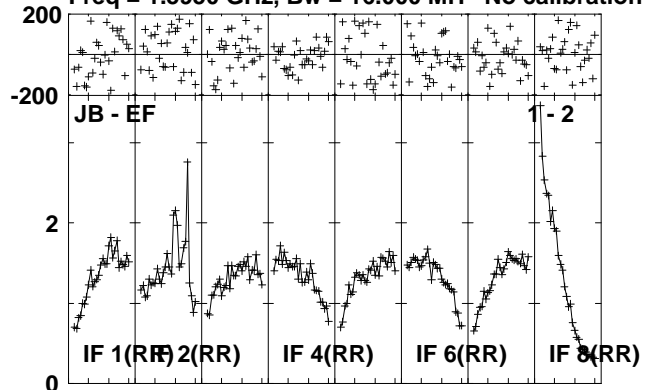

Lower frame: Milli Ampl Jy Top frame: Phas deg
Scalar averaged cross-power spectrum Several baselines displayed
Timerange: 01/01:17:01 to 01/01:20:29

Plot file version 154 created 23-AUG-2010 12:36:26

IRAS1929 EP064P.UVDATA.1

Freq = 1.5950 GHz, Bw = 16.000 MH No calibration applied and no bandpass applied

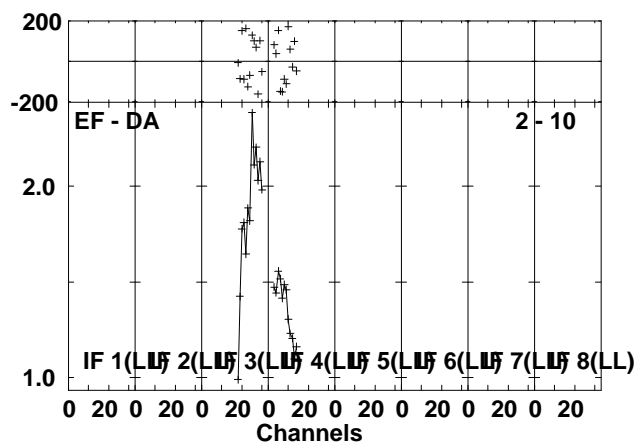
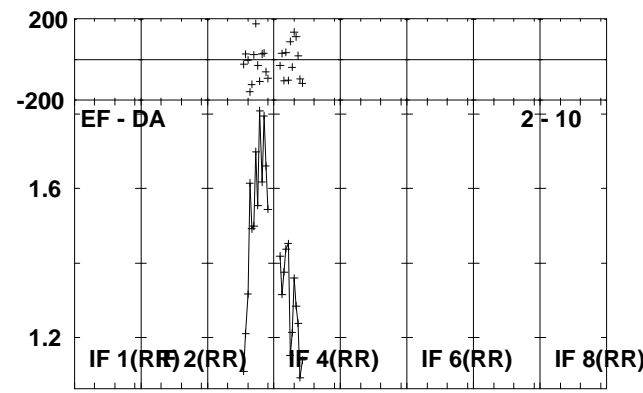
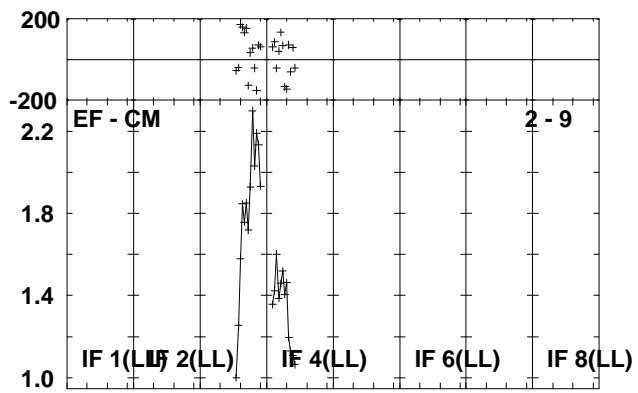
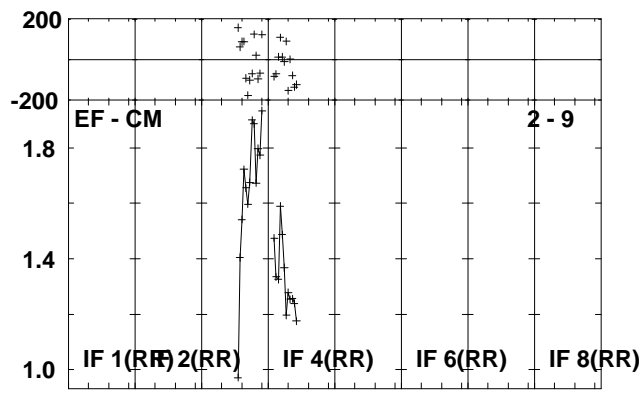
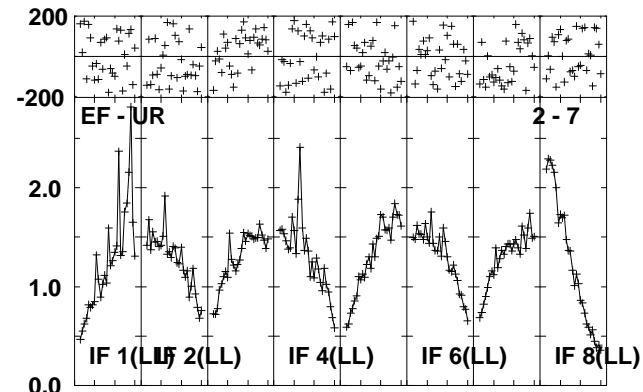
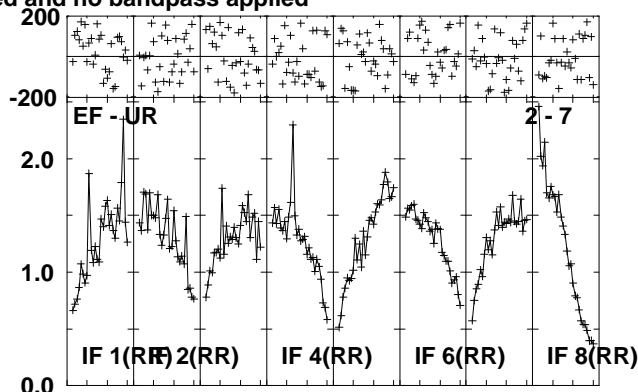
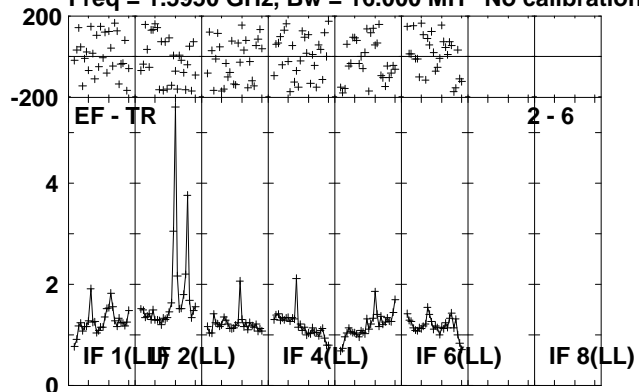

Lower frame: Milli Ampl Jy Top frame: Phas deg
Scalar averaged cross-power spectrum Several baselines displayed
Timerange: 01/01:17:01 to 01/01:20:29

Plot file version 155 created 23-AUG-2010 12:36:27

J1941-05 EP064P.UVDATA.1

Freq = 1.5950 GHz, Bw = 16.000 MH No calibration applied and no bandpass applied

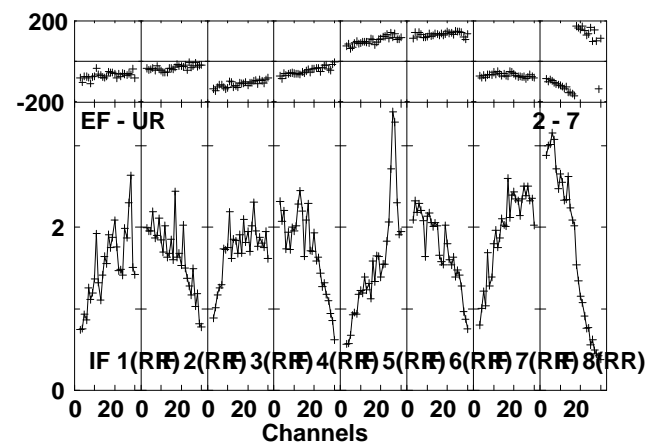
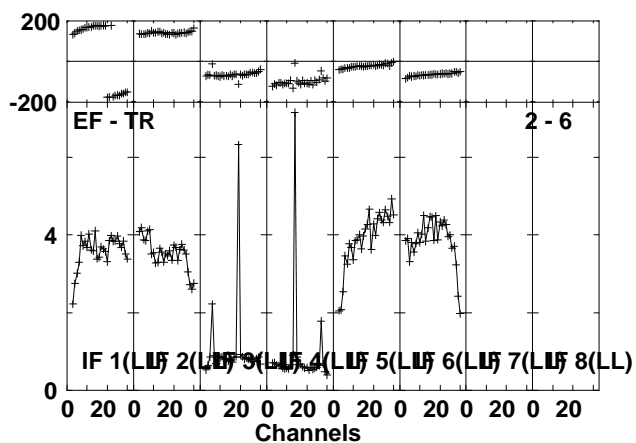
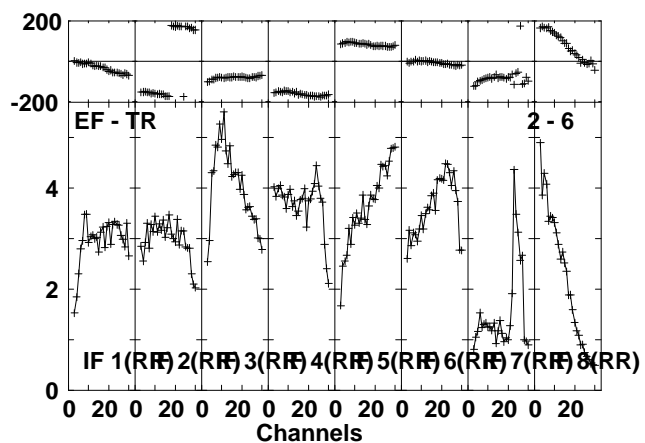
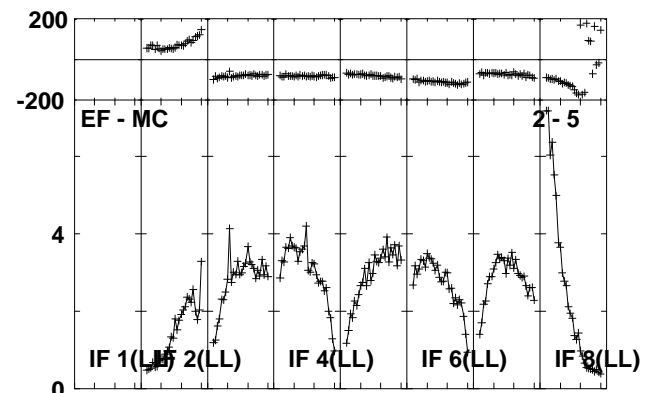
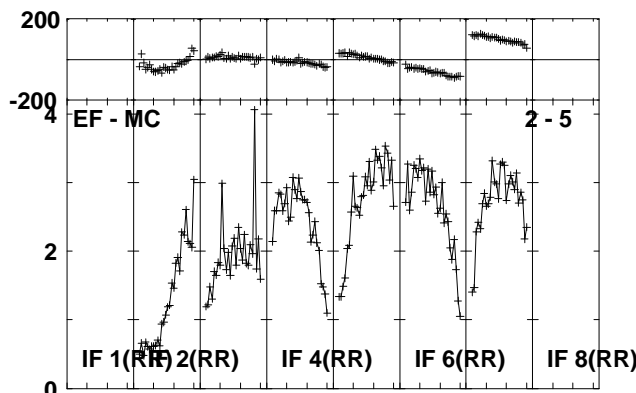
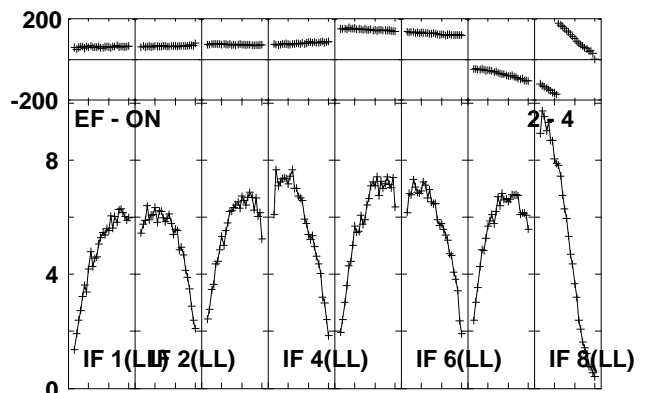
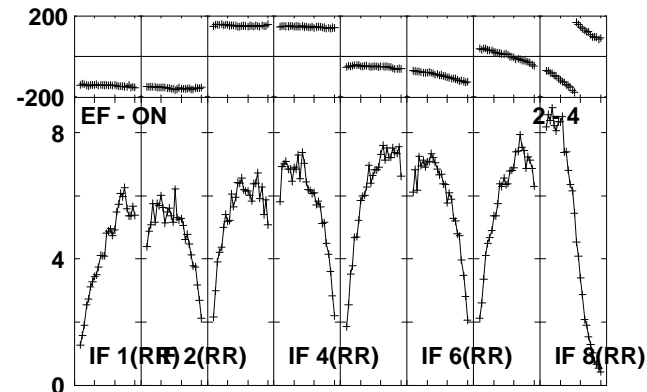
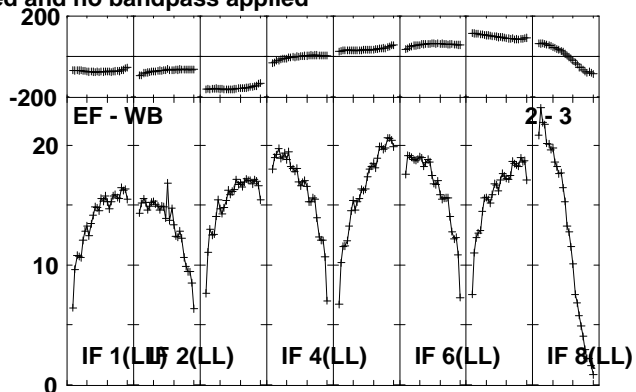
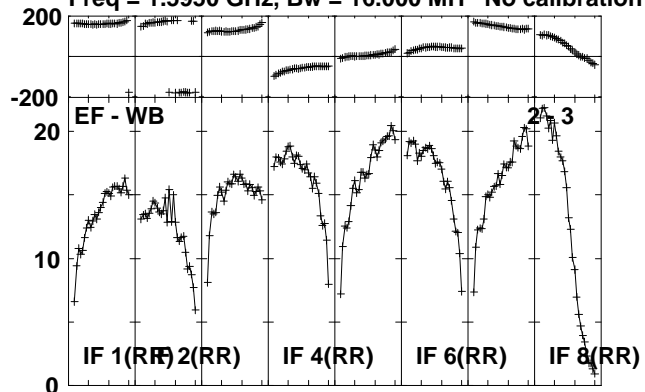

Lower frame: Milli Ampl Jy Top frame: Phas deg
Scalar averaged cross-power spectrum Several baselines displayed
Timerange: 01/01:20:31 to 01/01:21:59

Plot file version 156 created 23-AUG-2010 12:36:28
J1941-05 EP064P.UVDATA.1

Freq = 1.5950 GHz, Bw = 16.000 MH No calibration applied and no bandpass applied

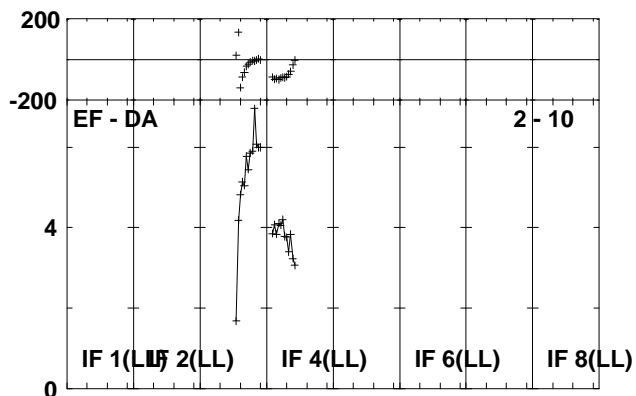
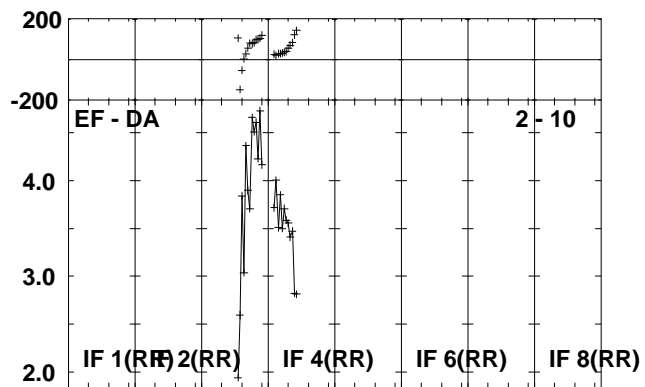
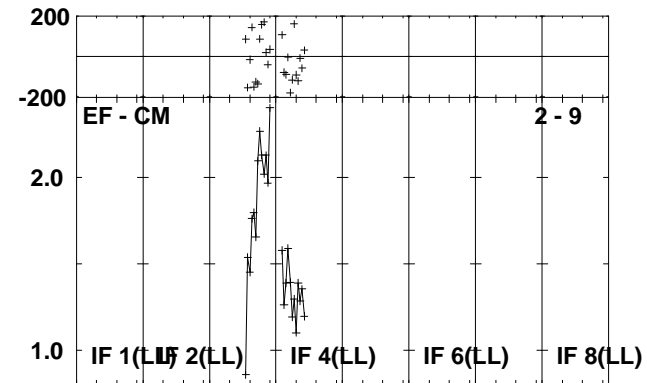
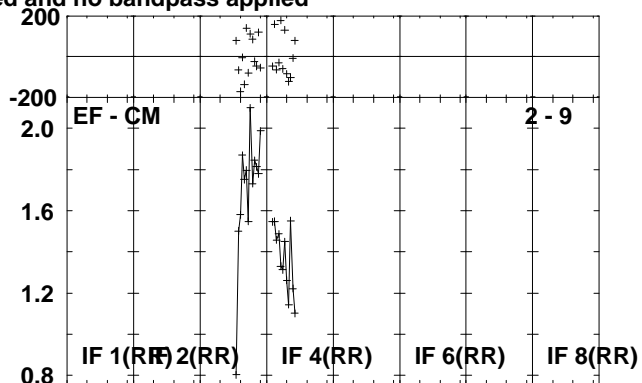
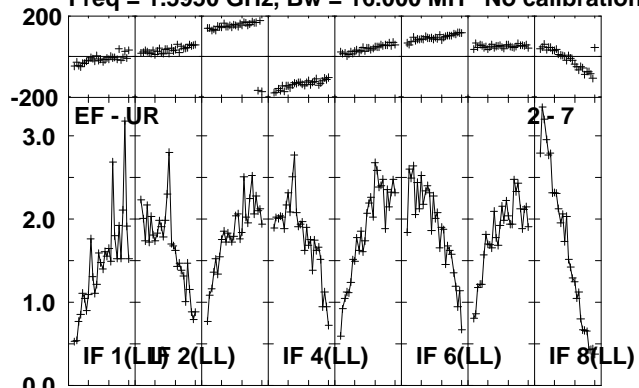

Lower frame: Milli Ampl Jy Top frame: Phas deg
Scalar averaged cross-power spectrum Several baselines displayed
Timerange: 01/01:20:31 to 01/01:21:59

Plot file version 157 created 23-AUG-2010 12:36:29

IRAS1929 EP064P.UVDATA.1

Freq = 1.5950 GHz, Bw = 16.000 MH No calibration applied and no bandpass applied

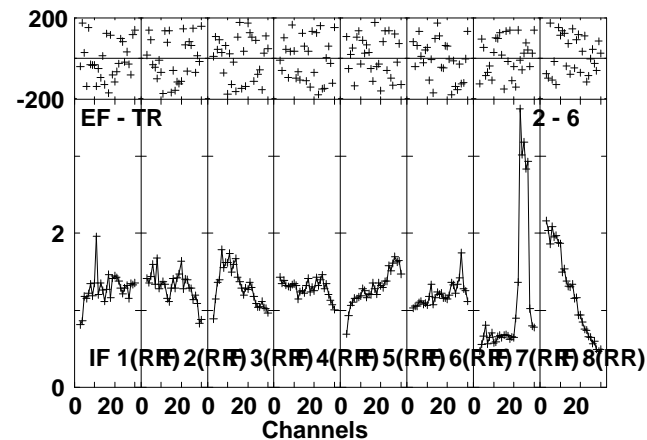
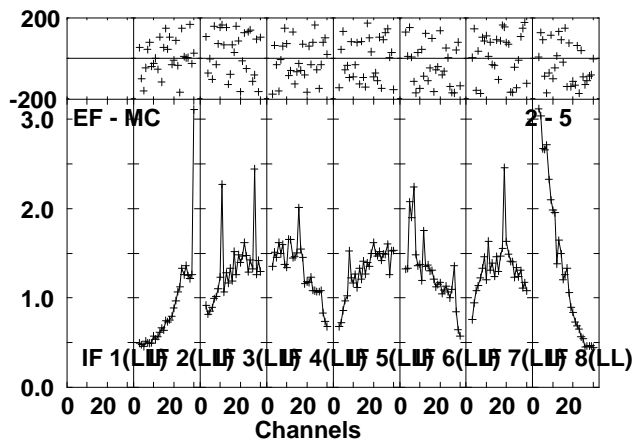
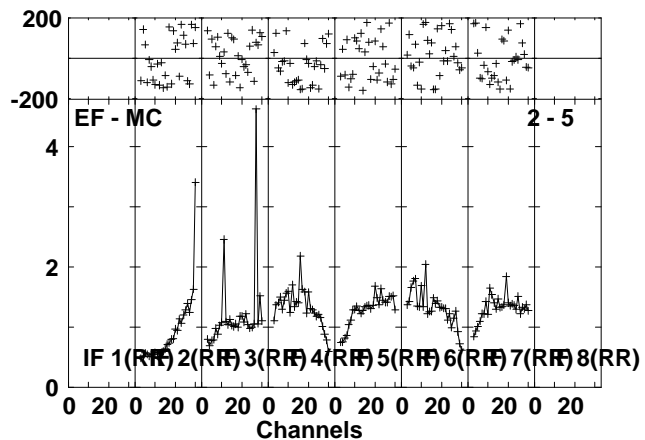
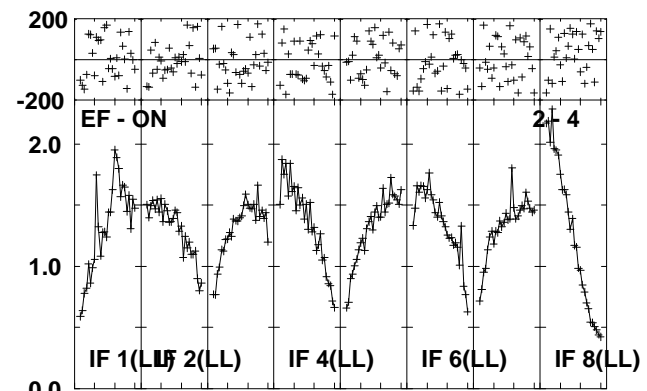
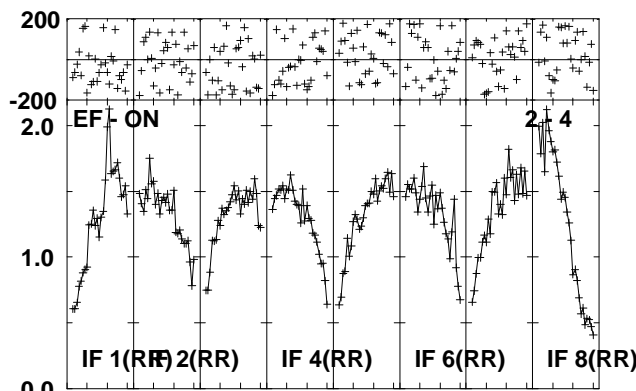
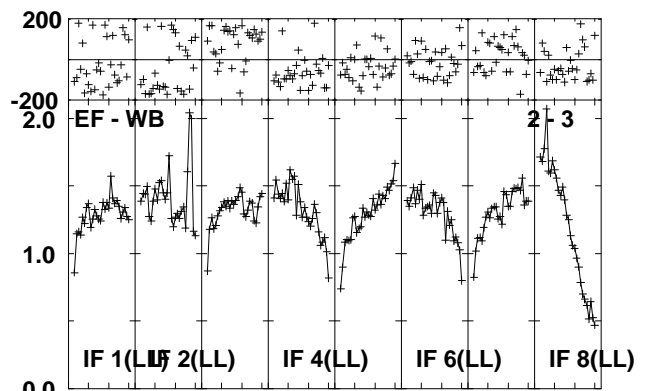
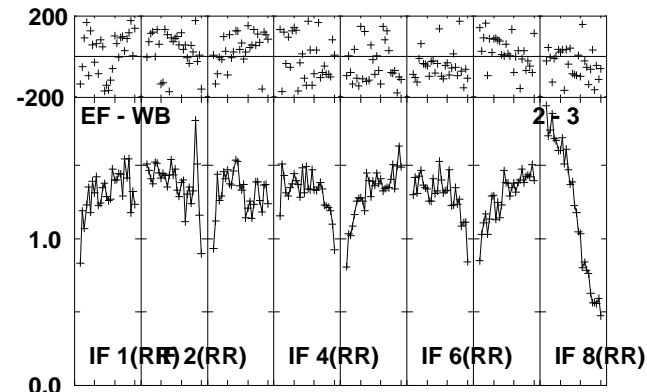
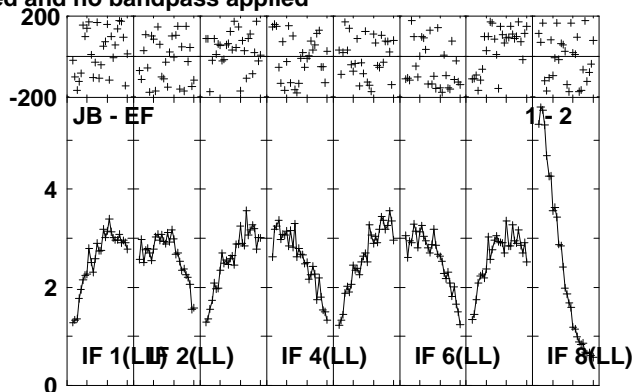
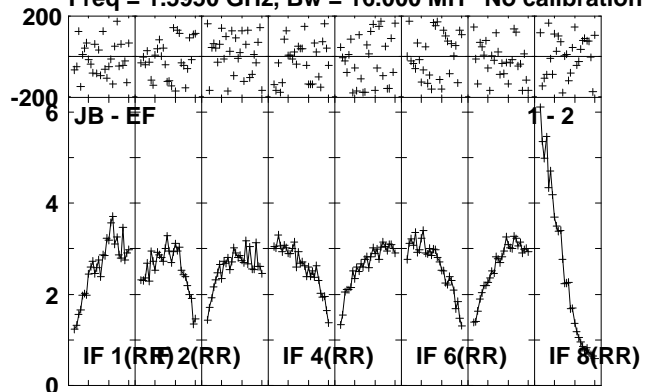

Lower frame: Milli Ampl Jy Top frame: Phas deg
Scalar averaged cross-power spectrum Several baselines displayed
Timerange: 01/01:22:01 to 01/01:25:29

Plot file version 158 created 23-AUG-2010 12:36:30

IRAS1929 EP064P.UVDATA.1

Freq = 1.5950 GHz, Bw = 16.000 MH No calibration applied and no bandpass applied

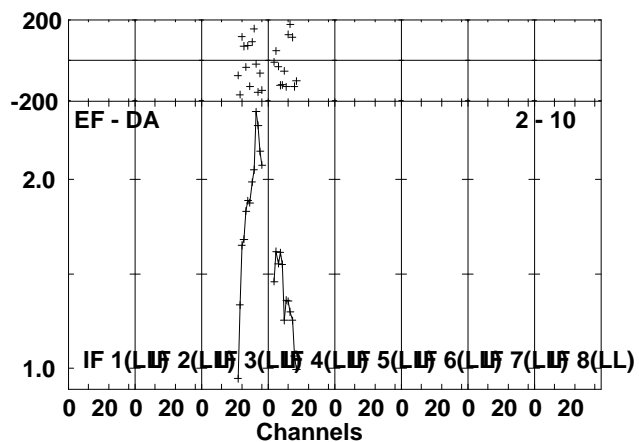
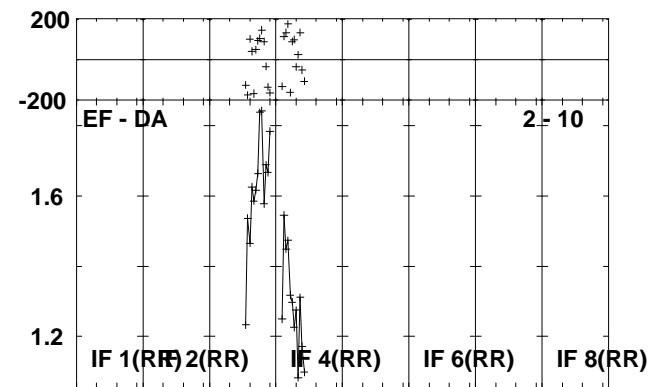
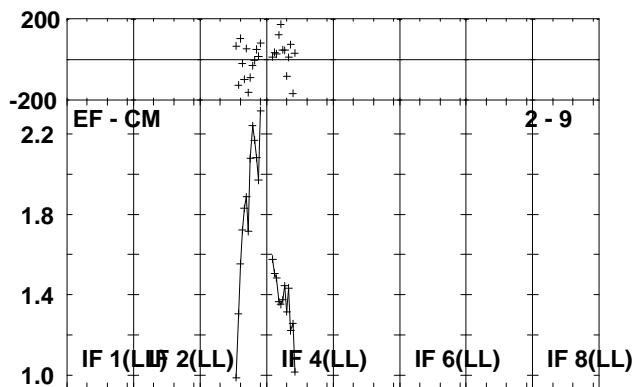
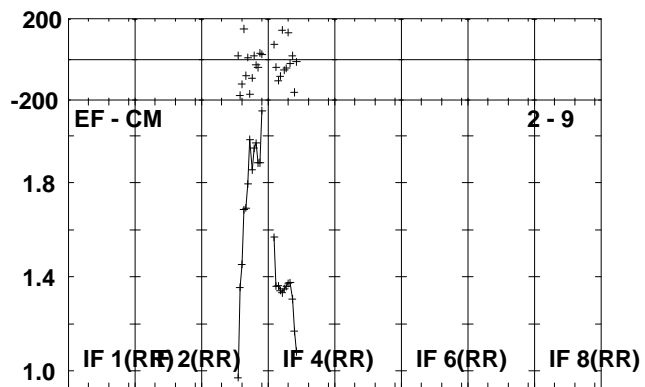
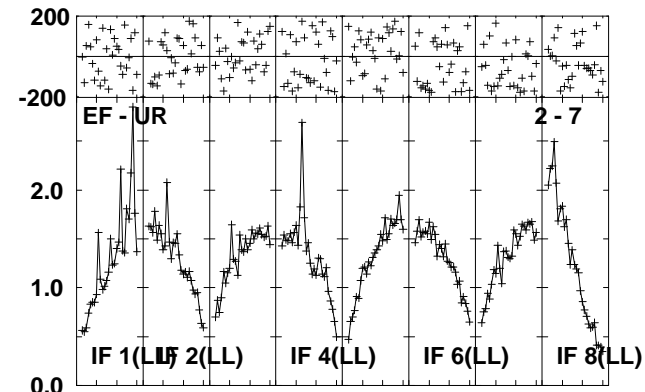
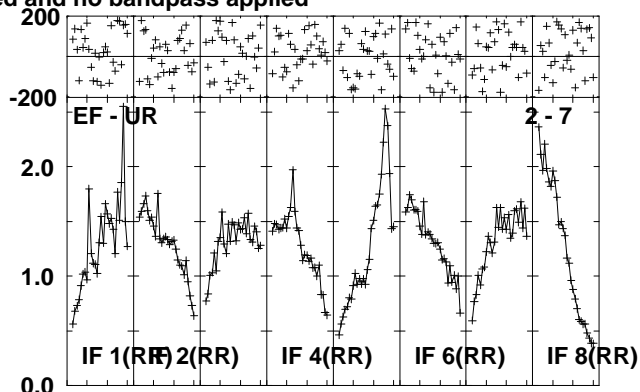
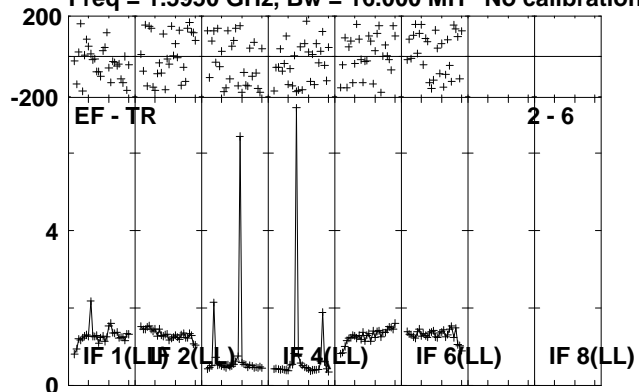

Lower frame: Milli Ampl Jy Top frame: Phas deg
Scalar averaged cross-power spectrum Several baselines displayed
Timerange: 01/01:22:01 to 01/01:25:29

Plot file version 159 created 23-AUG-2010 12:36:32

J1941-05 EP064P.UVDATA.1

Freq = 1.5950 GHz, Bw = 16.000 MH No calibration applied and no bandpass applied

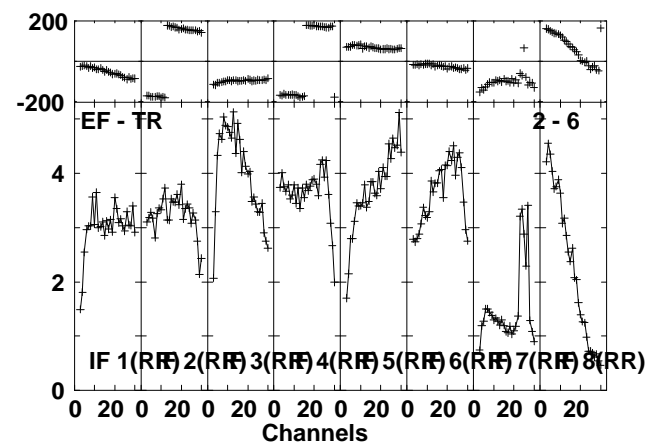
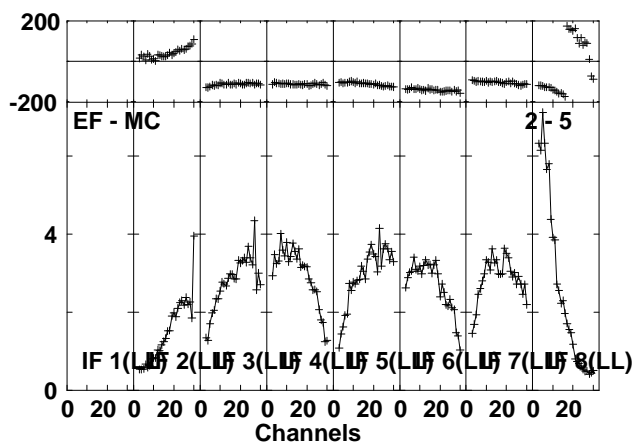
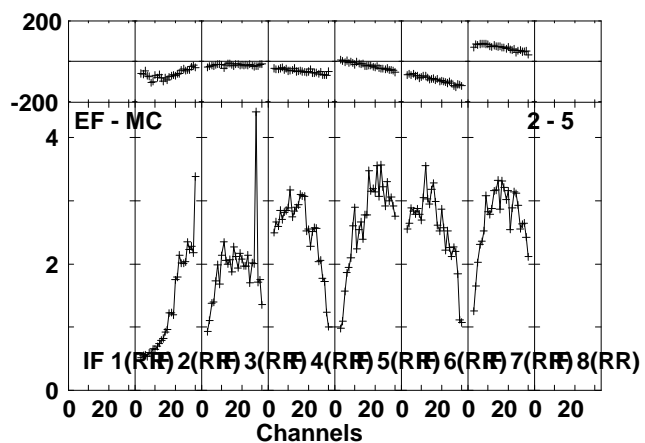
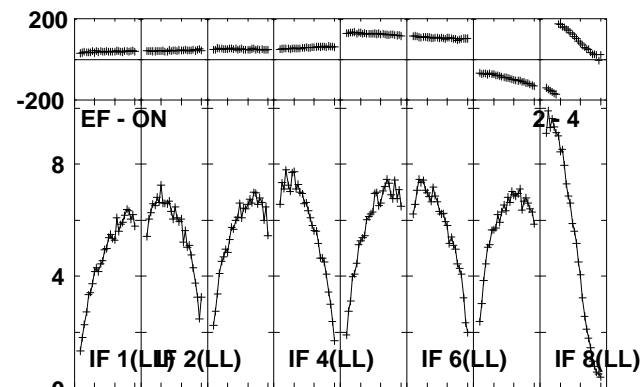
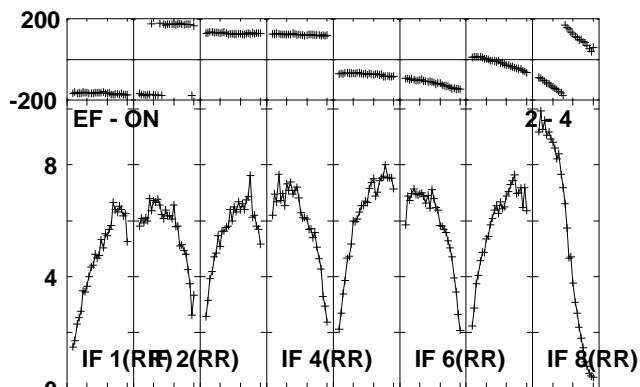
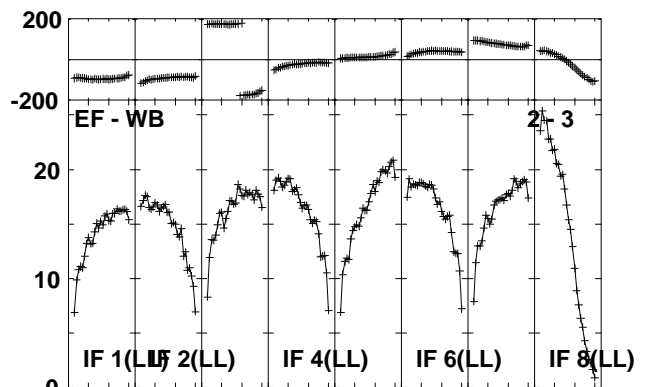
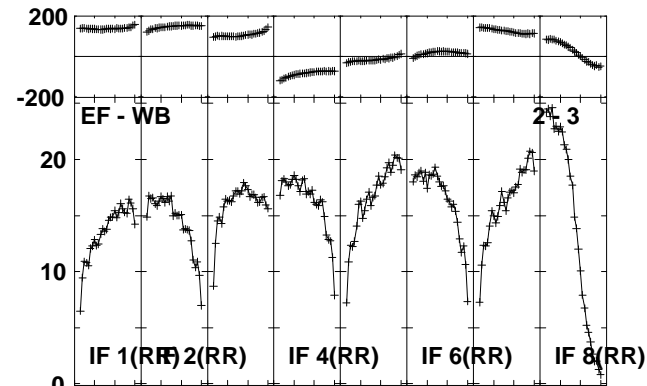
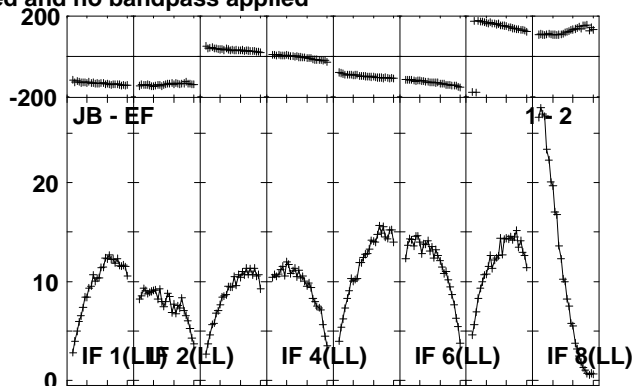
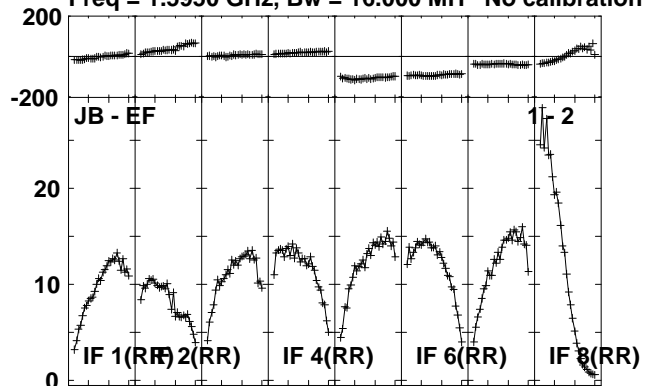

Lower frame: Milli Ampl Jy Top frame: Phas deg
Scalar averaged cross-power spectrum Several baselines displayed
Timerange: 01/01:25:31 to 01/01:26:59

Plot file version 160 created 23-AUG-2010 12:36:32

J1941-05 EP064P.UVDATA.1

Freq = 1.5950 GHz, Bw = 16.000 MH No calibration applied and no bandpass applied

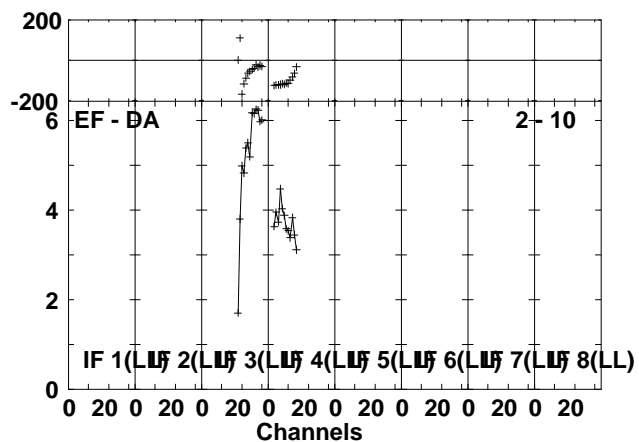
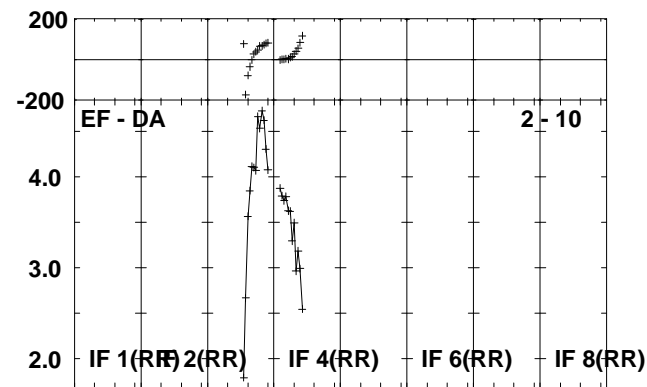
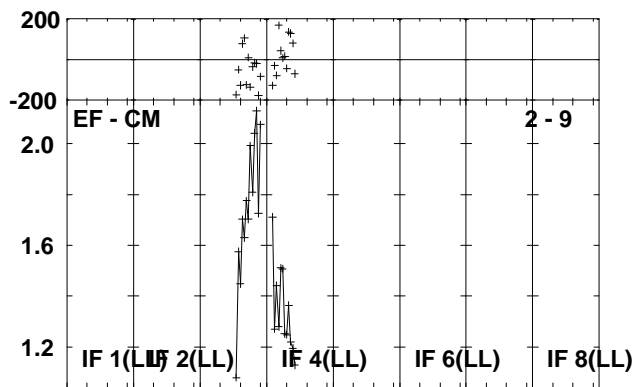
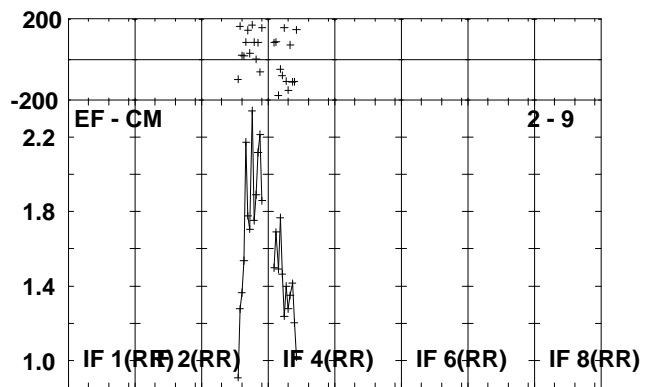
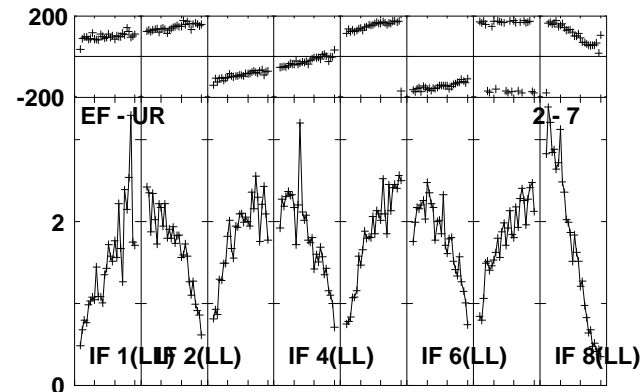
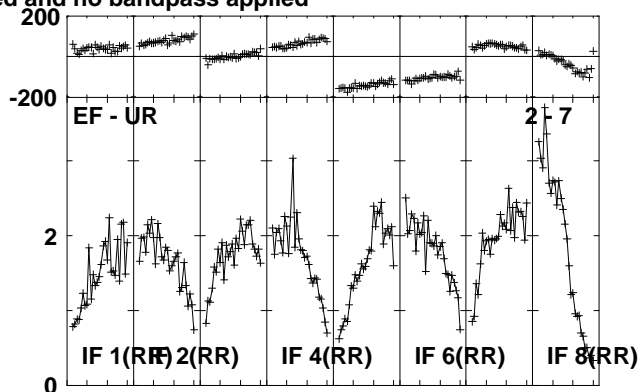
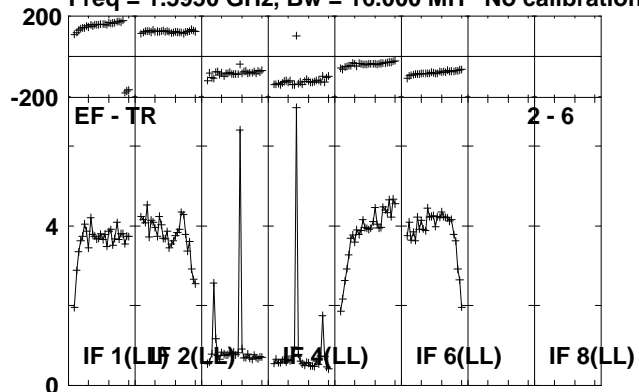

Lower frame: Milli Ampl Jy Top frame: Phas deg
Scalar averaged cross-power spectrum Several baselines displayed
Timerange: 01/01:25:31 to 01/01:26:59

Plot file version 161 created 23-AUG-2010 12:36:34

IRAS1929 EP064P.UVDATA.1

Freq = 1.5950 GHz, Bw = 16.000 MH No calibration applied and no bandpass applied

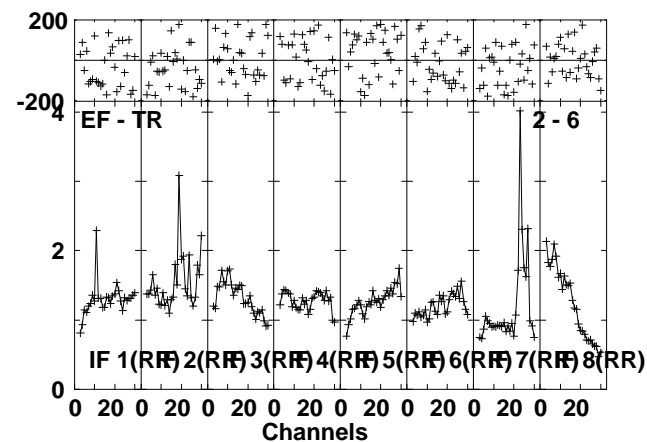
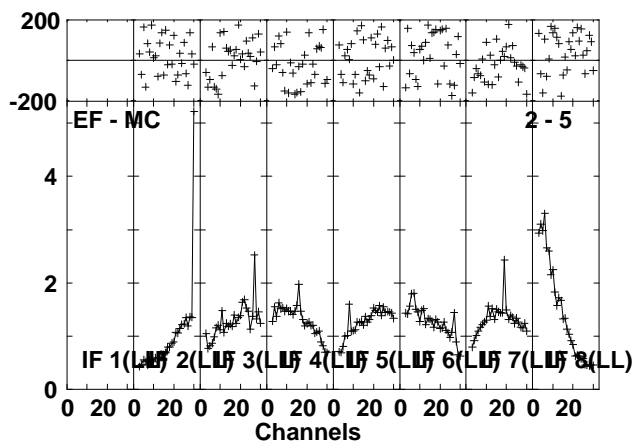
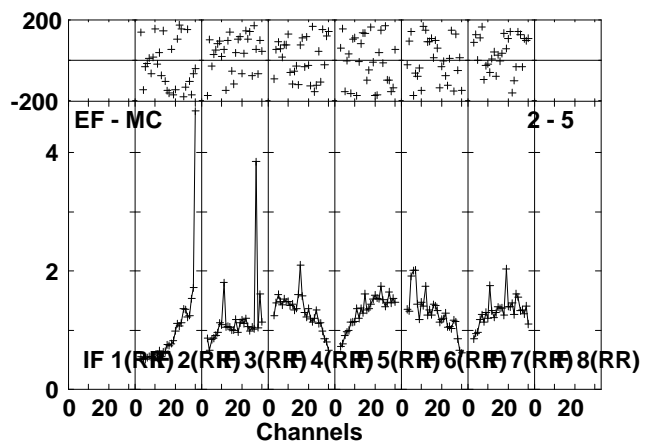
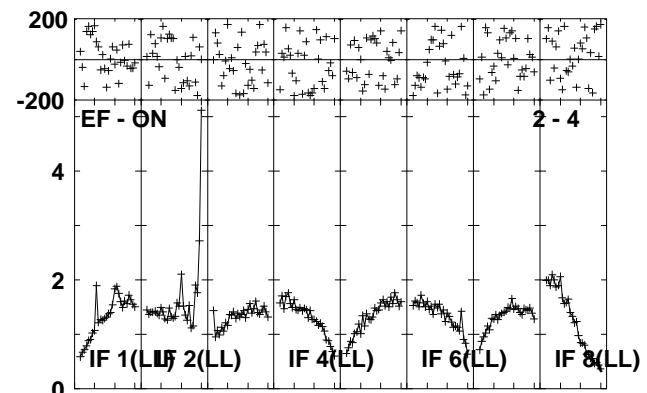
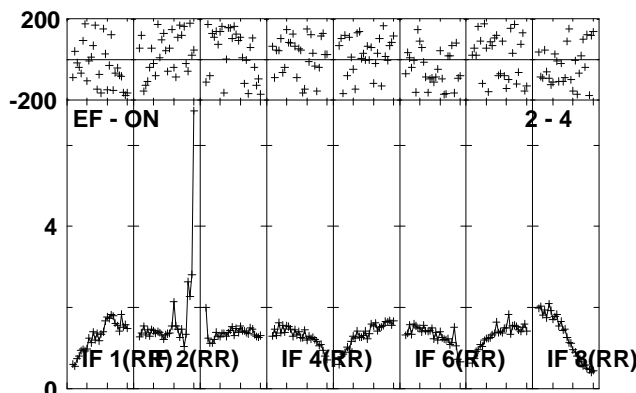
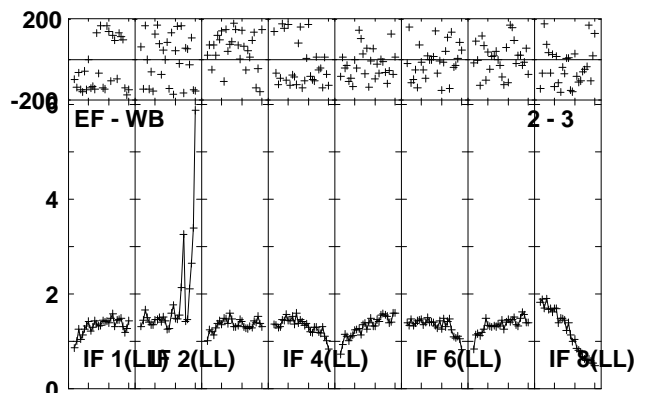
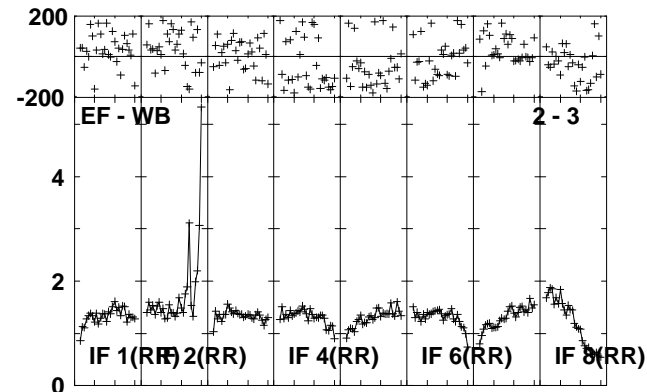
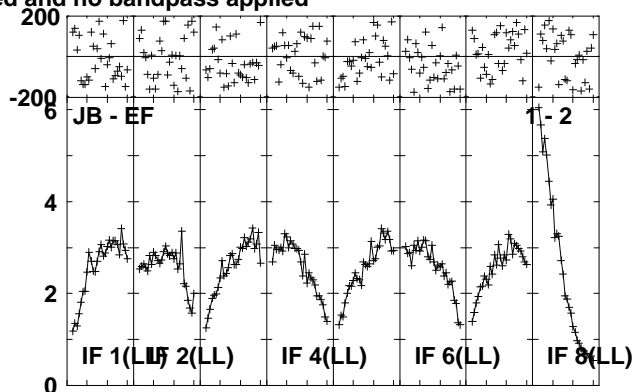
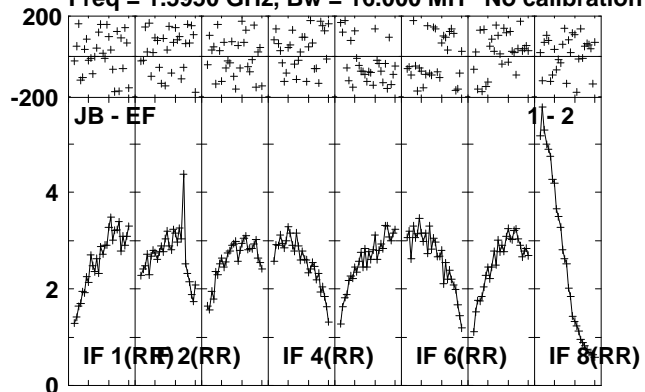

Lower frame: Milli Ampl Jy Top frame: Phas deg
Scalar averaged cross-power spectrum Several baselines displayed
Timerange: 01/01:27:01 to 01/01:30:29

Plot file version 162 created 23-AUG-2010 12:36:35

IRAS1929 EP064P.UVDATA.1

Freq = 1.5950 GHz, Bw = 16.000 MH No calibration applied and no bandpass applied

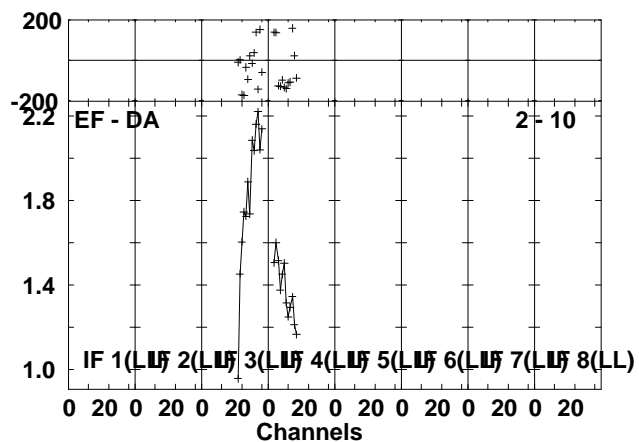
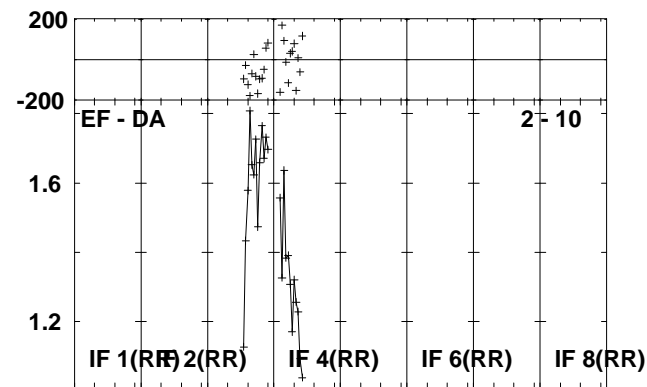
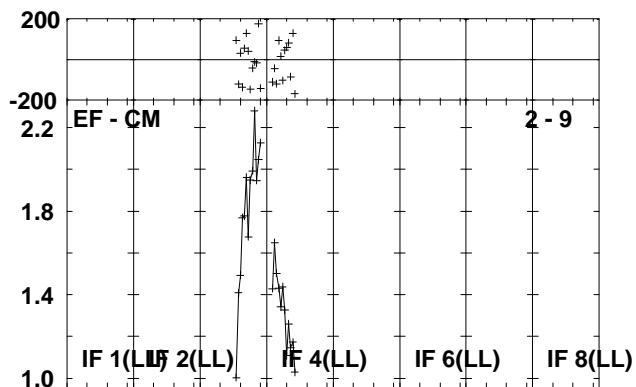
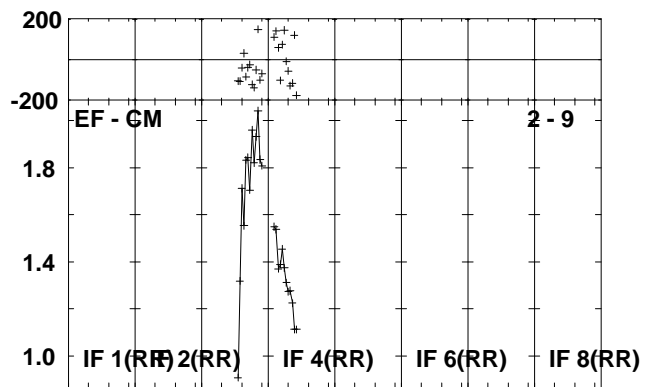
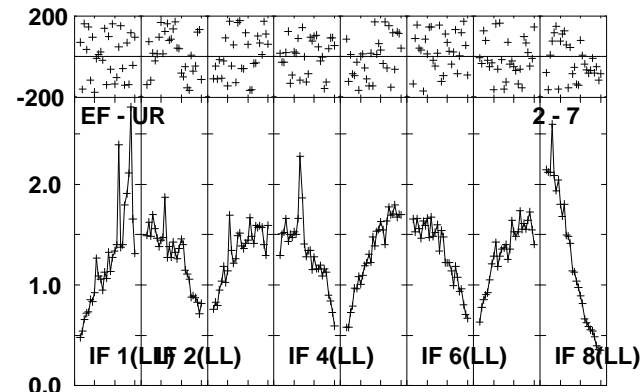
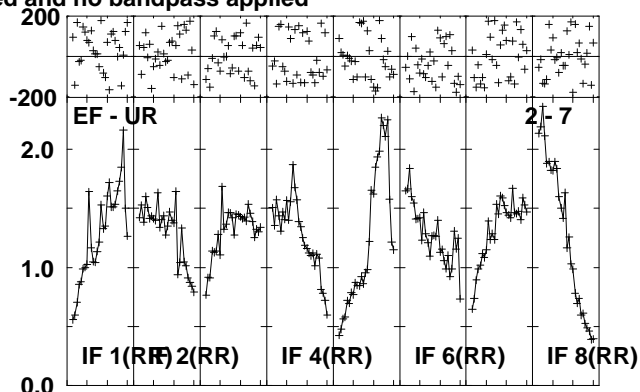
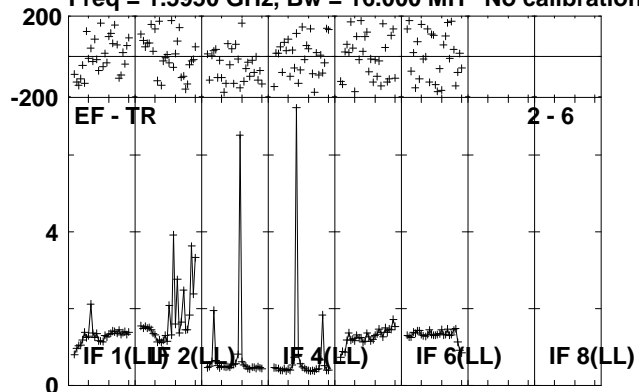

Lower frame: Milli Ampl Jy Top frame: Phas deg
Scalar averaged cross-power spectrum Several baselines displayed
Timerange: 01/01:27:01 to 01/01:30:29

Plot file version 163 created 23-AUG-2010 12:36:37

J1941-05 EP064P.UVDATA.1

Freq = 1.5950 GHz, Bw = 16.000 MH No calibration applied and no bandpass applied

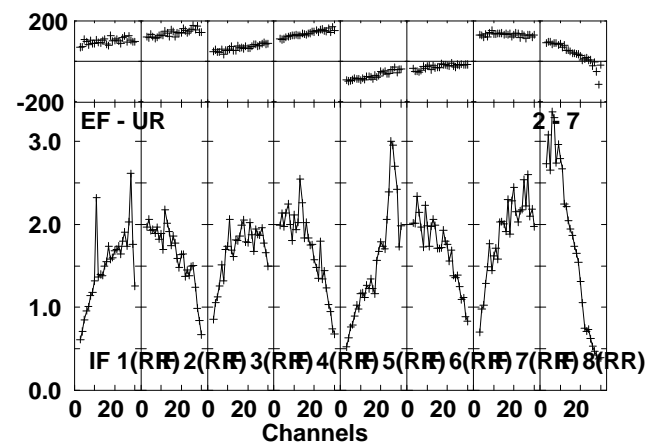
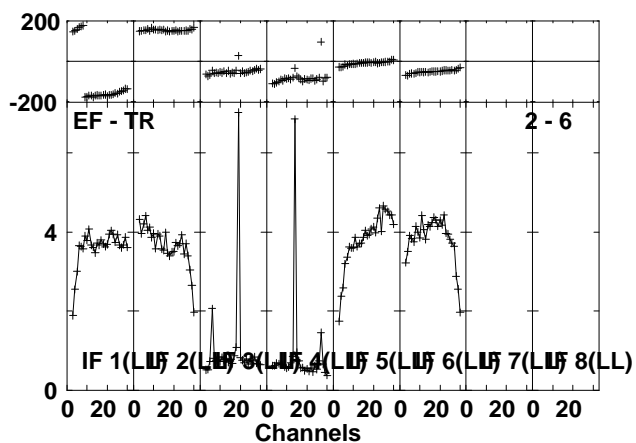
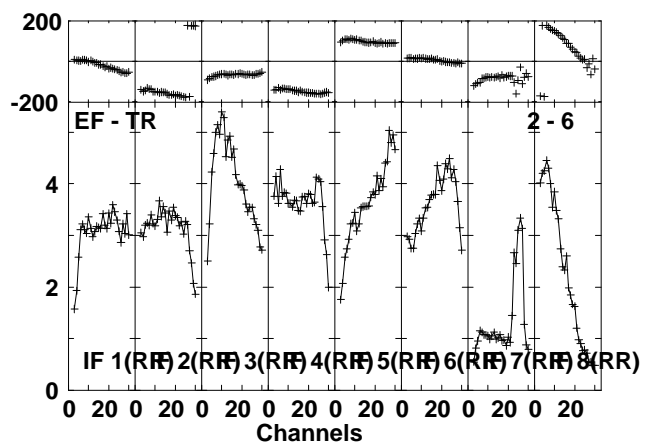
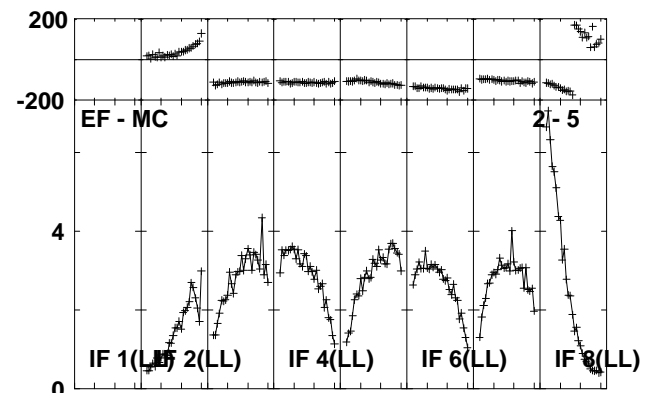
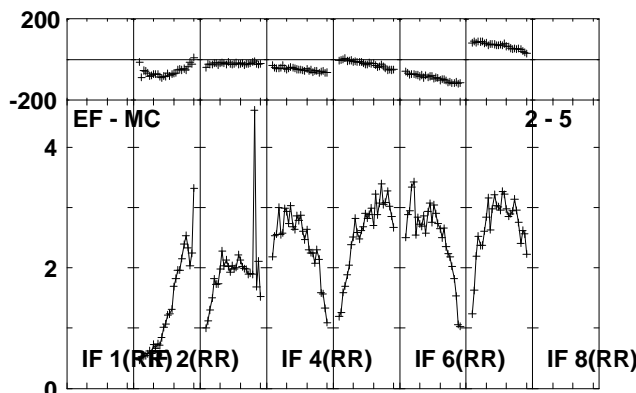
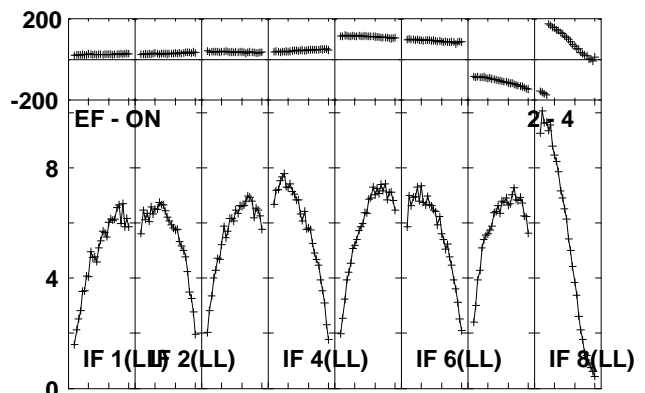
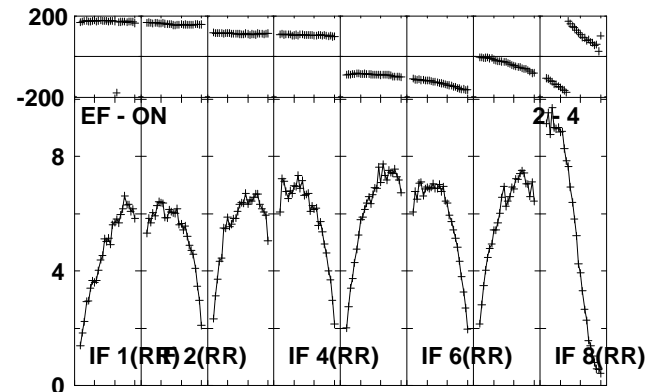
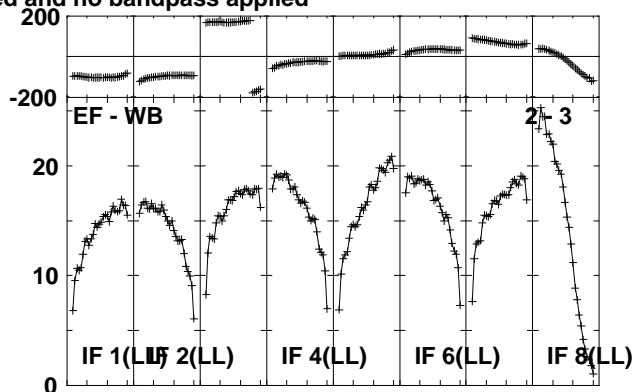
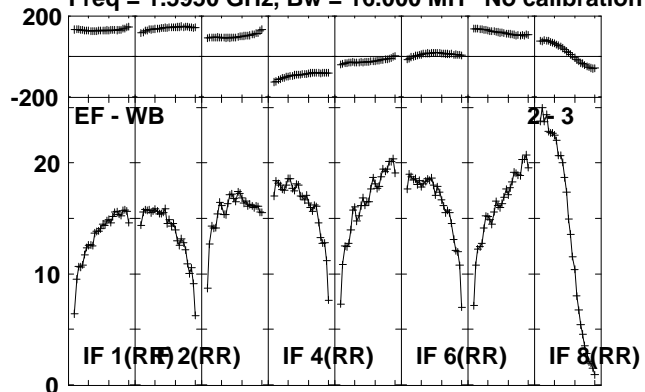

Lower frame: Milli Ampl Jy Top frame: Phas deg
Scalar averaged cross-power spectrum Several baselines displayed
Timerange: 01/01:31:31 to 01/01:32:57

Plot file version 164 created 23-AUG-2010 12:36:38
J1941-05 EP064P.UVDATA.1

Freq = 1.5950 GHz, Bw = 16.000 MH No calibration applied and no bandpass applied

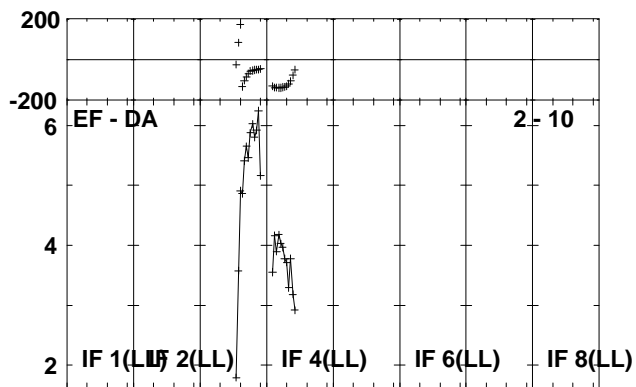
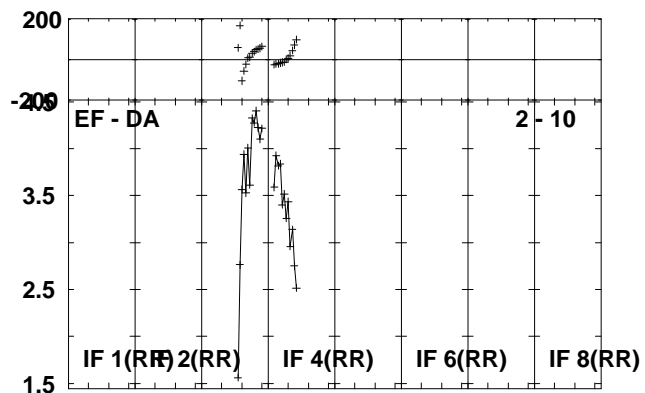
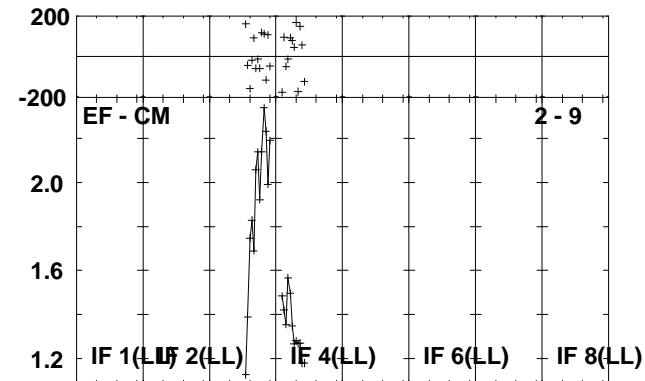
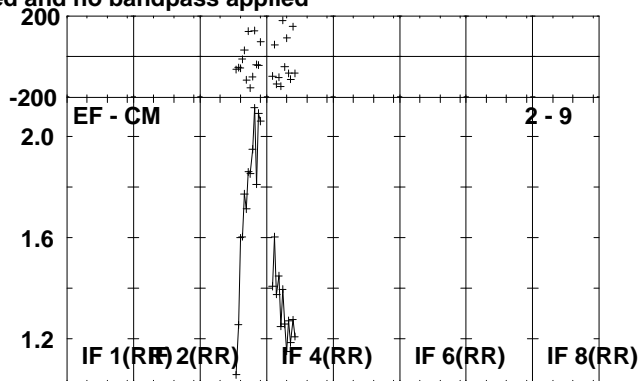
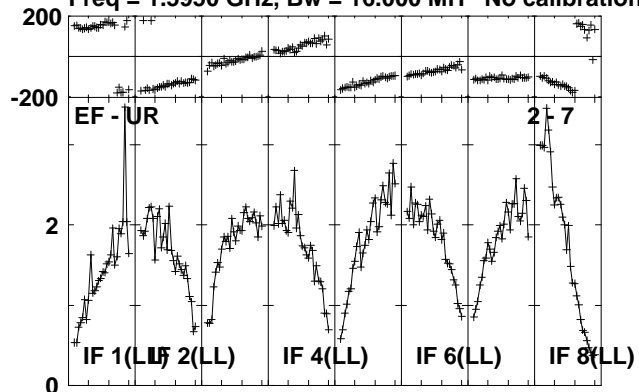

Lower frame: Milli Ampl Jy Top frame: Phas deg
Scalar averaged cross-power spectrum Several baselines displayed
Timerange: 01/01:31:31 to 01/01:32:57

Plot file version 165 created 23-AUG-2010 12:36:38

IRAS1929 EP064P.UVDATA.1

Freq = 1.5950 GHz, Bw = 16.000 MH No calibration applied and no bandpass applied

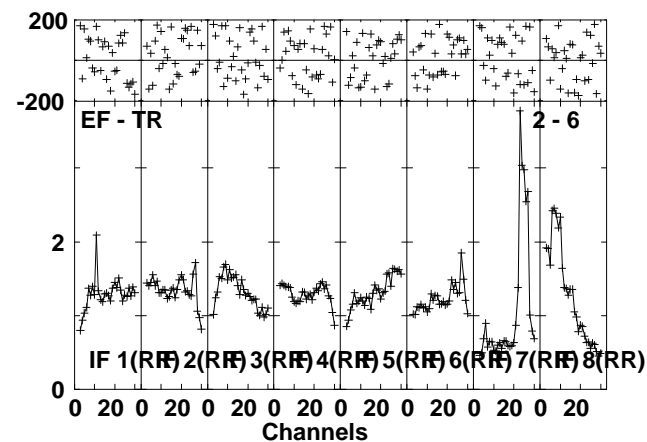
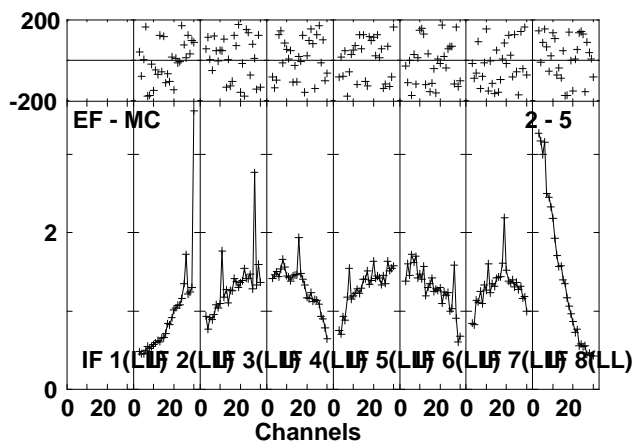
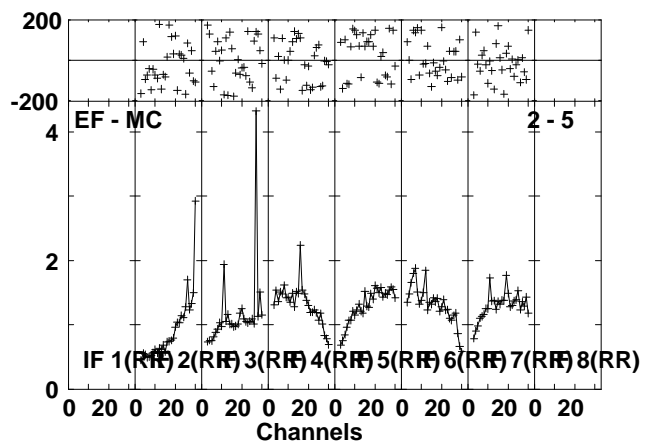
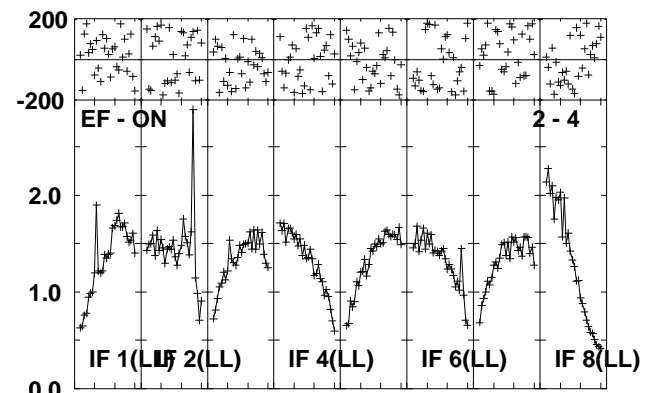
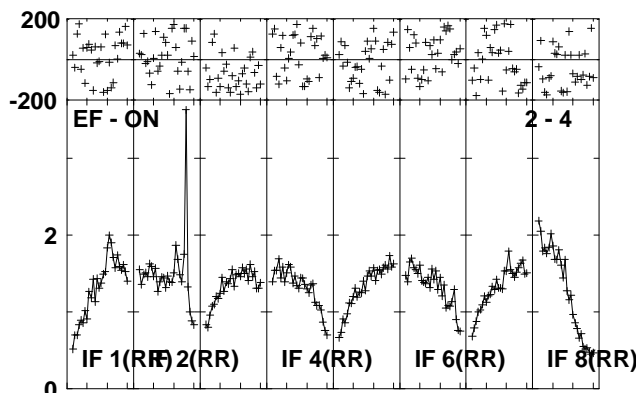
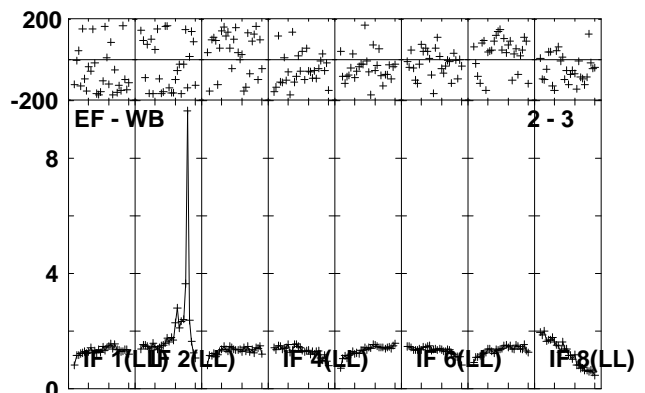
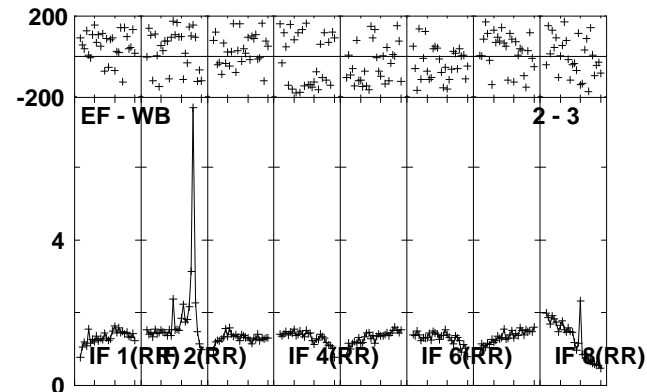
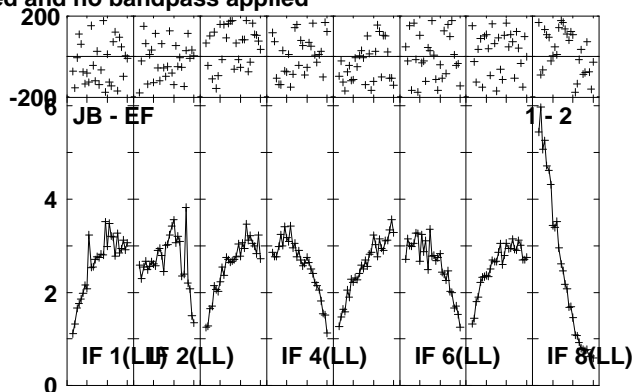
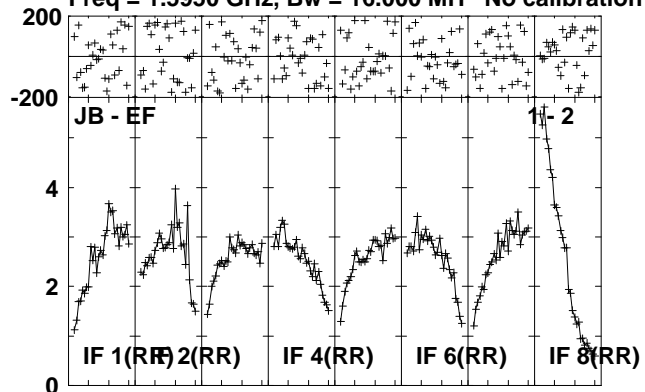

Lower frame: Milli Ampl Jy Top frame: Phas deg
Scalar averaged cross-power spectrum Several baselines displayed
Timerange: 01/01:33:01 to 01/01:36:29

Plot file version 166 created 23-AUG-2010 12:36:40

IRAS1929 EP064P.UVDATA.1

Freq = 1.5950 GHz, Bw = 16.000 MH No calibration applied and no bandpass applied

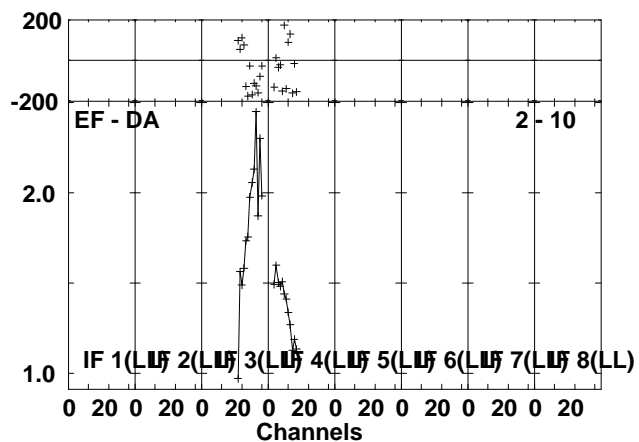
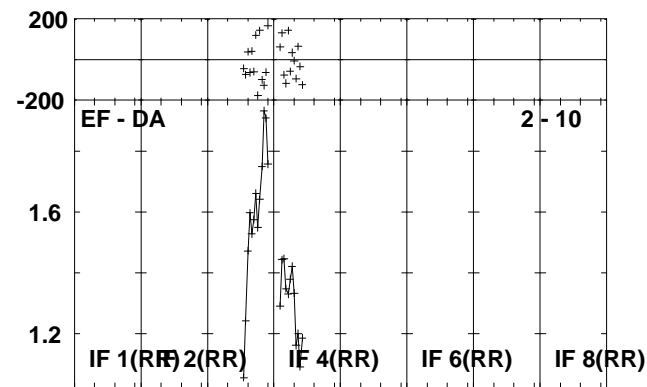
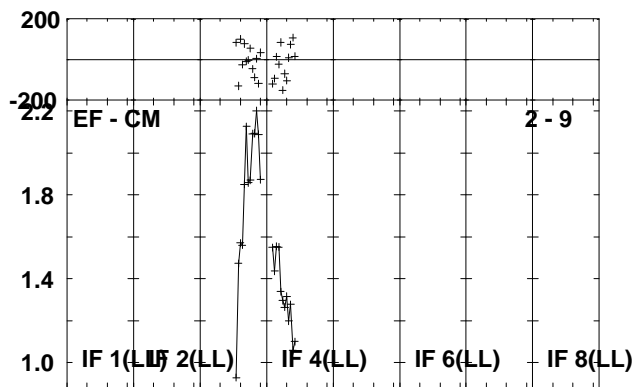
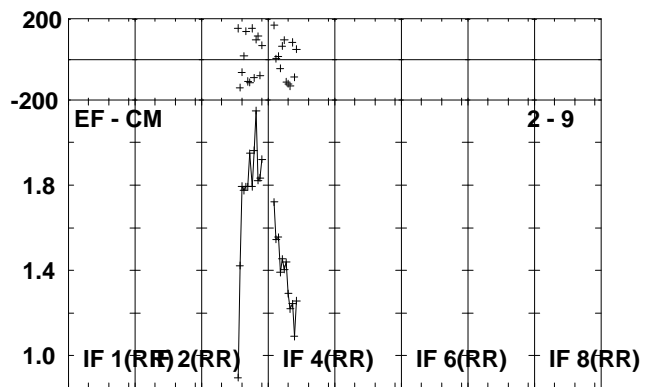
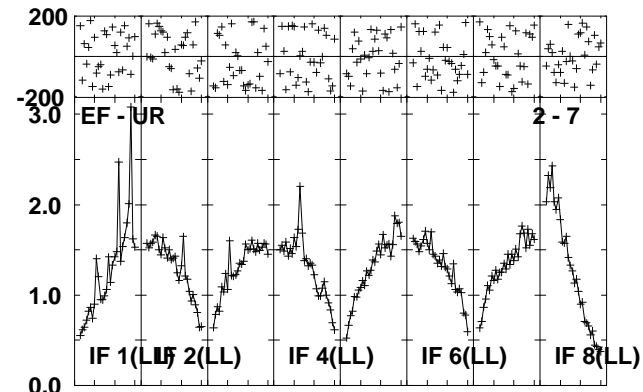
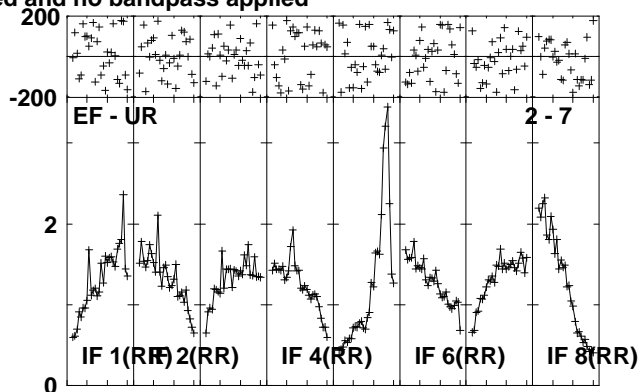
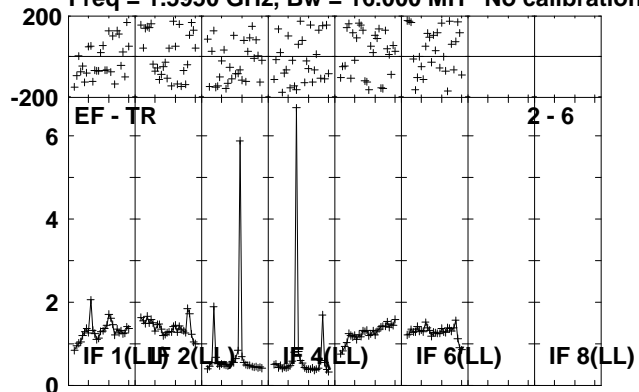

Lower frame: Milli Ampl Jy Top frame: Phas deg
Scalar averaged cross-power spectrum Several baselines displayed
Timerange: 01/01:33:01 to 01/01:36:29

Plot file version 167 created 23-AUG-2010 12:36:42

J1941-05 EP064P.UVDATA.1

Freq = 1.5950 GHz, Bw = 16.000 MH No calibration applied and no bandpass applied

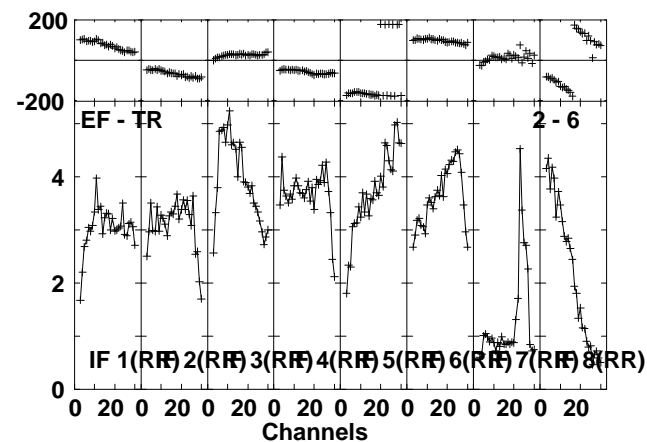
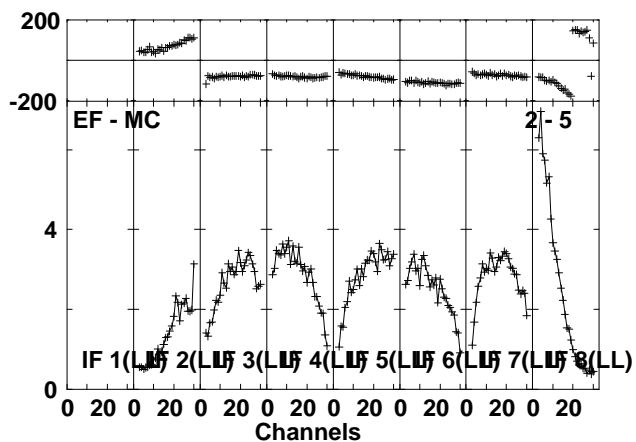
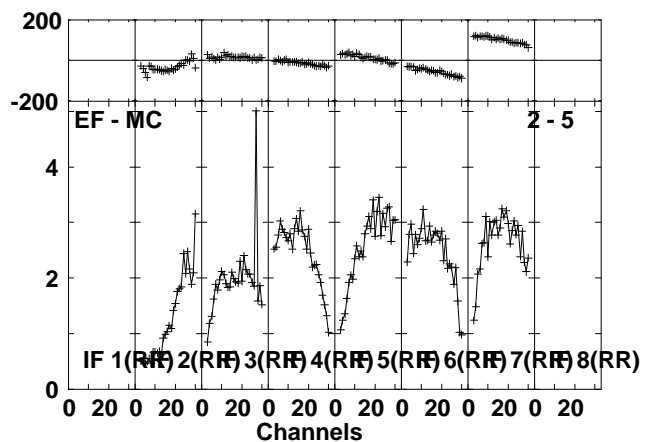
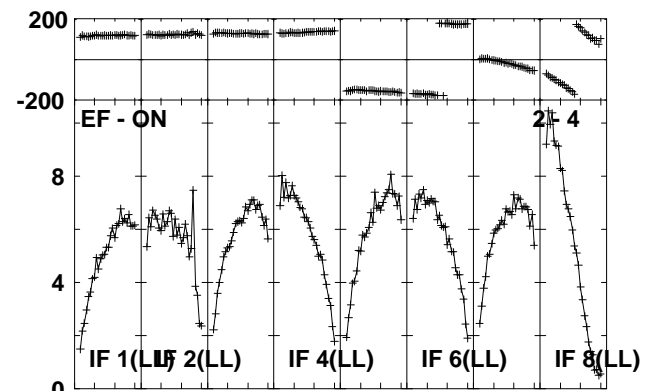
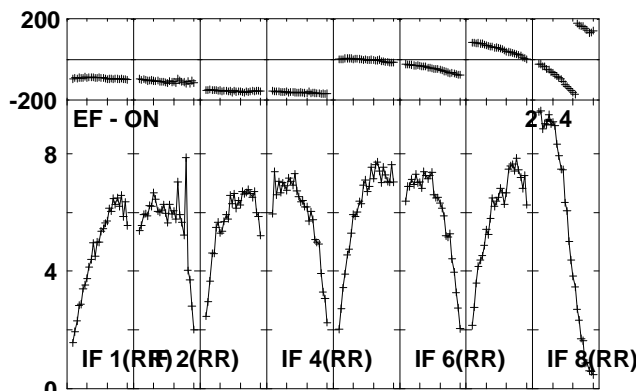
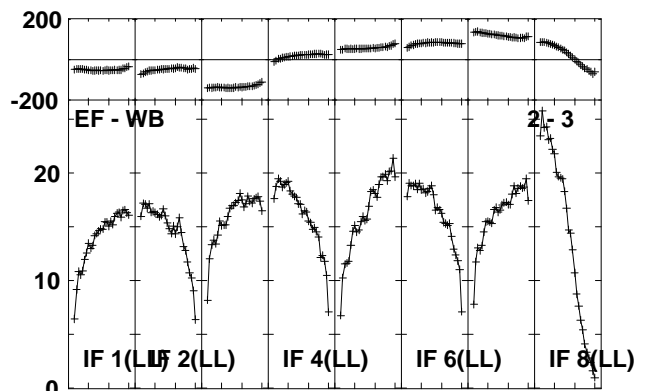
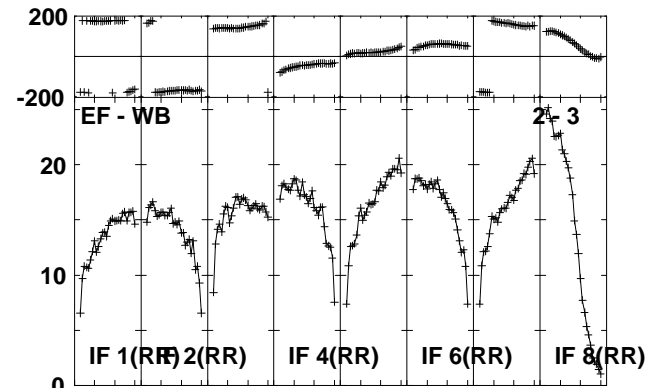
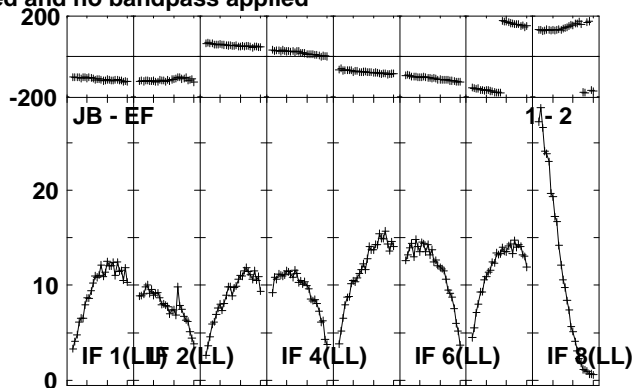
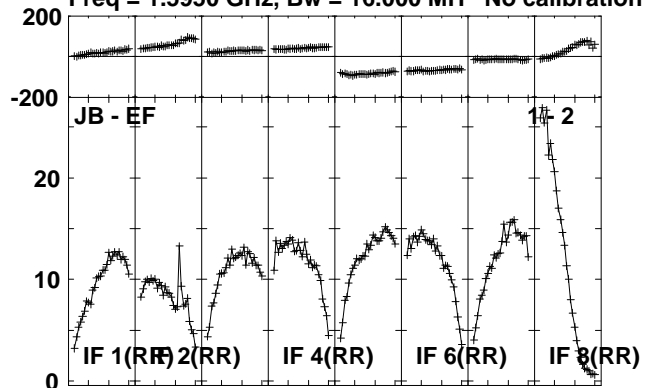

Lower frame: Milli Ampl Jy Top frame: Phas deg
Scalar averaged cross-power spectrum Several baselines displayed
Timerange: 01/01:36:31 to 01/01:37:59

Plot file version 168 created 23-AUG-2010 12:36:42
 J1941-05 EP064P.UVDATA.1

Freq = 1.5950 GHz, Bw = 16.000 MH No calibration applied and no bandpass applied

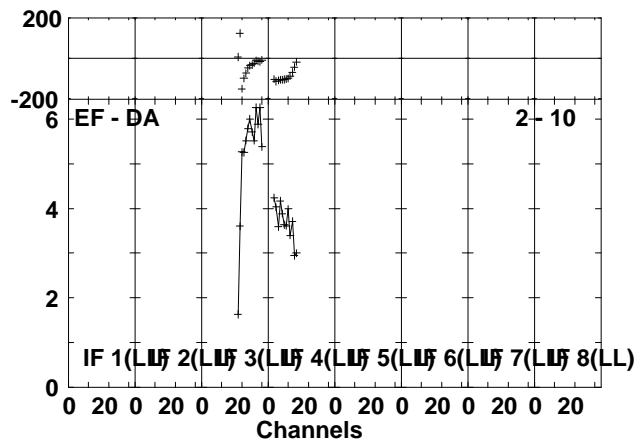
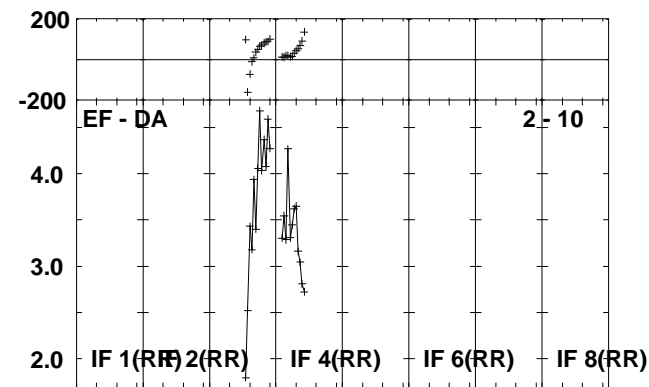
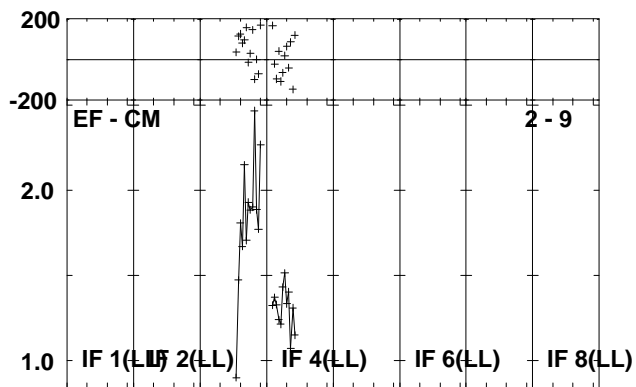
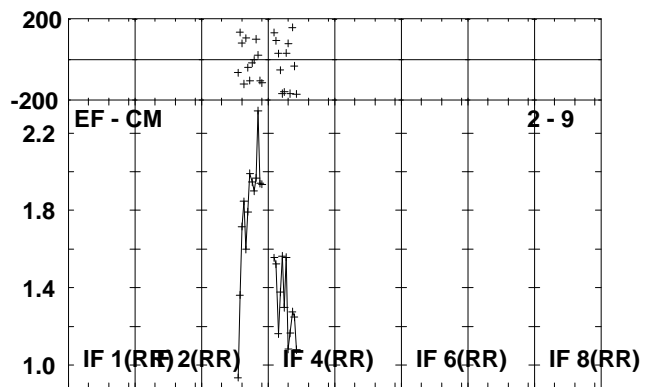
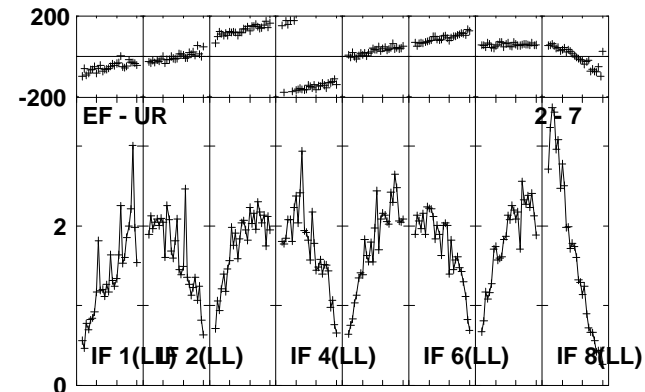
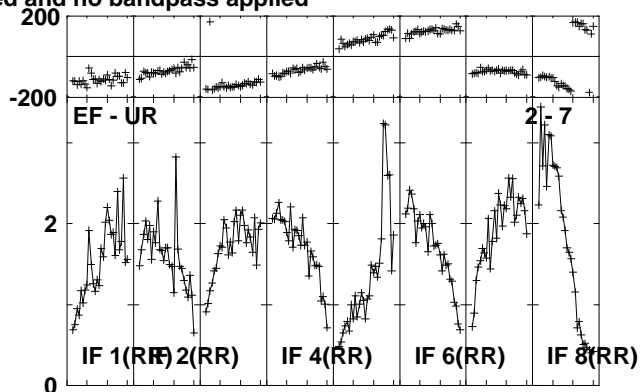
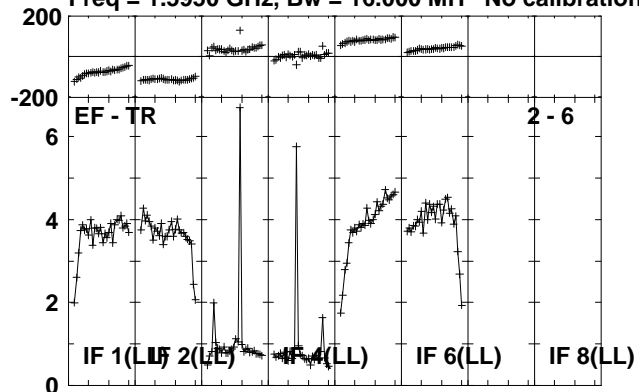

Lower frame: Milli Ampl Jy Top frame: Phas deg
 Scalar averaged cross-power spectrum Several baselines displayed
 Timerange: 01/01:36:31 to 01/01:37:59

Plot file version 169 created 23-AUG-2010 12:36:43

IRAS1929 EP064P.UVDATA.1

Freq = 1.5950 GHz, Bw = 16.000 MH No calibration applied and no bandpass applied

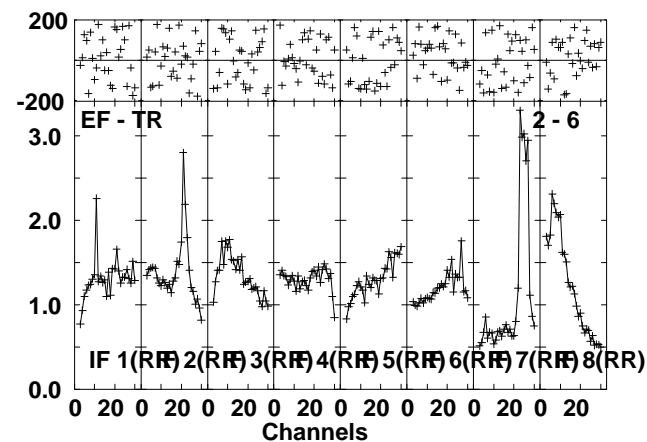
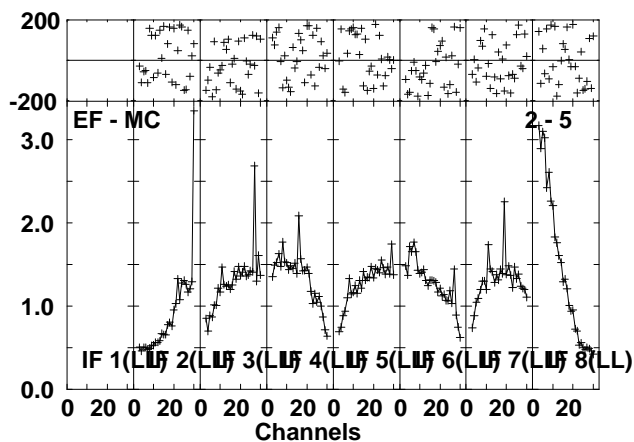
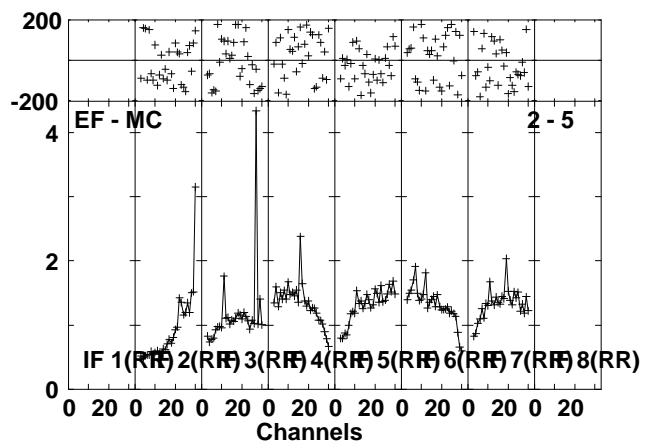
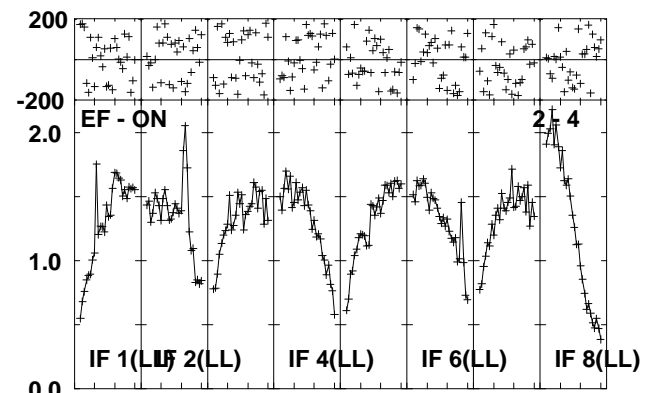
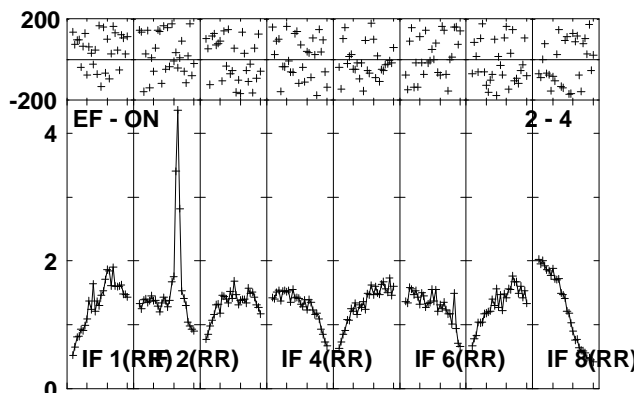
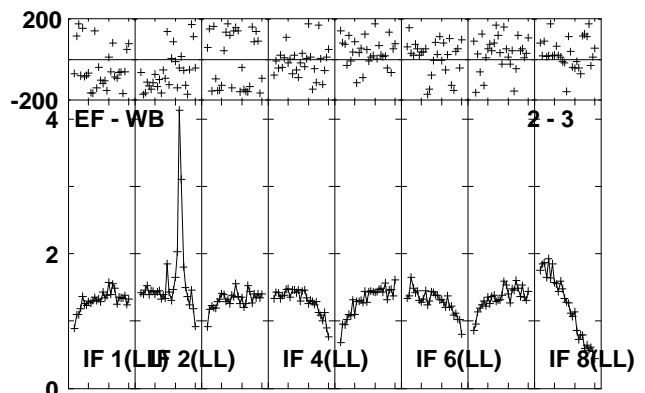
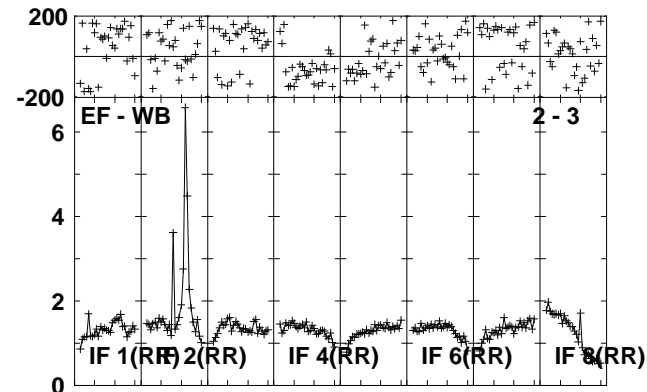
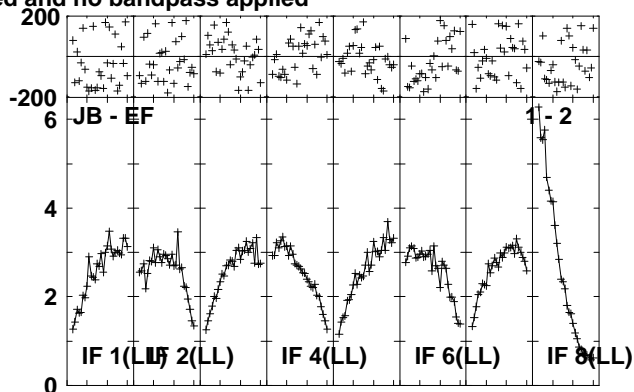
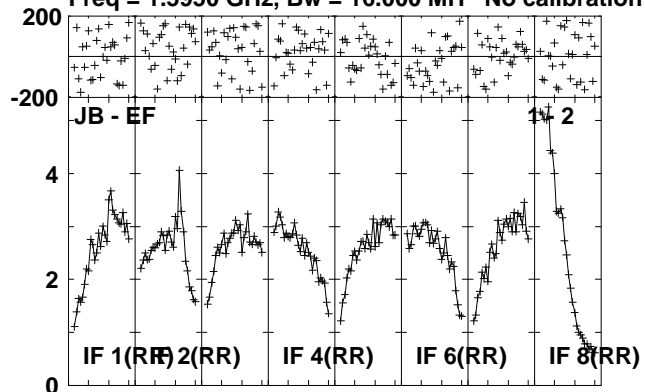

Lower frame: Milli Ampl Jy Top frame: Phas deg
Scalar averaged cross-power spectrum Several baselines displayed
Timerange: 01/01:38:01 to 01/01:41:29

Plot file version 170 created 23-AUG-2010 12:36:45

IRAS1929 EP064P.UVDATA.1

Freq = 1.5950 GHz, Bw = 16.000 MH No calibration applied and no bandpass applied

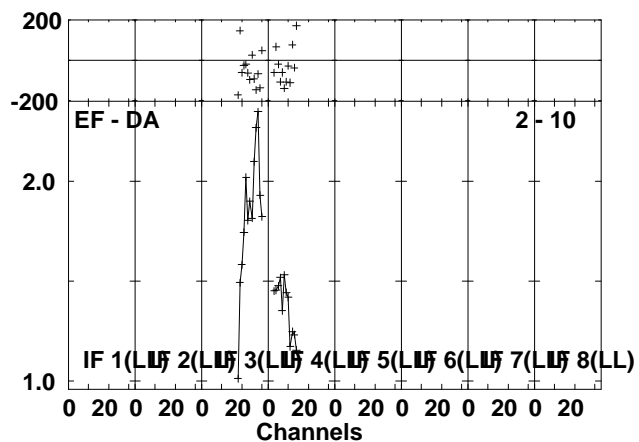
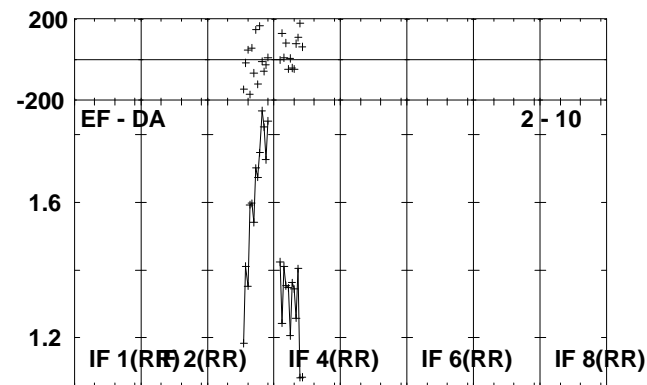
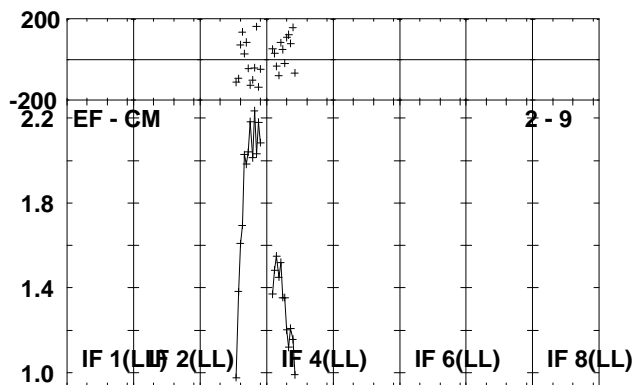
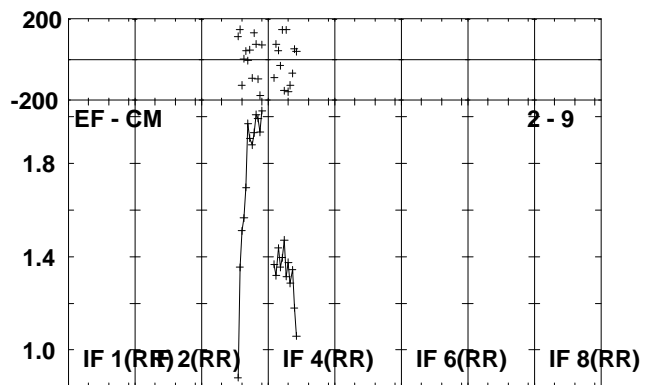
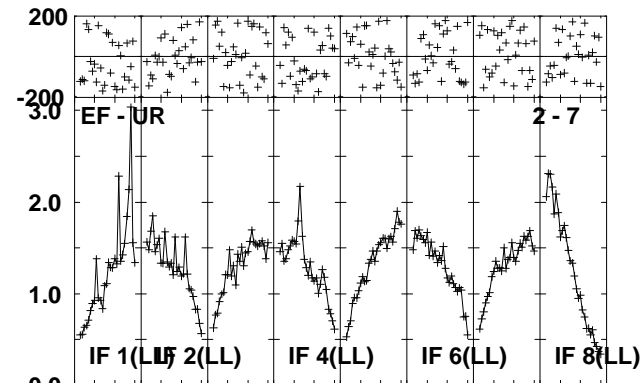
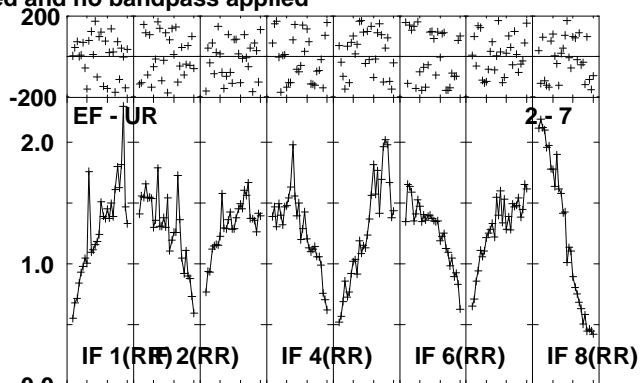
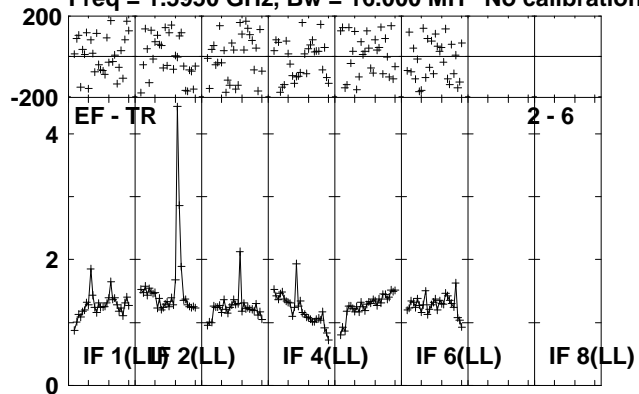

Lower frame: Milli Ampl Jy Top frame: Phas deg
Scalar averaged cross-power spectrum Several baselines displayed
Timerange: 01/01:38:01 to 01/01:41:29

Plot file version 171 created 23-AUG-2010 12:36:47

J1941-05 EP064P.UVDATA.1

Freq = 1.5950 GHz, Bw = 16.000 MH No calibration applied and no bandpass applied

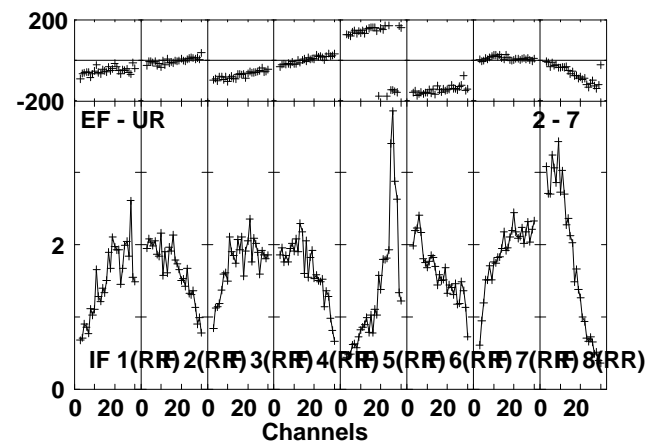
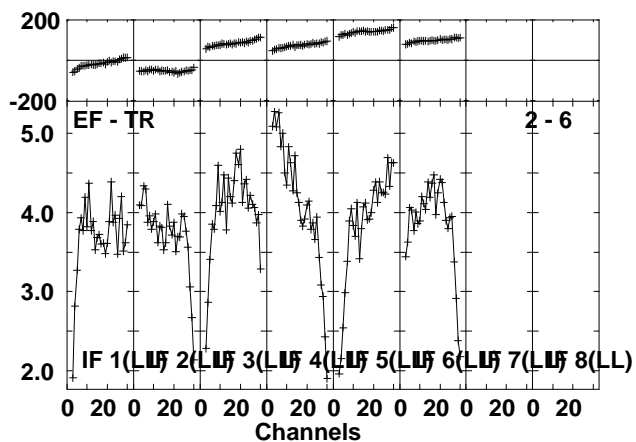
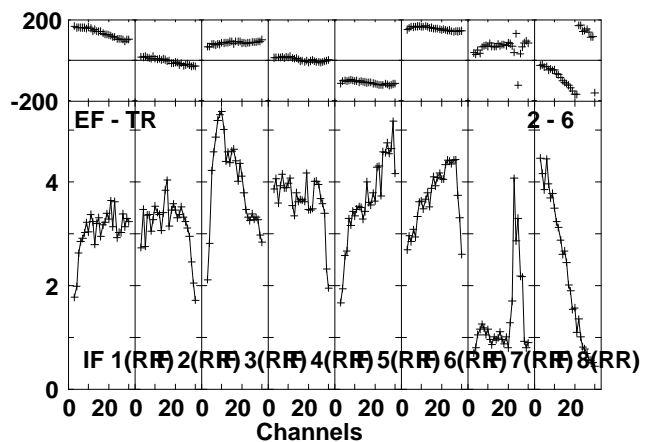
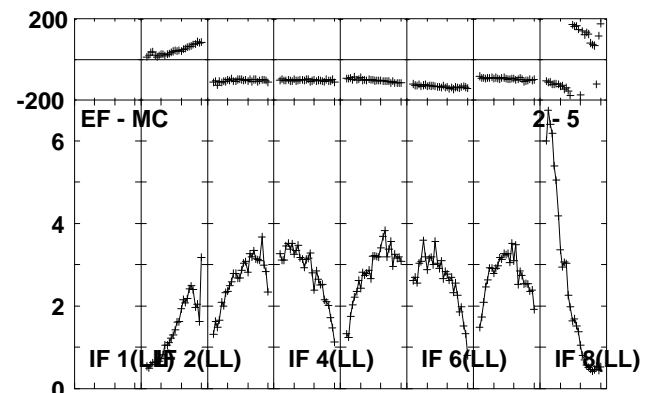
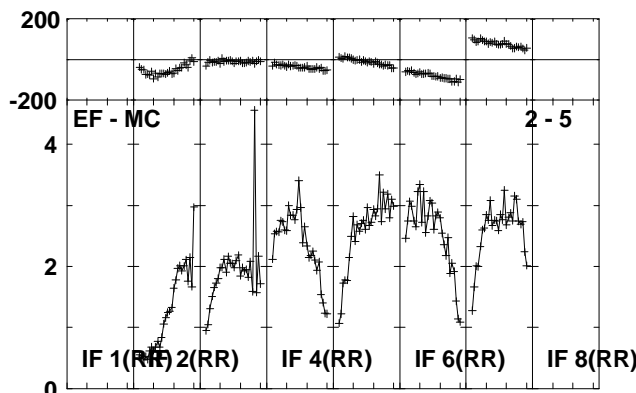
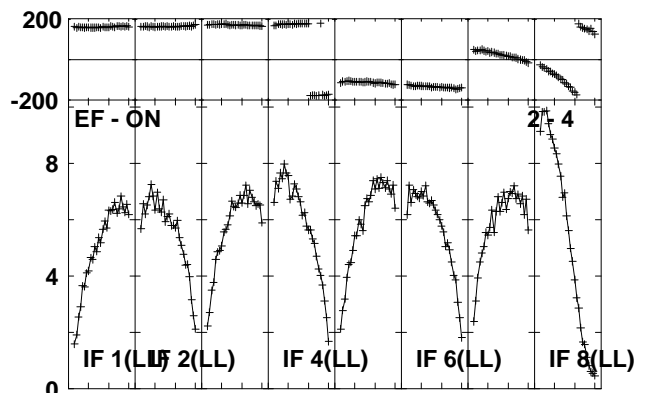
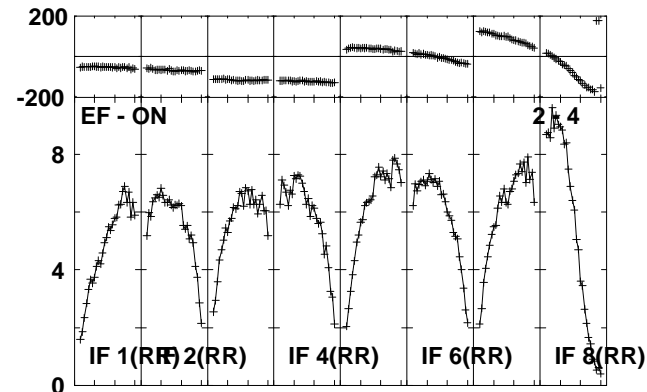
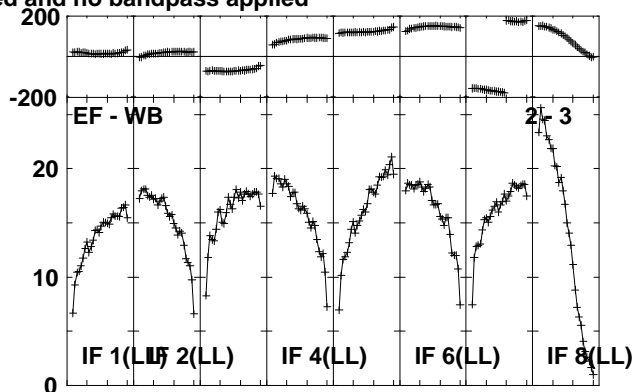
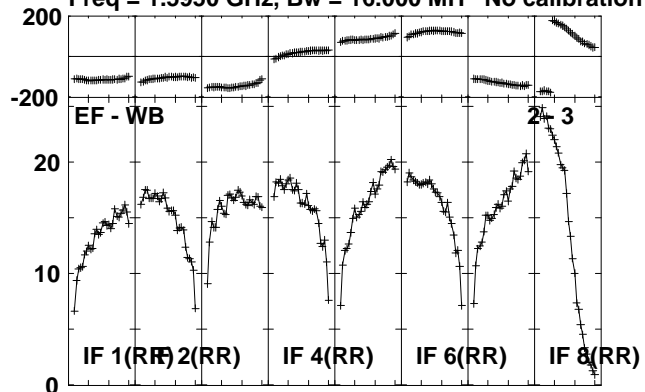

Lower frame: Milli Ampl Jy Top frame: Phas deg
Scalar averaged cross-power spectrum Several baselines displayed
Timerange: 01/01:41:31 to 01/01:42:57

Plot file version 172 created 23-AUG-2010 12:36:48
J1941-05 EP064P.UVDATA.1

Freq = 1.5950 GHz, Bw = 16.000 MH No calibration applied and no bandpass applied

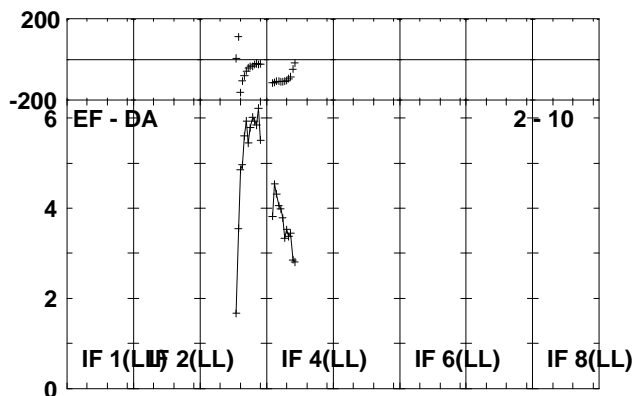
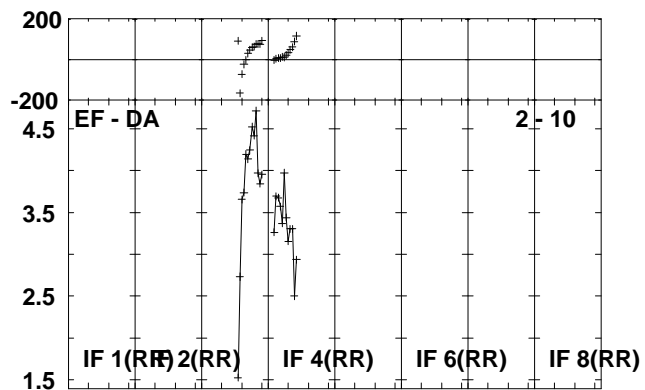
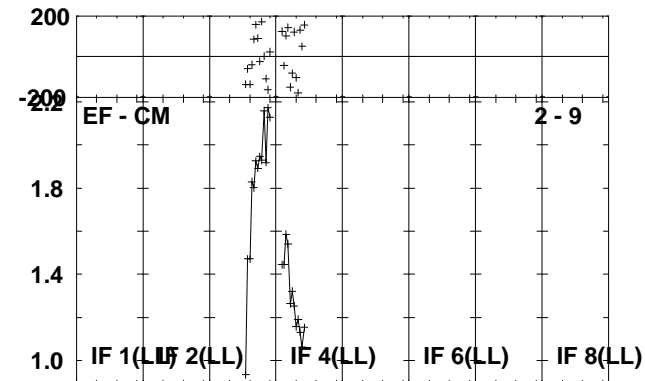
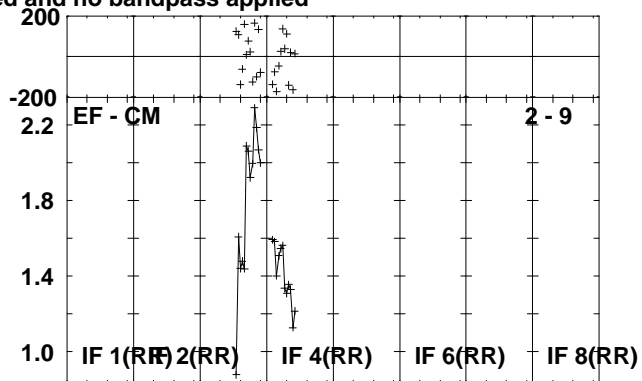
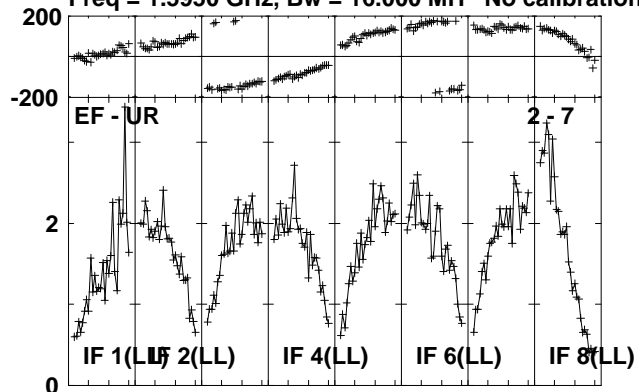

Lower frame: Milli Ampl Jy Top frame: Phas deg
Scalar averaged cross-power spectrum Several baselines displayed
Timerange: 01/01:41:31 to 01/01:42:57

Plot file version 173 created 23-AUG-2010 12:36:48

IRAS1929 EP064P.UVDATA.1

Freq = 1.5950 GHz, Bw = 16.000 MH No calibration applied and no bandpass applied

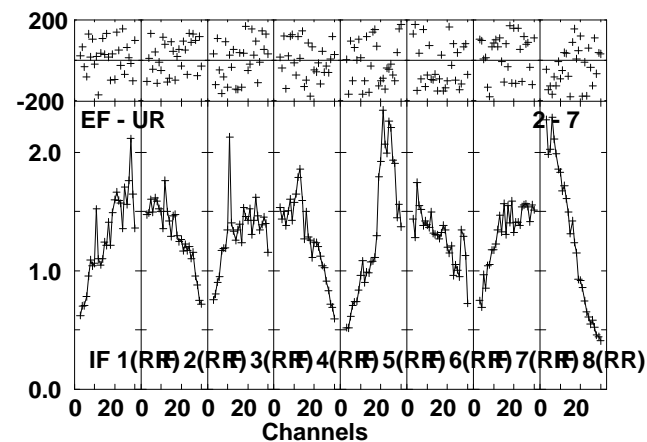
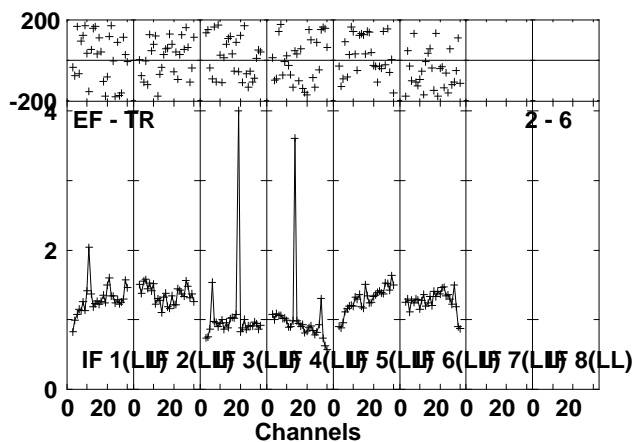
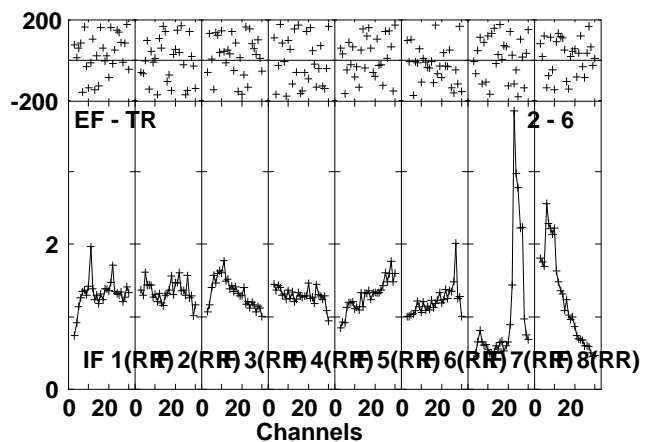
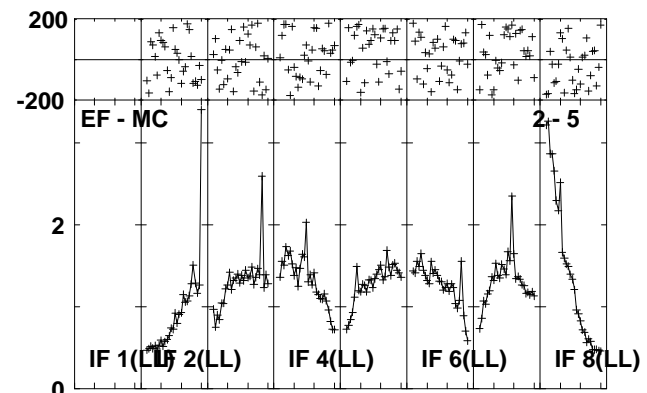
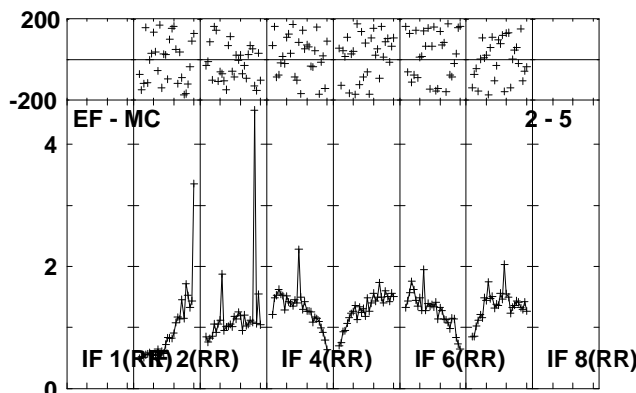
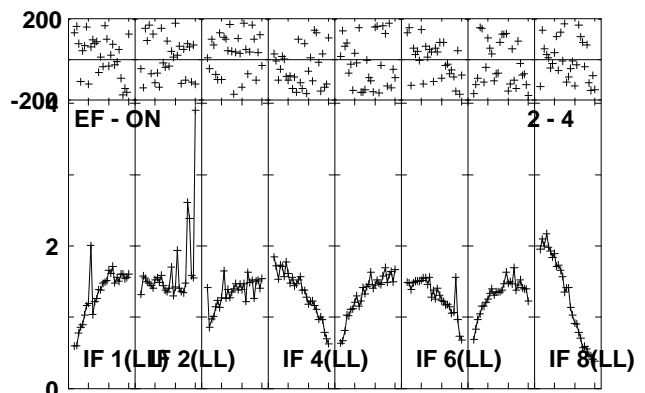
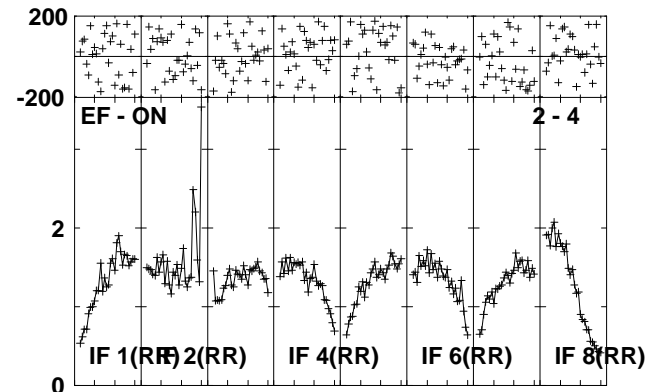
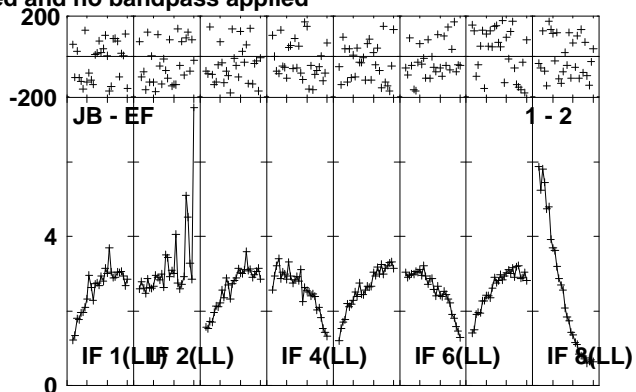
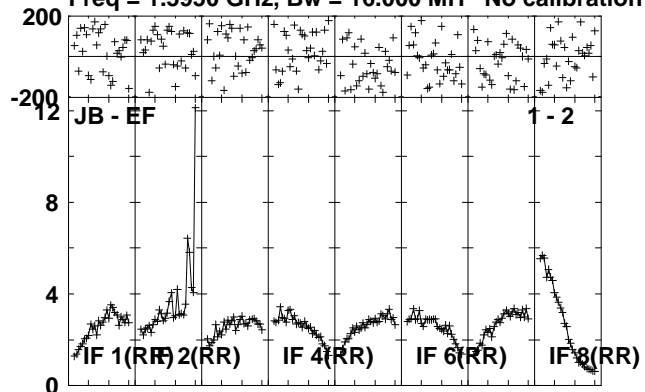

Lower frame: Milli Ampl Jy Top frame: Phas deg
Scalar averaged cross-power spectrum Several baselines displayed
Timerange: 01/01:43:01 to 01/01:46:29

Plot file version 174 created 23-AUG-2010 12:36:50

IRAS1929 EP064P.UVDATA.1

Freq = 1.5950 GHz, Bw = 16.000 MH No calibration applied and no bandpass applied

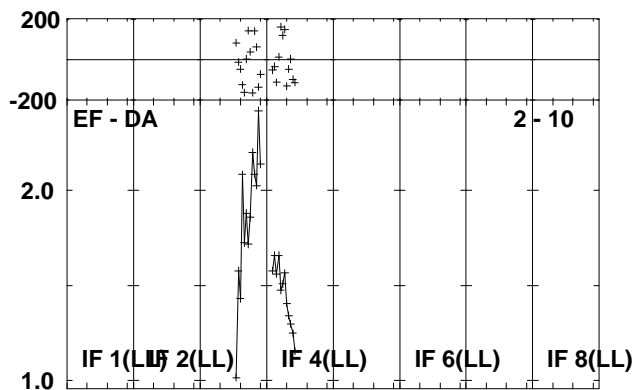
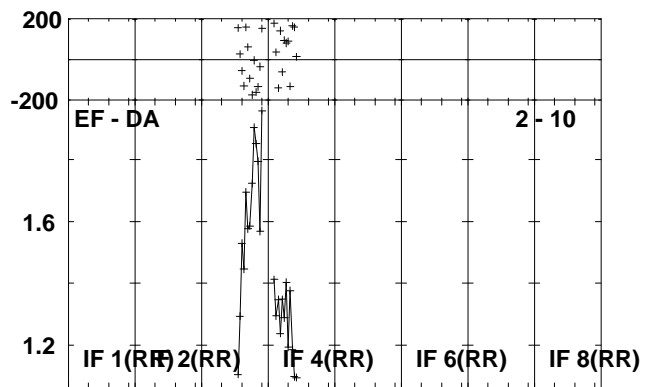
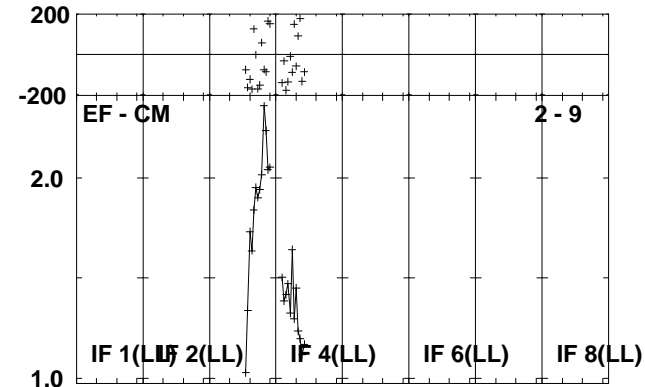
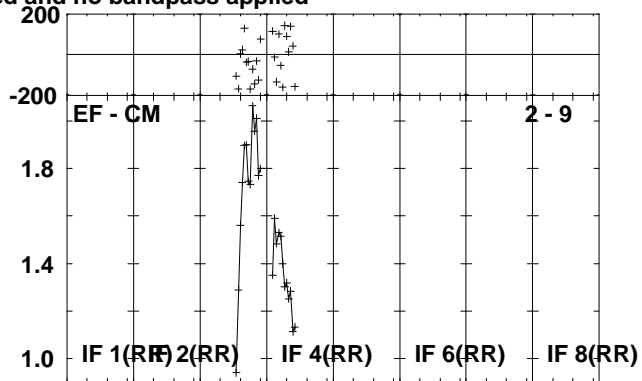
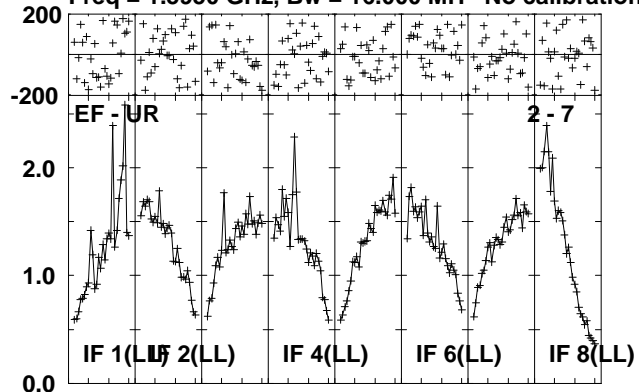

Lower frame: Milli Ampl Jy Top frame: Phas deg
Scalar averaged cross-power spectrum Several baselines displayed
Timerange: 01/01:43:01 to 01/01:46:29

Plot file version 175 created 23-AUG-2010 12:36:51

J1941-05 EP064P.UVDATA.1

Freq = 1.5950 GHz, Bw = 16.000 MH No calibration applied and no bandpass applied

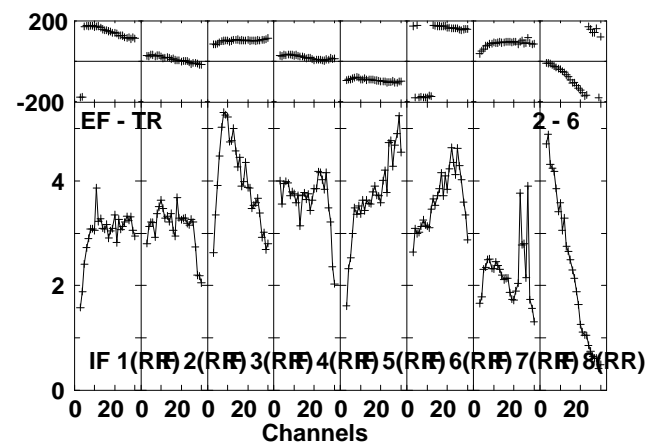
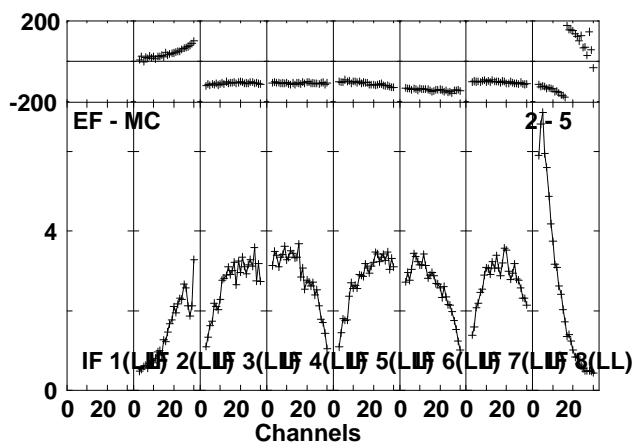
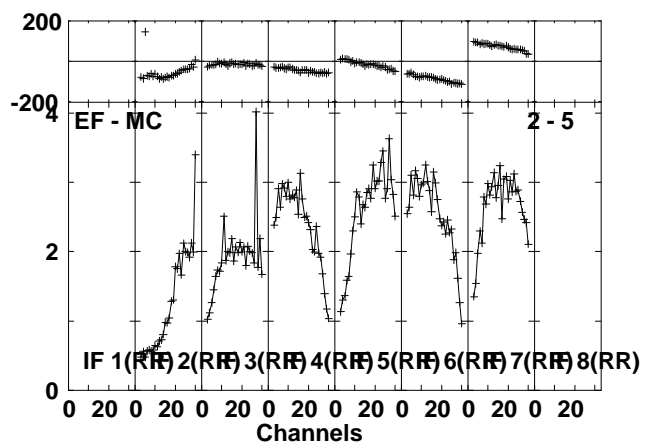
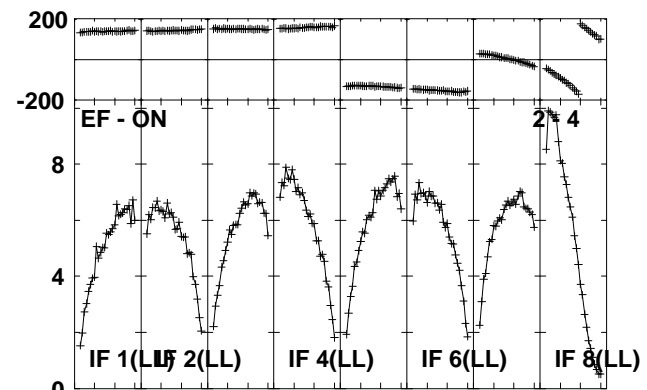
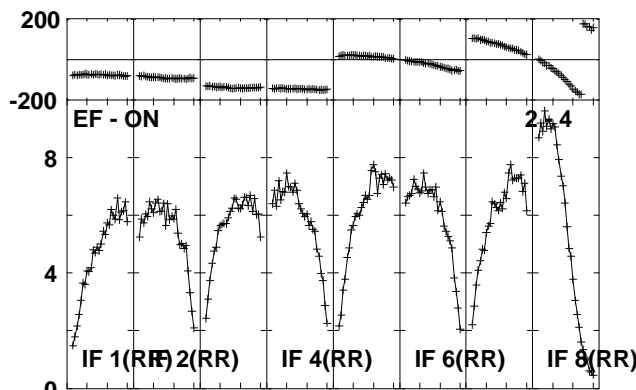
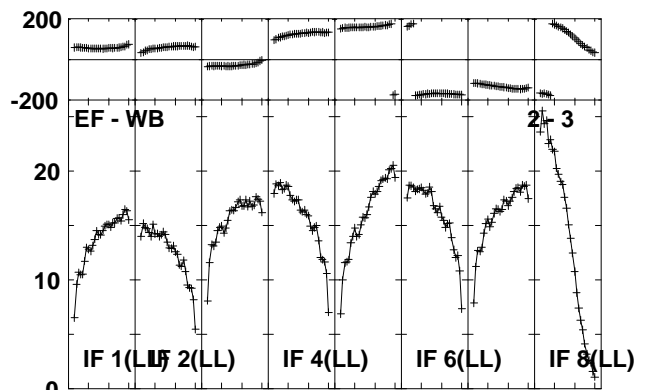
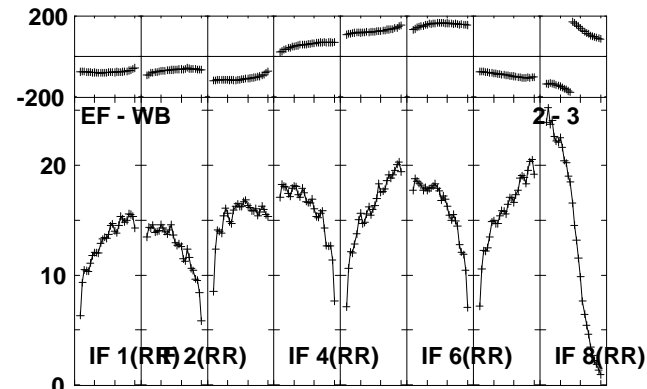
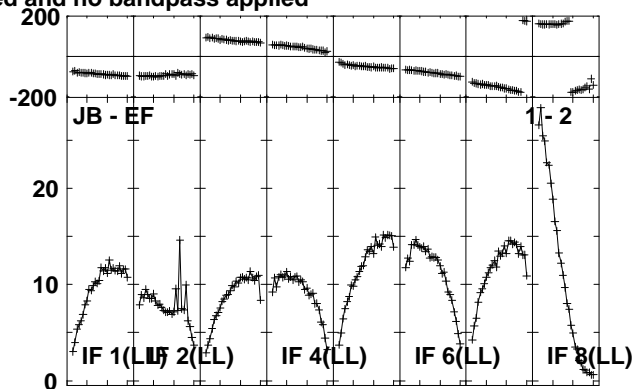
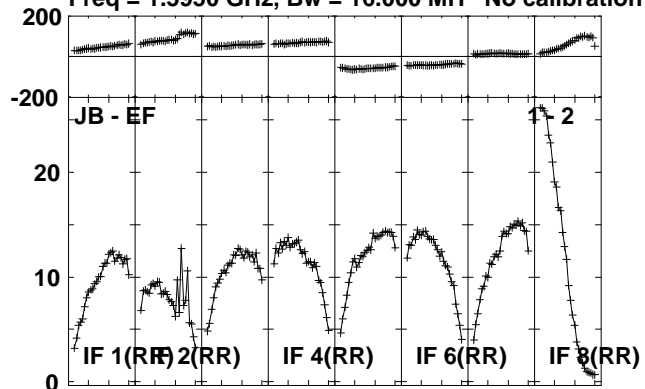

Lower frame: Milli Ampl Jy Top frame: Phas deg
Scalar averaged cross-power spectrum Several baselines displayed
Timerange: 01/01:47:31 to 01/01:48:59

Plot file version 176 created 23-AUG-2010 12:36:52

J1941-05 EP064P.UVDATA.1

Freq = 1.5950 GHz, Bw = 16.000 MH No calibration applied and no bandpass applied

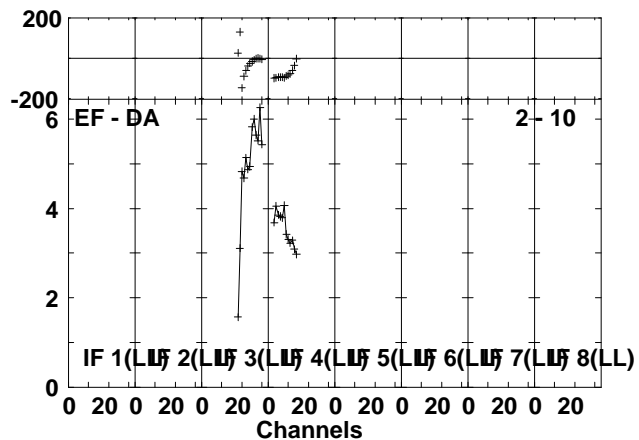
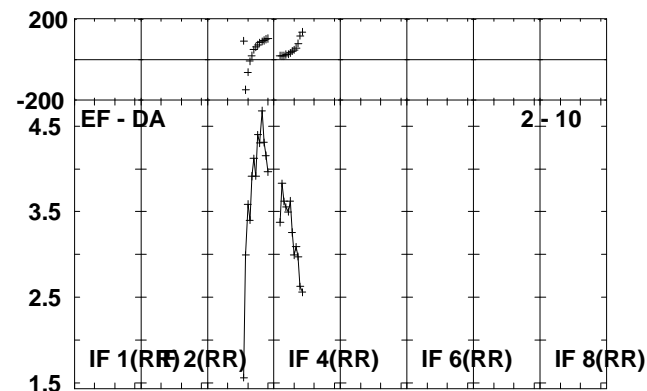
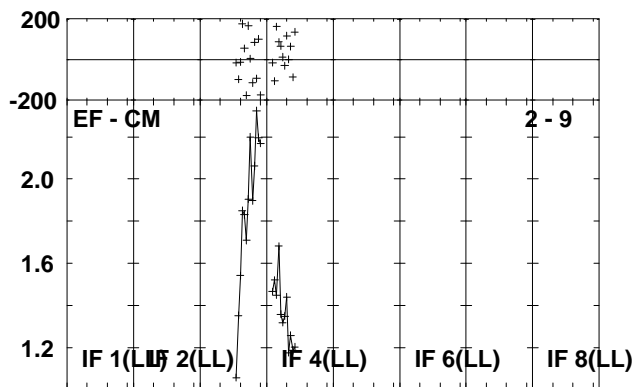
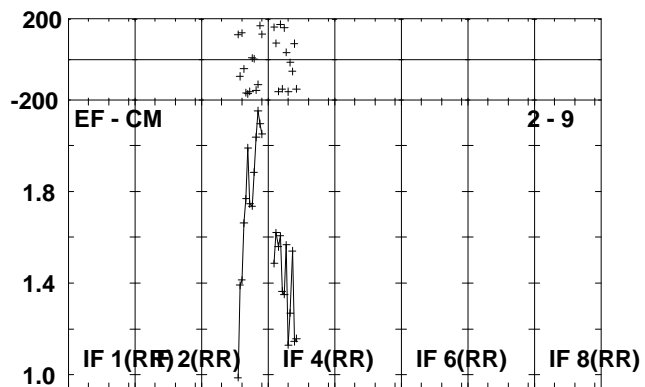
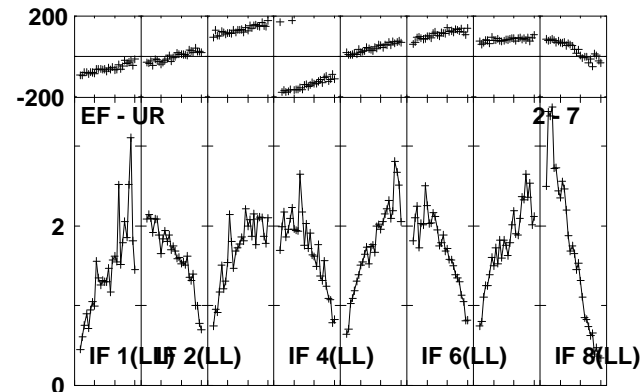
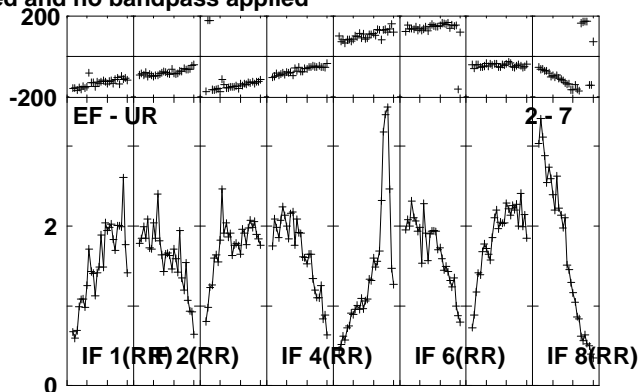
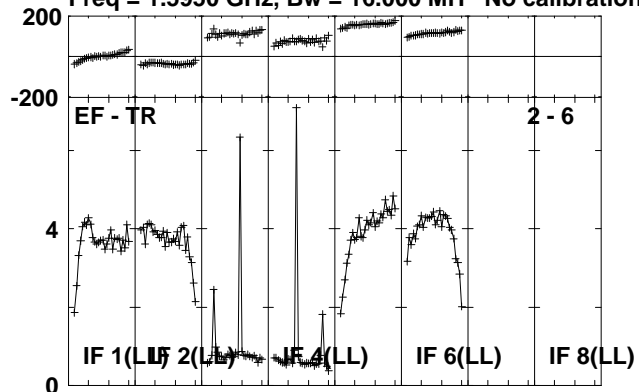

Lower frame: Milli Ampl Jy Top frame: Phas deg
Scalar averaged cross-power spectrum Several baselines displayed
Timerange: 01/01:47:31 to 01/01:48:59

Plot file version 177 created 23-AUG-2010 12:36:53

IRAS1929 EP064P.UVDATA.1

Freq = 1.5950 GHz, Bw = 16.000 MH No calibration applied and no bandpass applied

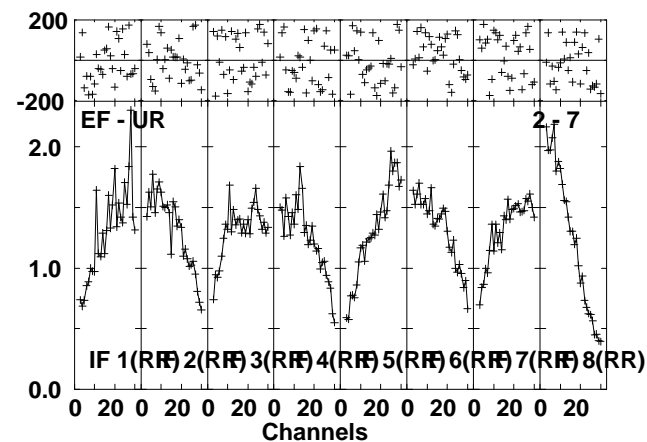
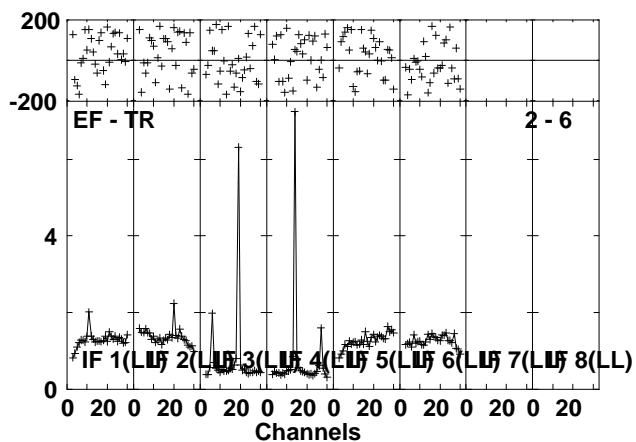
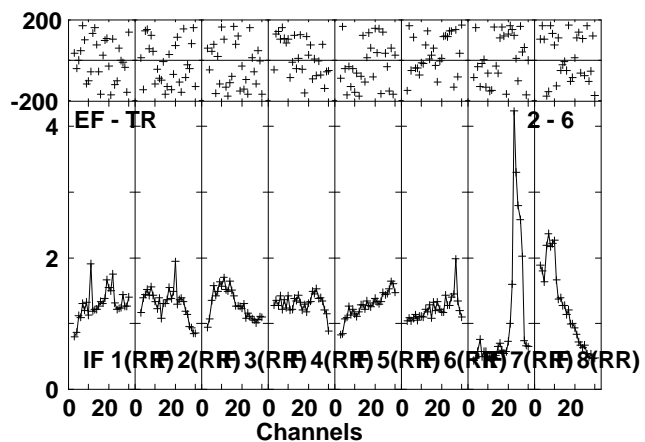
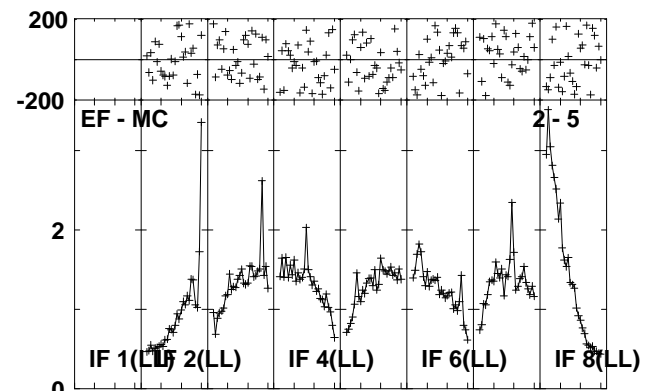
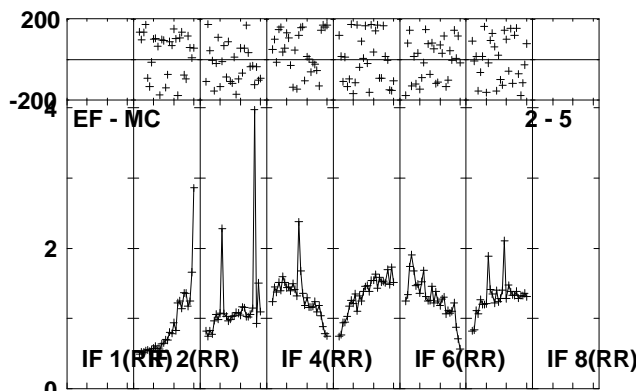
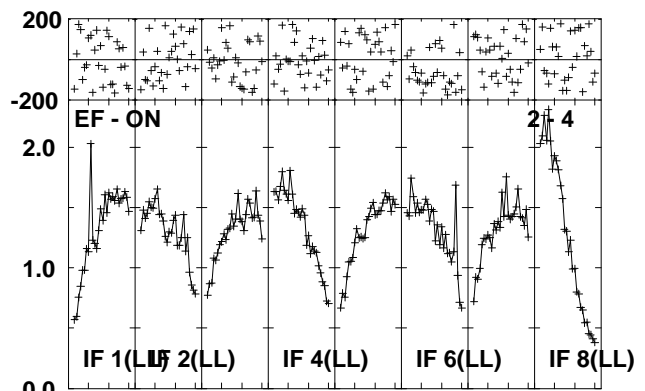
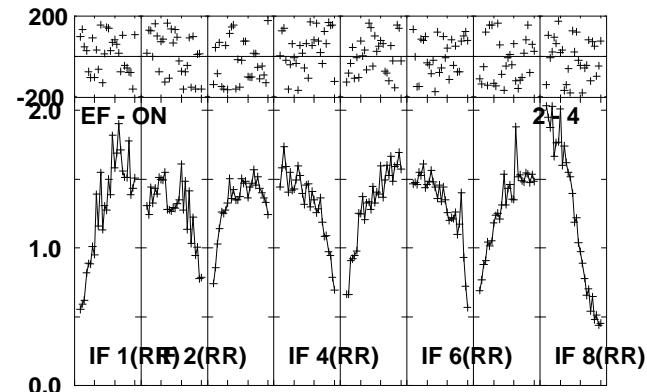
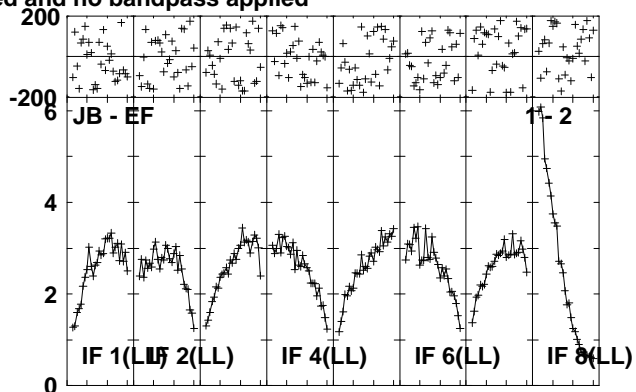
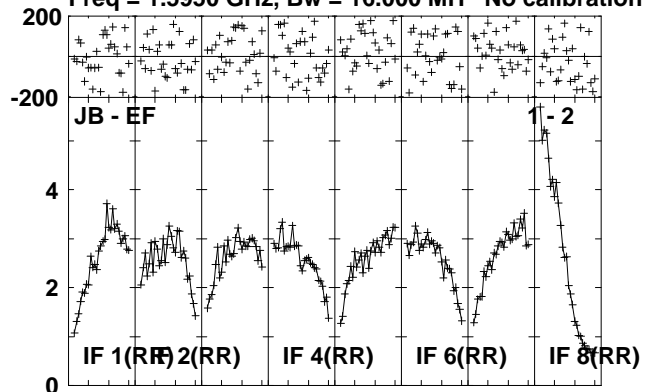

Lower frame: Milli Ampl Jy Top frame: Phas deg
Scalar averaged cross-power spectrum Several baselines displayed
Timerange: 01/01:49:01 to 01/01:52:29

Plot file version 178 created 23-AUG-2010 12:36:55

IRAS1929 EP064P.UVDATA.1

Freq = 1.5950 GHz, Bw = 16.000 MH No calibration applied and no bandpass applied

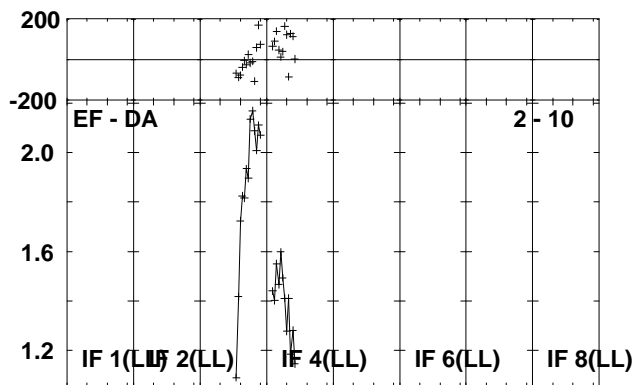
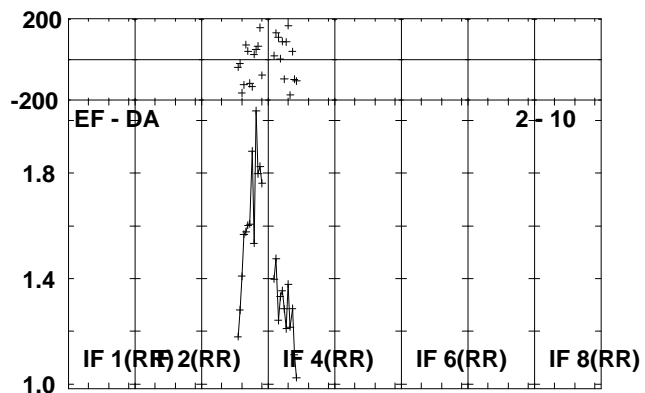
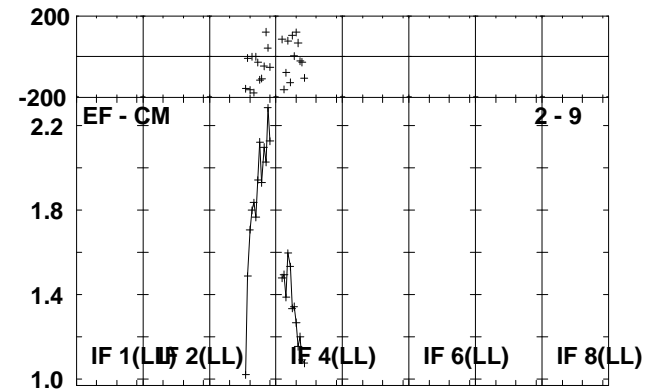
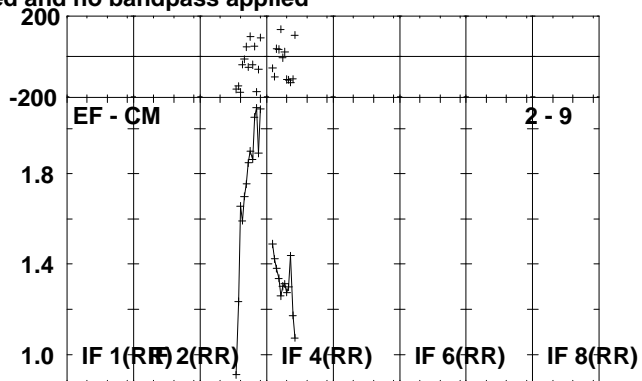
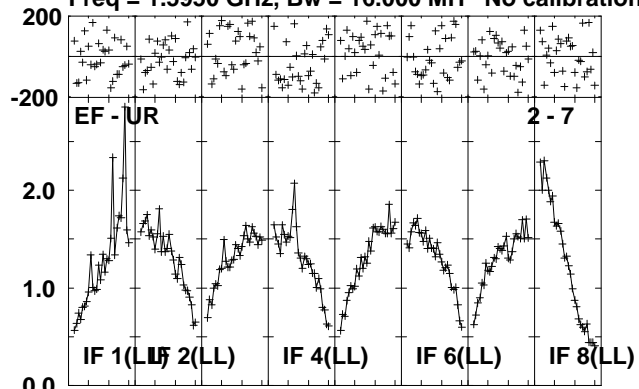

Lower frame: Milli Ampl Jy Top frame: Phas deg
Scalar averaged cross-power spectrum Several baselines displayed
Timerange: 01/01:49:01 to 01/01:52:29

Plot file version 179 created 23-AUG-2010 12:36:57

J1941-05 EP064P.UVDATA.1

Freq = 1.5950 GHz, Bw = 16.000 MH No calibration applied and no bandpass applied

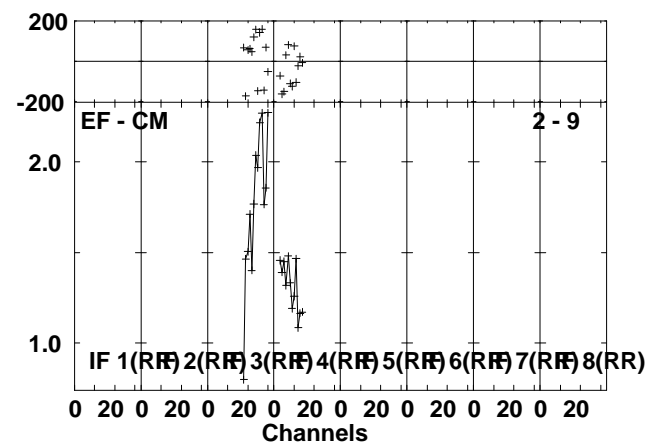
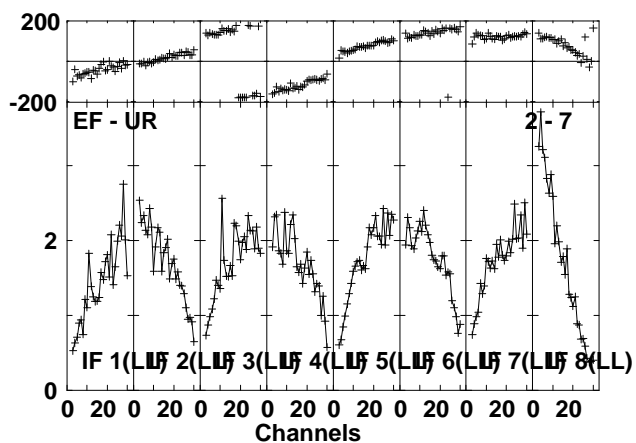
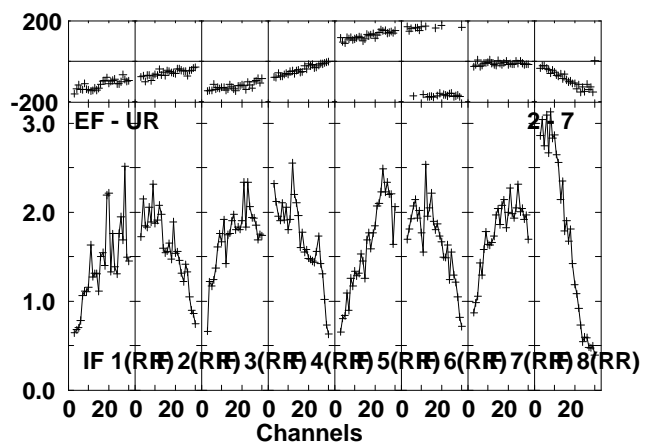
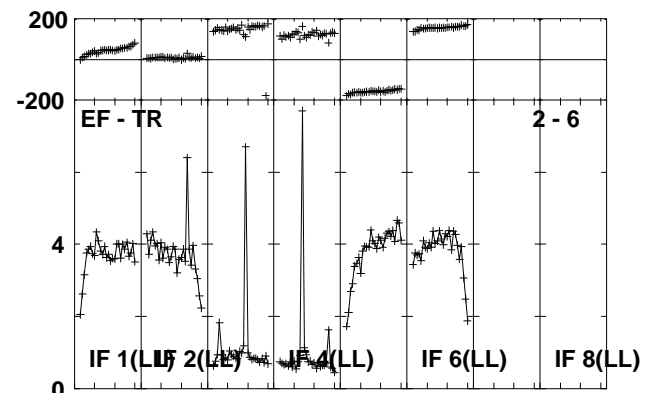
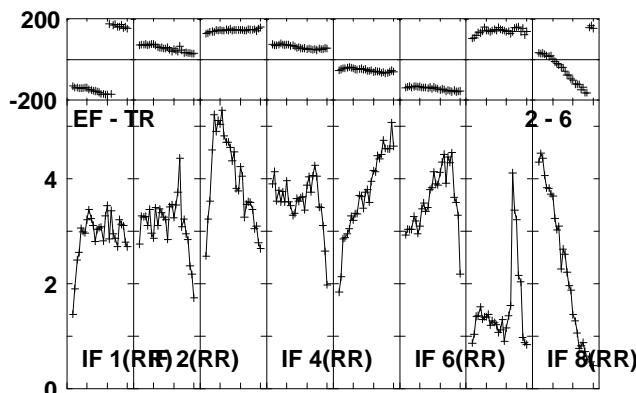
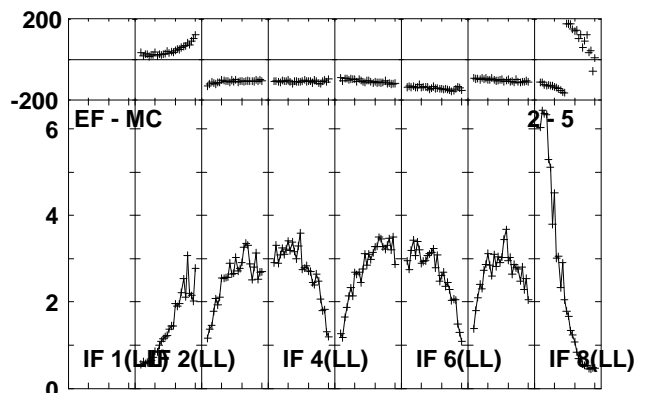
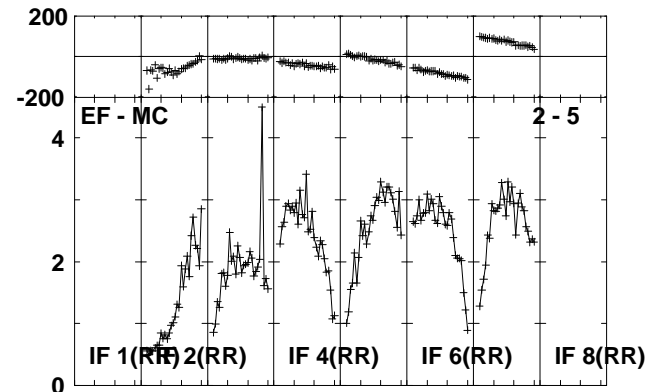
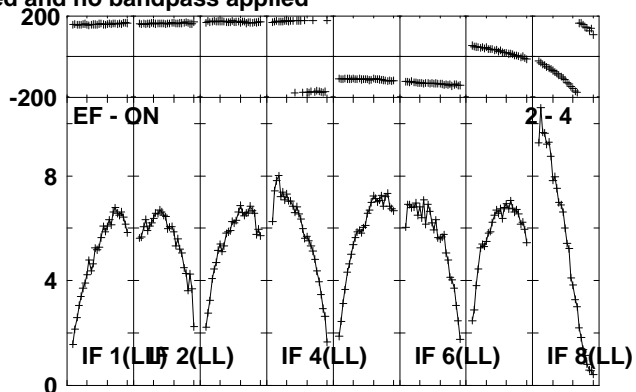
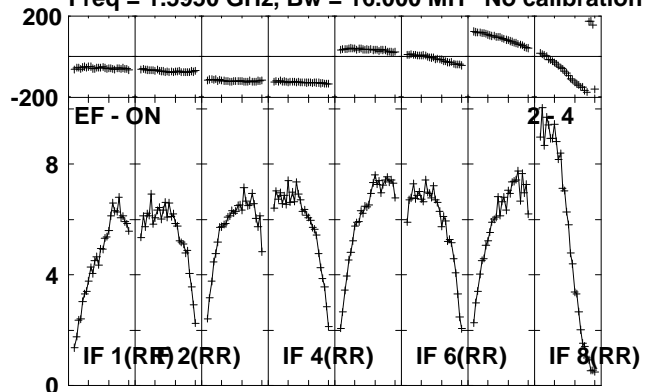

Lower frame: Milli Ampl Jy Top frame: Phas deg
Scalar averaged cross-power spectrum Several baselines displayed
Timerange: 01/01:52:31 to 01/01:53:57

Plot file version 180 created 23-AUG-2010 12:36:57

J1941-05 EP064P.UVDATA.1

Freq = 1.5950 GHz, Bw = 16.000 MH No calibration applied and no bandpass applied

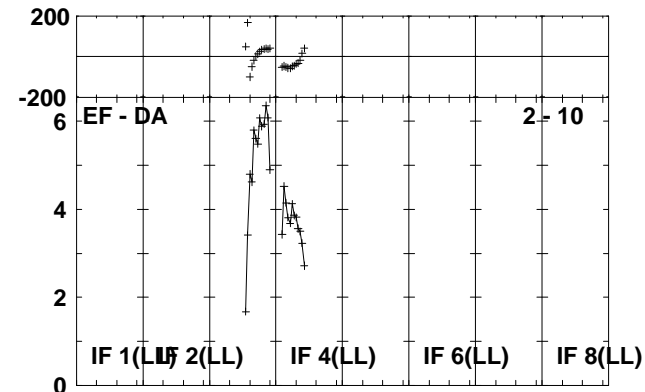
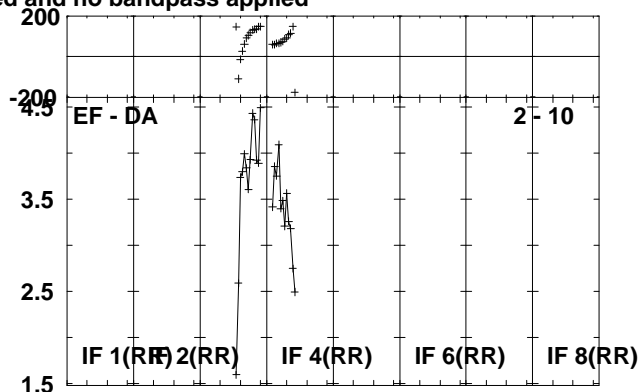
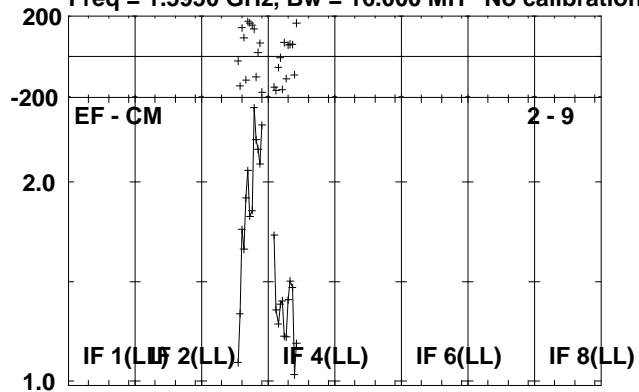

Lower frame: Milli Ampl Jy Top frame: Phas deg
Scalar averaged cross-power spectrum Several baselines displayed
Timerange: 01/01:52:31 to 01/01:53:57

Plot file version 181 created 23-AUG-2010 12:36:58

IRAS1929 EP064P.UVDATA.1

Freq = 1.5950 GHz, Bw = 16.000 MH No calibration applied and no bandpass applied

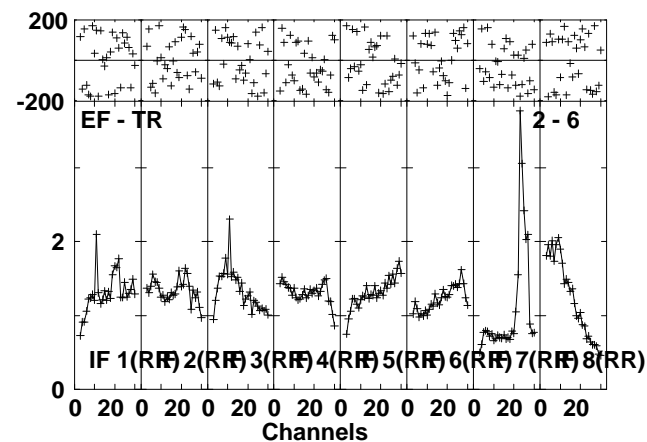
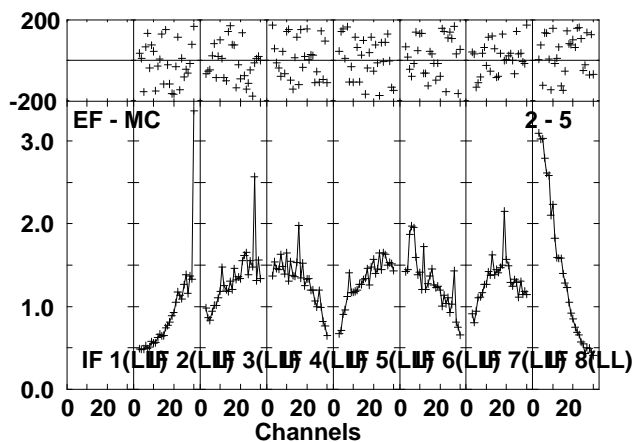
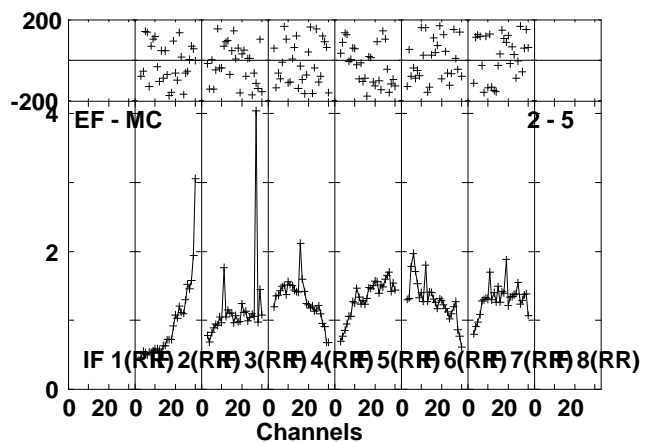
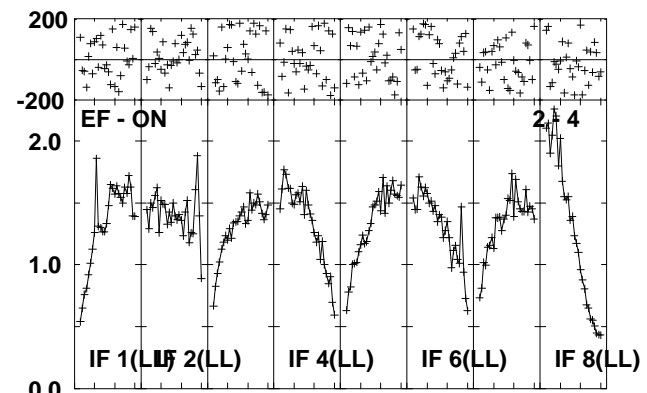
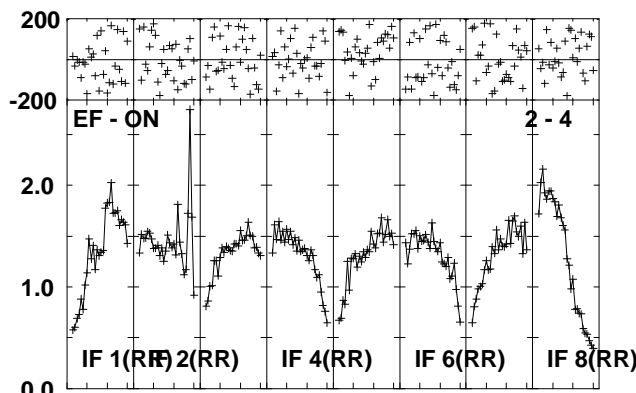
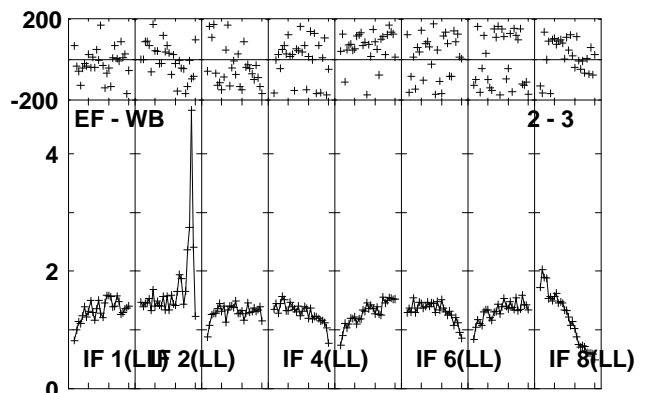
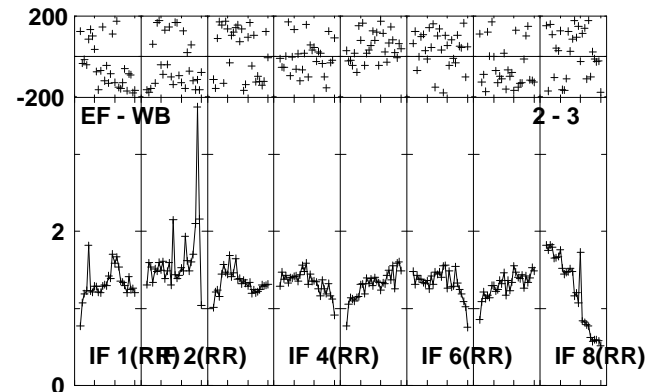
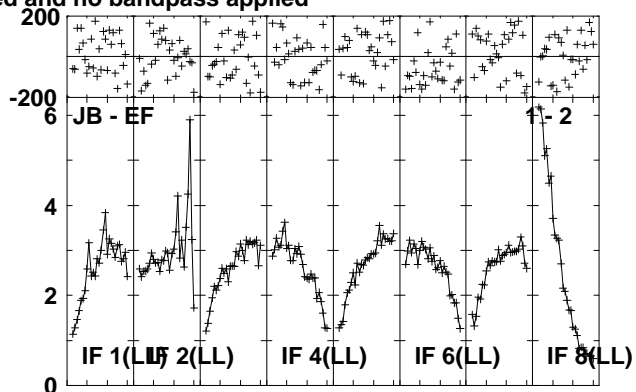
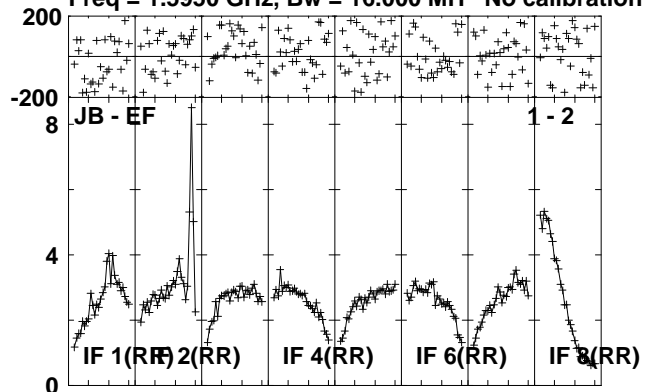

Lower frame: Milli Ampl Jy Top frame: Phas deg
Scalar averaged cross-power spectrum Several baselines displayed
Timerange: 01/01:54:01 to 01/01:57:29

Plot file version 182 created 23-AUG-2010 12:36:59

IRAS1929 EP064P.UVDATA.1

Freq = 1.5950 GHz, Bw = 16.000 MH No calibration applied and no bandpass applied

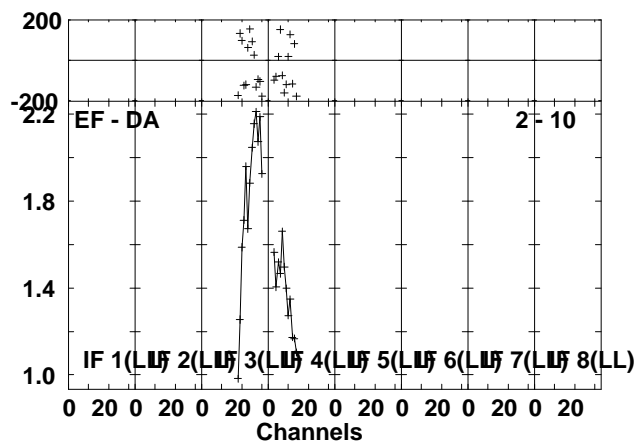
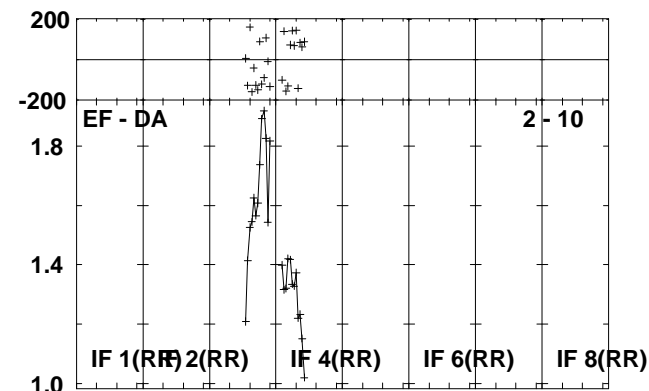
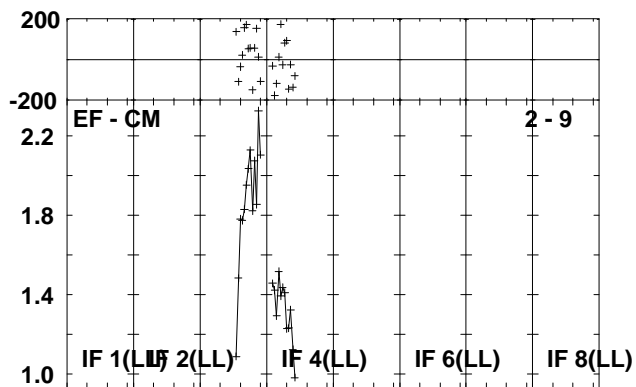
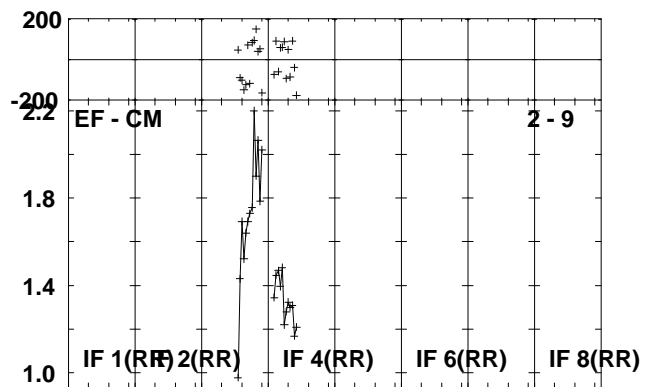
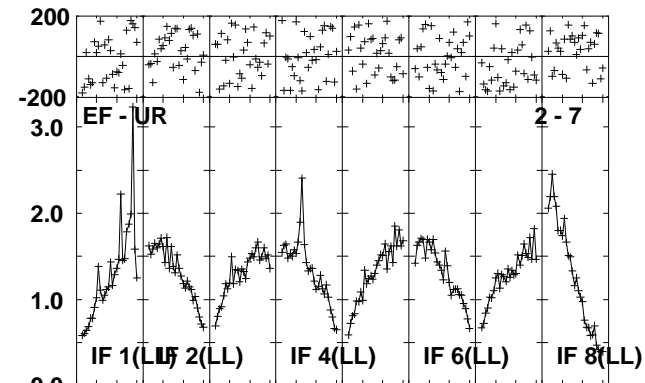
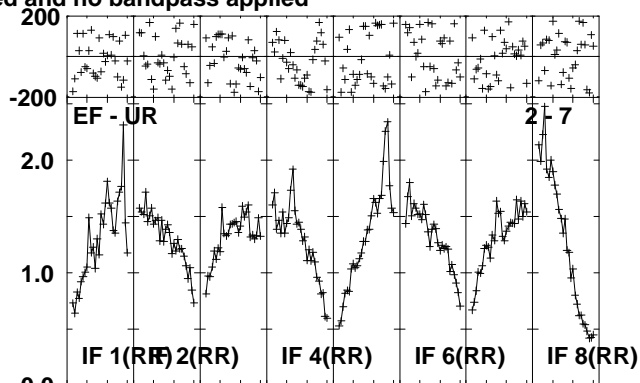
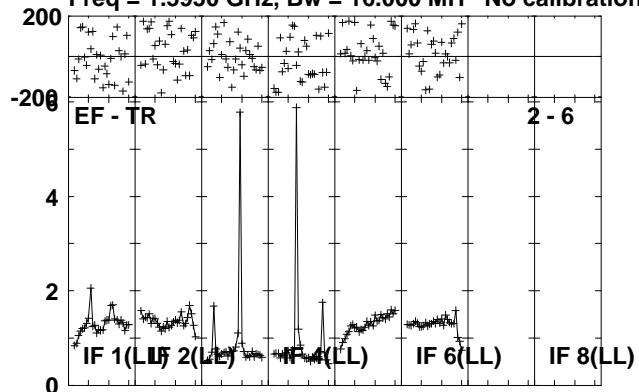

Lower frame: Milli Ampl Jy Top frame: Phas deg
Scalar averaged cross-power spectrum Several baselines displayed
Timerange: 01/01:54:01 to 01/01:57:29

Plot file version 183 created 23-AUG-2010 12:37:01

J1941-05 EP064P.UVDATA.1

Freq = 1.5950 GHz, Bw = 16.000 MH No calibration applied and no bandpass applied

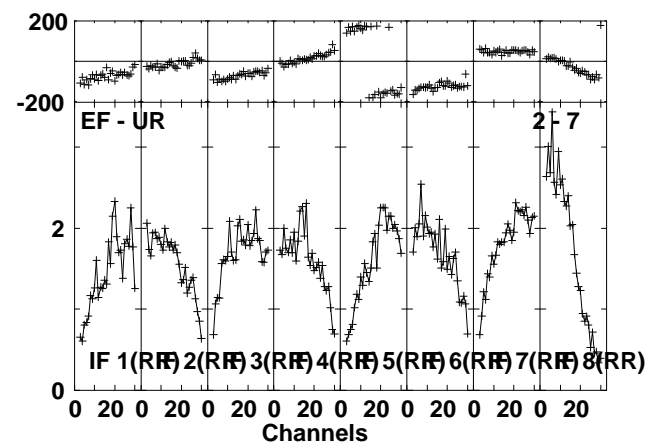
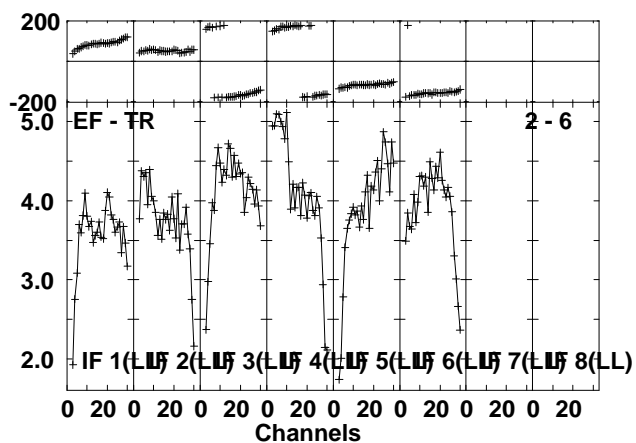
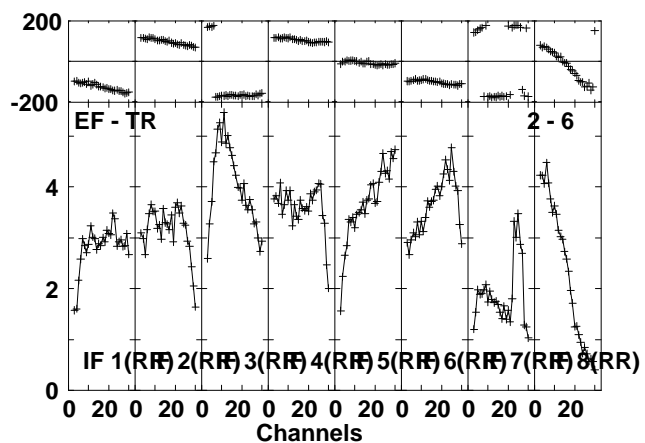
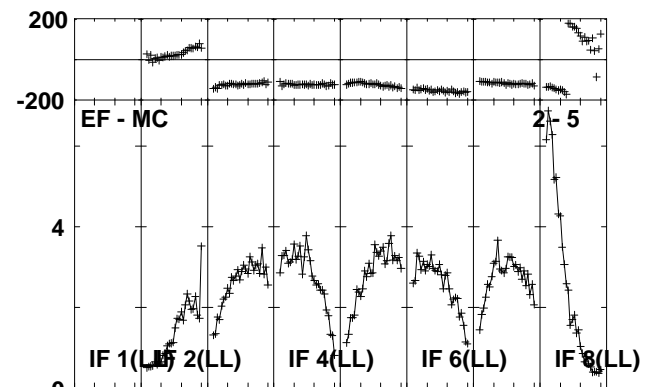
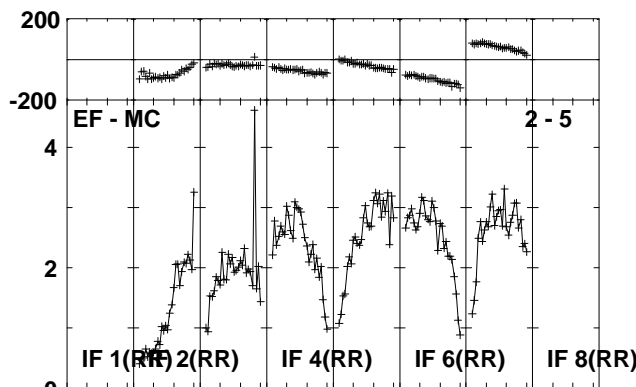
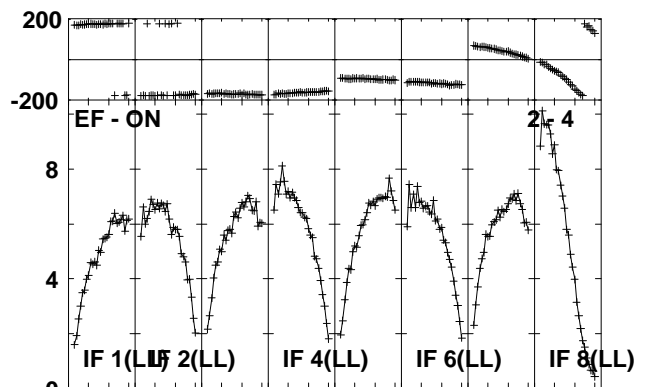
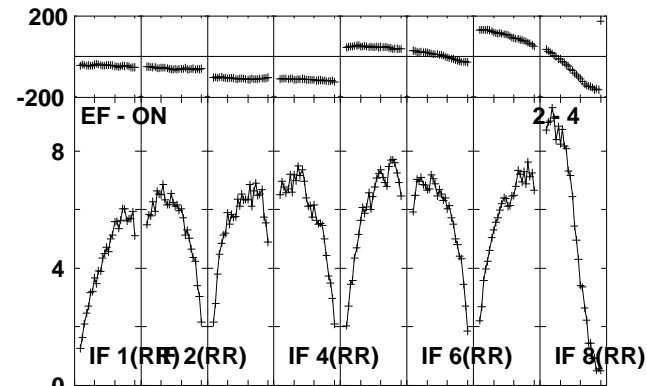
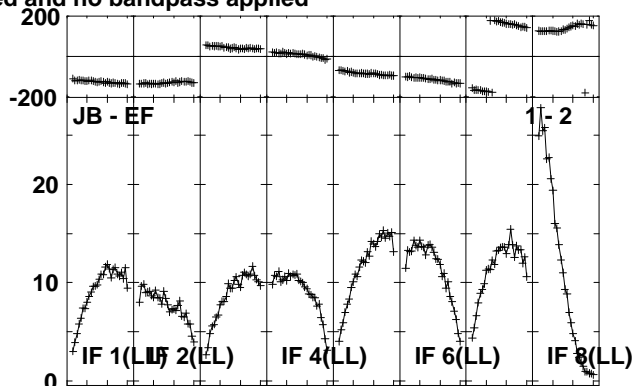
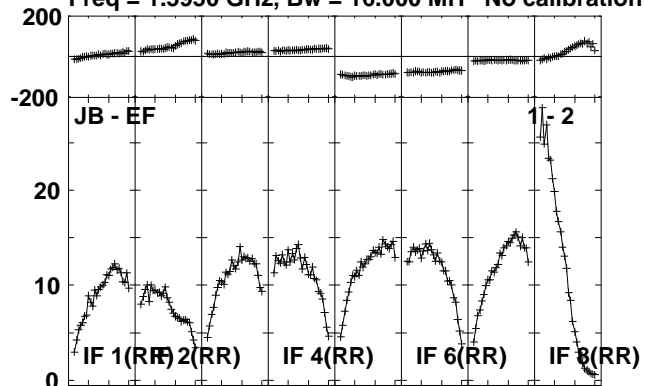

Lower frame: Milli Ampl Jy Top frame: Phas deg
Scalar averaged cross-power spectrum Several baselines displayed
Timerange: 01/01:57:31 to 01/01:58:59

Plot file version 184 created 23-AUG-2010 12:37:02
J1941-05 EP064P.UVDATA.1

Freq = 1.5950 GHz, Bw = 16.000 MH No calibration applied and no bandpass applied

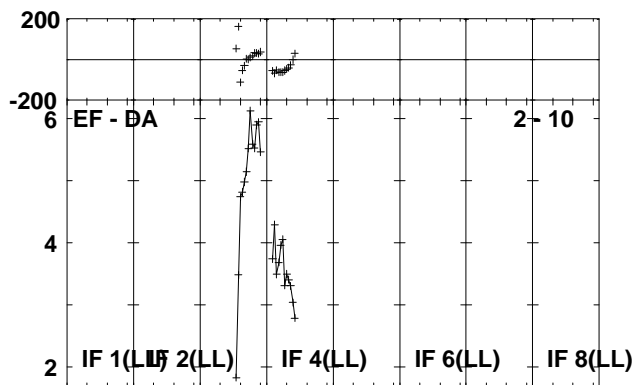
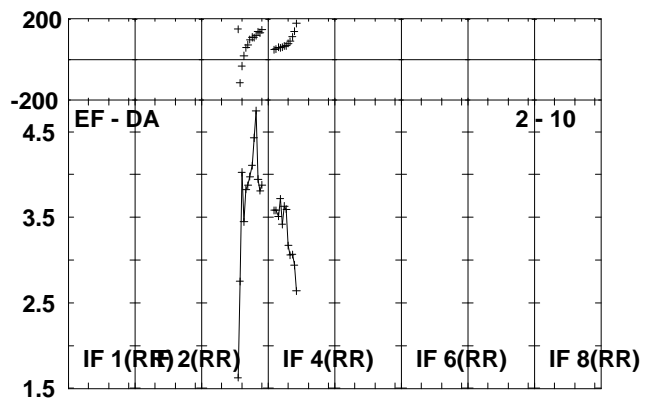
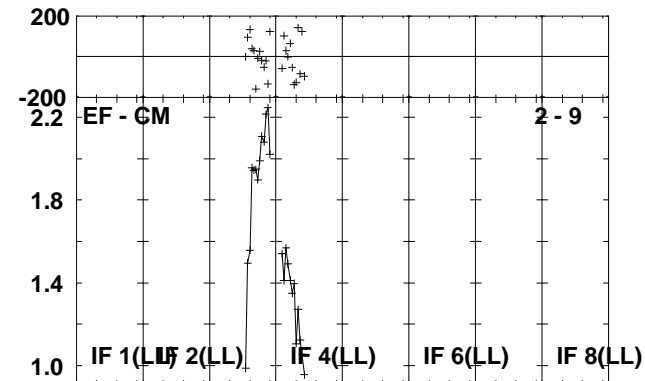
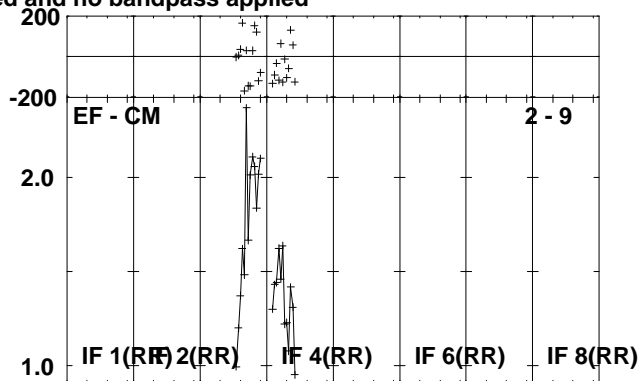
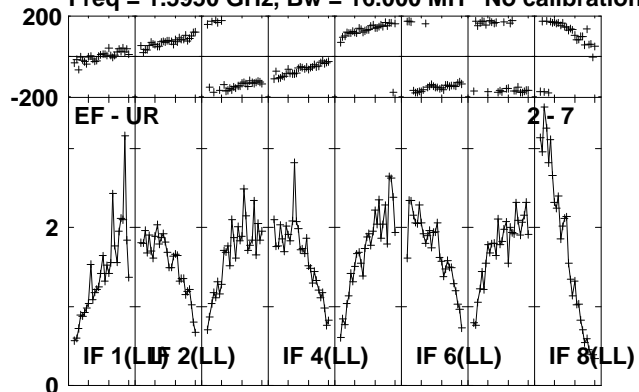

Lower frame: Milli Ampl Jy Top frame: Phas deg
Scalar averaged cross-power spectrum Several baselines displayed
Timerange: 01/01:57:31 to 01/01:58:59

Plot file version 185 created 23-AUG-2010 12:37:03

IRAS1929 EP064P.UVDATA.1

Freq = 1.5950 GHz, Bw = 16.000 MH No calibration applied and no bandpass applied

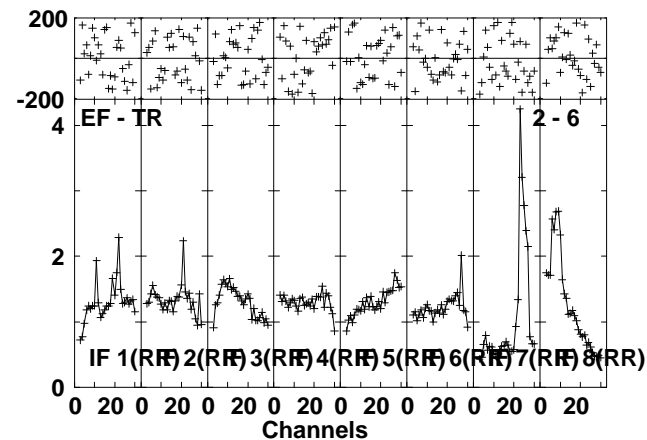
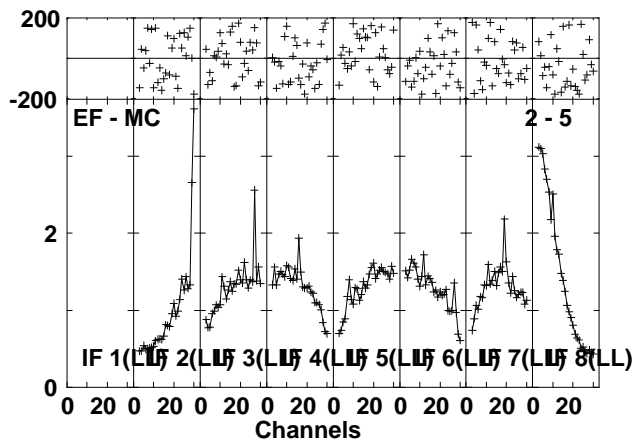
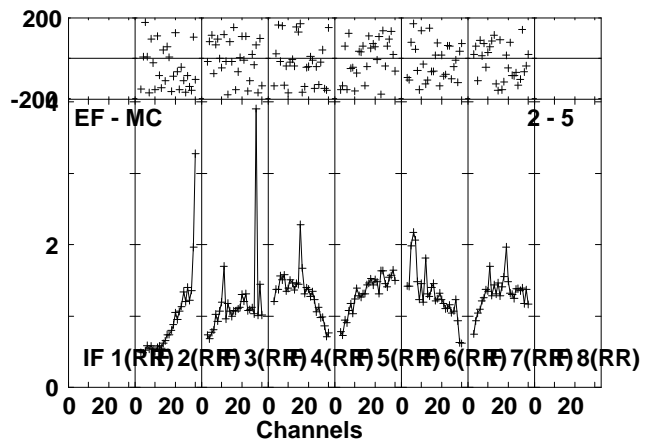
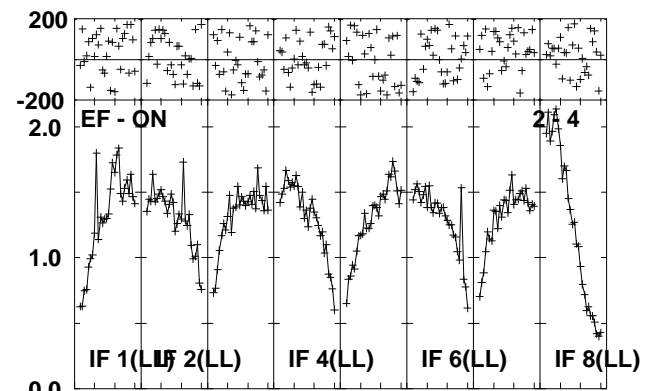
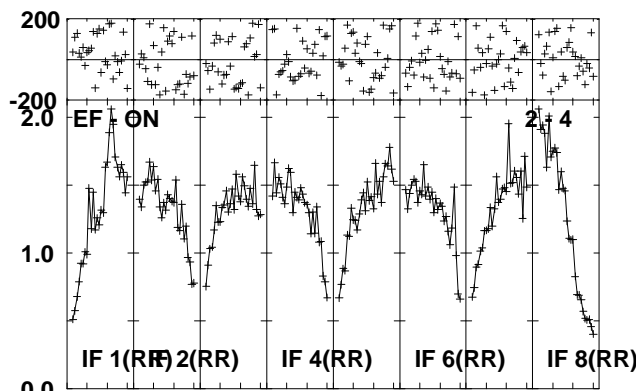
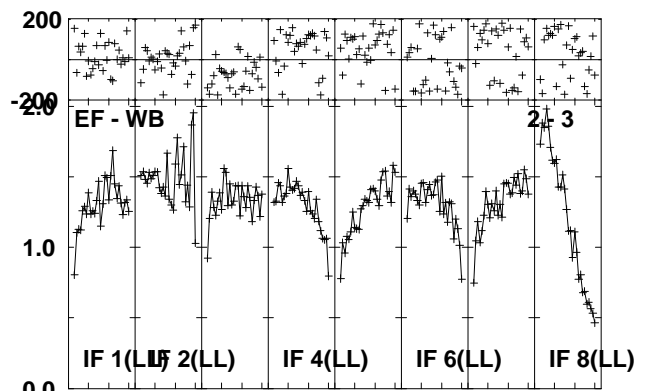
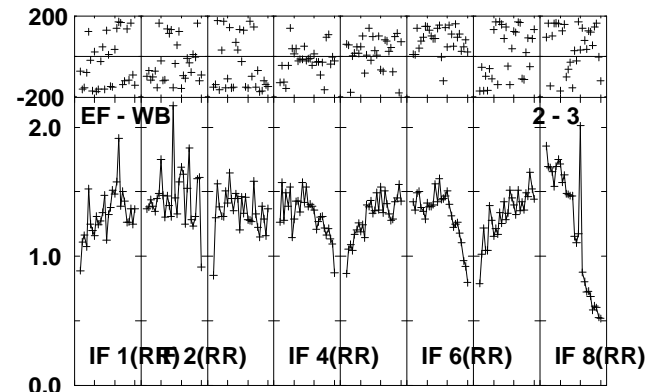
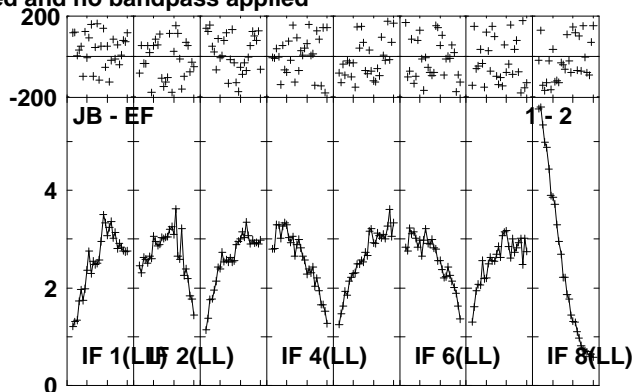
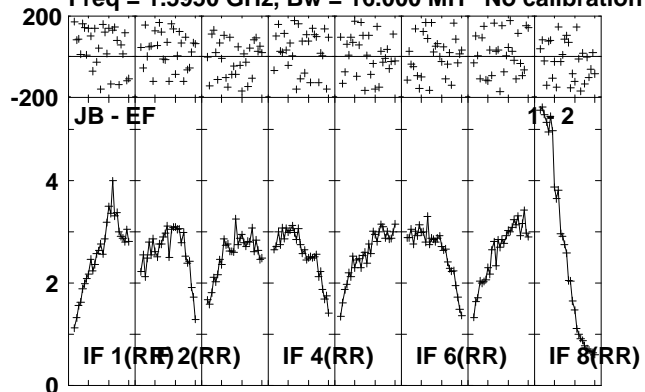

Lower frame: Milli Ampl Jy Top frame: Phas deg
Scalar averaged cross-power spectrum Several baselines displayed
Timerange: 01/01:59:01 to 01/02:02:29

Plot file version 186 created 23-AUG-2010 12:37:05

IRAS1929 EP064P.UVDATA.1

Freq = 1.5950 GHz, Bw = 16.000 MH No calibration applied and no bandpass applied

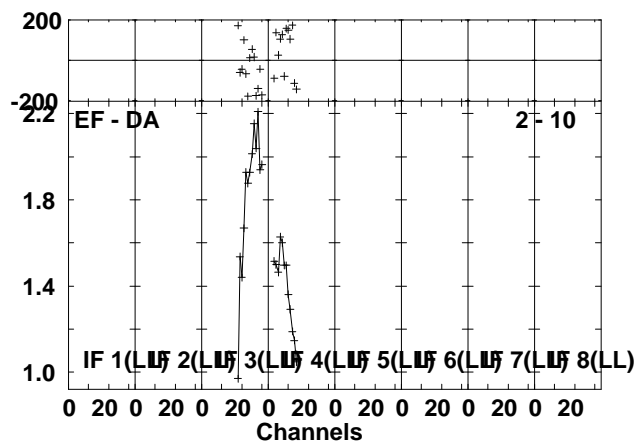
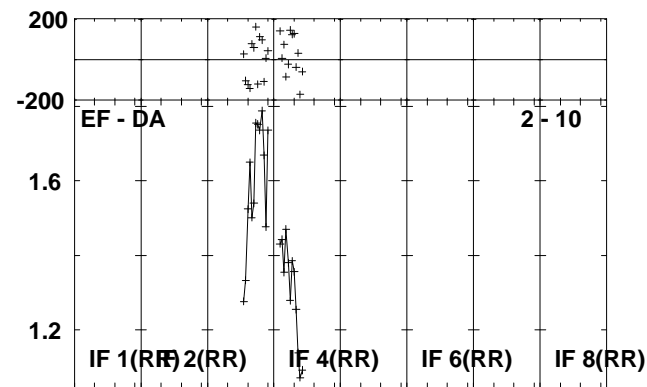
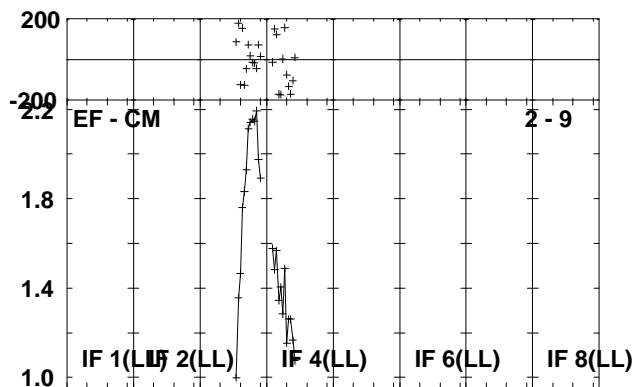
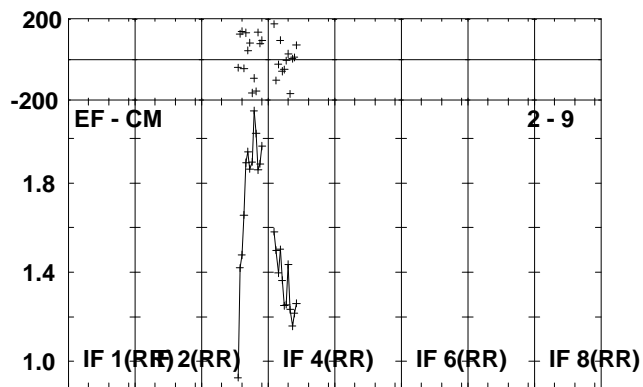
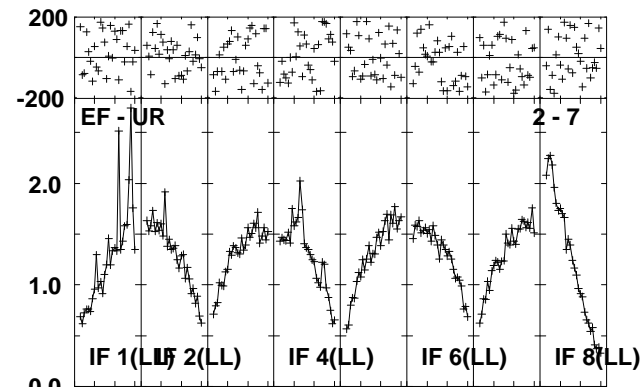
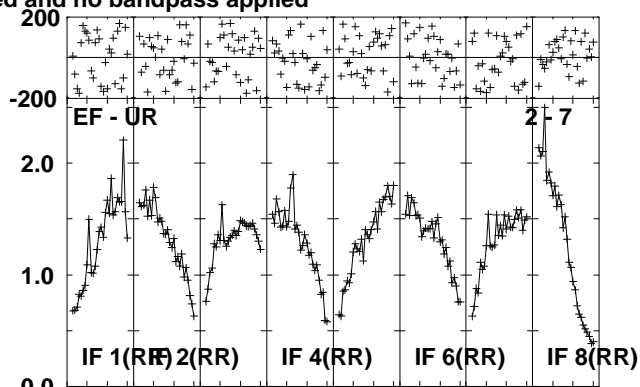
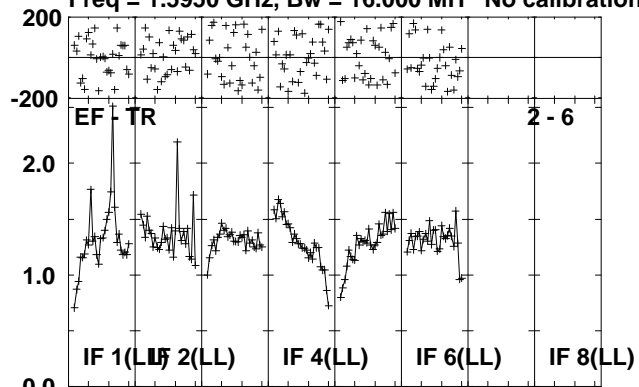

Lower frame: Milli Ampl Jy Top frame: Phas deg
Scalar averaged cross-power spectrum Several baselines displayed
Timerange: 01/01:59:01 to 01/02:02:29

Plot file version 187 created 23-AUG-2010 12:37:06

J1941-05 EP064P.UVDATA.1

Freq = 1.5950 GHz, Bw = 16.000 MH No calibration applied and no bandpass applied

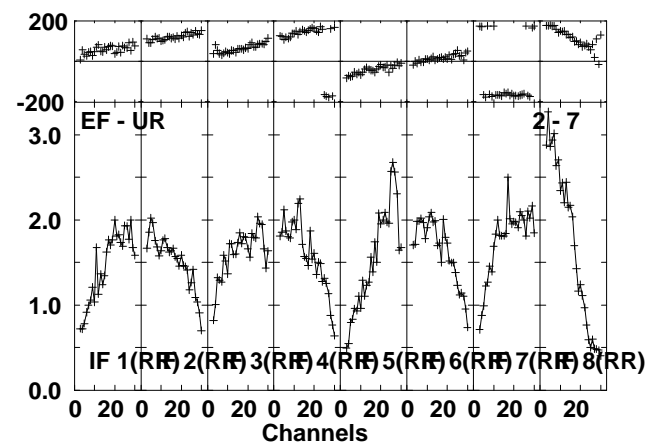
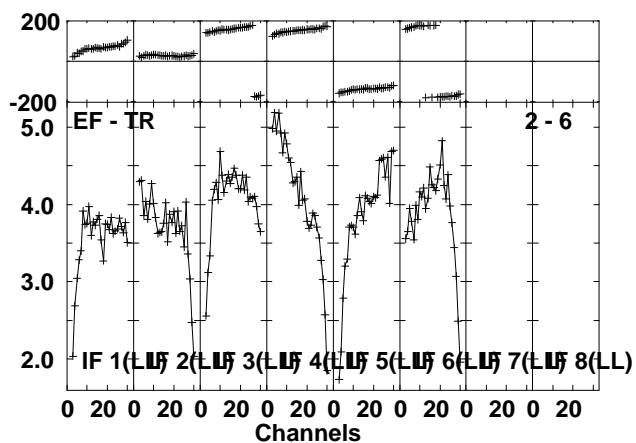
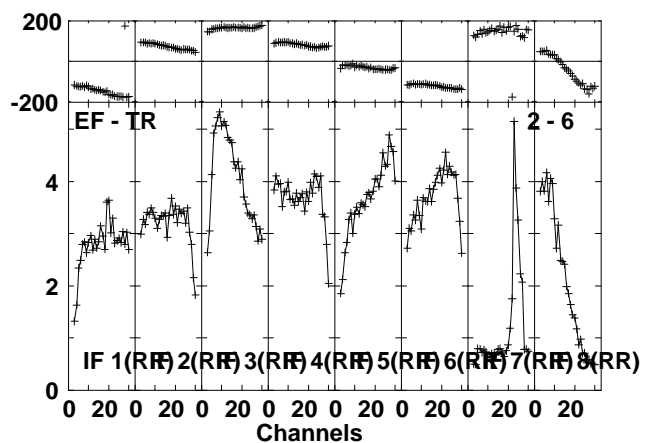
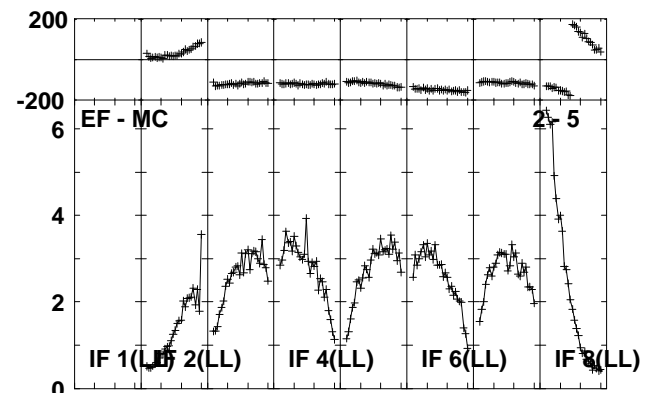
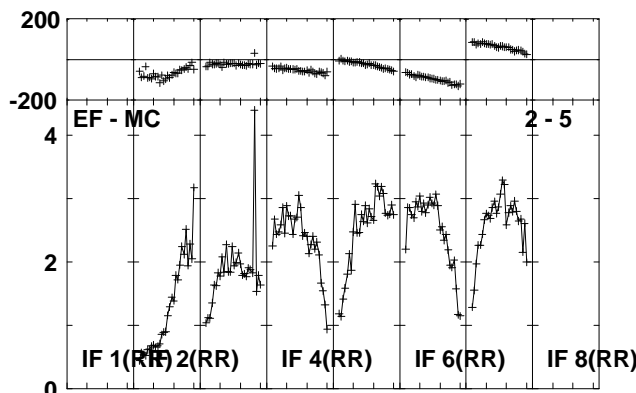
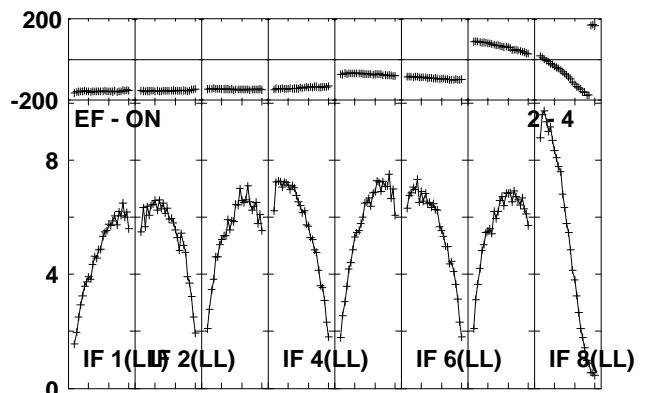
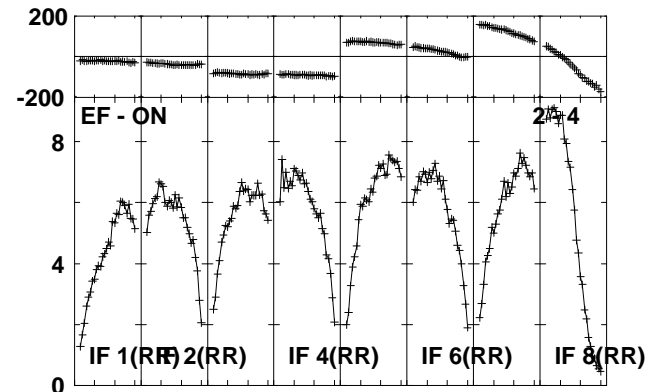
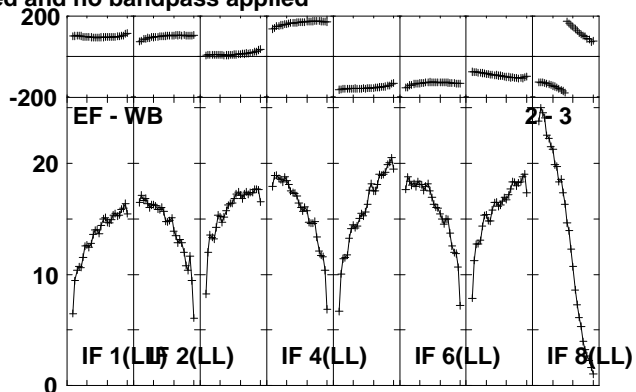
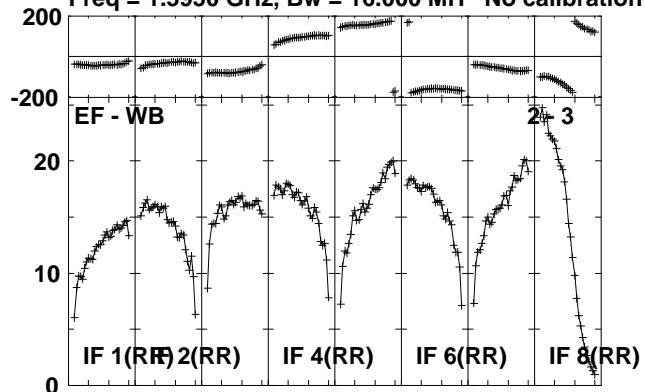

Lower frame: Milli Ampl Jy Top frame: Phas deg
Scalar averaged cross-power spectrum Several baselines displayed
Timerange: 01/02:03:33 to 01/02:04:59

Plot file version 188 created 23-AUG-2010 12:37:07

J1941-05 EP064P.UVDATA.1

Freq = 1.5950 GHz, Bw = 16.000 MH No calibration applied and no bandpass applied

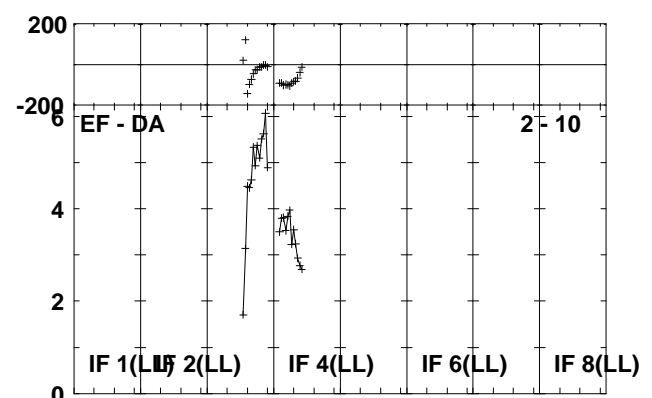
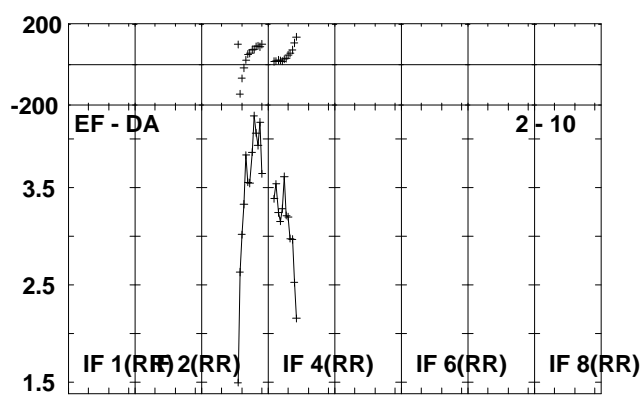
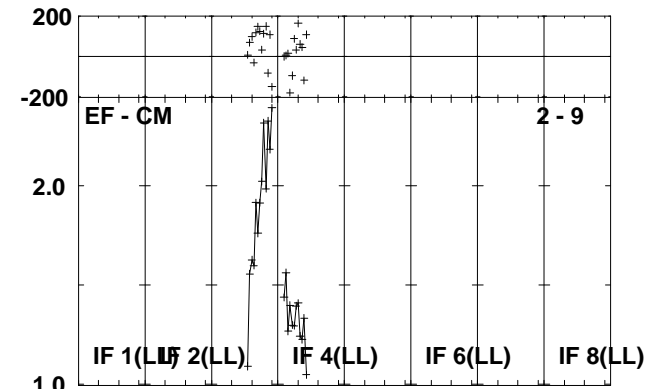
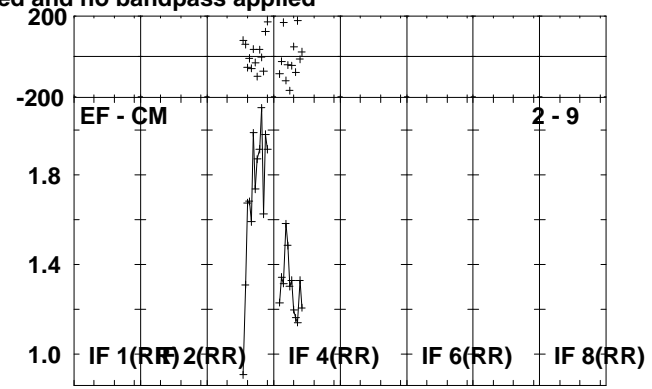
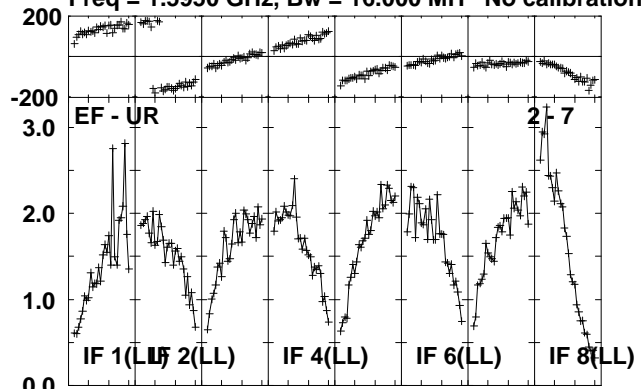

Lower frame: Milli Ampl Jy Top frame: Phas deg
Scalar averaged cross-power spectrum Several baselines displayed
Timerange: 01/02:03:33 to 01/02:04:59

Plot file version 189 created 23-AUG-2010 12:37:08

IRAS1929 EP064P.UVDATA.1

Freq = 1.5950 GHz, Bw = 16.000 MH No calibration applied and no bandpass applied

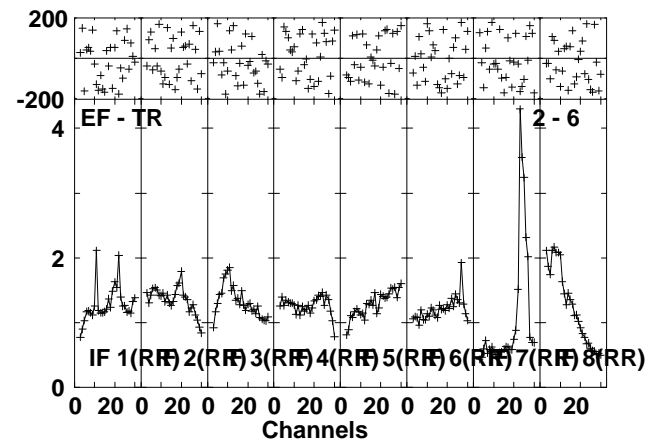
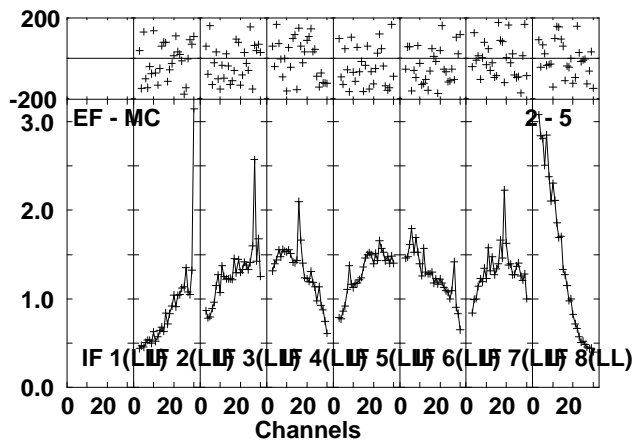
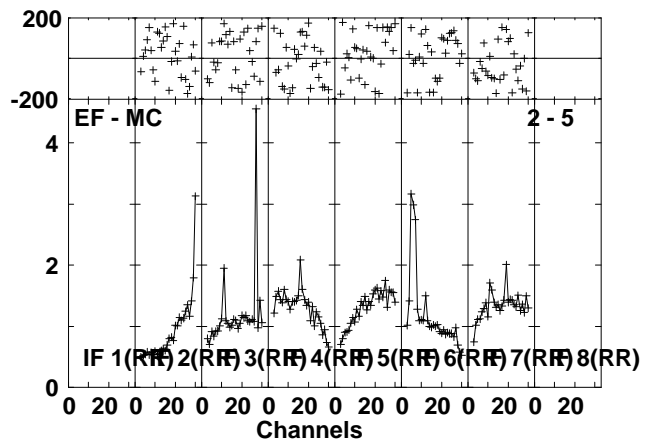
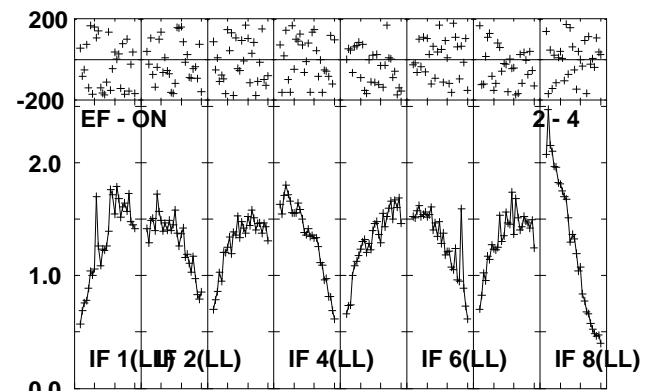
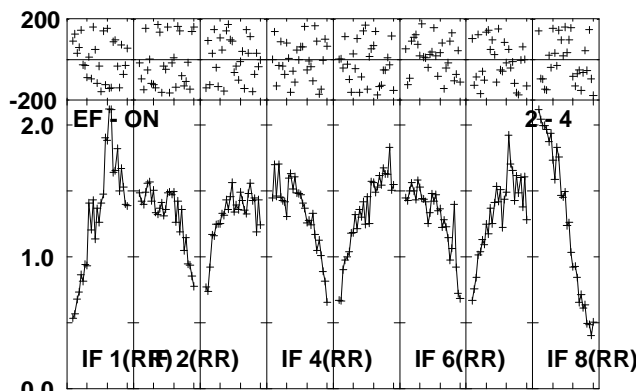
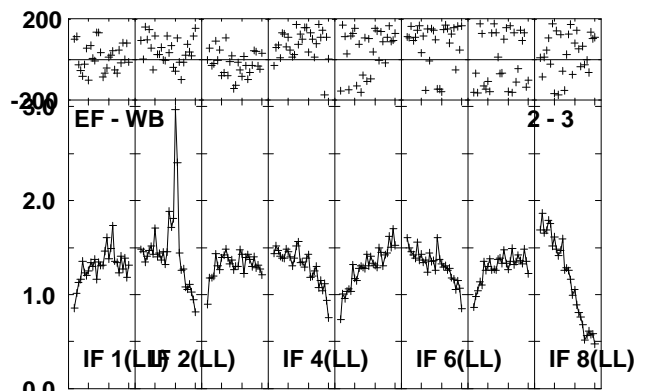
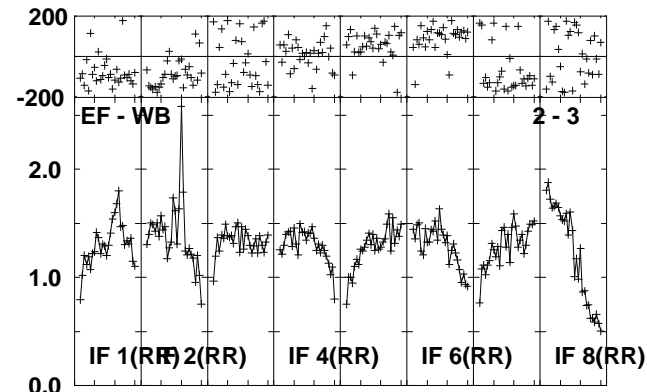
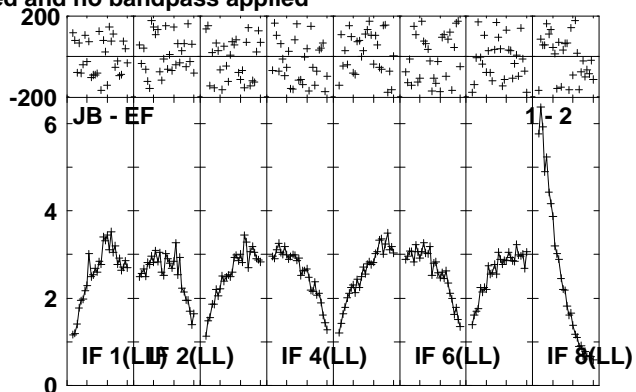
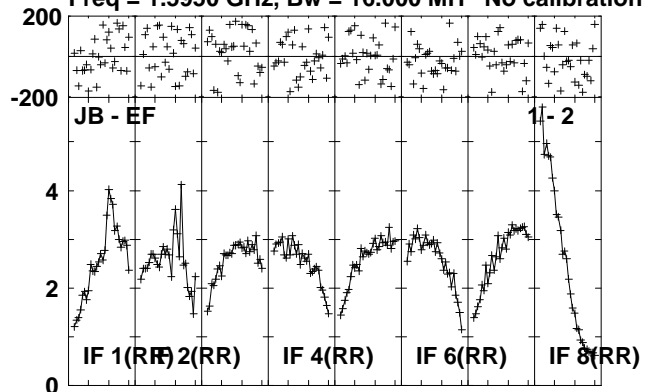

Lower frame: Milli Ampl Jy Top frame: Phas deg
Scalar averaged cross-power spectrum Several baselines displayed
Timerange: 01/02:05:01 to 01/02:08:29

Plot file version 190 created 23-AUG-2010 12:37:09

IRAS1929 EP064P.UVDATA.1

Freq = 1.5950 GHz, Bw = 16.000 MH No calibration applied and no bandpass applied

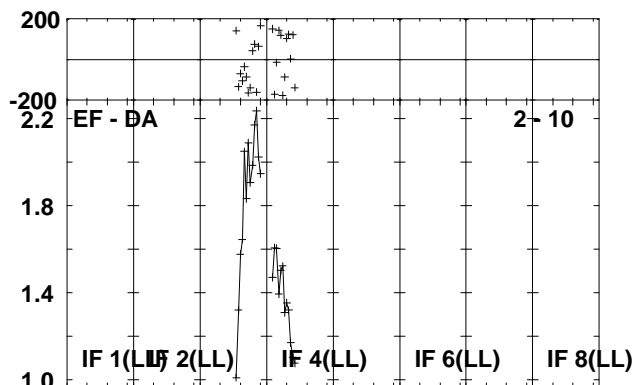
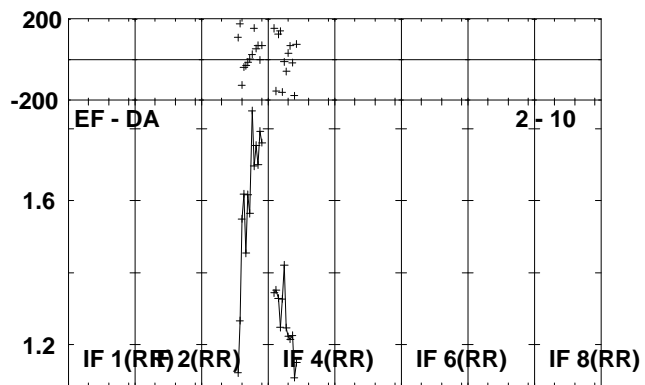
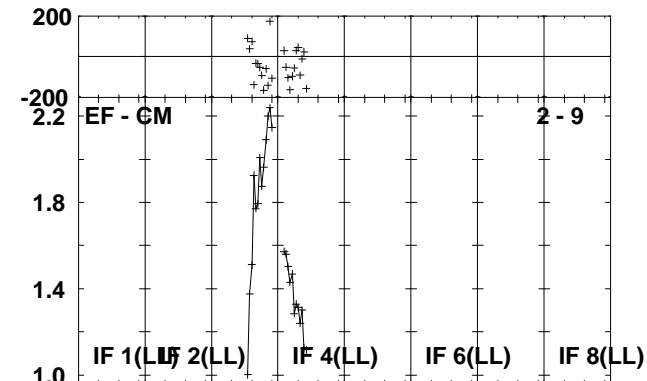
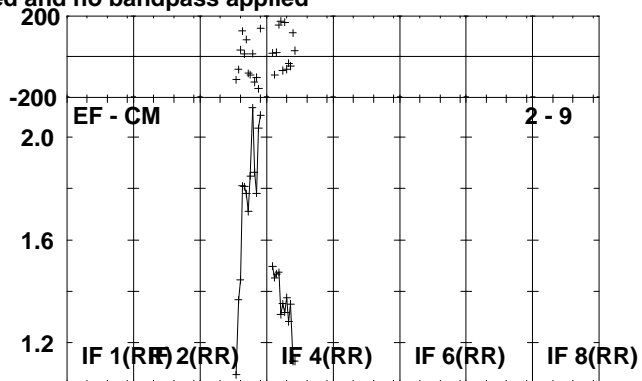
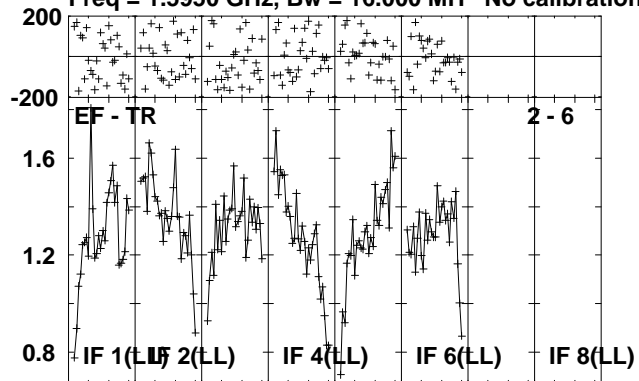

Lower frame: Milli Ampl Jy Top frame: Phas deg
Scalar averaged cross-power spectrum Several baselines displayed
Timerange: 01/02:05:01 to 01/02:08:29

Plot file version 191 created 23-AUG-2010 12:37:10

J1941-05 EP064P.UVDATA.1

Freq = 1.5950 GHz, Bw = 16.000 MH No calibration applied and no bandpass applied

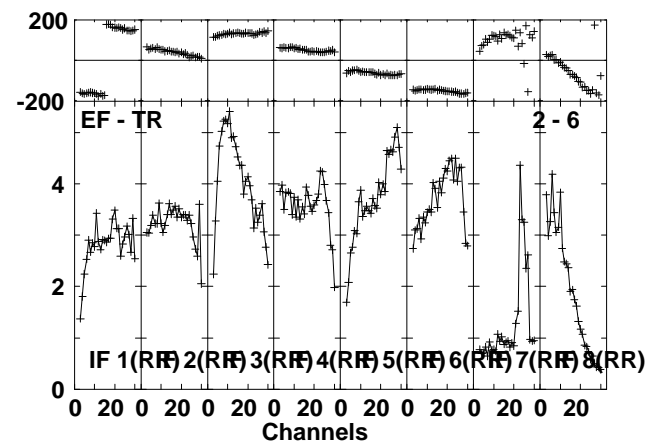
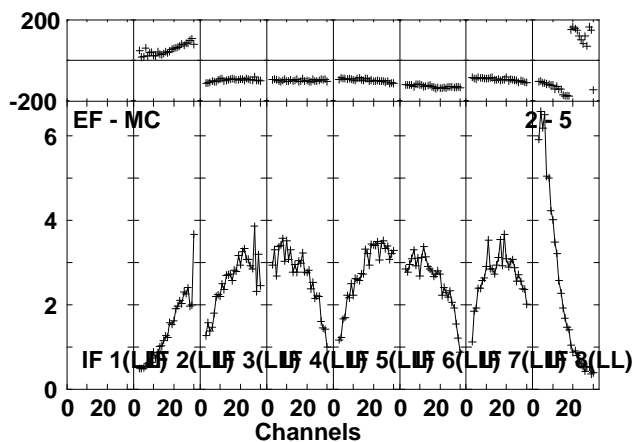
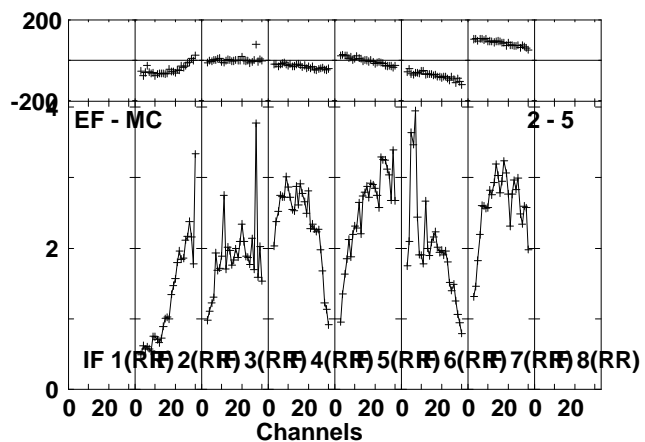
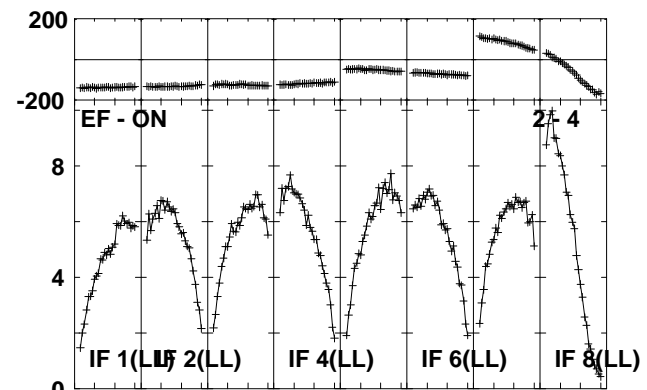
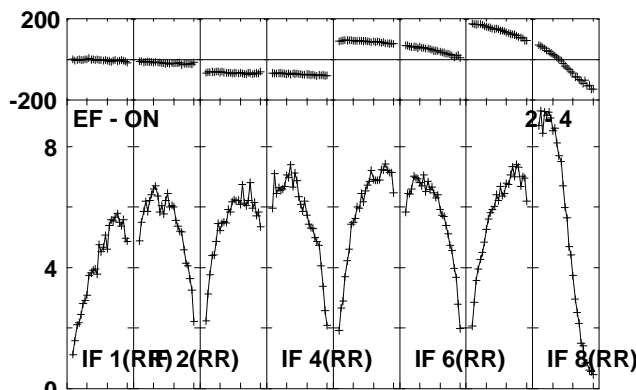
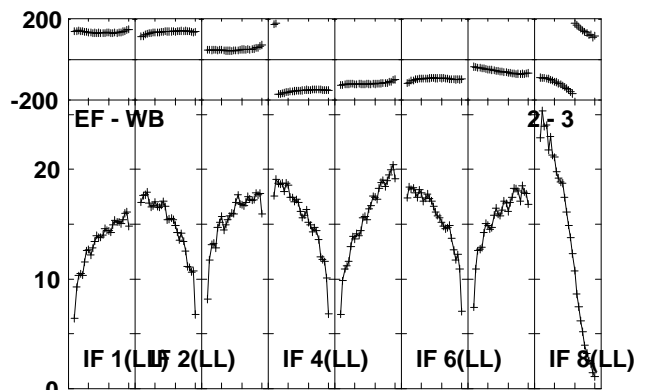
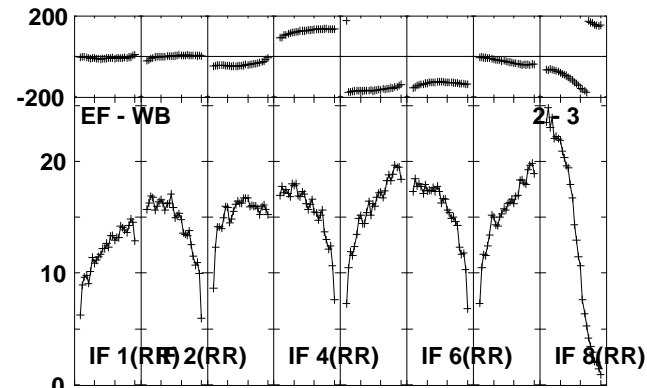
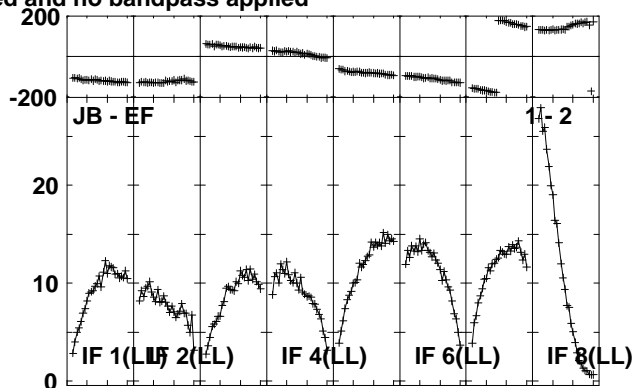
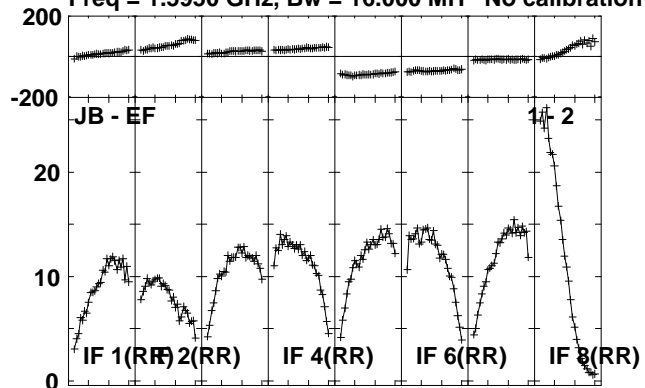

Lower frame: Milli Ampl Jy Top frame: Phas deg
Scalar averaged cross-power spectrum Several baselines displayed
Timerange: 01/02:08:31 to 01/02:09:59

Plot file version 192 created 23-AUG-2010 12:37:11
J1941-05 EP064P.UVDATA.1

Freq = 1.5950 GHz, Bw = 16.000 MH No calibration applied and no bandpass applied

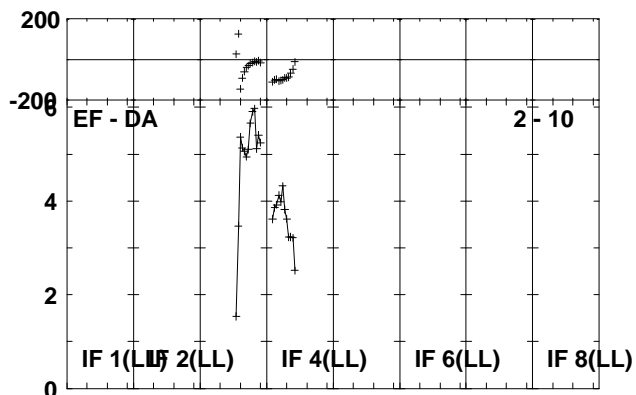
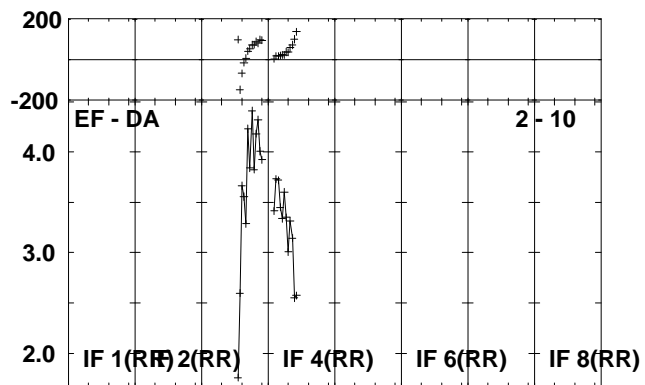
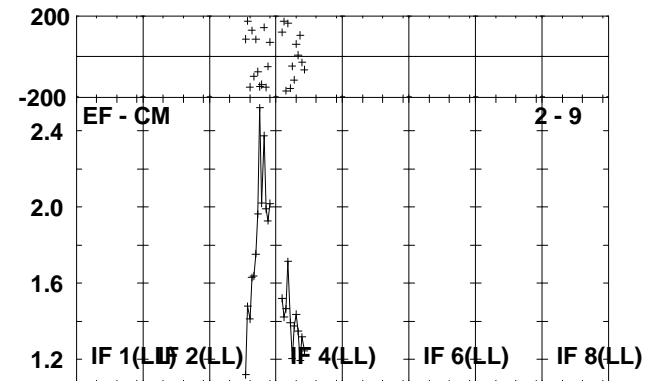
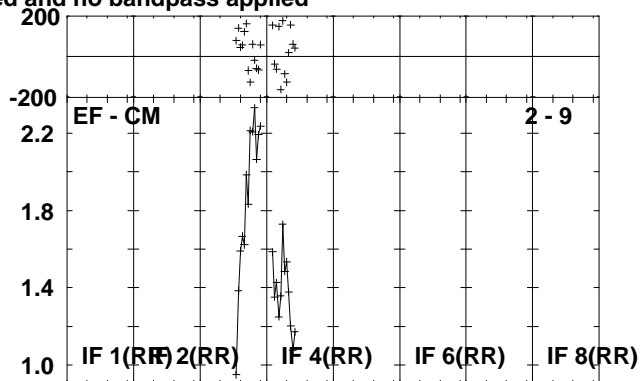
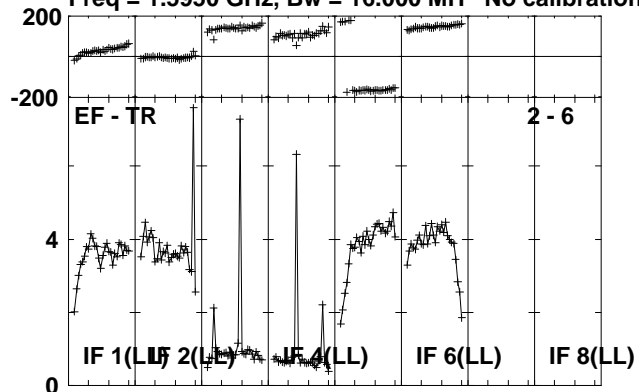

Lower frame: Milli Ampl Jy Top frame: Phas deg
Scalar averaged cross-power spectrum Several baselines displayed
Timerange: 01/02:08:31 to 01/02:09:59

Plot file version 193 created 23-AUG-2010 12:37:12

IRAS1929 EP064P.UVDATA.1

Freq = 1.5950 GHz, Bw = 16.000 MH No calibration applied and no bandpass applied

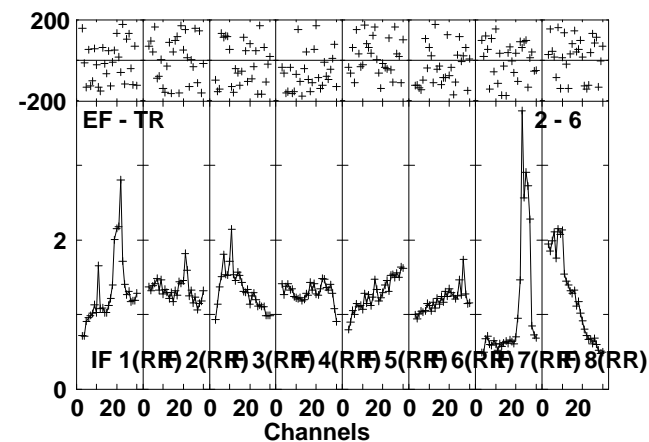
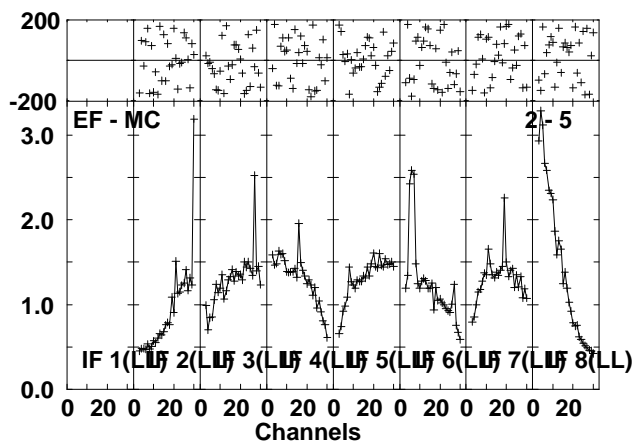
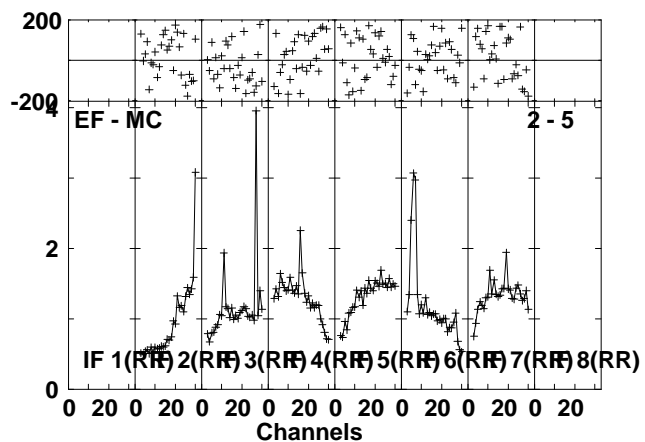
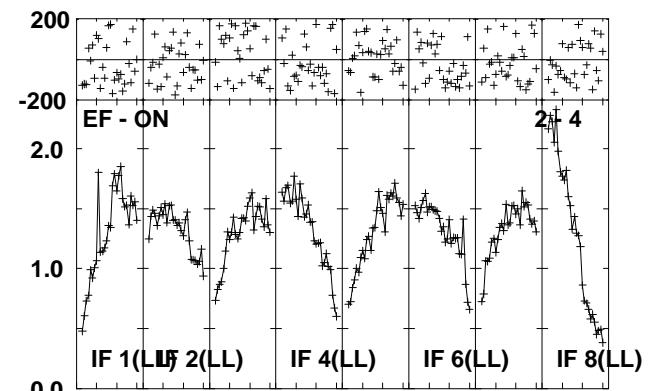
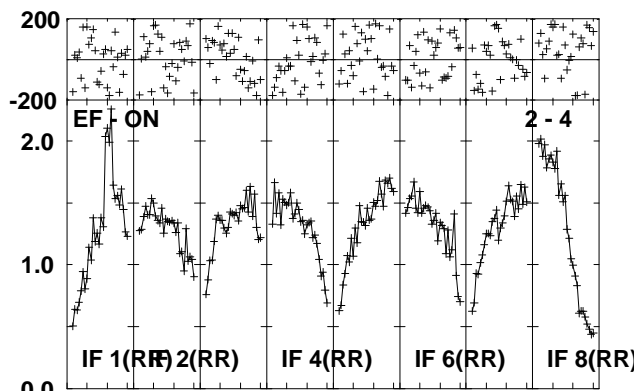
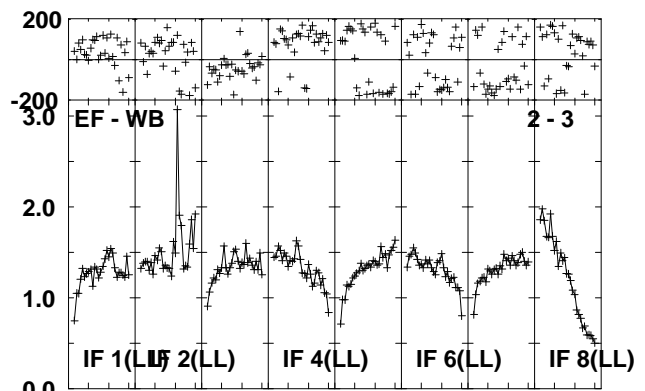
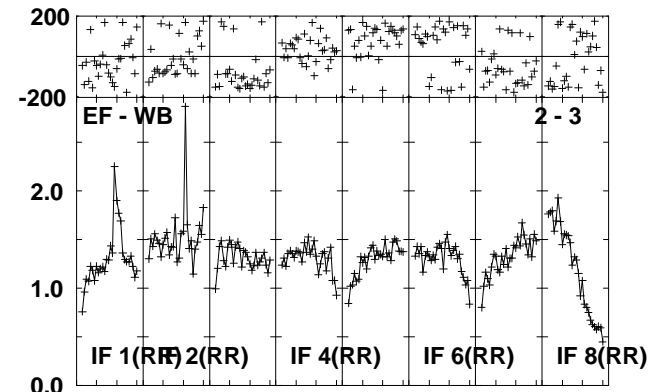
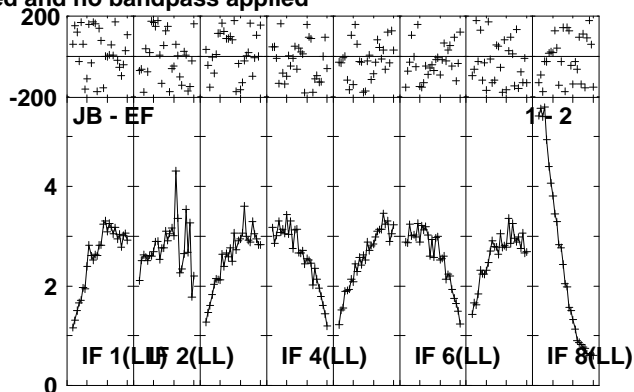
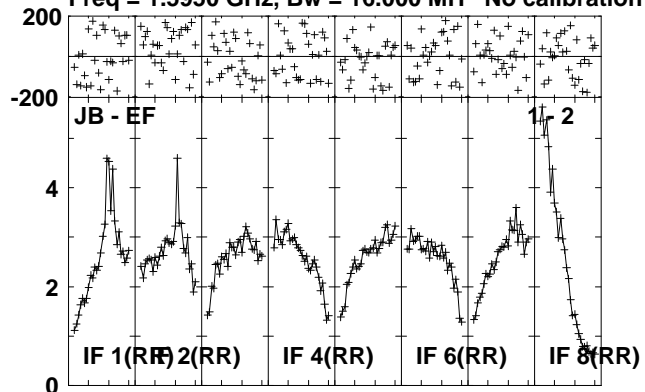

Lower frame: Milli Ampl Jy Top frame: Phas deg
Scalar averaged cross-power spectrum Several baselines displayed
Timerange: 01/02:10:01 to 01/02:13:29

Plot file version 194 created 23-AUG-2010 12:37:13

IRAS1929 EP064P.UVDATA.1

Freq = 1.5950 GHz, Bw = 16.000 MH No calibration applied and no bandpass applied

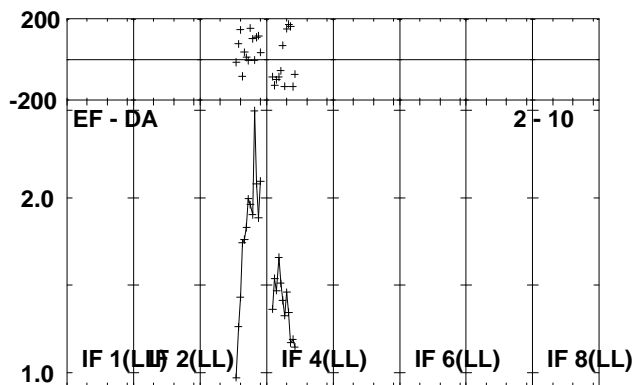
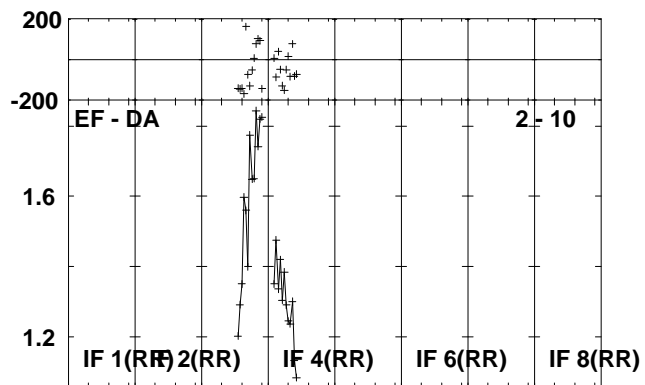
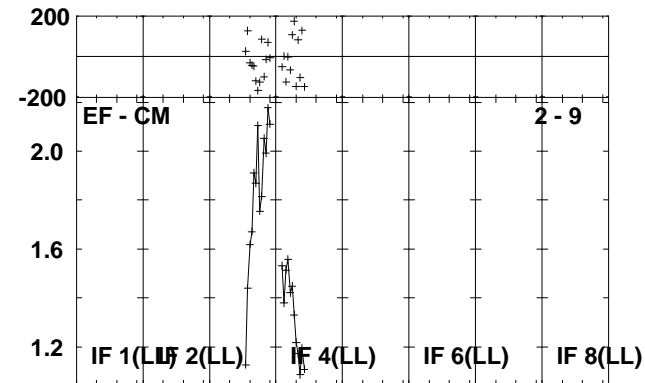
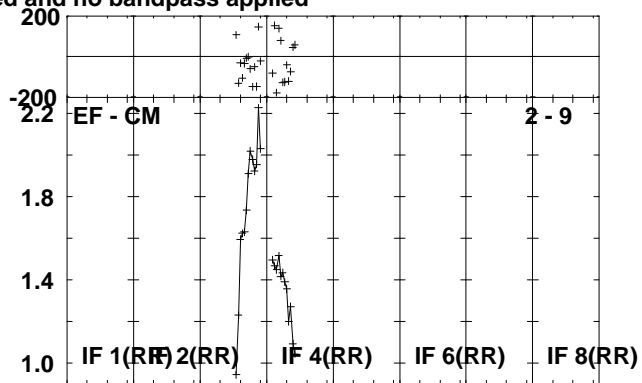
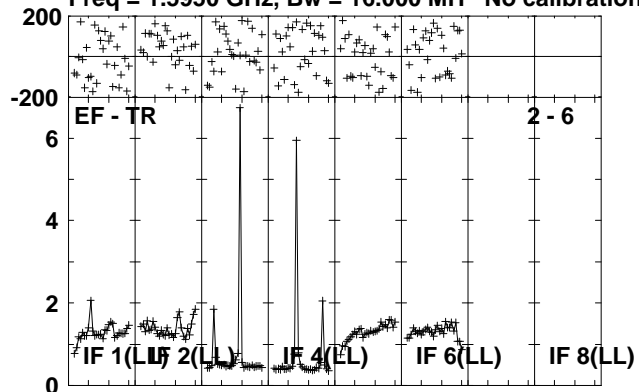

Lower frame: Milli Ampl Jy Top frame: Phas deg
Scalar averaged cross-power spectrum Several baselines displayed
Timerange: 01/02:10:01 to 01/02:13:29

Plot file version 195 created 23-AUG-2010 12:37:14

J1941-05 EP064P.UVDATA.1

Freq = 1.5950 GHz, Bw = 16.000 MH No calibration applied and no bandpass applied

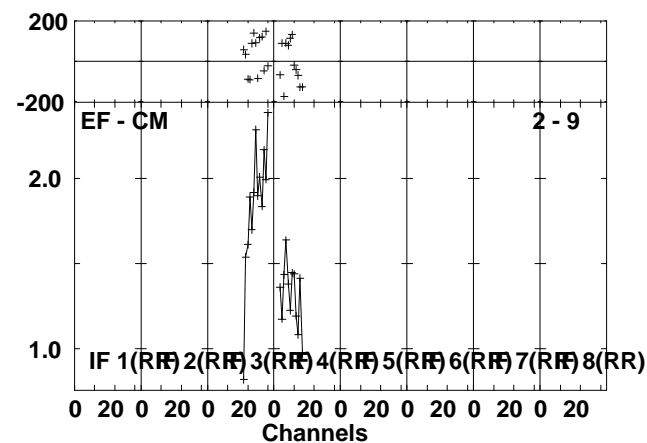
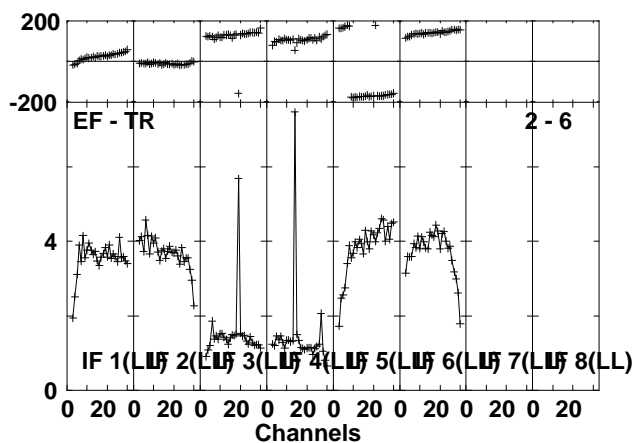
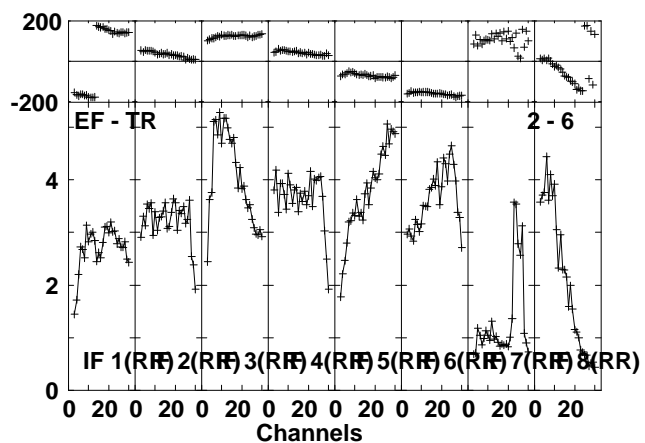
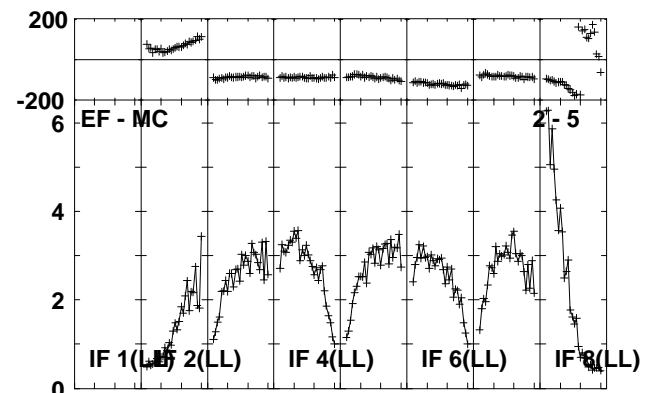
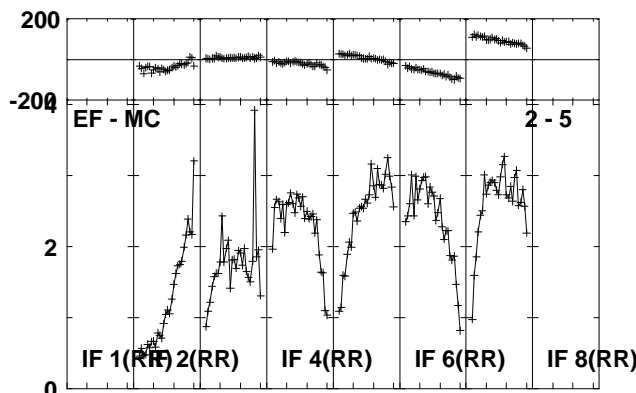
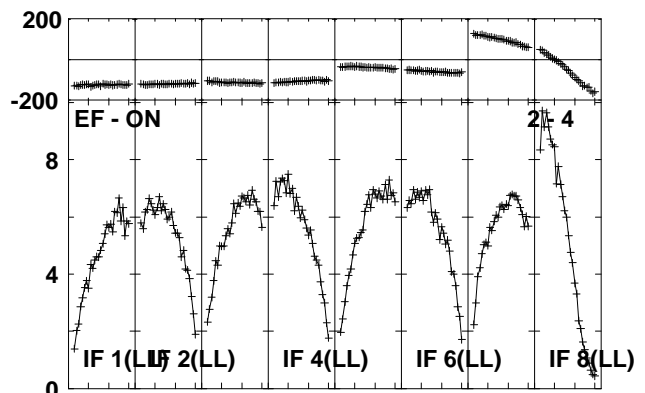
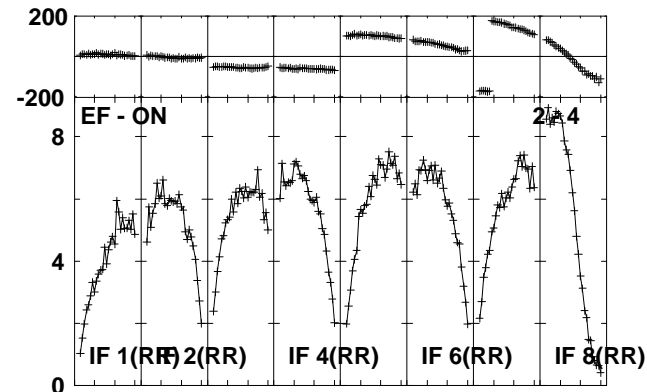
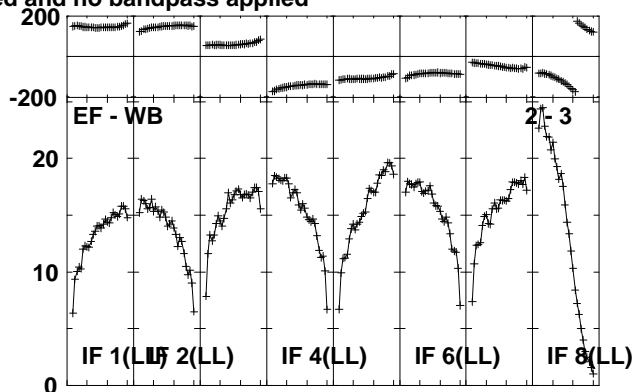
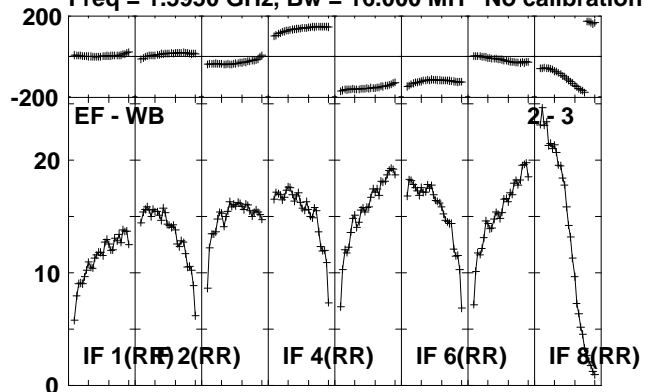

Lower frame: Milli Ampl Jy Top frame: Phas deg
Scalar averaged cross-power spectrum Several baselines displayed
Timerange: 01/02:13:31 to 01/02:14:57

Plot file version 196 created 23-AUG-2010 12:37:15
J1941-05 EP064P.UVDATA.1

Freq = 1.5950 GHz, Bw = 16.000 MH No calibration applied and no bandpass applied

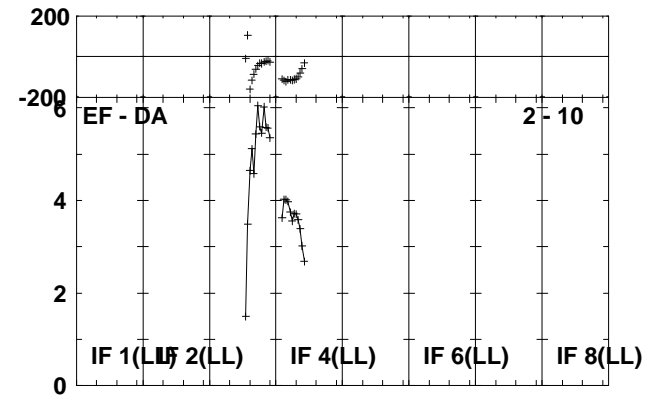
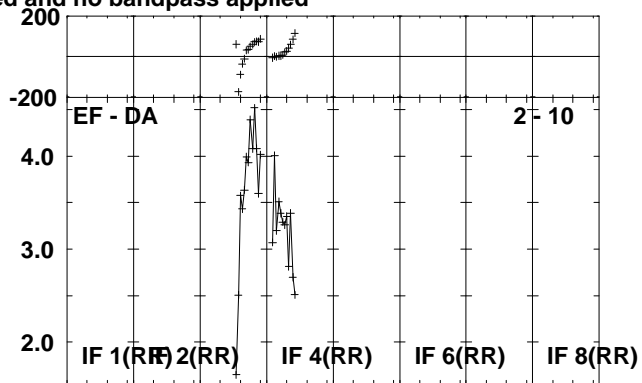
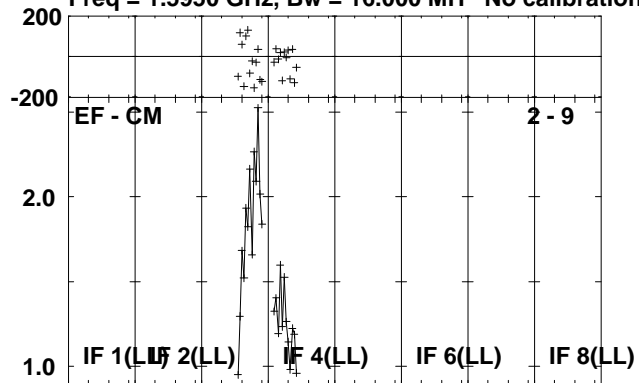

Lower frame: Milli Ampl Jy Top frame: Phas deg
Scalar averaged cross-power spectrum Several baselines displayed
Timerange: 01/02:13:31 to 01/02:14:57

Plot file version 197 created 23-AUG-2010 12:37:15

IRAS1929 EP064P.UVDATA.1

Freq = 1.5950 GHz, Bw = 16.000 MH No calibration applied and no bandpass applied

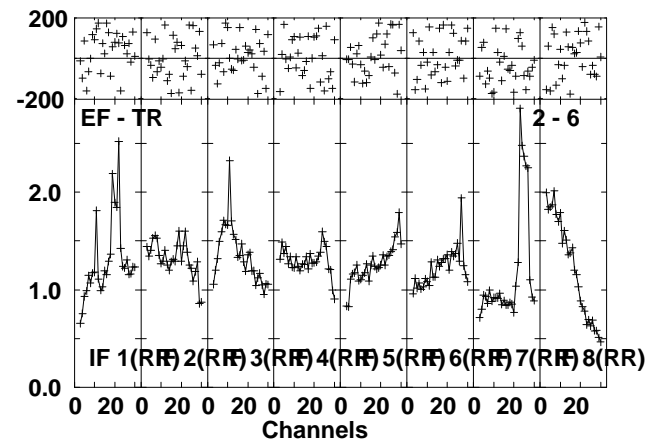
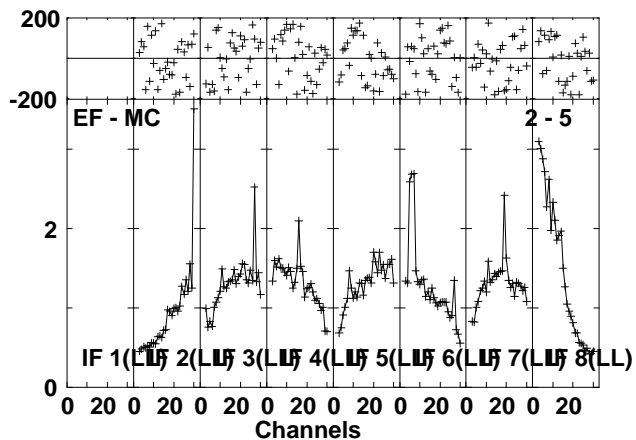
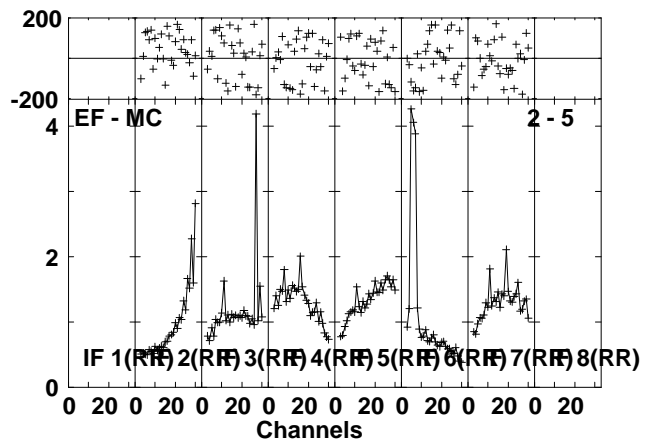
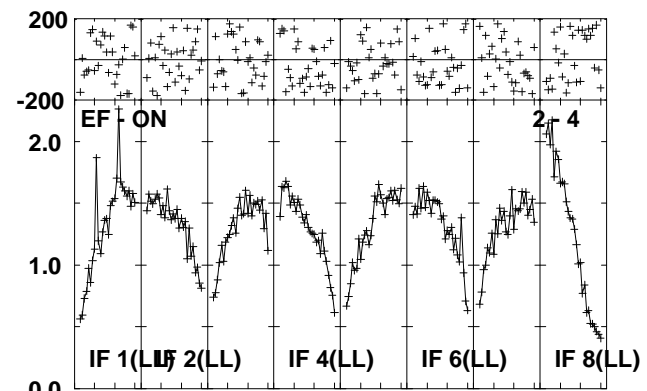
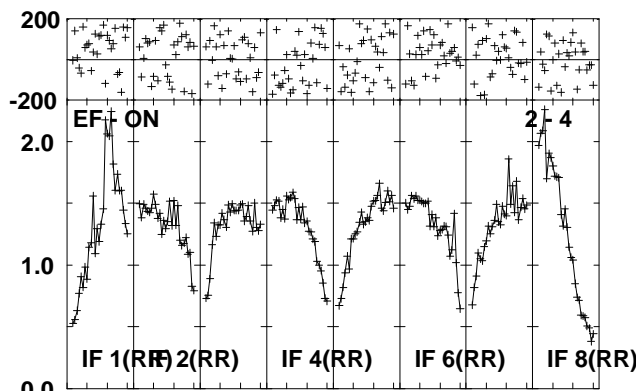
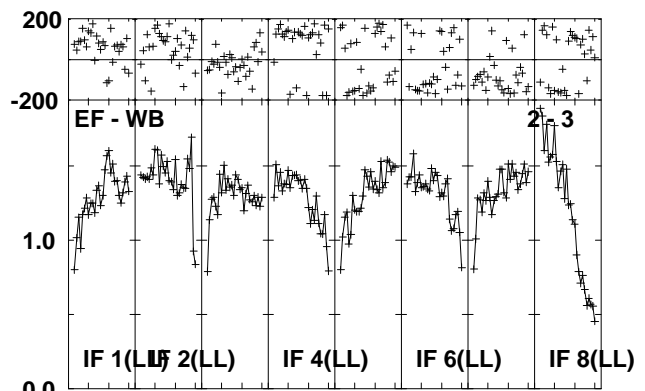
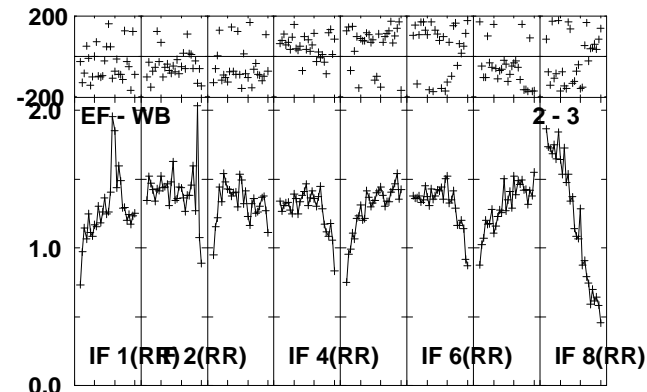
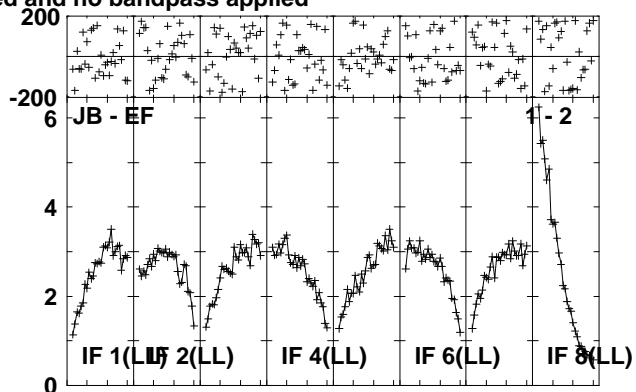
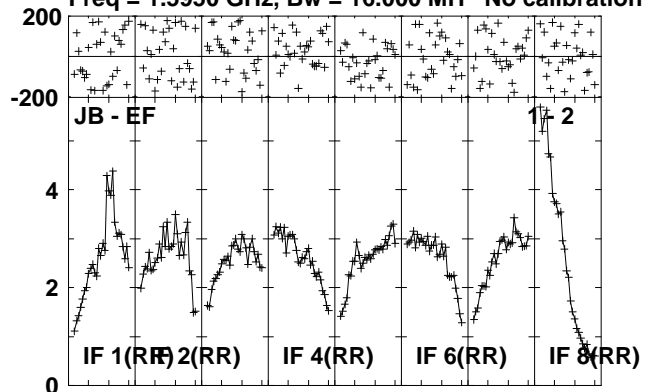

Lower frame: Milli Ampl Jy Top frame: Phas deg
Scalar averaged cross-power spectrum Several baselines displayed
Timerange: 01/02:15:01 to 01/02:18:29

Plot file version 198 created 23-AUG-2010 12:37:16

IRAS1929 EP064P.UVDATA.1

Freq = 1.5950 GHz, Bw = 16.000 MH No calibration applied and no bandpass applied

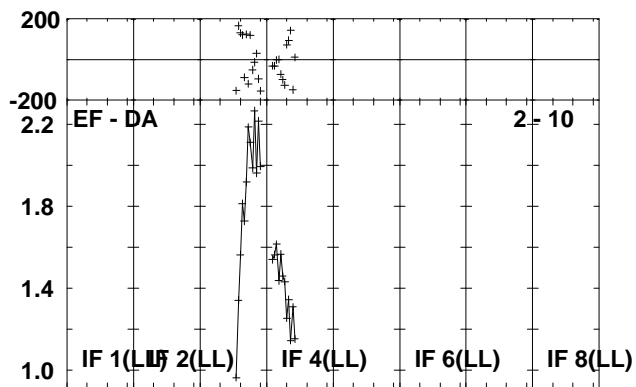
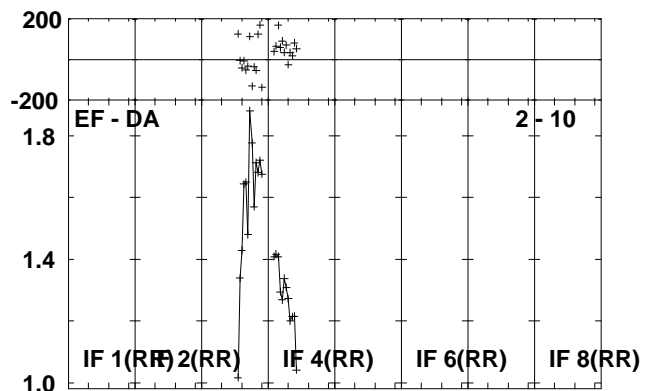
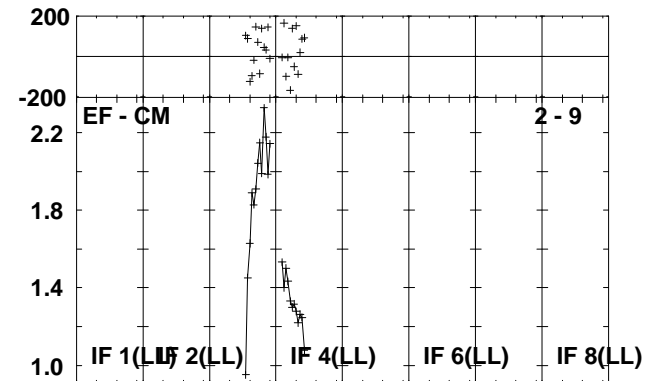
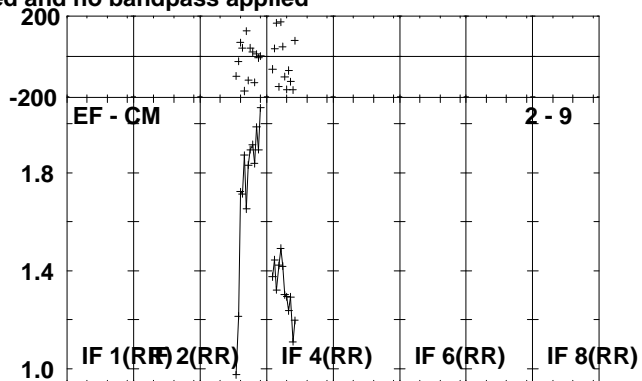
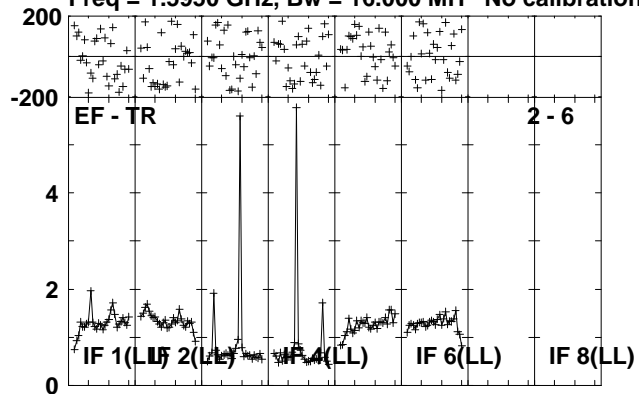

Lower frame: Milli Ampl Jy Top frame: Phas deg
Scalar averaged cross-power spectrum Several baselines displayed
Timerange: 01/02:15:01 to 01/02:18:29

Plot file version 199 created 23-AUG-2010 12:37:17

J1941-05 EP064P.UVDATA.1

Freq = 1.5950 GHz, Bw = 16.000 MH No calibration applied and no bandpass applied

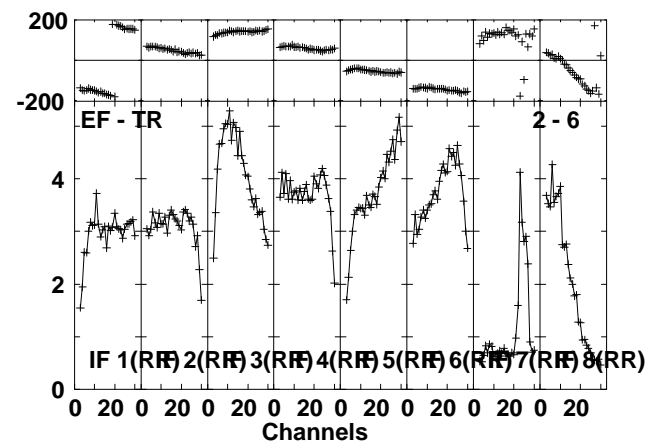
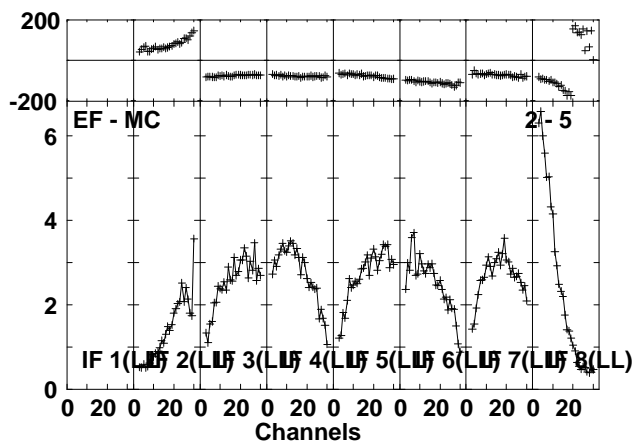
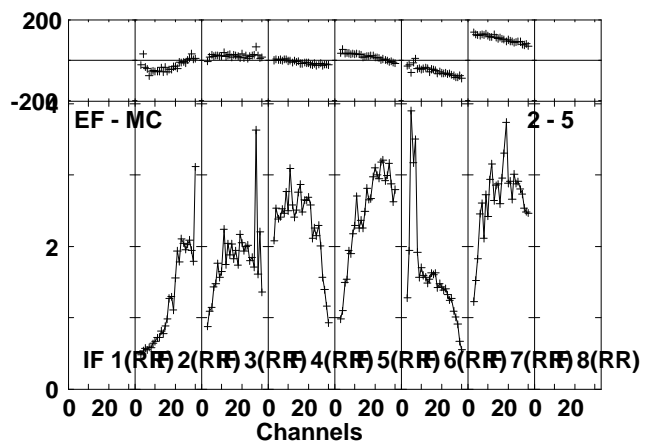
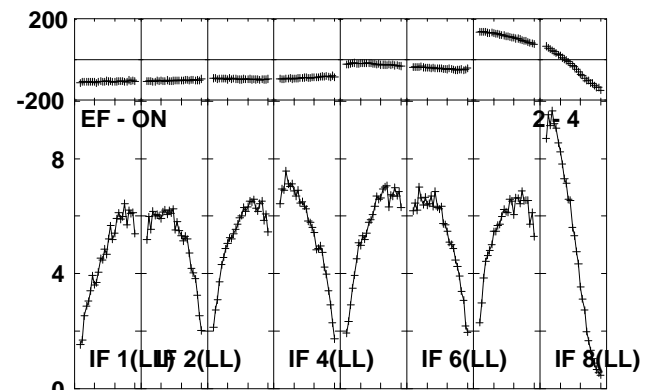
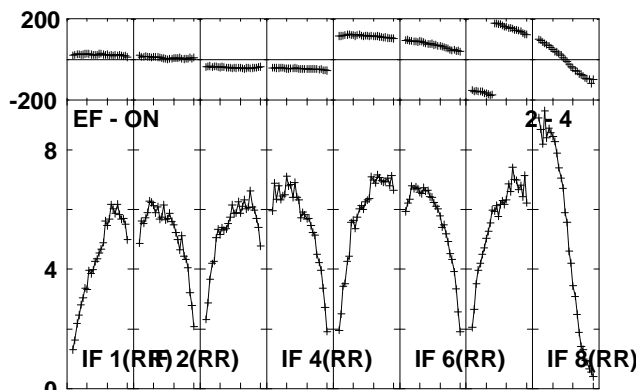
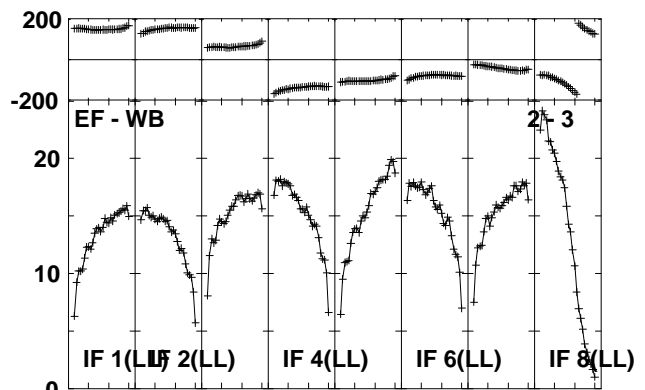
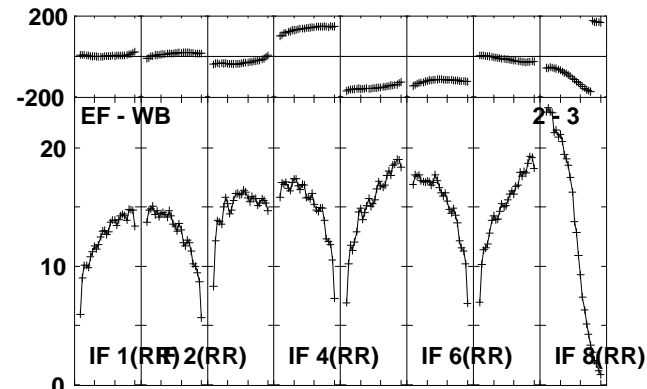
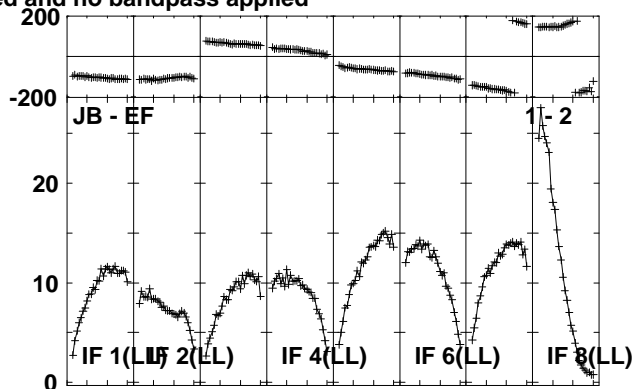
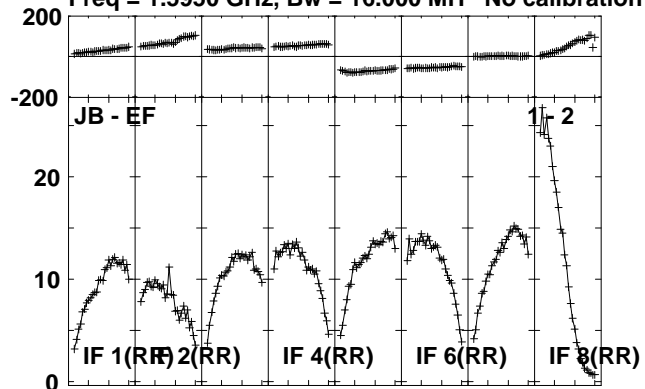

Lower frame: Milli Ampl Jy Top frame: Phas deg
Scalar averaged cross-power spectrum Several baselines displayed
Timerange: 01/02:19:31 to 01/02:20:59

Plot file version 200 created 23-AUG-2010 12:37:18
J1941-05 EP064P.UVDATA.1

Freq = 1.5950 GHz, Bw = 16.000 MH No calibration applied and no bandpass applied

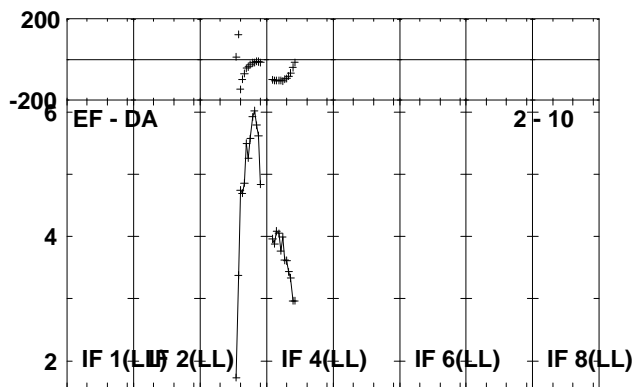
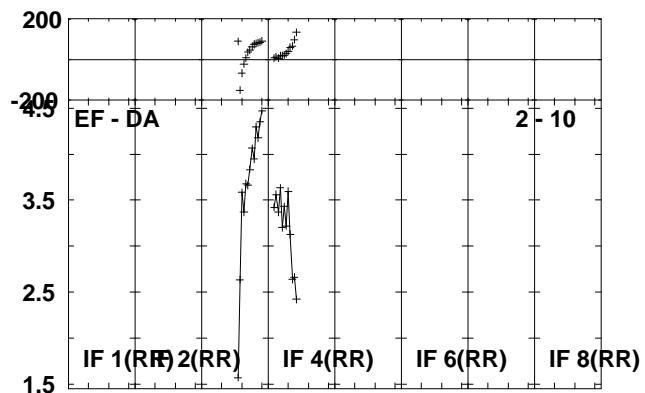
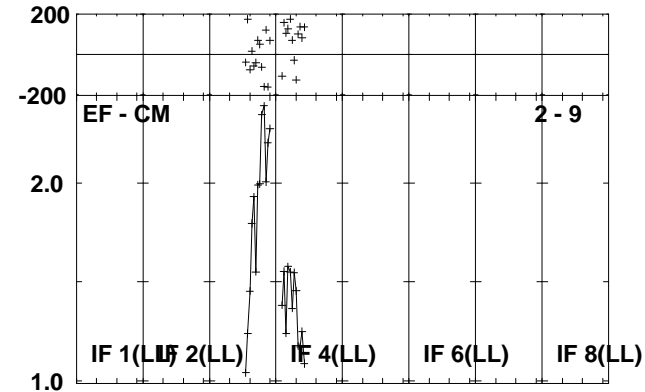
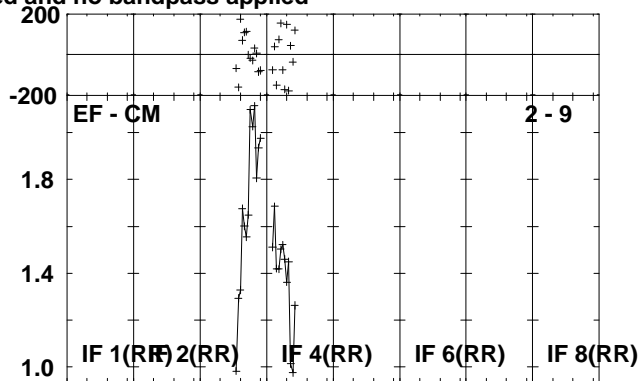
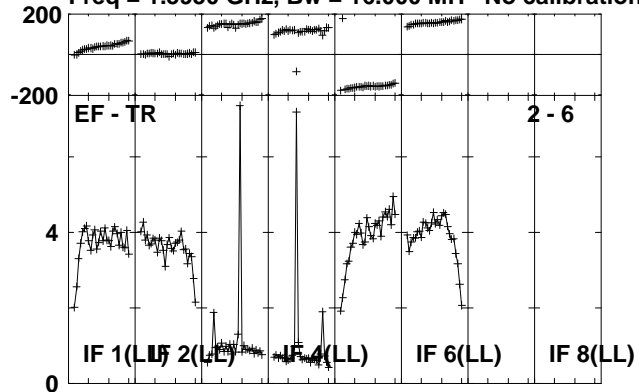

Lower frame: Milli Ampl Jy Top frame: Phas deg
Scalar averaged cross-power spectrum Several baselines displayed
Timerange: 01/02:19:31 to 01/02:20:59

Plot file version 201 created 23-AUG-2010 12:37:19

IRAS1929 EP064P.UVDATA.1

Freq = 1.5950 GHz, Bw = 16.000 MH No calibration applied and no bandpass applied

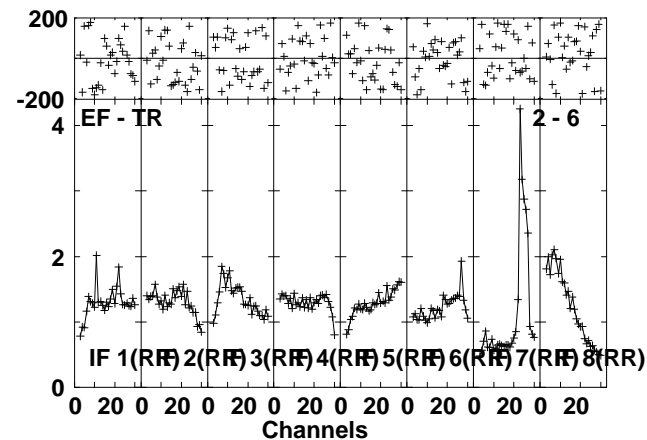
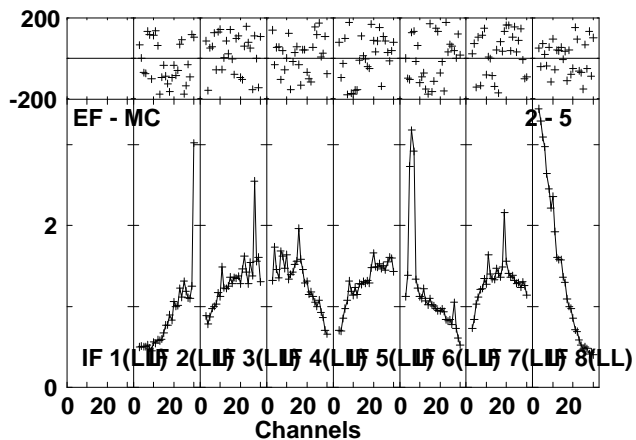
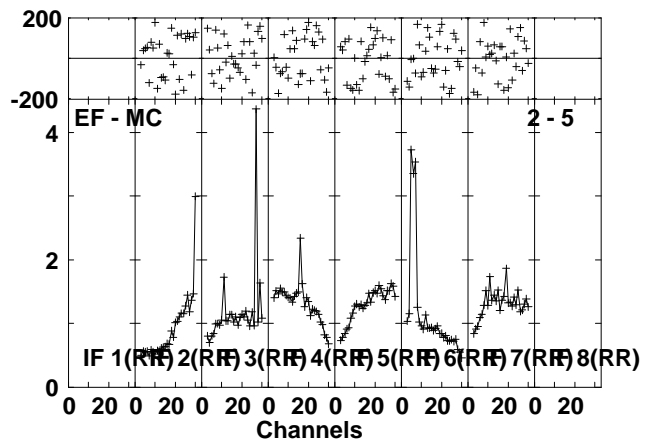
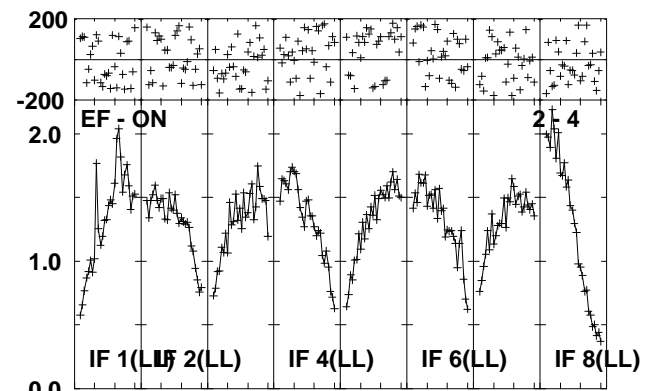
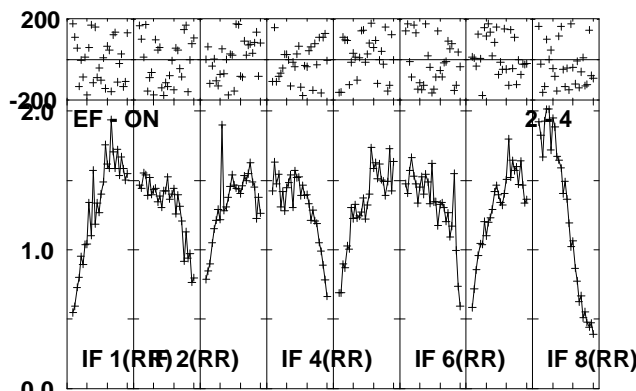
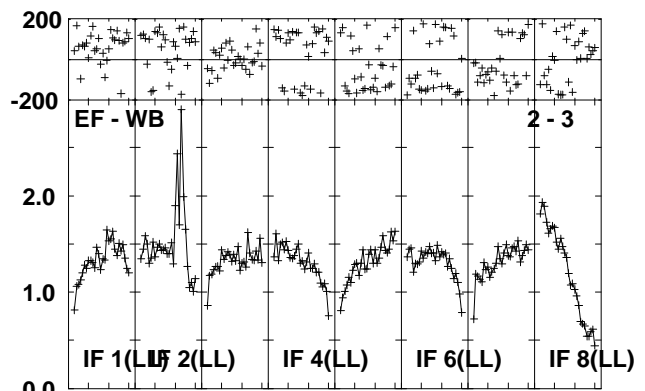
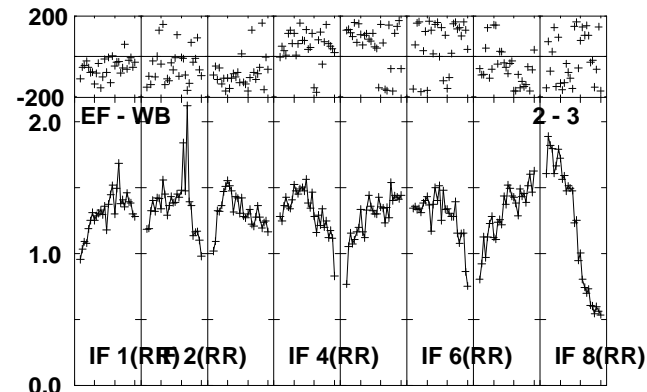
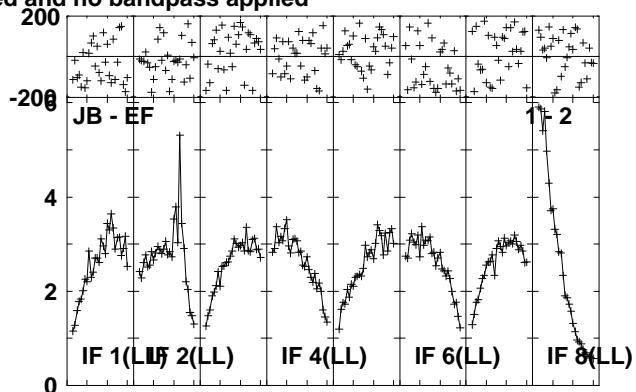
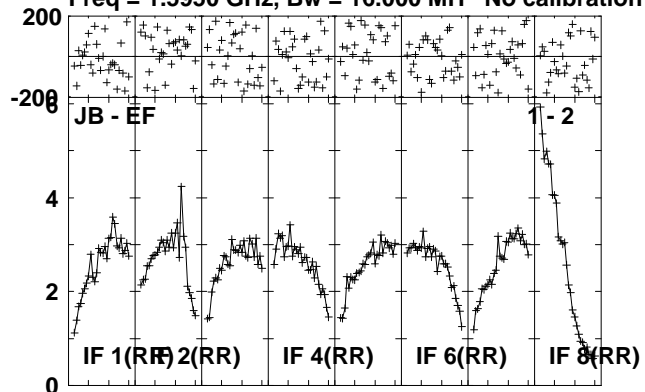

Lower frame: Milli Ampl Jy Top frame: Phas deg
Scalar averaged cross-power spectrum Several baselines displayed
Timerange: 01/02:21:01 to 01/02:24:29

Plot file version 202 created 23-AUG-2010 12:37:20

IRAS1929 EP064P.UVDATA.1

Freq = 1.5950 GHz, Bw = 16.000 MH No calibration applied and no bandpass applied

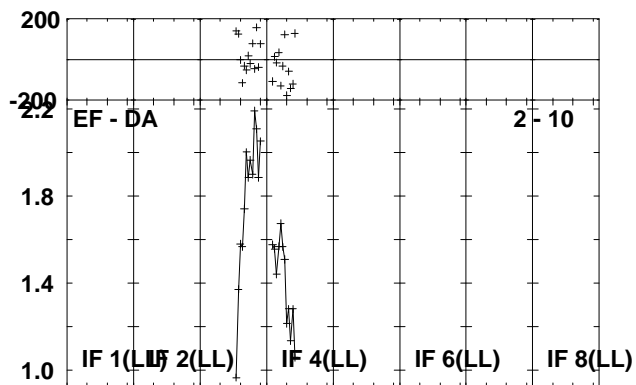
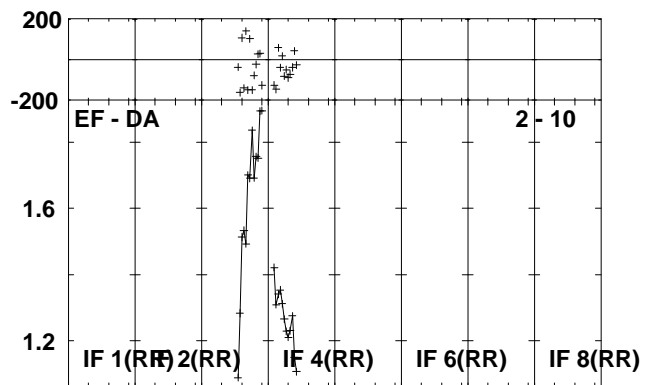
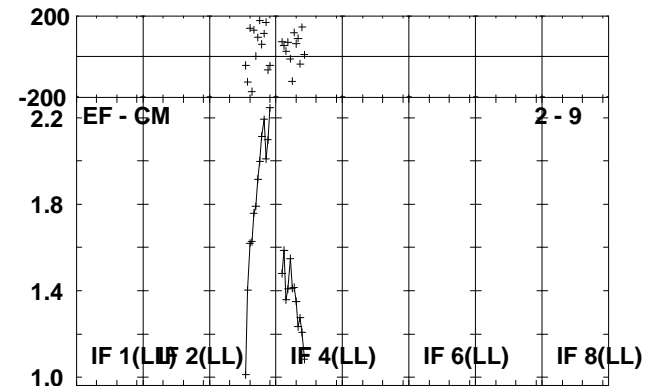
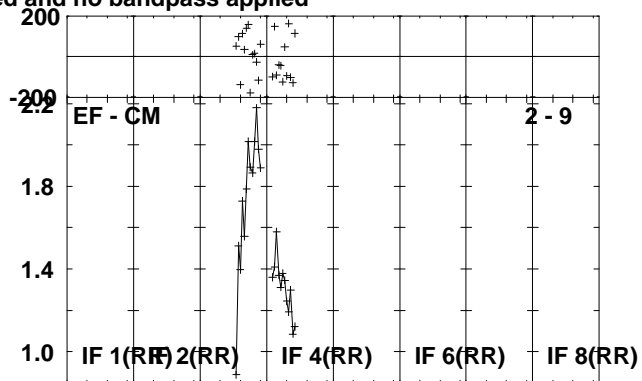
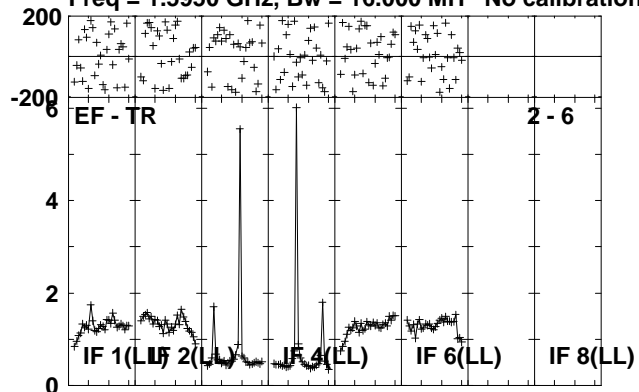

Lower frame: Milli Ampl Jy Top frame: Phas deg
Scalar averaged cross-power spectrum Several baselines displayed
Timerange: 01/02:21:01 to 01/02:24:29

Plot file version 203 created 23-AUG-2010 12:37:21

J1941-05 EP064P.UVDATA.1

Freq = 1.5950 GHz, Bw = 16.000 MH No calibration applied and no bandpass applied

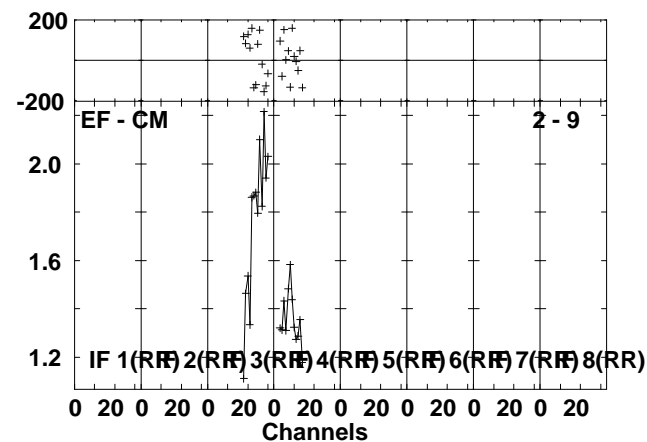
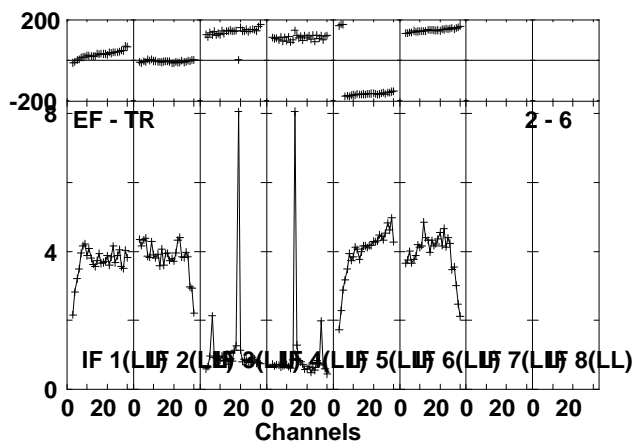
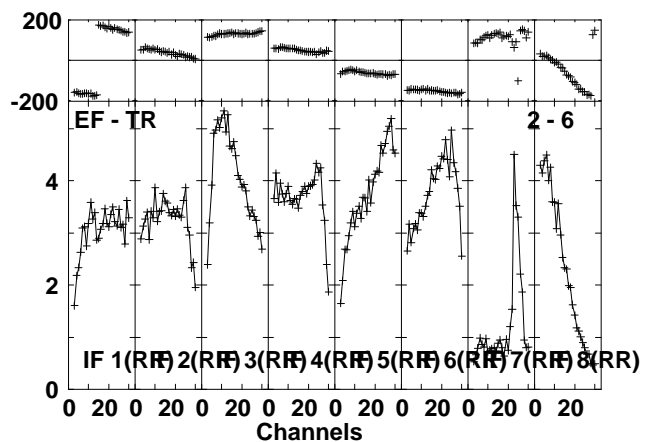
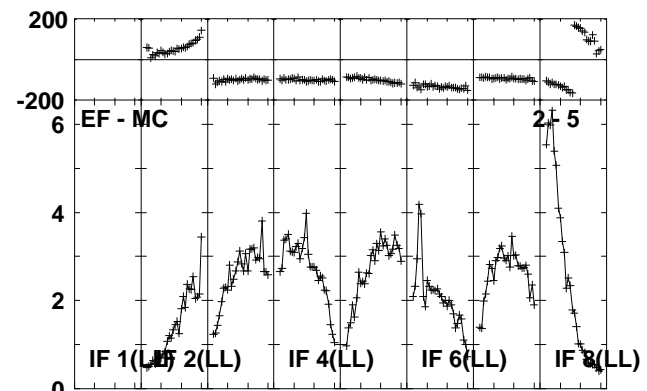
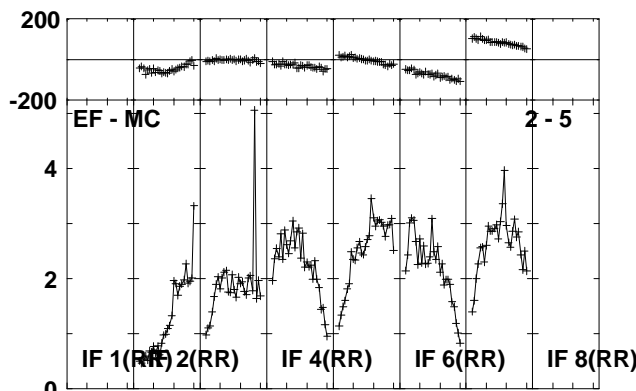
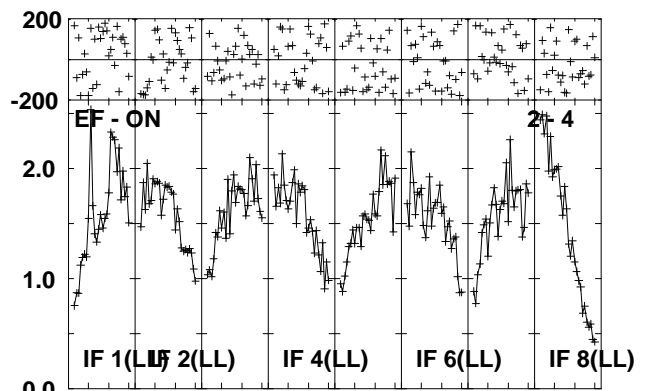
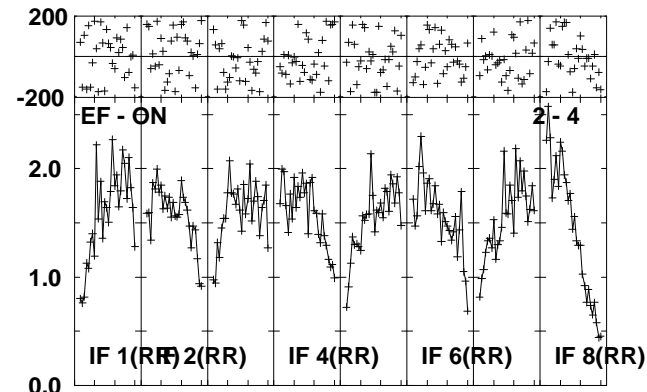
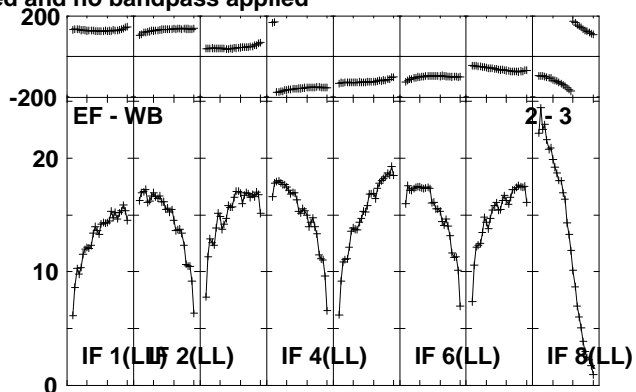
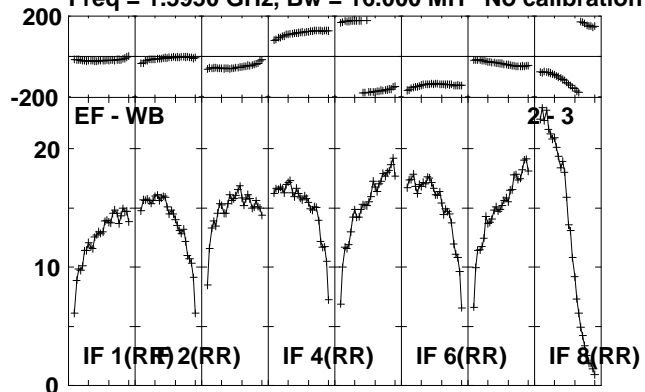

Lower frame: Milli Ampl Jy Top frame: Phas deg
Scalar averaged cross-power spectrum Several baselines displayed
Timerange: 01/02:24:31 to 01/02:25:57

Plot file version 204 created 23-AUG-2010 12:37:22
J1941-05 EP064P.UVDATA.1

Freq = 1.5950 GHz, Bw = 16.000 MH No calibration applied and no bandpass applied

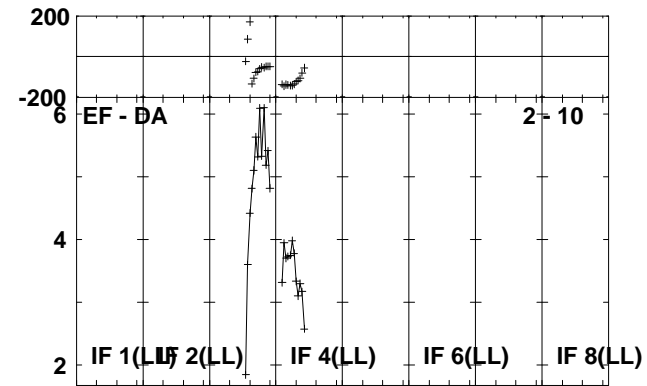
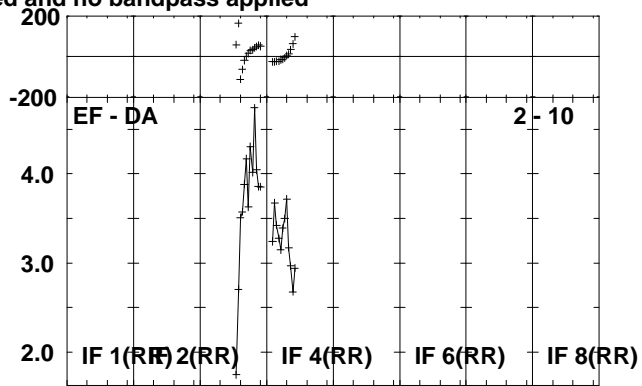
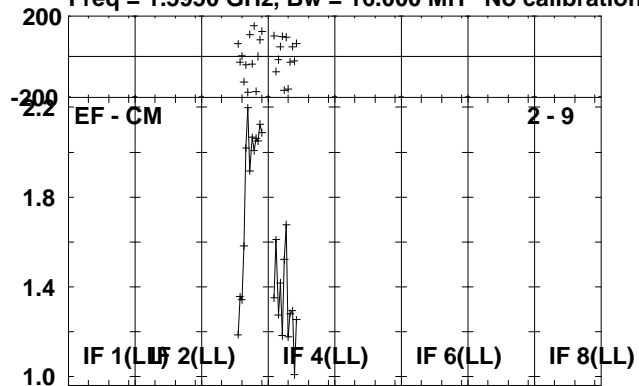

Lower frame: Milli Ampl Jy Top frame: Phas deg
Scalar averaged cross-power spectrum Several baselines displayed
Timerange: 01/02:24:31 to 01/02:25:57

Plot file version 205 created 23-AUG-2010 12:37:22

IRAS1929 EP064P.UVDATA.1

Freq = 1.5950 GHz, Bw = 16.000 MH No calibration applied and no bandpass applied

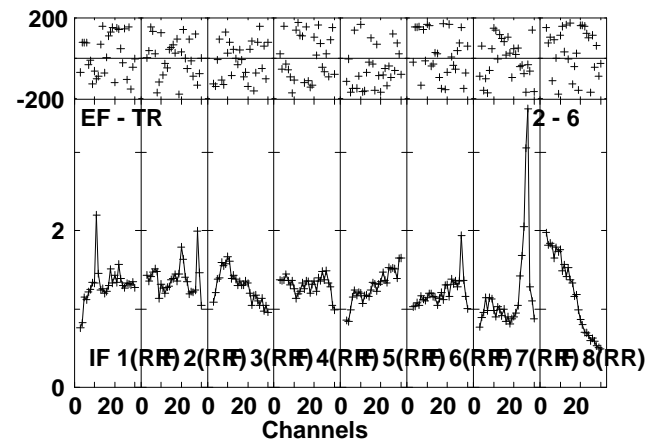
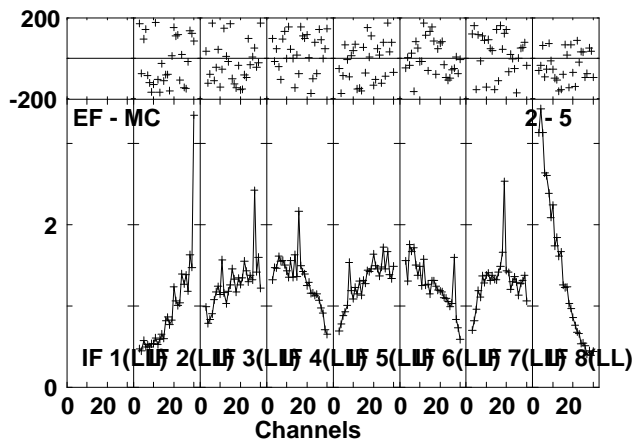
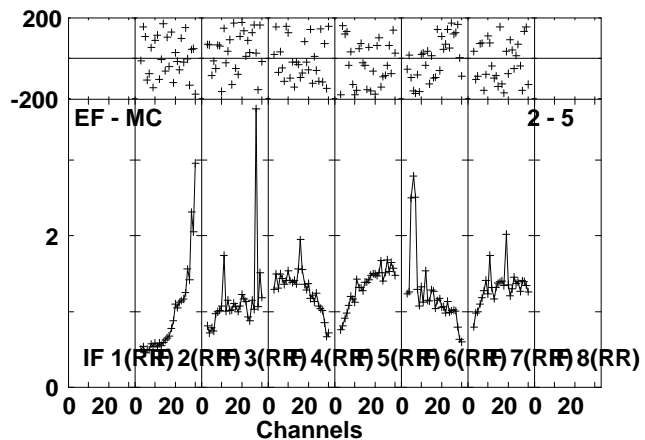
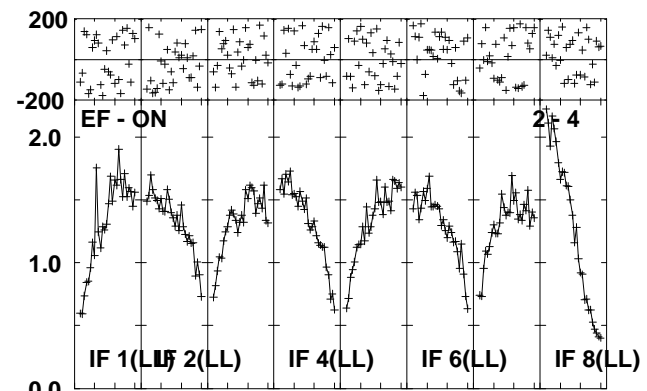
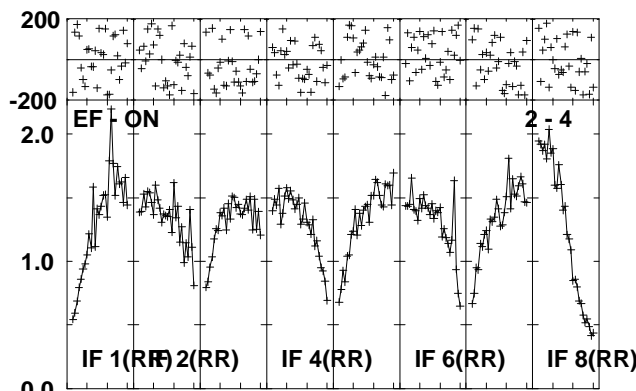
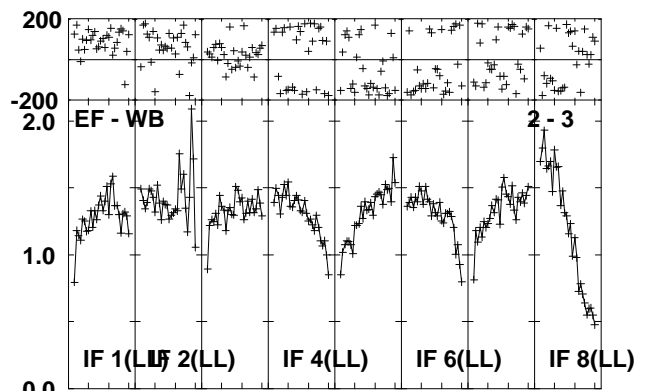
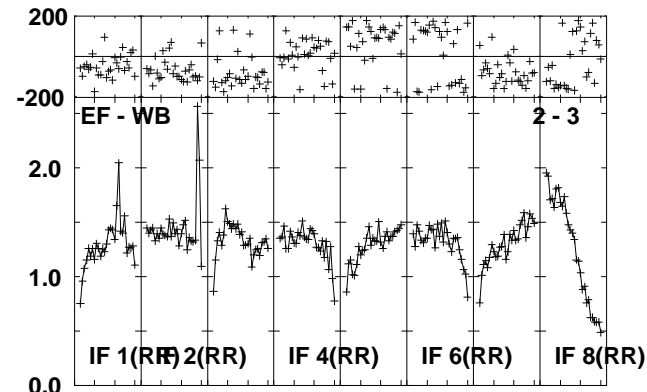
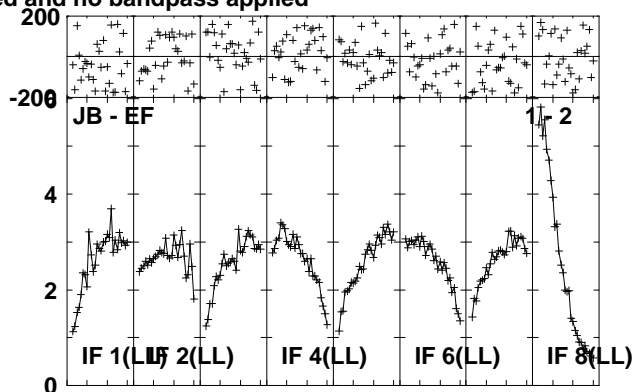
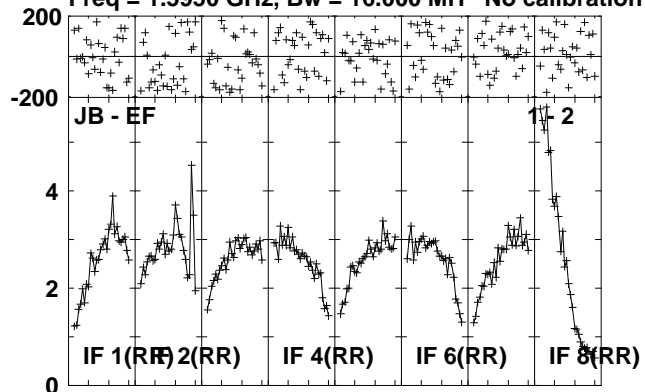

Lower frame: Milli Ampl Jy Top frame: Phas deg
Scalar averaged cross-power spectrum Several baselines displayed
Timerange: 01/02:26:01 to 01/02:29:29

Plot file version 206 created 23-AUG-2010 12:37:23

IRAS1929 EP064P.UVDATA.1

Freq = 1.5950 GHz, Bw = 16.000 MH No calibration applied and no bandpass applied

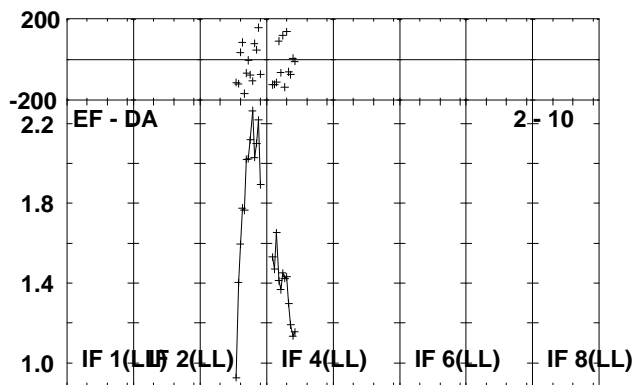
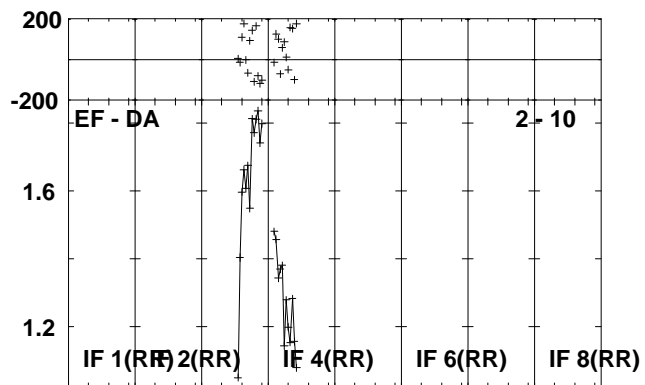
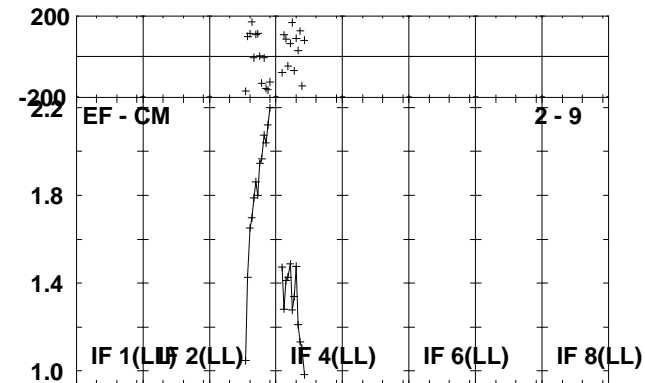
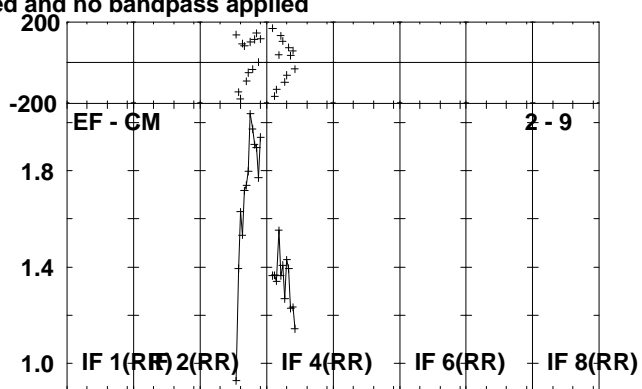
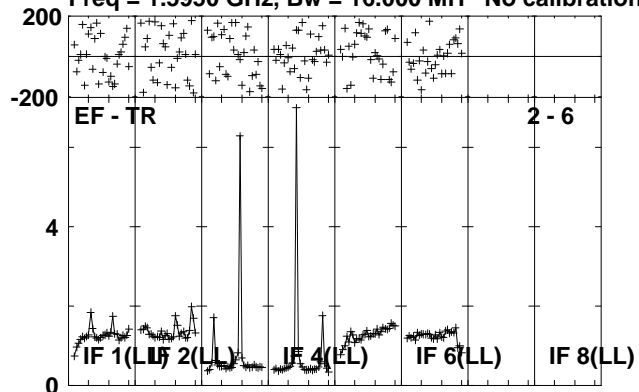

Lower frame: Milli Ampl Jy Top frame: Phas deg
Scalar averaged cross-power spectrum Several baselines displayed
Timerange: 01/02:26:01 to 01/02:29:29

Plot file version 207 created 23-AUG-2010 12:37:25

J1941-05 EP064P.UVDATA.1

Freq = 1.5950 GHz, Bw = 16.000 MH No calibration applied and no bandpass applied

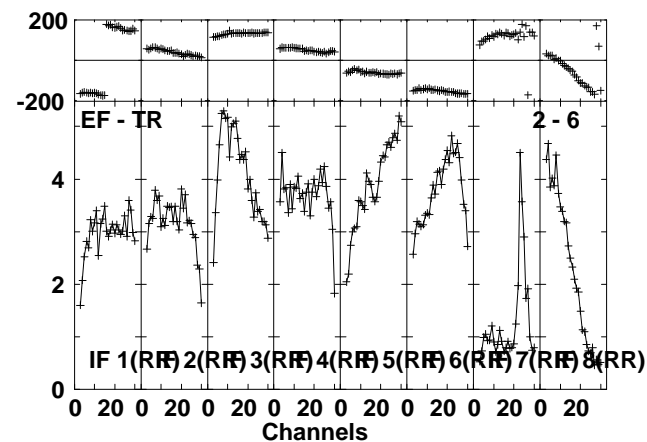
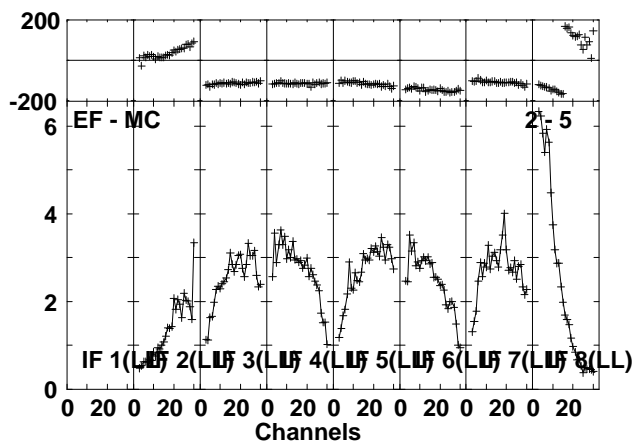
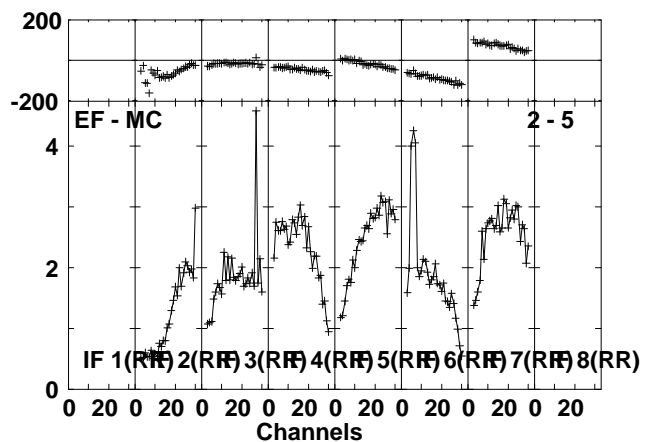
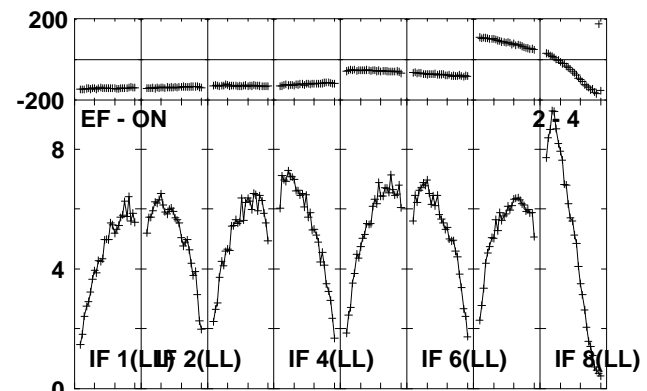
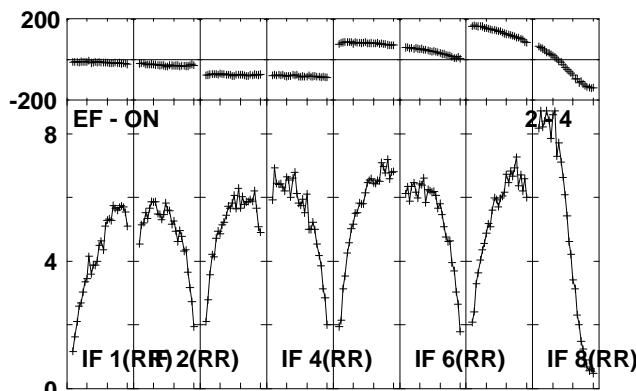
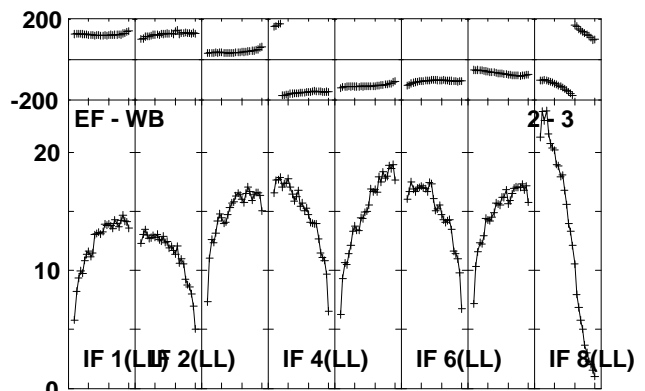
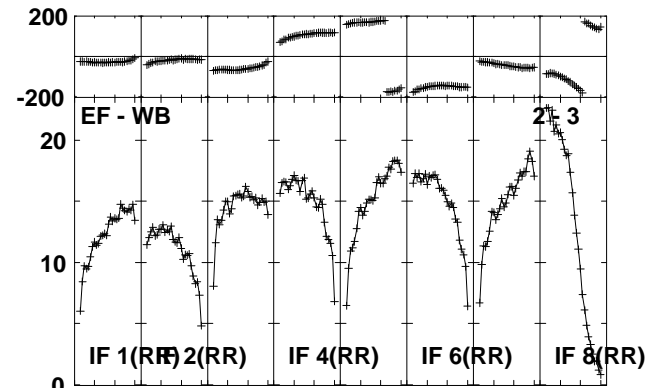
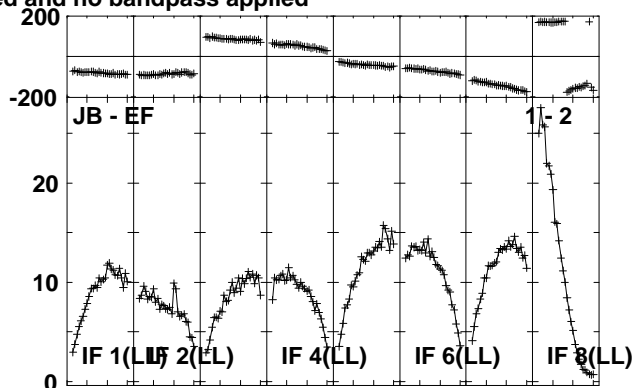
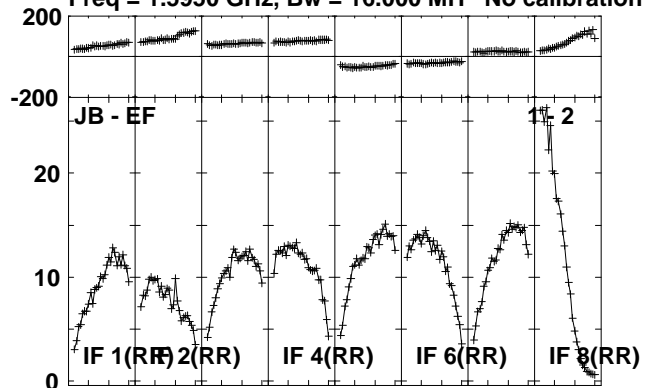

Lower frame: Milli Ampl Jy Top frame: Phas deg
Scalar averaged cross-power spectrum Several baselines displayed
Timerange: 01/02:29:31 to 01/02:30:59

Plot file version 208 created 23-AUG-2010 12:37:25

J1941-05 EP064P.UVDATA.1

Freq = 1.5950 GHz, Bw = 16.000 MH No calibration applied and no bandpass applied

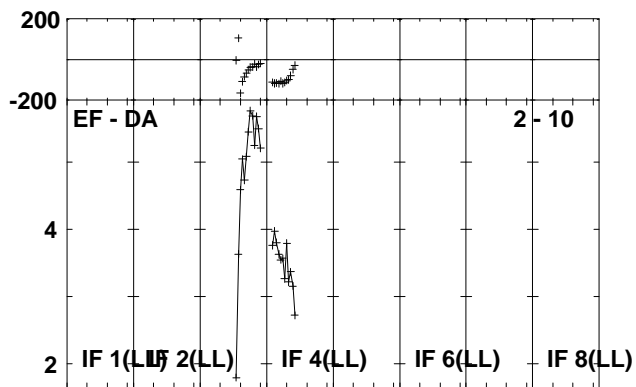
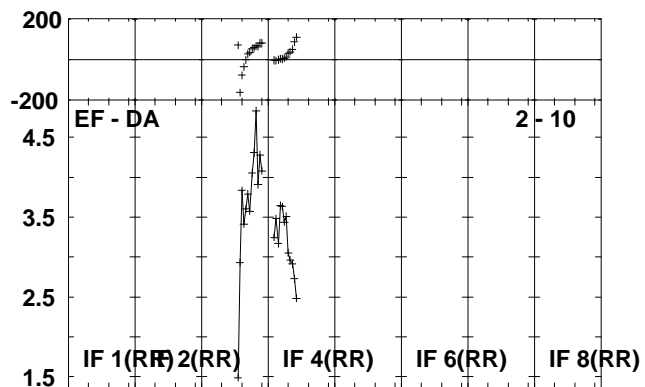
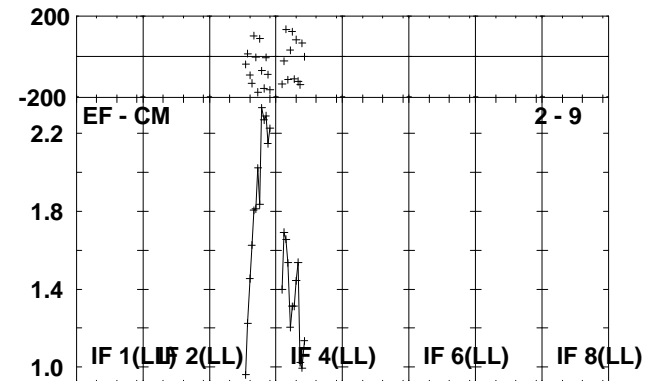
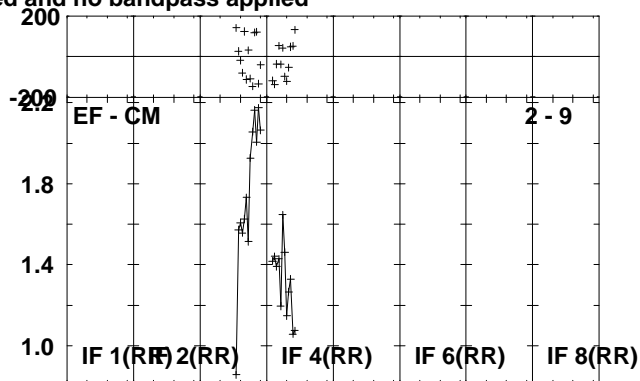
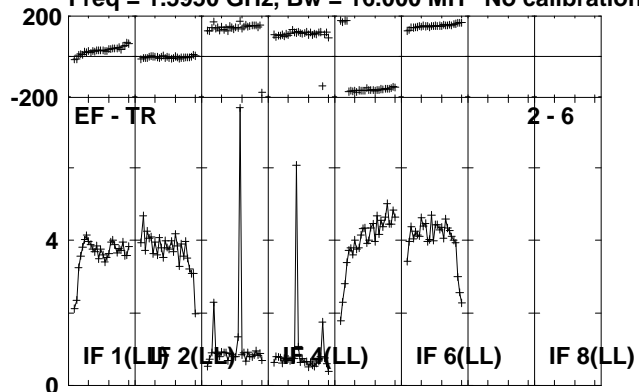

Lower frame: Milli Ampl Jy Top frame: Phas deg
Scalar averaged cross-power spectrum Several baselines displayed
Timerange: 01/02:29:31 to 01/02:30:59

Plot file version 209 created 23-AUG-2010 12:37:26

IRAS1929 EP064P.UVDATA.1

Freq = 1.5950 GHz, Bw = 16.000 MH No calibration applied and no bandpass applied

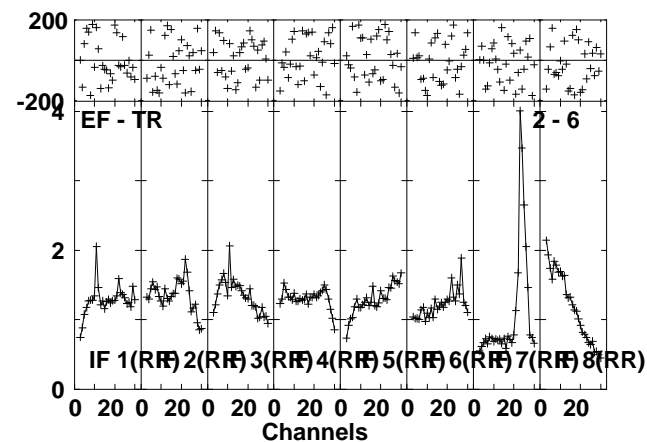
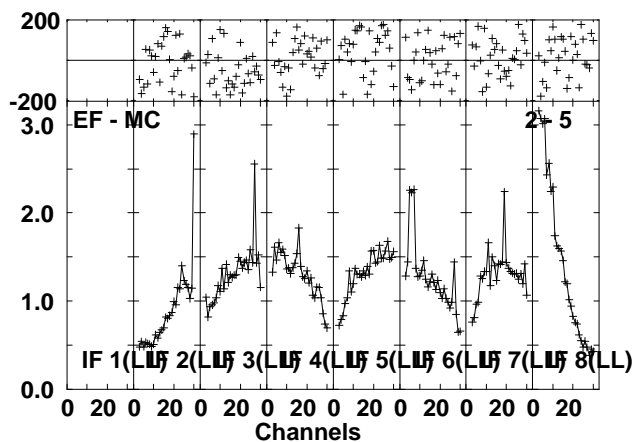
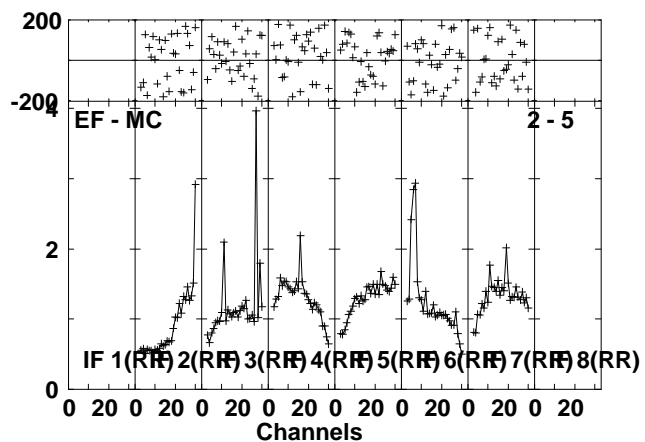
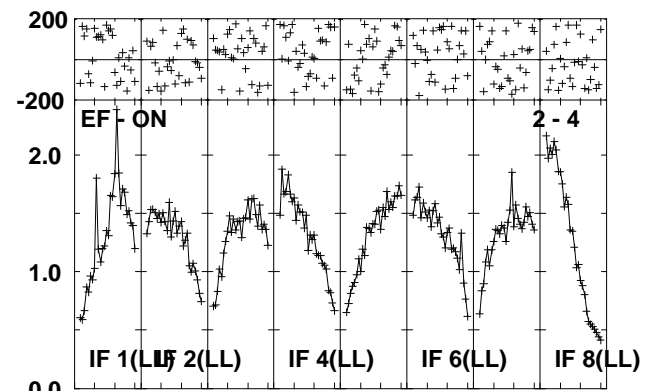
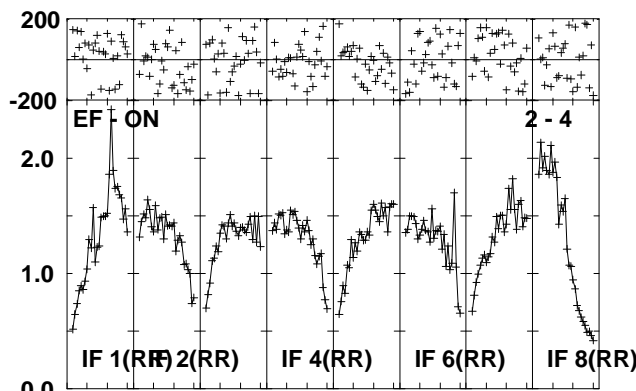
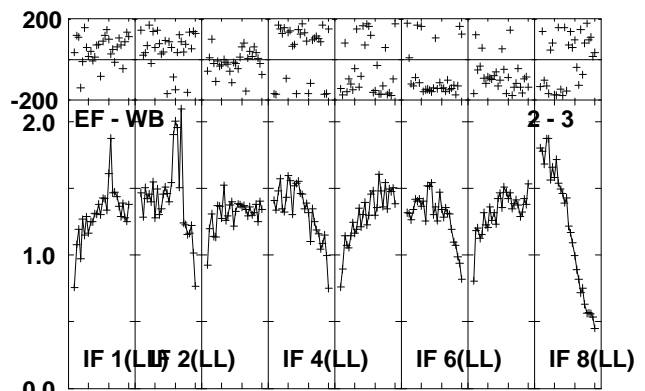
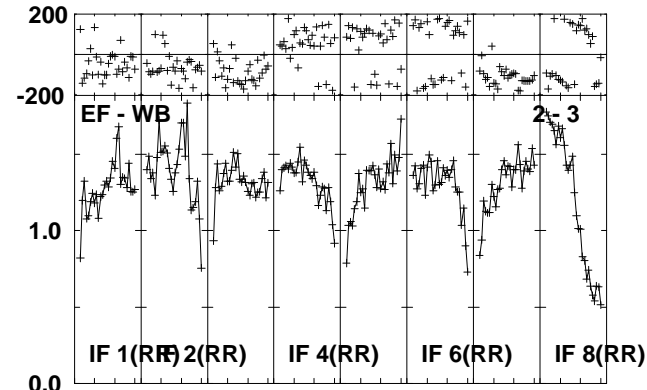
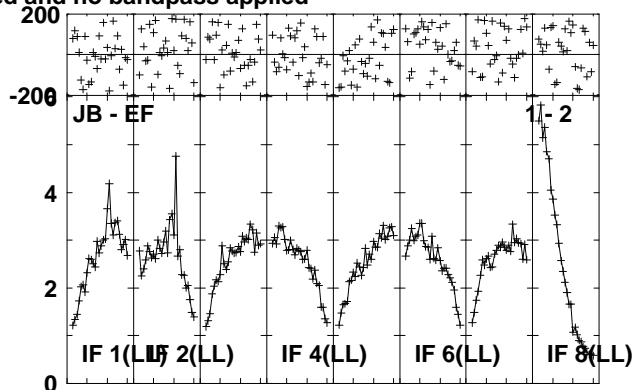
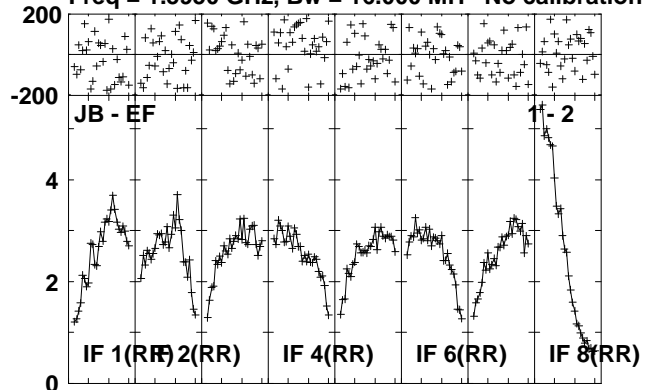

Lower frame: Milli Ampl Jy Top frame: Phas deg
Scalar averaged cross-power spectrum Several baselines displayed
Timerange: 01/02:31:01 to 01/02:34:29

Plot file version 210 created 23-AUG-2010 12:37:28

IRAS1929 EP064P.UVDATA.1

Freq = 1.5950 GHz, Bw = 16.000 MH No calibration applied and no bandpass applied

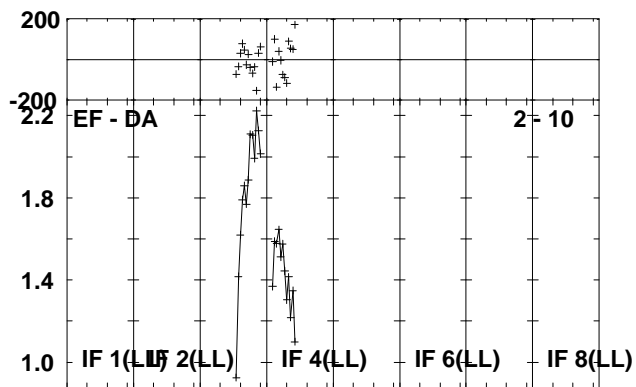
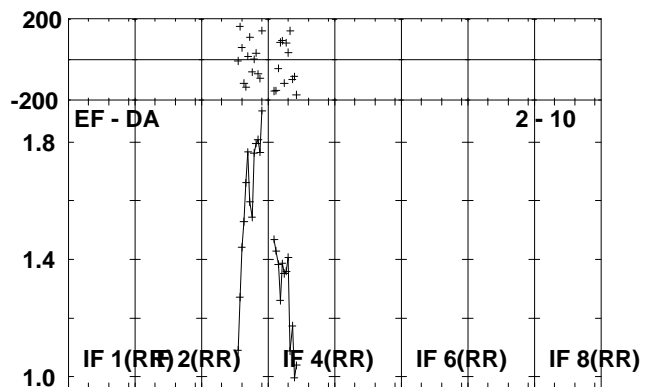
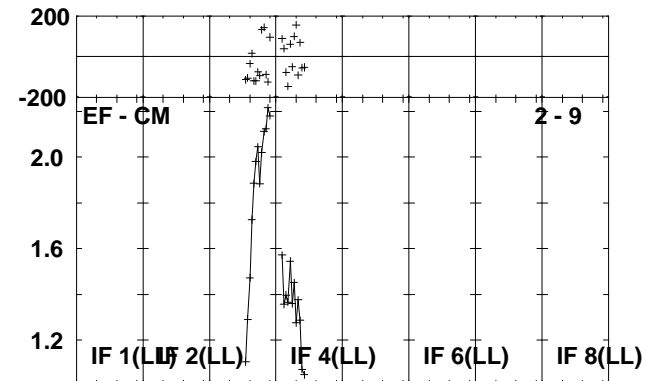
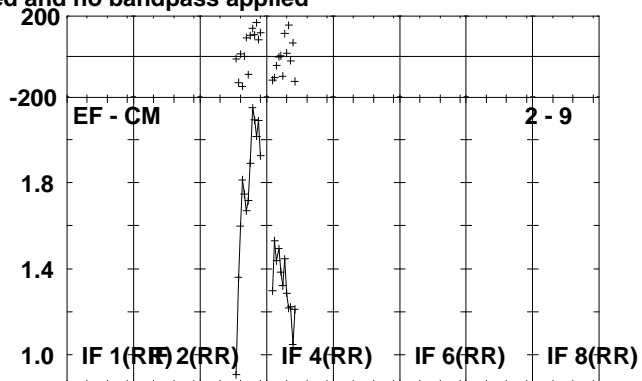
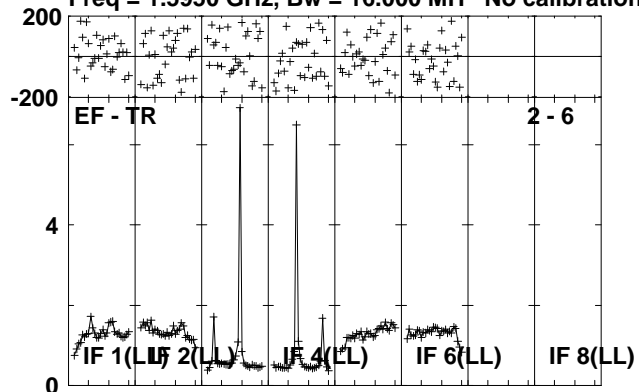

Lower frame: Milli Ampl Jy Top frame: Phas deg
Scalar averaged cross-power spectrum Several baselines displayed
Timerange: 01/02:31:01 to 01/02:34:29

Plot file version 211 created 23-AUG-2010 12:37:29

J1941-05 EP064P.UVDATA.1

Freq = 1.5950 GHz, Bw = 16.000 MH No calibration applied and no bandpass applied

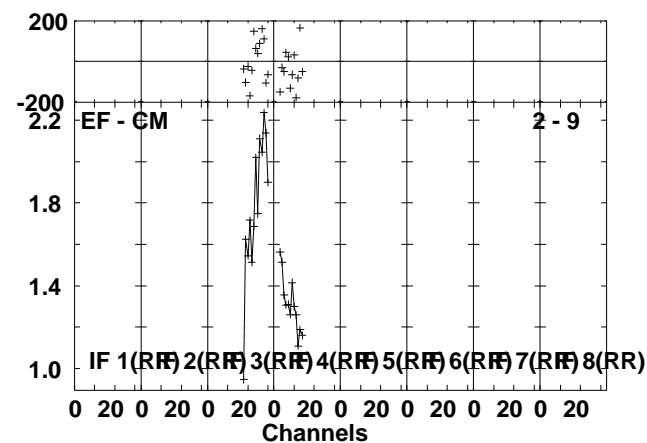
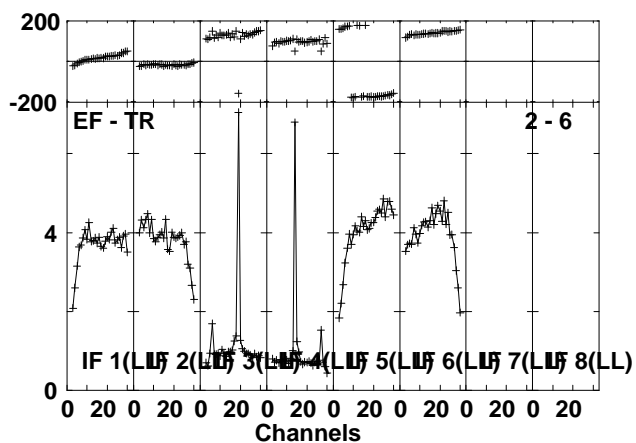
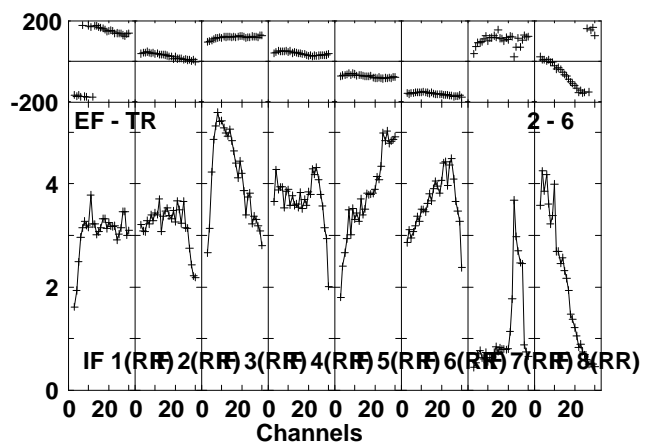
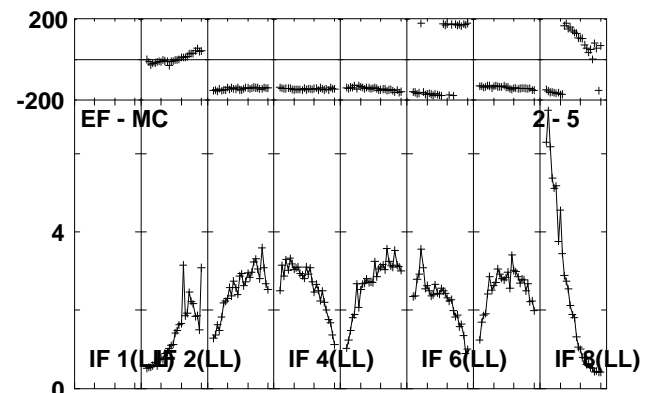
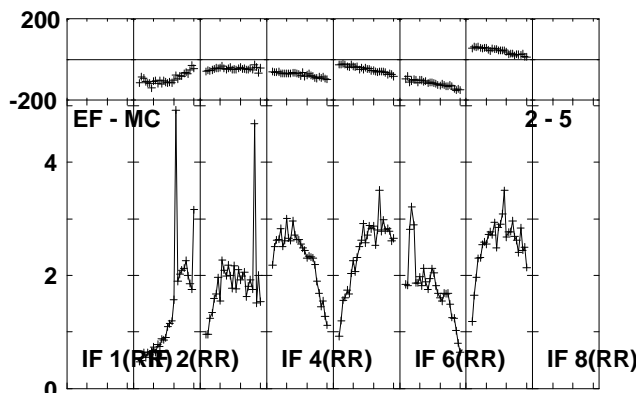
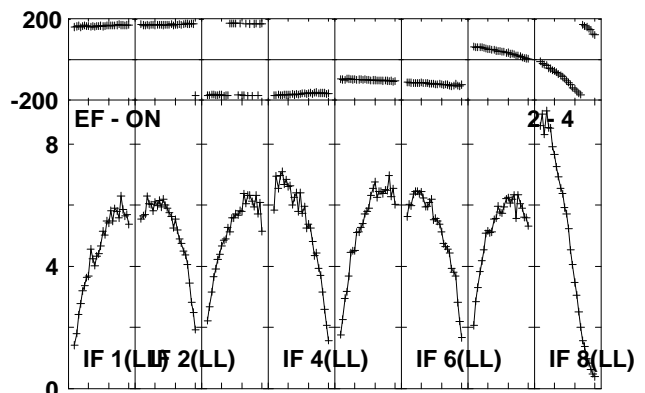
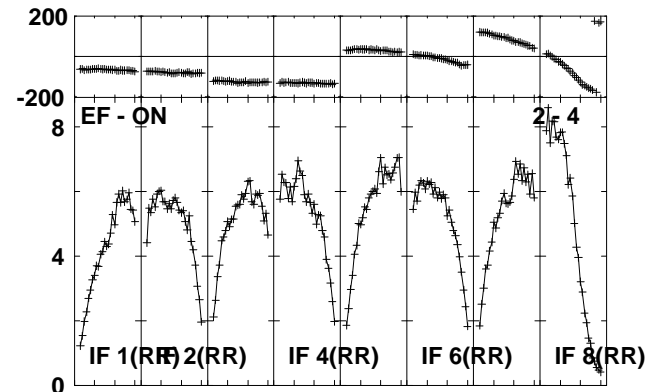
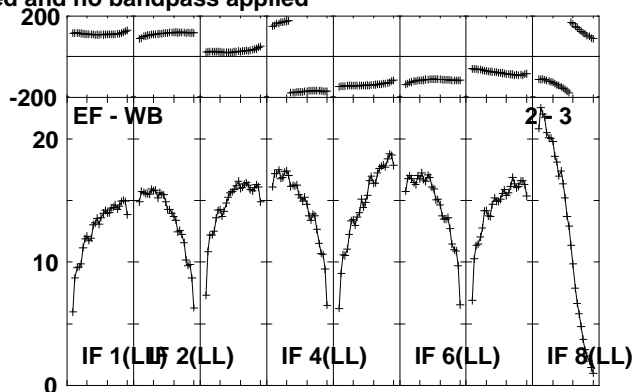
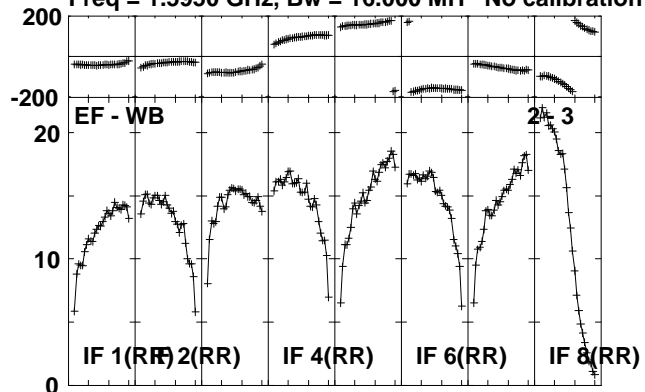

Lower frame: Milli Ampl Jy Top frame: Phas deg
Scalar averaged cross-power spectrum Several baselines displayed
Timerange: 01/02:35:31 to 01/02:36:57

Plot file version 212 created 23-AUG-2010 12:37:30

J1941-05 EP064P.UVDATA.1

Freq = 1.5950 GHz, Bw = 16.000 MH No calibration applied and no bandpass applied

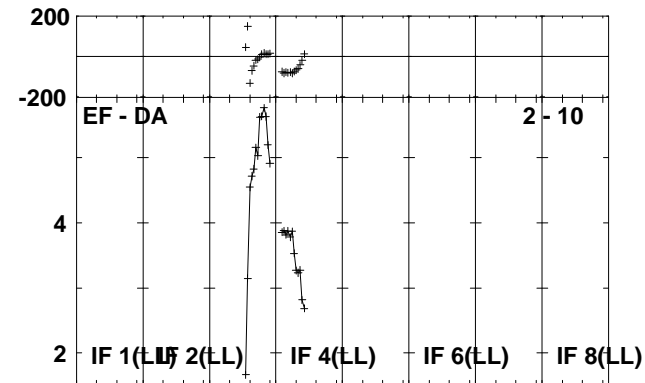
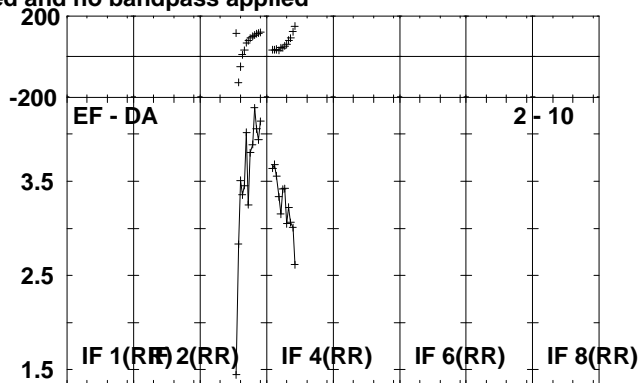
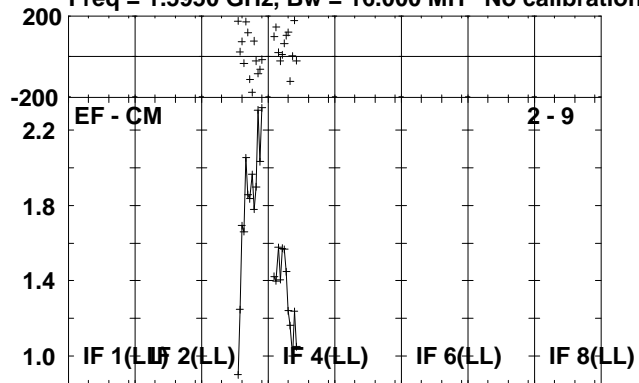

Lower frame: Milli Amp Jy Top frame: Phas deg
Scalar averaged cross-power spectrum Several baselines displayed
Timerange: 01/02:35:31 to 01/02:36:57

Plot file version 213 created 23-AUG-2010 12:37:30

IRAS1929 EP064P.UVDATA.1

Freq = 1.5950 GHz, Bw = 16.000 MH No calibration applied and no bandpass applied

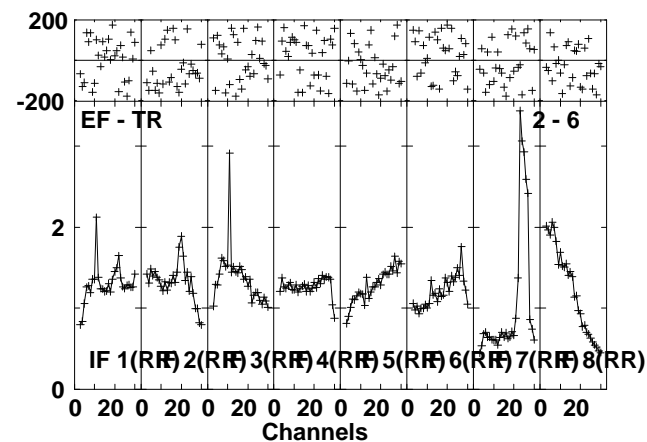
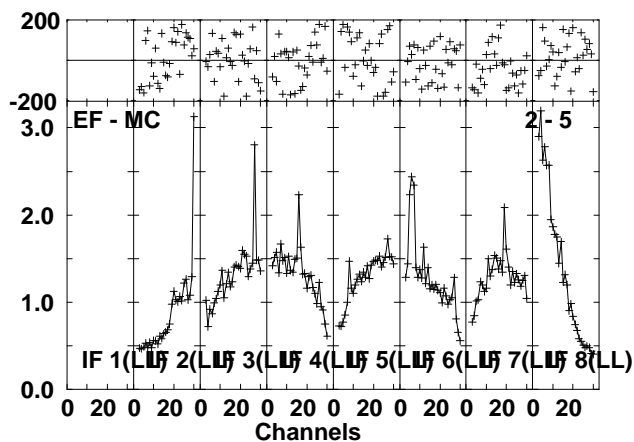
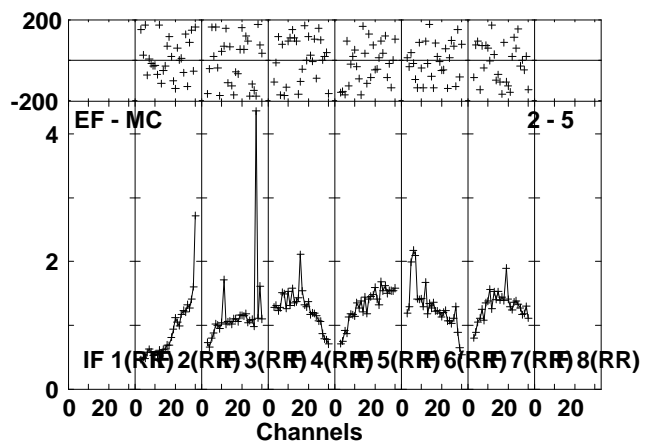
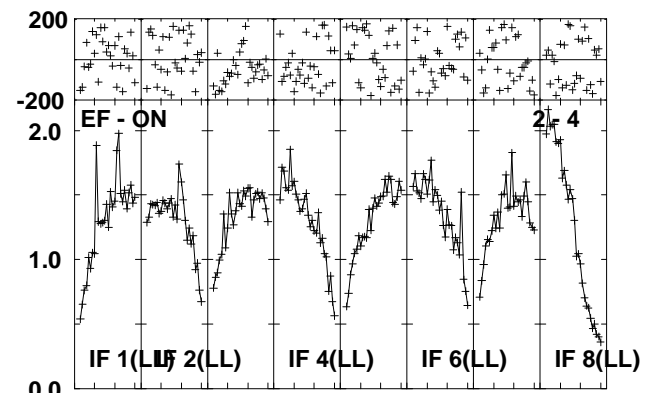
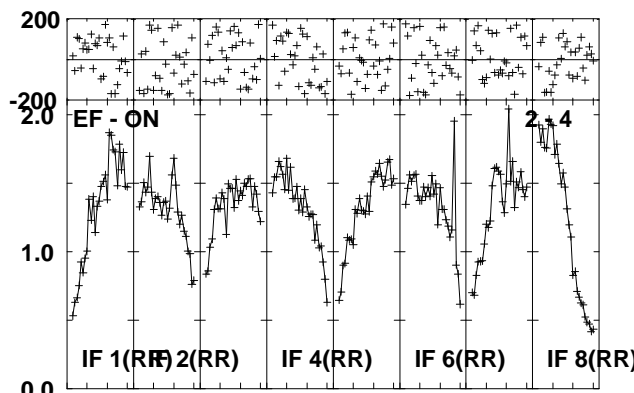
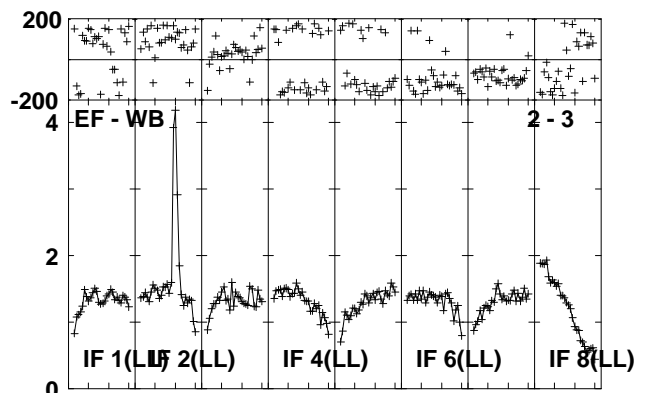
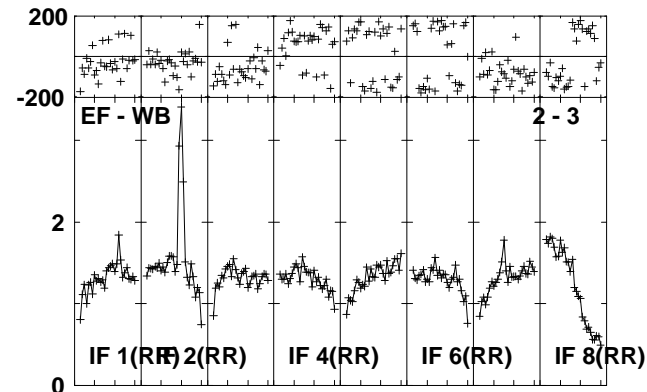
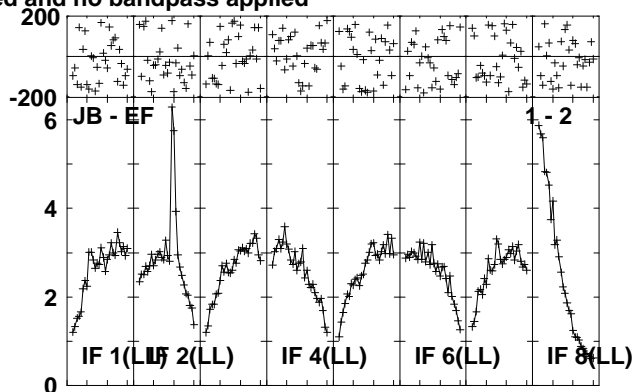
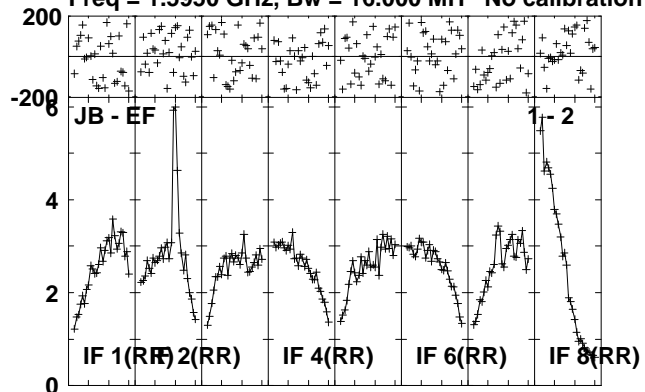

Lower frame: Milli Ampl Jy Top frame: Phas deg
Scalar averaged cross-power spectrum Several baselines displayed
Timerange: 01/02:37:01 to 01/02:40:29

Plot file version 214 created 23-AUG-2010 12:37:31

IRAS1929 EP064P.UVDATA.1

Freq = 1.5950 GHz, Bw = 16.000 MH No calibration applied and no bandpass applied

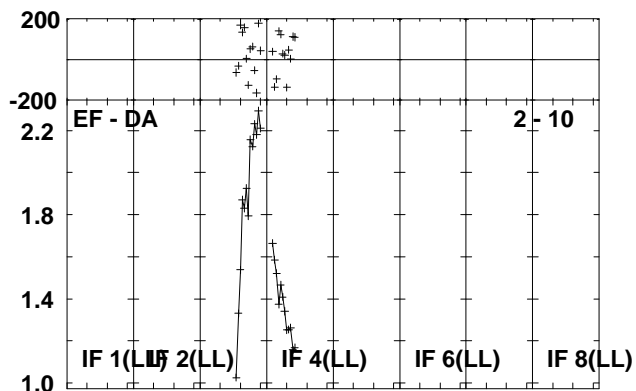
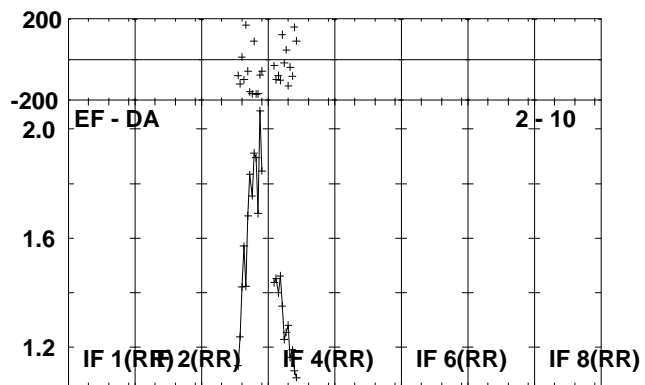
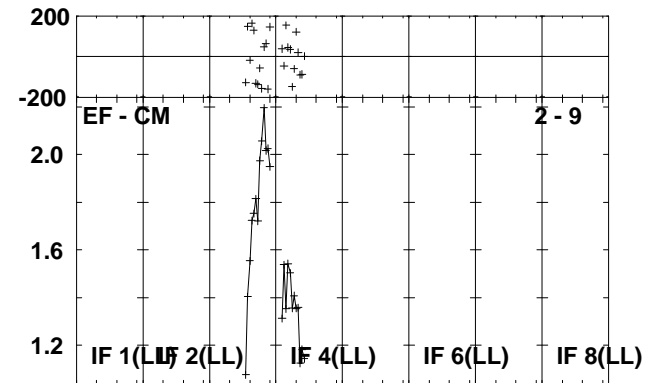
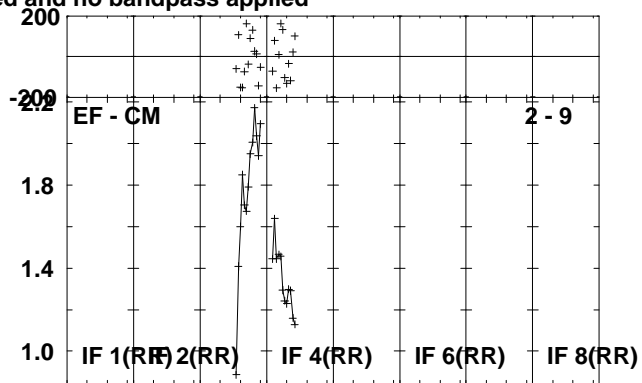
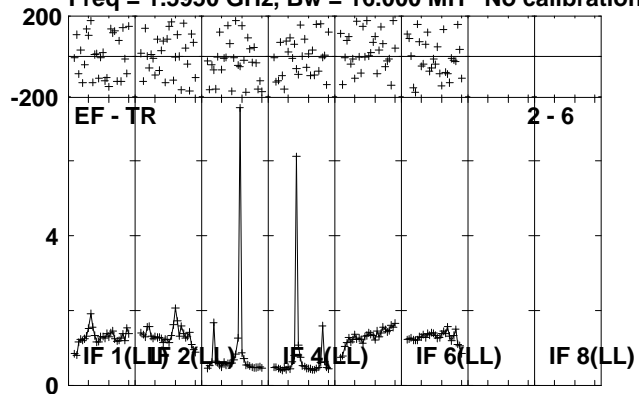

Lower frame: Milli Ampl Jy Top frame: Phas deg
Scalar averaged cross-power spectrum Several baselines displayed
Timerange: 01/02:37:01 to 01/02:40:29

Plot file version 215 created 23-AUG-2010 12:37:32

J1941-05 EP064P.UVDATA.1

Freq = 1.5950 GHz, Bw = 16.000 MH No calibration applied and no bandpass applied

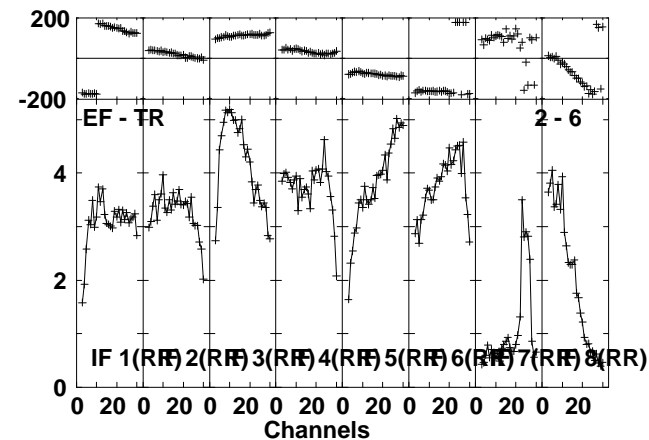
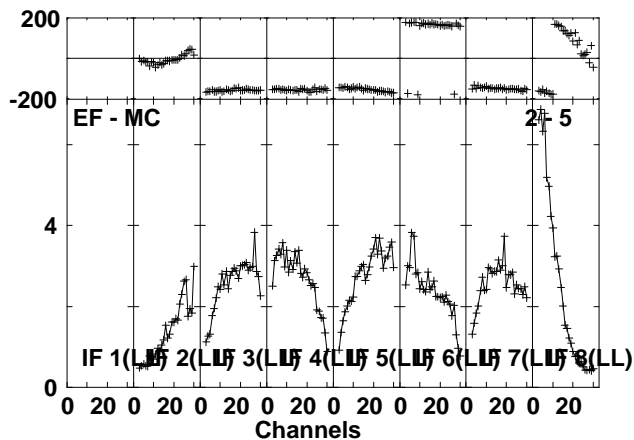
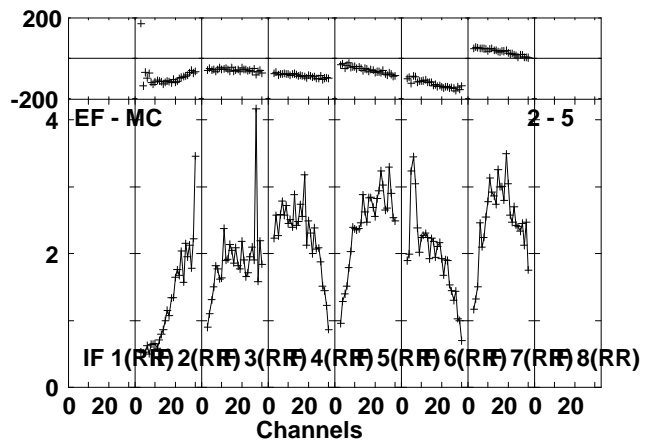
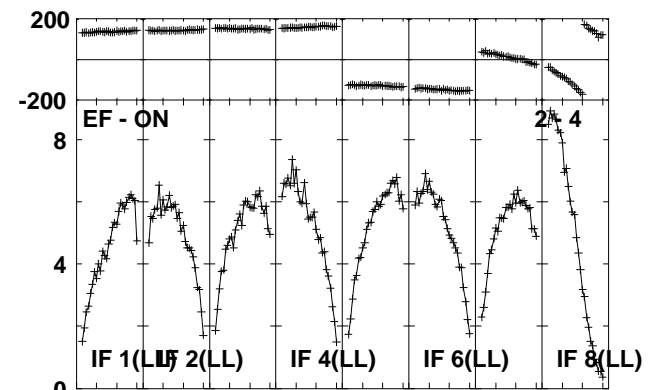
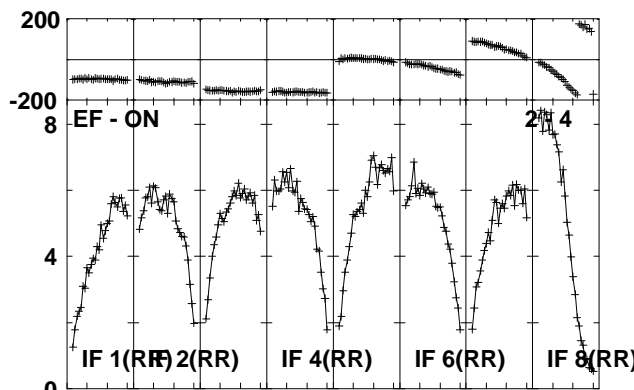
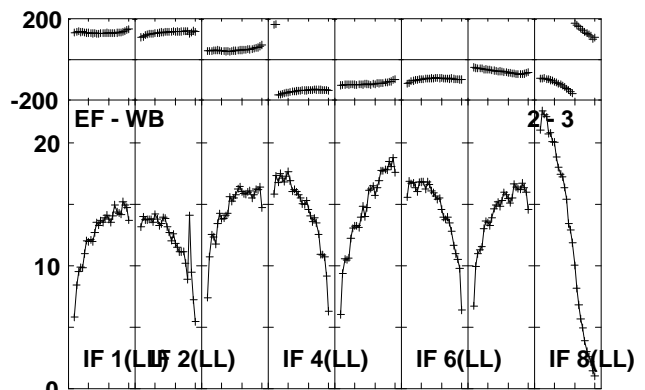
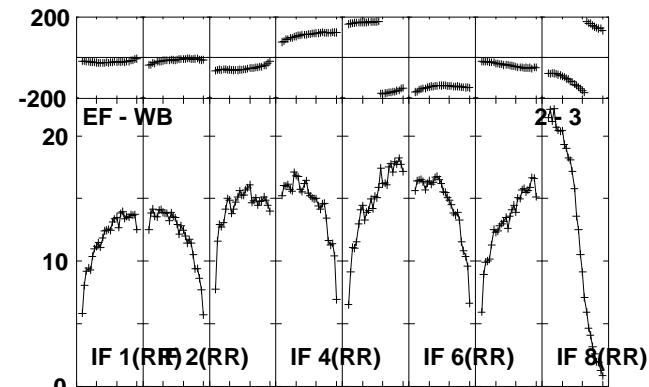
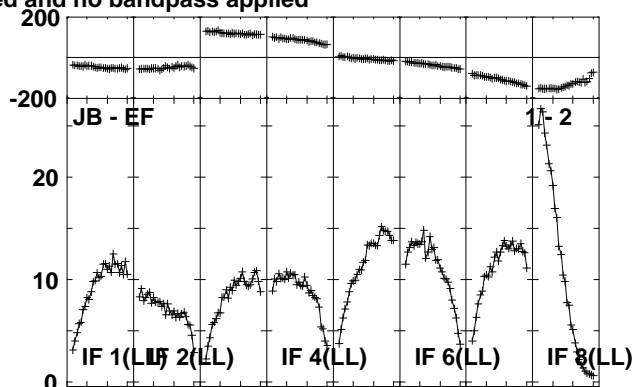
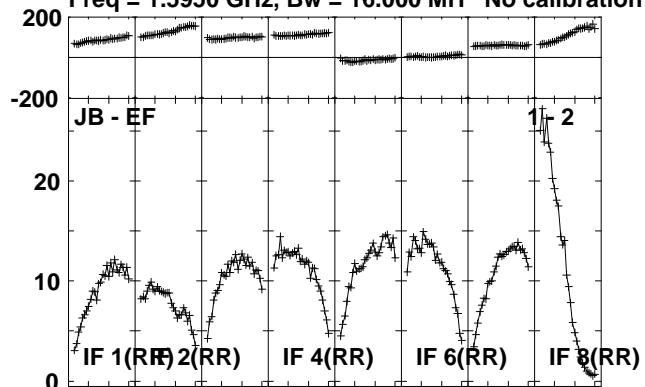

Lower frame: Milli Ampl Jy Top frame: Phas deg
Scalar averaged cross-power spectrum Several baselines displayed
Timerange: 01/02:40:31 to 01/02:41:59

Plot file version 216 created 23-AUG-2010 12:37:33

J1941-05 EP064P.UVDATA.1

Freq = 1.5950 GHz, Bw = 16.000 MH No calibration applied and no bandpass applied

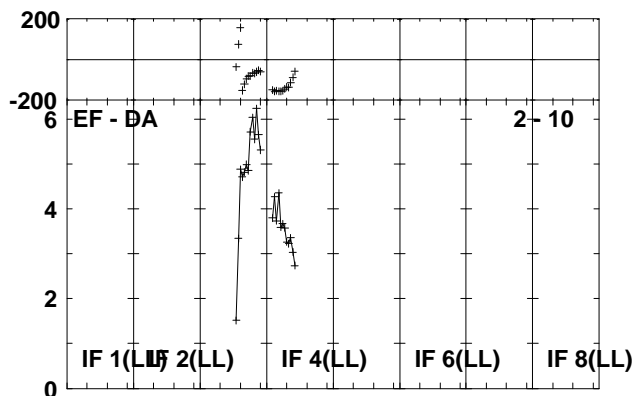
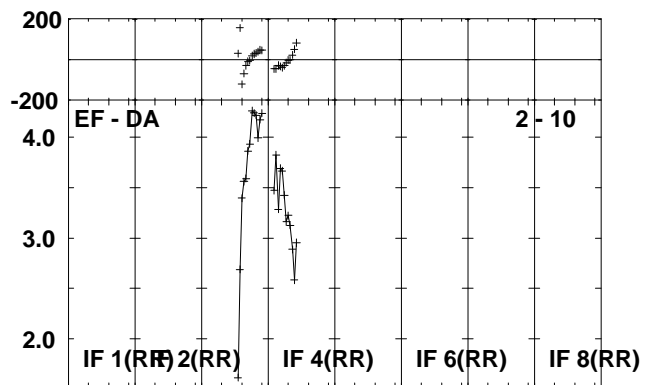
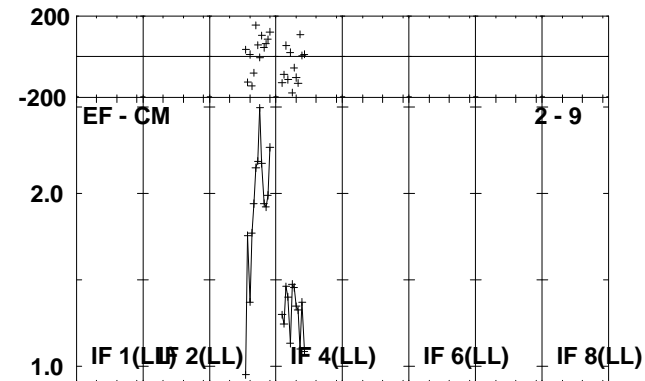
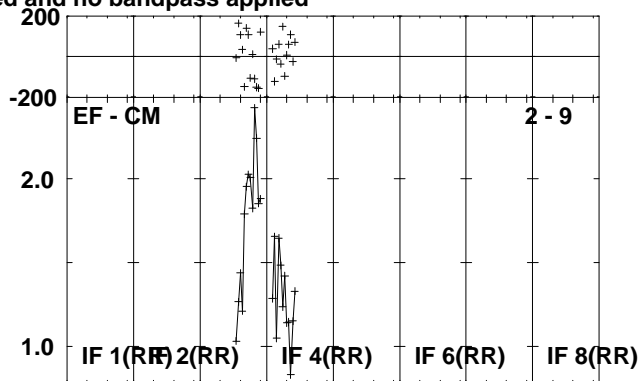
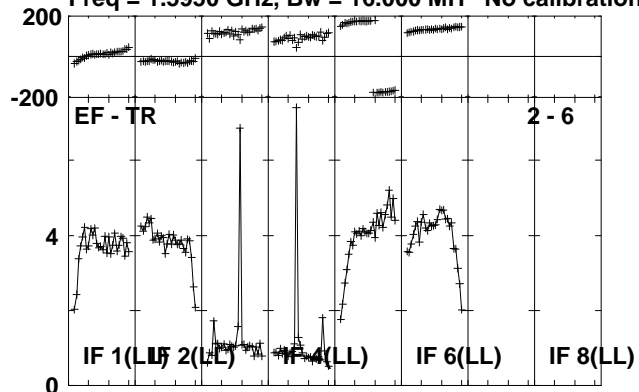

Lower frame: Milli Ampl Jy Top frame: Phas deg
Scalar averaged cross-power spectrum Several baselines displayed
Timerange: 01/02:40:31 to 01/02:41:59

Plot file version 217 created 23-AUG-2010 12:37:34

IRAS1929 EP064P.UVDATA.1

Freq = 1.5950 GHz, Bw = 16.000 MH No calibration applied and no bandpass applied

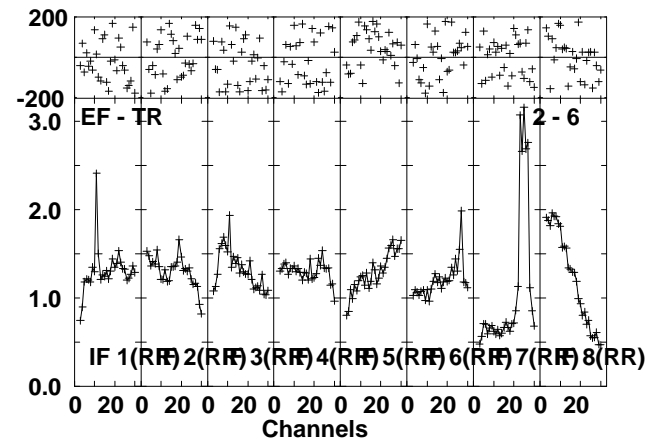
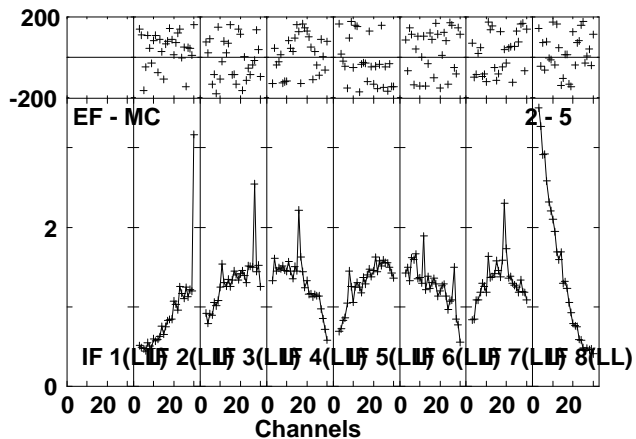
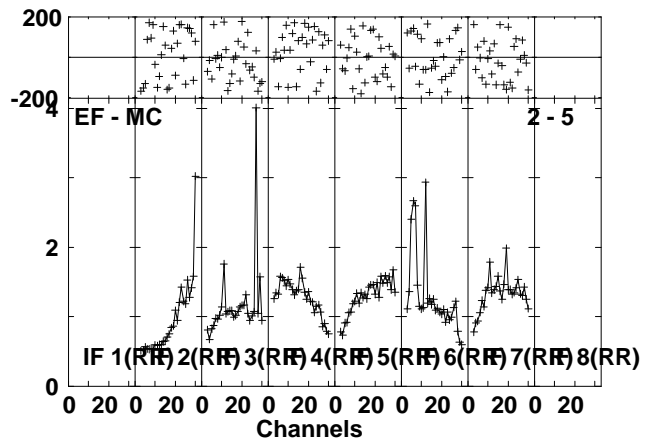
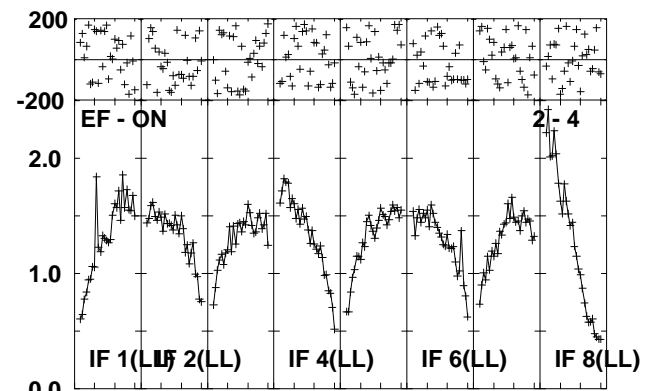
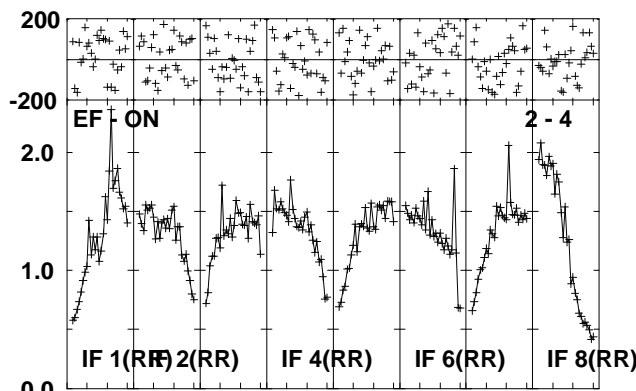
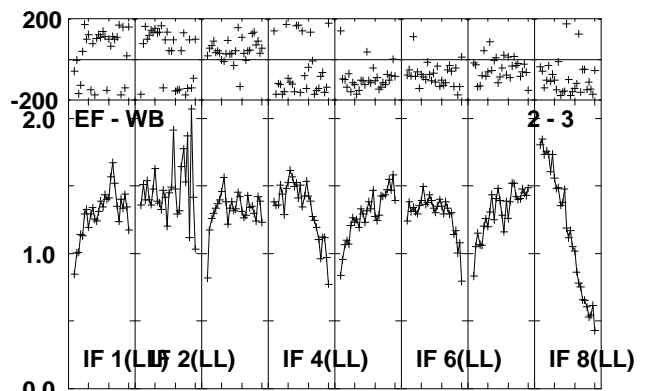
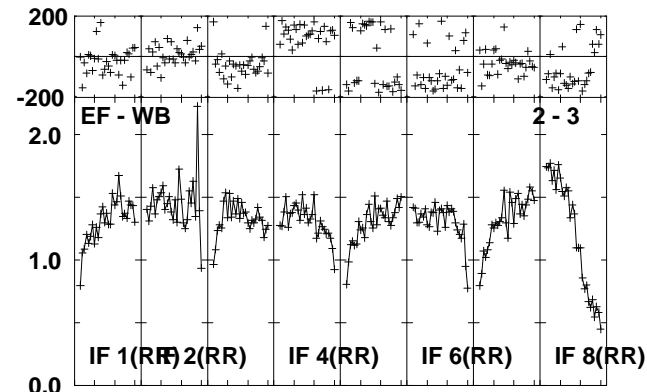
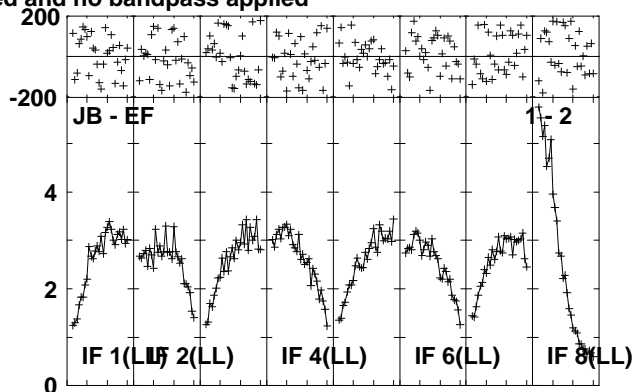
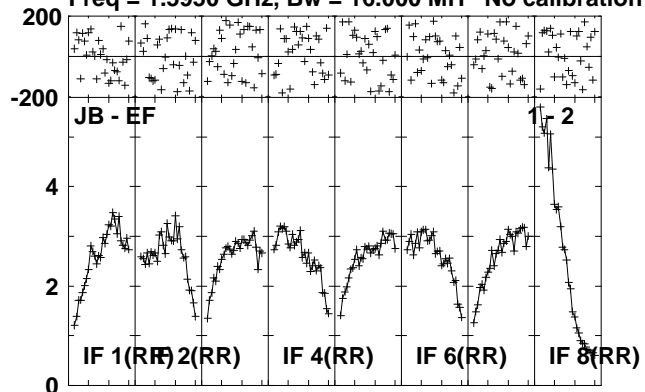

Lower frame: Milli Ampl Jy Top frame: Phas deg
Scalar averaged cross-power spectrum Several baselines displayed
Timerange: 01/02:42:01 to 01/02:45:29

Plot file version 218 created 23-AUG-2010 12:37:35

IRAS1929 EP064P.UVDATA.1

Freq = 1.5950 GHz, Bw = 16.000 MH No calibration applied and no bandpass applied

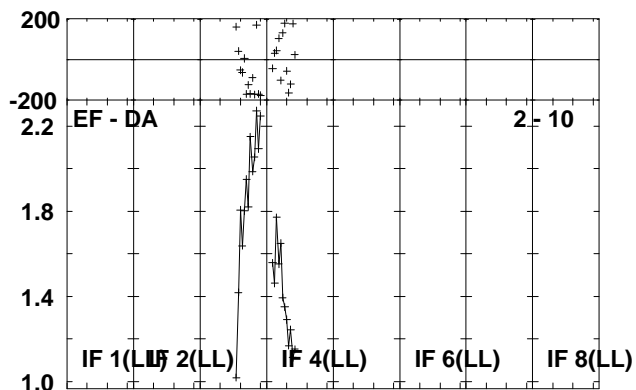
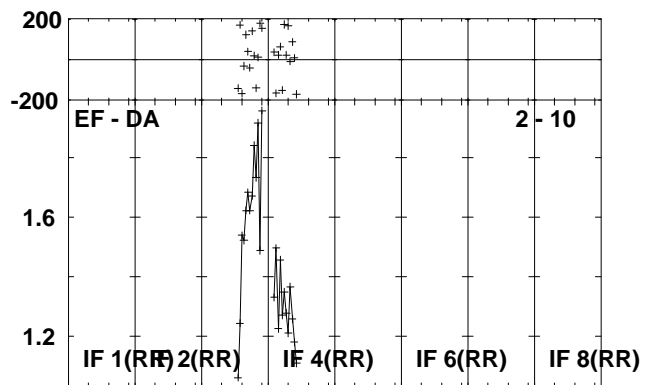
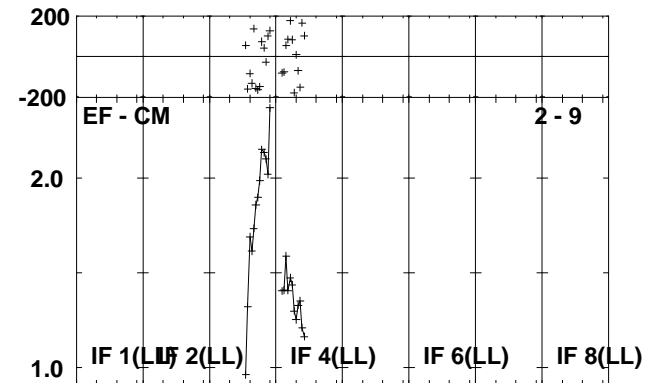
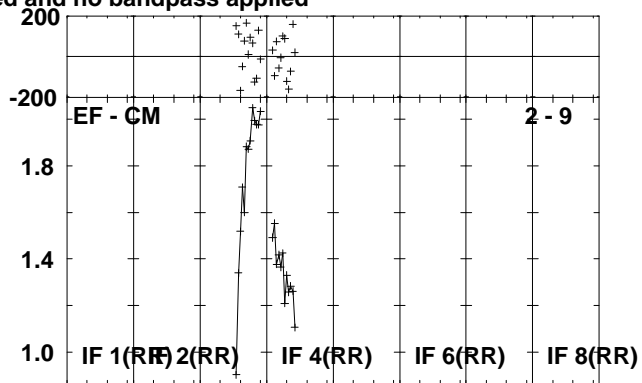
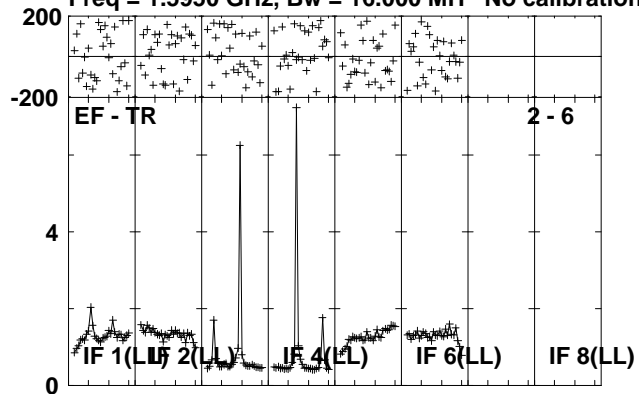

Lower frame: Milli Ampl Jy Top frame: Phas deg
Scalar averaged cross-power spectrum Several baselines displayed
Timerange: 01/02:42:01 to 01/02:45:29

Plot file version 219 created 23-AUG-2010 12:37:37

J1941-05 EP064P.UVDATA.1

Freq = 1.5950 GHz, Bw = 16.000 MH No calibration applied and no bandpass applied

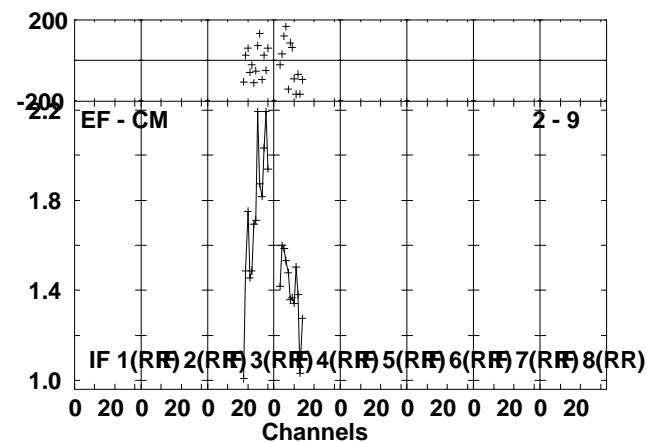
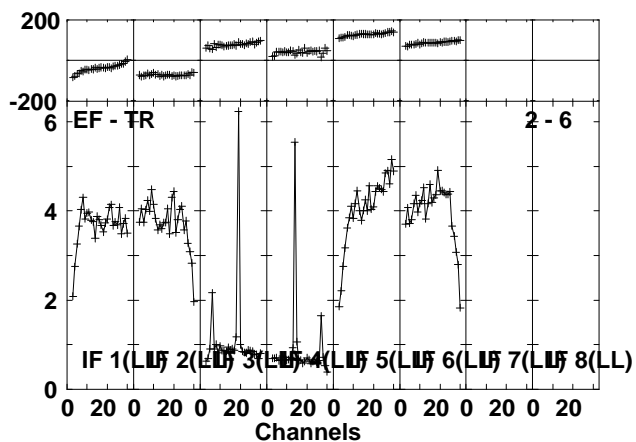
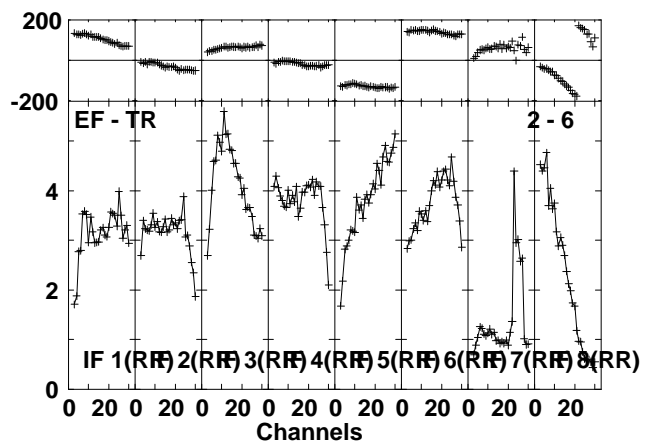
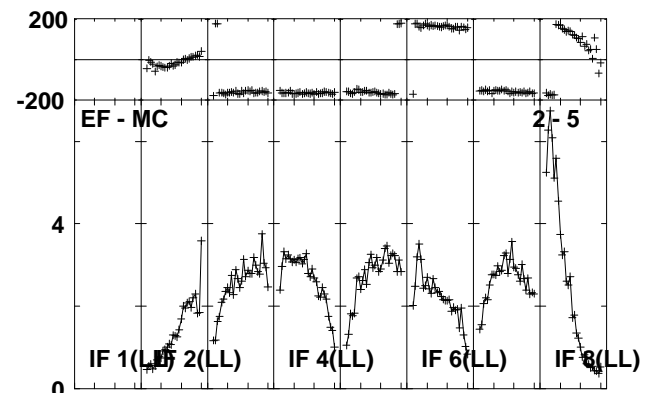
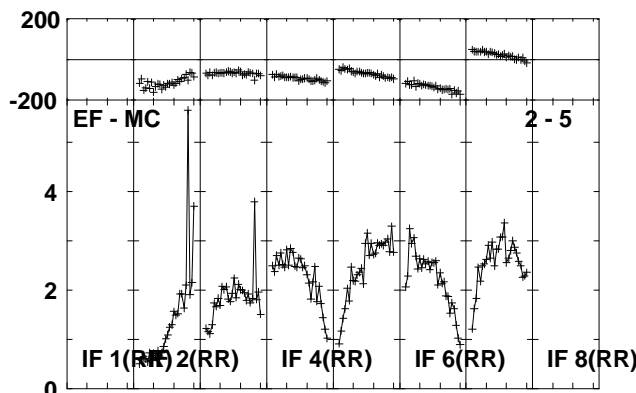
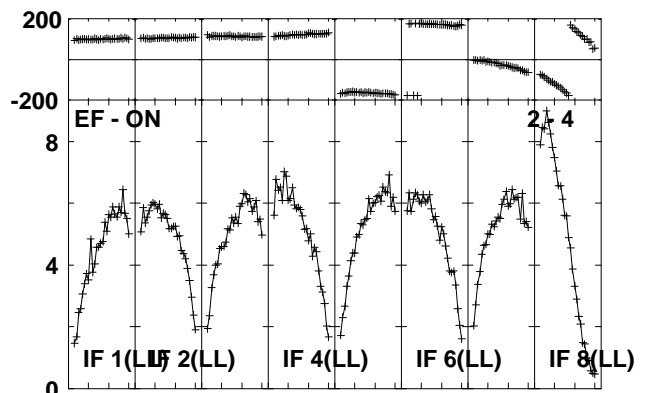
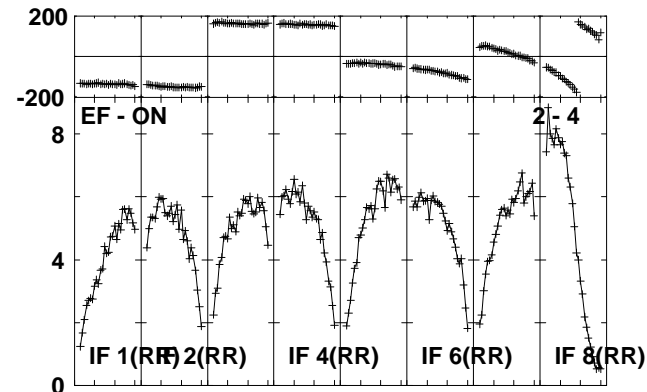
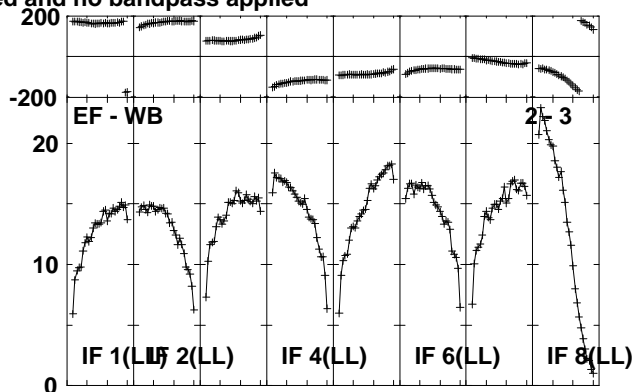
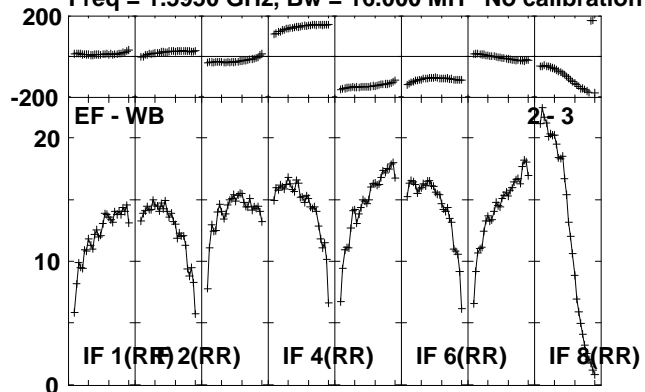

Lower frame: Milli Ampl Jy Top frame: Phas deg
Scalar averaged cross-power spectrum Several baselines displayed
Timerange: 01/02:45:31 to 01/02:46:57

Plot file version 220 created 23-AUG-2010 12:37:37
J1941-05 EP064P.UVDATA.1

Freq = 1.5950 GHz, Bw = 16.000 MH No calibration applied and no bandpass applied

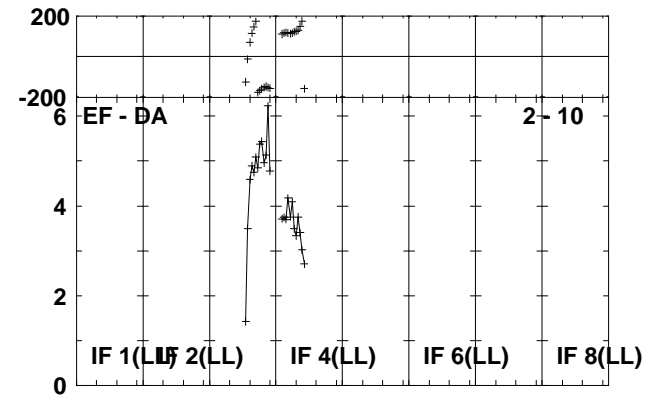
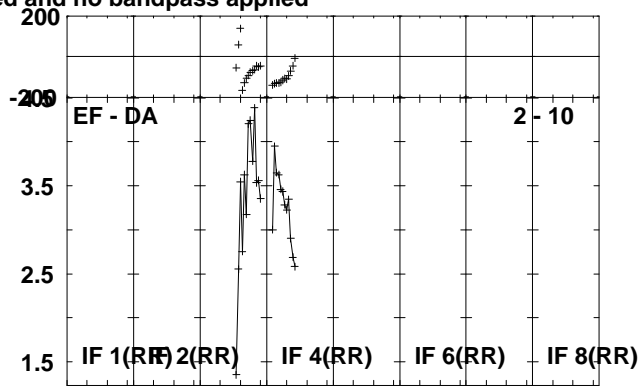
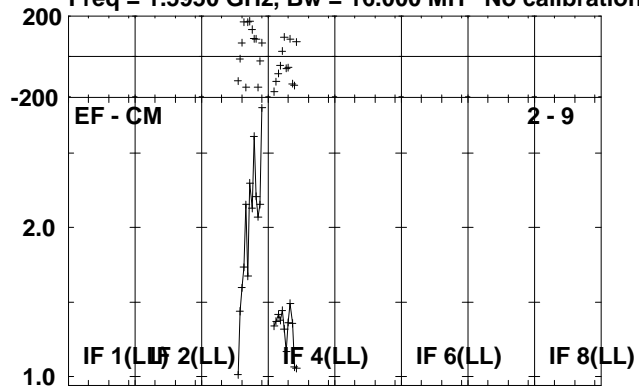

Lower frame: Milli Ampl Jy Top frame: Phas deg
Scalar averaged cross-power spectrum Several baselines displayed
Timerange: 01/02:45:31 to 01/02:46:57

Plot file version 221 created 23-AUG-2010 12:37:38

IRAS1929 EP064P.UVDATA.1

Freq = 1.5950 GHz, Bw = 16.000 MH No calibration applied and no bandpass applied

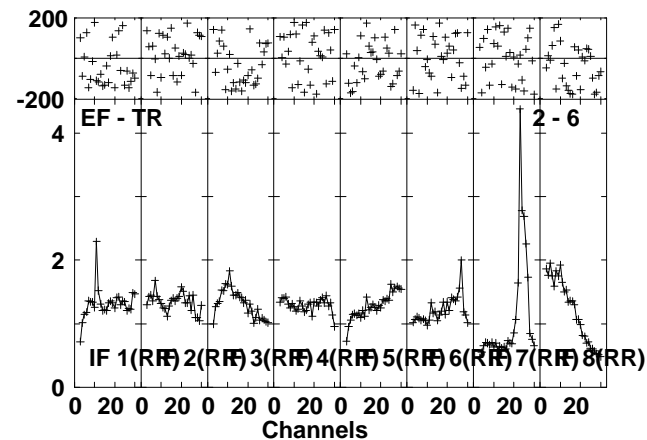
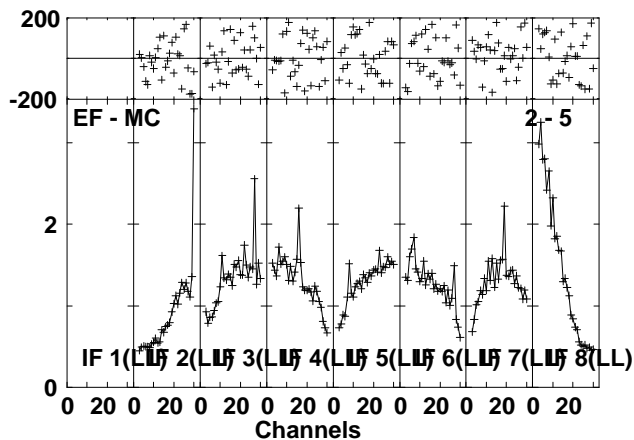
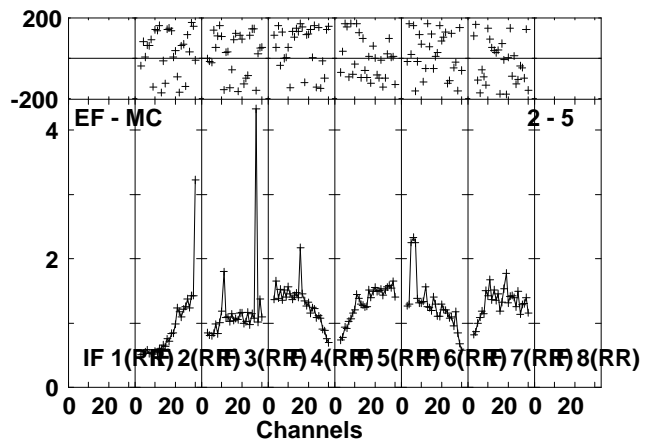
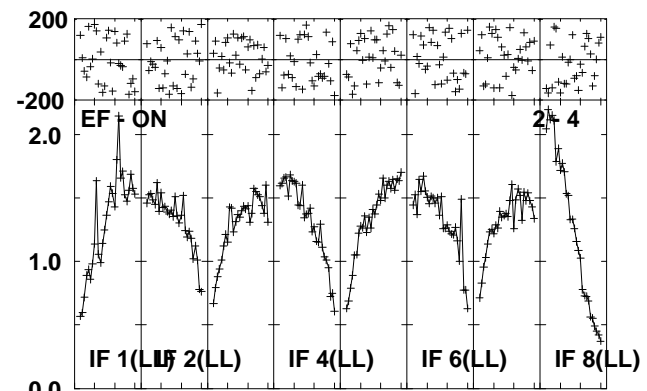
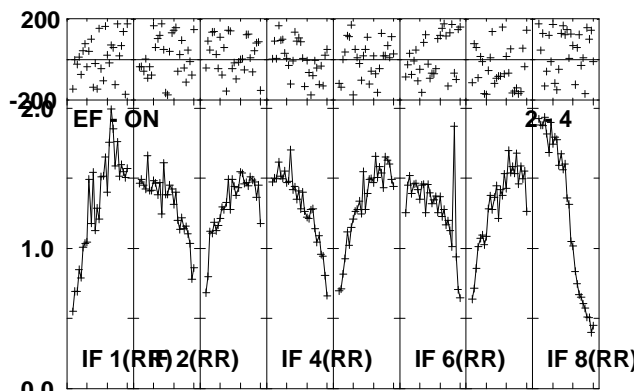
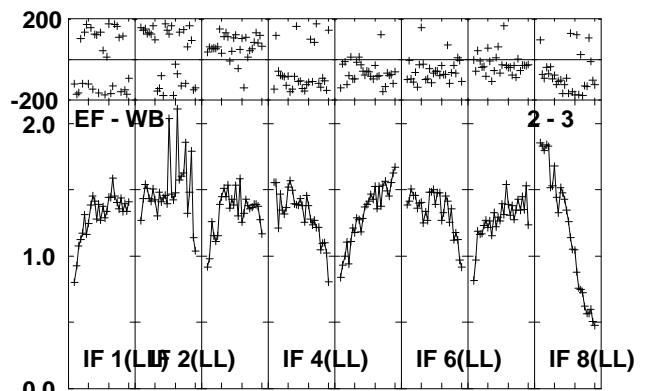
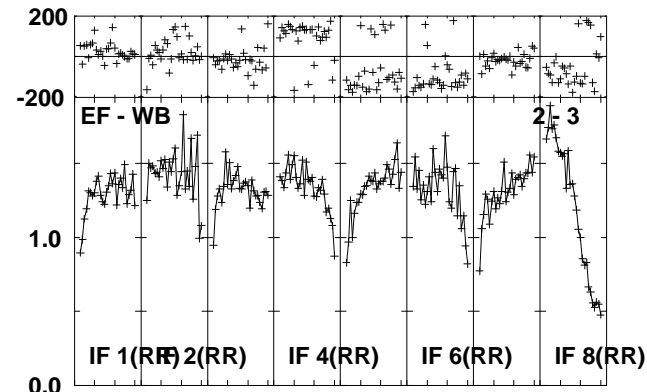
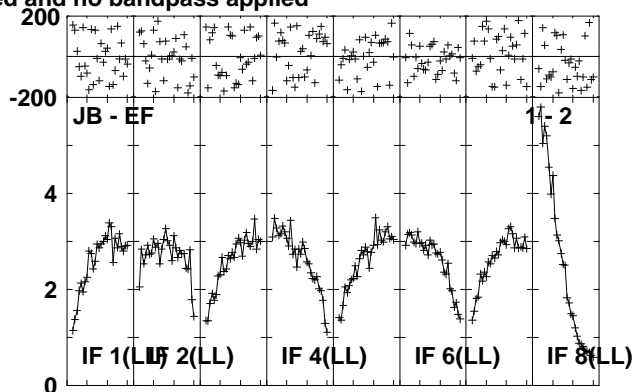
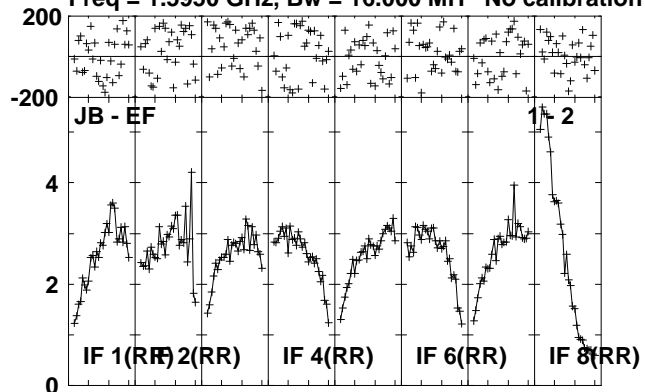

Lower frame: Milli Ampl Jy Top frame: Phas deg
Scalar averaged cross-power spectrum Several baselines displayed
Timerange: 01/02:47:01 to 01/02:50:29

Plot file version 222 created 23-AUG-2010 12:37:39

IRAS1929 EP064P.UVDATA.1

Freq = 1.5950 GHz, Bw = 16.000 MH No calibration applied and no bandpass applied

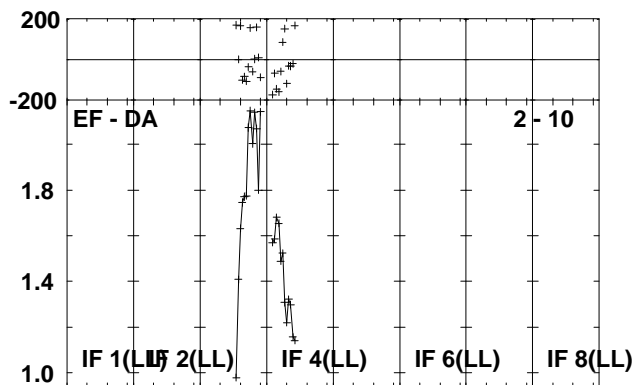
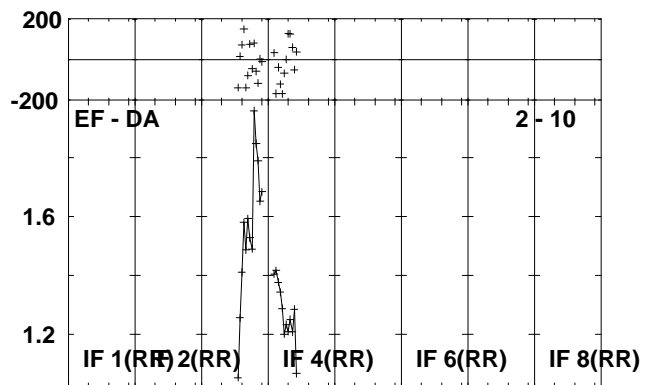
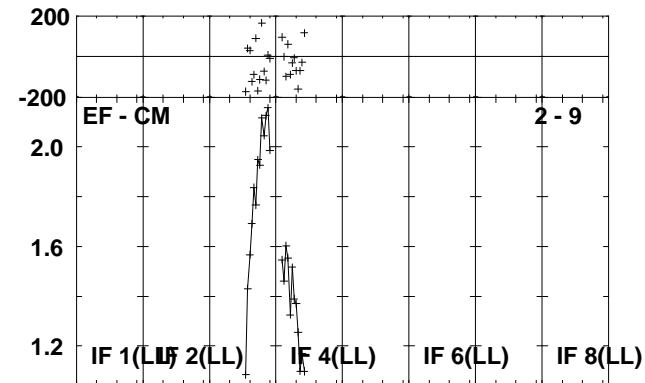
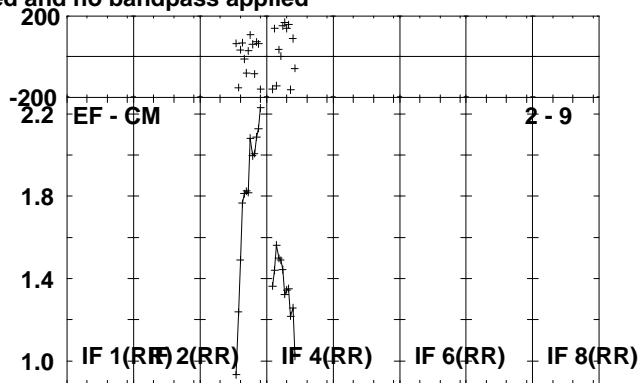
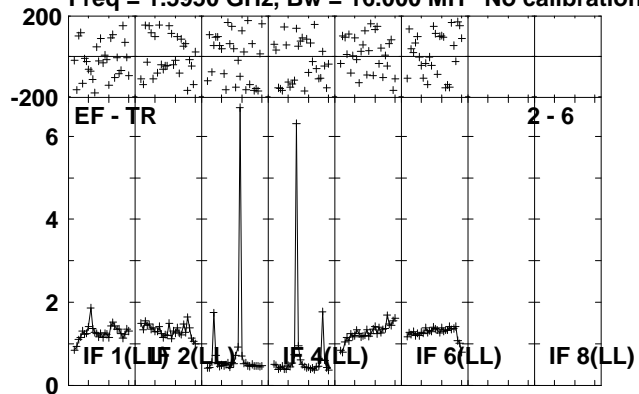

Lower frame: Milli Ampl Jy Top frame: Phas deg
Scalar averaged cross-power spectrum Several baselines displayed
Timerange: 01/02:47:01 to 01/02:50:29

Plot file version 223 created 23-AUG-2010 12:37:40

J1941-05 EP064P.UVDATA.1

Freq = 1.5950 GHz, Bw = 16.000 MH No calibration applied and no bandpass applied

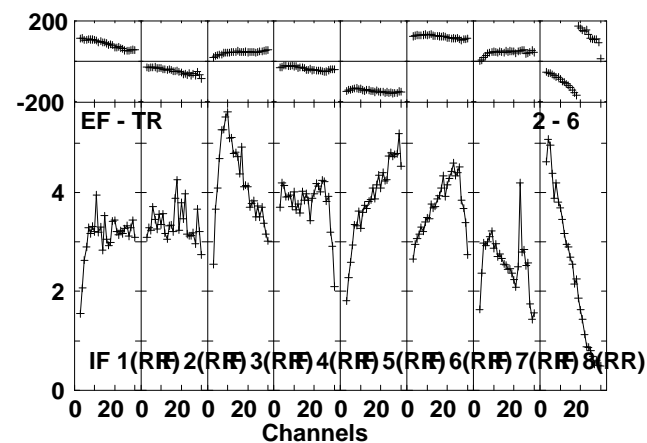
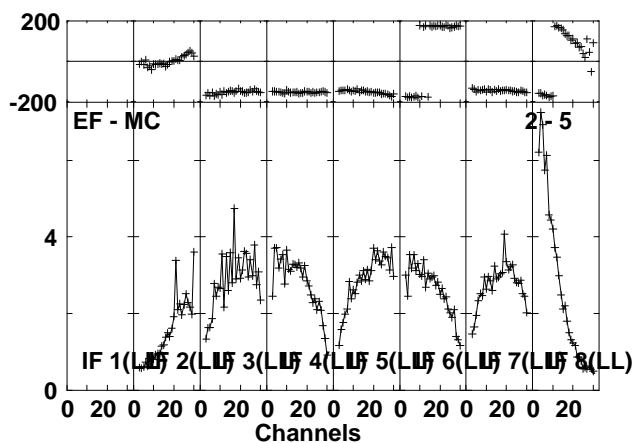
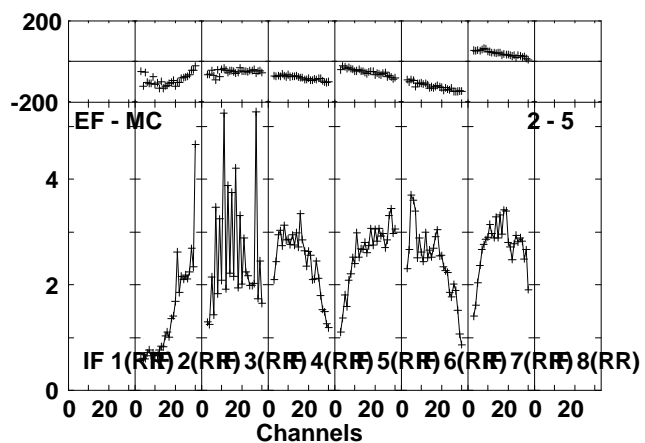
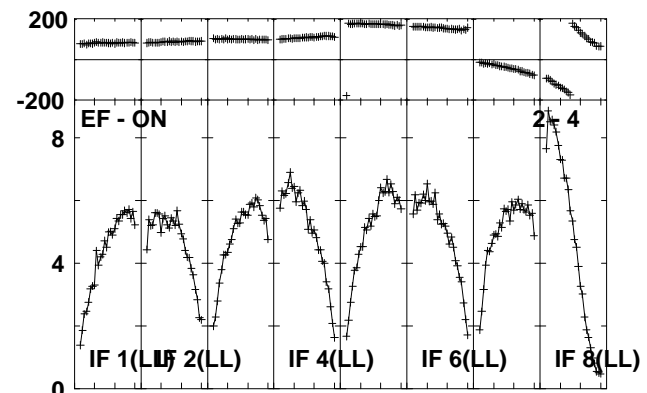
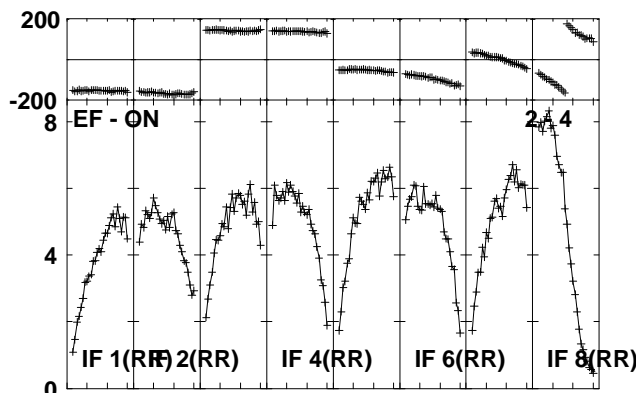
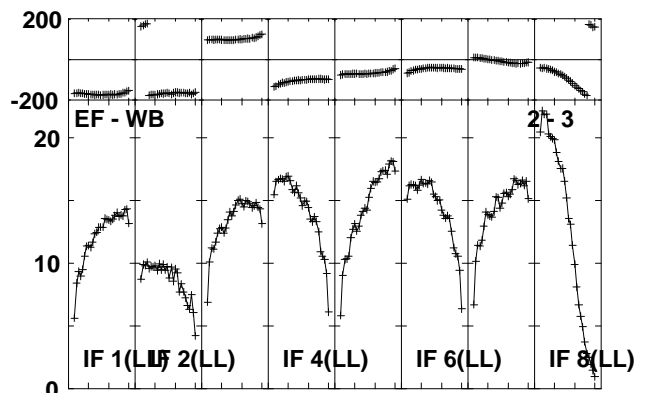
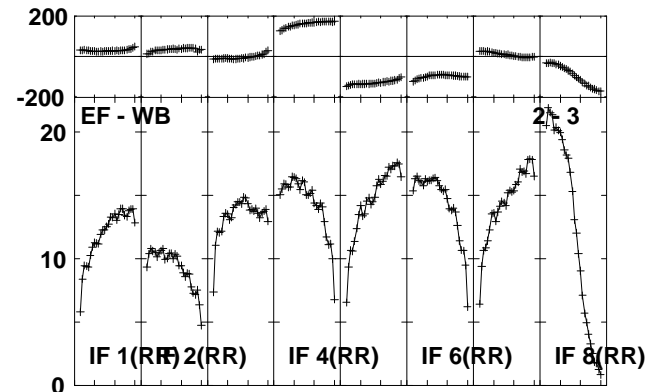
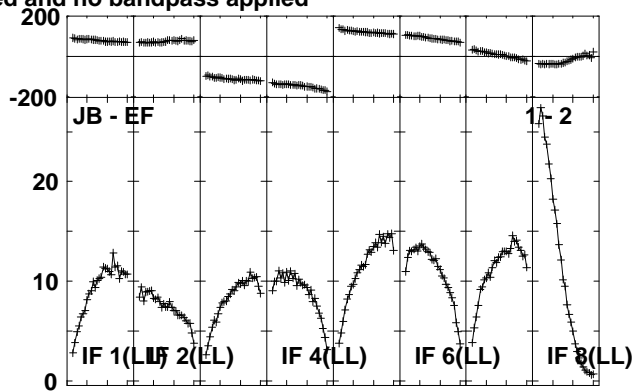
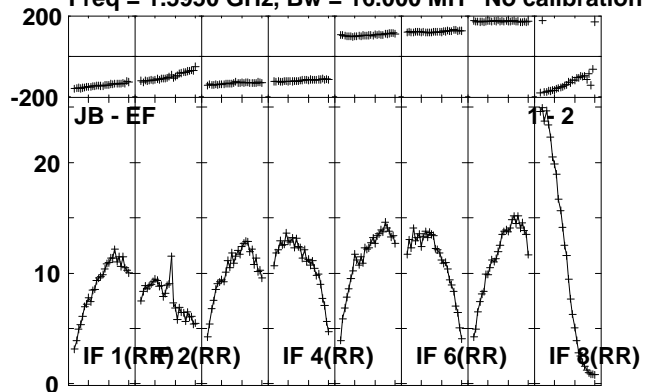

Lower frame: Milli Ampl Jy Top frame: Phas deg
Scalar averaged cross-power spectrum Several baselines displayed
Timerange: 01/02:51:31 to 01/02:52:59

Plot file version 224 created 23-AUG-2010 12:37:41
J1941-05 EP064P.UVDATA.1

Freq = 1.5950 GHz, Bw = 16.000 MH No calibration applied and no bandpass applied

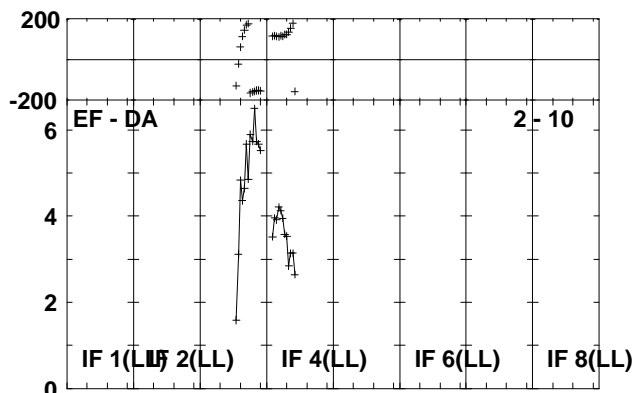
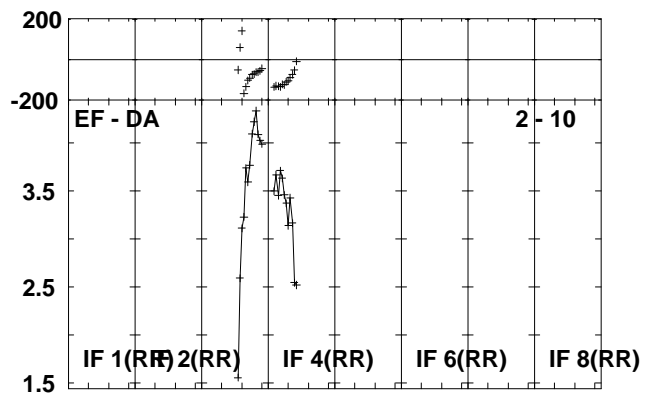
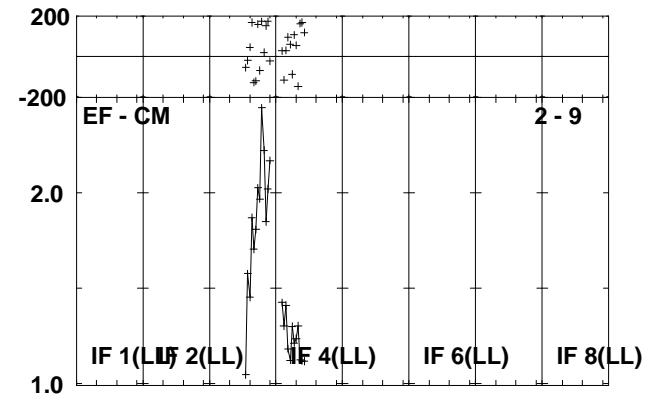
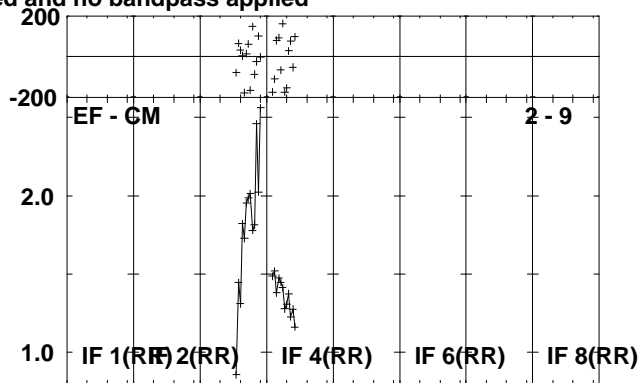
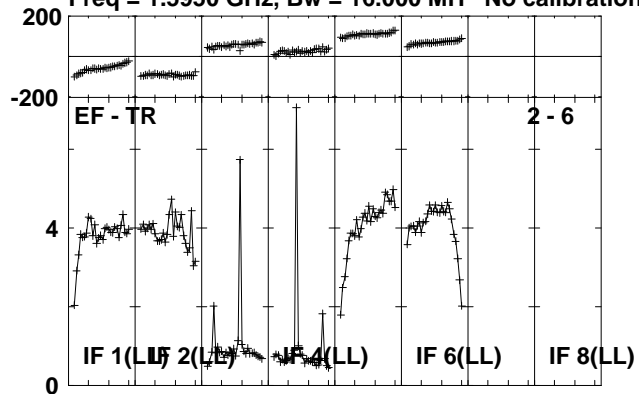

Lower frame: Milli Ampl Jy Top frame: Phas deg
Scalar averaged cross-power spectrum Several baselines displayed
Timerange: 01/02:51:31 to 01/02:52:59

Plot file version 225 created 23-AUG-2010 12:37:42

IRAS1929 EP064P.UVDATA.1

Freq = 1.5950 GHz, Bw = 16.000 MH No calibration applied and no bandpass applied

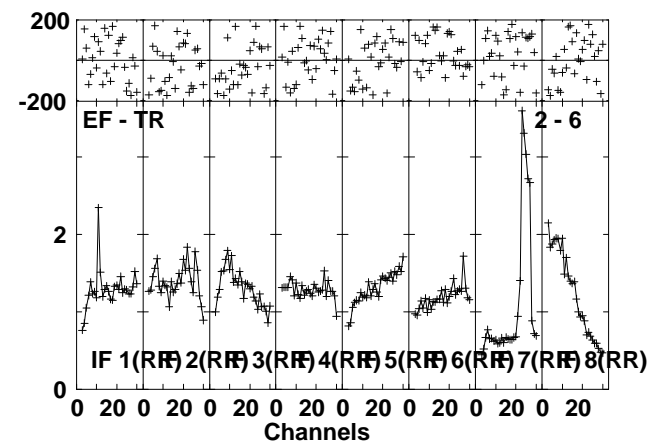
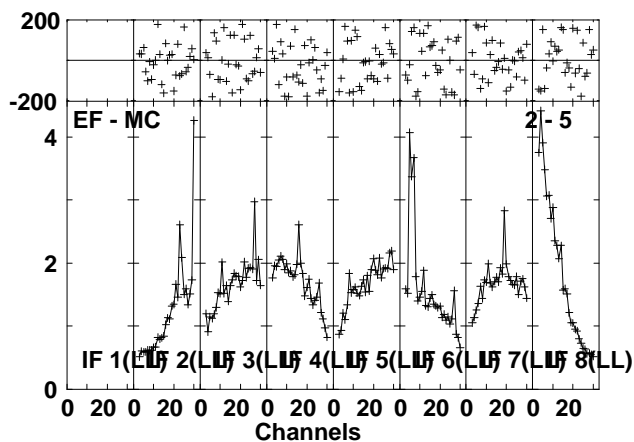
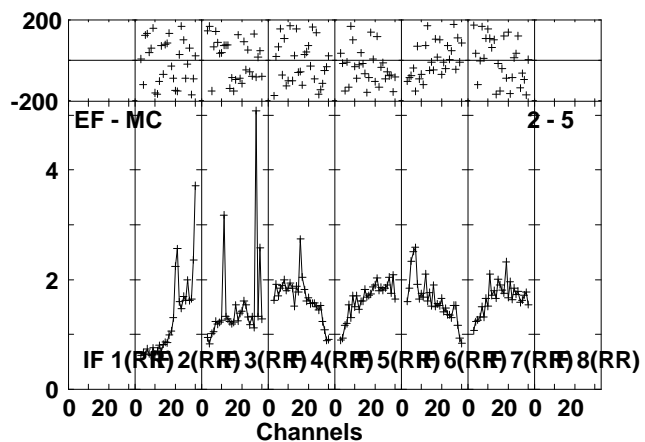
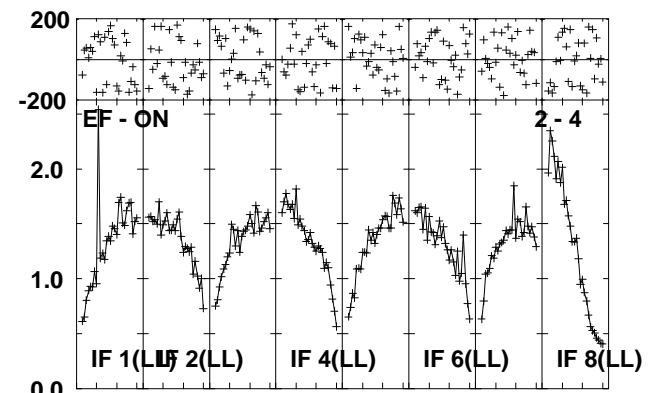
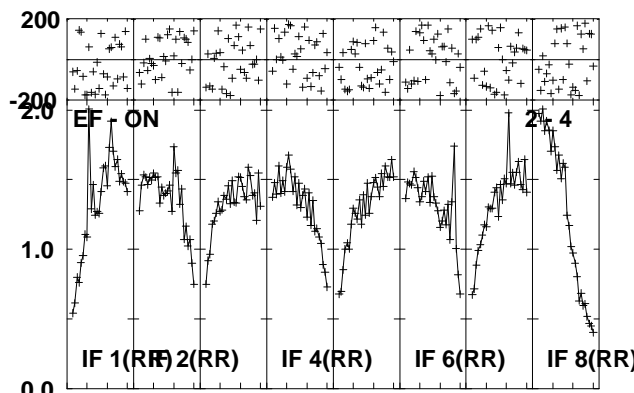
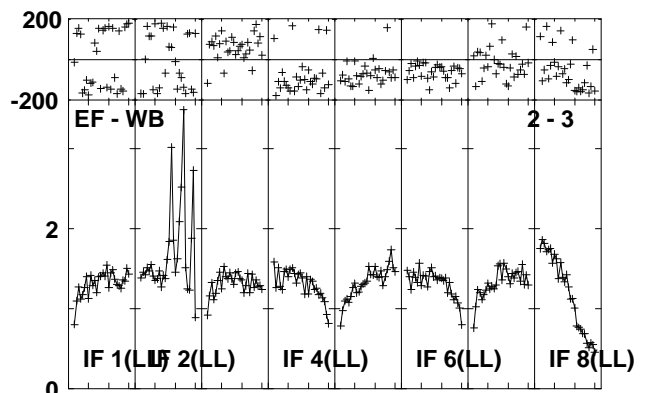
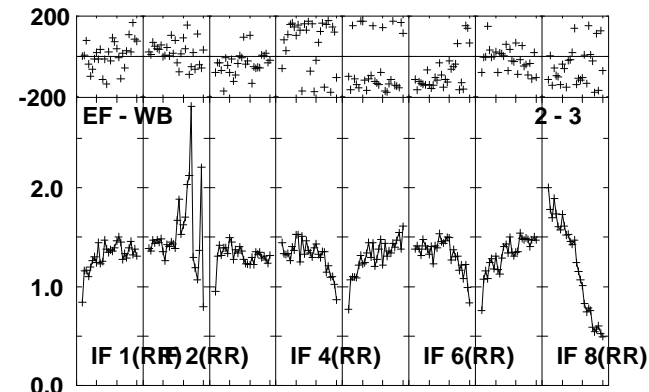
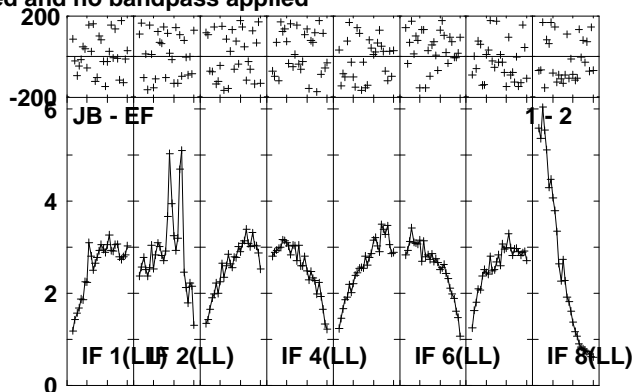
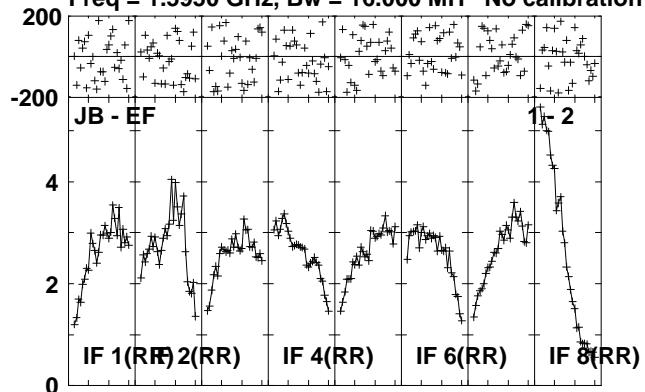

Lower frame: Milli Ampl Jy Top frame: Phas deg
Scalar averaged cross-power spectrum Several baselines displayed
Timerange: 01/02:53:01 to 01/02:56:29

Plot file version 226 created 23-AUG-2010 12:37:43

IRAS1929 EP064P.UVDATA.1

Freq = 1.5950 GHz, Bw = 16.000 MH No calibration applied and no bandpass applied

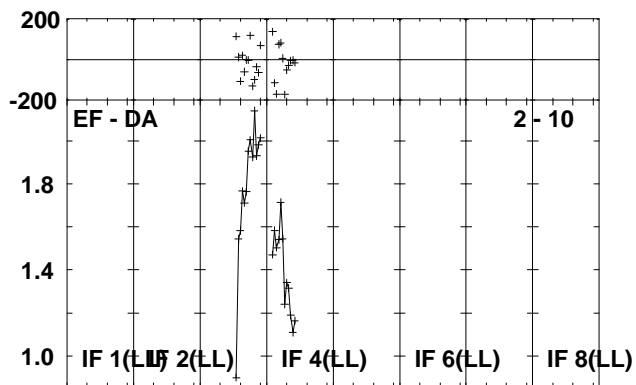
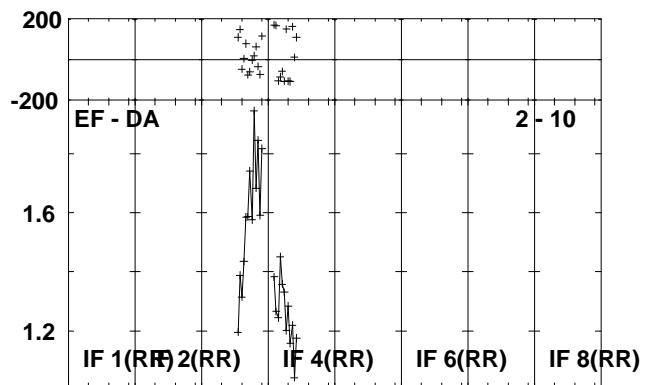
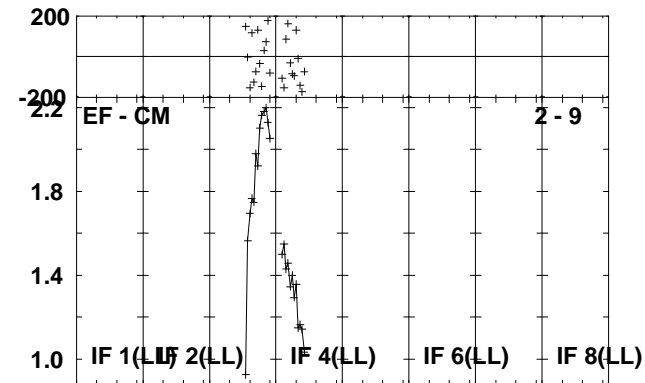
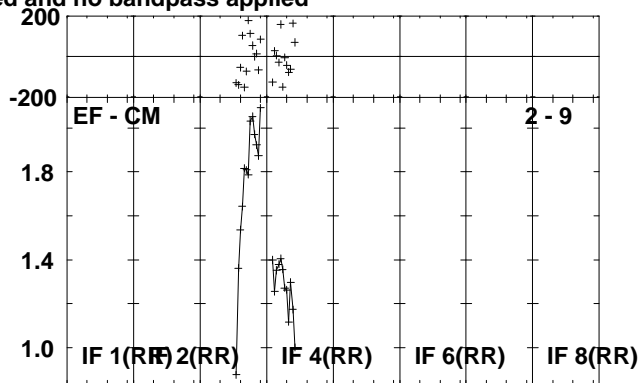
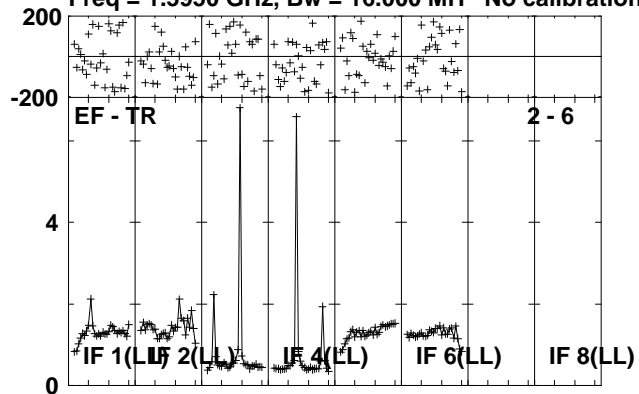

Lower frame: Milli Ampl Jy Top frame: Phas deg
Scalar averaged cross-power spectrum Several baselines displayed
Timerange: 01/02:53:01 to 01/02:56:29

Plot file version 227 created 23-AUG-2010 12:37:44
 J1941-05 EP064P.UVDATA.1

Freq = 1.5950 GHz, Bw = 16.000 MH No calibration applied and no bandpass applied

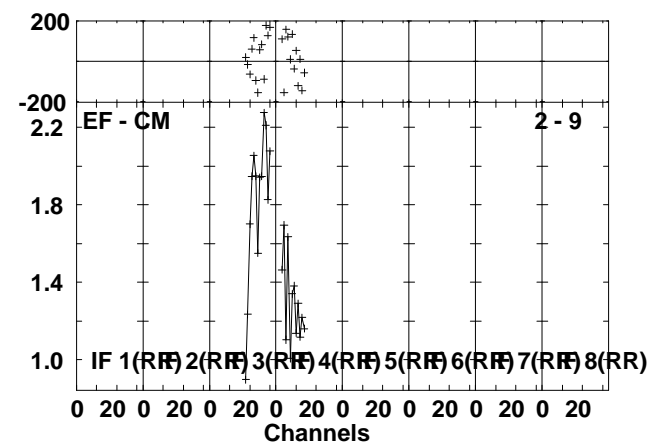
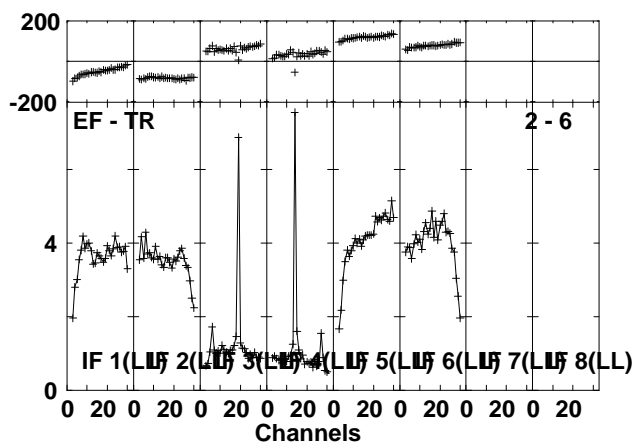
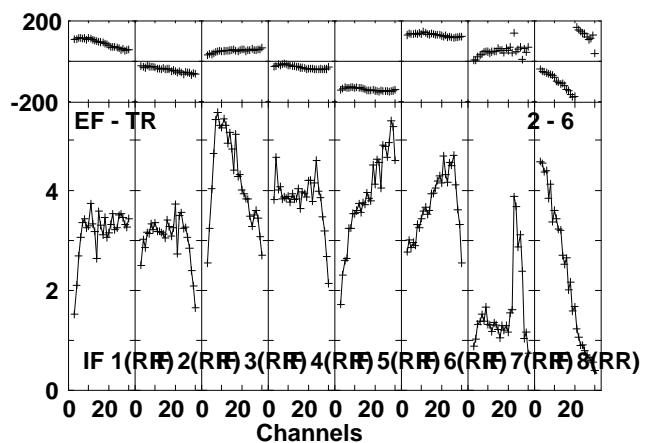
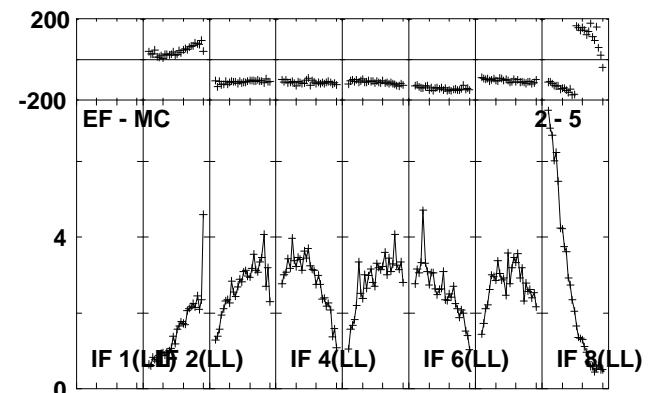
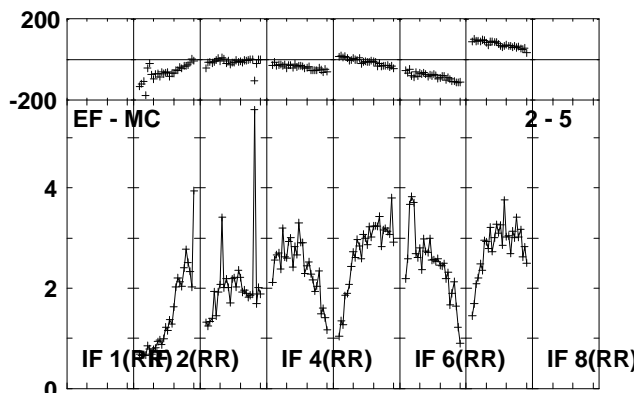
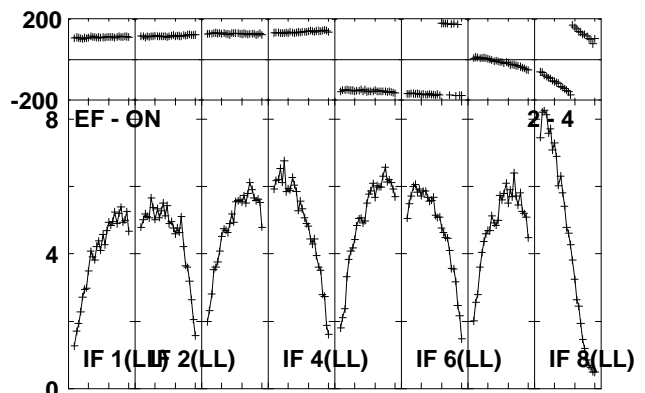
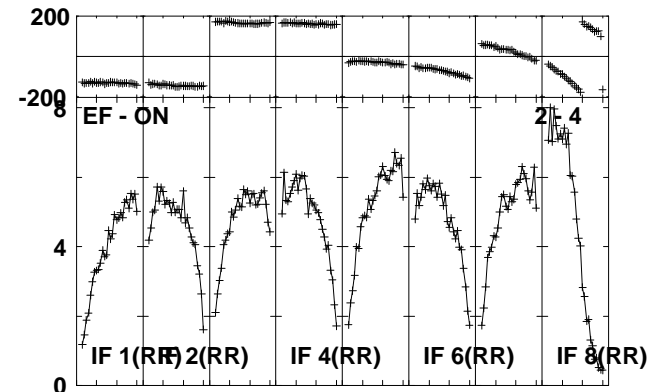
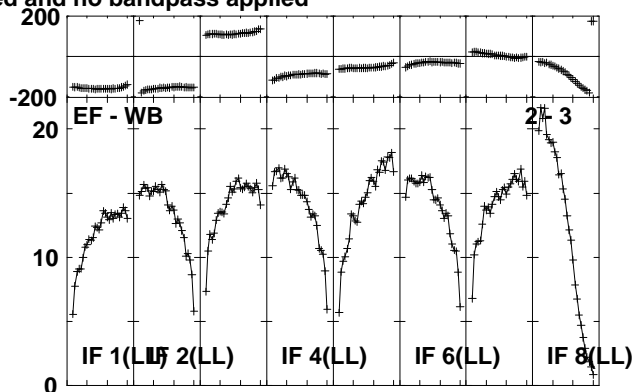
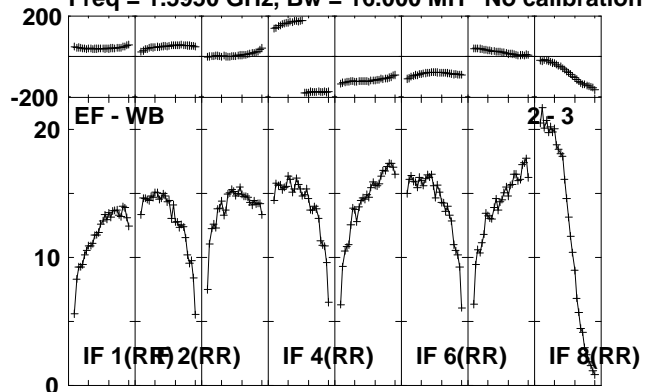

Lower frame: Milli Ampl Jy Top frame: Phas deg
 Scalar averaged cross-power spectrum Several baselines displayed
 Timerange: 01/02:56:31 to 01/02:57:57

Plot file version 228 created 23-AUG-2010 12:37:45

J1941-05 EP064P.UVDATA.1

Freq = 1.5950 GHz, Bw = 16.000 MH No calibration applied and no bandpass applied

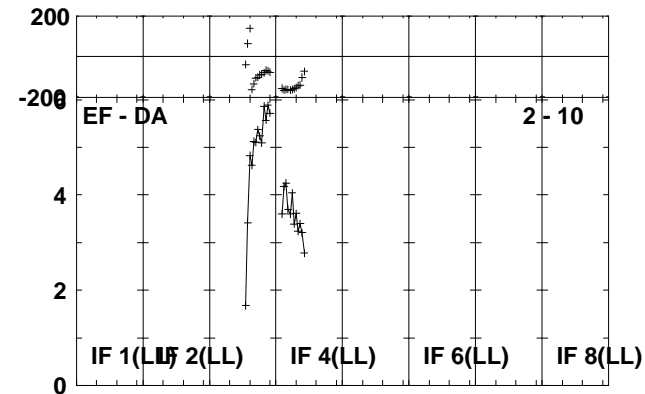
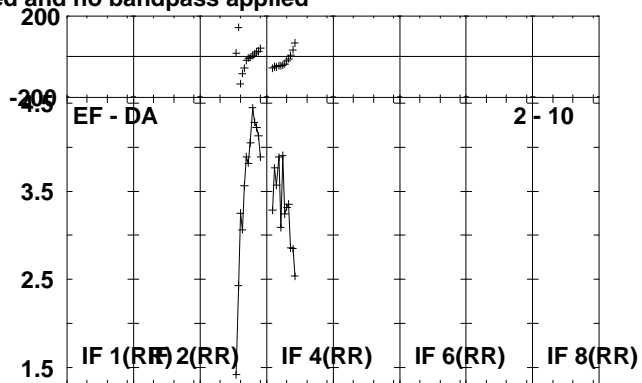
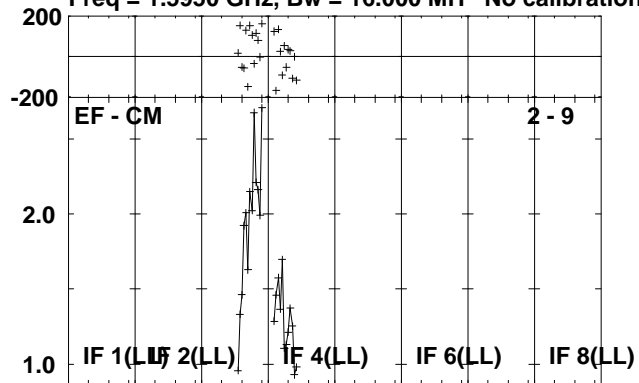

Lower frame: Milli Ampl Jy Top frame: Phas deg
Scalar averaged cross-power spectrum Several baselines displayed
Timerange: 01/02:56:31 to 01/02:57:57

Plot file version 229 created 23-AUG-2010 12:37:45

IRAS1929 EP064P.UVDATA.1

Freq = 1.5950 GHz, Bw = 16.000 MH No calibration applied and no bandpass applied

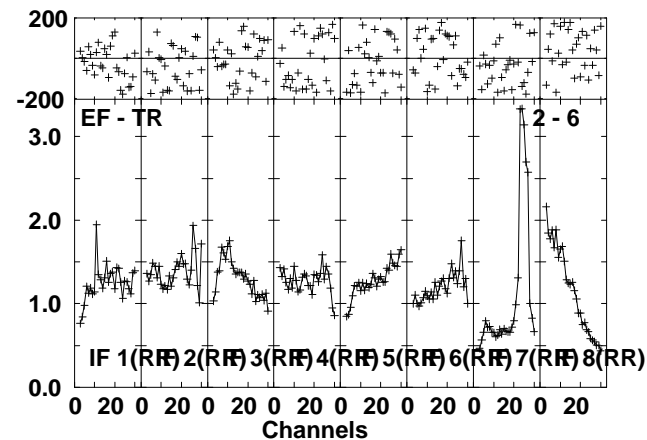
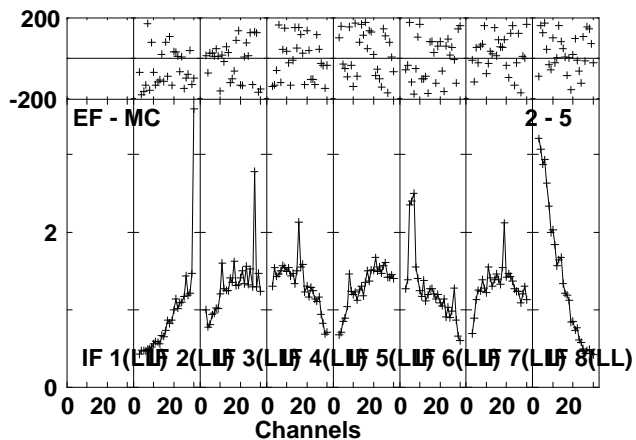
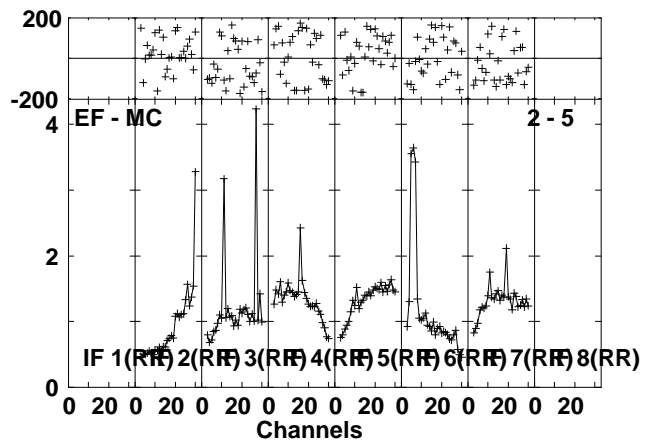
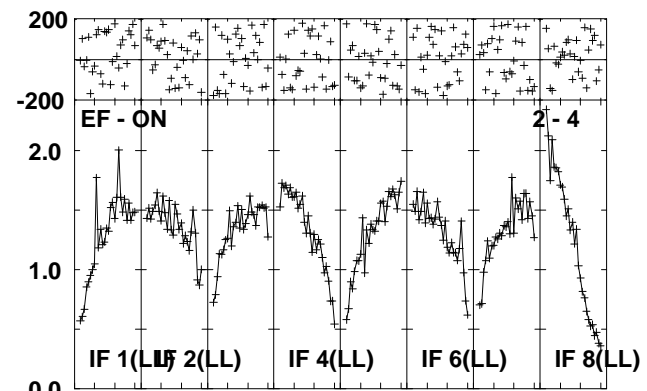
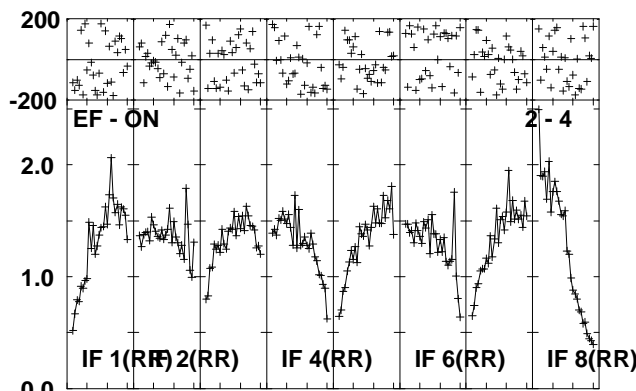
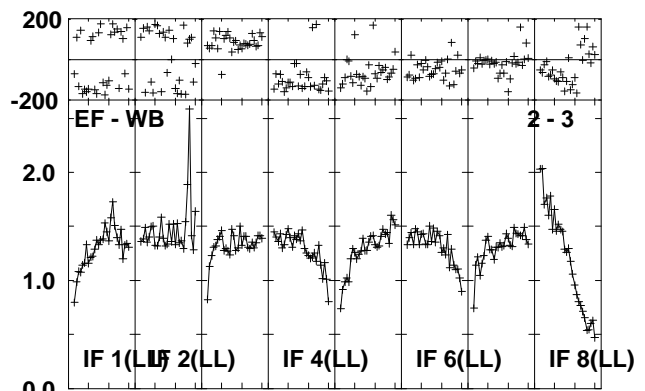
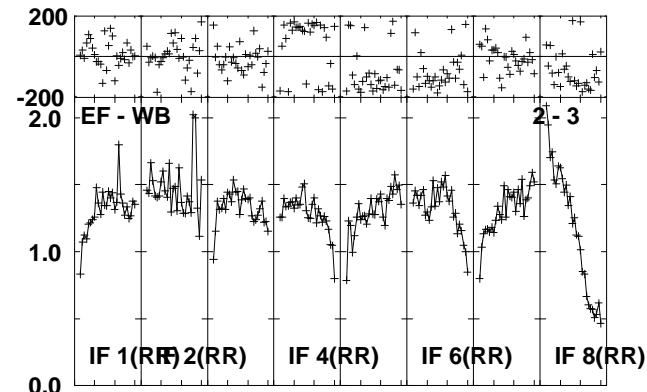
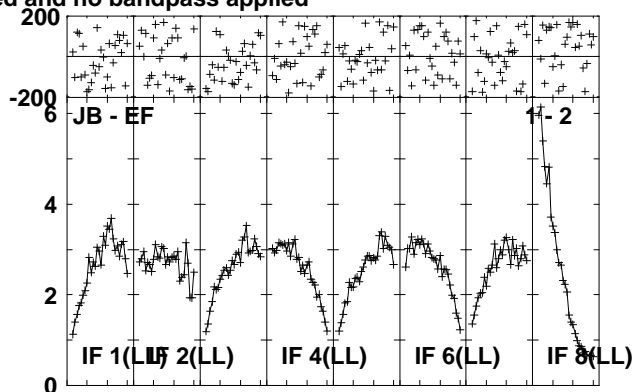
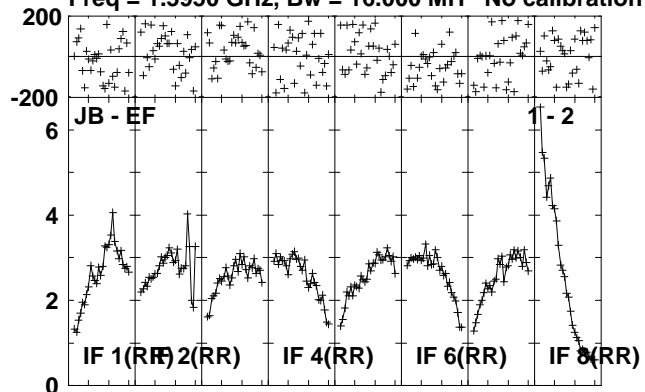

Lower frame: Milli Ampl Jy Top frame: Phas deg
Scalar averaged cross-power spectrum Several baselines displayed
Timerange: 01/02:58:01 to 01/03:01:29

Plot file version 230 created 23-AUG-2010 12:37:46

IRAS1929 EP064P.UVDATA.1

Freq = 1.5950 GHz, Bw = 16.000 MH No calibration applied and no bandpass applied

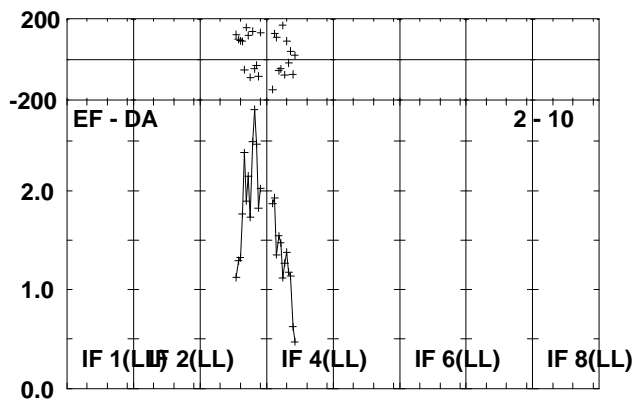
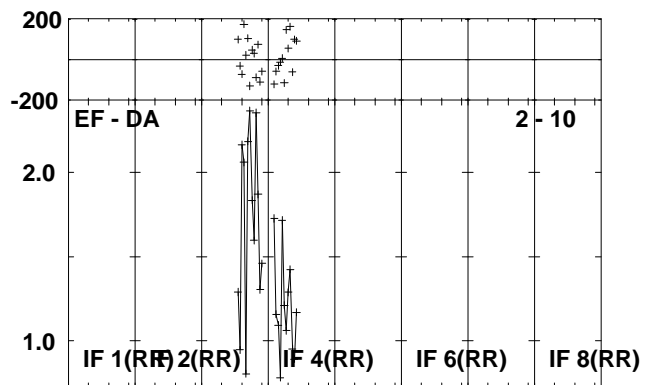
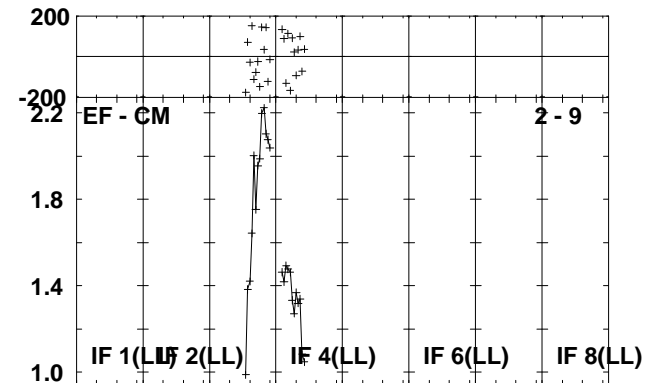
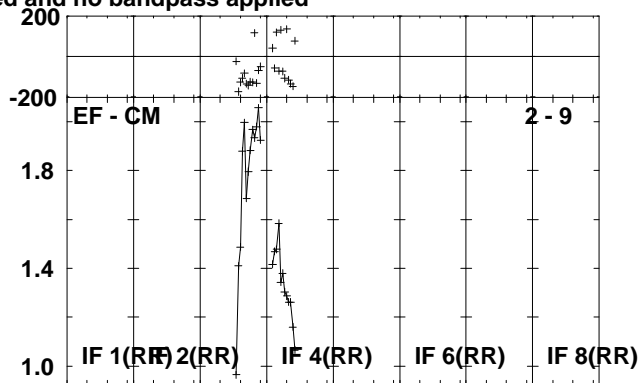
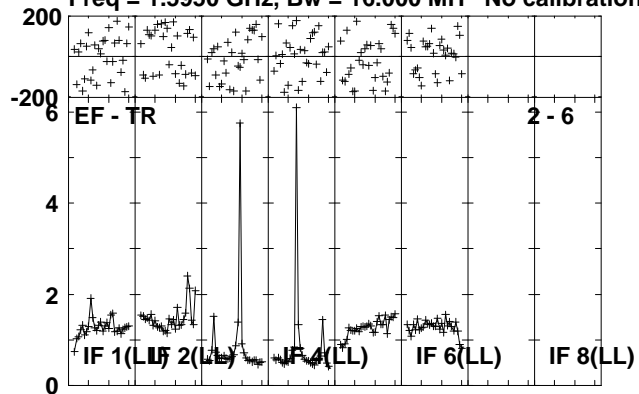

Lower frame: Milli Ampl Jy Top frame: Phas deg
Scalar averaged cross-power spectrum Several baselines displayed
Timerange: 01/02:58:01 to 01/03:01:29

Plot file version 231 created 23-AUG-2010 12:37:47

J1941-05 EP064P.UVDATA.1

Freq = 1.5950 GHz, Bw = 16.000 MH No calibration applied and no bandpass applied

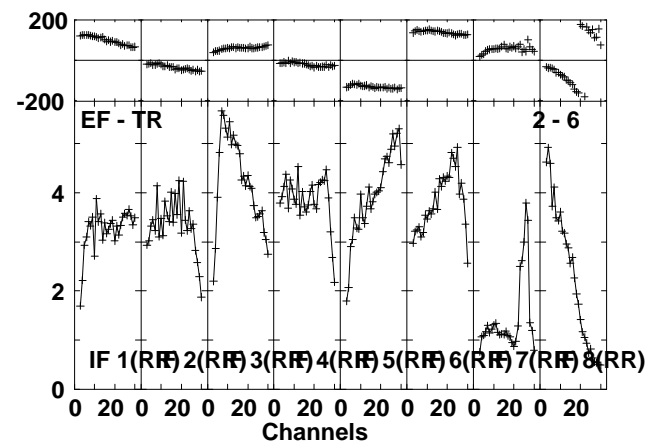
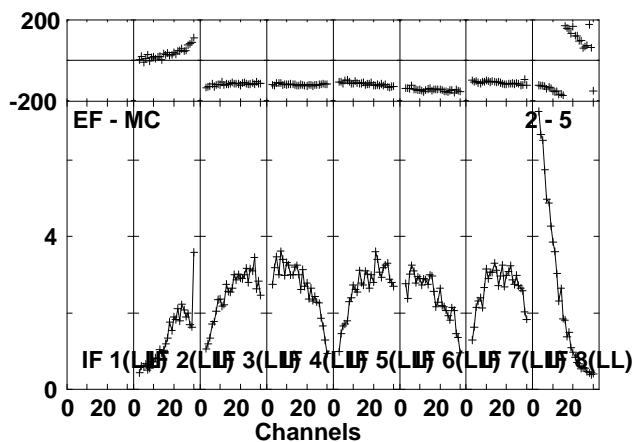
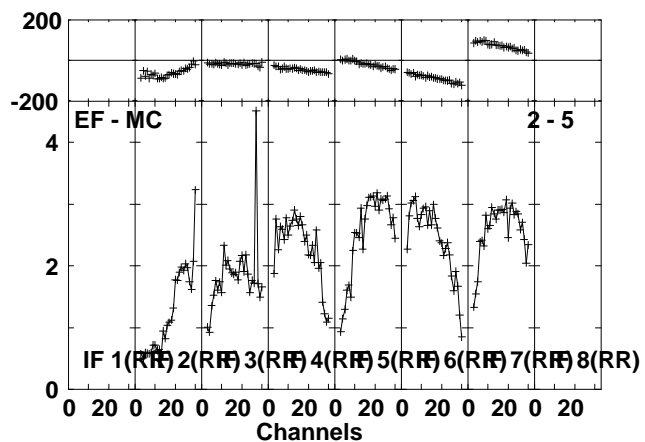
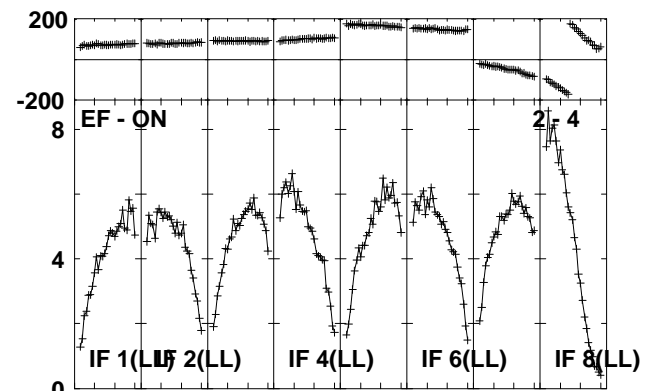
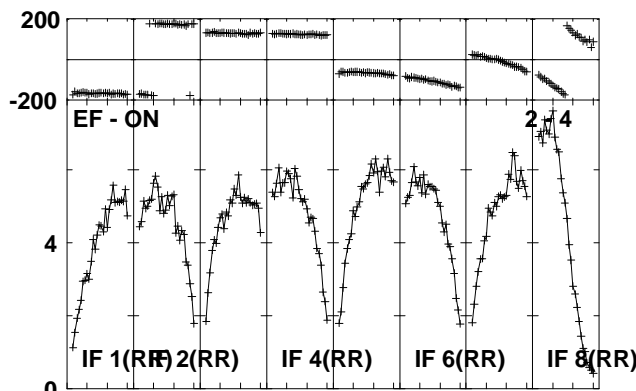
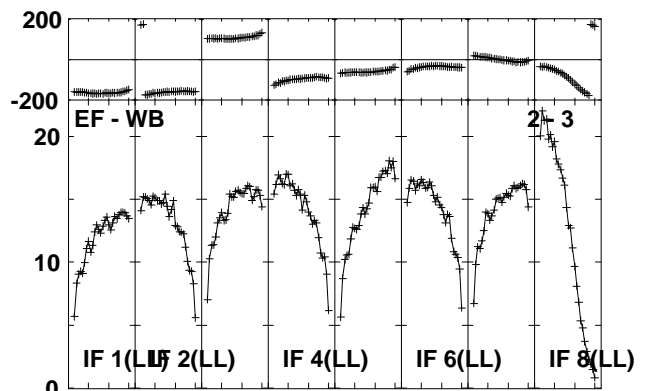
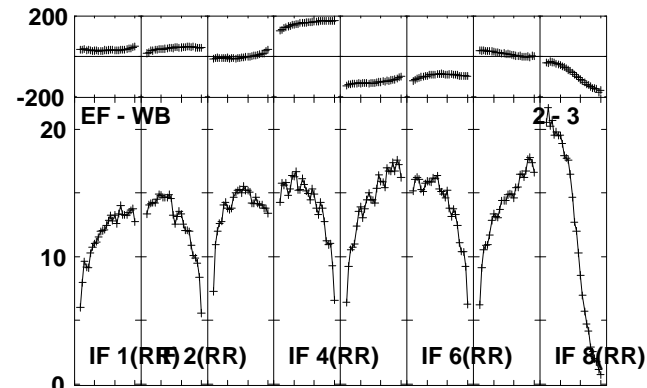
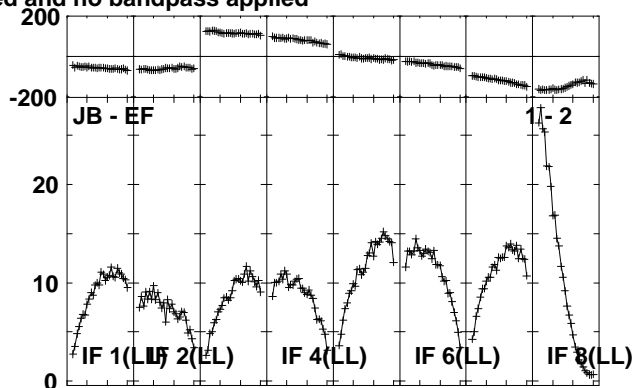
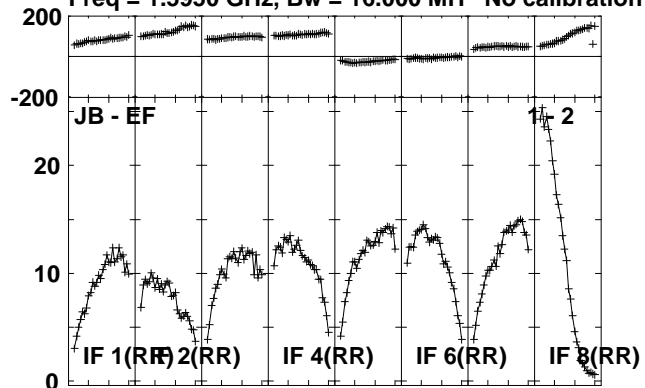

Lower frame: Milli Ampl Jy Top frame: Phas deg
Scalar averaged cross-power spectrum Several baselines displayed
Timerange: 01/03:01:31 to 01/03:02:59

Plot file version 232 created 23-AUG-2010 12:37:48
J1941-05 EP064P.UVDATA.1

Freq = 1.5950 GHz, Bw = 16.000 MH No calibration applied and no bandpass applied

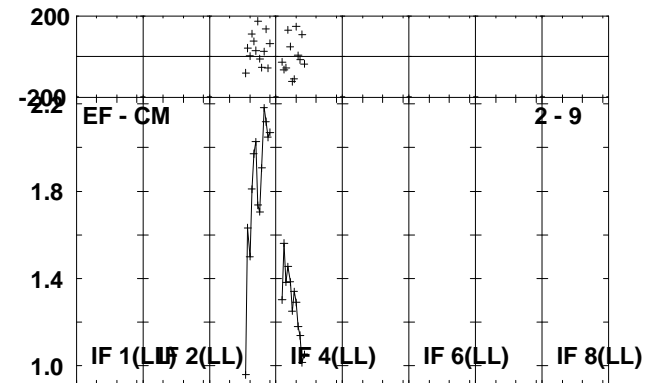
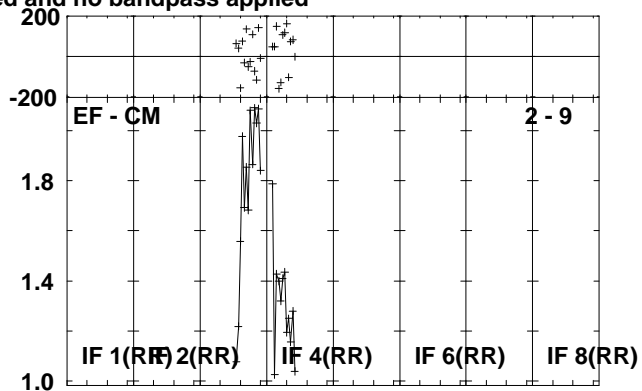
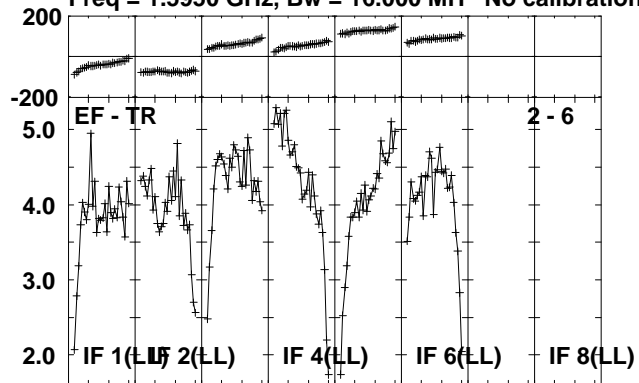

Lower frame: Milli Ampl Jy Top frame: Phas deg
Scalar averaged cross-power spectrum Several baselines displayed
Timerange: 01/03:01:31 to 01/03:02:59

Plot file version 233 created 23-AUG-2010 12:37:49

IRAS1929 EP064P.UVDATA.1

Freq = 1.5950 GHz, Bw = 16.000 MH No calibration applied and no bandpass applied

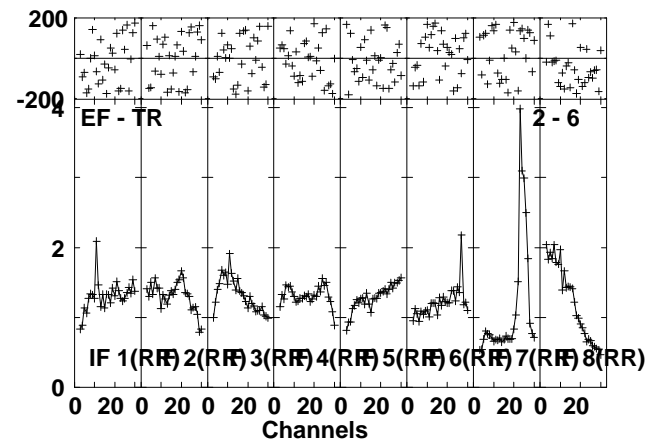
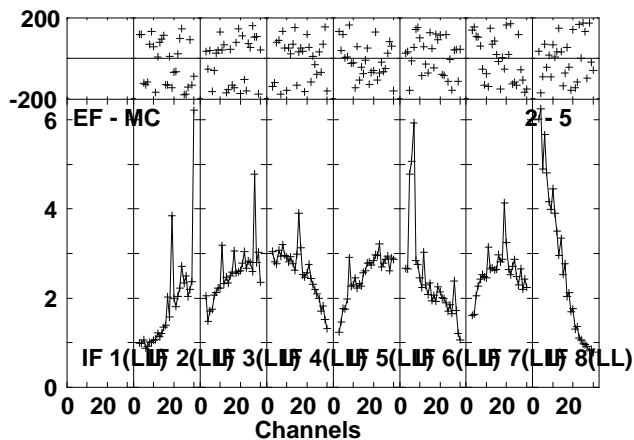
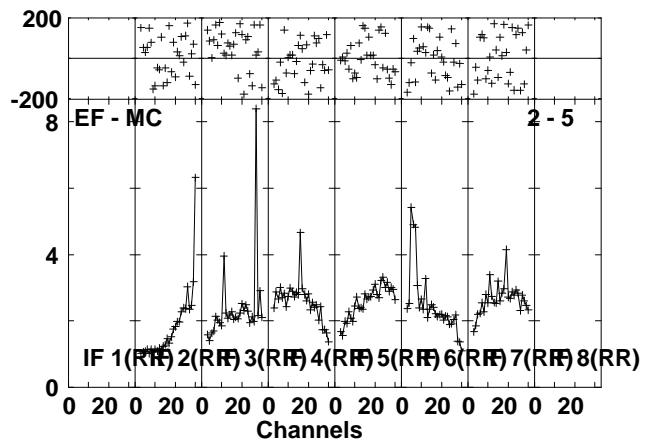
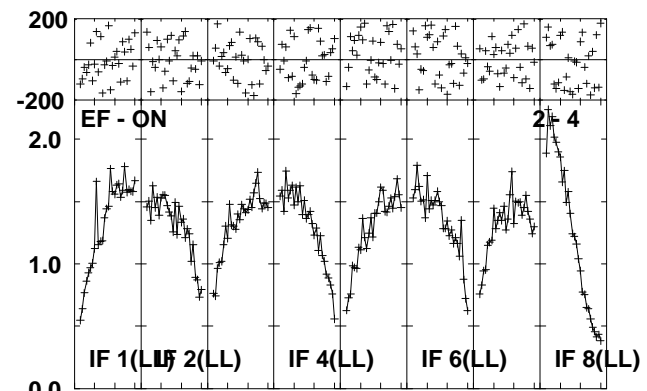
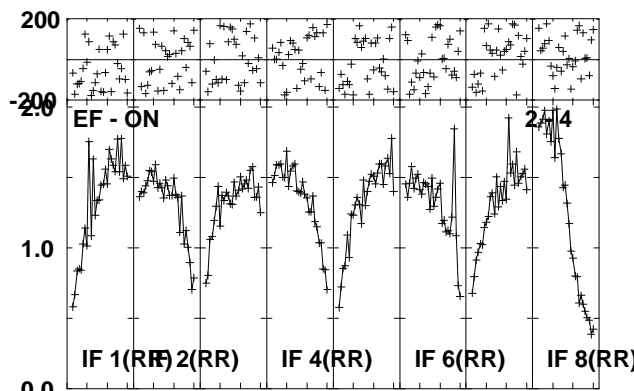
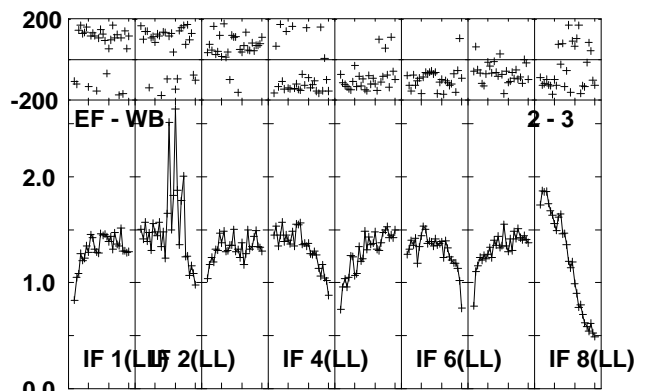
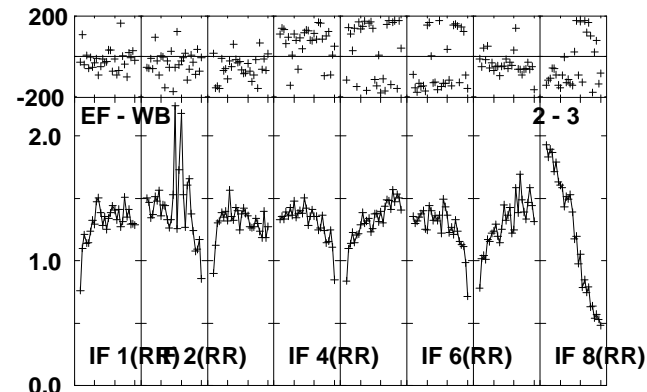
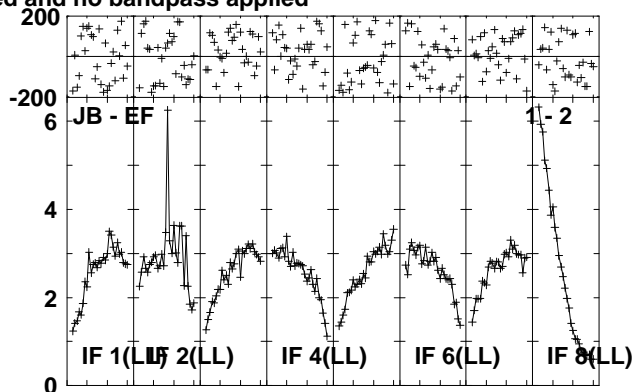
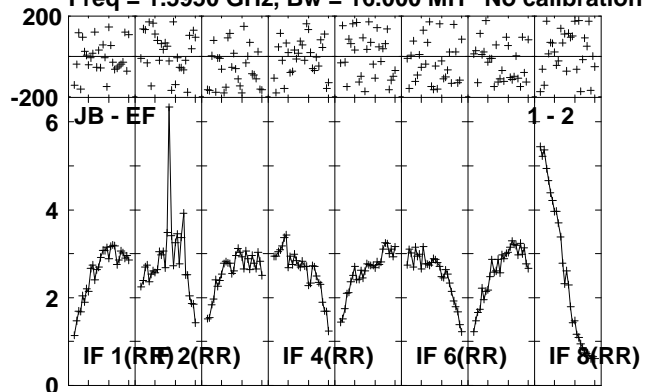

Lower frame: Milli Ampl Jy Top frame: Phas deg
Scalar averaged cross-power spectrum Several baselines displayed
Timerange: 01/03:03:01 to 01/03:06:29

Plot file version 234 created 23-AUG-2010 12:37:50

IRAS1929 EP064P.UVDATA.1

Freq = 1.5950 GHz, Bw = 16.000 MH No calibration applied and no bandpass applied

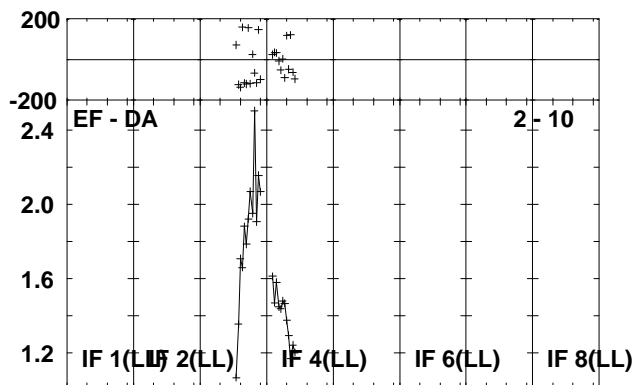
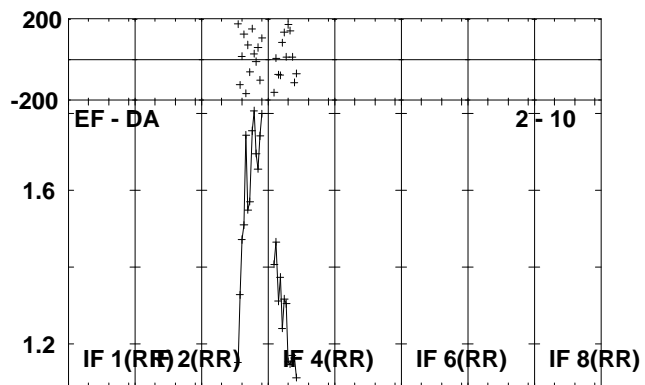
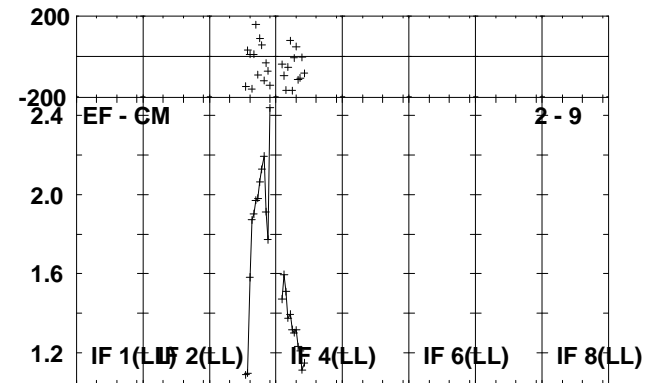
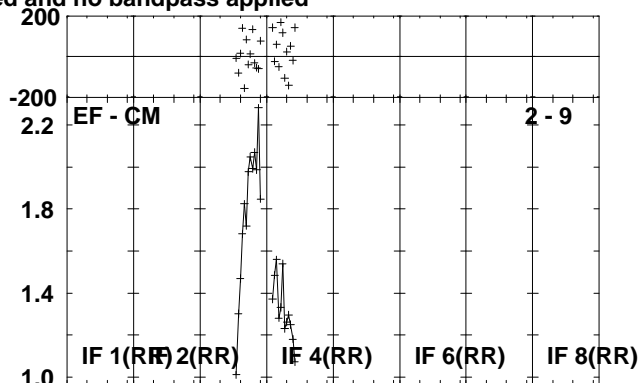
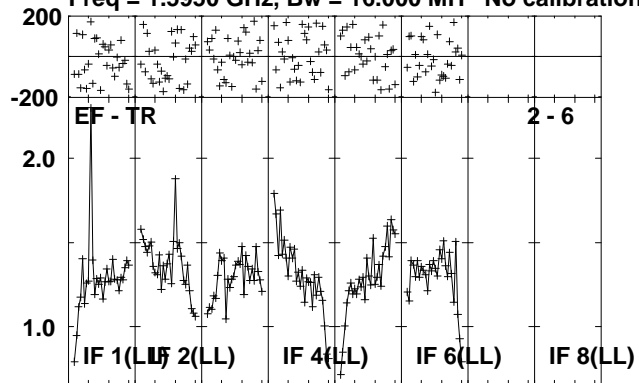

Lower frame: Milli Ampl Jy Top frame: Phas deg
Scalar averaged cross-power spectrum Several baselines displayed
Timerange: 01/03:03:01 to 01/03:06:29

Plot file version 235 created 23-AUG-2010 12:37:51

J1941-05 EP064P.UVDATA.1

Freq = 1.5950 GHz, Bw = 16.000 MH No calibration applied and no bandpass applied

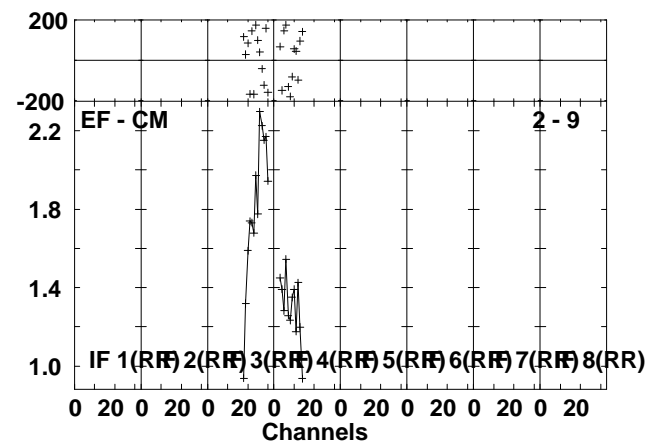
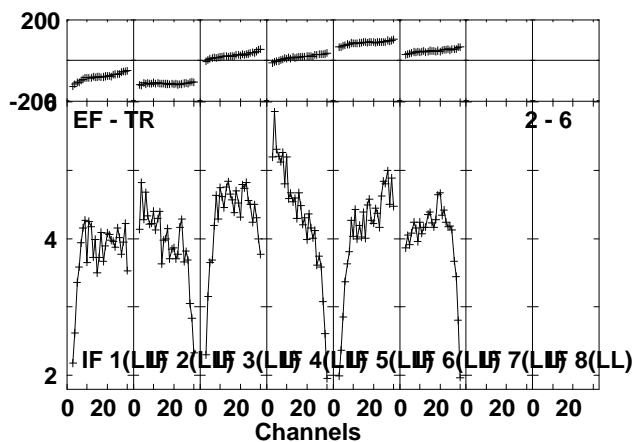
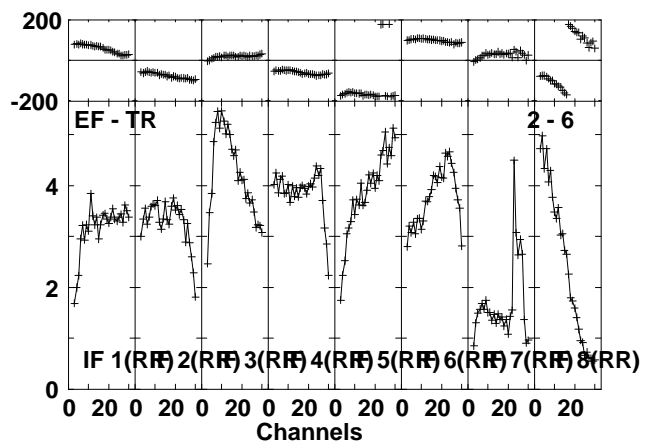
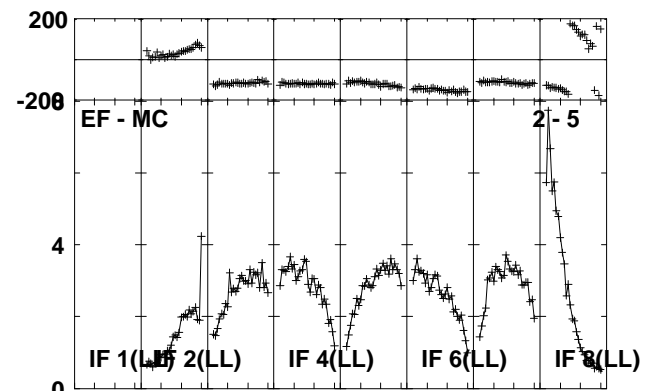
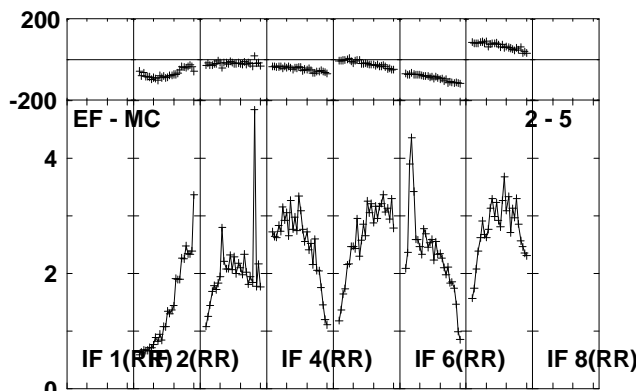
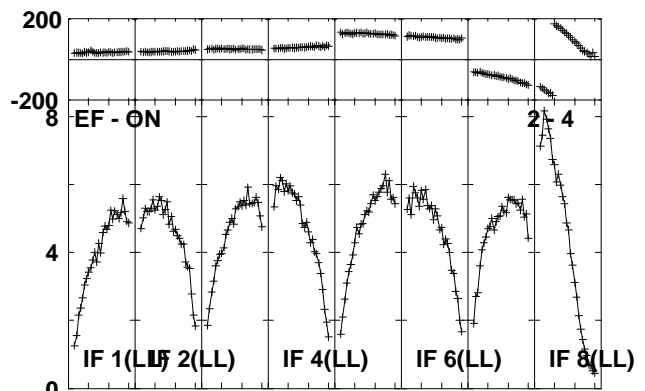
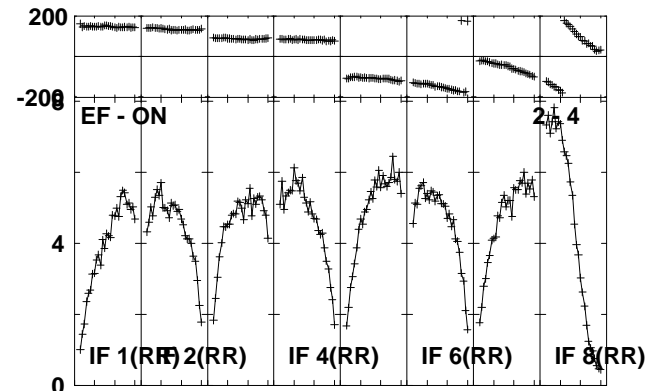
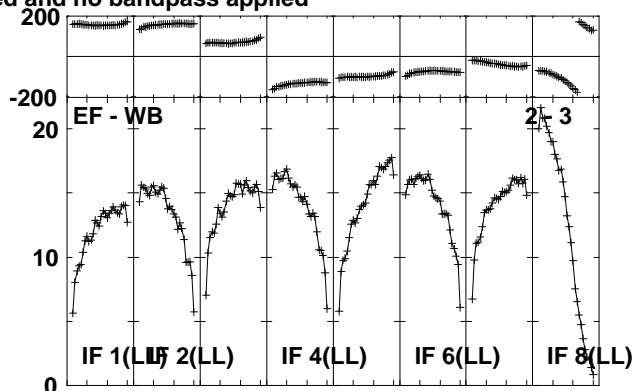
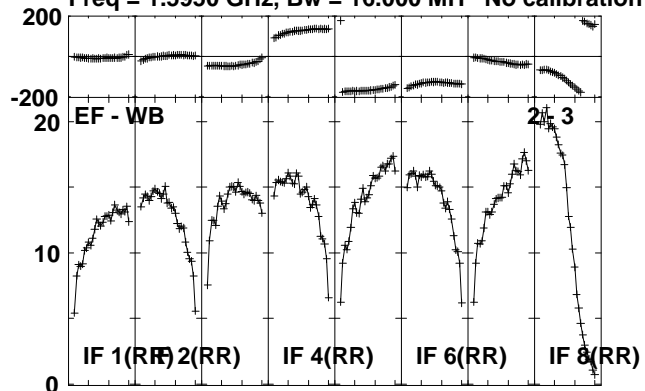

Lower frame: Milli Ampl Jy Top frame: Phas deg
Scalar averaged cross-power spectrum Several baselines displayed
Timerange: 01/03:07:31 to 01/03:08:57

Plot file version 236 created 23-AUG-2010 12:37:52

J1941-05 EP064P.UVDATA.1

Freq = 1.5950 GHz, Bw = 16.000 MH No calibration applied and no bandpass applied

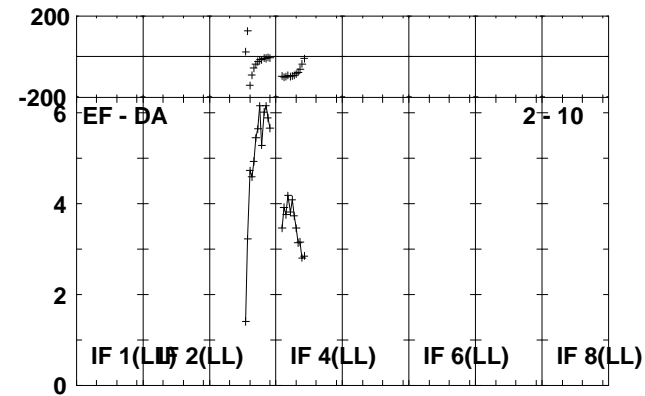
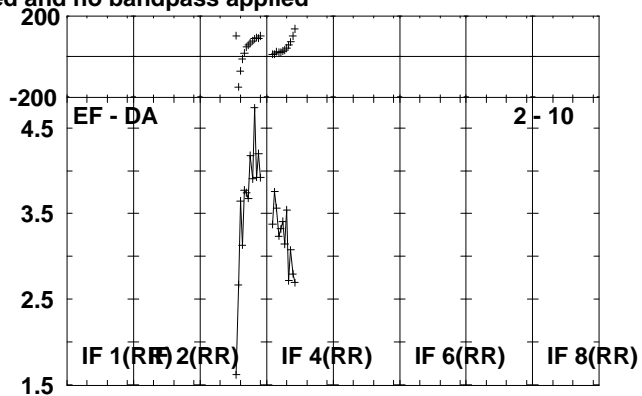
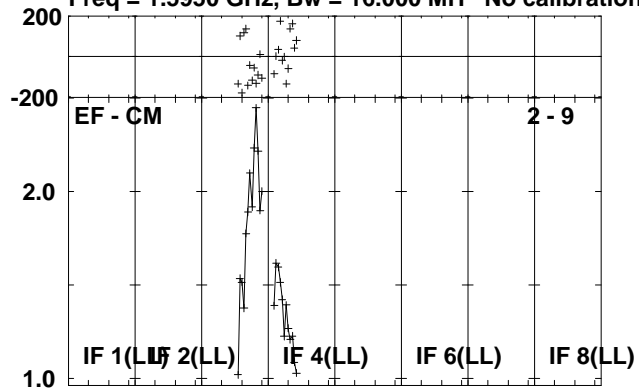

Lower frame: Milli Ampl Jy Top frame: Phas deg
Scalar averaged cross-power spectrum Several baselines displayed
Timerange: 01/03:07:31 to 01/03:08:57

Plot file version 237 created 23-AUG-2010 12:37:52

IRAS1929 EP064P.UVDATA.1

Freq = 1.5950 GHz, Bw = 16.000 MH No calibration applied and no bandpass applied

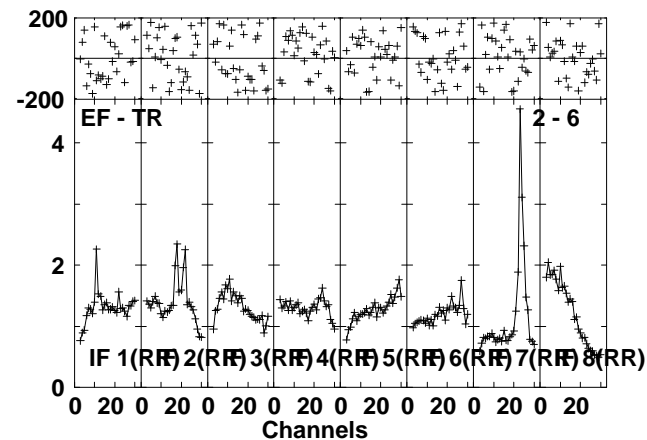
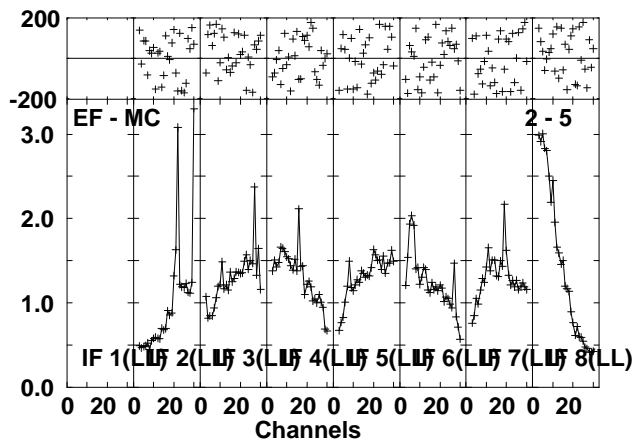
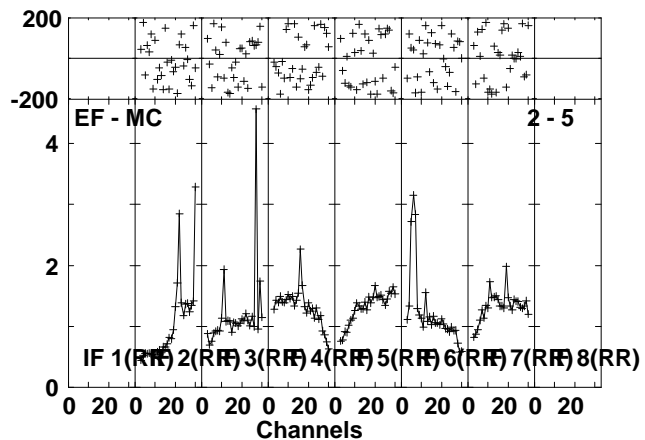
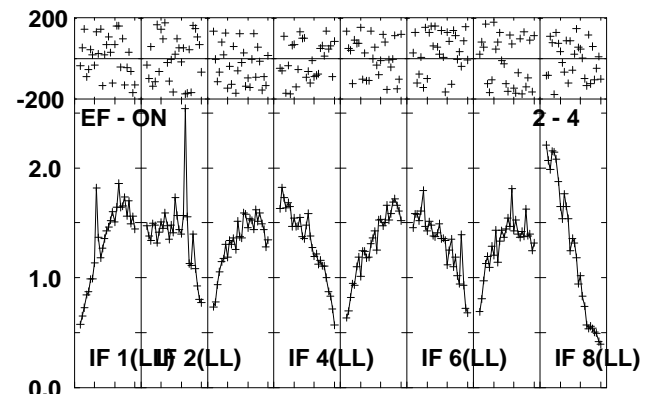
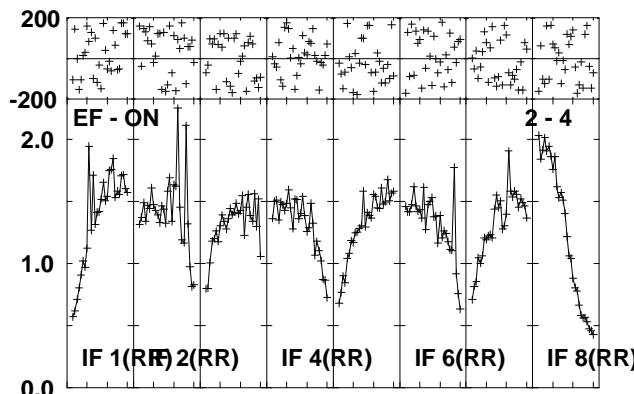
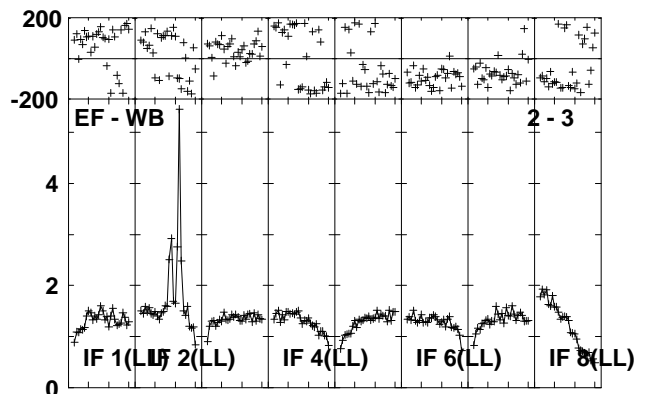
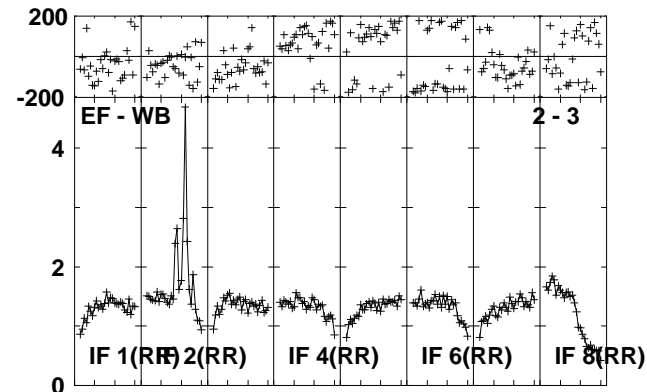
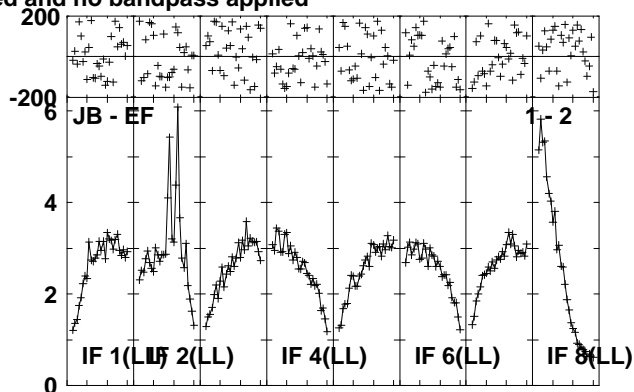
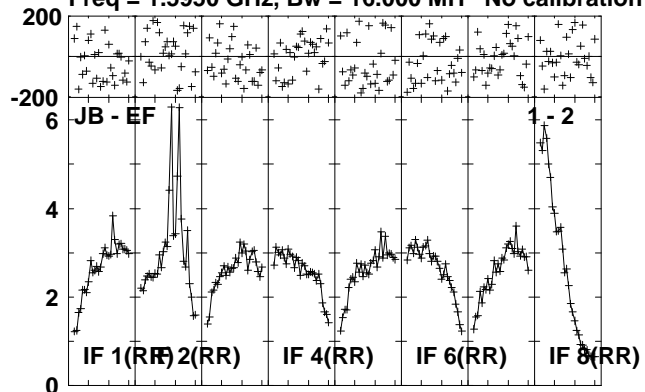

Lower frame: Milli Ampl Jy Top frame: Phas deg
Scalar averaged cross-power spectrum Several baselines displayed
Timerange: 01/03:09:01 to 01/03:12:29

Plot file version 238 created 23-AUG-2010 12:37:53

IRAS1929 EP064P.UVDATA.1

Freq = 1.5950 GHz, Bw = 16.000 MH No calibration applied and no bandpass applied

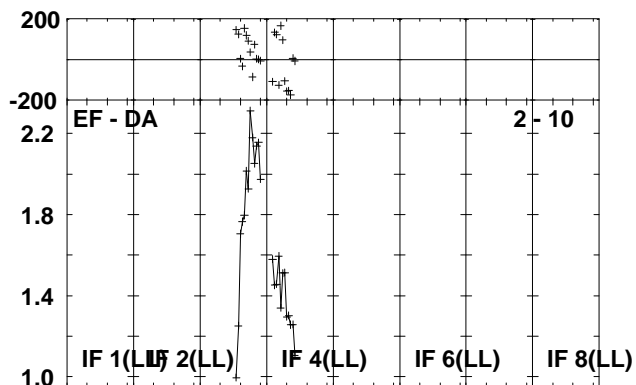
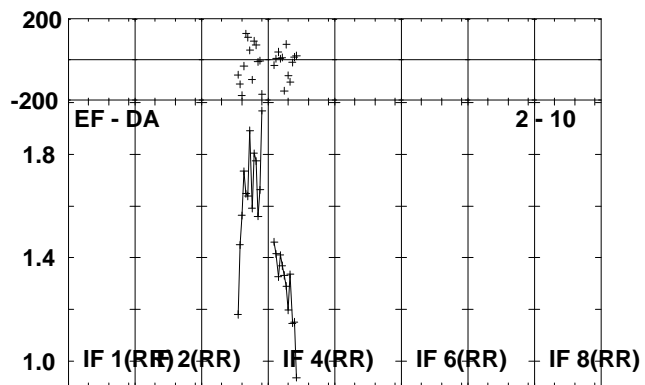
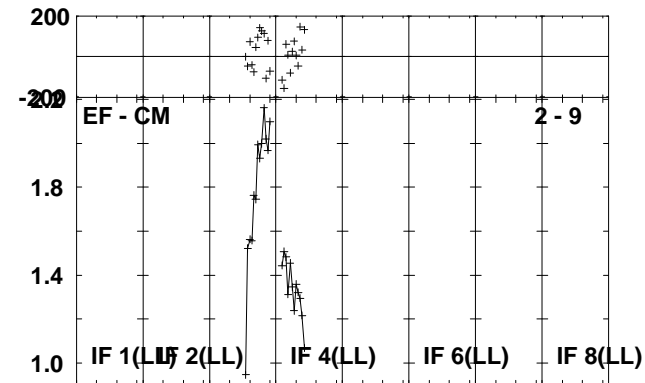
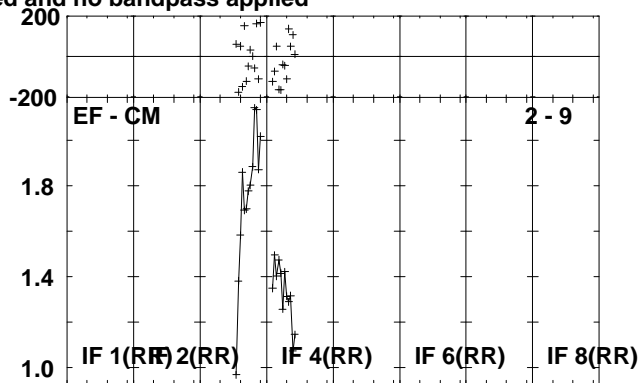
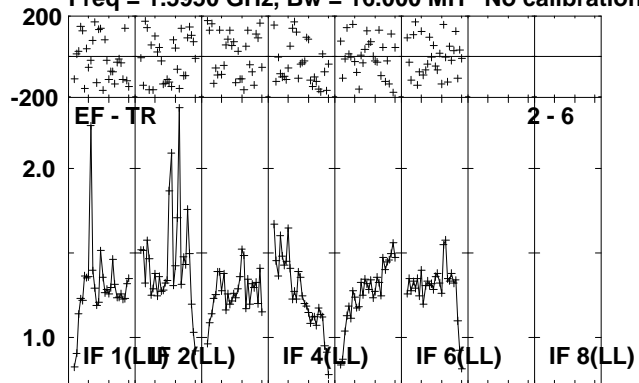

Lower frame: Milli Ampl Jy Top frame: Phas deg
Scalar averaged cross-power spectrum Several baselines displayed
Timerange: 01/03:09:01 to 01/03:12:29

Plot file version 239 created 23-AUG-2010 12:37:55

J1941-05 EP064P.UVDATA.1

Freq = 1.5950 GHz, Bw = 16.000 MH No calibration applied and no bandpass applied

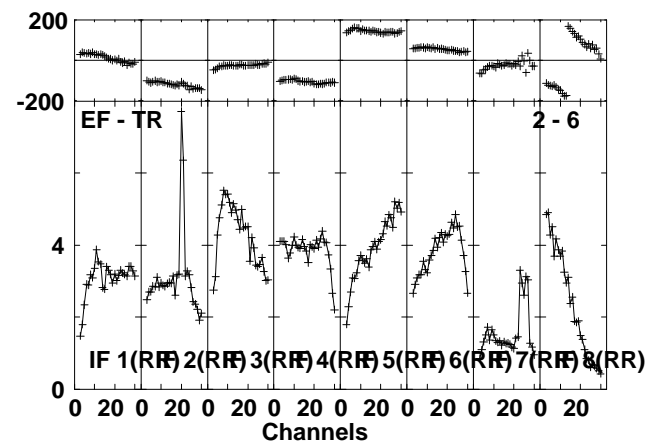
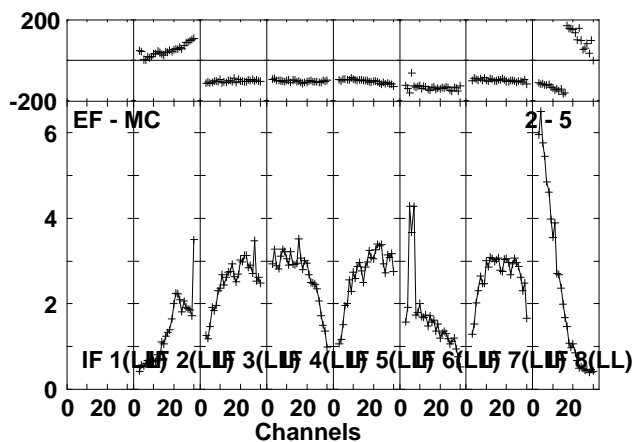
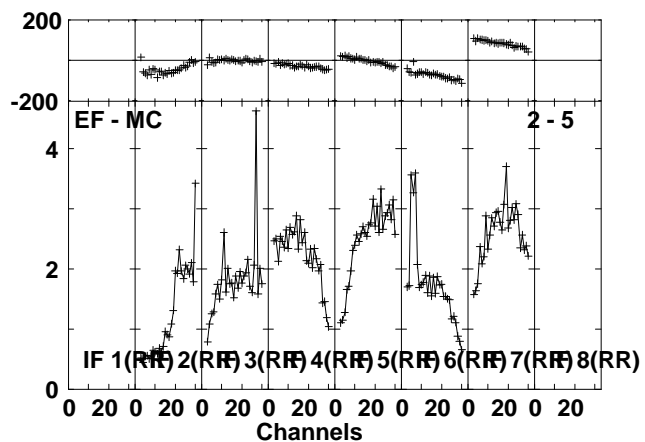
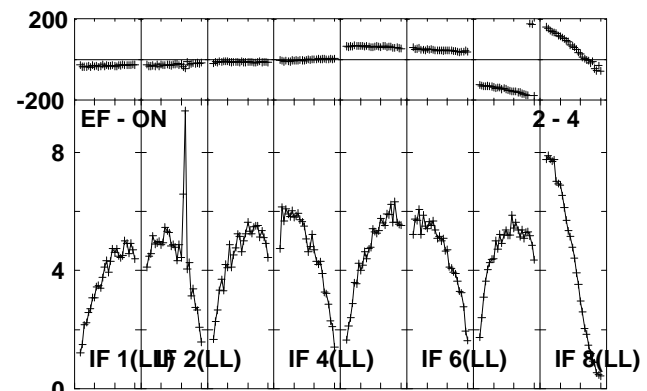
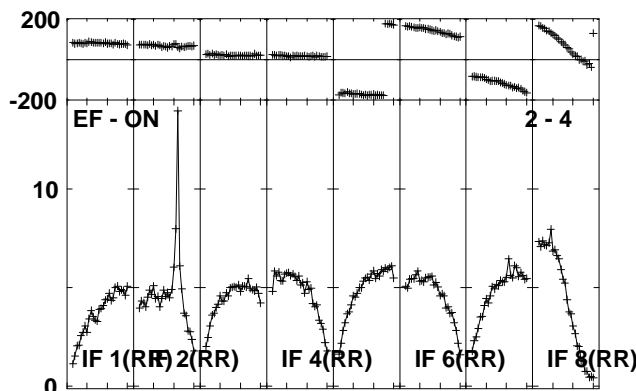
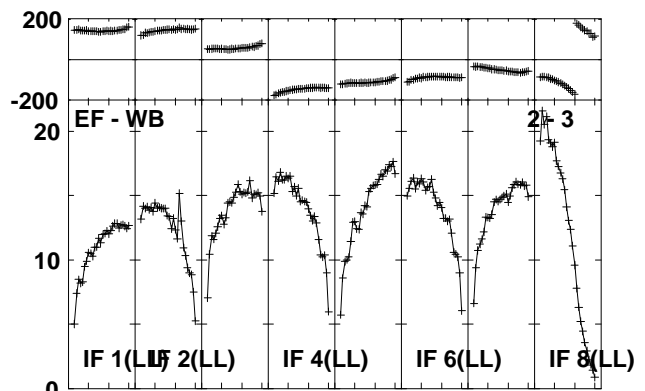
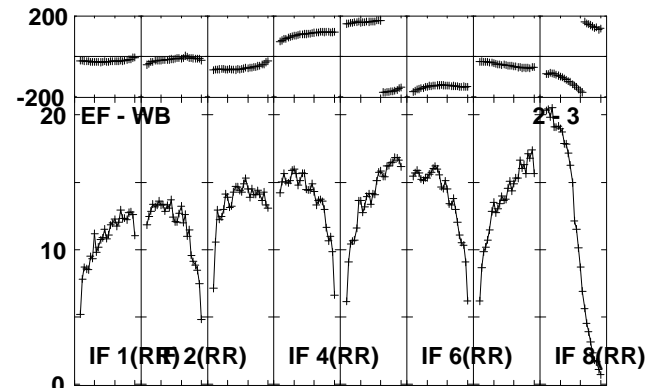
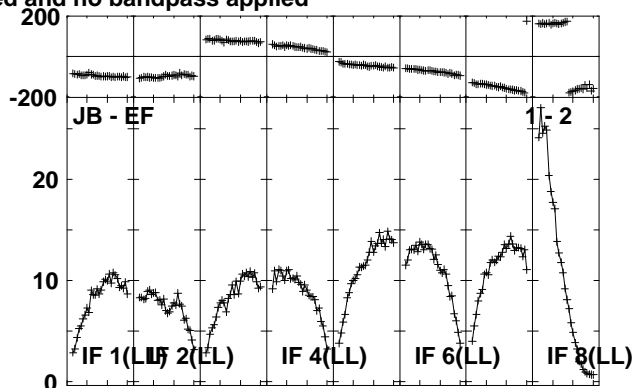
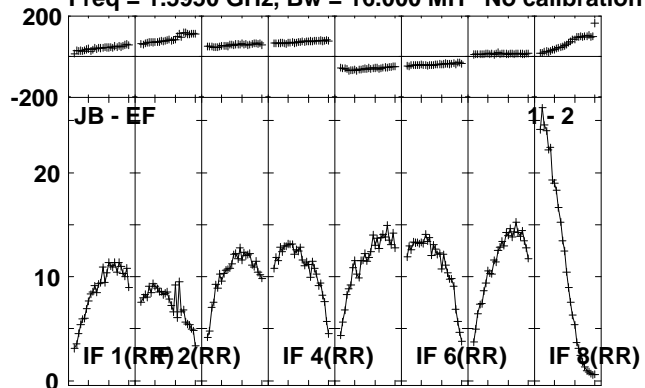

Lower frame: Milli Ampl Jy Top frame: Phas deg
Scalar averaged cross-power spectrum Several baselines displayed
Timerange: 01/03:12:31 to 01/03:13:59

Plot file version 240 created 23-AUG-2010 12:37:55

J1941-05 EP064P.UVDATA.1

Freq = 1.5950 GHz, Bw = 16.000 MH No calibration applied and no bandpass applied

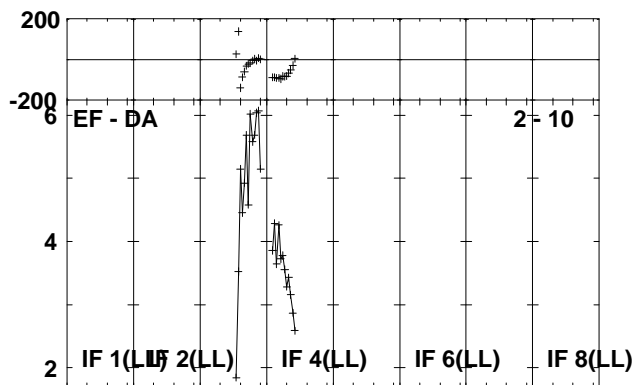
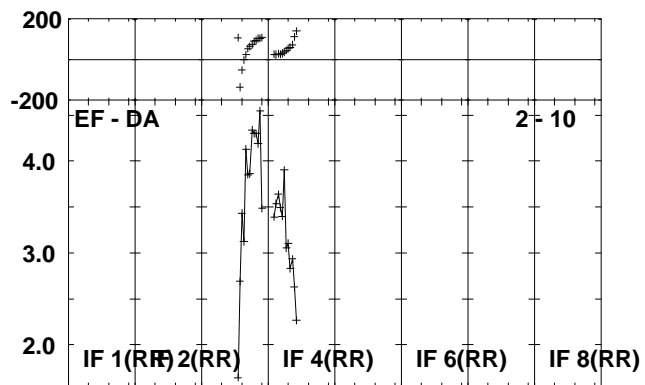
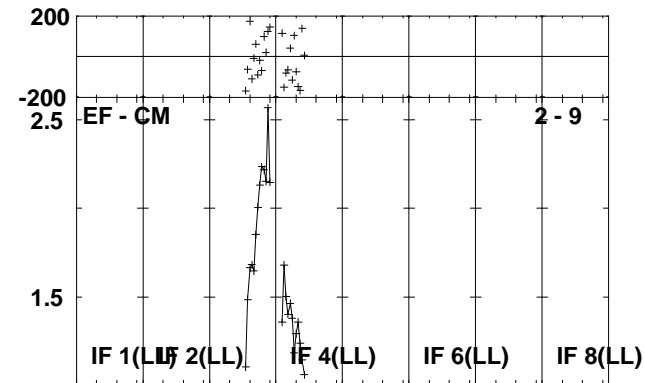
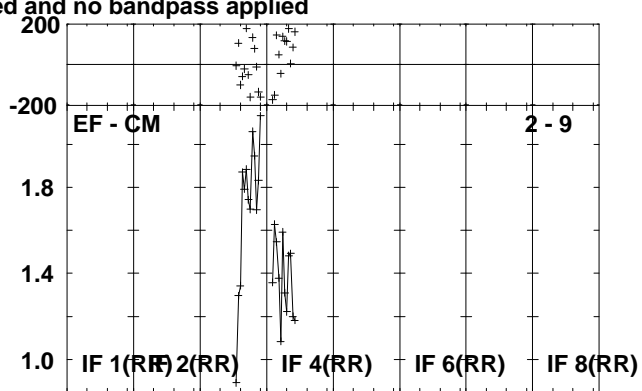
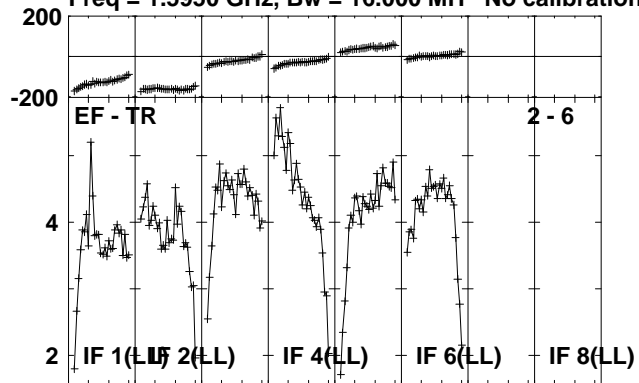

Lower frame: Milli Ampl Jy Top frame: Phas deg
Scalar averaged cross-power spectrum Several baselines displayed
Timerange: 01/03:12:31 to 01/03:13:59

Plot file version 241 created 23-AUG-2010 12:37:56

IRAS1929 EP064P.UVDATA.1

Freq = 1.5950 GHz, Bw = 16.000 MH No calibration applied and no bandpass applied

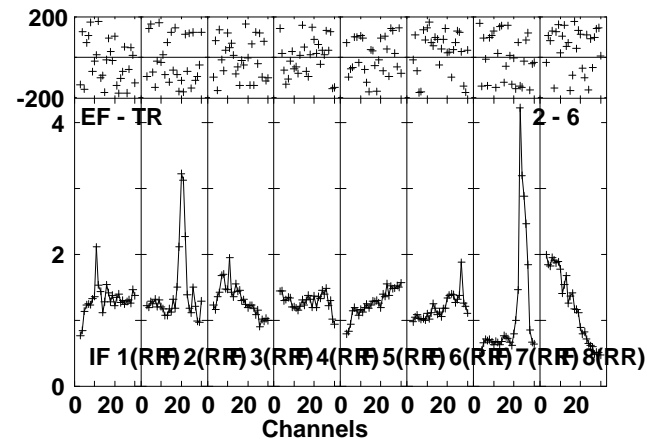
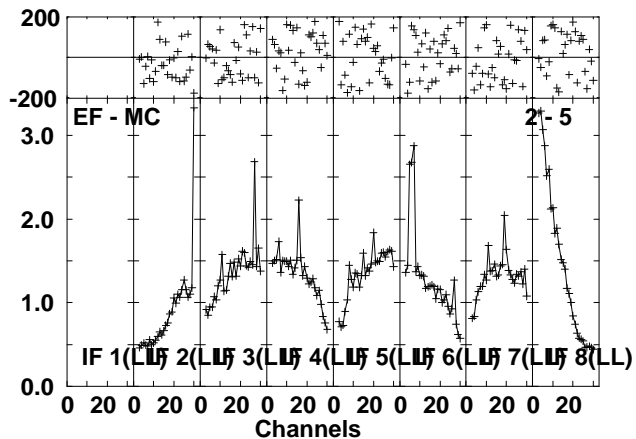
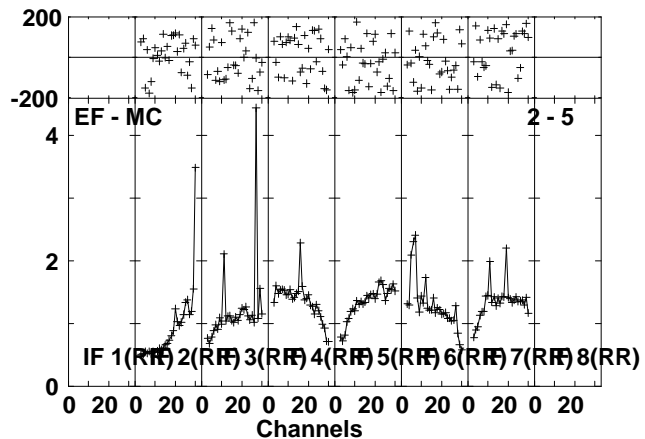
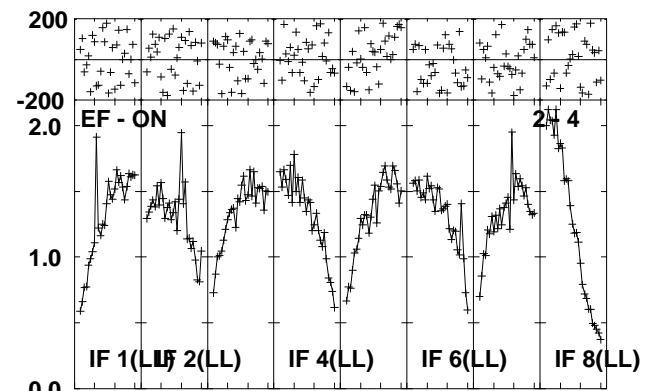
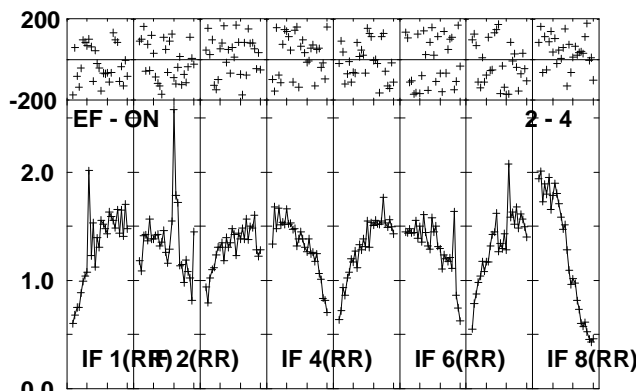
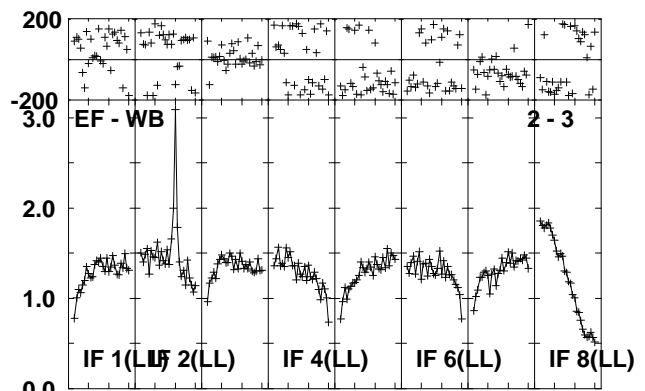
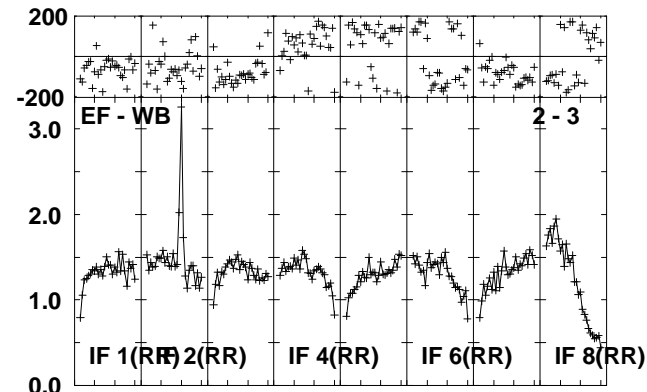
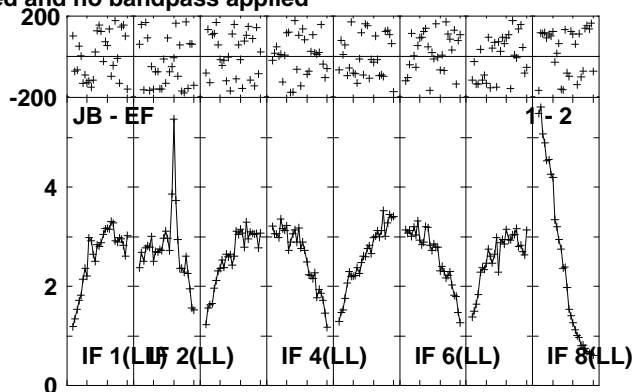
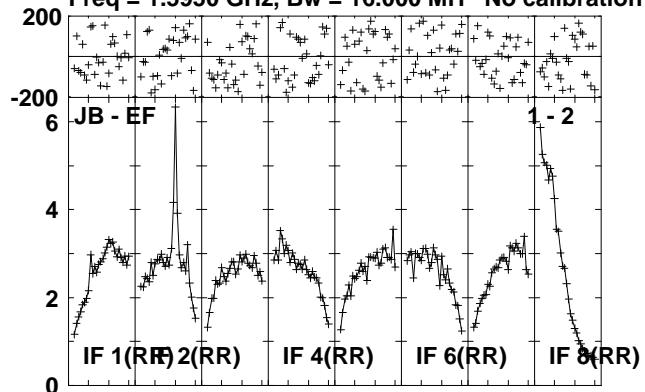

Lower frame: Milli Ampl Jy Top frame: Phas deg
Scalar averaged cross-power spectrum Several baselines displayed
Timerange: 01/03:14:01 to 01/03:17:29

Plot file version 242 created 23-AUG-2010 12:37:57

IRAS1929 EP064P.UVDATA.1

Freq = 1.5950 GHz, Bw = 16.000 MH No calibration applied and no bandpass applied

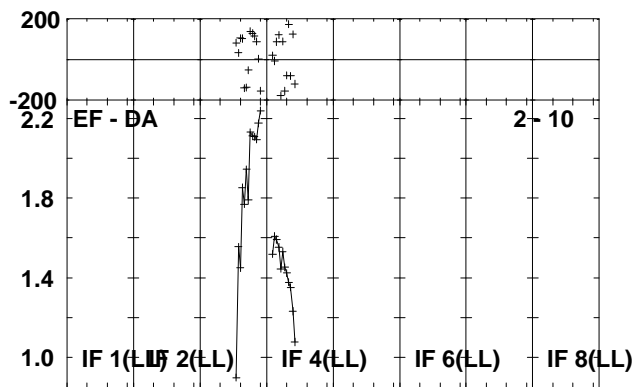
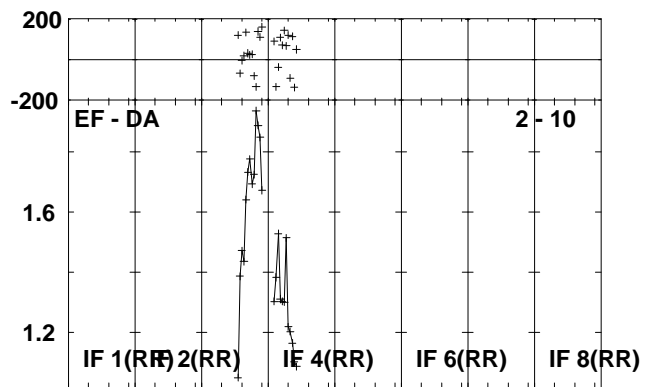
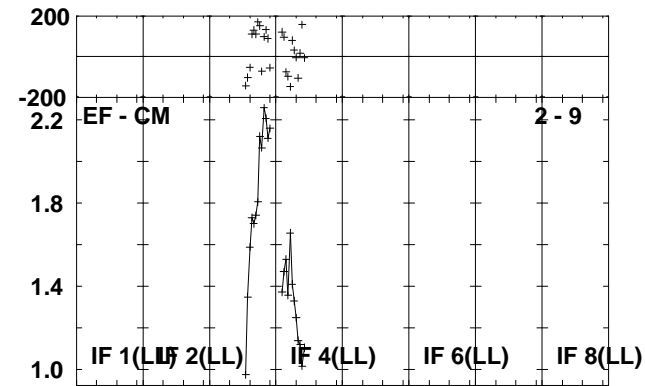
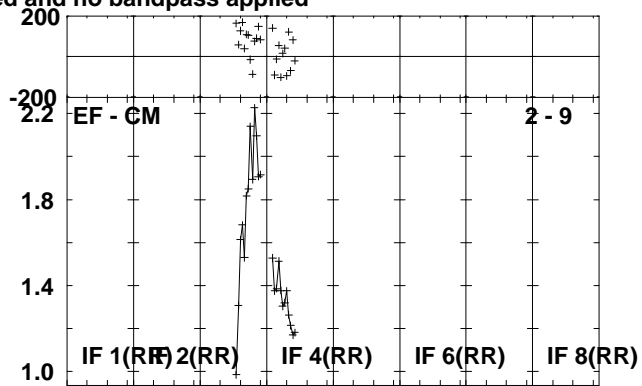
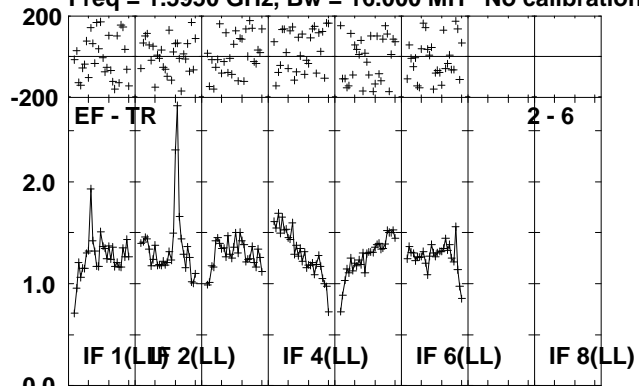

Lower frame: Milli Ampl Jy Top frame: Phas deg
Scalar averaged cross-power spectrum Several baselines displayed
Timerange: 01/03:14:01 to 01/03:17:29

Plot file version 243 created 23-AUG-2010 12:37:59

J1941-05 EP064P.UVDATA.1

Freq = 1.5950 GHz, Bw = 16.000 MH No calibration applied and no bandpass applied

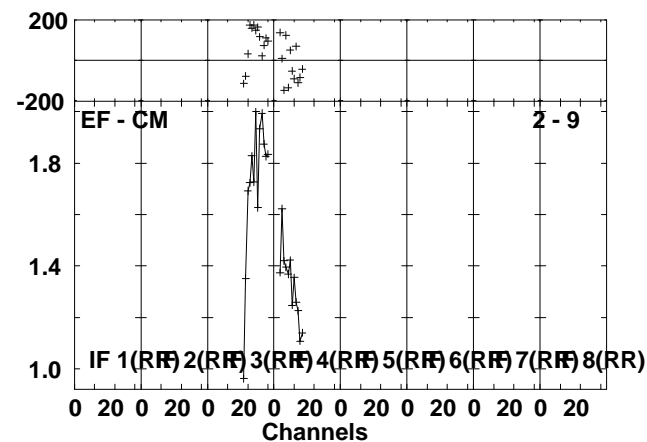
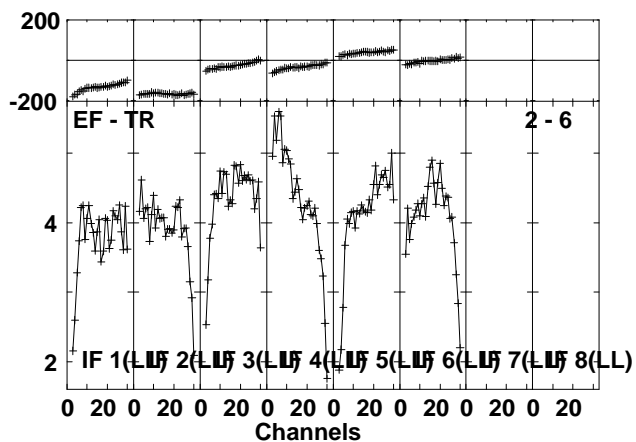
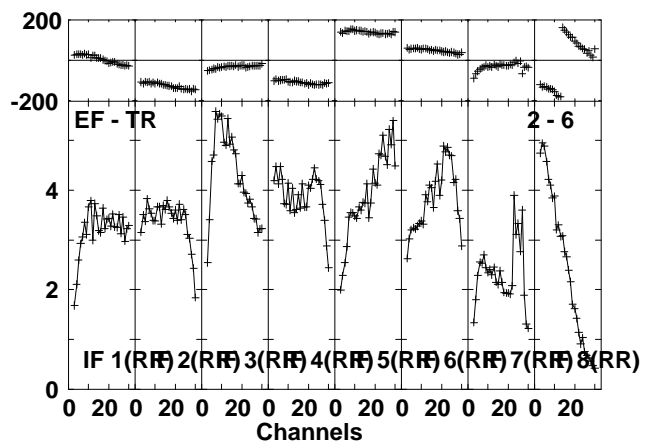
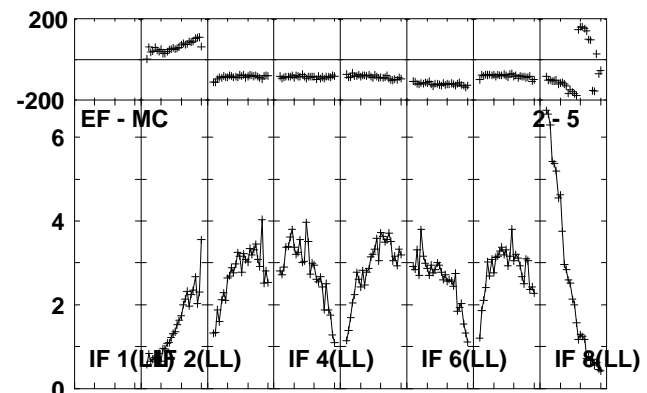
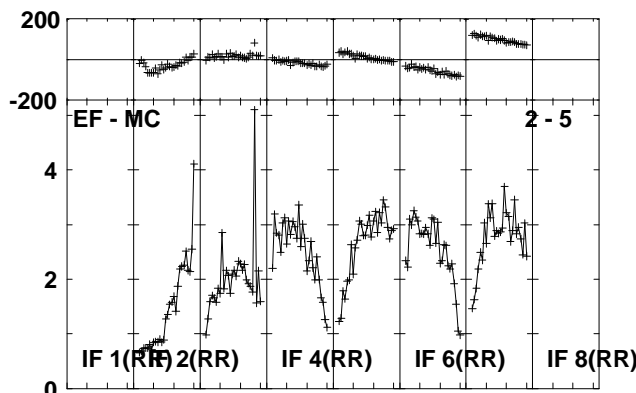
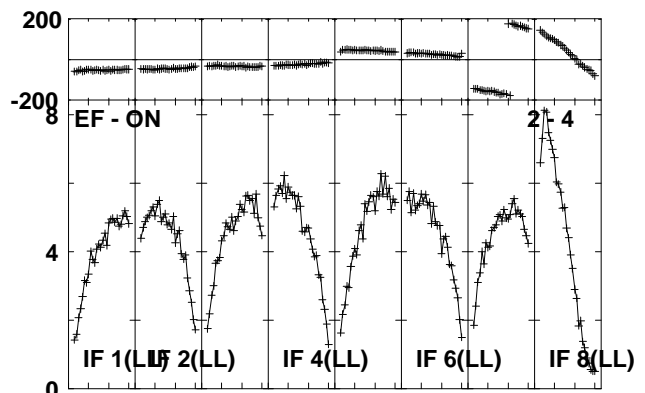
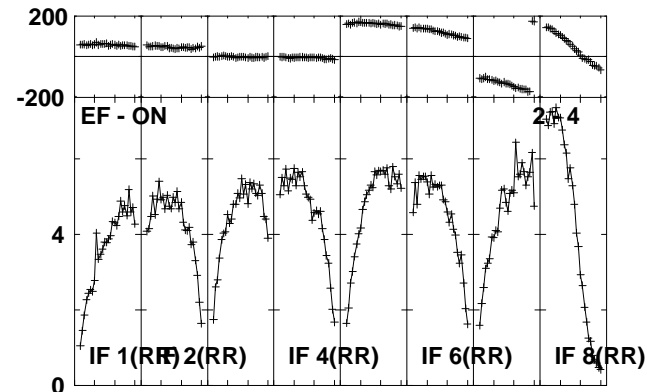
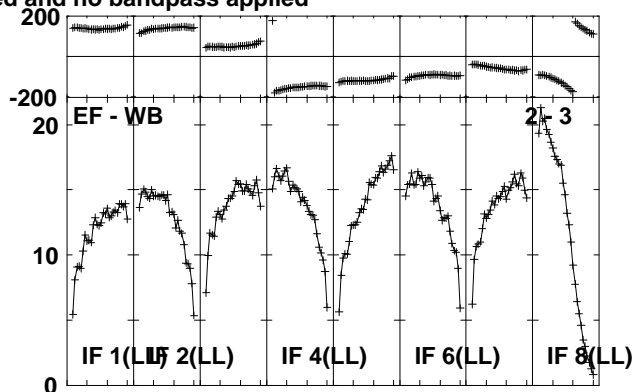
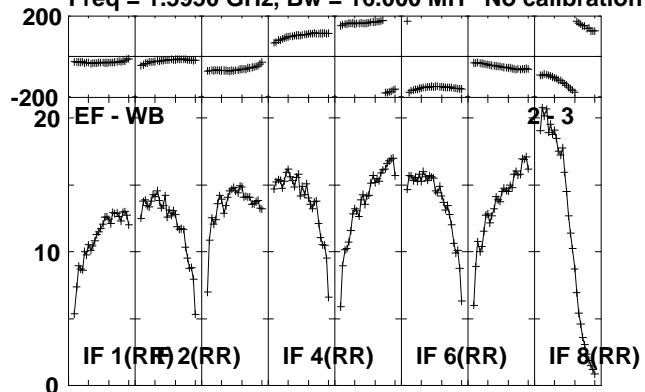

Lower frame: Milli Ampl Jy Top frame: Phas deg
Scalar averaged cross-power spectrum Several baselines displayed
Timerange: 01/03:17:31 to 01/03:18:57

Plot file version 244 created 23-AUG-2010 12:38:00

J1941-05 EP064P.UVDATA.1

Freq = 1.5950 GHz, Bw = 16.000 MH No calibration applied and no bandpass applied

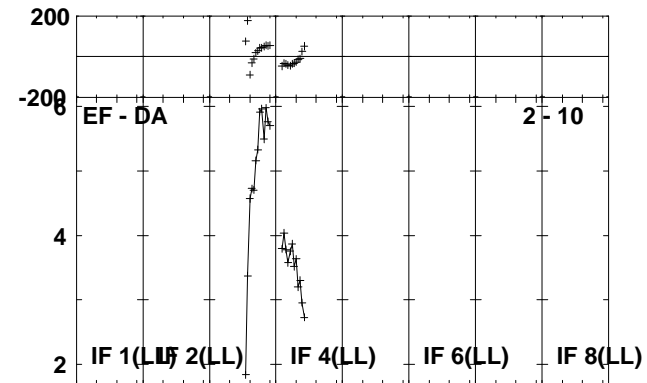
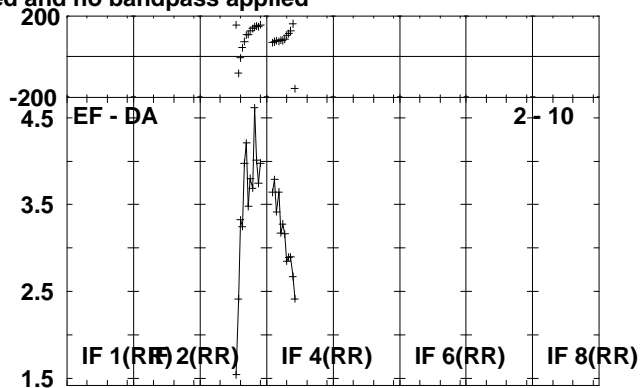
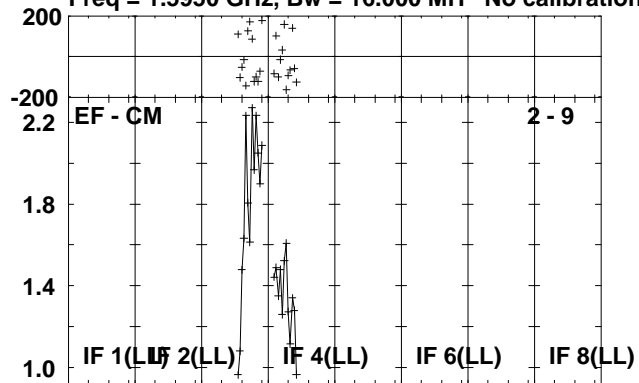

Lower frame: Milli Ampl Jy Top frame: Phas deg
Scalar averaged cross-power spectrum Several baselines displayed
Timerange: 01/03:17:31 to 01/03:18:57

Plot file version 245 created 23-AUG-2010 12:38:01

IRAS1929 EP064P.UVDATA.1

Freq = 1.5950 GHz, Bw = 16.000 MH No calibration applied and no bandpass applied

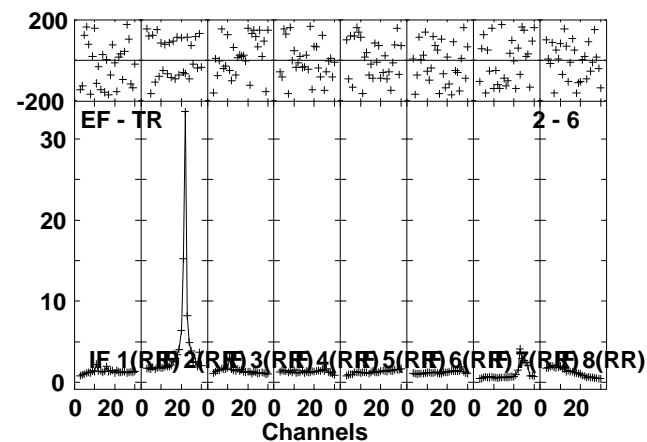
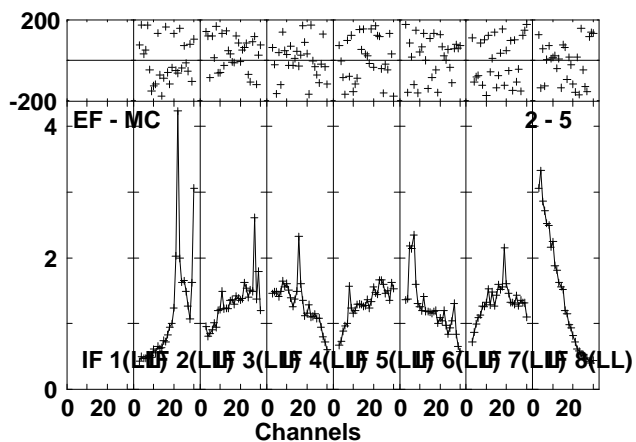
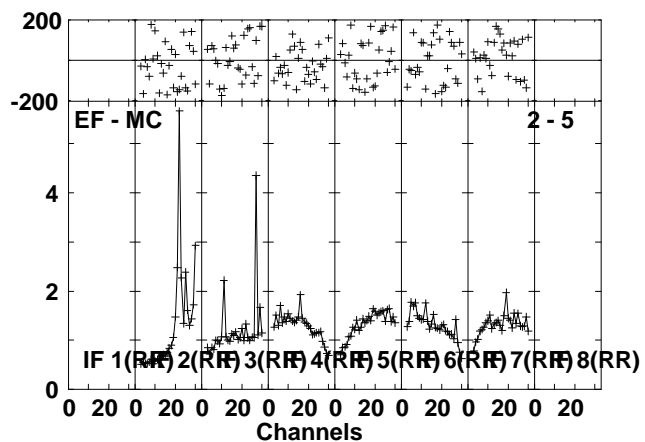
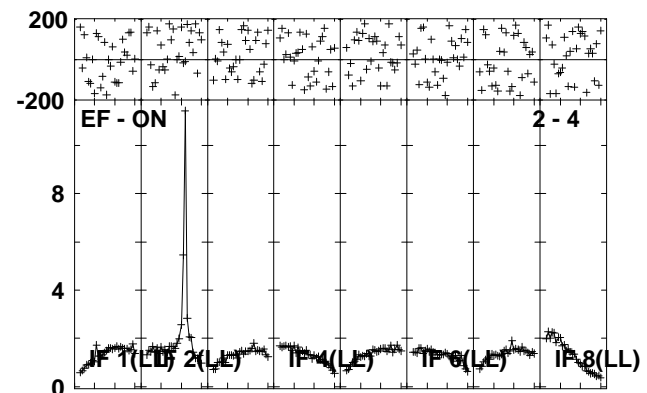
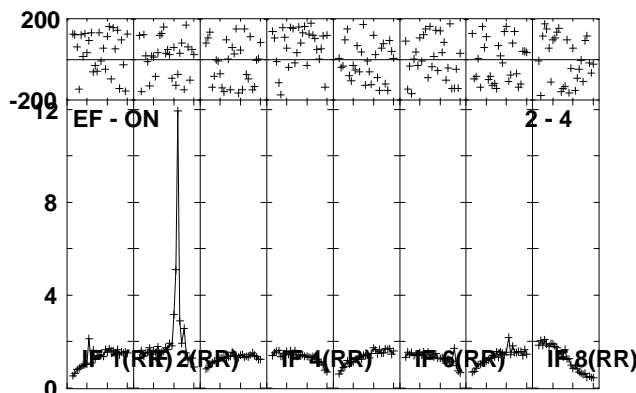
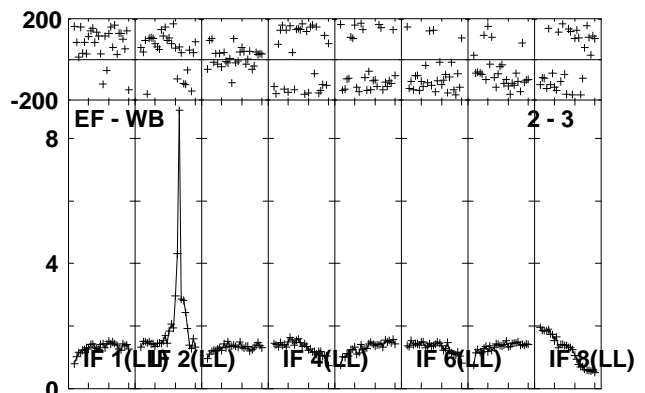
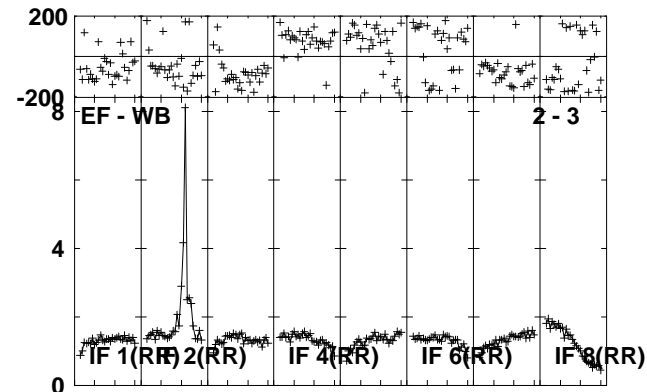
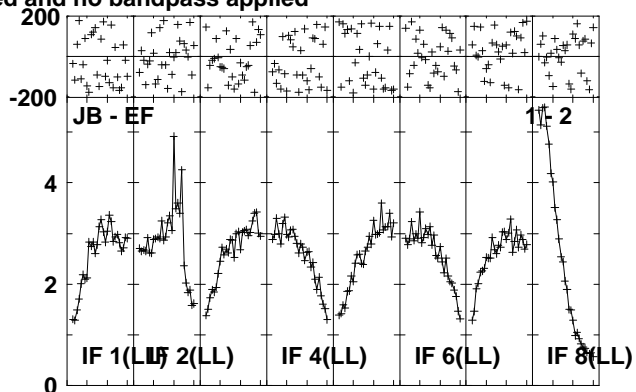
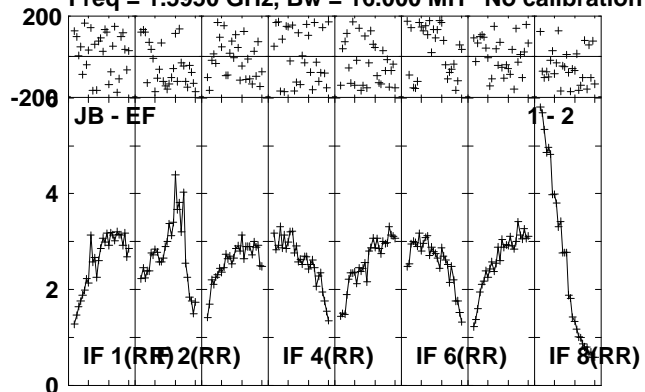

Lower frame: Milli Ampl Jy Top frame: Phas deg
Scalar averaged cross-power spectrum Several baselines displayed
Timerange: 01/03:19:01 to 01/03:22:29

Plot file version 246 created 23-AUG-2010 12:38:03

IRAS1929 EP064P.UVDATA.1

Freq = 1.5950 GHz, Bw = 16.000 MH No calibration applied and no bandpass applied

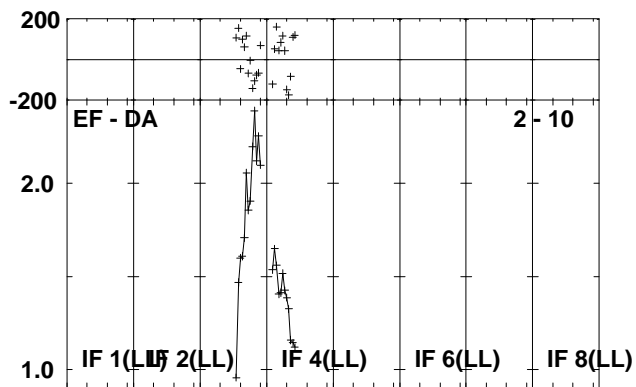
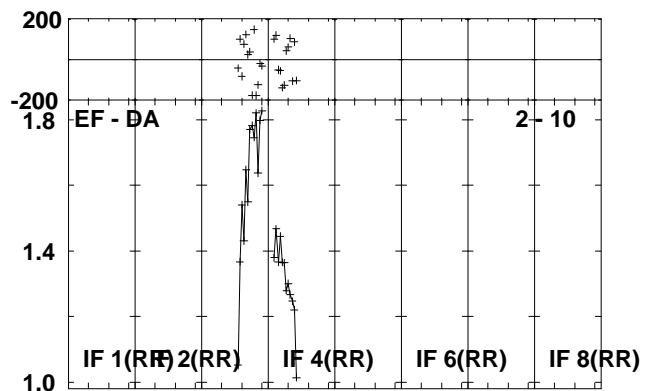
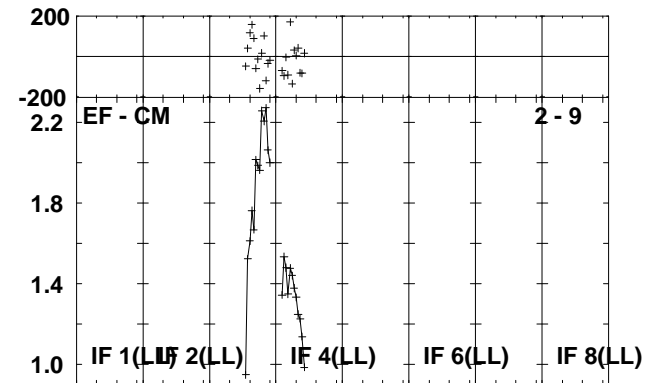
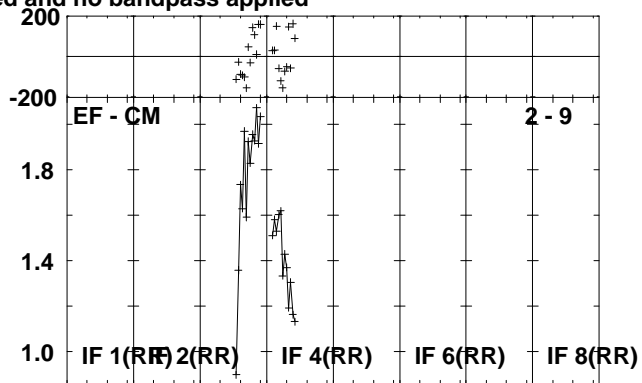
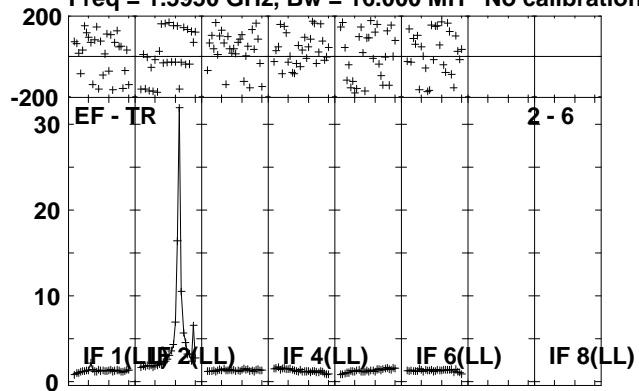

Lower frame: Milli Ampl Jy Top frame: Phas deg
Scalar averaged cross-power spectrum Several baselines displayed
Timerange: 01/03:19:01 to 01/03:22:29

Plot file version 247 created 23-AUG-2010 12:38:06

J1941-05 EP064P.UVDATA.1

Freq = 1.5950 GHz, Bw = 16.000 MH No calibration applied and no bandpass applied

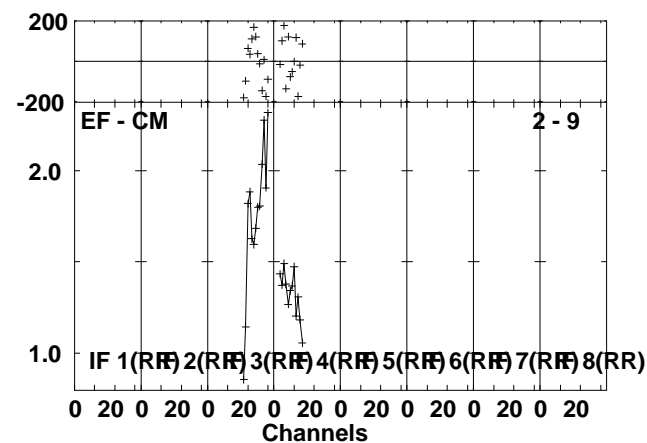
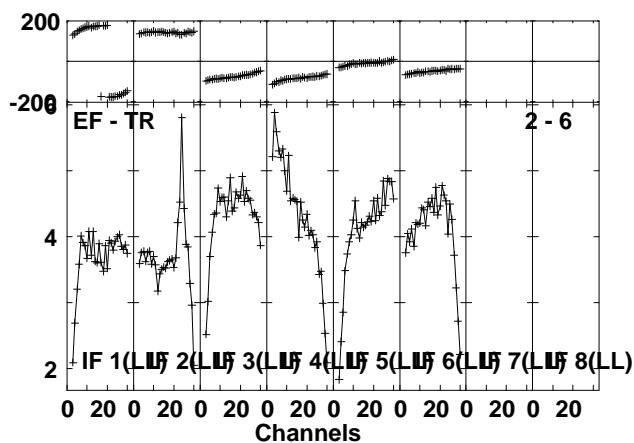
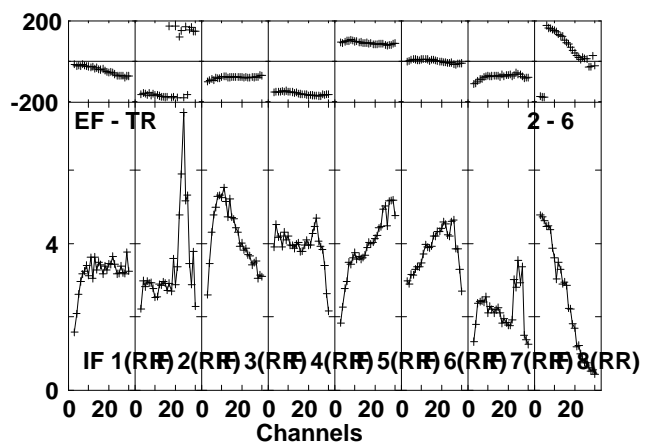
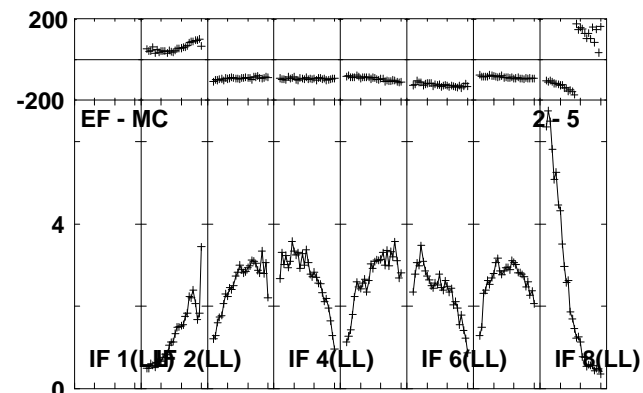
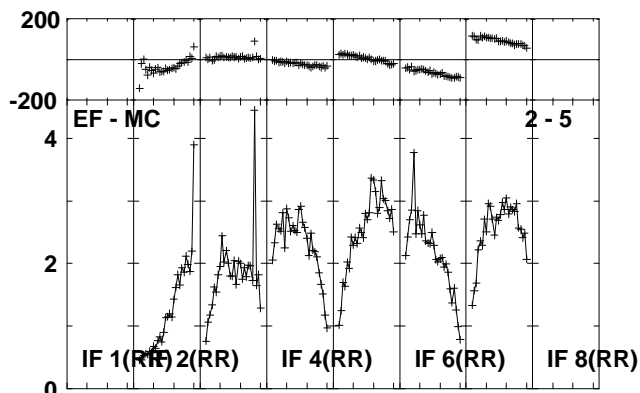
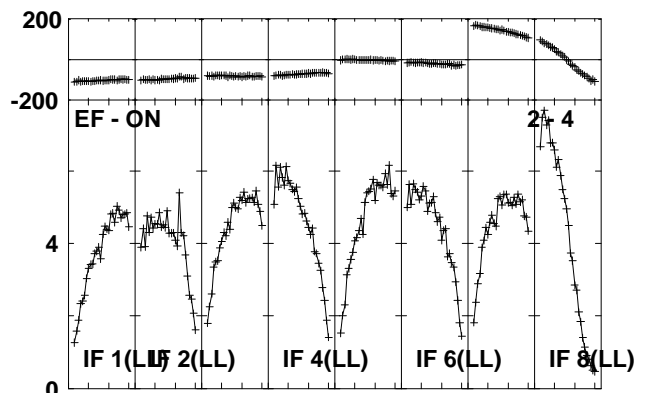
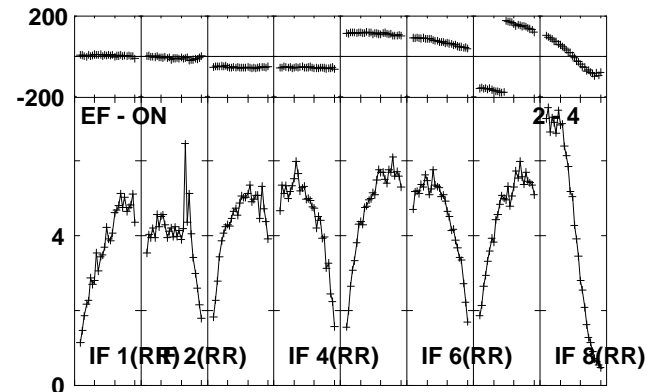
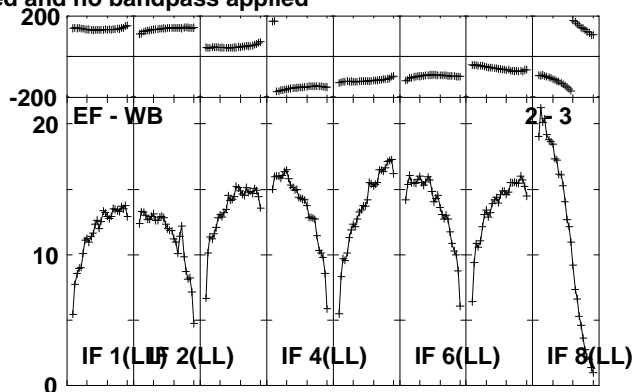
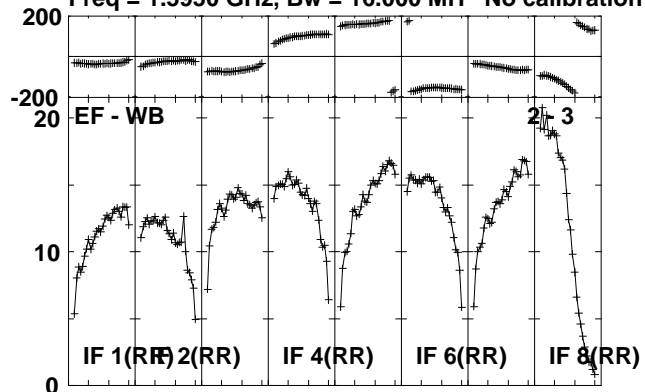

Lower frame: Milli Ampl Jy Top frame: Phas deg
Scalar averaged cross-power spectrum Several baselines displayed
Timerange: 01/03:23:31 to 01/03:24:59

Plot file version 248 created 23-AUG-2010 12:38:06

J1941-05 EP064P.UVDATA.1

Freq = 1.5950 GHz, Bw = 16.000 MH No calibration applied and no bandpass applied

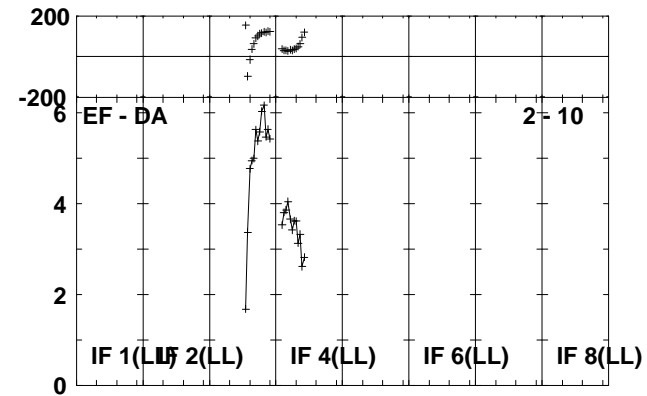
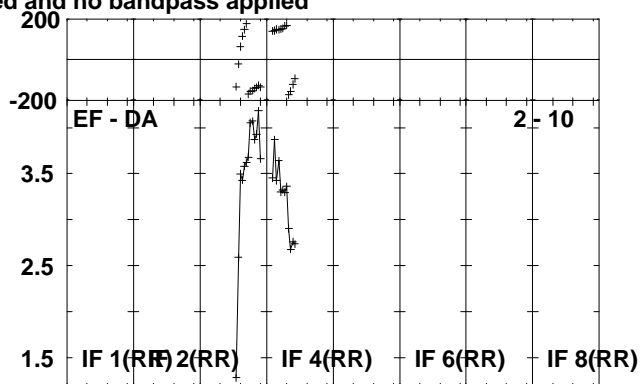
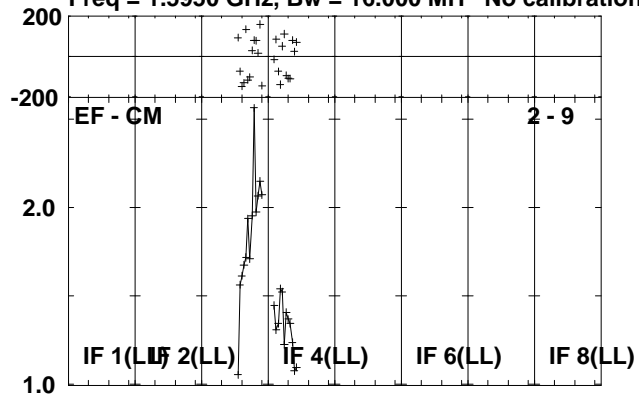

Lower frame: Milli Ampl Jy Top frame: Phas deg
Scalar averaged cross-power spectrum Several baselines displayed
Timerange: 01/03:23:31 to 01/03:24:59

Plot file version 249 created 23-AUG-2010 12:38:07

IRAS1929 EP064P.UVDATA.1

Freq = 1.5950 GHz, Bw = 16.000 MH No calibration applied and no bandpass applied

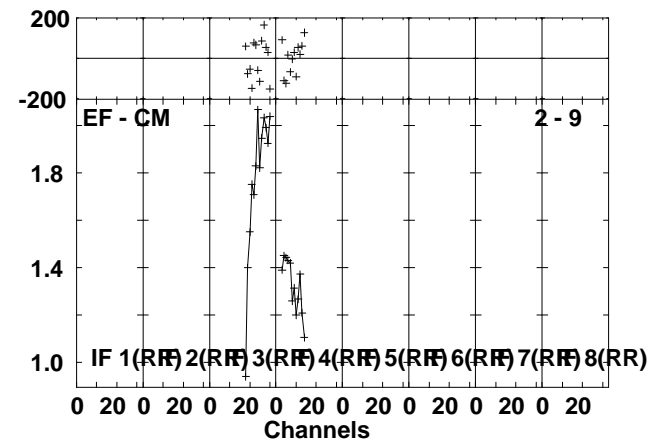
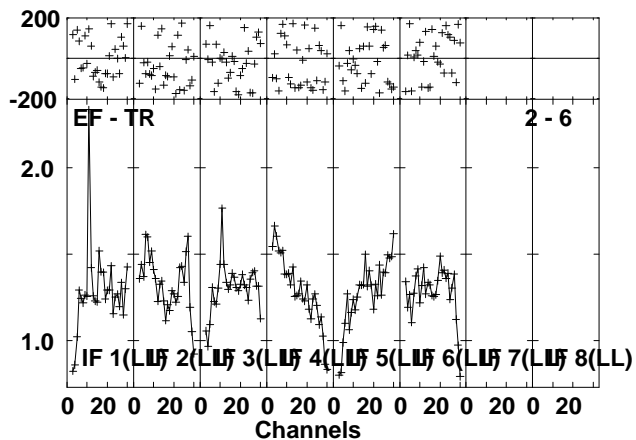
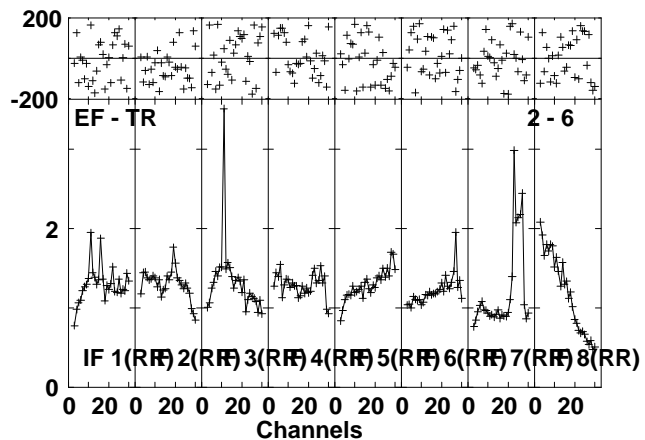
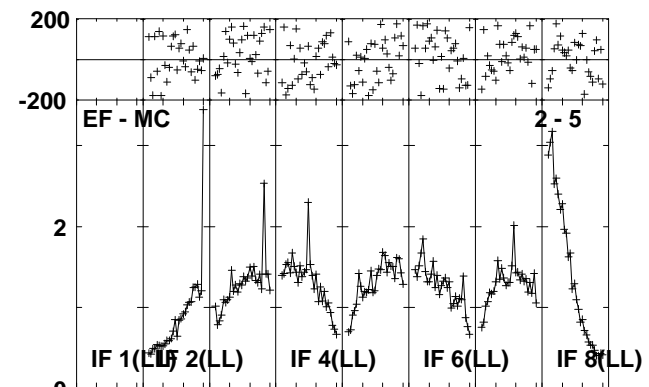
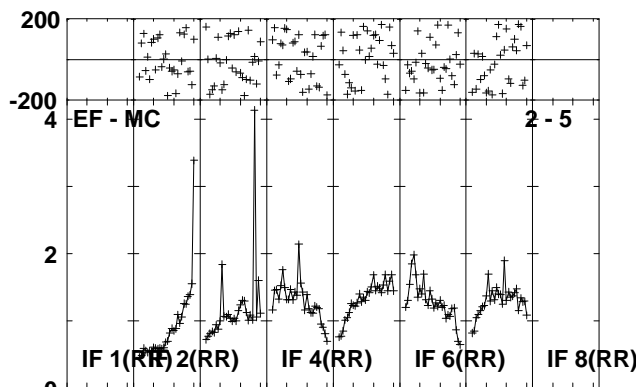
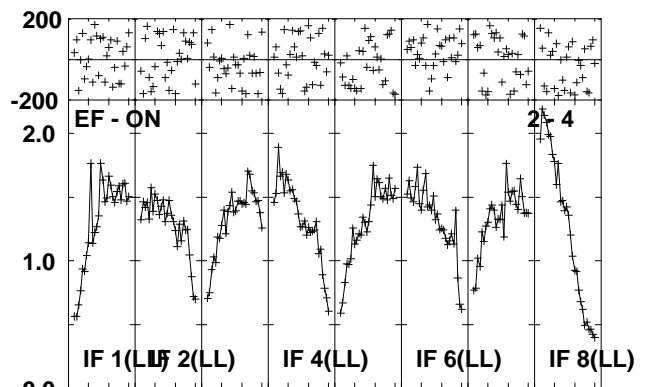
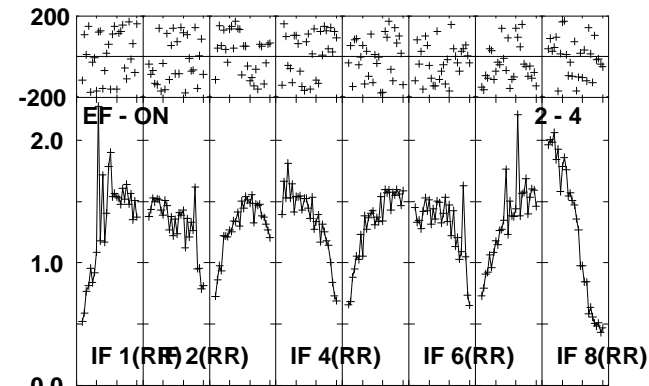
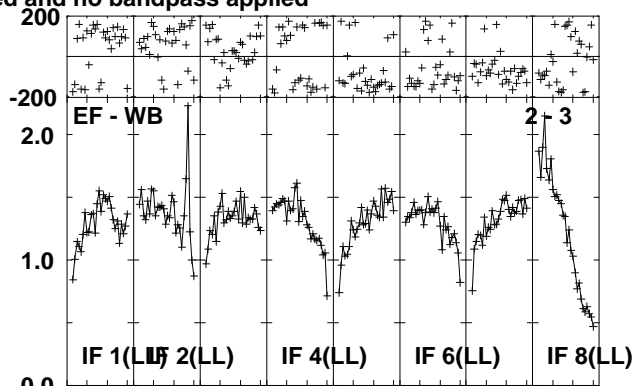
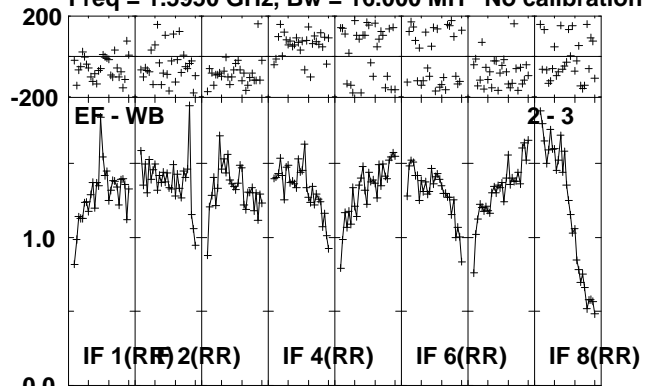

Lower frame: Milli Ampl Jy Top frame: Phas deg
Scalar averaged cross-power spectrum Several baselines displayed
Timerange: 01/03:25:01 to 01/03:28:29

Plot file version 250 created 23-AUG-2010 12:38:08

IRAS1929 EP064P.UVDATA.1

Freq = 1.5950 GHz, Bw = 16.000 MH No calibration applied and no bandpass applied

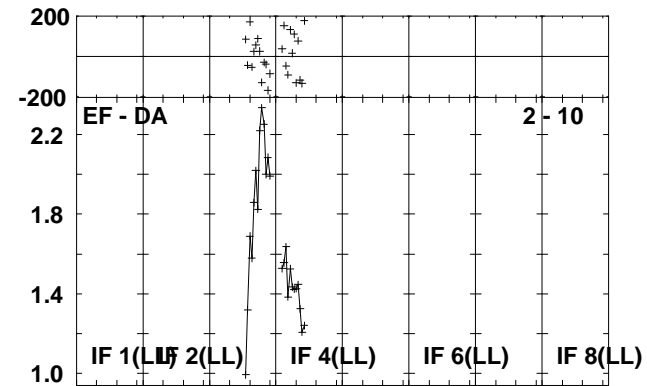
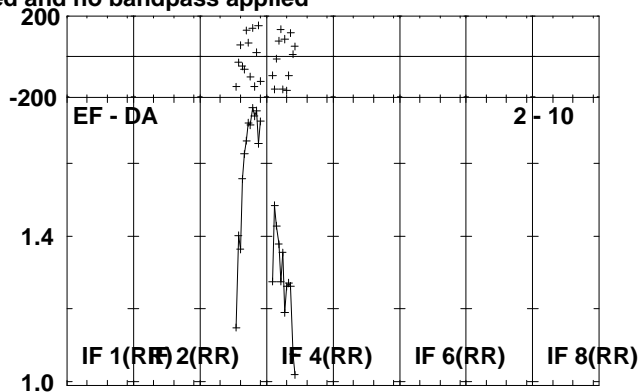
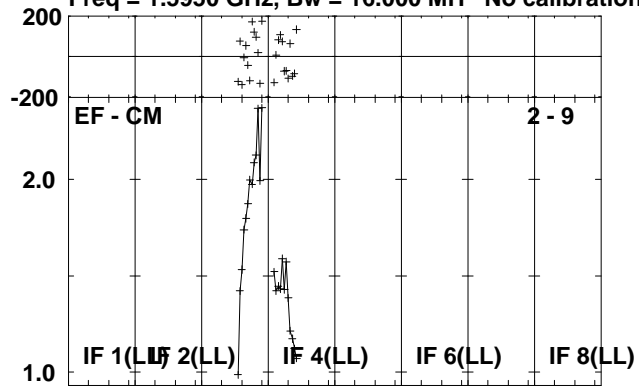

Lower frame: Milli Ampl Jy Top frame: Phas deg
Scalar averaged cross-power spectrum Several baselines displayed
Timerange: 01/03:25:01 to 01/03:28:29

Plot file version 251 created 23-AUG-2010 12:38:09

J1941-05 EP064P.UVDATA.1

Freq = 1.5950 GHz, Bw = 16.000 MH No calibration applied and no bandpass applied

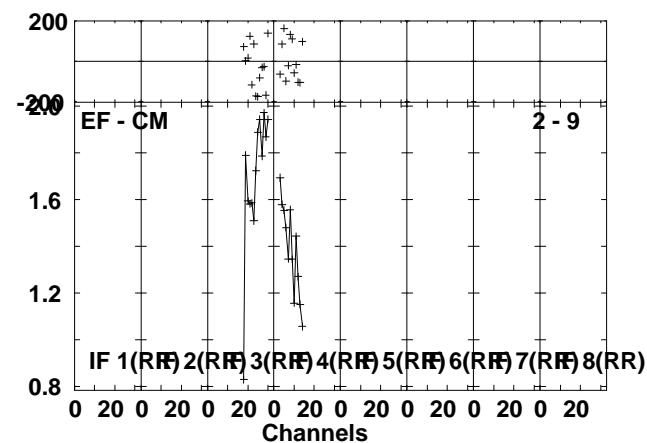
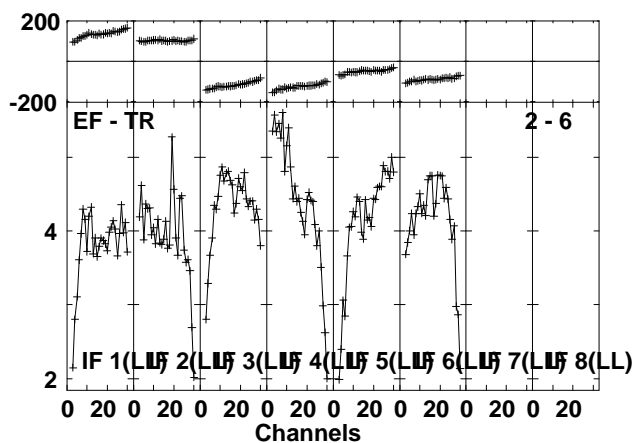
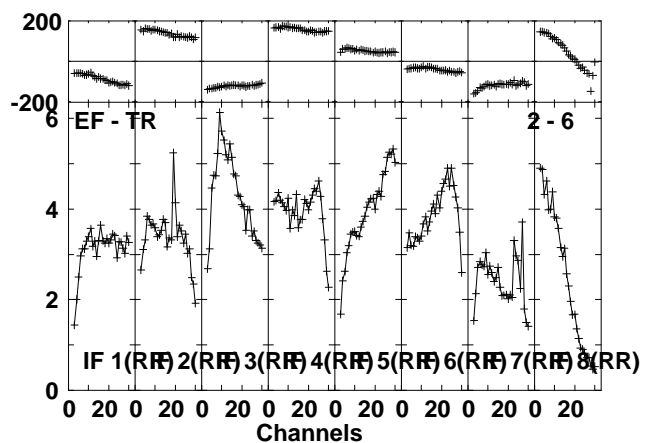
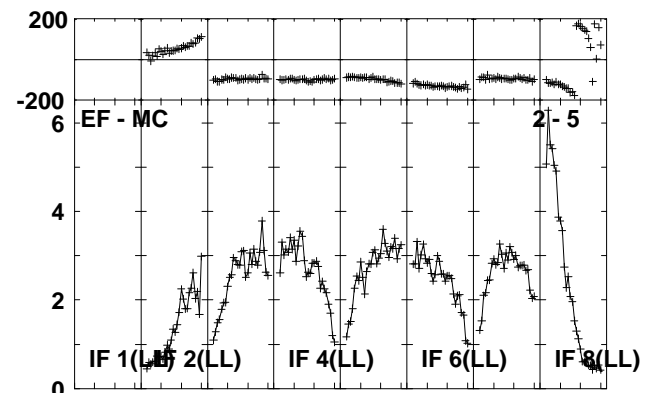
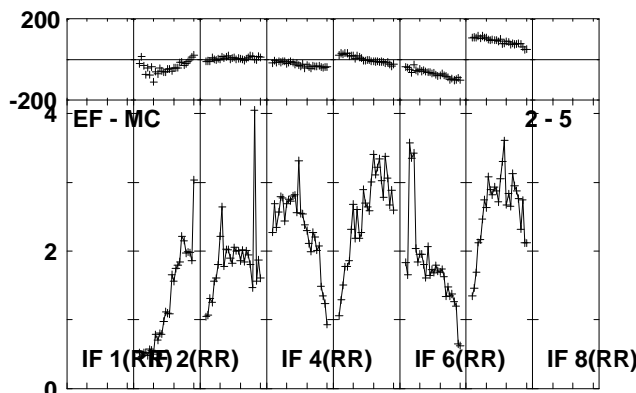
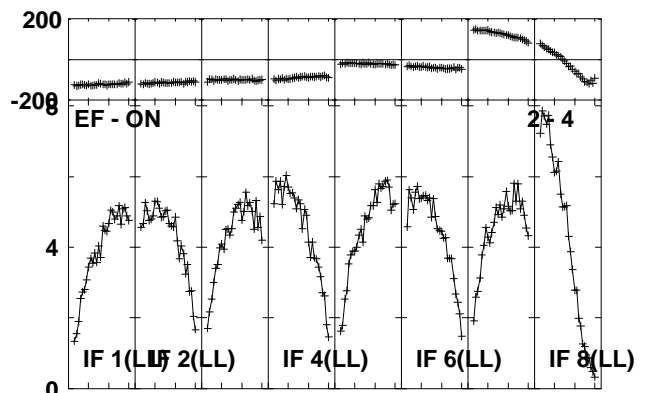
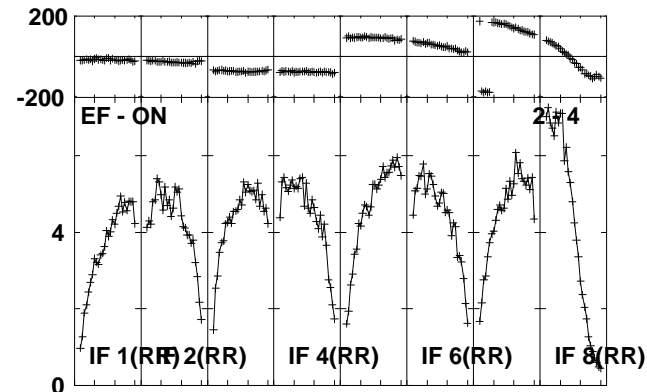
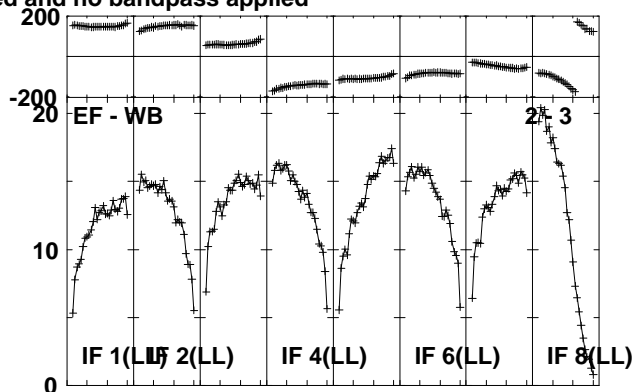
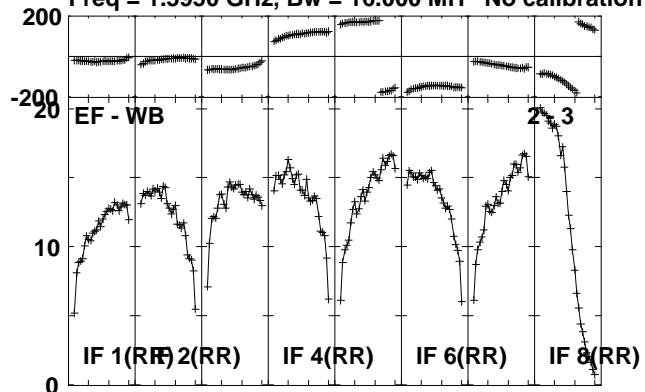

Lower frame: Milli Ampl Jy Top frame: Phas deg
Scalar averaged cross-power spectrum Several baselines displayed
Timerange: 01/03:28:31 to 01/03:29:57

Plot file version 252 created 23-AUG-2010 12:38:09

J1941-05 EP064P.UVDATA.1

Freq = 1.5950 GHz, Bw = 16.000 MH No calibration applied and no bandpass applied

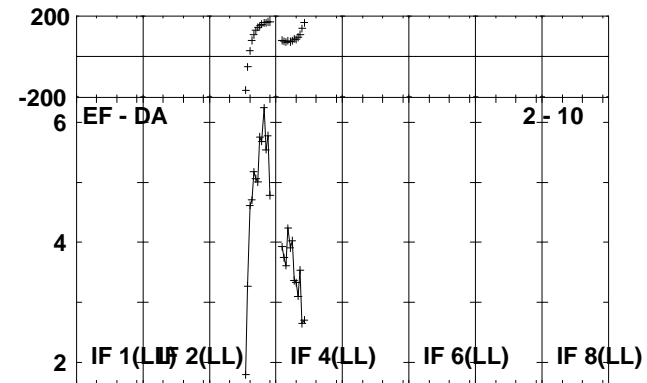
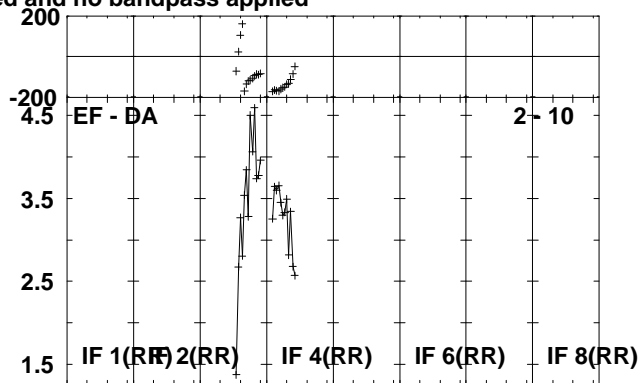
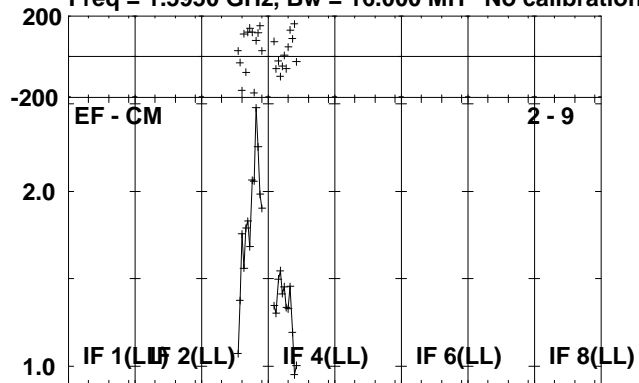

Lower frame: Milli Ampl Jy Top frame: Phas deg
Scalar averaged cross-power spectrum Several baselines displayed
Timerange: 01/03:28:31 to 01/03:29:57