

Plot file version 1 created 17-NOV-2010 16:16:14

4C39.25 EP068A 5.UVDATA.1

Freq = 4.9270 GHz, Bw = 16.000 MH Calibrated with CL # 3 and BP # 1 (BP mode 1)

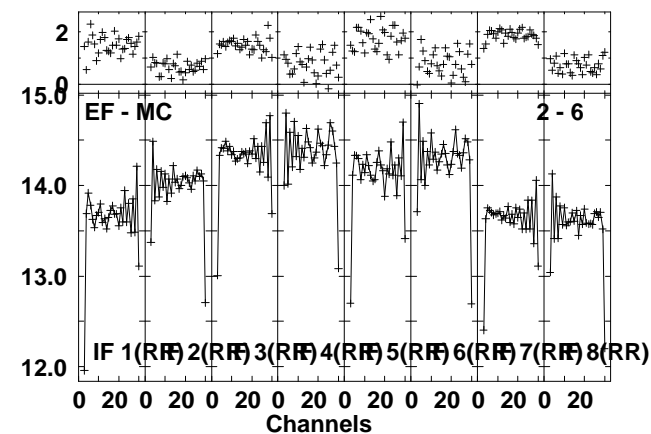
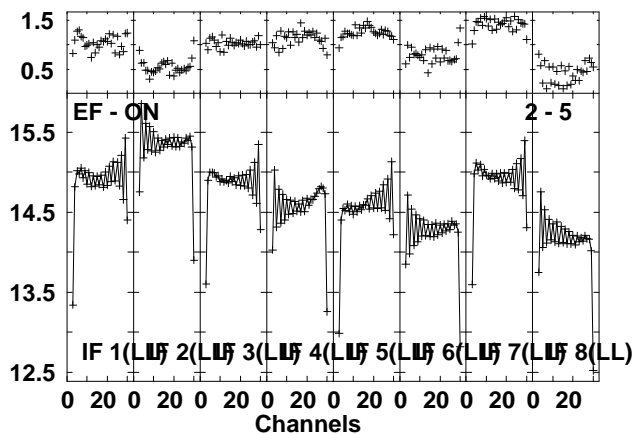
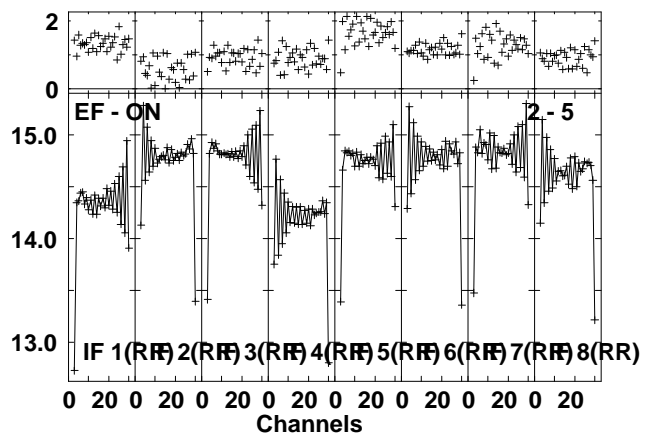
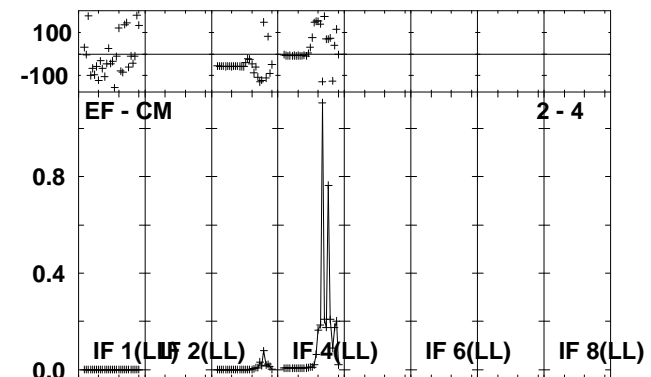
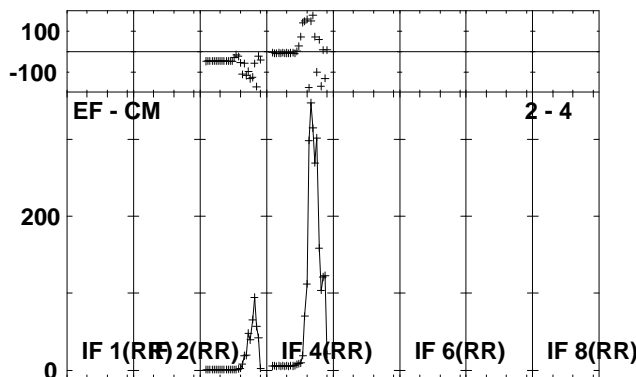
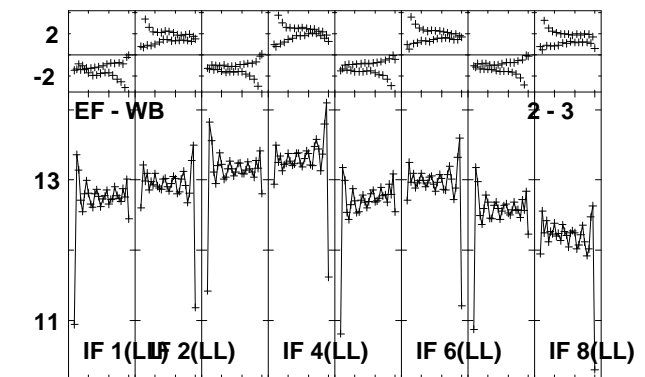
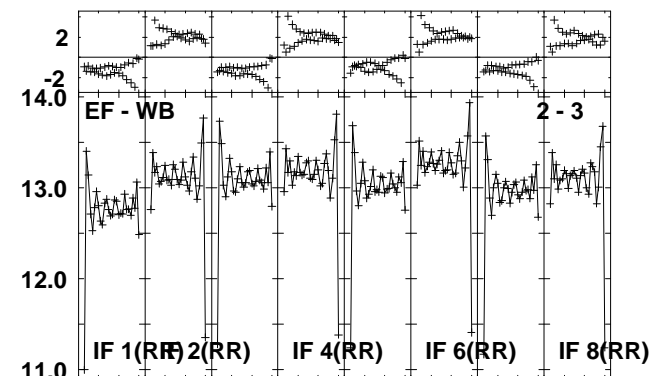
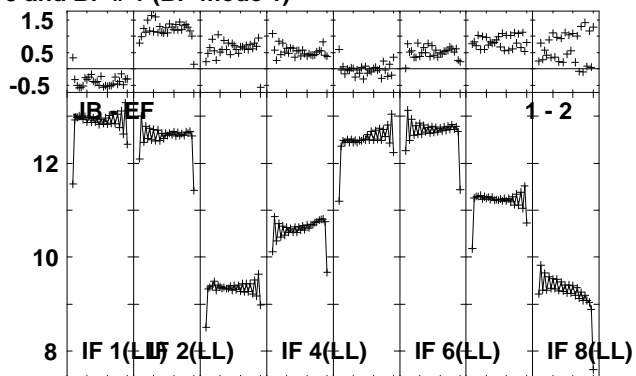
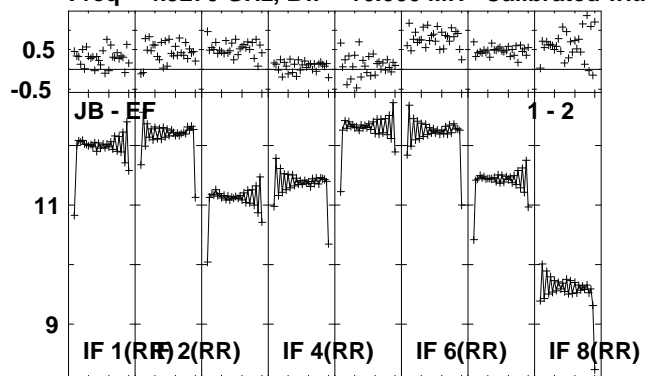

Lower frame: Ampl Jy Top frame: Phas deg
Vector averaged cross-power spectrum Several baselines displayed
Timerange: 00/13:00:01 to 00/13:07:59

Plot file version 2 created 17-NOV-2010 16:16:18

4C39.25 EP068A 5.UVDATA.1

Freq = 4.9270 GHz, Bw = 16.000 MH Calibrated with CL # 3 and BP # 1 (BP mode 1)

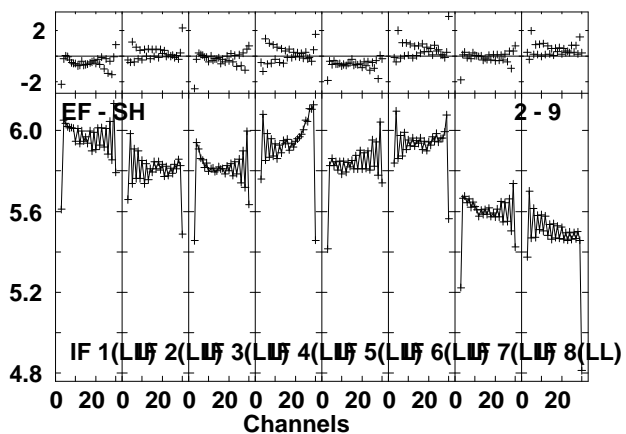
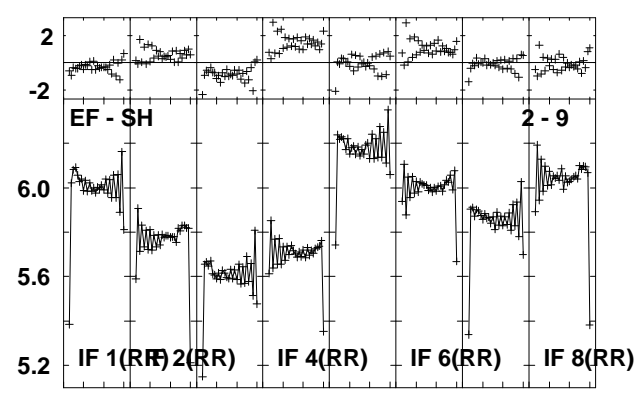
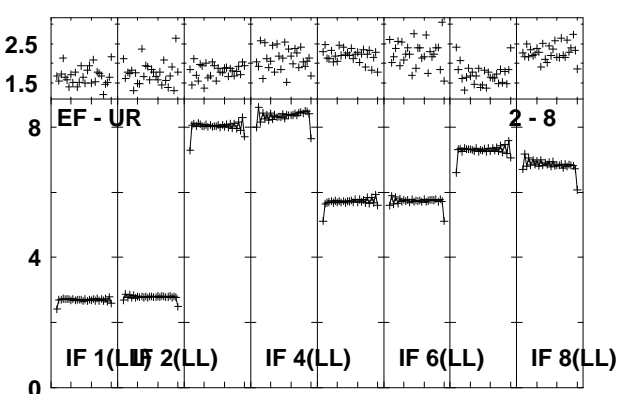
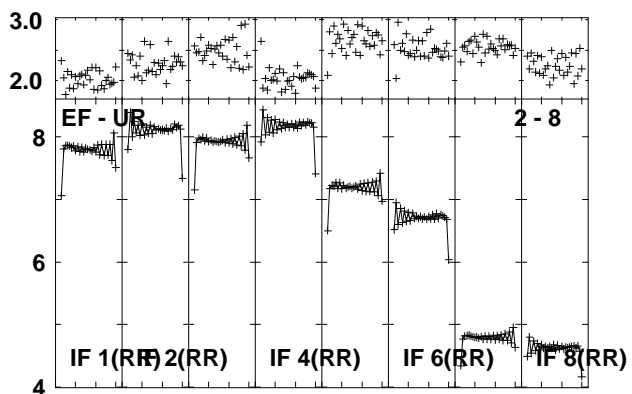
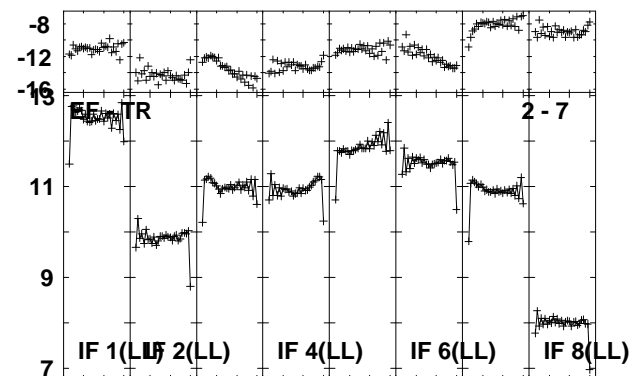
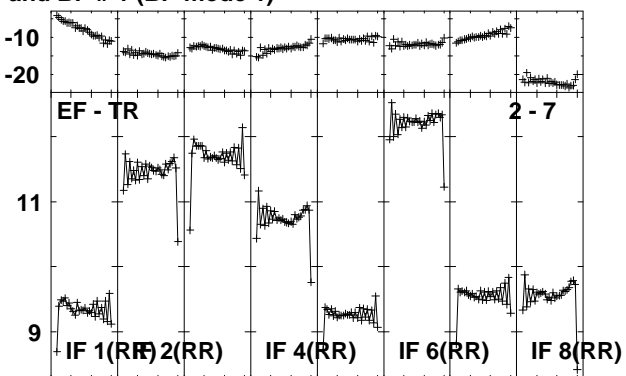
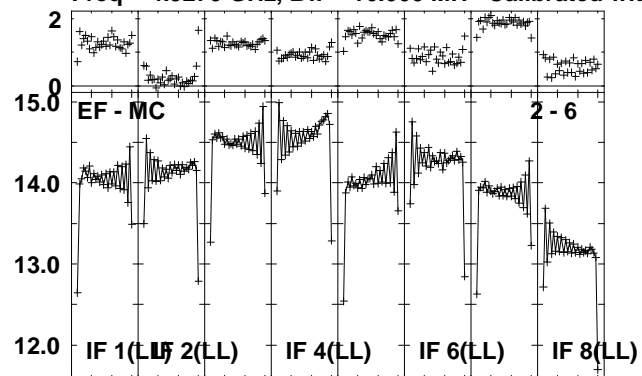

Lower frame: Ampl Jy Top frame: Phas deg
Vector averaged cross-power spectrum Several baselines displayed
Timerange: 00/13:00:01 to 00/13:07:59

Plot file version 3 created 17-NOV-2010 16:16:31

ARP299D EP068A 5.UVDATA.1

Freq = 4.9270 GHz, Bw = 16.000 MH Calibrated with CL # 3 and BP # 1 (BP mode 1)

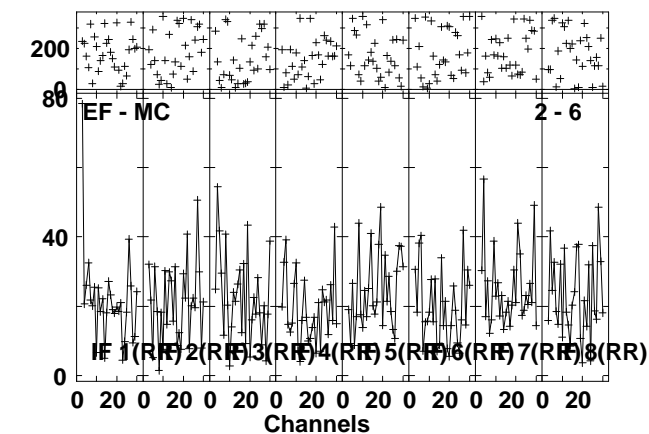
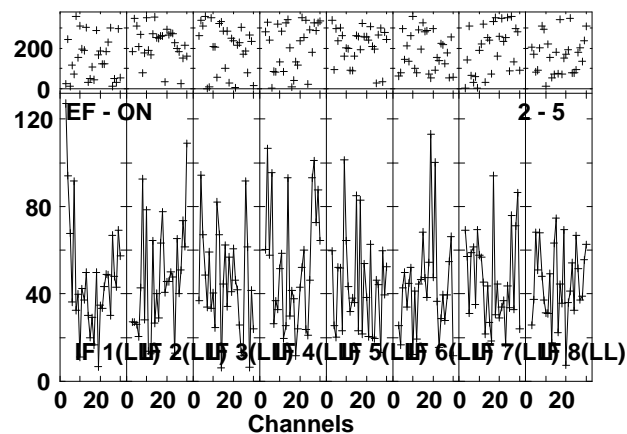
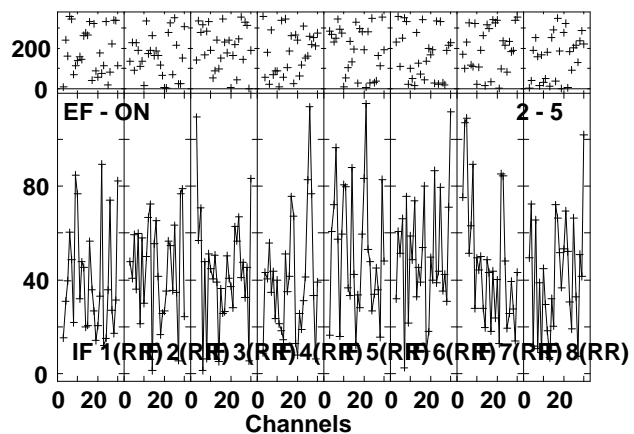
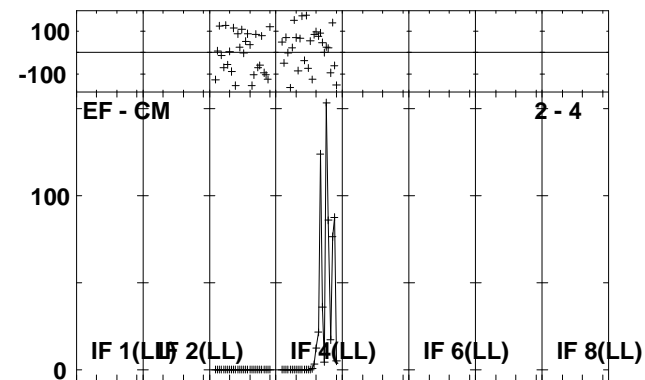
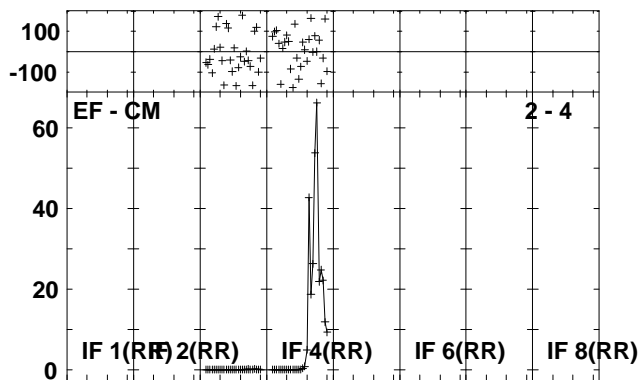
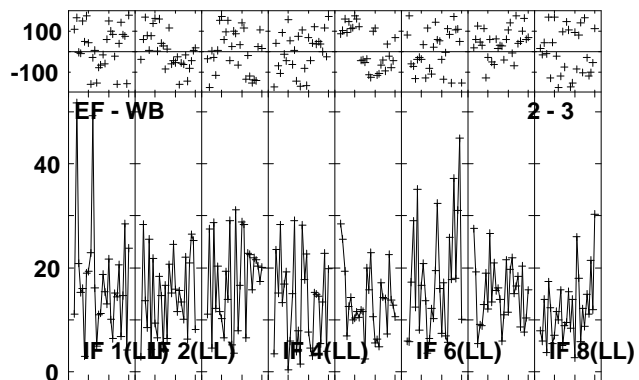
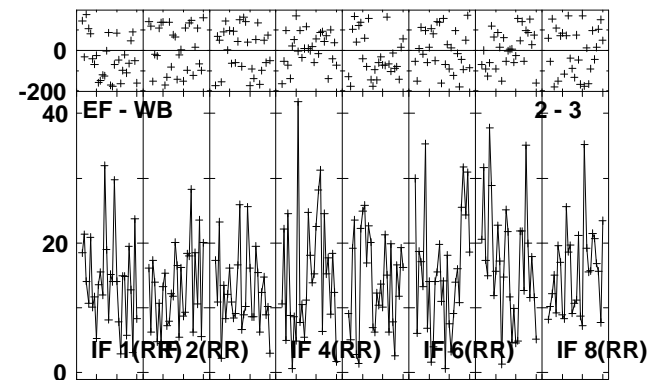
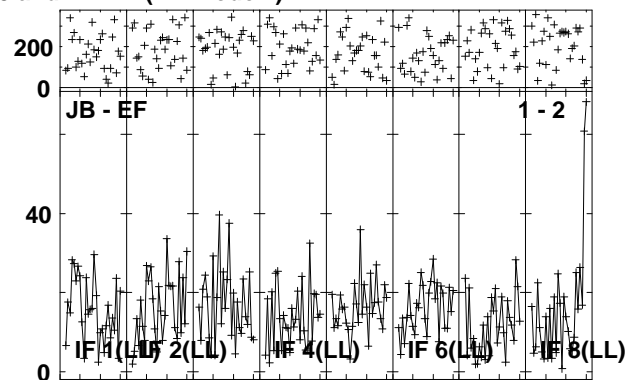
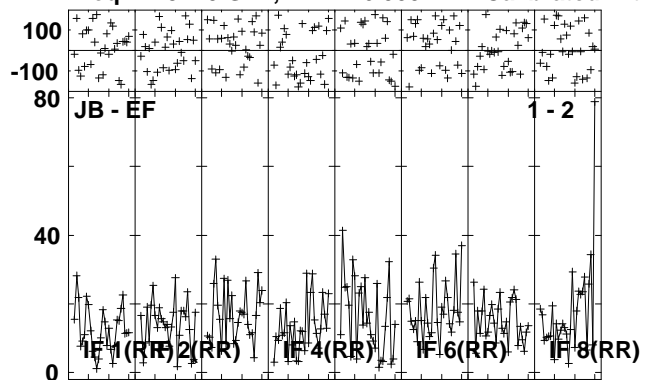

Lower frame: Milli Ampl Jy Top frame: Phas deg
Vector averaged cross-power spectrum Several baselines displayed
Timerange: 00/13:17:01 to 00/13:20:29

Plot file version 4 created 17-NOV-2010 16:16:33

ARP299D EP068A 5.UVDATA.1

Freq = 4.9270 GHz, Bw = 16.000 MH Calibrated with CL # 3 and BP # 1 (BP mode 1)

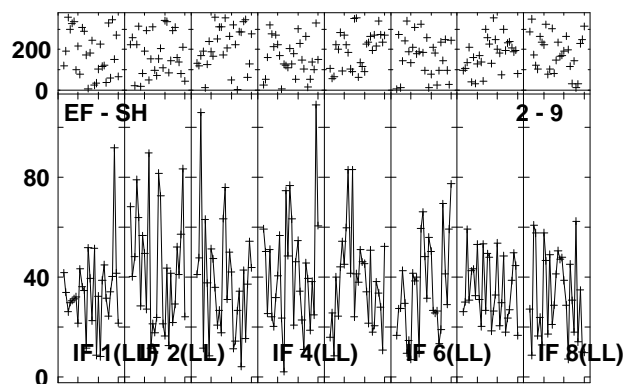
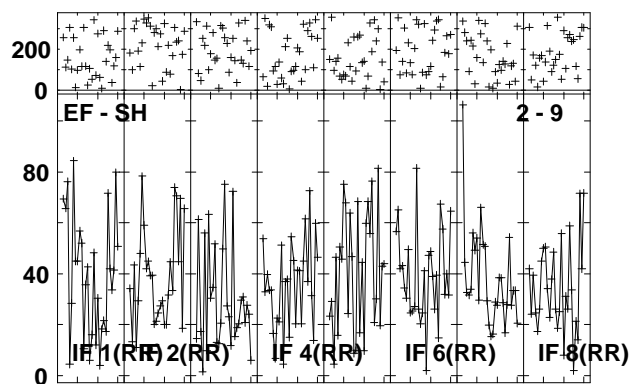
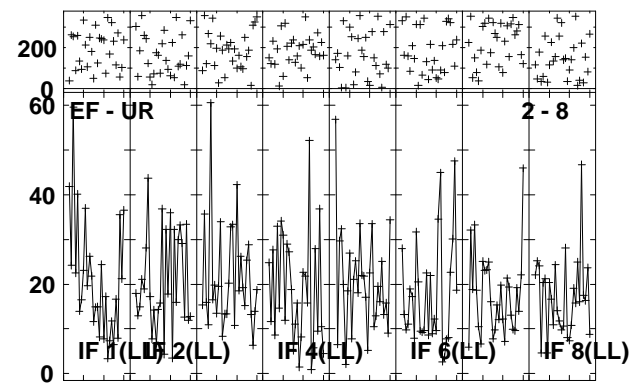
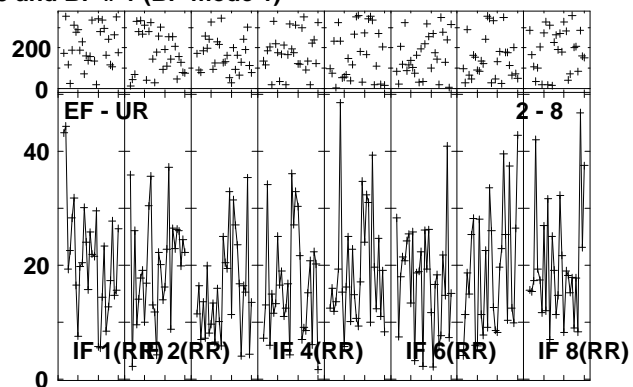
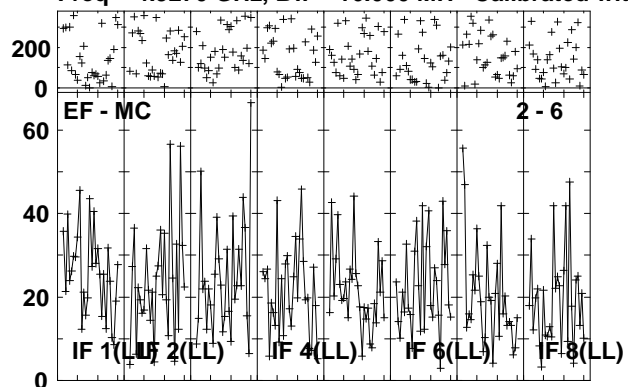

Lower frame: Milli Ampl Jy Top frame: Phas deg
Vector averaged cross-power spectrum Several baselines displayed
Timerange: 00/13:17:01 to 00/13:20:29

Plot file version 5 created 17-NOV-2010 16:16:35

J1128+59 EP068A 5.UVDATA.1

Freq = 4.9270 GHz, Bw = 16.000 MH Calibrated with CL # 3 and BP # 1 (BP mode 1)

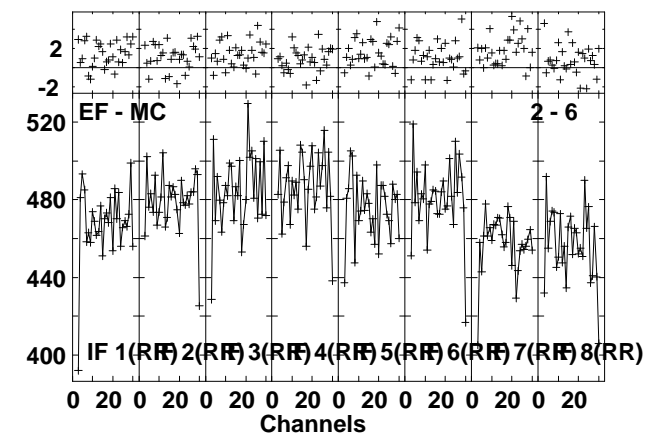
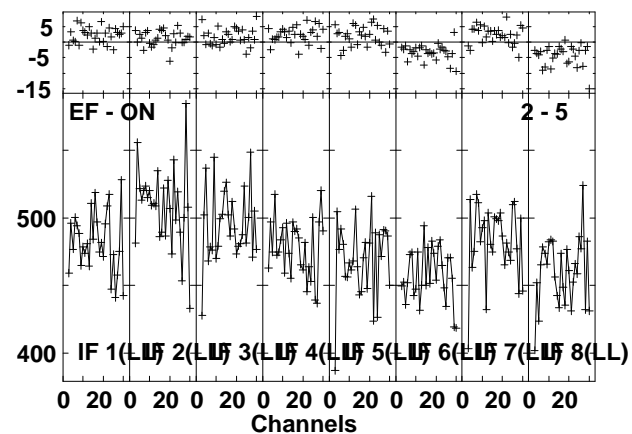
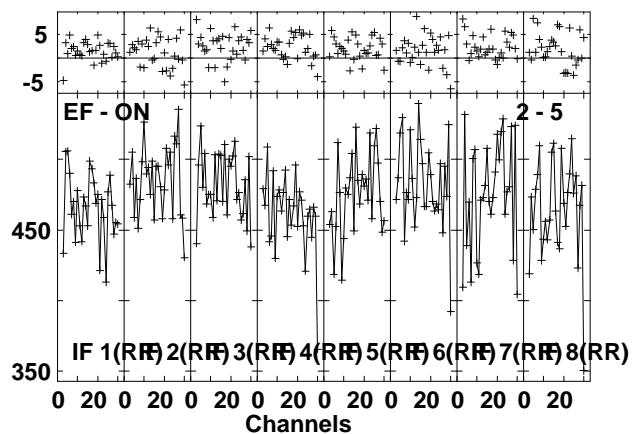
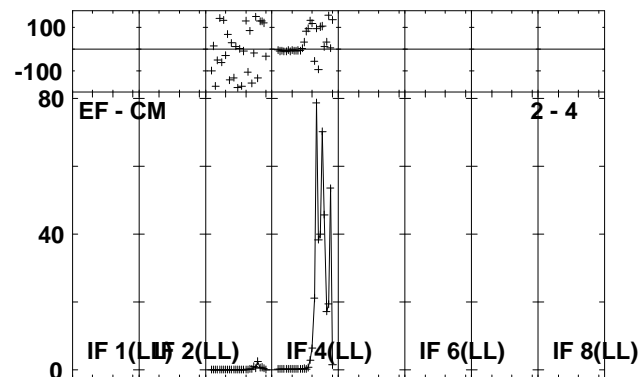
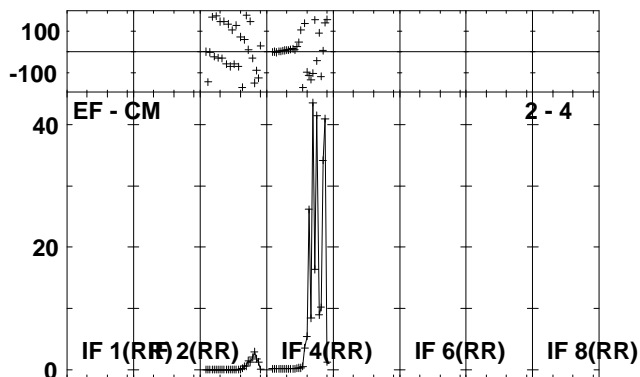
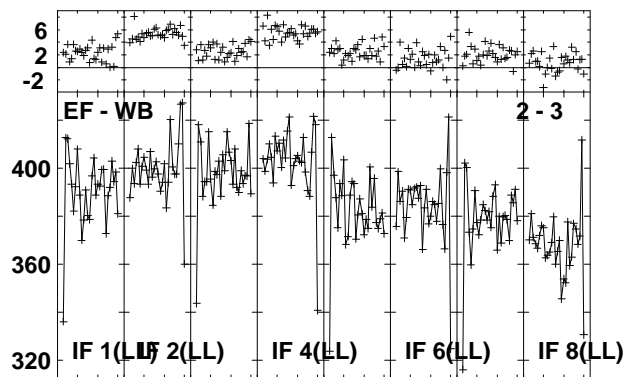
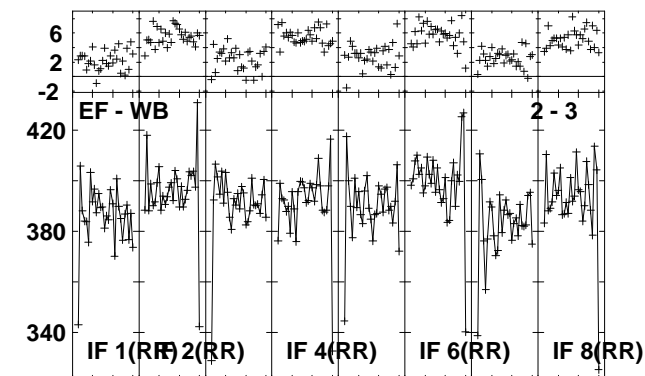
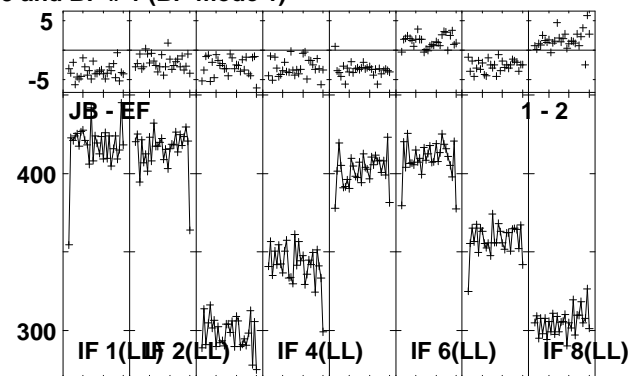
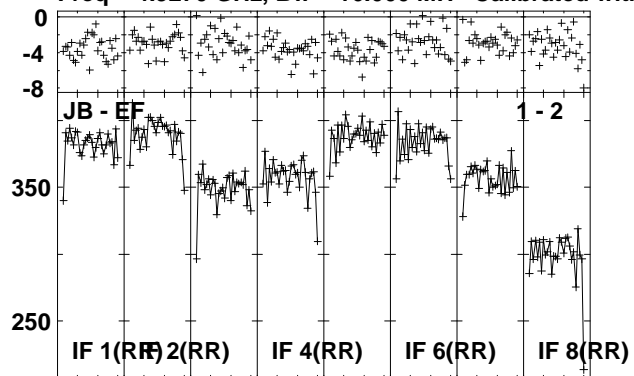

Lower frame: Milli Ampl Jy Top frame: Phas deg
Vector averaged cross-power spectrum Several baselines displayed
Timerange: 00/13:21:31 to 00/13:22:59

Plot file version 6 created 17-NOV-2010 16:16:35

J1128+59 EP068A 5.UVDATA.1

Freq = 4.9270 GHz, Bw = 16.000 MH Calibrated with CL # 3 and BP # 1 (BP mode 1)

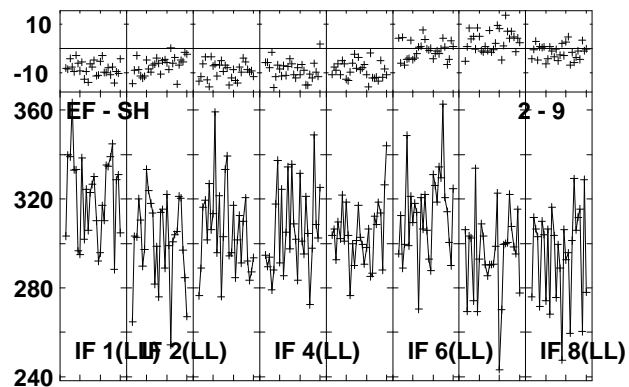
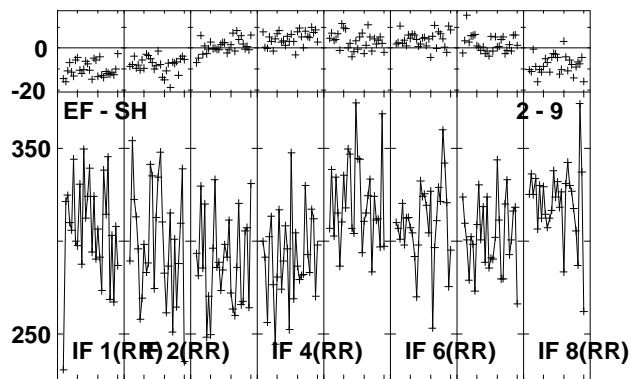
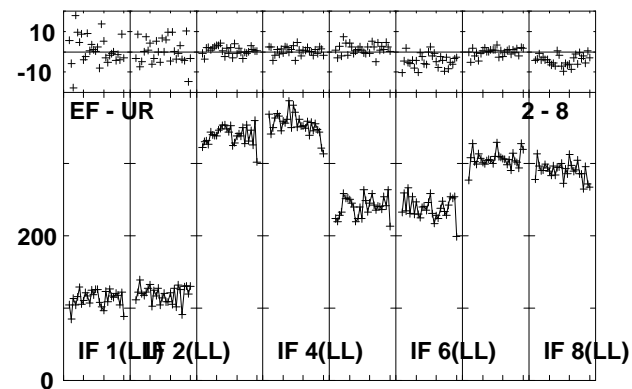
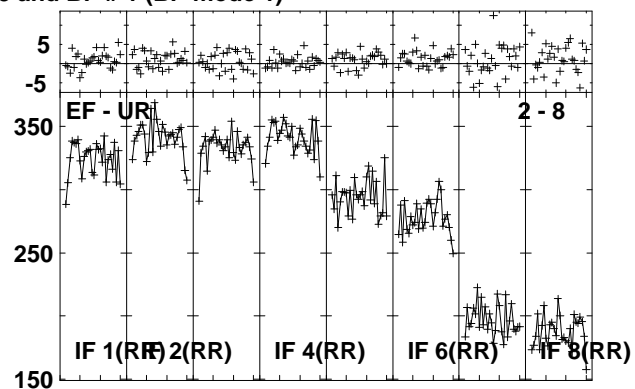
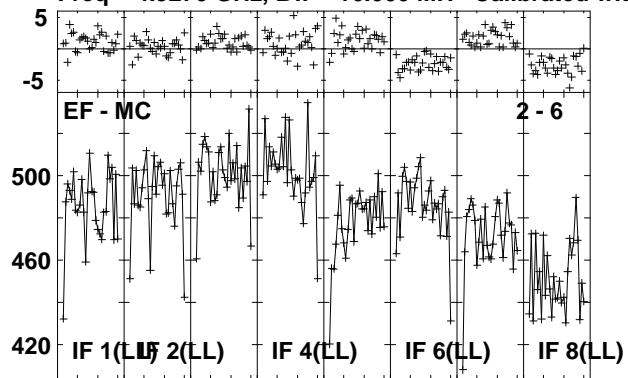

Lower frame: Milli Ampl Jy Top frame: Phas deg
Vector averaged cross-power spectrum Several baselines displayed
Timerange: 00/13:21:31 to 00/13:22:59

Plot file version 7 created 17-NOV-2010 16:16:37

ARP299D EP068A 5.UVDATA.1

Freq = 4.9270 GHz, Bw = 16.000 MH Calibrated with CL # 3 and BP # 1 (BP mode 1)

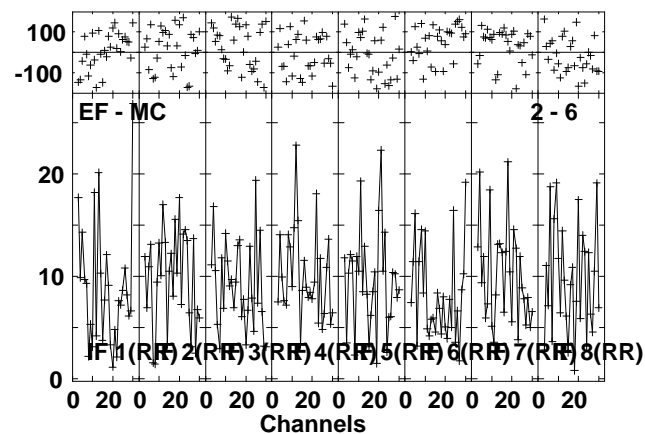
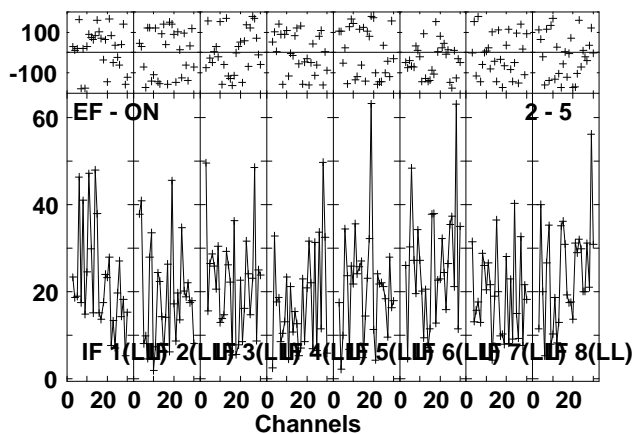
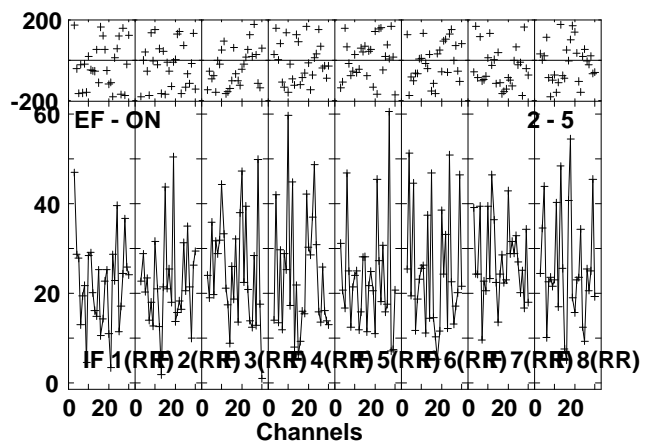
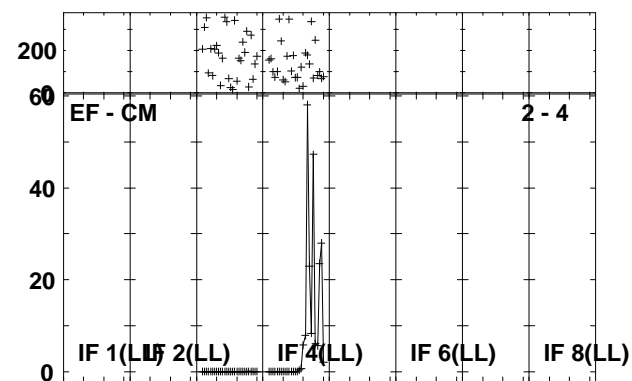
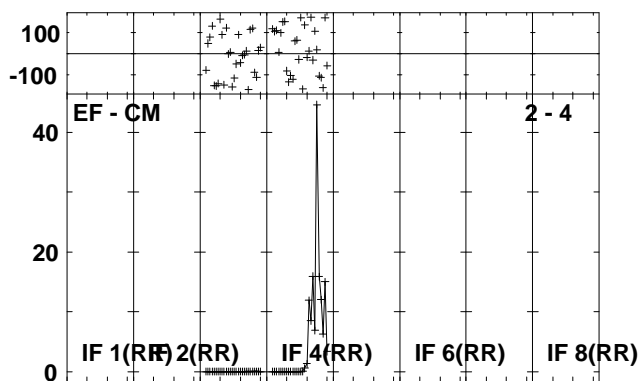
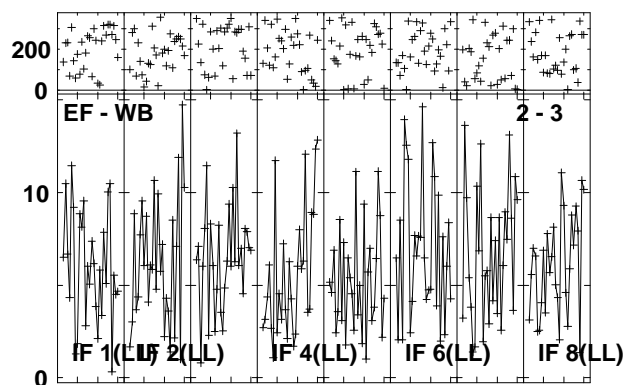
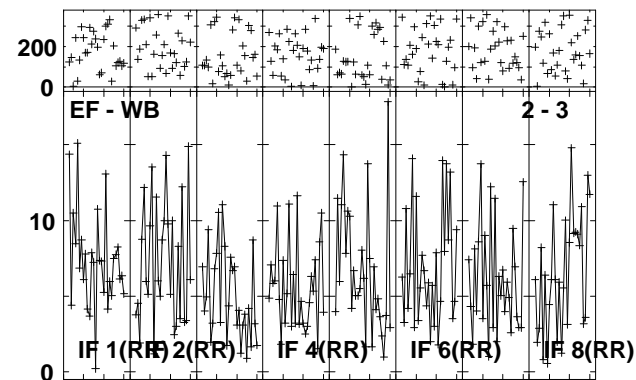
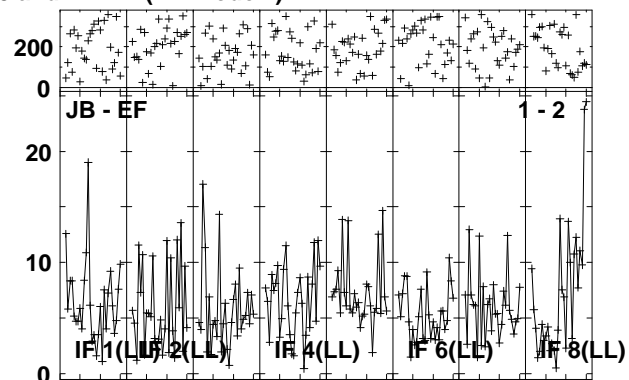
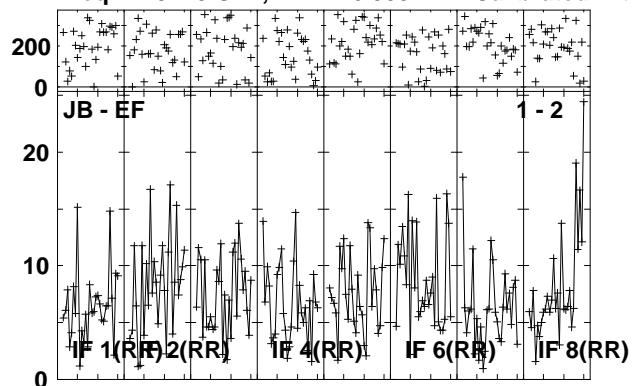

Lower frame: Milli Ampl Jy Top frame: Phas deg
Vector averaged cross-power spectrum Several baselines displayed
Timerange: 00/13:23:01 to 00/13:26:29

Plot file version 8 created 17-NOV-2010 16:16:39

ARP299D EP068A 5.UVDATA.1

Freq = 4.9270 GHz, Bw = 16.000 MH Calibrated with CL # 3 and BP # 1 (BP mode 1)

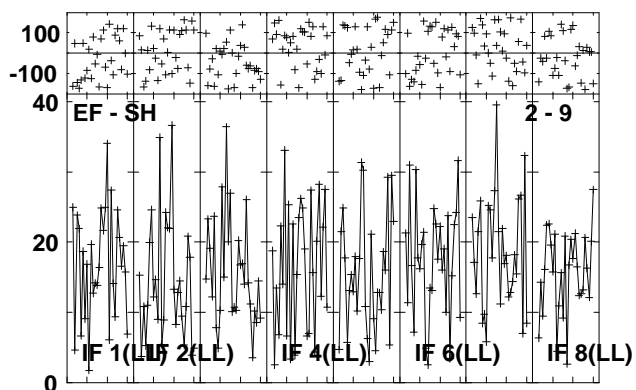
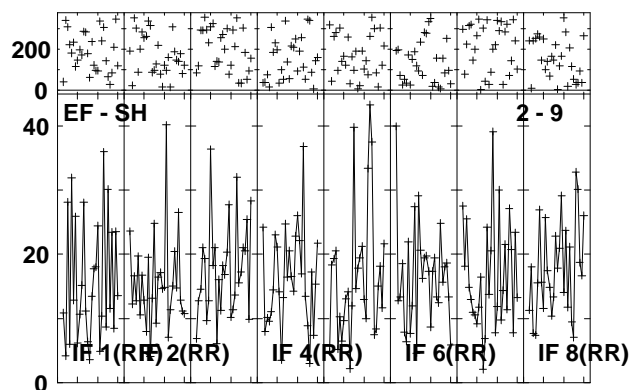
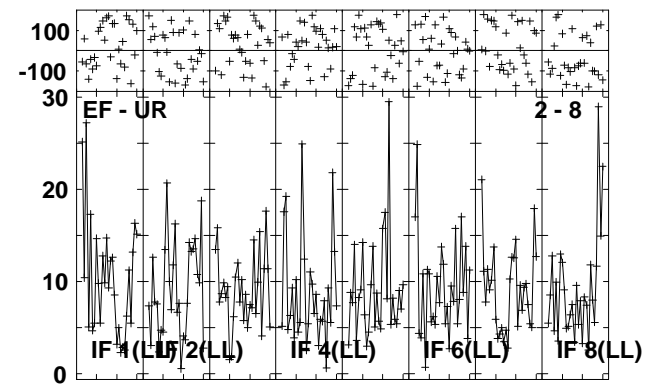
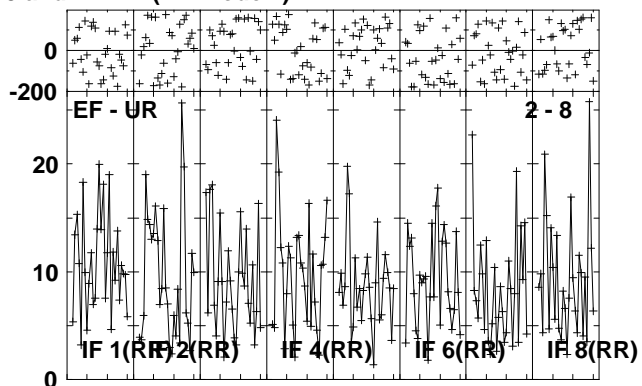
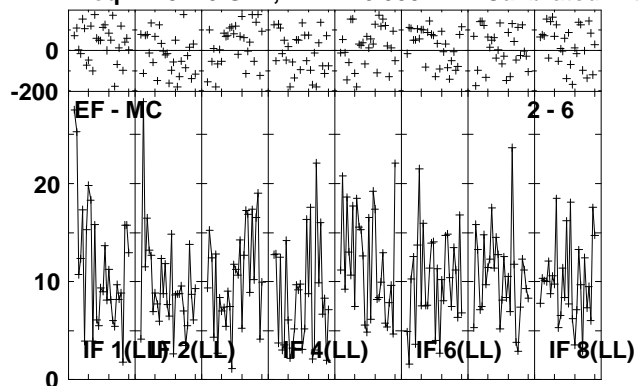

Lower frame: Milli Ampl Jy Top frame: Phas deg
Vector averaged cross-power spectrum Several baselines displayed
Timerange: 00/13:23:01 to 00/13:26:29

Plot file version 10 created 17-NOV-2010 16:16:42

J1128+59 EP068A 5.UVDATA.1

Freq = 4.9270 GHz, Bw = 16.000 MH Calibrated with CL # 3 and BP # 1 (BP mode 1)

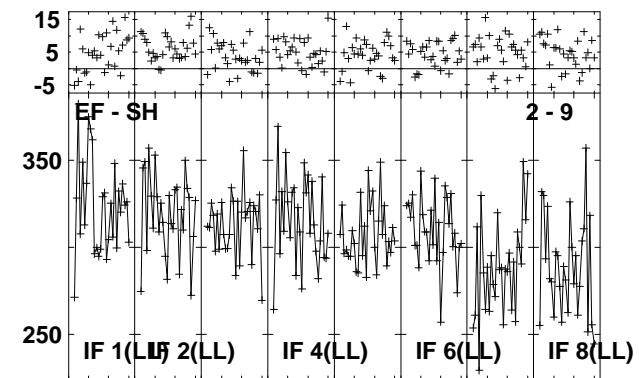
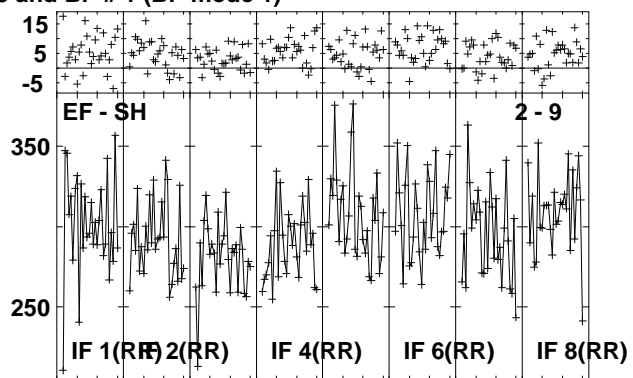
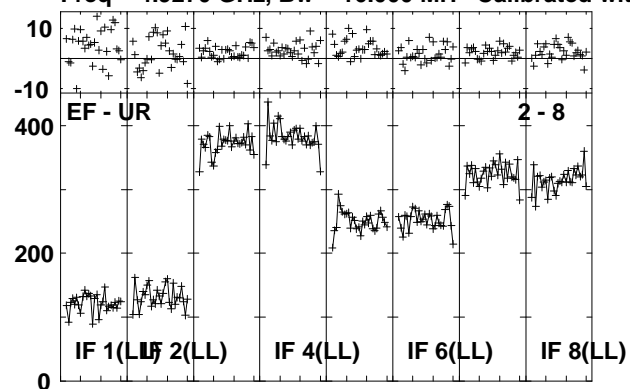

Lower frame: Milli Ampl Jy Top frame: Phas deg
Vector averaged cross-power spectrum Several baselines displayed
Timerange: 00/13:26:31 to 00/13:27:59

Plot file version 11 created 17-NOV-2010 16:16:43

ARP299D EP068A 5.UVDATA.1

Freq = 4.9270 GHz, Bw = 16.000 MH Calibrated with CL # 3 and BP # 1 (BP mode 1)

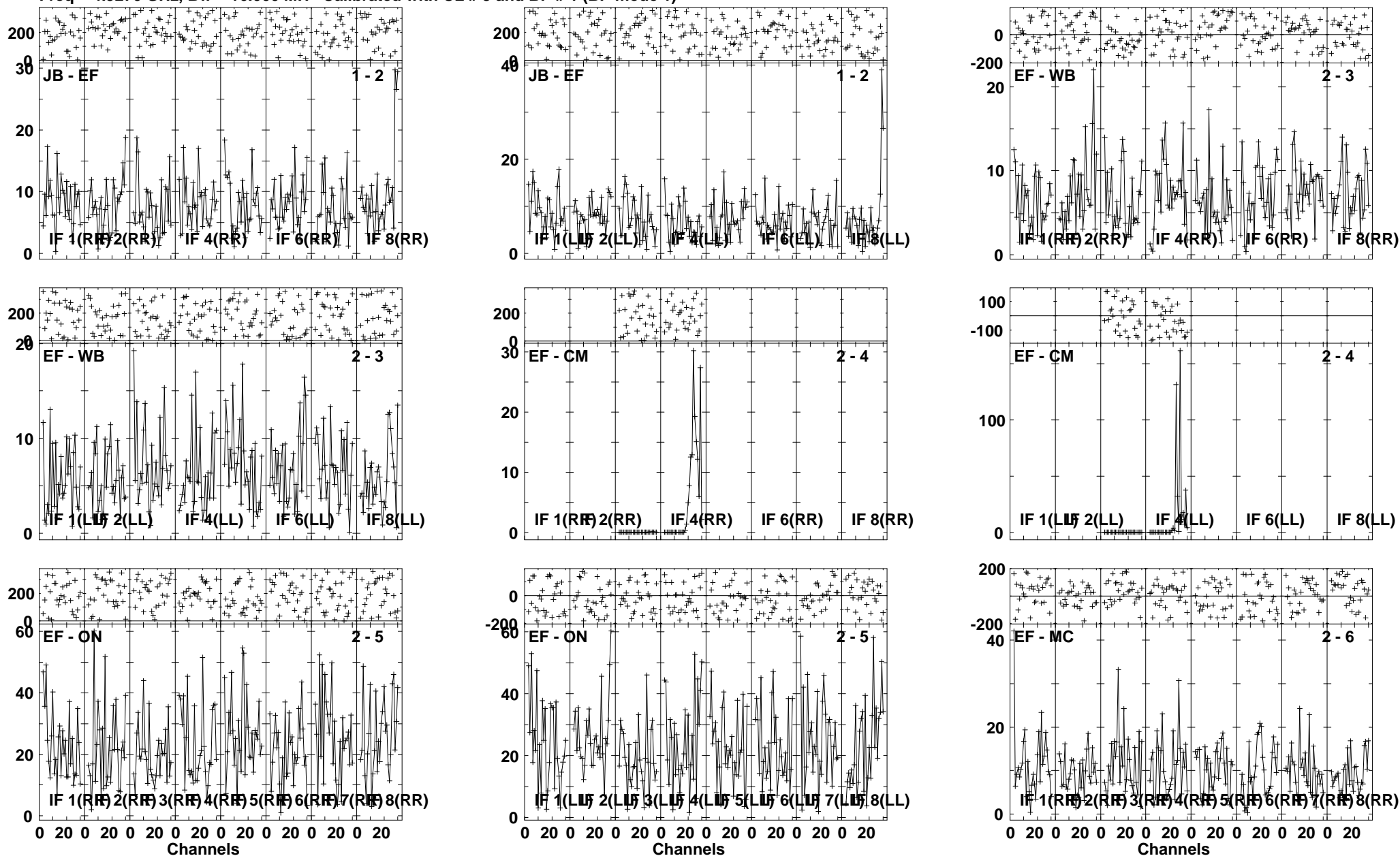

Lower frame: Milli Ampl Jy Top frame: Phas deg
Vector averaged cross-power spectrum Several baselines displayed
Timerange: 00/13:28:01 to 00/13:31:29

Plot file version 12 created 17-NOV-2010 16:16:45

ARP299D EP068A 5.UVDATA.1

Freq = 4.9270 GHz, Bw = 16.000 MH Calibrated with CL # 3 and BP # 1 (BP mode 1)

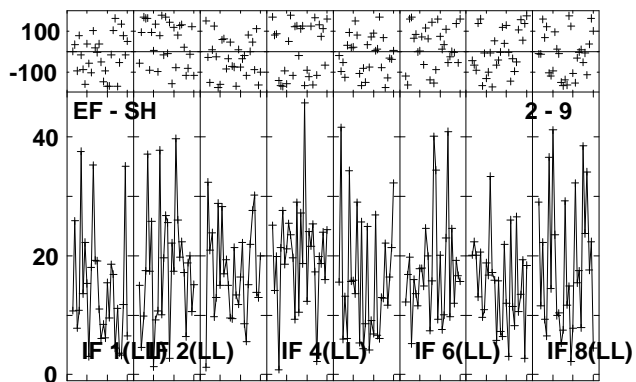
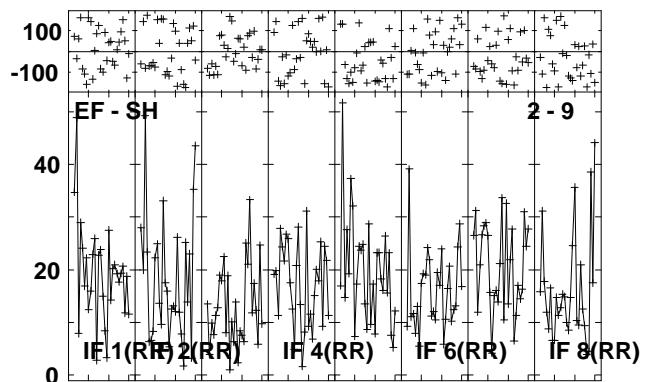
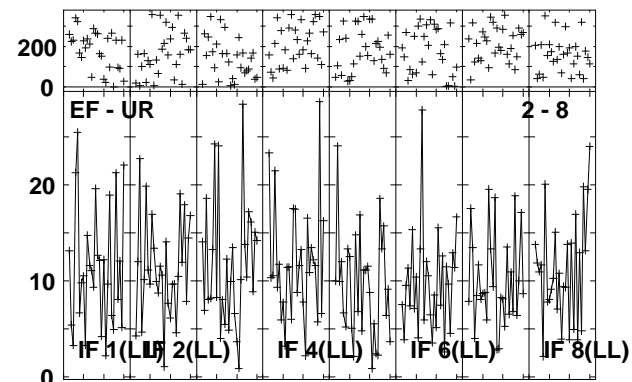
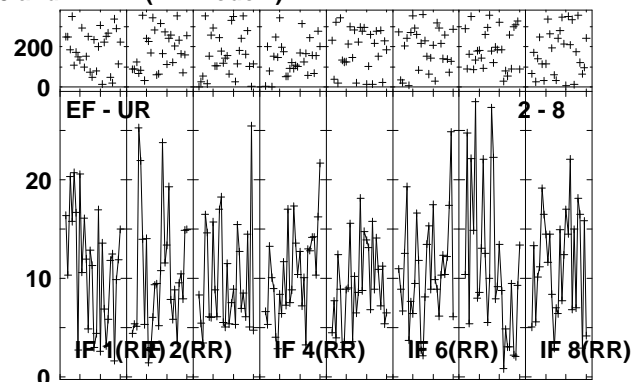
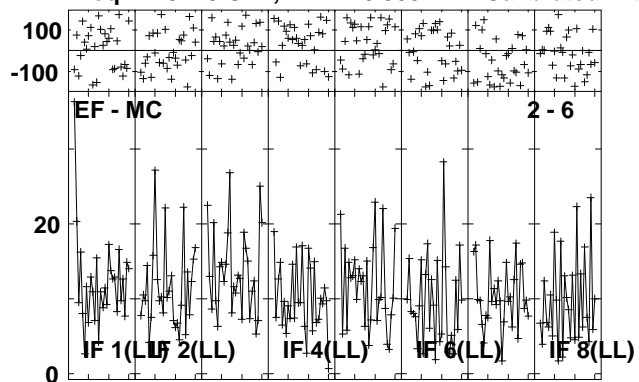

Lower frame: Milli Ampl Jy Top frame: Phas deg
Vector averaged cross-power spectrum Several baselines displayed
Timerange: 00/13:28:01 to 00/13:31:29

Plot file version 13 created 17-NOV-2010 16:16:47

J1128+59 EP068A 5.UVDATA.1

Freq = 4.9270 GHz, Bw = 16.000 MH Calibrated with CL # 3 and BP # 1 (BP mode 1)

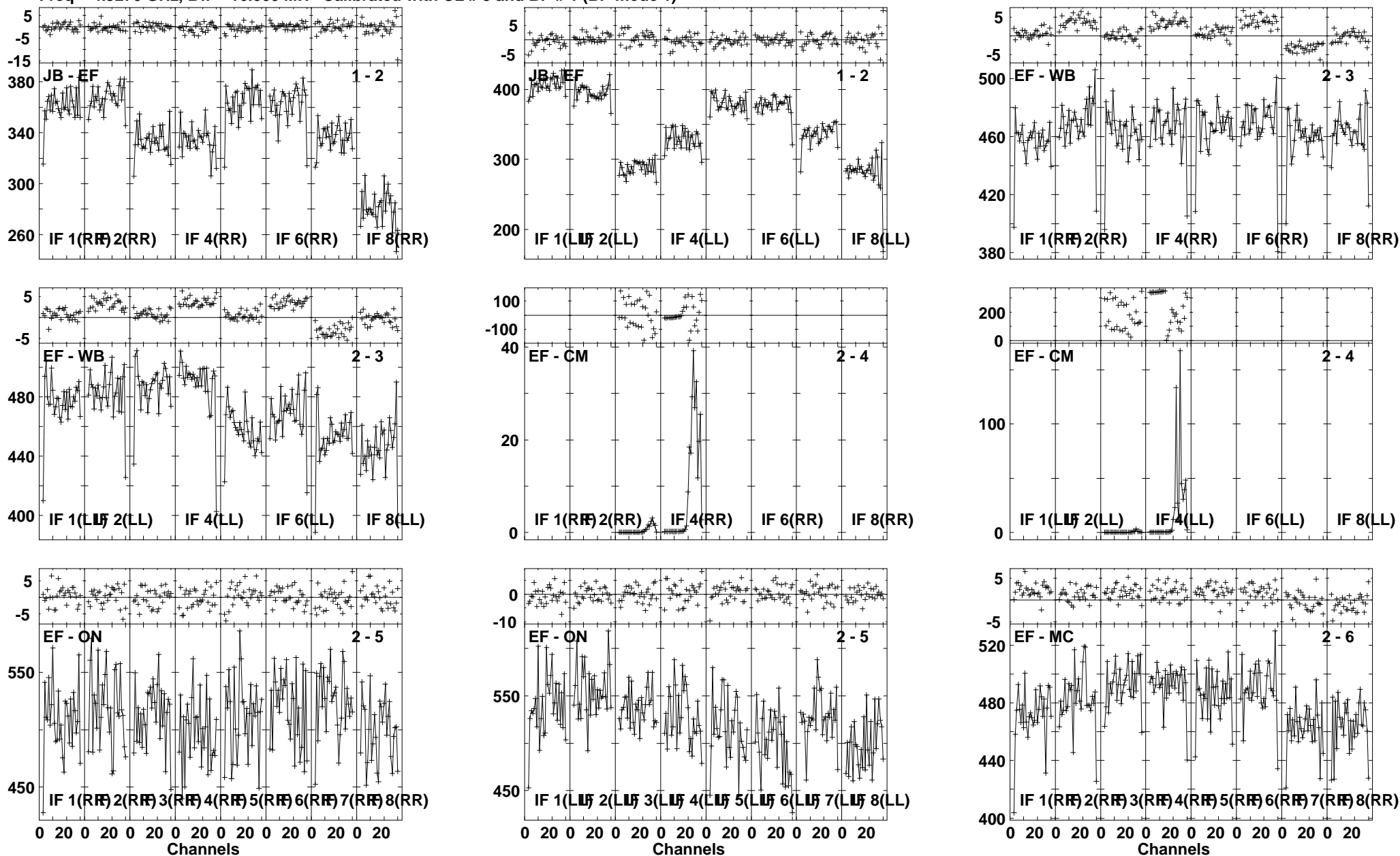

Lower frame: Milli Ampl Jy Top frame: Phas deg
Vector averaged cross-power spectrum Several baselines displayed
Timerange: 00/13:31:31 to 00/13:32:59

Plot file version 14 created 17-NOV-2010 16:16:48

J1128+59 EP068A 5.UVDATA.1

Freq = 4.9270 GHz, Bw = 16.000 MH Calibrated with CL # 3 and BP # 1 (BP mode 1)

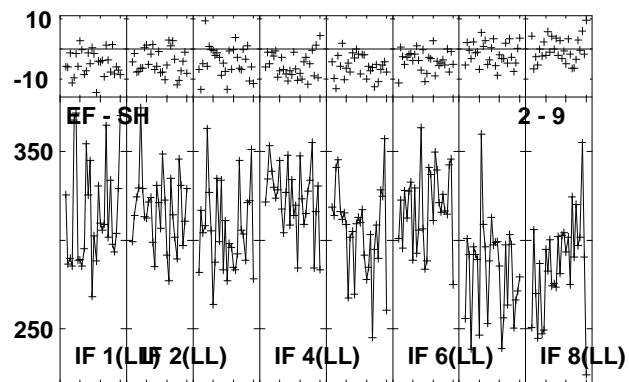
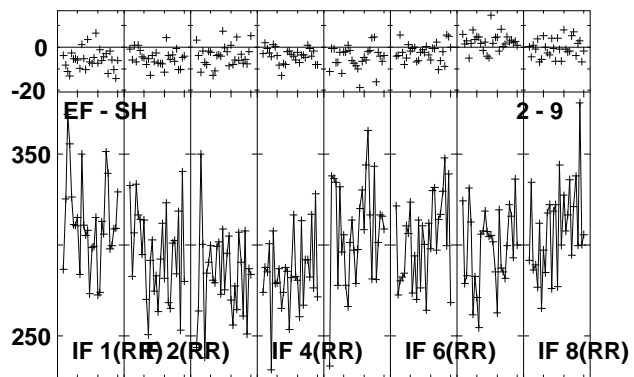
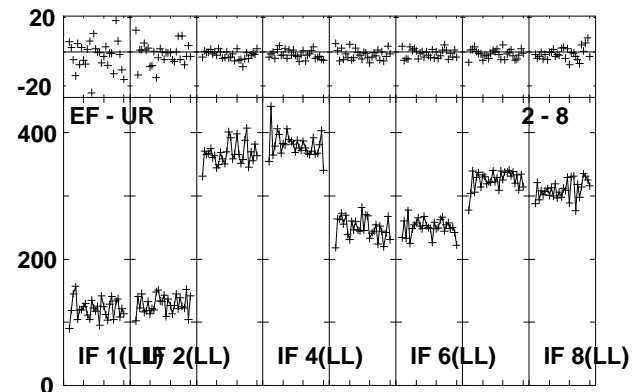
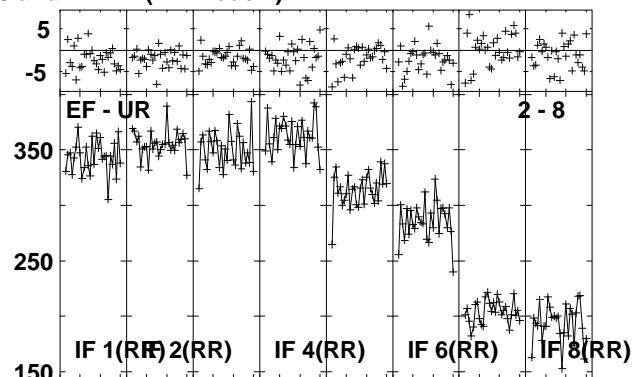
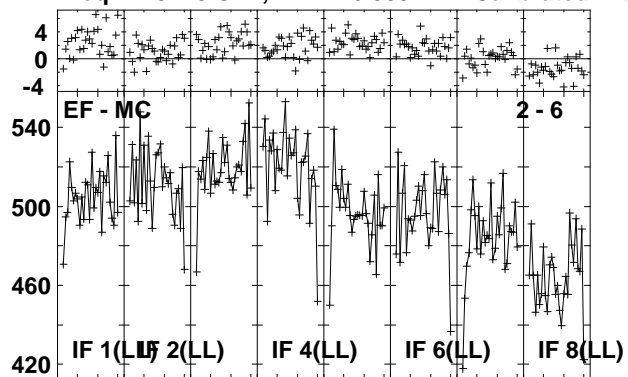

Lower frame: Milli Ampl Jy Top frame: Phas deg
Vector averaged cross-power spectrum Several baselines displayed
Timerange: 00/13:31:31 to 00/13:32:59

Plot file version 15 created 17-NOV-2010 16:16:49

ARP299D EP068A 5.UVDATA.1

Freq = 4.9270 GHz, Bw = 16.000 MH Calibrated with CL # 3 and BP # 1 (BP mode 1)

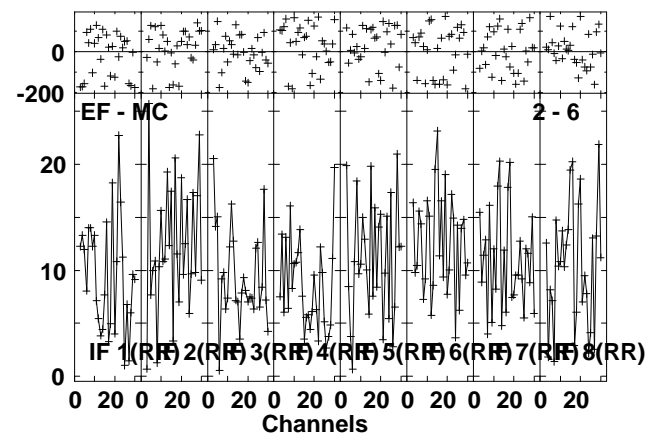
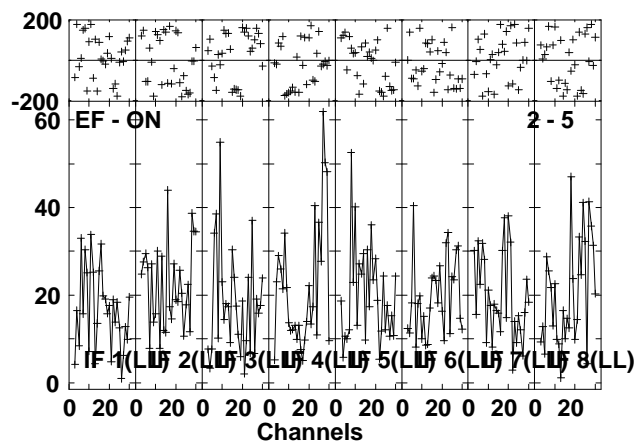
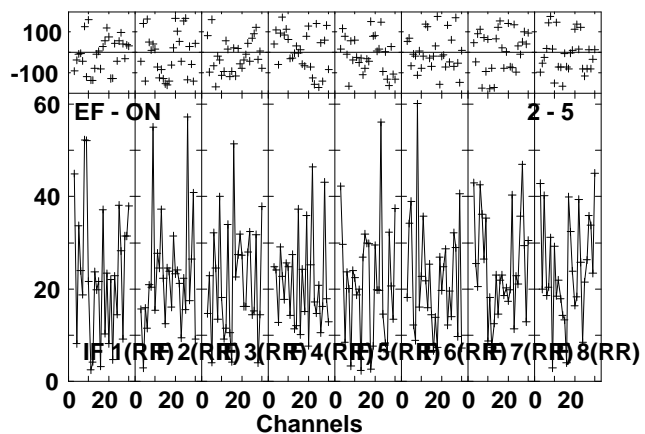
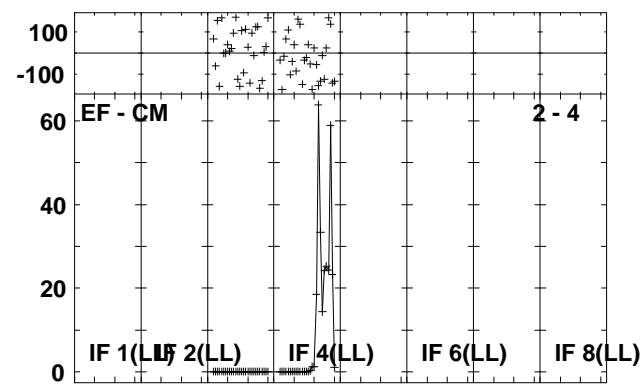
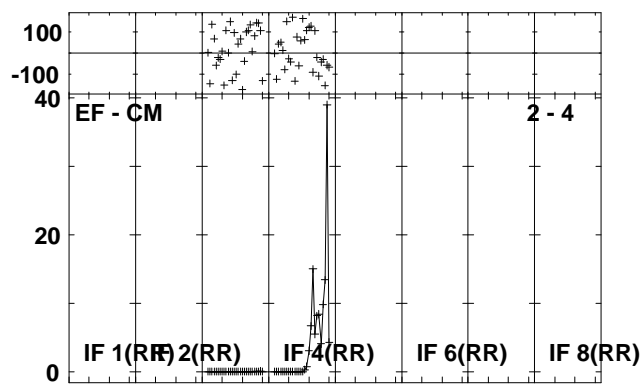
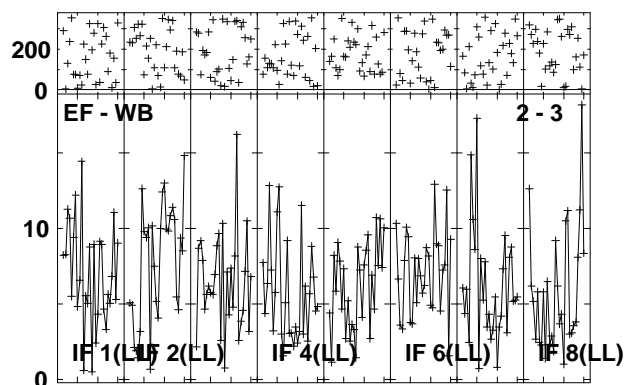
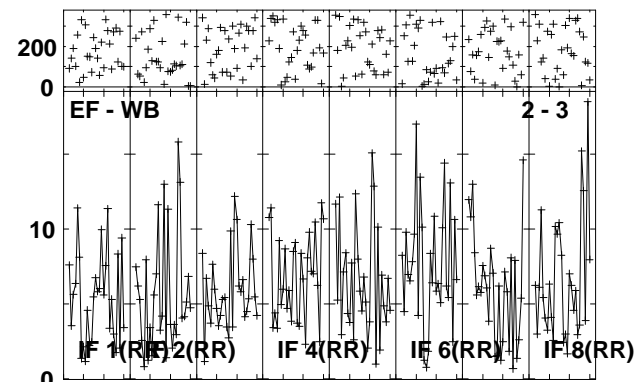
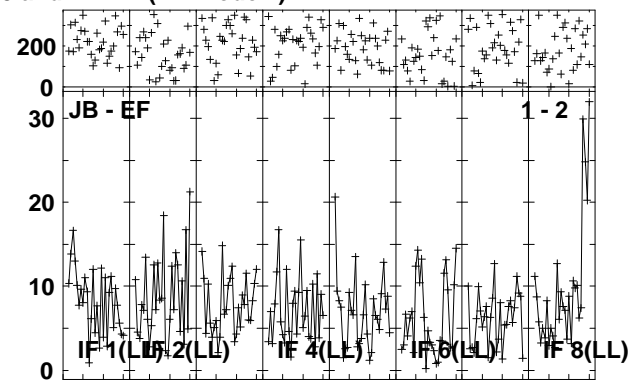
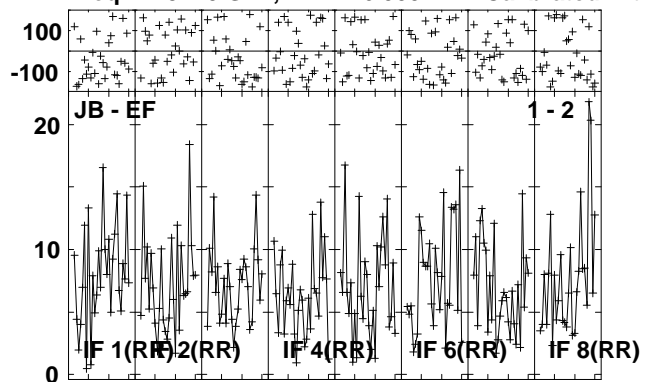

Lower frame: Milli Ampl Jy Top frame: Phas deg
Vector averaged cross-power spectrum Several baselines displayed
Timerange: 00/13:33:01 to 00/13:36:29

Plot file version 16 created 17-NOV-2010 16:16:51

ARP299D EP068A 5.UVDATA.1

Freq = 4.9270 GHz, Bw = 16.000 MH Calibrated with CL # 3 and BP # 1 (BP mode 1)

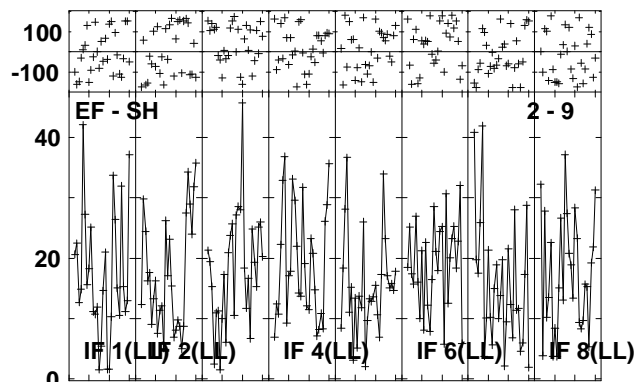
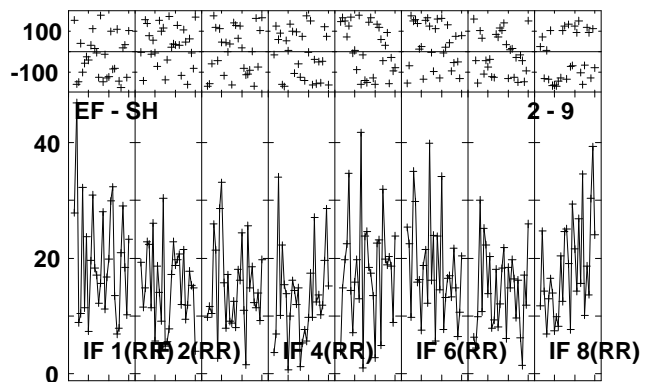
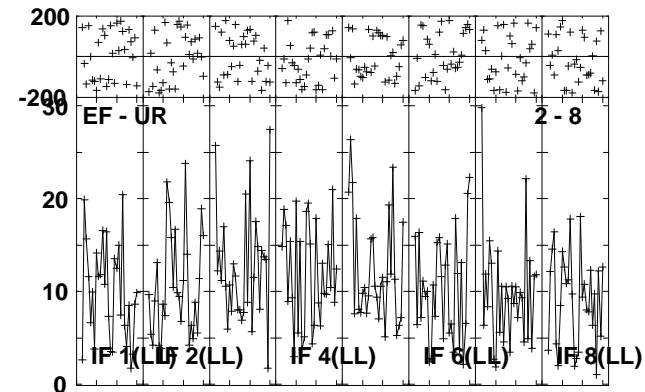
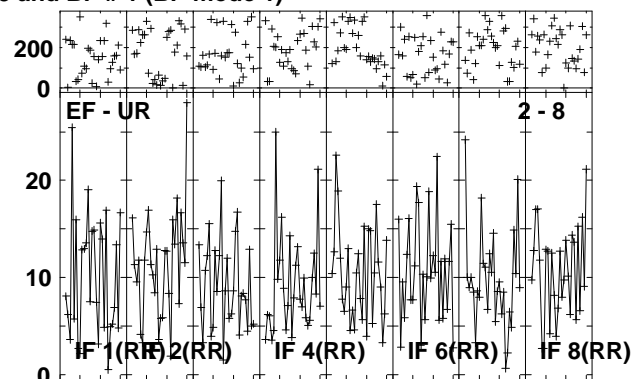
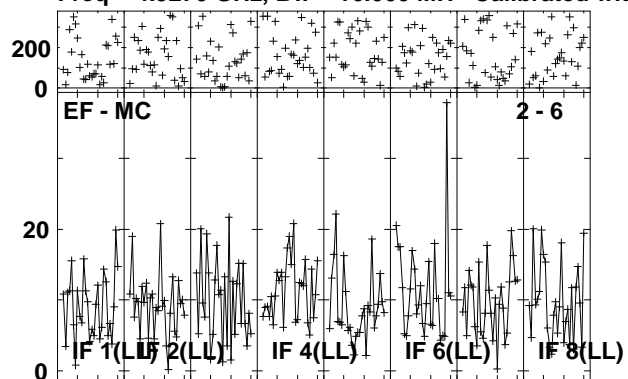

Lower frame: Milli Ampl Jy Top frame: Phas deg
Vector averaged cross-power spectrum Several baselines displayed
Timerange: 00/13:33:01 to 00/13:36:29

Plot file version 17 created 17-NOV-2010 16:16:53

J1128+59 EP068A 5.UVDATA.1

Freq = 4.9270 GHz, Bw = 16.000 MH Calibrated with CL # 3 and BP # 1 (BP mode 1)

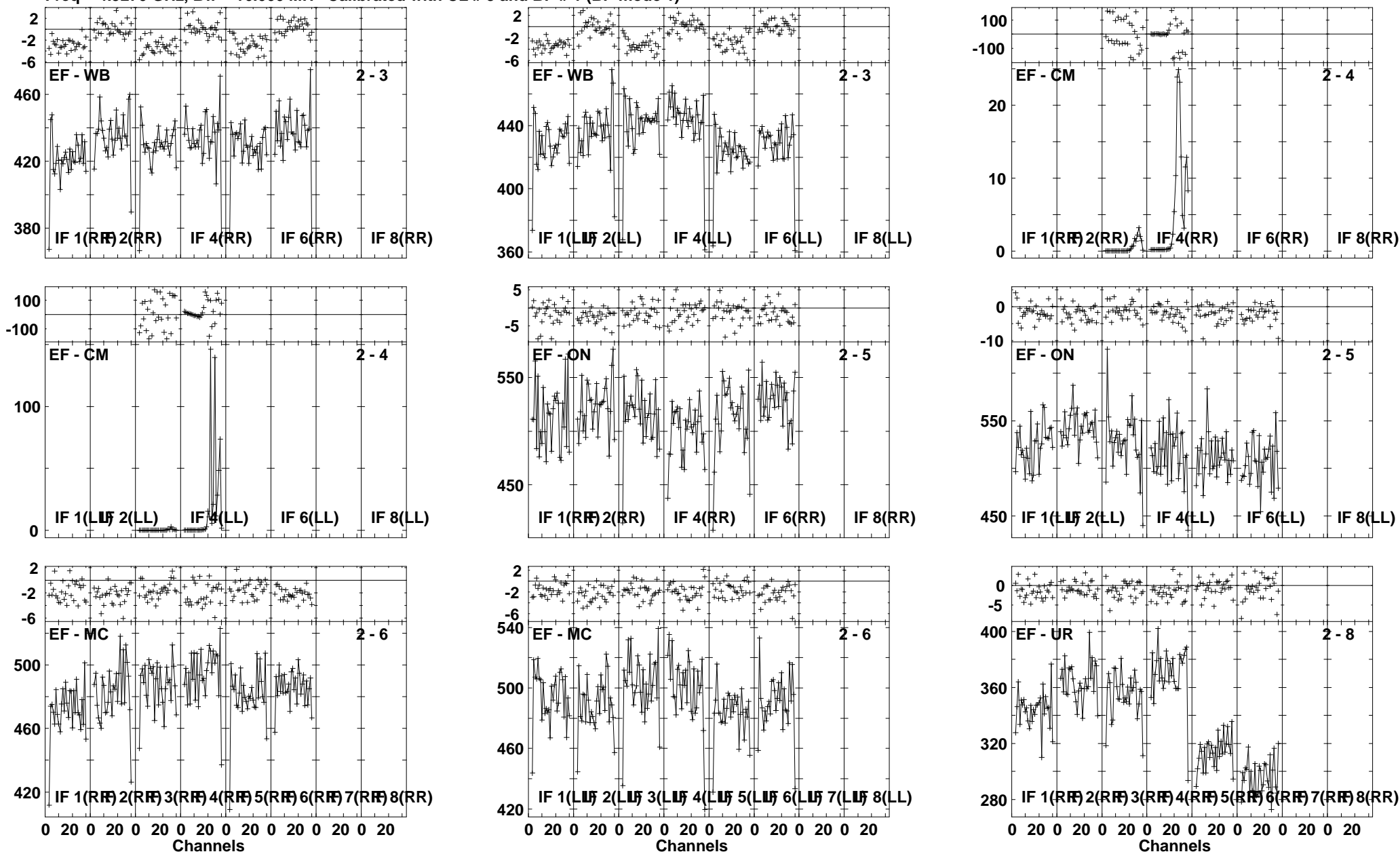

Lower frame: Milli Ampl Jy Top frame: Phas deg
Vector averaged cross-power spectrum Several baselines displayed
Timerange: 00/13:37:31 to 00/13:38:57

Plot file version 18 created 17-NOV-2010 16:16:54

J1128+59 EP068A 5.UVDATA.1

Freq = 4.9270 GHz, Bw = 16.000 MH Calibrated with CL # 3 and BP # 1 (BP mode 1)

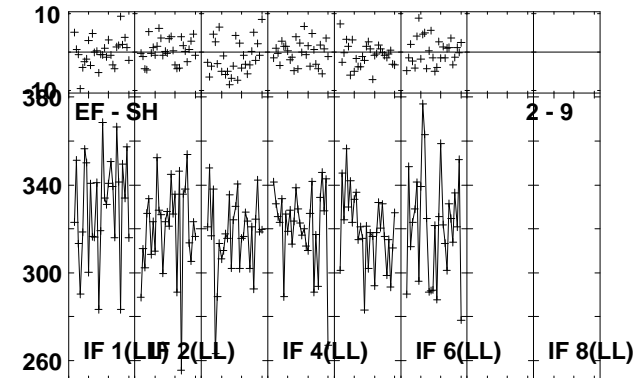
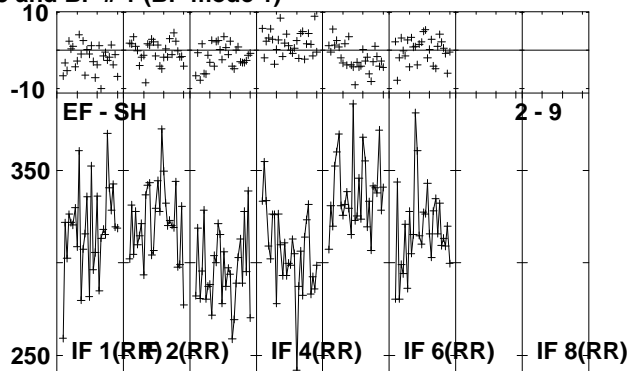
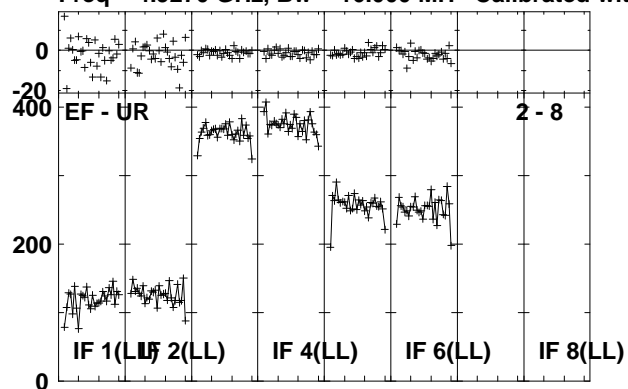

Lower frame: Milli Ampl Jy Top frame: Phas deg
Vector averaged cross-power spectrum Several baselines displayed
Timerange: 00/13:37:31 to 00/13:38:57

Plot file version 19 created 17-NOV-2010 16:16:55

ARP299D EP068A 5.UVDATA.1

Freq = 4.9270 GHz, Bw = 16.000 MH Calibrated with CL # 3 and BP # 1 (BP mode 1)

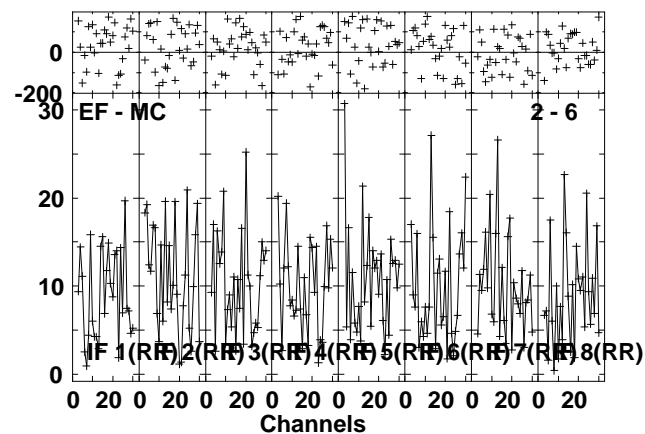
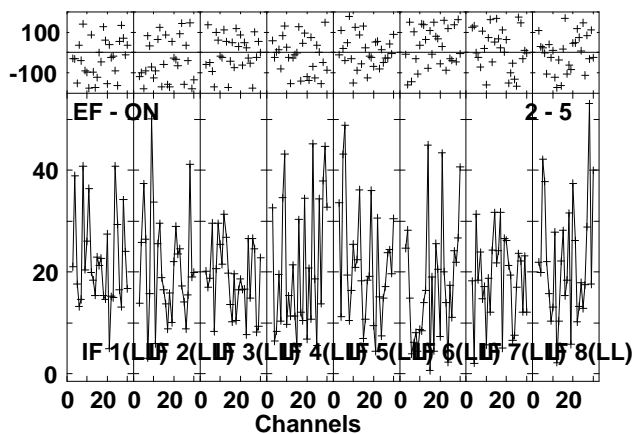
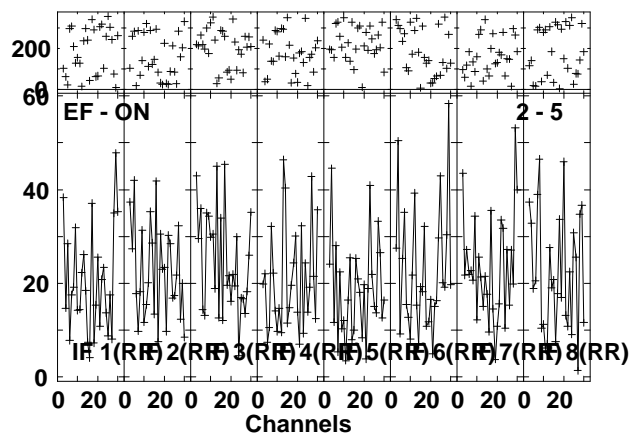
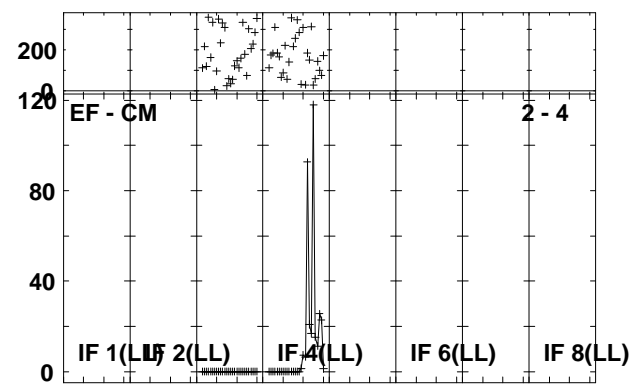
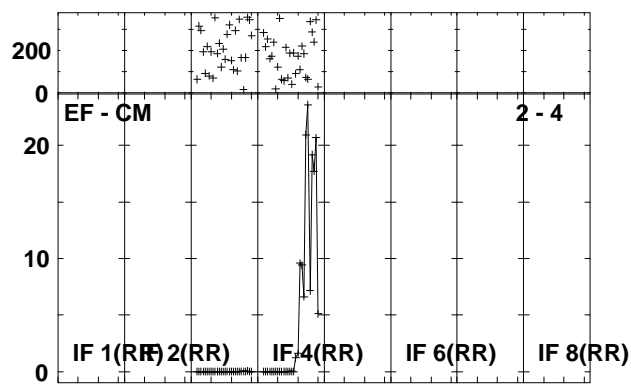
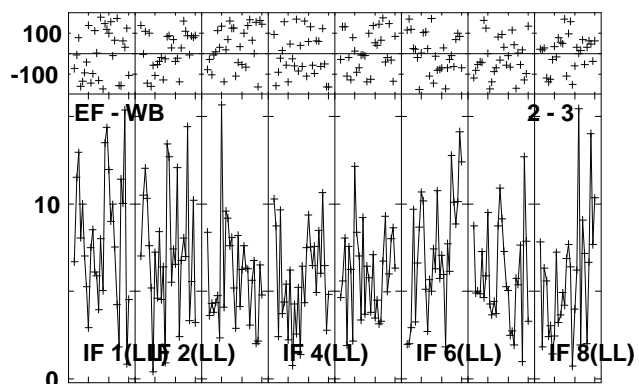
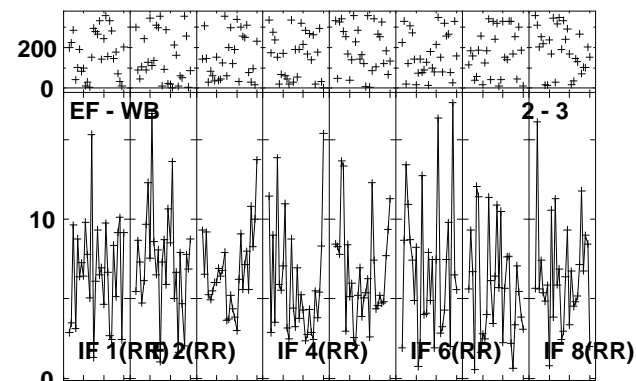
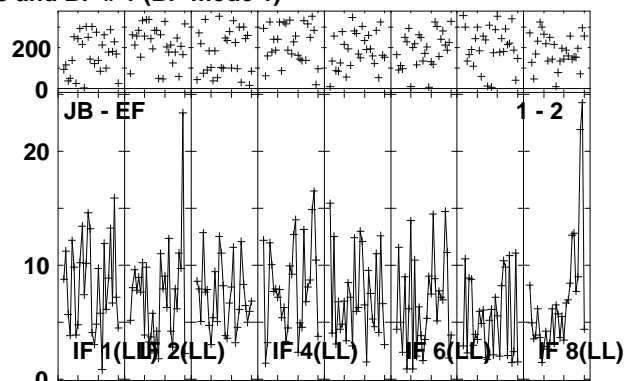
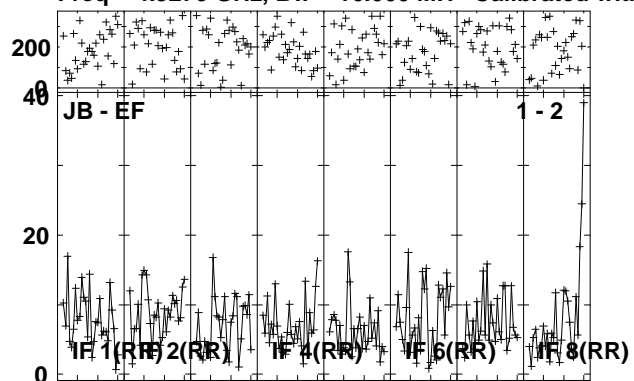

Lower frame: Milli Ampl Jy Top frame: Phas deg
Vector averaged cross-power spectrum Several baselines displayed
Timerange: 00/13:39:01 to 00/13:42:29

Plot file version 20 created 17-NOV-2010 16:16:57

ARP299D EP068A 5.UVDATA.1

Freq = 4.9270 GHz, Bw = 16.000 MH Calibrated with CL # 3 and BP # 1 (BP mode 1)

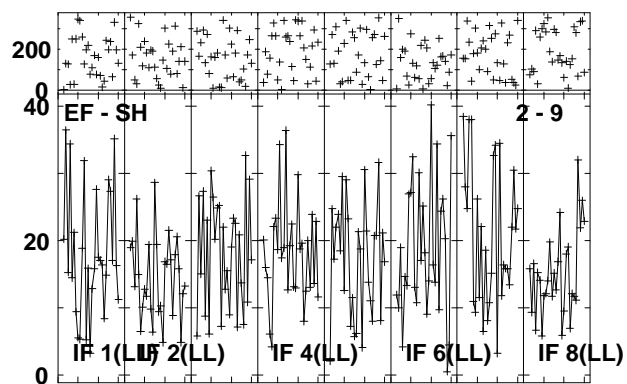
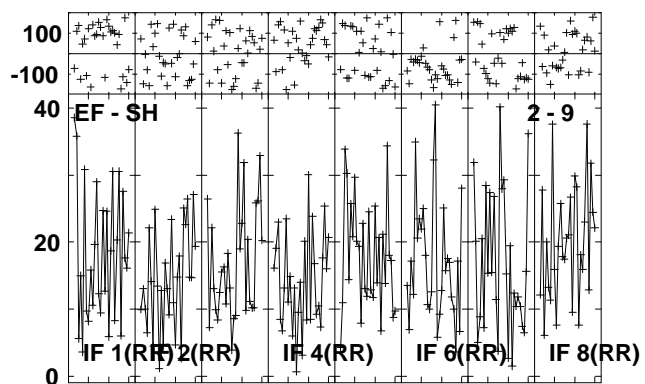
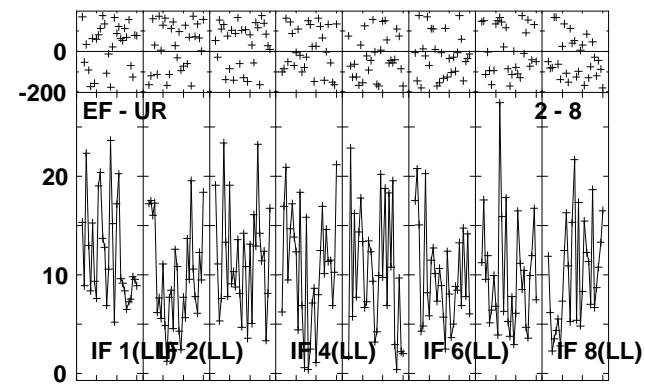
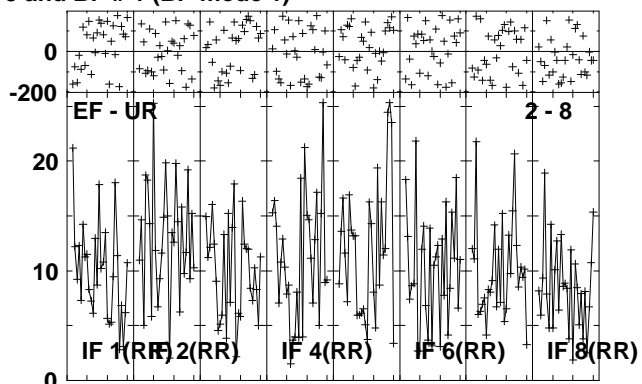
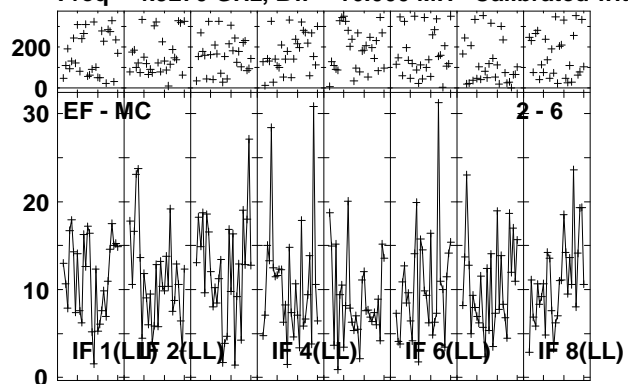

Lower frame: Milli Ampl Jy Top frame: Phas deg
Vector averaged cross-power spectrum Several baselines displayed
Timerange: 00/13:39:01 to 00/13:42:29

Plot file version 21 created 17-NOV-2010 16:16:59

J1128+59 EP068A 5.UVDATA.1

Freq = 4.9270 GHz, Bw = 16.000 MH Calibrated with CL # 3 and BP # 1 (BP mode 1)

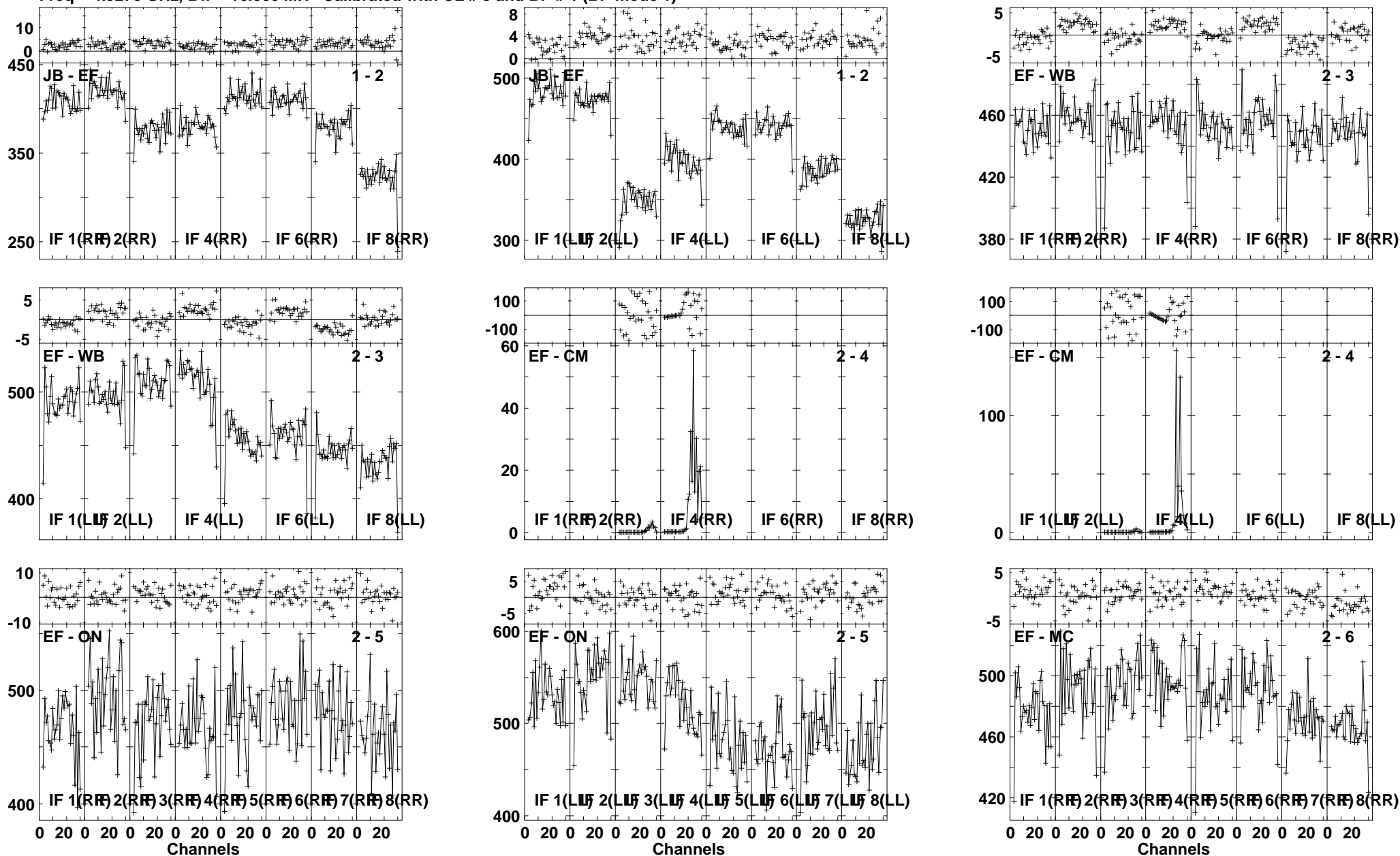

Lower frame: Milli Ampl Jy Top frame: Phas deg
Vector averaged cross-power spectrum Several baselines displayed
Timerange: 00/13:42:31 to 00/13:43:59

Plot file version 22 created 17-NOV-2010 16:17:00

J1128+59 EP068A 5.UVDATA.1

Freq = 4.9270 GHz, Bw = 16.000 MH Calibrated with CL # 3 and BP # 1 (BP mode 1)

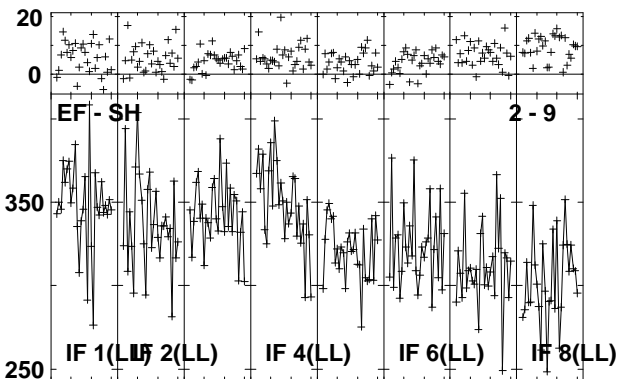
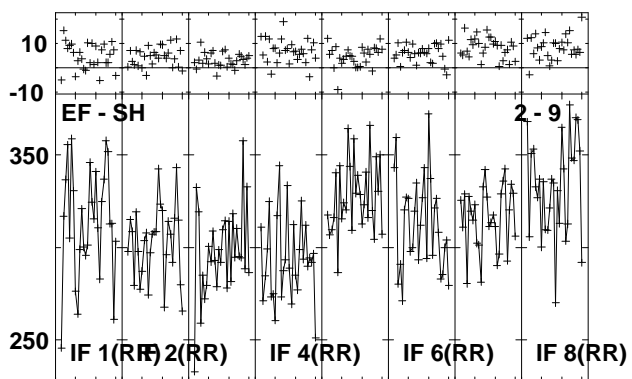
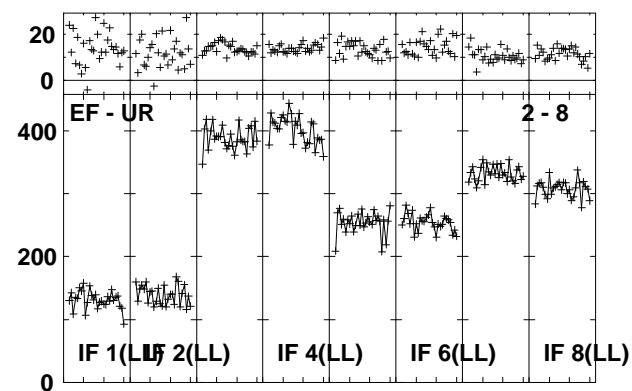
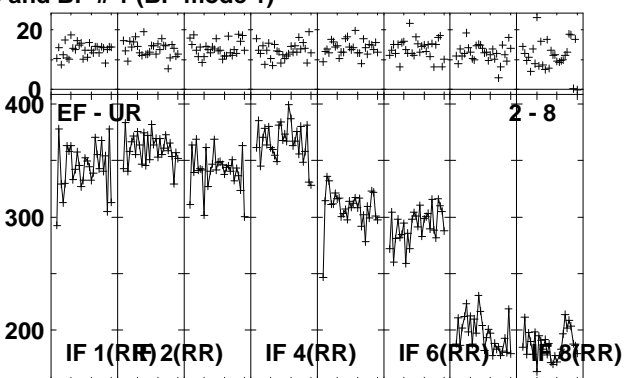
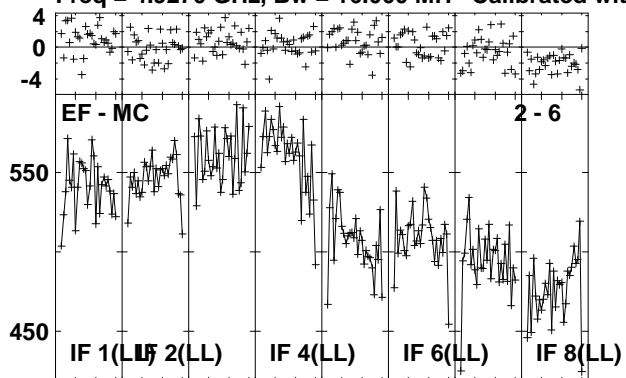

Lower frame: Milli Ampl Jy Top frame: Phas deg
Vector averaged cross-power spectrum Several baselines displayed
Timerange: 00/13:42:31 to 00/13:43:59

Plot file version 23 created 17-NOV-2010 16:17:01

ARP299D EP068A 5.UVDATA.1

Freq = 4.9270 GHz, Bw = 16.000 MH Calibrated with CL # 3 and BP # 1 (BP mode 1)

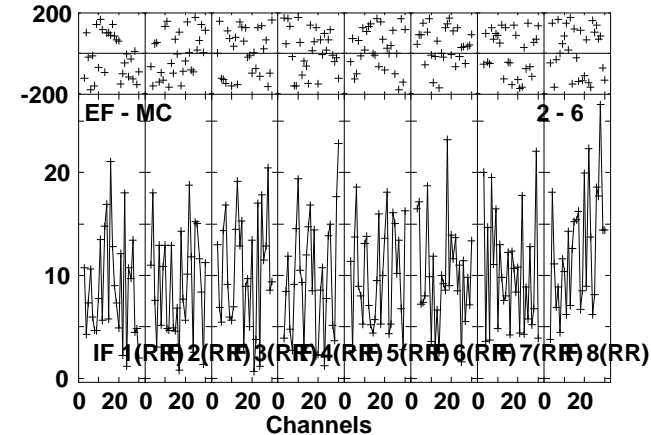
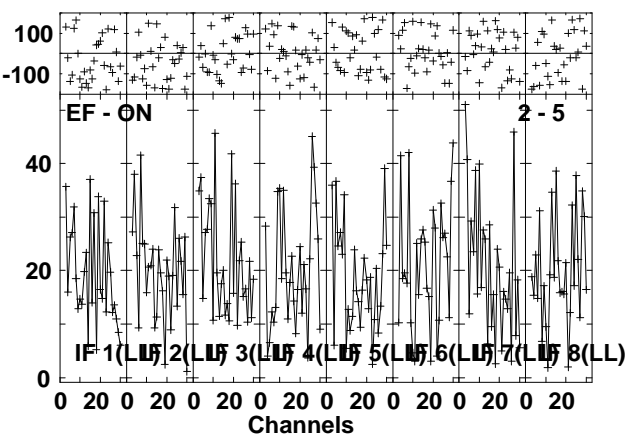
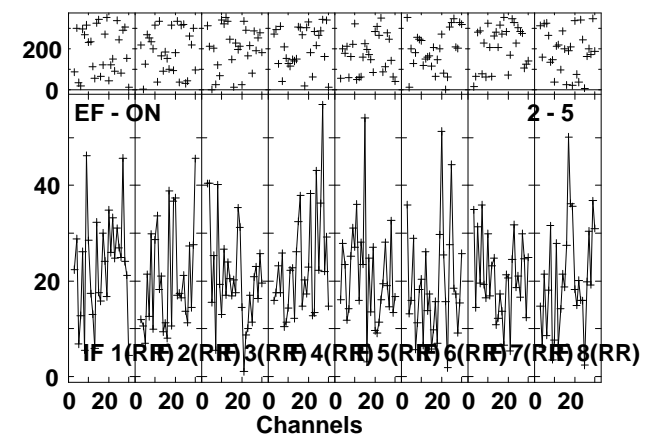
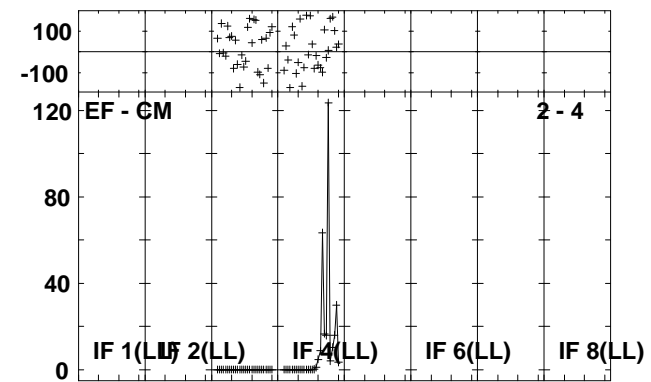
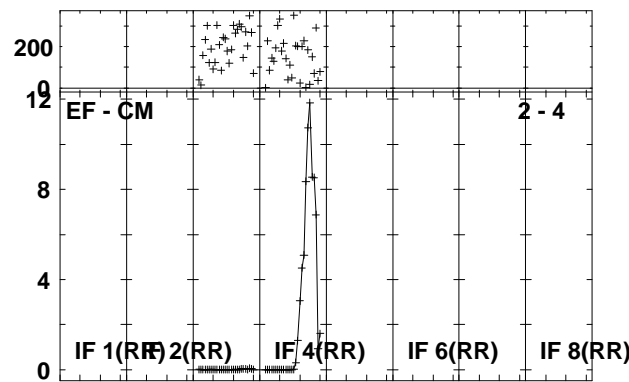
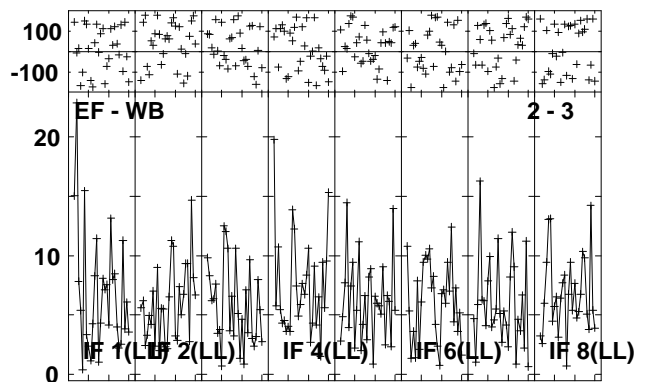
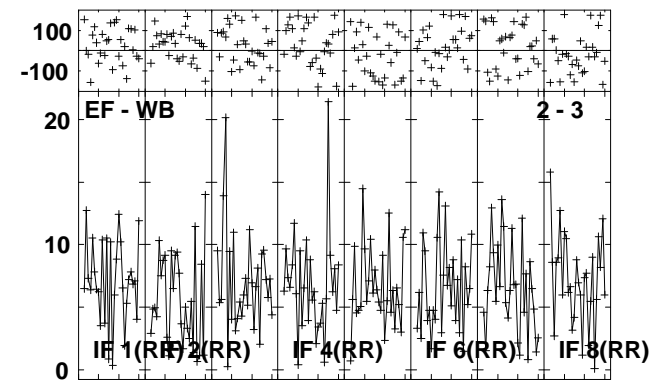
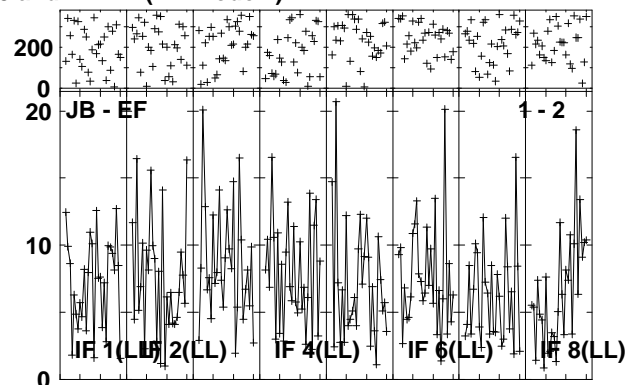
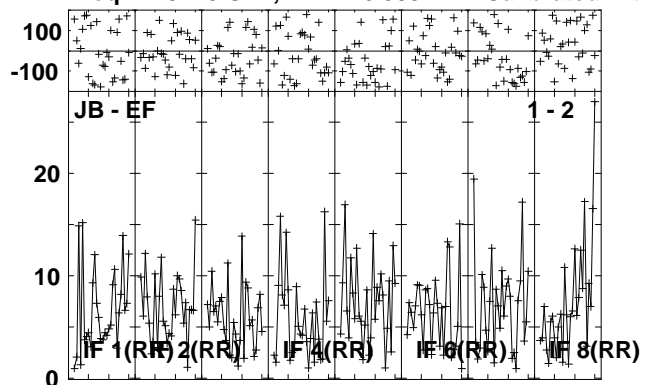

Lower frame: Milli Ampl Jy Top frame: Phas deg
Vector averaged cross-power spectrum Several baselines displayed
Timerange: 00/13:44:01 to 00/13:47:29

Plot file version 24 created 17-NOV-2010 16:17:03

ARP299D EP068A 5.UVDATA.1

Freq = 4.9270 GHz, Bw = 16.000 MH Calibrated with CL # 3 and BP # 1 (BP mode 1)

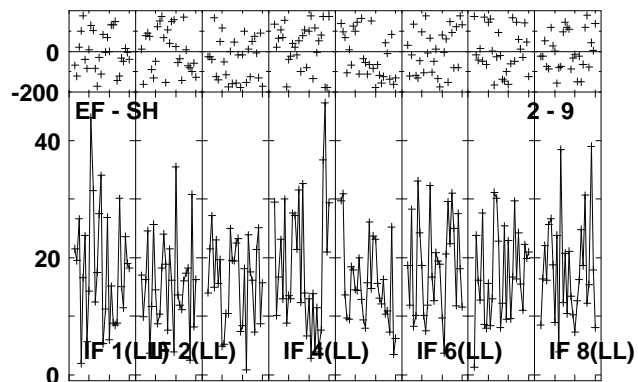
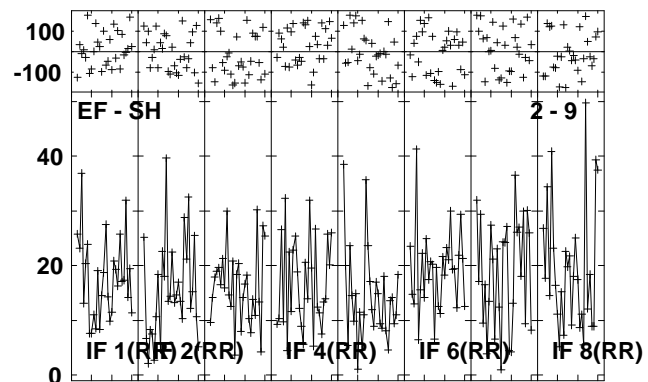
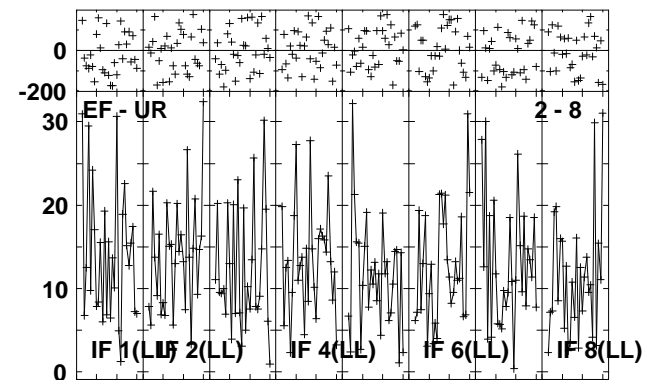
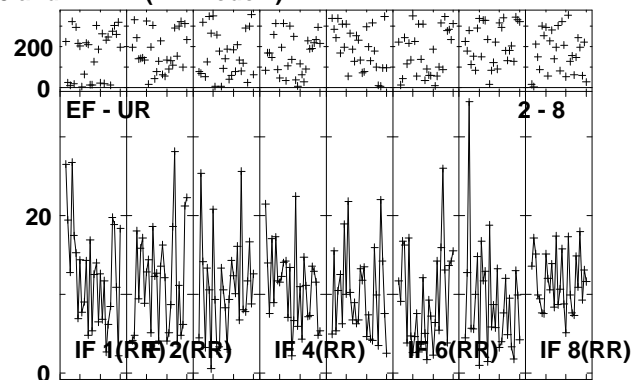
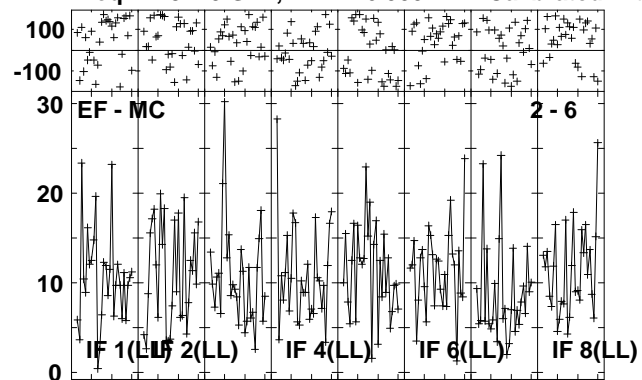

Lower frame: Milli Ampl Jy Top frame: Phas deg
Vector averaged cross-power spectrum Several baselines displayed
Timerange: 00/13:44:01 to 00/13:47:29

Plot file version 25 created 17-NOV-2010 16:17:06

J1128+59 EP068A 5.UVDATA.1

Freq = 4.9270 GHz, Bw = 16.000 MH Calibrated with CL # 3 and BP # 1 (BP mode 1)

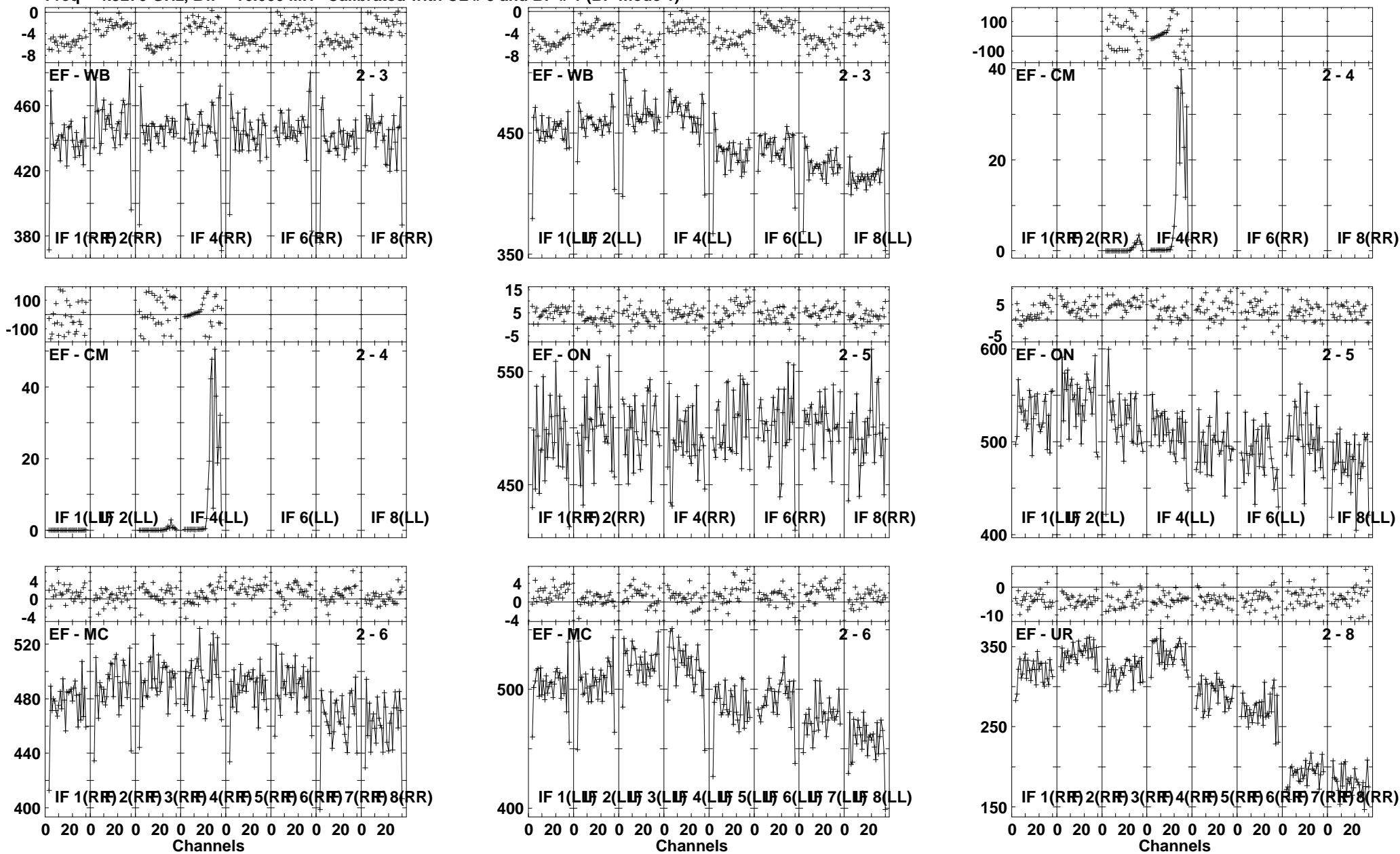

Lower frame: Milli Ampl Jy Top frame: Phas deg
Vector averaged cross-power spectrum Several baselines displayed
Timerange: 00/13:48:31 to 00/13:49:57

Plot file version 26 created 17-NOV-2010 16:17:06

J1128+59 EP068A 5.UVDATA.1

Freq = 4.9270 GHz, Bw = 16.000 MH Calibrated with CL # 3 and BP # 1 (BP mode 1)

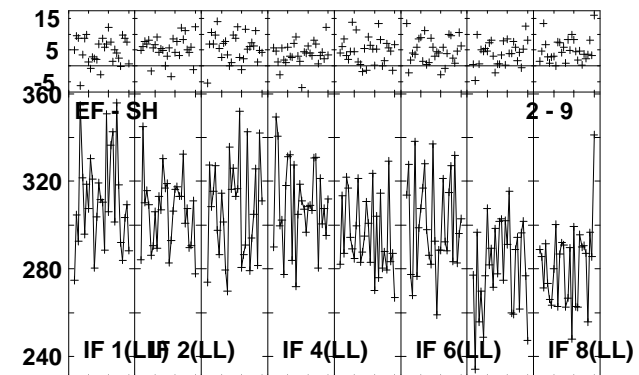
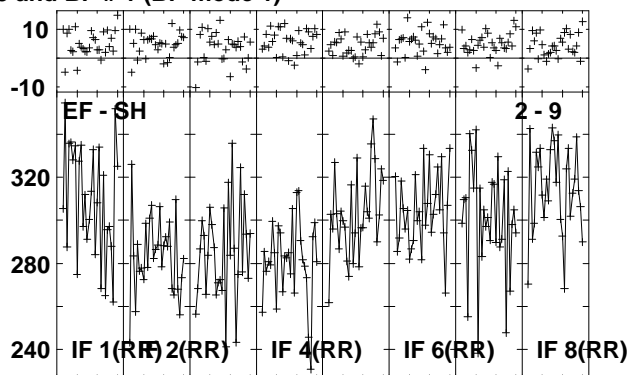
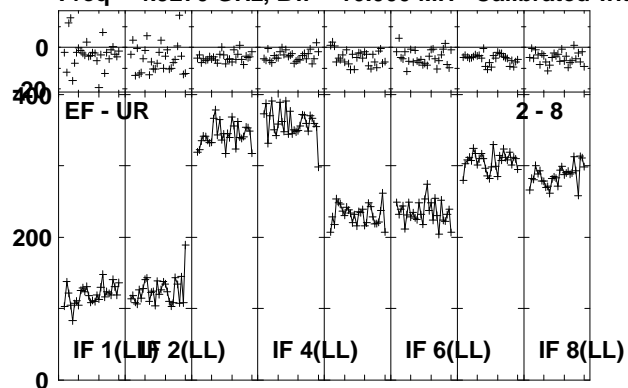

Lower frame: Milli Ampl Jy Top frame: Phas deg
Vector averaged cross-power spectrum Several baselines displayed
Timerange: 00/13:48:31 to 00/13:49:57

Plot file version 27 created 17-NOV-2010 16:17:07

ARP299D EP068A 5.UVDATA.1

Freq = 4.9270 GHz, Bw = 16.000 MH Calibrated with CL # 3 and BP # 1 (BP mode 1)

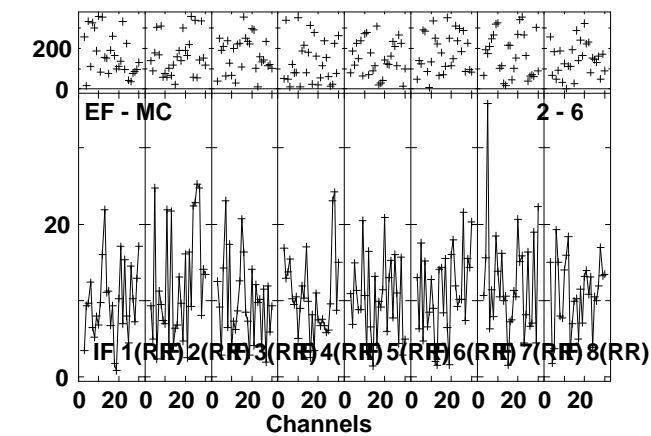
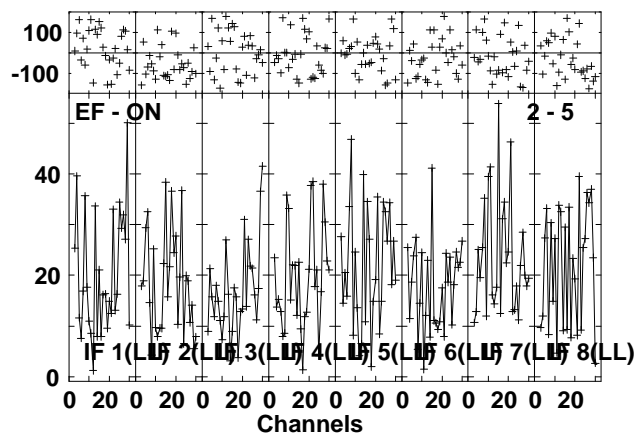
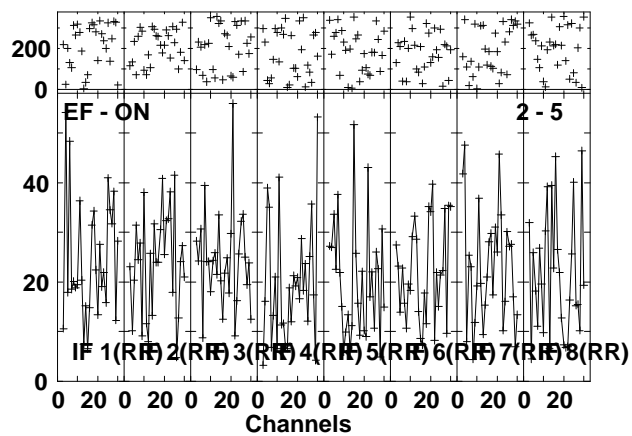
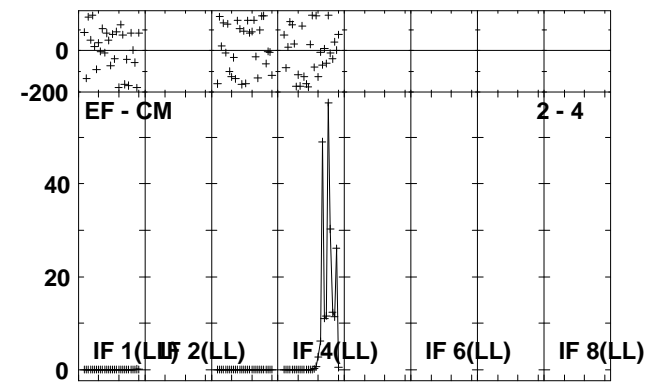
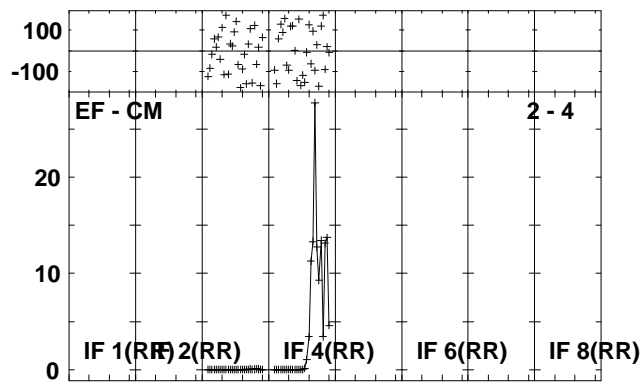
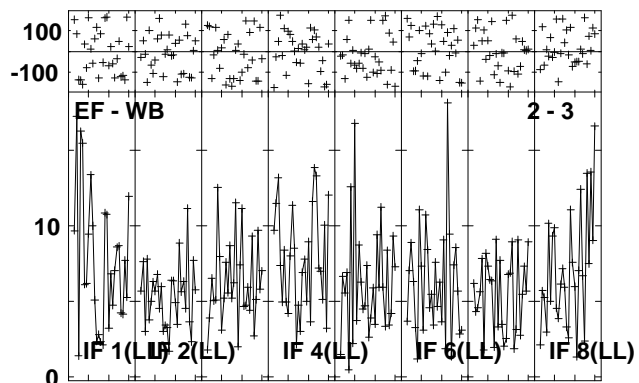
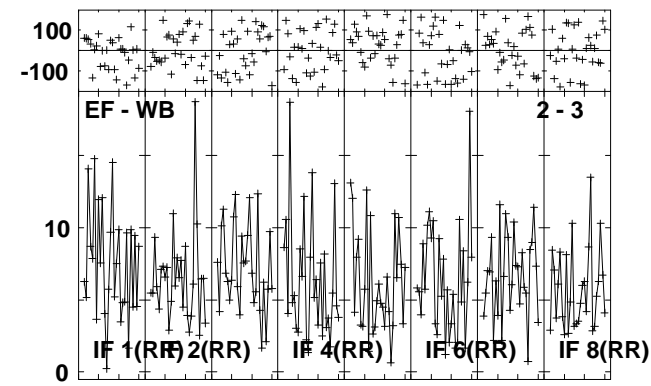
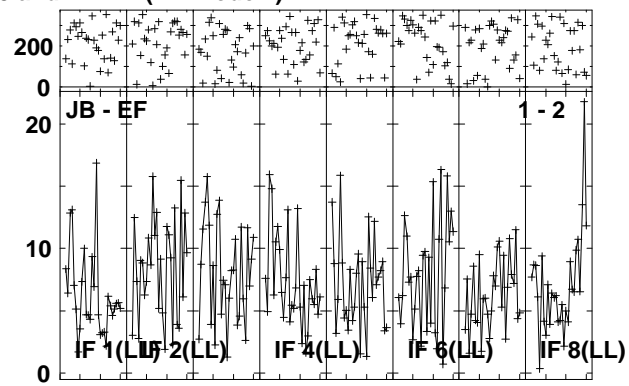
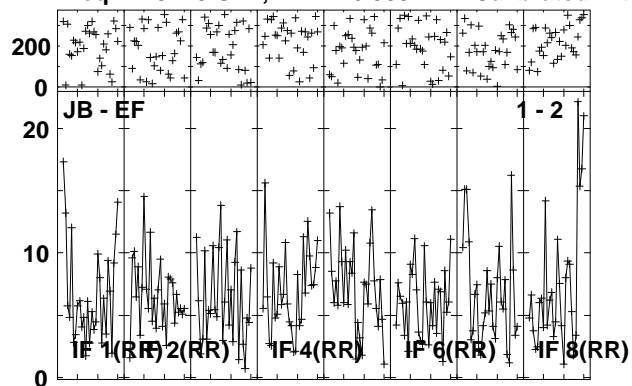

Lower frame: Milli Ampl Jy Top frame: Phas deg
Vector averaged cross-power spectrum Several baselines displayed
Timerange: 00/13:50:01 to 00/13:53:29

Plot file version 28 created 17-NOV-2010 16:17:09

ARP299D EP068A 5.UVDATA.1

Freq = 4.9270 GHz, Bw = 16.000 MH Calibrated with CL # 3 and BP # 1 (BP mode 1)

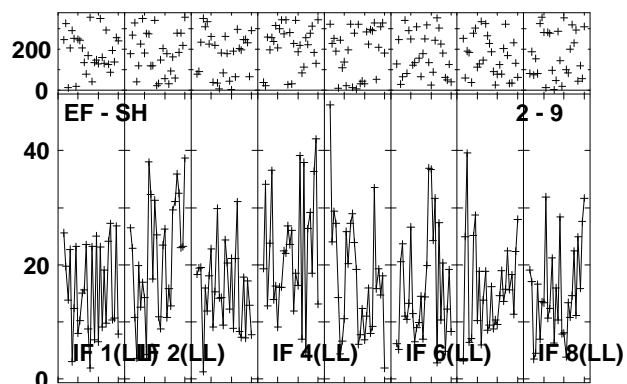
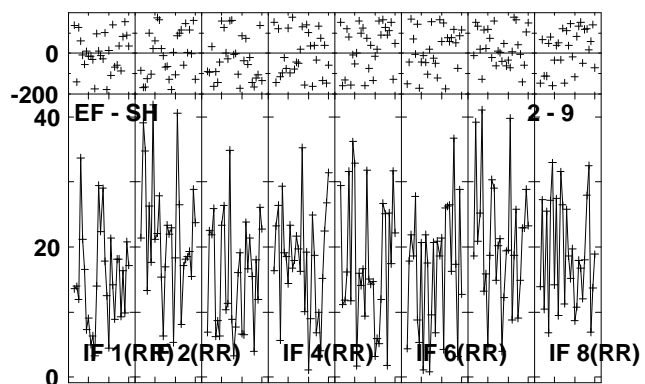
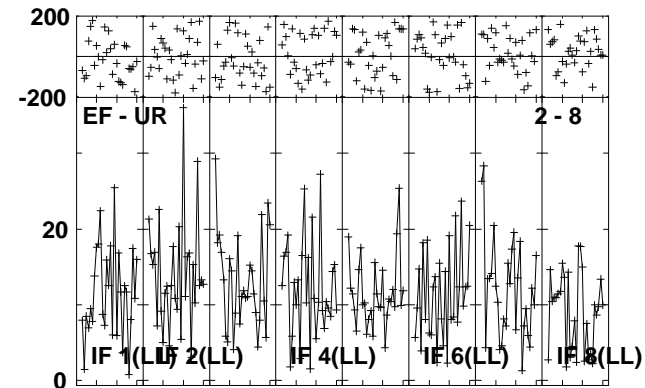
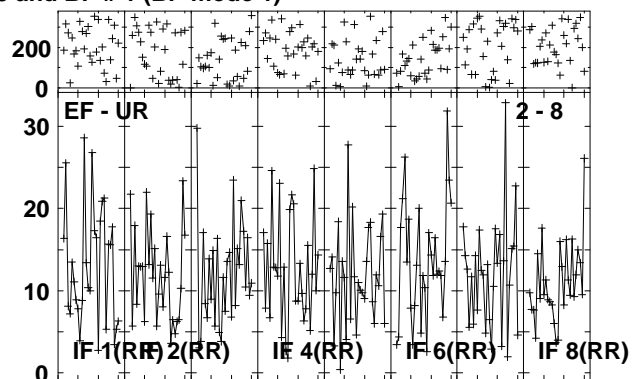
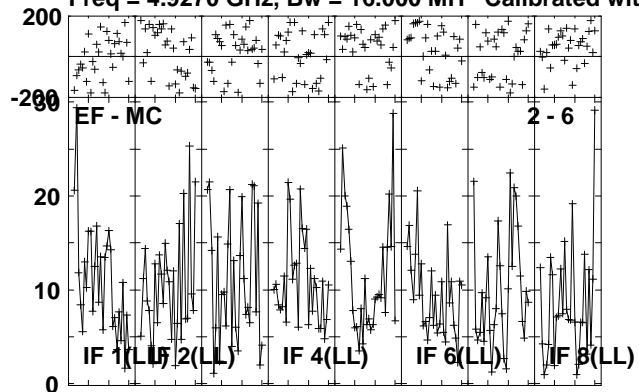

Lower frame: Milli Ampl Jy Top frame: Phas deg
Vector averaged cross-power spectrum Several baselines displayed
Timerange: 00/13:50:01 to 00/13:53:29

Plot file version 29 created 17-NOV-2010 16:17:11

J1128+59 EP068A 5.UVDATA.1

Freq = 4.9270 GHz, Bw = 16.000 MH Calibrated with CL # 3 and BP # 1 (BP mode 1)

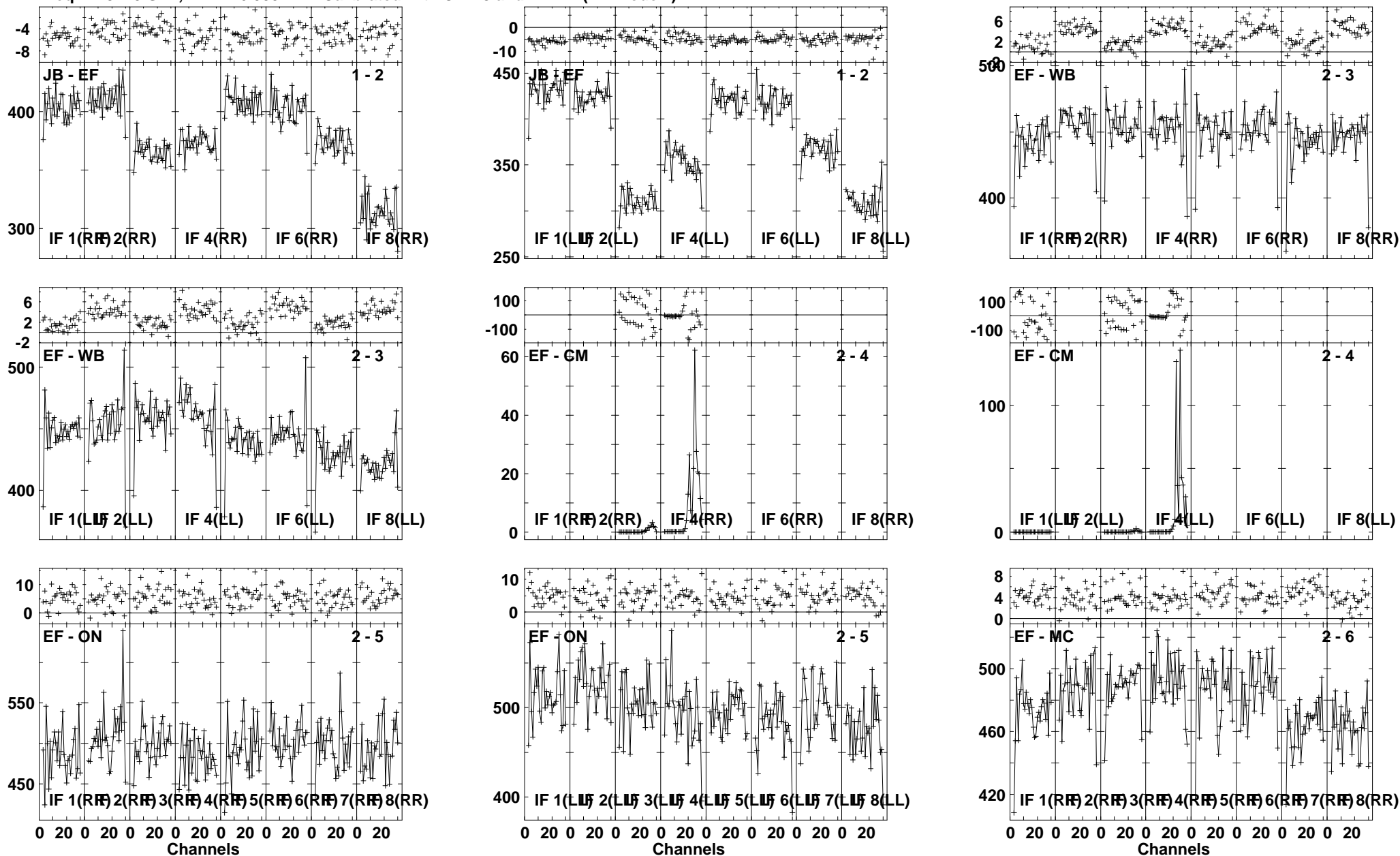

Lower frame: Milli Ampl Jy Top frame: Phas deg
Vector averaged cross-power spectrum Several baselines displayed
Timerange: 00/13:53:31 to 00/13:54:59

Plot file version 30 created 17-NOV-2010 16:17:12

J1128+59 EP068A 5.UVDATA.1

Freq = 4.9270 GHz, Bw = 16.000 MH Calibrated with CL # 3 and BP # 1 (BP mode 1)

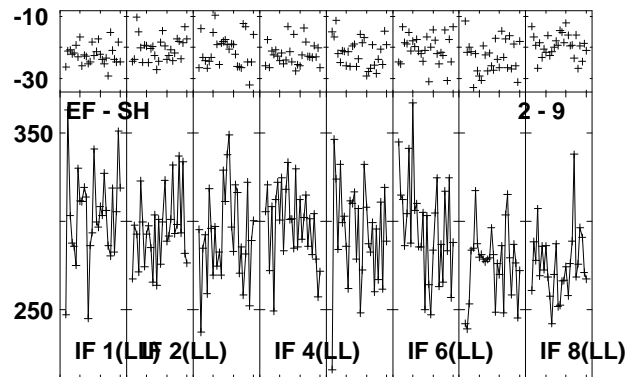
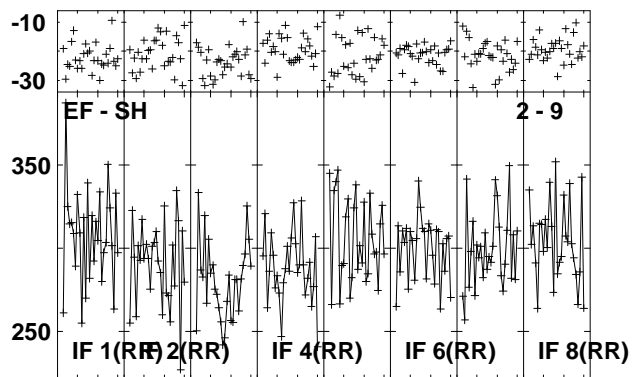
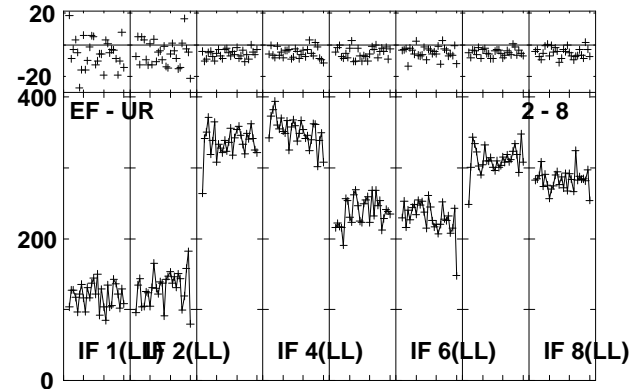
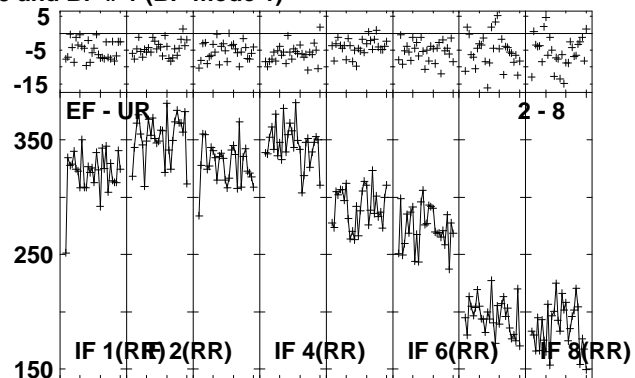
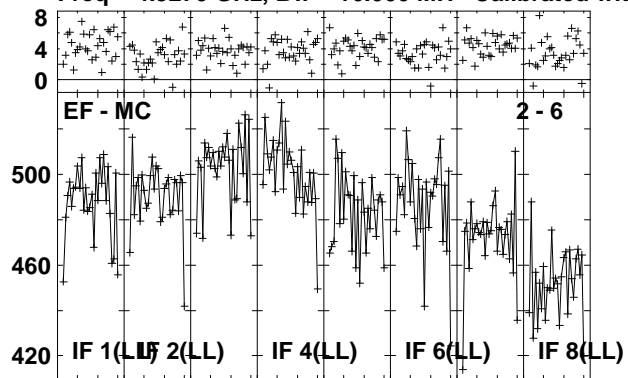

Lower frame: Milli Ampl Jy Top frame: Phas deg
Vector averaged cross-power spectrum Several baselines displayed
Timerange: 00/13:53:31 to 00/13:54:59

Plot file version 31 created 17-NOV-2010 16:17:13

ARP299D EP068A 5.UVDATA.1

Freq = 4.9270 GHz, Bw = 16.000 MH Calibrated with CL # 3 and BP # 1 (BP mode 1)

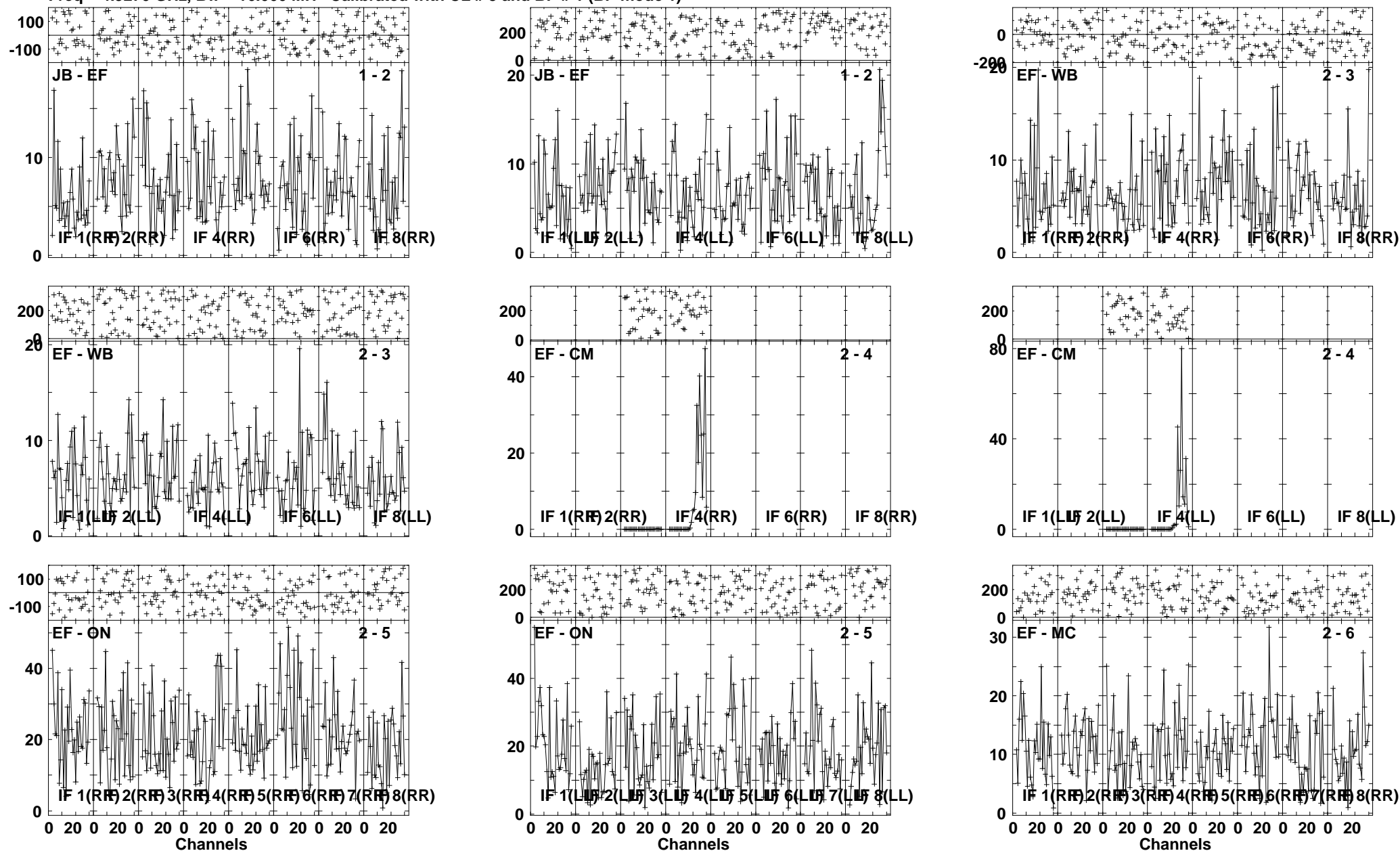

Lower frame: Milli Ampl Jy Top frame: Phas deg
Vector averaged cross-power spectrum Several baselines displayed
Timerange: 00/13:55:01 to 00/13:58:29

Plot file version 32 created 17-NOV-2010 16:17:15

ARP299D EP068A 5.UVDATA.1

Freq = 4.9270 GHz, Bw = 16.000 MH Calibrated with CL # 3 and BP # 1 (BP mode 1)

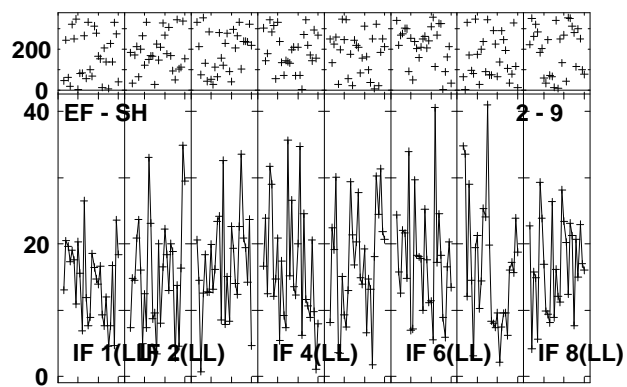
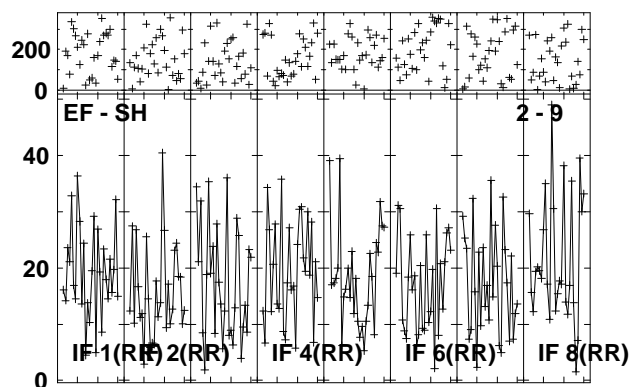
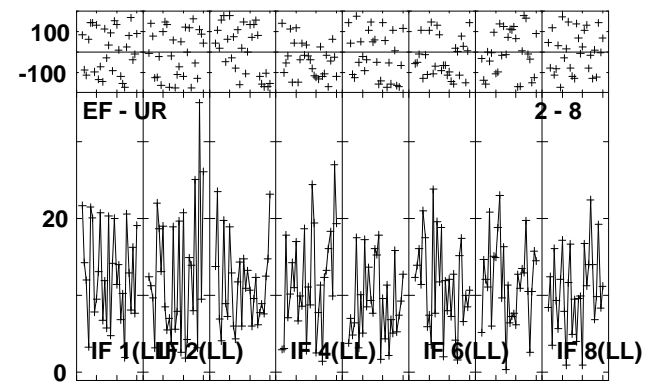
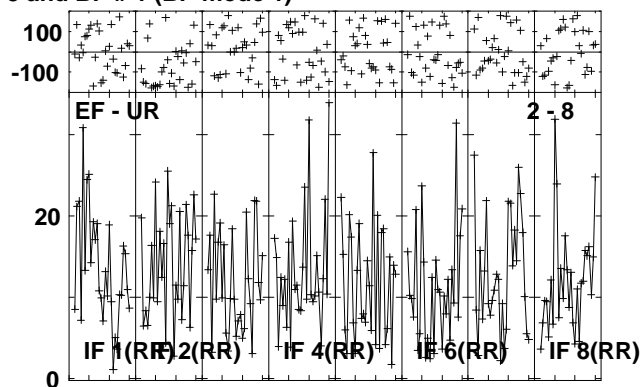
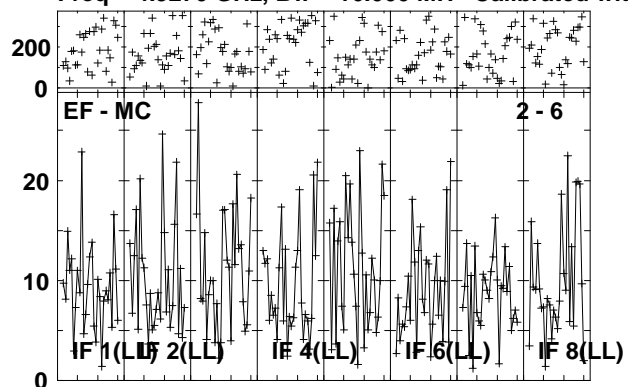

Lower frame: Milli Ampl Jy Top frame: Phas deg
Vector averaged cross-power spectrum Several baselines displayed
Timerange: 00/13:55:01 to 00/13:58:29

Plot file version 33 created 17-NOV-2010 16:17:18

J1128+59 EP068A 5.UVDATA.1

Freq = 4.9270 GHz, Bw = 16.000 MH Calibrated with CL # 3 and BP # 1 (BP mode 1)

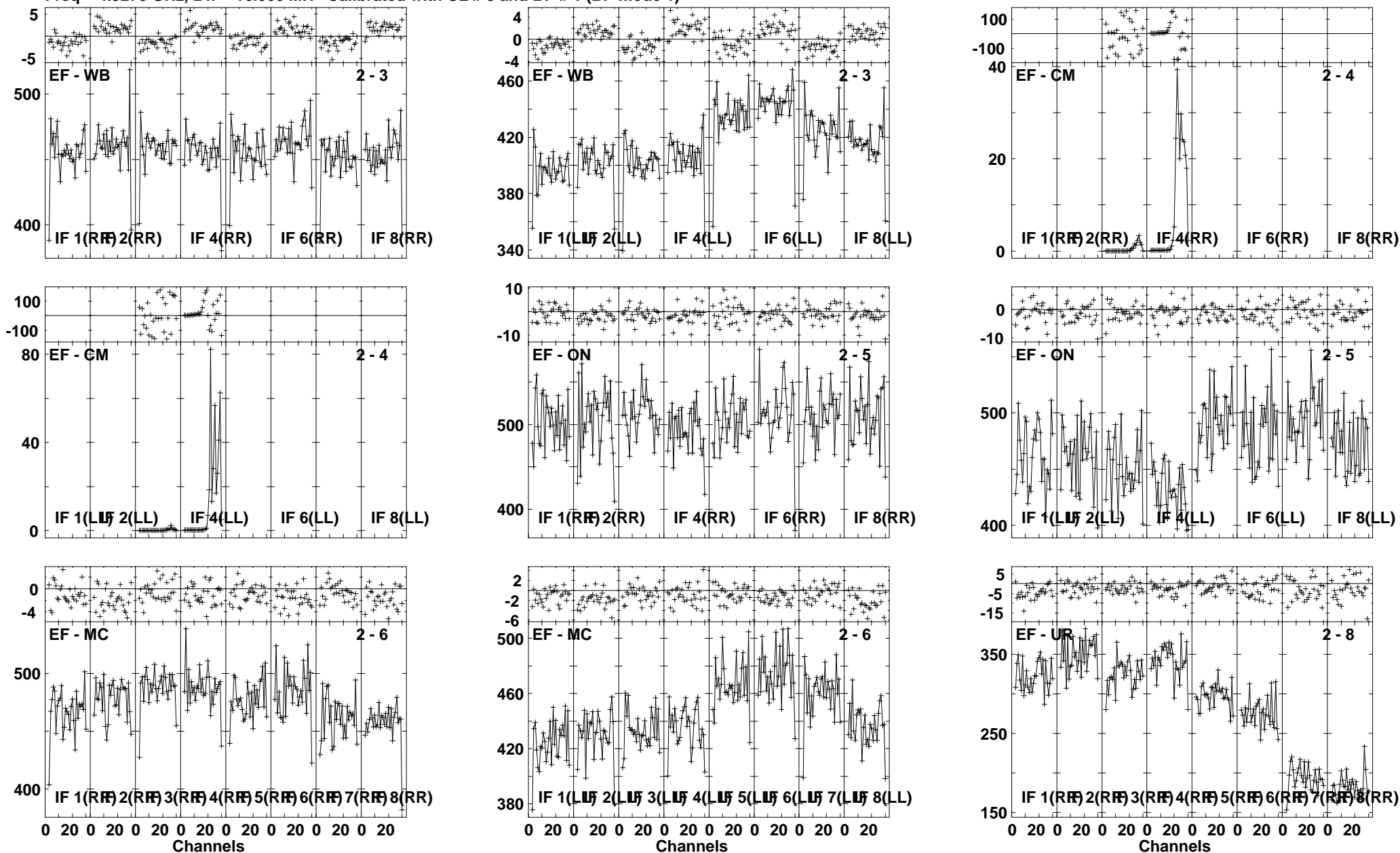

Lower frame: Milli Ampl Jy Top frame: Phas deg
Vector averaged cross-power spectrum Several baselines displayed
Timerange: 00/13:58:31 to 00/13:59:59

Plot file version 34 created 17-NOV-2010 16:17:18

J1128+59 EP068A 5.UVDATA.1

Freq = 4.9270 GHz, Bw = 16.000 MH Calibrated with CL # 3 and BP # 1 (BP mode 1)

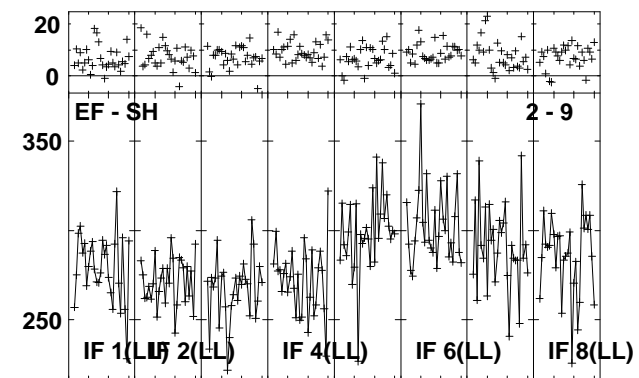
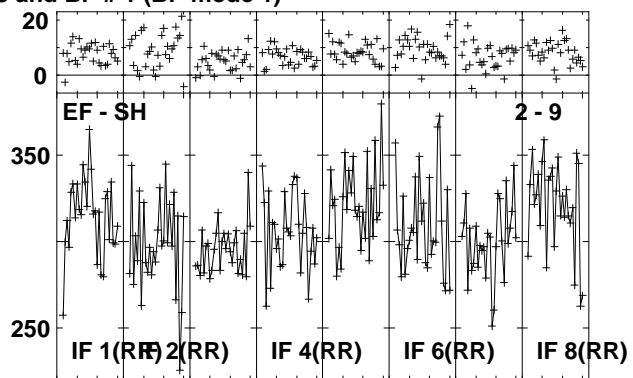
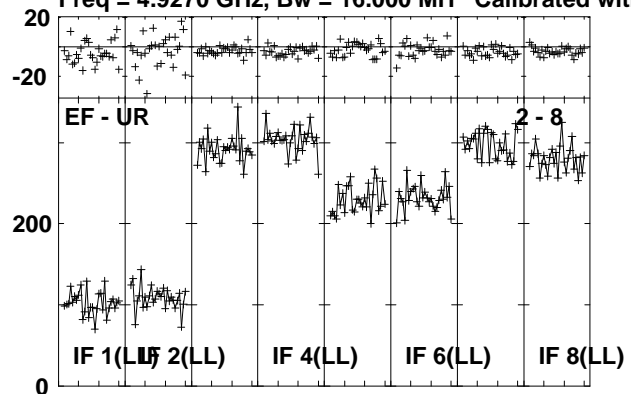

Lower frame: Milli Ampl Jy Top frame: Phas deg
Vector averaged cross-power spectrum Several baselines displayed
Timerange: 00/13:58:31 to 00/13:59:59

Plot file version 35 created 17-NOV-2010 16:17:19

ARP299D EP068A 5.UVDATA.1

Freq = 4.9270 GHz, Bw = 16.000 MH Calibrated with CL # 3 and BP # 1 (BP mode 1)

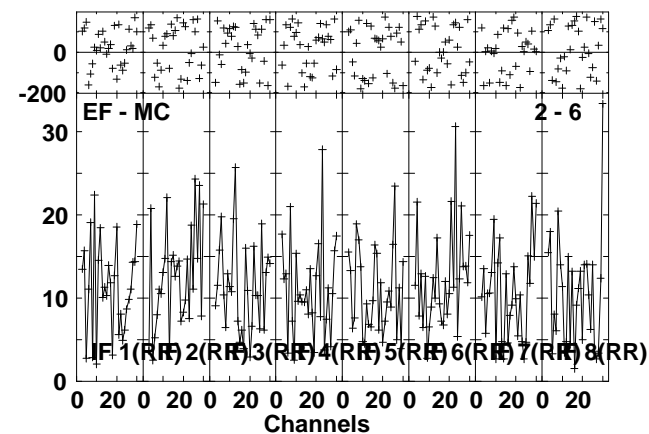
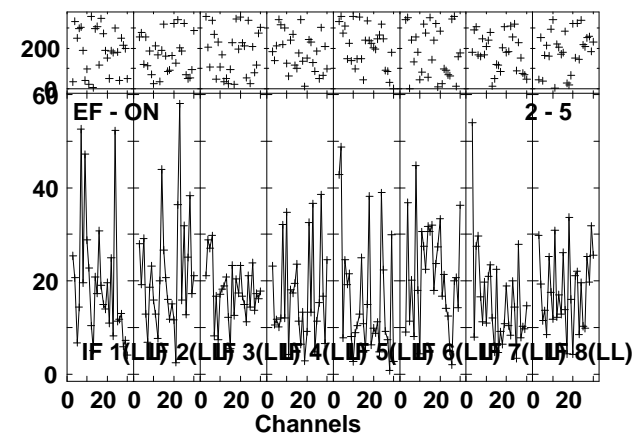
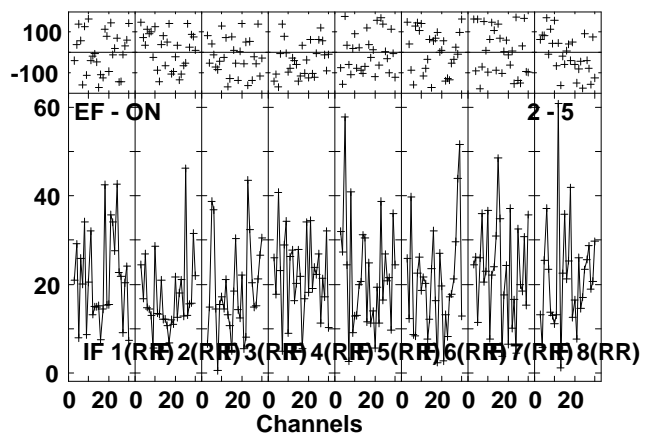
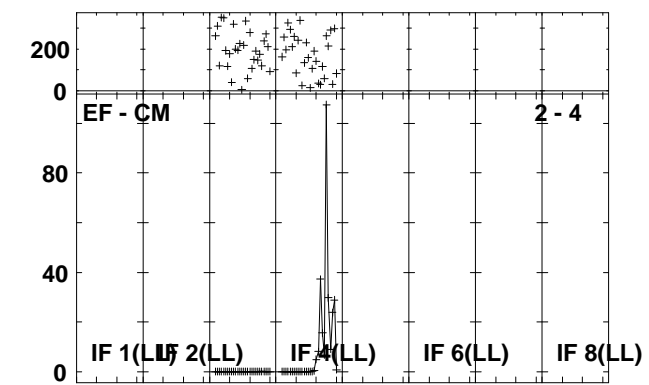
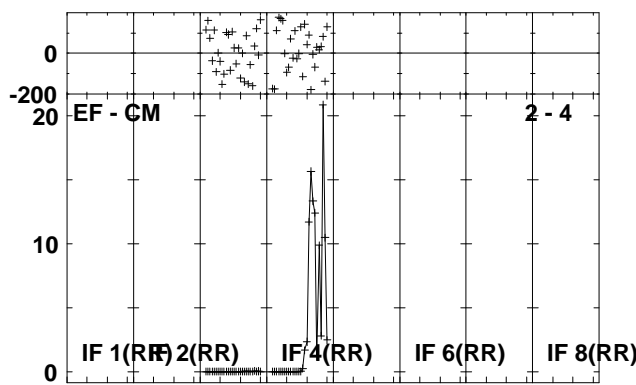
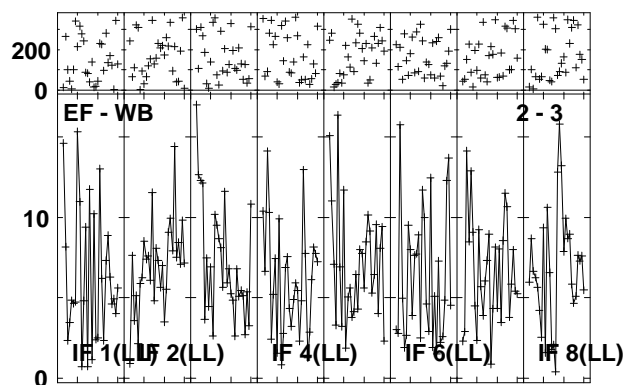
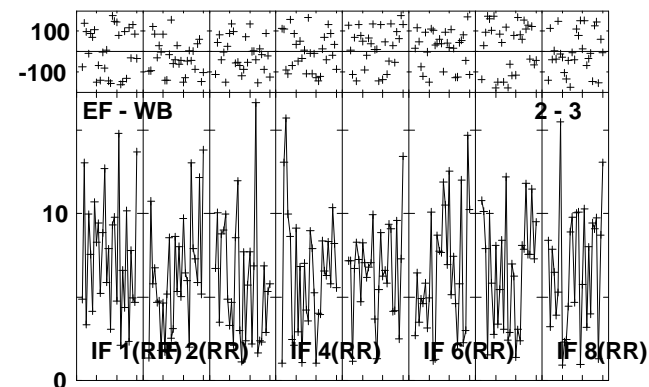
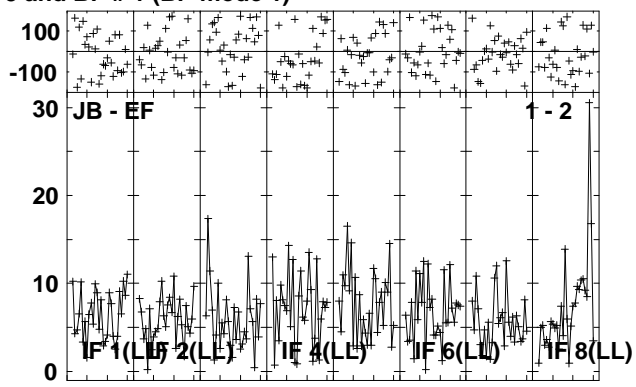
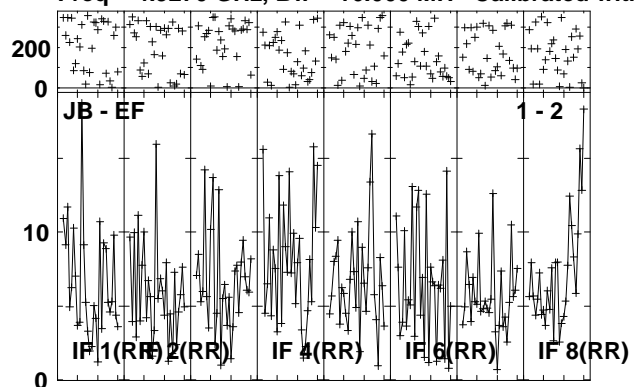

Lower frame: Milli Ampl Jy Top frame: Phas deg
Vector averaged cross-power spectrum Several baselines displayed
Timerange: 00/14:00:01 to 00/14:03:29

Plot file version 36 created 17-NOV-2010 16:17:21

ARP299D EP068A 5.UVDATA.1

Freq = 4.9270 GHz, Bw = 16.000 MH Calibrated with CL # 3 and BP # 1 (BP mode 1)

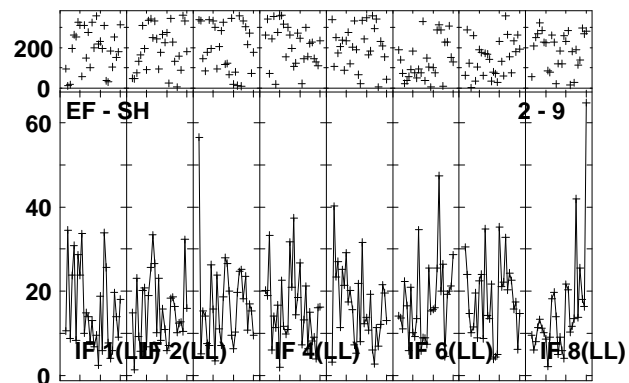
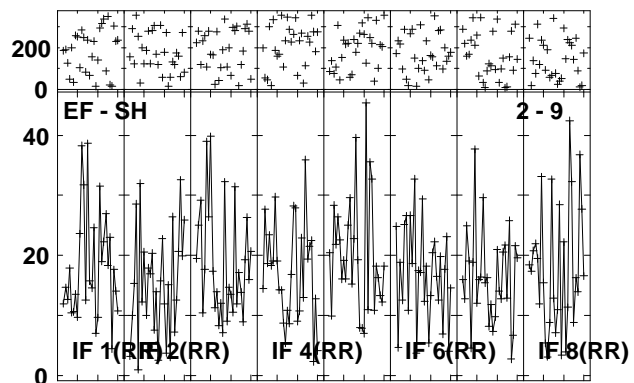
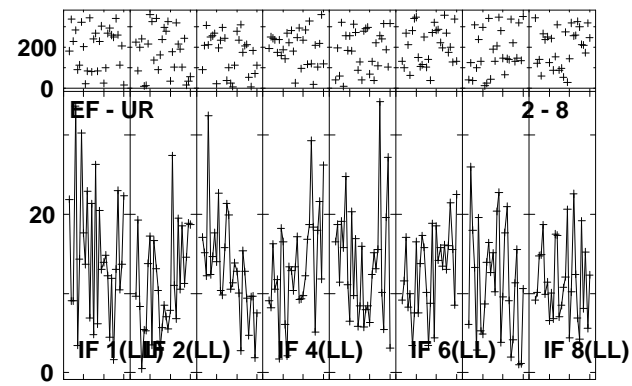
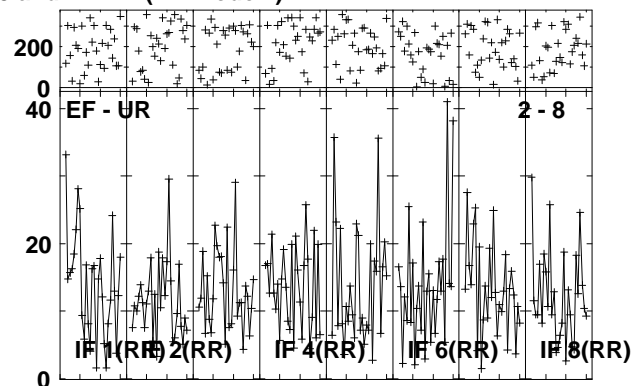
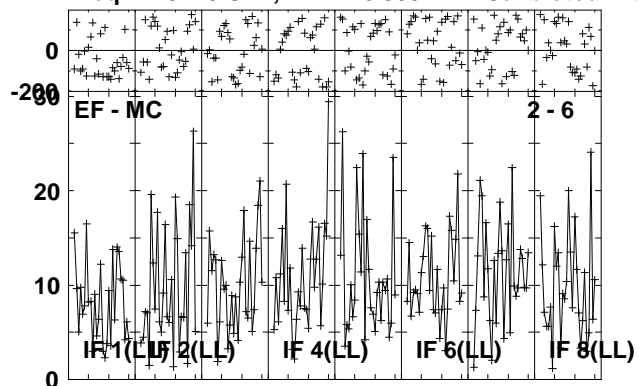

Lower frame: Milli Ampl Jy Top frame: Phas deg
Vector averaged cross-power spectrum Several baselines displayed
Timerange: 00/14:00:01 to 00/14:03:29

Plot file version 37 created 17-NOV-2010 16:17:23

J1128+59 EP068A 5.UVDATA.1

Freq = 4.9270 GHz, Bw = 16.000 MH Calibrated with CL # 3 and BP # 1 (BP mode 1)

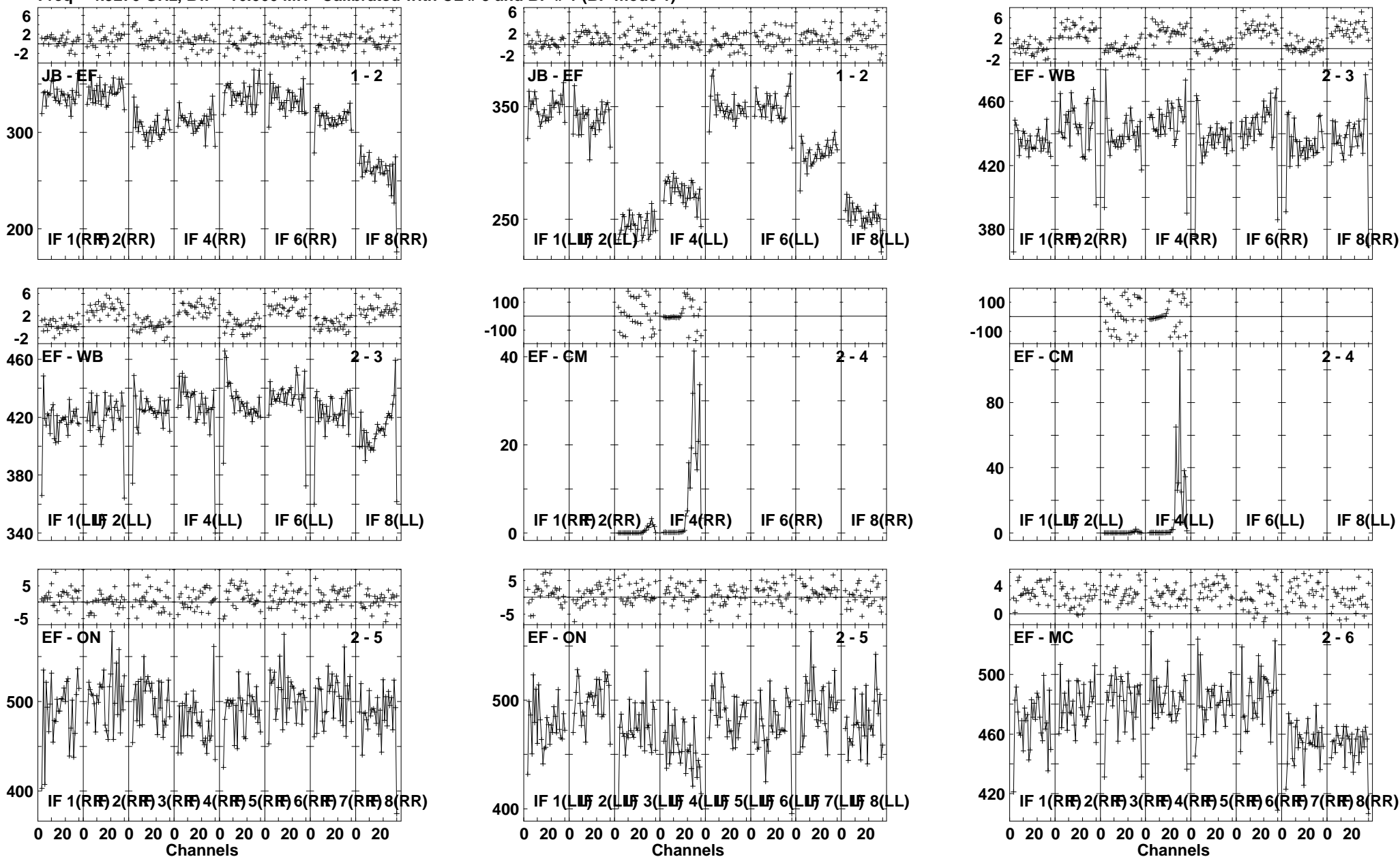

Lower frame: Milli Ampl Jy Top frame: Phas deg
Vector averaged cross-power spectrum Several baselines displayed
Timerange: 00/14:04:31 to 00/14:05:59

Plot file version 38 created 17-NOV-2010 16:17:25

J1128+59 EP068A 5.UVDATA.1

Freq = 4.9270 GHz, Bw = 16.000 MH Calibrated with CL # 3 and BP # 1 (BP mode 1)

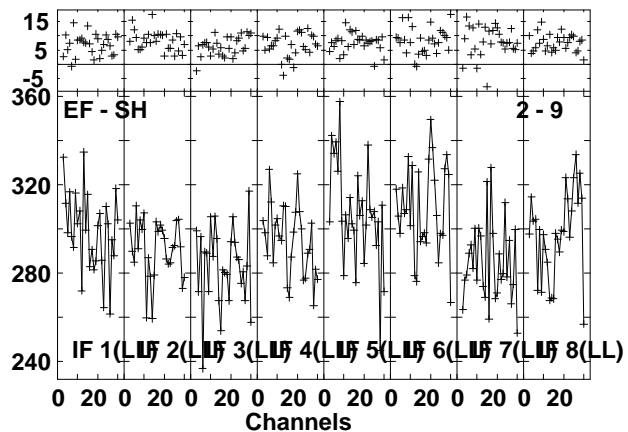
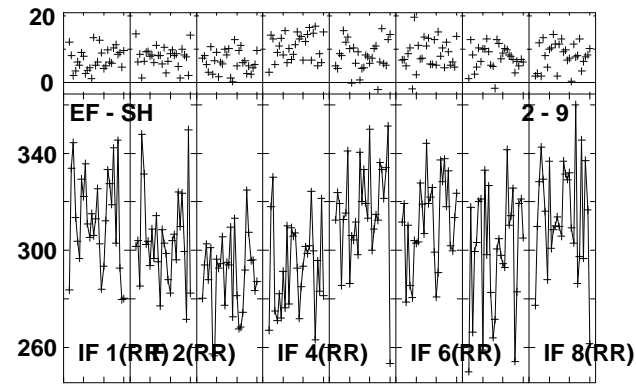
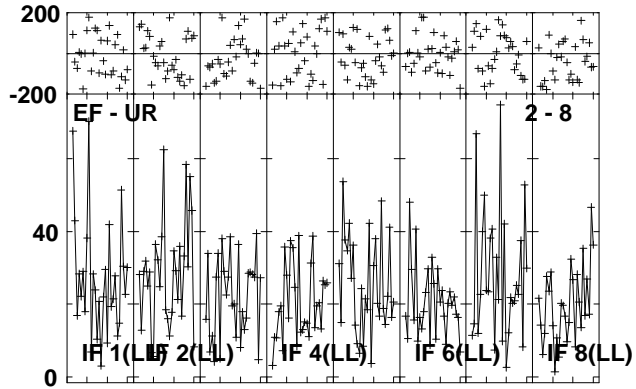
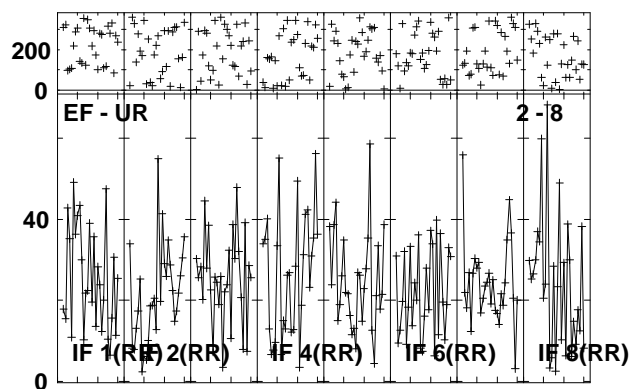
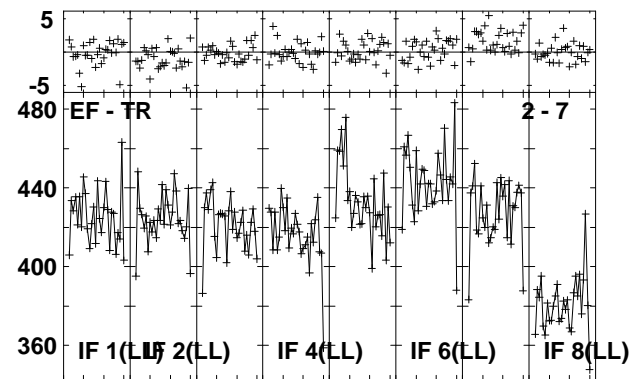
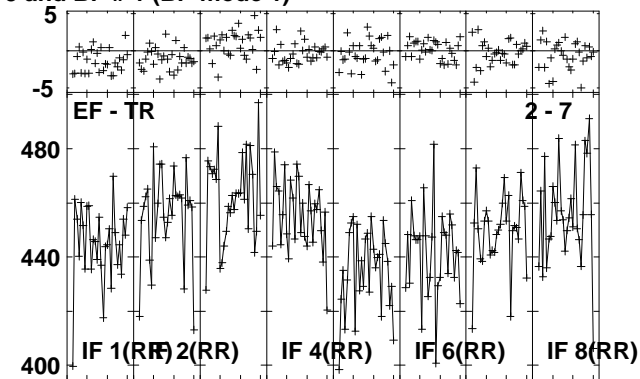
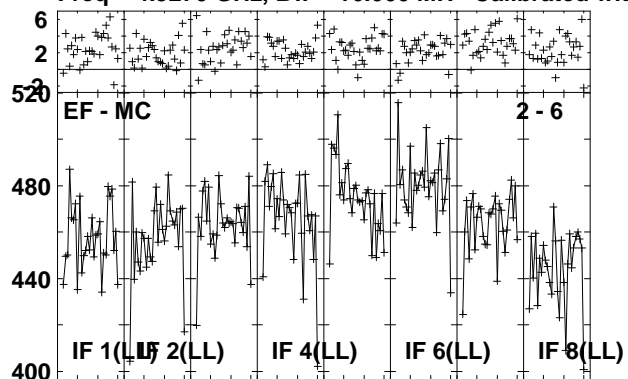

Lower frame: Milli Ampl Jy Top frame: Phas deg
Vector averaged cross-power spectrum Several baselines displayed
Timerange: 00/14:04:31 to 00/14:05:59

Plot file version 39 created 17-NOV-2010 16:17:26

ARP299D EP068A 5.UVDATA.1

Freq = 4.9270 GHz, Bw = 16.000 MH Calibrated with CL # 3 and BP # 1 (BP mode 1)

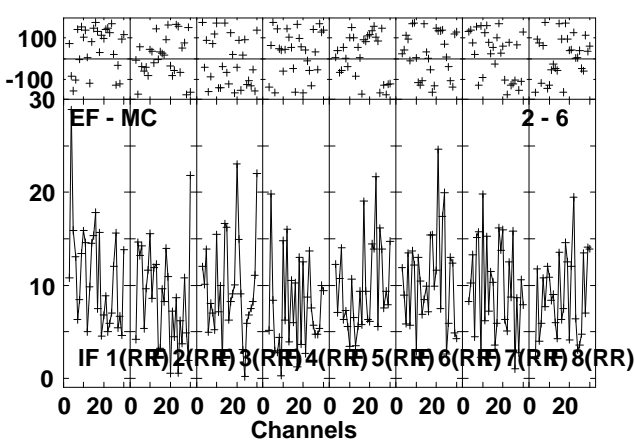
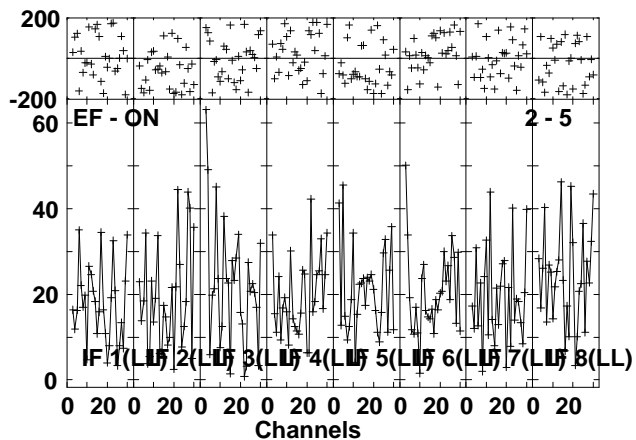
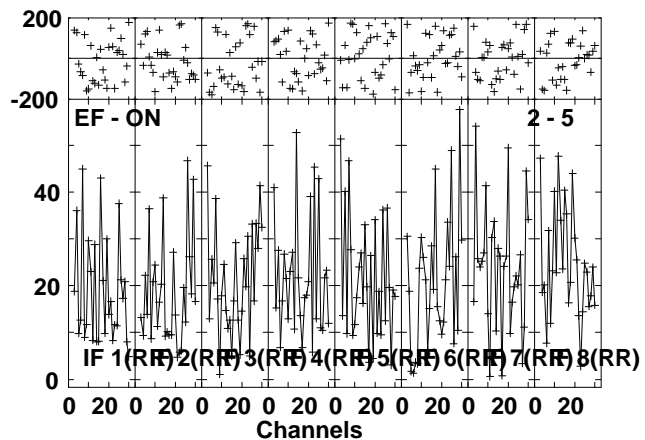
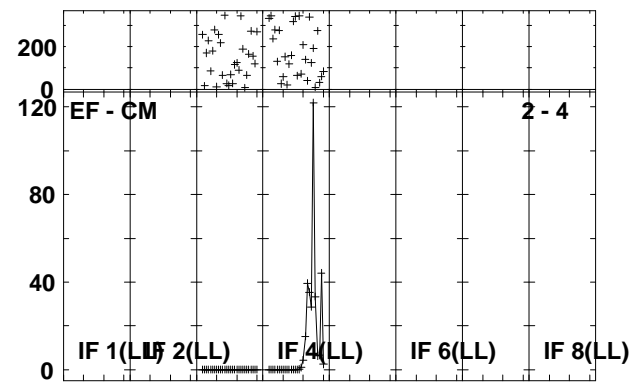
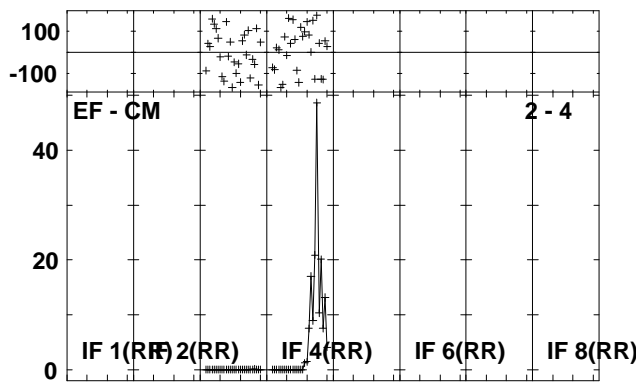
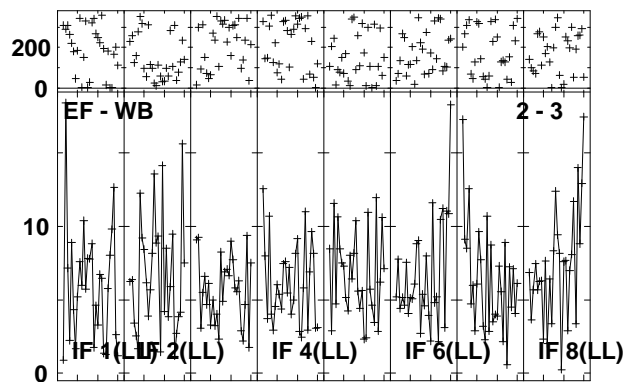
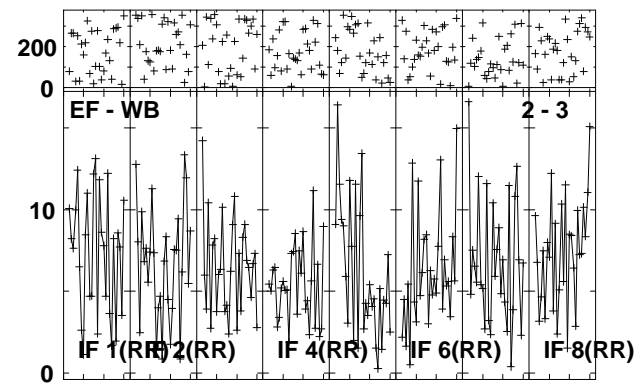
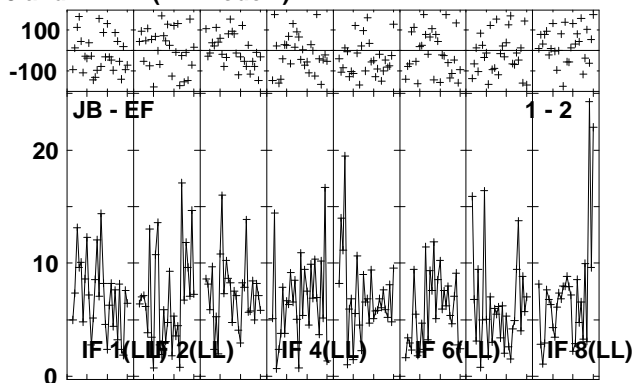
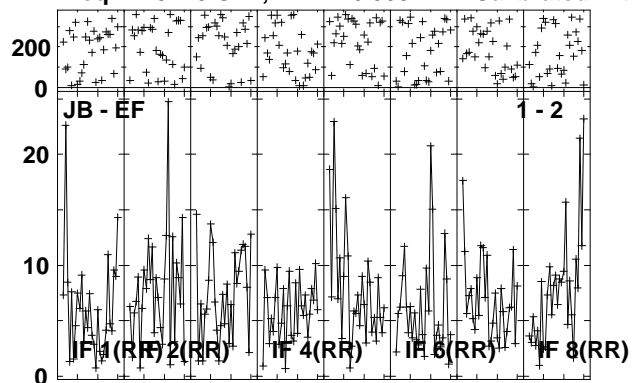

Lower frame: Milli Ampl Jy Top frame: Phas deg
Vector averaged cross-power spectrum Several baselines displayed
Timerange: 00/14:06:01 to 00/14:09:29

Plot file version 40 created 17-NOV-2010 16:17:29

ARP299D EP068A 5.UVDATA.1

Freq = 4.9270 GHz, Bw = 16.000 MH Calibrated with CL # 3 and BP # 1 (BP mode 1)

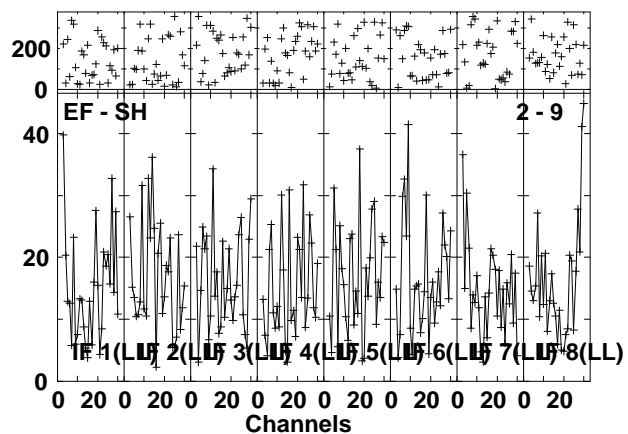
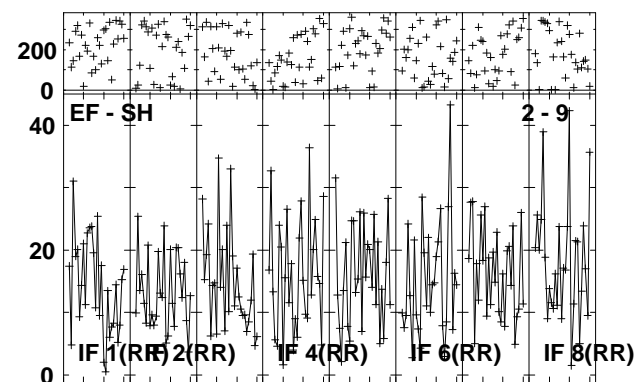
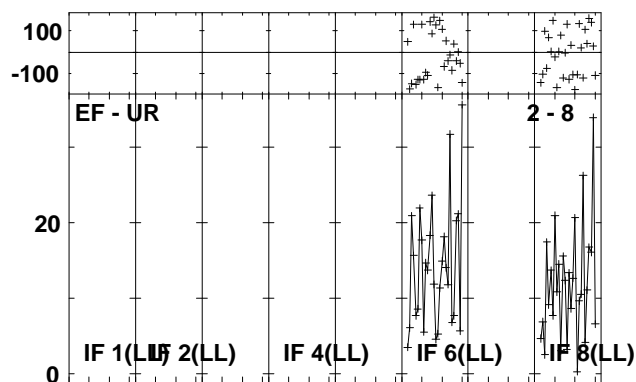
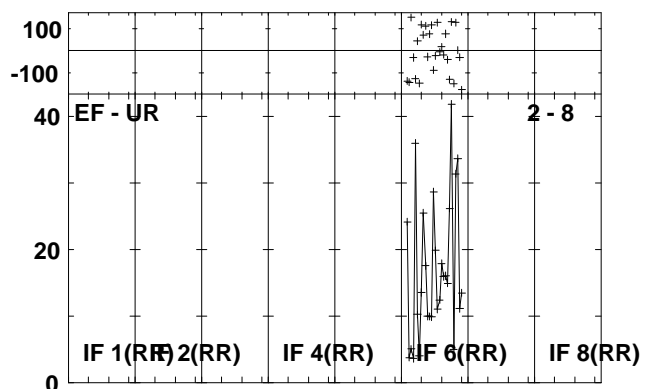
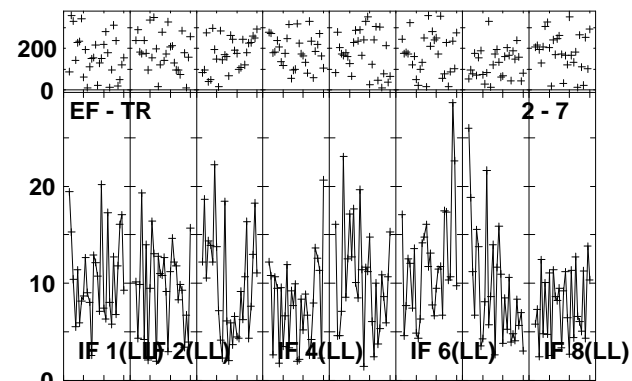
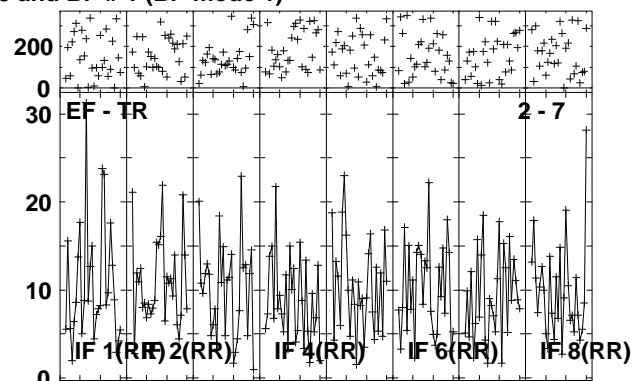
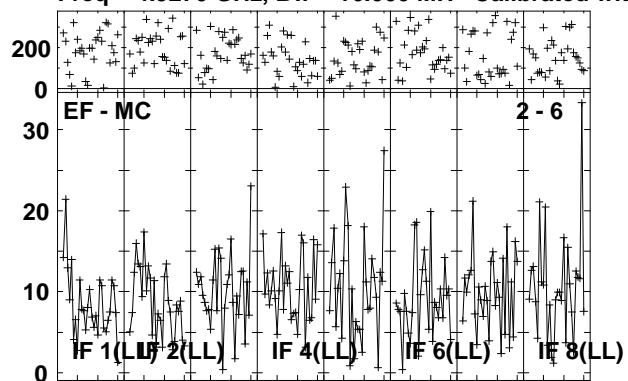

Lower frame: Milli Ampl Jy Top frame: Phas deg
Vector averaged cross-power spectrum Several baselines displayed
Timerange: 00/14:06:01 to 00/14:09:29

Plot file version 41 created 17-NOV-2010 16:17:32

J1128+59 EP068A 5.UVDATA.1

Freq = 4.9270 GHz, Bw = 16.000 MH Calibrated with CL # 3 and BP # 1 (BP mode 1)

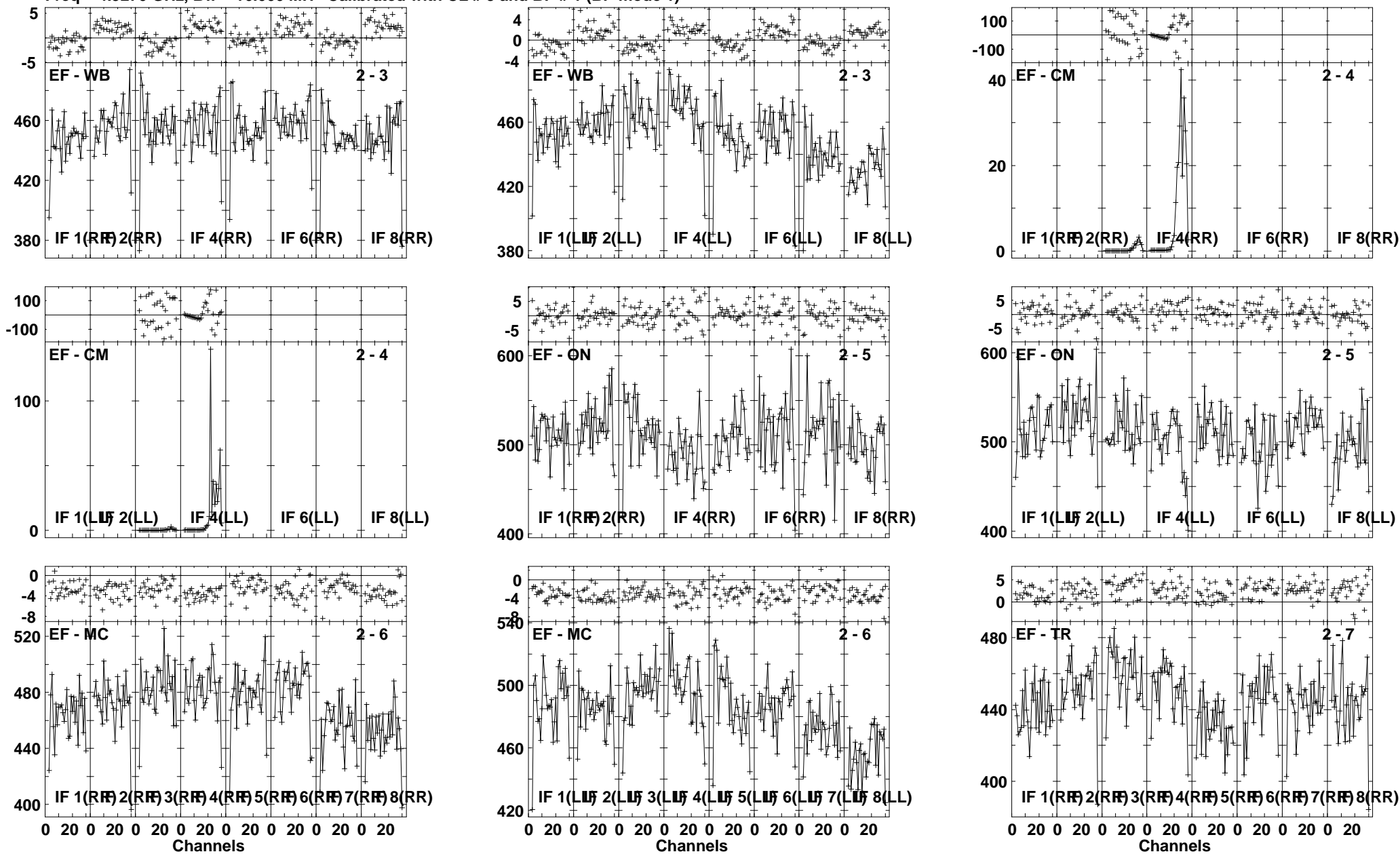

Lower frame: Milli Ampl Jy Top frame: Phas deg
Vector averaged cross-power spectrum Several baselines displayed
Timerange: 00/14:09:31 to 00/14:10:59

Plot file version 42 created 17-NOV-2010 16:17:33

J1128+59 EP068A 5.UVDATA.1

Freq = 4.9270 GHz, Bw = 16.000 MH Calibrated with CL # 3 and BP # 1 (BP mode 1)

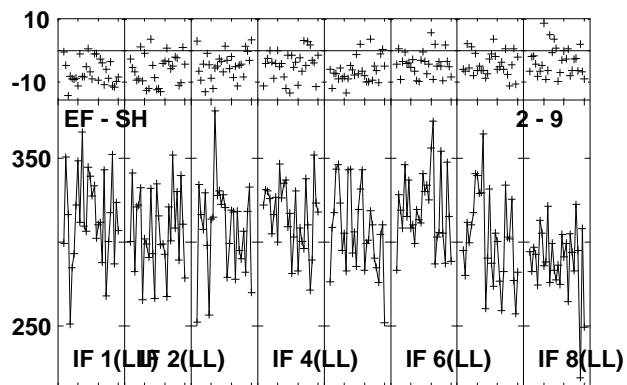
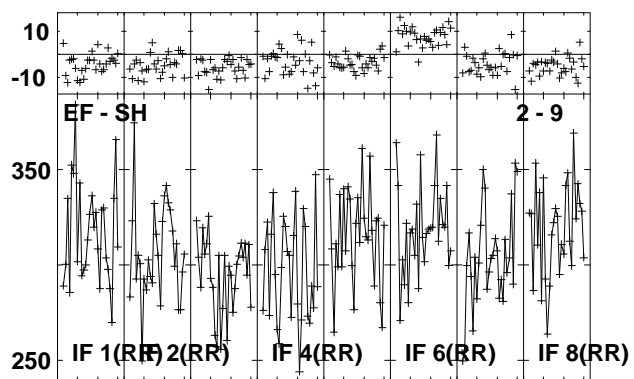
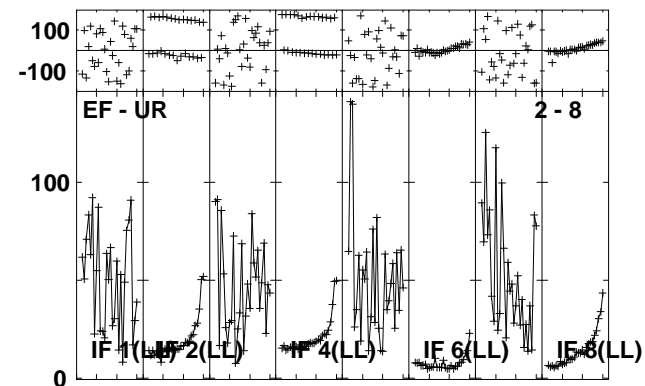
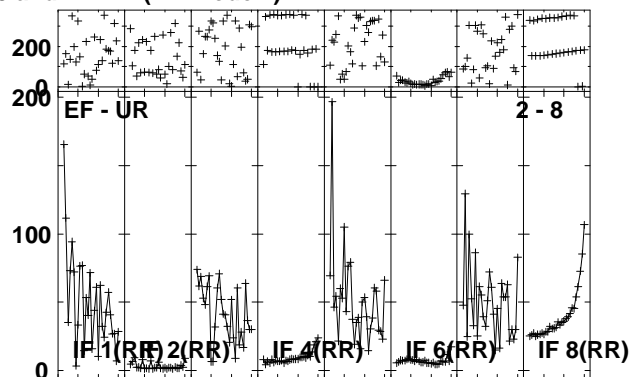
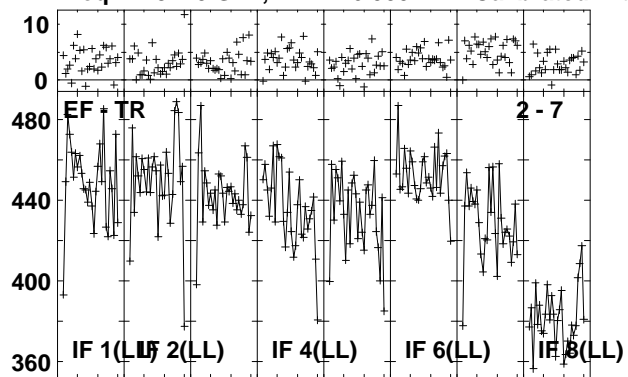

Lower frame: Milli Ampl Jy Top frame: Phas deg
Vector averaged cross-power spectrum Several baselines displayed
Timerange: 00/14:09:31 to 00/14:10:59

Plot file version 43 created 17-NOV-2010 16:17:34

ARP299D EP068A 5.UVDATA.1

Freq = 4.9270 GHz, Bw = 16.000 MH Calibrated with CL # 3 and BP # 1 (BP mode 1)

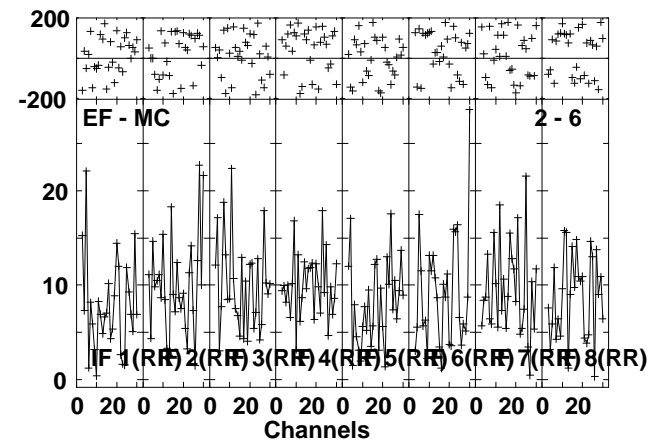
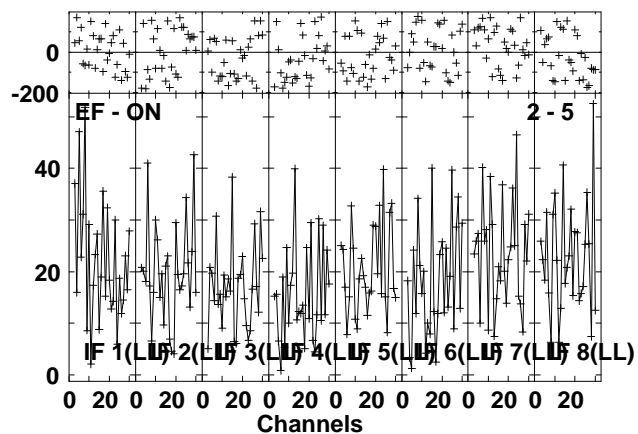
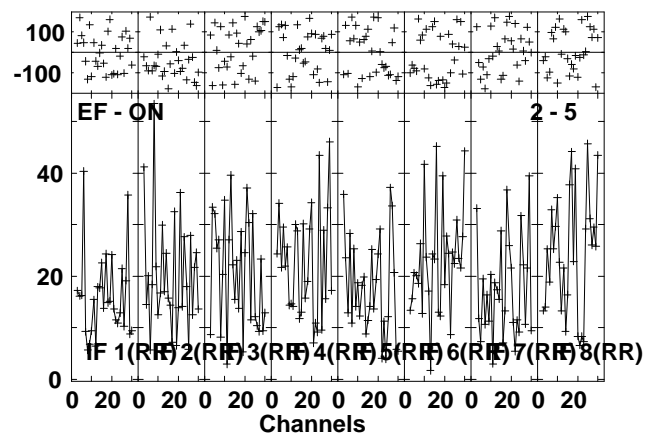
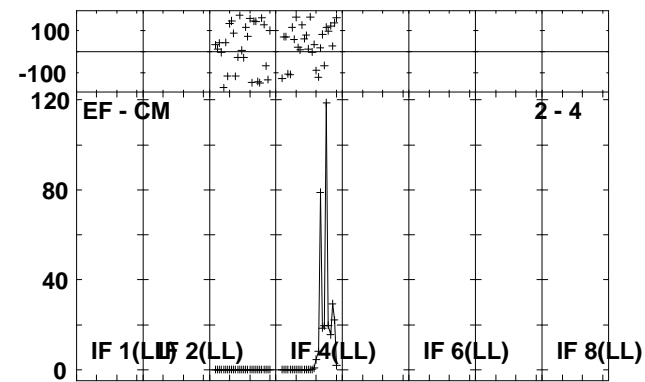
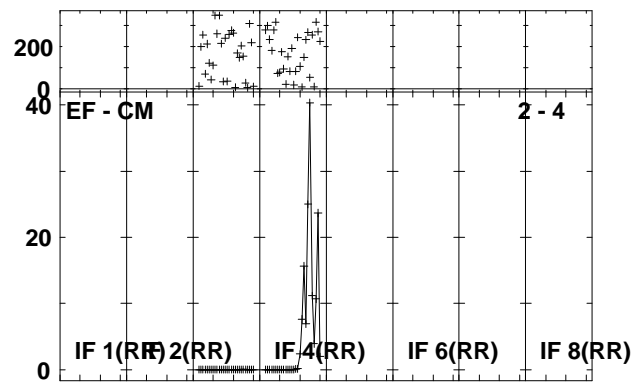
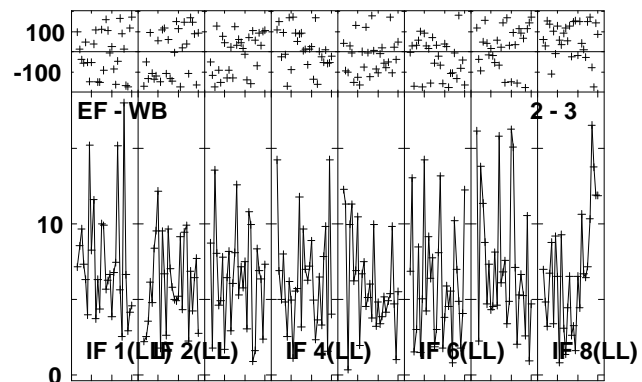
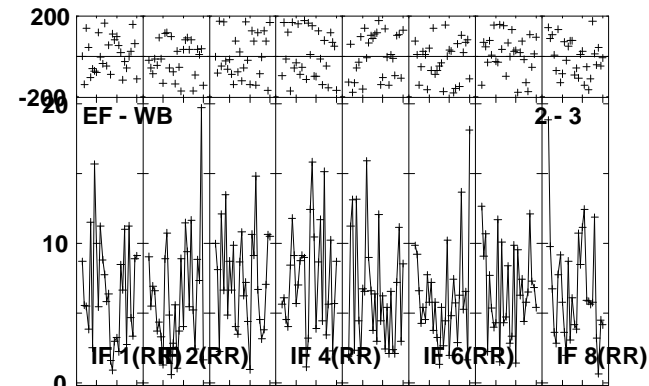
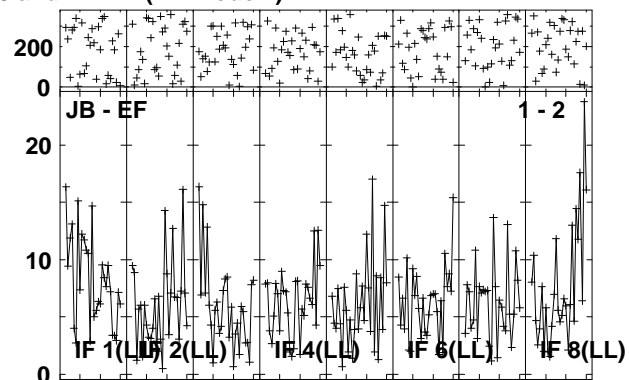
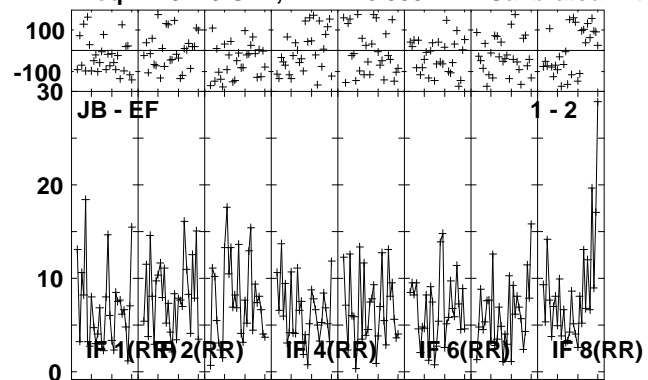

Lower frame: Milli Ampl Jy Top frame: Phas deg
Vector averaged cross-power spectrum Several baselines displayed
Timerange: 00/14:11:01 to 00/14:14:29

Plot file version 44 created 17-NOV-2010 16:17:36

ARP299D EP068A 5.UVDATA.1

Freq = 4.9270 GHz, Bw = 16.000 MH Calibrated with CL # 3 and BP # 1 (BP mode 1)

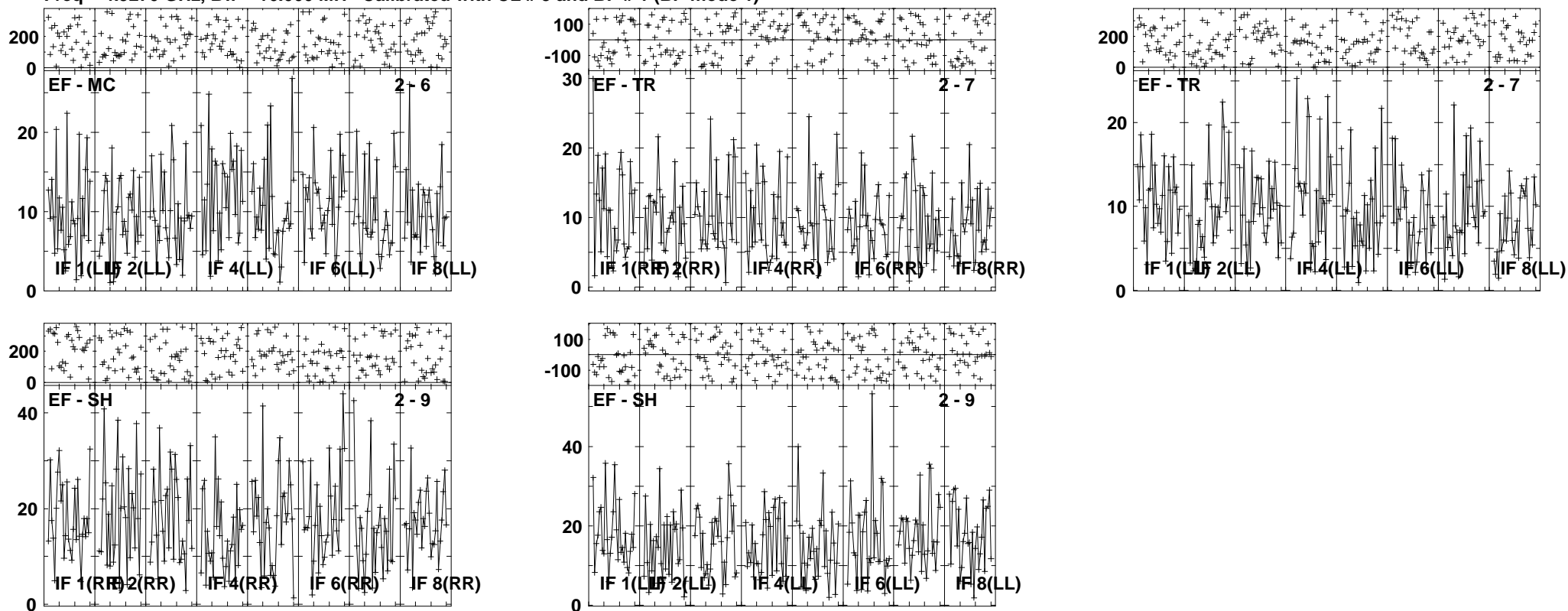

Lower frame: Milli Ampl Jy Top frame: Phas deg
Vector averaged cross-power spectrum Several baselines displayed
Timerange: 00/14:11:01 to 00/14:14:29

Plot file version 45 created 17-NOV-2010 16:17:38

J1128+59 EP068A 5.UVDATA.1

Freq = 4.9270 GHz, Bw = 16.000 MH Calibrated with CL # 3 and BP # 1 (BP mode 1)

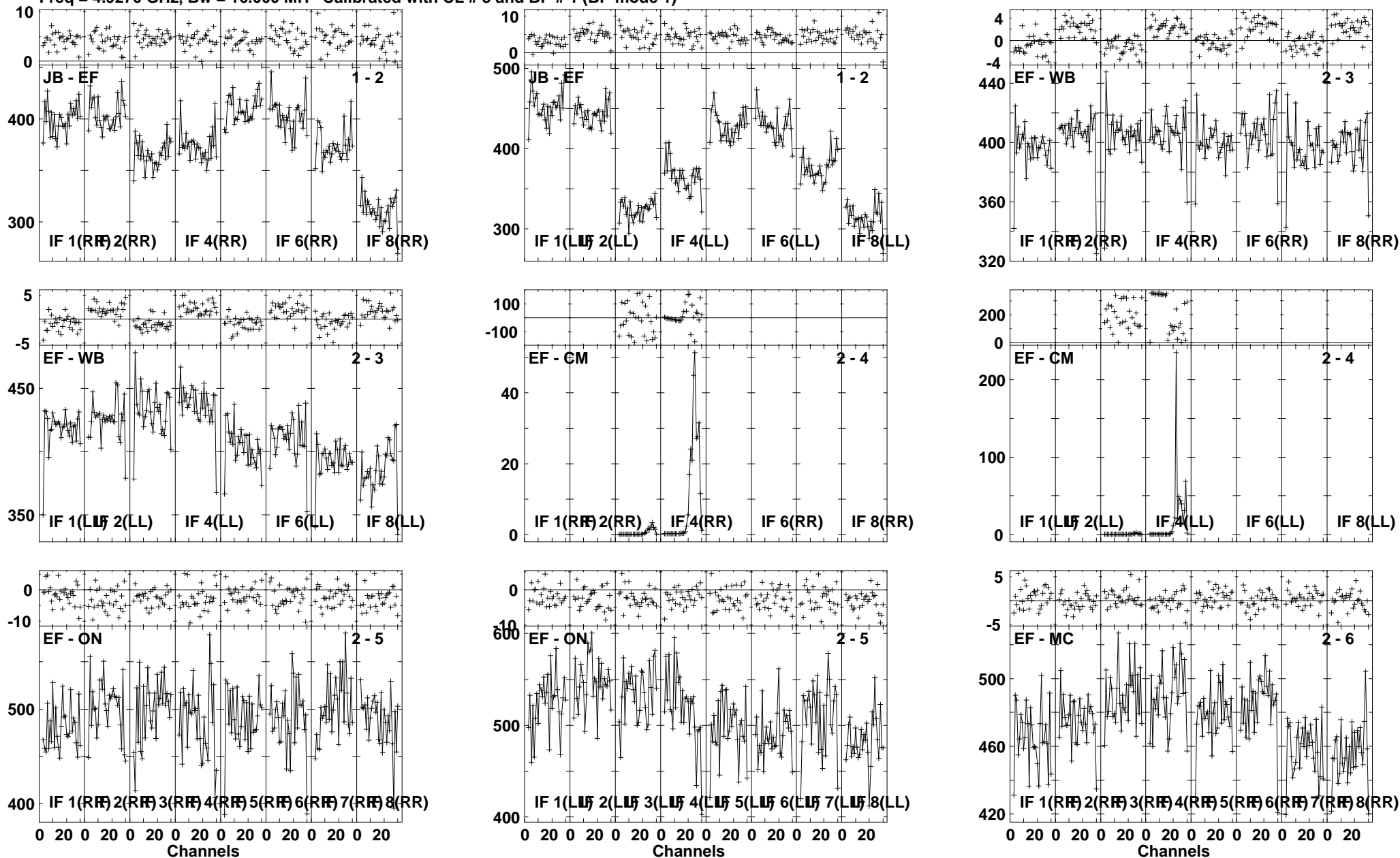

Lower frame: Milli Ampl Jy Top frame: Phas deg
Vector averaged cross-power spectrum Several baselines displayed
Timerange: 00/14:14:31 to 00/14:15:59

Plot file version 47 created 17-NOV-2010 16:17:40

ARP299D EP068A 5.UVDATA.1

Freq = 4.9270 GHz, Bw = 16.000 MH Calibrated with CL # 3 and BP # 1 (BP mode 1)

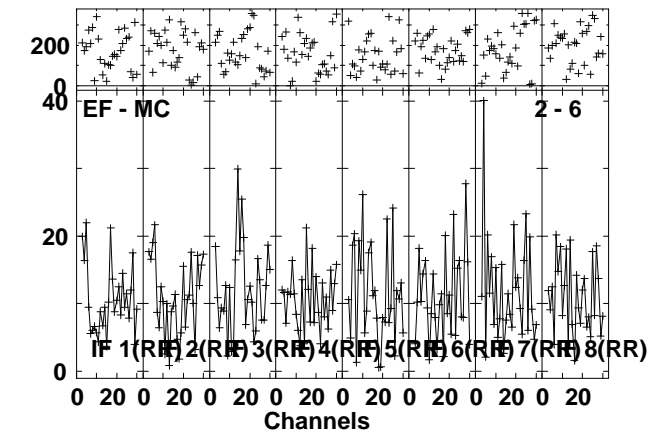
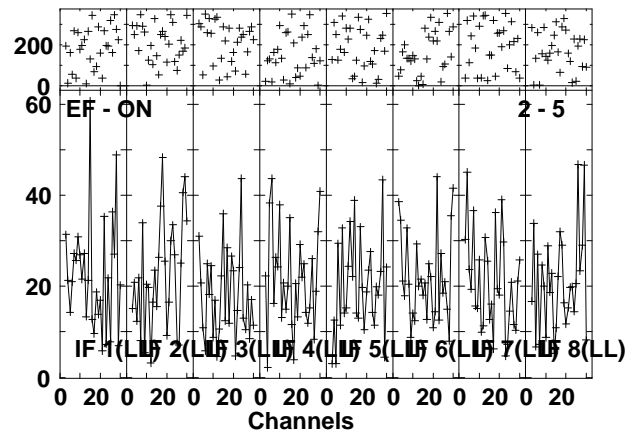
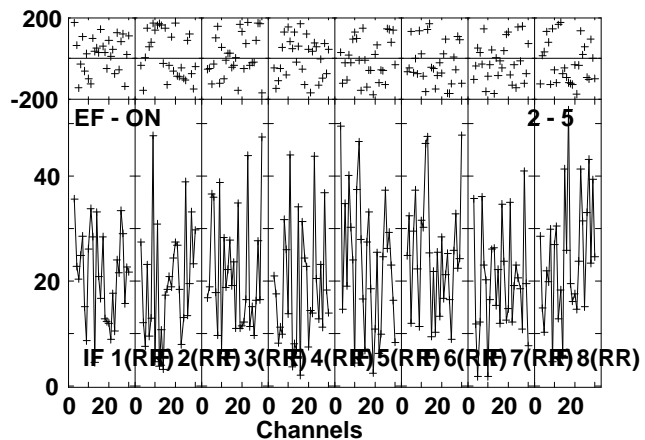
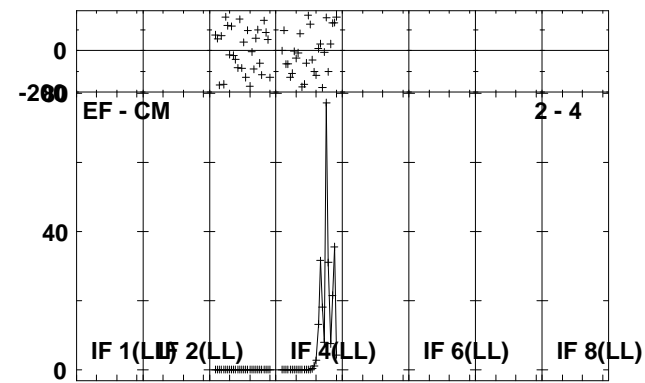
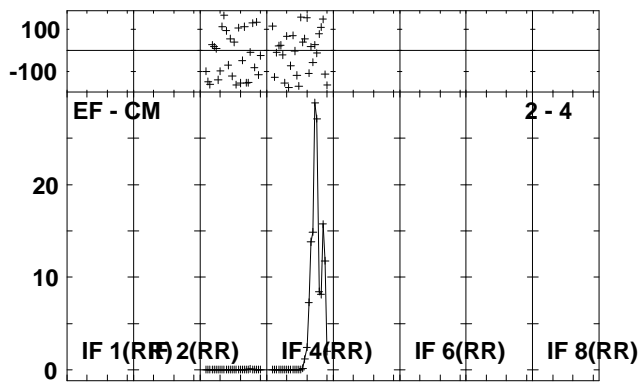
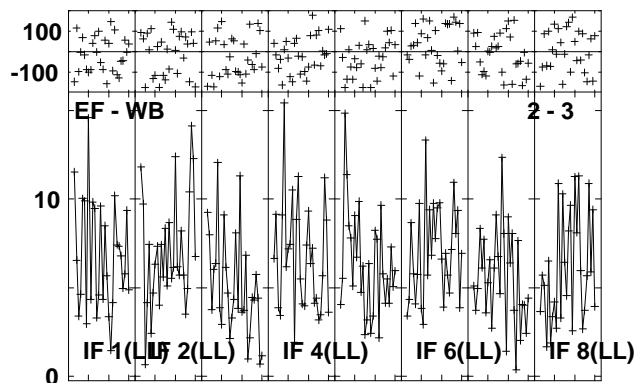
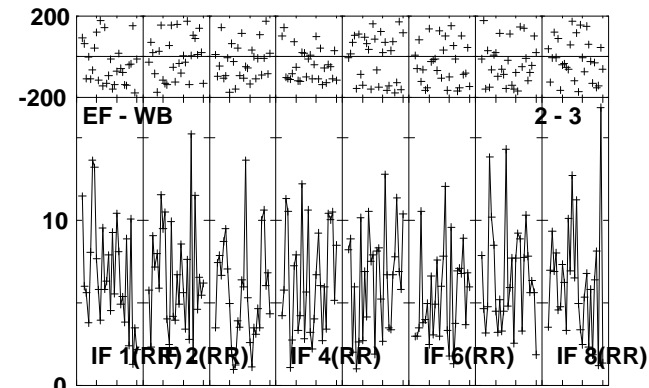
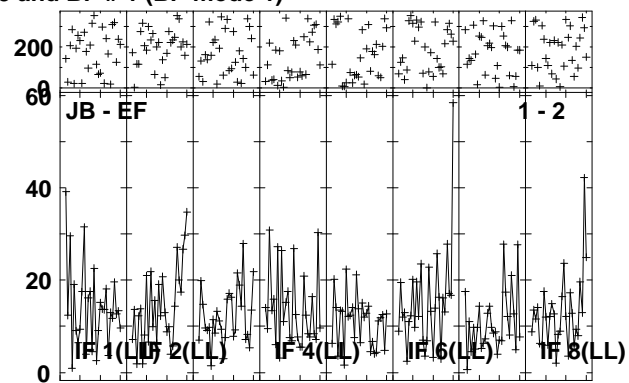
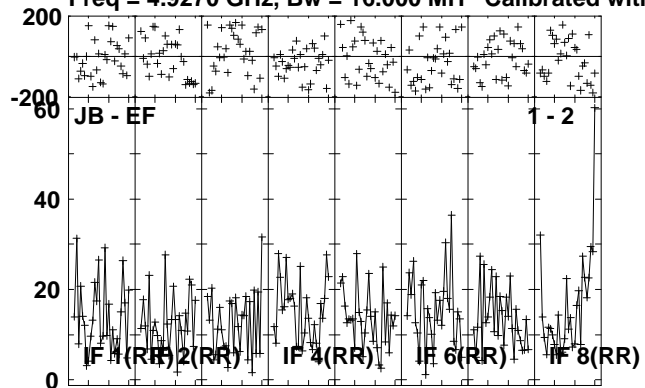

Lower frame: Milli Ampl Jy Top frame: Phas deg
Vector averaged cross-power spectrum Several baselines displayed
Timerange: 00/14:16:01 to 00/14:19:29

Plot file version 48 created 17-NOV-2010 16:17:43

ARP299D EP068A 5.UVDATA.1

Freq = 4.9270 GHz, Bw = 16.000 MH Calibrated with CL # 3 and BP # 1 (BP mode 1)

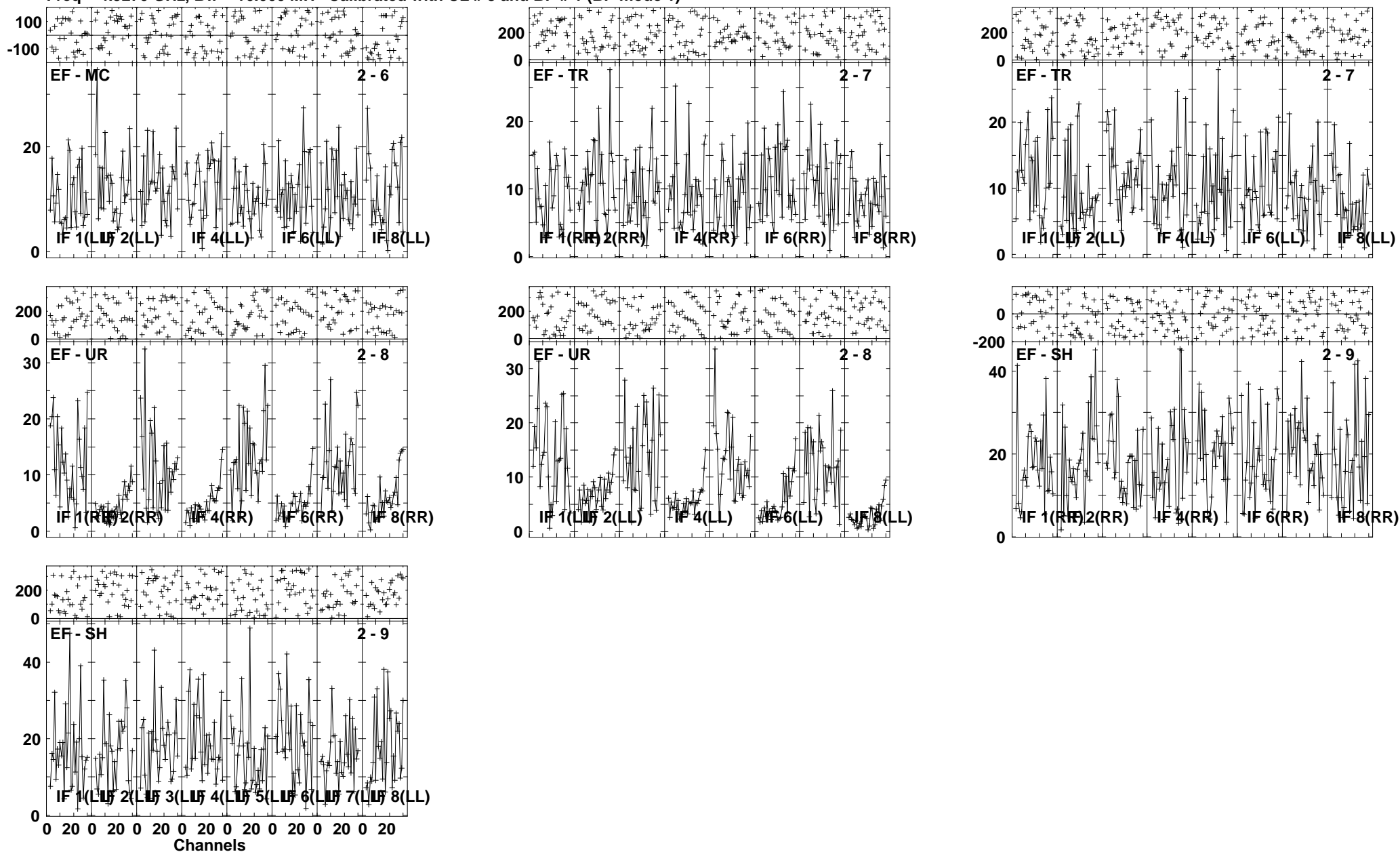

Lower frame: Milli Ampl Jy Top frame: Phas deg
Vector averaged cross-power spectrum Several baselines displayed
Timerange: 00/14:16:01 to 00/14:19:29

Plot file version 49 created 17-NOV-2010 16:17:46

J1128+59 EP068A 5.UVDATA.1

Freq = 4.9270 GHz, Bw = 16.000 MH Calibrated with CL # 3 and BP # 1 (BP mode 1)

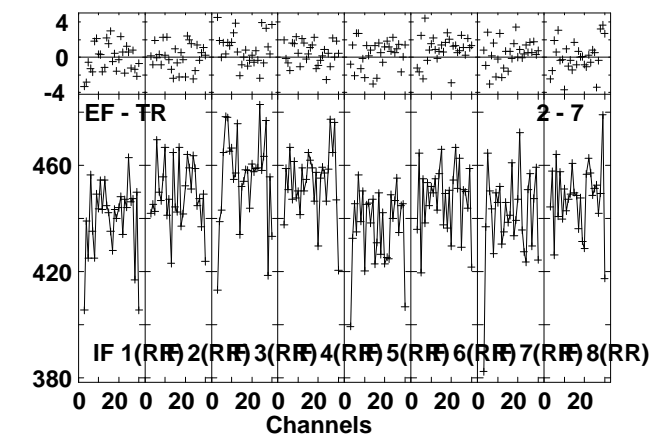
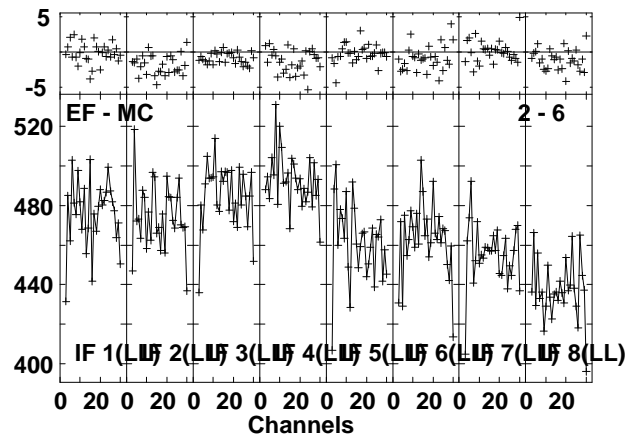
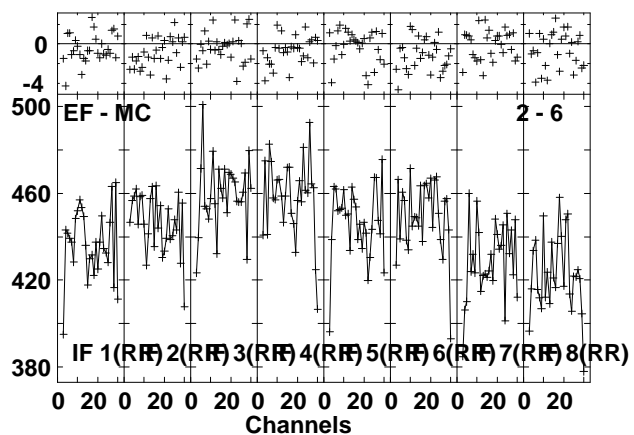
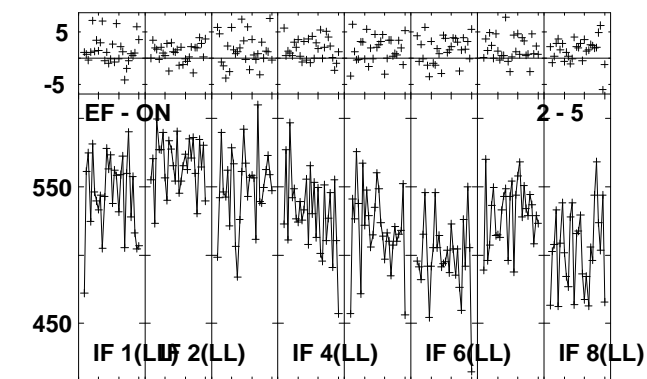
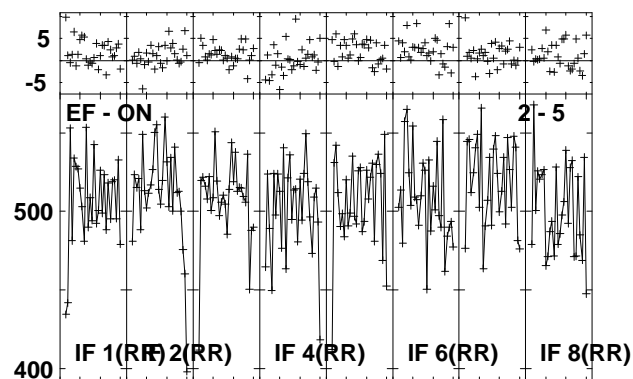
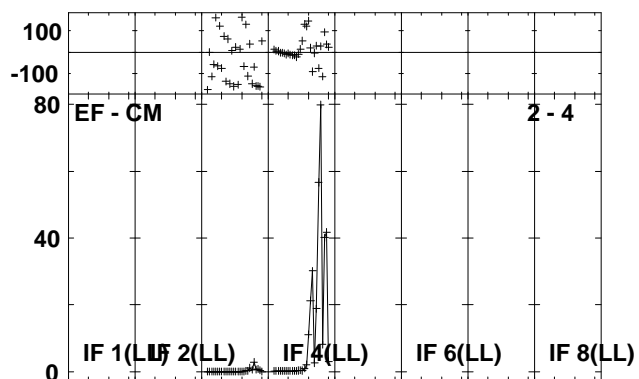
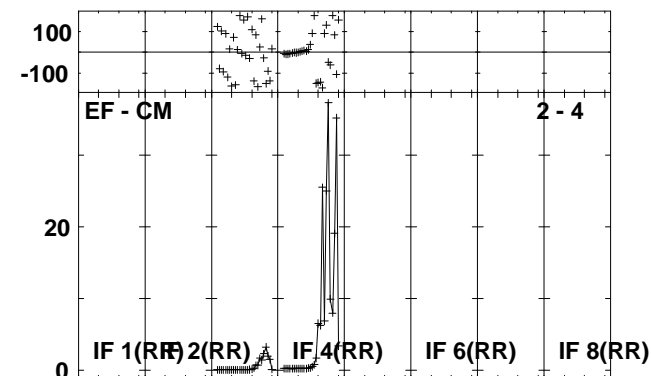
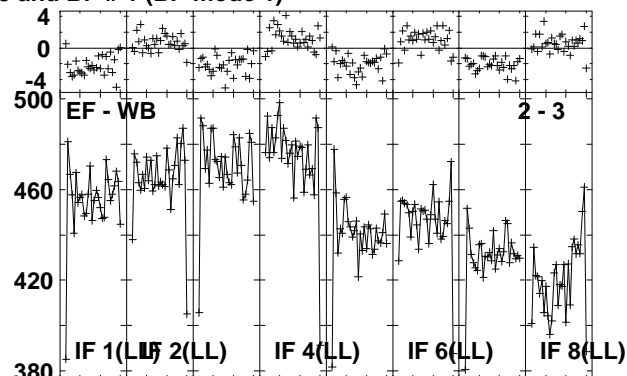
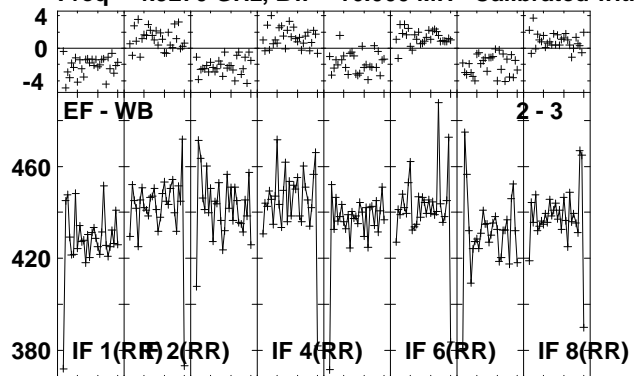

Lower frame: Milli Ampl Jy Top frame: Phas deg
Vector averaged cross-power spectrum Several baselines displayed
Timerange: 00/14:20:31 to 00/14:21:59

Plot file version 50 created 17-NOV-2010 16:17:47

J1128+59 EP068A 5.UVDATA.1

Freq = 4.9270 GHz, Bw = 16.000 MH Calibrated with CL # 3 and BP # 1 (BP mode 1)

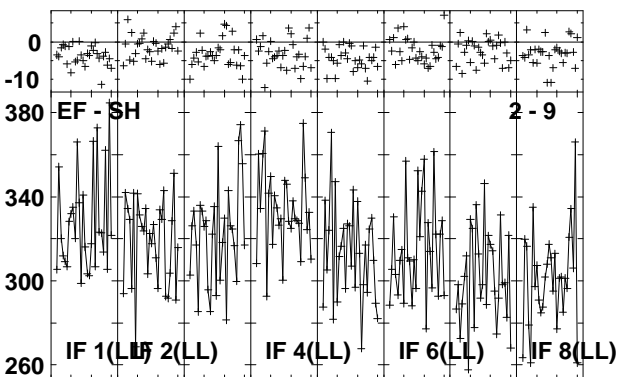
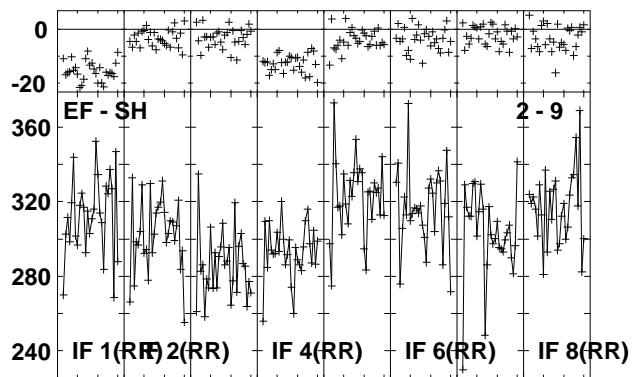
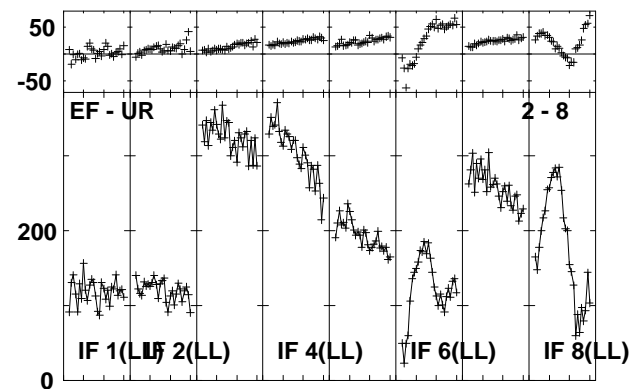
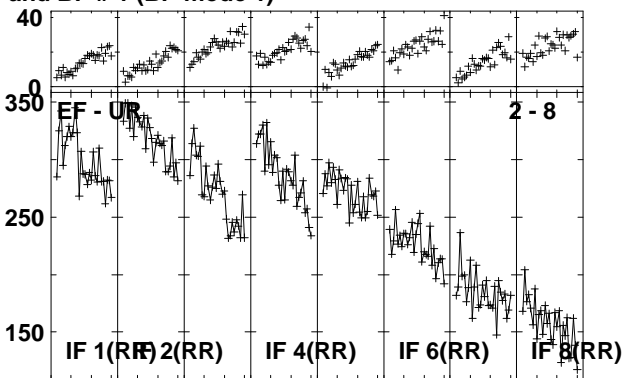
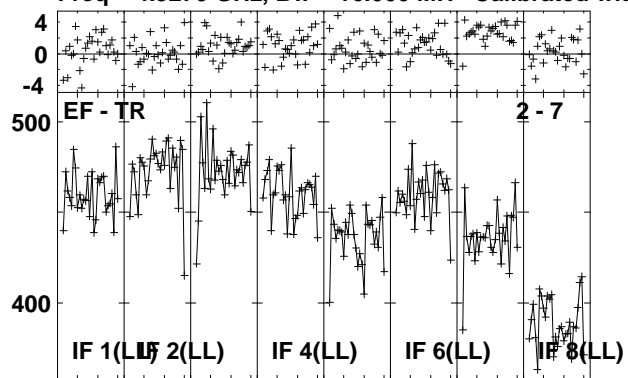

Lower frame: Milli Ampl Jy Top frame: Phas deg
Vector averaged cross-power spectrum Several baselines displayed
Timerange: 00/14:20:31 to 00/14:21:59

Plot file version 51 created 17-NOV-2010 16:17:48

ARP299D EP068A 5.UVDATA.1

Freq = 4.9270 GHz, Bw = 16.000 MH Calibrated with CL # 3 and BP # 1 (BP mode 1)

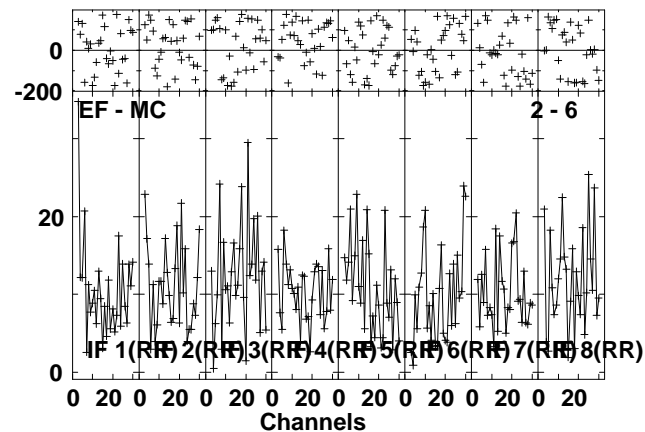
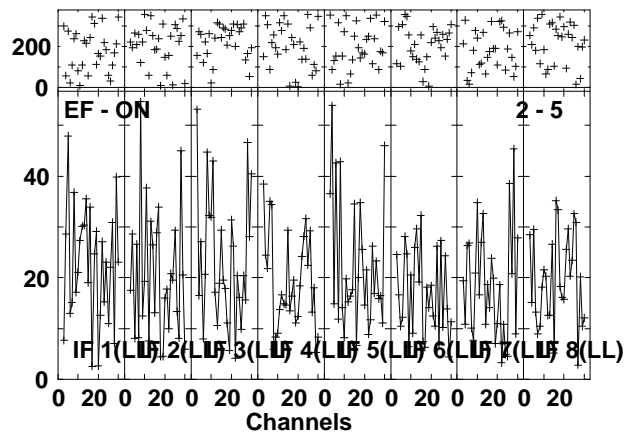
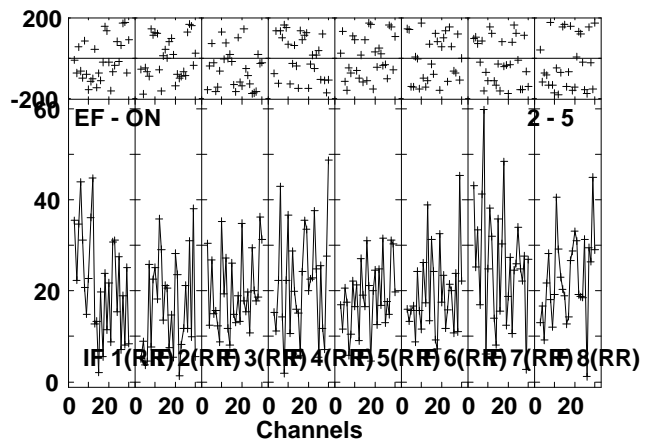
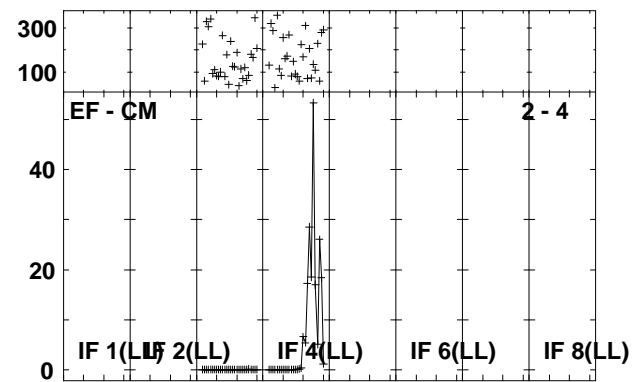
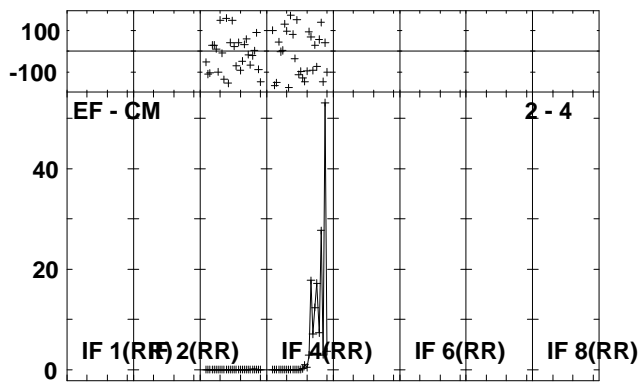
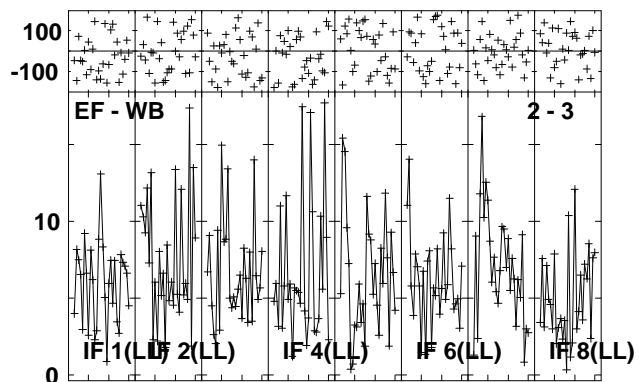
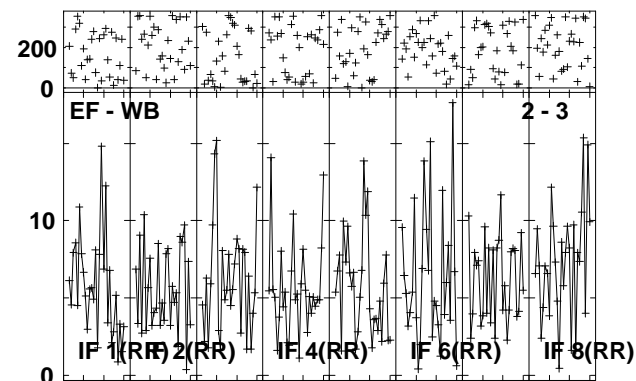
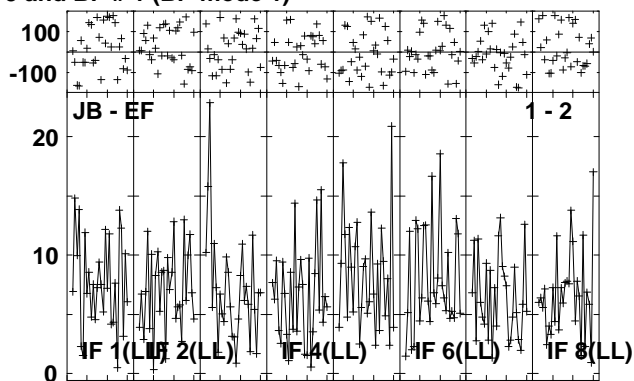
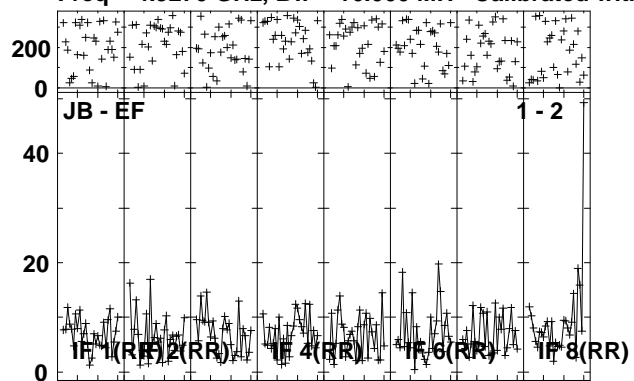

Lower frame: Milli Ampl Jy Top frame: Phas deg
Vector averaged cross-power spectrum Several baselines displayed
Timerange: 00/14:22:01 to 00/14:25:29

Plot file version 53 created 17-NOV-2010 16:17:53

J1128+59 EP068A 5.UVDATA.1

Freq = 4.9270 GHz, Bw = 16.000 MH Calibrated with CL # 3 and BP # 1 (BP mode 1)

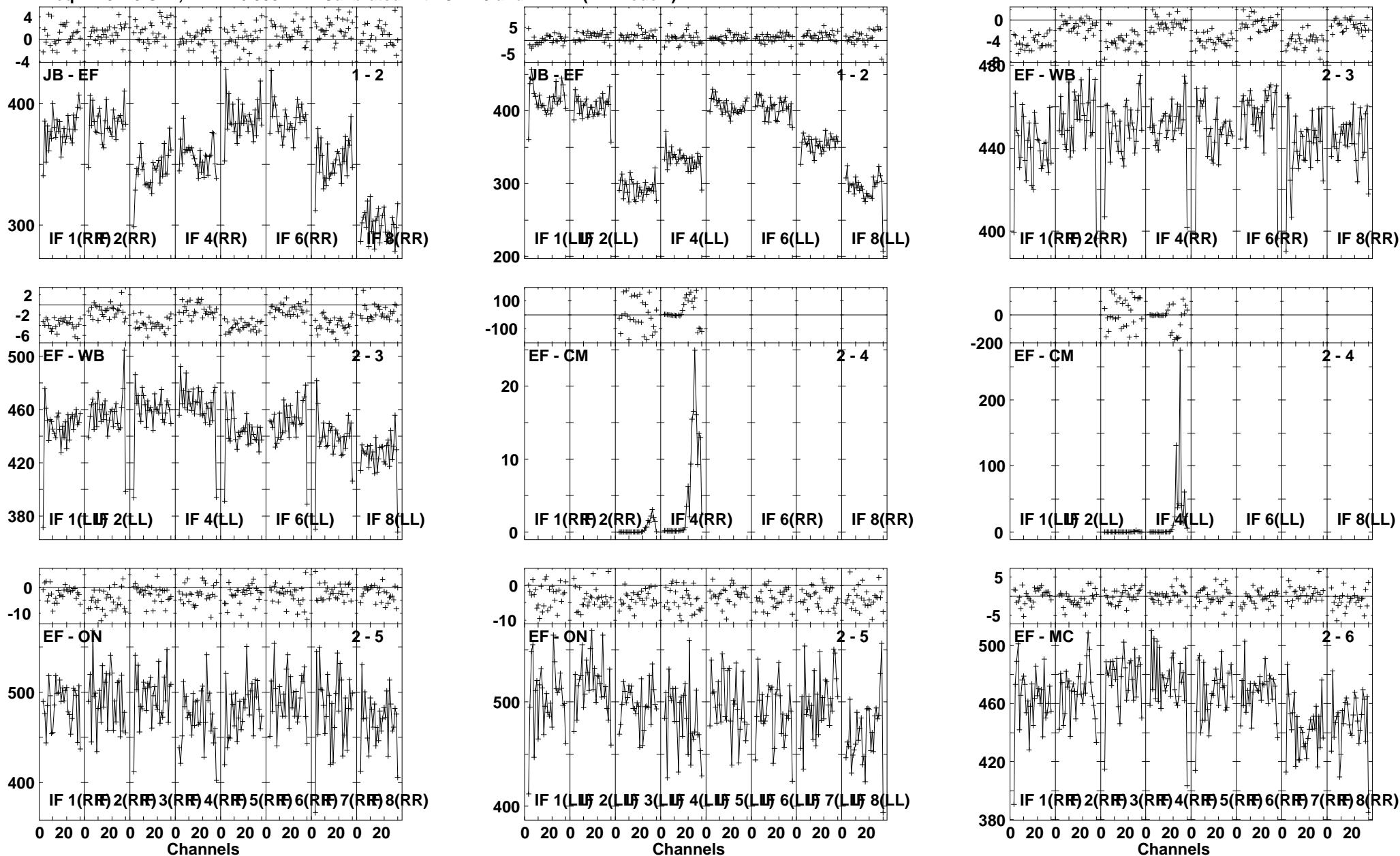

Lower frame: Milli Ampl Jy Top frame: Phas deg
Vector averaged cross-power spectrum Several baselines displayed
Timerange: 00/14:25:31 to 00/14:26:59

Plot file version 55 created 17-NOV-2010 16:17:56

ARP299D EP068A 5.UVDATA.1

Freq = 4.9270 GHz, Bw = 16.000 MH Calibrated with CL # 3 and BP # 1 (BP mode 1)

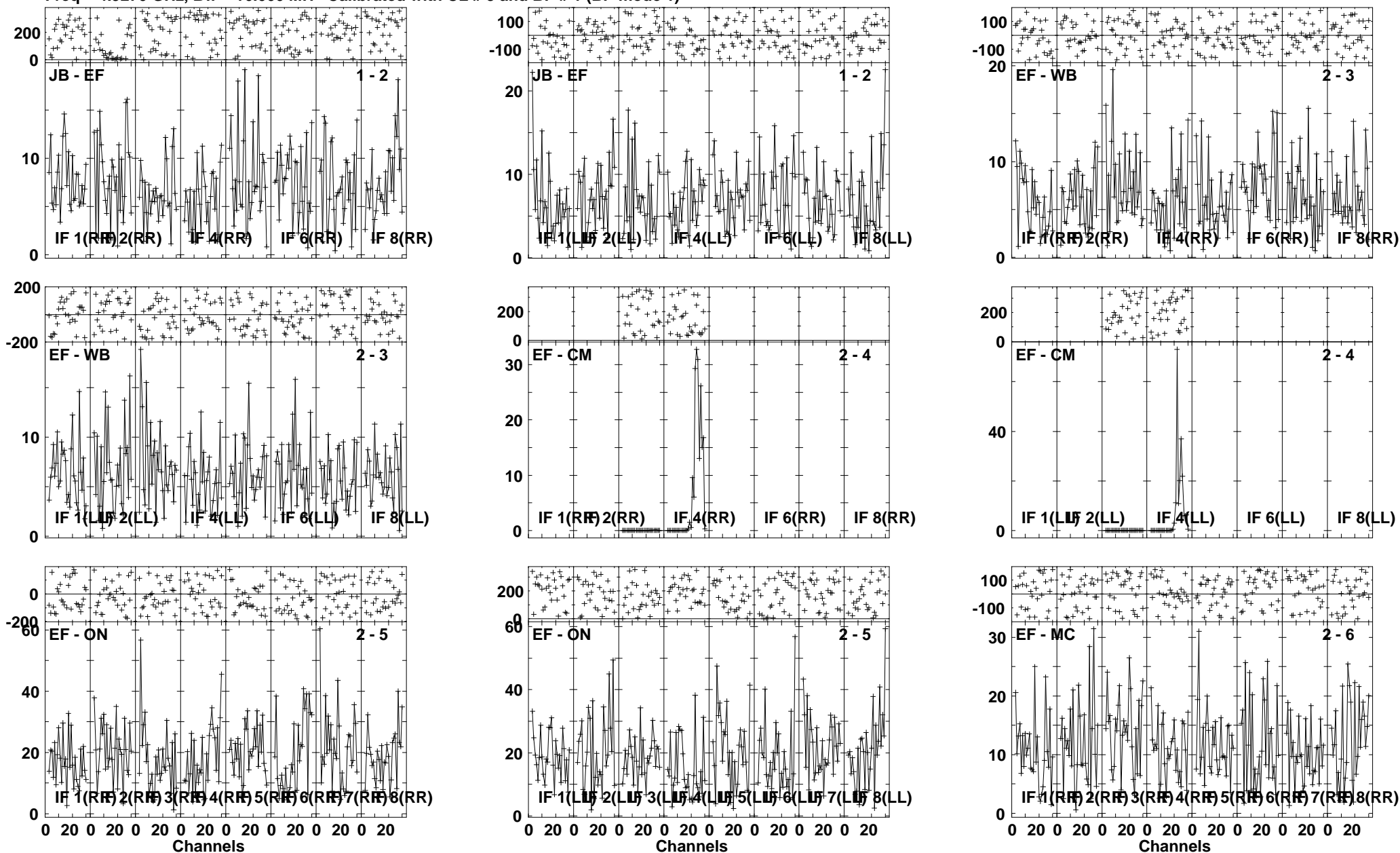

Lower frame: Milli Ampl Jy Top frame: Phas deg
Vector averaged cross-power spectrum Several baselines displayed
Timerange: 00/14:27:01 to 00/14:30:29

Plot file version 56 created 17-NOV-2010 16:17:58

ARP299D EP068A 5.UVDATA.1

Freq = 4.9270 GHz, Bw = 16.000 MH Calibrated with CL # 3 and BP # 1 (BP mode 1)

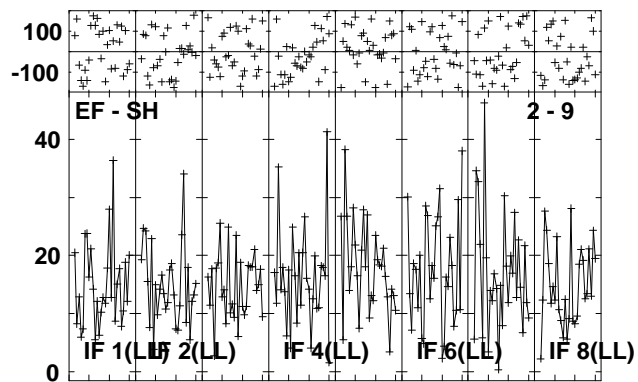
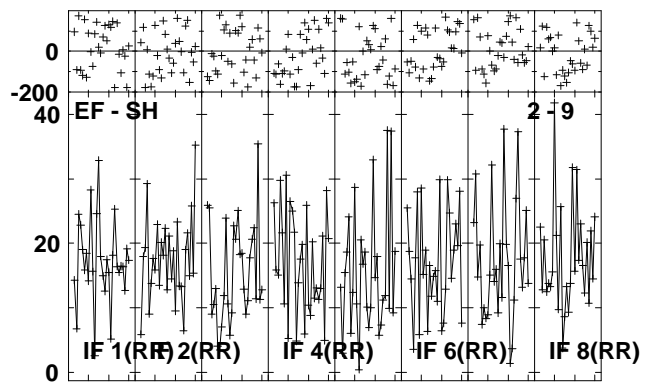
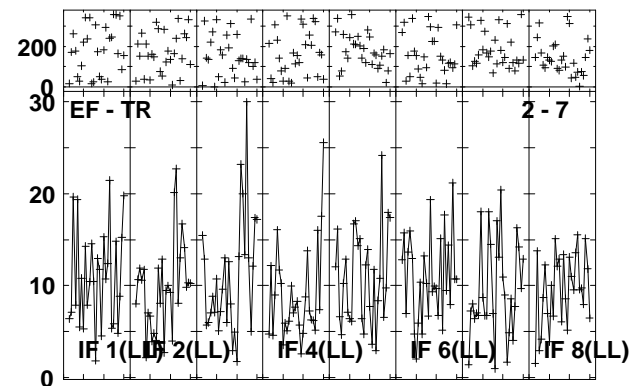
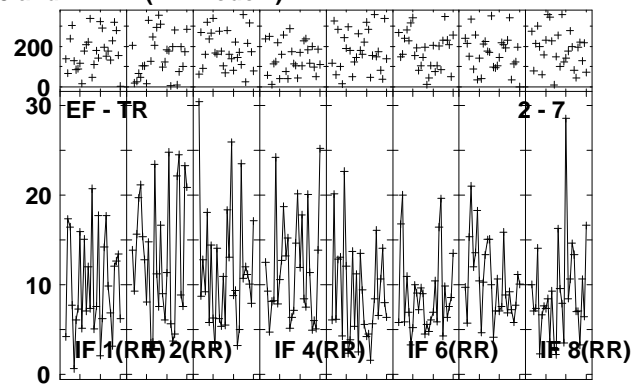
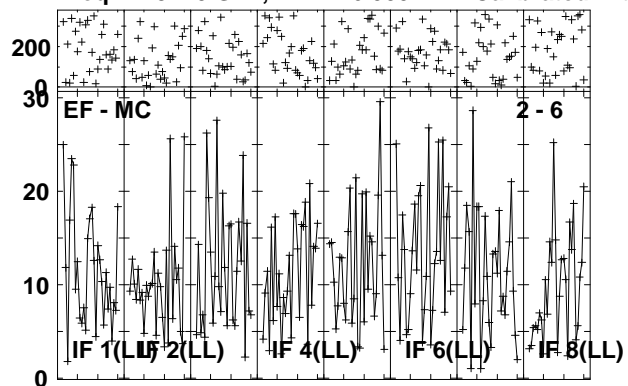

Lower frame: Milli Ampl Jy Top frame: Phas deg
Vector averaged cross-power spectrum Several baselines displayed
Timerange: 00/14:27:01 to 00/14:30:29

Plot file version 57 created 17-NOV-2010 16:18:00

J1128+59 EP068A 5.UVDATA.1

Freq = 4.9270 GHz, Bw = 16.000 MH Calibrated with CL # 3 and BP # 1 (BP mode 1)

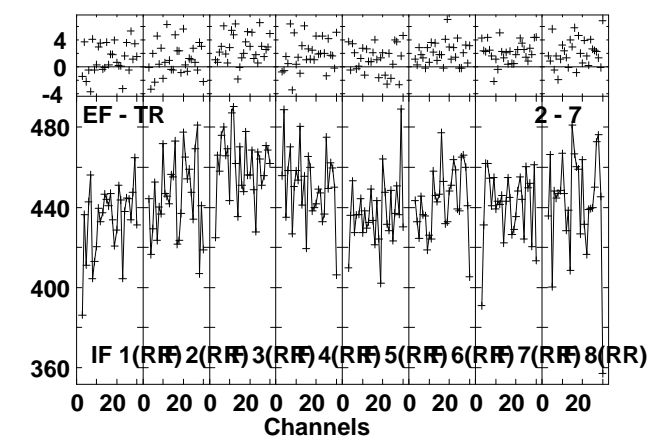
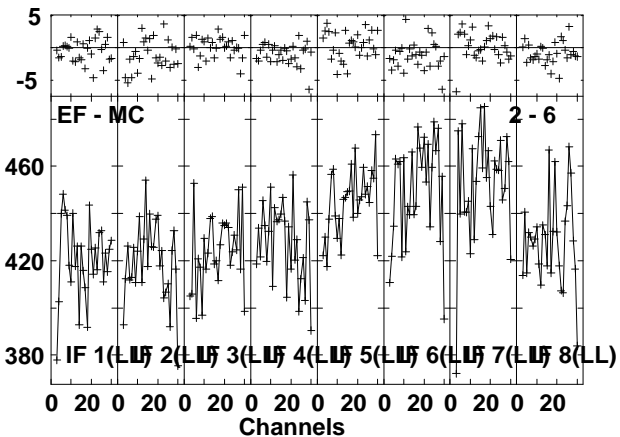
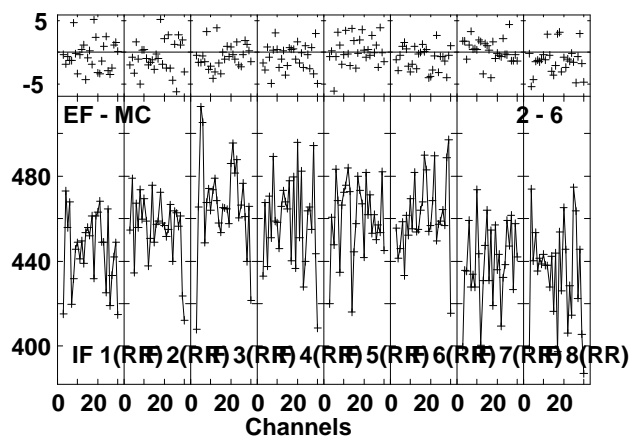
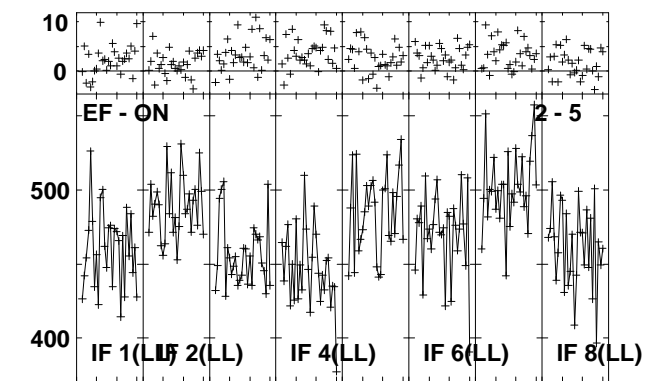
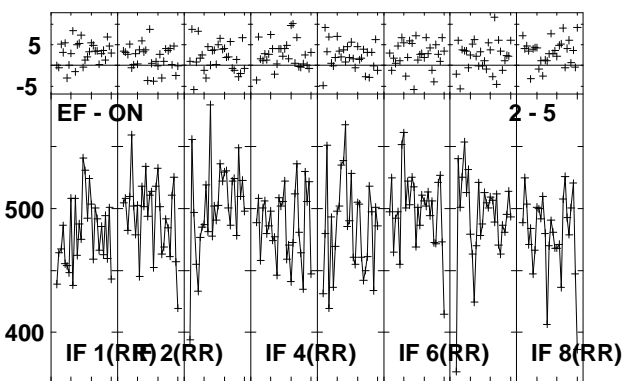
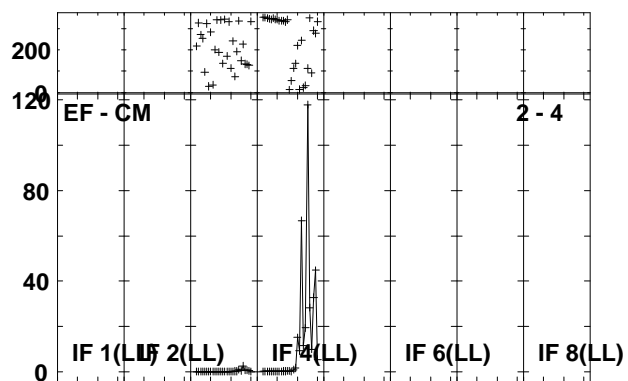
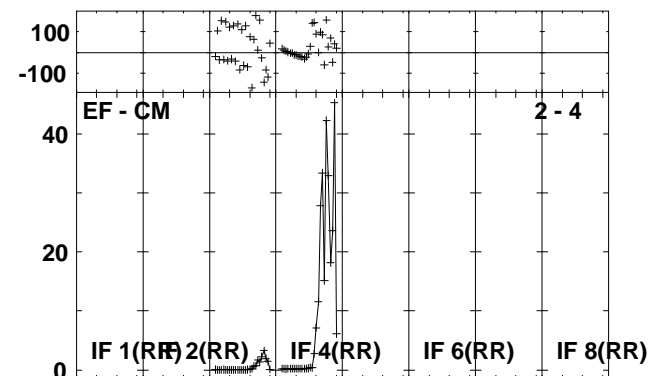
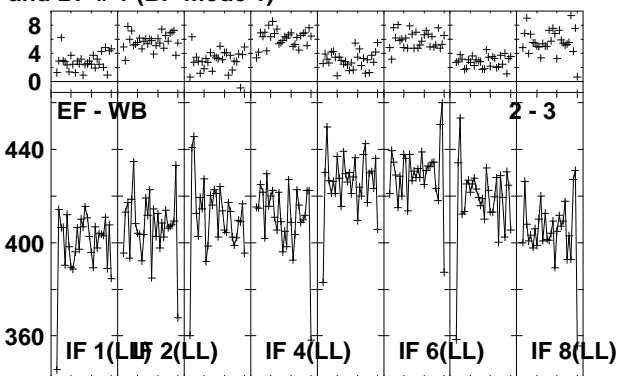
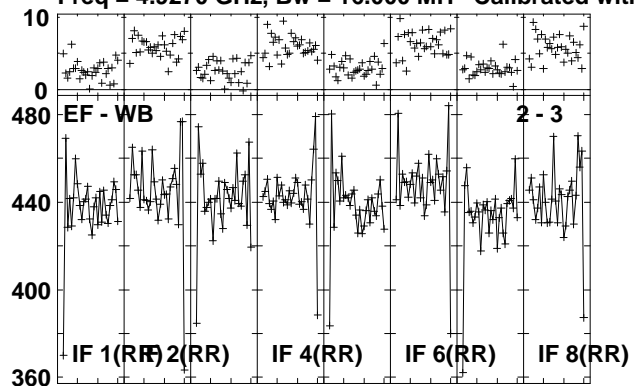

Lower frame: Milli Ampl Jy Top frame: Phas deg
Vector averaged cross-power spectrum Several baselines displayed
Timerange: 00/14:30:31 to 00/14:31:59

Plot file version 58 created 17-NOV-2010 16:18:01

J1128+59 EP068A 5.UVDATA.1

Freq = 4.9270 GHz, Bw = 16.000 MH Calibrated with CL # 3 and BP # 1 (BP mode 1)

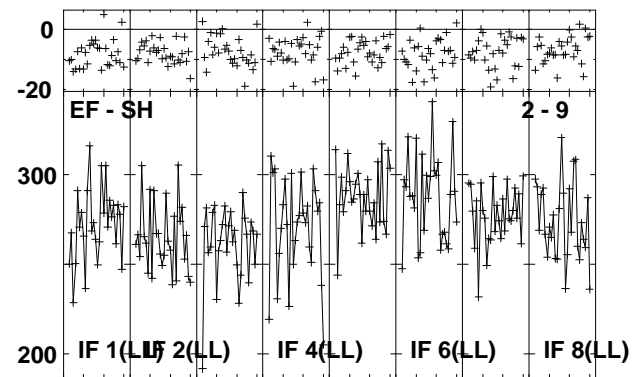
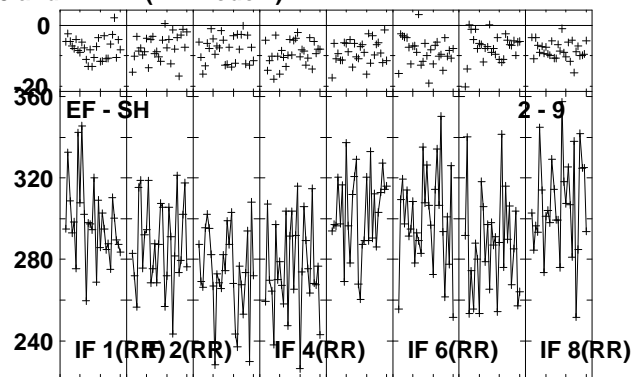
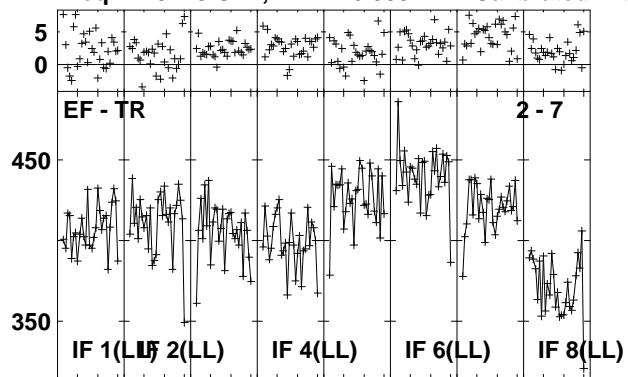

Lower frame: Milli Ampl Jy Top frame: Phas deg
Vector averaged cross-power spectrum Several baselines displayed
Timerange: 00/14:30:31 to 00/14:31:59

Plot file version 59 created 17-NOV-2010 16:18:02

ARP299D EP068A 5.UVDATA.1

Freq = 4.9270 GHz, Bw = 16.000 MH Calibrated with CL # 3 and BP # 1 (BP mode 1)

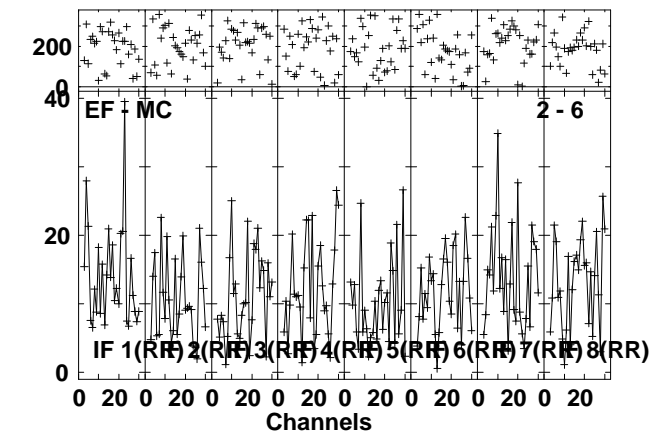
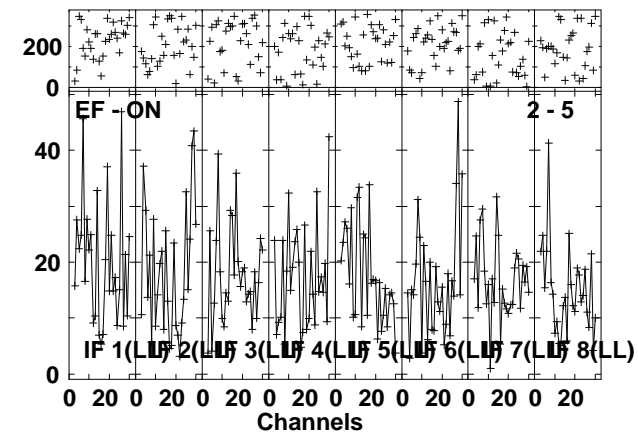
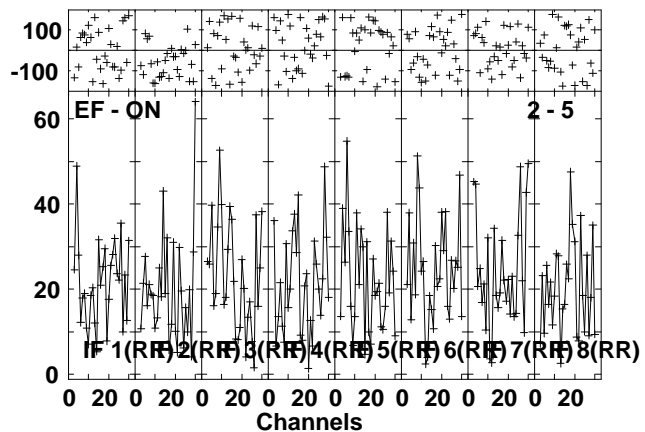
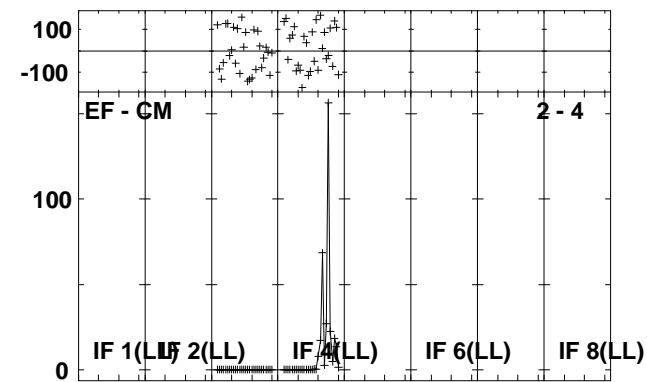
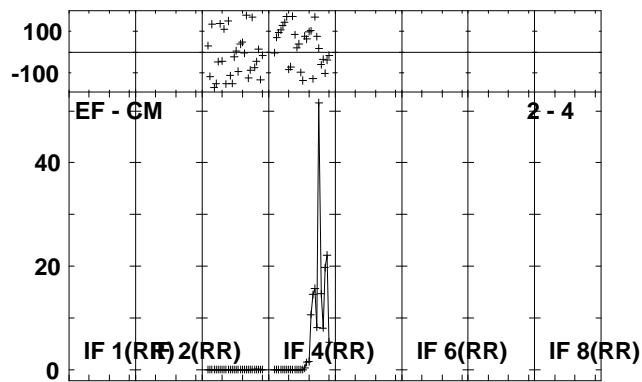
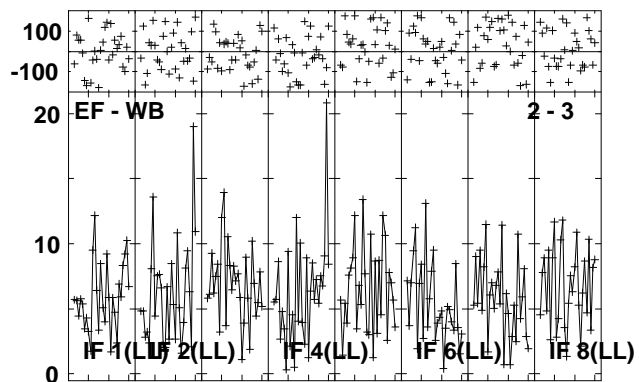
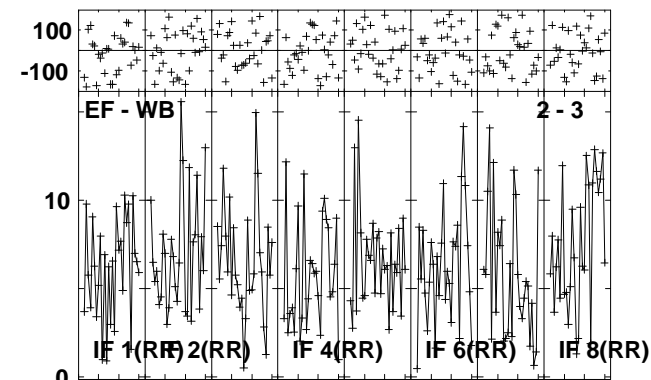
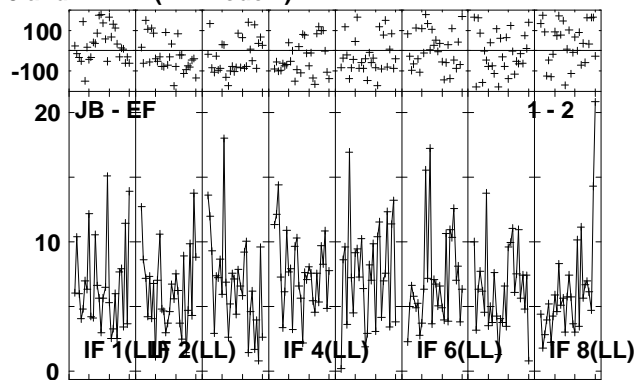
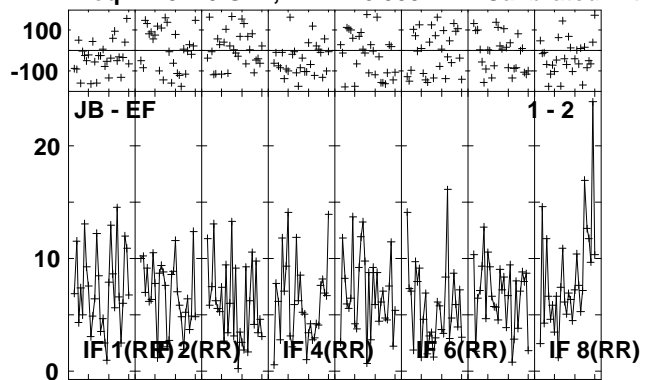

Lower frame: Milli Ampl Jy Top frame: Phas deg
Vector averaged cross-power spectrum Several baselines displayed
Timerange: 00/14:32:01 to 00/14:35:29

Plot file version 60 created 17-NOV-2010 16:18:04

ARP299D EP068A 5.UVDATA.1

Freq = 4.9270 GHz, Bw = 16.000 MH Calibrated with CL # 3 and BP # 1 (BP mode 1)

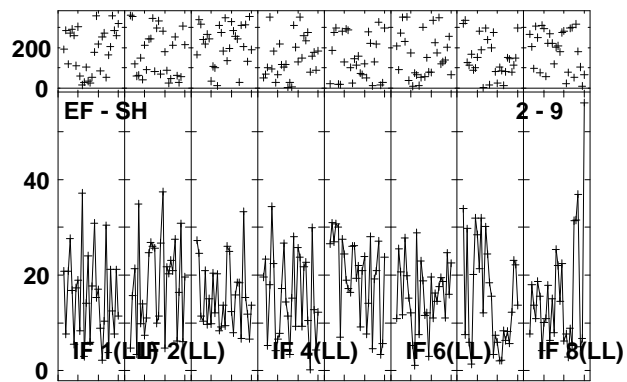
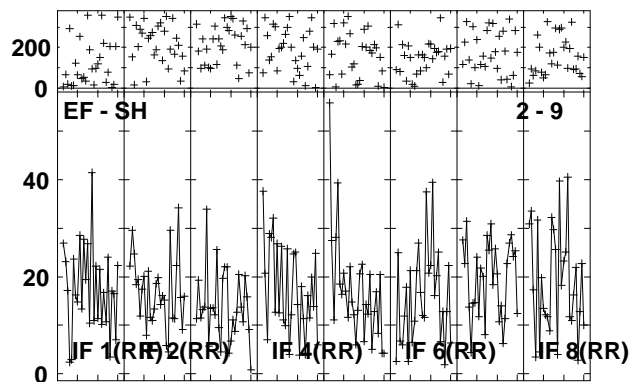
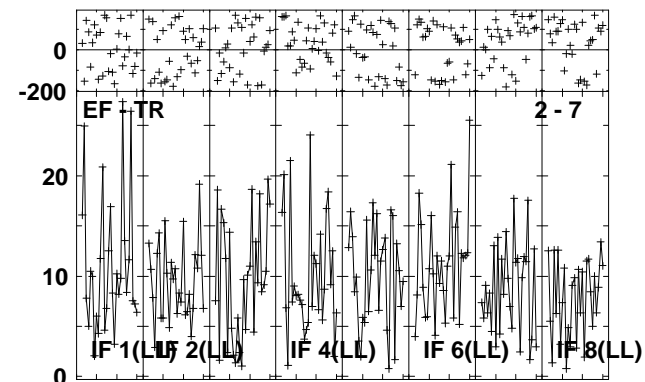
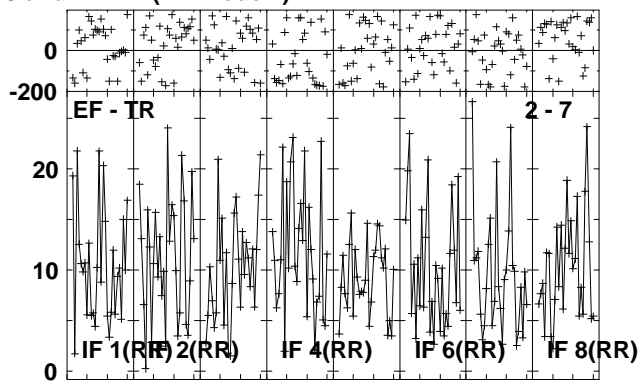
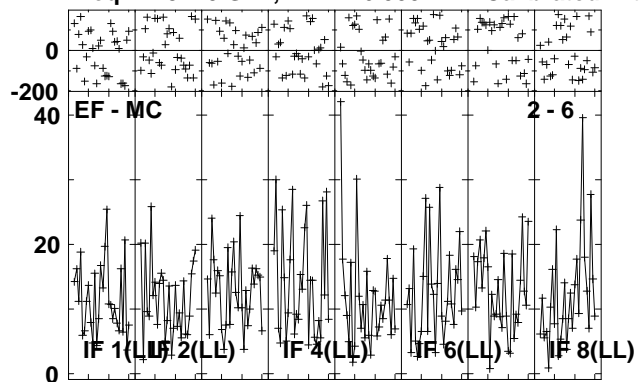

Lower frame: Milli Ampl Jy Top frame: Phas deg
Vector averaged cross-power spectrum Several baselines displayed
Timerange: 00/14:32:01 to 00/14:35:29

Plot file version 61 created 17-NOV-2010 16:18:06

J1128+59 EP068A 5.UVDATA.1

Freq = 4.9270 GHz, Bw = 16.000 MH Calibrated with CL # 3 and BP # 1 (BP mode 1)

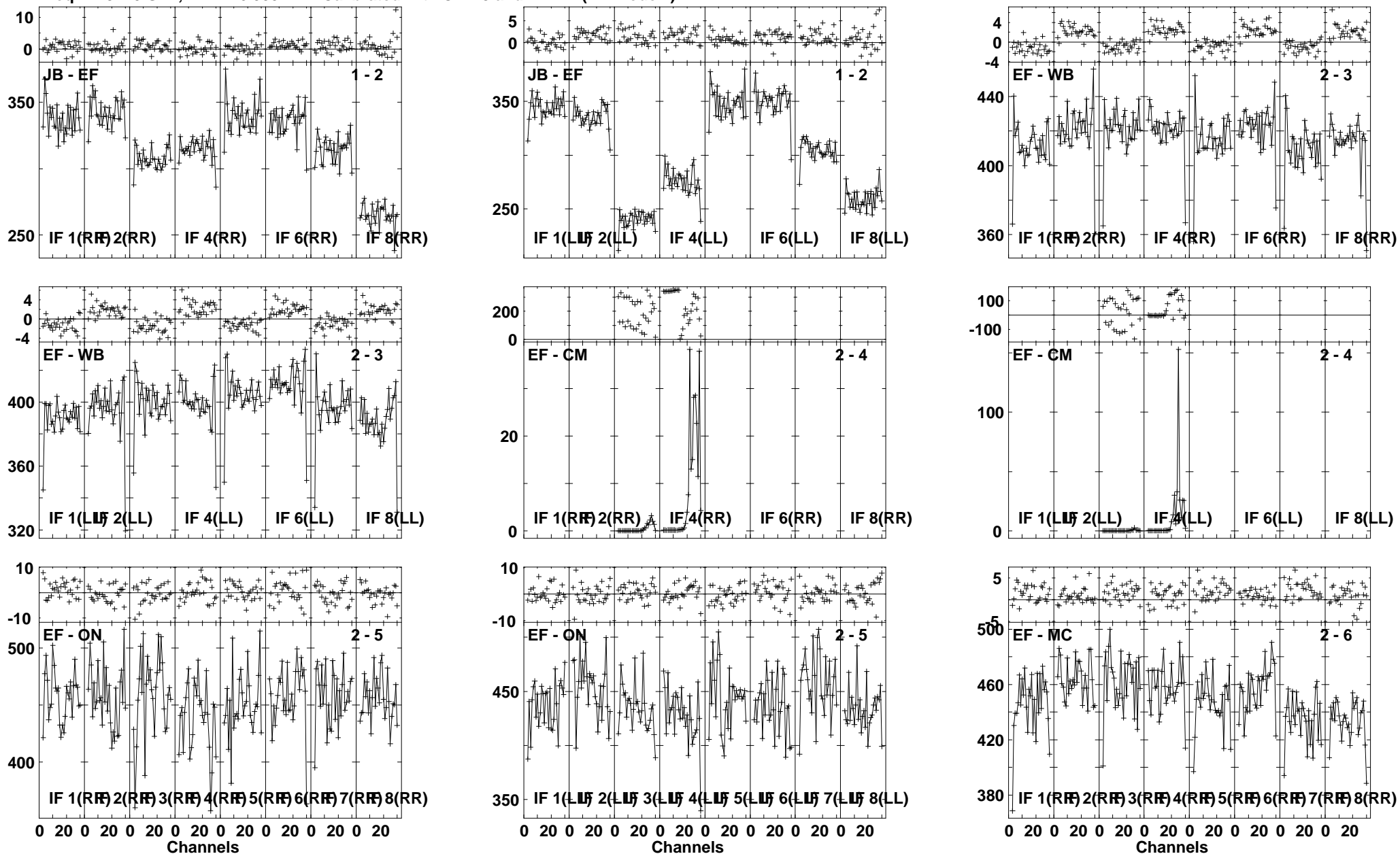

Lower frame: Milli Ampl Jy Top frame: Phas deg
Vector averaged cross-power spectrum Several baselines displayed
Timerange: 00/14:36:31 to 00/14:37:59

Plot file version 63 created 17-NOV-2010 16:18:09

ARP299D EP068A 5.UVDATA.1

Freq = 4.9270 GHz, Bw = 16.000 MH Calibrated with CL # 3 and BP # 1 (BP mode 1)

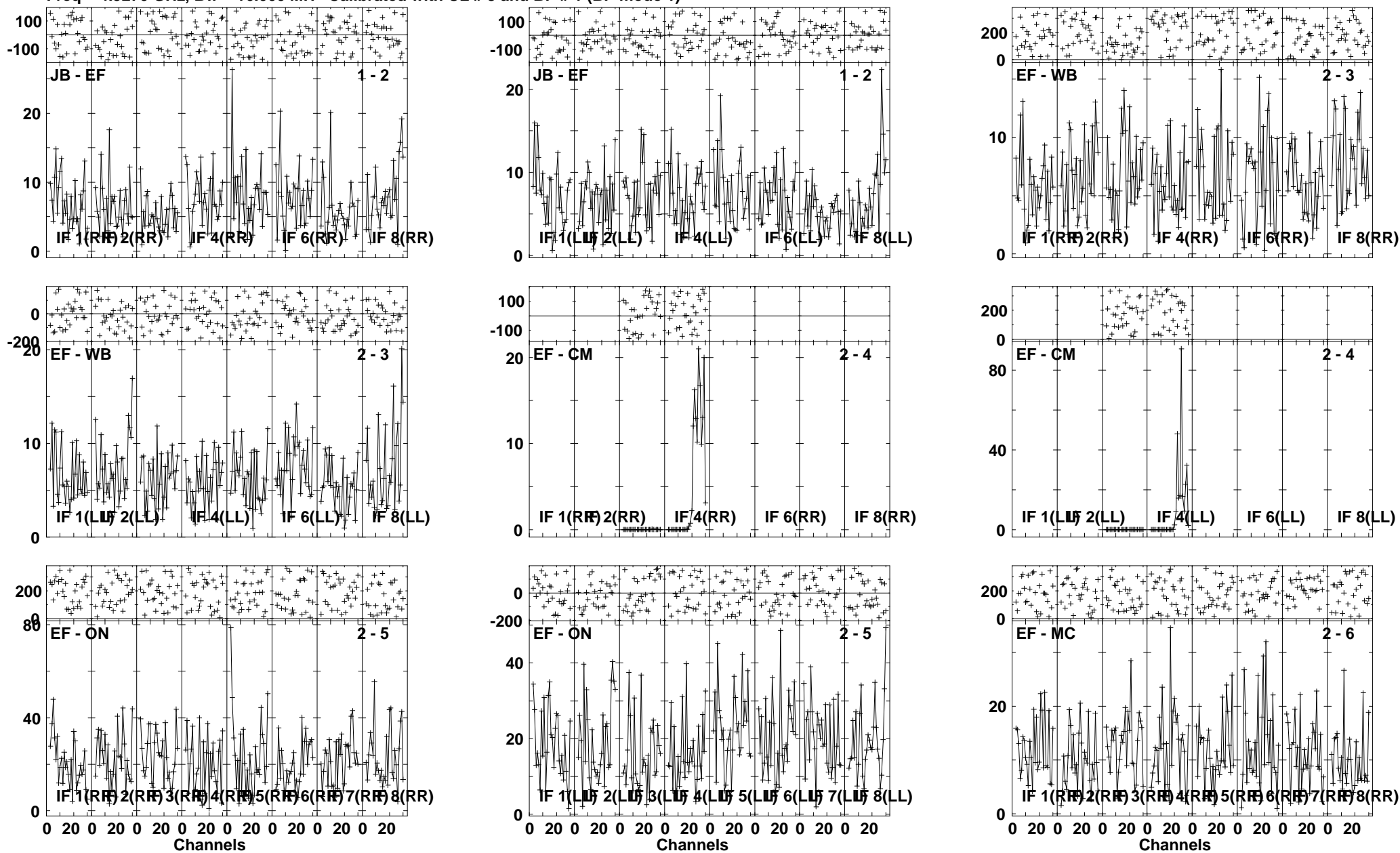

Lower frame: Milli Ampl Jy Top frame: Phas deg
Vector averaged cross-power spectrum Several baselines displayed
Timerange: 00/14:38:01 to 00/14:41:29

Plot file version 65 created 17-NOV-2010 16:18:14

J1128+59 EP068A 5.UVDATA.1

Freq = 4.9270 GHz, Bw = 16.000 MH Calibrated with CL # 3 and BP # 1 (BP mode 1)

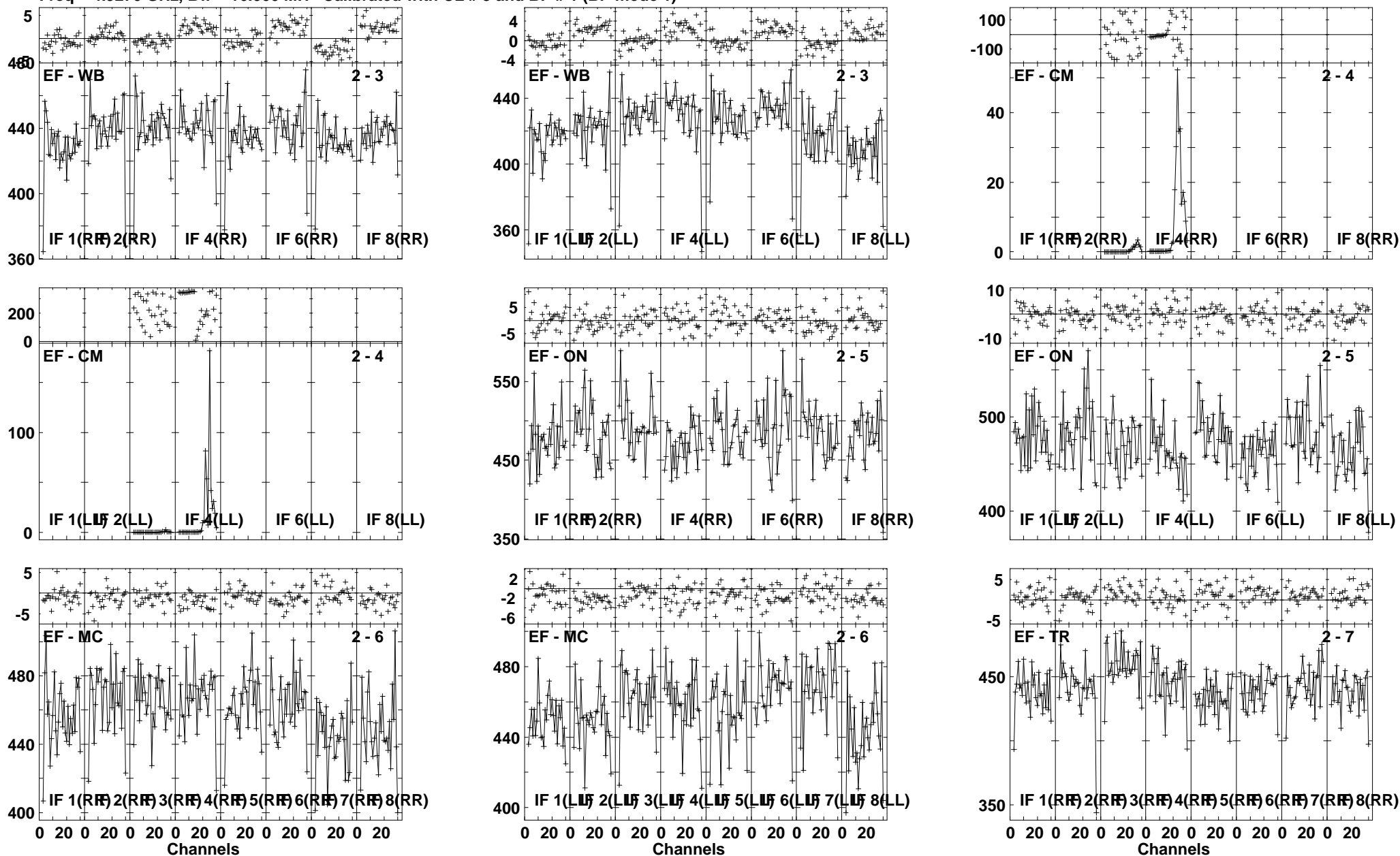

Lower frame: Milli Ampl Jy Top frame: Phas deg
Vector averaged cross-power spectrum Several baselines displayed
Timerange: 00/14:41:31 to 00/14:42:59

Plot file version 66 created 17-NOV-2010 16:18:15

J1128+59 EP068A 5.UVDATA.1

Freq = 4.9270 GHz, Bw = 16.000 MH Calibrated with CL # 3 and BP # 1 (BP mode 1)

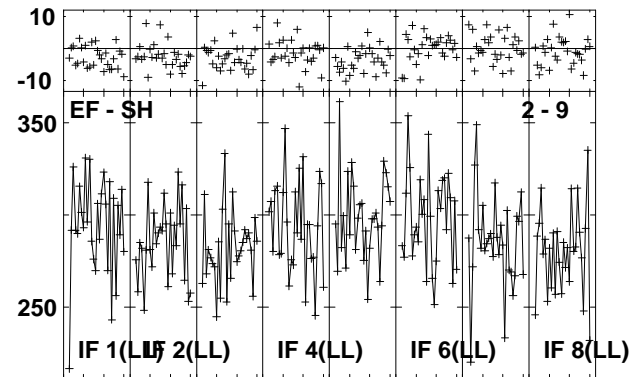
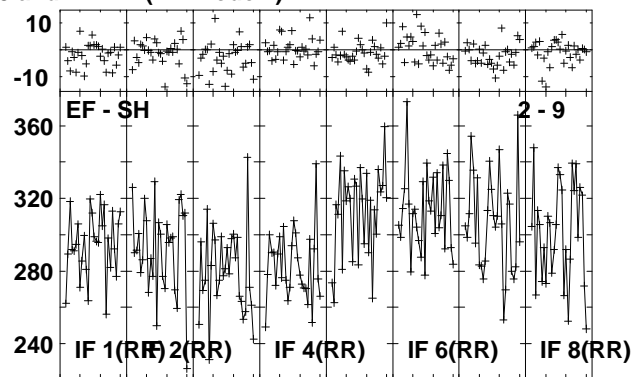
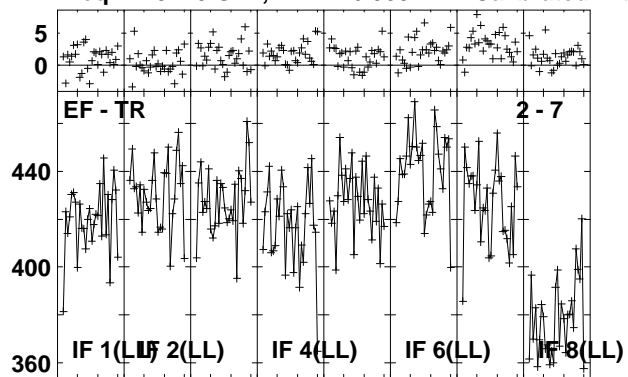

Lower frame: Milli Ampl Jy Top frame: Phas deg
Vector averaged cross-power spectrum Several baselines displayed
Timerange: 00/14:41:31 to 00/14:42:59

Plot file version 67 created 17-NOV-2010 16:18:16

ARP299D EP068A 5.UVDATA.1

Freq = 4.9270 GHz, Bw = 16.000 MH Calibrated with CL # 3 and BP # 1 (BP mode 1)

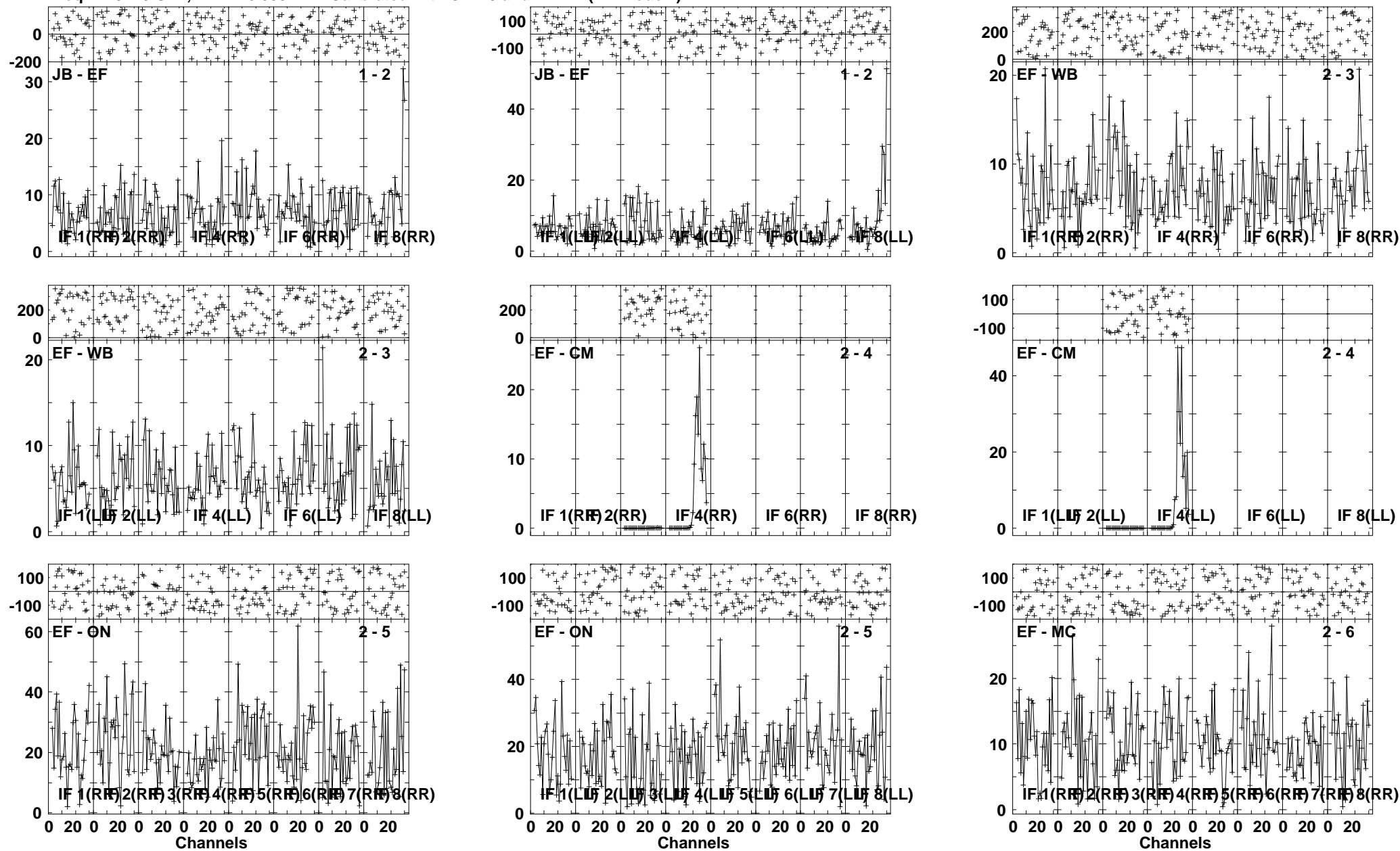

Lower frame: Milli Ampl Jy Top frame: Phas deg
Vector averaged cross-power spectrum Several baselines displayed
Timerange: 00/14:43:01 to 00/14:46:29

Plot file version 68 created 17-NOV-2010 16:18:18

ARP299D EP068A 5.UVDATA.1

Freq = 4.9270 GHz, Bw = 16.000 MH Calibrated with CL # 3 and BP # 1 (BP mode 1)

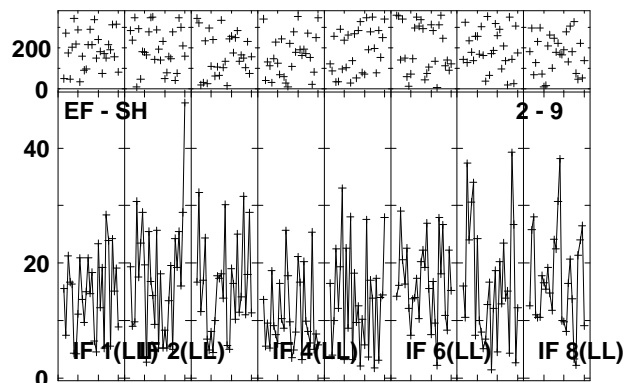
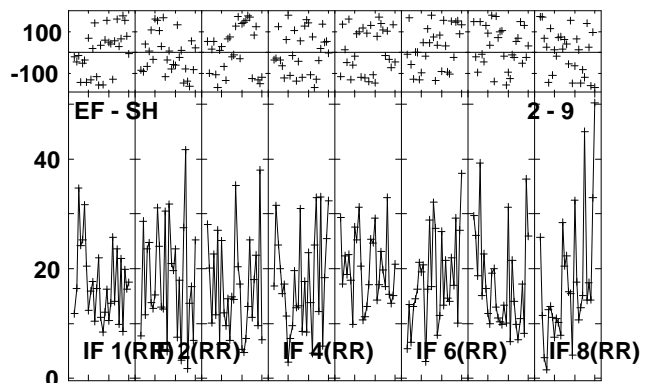
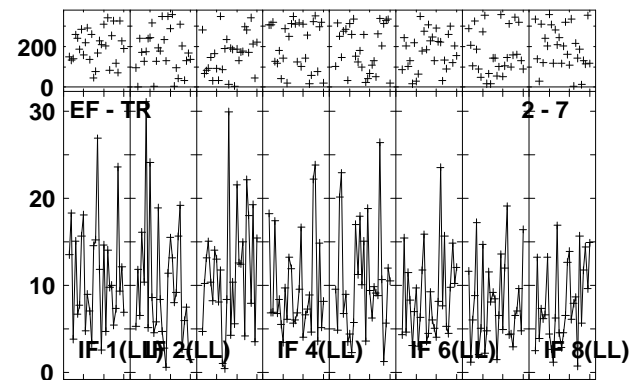
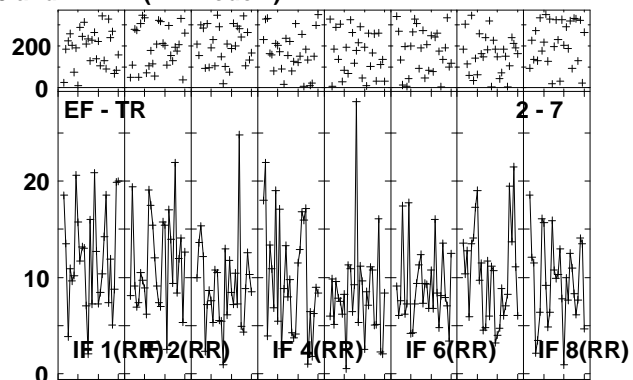
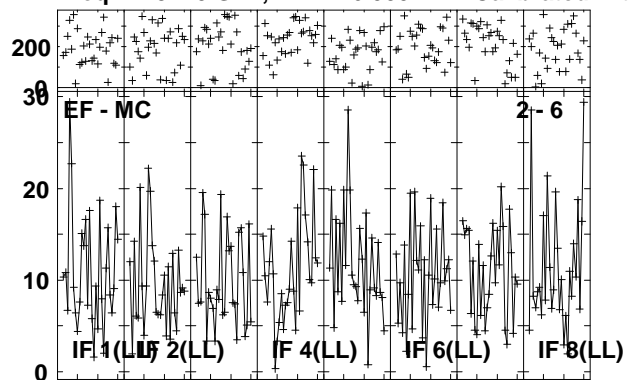

Lower frame: Milli Ampl Jy Top frame: Phas deg
Vector averaged cross-power spectrum Several baselines displayed
Timerange: 00/14:43:01 to 00/14:46:29

Plot file version 69 created 17-NOV-2010 16:18:21

4C39.25 EP068A 5.UVDATA.1

Freq = 4.9270 GHz, Bw = 16.000 MH Calibrated with CL # 3 and BP # 1 (BP mode 1)

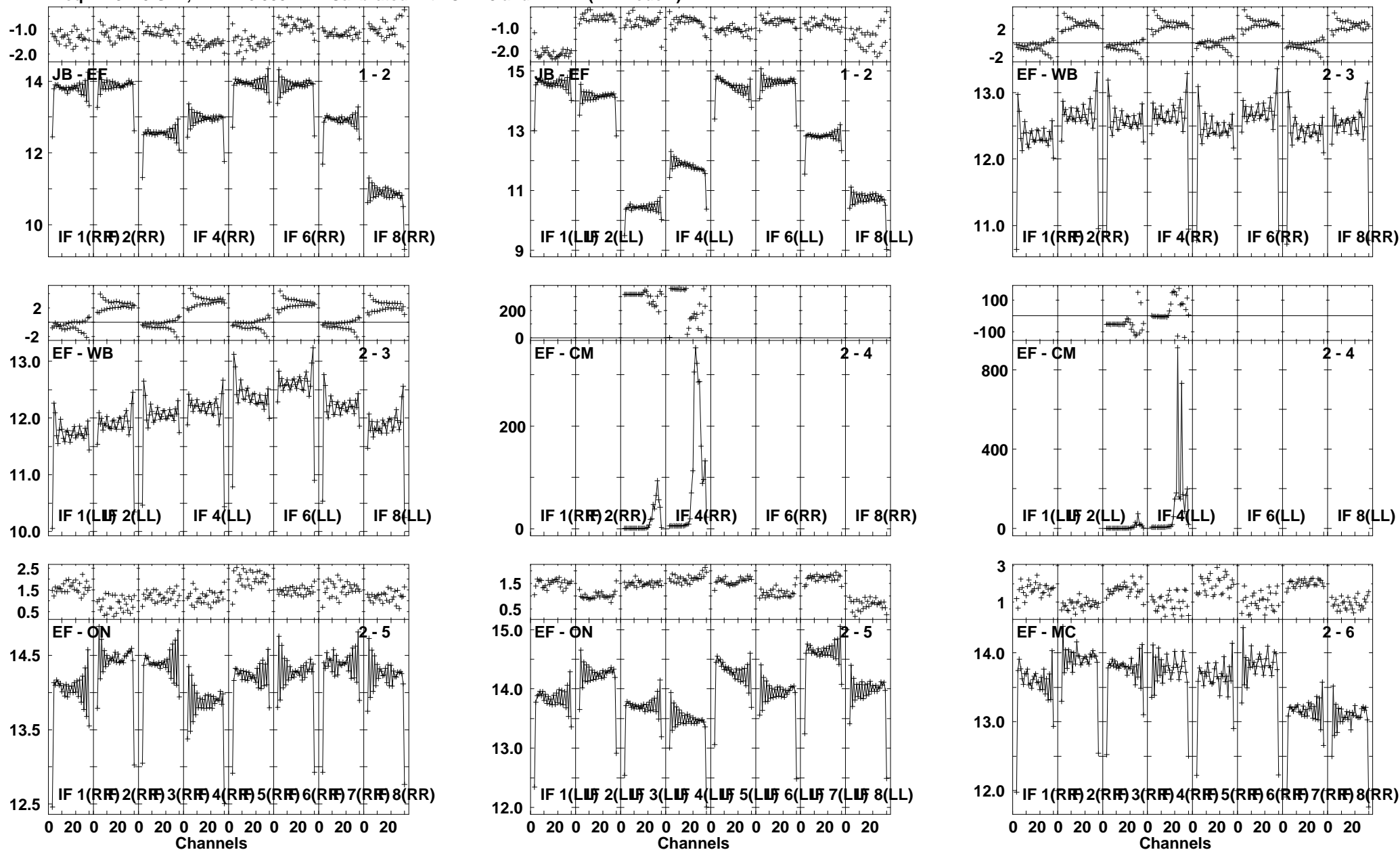

Lower frame: Ampl Jy Top frame: Phas deg
Vector averaged cross-power spectrum Several baselines displayed
Timerange: 00/14:47:31 to 00/14:54:59

Plot file version 70 created 17-NOV-2010 16:18:26

4C39.25 EP068A 5.UVDATA.1

Freq = 4.9270 GHz, Bw = 16.000 MH Calibrated with CL # 3 and BP # 1 (BP mode 1)

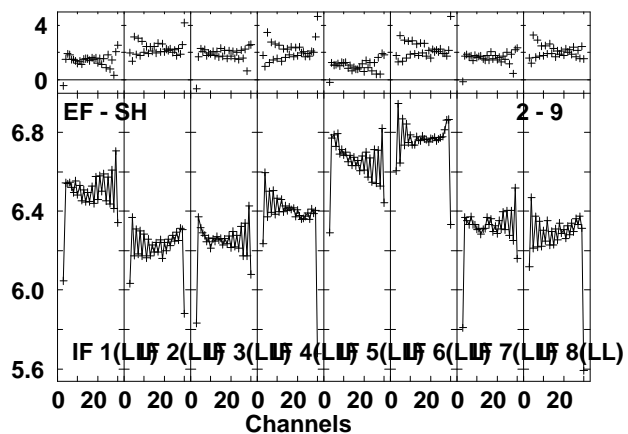
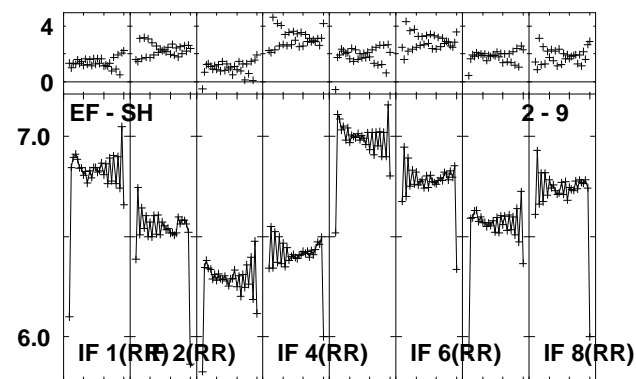
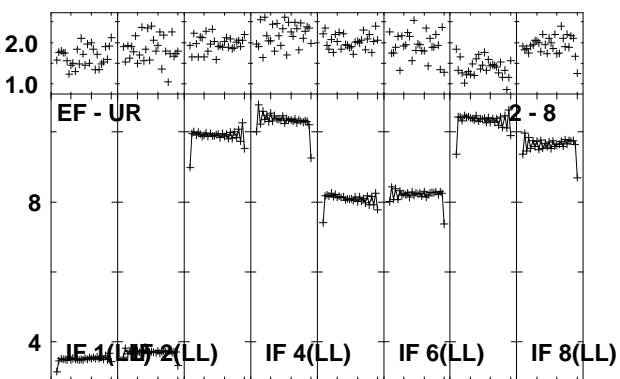
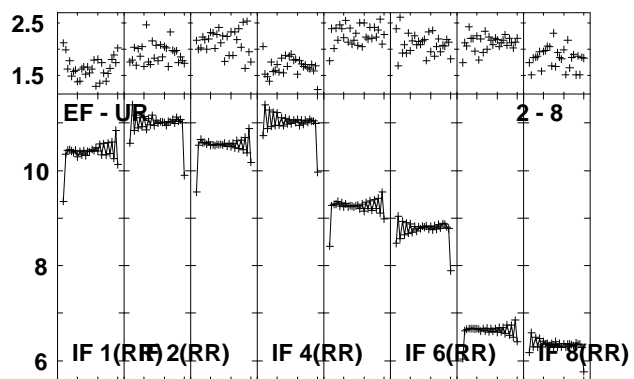
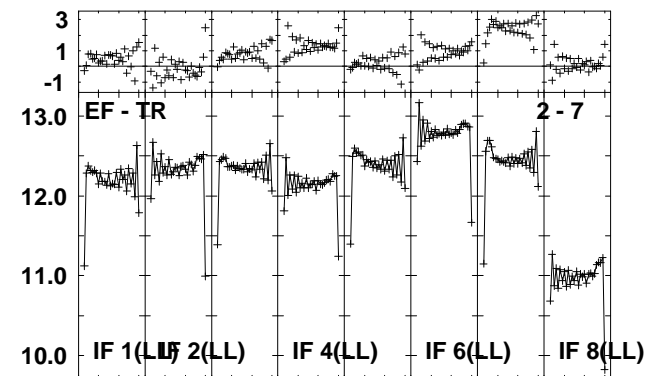
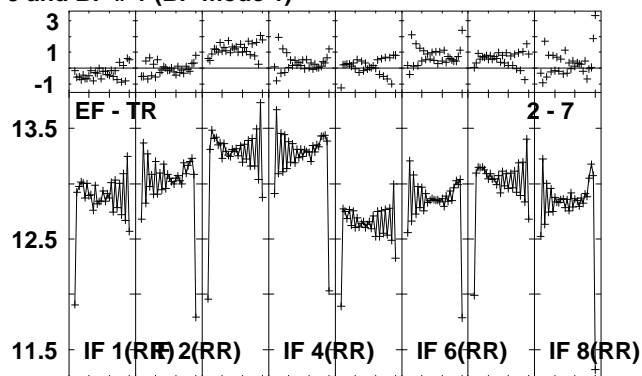
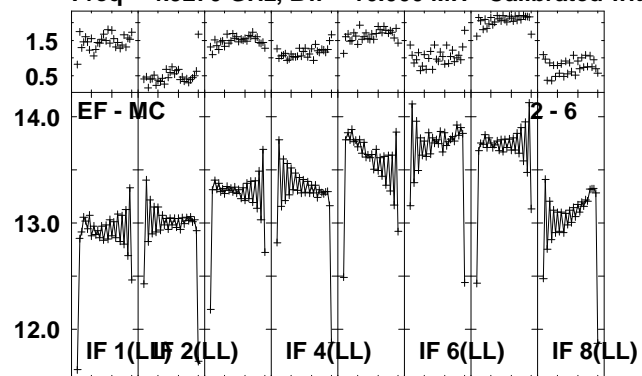

Lower frame: Ampl Jy Top frame: Phas deg
Vector averaged cross-power spectrum Several baselines displayed
Timerange: 00/14:47:31 to 00/14:54:59

Plot file version 71 created 17-NOV-2010 16:18:30

J1128+59 EP068A 5.UVDATA.1

Freq = 4.9270 GHz, Bw = 16.000 MH Calibrated with CL # 3 and BP # 1 (BP mode 1)

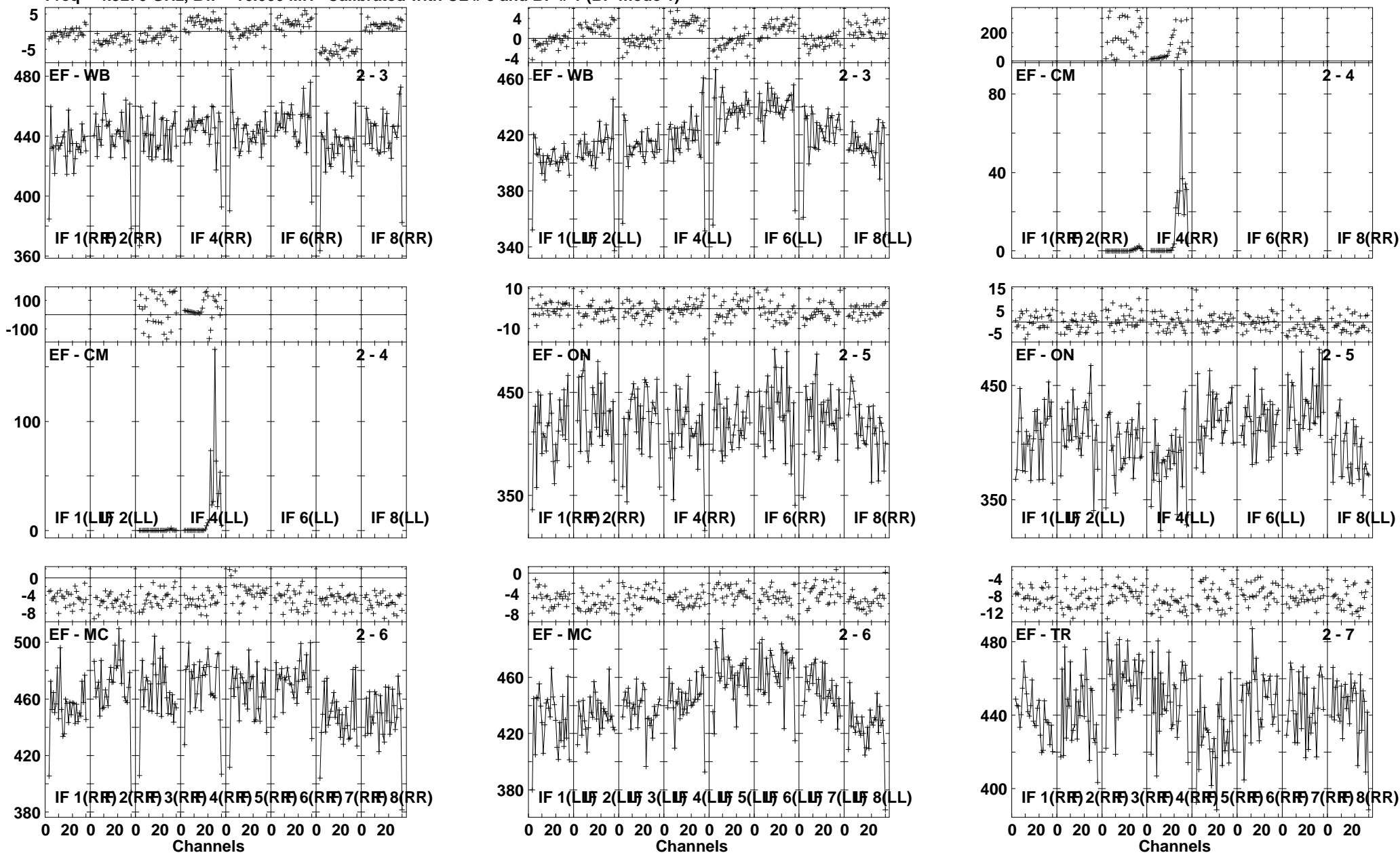

Lower frame: Milli Ampl Jy Top frame: Phas deg
Vector averaged cross-power spectrum Several baselines displayed
Timerange: 00/14:56:01 to 00/14:58:59

Plot file version 72 created 17-NOV-2010 16:18:32

J1128+59 EP068A 5.UVDATA.1

Freq = 4.9270 GHz, Bw = 16.000 MH Calibrated with CL # 3 and BP # 1 (BP mode 1)

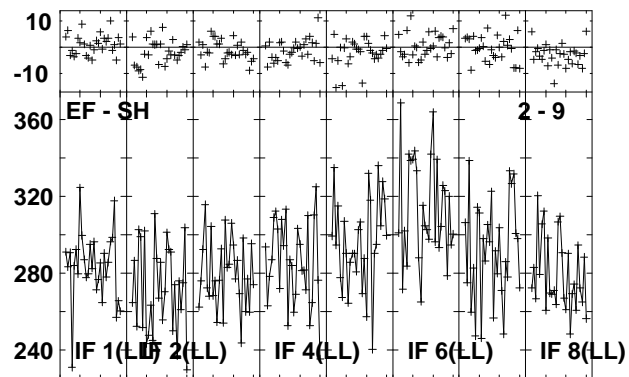
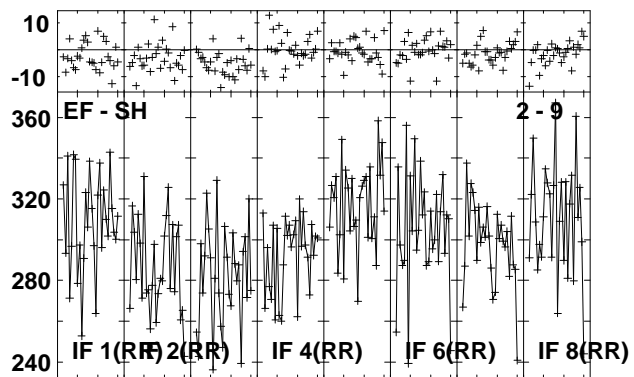
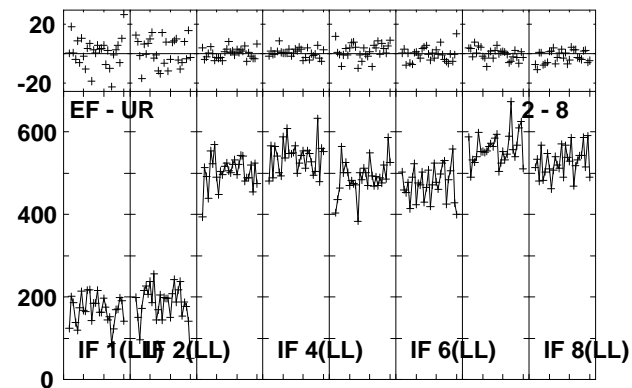
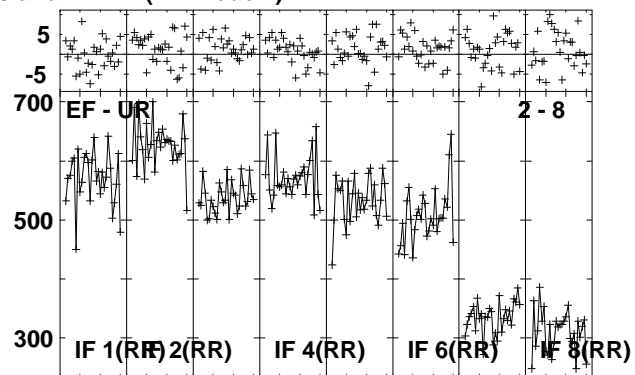
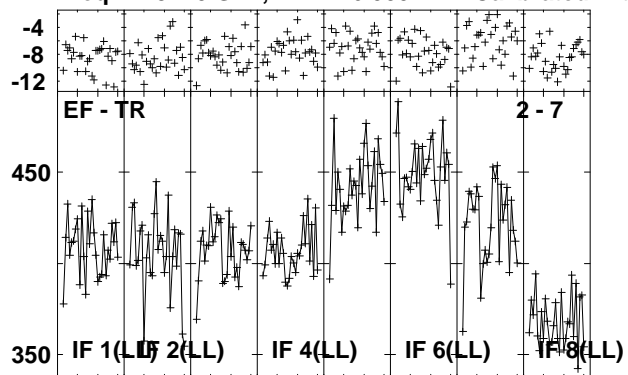

Lower frame: Milli Ampl Jy Top frame: Phas deg
Vector averaged cross-power spectrum Several baselines displayed
Timerange: 00/14:56:01 to 00/14:58:59

Plot file version 73 created 17-NOV-2010 16:18:33

ARP299D EP068A 5.UVDATA.1

Freq = 4.9270 GHz, Bw = 16.000 MH Calibrated with CL # 3 and BP # 1 (BP mode 1)

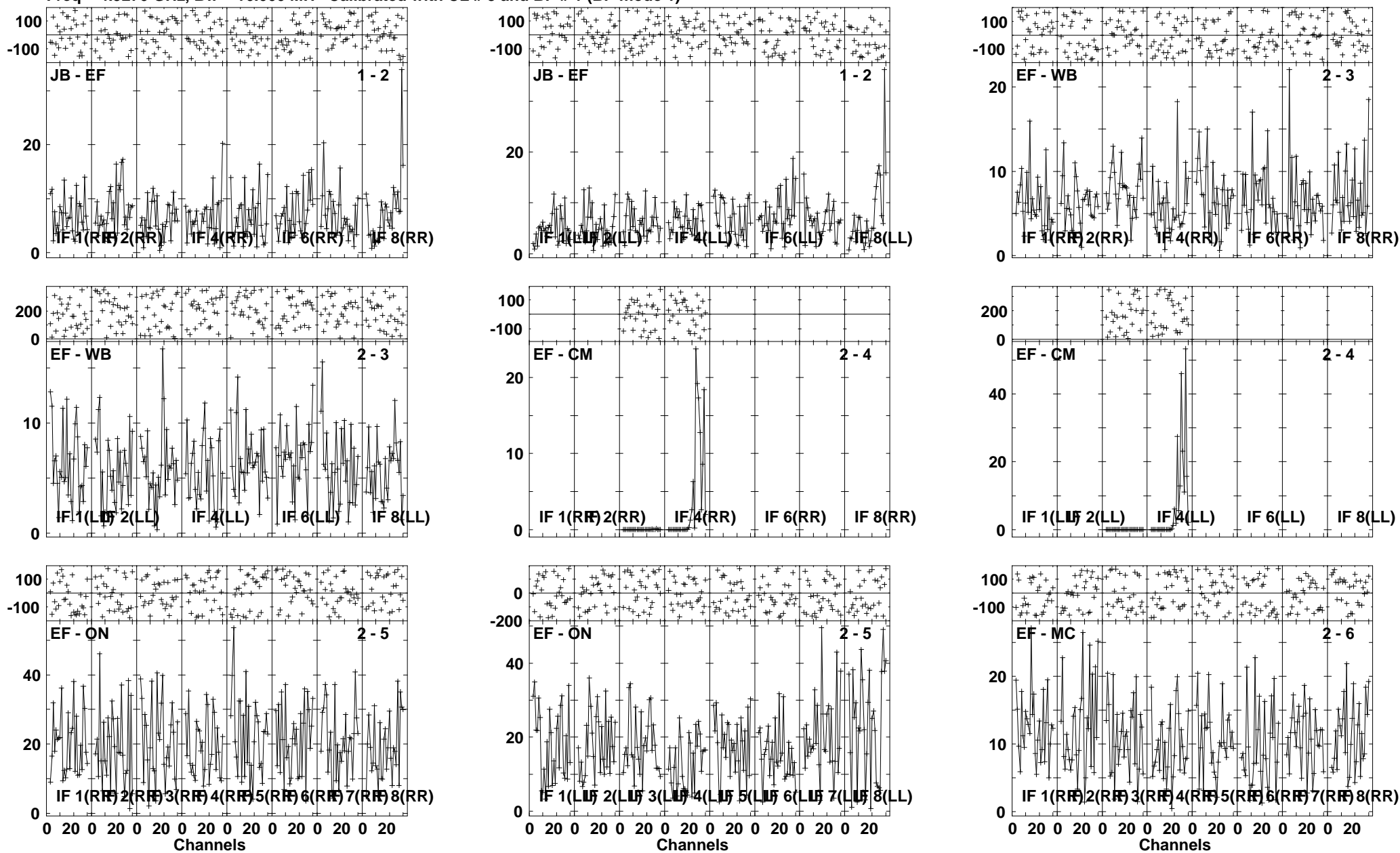

Lower frame: Milli Ampl Jy Top frame: Phas deg
Vector averaged cross-power spectrum Several baselines displayed
Timerange: 00/14:59:01 to 00/15:02:29

Plot file version 74 created 17-NOV-2010 16:18:36

ARP299D EP068A 5.UVDATA.1

Freq = 4.9270 GHz, Bw = 16.000 MH Calibrated with CL # 3 and BP # 1 (BP mode 1)

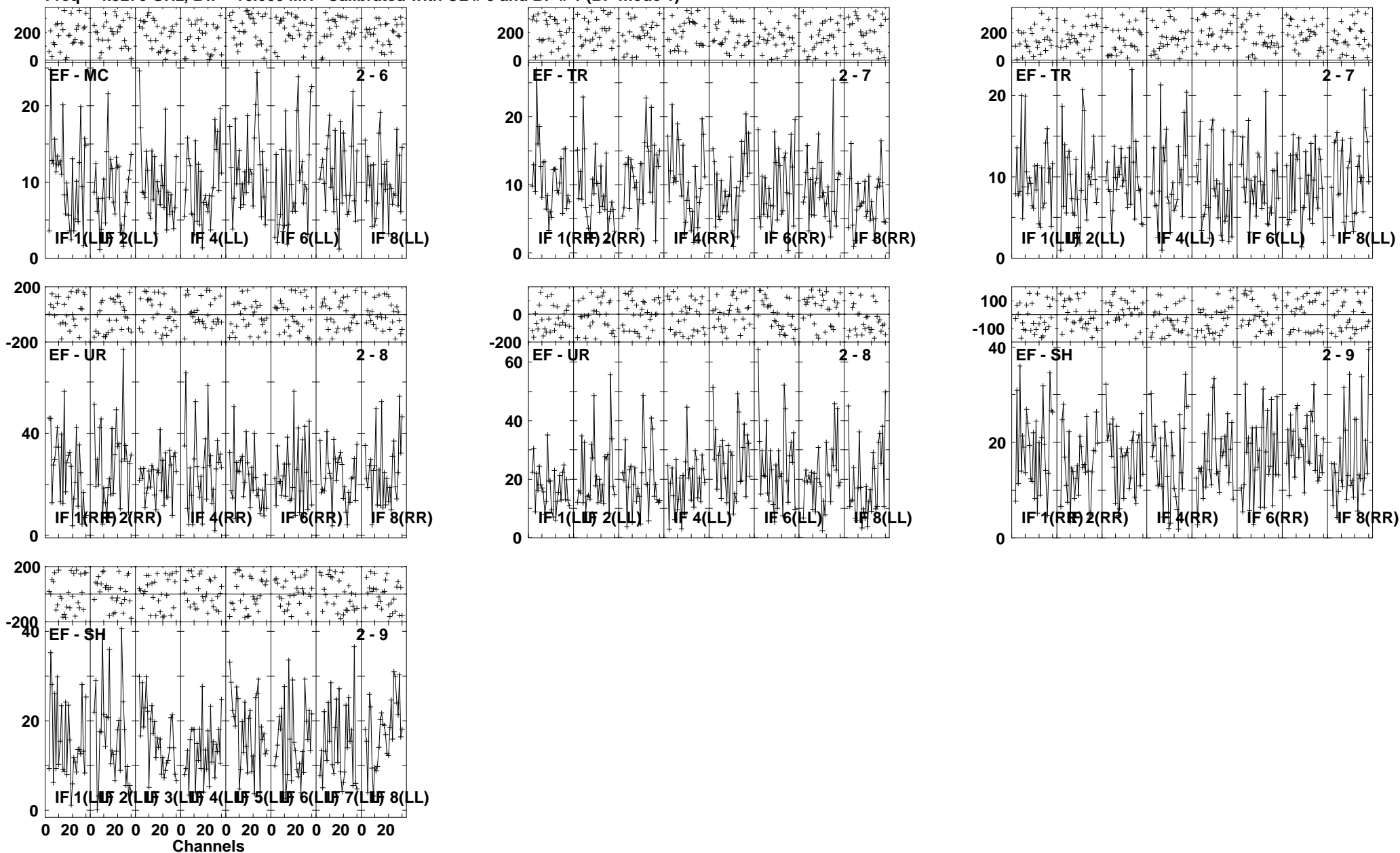

Lower frame: Milli Ampl Jy Top frame: Phas deg
Vector averaged cross-power spectrum Several baselines displayed
Timerange: 00/14:59:01 to 00/15:02:29

Plot file version 75 created 17-NOV-2010 16:18:38

J1128+59 EP068A 5.UVDATA.1

Freq = 4.9270 GHz, Bw = 16.000 MH Calibrated with CL # 3 and BP # 1 (BP mode 1)

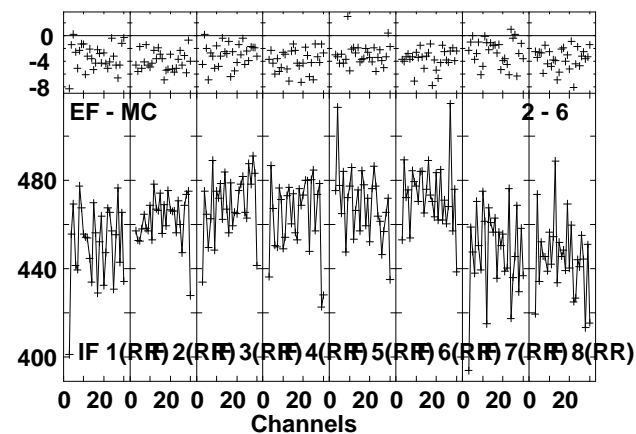
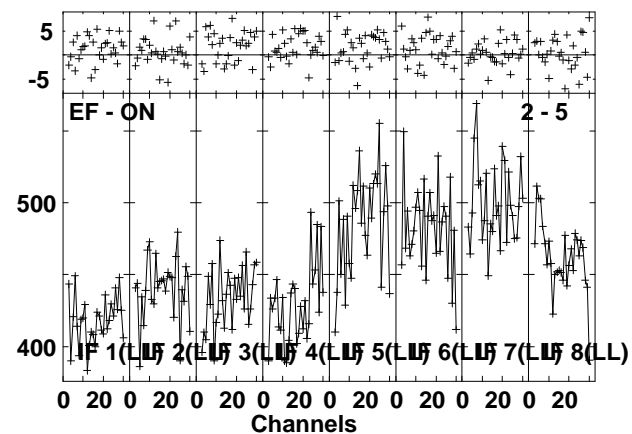
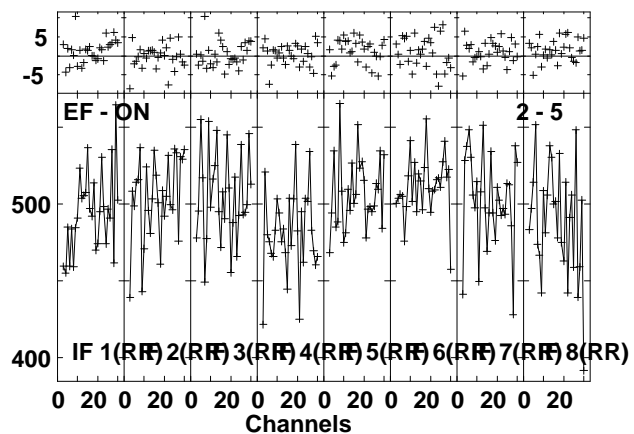
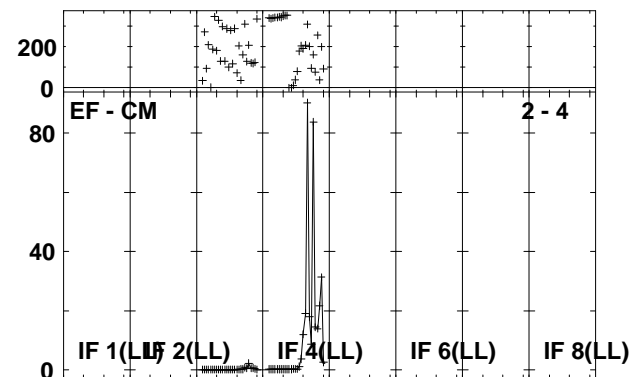
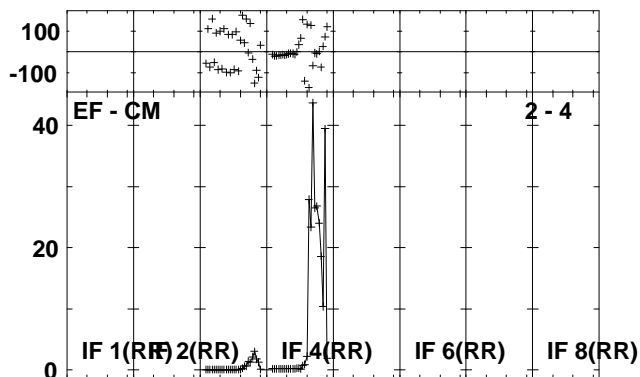
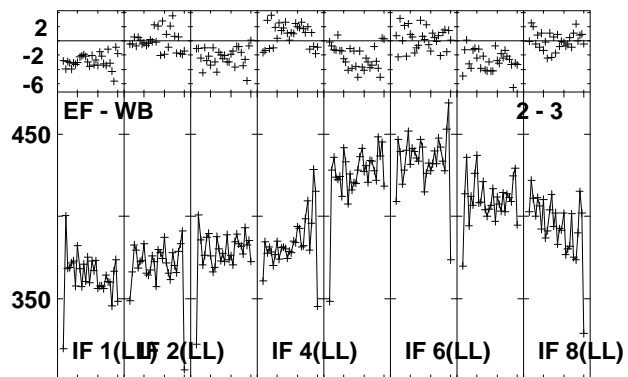
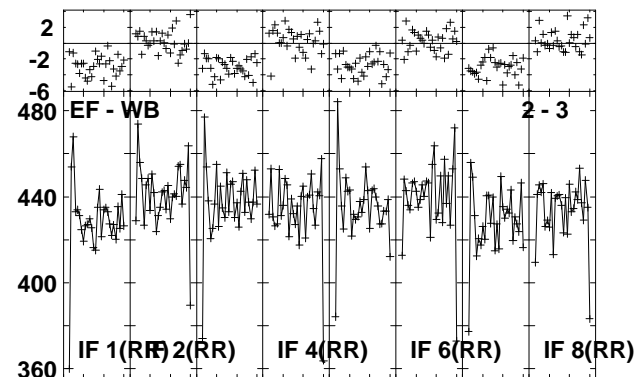
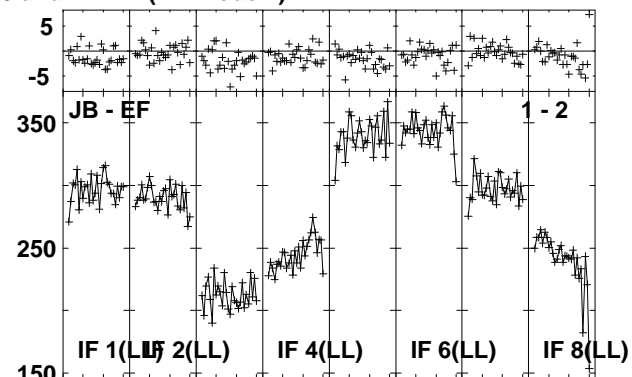
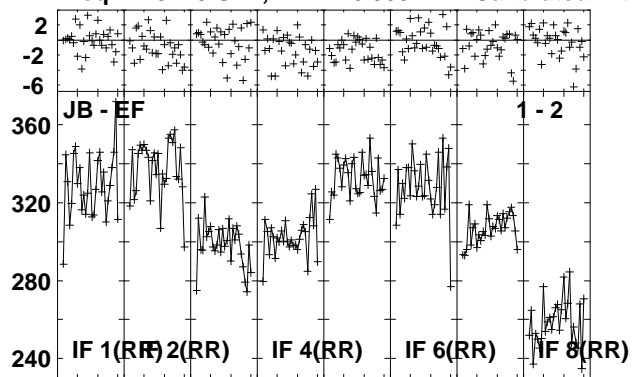

Lower frame: Milli Ampl Jy Top frame: Phas deg
Vector averaged cross-power spectrum Several baselines displayed
Timerange: 00/15:02:31 to 00/15:03:59

Plot file version 77 created 17-NOV-2010 16:18:41

ARP299D EP068A 5.UVDATA.1

Freq = 4.9270 GHz, Bw = 16.000 MH Calibrated with CL # 3 and BP # 1 (BP mode 1)

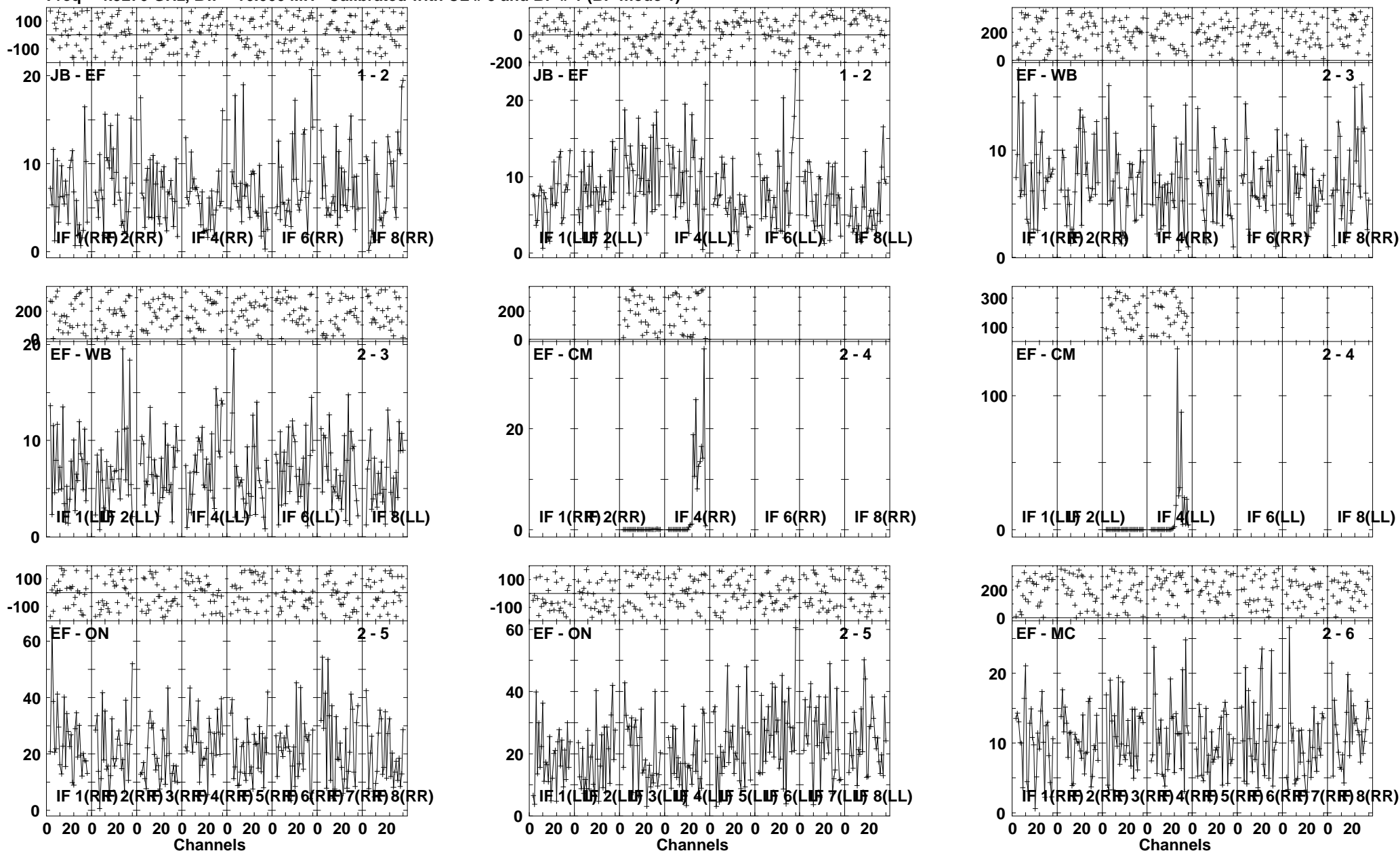

Lower frame: Milli Ampl Jy Top frame: Phas deg
Vector averaged cross-power spectrum Several baselines displayed
Timerange: 00/15:04:01 to 00/15:07:29

Plot file version 78 created 17-NOV-2010 16:18:43

ARP299D EP068A 5.UVDATA.1

Freq = 4.9270 GHz, Bw = 16.000 MH Calibrated with CL # 3 and BP # 1 (BP mode 1)

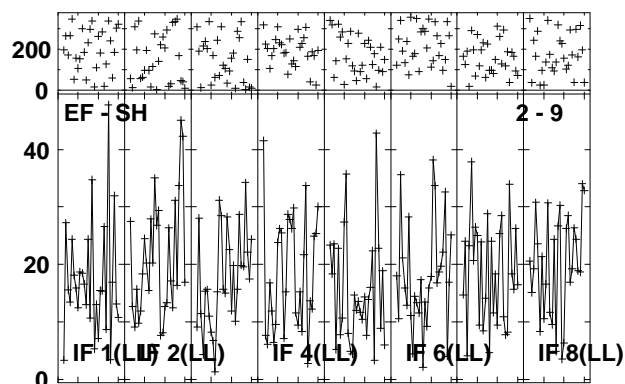
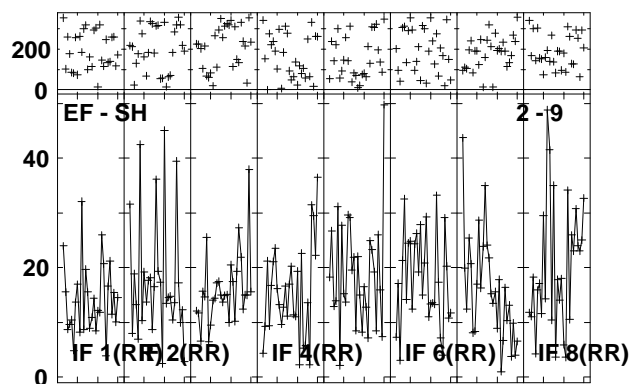
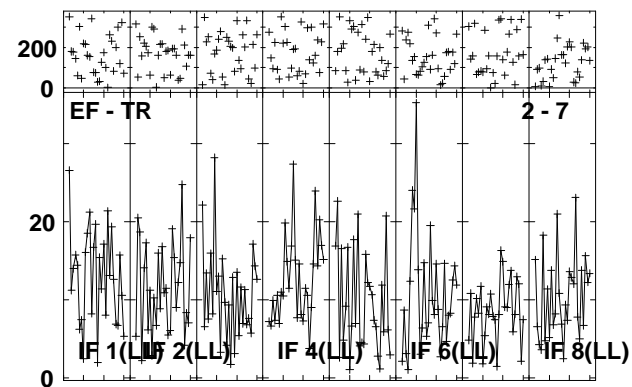
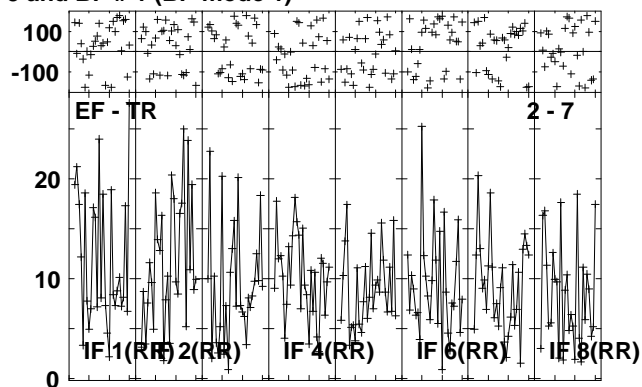
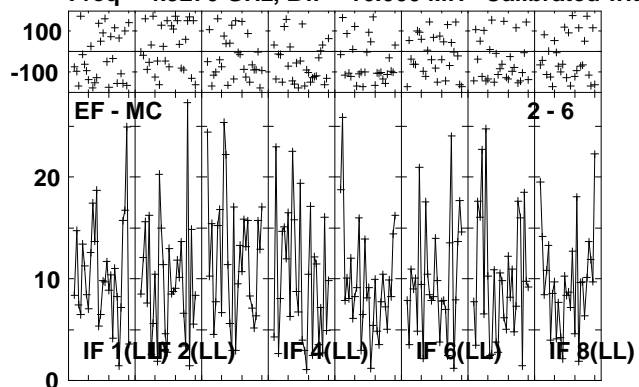

Lower frame: Milli Ampl Jy Top frame: Phas deg
Vector averaged cross-power spectrum Several baselines displayed
Timerange: 00/15:04:01 to 00/15:07:29

Plot file version 79 created 17-NOV-2010 16:18:45

J1128+59 EP068A 5.UVDATA.1

Freq = 4.9270 GHz, Bw = 16.000 MH Calibrated with CL # 3 and BP # 1 (BP mode 1)

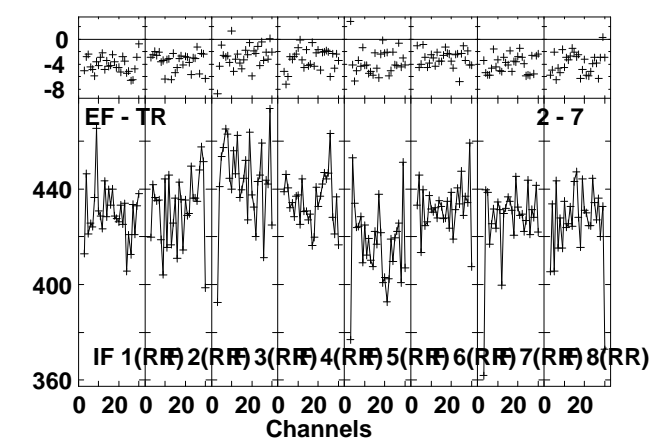
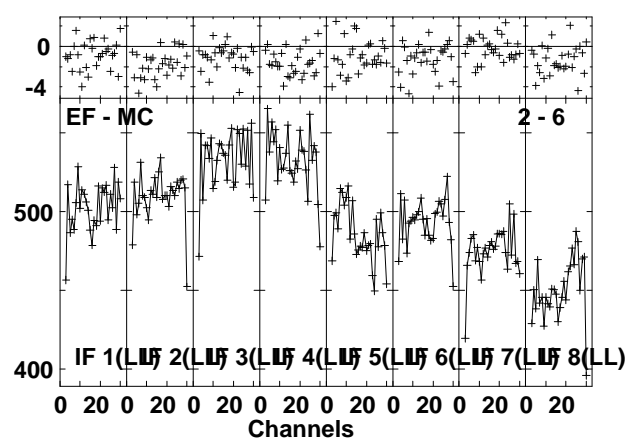
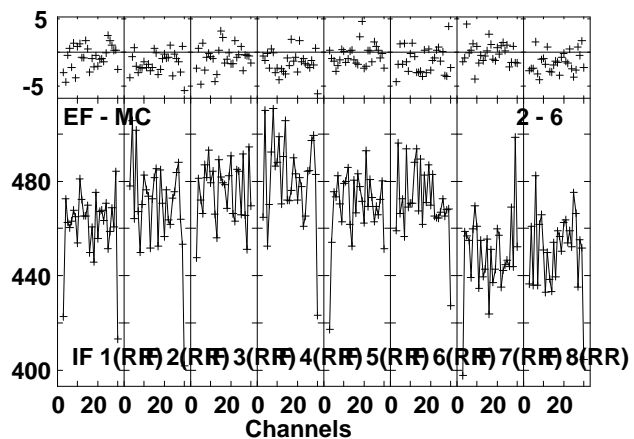
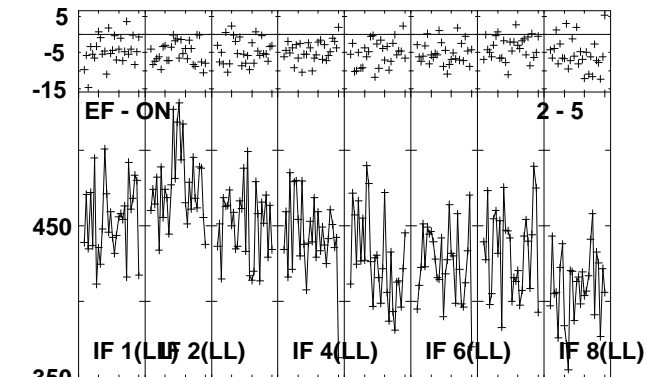
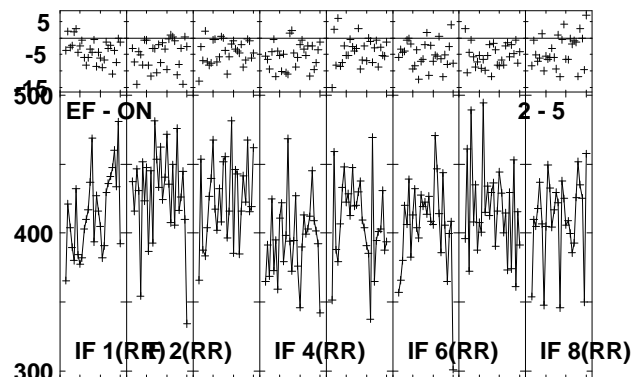
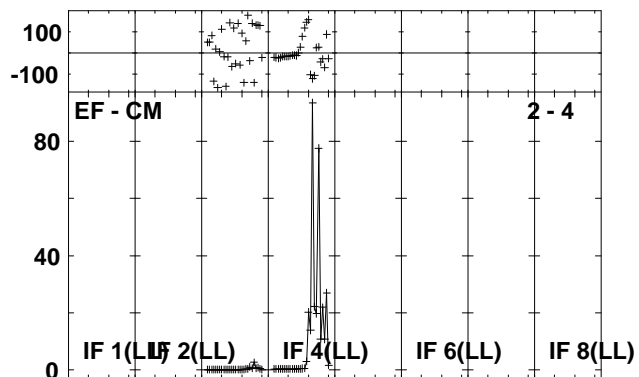
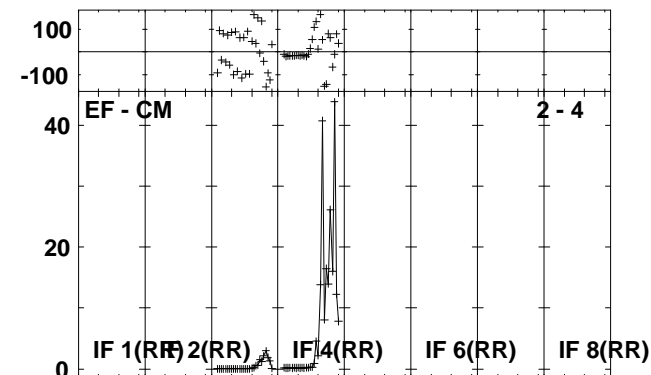
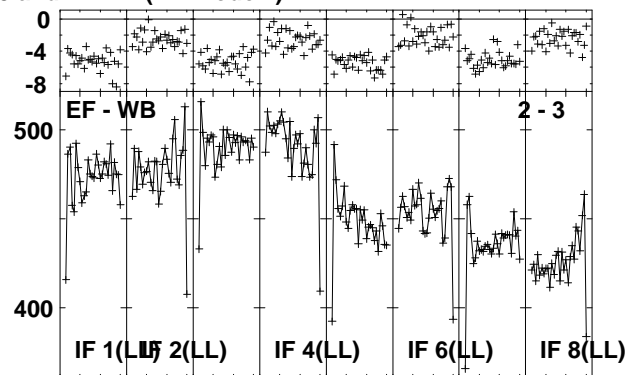
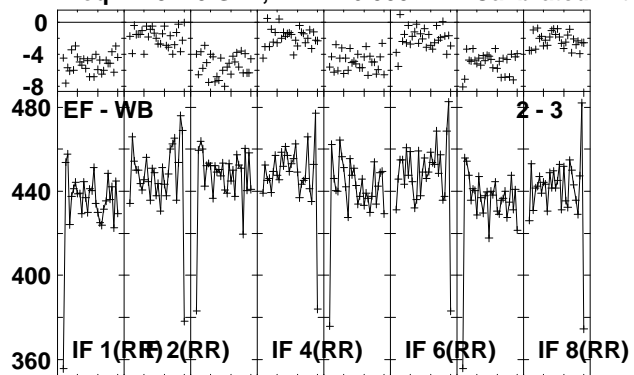

Lower frame: Milli Ampl Jy Top frame: Phas deg
Vector averaged cross-power spectrum Several baselines displayed
Timerange: 00/15:08:31 to 00/15:09:59

Plot file version 80 created 17-NOV-2010 16:18:46

J1128+59 EP068A 5.UVDATA.1

Freq = 4.9270 GHz, Bw = 16.000 MH Calibrated with CL # 3 and BP # 1 (BP mode 1)

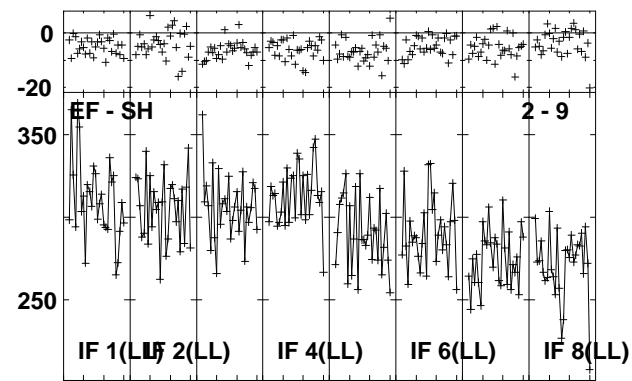
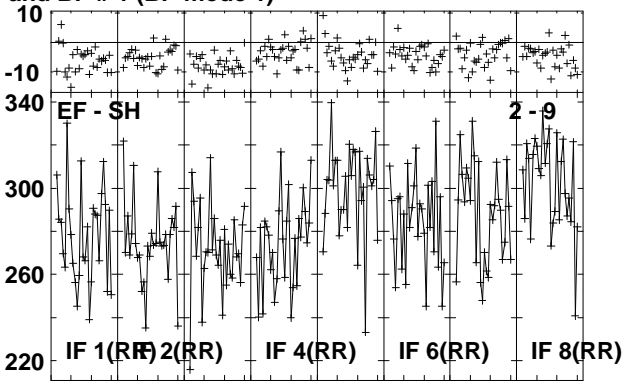
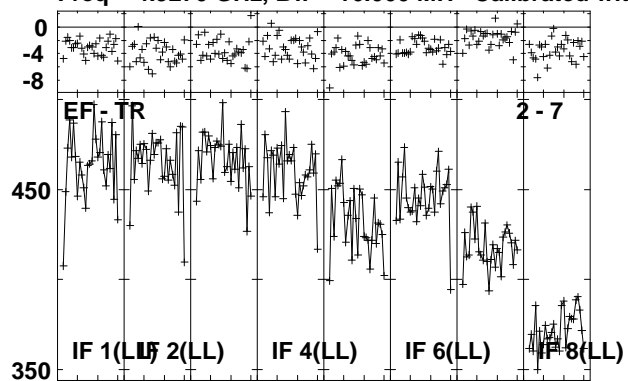

Lower frame: Milli Ampl Jy Top frame: Phas deg
Vector averaged cross-power spectrum Several baselines displayed
Timerange: 00/15:08:31 to 00/15:09:59

Plot file version 82 created 17-NOV-2010 16:18:49

ARP299D EP068A 5.UVDATA.1

Freq = 4.9270 GHz, Bw = 16.000 MH Calibrated with CL # 3 and BP # 1 (BP mode 1)

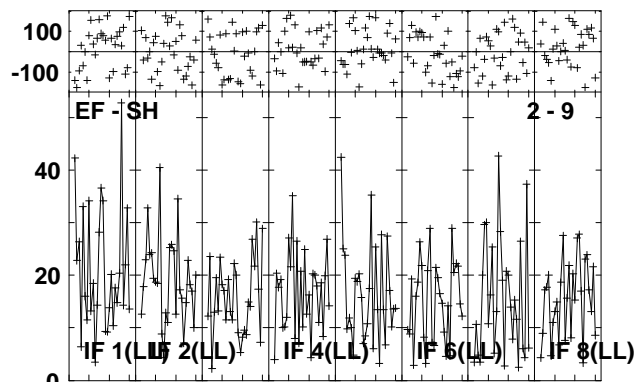
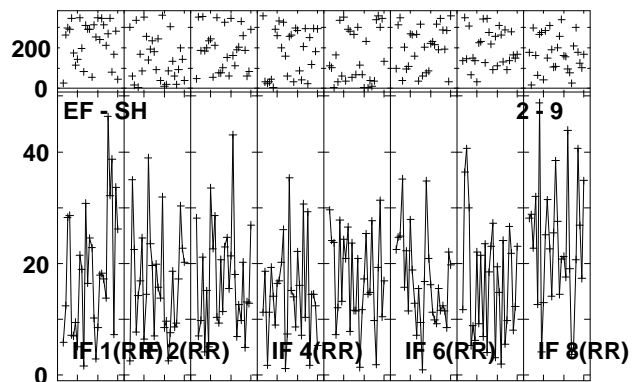
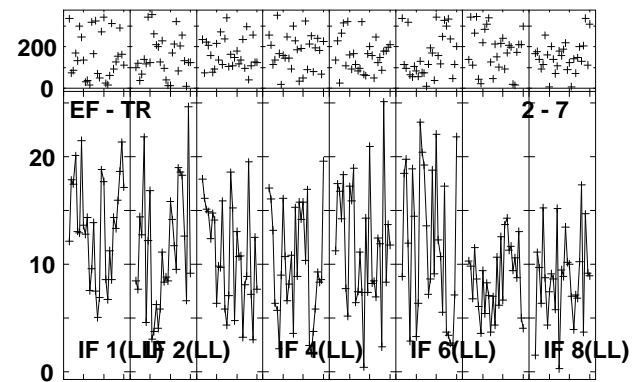
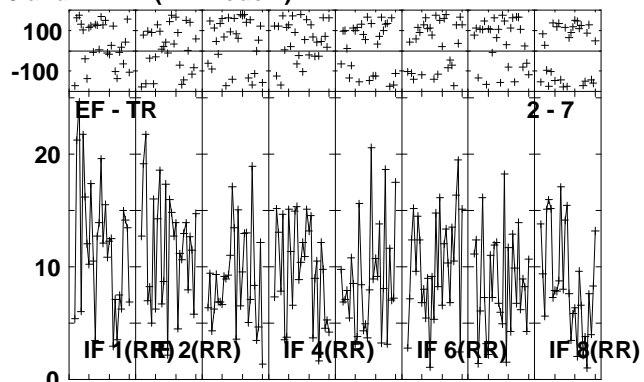
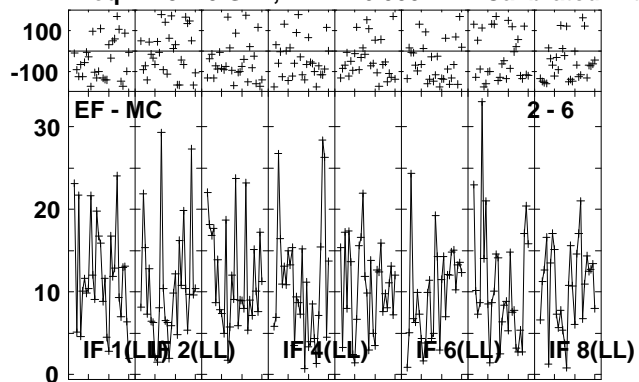

Lower frame: Milli Ampl Jy Top frame: Phas deg
Vector averaged cross-power spectrum Several baselines displayed
Timerange: 00/15:10:01 to 00/15:13:29

Plot file version 83 created 17-NOV-2010 16:18:51

J1128+59 EP068A 5.UVDATA.1

Freq = 4.9270 GHz, Bw = 16.000 MH Calibrated with CL # 3 and BP # 1 (BP mode 1)

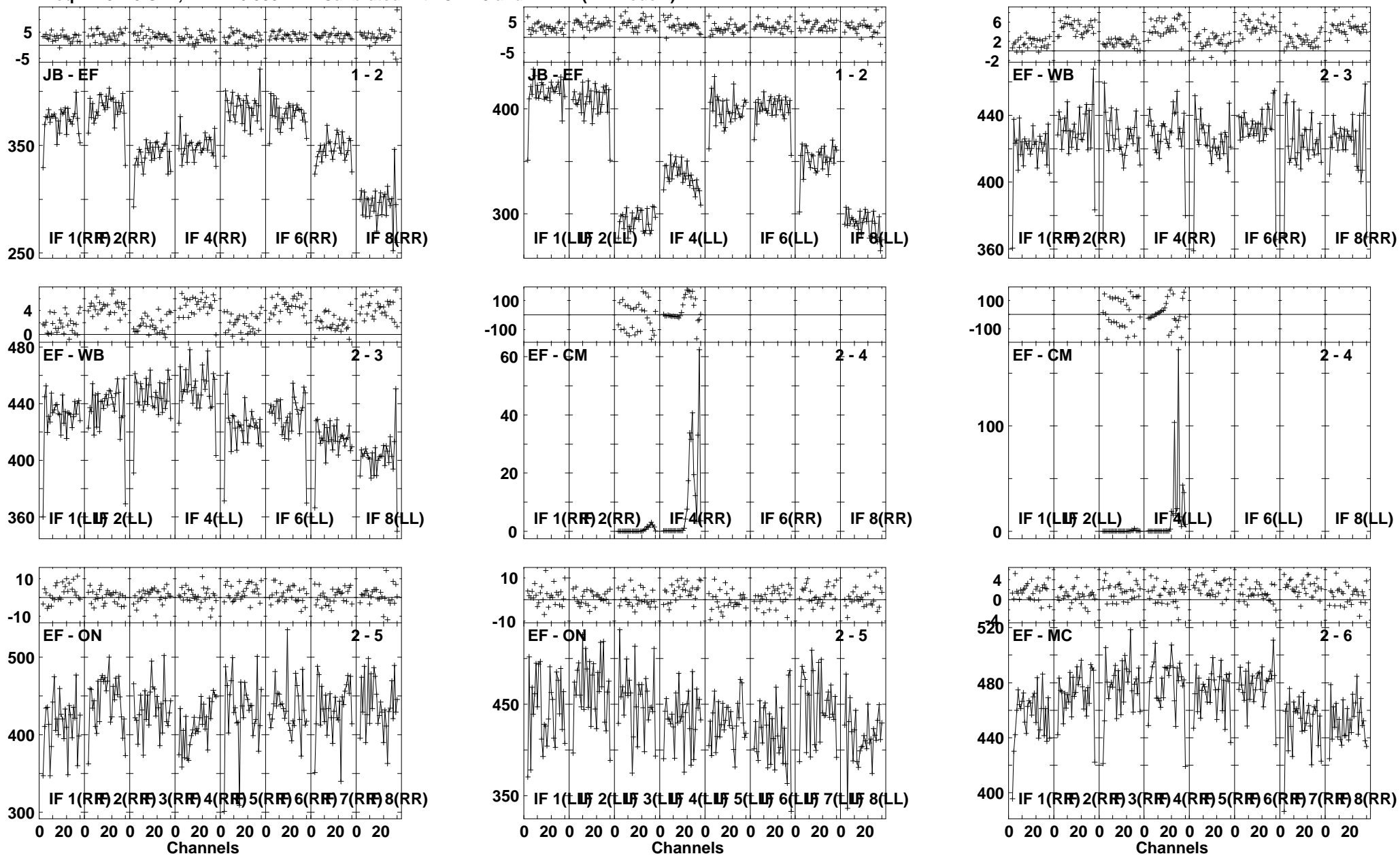

Lower frame: Milli Ampl Jy Top frame: Phas deg
Vector averaged cross-power spectrum Several baselines displayed
Timerange: 00/15:13:31 to 00/15:14:59

Plot file version 84 created 17-NOV-2010 16:18:52

J1128+59 EP068A 5.UVDATA.1

Freq = 4.9270 GHz, Bw = 16.000 MH Calibrated with CL # 3 and BP # 1 (BP mode 1)

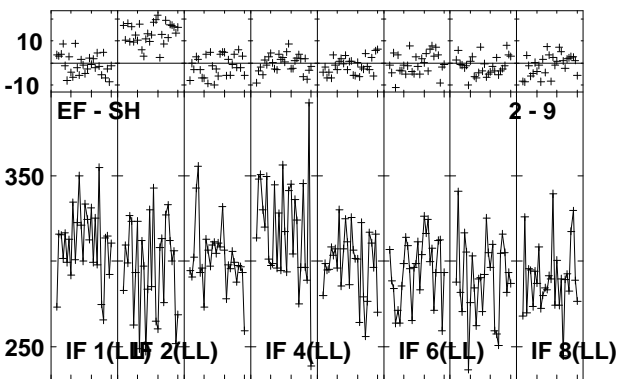
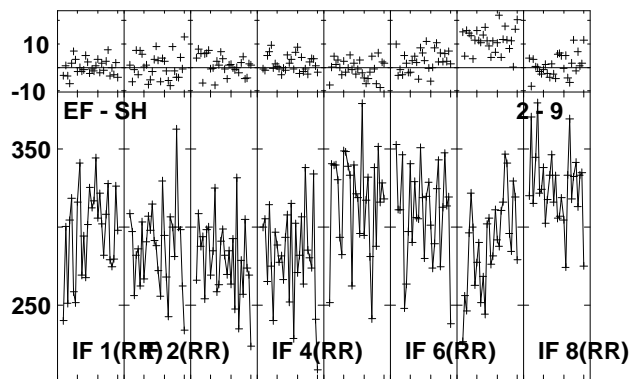
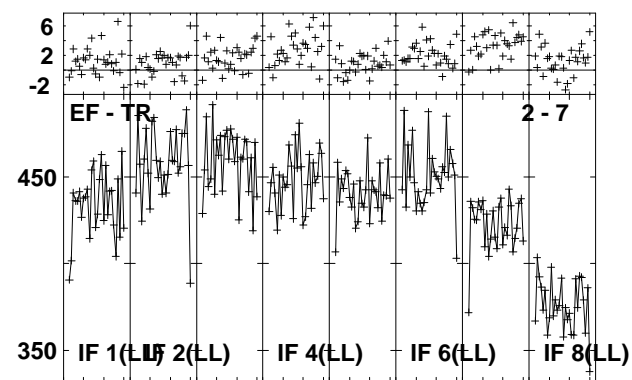
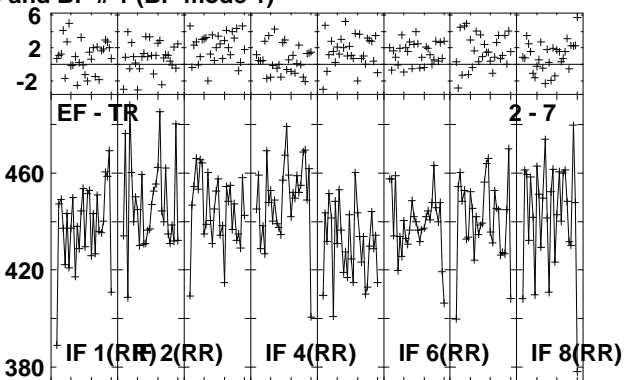
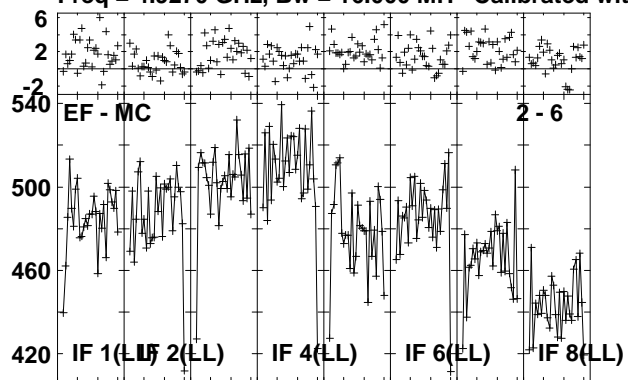

Lower frame: Milli Ampl Jy Top frame: Phas deg
Vector averaged cross-power spectrum Several baselines displayed
Timerange: 00/15:13:31 to 00/15:14:59

Plot file version 85 created 17-NOV-2010 16:18:53

ARP299D EP068A 5.UVDATA.1

Freq = 4.9270 GHz, Bw = 16.000 MH Calibrated with CL # 3 and BP # 1 (BP mode 1)

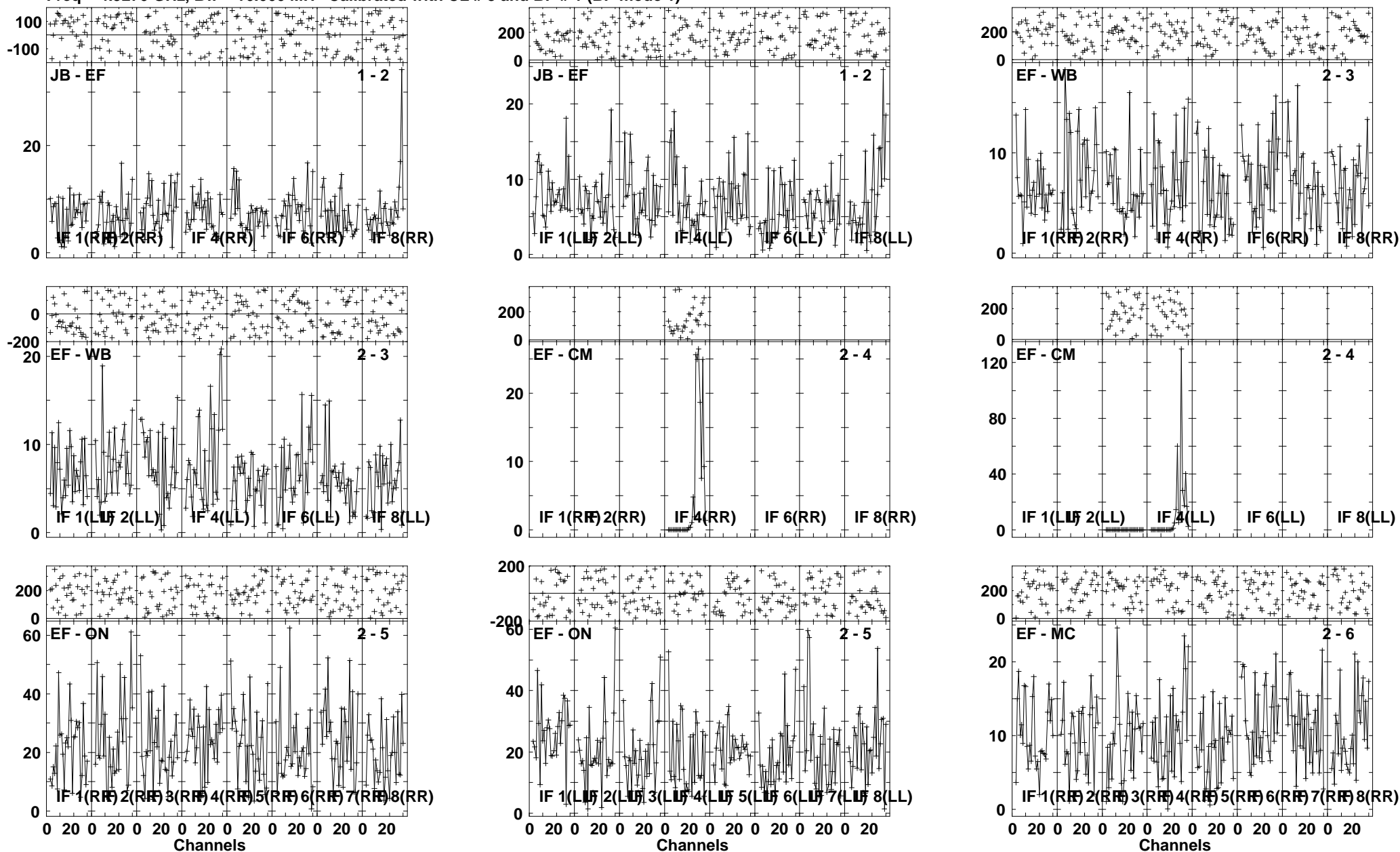

Lower frame: Milli Ampl Jy Top frame: Phas deg
Vector averaged cross-power spectrum Several baselines displayed
Timerange: 00/15:15:01 to 00/15:18:29

Plot file version 86 created 17-NOV-2010 16:18:55

ARP299D EP068A 5.UVDATA.1

Freq = 4.9270 GHz, Bw = 16.000 MH Calibrated with CL # 3 and BP # 1 (BP mode 1)

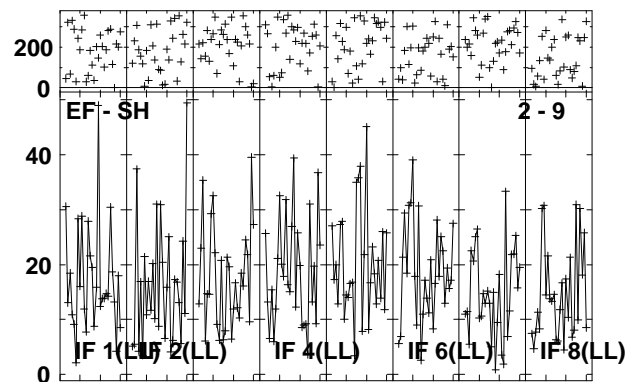
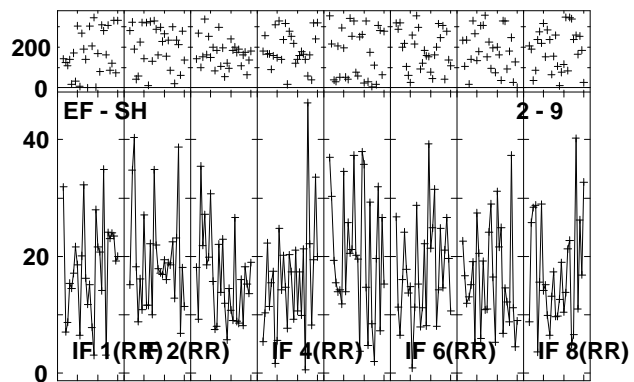
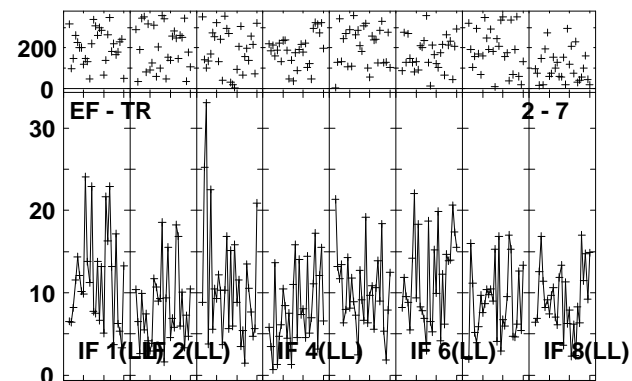
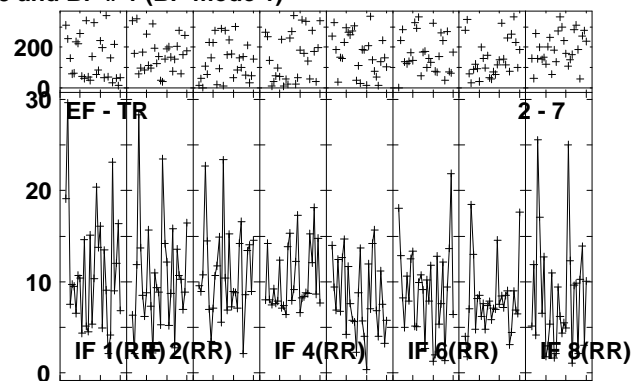
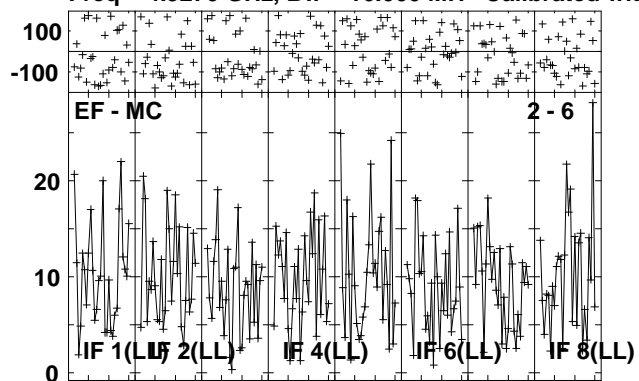

Lower frame: Milli Ampl Jy Top frame: Phas deg
Vector averaged cross-power spectrum Several baselines displayed
Timerange: 00/15:15:01 to 00/15:18:29

Plot file version 87 created 17-NOV-2010 16:18:57

J1128+59 EP068A 5.UVDATA.1

Freq = 4.9270 GHz, Bw = 16.000 MH Calibrated with CL # 3 and BP # 1 (BP mode 1)

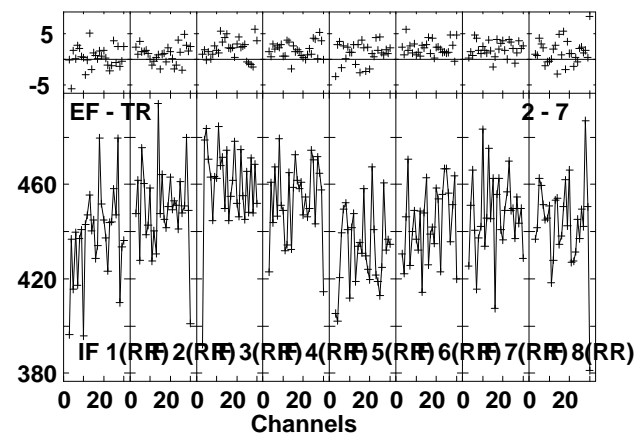
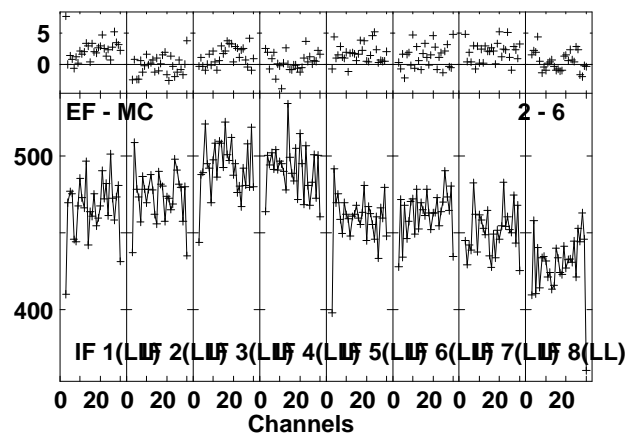
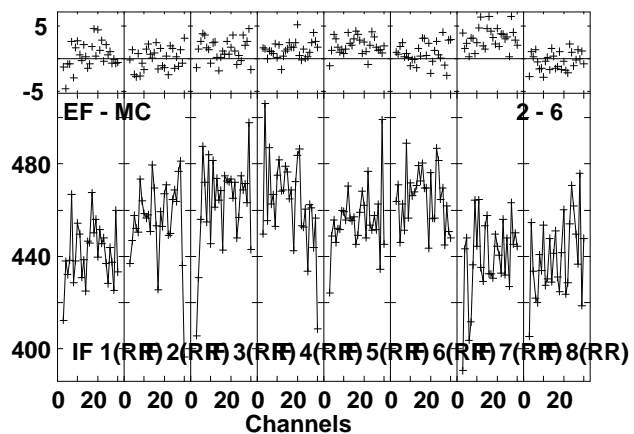
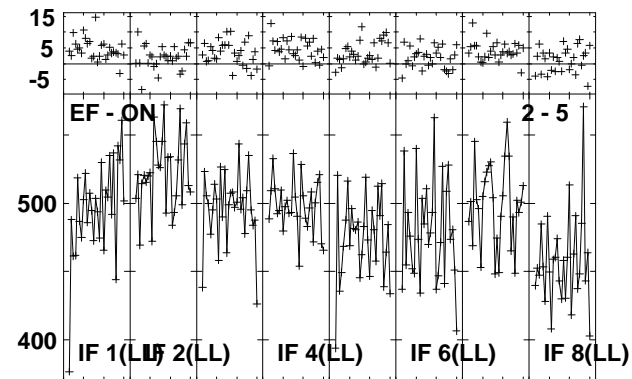
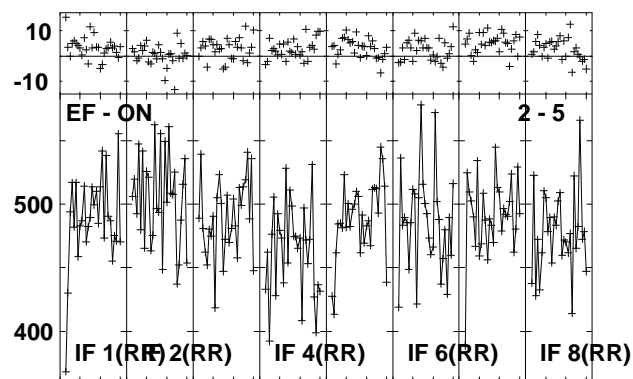
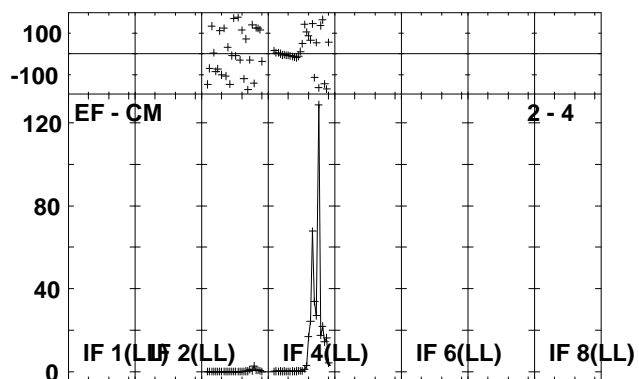
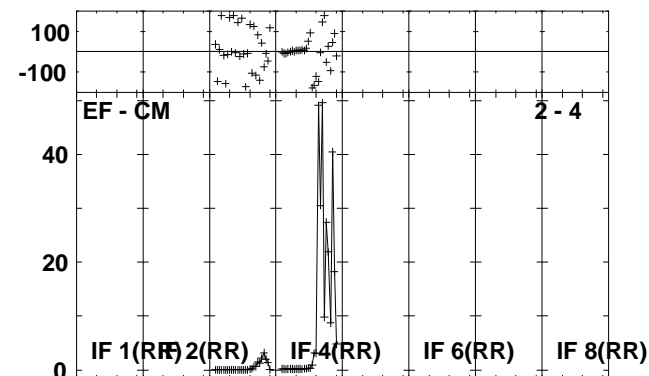
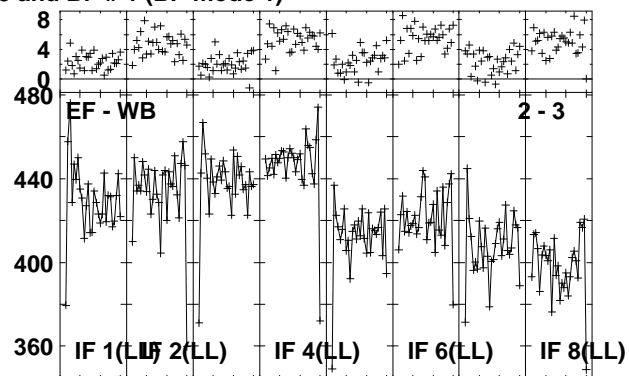
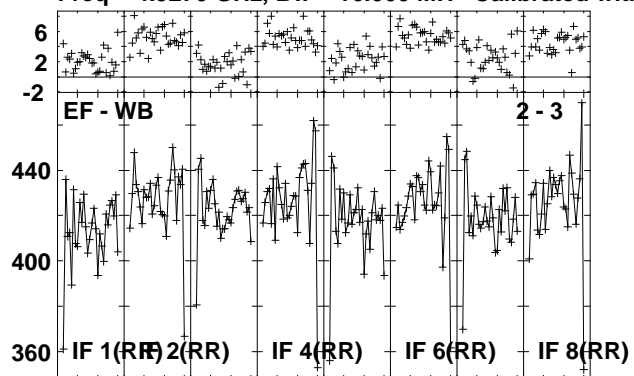

Lower frame: Milli Ampl Jy Top frame: Phas deg
Vector averaged cross-power spectrum Several baselines displayed
Timerange: 00/15:18:31 to 00/15:19:59

Plot file version 88 created 17-NOV-2010 16:18:58

J1128+59 EP068A 5.UVDATA.1

Freq = 4.9270 GHz, Bw = 16.000 MH Calibrated with CL # 3 and BP # 1 (BP mode 1)

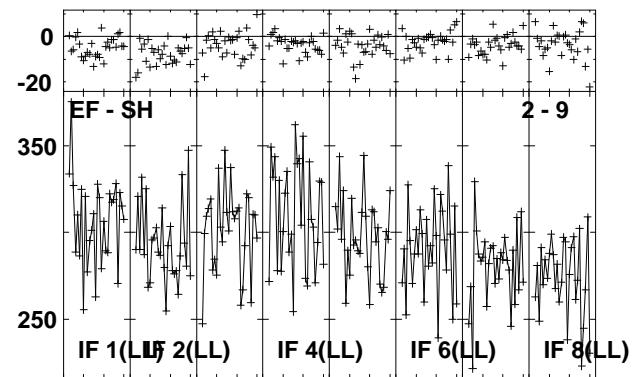
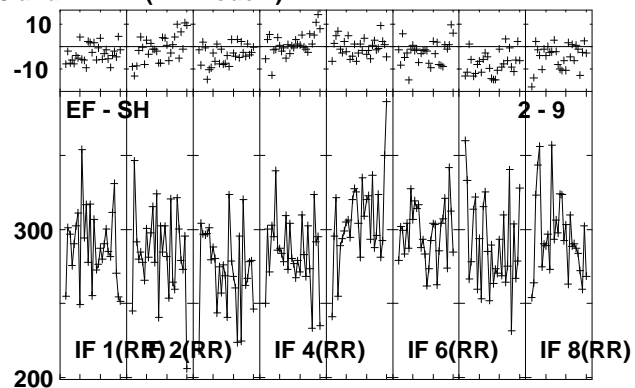
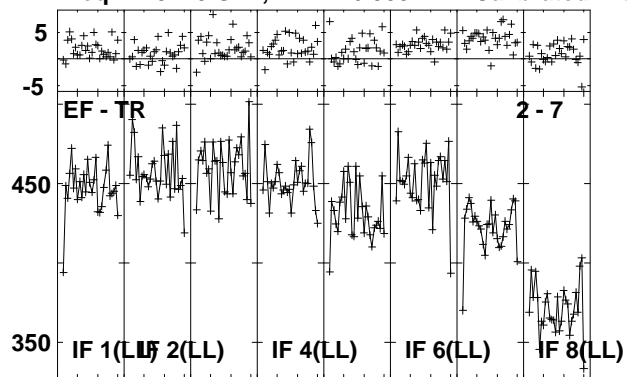

Lower frame: Milli Ampl Jy Top frame: Phas deg
Vector averaged cross-power spectrum Several baselines displayed
Timerange: 00/15:18:31 to 00/15:19:59

Plot file version 89 created 17-NOV-2010 16:18:59

ARP299D EP068A 5.UVDATA.1

Freq = 4.9270 GHz, Bw = 16.000 MH Calibrated with CL # 3 and BP # 1 (BP mode 1)

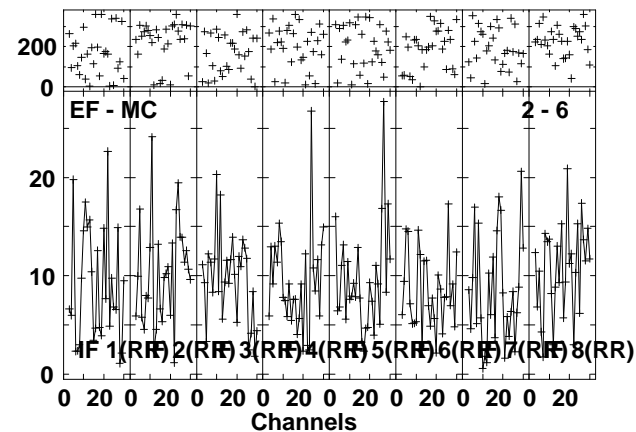
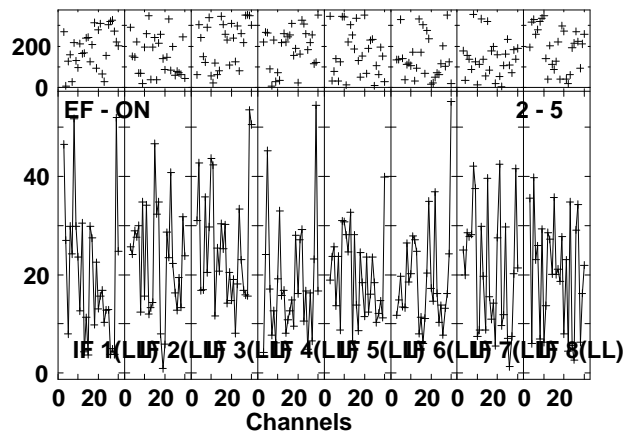
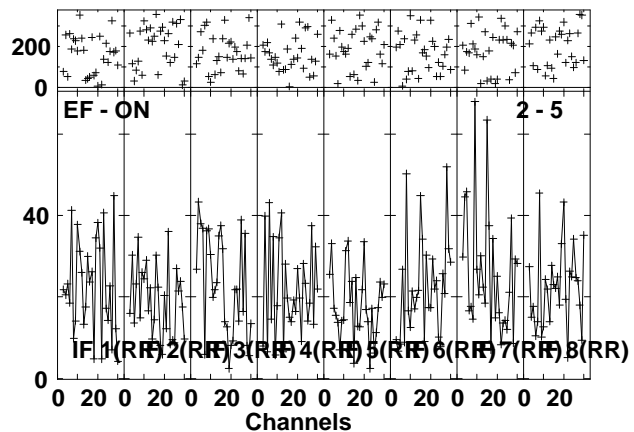
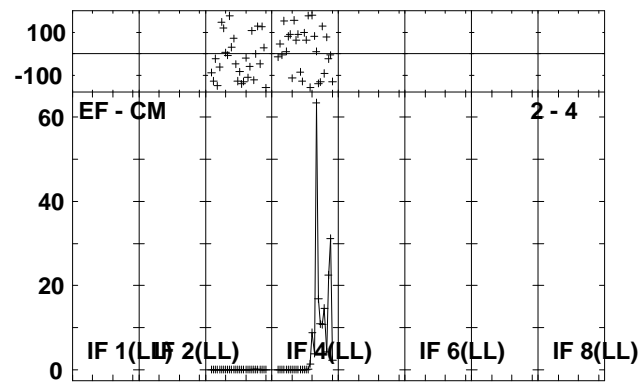
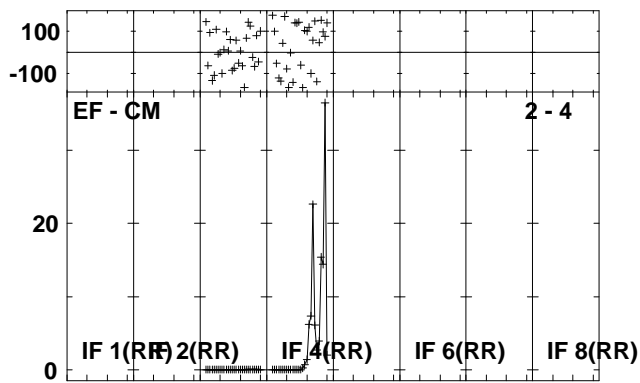
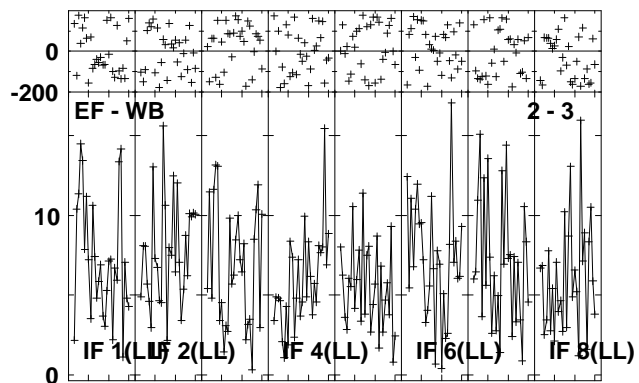
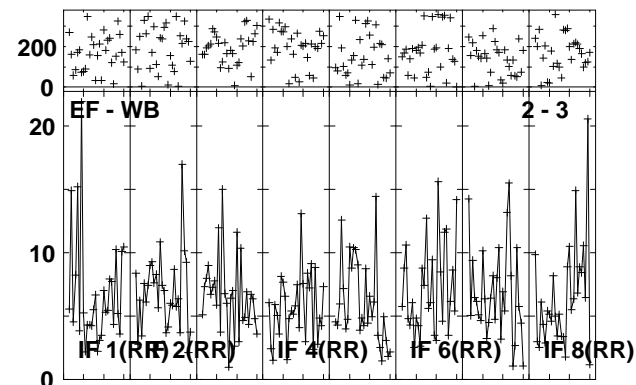
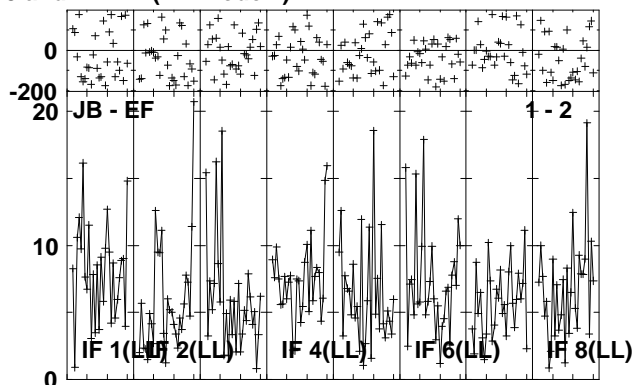
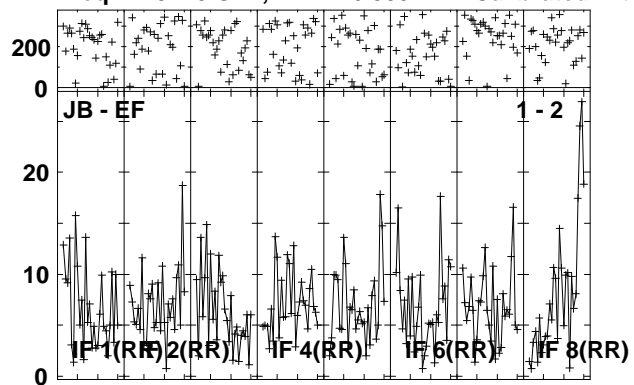

Lower frame: Milli Ampl Jy Top frame: Phas deg
Vector averaged cross-power spectrum Several baselines displayed
Timerange: 00/15:20:01 to 00/15:23:29

Plot file version 90 created 17-NOV-2010 16:19:01

ARP299D EP068A 5.UVDATA.1

Freq = 4.9270 GHz, Bw = 16.000 MH Calibrated with CL # 3 and BP # 1 (BP mode 1)

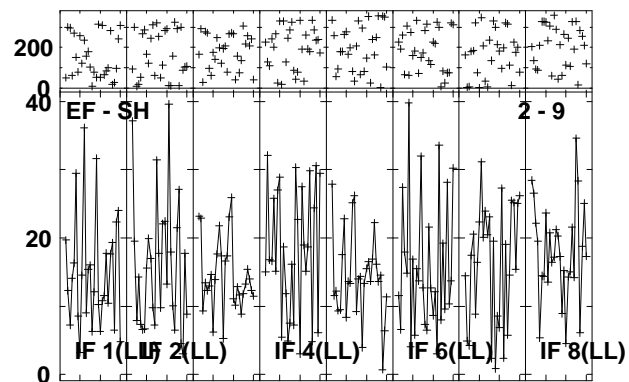
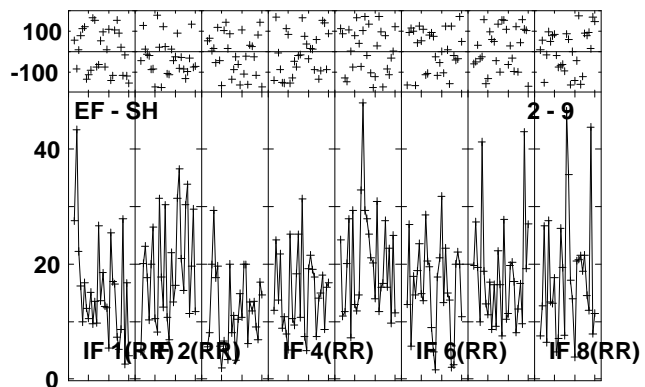
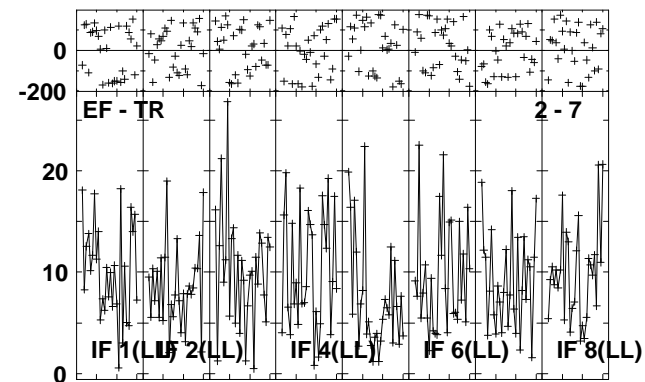
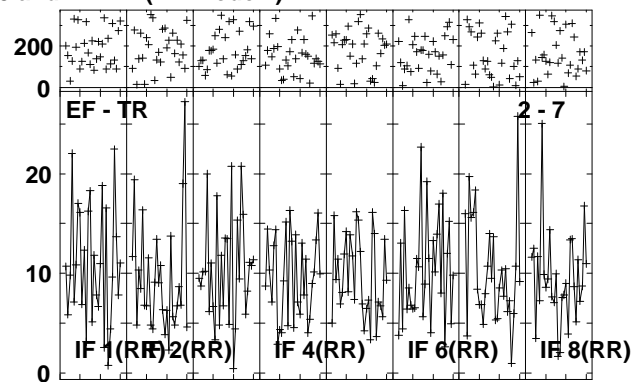
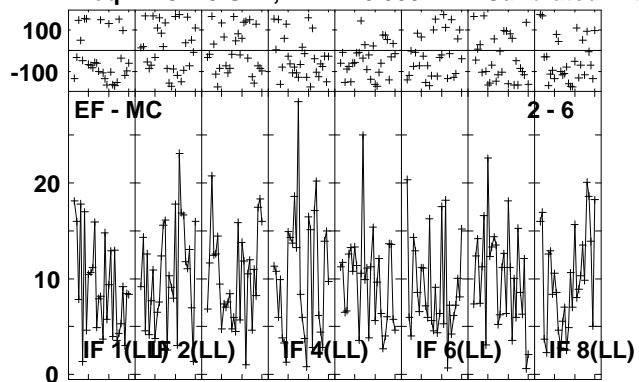

Lower frame: Milli Ampl Jy Top frame: Phas deg
Vector averaged cross-power spectrum Several baselines displayed
Timerange: 00/15:20:01 to 00/15:23:29

Plot file version 91 created 17-NOV-2010 16:19:03

J1128+59 EP068A 5.UVDATA.1

Freq = 4.9270 GHz, Bw = 16.000 MH Calibrated with CL # 3 and BP # 1 (BP mode 1)

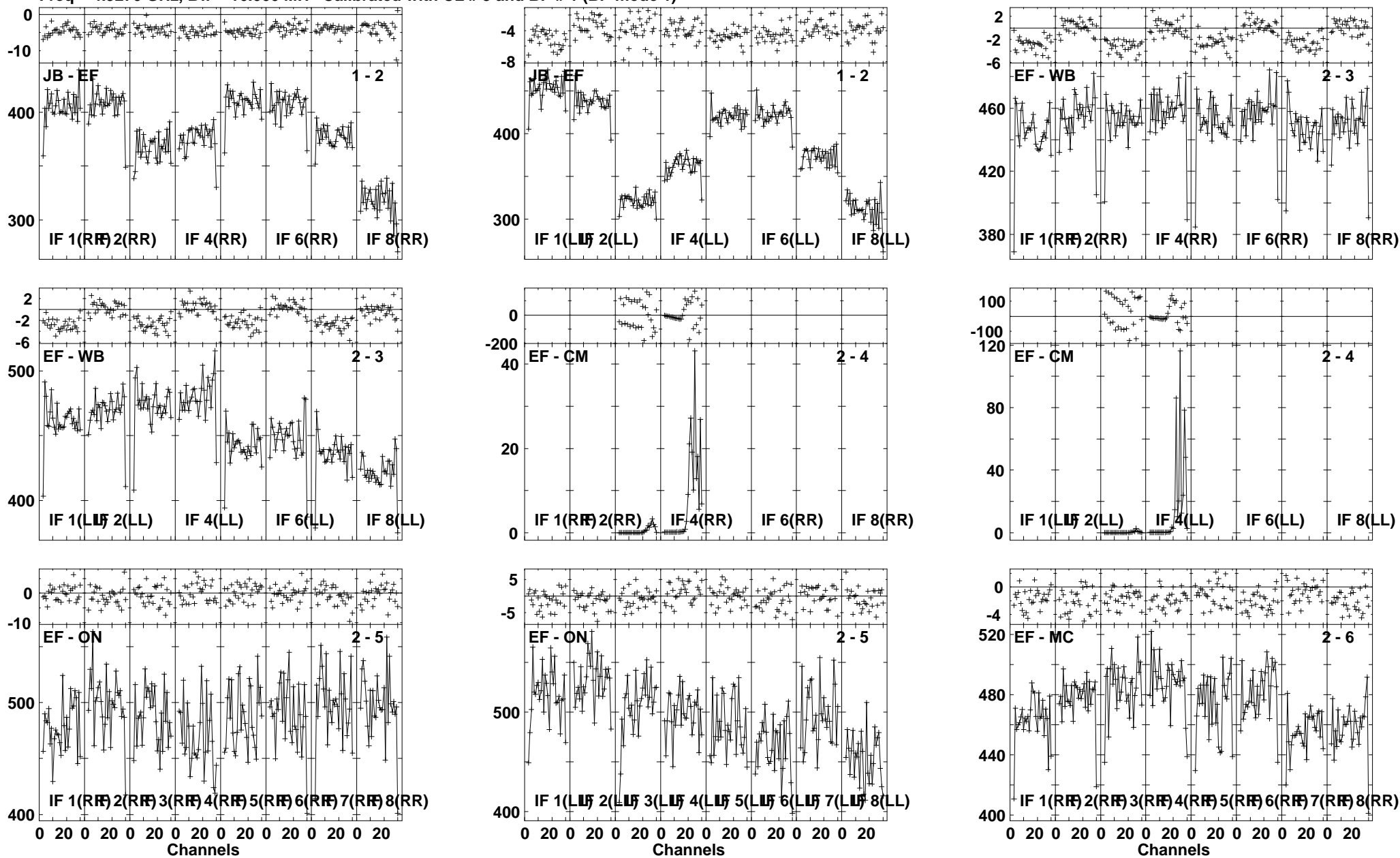

Lower frame: Milli Ampl Jy Top frame: Phas deg
Vector averaged cross-power spectrum Several baselines displayed
Timerange: 00/15:24:31 to 00/15:25:59

Plot file version 93 created 17-NOV-2010 16:19:06

ARP299D EP068A 5.UVDATA.1

Freq = 4.9270 GHz, Bw = 16.000 MH Calibrated with CL # 3 and BP # 1 (BP mode 1)

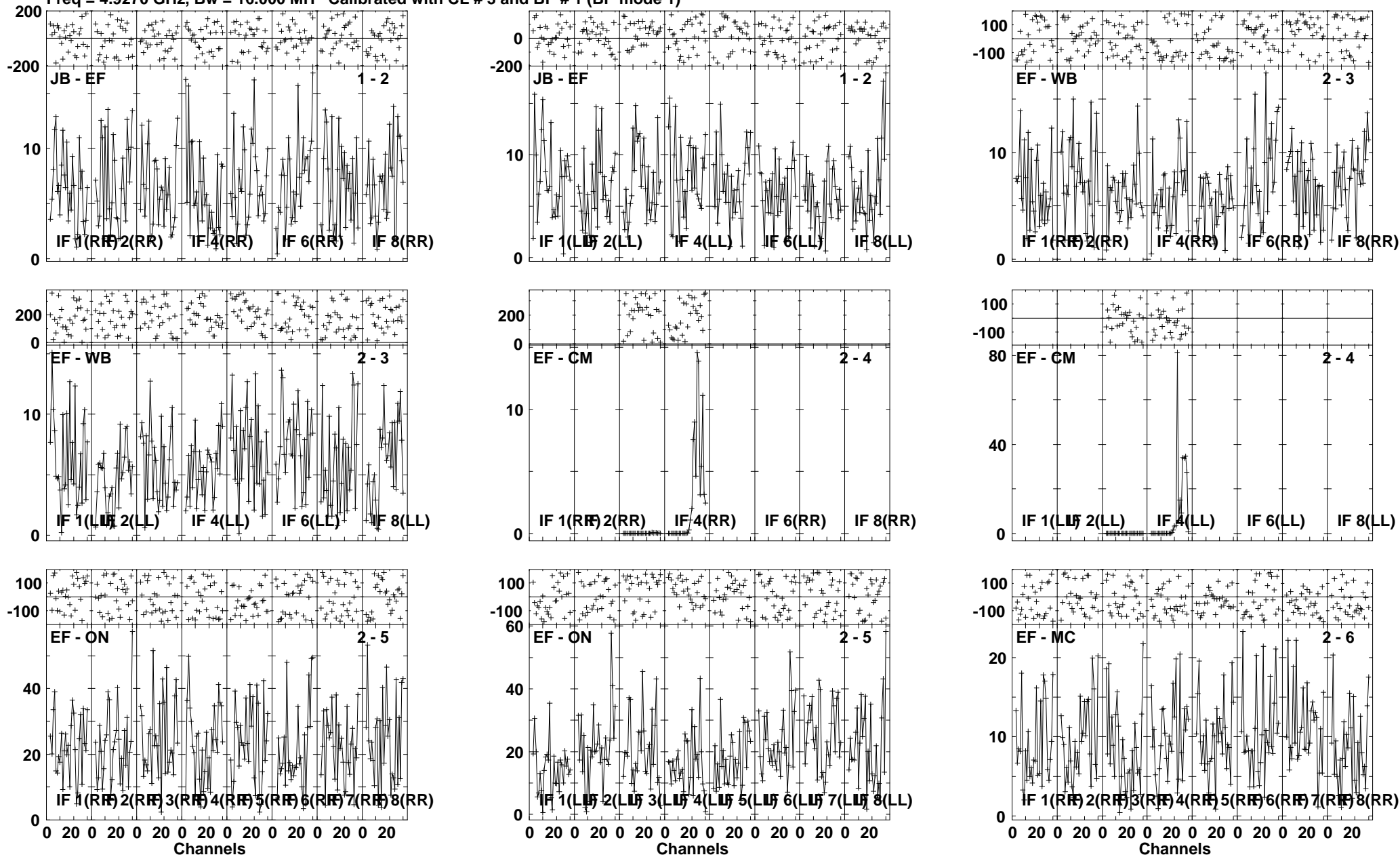

Lower frame: Milli Ampl Jy Top frame: Phas deg
Vector averaged cross-power spectrum Several baselines displayed
Timerange: 00/15:26:01 to 00/15:29:29

Plot file version 94 created 17-NOV-2010 16:19:09

ARP299D EP068A 5.UVDATA.1

Freq = 4.9270 GHz, Bw = 16.000 MH Calibrated with CL # 3 and BP # 1 (BP mode 1)

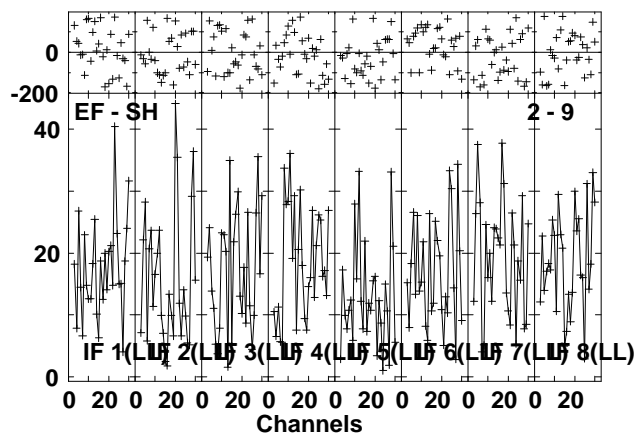
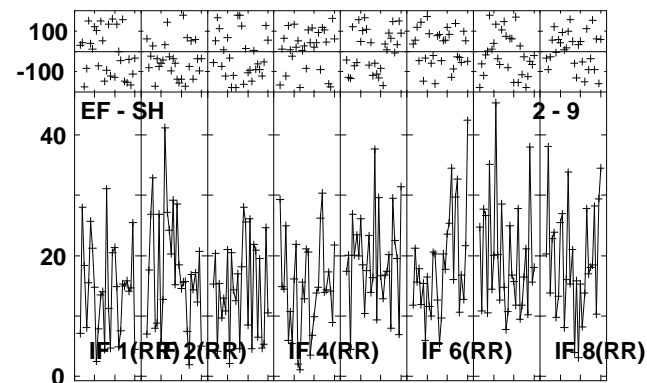
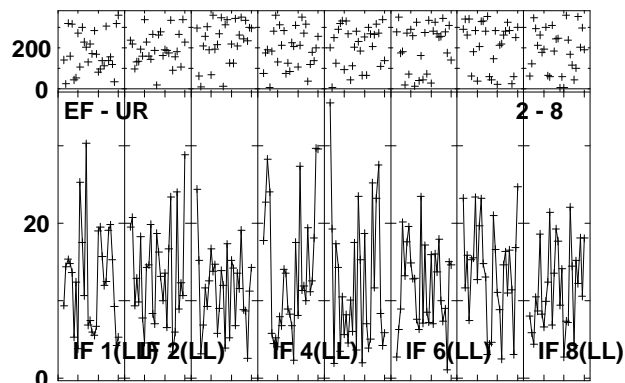
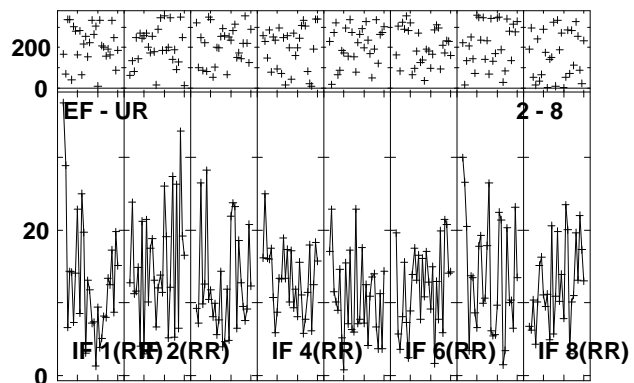
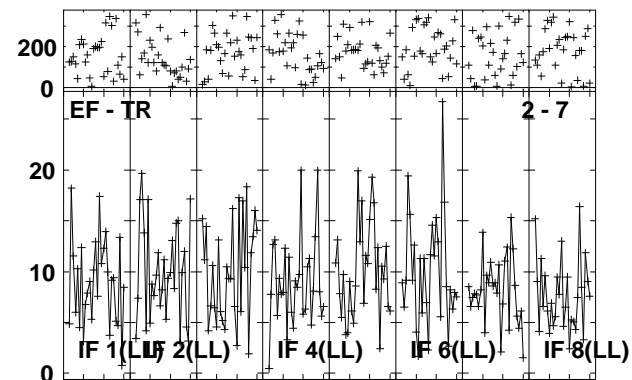
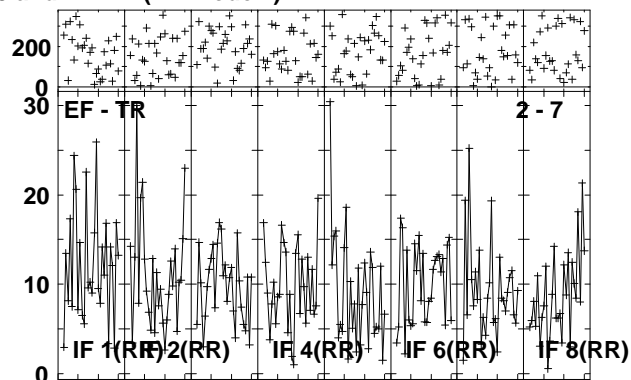
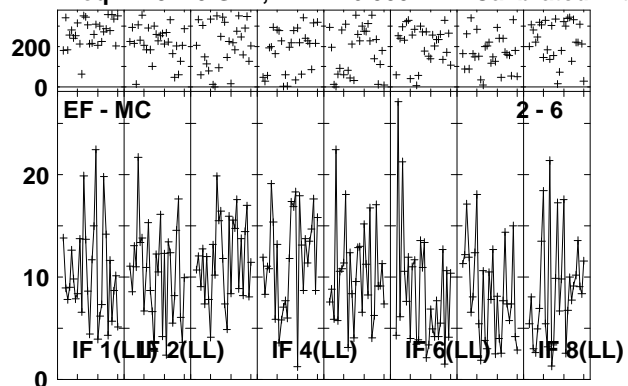

Lower frame: Milli Ampl Jy Top frame: Phas deg
Vector averaged cross-power spectrum Several baselines displayed
Timerange: 00/15:26:01 to 00/15:29:29

Plot file version 95 created 17-NOV-2010 16:19:12

J1128+59 EP068A 5.UVDATA.1

Freq = 4.9270 GHz, Bw = 16.000 MH Calibrated with CL # 3 and BP # 1 (BP mode 1)

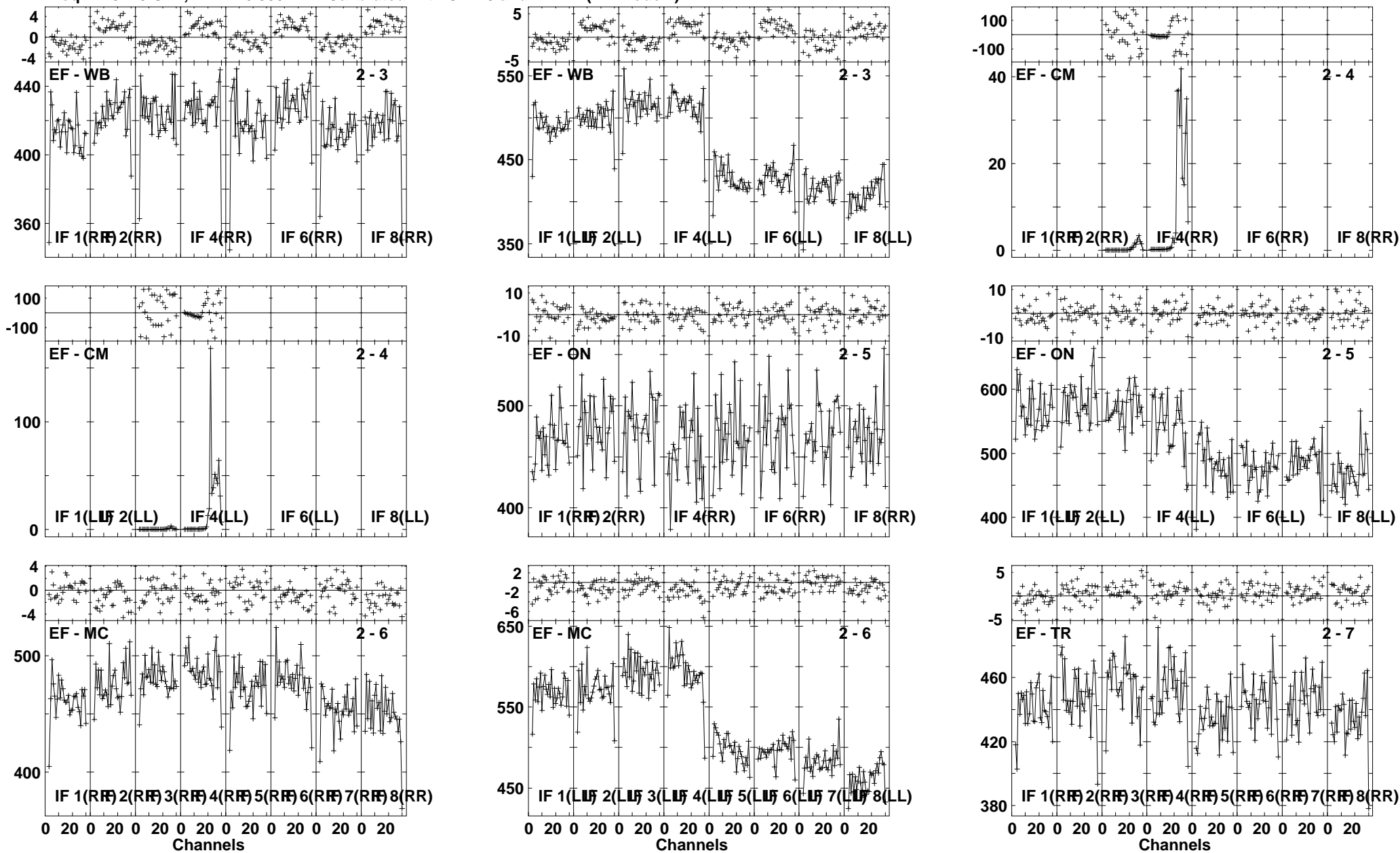

Lower frame: Milli Ampl Jy Top frame: Phas deg
Vector averaged cross-power spectrum Several baselines displayed
Timerange: 00/15:29:31 to 00/15:30:57

Plot file version 96 created 17-NOV-2010 16:19:13

J1128+59 EP068A 5.UVDATA.1

Freq = 4.9270 GHz, Bw = 16.000 MH Calibrated with CL # 3 and BP # 1 (BP mode 1)

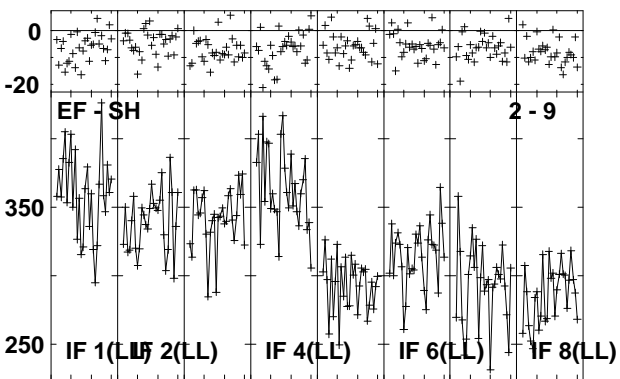
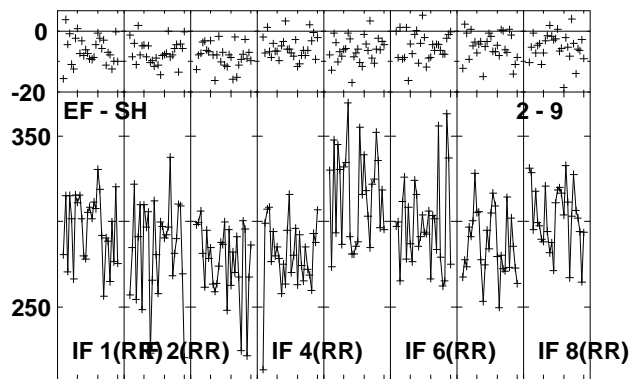
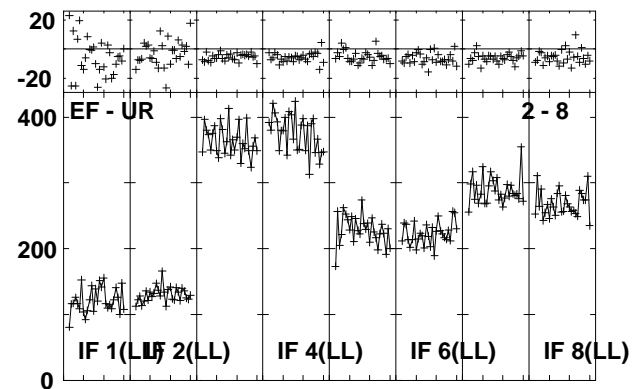
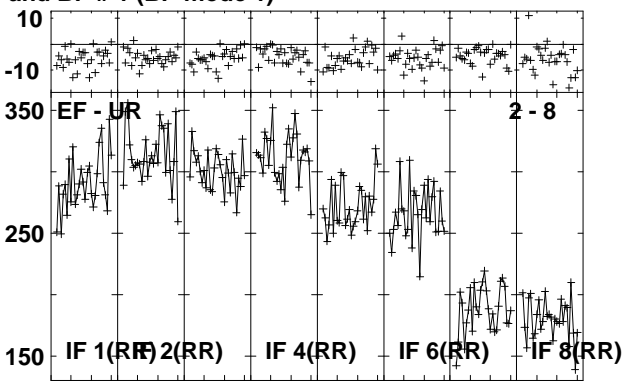
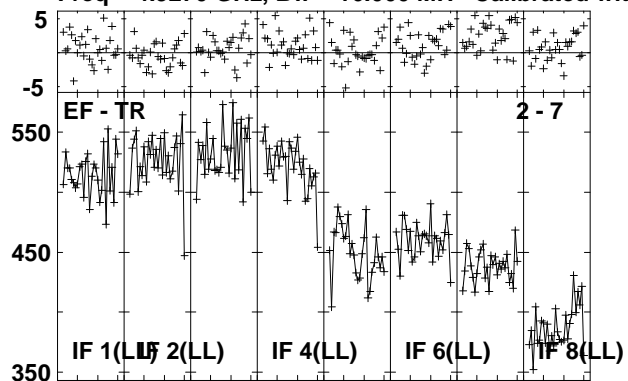

Lower frame: Milli Ampl Jy Top frame: Phas deg
Vector averaged cross-power spectrum Several baselines displayed
Timerange: 00/15:29:31 to 00/15:30:57

Plot file version 97 created 17-NOV-2010 16:19:14

ARP299D EP068A 5.UVDATA.1

Freq = 4.9270 GHz, Bw = 16.000 MH Calibrated with CL # 3 and BP # 1 (BP mode 1)

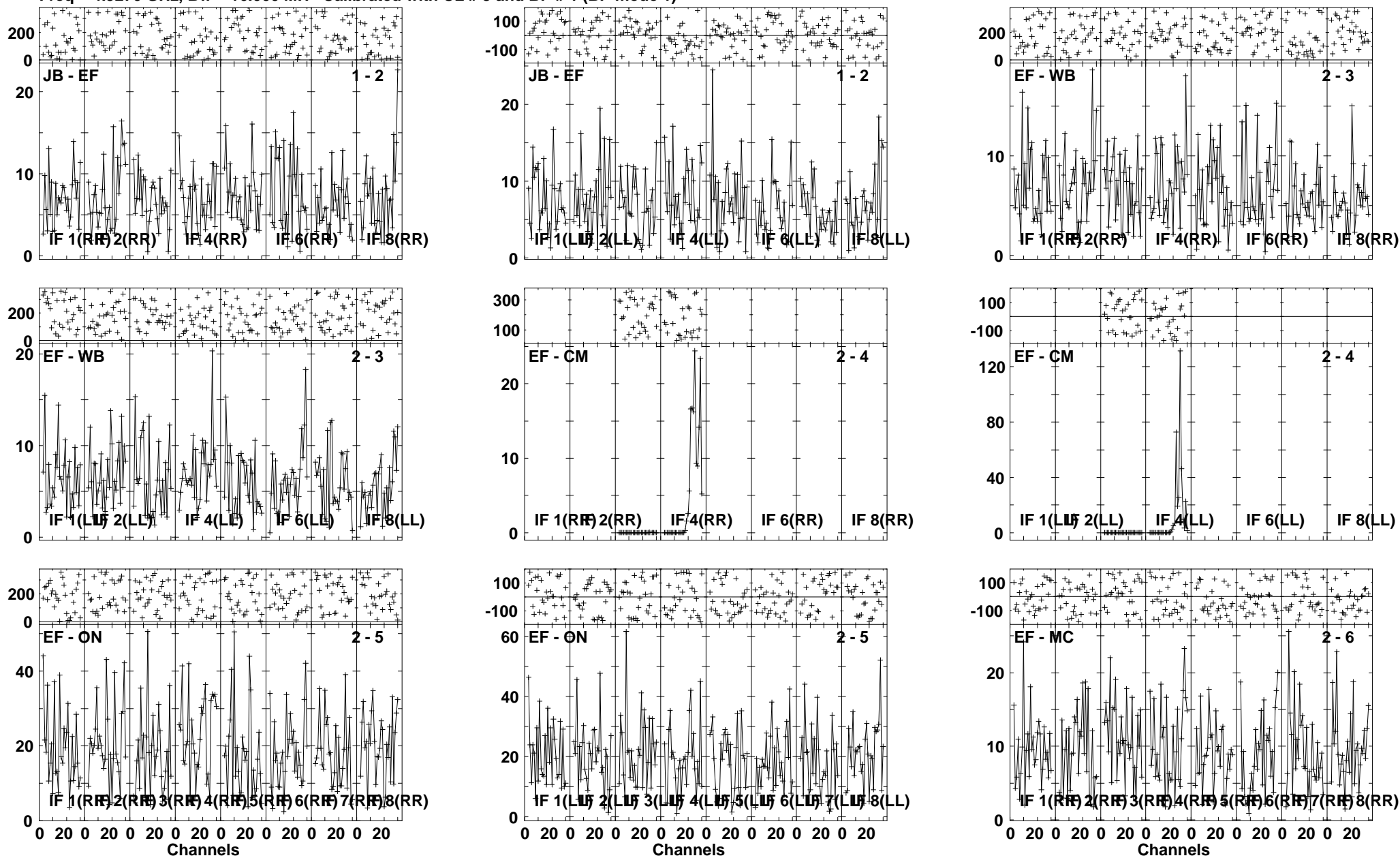

Lower frame: Milli Ampl Jy Top frame: Phas deg
Vector averaged cross-power spectrum Several baselines displayed
Timerange: 00/15:31:01 to 00/15:34:29

Plot file version 99 created 17-NOV-2010 16:19:19

J1128+59 EP068A 5.UVDATA.1

Freq = 4.9270 GHz, Bw = 16.000 MH Calibrated with CL # 3 and BP # 1 (BP mode 1)

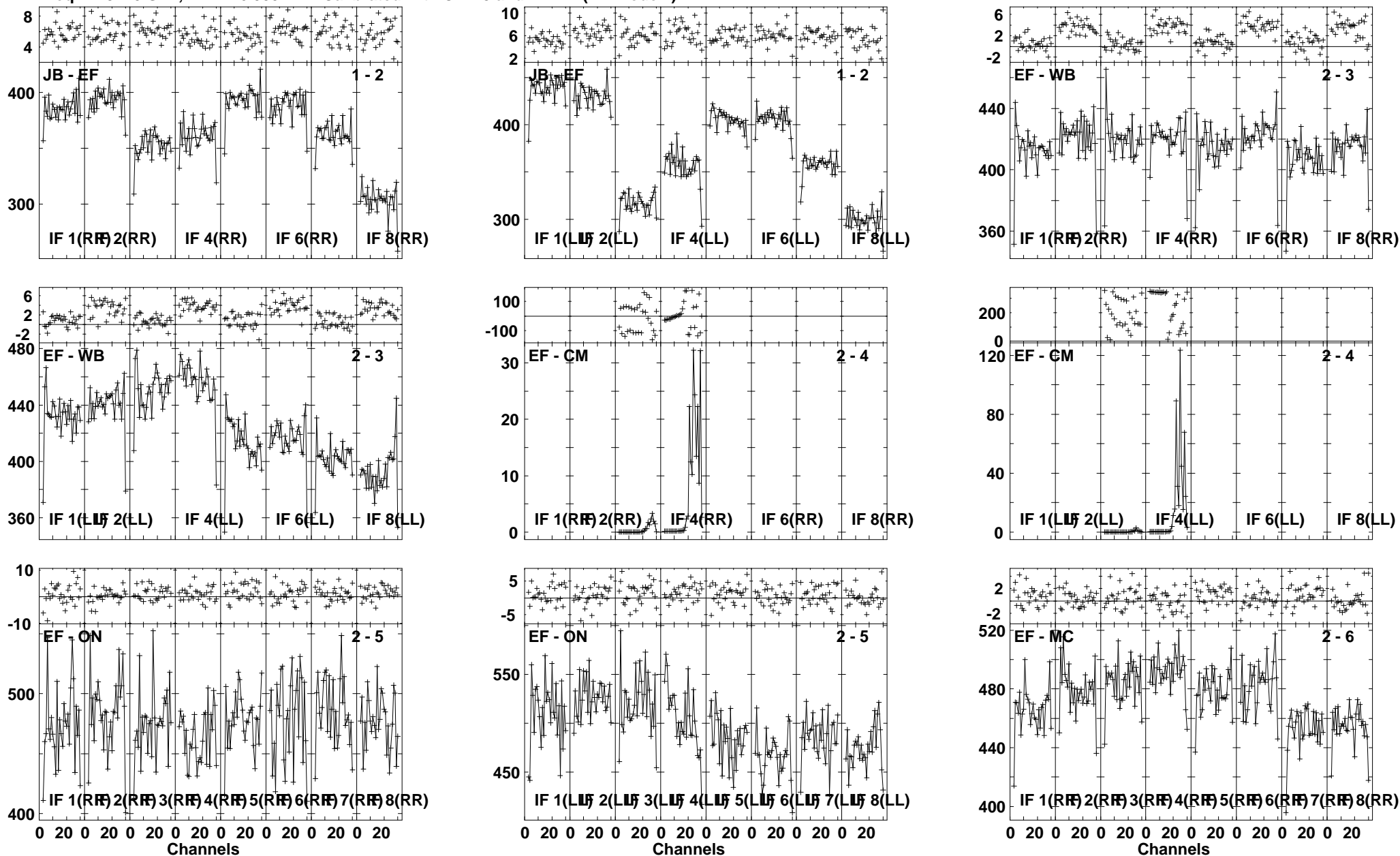

Lower frame: Milli Ampl Jy Top frame: Phas deg
Vector averaged cross-power spectrum Several baselines displayed
Timerange: 00/15:35:31 to 00/15:36:59

Plot file version 100 created 17-NOV-2010 16:19:20

J1128+59 EP068A 5.UVDATA.1

Freq = 4.9270 GHz, Bw = 16.000 MH Calibrated with CL # 3 and BP # 1 (BP mode 1)

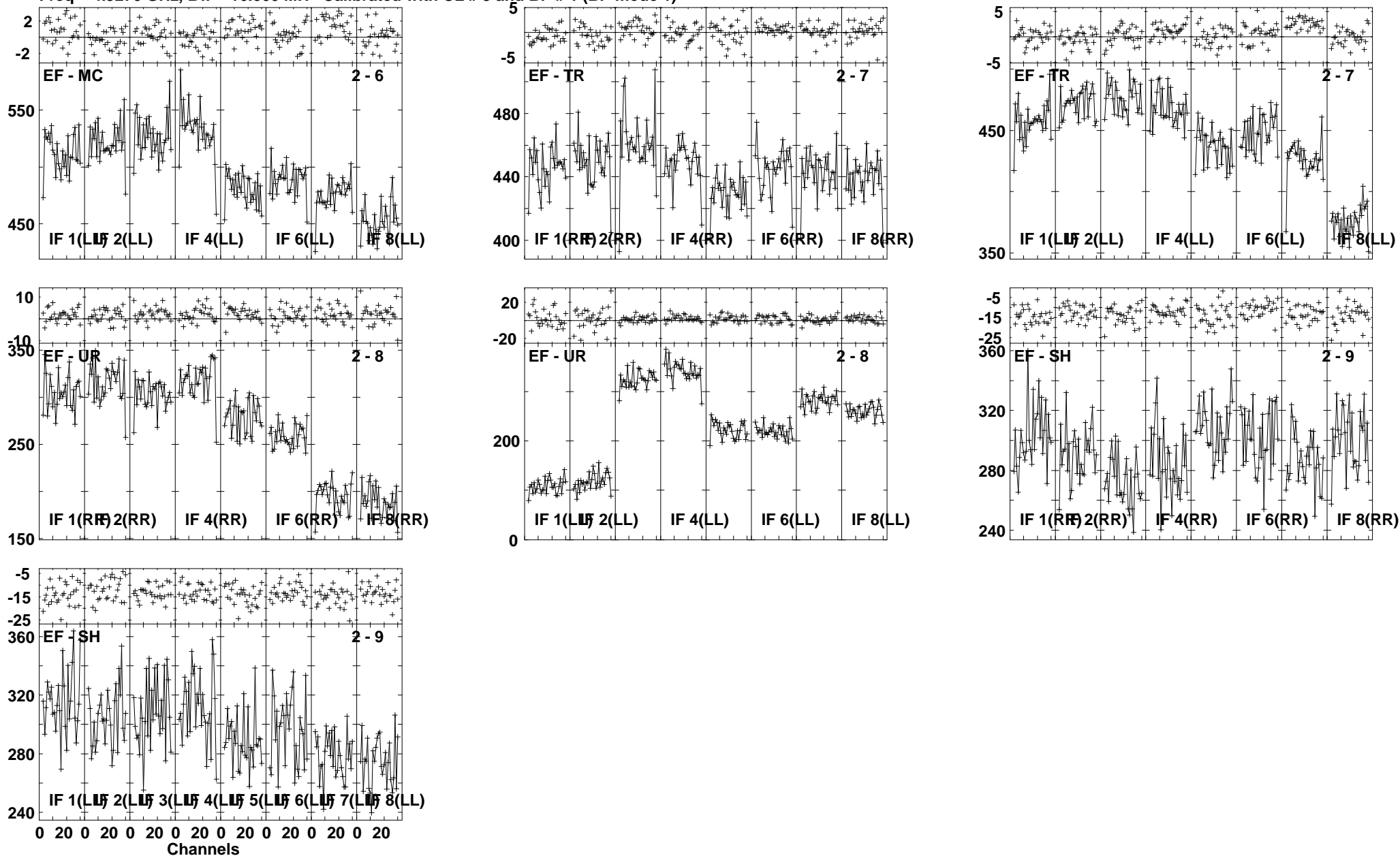

Lower frame: Milli Ampl Jy Top frame: Phas deg
Vector averaged cross-power spectrum Several baselines displayed
Timerange: 00/15:35:31 to 00/15:36:59

Plot file version 101 created 17-NOV-2010 16:19:22

ARP299D EP068A 5.UVDATA.1

Freq = 4.9270 GHz, Bw = 16.000 MH Calibrated with CL # 3 and BP # 1 (BP mode 1)

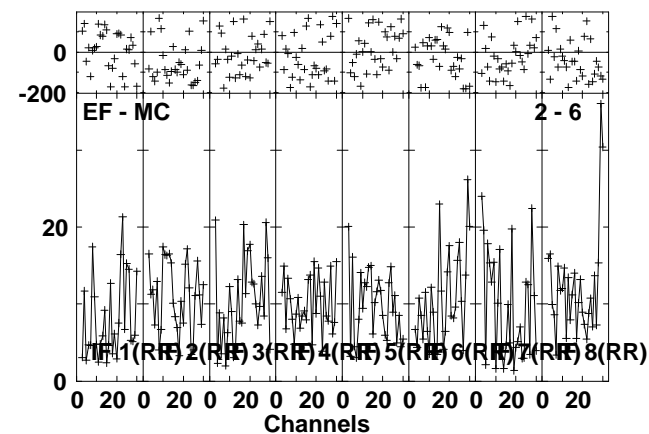
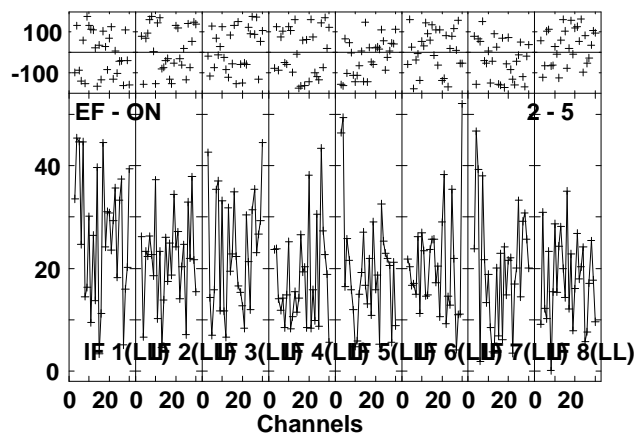
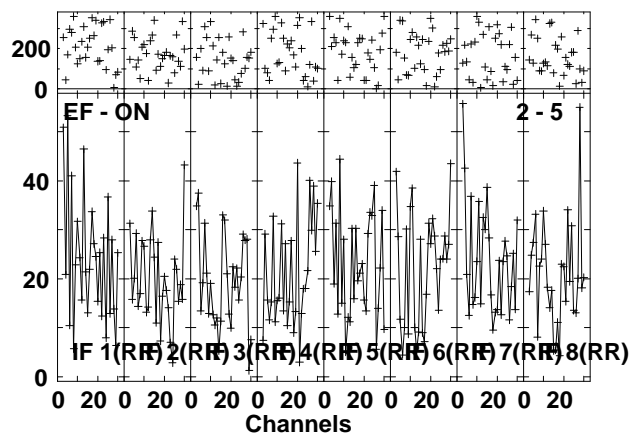
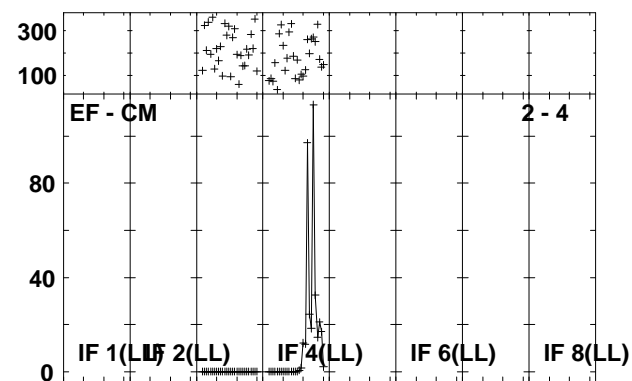
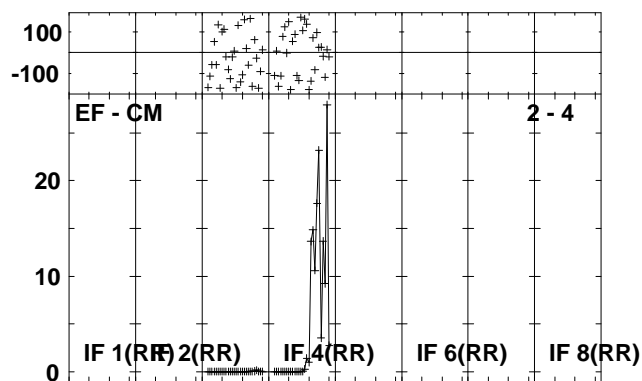
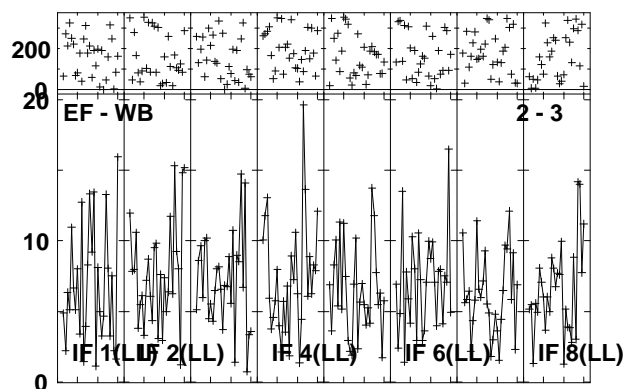
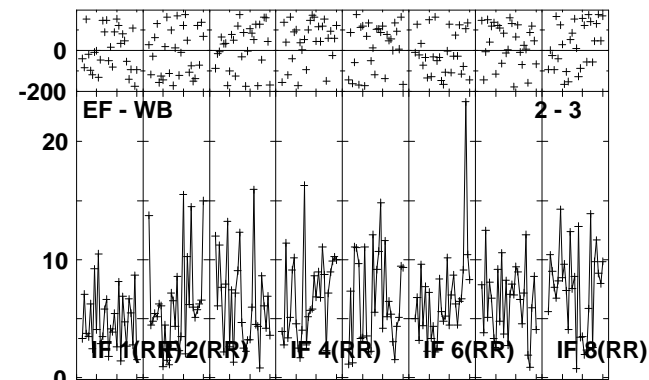
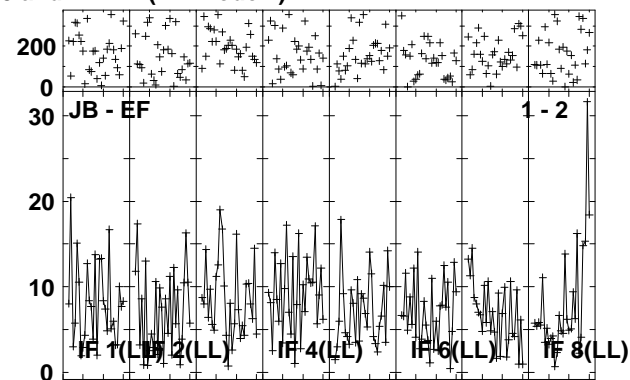
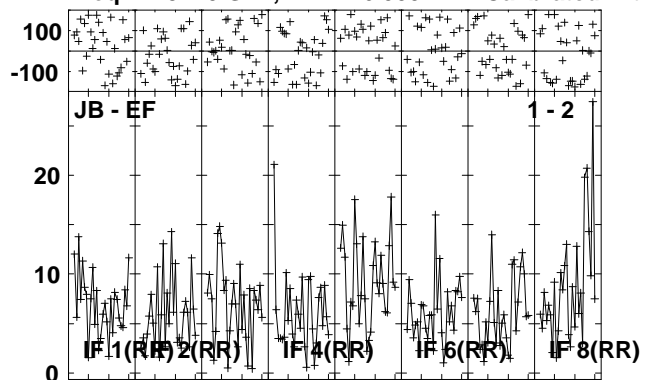

Lower frame: Milli Ampl Jy Top frame: Phas deg
Vector averaged cross-power spectrum Several baselines displayed
Timerange: 00/15:37:01 to 00/15:40:29

Plot file version 102 created 17-NOV-2010 16:19:25

ARP299D EP068A 5.UVDATA.1

Freq = 4.9270 GHz, Bw = 16.000 MH Calibrated with CL # 3 and BP # 1 (BP mode 1)

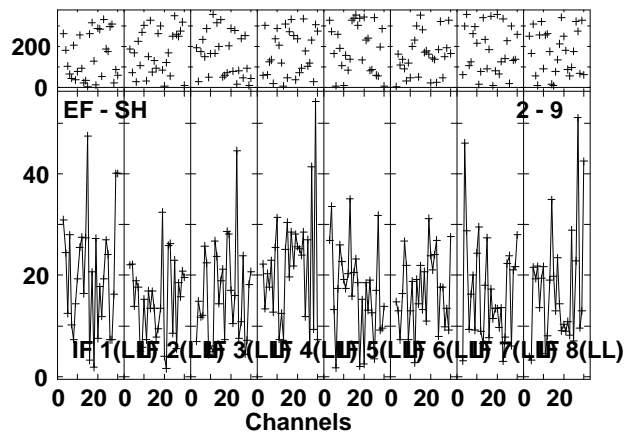
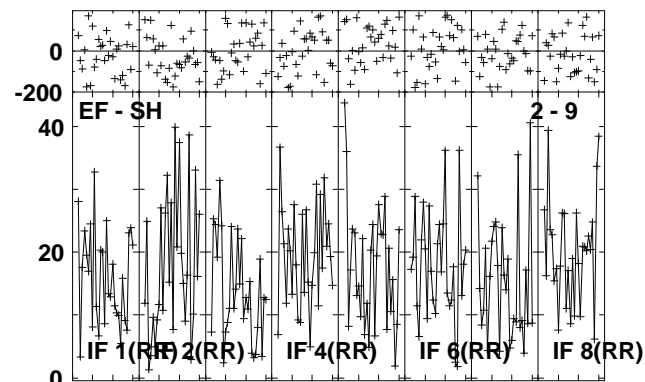
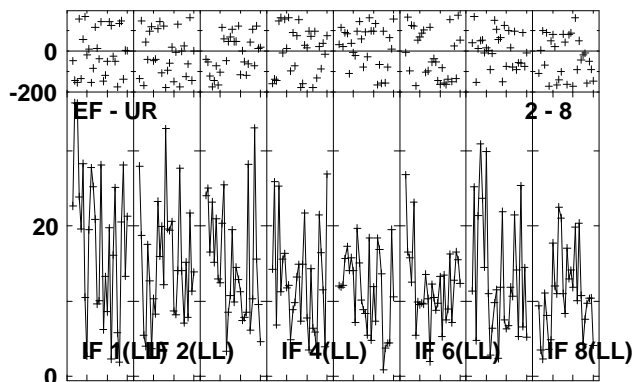
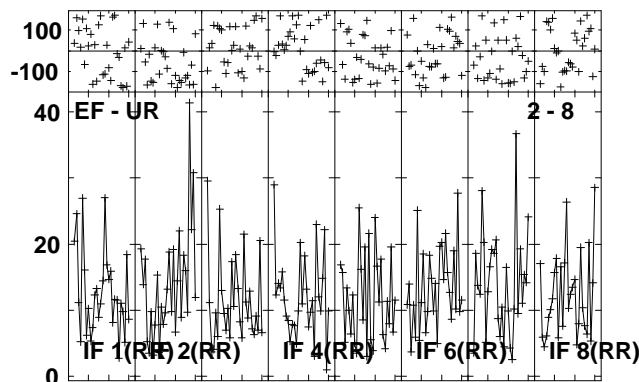
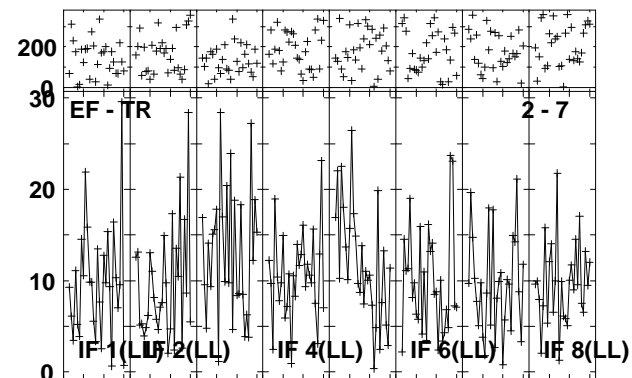
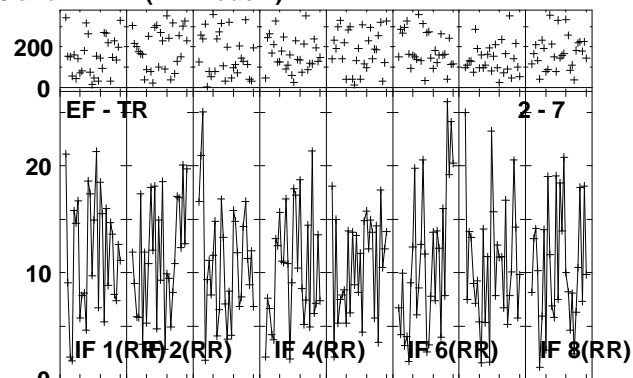
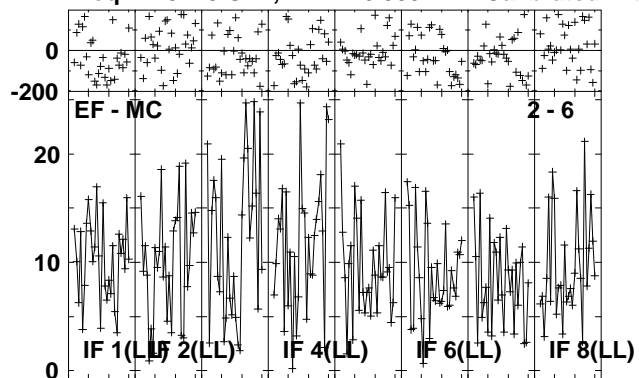

Lower frame: Milli Ampl Jy Top frame: Phas deg
Vector averaged cross-power spectrum Several baselines displayed
Timerange: 00/15:37:01 to 00/15:40:29

Plot file version 103 created 17-NOV-2010 16:19:28

J1128+59 EP068A 5.UVDATA.1

Freq = 4.9270 GHz, Bw = 16.000 MH Calibrated with CL # 3 and BP # 1 (BP mode 1)

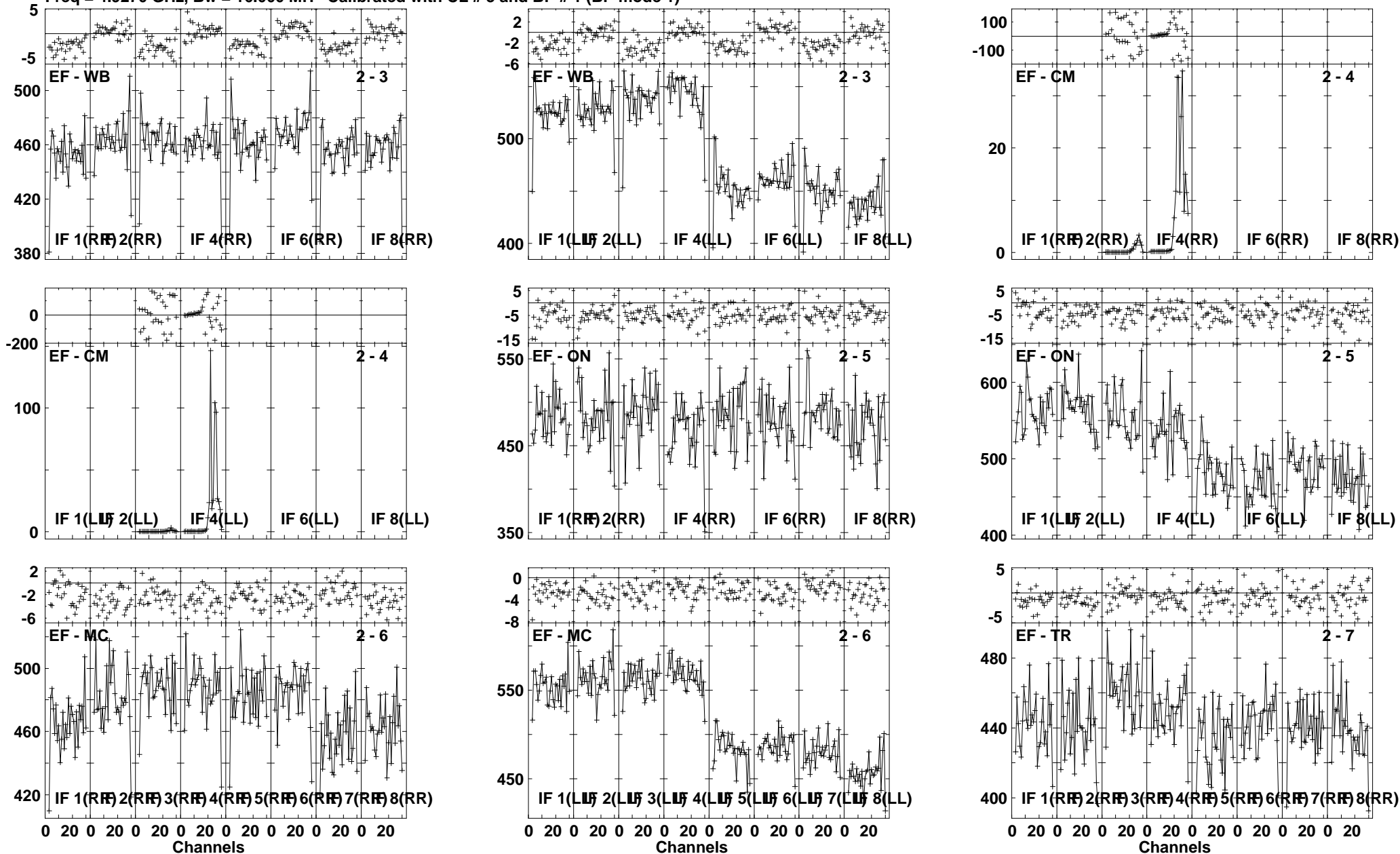

Lower frame: Milli Ampl Jy Top frame: Phas deg
Vector averaged cross-power spectrum Several baselines displayed
Timerange: 00/15:40:31 to 00/15:41:59

Plot file version 104 created 17-NOV-2010 16:19:28

J1128+59 EP068A 5.UVDATA.1

Freq = 4.9270 GHz, Bw = 16.000 MH Calibrated with CL # 3 and BP # 1 (BP mode 1)

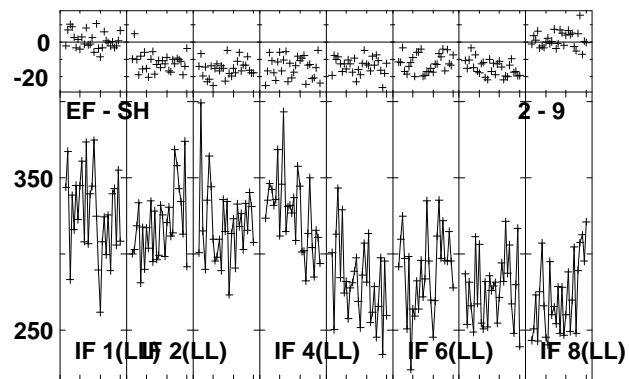
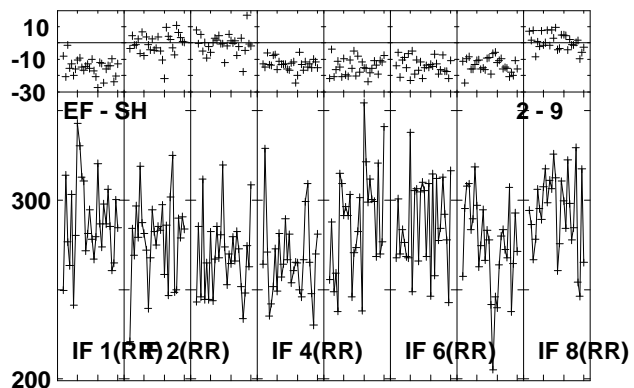
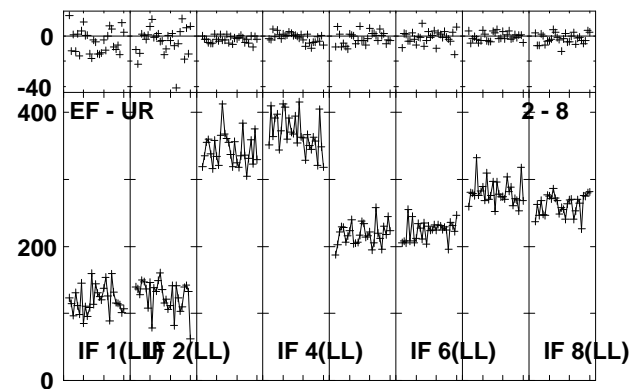
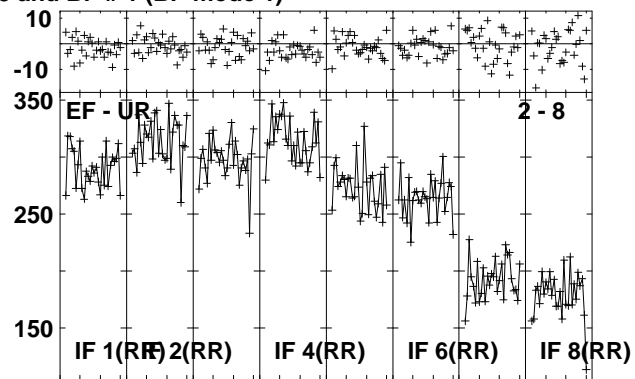
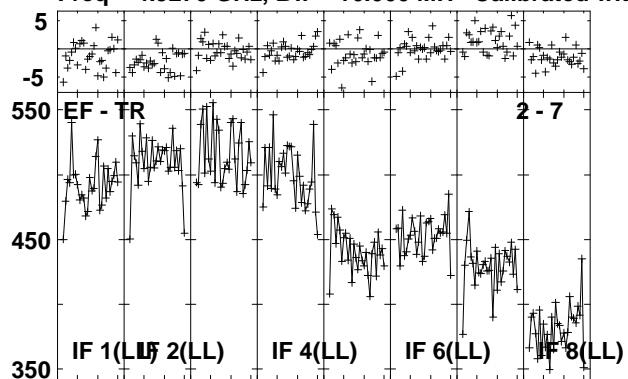

Lower frame: Milli Ampl Jy Top frame: Phas deg
Vector averaged cross-power spectrum Several baselines displayed
Timerange: 00/15:40:31 to 00/15:41:59

Plot file version 105 created 17-NOV-2010 16:19:30

ARP299D EP068A 5.UVDATA.1

Freq = 4.9270 GHz, Bw = 16.000 MH Calibrated with CL # 3 and BP # 1 (BP mode 1)

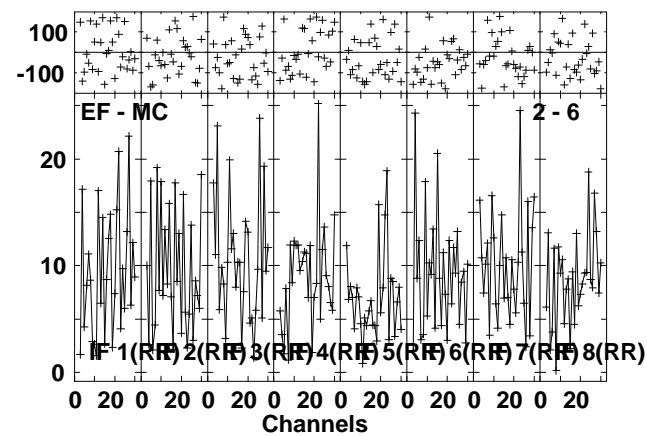
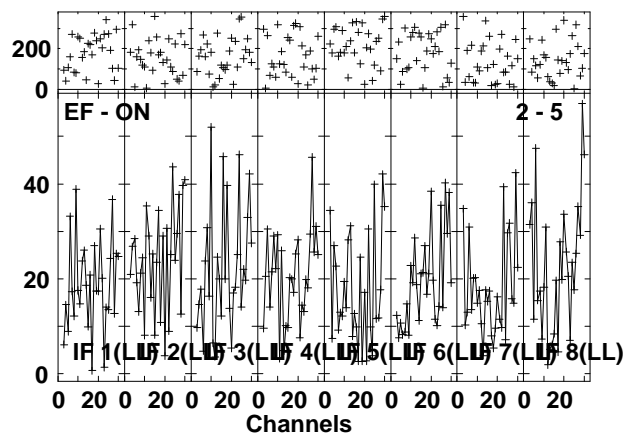
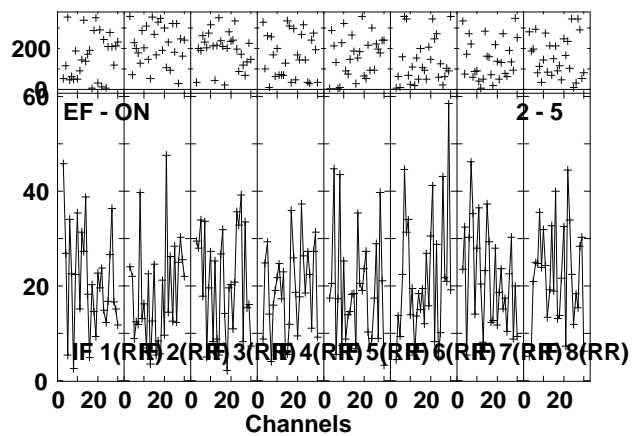
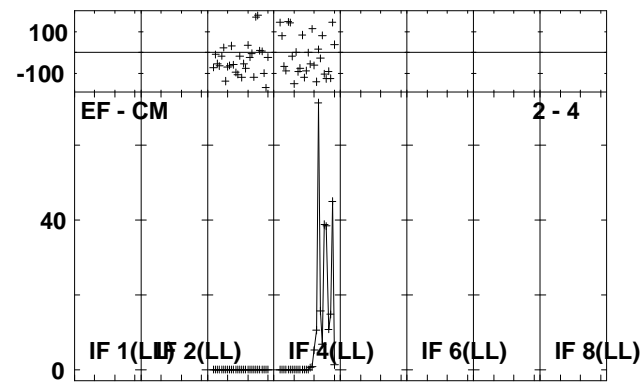
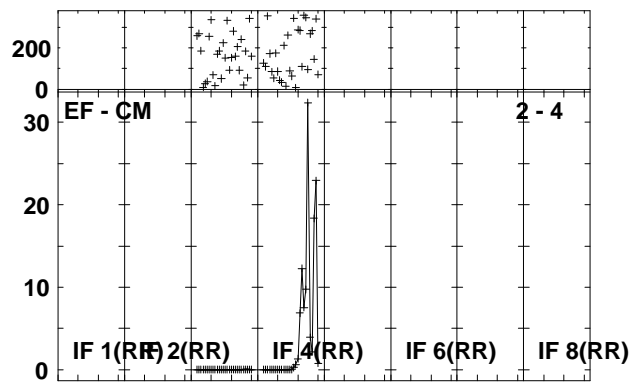
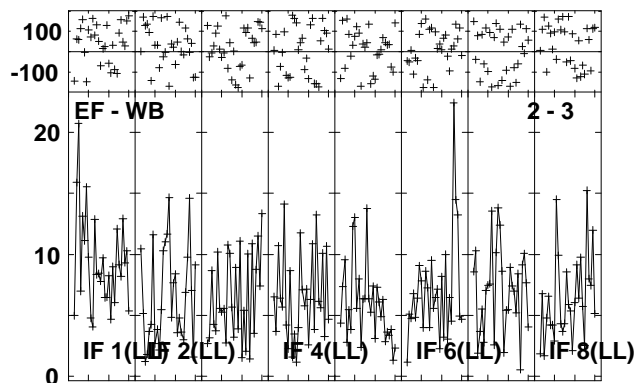
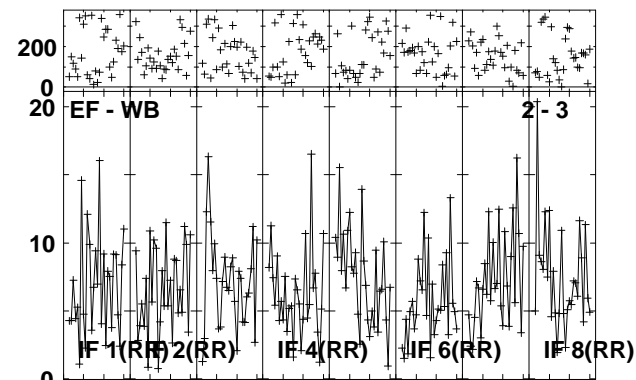
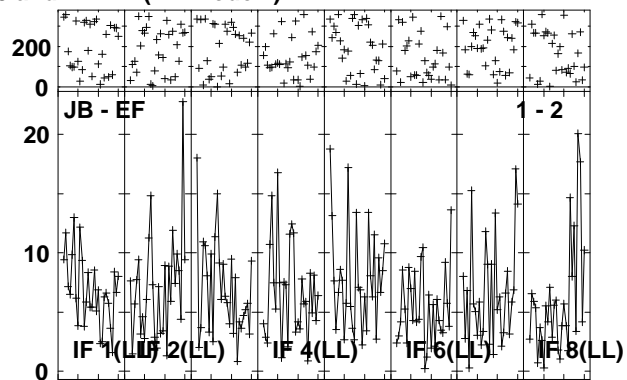
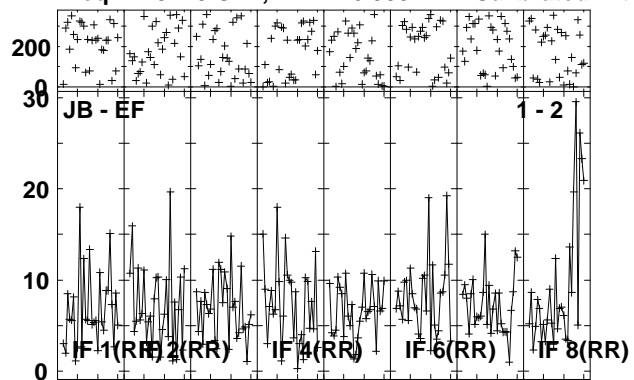

Lower frame: Milli Ampl Jy Top frame: Phas deg
Vector averaged cross-power spectrum Several baselines displayed
Timerange: 00/15:42:01 to 00/15:45:29

Plot file version 106 created 17-NOV-2010 16:19:32

ARP299D EP068A 5.UVDATA.1

Freq = 4.9270 GHz, Bw = 16.000 MH Calibrated with CL # 3 and BP # 1 (BP mode 1)

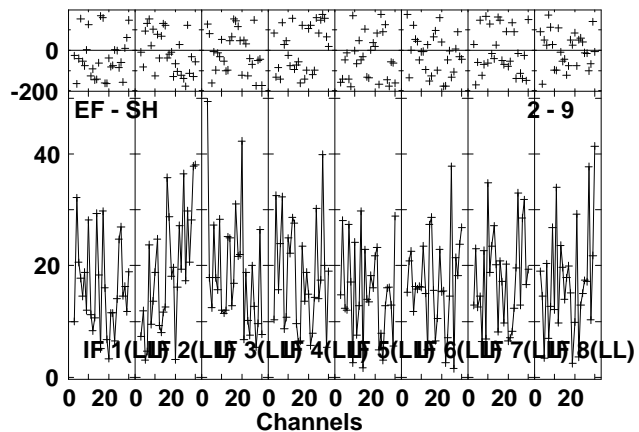
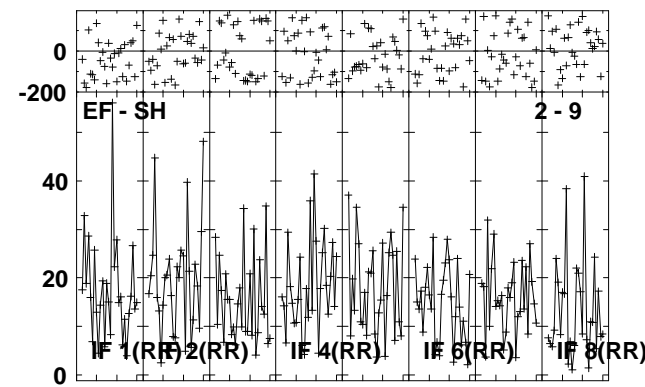
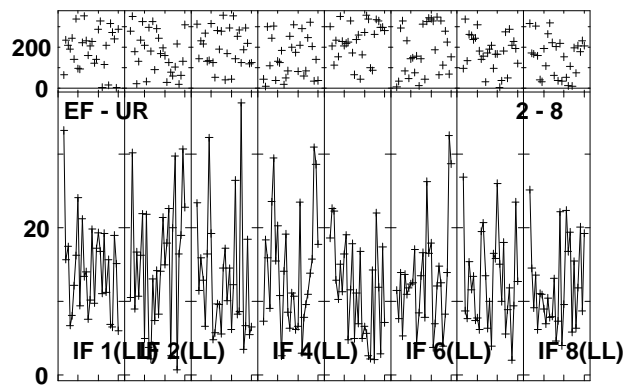
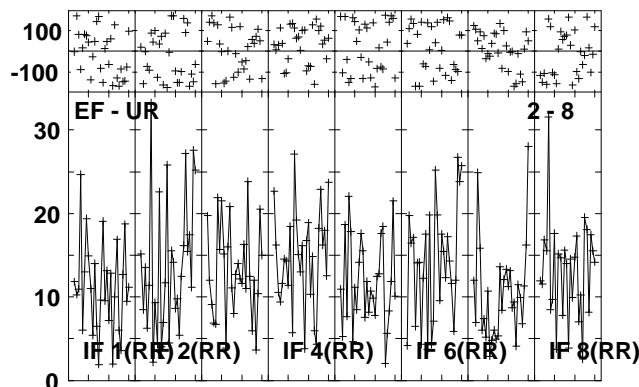
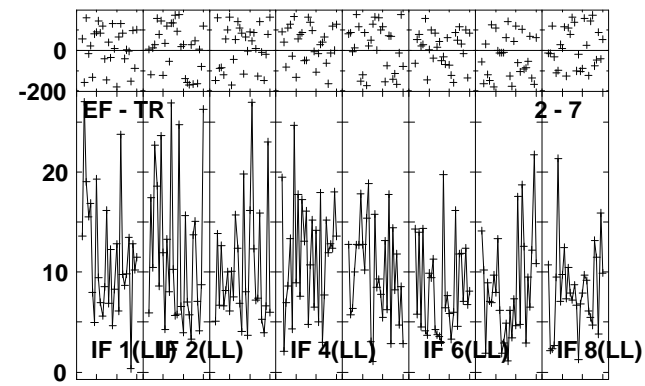
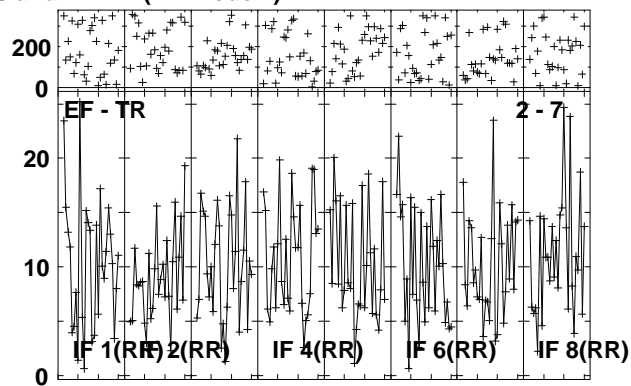
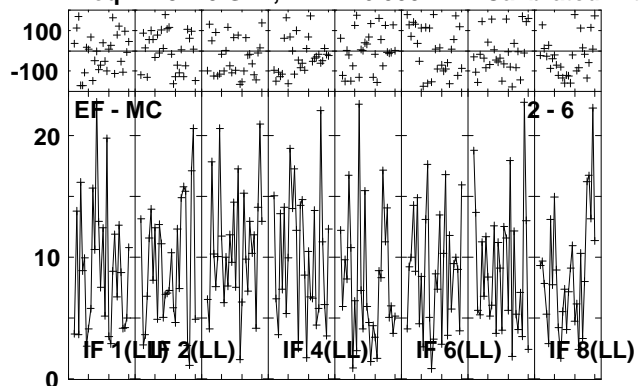

Lower frame: Milli Ampl Jy Top frame: Phas deg
Vector averaged cross-power spectrum Several baselines displayed
Timerange: 00/15:42:01 to 00/15:45:29

Plot file version 107 created 17-NOV-2010 16:19:35

J1128+59 EP068A 5.UVDATA.1

Freq = 4.9270 GHz, Bw = 16.000 MH Calibrated with CL # 3 and BP # 1 (BP mode 1)

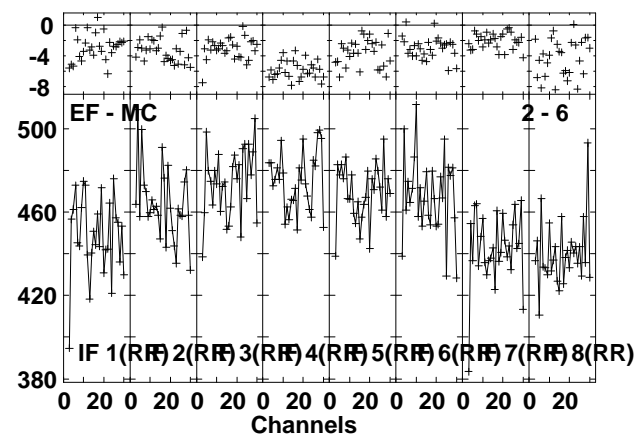
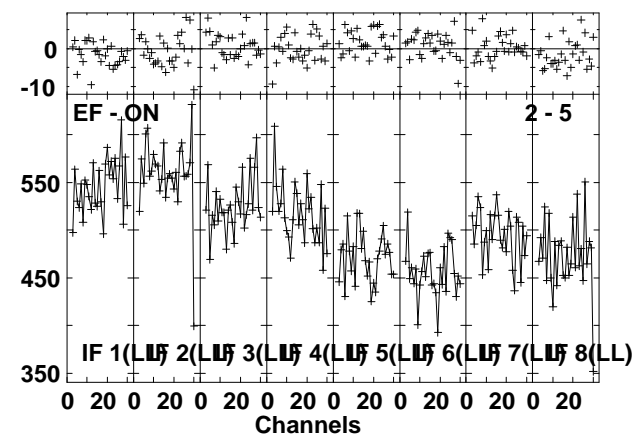
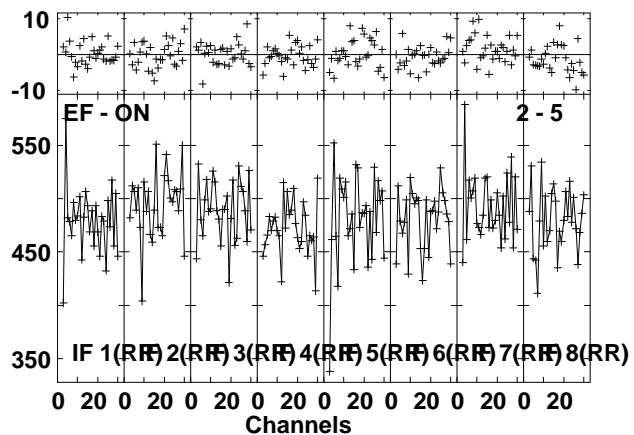
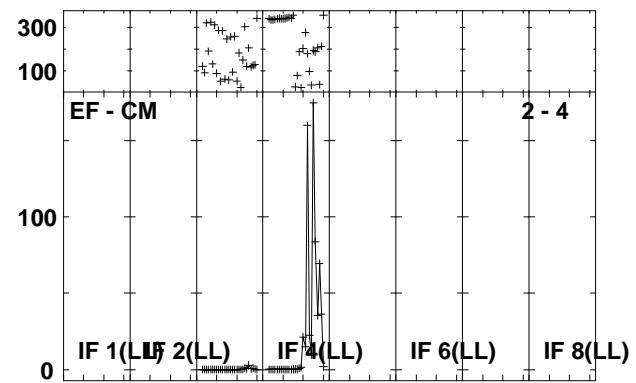
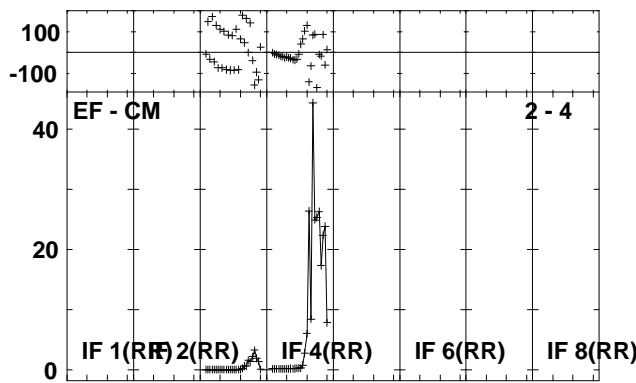
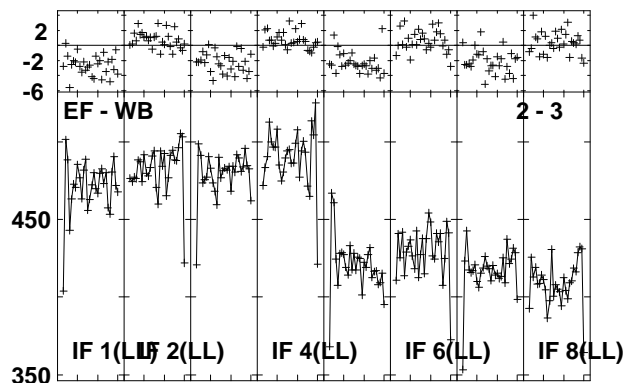
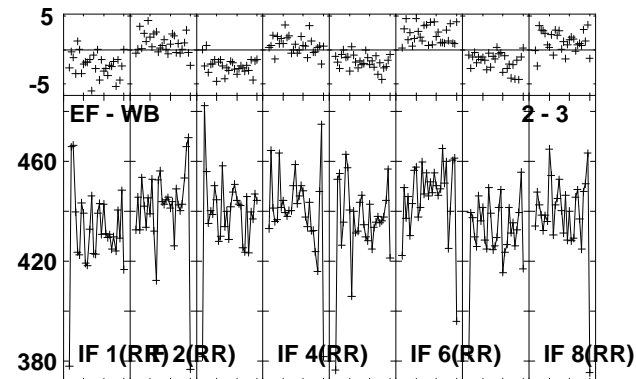
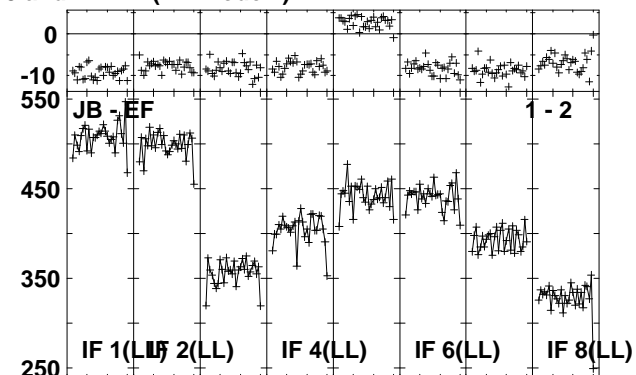
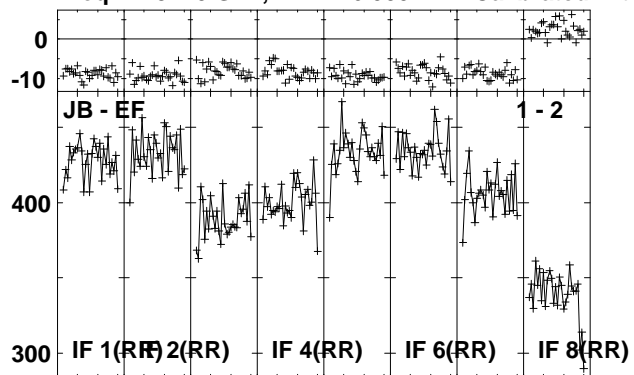

Lower frame: Milli Ampl Jy Top frame: Phas deg
Vector averaged cross-power spectrum Several baselines displayed
Timerange: 00/15:45:31 to 00/15:46:59

Plot file version 109 created 17-NOV-2010 16:19:38

ARP299D EP068A 5.UVDATA.1

Freq = 4.9270 GHz, Bw = 16.000 MH Calibrated with CL # 3 and BP # 1 (BP mode 1)

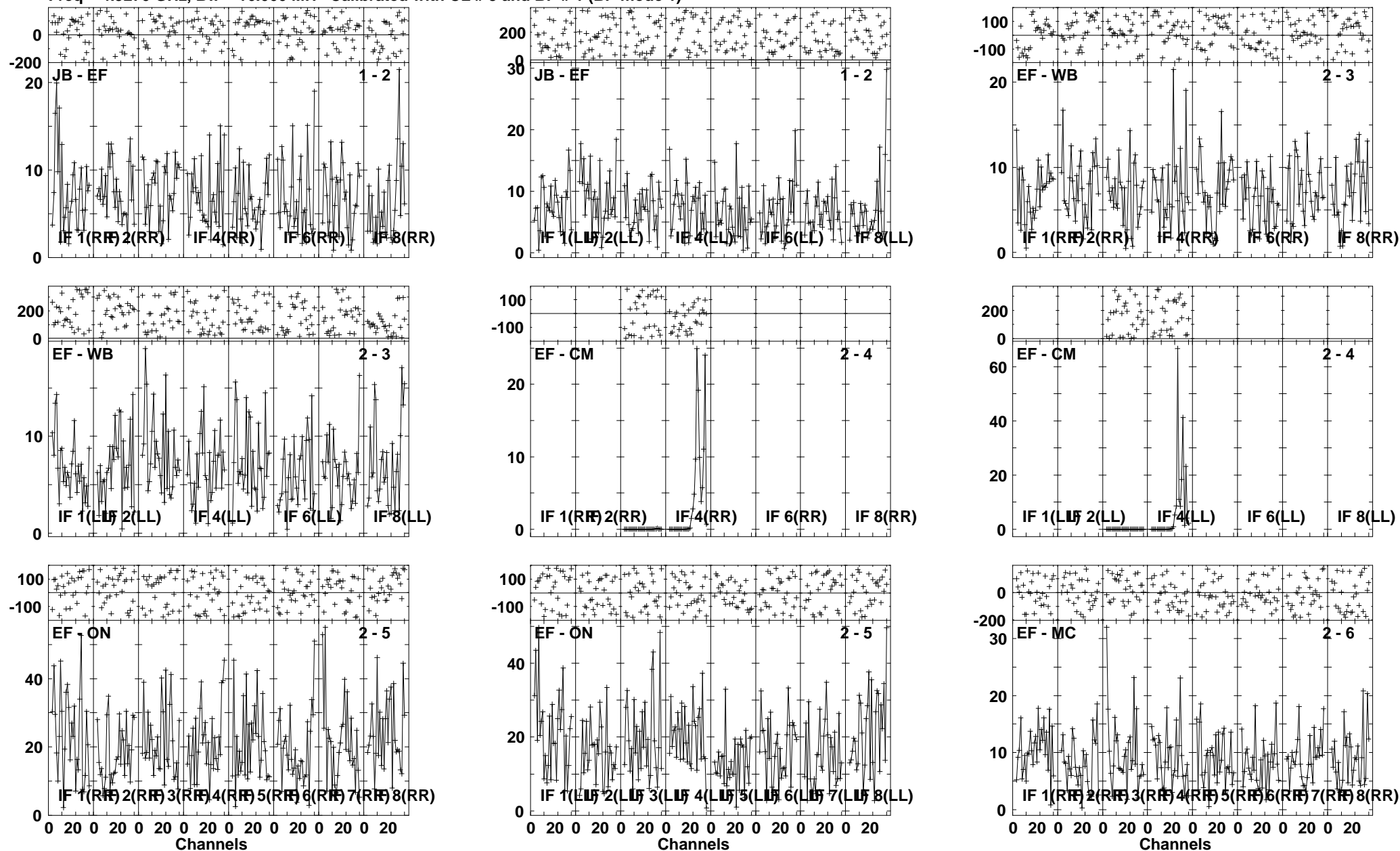

Plot file version 111 created 17-NOV-2010 16:19:43

J1128+59 EP068A 5.UVDATA.1

Freq = 4.9270 GHz, Bw = 16.000 MH Calibrated with CL # 3 and BP # 1 (BP mode 1)

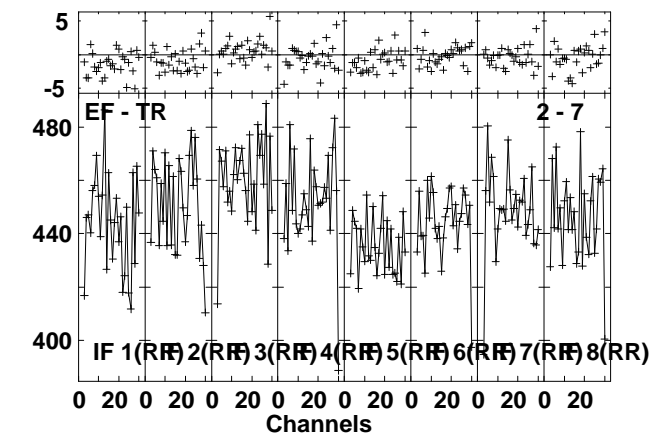
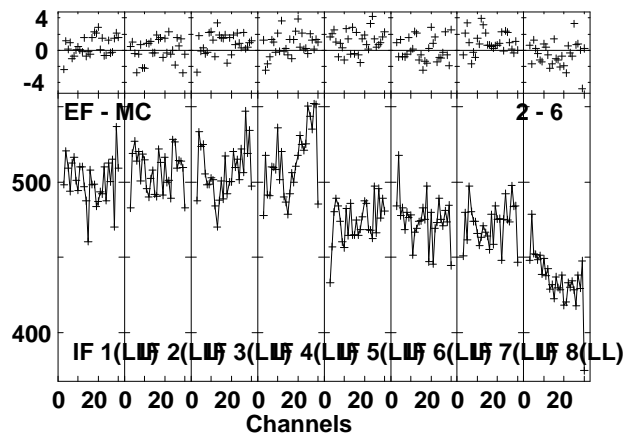
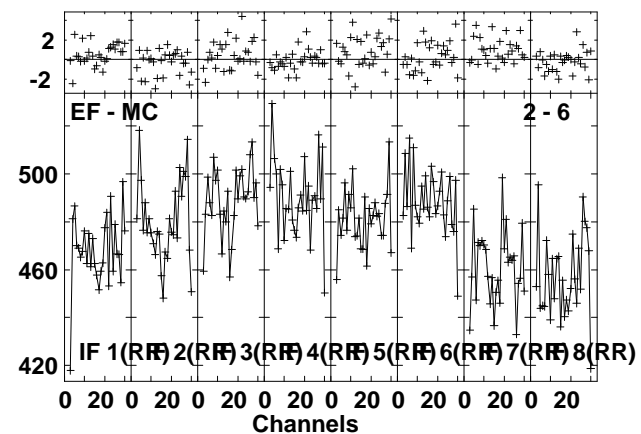
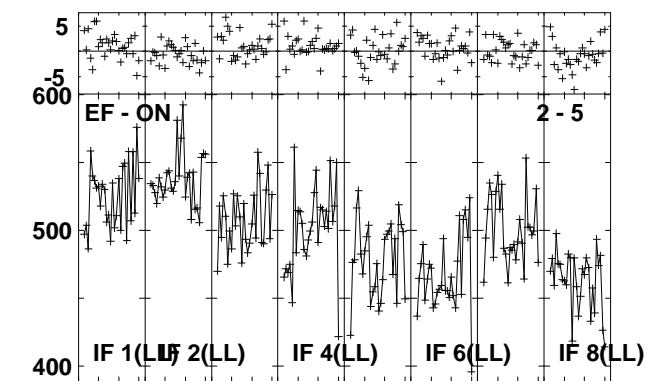
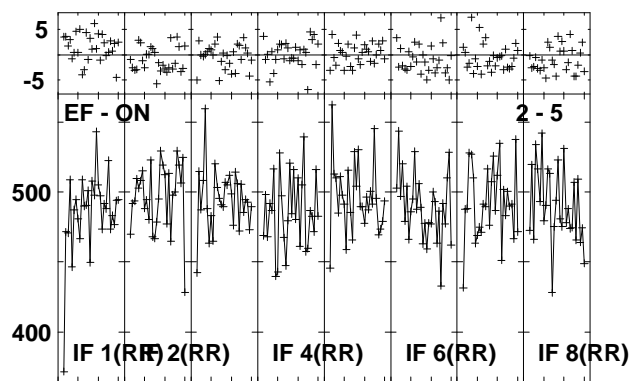
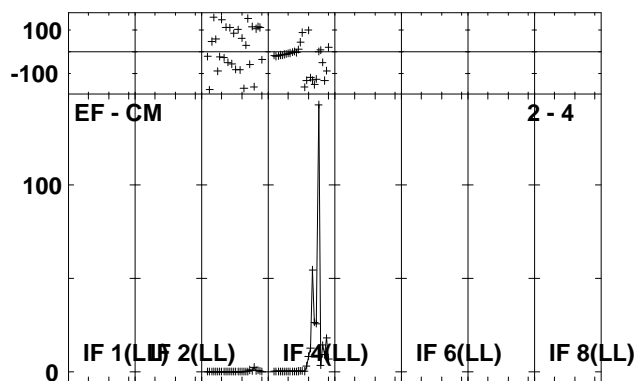
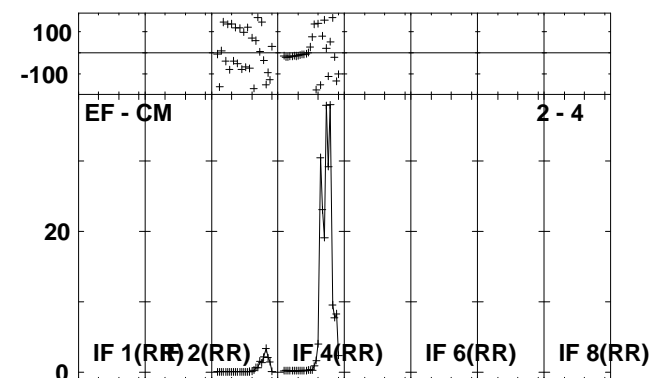
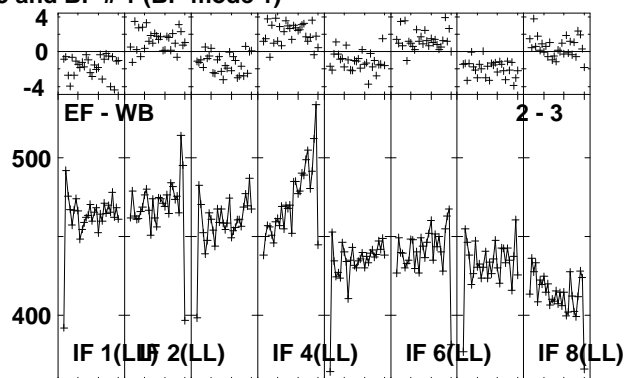
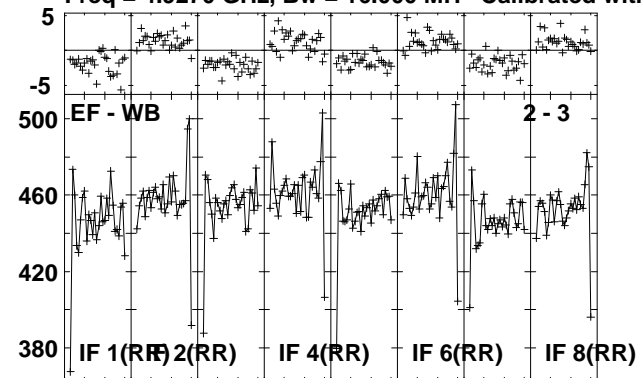

Lower frame: Milli Ampl Jy Top frame: Phas deg
Vector averaged cross-power spectrum Several baselines displayed
Timerange: 00/15:51:31 to 00/15:52:59

Plot file version 112 created 17-NOV-2010 16:19:44

J1128+59 EP068A 5.UVDATA.1

Freq = 4.9270 GHz, Bw = 16.000 MH Calibrated with CL # 3 and BP # 1 (BP mode 1)

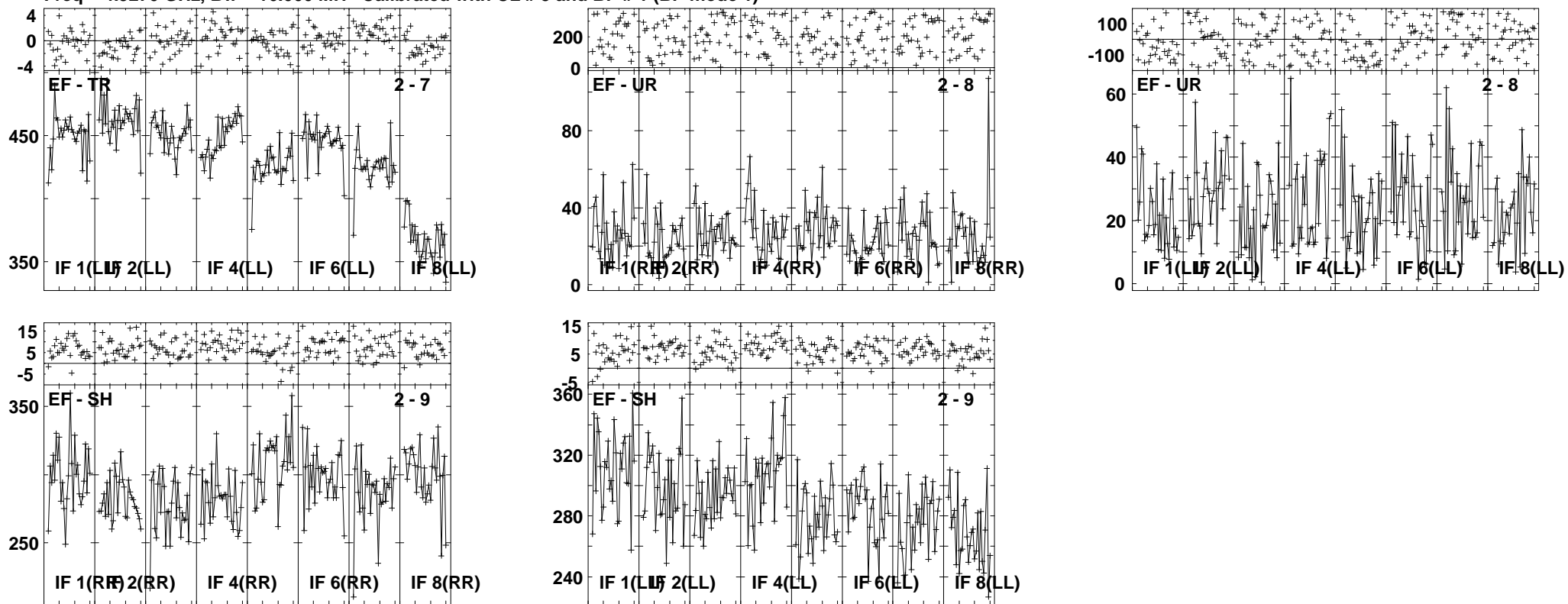

Lower frame: Milli Ampl Jy Top frame: Phas deg
Vector averaged cross-power spectrum Several baselines displayed
Timerange: 00/15:51:31 to 00/15:52:59

Plot file version 113 created 17-NOV-2010 16:19:46

ARP299D EP068A 5.UVDATA.1

Freq = 4.9270 GHz, Bw = 16.000 MH Calibrated with CL # 3 and BP # 1 (BP mode 1)

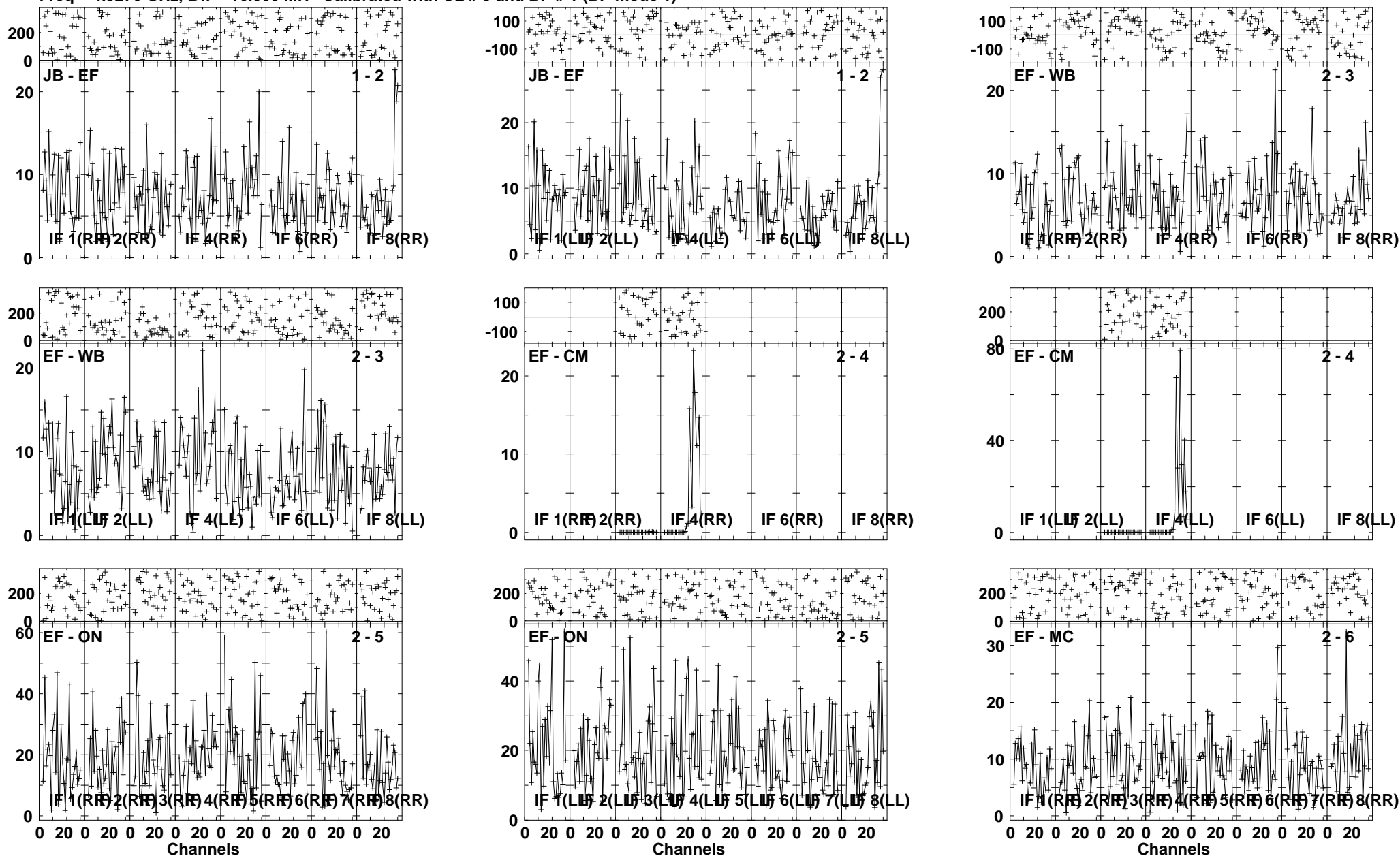

Lower frame: Milli Ampl Jy Top frame: Phas deg
Vector averaged cross-power spectrum Several baselines displayed
Timerange: 00/15:53:01 to 00/15:56:29

Plot file version 114 created 17-NOV-2010 16:19:48

ARP299D EP068A 5.UVDATA.1

Freq = 4.9270 GHz, Bw = 16.000 MH Calibrated with CL # 3 and BP # 1 (BP mode 1)

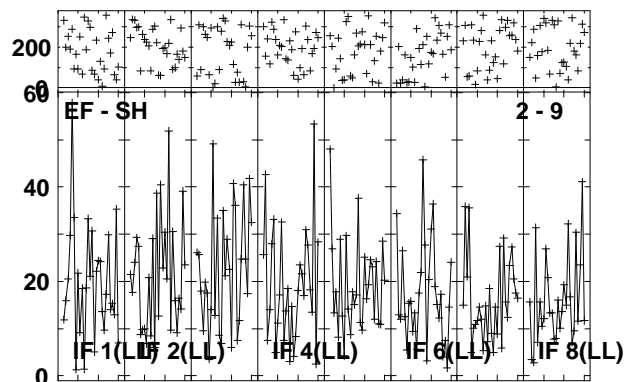
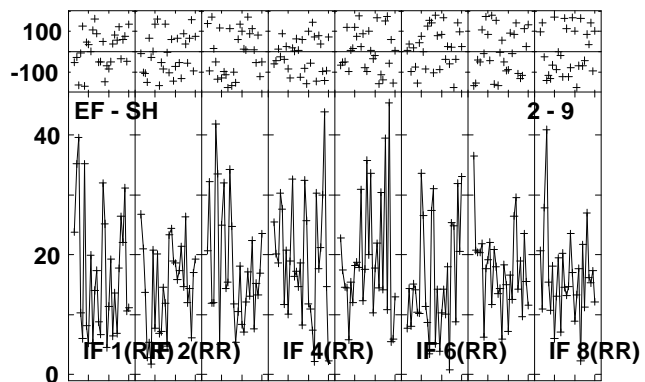
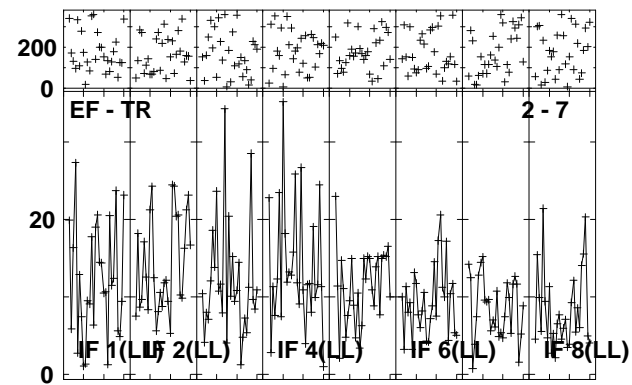
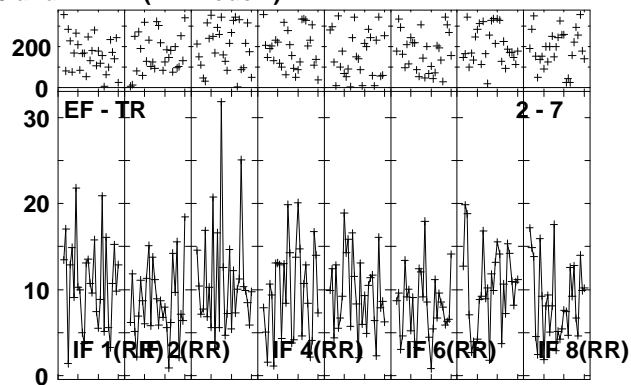
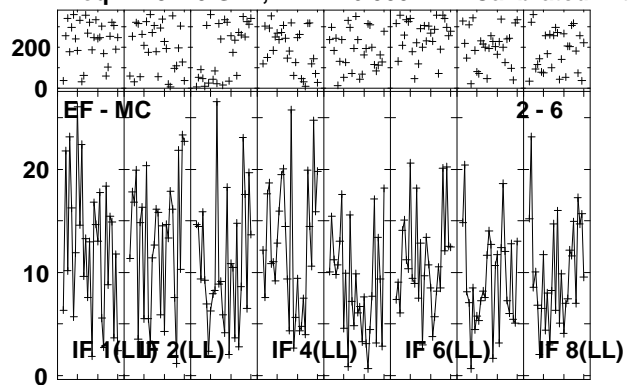

Lower frame: Milli Ampl Jy Top frame: Phas deg
Vector averaged cross-power spectrum Several baselines displayed
Timerange: 00/15:53:01 to 00/15:56:29

Plot file version 115 created 17-NOV-2010 16:19:51

J1128+59 EP068A 5.UVDATA.1

Freq = 4.9270 GHz, Bw = 16.000 MH Calibrated with CL # 3 and BP # 1 (BP mode 1)

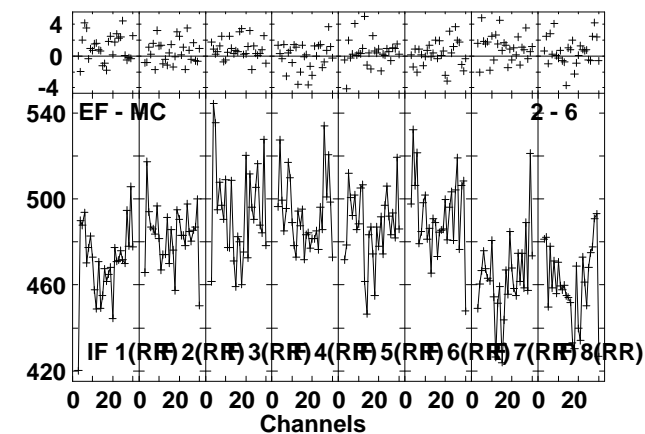
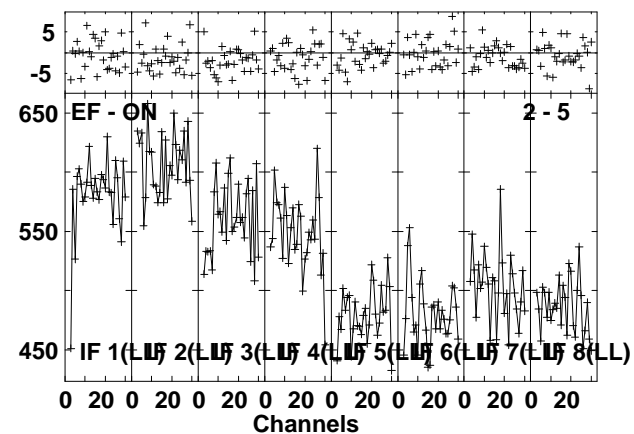
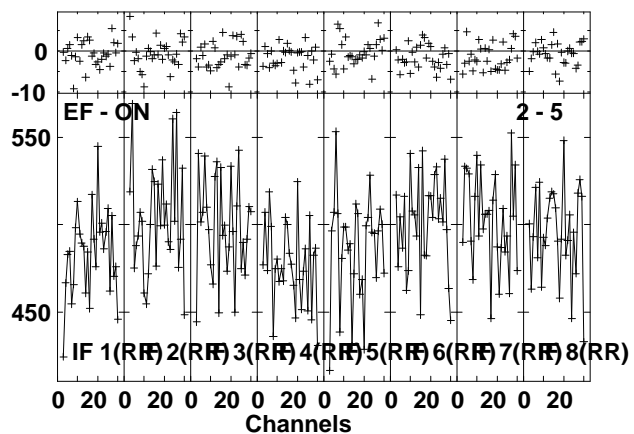
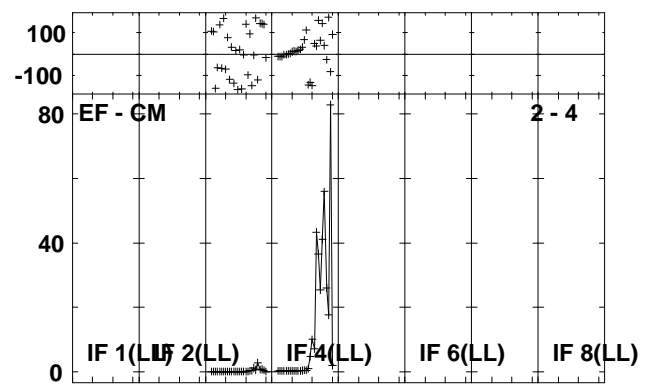
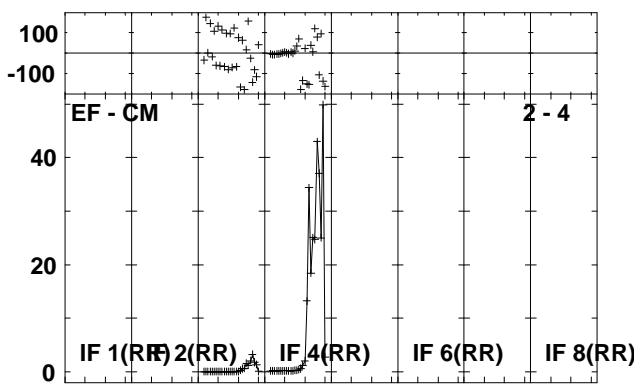
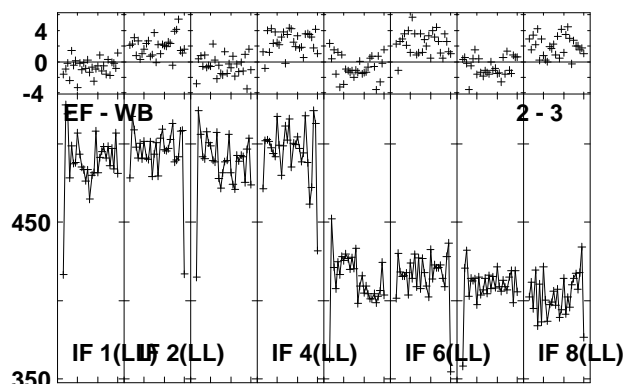
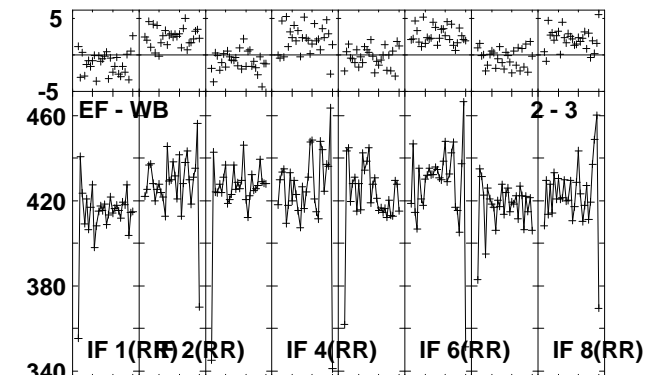
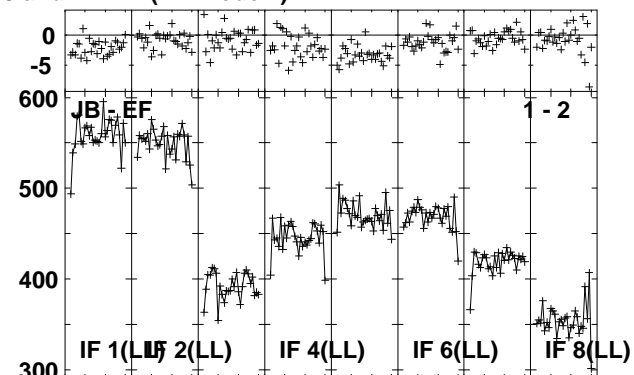
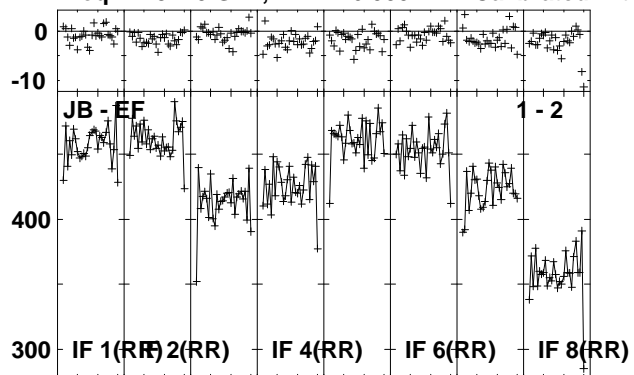

Lower frame: Milli Ampl Jy Top frame: Phas deg
Vector averaged cross-power spectrum Several baselines displayed
Timerange: 00/15:56:31 to 00/15:57:59

Plot file version 116 created 17-NOV-2010 16:19:52

J1128+59 EP068A 5.UVDATA.1

Freq = 4.9270 GHz, Bw = 16.000 MH Calibrated with CL # 3 and BP # 1 (BP mode 1)

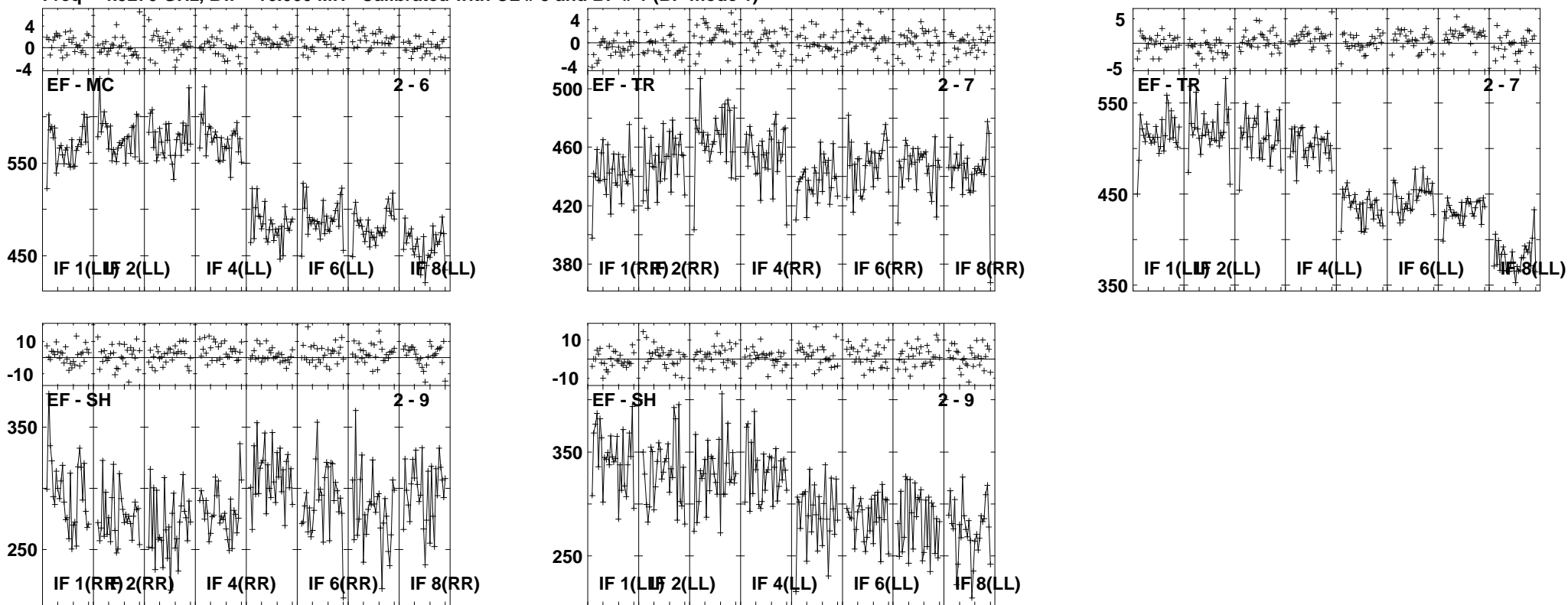

Lower frame: Milli Ampl Jy Top frame: Phas deg
Vector averaged cross-power spectrum Several baselines displayed
Timerange: 00/15:56:31 to 00/15:57:59

Plot file version 117 created 17-NOV-2010 16:19:53

ARP299D EP068A 5.UVDATA.1

Freq = 4.9270 GHz, Bw = 16.000 MH Calibrated with CL # 3 and BP # 1 (BP mode 1)

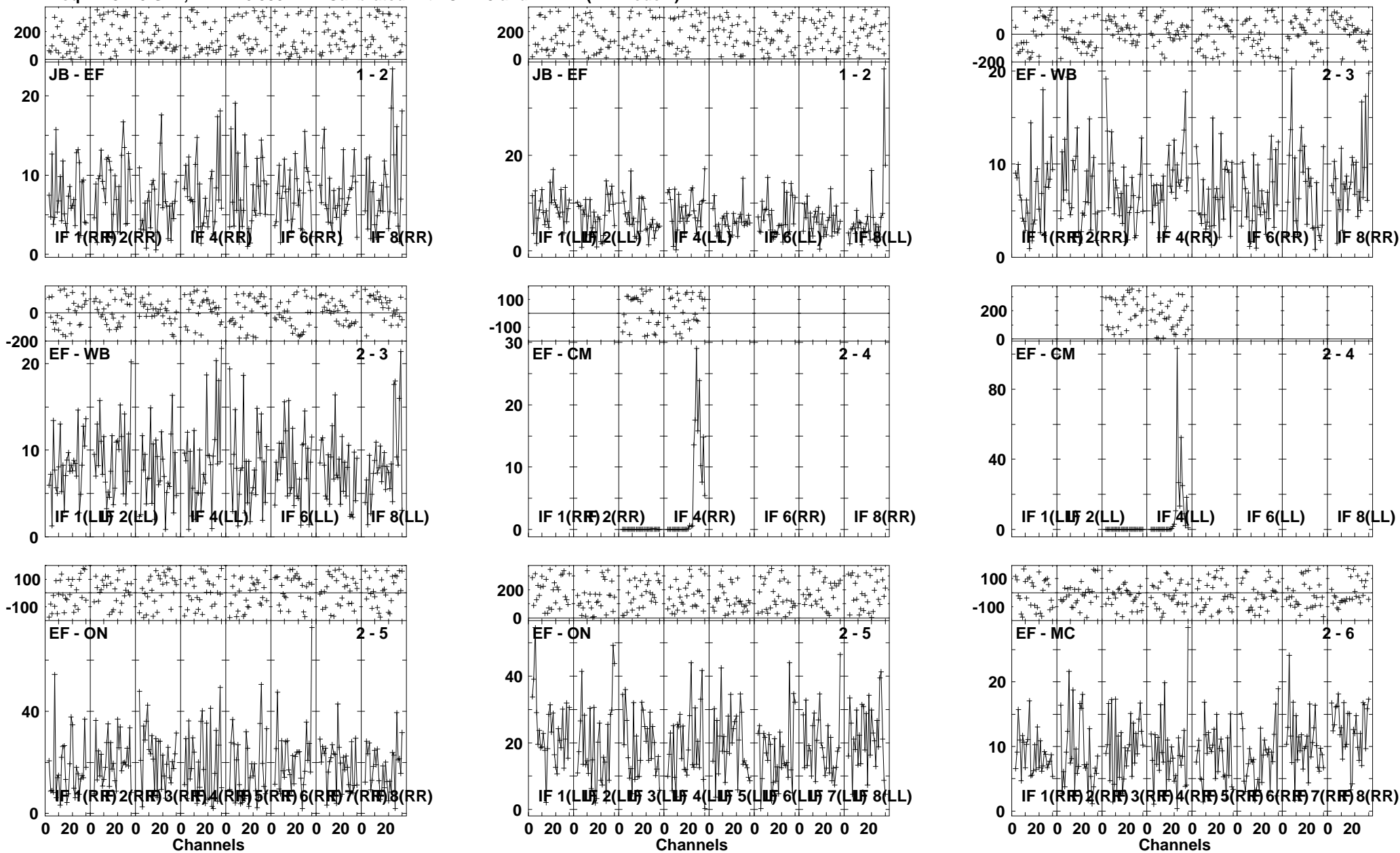

Lower frame: Milli Ampl Jy Top frame: Phas deg
Vector averaged cross-power spectrum Several baselines displayed
Timerange: 00/15:58:01 to 00/16:01:29

Plot file version 118 created 17-NOV-2010 16:19:56

ARP299D EP068A 5.UVDATA.1

Freq = 4.9270 GHz, Bw = 16.000 MH Calibrated with CL # 3 and BP # 1 (BP mode 1)

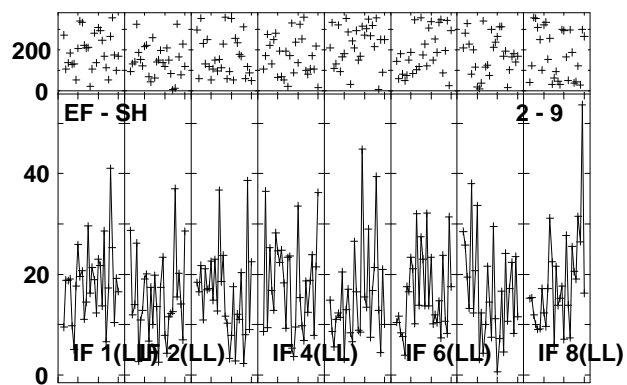
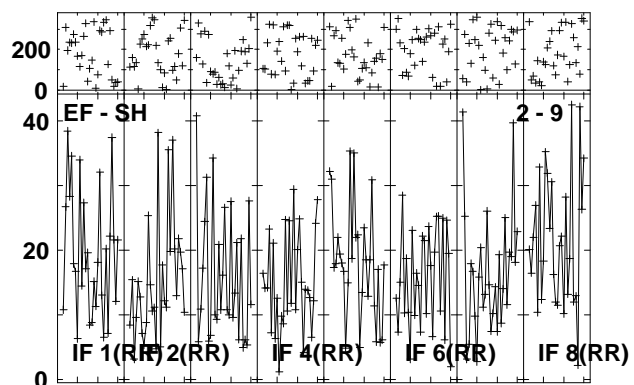
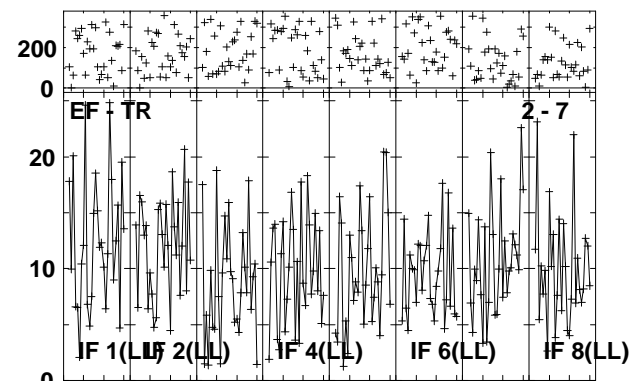
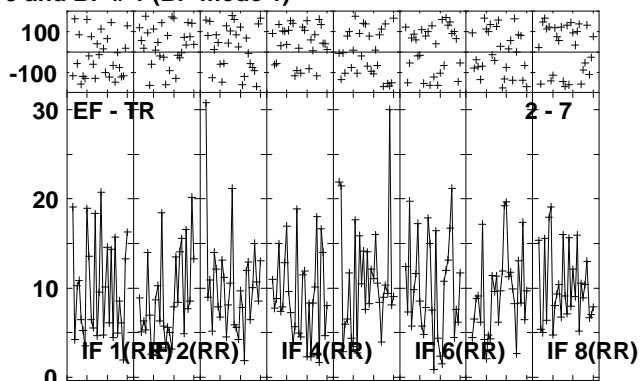
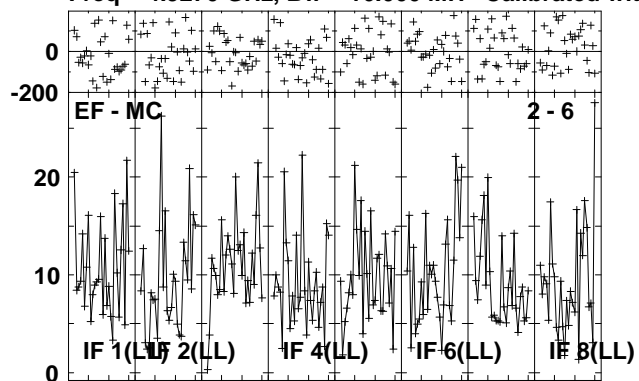

Lower frame: Milli Ampl Jy Top frame: Phas deg
Vector averaged cross-power spectrum Several baselines displayed
Timerange: 00/15:58:01 to 00/16:01:29

Plot file version 119 created 17-NOV-2010 16:19:59

J1128+59 EP068A 5.UVDATA.1

Freq = 4.9270 GHz, Bw = 16.000 MH Calibrated with CL # 3 and BP # 1 (BP mode 1)

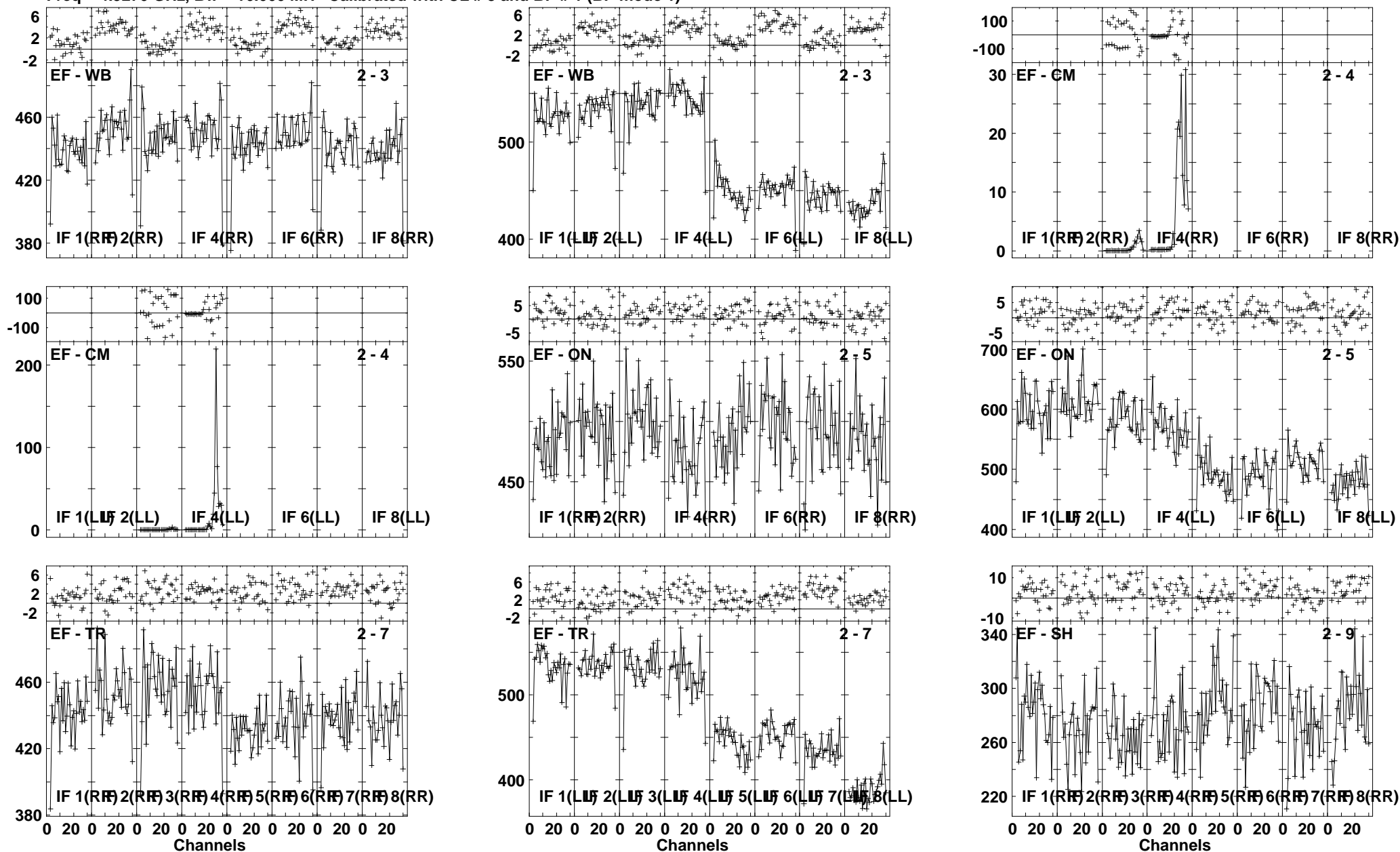

Lower frame: Milli Ampl Jy Top frame: Phas deg
Vector averaged cross-power spectrum Several baselines displayed
Timerange: 00/16:01:31 to 00/16:02:59

Plot file version 120 created 17-NOV-2010 16:20:00

J1128+59 EP068A 5.UVDATA.1

Freq = 4.9270 GHz, Bw = 16.000 MH Calibrated with CL # 3 and BP # 1 (BP mode 1)

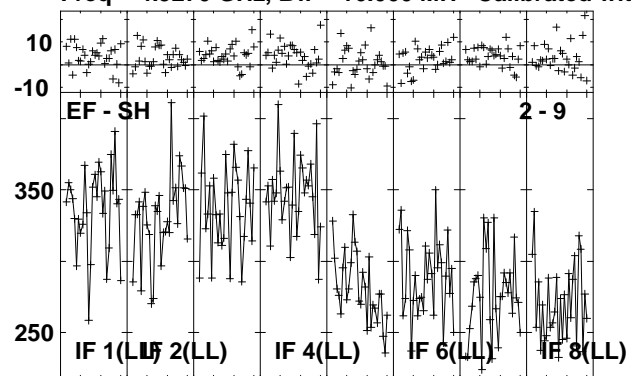

Lower frame: Milli Ampl Jy Top frame: Phas deg
Vector averaged cross-power spectrum Several baselines displayed
Timerange: 00/16:01:31 to 00/16:02:59

Plot file version 121 created 17-NOV-2010 16:20:01

ARP299D EP068A 5.UVDATA.1

Freq = 4.9270 GHz, Bw = 16.000 MH Calibrated with CL # 3 and BP # 1 (BP mode 1)

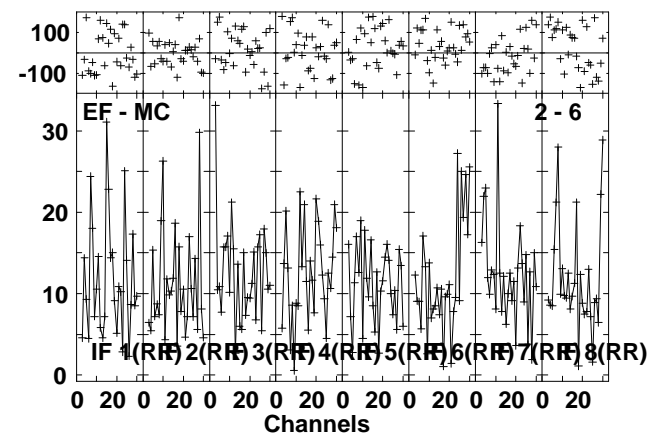
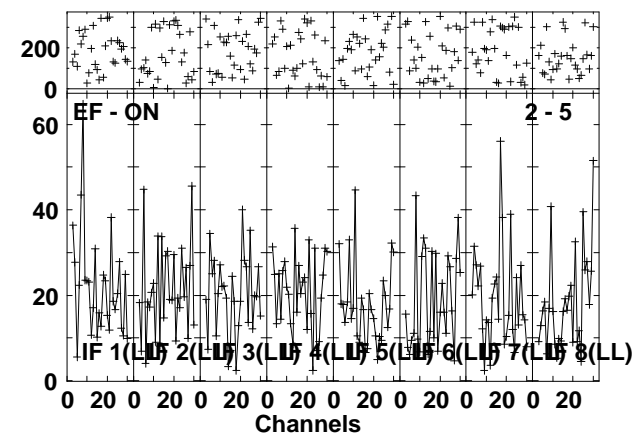
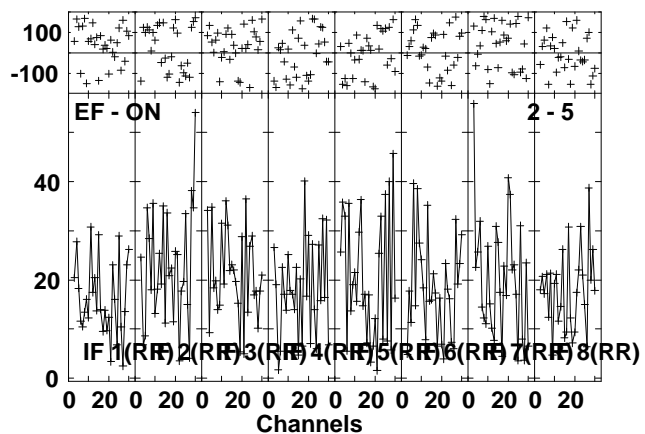
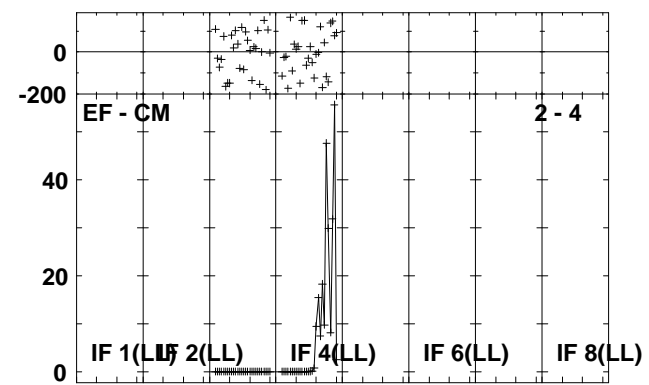
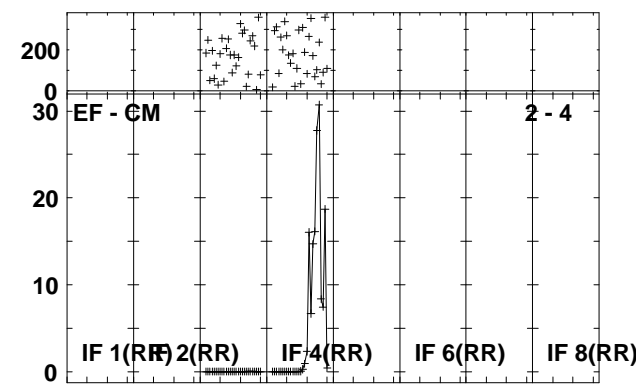
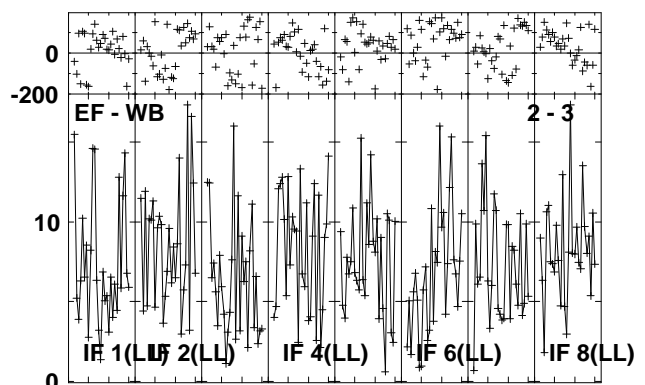
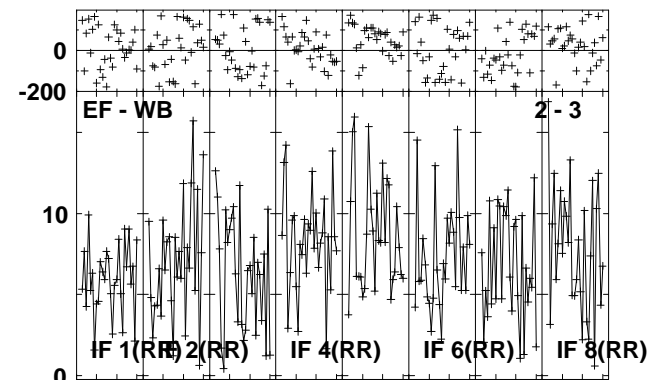
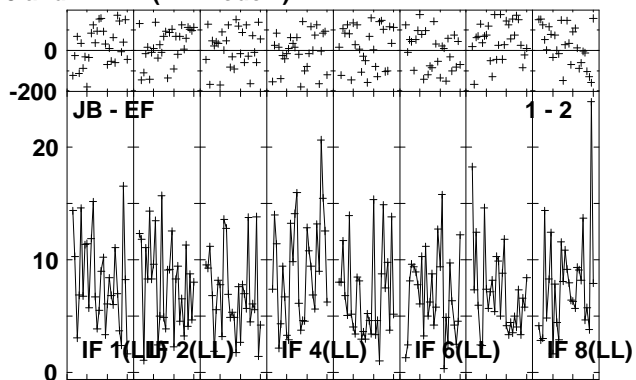
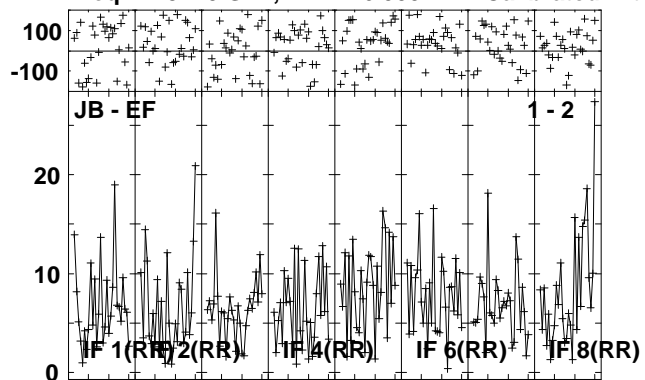

Lower frame: Milli Ampl Jy Top frame: Phas deg
Vector averaged cross-power spectrum Several baselines displayed
Timerange: 00/16:03:01 to 00/16:06:29

Plot file version 122 created 17-NOV-2010 16:20:03

ARP299D EP068A 5.UVDATA.1

Freq = 4.9270 GHz, Bw = 16.000 MH Calibrated with CL # 3 and BP # 1 (BP mode 1)

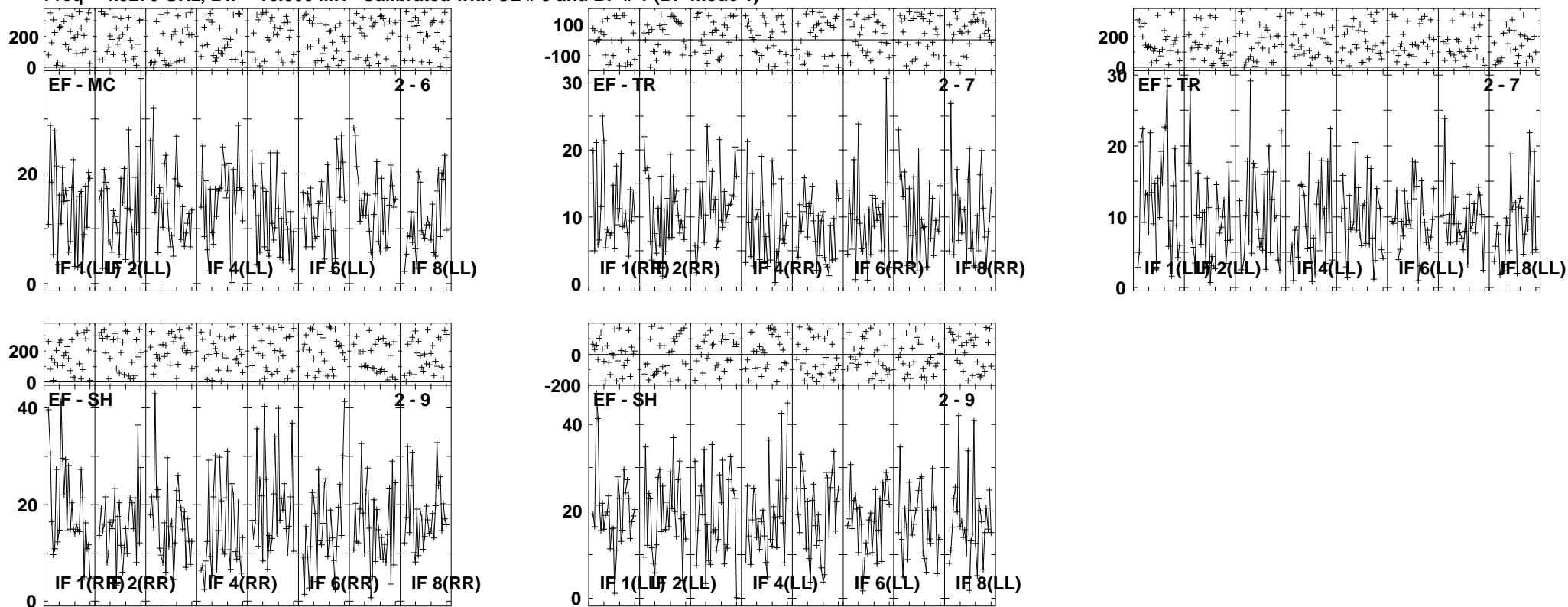

Lower frame: Milli Ampl Jy Top frame: Phas deg
Vector averaged cross-power spectrum Several baselines displayed
Timerange: 00/16:03:01 to 00/16:06:29

Plot file version 123 created 17-NOV-2010 16:20:06

J1128+59 EP068A 5.UVDATA.1

Freq = 4.9270 GHz, Bw = 16.000 MH Calibrated with CL # 3 and BP # 1 (BP mode 1)

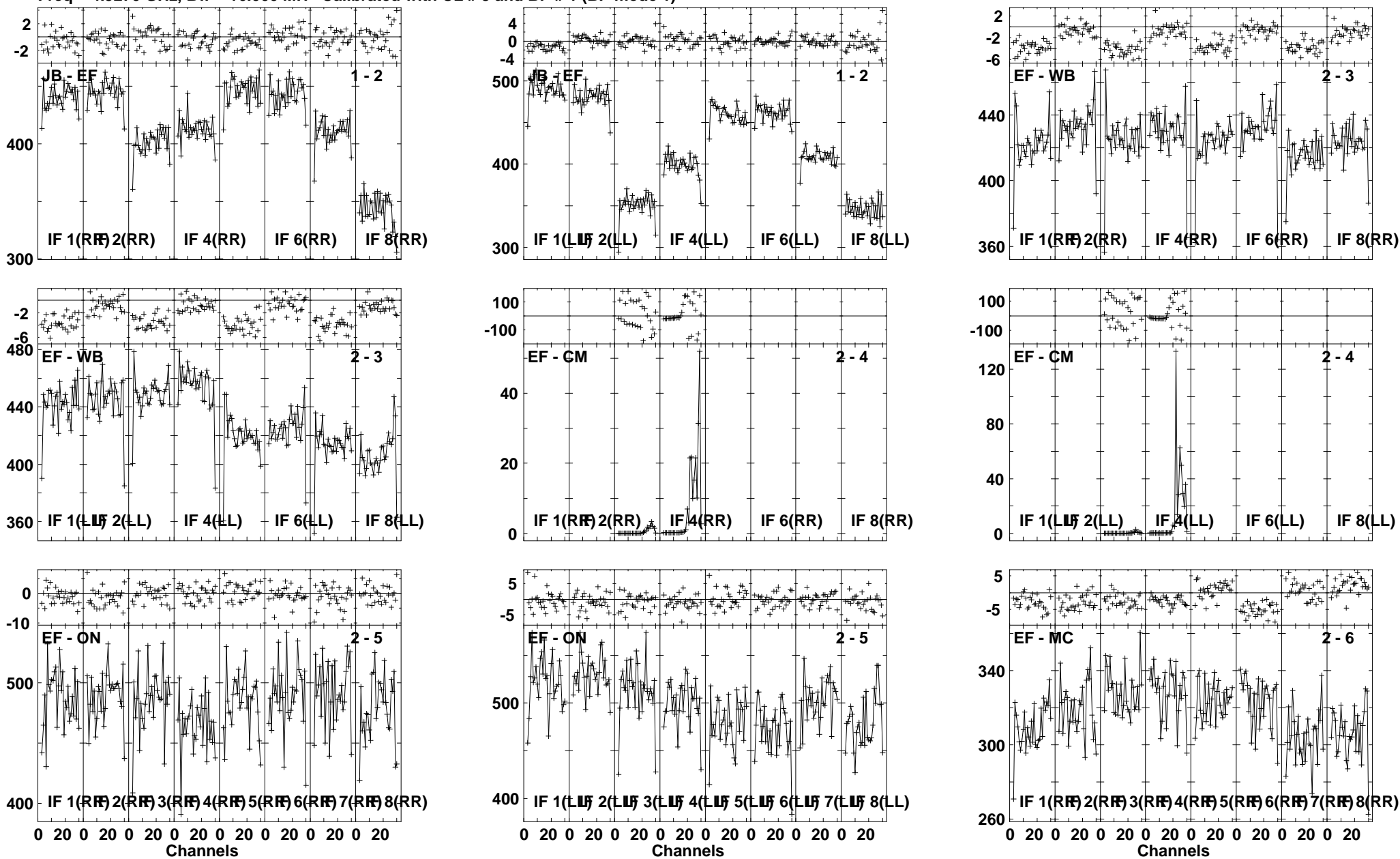

Lower frame: Milli Ampl Jy Top frame: Phas deg
Vector averaged cross-power spectrum Several baselines displayed
Timerange: 00/16:07:31 to 00/16:08:59

Plot file version 124 created 17-NOV-2010 16:20:07

J1128+59 EP068A 5.UVDATA.1

Freq = 4.9270 GHz, Bw = 16.000 MH Calibrated with CL # 3 and BP # 1 (BP mode 1)

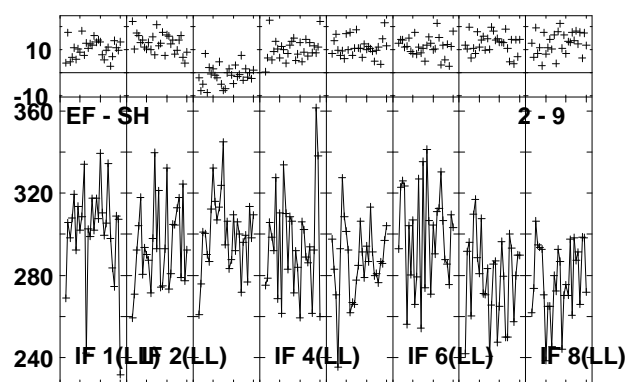
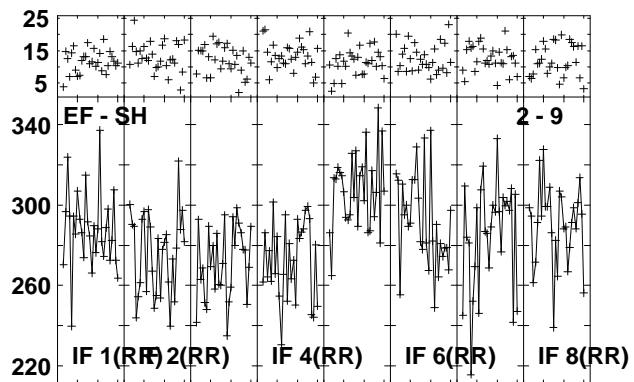
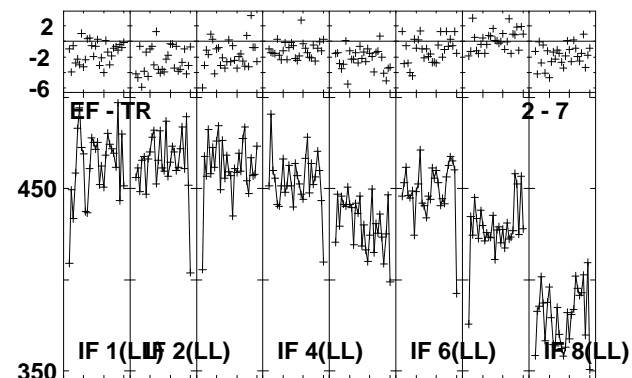
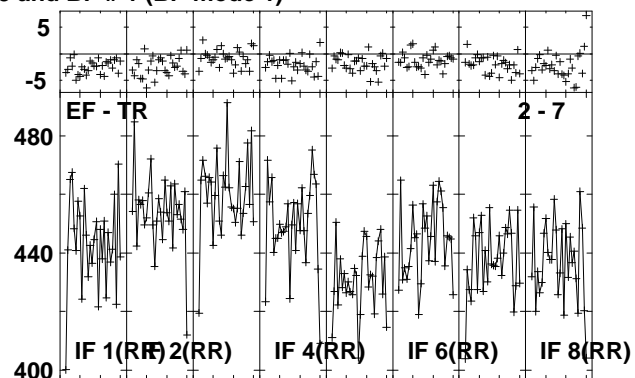
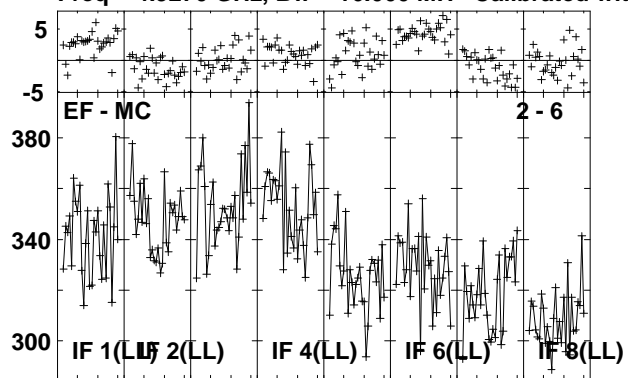

Lower frame: Milli Ampl Jy Top frame: Phas deg
Vector averaged cross-power spectrum Several baselines displayed
Timerange: 00/16:07:31 to 00/16:08:59

Plot file version 125 created 17-NOV-2010 16:20:09

ARP299D EP068A 5.UVDATA.1

Freq = 4.9270 GHz, Bw = 16.000 MH Calibrated with CL # 3 and BP # 1 (BP mode 1)

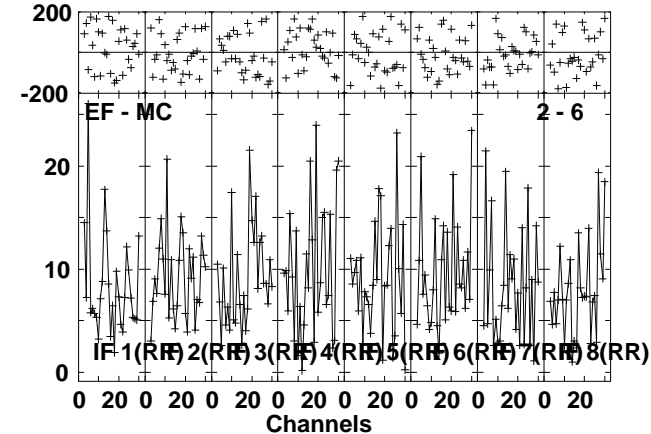
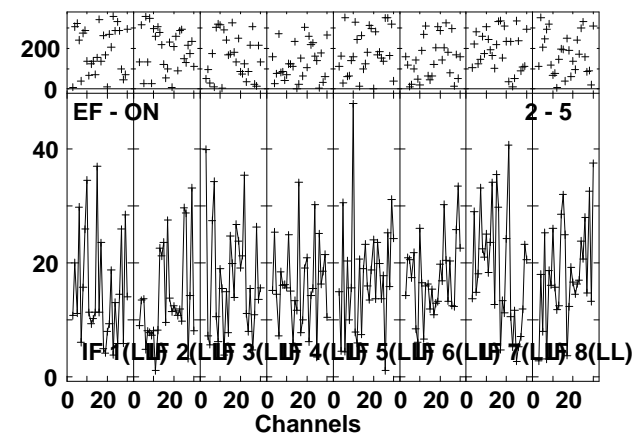
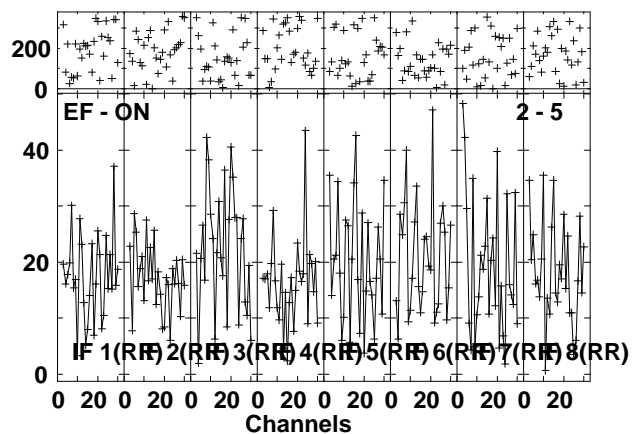
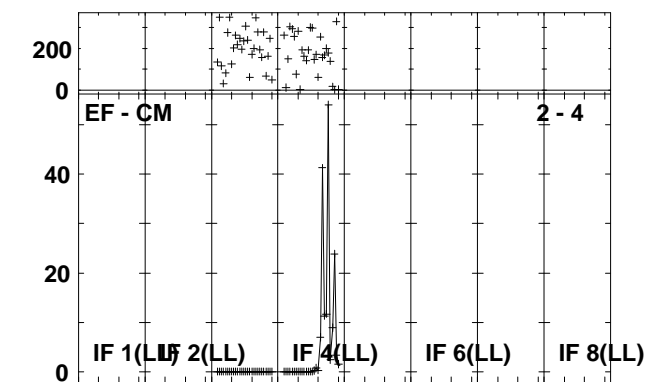
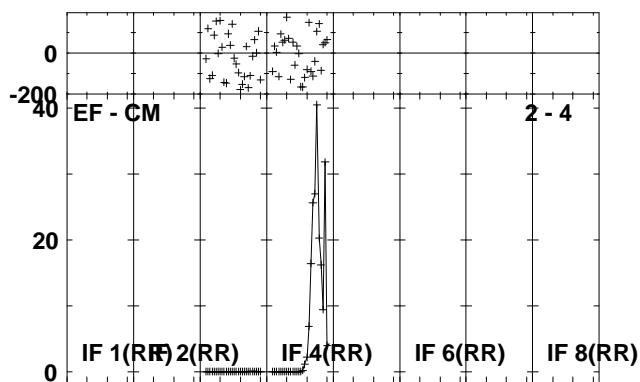
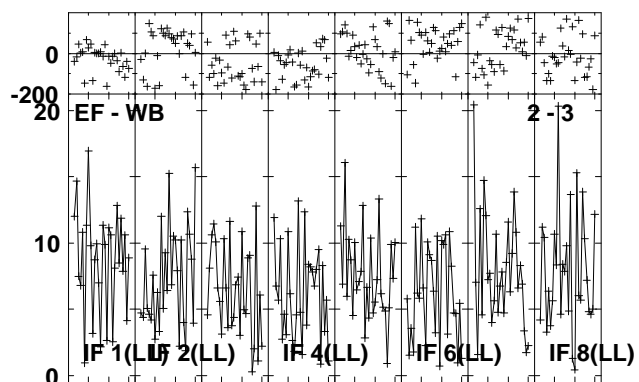
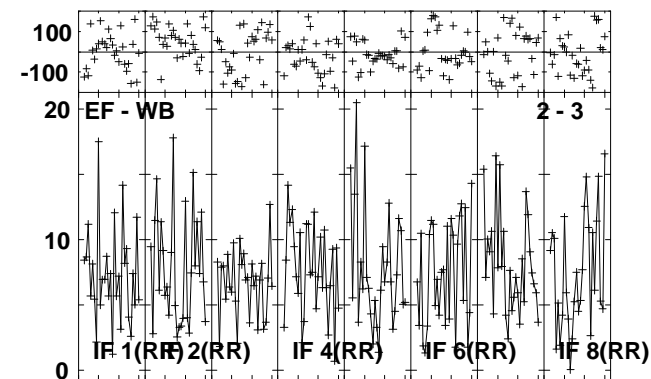
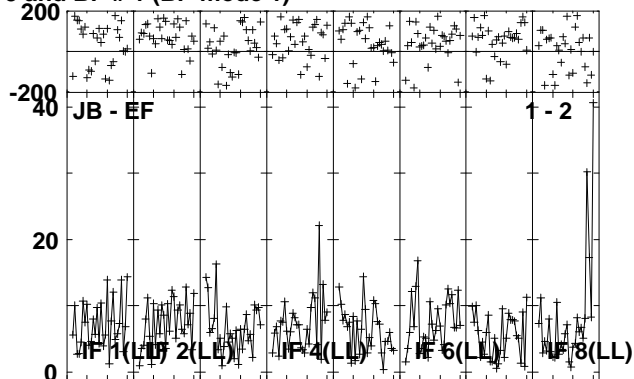
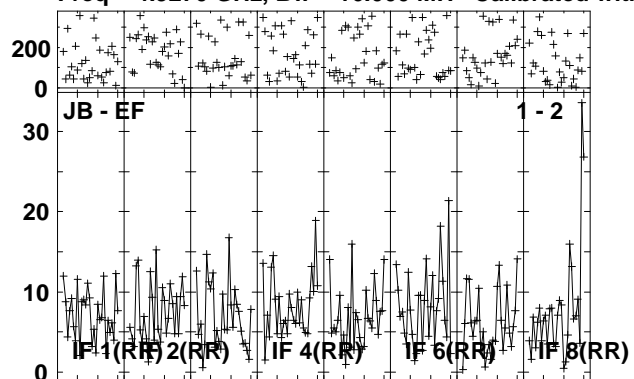

Lower frame: Milli Ampl Jy Top frame: Phas deg
Vector averaged cross-power spectrum Several baselines displayed
Timerange: 00/16:09:01 to 00/16:12:29

Plot file version 126 created 17-NOV-2010 16:20:11

ARP299D EP068A 5.UVDATA.1

Freq = 4.9270 GHz, Bw = 16.000 MH Calibrated with CL # 3 and BP # 1 (BP mode 1)

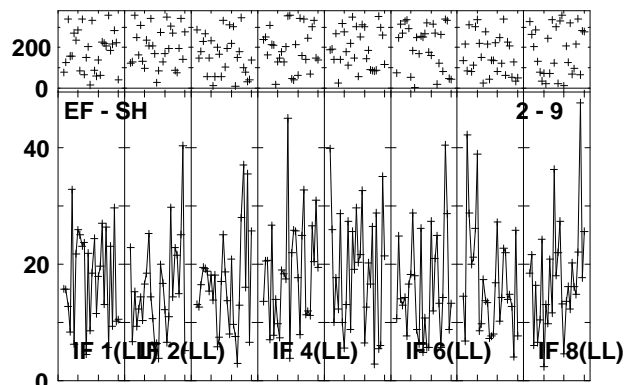
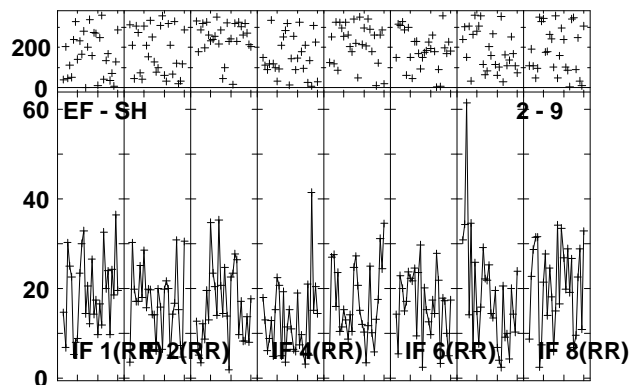
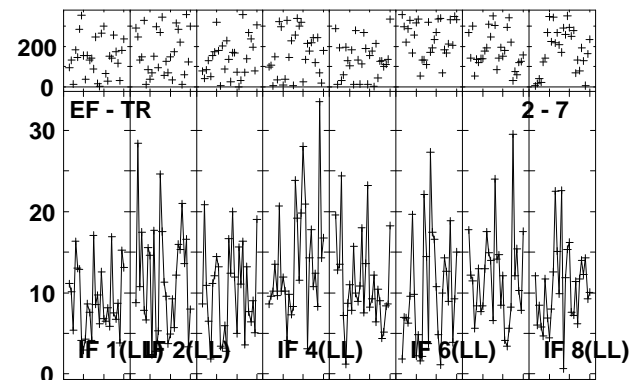
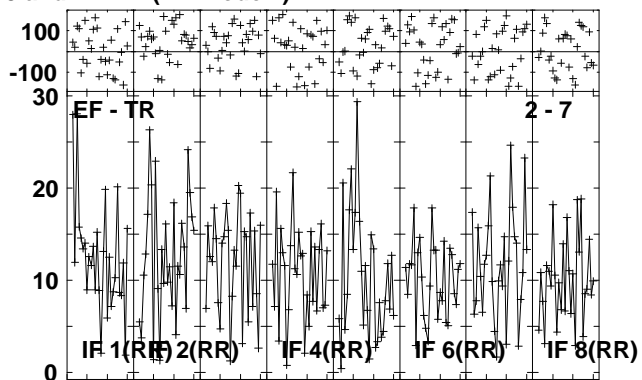
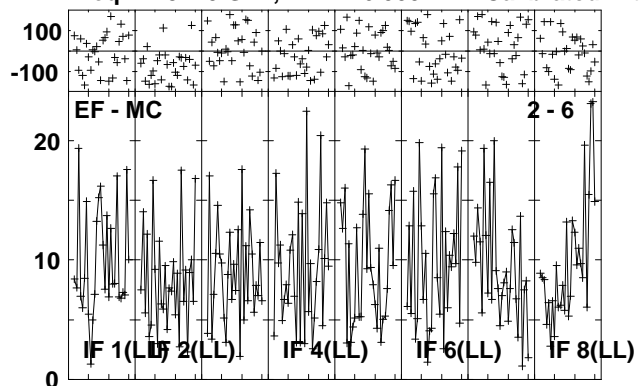

Lower frame: Milli Ampl Jy Top frame: Phas deg
Vector averaged cross-power spectrum Several baselines displayed
Timerange: 00/16:09:01 to 00/16:12:29

Plot file version 127 created 17-NOV-2010 16:20:14

J1128+59 EP068A 5.UVDATA.1

Freq = 4.9270 GHz, Bw = 16.000 MH Calibrated with CL # 3 and BP # 1 (BP mode 1)

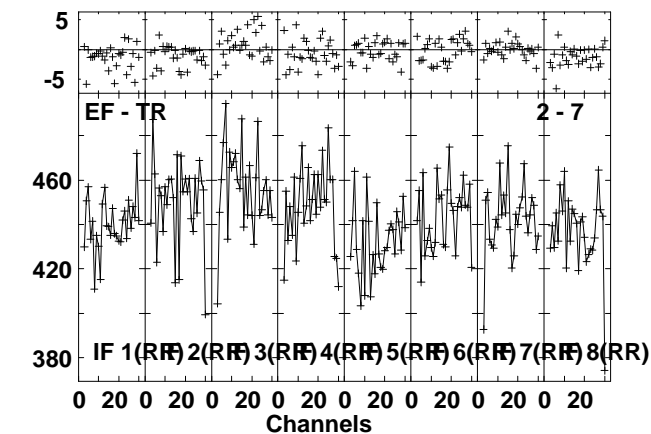
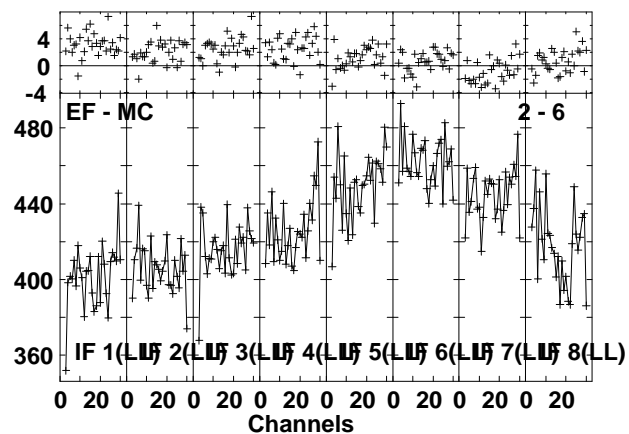
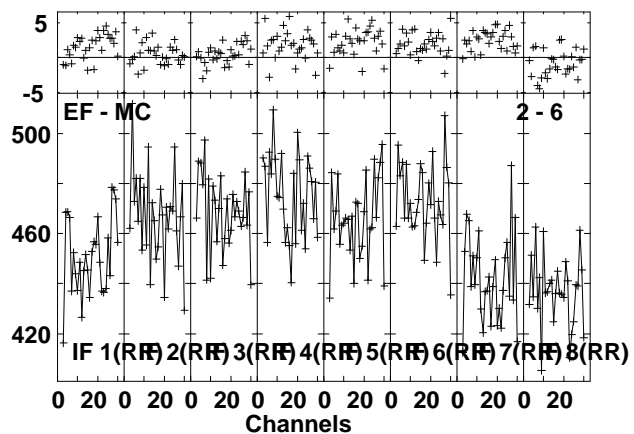
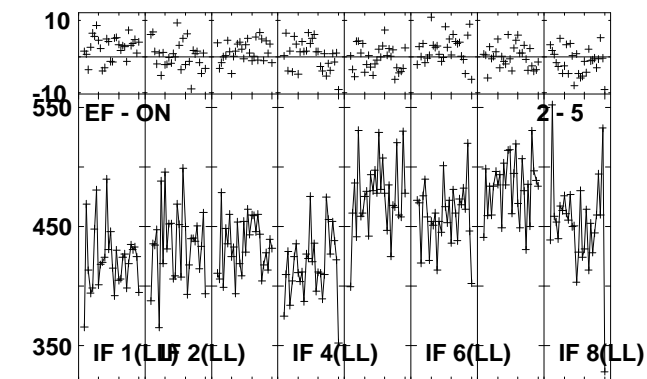
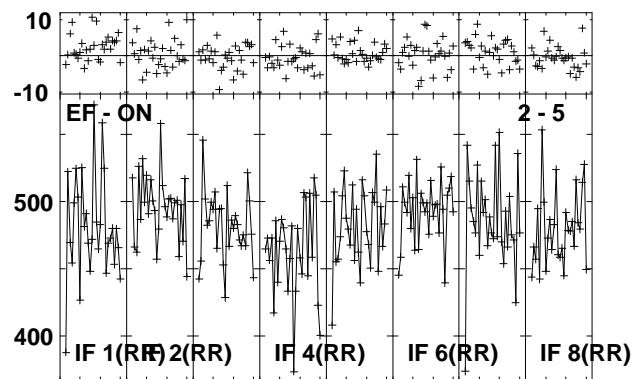
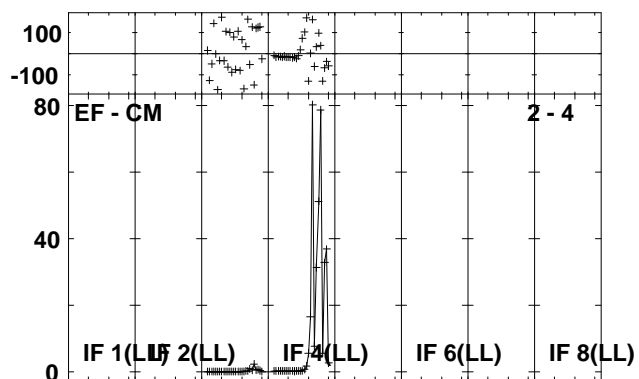
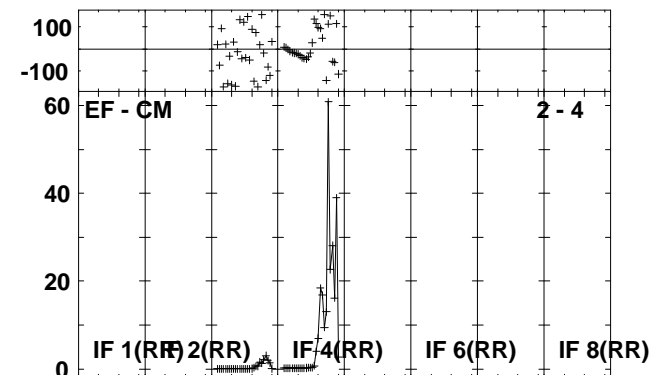
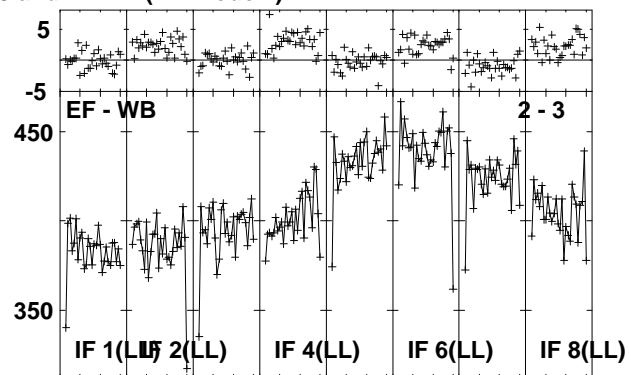
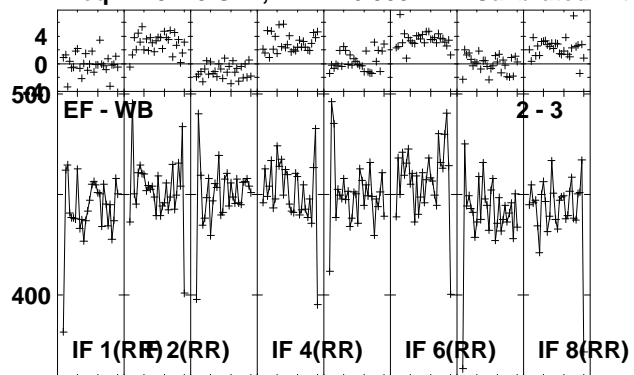

Lower frame: Milli Ampl Jy Top frame: Phas deg
Vector averaged cross-power spectrum Several baselines displayed
Timerange: 00/16:12:31 to 00/16:13:57

Plot file version 128 created 17-NOV-2010 16:20:15

J1128+59 EP068A 5.UVDATA.1

Freq = 4.9270 GHz, Bw = 16.000 MH Calibrated with CL # 3 and BP # 1 (BP mode 1)

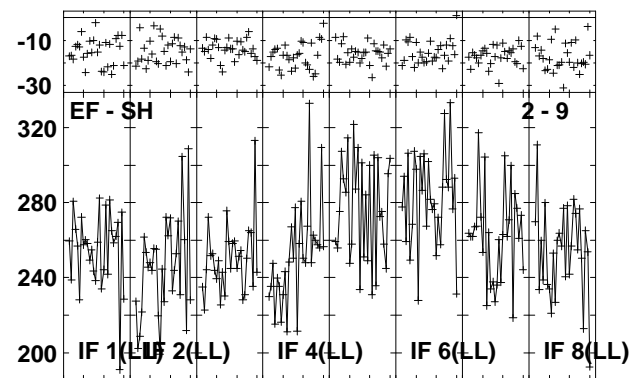
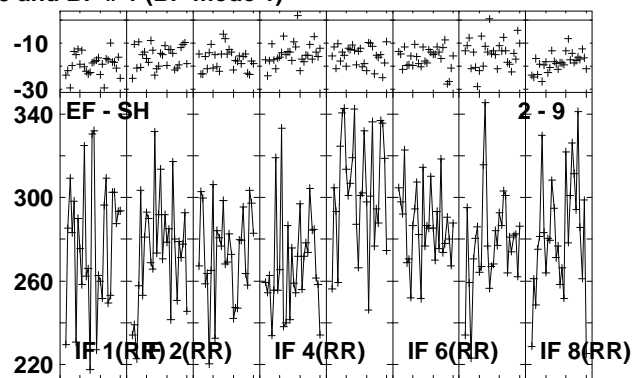
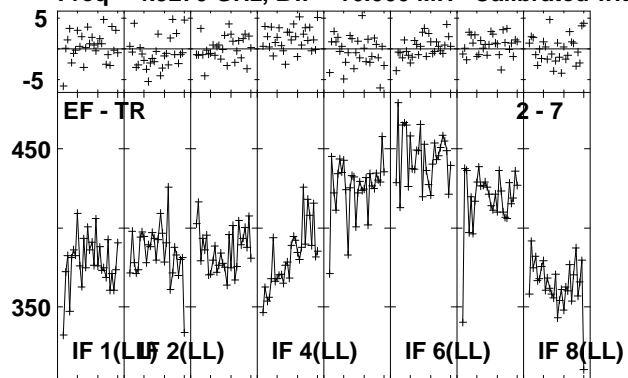

Lower frame: Milli Ampl Jy Top frame: Phas deg
Vector averaged cross-power spectrum Several baselines displayed
Timerange: 00/16:12:31 to 00/16:13:57

Plot file version 129 created 17-NOV-2010 16:20:16

ARP299D EP068A 5.UVDATA.1

Freq = 4.9270 GHz, Bw = 16.000 MH Calibrated with CL # 3 and BP # 1 (BP mode 1)

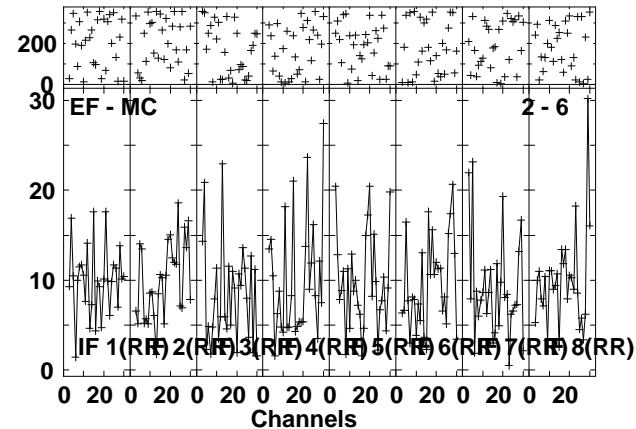
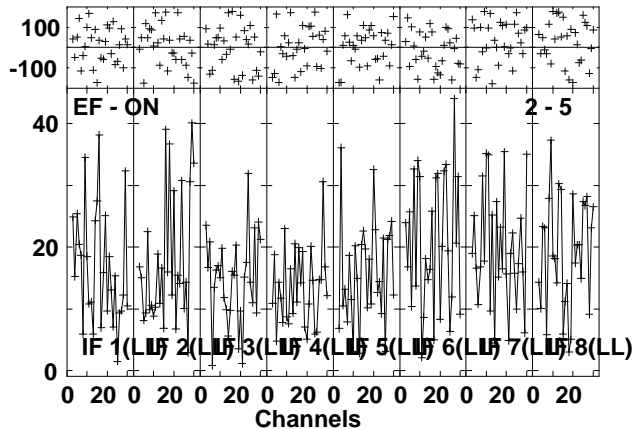
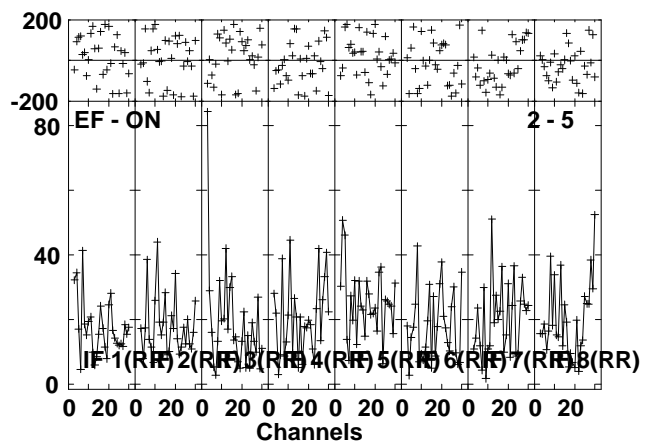
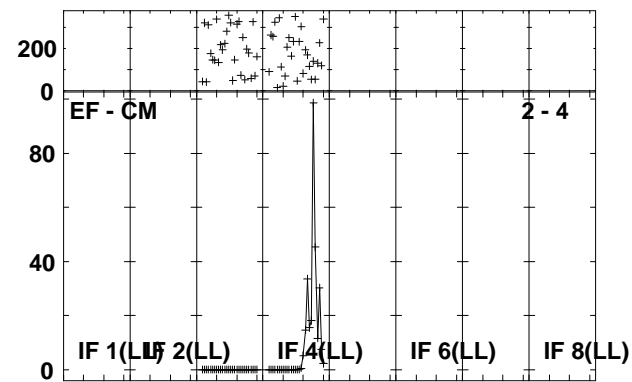
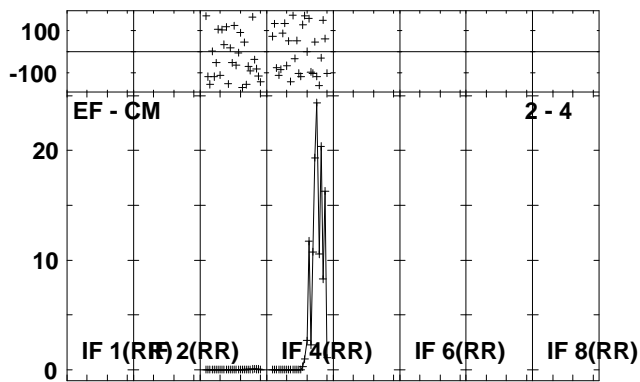
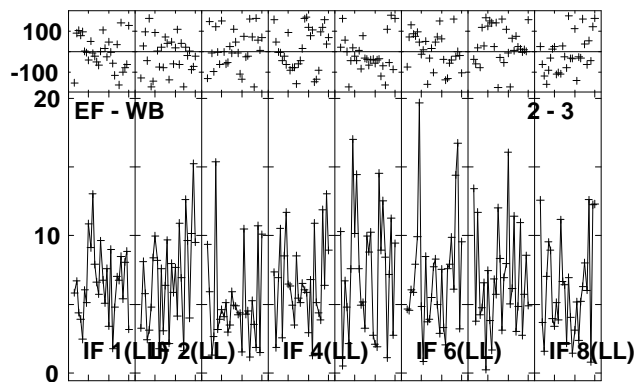
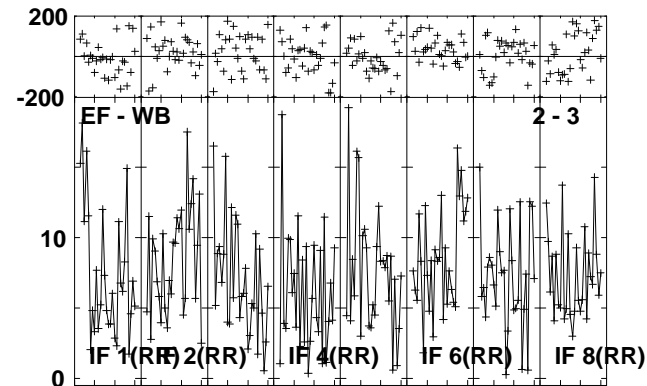
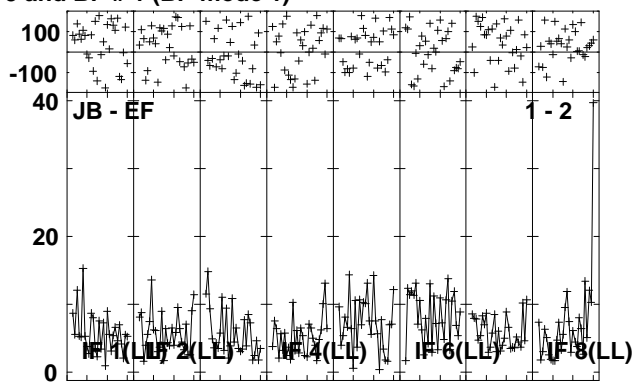
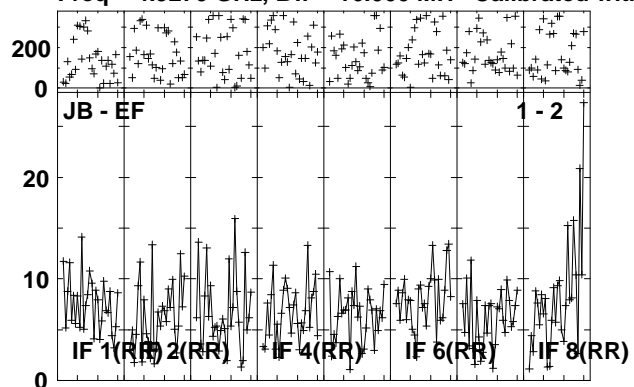

Lower frame: Milli Ampl Jy Top frame: Phas deg
Vector averaged cross-power spectrum Several baselines displayed
Timerange: 00/16:14:01 to 00/16:17:29

Plot file version 130 created 17-NOV-2010 16:20:18

ARP299D EP068A 5.UVDATA.1

Freq = 4.9270 GHz, Bw = 16.000 MH Calibrated with CL # 3 and BP # 1 (BP mode 1)

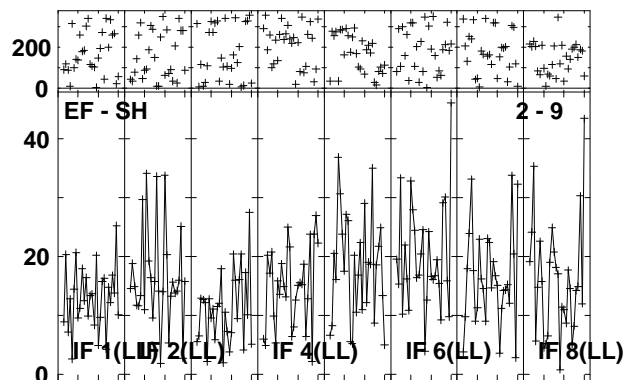
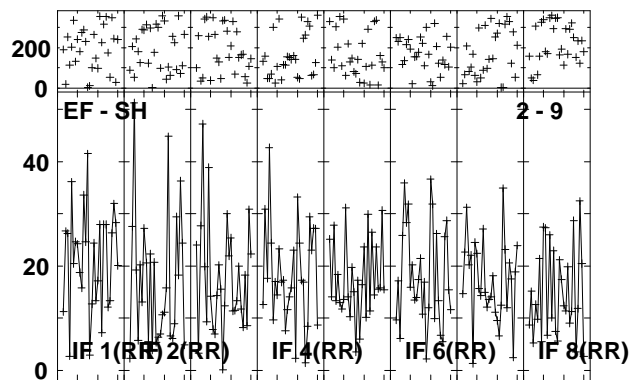
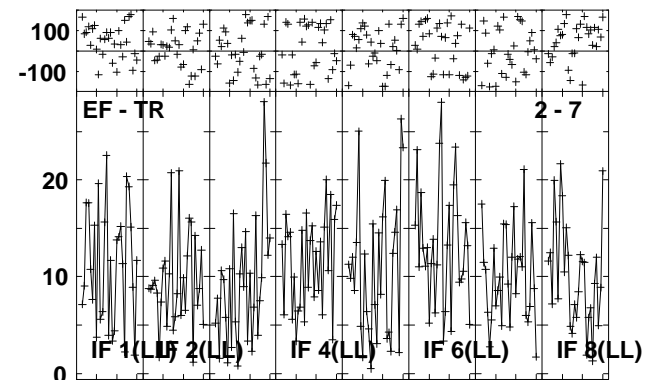
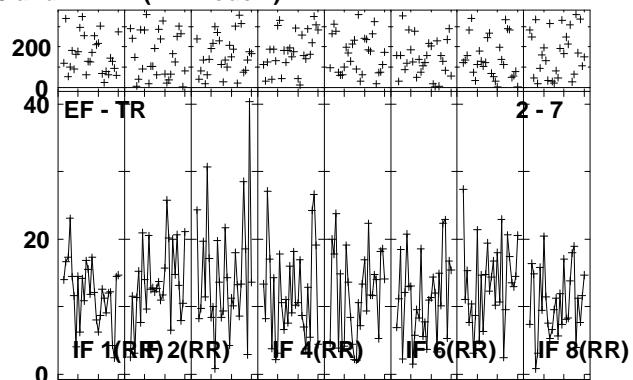
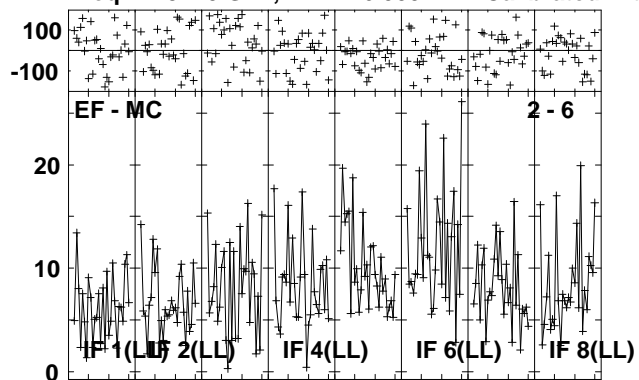

Lower frame: Milli Ampl Jy Top frame: Phas deg
Vector averaged cross-power spectrum Several baselines displayed
Timerange: 00/16:14:01 to 00/16:17:29

Plot file version 131 created 17-NOV-2010 16:20:21

J1128+59 EP068A 5.UVDATA.1

Freq = 4.9270 GHz, Bw = 16.000 MH Calibrated with CL # 3 and BP # 1 (BP mode 1)

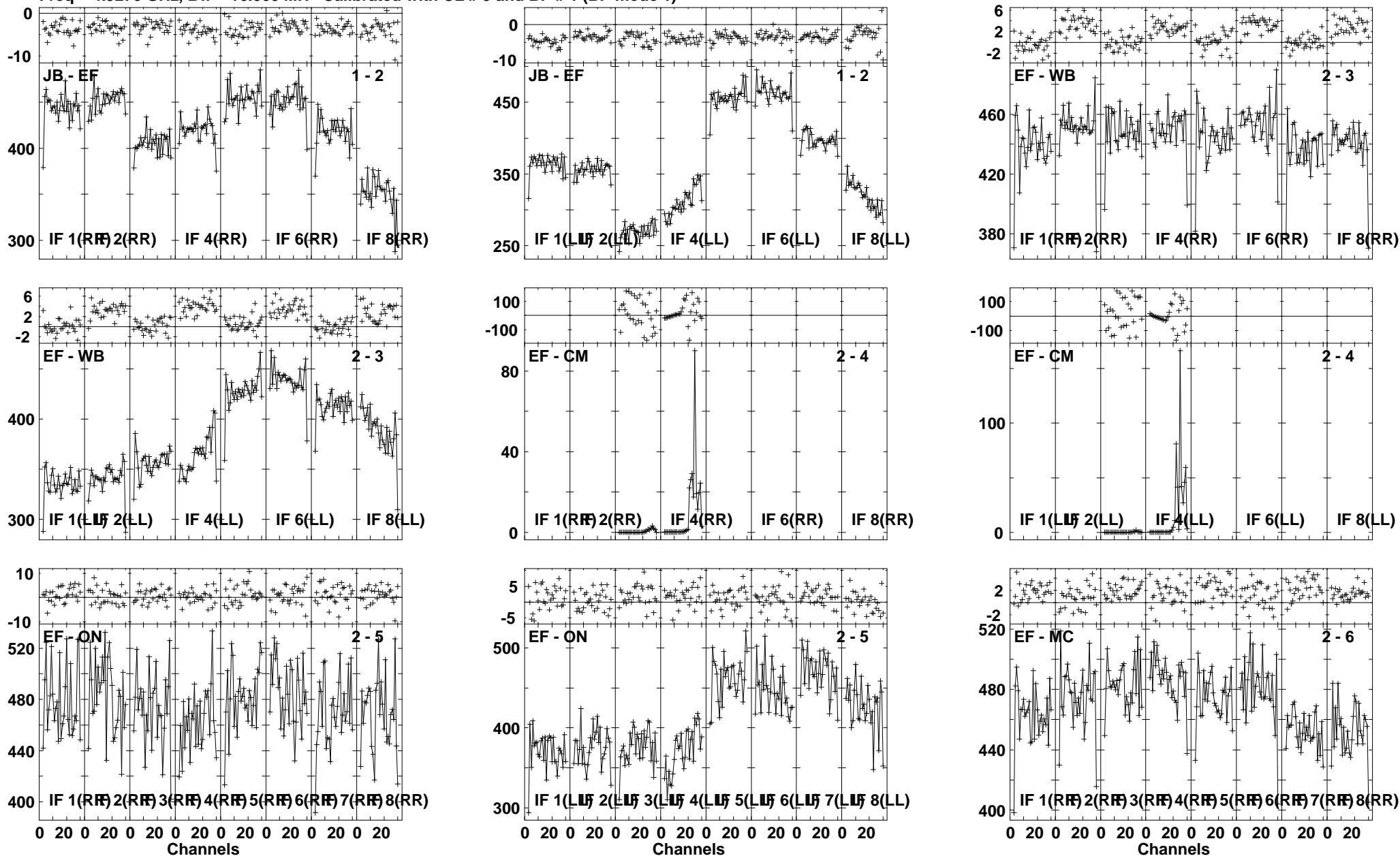

Lower frame: Milli Ampl Jy Top frame: Phas deg
Vector averaged cross-power spectrum Several baselines displayed
Timerange: 00/16:17:31 to 00/16:18:59

Plot file version 133 created 17-NOV-2010 16:20:24

ARP299D EP068A 5.UVDATA.1

Freq = 4.9270 GHz, Bw = 16.000 MH Calibrated with CL # 3 and BP # 1 (BP mode 1)

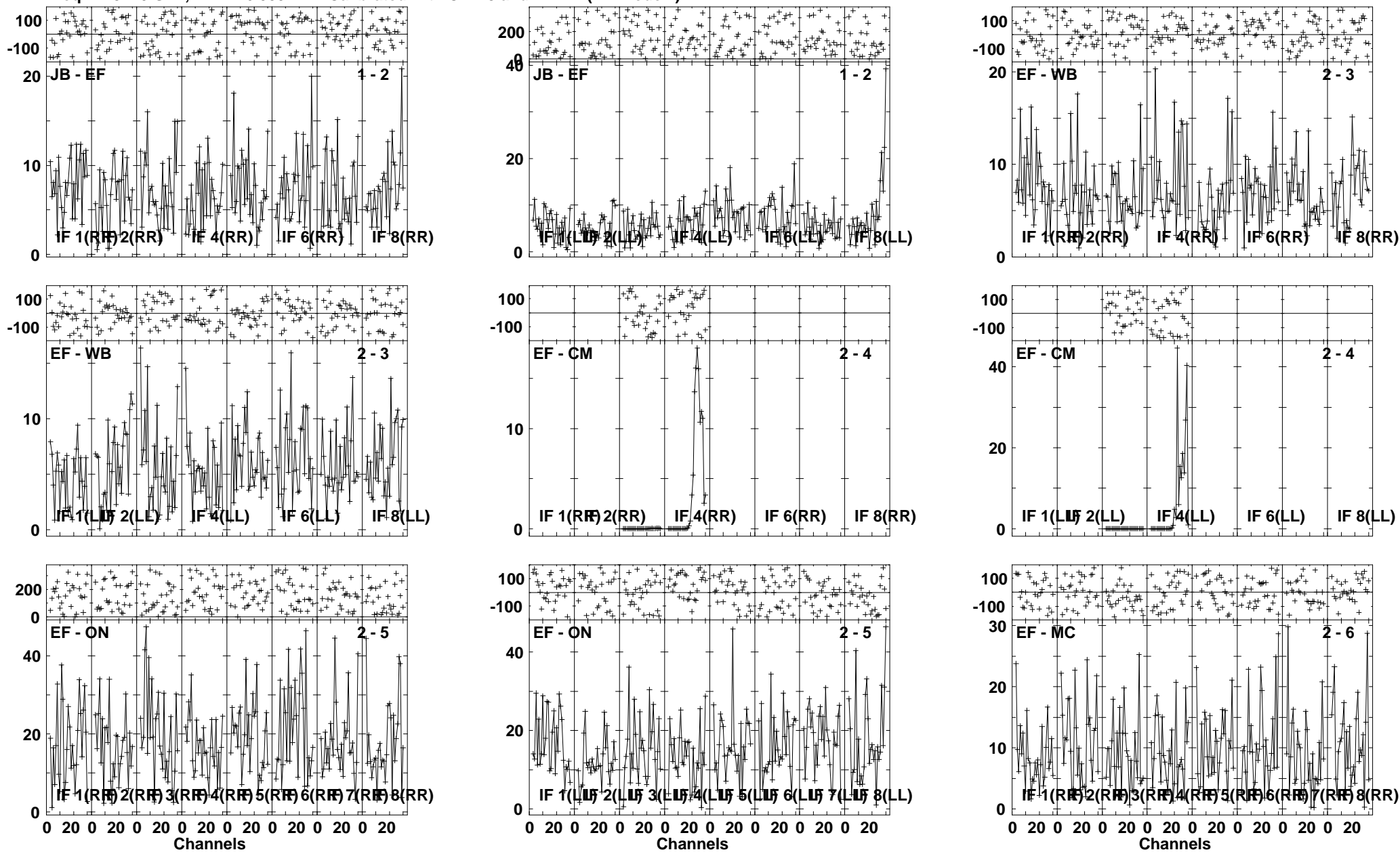

Lower frame: Milli Ampl Jy Top frame: Phas deg
Vector averaged cross-power spectrum Several baselines displayed
Timerange: 00/16:19:01 to 00/16:22:29

Plot file version 134 created 17-NOV-2010 16:20:26

ARP299D EP068A 5.UVDATA.1

Freq = 4.9270 GHz, Bw = 16.000 MH Calibrated with CL # 3 and BP # 1 (BP mode 1)

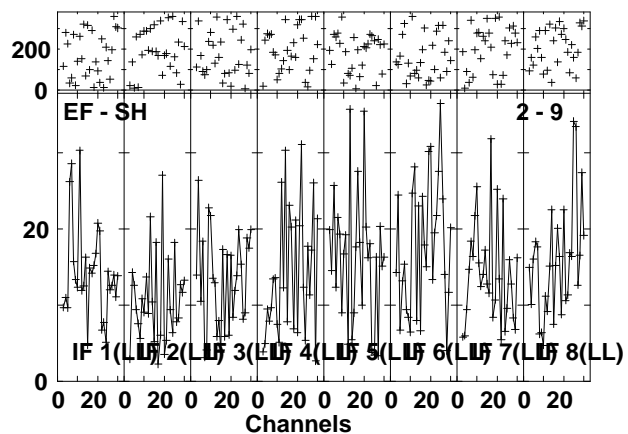
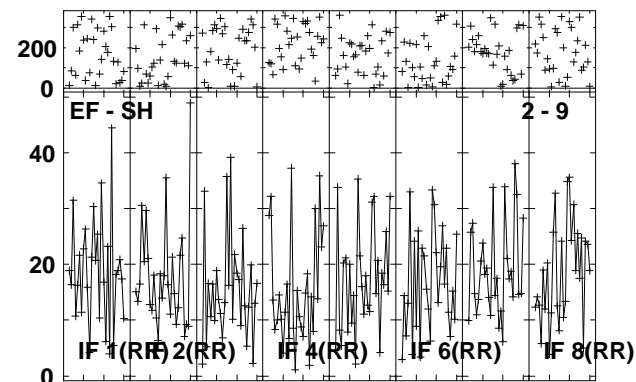
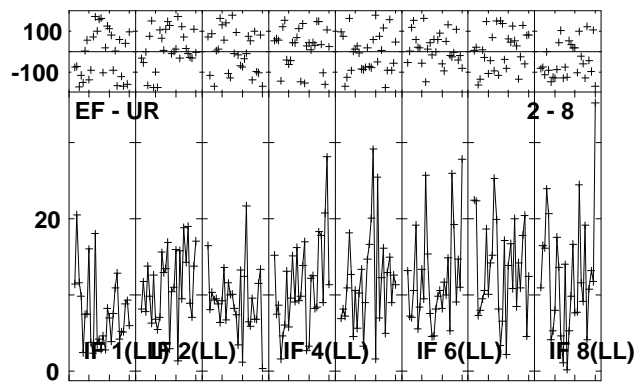
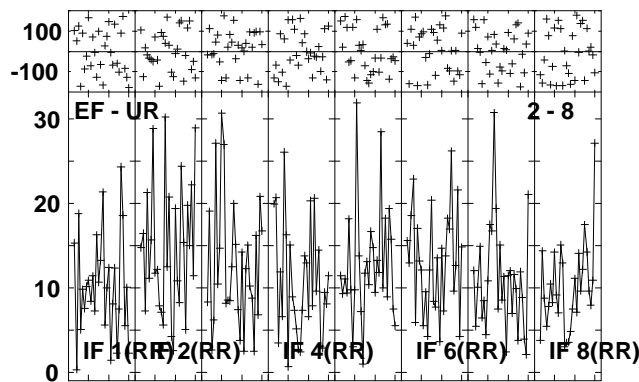
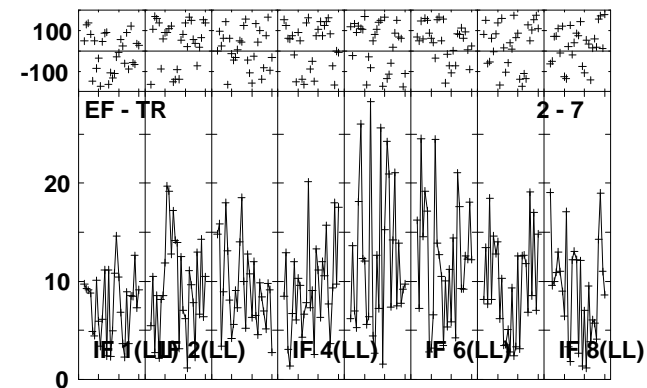
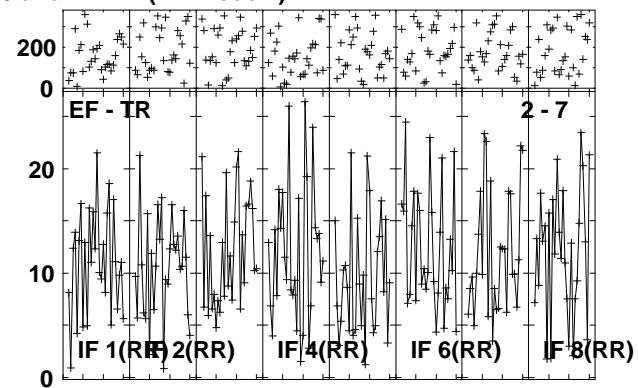
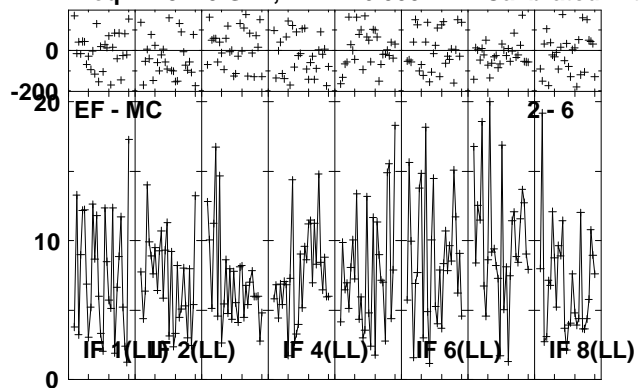

Lower frame: Milli Ampl Jy Top frame: Phas deg
Vector averaged cross-power spectrum Several baselines displayed
Timerange: 00/16:19:01 to 00/16:22:29

Plot file version 135 created 17-NOV-2010 16:20:29

J1128+59 EP068A 5.UVDATA.1

Freq = 4.9270 GHz, Bw = 16.000 MH Calibrated with CL # 3 and BP # 1 (BP mode 1)

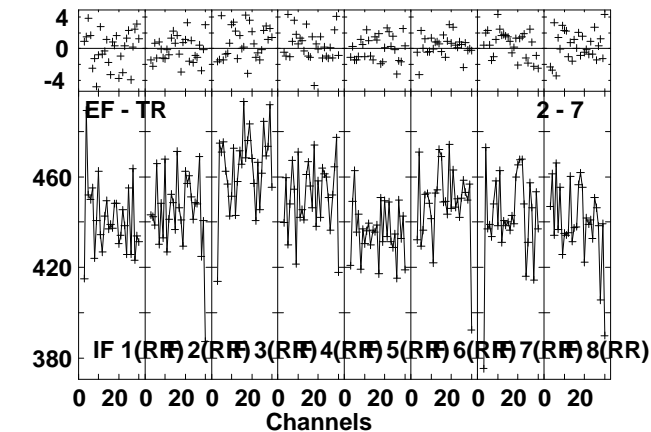
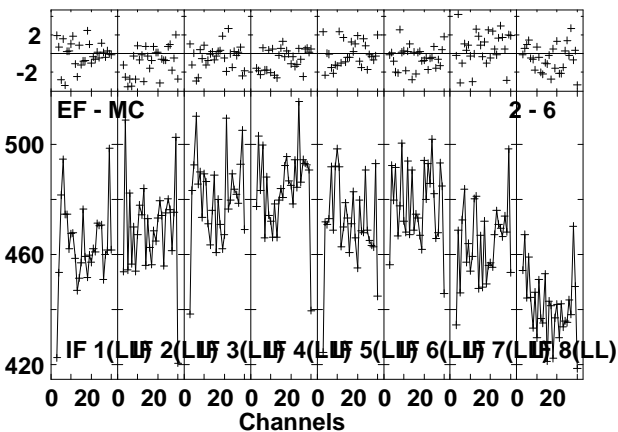
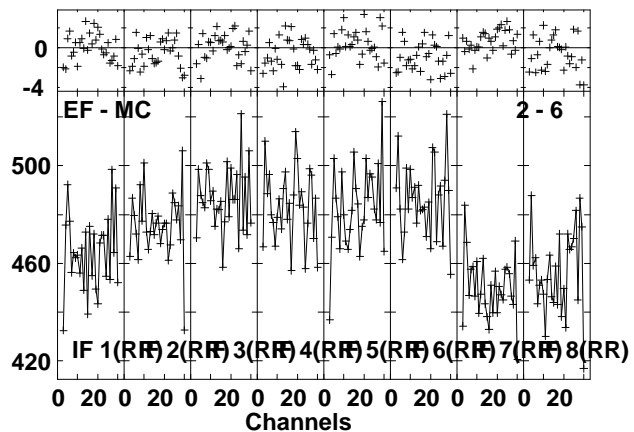
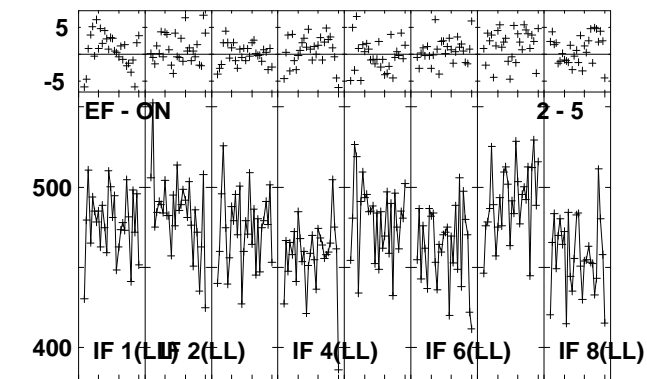
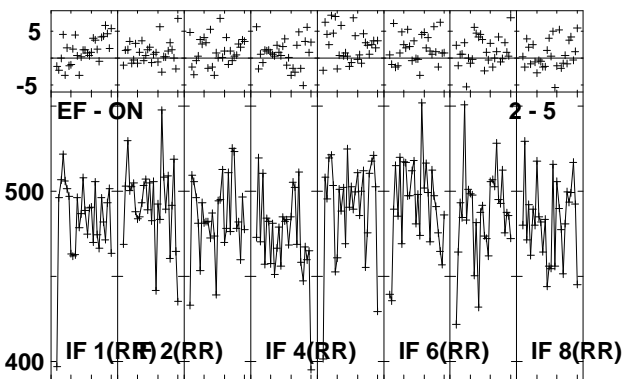
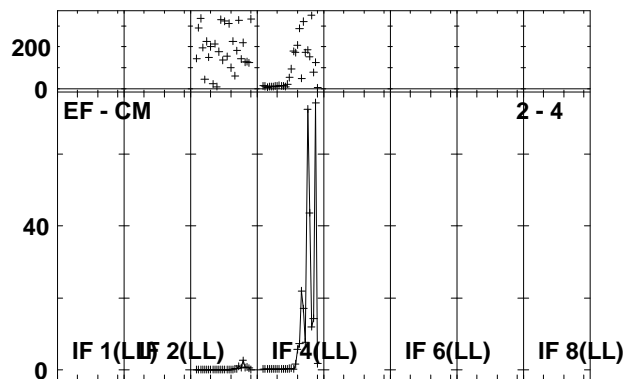
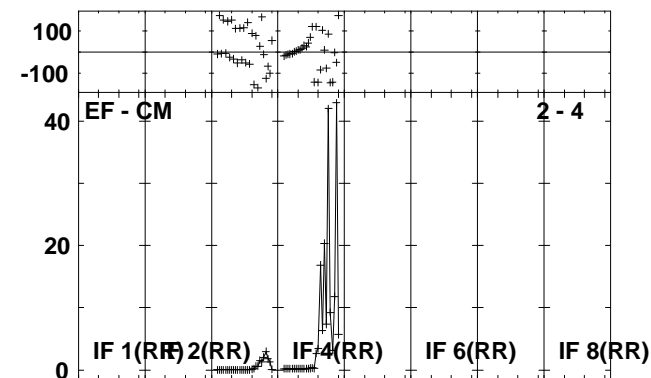
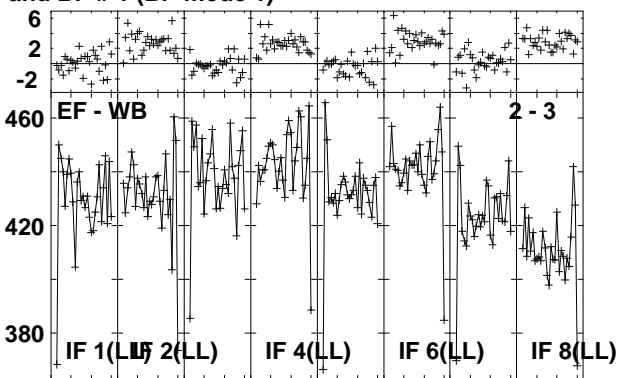
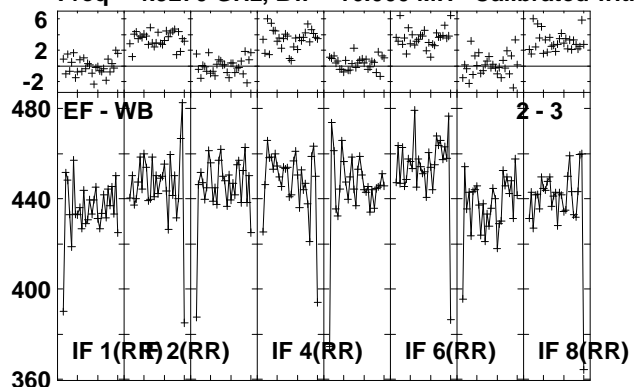

Lower frame: Milli Ampl Jy Top frame: Phas deg
Vector averaged cross-power spectrum Several baselines displayed
Timerange: 00/16:23:31 to 00/16:24:59

Plot file version 136 created 17-NOV-2010 16:20:30

J1128+59 EP068A 5.UVDATA.1

Freq = 4.9270 GHz, Bw = 16.000 MH Calibrated with CL # 3 and BP # 1 (BP mode 1)

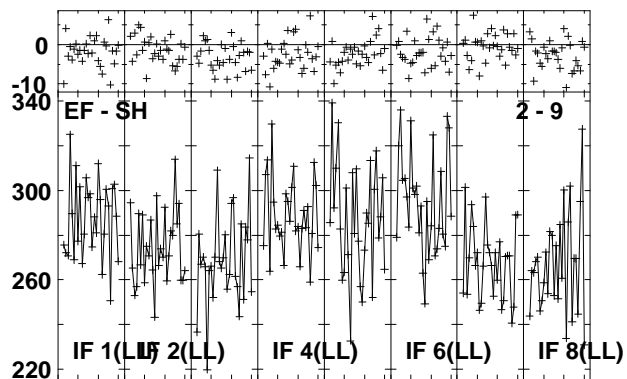
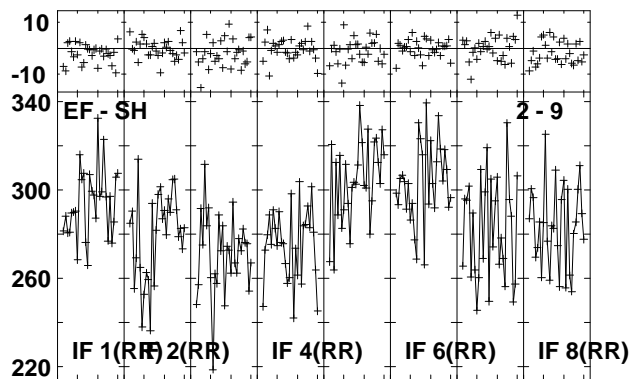
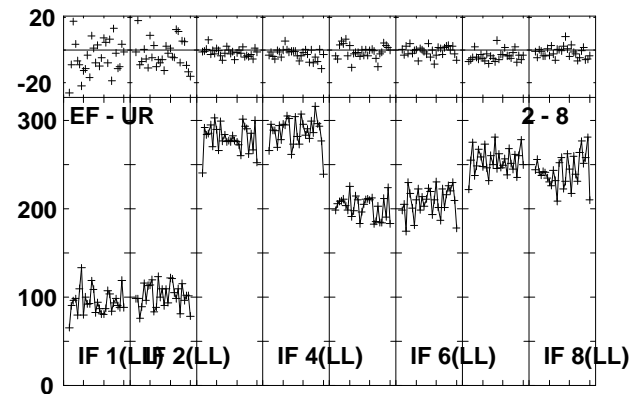
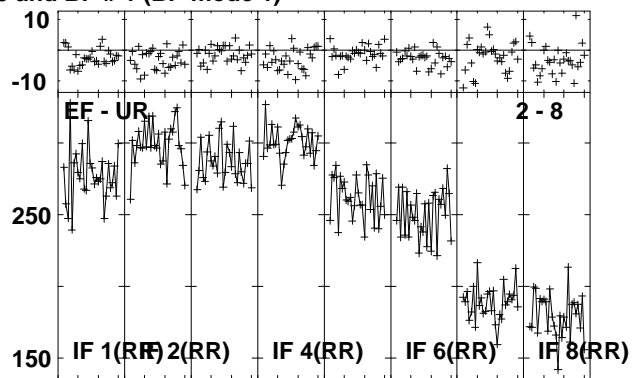
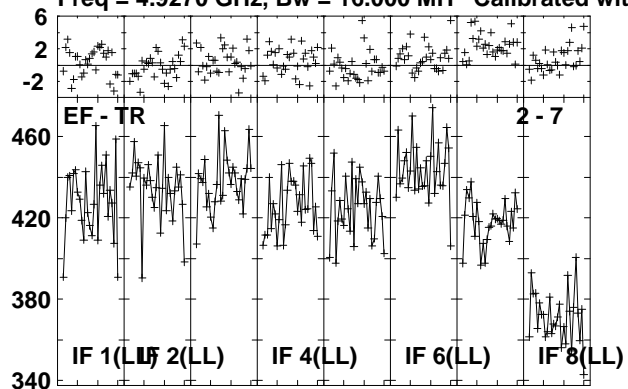

Lower frame: Milli Ampl Jy Top frame: Phas deg
Vector averaged cross-power spectrum Several baselines displayed
Timerange: 00/16:23:31 to 00/16:24:59

Plot file version 137 created 17-NOV-2010 16:20:32

ARP299D EP068A 5.UVDATA.1

Freq = 4.9270 GHz, Bw = 16.000 MH Calibrated with CL # 3 and BP # 1 (BP mode 1)

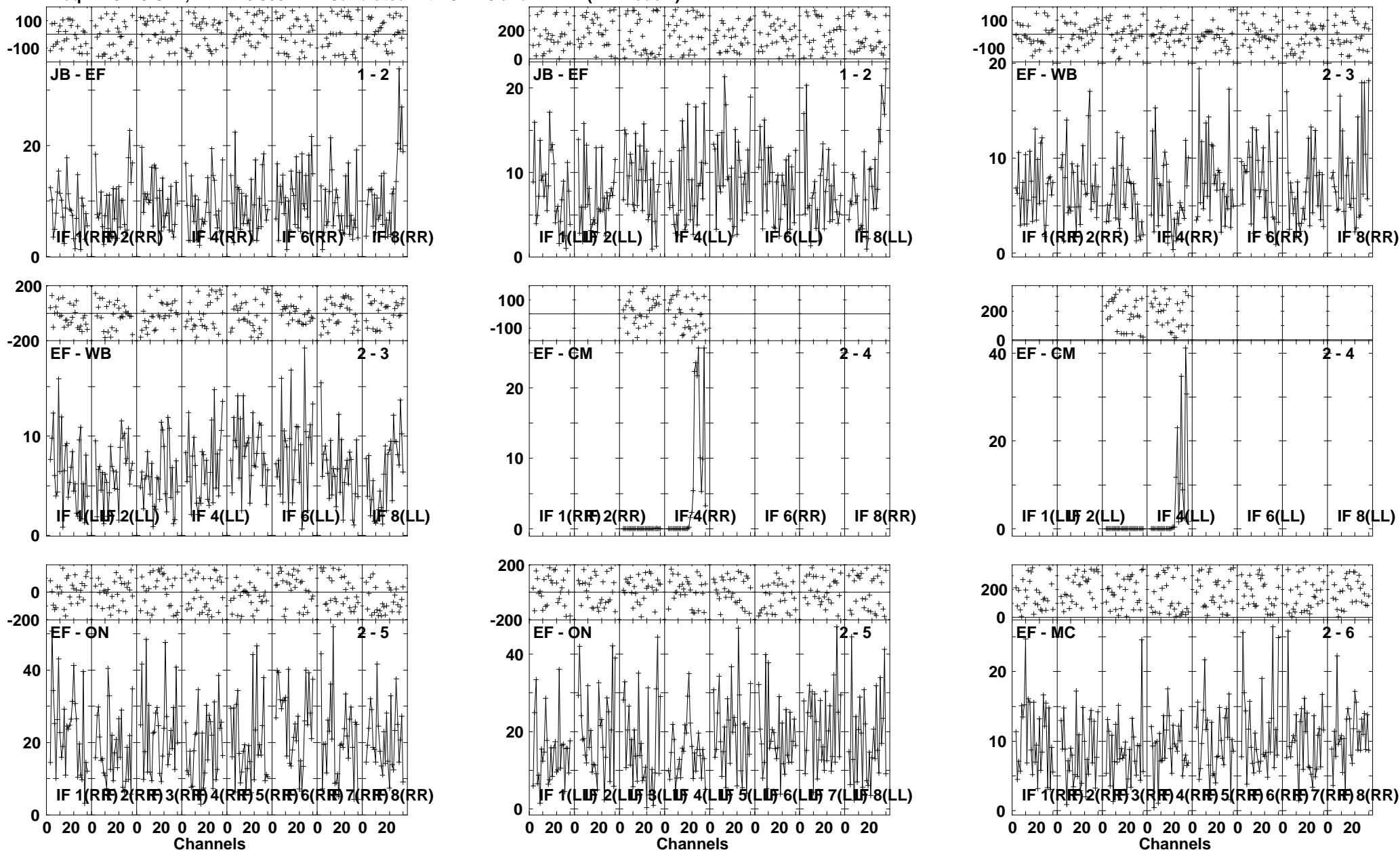

Lower frame: Milli Ampl Jy Top frame: Phas deg
Vector averaged cross-power spectrum Several baselines displayed
Timerange: 00/16:25:01 to 00/16:28:29

Plot file version 138 created 17-NOV-2010 16:20:34

ARP299D EP068A 5.UVDATA.1

Freq = 4.9270 GHz, Bw = 16.000 MH Calibrated with CL # 3 and BP # 1 (BP mode 1)

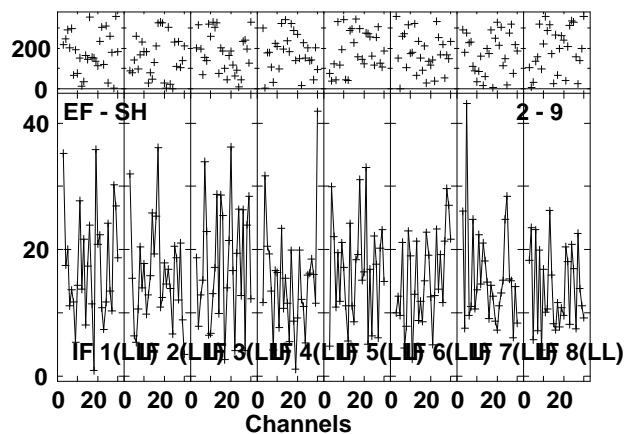
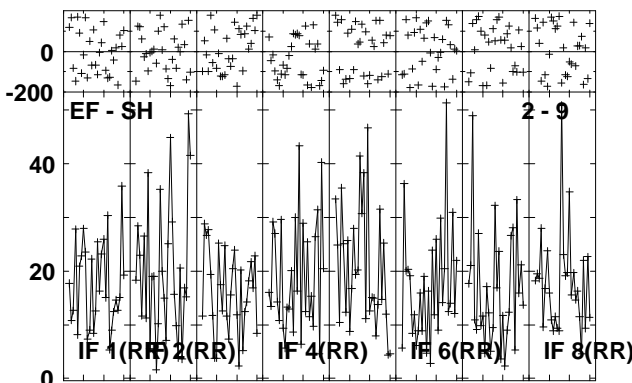
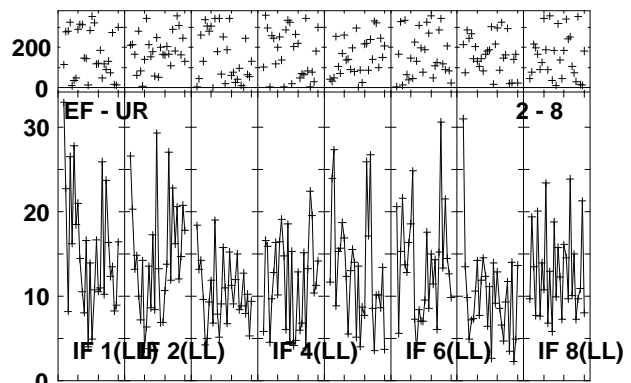
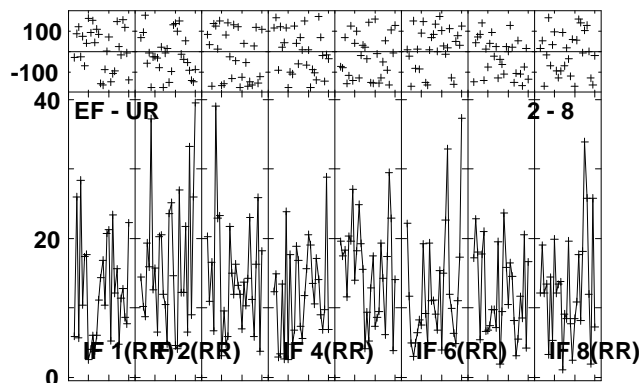
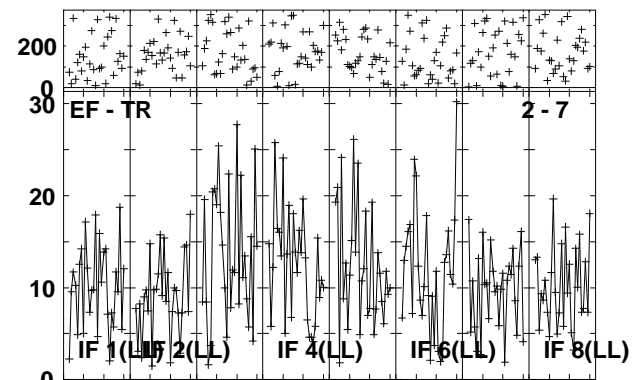
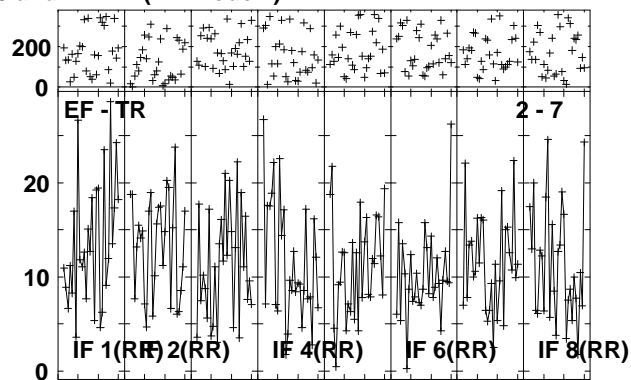
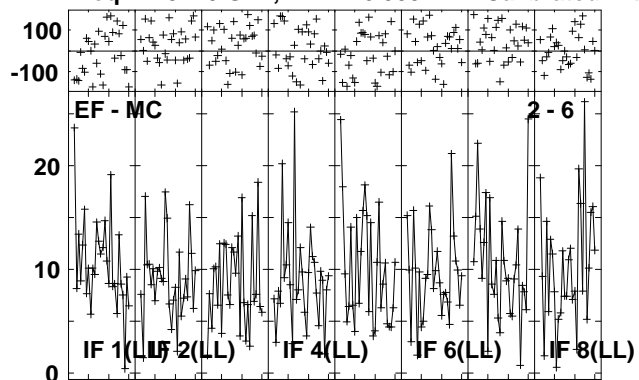

Lower frame: Milli Ampl Jy Top frame: Phas deg
Vector averaged cross-power spectrum Several baselines displayed
Timerange: 00/16:25:01 to 00/16:28:29

Plot file version 139 created 17-NOV-2010 16:20:37

J1128+59 EP068A 5.UVDATA.1

Freq = 4.9270 GHz, Bw = 16.000 MH Calibrated with CL # 3 and BP # 1 (BP mode 1)

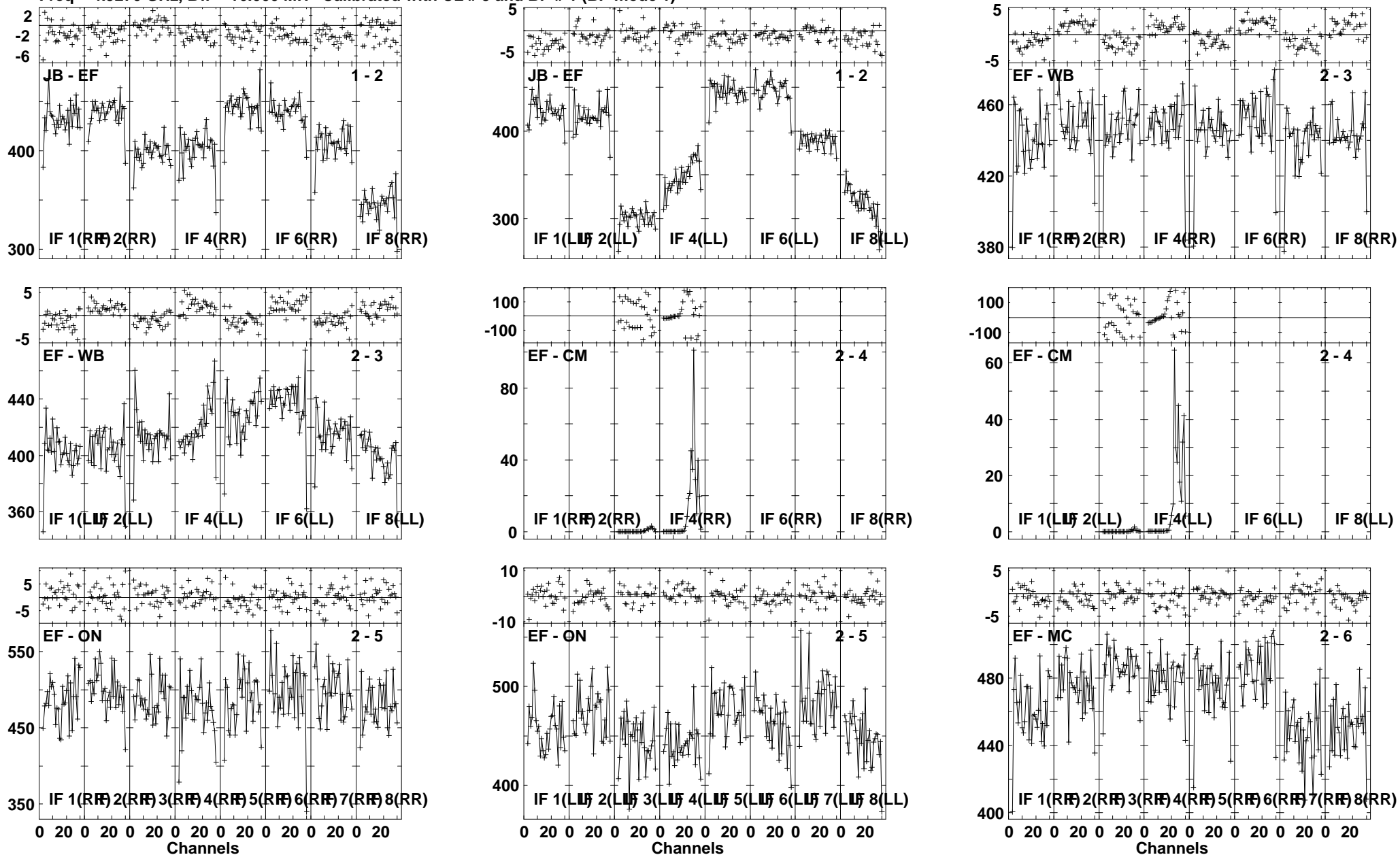

Lower frame: Milli Ampl Jy Top frame: Phas deg
Vector averaged cross-power spectrum Several baselines displayed
Timerange: 00/16:28:31 to 00/16:29:59

Plot file version 141 created 17-NOV-2010 16:20:40

ARP299D EP068A 5.UVDATA.1

Freq = 4.9270 GHz, Bw = 16.000 MH Calibrated with CL # 3 and BP # 1 (BP mode 1)

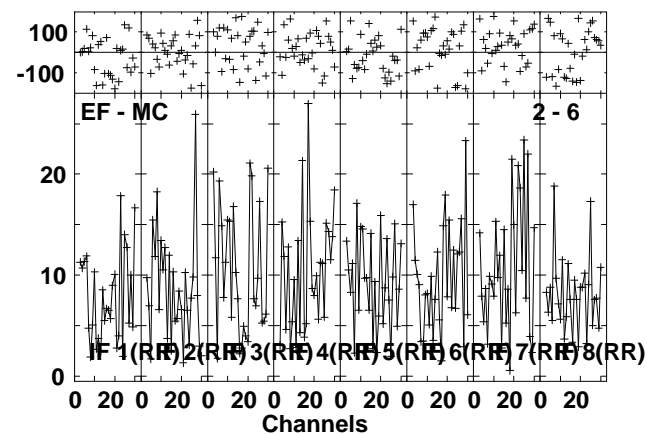
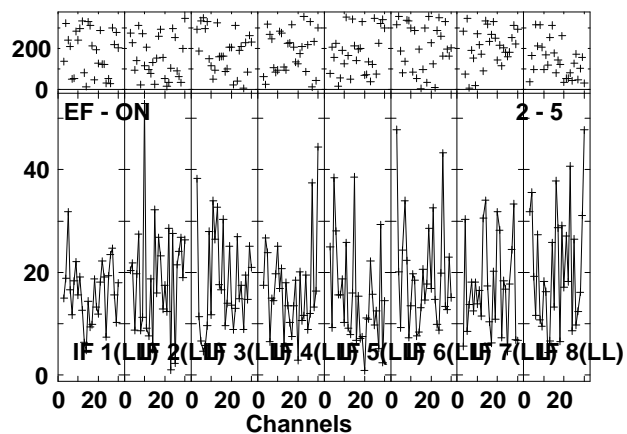
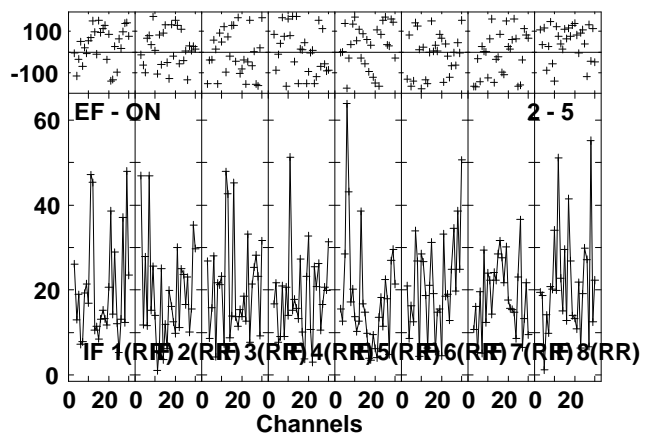
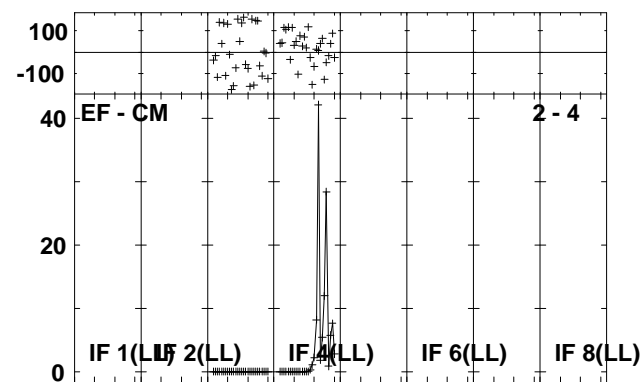
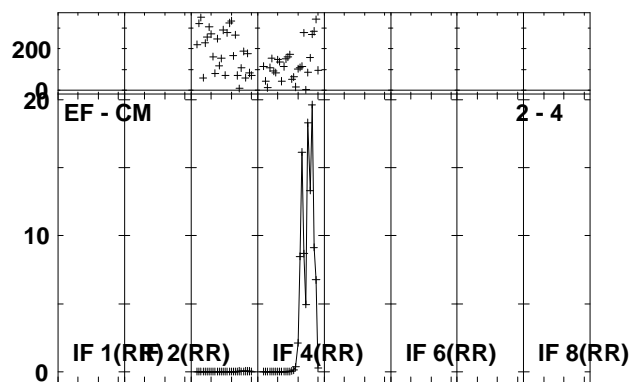
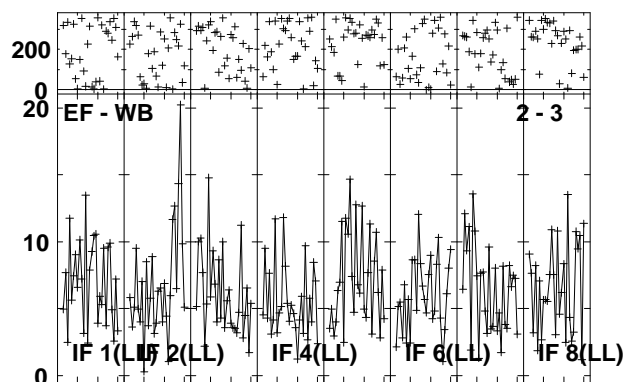
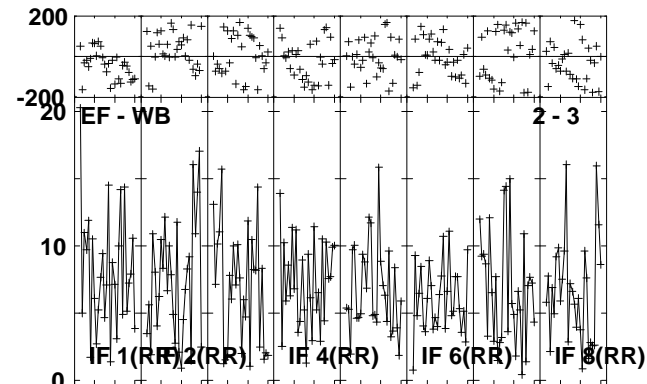
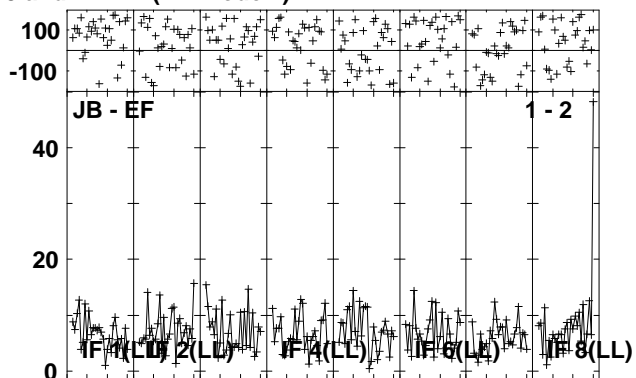
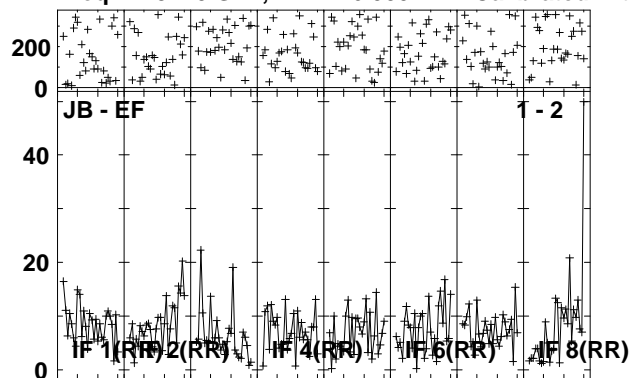

Lower frame: Milli Ampl Jy Top frame: Phas deg
Vector averaged cross-power spectrum Several baselines displayed
Timerange: 00/16:30:01 to 00/16:33:29

Plot file version 142 created 17-NOV-2010 16:20:42

ARP299D EP068A 5.UVDATA.1

Freq = 4.9270 GHz, Bw = 16.000 MH Calibrated with CL # 3 and BP # 1 (BP mode 1)

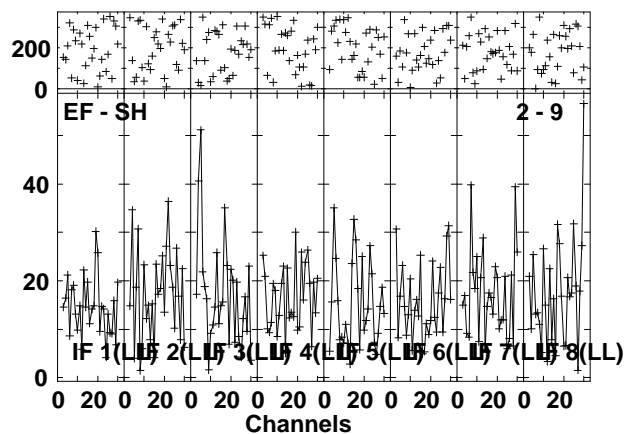
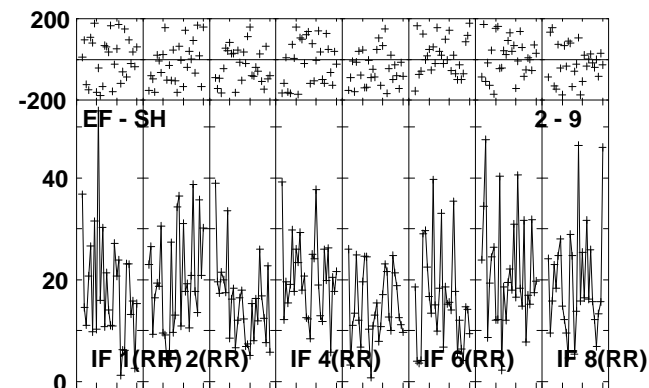
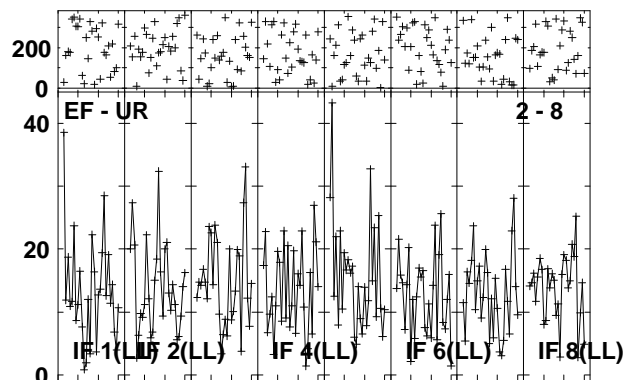
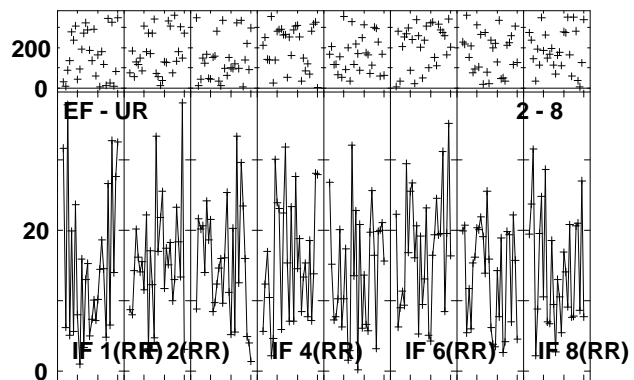
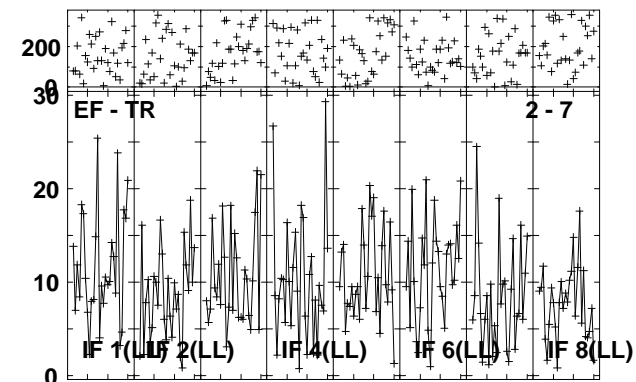
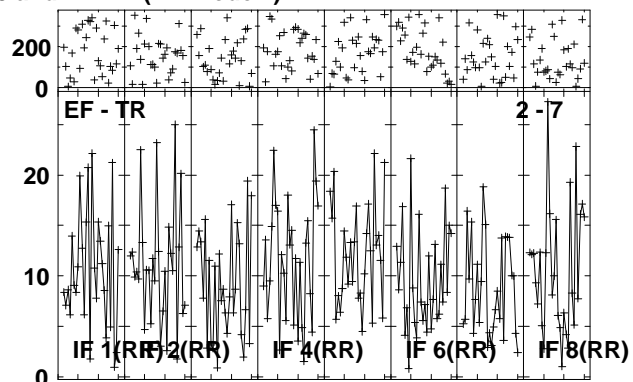
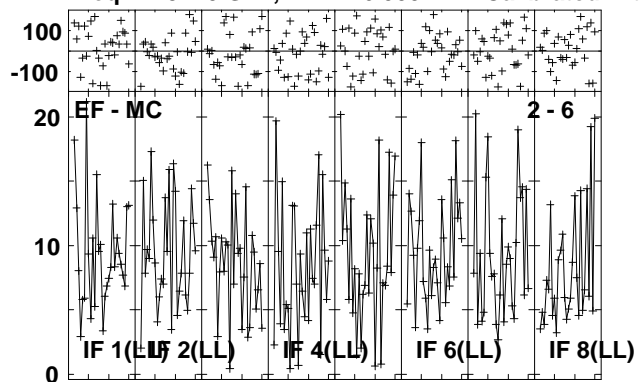

Lower frame: Milli Ampl Jy Top frame: Phas deg
Vector averaged cross-power spectrum Several baselines displayed
Timerange: 00/16:30:01 to 00/16:33:29

Plot file version 143 created 17-NOV-2010 16:20:45

J1128+59 EP068A 5.UVDATA.1

Freq = 4.9270 GHz, Bw = 16.000 MH Calibrated with CL # 3 and BP # 1 (BP mode 1)

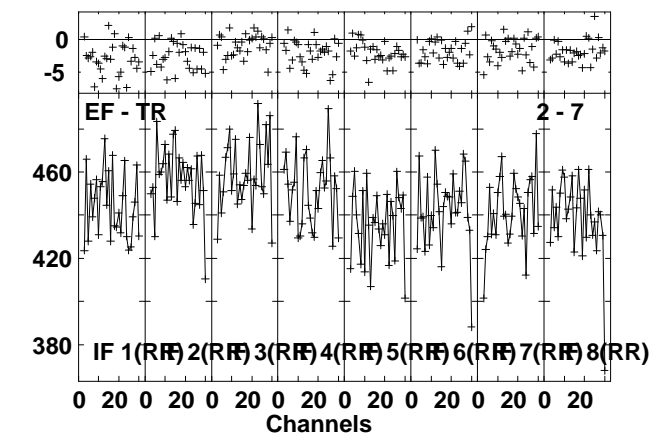
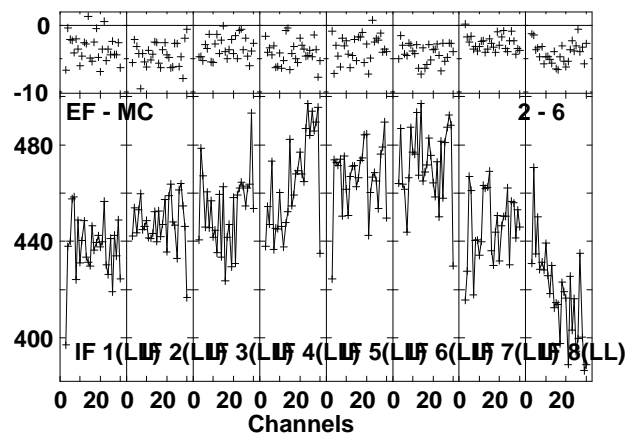
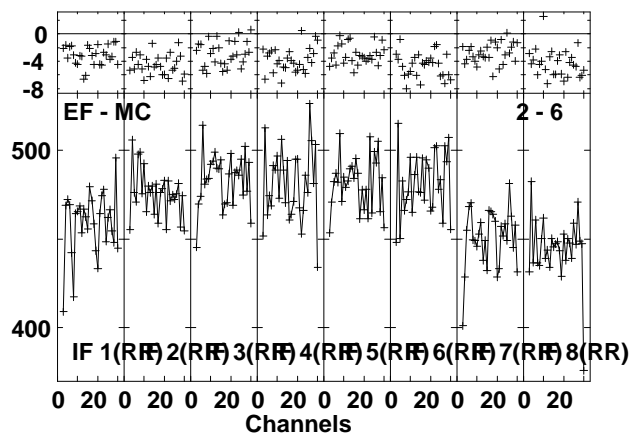
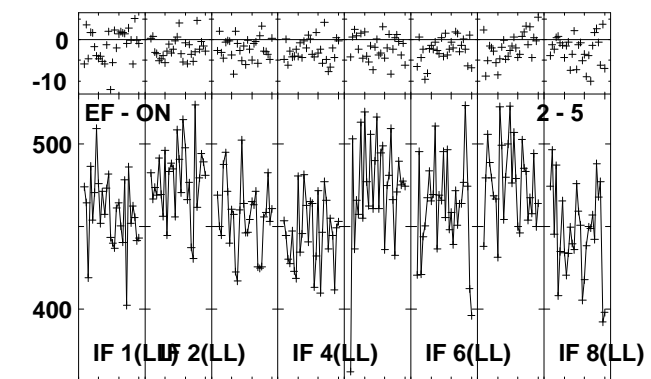
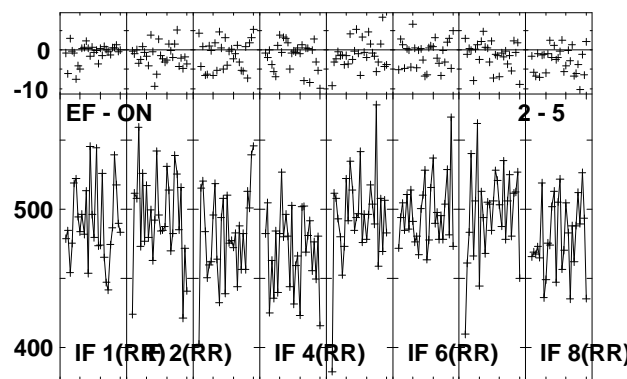
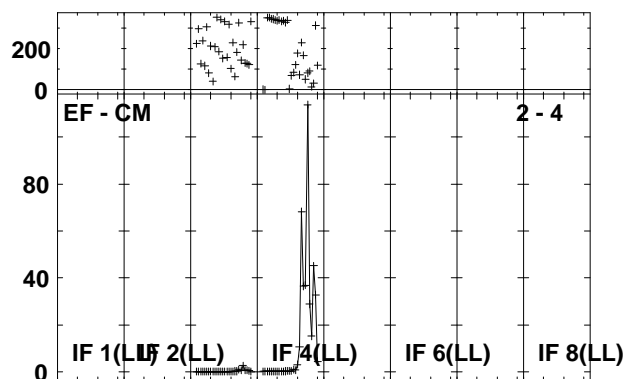
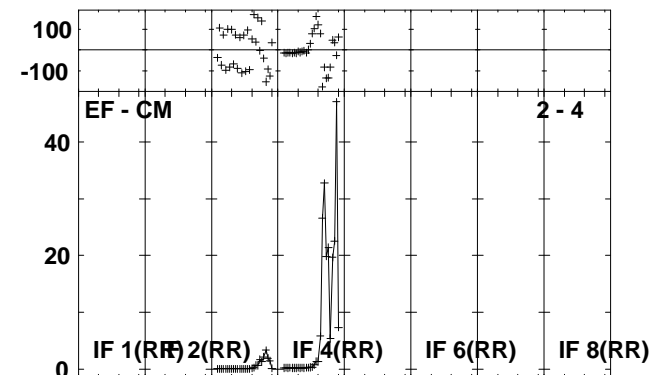
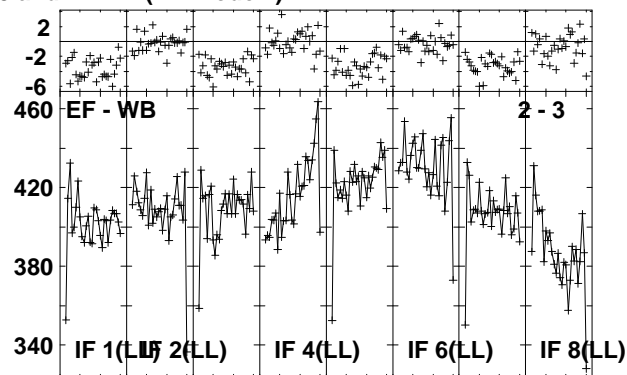
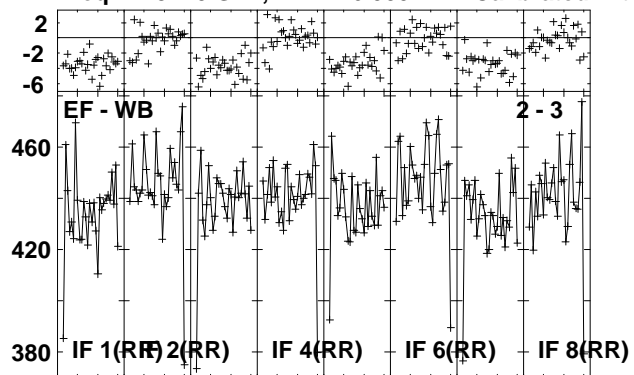

Lower frame: Milli Ampl Jy Top frame: Phas deg
Vector averaged cross-power spectrum Several baselines displayed
Timerange: 00/16:33:31 to 00/16:34:59

Plot file version 144 created 17-NOV-2010 16:20:46

J1128+59 EP068A 5.UVDATA.1

Freq = 4.9270 GHz, Bw = 16.000 MH Calibrated with CL # 3 and BP # 1 (BP mode 1)

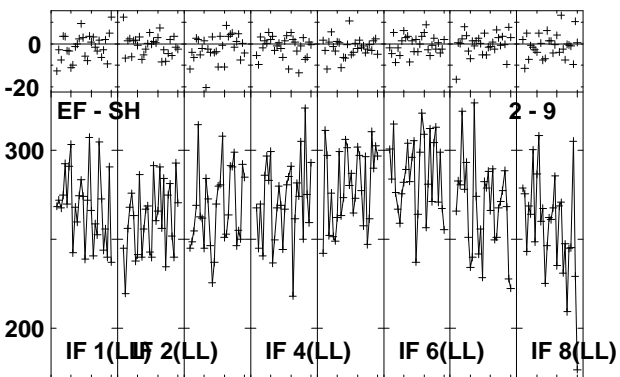
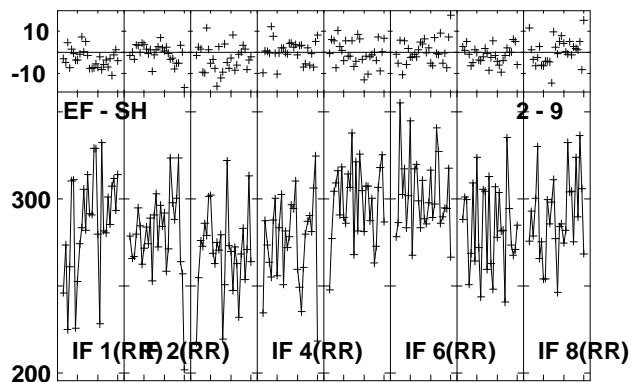
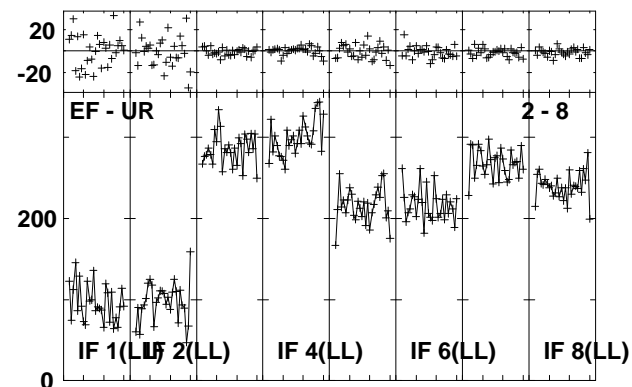
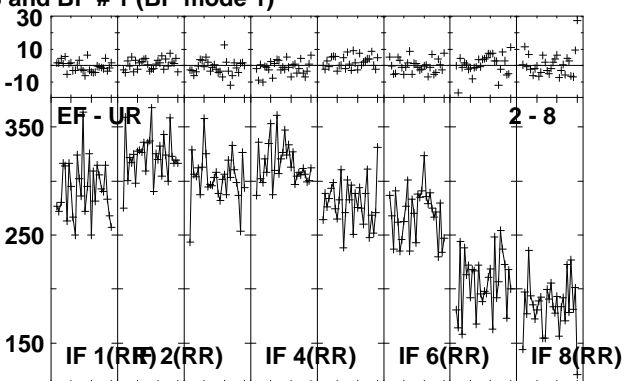
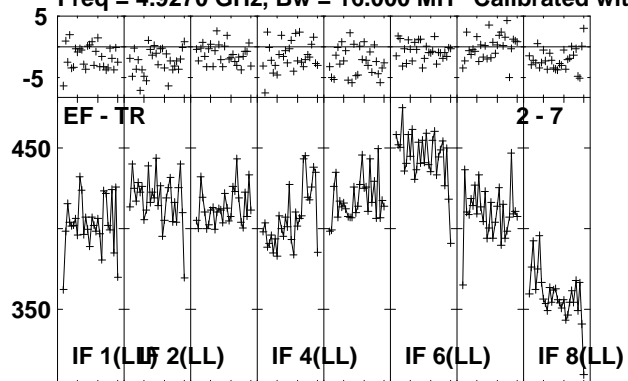

Lower frame: Milli Ampl Jy Top frame: Phas deg
Vector averaged cross-power spectrum Several baselines displayed
Timerange: 00/16:33:31 to 00/16:34:59

Plot file version 145 created 17-NOV-2010 16:20:48

ARP299D EP068A 5.UVDATA.1

Freq = 4.9270 GHz, Bw = 16.000 MH Calibrated with CL # 3 and BP # 1 (BP mode 1)

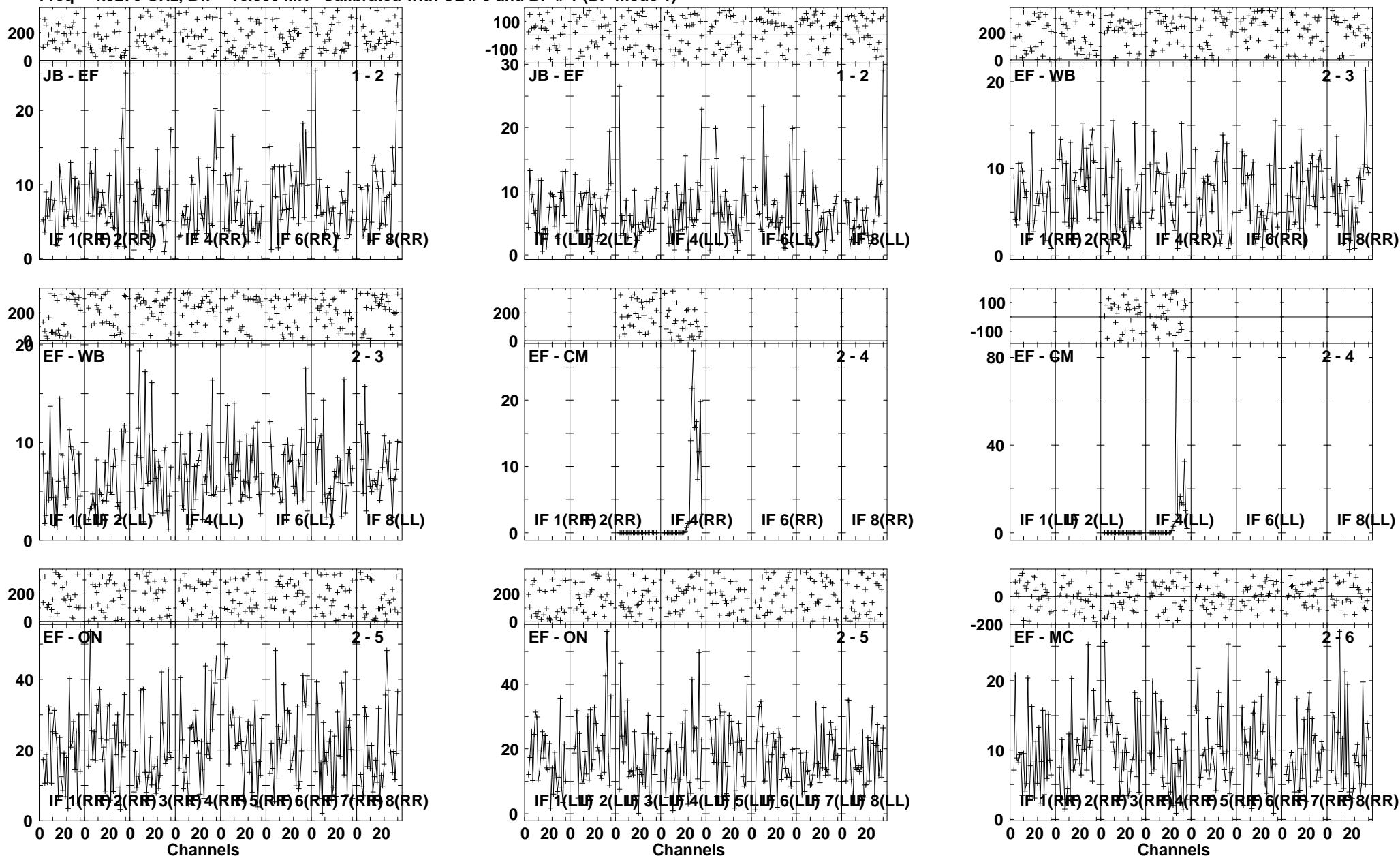

Lower frame: Milli Ampl Jy Top frame: Phas deg
Vector averaged cross-power spectrum Several baselines displayed
Timerange: 00/16:35:01 to 00/16:38:29

Plot file version 146 created 17-NOV-2010 16:20:50

ARP299D EP068A 5.UVDATA.1

Freq = 4.9270 GHz, Bw = 16.000 MH Calibrated with CL # 3 and BP # 1 (BP mode 1)

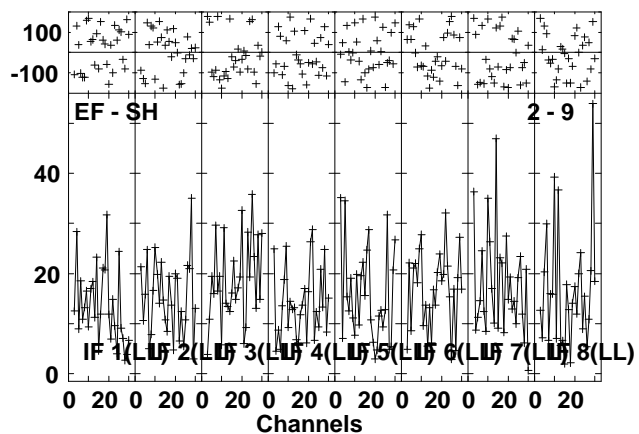
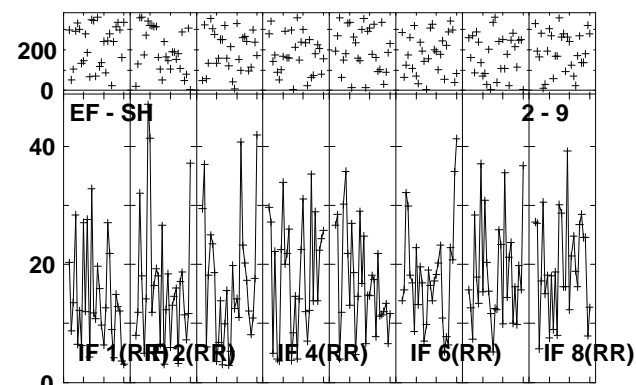
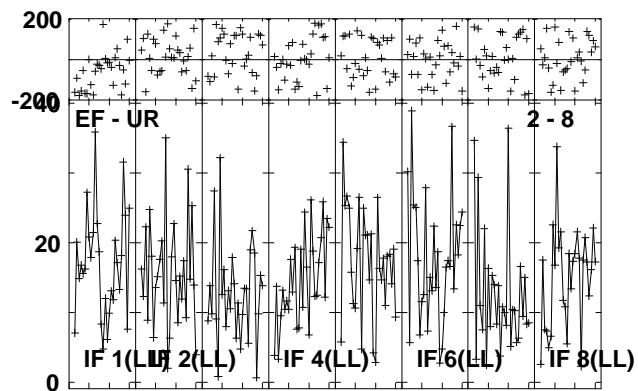
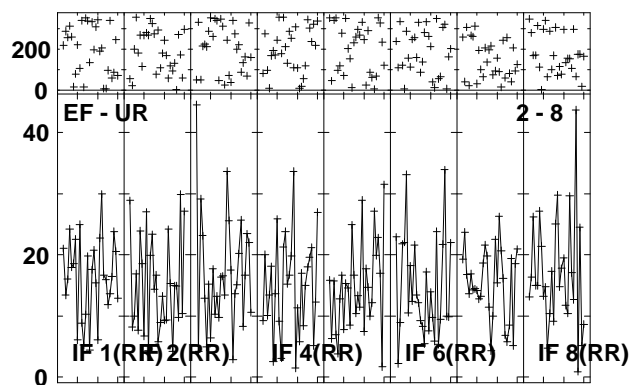
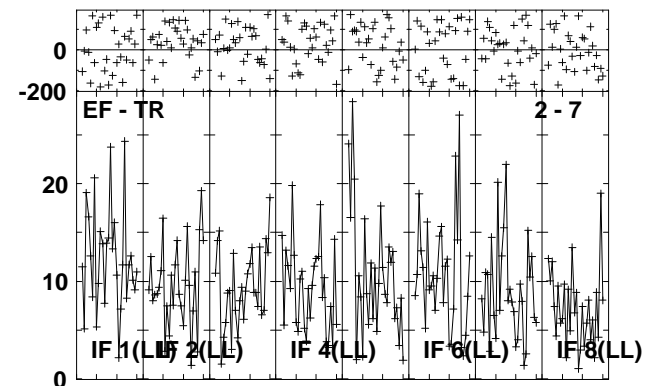
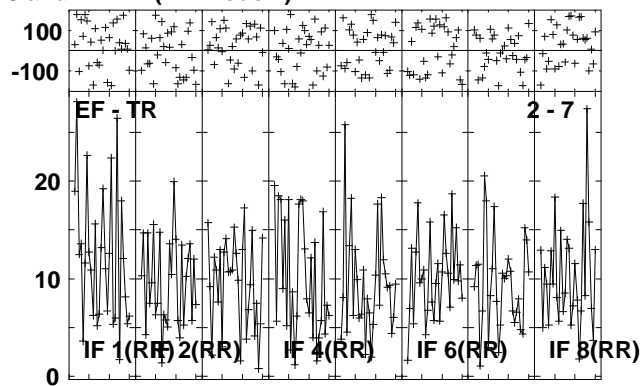
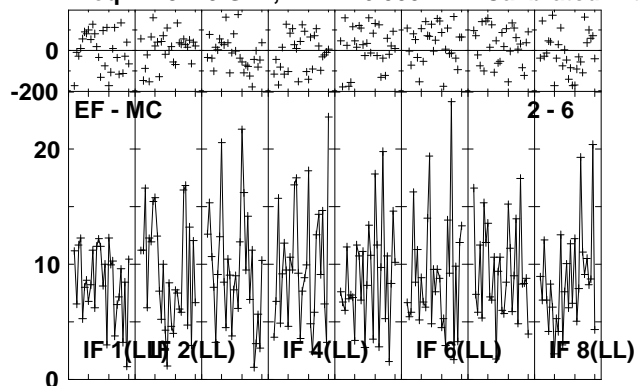

Lower frame: Milli Ampl Jy Top frame: Phas deg
Vector averaged cross-power spectrum Several baselines displayed
Timerange: 00/16:35:01 to 00/16:38:29

Plot file version 147 created 17-NOV-2010 16:20:53

J1128+59 EP068A 5.UVDATA.1

Freq = 4.9270 GHz, Bw = 16.000 MH Calibrated with CL # 3 and BP # 1 (BP mode 1)

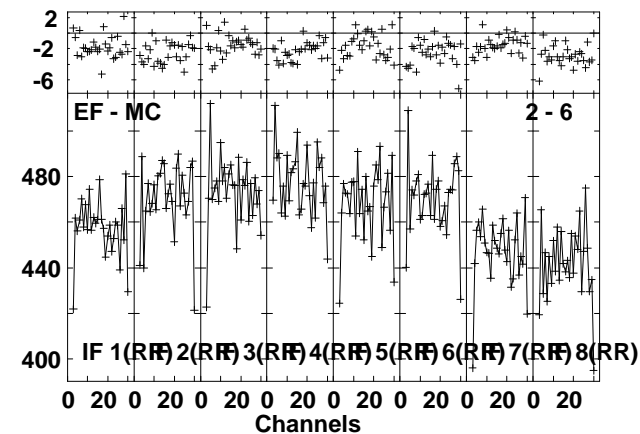
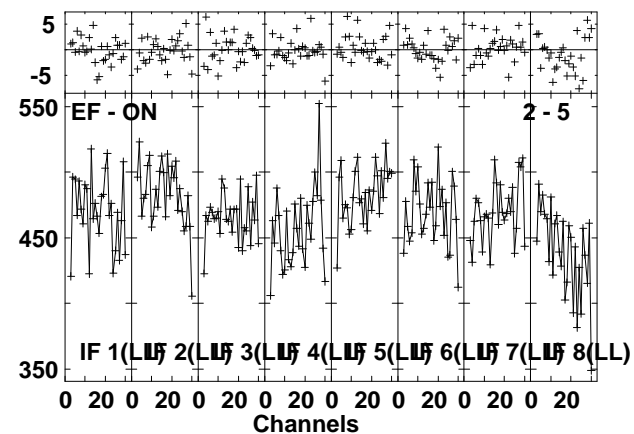
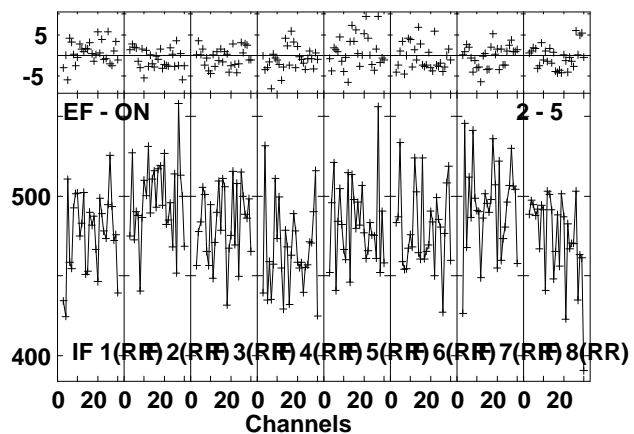
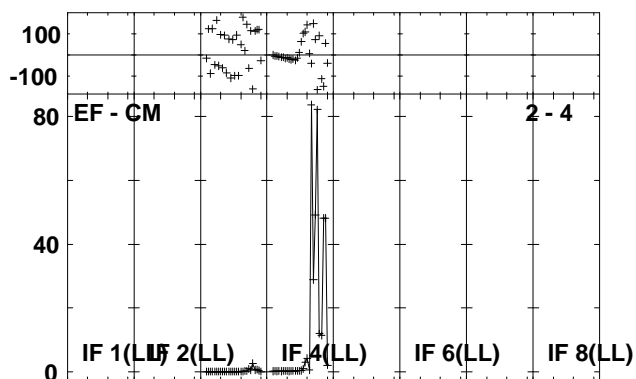
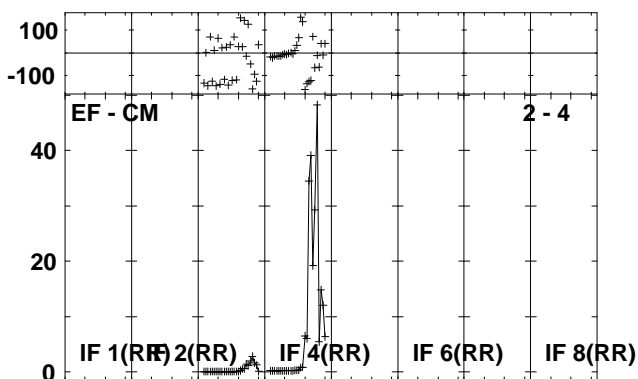
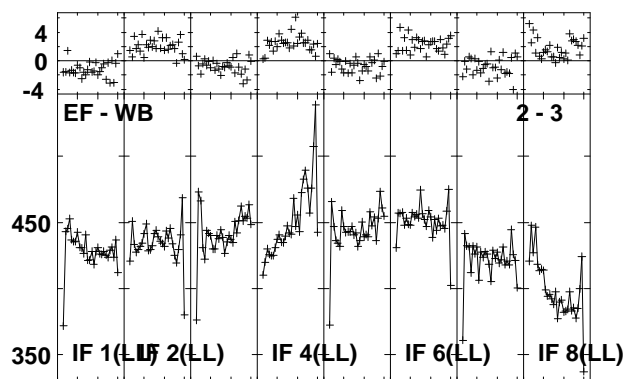
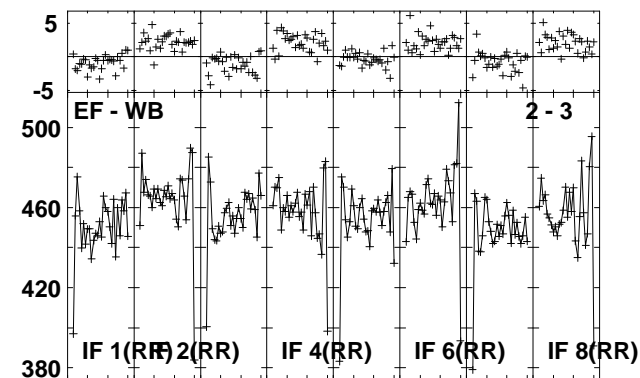
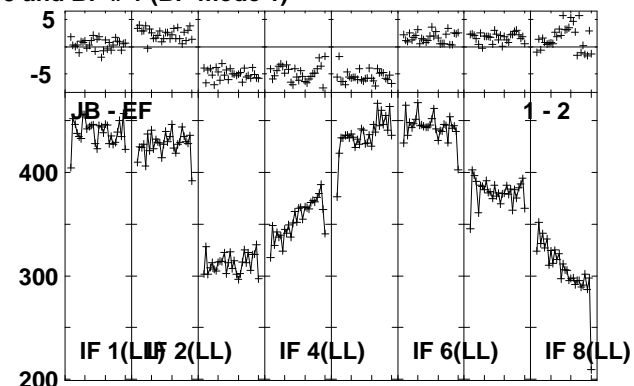
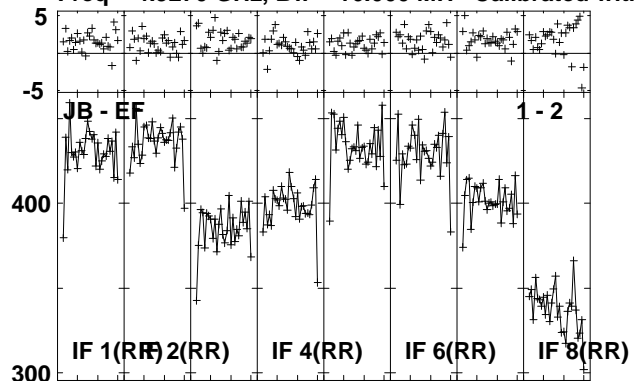

Lower frame: Milli Ampl Jy Top frame: Phas deg
Vector averaged cross-power spectrum Several baselines displayed
Timerange: 00/16:39:31 to 00/16:40:59

Plot file version 148 created 17-NOV-2010 16:20:54

J1128+59 EP068A 5.UVDATA.1

Freq = 4.9270 GHz, Bw = 16.000 MH Calibrated with CL # 3 and BP # 1 (BP mode 1)

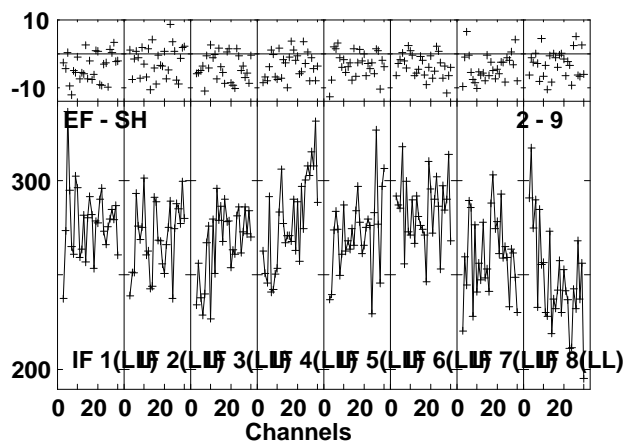
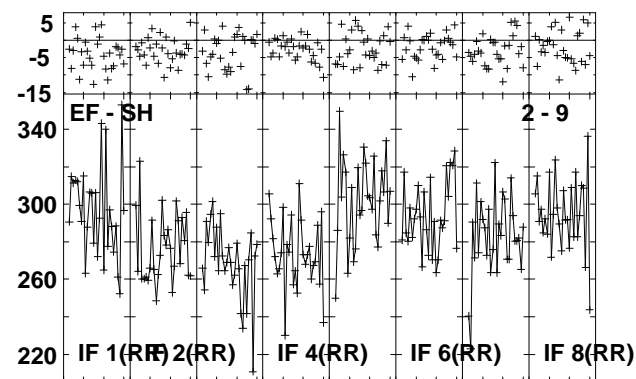
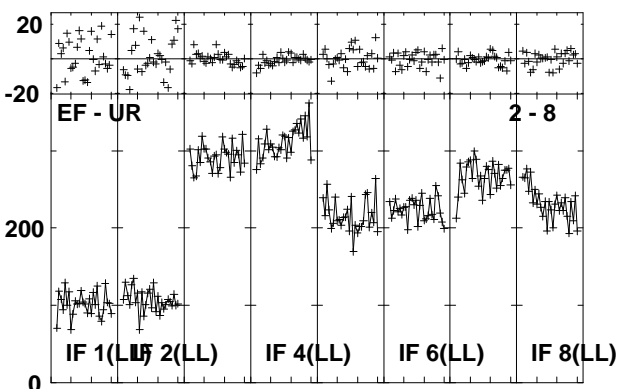
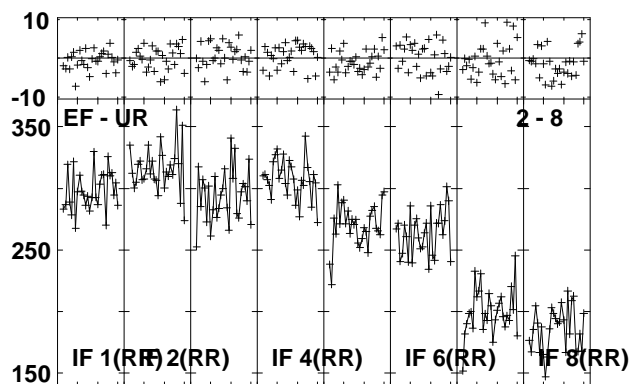
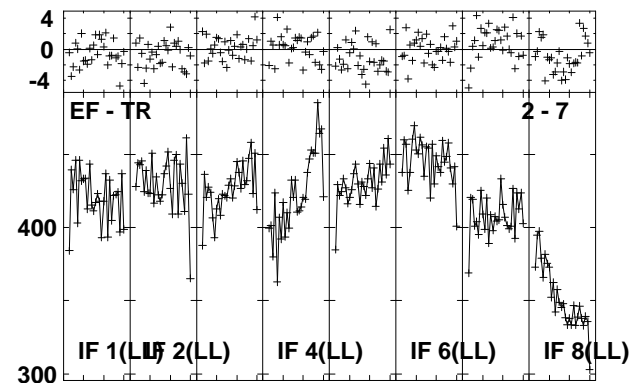
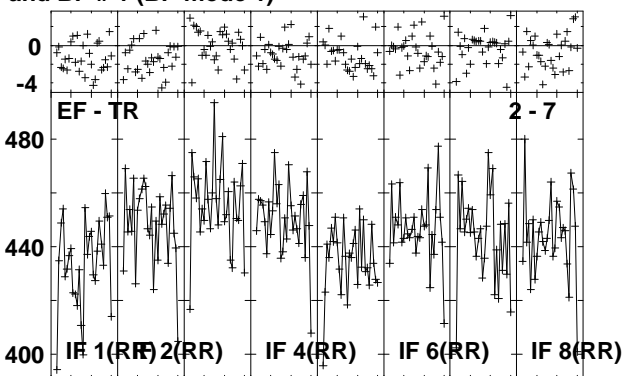
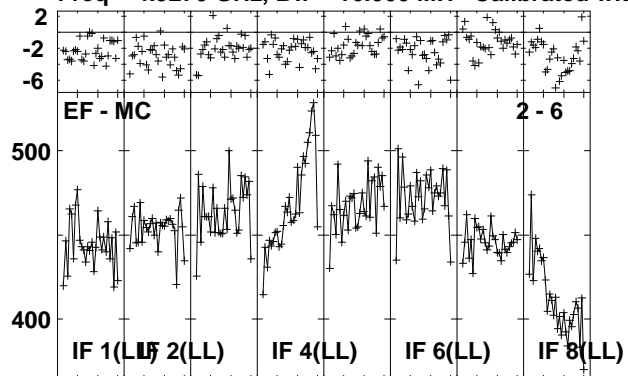

Lower frame: Milli Ampl Jy Top frame: Phas deg
Vector averaged cross-power spectrum Several baselines displayed
Timerange: 00/16:39:31 to 00/16:40:59

Plot file version 149 created 17-NOV-2010 16:20:56

ARP299D EP068A 5.UVDATA.1

Freq = 4.9270 GHz, Bw = 16.000 MH Calibrated with CL # 3 and BP # 1 (BP mode 1)

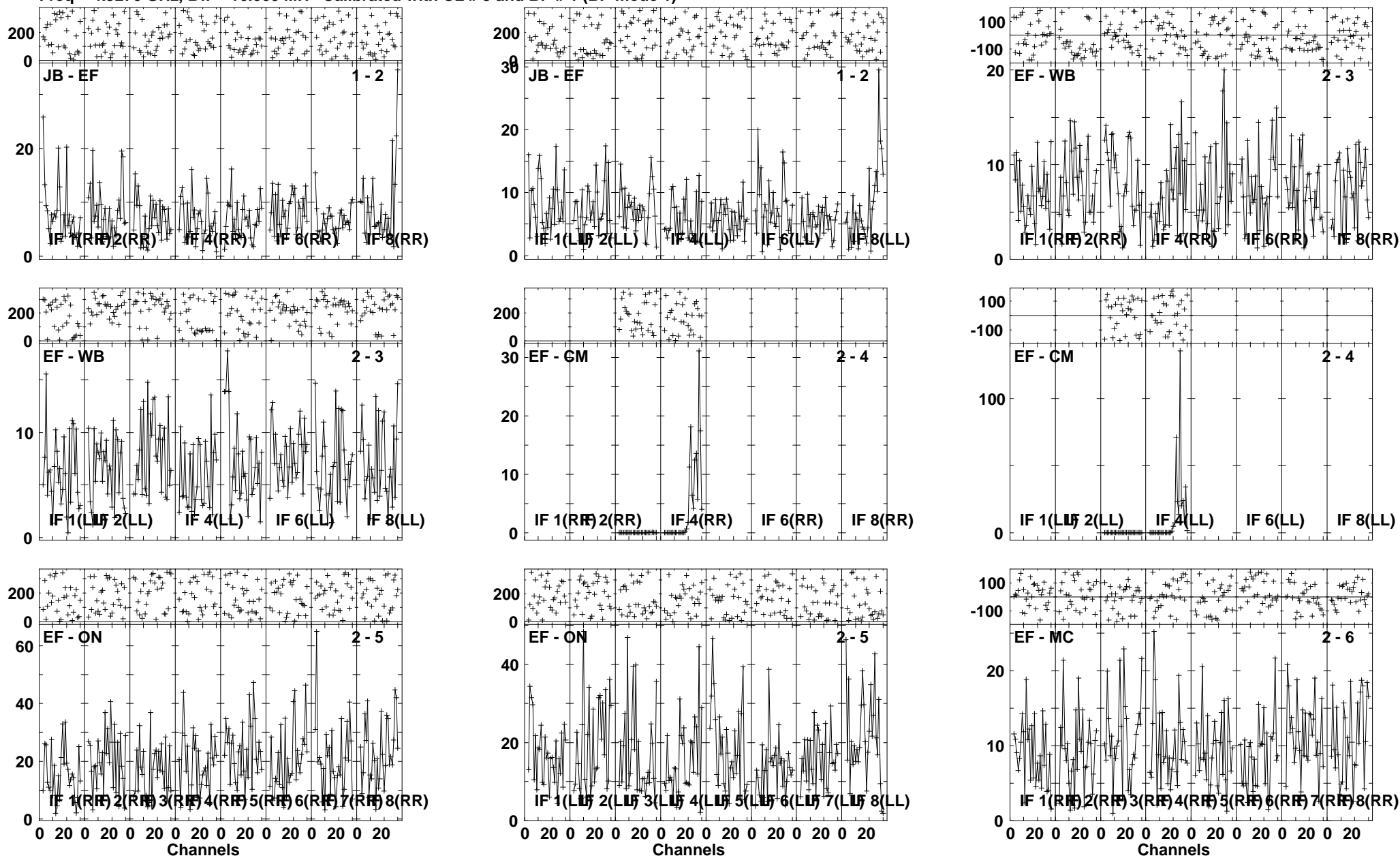

Lower frame: Milli Ampl Jy Top frame: Phas deg
Vector averaged cross-power spectrum Several baselines displayed
Timerange: 00/16:41:01 to 00/16:44:29

Plot file version 151 created 17-NOV-2010 16:21:02

J1128+59 EP068A 5.UVDATA.1

Freq = 4.9270 GHz, Bw = 16.000 MH Calibrated with CL # 3 and BP # 1 (BP mode 1)

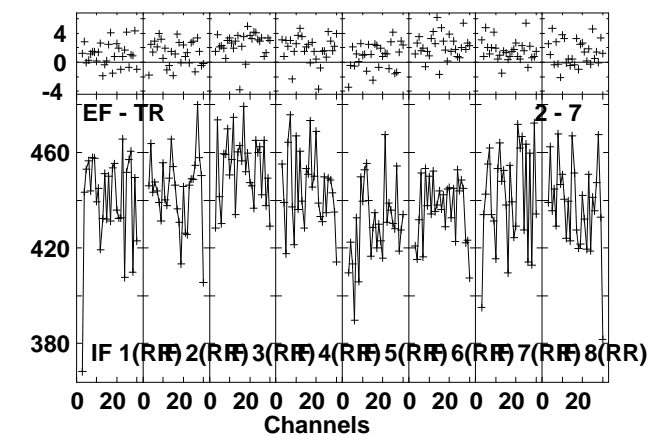
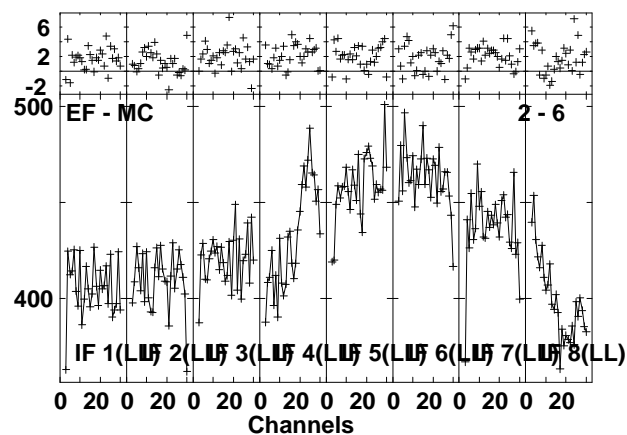
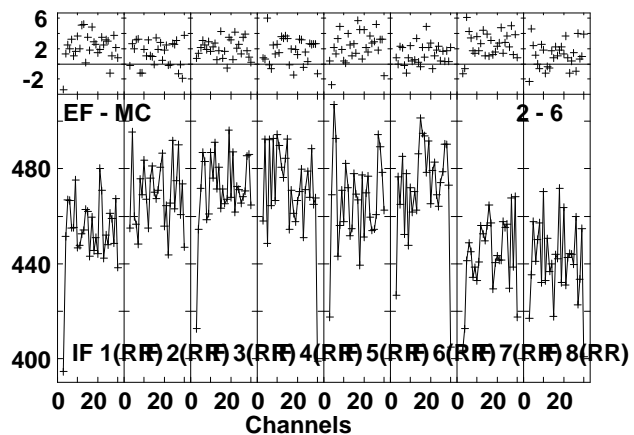
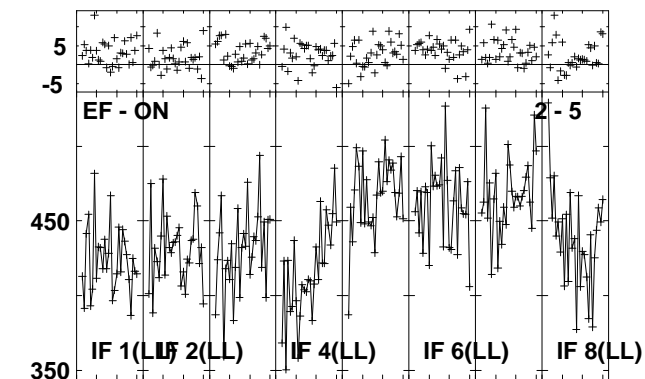
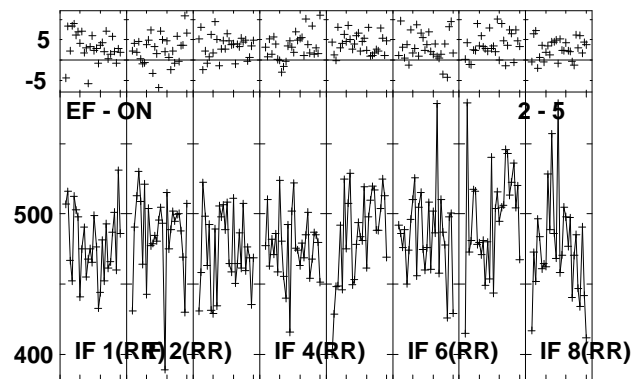
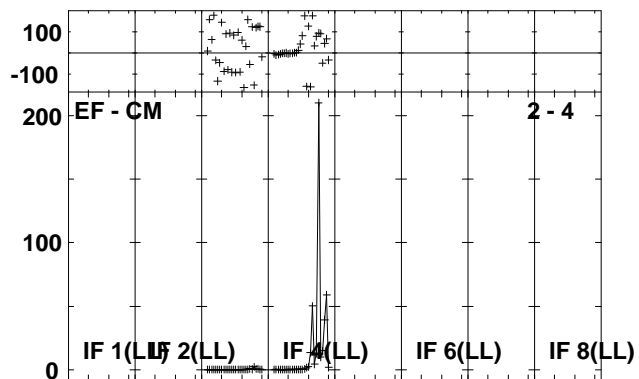
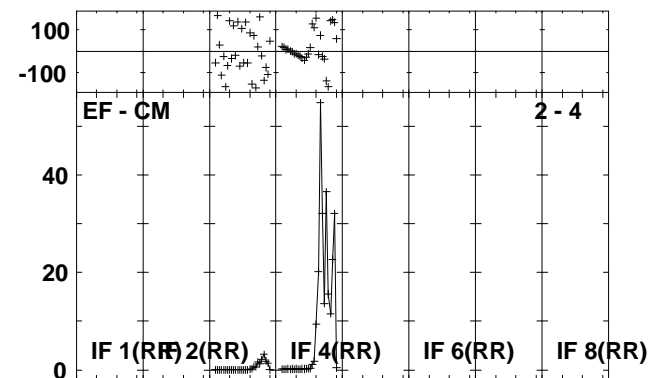
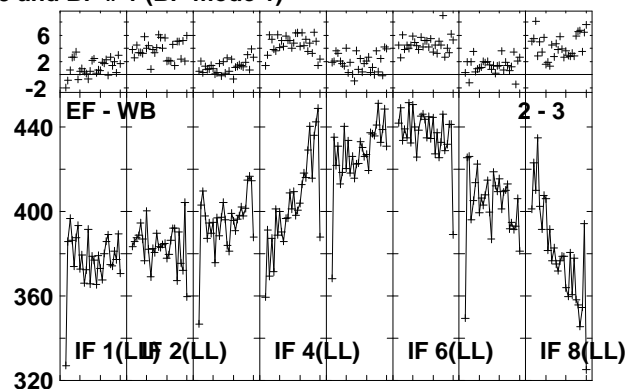
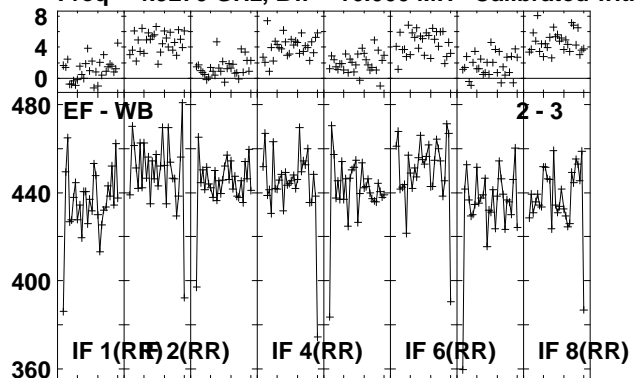

Lower frame: Milli Ampl Jy Top frame: Phas deg
Vector averaged cross-power spectrum Several baselines displayed
Timerange: 00/16:44:31 to 00/16:45:57

Plot file version 152 created 17-NOV-2010 16:21:03

J1128+59 EP068A 5.UVDATA.1

Freq = 4.9270 GHz, Bw = 16.000 MH Calibrated with CL # 3 and BP # 1 (BP mode 1)

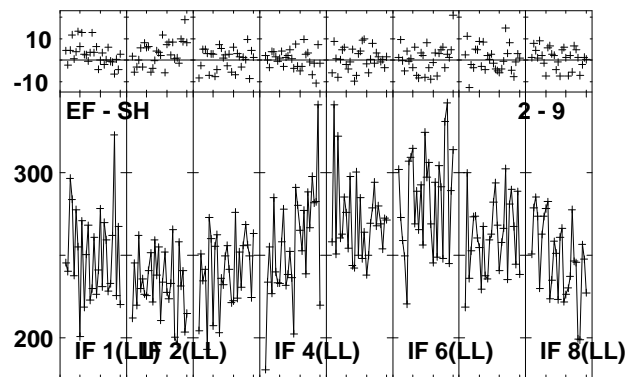
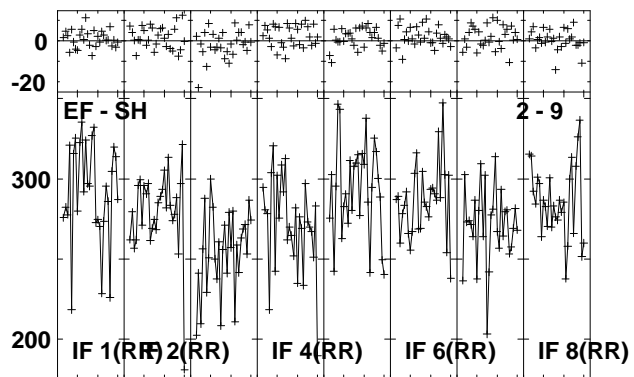
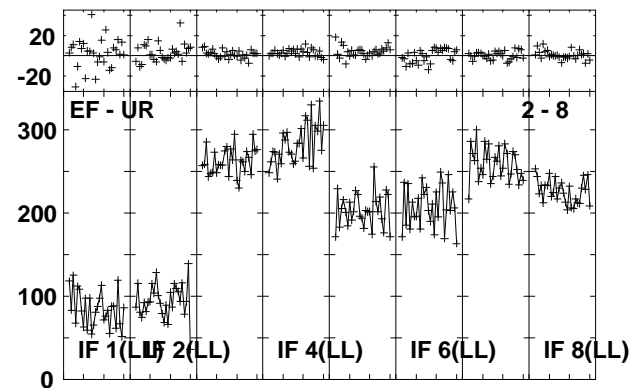
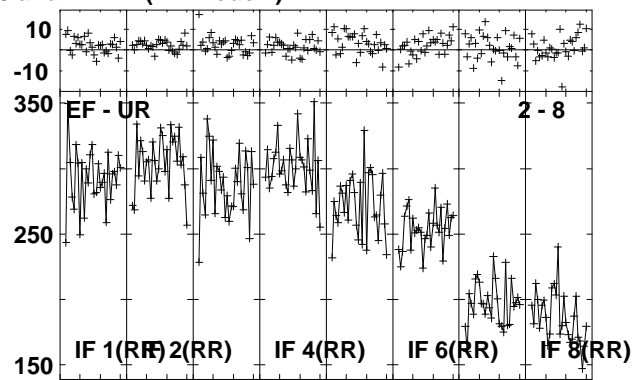
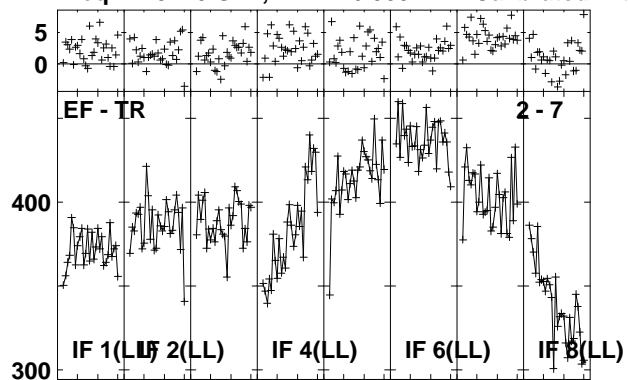

Lower frame: Milli Ampl Jy Top frame: Phas deg
Vector averaged cross-power spectrum Several baselines displayed
Timerange: 00/16:44:31 to 00/16:45:57

Plot file version 153 created 17-NOV-2010 16:21:04

ARP299D EP068A 5.UVDATA.1

Freq = 4.9270 GHz, Bw = 16.000 MH Calibrated with CL # 3 and BP # 1 (BP mode 1)

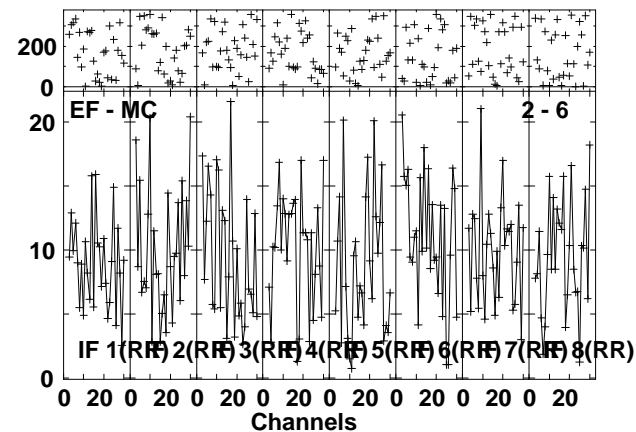
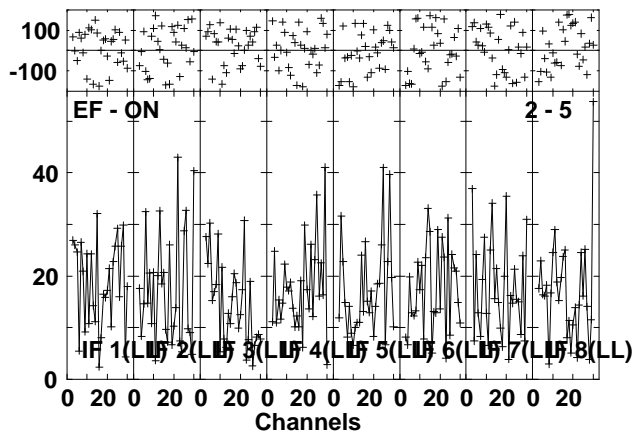
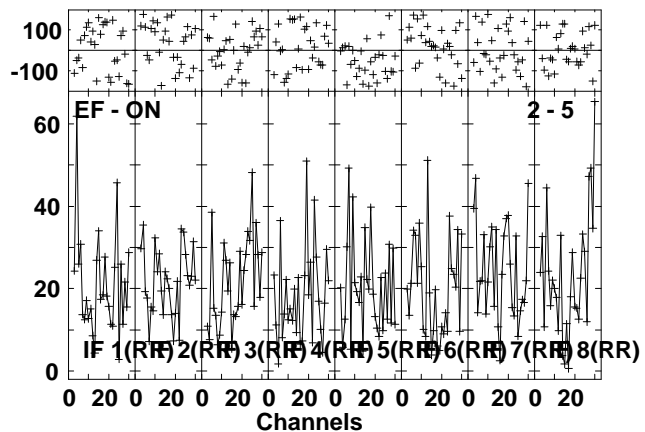
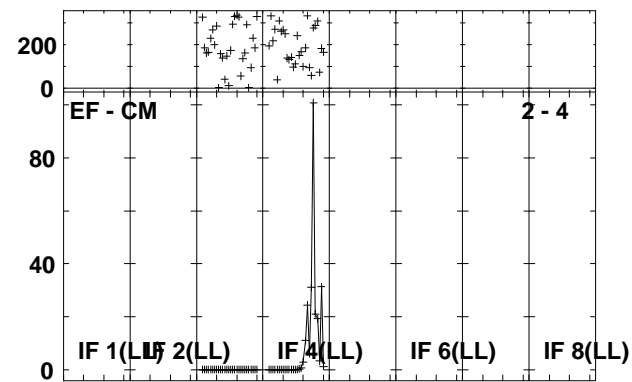
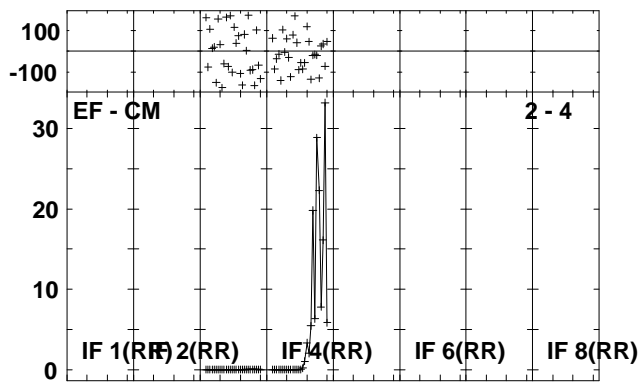
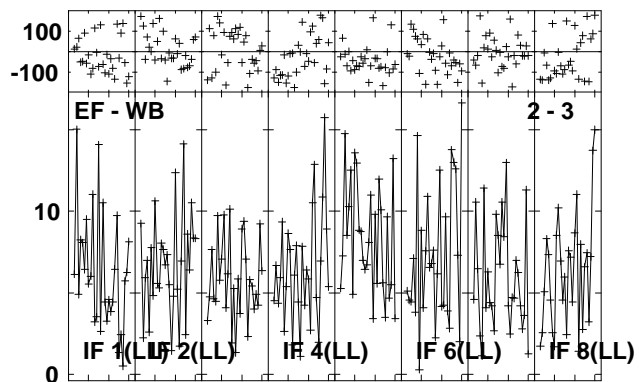
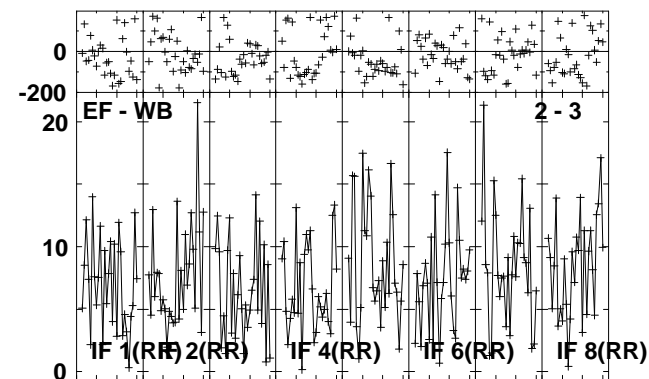
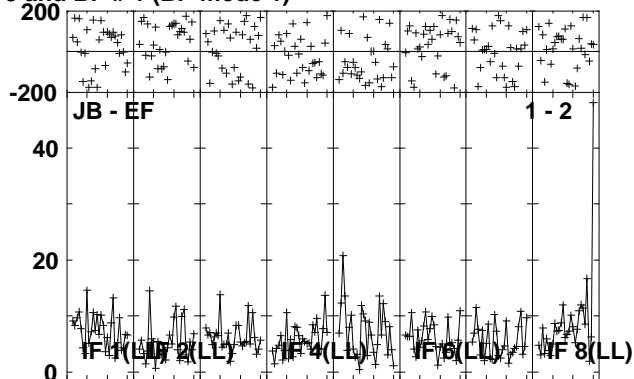
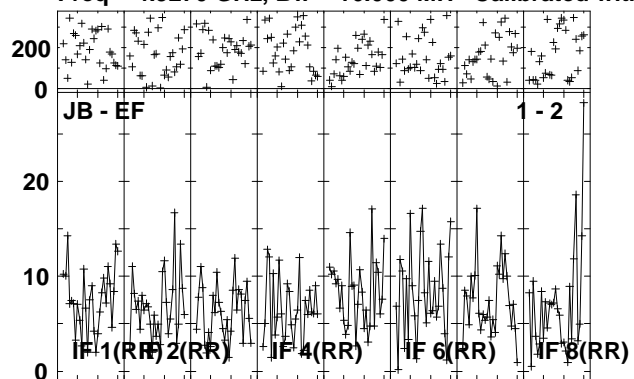

Lower frame: Milli Ampl Jy Top frame: Phas deg
Vector averaged cross-power spectrum Several baselines displayed
Timerange: 00/16:46:01 to 00/16:49:29

Plot file version 154 created 17-NOV-2010 16:21:07

ARP299D EP068A 5.UVDATA.1

Freq = 4.9270 GHz, Bw = 16.000 MH Calibrated with CL # 3 and BP # 1 (BP mode 1)

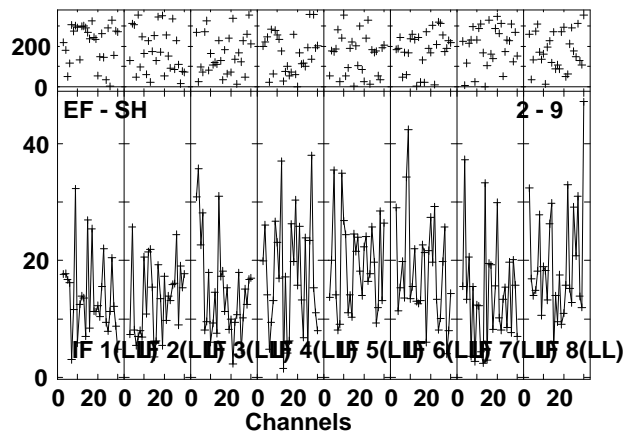
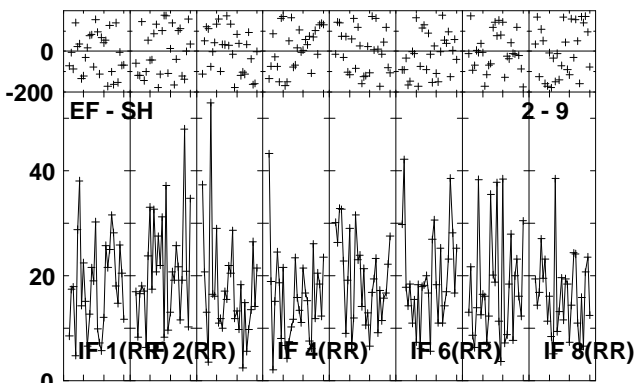
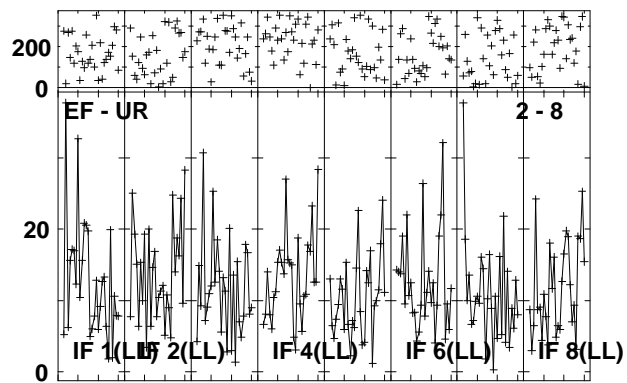
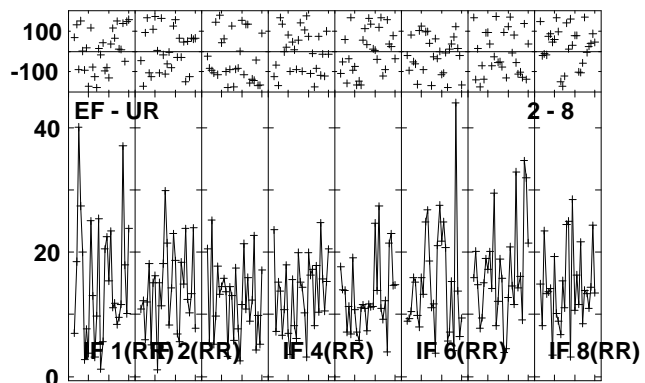
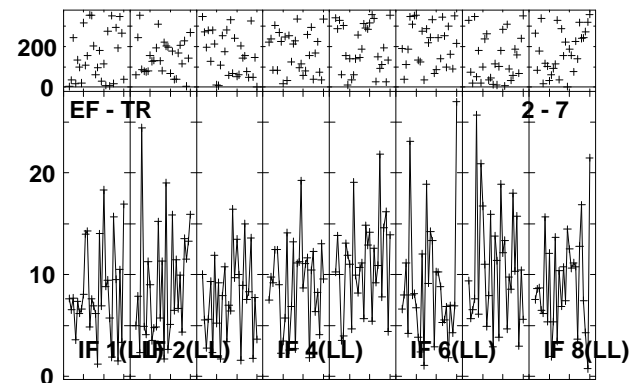
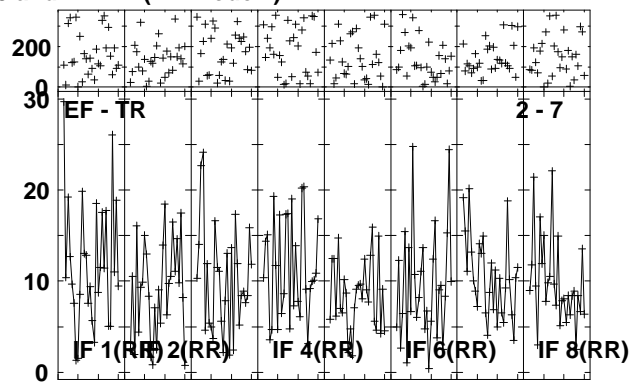
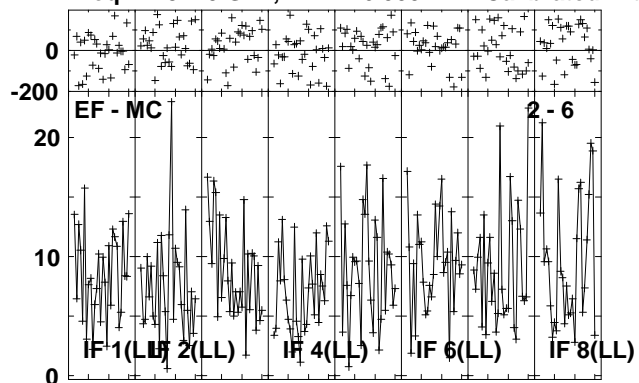

Lower frame: Milli Ampl Jy Top frame: Phas deg
Vector averaged cross-power spectrum Several baselines displayed
Timerange: 00/16:46:01 to 00/16:49:29

Plot file version 155 created 17-NOV-2010 16:21:10

J1128+59 EP068A 5.UVDATA.1

Freq = 4.9270 GHz, Bw = 16.000 MH Calibrated with CL # 3 and BP # 1 (BP mode 1)

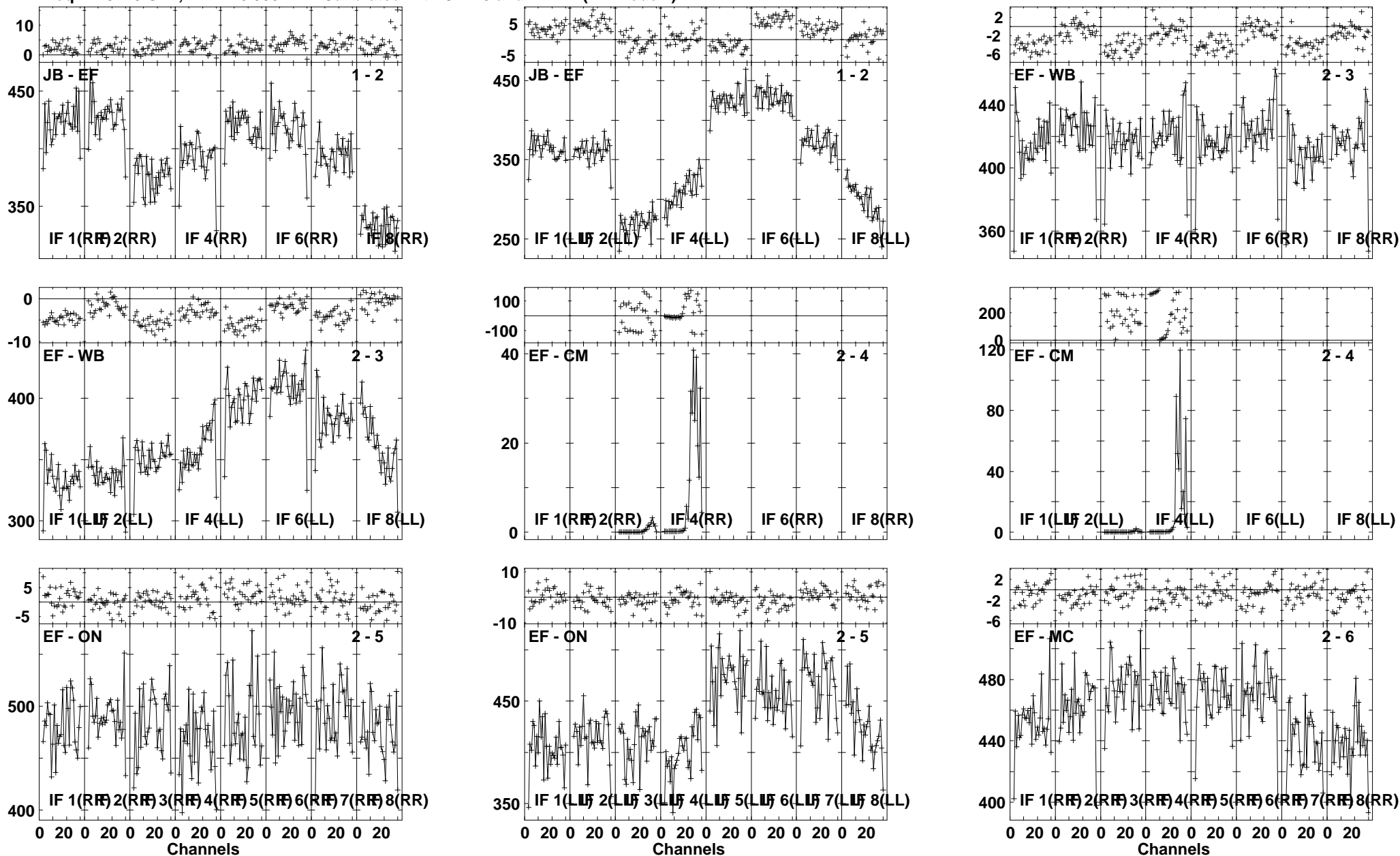

Lower frame: Milli Ampl Jy Top frame: Phas deg
Vector averaged cross-power spectrum Several baselines displayed
Timerange: 00/16:49:31 to 00/16:50:59

Plot file version 156 created 17-NOV-2010 16:21:11
 J1128+59 EP068A 5.UVDATA.1
 Freq = 4.9270 GHz, Bw = 16.000 MH Calibrated with CL # 3 and BP # 1 (BP mode 1)

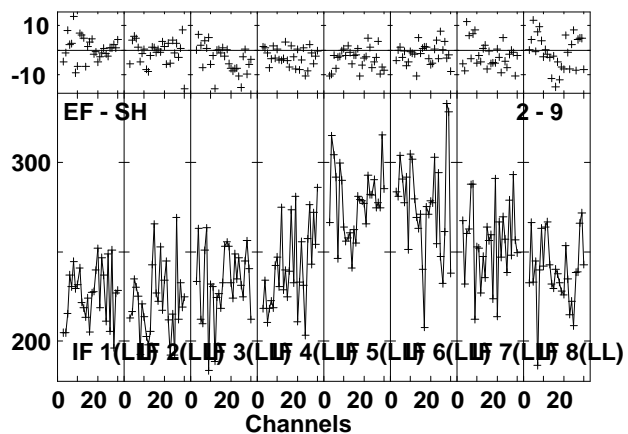
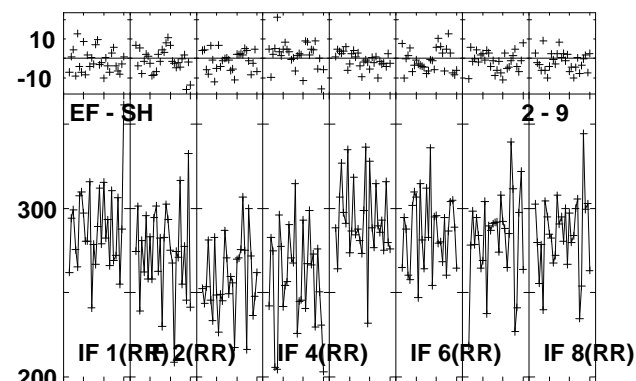
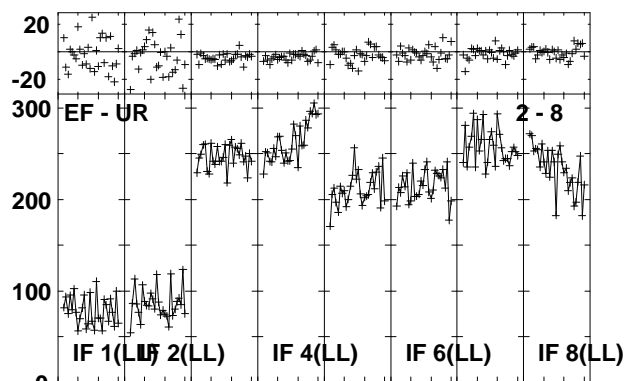
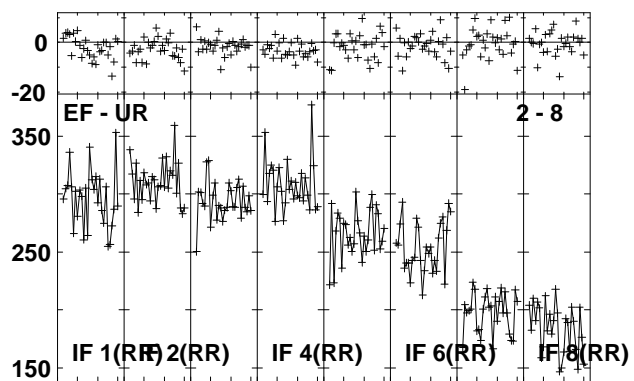
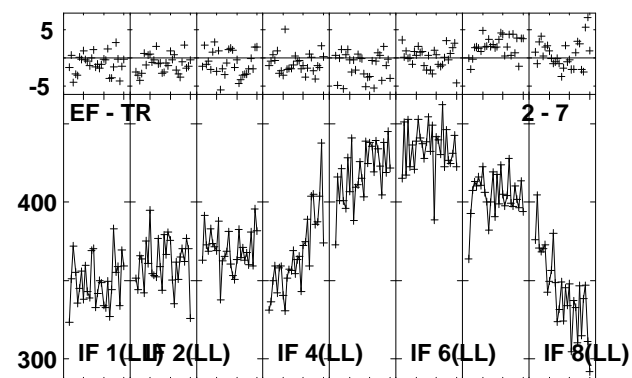
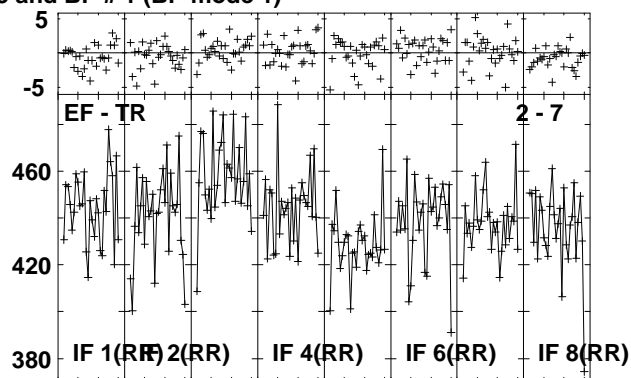
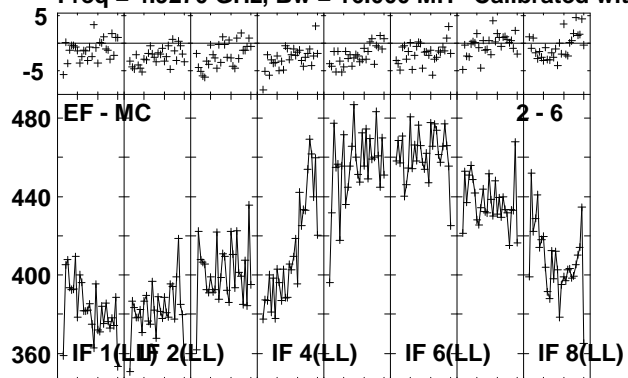

0 20 0 20 0 20 0 20 0 20 0 20 0 20 0 20 0 20 0 20 0 20
 Channels
 Lower frame: Milli Ampl Jy Top frame: Phas deg
 Vector averaged cross-power spectrum Several baselines displayed
 Timerange: 00/16:49:31 to 00/16:50:59

Plot file version 157 created 17-NOV-2010 16:21:12

ARP299D EP068A 5.UVDATA.1

Freq = 4.9270 GHz, Bw = 16.000 MH Calibrated with CL # 3 and BP # 1 (BP mode 1)

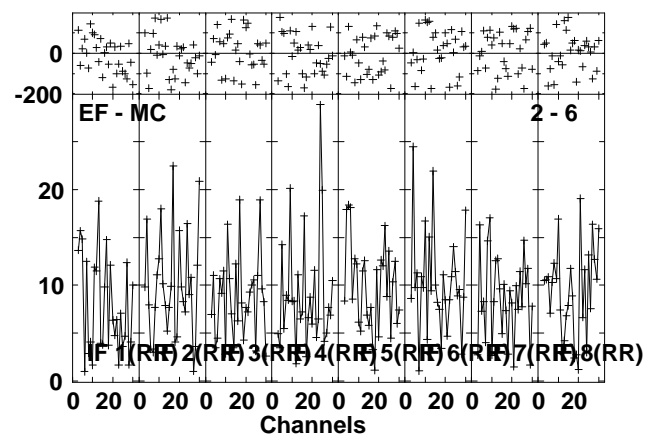
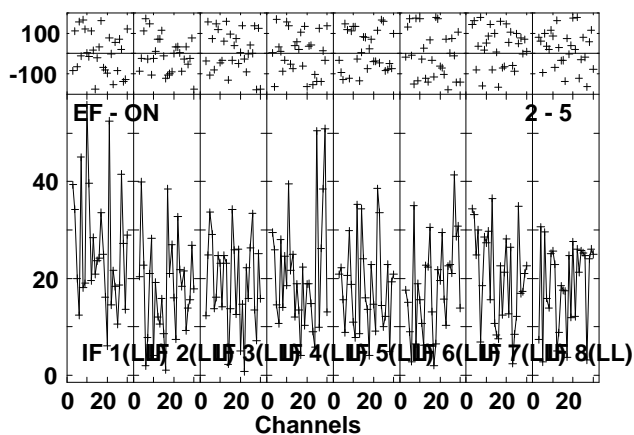
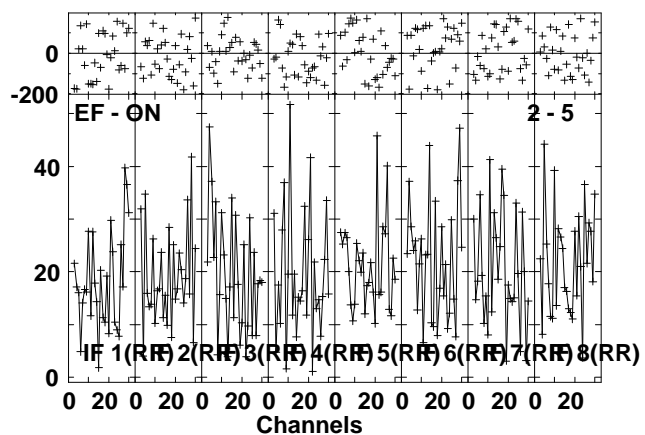
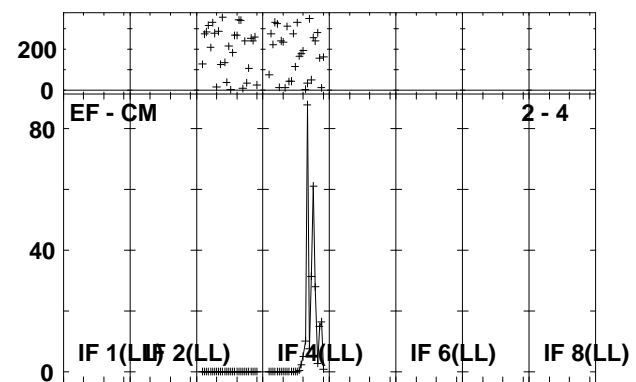
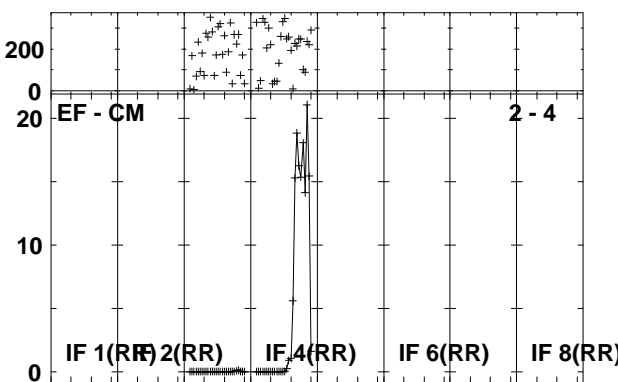
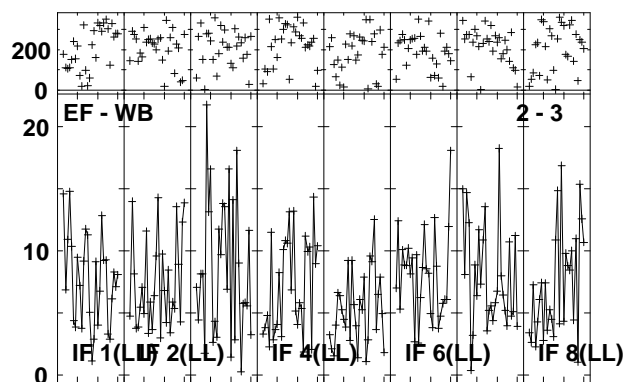
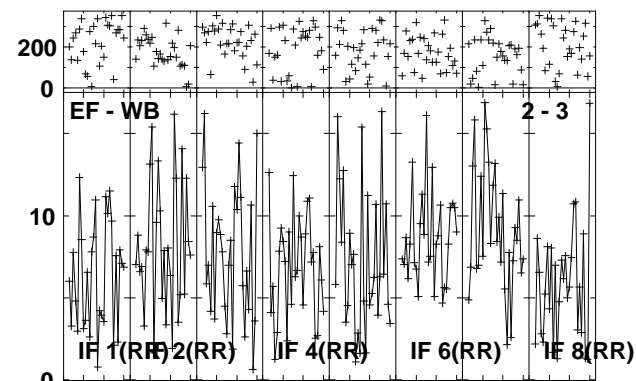
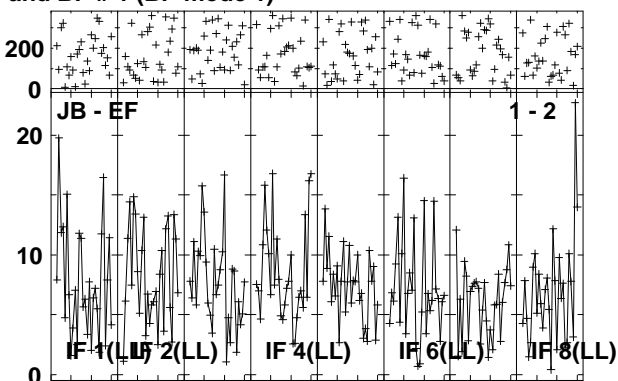
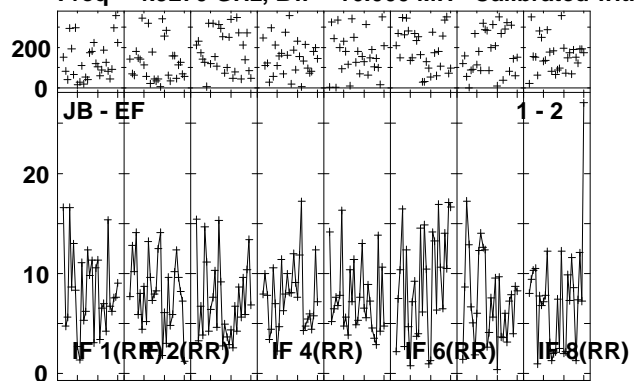

Lower frame: Milli Ampl Jy Top frame: Phas deg
Vector averaged cross-power spectrum Several baselines displayed
Timerange: 00/16:51:01 to 00/16:54:29

Plot file version 158 created 17-NOV-2010 16:21:15

ARP299D EP068A 5.UVDATA.1

Freq = 4.9270 GHz, Bw = 16.000 MH Calibrated with CL # 3 and BP # 1 (BP mode 1)

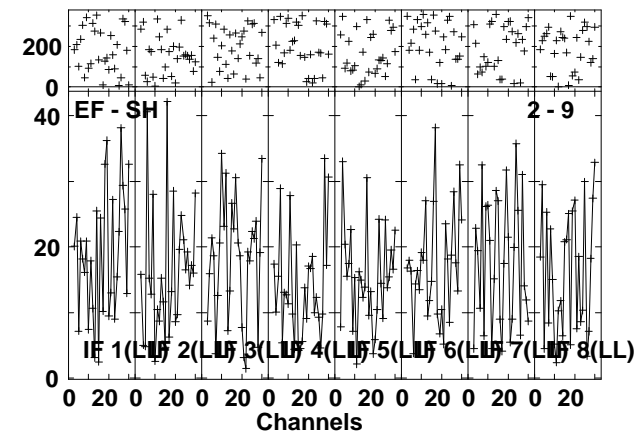
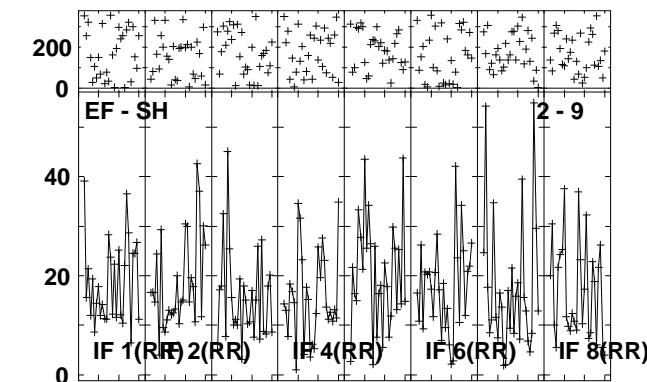
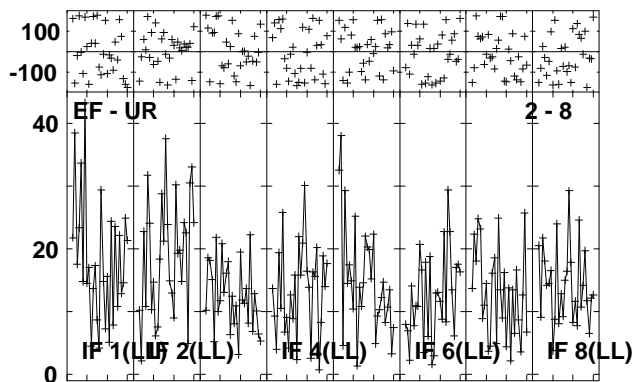
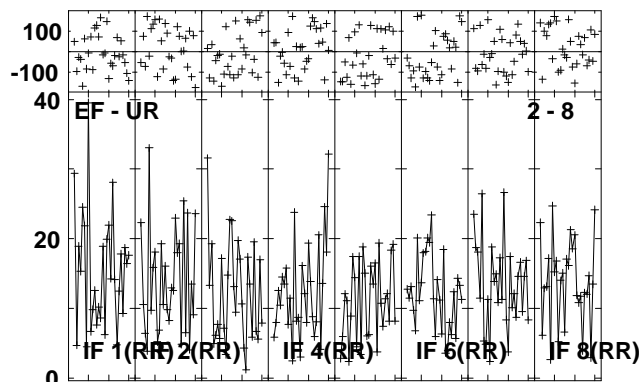
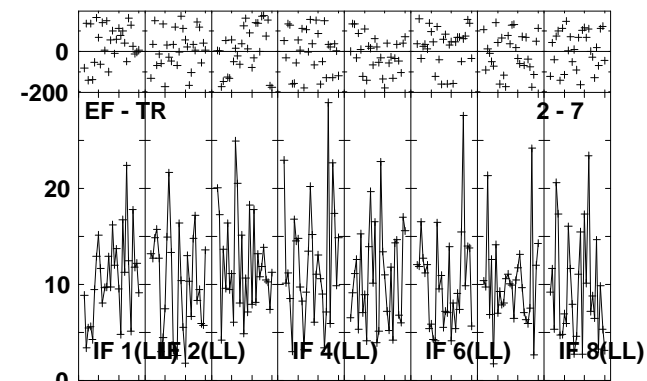
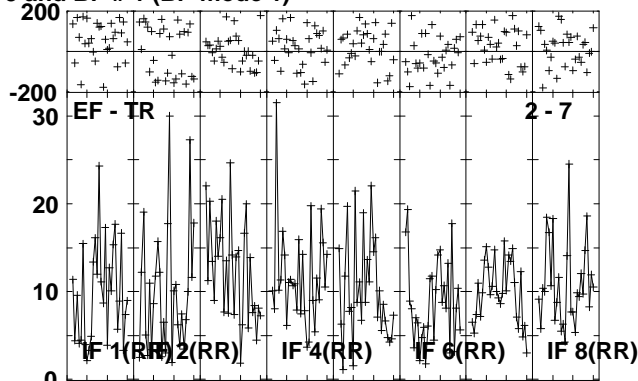
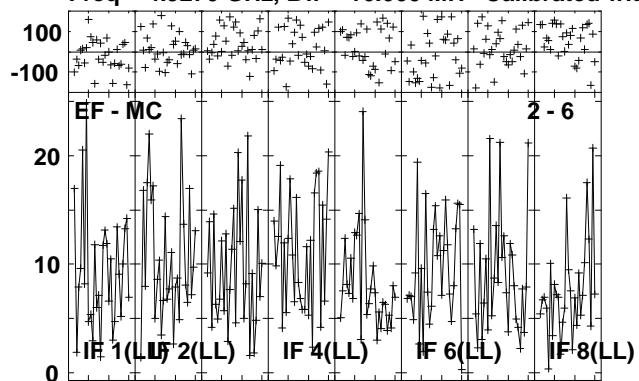

Lower frame: Milli Ampl Jy Top frame: Phas deg
Vector averaged cross-power spectrum Several baselines displayed
Timerange: 00/16:51:01 to 00/16:54:29

Plot file version 160 created 17-NOV-2010 16:21:19

J1128+59 EP068A 5.UVDATA.1

Freq = 4.9270 GHz, Bw = 16.000 MH Calibrated with CL # 3 and BP # 1 (BP mode 1)

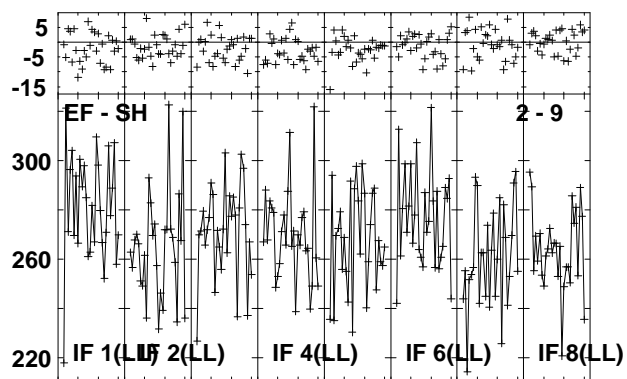
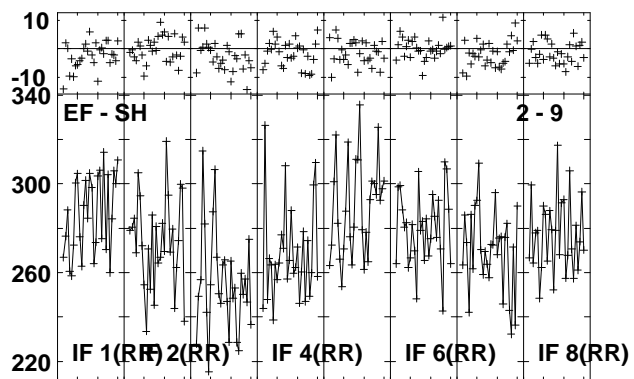
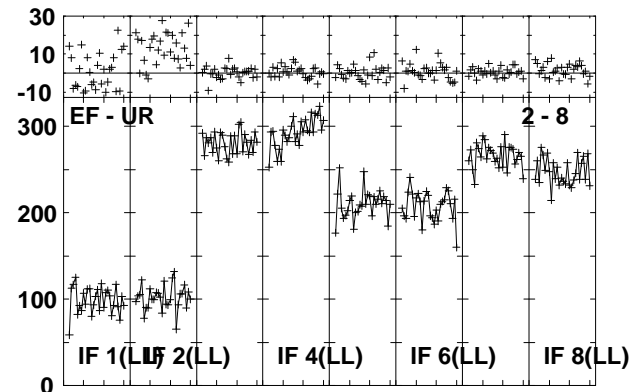
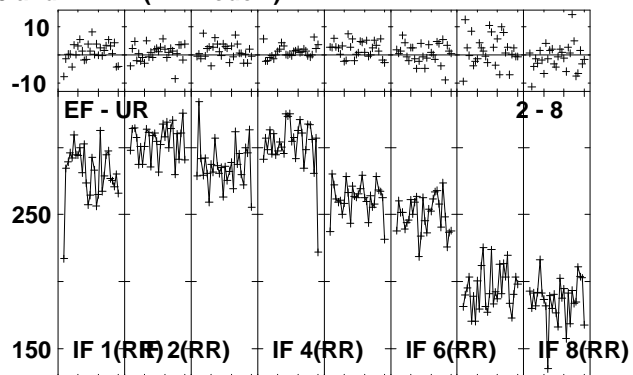
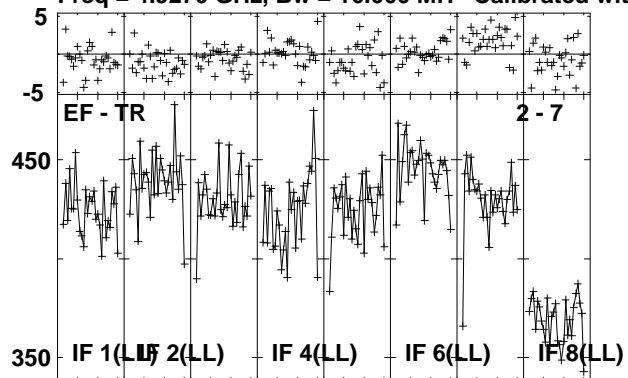

Lower frame: Milli Ampl Jy Top frame: Phas deg
Vector averaged cross-power spectrum Several baselines displayed
Timerange: 00/16:55:31 to 00/16:56:59

Plot file version 161 created 17-NOV-2010 16:21:21

ARP299D EP068A 5.UVDATA.1

Freq = 4.9270 GHz, Bw = 16.000 MH Calibrated with CL # 3 and BP # 1 (BP mode 1)

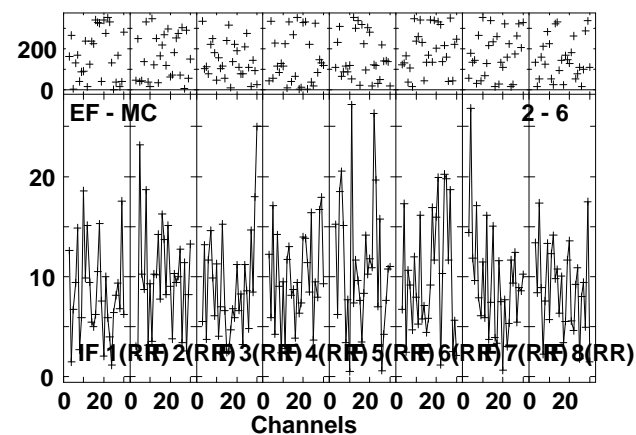
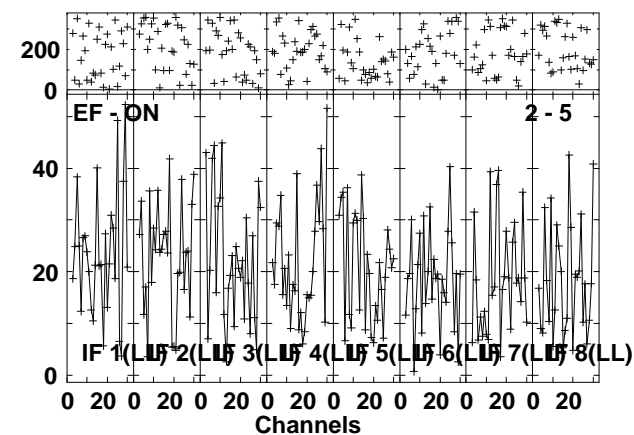
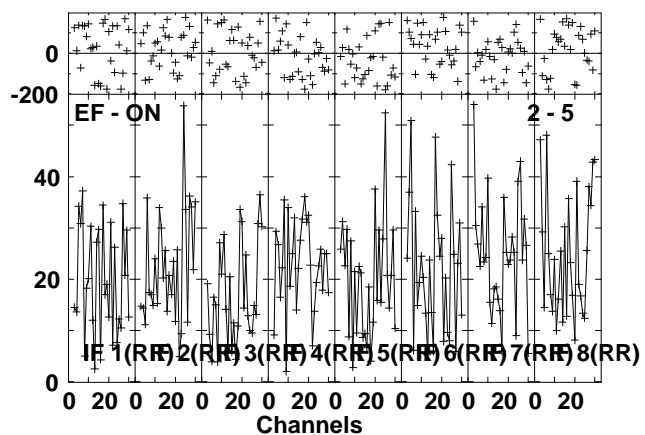
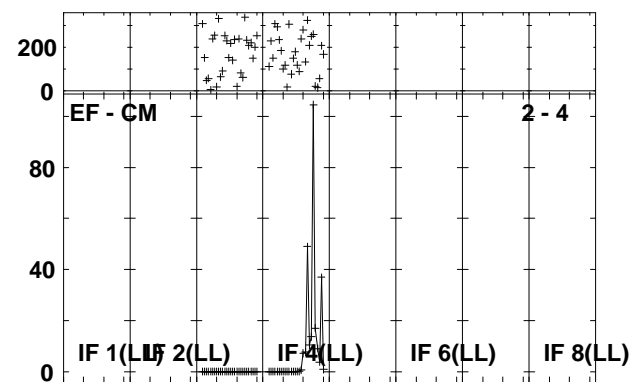
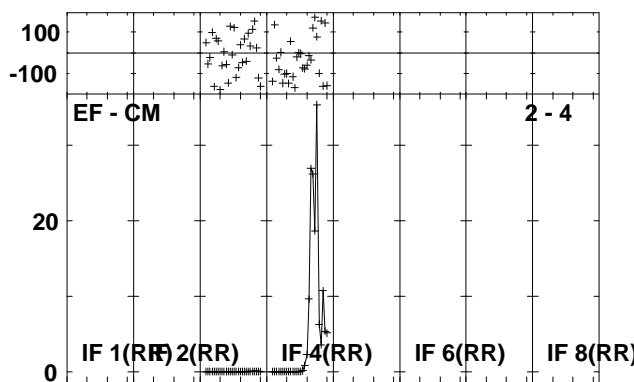
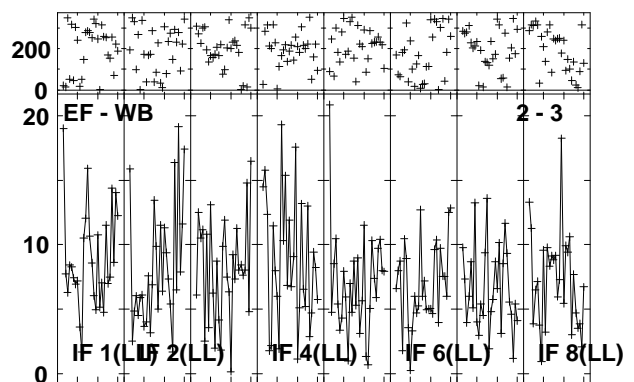
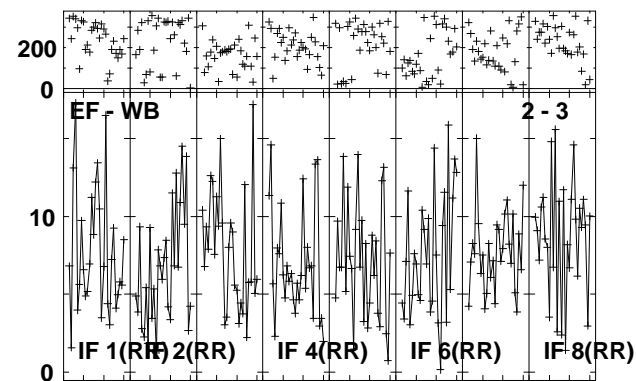
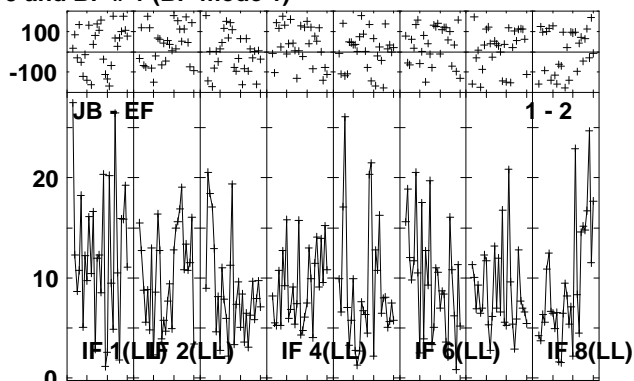
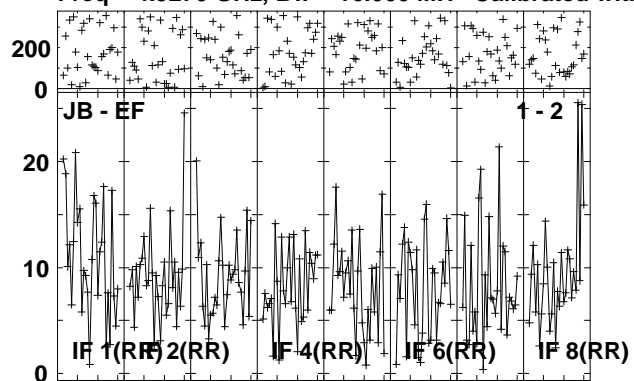

Lower frame: Milli Ampl Jy Top frame: Phas deg
Vector averaged cross-power spectrum Several baselines displayed
Timerange: 00:16:57:01 to 00:17:00:29

Plot file version 163 created 17-NOV-2010 16:21:26

J1128+59 EP068A 5.UVDATA.1

Freq = 4.9270 GHz, Bw = 16.000 MH Calibrated with CL # 3 and BP # 1 (BP mode 1)

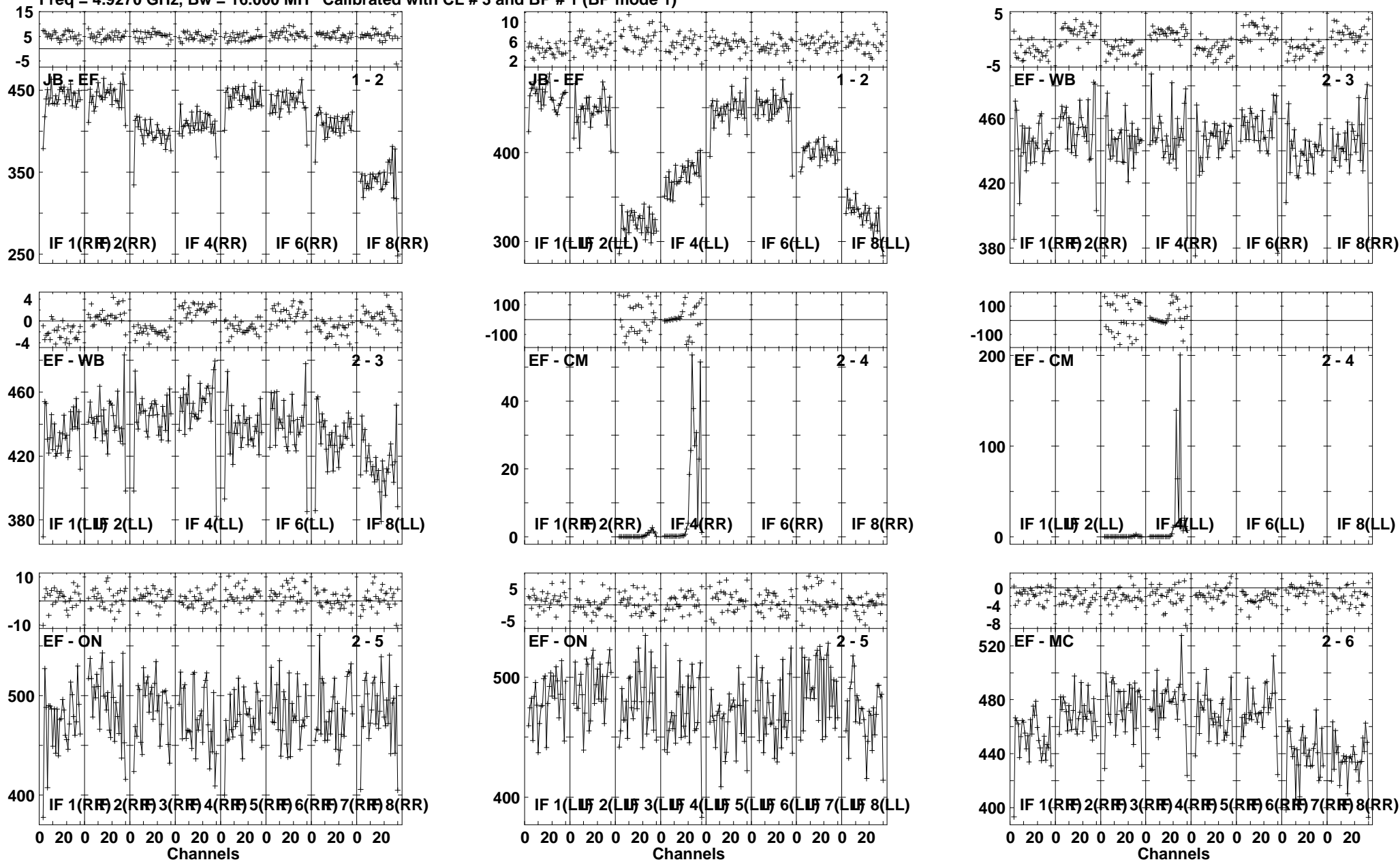

Lower frame: Milli Ampl Jy Top frame: Phas deg
Vector averaged cross-power spectrum Several baselines displayed
Timerange: 00/17:00:31 to 00/17:01:59

Plot file version 165 created 17-NOV-2010 16:21:29

ARP299D EP068A 5.UVDATA.1

Freq = 4.9270 GHz, Bw = 16.000 MH Calibrated with CL # 3 and BP # 1 (BP mode 1)

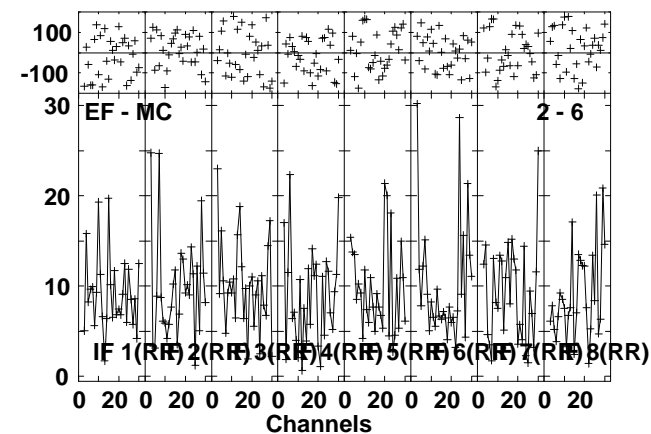
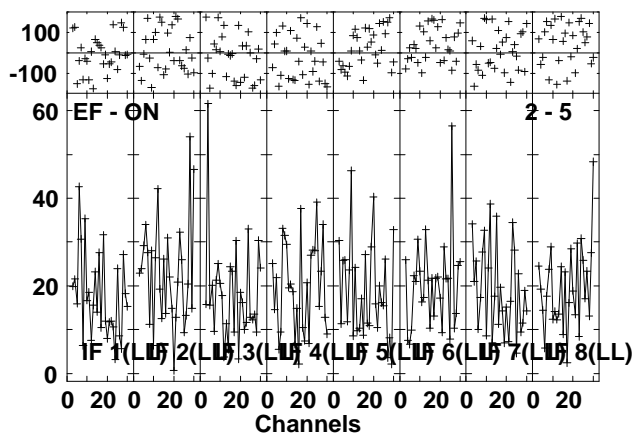
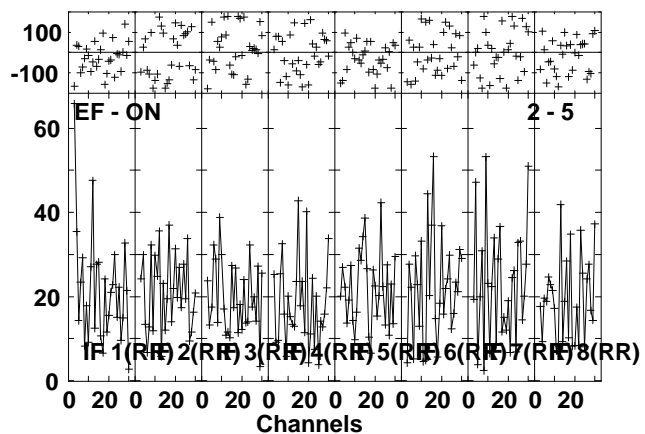
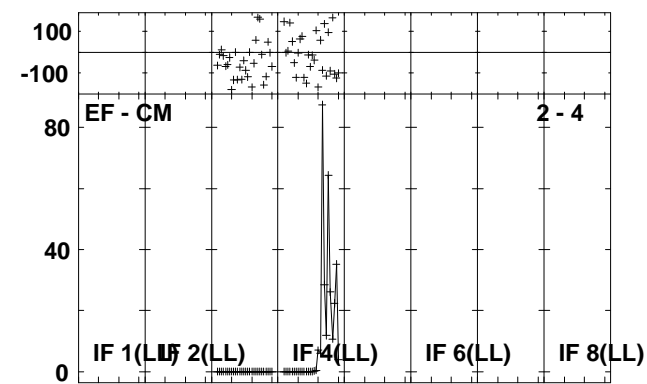
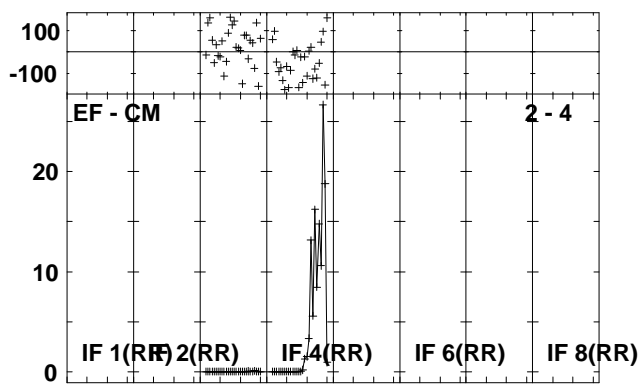
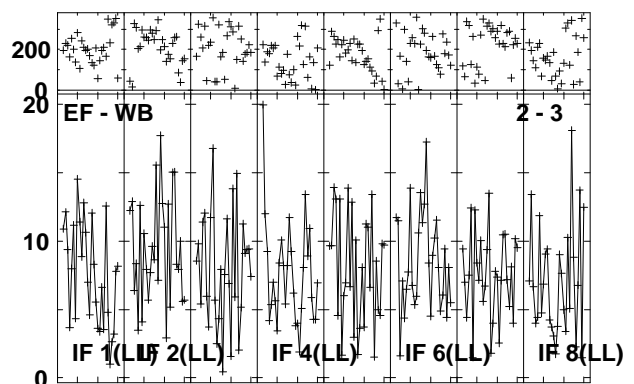
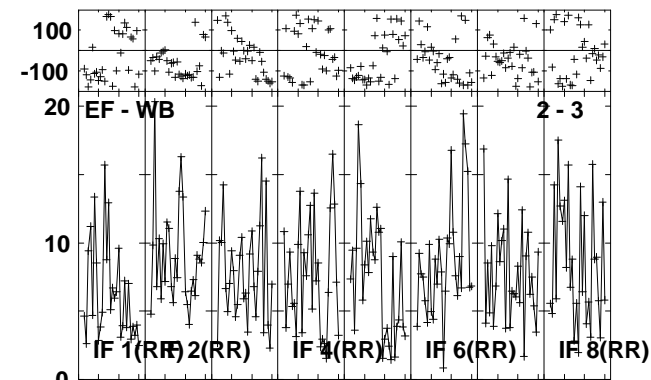
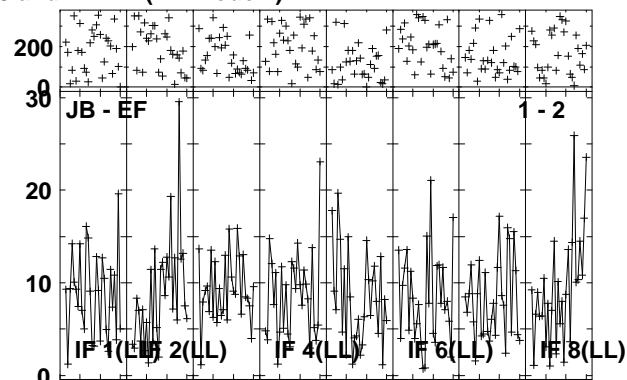
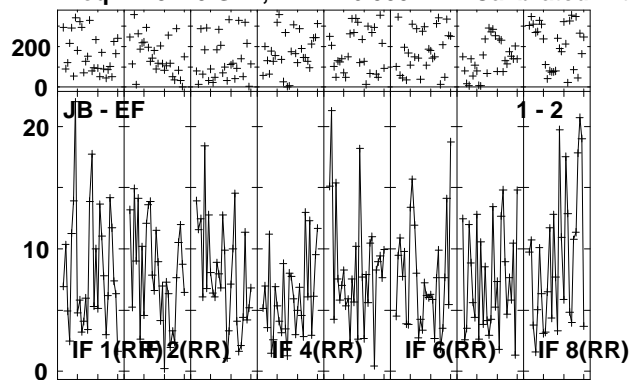

Lower frame: Milli Ampl Jy Top frame: Phas deg
Vector averaged cross-power spectrum Several baselines displayed
Timerange: 00/17:02:01 to 00/17:05:29

Plot file version 166 created 17-NOV-2010 16:21:31

ARP299D EP068A 5.UVDATA.1

Freq = 4.9270 GHz, Bw = 16.000 MH Calibrated with CL # 3 and BP # 1 (BP mode 1)

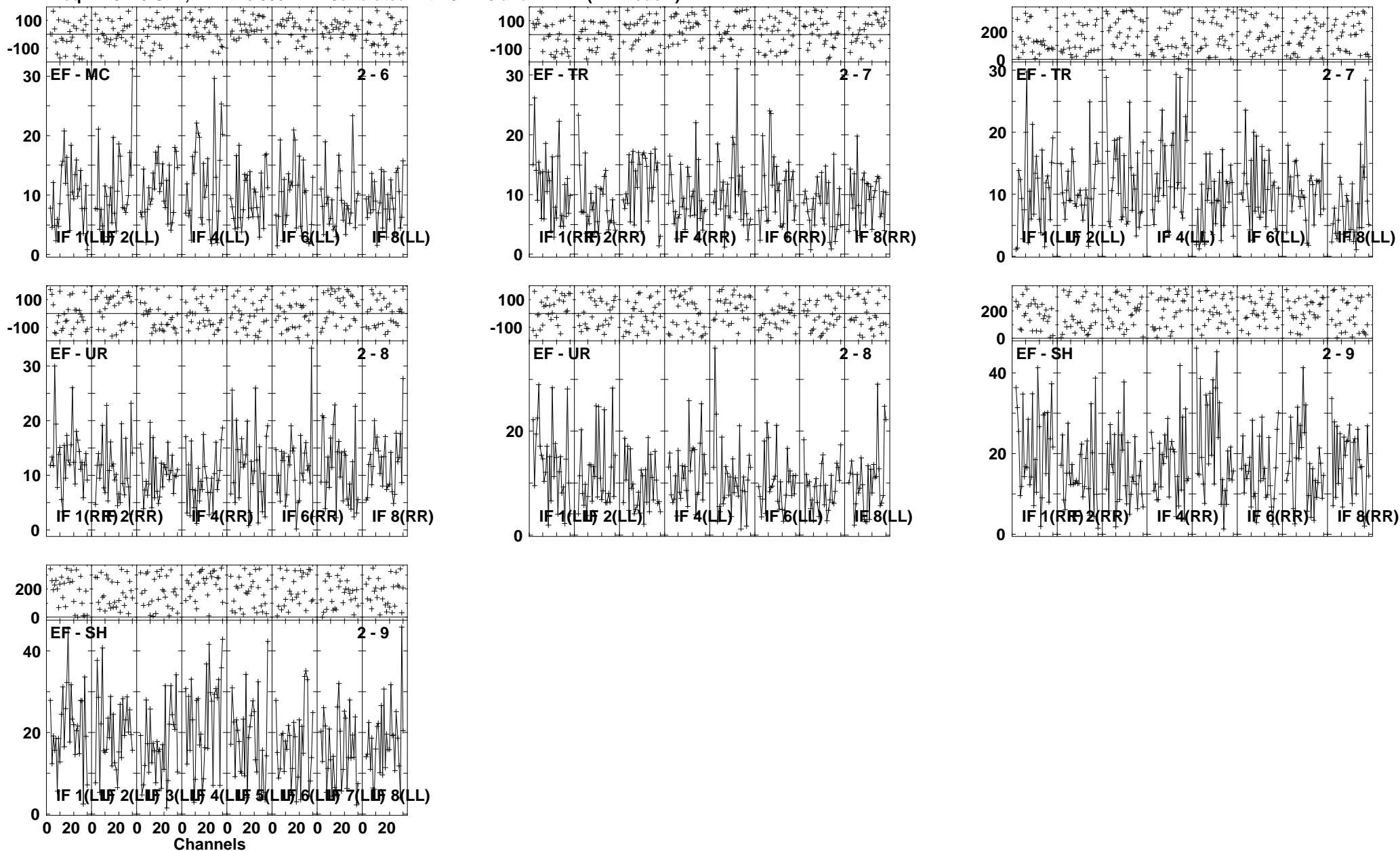

Lower frame: Milli Ampl Jy Top frame: Phas deg
Vector averaged cross-power spectrum Several baselines displayed
Timerange: 00/17:02:01 to 00/17:05:29

Plot file version 167 created 17-NOV-2010 16:21:34

J1128+59 EP068A 5.UVDATA.1

Freq = 4.9270 GHz, Bw = 16.000 MH Calibrated with CL # 3 and BP # 1 (BP mode 1)

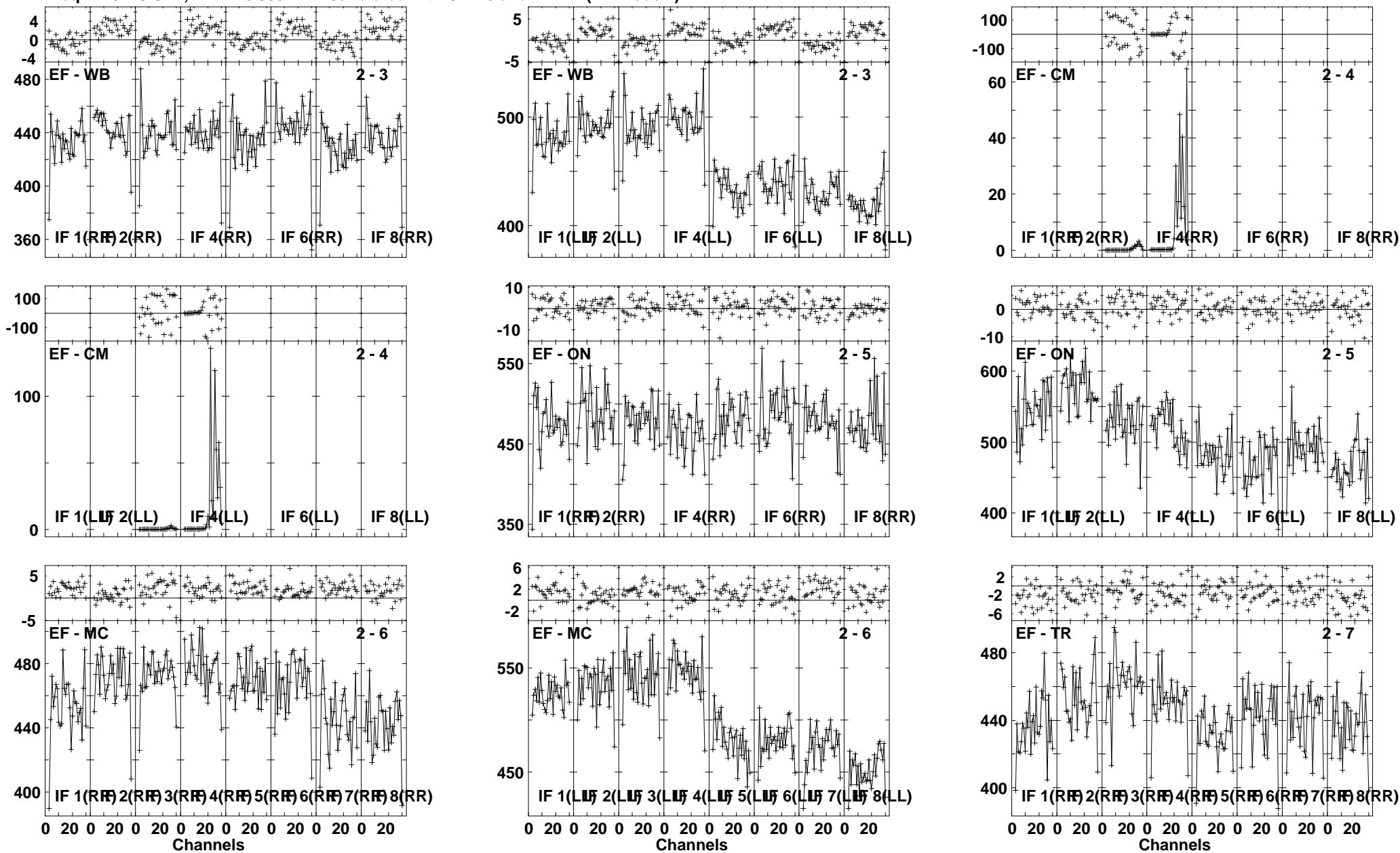

Lower frame: Milli Ampl Jy Top frame: Phas deg
Vector averaged cross-power spectrum Several baselines displayed
Timerange: 00/17:05:31 to 00/17:06:59

Plot file version 168 created 17-NOV-2010 16:21:35

J1128+59 EP068A 5.UVDATA.1

Freq = 4.9270 GHz, Bw = 16.000 MH Calibrated with CL # 3 and BP # 1 (BP mode 1)

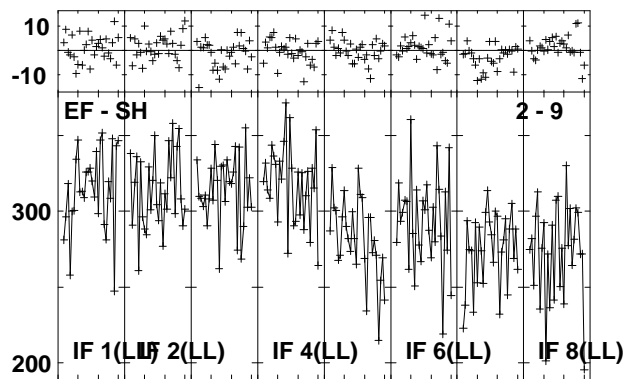
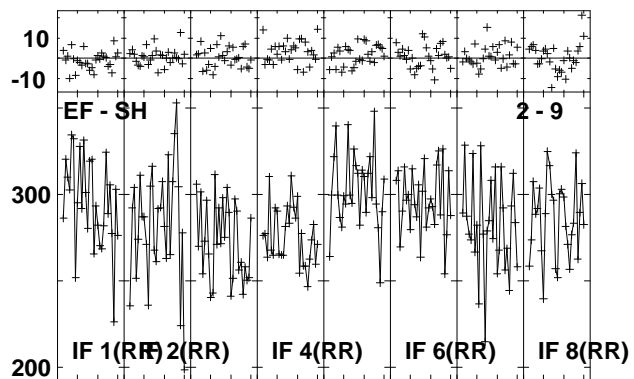
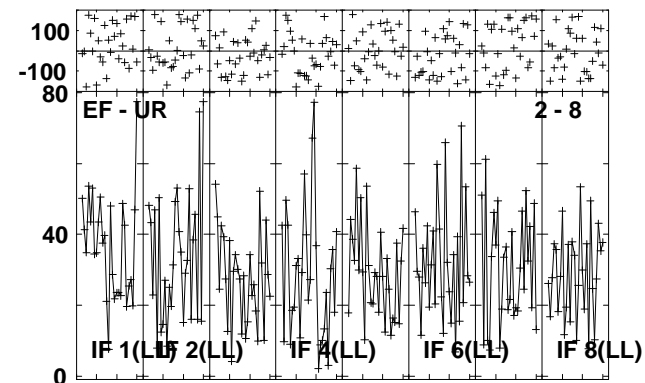
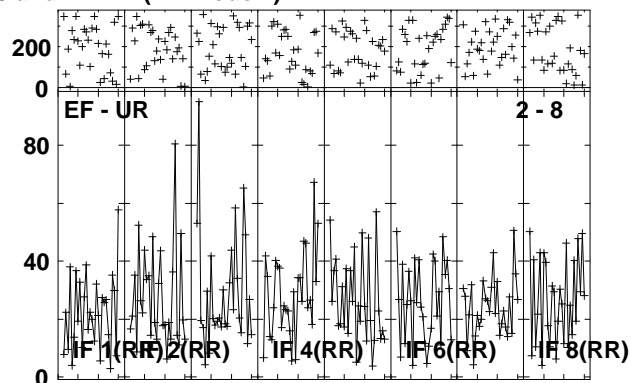
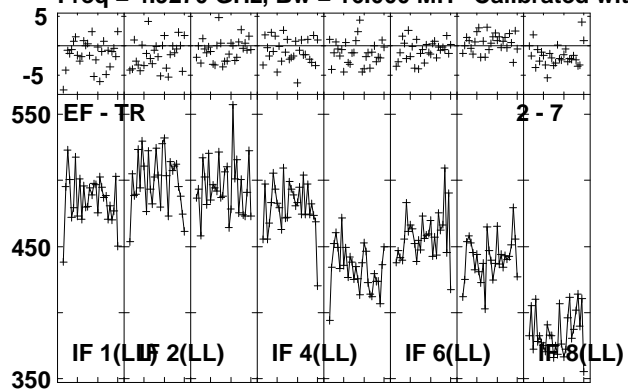

Lower frame: Milli Ampl Jy Top frame: Phas deg
Vector averaged cross-power spectrum Several baselines displayed
Timerange: 00/17:05:31 to 00/17:06:59

Plot file version 169 created 17-NOV-2010 16:21:37

ARP299D EP068A 5.UVDATA.1

Freq = 4.9270 GHz, Bw = 16.000 MH Calibrated with CL # 3 and BP # 1 (BP mode 1)

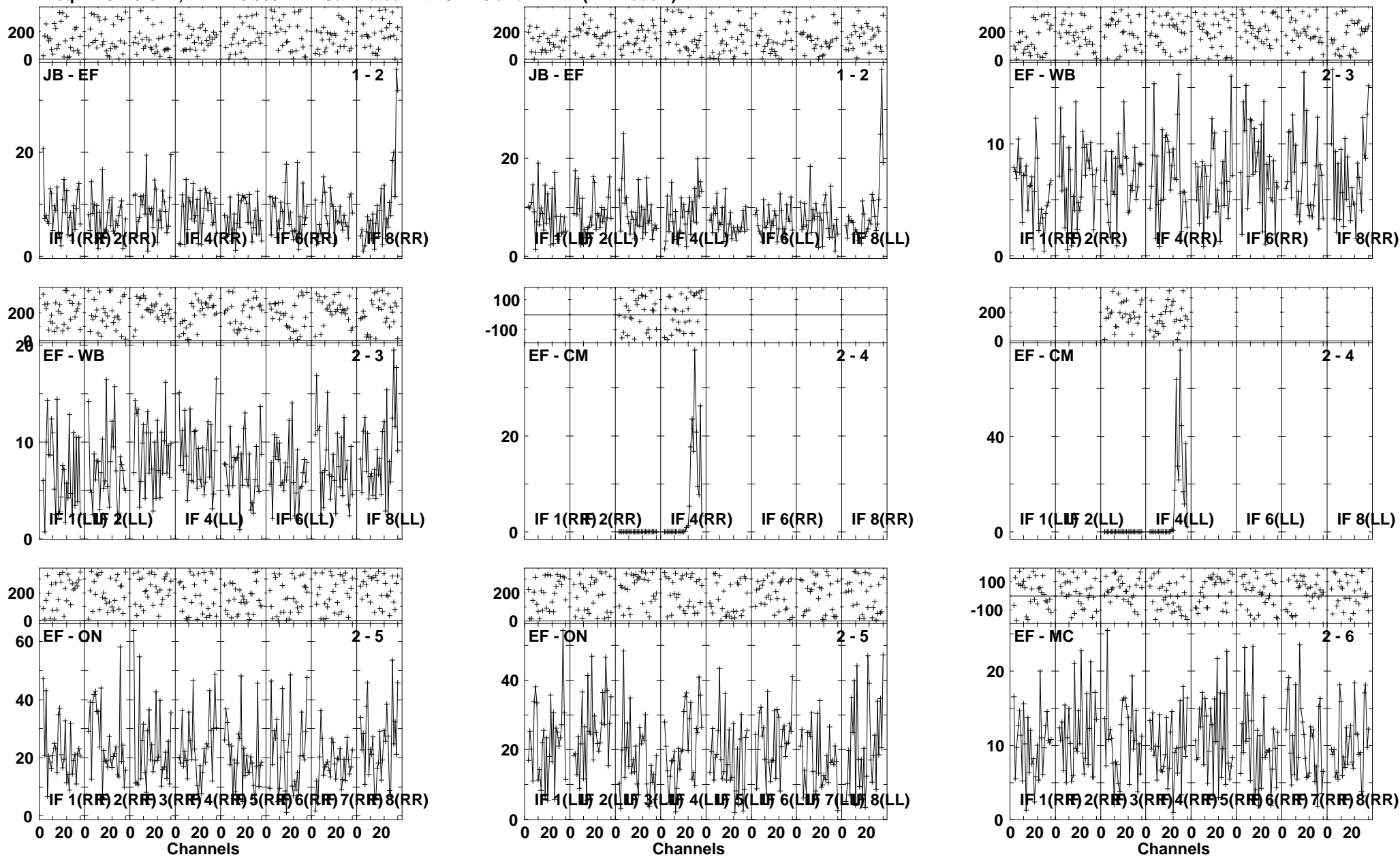

Lower frame: Milli Ampl Jy Top frame: Phas deg
Vector averaged cross-power spectrum Several baselines displayed
Timerange: 00/17:07:01 to 00/17:10:29

Plot file version 170 created 17-NOV-2010 16:21:39

ARP299D EP068A 5.UVDATA.1

Freq = 4.9270 GHz, Bw = 16.000 MH Calibrated with CL # 3 and BP # 1 (BP mode 1)

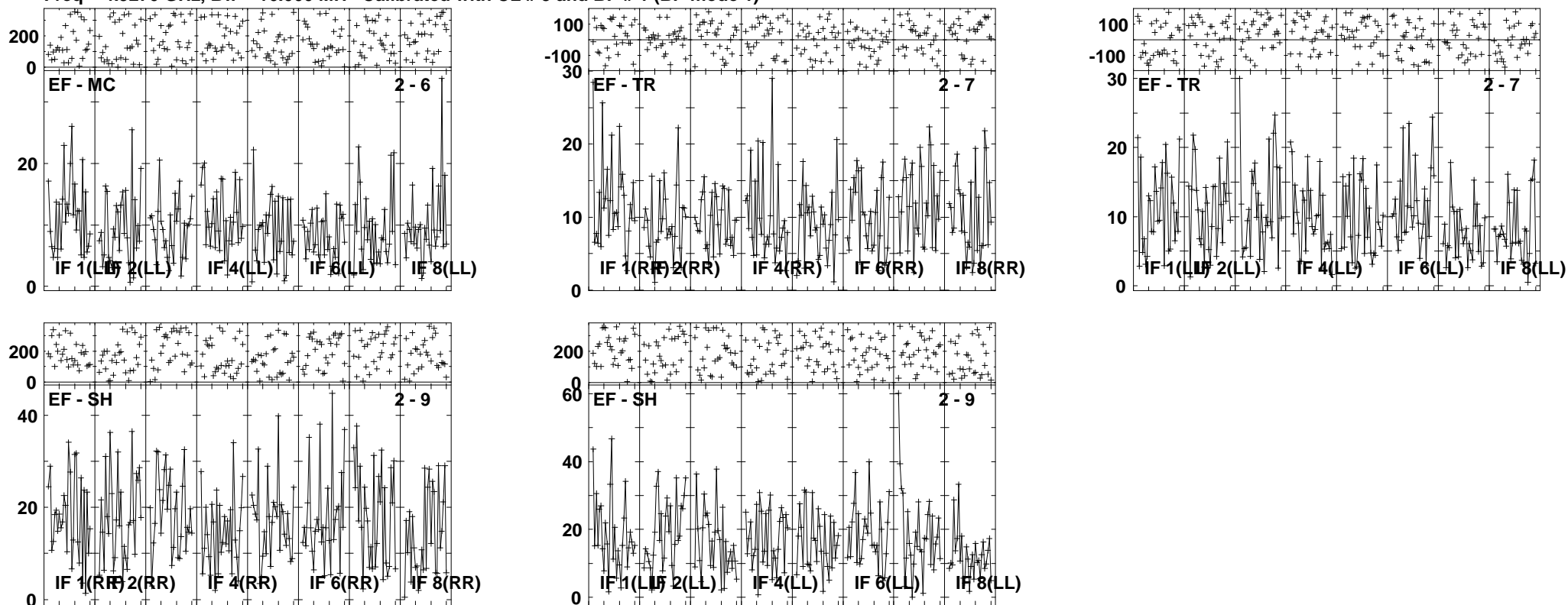

Lower frame: Milli Ampl Jy Top frame: Phas deg
Vector averaged cross-power spectrum Several baselines displayed
Timerange: 00/17:07:01 to 00/17:10:29

Plot file version 172 created 17-NOV-2010 16:21:43

J1128+59 EP068A 5.UVDATA.1

Freq = 4.9270 GHz, Bw = 16.000 MH Calibrated with CL # 3 and BP # 1 (BP mode 1)

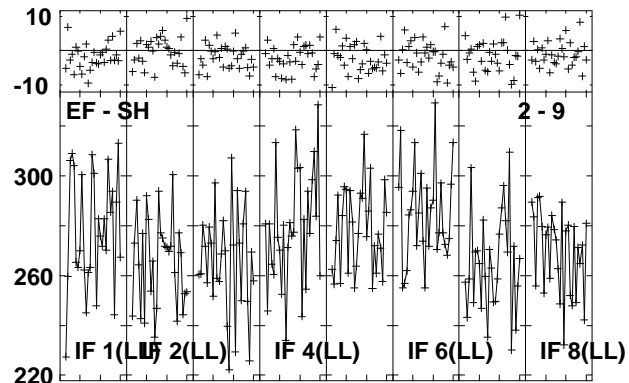
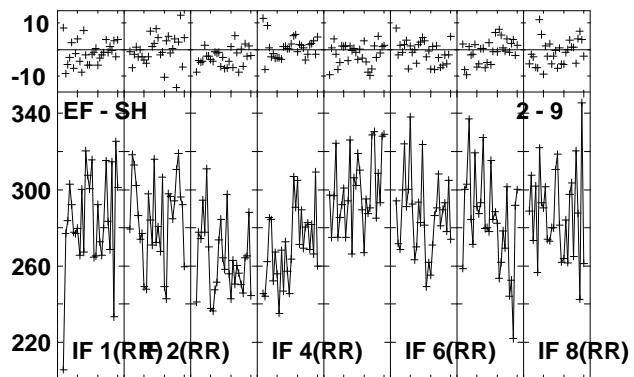
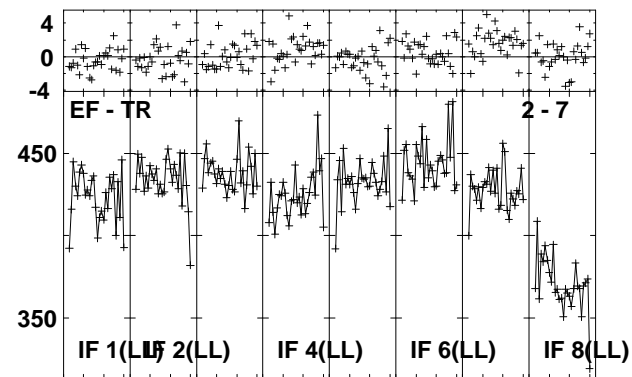
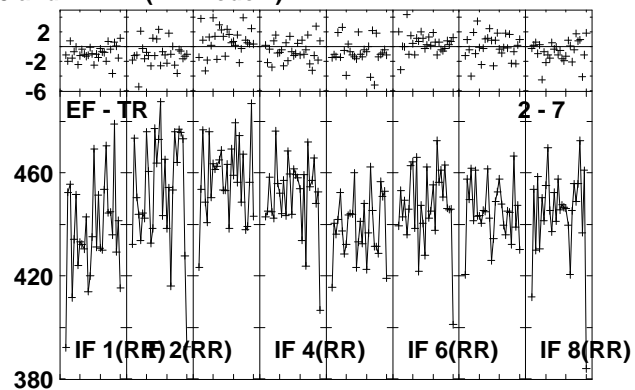
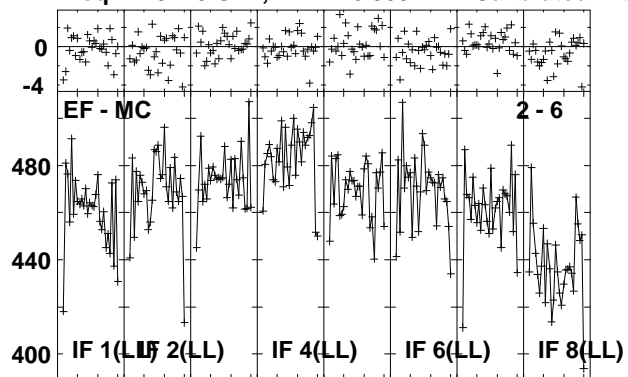

Lower frame: Milli Ampl Jy Top frame: Phas deg
Vector averaged cross-power spectrum Several baselines displayed
Timerange: 00:17:11:31 to 00:17:12:59

Plot file version 173 created 17-NOV-2010 16:21:45

ARP299D EP068A 5.UVDATA.1

Freq = 4.9270 GHz, Bw = 16.000 MH Calibrated with CL # 3 and BP # 1 (BP mode 1)

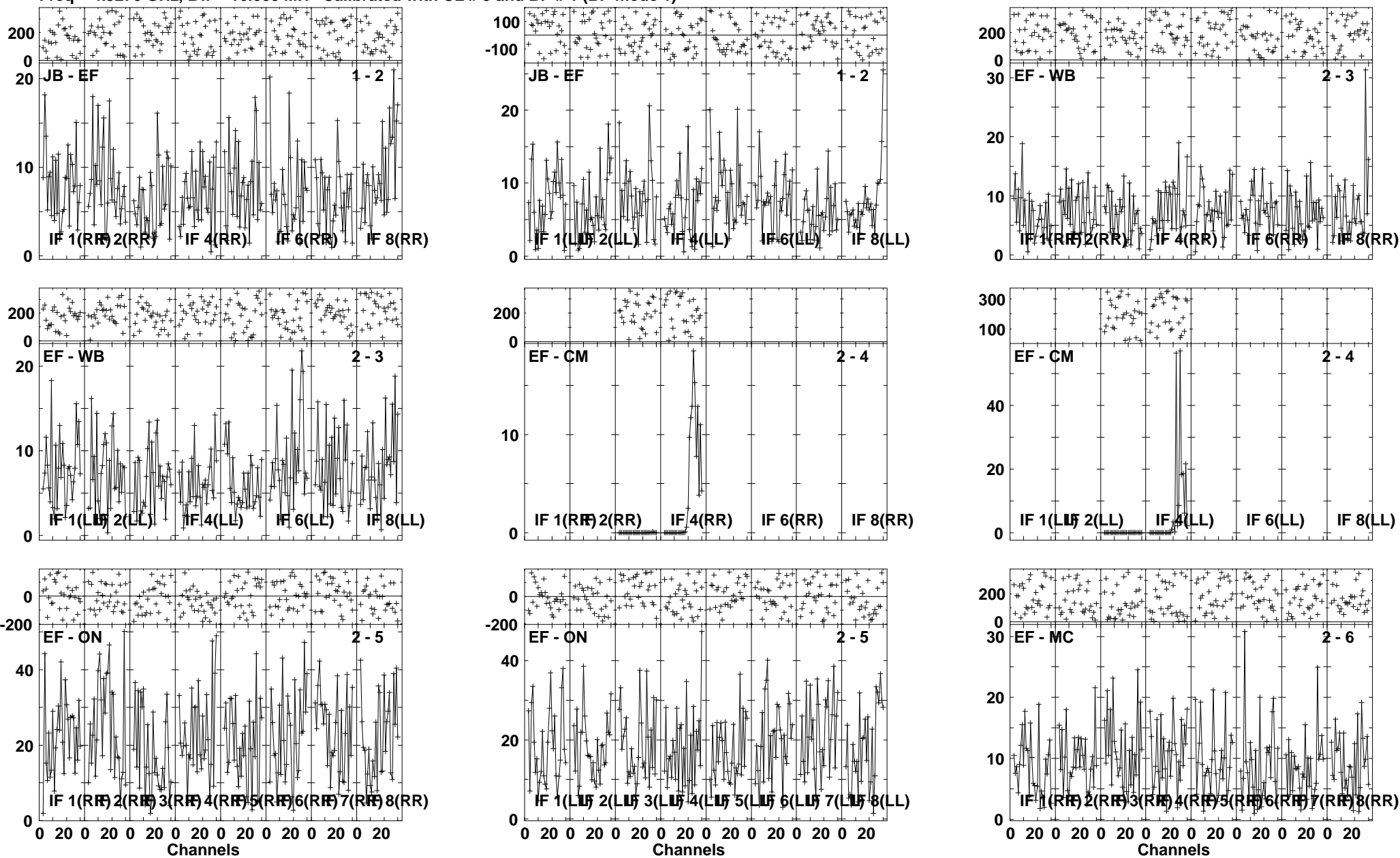

Lower frame: Milli Ampl Jy Top frame: Phas deg
Vector averaged cross-power spectrum Several baselines displayed
Timerange: 00/17:13:01 to 00/17:16:29

Plot file version 174 created 17-NOV-2010 16:21:47

ARP299D EP068A 5.UVDATA.1

Freq = 4.9270 GHz, Bw = 16.000 MH Calibrated with CL # 3 and BP # 1 (BP mode 1)

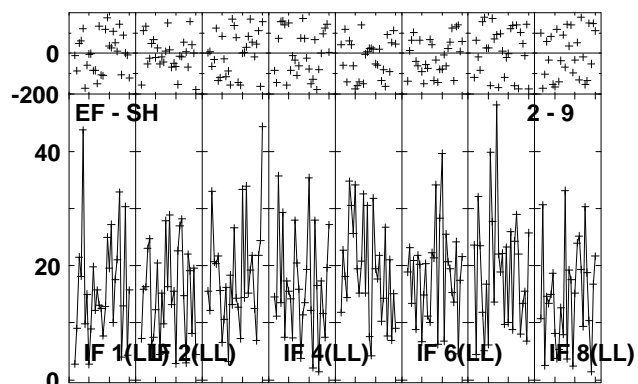
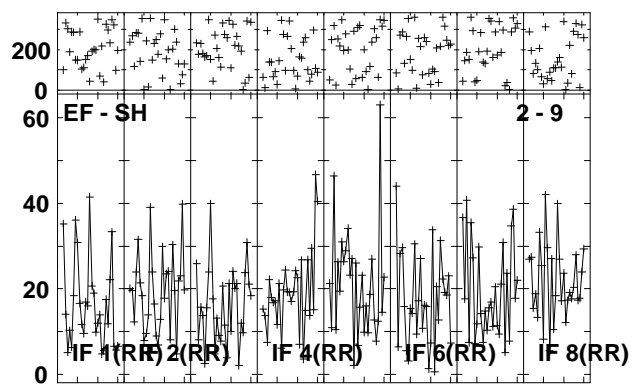
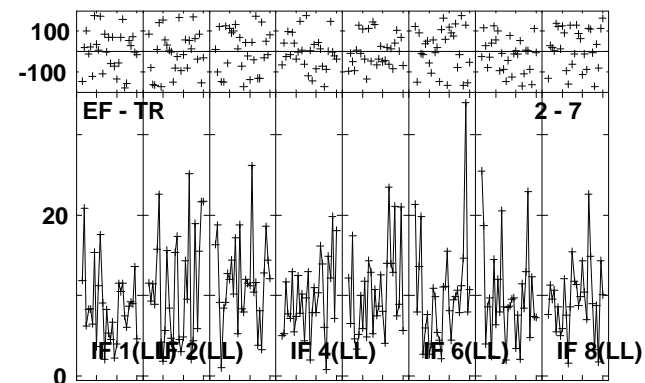
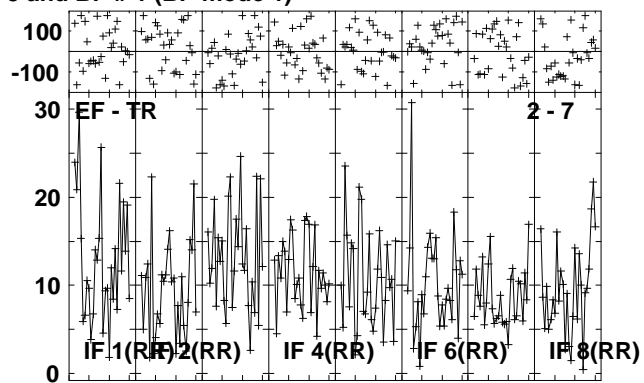
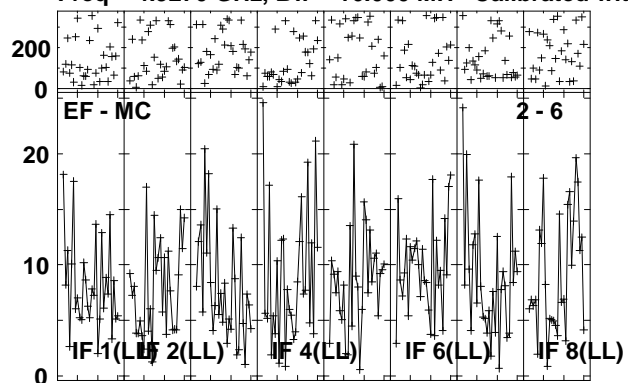

Lower frame: Milli Ampl Jy Top frame: Phas deg
Vector averaged cross-power spectrum Several baselines displayed
Timerange: 00/17:13:01 to 00/17:16:29

Plot file version 175 created 17-NOV-2010 16:21:50

J1128+59 EP068A 5.UVDATA.1

Freq = 4.9270 GHz, Bw = 16.000 MH Calibrated with CL # 3 and BP # 1 (BP mode 1)

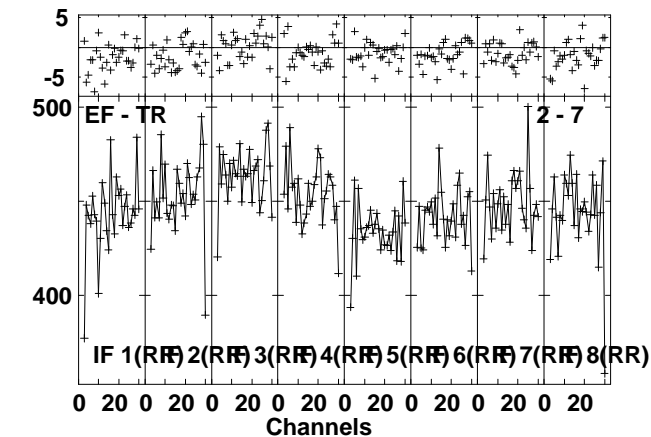
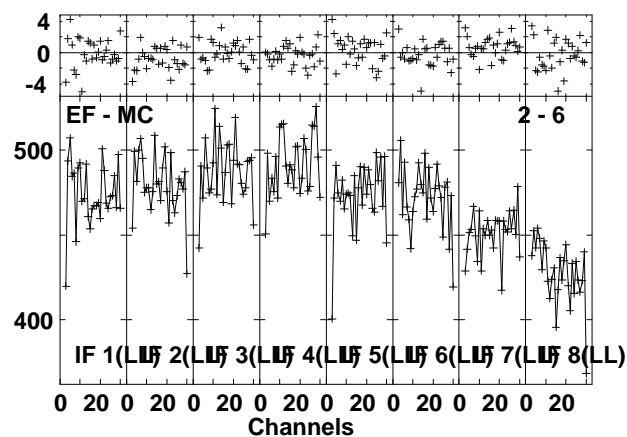
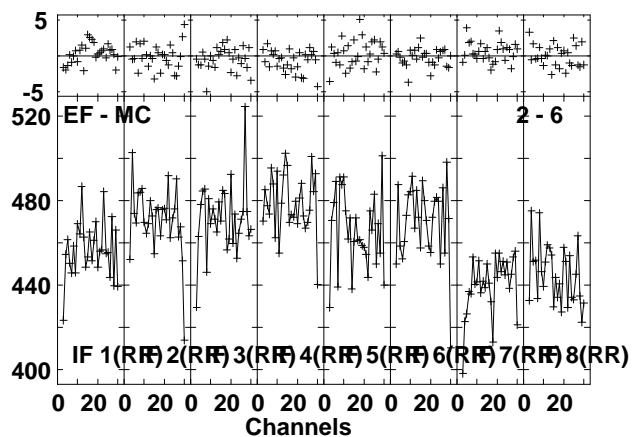
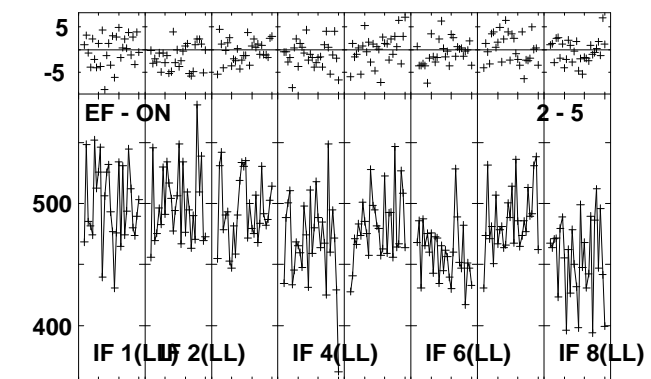
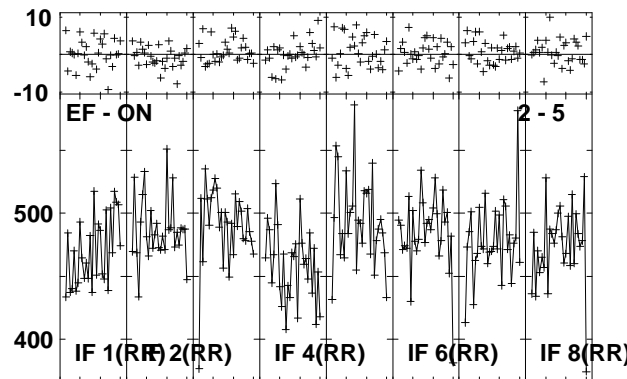
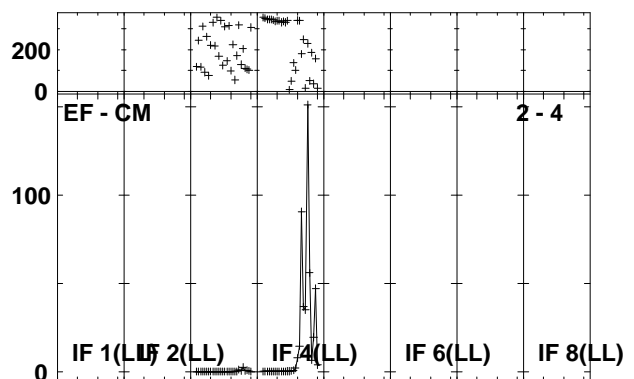
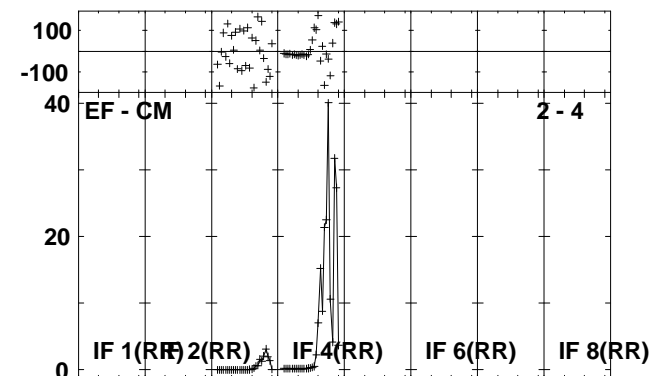
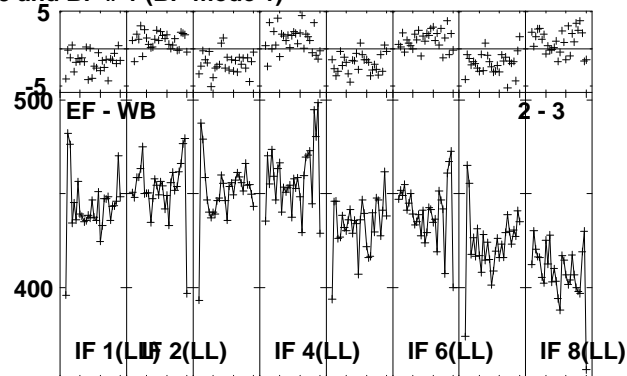
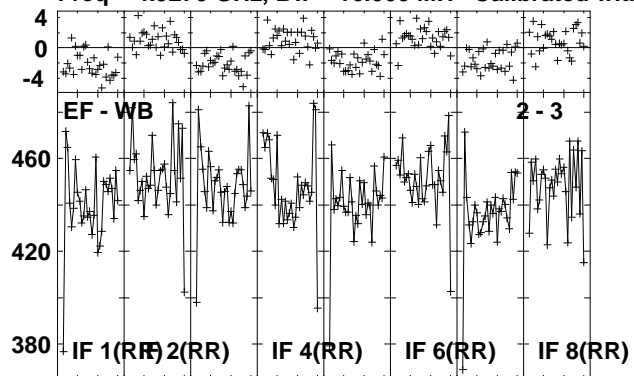

Lower frame: Milli Ampl Jy Top frame: Phas deg
Vector averaged cross-power spectrum Several baselines displayed
Timerange: 00/17:16:31 to 00/17:17:59

Plot file version 176 created 17-NOV-2010 16:21:51

J1128+59 EP068A 5.UVDATA.1

Freq = 4.9270 GHz, Bw = 16.000 MH Calibrated with CL # 3 and BP # 1 (BP mode 1)

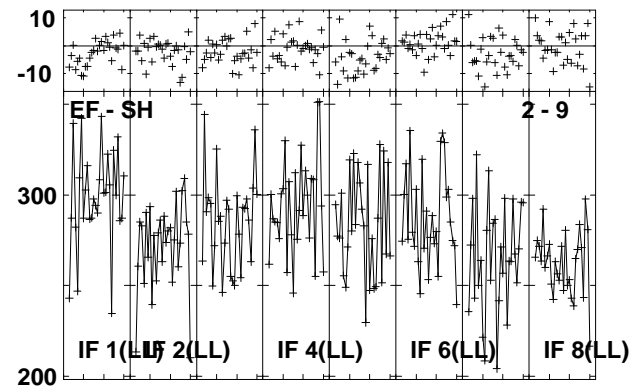
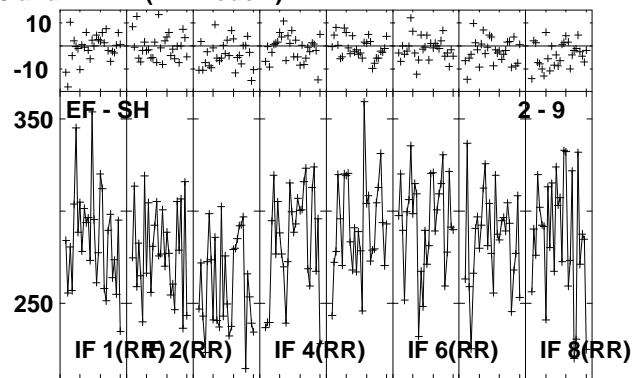
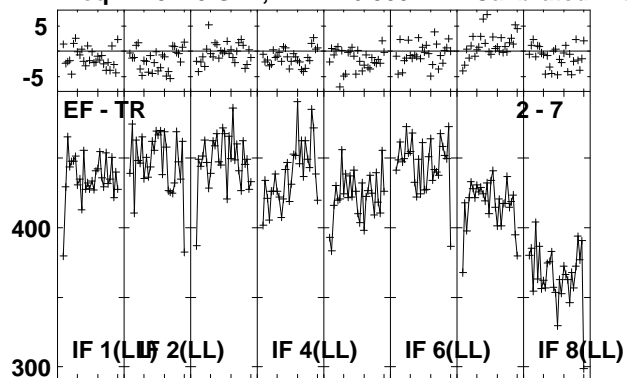

Lower frame: Milli Ampl Jy Top frame: Phas deg
Vector averaged cross-power spectrum Several baselines displayed
Timerange: 00/17:16:31 to 00/17:17:59

Plot file version 177 created 17-NOV-2010 16:21:53

ARP299D EP068A 5.UVDATA.1

Freq = 4.9270 GHz, Bw = 16.000 MH Calibrated with CL # 3 and BP # 1 (BP mode 1)

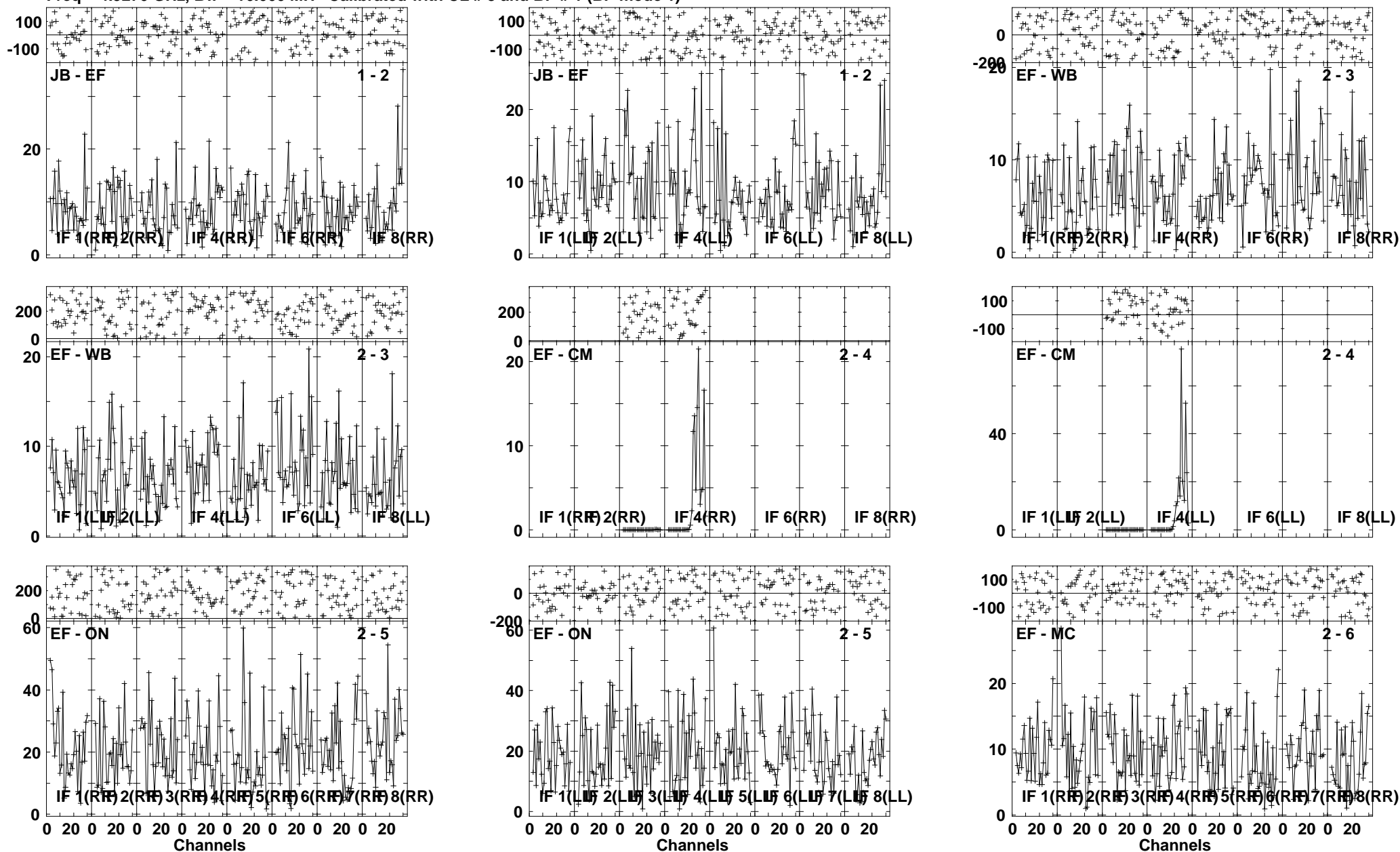

Lower frame: Milli Ampl Jy Top frame: Phas deg
Vector averaged cross-power spectrum Several baselines displayed
Timerange: 00/17:18:01 to 00/17:21:29

Plot file version 178 created 17-NOV-2010 16:21:55

ARP299D EP068A 5.UVDATA.1

Freq = 4.9270 GHz, Bw = 16.000 MH Calibrated with CL # 3 and BP # 1 (BP mode 1)

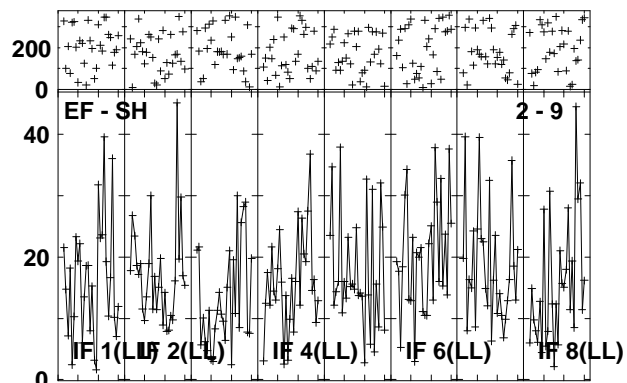
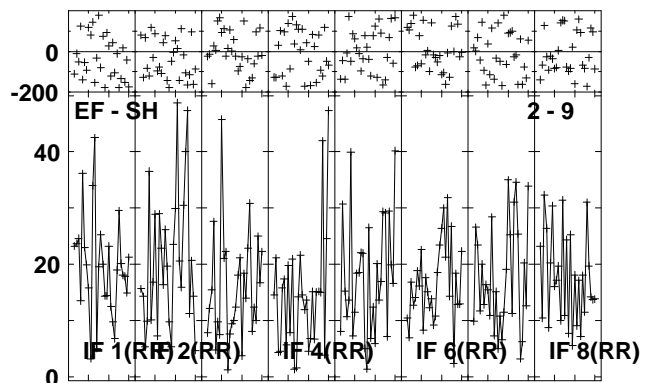
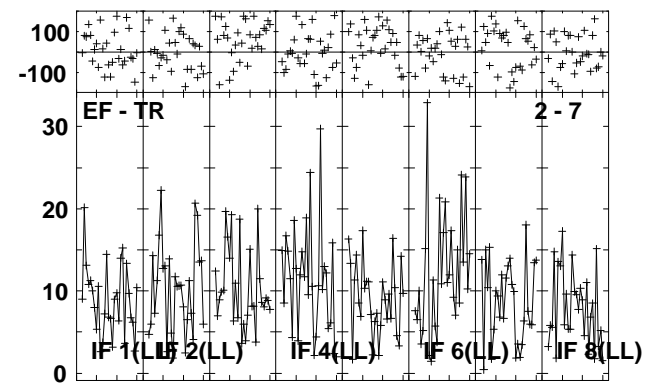
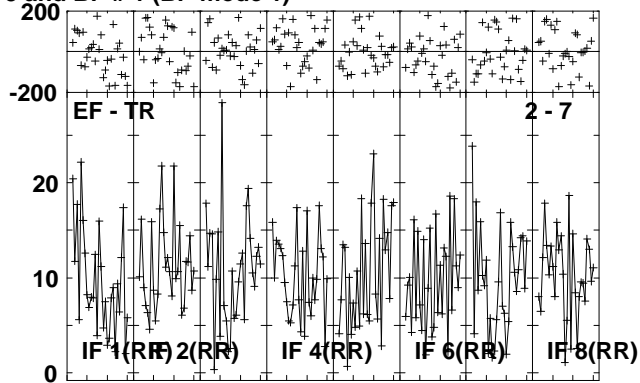
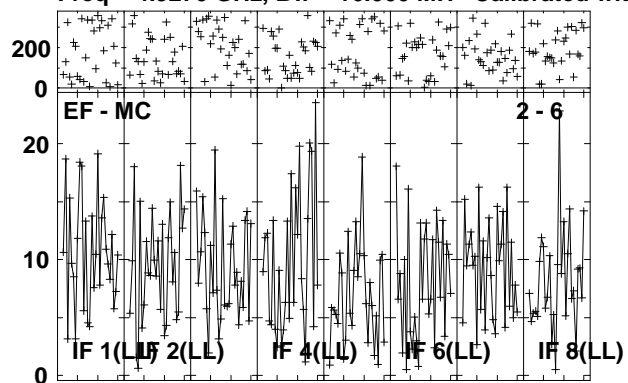

Lower frame: Milli Ampl Jy Top frame: Phas deg
Vector averaged cross-power spectrum Several baselines displayed
Timerange: 00/17:18:01 to 00/17:21:29

Plot file version 179 created 17-NOV-2010 16:21:58
 J1128+59 EP068A 5.UVDATA.1
 Freq = 4.9270 GHz, Bw = 16.000 MH Calibrated with CL # 3 and BP # 1 (BP mode 1)

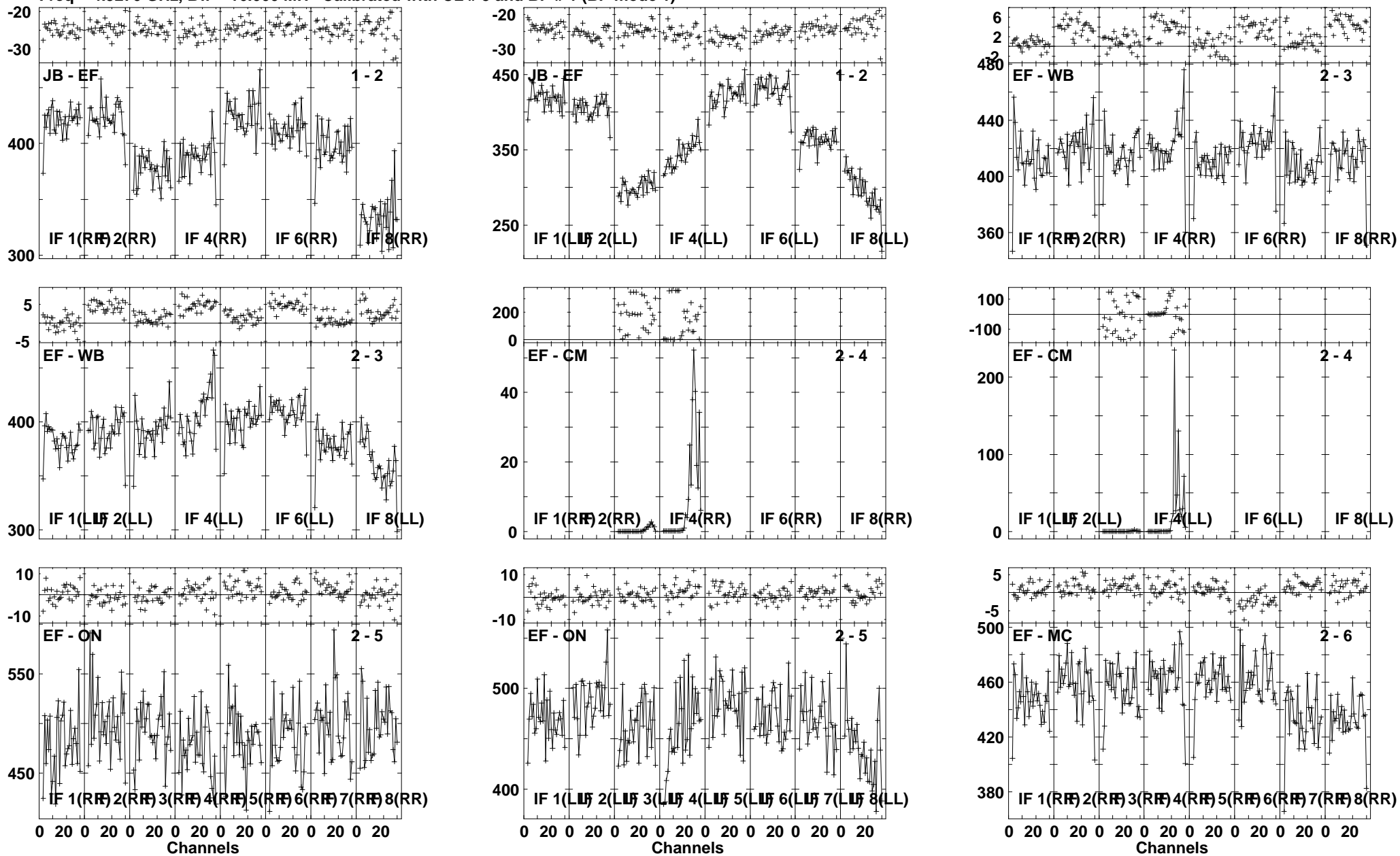

Lower frame: Milli Ampl Jy Top frame: Phas deg
 Vector averaged cross-power spectrum Several baselines displayed
 Timerange: 00/17:21:31 to 00/17:22:59

Plot file version 180 created 17-NOV-2010 16:21:59

J1128+59 EP068A 5.UVDATA.1

Freq = 4.9270 GHz, Bw = 16.000 MH Calibrated with CL # 3 and BP # 1 (BP mode 1)

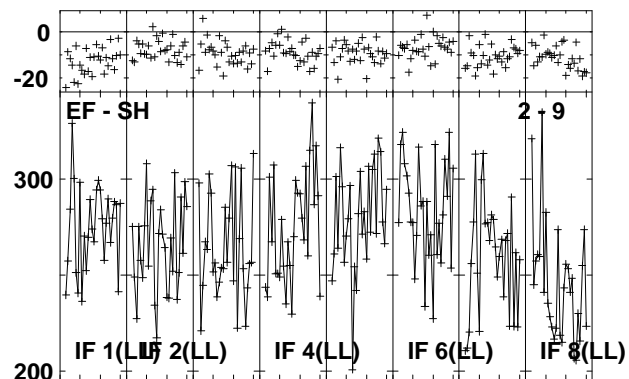
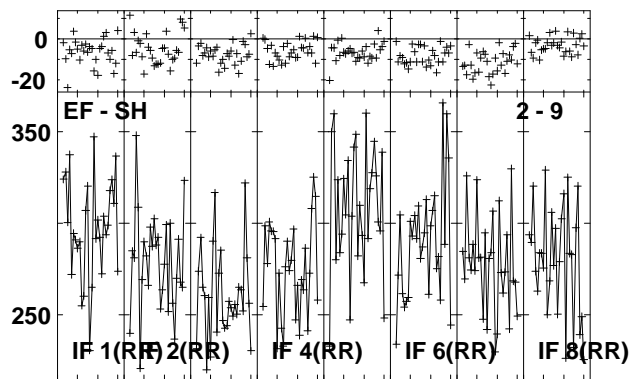
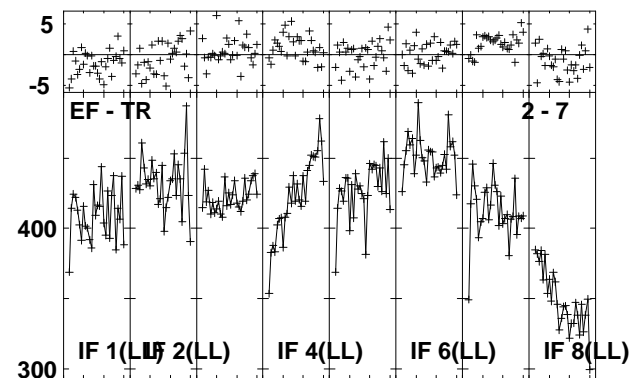
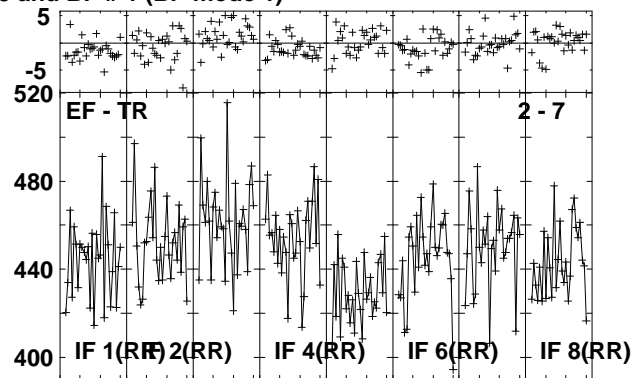
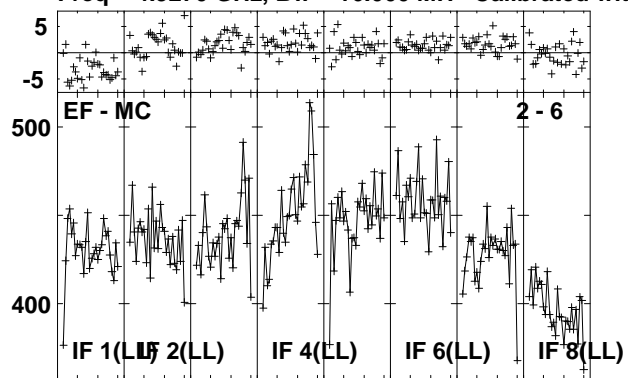

Lower frame: Milli Ampl Jy Top frame: Phas deg
Vector averaged cross-power spectrum Several baselines displayed
Timerange: 00/17:21:31 to 00/17:22:59

Plot file version 181 created 17-NOV-2010 16:22:00

ARP299D EP068A 5.UVDATA.1

Freq = 4.9270 GHz, Bw = 16.000 MH Calibrated with CL # 3 and BP # 1 (BP mode 1)

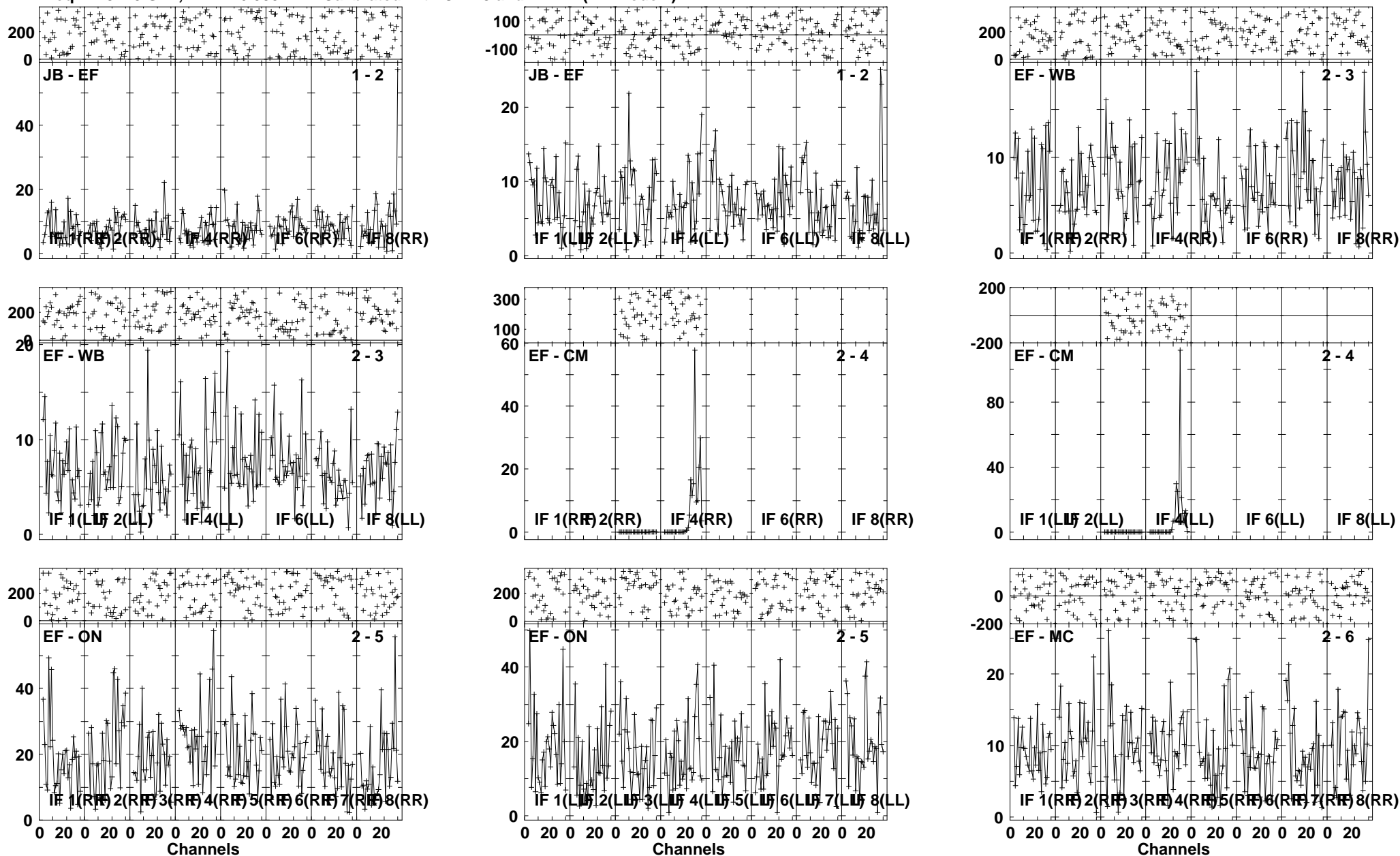

Lower frame: Milli Ampl Jy Top frame: Phas deg
Vector averaged cross-power spectrum Several baselines displayed
Timerange: 00/17:23:01 to 00/17:26:29

Plot file version 182 created 17-NOV-2010 16:22:03

ARP299D EP068A 5.UVDATA.1

Freq = 4.9270 GHz, Bw = 16.000 MH Calibrated with CL # 3 and BP # 1 (BP mode 1)

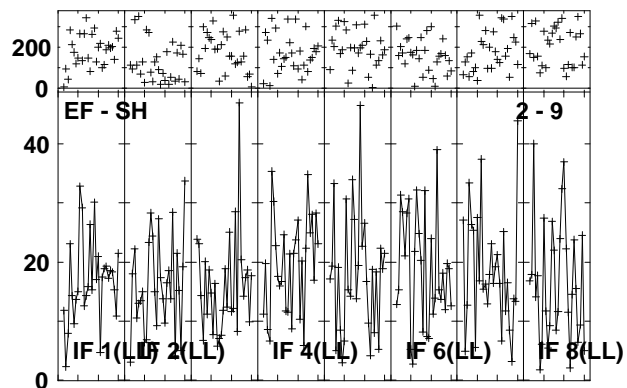
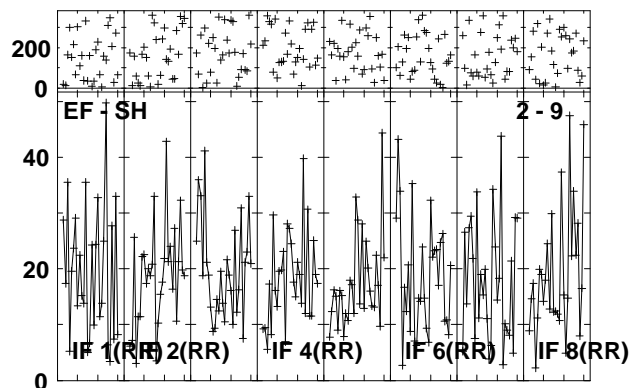
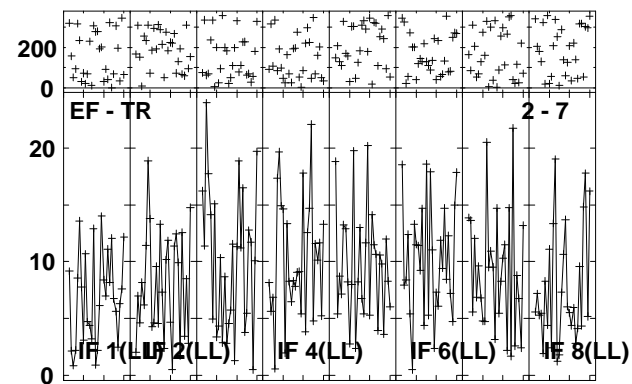
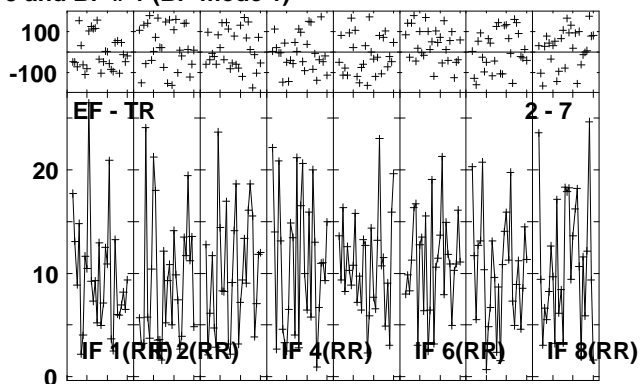
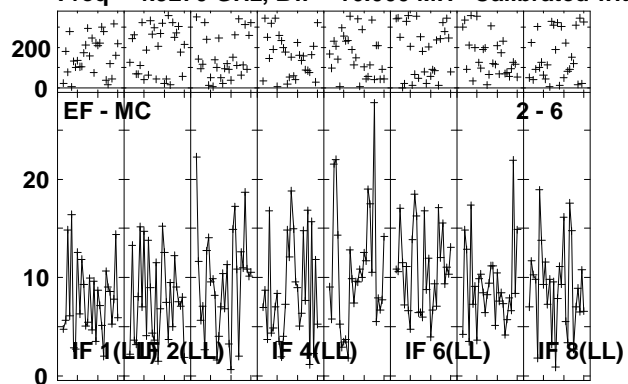

Lower frame: Milli Ampl Jy Top frame: Phas deg
Vector averaged cross-power spectrum Several baselines displayed
Timerange: 00/17:23:01 to 00/17:26:29

Plot file version 183 created 17-NOV-2010 16:22:06

J1128+59 EP068A 5.UVDATA.1

Freq = 4.9270 GHz, Bw = 16.000 MH Calibrated with CL # 3 and BP # 1 (BP mode 1)

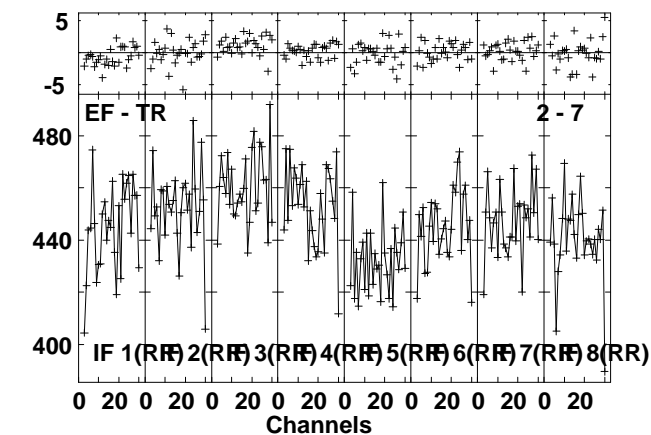
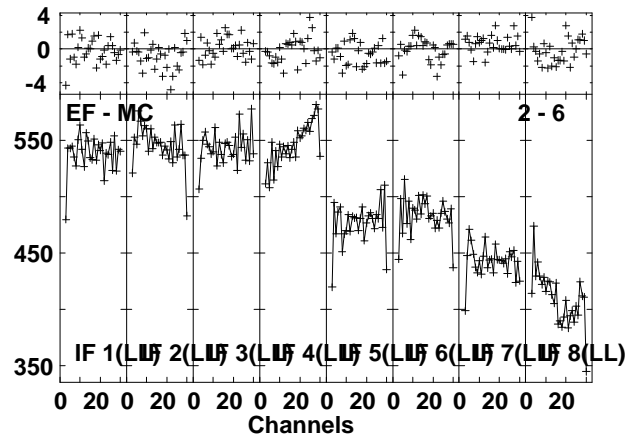
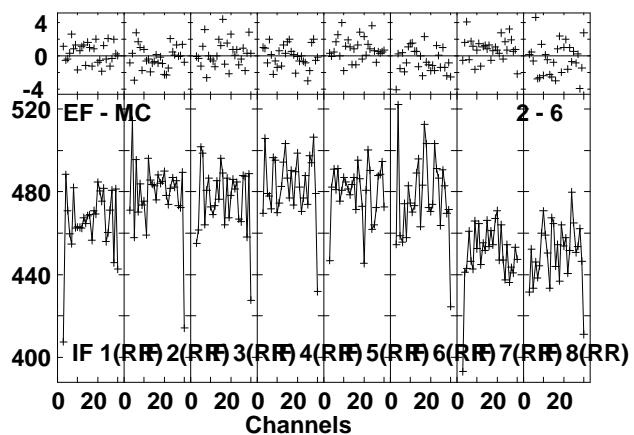
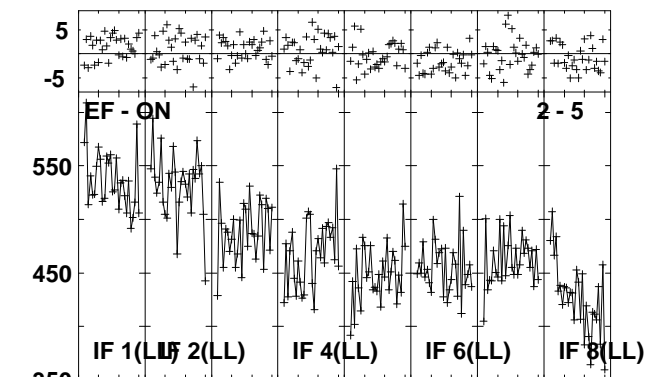
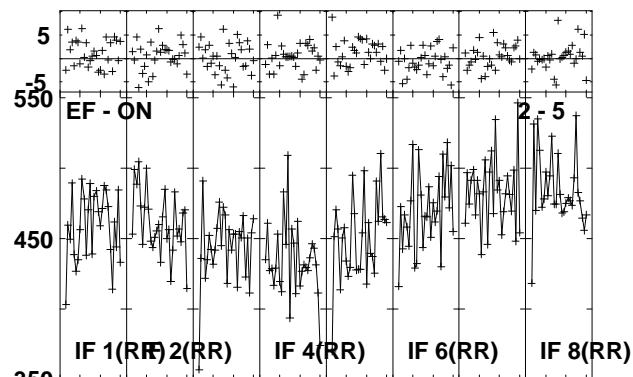
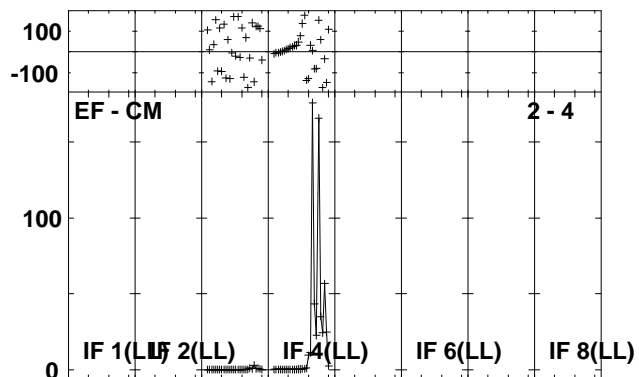
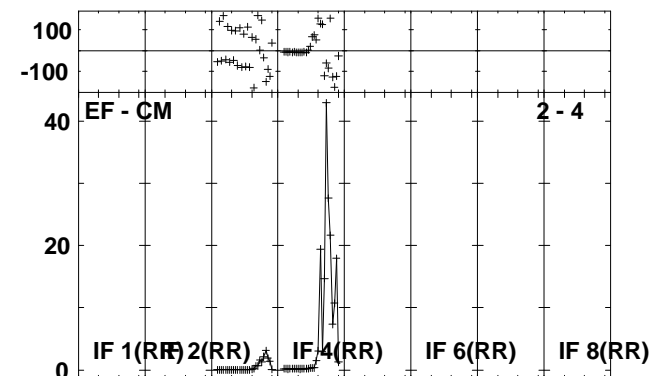
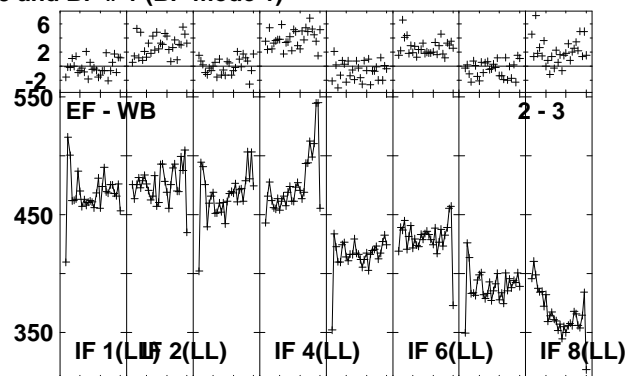
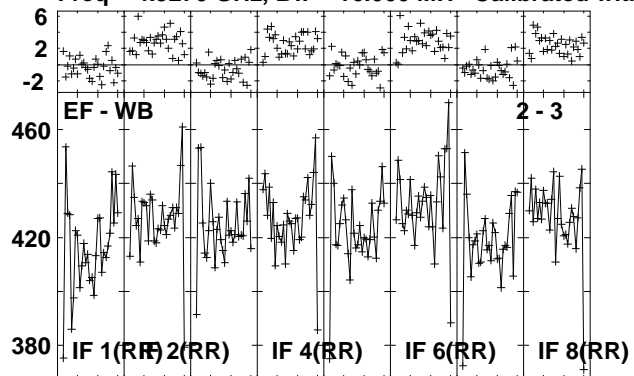

Lower frame: Milli Ampl Jy Top frame: Phas deg
Vector averaged cross-power spectrum Several baselines displayed
Timerange: 00/17:27:31 to 00/17:28:57

Plot file version 184 created 17-NOV-2010 16:22:07

J1128+59 EP068A 5.UVDATA.1

Freq = 4.9270 GHz, Bw = 16.000 MH Calibrated with CL # 3 and BP # 1 (BP mode 1)

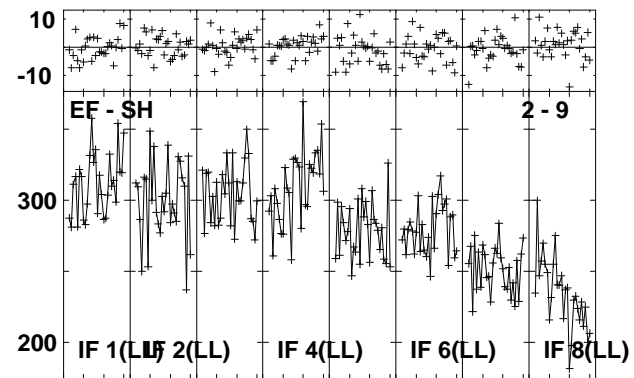
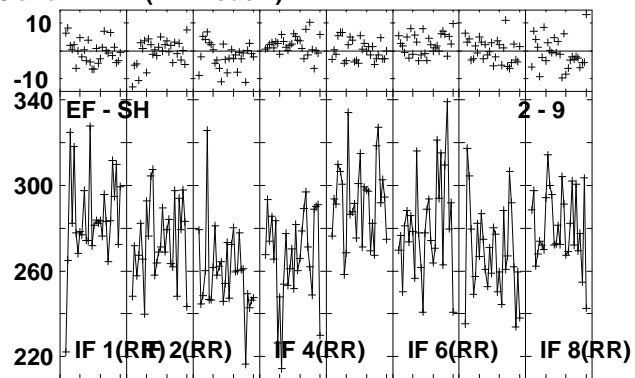
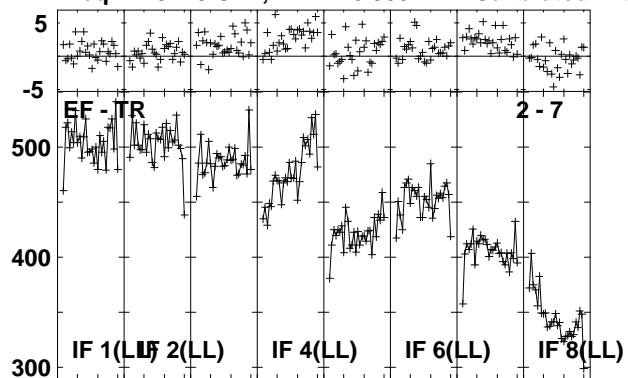

Lower frame: Milli Ampl Jy Top frame: Phas deg
Vector averaged cross-power spectrum Several baselines displayed
Timerange: 00/17:27:31 to 00/17:28:57

Plot file version 185 created 17-NOV-2010 16:22:08

ARP299D EP068A 5.UVDATA.1

Freq = 4.9270 GHz, Bw = 16.000 MH Calibrated with CL # 3 and BP # 1 (BP mode 1)

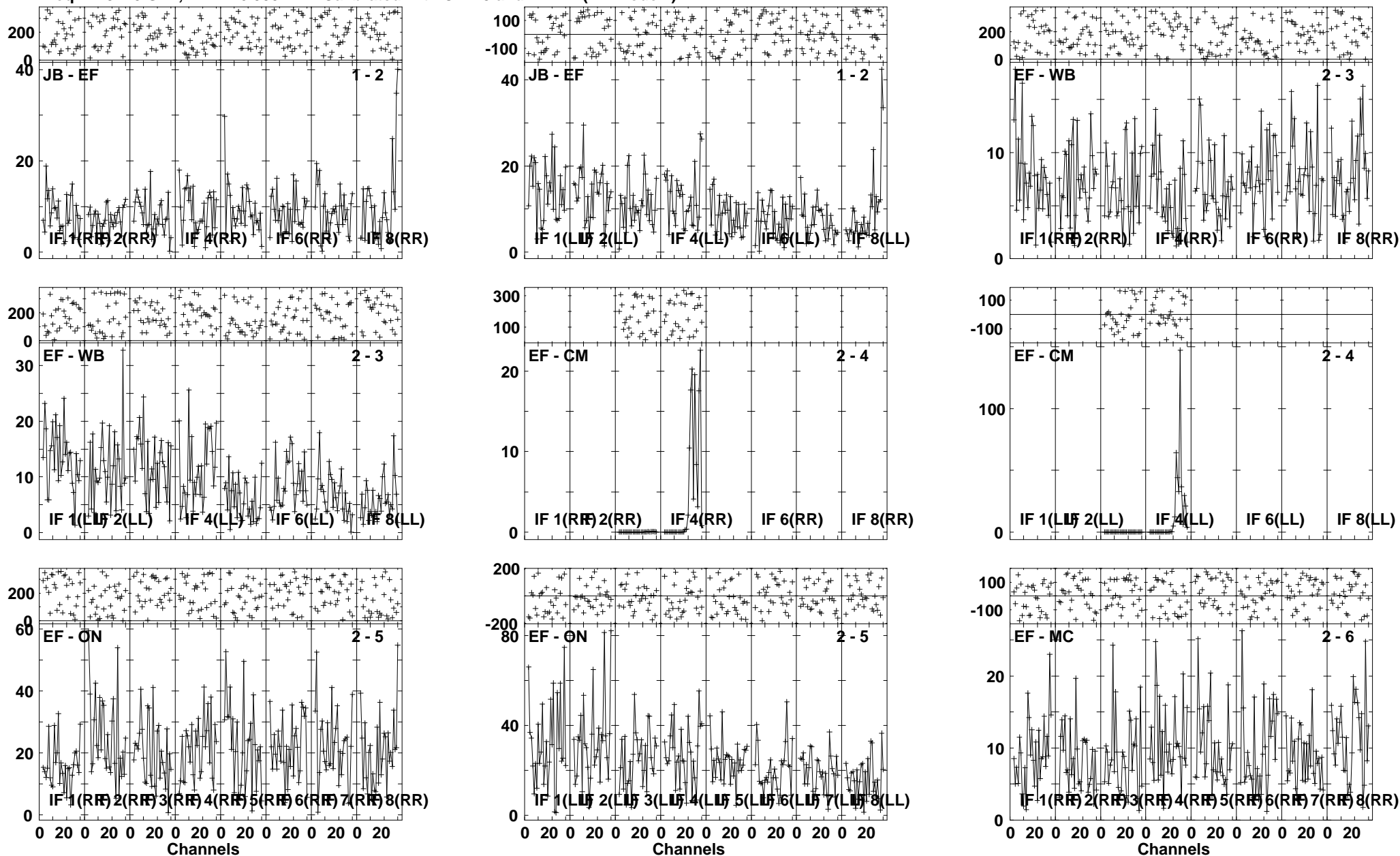

Lower frame: Milli Ampl Jy Top frame: Phas deg
Vector averaged cross-power spectrum Several baselines displayed
Timerange: 00/17:29:01 to 00/17:32:29

Plot file version 186 created 17-NOV-2010 16:22:11

ARP299D EP068A 5.UVDATA.1

Freq = 4.9270 GHz, Bw = 16.000 MH Calibrated with CL # 3 and BP # 1 (BP mode 1)

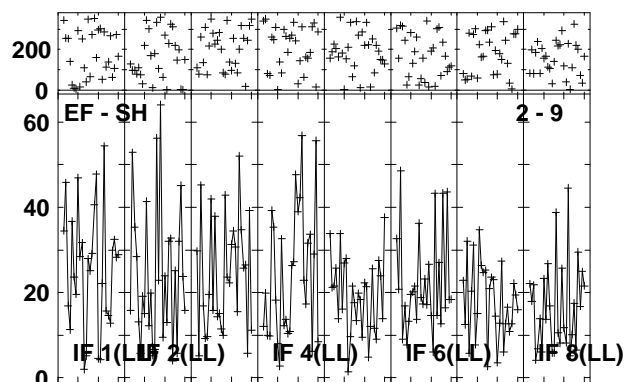
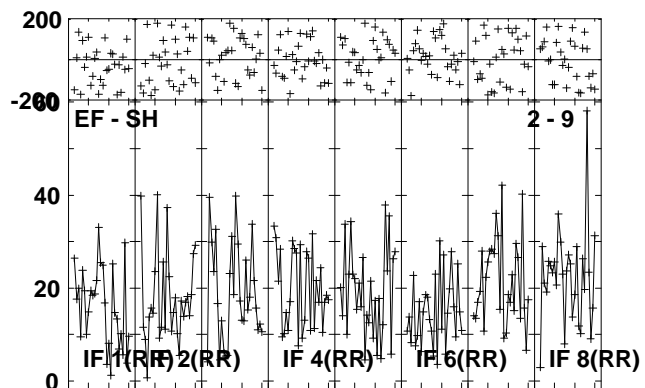
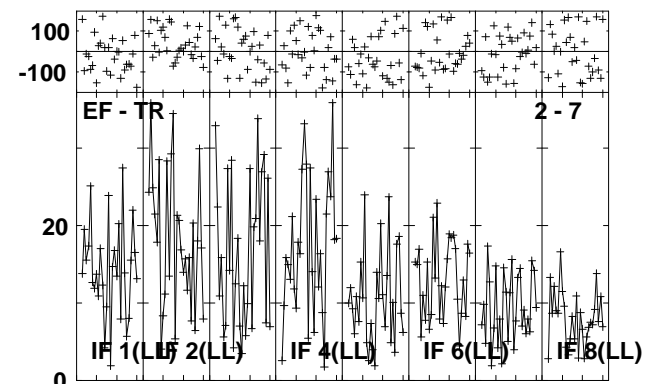
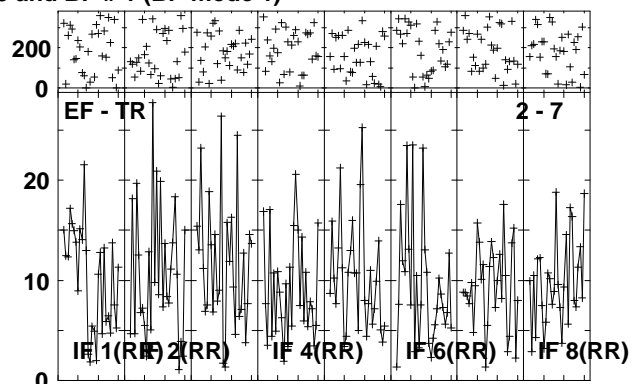
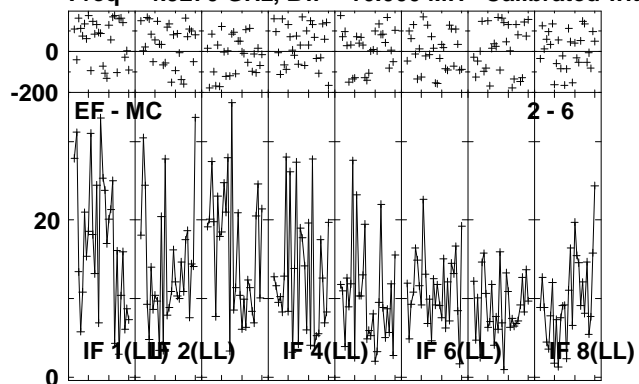

Lower frame: Milli Ampl Jy Top frame: Phas deg
Vector averaged cross-power spectrum Several baselines displayed
Timerange: 00/17:29:01 to 00/17:32:29

Plot file version 187 created 17-NOV-2010 16:22:13

J1128+59 EP068A 5.UVDATA.1

Freq = 4.9270 GHz, Bw = 16.000 MH Calibrated with CL # 3 and BP # 1 (BP mode 1)

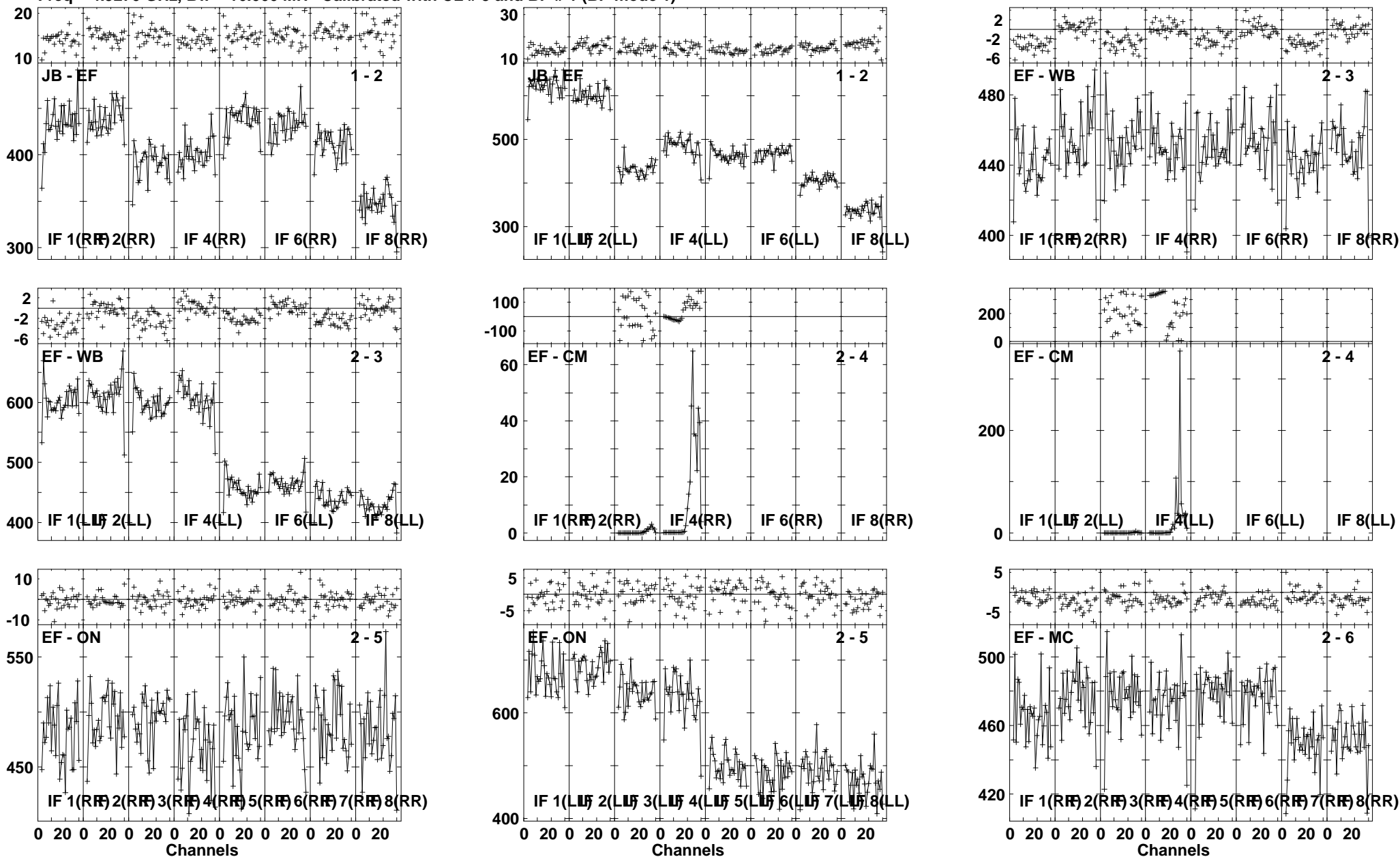

Lower frame: Milli Ampl Jy Top frame: Phas deg
Vector averaged cross-power spectrum Several baselines displayed
Timerange: 00/17:32:31 to 00/17:33:59

Plot file version 188 created 17-NOV-2010 16:22:14

J1128+59 EP068A 5.UVDATA.1

Freq = 4.9270 GHz, Bw = 16.000 MH Calibrated with CL # 3 and BP # 1 (BP mode 1)

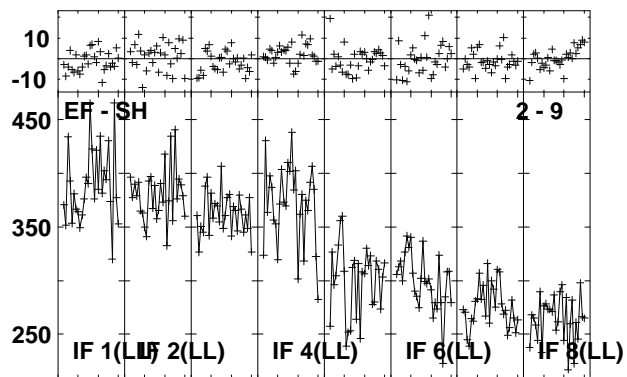
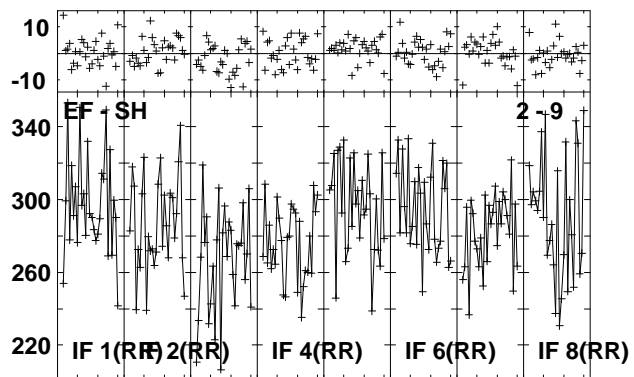
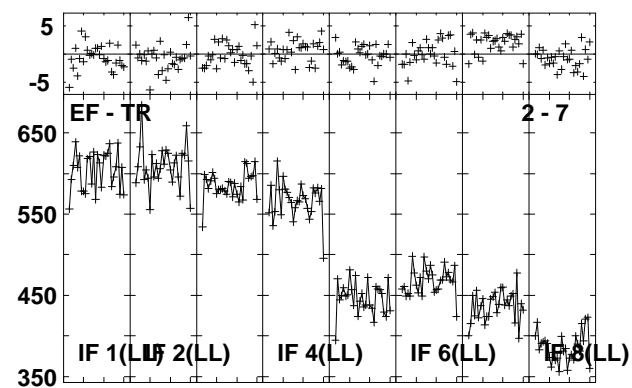
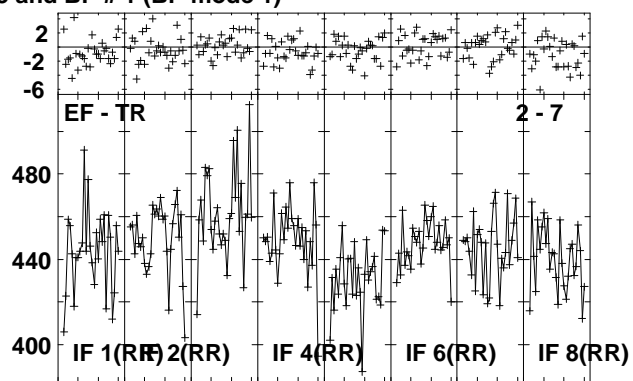
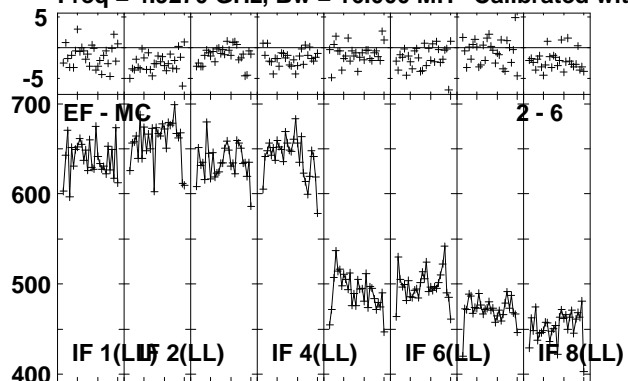

Lower frame: Milli Ampl Jy Top frame: Phas deg
Vector averaged cross-power spectrum Several baselines displayed
Timerange: 00:17:32:31 to 00:17:33:59

Plot file version 189 created 17-NOV-2010 16:22:16

ARP299D EP068A 5.UVDATA.1

Freq = 4.9270 GHz, Bw = 16.000 MH Calibrated with CL # 3 and BP # 1 (BP mode 1)

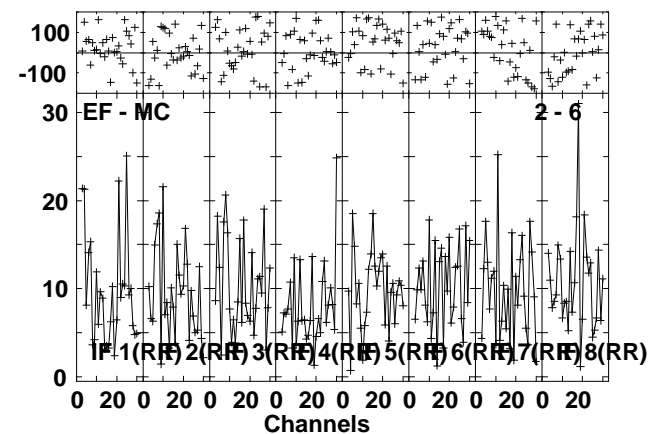
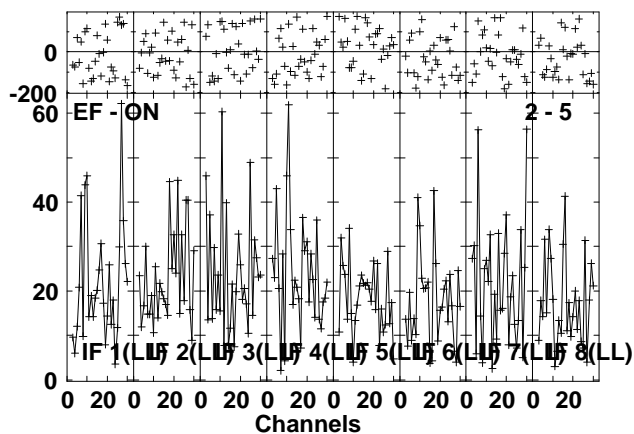
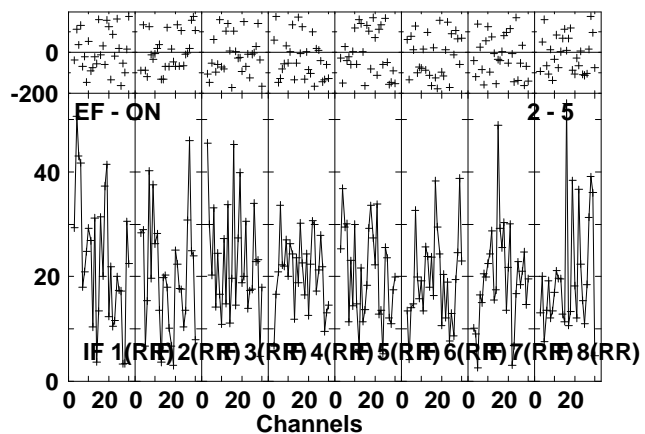
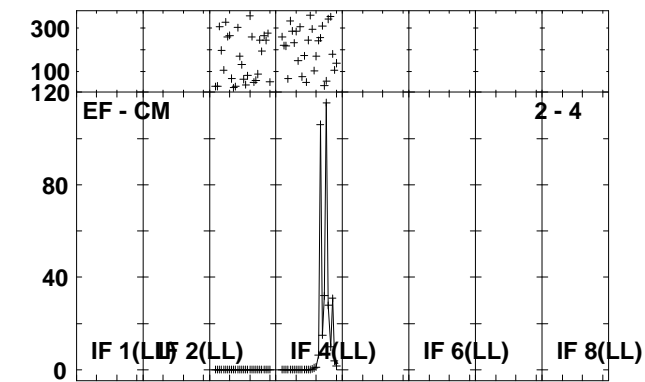
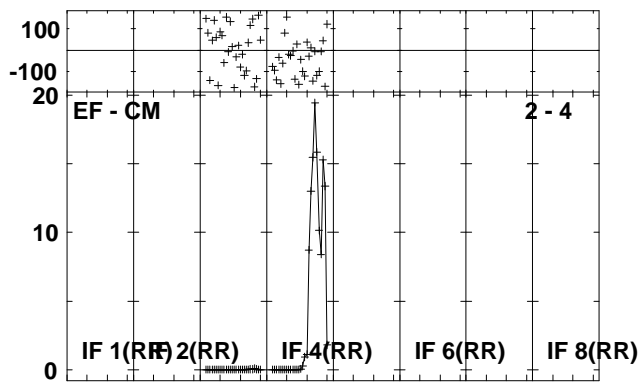
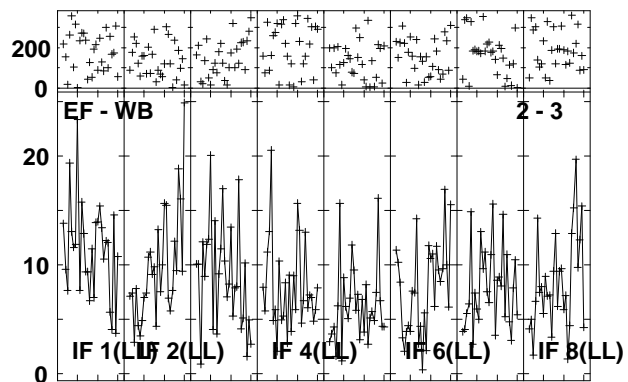
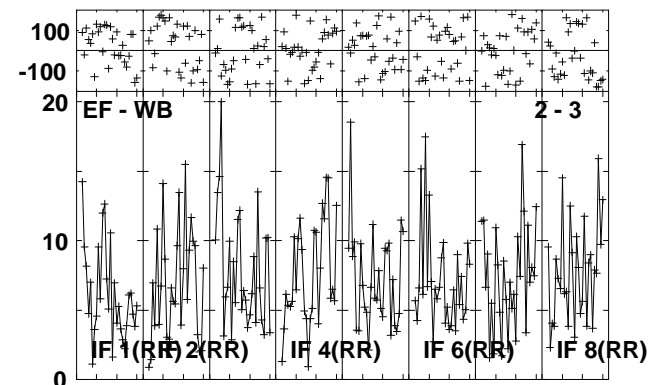
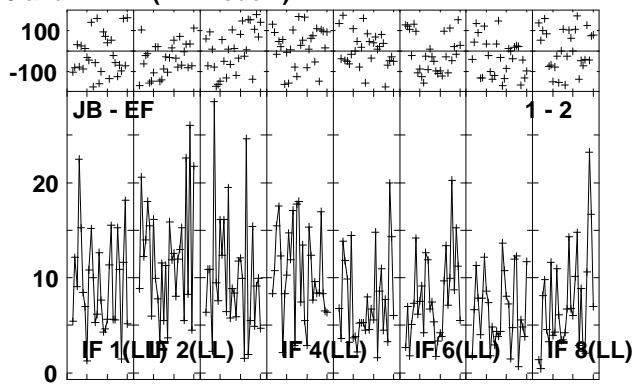
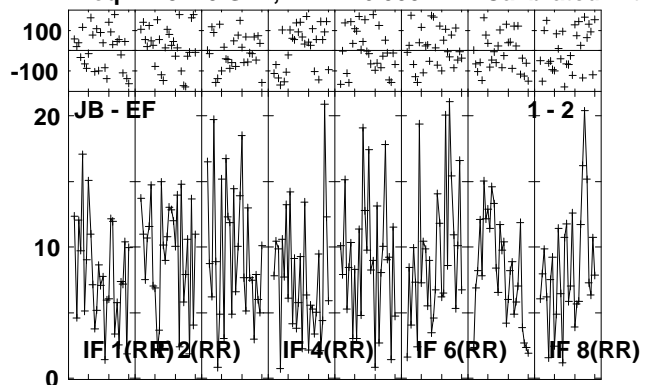

Lower frame: Milli Ampl Jy Top frame: Phas deg
Vector averaged cross-power spectrum Several baselines displayed
Timerange: 00/17:34:01 to 00/17:37:29

Plot file version 190 created 17-NOV-2010 16:22:18

ARP299D EP068A 5.UVDATA.1

Freq = 4.9270 GHz, Bw = 16.000 MH Calibrated with CL # 3 and BP # 1 (BP mode 1)

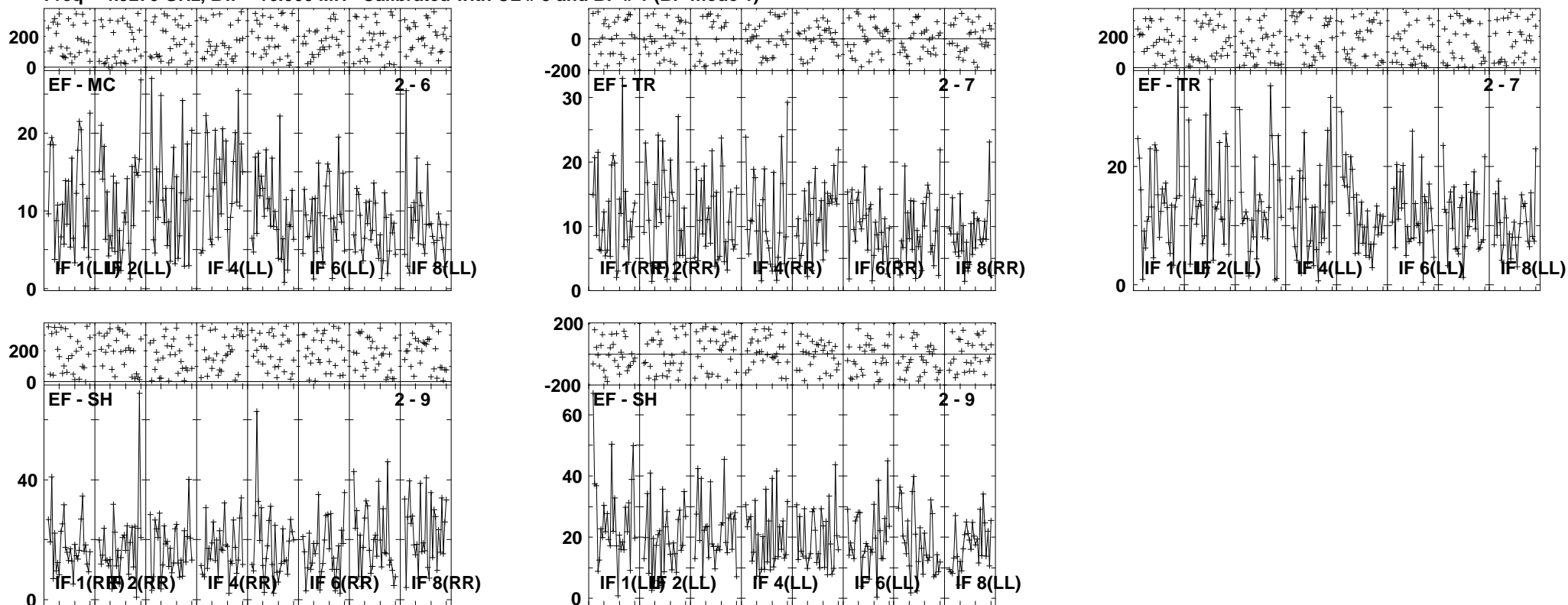

Lower frame: Milli Ampl Jy Top frame: Phas deg
Vector averaged cross-power spectrum Several baselines displayed
Timerange: 00/17:34:01 to 00/17:37:29

Plot file version 191 created 17-NOV-2010 16:22:21
 J1128+59 EP068A 5.UVDATA.1
 Freq = 4.9270 GHz, Bw = 16.000 MH Calibrated with CL # 3 and BP # 1 (BP mode 1)

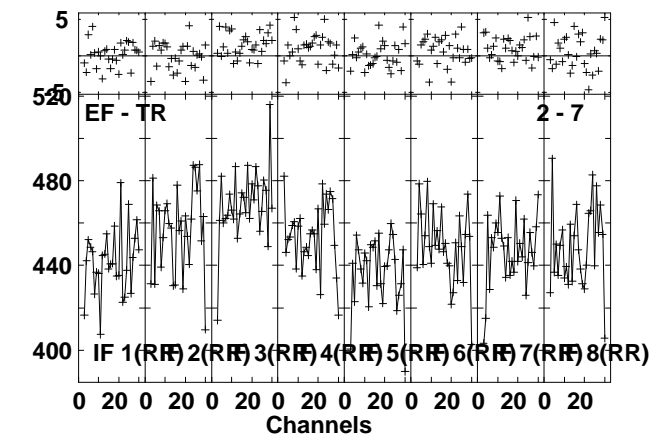
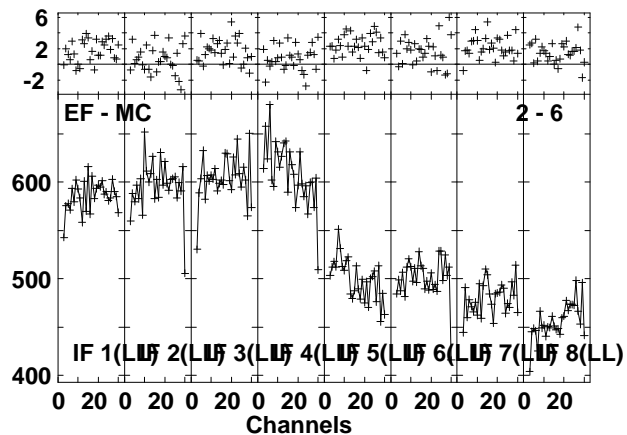
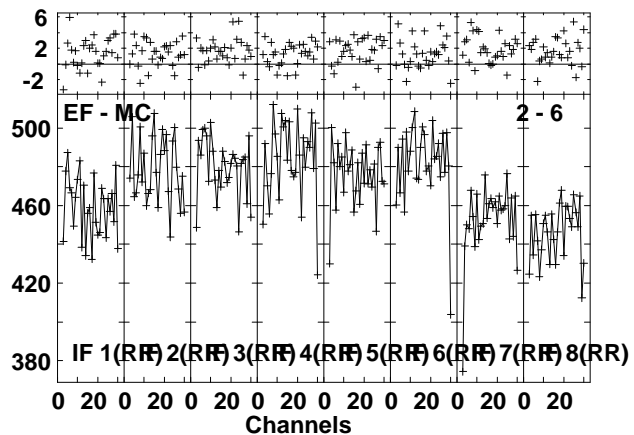
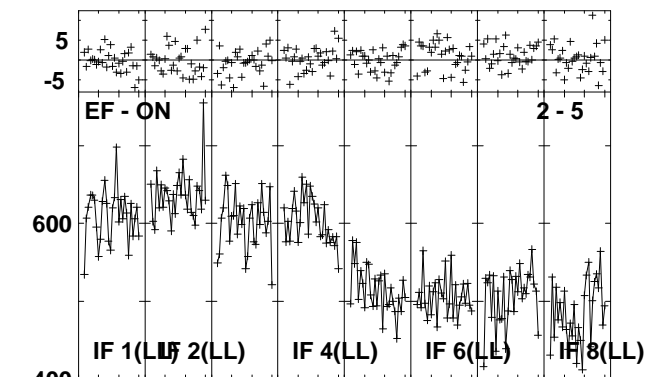
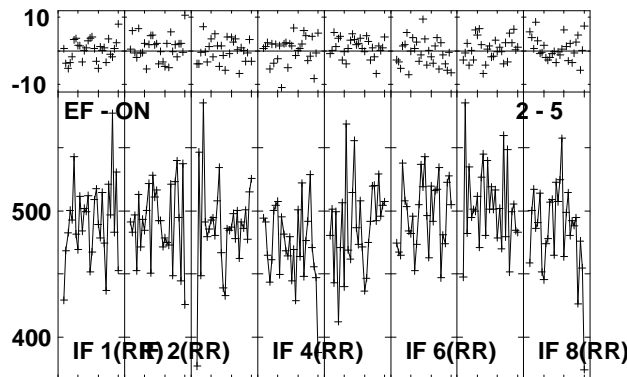
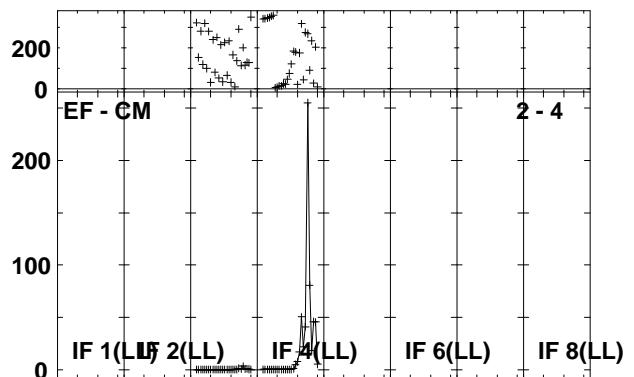
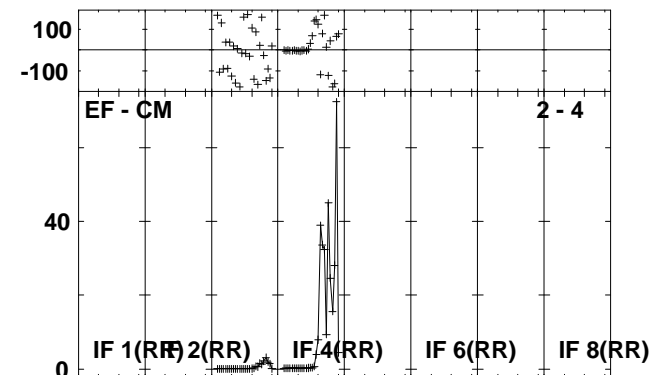
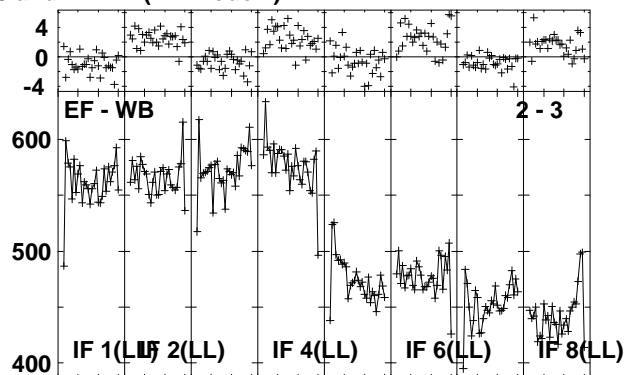
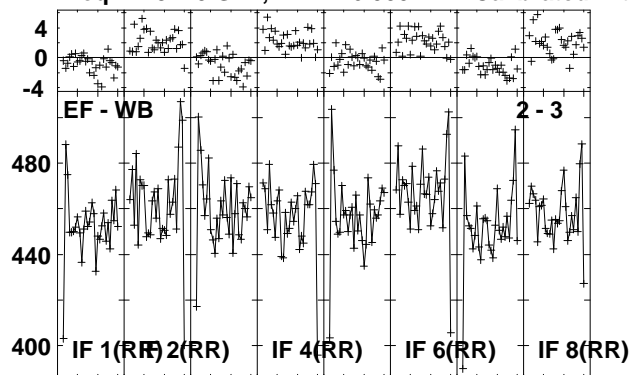

Lower frame: Milli Ampl Jy Top frame: Phas deg
 Vector averaged cross-power spectrum Several baselines displayed
 Timerange: 00/17:37:31 to 00/17:38:59

Plot file version 192 created 17-NOV-2010 16:22:22

J1128+59 EP068A 5.UVDATA.1

Freq = 4.9270 GHz, Bw = 16.000 MH Calibrated with CL # 3 and BP # 1 (BP mode 1)

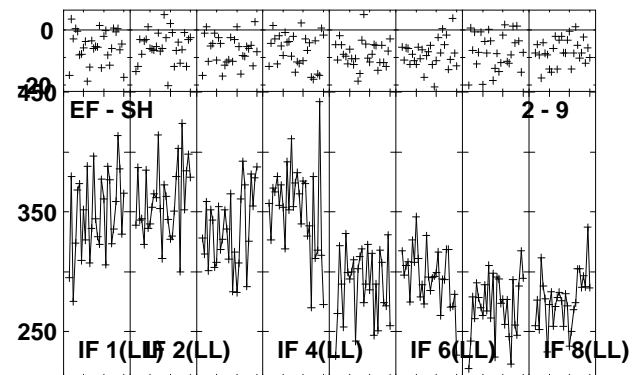
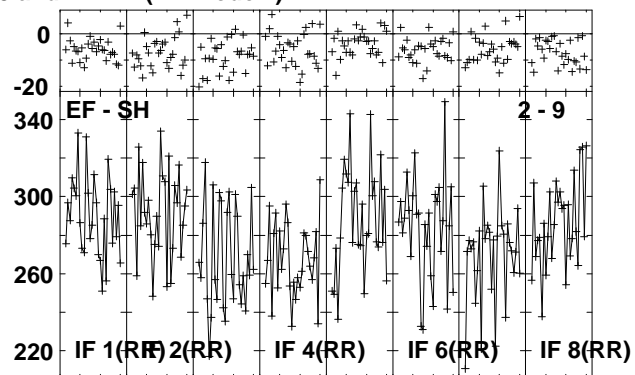
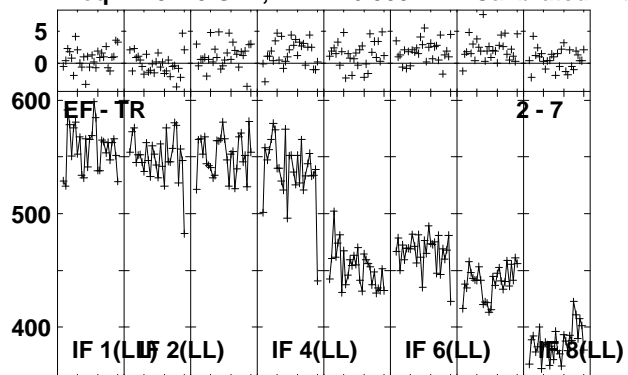

Lower frame: Milli Ampl Jy Top frame: Phas deg
Vector averaged cross-power spectrum Several baselines displayed
Timerange: 00/17:37:31 to 00/17:38:59

Plot file version 193 created 17-NOV-2010 16:22:24

ARP299D EP068A 5.UVDATA.1

Freq = 4.9270 GHz, Bw = 16.000 MH Calibrated with CL # 3 and BP # 1 (BP mode 1)

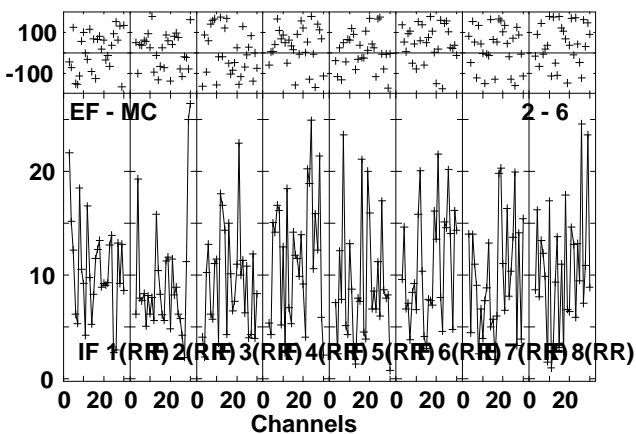
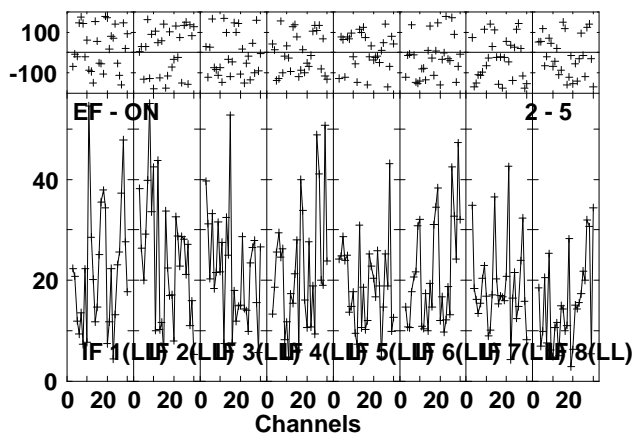
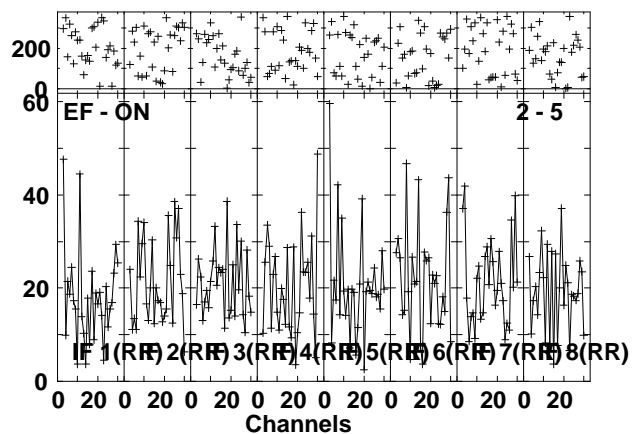
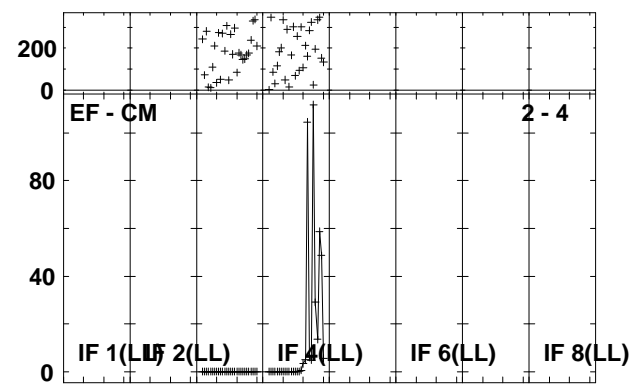
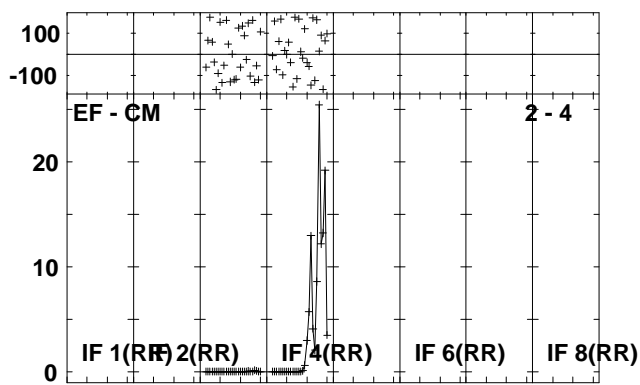
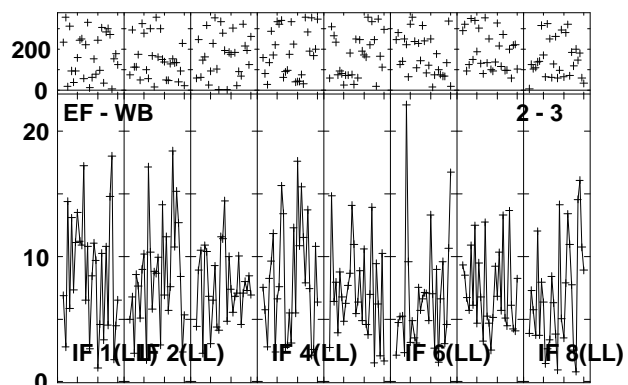
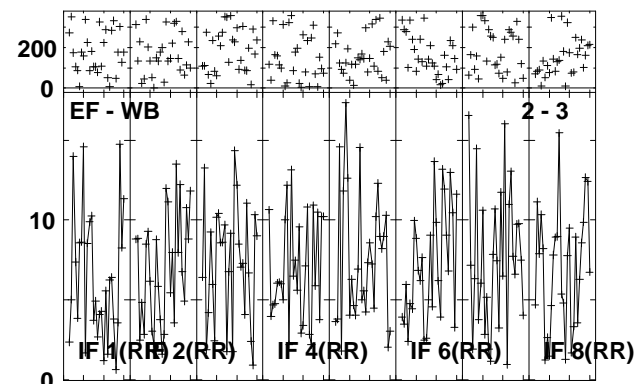
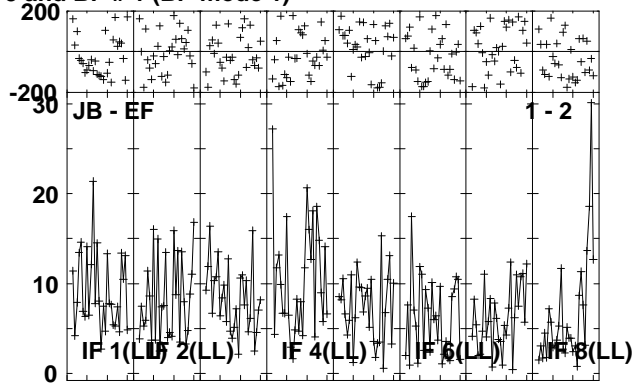
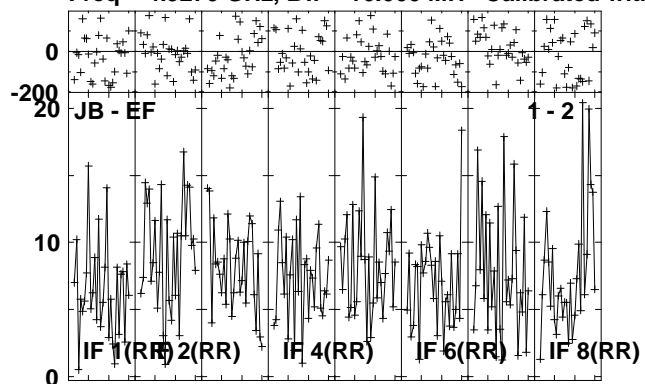

Lower frame: Milli Ampl Jy Top frame: Phas deg
Vector averaged cross-power spectrum Several baselines displayed
Timerange: 00/17:39:01 to 00/17:42:29

Plot file version 194 created 17-NOV-2010 16:22:26

ARP299D EP068A 5.UVDATA.1

Freq = 4.9270 GHz, Bw = 16.000 MH Calibrated with CL # 3 and BP # 1 (BP mode 1)

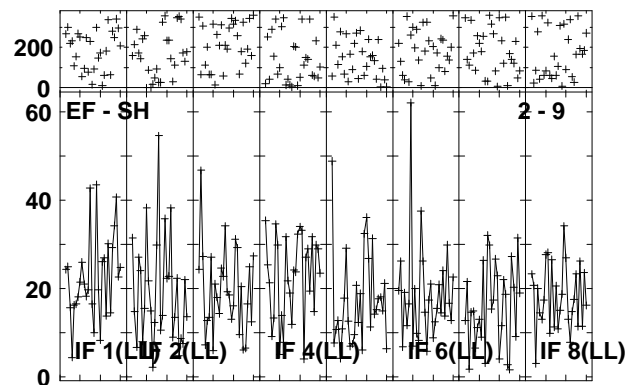
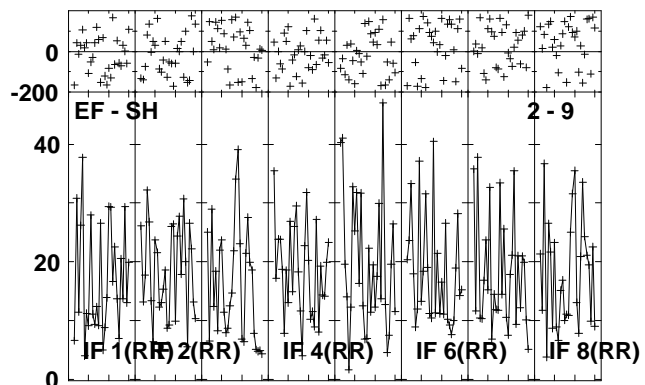
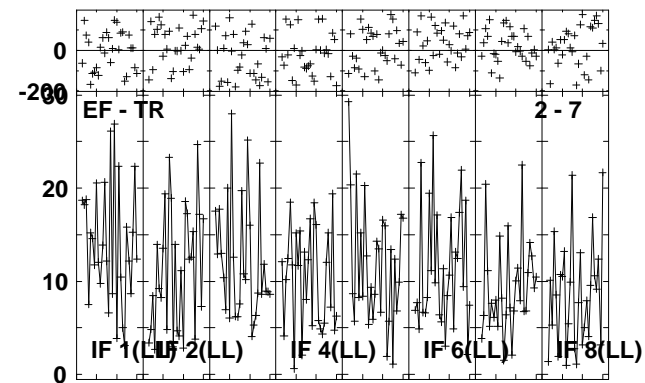
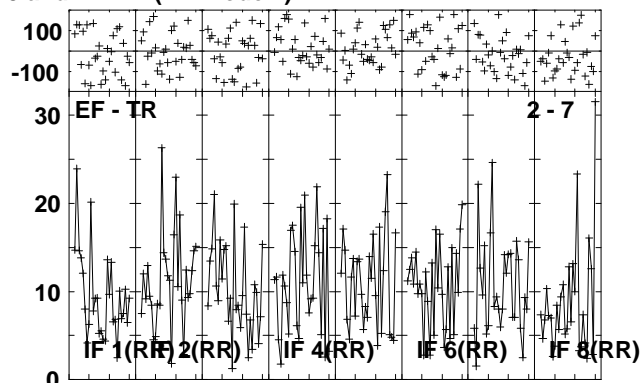
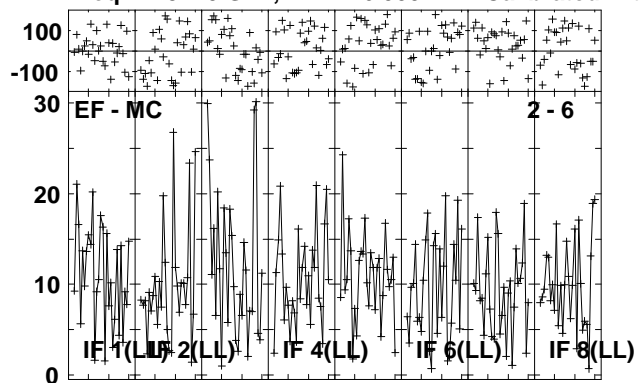

Lower frame: Milli Ampl Jy Top frame: Phas deg
Vector averaged cross-power spectrum Several baselines displayed
Timerange: 00:17:39:01 to 00:17:42:29

Plot file version 195 created 17-NOV-2010 16:22:29

J1128+59 EP068A 5.UVDATA.1

Freq = 4.9270 GHz, Bw = 16.000 MH Calibrated with CL # 3 and BP # 1 (BP mode 1)

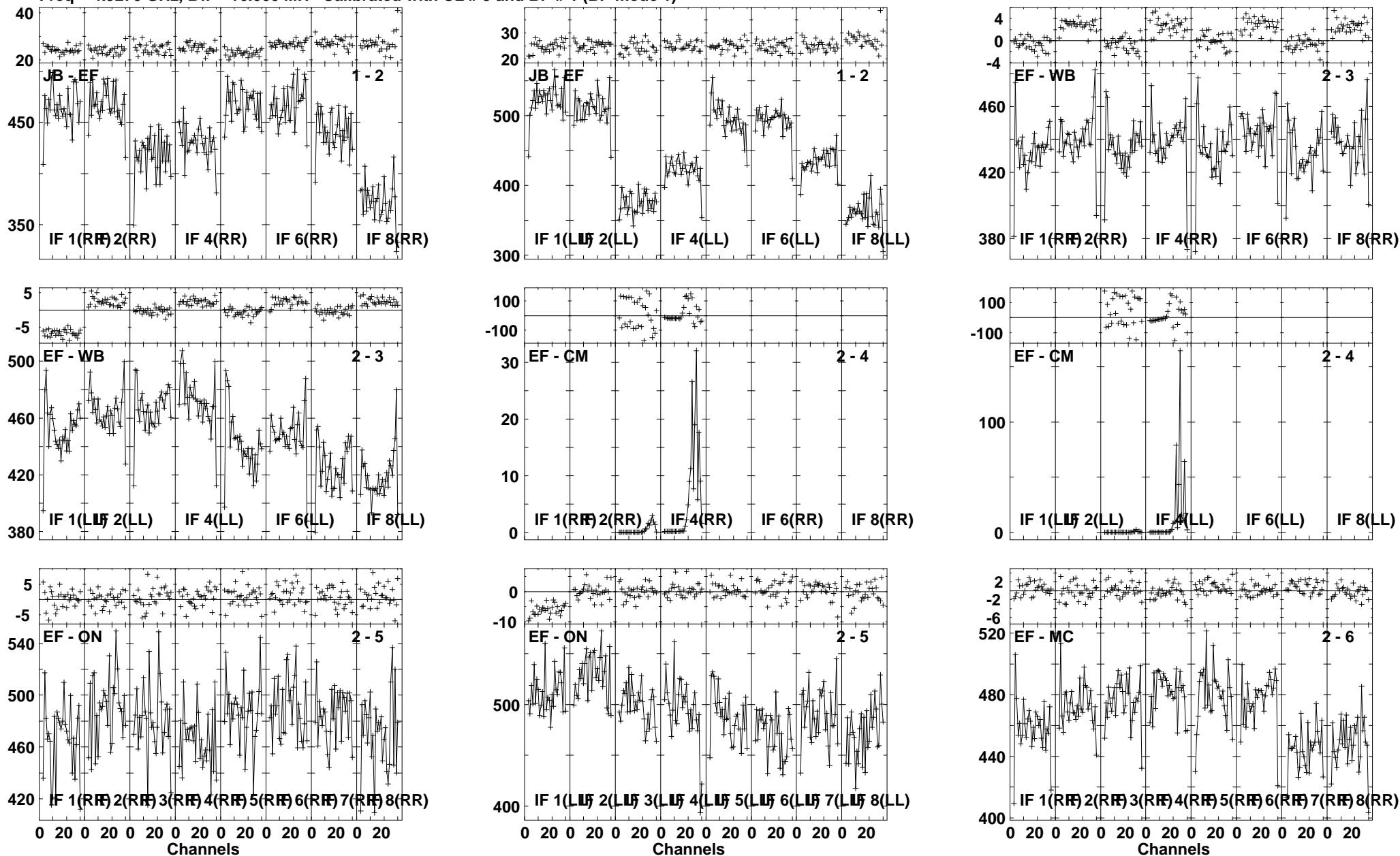

Lower frame: Milli Ampl Jy Top frame: Phas deg
Vector averaged cross-power spectrum Several baselines displayed
Timerange: 00/17:43:31 to 00/17:44:59

Plot file version 196 created 17-NOV-2010 16:22:30
 J1128+59 EP068A 5.UVDATA.1
 Freq = 4.9270 GHz, Bw = 16.000 MH Calibrated with CL # 3 and BP # 1 (BP mode 1)

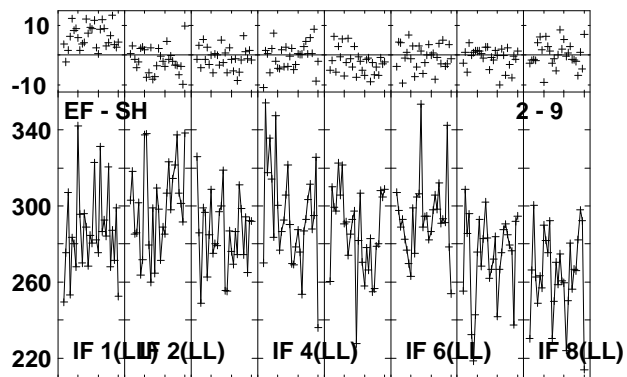
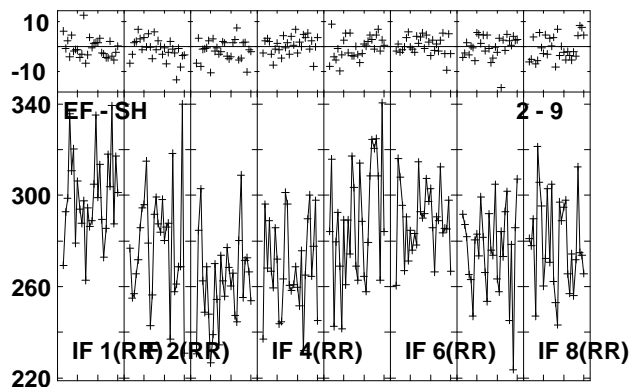
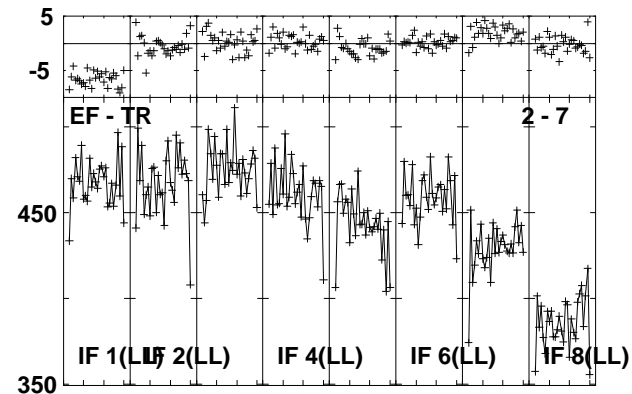
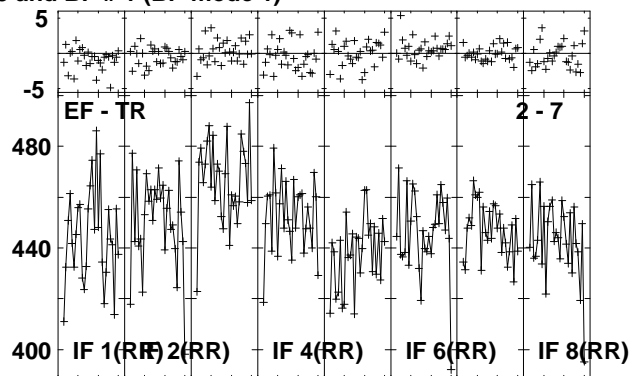
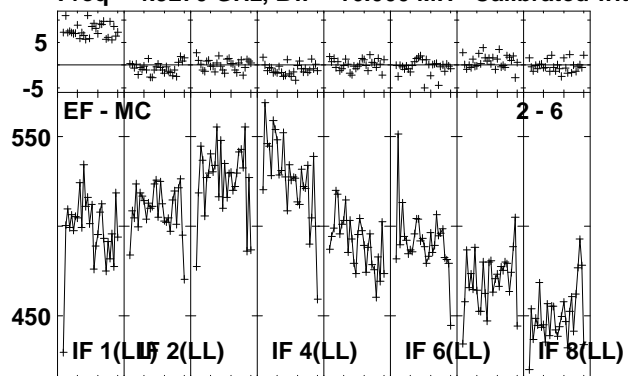

Lower frame: Milli Ampl Jy Top frame: Phas deg
 Vector averaged cross-power spectrum Several baselines displayed
 Timerange: 00:17:43:31 to 00:17:44:59

Plot file version 197 created 17-NOV-2010 16:22:32

ARP299D EP068A 5.UVDATA.1

Freq = 4.9270 GHz, Bw = 16.000 MH Calibrated with CL # 3 and BP # 1 (BP mode 1)

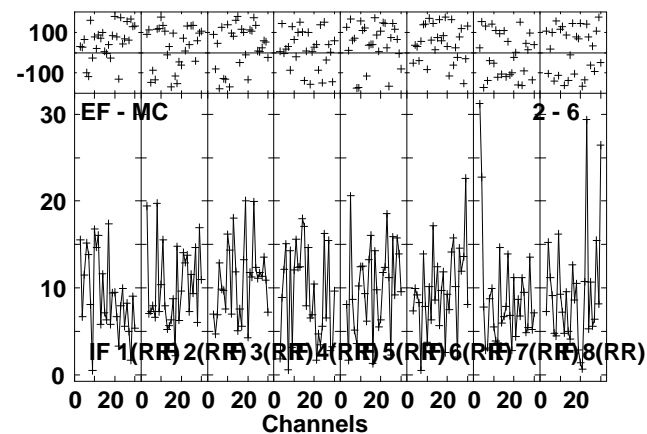
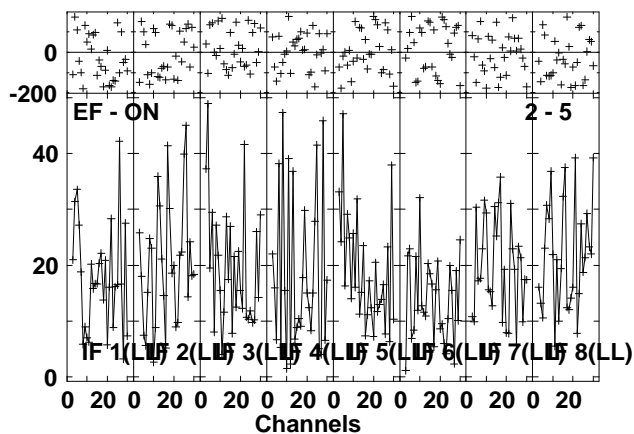
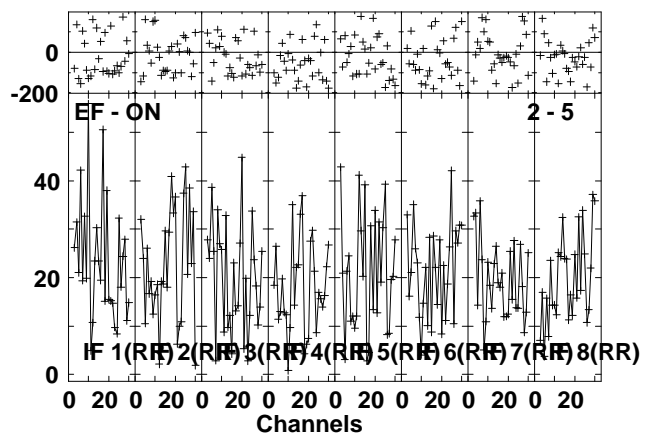
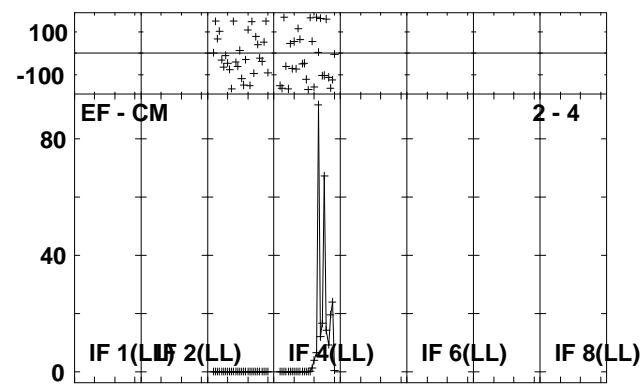
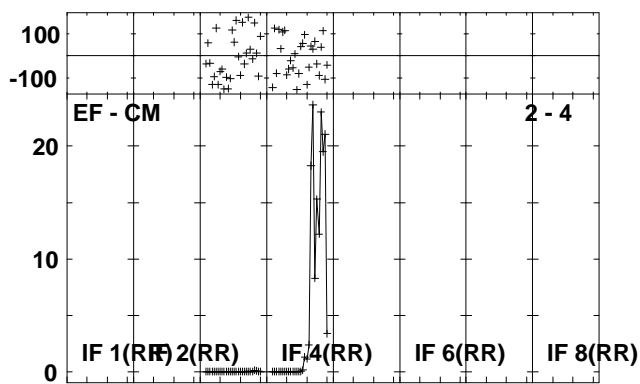
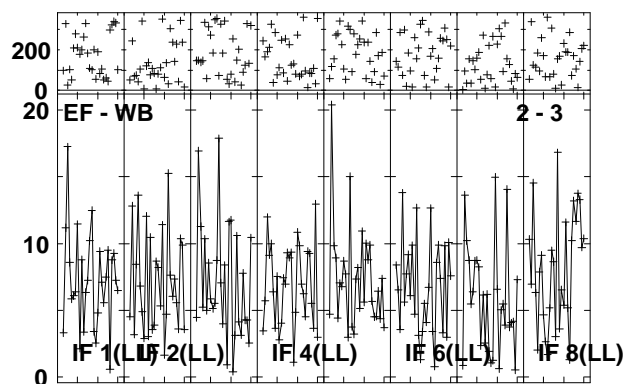
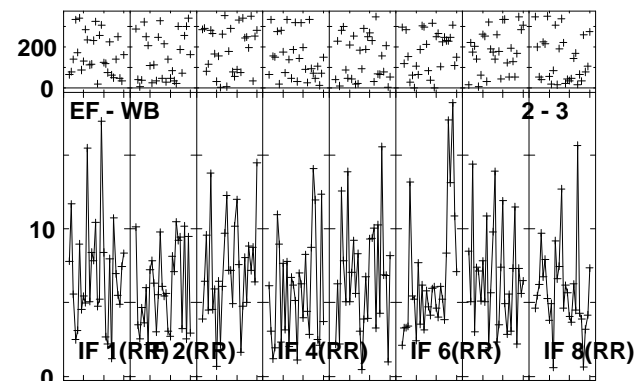
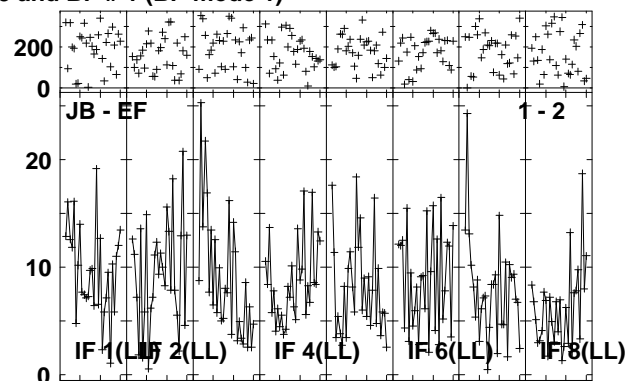
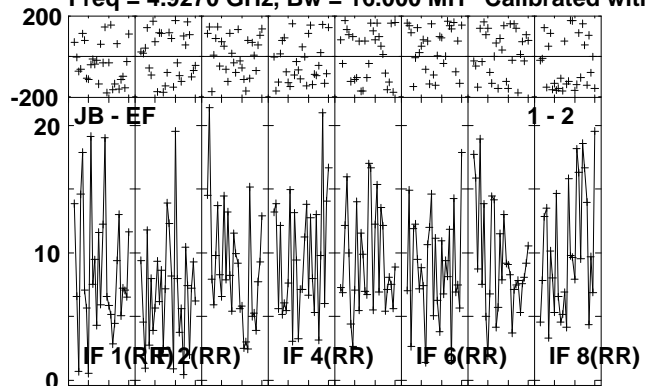

Lower frame: Milli Ampl Jy Top frame: Phas deg
Vector averaged cross-power spectrum Several baselines displayed
Timerange: 00/17:45:01 to 00/17:48:29

Plot file version 198 created 17-NOV-2010 16:22:34

ARP299D EP068A 5.UVDATA.1

Freq = 4.9270 GHz, Bw = 16.000 MH Calibrated with CL # 3 and BP # 1 (BP mode 1)

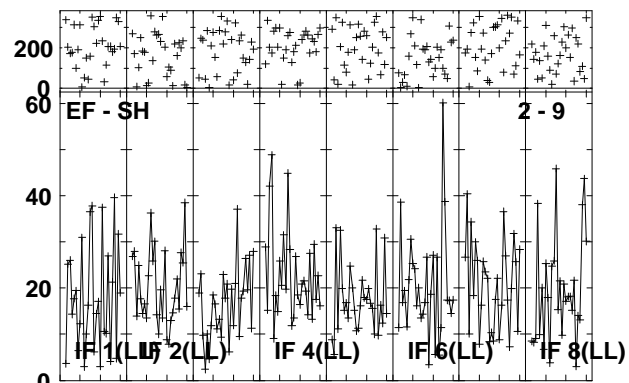
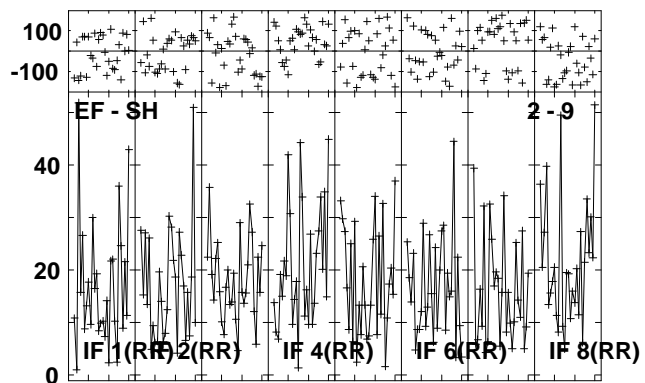
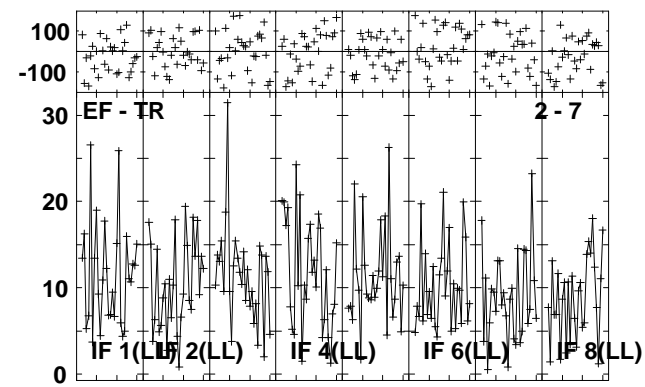
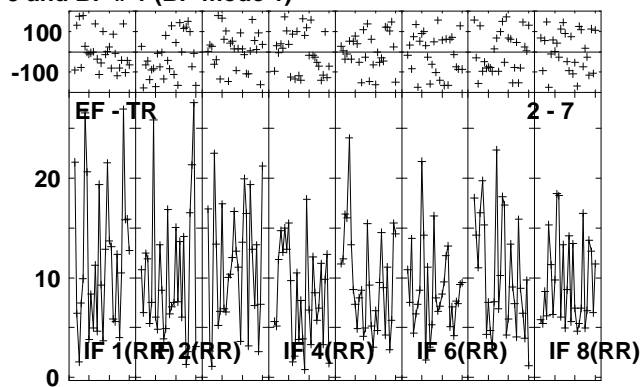
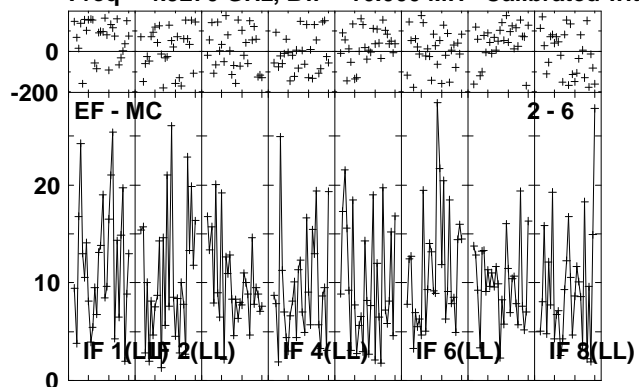

Lower frame: Milli Ampl Jy Top frame: Phas deg
Vector averaged cross-power spectrum Several baselines displayed
Timerange: 00/17:45:01 to 00/17:48:29

Plot file version 199 created 17-NOV-2010 16:22:39

ARP299D EP068A 5.UVDATA.1

Freq = 4.9270 GHz, Bw = 16.000 MH Calibrated with CL # 3 and BP # 1 (BP mode 1)

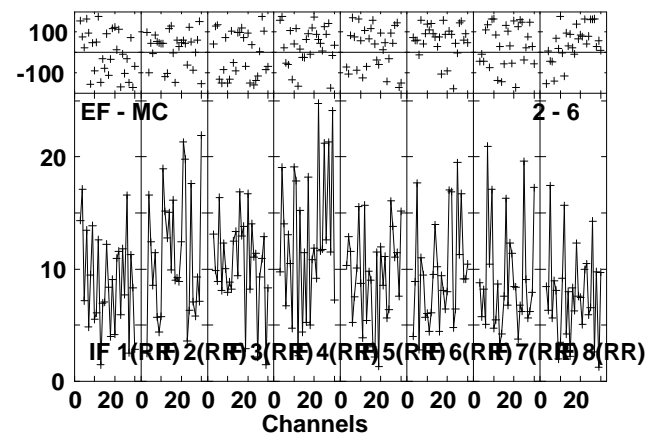
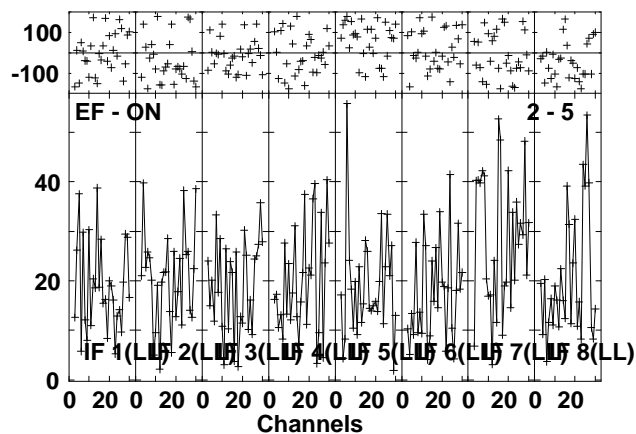
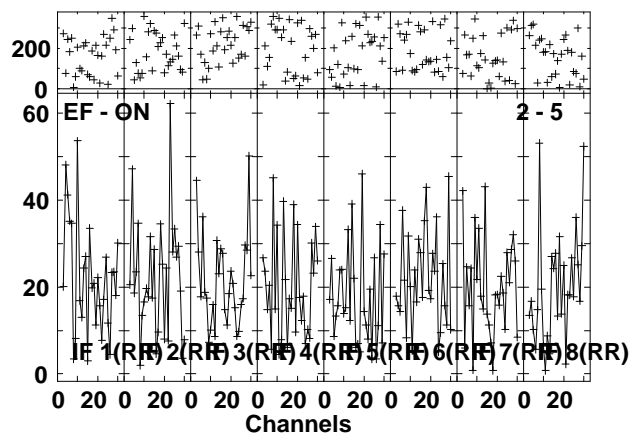
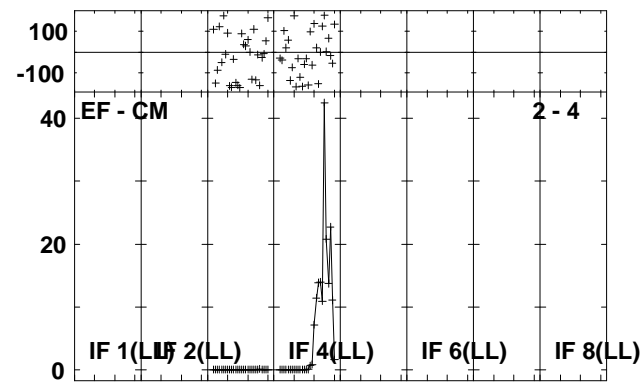
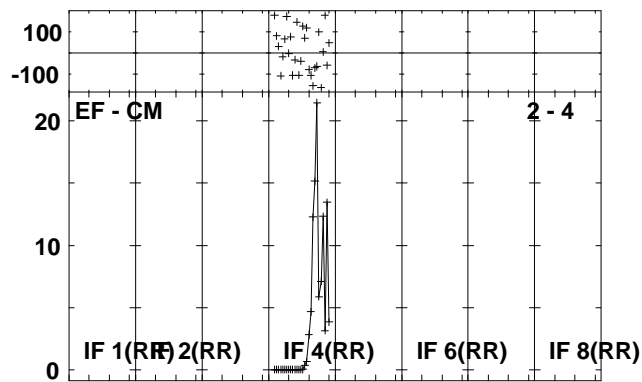
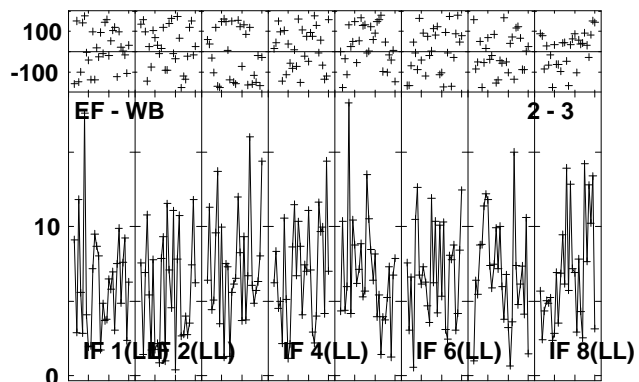
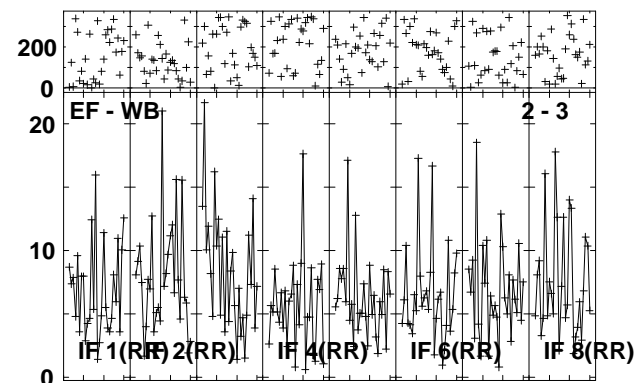
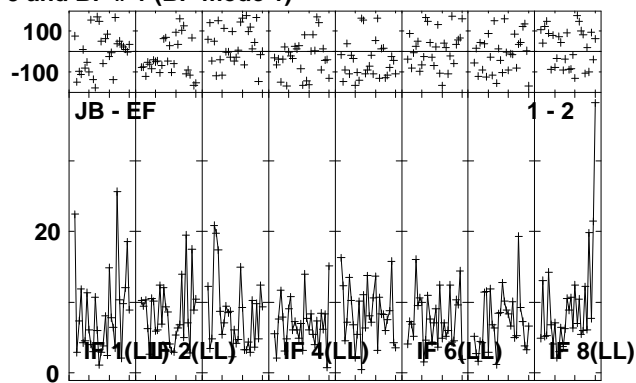
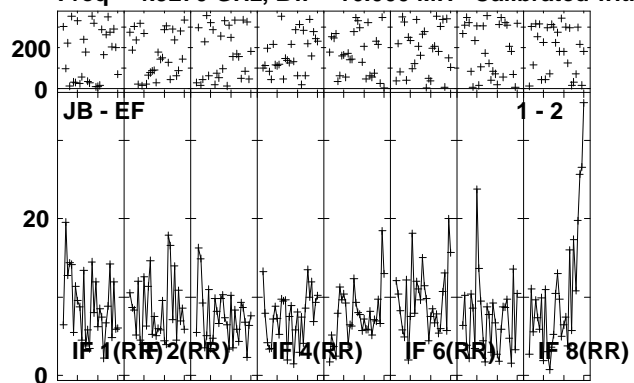

Lower frame: Milli Ampl Jy Top frame: Phas deg
Vector averaged cross-power spectrum Several baselines displayed
Timerange: 00/17:50:01 to 00/17:53:29

Plot file version 200 created 17-NOV-2010 16:22:42

ARP299D EP068A 5.UVDATA.1

Freq = 4.9270 GHz, Bw = 16.000 MH Calibrated with CL # 3 and BP # 1 (BP mode 1)

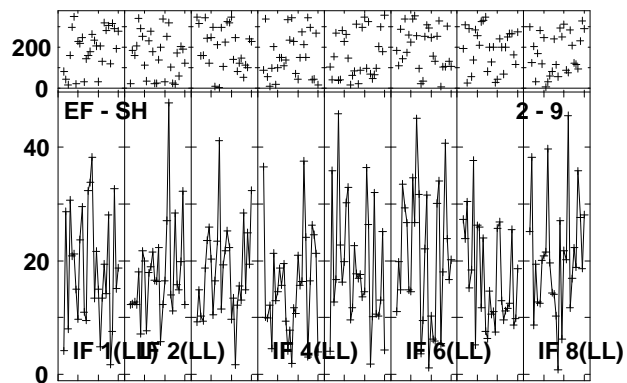
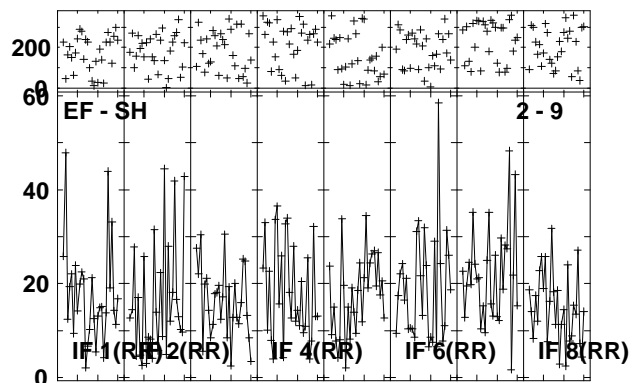
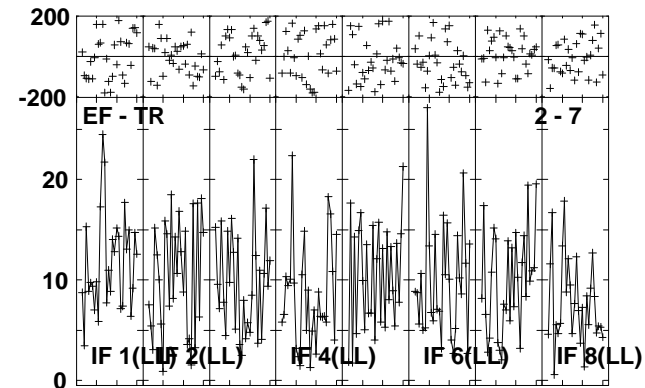
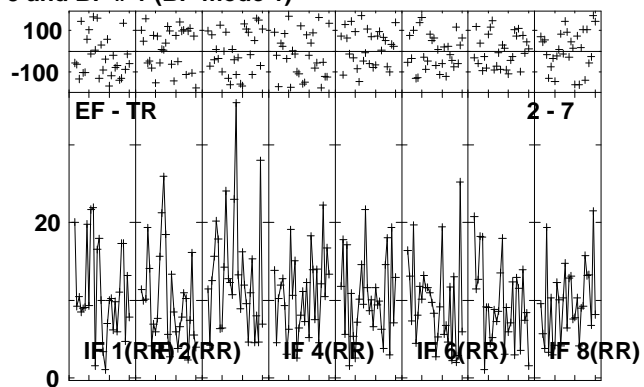
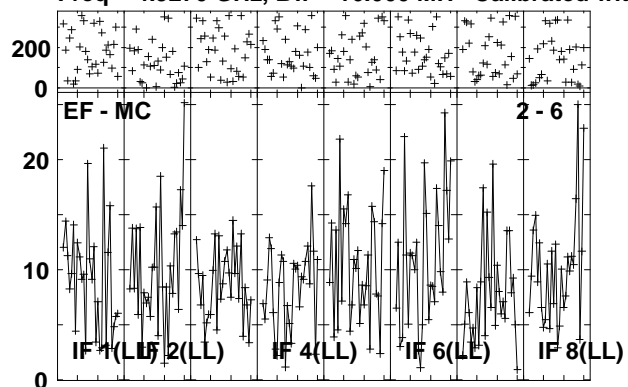

Lower frame: Milli Ampl Jy Top frame: Phas deg
Vector averaged cross-power spectrum Several baselines displayed
Timerange: 00/17:50:01 to 00/17:53:29

Plot file version 201 created 17-NOV-2010 16:22:44

J1128+59 EP068A 5.UVDATA.1

Freq = 4.9270 GHz, Bw = 16.000 MH Calibrated with CL # 3 and BP # 1 (BP mode 1)

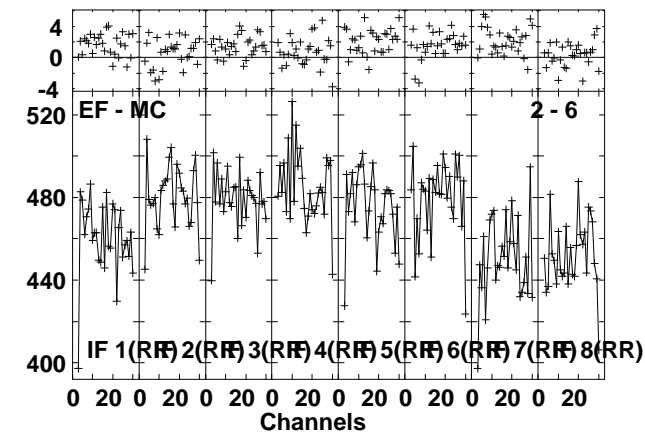
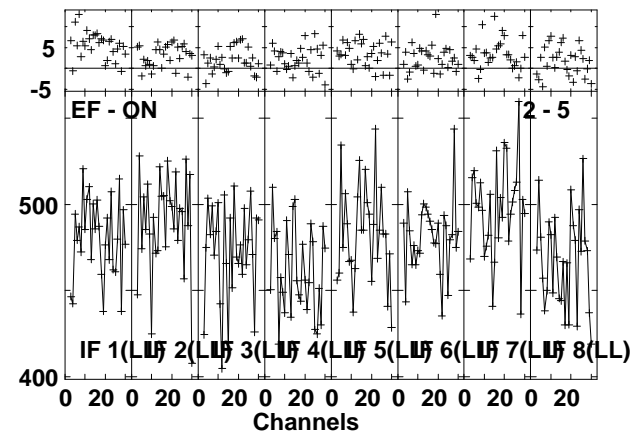
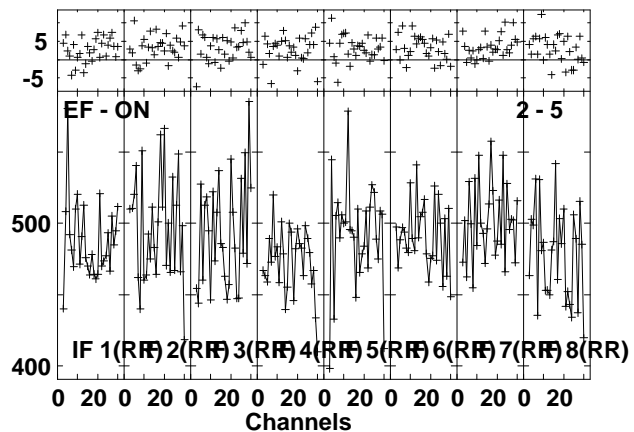
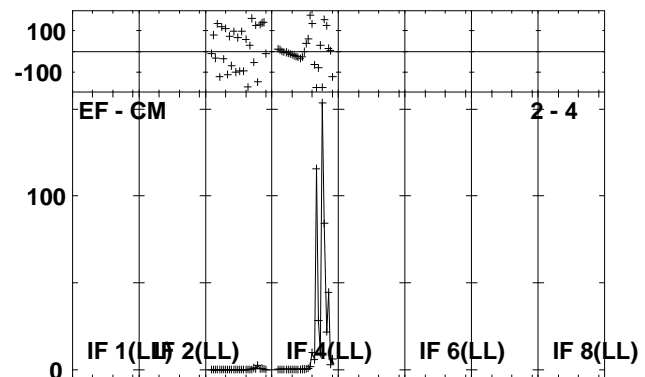
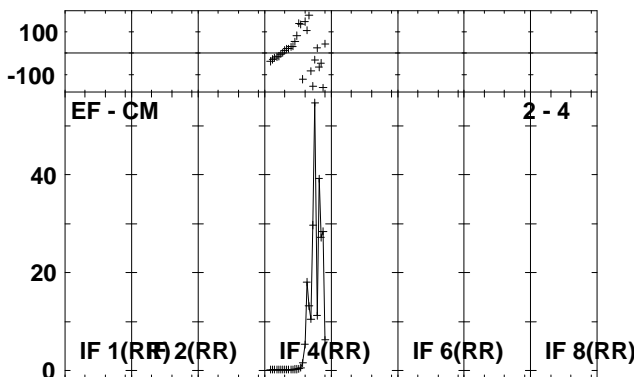
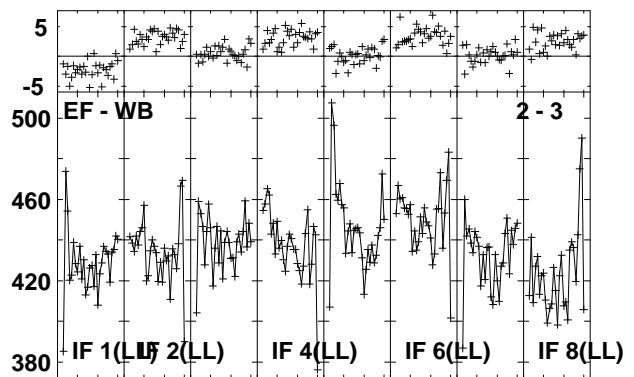
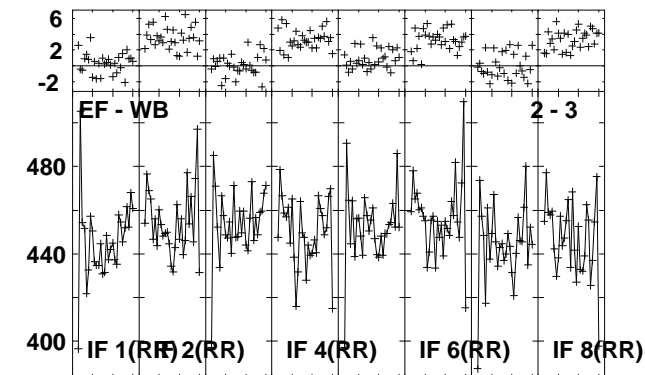
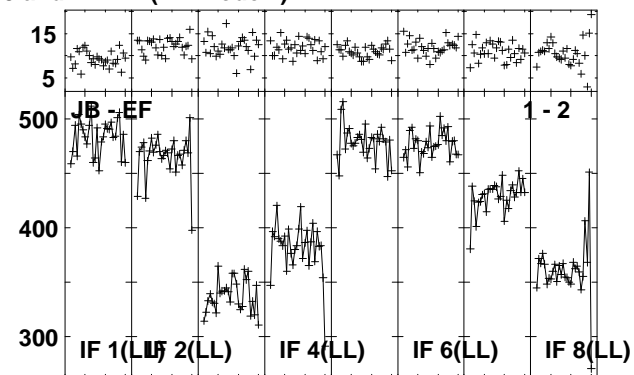
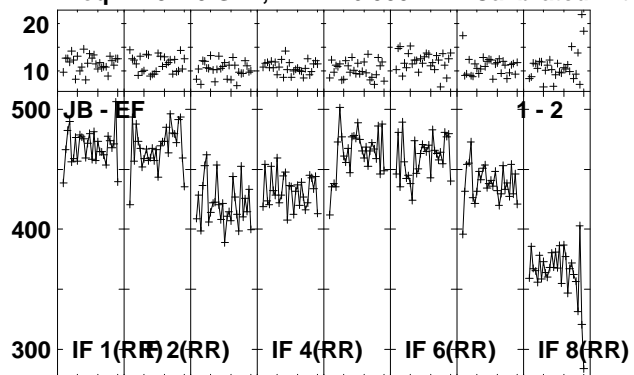

Lower frame: Milli Ampl Jy Top frame: Phas deg
Vector averaged cross-power spectrum Several baselines displayed
Timerange: 00/17:53:31 to 00/17:54:59

Plot file version 202 created 17-NOV-2010 16:22:45

J1128+59 EP068A 5.UVDATA.1

Freq = 4.9270 GHz, Bw = 16.000 MH Calibrated with CL # 3 and BP # 1 (BP mode 1)

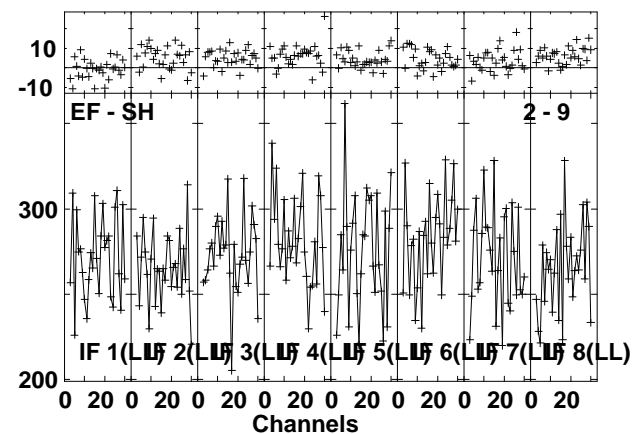
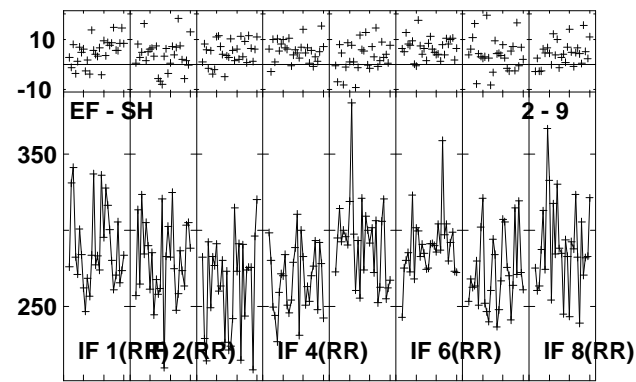
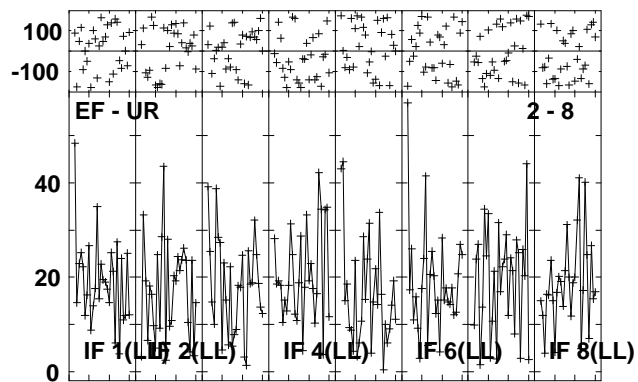
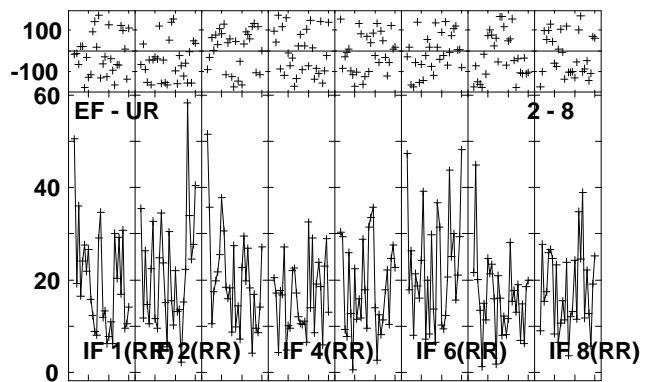
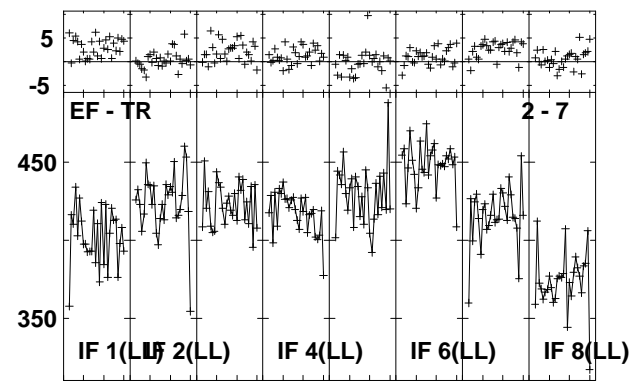
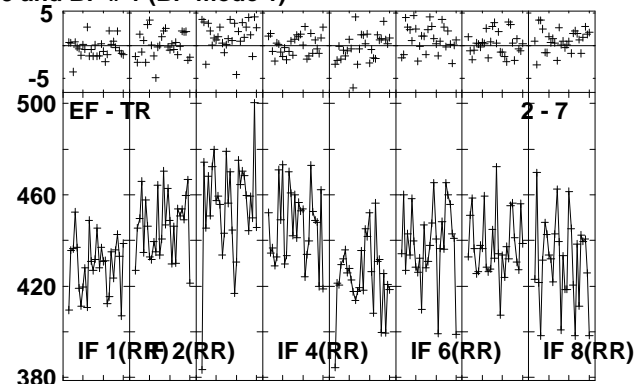
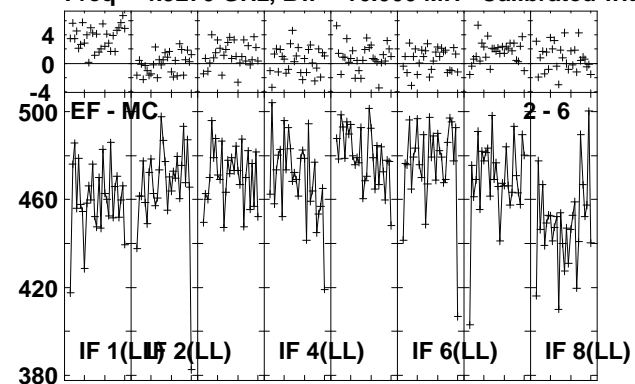

Lower frame: Milli Ampl Jy Top frame: Phas deg
Vector averaged cross-power spectrum Several baselines displayed
Timerange: 00/17:53:31 to 00/17:54:59

Plot file version 203 created 17-NOV-2010 16:22:47

ARP299D EP068A 5.UVDATA.1

Freq = 4.9270 GHz, Bw = 16.000 MH Calibrated with CL # 3 and BP # 1 (BP mode 1)

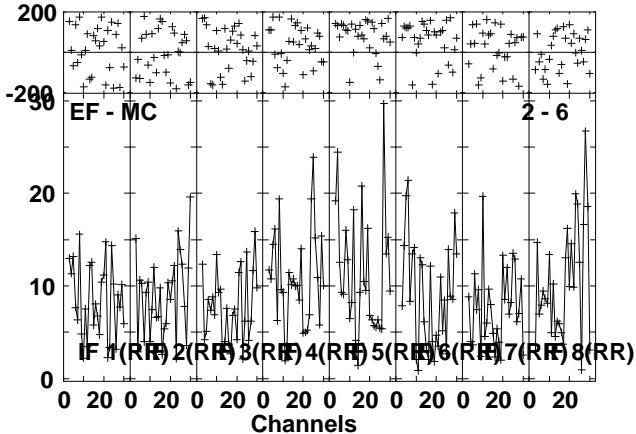
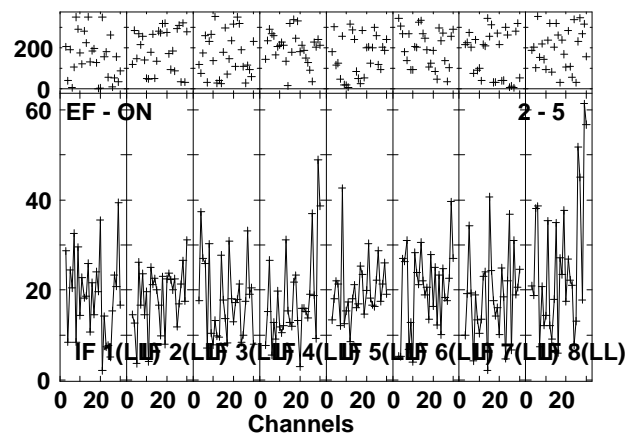
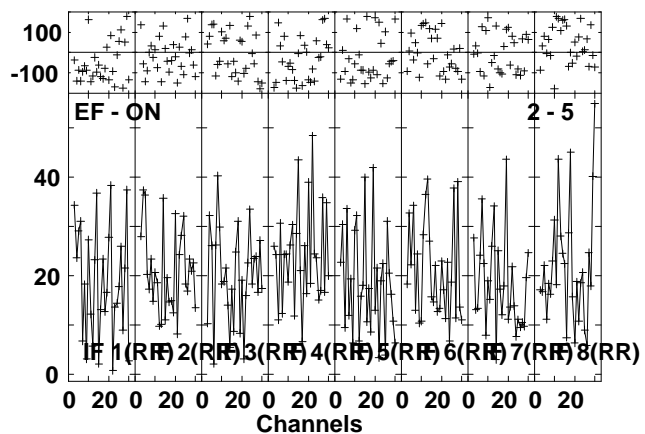
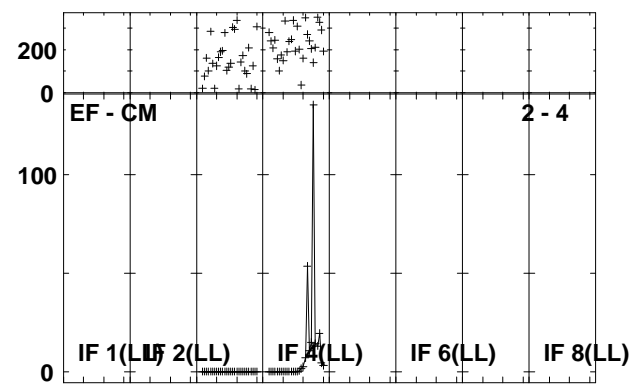
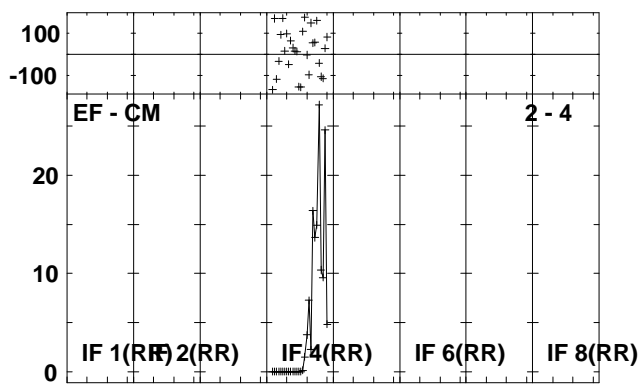
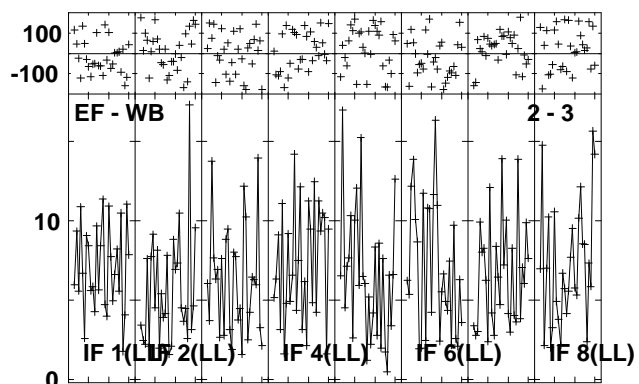
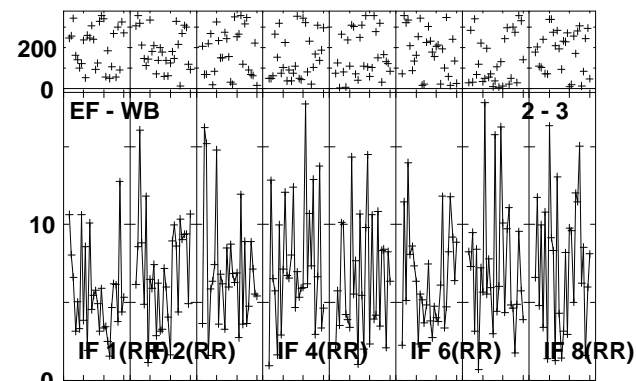
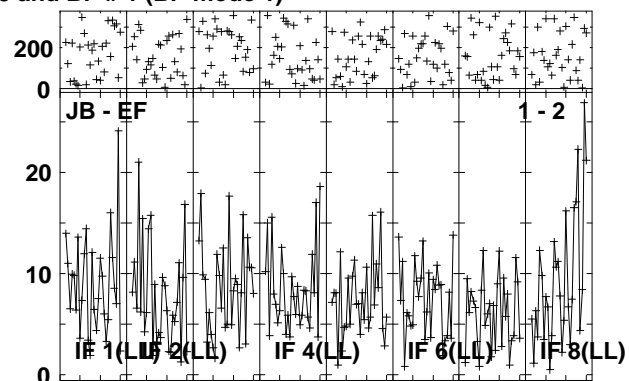
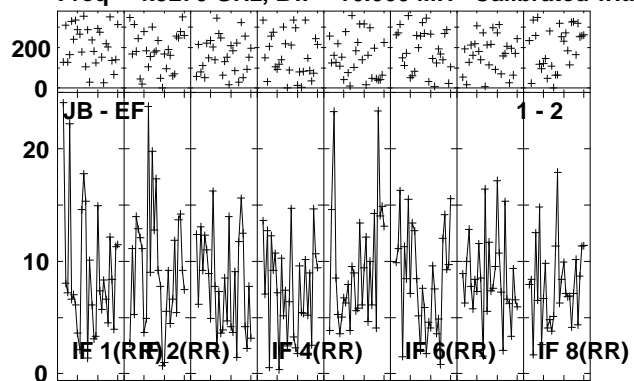

Lower frame: Milli Ampl Jy Top frame: Phas deg
Vector averaged cross-power spectrum Several baselines displayed
Timerange: 00:17:55:01 to 00:17:58:29

Plot file version 204 created 17-NOV-2010 16:22:50

ARP299D EP068A 5.UVDATA.1

Freq = 4.9270 GHz, Bw = 16.000 MH Calibrated with CL # 3 and BP # 1 (BP mode 1)

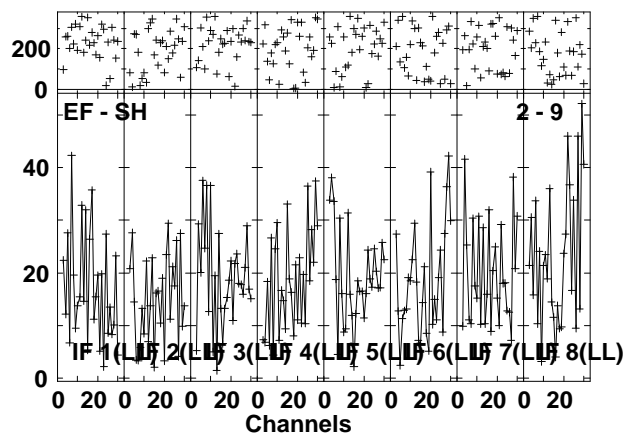
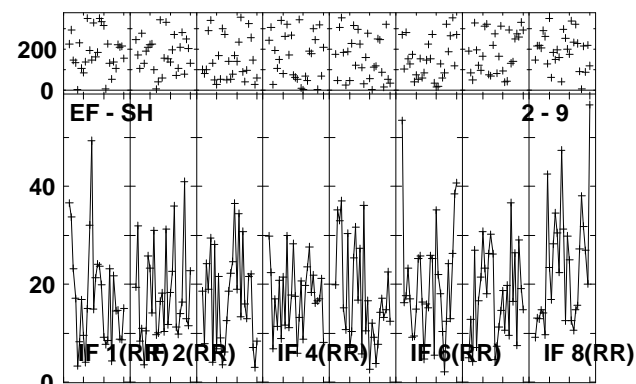
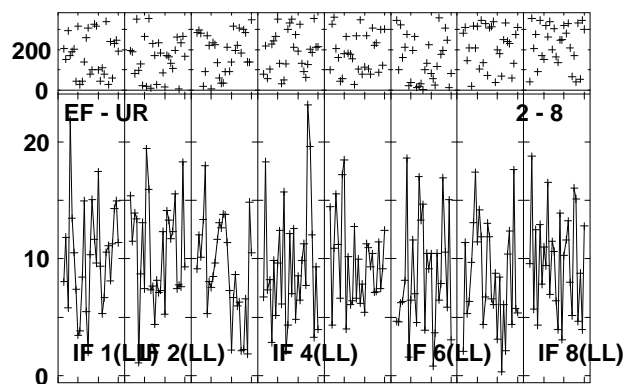
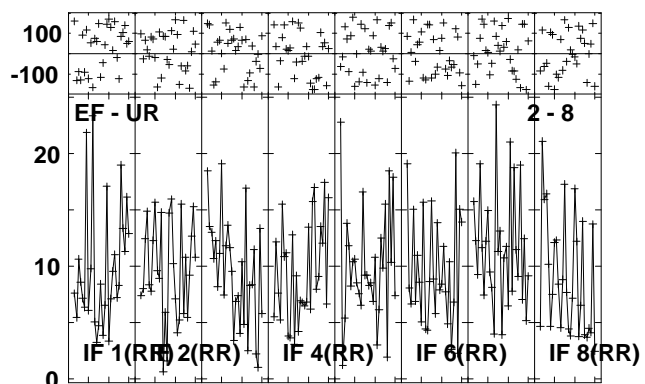
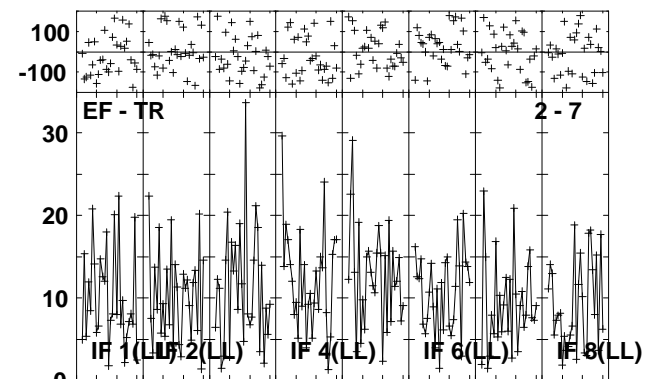
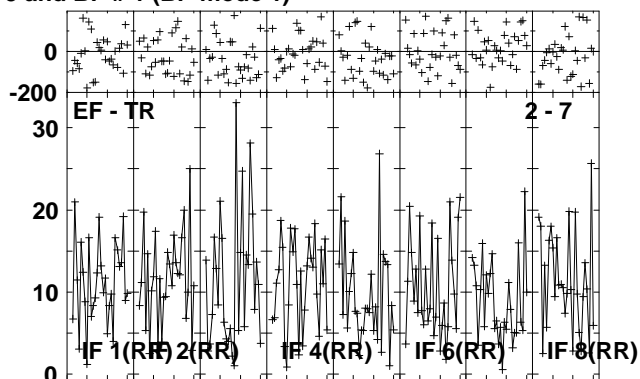
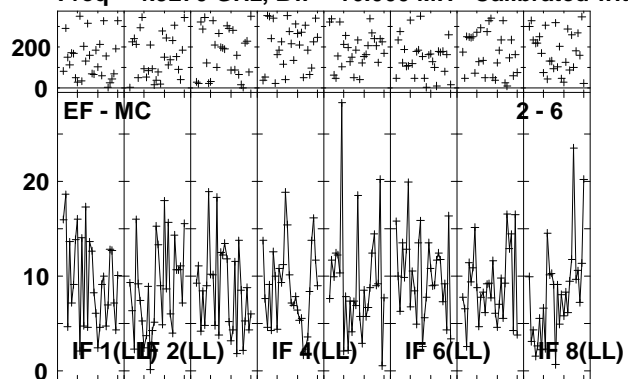

Lower frame: Milli Ampl Jy Top frame: Phas deg
Vector averaged cross-power spectrum Several baselines displayed
Timerange: 00/17:55:01 to 00/17:58:29

Plot file version 205 created 17-NOV-2010 16:22:53

J1128+59 EP068A 5.UVDATA.1

Freq = 4.9270 GHz, Bw = 16.000 MH Calibrated with CL # 3 and BP # 1 (BP mode 1)

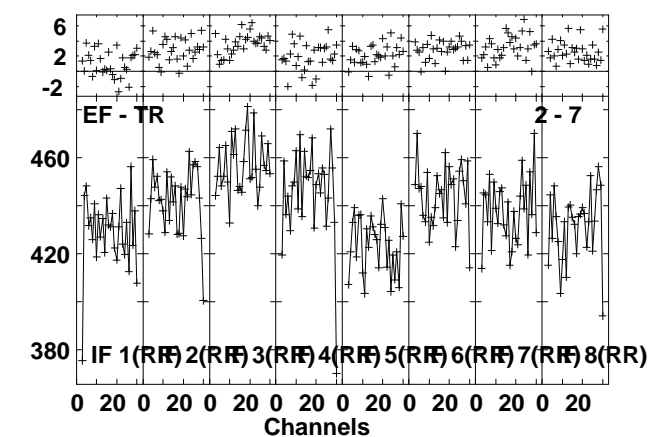
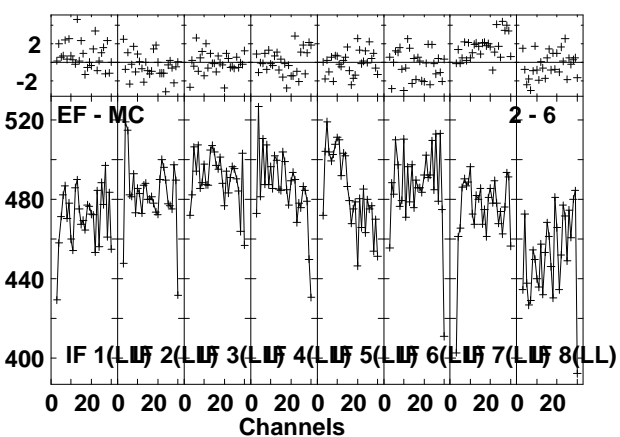
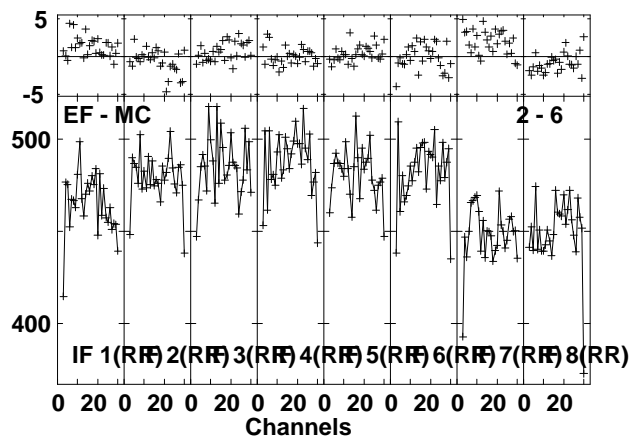
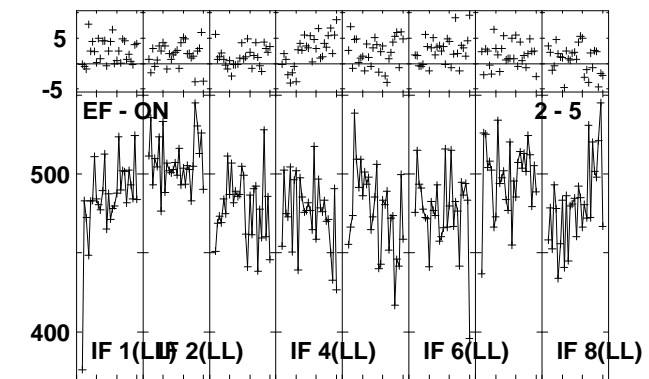
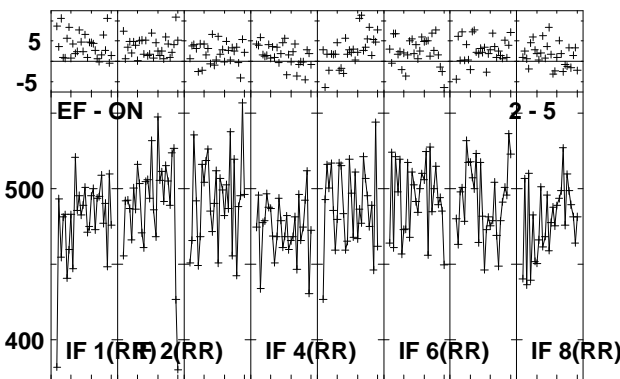
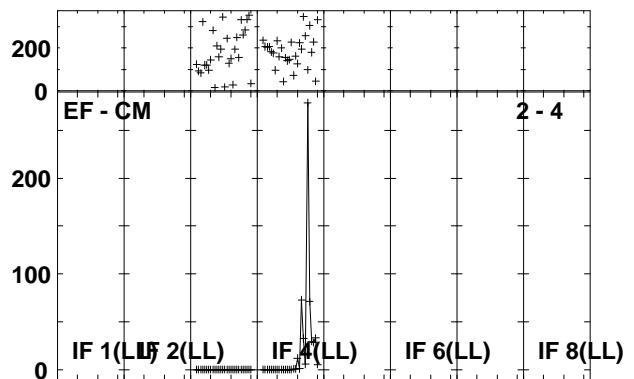
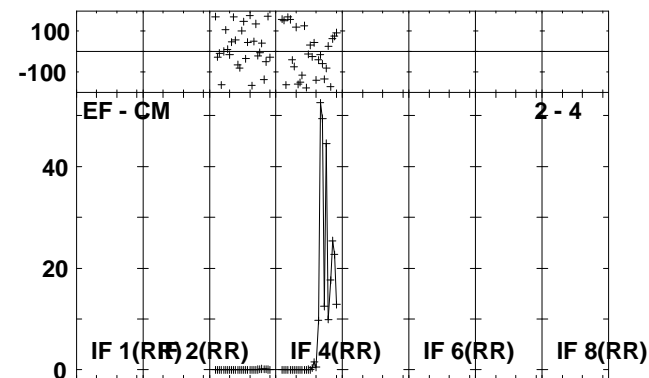
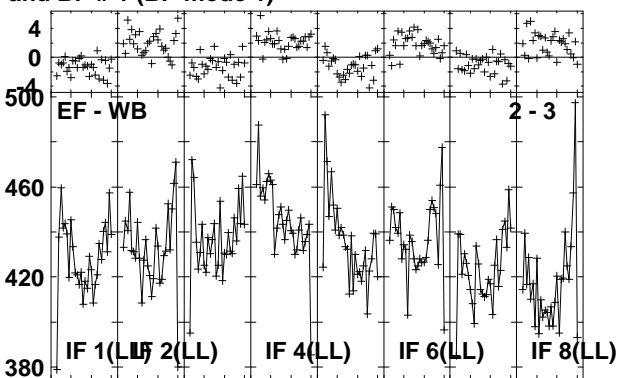
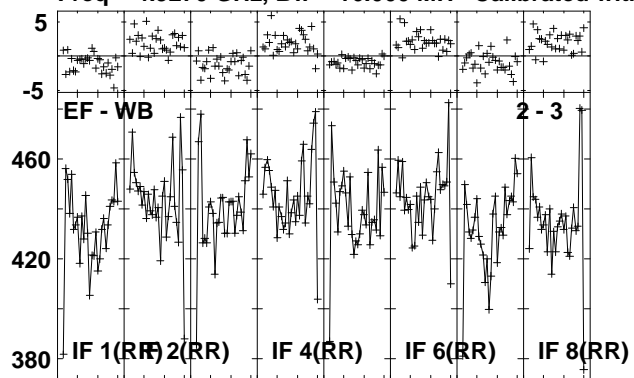

Lower frame: Milli Ampl Jy Top frame: Phas deg
Vector averaged cross-power spectrum Several baselines displayed
Timerange: 00/17:59:31 to 00/18:00:57

Plot file version 206 created 17-NOV-2010 16:22:54

J1128+59 EP068A 5.UVDATA.1

Freq = 4.9270 GHz, Bw = 16.000 MH Calibrated with CL # 3 and BP # 1 (BP mode 1)

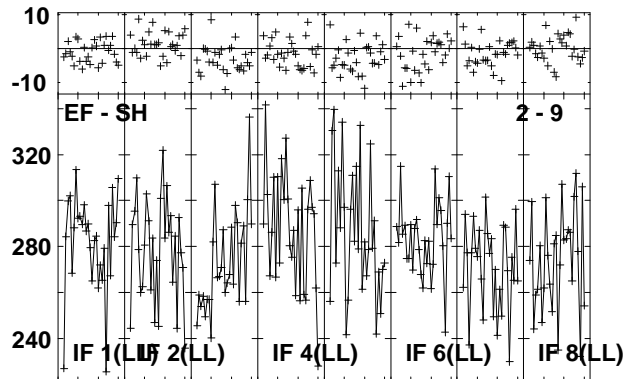
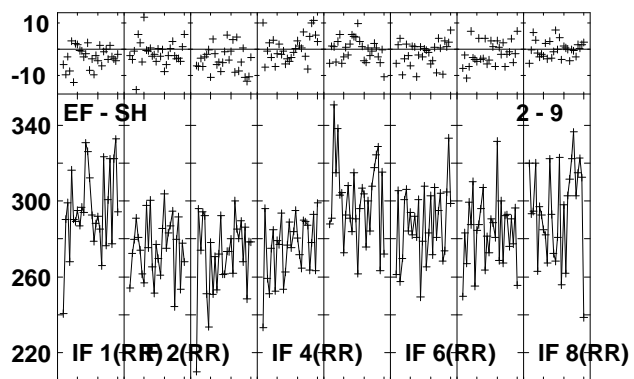
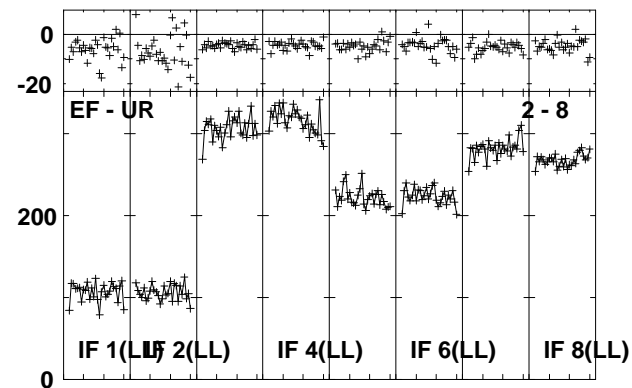
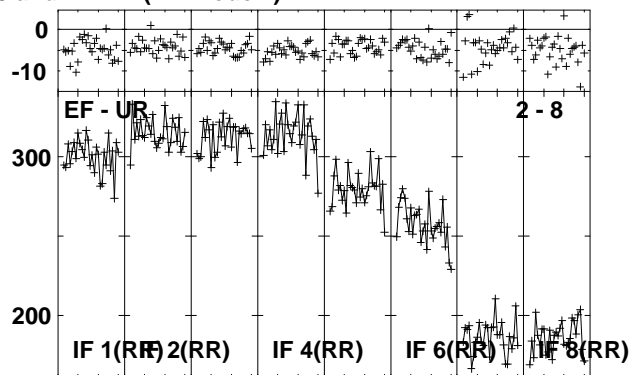
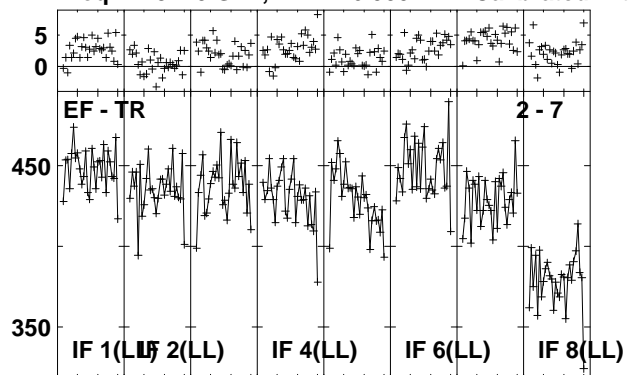

Lower frame: Milli Ampl Jy Top frame: Phas deg
Vector averaged cross-power spectrum Several baselines displayed
Timerange: 00/17:59:31 to 00/18:00:57

Plot file version 207 created 17-NOV-2010 16:22:56

ARP299D EP068A 5.UVDATA.1

Freq = 4.9270 GHz, Bw = 16.000 MH Calibrated with CL # 3 and BP # 1 (BP mode 1)

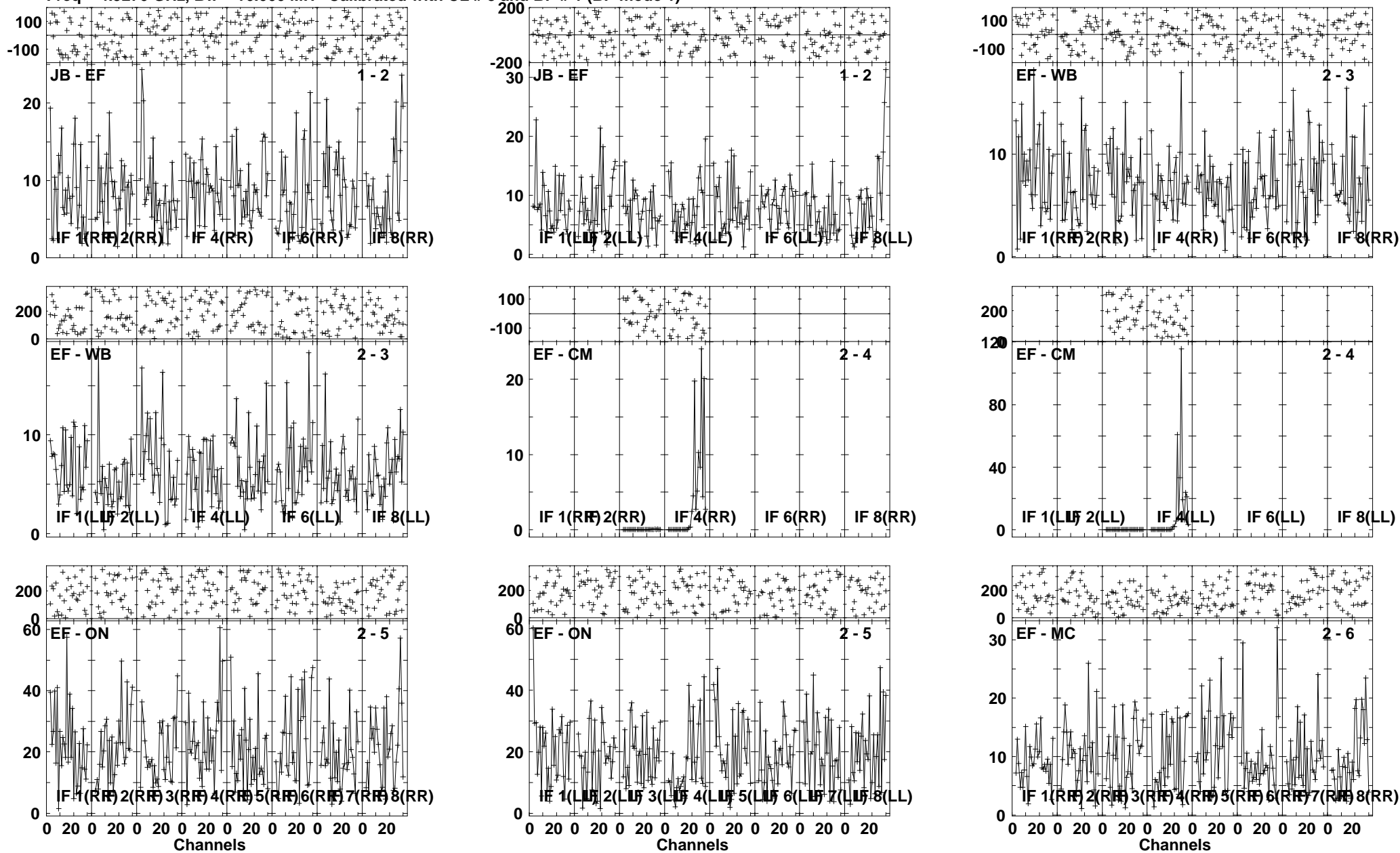

Lower frame: Milli Ampl Jy Top frame: Phas deg
Vector averaged cross-power spectrum Several baselines displayed
Timerange: 00/18:01:01 to 00/18:04:29

Plot file version 208 created 17-NOV-2010 16:22:58

ARP299D EP068A 5.UVDATA.1

Freq = 4.9270 GHz, Bw = 16.000 MH Calibrated with CL # 3 and BP # 1 (BP mode 1)

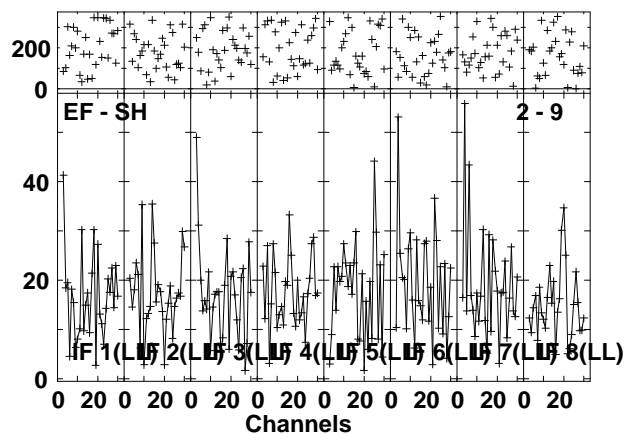
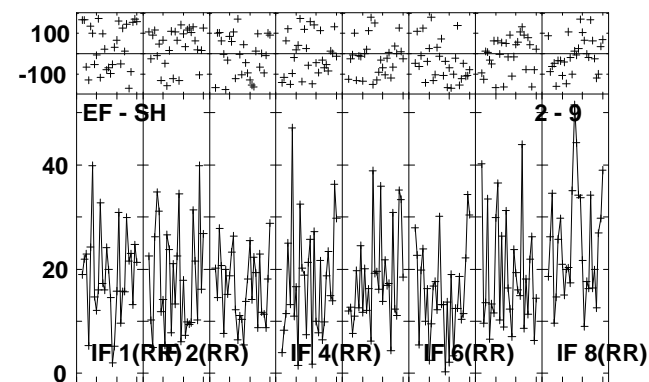
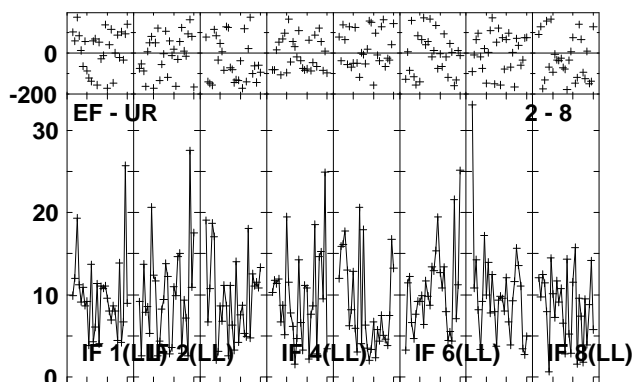
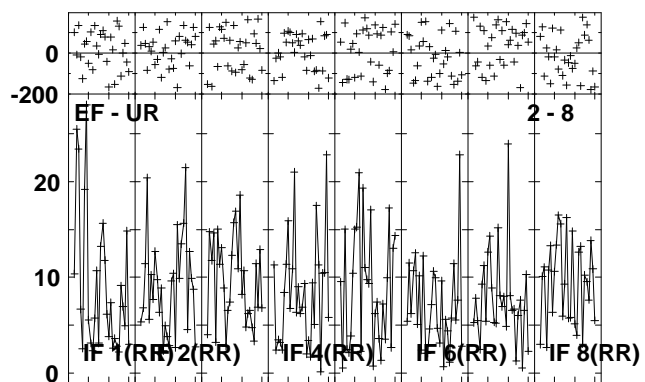
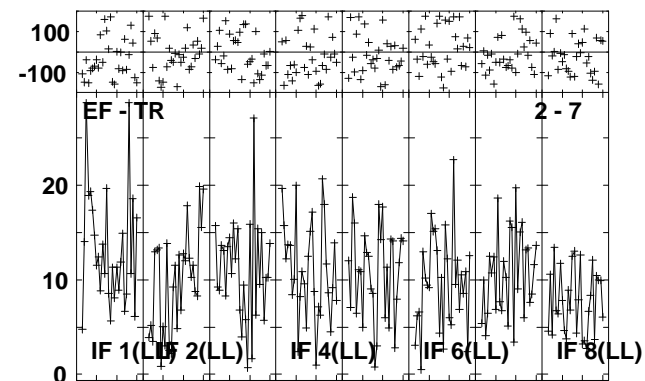
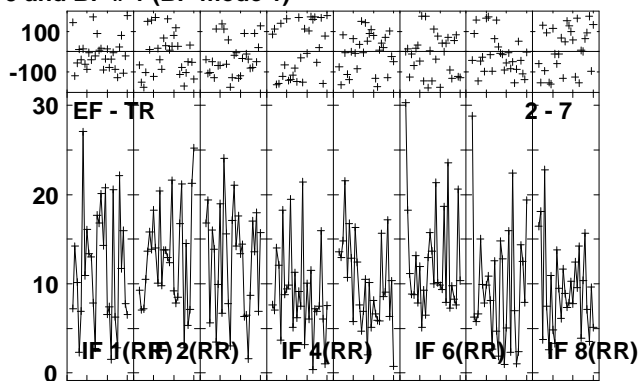
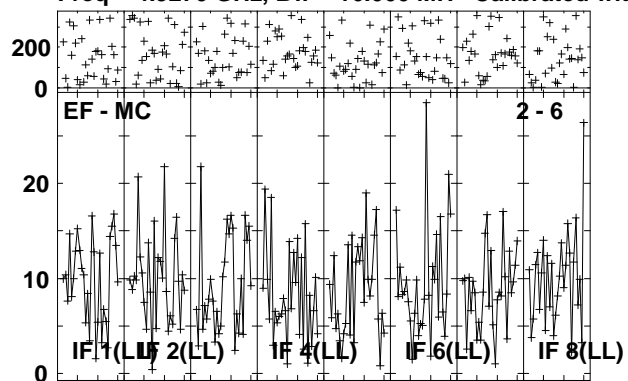

Lower frame: Milli Ampl Jy Top frame: Phas deg
Vector averaged cross-power spectrum Several baselines displayed
Timerange: 00/18:01:01 to 00/18:04:29

Plot file version 209 created 17-NOV-2010 16:23:01

J1128+59 EP068A 5.UVDATA.1

Freq = 4.9270 GHz, Bw = 16.000 MH Calibrated with CL # 3 and BP # 1 (BP mode 1)

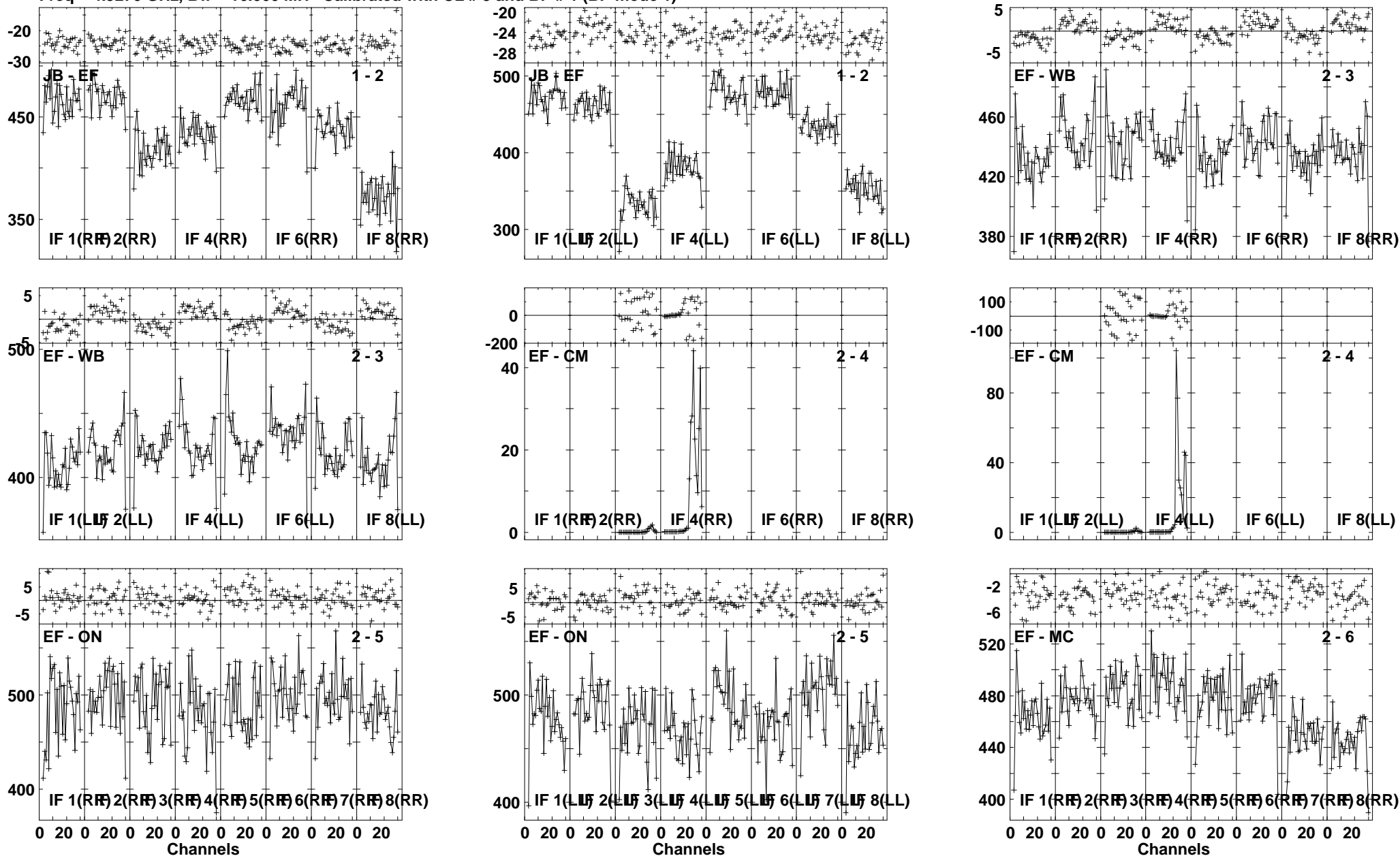

Lower frame: Milli Ampl Jy Top frame: Phas deg
Vector averaged cross-power spectrum Several baselines displayed
Timerange: 00:18:04:31 to 00:18:05:59

Plot file version 210 created 17-NOV-2010 16:23:02

J1128+59 EP068A 5.UVDATA.1

Freq = 4.9270 GHz, Bw = 16.000 MH Calibrated with CL # 3 and BP # 1 (BP mode 1)

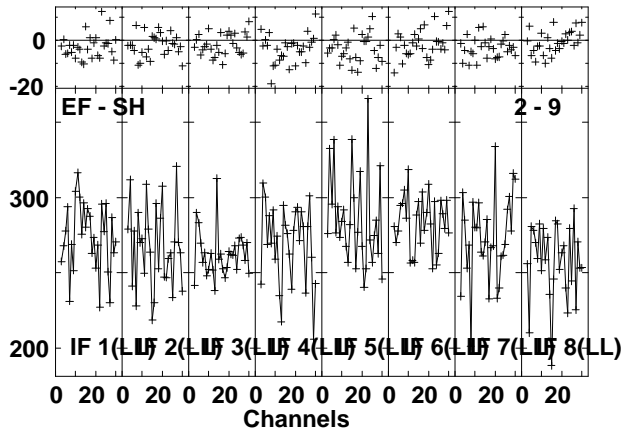
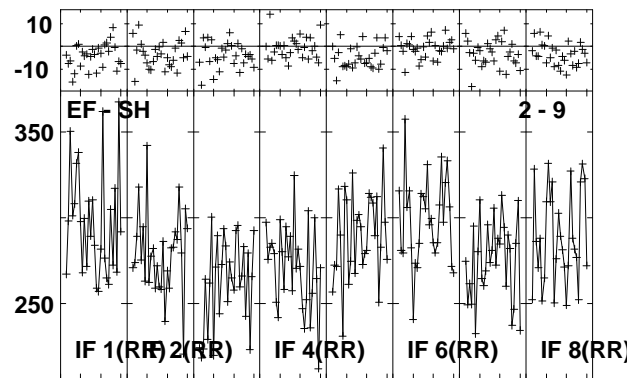
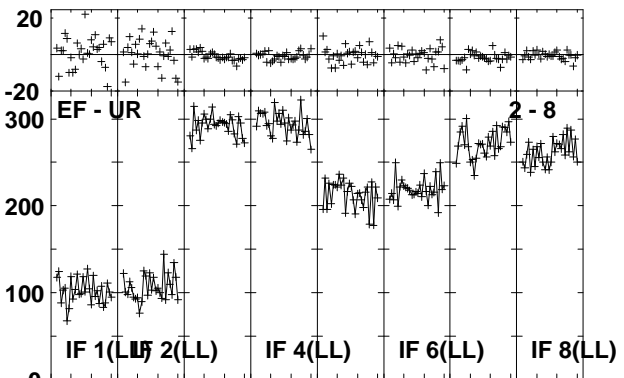
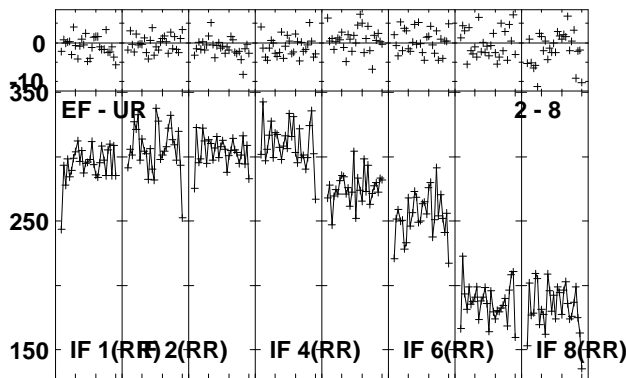
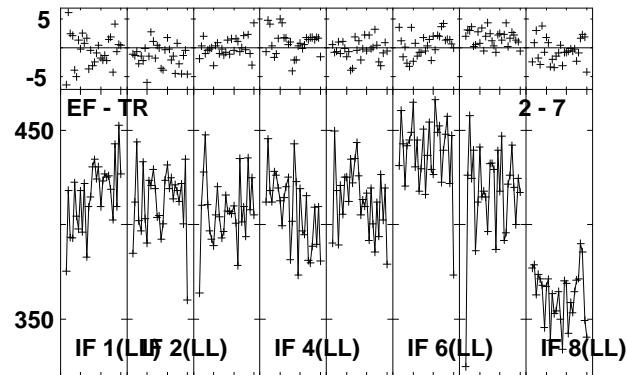
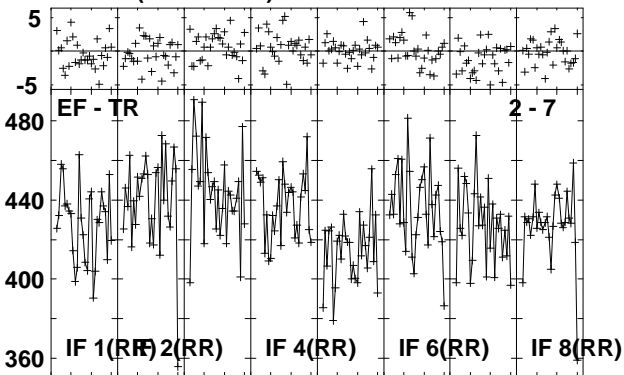
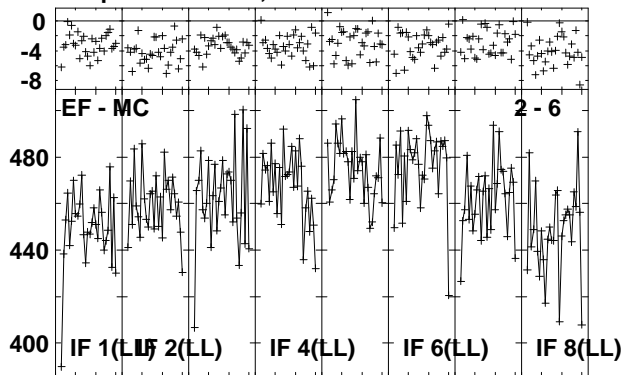

Lower frame: Milli Ampl Jy Top frame: Phas deg
Vector averaged cross-power spectrum Several baselines displayed
Timerange: 00:18:04:31 to 00:18:05:59

Plot file version 211 created 17-NOV-2010 16:23:04

ARP299D EP068A 5.UVDATA.1

Freq = 4.9270 GHz, Bw = 16.000 MH Calibrated with CL # 3 and BP # 1 (BP mode 1)

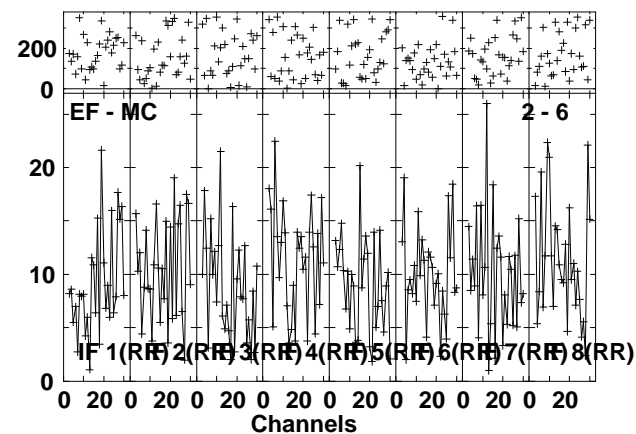
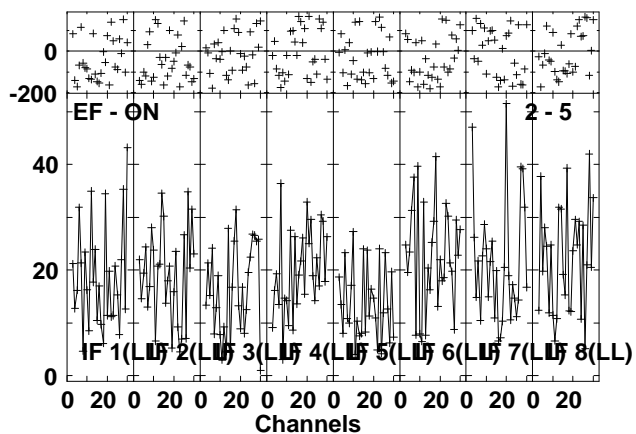
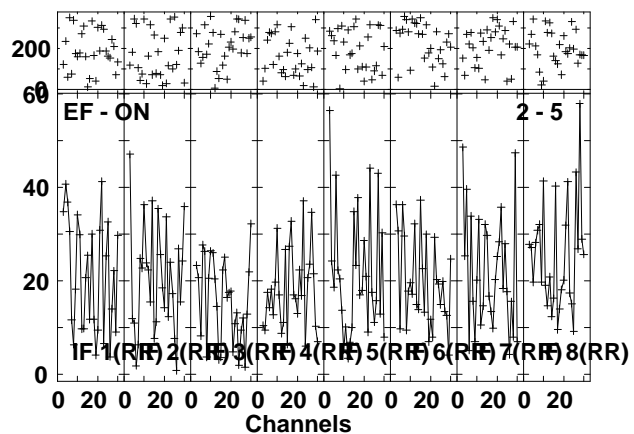
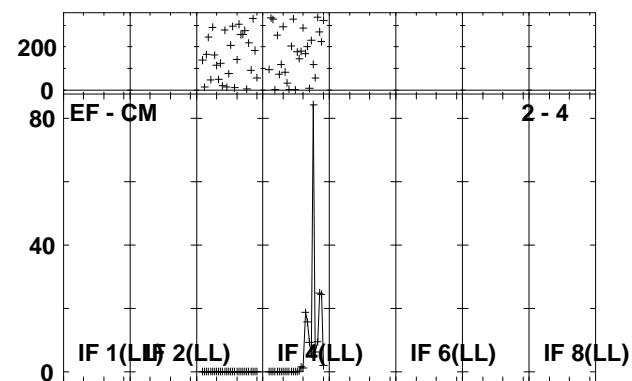
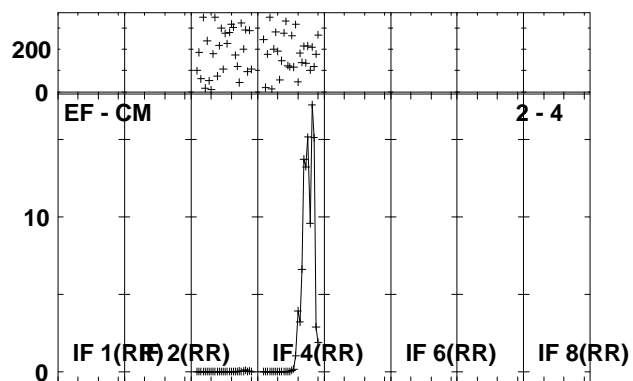
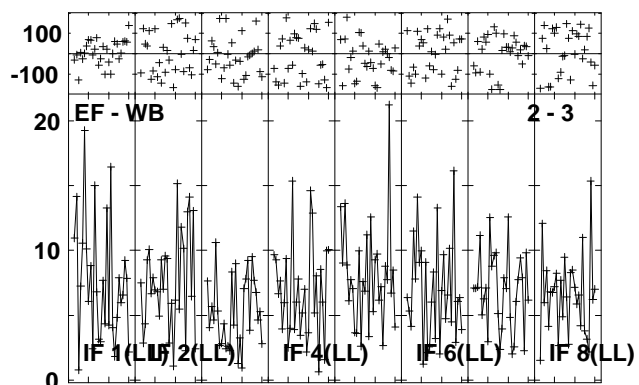
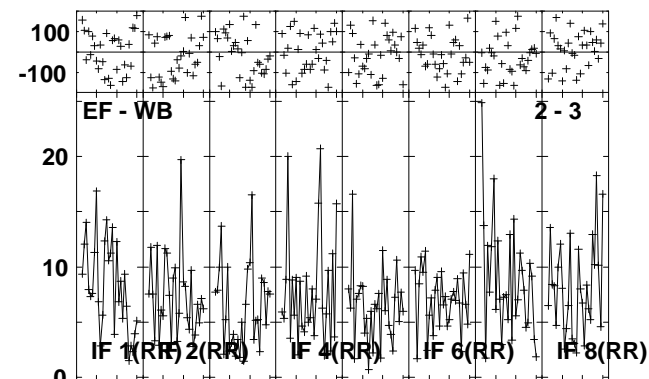
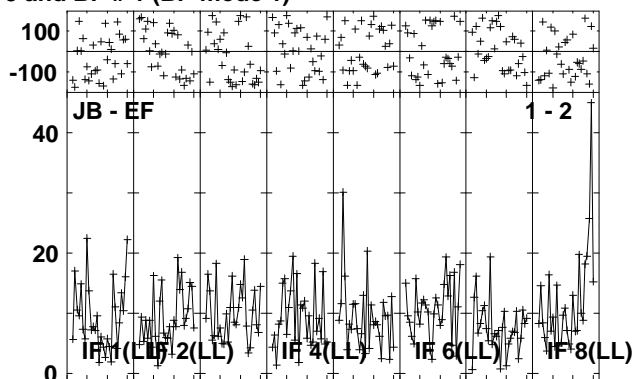
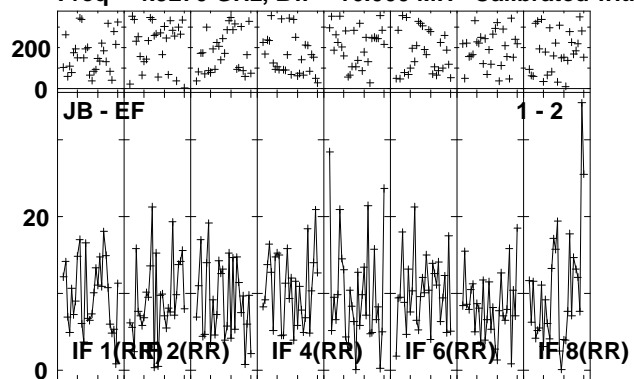

Lower frame: Milli Ampl Jy Top frame: Phas deg
Vector averaged cross-power spectrum Several baselines displayed
Timerange: 00/18:06:01 to 00/18:09:29

Plot file version 212 created 17-NOV-2010 16:23:07

ARP299D EP068A 5.UVDATA.1

Freq = 4.9270 GHz, Bw = 16.000 MH Calibrated with CL # 3 and BP # 1 (BP mode 1)

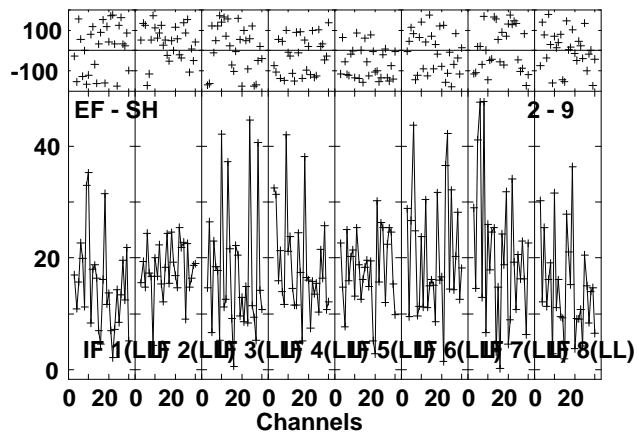
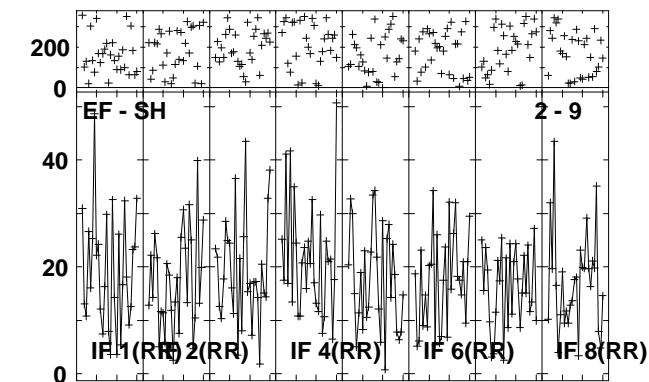
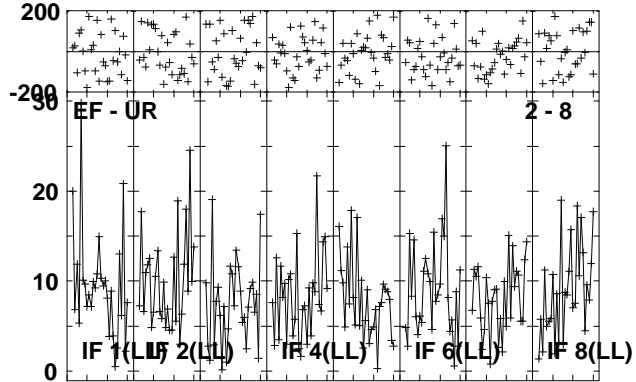
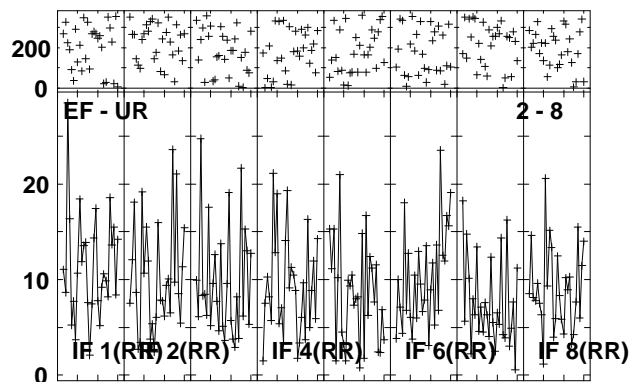
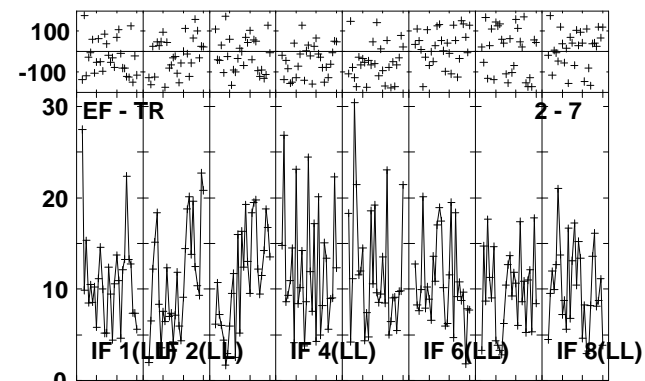
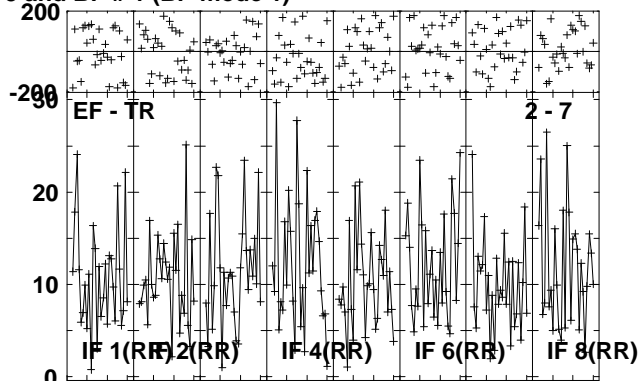
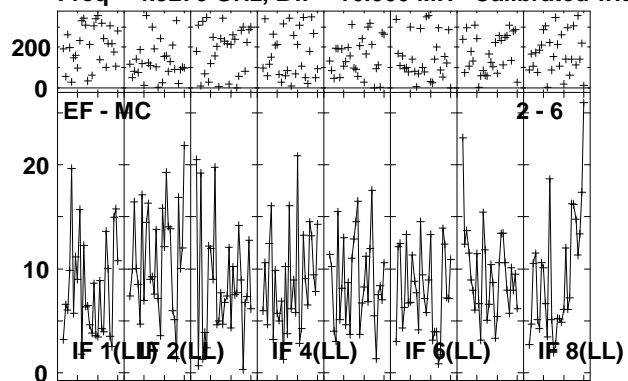

Lower frame: Milli Ampl Jy Top frame: Phas deg
Vector averaged cross-power spectrum Several baselines displayed
Timerange: 00:18:06:01 to 00:18:09:29

Plot file version 213 created 17-NOV-2010 16:23:10

J1128+59 EP068A 5.UVDATA.1

Freq = 4.9270 GHz, Bw = 16.000 MH Calibrated with CL # 3 and BP # 1 (BP mode 1)

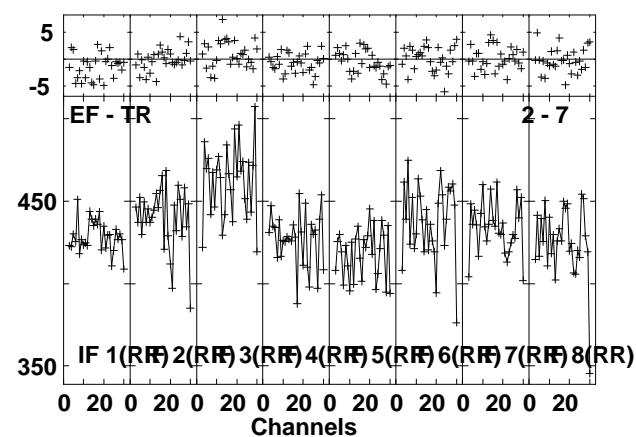
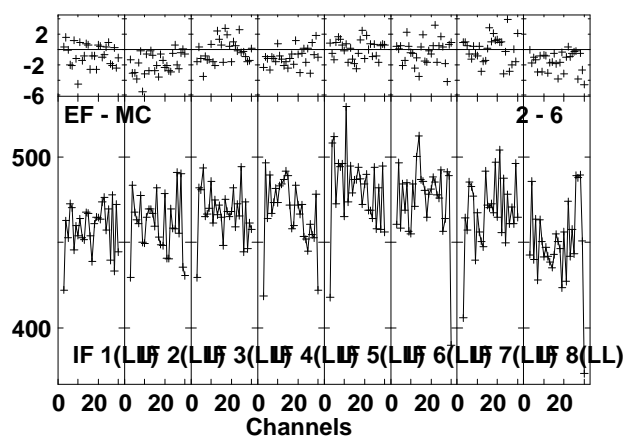
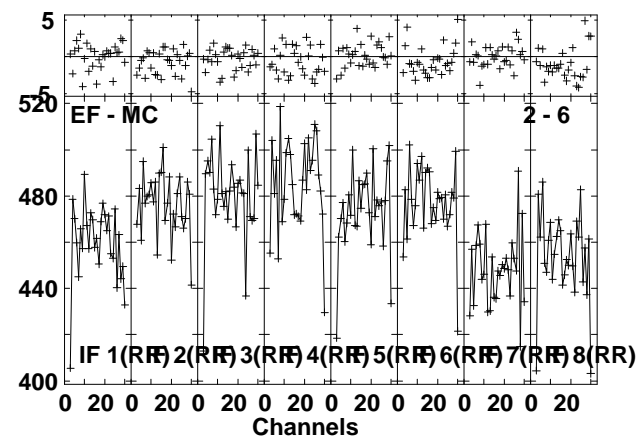
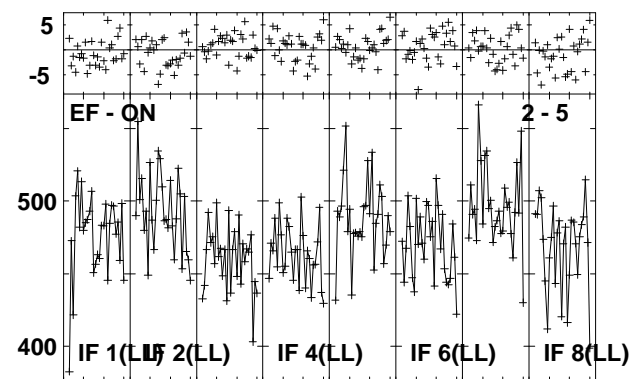
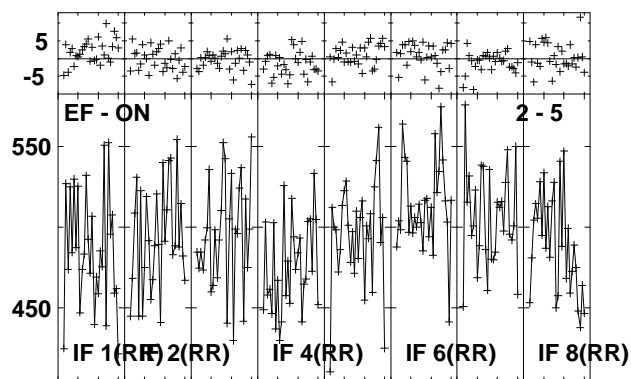
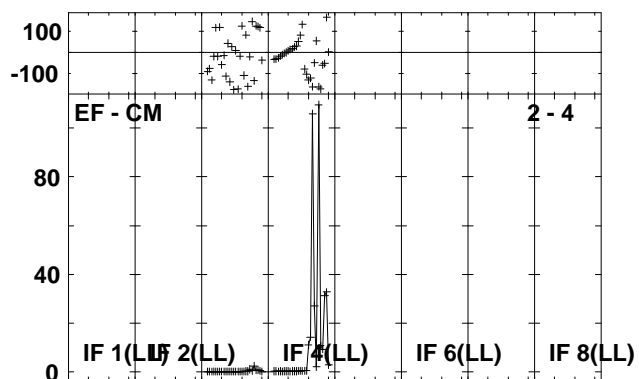
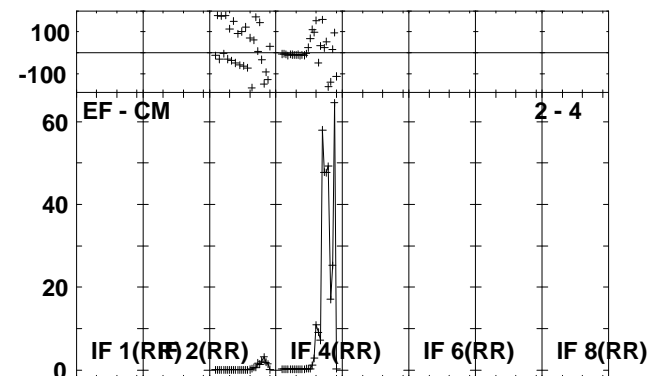
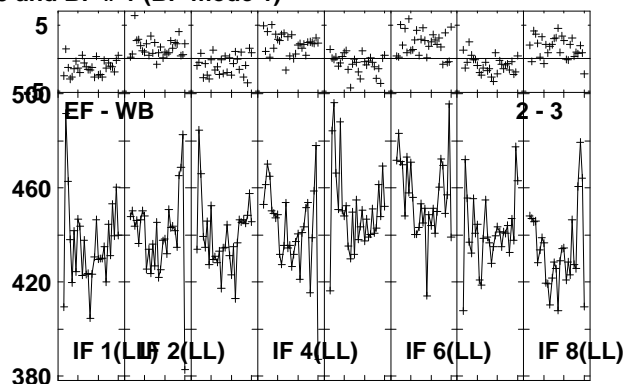
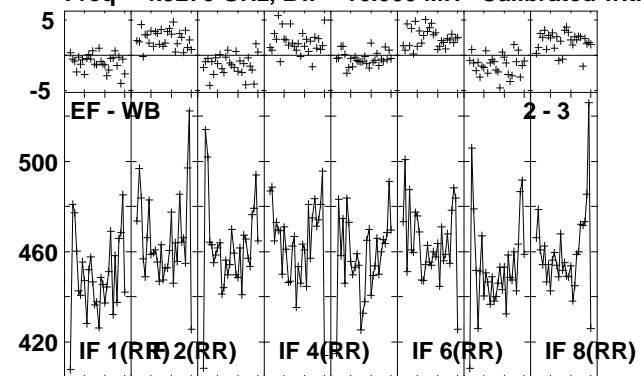

Lower frame: Milli Ampl Jy Top frame: Phas deg
Vector averaged cross-power spectrum Several baselines displayed
Timerange: 00/18:09:31 to 00/18:10:59

Plot file version 214 created 17-NOV-2010 16:23:11

J1128+59 EP068A 5.UVDATA.1

Freq = 4.9270 GHz, Bw = 16.000 MH Calibrated with CL # 3 and BP # 1 (BP mode 1)

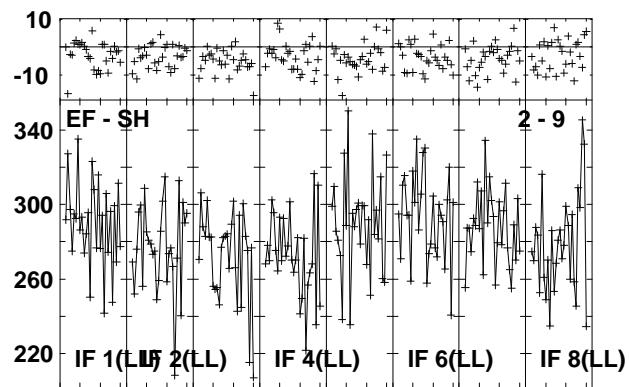
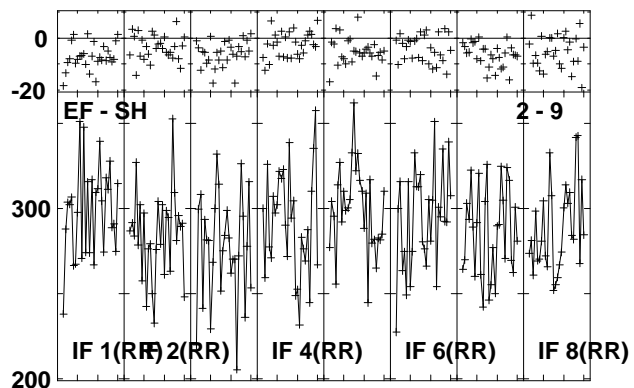
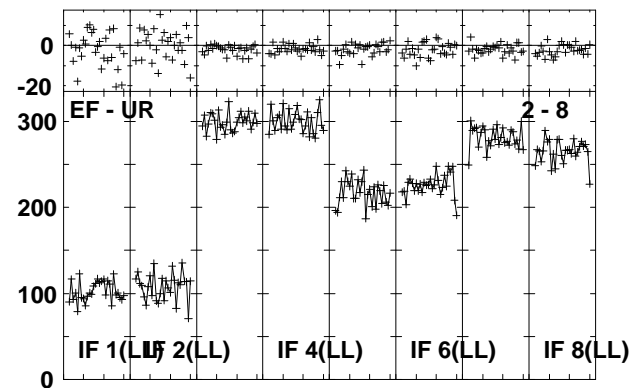
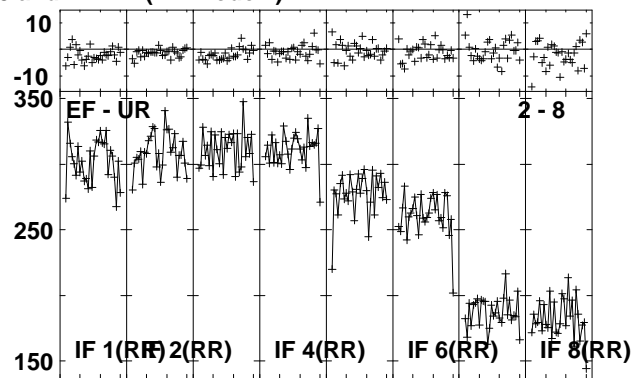
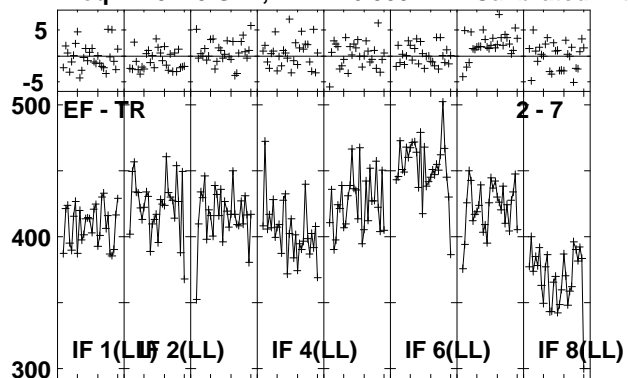

Lower frame: Milli Ampl Jy Top frame: Phas deg
Vector averaged cross-power spectrum Several baselines displayed
Timerange: 00:18:09:31 to 00:18:10:59

Plot file version 215 created 17-NOV-2010 16:23:12

ARP299D EP068A 5.UVDATA.1

Freq = 4.9270 GHz, Bw = 16.000 MH Calibrated with CL # 3 and BP # 1 (BP mode 1)

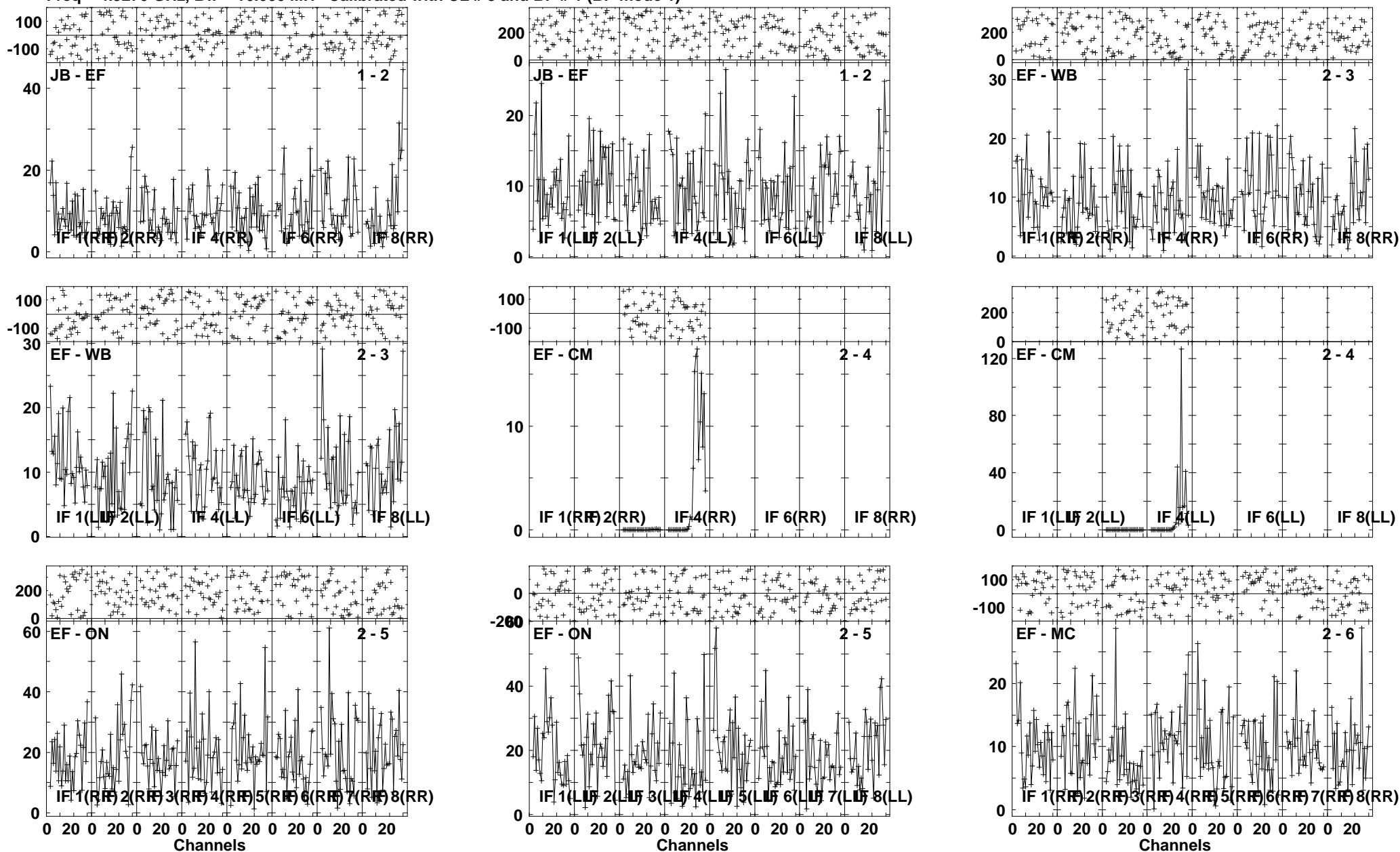

Lower frame: Milli Ampl Jy Top frame: Phas deg
Vector averaged cross-power spectrum Several baselines displayed
Timerange: 00:18:11:01 to 00:18:14:29

Plot file version 216 created 17-NOV-2010 16:23:15

ARP299D EP068A 5.UVDATA.1

Freq = 4.9270 GHz, Bw = 16.000 MH Calibrated with CL # 3 and BP # 1 (BP mode 1)

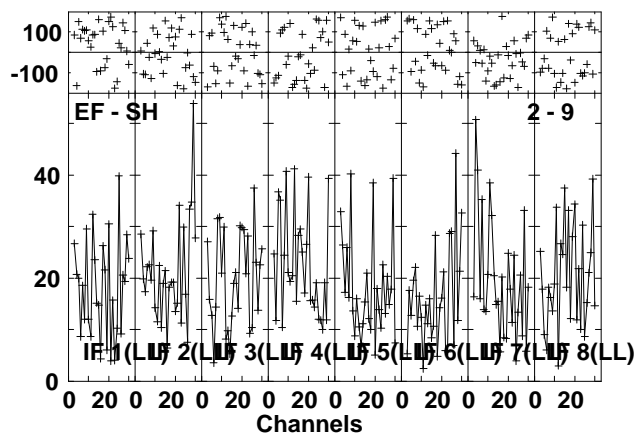
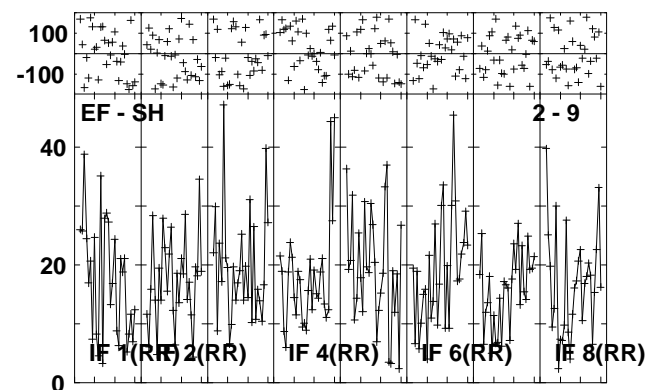
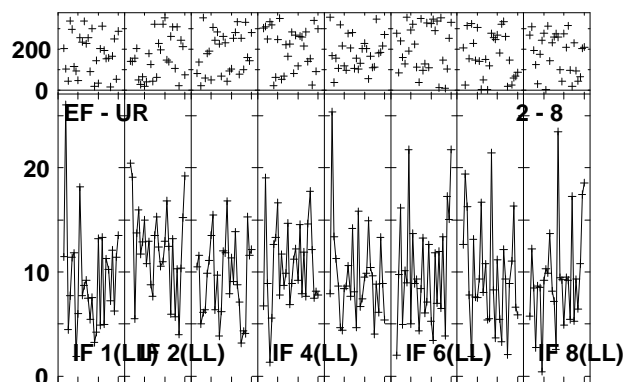
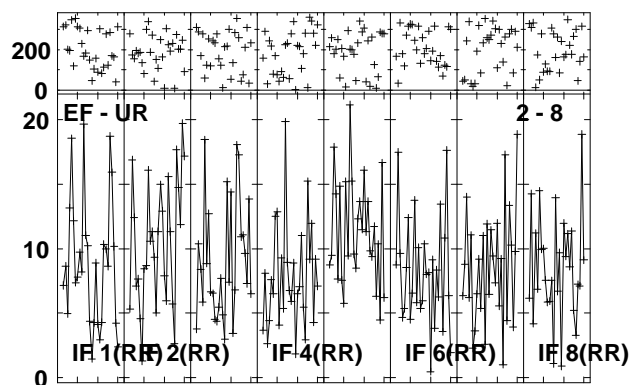
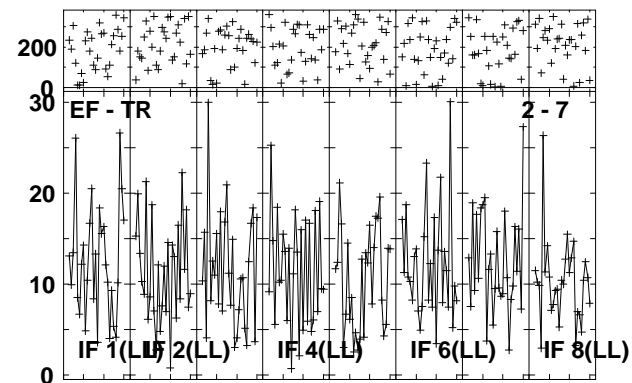
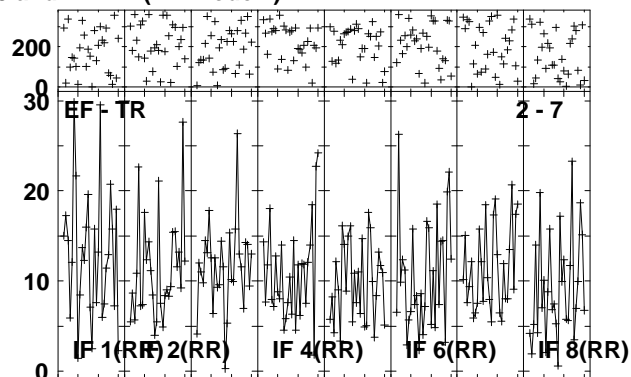
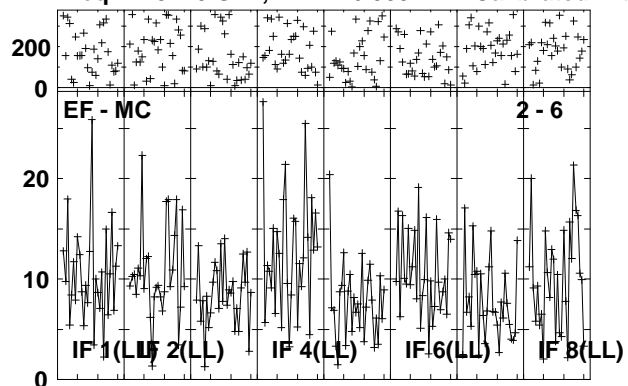

Lower frame: Milli Ampl Jy Top frame: Phas deg
Vector averaged cross-power spectrum Several baselines displayed
Timerange: 00:18:11:01 to 00:18:14:29

Plot file version 217 created 17-NOV-2010 16:23:18

J1128+59 EP068A 5.UVDATA.1

Freq = 4.9270 GHz, Bw = 16.000 MH Calibrated with CL # 3 and BP # 1 (BP mode 1)

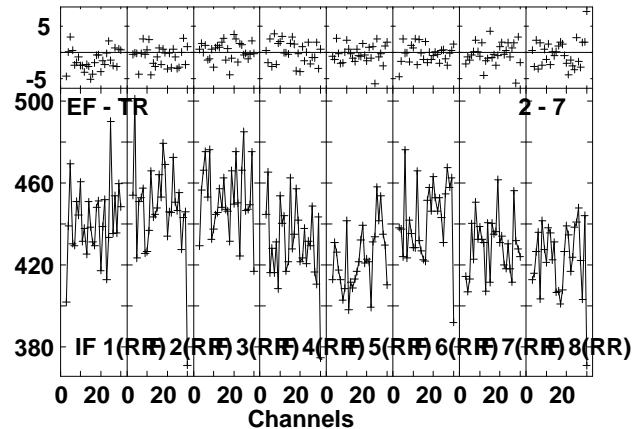
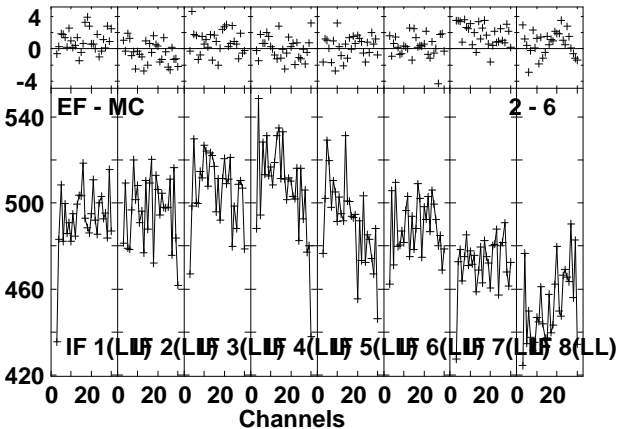
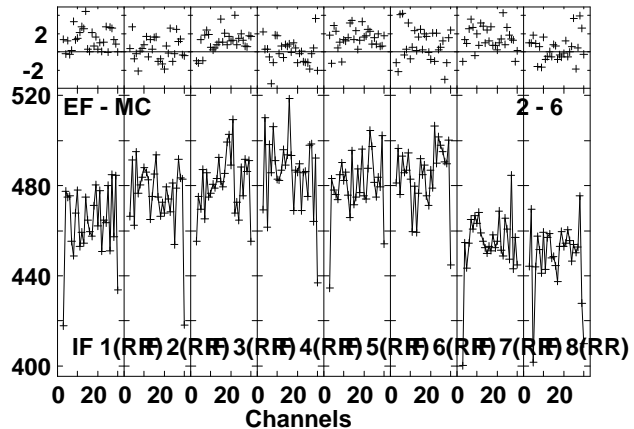
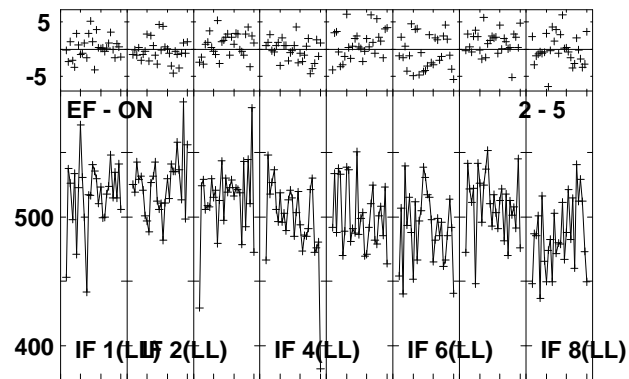
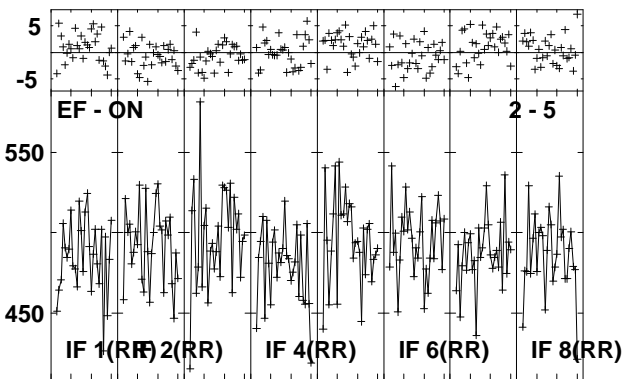
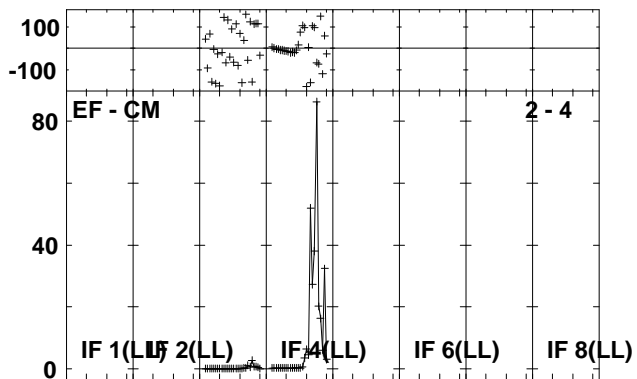
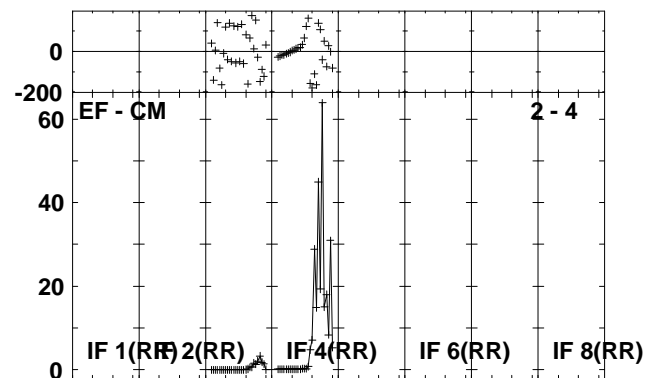
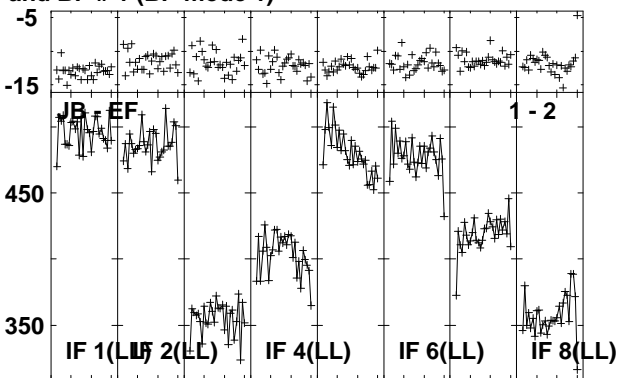
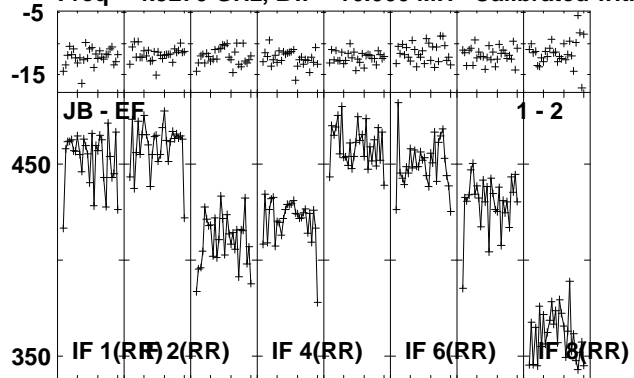

Lower frame: Milli Ampl Jy Top frame: Phas deg
 Vector averaged cross-power spectrum Several baselines displayed
 Timerange: 00/18:15:31 to 00/18:16:59

Plot file version 218 created 17-NOV-2010 16:23:20

J1128+59 EP068A 5.UVDATA.1

Freq = 4.9270 GHz, Bw = 16.000 MH Calibrated with CL # 3 and BP # 1 (BP mode 1)

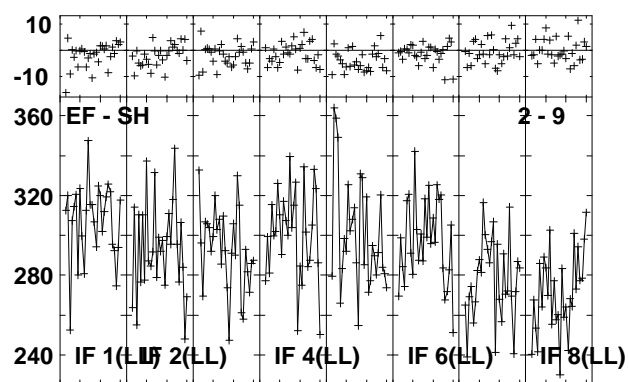
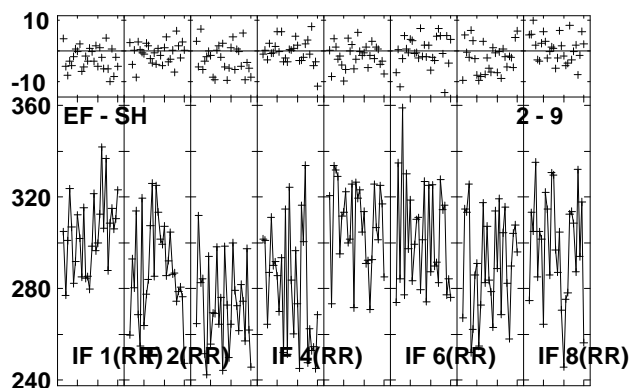
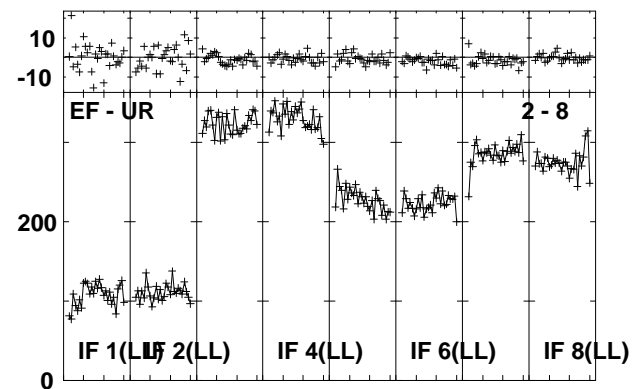
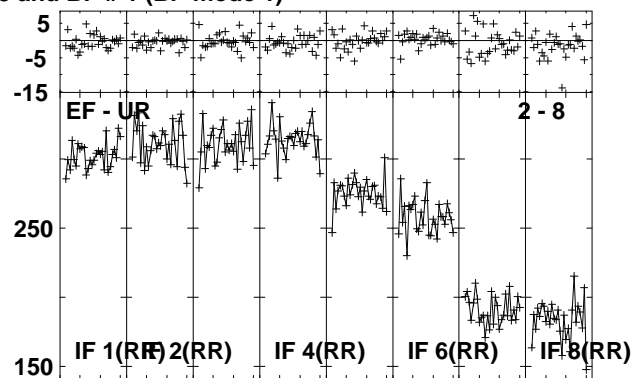
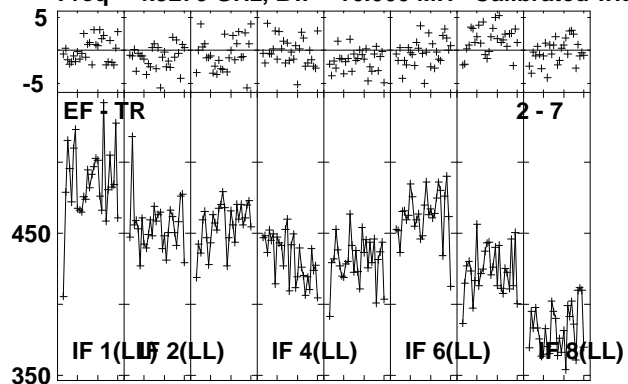

Lower frame: Milli Ampl Jy Top frame: Phas deg
Vector averaged cross-power spectrum Several baselines displayed
Timerange: 00/18:15:31 to 00/18:16:59

Plot file version 219 created 17-NOV-2010 16:23:21

ARP299D EP068A 5.UVDATA.1

Freq = 4.9270 GHz, Bw = 16.000 MH Calibrated with CL # 3 and BP # 1 (BP mode 1)

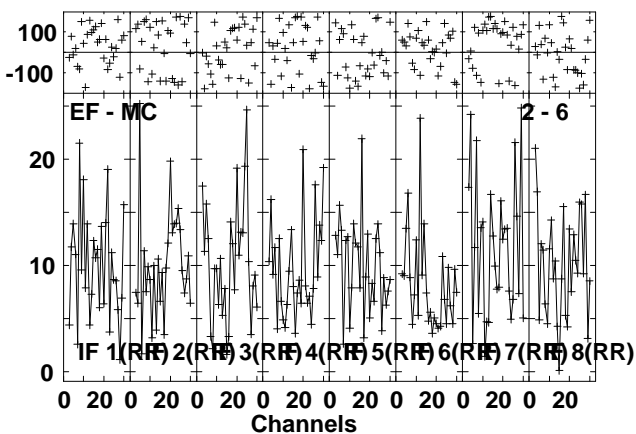
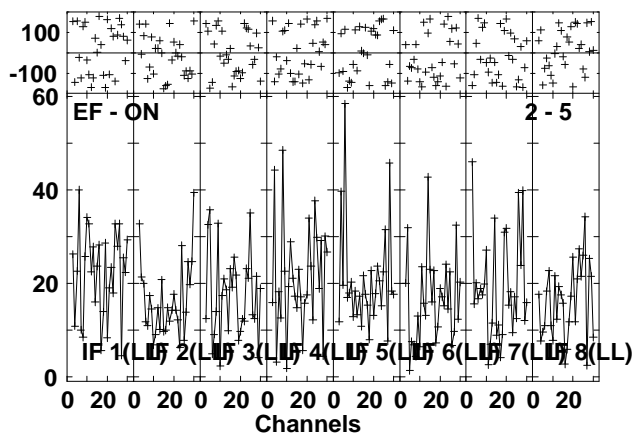
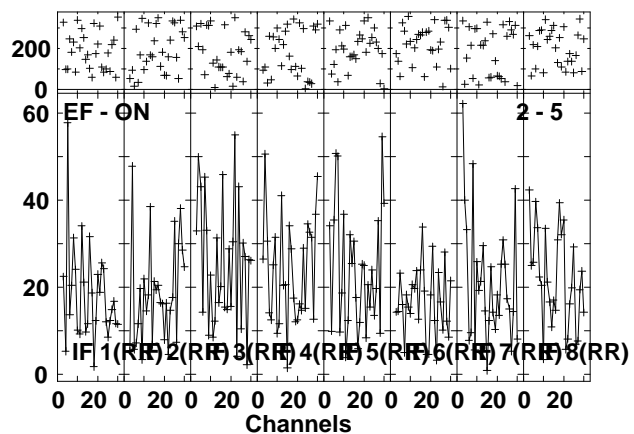
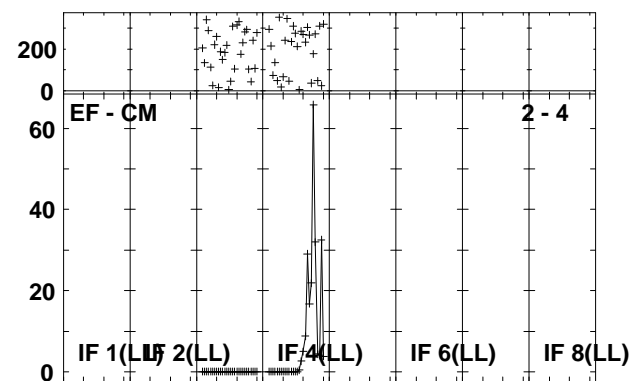
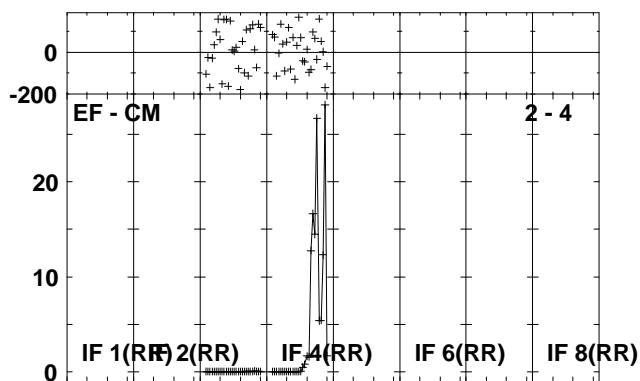
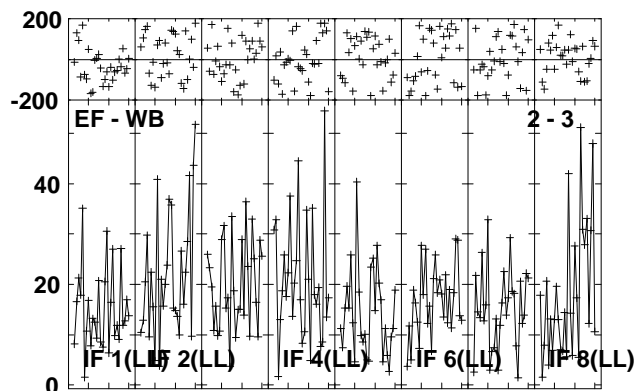
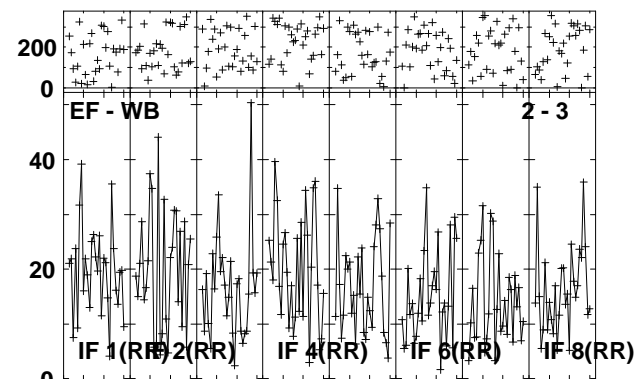
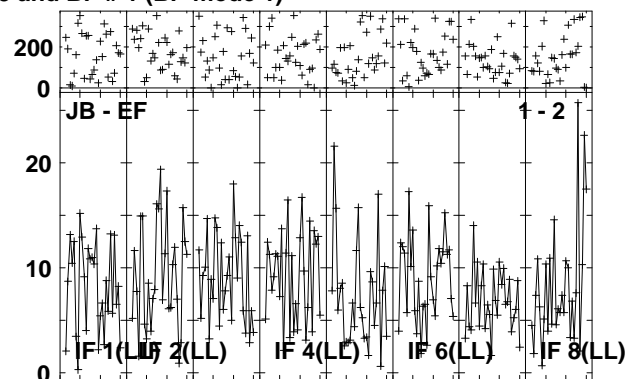
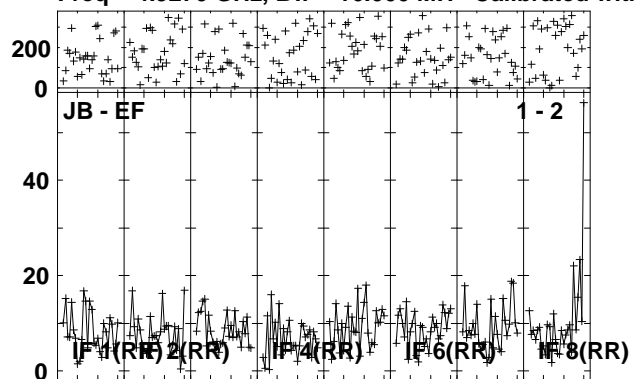

Lower frame: Milli Ampl Jy Top frame: Phas deg
Vector averaged cross-power spectrum Several baselines displayed
Timerange: 00:18:17:01 to 00:18:20:29

Plot file version 220 created 17-NOV-2010 16:23:24

ARP299D EP068A 5.UVDATA.1

Freq = 4.9270 GHz, Bw = 16.000 MH Calibrated with CL # 3 and BP # 1 (BP mode 1)

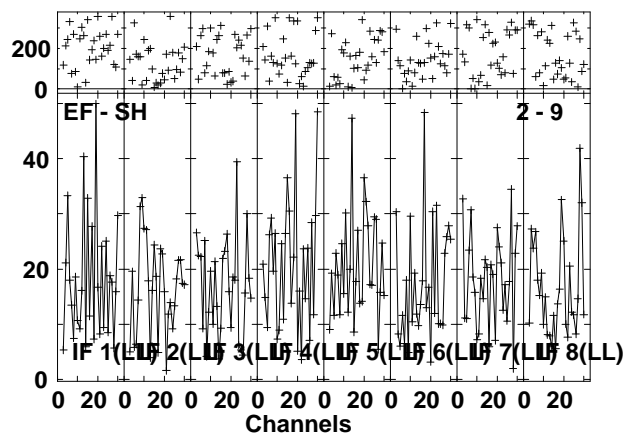
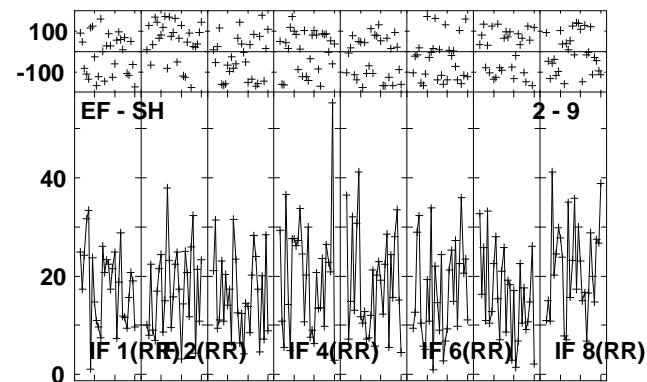
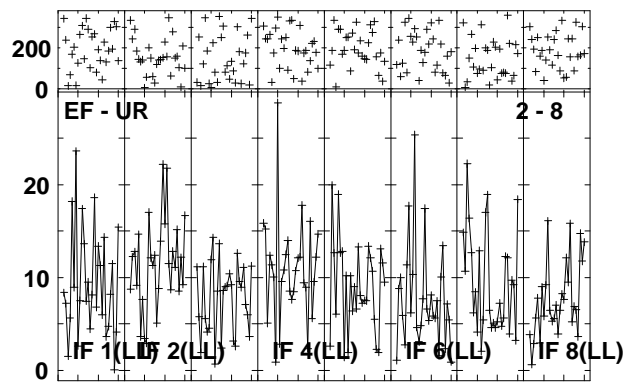
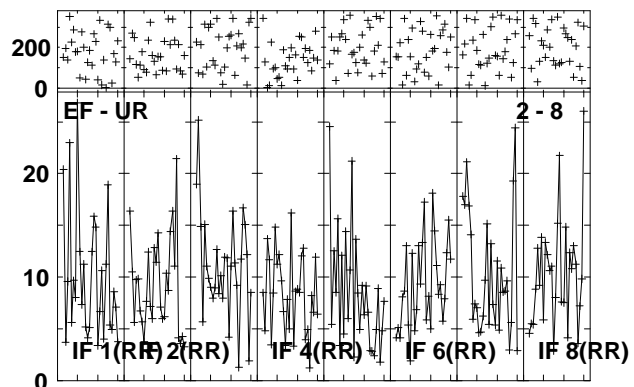
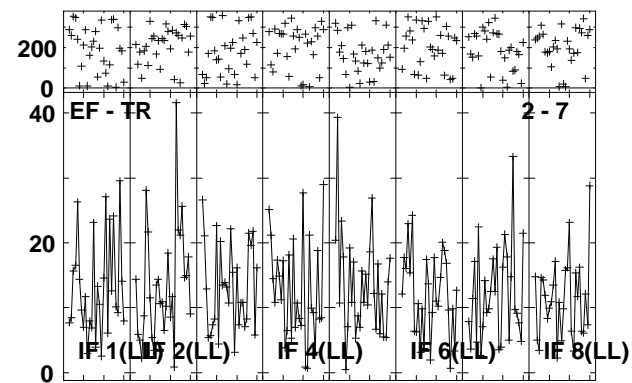
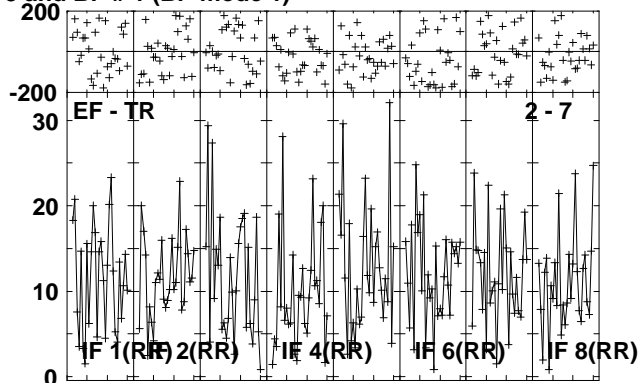
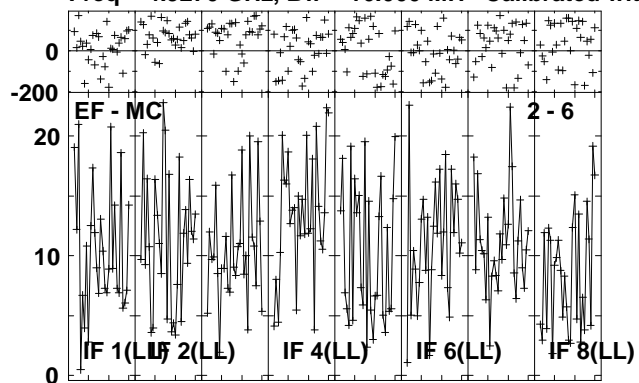

Lower frame: Milli Ampl Jy Top frame: Phas deg
Vector averaged cross-power spectrum Several baselines displayed
Timerange: 00:18:17:01 to 00:18:20:29

Plot file version 221 created 17-NOV-2010 16:23:27

J1128+59 EP068A 5.UVDATA.1

Freq = 4.9270 GHz, Bw = 16.000 MH Calibrated with CL # 3 and BP # 1 (BP mode 1)

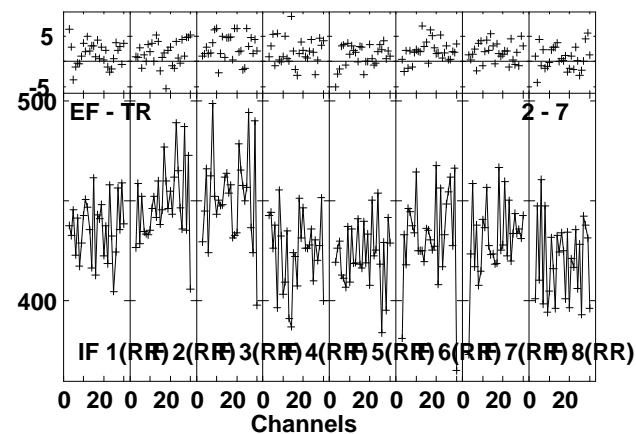
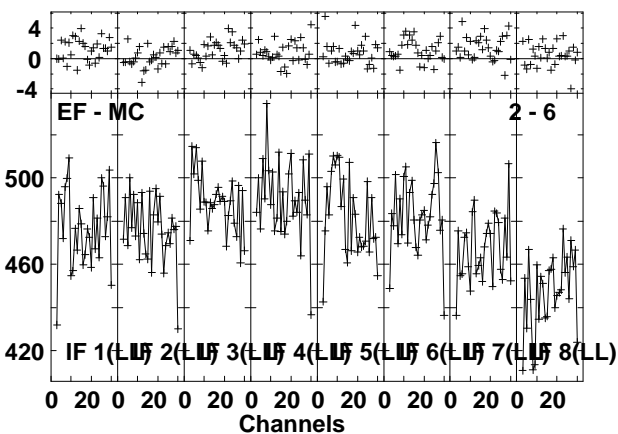
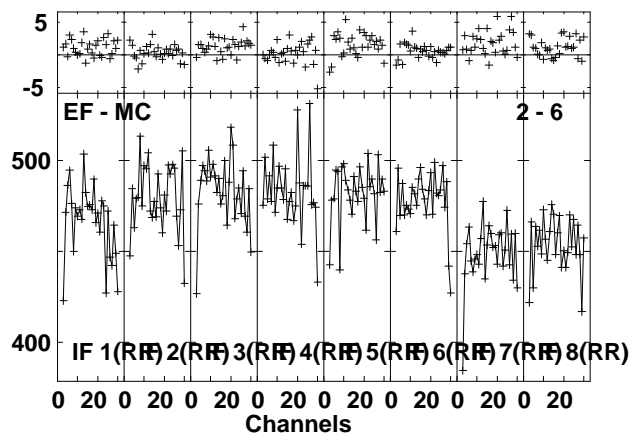
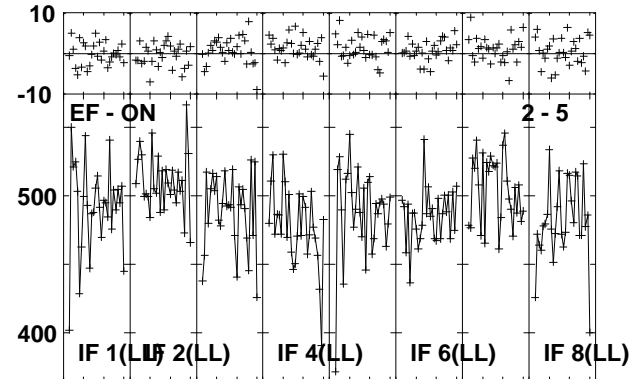
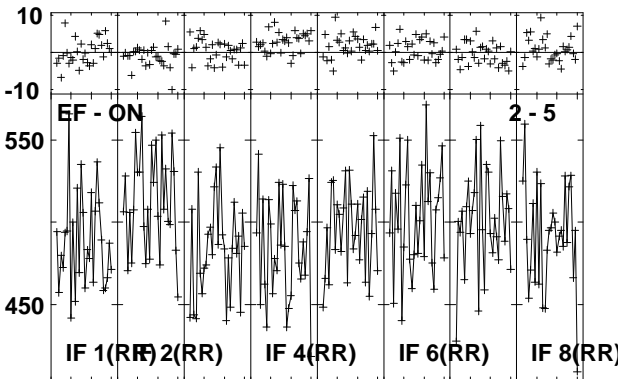
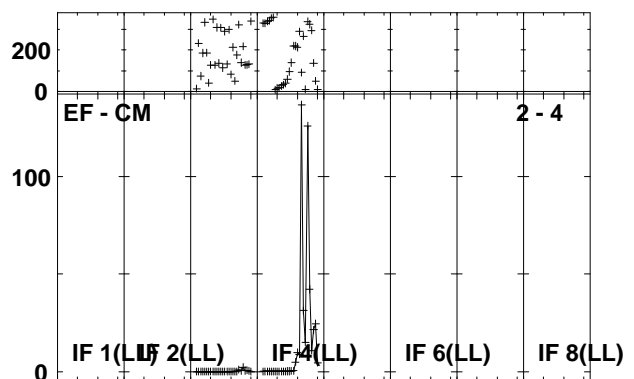
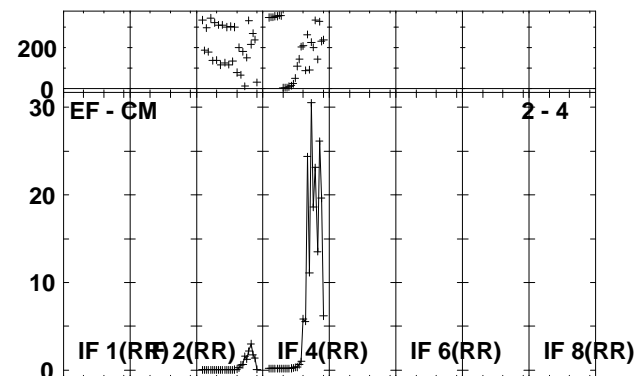
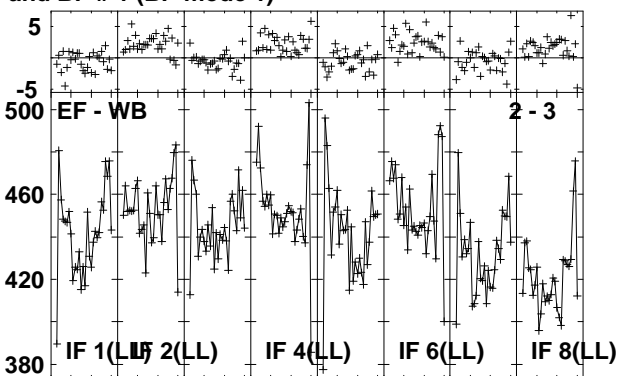
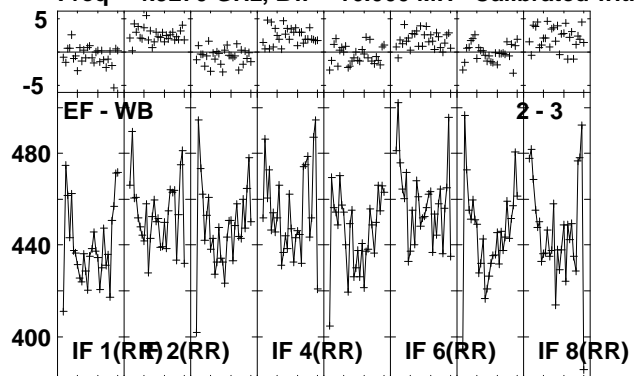

Lower frame: Milli Ampl Jy Top frame: Phas deg
Vector averaged cross-power spectrum Several baselines displayed
Timerange: 00/18:20:31 to 00/18:21:59

Plot file version 222 created 17-NOV-2010 16:23:28

J1128+59 EP068A 5.UVDATA.1

Freq = 4.9270 GHz, Bw = 16.000 MH Calibrated with CL # 3 and BP # 1 (BP mode 1)

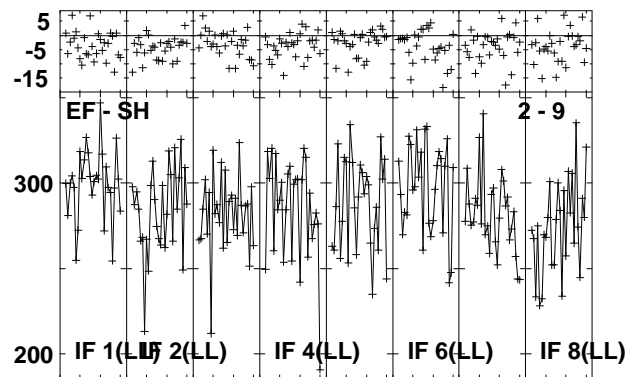
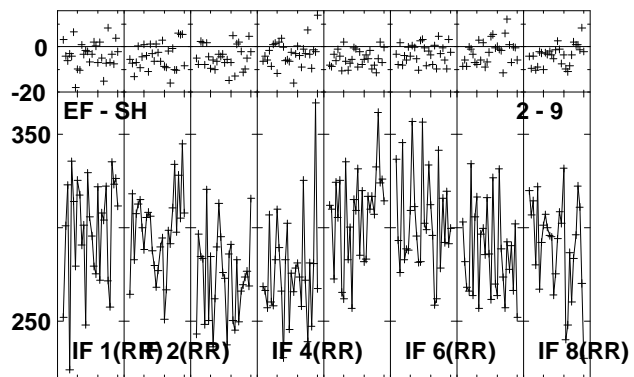
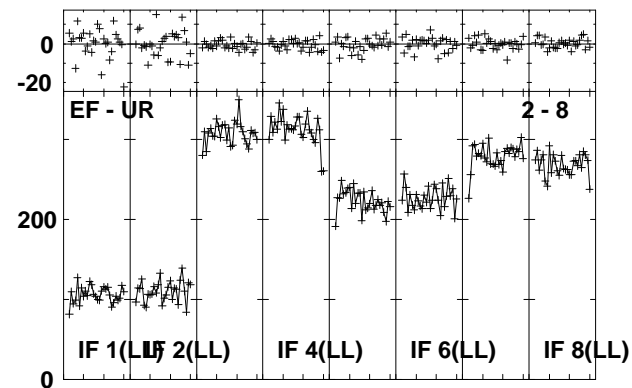
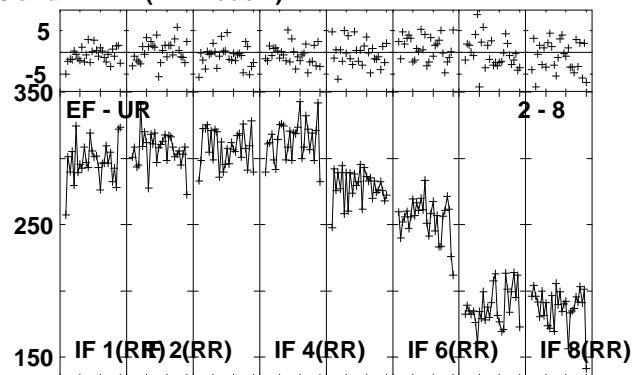
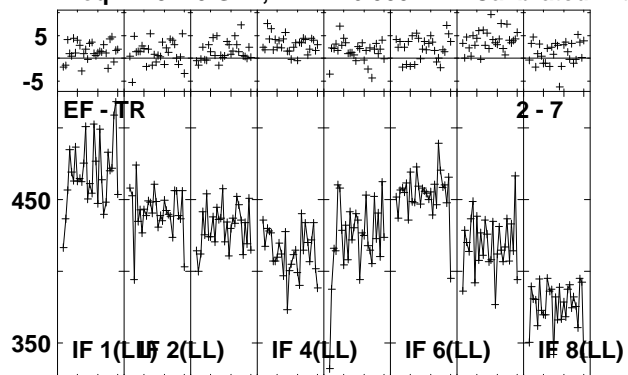

Lower frame: Milli Ampl Jy Top frame: Phas deg
Vector averaged cross-power spectrum Several baselines displayed
Timerange: 00/18:20:31 to 00/18:21:59

Plot file version 223 created 17-NOV-2010 16:23:29

ARP299D EP068A 5.UVDATA.1

Freq = 4.9270 GHz, Bw = 16.000 MH Calibrated with CL # 3 and BP # 1 (BP mode 1)

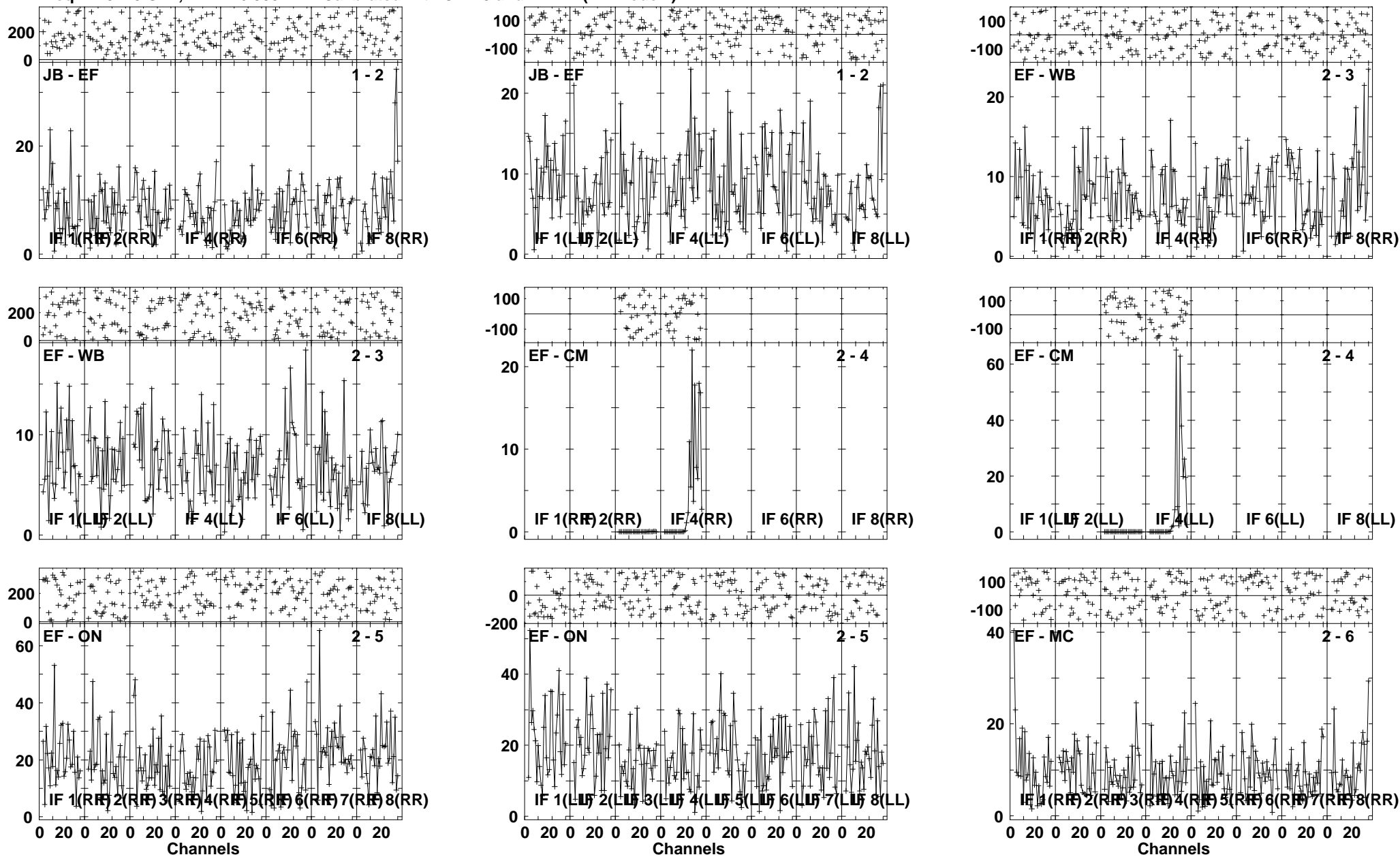

Lower frame: Milli Ampl Jy Top frame: Phas deg
Vector averaged cross-power spectrum Several baselines displayed
Timerange: 00/18:22:01 to 00/18:25:29

Plot file version 224 created 17-NOV-2010 16:23:32

ARP299D EP068A 5.UVDATA.1

Freq = 4.9270 GHz, Bw = 16.000 MH Calibrated with CL # 3 and BP # 1 (BP mode 1)

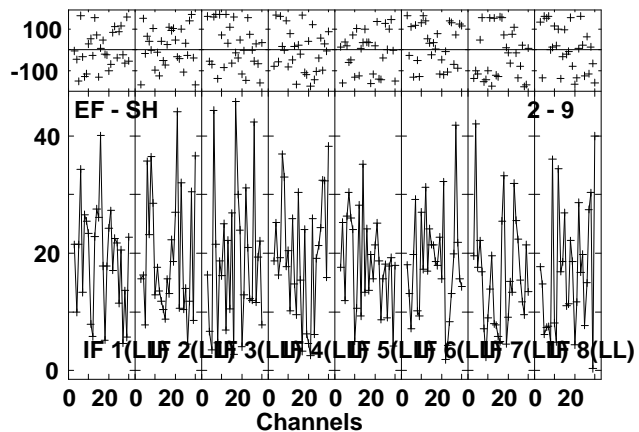
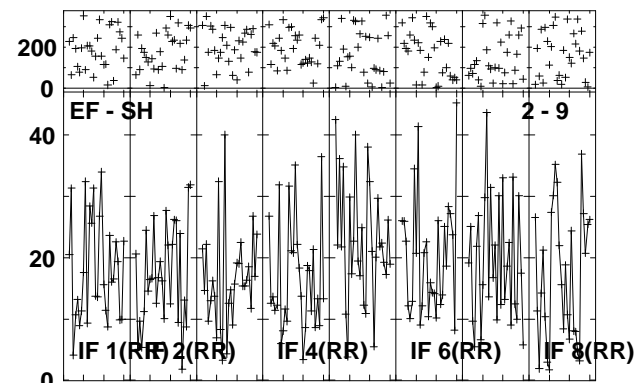
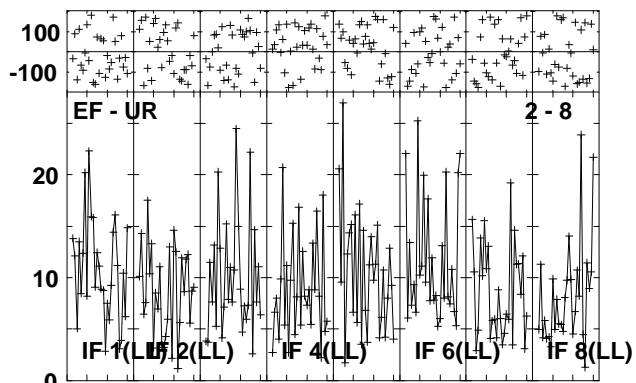
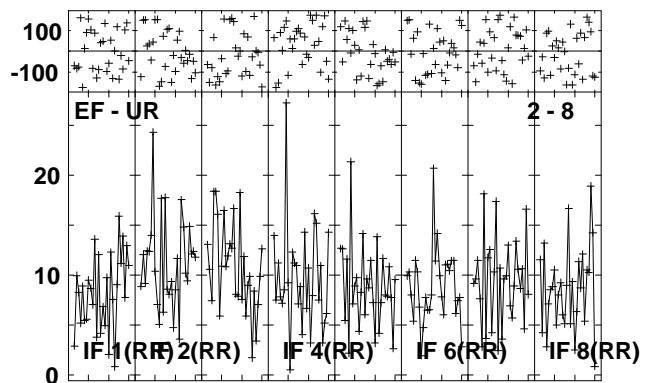
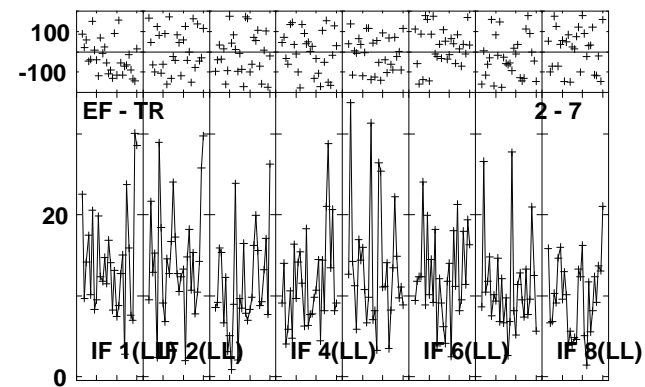
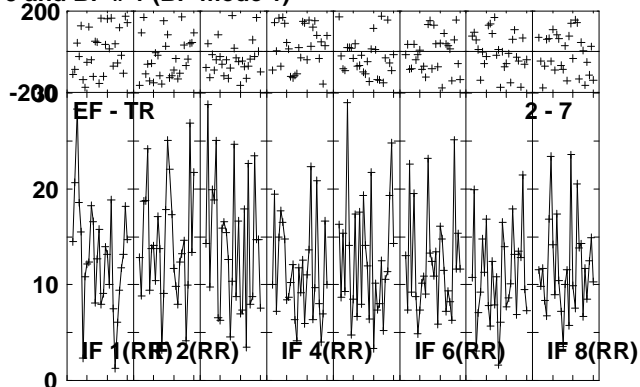
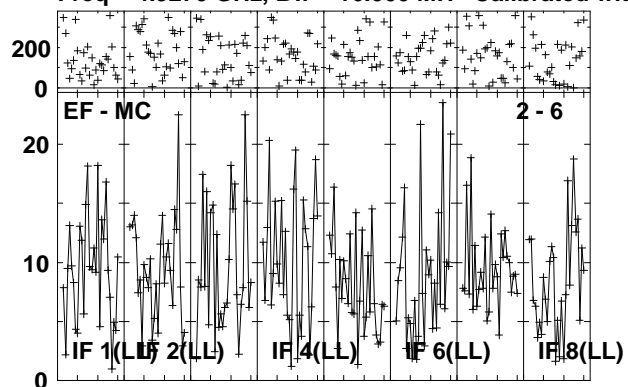

Lower frame: Milli Ampl Jy Top frame: Phas deg
Vector averaged cross-power spectrum Several baselines displayed
Timerange: 00:18:22:01 to 00:18:25:29

Plot file version 225 created 17-NOV-2010 16:23:35

J1128+59 EP068A 5.UVDATA.1

Freq = 4.9270 GHz, Bw = 16.000 MH Calibrated with CL # 3 and BP # 1 (BP mode 1)

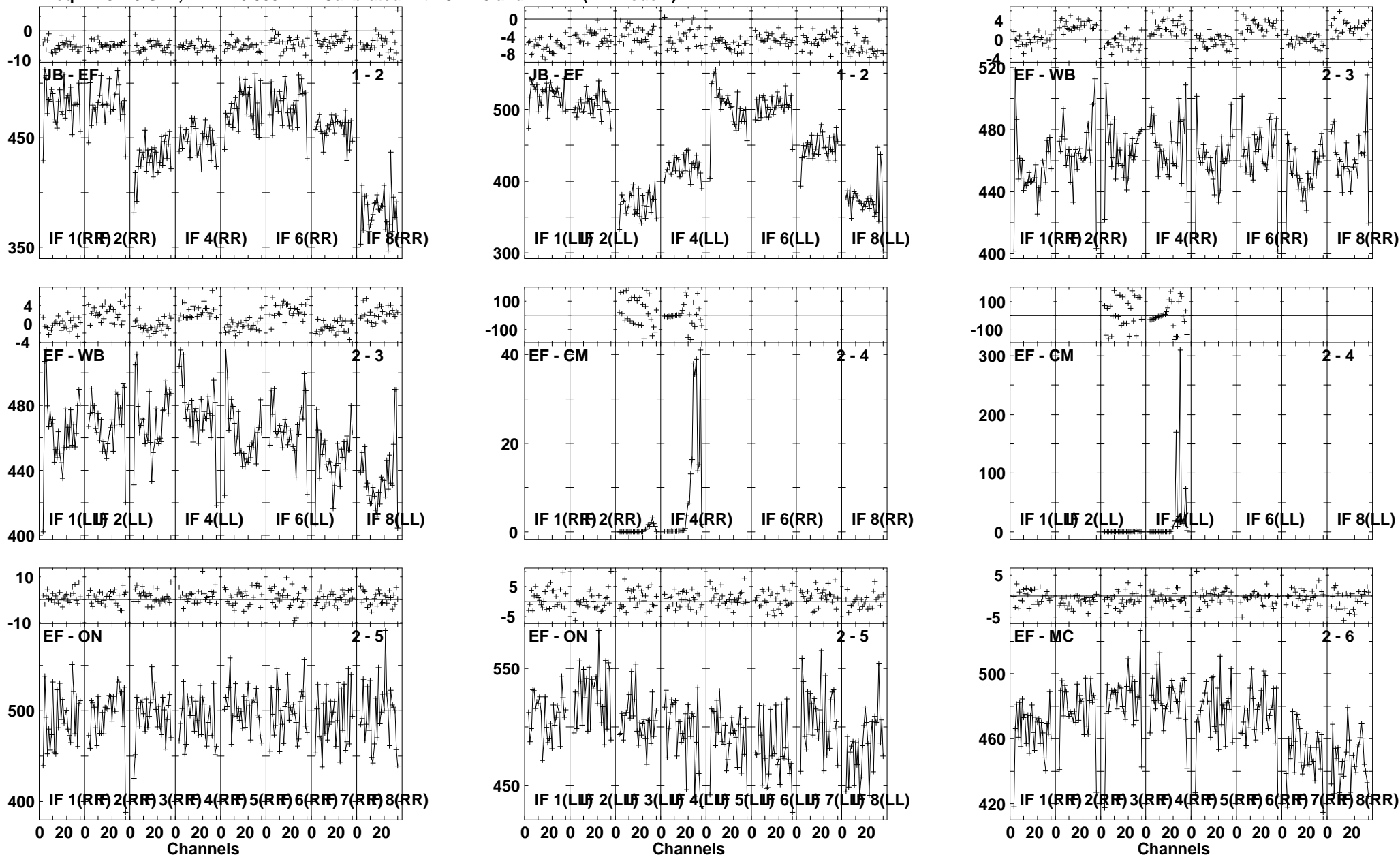

Lower frame: Milli Ampl Jy Top frame: Phas deg
Vector averaged cross-power spectrum Several baselines displayed
Timerange: 00:18:25:31 to 00:18:26:59

Plot file version 226 created 17-NOV-2010 16:23:36

J1128+59 EP068A 5.UVDATA.1

Freq = 4.9270 GHz, Bw = 16.000 MH Calibrated with CL # 3 and BP # 1 (BP mode 1)

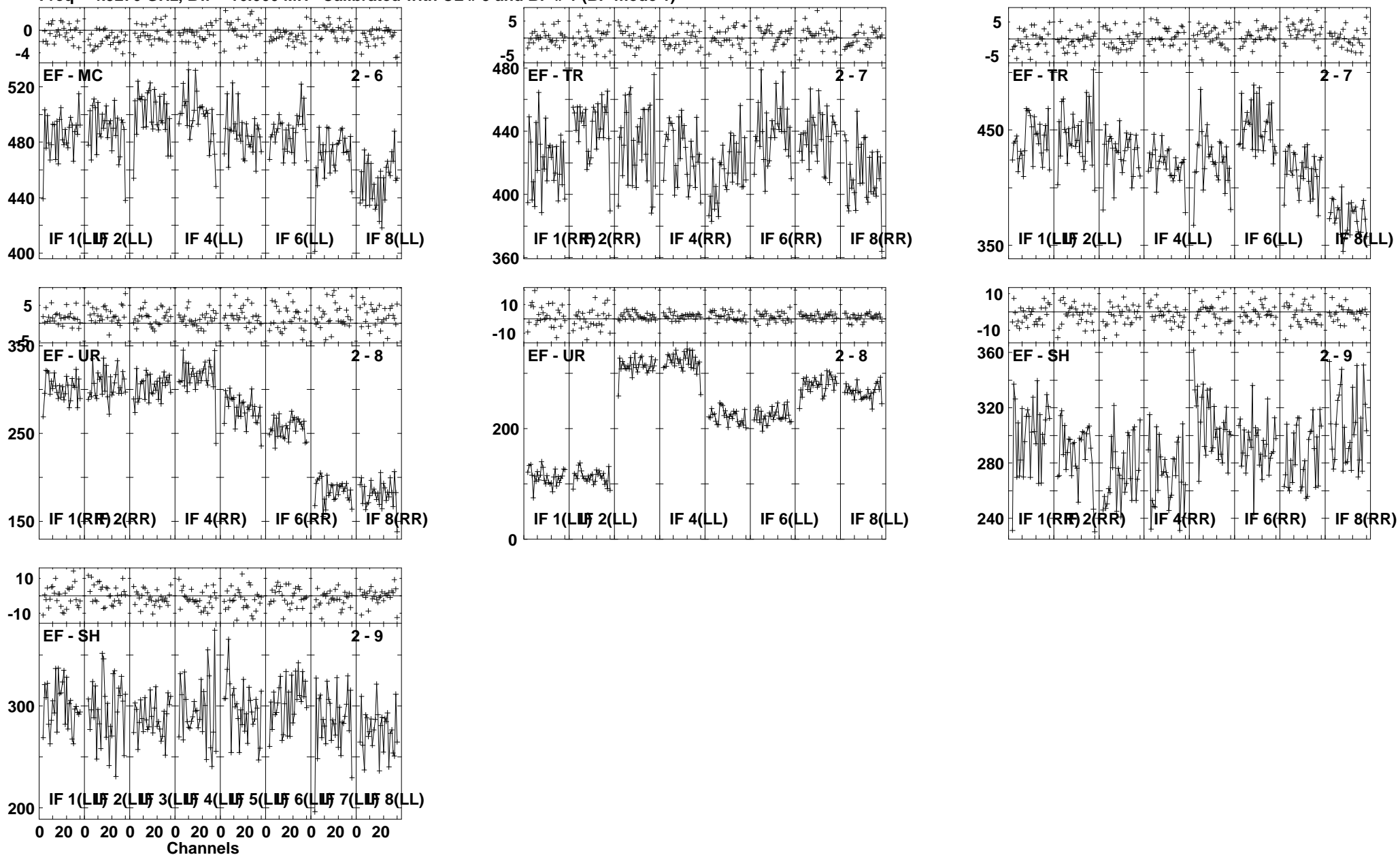

Lower frame: Milli Ampl Jy Top frame: Phas deg
Vector averaged cross-power spectrum Several baselines displayed
Timerange: 00/18:25:31 to 00/18:26:59

Plot file version 227 created 17-NOV-2010 16:23:38

ARP299D EP068A 5.UVDATA.1

Freq = 4.9270 GHz, Bw = 16.000 MH Calibrated with CL # 3 and BP # 1 (BP mode 1)

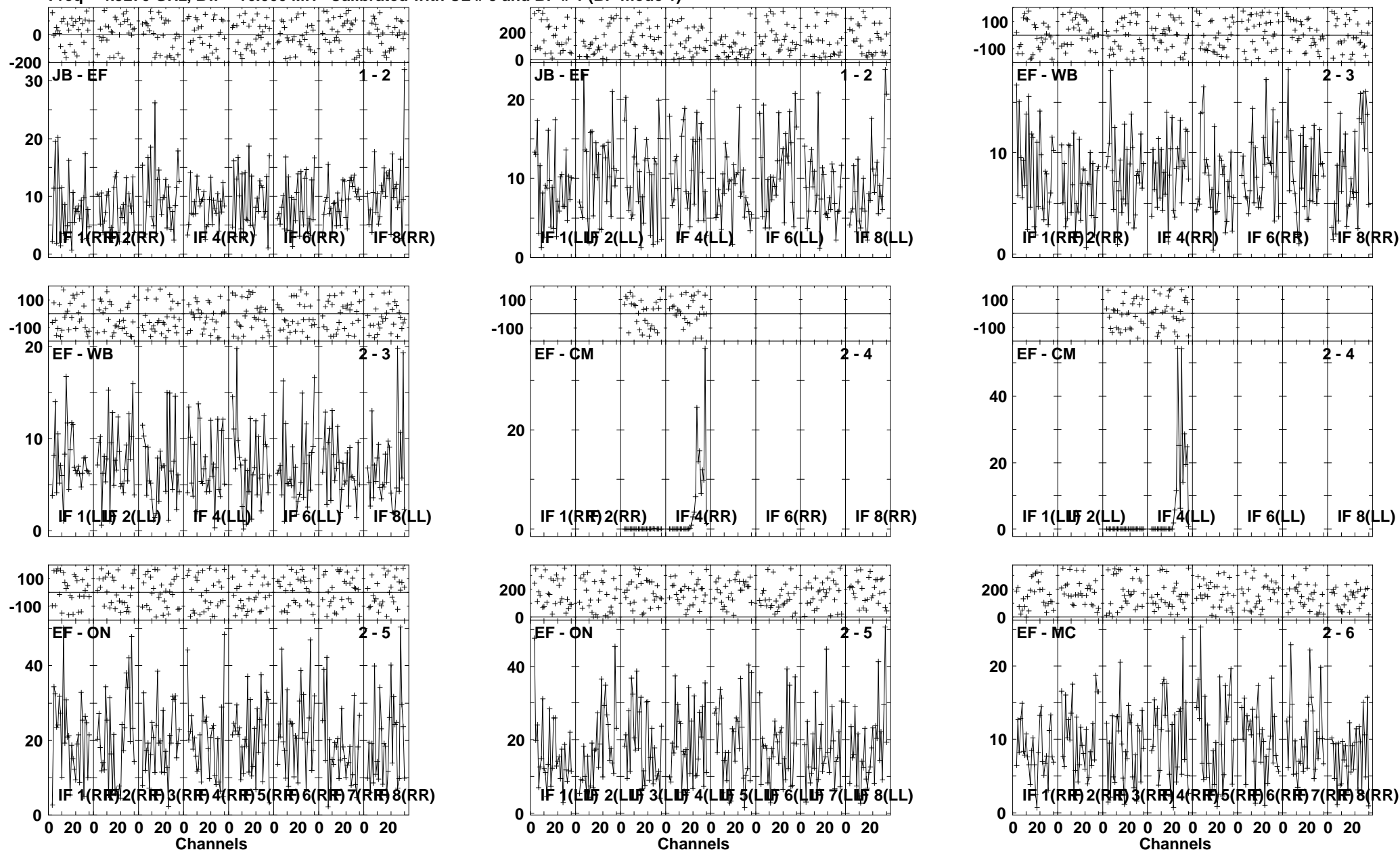

Lower frame: Milli Ampl Jy Top frame: Phas deg
Vector averaged cross-power spectrum Several baselines displayed
Timerange: 00/18:27:01 to 00/18:30:29

Plot file version 228 created 17-NOV-2010 16:23:41

ARP299D EP068A 5.UVDATA.1

Freq = 4.9270 GHz, Bw = 16.000 MH Calibrated with CL # 3 and BP # 1 (BP mode 1)

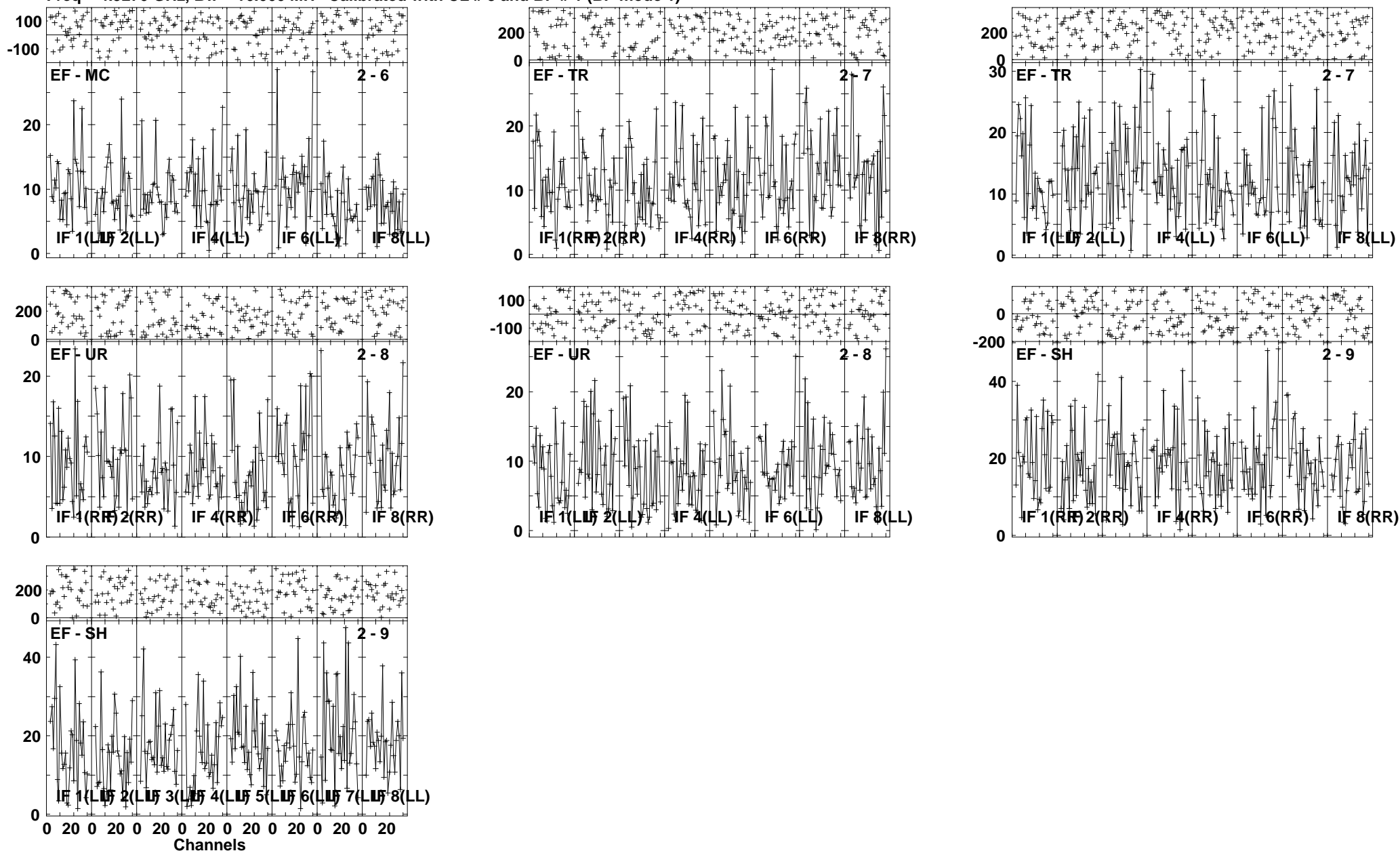

Lower frame: Milli Ampl Jy Top frame: Phas deg
Vector averaged cross-power spectrum Several baselines displayed
Timerange: 00/18:27:01 to 00/18:30:29

Plot file version 229 created 17-NOV-2010 16:23:44

J1128+59 EP068A 5.UVDATA.1

Freq = 4.9270 GHz, Bw = 16.000 MH Calibrated with CL # 3 and BP # 1 (BP mode 1)

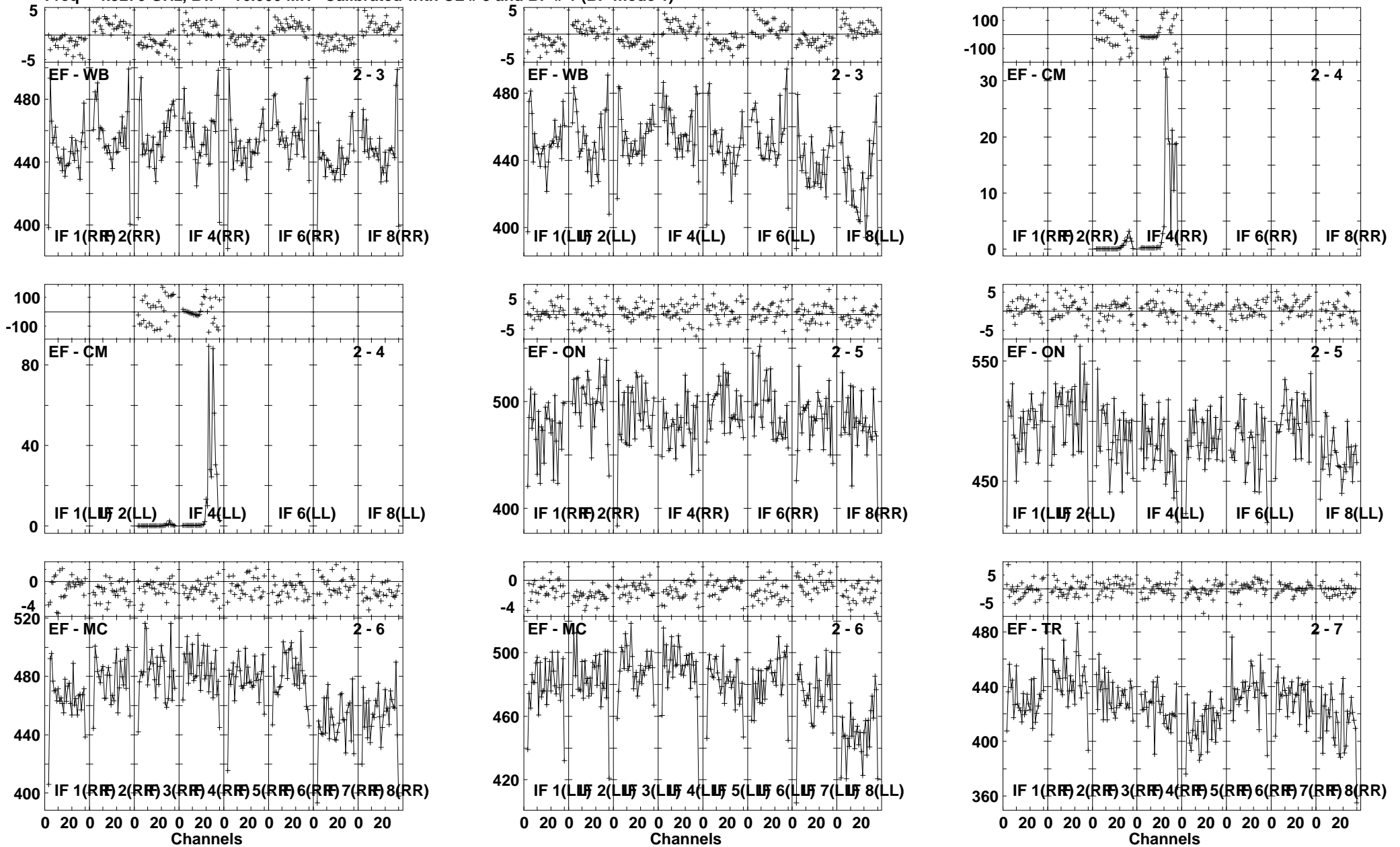

Lower frame: Milli Ampl Jy Top frame: Phas deg
Vector averaged cross-power spectrum Several baselines displayed
Timerange: 00/18:31:31 to 00/18:32:59

Plot file version 230 created 17-NOV-2010 16:23:45

J1128+59 EP068A 5.UVDATA.1

Freq = 4.9270 GHz, Bw = 16.000 MH Calibrated with CL # 3 and BP # 1 (BP mode 1)

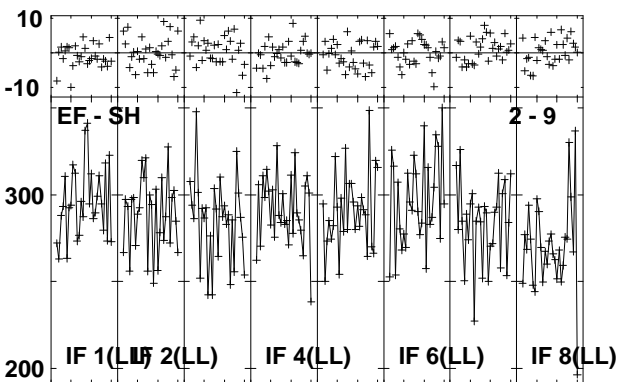
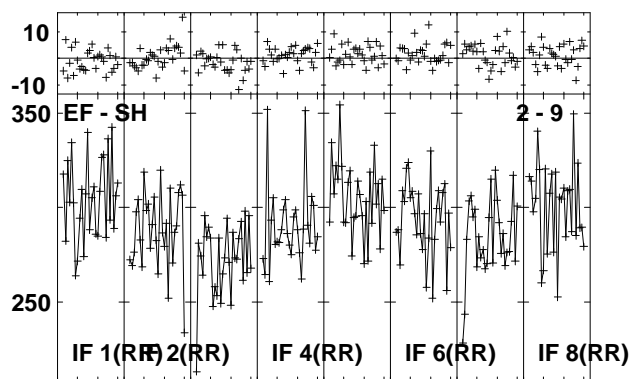
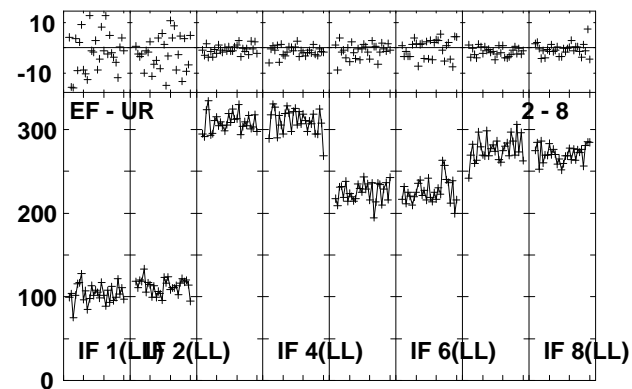
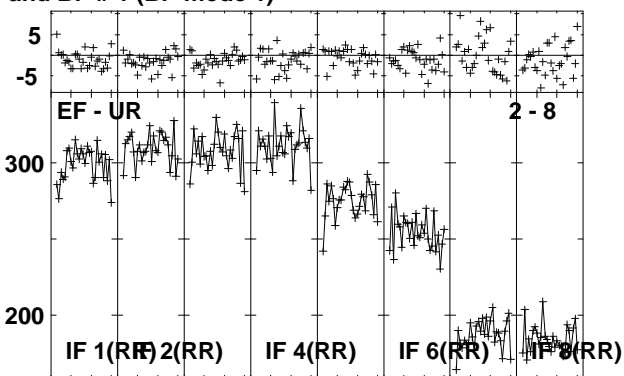
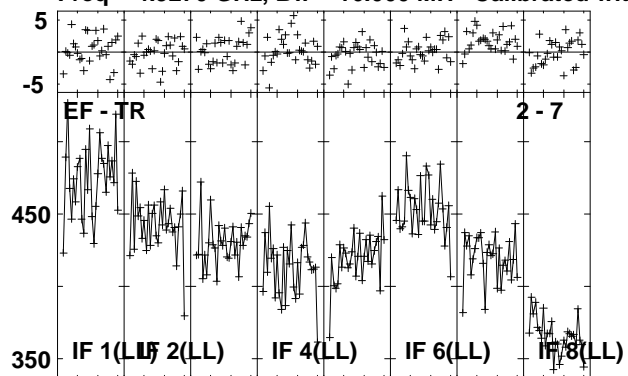

Lower frame: Milli Ampl Jy Top frame: Phas deg
Vector averaged cross-power spectrum Several baselines displayed
Timerange: 00:18:31:31 to 00:18:32:59

Plot file version 231 created 17-NOV-2010 16:23:46

ARP299D EP068A 5.UVDATA.1

Freq = 4.9270 GHz, Bw = 16.000 MH Calibrated with CL # 3 and BP # 1 (BP mode 1)

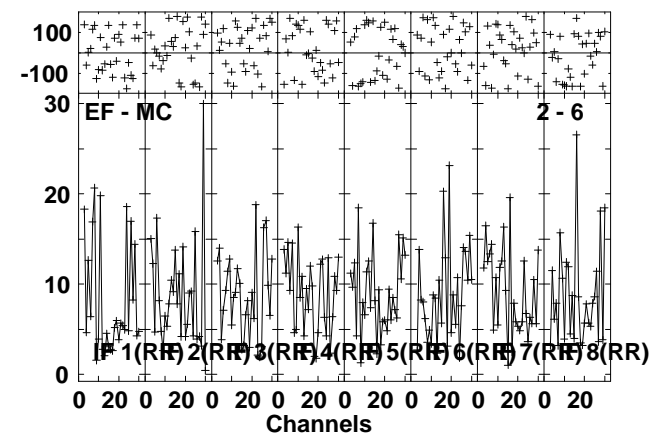
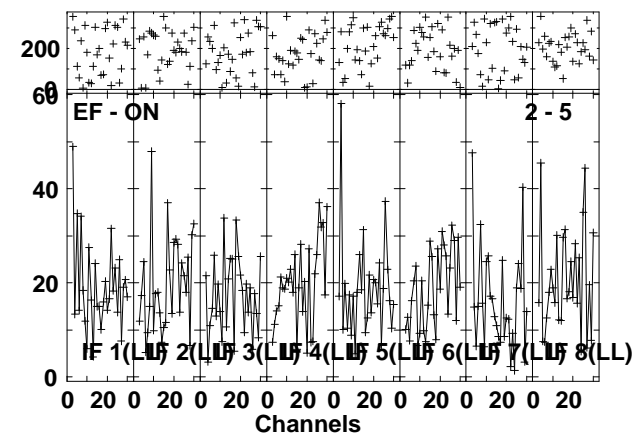
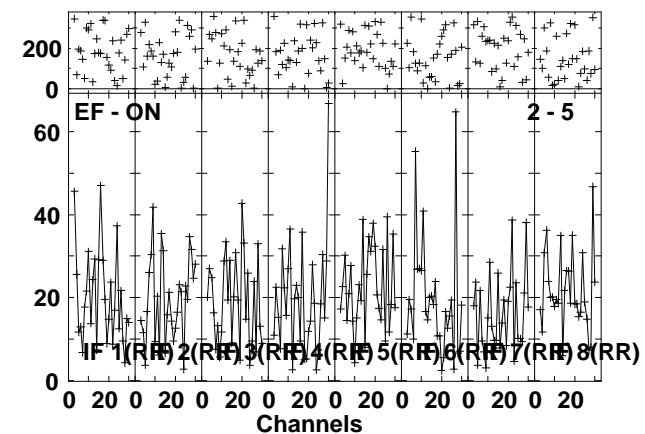
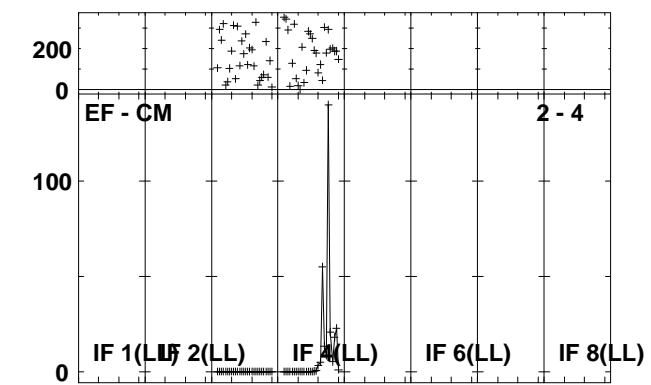
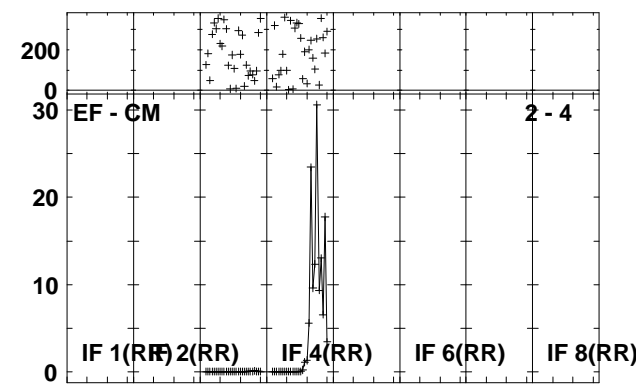
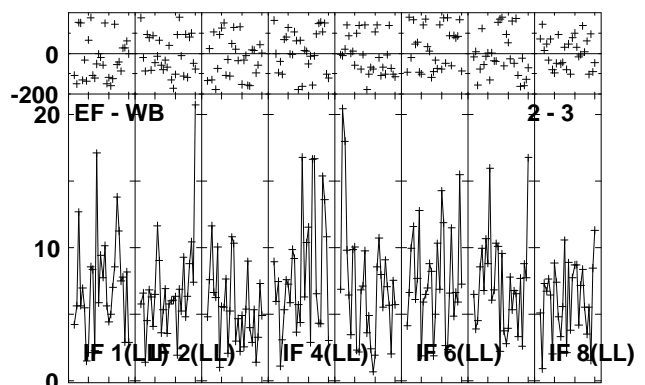
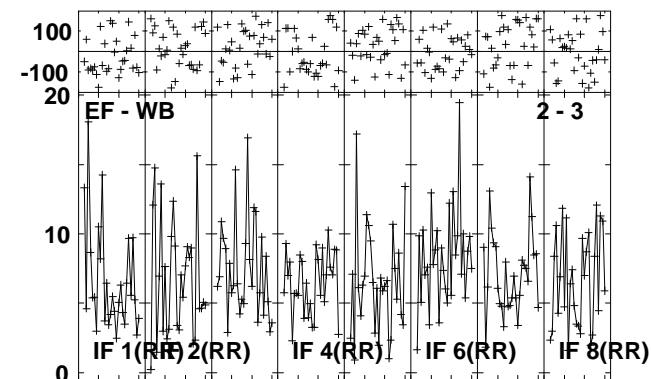
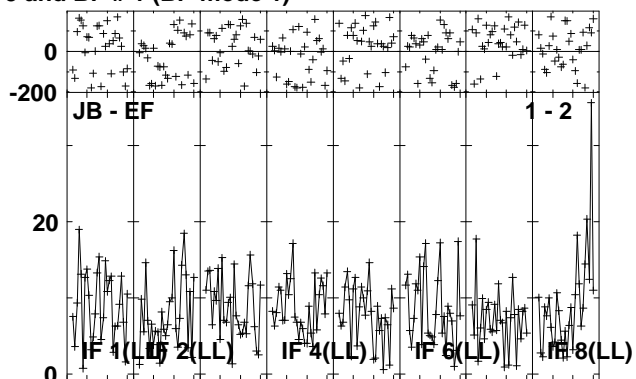
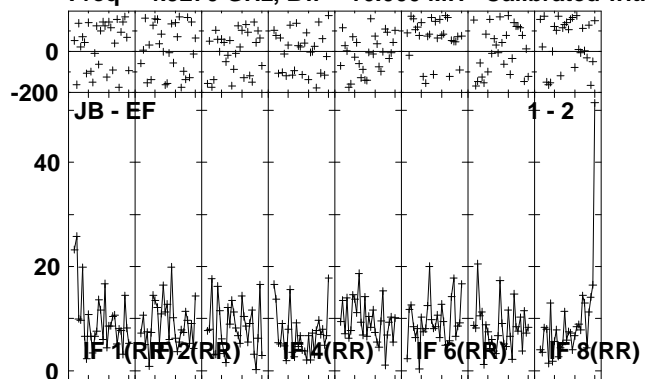

Lower frame: Milli Ampl Jy Top frame: Phas deg
Vector averaged cross-power spectrum Several baselines displayed
Timerange: 00/18:33:01 to 00/18:36:29

Plot file version 232 created 17-NOV-2010 16:23:49

ARP299D EP068A 5.UVDATA.1

Freq = 4.9270 GHz, Bw = 16.000 MH Calibrated with CL # 3 and BP # 1 (BP mode 1)

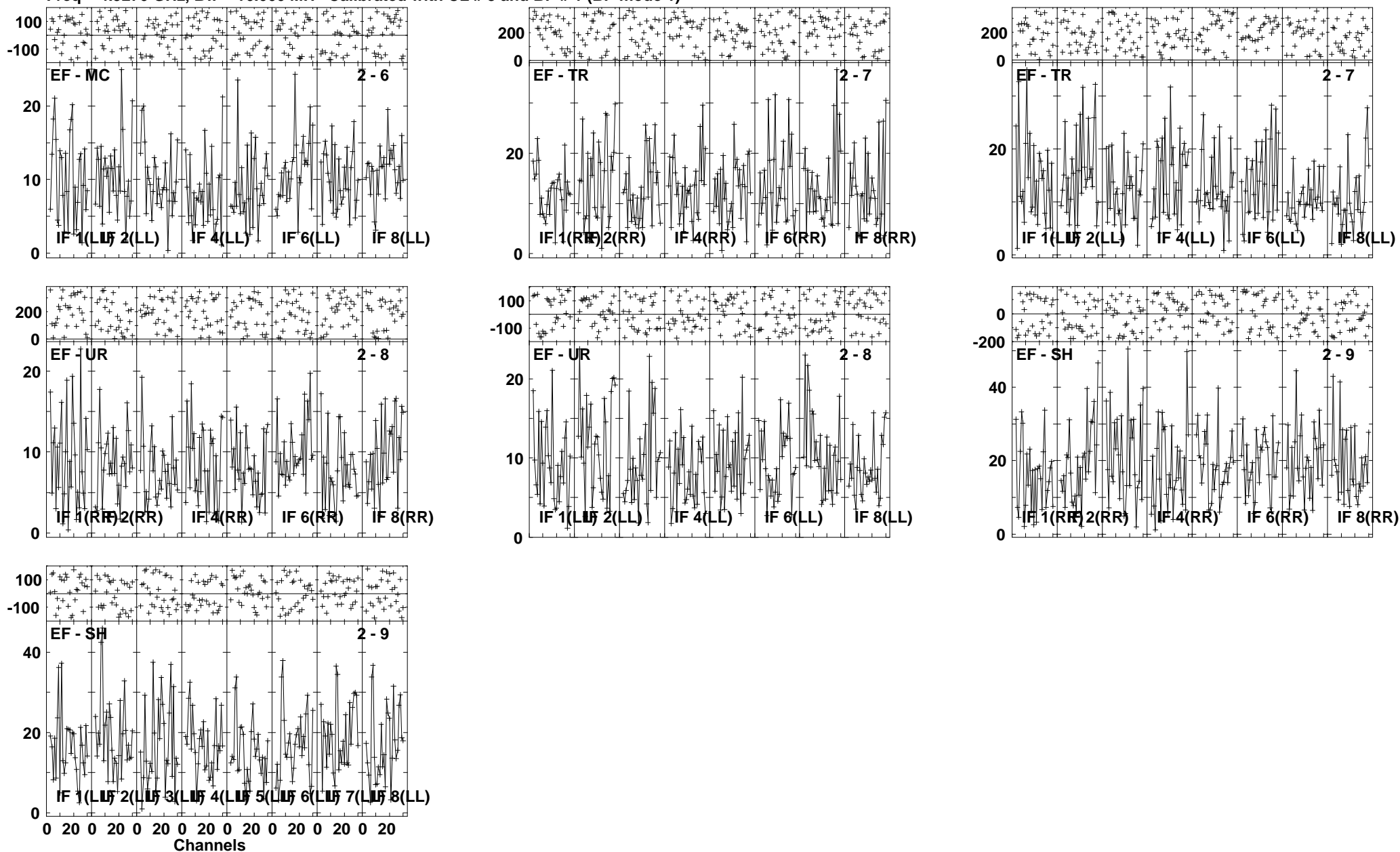

Lower frame: Milli Ampl Jy Top frame: Phas deg
Vector averaged cross-power spectrum Several baselines displayed
Timerange: 00/18:33:01 to 00/18:36:29

Plot file version 233 created 17-NOV-2010 16:23:52

J1128+59 EP068A 5.UVDATA.1

Freq = 4.9270 GHz, Bw = 16.000 MH Calibrated with CL # 3 and BP # 1 (BP mode 1)

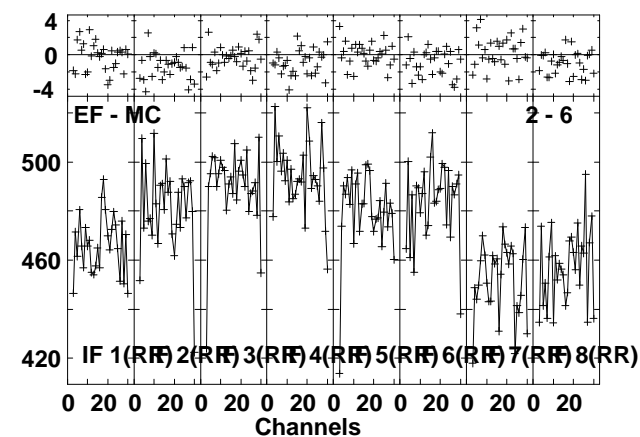
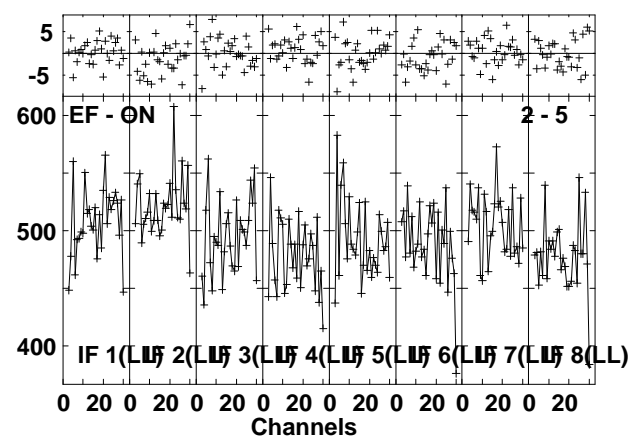
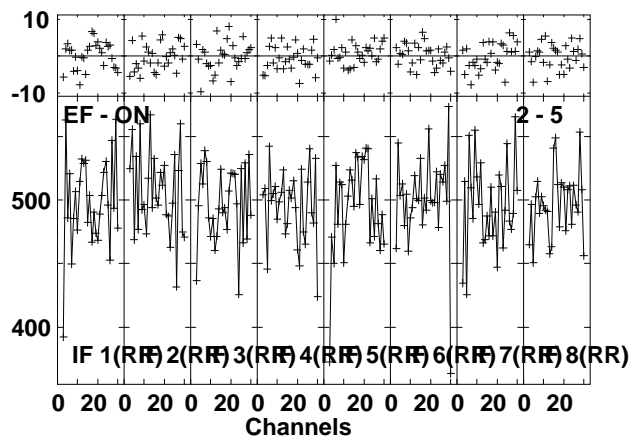
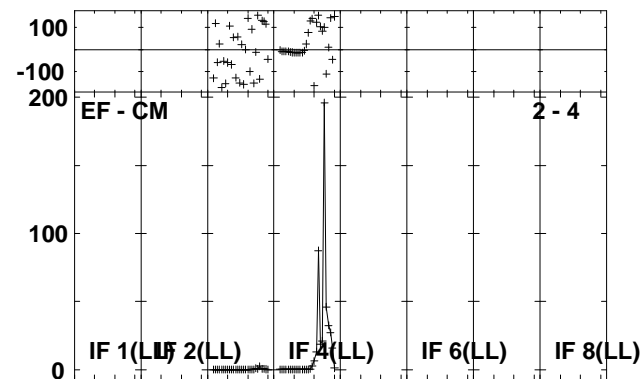
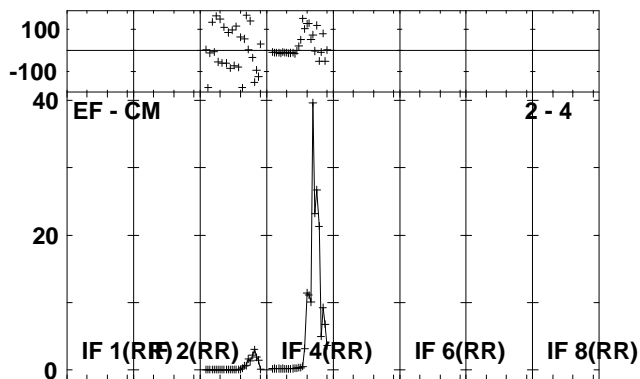
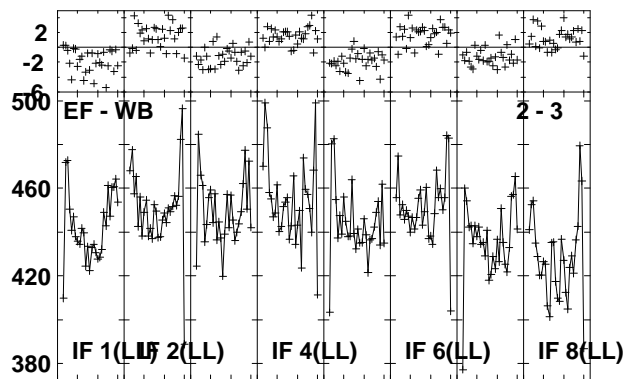
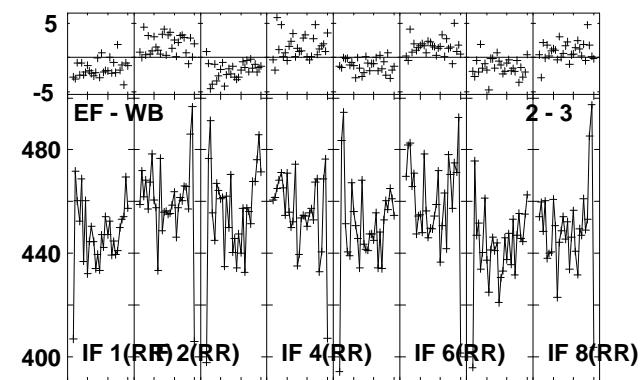
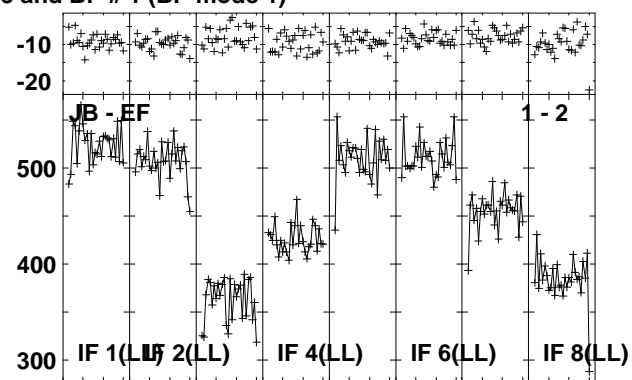
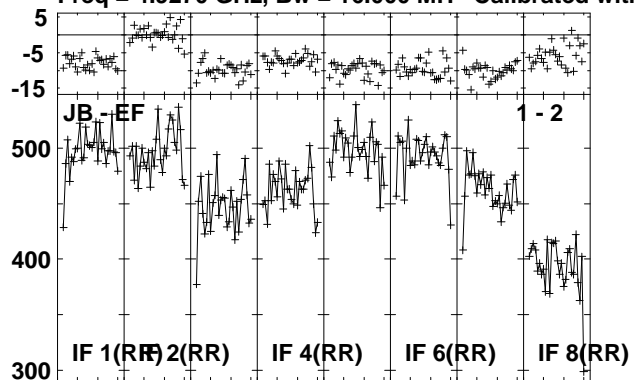

Lower frame: Milli Ampl Jy Top frame: Phas deg
Vector averaged cross-power spectrum Several baselines displayed
Timerange: 00:18:36:31 to 00:18:37:59

Plot file version 234 created 17-NOV-2010 16:23:53

J1128+59 EP068A 5.UVDATA.1

Freq = 4.9270 GHz, Bw = 16.000 MH Calibrated with CL # 3 and BP # 1 (BP mode 1)

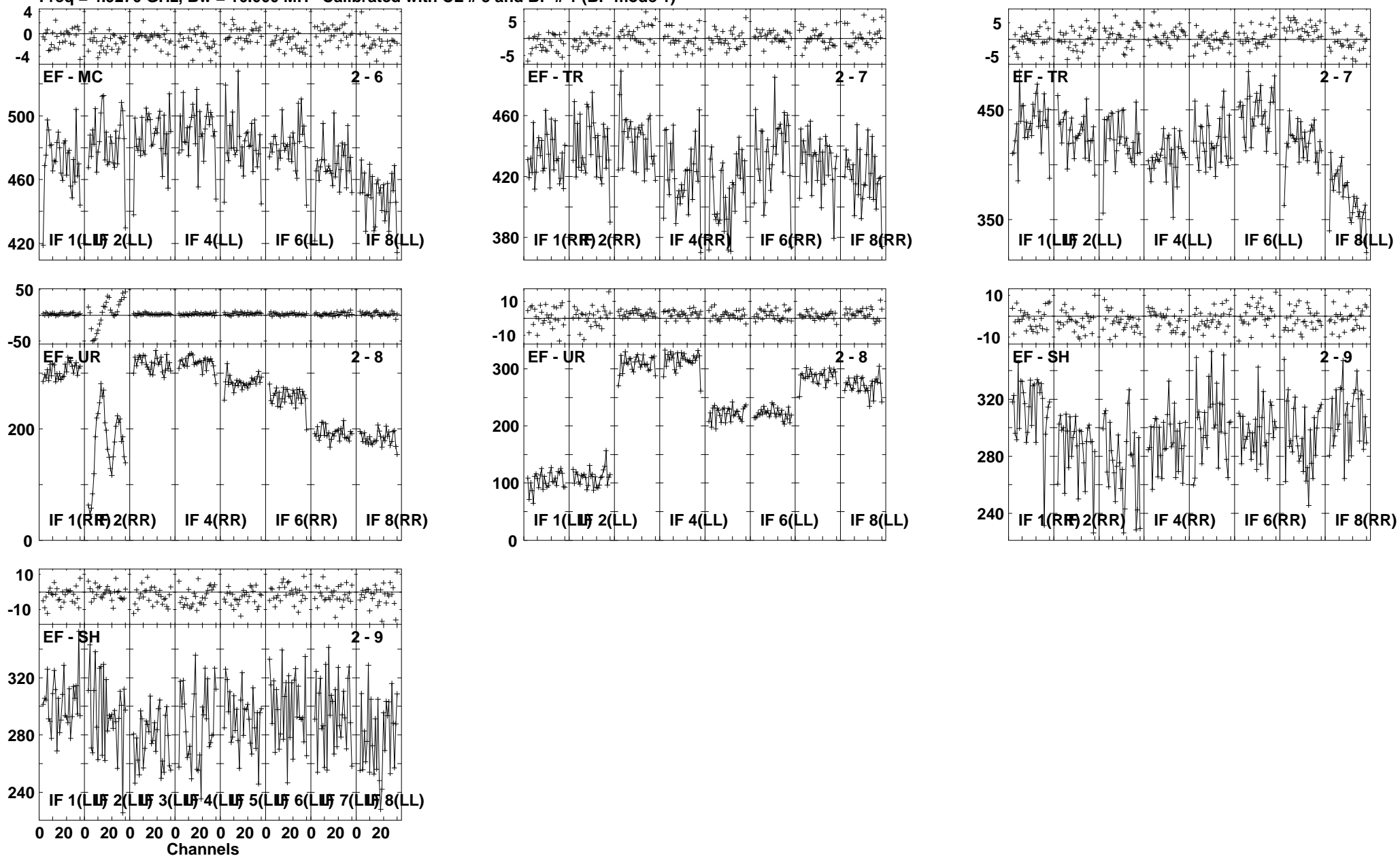

Lower frame: Milli Ampl Jy Top frame: Phas deg
Vector averaged cross-power spectrum Several baselines displayed
Timerange: 00/18:36:31 to 00/18:37:59

Plot file version 235 created 17-NOV-2010 16:23:55

ARP299D EP068A 5.UVDATA.1

Freq = 4.9270 GHz, Bw = 16.000 MH Calibrated with CL # 3 and BP # 1 (BP mode 1)

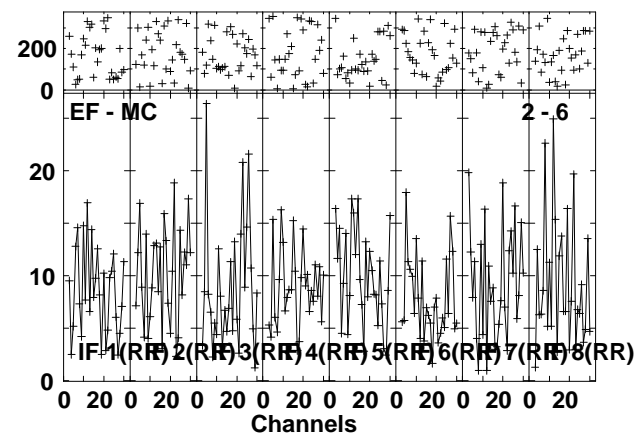
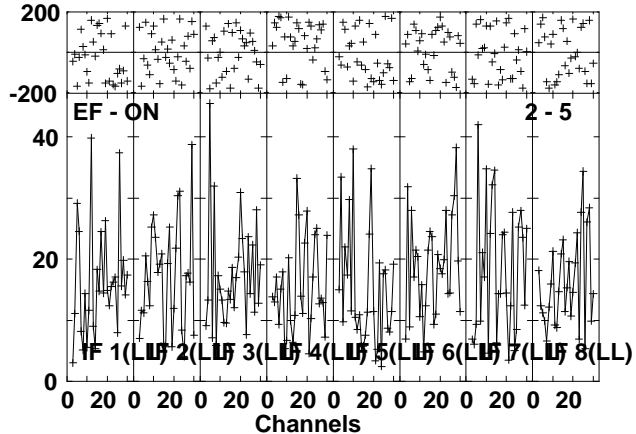
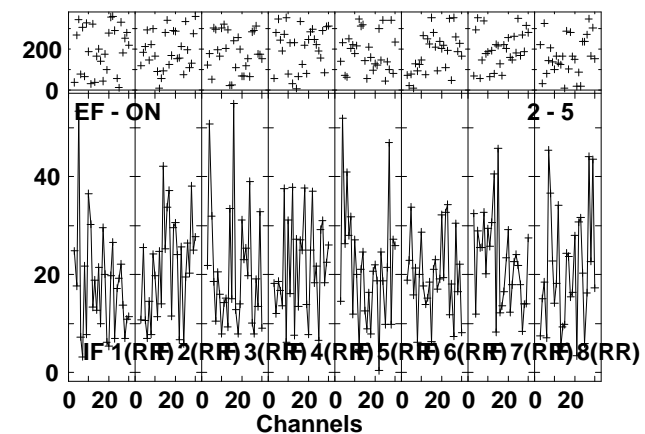
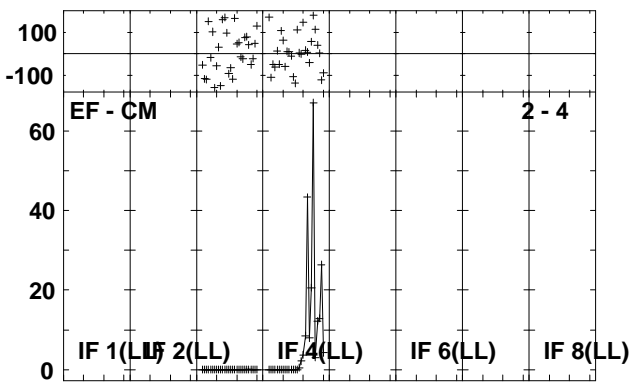
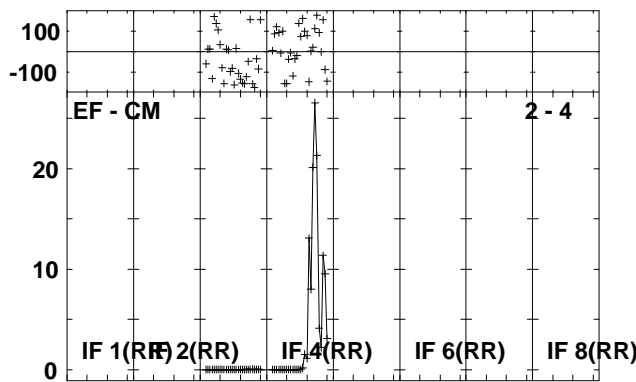
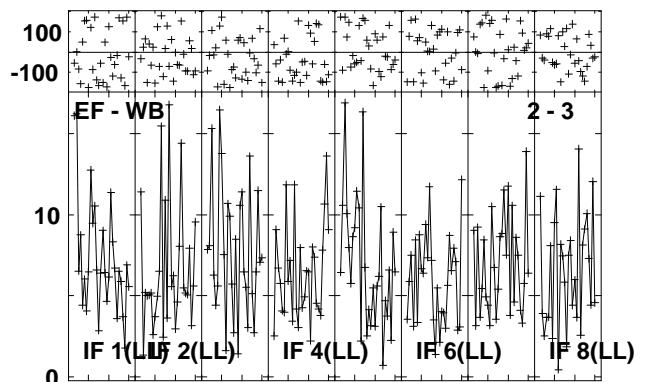
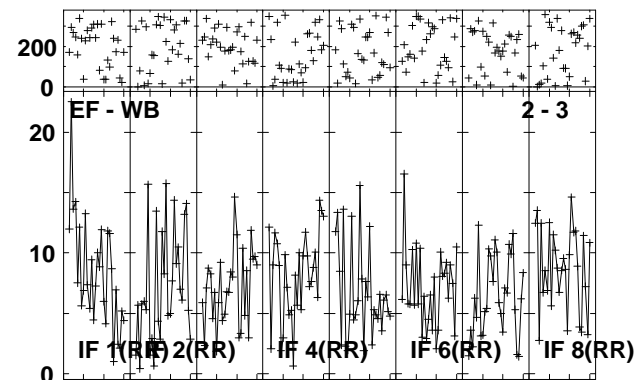
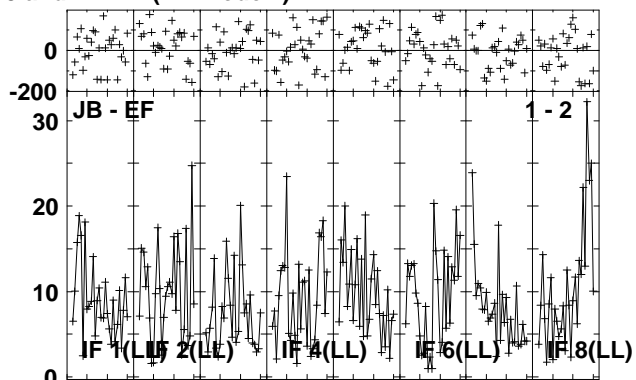
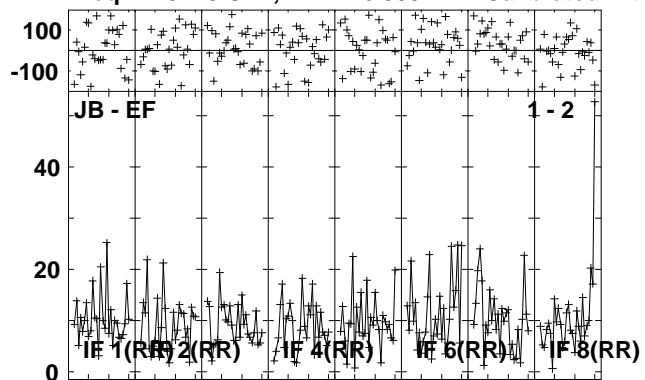

Lower frame: Milli Ampl Jy Top frame: Phas deg
Vector averaged cross-power spectrum Several baselines displayed
Timerange: 00:18:38:01 to 00:18:41:29

Plot file version 236 created 17-NOV-2010 16:23:58

ARP299D EP068A 5.UVDATA.1

Freq = 4.9270 GHz, Bw = 16.000 MH Calibrated with CL # 3 and BP # 1 (BP mode 1)

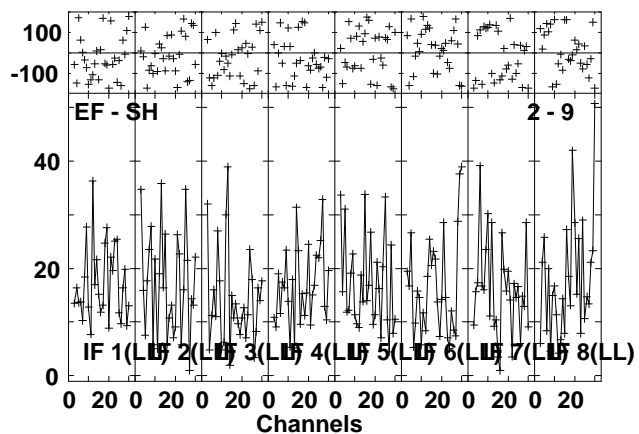
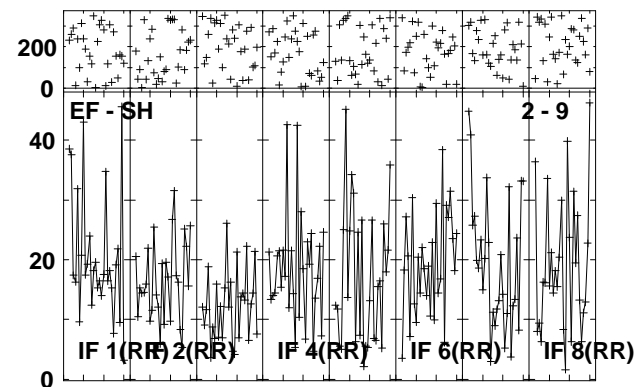
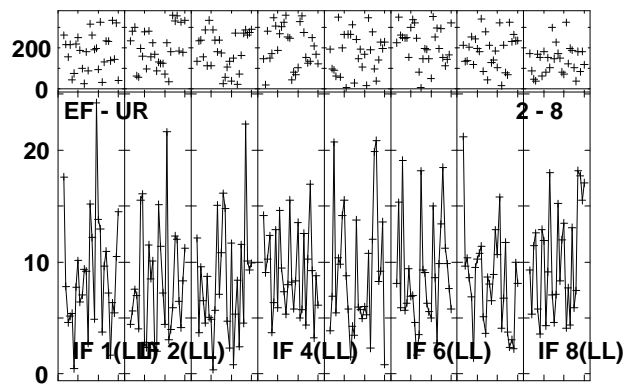
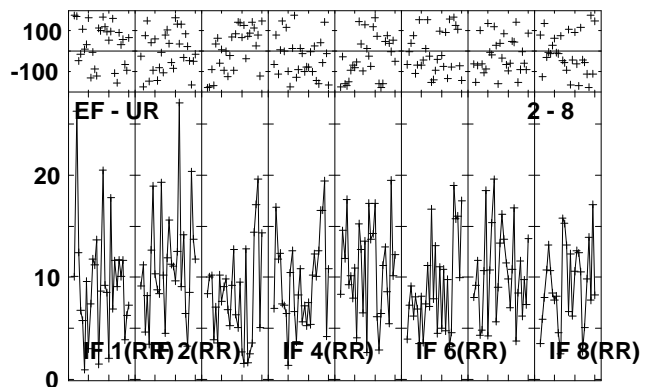
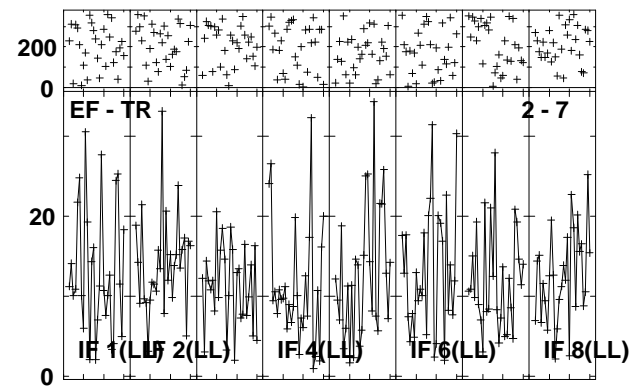
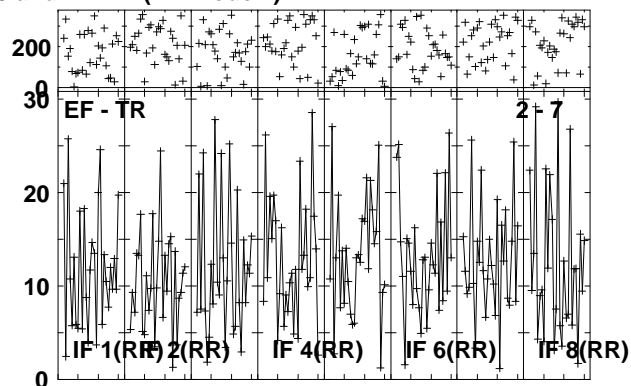
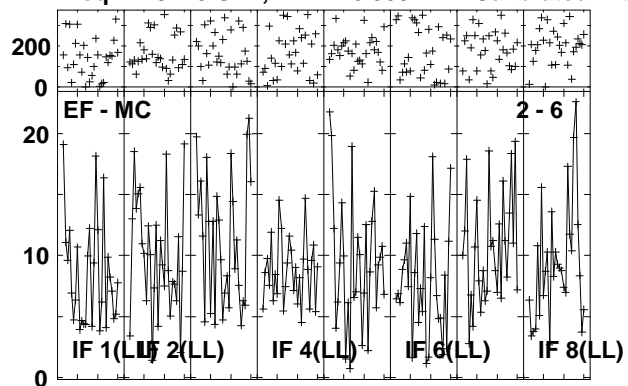

Lower frame: Milli Ampl Jy Top frame: Phas deg
Vector averaged cross-power spectrum Several baselines displayed
Timerange: 00/18:38:01 to 00/18:41:29

Plot file version 237 created 17-NOV-2010 16:24:01

J1128+59 EP068A 5.UVDATA.1

Freq = 4.9270 GHz, Bw = 16.000 MH Calibrated with CL # 3 and BP # 1 (BP mode 1)

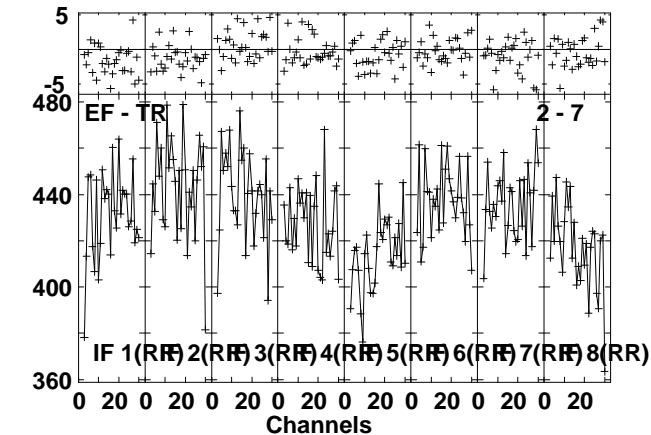
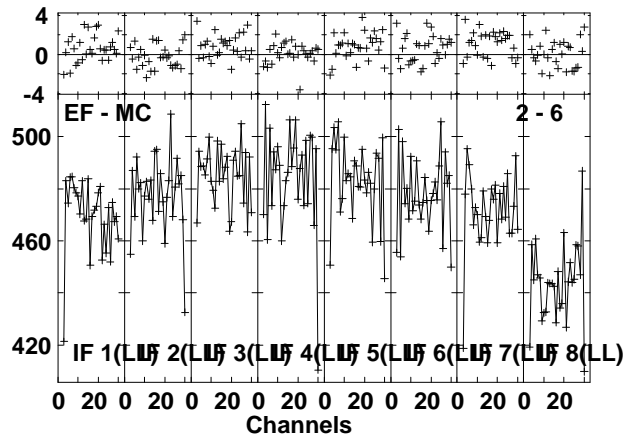
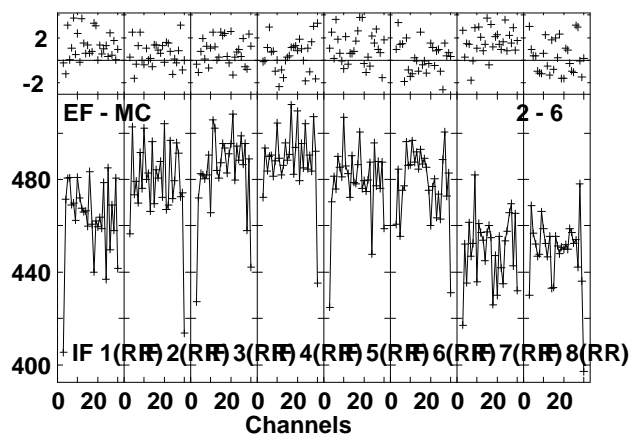
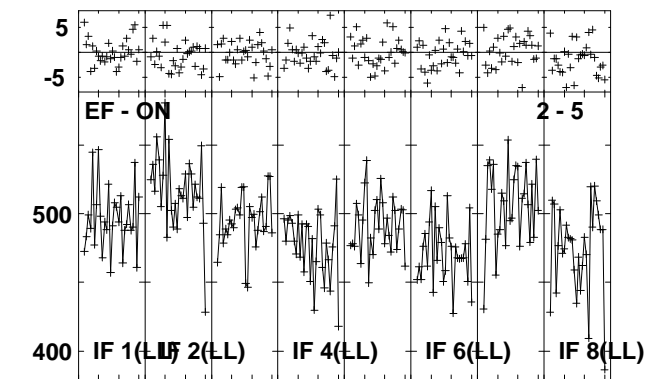
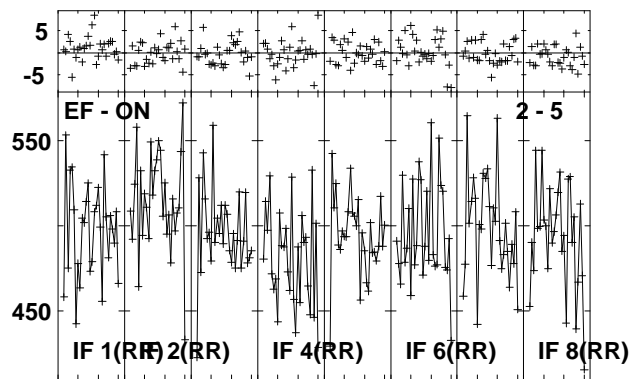
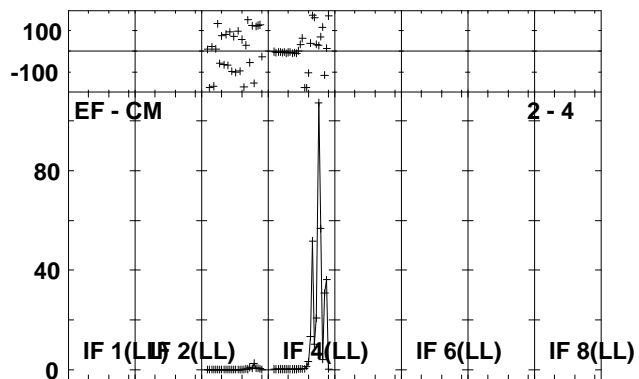
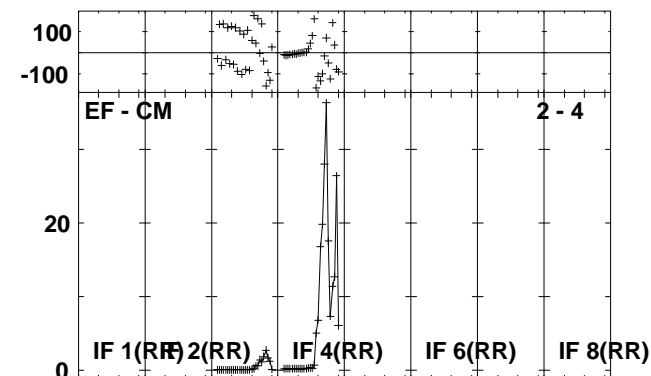
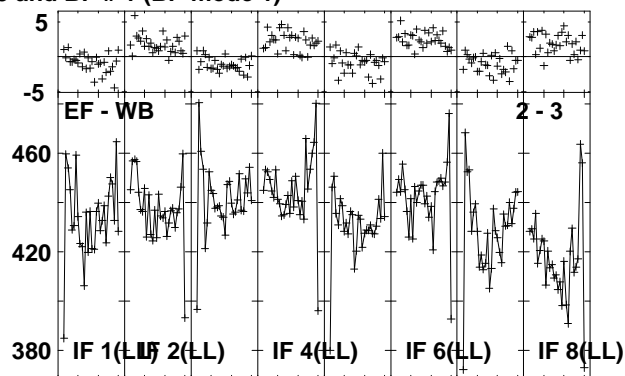
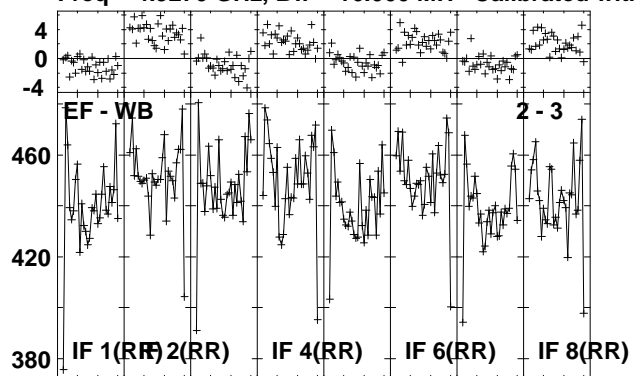

Lower frame: Milli Ampl Jy Top frame: Phas deg
Vector averaged cross-power spectrum Several baselines displayed
Timerange: 00:18:42:31 to 00:18:43:59

Plot file version 238 created 17-NOV-2010 16:24:02

J1128+59 EP068A 5.UVDATA.1

Freq = 4.9270 GHz, Bw = 16.000 MH Calibrated with CL # 3 and BP # 1 (BP mode 1)

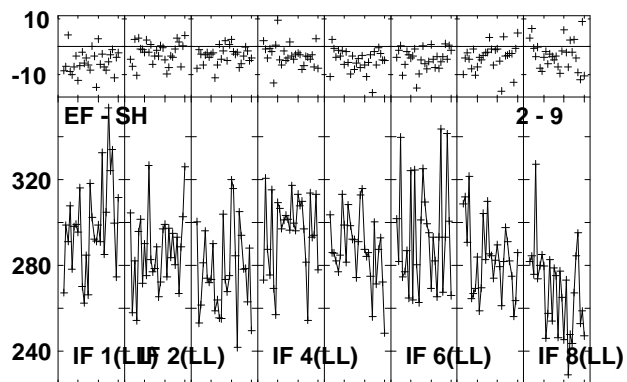
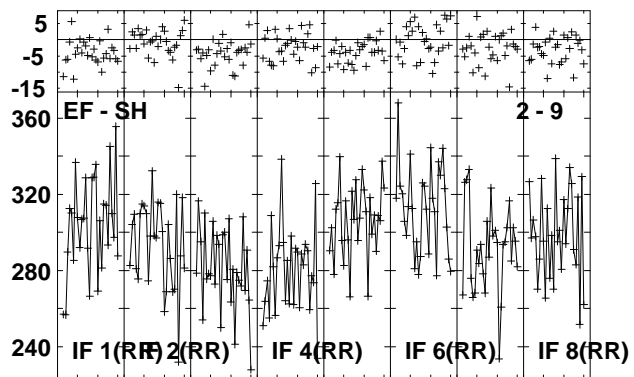
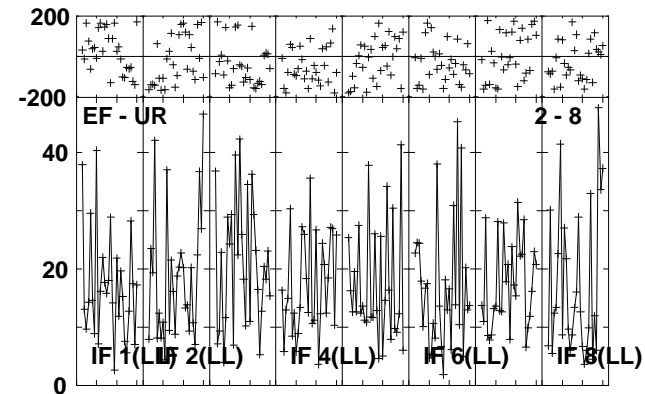
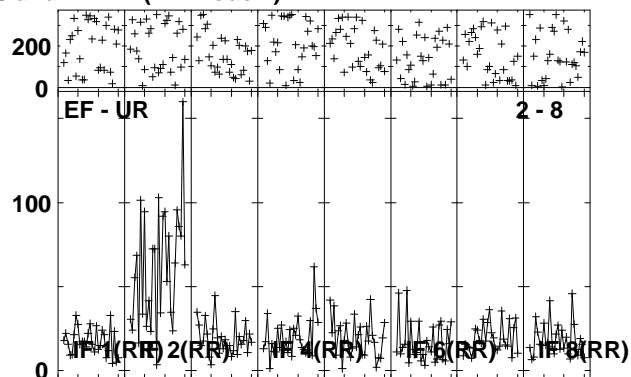
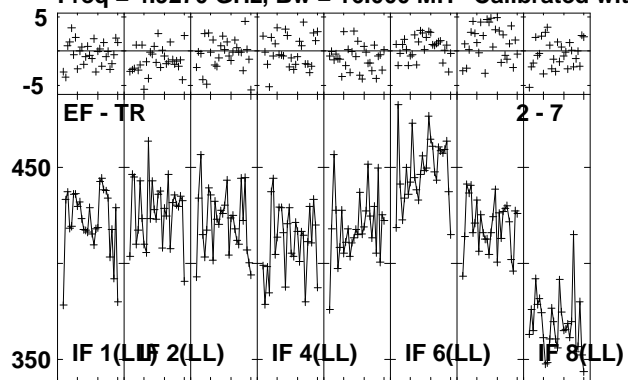

Lower frame: Milli Ampl Jy Top frame: Phas deg
Vector averaged cross-power spectrum Several baselines displayed
Timerange: 00/18:42:31 to 00/18:43:59

Plot file version 239 created 17-NOV-2010 16:24:04

ARP299D EP068A 5.UVDATA.1

Freq = 4.9270 GHz, Bw = 16.000 MH Calibrated with CL # 3 and BP # 1 (BP mode 1)

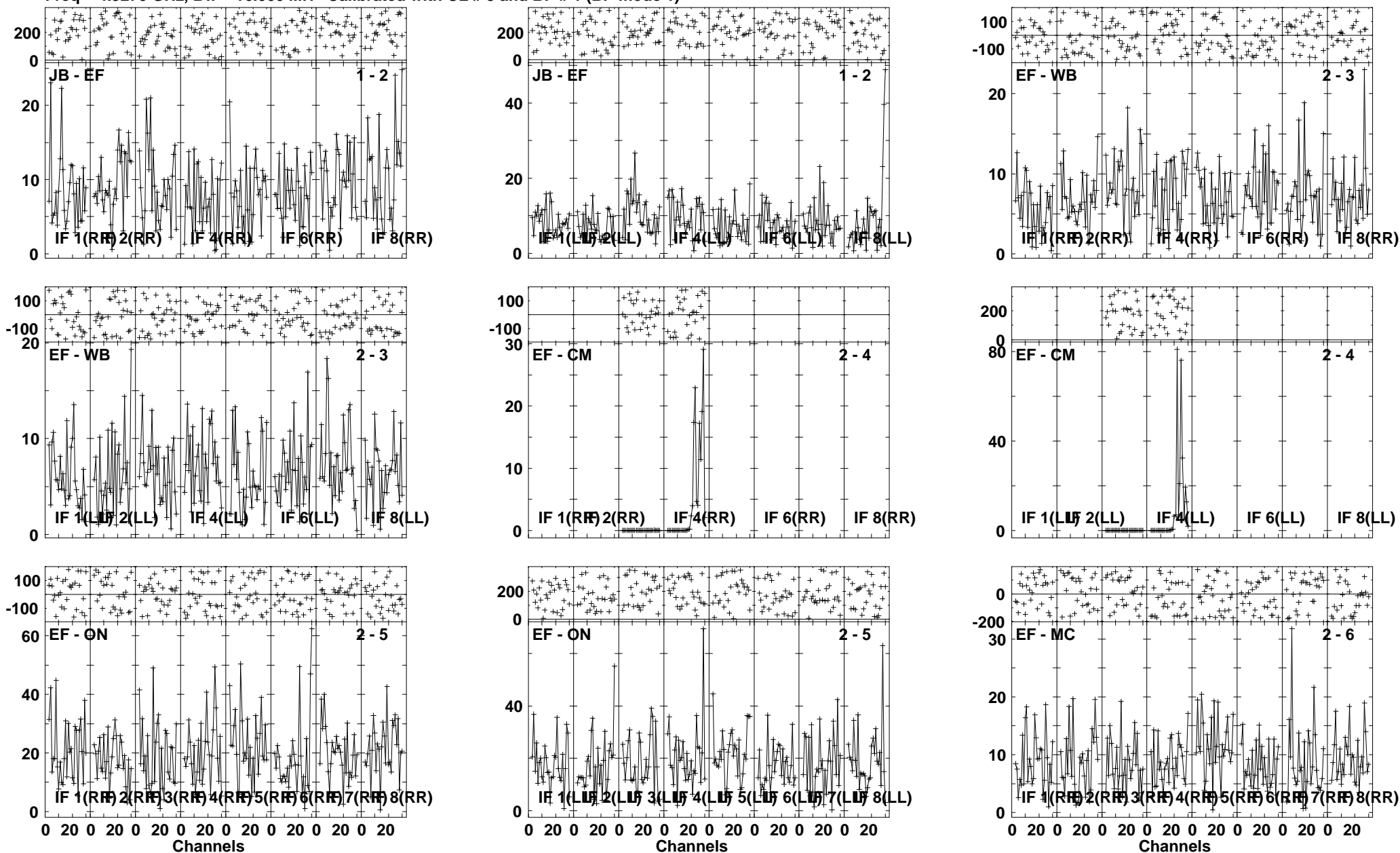

Lower frame: Milli Ampl Jy Top frame: Phas deg
Vector averaged cross-power spectrum Several baselines displayed
Timerange: 00:18:44:01 to 00:18:47:29

Plot file version 240 created 17-NOV-2010 16:24:06

ARP299D EP068A 5.UVDATA.1

Freq = 4.9270 GHz, Bw = 16.000 MH Calibrated with CL # 3 and BP # 1 (BP mode 1)

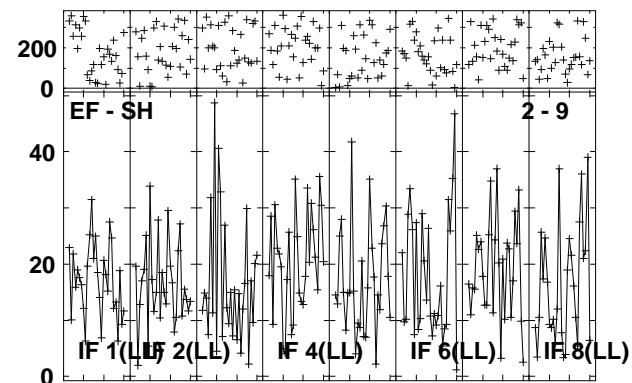
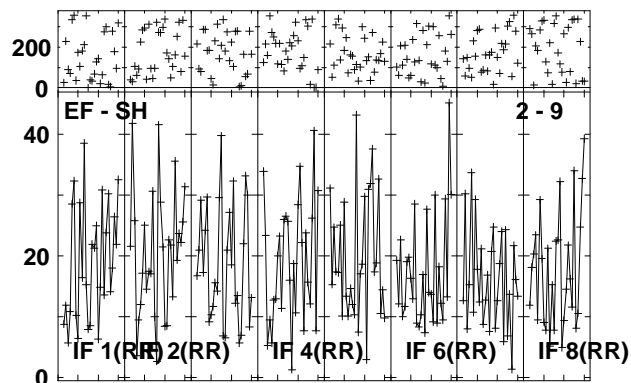
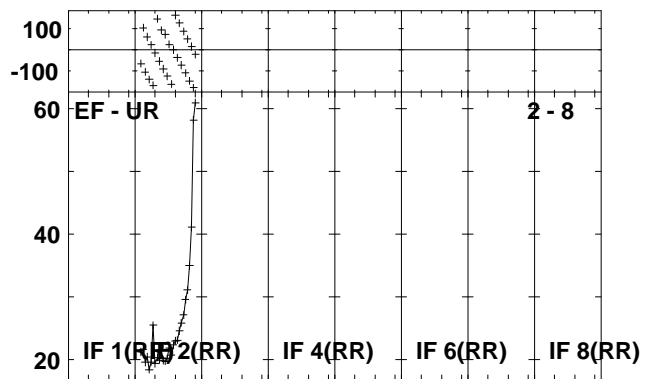
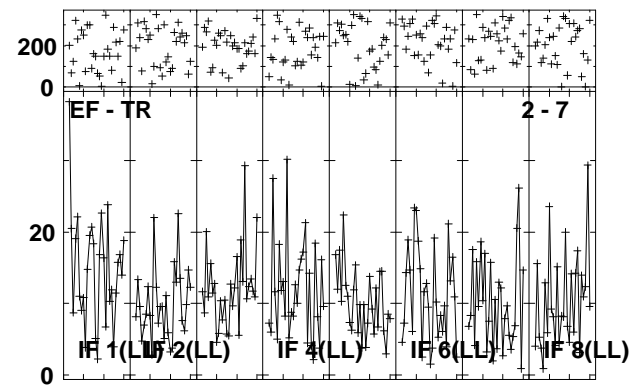
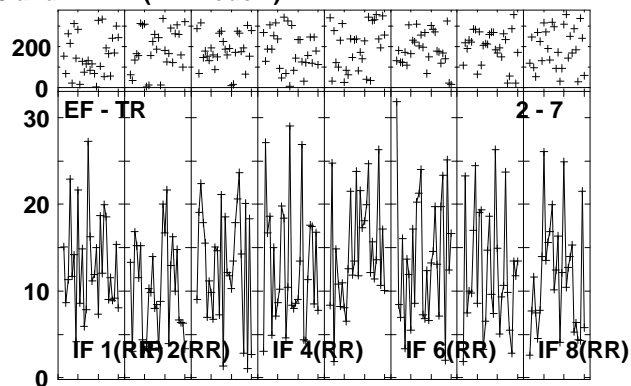
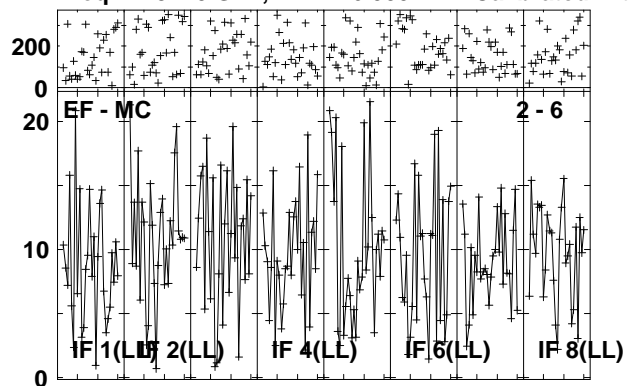

Lower frame: Milli Ampl Jy Top frame: Phas deg
Vector averaged cross-power spectrum Several baselines displayed
Timerange: 00:18:44:01 to 00:18:47:29

Plot file version 241 created 17-NOV-2010 16:24:09

J1128+59 EP068A 5.UVDATA.1

Freq = 4.9270 GHz, Bw = 16.000 MH Calibrated with CL # 3 and BP # 1 (BP mode 1)

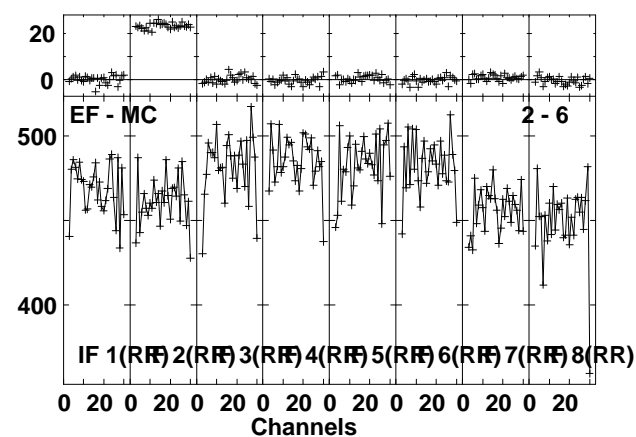
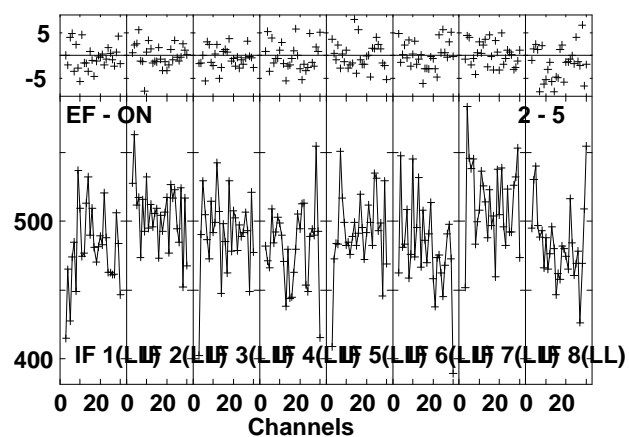
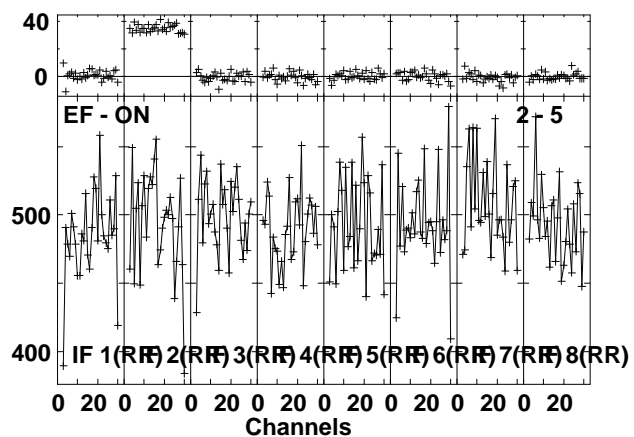
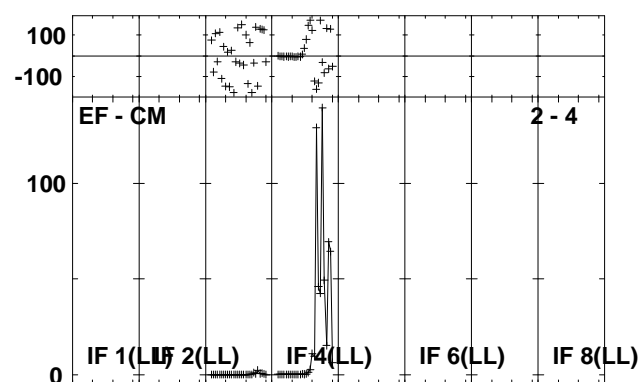
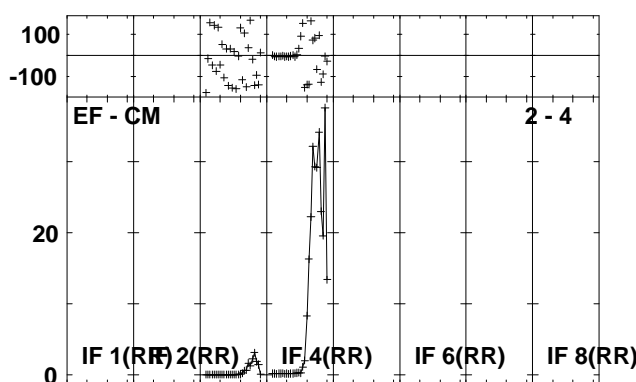
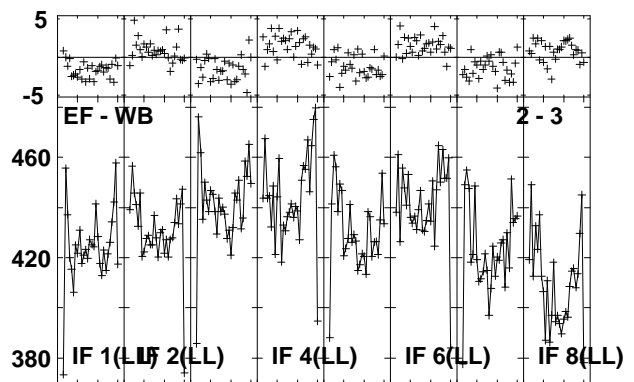
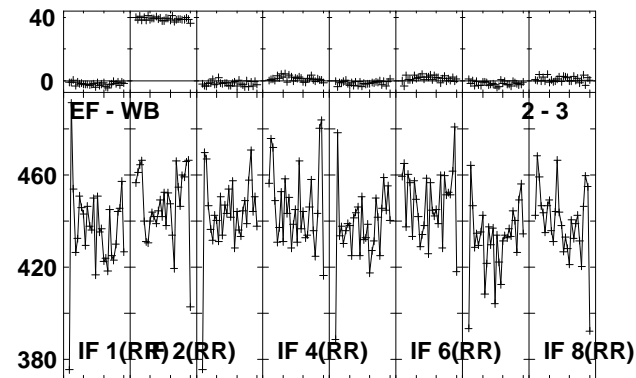
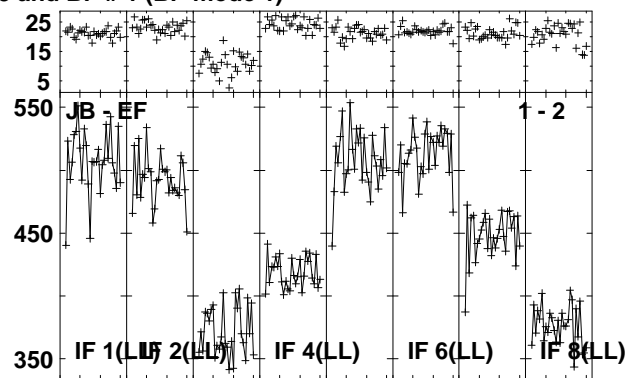
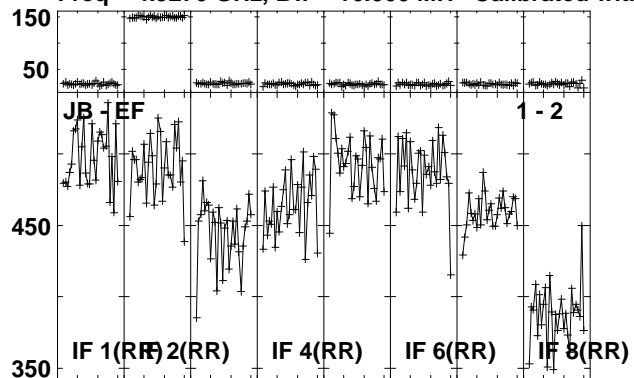

Lower frame: Milli Ampl Jy Top frame: Phas deg
Vector averaged cross-power spectrum Several baselines displayed
Timerange: 00:18:47:31 to 00:18:48:59

Plot file version 242 created 17-NOV-2010 16:24:10

J1128+59 EP068A 5.UVDATA.1

Freq = 4.9270 GHz, Bw = 16.000 MH Calibrated with CL # 3 and BP # 1 (BP mode 1)

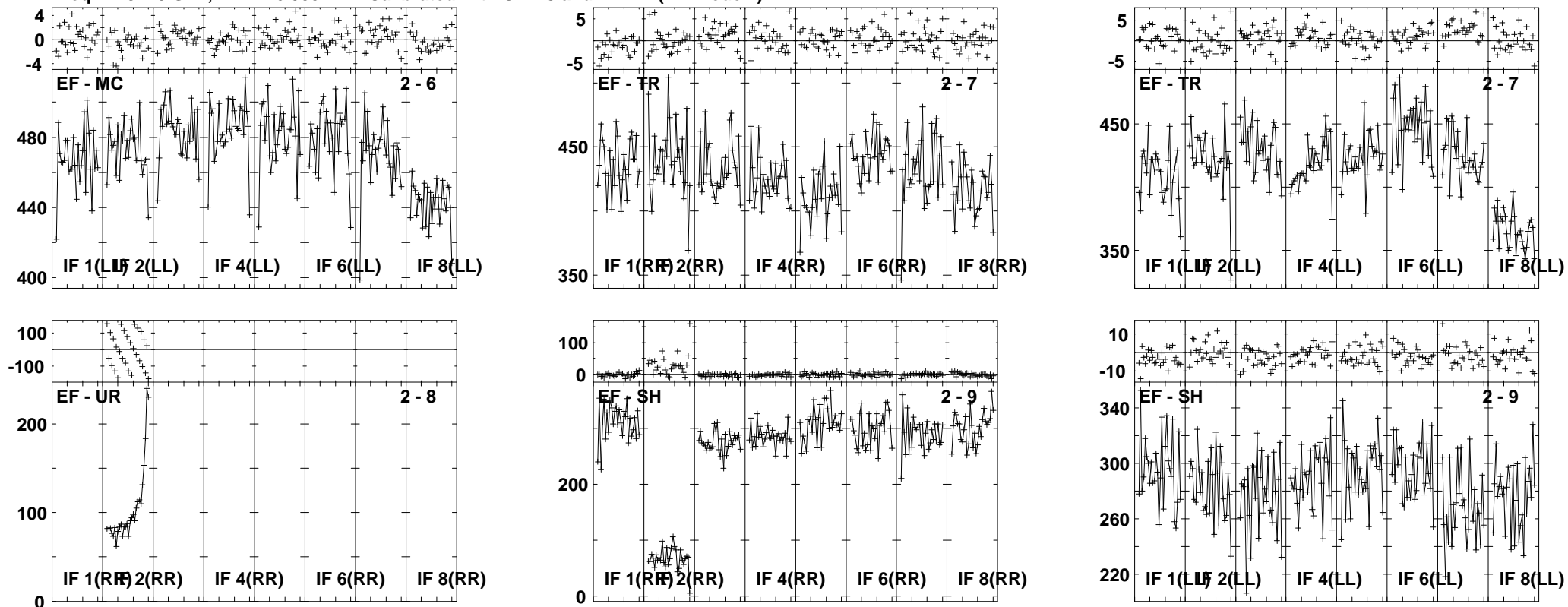

Lower frame: Milli Ampl Jy Top frame: Phas deg
Vector averaged cross-power spectrum Several baselines displayed
Timerange: 00:18:47:31 to 00:18:48:59

Plot file version 243 created 17-NOV-2010 16:24:12

ARP299D EP068A 5.UVDATA.1

Freq = 4.9270 GHz, Bw = 16.000 MH Calibrated with CL # 3 and BP # 1 (BP mode 1)

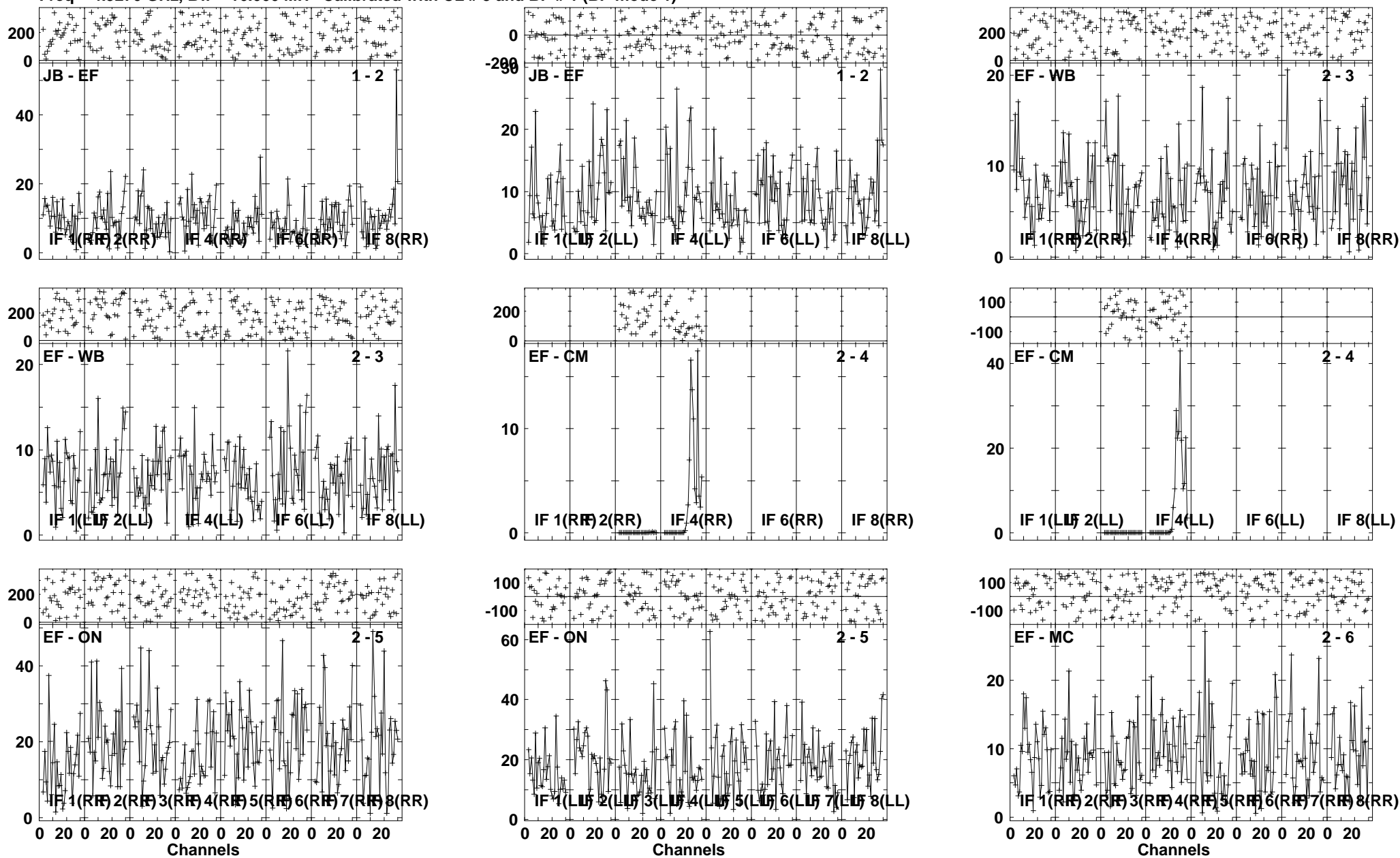

Lower frame: Milli Ampl Jy Top frame: Phas deg
Vector averaged cross-power spectrum Several baselines displayed
Timerange: 00/18:49:01 to 00/18:52:29

Plot file version 244 created 17-NOV-2010 16:24:14

ARP299D EP068A 5.UVDATA.1

Freq = 4.9270 GHz, Bw = 16.000 MH Calibrated with CL # 3 and BP # 1 (BP mode 1)

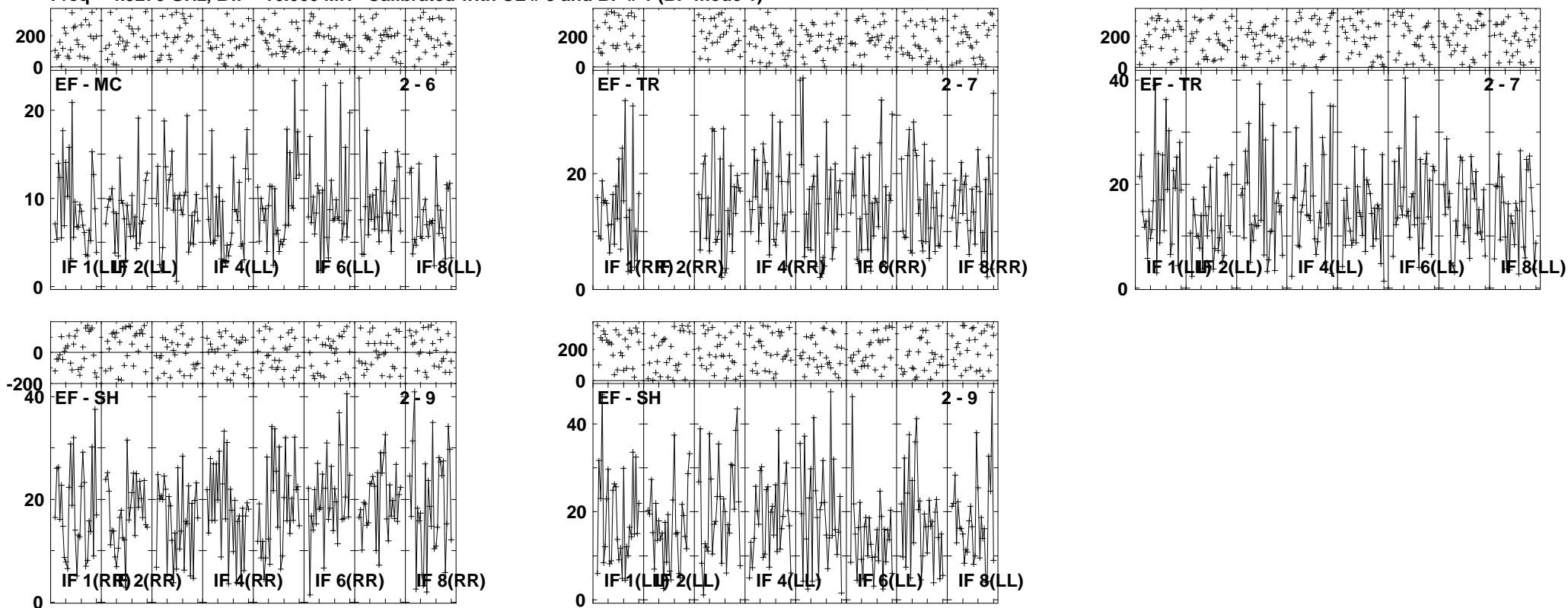

Lower frame: Milli Ampl Jy Top frame: Phas deg
Vector averaged cross-power spectrum Several baselines displayed
Timerange: 00/18:49:01 to 00/18:52:29

Plot file version 245 created 17-NOV-2010 16:24:17

J1128+59 EP068A 5.UVDATA.1

Freq = 4.9270 GHz, Bw = 16.000 MH Calibrated with CL # 3 and BP # 1 (BP mode 1)

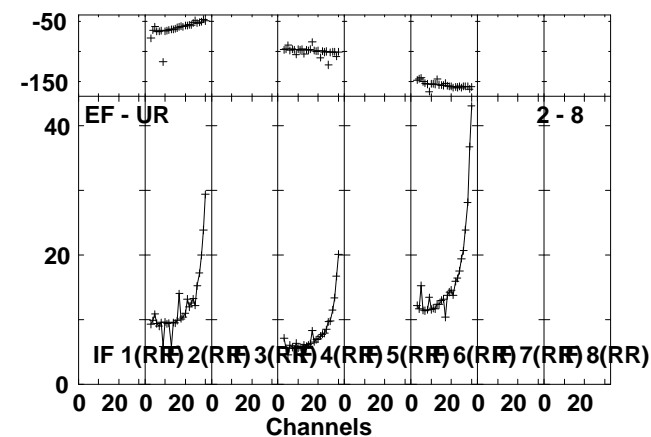
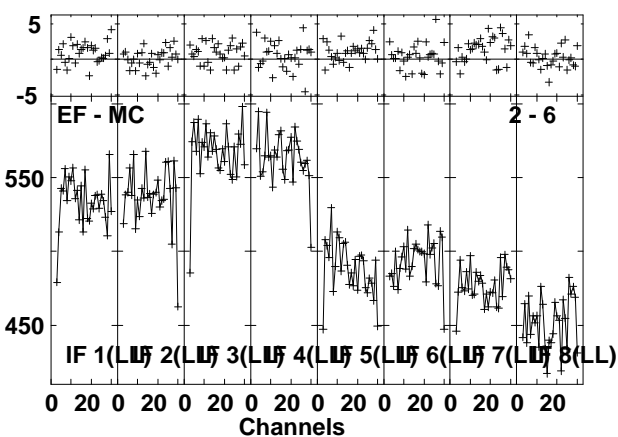
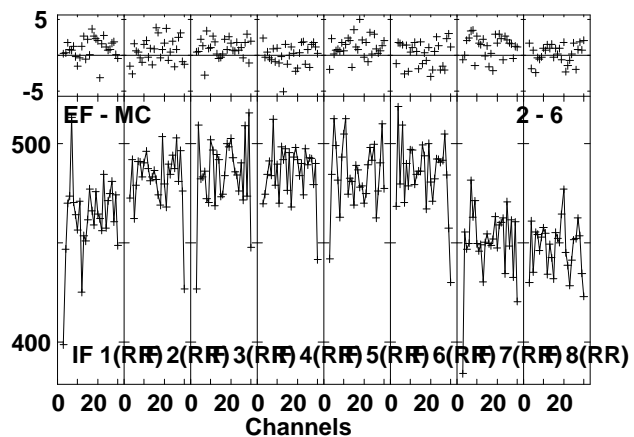
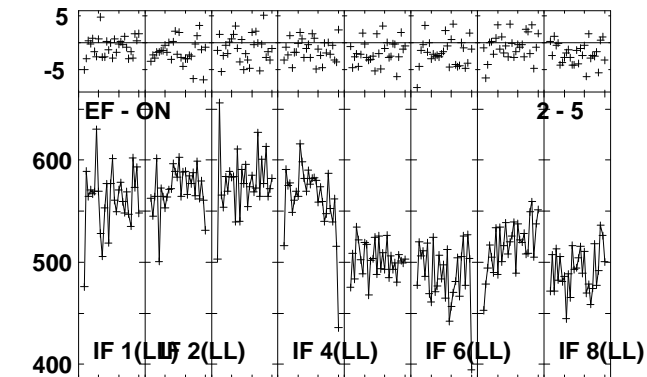
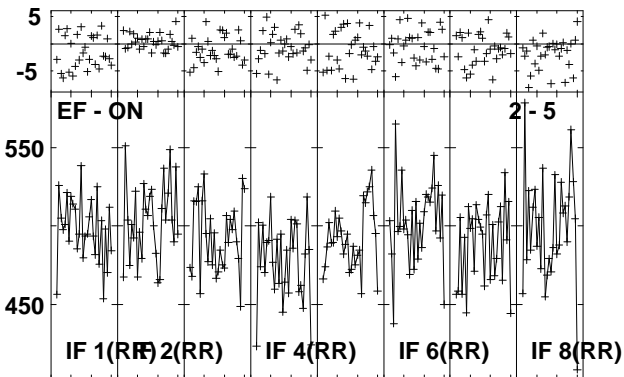
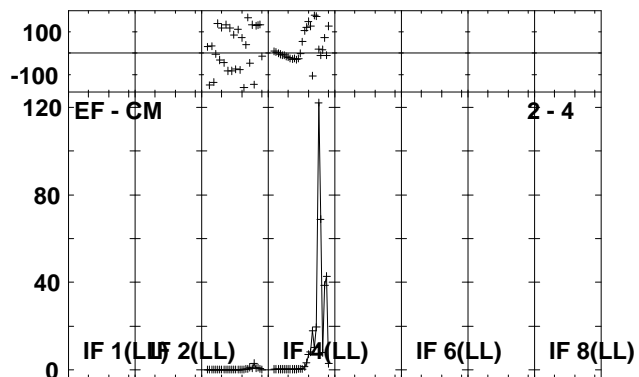
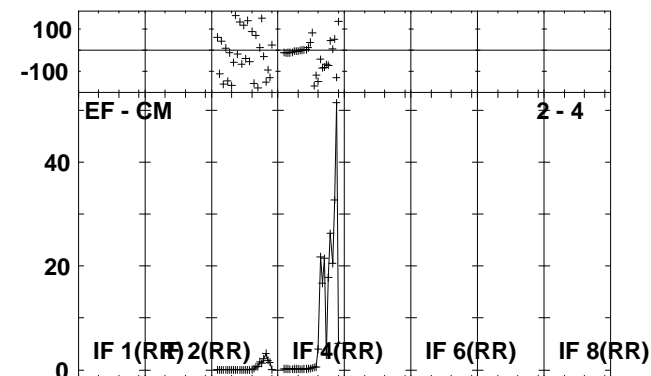
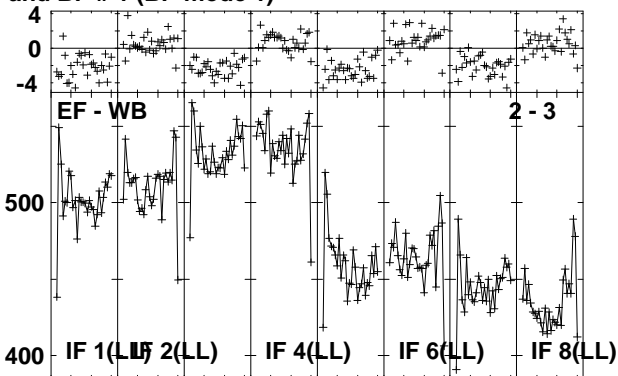
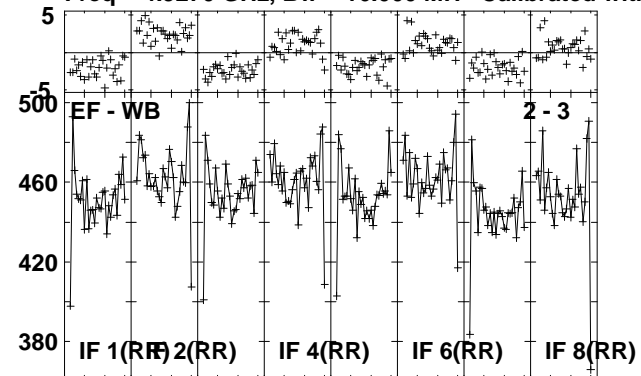

Lower frame: Milli Ampl Jy Top frame: Phas deg
Vector averaged cross-power spectrum Several baselines displayed
Timerange: 00/18:53:31 to 00/18:54:57

Plot file version 246 created 17-NOV-2010 16:24:18

J1128+59 EP068A 5.UVDATA.1

Freq = 4.9270 GHz, Bw = 16.000 MH Calibrated with CL # 3 and BP # 1 (BP mode 1)

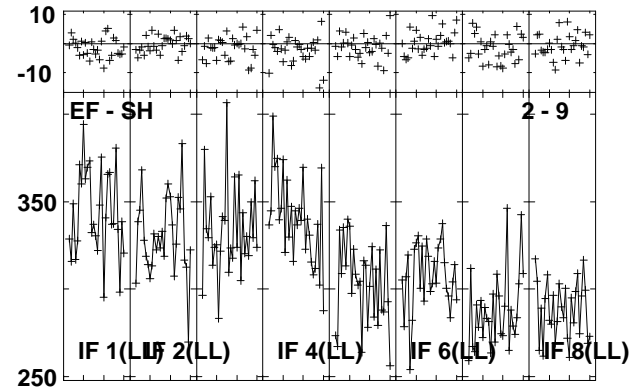
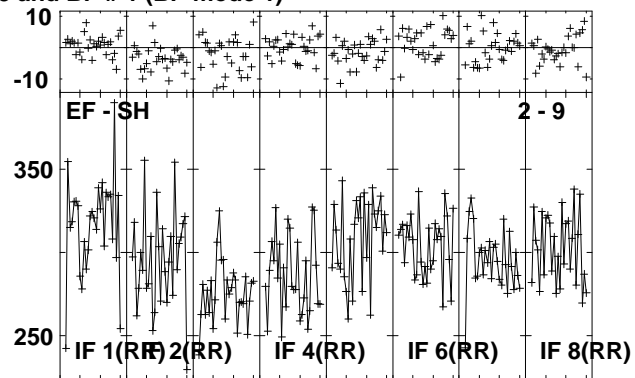
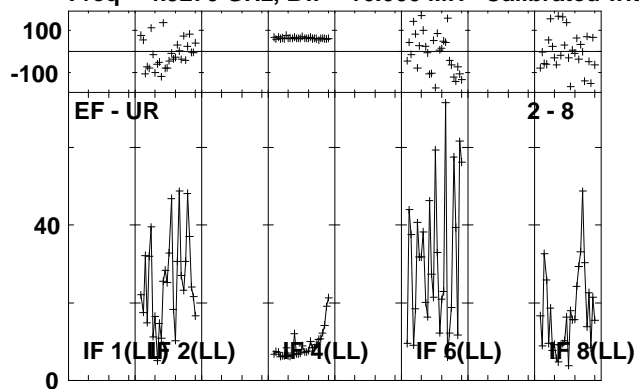

Lower frame: Milli Ampl Jy Top frame: Phas deg
Vector averaged cross-power spectrum Several baselines displayed
Timerange: 00/18:53:31 to 00/18:54:57

Plot file version 247 created 17-NOV-2010 16:24:19

ARP299D EP068A 5.UVDATA.1

Freq = 4.9270 GHz, Bw = 16.000 MH Calibrated with CL # 3 and BP # 1 (BP mode 1)

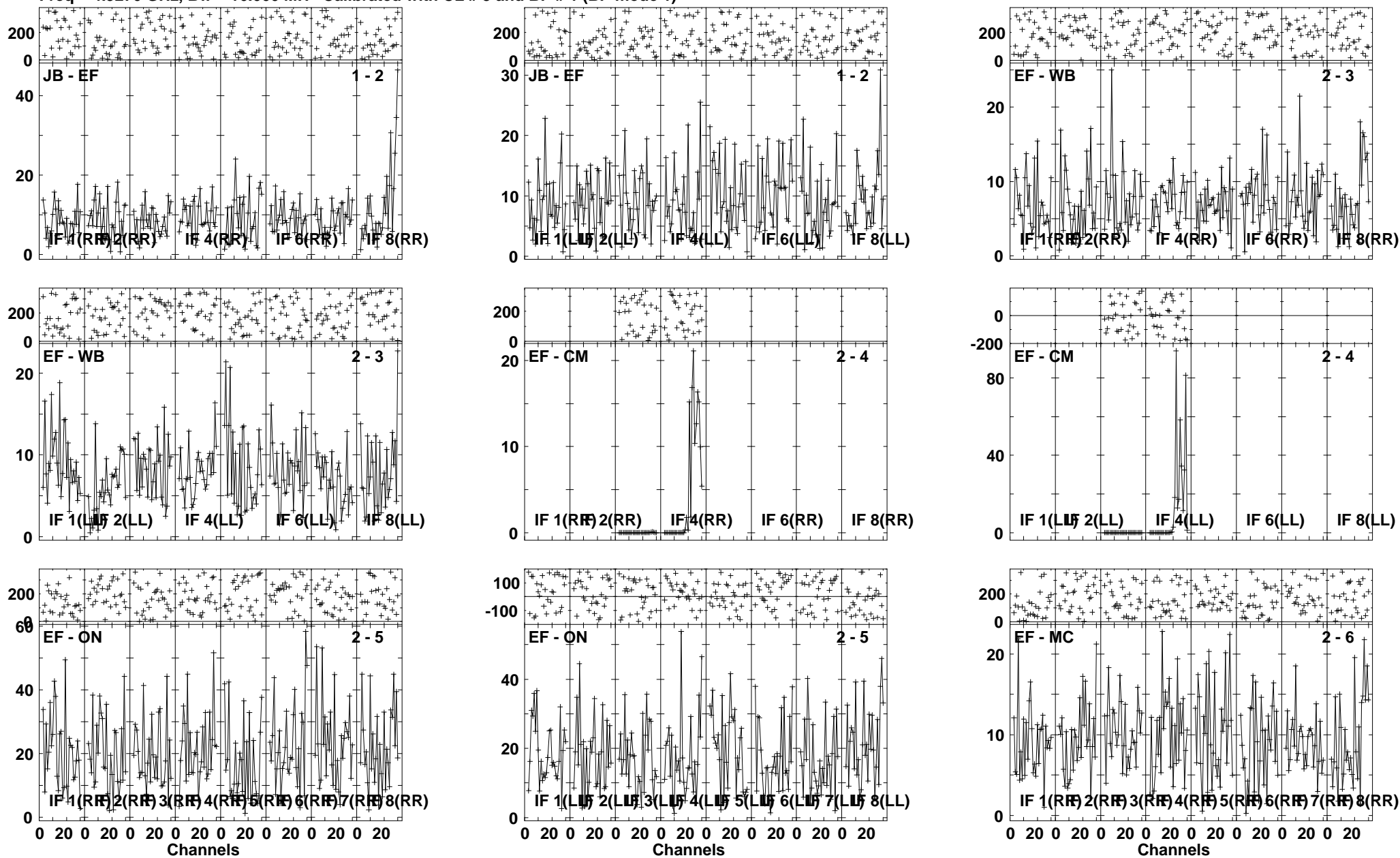

Lower frame: Milli Ampl Jy Top frame: Phas deg
Vector averaged cross-power spectrum Several baselines displayed
Timerange: 00/18:55:01 to 00/18:58:29

Plot file version 248 created 17-NOV-2010 16:24:21

ARP299D EP068A 5.UVDATA.1

Freq = 4.9270 GHz, Bw = 16.000 MH Calibrated with CL # 3 and BP # 1 (BP mode 1)

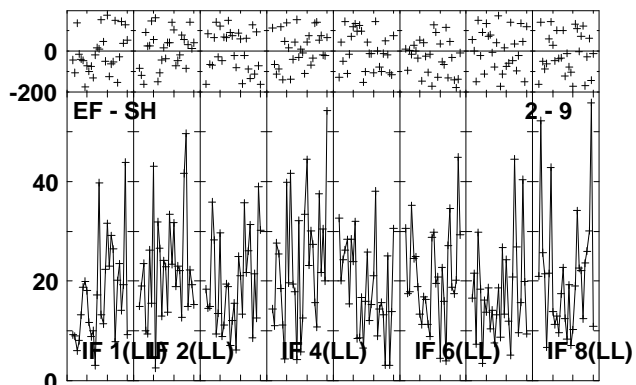
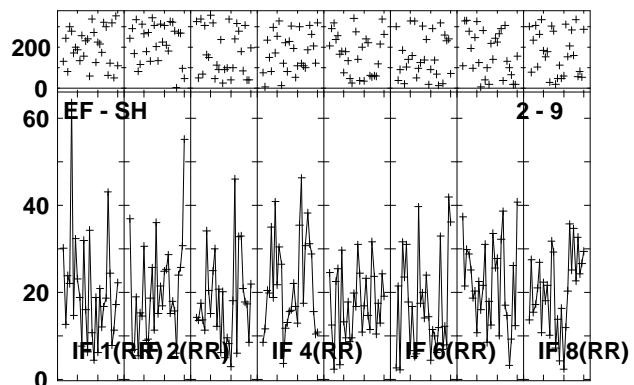
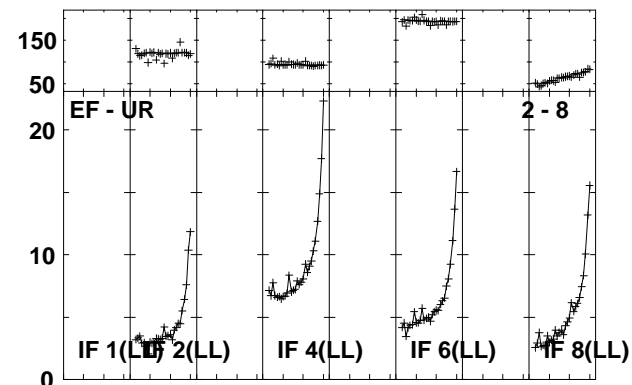
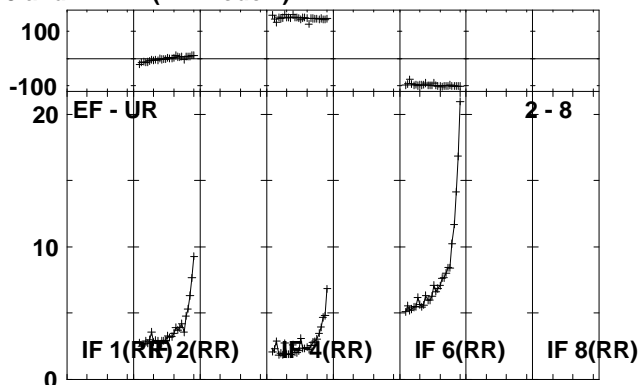
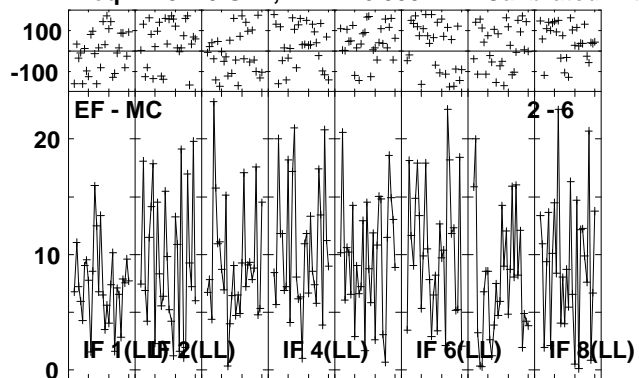

Lower frame: Milli Ampl Jy Top frame: Phas deg
Vector averaged cross-power spectrum Several baselines displayed
Timerange: 00/18:55:01 to 00/18:58:29

Plot file version 249 created 17-NOV-2010 16:24:23

J1128+59 EP068A 5.UVDATA.1

Freq = 4.9270 GHz, Bw = 16.000 MH Calibrated with CL # 3 and BP # 1 (BP mode 1)

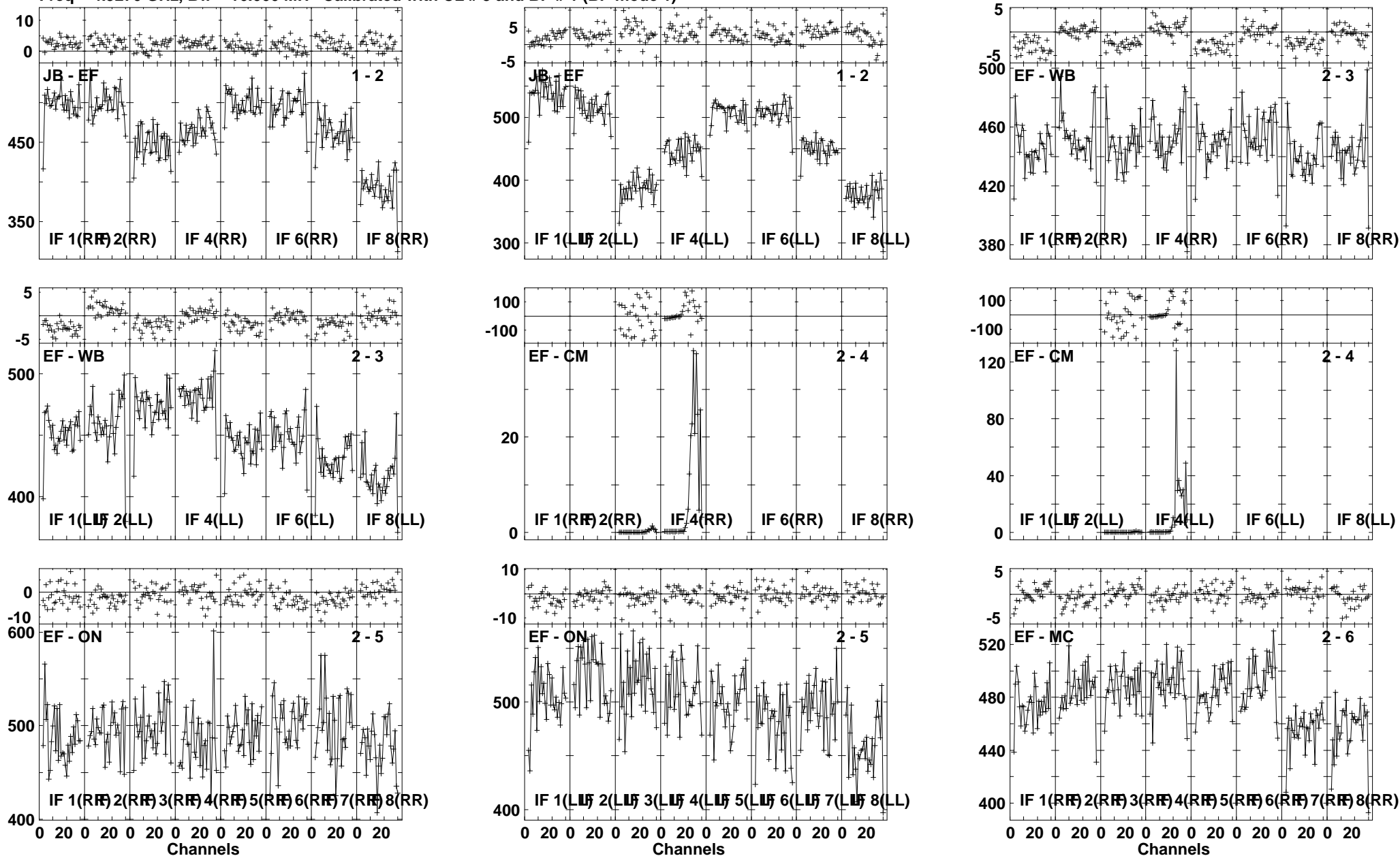

Lower frame: Milli Ampl Jy Top frame: Phas deg
Vector averaged cross-power spectrum Several baselines displayed
Timerange: 00:18:58:31 to 00:18:59:59

Plot file version 250 created 17-NOV-2010 16:24:24

J1128+59 EP068A 5.UVDATA.1

Freq = 4.9270 GHz, Bw = 16.000 MH Calibrated with CL # 3 and BP # 1 (BP mode 1)

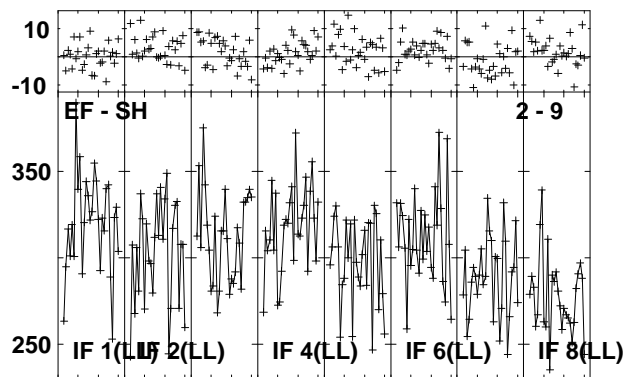
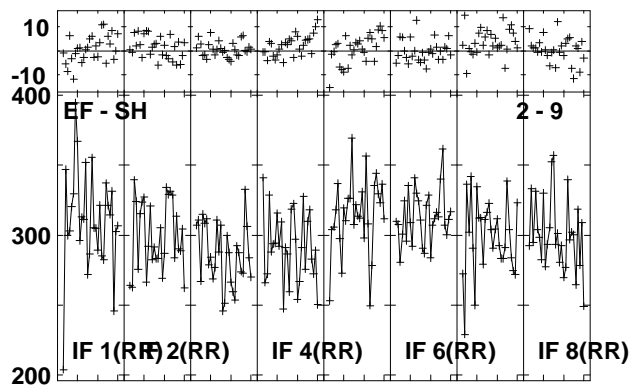
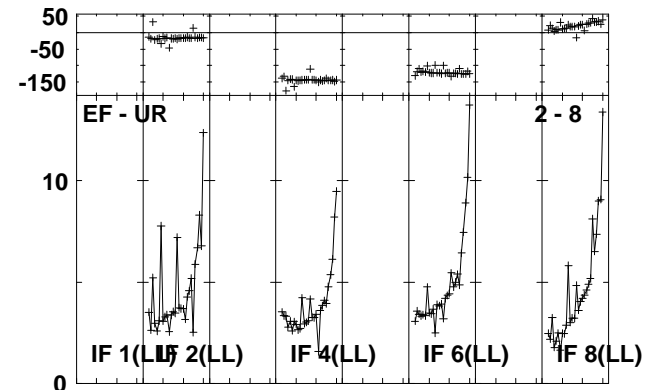
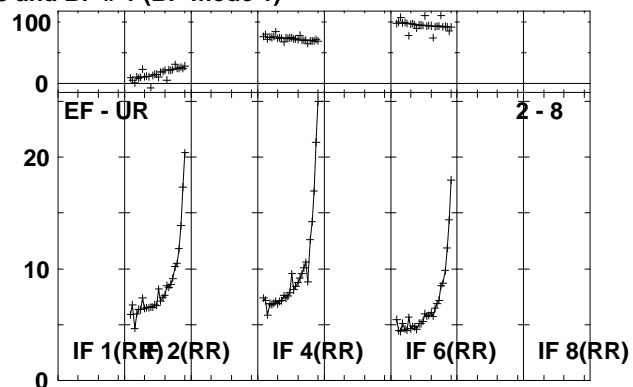
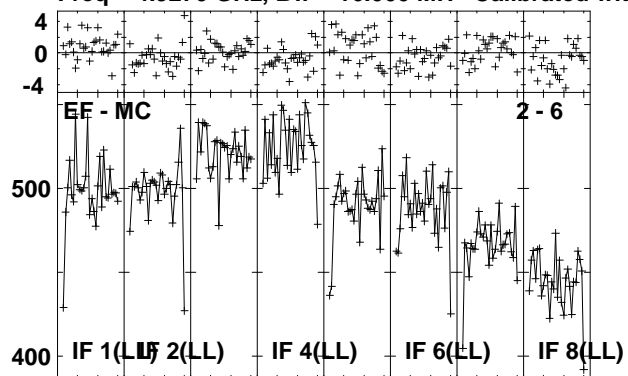

Lower frame: Milli Ampl Jy Top frame: Phas deg
Vector averaged cross-power spectrum Several baselines displayed
Timerange: 00/18:58:31 to 00/18:59:59