

Plot file version 1 created 30-NOV-2010 14:26:18

4C39.25 EP068B 3.UVDATA.1

Freq = 1.5950 GHz, Bw = 16.000 MH Calibrated with CL # 3 and BP # 1 (BP mode 1)

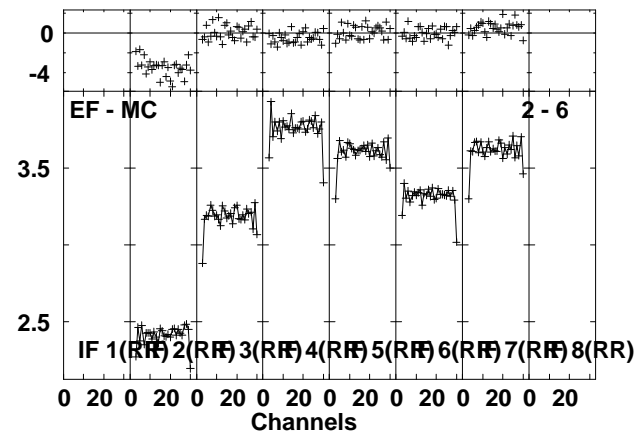
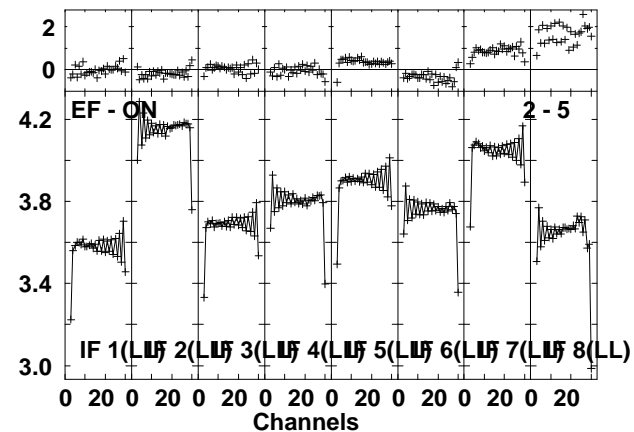
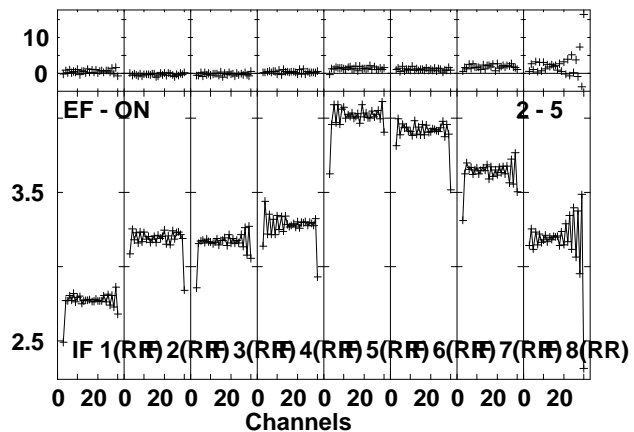
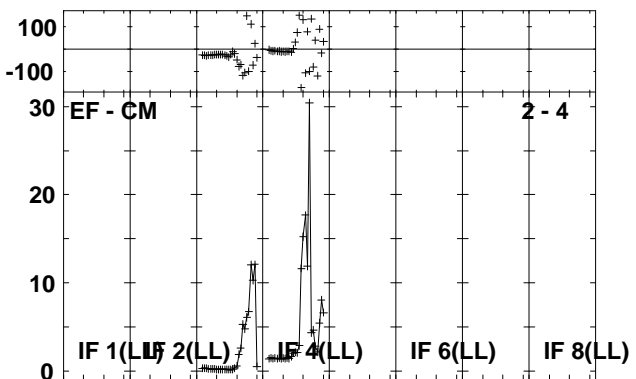
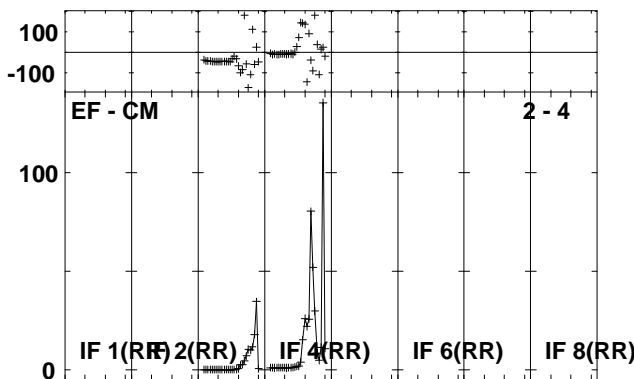
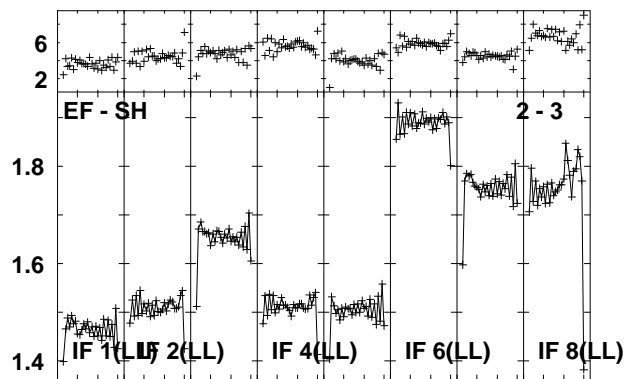
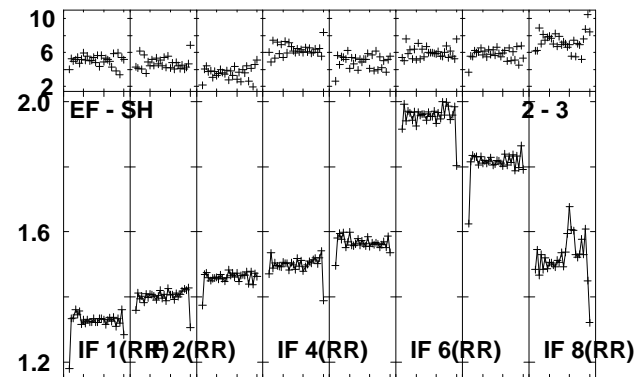
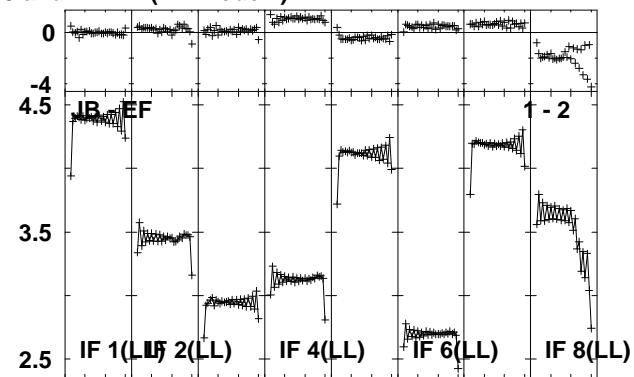
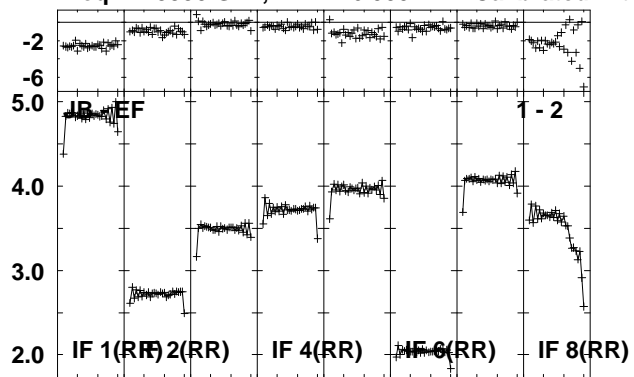

Lower frame: Ampl Jy Top frame: Phas deg  
Vector averaged cross-power spectrum Several baselines displayed  
Timerange: 00/12:30:01 to 00/12:37:59

Plot file version 2 created 30-NOV-2010 14:26:26

4C39.25 EP068B 3.UVDATA.1

Freq = 1.5950 GHz, Bw = 16.000 MH Calibrated with CL # 3 and BP # 1 (BP mode 1)

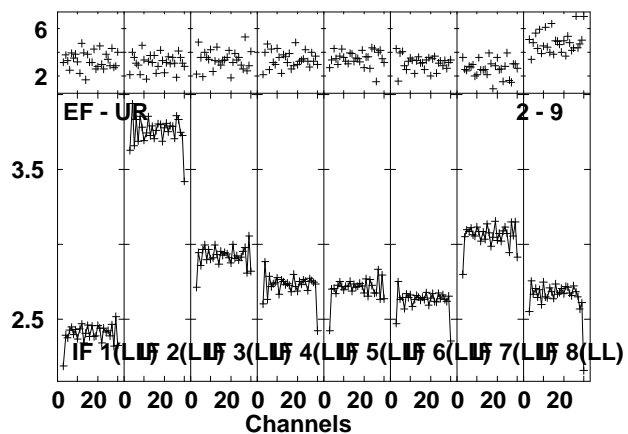
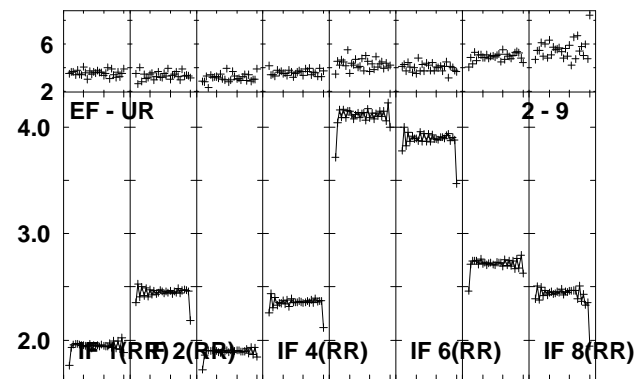
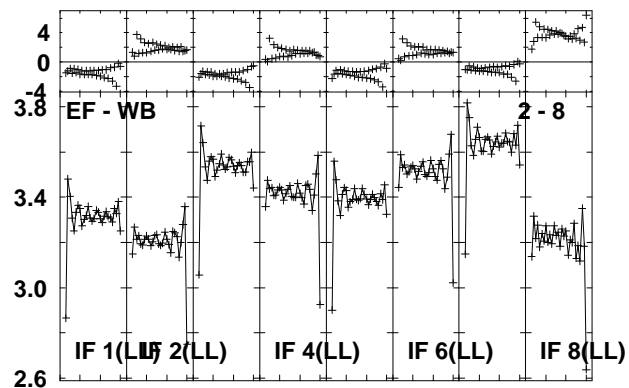
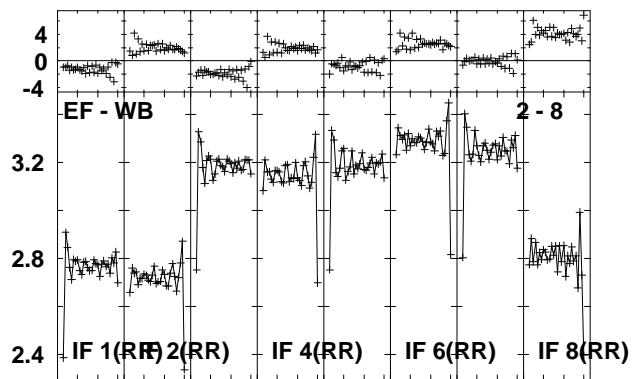
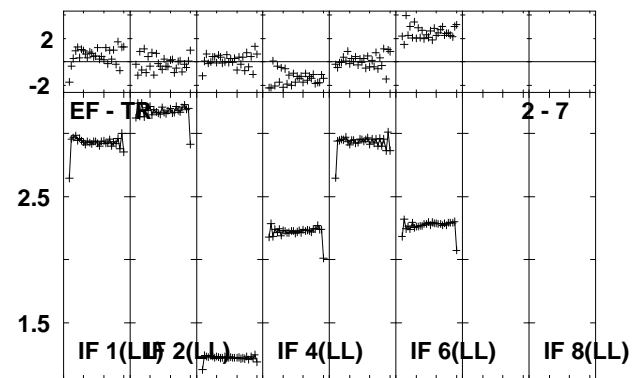
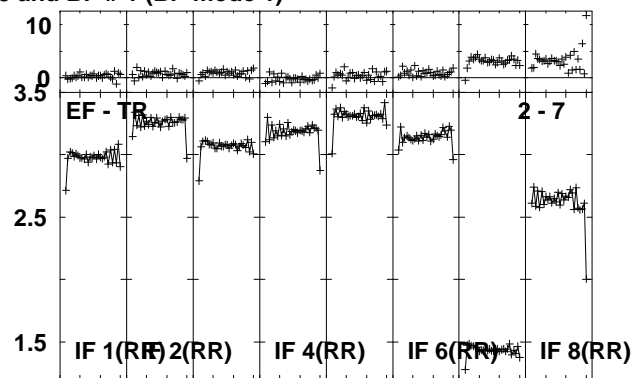
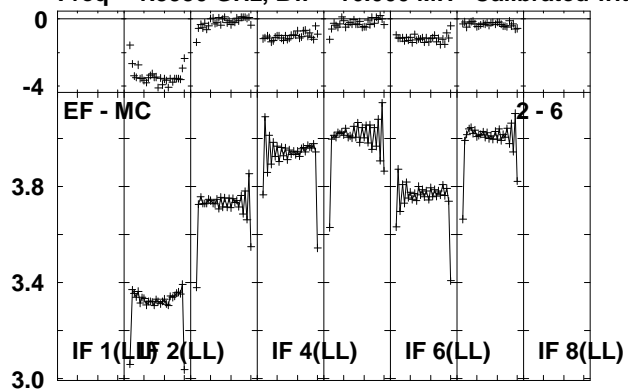

Lower frame: Ampl Jy Top frame: Phas deg  
Vector averaged cross-power spectrum Several baselines displayed  
Timerange: 00/12:30:01 to 00/12:37:59

Plot file version 3 created 30-NOV-2010 14:26:31

J1128+59 EP068B 3.UVDATA.1

Freq = 1.5950 GHz, Bw = 16.000 MH Calibrated with CL # 3 and BP # 1 (BP mode 1)

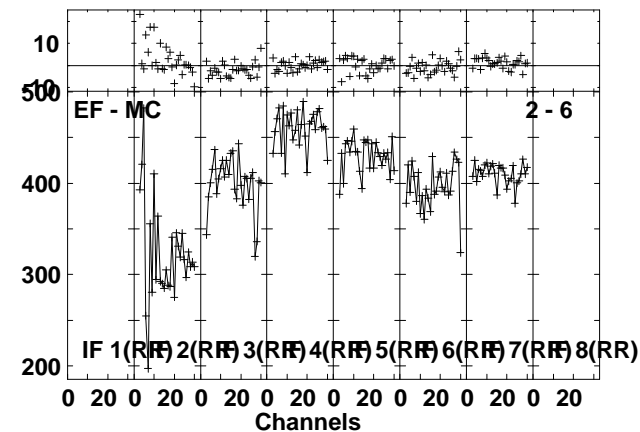
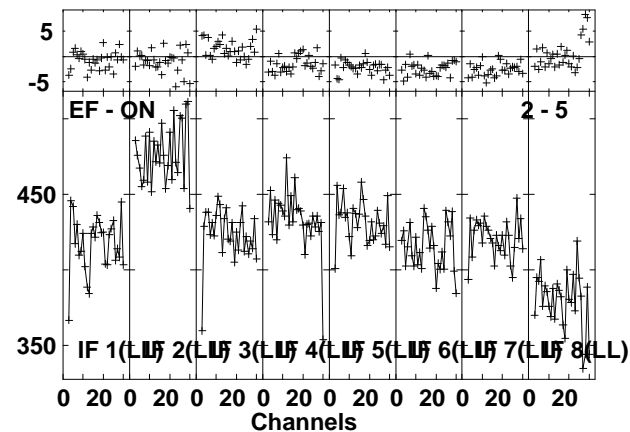
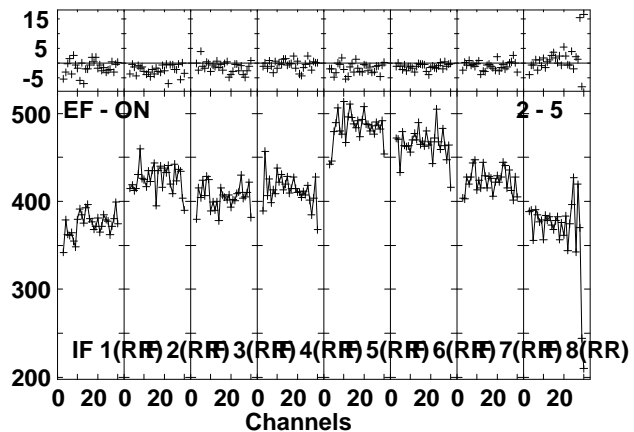
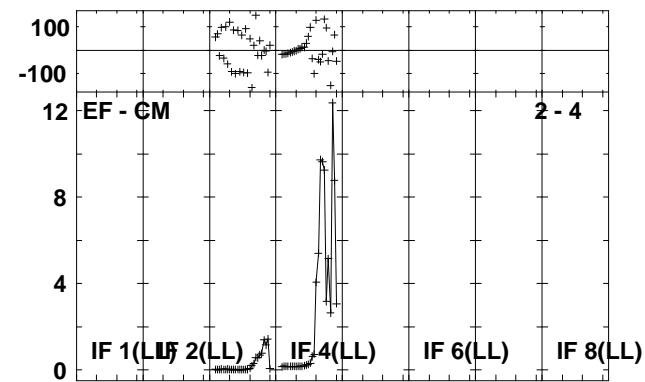
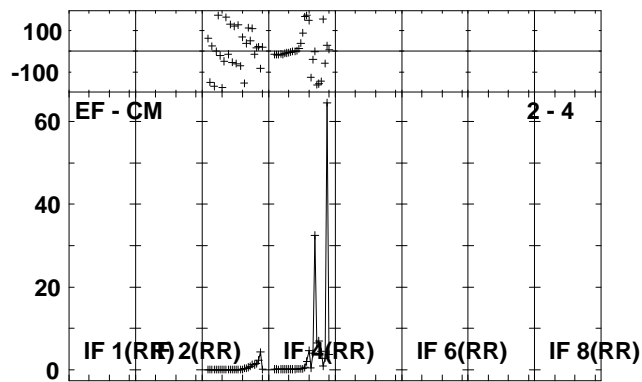
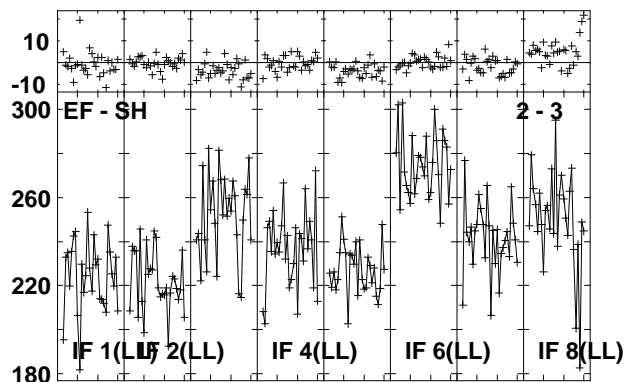
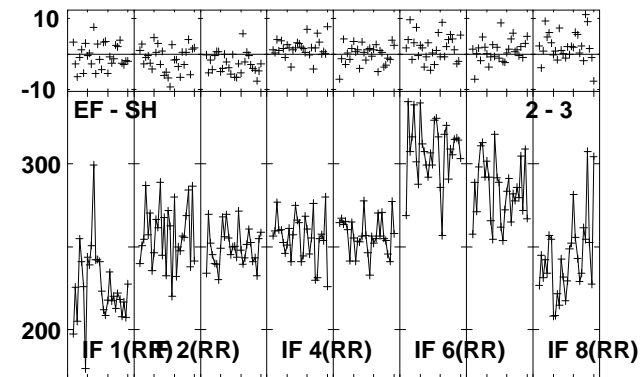
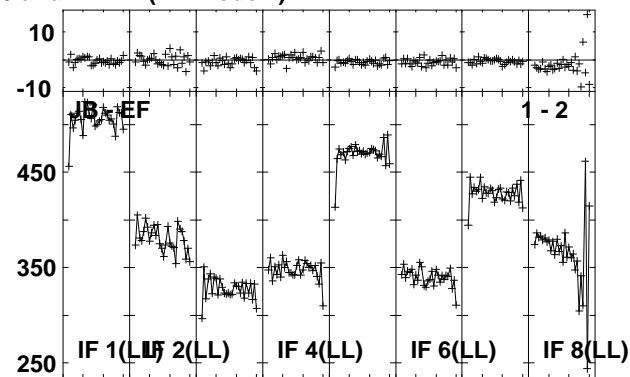
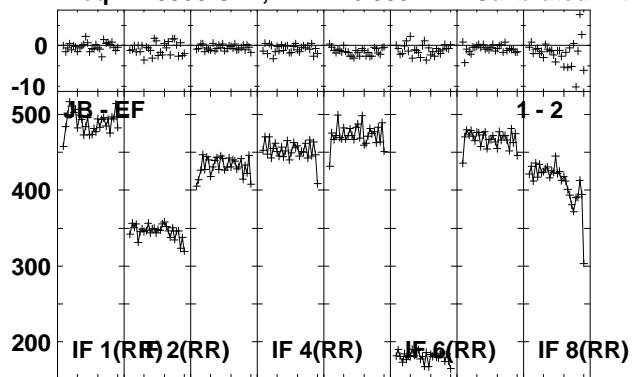

Lower frame: Milli Ampl Jy Top frame: Phas deg  
Vector averaged cross-power spectrum Several baselines displayed  
Timerange: 00/12:39:01 to 00/12:41:59

Plot file version 4 created 30-NOV-2010 14:26:32

J1128+59 EP068B 3.UVDATA.1

Freq = 1.5950 GHz, Bw = 16.000 MH Calibrated with CL # 3 and BP # 1 (BP mode 1)

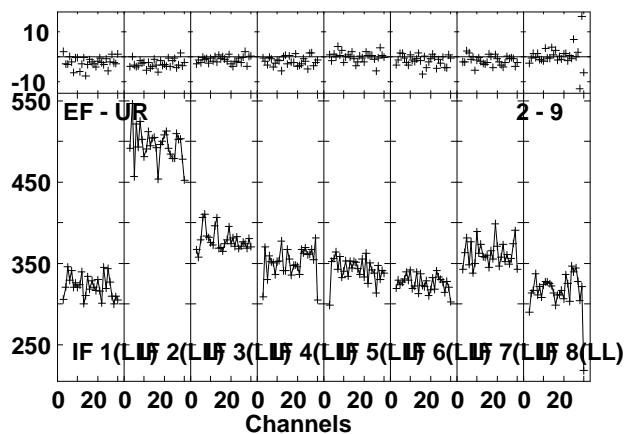
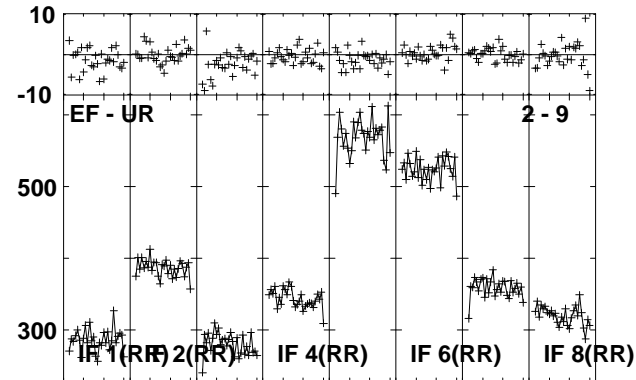
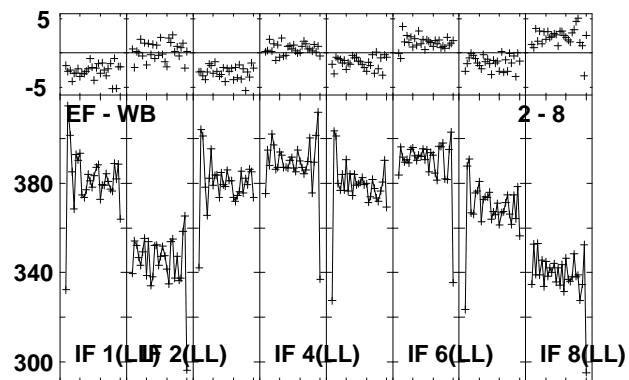
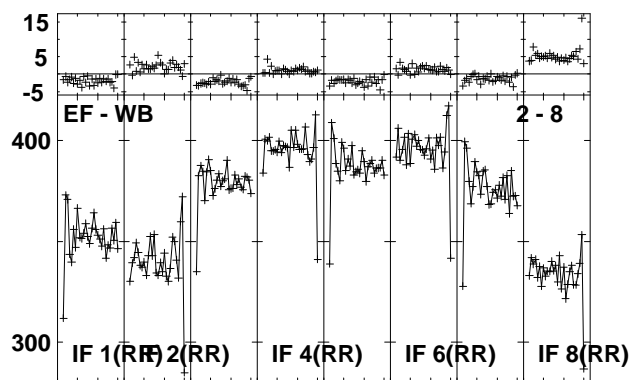
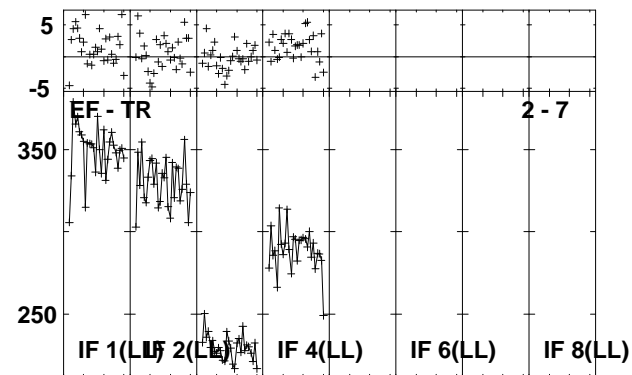
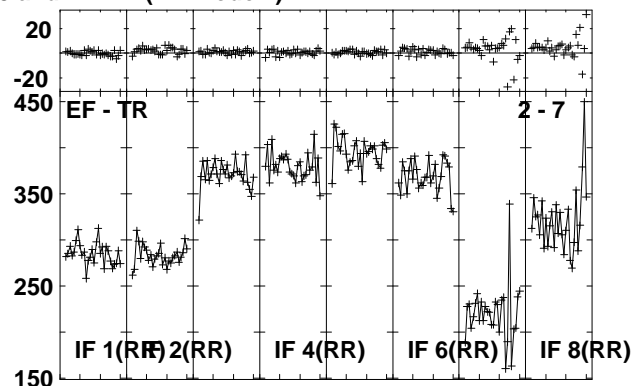
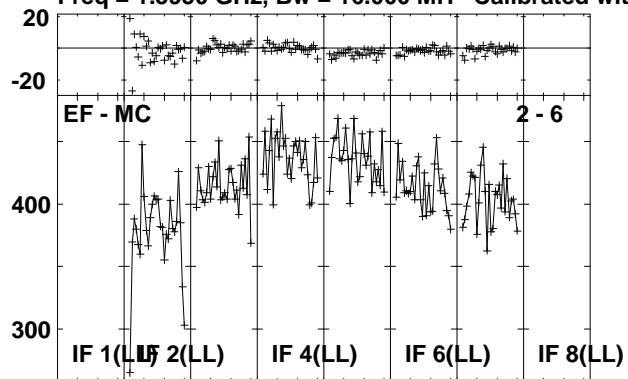

Lower frame: Milli Ampl Jy Top frame: Phas deg  
Vector averaged cross-power spectrum Several baselines displayed  
Timerange: 00/12:39:01 to 00/12:41:59

Plot file version 5 created 30-NOV-2010 14:26:34

ARP299C EP068B 3.UVDATA.1

Freq = 1.5950 GHz, Bw = 16.000 MH Calibrated with CL # 3 and BP # 1 (BP mode 1)

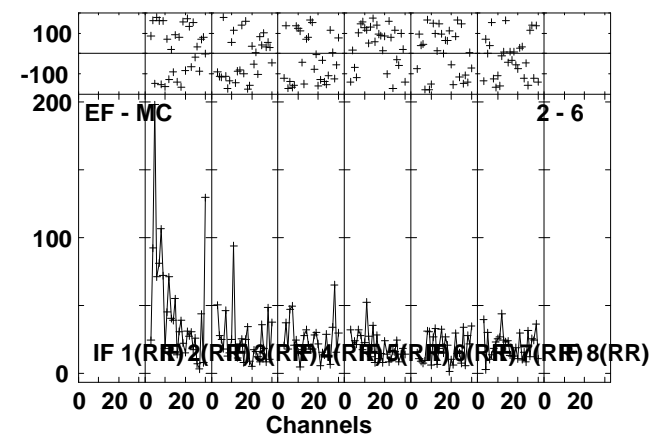
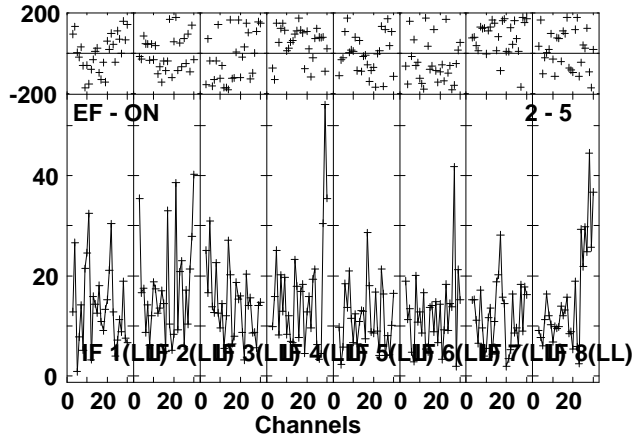
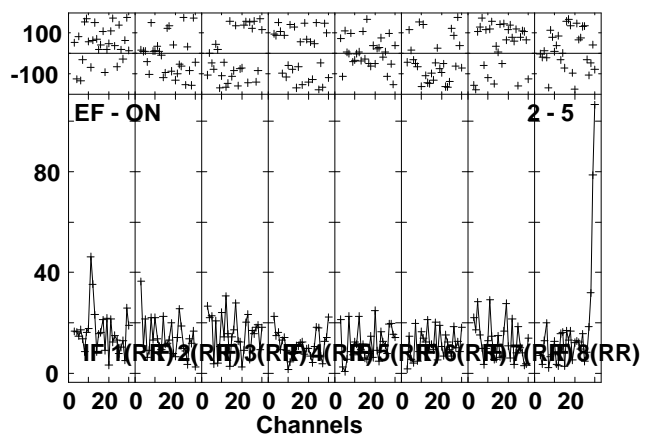
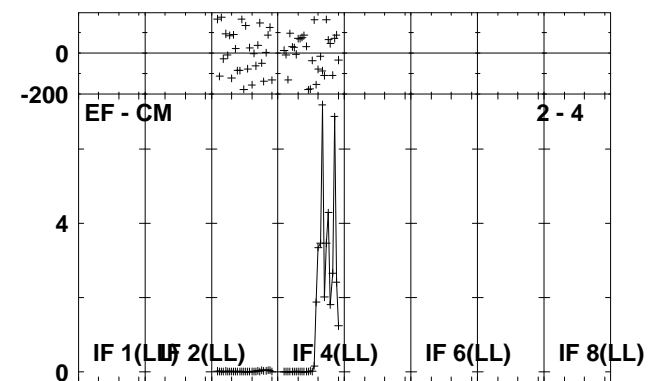
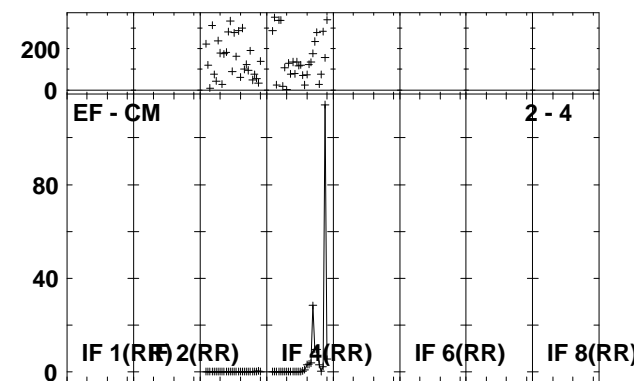
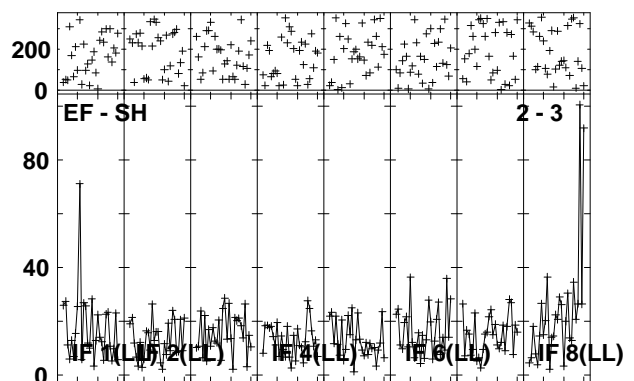
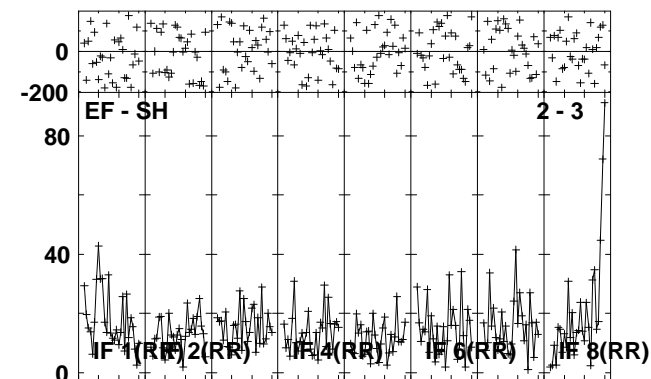
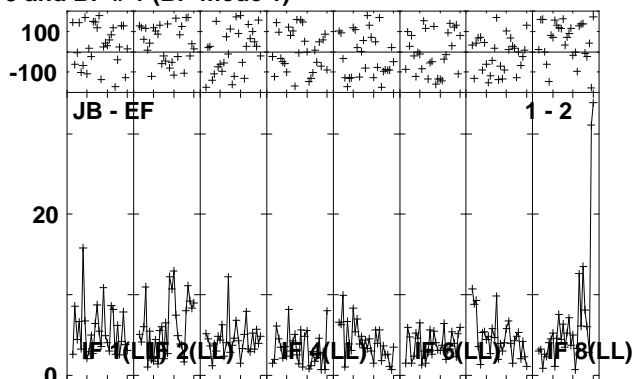
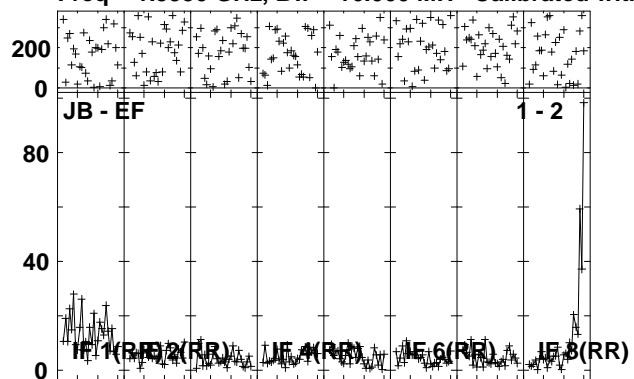

Lower frame: Milli Ampl Jy Top frame: Phas deg  
Vector averaged cross-power spectrum Several baselines displayed  
Timerange: 00:12:42:01 to 00:12:45:29

Plot file version 6 created 30-NOV-2010 14:26:36

ARP299C EP068B 3.UVDATA.1

Freq = 1.5950 GHz, Bw = 16.000 MH Calibrated with CL # 3 and BP # 1 (BP mode 1)

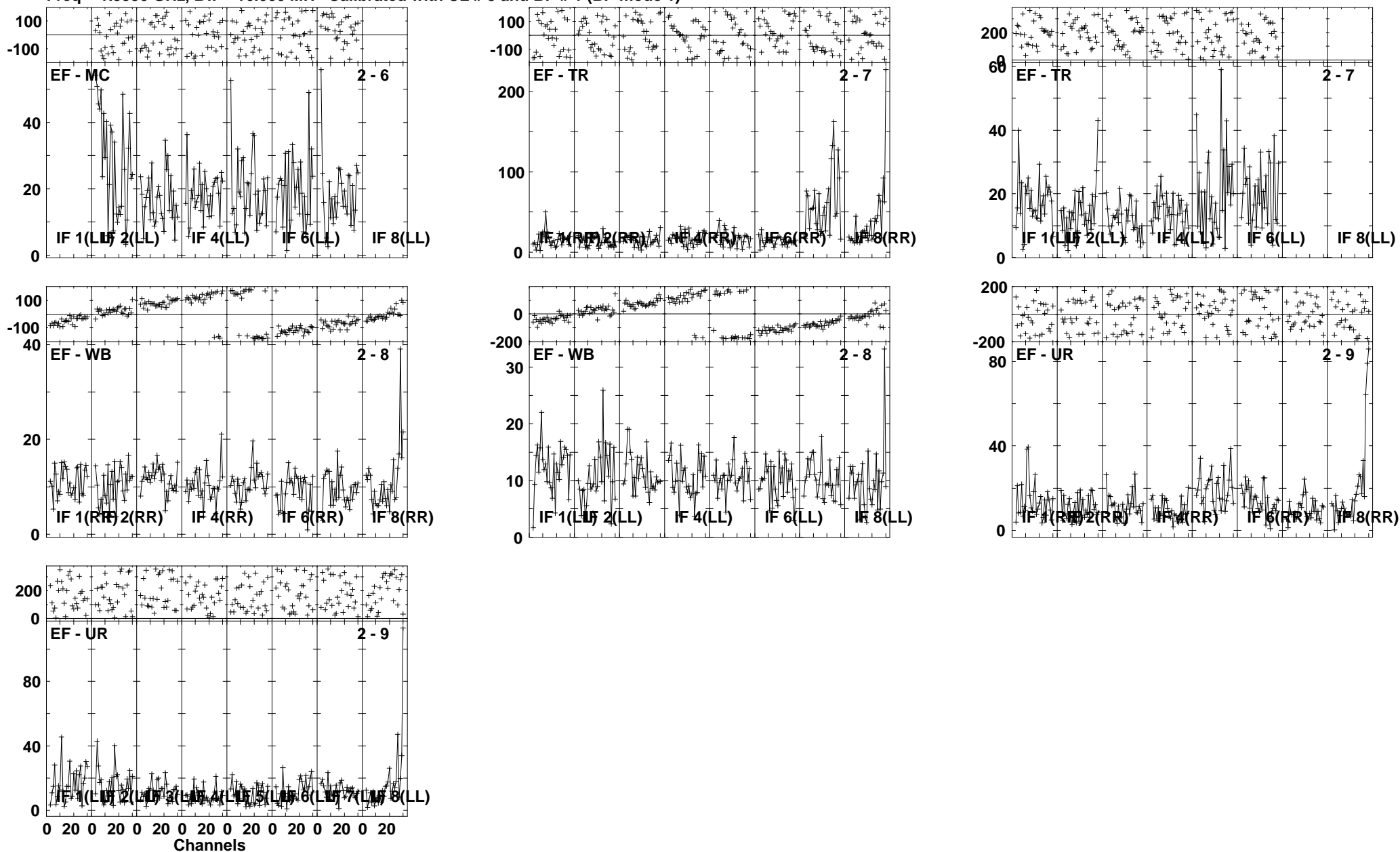

Lower frame: Milli Ampl Jy Top frame: Phas deg  
Vector averaged cross-power spectrum Several baselines displayed  
Timerange: 00:12:42:01 to 00:12:45:29

Plot file version 7 created 30-NOV-2010 14:26:39

J1128+59 EP068B 3.UVDATA.1

Freq = 1.5950 GHz, Bw = 16.000 MH Calibrated with CL # 3 and BP # 1 (BP mode 1)

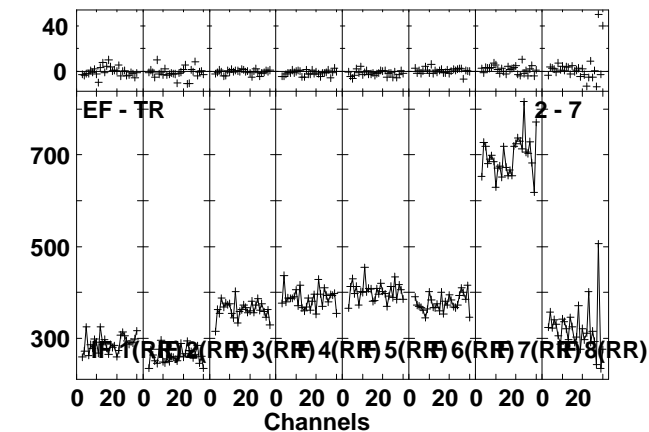
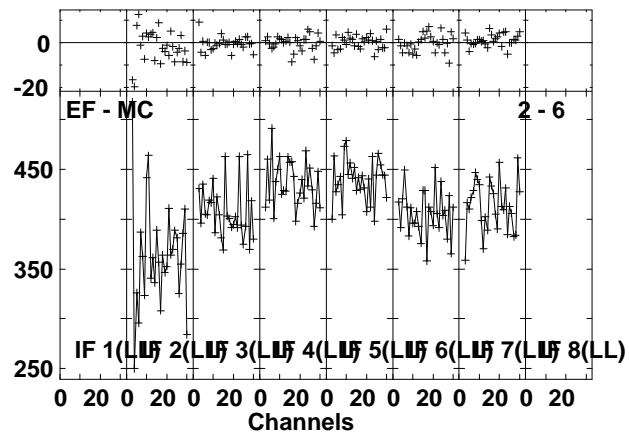
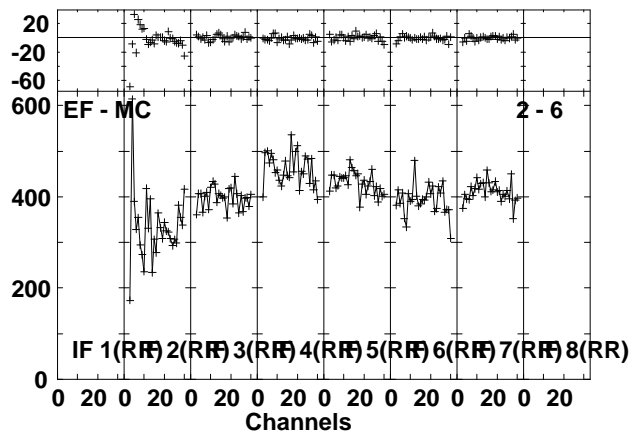
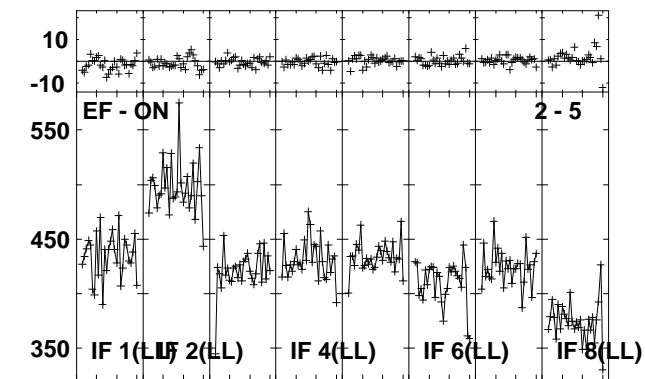
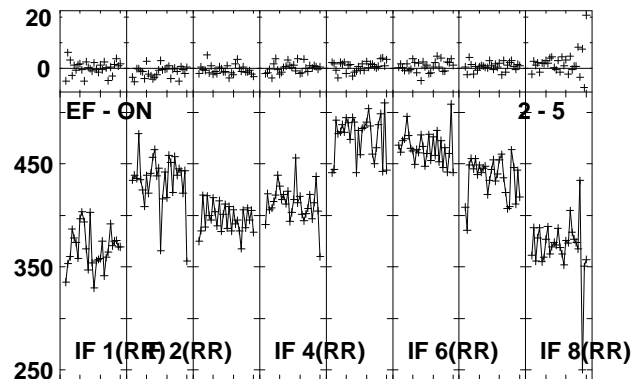
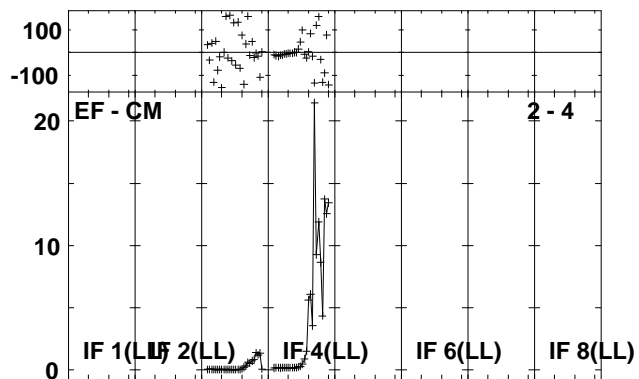
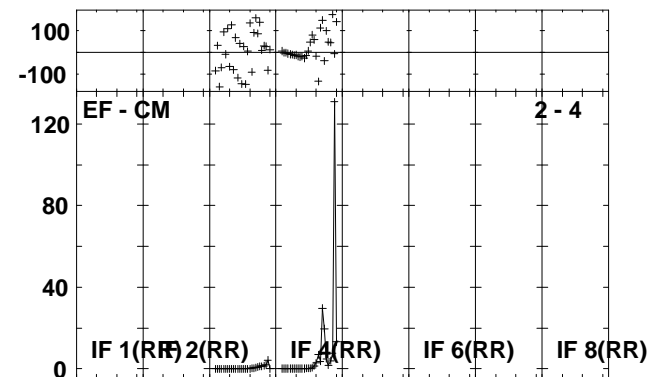
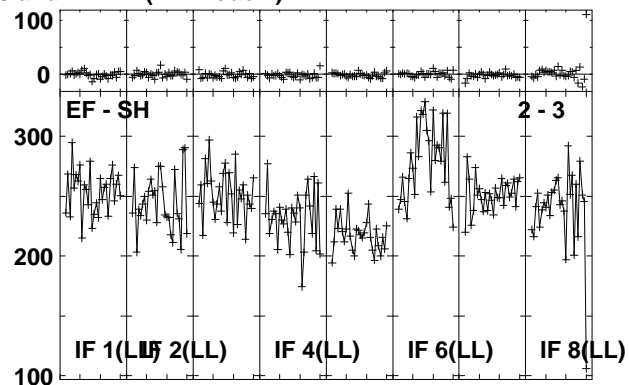
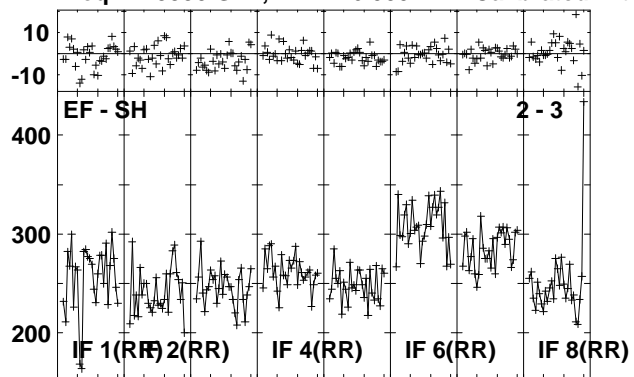

Lower frame: Milli Ampl Jy Top frame: Phas deg  
Vector averaged cross-power spectrum Several baselines displayed  
Timerange: 00/12:45:31 to 00/12:46:59

Plot file version 8 created 30-NOV-2010 14:26:40

J1128+59 EP068B 3.UVDATA.1

Freq = 1.5950 GHz, Bw = 16.000 MH Calibrated with CL # 3 and BP # 1 (BP mode 1)

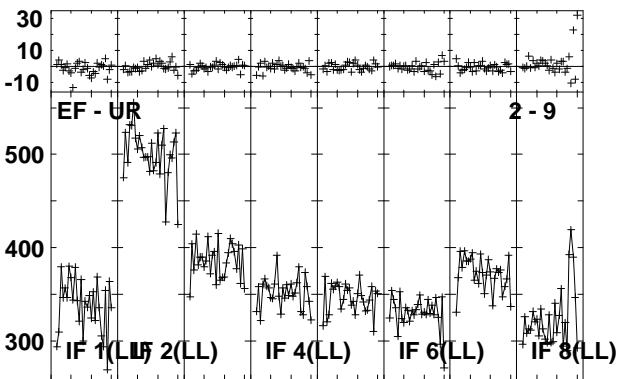
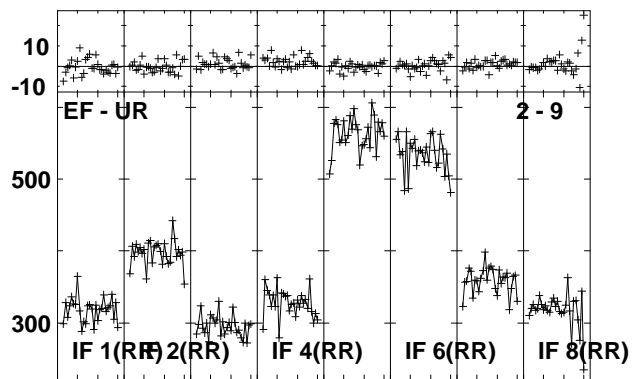
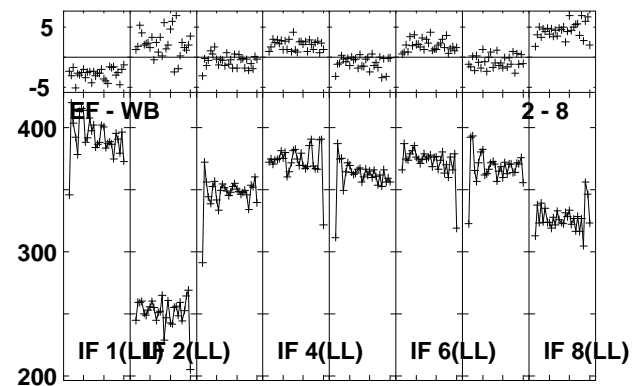
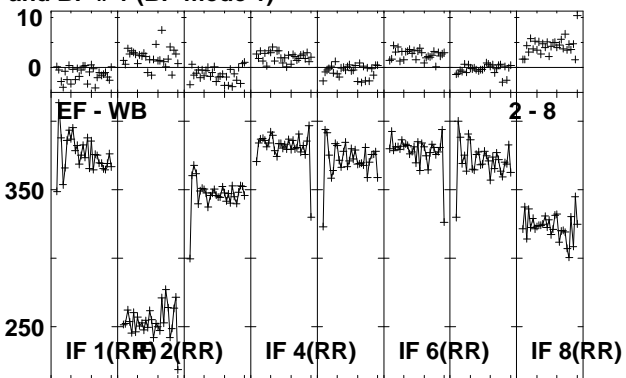
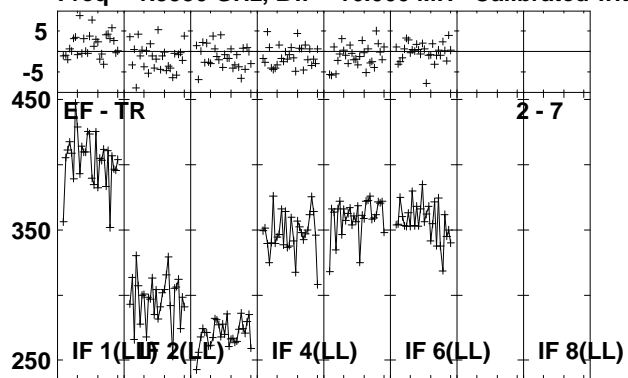

Lower frame: Milli Ampl Jy Top frame: Phas deg  
Vector averaged cross-power spectrum Several baselines displayed  
Timerange: 00:12:45:31 to 00:12:46:59



Plot file version 9 created 30-NOV-2010 14:26:41

ARP299C EP068B 3.UVDATA.1

Freq = 1.5950 GHz, Bw = 16.000 MH Calibrated with CL # 3 and BP # 1 (BP mode 1)

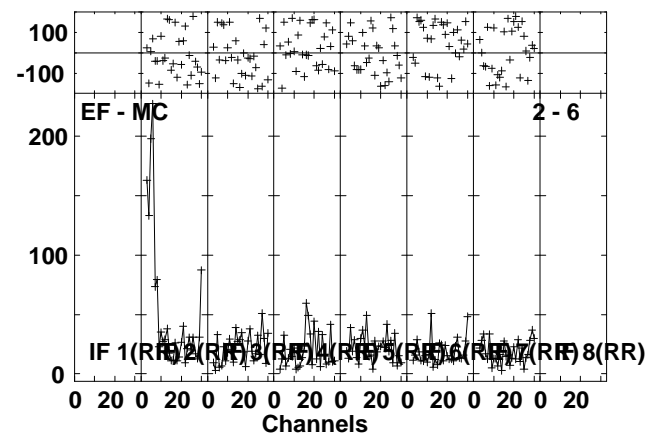
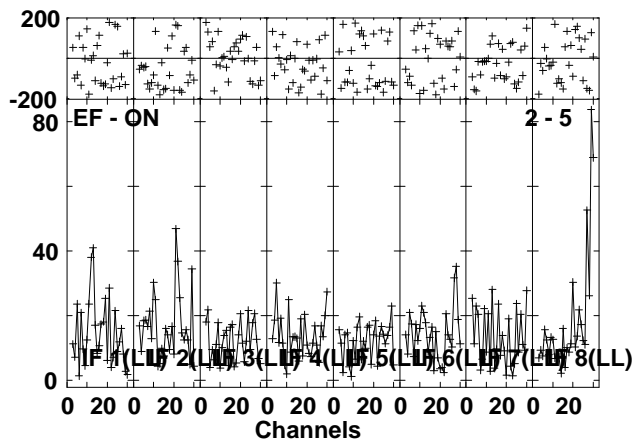
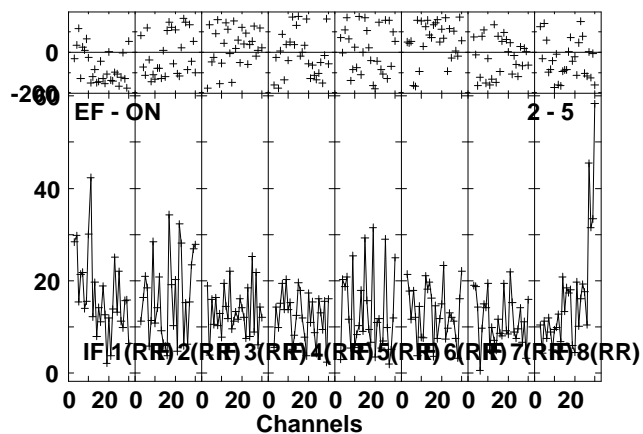
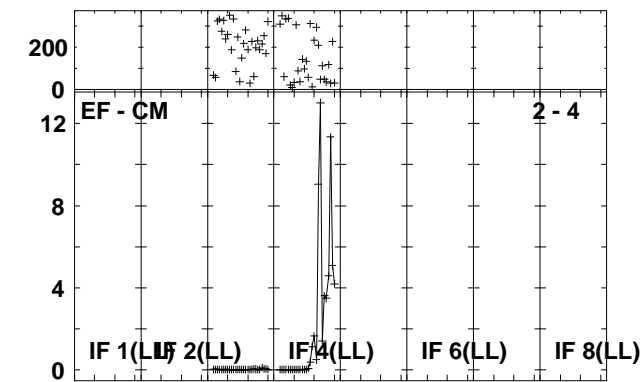
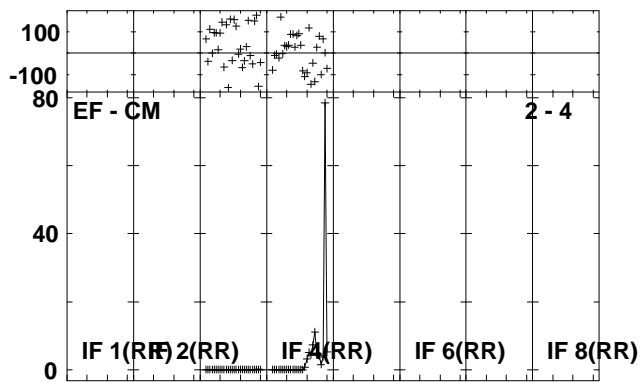
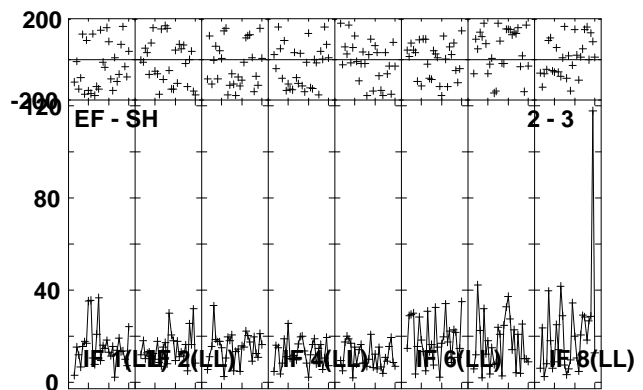
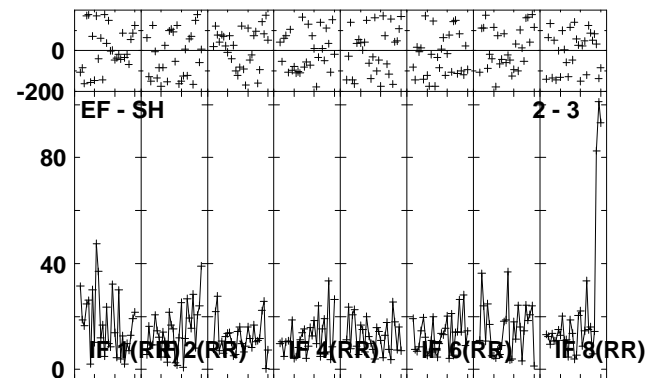
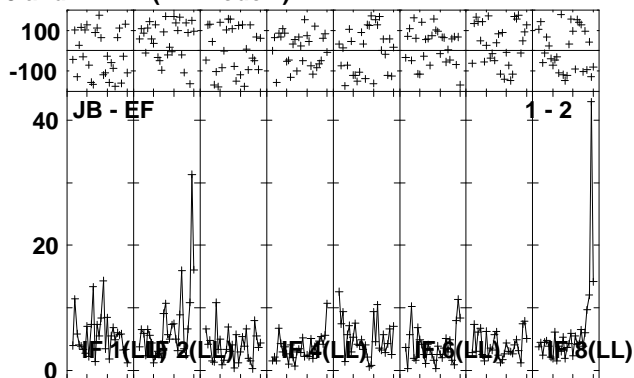
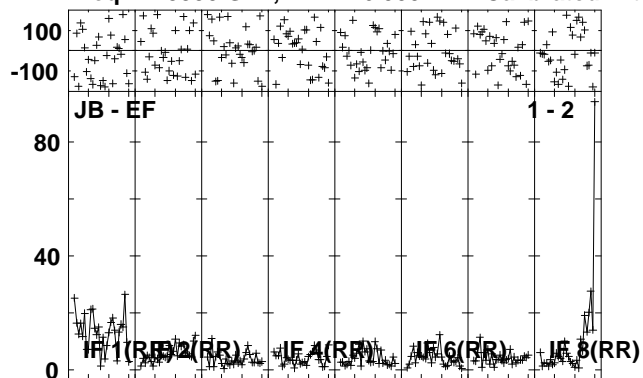

Lower frame: Milli Ampl Jy Top frame: Phas deg  
Vector averaged cross-power spectrum Several baselines displayed  
Timerange: 00/12:47:01 to 00/12:50:29

Plot file version 10 created 30-NOV-2010 14:26:44

ARP299C EP068B 3.UVDATA.1

Freq = 1.5950 GHz, Bw = 16.000 MH Calibrated with CL # 3 and BP # 1 (BP mode 1)

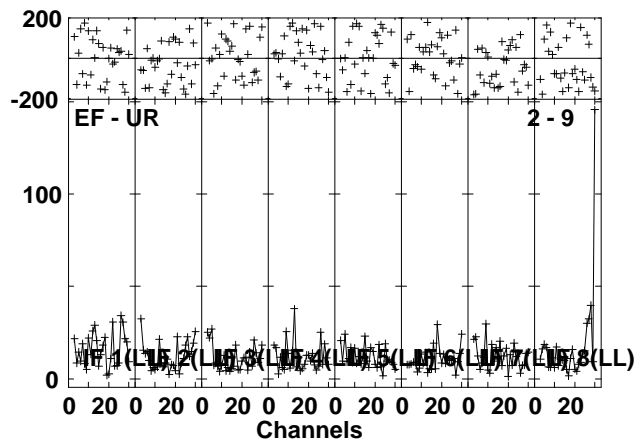
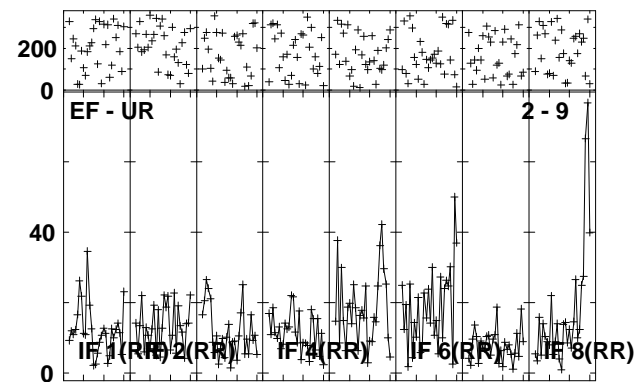
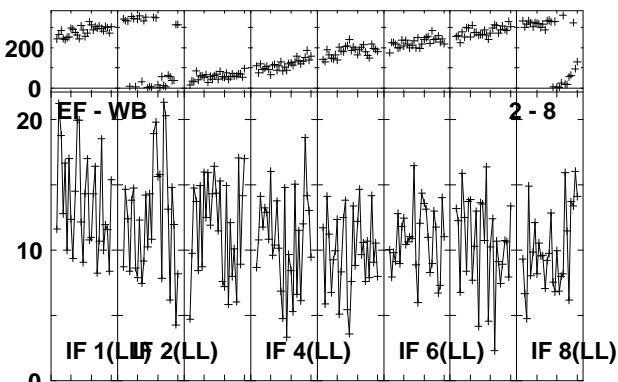
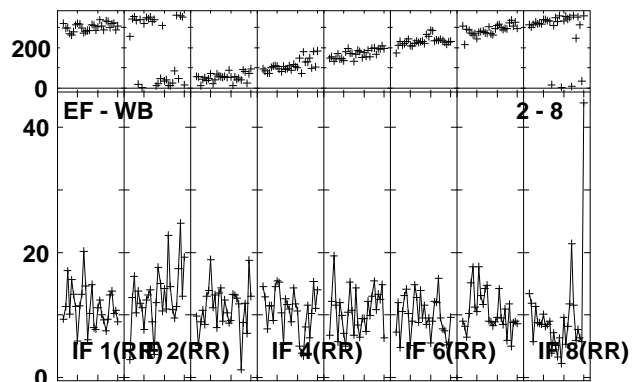
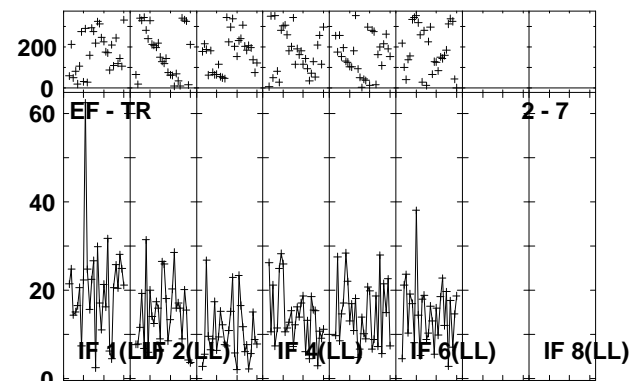
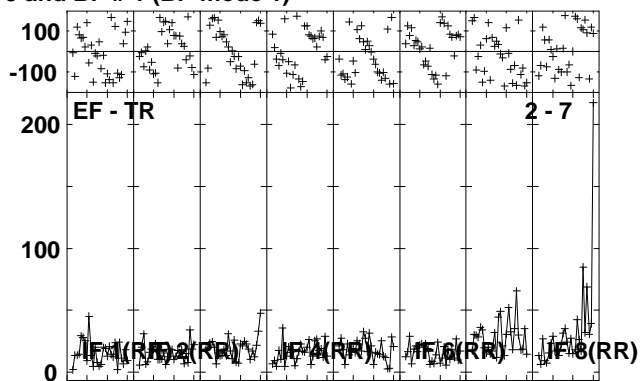
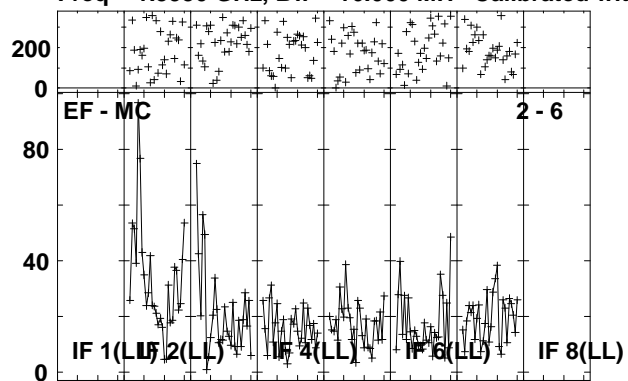

Lower frame: Milli Ampl Jy Top frame: Phas deg  
Vector averaged cross-power spectrum Several baselines displayed  
Timerange: 00:12:47:01 to 00:12:50:29

Plot file version 11 created 30-NOV-2010 14:26:46

J1128+59 EP068B 3.UVDATA.1

Freq = 1.5950 GHz, Bw = 16.000 MH Calibrated with CL # 3 and BP # 1 (BP mode 1)

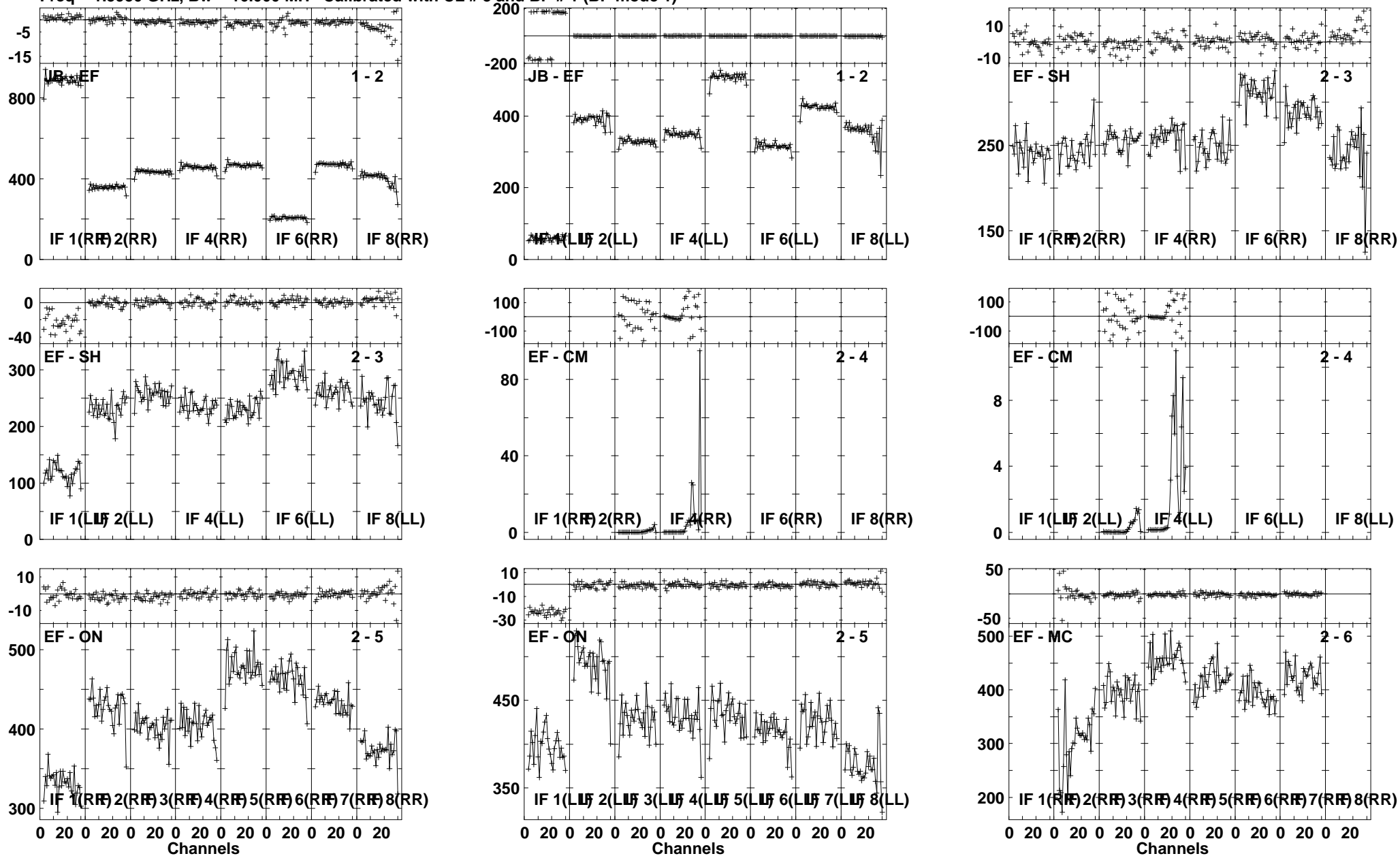

Lower frame: Milli Ampl Jy Top frame: Phas deg  
Vector averaged cross-power spectrum Several baselines displayed  
Timerange: 00/12:51:31 to 00/12:52:59

Plot file version 12 created 30-NOV-2010 14:26:47

J1128+59 EP068B 3.UVDATA.1

Freq = 1.5950 GHz, Bw = 16.000 MH Calibrated with CL # 3 and BP # 1 (BP mode 1)

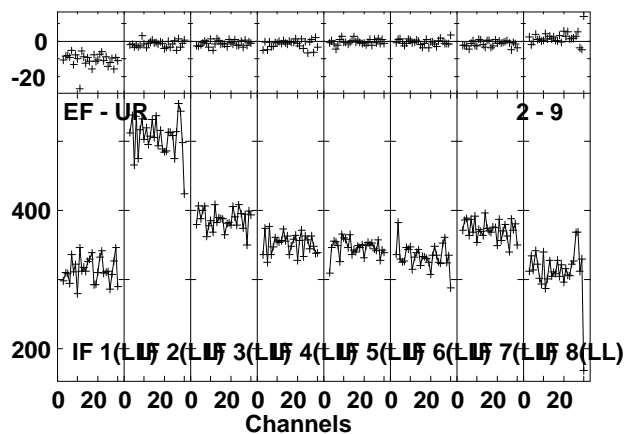
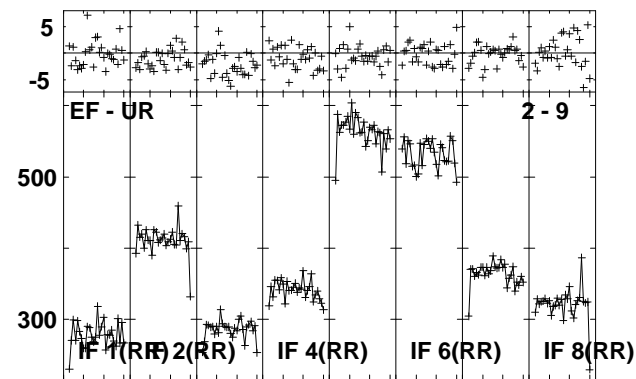
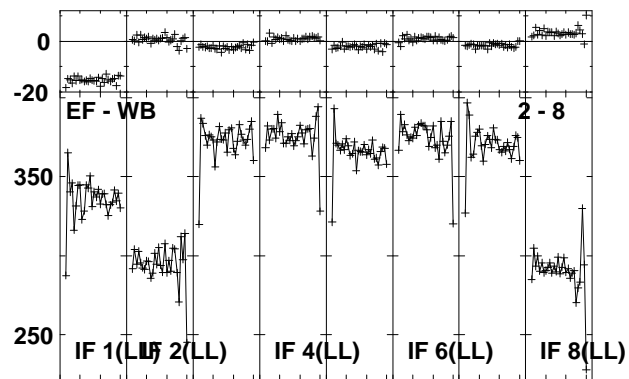
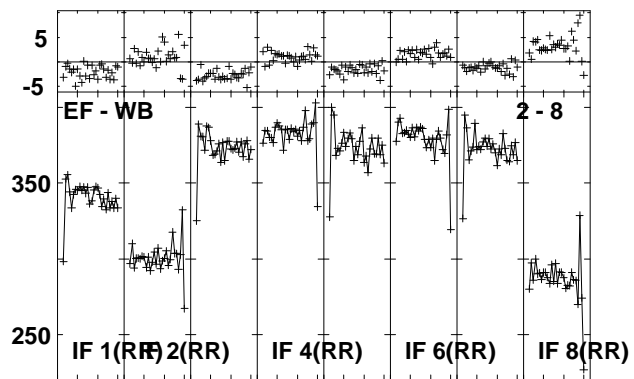
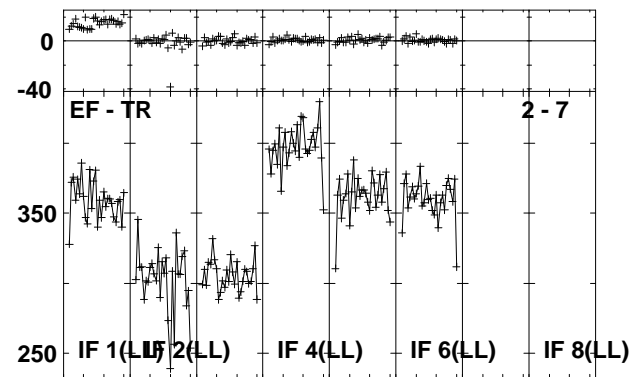
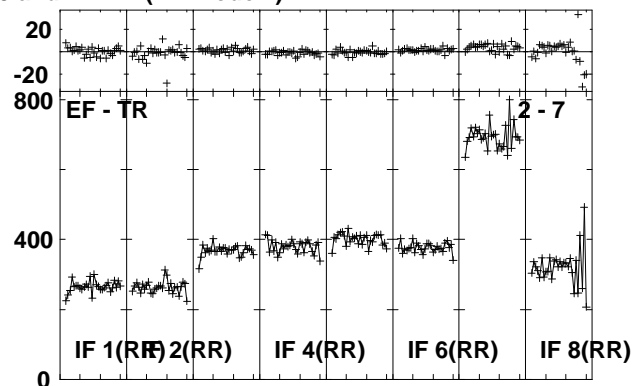
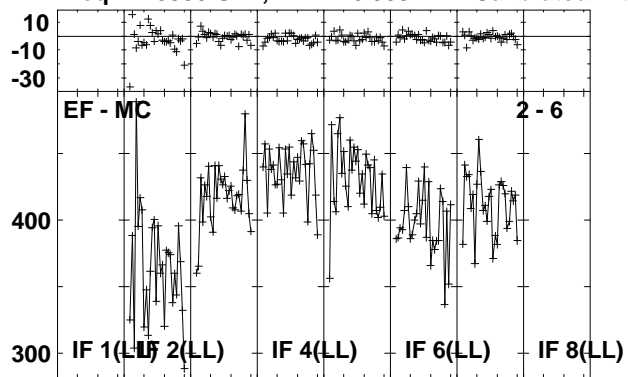

Lower frame: Milli Ampl Jy Top frame: Phas deg  
Vector averaged cross-power spectrum Several baselines displayed  
Timerange: 00/12:51:31 to 00/12:52:59

Plot file version 13 created 30-NOV-2010 14:26:49

ARP299C EP068B 3.UVDATA.1

Freq = 1.5950 GHz, Bw = 16.000 MH Calibrated with CL # 3 and BP # 1 (BP mode 1)

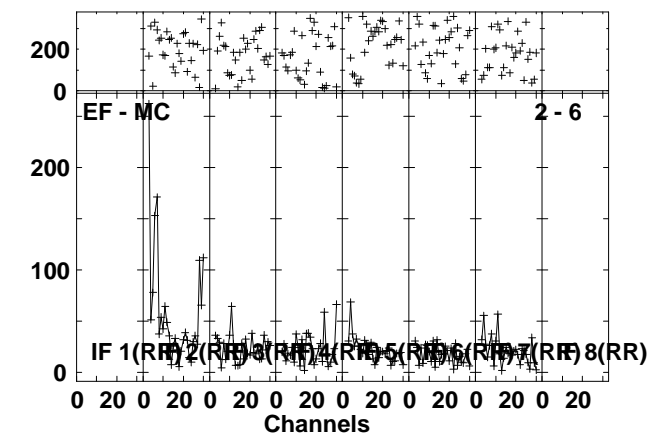
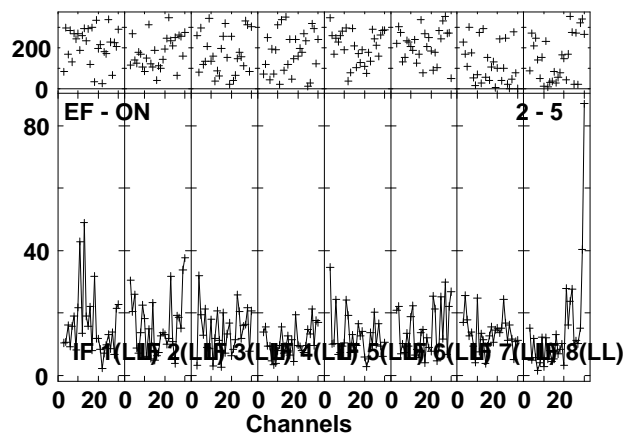
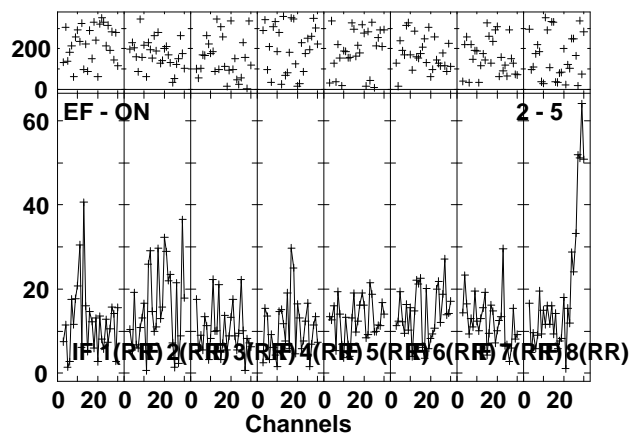
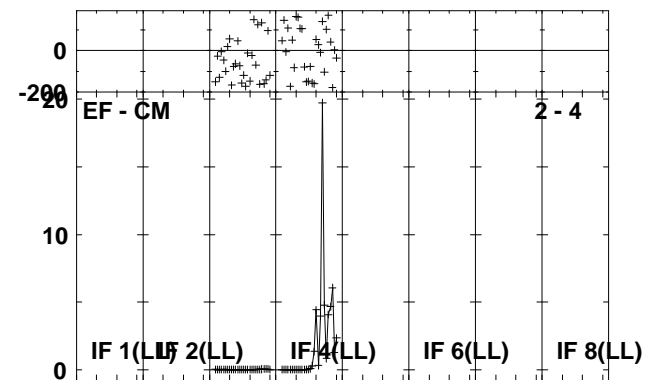
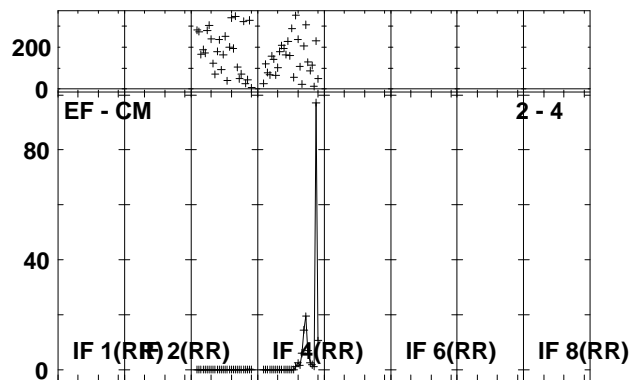
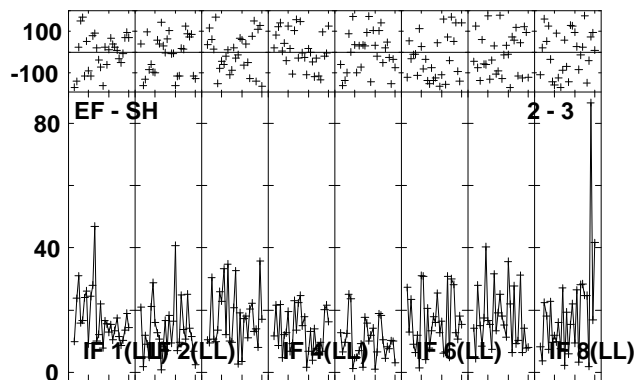
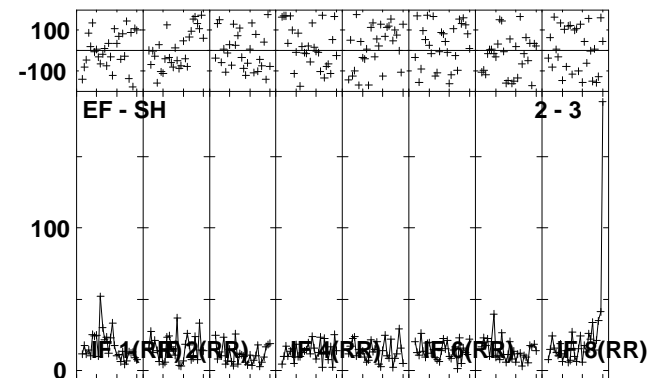
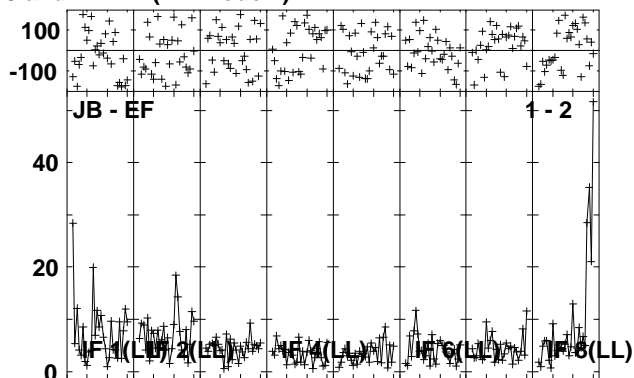
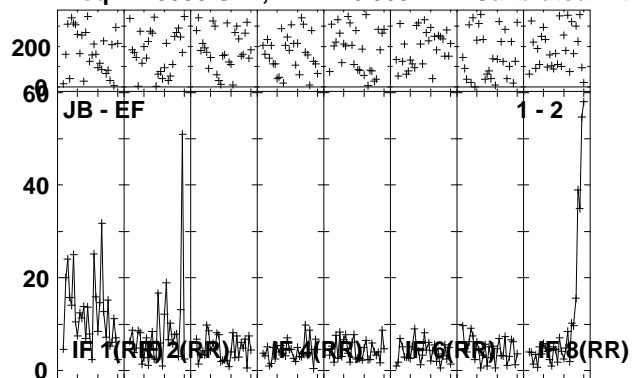

Lower frame: Milli Ampl Jy Top frame: Phas deg  
Vector averaged cross-power spectrum Several baselines displayed  
Timerange: 00/12:53:01 to 00/12:56:29

Plot file version 14 created 30-NOV-2010 14:26:51

ARP299C EP068B 3.UVDATA.1

Freq = 1.5950 GHz, Bw = 16.000 MH Calibrated with CL # 3 and BP # 1 (BP mode 1)

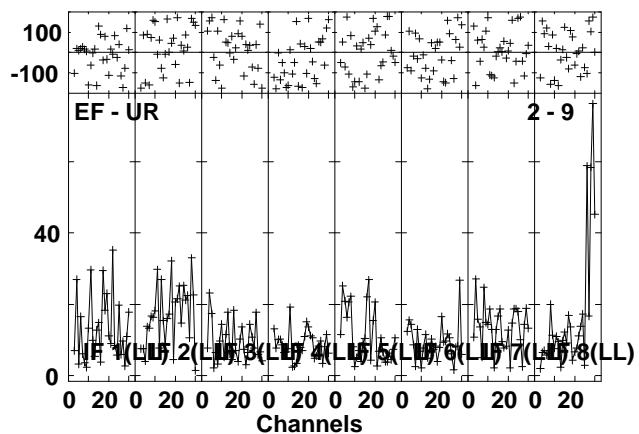
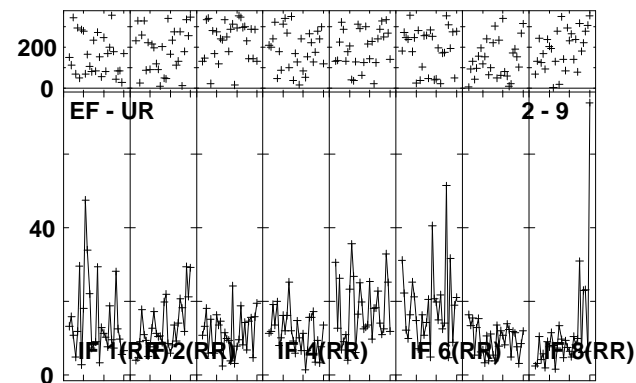
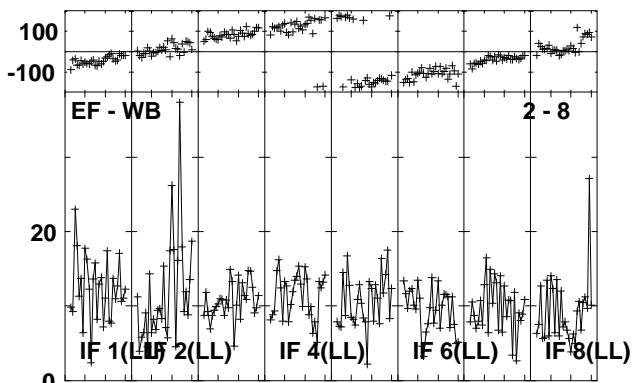
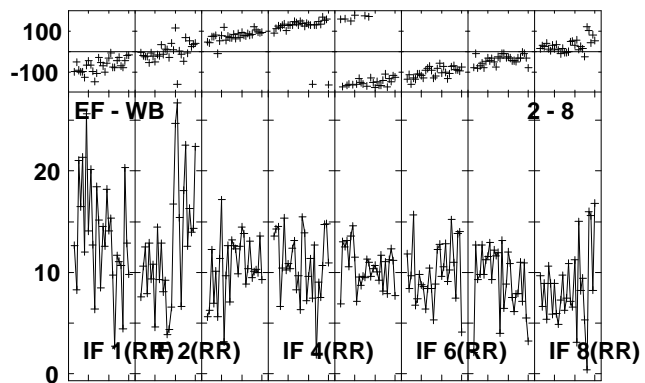
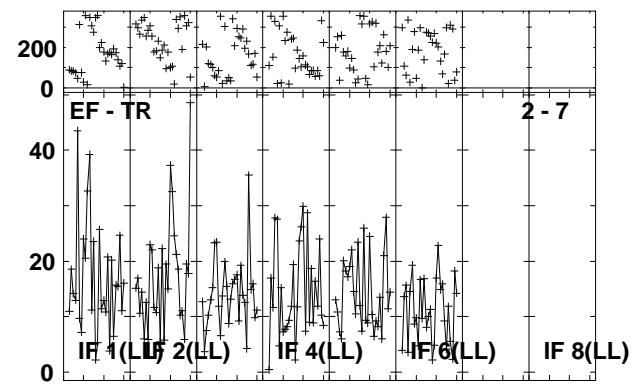
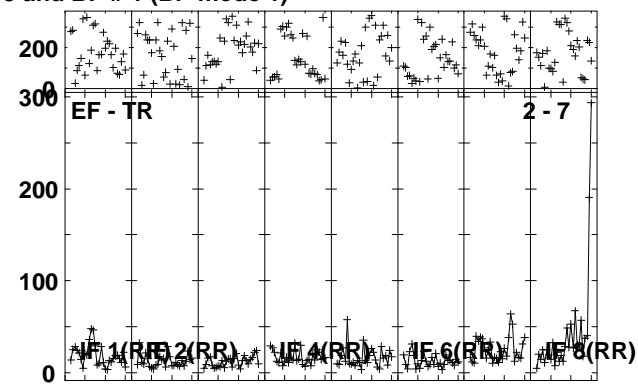
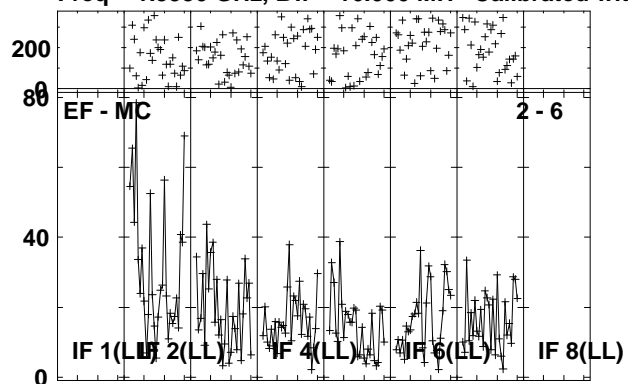

Lower frame: Milli Ampl Jy Top frame: Phas deg  
Vector averaged cross-power spectrum Several baselines displayed  
Timerange: 00/12:53:01 to 00/12:56:29

Plot file version 15 created 30-NOV-2010 14:26:54

J1128+59 EP068B 3.UVDATA.1

Freq = 1.5950 GHz, Bw = 16.000 MH Calibrated with CL # 3 and BP # 1 (BP mode 1)

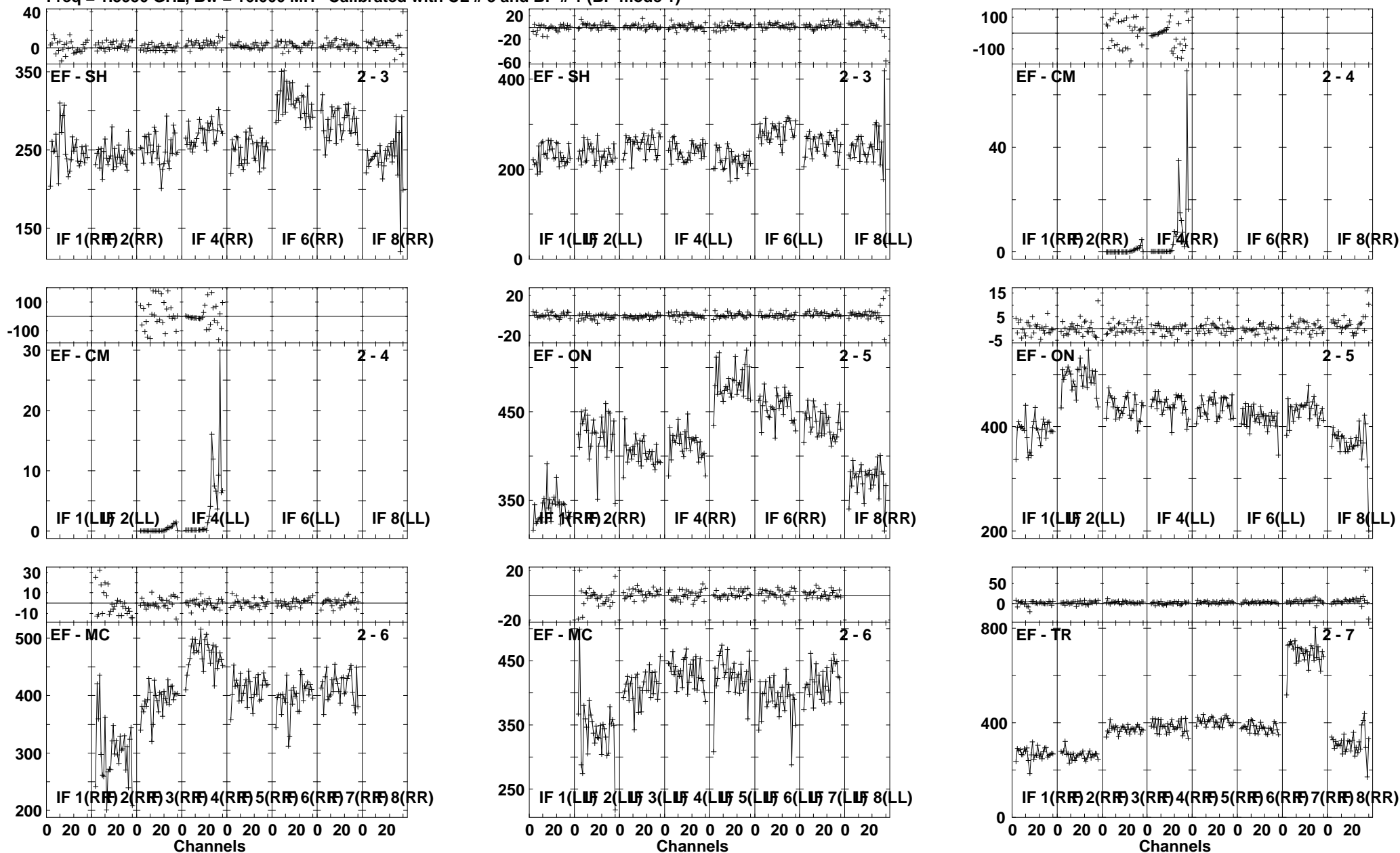

Lower frame: Milli Ampl Jy Top frame: Phas deg  
Vector averaged cross-power spectrum Several baselines displayed  
Timerange: 00/12:56:31 to 00/12:57:59

Plot file version 16 created 30-NOV-2010 14:26:54

J1128+59 EP068B 3.UVDATA.1

Freq = 1.5950 GHz, Bw = 16.000 MH Calibrated with CL # 3 and BP # 1 (BP mode 1)

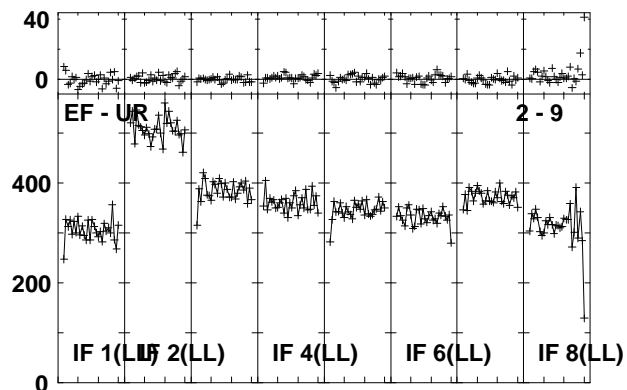
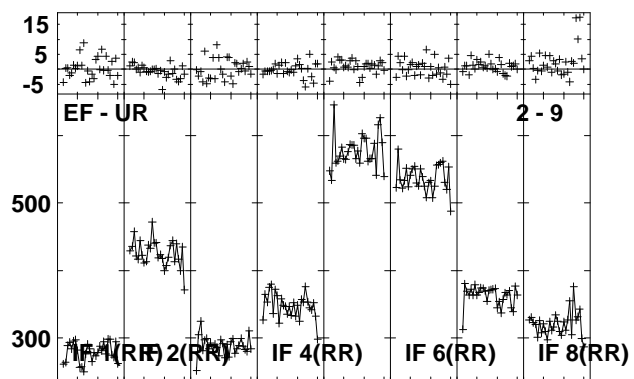
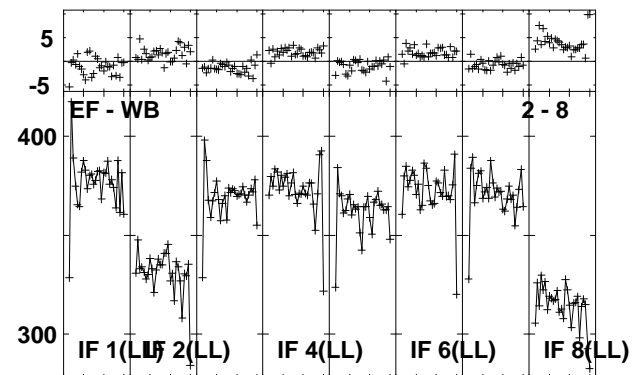
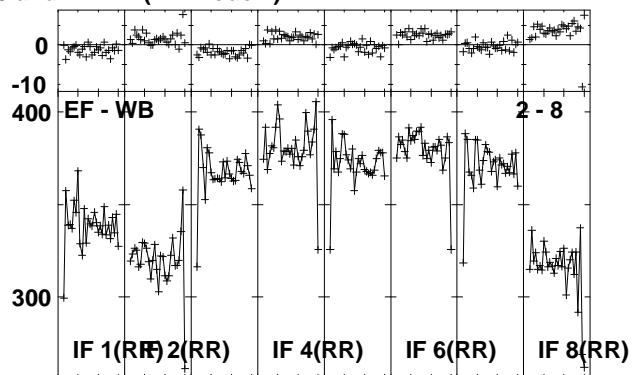
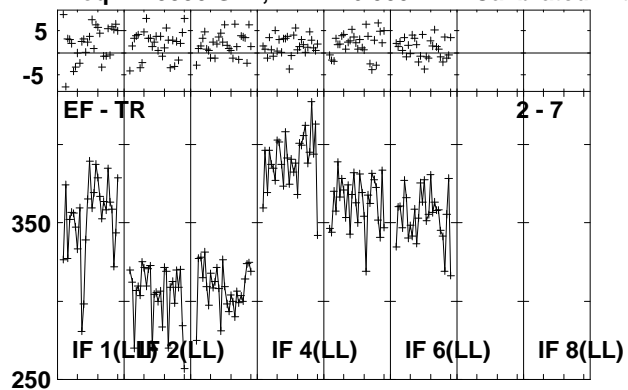

Lower frame: Milli Ampl Jy Top frame: Phas deg  
Vector averaged cross-power spectrum Several baselines displayed  
Timerange: 00/12:56:31 to 00/12:57:59



Plot file version 17 created 30-NOV-2010 14:26:56

ARP299C EP068B 3.UVDATA.1

Freq = 1.5950 GHz, Bw = 16.000 MH Calibrated with CL # 3 and BP # 1 (BP mode 1)

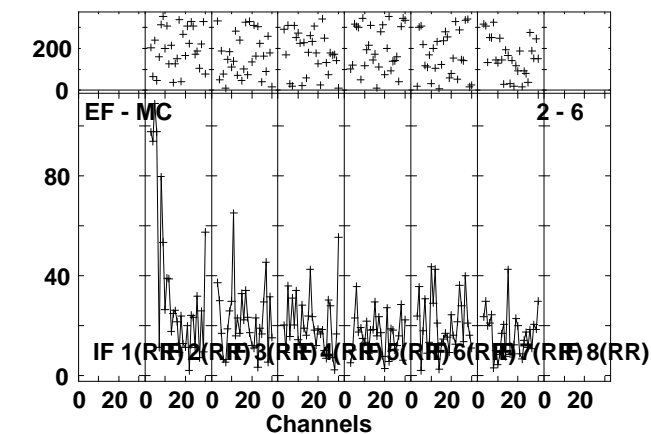
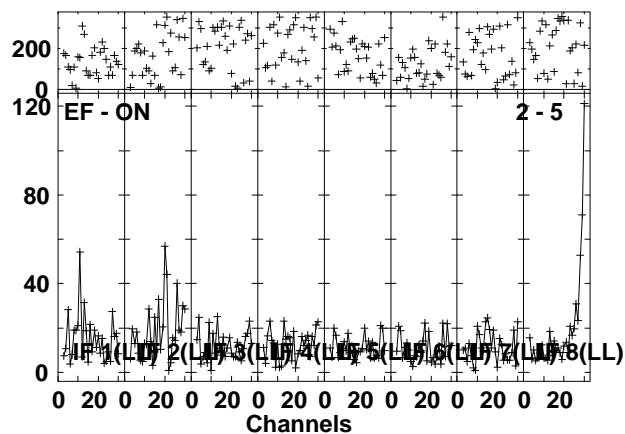
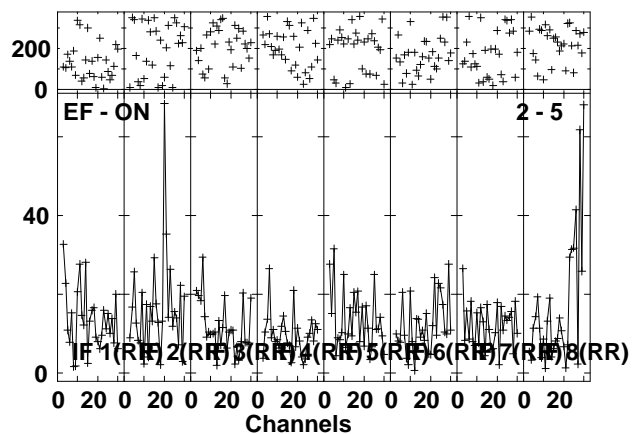
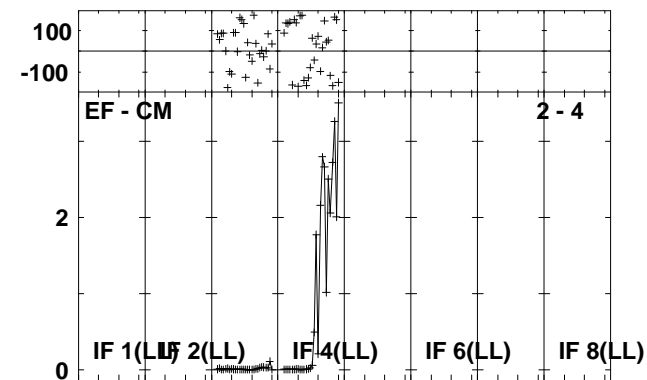
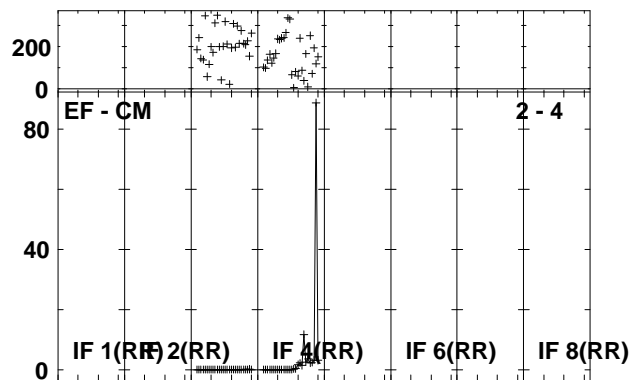
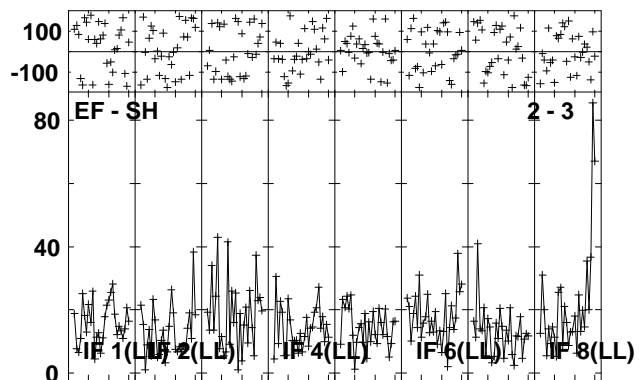
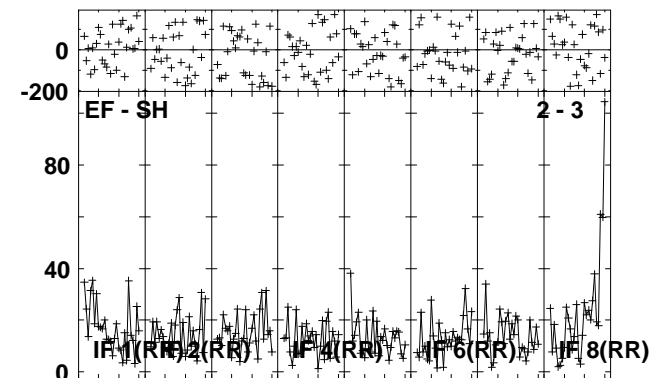
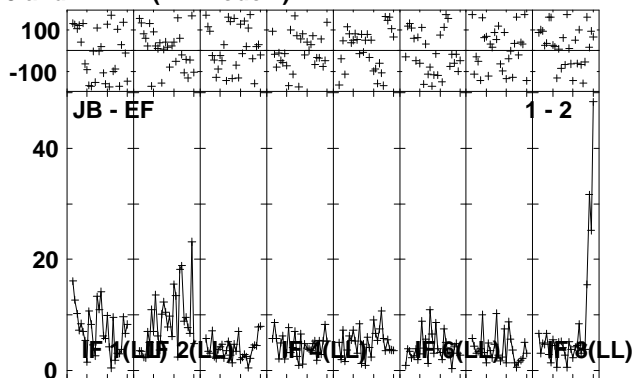
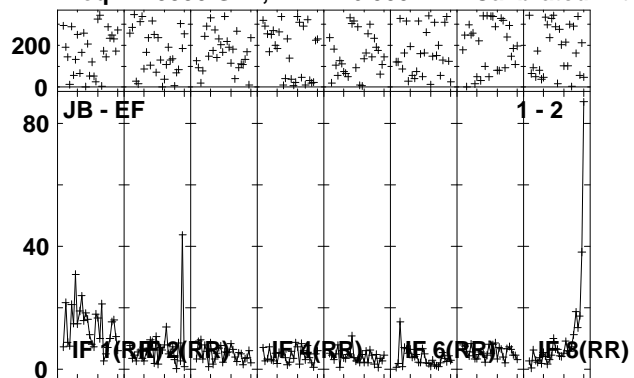

Lower frame: Milli Ampl Jy Top frame: Phas deg  
 Vector averaged cross-power spectrum Several baselines displayed  
 Timerange: 00/12:58:01 to 00/13:01:29

Plot file version 18 created 30-NOV-2010 14:26:58

ARP299C EP068B 3.UVDATA.1

Freq = 1.5950 GHz, Bw = 16.000 MH Calibrated with CL # 3 and BP # 1 (BP mode 1)

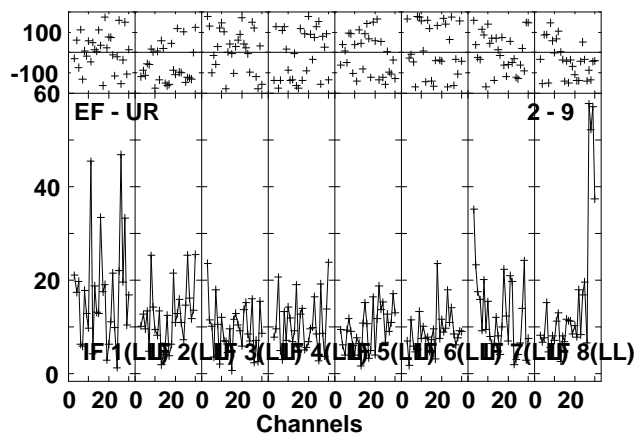
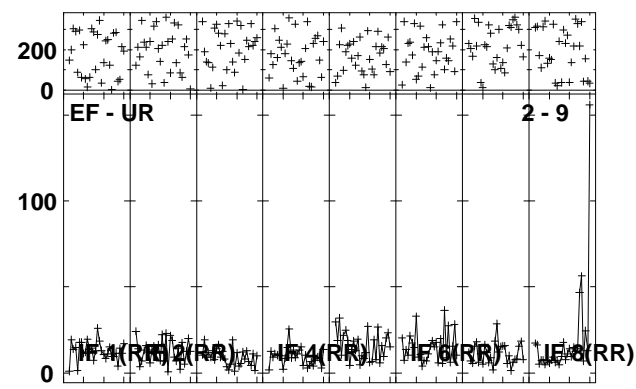
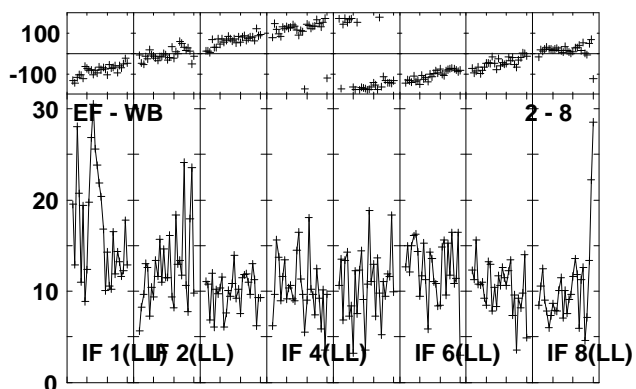
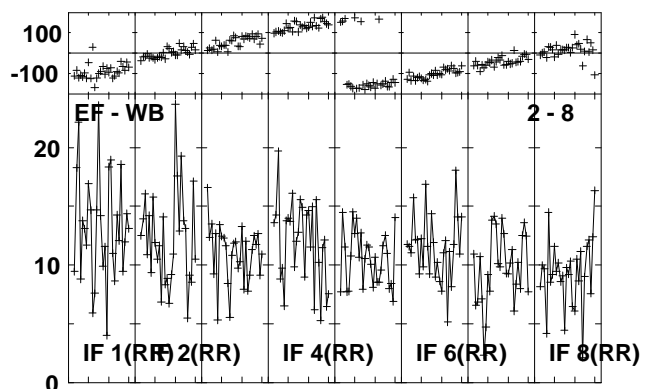
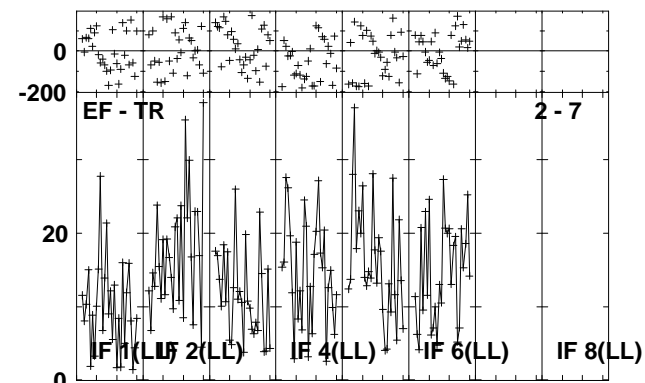
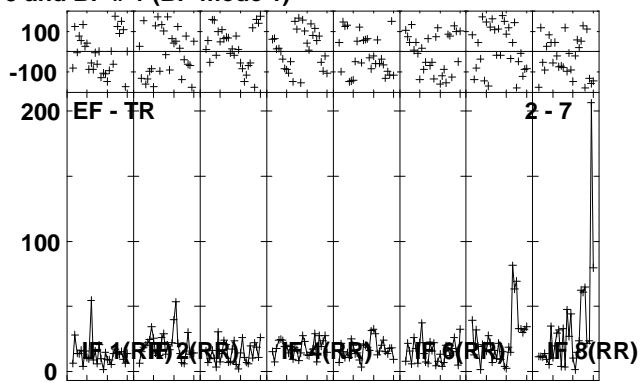
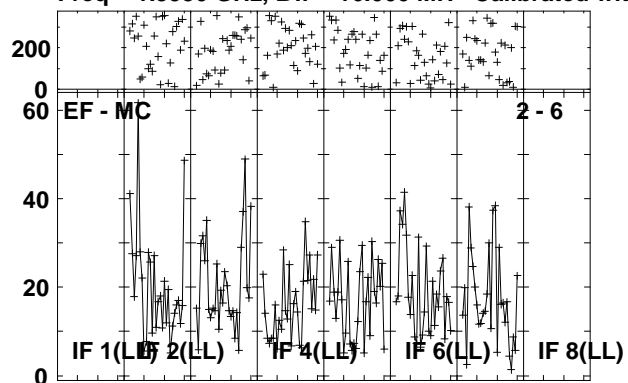

Lower frame: Milli Ampl Jy Top frame: Phas deg  
Vector averaged cross-power spectrum Several baselines displayed  
Timerange: 00/12:58:01 to 00/13:01:29

Plot file version 19 created 30-NOV-2010 14:27:00

J1128+59 EP068B 3.UVDATA.1

Freq = 1.5950 GHz, Bw = 16.000 MH Calibrated with CL # 3 and BP # 1 (BP mode 1)

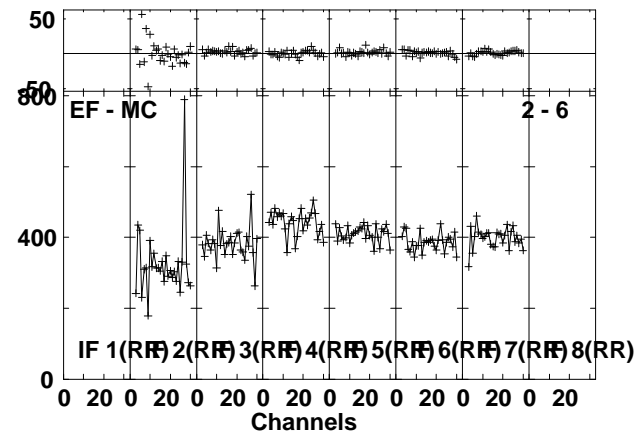
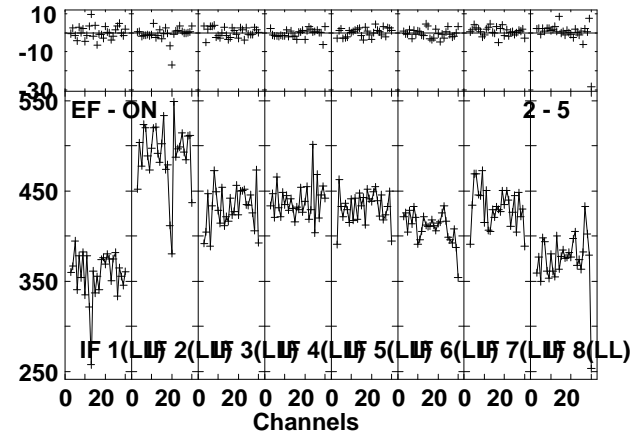
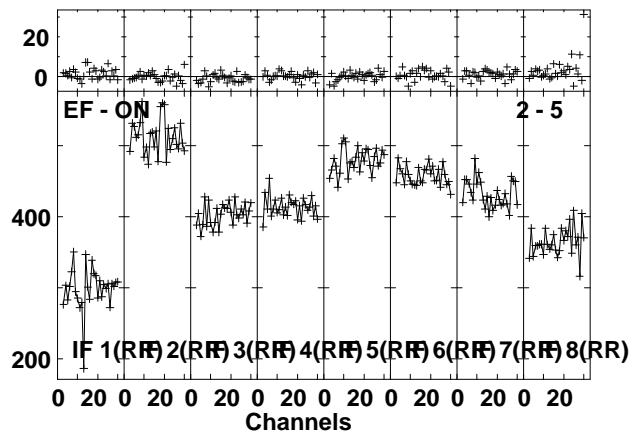
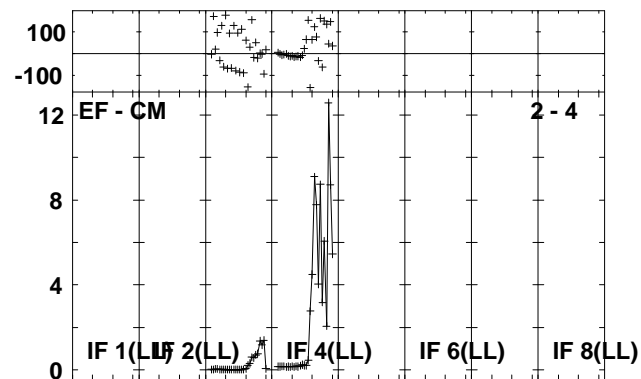
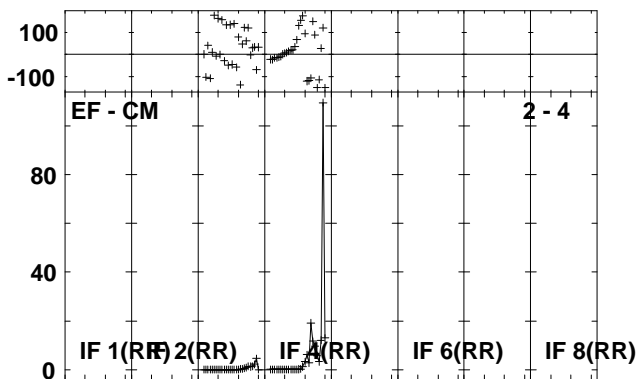
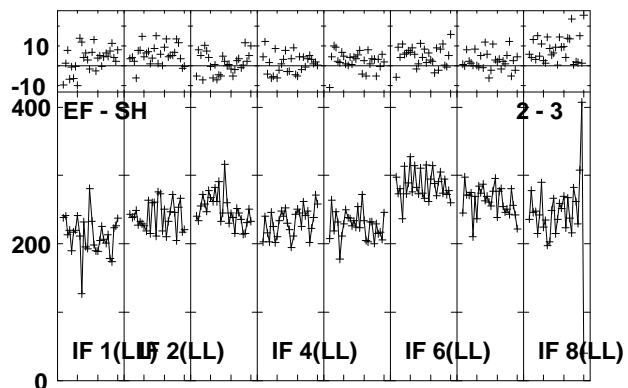
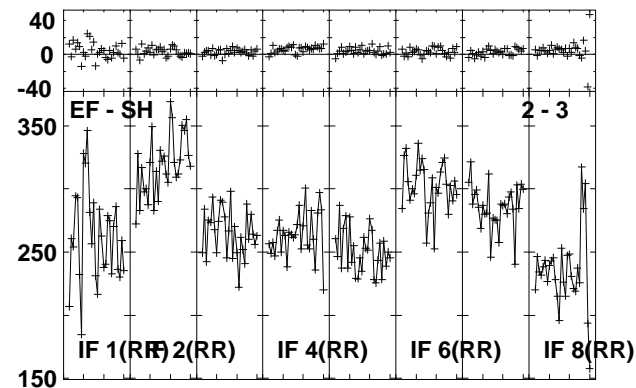
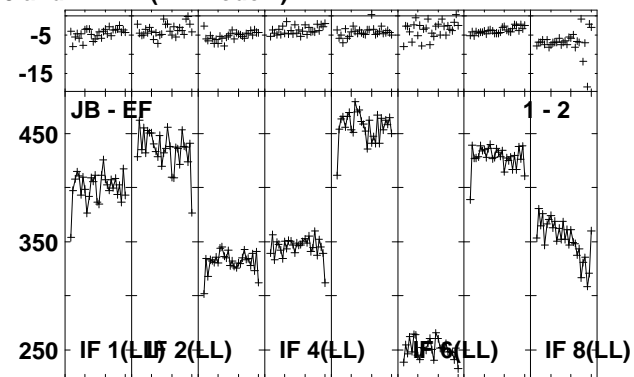
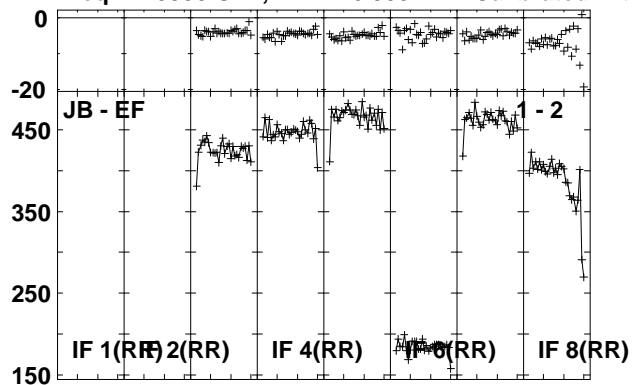

Lower frame: Milli Ampl Jy Top frame: Phas deg  
Vector averaged cross-power spectrum Several baselines displayed  
Timerange: 00/13:01:31 to 00/13:02:59

Plot file version 20 created 30-NOV-2010 14:27:02

J1128+59 EP068B 3.UVDATA.1

Freq = 1.5950 GHz, Bw = 16.000 MH Calibrated with CL # 3 and BP # 1 (BP mode 1)

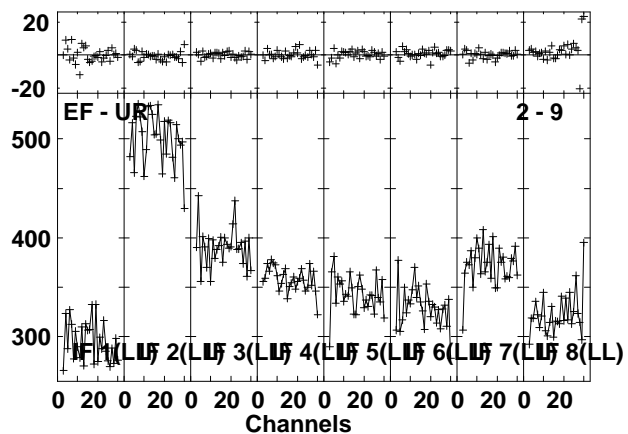
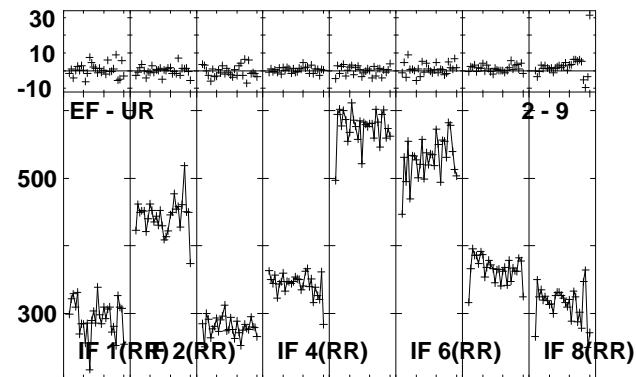
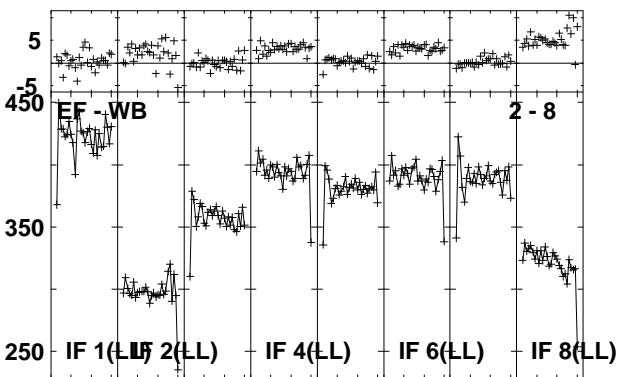
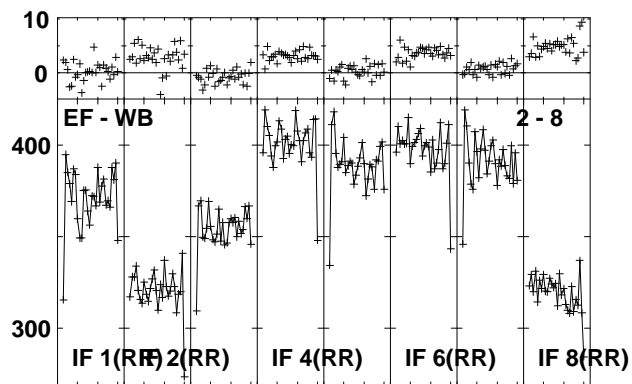
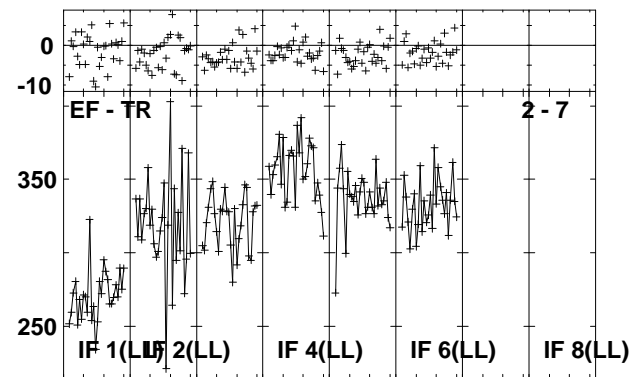
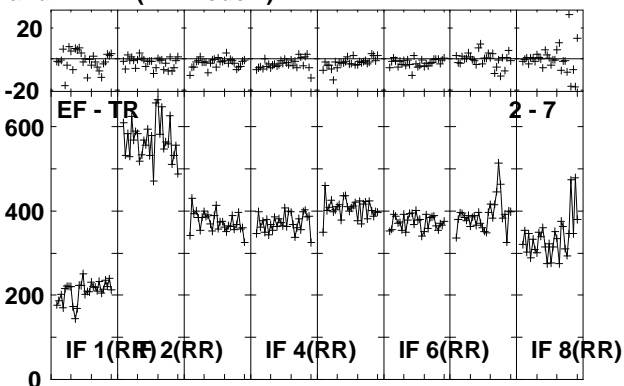
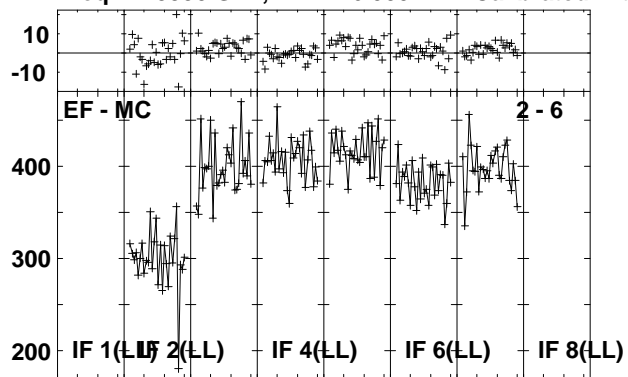

Lower frame: Milli Ampl Jy Top frame: Phas deg  
Vector averaged cross-power spectrum Several baselines displayed  
Timerange: 00/13:01:31 to 00/13:02:59

Plot file version 21 created 30-NOV-2010 14:27:03

ARP299C EP068B 3.UVDATA.1

Freq = 1.5950 GHz, Bw = 16.000 MH Calibrated with CL # 3 and BP # 1 (BP mode 1)

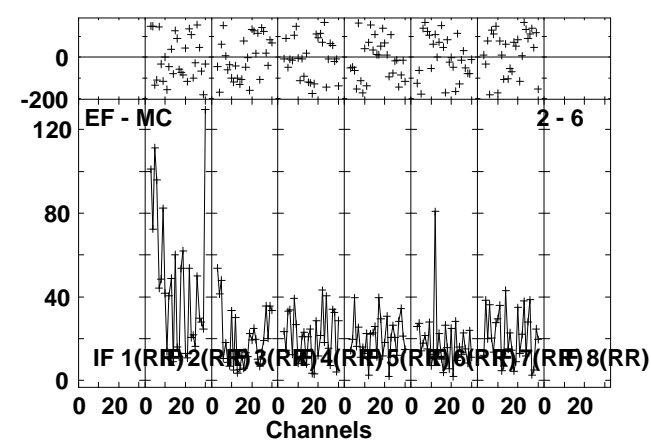
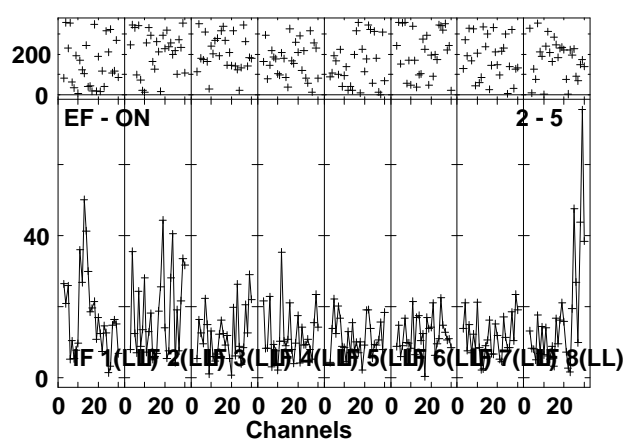
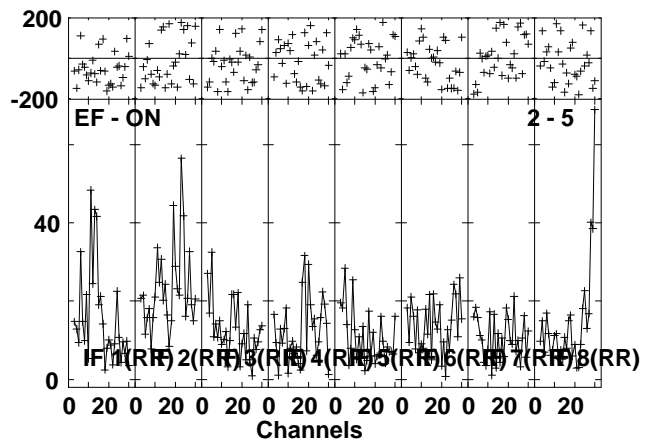
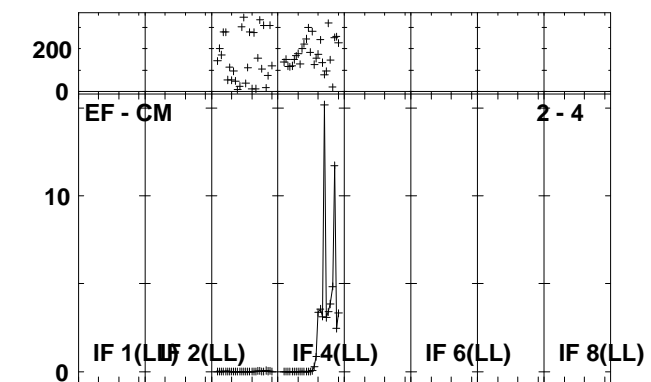
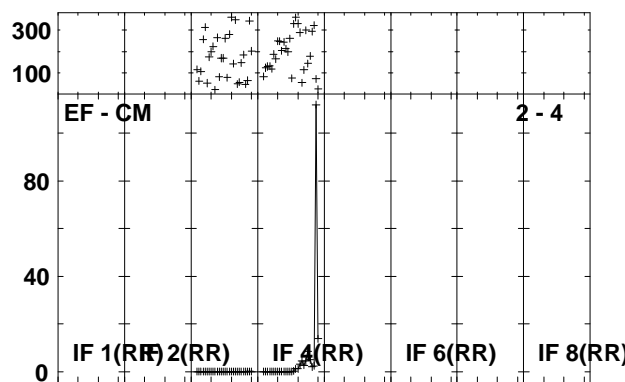
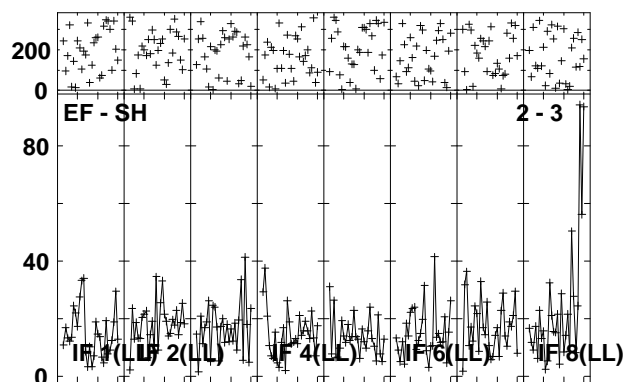
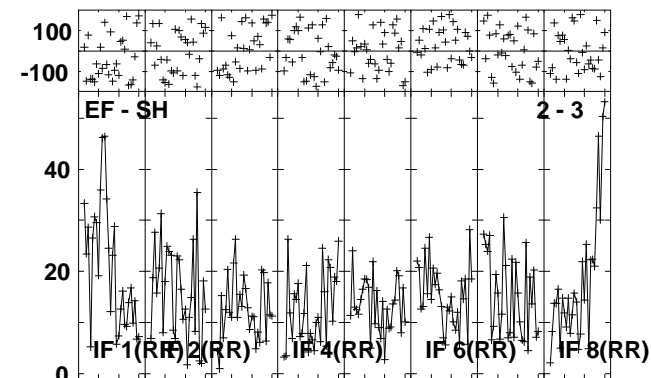
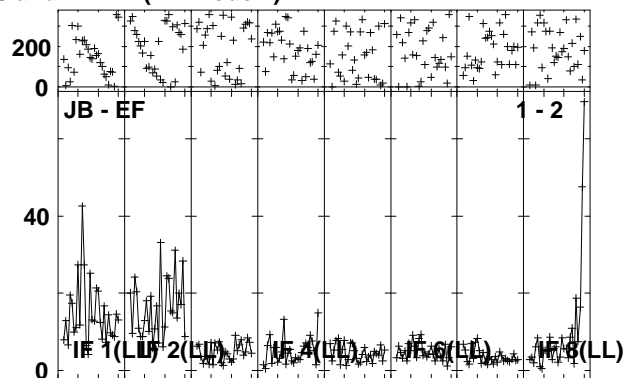
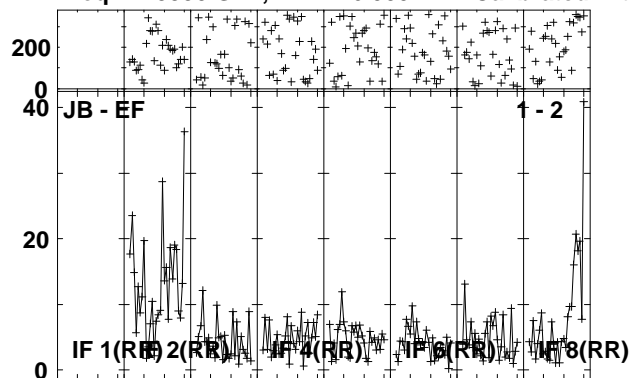

Lower frame: Milli Ampl Jy Top frame: Phas deg  
Vector averaged cross-power spectrum Several baselines displayed  
Timerange: 00/13:03:01 to 00/13:06:29

Plot file version 22 created 30-NOV-2010 14:27:06

ARP299C EP068B 3.UVDATA.1

Freq = 1.5950 GHz, Bw = 16.000 MH Calibrated with CL # 3 and BP # 1 (BP mode 1)

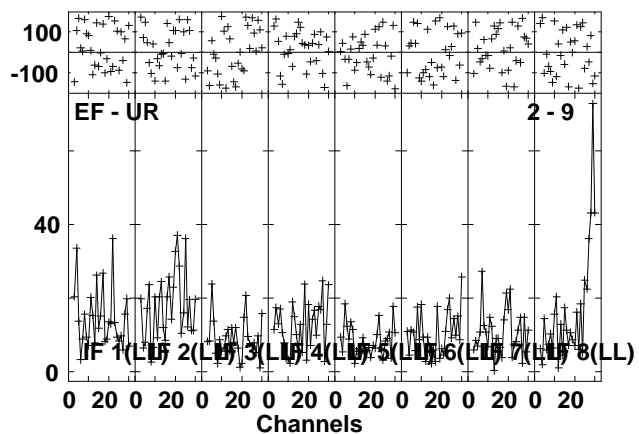
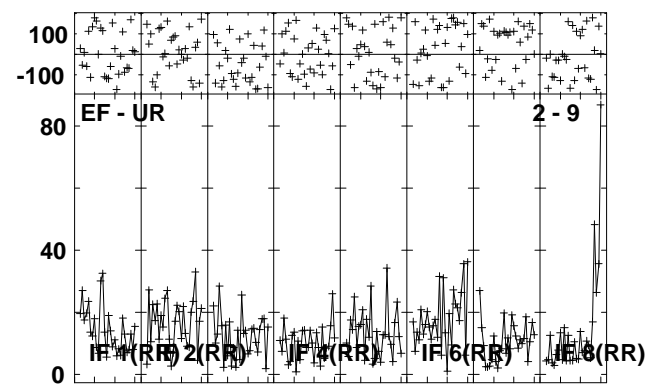
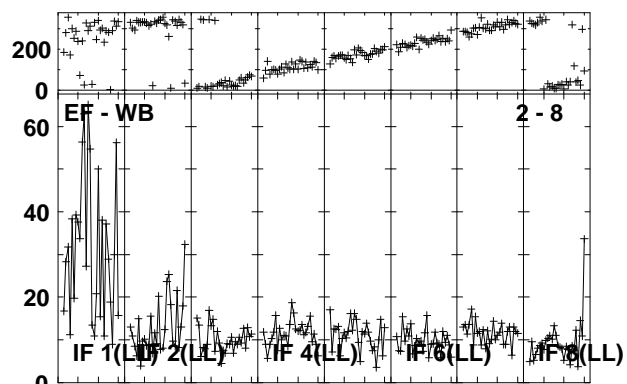
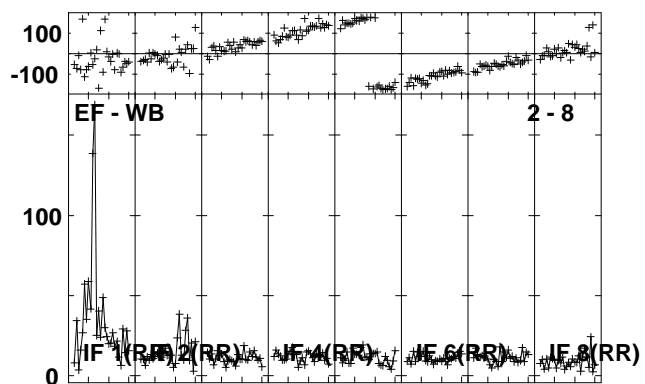
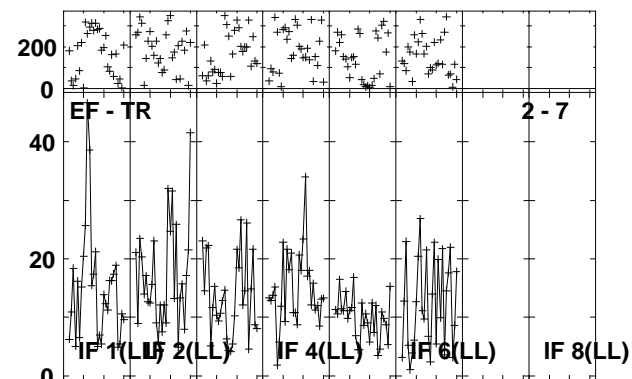
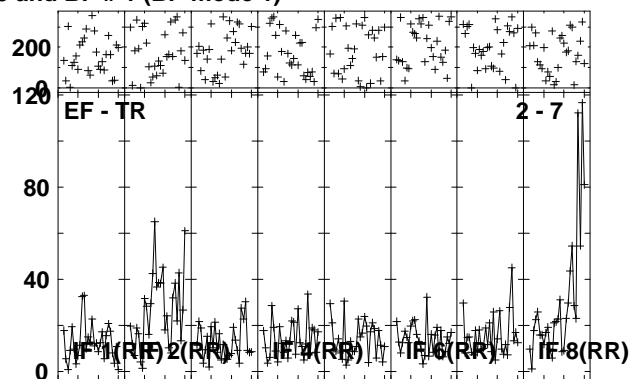
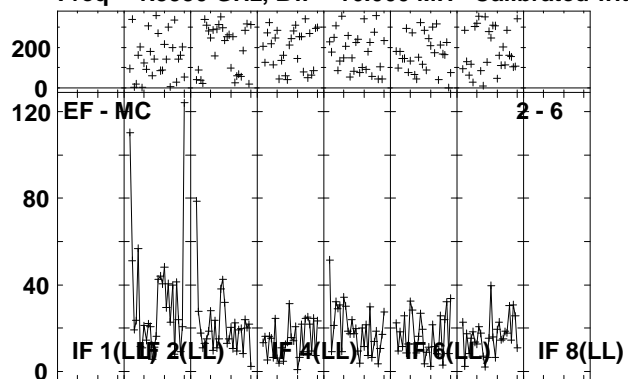

Lower frame: Milli Ampl Jy Top frame: Phas deg  
Vector averaged cross-power spectrum Several baselines displayed  
Timerange: 00/13:03:01 to 00/13:06:29

Plot file version 23 created 30-NOV-2010 14:27:08

J1128+59 EP068B 3.UVDATA.1

Freq = 1.5950 GHz, Bw = 16.000 MH Calibrated with CL # 3 and BP # 1 (BP mode 1)

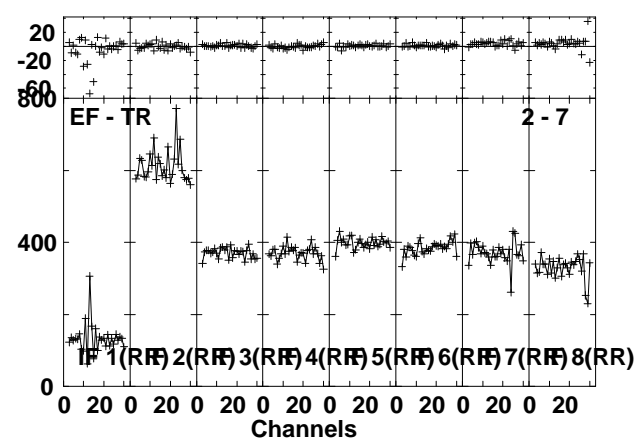
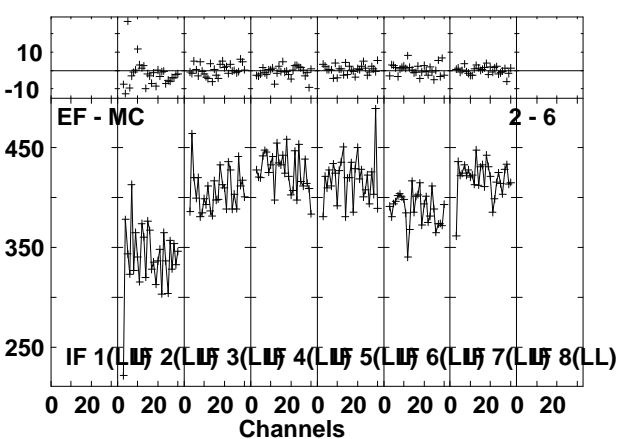
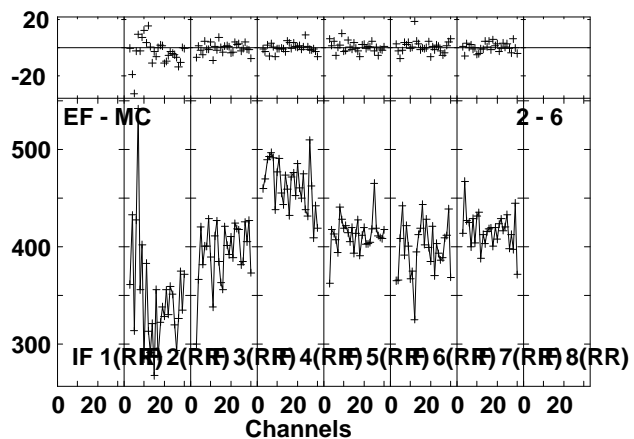
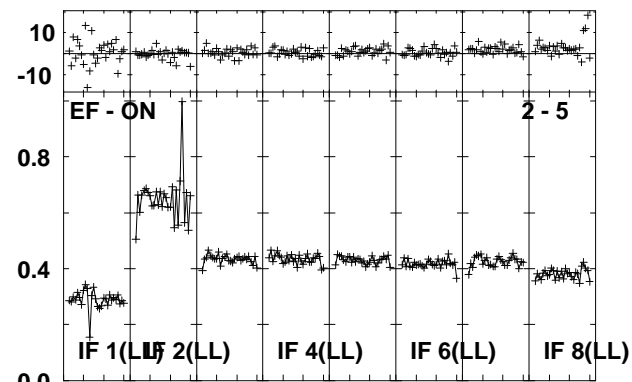
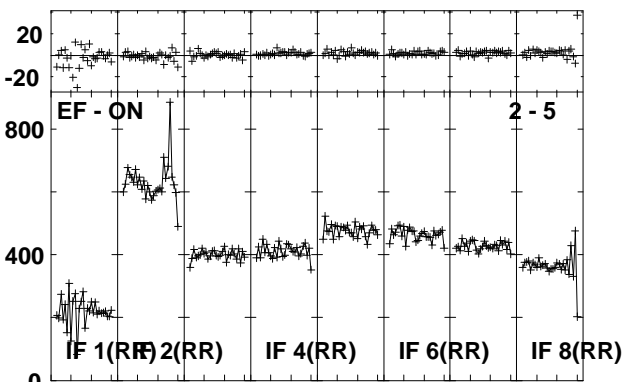
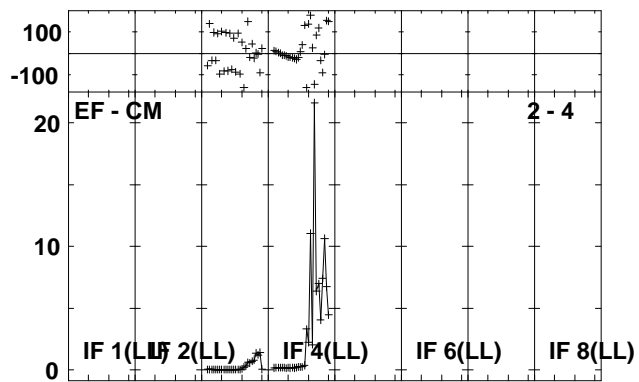
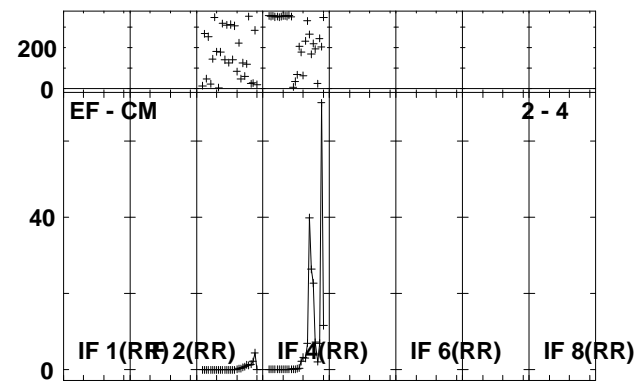
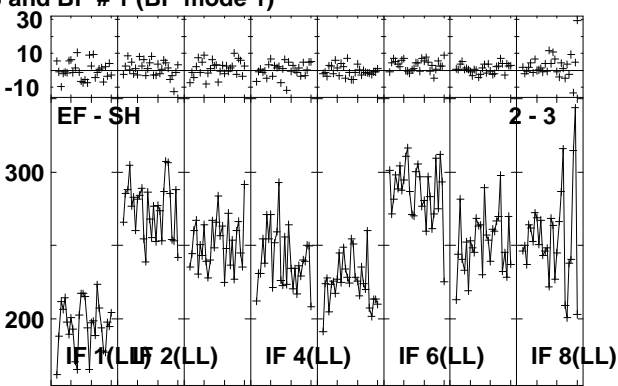
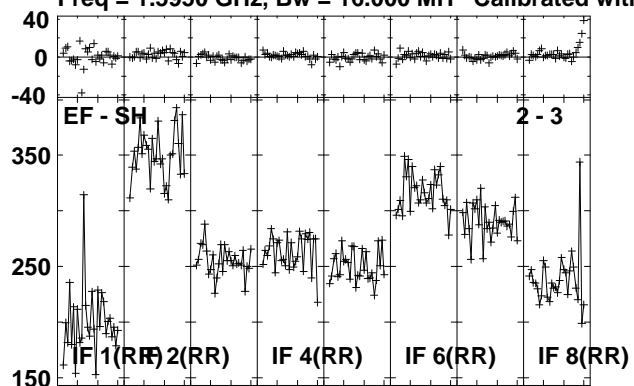

Lower frame: Milli Ampl Jy Top frame: Phas deg  
Vector averaged cross-power spectrum Several baselines displayed  
Timerange: 00/13:07:31 to 00/13:08:57

Plot file version 24 created 30-NOV-2010 14:27:09

J1128+59 EP068B 3.UVDATA.1

Freq = 1.5950 GHz, Bw = 16.000 MH Calibrated with CL # 3 and BP # 1 (BP mode 1)

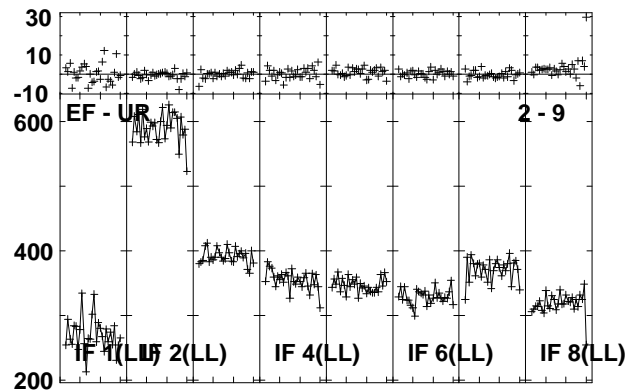
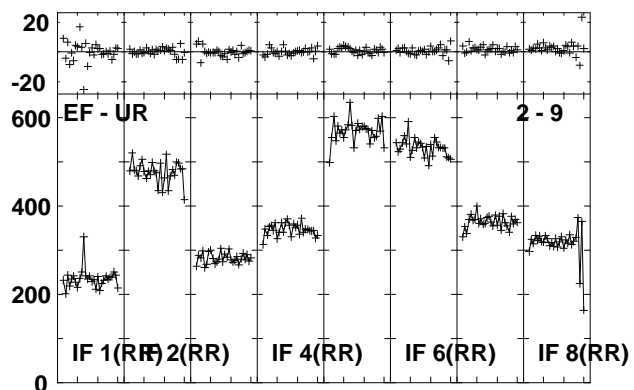
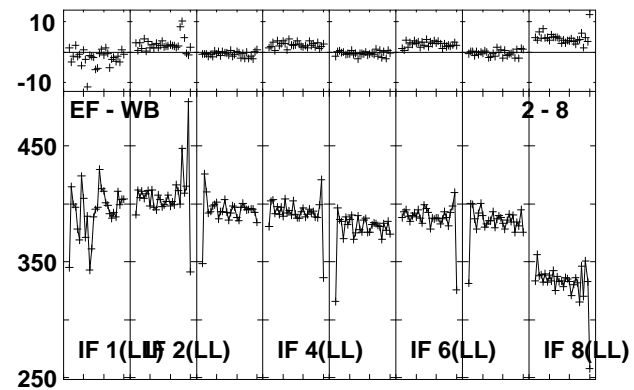
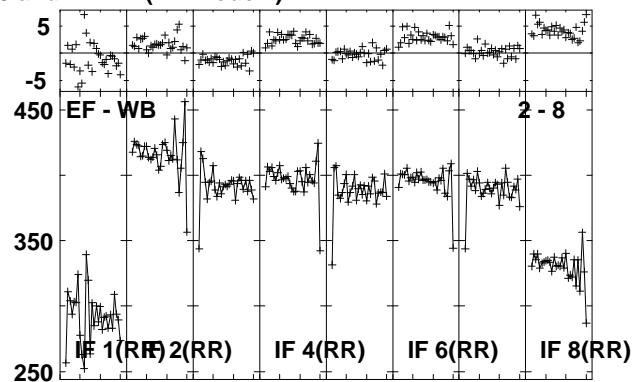
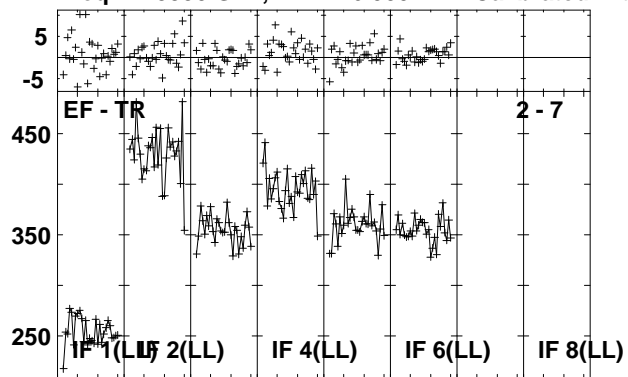

Lower frame: Milli Ampl Jy Top frame: Phas deg  
Vector averaged cross-power spectrum Several baselines displayed  
Timerange: 00/13:07:31 to 00/13:08:57



Plot file version 25 created 30-NOV-2010 14:27:10

ARP299C EP068B 3.UVDATA.1

Freq = 1.5950 GHz, Bw = 16.000 MH Calibrated with CL # 3 and BP # 1 (BP mode 1)

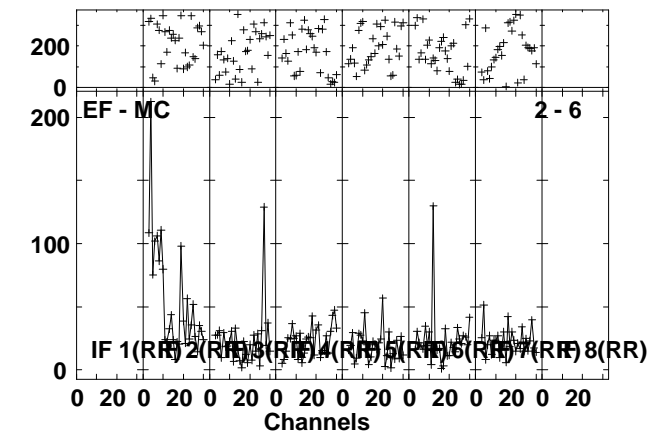
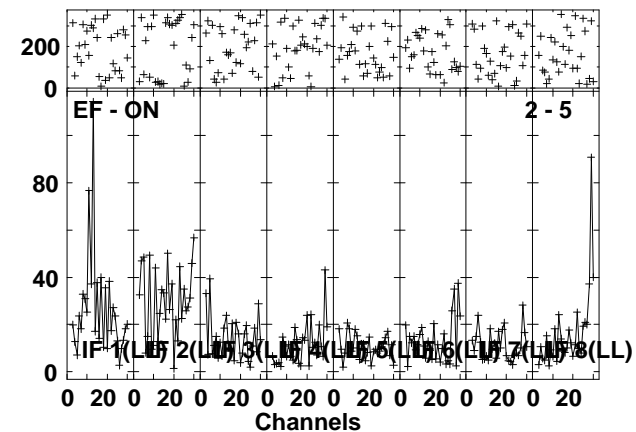
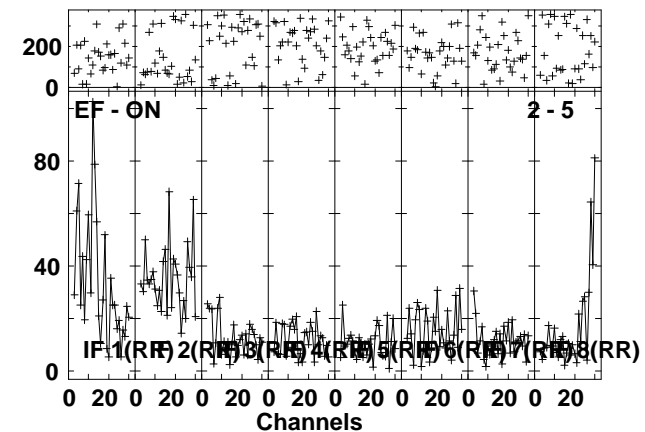
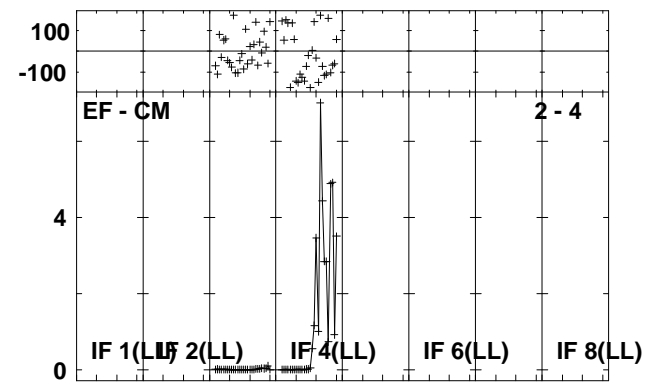
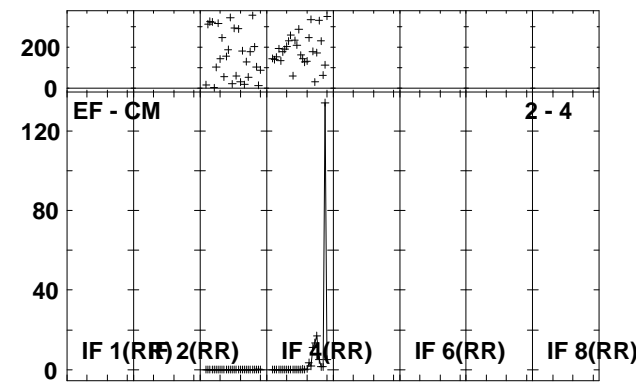
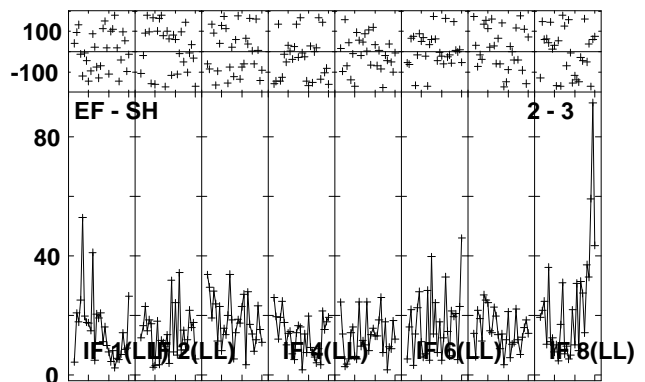
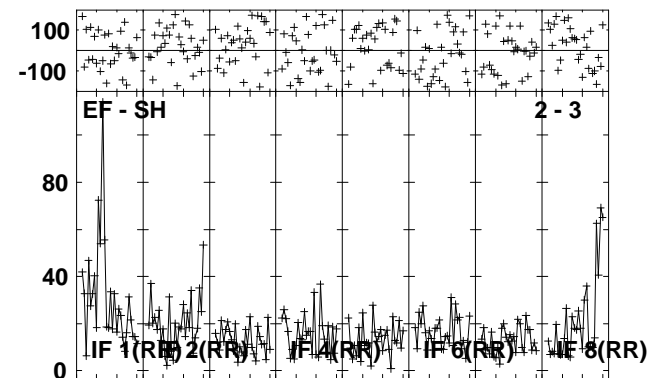
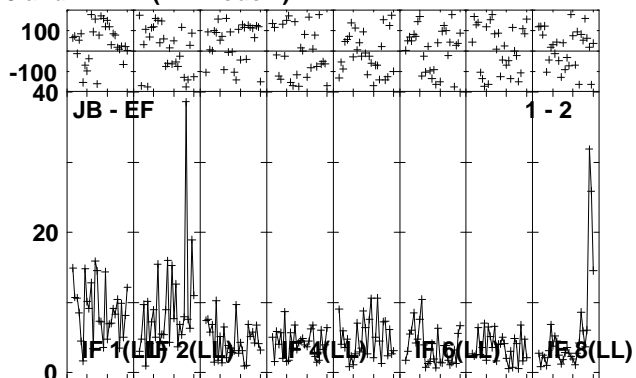
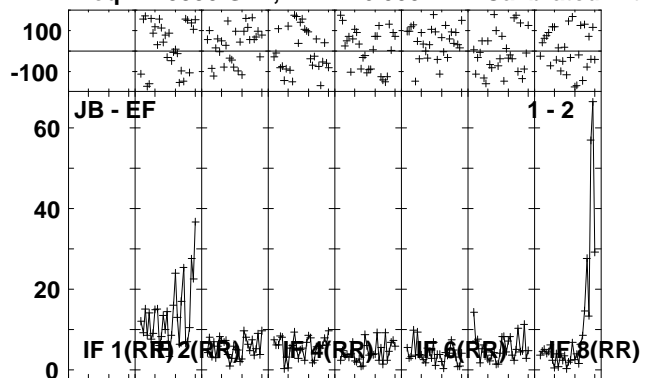

Lower frame: Milli Ampl Jy Top frame: Phas deg  
Vector averaged cross-power spectrum Several baselines displayed  
Timerange: 00/13:09:01 to 00/13:12:29

Plot file version 26 created 30-NOV-2010 14:27:13

ARP299C EP068B 3.UVDATA.1

Freq = 1.5950 GHz, Bw = 16.000 MH Calibrated with CL # 3 and BP # 1 (BP mode 1)

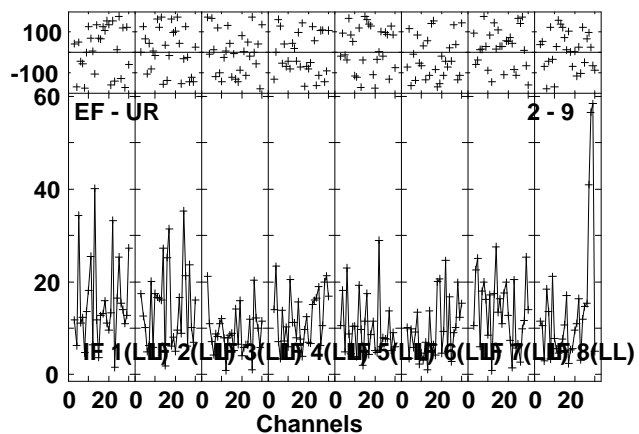
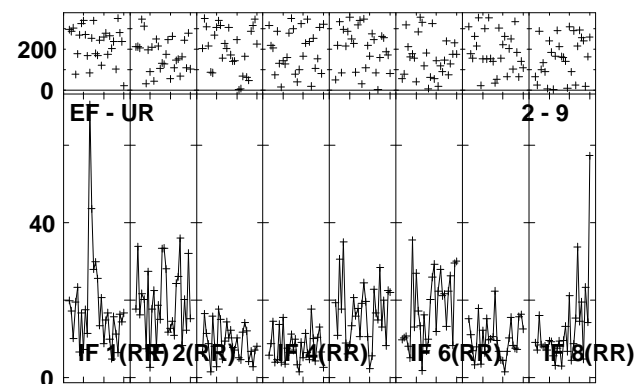
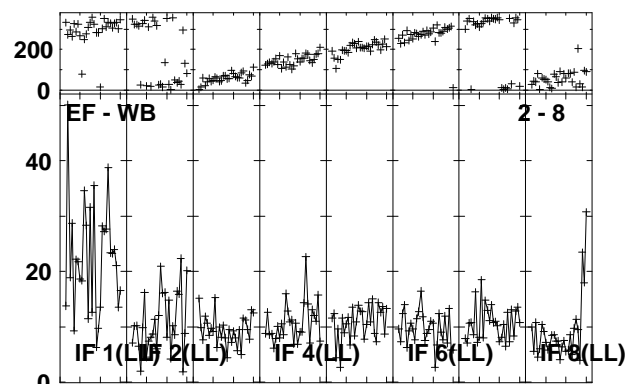
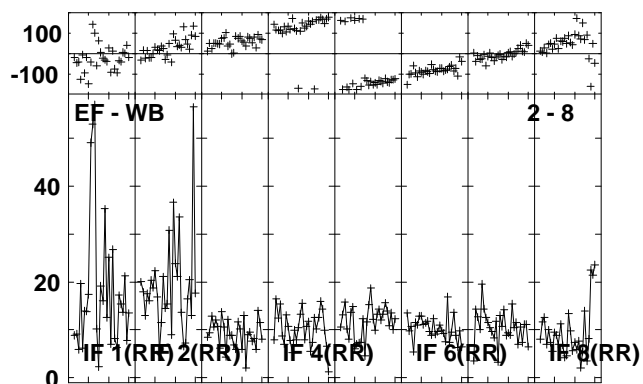
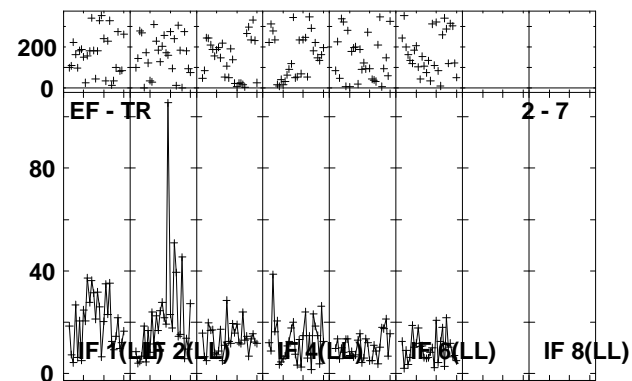
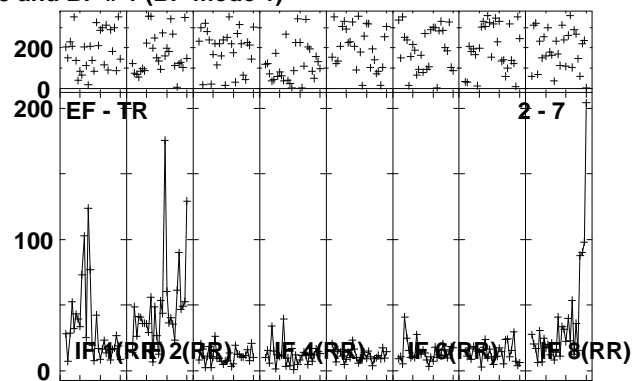
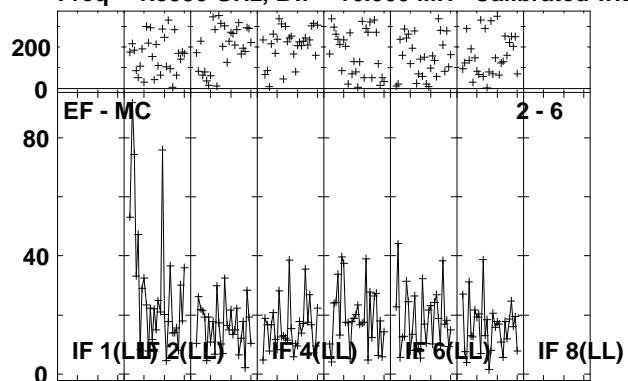

Lower frame: Milli Ampl Jy Top frame: Phas deg  
Vector averaged cross-power spectrum Several baselines displayed  
Timerange: 00/13:09:01 to 00/13:12:29

Plot file version 27 created 30-NOV-2010 14:27:15

J1128+59 EP068B 3.UVDATA.1

Freq = 1.5950 GHz, Bw = 16.000 MH Calibrated with CL # 3 and BP # 1 (BP mode 1)

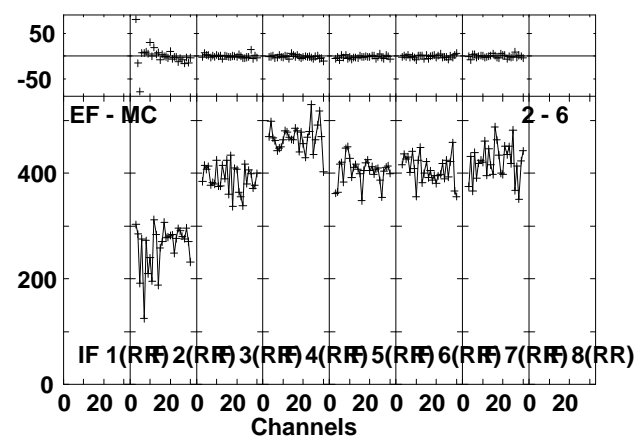
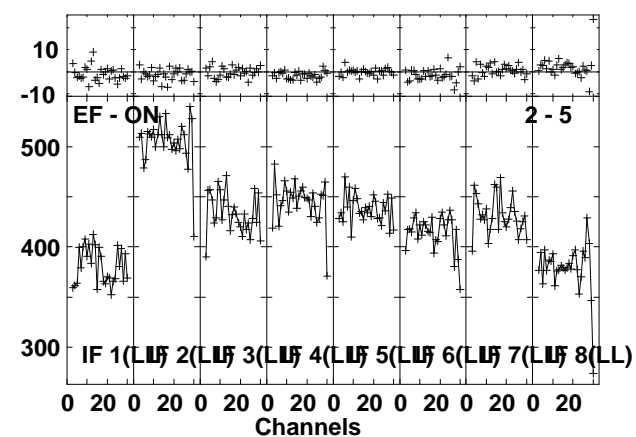
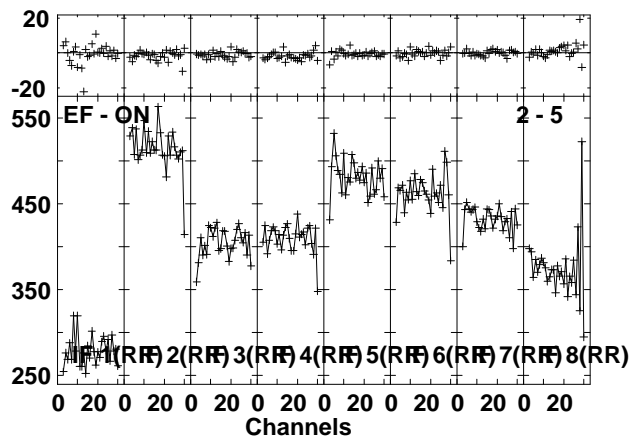
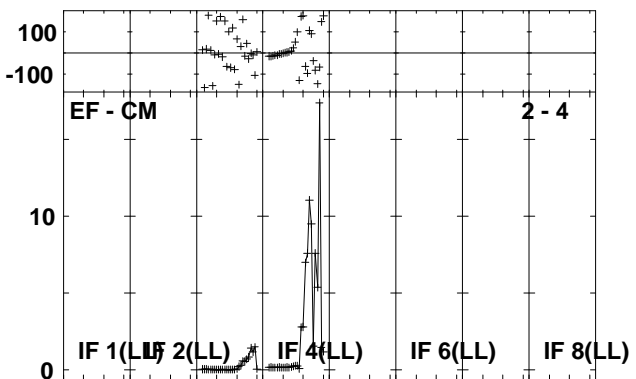
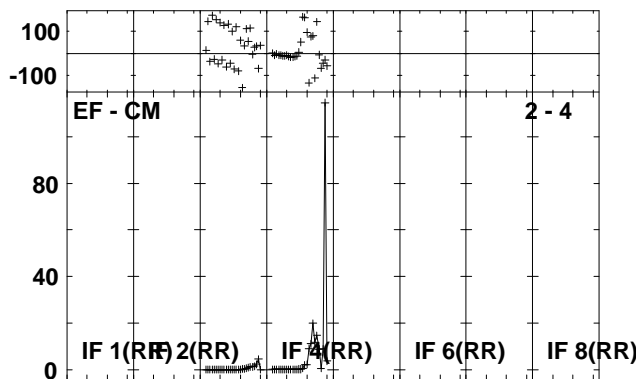
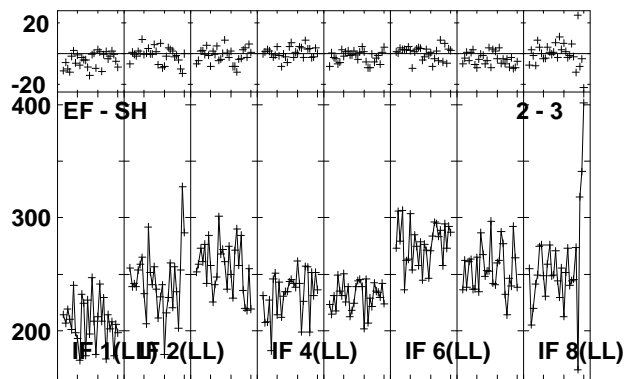
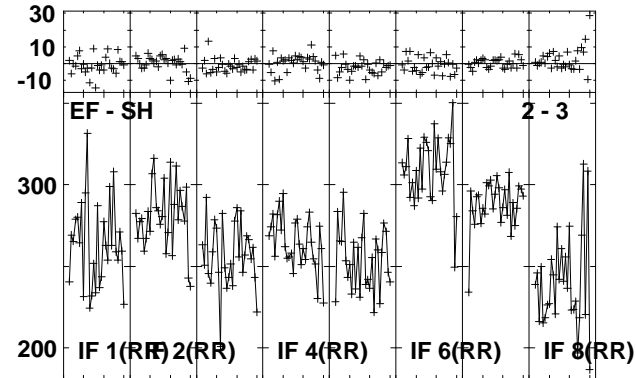
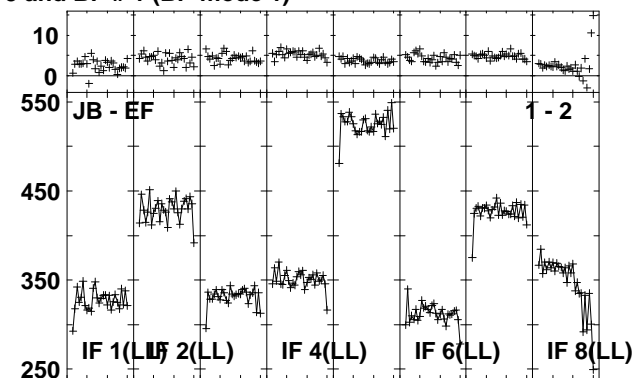
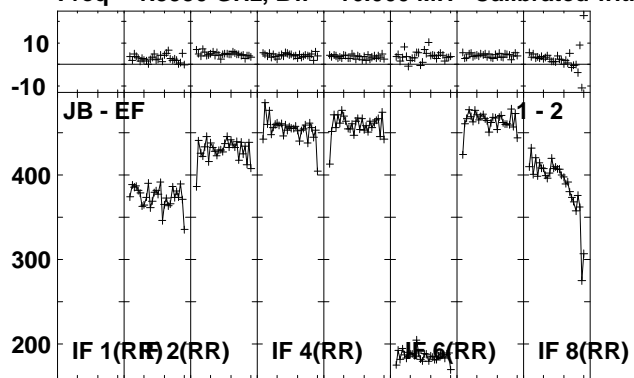

Lower frame: Milli Ampl Jy Top frame: Phas deg  
Vector averaged cross-power spectrum Several baselines displayed  
Timerange: 00/13:12:31 to 00/13:13:59

Plot file version 28 created 30-NOV-2010 14:27:16

J1128+59 EP068B 3.UVDATA.1

Freq = 1.5950 GHz, Bw = 16.000 MH Calibrated with CL # 3 and BP # 1 (BP mode 1)

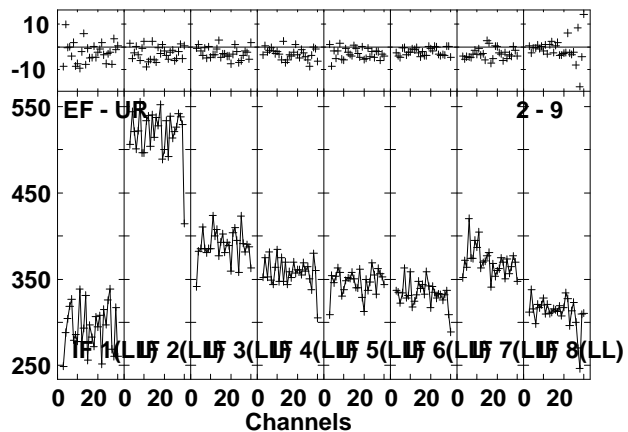
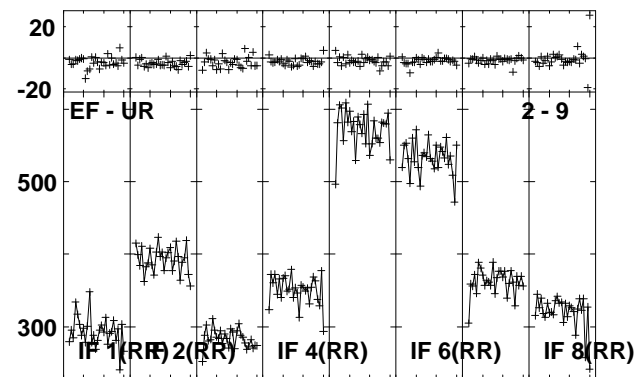
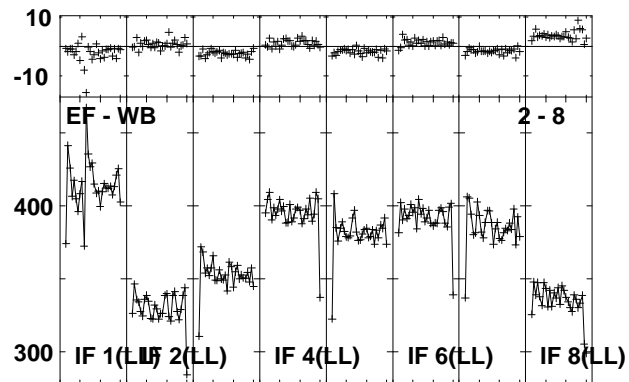
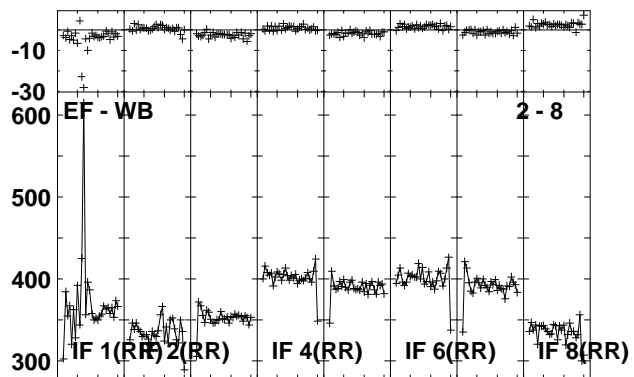
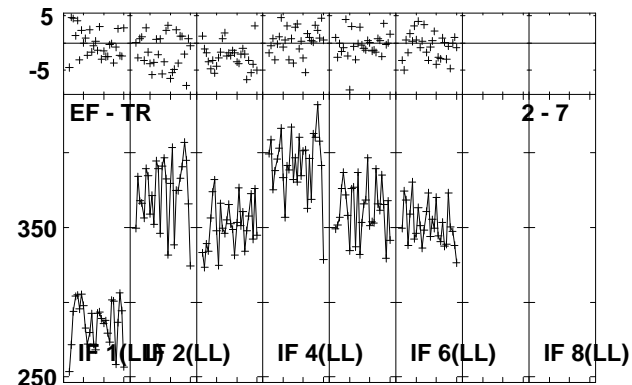
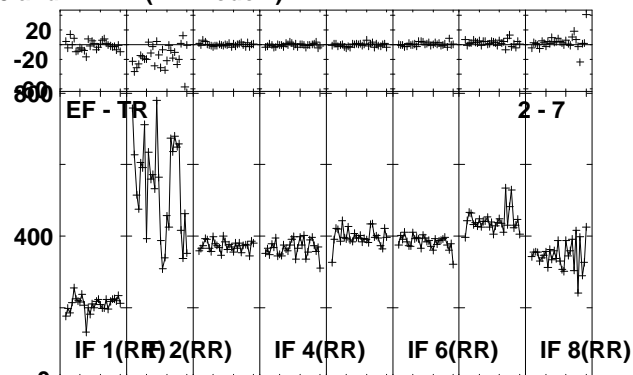
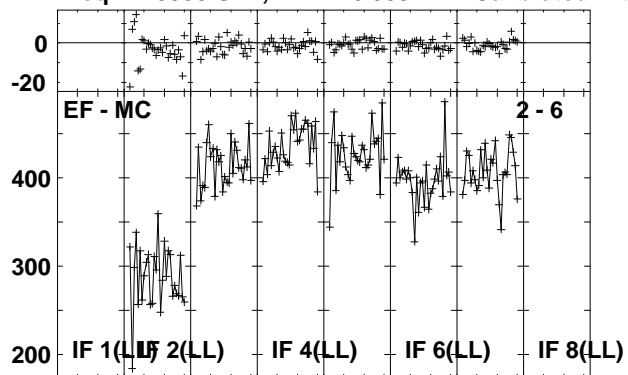

Lower frame: Milli Ampl Jy Top frame: Phas deg  
Vector averaged cross-power spectrum Several baselines displayed  
Timerange: 00/13:12:31 to 00/13:13:59

Plot file version 29 created 30-NOV-2010 14:27:18

ARP299C EP068B 3.UVDATA.1

Freq = 1.5950 GHz, Bw = 16.000 MH Calibrated with CL # 3 and BP # 1 (BP mode 1)

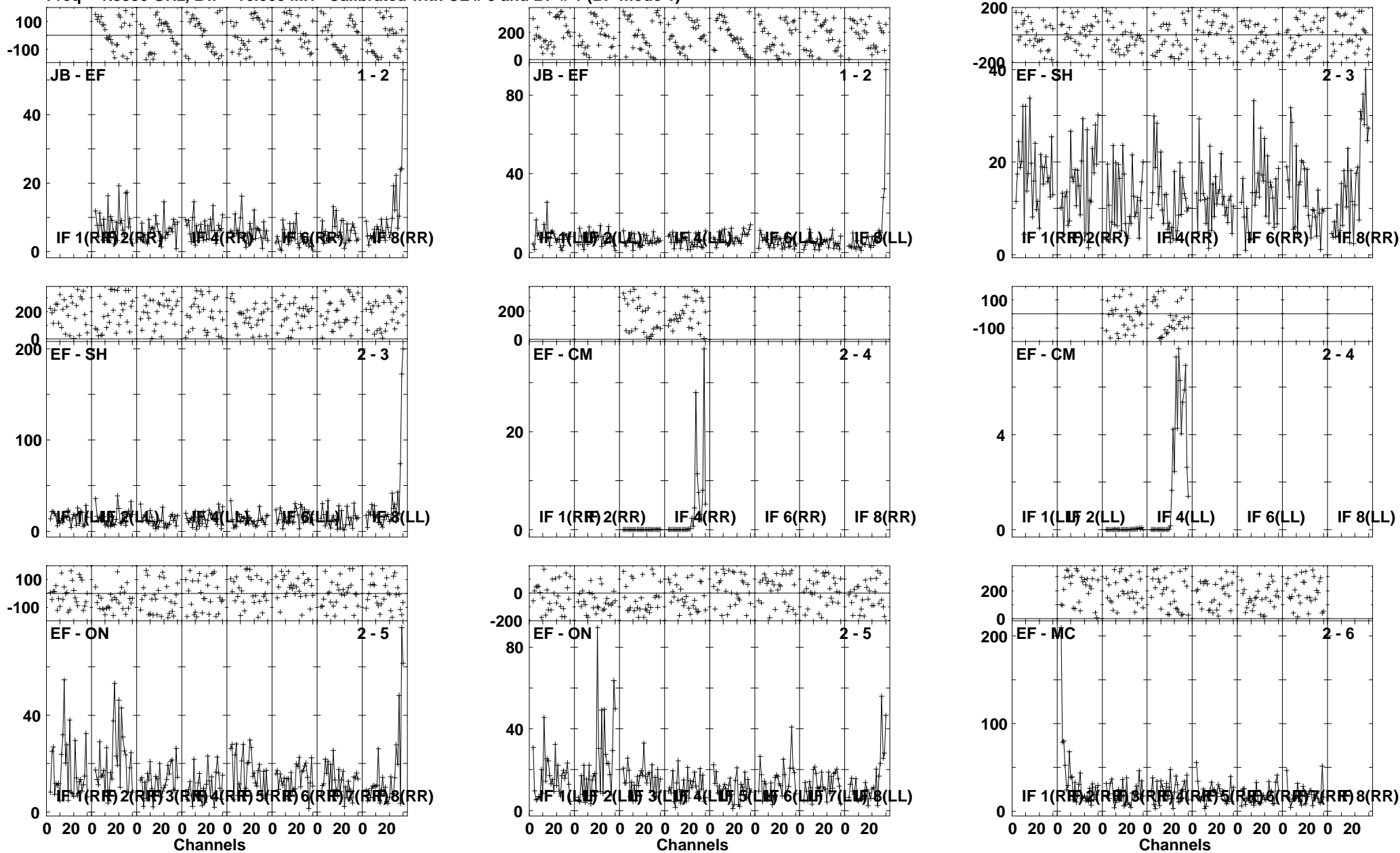

Lower frame: Milli Ampl Jy Top frame: Phas deg  
Vector averaged cross-power spectrum Several baselines displayed  
Timerange: 00/13:14:01 to 00/13:17:29

Plot file version 30 created 30-NOV-2010 14:27:20

ARP299C EP068B 3.UVDATA.1

Freq = 1.5950 GHz, Bw = 16.000 MH Calibrated with CL # 3 and BP # 1 (BP mode 1)

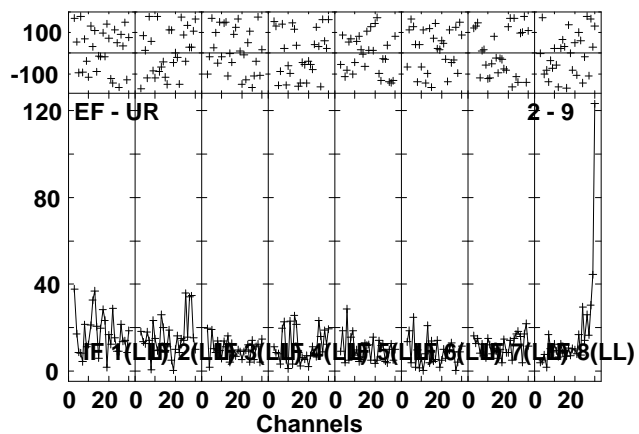
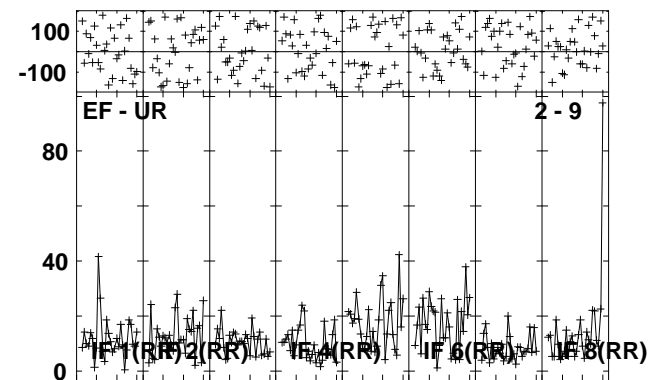
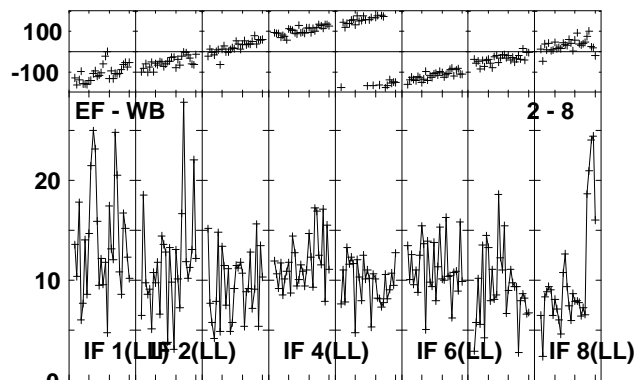
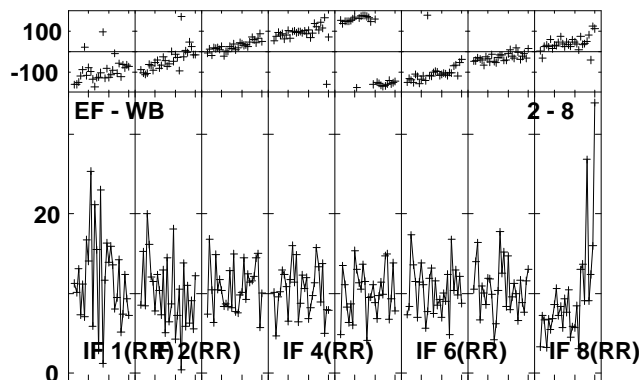
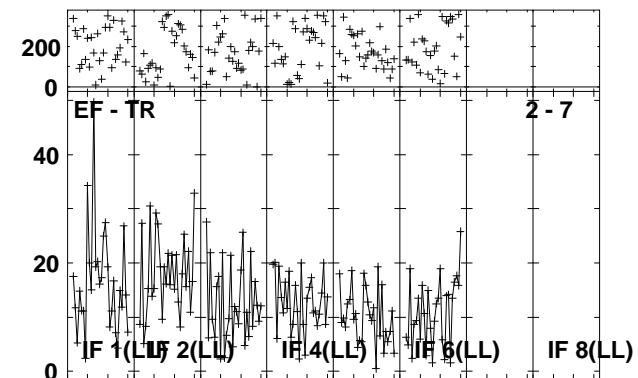
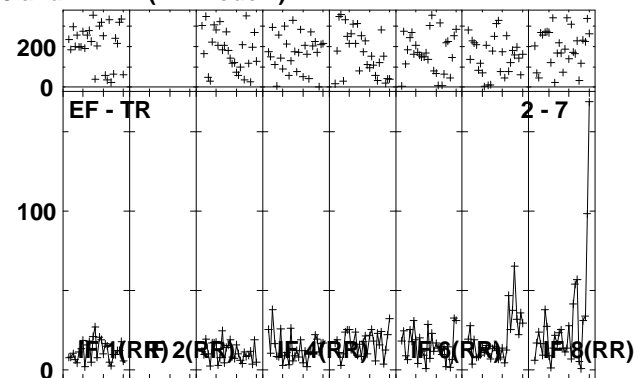
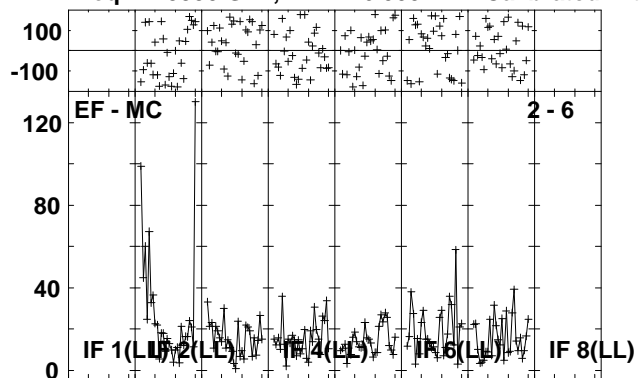

Lower frame: Milli Ampl Jy Top frame: Phas deg  
Vector averaged cross-power spectrum Several baselines displayed  
Timerange: 00/13:14:01 to 00/13:17:29

Plot file version 31 created 30-NOV-2010 14:27:23

J1128+59 EP068B 3.UVDATA.1

Freq = 1.5950 GHz, Bw = 16.000 MH Calibrated with CL # 3 and BP # 1 (BP mode 1)

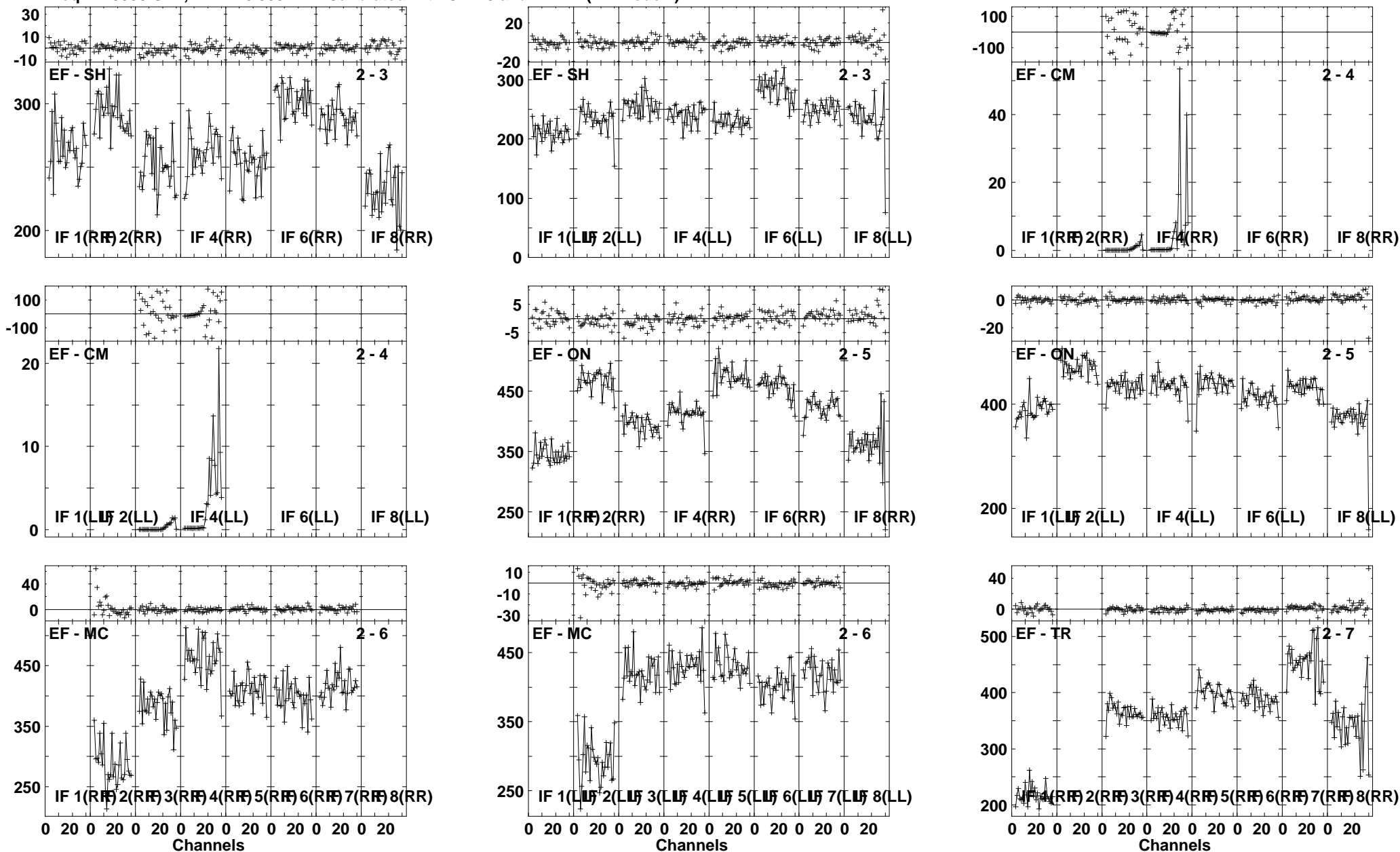

Lower frame: Milli Ampl Jy Top frame: Phas deg  
Vector averaged cross-power spectrum Several baselines displayed  
Timerange: 00/13:18:31 to 00/13:19:59

Plot file version 32 created 30-NOV-2010 14:27:24

J1128+59 EP068B 3.UVDATA.1

Freq = 1.5950 GHz, Bw = 16.000 MH Calibrated with CL # 3 and BP # 1 (BP mode 1)

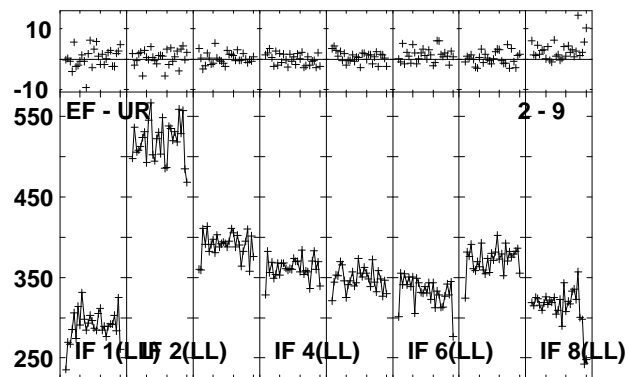
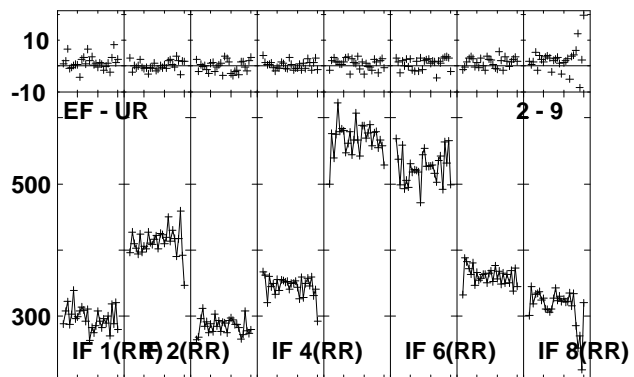
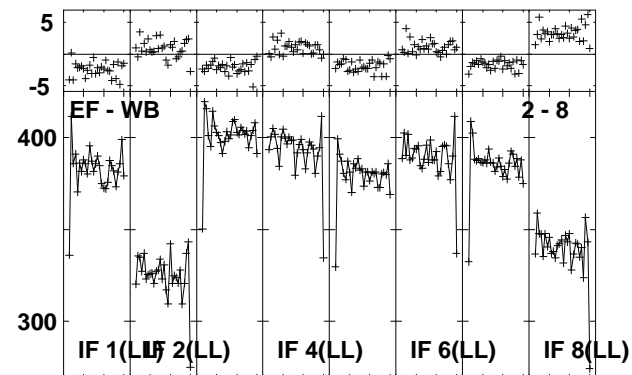
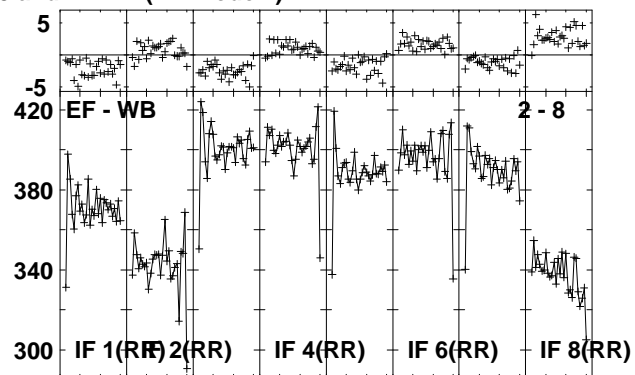
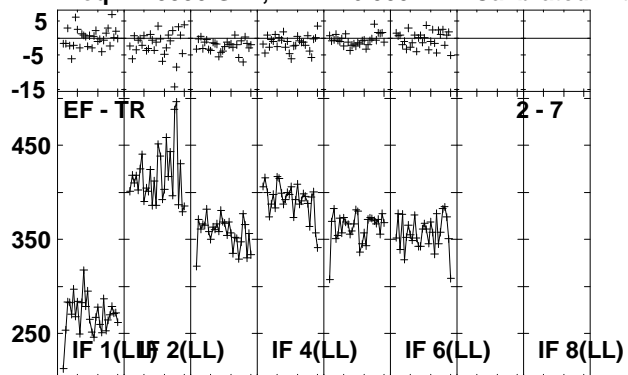

Lower frame: Milli Ampl Jy Top frame: Phas deg  
Vector averaged cross-power spectrum Several baselines displayed  
Timerange: 00/13:18:31 to 00/13:19:59



Plot file version 33 created 30-NOV-2010 14:27:25

ARP299C EP068B 3.UVDATA.1

Freq = 1.5950 GHz, Bw = 16.000 MH Calibrated with CL # 3 and BP # 1 (BP mode 1)

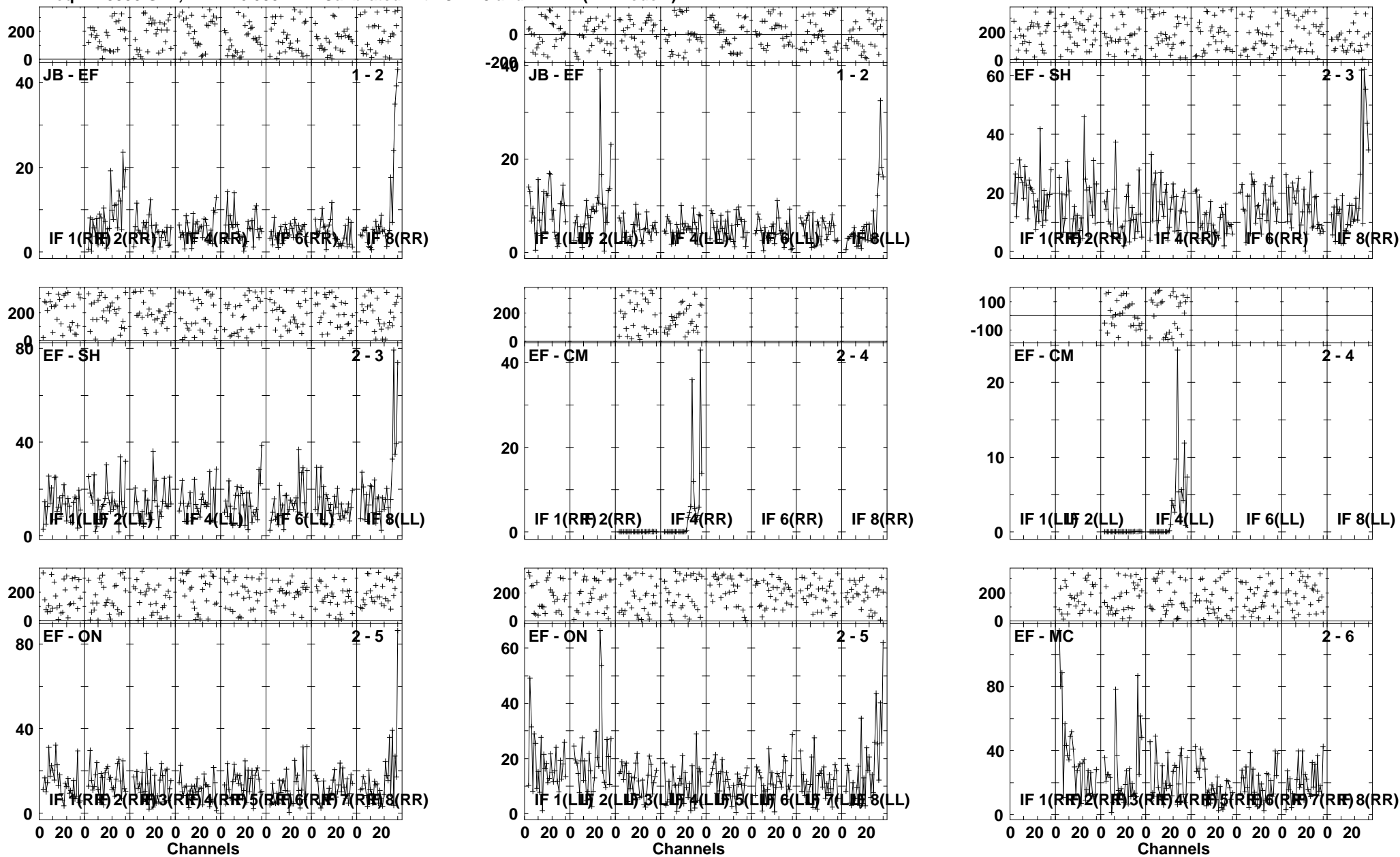

Lower frame: Milli Ampl Jy Top frame: Phas deg  
Vector averaged cross-power spectrum Several baselines displayed  
Timerange: 00/13:20:01 to 00/13:23:29

Plot file version 34 created 30-NOV-2010 14:27:27

ARP299C EP068B 3.UVDATA.1

Freq = 1.5950 GHz, Bw = 16.000 MH Calibrated with CL # 3 and BP # 1 (BP mode 1)

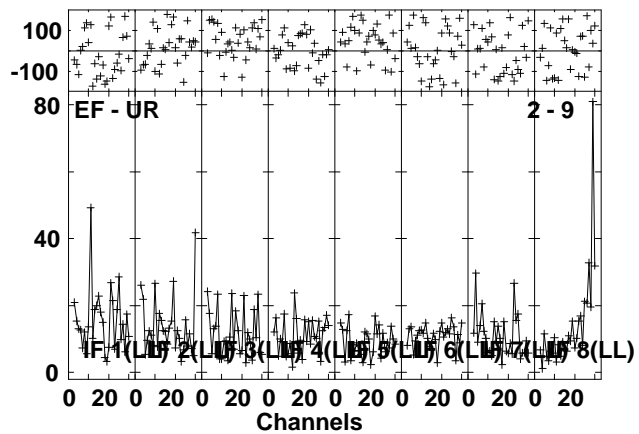
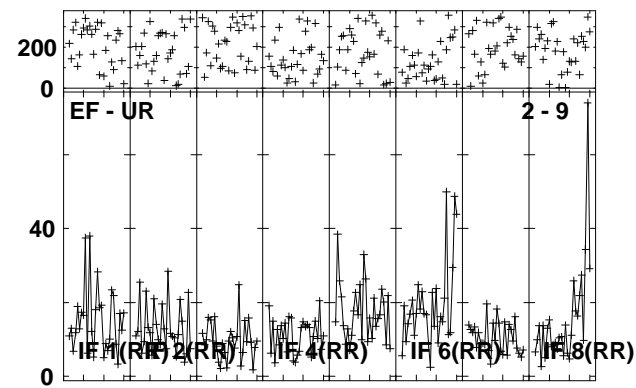
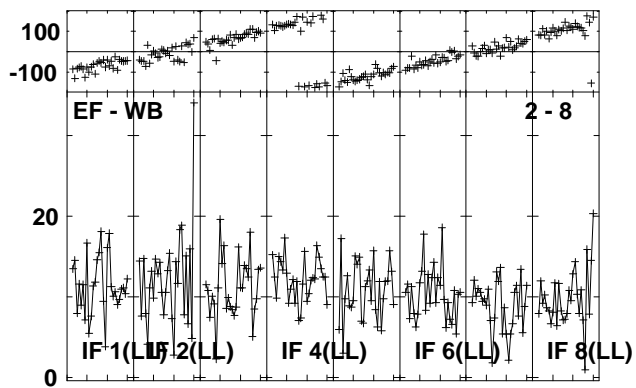
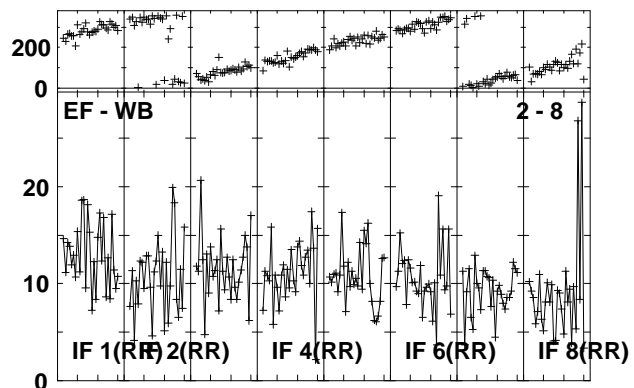
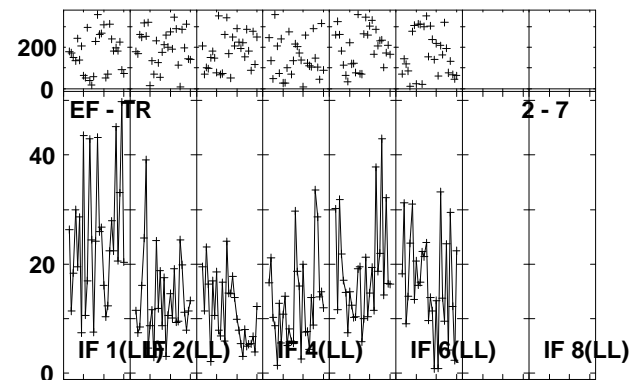
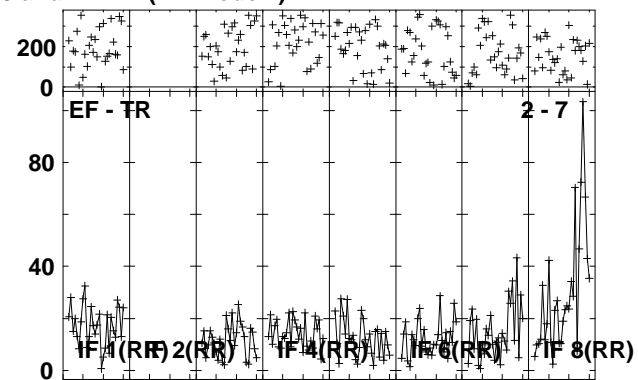
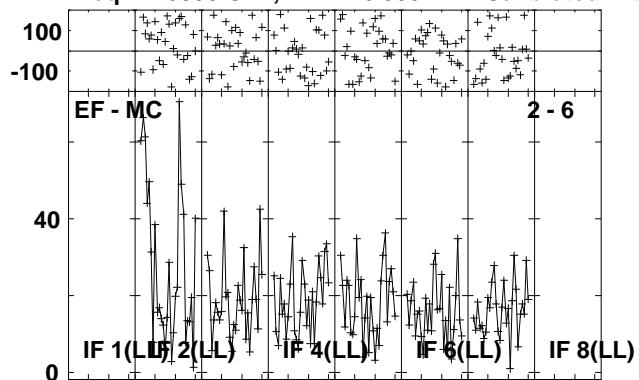

Lower frame: Milli Ampl Jy Top frame: Phas deg  
Vector averaged cross-power spectrum Several baselines displayed  
Timerange: 00/13:20:01 to 00/13:23:29

Plot file version 35 created 30-NOV-2010 14:27:30

J1128+59 EP068B 3.UVDATA.1

Freq = 1.5950 GHz, Bw = 16.000 MH Calibrated with CL # 3 and BP # 1 (BP mode 1)

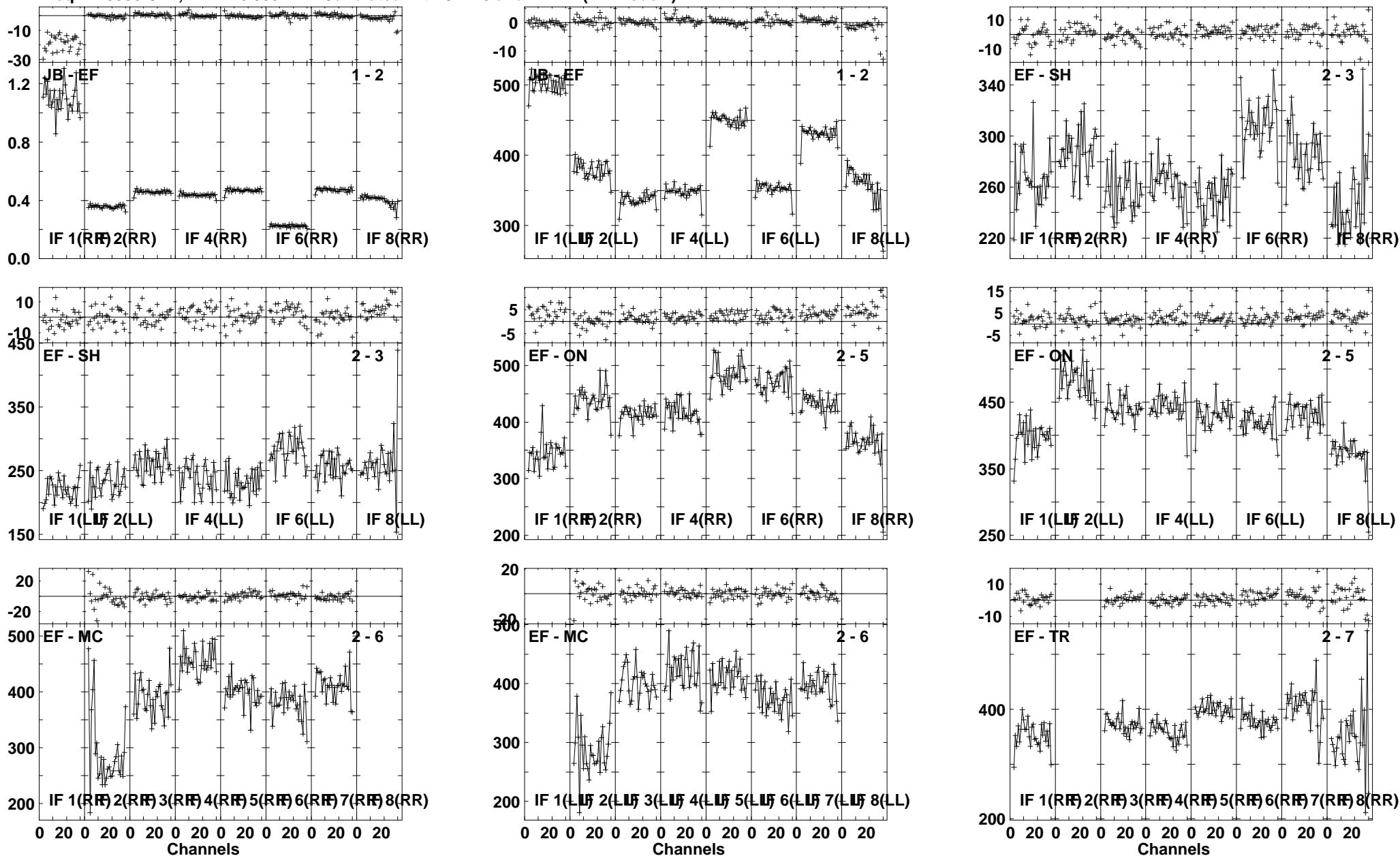

Plot file version 36 created 30-NOV-2010 14:27:31  
 J1128+59 EP068B 3.UVDATA.1  
 Freq = 1.5950 GHz, Bw = 16.000 MH Calibrated with CL # 3 and BP # 1 (BP mode 1)

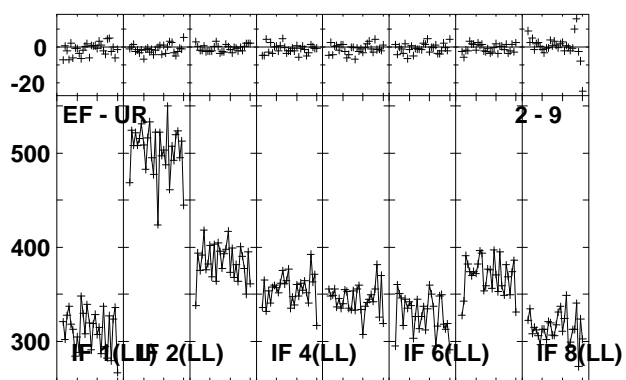
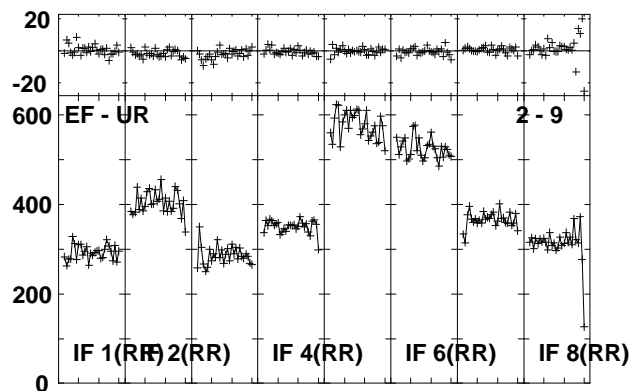
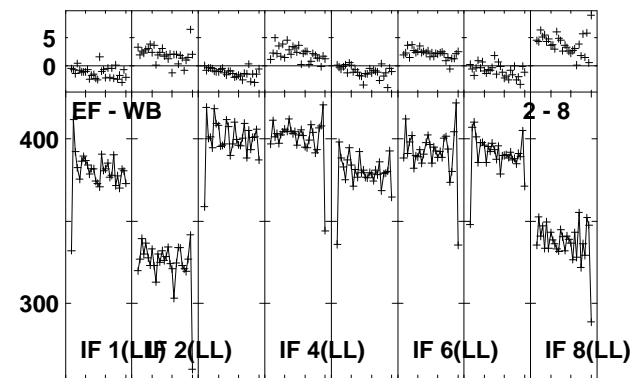
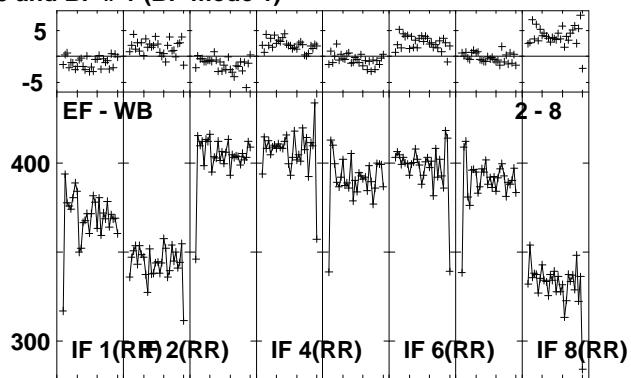
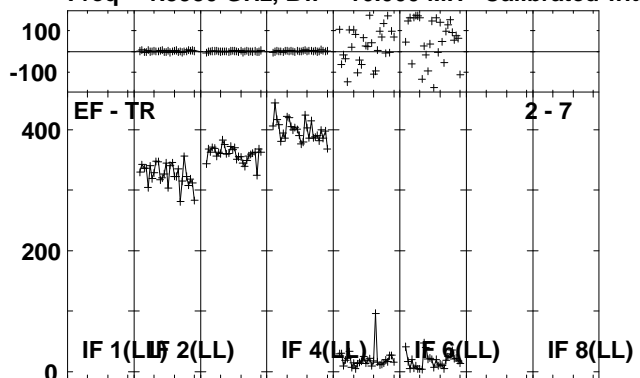

Lower frame: Milli Ampl Jy Top frame: Phas deg  
 Vector averaged cross-power spectrum Several baselines displayed  
 Timerange: 00/13:23:31 to 00/13:24:59

Plot file version 37 created 30-NOV-2010 14:27:32

ARP299C EP068B 3.UVDATA.1

Freq = 1.5950 GHz, Bw = 16.000 MH Calibrated with CL # 3 and BP # 1 (BP mode 1)

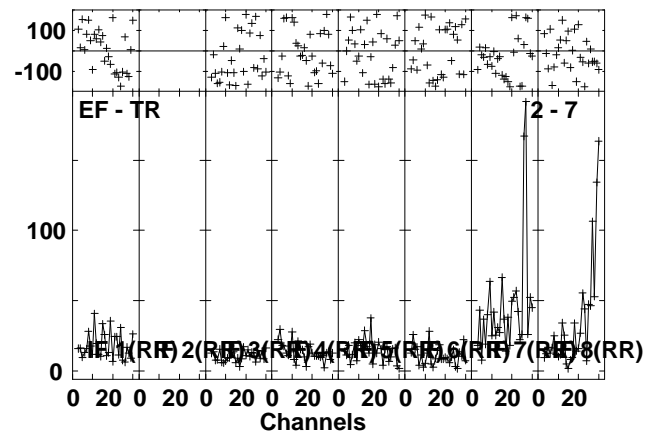
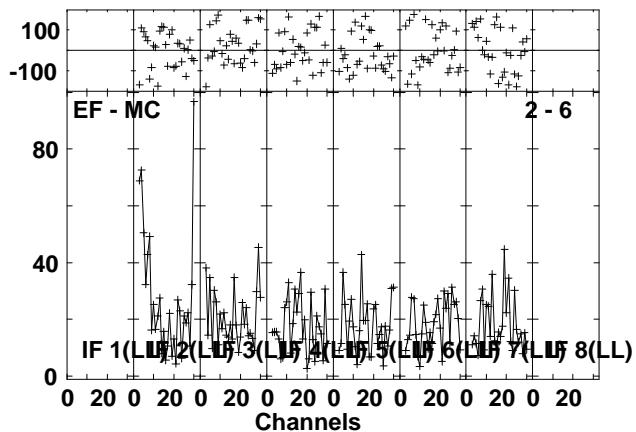
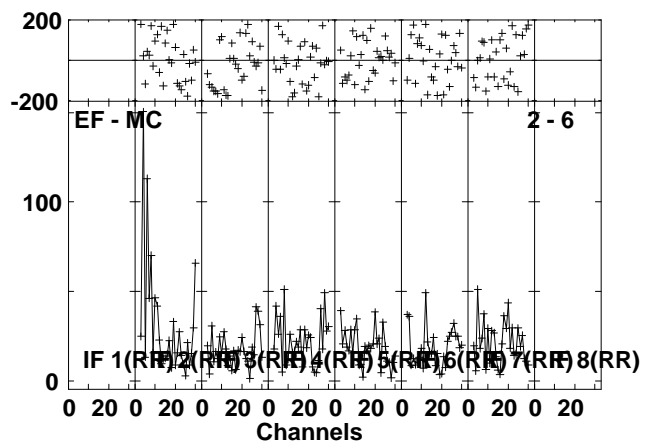
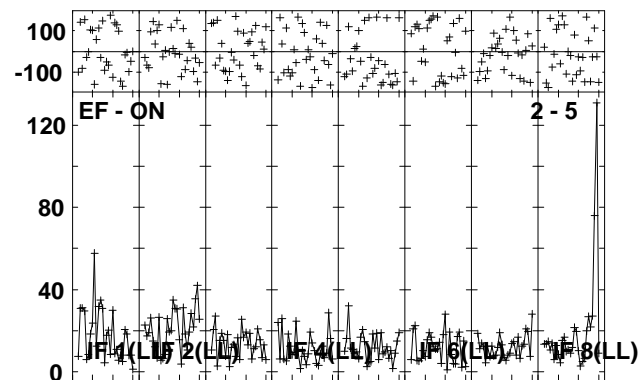
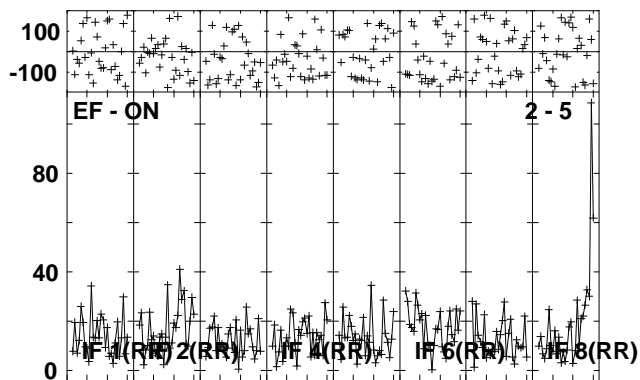
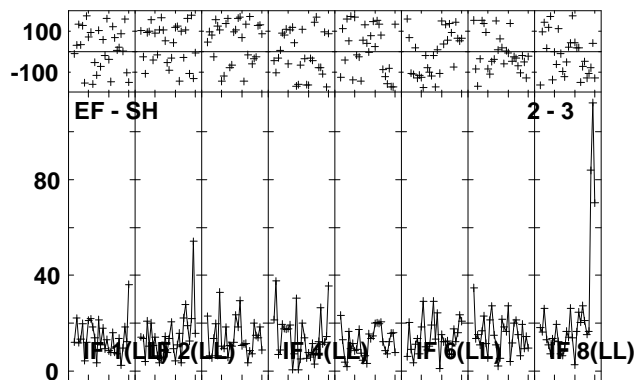
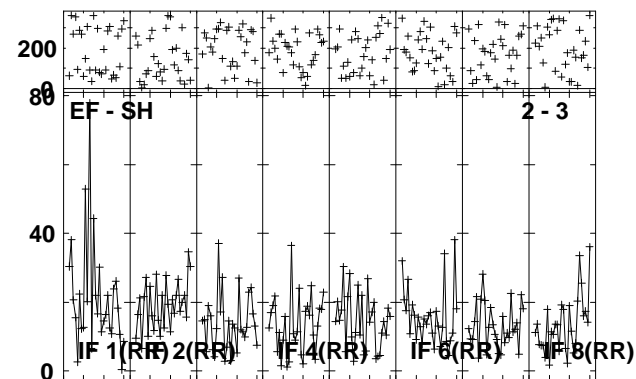
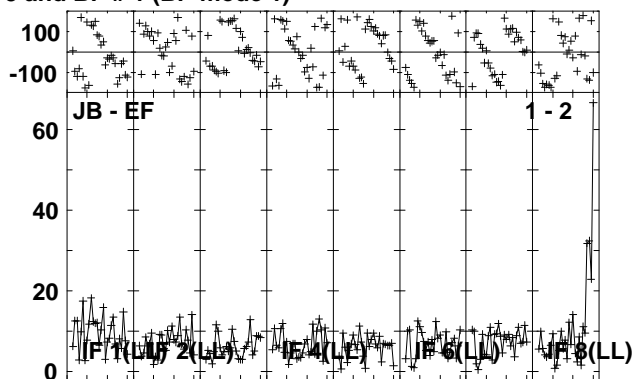
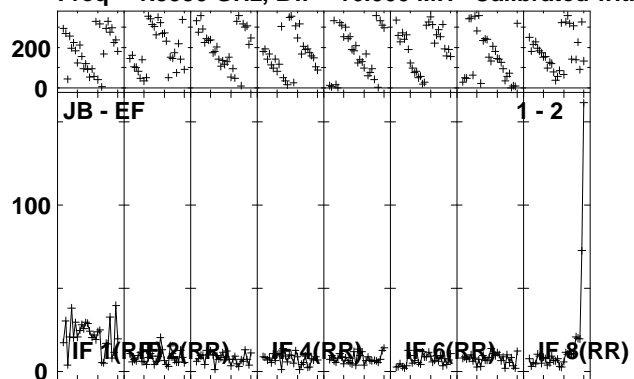

Lower frame: Milli Ampl Jy Top frame: Phas deg  
Vector averaged cross-power spectrum Several baselines displayed  
Timerange: 00/13:25:01 to 00/13:28:29

Plot file version 38 created 30-NOV-2010 14:27:35

ARP299C EP068B 3.UVDATA.1

Freq = 1.5950 GHz, Bw = 16.000 MH Calibrated with CL # 3 and BP # 1 (BP mode 1)

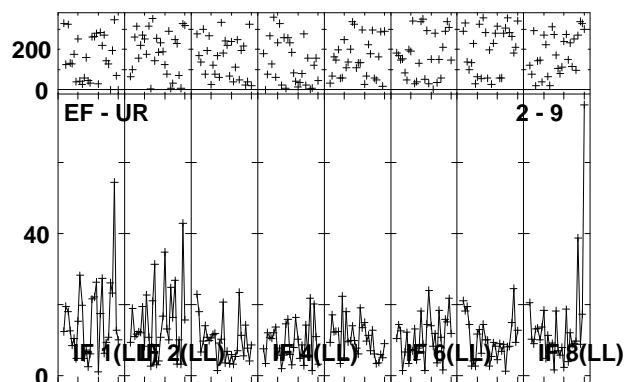
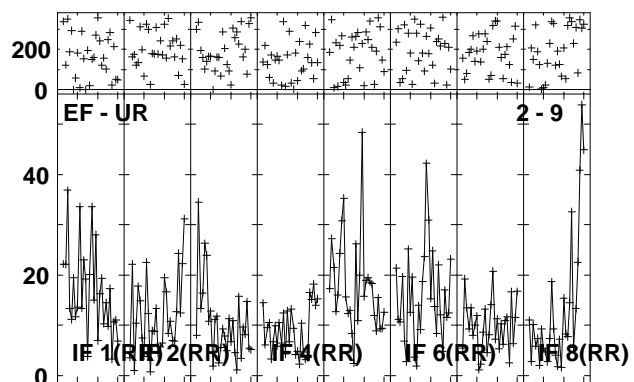
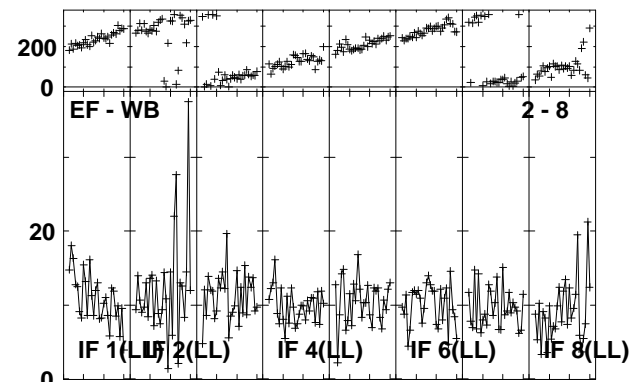
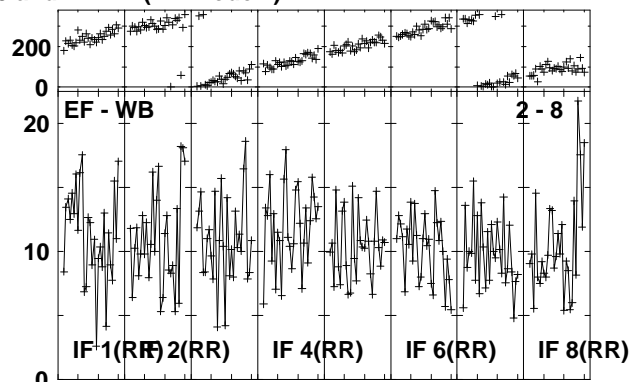
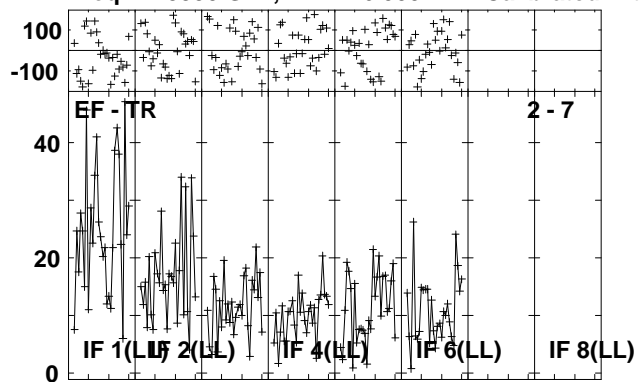

Lower frame: Milli Ampl Jy Top frame: Phas deg  
Vector averaged cross-power spectrum Several baselines displayed  
Timerange: 00/13:25:01 to 00/13:28:29

Plot file version 39 created 30-NOV-2010 14:27:37

J1128+59 EP068B 3.UVDATA.1

Freq = 1.5950 GHz, Bw = 16.000 MH Calibrated with CL # 3 and BP # 1 (BP mode 1)

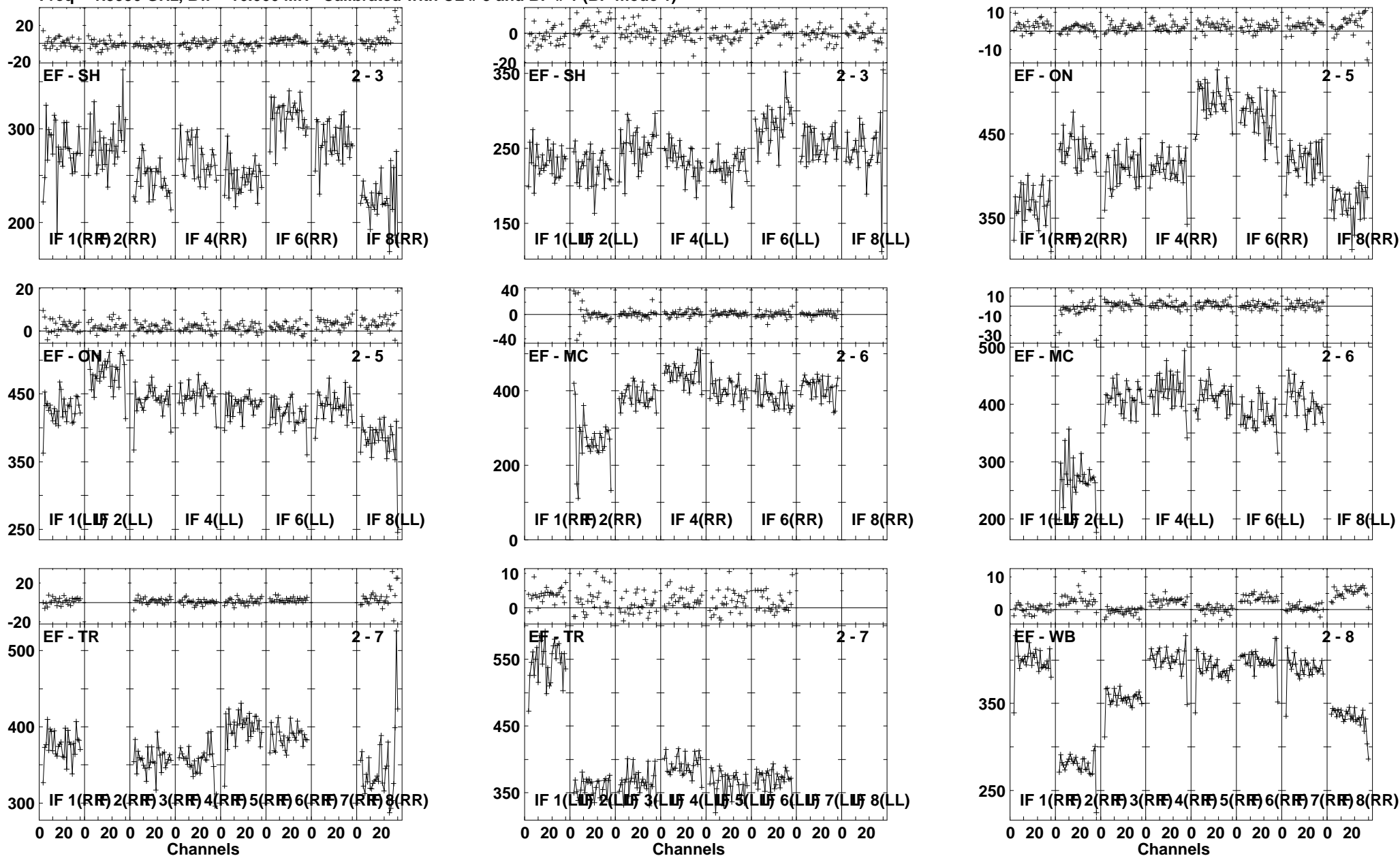

Lower frame: Milli Ampl Jy Top frame: Phas deg  
Vector averaged cross-power spectrum Several baselines displayed  
Timerange: 00/13:28:31 to 00/13:29:59

Plot file version 40 created 30-NOV-2010 14:27:38

J1128+59 EP068B 3.UVDATA.1

Freq = 1.5950 GHz, Bw = 16.000 MH Calibrated with CL # 3 and BP # 1 (BP mode 1)

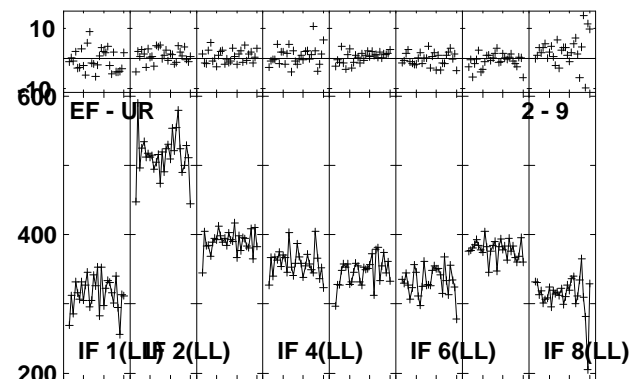
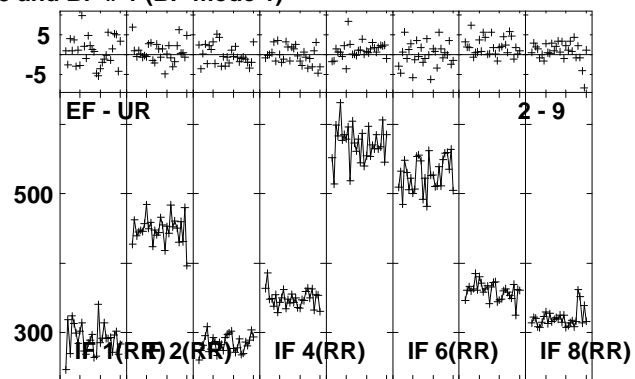
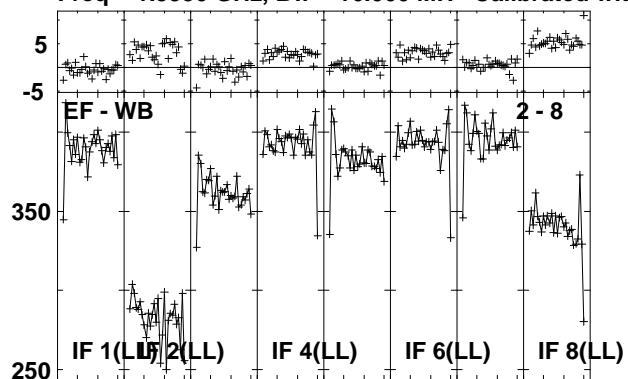

Lower frame: Milli Ampl Jy Top frame: Phas deg  
Vector averaged cross-power spectrum Several baselines displayed  
Timerange: 00/13:28:31 to 00/13:29:59



Plot file version 41 created 30-NOV-2010 14:27:39

ARP299C EP068B 3.UVDATA.1

Freq = 1.5950 GHz, Bw = 16.000 MH Calibrated with CL # 3 and BP # 1 (BP mode 1)

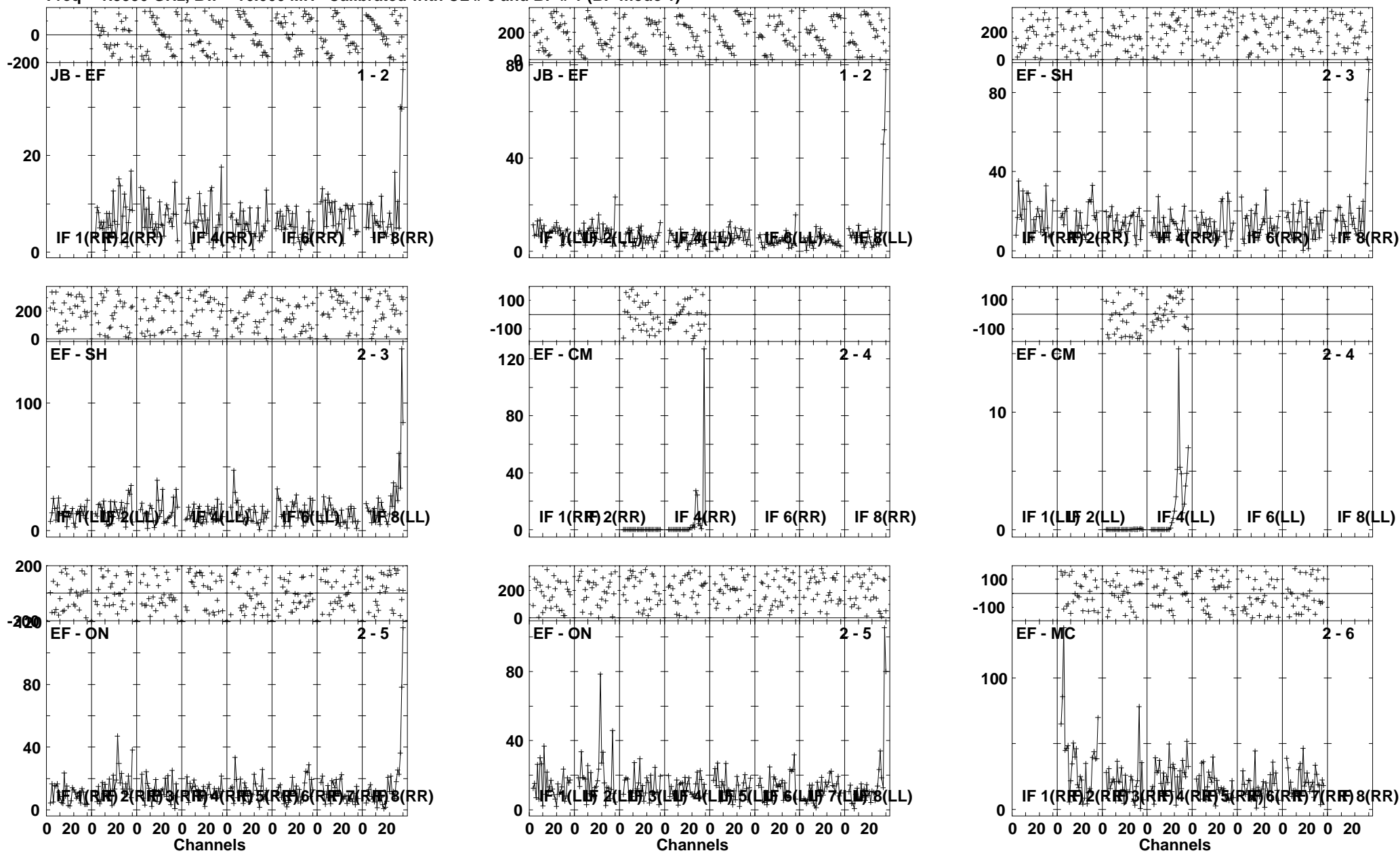

Lower frame: Milli Ampl Jy Top frame: Phas deg  
Vector averaged cross-power spectrum Several baselines displayed  
Timerange: 00/13:30:01 to 00/13:33:29

Plot file version 42 created 30-NOV-2010 14:27:42

ARP299C EP068B 3.UVDATA.1

Freq = 1.5950 GHz, Bw = 16.000 MH Calibrated with CL # 3 and BP # 1 (BP mode 1)

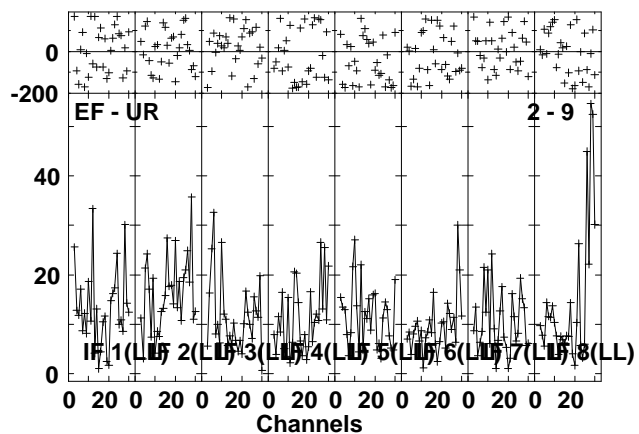
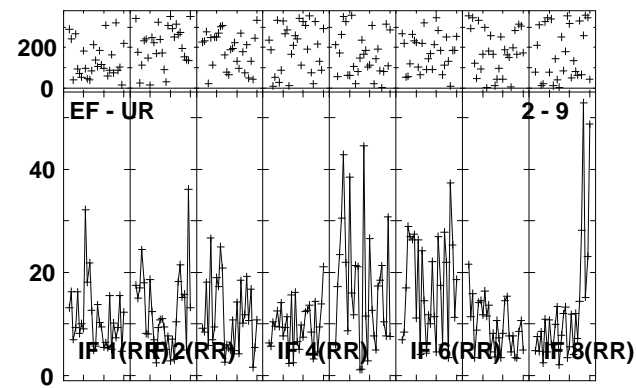
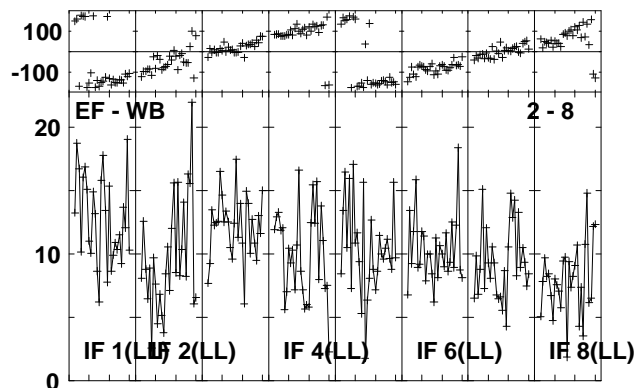
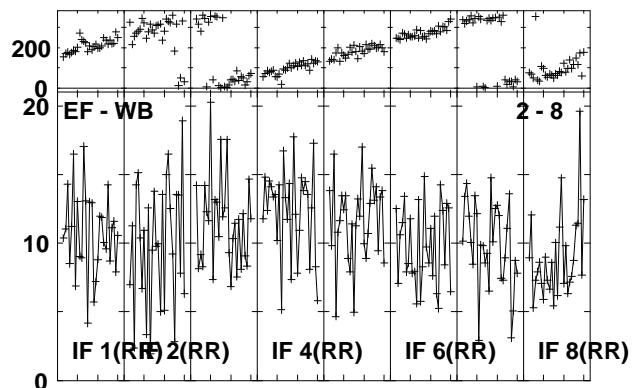
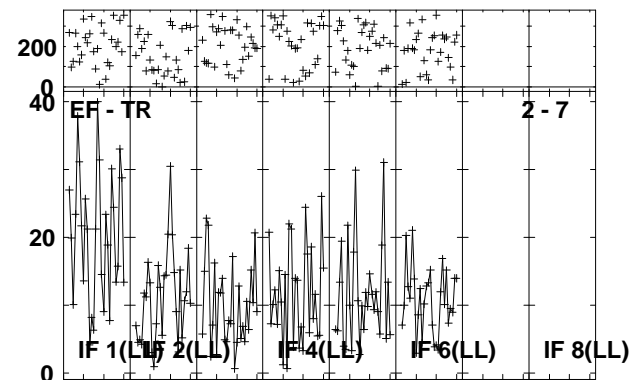
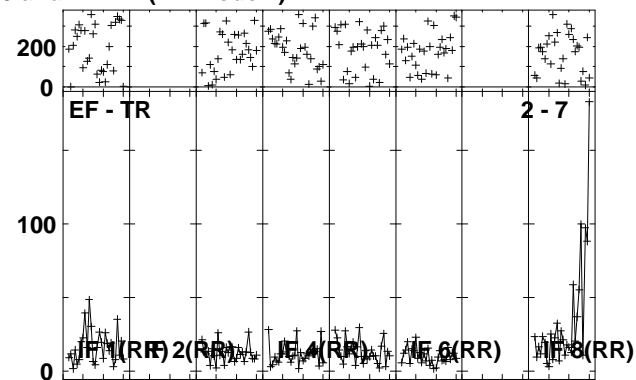
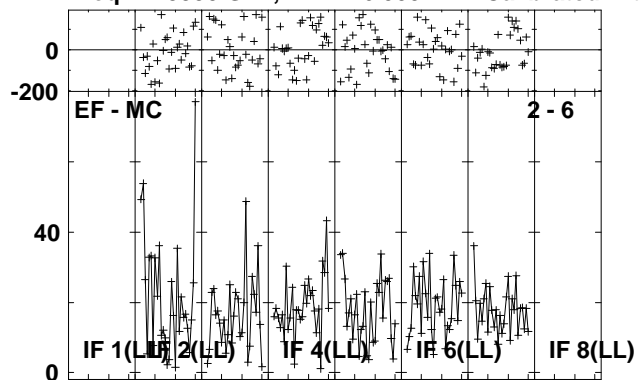

Lower frame: Milli Ampl Jy Top frame: Phas deg  
Vector averaged cross-power spectrum Several baselines displayed  
Timerange: 00/13:30:01 to 00/13:33:29

Plot file version 43 created 30-NOV-2010 14:27:44

J1128+59 EP068B 3.UVDATA.1

Freq = 1.5950 GHz, Bw = 16.000 MH Calibrated with CL # 3 and BP # 1 (BP mode 1)

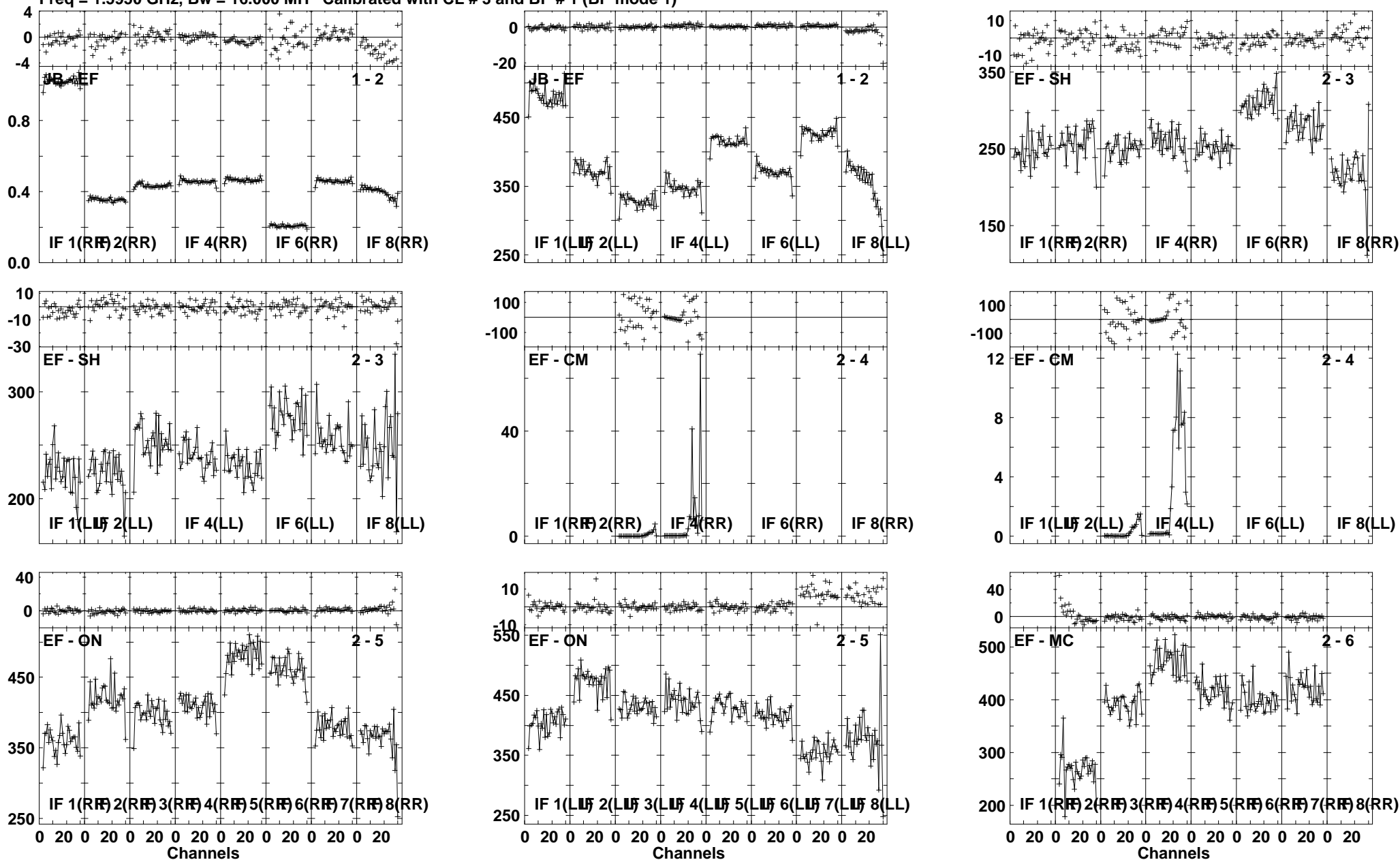

Plot file version 44 created 30-NOV-2010 14:27:45

J1128+59 EP068B 3.UVDATA.1

Freq = 1.5950 GHz, Bw = 16.000 MH Calibrated with CL # 3 and BP # 1 (BP mode 1)

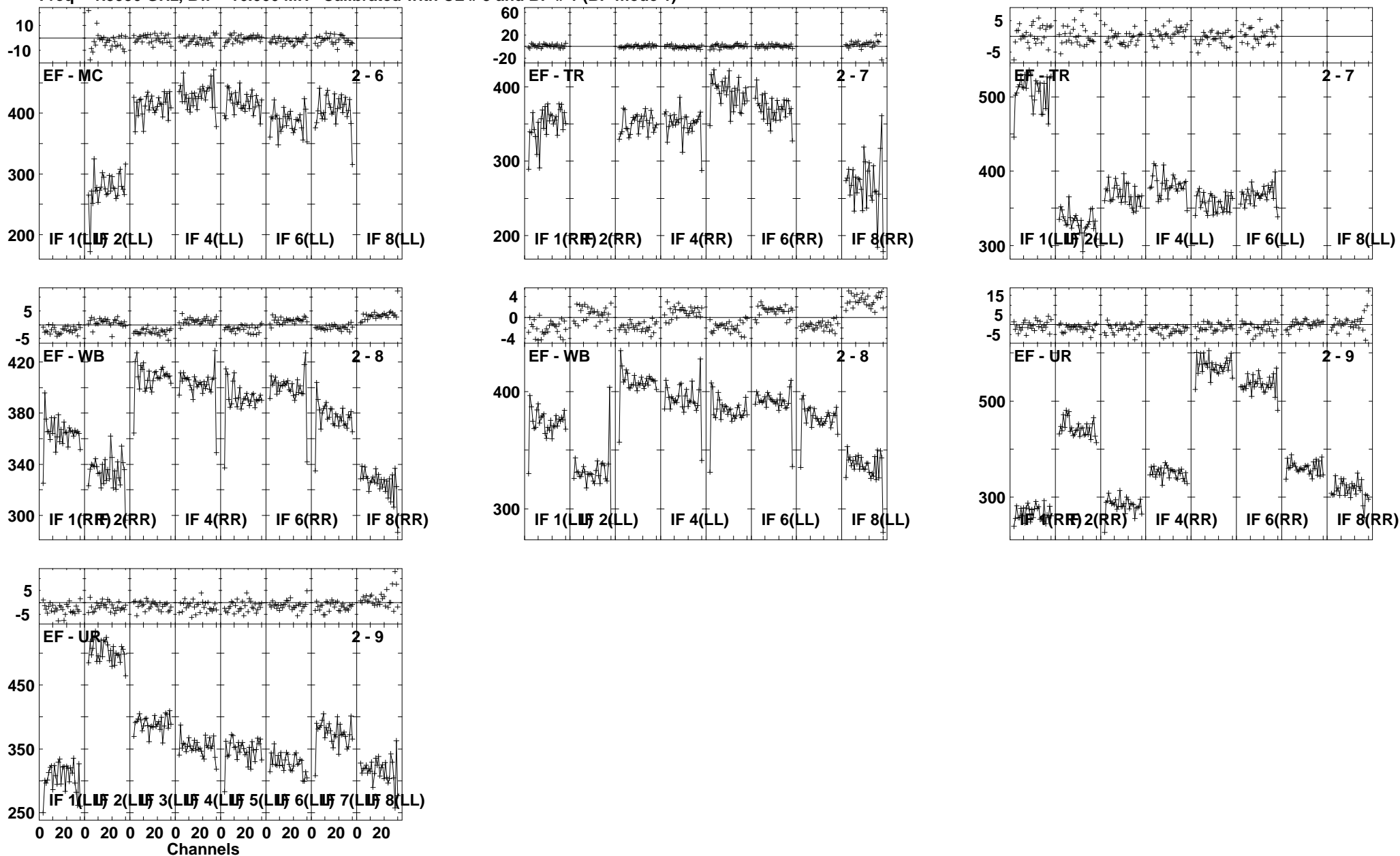

Lower frame: Milli Ampl Jy Top frame: Phas deg  
Vector averaged cross-power spectrum Several baselines displayed  
Timerange: 00/13:34:31 to 00/13:35:59

Plot file version 45 created 30-NOV-2010 14:27:47

ARP299C EP068B 3.UVDATA.1

Freq = 1.5950 GHz, Bw = 16.000 MH Calibrated with CL # 3 and BP # 1 (BP mode 1)

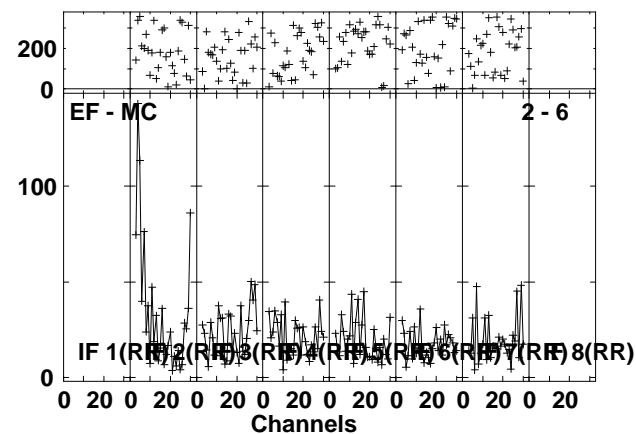
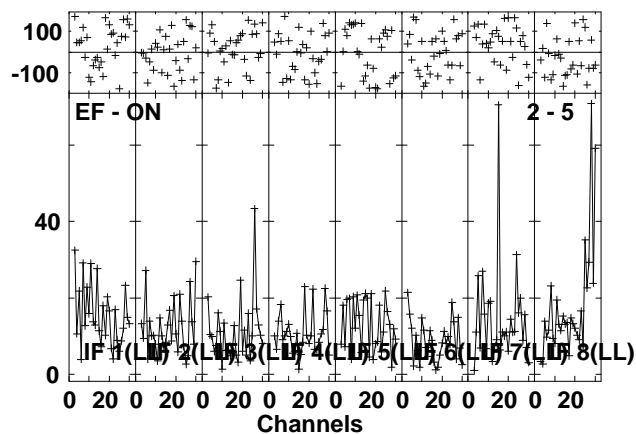
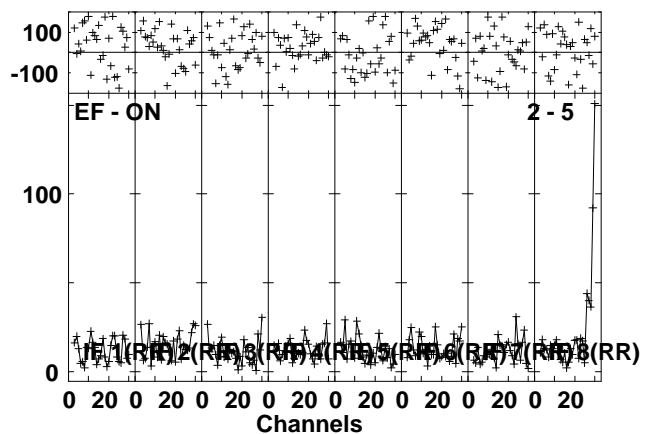
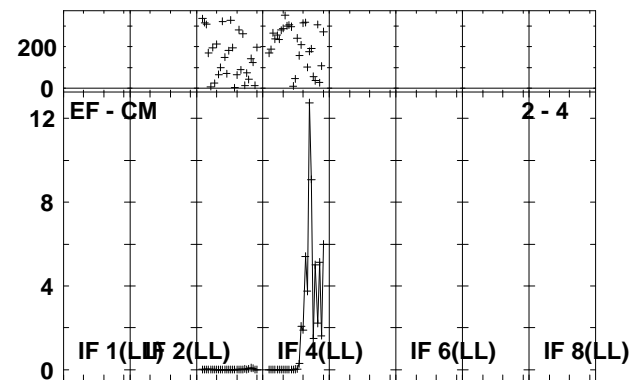
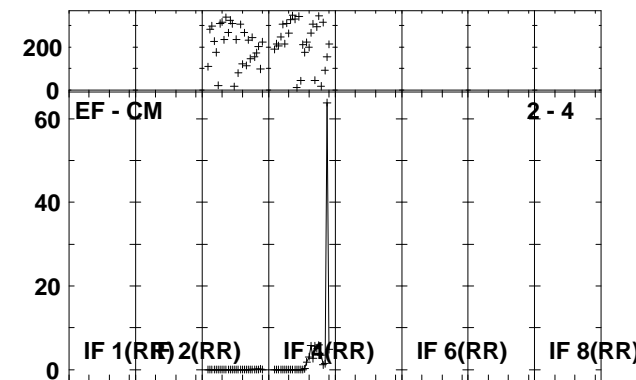
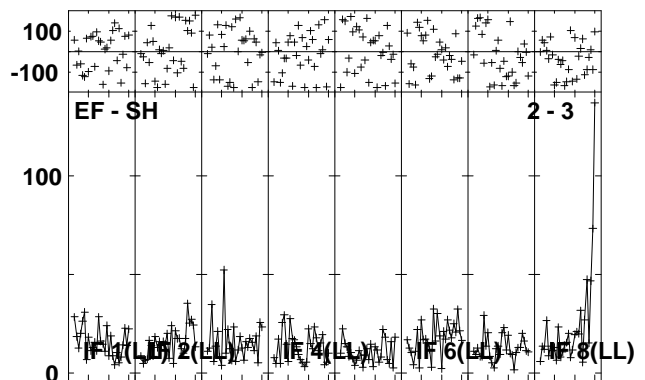
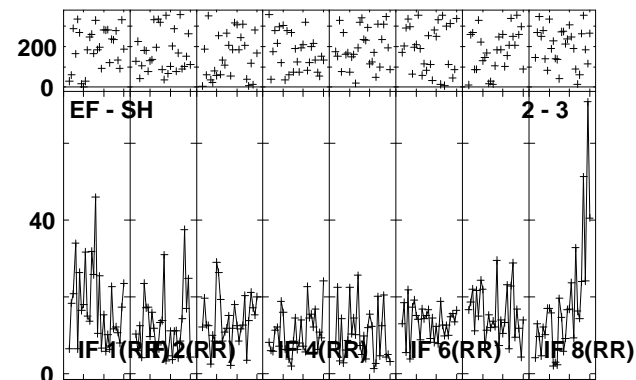
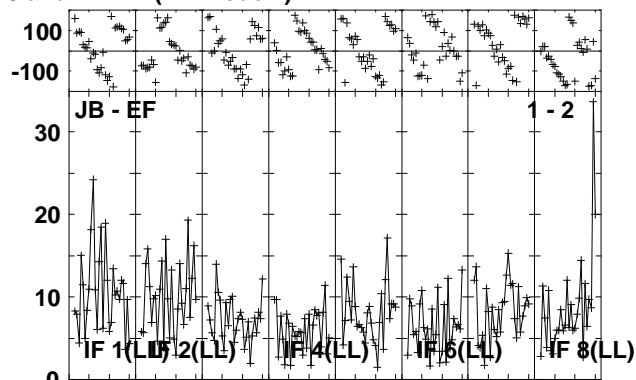
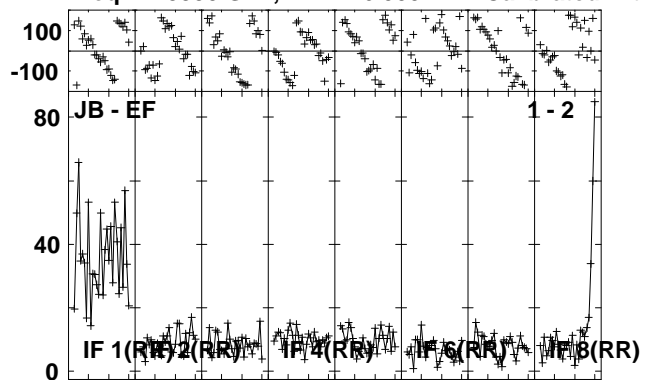

Lower frame: Milli Ampl Jy Top frame: Phas deg  
Vector averaged cross-power spectrum Several baselines displayed  
Timerange: 00/13:36:01 to 00/13:39:29

Plot file version 46 created 30-NOV-2010 14:27:49

ARP299C EP068B 3.UVDATA.1

Freq = 1.5950 GHz, Bw = 16.000 MH Calibrated with CL # 3 and BP # 1 (BP mode 1)

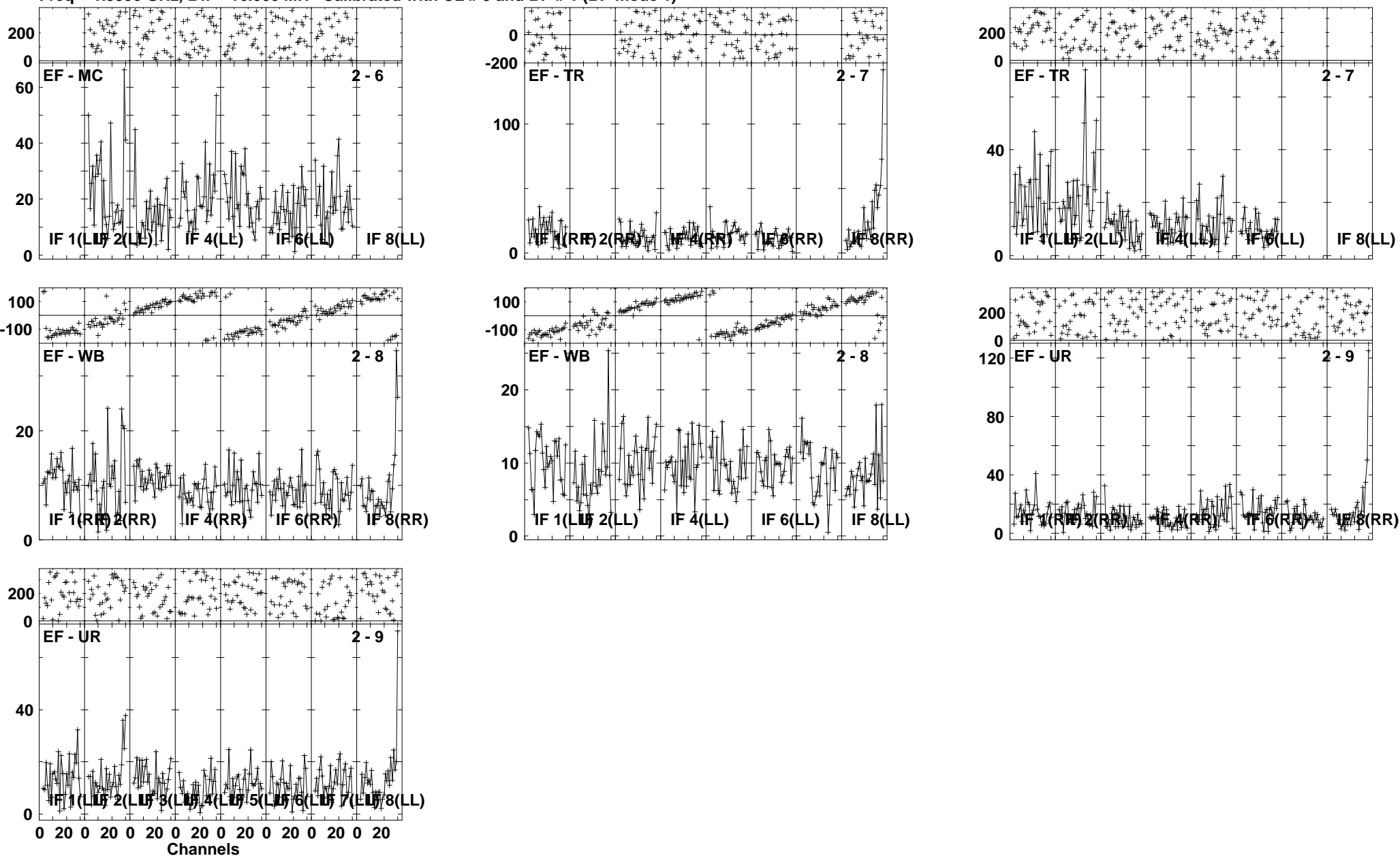

Lower frame: Milli Ampl Jy Top frame: Phas deg  
Vector averaged cross-power spectrum Several baselines displayed  
Timerange: 00/13:36:01 to 00/13:39:29

Plot file version 47 created 30-NOV-2010 14:27:52

J1128+59 EP068B 3.UVDATA.1

Freq = 1.5950 GHz, Bw = 16.000 MH Calibrated with CL # 3 and BP # 1 (BP mode 1)

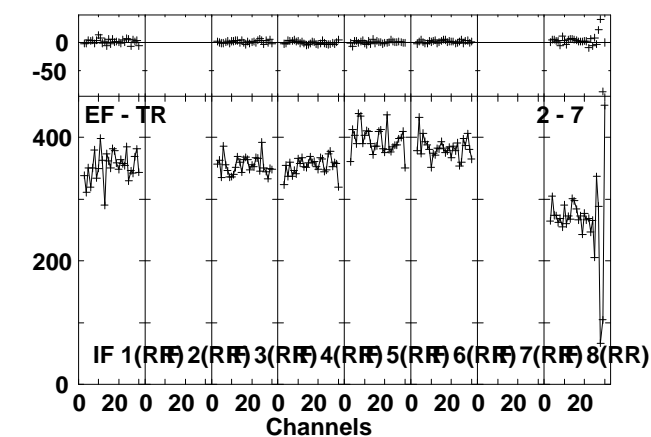
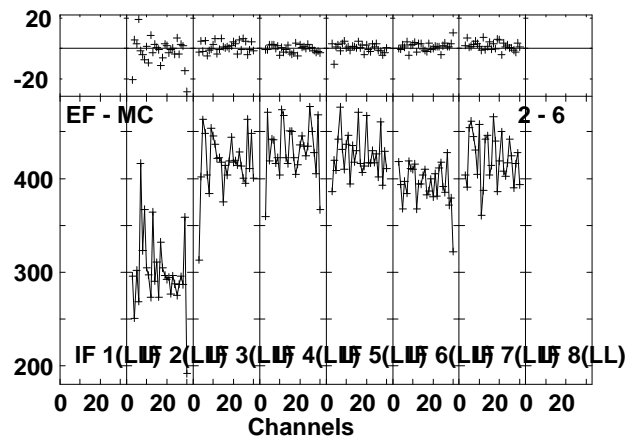
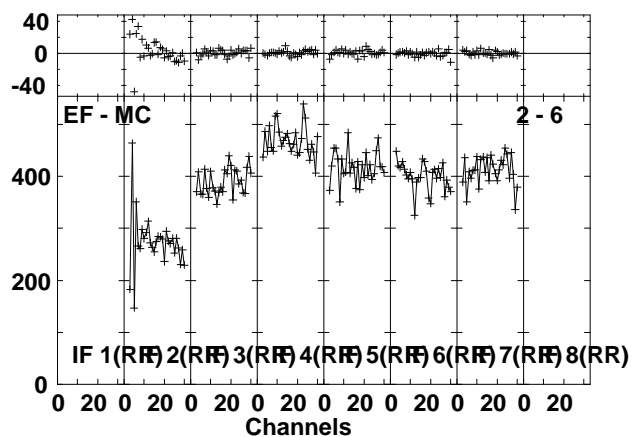
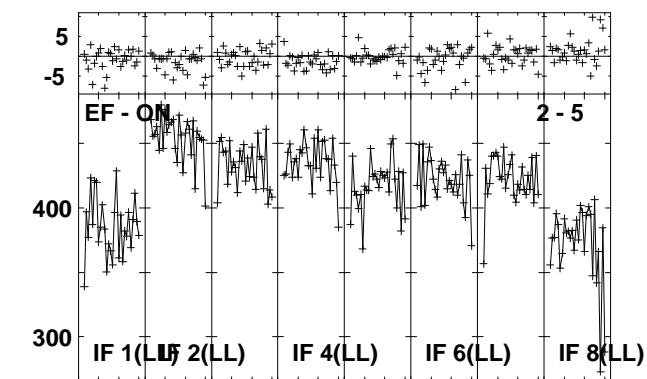
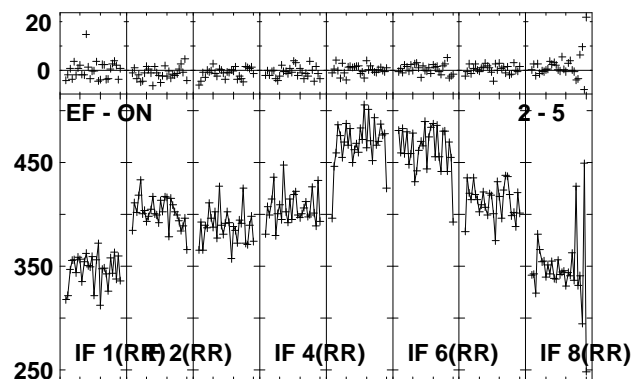
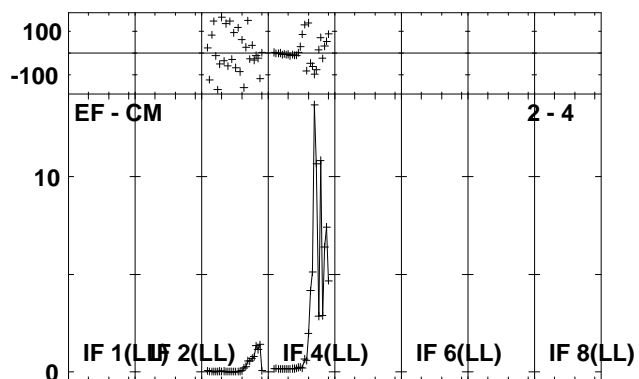
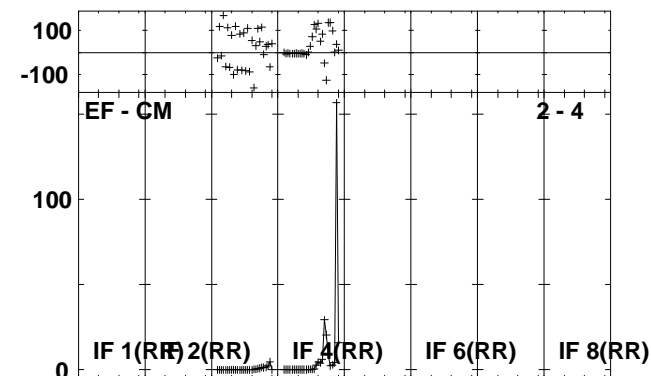
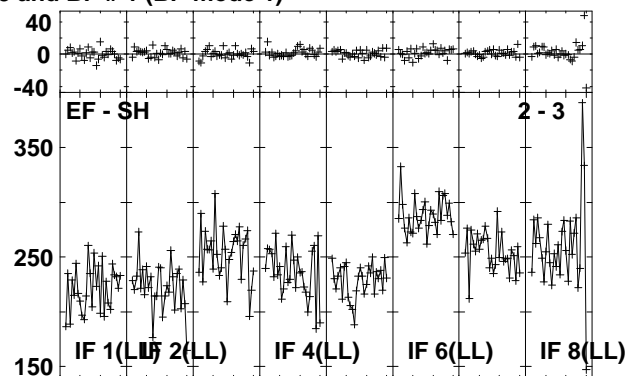
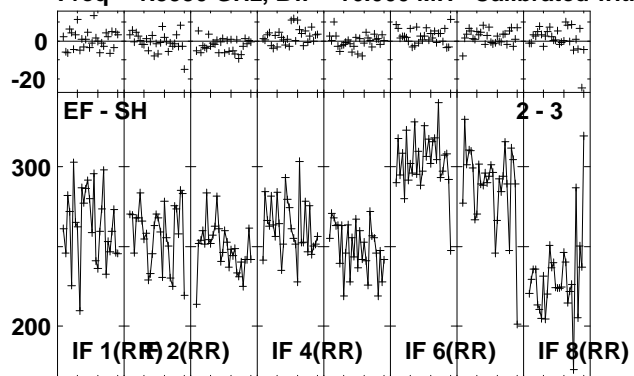

Lower frame: Milli Ampl Jy Top frame: Phas deg  
Vector averaged cross-power spectrum Several baselines displayed  
Timerange: 00/13:39:31 to 00/13:40:59

Plot file version 48 created 30-NOV-2010 14:27:53

J1128+59 EP068B 3.UVDATA.1

Freq = 1.5950 GHz, Bw = 16.000 MH Calibrated with CL # 3 and BP # 1 (BP mode 1)

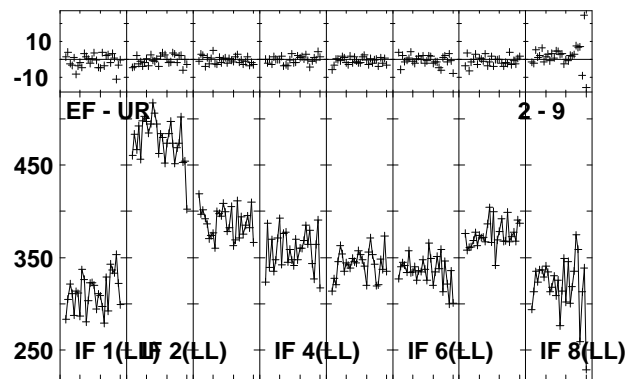
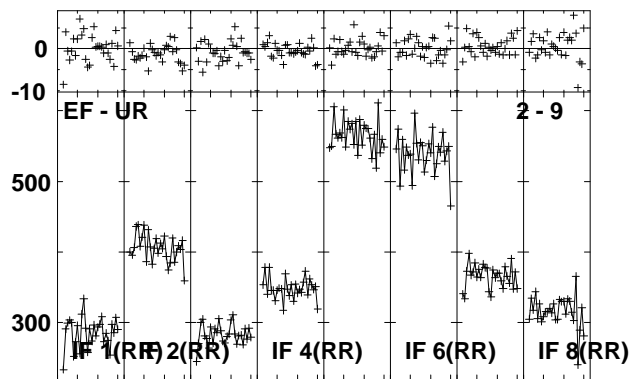
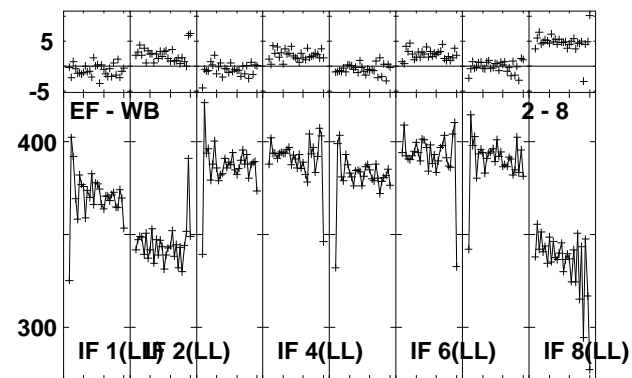
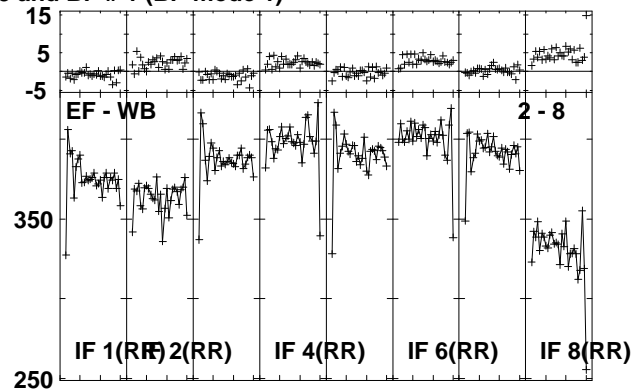
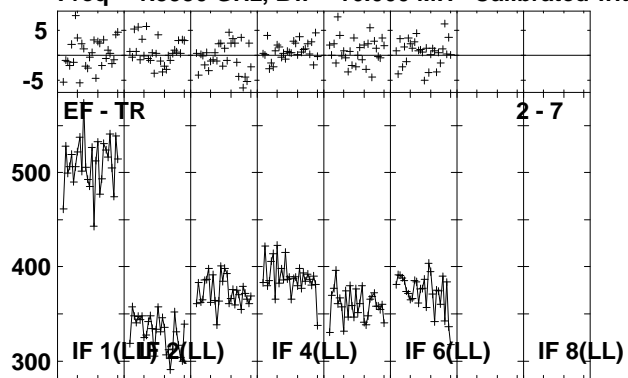

Lower frame: Milli Ampl Jy Top frame: Phas deg  
Vector averaged cross-power spectrum Several baselines displayed  
Timerange: 00/13:39:31 to 00/13:40:59



Plot file version 49 created 30-NOV-2010 14:27:54

ARP299C EP068B 3.UVDATA.1

Freq = 1.5950 GHz, Bw = 16.000 MH Calibrated with CL # 3 and BP # 1 (BP mode 1)

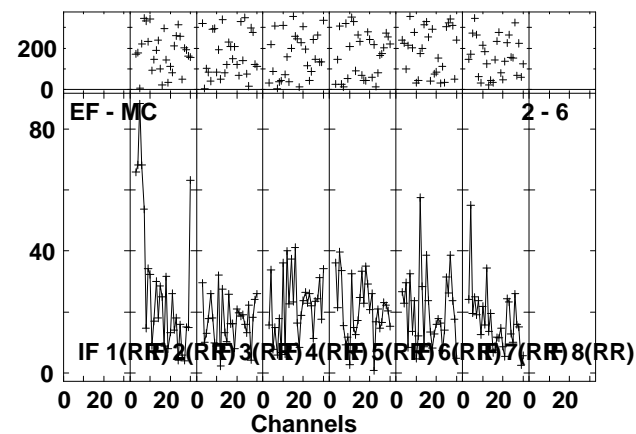
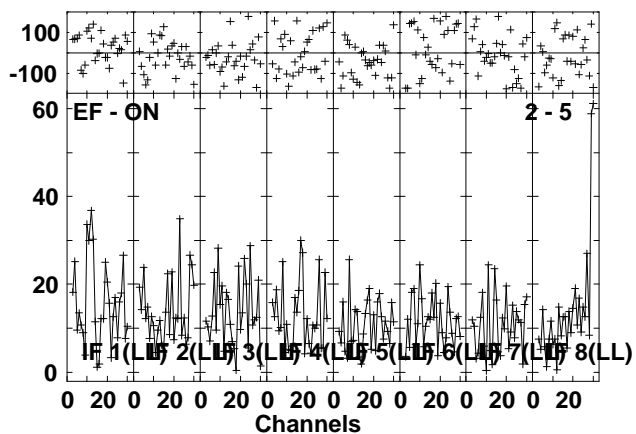
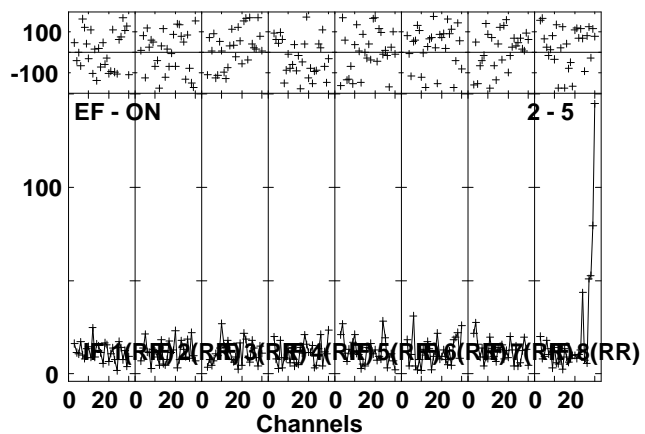
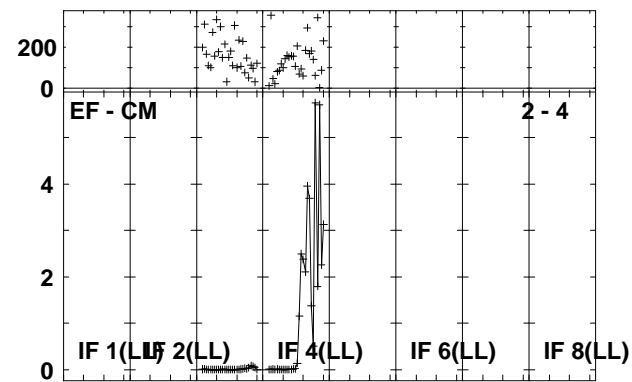
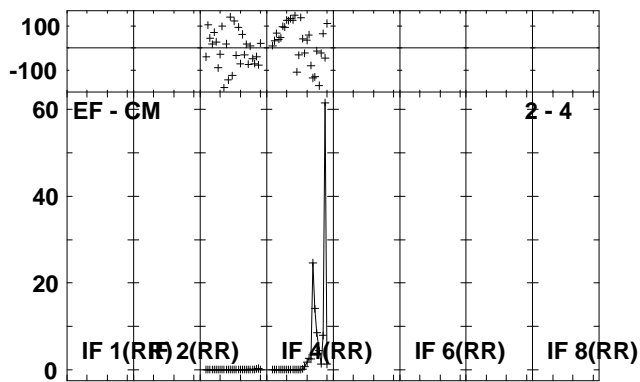
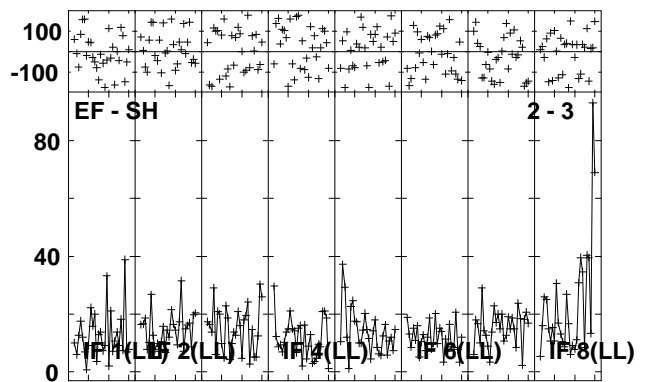
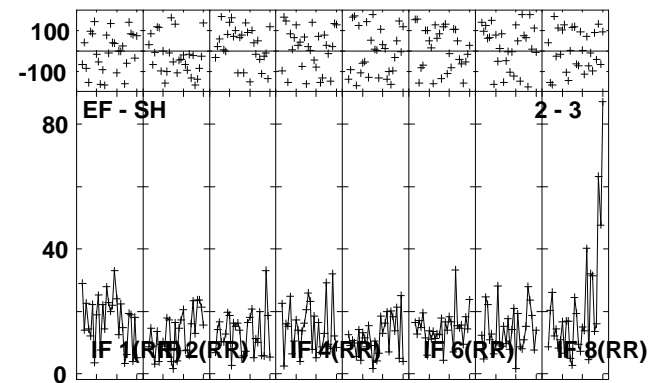
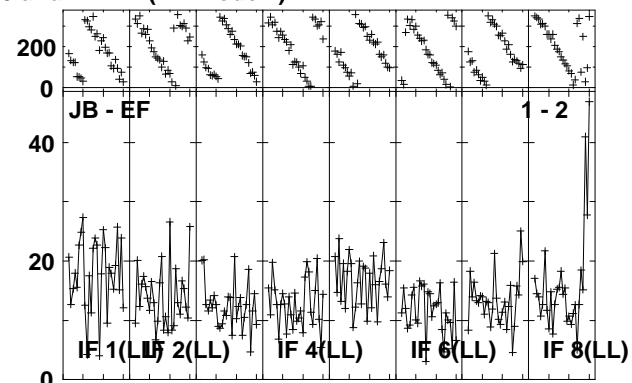
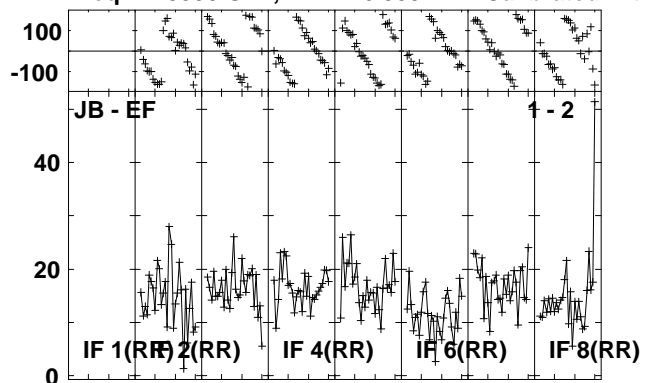

Lower frame: Milli Ampl Jy Top frame: Phas deg  
Vector averaged cross-power spectrum Several baselines displayed  
Timerange: 00/13:41:01 to 00/13:44:29

Plot file version 50 created 30-NOV-2010 14:27:56

ARP299C EP068B 3.UVDATA.1

Freq = 1.5950 GHz, Bw = 16.000 MH Calibrated with CL # 3 and BP # 1 (BP mode 1)

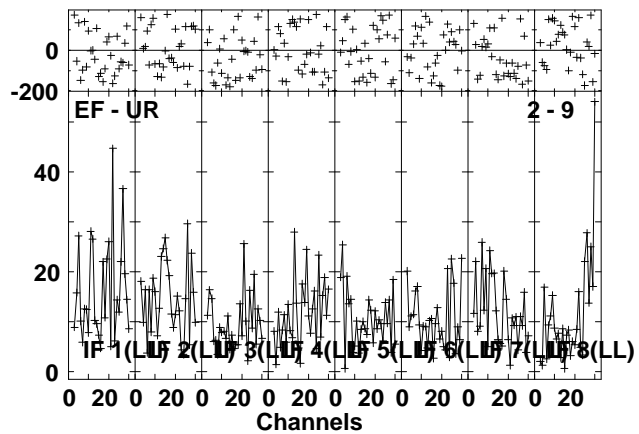
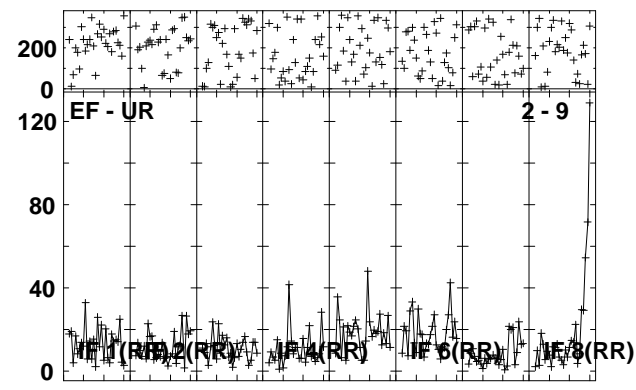
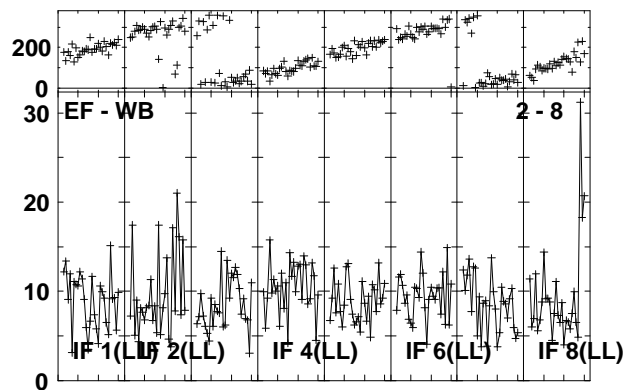
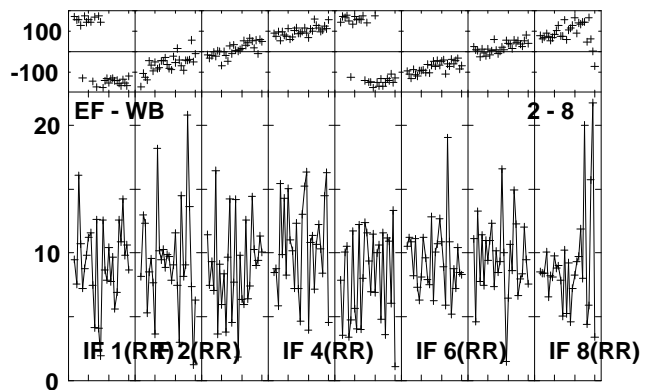
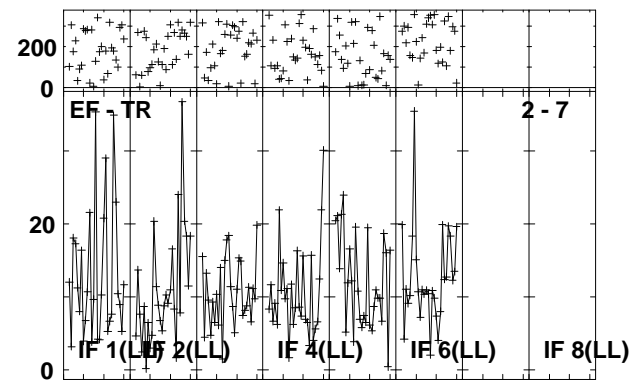
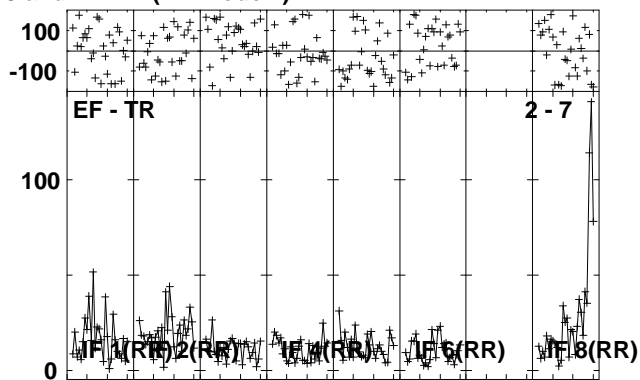
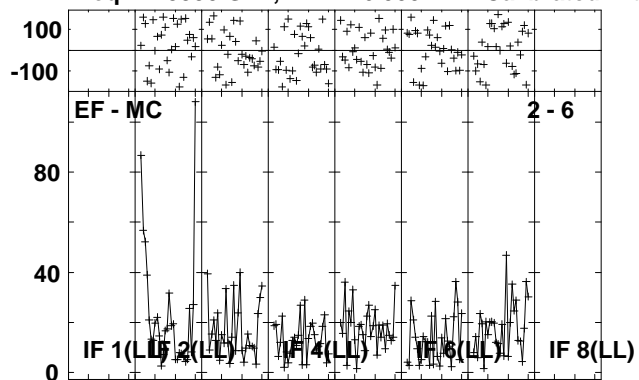

Lower frame: Milli Ampl Jy Top frame: Phas deg  
 Vector averaged cross-power spectrum Several baselines displayed  
 Timerange: 00/13:41:01 to 00/13:44:29

Plot file version 51 created 30-NOV-2010 14:27:59

J1128+59 EP068B 3.UVDATA.1

Freq = 1.5950 GHz, Bw = 16.000 MH Calibrated with CL # 3 and BP # 1 (BP mode 1)

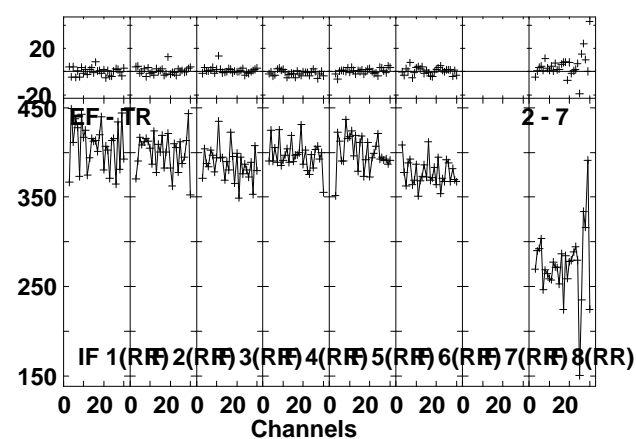
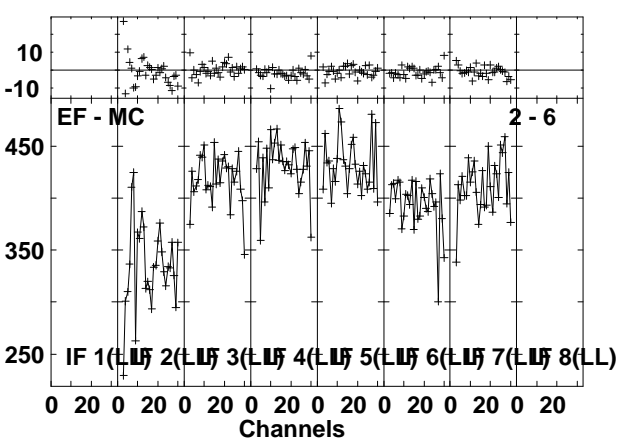
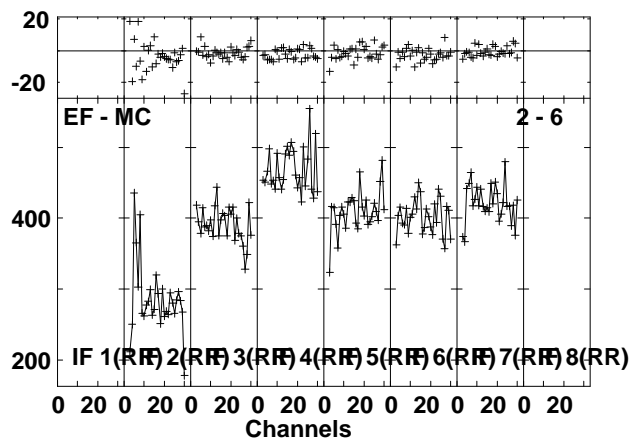
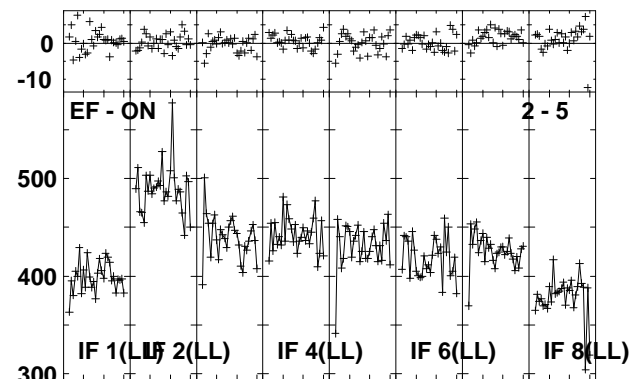
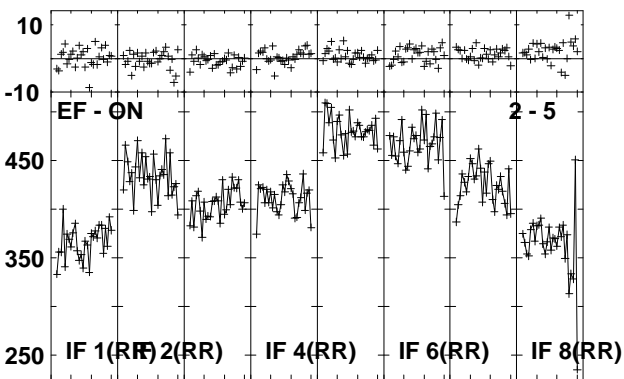
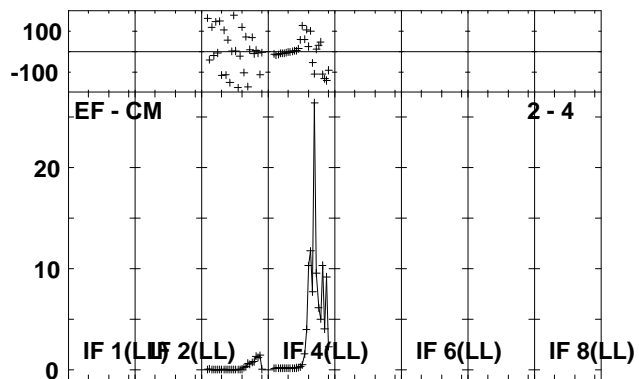
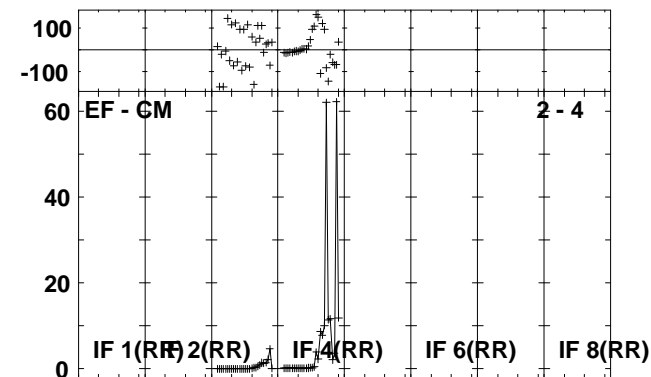
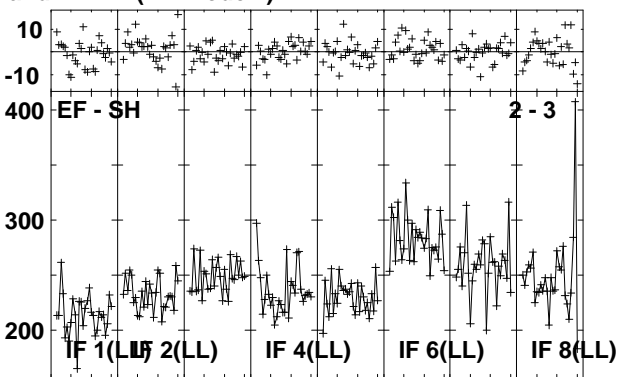
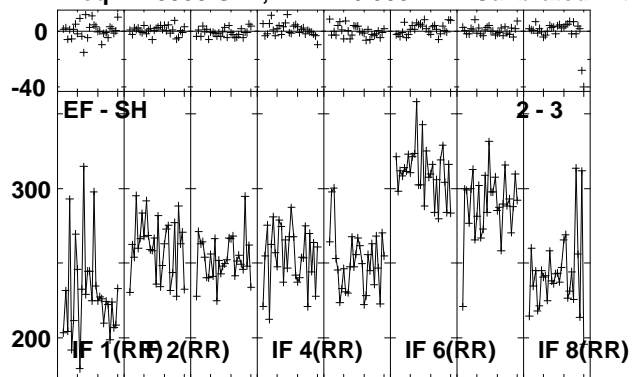

Lower frame: Milli Ampl Jy Top frame: Phas deg  
Vector averaged cross-power spectrum Several baselines displayed  
Timerange: 00/13:44:31 to 00/13:45:59

Plot file version 52 created 30-NOV-2010 14:27:59

J1128+59 EP068B 3.UVDATA.1

Freq = 1.5950 GHz, Bw = 16.000 MH Calibrated with CL # 3 and BP # 1 (BP mode 1)

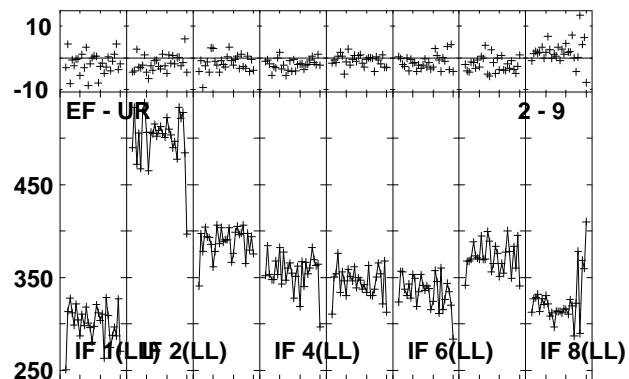
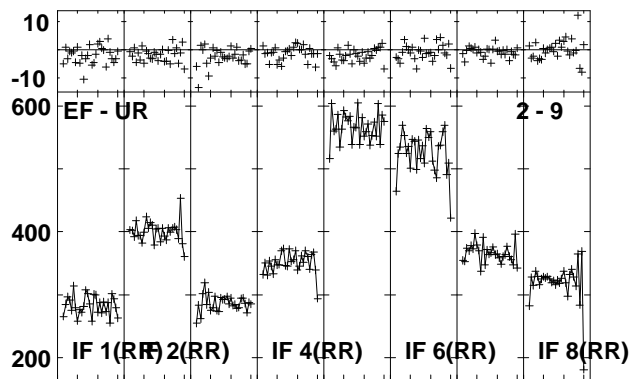
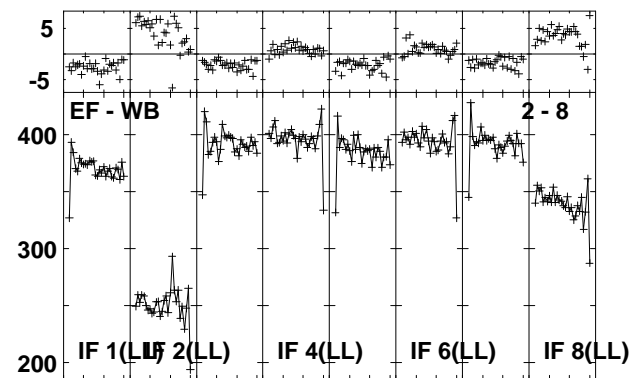
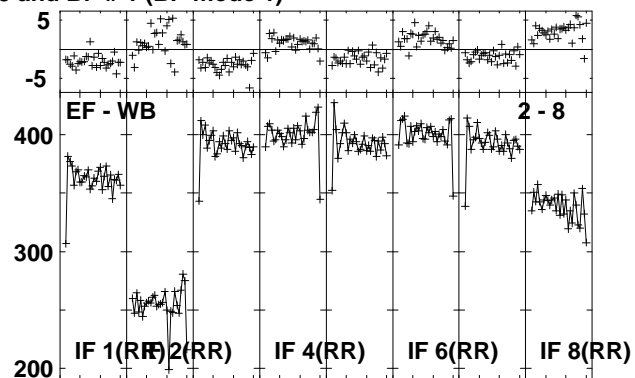
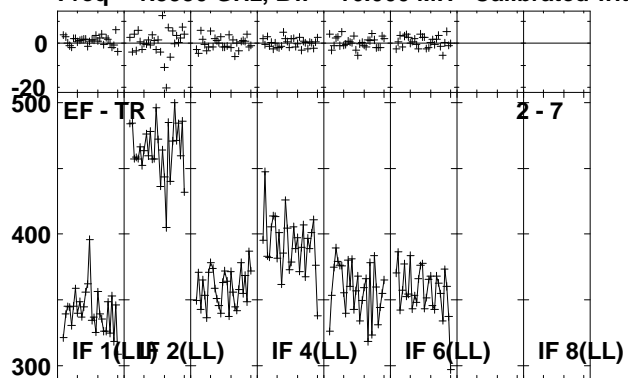

Lower frame: Milli Ampl Jy Top frame: Phas deg  
Vector averaged cross-power spectrum Several baselines displayed  
Timerange: 00/13:44:31 to 00/13:45:59

Plot file version 53 created 30-NOV-2010 14:28:01

ARP299C EP068B 3.UVDATA.1

Freq = 1.5950 GHz, Bw = 16.000 MH Calibrated with CL # 3 and BP # 1 (BP mode 1)

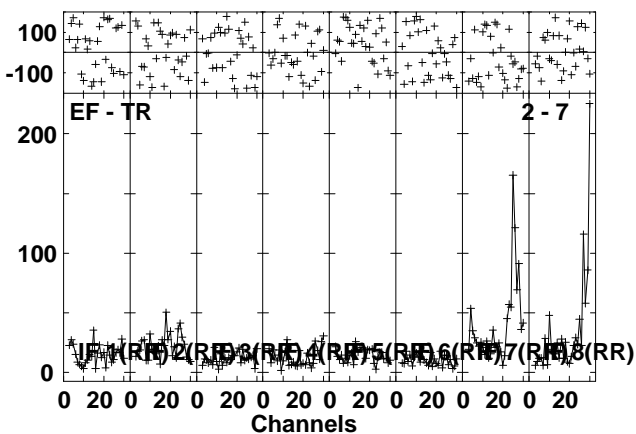
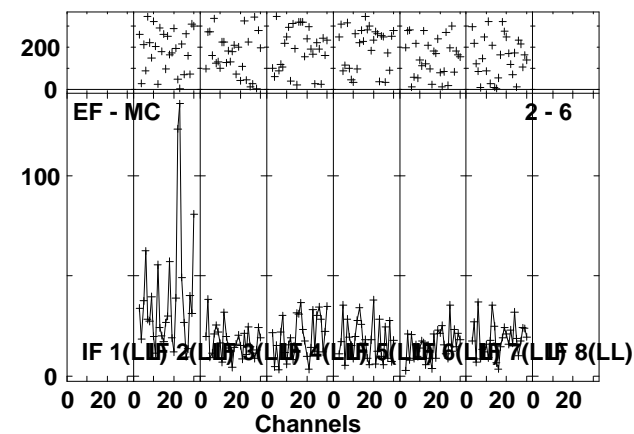
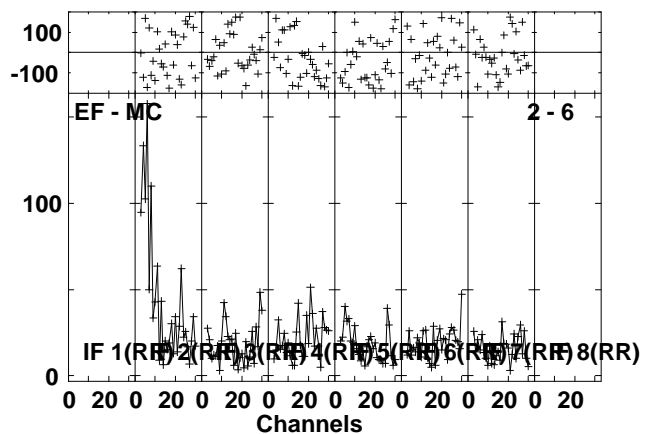
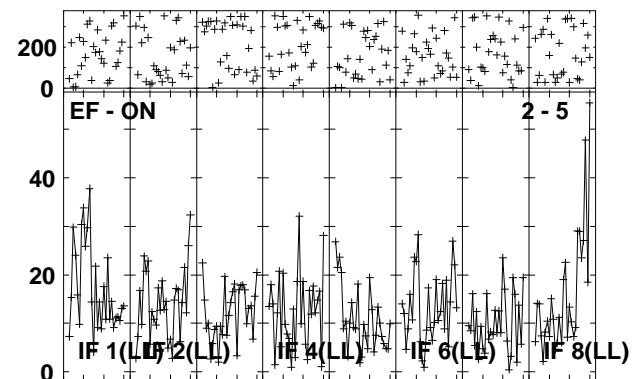
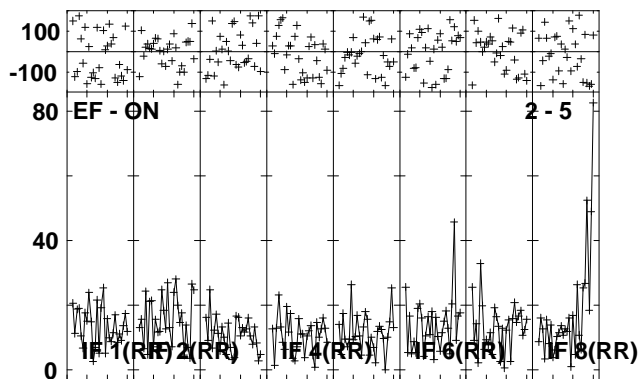
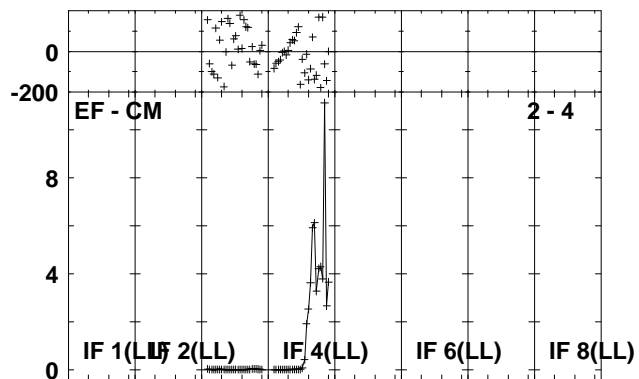
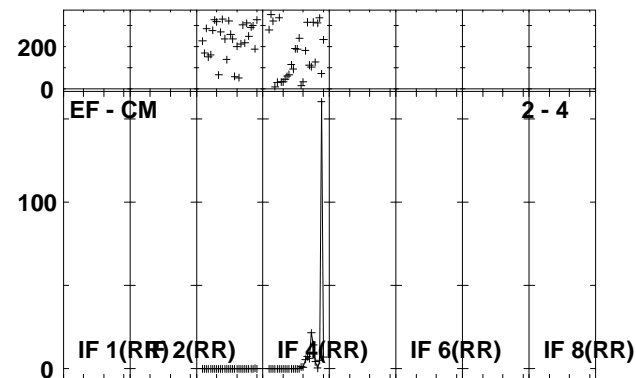
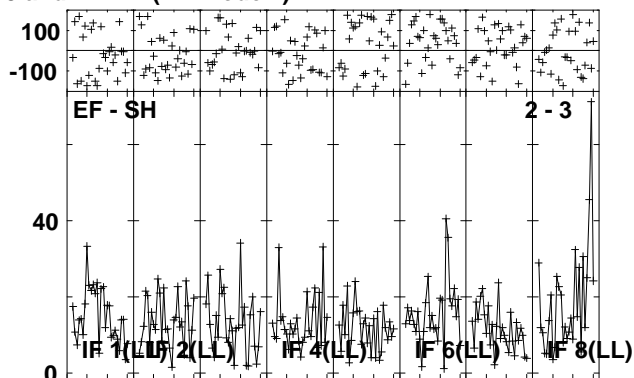
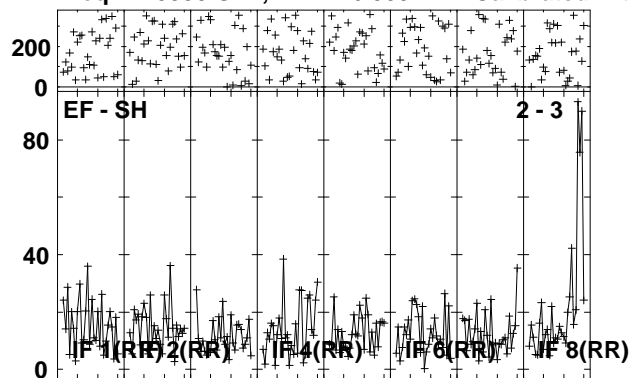

Lower frame: Milli Ampl Jy Top frame: Phas deg  
Vector averaged cross-power spectrum Several baselines displayed  
Timerange: 00/13:46:01 to 00/13:49:29

Plot file version 54 created 30-NOV-2010 14:28:04

ARP299C EP068B 3.UVDATA.1

Freq = 1.5950 GHz, Bw = 16.000 MH Calibrated with CL # 3 and BP # 1 (BP mode 1)

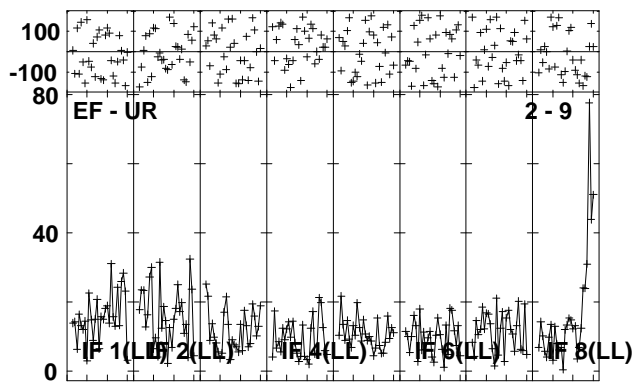
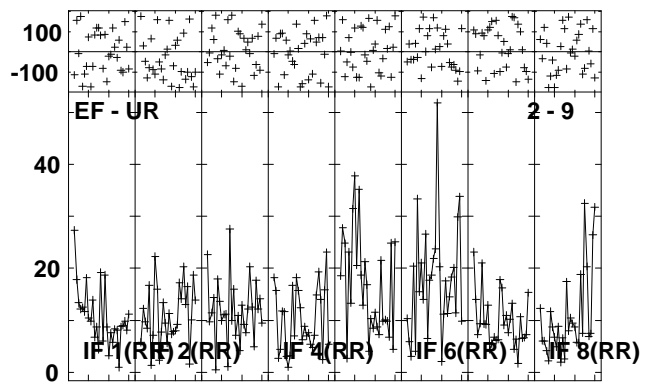
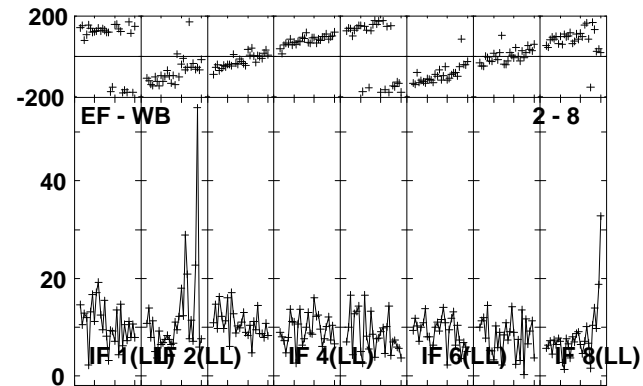
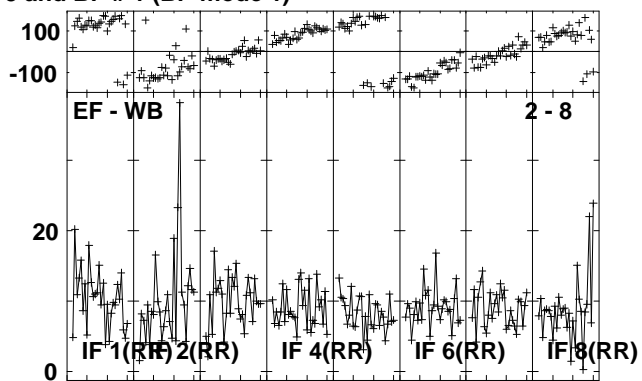
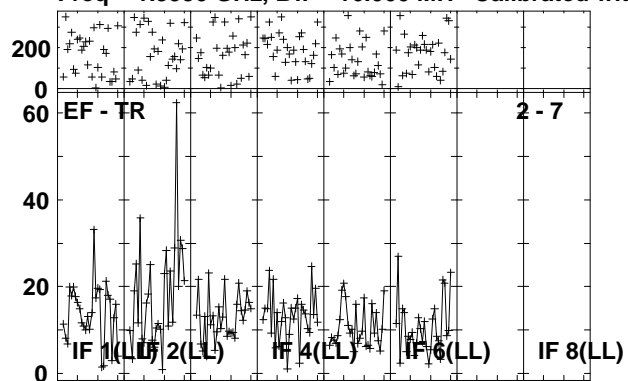

Lower frame: Milli Ampl Jy Top frame: Phas deg  
Vector averaged cross-power spectrum Several baselines displayed  
Timerange: 00/13:46:01 to 00/13:49:29

Plot file version 55 created 30-NOV-2010 14:28:05

J1128+59 EP068B 3.UVDATA.1

Freq = 1.5950 GHz, Bw = 16.000 MH Calibrated with CL # 3 and BP # 1 (BP mode 1)

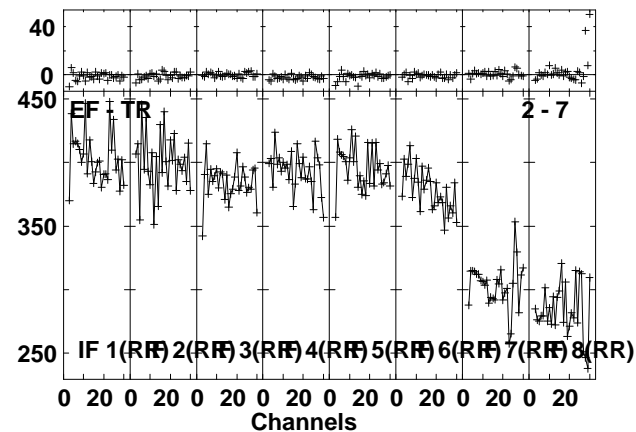
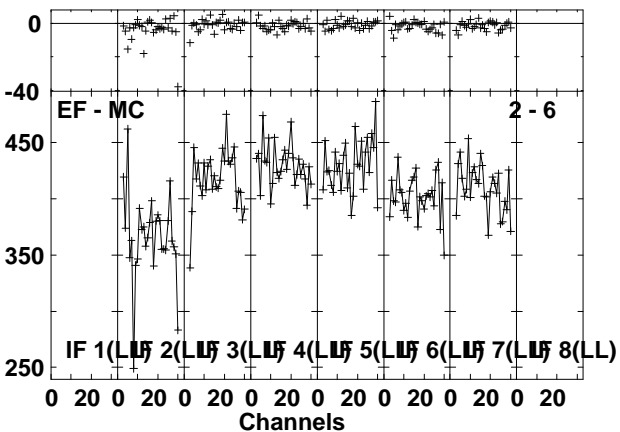
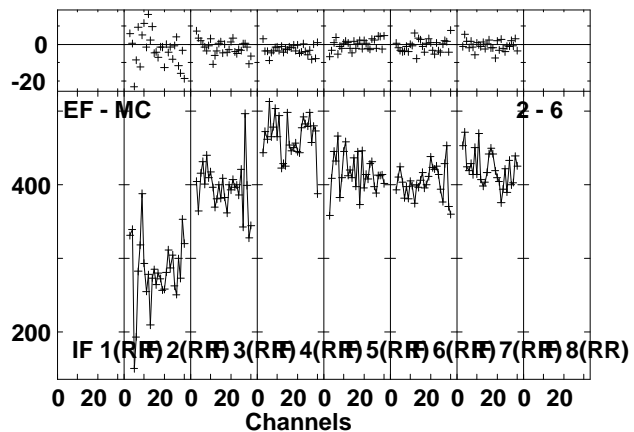
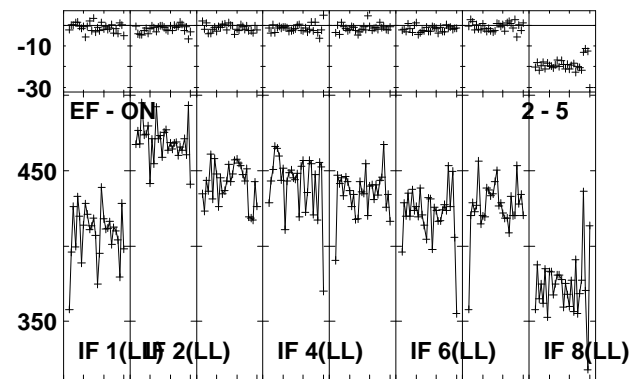
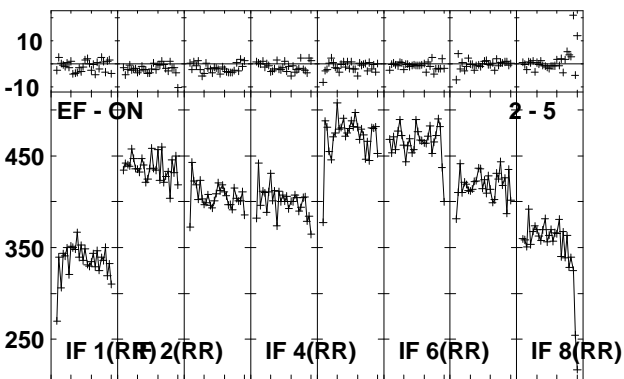
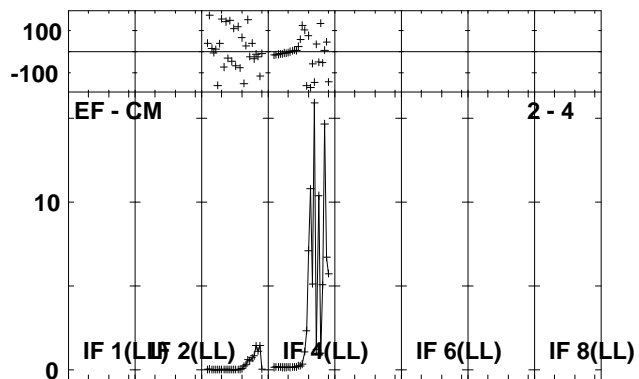
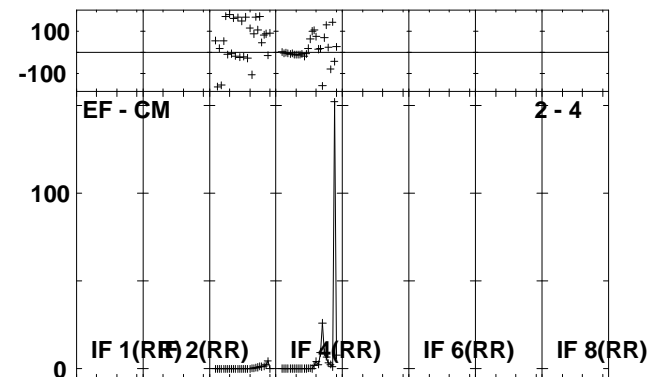
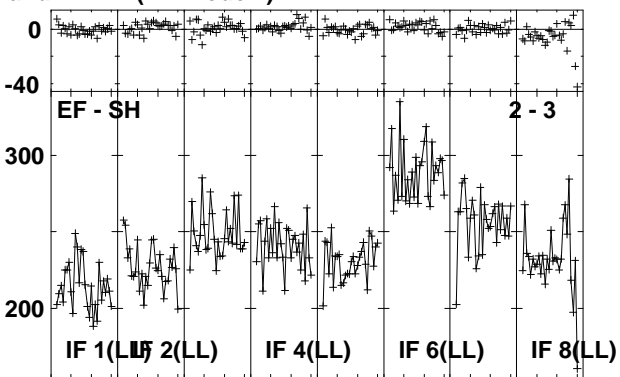
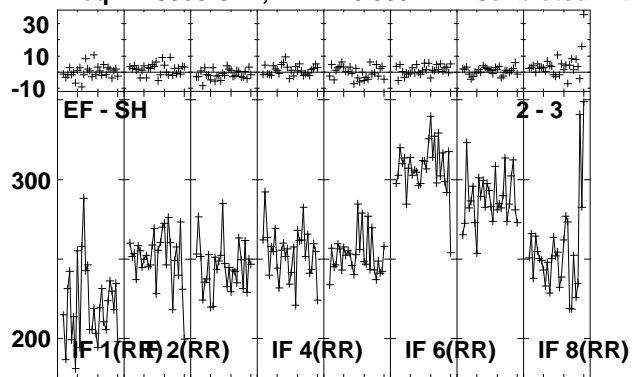

Lower frame: Milli Ampl Jy Top frame: Phas deg  
Vector averaged cross-power spectrum Several baselines displayed  
Timerange: 00/13:50:31 to 00/13:51:59

Plot file version 56 created 30-NOV-2010 14:28:06

J1128+59 EP068B 3.UVDATA.1

Freq = 1.5950 GHz, Bw = 16.000 MH Calibrated with CL # 3 and BP # 1 (BP mode 1)

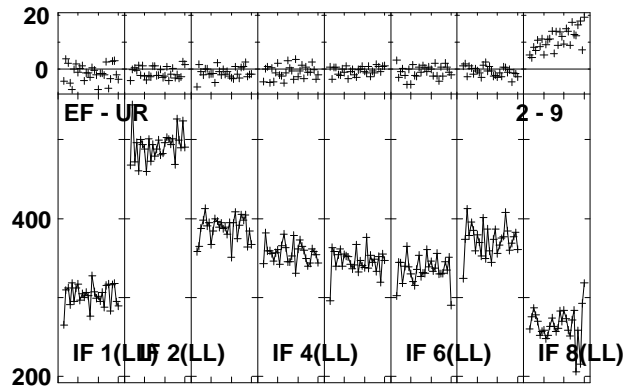
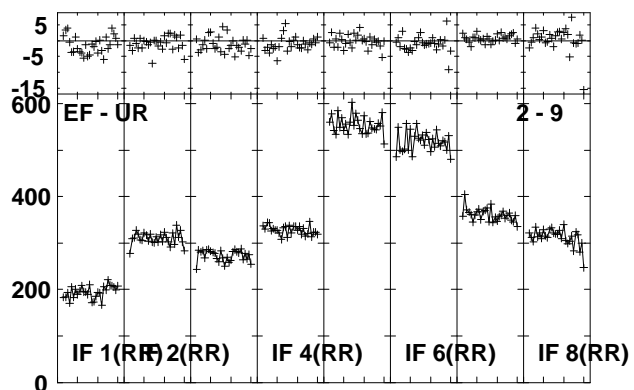
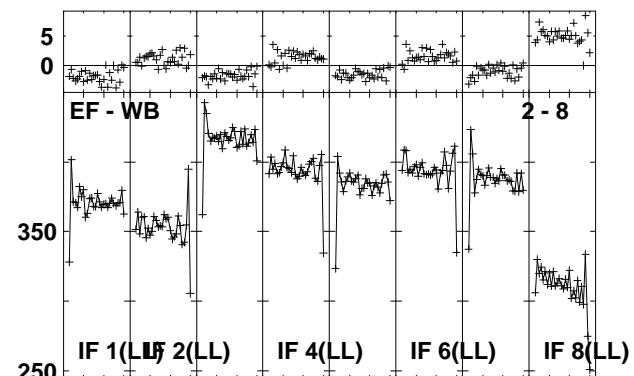
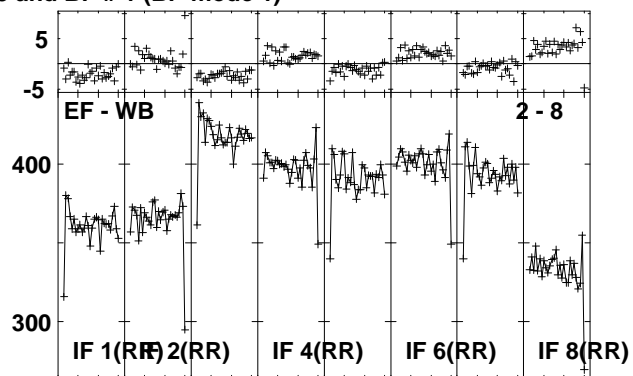
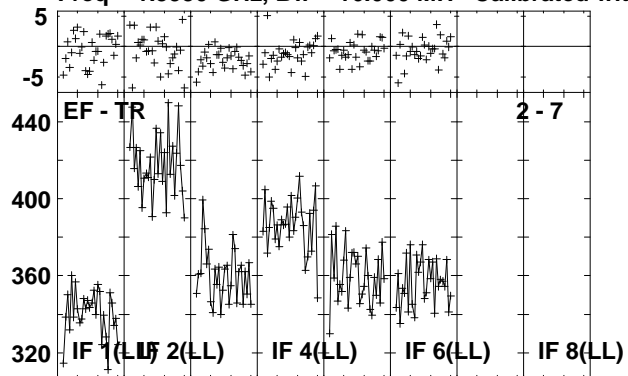

Lower frame: Milli Ampl Jy Top frame: Phas deg  
Vector averaged cross-power spectrum Several baselines displayed  
Timerange: 00/13:50:31 to 00/13:51:59



Plot file version 57 created 30-NOV-2010 14:28:08

ARP299C EP068B 3.UVDATA.1

Freq = 1.5950 GHz, Bw = 16.000 MH Calibrated with CL # 3 and BP # 1 (BP mode 1)

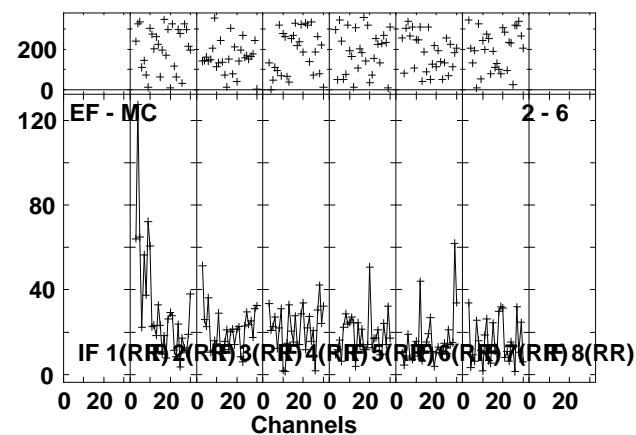
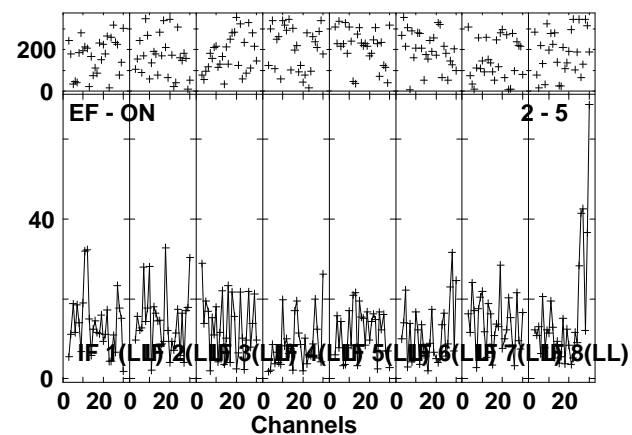
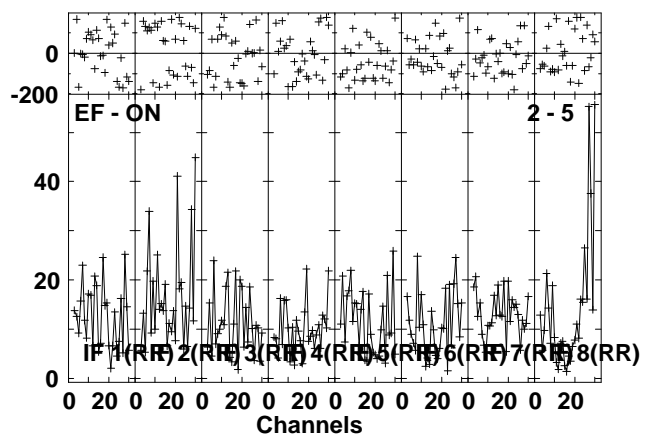
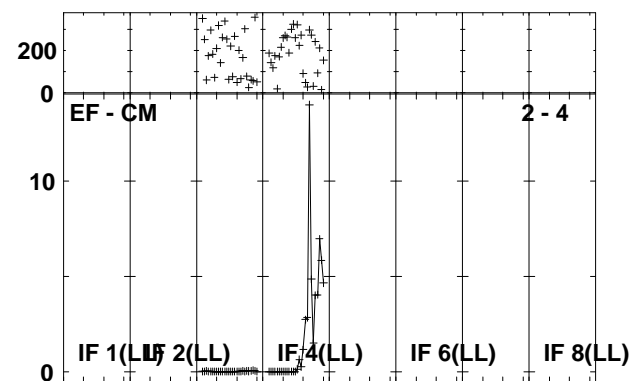
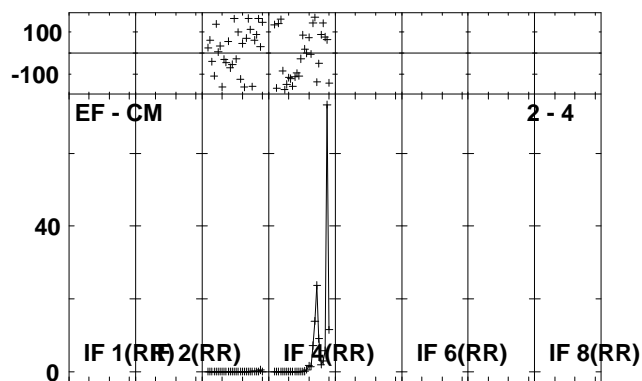
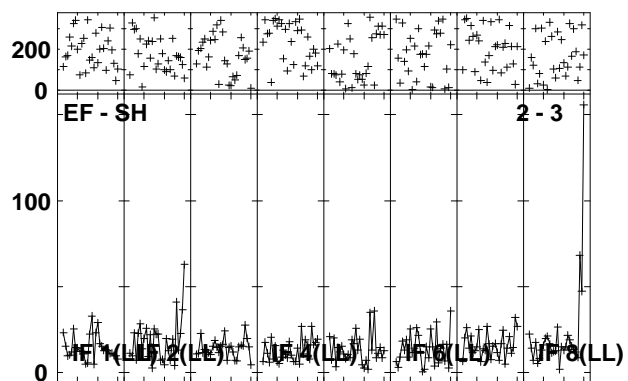
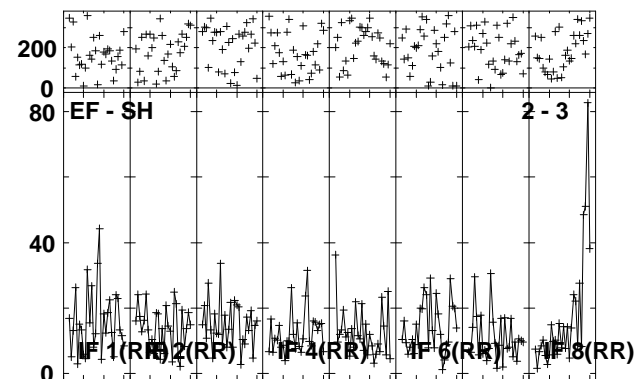
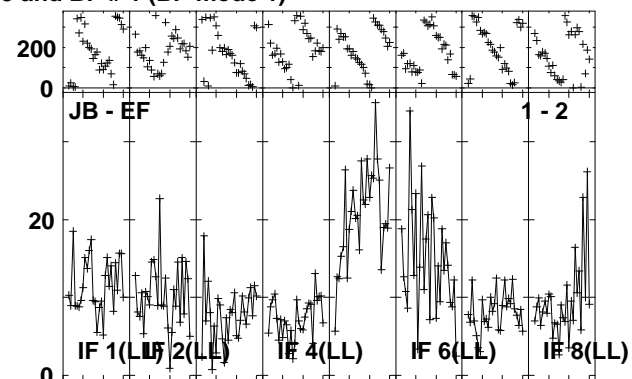
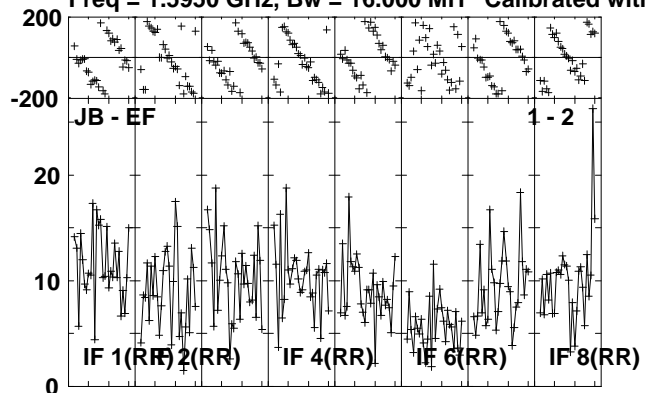

Lower frame: Milli Ampl Jy Top frame: Phas deg  
Vector averaged cross-power spectrum Several baselines displayed  
Timerange: 00/13:52:01 to 00/13:55:29

Plot file version 58 created 30-NOV-2010 14:28:10

ARP299C EP068B 3.UVDATA.1

Freq = 1.5950 GHz, Bw = 16.000 MH Calibrated with CL # 3 and BP # 1 (BP mode 1)

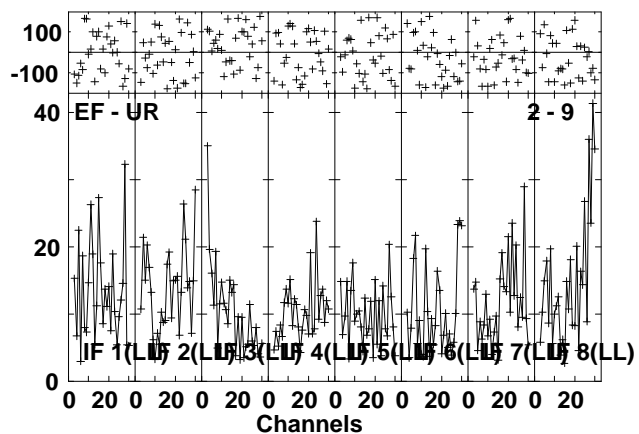
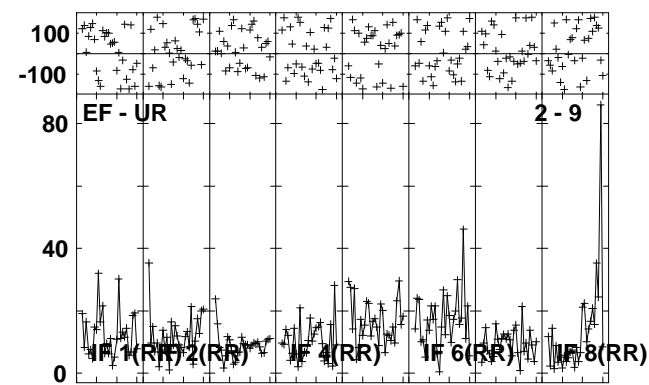
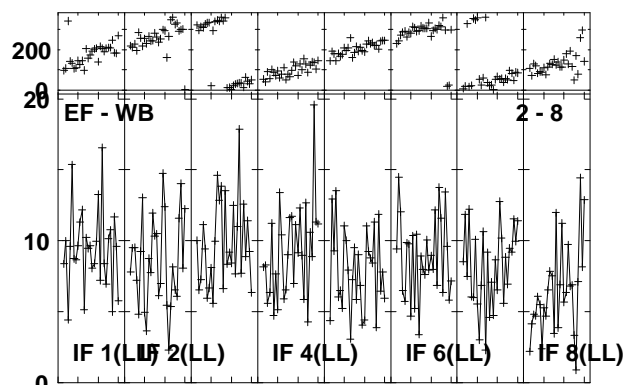
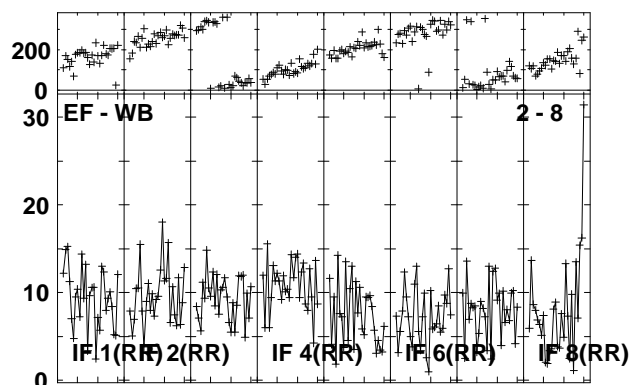
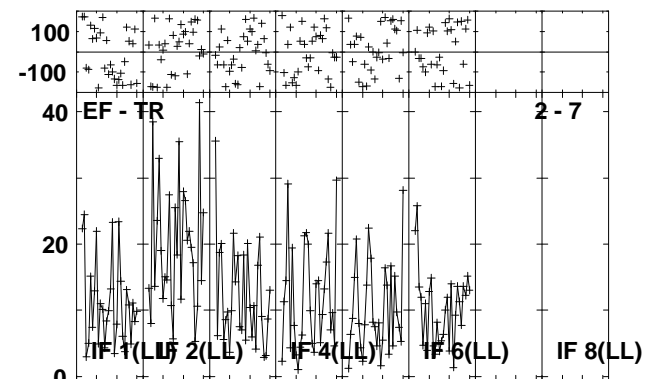
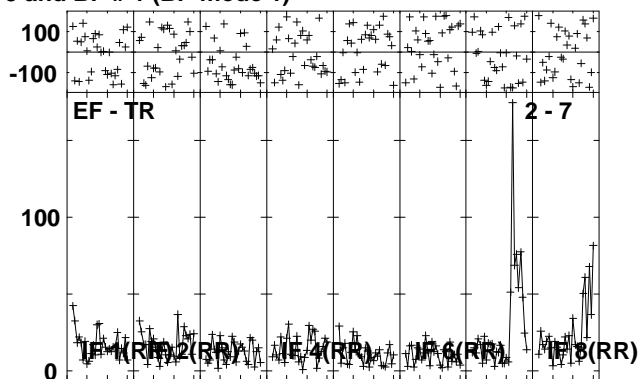
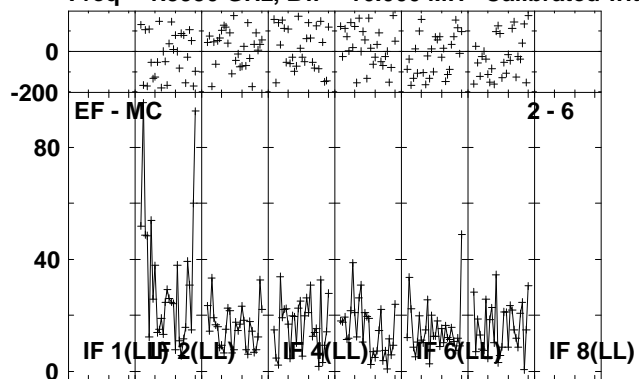

Lower frame: Milli Ampl Jy Top frame: Phas deg  
Vector averaged cross-power spectrum Several baselines displayed  
Timerange: 00/13:52:01 to 00/13:55:29

Plot file version 59 created 30-NOV-2010 14:28:12

J1128+59 EP068B 3.UVDATA.1

Freq = 1.5950 GHz, Bw = 16.000 MH Calibrated with CL # 3 and BP # 1 (BP mode 1)

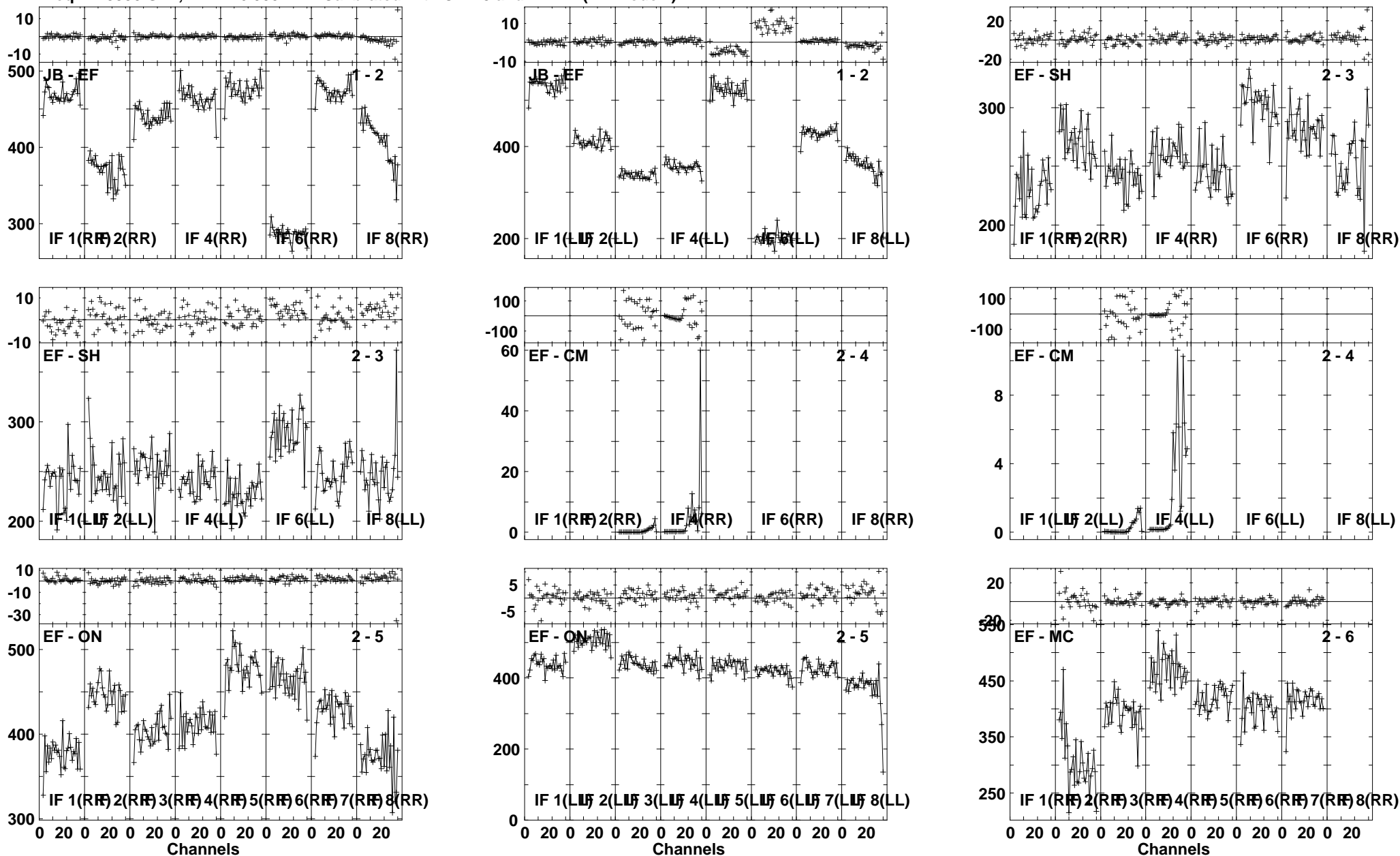

Lower frame: Milli Ampl Jy Top frame: Phas deg  
Vector averaged cross-power spectrum Several baselines displayed  
Timerange: 00/13:55:31 to 00/13:56:59

Plot file version 60 created 30-NOV-2010 14:28:14

J1128+59 EP068B 3.UVDATA.1

Freq = 1.5950 GHz, Bw = 16.000 MH Calibrated with CL # 3 and BP # 1 (BP mode 1)

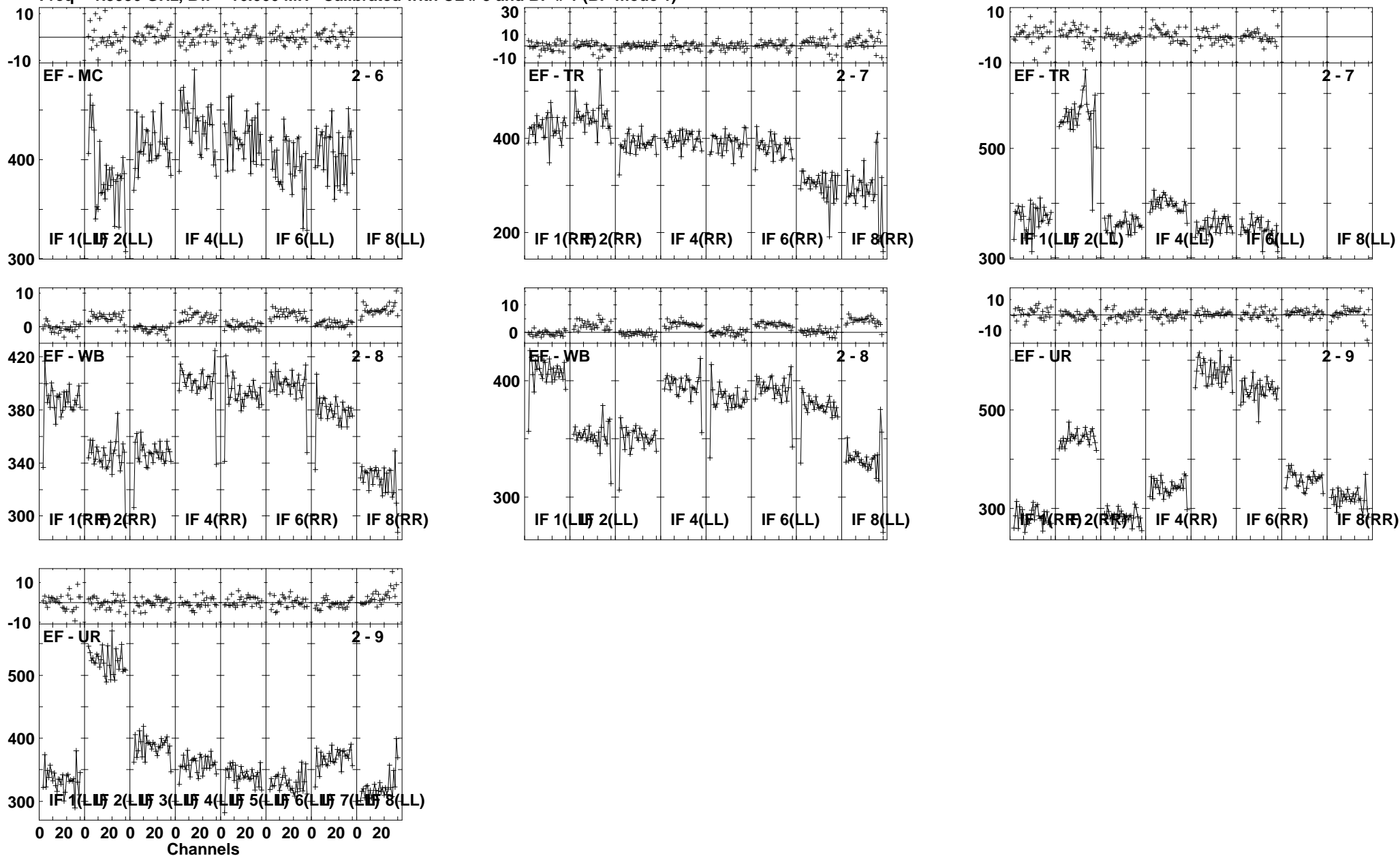

Lower frame: Milli Ampl Jy Top frame: Phas deg  
Vector averaged cross-power spectrum Several baselines displayed  
Timerange: 00/13:55:31 to 00/13:56:59

Plot file version 61 created 30-NOV-2010 14:28:15

ARP299C EP068B 3.UVDATA.1

Freq = 1.5950 GHz, Bw = 16.000 MH Calibrated with CL # 3 and BP # 1 (BP mode 1)

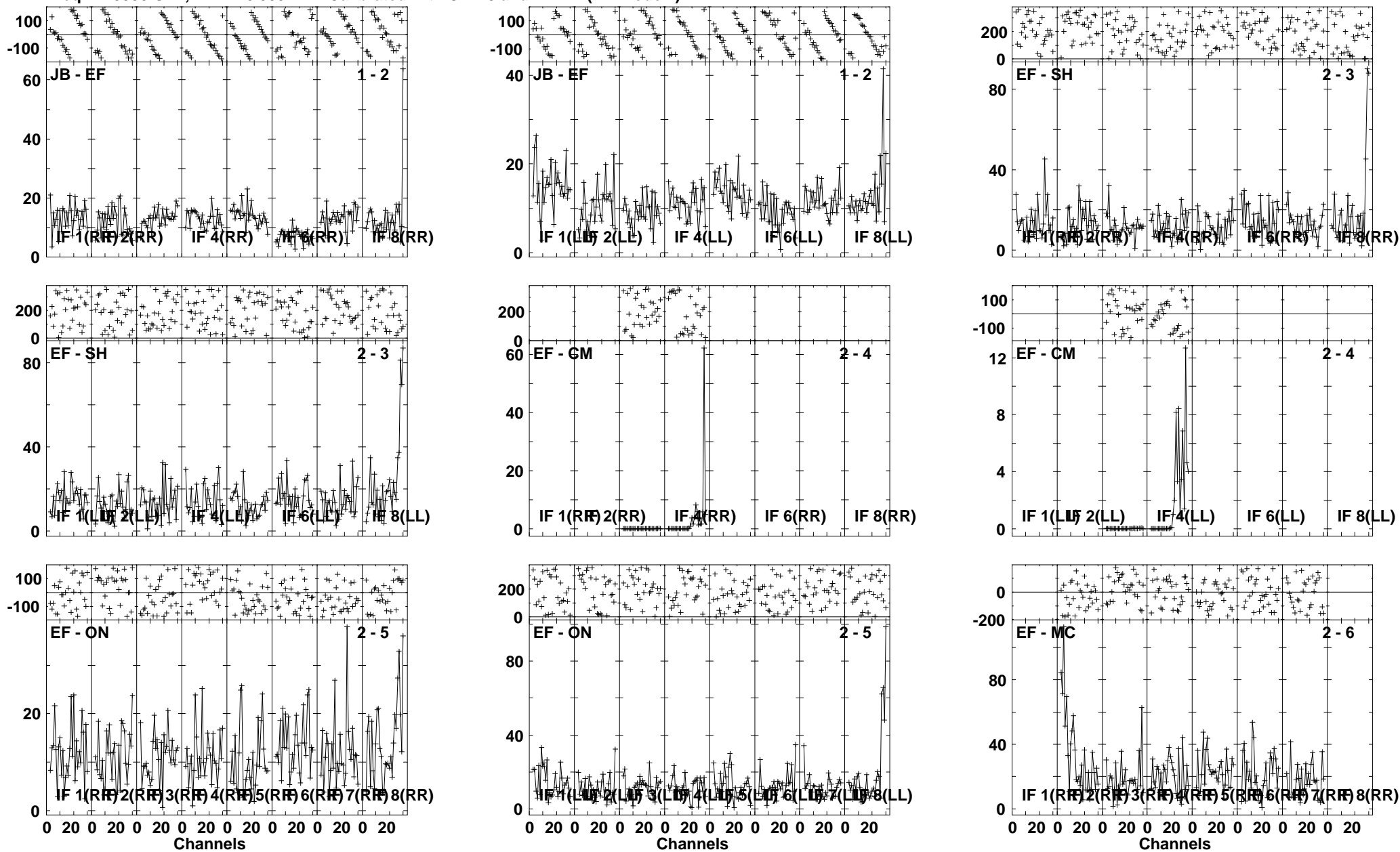

Lower frame: Milli Ampl Jy Top frame: Phas deg  
Vector averaged cross-power spectrum Several baselines displayed  
Timerange: 00/13:57:01 to 00/14:00:29

Plot file version 62 created 30-NOV-2010 14:28:18

ARP299C EP068B 3.UVDATA.1

Freq = 1.5950 GHz, Bw = 16.000 MH Calibrated with CL # 3 and BP # 1 (BP mode 1)

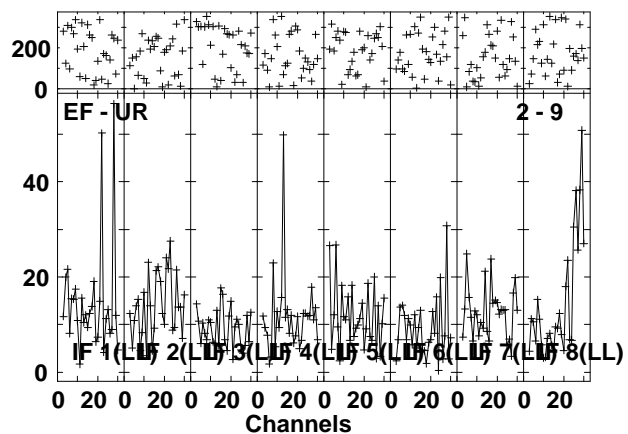
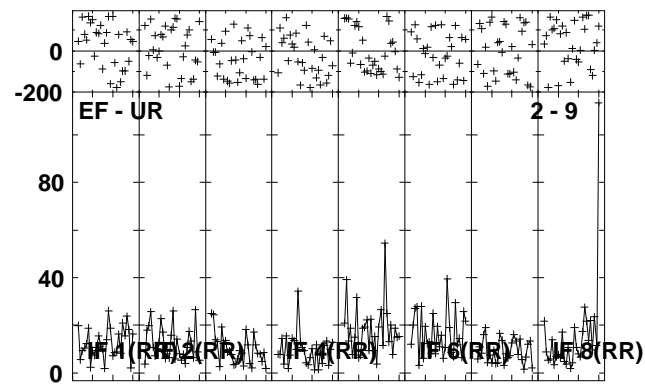
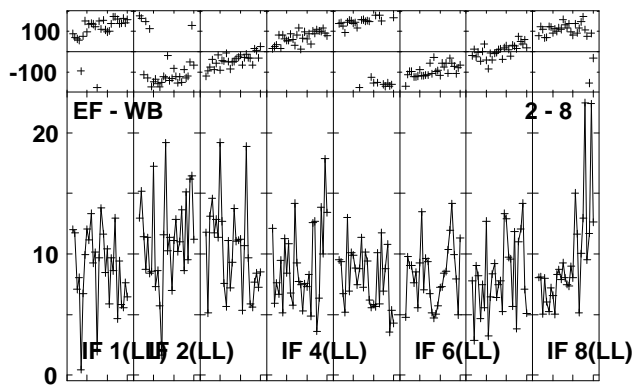
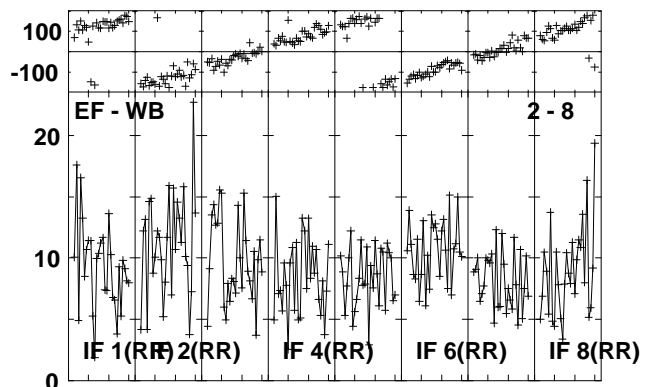
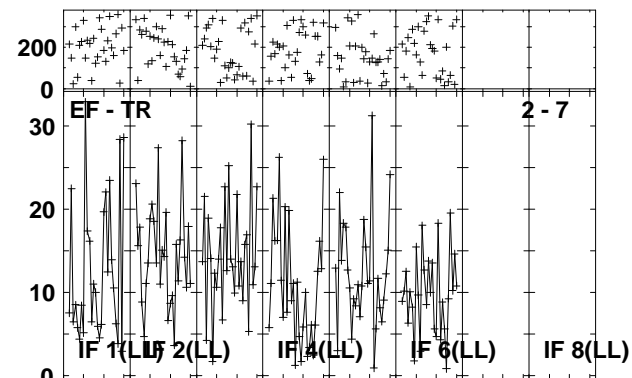
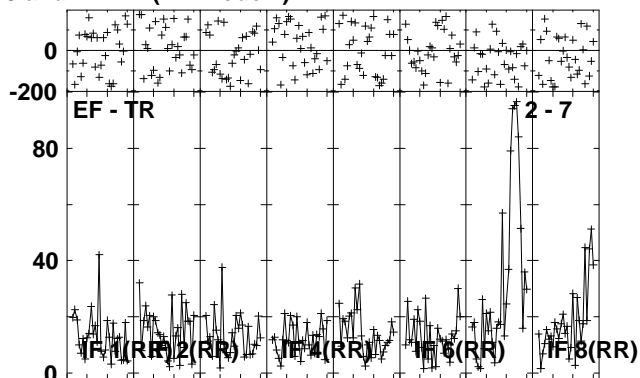
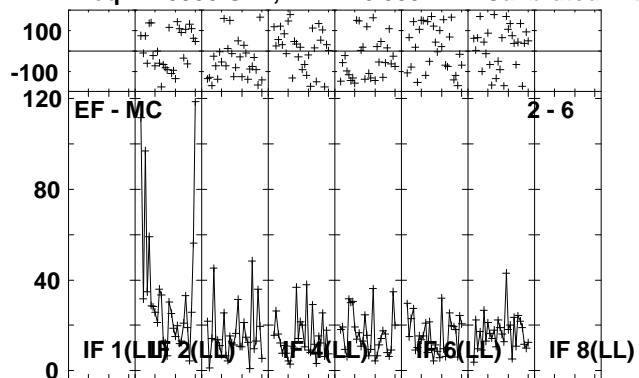

Lower frame: Milli Ampl Jy Top frame: Phas deg  
Vector averaged cross-power spectrum Several baselines displayed  
Timerange: 00/13:57:01 to 00/14:00:29

Plot file version 63 created 30-NOV-2010 14:28:20

J1128+59 EP068B 3.UVDATA.1

Freq = 1.5950 GHz, Bw = 16.000 MH Calibrated with CL # 3 and BP # 1 (BP mode 1)

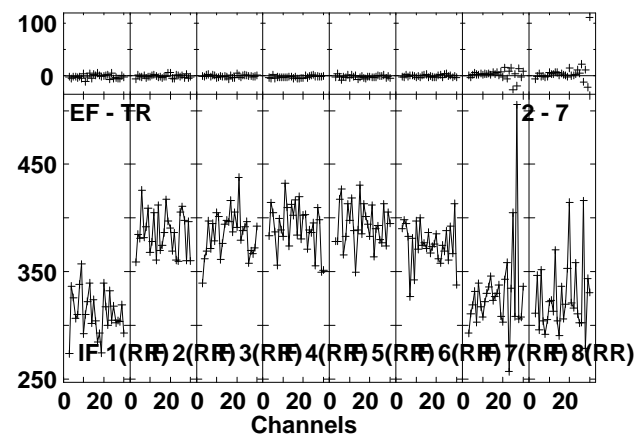
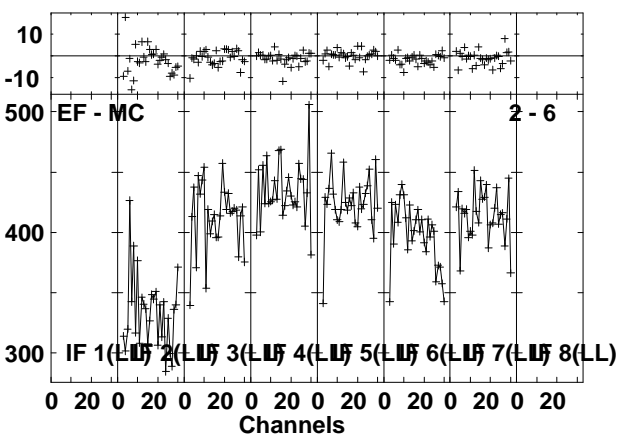
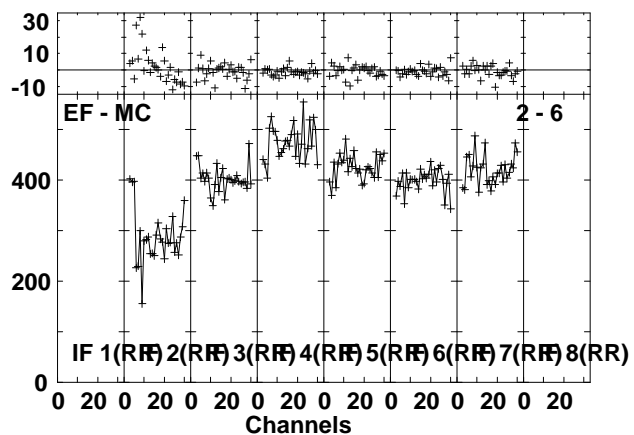
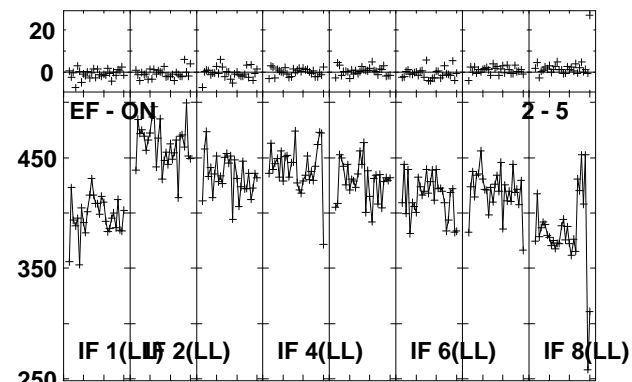
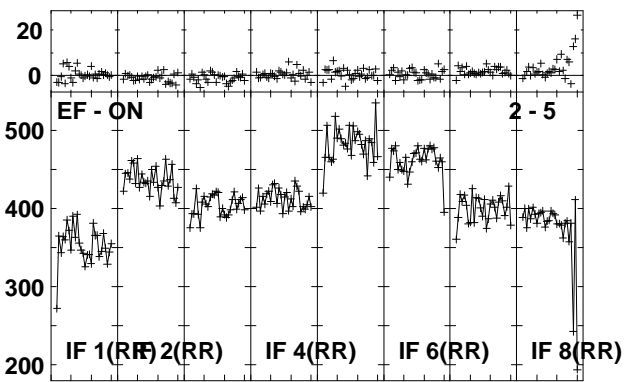
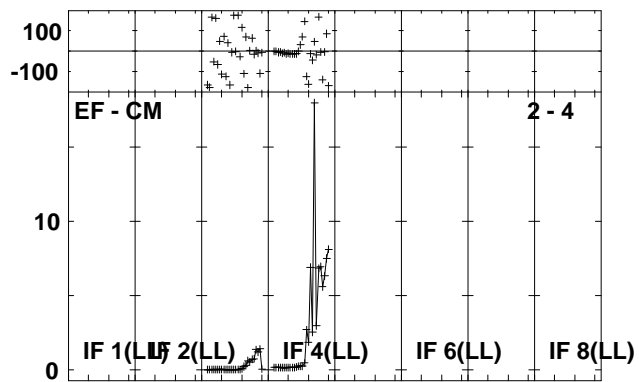
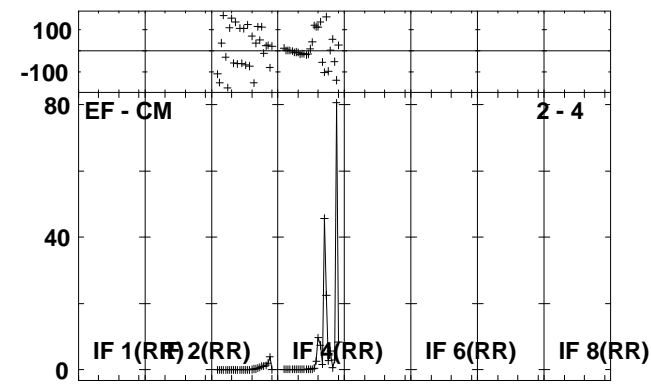
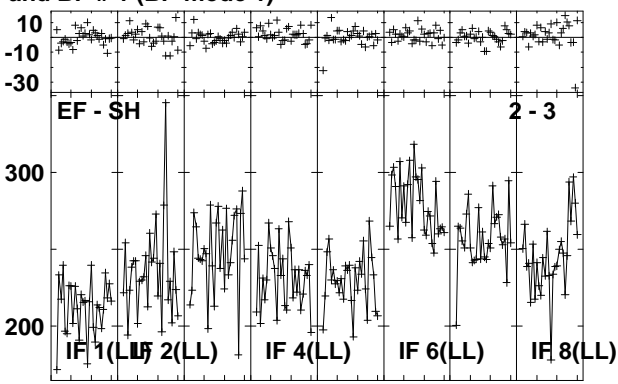
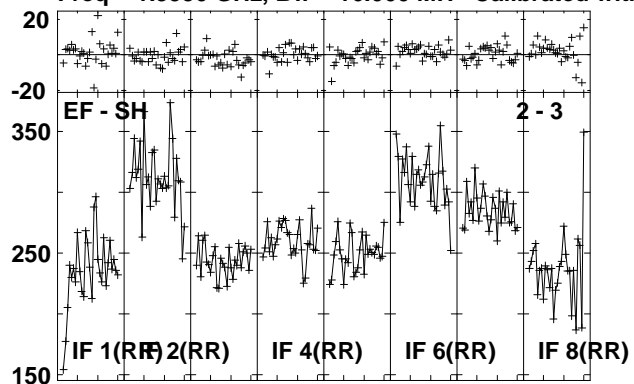

Lower frame: Milli Ampl Jy Top frame: Phas deg  
Vector averaged cross-power spectrum Several baselines displayed  
Timerange: 00/14:00:31 to 00/14:01:59

Plot file version 64 created 30-NOV-2010 14:28:21

J1128+59 EP068B 3.UVDATA.1

Freq = 1.5950 GHz, Bw = 16.000 MH Calibrated with CL # 3 and BP # 1 (BP mode 1)

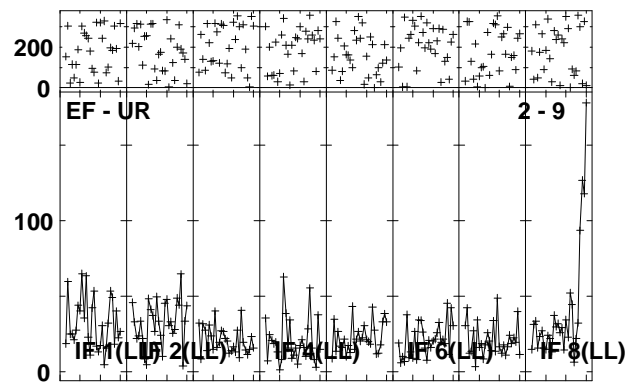
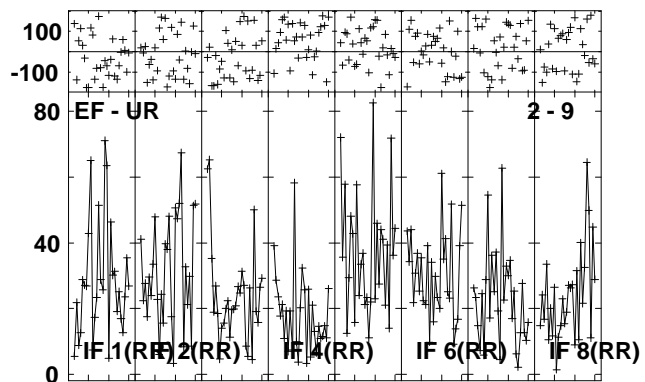
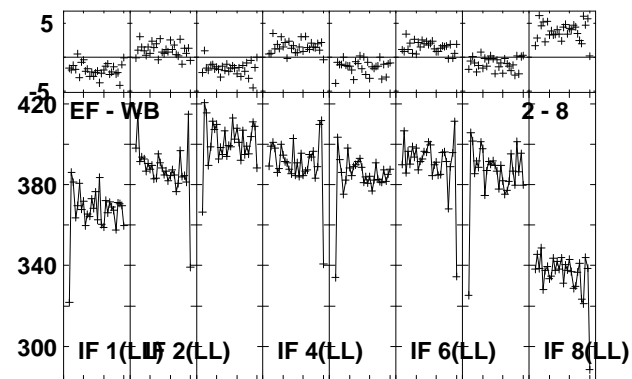
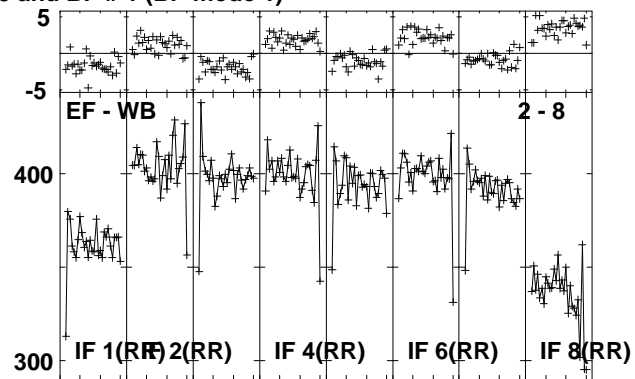
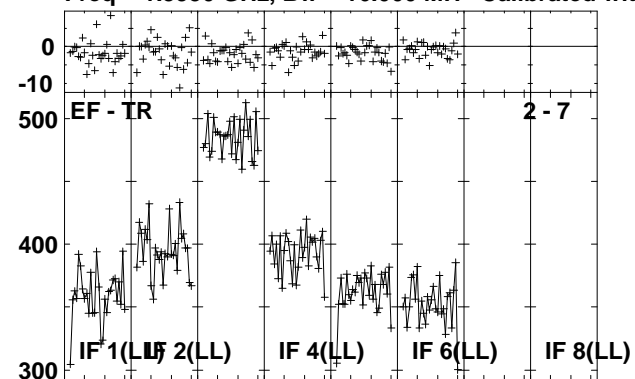

Lower frame: Milli Ampl Jy Top frame: Phas deg  
Vector averaged cross-power spectrum Several baselines displayed  
Timerange: 00/14:00:31 to 00/14:01:59



Plot file version 65 created 30-NOV-2010 14:28:22

ARP299C EP068B 3.UVDATA.1

Freq = 1.5950 GHz, Bw = 16.000 MH Calibrated with CL # 3 and BP # 1 (BP mode 1)

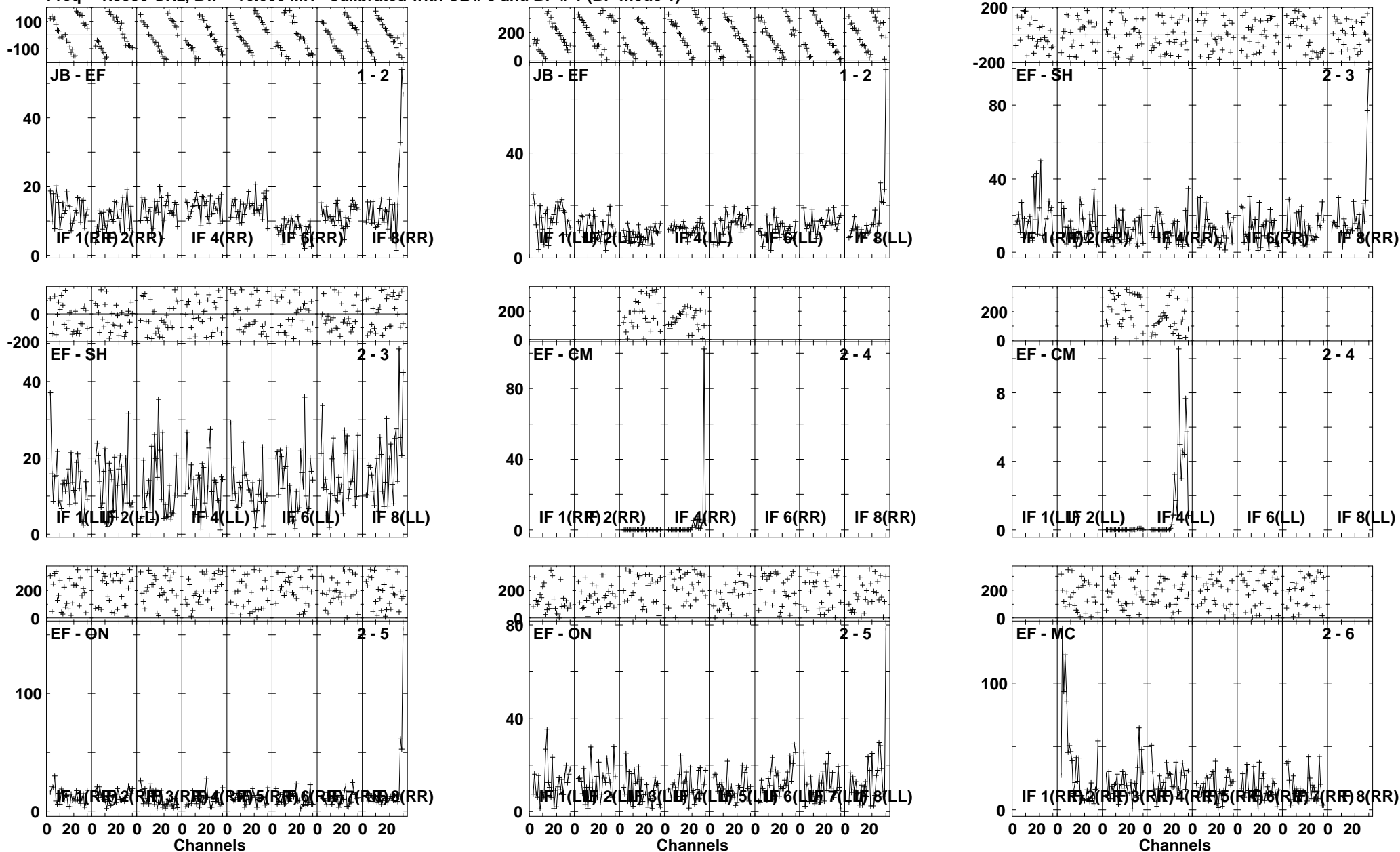

Lower frame: Milli Ampl Jy Top frame: Phas deg  
Vector averaged cross-power spectrum Several baselines displayed  
Timerange: 00/14:02:01 to 00/14:05:29

Plot file version 66 created 30-NOV-2010 14:28:24

ARP299C EP068B 3.UVDATA.1

Freq = 1.5950 GHz, Bw = 16.000 MH Calibrated with CL # 3 and BP # 1 (BP mode 1)

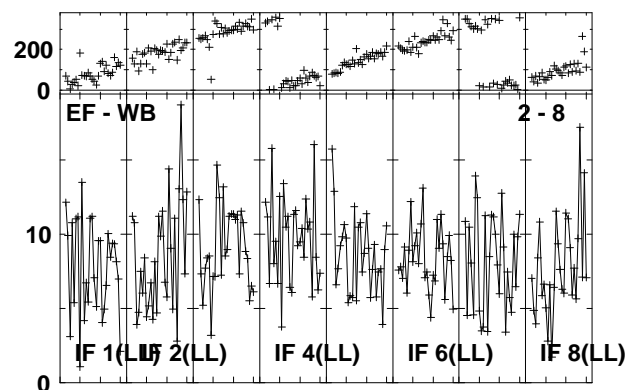
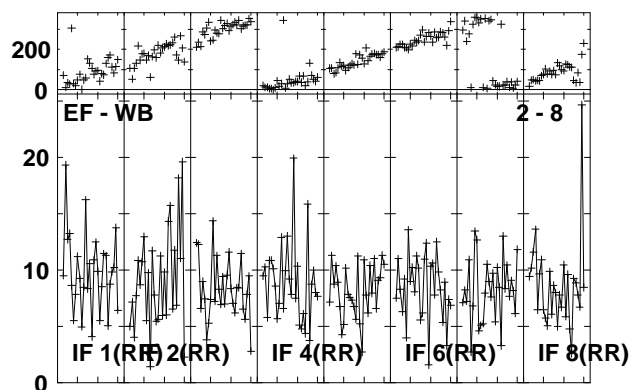
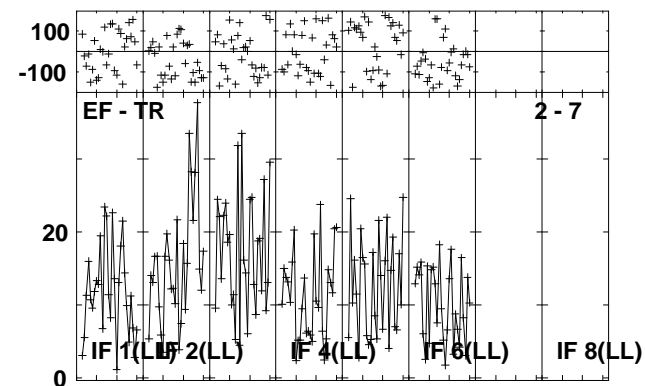
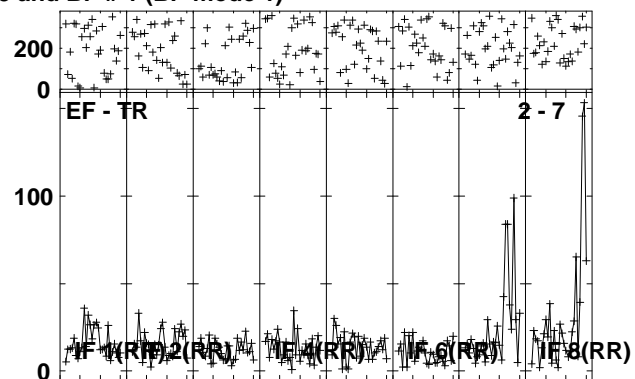
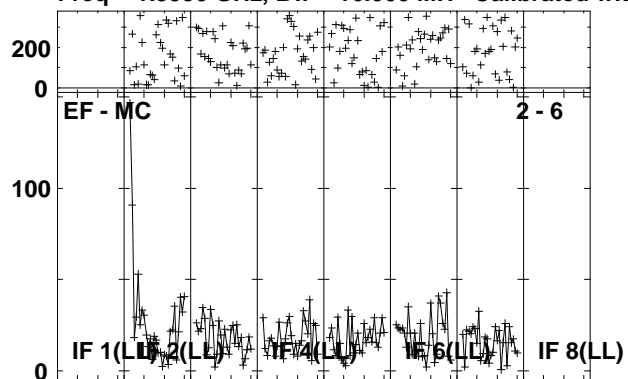

Lower frame: Milli Ampl Jy Top frame: Phas deg  
Vector averaged cross-power spectrum Several baselines displayed  
Timerange: 00/14:02:01 to 00/14:05:29

Plot file version 67 created 30-NOV-2010 14:28:27  
 J1128+59 EP068B 3.UVDATA.1  
 Freq = 1.5950 GHz, Bw = 16.000 MH Calibrated with CL # 3 and BP # 1 (BP mode 1)

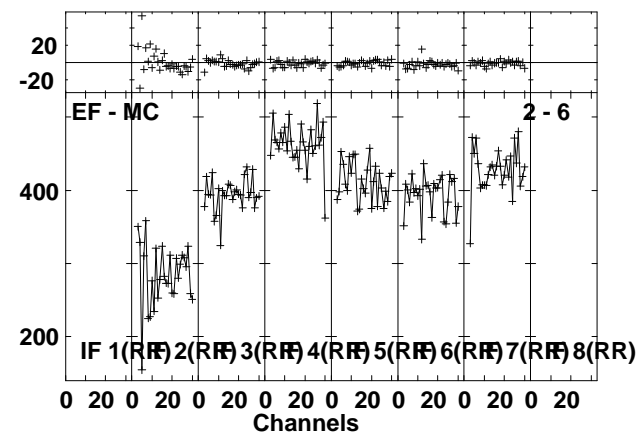
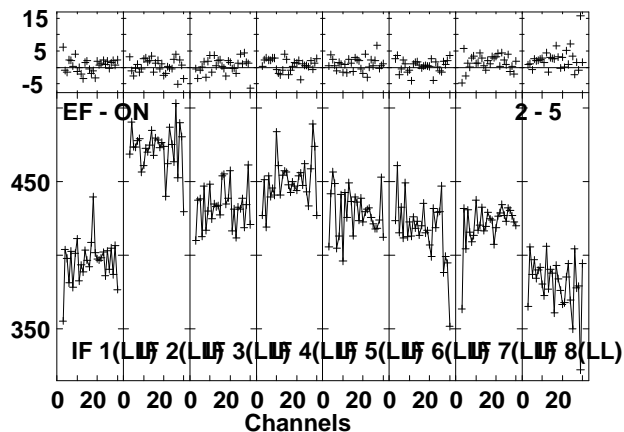
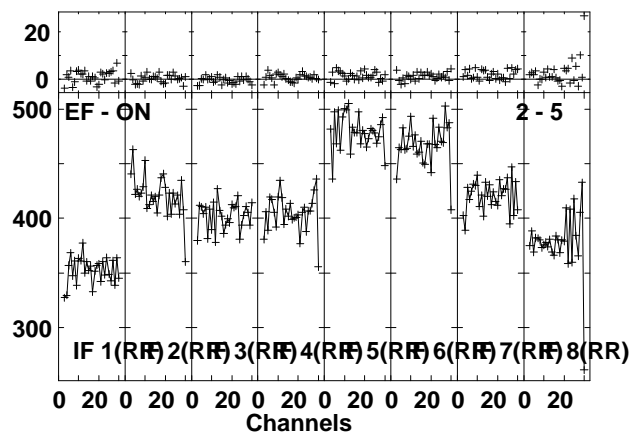
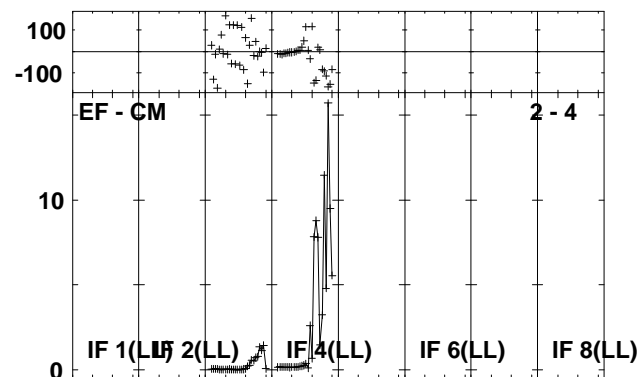
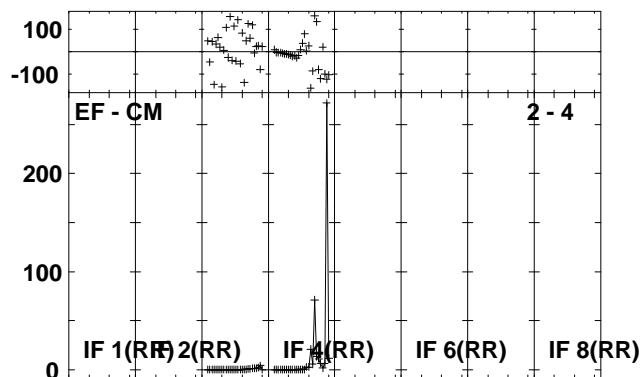
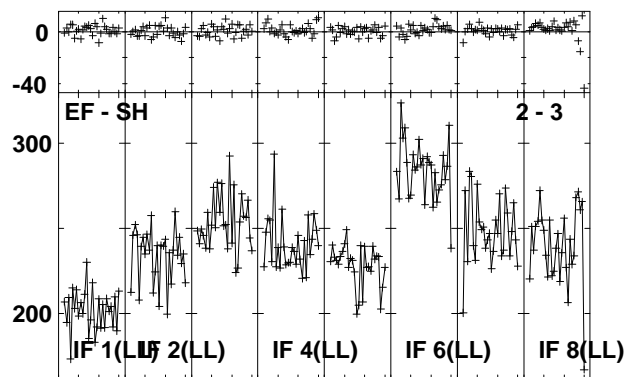
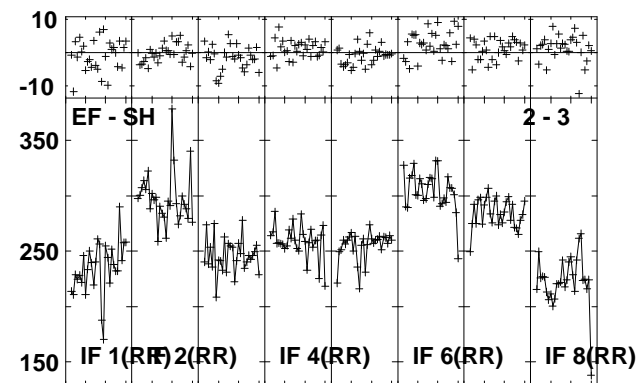
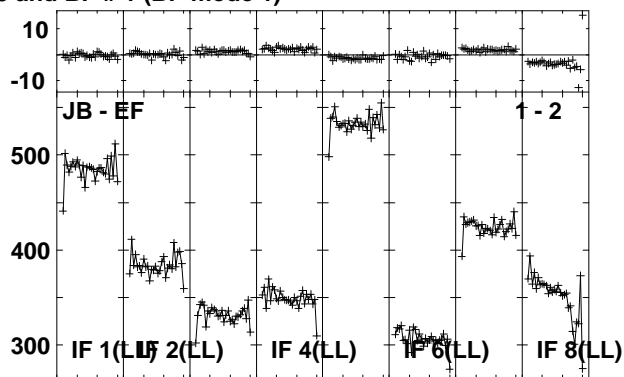
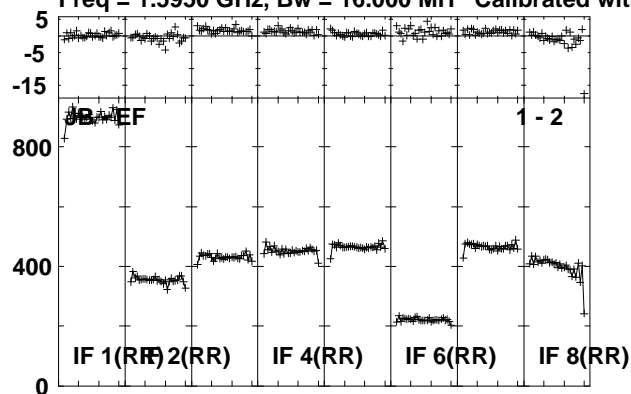

Lower frame: Milli Ampl Jy Top frame: Phas deg  
 Vector averaged cross-power spectrum Several baselines displayed  
 Timerange: 00/14:06:31 to 00/14:07:59

Plot file version 68 created 30-NOV-2010 14:28:28

J1128+59 EP068B 3.UVDATA.1

Freq = 1.5950 GHz, Bw = 16.000 MH Calibrated with CL # 3 and BP # 1 (BP mode 1)

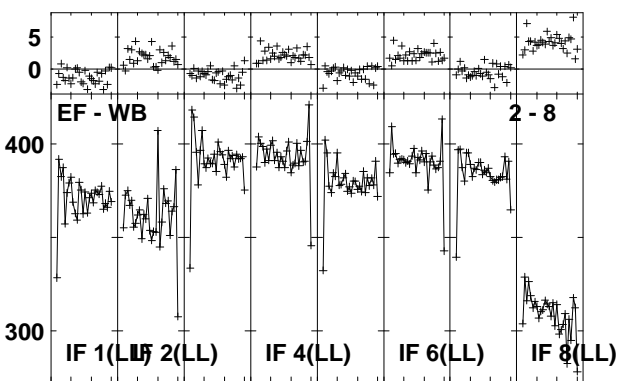
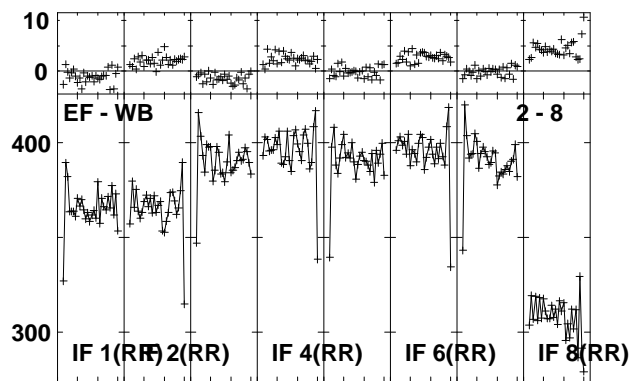
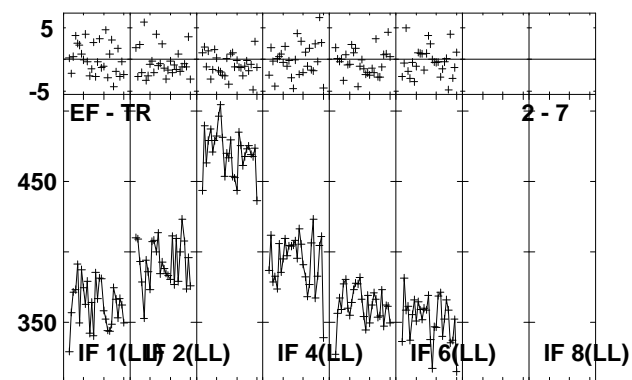
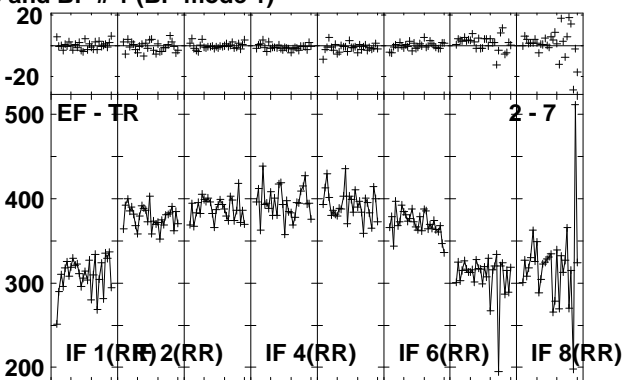
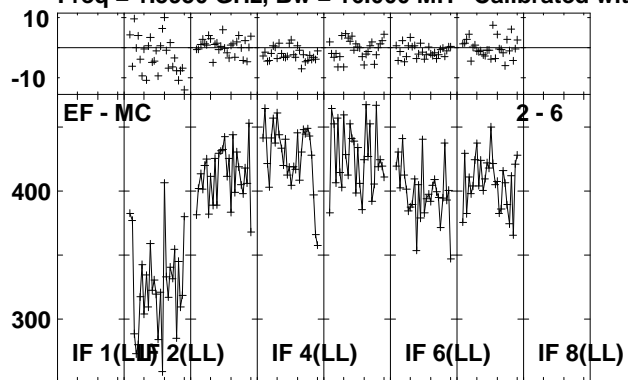

Lower frame: Milli Ampl Jy Top frame: Phas deg  
Vector averaged cross-power spectrum Several baselines displayed  
Timerange: 00/14:06:31 to 00/14:07:59

Plot file version 69 created 30-NOV-2010 14:28:30

ARP299C EP068B 3.UVDATA.1

Freq = 1.5950 GHz, Bw = 16.000 MH Calibrated with CL # 3 and BP # 1 (BP mode 1)

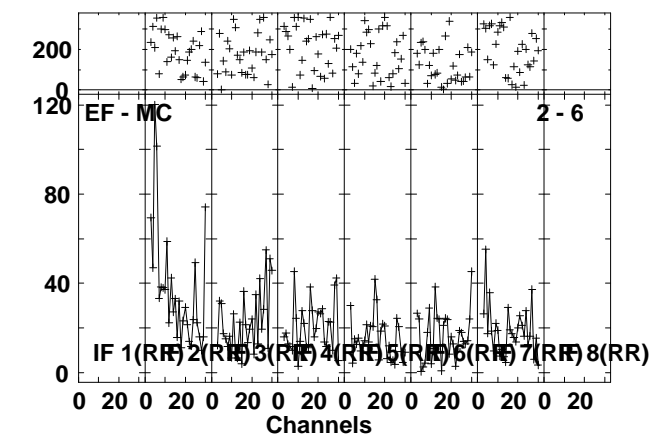
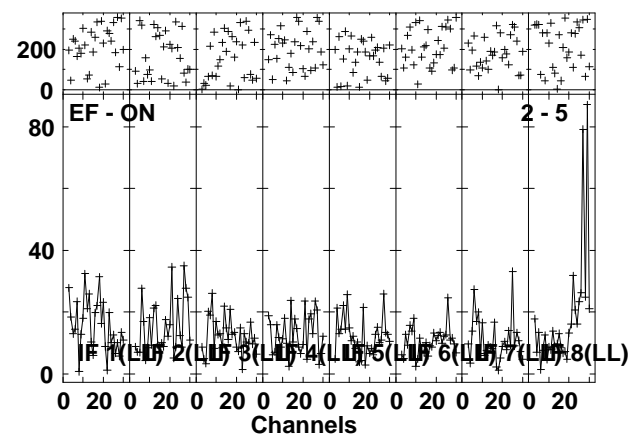
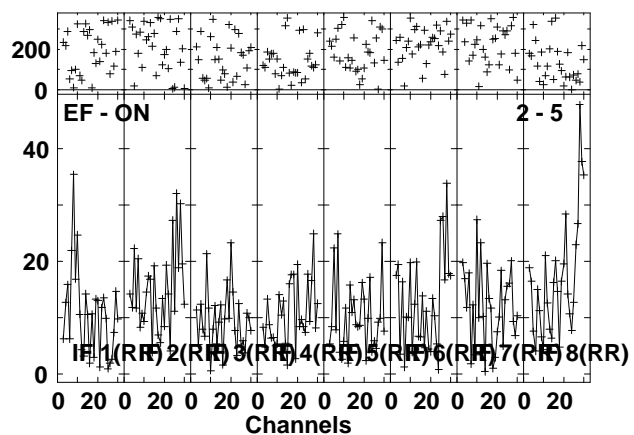
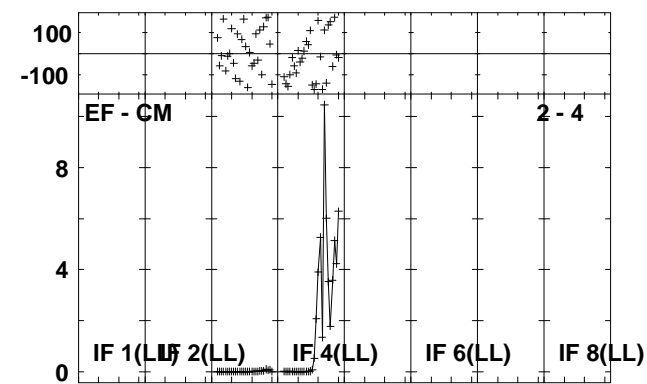
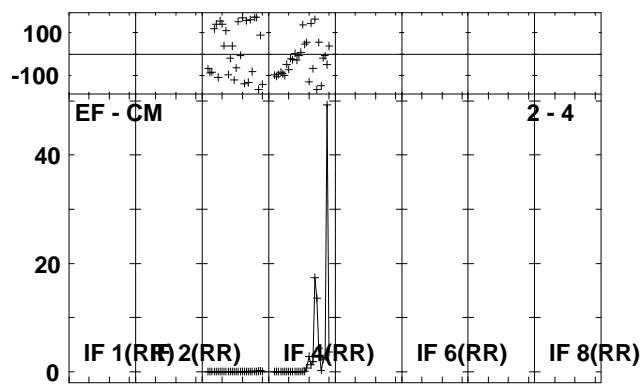
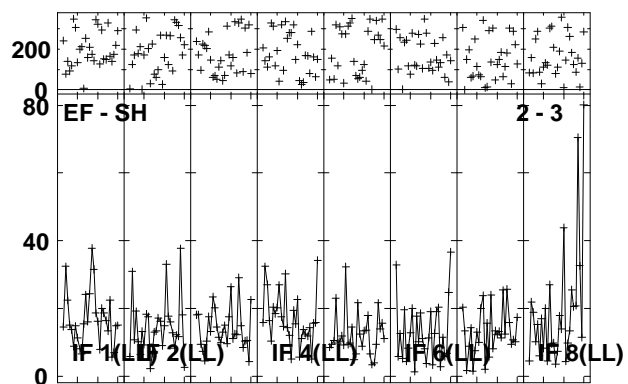
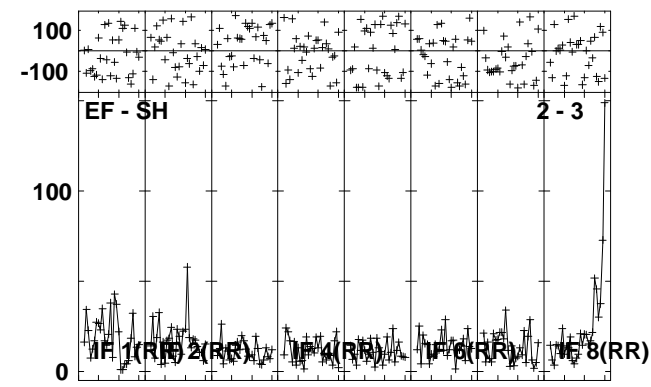
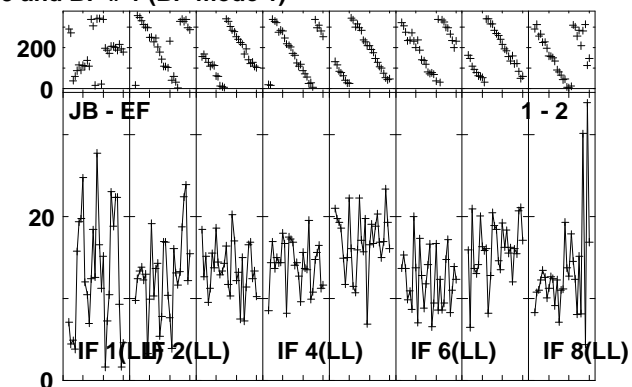
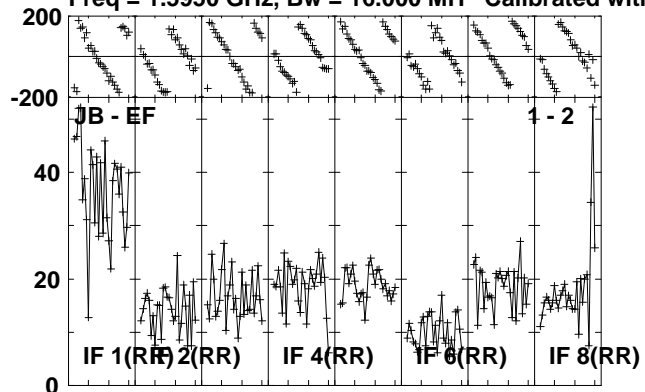

Lower frame: Milli Ampl Jy Top frame: Phas deg  
Vector averaged cross-power spectrum Several baselines displayed  
Timerange: 00/14:08:01 to 00/14:11:29

Plot file version 70 created 30-NOV-2010 14:28:32

ARP299C EP068B 3.UVDATA.1

Freq = 1.5950 GHz, Bw = 16.000 MH Calibrated with CL # 3 and BP # 1 (BP mode 1)

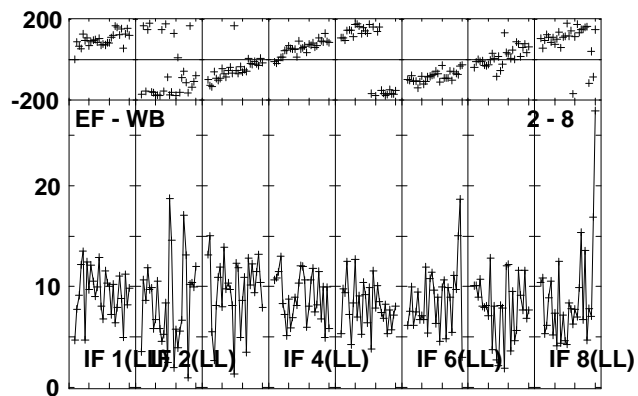
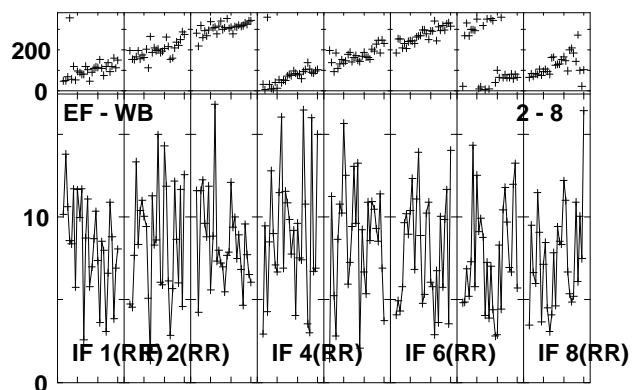
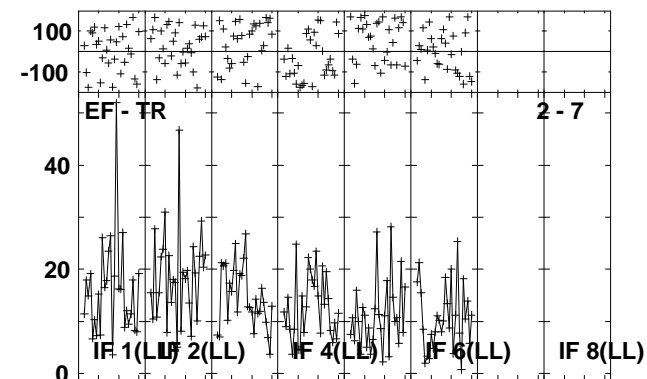
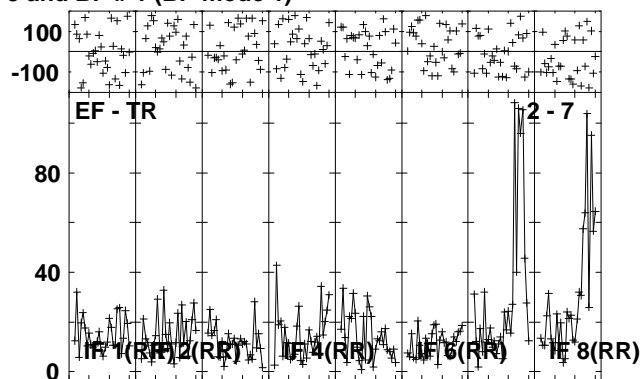
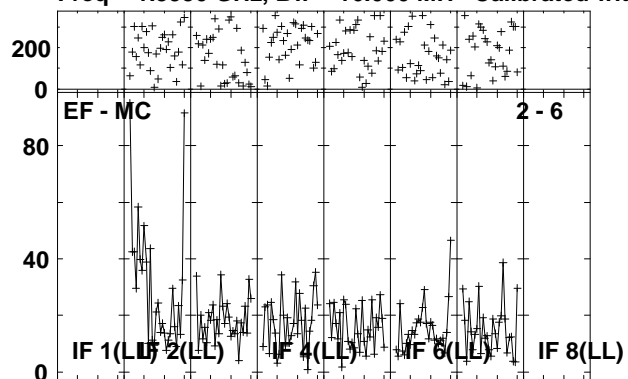

Lower frame: Milli Ampl Jy Top frame: Phas deg  
Vector averaged cross-power spectrum Several baselines displayed  
Timerange: 00/14:08:01 to 00/14:11:29

Plot file version 71 created 30-NOV-2010 14:28:35  
 J1128+59 EP068B 3.UVDATA.1  
 Freq = 1.5950 GHz, Bw = 16.000 MH Calibrated with CL # 3 and BP # 1 (BP mode 1)

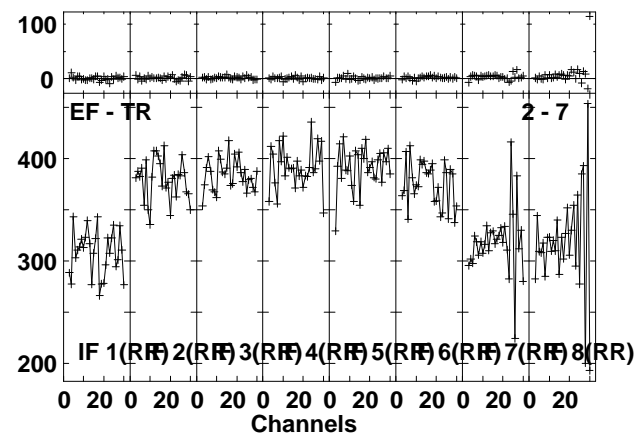
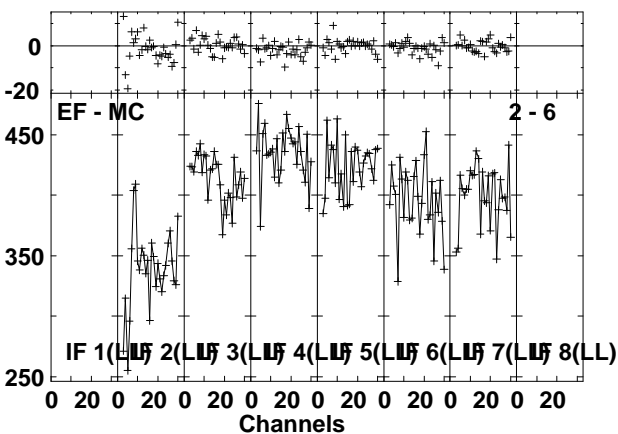
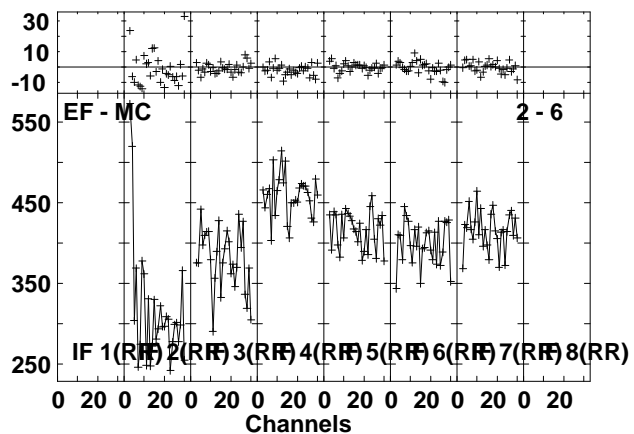
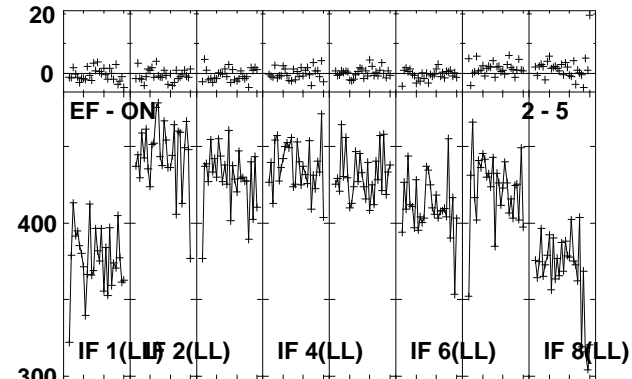
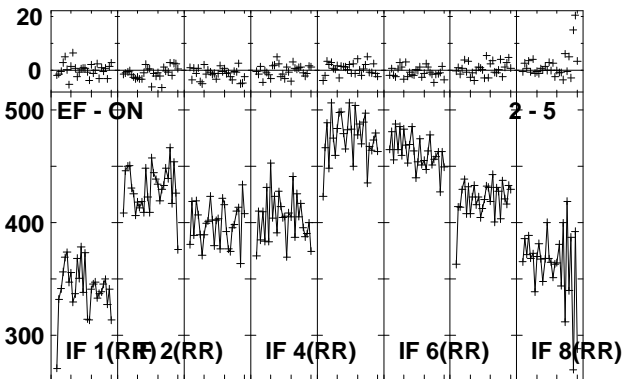
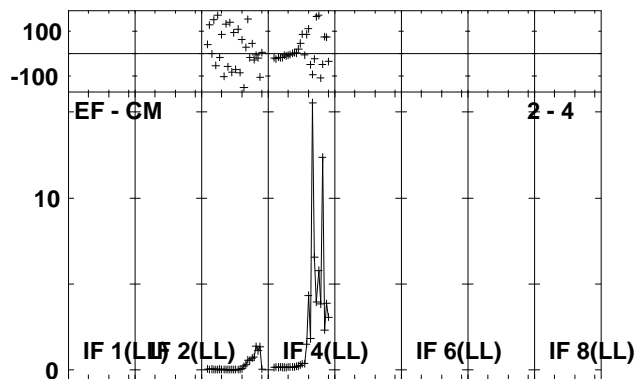
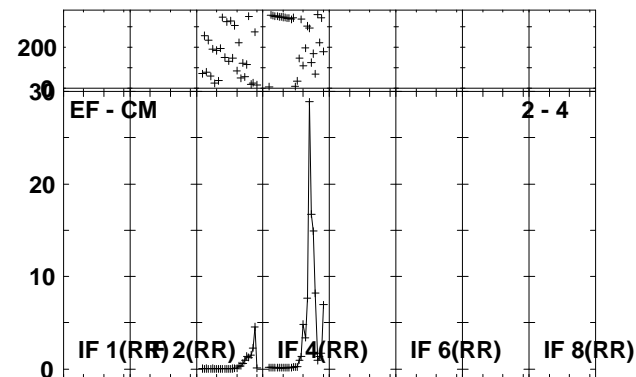
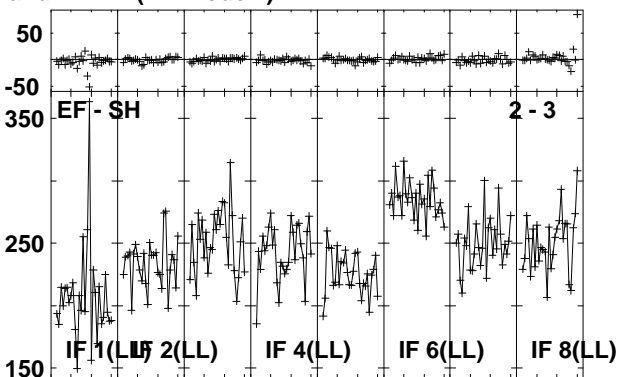
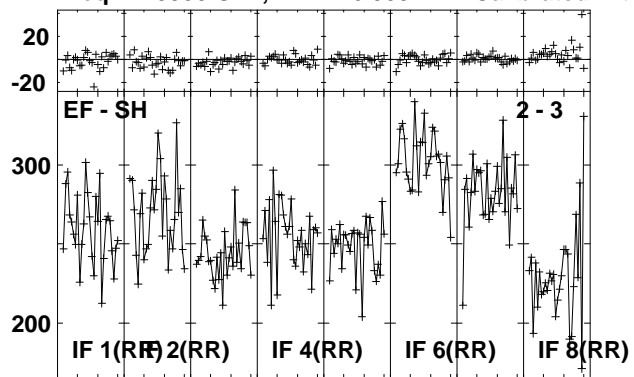

Lower frame: Milli Ampl Jy Top frame: Phas deg  
 Vector averaged cross-power spectrum Several baselines displayed  
 Timerange: 00/14:11:31 to 00/14:12:59

Plot file version 72 created 30-NOV-2010 14:28:36

J1128+59 EP068B 3.UVDATA.1

Freq = 1.5950 GHz, Bw = 16.000 MH Calibrated with CL # 3 and BP # 1 (BP mode 1)

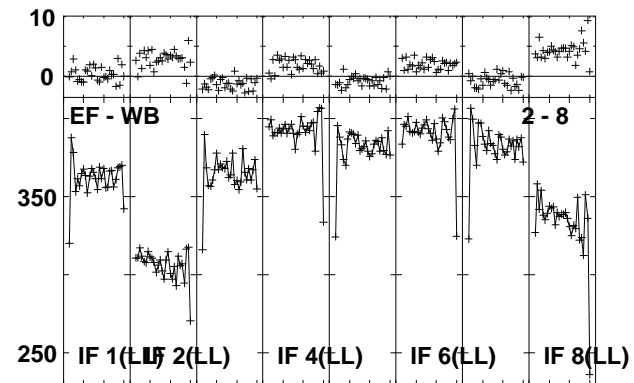
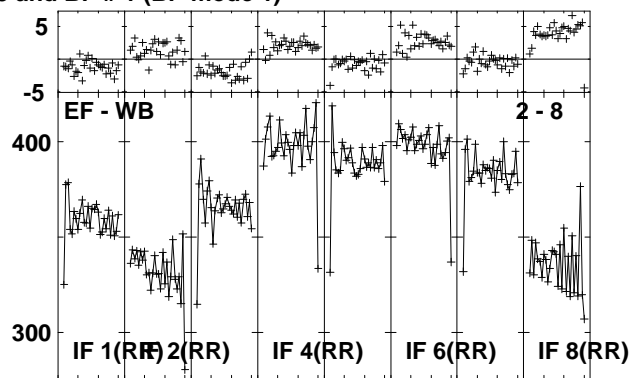
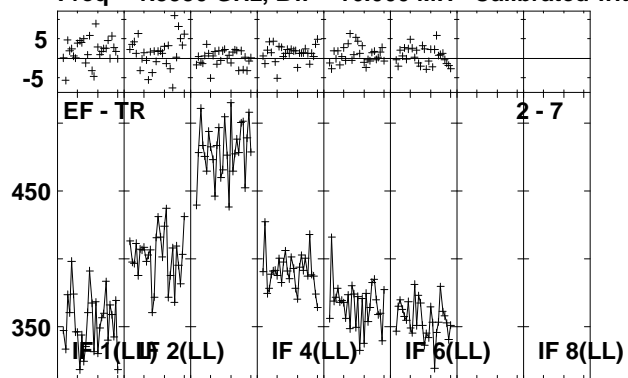

Lower frame: Milli Ampl Jy Top frame: Phas deg  
Vector averaged cross-power spectrum Several baselines displayed  
Timerange: 00/14:11:31 to 00/14:12:59



Plot file version 73 created 30-NOV-2010 14:28:37

ARP299C EP068B 3.UVDATA.1

Freq = 1.5950 GHz, Bw = 16.000 MH Calibrated with CL # 3 and BP # 1 (BP mode 1)

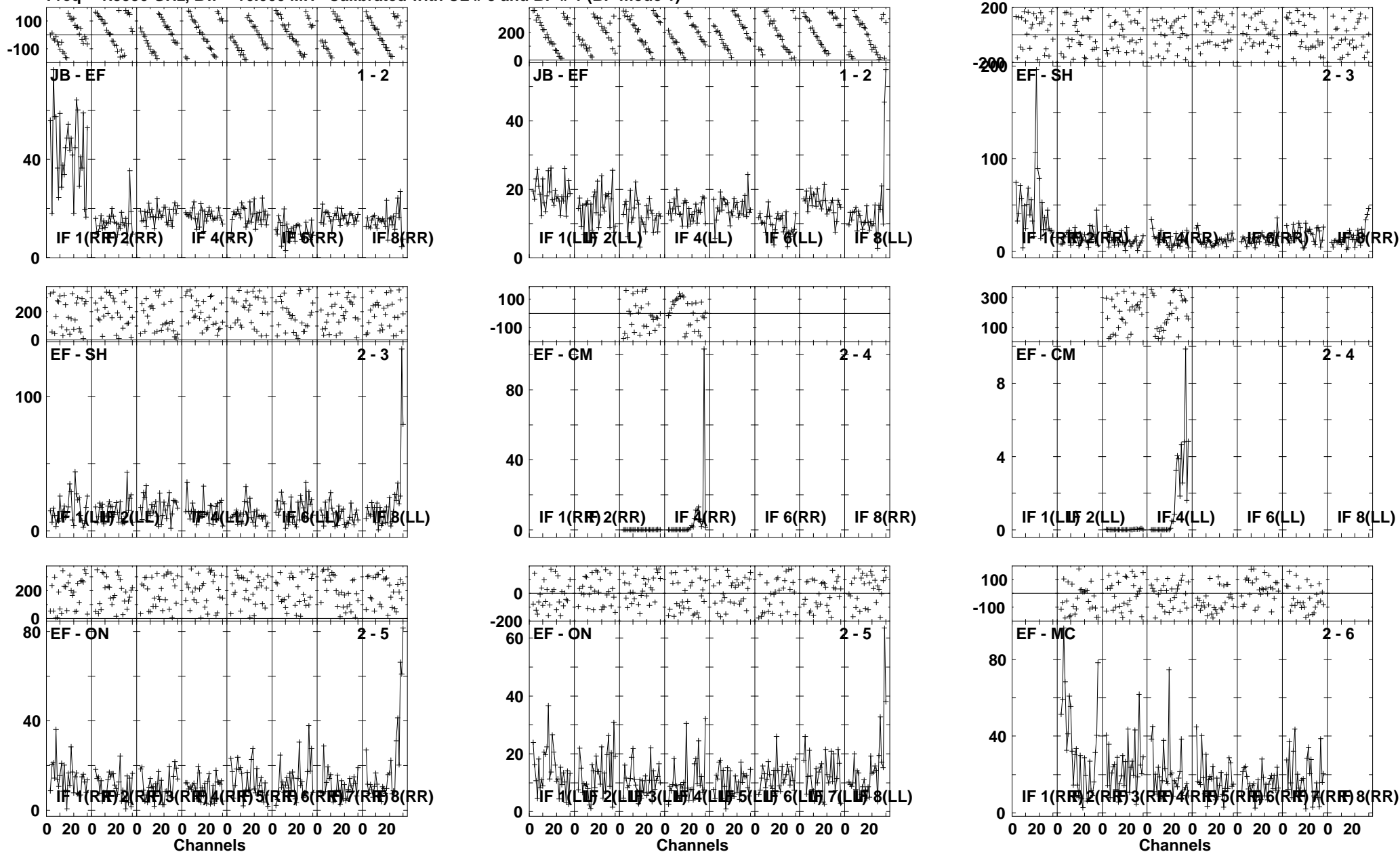

Lower frame: Milli Ampl Jy Top frame: Phas deg  
Vector averaged cross-power spectrum Several baselines displayed  
Timerange: 00/14:13:01 to 00/14:16:29

Plot file version 74 created 30-NOV-2010 14:28:39

ARP299C EP068B 3.UVDATA.1

Freq = 1.5950 GHz, Bw = 16.000 MH Calibrated with CL # 3 and BP # 1 (BP mode 1)

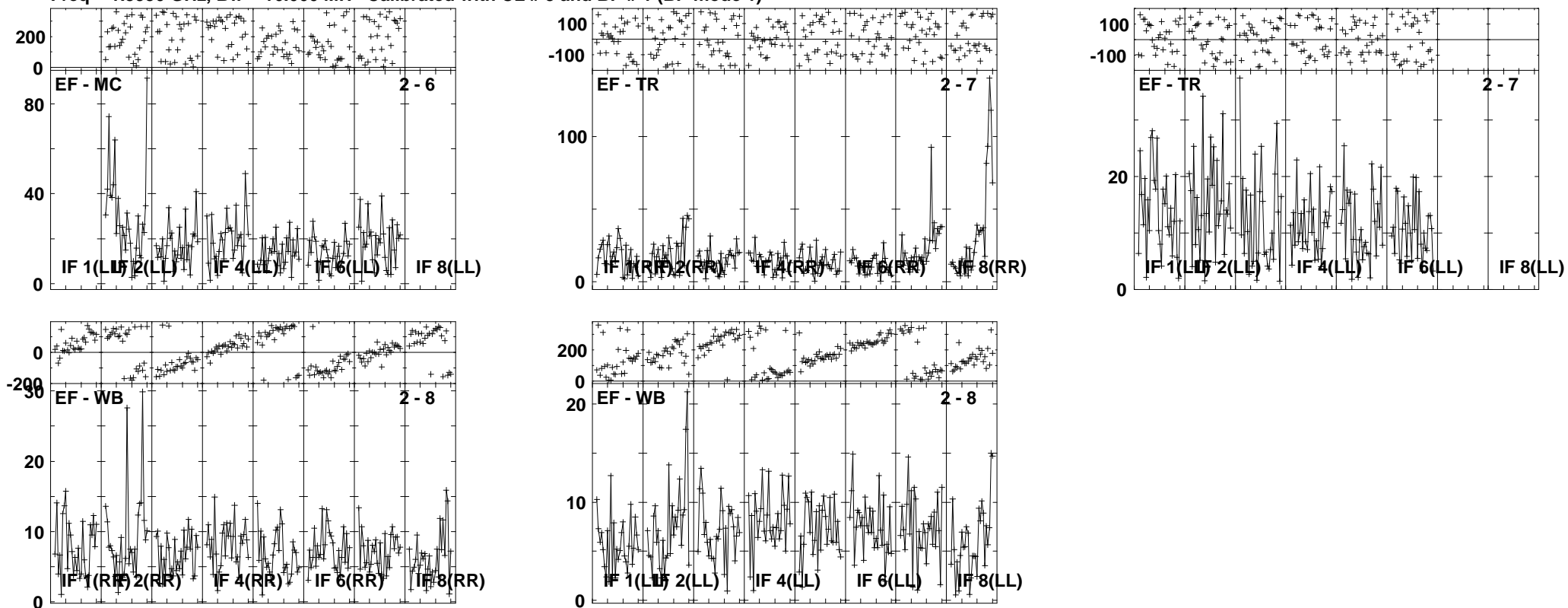

Lower frame: Milli Ampl Jy Top frame: Phas deg  
Vector averaged cross-power spectrum Several baselines displayed  
Timerange: 00/14:13:01 to 00/14:16:29

Plot file version 75 created 30-NOV-2010 14:28:42  
 4C39.25 EP068B 3.UVDATA.1  
 Freq = 1.5950 GHz, Bw = 16.000 MH Calibrated with CL # 3 and BP # 1 (BP mode 1)

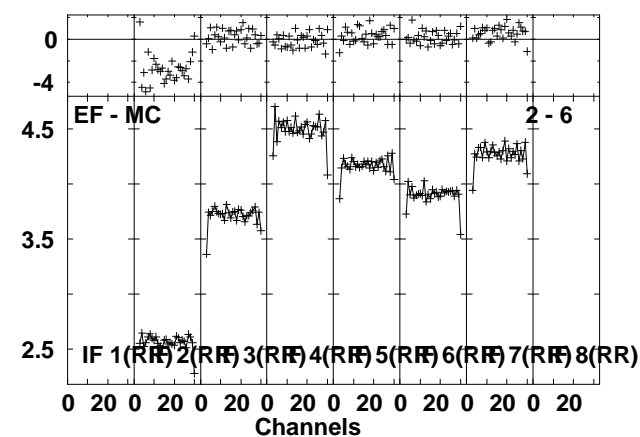
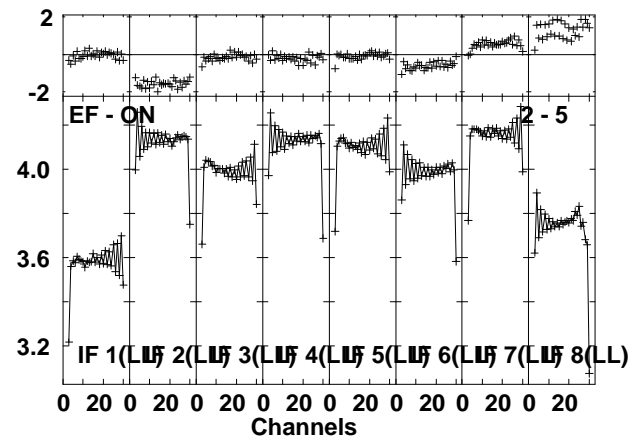
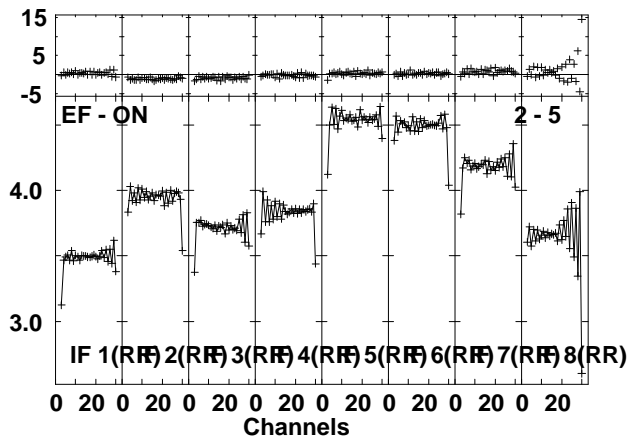
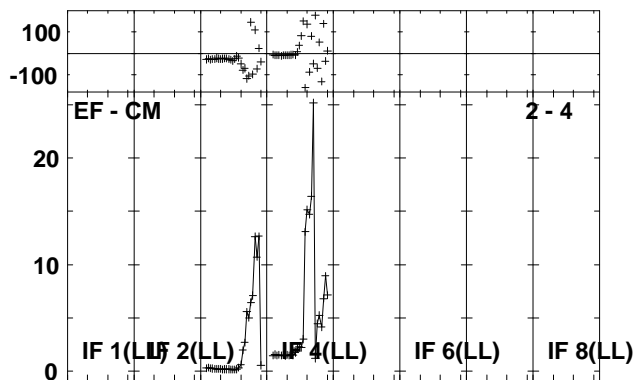
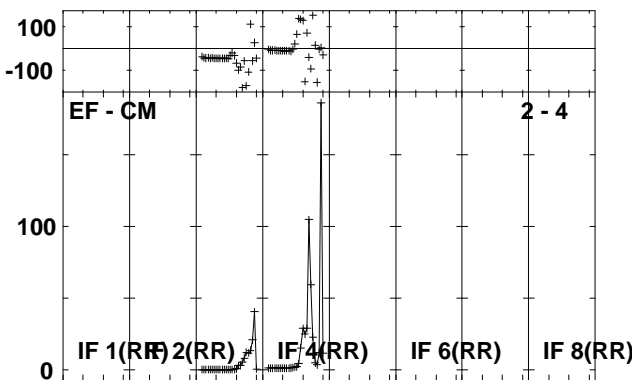
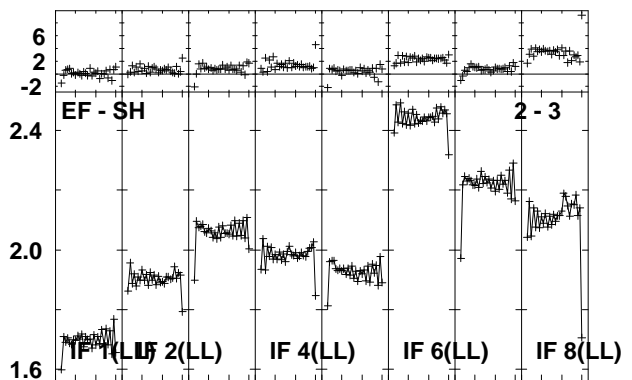
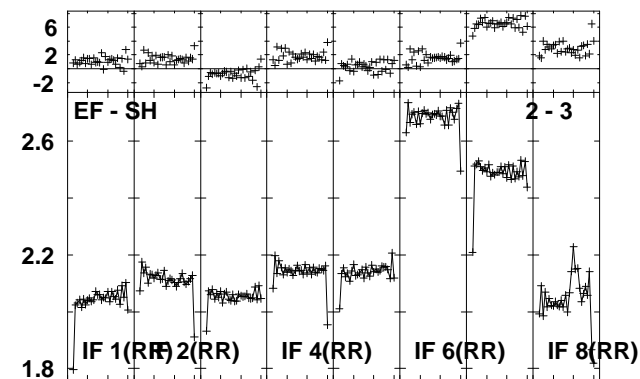
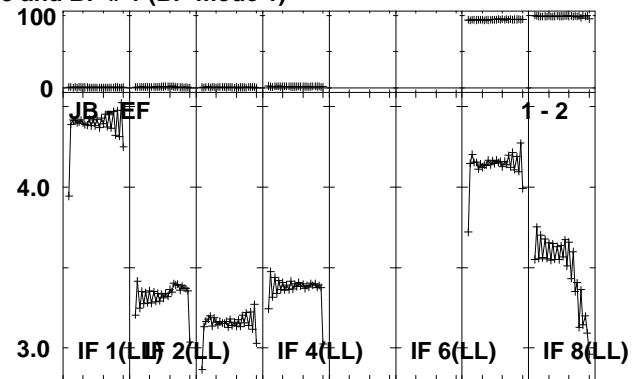
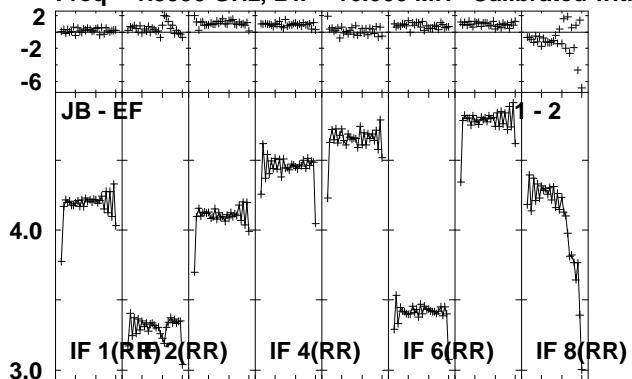

Lower frame: Ampl Jy Top frame: Phas deg  
 Vector averaged cross-power spectrum Several baselines displayed  
 Timerange: 00/14:17:31 to 00/14:24:59

Plot file version 76 created 30-NOV-2010 14:28:46

4C39.25 EP068B 3.UVDATA.1

Freq = 1.5950 GHz, Bw = 16.000 MH Calibrated with CL # 3 and BP # 1 (BP mode 1)

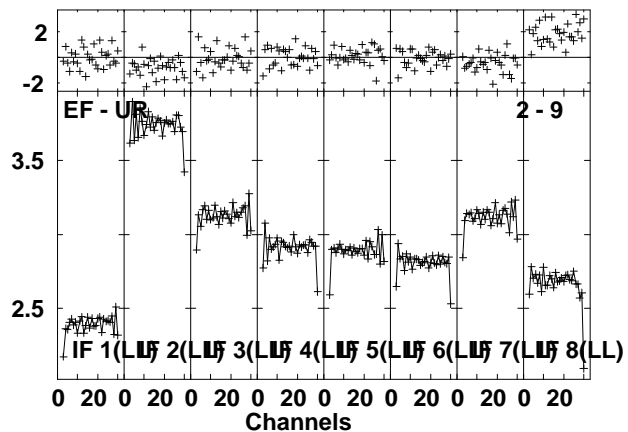
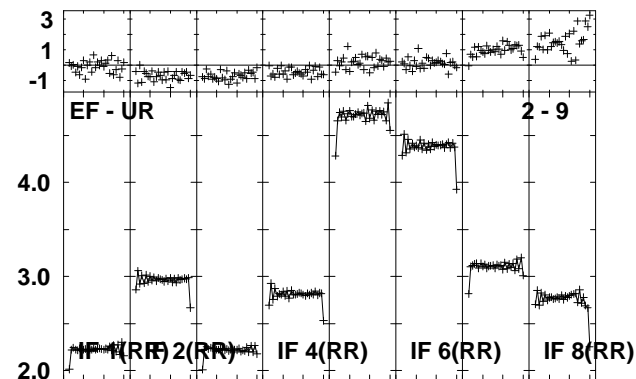
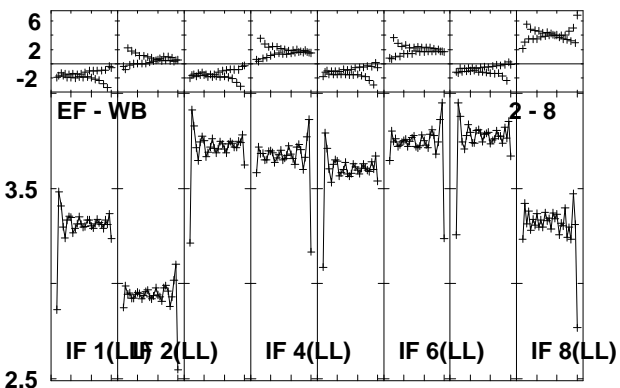
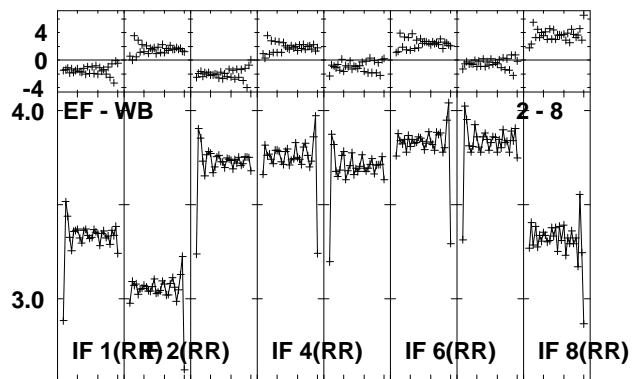
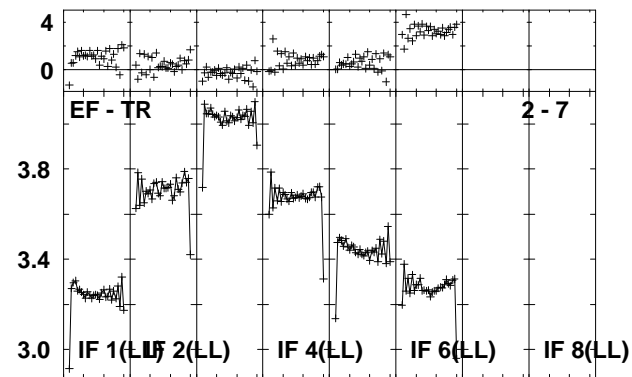
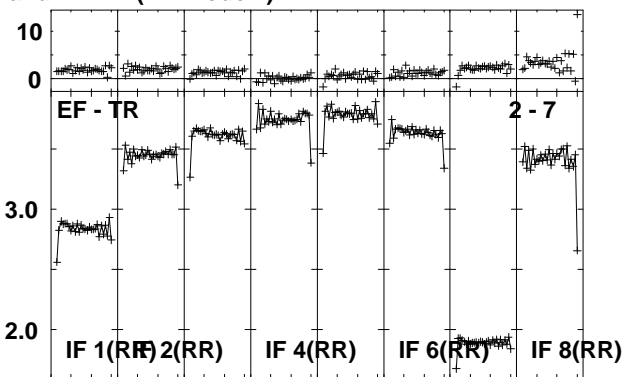
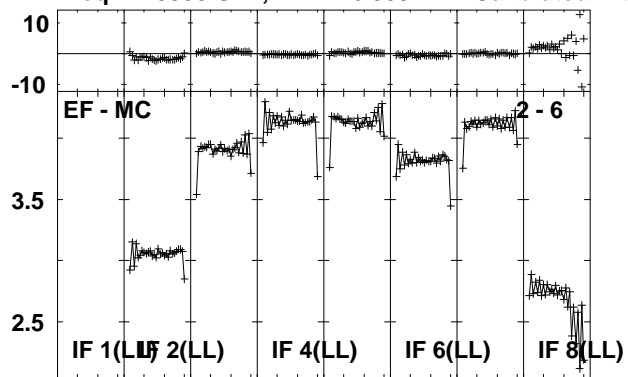

Lower frame: Ampl Jy Top frame: Phas deg  
Vector averaged cross-power spectrum Several baselines displayed  
Timerange: 00/14:17:31 to 00/14:24:59

Plot file version 77 created 30-NOV-2010 14:28:50

J1128+59 EP068B 3.UVDATA.1

Freq = 1.5950 GHz, Bw = 16.000 MH Calibrated with CL # 3 and BP # 1 (BP mode 1)

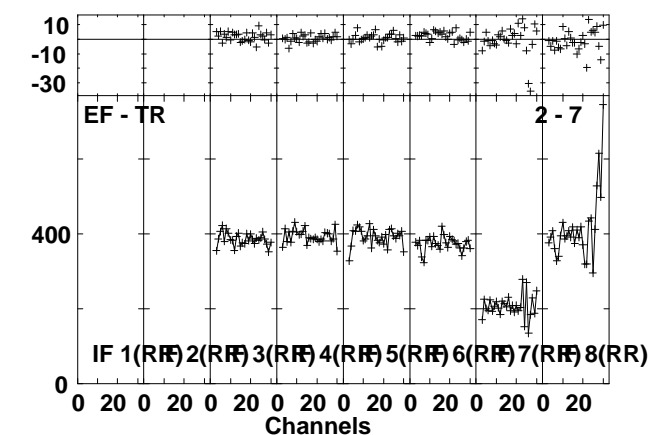
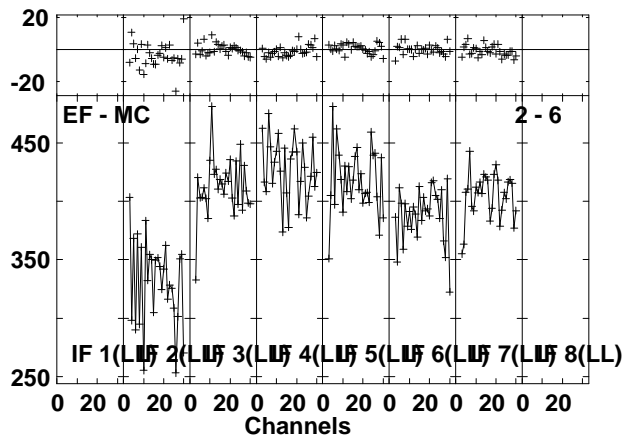
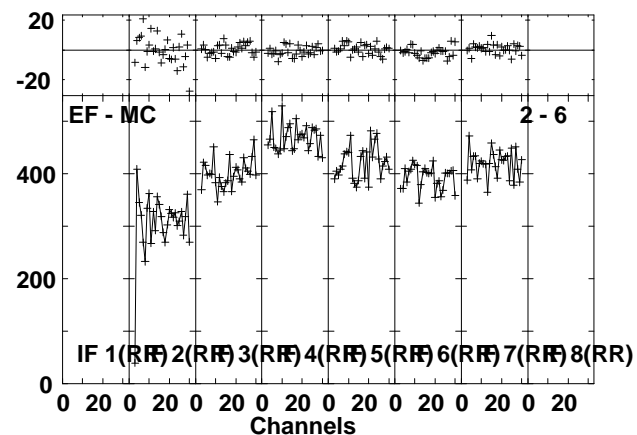
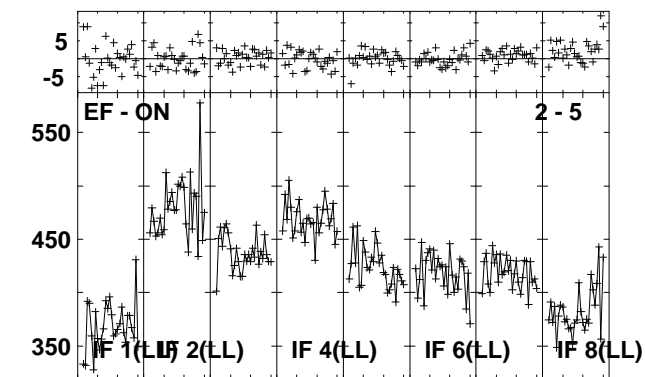
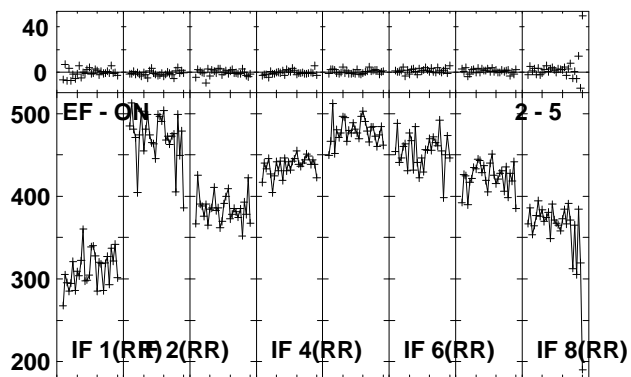
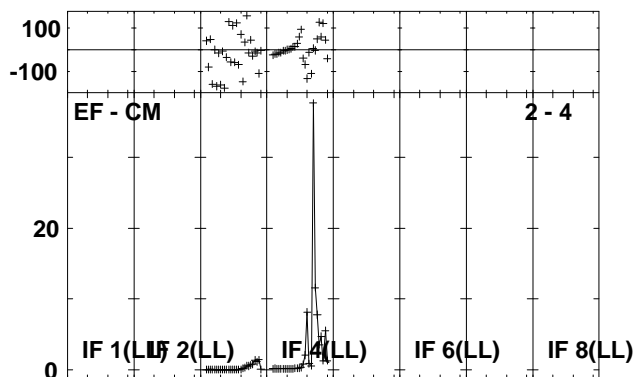
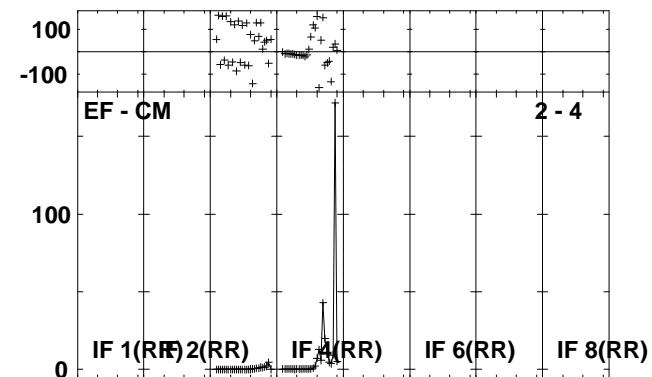
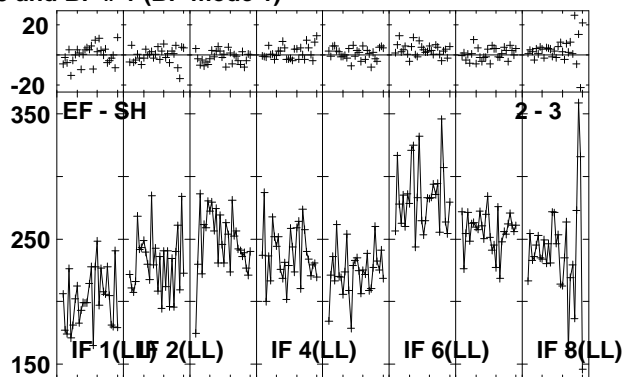
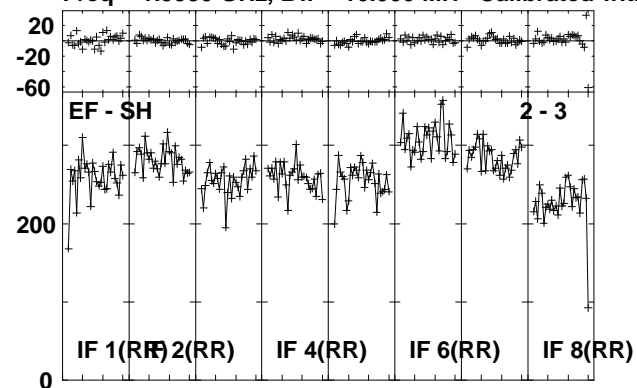

Lower frame: Milli Ampl Jy Top frame: Phas deg  
Vector averaged cross-power spectrum Several baselines displayed  
Timerange: 00/14:26:01 to 00/14:28:57

Plot file version 78 created 30-NOV-2010 14:28:51

J1128+59 EP068B 3.UVDATA.1

Freq = 1.5950 GHz, Bw = 16.000 MH Calibrated with CL # 3 and BP # 1 (BP mode 1)

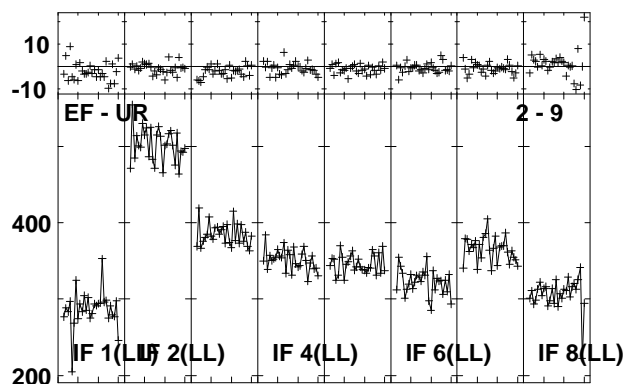
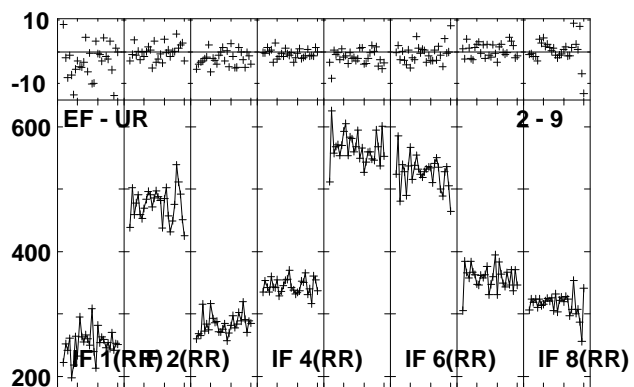
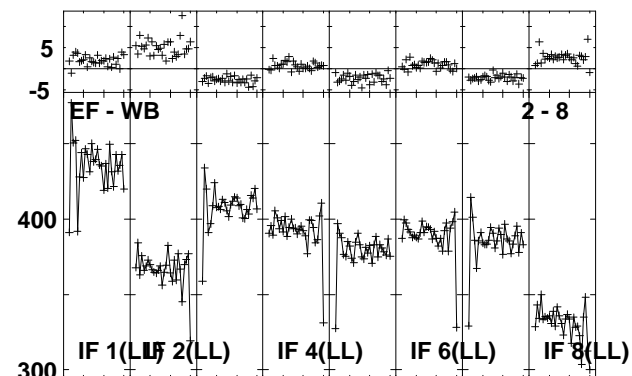
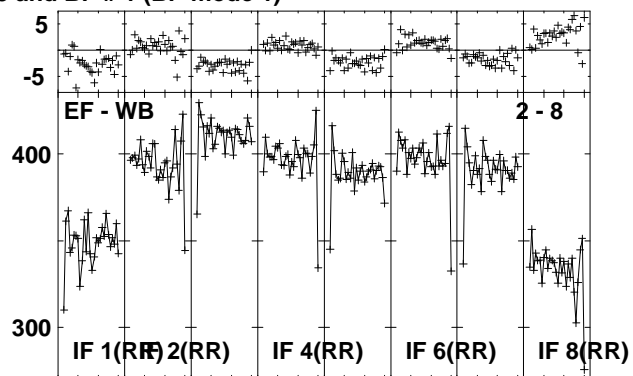
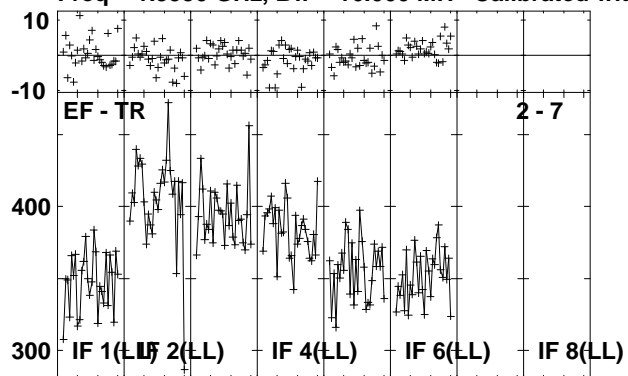

Lower frame: Milli Ampl Jy Top frame: Phas deg  
Vector averaged cross-power spectrum Several baselines displayed  
Timerange: 00/14:26:01 to 00/14:28:57

Plot file version 79 created 30-NOV-2010 14:28:52

ARP299C EP068B 3.UVDATA.1

Freq = 1.5950 GHz, Bw = 16.000 MH Calibrated with CL # 3 and BP # 1 (BP mode 1)

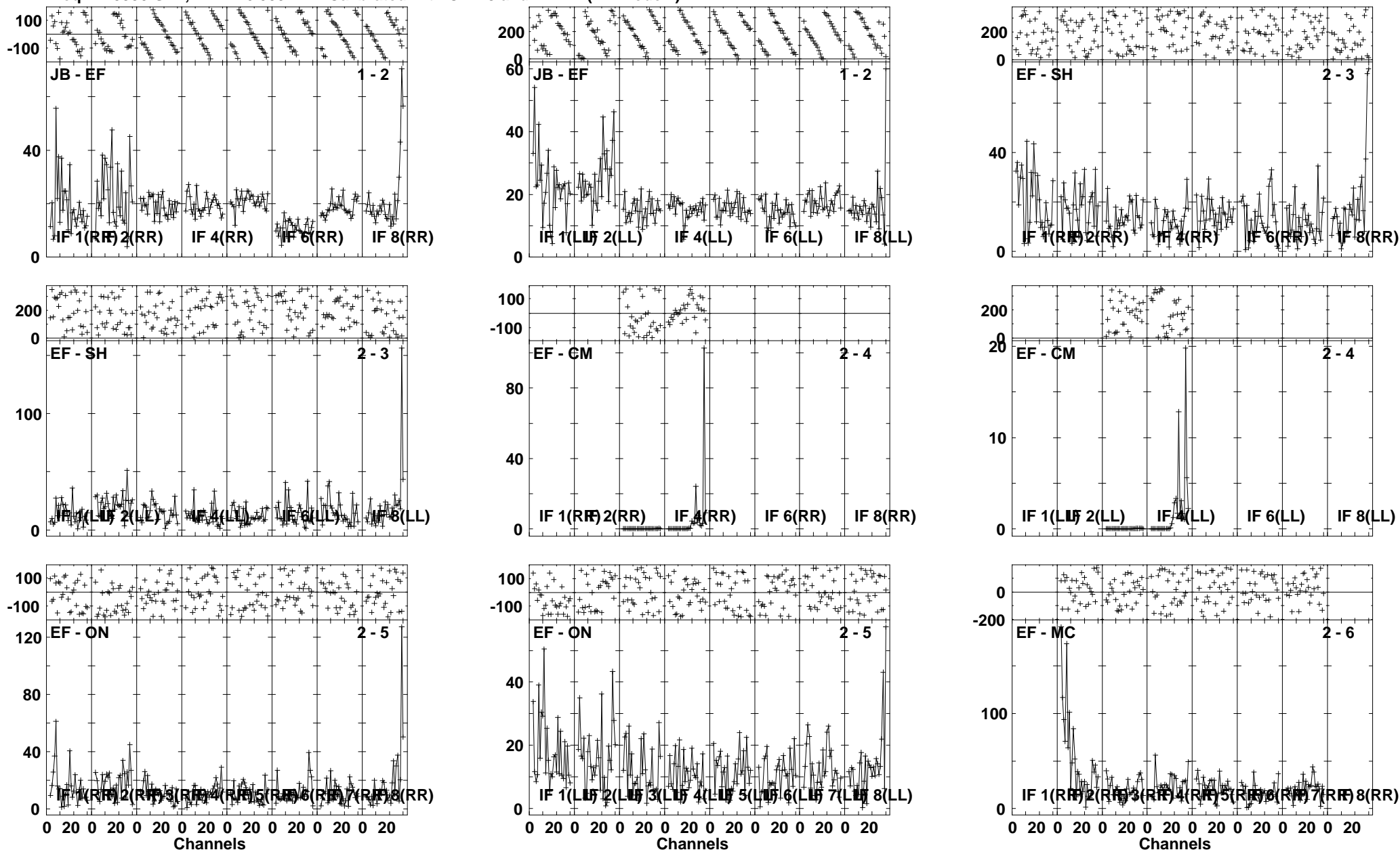

Lower frame: Milli Ampl Jy Top frame: Phas deg  
Vector averaged cross-power spectrum Several baselines displayed  
Timerange: 00/14:29:01 to 00/14:32:29

Plot file version 80 created 30-NOV-2010 14:28:55

ARP299C EP068B 3.UVDATA.1

Freq = 1.5950 GHz, Bw = 16.000 MH Calibrated with CL # 3 and BP # 1 (BP mode 1)

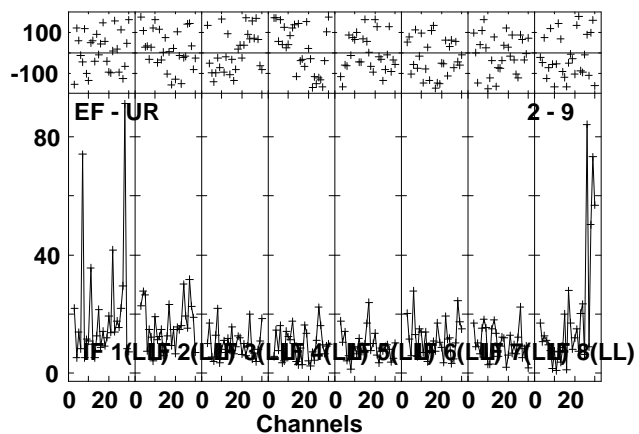
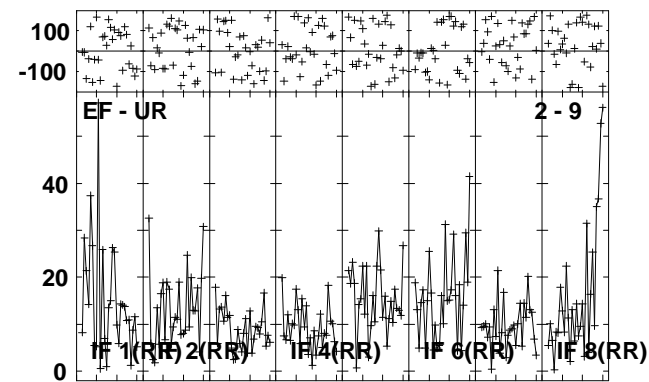
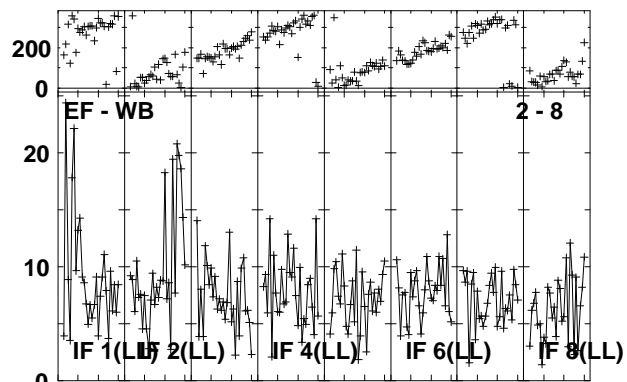
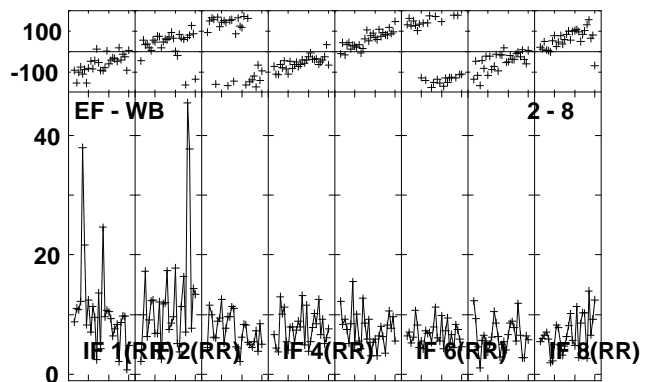
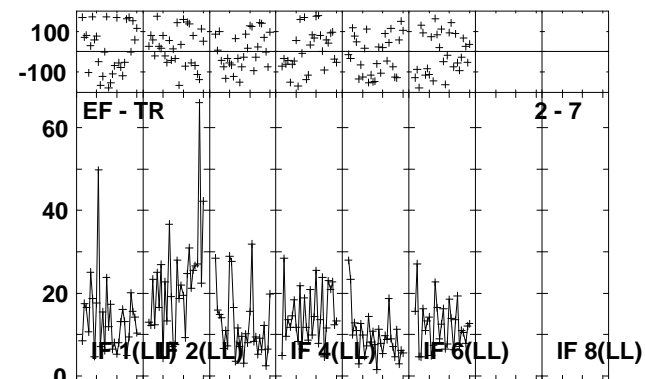
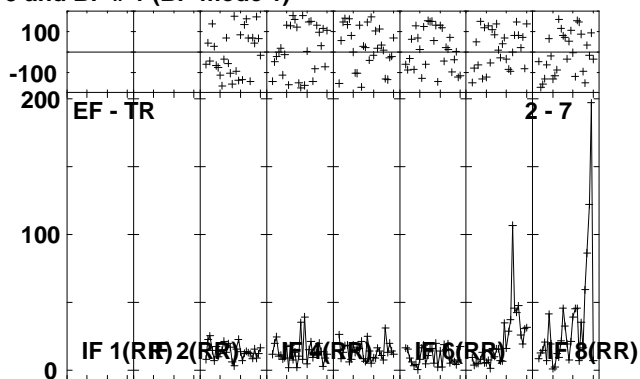
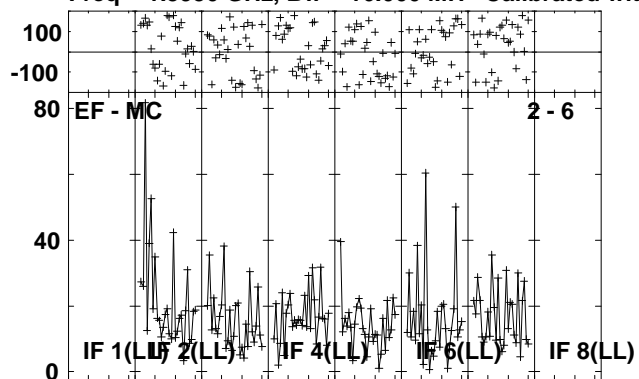

Lower frame: Milli Ampl Jy Top frame: Phas deg  
Vector averaged cross-power spectrum Several baselines displayed  
Timerange: 00/14:29:01 to 00/14:32:29



Plot file version 81 created 30-NOV-2010 14:28:57

J1128+59 EP068B 3.UVDATA.1

Freq = 1.5950 GHz, Bw = 16.000 MH Calibrated with CL # 3 and BP # 1 (BP mode 1)

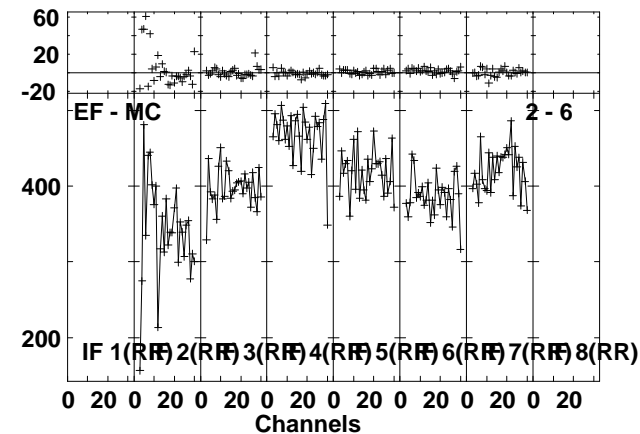
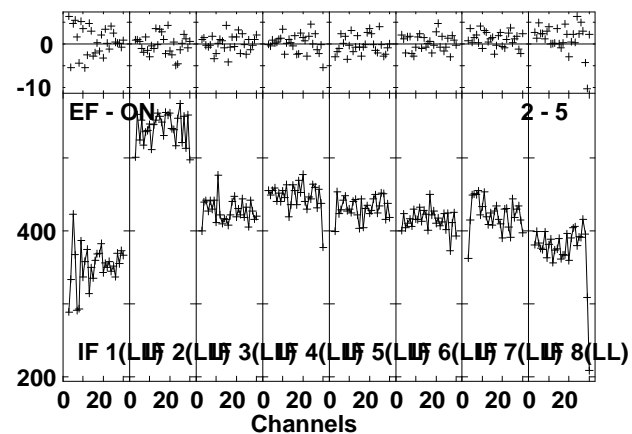
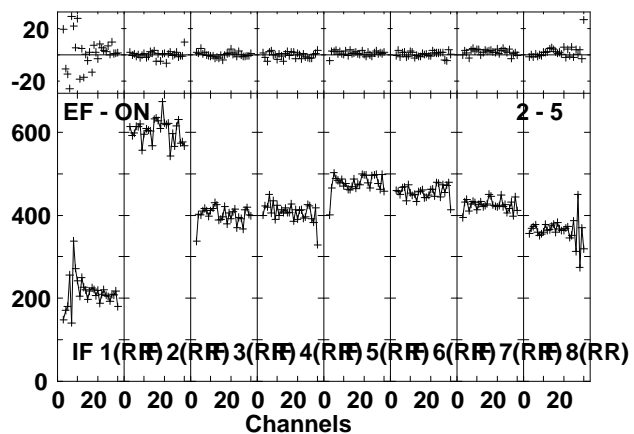
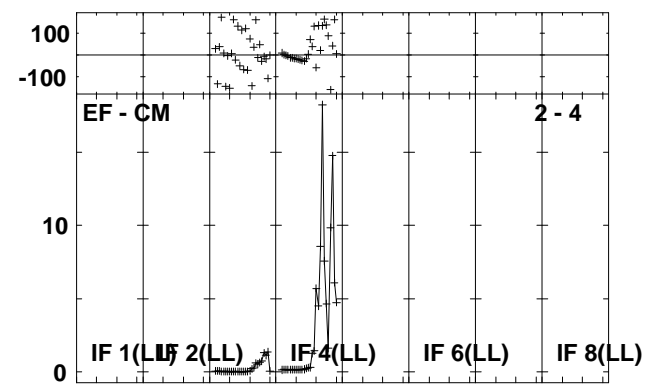
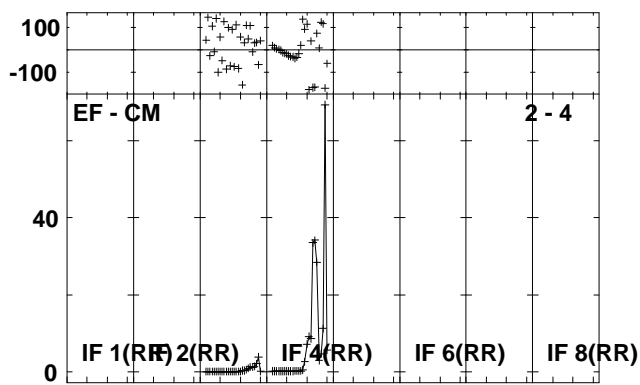
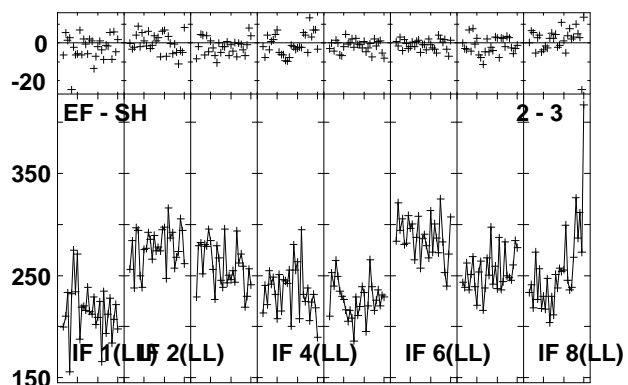
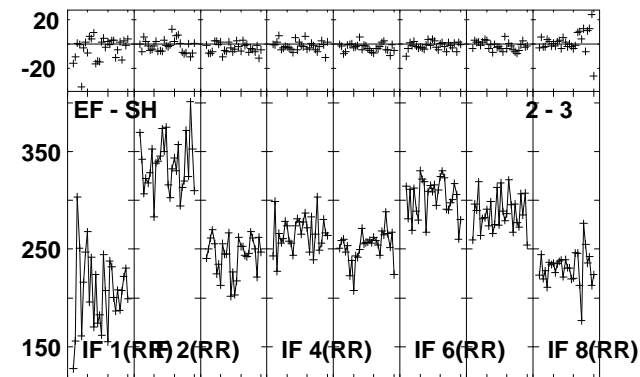
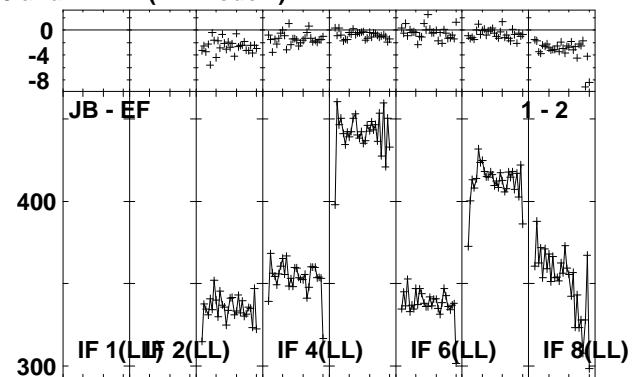
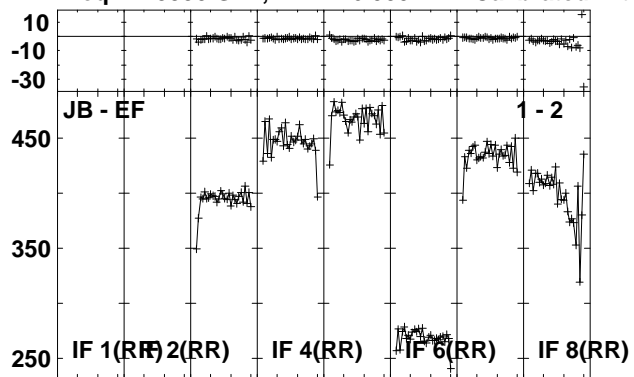

Lower frame: Milli Ampl Jy Top frame: Phas deg  
Vector averaged cross-power spectrum Several baselines displayed  
Timerange: 00/14:32:31 to 00/14:33:59

Plot file version 82 created 30-NOV-2010 14:28:58  
 J1128+59 EP068B 3.UVDATA.1  
 Freq = 1.5950 GHz, Bw = 16.000 MH Calibrated with CL # 3 and BP # 1 (BP mode 1)

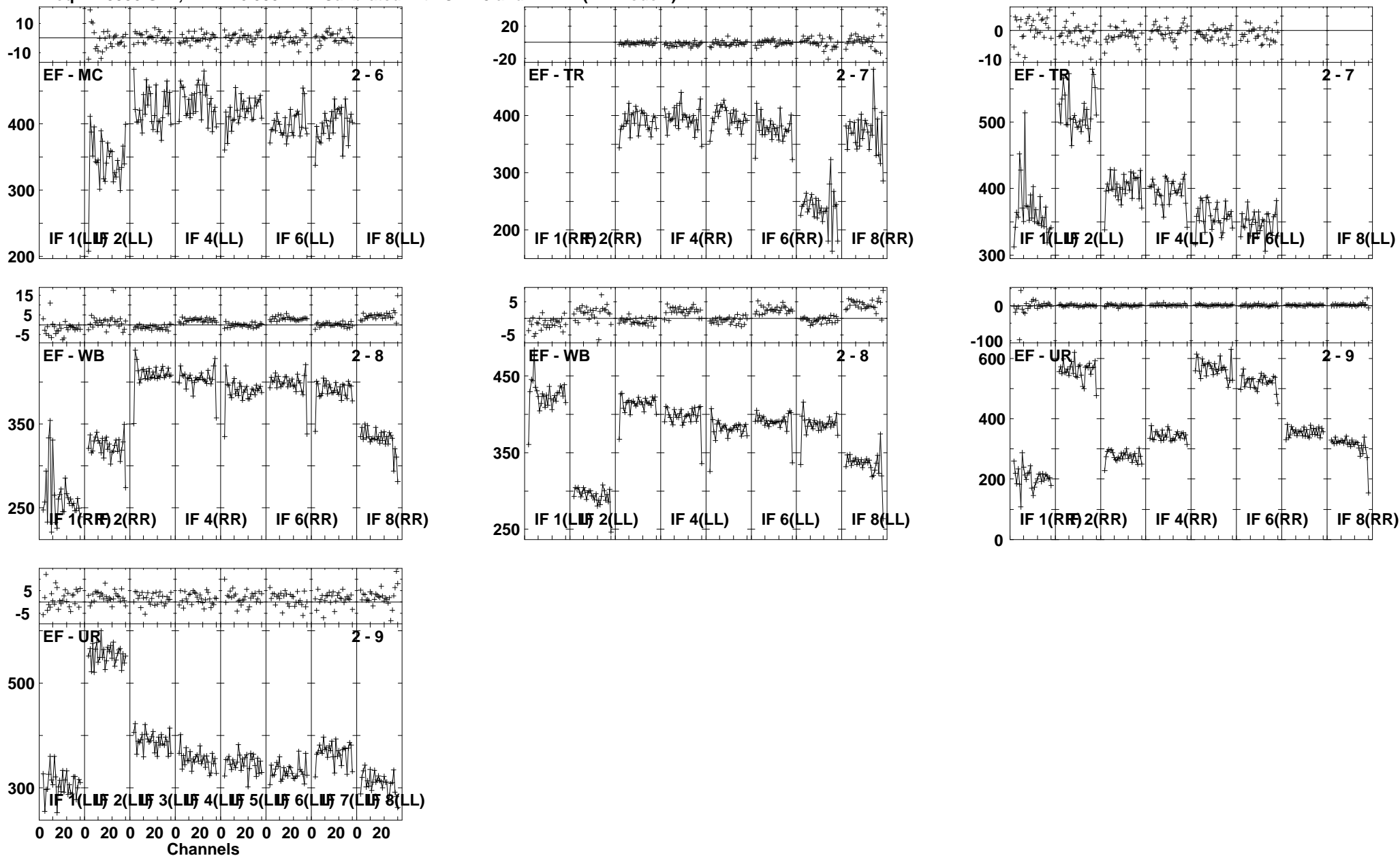

Lower frame: Milli Ampl Jy Top frame: Phas deg  
 Vector averaged cross-power spectrum Several baselines displayed  
 Timerange: 00/14:32:31 to 00/14:33:59

Plot file version 83 created 30-NOV-2010 14:29:00

ARP299C EP068B 3.UVDATA.1

Freq = 1.5950 GHz, Bw = 16.000 MH Calibrated with CL # 3 and BP # 1 (BP mode 1)

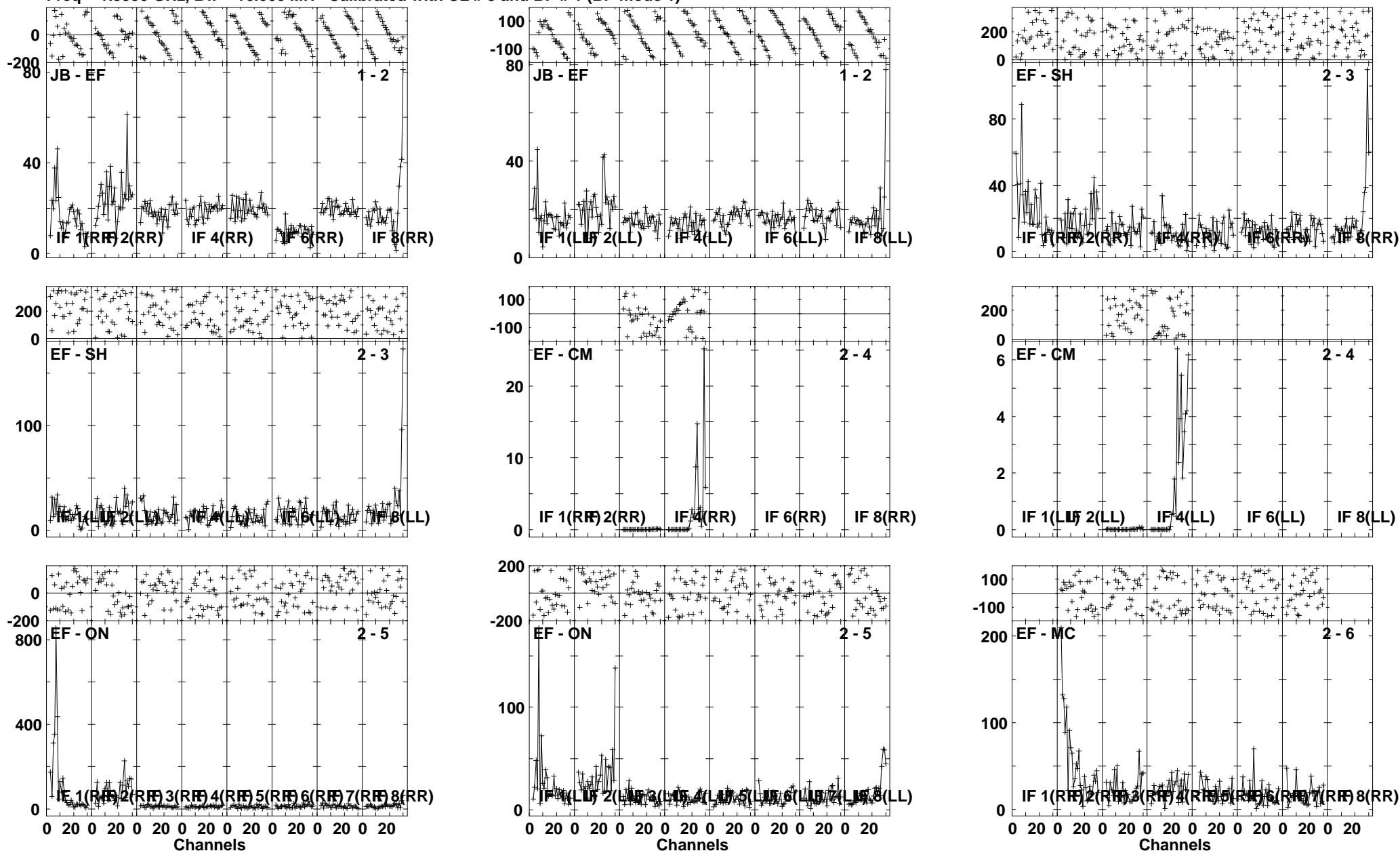

Lower frame: Milli Ampl Jy Top frame: Phas deg  
Vector averaged cross-power spectrum Several baselines displayed  
Timerange: 00/14:34:01 to 00/14:37:29

Plot file version 84 created 30-NOV-2010 14:29:02

ARP299C EP068B 3.UVDATA.1

Freq = 1.5950 GHz, Bw = 16.000 MH Calibrated with CL # 3 and BP # 1 (BP mode 1)

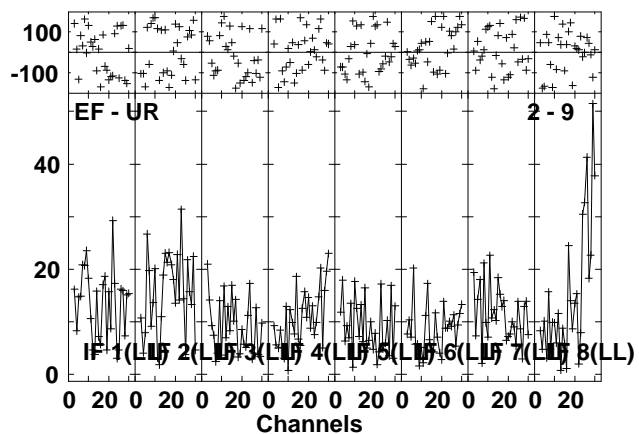
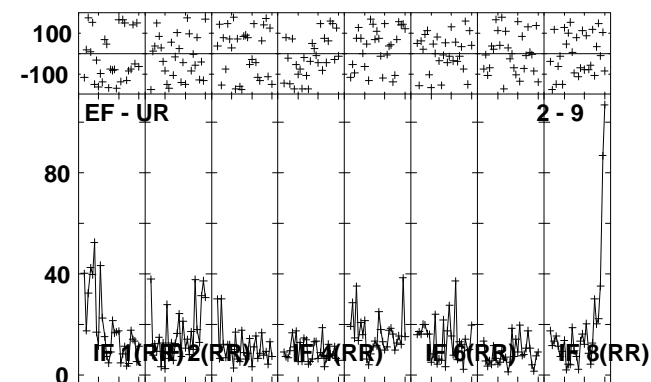
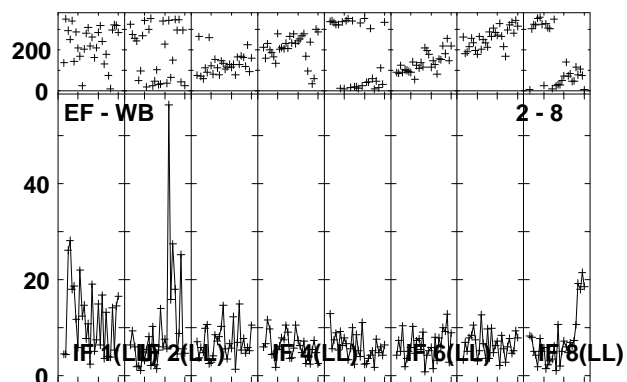
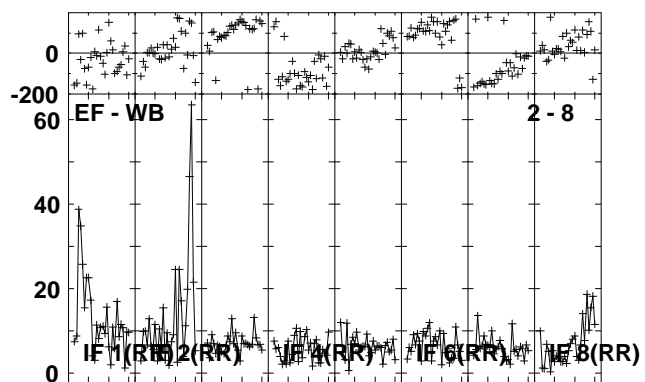
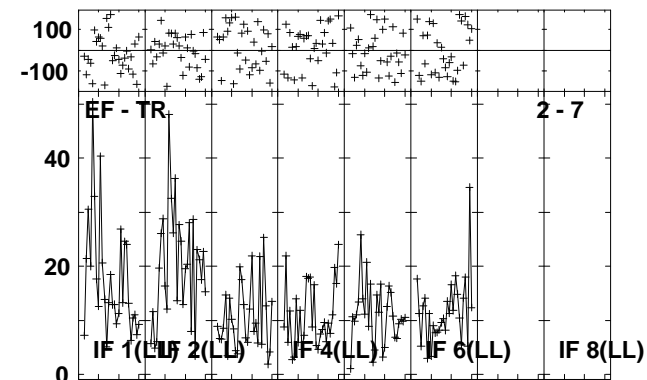
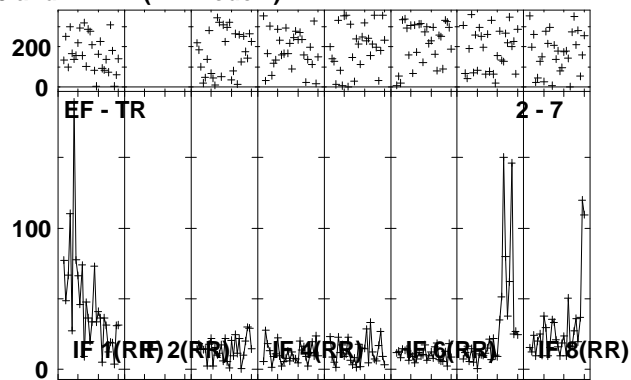
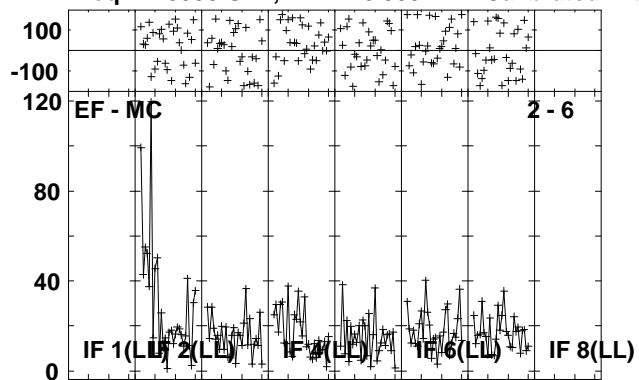

Lower frame: Milli Ampl Jy Top frame: Phas deg  
Vector averaged cross-power spectrum Several baselines displayed  
Timerange: 00/14:34:01 to 00/14:37:29

Plot file version 85 created 30-NOV-2010 14:29:05

J1128+59 EP068B 3.UVDATA.1

Freq = 1.5950 GHz, Bw = 16.000 MH Calibrated with CL # 3 and BP # 1 (BP mode 1)

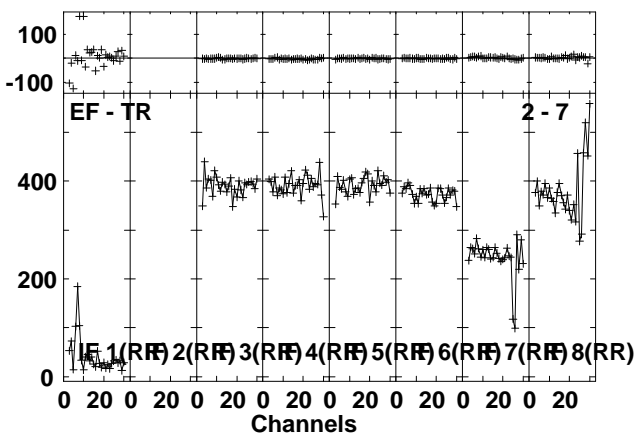
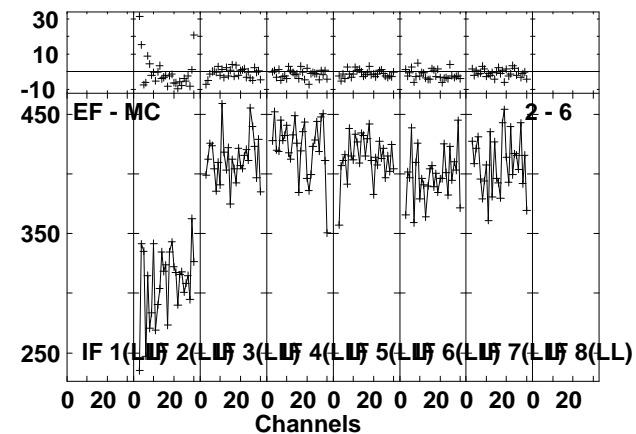
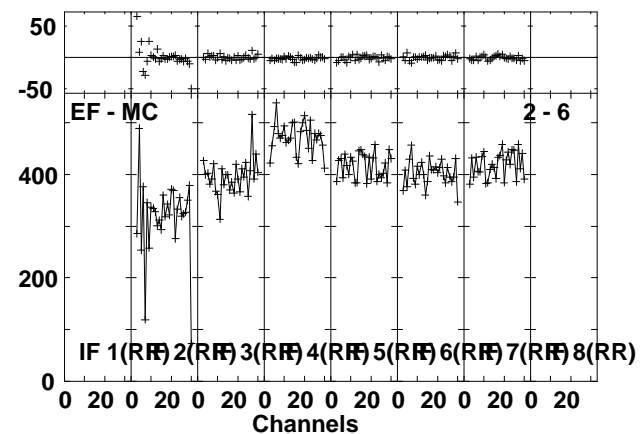
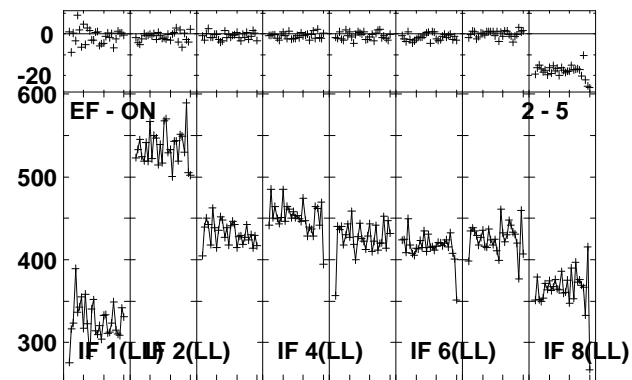
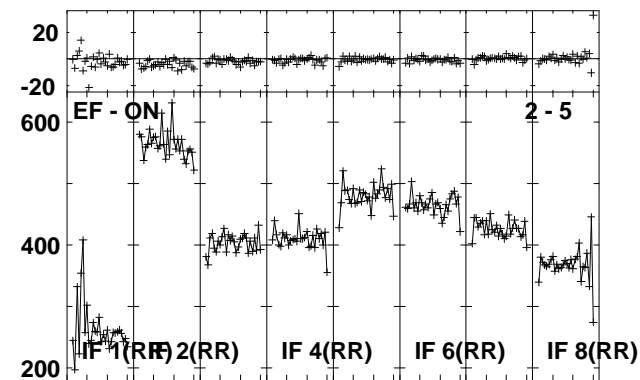
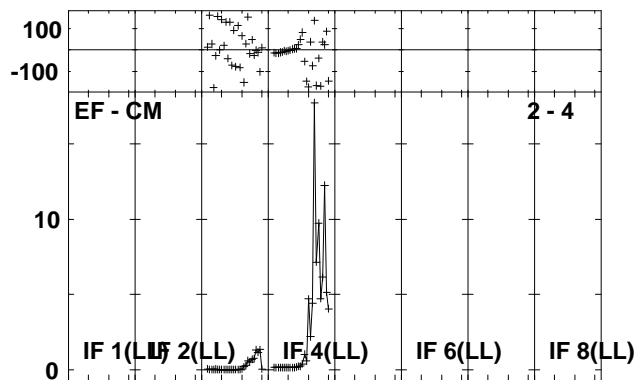
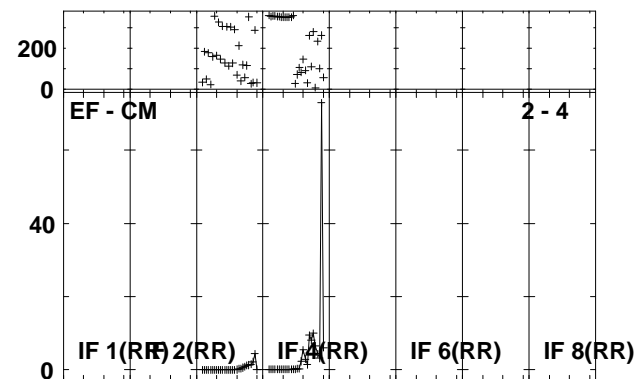
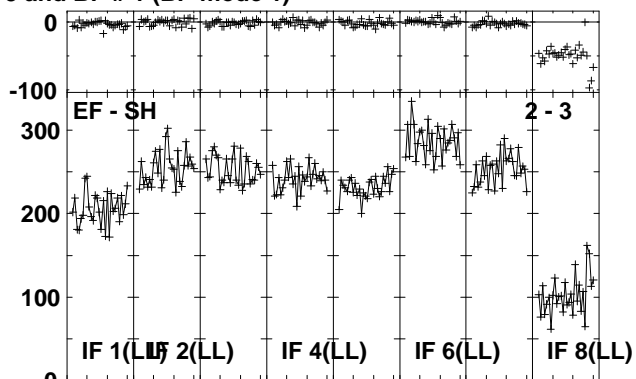
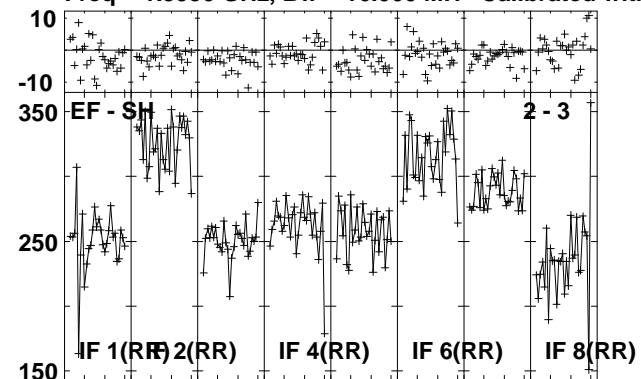

Lower frame: Milli Ampl Jy Top frame: Phas deg  
Vector averaged cross-power spectrum Several baselines displayed  
Timerange: 00/14:38:31 to 00/14:39:59

Plot file version 86 created 30-NOV-2010 14:29:06

J1128+59 EP068B 3.UVDATA.1

Freq = 1.5950 GHz, Bw = 16.000 MH Calibrated with CL # 3 and BP # 1 (BP mode 1)

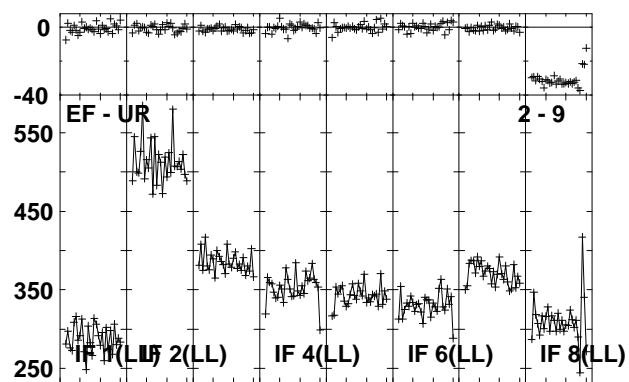
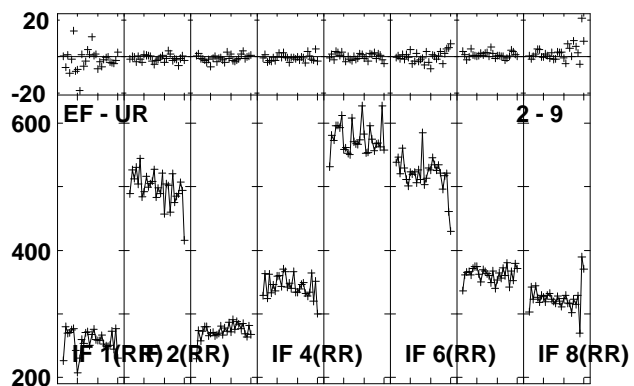
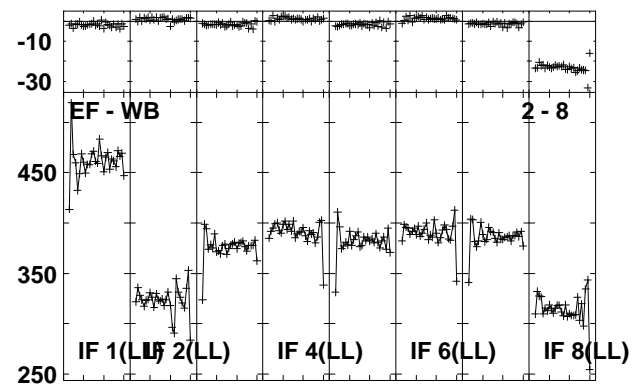
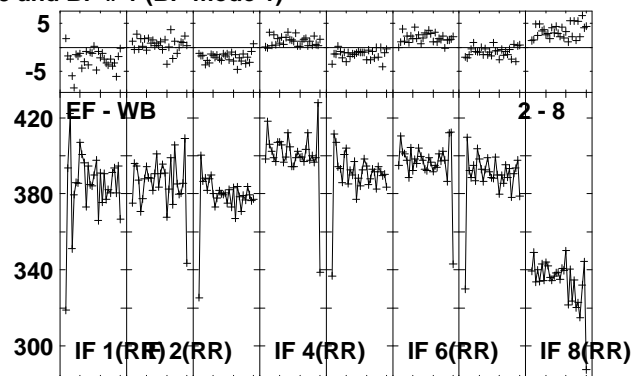
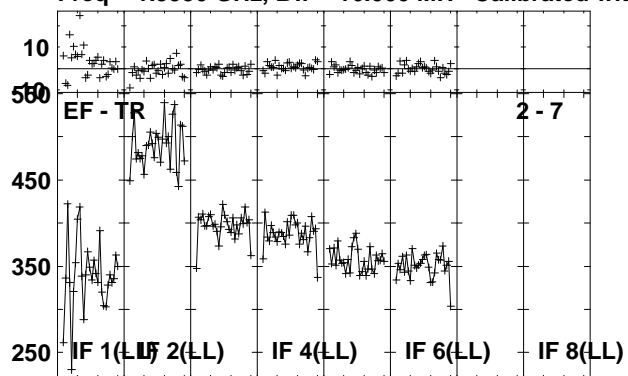

Lower frame: Milli Ampl Jy Top frame: Phas deg  
Vector averaged cross-power spectrum Several baselines displayed  
Timerange: 00/14:38:31 to 00/14:39:59

Plot file version 87 created 30-NOV-2010 14:29:07

ARP299C EP068B 3.UVDATA.1

Freq = 1.5950 GHz, Bw = 16.000 MH Calibrated with CL # 3 and BP # 1 (BP mode 1)

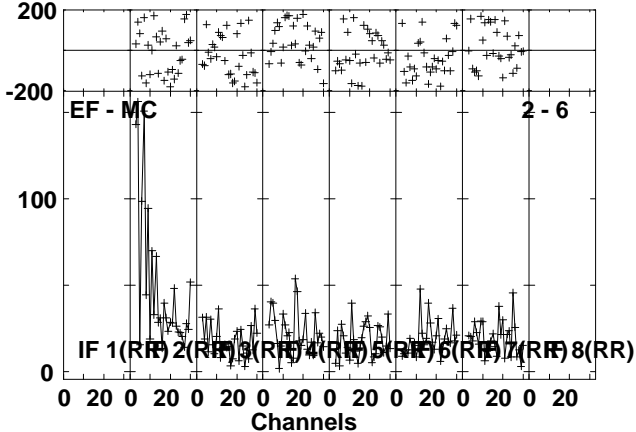
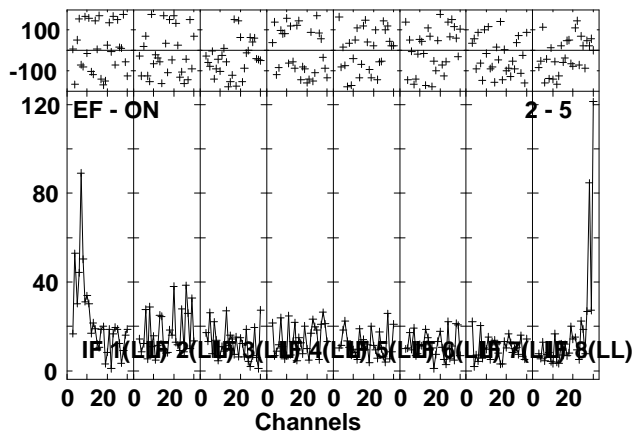
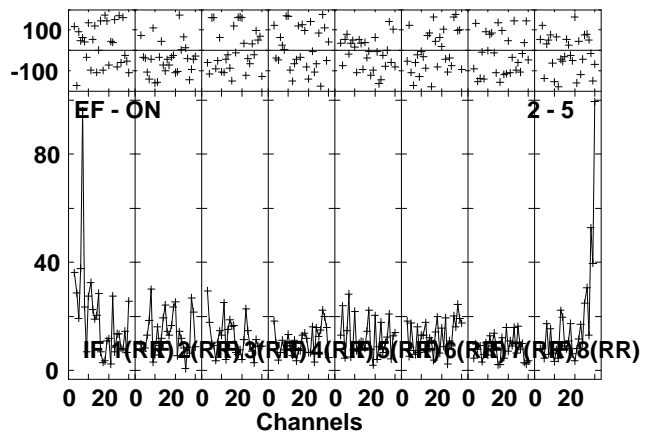
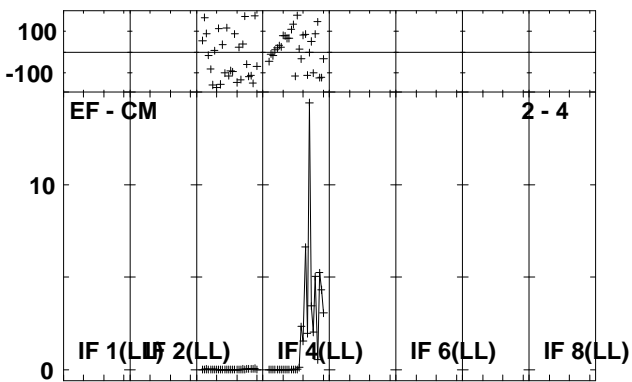
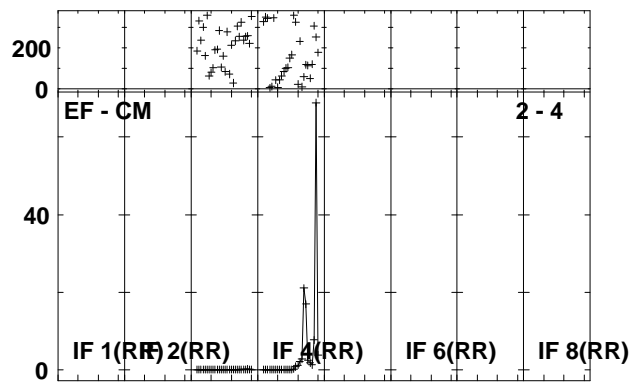
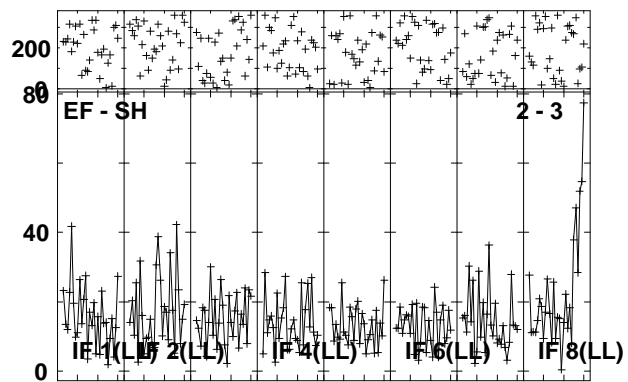
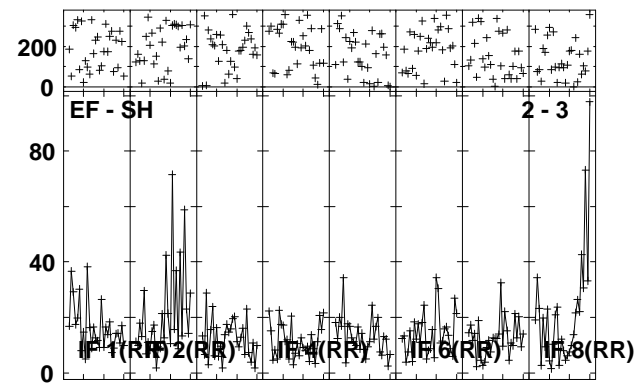
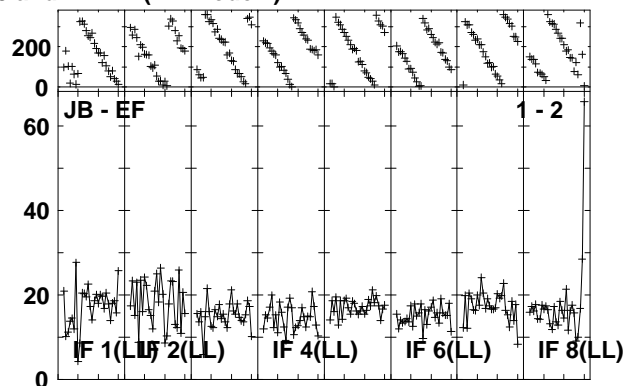
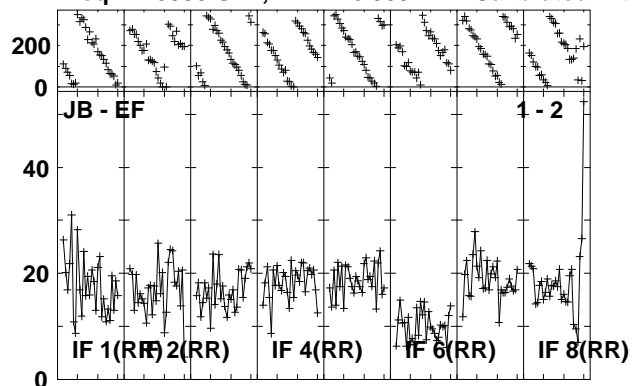

Lower frame: Milli Ampl Jy Top frame: Phas deg  
Vector averaged cross-power spectrum Several baselines displayed  
Timerange: 00/14:40:01 to 00/14:43:29

Plot file version 88 created 30-NOV-2010 14:29:10

ARP299C EP068B 3.UVDATA.1

Freq = 1.5950 GHz, Bw = 16.000 MH Calibrated with CL # 3 and BP # 1 (BP mode 1)

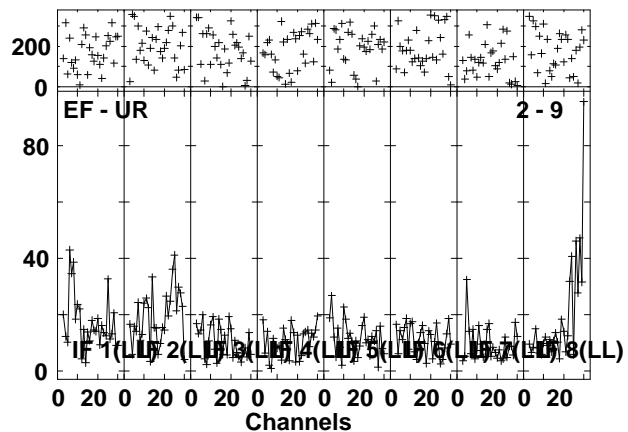
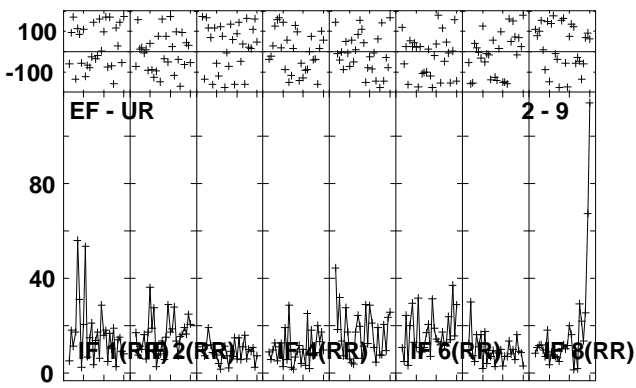
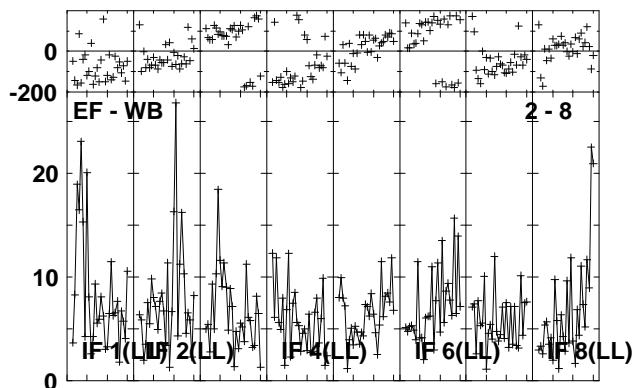
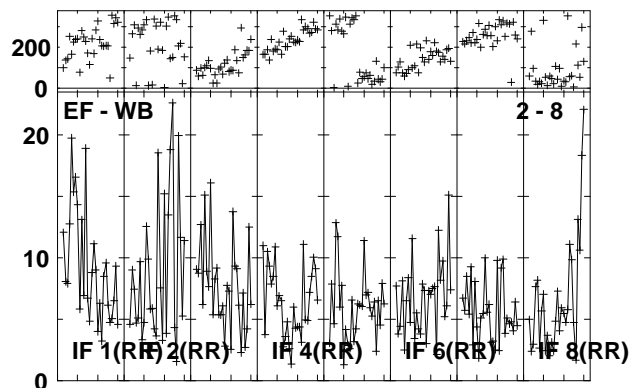
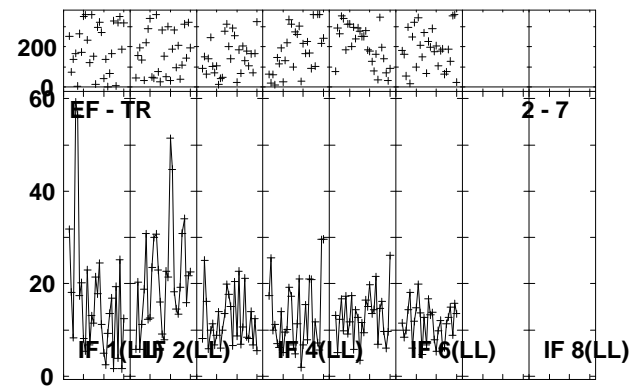
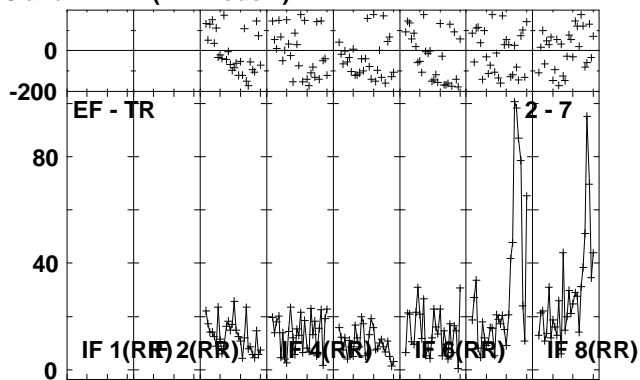
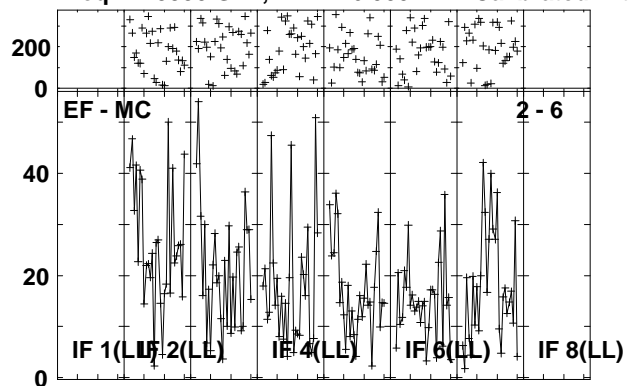

Lower frame: Milli Ampl Jy Top frame: Phas deg  
Vector averaged cross-power spectrum Several baselines displayed  
Timerange: 00/14:40:01 to 00/14:43:29



Plot file version 89 created 30-NOV-2010 14:29:12

J1128+59 EP068B 3.UVDATA.1

Freq = 1.5950 GHz, Bw = 16.000 MH Calibrated with CL # 3 and BP # 1 (BP mode 1)

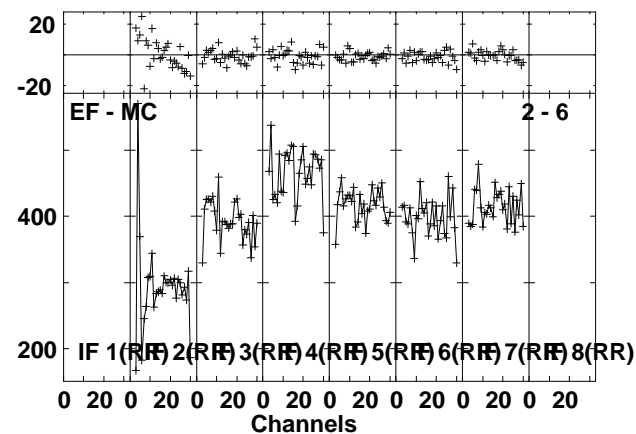
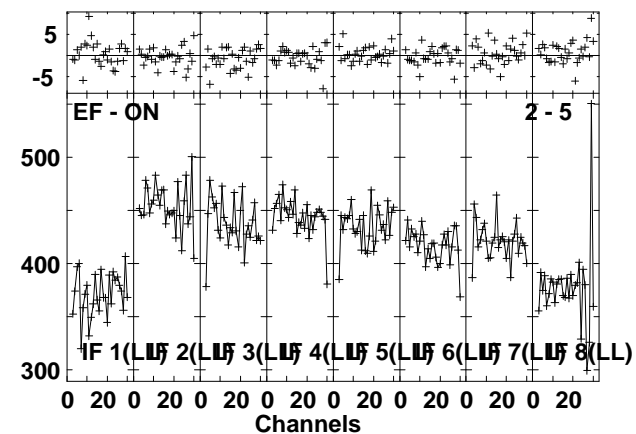
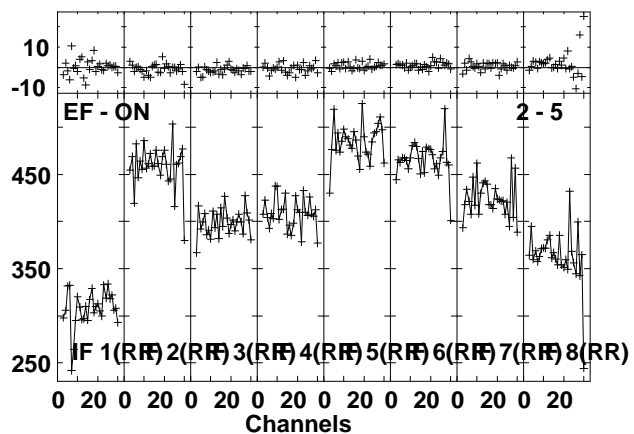
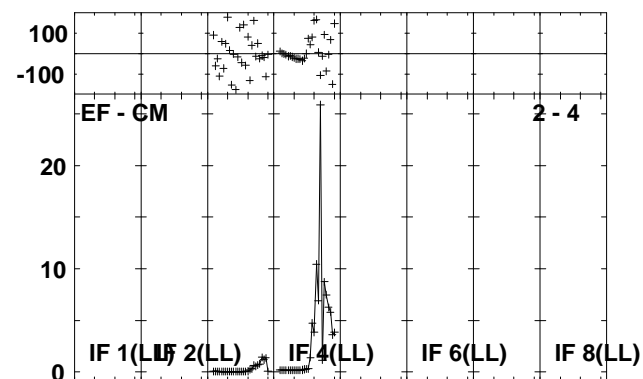
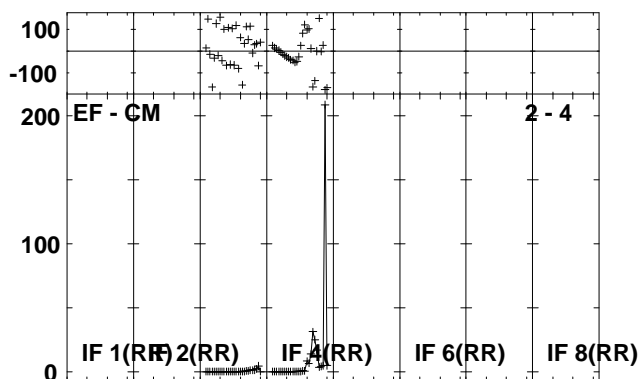
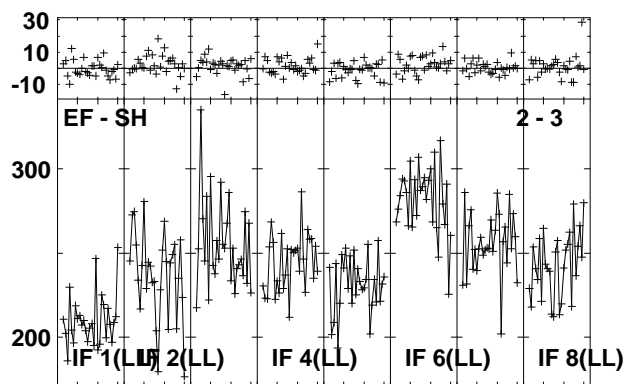
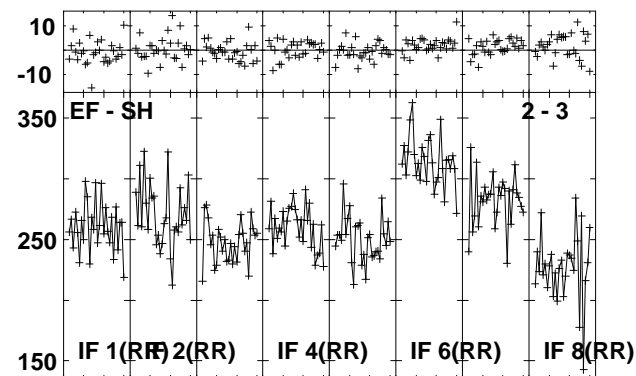
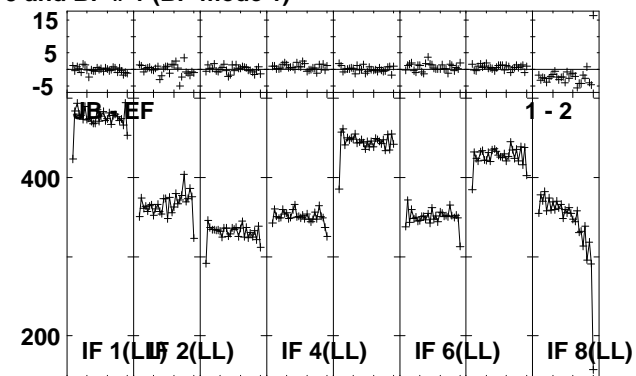
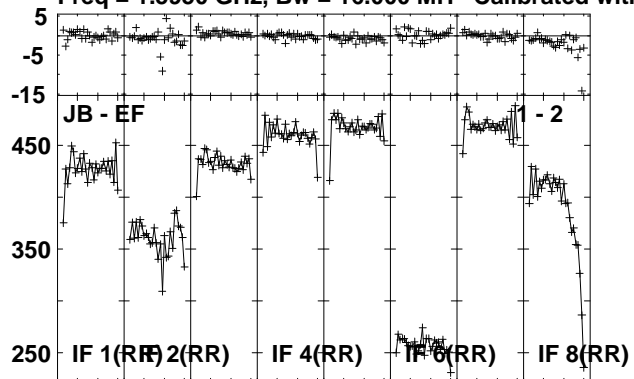

Lower frame: Milli Ampl Jy Top frame: Phas deg  
Vector averaged cross-power spectrum Several baselines displayed  
Timerange: 00/14:43:31 to 00/14:44:59

Plot file version 90 created 30-NOV-2010 14:29:13

J1128+59 EP068B 3.UVDATA.1

Freq = 1.5950 GHz, Bw = 16.000 MH Calibrated with CL # 3 and BP # 1 (BP mode 1)

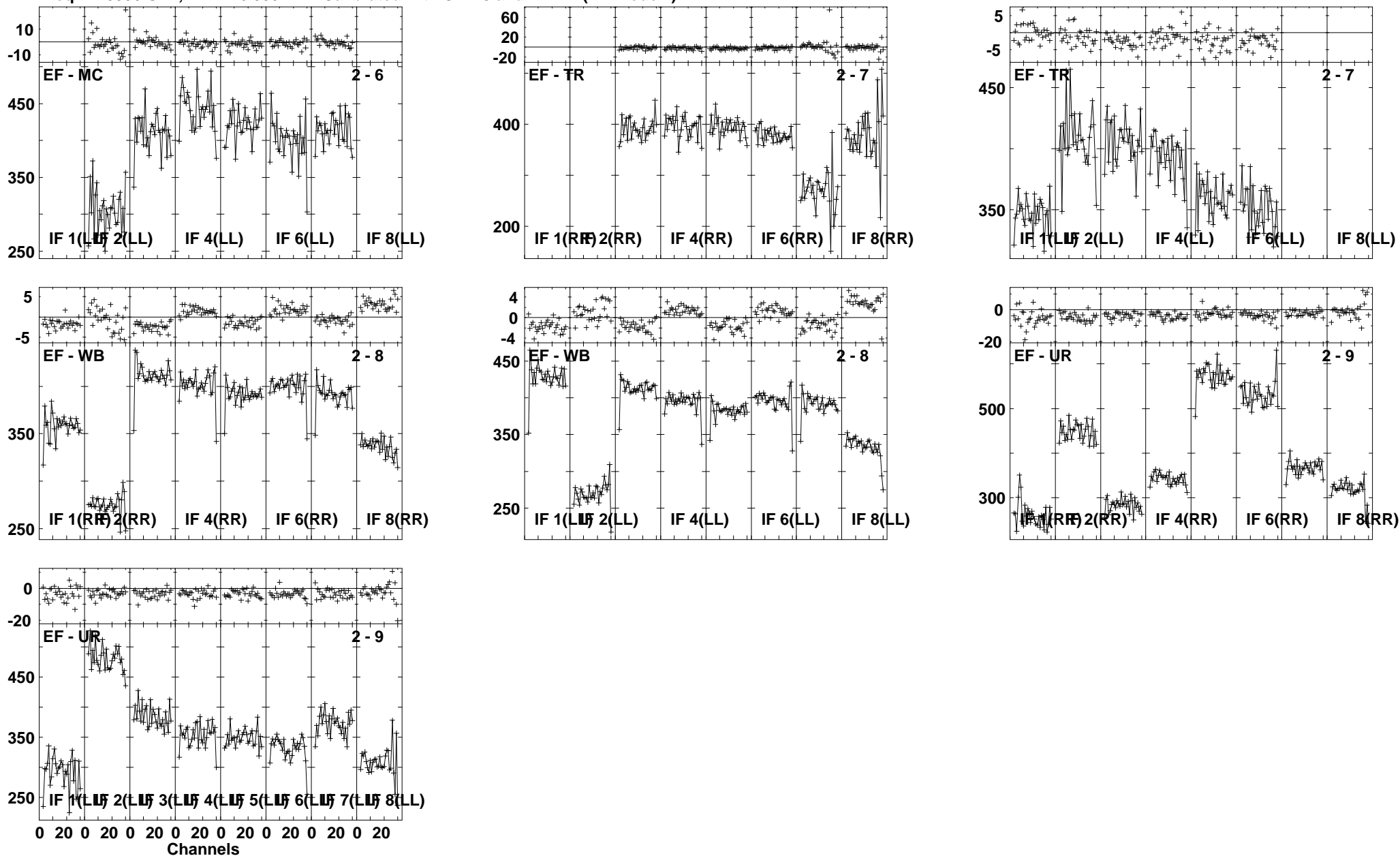

Lower frame: Milli Ampl Jy Top frame: Phas deg  
Vector averaged cross-power spectrum Several baselines displayed  
Timerange: 00/14:43:31 to 00/14:44:59

Plot file version 91 created 30-NOV-2010 14:29:14

ARP299C EP068B 3.UVDATA.1

Freq = 1.5950 GHz, Bw = 16.000 MH Calibrated with CL # 3 and BP # 1 (BP mode 1)

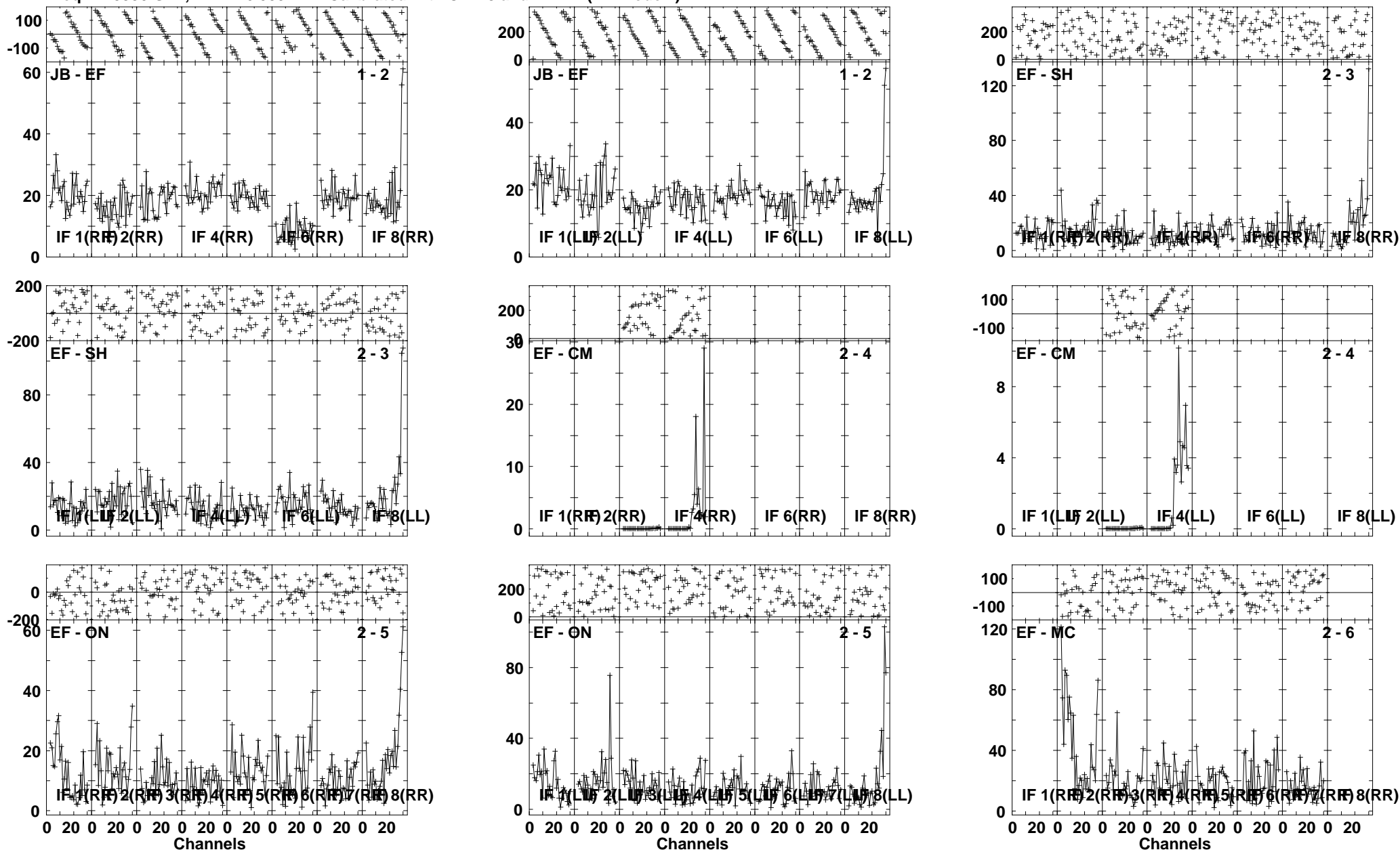

Lower frame: Milli Ampl Jy Top frame: Phas deg  
Vector averaged cross-power spectrum Several baselines displayed  
Timerange: 00/14:45:01 to 00/14:48:29

Plot file version 92 created 30-NOV-2010 14:29:17

ARP299C EP068B 3.UVDATA.1

Freq = 1.5950 GHz, Bw = 16.000 MH Calibrated with CL # 3 and BP # 1 (BP mode 1)

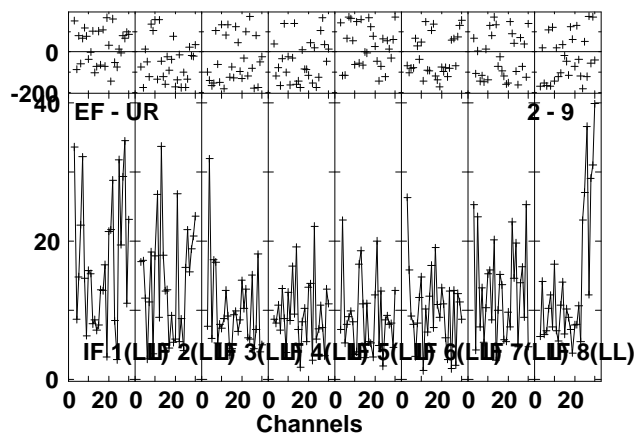
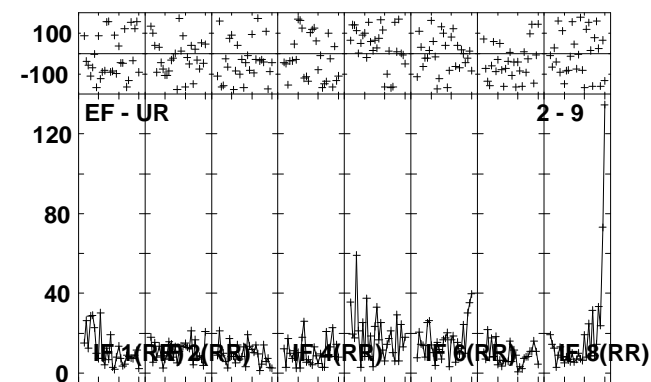
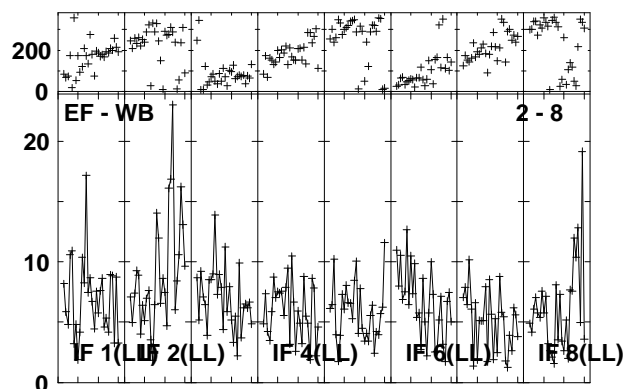
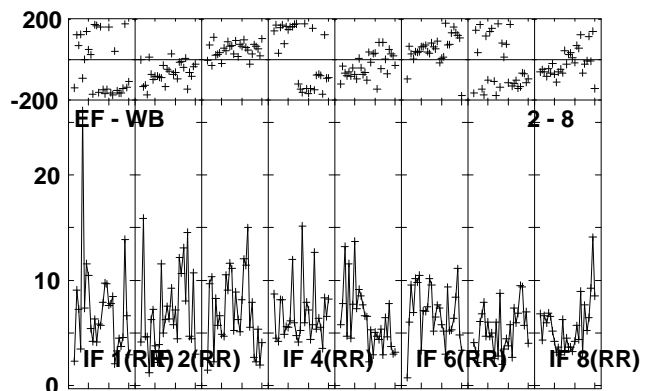
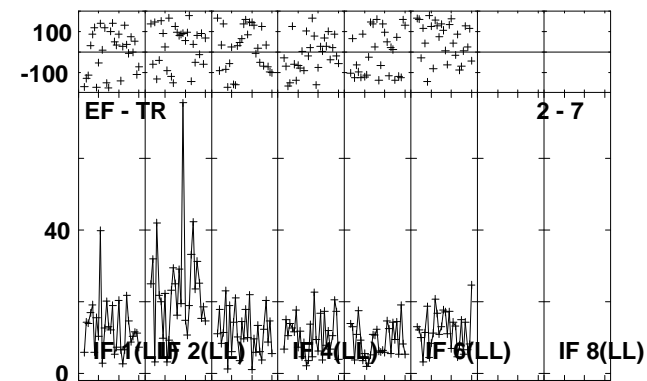
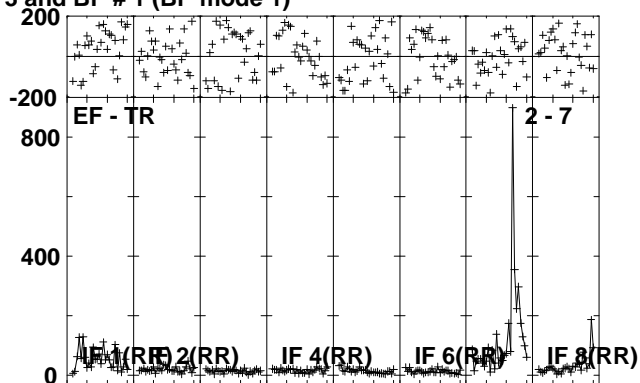
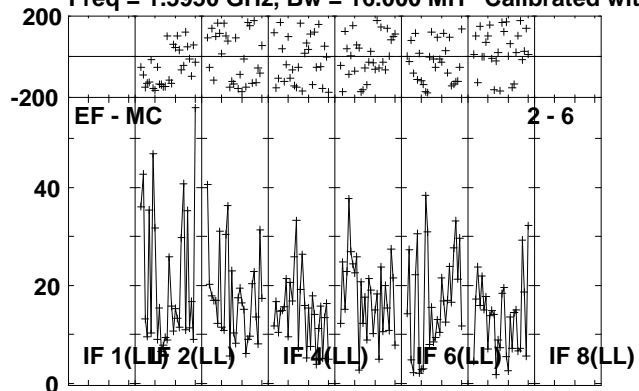

Lower frame: Milli Ampl Jy Top frame: Phas deg  
Vector averaged cross-power spectrum Several baselines displayed  
Timerange: 00/14:45:01 to 00/14:48:29

Plot file version 93 created 30-NOV-2010 14:29:20

J1128+59 EP068B 3.UVDATA.1

Freq = 1.5950 GHz, Bw = 16.000 MH Calibrated with CL # 3 and BP # 1 (BP mode 1)

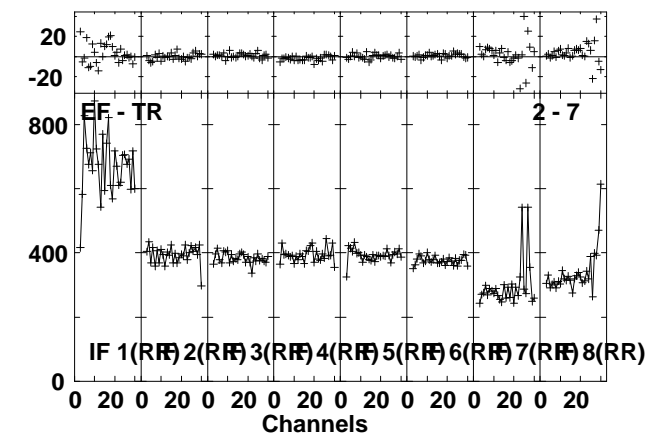
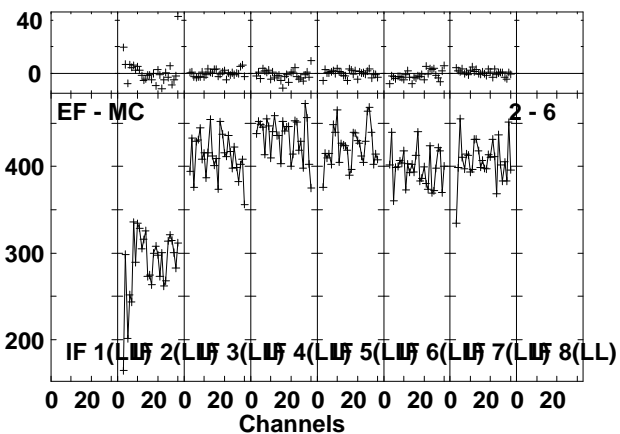
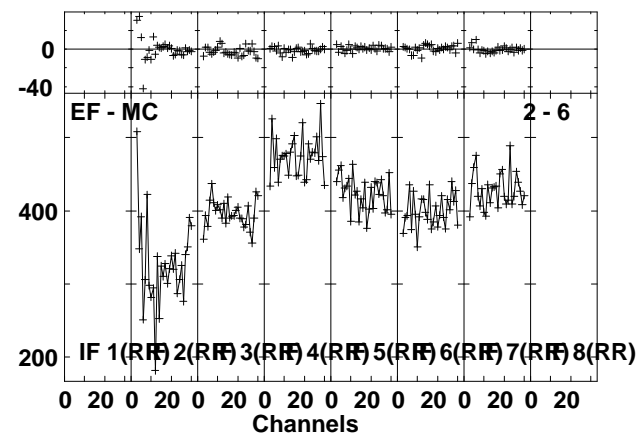
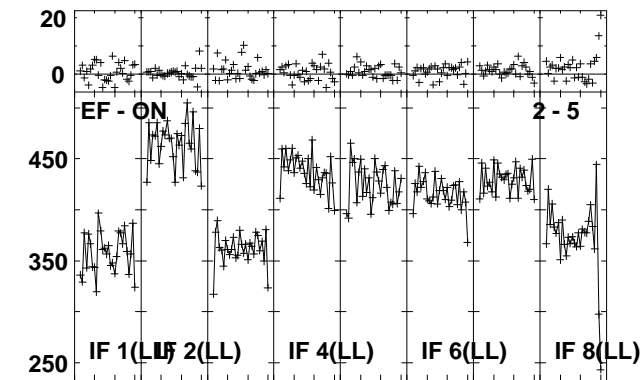
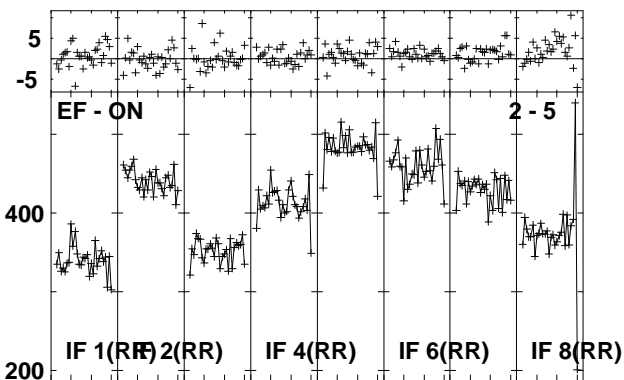
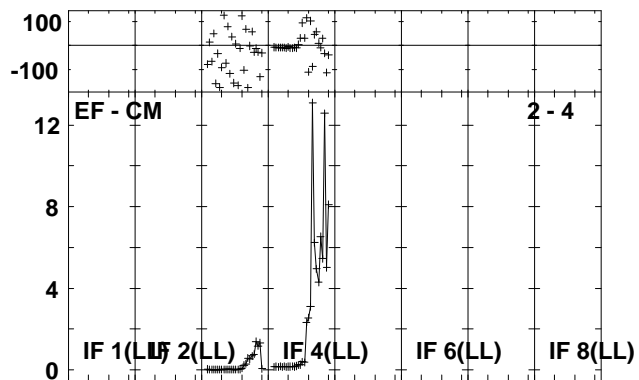
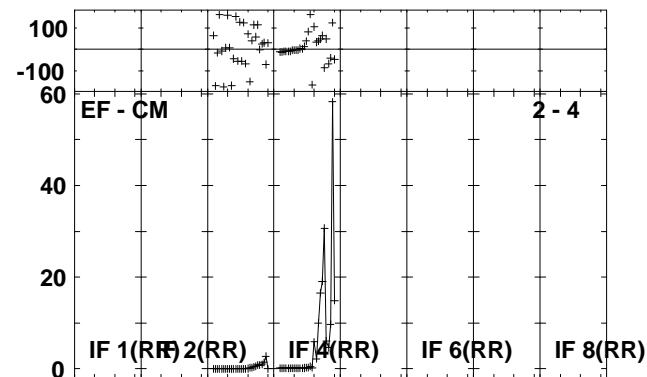
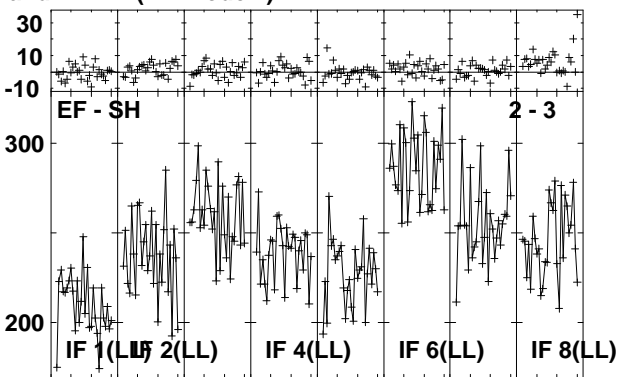
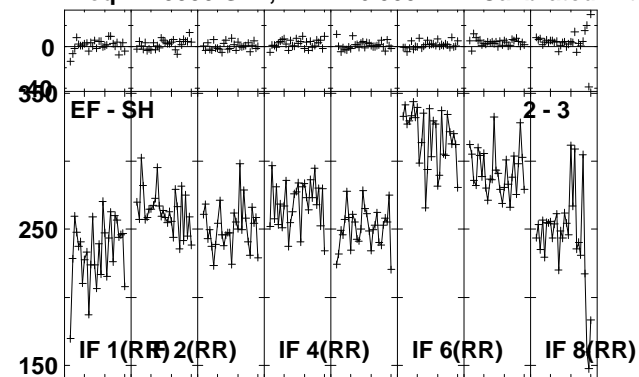

Lower frame: Milli Ampl Jy Top frame: Phas deg  
Vector averaged cross-power spectrum Several baselines displayed  
Timerange: 00/14:48:31 to 00/14:49:59

Plot file version 94 created 30-NOV-2010 14:29:21

J1128+59 EP068B 3.UVDATA.1

Freq = 1.5950 GHz, Bw = 16.000 MH Calibrated with CL # 3 and BP # 1 (BP mode 1)

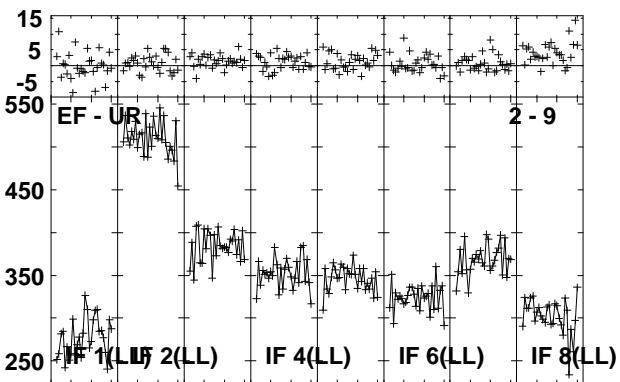
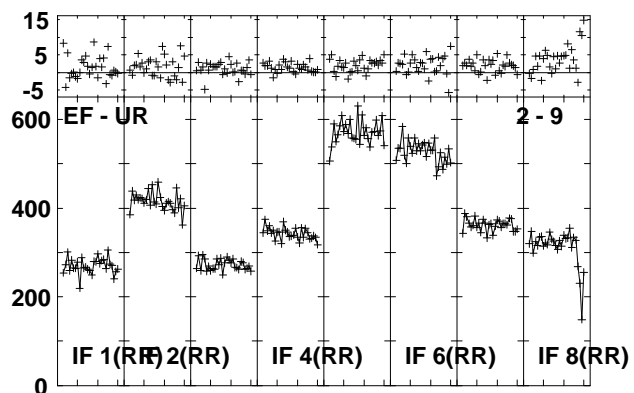
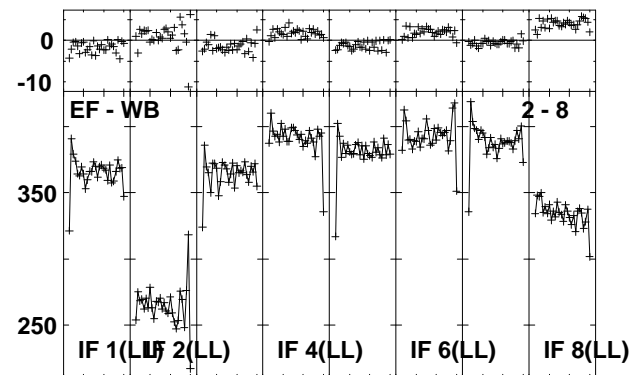
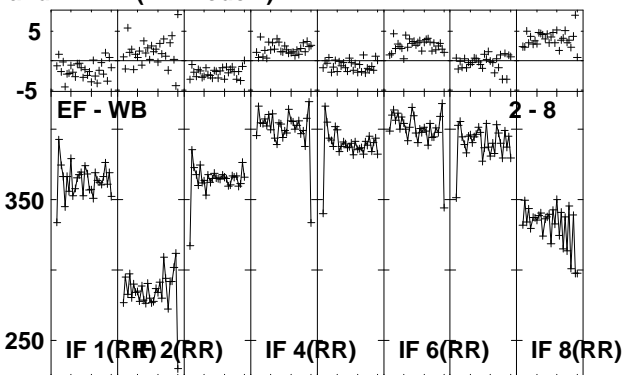
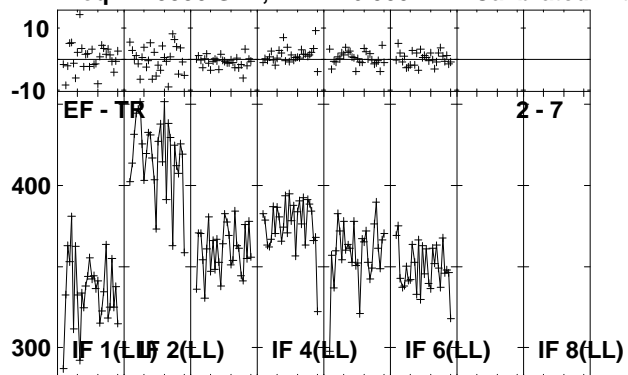

Lower frame: Milli Ampl Jy Top frame: Phas deg  
Vector averaged cross-power spectrum Several baselines displayed  
Timerange: 00/14:48:31 to 00/14:49:59

Plot file version 95 created 30-NOV-2010 14:29:22

ARP299C EP068B 3.UVDATA.1

Freq = 1.5950 GHz, Bw = 16.000 MH Calibrated with CL # 3 and BP # 1 (BP mode 1)

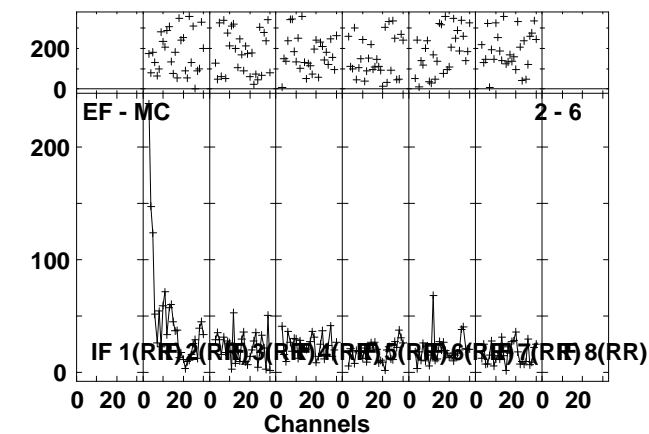
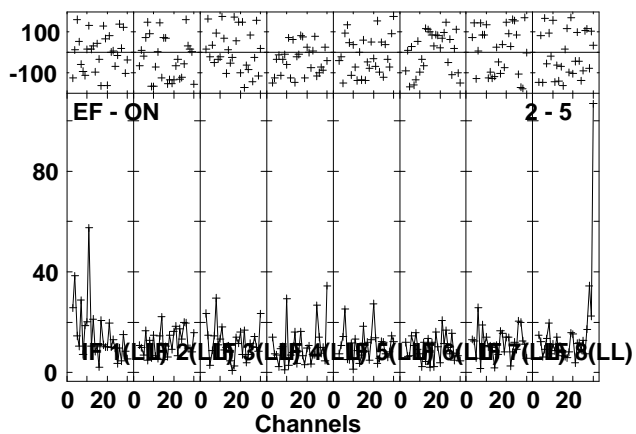
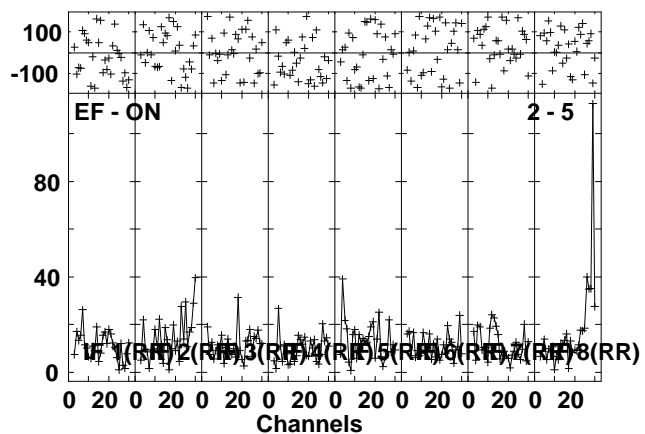
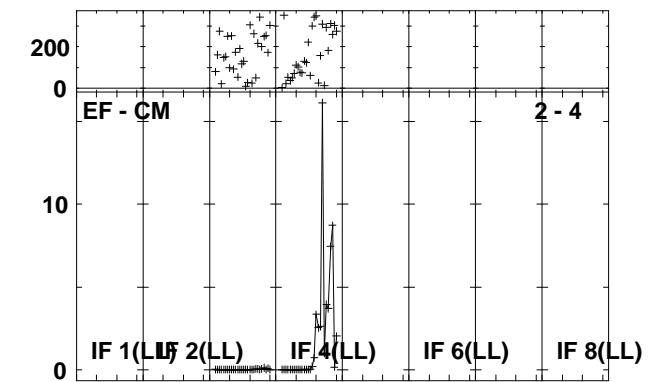
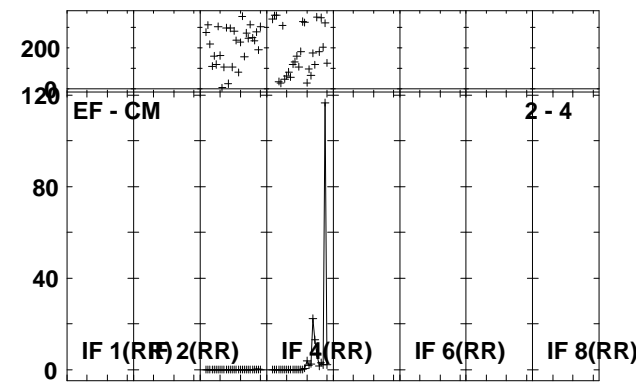
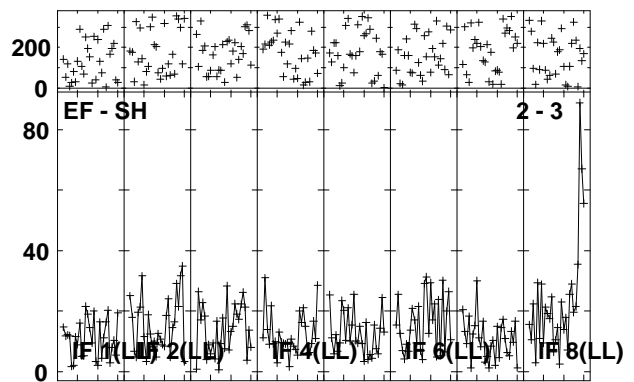
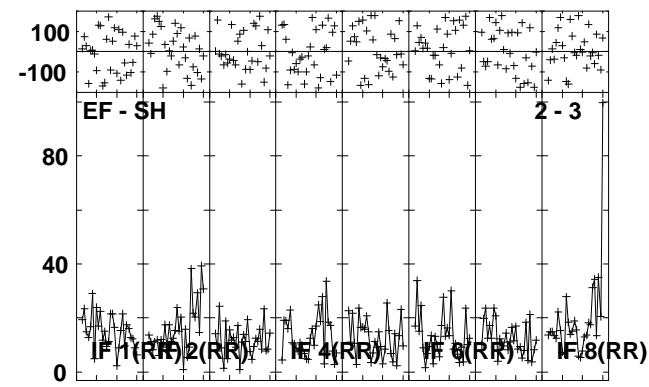
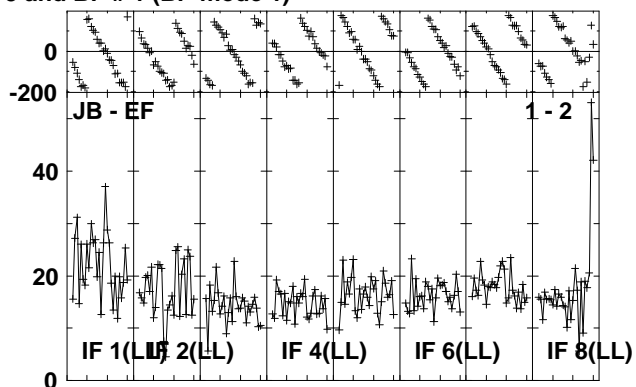
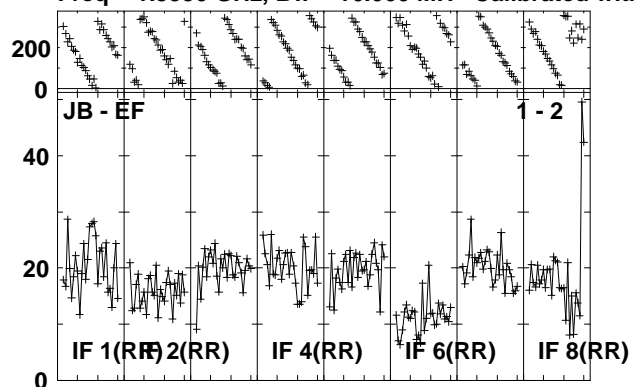

Lower frame: Milli Ampl Jy Top frame: Phas deg  
Vector averaged cross-power spectrum Several baselines displayed  
Timerange: 00/14:50:01 to 00/14:53:29

Plot file version 96 created 30-NOV-2010 14:29:24

ARP299C EP068B 3.UVDATA.1

Freq = 1.5950 GHz, Bw = 16.000 MH Calibrated with CL # 3 and BP # 1 (BP mode 1)

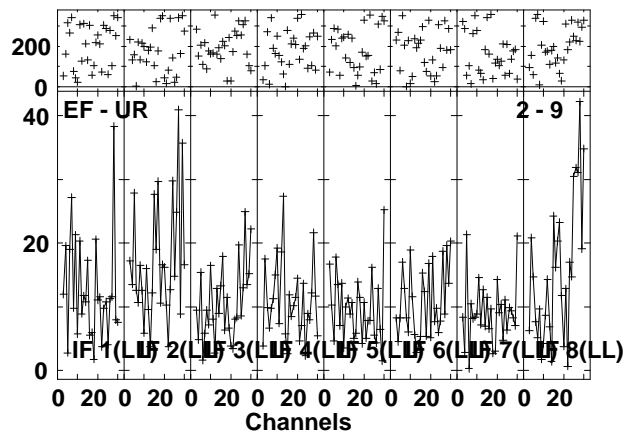
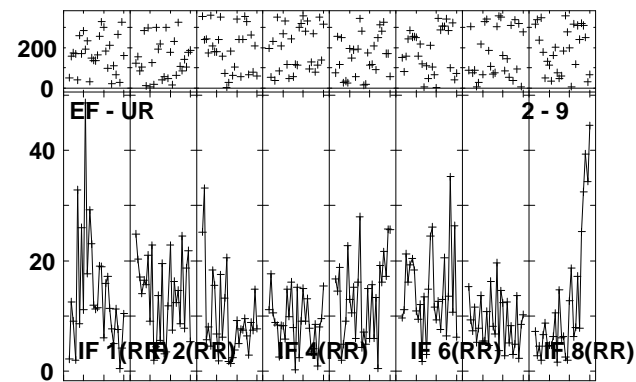
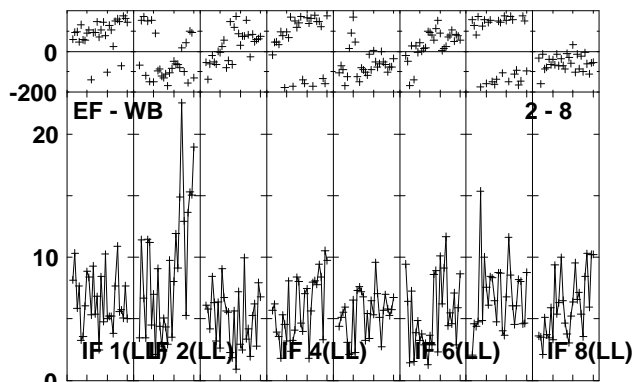
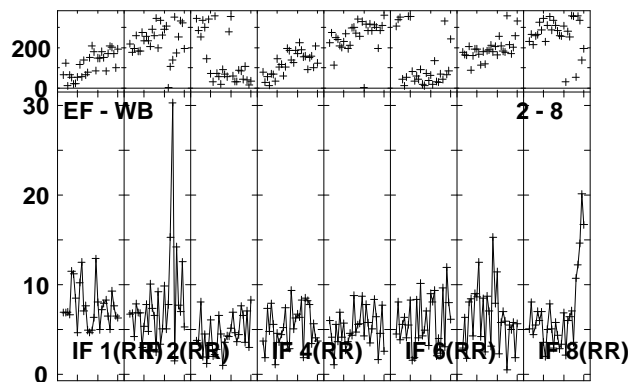
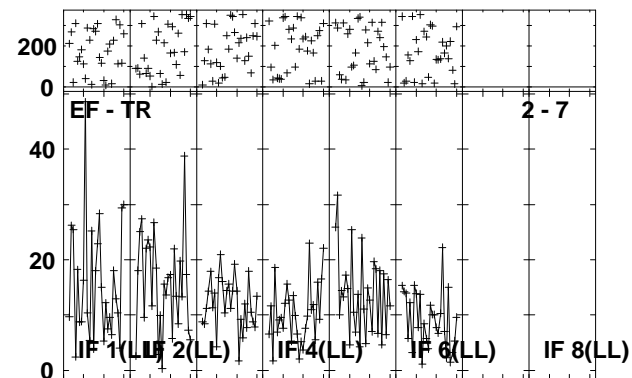
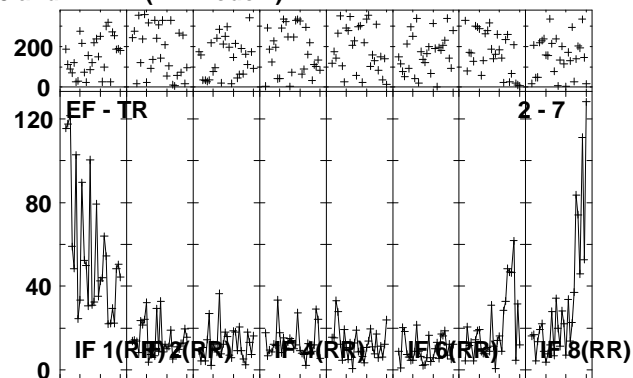
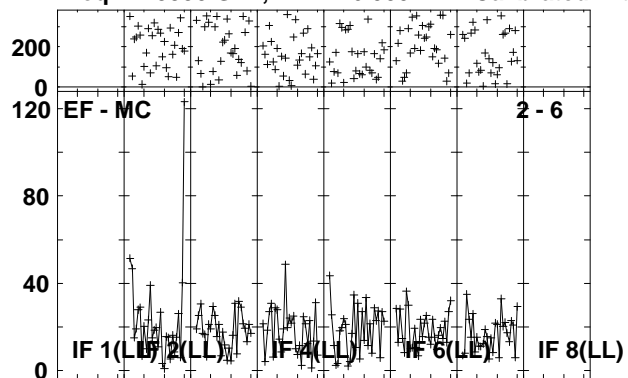

Lower frame: Milli Ampl Jy Top frame: Phas deg  
Vector averaged cross-power spectrum Several baselines displayed  
Timerange: 00/14:50:01 to 00/14:53:29



Plot file version 97 created 30-NOV-2010 14:29:27

J1128+59 EP068B 3.UVDATA.1

Freq = 1.5950 GHz, Bw = 16.000 MH Calibrated with CL # 3 and BP # 1 (BP mode 1)

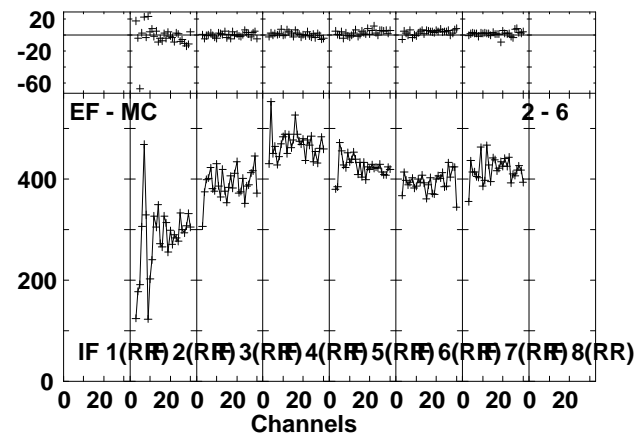
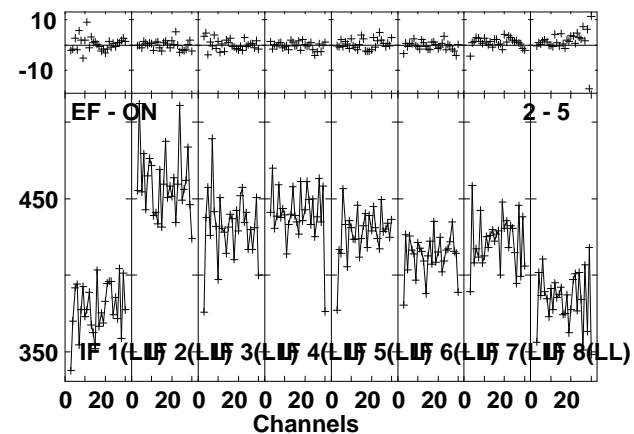
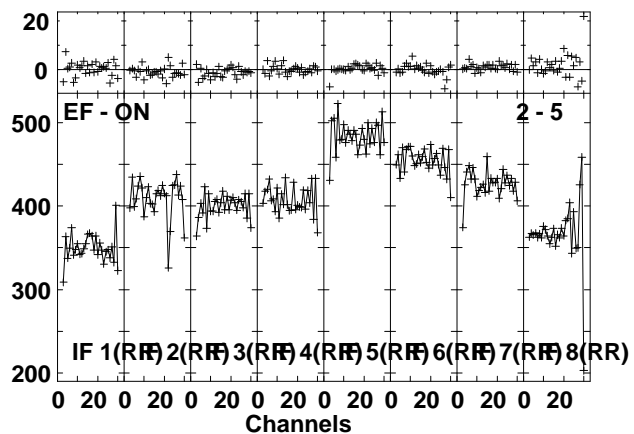
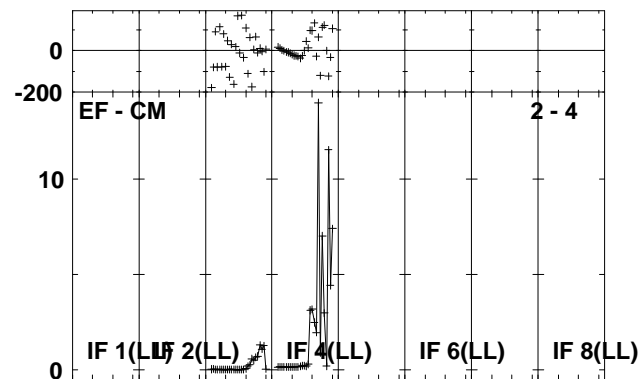
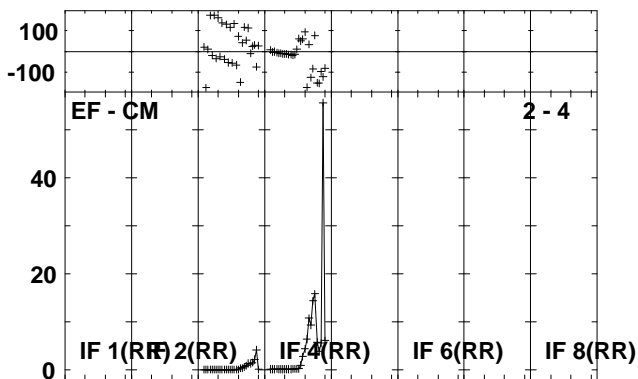
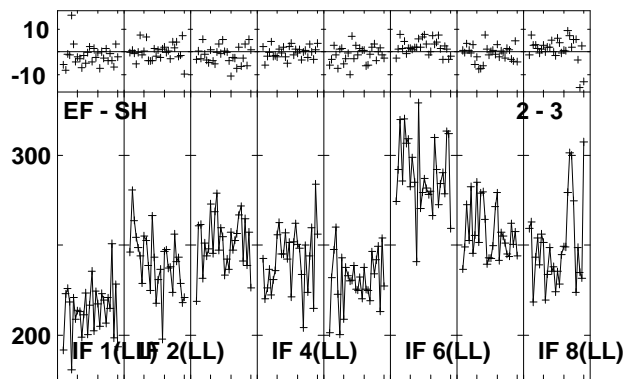
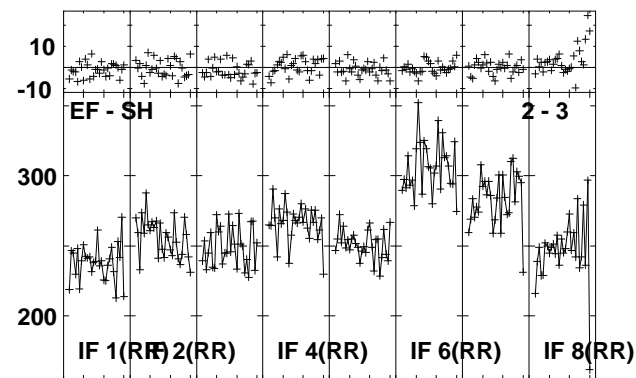
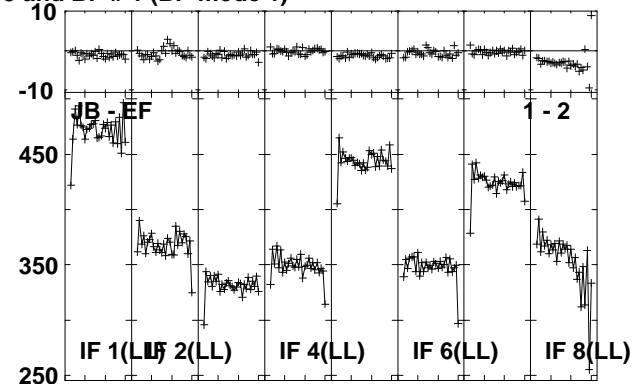
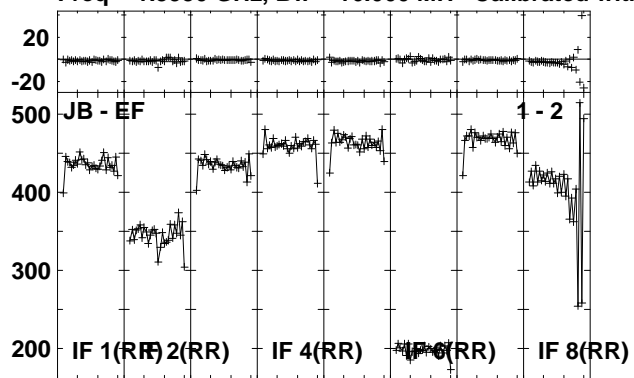

Lower frame: Milli Ampl Jy Top frame: Phas deg  
Vector averaged cross-power spectrum Several baselines displayed  
Timerange: 00/14:54:31 to 00/14:55:59

Plot file version 98 created 30-NOV-2010 14:29:28

J1128+59 EP068B 3.UVDATA.1

Freq = 1.5950 GHz, Bw = 16.000 MH Calibrated with CL # 3 and BP # 1 (BP mode 1)

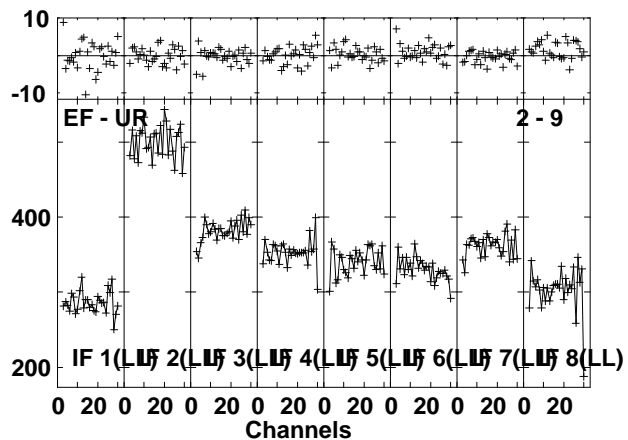
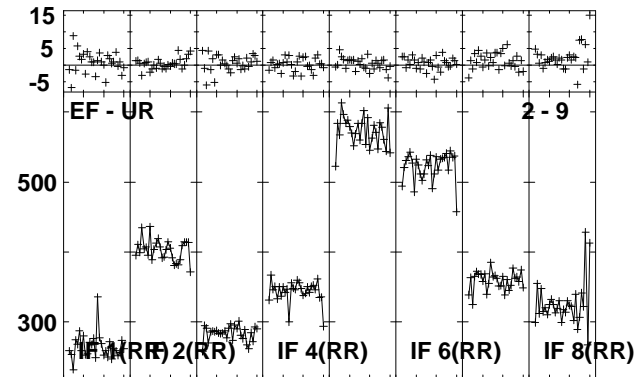
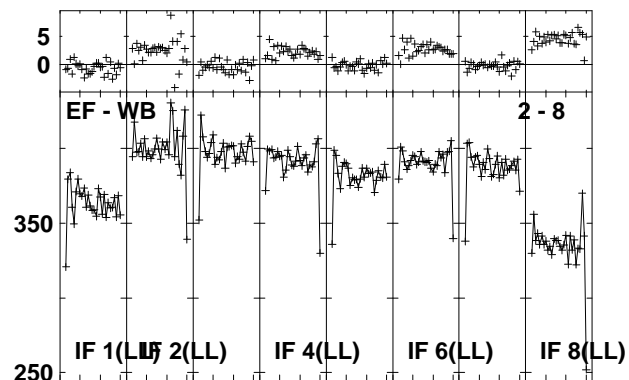
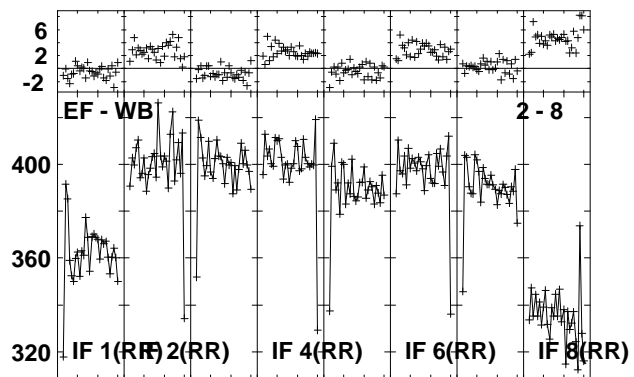
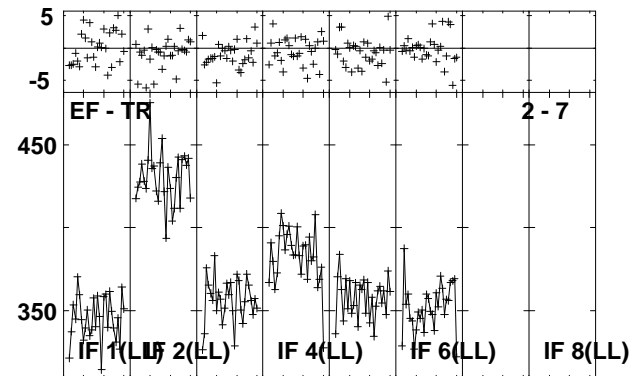
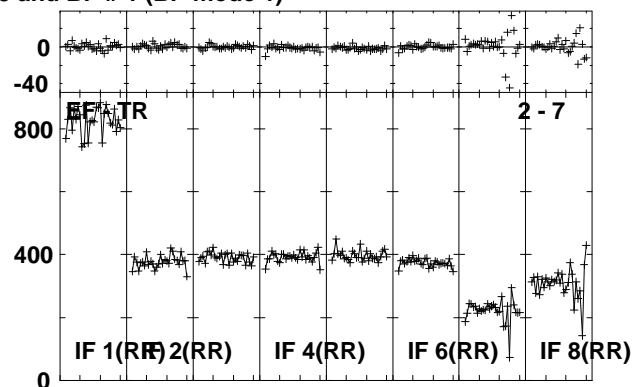
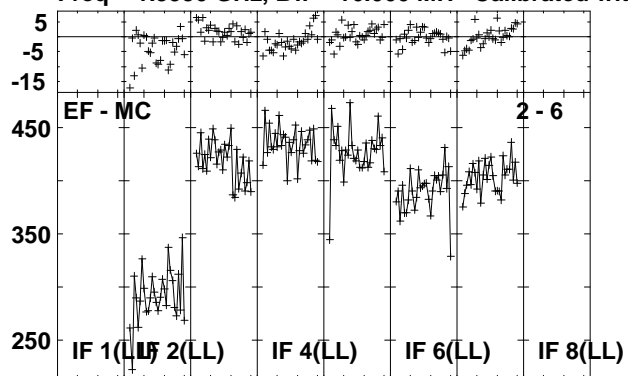

Lower frame: Milli Ampl Jy Top frame: Phas deg  
Vector averaged cross-power spectrum Several baselines displayed  
Timerange: 00/14:54:31 to 00/14:55:59

Plot file version 99 created 30-NOV-2010 14:29:30

ARP299C EP068B 3.UVDATA.1

Freq = 1.5950 GHz, Bw = 16.000 MH Calibrated with CL # 3 and BP # 1 (BP mode 1)

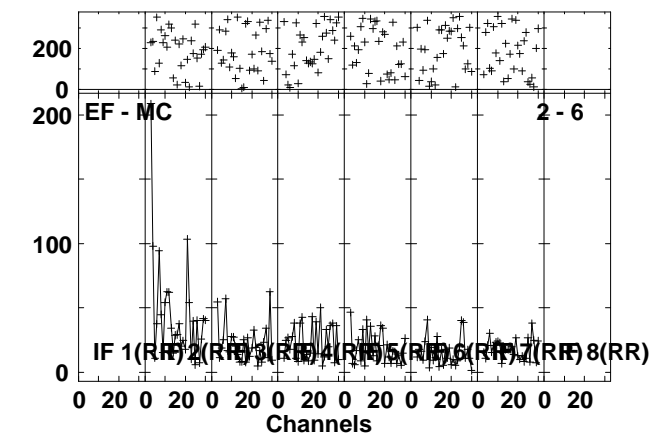
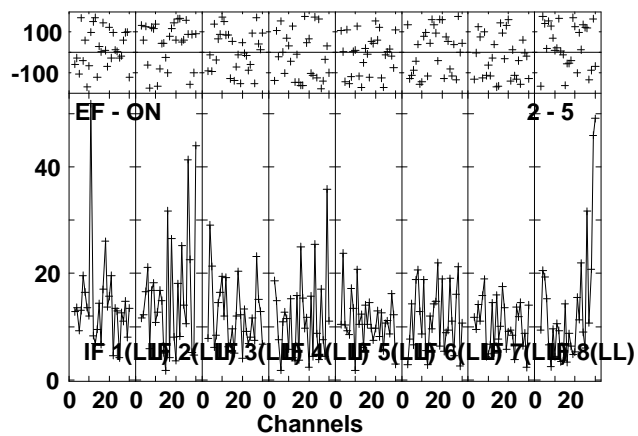
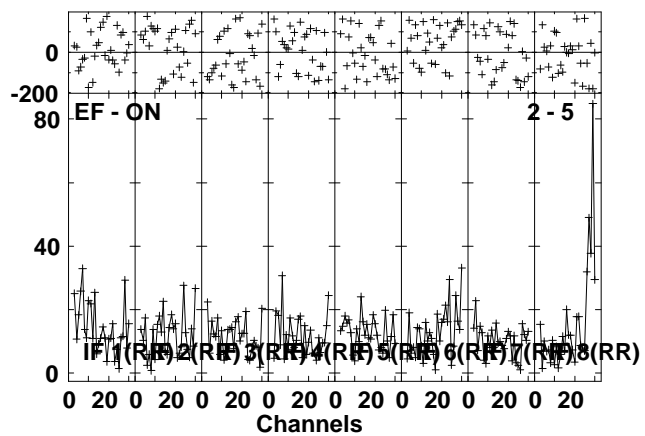
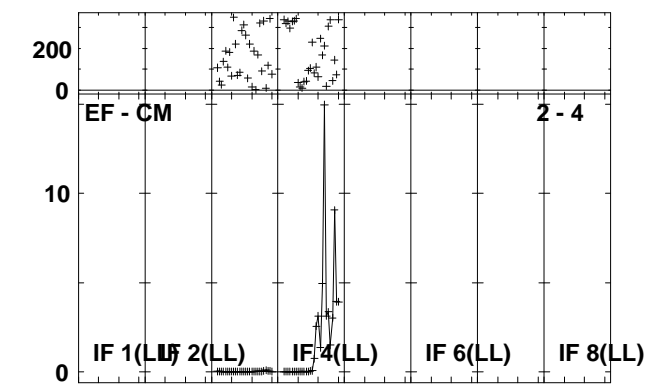
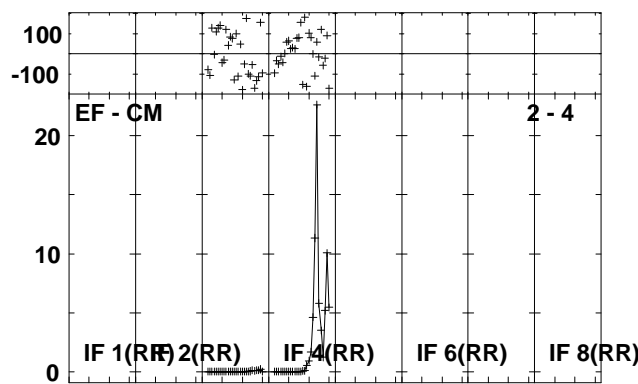
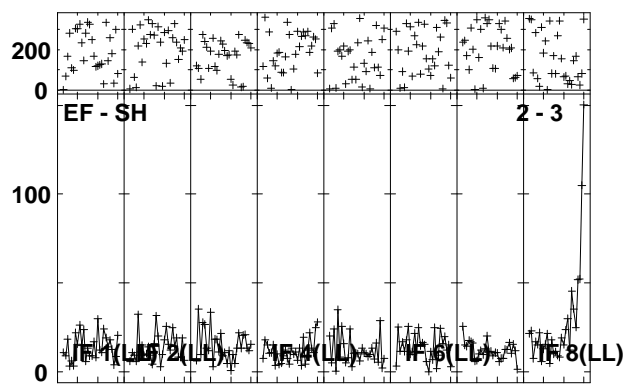
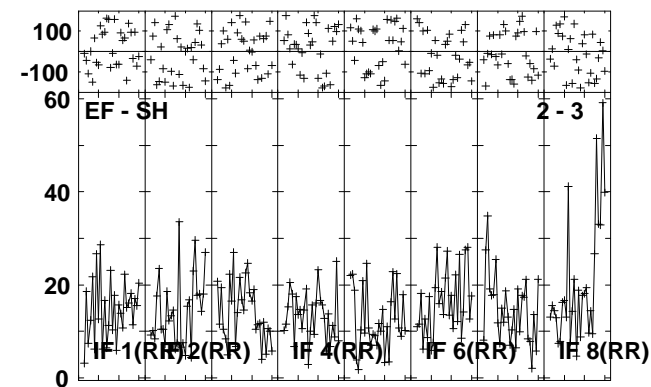
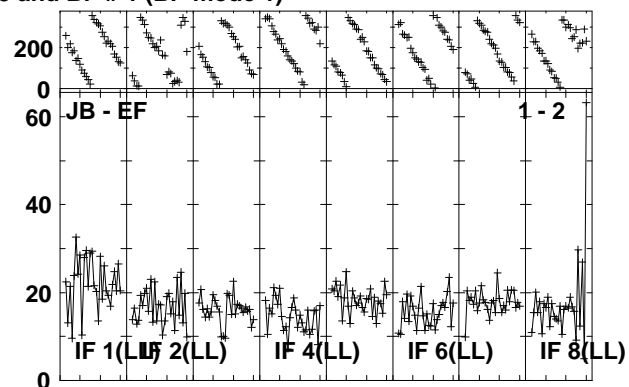
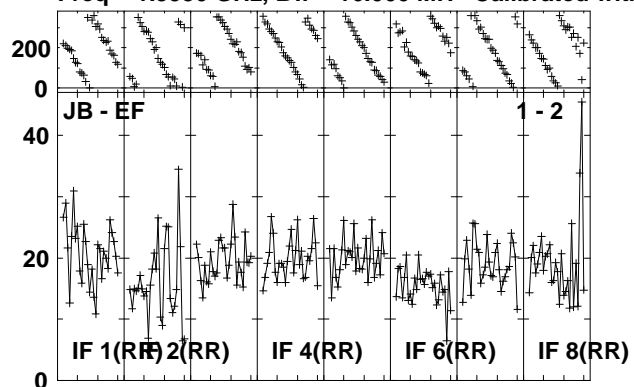

Lower frame: Milli Ampl Jy Top frame: Phas deg  
Vector averaged cross-power spectrum Several baselines displayed  
Timerange: 00/14:56:01 to 00/14:59:29

Plot file version 100 created 30-NOV-2010 14:29:32

ARP299C EP068B 3.UVDATA.1

Freq = 1.5950 GHz, Bw = 16.000 MH Calibrated with CL # 3 and BP # 1 (BP mode 1)

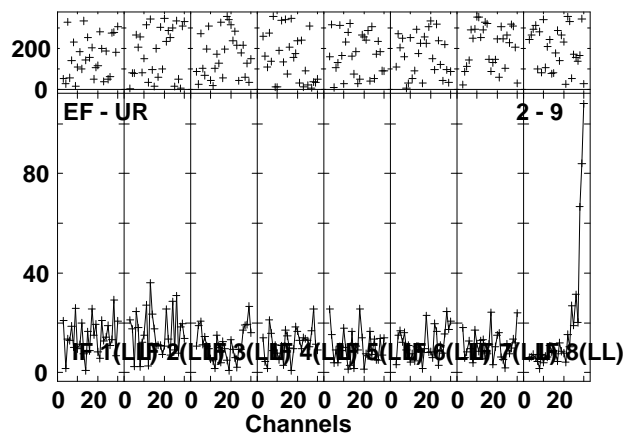
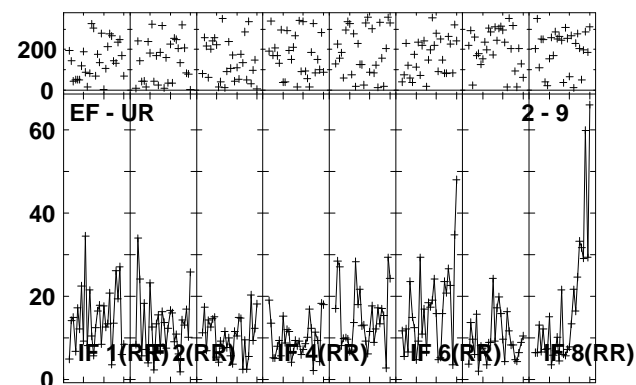
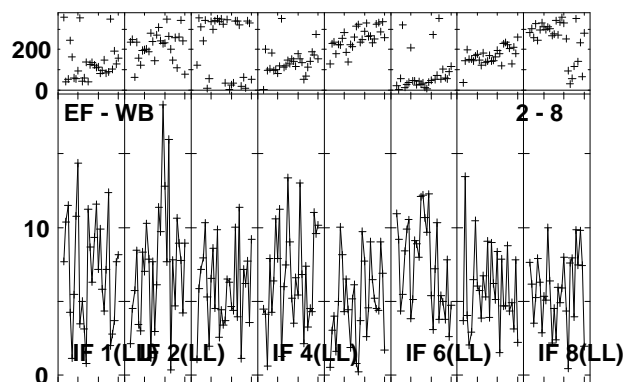
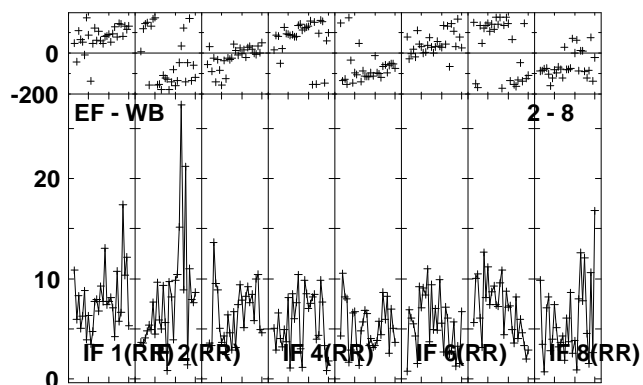
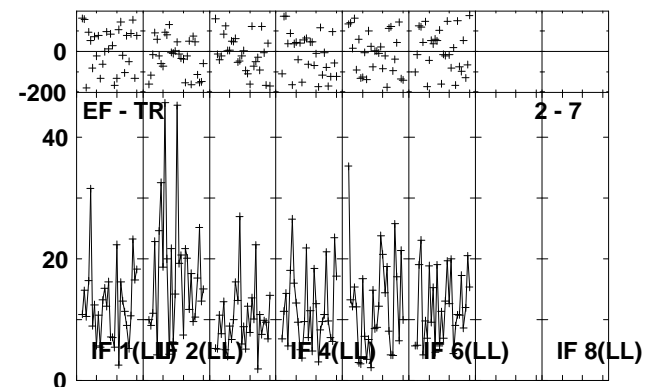
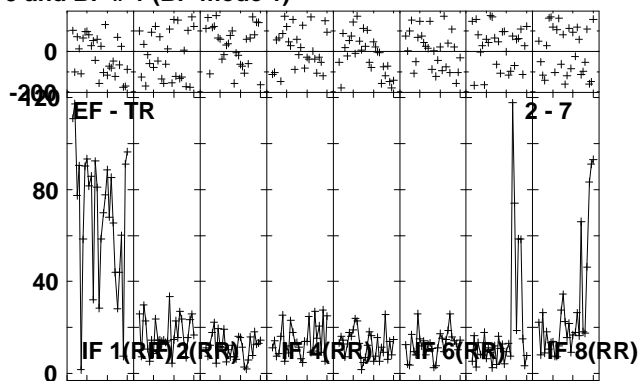
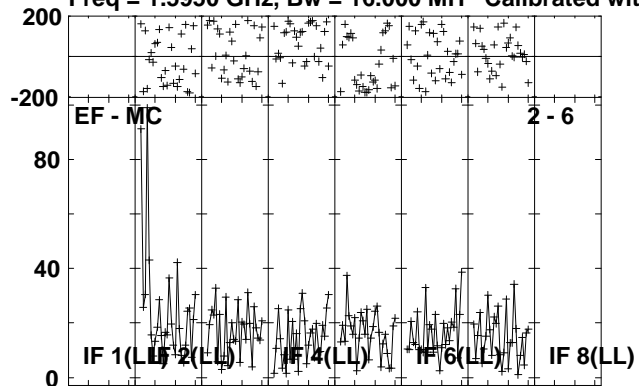

Lower frame: Milli Ampl Jy Top frame: Phas deg  
Vector averaged cross-power spectrum Several baselines displayed  
Timerange: 00/14:56:01 to 00/14:59:29

Plot file version 101 created 30-NOV-2010 14:29:35

J1128+59 EP068B 3.UVDATA.1

Freq = 1.5950 GHz, Bw = 16.000 MH Calibrated with CL # 3 and BP # 1 (BP mode 1)

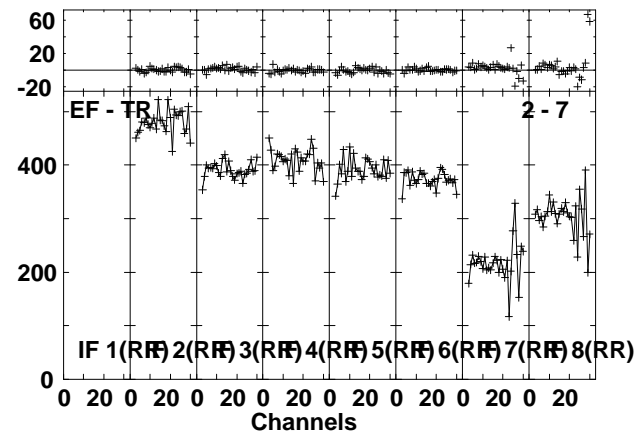
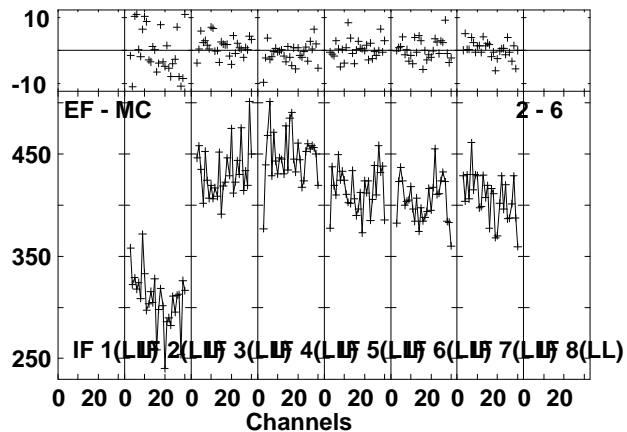
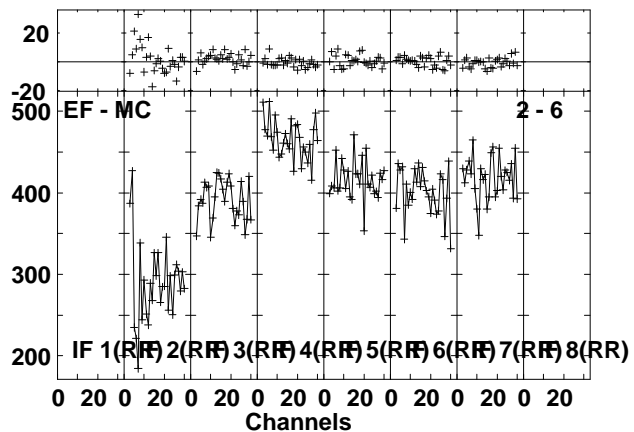
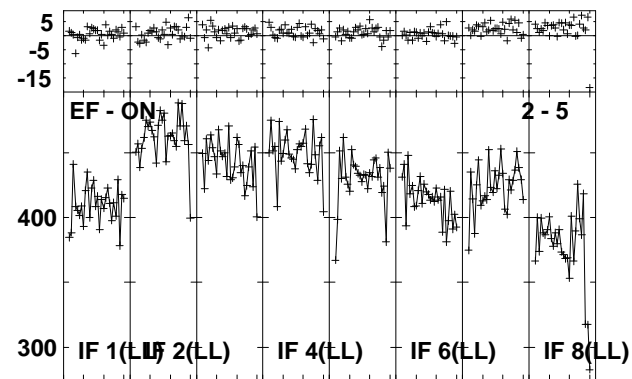
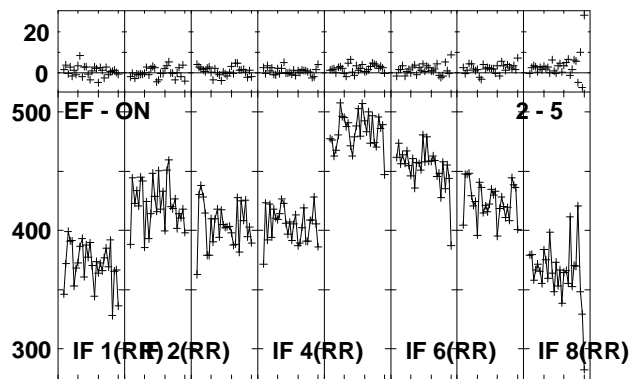
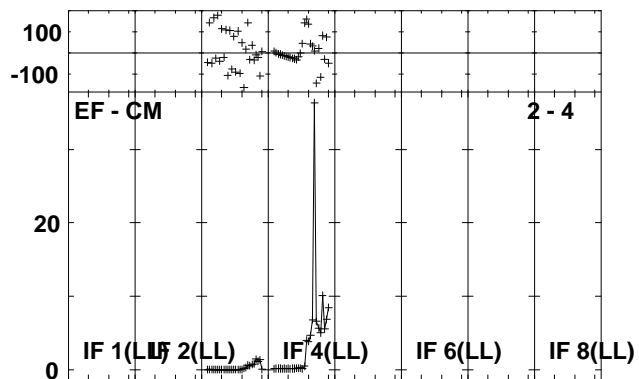
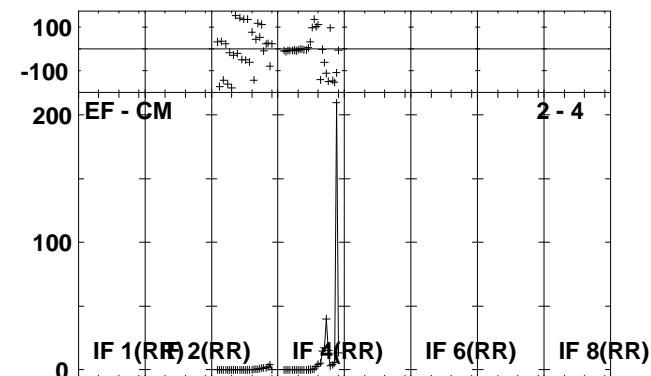
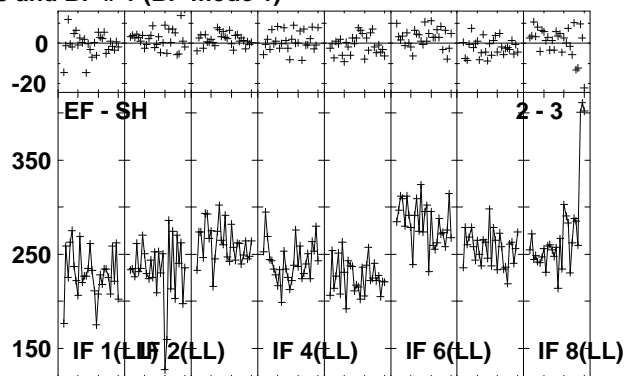
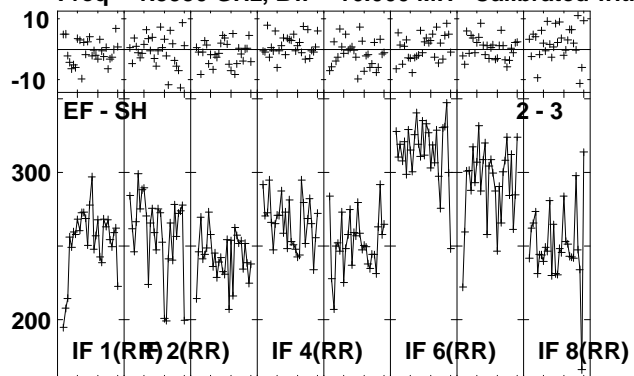

Lower frame: Milli Ampl Jy Top frame: Phas deg  
Vector averaged cross-power spectrum Several baselines displayed  
Timerange: 00/14:59:31 to 00/15:00:59

Plot file version 102 created 30-NOV-2010 14:29:36

J1128+59 EP068B 3.UVDATA.1

Freq = 1.5950 GHz, Bw = 16.000 MH Calibrated with CL # 3 and BP # 1 (BP mode 1)

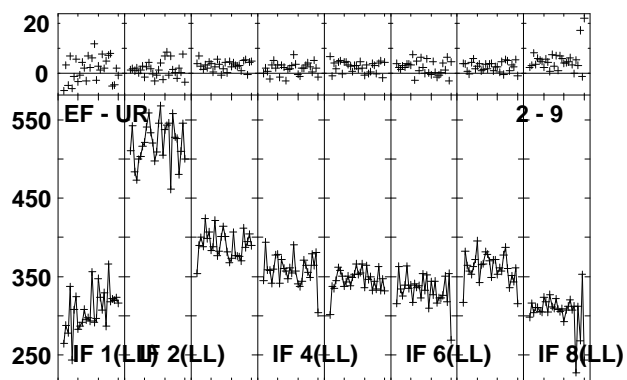
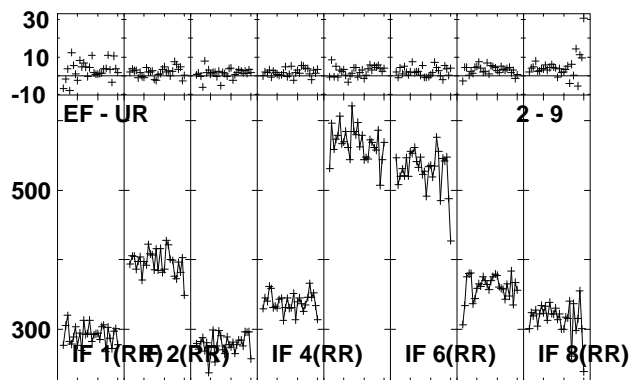
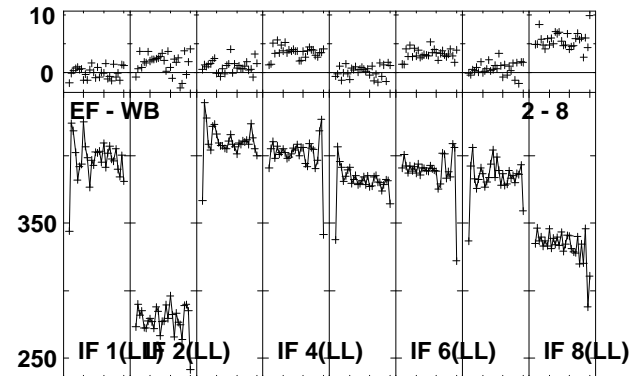
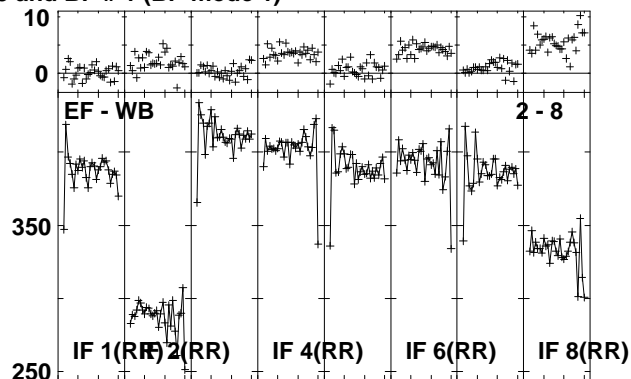
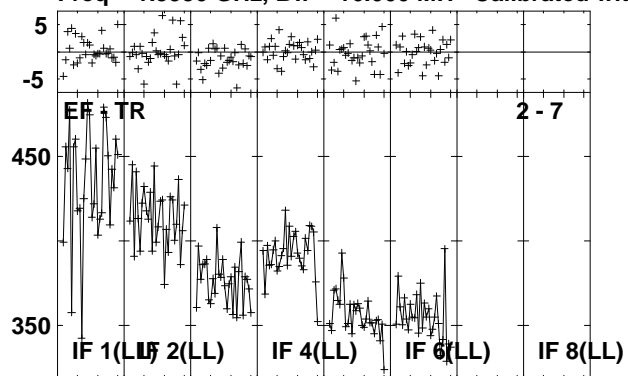

Lower frame: Milli Ampl Jy Top frame: Phas deg  
Vector averaged cross-power spectrum Several baselines displayed  
Timerange: 00/14:59:31 to 00/15:00:59

Plot file version 103 created 30-NOV-2010 14:29:37

ARP299C EP068B 3.UVDATA.1

Freq = 1.5950 GHz, Bw = 16.000 MH Calibrated with CL # 3 and BP # 1 (BP mode 1)

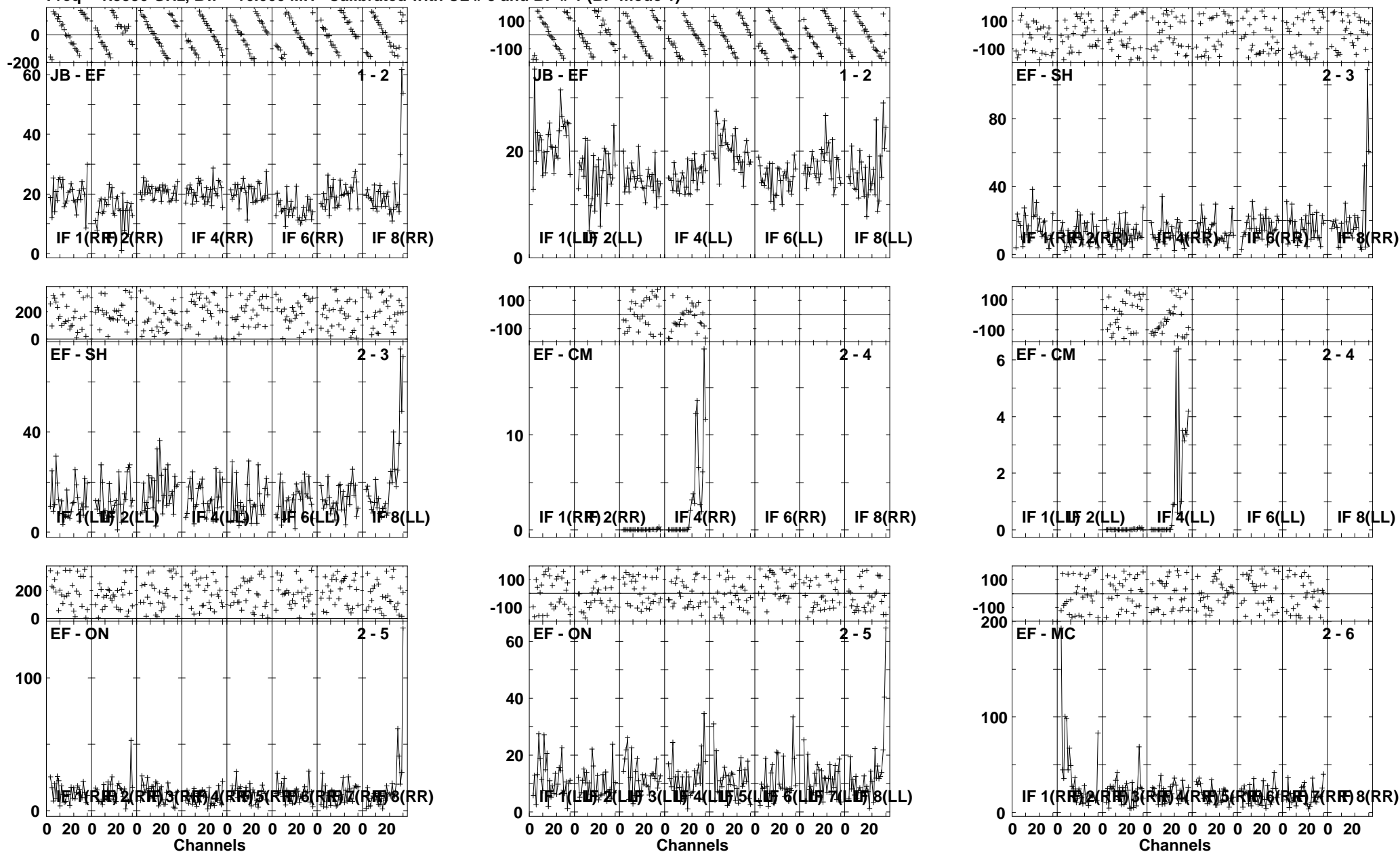

Lower frame: Milli Ampl Jy Top frame: Phas deg  
Vector averaged cross-power spectrum Several baselines displayed  
Timerange: 00/15:01:01 to 00/15:04:29

Plot file version 104 created 30-NOV-2010 14:29:41

ARP299C EP068B 3.UVDATA.1

Freq = 1.5950 GHz, Bw = 16.000 MH Calibrated with CL # 3 and BP # 1 (BP mode 1)

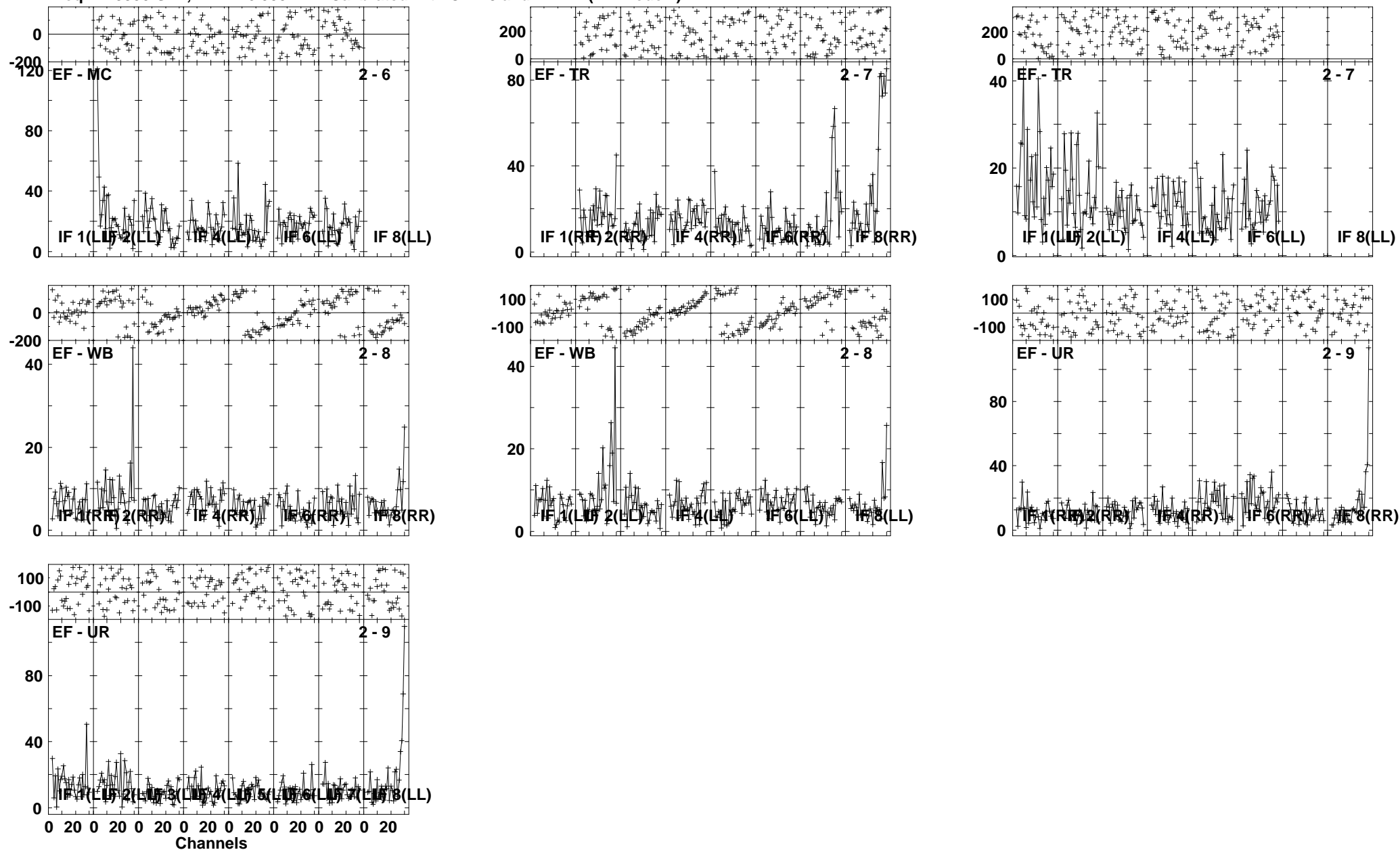

Lower frame: Milli Ampl Jy Top frame: Phas deg  
Vector averaged cross-power spectrum Several baselines displayed  
Timerange: 00/15:01:01 to 00/15:04:29



Plot file version 105 created 30-NOV-2010 14:29:45

J1128+59 EP068B 3.UVDATA.1

Freq = 1.5950 GHz, Bw = 16.000 MH Calibrated with CL # 3 and BP # 1 (BP mode 1)

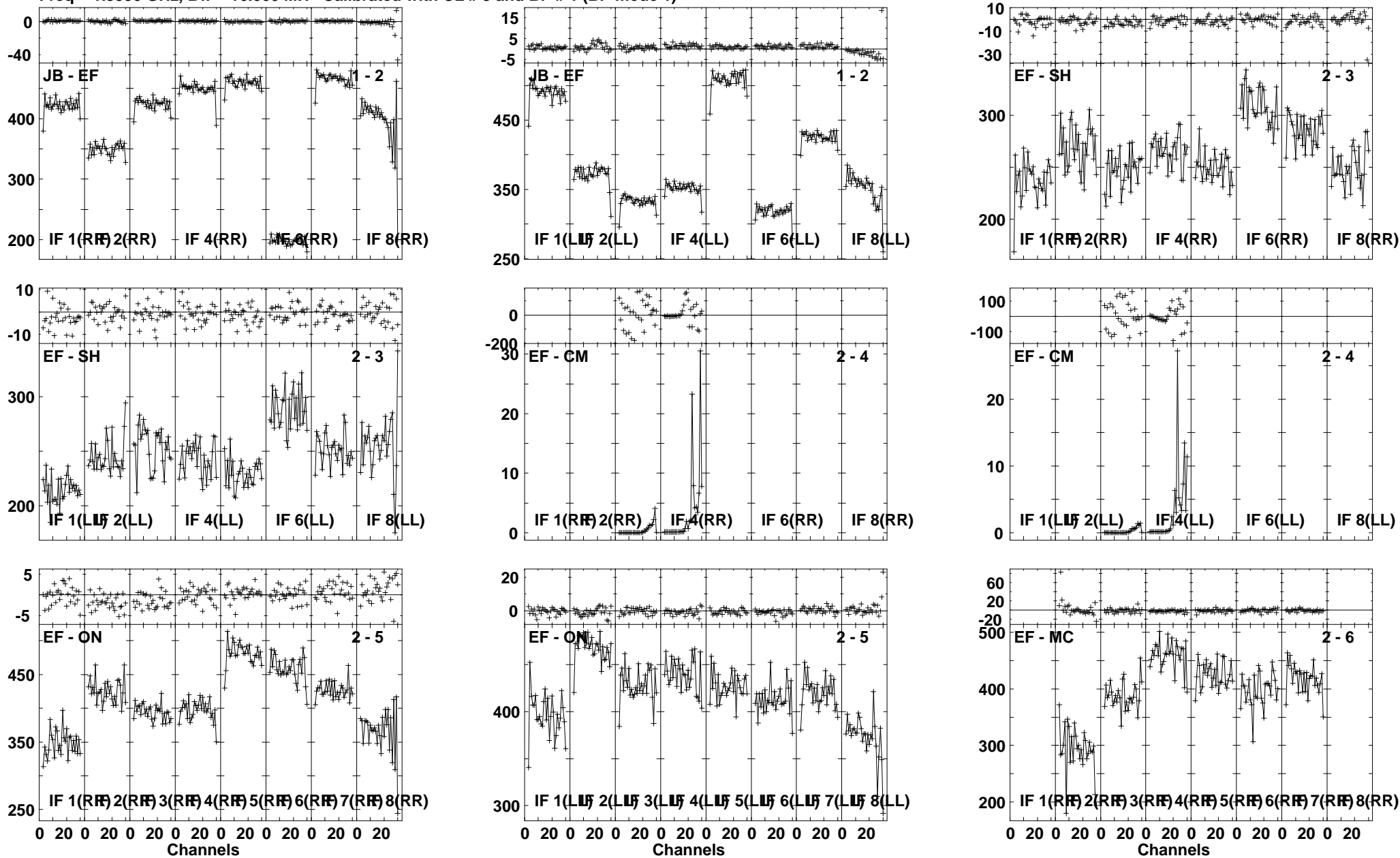

Lower frame: Milli Ampl Jy Top frame: Phas deg  
Vector averaged cross-power spectrum Several baselines displayed  
Timerange: 00/15:05:31 to 00/15:06:59

Plot file version 106 created 30-NOV-2010 14:29:47

J1128+59 EP068B 3.UVDATA.1

Freq = 1.5950 GHz, Bw = 16.000 MH Calibrated with CL # 3 and BP # 1 (BP mode 1)

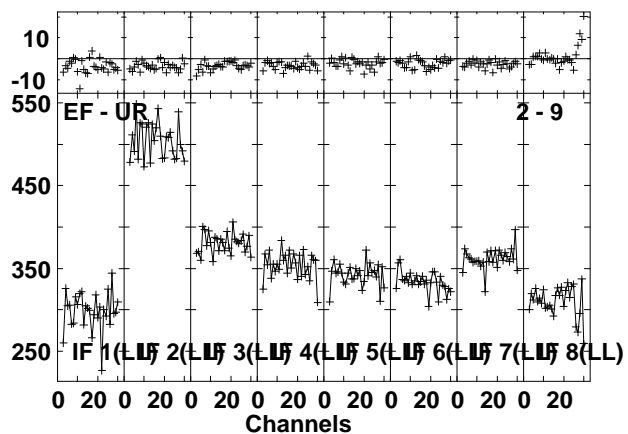
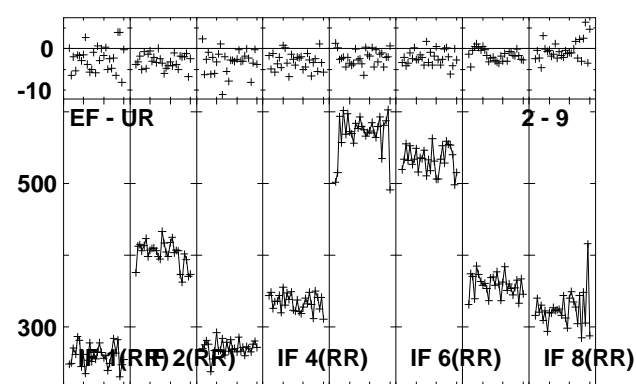
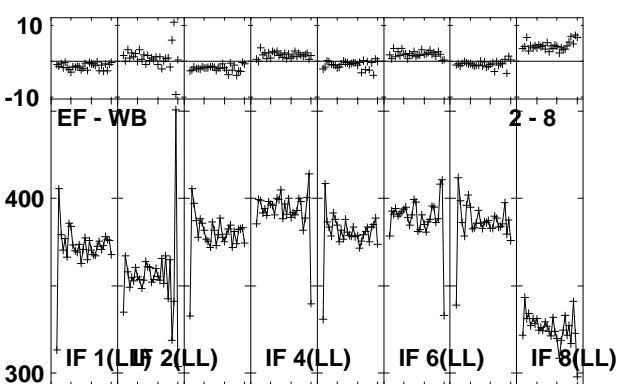
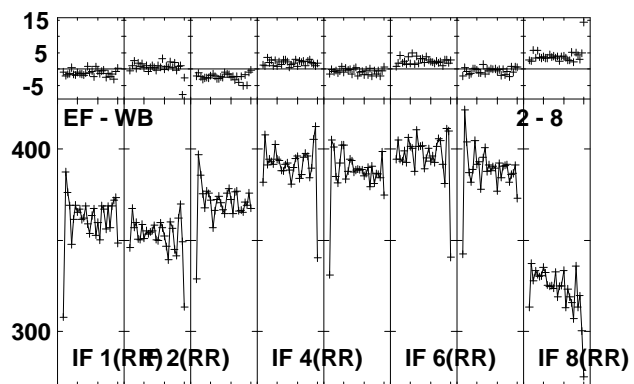
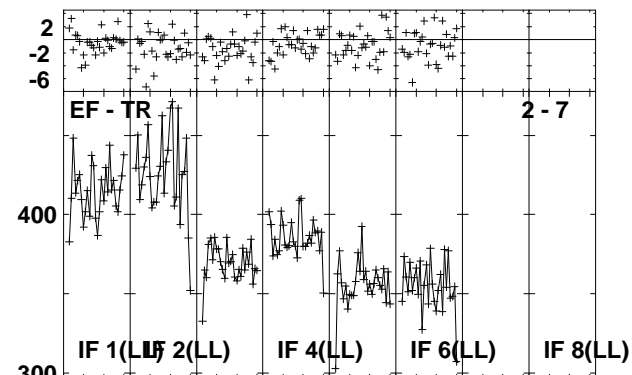
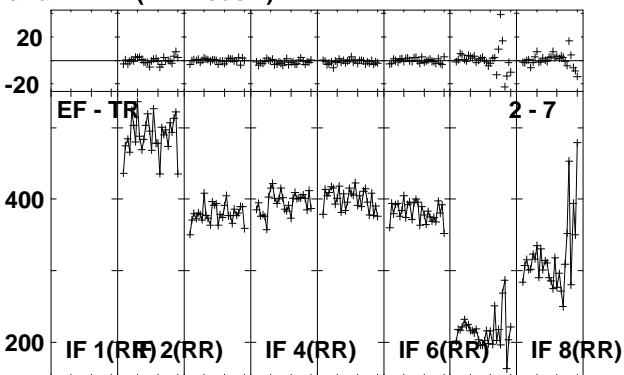
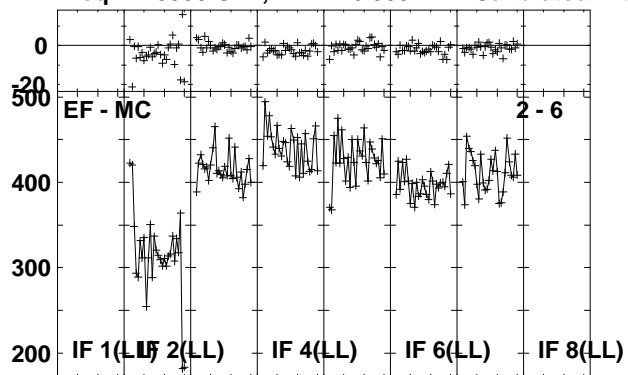

Lower frame: Milli Ampl Jy Top frame: Phas deg  
Vector averaged cross-power spectrum Several baselines displayed  
Timerange: 00/15:05:31 to 00/15:06:59

Plot file version 107 created 30-NOV-2010 14:29:48

ARP299C EP068B 3.UVDATA.1

Freq = 1.5950 GHz, Bw = 16.000 MH Calibrated with CL # 3 and BP # 1 (BP mode 1)

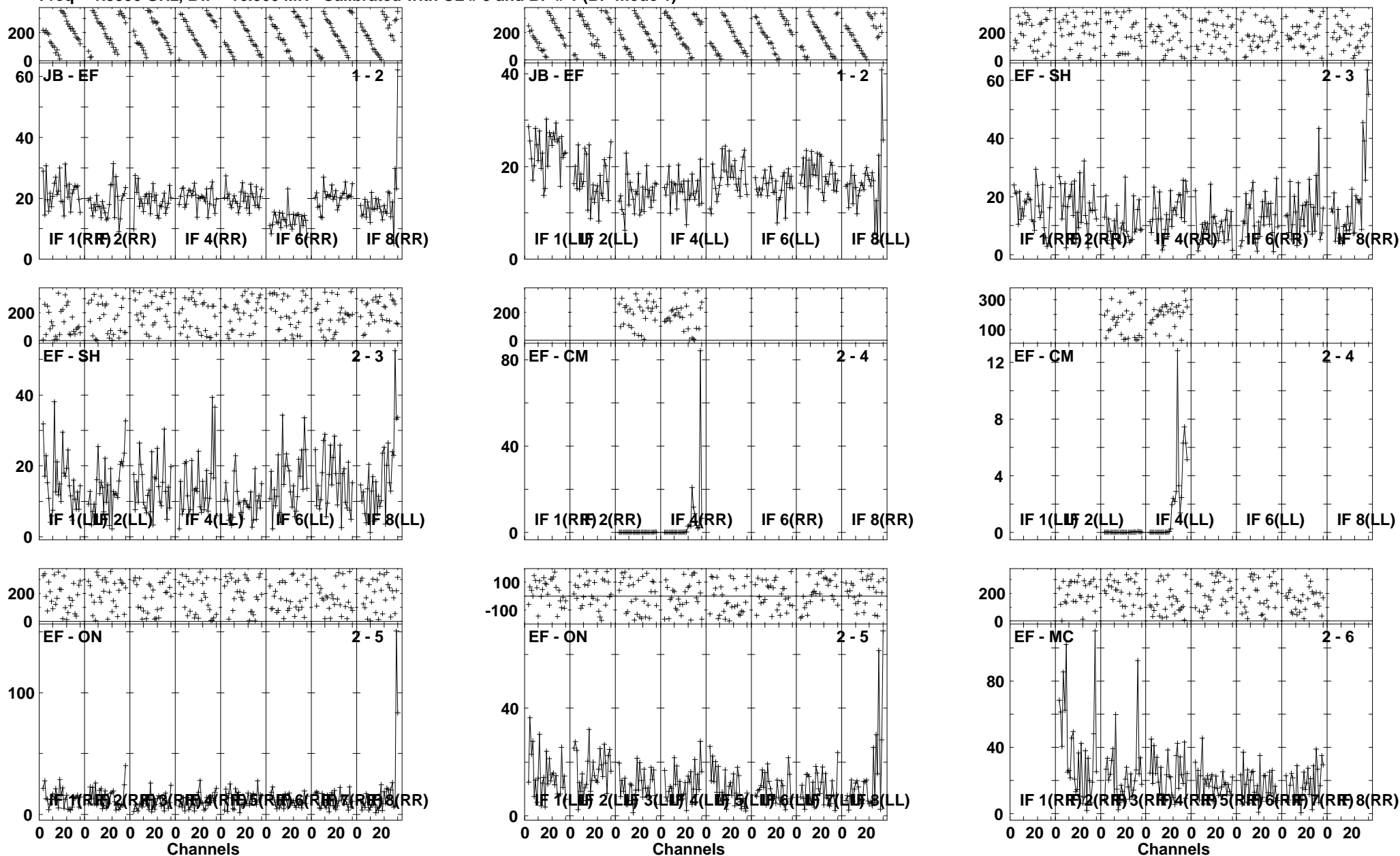

Lower frame: Milli Ampl Jy Top frame: Phas deg  
Vector averaged cross-power spectrum Several baselines displayed  
Timerange: 00/15:07:01 to 00/15:10:29

Plot file version 108 created 30-NOV-2010 14:29:51

ARP299C EP068B 3.UVDATA.1

Freq = 1.5950 GHz, Bw = 16.000 MH Calibrated with CL # 3 and BP # 1 (BP mode 1)

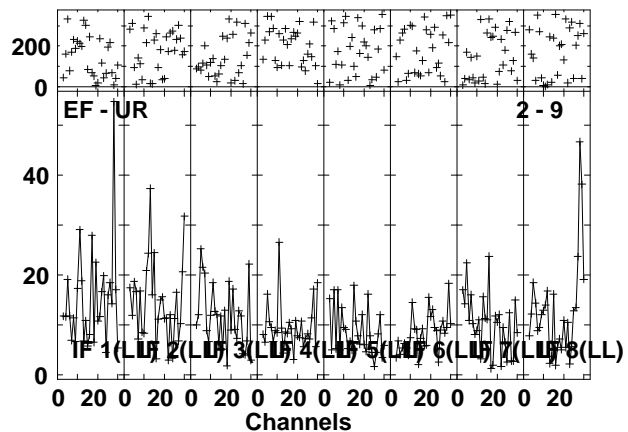
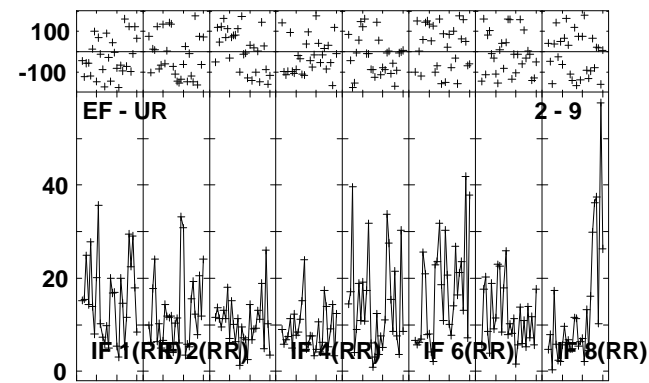
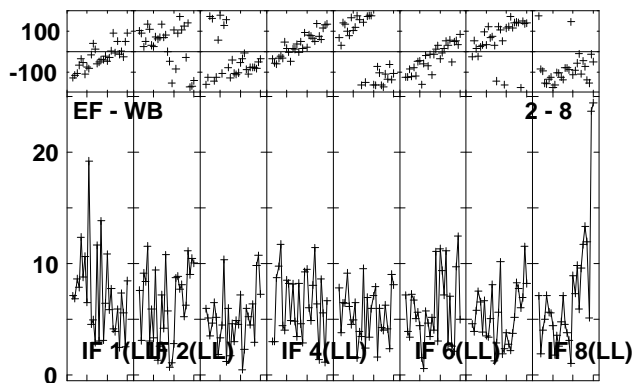
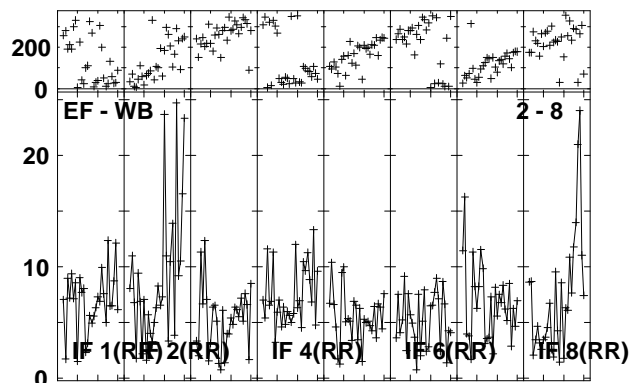
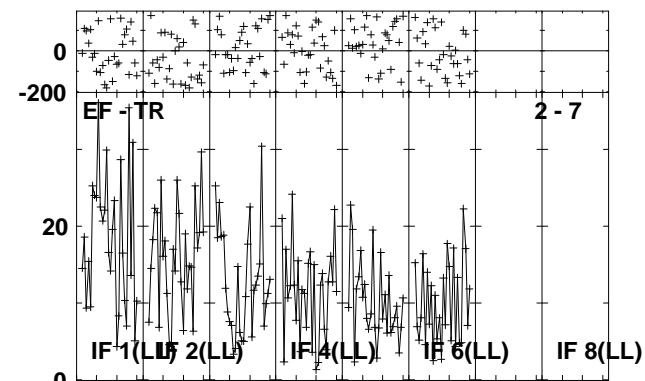
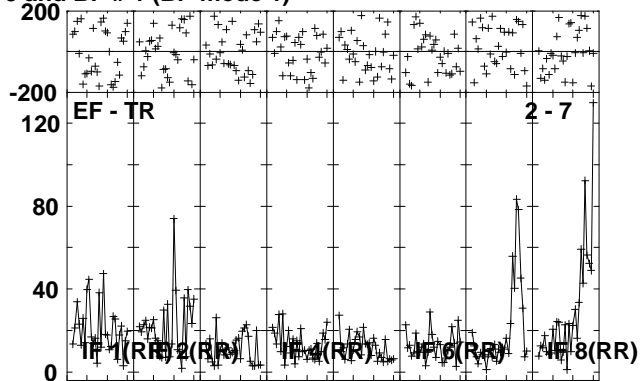
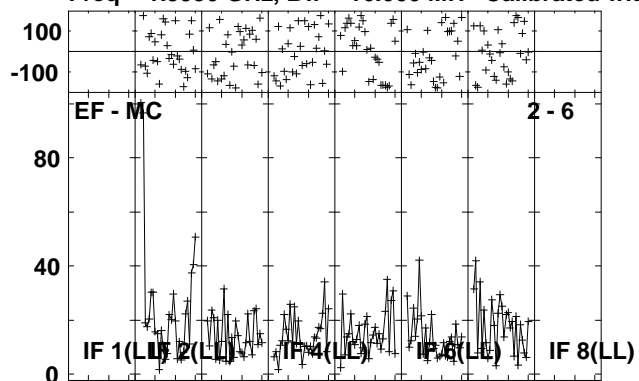

Lower frame: Milli Ampl Jy Top frame: Phas deg  
Vector averaged cross-power spectrum Several baselines displayed  
Timerange: 00:15:07:01 to 00:15:10:29

Plot file version 109 created 30-NOV-2010 14:29:54

J1128+59 EP068B 3.UVDATA.1

Freq = 1.5950 GHz, Bw = 16.000 MH Calibrated with CL # 3 and BP # 1 (BP mode 1)

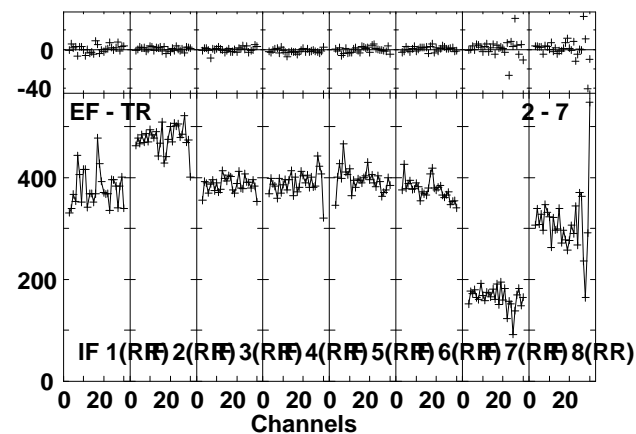
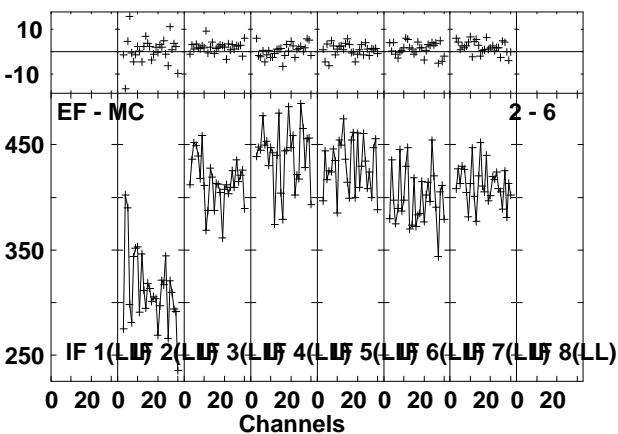
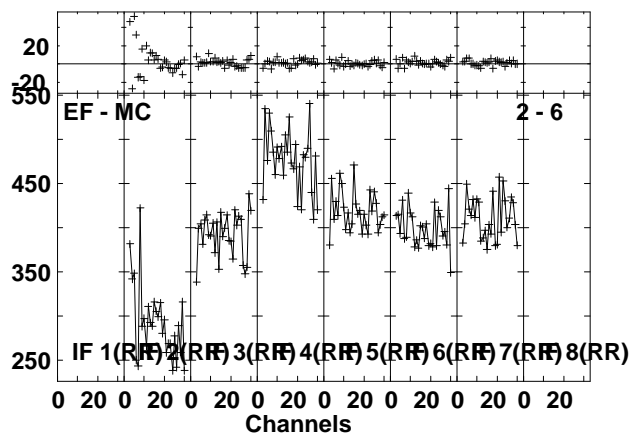
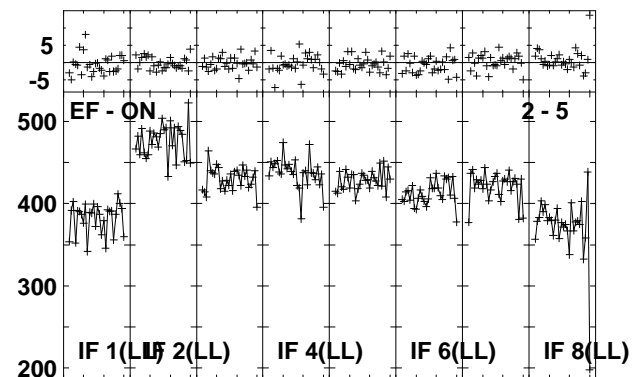
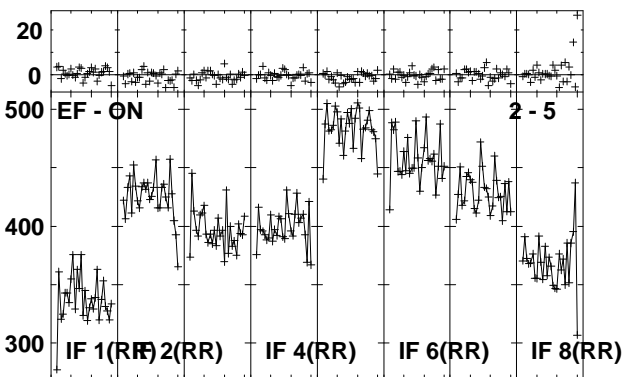
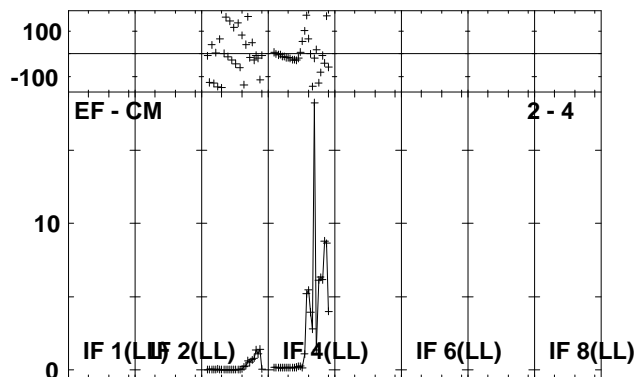
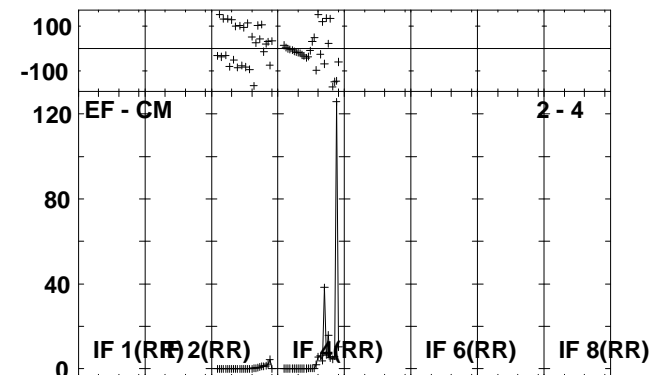
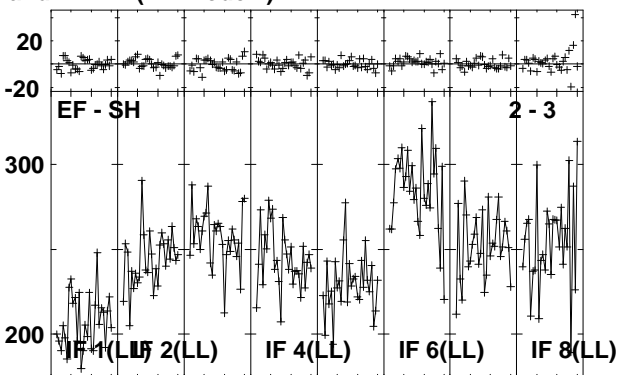
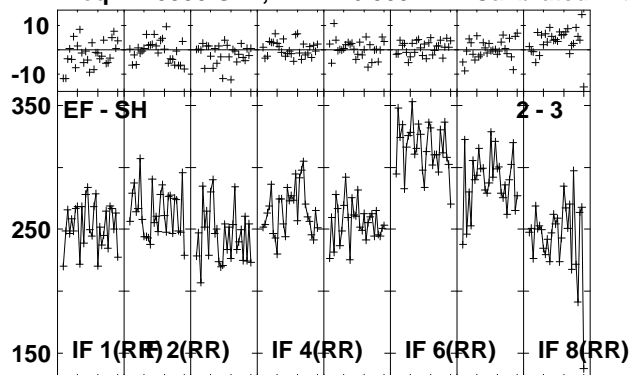

Lower frame: Milli Ampl Jy Top frame: Phas deg  
Vector averaged cross-power spectrum Several baselines displayed  
Timerange: 00/15:10:31 to 00/15:11:59

Plot file version 110 created 30-NOV-2010 14:29:54

J1128+59 EP068B 3.UVDATA.1

Freq = 1.5950 GHz, Bw = 16.000 MH Calibrated with CL # 3 and BP # 1 (BP mode 1)

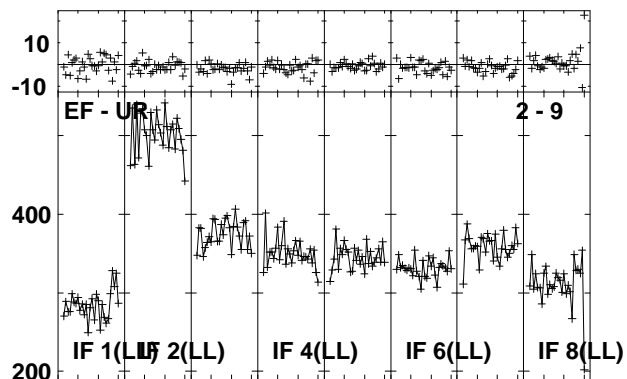
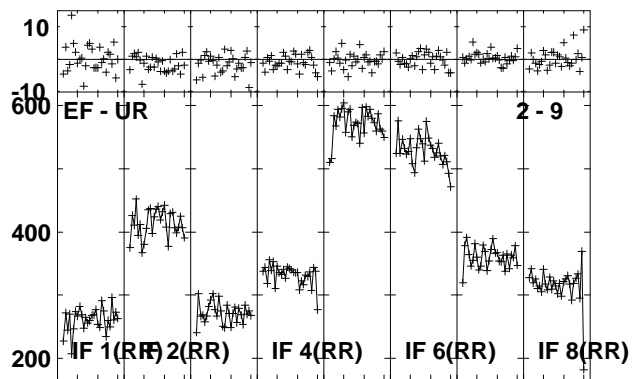
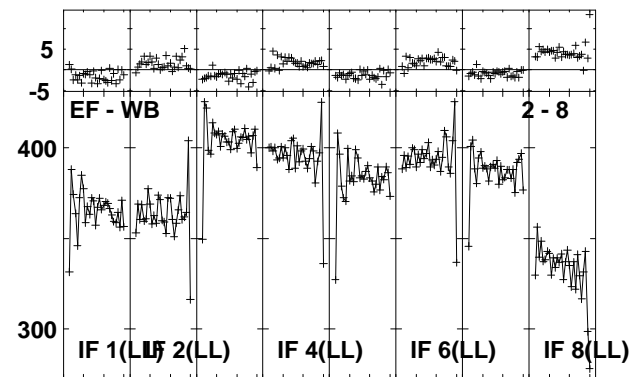
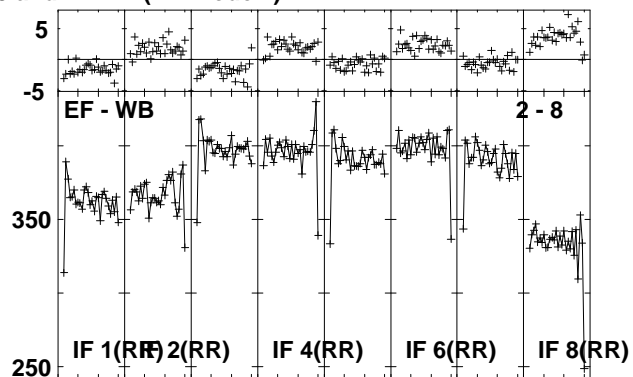
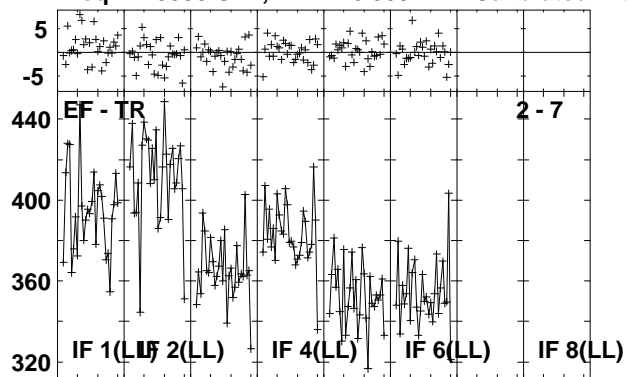

Lower frame: Milli Ampl Jy Top frame: Phas deg  
Vector averaged cross-power spectrum Several baselines displayed  
Timerange: 00/15:10:31 to 00/15:11:59

Plot file version 111 created 30-NOV-2010 14:29:56

ARP299C EP068B 3.UVDATA.1

Freq = 1.5950 GHz, Bw = 16.000 MH Calibrated with CL # 3 and BP # 1 (BP mode 1)

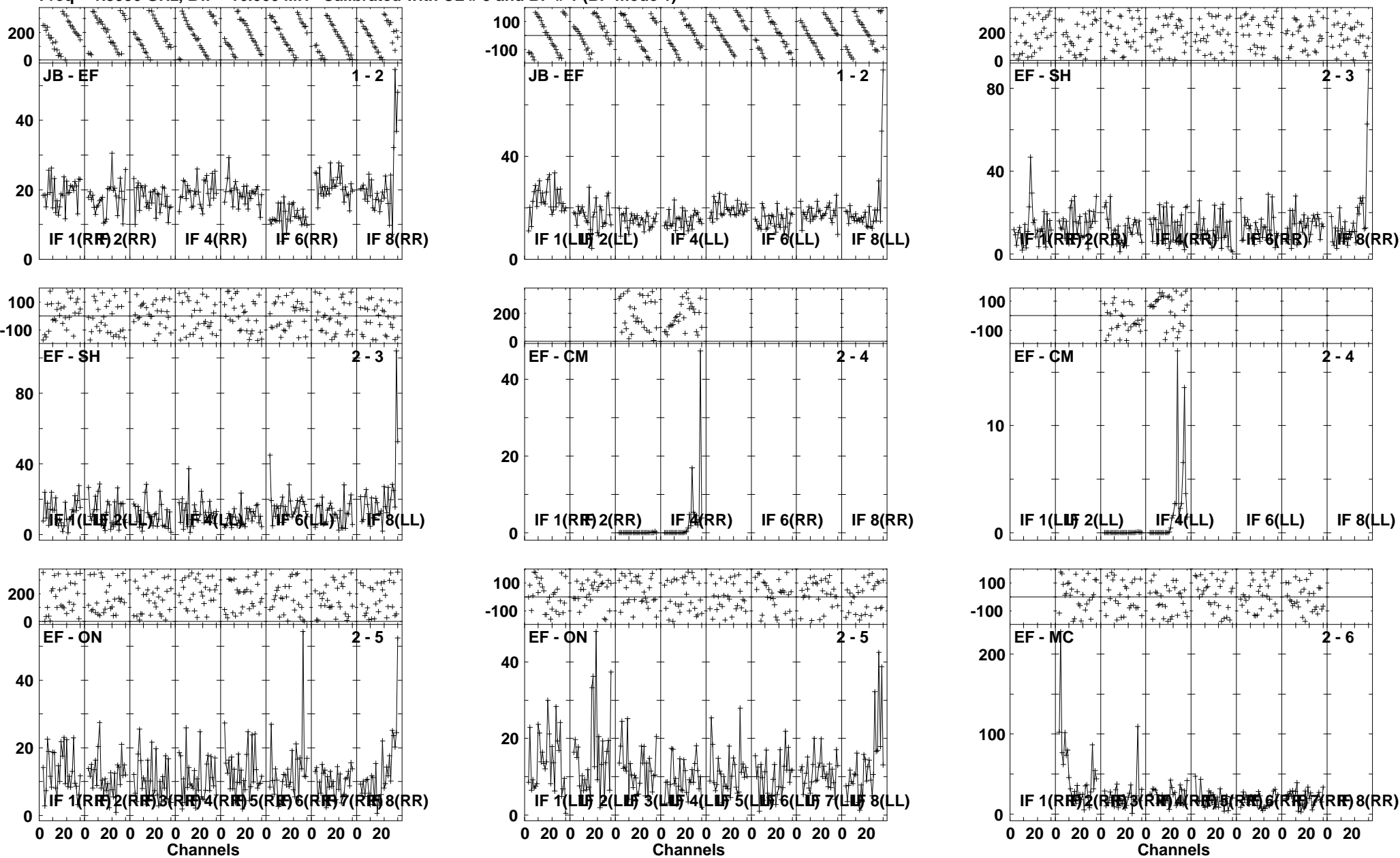

Lower frame: Milli Ampl Jy Top frame: Phas deg  
Vector averaged cross-power spectrum Several baselines displayed  
Timerange: 00/15:12:01 to 00/15:15:29

Plot file version 112 created 30-NOV-2010 14:29:58

ARP299C EP068B 3.UVDATA.1

Freq = 1.5950 GHz, Bw = 16.000 MH Calibrated with CL # 3 and BP # 1 (BP mode 1)

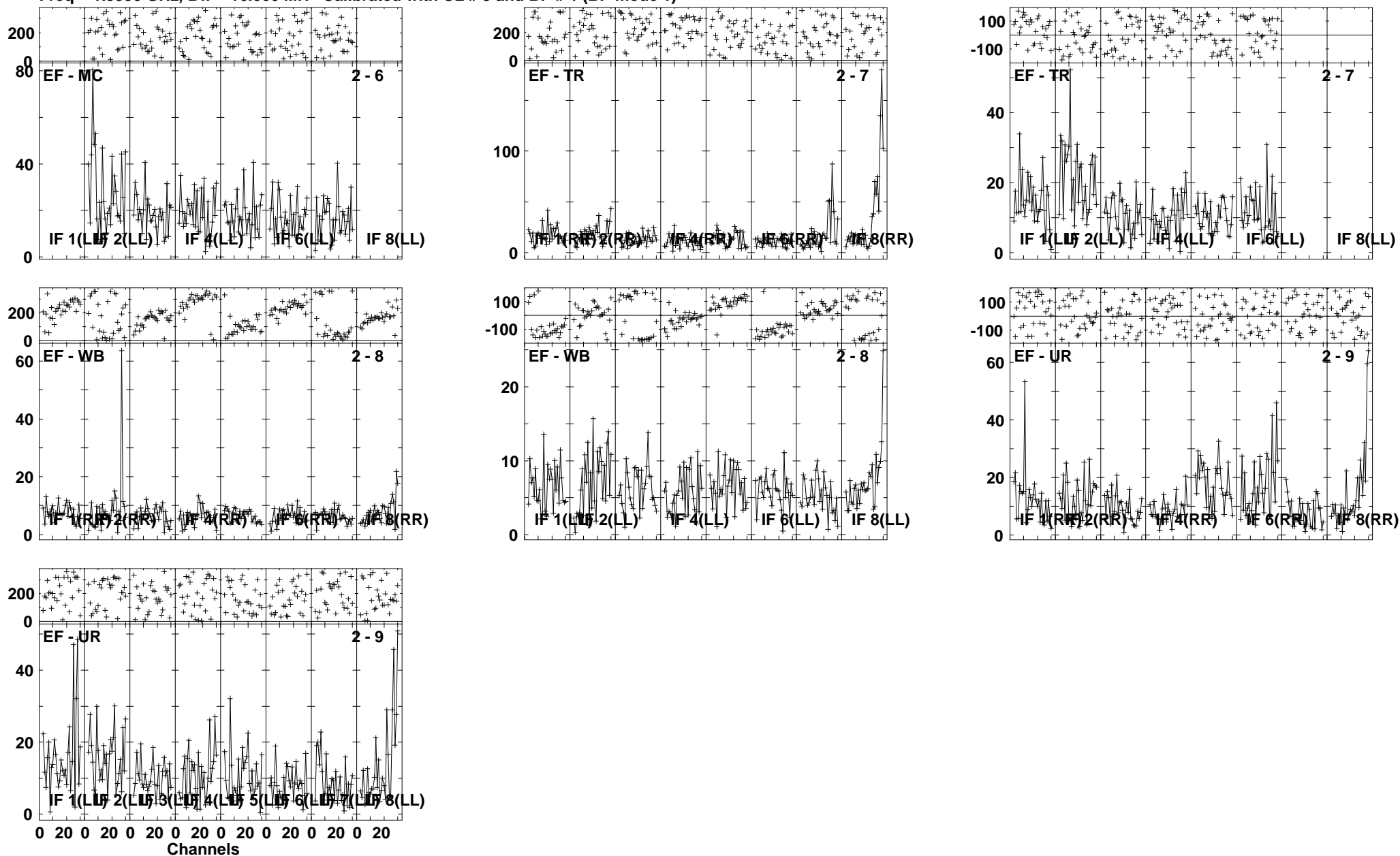

Lower frame: Milli Ampl Jy Top frame: Phas deg  
Vector averaged cross-power spectrum Several baselines displayed  
Timerange: 00/15:12:01 to 00/15:15:29



Plot file version 113 created 30-NOV-2010 14:30:01

J1128+59 EP068B 3.UVDATA.1

Freq = 1.5950 GHz, Bw = 16.000 MH Calibrated with CL # 3 and BP # 1 (BP mode 1)

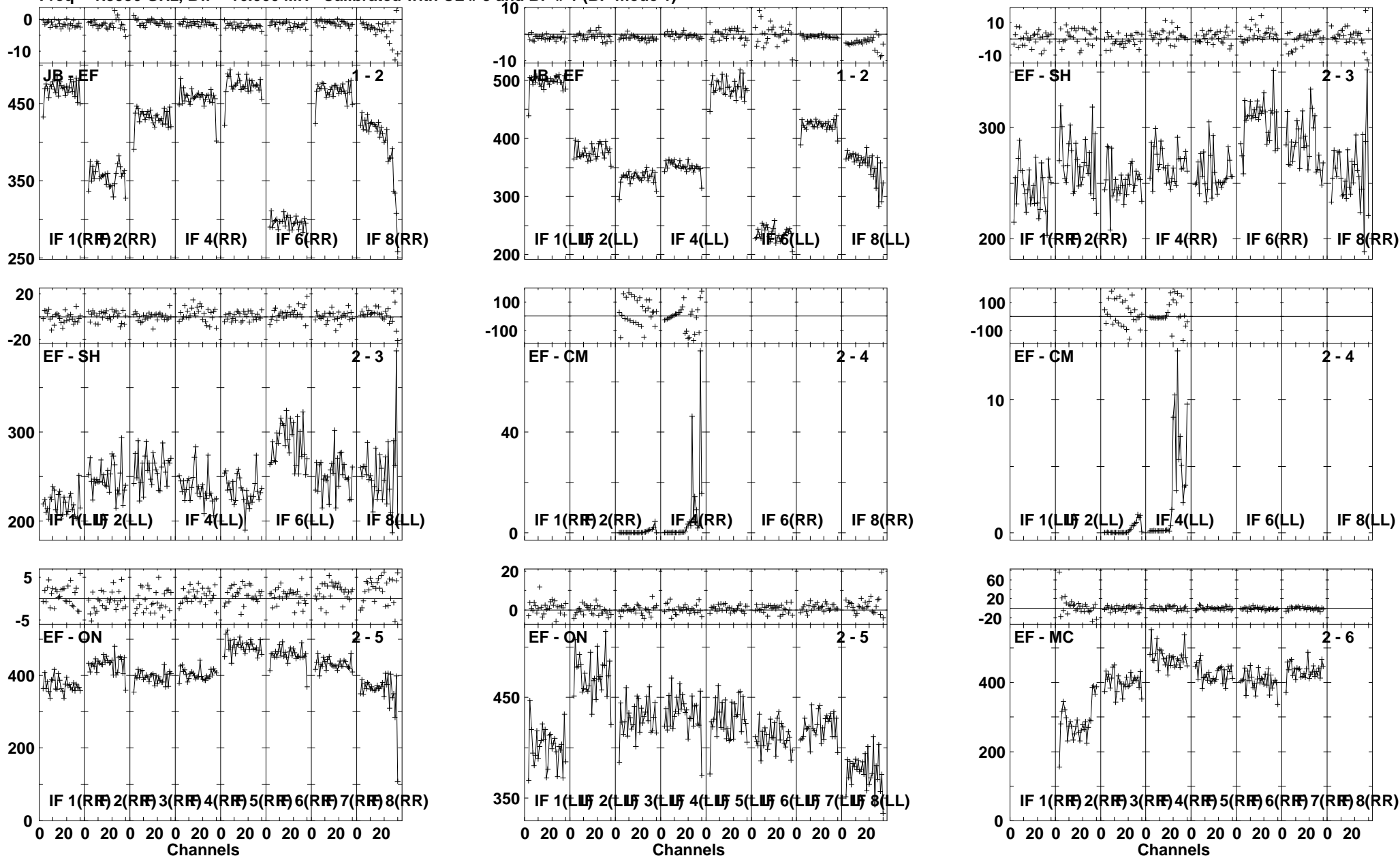

Plot file version 114 created 30-NOV-2010 14:30:02  
 J1128+59 EP068B 3.UVDATA.1  
 Freq = 1.5950 GHz, Bw = 16.000 MH Calibrated with CL # 3 and BP # 1 (BP mode 1)

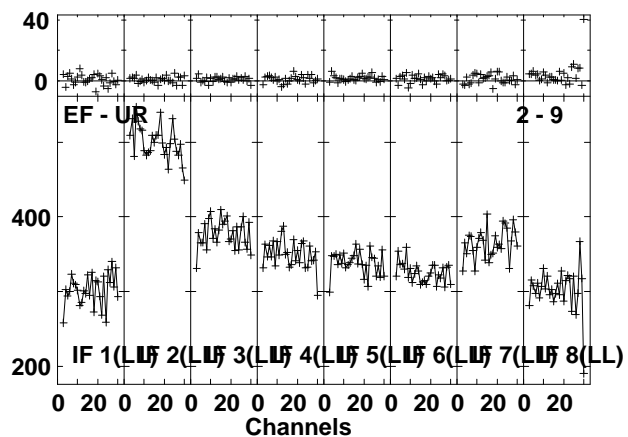
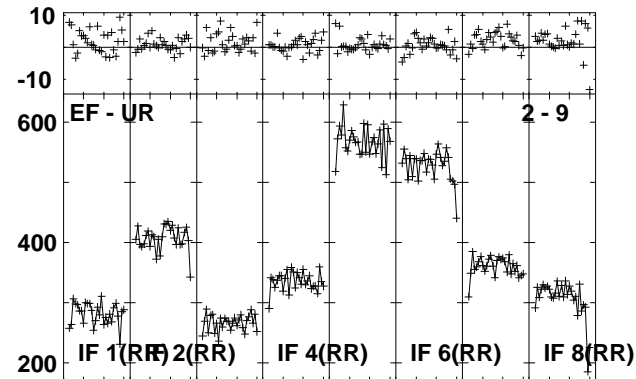
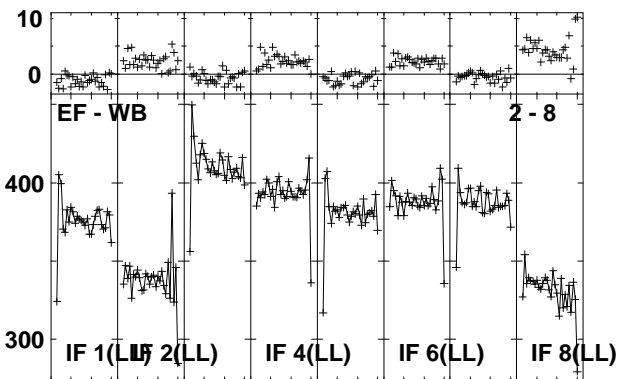
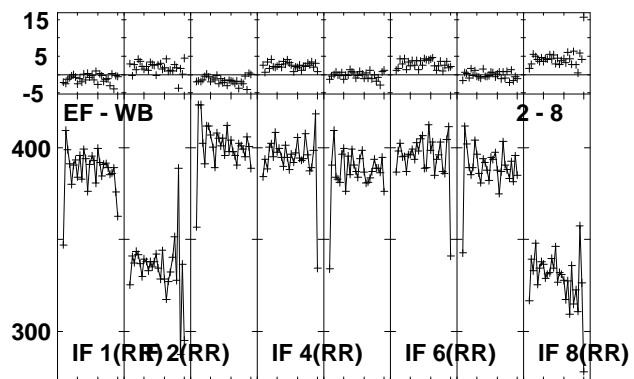
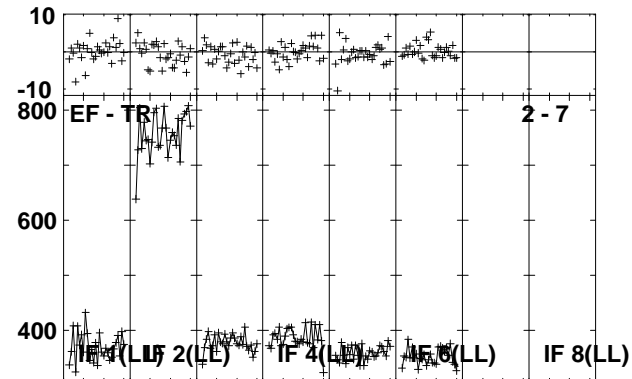
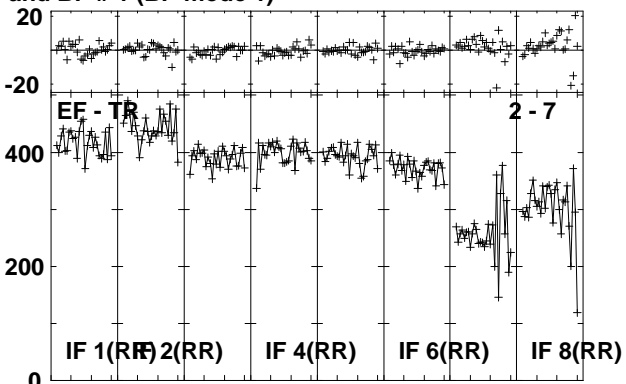
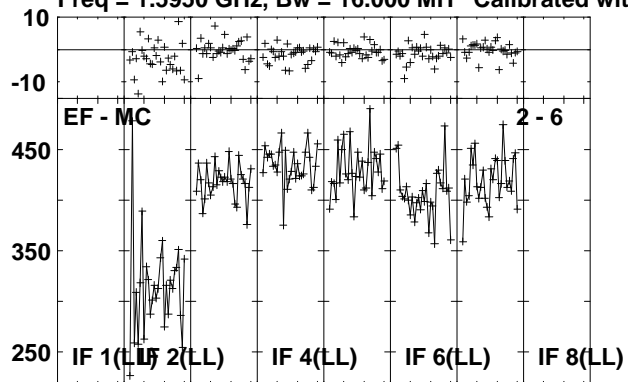

Lower frame: Milli Ampl Jy Top frame: Phas deg  
 Vector averaged cross-power spectrum Several baselines displayed  
 Timerange: 00/15:15:31 to 00/15:16:59

Plot file version 115 created 30-NOV-2010 14:30:04

ARP299C EP068B 3.UVDATA.1

Freq = 1.5950 GHz, Bw = 16.000 MH Calibrated with CL # 3 and BP # 1 (BP mode 1)

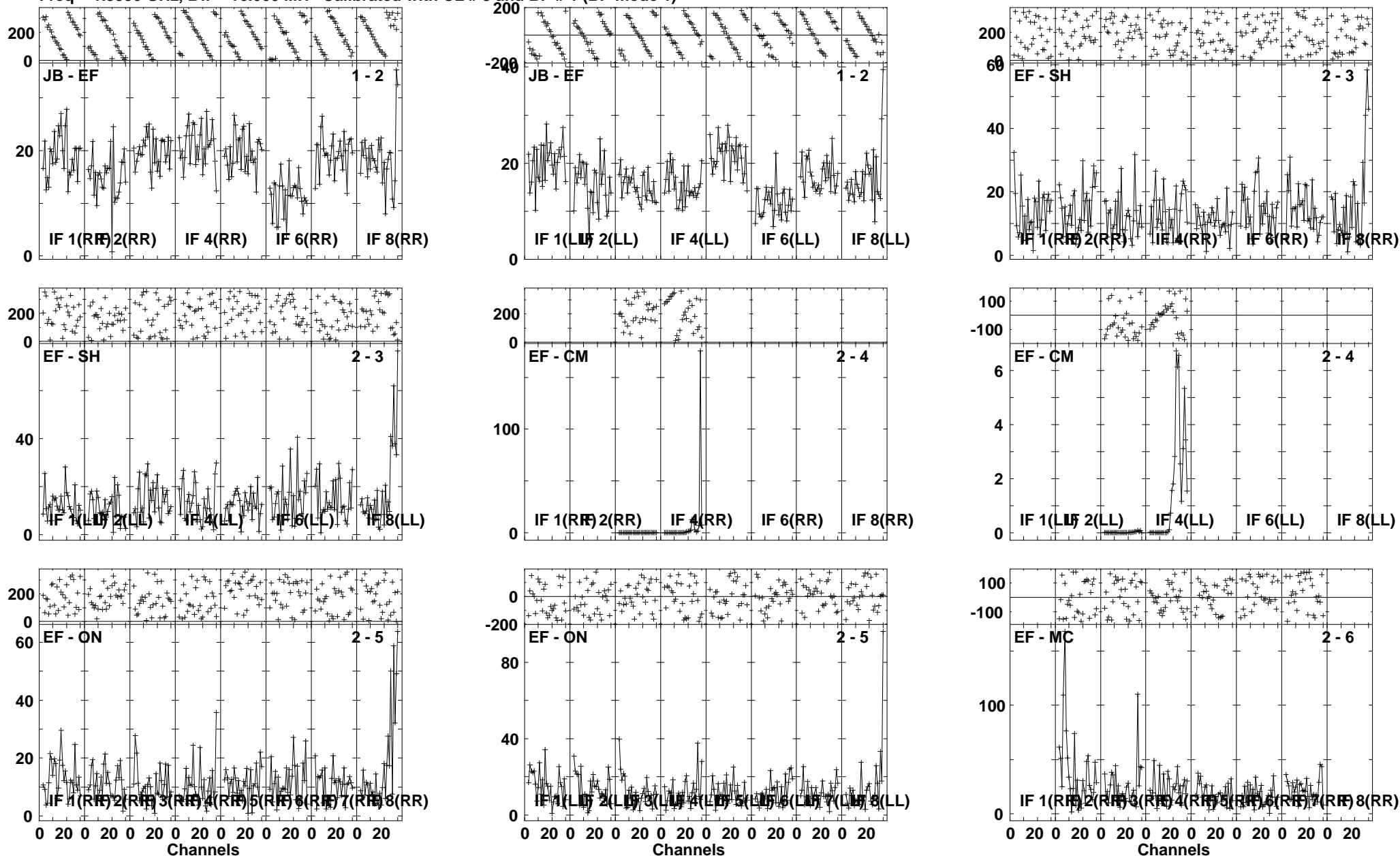

Lower frame: Milli Ampl Jy Top frame: Phas deg  
Vector averaged cross-power spectrum Several baselines displayed  
Timerange: 00/15:17:01 to 00/15:20:29

Plot file version 116 created 30-NOV-2010 14:30:07

ARP299C EP068B 3.UVDATA.1

Freq = 1.5950 GHz, Bw = 16.000 MH Calibrated with CL # 3 and BP # 1 (BP mode 1)

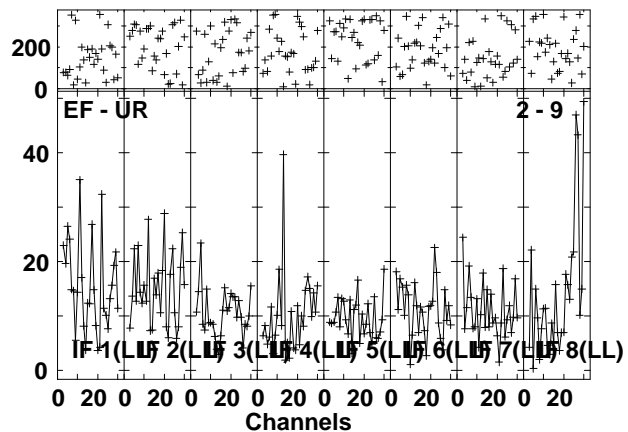
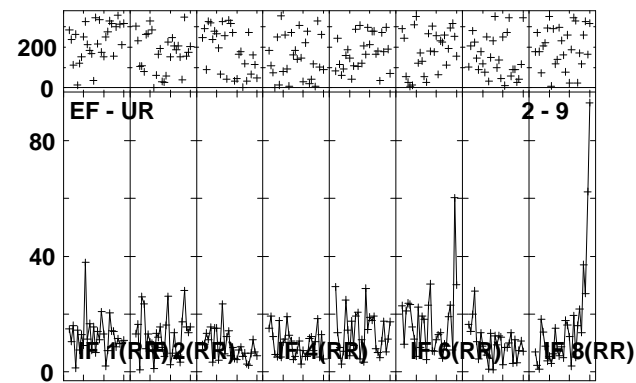
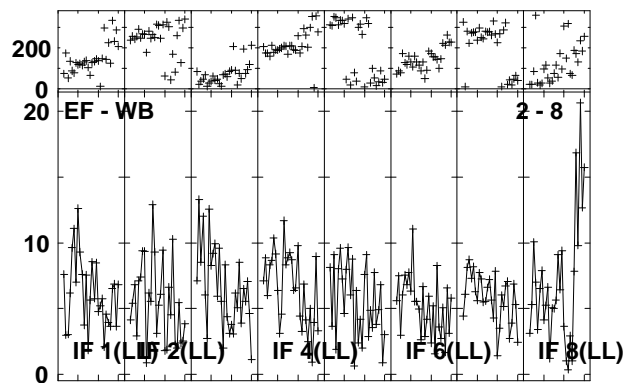
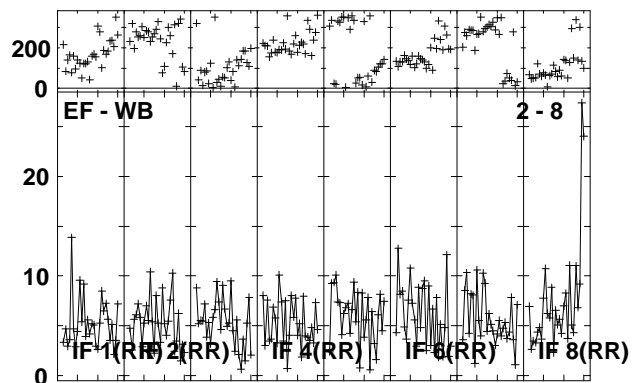
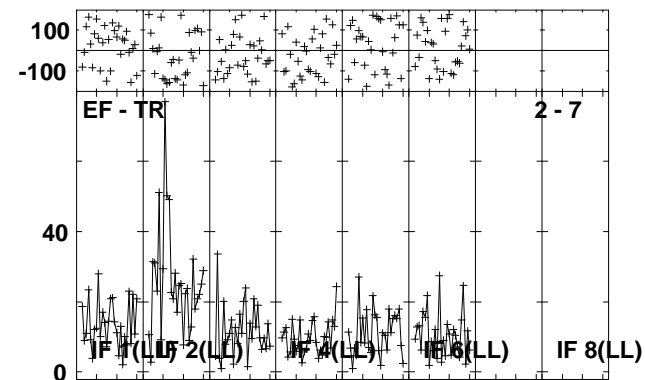
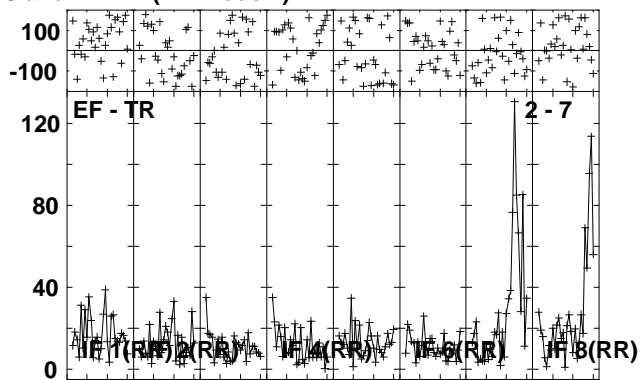
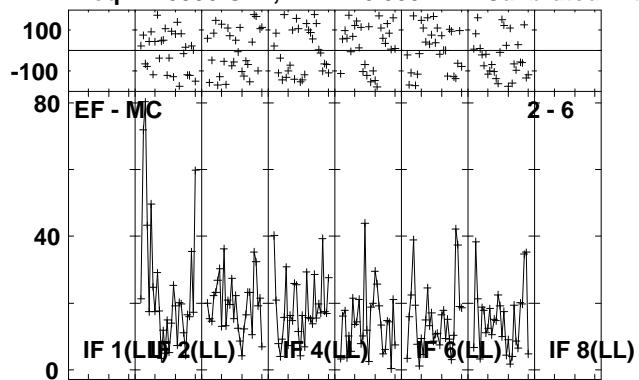

Lower frame: Milli Ampl Jy Top frame: Phas deg  
Vector averaged cross-power spectrum Several baselines displayed  
Timerange: 00/15:17:01 to 00/15:20:29

Plot file version 117 created 30-NOV-2010 14:30:10

J1128+59 EP068B 3.UVDATA.1

Freq = 1.5950 GHz, Bw = 16.000 MH Calibrated with CL # 3 and BP # 1 (BP mode 1)

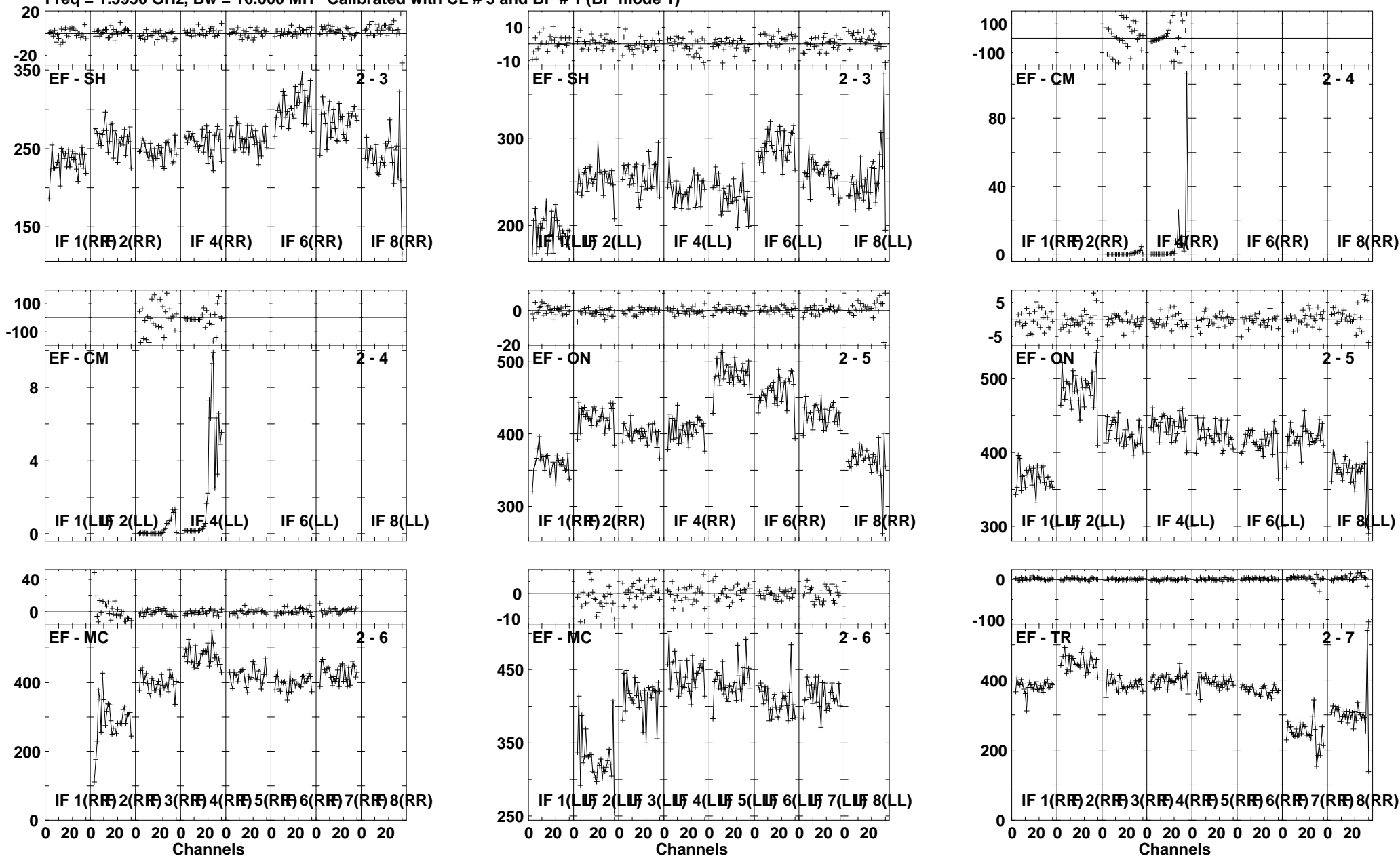

Lower frame: Milli Ampl Jy Top frame: Phas deg  
Vector averaged cross-power spectrum Several baselines displayed  
Timerange: 00/15:21:31 to 00/15:22:57

Plot file version 118 created 30-NOV-2010 14:30:11

J1128+59 EP068B 3.UVDATA.1

Freq = 1.5950 GHz, Bw = 16.000 MH Calibrated with CL # 3 and BP # 1 (BP mode 1)

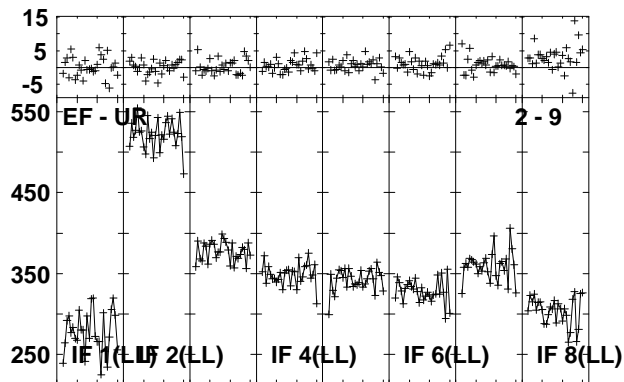
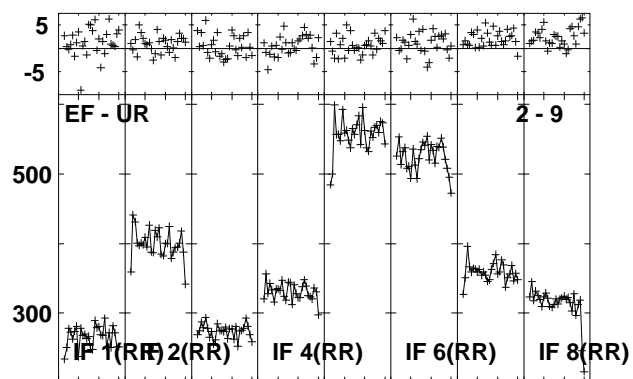
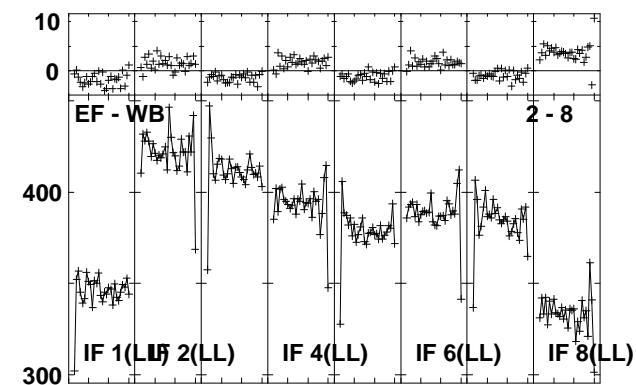
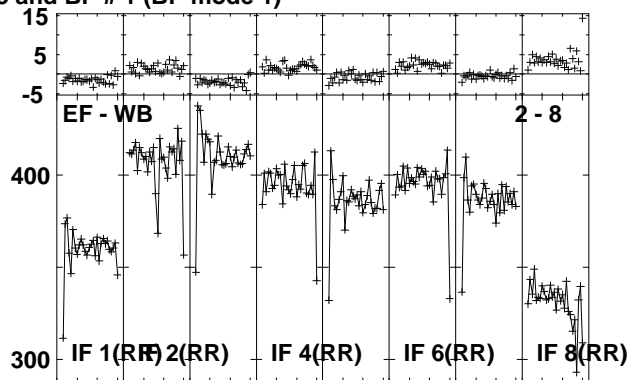
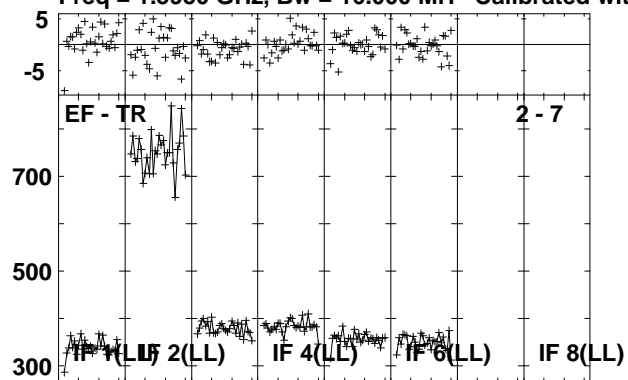

Lower frame: Milli Ampl Jy Top frame: Phas deg  
Vector averaged cross-power spectrum Several baselines displayed  
Timerange: 00/15:21:31 to 00/15:22:57

Plot file version 119 created 30-NOV-2010 14:30:12

ARP299C EP068B 3.UVDATA.1

Freq = 1.5950 GHz, Bw = 16.000 MH Calibrated with CL # 3 and BP # 1 (BP mode 1)

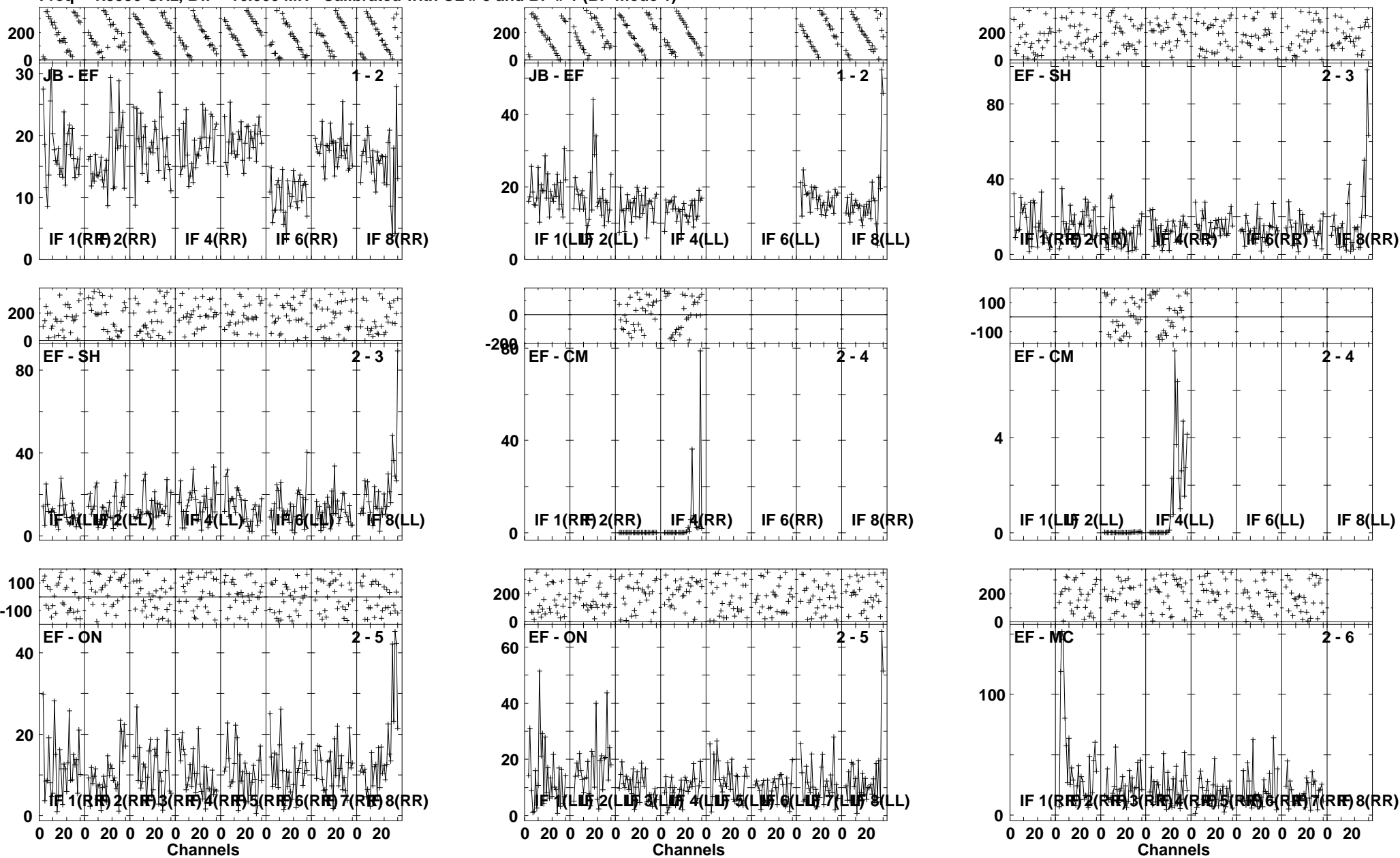

Lower frame: Milli Ampl Jy Top frame: Phas deg  
Vector averaged cross-power spectrum Several baselines displayed  
Timerange: 00/15:23:01 to 00/15:26:29

Plot file version 120 created 30-NOV-2010 14:30:14

ARP299C EP068B 3.UVDATA.1

Freq = 1.5950 GHz, Bw = 16.000 MH Calibrated with CL # 3 and BP # 1 (BP mode 1)

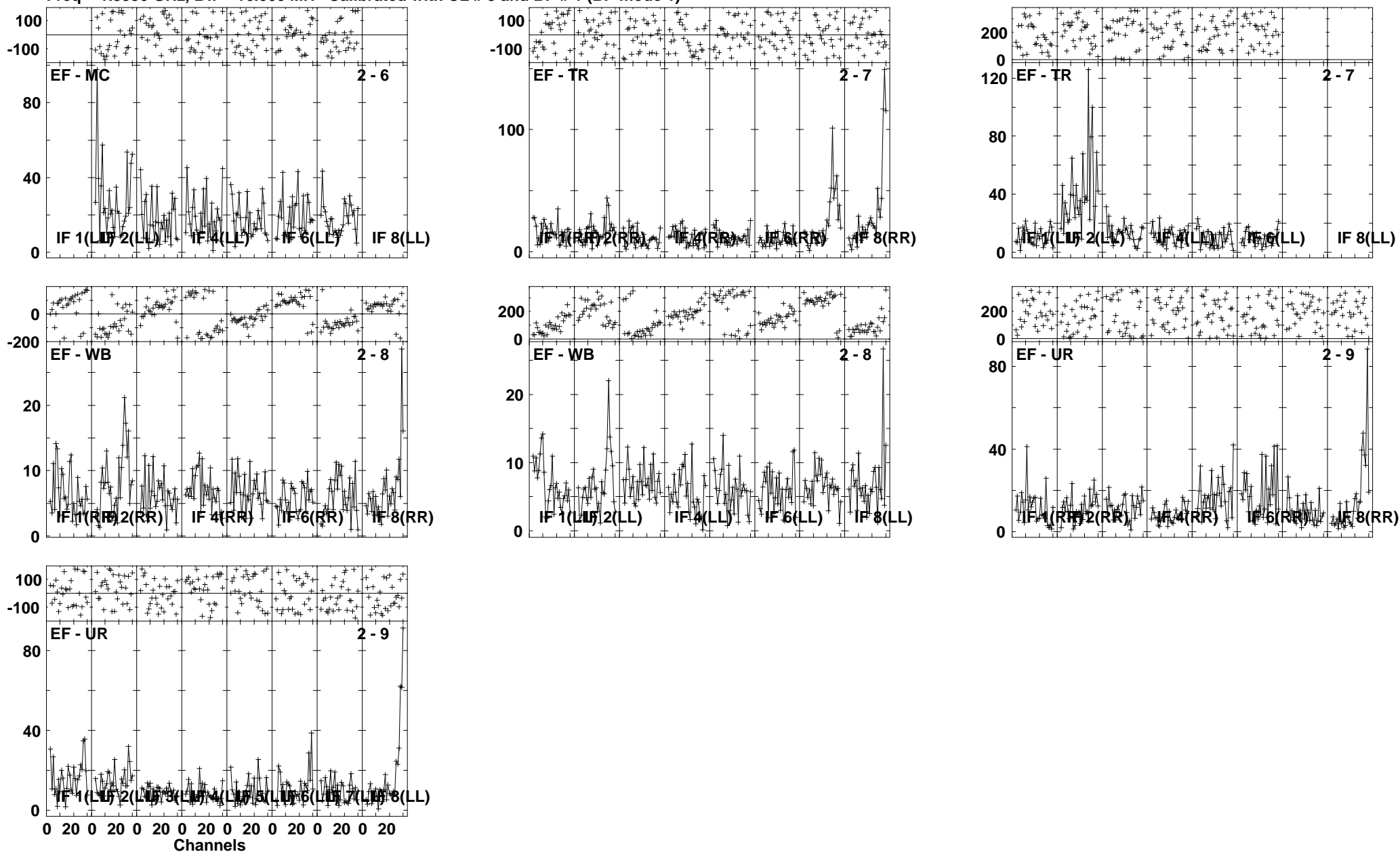

Lower frame: Milli Ampl Jy Top frame: Phas deg  
Vector averaged cross-power spectrum Several baselines displayed  
Timerange: 00/15:23:01 to 00/15:26:29



Plot file version 121 created 30-NOV-2010 14:30:17

J1128+59 EP068B 3.UVDATA.1

Freq = 1.5950 GHz, Bw = 16.000 MH Calibrated with CL # 3 and BP # 1 (BP mode 1)

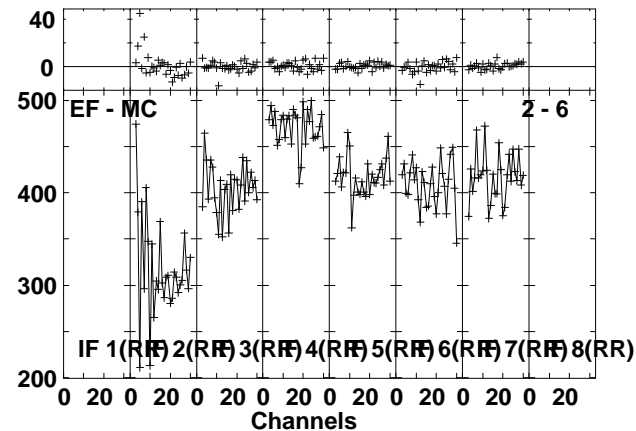
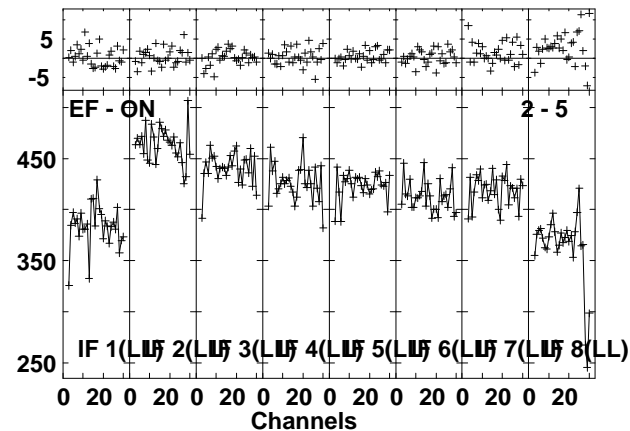
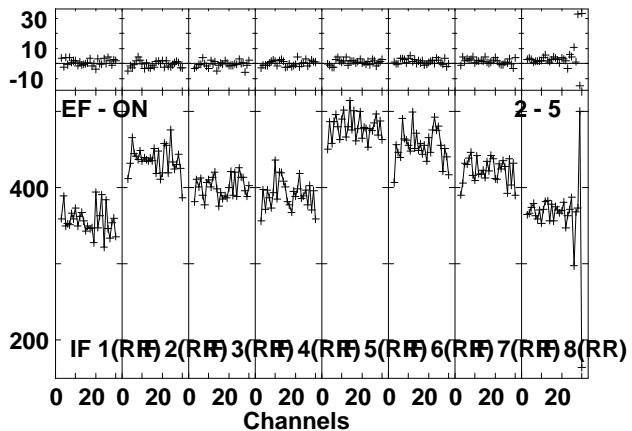
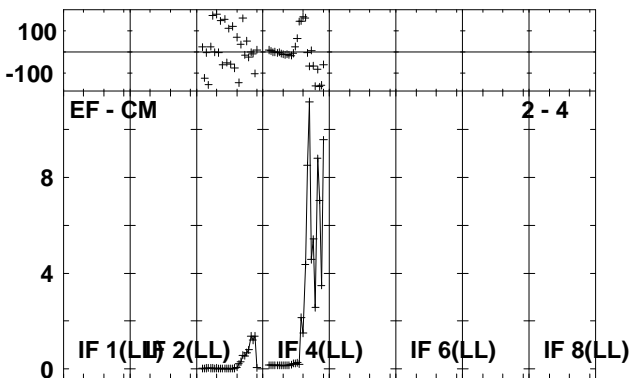
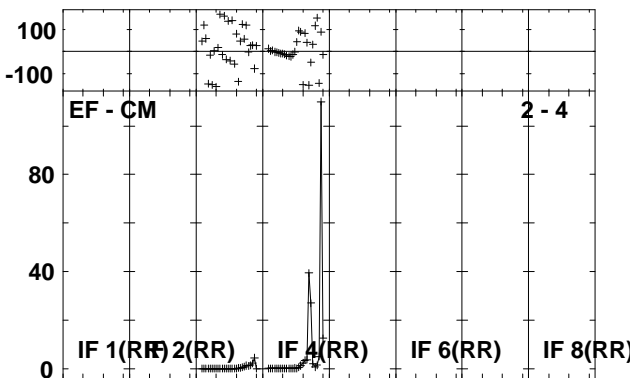
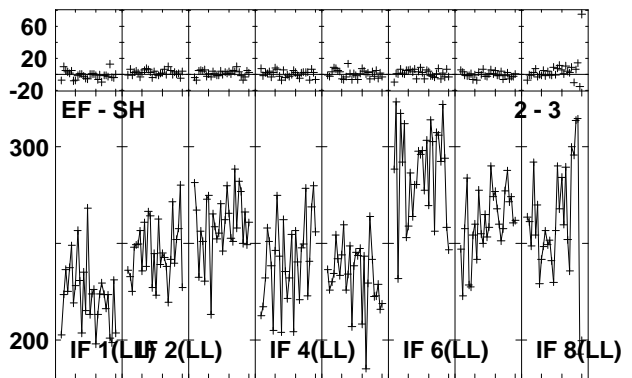
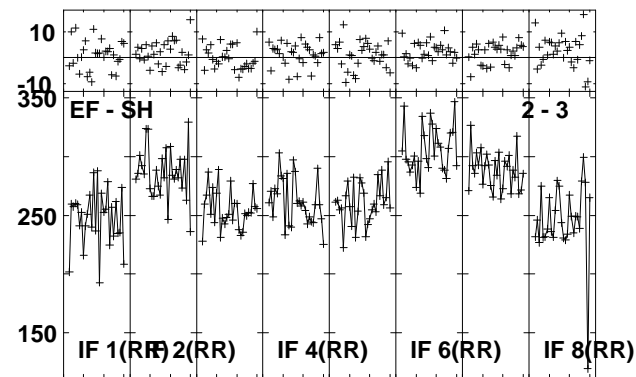
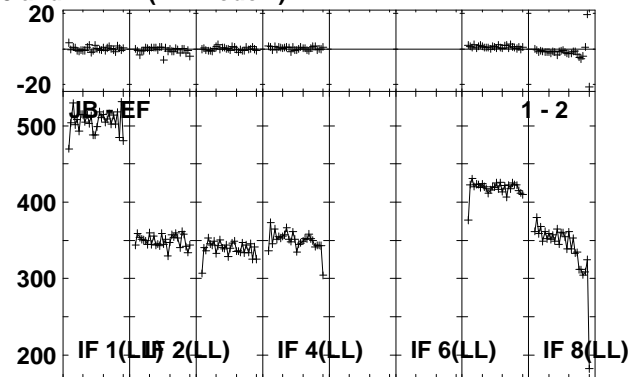
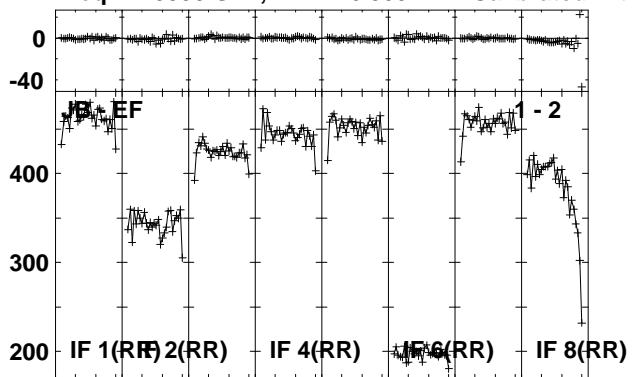

Lower frame: Milli Ampl Jy Top frame: Phas deg  
Vector averaged cross-power spectrum Several baselines displayed  
Timerange: 00/15:26:31 to 00/15:27:59

Plot file version 122 created 30-NOV-2010 14:30:18

J1128+59 EP068B 3.UVDATA.1

Freq = 1.5950 GHz, Bw = 16.000 MH Calibrated with CL # 3 and BP # 1 (BP mode 1)

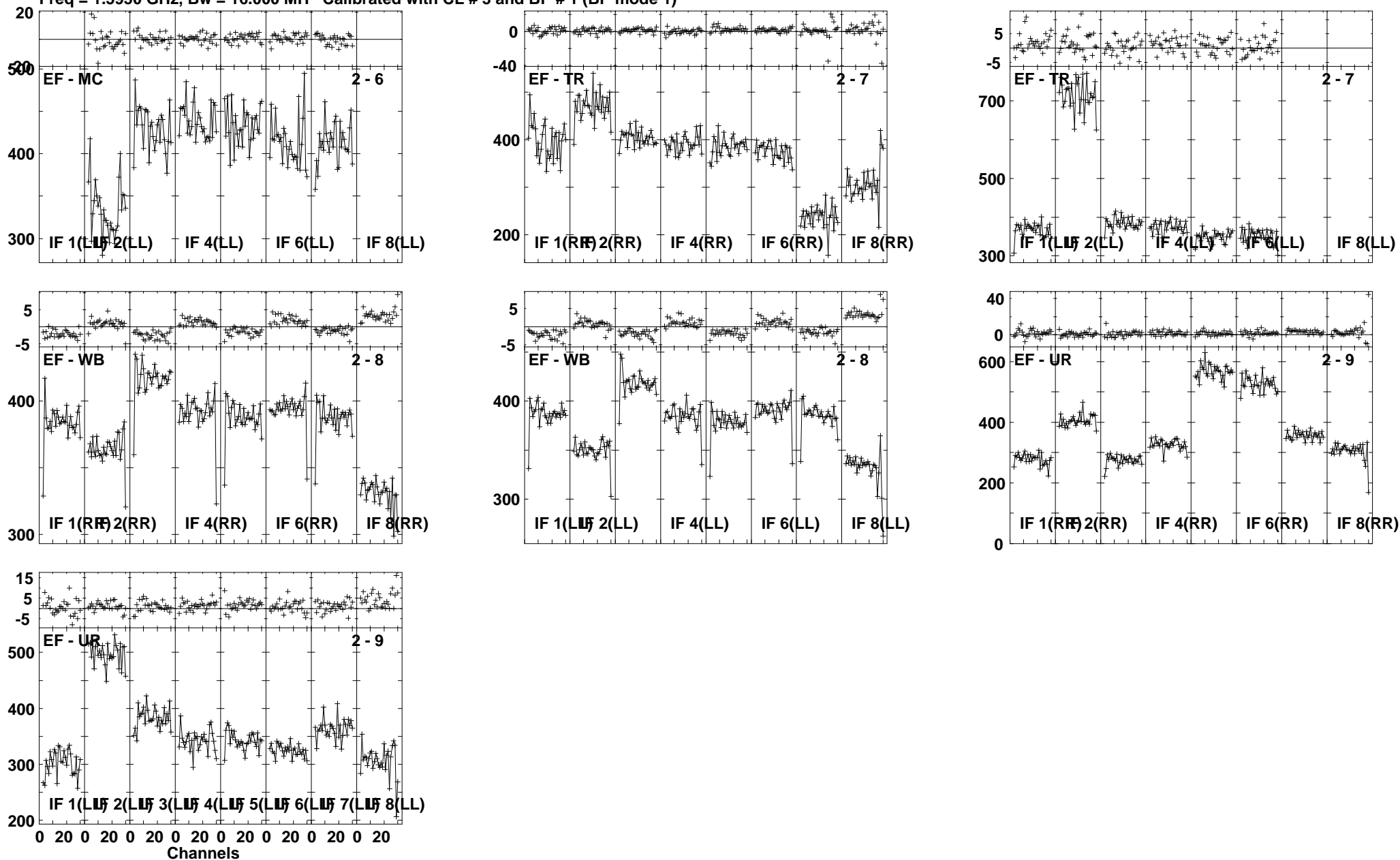

Lower frame: Milli Ampl Jy Top frame: Phas deg  
Vector averaged cross-power spectrum Several baselines displayed  
Timerange: 00/15:26:31 to 00/15:27:59

Plot file version 123 created 30-NOV-2010 14:30:19

ARP299C EP068B 3.UVDATA.1

Freq = 1.5950 GHz, Bw = 16.000 MH Calibrated with CL # 3 and BP # 1 (BP mode 1)

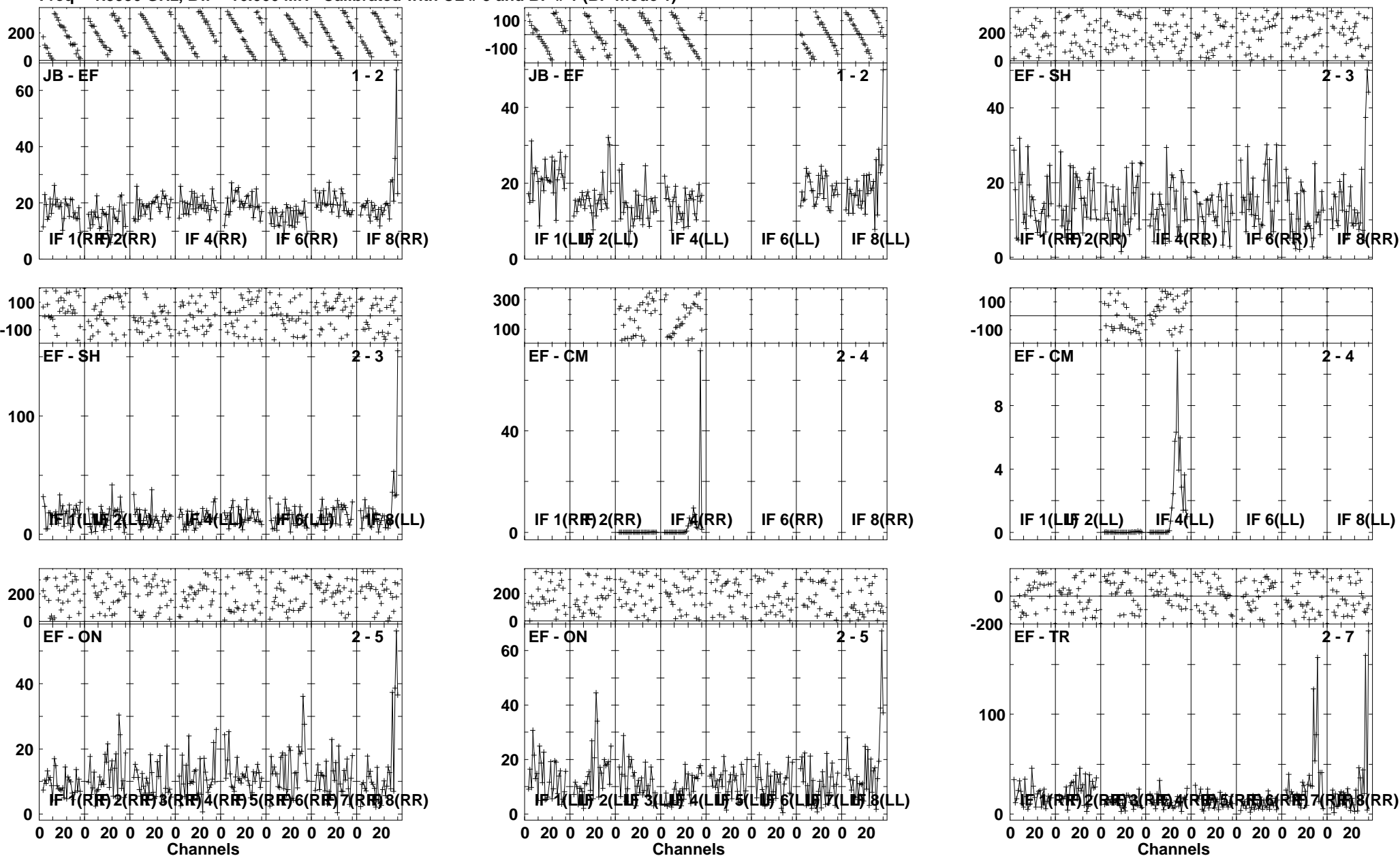

Plot file version 124 created 30-NOV-2010 14:30:22

ARP299C EP068B 3.UVDATA.1

Freq = 1.5950 GHz, Bw = 16.000 MH Calibrated with CL # 3 and BP # 1 (BP mode 1)

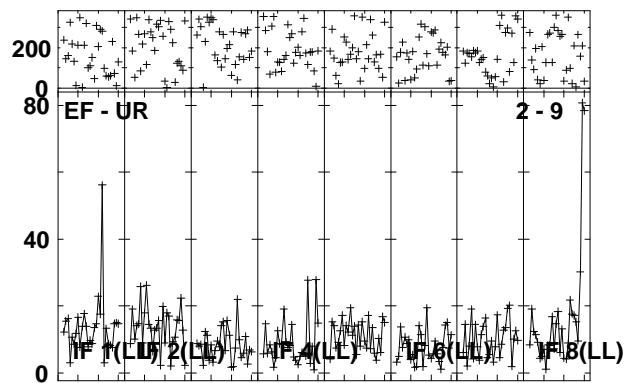
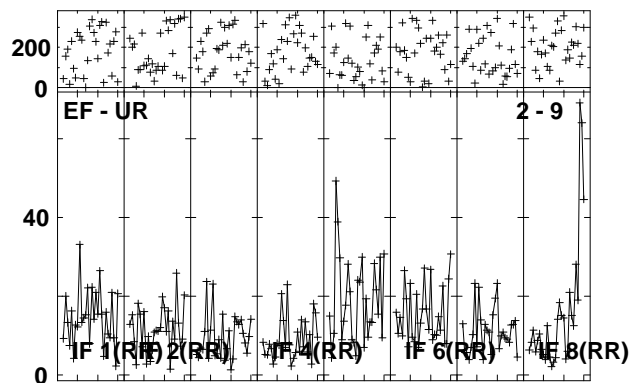
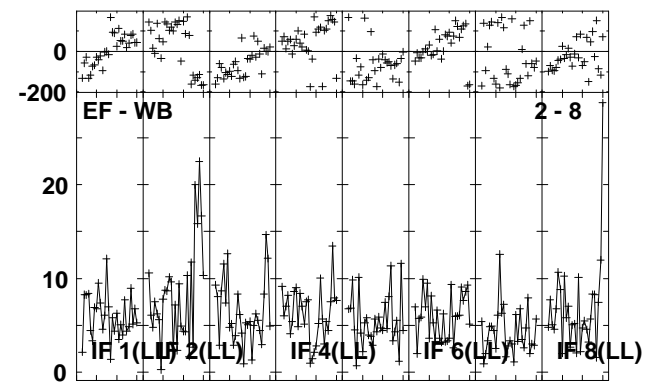
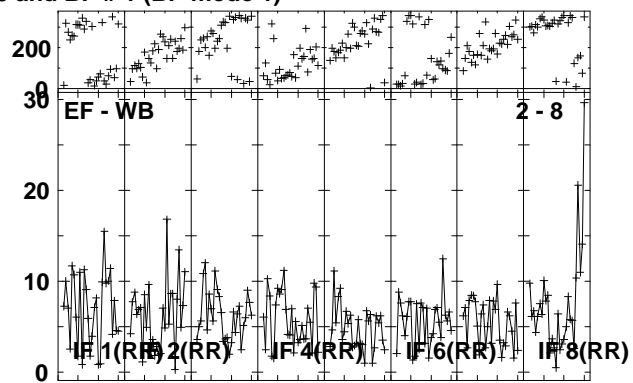
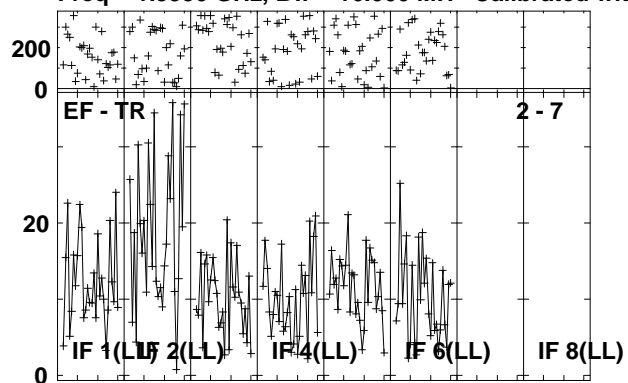

Lower frame: Milli Ampl Jy Top frame: Phas deg  
Vector averaged cross-power spectrum Several baselines displayed  
Timerange: 00/15:28:01 to 00/15:31:29

Plot file version 125 created 30-NOV-2010 14:30:24

J1128+59 EP068B 3.UVDATA.1

Freq = 1.5950 GHz, Bw = 16.000 MH Calibrated with CL # 3 and BP # 1 (BP mode 1)

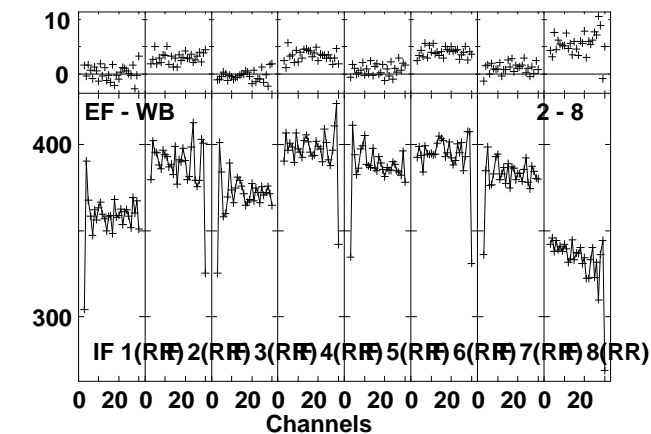
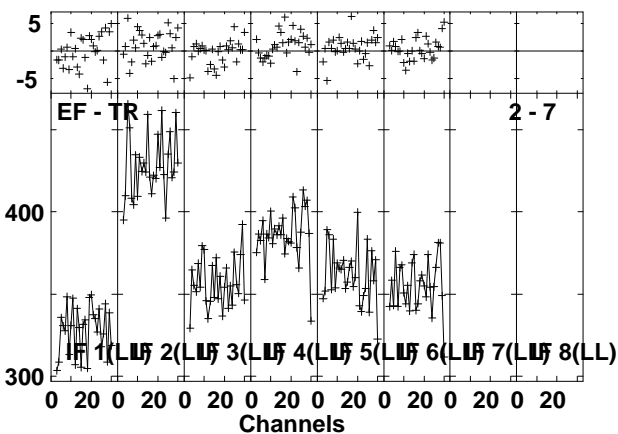
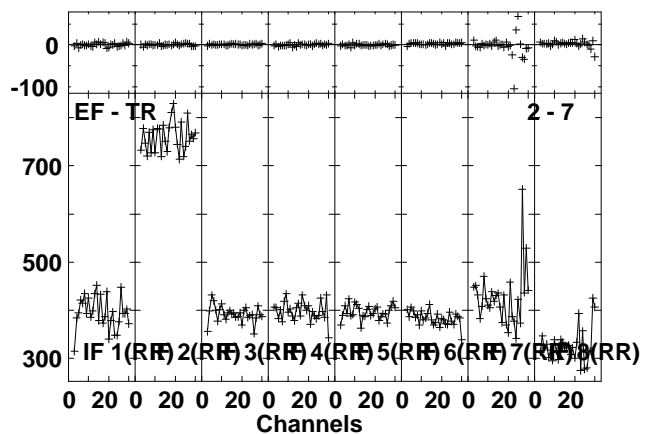
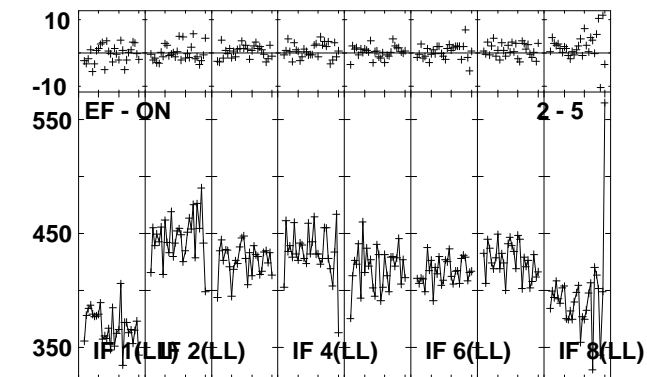
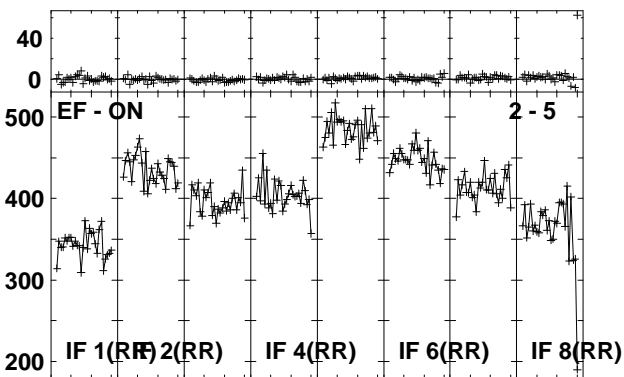
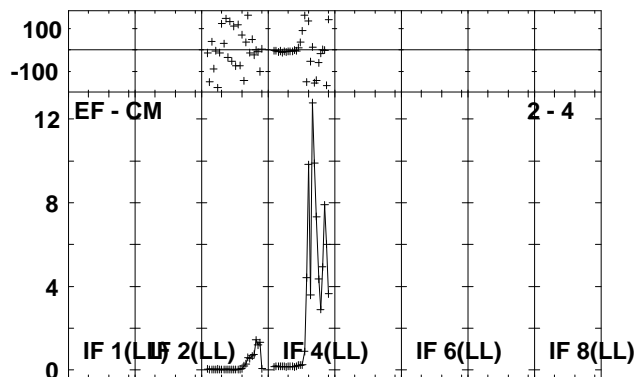
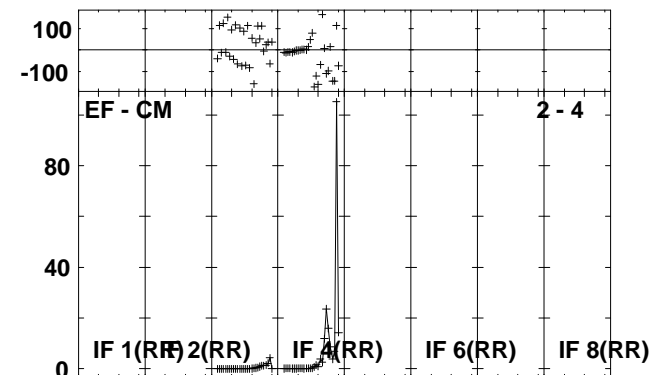
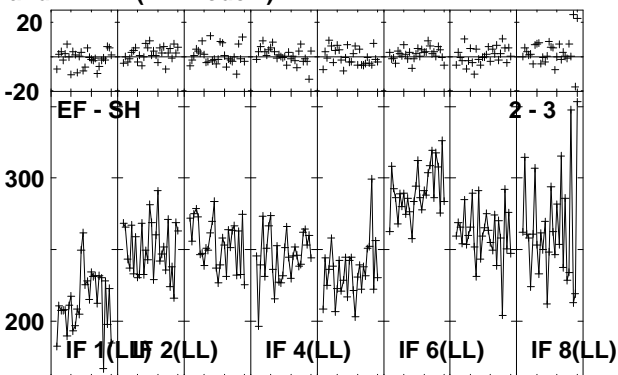
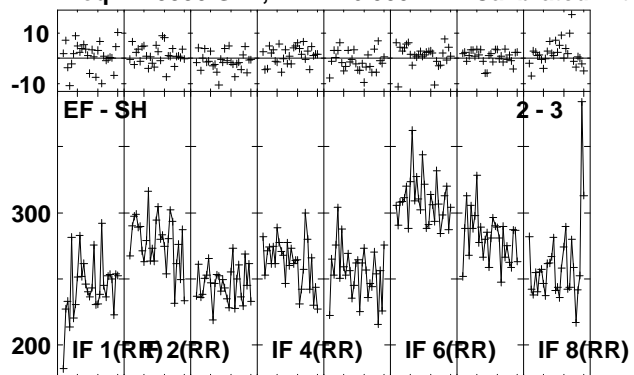

Lower frame: Milli Ampl Jy Top frame: Phas deg  
Vector averaged cross-power spectrum Several baselines displayed  
Timerange: 00/15:31:31 to 00/15:32:59

Plot file version 126 created 30-NOV-2010 14:30:25

J1128+59 EP068B 3.UVDATA.1

Freq = 1.5950 GHz, Bw = 16.000 MH Calibrated with CL # 3 and BP # 1 (BP mode 1)

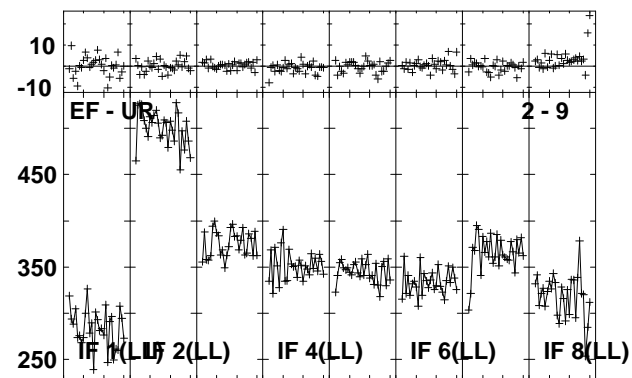
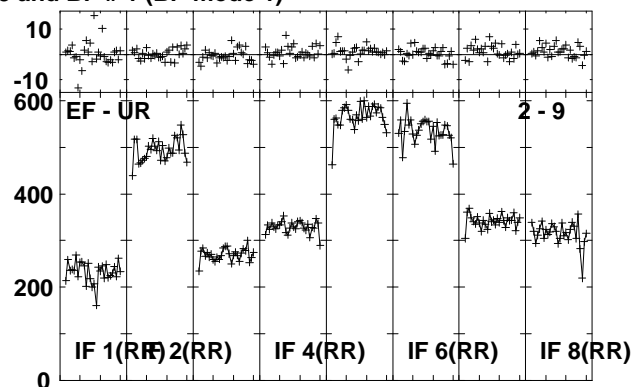
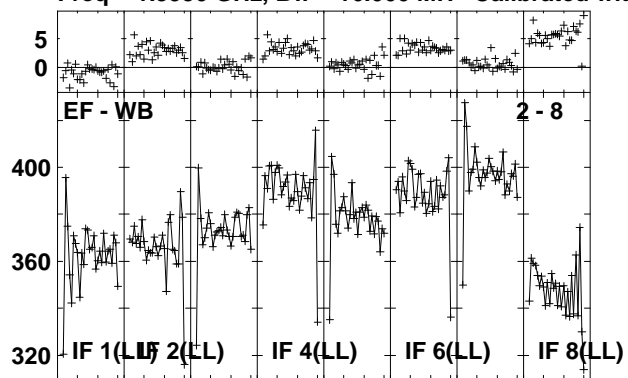

Lower frame: Milli Ampl Jy Top frame: Phas deg  
Vector averaged cross-power spectrum Several baselines displayed  
Timerange: 00/15:31:31 to 00/15:32:59

Plot file version 127 created 30-NOV-2010 14:30:26

ARP299C EP068B 3.UVDATA.1

Freq = 1.5950 GHz, Bw = 16.000 MH Calibrated with CL # 3 and BP # 1 (BP mode 1)

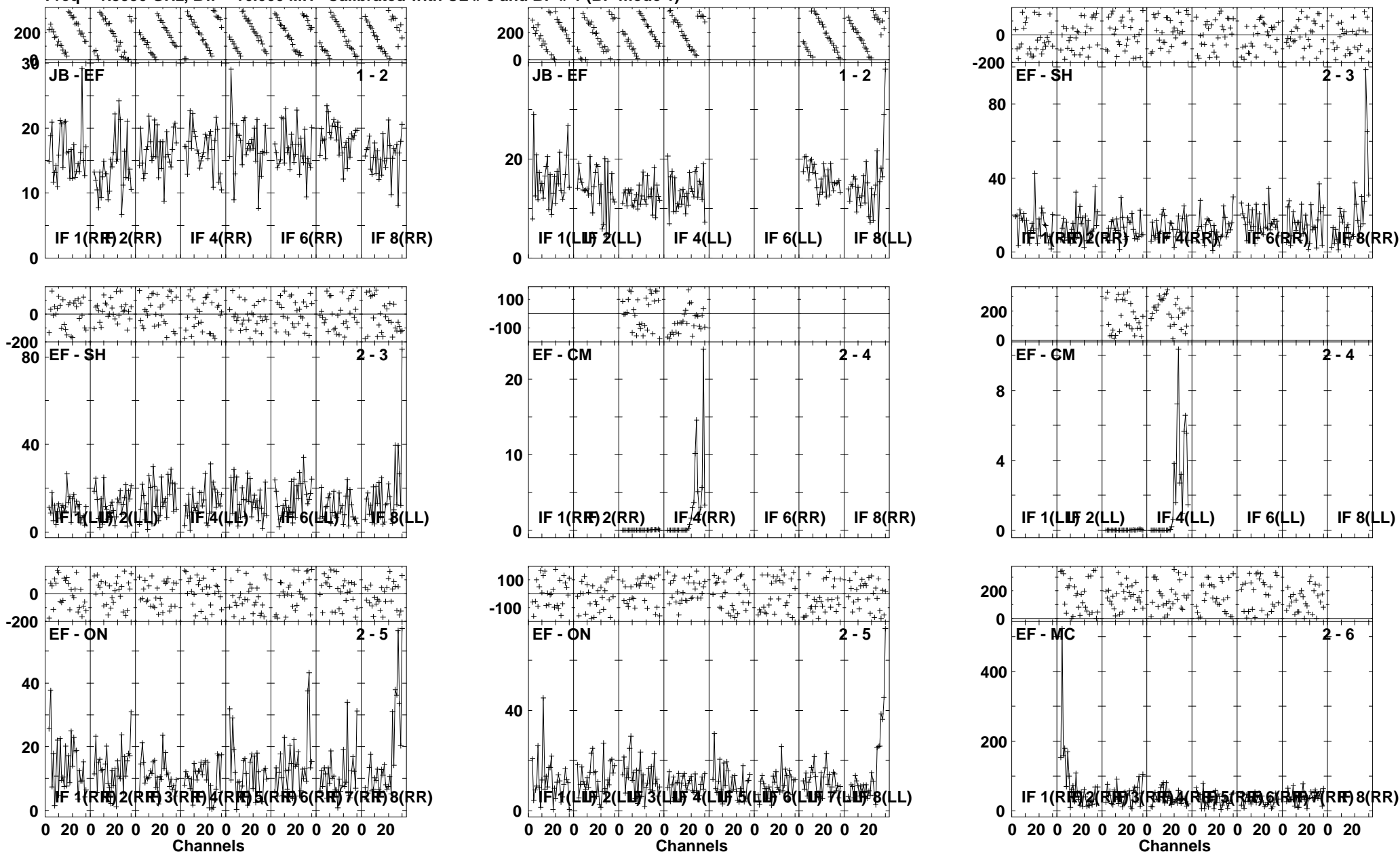

Lower frame: Milli Ampl Jy Top frame: Phas deg  
Vector averaged cross-power spectrum Several baselines displayed  
Timerange: 00/15:33:01 to 00/15:36:29

Plot file version 128 created 30-NOV-2010 14:30:29

ARP299C EP068B 3.UVDATA.1

Freq = 1.5950 GHz, Bw = 16.000 MH Calibrated with CL # 3 and BP # 1 (BP mode 1)

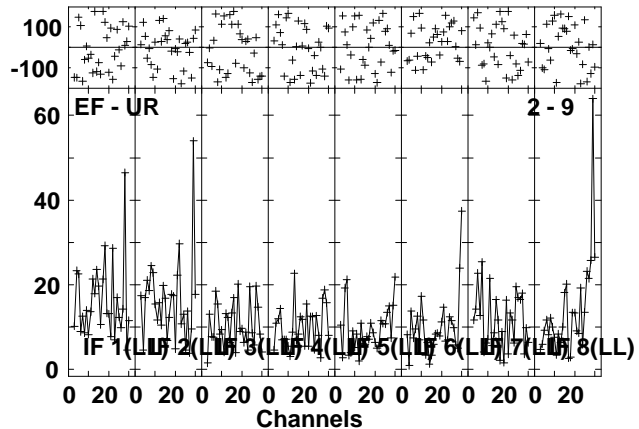
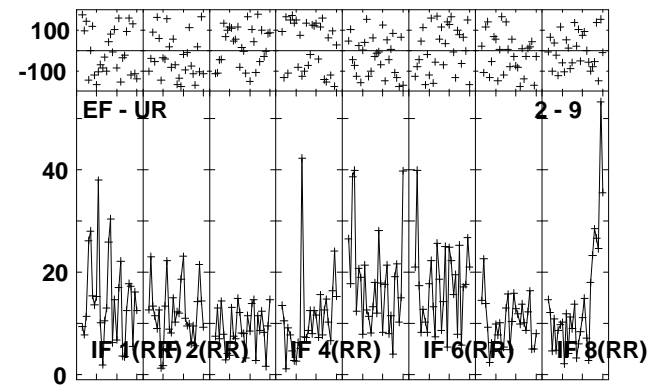
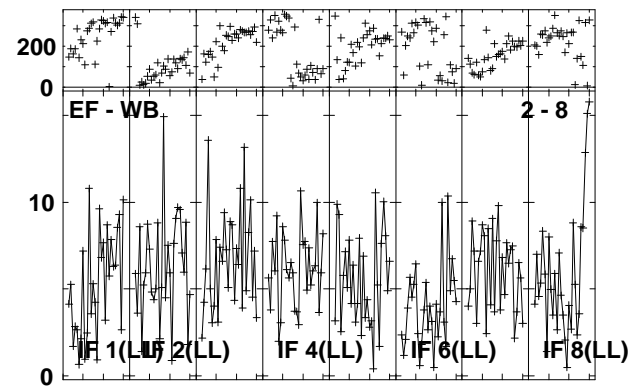
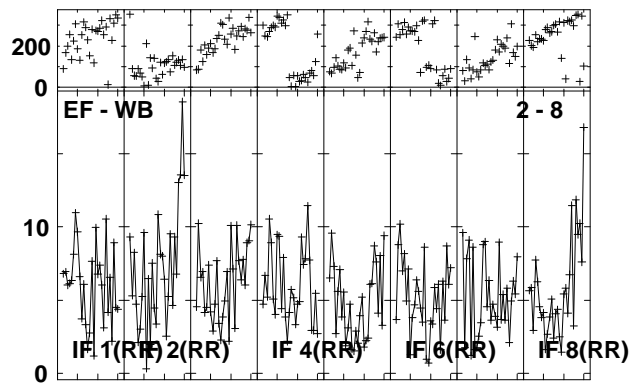
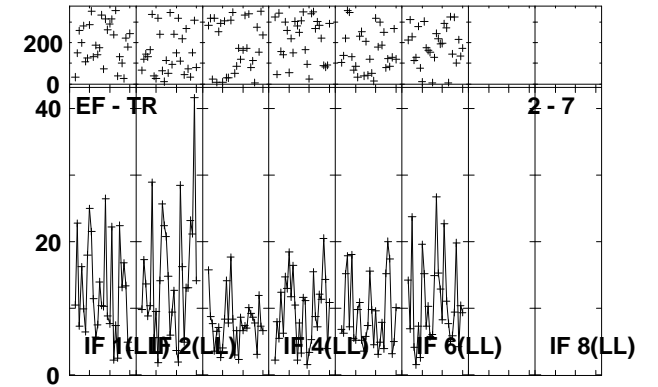
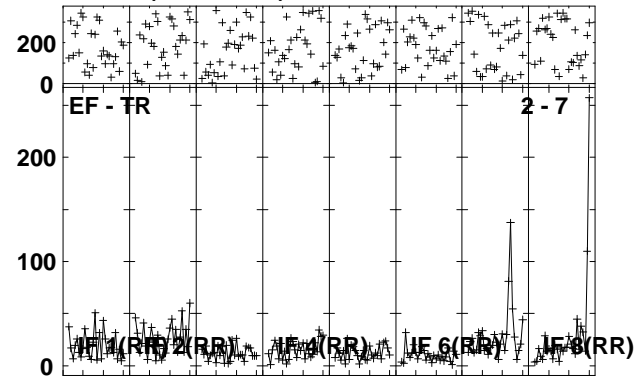
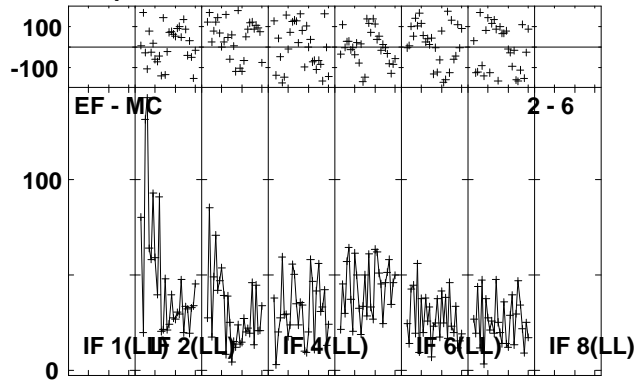

Lower frame: Milli Ampl Jy Top frame: Phas deg  
Vector averaged cross-power spectrum Several baselines displayed  
Timerange: 00/15:33:01 to 00/15:36:29



Plot file version 129 created 30-NOV-2010 14:30:32

J1128+59 EP068B 3.UVDATA.1

Freq = 1.5950 GHz, Bw = 16.000 MH Calibrated with CL # 3 and BP # 1 (BP mode 1)

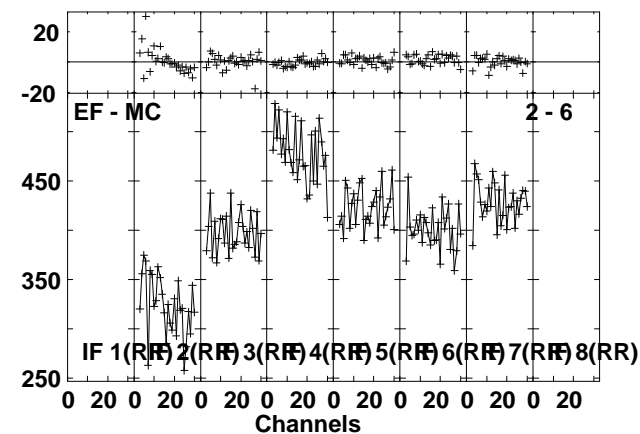
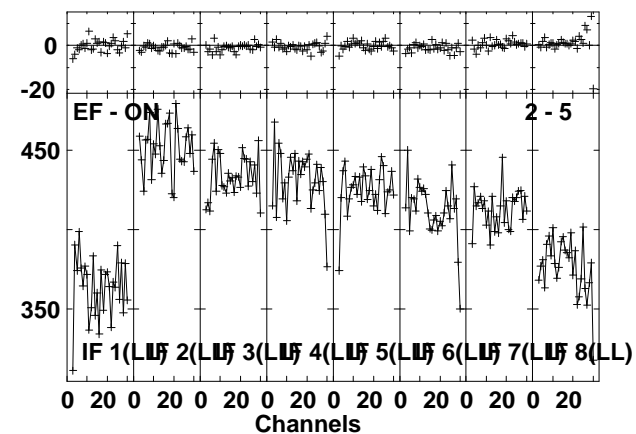
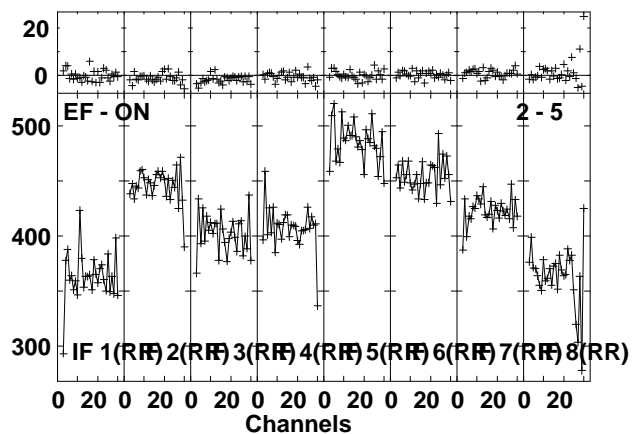
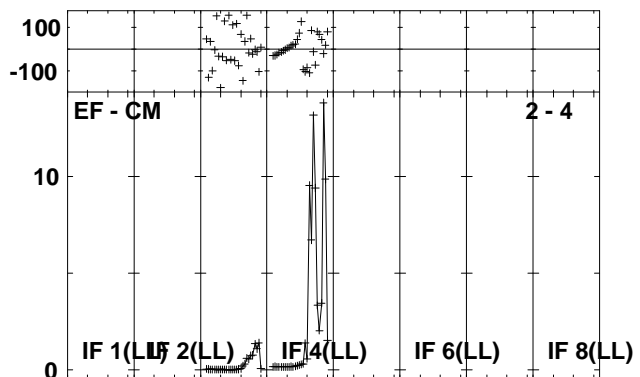
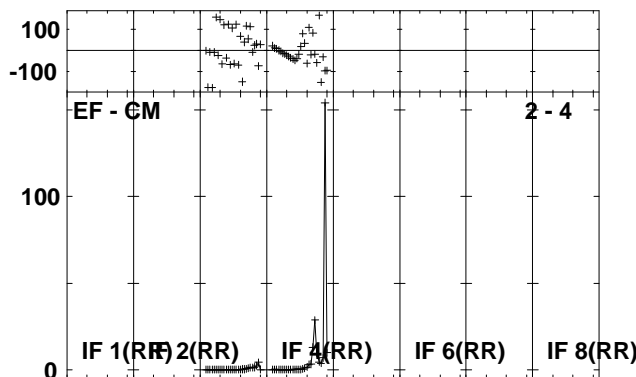
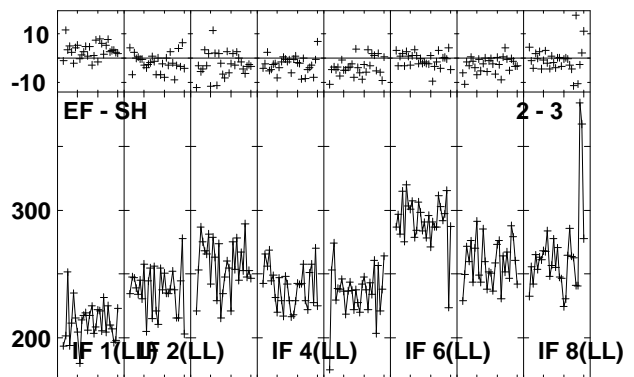
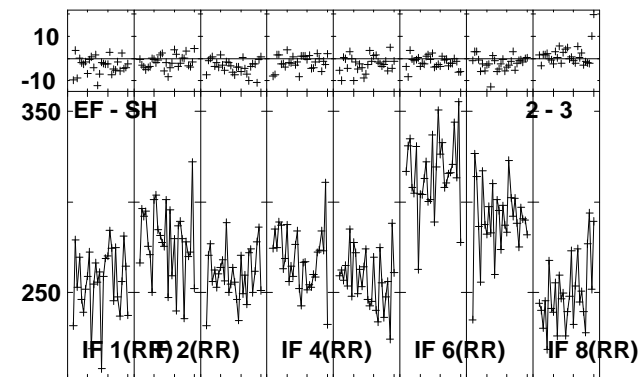
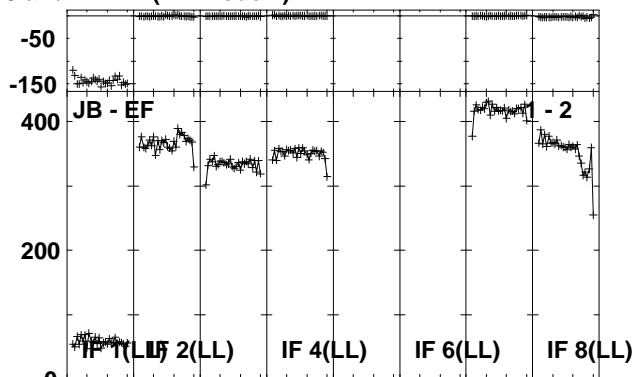
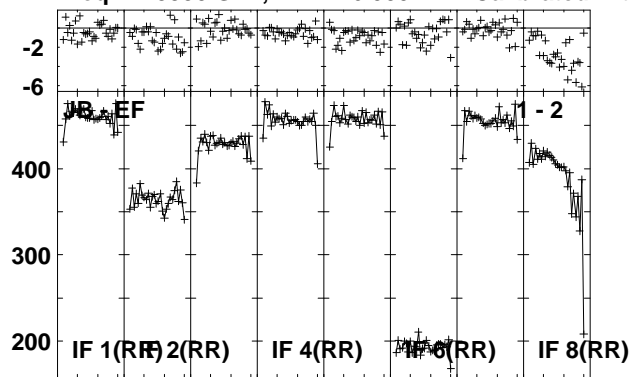

Lower frame: Milli Ampl Jy Top frame: Phas deg  
Vector averaged cross-power spectrum Several baselines displayed  
Timerange: 00/15:37:31 to 00/15:38:59

Plot file version 130 created 30-NOV-2010 14:30:33  
 J1128+59 EP068B 3.UVDATA.1  
 Freq = 1.5950 GHz, Bw = 16.000 MH Calibrated with CL # 3 and BP # 1 (BP mode 1)

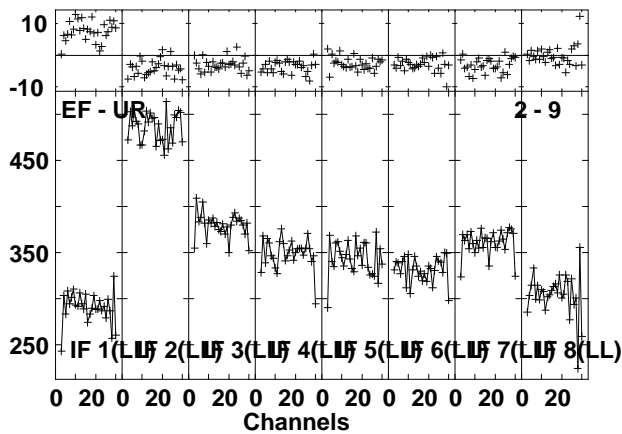
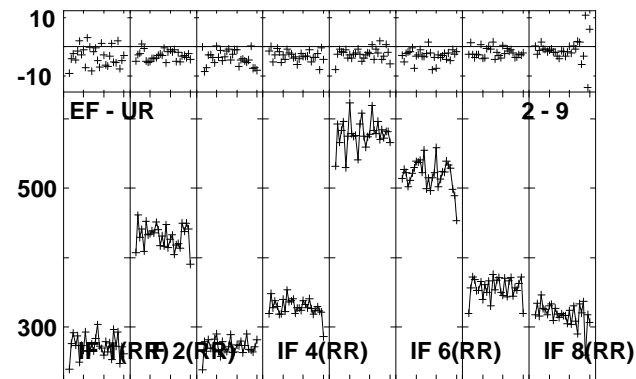
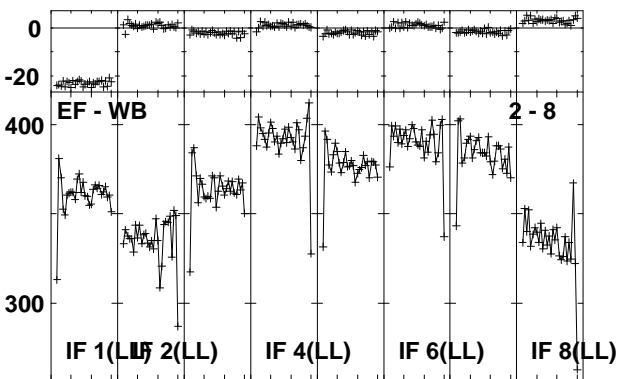
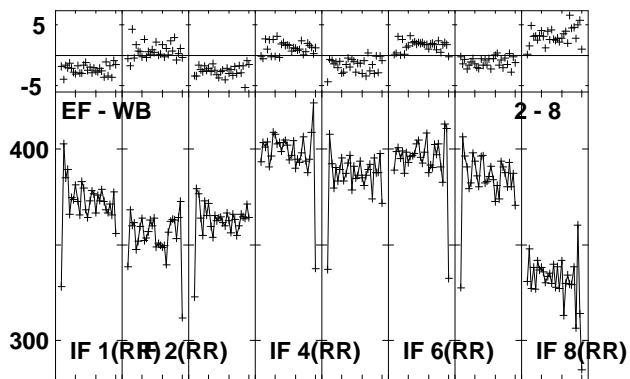
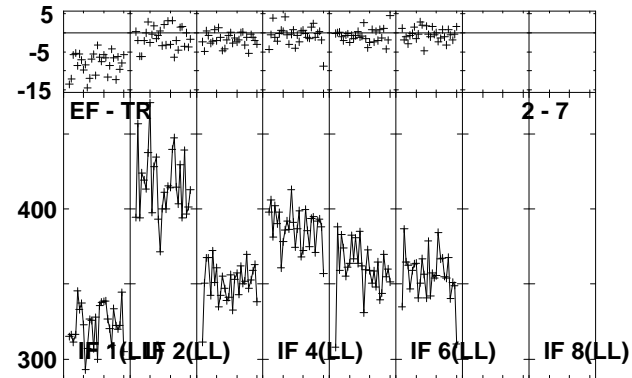
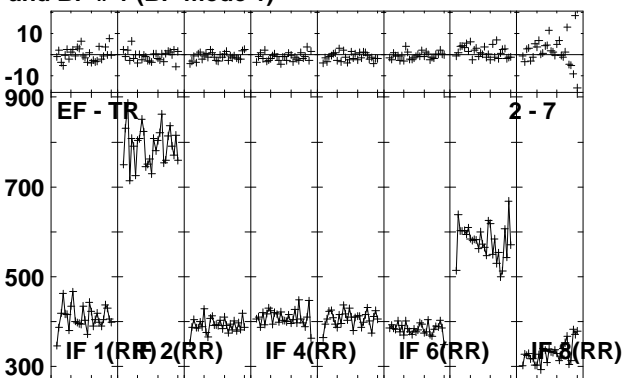
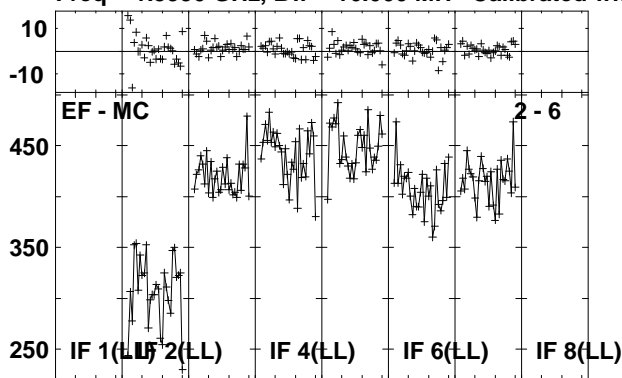

Lower frame: Milli Ampl Jy Top frame: Phas deg  
 Vector averaged cross-power spectrum Several baselines displayed  
 Timerange: 00/15:37:31 to 00/15:38:59

Plot file version 131 created 30-NOV-2010 14:30:35

ARP299C EP068B 3.UVDATA.1

Freq = 1.5950 GHz, Bw = 16.000 MH Calibrated with CL # 3 and BP # 1 (BP mode 1)

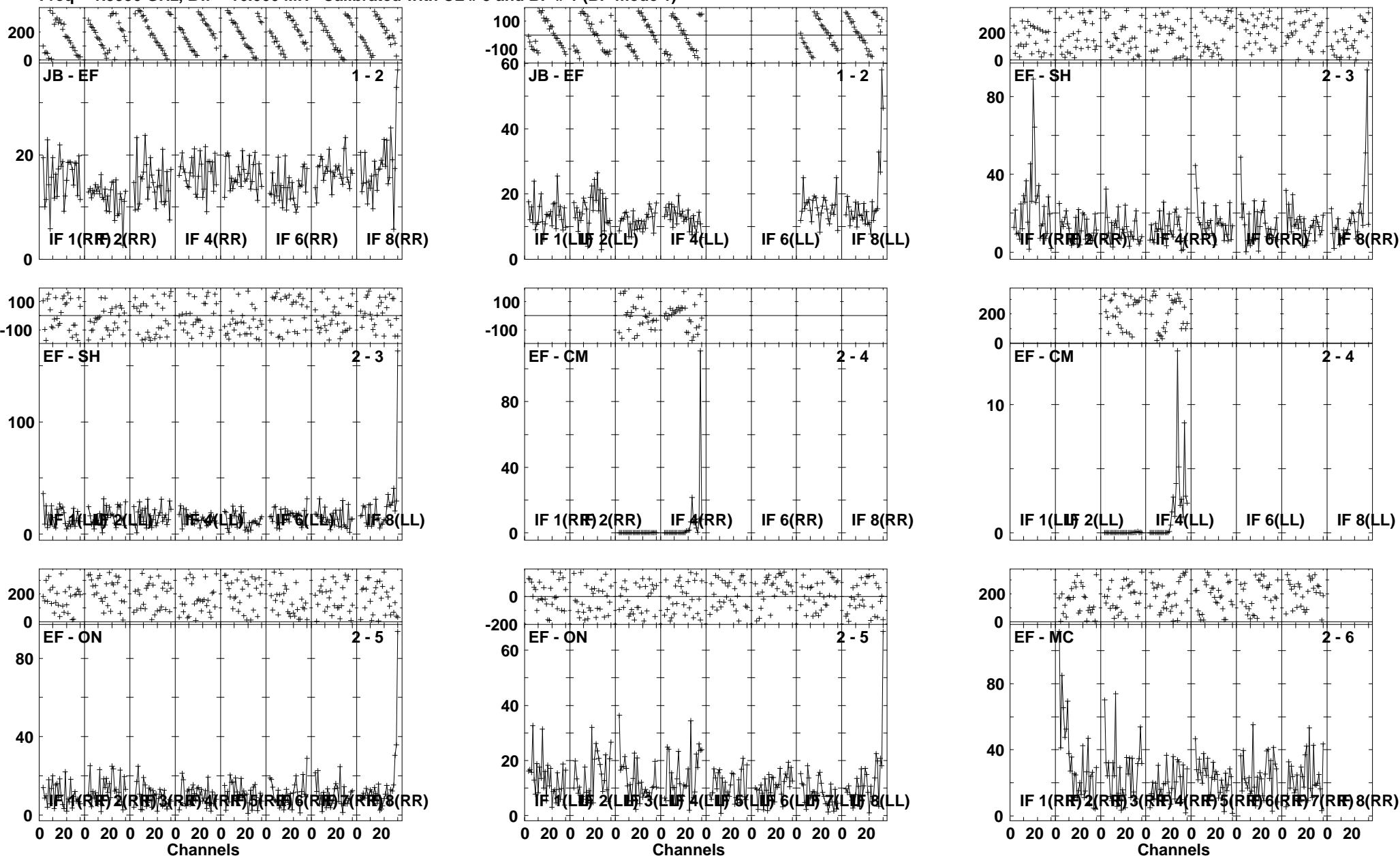

Lower frame: Milli Ampl Jy Top frame: Phas deg  
Vector averaged cross-power spectrum Several baselines displayed  
Timerange: 00/15:39:01 to 00/15:42:29

Plot file version 132 created 30-NOV-2010 14:30:38

ARP299C EP068B 3.UVDATA.1

Freq = 1.5950 GHz, Bw = 16.000 MH Calibrated with CL # 3 and BP # 1 (BP mode 1)

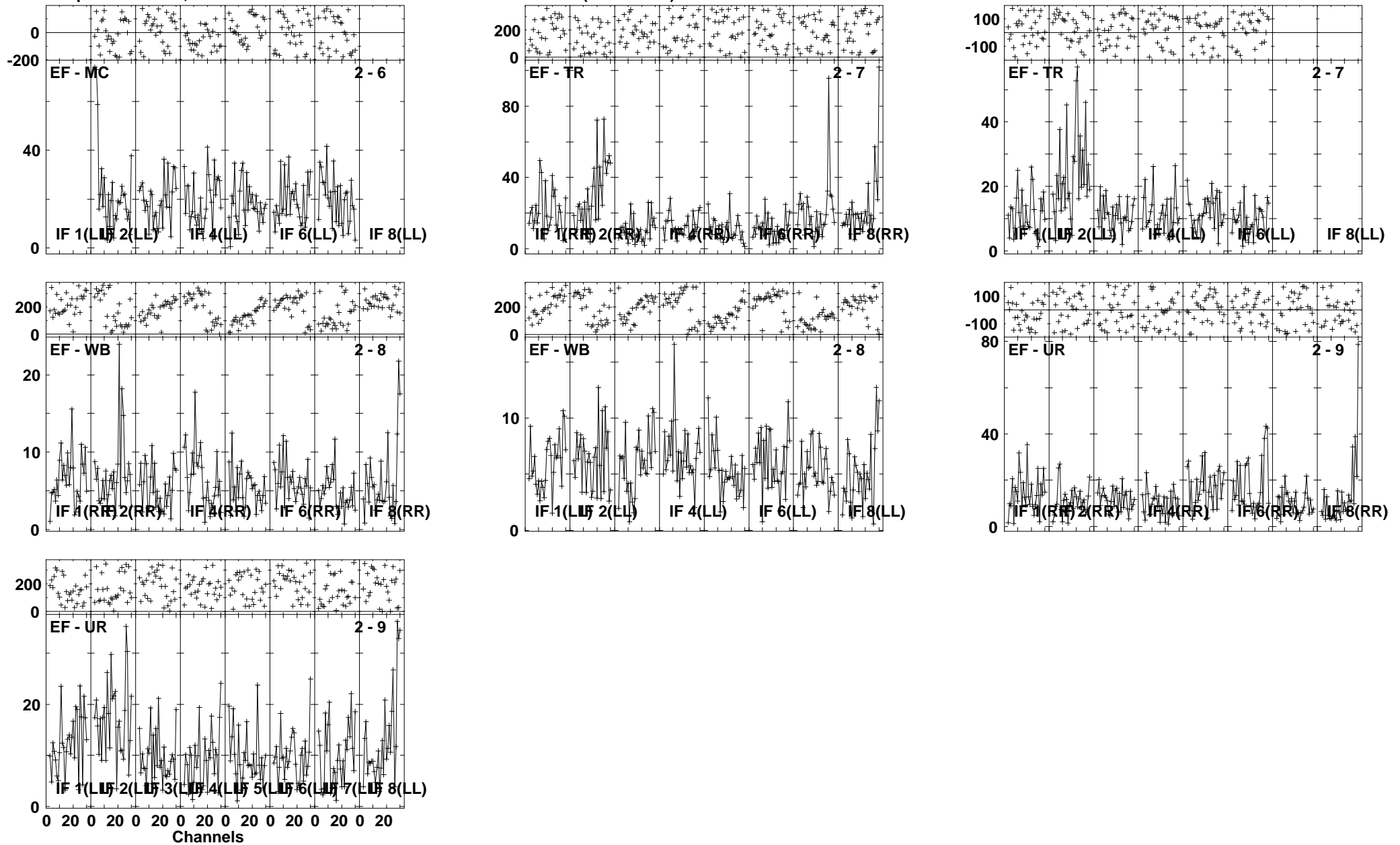

Lower frame: Milli Ampl Jy Top frame: Phas deg  
Vector averaged cross-power spectrum Several baselines displayed  
Timerange: 00/15:39:01 to 00/15:42:29

Plot file version 133 created 30-NOV-2010 14:30:40

J1128+59 EP068B 3.UVDATA.1

Freq = 1.5950 GHz, Bw = 16.000 MH Calibrated with CL # 3 and BP # 1 (BP mode 1)

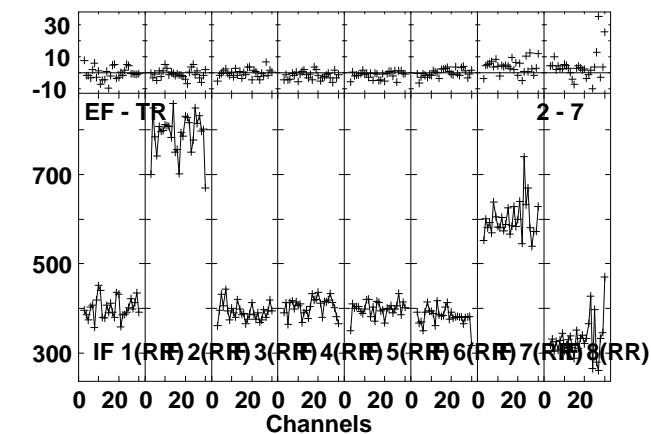
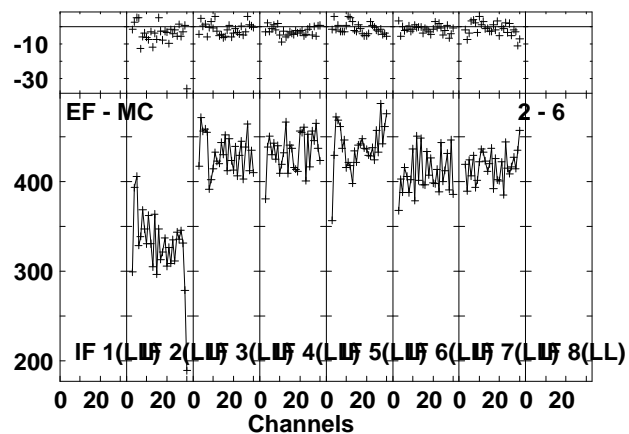
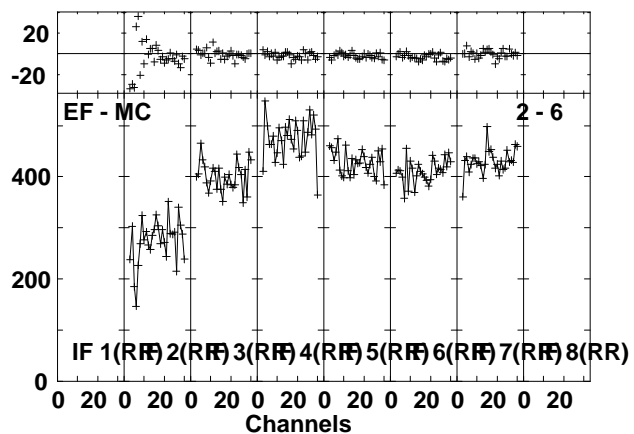
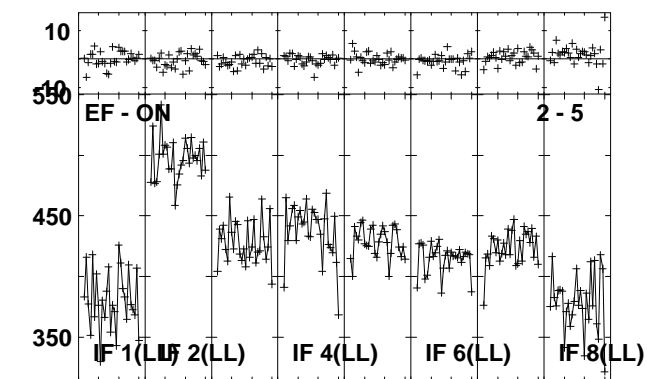
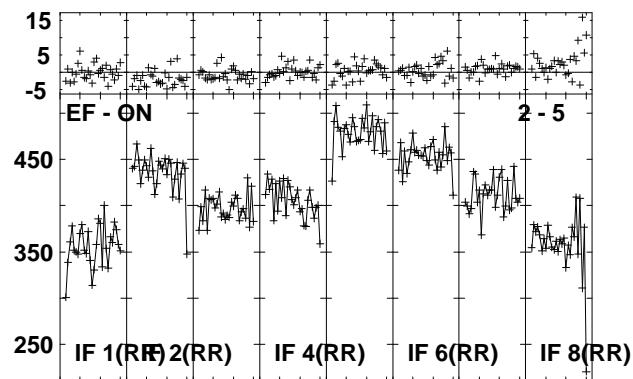
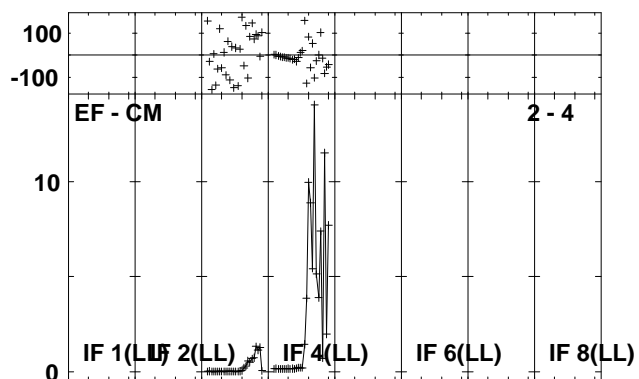
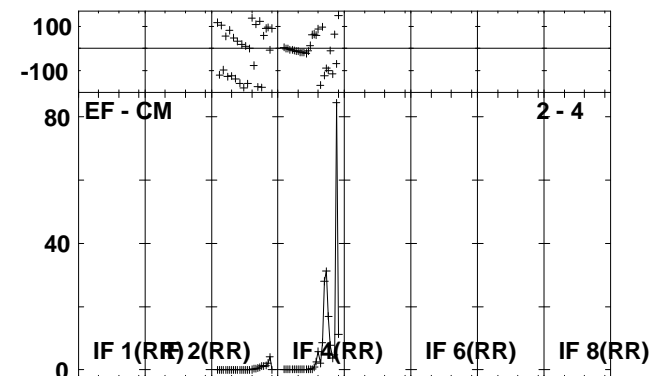
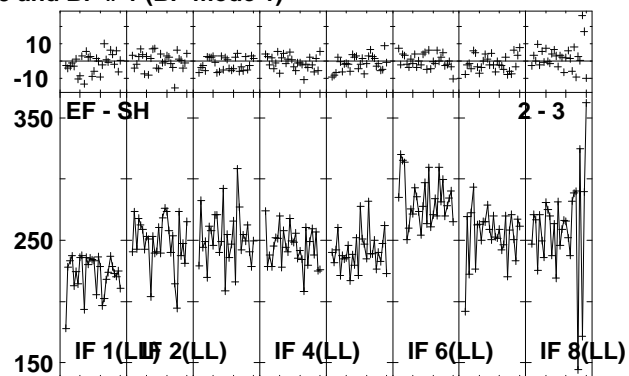
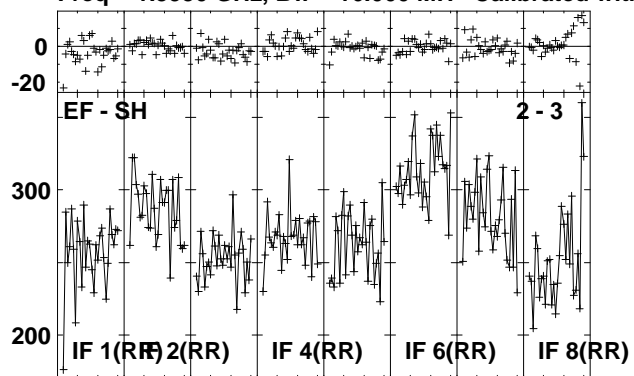

Lower frame: Milli Ampl Jy Top frame: Phas deg  
Vector averaged cross-power spectrum Several baselines displayed  
Timerange: 00/15:42:31 to 00/15:43:57

Plot file version 134 created 30-NOV-2010 14:30:41  
 J1128+59 EP068B 3.UVDATA.1  
 Freq = 1.5950 GHz, Bw = 16.000 MH Calibrated with CL # 3 and BP # 1 (BP mode 1)

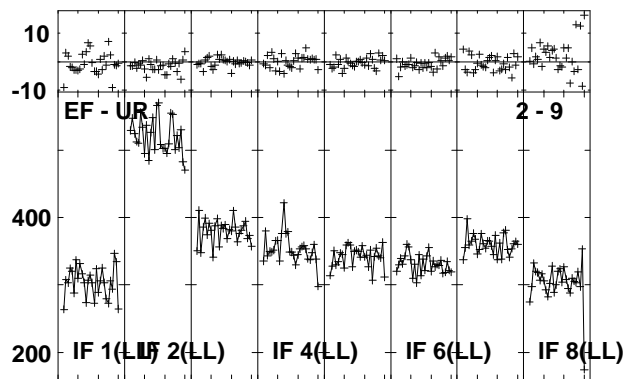
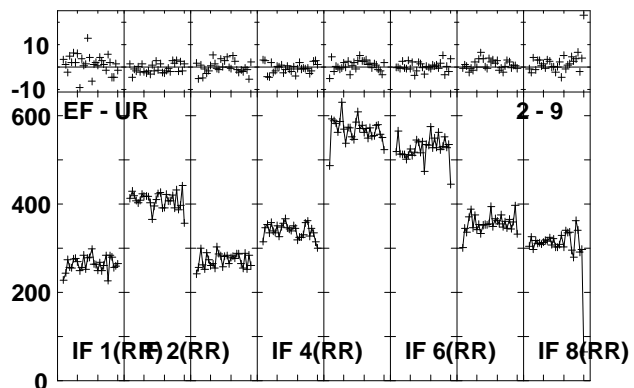
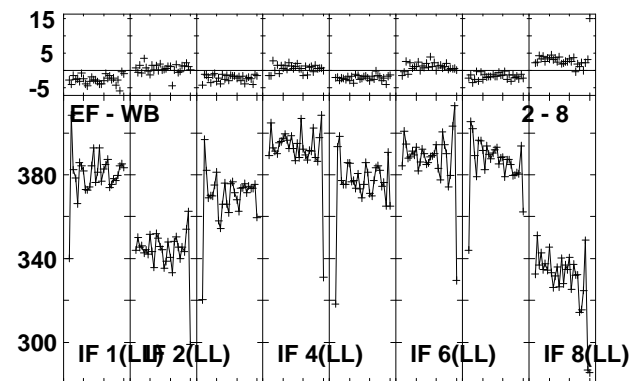
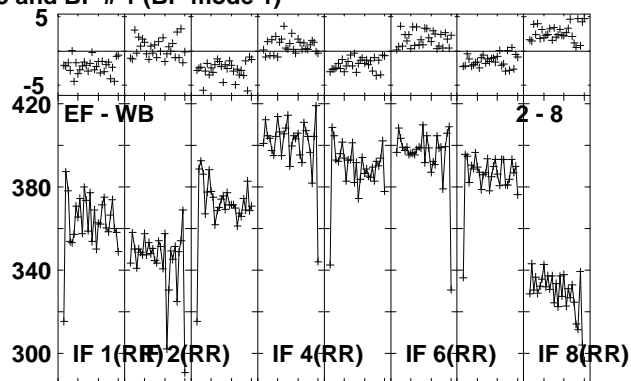
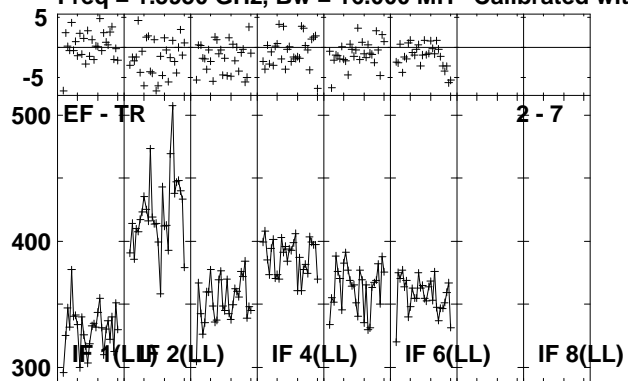

Lower frame: Milli Ampl Jy Top frame: Phas deg  
 Vector averaged cross-power spectrum Several baselines displayed  
 Timerange: 00/15:42:31 to 00/15:43:57

Plot file version 135 created 30-NOV-2010 14:30:43

ARP299C EP068B 3.UVDATA.1

Freq = 1.5950 GHz, Bw = 16.000 MH Calibrated with CL # 3 and BP # 1 (BP mode 1)

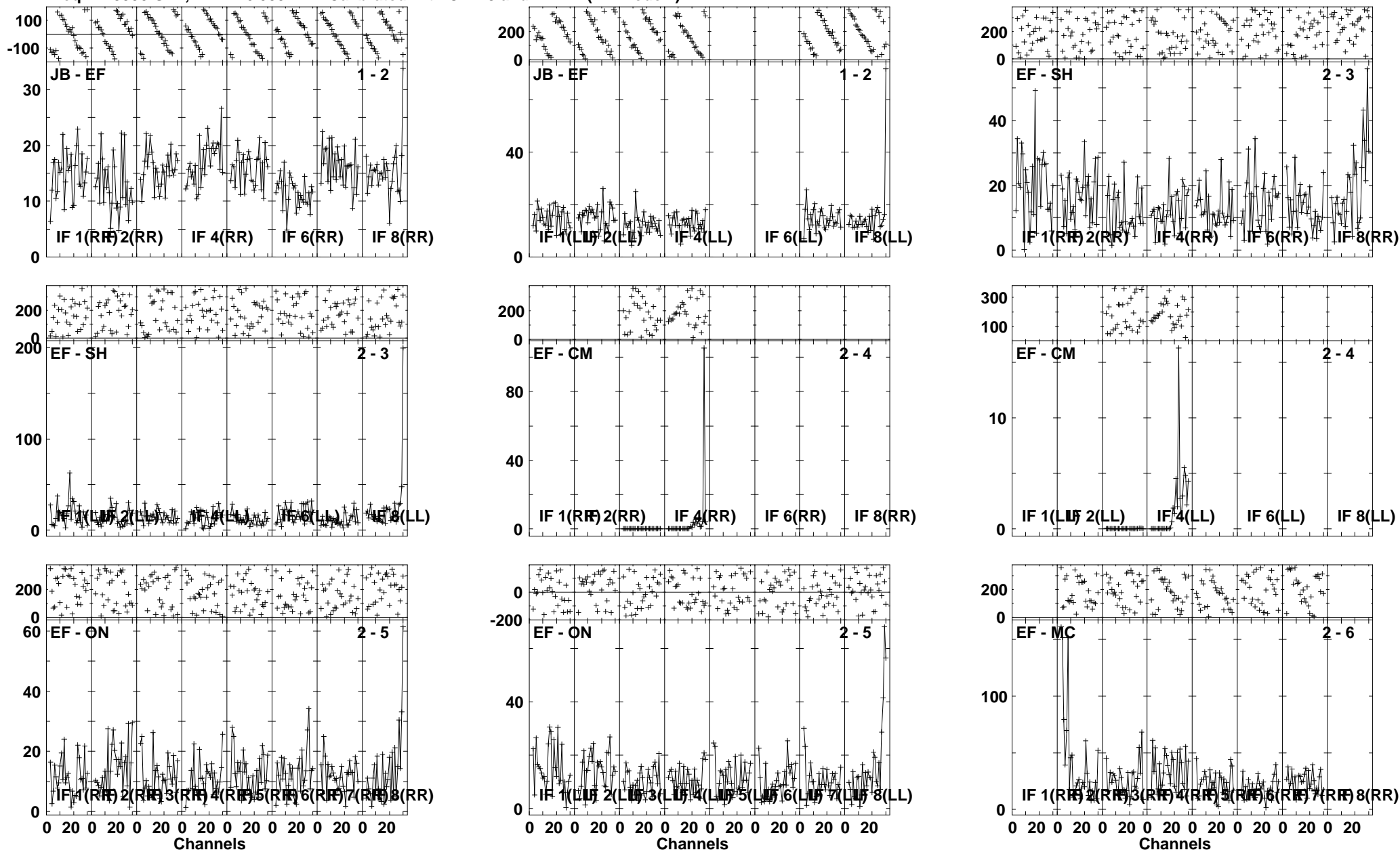

Lower frame: Milli Ampl Jy Top frame: Phas deg  
Vector averaged cross-power spectrum Several baselines displayed  
Timerange: 00/15:44:01 to 00/15:47:29

Plot file version 136 created 30-NOV-2010 14:30:45

ARP299C EP068B 3.UVDATA.1

Freq = 1.5950 GHz, Bw = 16.000 MH Calibrated with CL # 3 and BP # 1 (BP mode 1)

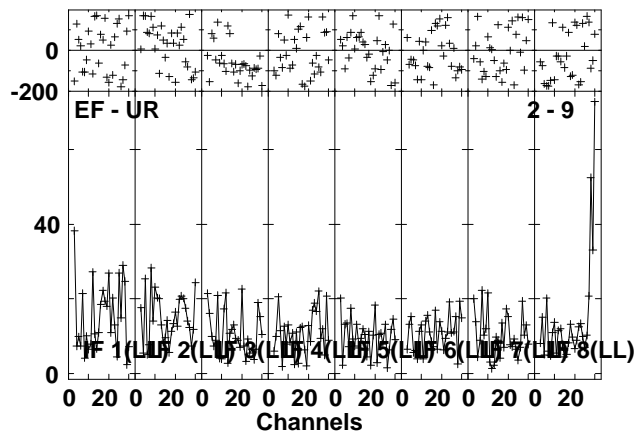
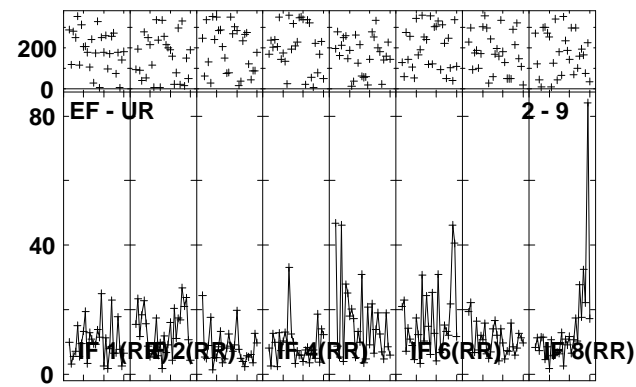
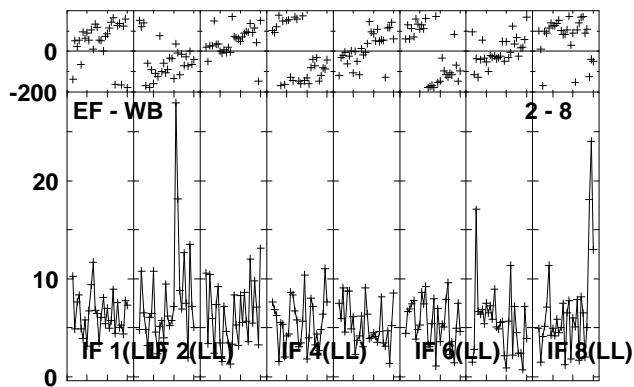
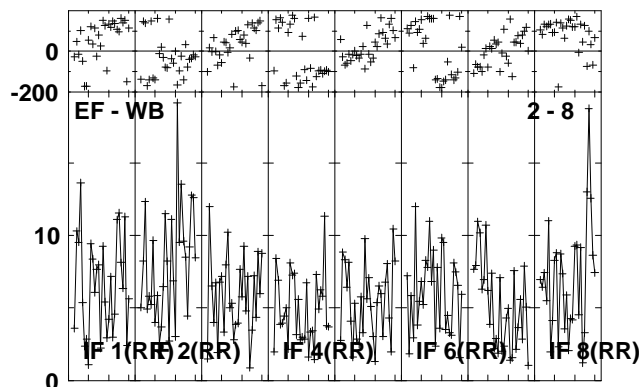
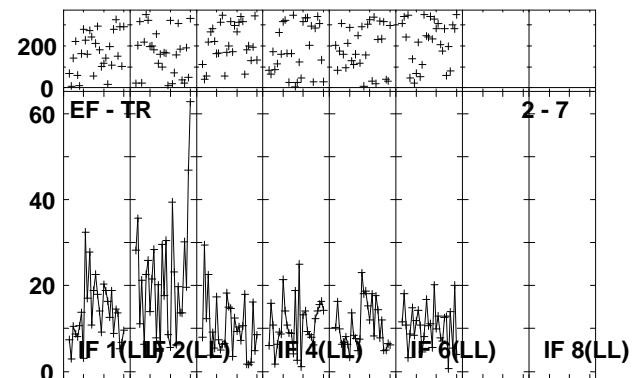
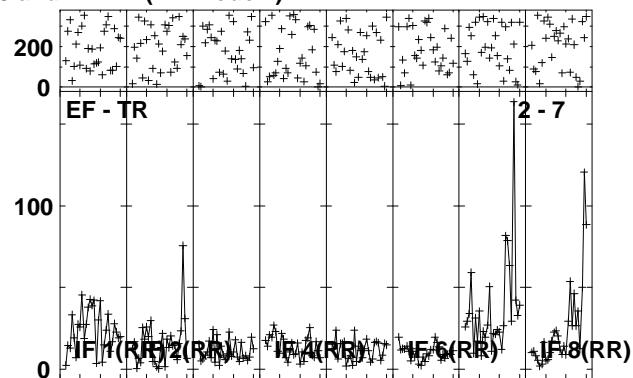
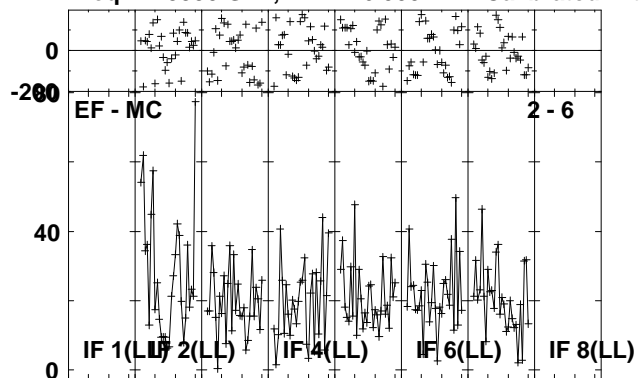

Lower frame: Milli Ampl Jy Top frame: Phas deg  
Vector averaged cross-power spectrum Several baselines displayed  
Timerange: 00:15:44:01 to 00:15:47:29



Plot file version 137 created 30-NOV-2010 14:30:48

J1128+59 EP068B 3.UVDATA.1

Freq = 1.5950 GHz, Bw = 16.000 MH Calibrated with CL # 3 and BP # 1 (BP mode 1)

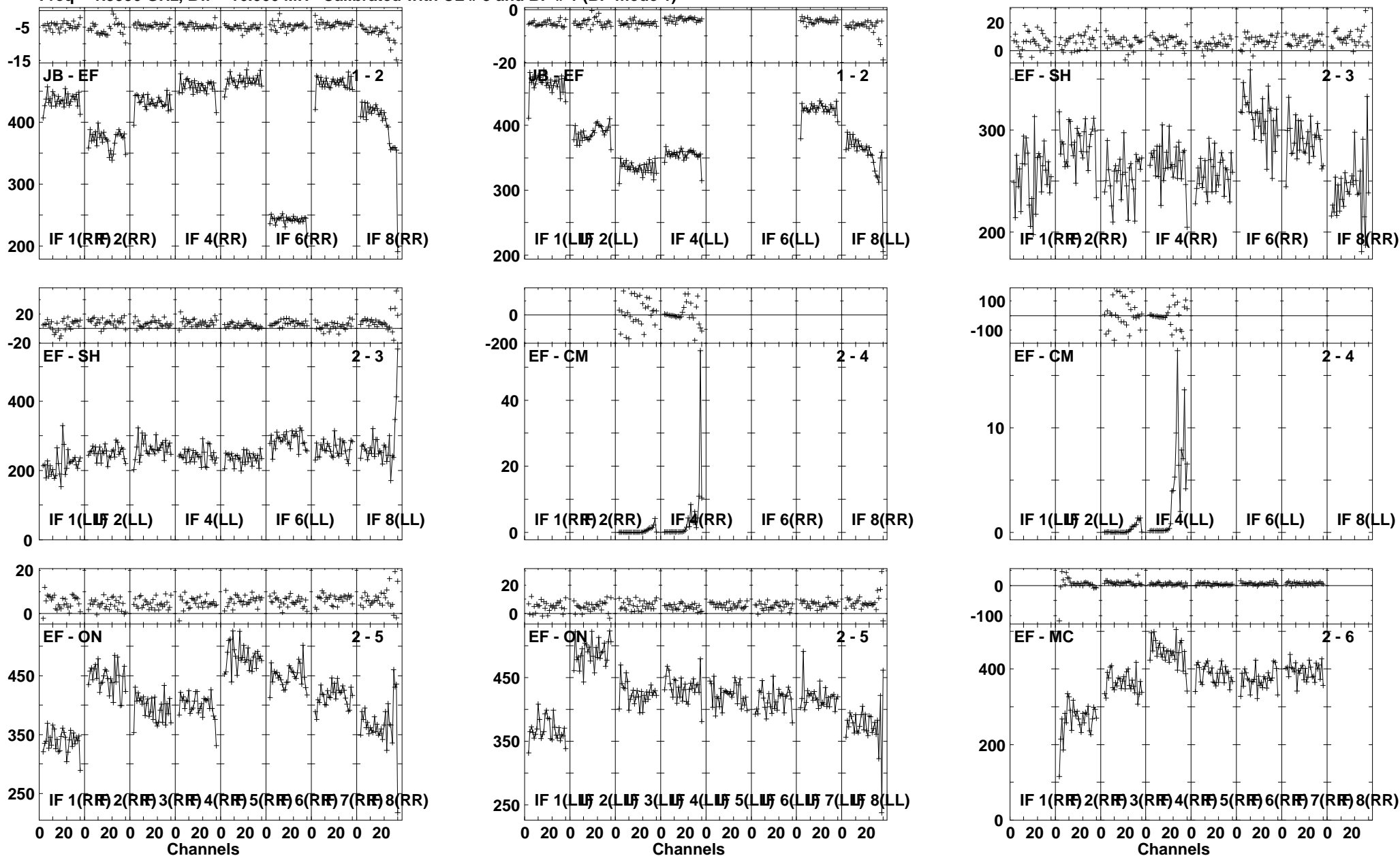

Lower frame: Milli Ampl Jy Top frame: Phas deg  
Vector averaged cross-power spectrum Several baselines displayed  
Timerange: 00/15:47:31 to 00/15:48:59

Plot file version 138 created 30-NOV-2010 14:30:49

J1128+59 EP068B 3.UVDATA.1

Freq = 1.5950 GHz, Bw = 16.000 MH Calibrated with CL # 3 and BP # 1 (BP mode 1)

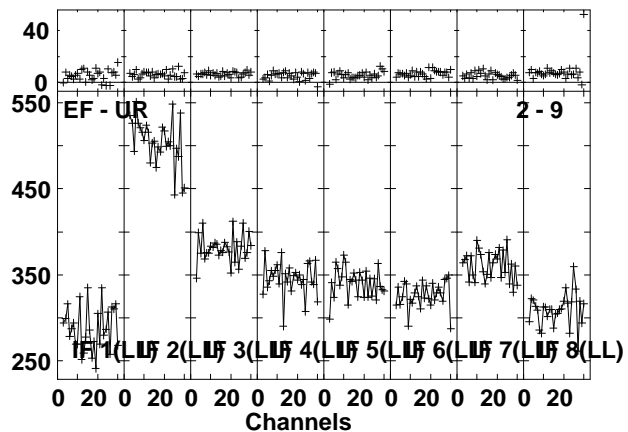
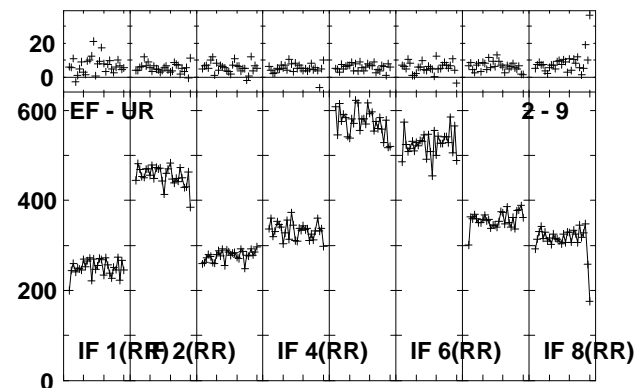
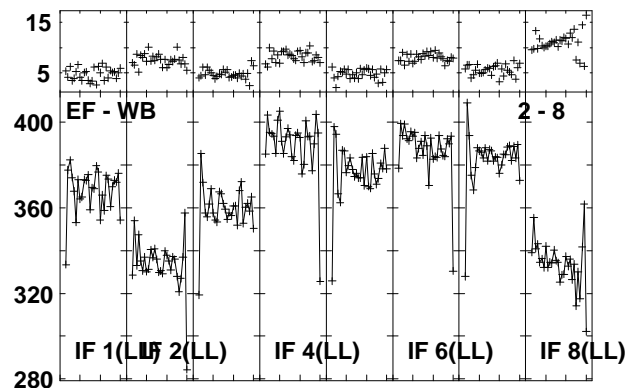
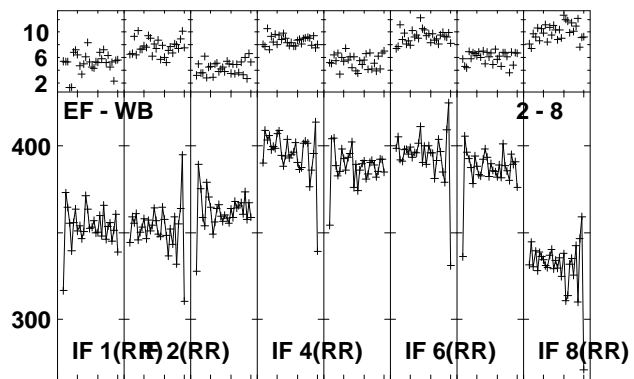
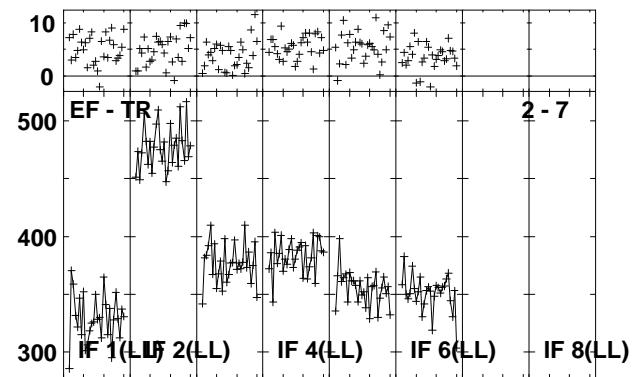
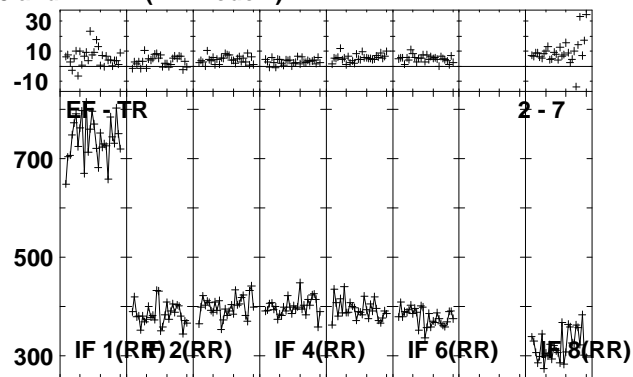
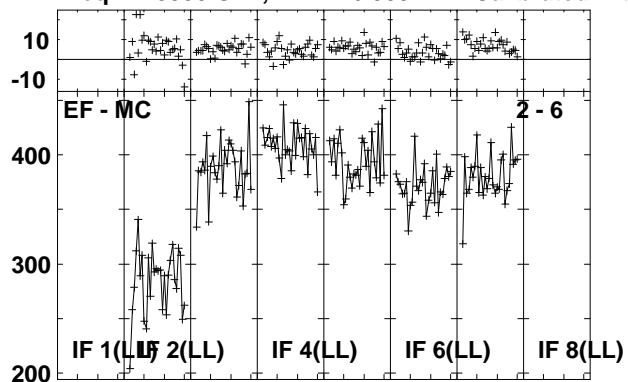

Lower frame: Milli Ampl Jy Top frame: Phas deg  
Vector averaged cross-power spectrum Several baselines displayed  
Timerange: 00/15:47:31 to 00/15:48:59

Plot file version 139 created 30-NOV-2010 14:30:50

ARP299C EP068B 3.UVDATA.1

Freq = 1.5950 GHz, Bw = 16.000 MH Calibrated with CL # 3 and BP # 1 (BP mode 1)

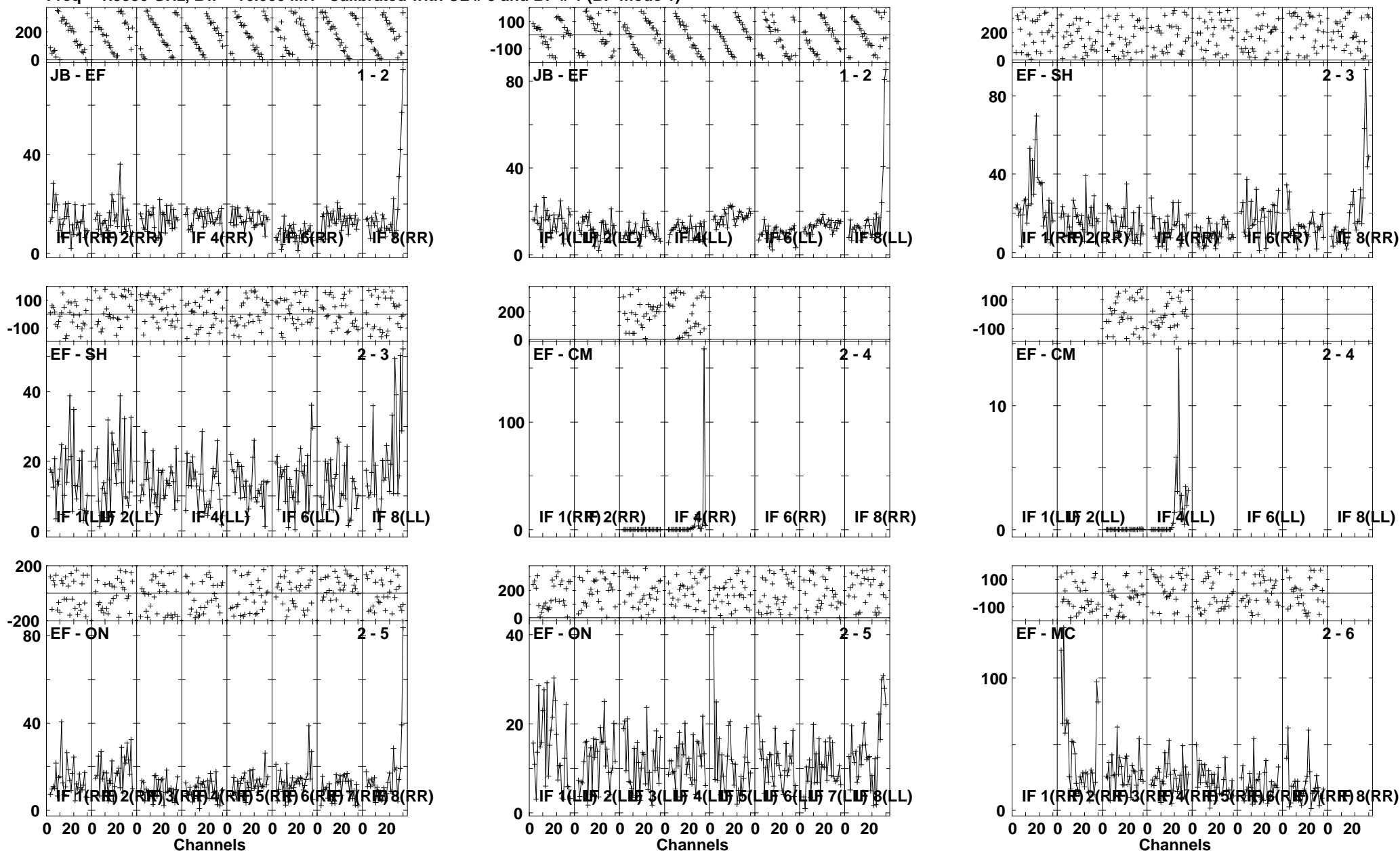

Lower frame: Milli Ampl Jy Top frame: Phas deg  
Vector averaged cross-power spectrum Several baselines displayed  
Timerange: 00/15:49:01 to 00/15:52:29

Plot file version 140 created 30-NOV-2010 14:30:53

ARP299C EP068B 3.UVDATA.1

Freq = 1.5950 GHz, Bw = 16.000 MH Calibrated with CL # 3 and BP # 1 (BP mode 1)

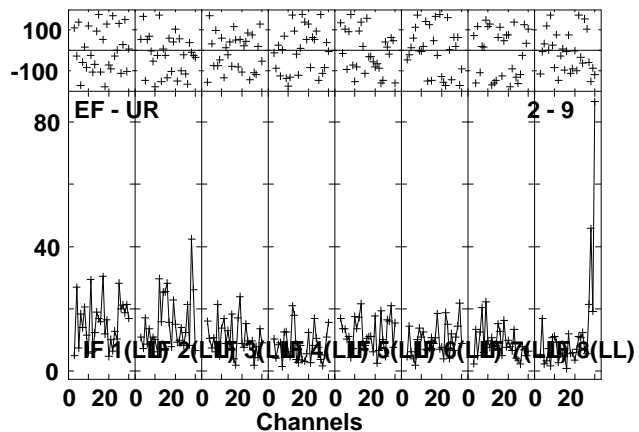
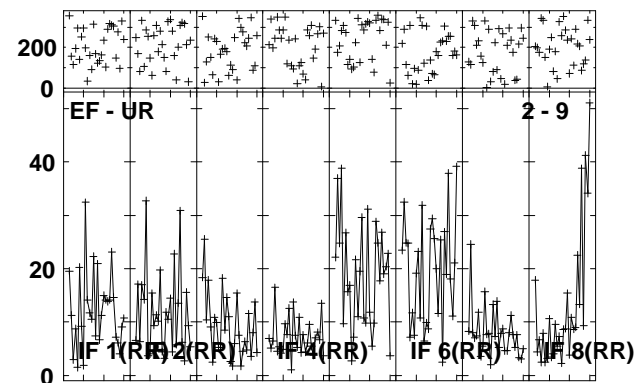
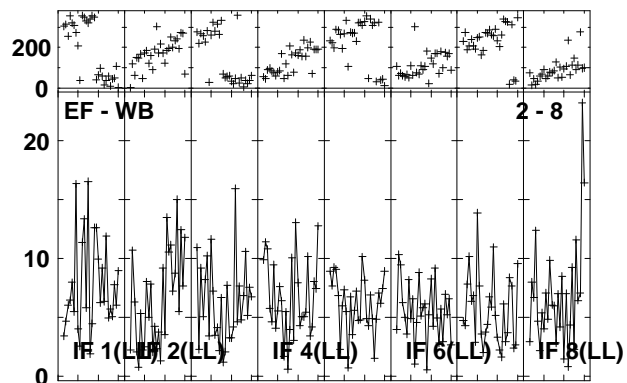
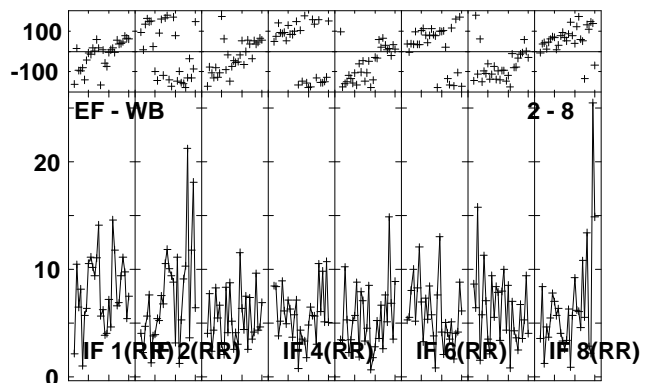
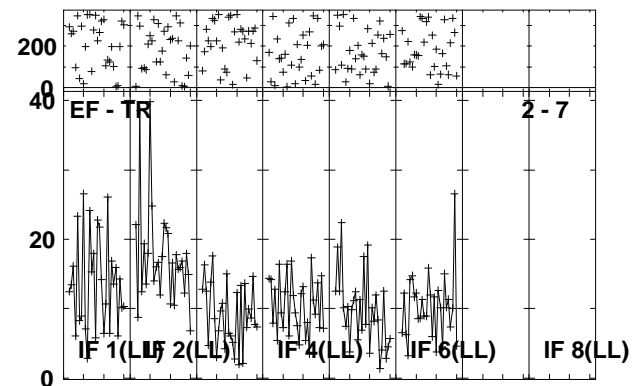
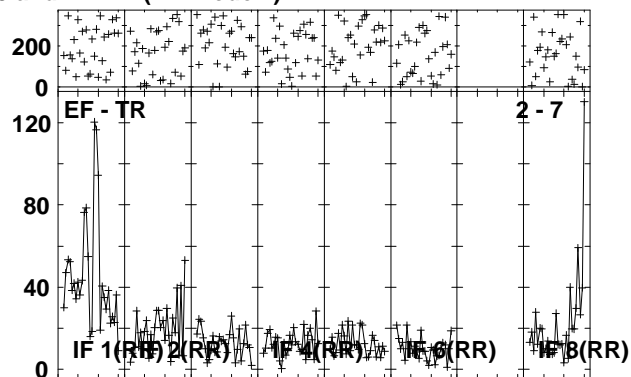
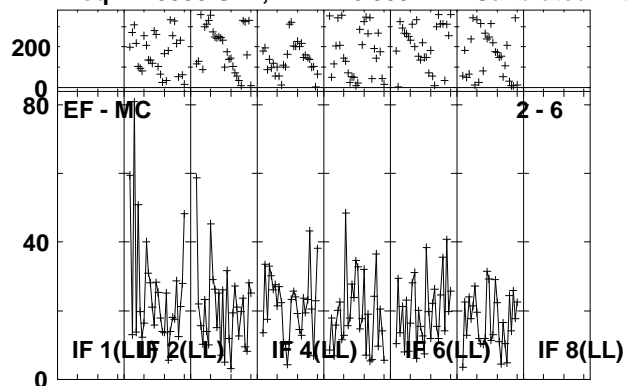

Lower frame: Milli Ampl Jy Top frame: Phas deg  
Vector averaged cross-power spectrum Several baselines displayed  
Timerange: 00/15:49:01 to 00/15:52:29

Plot file version 141 created 30-NOV-2010 14:30:56

J1128+59 EP068B 3.UVDATA.1

Freq = 1.5950 GHz, Bw = 16.000 MH Calibrated with CL # 3 and BP # 1 (BP mode 1)

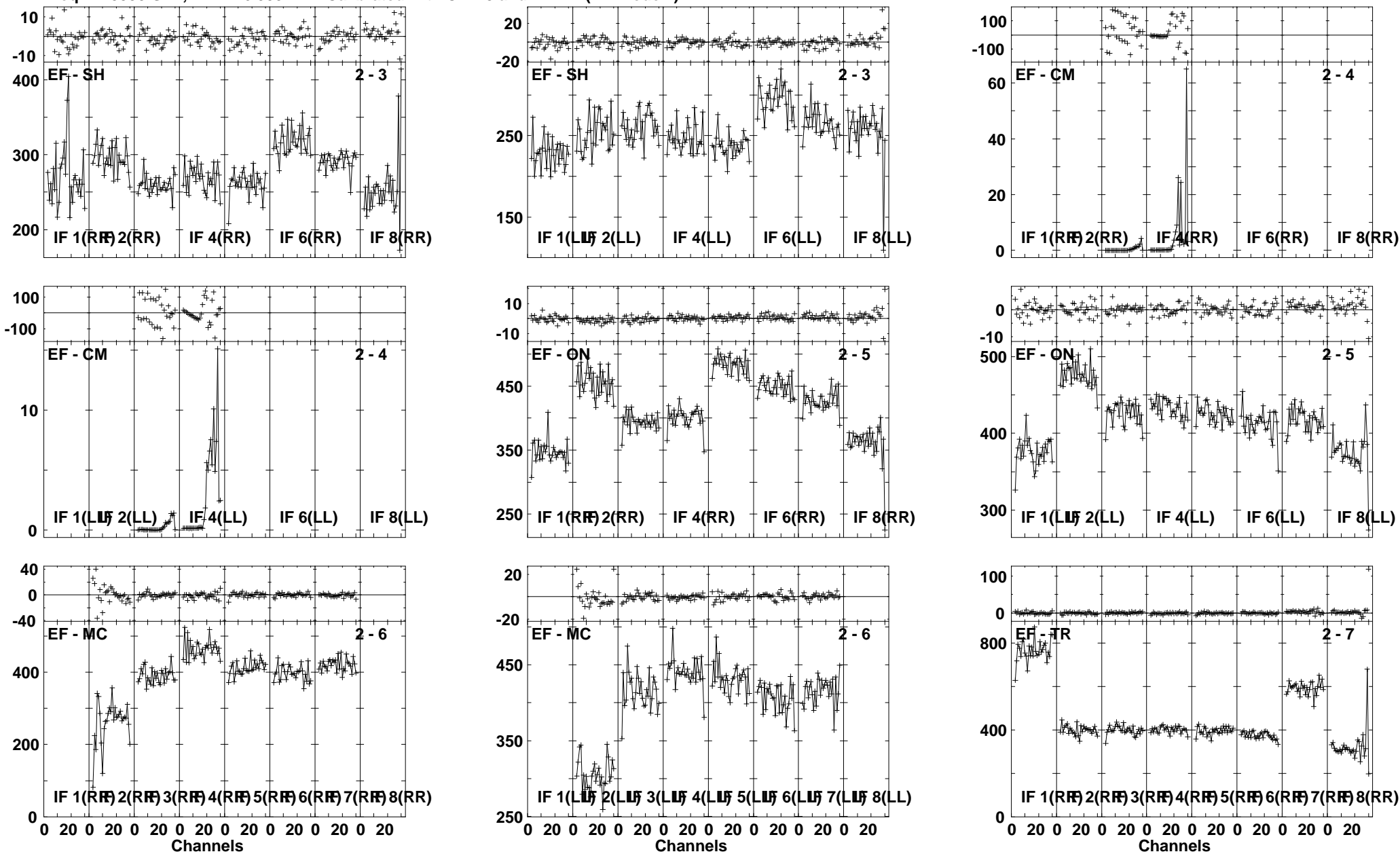

Lower frame: Milli Ampl Jy Top frame: Phas deg  
Vector averaged cross-power spectrum Several baselines displayed  
Timerange: 00/15:53:31 to 00/15:54:59

Plot file version 142 created 30-NOV-2010 14:30:57

J1128+59 EP068B 3.UVDATA.1

Freq = 1.5950 GHz, Bw = 16.000 MH Calibrated with CL # 3 and BP # 1 (BP mode 1)

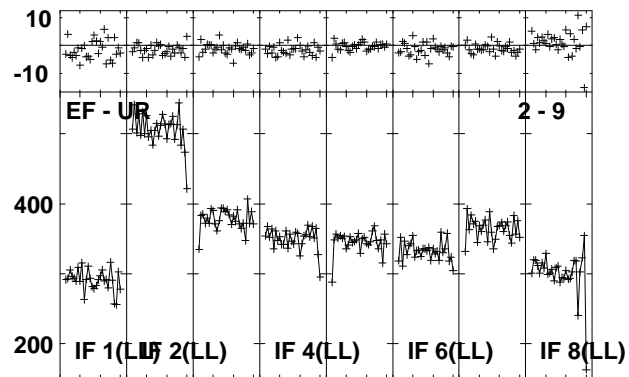
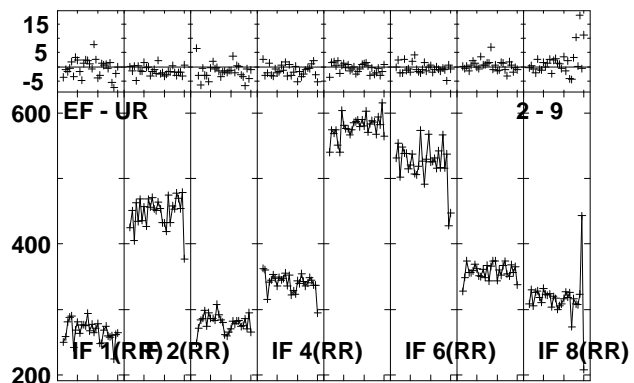
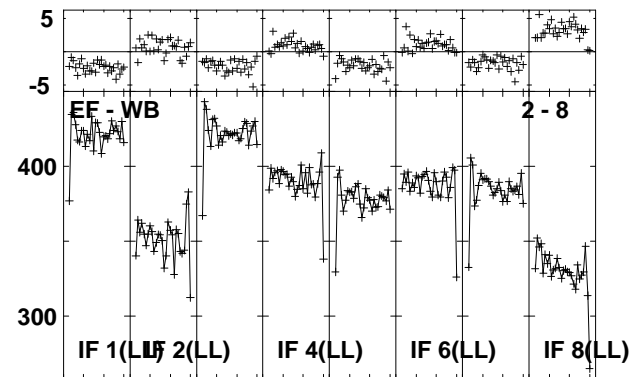
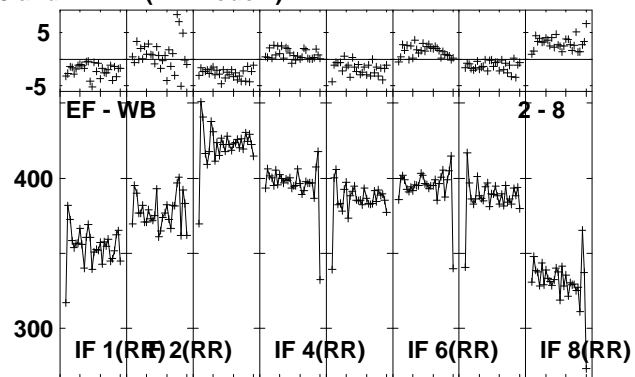
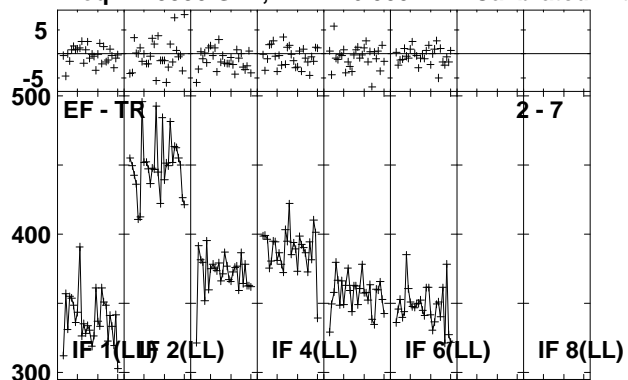

Lower frame: Milli Ampl Jy Top frame: Phas deg  
Vector averaged cross-power spectrum Several baselines displayed  
Timerange: 00/15:53:31 to 00/15:54:59

Plot file version 143 created 30-NOV-2010 14:30:58

ARP299C EP068B 3.UVDATA.1

Freq = 1.5950 GHz, Bw = 16.000 MH Calibrated with CL # 3 and BP # 1 (BP mode 1)

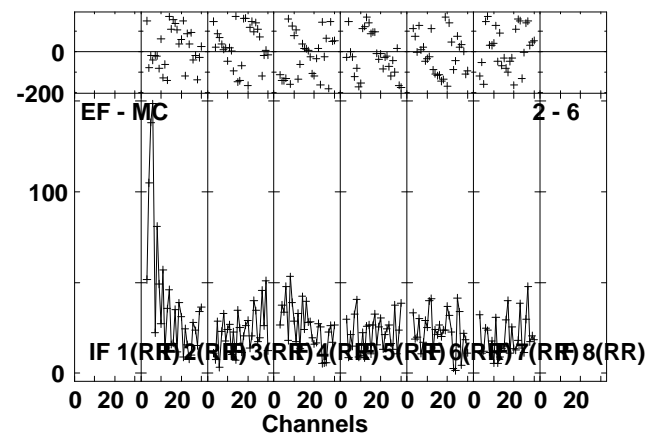
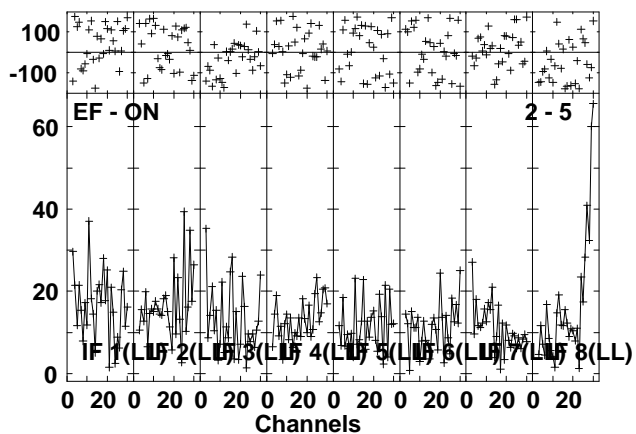
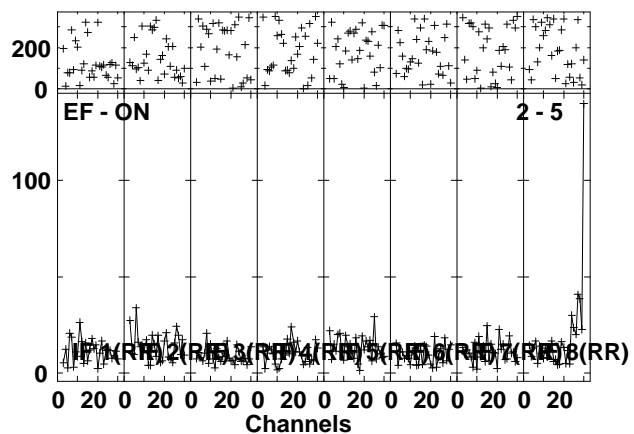
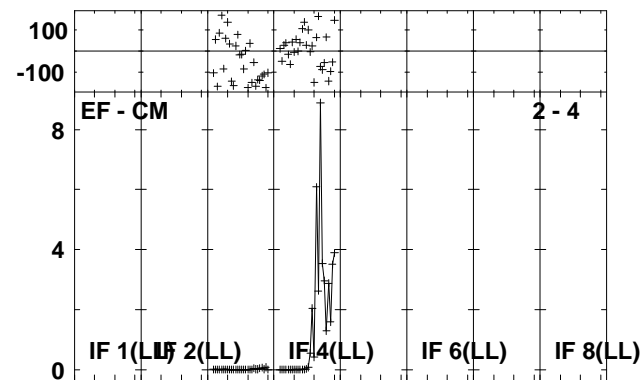
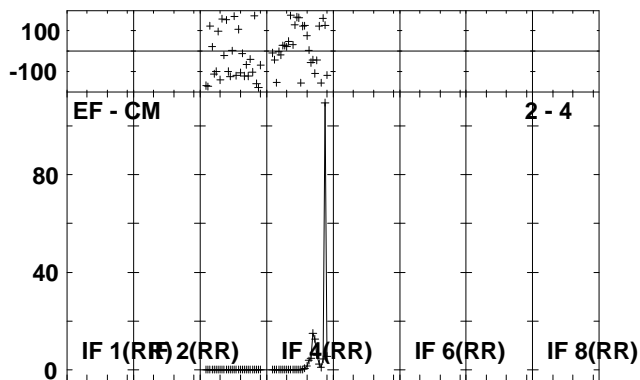
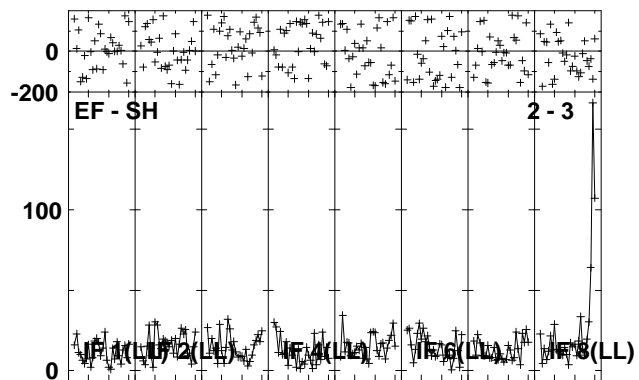
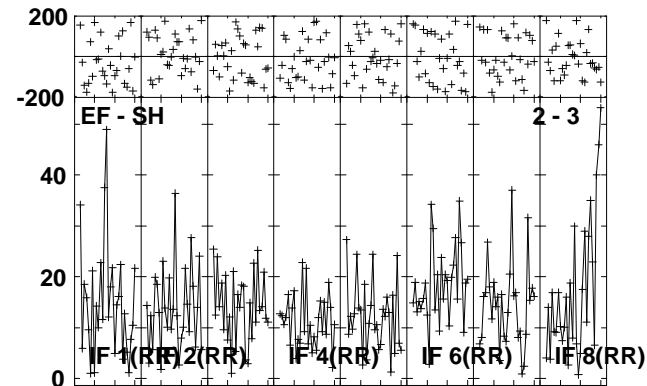
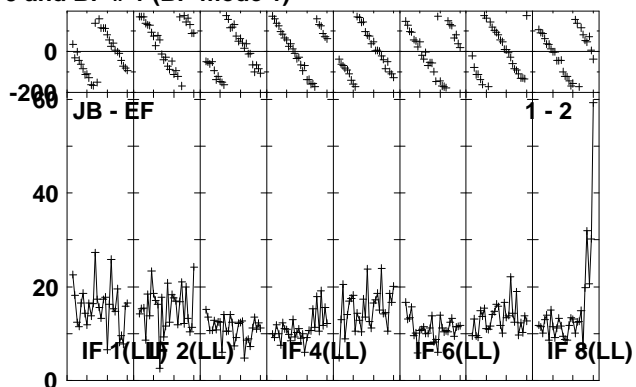
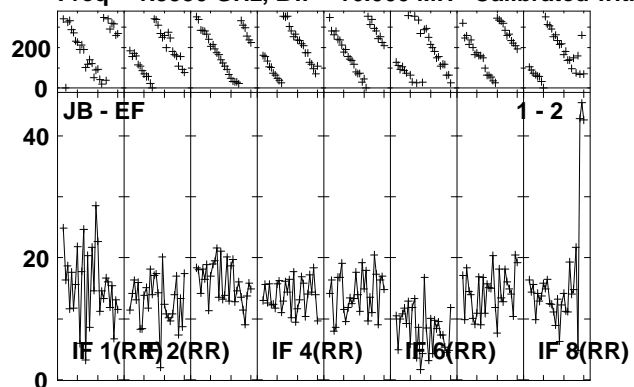

Lower frame: Milli Ampl Jy Top frame: Phas deg  
Vector averaged cross-power spectrum Several baselines displayed  
Timerange: 00/15:55:01 to 00/15:58:29

Plot file version 144 created 30-NOV-2010 14:31:00

ARP299C EP068B 3.UVDATA.1

Freq = 1.5950 GHz, Bw = 16.000 MH Calibrated with CL # 3 and BP # 1 (BP mode 1)

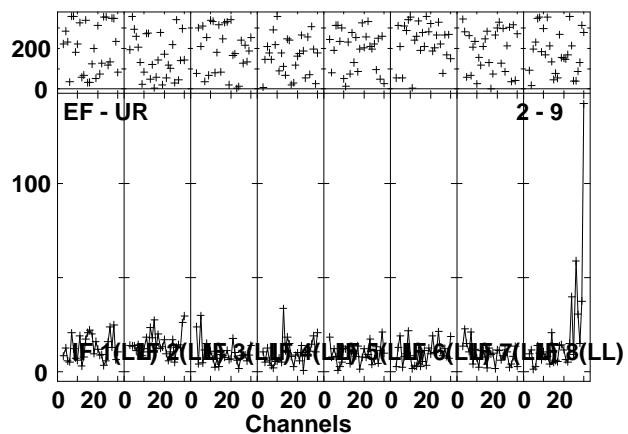
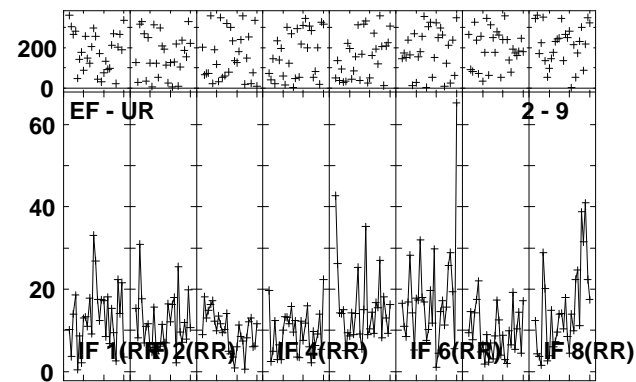
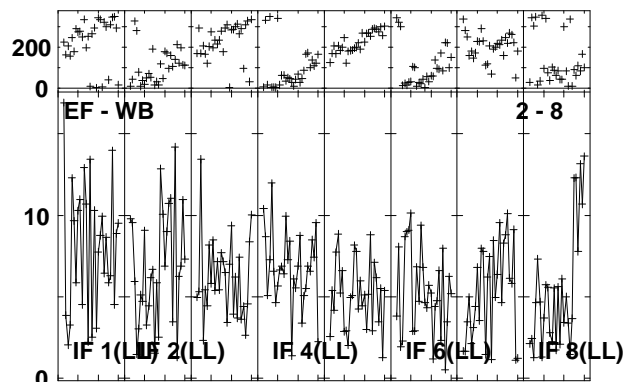
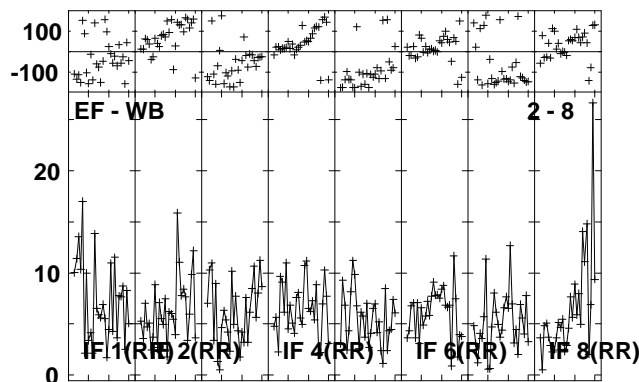
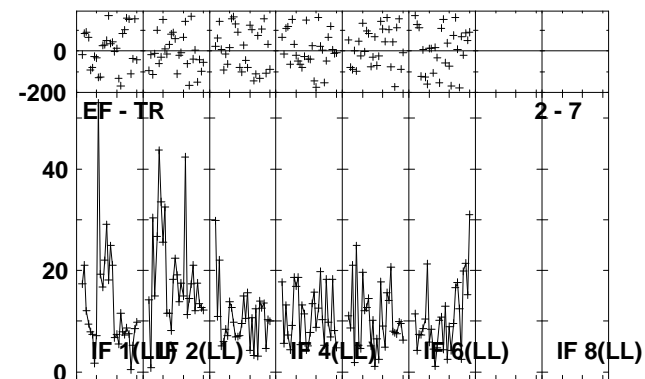
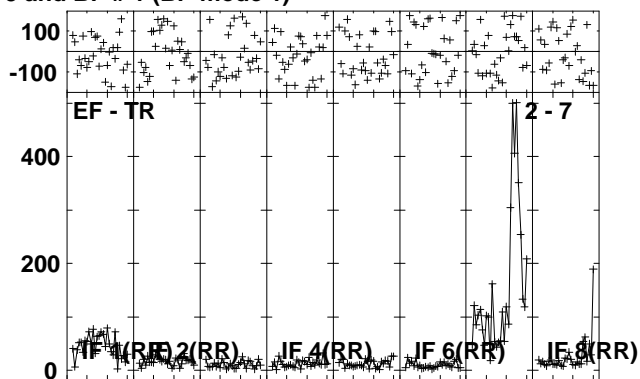
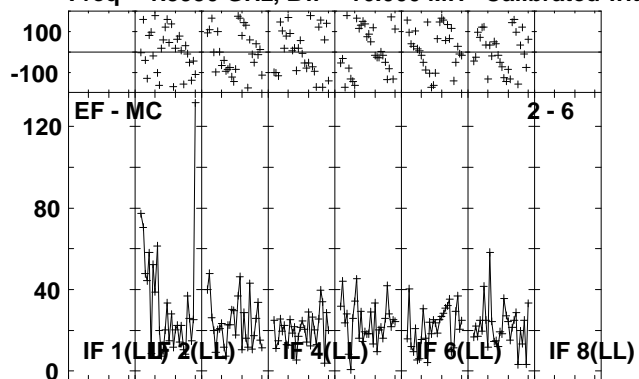

Lower frame: Milli Ampl Jy Top frame: Phas deg  
Vector averaged cross-power spectrum Several baselines displayed  
Timerange: 00/15:55:01 to 00/15:58:29



Plot file version 145 created 30-NOV-2010 14:31:03

J1128+59 EP068B 3.UVDATA.1

Freq = 1.5950 GHz, Bw = 16.000 MH Calibrated with CL # 3 and BP # 1 (BP mode 1)

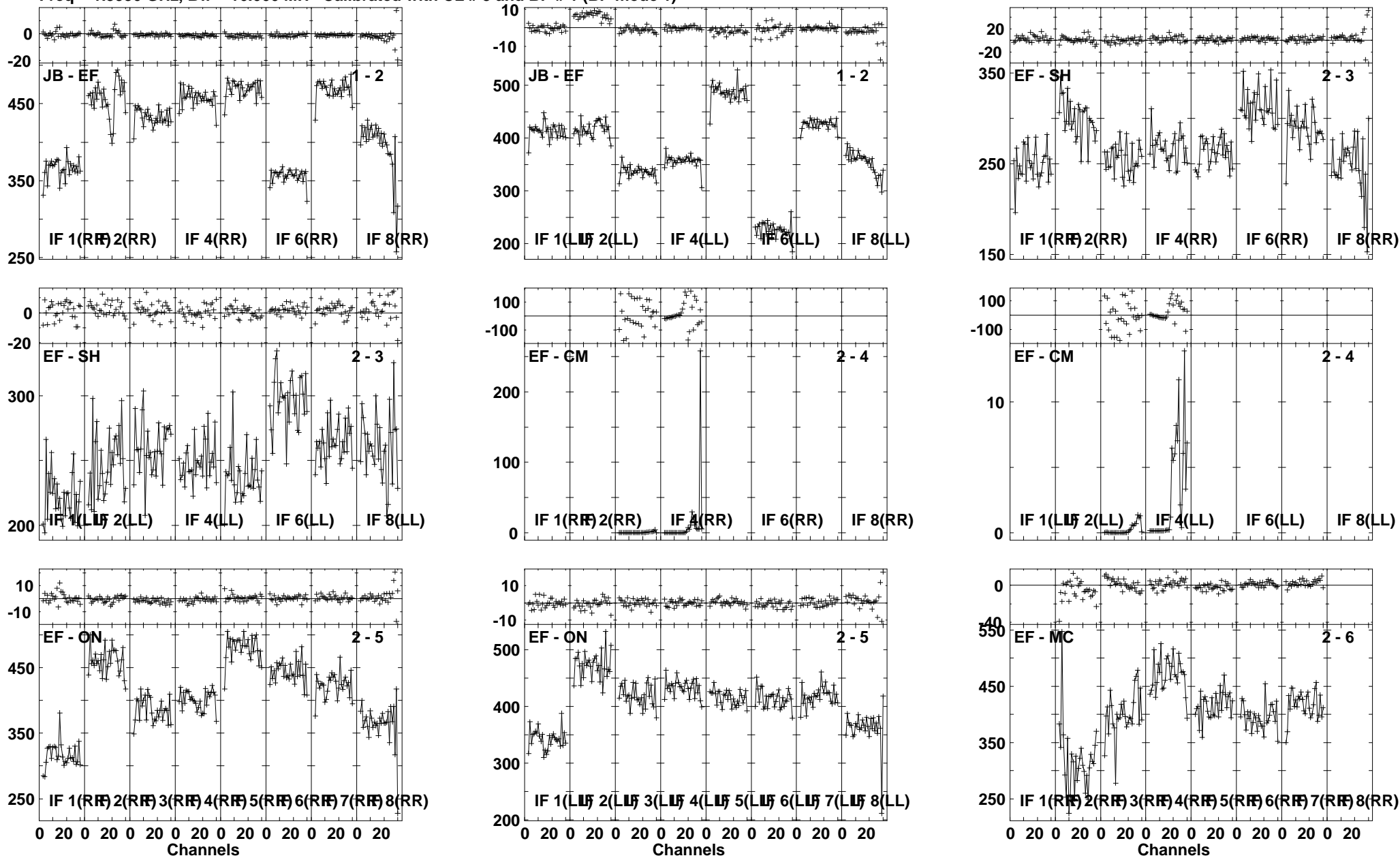

Lower frame: Milli Ampl Jy Top frame: Phas deg  
Vector averaged cross-power spectrum Several baselines displayed  
Timerange: 00/15:58:31 to 00/15:59:59

Plot file version 146 created 30-NOV-2010 14:31:04

J1128+59 EP068B 3.UVDATA.1

Freq = 1.5950 GHz, Bw = 16.000 MH Calibrated with CL # 3 and BP # 1 (BP mode 1)

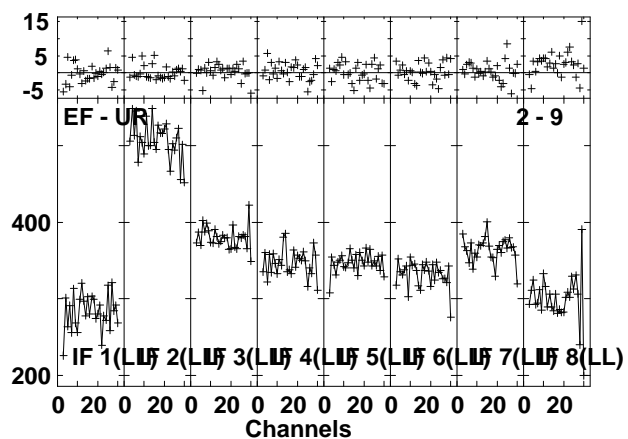
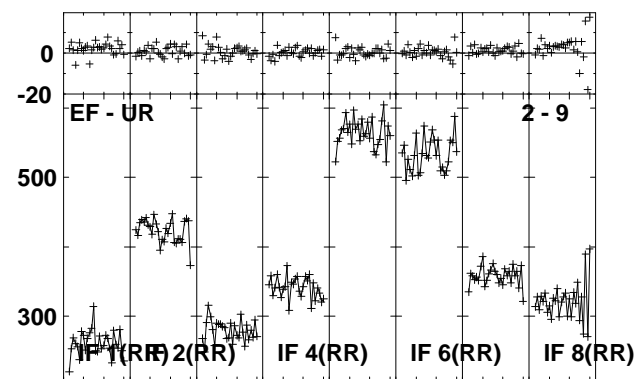
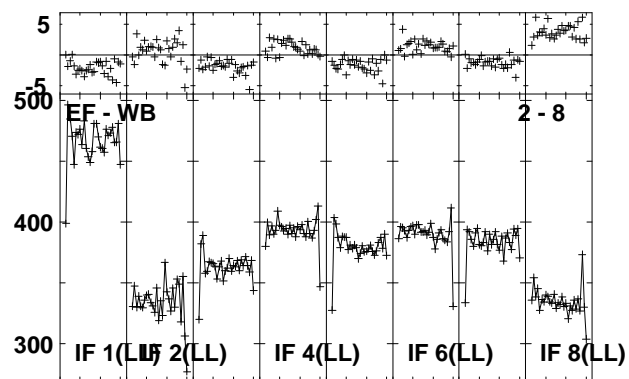
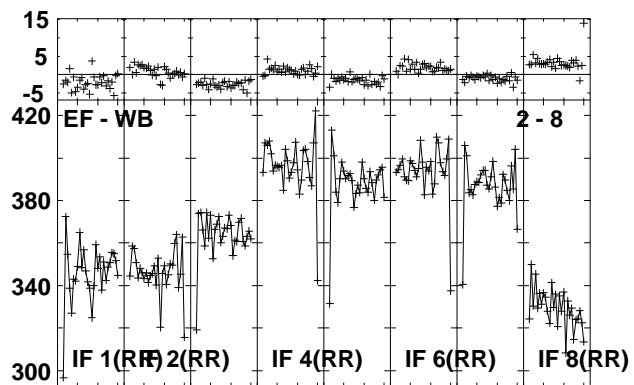
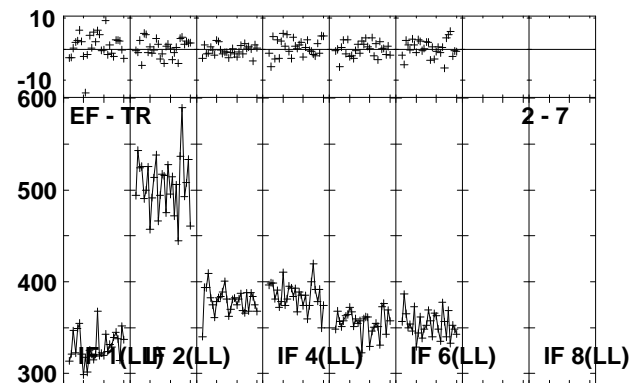
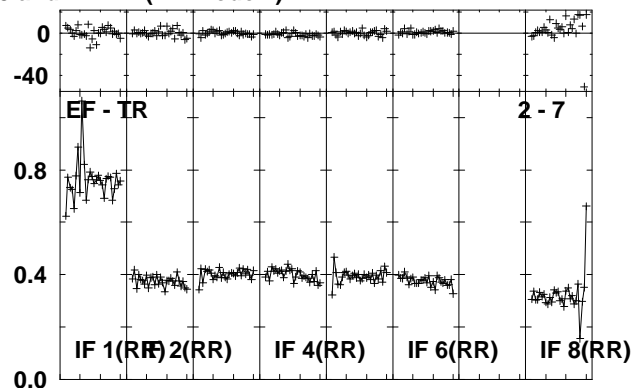
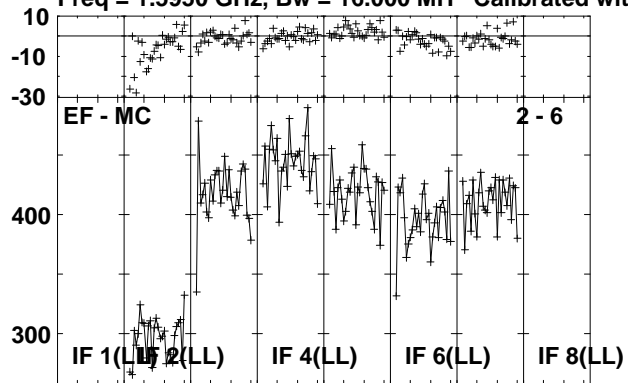

Lower frame: Milli Ampl Jy Top frame: Phas deg  
 Vector averaged cross-power spectrum Several baselines displayed  
 Timerange: 00/15:58:31 to 00/15:59:59

Plot file version 147 created 30-NOV-2010 14:31:06

ARP299C EP068B 3.UVDATA.1

Freq = 1.5950 GHz, Bw = 16.000 MH Calibrated with CL # 3 and BP # 1 (BP mode 1)

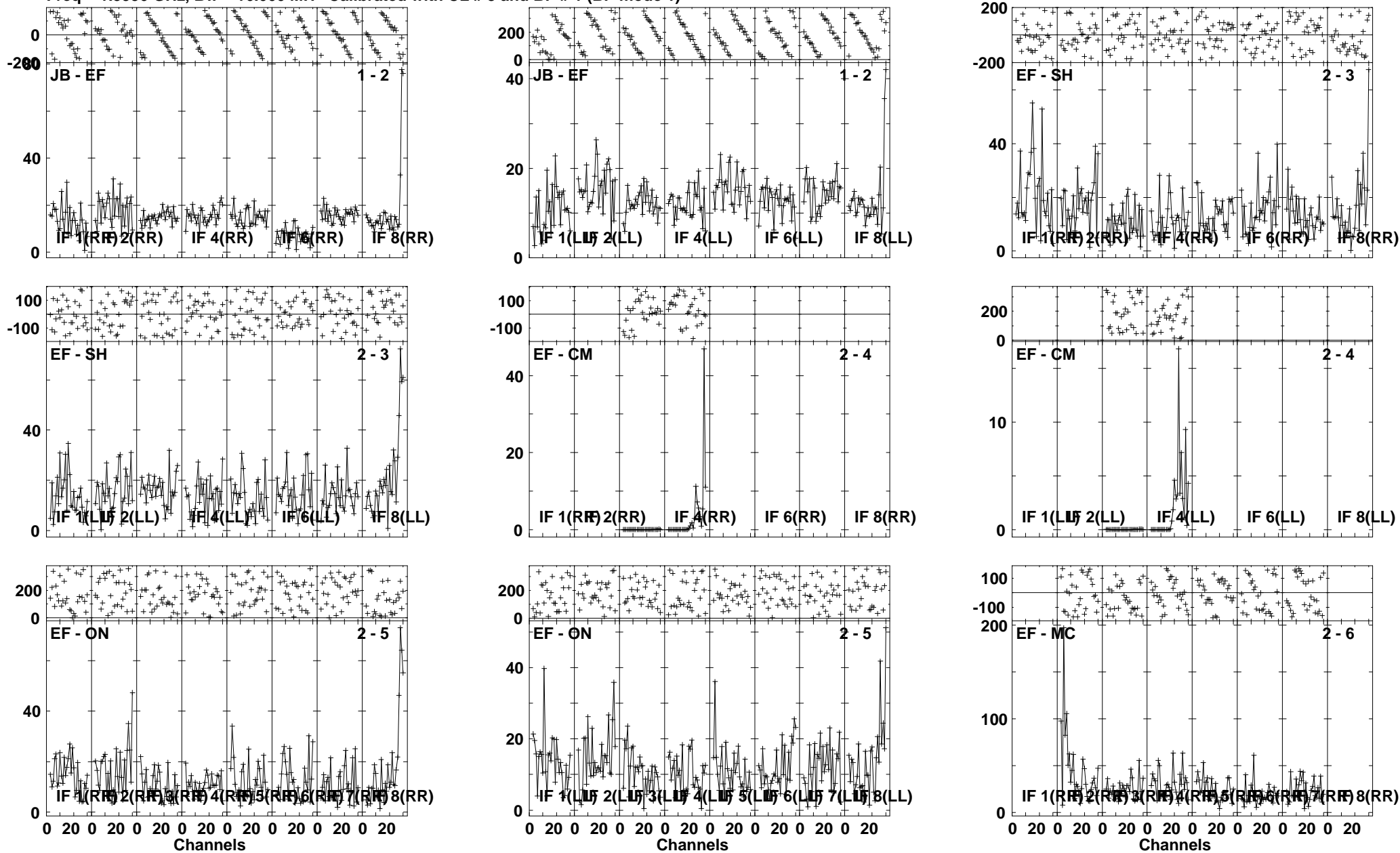

Lower frame: Milli Ampl Jy Top frame: Phas deg  
Vector averaged cross-power spectrum Several baselines displayed  
Timerange: 00/16:00:01 to 00/16:03:29

Plot file version 148 created 30-NOV-2010 14:31:09

ARP299C EP068B 3.UVDATA.1

Freq = 1.5950 GHz, Bw = 16.000 MH Calibrated with CL # 3 and BP # 1 (BP mode 1)

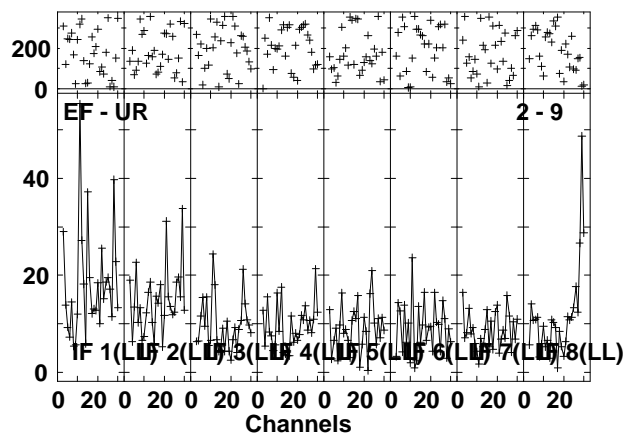
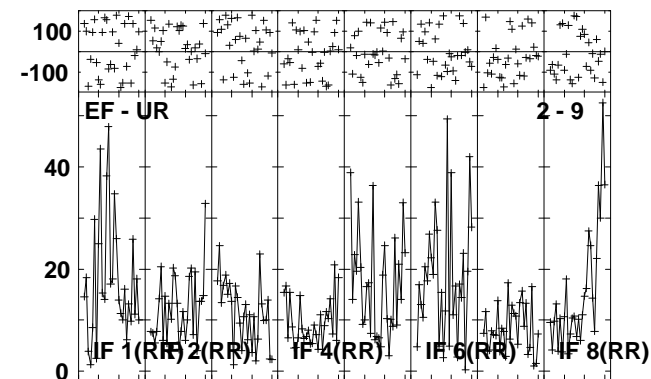
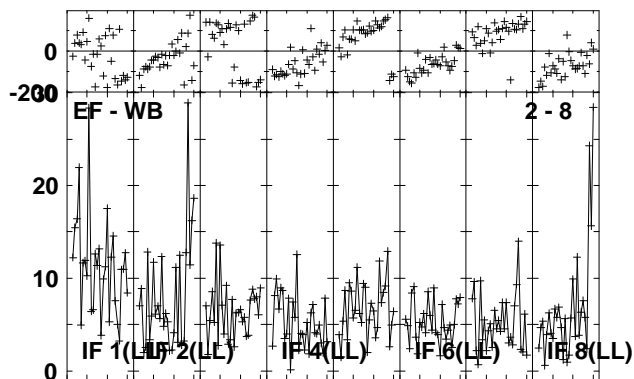
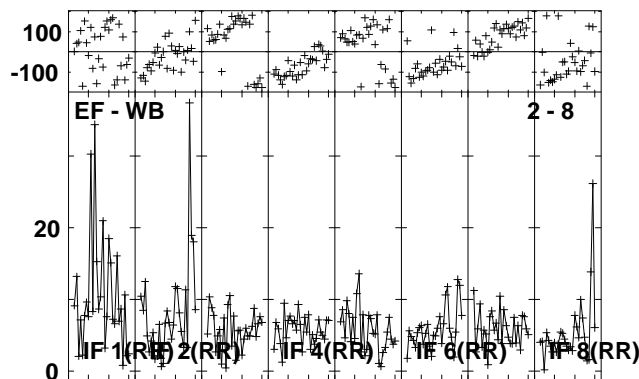
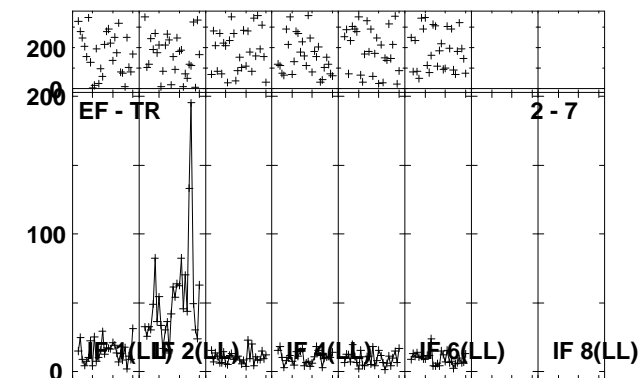
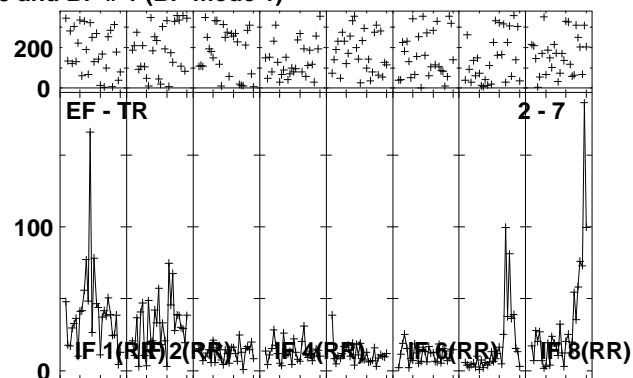
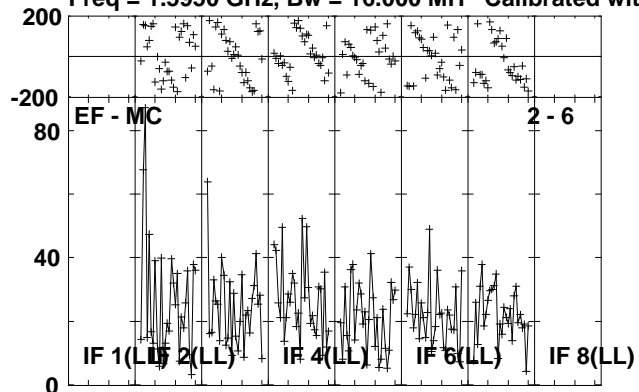

Lower frame: Milli Ampl Jy Top frame: Phas deg  
Vector averaged cross-power spectrum Several baselines displayed  
Timerange: 00/16:00:01 to 00/16:03:29

Plot file version 149 created 30-NOV-2010 14:31:11

J1128+59 EP068B 3.UVDATA.1

Freq = 1.5950 GHz, Bw = 16.000 MH Calibrated with CL # 3 and BP # 1 (BP mode 1)

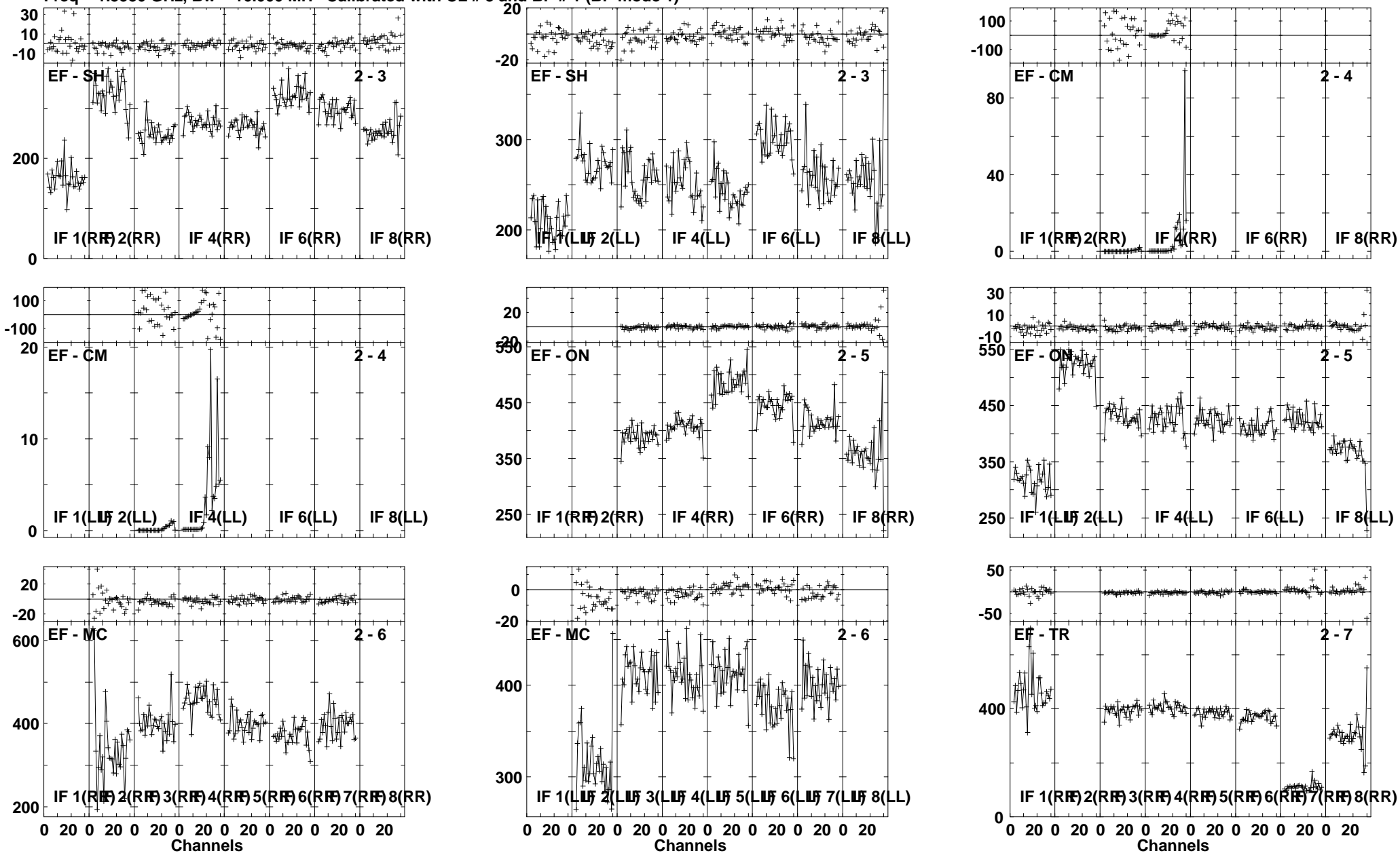

Lower frame: Milli Ampl Jy Top frame: Phas deg  
Vector averaged cross-power spectrum Several baselines displayed  
Timerange: 00/16:03:31 to 00/16:04:59

Plot file version 150 created 30-NOV-2010 14:31:12

J1128+59 EP068B 3.UVDATA.1

Freq = 1.5950 GHz, Bw = 16.000 MH Calibrated with CL # 3 and BP # 1 (BP mode 1)

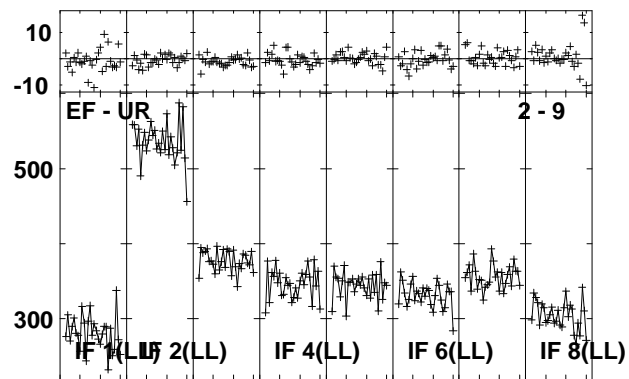
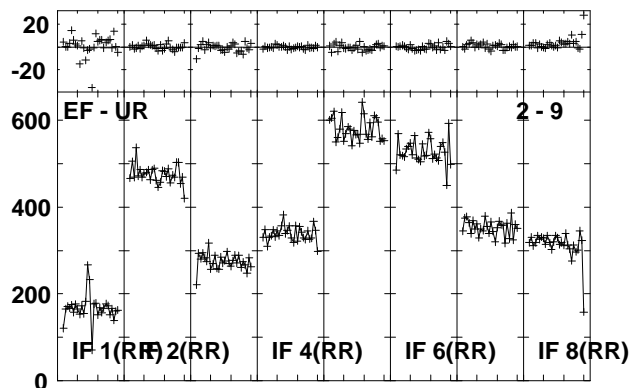
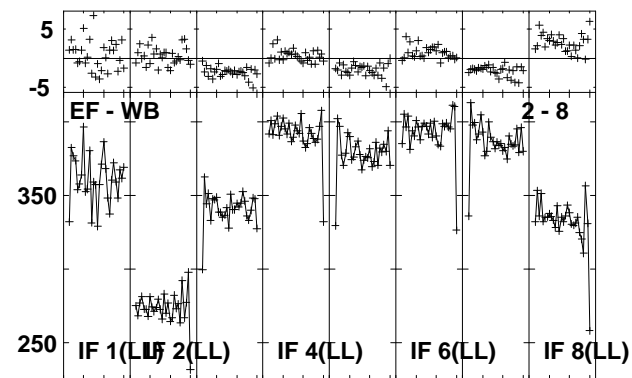
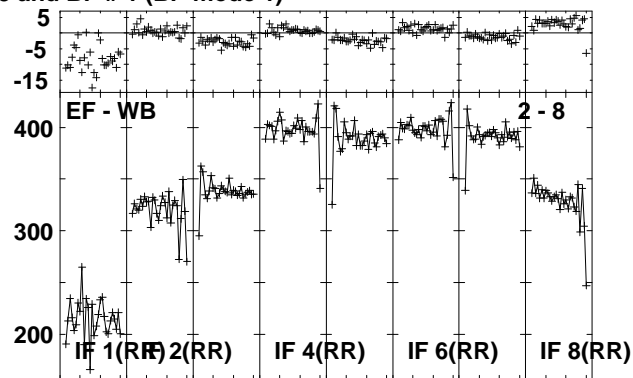
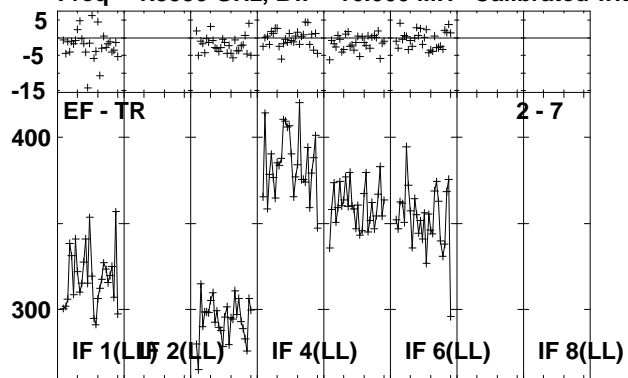

Lower frame: Milli Ampl Jy Top frame: Phas deg  
Vector averaged cross-power spectrum Several baselines displayed  
Timerange: 00/16:03:31 to 00/16:04:59

Plot file version 151 created 30-NOV-2010 14:31:14

ARP299C EP068B 3.UVDATA.1

Freq = 1.5950 GHz, Bw = 16.000 MH Calibrated with CL # 3 and BP # 1 (BP mode 1)

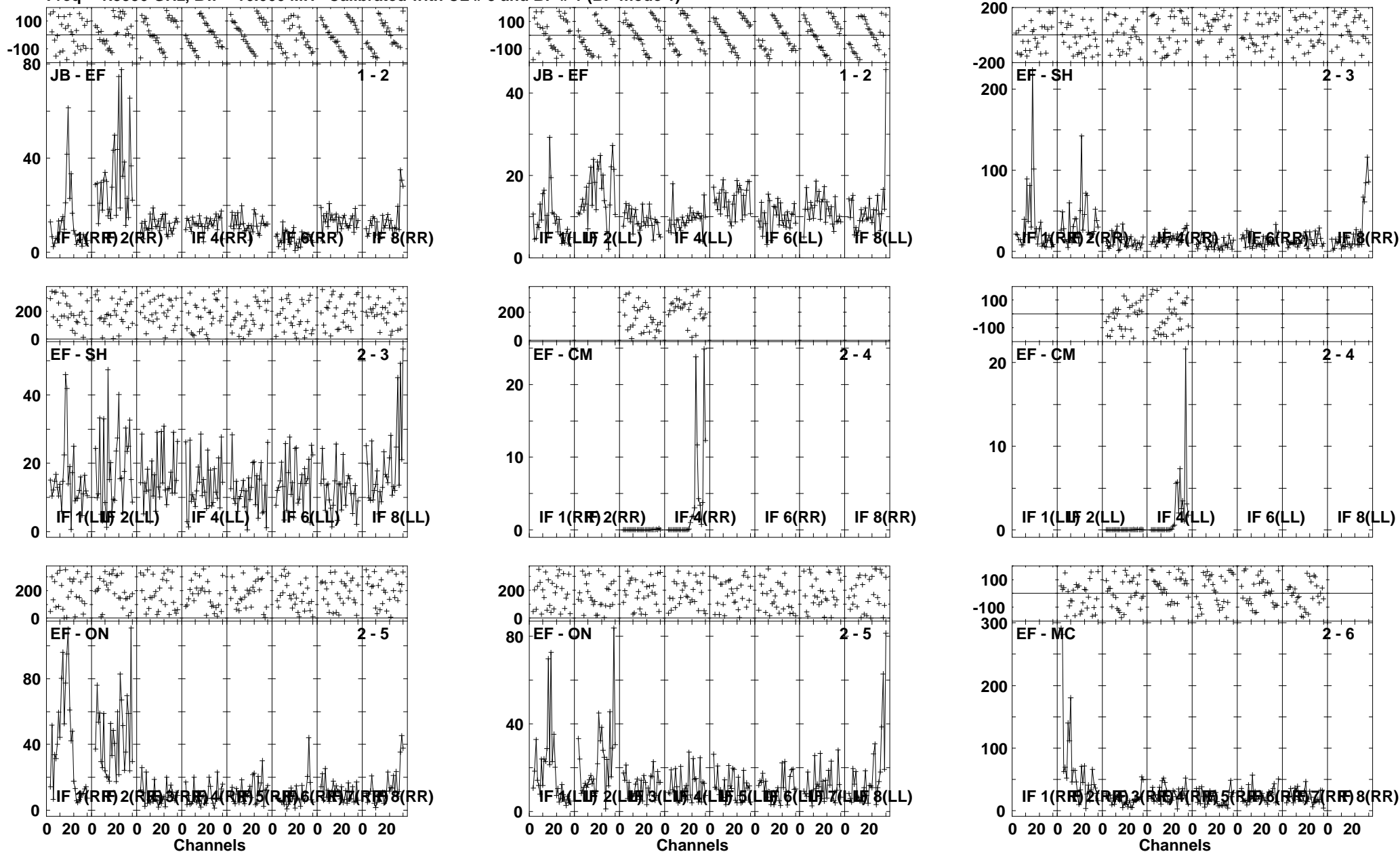

Lower frame: Milli Ampl Jy Top frame: Phas deg  
Vector averaged cross-power spectrum Several baselines displayed  
Timerange: 00/16:05:01 to 00/16:08:29

Plot file version 152 created 30-NOV-2010 14:31:16

ARP299C EP068B 3.UVDATA.1

Freq = 1.5950 GHz, Bw = 16.000 MH Calibrated with CL # 3 and BP # 1 (BP mode 1)

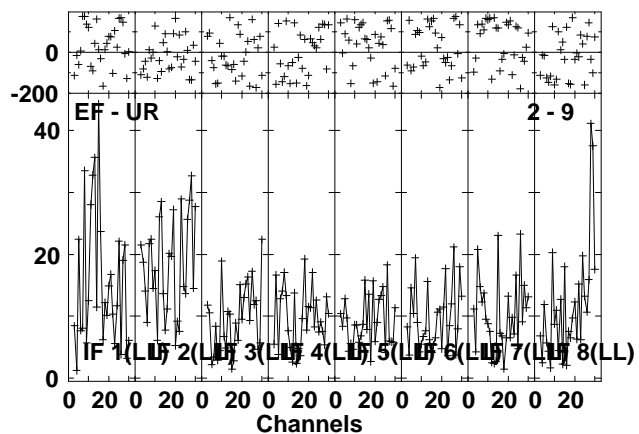
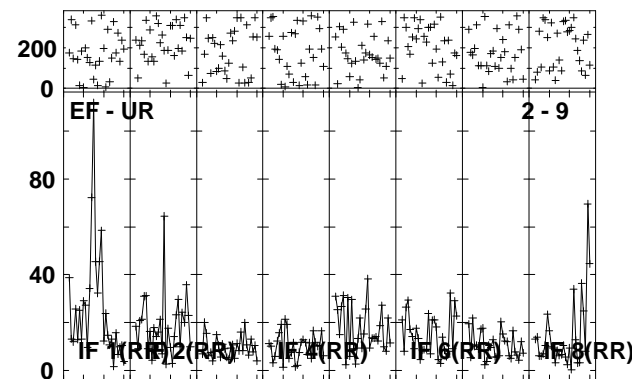
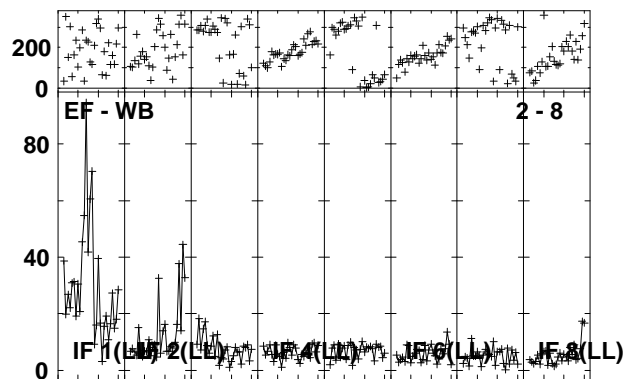
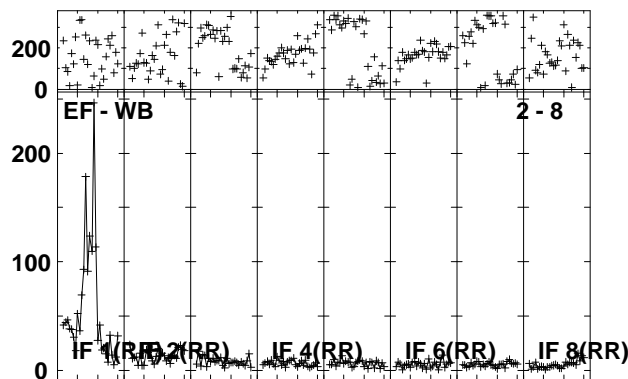
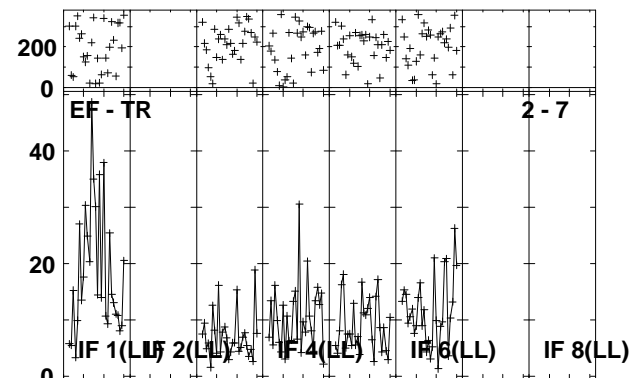
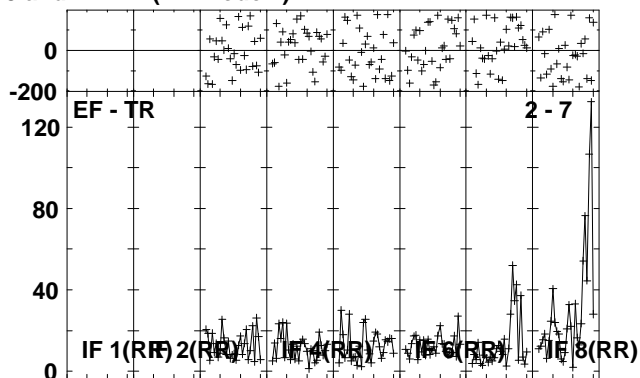
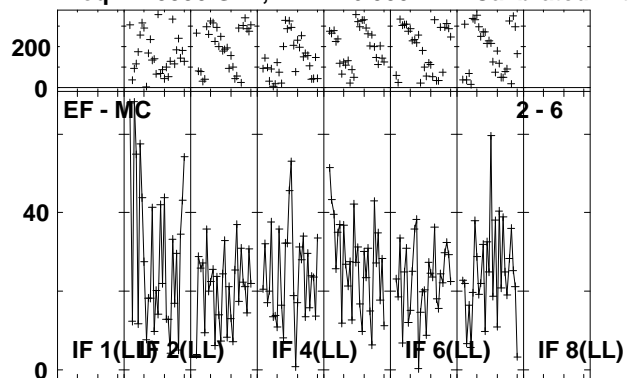

Lower frame: Milli Ampl Jy Top frame: Phas deg  
Vector averaged cross-power spectrum Several baselines displayed  
Timerange: 00/16:05:01 to 00/16:08:29



Plot file version 153 created 30-NOV-2010 14:31:19

J1128+59 EP068B 3.UVDATA.1

Freq = 1.5950 GHz, Bw = 16.000 MH Calibrated with CL # 3 and BP # 1 (BP mode 1)

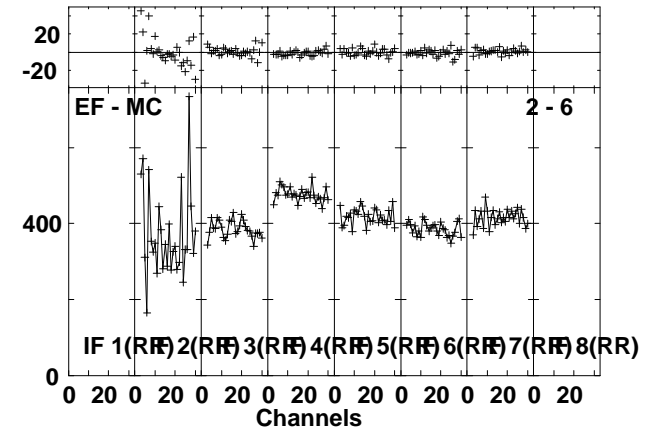
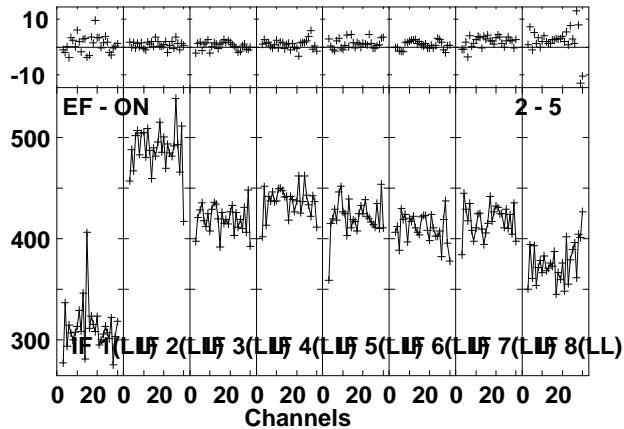
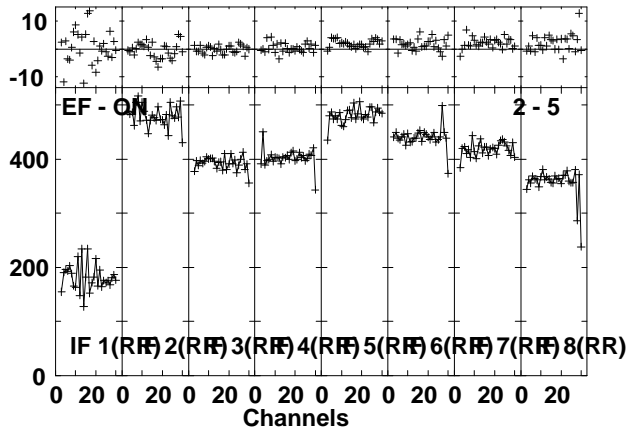
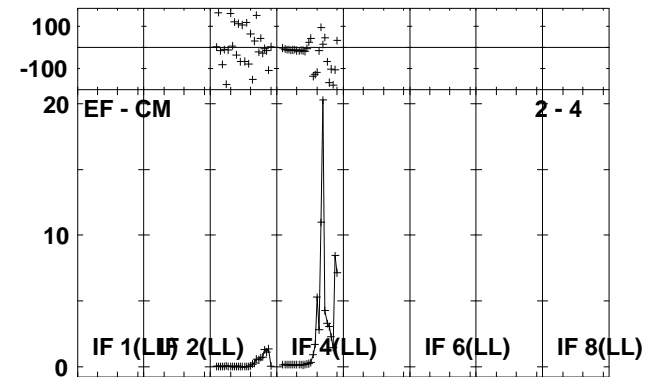
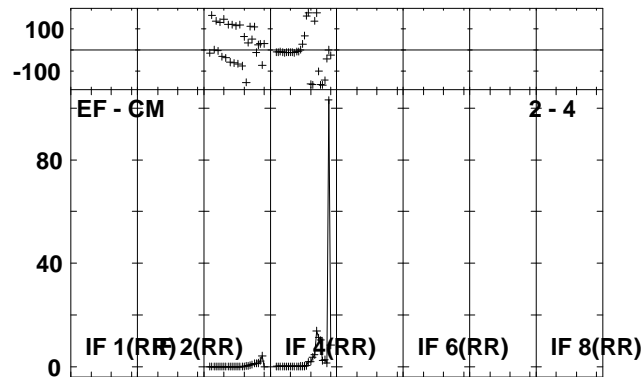
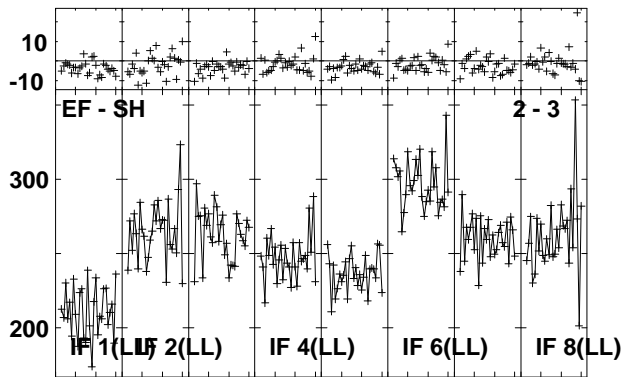
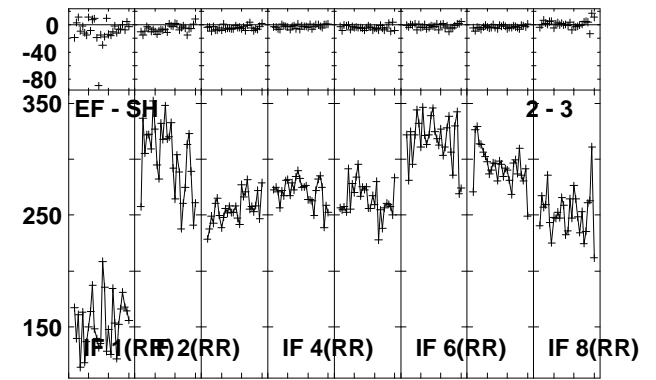
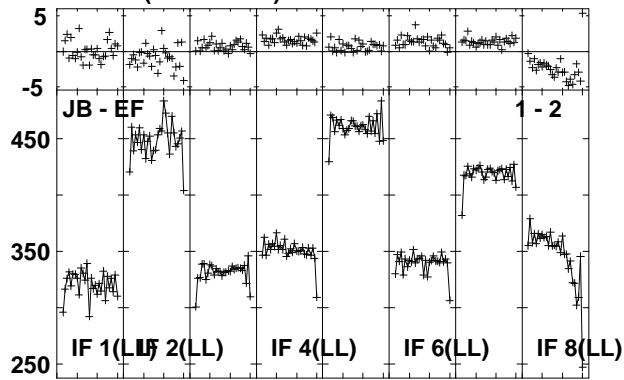
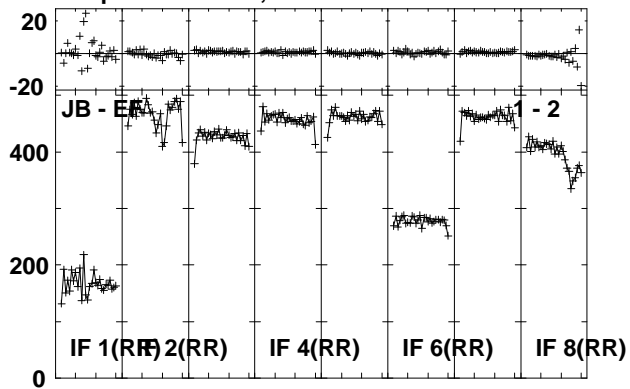

Lower frame: Milli Ampl Jy Top frame: Phas deg  
Vector averaged cross-power spectrum Several baselines displayed  
Timerange: 00/16:09:31 to 00/16:10:59



Plot file version 155 created 30-NOV-2010 14:31:22

ARP299C EP068B 3.UVDATA.1

Freq = 1.5950 GHz, Bw = 16.000 MH Calibrated with CL # 3 and BP # 1 (BP mode 1)

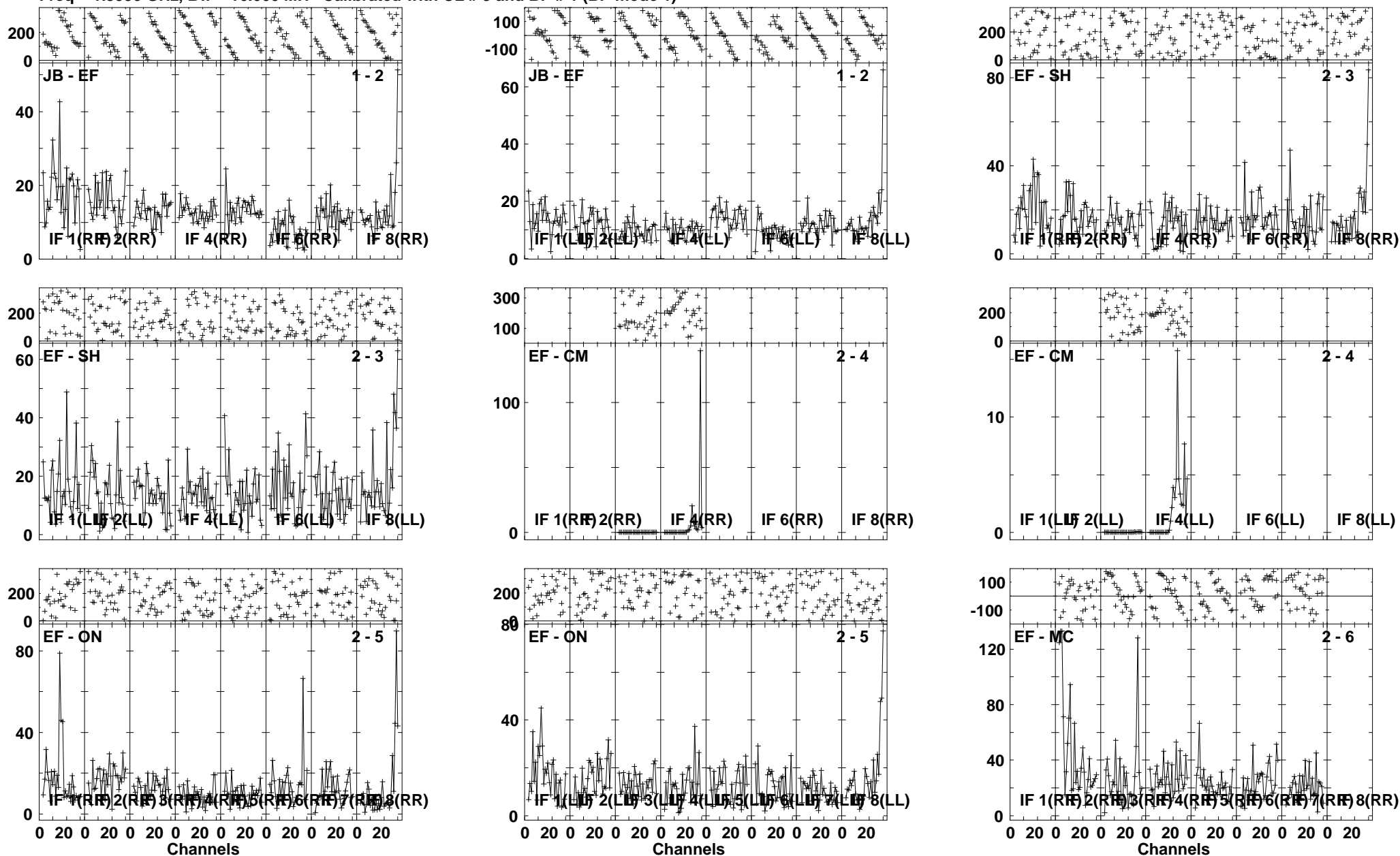

Lower frame: Milli Ampl Jy Top frame: Phas deg  
Vector averaged cross-power spectrum Several baselines displayed  
Timerange: 00/16:11:01 to 00/16:14:29

Plot file version 156 created 30-NOV-2010 14:31:24

ARP299C EP068B 3.UVDATA.1

Freq = 1.5950 GHz, Bw = 16.000 MH Calibrated with CL # 3 and BP # 1 (BP mode 1)

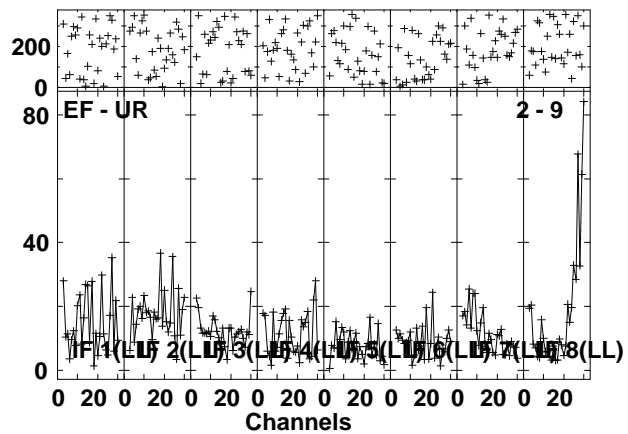
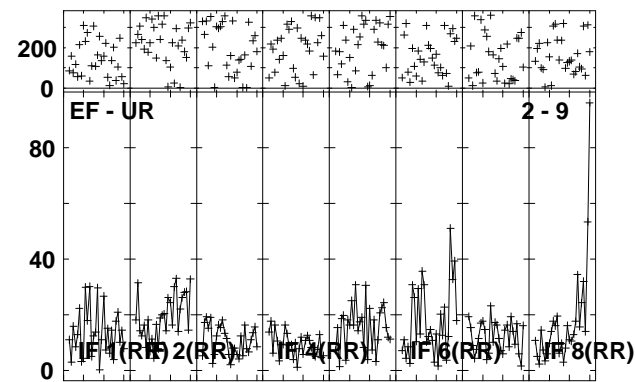
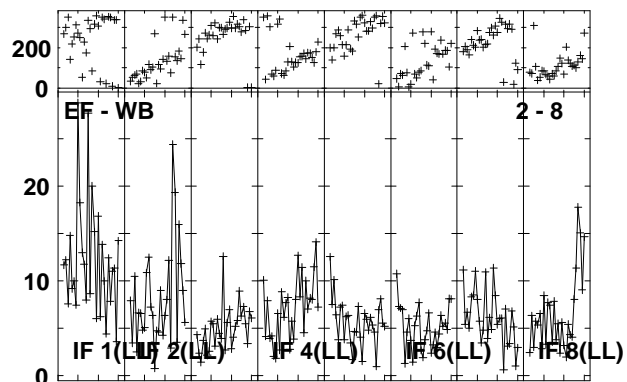
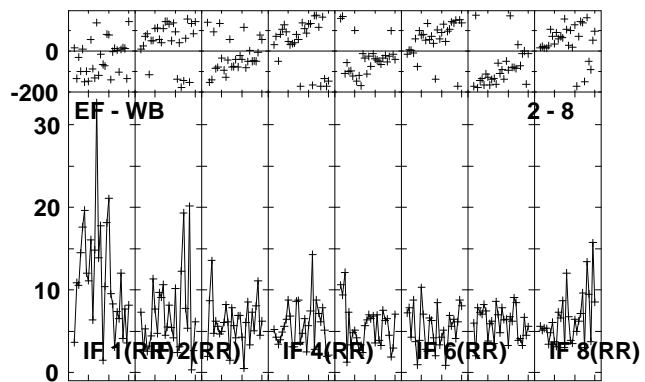
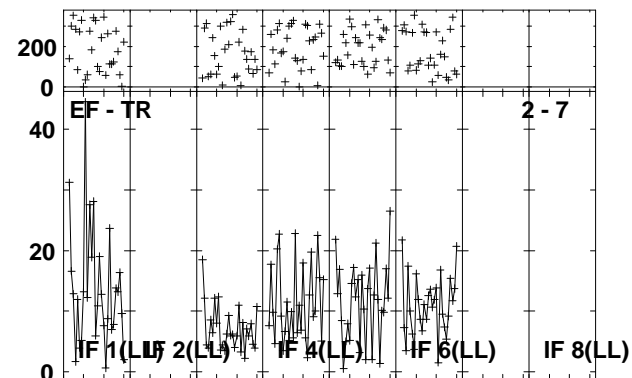
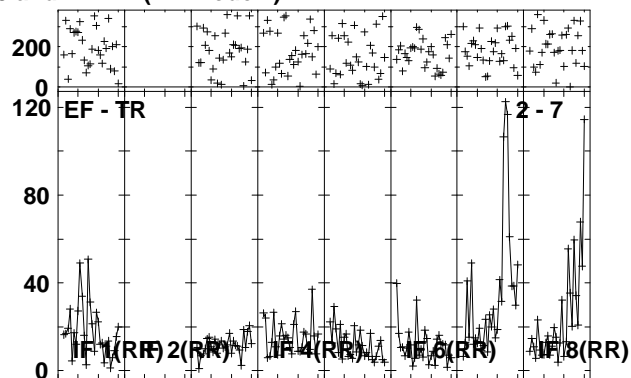
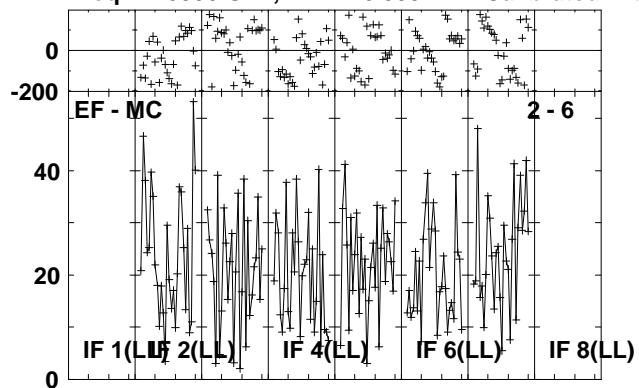

Lower frame: Milli Ampl Jy Top frame: Phas deg  
Vector averaged cross-power spectrum Several baselines displayed  
Timerange: 00/16:11:01 to 00/16:14:29

Plot file version 157 created 30-NOV-2010 14:31:27

J1128+59 EP068B 3.UVDATA.1

Freq = 1.5950 GHz, Bw = 16.000 MH Calibrated with CL # 3 and BP # 1 (BP mode 1)

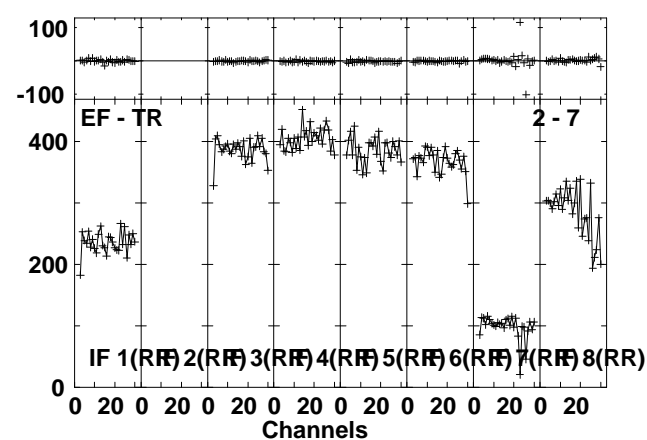
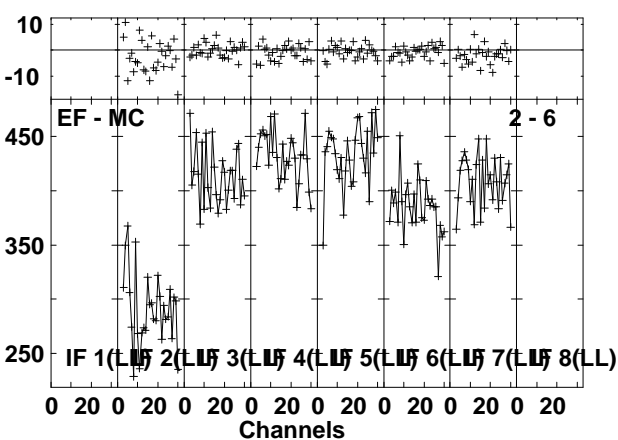
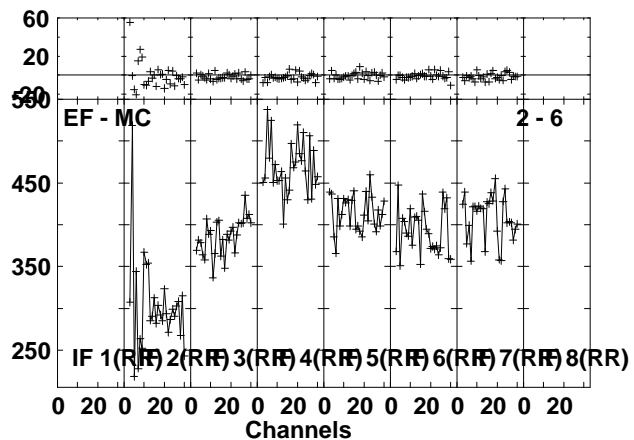
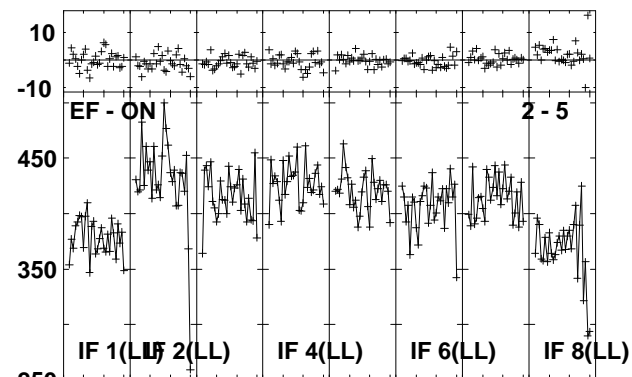
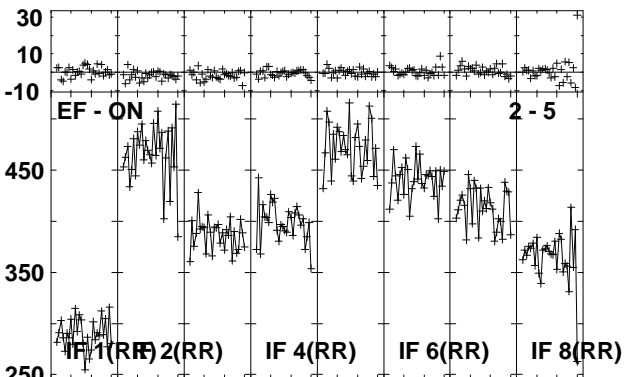
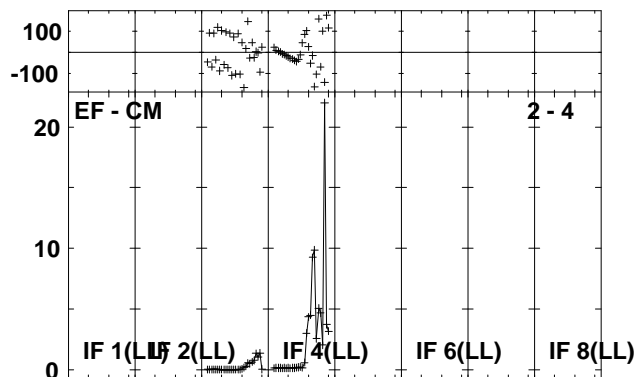
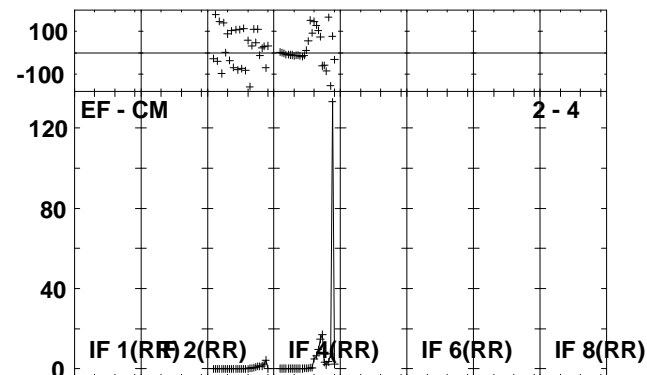
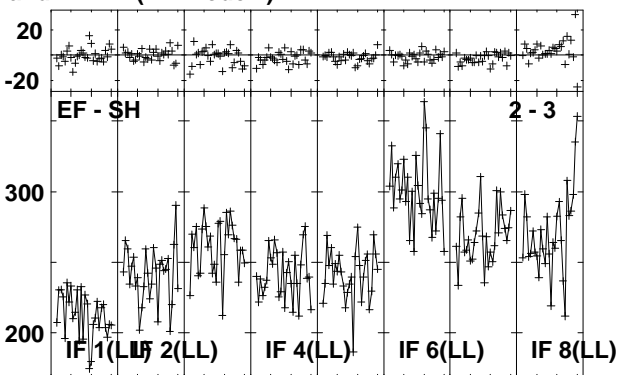
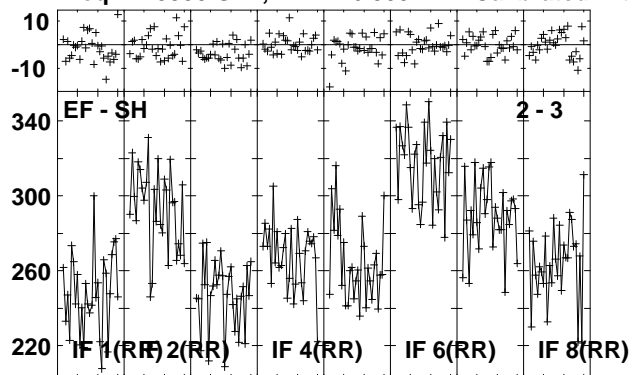

Lower frame: Milli Ampl Jy Top frame: Phas deg  
Vector averaged cross-power spectrum Several baselines displayed  
Timerange: 00/16:14:31 to 00/16:15:59

Plot file version 158 created 30-NOV-2010 14:31:28

J1128+59 EP068B 3.UVDATA.1

Freq = 1.5950 GHz, Bw = 16.000 MH Calibrated with CL # 3 and BP # 1 (BP mode 1)

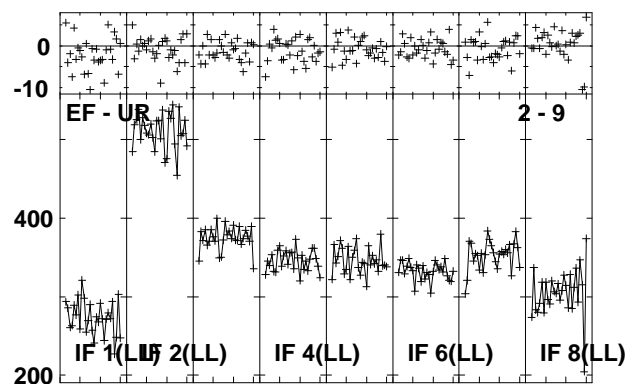
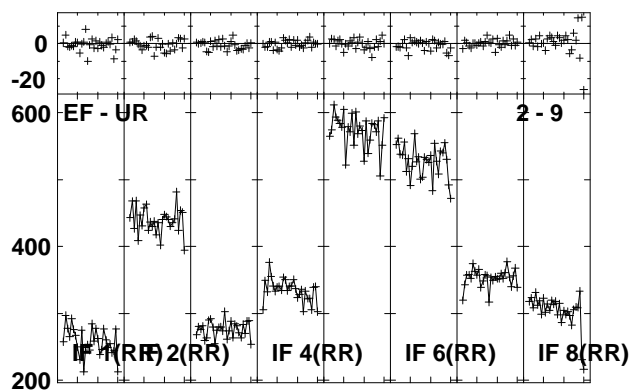
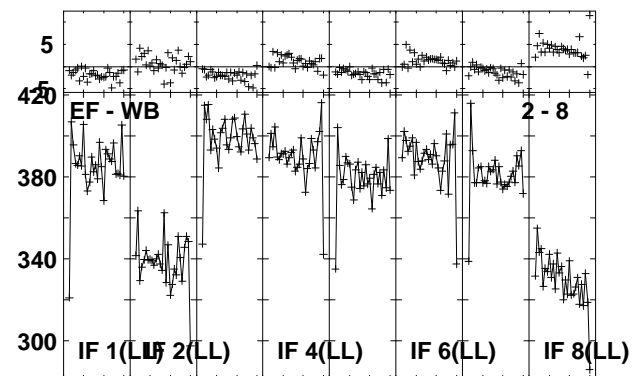
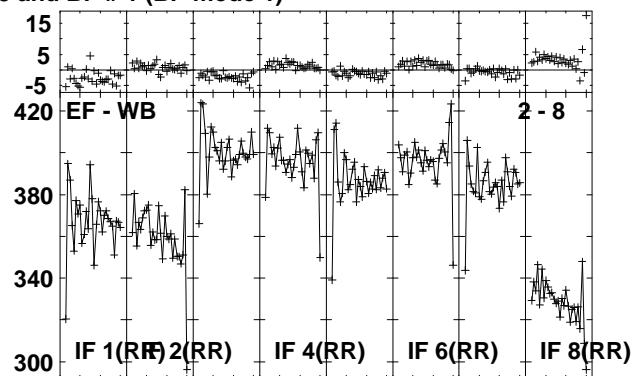
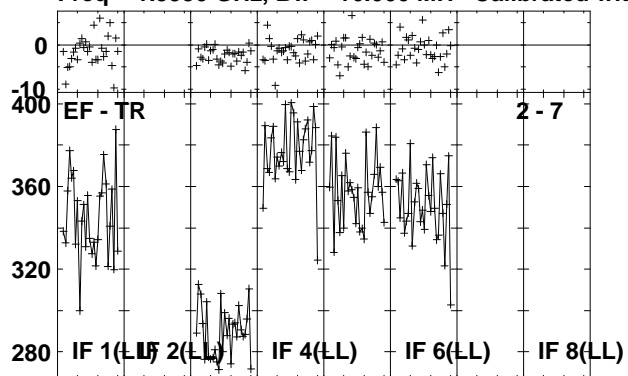

Lower frame: Milli Ampl Jy Top frame: Phas deg  
Vector averaged cross-power spectrum Several baselines displayed  
Timerange: 00/16:14:31 to 00/16:15:59

Plot file version 159 created 30-NOV-2010 14:31:29

ARP299C EP068B 3.UVDATA.1

Freq = 1.5950 GHz, Bw = 16.000 MH Calibrated with CL # 3 and BP # 1 (BP mode 1)

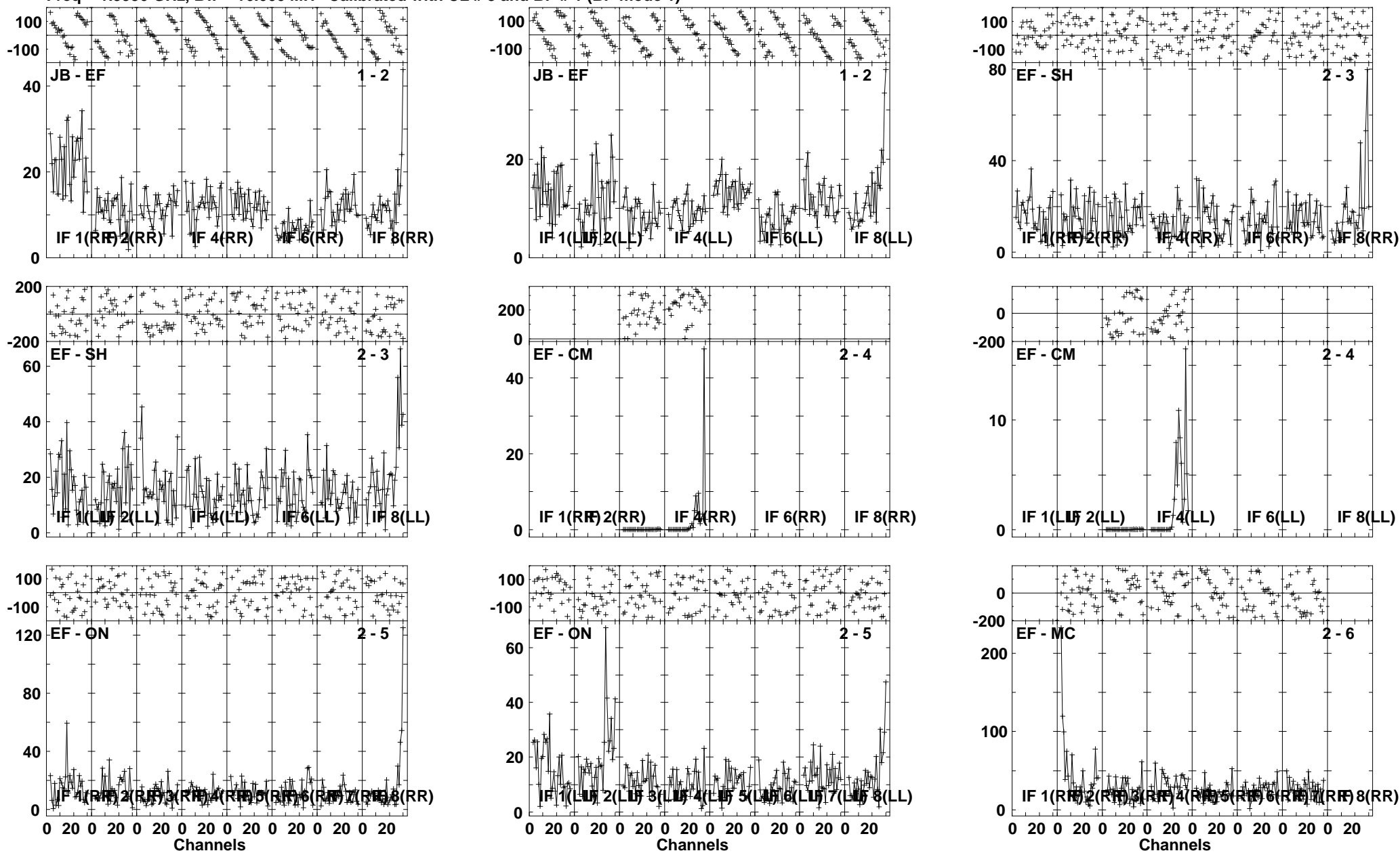

Lower frame: Milli Ampl Jy Top frame: Phas deg  
Vector averaged cross-power spectrum Several baselines displayed  
Timerange: 00/16:16:01 to 00/16:19:29

Plot file version 160 created 30-NOV-2010 14:31:33

ARP299C EP068B 3.UVDATA.1

Freq = 1.5950 GHz, Bw = 16.000 MH Calibrated with CL # 3 and BP # 1 (BP mode 1)

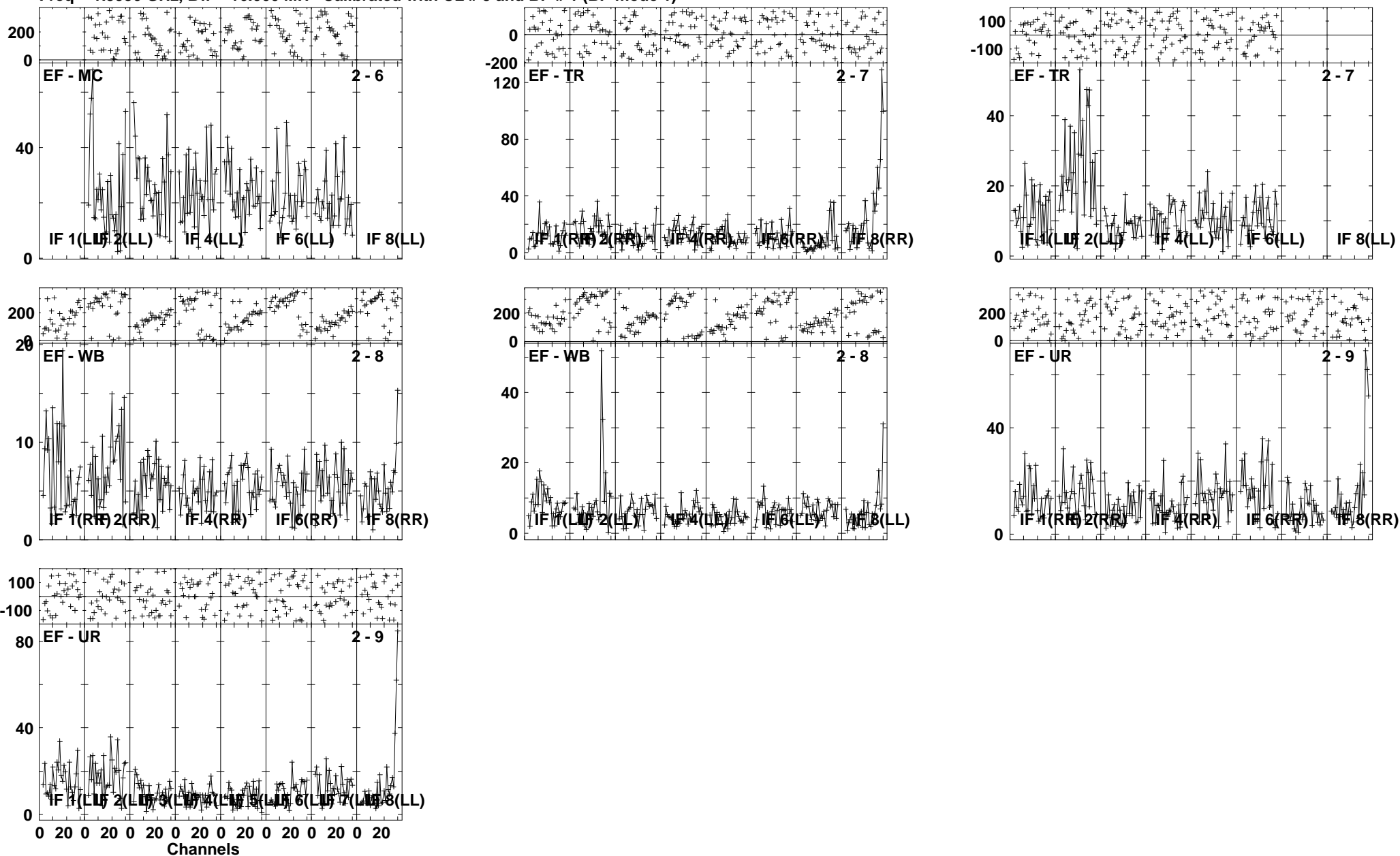

Lower frame: Milli Ampl Jy Top frame: Phas deg  
Vector averaged cross-power spectrum Several baselines displayed  
Timerange: 00/16:16:01 to 00/16:19:29



Plot file version 161 created 30-NOV-2010 14:31:35

J1128+59 EP068B 3.UVDATA.1

Freq = 1.5950 GHz, Bw = 16.000 MH Calibrated with CL # 3 and BP # 1 (BP mode 1)

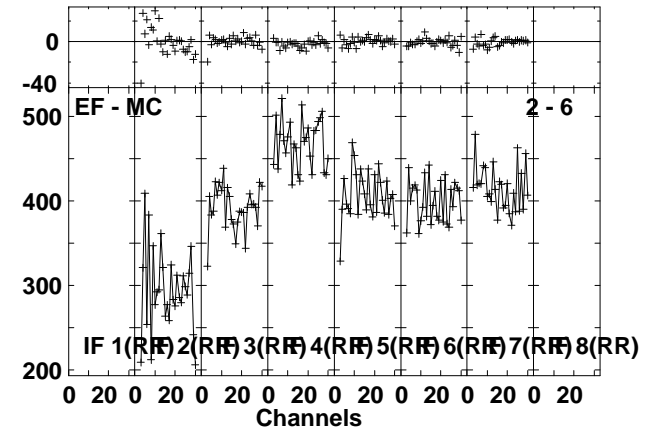
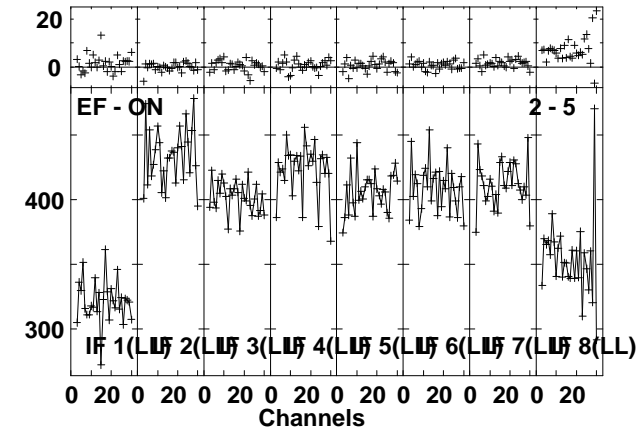
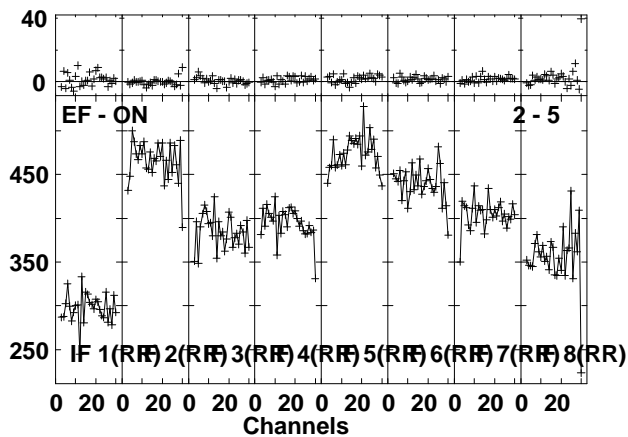
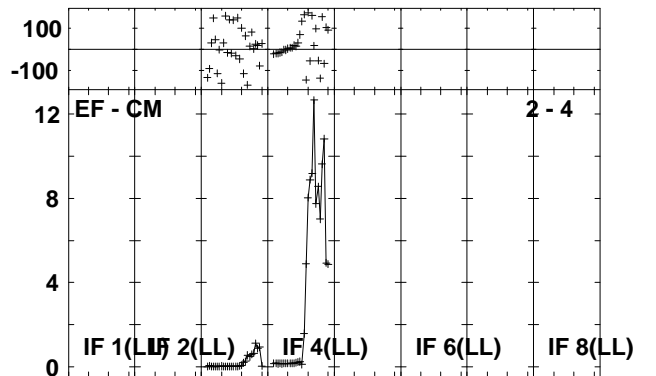
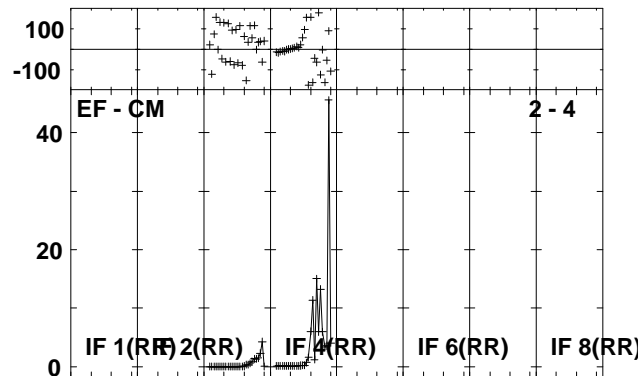
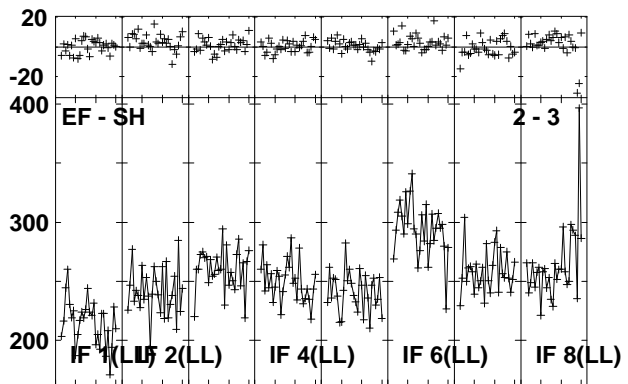
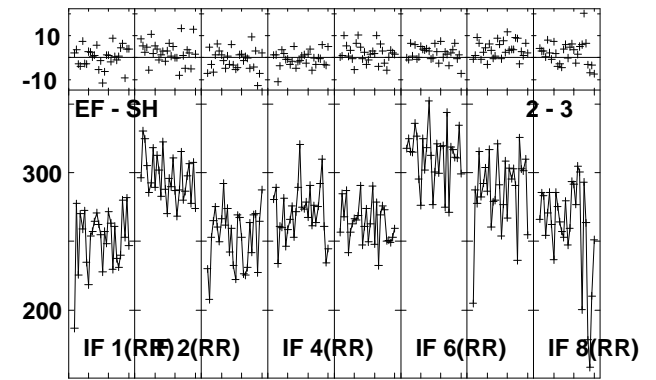
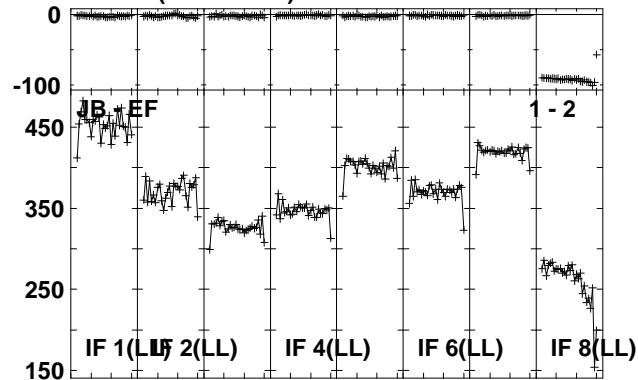
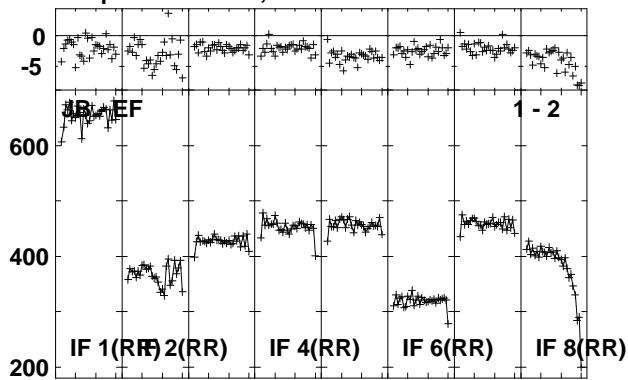

Lower frame: Milli Ampl Jy Top frame: Phas deg  
Vector averaged cross-power spectrum Several baselines displayed  
Timerange: 00/16:19:31 to 00/16:20:59

Plot file version 162 created 30-NOV-2010 14:31:37

J1128+59 EP068B 3.UVDATA.1

Freq = 1.5950 GHz, Bw = 16.000 MH Calibrated with CL # 3 and BP # 1 (BP mode 1)

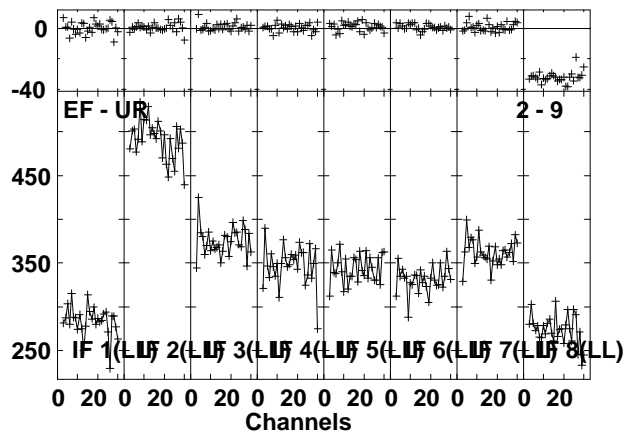
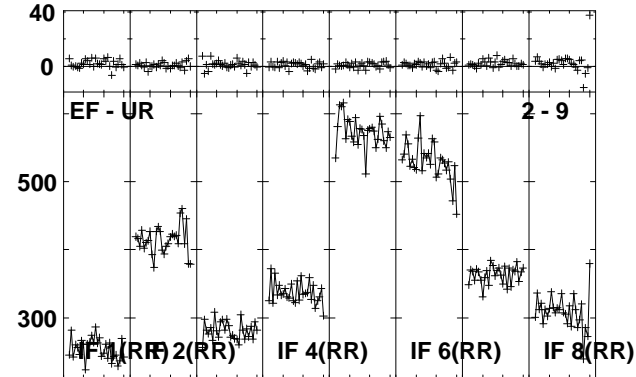
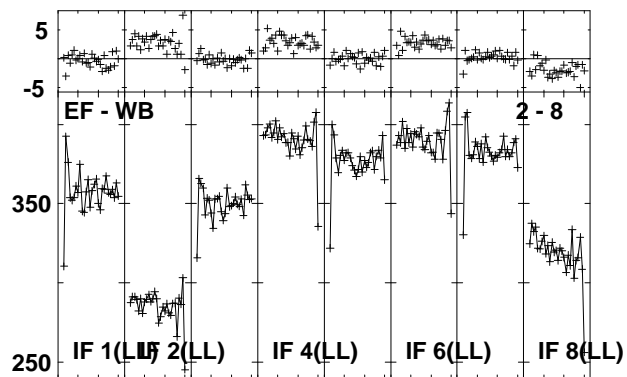
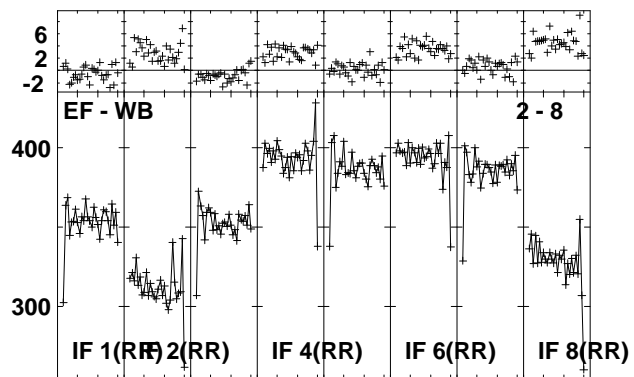
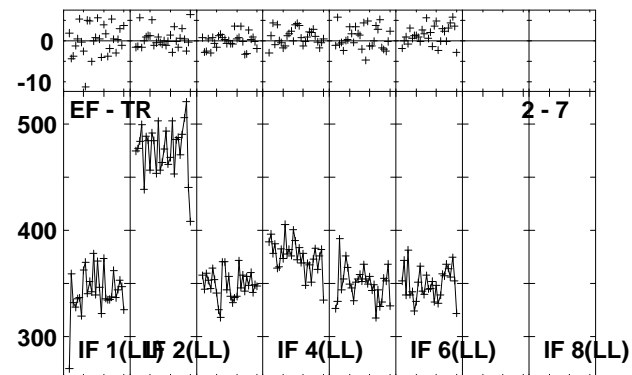
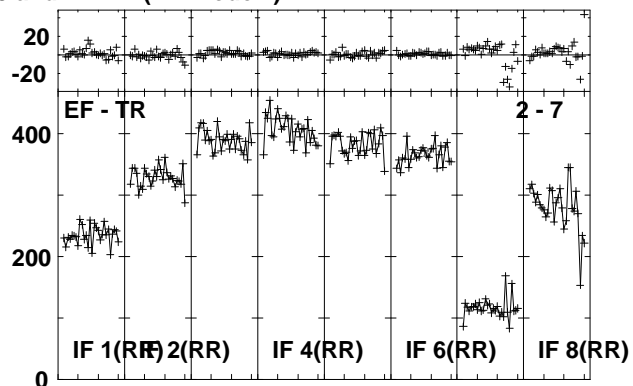
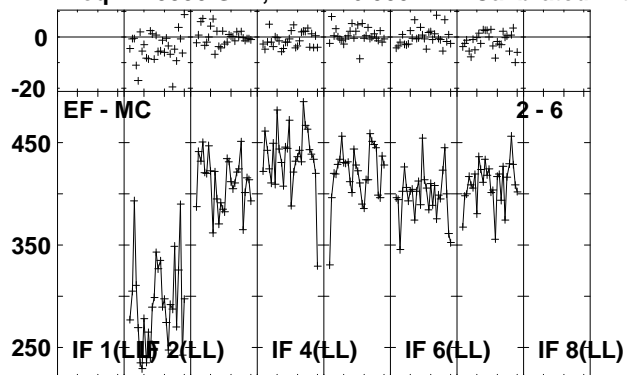

Lower frame: Milli Ampl Jy Top frame: Phas deg  
Vector averaged cross-power spectrum Several baselines displayed  
Timerange: 00/16:19:31 to 00/16:20:59

Plot file version 163 created 30-NOV-2010 14:31:39

ARP299C EP068B 3.UVDATA.1

Freq = 1.5950 GHz, Bw = 16.000 MH Calibrated with CL # 3 and BP # 1 (BP mode 1)

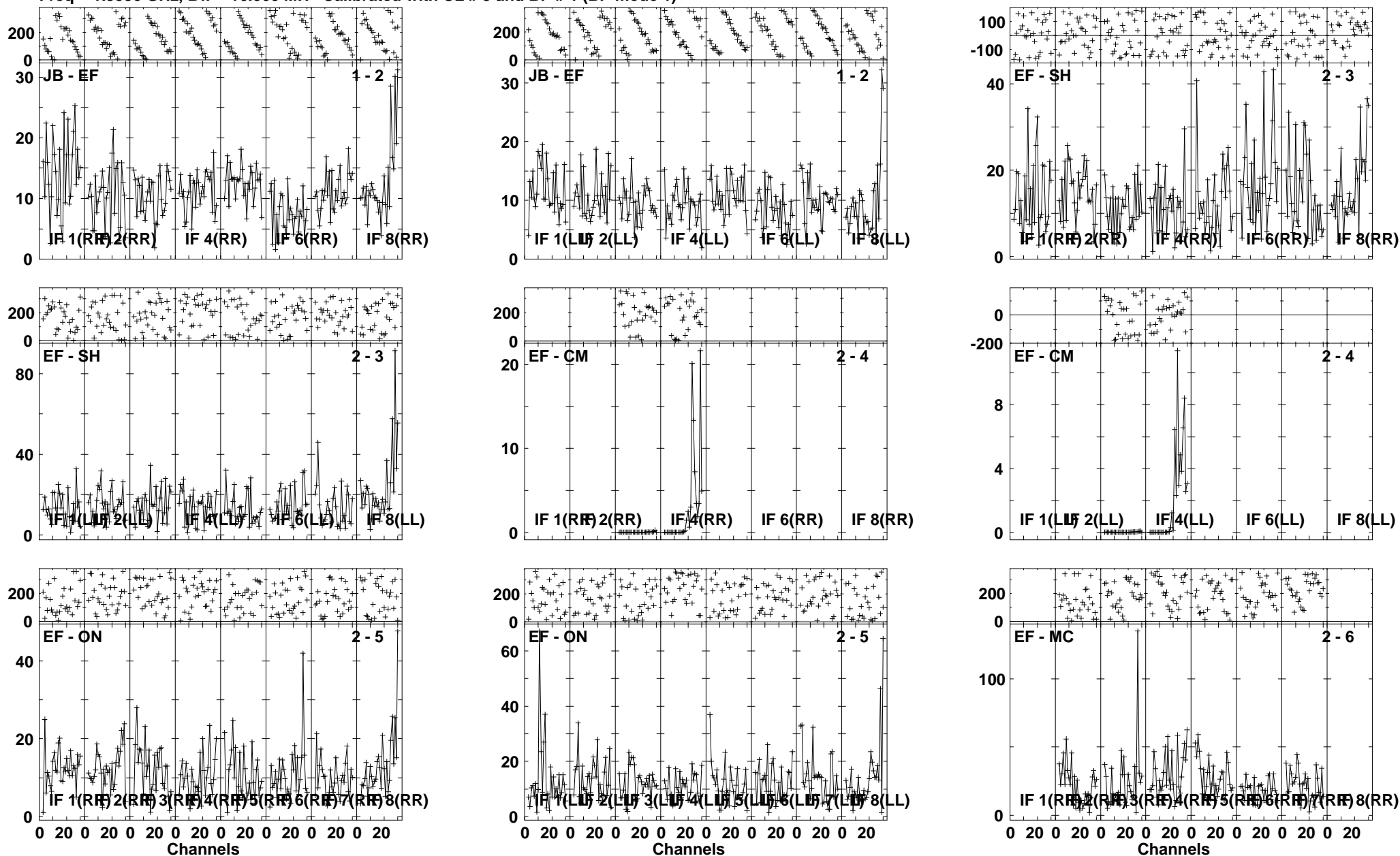

Lower frame: Milli Ampl Jy Top frame: Phas deg  
Vector averaged cross-power spectrum Several baselines displayed  
Timerange: 00/16:21:01 to 00/16:24:29

Plot file version 164 created 30-NOV-2010 14:31:41

ARP299C EP068B 3.UVDATA.1

Freq = 1.5950 GHz, Bw = 16.000 MH Calibrated with CL # 3 and BP # 1 (BP mode 1)

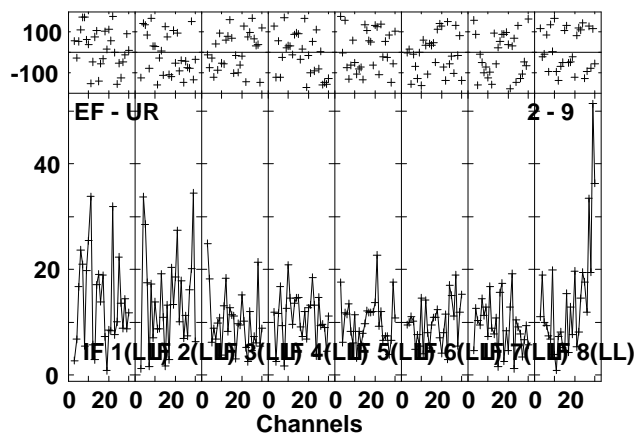
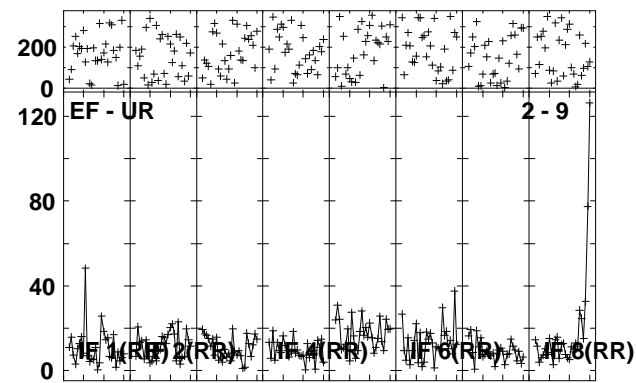
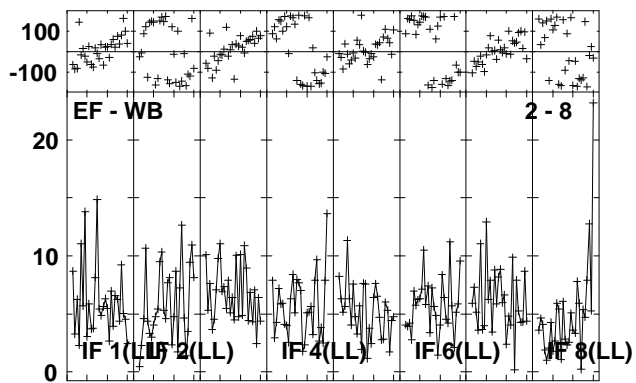
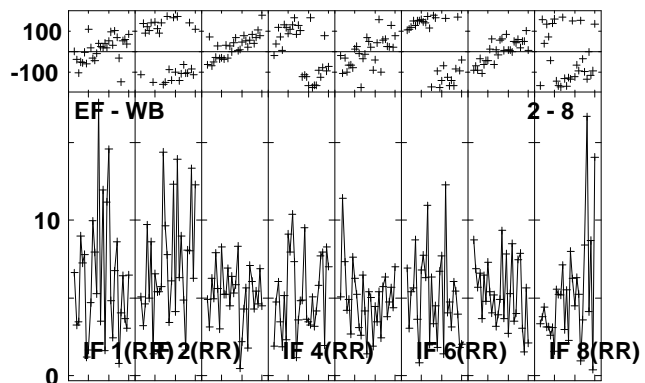
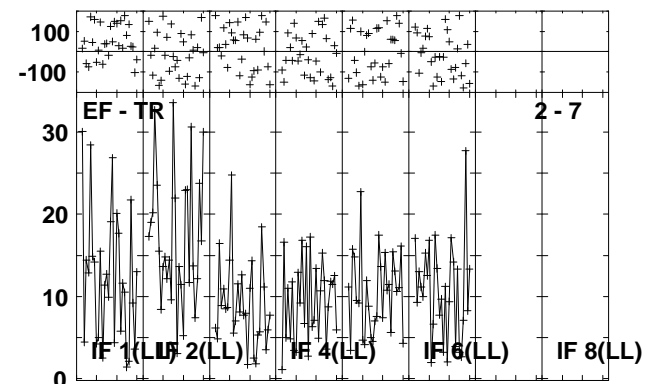
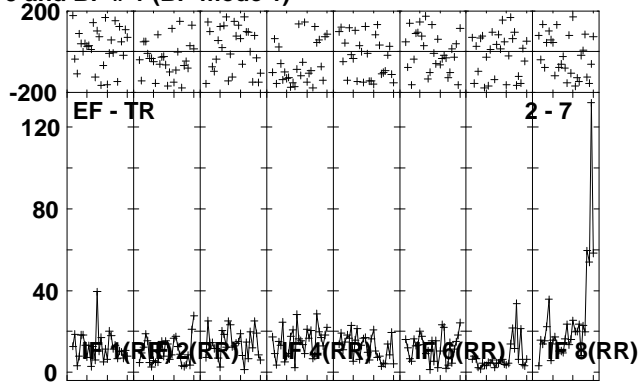
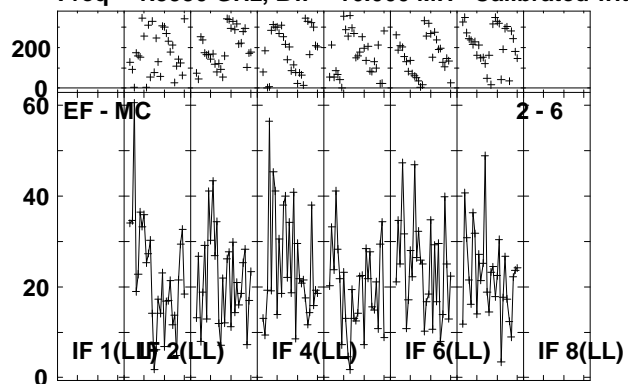

Lower frame: Milli Ampl Jy Top frame: Phas deg  
Vector averaged cross-power spectrum Several baselines displayed  
Timerange: 00/16:21:01 to 00/16:24:29

Plot file version 165 created 30-NOV-2010 14:31:44

J1128+59 EP068B 3.UVDATA.1

Freq = 1.5950 GHz, Bw = 16.000 MH Calibrated with CL # 3 and BP # 1 (BP mode 1)

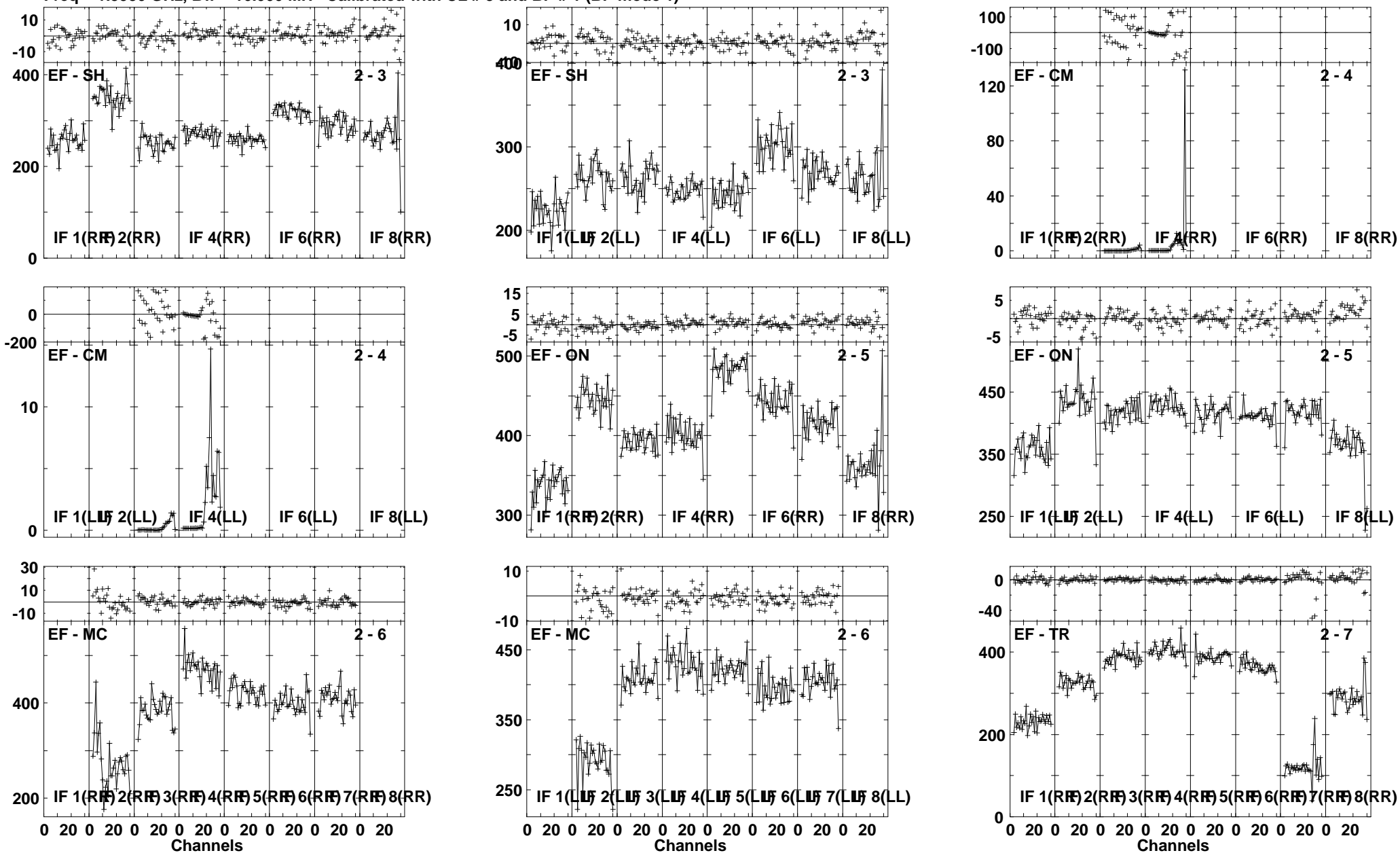

Lower frame: Milli Ampl Jy Top frame: Phas deg  
Vector averaged cross-power spectrum Several baselines displayed  
Timerange: 00/16:25:31 to 00/16:26:59

Plot file version 166 created 30-NOV-2010 14:31:45

J1128+59 EP068B 3.UVDATA.1

Freq = 1.5950 GHz, Bw = 16.000 MH Calibrated with CL # 3 and BP # 1 (BP mode 1)

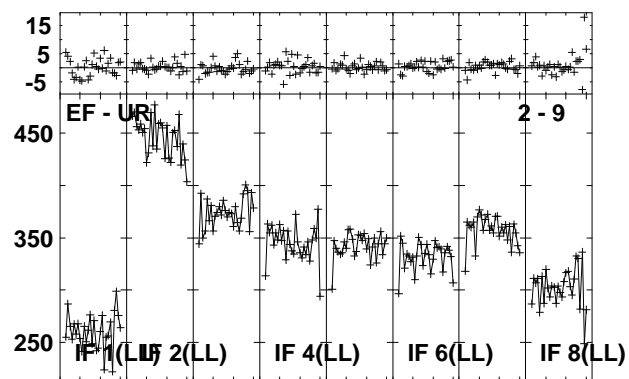
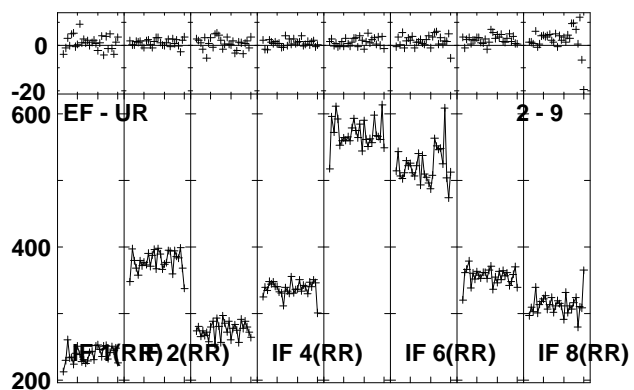
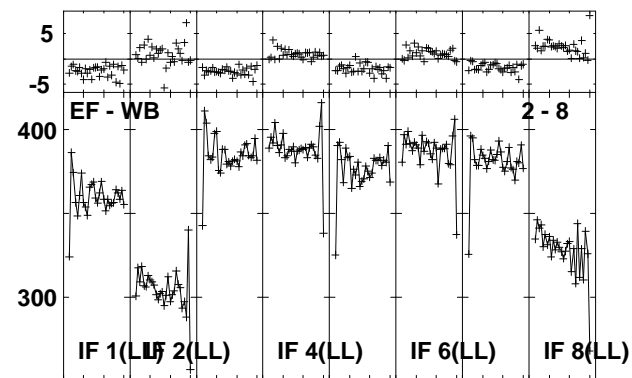
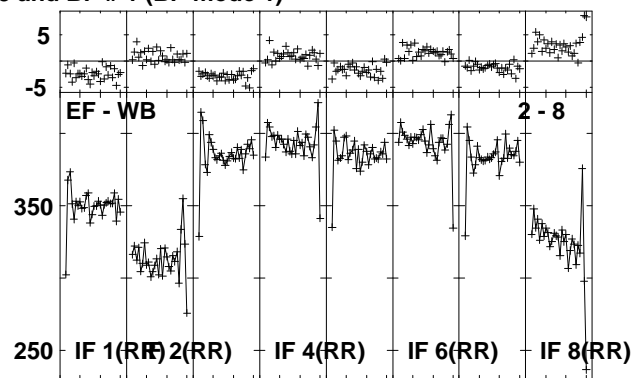
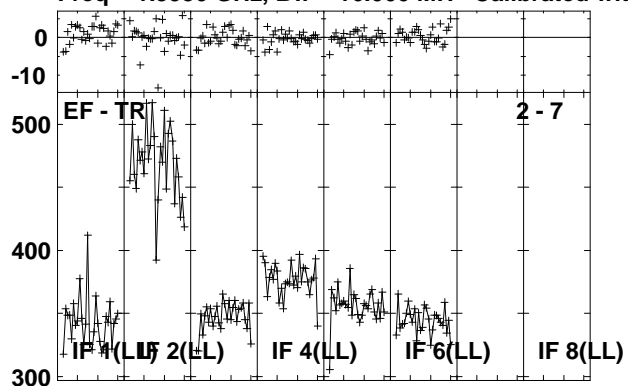

Lower frame: Milli Ampl Jy Top frame: Phas deg  
Vector averaged cross-power spectrum Several baselines displayed  
Timerange: 00/16:25:31 to 00/16:26:59

Plot file version 167 created 30-NOV-2010 14:31:46

ARP299C EP068B 3.UVDATA.1

Freq = 1.5950 GHz, Bw = 16.000 MH Calibrated with CL # 3 and BP # 1 (BP mode 1)

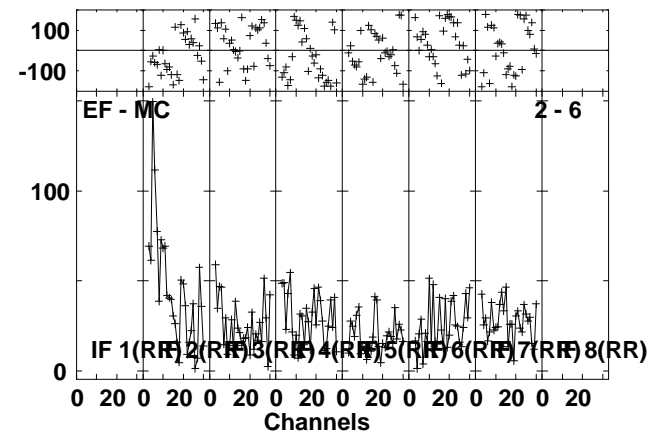
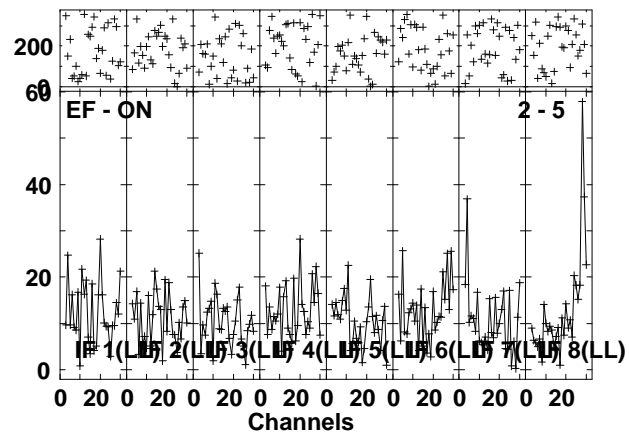
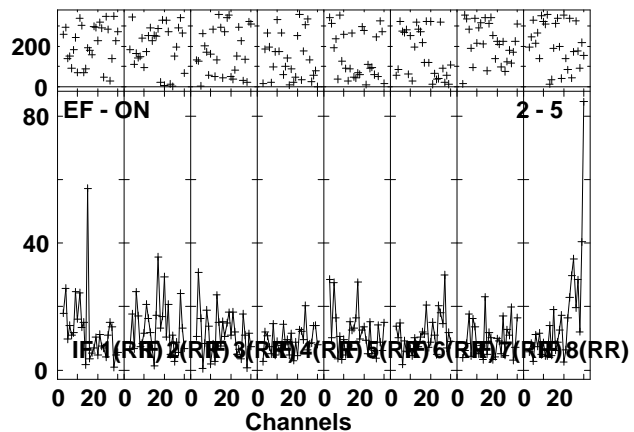
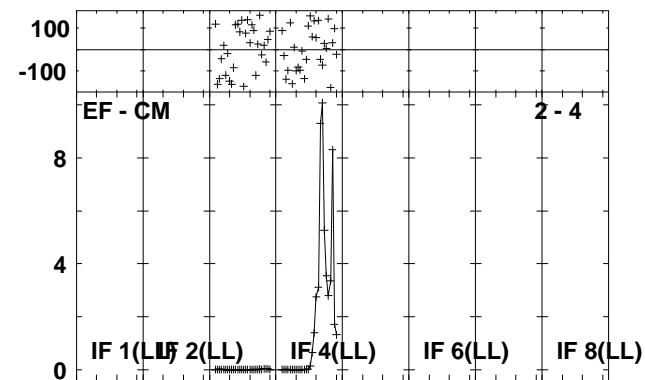
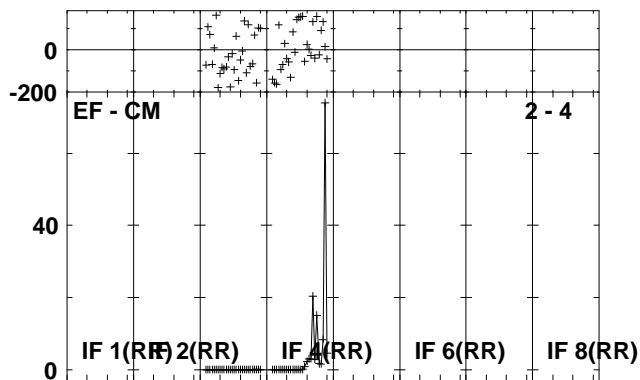
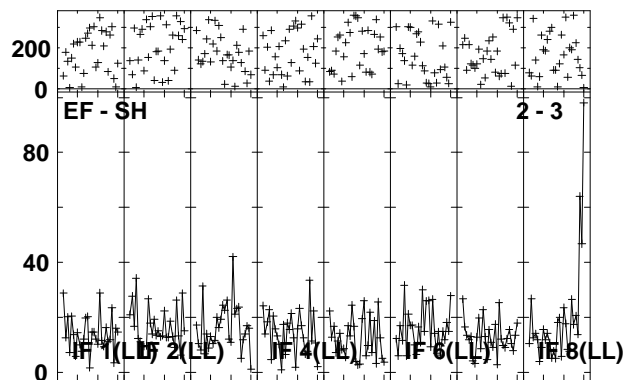
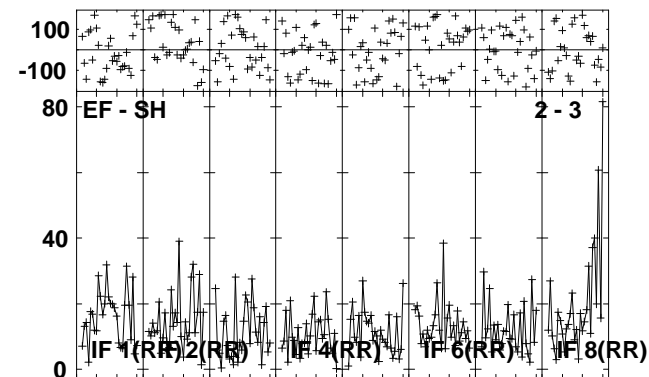
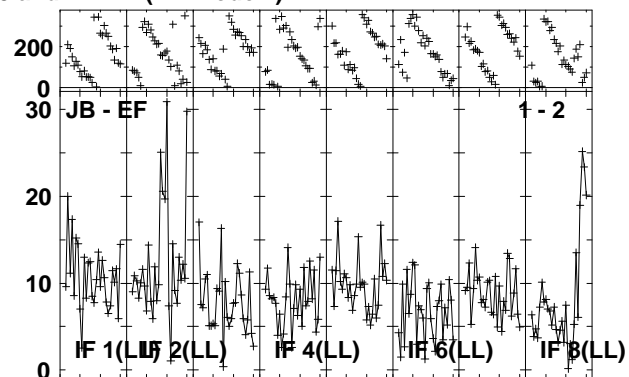
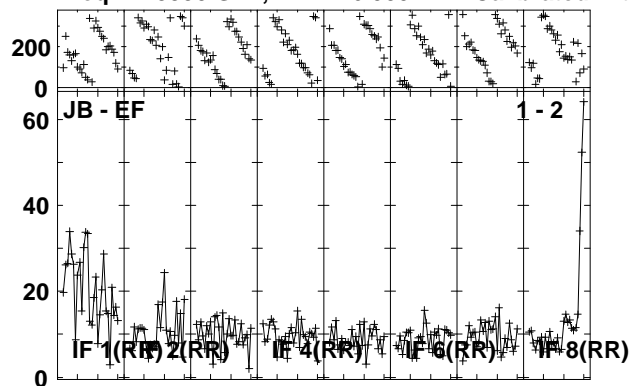

Lower frame: Milli Ampl Jy Top frame: Phas deg  
Vector averaged cross-power spectrum Several baselines displayed  
Timerange: 00/16:27:01 to 00/16:30:29

Plot file version 168 created 30-NOV-2010 14:31:49

ARP299C EP068B 3.UVDATA.1

Freq = 1.5950 GHz, Bw = 16.000 MH Calibrated with CL # 3 and BP # 1 (BP mode 1)

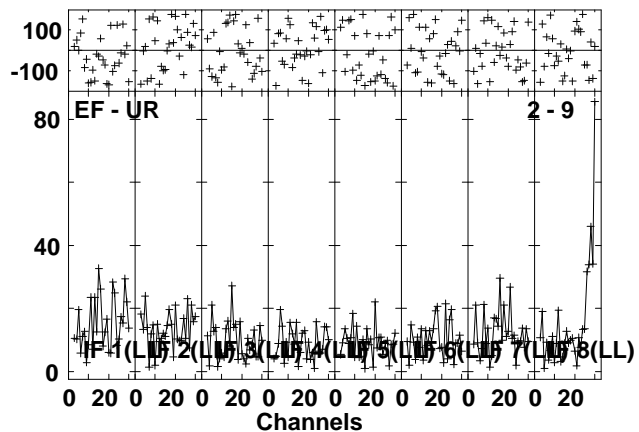
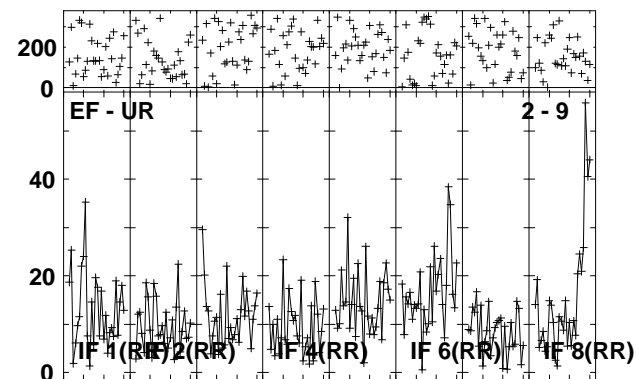
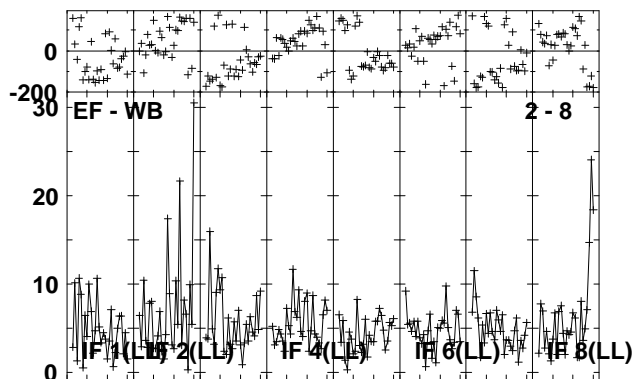
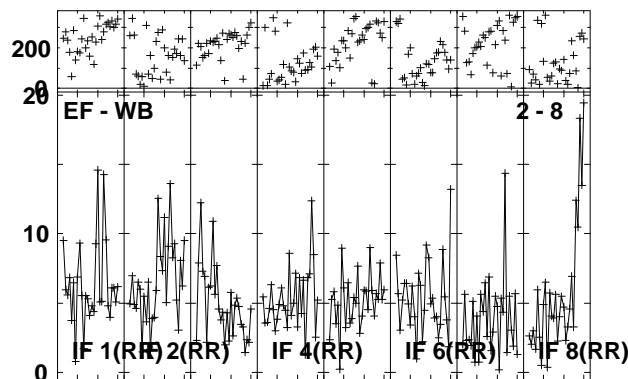
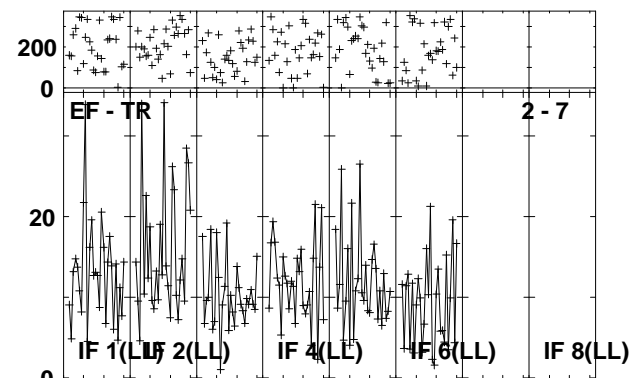
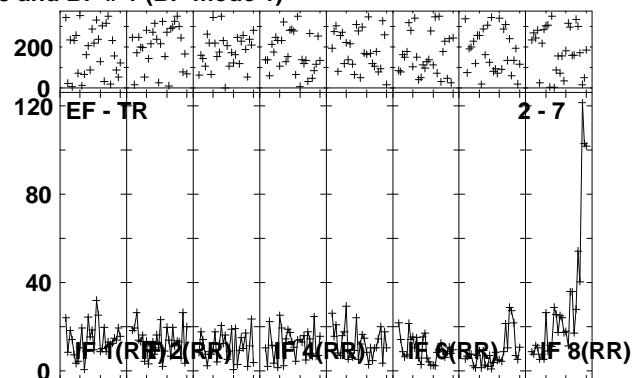
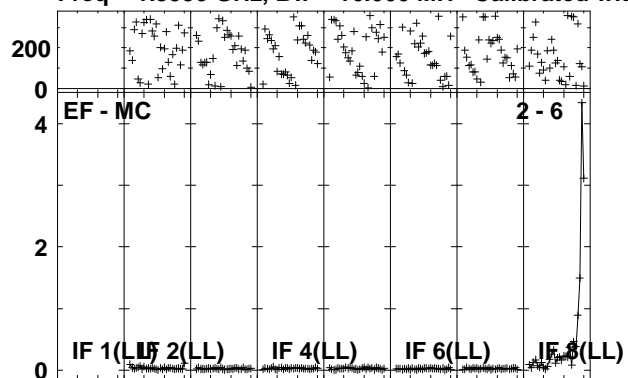

Lower frame: Ampl Jy Top frame: Phas deg  
Vector averaged cross-power spectrum Several baselines displayed  
Timerange: 00/16:27:01 to 00/16:30:29



Plot file version 169 created 30-NOV-2010 14:31:51

J1128+59 EP068B 3.UVDATA.1

Freq = 1.5950 GHz, Bw = 16.000 MH Calibrated with CL # 3 and BP # 1 (BP mode 1)

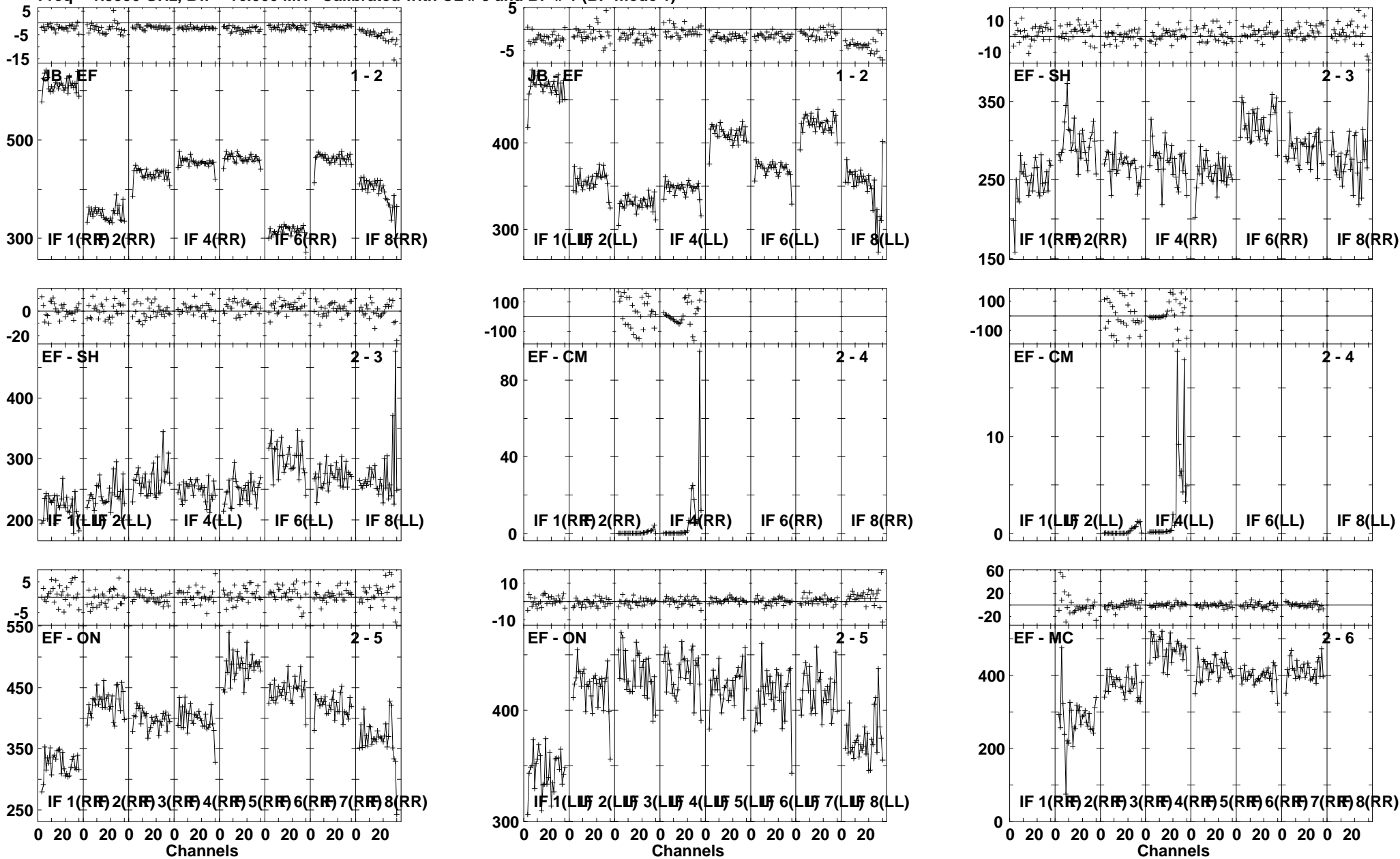

Lower frame: Milli Ampl Jy Top frame: Phas deg  
 Vector averaged cross-power spectrum Several baselines displayed  
 Timerange: 00/16:30:31 to 00/16:31:59

Plot file version 170 created 30-NOV-2010 14:31:52

J1128+59 EP068B 3.UVDATA.1

Freq = 1.5950 GHz, Bw = 16.000 MH Calibrated with CL # 3 and BP # 1 (BP mode 1)

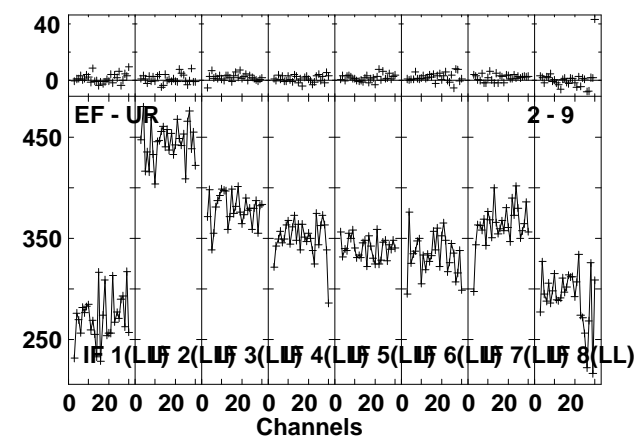
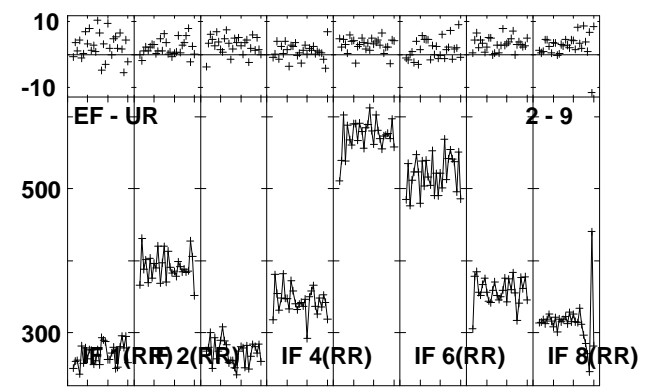
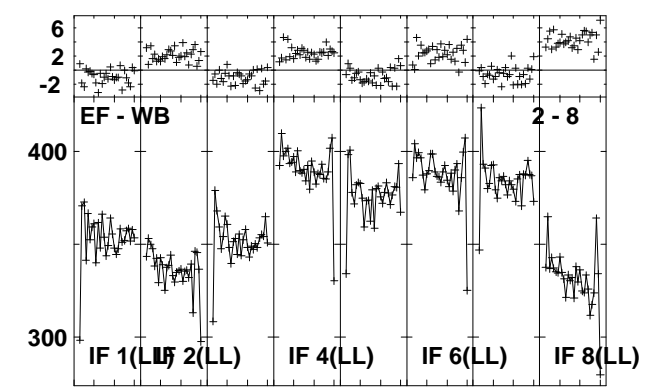
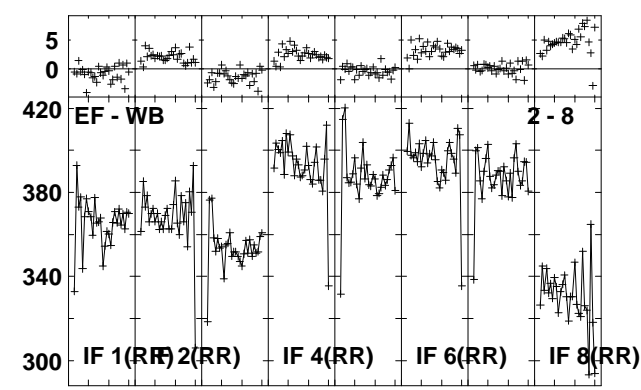
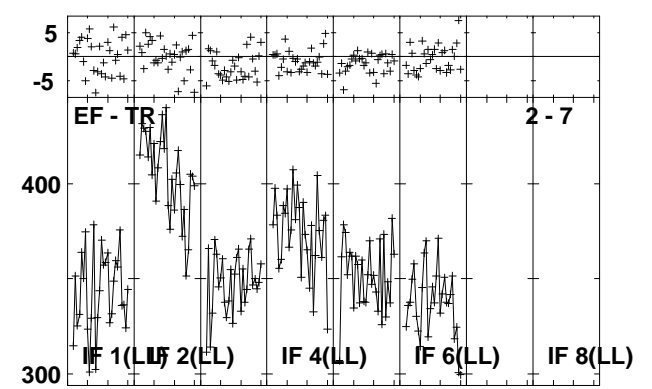
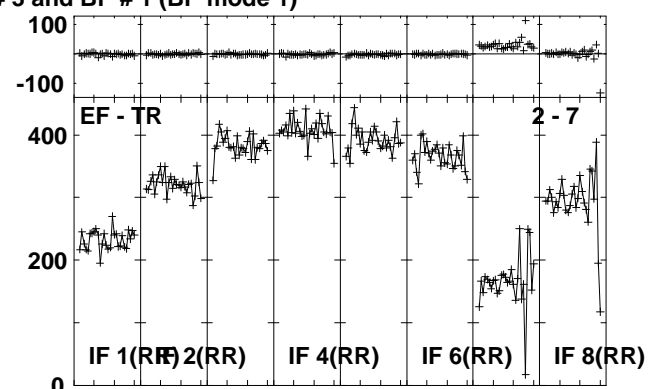
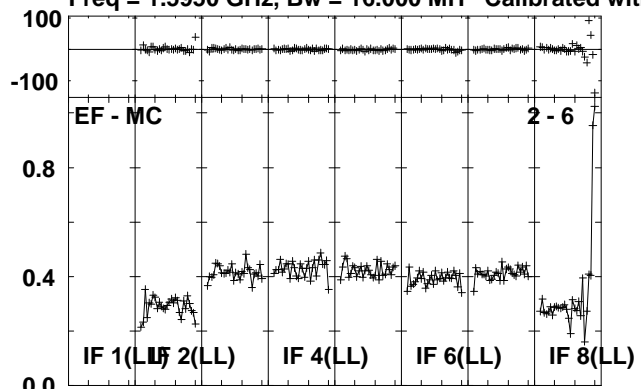

Lower frame: Ampl Jy Top frame: Phas deg  
Vector averaged cross-power spectrum Several baselines displayed  
Timerange: 00/16:30:31 to 00/16:31:59

Plot file version 171 created 30-NOV-2010 14:31:54

ARP299C EP068B 3.UVDATA.1

Freq = 1.5950 GHz, Bw = 16.000 MH Calibrated with CL # 3 and BP # 1 (BP mode 1)

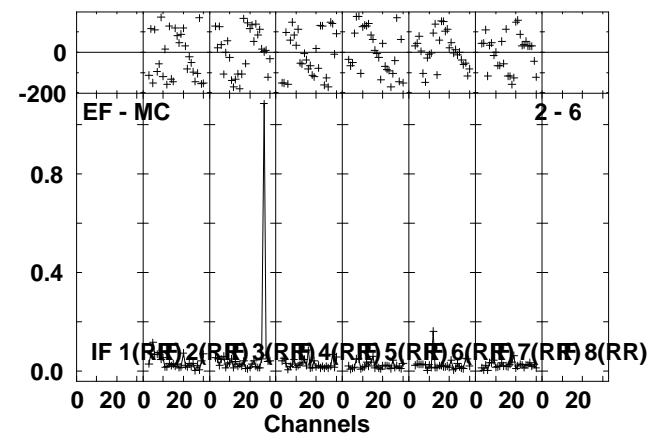
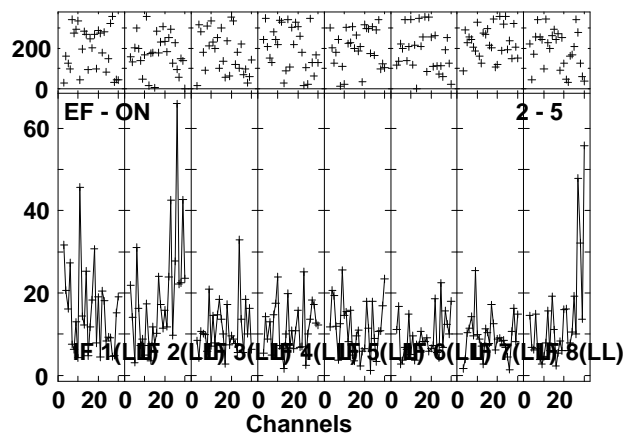
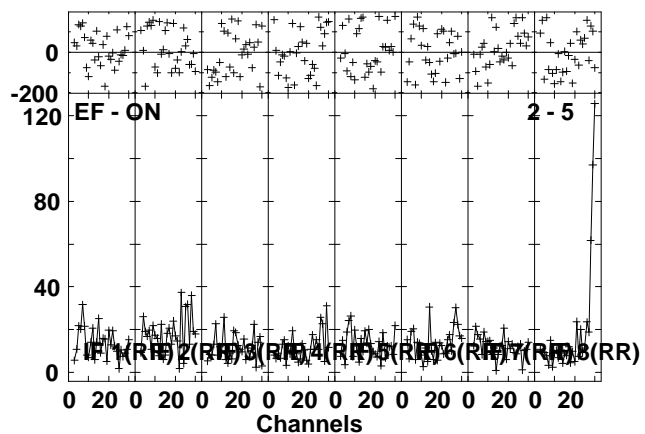
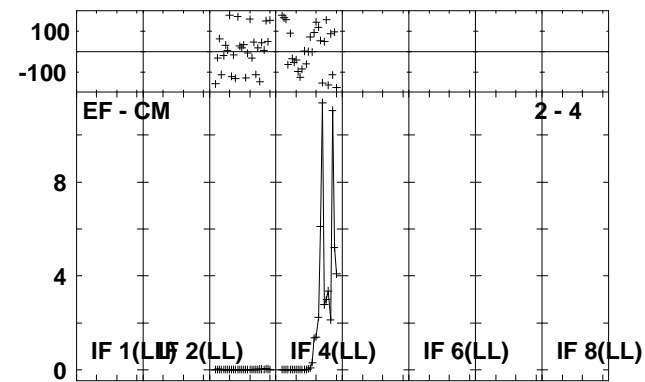
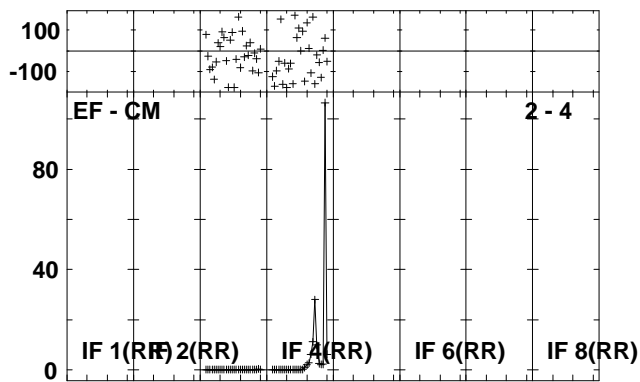
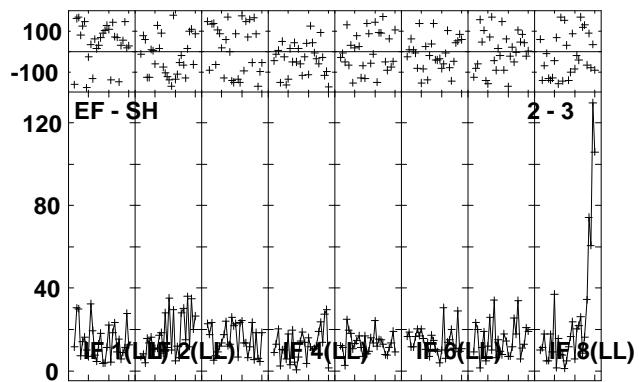
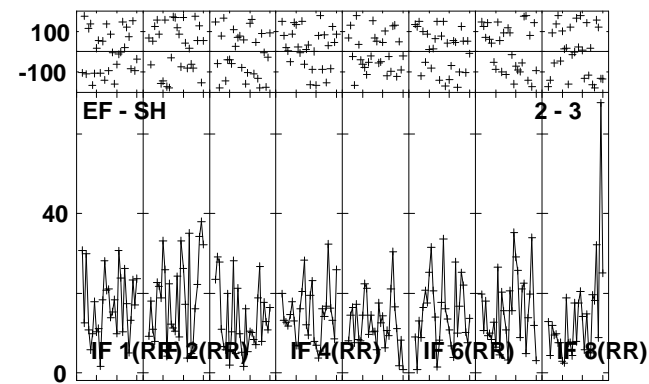
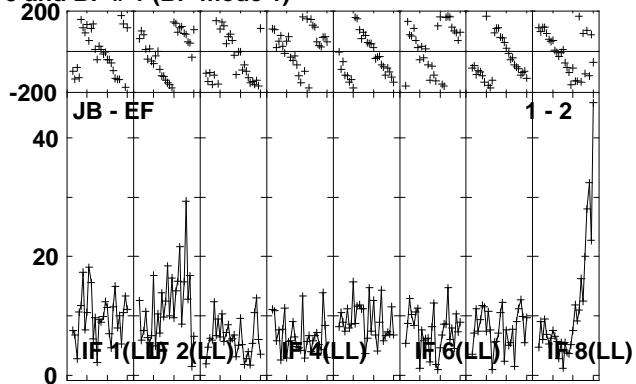
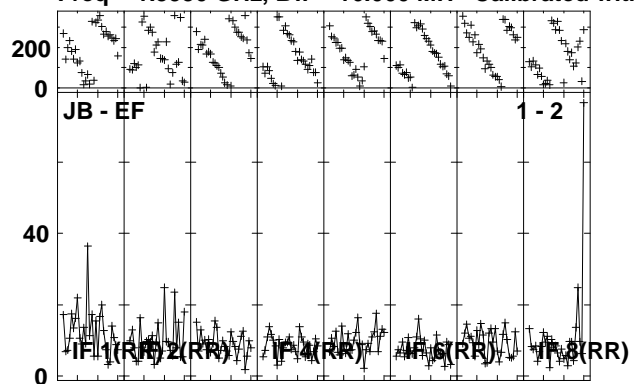

Lower frame: Milli Ampl Jy Top frame: Phas deg  
Vector averaged cross-power spectrum Several baselines displayed  
Timerange: 00/16:32:01 to 00/16:35:29

Plot file version 172 created 30-NOV-2010 14:31:57

ARP299C EP068B 3.UVDATA.1

Freq = 1.5950 GHz, Bw = 16.000 MH Calibrated with CL # 3 and BP # 1 (BP mode 1)

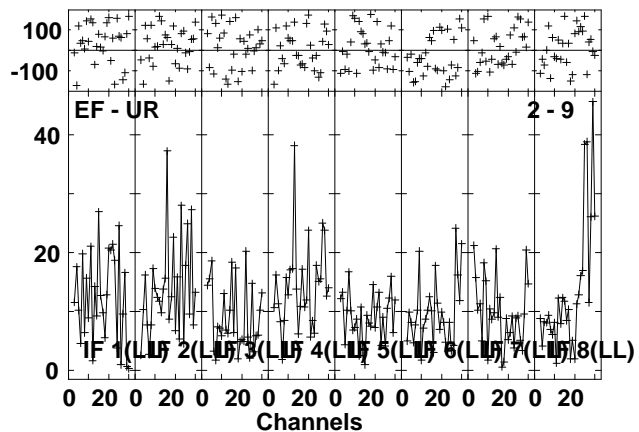
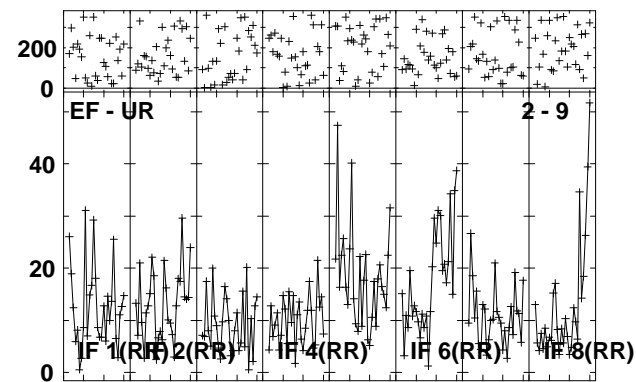
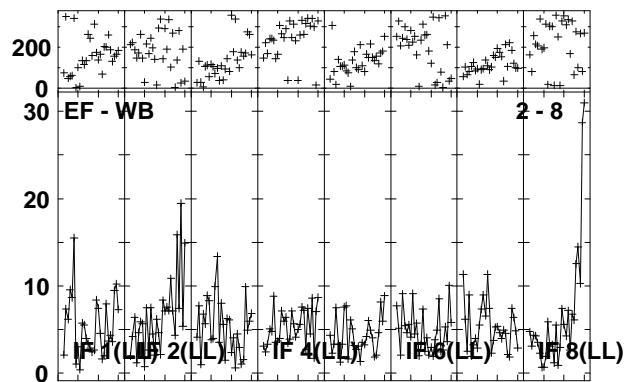
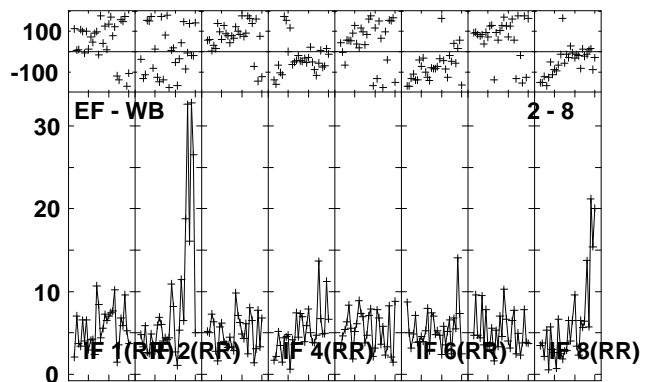
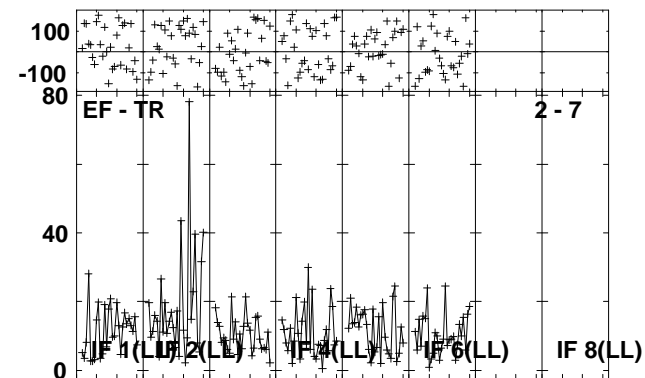
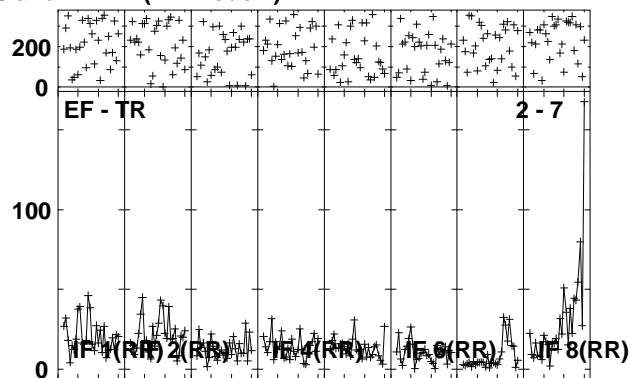
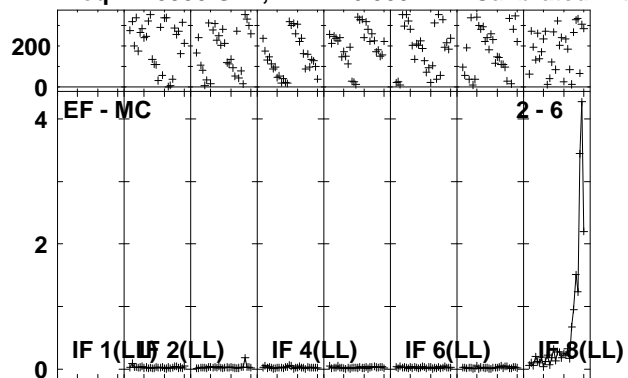

Lower frame: Ampl Jy Top frame: Phas deg  
Vector averaged cross-power spectrum Several baselines displayed  
Timerange: 00/16:32:01 to 00/16:35:29

Plot file version 173 created 30-NOV-2010 14:31:59

J1128+59 EP068B 3.UVDATA.1

Freq = 1.5950 GHz, Bw = 16.000 MH Calibrated with CL # 3 and BP # 1 (BP mode 1)

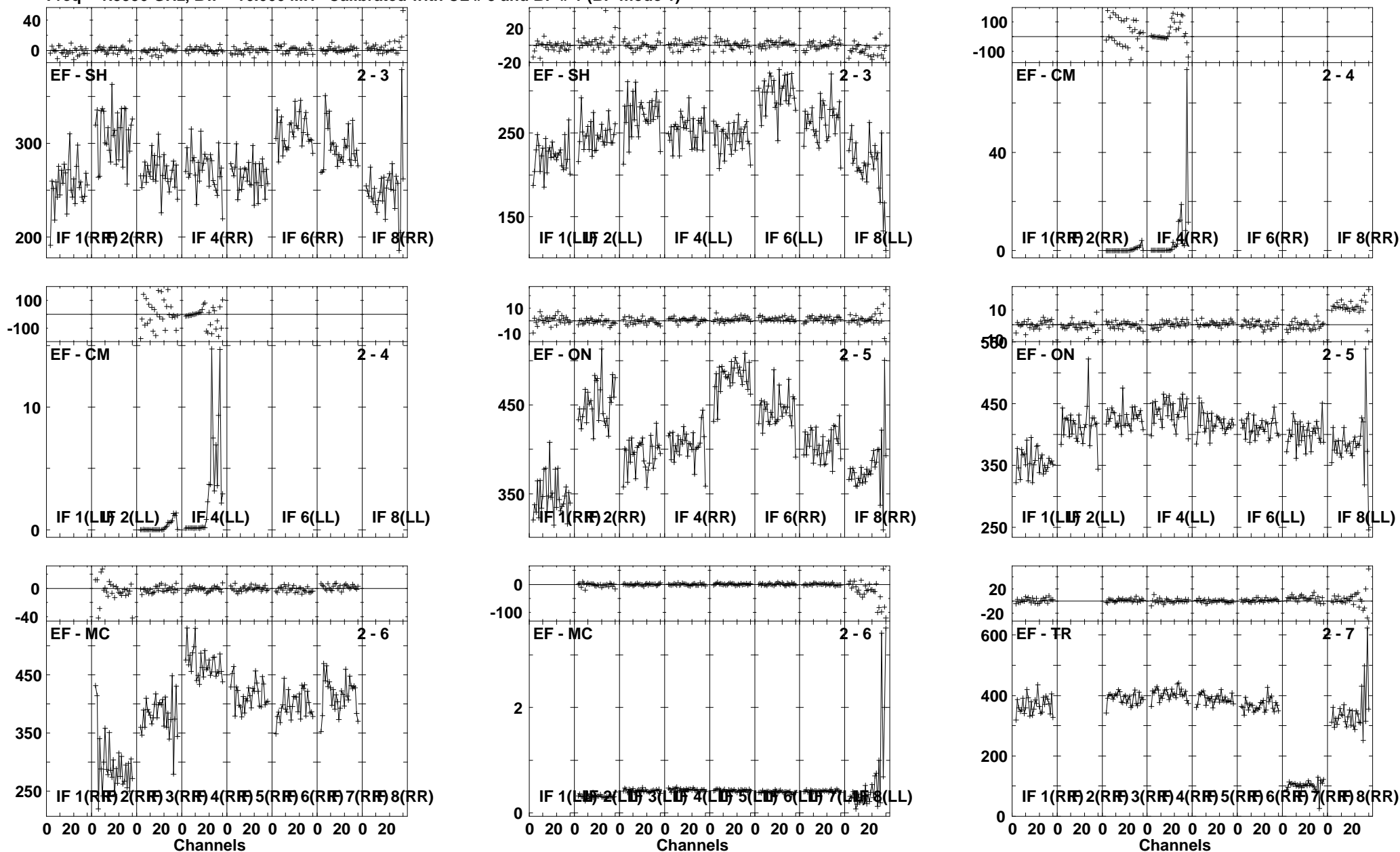

Lower frame: Milli Ampl Jy Top frame: Phas deg  
Vector averaged cross-power spectrum Several baselines displayed  
Timerange: 00/16:35:31 to 00/16:36:59

Plot file version 174 created 30-NOV-2010 14:32:00

J1128+59 EP068B 3.UVDATA.1

Freq = 1.5950 GHz, Bw = 16.000 MH Calibrated with CL # 3 and BP # 1 (BP mode 1)

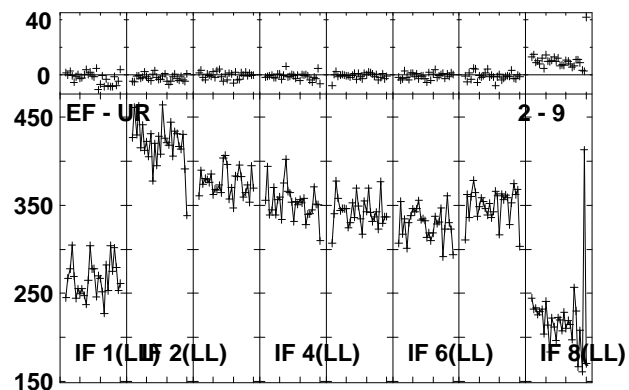
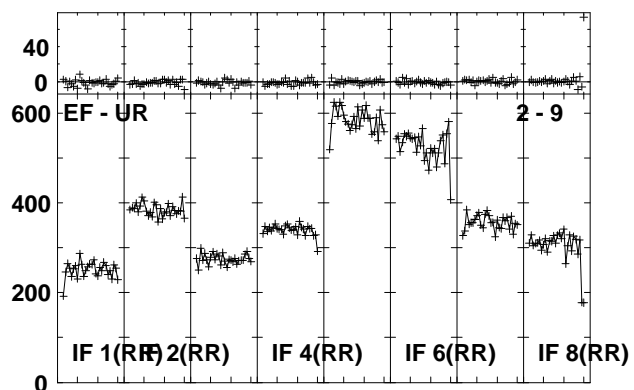
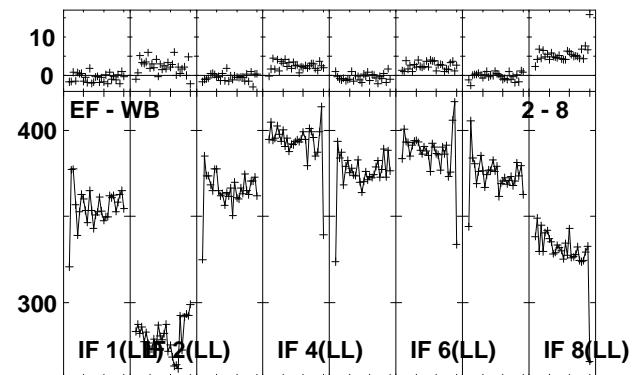
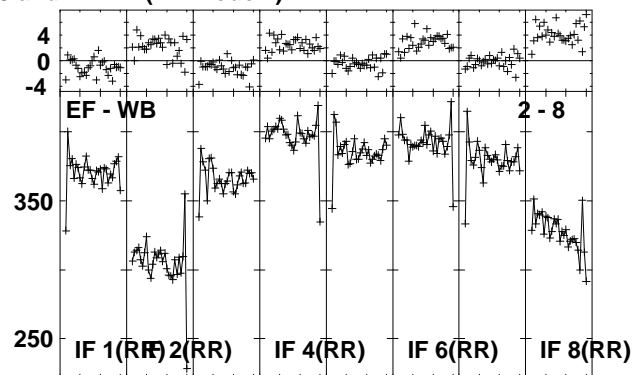
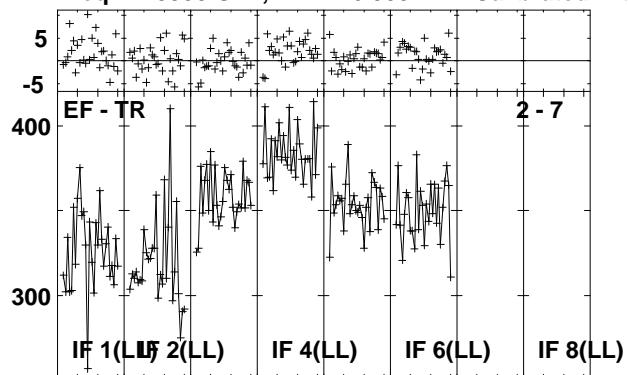

Lower frame: Milli Ampl Jy Top frame: Phas deg  
Vector averaged cross-power spectrum Several baselines displayed  
Timerange: 00/16:35:31 to 00/16:36:59

Plot file version 175 created 30-NOV-2010 14:32:02

ARP299C EP068B 3.UVDATA.1

Freq = 1.5950 GHz, Bw = 16.000 MH Calibrated with CL # 3 and BP # 1 (BP mode 1)

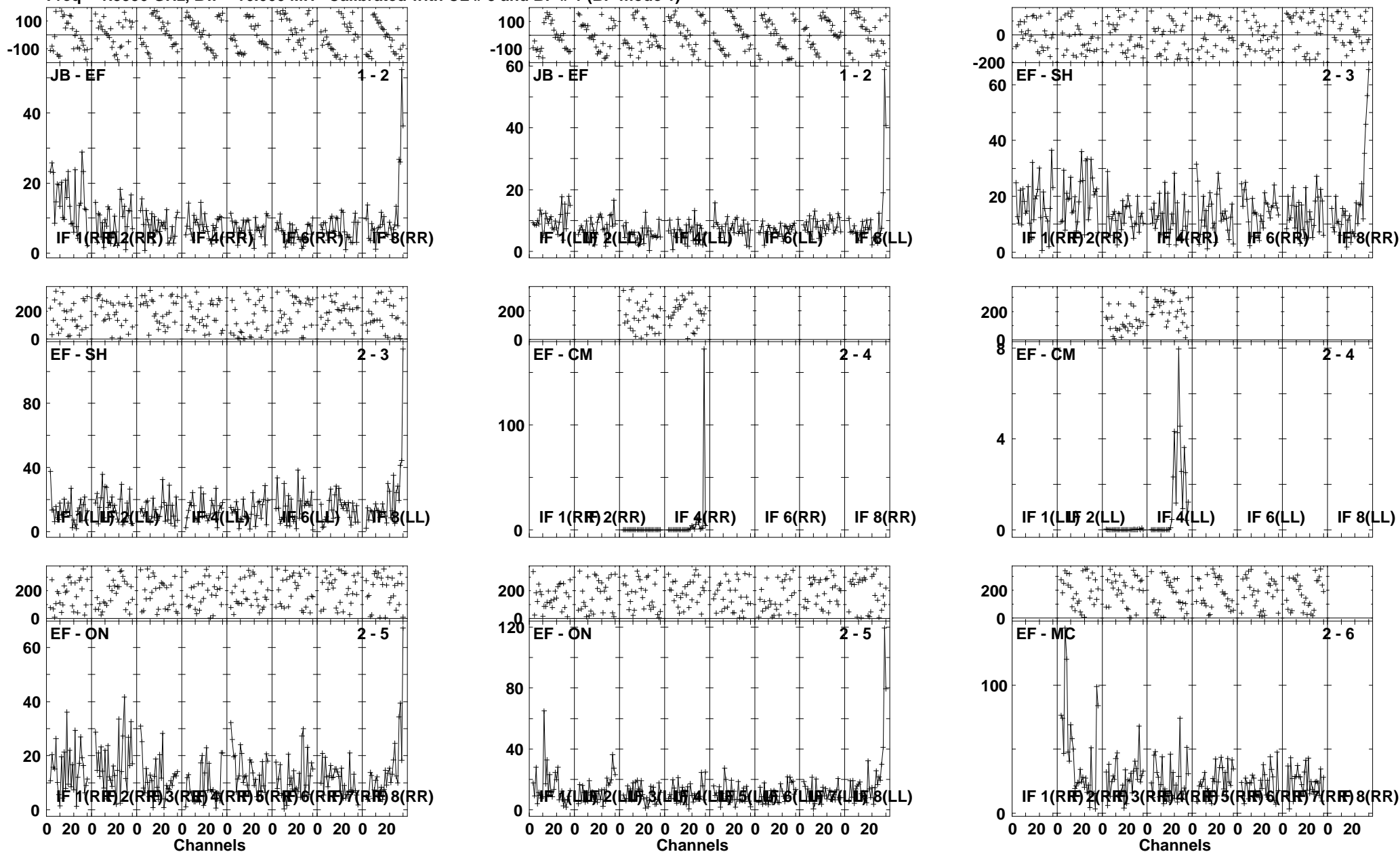

Lower frame: Milli Ampl Jy Top frame: Phas deg  
Vector averaged cross-power spectrum Several baselines displayed  
Timerange: 00/16:37:01 to 00/16:40:29

Plot file version 176 created 30-NOV-2010 14:32:05

ARP299C EP068B 3.UVDATA.1

Freq = 1.5950 GHz, Bw = 16.000 MH Calibrated with CL # 3 and BP # 1 (BP mode 1)

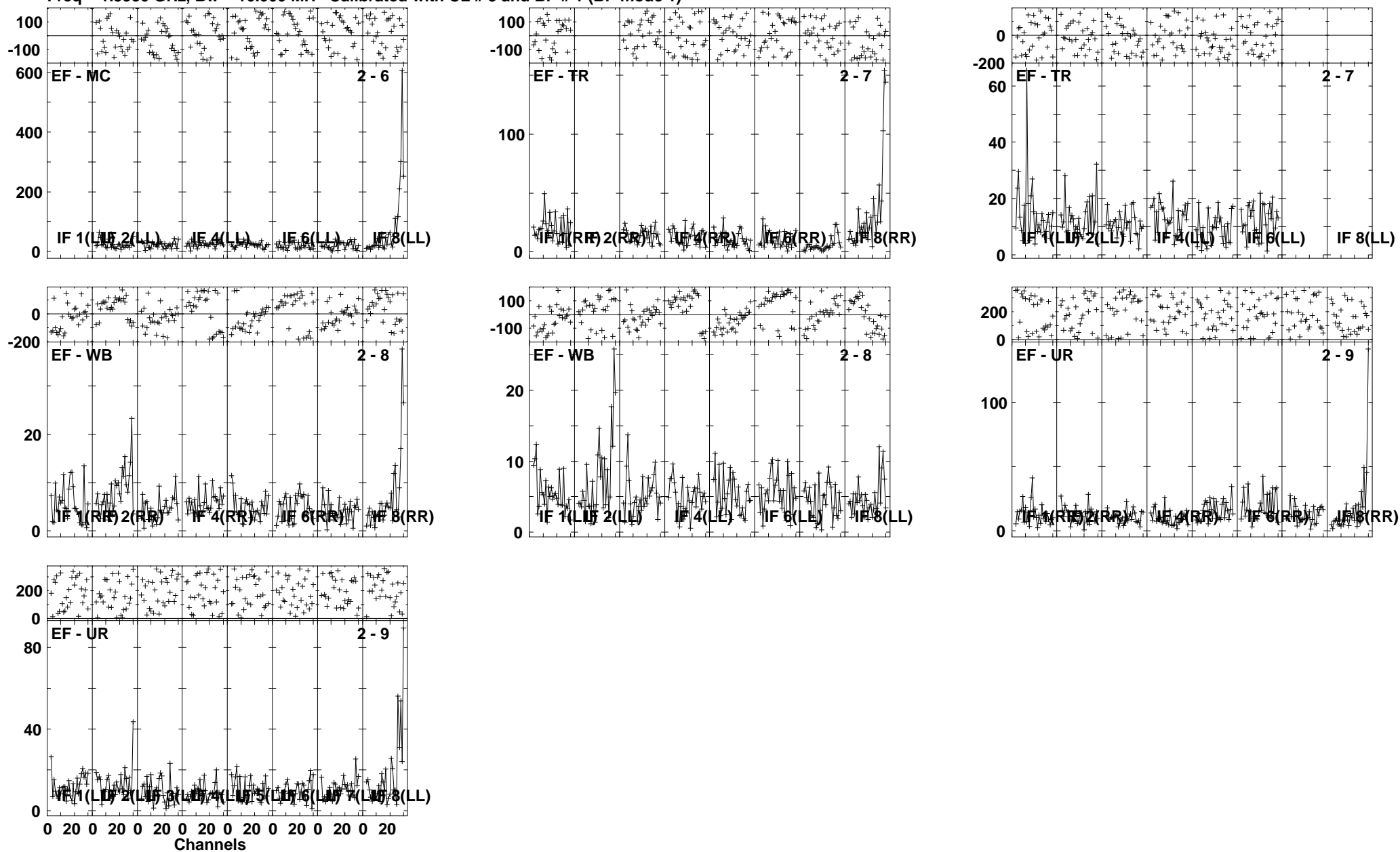

Lower frame: Milli Ampl Jy Top frame: Phas deg  
Vector averaged cross-power spectrum Several baselines displayed  
Timerange: 00/16:37:01 to 00/16:40:29



Plot file version 177 created 30-NOV-2010 14:32:08

J1128+59 EP068B 3.UVDATA.1

Freq = 1.5950 GHz, Bw = 16.000 MH Calibrated with CL # 3 and BP # 1 (BP mode 1)

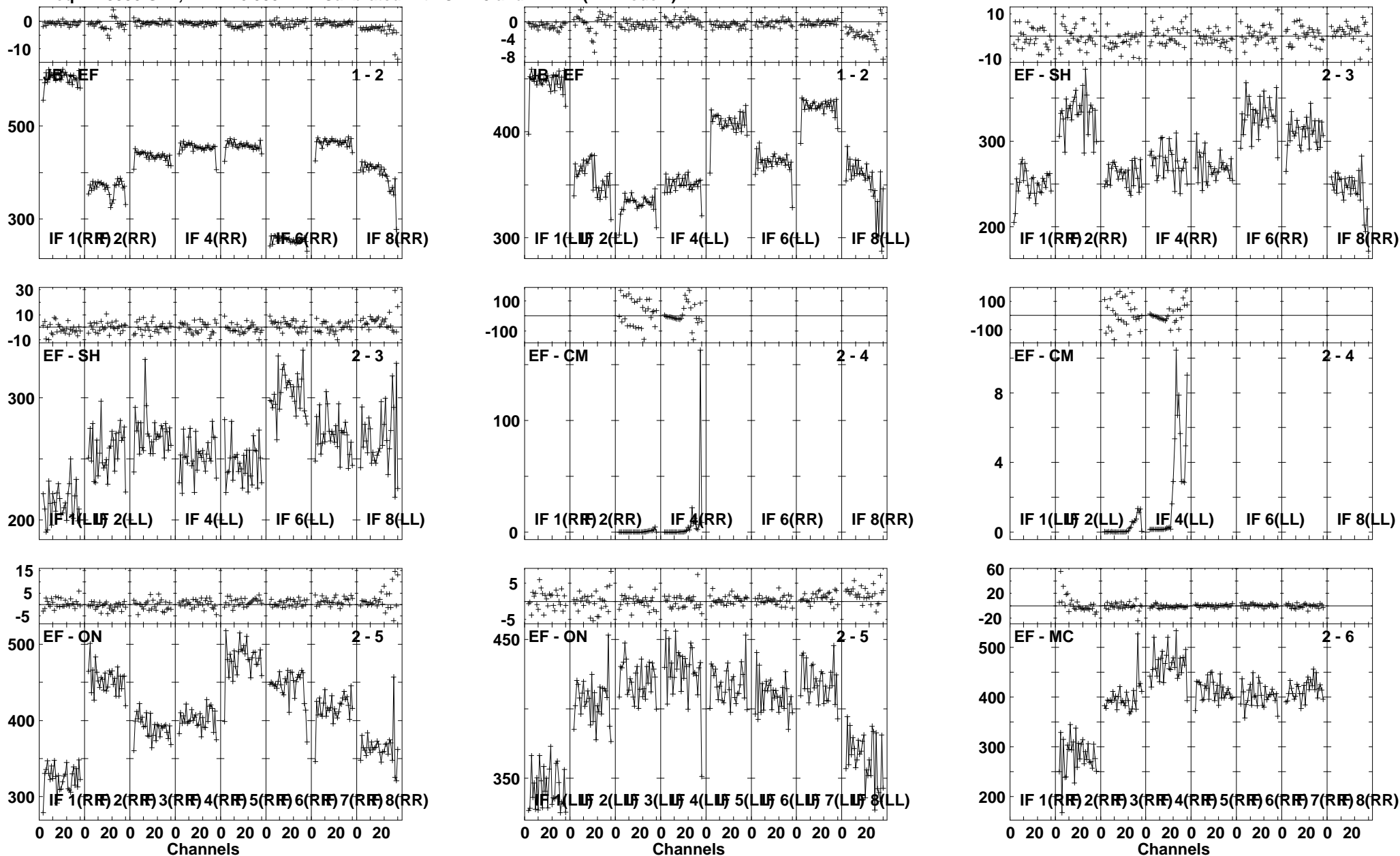

Lower frame: Milli Ampl Jy Top frame: Phas deg  
Vector averaged cross-power spectrum Several baselines displayed  
Timerange: 00/16:41:31 to 00/16:42:59

Plot file version 178 created 30-NOV-2010 14:32:09

J1128+59 EP068B 3.UVDATA.1

Freq = 1.5950 GHz, Bw = 16.000 MH Calibrated with CL # 3 and BP # 1 (BP mode 1)

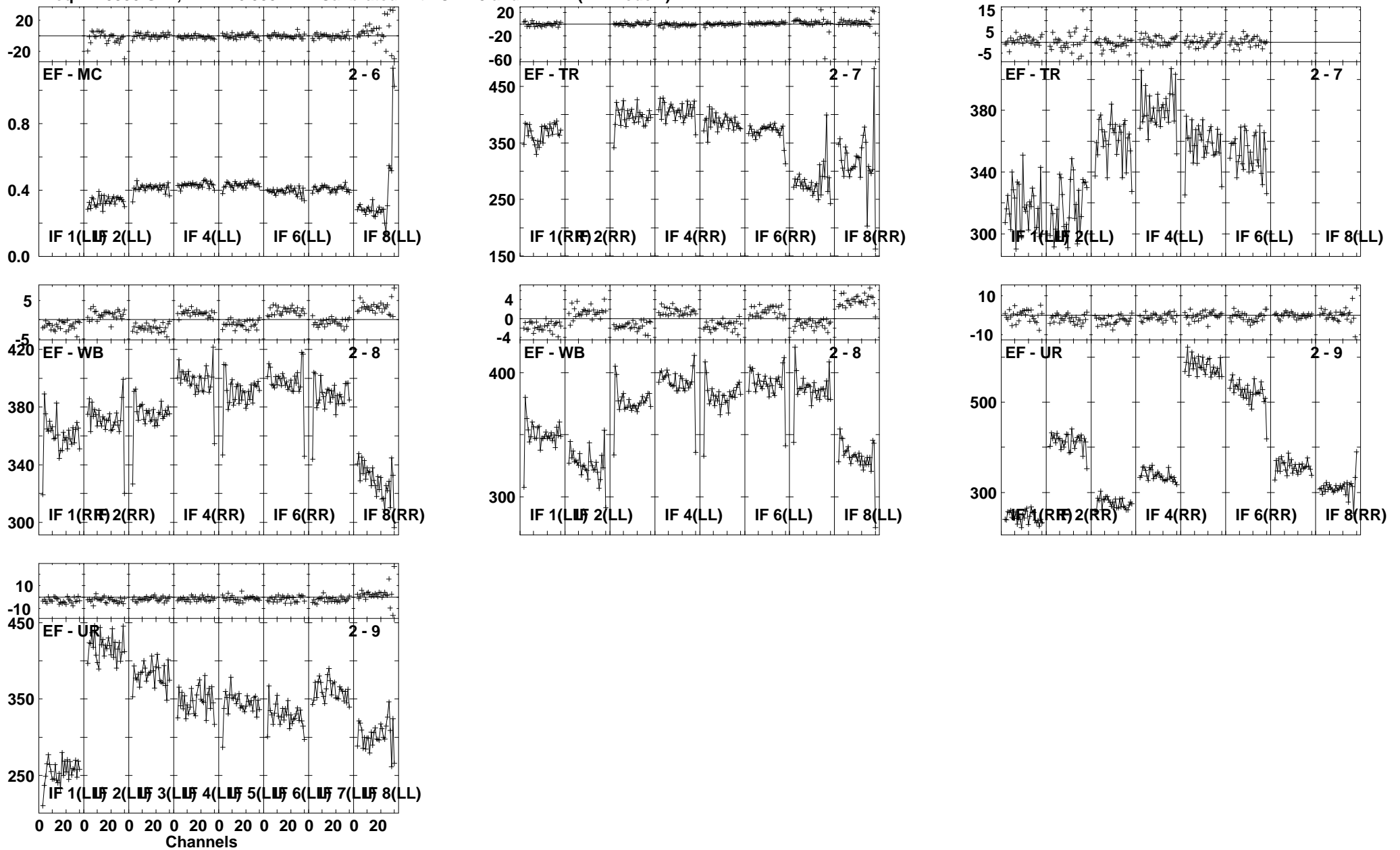

Lower frame: Ampl Jy Top frame: Phas deg  
Vector averaged cross-power spectrum Several baselines displayed  
Timerange: 00/16:41:31 to 00/16:42:59

Plot file version 179 created 30-NOV-2010 14:32:11

ARP299C EP068B 3.UVDATA.1

Freq = 1.5950 GHz, Bw = 16.000 MH Calibrated with CL # 3 and BP # 1 (BP mode 1)

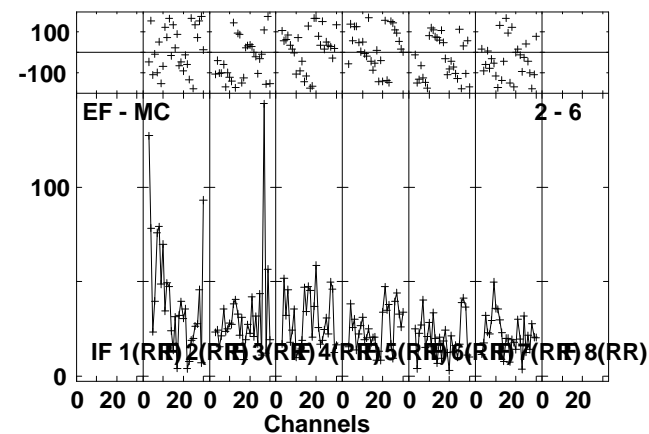
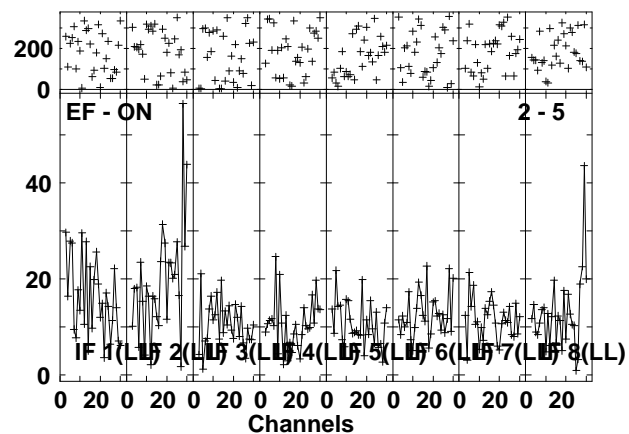
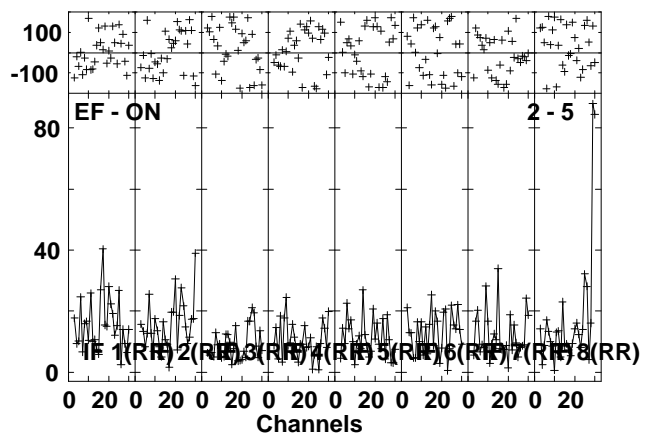
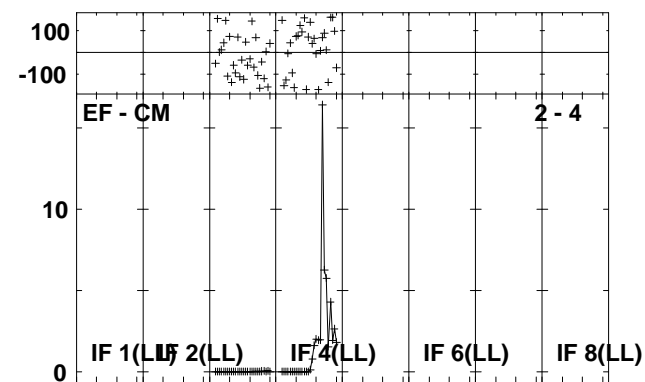
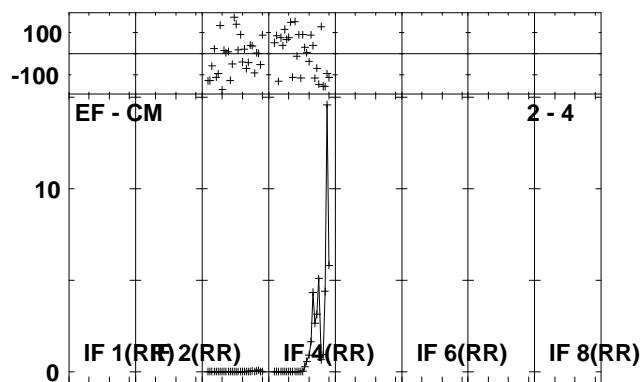
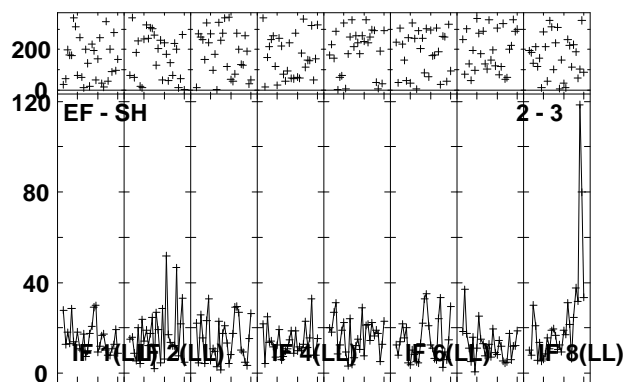
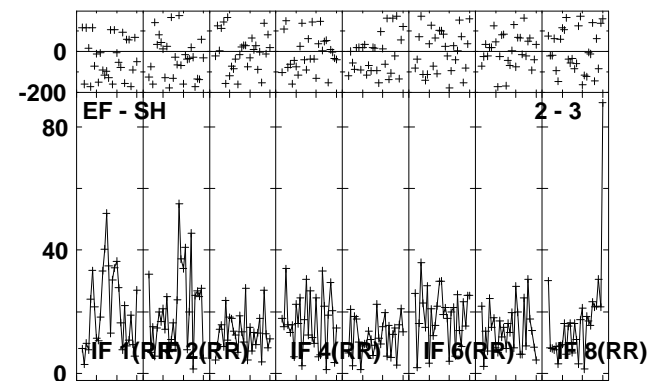
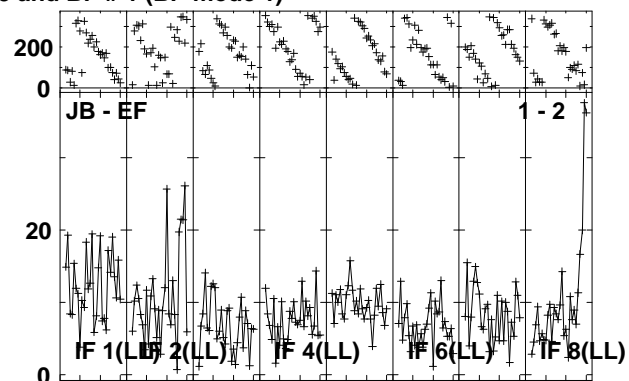
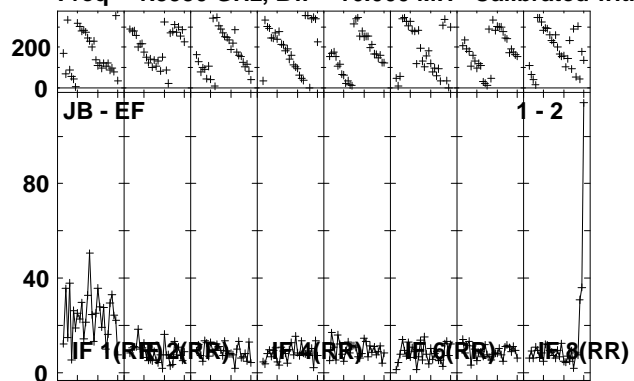

Lower frame: Milli Ampl Jy Top frame: Phas deg  
Vector averaged cross-power spectrum Several baselines displayed  
Timerange: 00/16:43:01 to 00/16:46:29

Plot file version 180 created 30-NOV-2010 14:32:14

ARP299C EP068B 3.UVDATA.1

Freq = 1.5950 GHz, Bw = 16.000 MH Calibrated with CL # 3 and BP # 1 (BP mode 1)

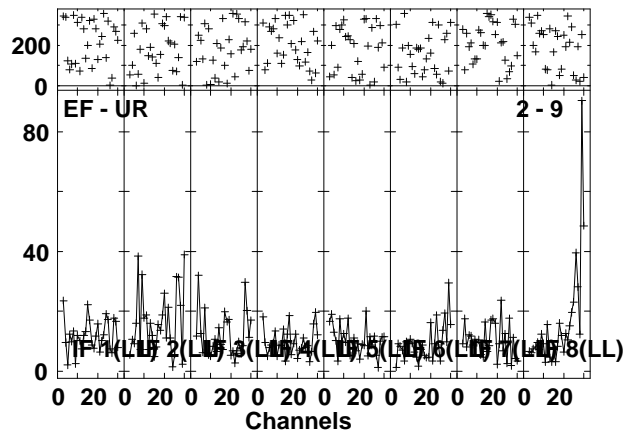
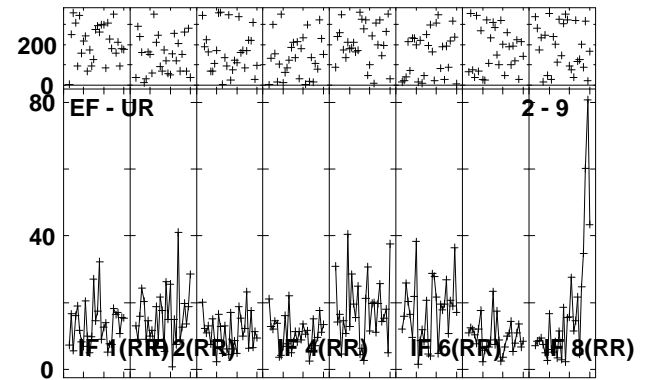
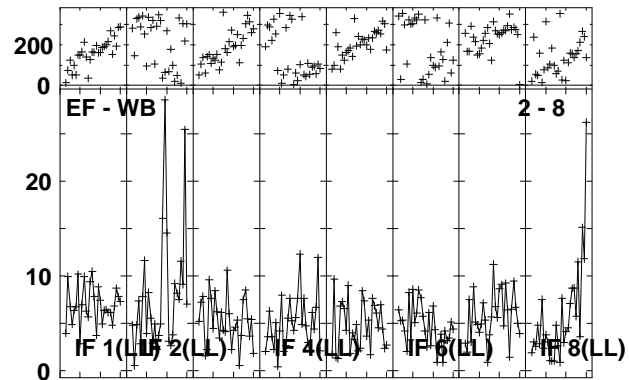
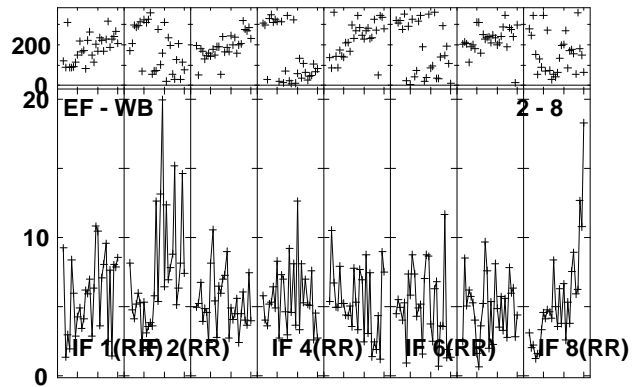
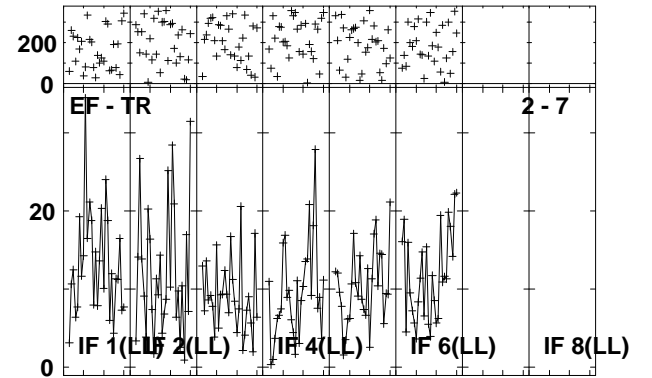
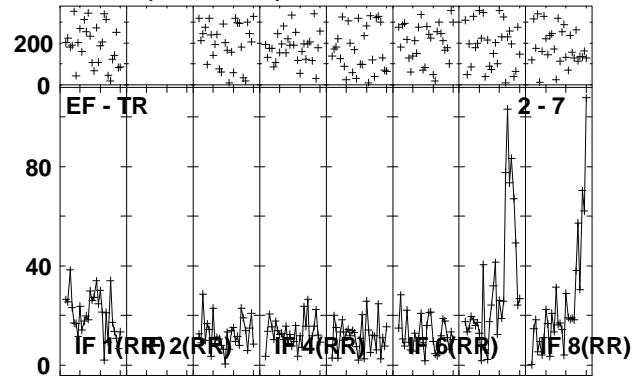
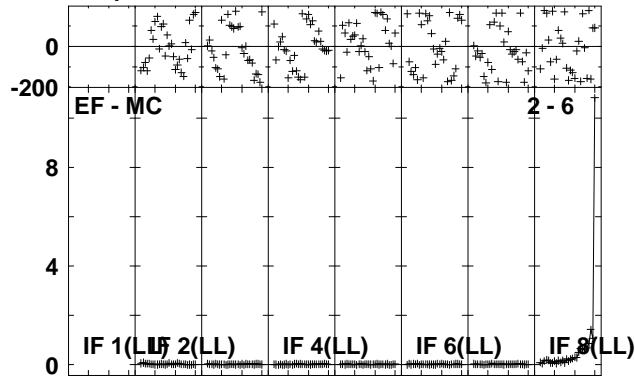

Lower frame: Ampl Jy Top frame: Phas deg  
 Vector averaged cross-power spectrum Several baselines displayed  
 Timerange: 00:16:43:01 to 00:16:46:29

Plot file version 181 created 30-NOV-2010 14:32:17

J1128+59 EP068B 3.UVDATA.1

Freq = 1.5950 GHz, Bw = 16.000 MH Calibrated with CL # 3 and BP # 1 (BP mode 1)

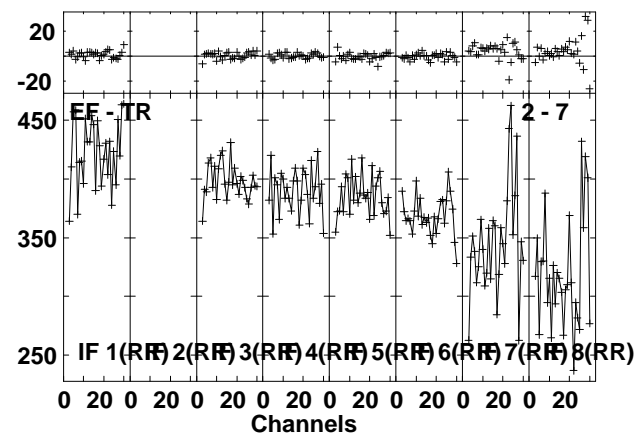
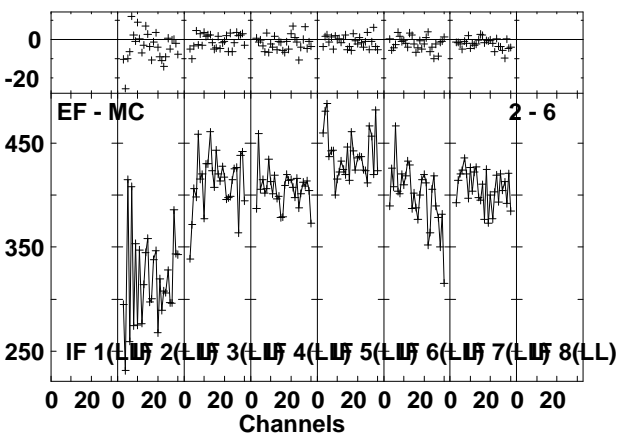
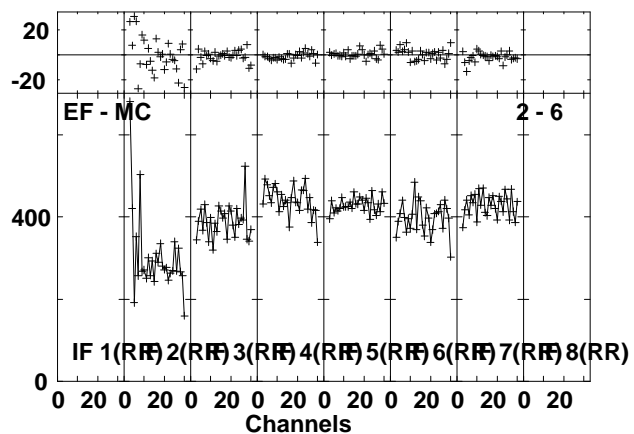
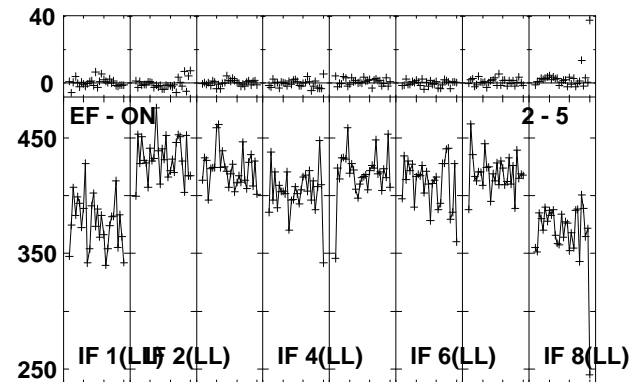
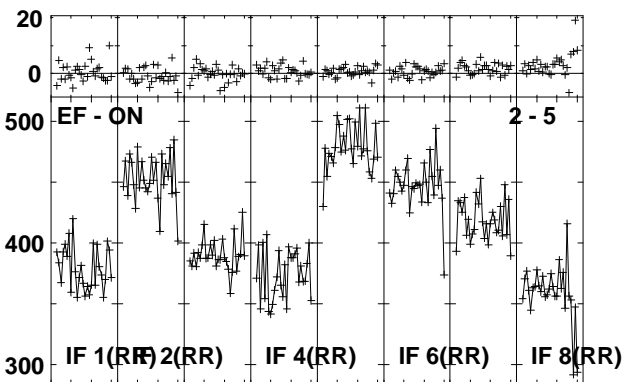
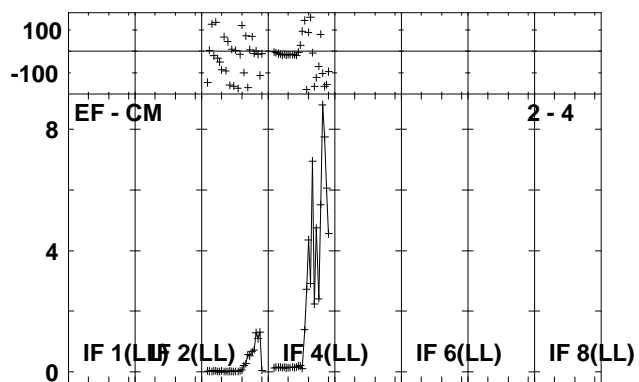
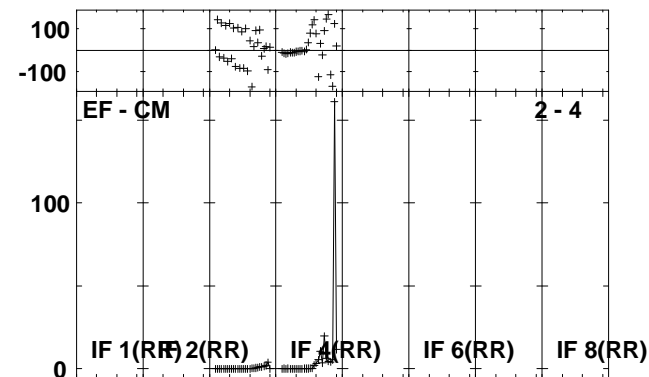
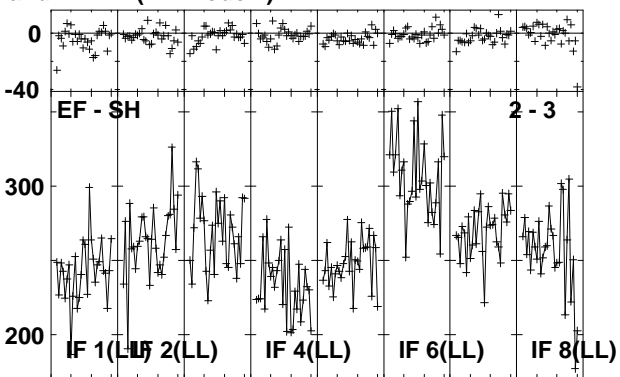
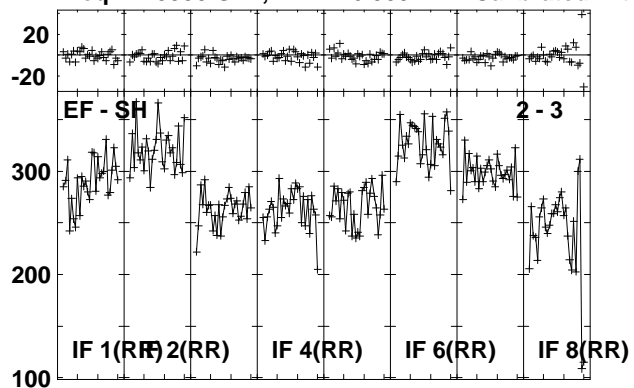

Lower frame: Milli Ampl Jy Top frame: Phas deg  
Vector averaged cross-power spectrum Several baselines displayed  
Timerange: 00/16:46:31 to 00/16:47:59

Plot file version 182 created 30-NOV-2010 14:32:18

J1128+59 EP068B 3.UVDATA.1

Freq = 1.5950 GHz, Bw = 16.000 MH Calibrated with CL # 3 and BP # 1 (BP mode 1)

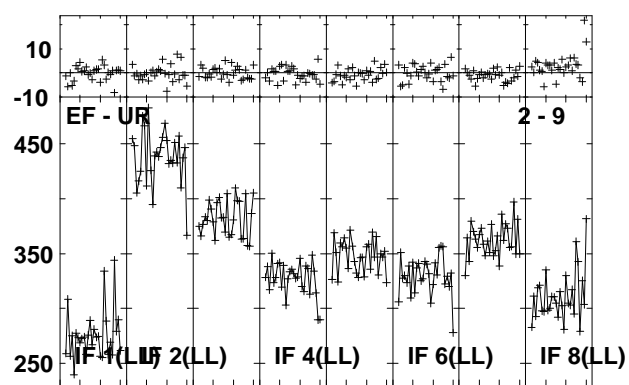
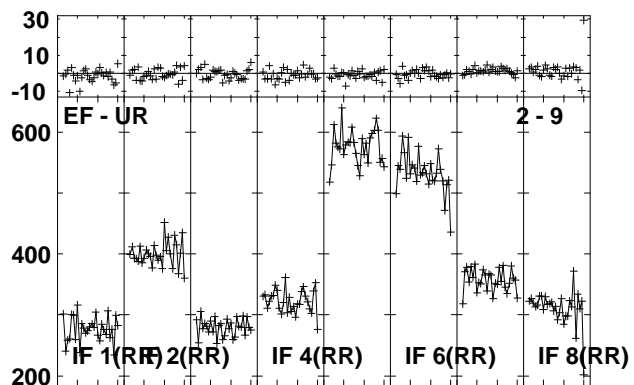
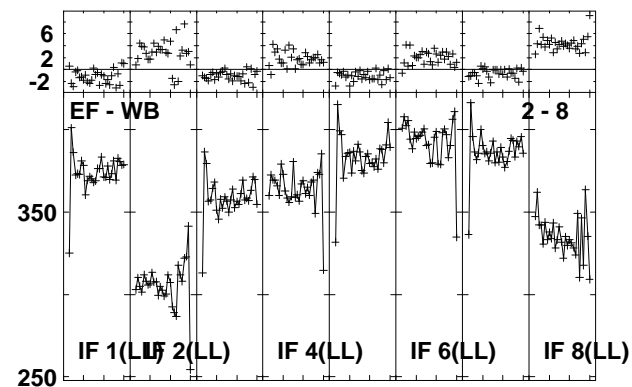
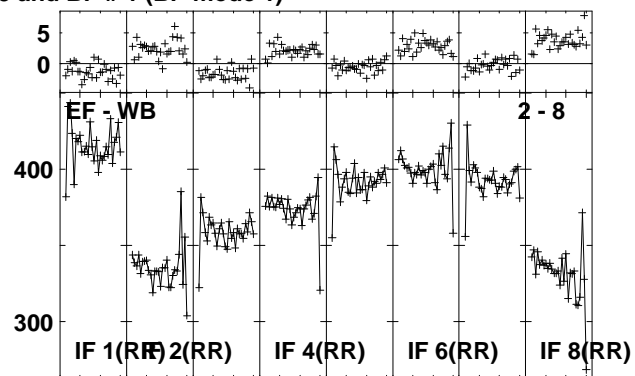
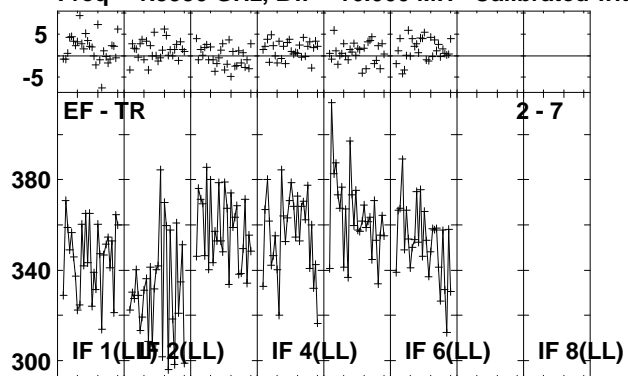

Lower frame: Milli Ampl Jy Top frame: Phas deg  
Vector averaged cross-power spectrum Several baselines displayed  
Timerange: 00/16:46:31 to 00/16:47:59

Plot file version 183 created 30-NOV-2010 14:32:19

ARP299C EP068B 3.UVDATA.1

Freq = 1.5950 GHz, Bw = 16.000 MH Calibrated with CL # 3 and BP # 1 (BP mode 1)

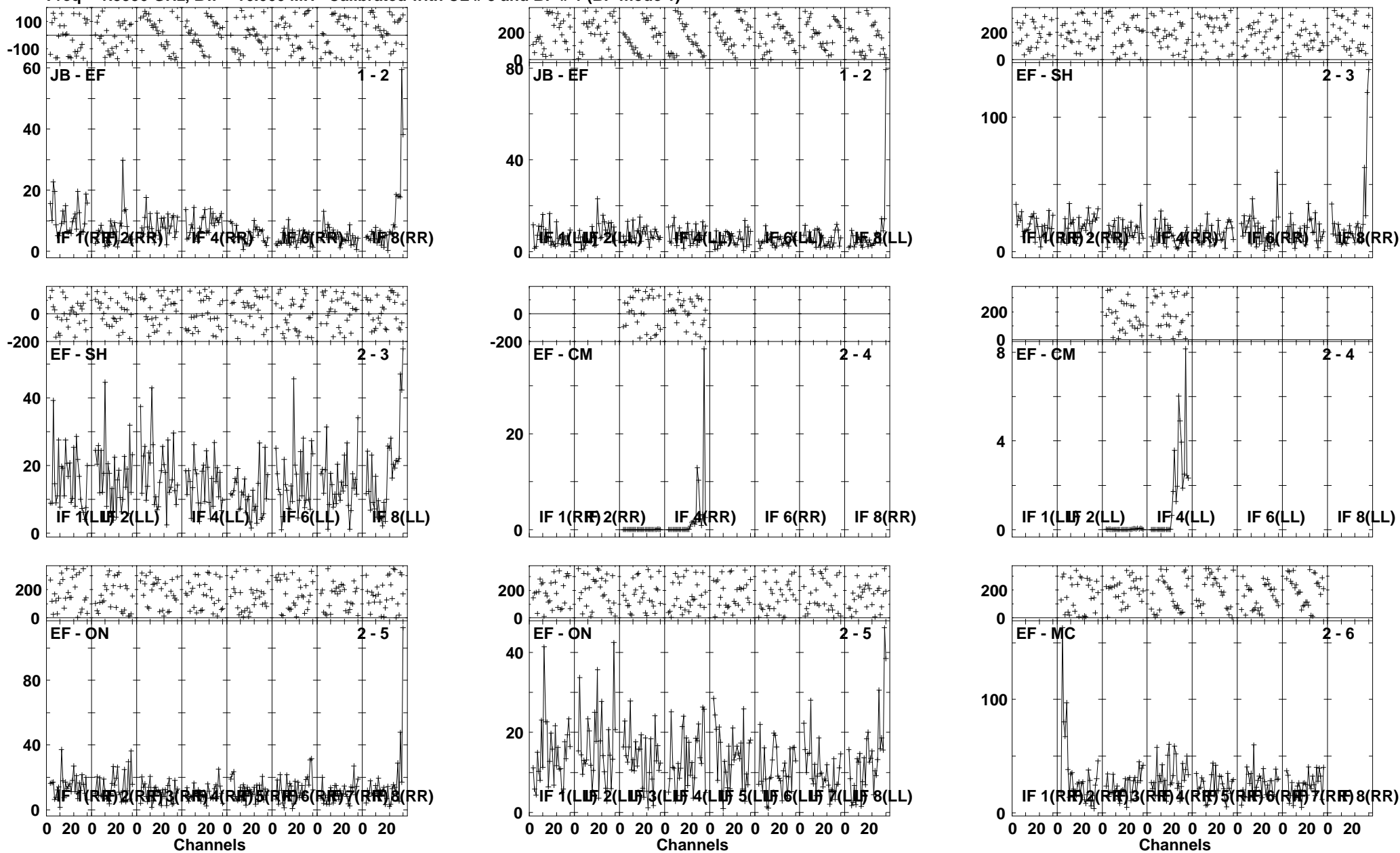

Lower frame: Milli Ampl Jy Top frame: Phas deg  
Vector averaged cross-power spectrum Several baselines displayed  
Timerange: 00/16:48:01 to 00/16:51:29

Plot file version 184 created 30-NOV-2010 14:32:22

ARP299C EP068B 3.UVDATA.1

Freq = 1.5950 GHz, Bw = 16.000 MH Calibrated with CL # 3 and BP # 1 (BP mode 1)

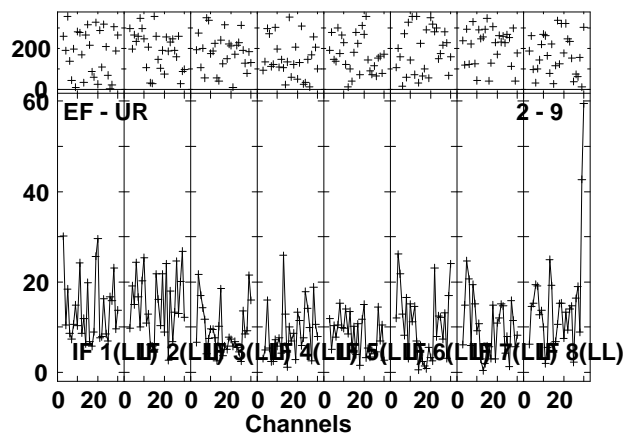
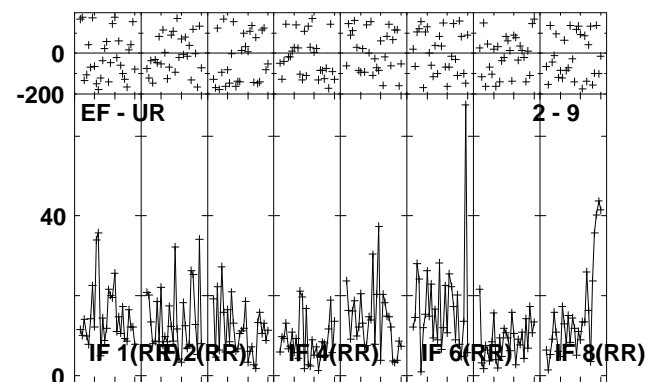
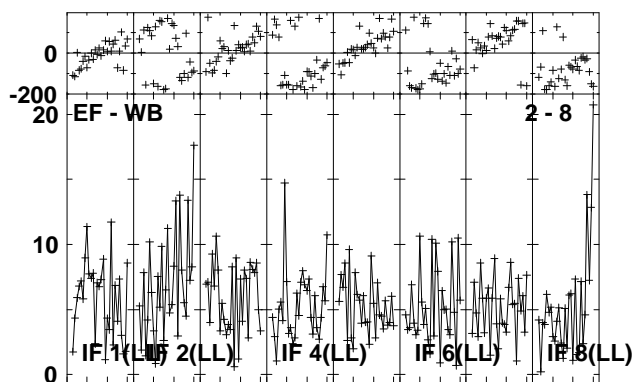
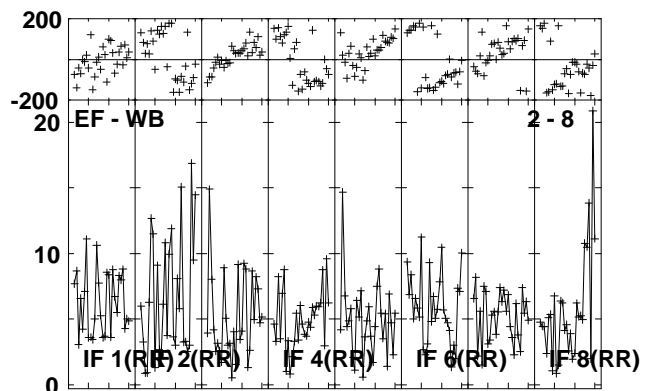
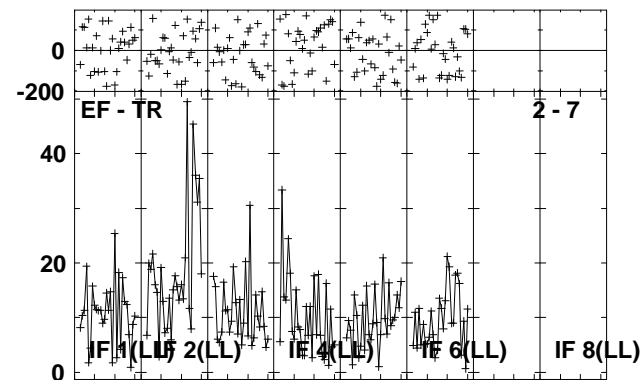
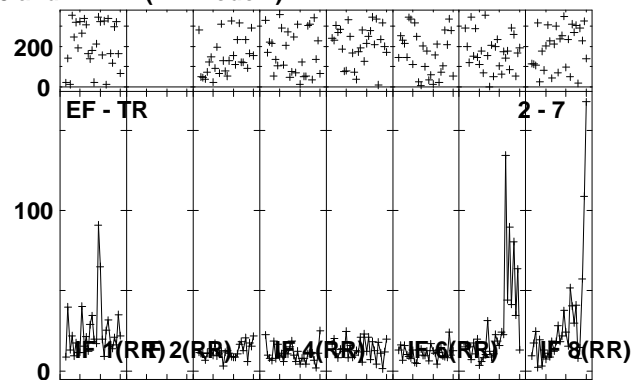
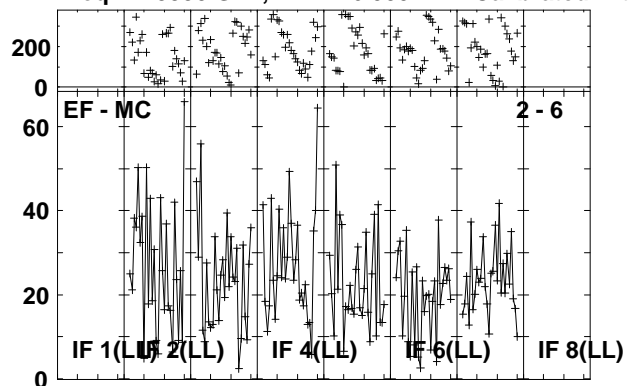

Lower frame: Milli Ampl Jy Top frame: Phas deg  
Vector averaged cross-power spectrum Several baselines displayed  
Timerange: 00/16:48:01 to 00/16:51:29



Plot file version 185 created 30-NOV-2010 14:32:24

J1128+59 EP068B 3.UVDATA.1

Freq = 1.5950 GHz, Bw = 16.000 MH Calibrated with CL # 3 and BP # 1 (BP mode 1)

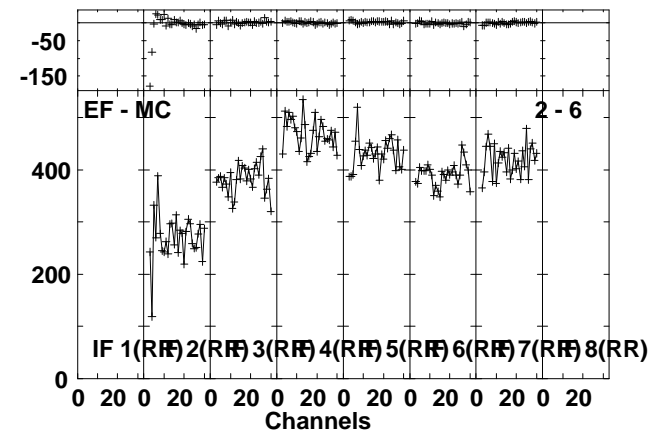
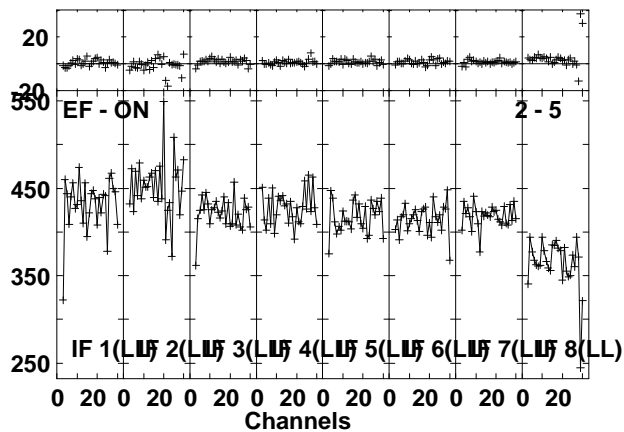
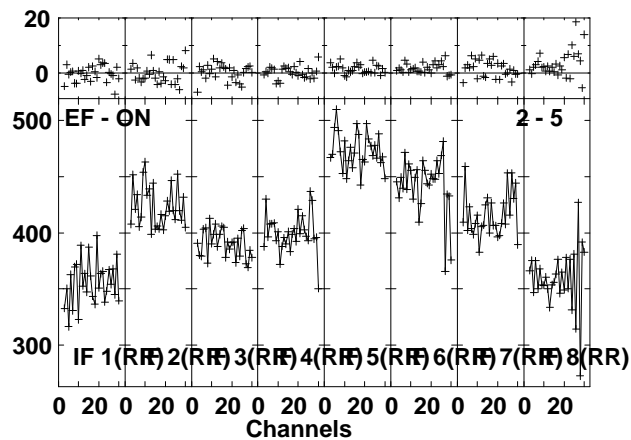
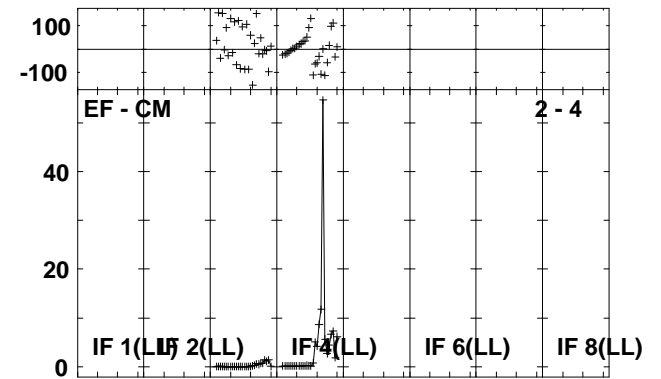
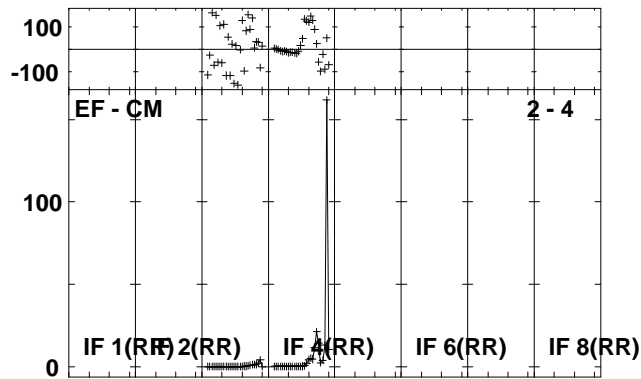
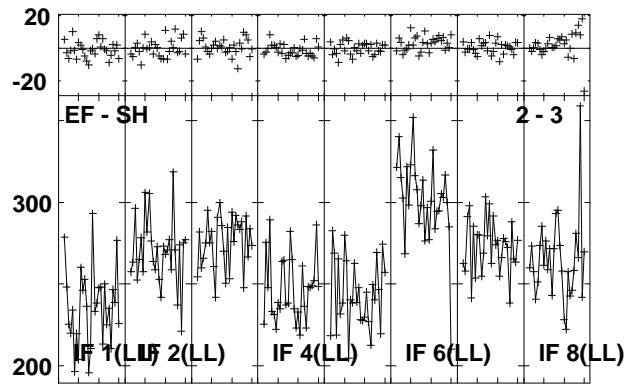
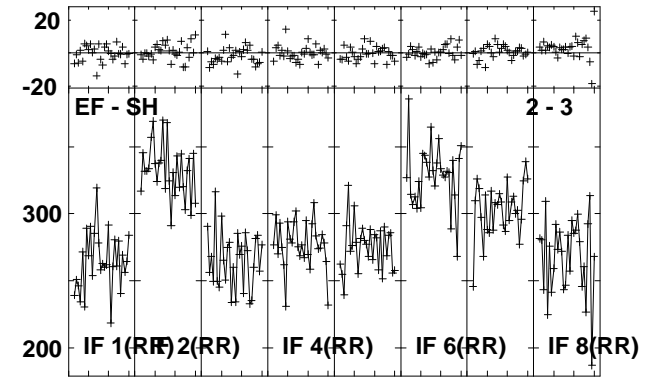
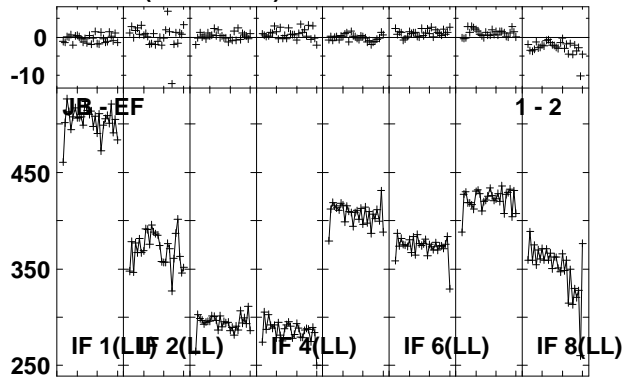
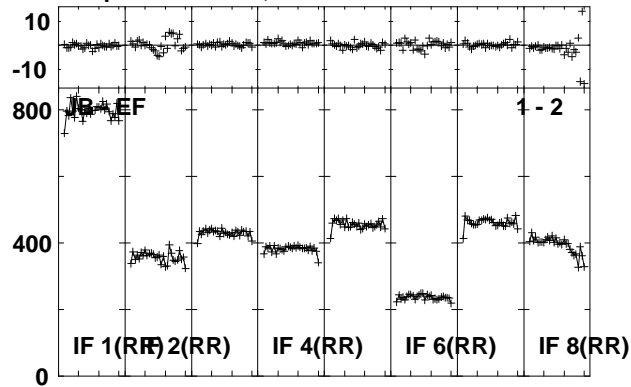

Lower frame: Milli Ampl Jy Top frame: Phas deg  
Vector averaged cross-power spectrum Several baselines displayed  
Timerange: 00/16:51:31 to 00/16:52:59

Plot file version 186 created 30-NOV-2010 14:32:26

J1128+59 EP068B 3.UVDATA.1

Freq = 1.5950 GHz, Bw = 16.000 MH Calibrated with CL # 3 and BP # 1 (BP mode 1)

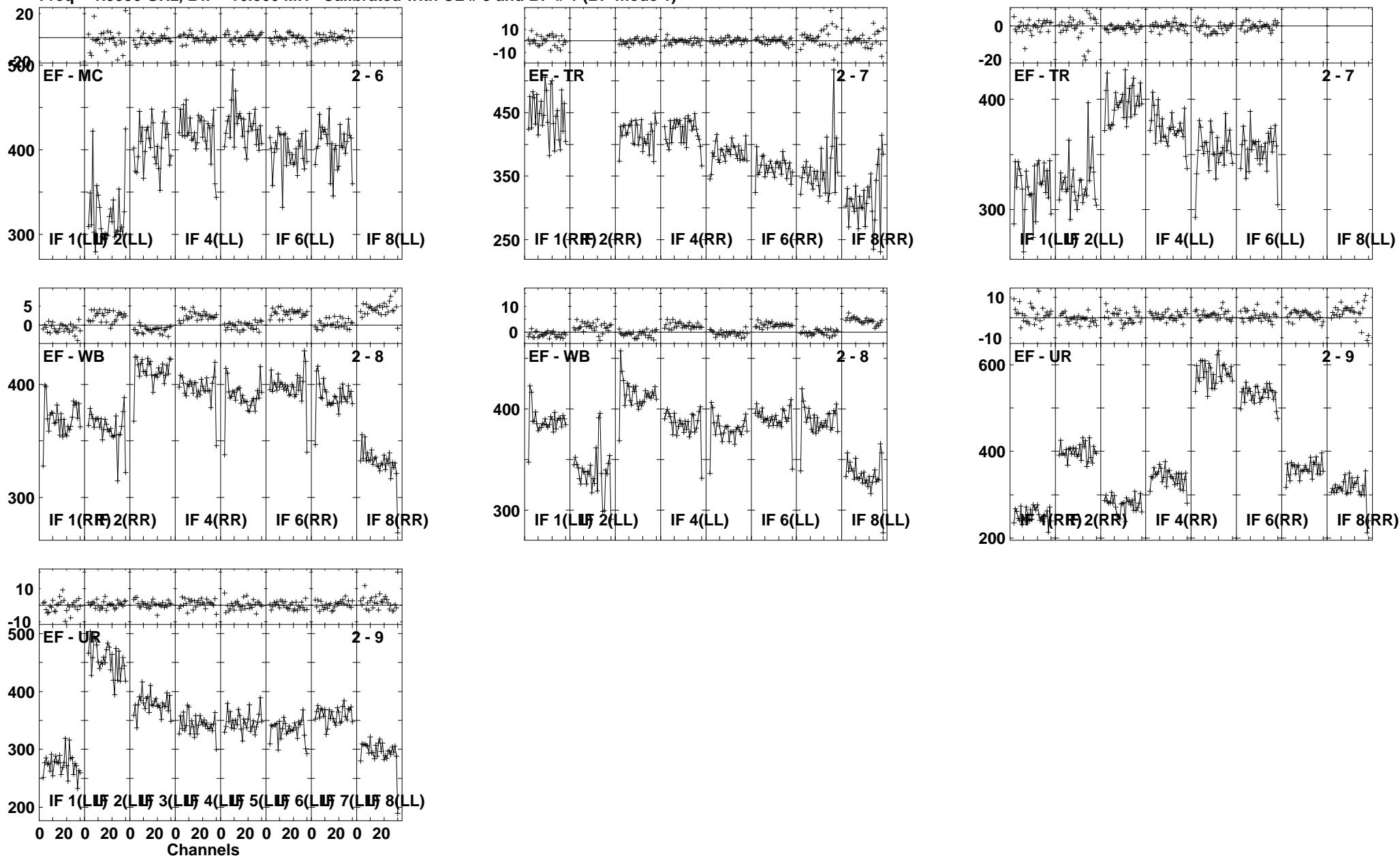

Lower frame: Milli Ampl Jy Top frame: Phas deg  
 Vector averaged cross-power spectrum Several baselines displayed  
 Timerange: 00/16:51:31 to 00/16:52:59

Plot file version 187 created 30-NOV-2010 14:32:27

ARP299C EP068B 3.UVDATA.1

Freq = 1.5950 GHz, Bw = 16.000 MH Calibrated with CL # 3 and BP # 1 (BP mode 1)

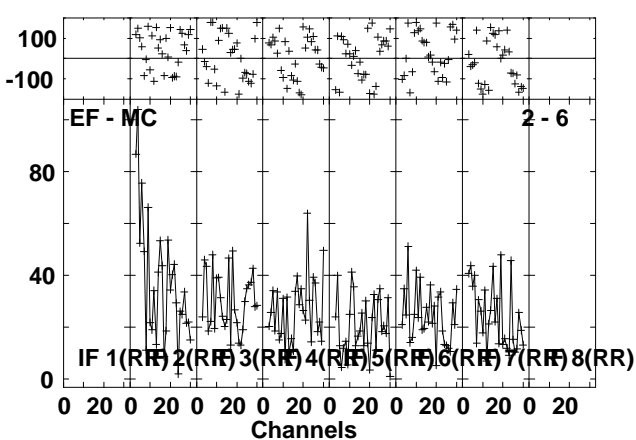
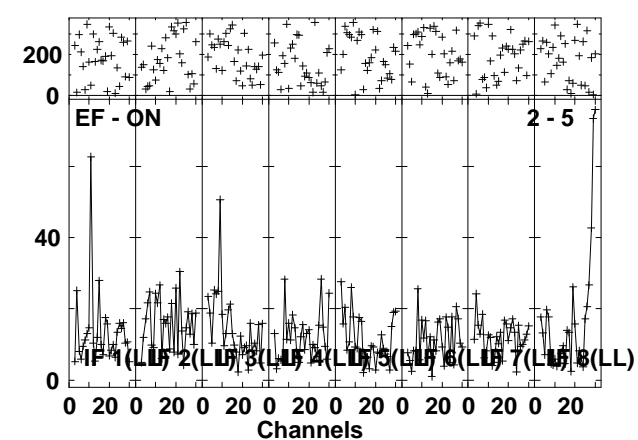
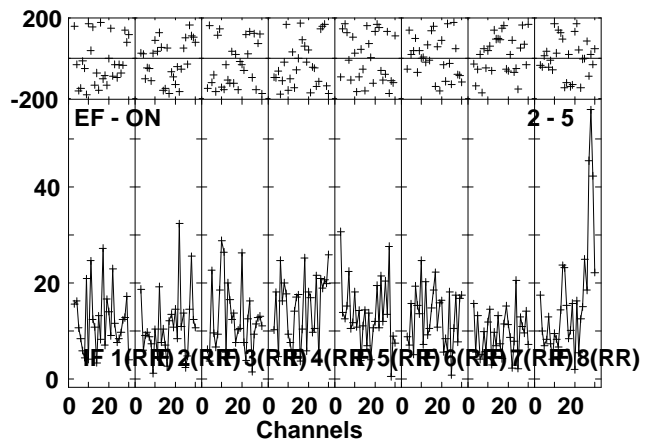
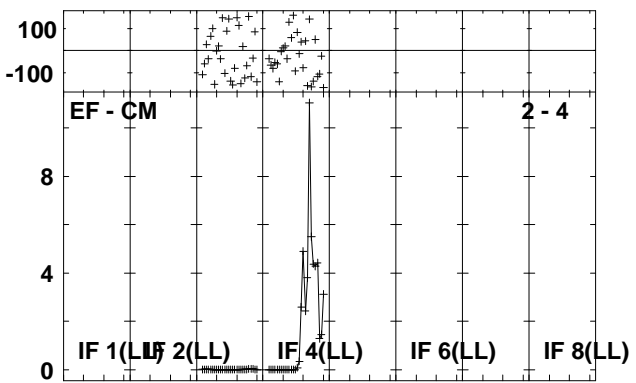
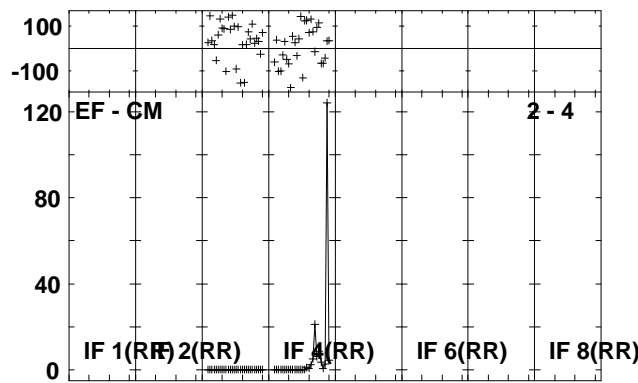
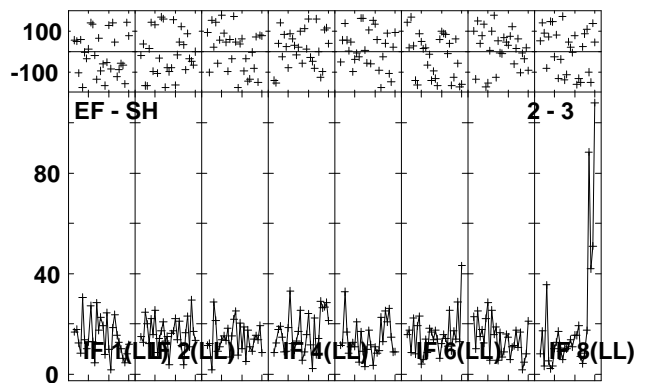
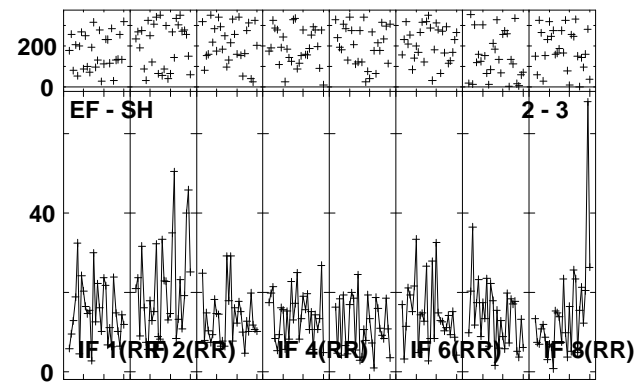
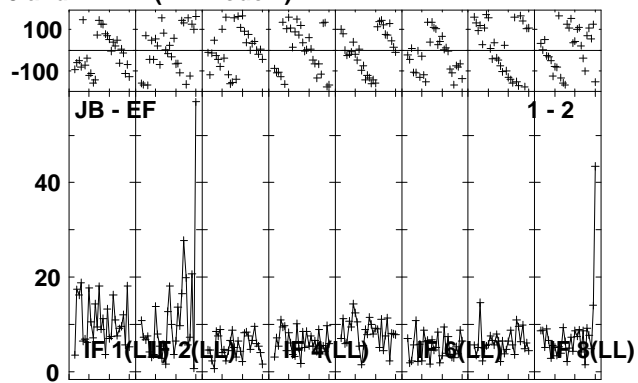
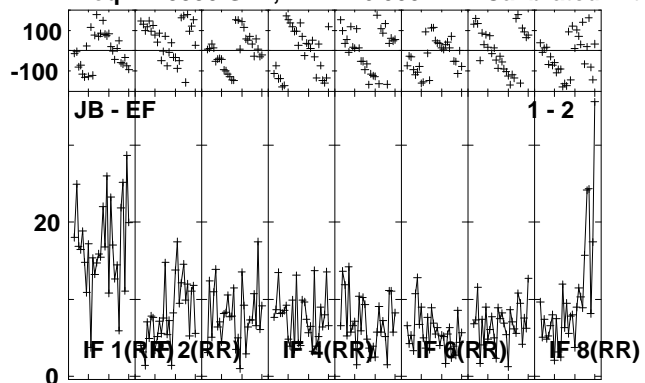

Lower frame: Milli Ampl Jy Top frame: Phas deg  
Vector averaged cross-power spectrum Several baselines displayed  
Timerange: 00/16:53:01 to 00/16:56:29

Plot file version 188 created 30-NOV-2010 14:32:30

ARP299C EP068B 3.UVDATA.1

Freq = 1.5950 GHz, Bw = 16.000 MH Calibrated with CL # 3 and BP # 1 (BP mode 1)

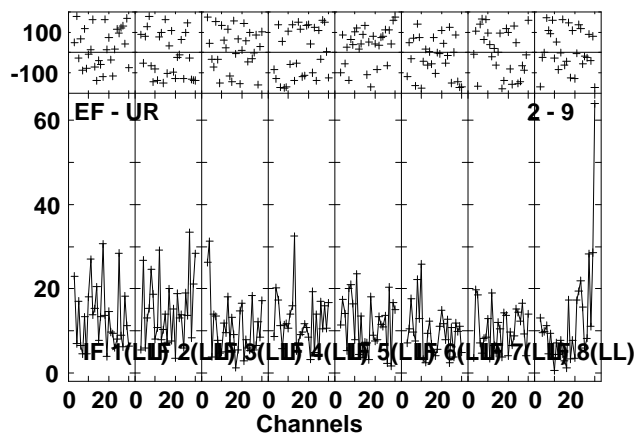
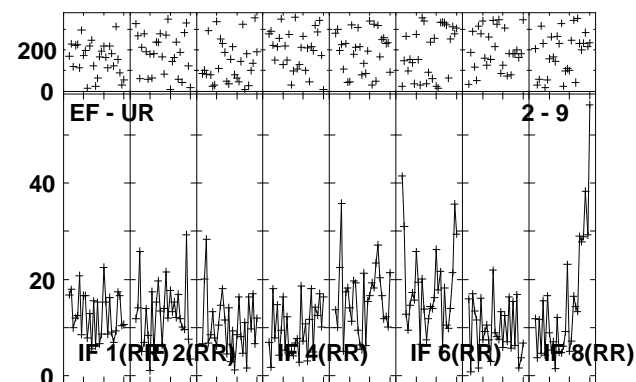
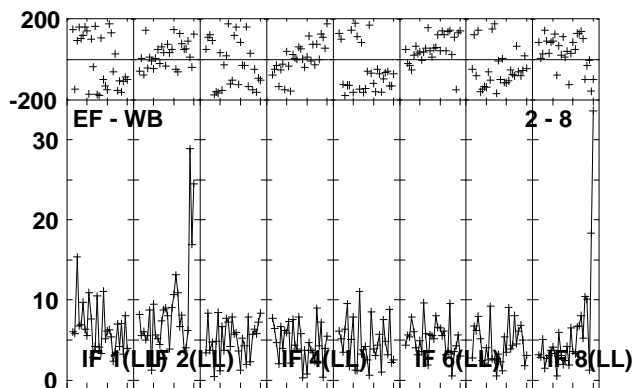
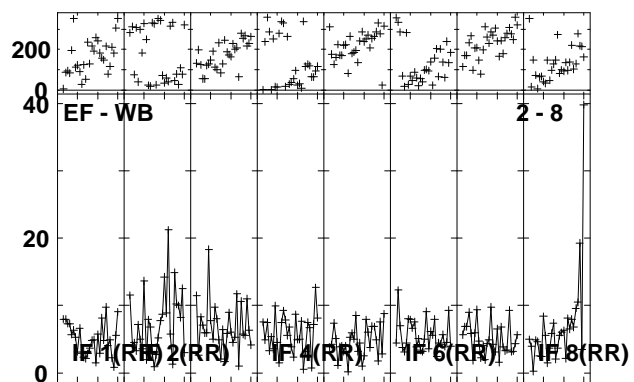
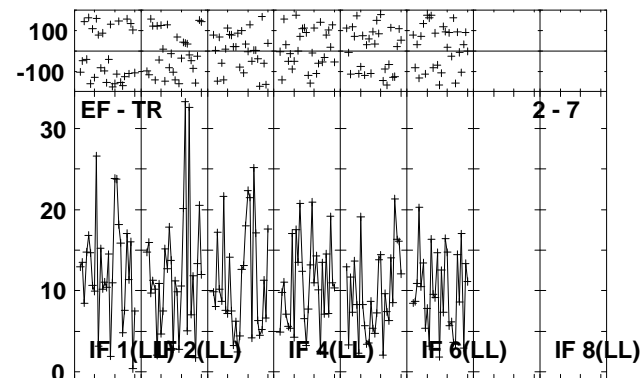
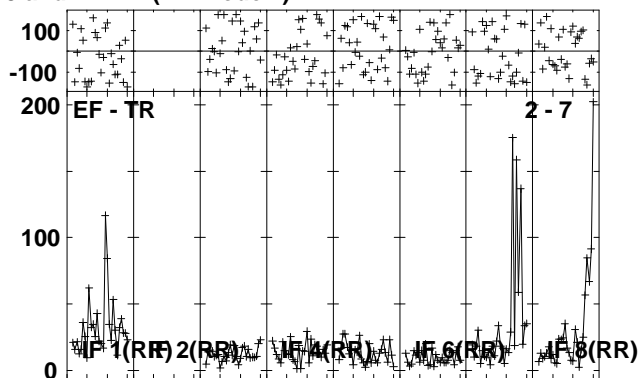
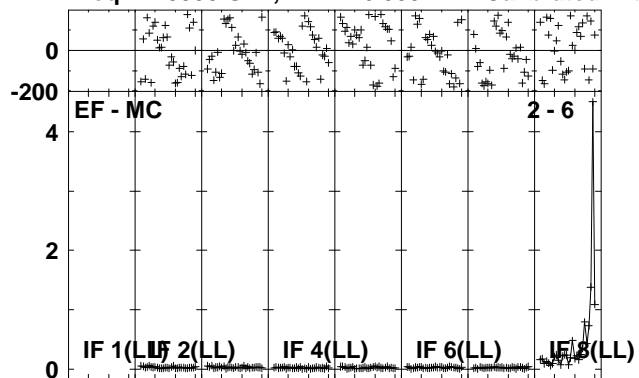

Lower frame: Ampl Jy Top frame: Phas deg  
Vector averaged cross-power spectrum Several baselines displayed  
Timerange: 00/16:53:01 to 00/16:56:29

Plot file version 189 created 30-NOV-2010 14:32:33

J1128+59 EP068B 3.UVDATA.1

Freq = 1.5950 GHz, Bw = 16.000 MH Calibrated with CL # 3 and BP # 1 (BP mode 1)

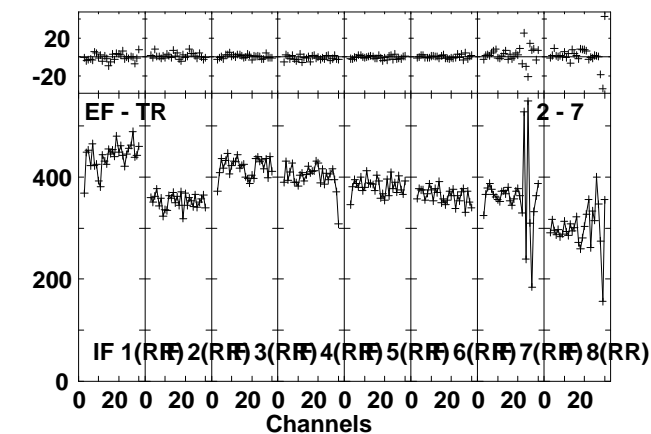
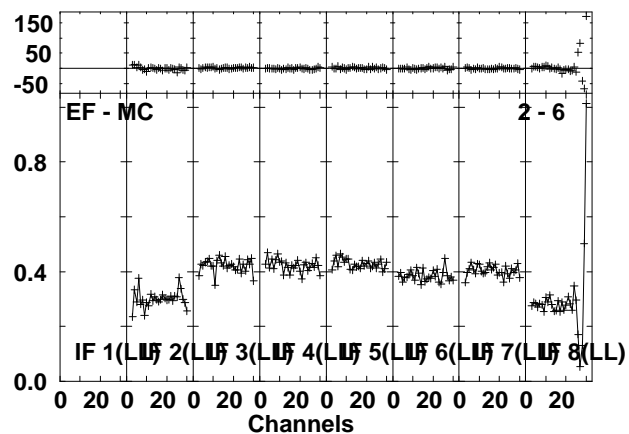
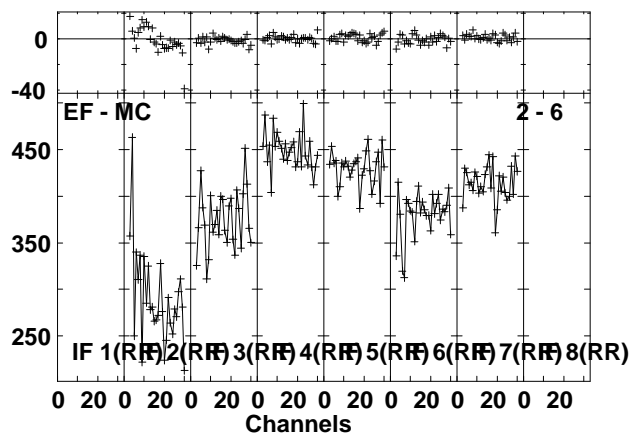
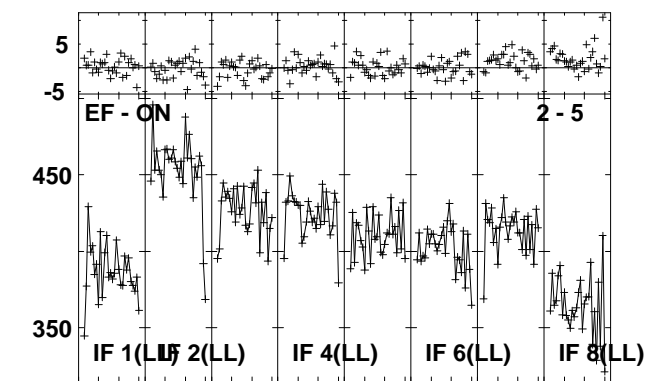
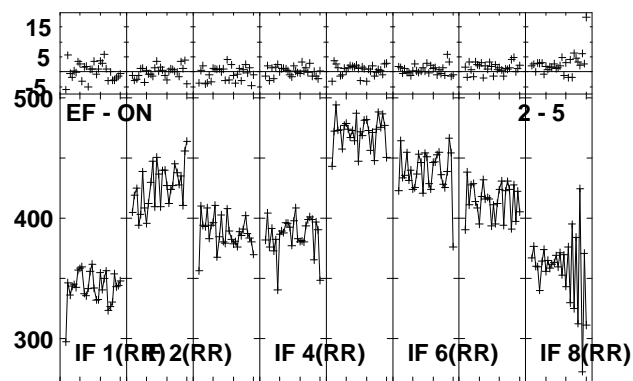
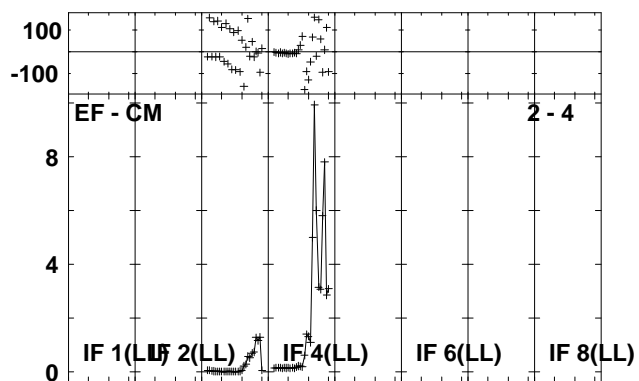
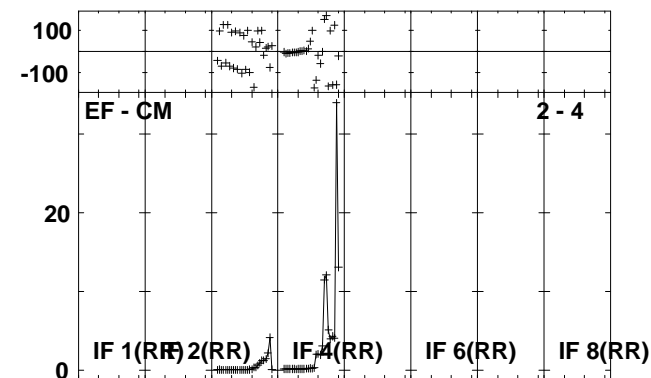
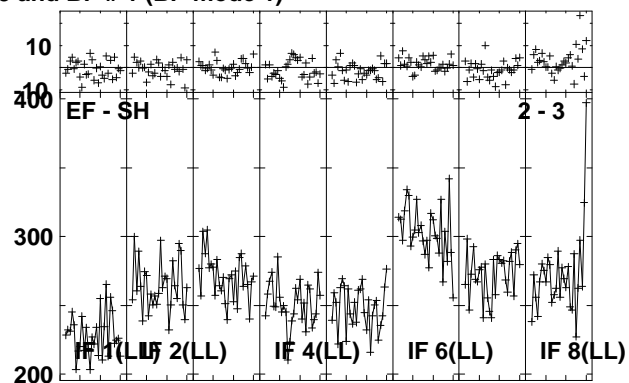
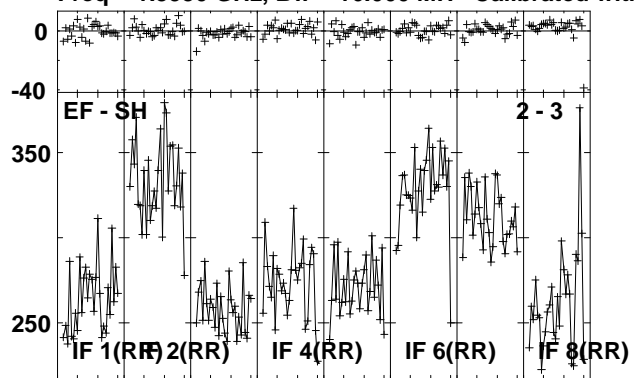

Lower frame: Milli Ampl Jy Top frame: Phas deg  
Vector averaged cross-power spectrum Several baselines displayed  
Timerange: 00/16:57:31 to 00/16:58:57

Plot file version 190 created 30-NOV-2010 14:32:34

J1128+59 EP068B 3.UVDATA.1

Freq = 1.5950 GHz, Bw = 16.000 MH Calibrated with CL # 3 and BP # 1 (BP mode 1)

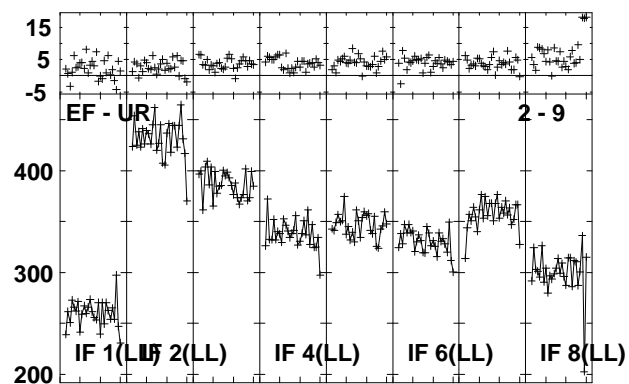
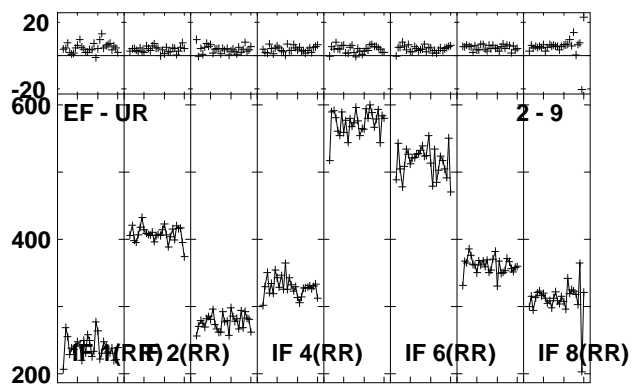
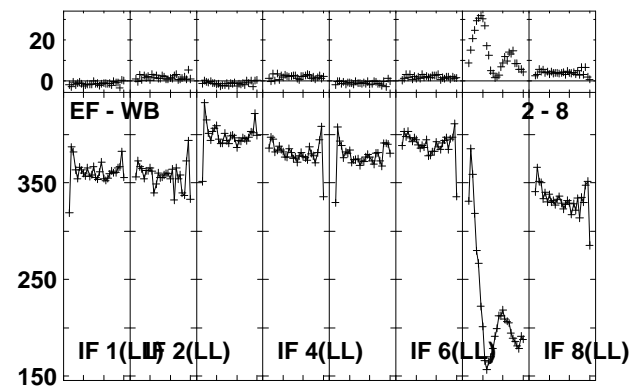
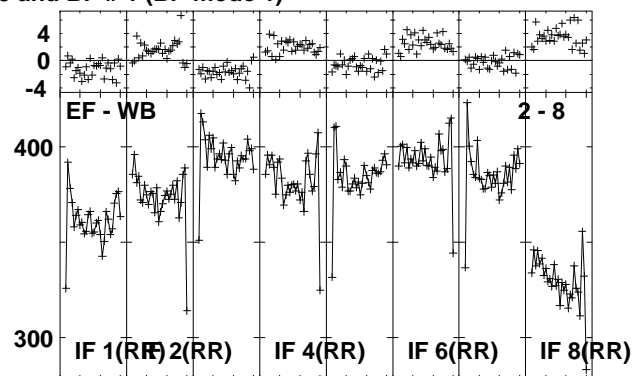
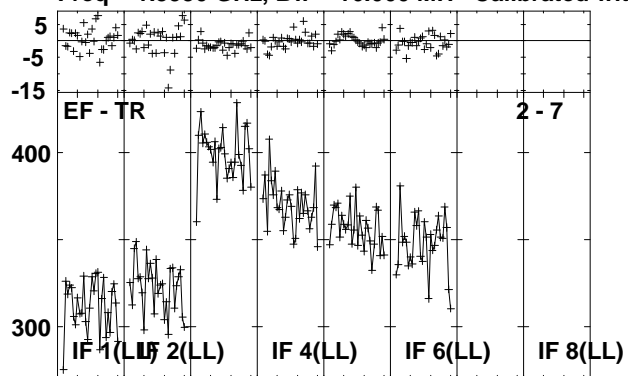

Lower frame: Milli Ampl Jy Top frame: Phas deg  
Vector averaged cross-power spectrum Several baselines displayed  
Timerange: 00/16:57:31 to 00/16:58:57

Plot file version 191 created 30-NOV-2010 14:32:36

ARP299C EP068B 3.UVDATA.1

Freq = 1.5950 GHz, Bw = 16.000 MH Calibrated with CL # 3 and BP # 1 (BP mode 1)

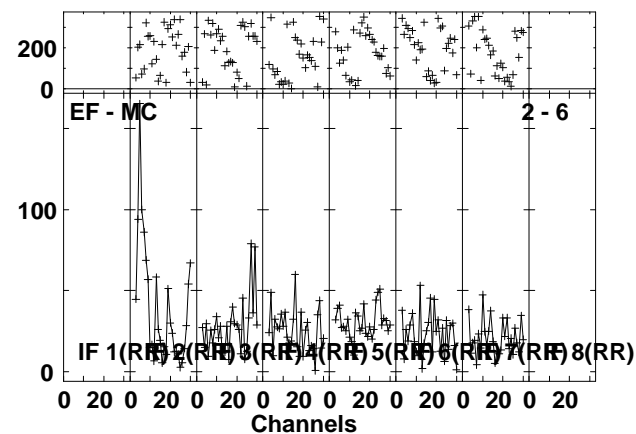
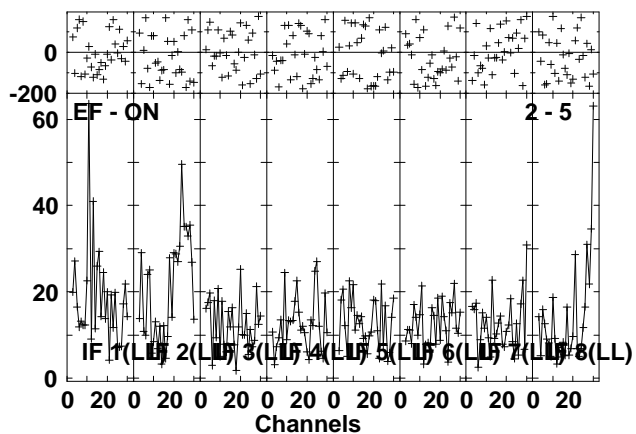
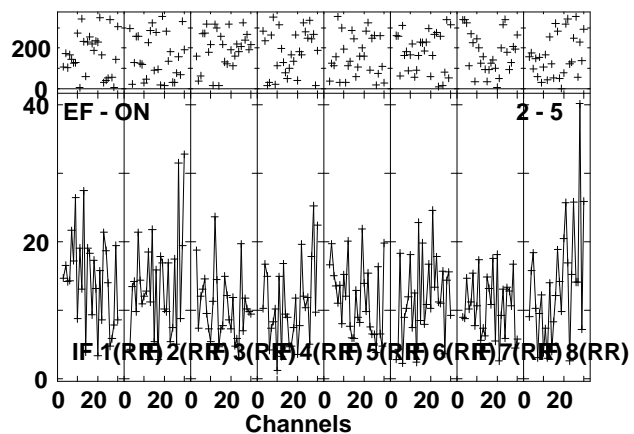
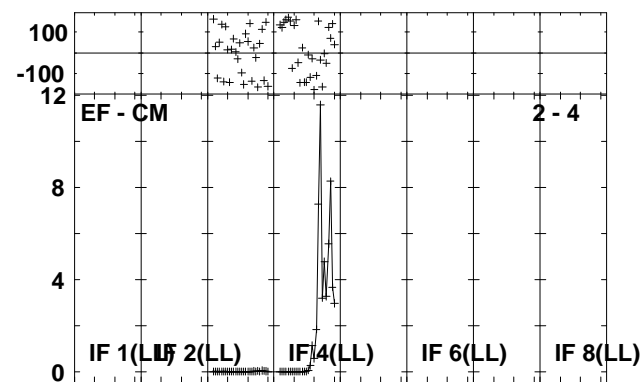
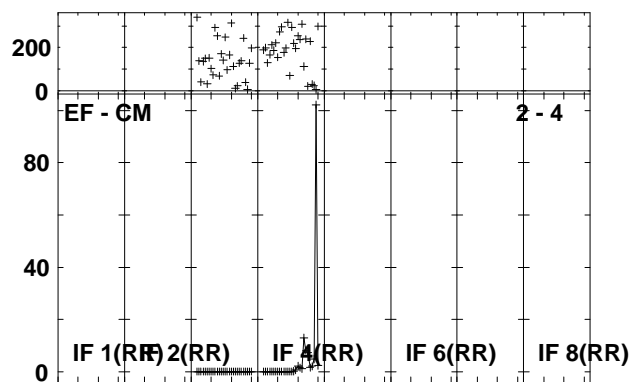
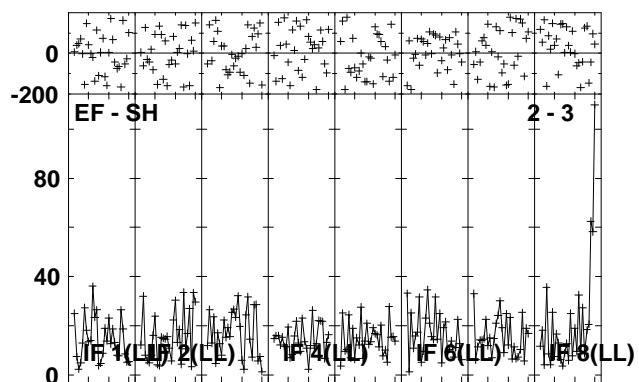
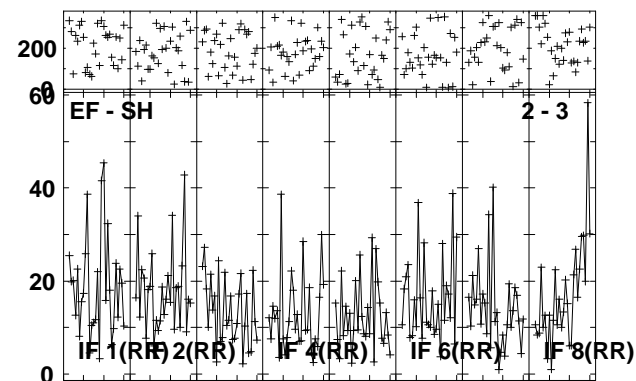
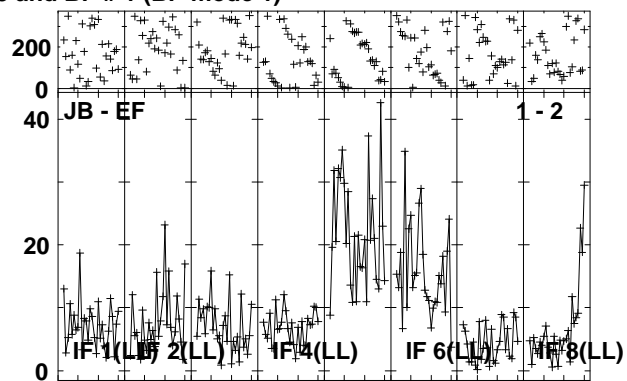
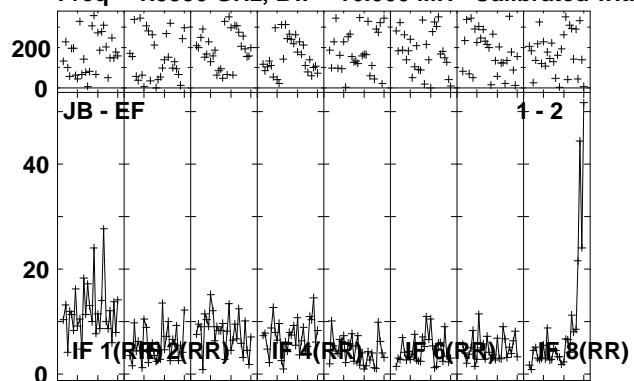

Lower frame: Milli Ampl Jy Top frame: Phas deg  
Vector averaged cross-power spectrum Several baselines displayed  
Timerange: 00/16:59:01 to 00/17:02:29

Plot file version 192 created 30-NOV-2010 14:32:38

ARP299C EP068B 3.UVDATA.1

Freq = 1.5950 GHz, Bw = 16.000 MH Calibrated with CL # 3 and BP # 1 (BP mode 1)

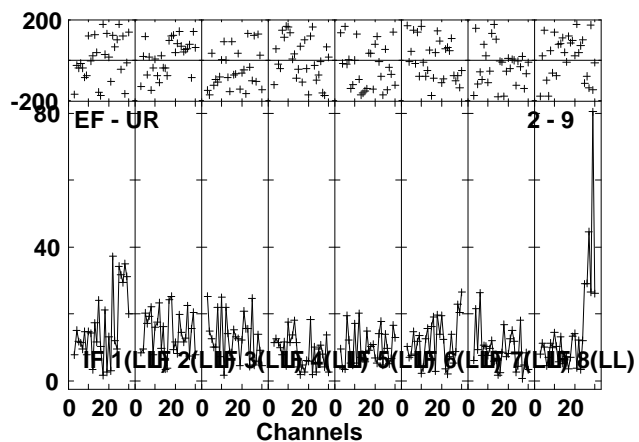
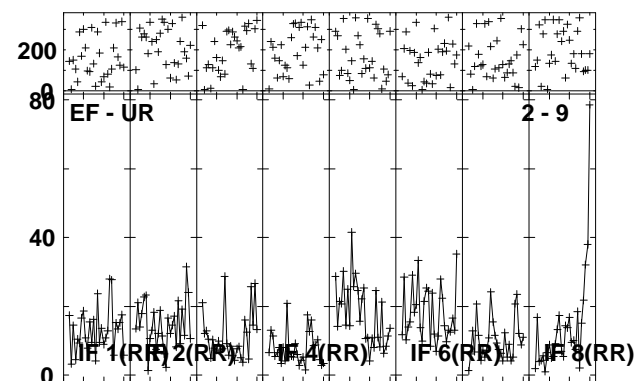
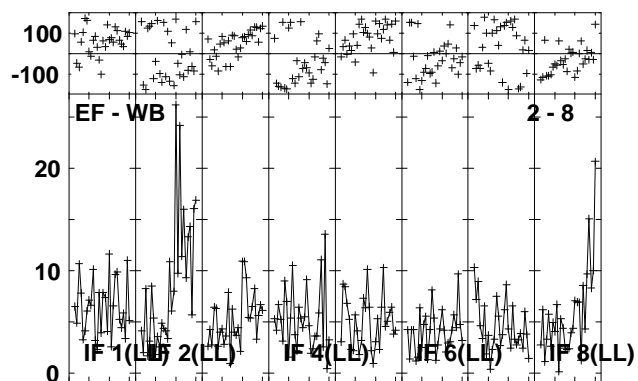
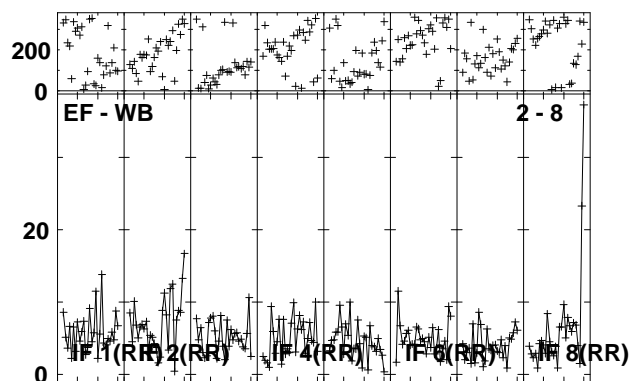
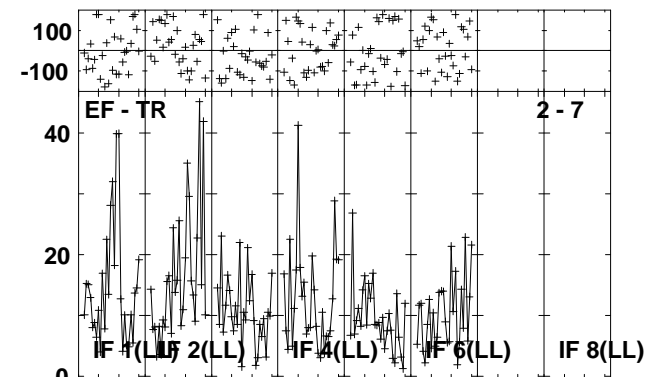
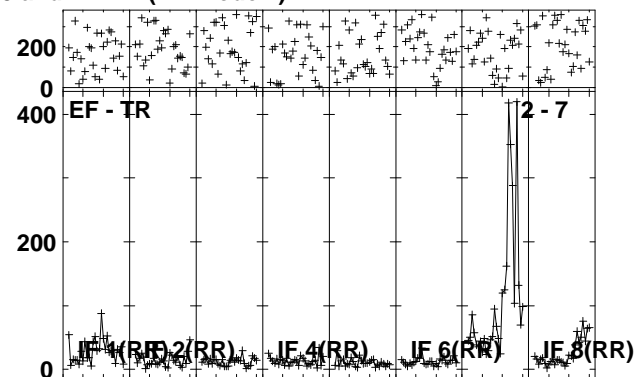
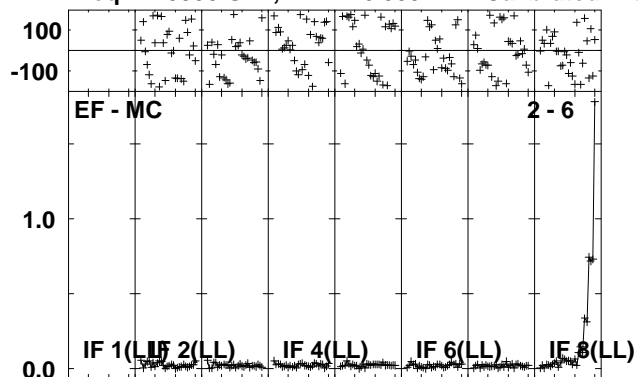

Lower frame: Ampl Jy Top frame: Phas deg

Vector averaged cross-power spectrum Several baselines displayed

Timerange: 00/16:59:01 to 00/17:02:29



Plot file version 193 created 30-NOV-2010 14:32:41

J1128+59 EP068B 3.UVDATA.1

Freq = 1.5950 GHz, Bw = 16.000 MH Calibrated with CL # 3 and BP # 1 (BP mode 1)

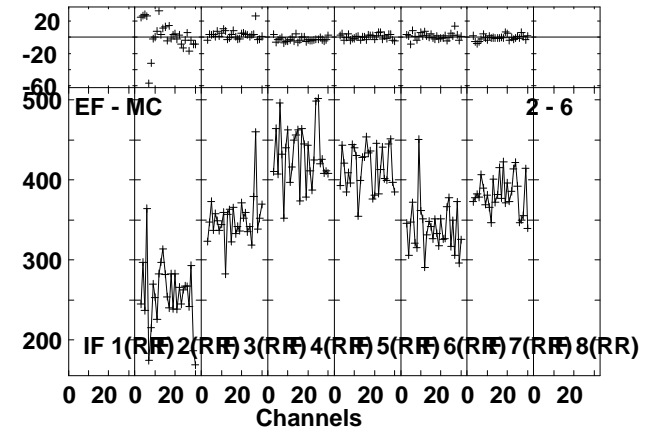
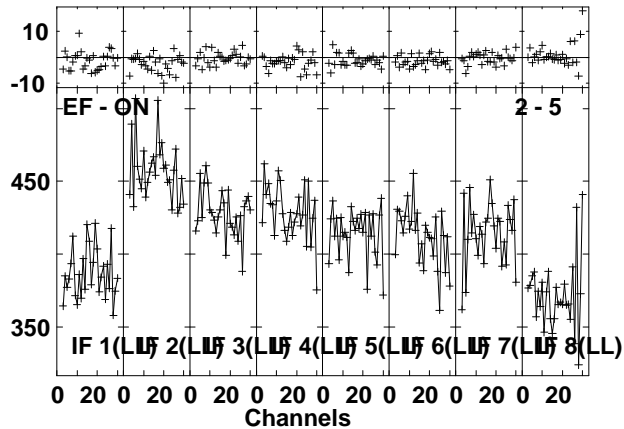
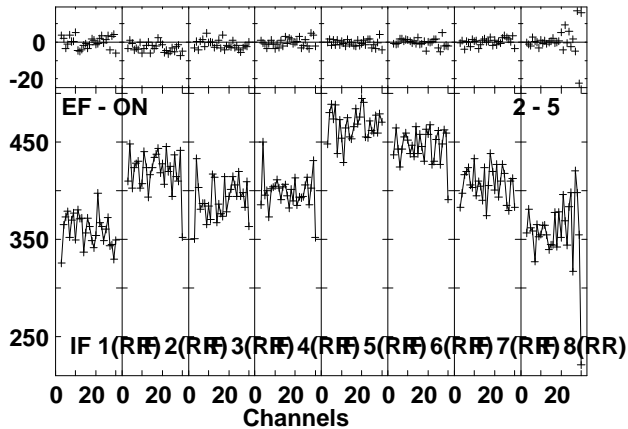
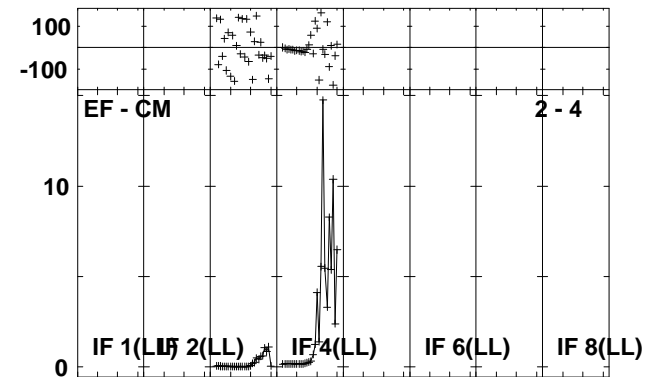
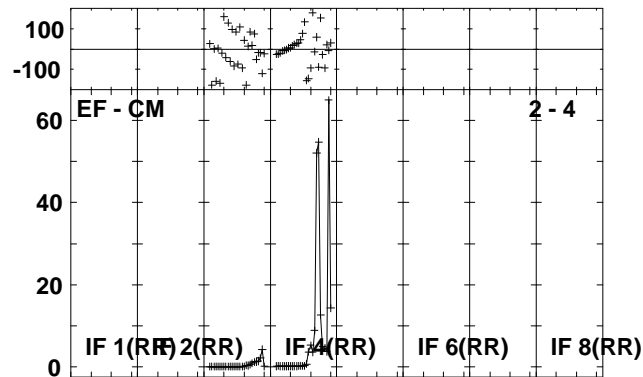
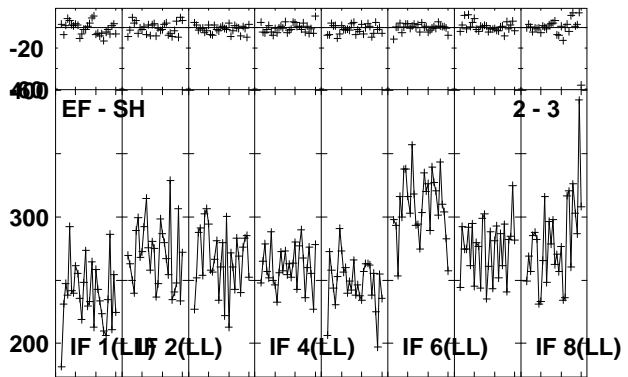
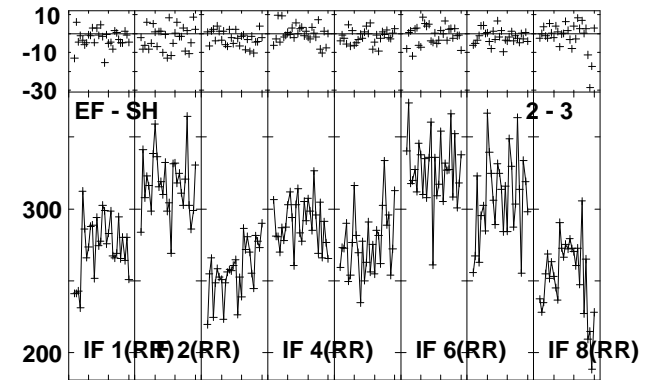
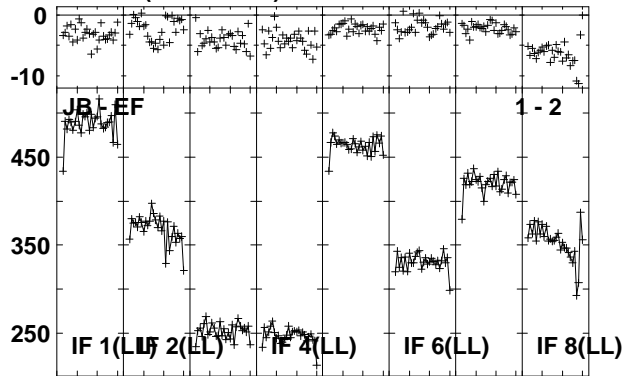
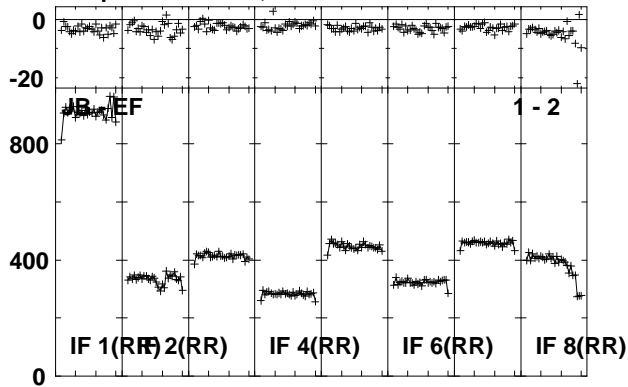

Lower frame: Milli Ampl Jy Top frame: Phas deg  
Vector averaged cross-power spectrum Several baselines displayed  
Timerange: 00/17:02:31 to 00/17:03:59

Plot file version 194 created 30-NOV-2010 14:32:42

J1128+59 EP068B 3.UVDATA.1

Freq = 1.5950 GHz, Bw = 16.000 MH Calibrated with CL # 3 and BP # 1 (BP mode 1)

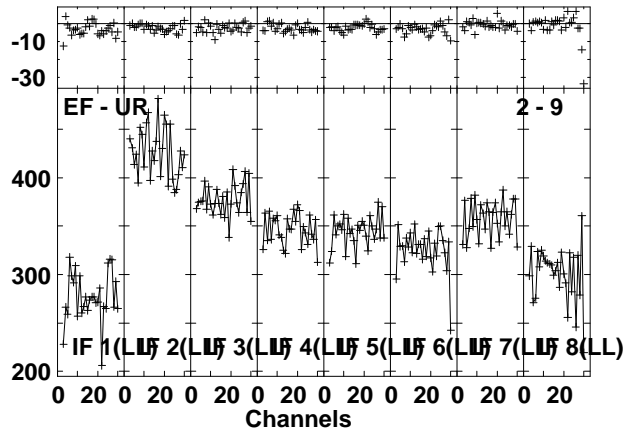
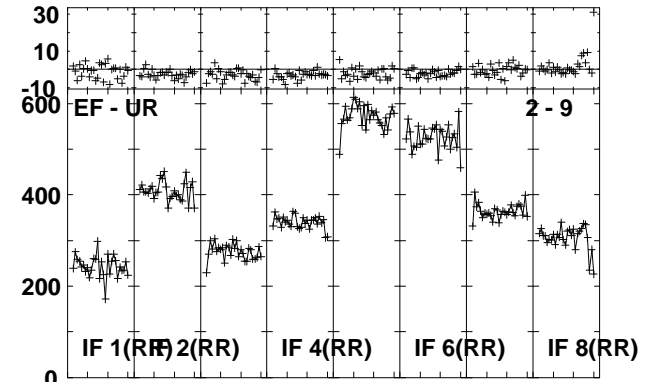
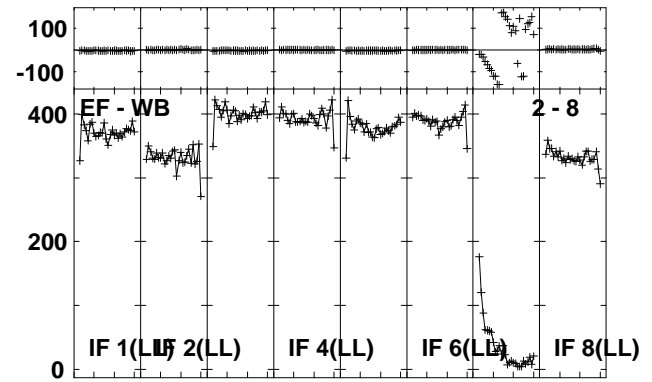
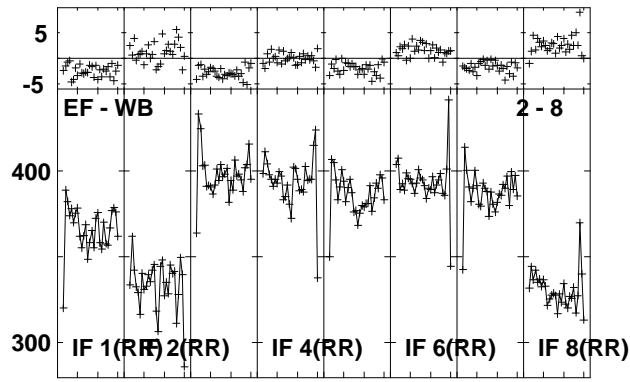
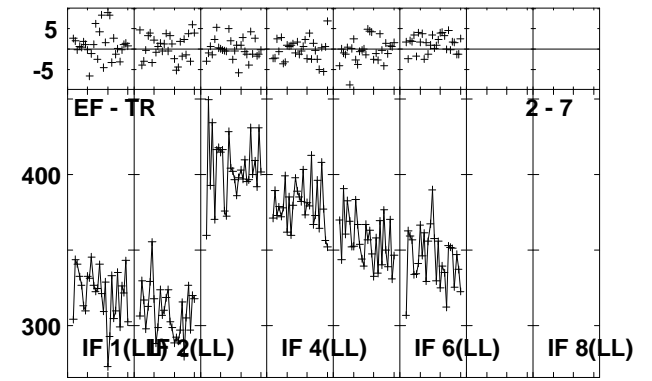
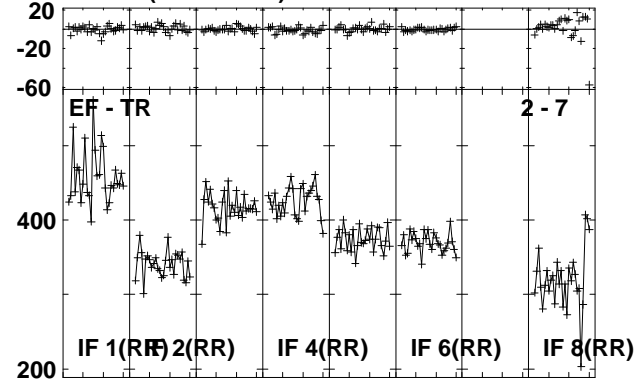
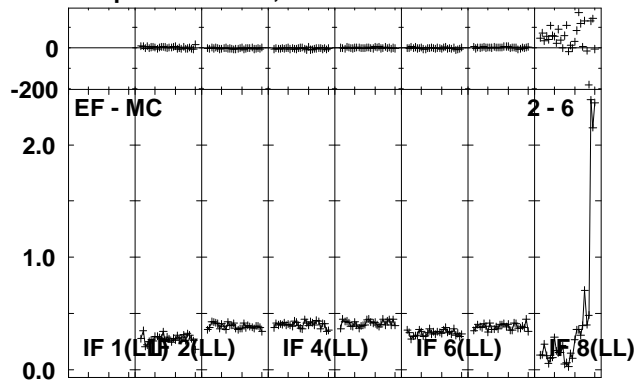

Lower frame: Ampl Jy Top frame: Phas deg  
Vector averaged cross-power spectrum Several baselines displayed  
Timerange: 00/17:02:31 to 00/17:03:59

Plot file version 195 created 30-NOV-2010 14:32:44

ARP299C EP068B 3.UVDATA.1

Freq = 1.5950 GHz, Bw = 16.000 MH Calibrated with CL # 3 and BP # 1 (BP mode 1)

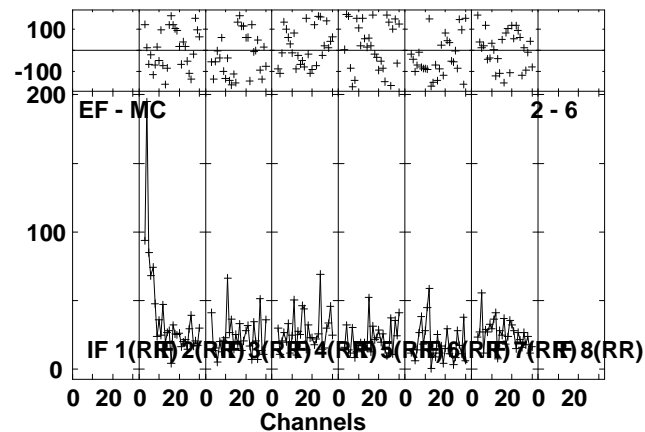
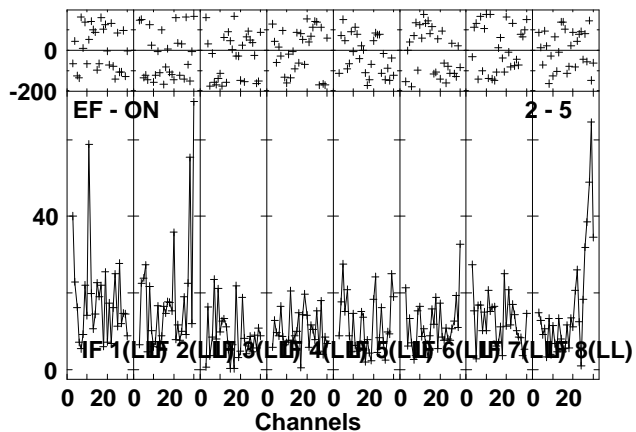
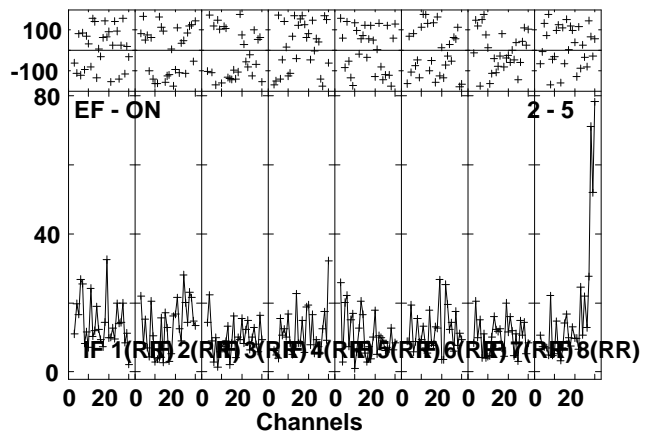
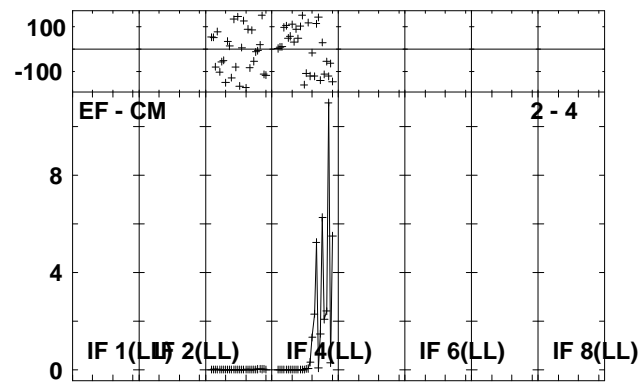
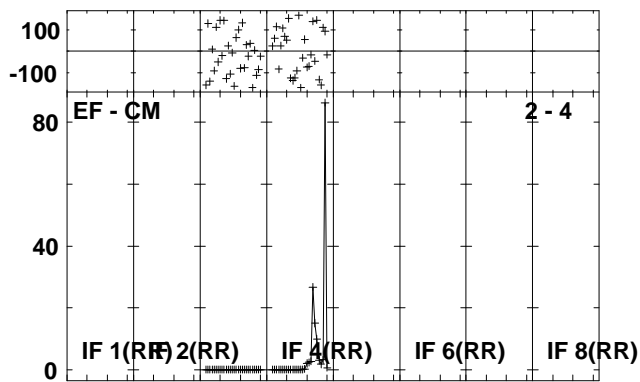
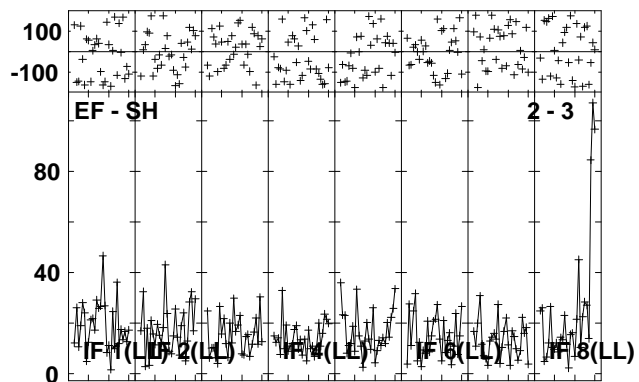
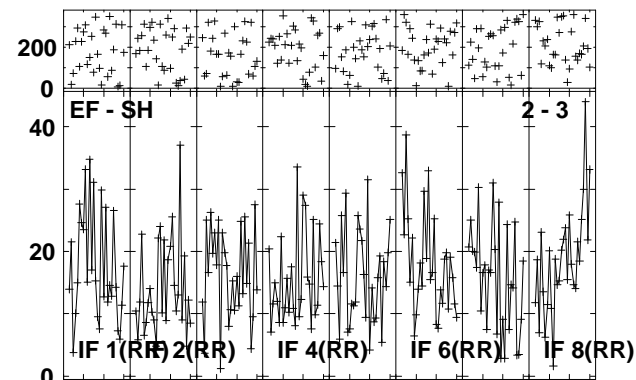
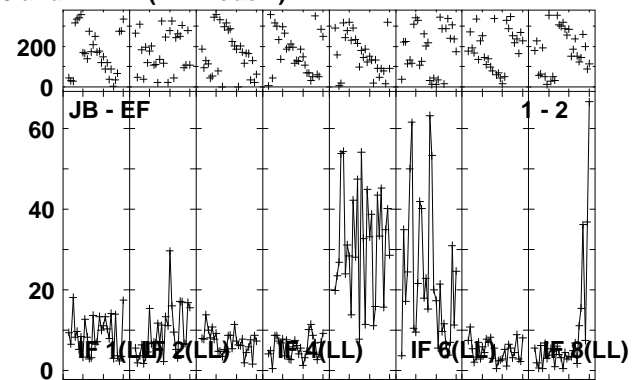
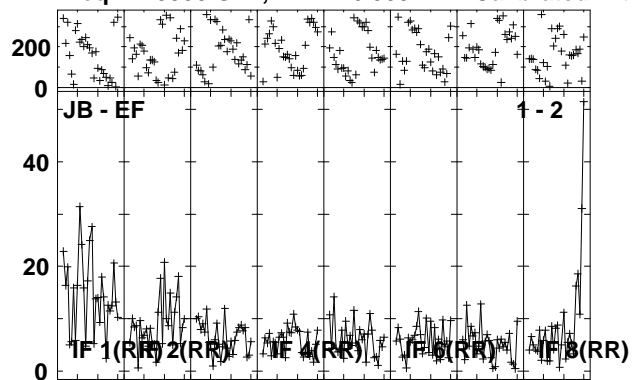

Lower frame: Milli Ampl Jy Top frame: Phas deg  
Vector averaged cross-power spectrum Several baselines displayed  
Timerange: 00/17:04:01 to 00/17:07:29

Plot file version 196 created 30-NOV-2010 14:32:47  
 ARP299C EP068B 3.UVDATA.1  
 Freq = 1.5950 GHz, Bw = 16.000 MH Calibrated with CL # 3 and BP # 1 (BP mode 1)

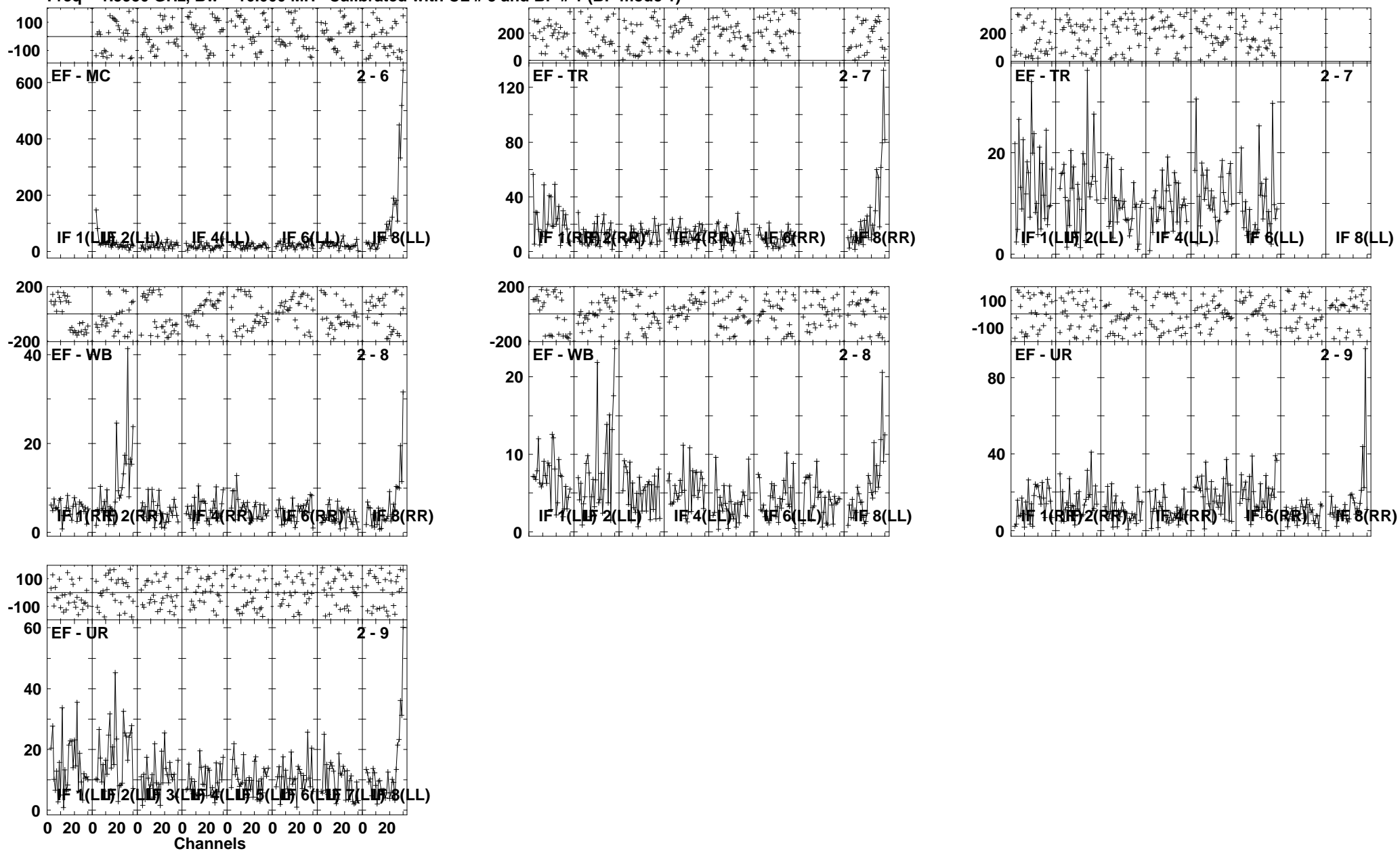

Lower frame: Milli Ampl Jy Top frame: Phas deg  
 Vector averaged cross-power spectrum Several baselines displayed  
 Timerange: 00/17:04:01 to 00/17:07:29

Plot file version 197 created 30-NOV-2010 14:32:50

J1128+59 EP068B 3.UVDATA.1

Freq = 1.5950 GHz, Bw = 16.000 MH Calibrated with CL # 3 and BP # 1 (BP mode 1)

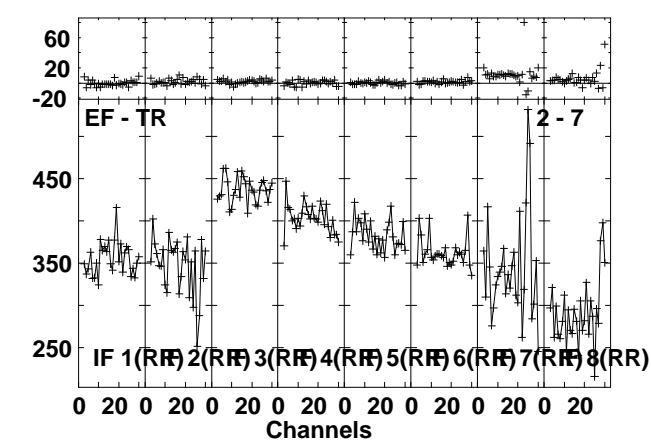
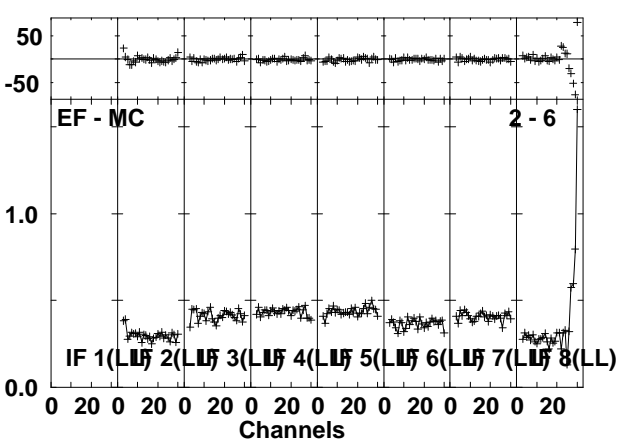
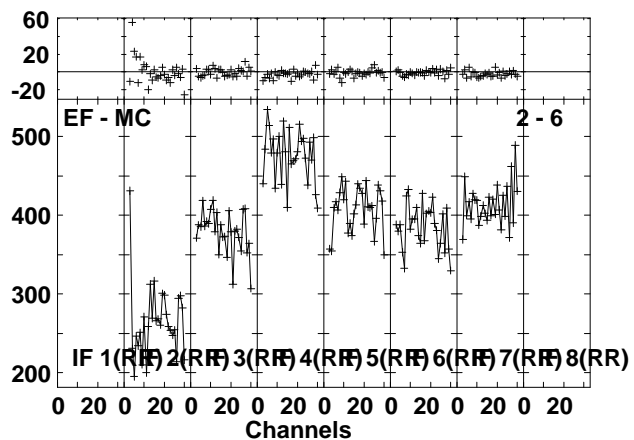
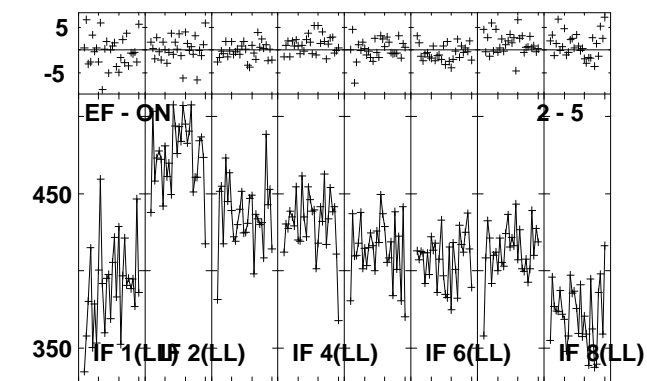
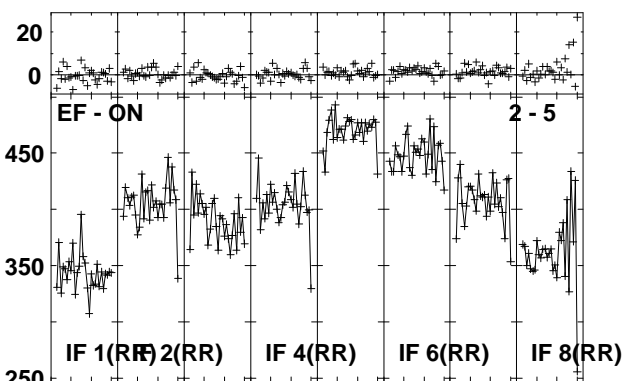
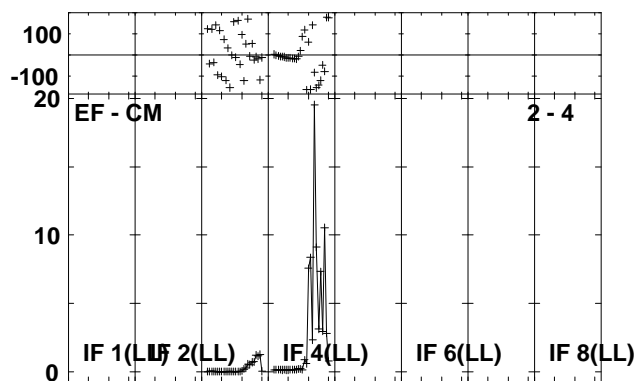
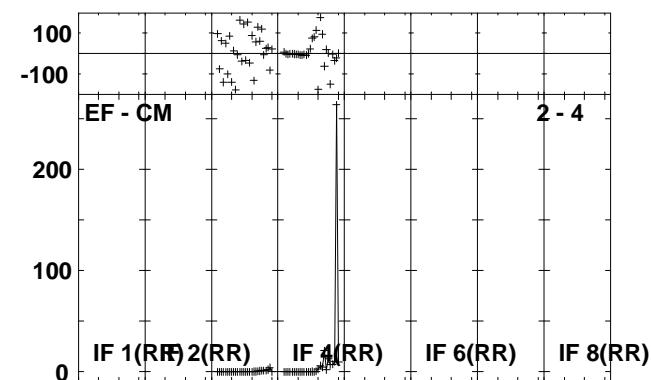
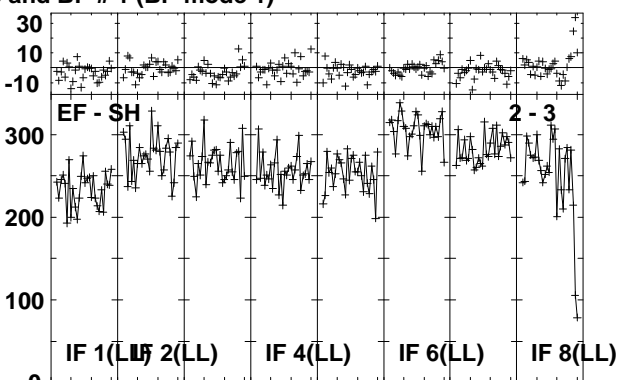
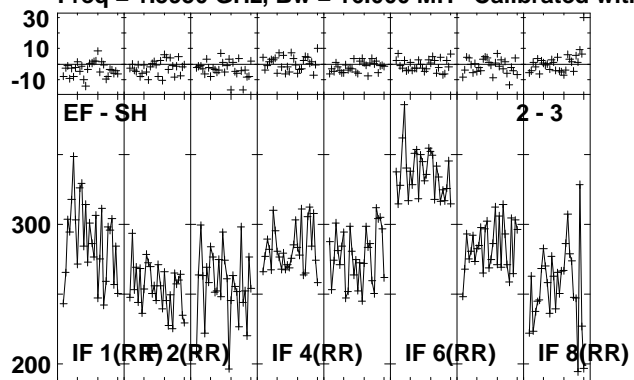

Lower frame: Milli Ampl Jy Top frame: Phas deg  
Vector averaged cross-power spectrum Several baselines displayed  
Timerange: 00/17:07:31 to 00/17:08:59

Plot file version 198 created 30-NOV-2010 14:32:51

J1128+59 EP068B 3.UVDATA.1

Freq = 1.5950 GHz, Bw = 16.000 MH Calibrated with CL # 3 and BP # 1 (BP mode 1)

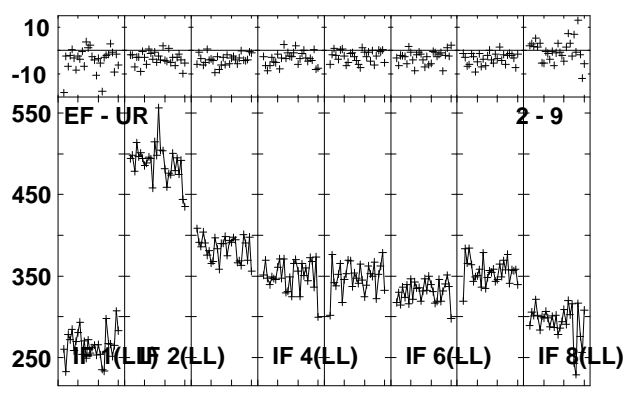
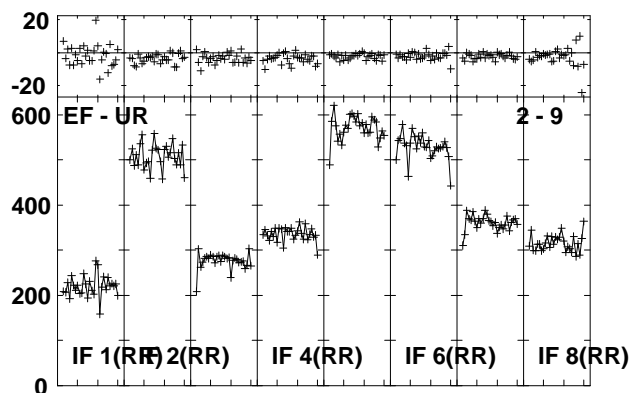
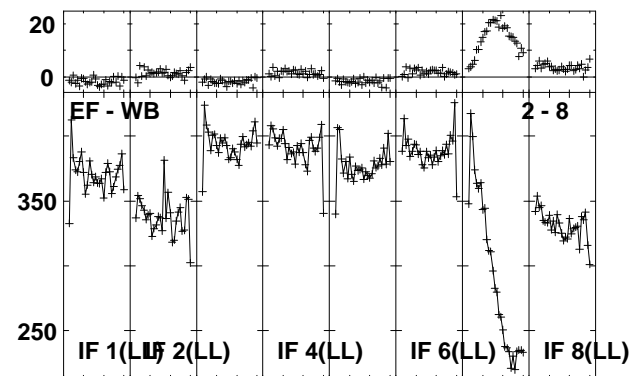
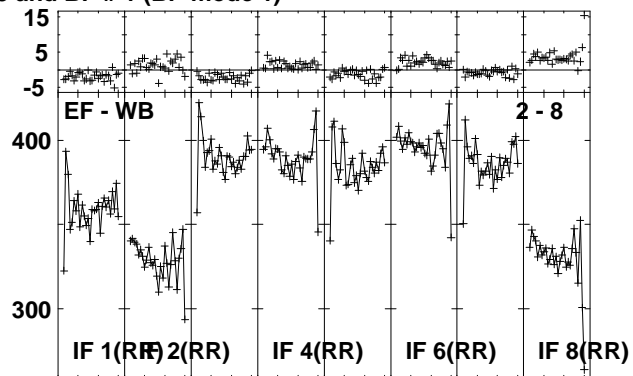
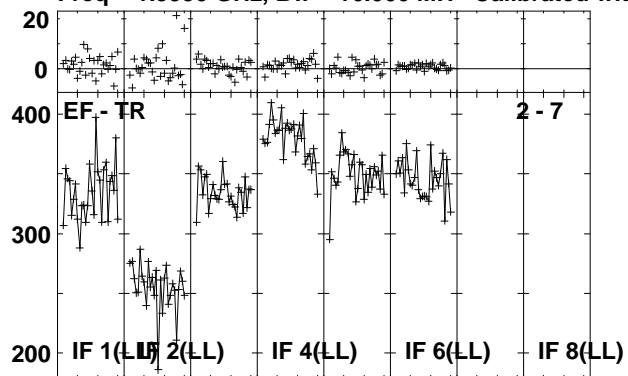

Lower frame: Milli Ampl Jy Top frame: Phas deg  
Vector averaged cross-power spectrum Several baselines displayed  
Timerange: 00/17:07:31 to 00/17:08:59

Plot file version 199 created 30-NOV-2010 14:32:52

ARP299C EP068B 3.UVDATA.1

Freq = 1.5950 GHz, Bw = 16.000 MH Calibrated with CL # 3 and BP # 1 (BP mode 1)

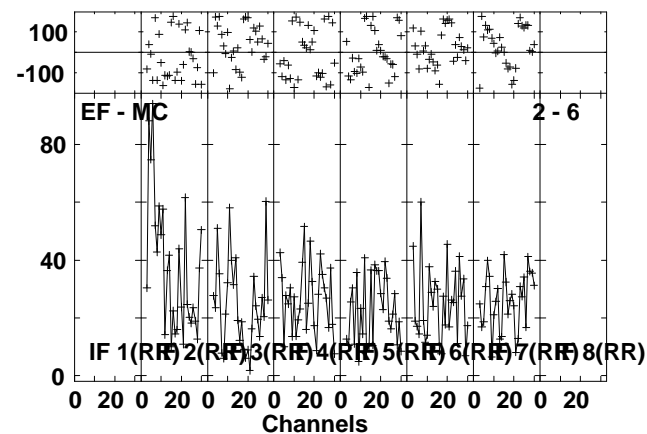
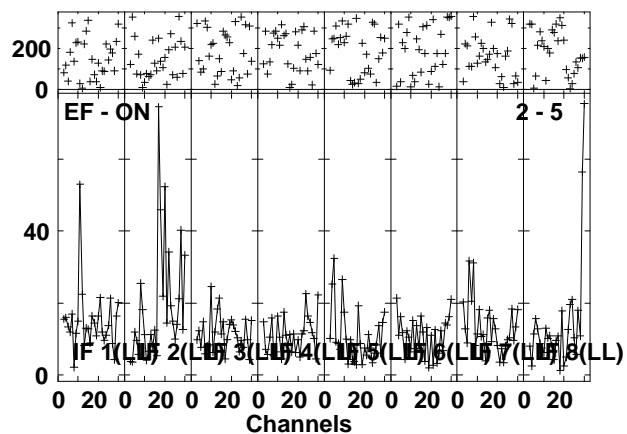
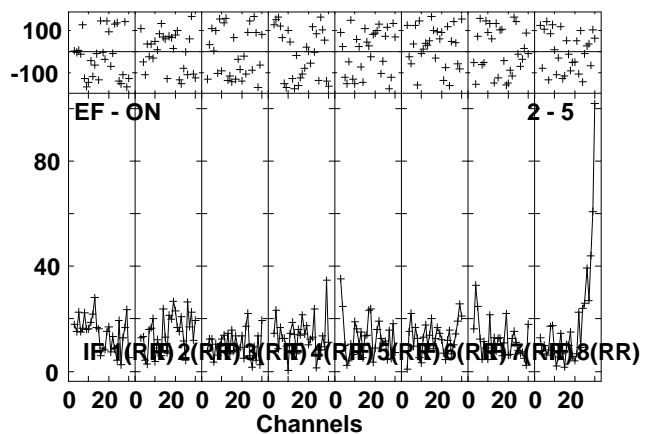
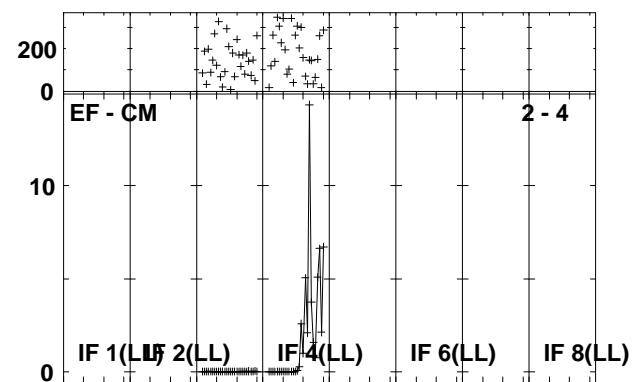
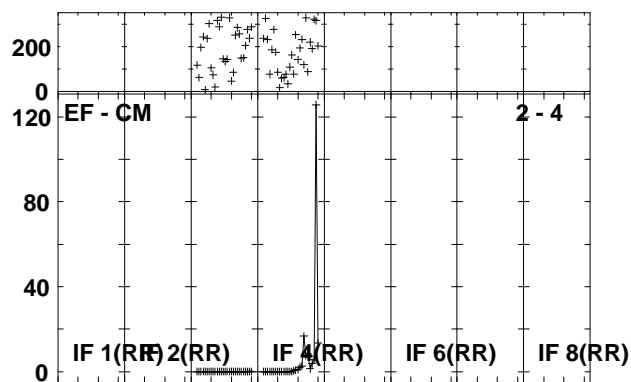
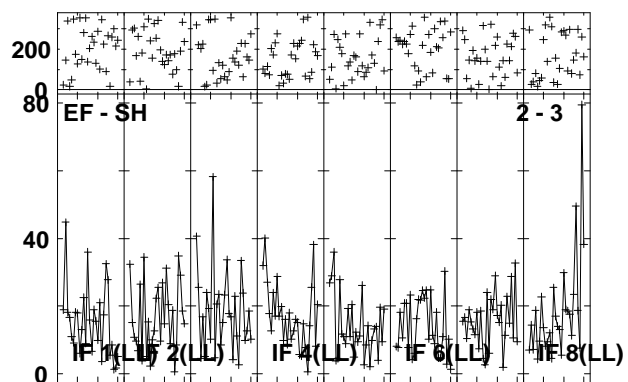
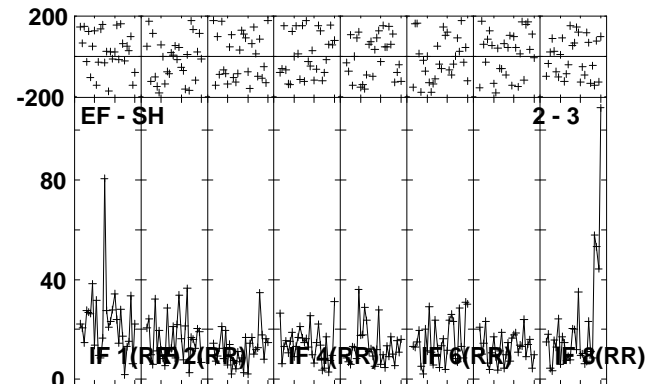
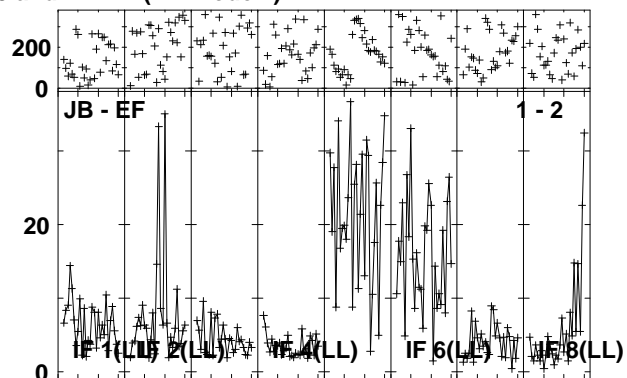
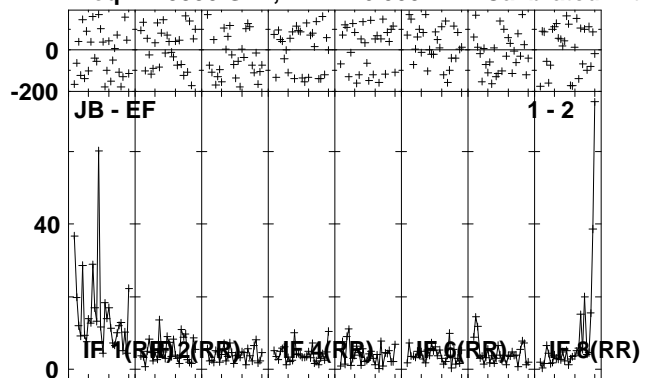

Lower frame: Milli Ampl Jy Top frame: Phas deg  
Vector averaged cross-power spectrum Several baselines displayed  
Timerange: 00/17:09:01 to 00/17:12:29

Plot file version 200 created 30-NOV-2010 14:32:55  
 ARP299C EP068B 3.UVDATA.1  
 Freq = 1.5950 GHz, Bw = 16.000 MH Calibrated with CL # 3 and BP # 1 (BP mode 1)

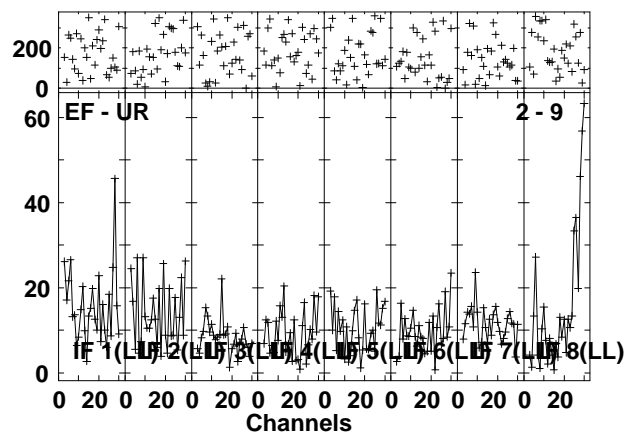
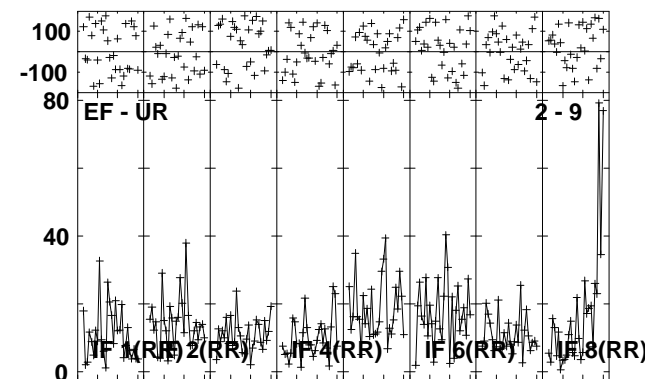
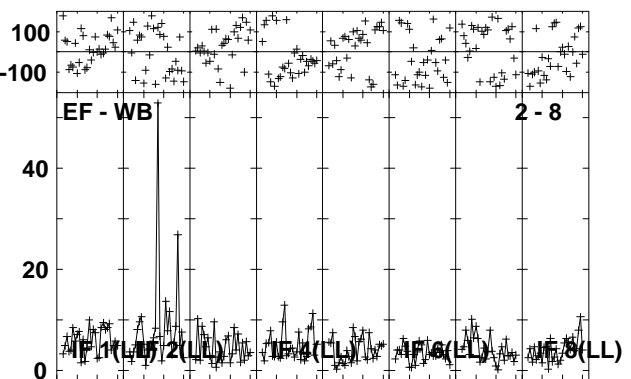
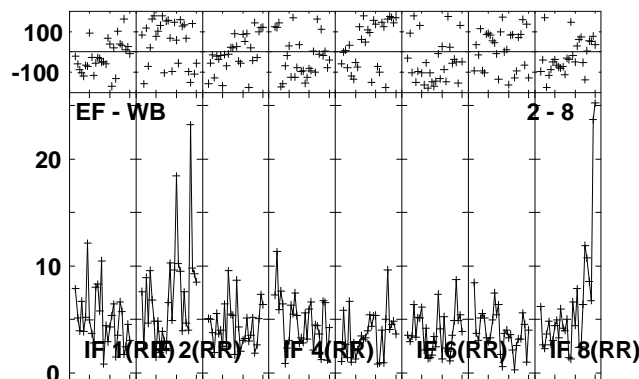
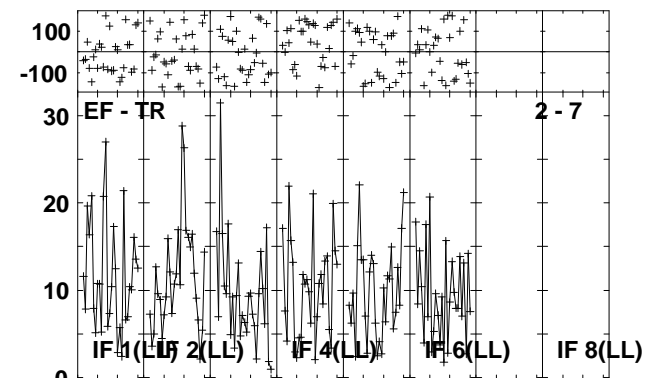
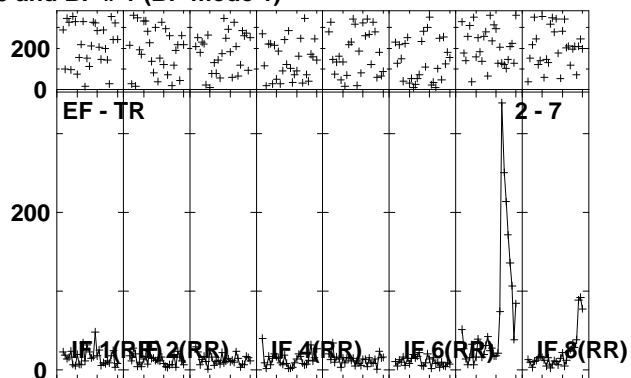
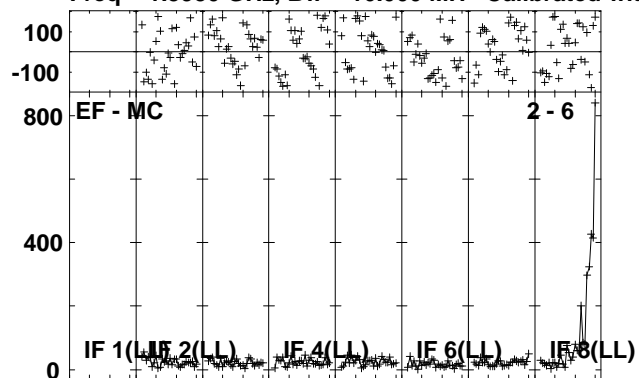

Lower frame: Milli Ampl Jy Top frame: Phas deg  
 Vector averaged cross-power spectrum Several baselines displayed  
 Timerange: 00/17:09:01 to 00/17:12:29



Plot file version 201 created 30-NOV-2010 14:32:58

J1128+59 EP068B 3.UVDATA.1

Freq = 1.5950 GHz, Bw = 16.000 MH Calibrated with CL # 3 and BP # 1 (BP mode 1)

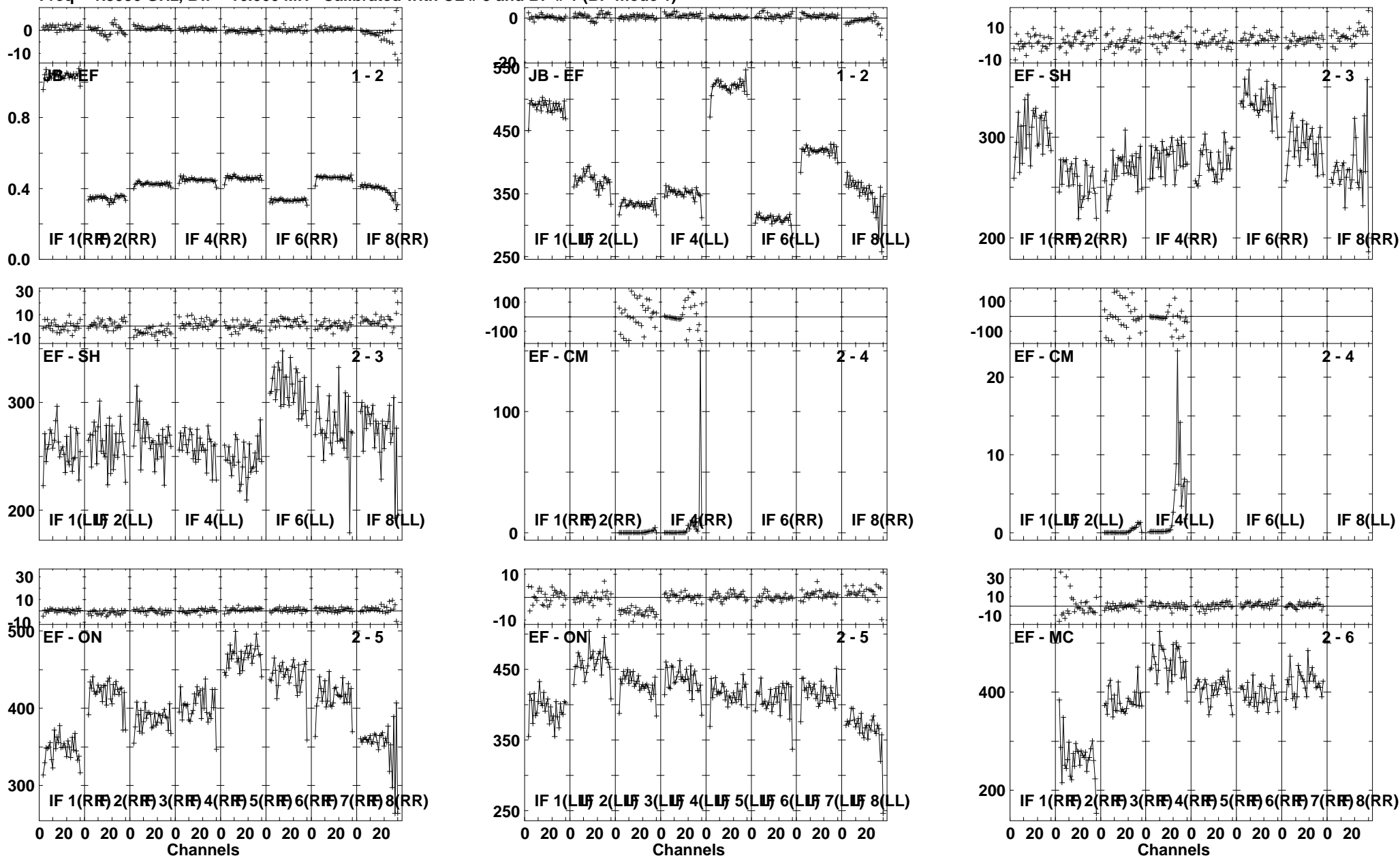

Lower frame: Ampl Jy Top frame: Phas deg  
Vector averaged cross-power spectrum Several baselines displayed  
Timerange: 00/17:13:31 to 00/17:14:59

Plot file version 202 created 30-NOV-2010 14:33:00

J1128+59 EP068B 3.UVDATA.1

Freq = 1.5950 GHz, Bw = 16.000 MH Calibrated with CL # 3 and BP # 1 (BP mode 1)

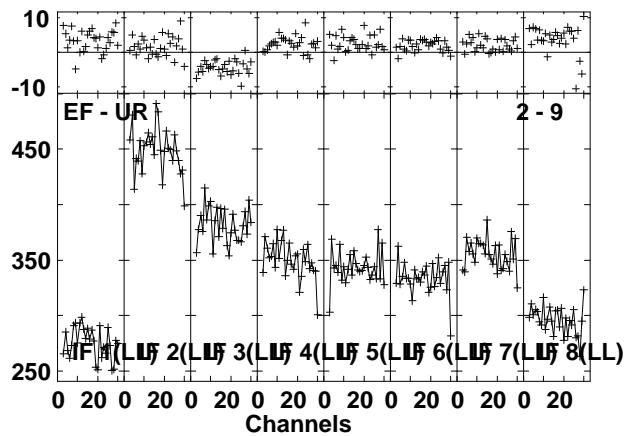
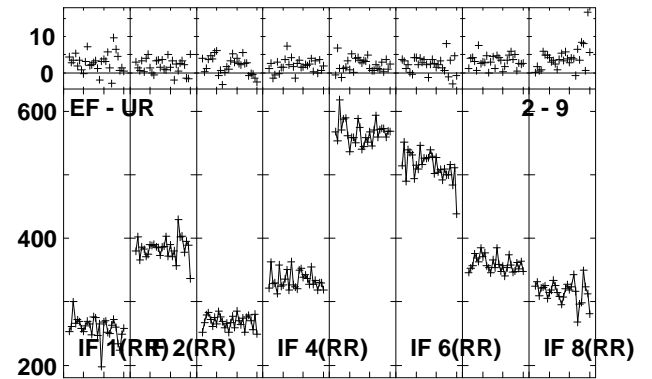
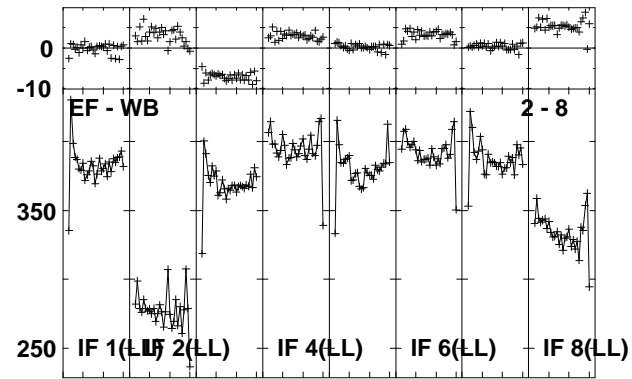
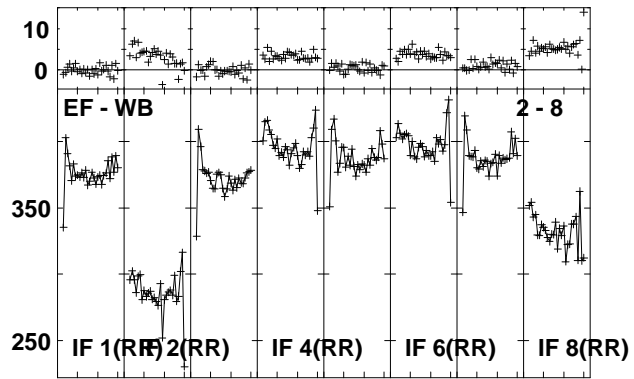
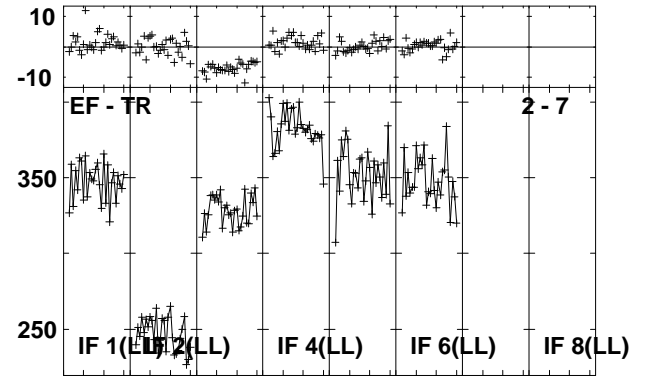
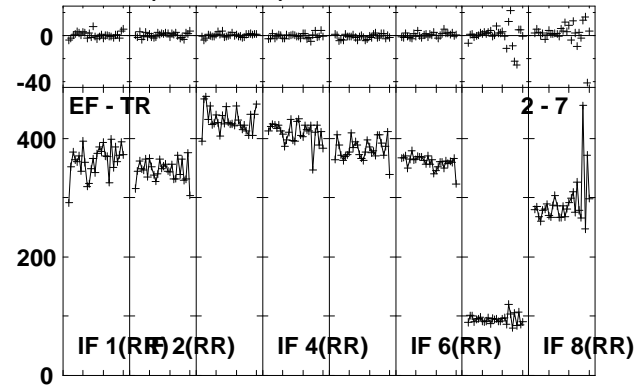
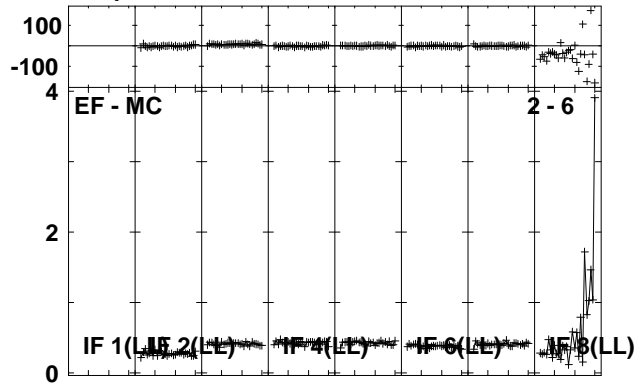

Lower frame: Ampl Jy Top frame: Phas deg  
Vector averaged cross-power spectrum Several baselines displayed  
Timerange: 00/17:13:31 to 00/17:14:59

Plot file version 203 created 30-NOV-2010 14:33:02

ARP299C EP068B 3.UVDATA.1

Freq = 1.5950 GHz, Bw = 16.000 MH Calibrated with CL # 3 and BP # 1 (BP mode 1)

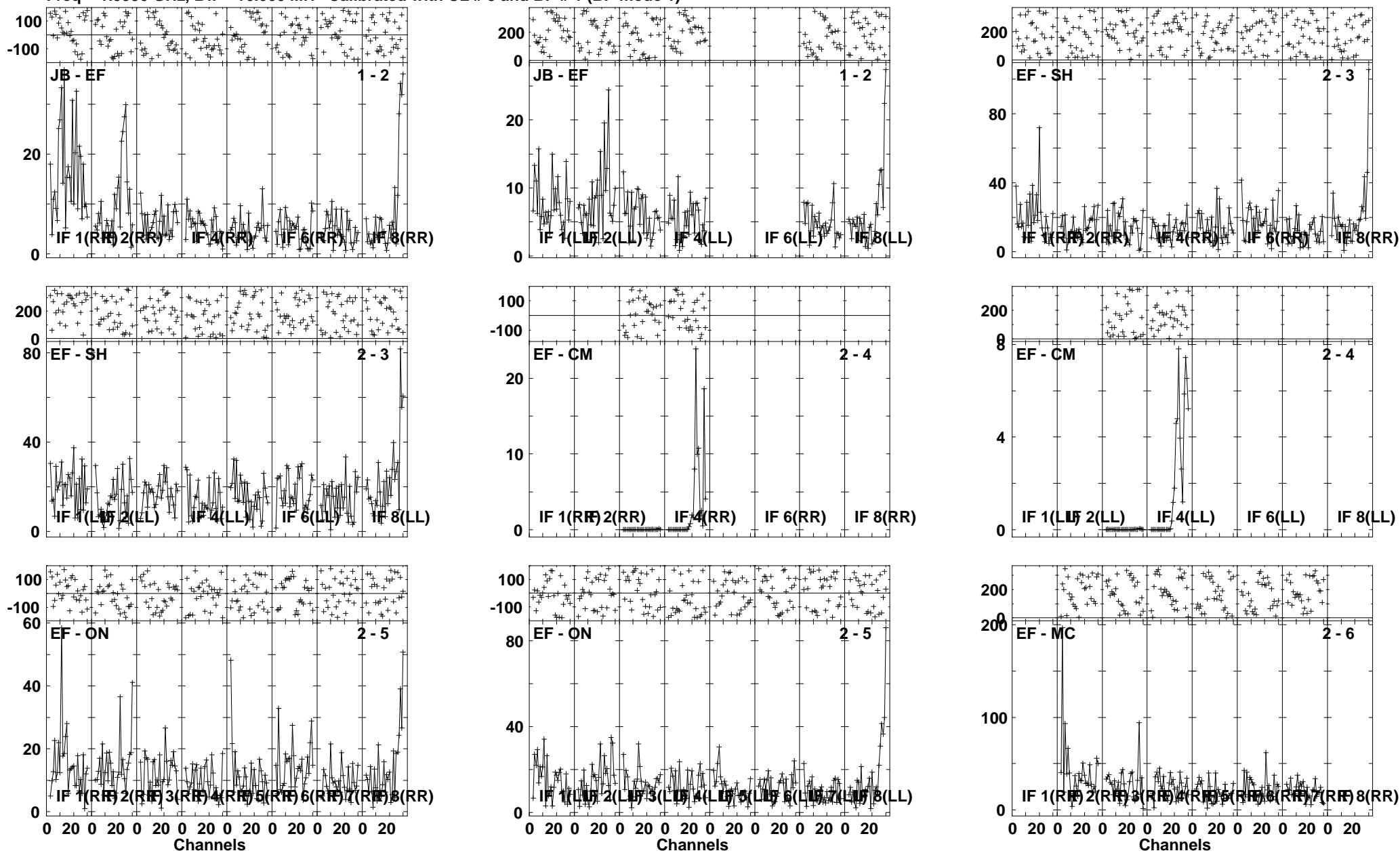

Lower frame: Milli Ampl Jy Top frame: Phas deg  
Vector averaged cross-power spectrum Several baselines displayed  
Timerange: 00/17:15:01 to 00/17:18:29

Plot file version 204 created 30-NOV-2010 14:33:05

ARP299C EP068B 3.UVDATA.1

Freq = 1.5950 GHz, Bw = 16.000 MH Calibrated with CL # 3 and BP # 1 (BP mode 1)

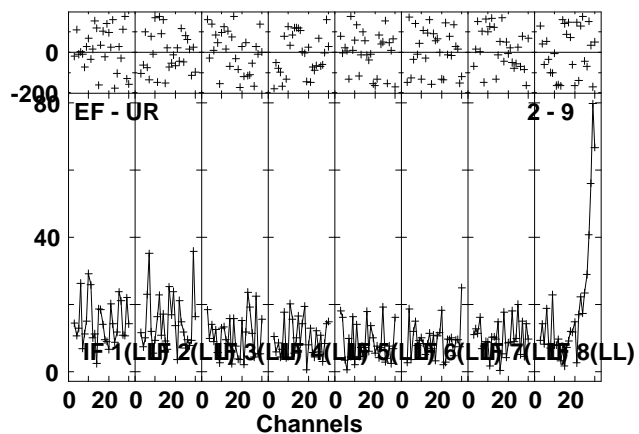
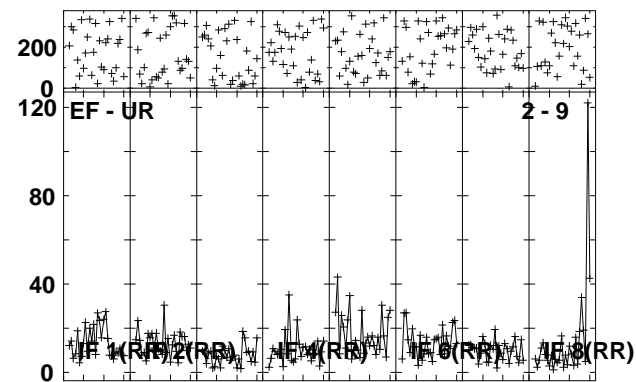
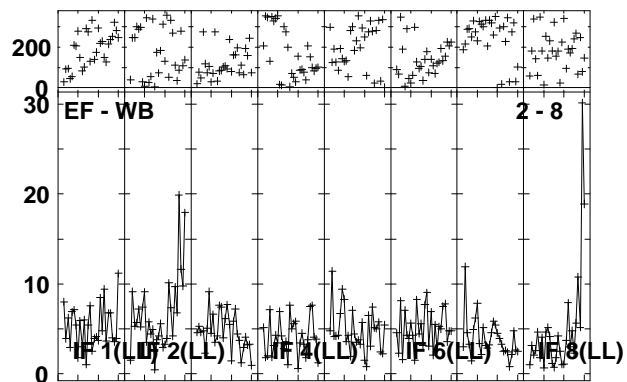
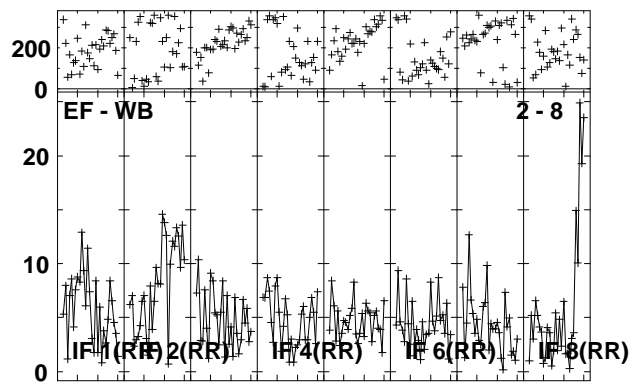
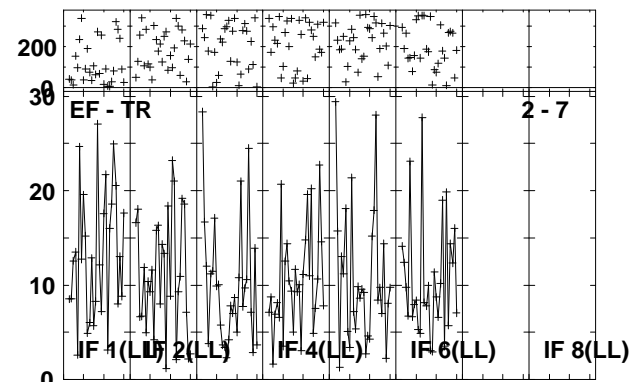
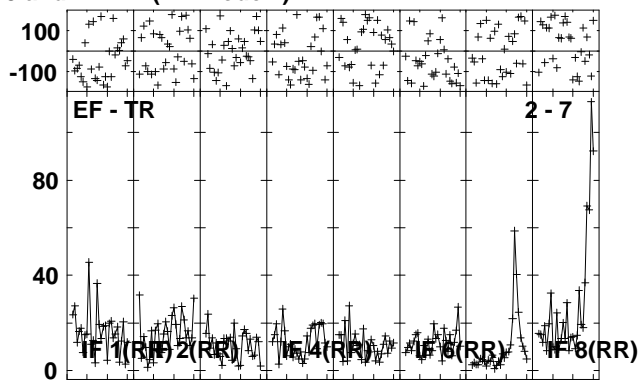
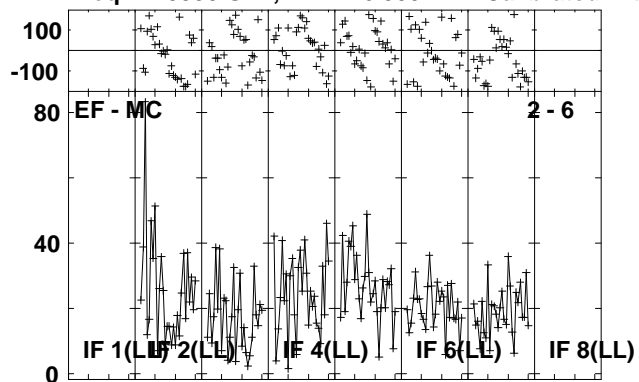

Lower frame: Milli Ampl Jy Top frame: Phas deg  
Vector averaged cross-power spectrum Several baselines displayed  
Timerange: 00/17:15:01 to 00/17:18:29

Plot file version 205 created 30-NOV-2010 14:33:10

ARP299C EP068B 3.UVDATA.1

Freq = 1.5950 GHz, Bw = 16.000 MH Calibrated with CL # 3 and BP # 1 (BP mode 1)

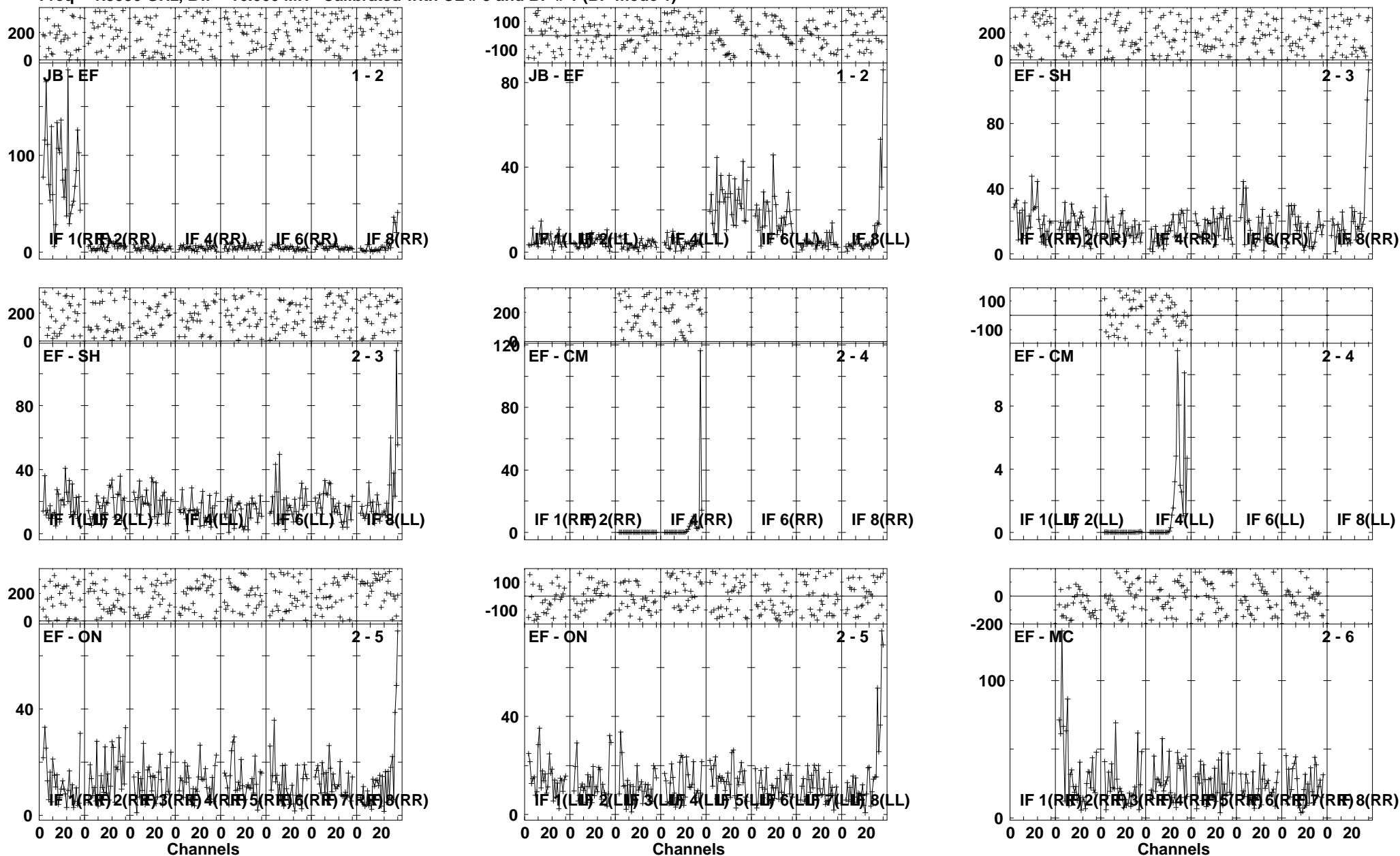

Lower frame: Milli Ampl Jy Top frame: Phas deg  
Vector averaged cross-power spectrum Several baselines displayed  
Timerange: 00/17:20:01 to 00/17:23:29

Plot file version 206 created 30-NOV-2010 14:33:13

ARP299C EP068B 3.UVDATA.1

Freq = 1.5950 GHz, Bw = 16.000 MH Calibrated with CL # 3 and BP # 1 (BP mode 1)

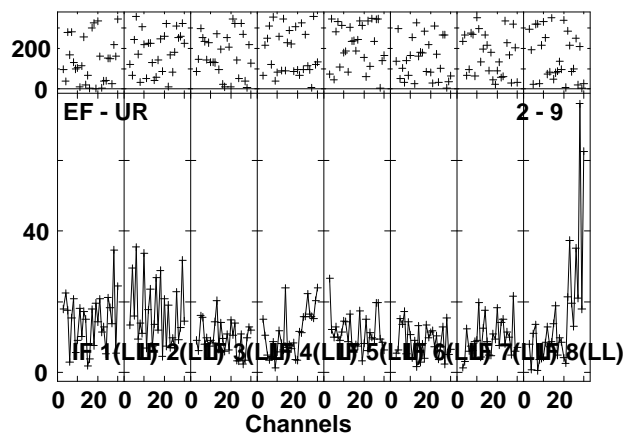
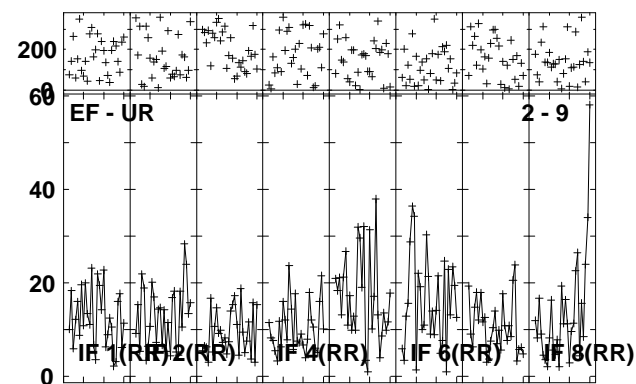
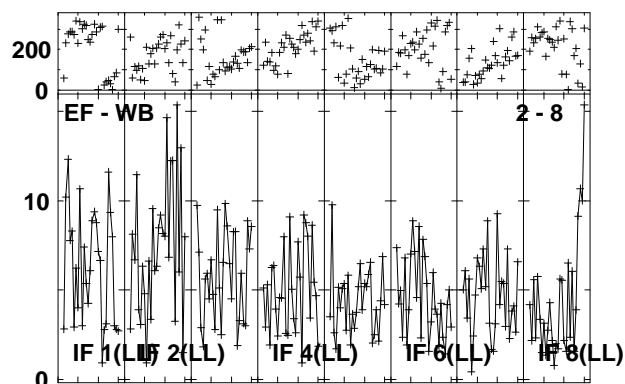
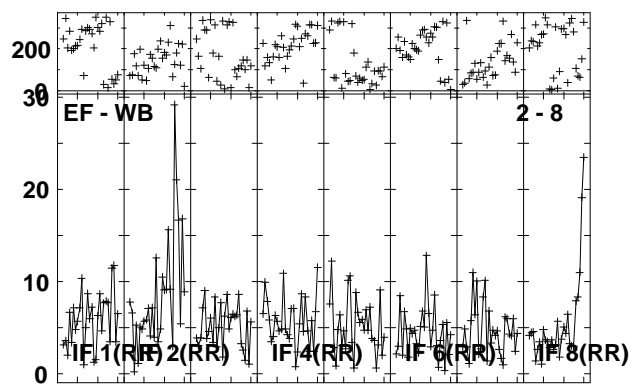
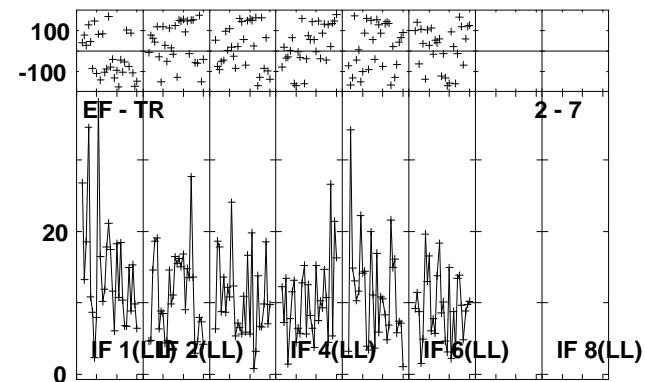
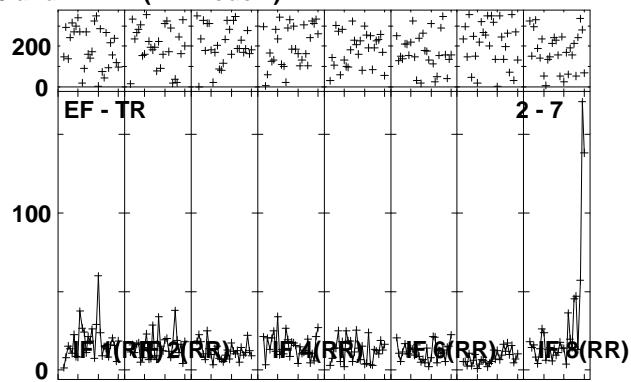
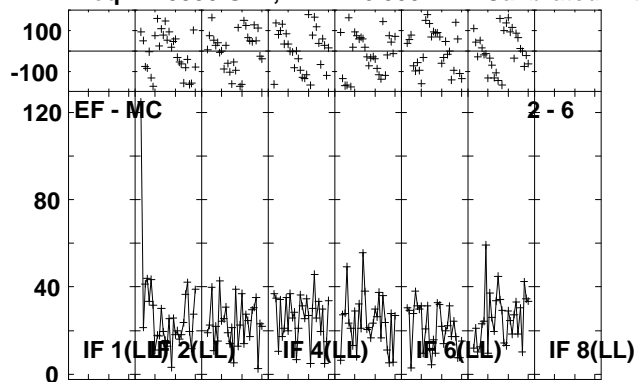

Lower frame: Milli Ampl Jy Top frame: Phas deg  
Vector averaged cross-power spectrum Several baselines displayed  
Timerange: 00/17:20:01 to 00/17:23:29

Plot file version 207 created 30-NOV-2010 14:33:15

J1128+59 EP068B 3.UVDATA.1

Freq = 1.5950 GHz, Bw = 16.000 MH Calibrated with CL # 3 and BP # 1 (BP mode 1)

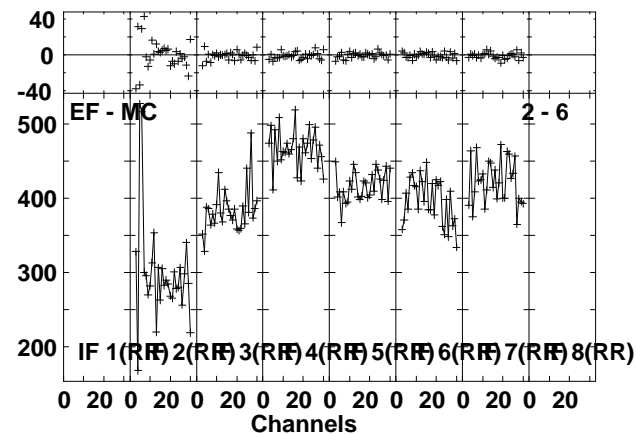
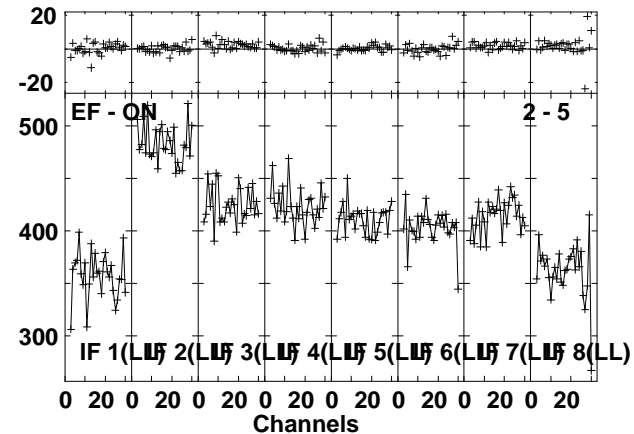
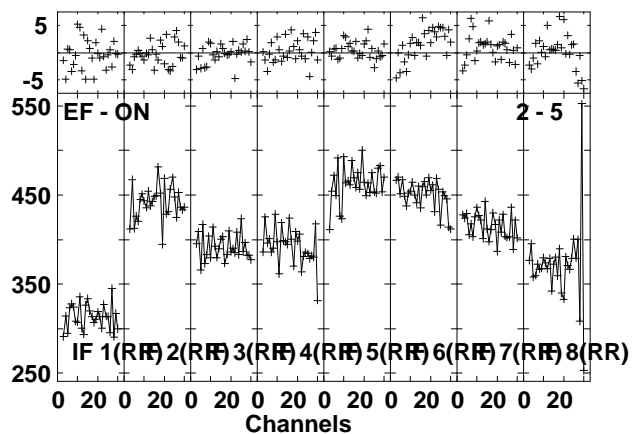
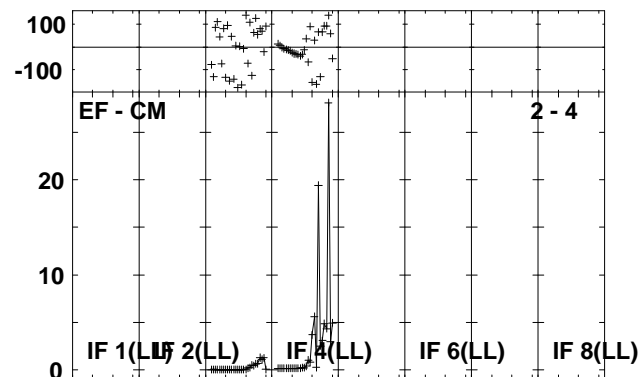
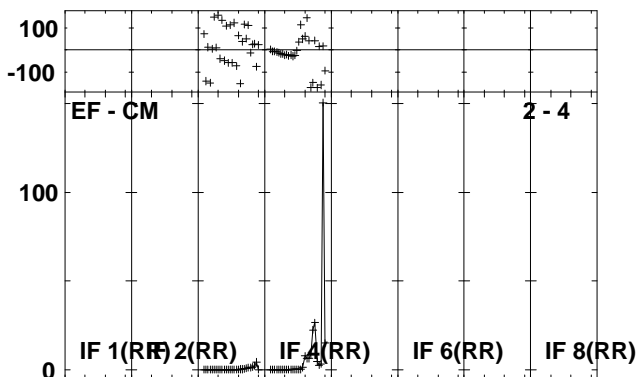
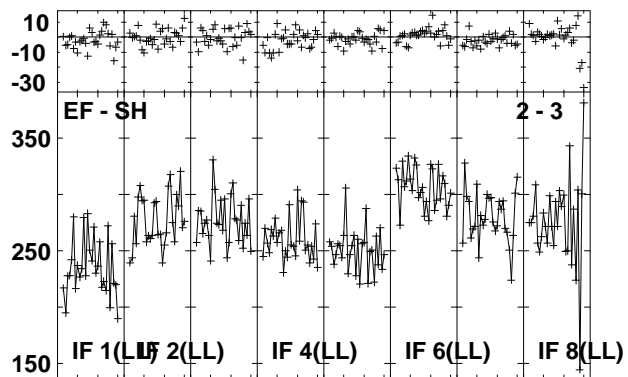
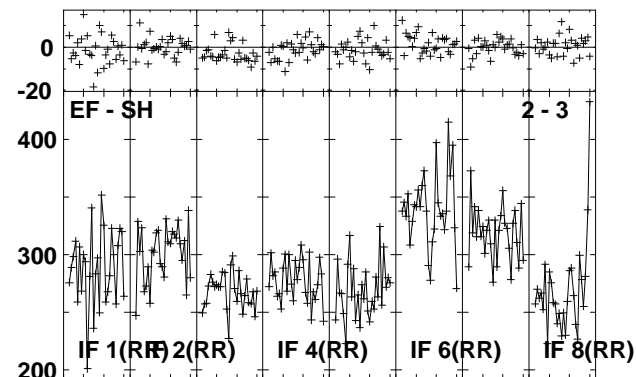
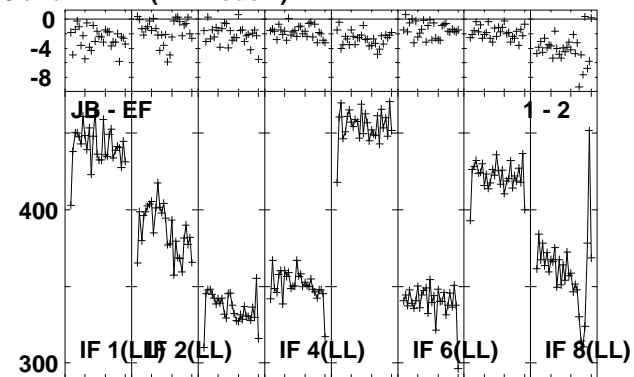
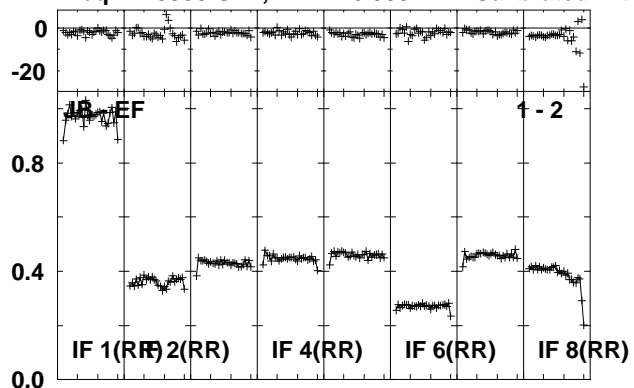

Lower frame: Ampl Jy Top frame: Phas deg  
Vector averaged cross-power spectrum Several baselines displayed  
Timerange: 00/17:23:31 to 00/17:24:59

Plot file version 208 created 30-NOV-2010 14:33:16

J1128+59 EP068B 3.UVDATA.1

Freq = 1.5950 GHz, Bw = 16.000 MH Calibrated with CL # 3 and BP # 1 (BP mode 1)

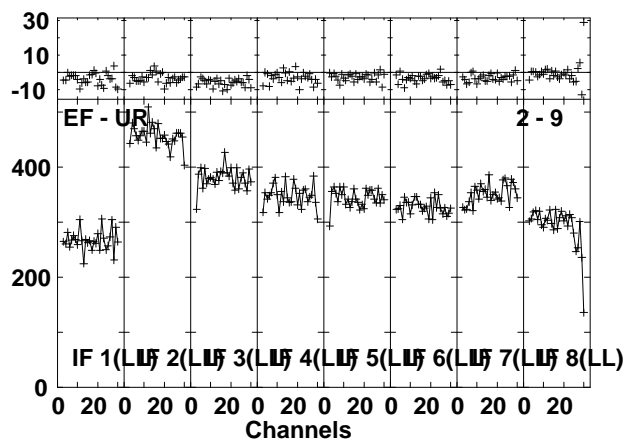
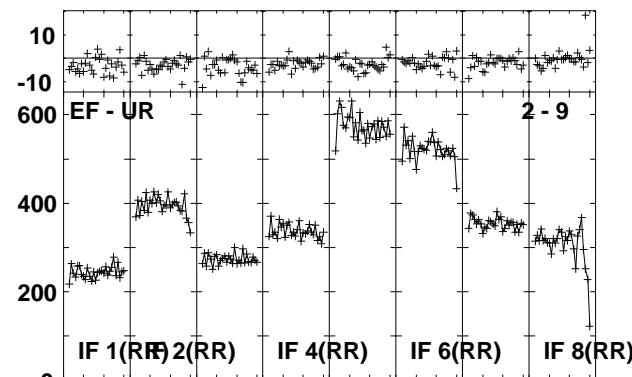
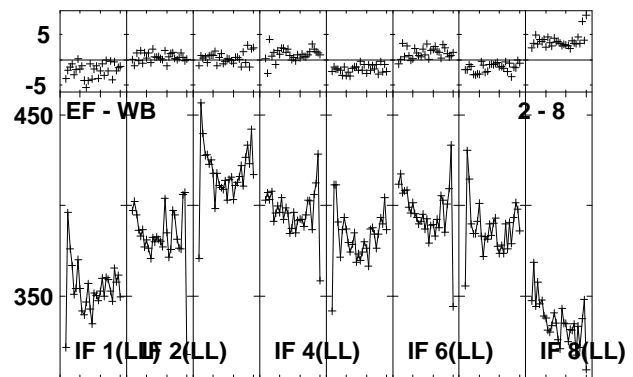
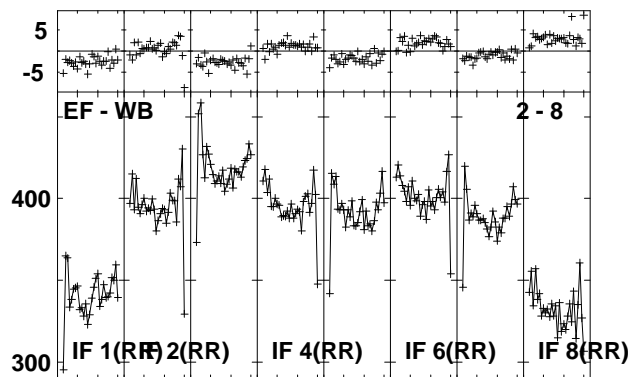
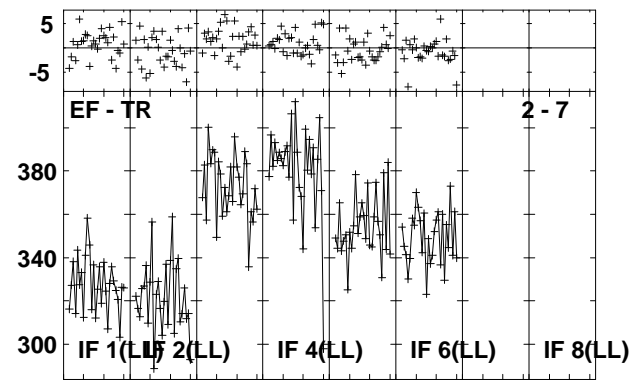
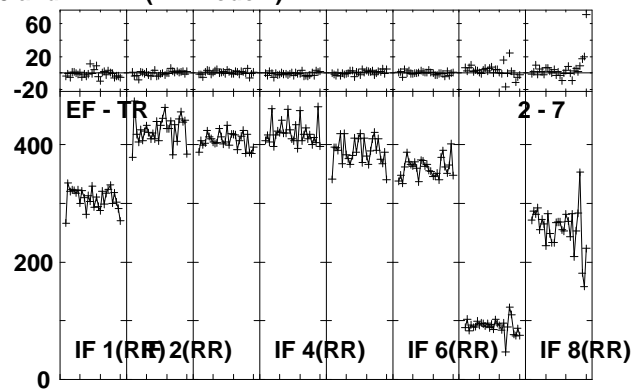
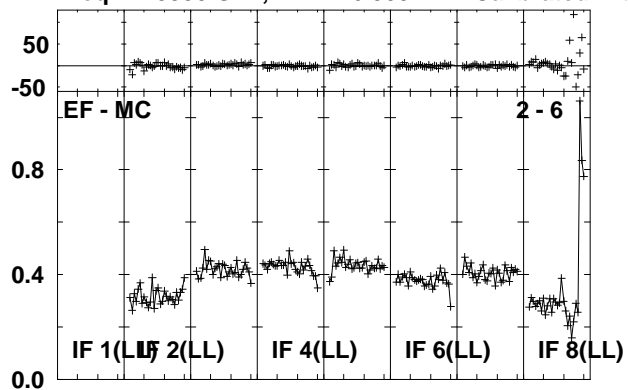

Lower frame: Ampl Jy Top frame: Phas deg  
Vector averaged cross-power spectrum Several baselines displayed  
Timerange: 00/17:23:31 to 00/17:24:59



Plot file version 209 created 30-NOV-2010 14:33:18

ARP299C EP068B 3.UVDATA.1

Freq = 1.5950 GHz, Bw = 16.000 MH Calibrated with CL # 3 and BP # 1 (BP mode 1)

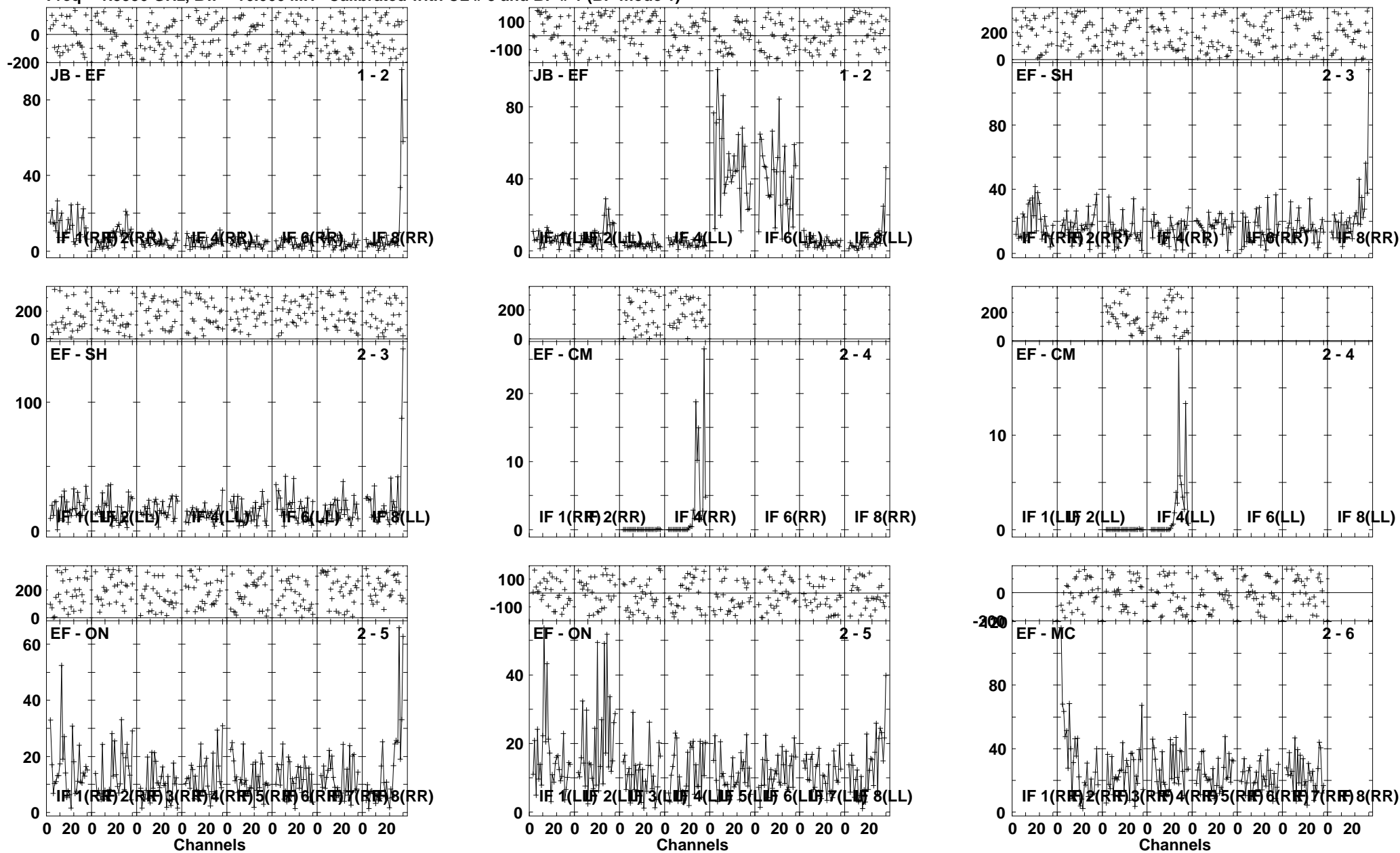

Plot file version 210 created 30-NOV-2010 14:33:21

ARP299C EP068B 3.UVDATA.1

Freq = 1.5950 GHz, Bw = 16.000 MH Calibrated with CL # 3 and BP # 1 (BP mode 1)

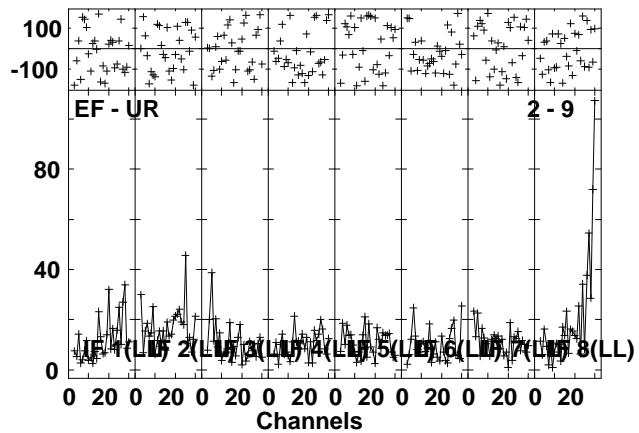
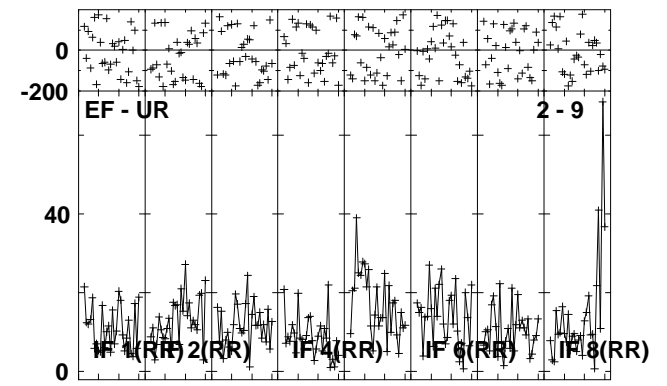
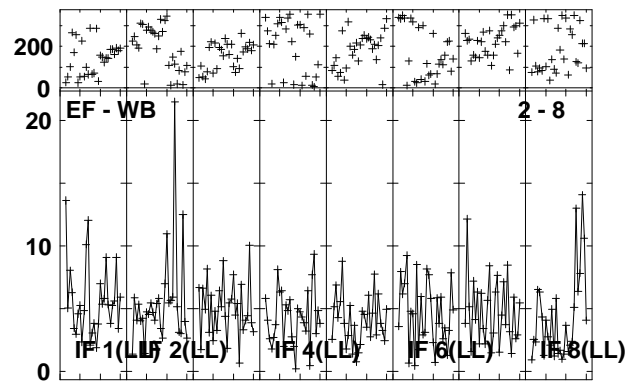
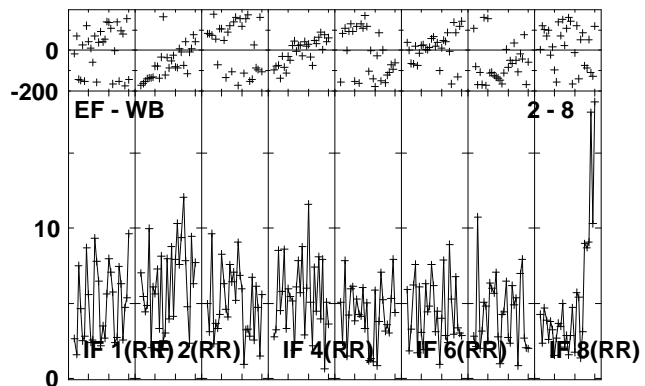
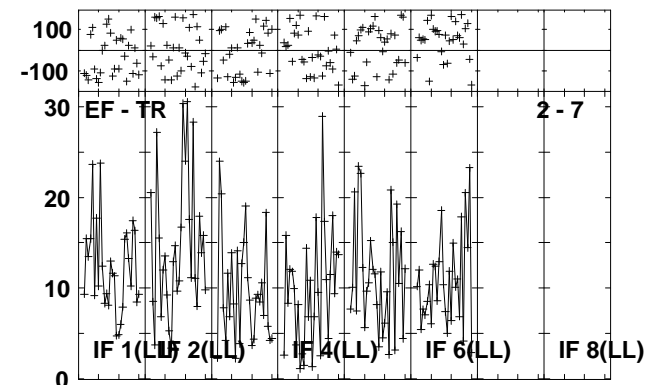
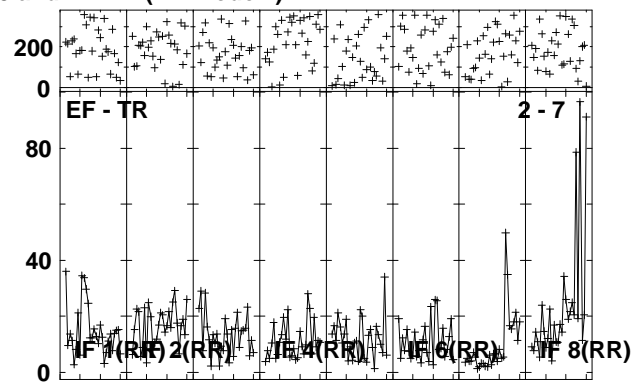
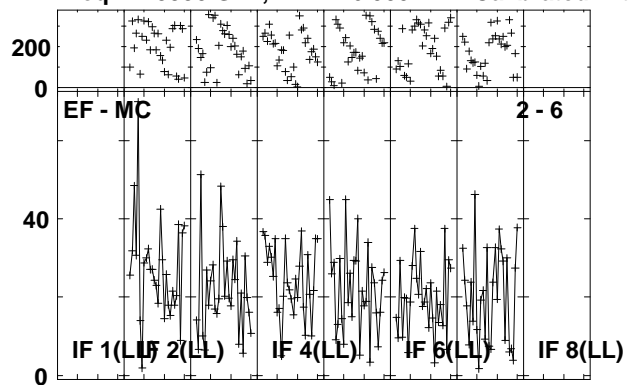

Lower frame: Milli Ampl Jy Top frame: Phas deg  
Vector averaged cross-power spectrum Several baselines displayed  
Timerange: 00/17:25:01 to 00/17:28:29

Plot file version 211 created 30-NOV-2010 14:33:23

J1128+59 EP068B 3.UVDATA.1

Freq = 1.5950 GHz, Bw = 16.000 MH Calibrated with CL # 3 and BP # 1 (BP mode 1)

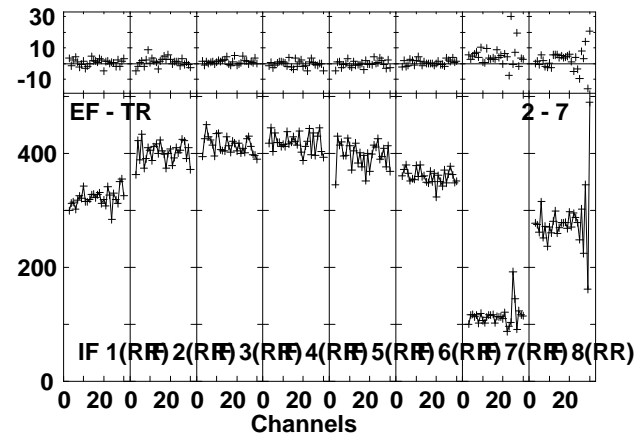
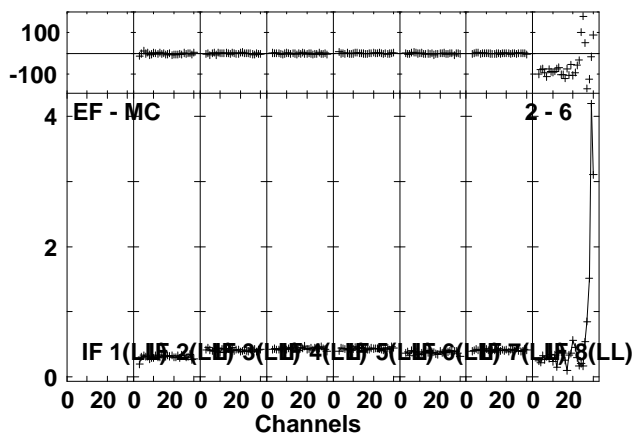
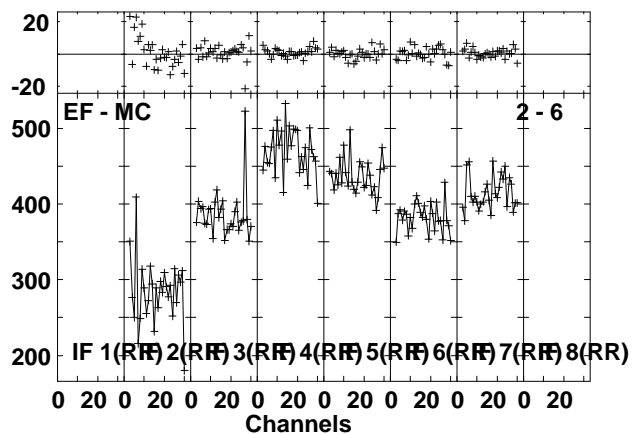
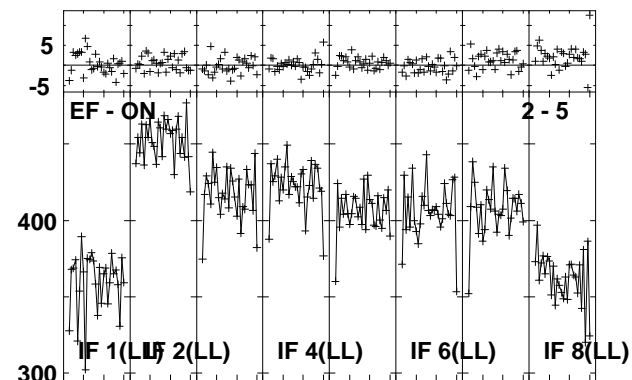
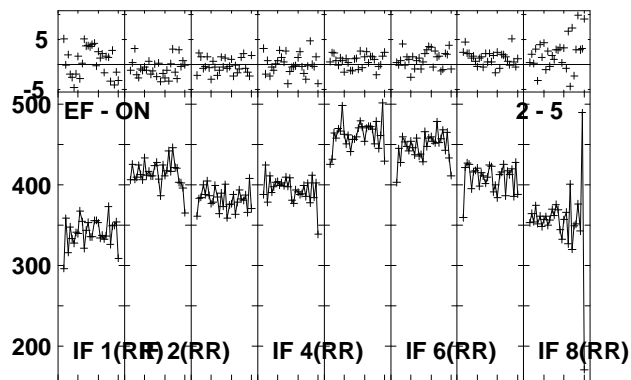
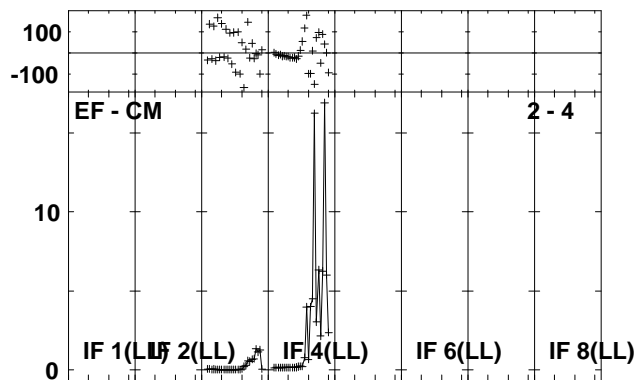
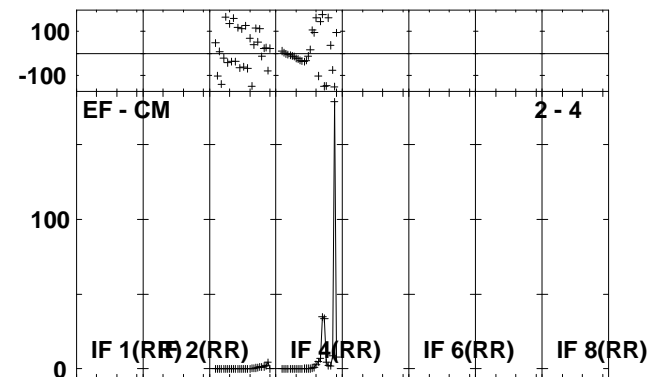
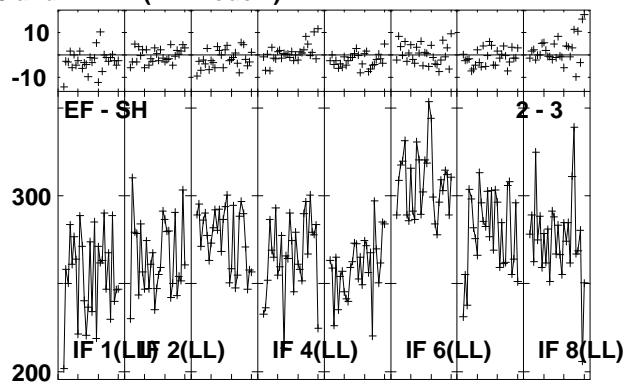
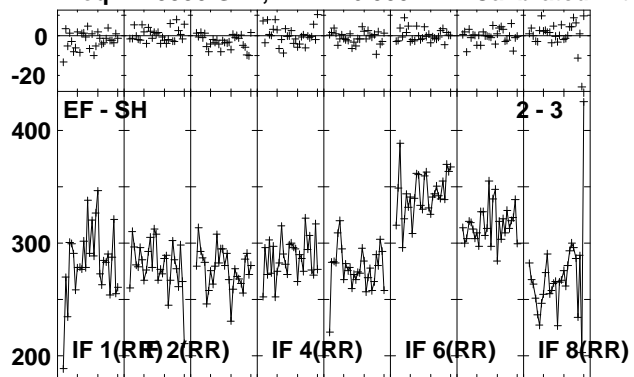

Lower frame: Milli Ampl Jy Top frame: Phas deg  
Vector averaged cross-power spectrum Several baselines displayed  
Timerange: 00/17:29:31 to 00/17:30:59

Plot file version 212 created 30-NOV-2010 14:33:25

J1128+59 EP068B 3.UVDATA.1

Freq = 1.5950 GHz, Bw = 16.000 MH Calibrated with CL # 3 and BP # 1 (BP mode 1)

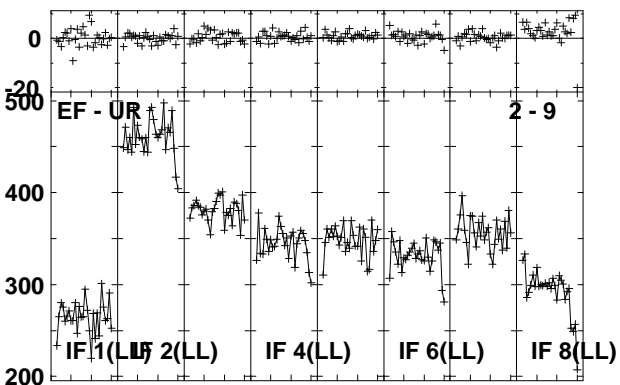
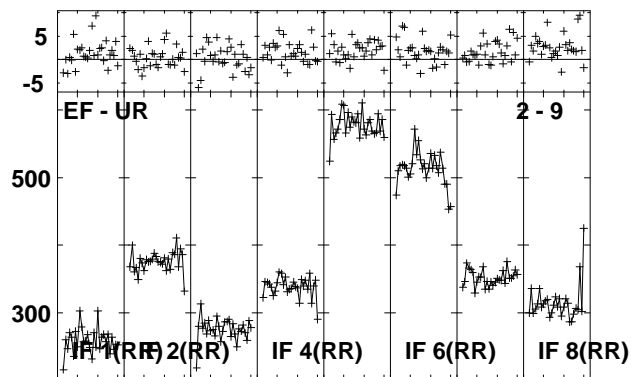
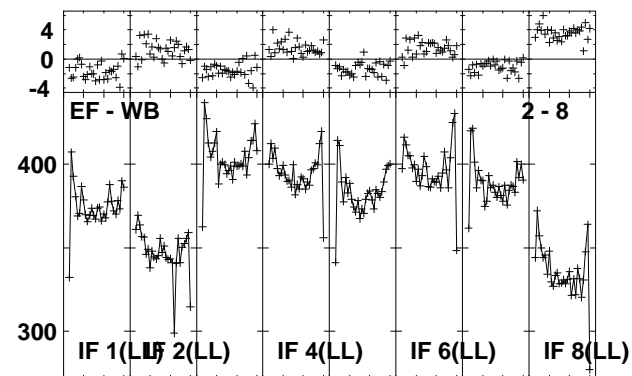
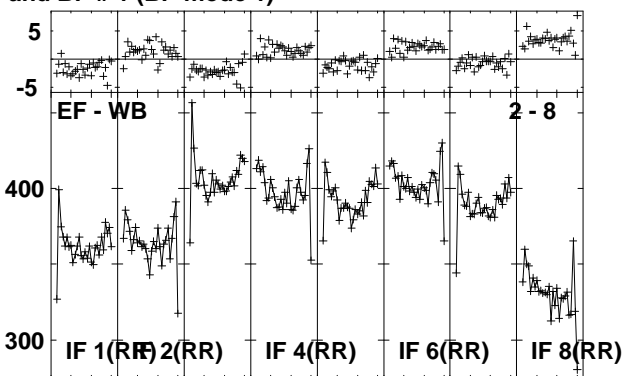
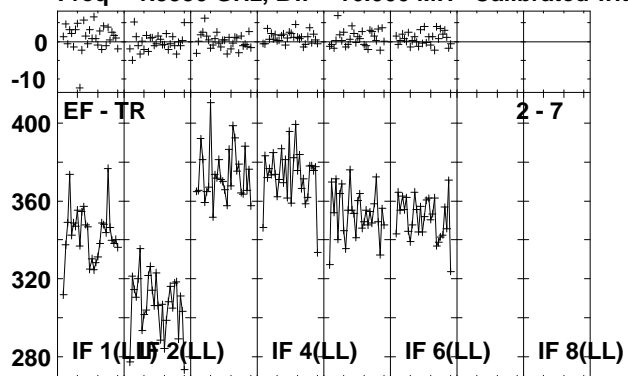

Lower frame: Milli Ampl Jy Top frame: Phas deg  
Vector averaged cross-power spectrum Several baselines displayed  
Timerange: 00/17:29:31 to 00/17:30:59

Plot file version 213 created 30-NOV-2010 14:33:26

ARP299C EP068B 3.UVDATA.1

Freq = 1.5950 GHz, Bw = 16.000 MH Calibrated with CL # 3 and BP # 1 (BP mode 1)

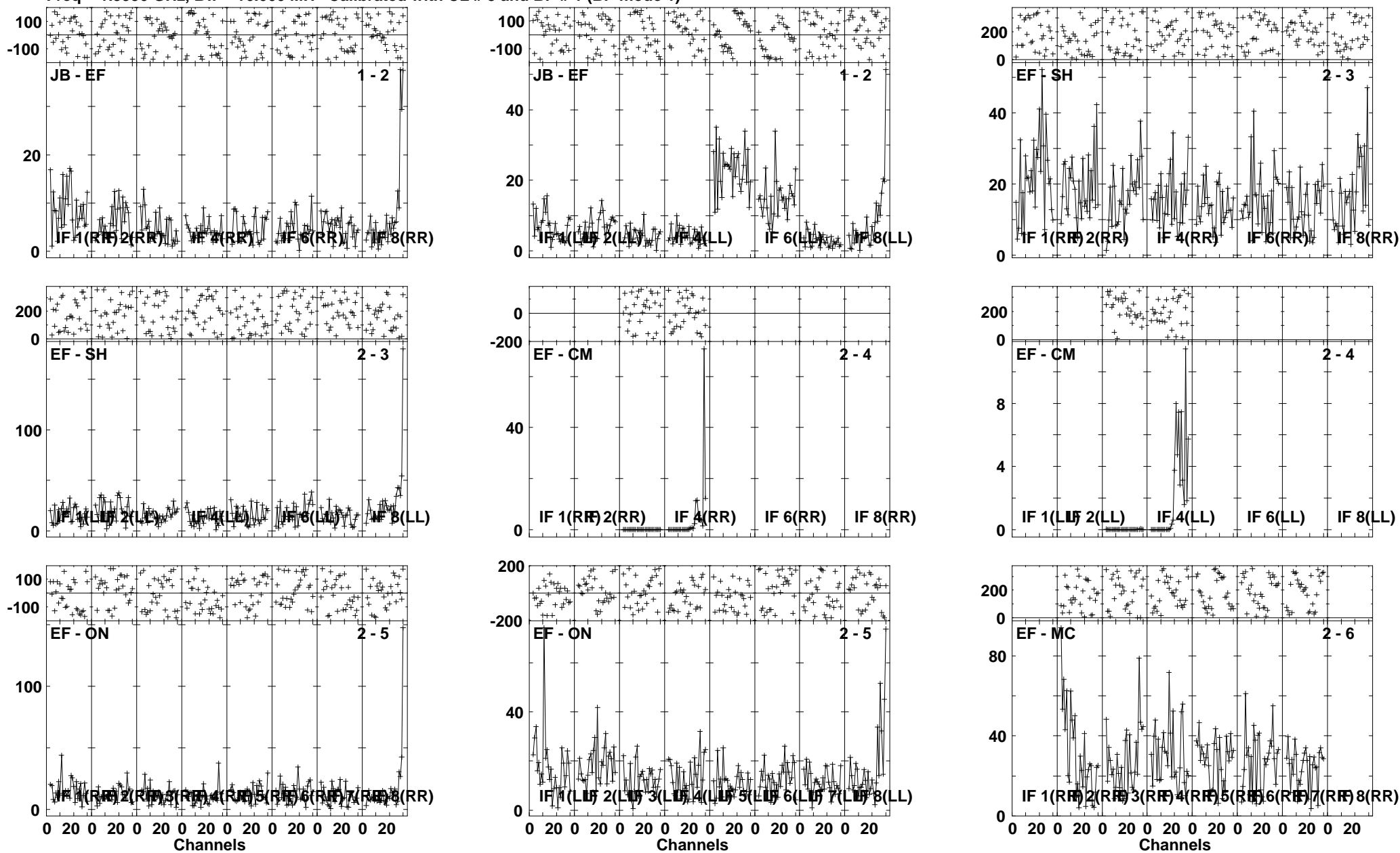

Lower frame: Milli Ampl Jy Top frame: Phas deg  
Vector averaged cross-power spectrum Several baselines displayed  
Timerange: 00:17:31:01 to 00:17:34:29

Plot file version 214 created 30-NOV-2010 14:33:29

ARP299C EP068B 3.UVDATA.1

Freq = 1.5950 GHz, Bw = 16.000 MH Calibrated with CL # 3 and BP # 1 (BP mode 1)

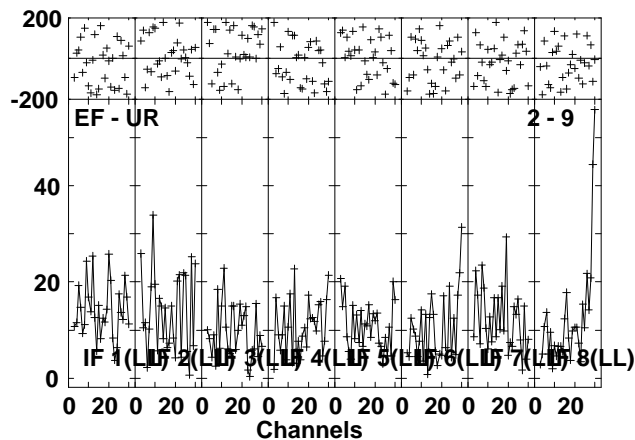
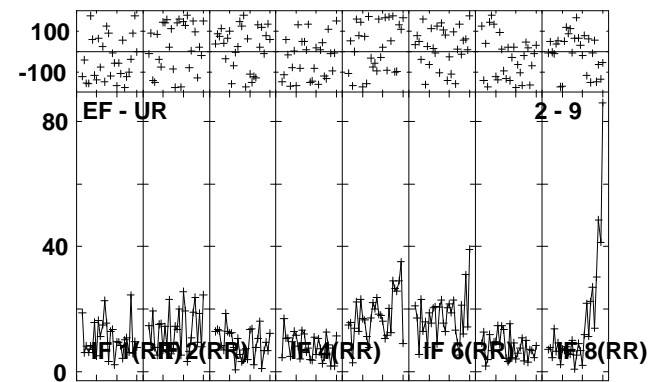
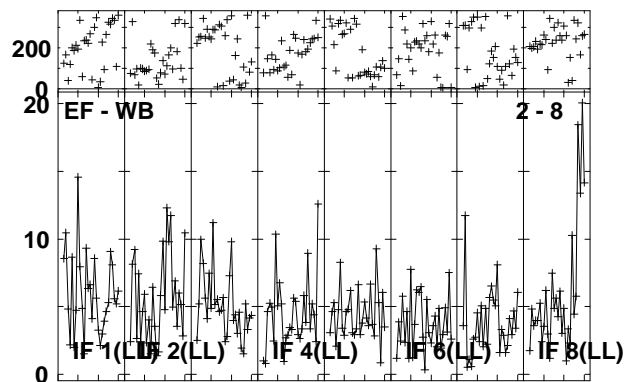
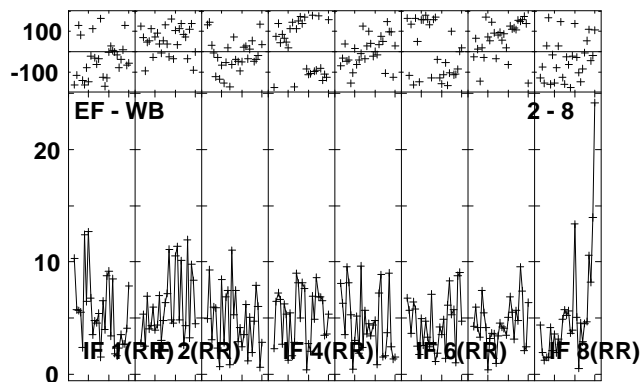
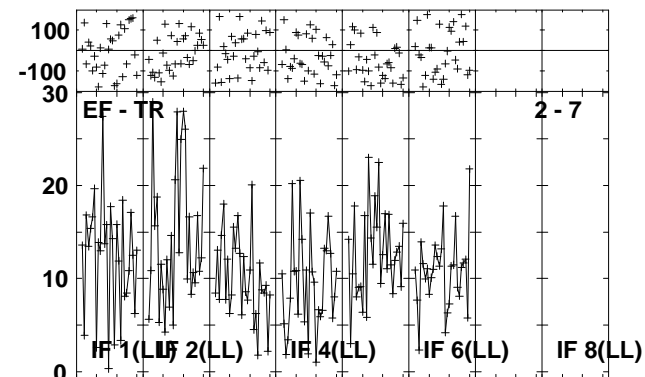
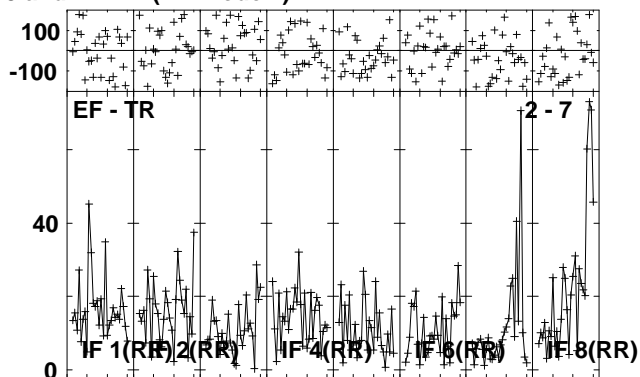
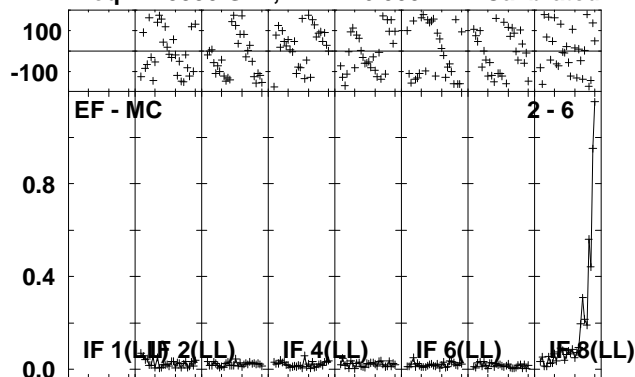

Lower frame: Ampl Jy Top frame: Phas deg

Vector averaged cross-power spectrum Several baselines displayed

Timerange: 00/17:31:01 to 00/17:34:29

Plot file version 215 created 30-NOV-2010 14:33:32

J1128+59 EP068B 3.UVDATA.1

Freq = 1.5950 GHz, Bw = 16.000 MH Calibrated with CL # 3 and BP # 1 (BP mode 1)

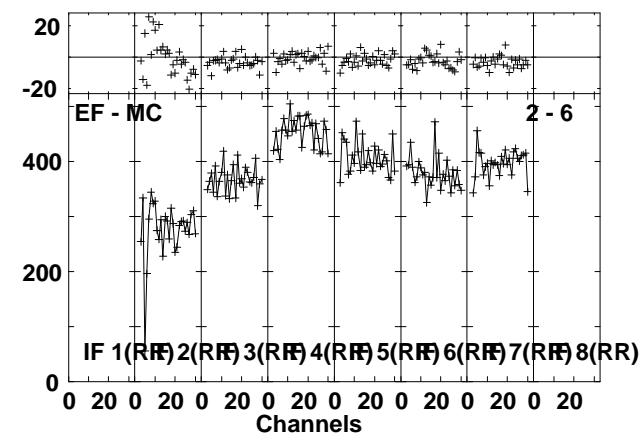
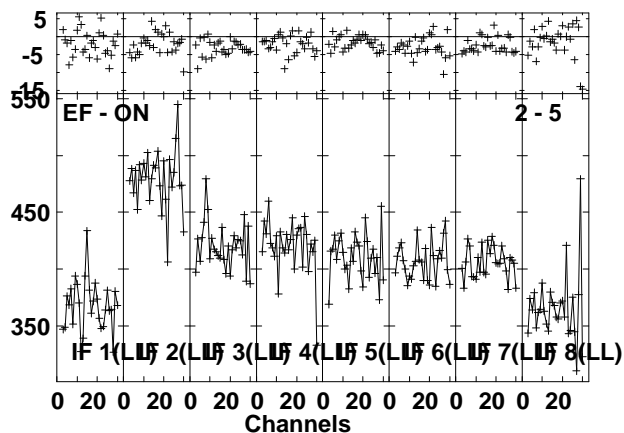
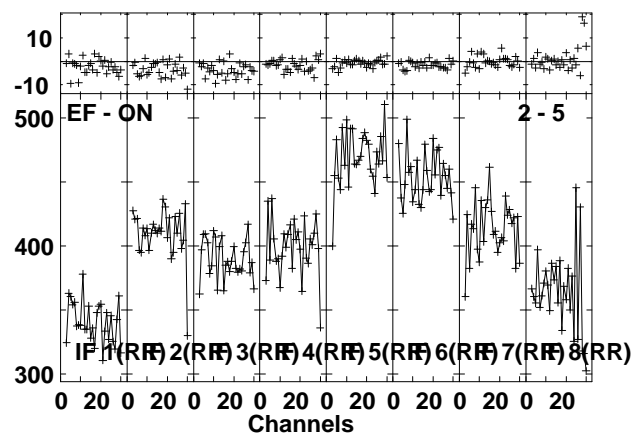
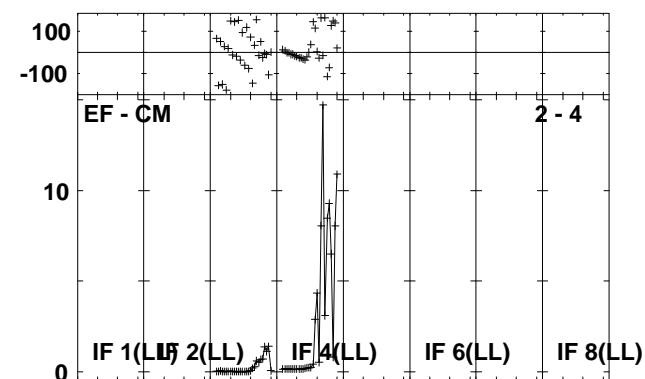
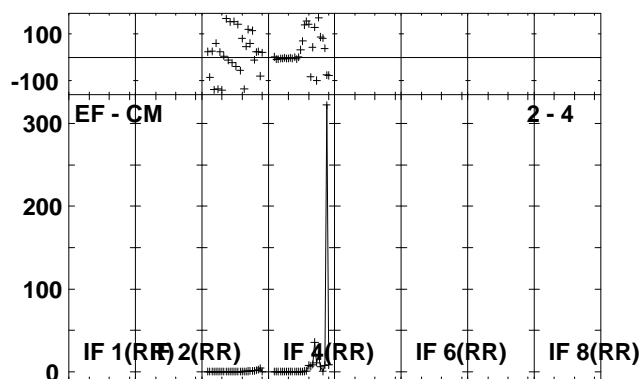
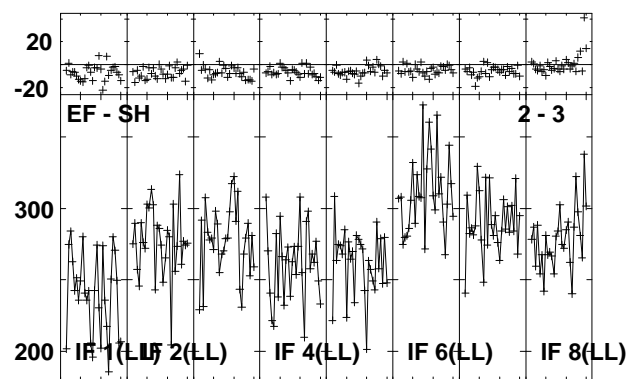
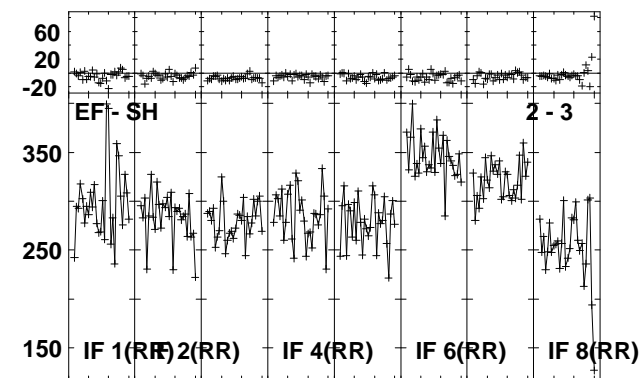
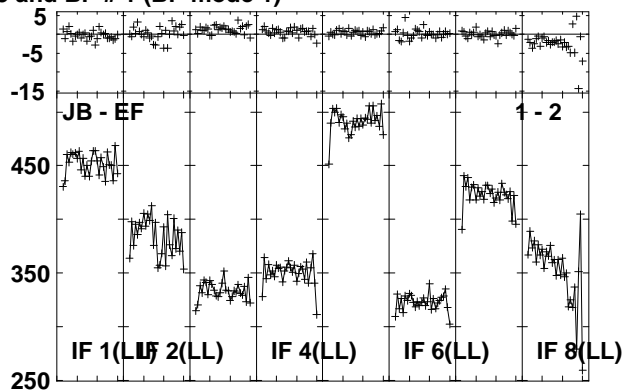
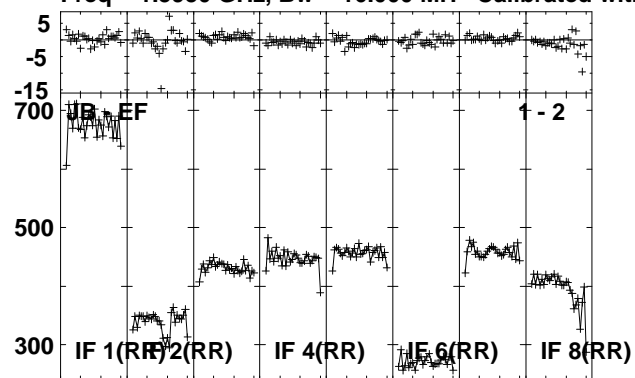

Lower frame: Milli Ampl Jy Top frame: Phas deg  
Vector averaged cross-power spectrum Several baselines displayed  
Timerange: 00:17:34:31 to 00:17:35:59

Plot file version 216 created 30-NOV-2010 14:33:33

J1128+59 EP068B 3.UVDATA.1

Freq = 1.5950 GHz, Bw = 16.000 MH Calibrated with CL # 3 and BP # 1 (BP mode 1)

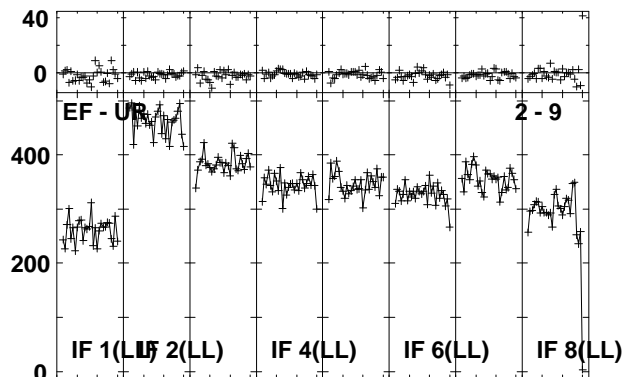
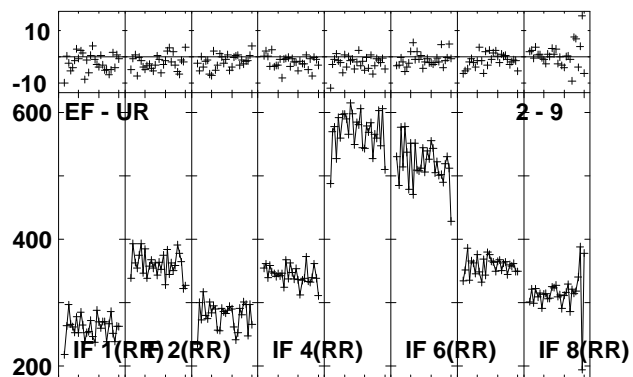
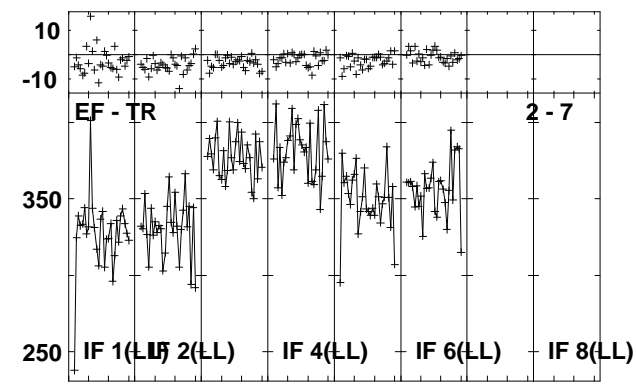
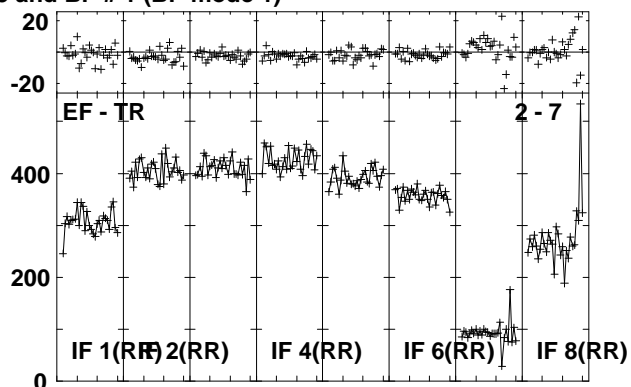
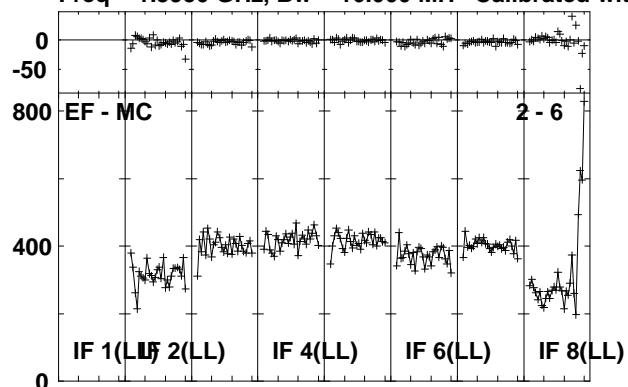

Lower frame: Milli Ampl Jy Top frame: Phas deg  
Vector averaged cross-power spectrum Several baselines displayed  
Timerange: 00/17:34:31 to 00/17:35:59



Plot file version 217 created 30-NOV-2010 14:33:35

ARP299C EP068B 3.UVDATA.1

Freq = 1.5950 GHz, Bw = 16.000 MH Calibrated with CL # 3 and BP # 1 (BP mode 1)

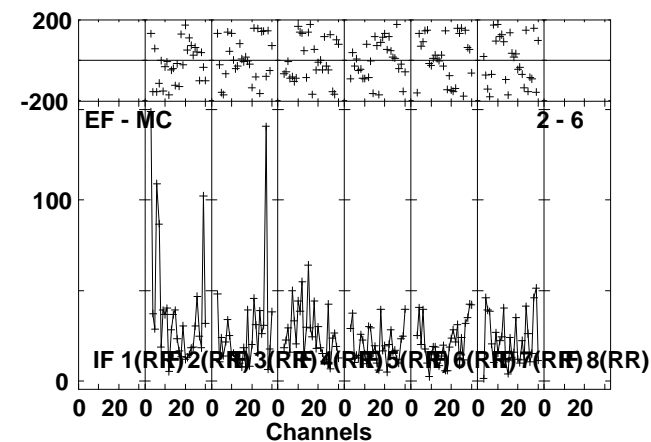
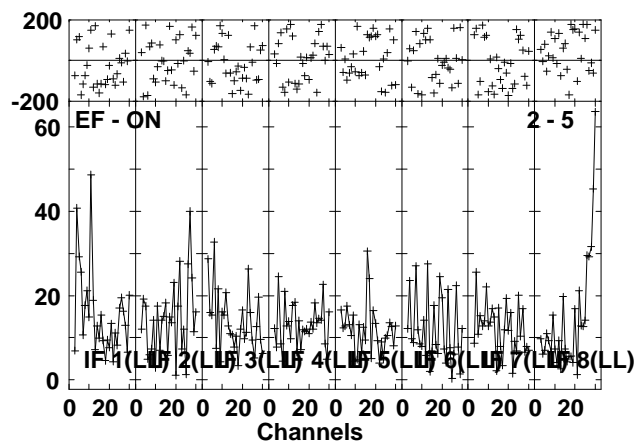
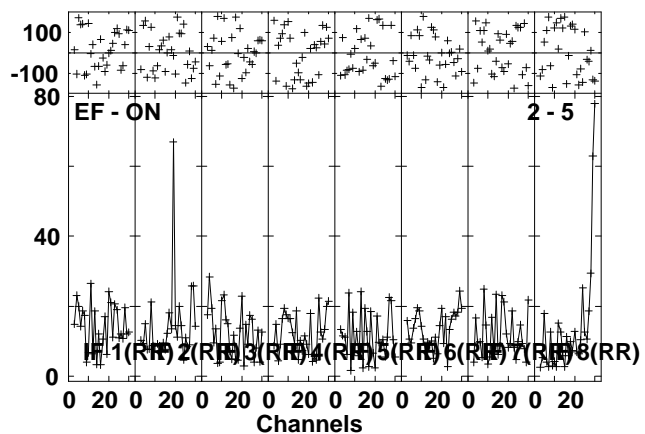
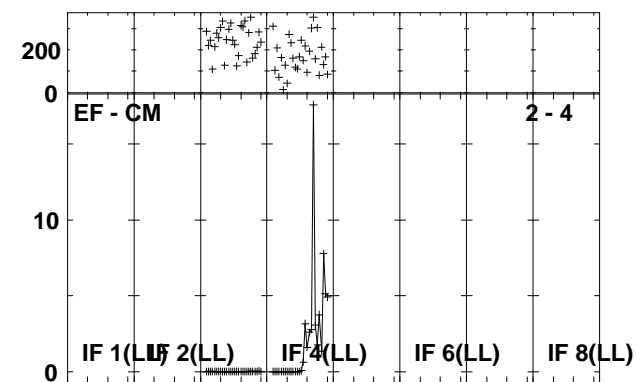
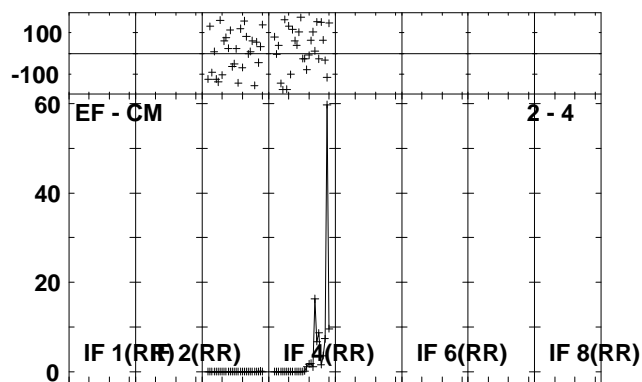
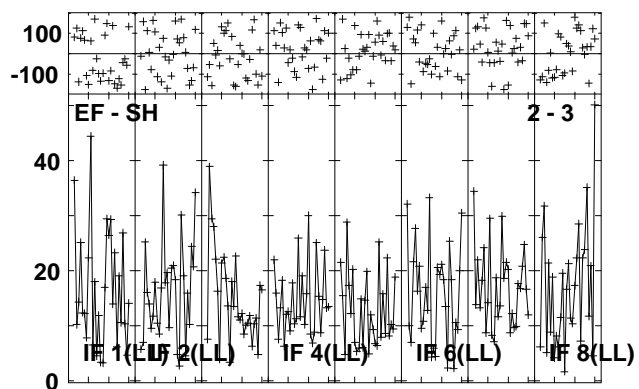
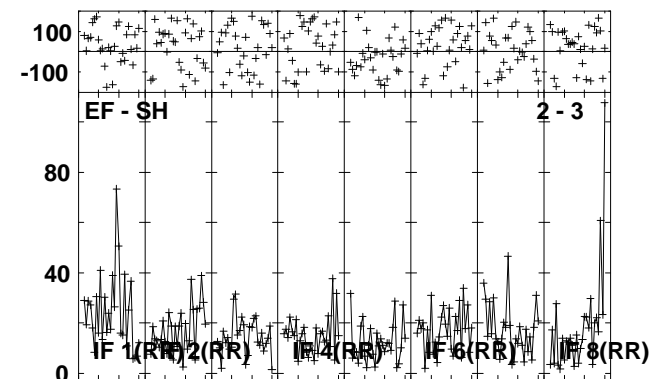
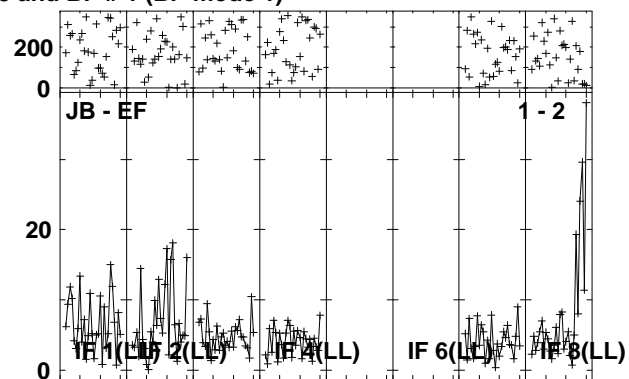
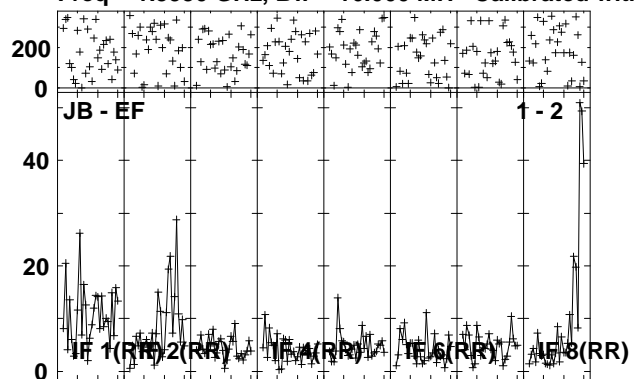

Lower frame: Milli Ampl Jy Top frame: Phas deg  
Vector averaged cross-power spectrum Several baselines displayed  
Timerange: 00/17:36:01 to 00/17:39:29

Plot file version 218 created 30-NOV-2010 14:33:37  
 ARP299C EP068B 3.UVDATA.1  
 Freq = 1.5950 GHz, Bw = 16.000 MH Calibrated with CL # 3 and BP # 1 (BP mode 1)

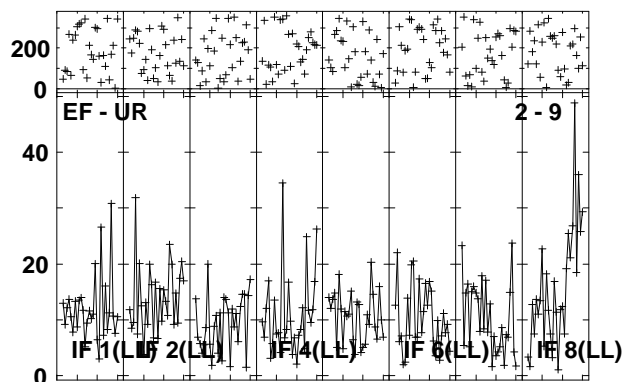
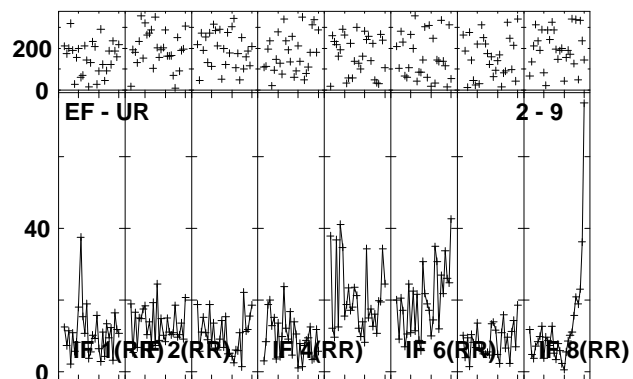
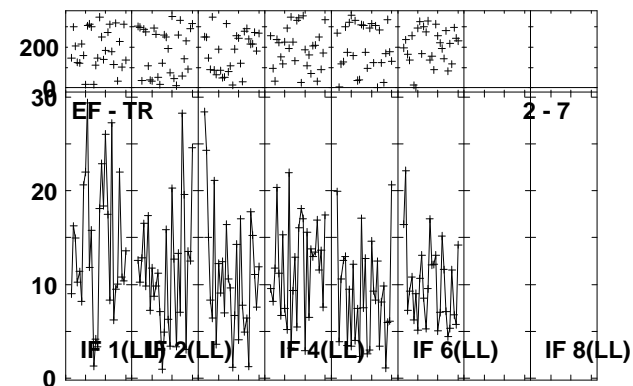
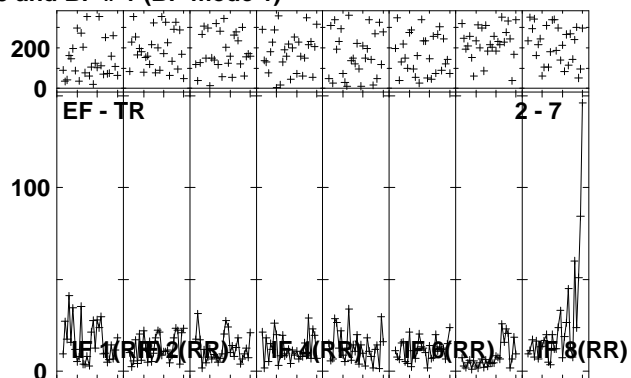
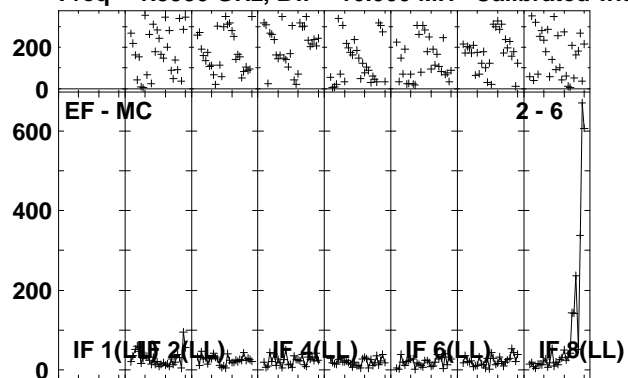

Lower frame: Milli Ampl Jy Top frame: Phas deg  
 Vector averaged cross-power spectrum Several baselines displayed  
 Timerange: 00/17:36:01 to 00/17:39:29

Plot file version 219 created 30-NOV-2010 14:33:40

J1128+59 EP068B 3.UVDATA.1

Freq = 1.5950 GHz, Bw = 16.000 MH Calibrated with CL # 3 and BP # 1 (BP mode 1)

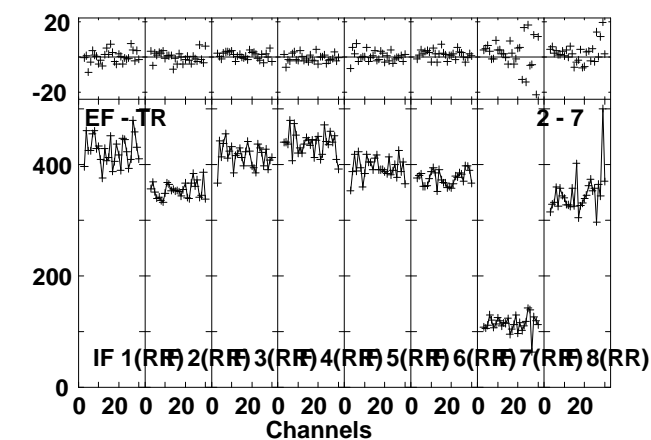
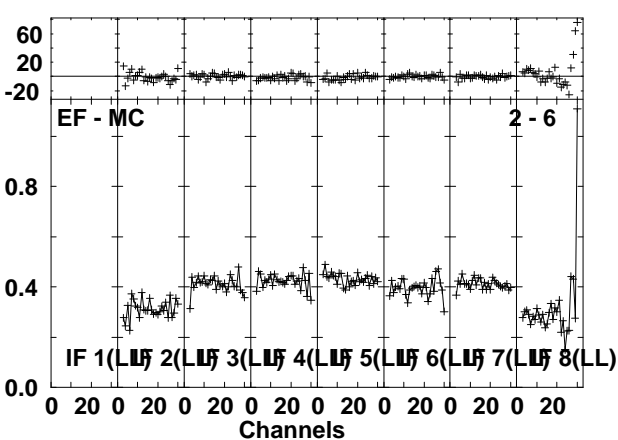
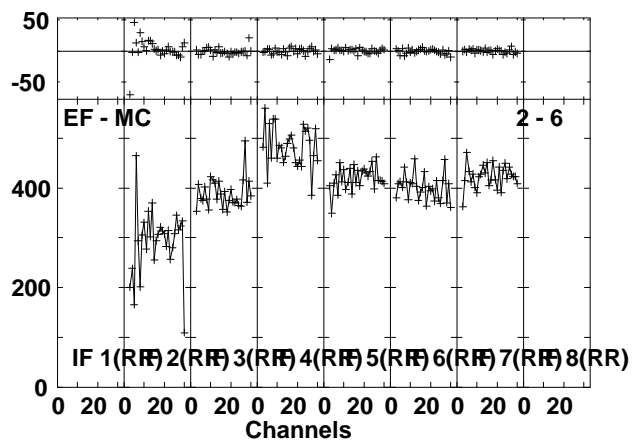
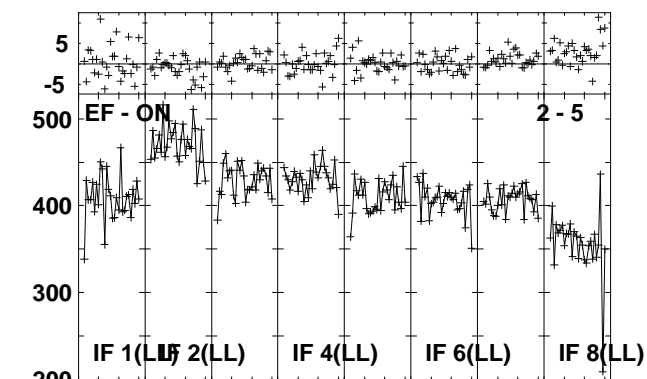
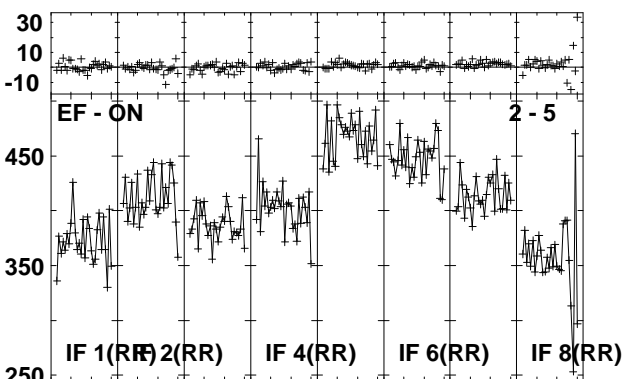
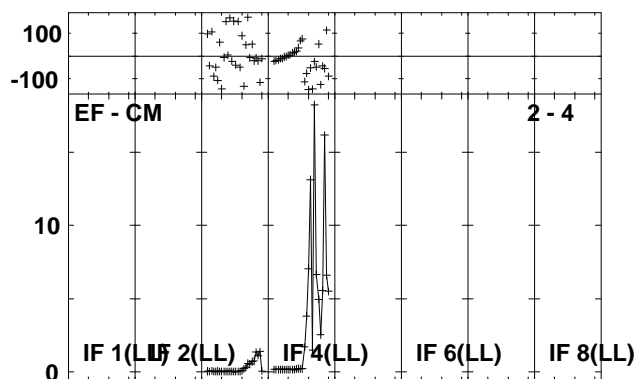
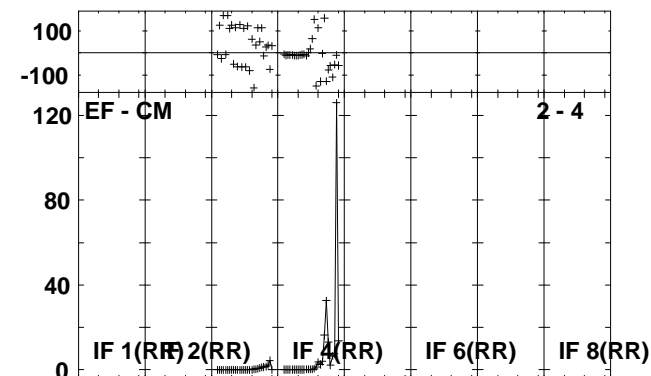
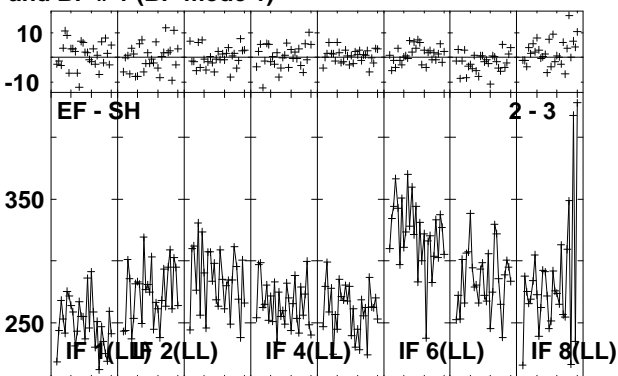
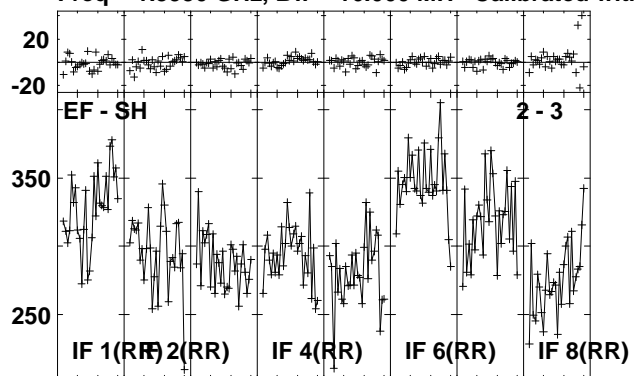

Lower frame: Milli Ampl Jy Top frame: Phas deg  
Vector averaged cross-power spectrum Several baselines displayed  
Timerange: 00:17:39:31 to 00:17:40:59

Plot file version 220 created 30-NOV-2010 14:33:42

J1128+59 EP068B 3.UVDATA.1

Freq = 1.5950 GHz, Bw = 16.000 MH Calibrated with CL # 3 and BP # 1 (BP mode 1)

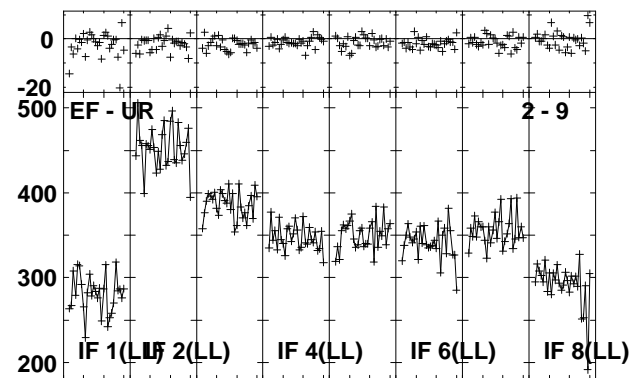
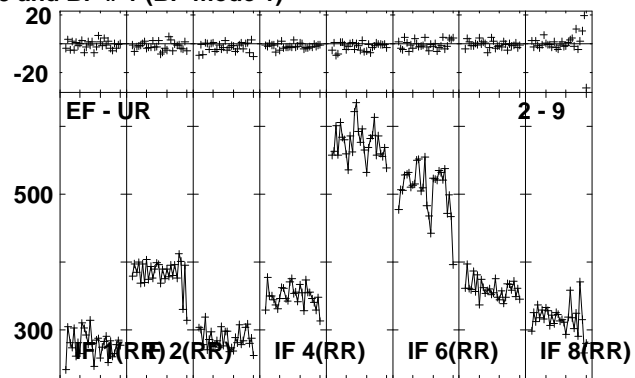
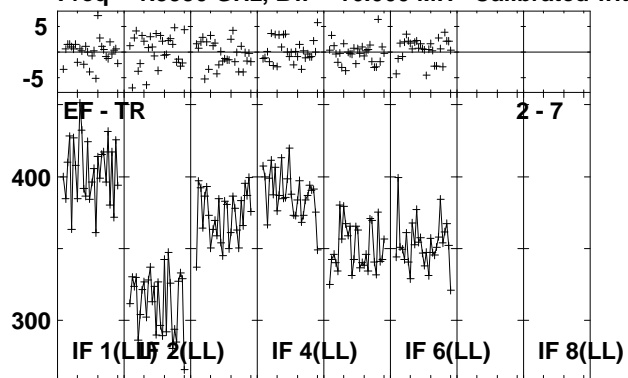

Lower frame: Milli Ampl Jy Top frame: Phas deg  
Vector averaged cross-power spectrum Several baselines displayed  
Timerange: 00/17:39:31 to 00/17:40:59

Plot file version 221 created 30-NOV-2010 14:33:43

ARP299C EP068B 3.UVDATA.1

Freq = 1.5950 GHz, Bw = 16.000 MH Calibrated with CL # 3 and BP # 1 (BP mode 1)

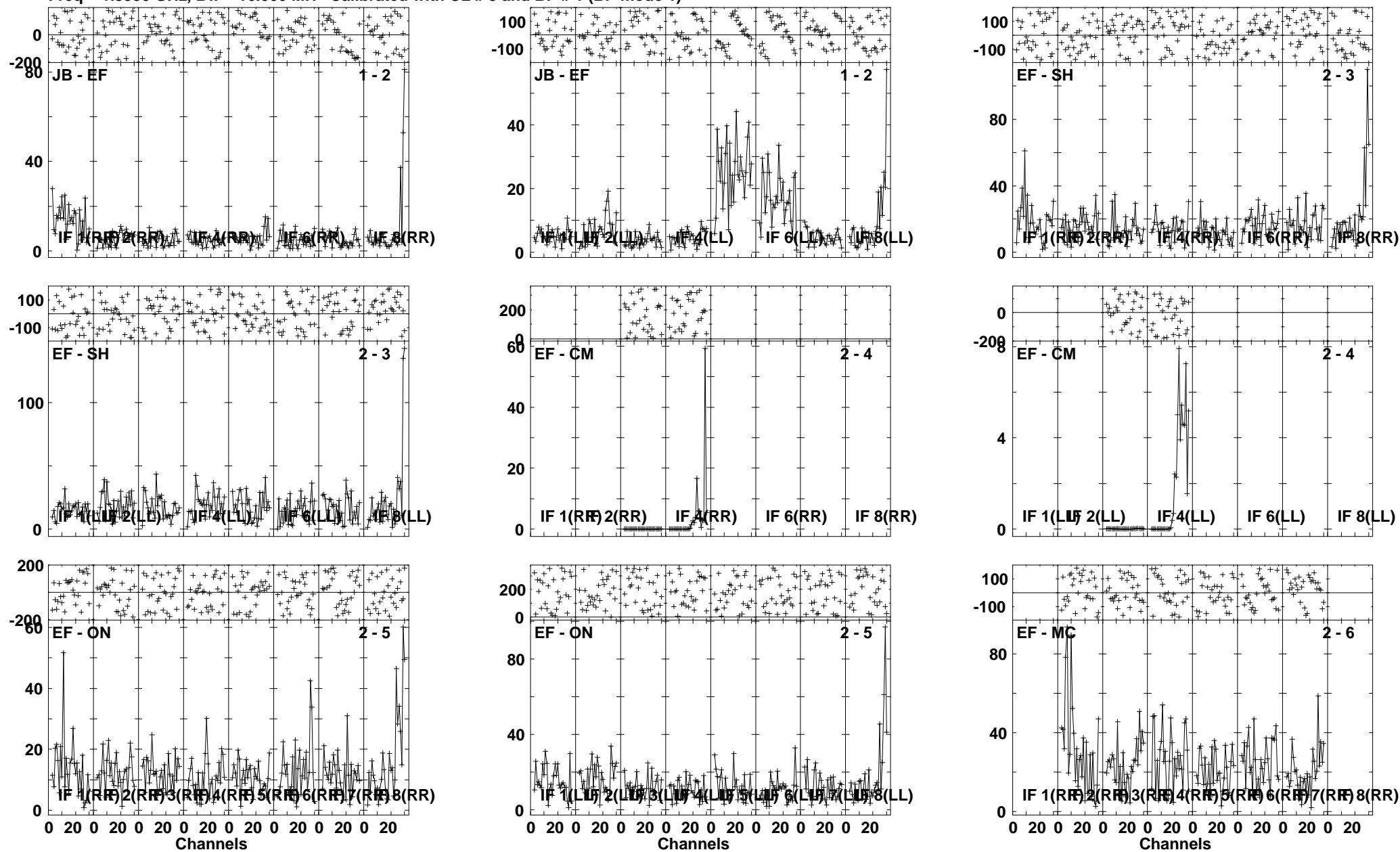

Lower frame: Milli Ampl Jy Top frame: Phas deg  
Vector averaged cross-power spectrum Several baselines displayed  
Timerange: 00/17:41:01 to 00/17:44:29

Plot file version 222 created 30-NOV-2010 14:33:46

ARP299C EP068B 3.UVDATA.1

Freq = 1.5950 GHz, Bw = 16.000 MH Calibrated with CL # 3 and BP # 1 (BP mode 1)

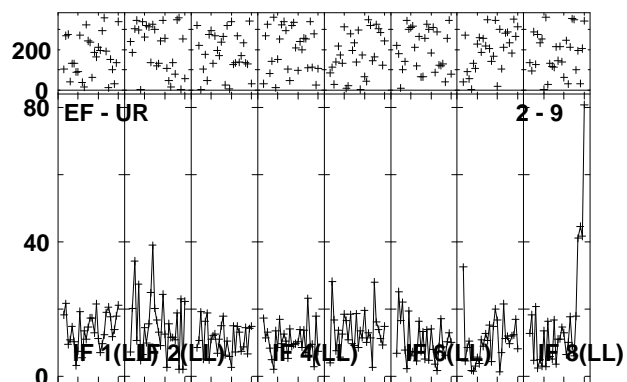
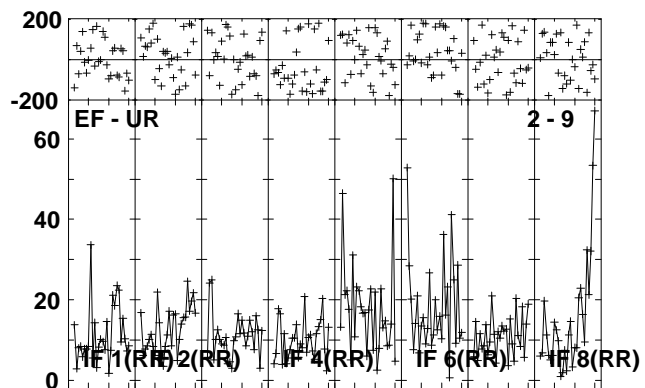
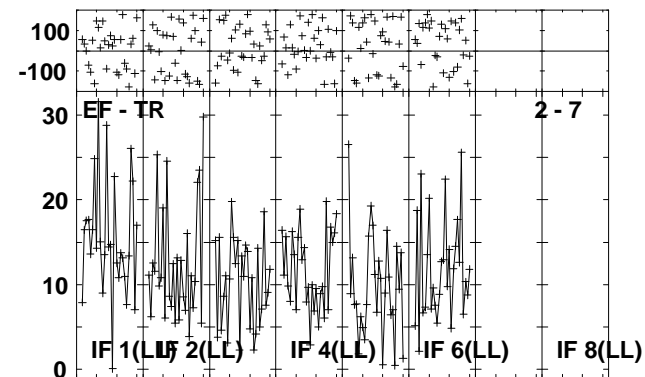
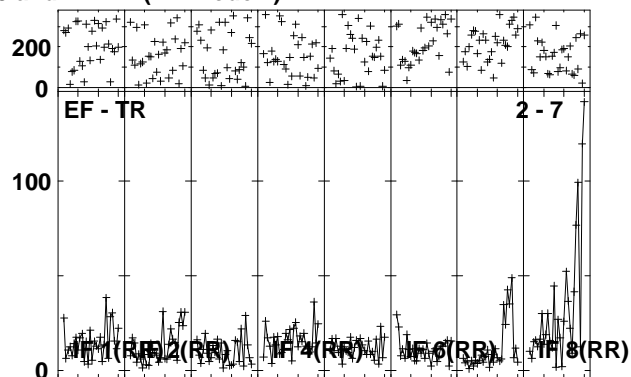
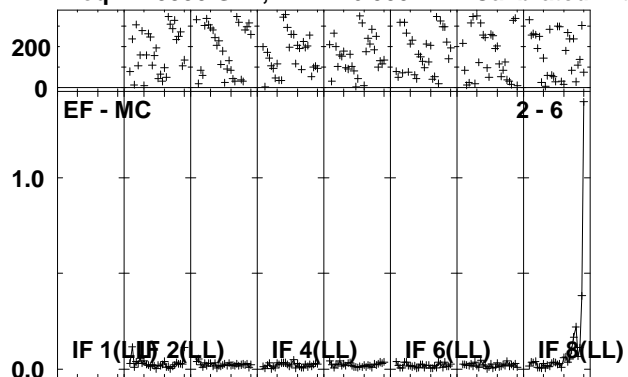

Lower frame: Ampl Jy Top frame: Phas deg  
Vector averaged cross-power spectrum Several baselines displayed  
Timerange: 00:17:41:01 to 00:17:44:29

Plot file version 223 created 30-NOV-2010 14:33:49

J1128+59 EP068B 3.UVDATA.1

Freq = 1.5950 GHz, Bw = 16.000 MH Calibrated with CL # 3 and BP # 1 (BP mode 1)

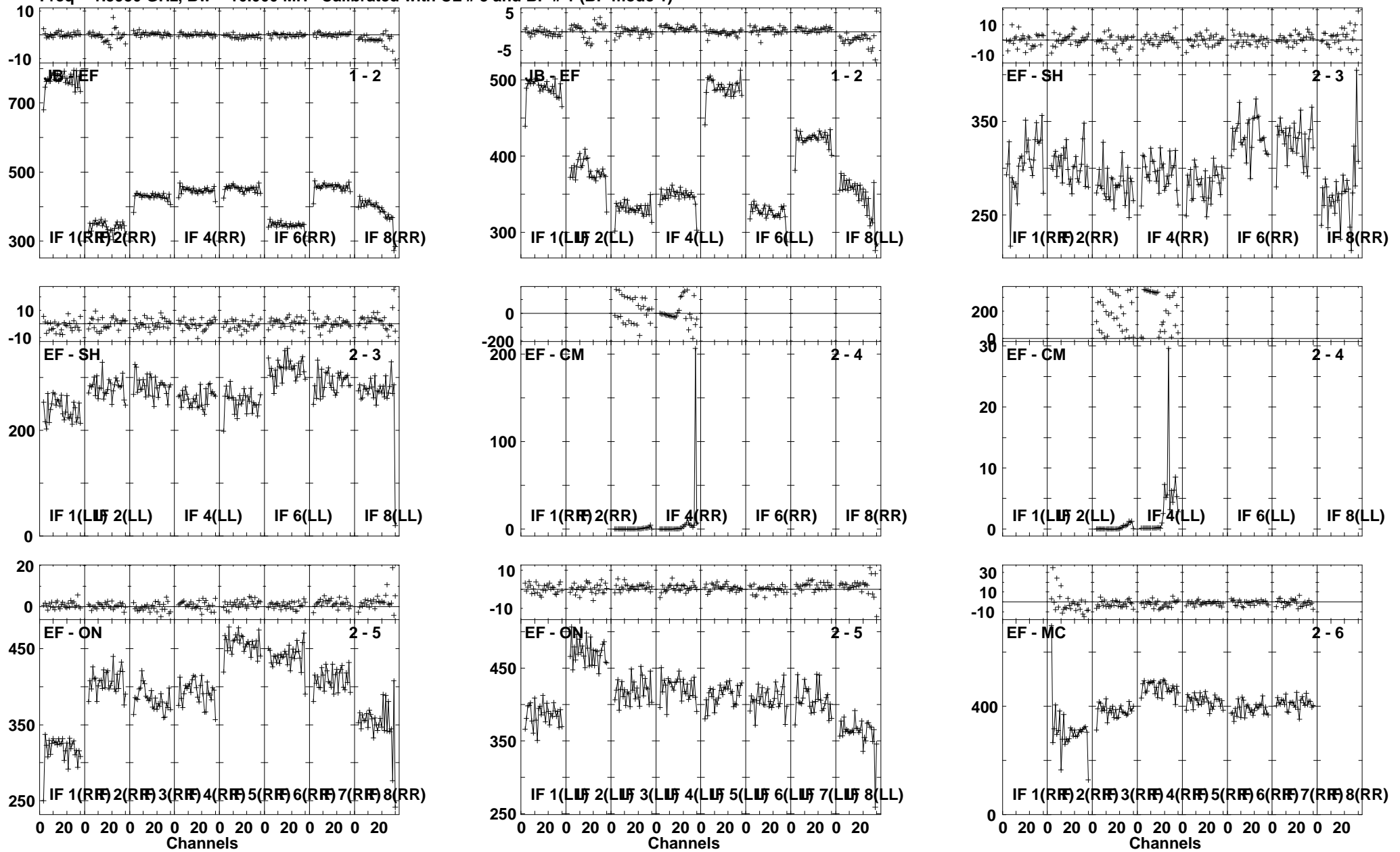

Lower frame: Milli Ampl Jy Top frame: Phas deg  
Vector averaged cross-power spectrum Several baselines displayed  
Timerange: 00:17:45:31 to 00:17:46:59

Plot file version 224 created 30-NOV-2010 14:33:52  
 J1128+59 EP068B 3.UVDATA.1  
 Freq = 1.5950 GHz, Bw = 16.000 MH Calibrated with CL # 3 and BP # 1 (BP mode 1)

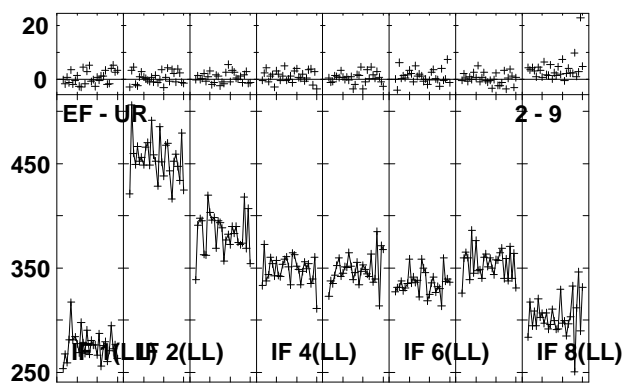
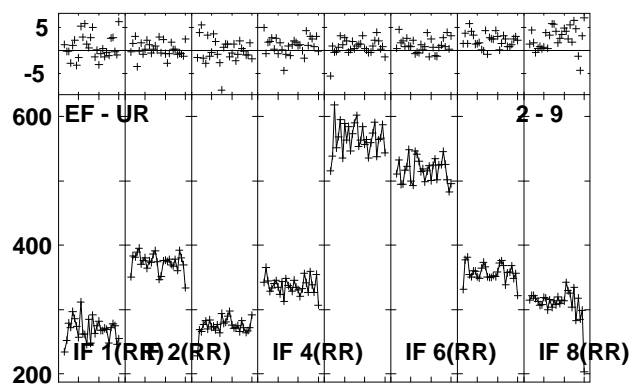
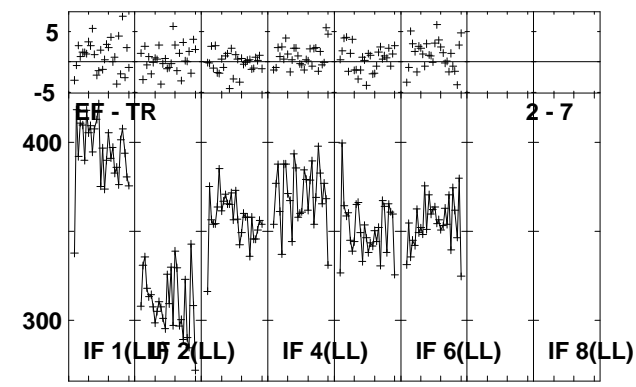
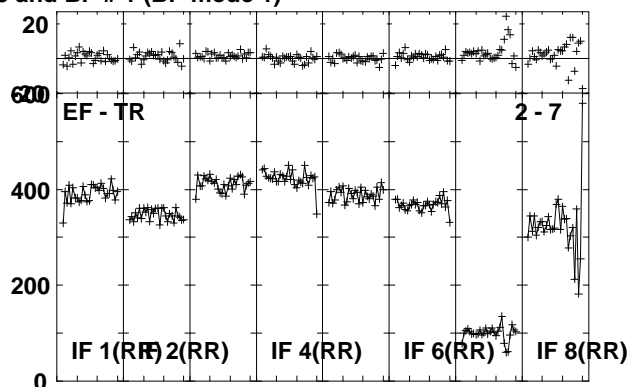
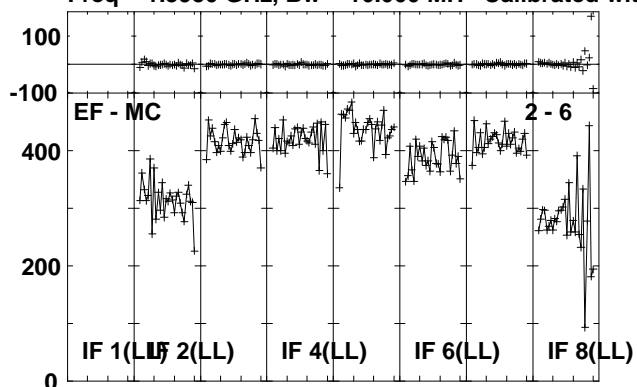

Lower frame: Milli Ampl Jy Top frame: Phas deg  
 Vector averaged cross-power spectrum Several baselines displayed  
 Timerange: 00/17:45:31 to 00/17:46:59



Plot file version 225 created 30-NOV-2010 14:33:55  
 ARP299C EP068B 3.UVDATA.1  
 Freq = 1.5950 GHz, Bw = 16.000 MH Calibrated with CL # 3 and BP # 1 (BP mode 1)

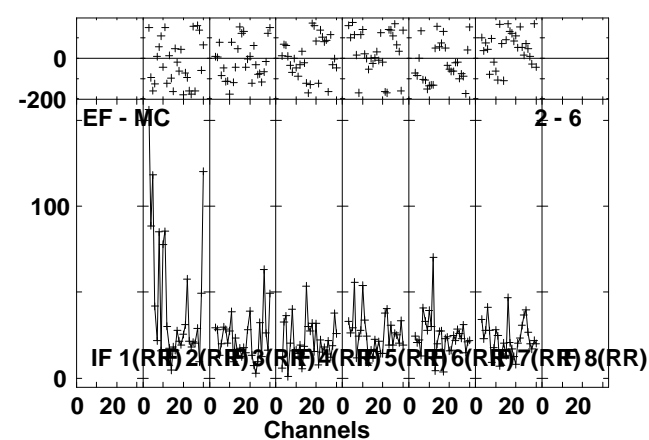
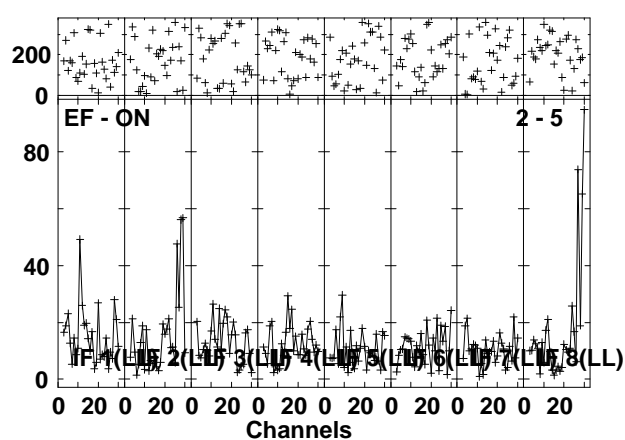
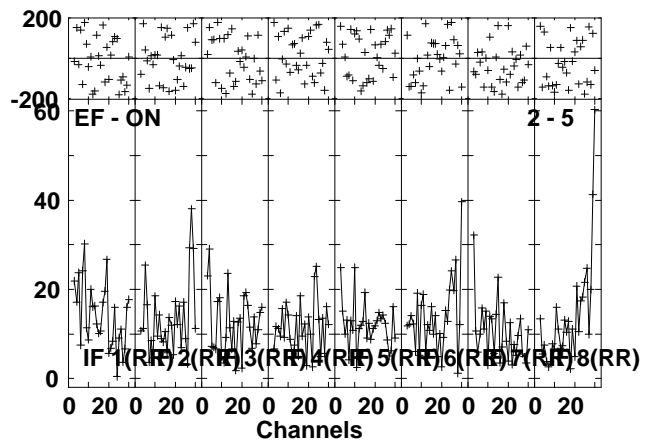
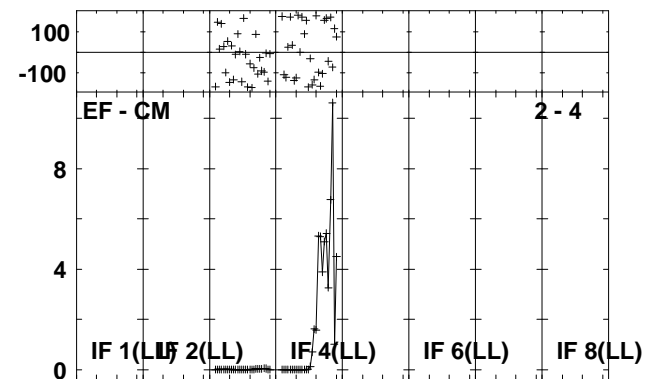
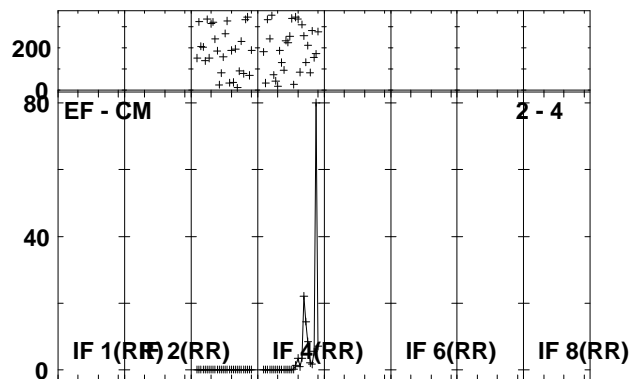
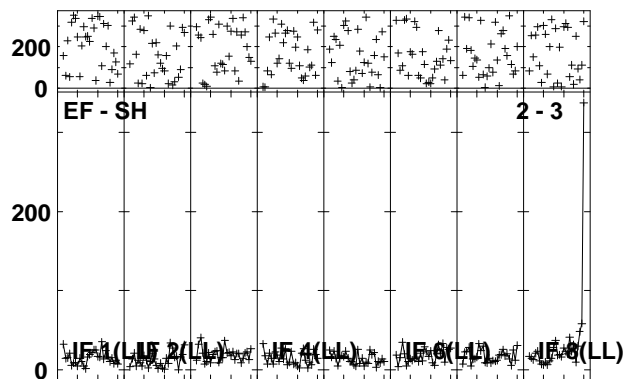
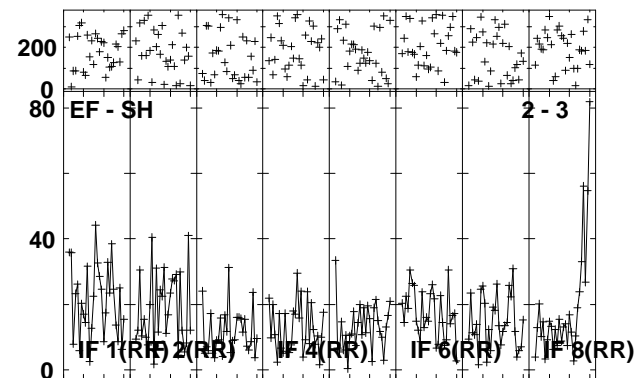
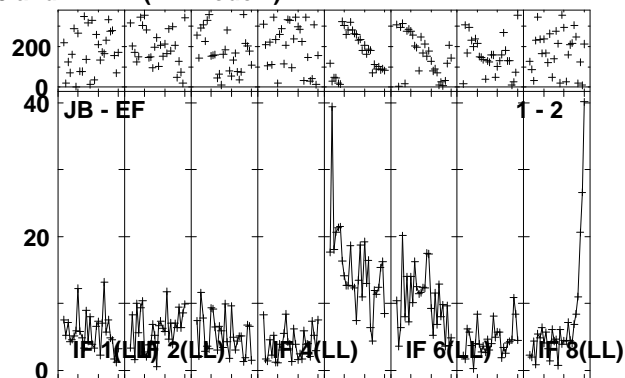
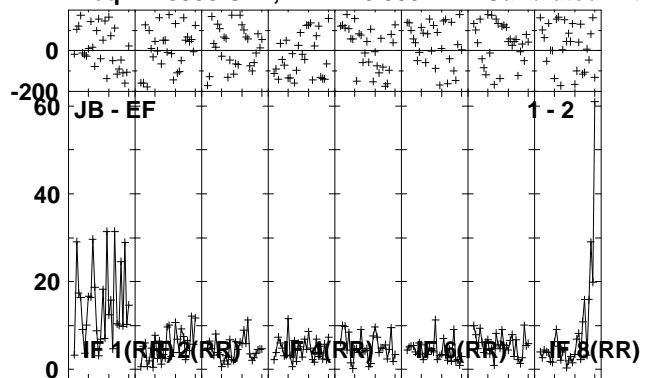

Lower frame: Milli Ampl Jy Top frame: Phas deg  
 Vector averaged cross-power spectrum Several baselines displayed  
 Timerange: 00/17:47:01 to 00/17:50:29

Plot file version 226 created 30-NOV-2010 14:33:59

ARP299C EP068B 3.UVDATA.1

Freq = 1.5950 GHz, Bw = 16.000 MH Calibrated with CL # 3 and BP # 1 (BP mode 1)

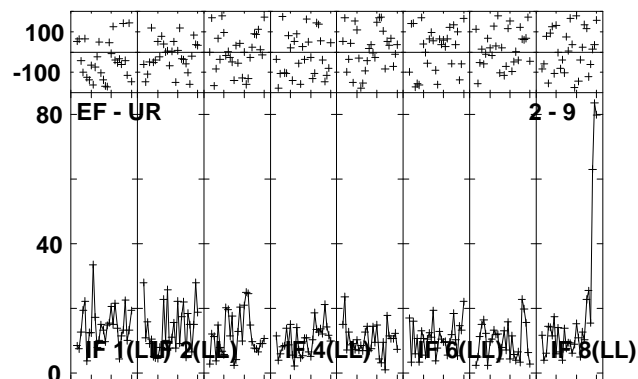
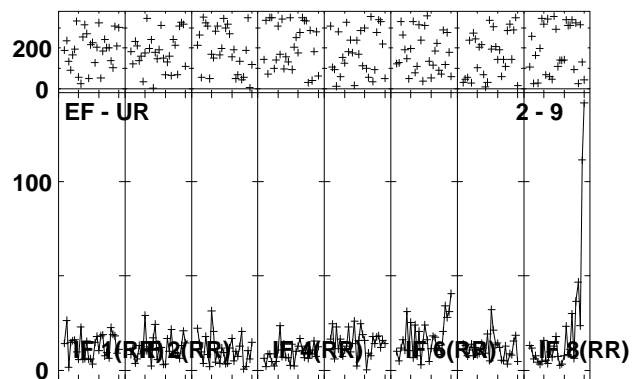
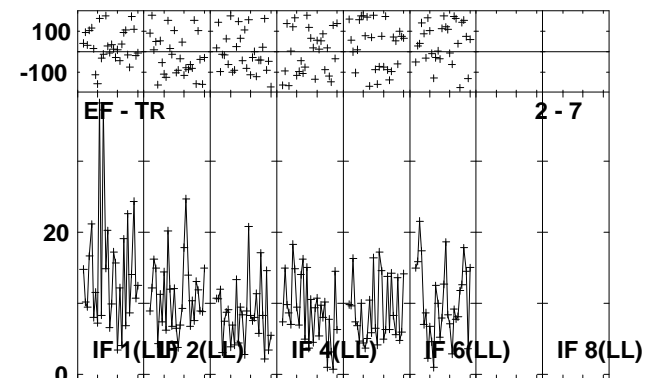
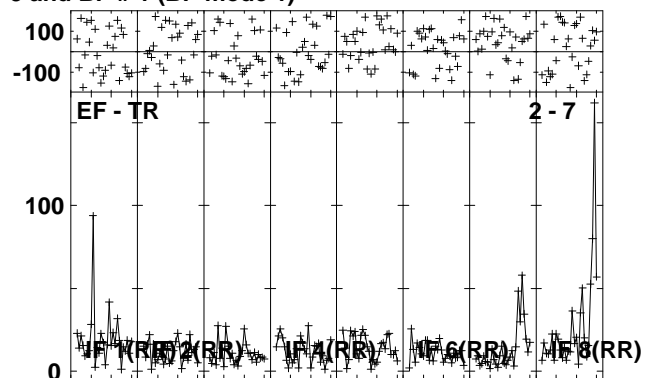
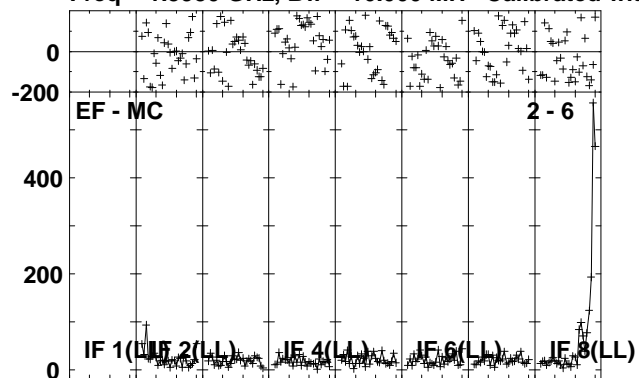

Lower frame: Milli Ampl Jy Top frame: Phas deg  
Vector averaged cross-power spectrum Several baselines displayed  
Timerange: 00/17:47:01 to 00/17:50:29

Plot file version 227 created 30-NOV-2010 14:34:03

J1128+59 EP068B 3.UVDATA.1

Freq = 1.5950 GHz, Bw = 16.000 MH Calibrated with CL # 3 and BP # 1 (BP mode 1)

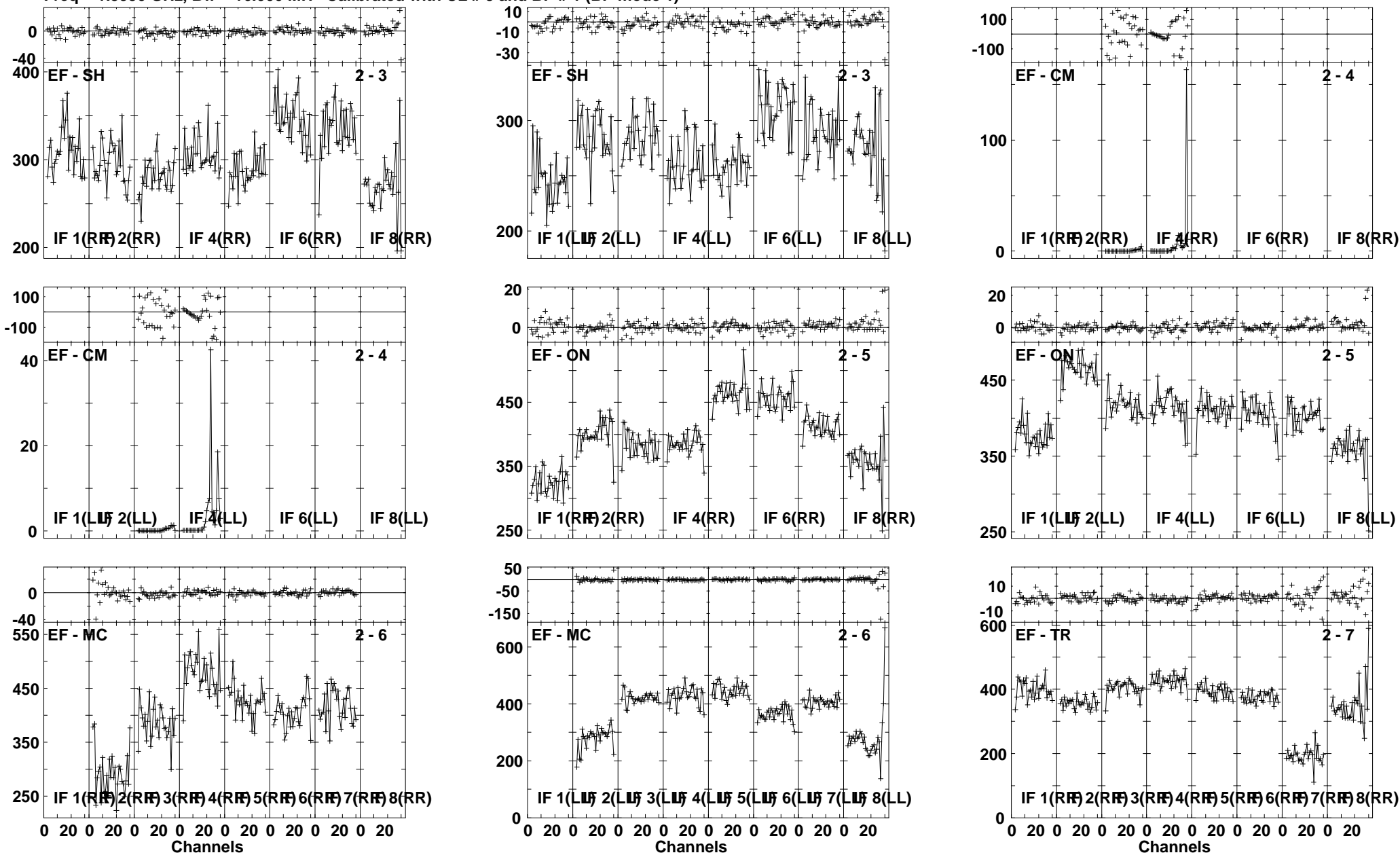

Plot file version 228 created 30-NOV-2010 14:34:05

J1128+59 EP068B 3.UVDATA.1

Freq = 1.5950 GHz, Bw = 16.000 MH Calibrated with CL # 3 and BP # 1 (BP mode 1)

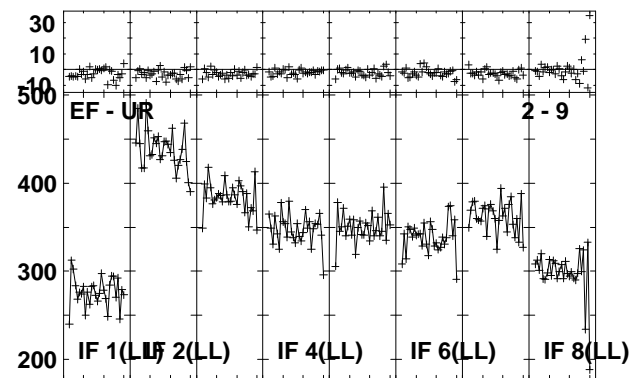
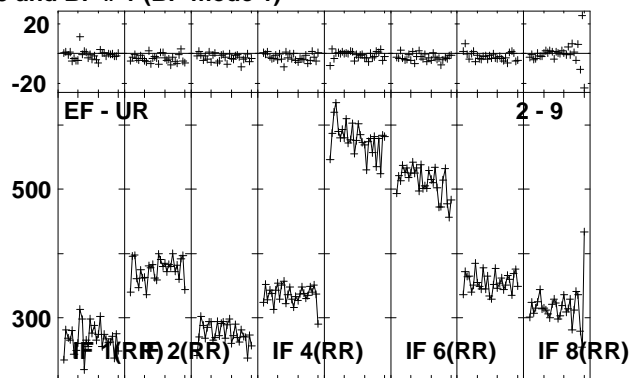
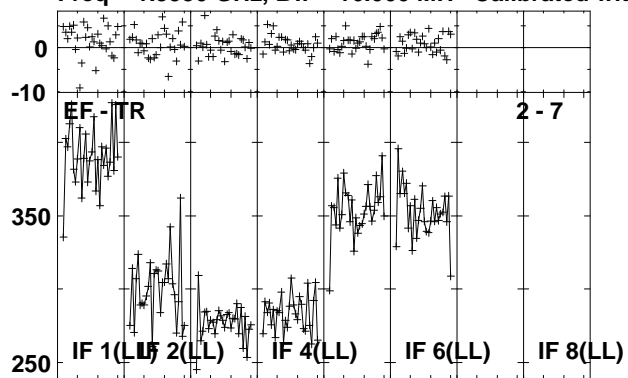

Lower frame: Milli Ampl Jy Top frame: Phas deg  
Vector averaged cross-power spectrum Several baselines displayed  
Timerange: 00/17:50:31 to 00/17:51:59

Plot file version 229 created 30-NOV-2010 14:34:07

ARP299C EP068B 3.UVDATA.1

Freq = 1.5950 GHz, Bw = 16.000 MH Calibrated with CL # 3 and BP # 1 (BP mode 1)

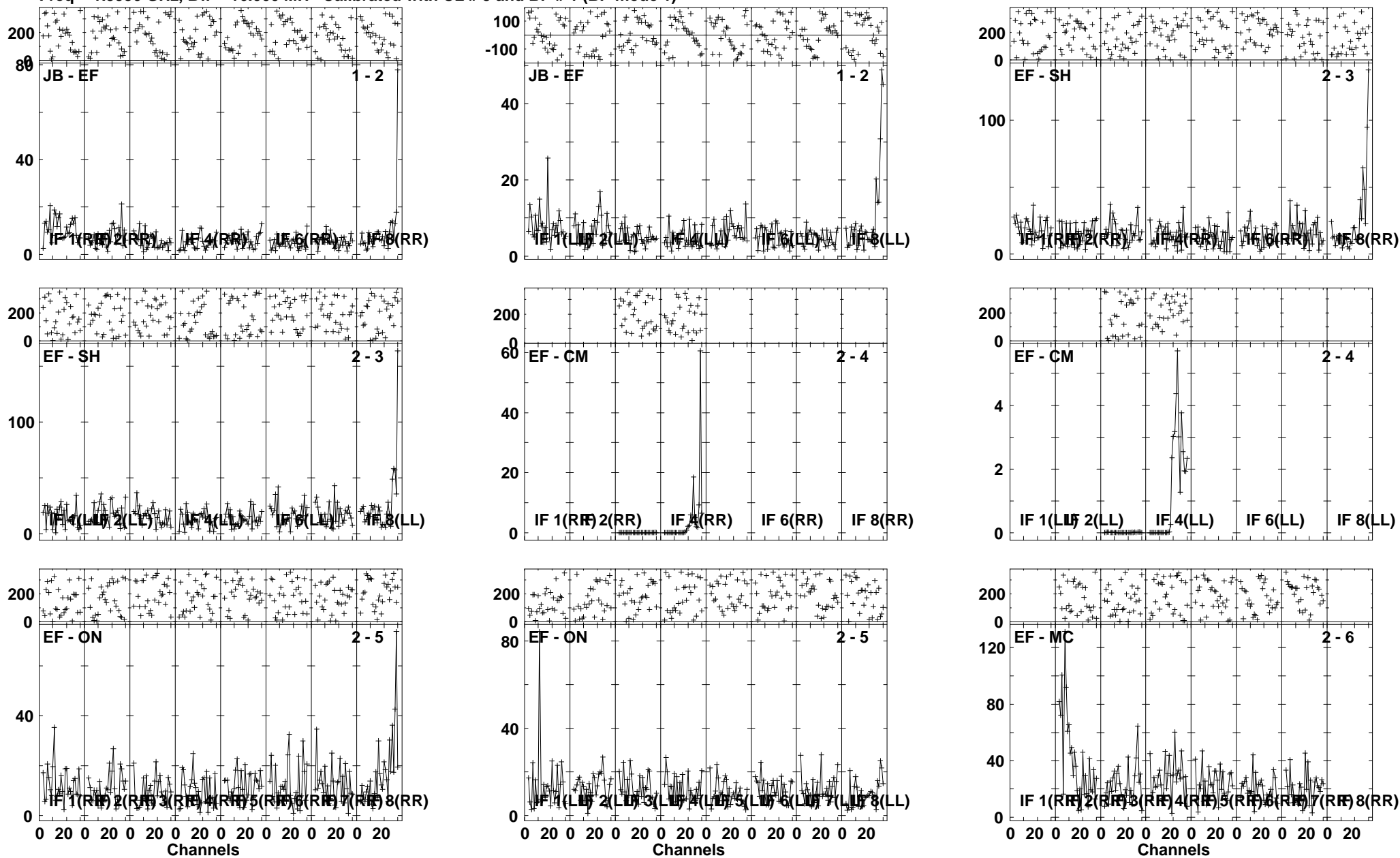

Lower frame: Milli Ampl Jy Top frame: Phas deg  
Vector averaged cross-power spectrum Several baselines displayed  
Timerange: 00/17:52:01 to 00/17:55:29

Plot file version 230 created 30-NOV-2010 14:34:10

ARP299C EP068B 3.UVDATA.1

Freq = 1.5950 GHz, Bw = 16.000 MH Calibrated with CL # 3 and BP # 1 (BP mode 1)

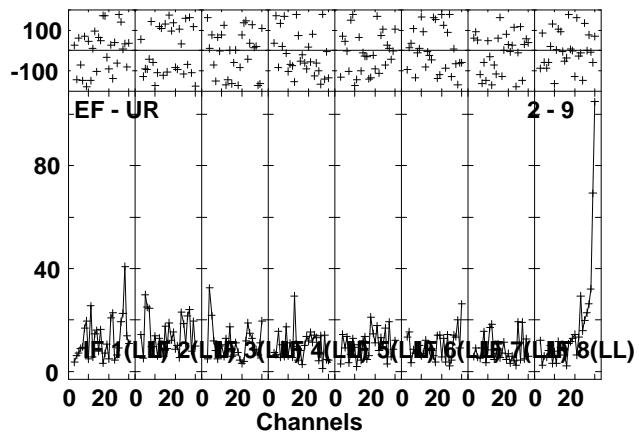
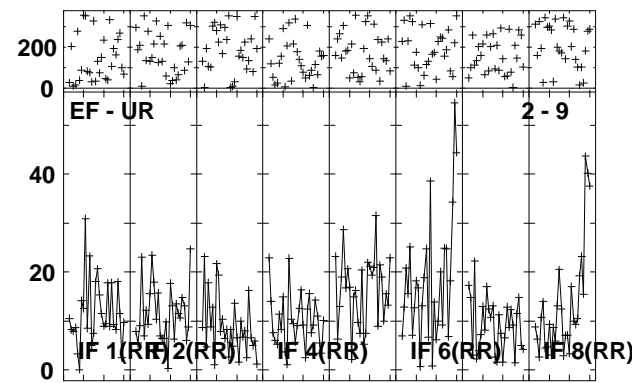
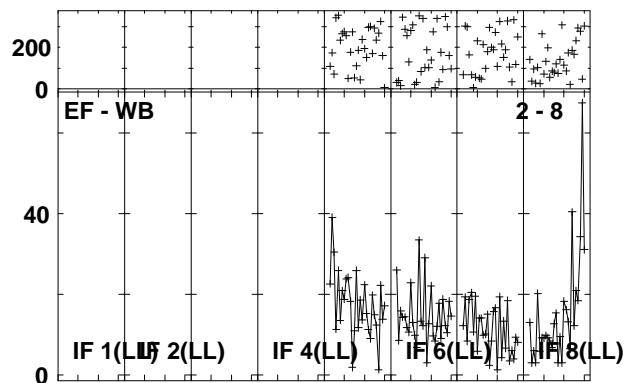
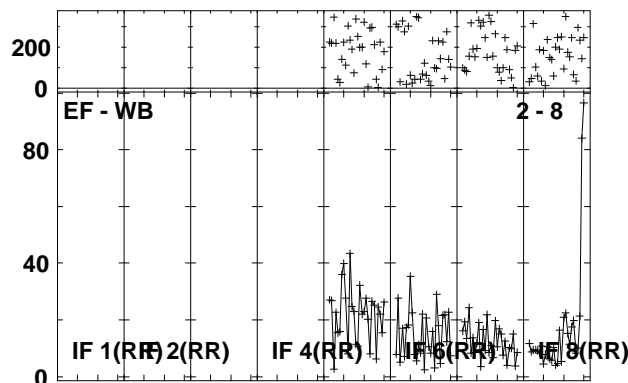
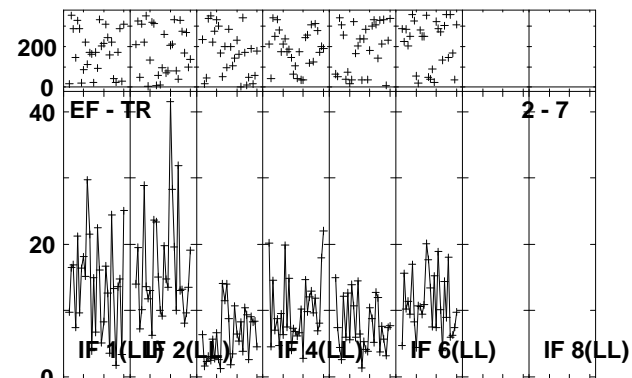
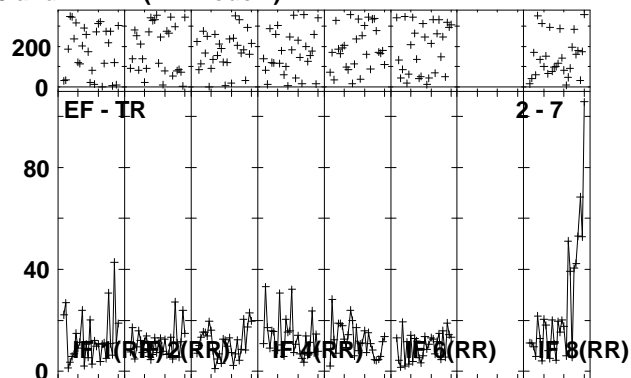
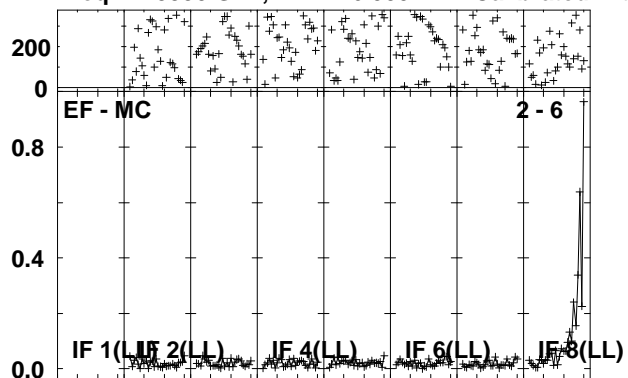

Lower frame: Ampl Jy Top frame: Phas deg  
Vector averaged cross-power spectrum Several baselines displayed  
Timerange: 00/17:52:01 to 00/17:55:29

Plot file version 231 created 30-NOV-2010 14:34:13

J1128+59 EP068B 3.UVDATA.1

Freq = 1.5950 GHz, Bw = 16.000 MH Calibrated with CL # 3 and BP # 1 (BP mode 1)

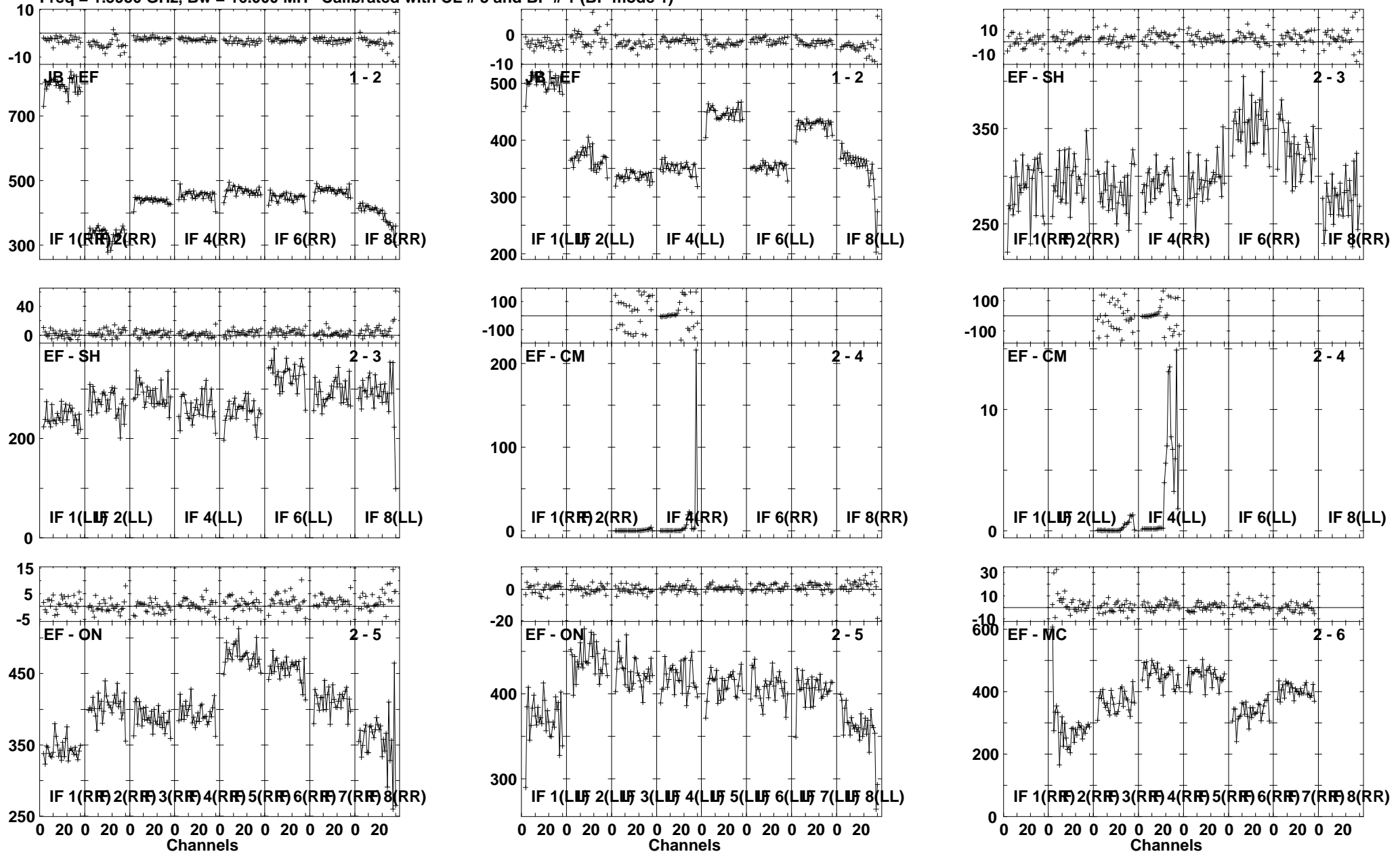

Plot file version 232 created 30-NOV-2010 14:34:14

J1128+59 EP068B 3.UVDATA.1

Freq = 1.5950 GHz, Bw = 16.000 MH Calibrated with CL # 3 and BP # 1 (BP mode 1)

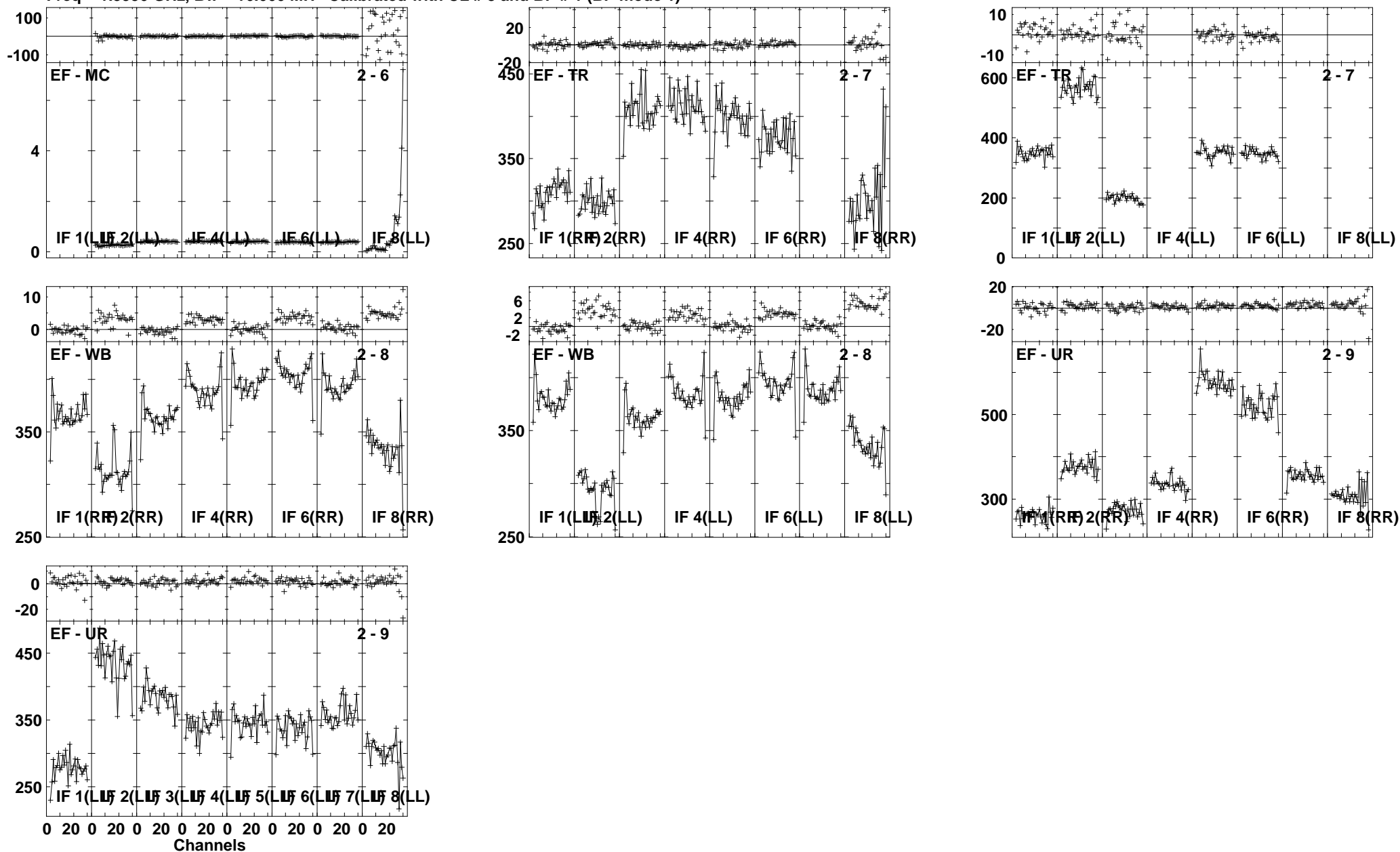

Lower frame: Ampl Jy Top frame: Phas deg  
Vector averaged cross-power spectrum Several baselines displayed  
Timerange: 00/17:55:31 to 00/17:56:59



Plot file version 233 created 30-NOV-2010 14:34:16

ARP299C EP068B 3.UVDATA.1

Freq = 1.5950 GHz, Bw = 16.000 MH Calibrated with CL # 3 and BP # 1 (BP mode 1)

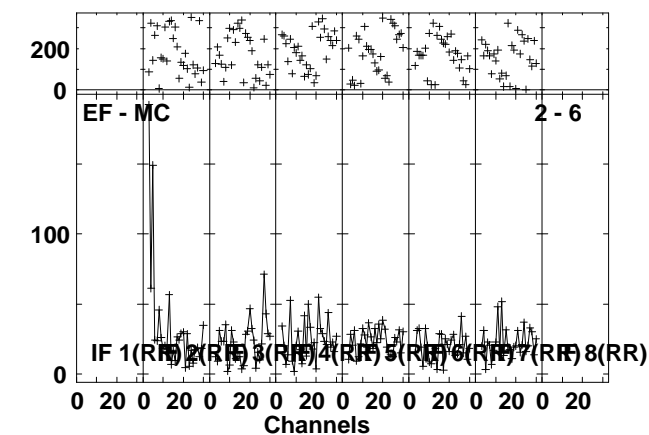
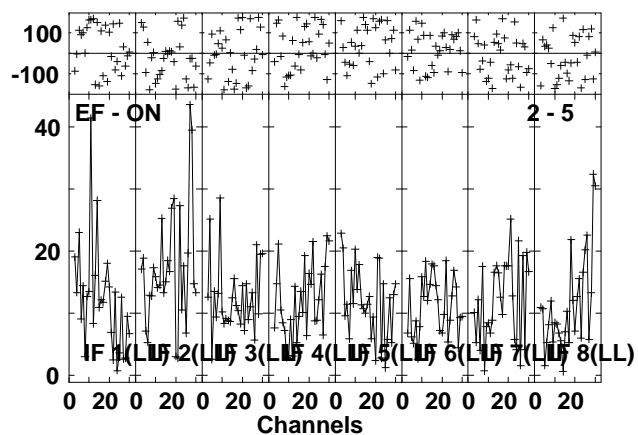
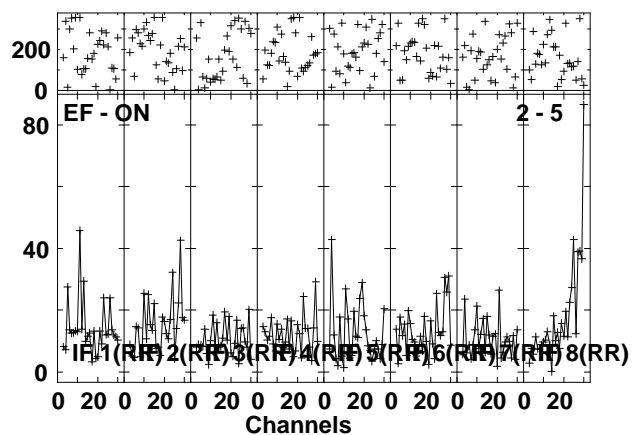
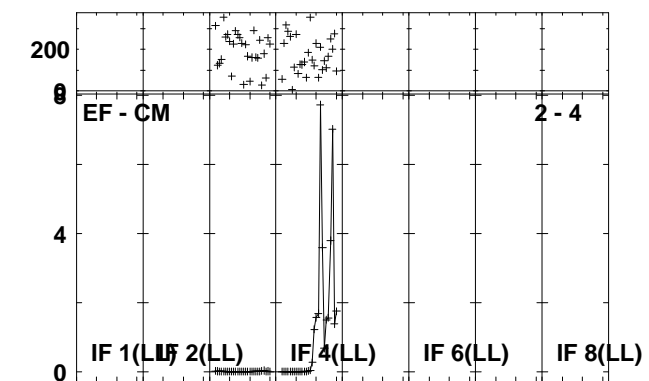
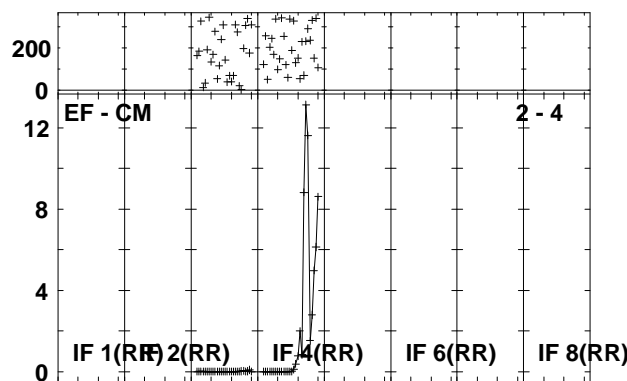
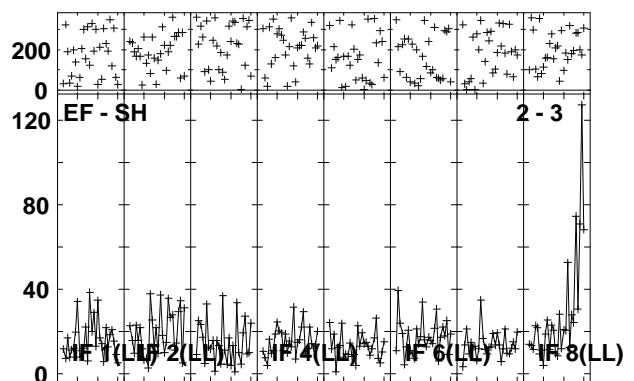
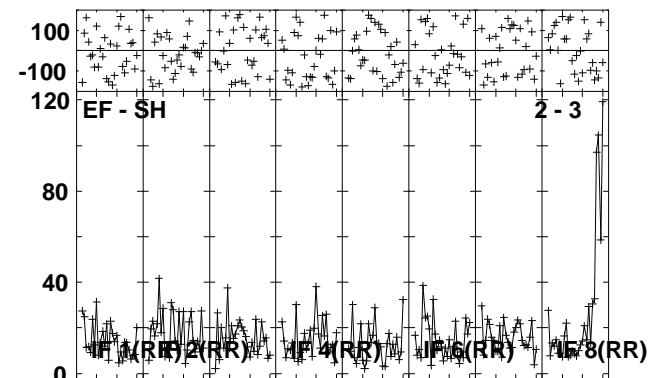
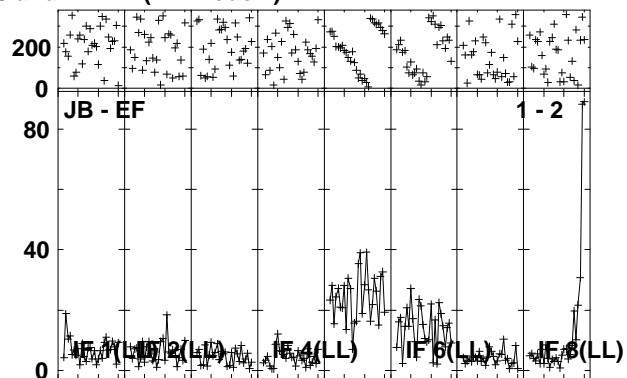
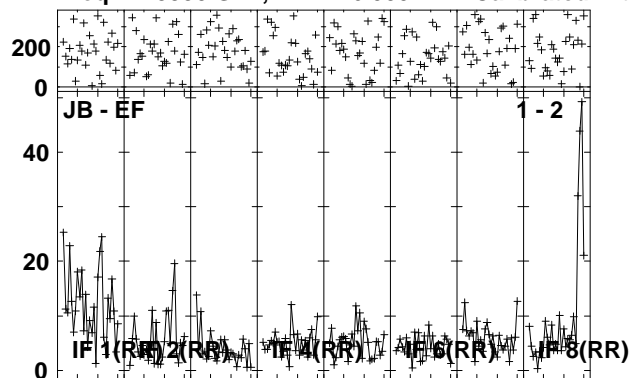

Lower frame: Milli Ampl Jy Top frame: Phas deg  
Vector averaged cross-power spectrum Several baselines displayed  
Timerange: 00/17:57:01 to 00/18:00:29

Plot file version 234 created 30-NOV-2010 14:34:19

ARP299C EP068B 3.UVDATA.1

Freq = 1.5950 GHz, Bw = 16.000 MH Calibrated with CL # 3 and BP # 1 (BP mode 1)

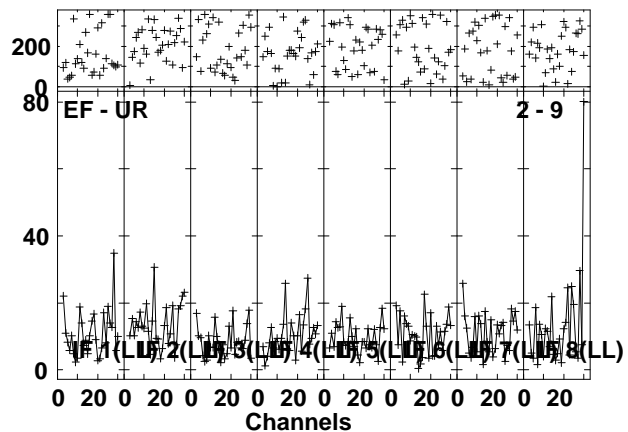
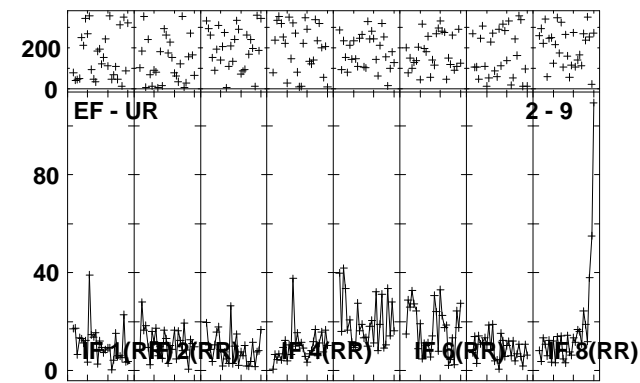
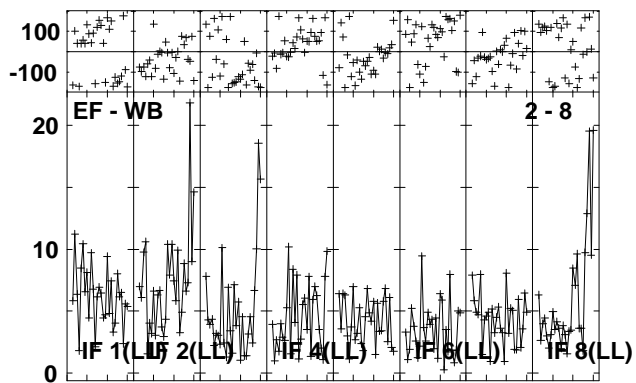
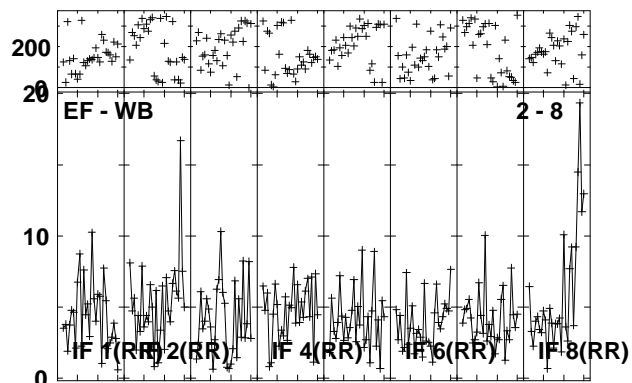
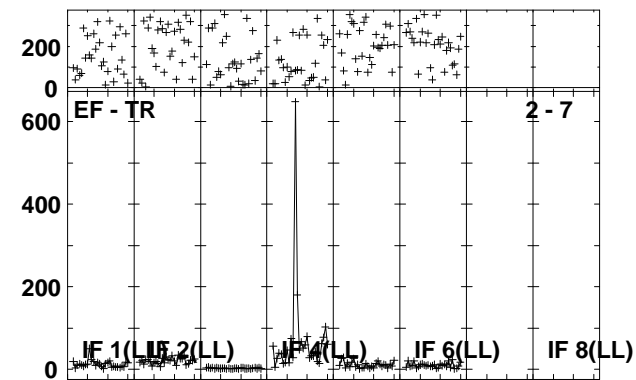
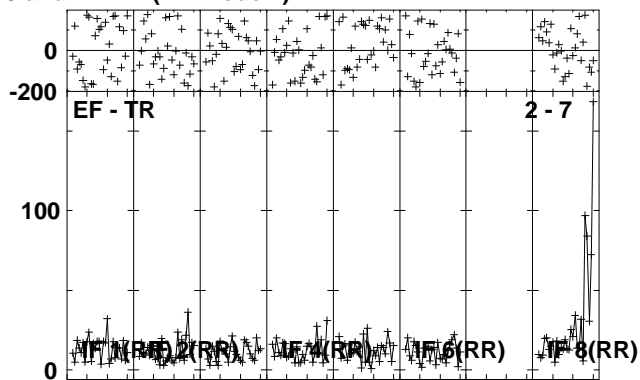
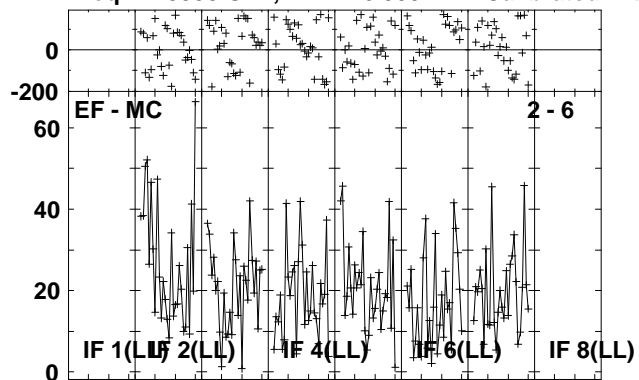

Lower frame: Milli Ampl Jy Top frame: Phas deg  
 Vector averaged cross-power spectrum Several baselines displayed  
 Timerange: 00/17:57:01 to 00/18:00:29

Plot file version 235 created 30-NOV-2010 14:34:21

J1128+59 EP068B 3.UVDATA.1

Freq = 1.5950 GHz, Bw = 16.000 MH Calibrated with CL # 3 and BP # 1 (BP mode 1)

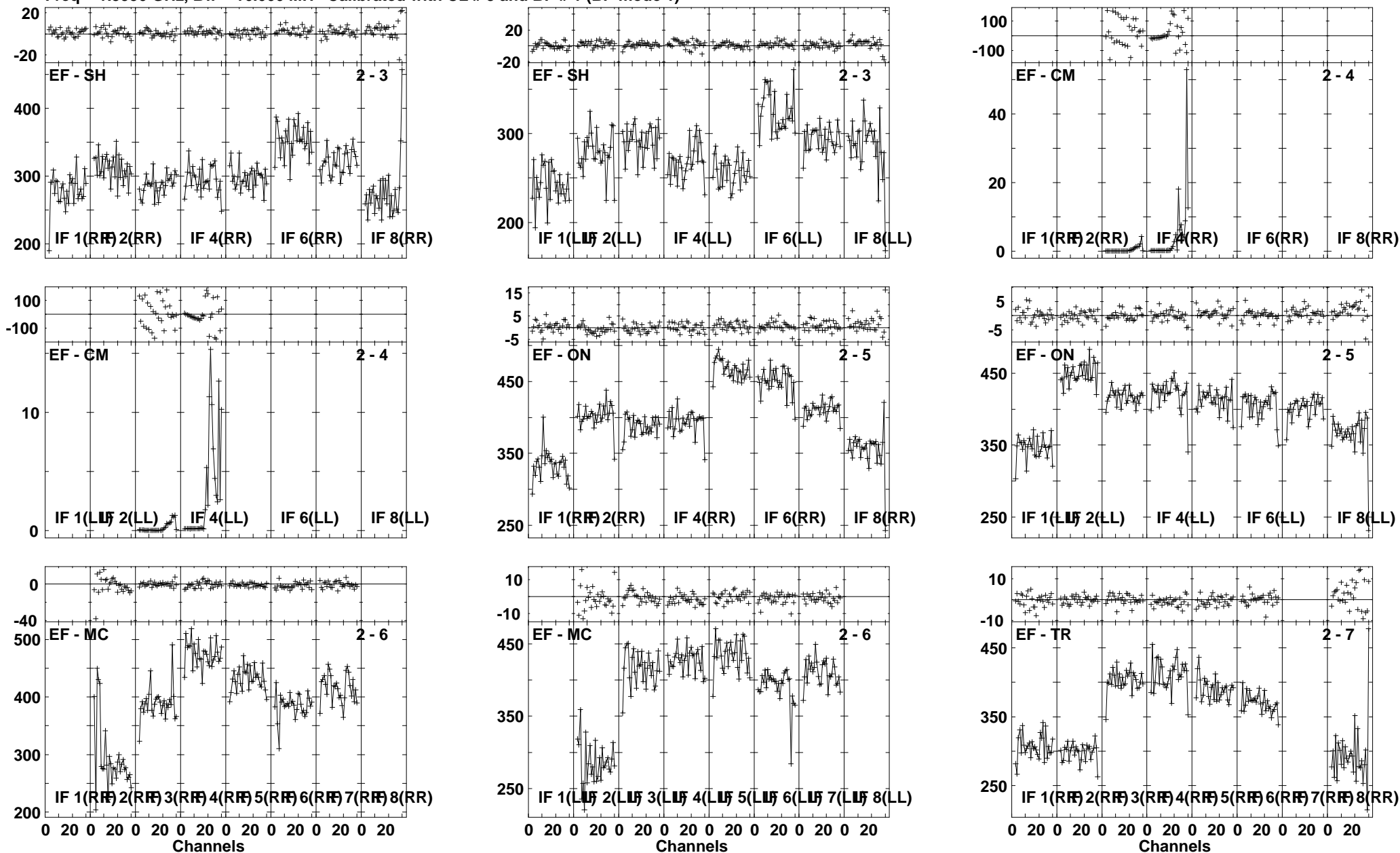

Lower frame: Milli Ampl Jy Top frame: Phas deg  
Vector averaged cross-power spectrum Several baselines displayed  
Timerange: 00:18:01:31 to 00:18:02:59

Plot file version 236 created 30-NOV-2010 14:34:23

J1128+59 EP068B 3.UVDATA.1

Freq = 1.5950 GHz, Bw = 16.000 MH Calibrated with CL # 3 and BP # 1 (BP mode 1)

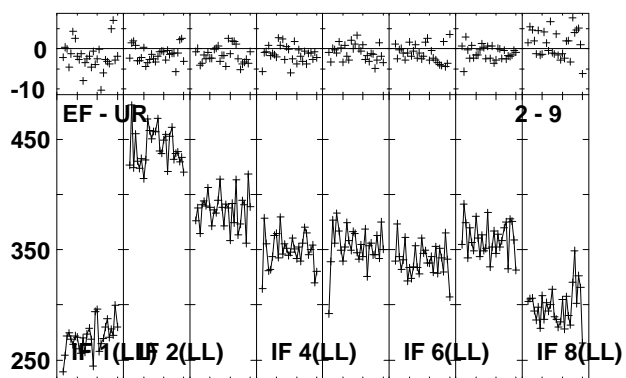
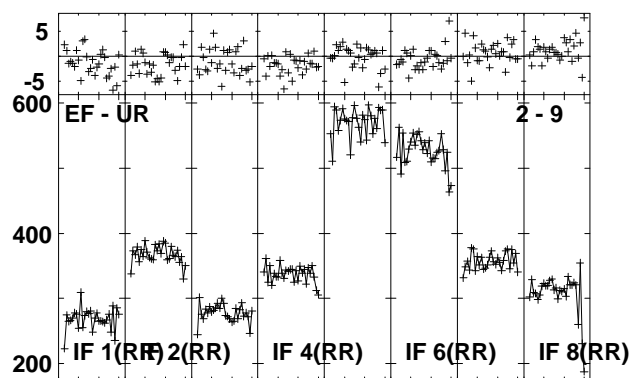
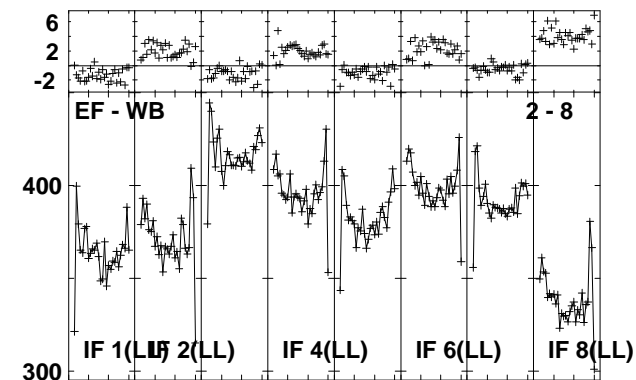
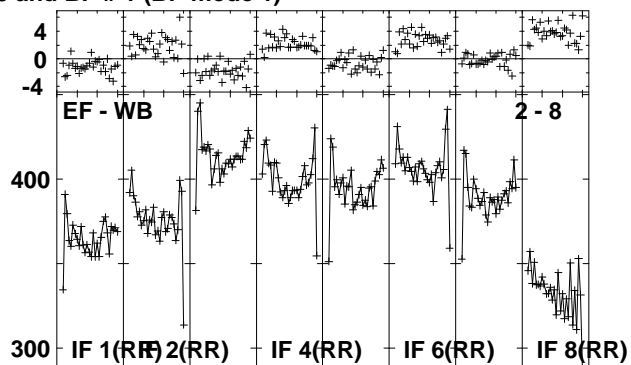
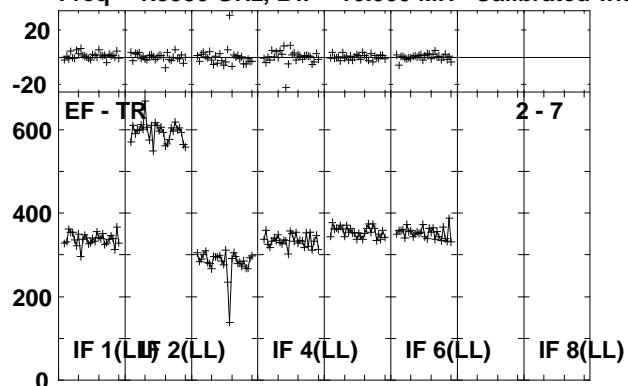

Lower frame: Milli Ampl Jy Top frame: Phas deg  
Vector averaged cross-power spectrum Several baselines displayed  
Timerange: 00:18:01:31 to 00:18:02:59

Plot file version 237 created 30-NOV-2010 14:34:24

ARP299C EP068B 3.UVDATA.1

Freq = 1.5950 GHz, Bw = 16.000 MH Calibrated with CL # 3 and BP # 1 (BP mode 1)

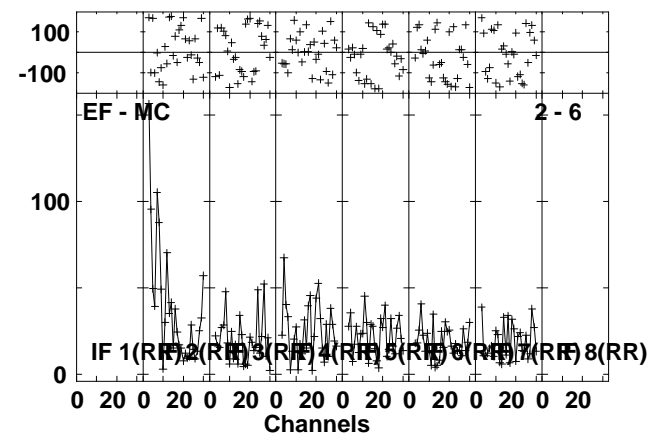
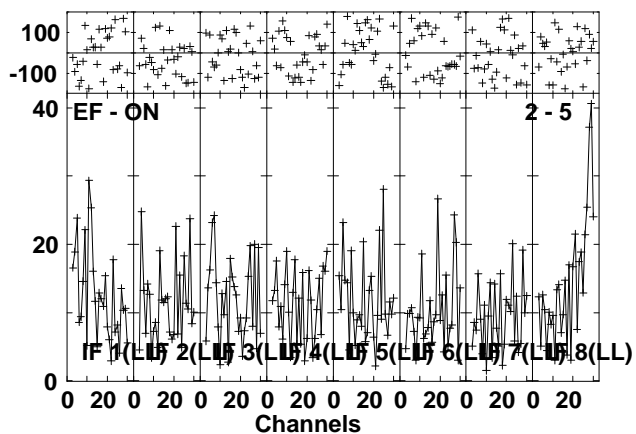
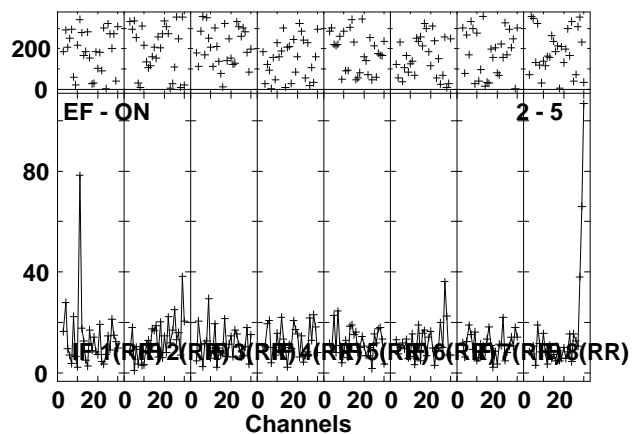
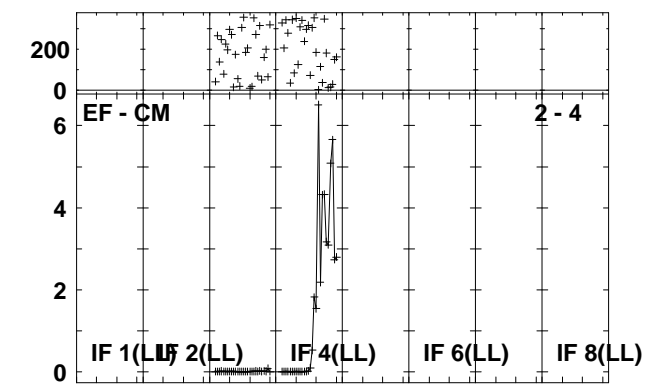
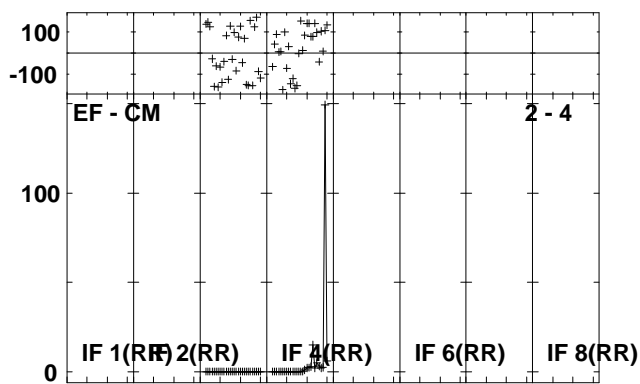
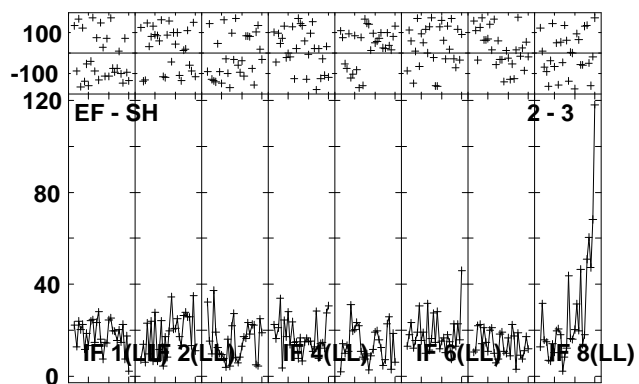
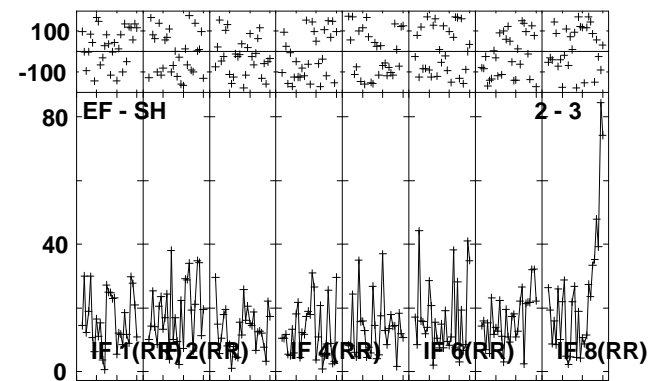
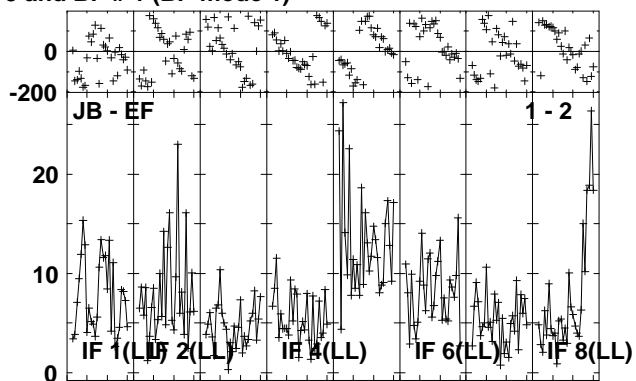
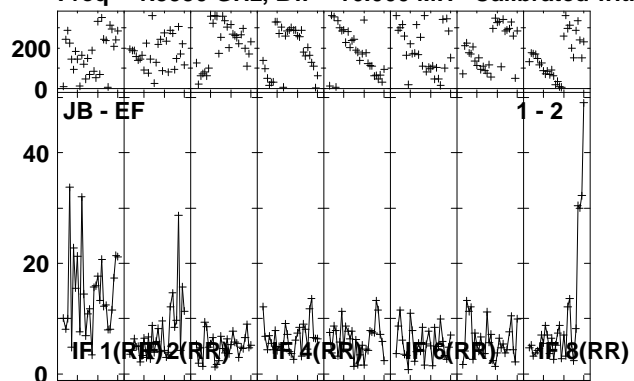

Lower frame: Milli Ampl Jy Top frame: Phas deg  
Vector averaged cross-power spectrum Several baselines displayed  
Timerange: 00:18:03:01 to 00:18:06:29

Plot file version 238 created 30-NOV-2010 14:34:27

ARP299C EP068B 3.UVDATA.1

Freq = 1.5950 GHz, Bw = 16.000 MH Calibrated with CL # 3 and BP # 1 (BP mode 1)

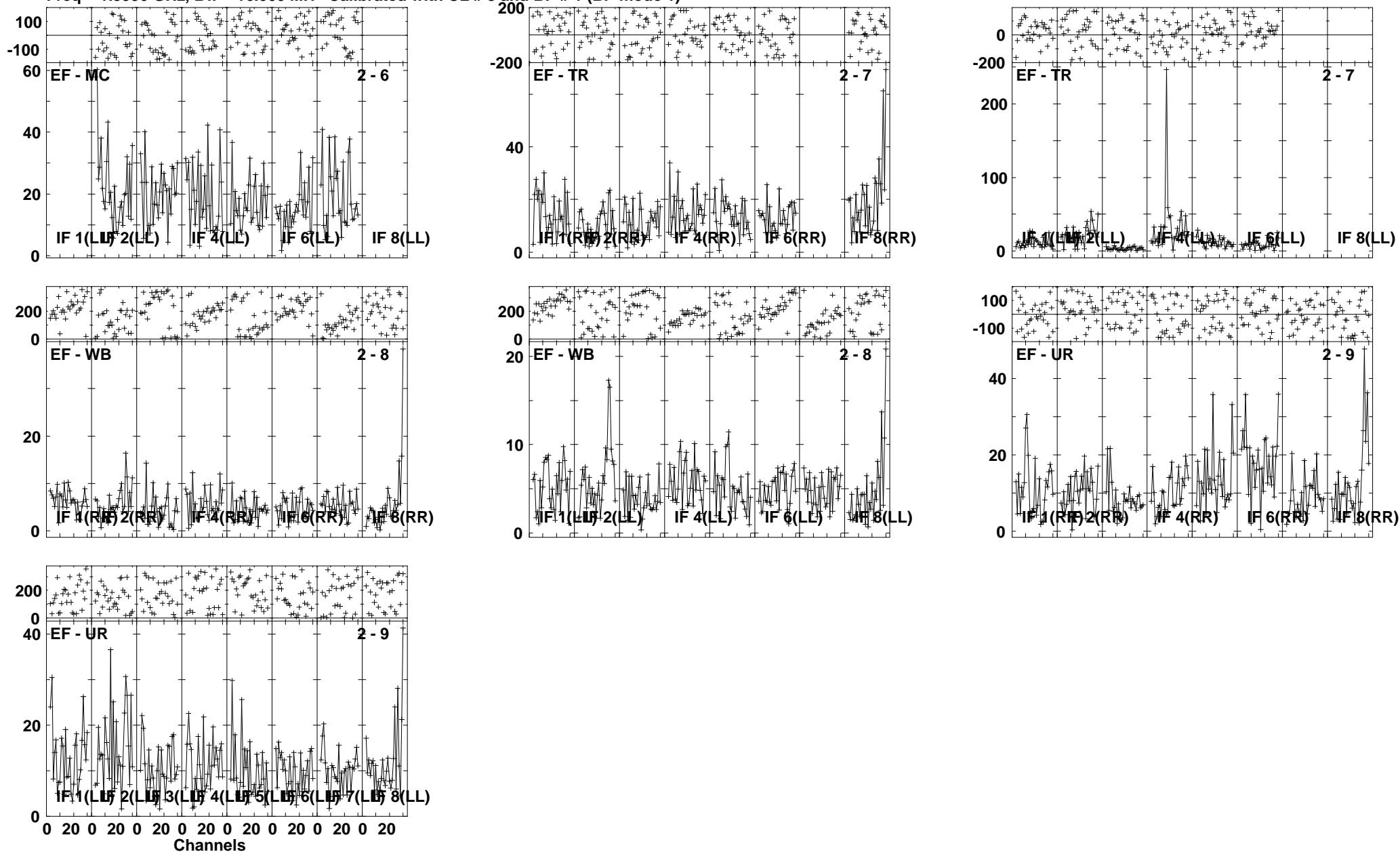

Lower frame: Milli Ampl Jy Top frame: Phas deg  
Vector averaged cross-power spectrum Several baselines displayed  
Timerange: 00/18:03:01 to 00/18:06:29

Plot file version 239 created 30-NOV-2010 14:34:30

J1128+59 EP068B 3.UVDATA.1

Freq = 1.5950 GHz, Bw = 16.000 MH Calibrated with CL # 3 and BP # 1 (BP mode 1)

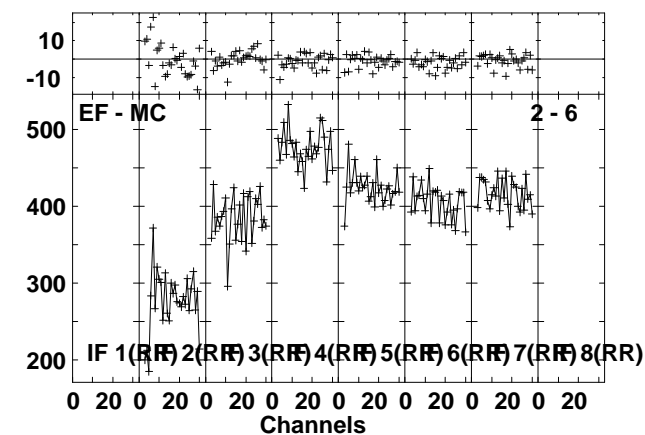
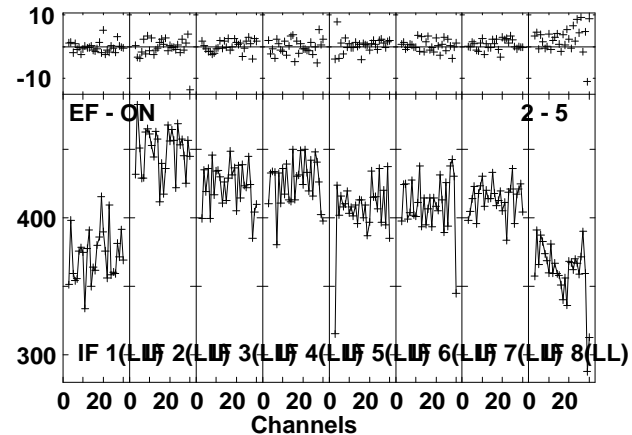
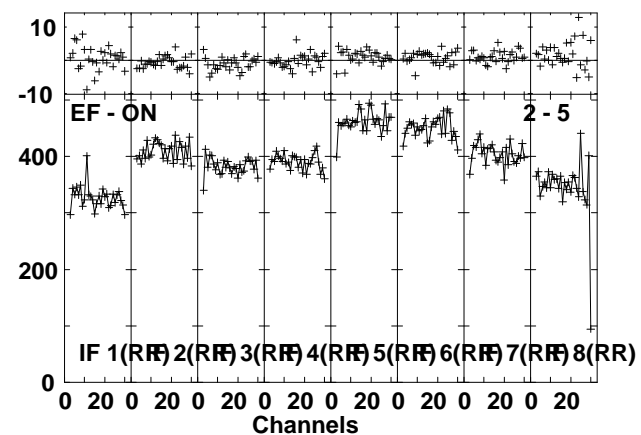
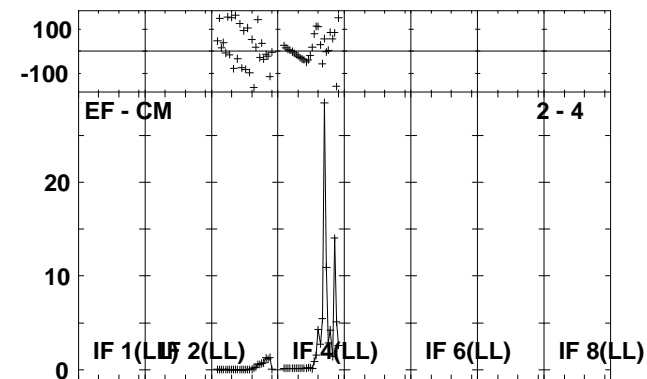
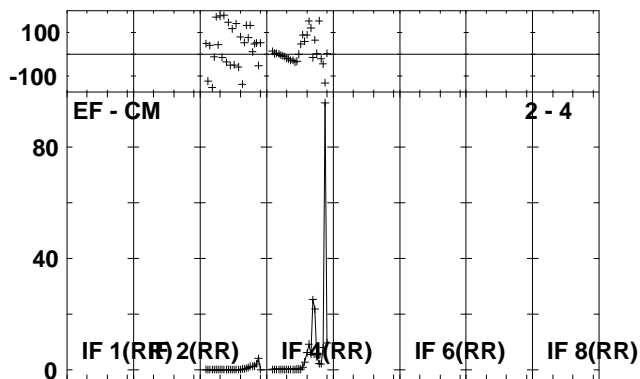
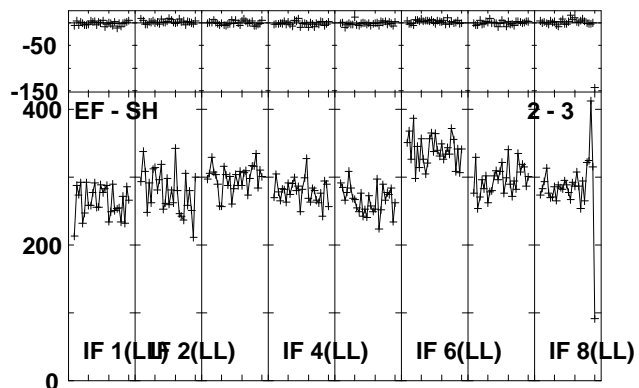
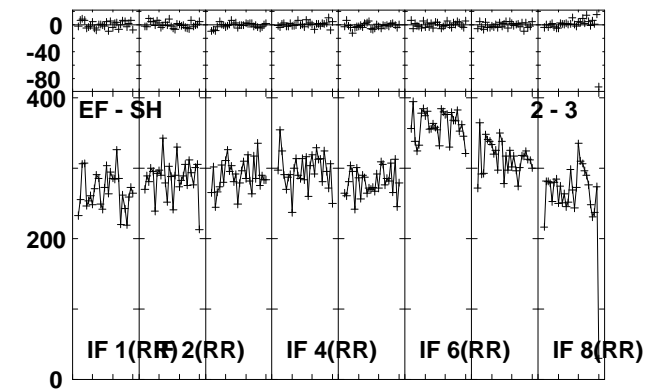
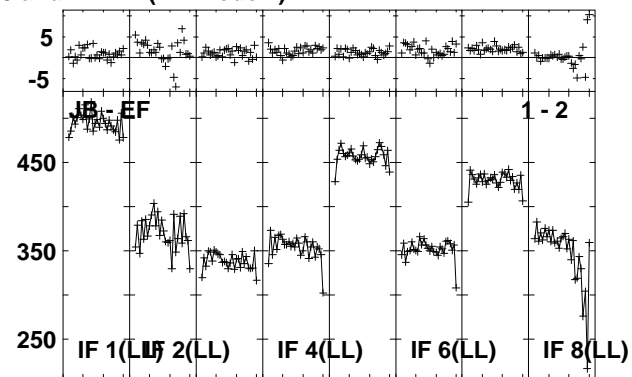
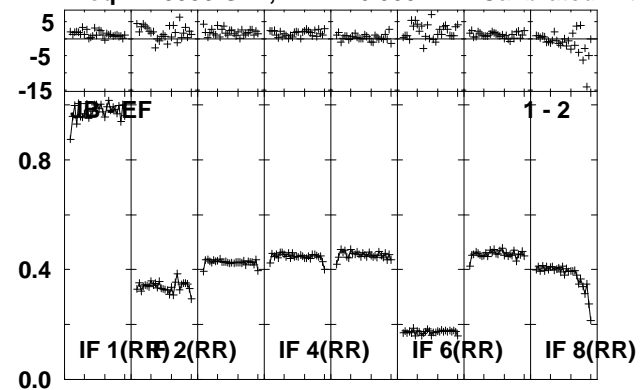

Lower frame: Ampl Jy Top frame: Phas deg  
Vector averaged cross-power spectrum Several baselines displayed  
Timerange: 00/18:06:31 to 00/18:07:59

Plot file version 240 created 30-NOV-2010 14:34:31

J1128+59 EP068B 3.UVDATA.1

Freq = 1.5950 GHz, Bw = 16.000 MH Calibrated with CL # 3 and BP # 1 (BP mode 1)

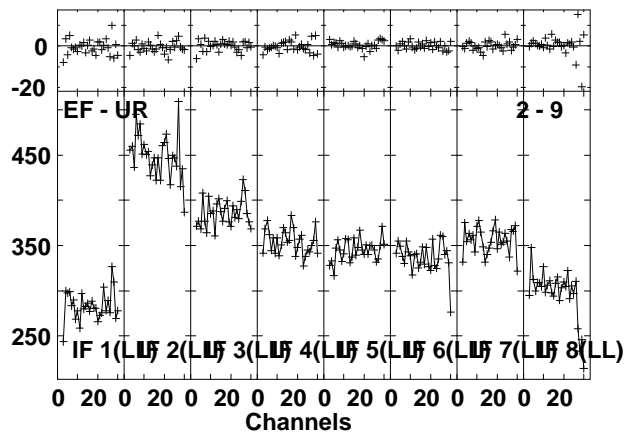
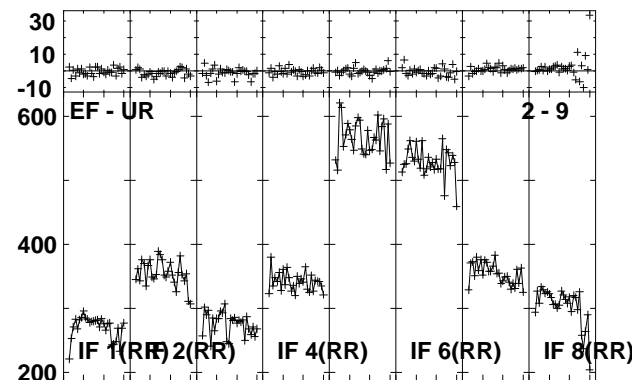
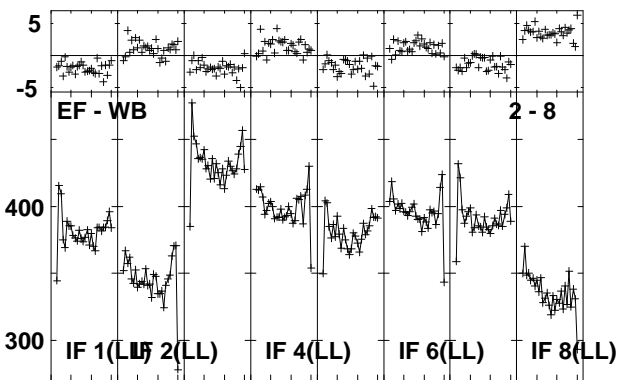
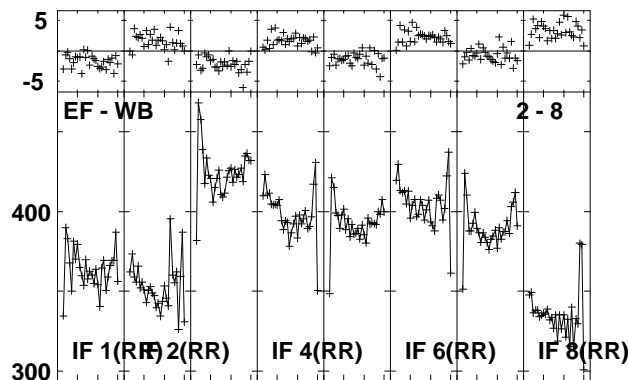
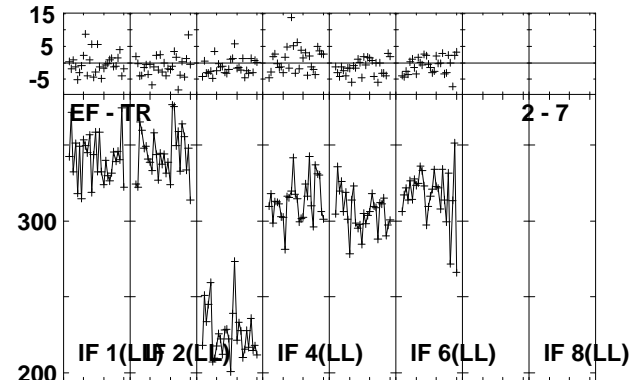
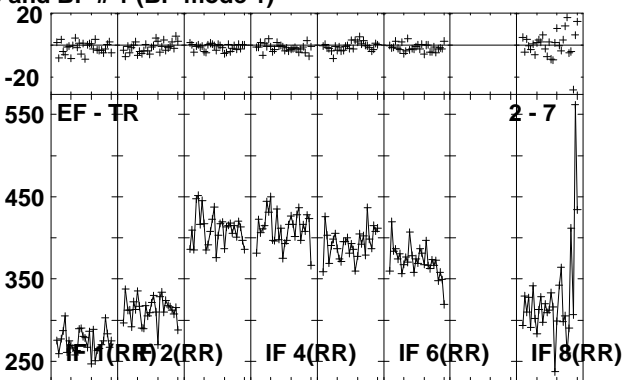
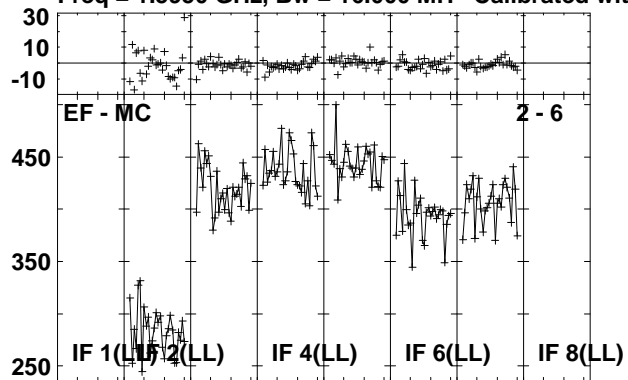

Lower frame: Milli Ampl Jy Top frame: Phas deg  
Vector averaged cross-power spectrum Several baselines displayed  
Timerange: 00:18:06:31 to 00:18:07:59



Plot file version 241 created 30-NOV-2010 14:34:33

ARP299C EP068B 3.UVDATA.1

Freq = 1.5950 GHz, Bw = 16.000 MH Calibrated with CL # 3 and BP # 1 (BP mode 1)

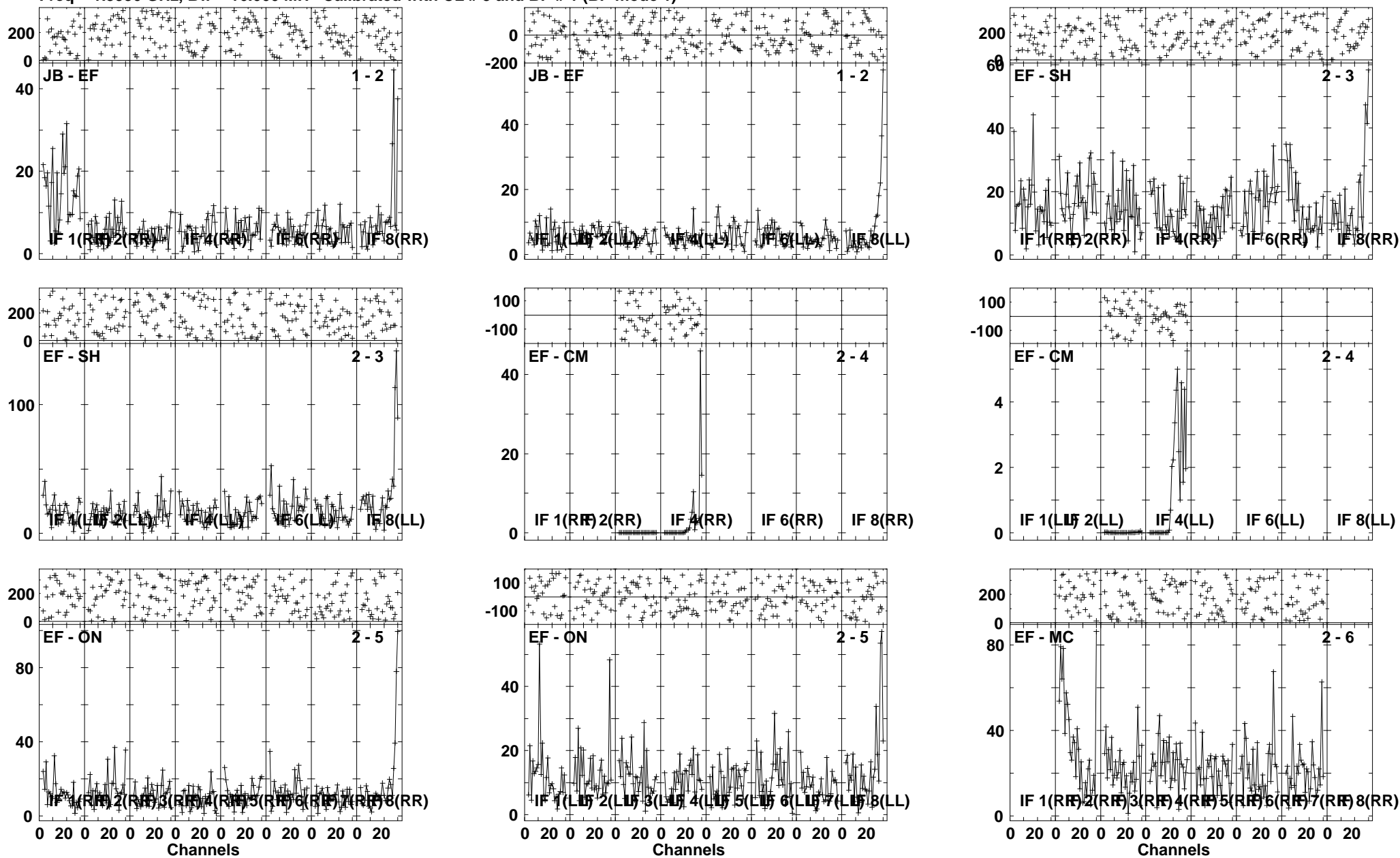

Lower frame: Milli Ampl Jy Top frame: Phas deg  
Vector averaged cross-power spectrum Several baselines displayed  
Timerange: 00:18:08:01 to 00:18:11:29

Plot file version 242 created 30-NOV-2010 14:34:36

ARP299C EP068B 3.UVDATA.1

Freq = 1.5950 GHz, Bw = 16.000 MH Calibrated with CL # 3 and BP # 1 (BP mode 1)

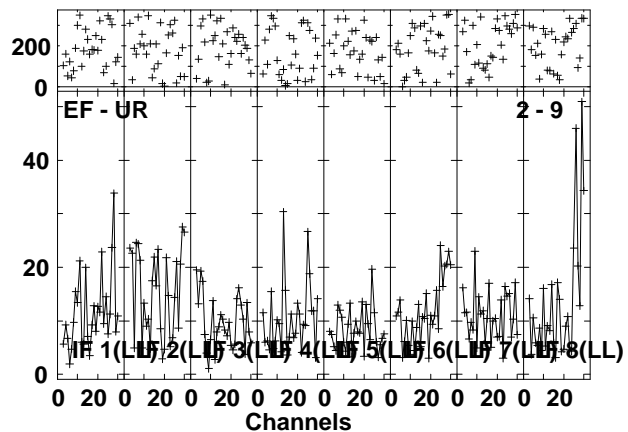
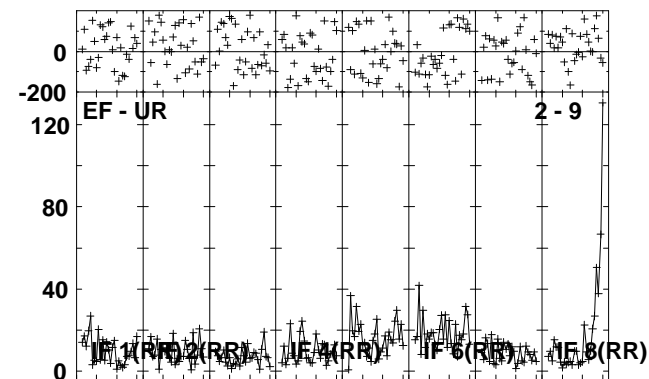
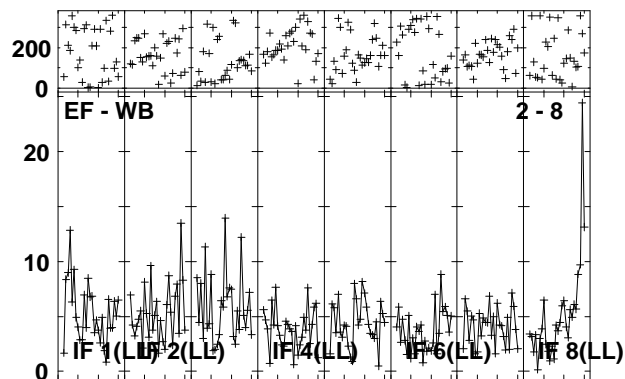
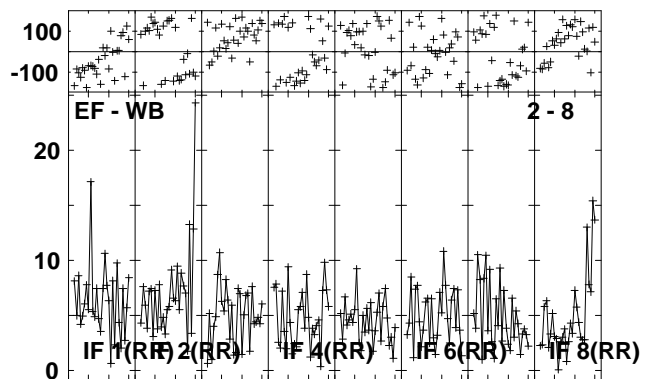
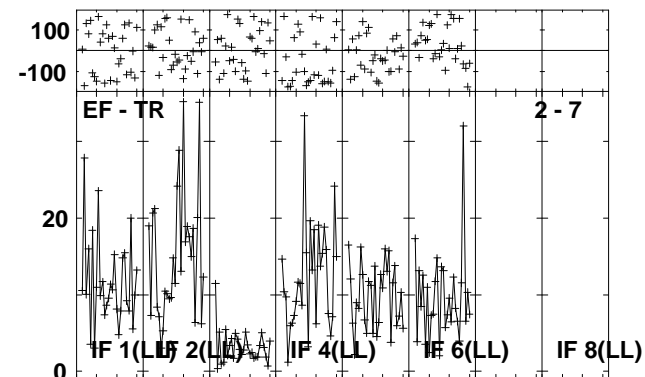
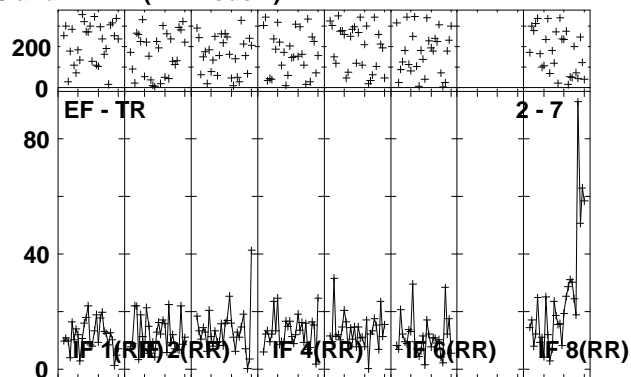
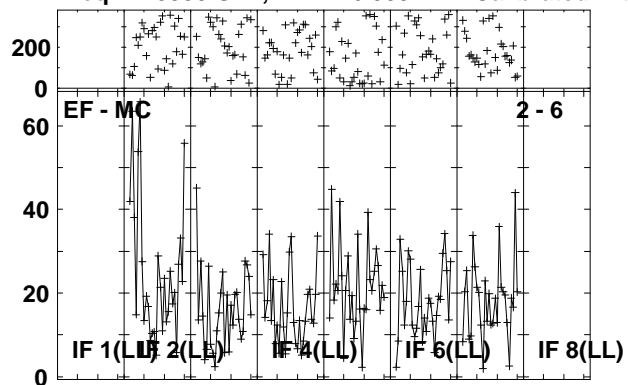

Lower frame: Milli Ampl Jy Top frame: Phas deg  
Vector averaged cross-power spectrum Several baselines displayed  
Timerange: 00:18:08:01 to 00:18:11:29

Plot file version 243 created 30-NOV-2010 14:34:38  
 J1128+59 EP068B 3.UVDATA.1  
 Freq = 1.5950 GHz, Bw = 16.000 MH Calibrated with CL # 3 and BP # 1 (BP mode 1)

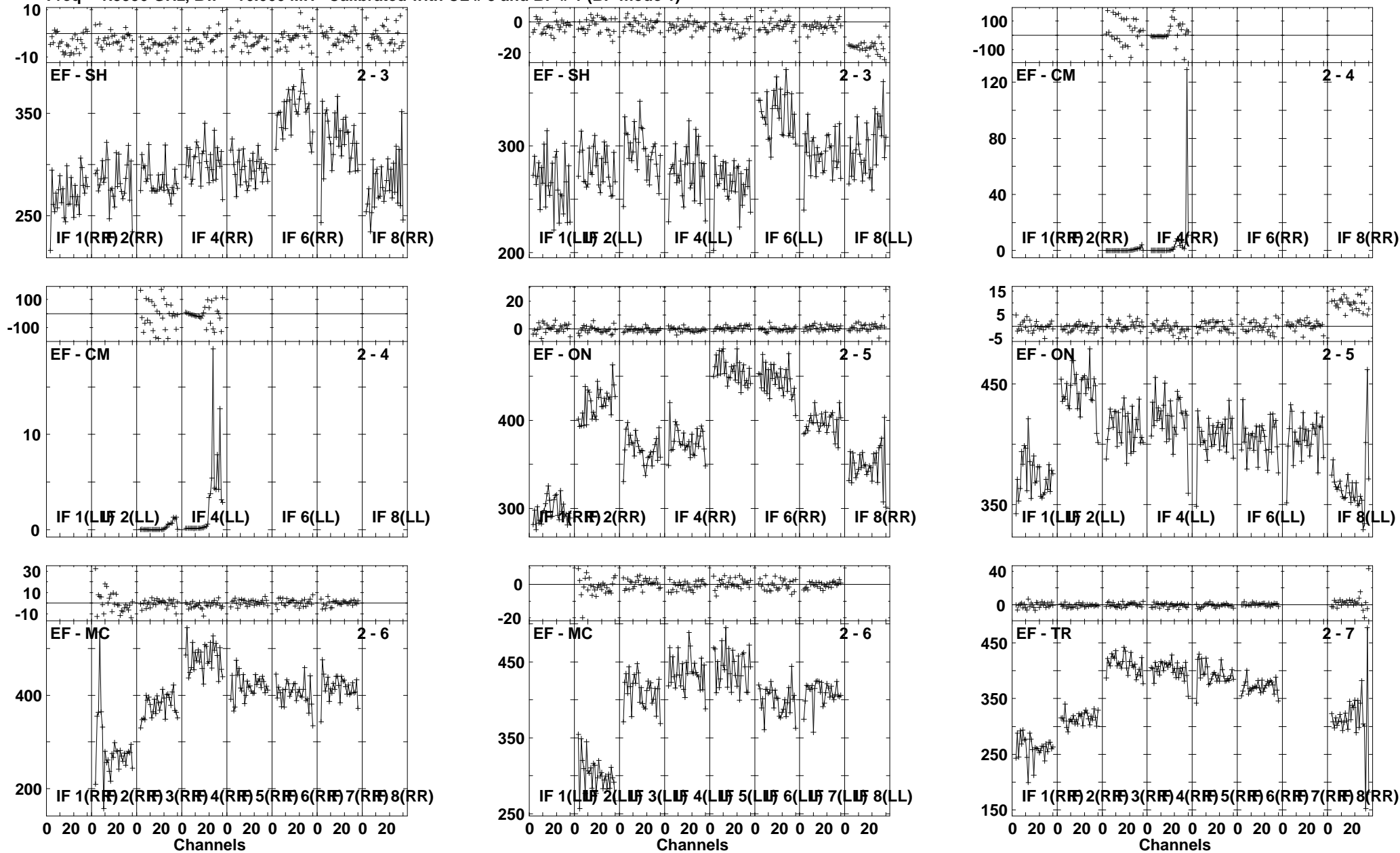

Lower frame: Milli Ampl Jy Top frame: Phas deg  
 Vector averaged cross-power spectrum Several baselines displayed  
 Timerange: 00/18:12:31 to 00/18:13:59

Plot file version 244 created 30-NOV-2010 14:34:40

J1128+59 EP068B 3.UVDATA.1

Freq = 1.5950 GHz, Bw = 16.000 MH Calibrated with CL # 3 and BP # 1 (BP mode 1)

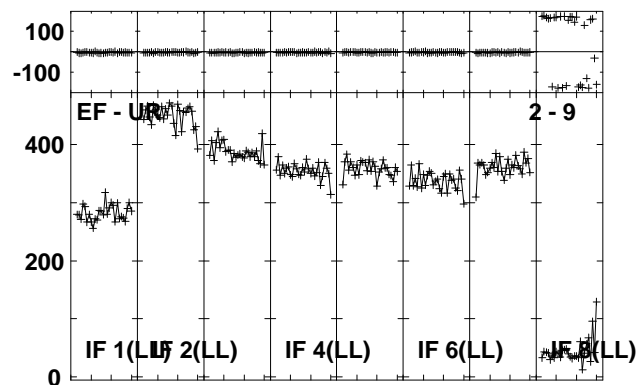
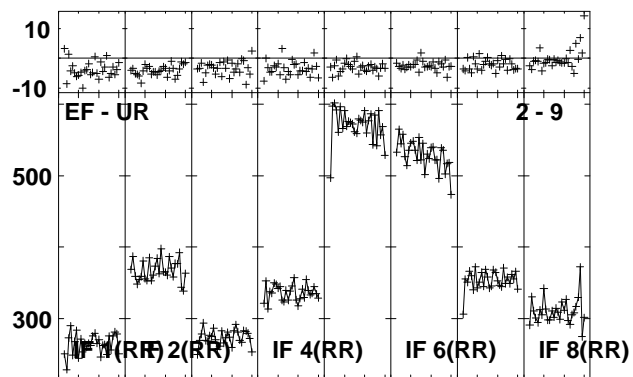
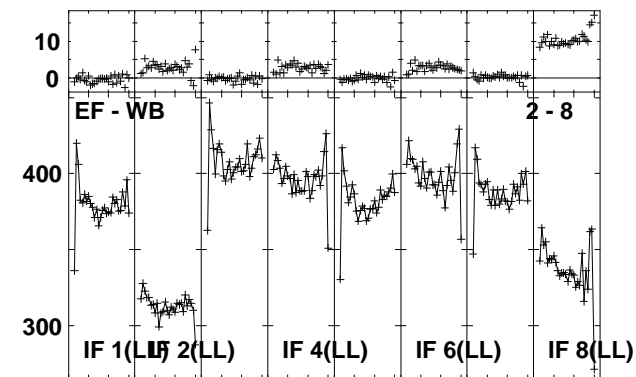
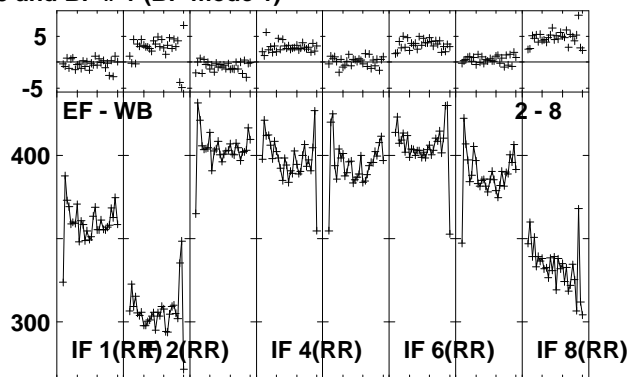
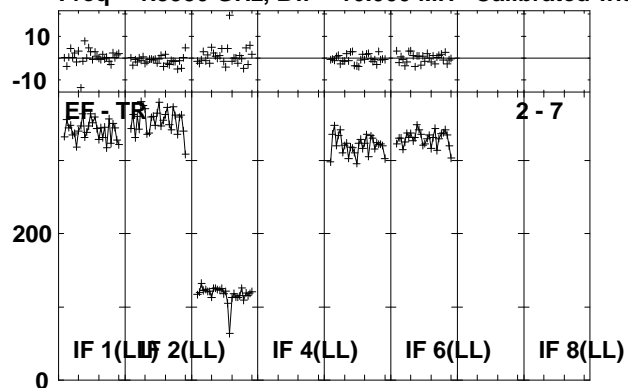

Lower frame: Milli Ampl Jy Top frame: Phas deg  
Vector averaged cross-power spectrum Several baselines displayed  
Timerange: 00:18:12:31 to 00:18:13:59

Plot file version 245 created 30-NOV-2010 14:34:41

ARP299C EP068B 3.UVDATA.1

Freq = 1.5950 GHz, Bw = 16.000 MH Calibrated with CL # 3 and BP # 1 (BP mode 1)

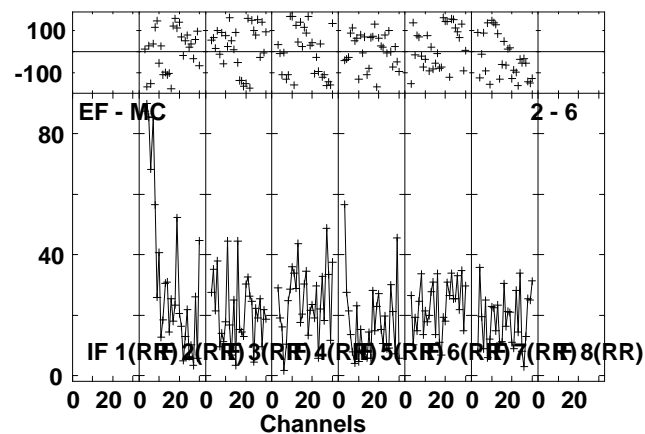
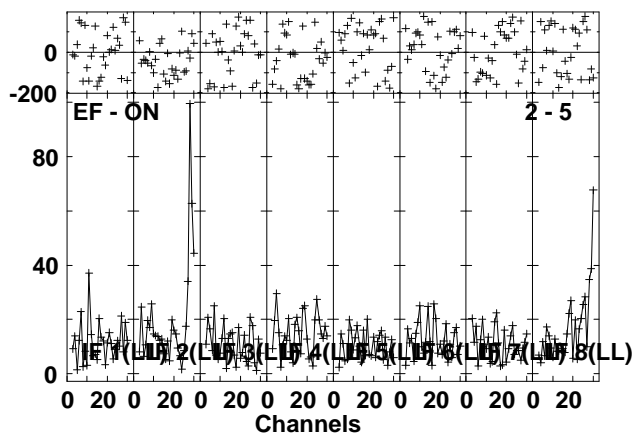
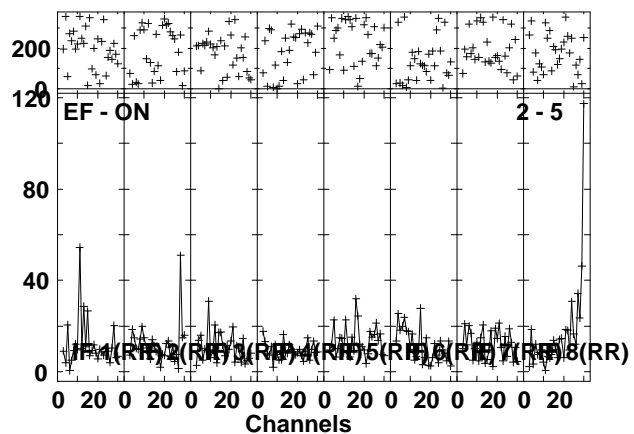
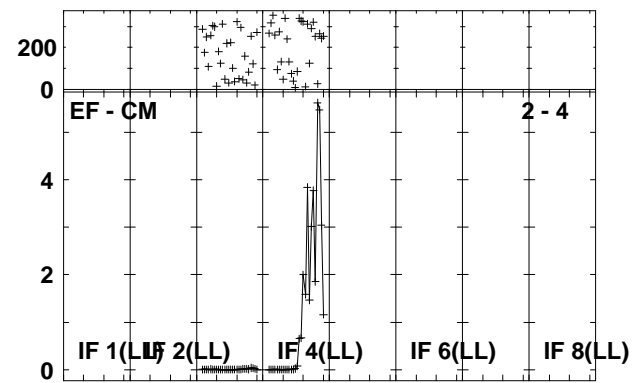
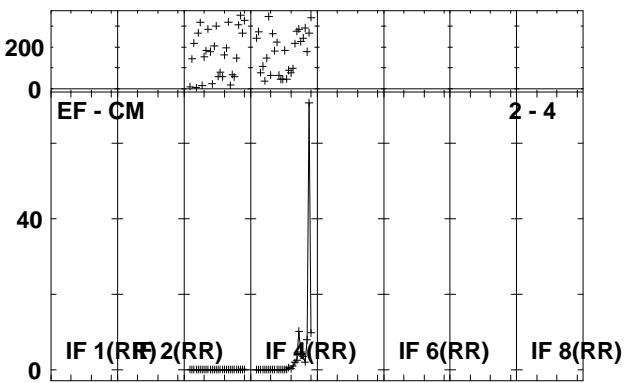
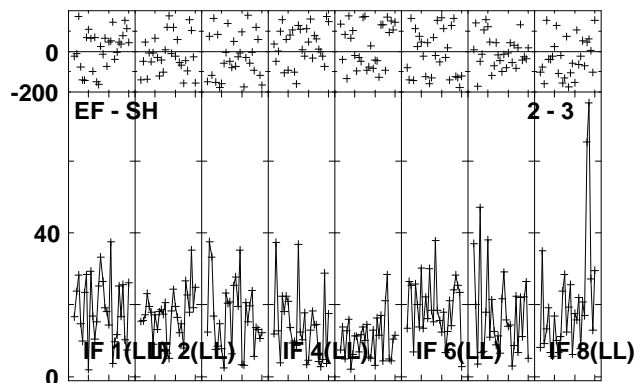
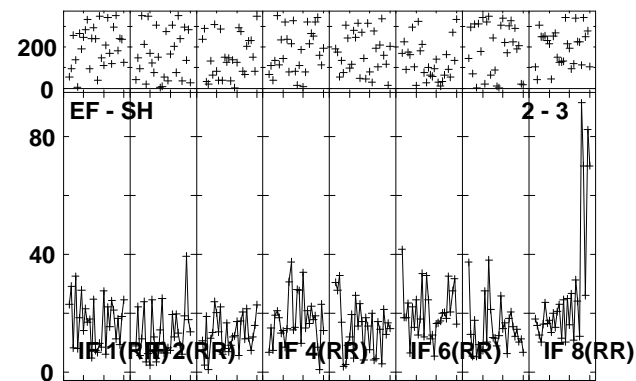
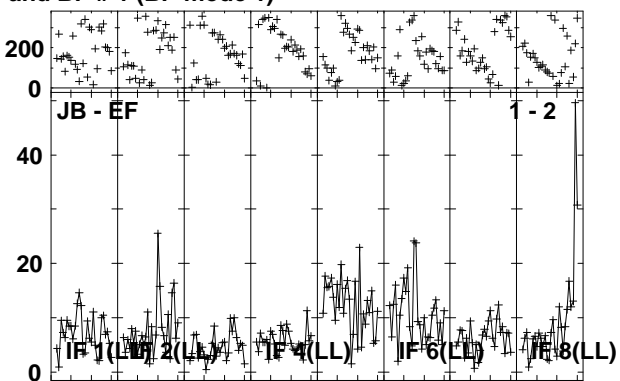
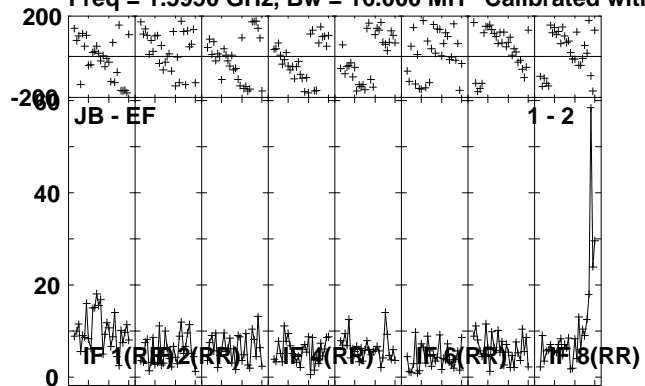

Lower frame: Milli Ampl Jy Top frame: Phas deg  
Vector averaged cross-power spectrum Several baselines displayed  
Timerange: 00:18:14:01 to 00:18:17:29

Plot file version 246 created 30-NOV-2010 14:34:44  
 ARP299C EP068B 3.UVDATA.1  
 Freq = 1.5950 GHz, Bw = 16.000 MH Calibrated with CL # 3 and BP # 1 (BP mode 1)

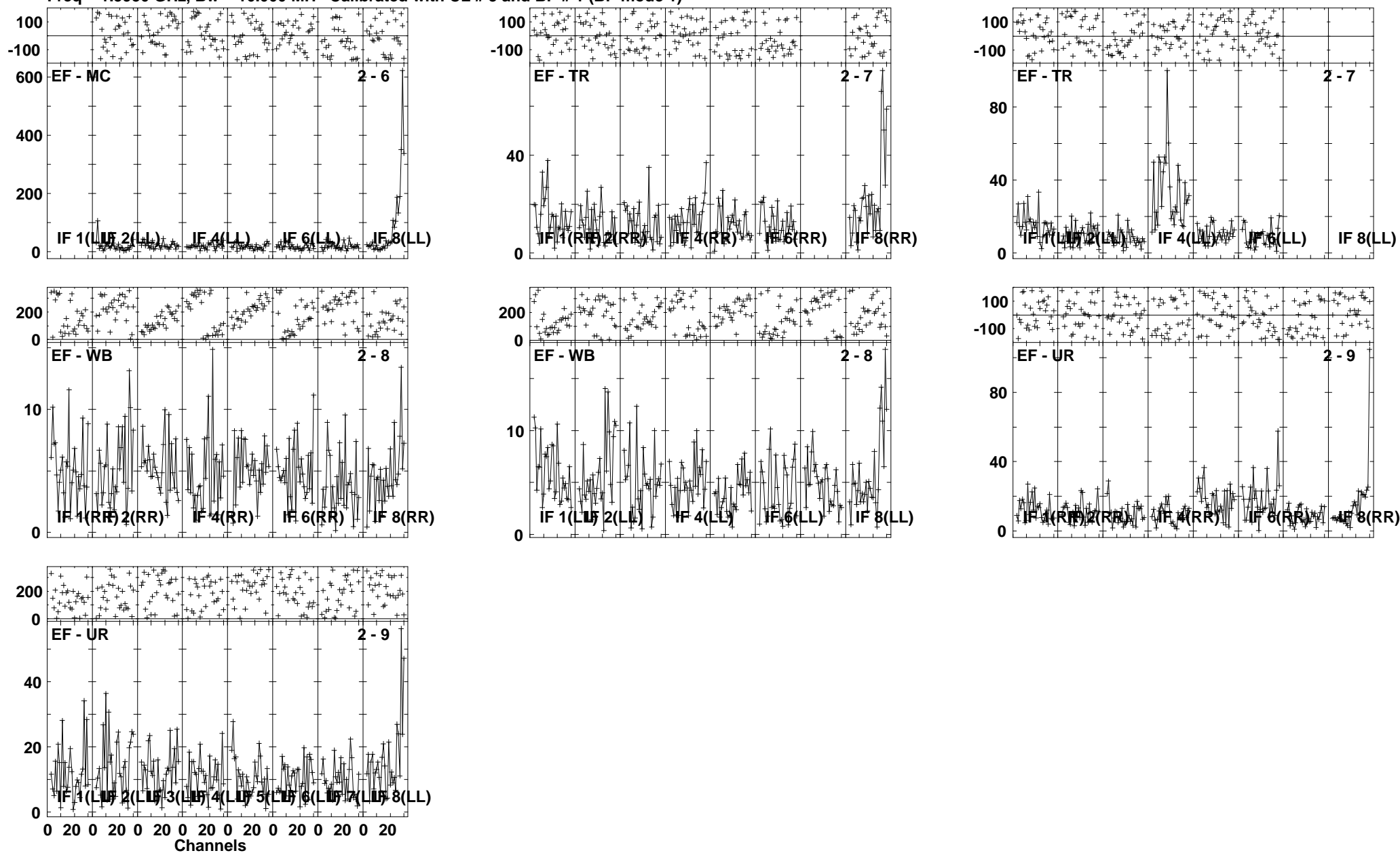

Lower frame: Milli Ampl Jy Top frame: Phas deg  
 Vector averaged cross-power spectrum Several baselines displayed  
 Timerange: 00:18:14:01 to 00:18:17:29

Plot file version 247 created 30-NOV-2010 14:34:46

J1128+59 EP068B 3.UVDATA.1

Freq = 1.5950 GHz, Bw = 16.000 MH Calibrated with CL # 3 and BP # 1 (BP mode 1)

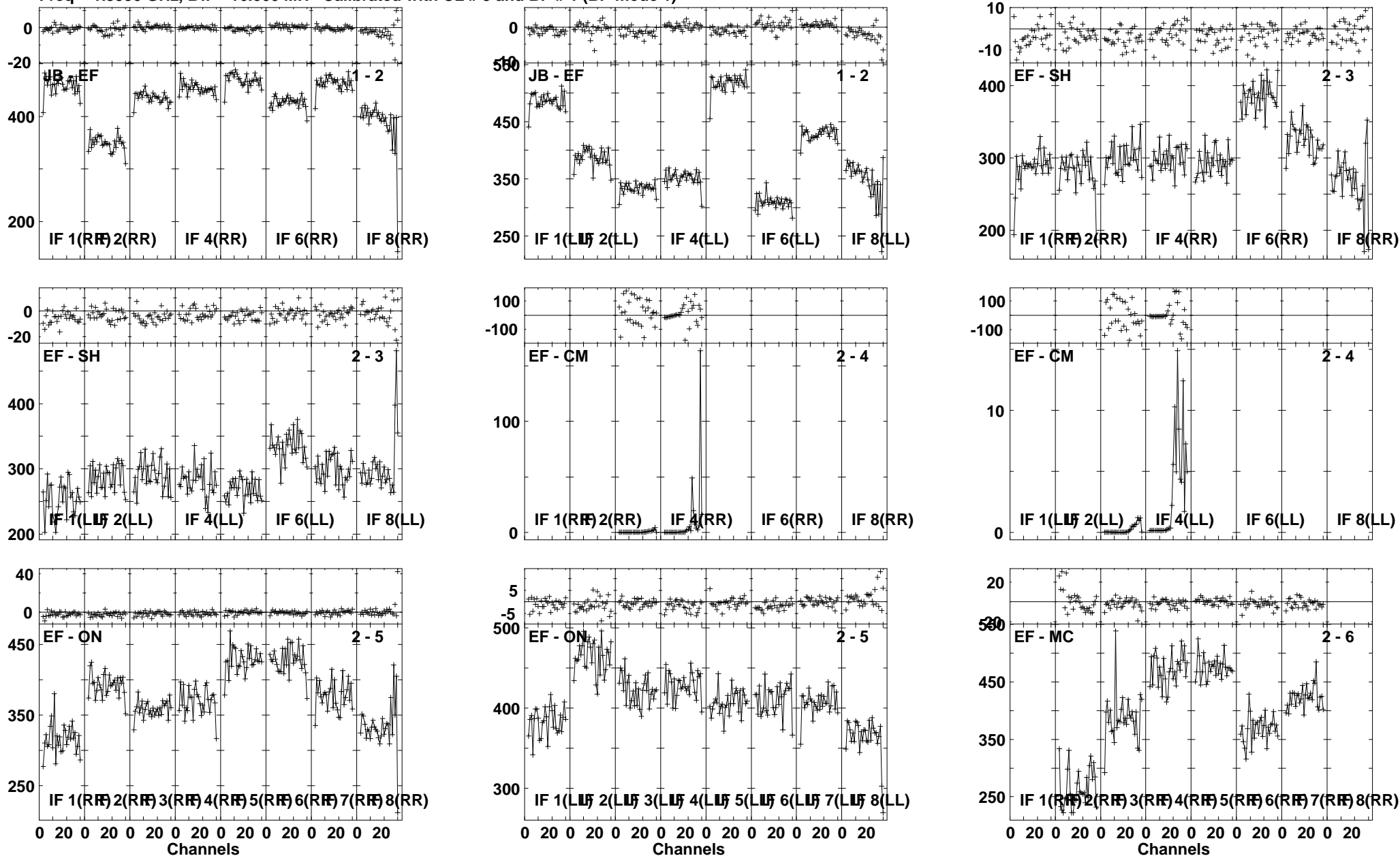

Lower frame: Milli Ampl Jy Top frame: Phas deg  
Vector averaged cross-power spectrum Several baselines displayed  
Timerange: 00/18:17:31 to 00/18:18:59

Plot file version 248 created 30-NOV-2010 14:34:48

J1128+59 EP068B 3.UVDATA.1

Freq = 1.5950 GHz, Bw = 16.000 MH Calibrated with CL # 3 and BP # 1 (BP mode 1)

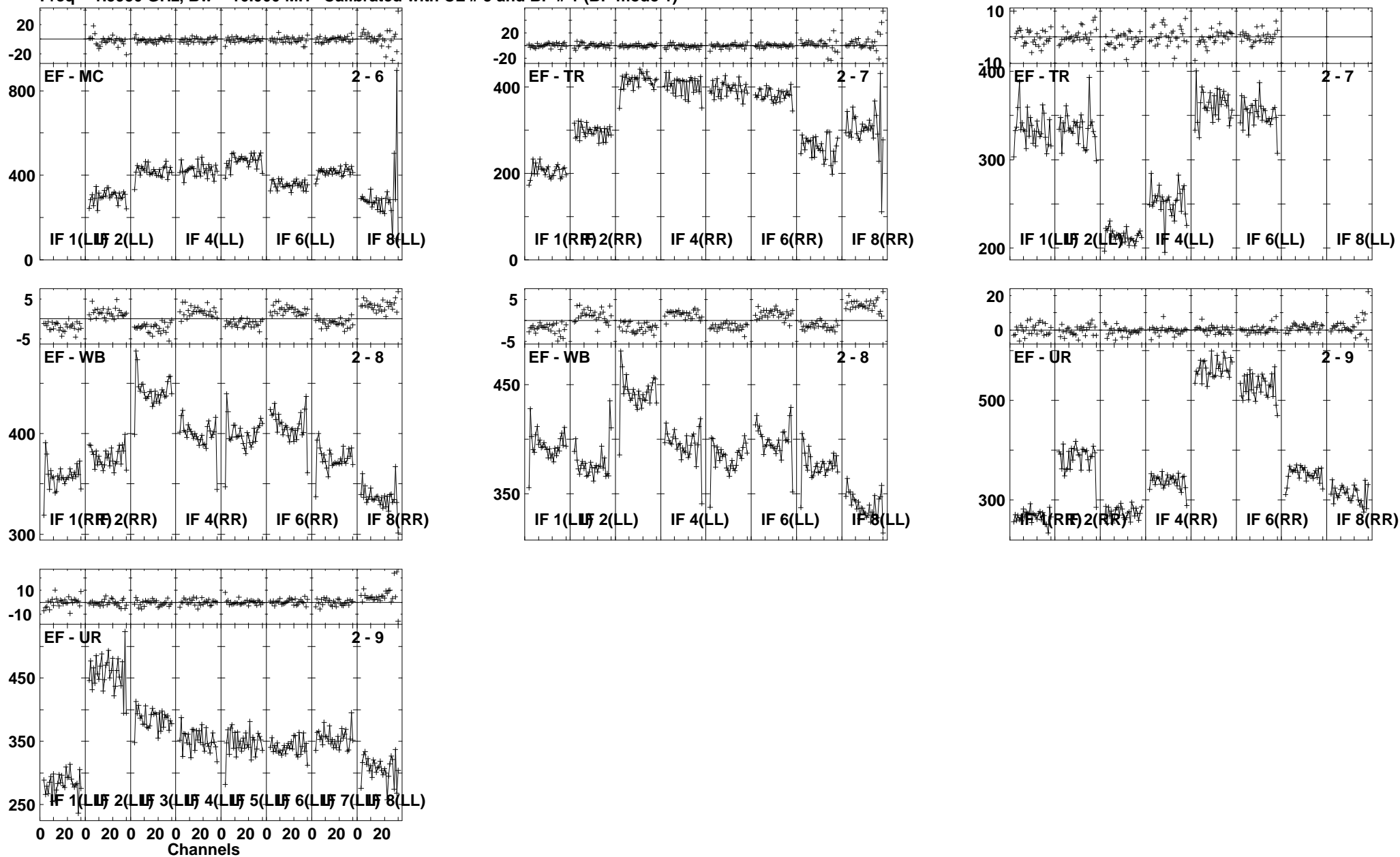

Lower frame: Milli Ampl Jy Top frame: Phas deg  
Vector averaged cross-power spectrum Several baselines displayed  
Timerange: 00/18:17:31 to 00/18:18:59



Plot file version 249 created 30-NOV-2010 14:34:50

ARP299C EP068B 3.UVDATA.1

Freq = 1.5950 GHz, Bw = 16.000 MH Calibrated with CL # 3 and BP # 1 (BP mode 1)

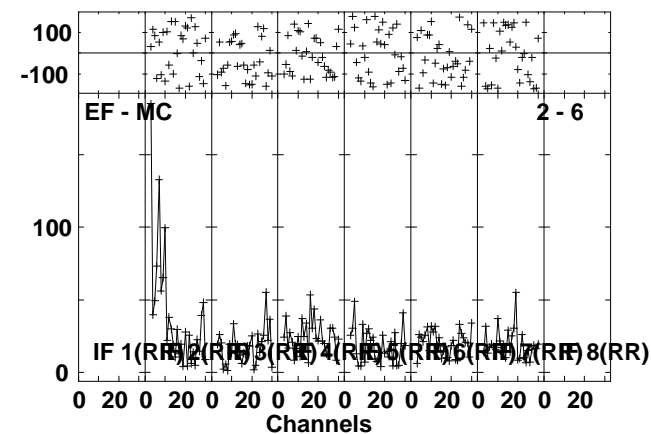
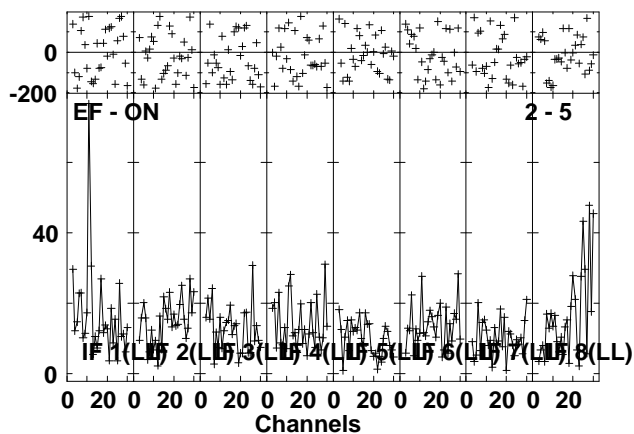
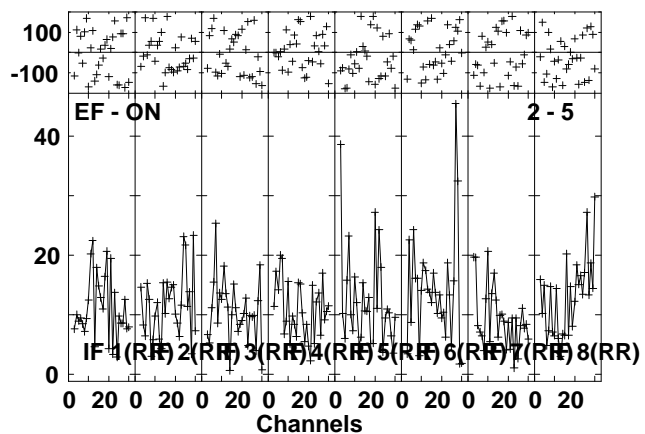
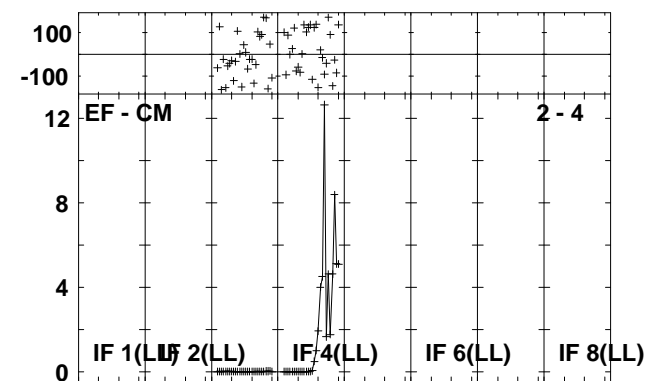
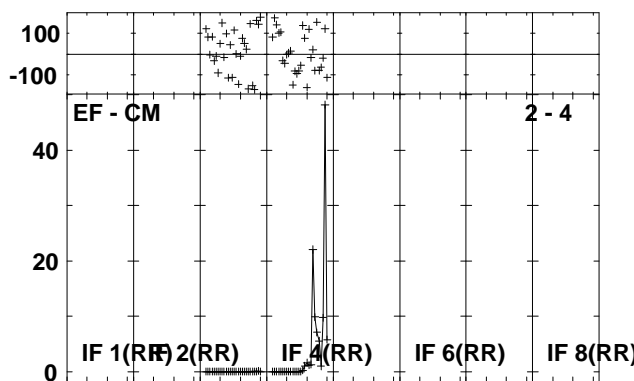
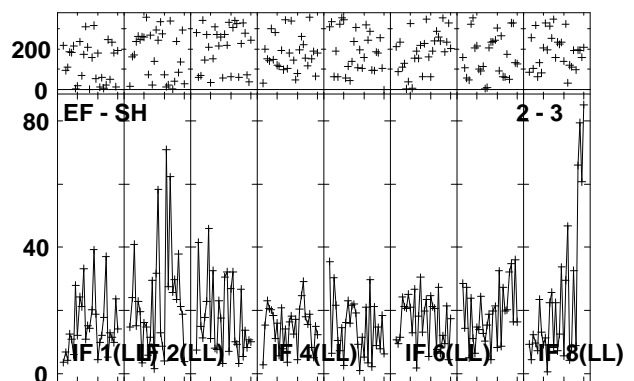
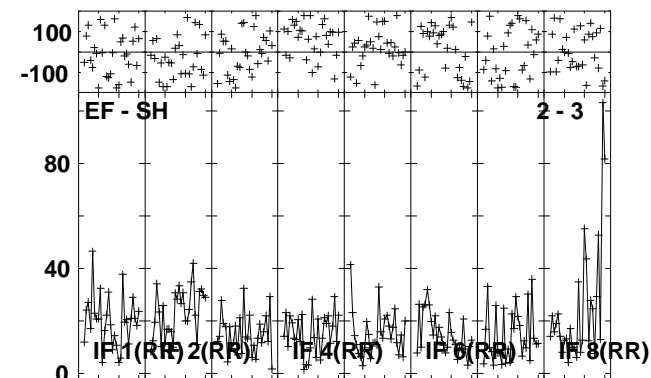
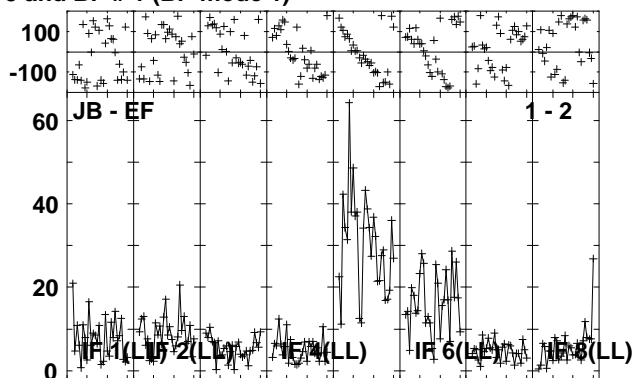
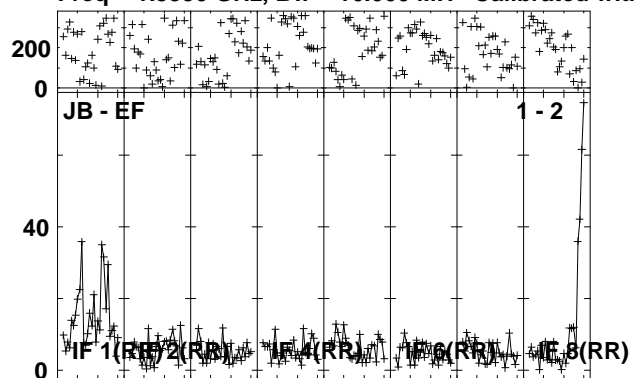

Lower frame: Milli Ampl Jy Top frame: Phas deg  
Vector averaged cross-power spectrum Several baselines displayed  
Timerange: 00/18:19:01 to 00/18:22:29

Plot file version 250 created 30-NOV-2010 14:34:52  
 ARP299C EP068B 3.UVDATA.1  
 Freq = 1.5950 GHz, Bw = 16.000 MH Calibrated with CL # 3 and BP # 1 (BP mode 1)

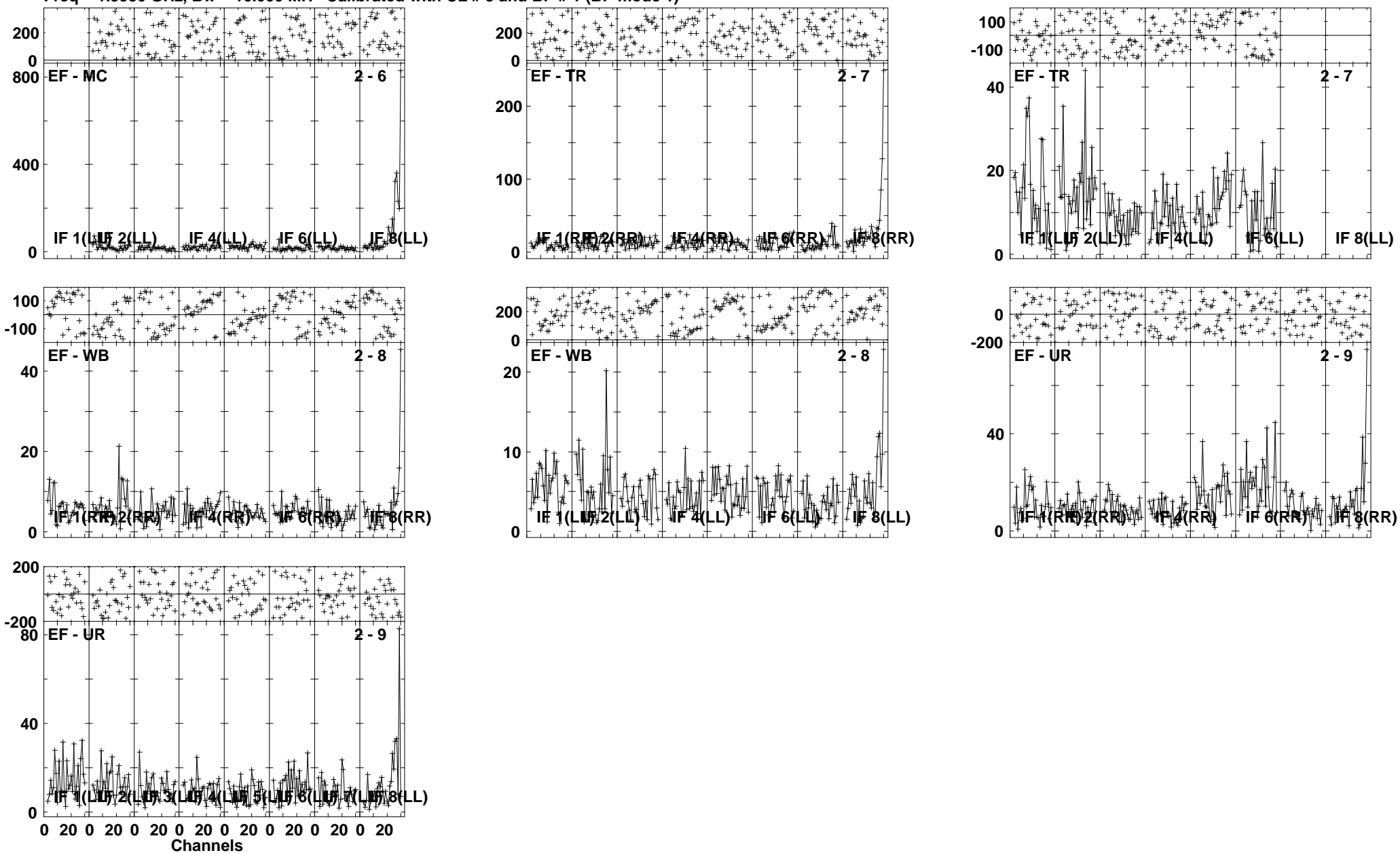

Lower frame: Milli Ampl Jy Top frame: Phas deg  
 Vector averaged cross-power spectrum Several baselines displayed  
 Timerange: 00/18:19:01 to 00/18:22:29

Plot file version 251 created 30-NOV-2010 14:34:55

J1128+59 EP068B 3.UVDATA.1

Freq = 1.5950 GHz, Bw = 16.000 MH Calibrated with CL # 3 and BP # 1 (BP mode 1)

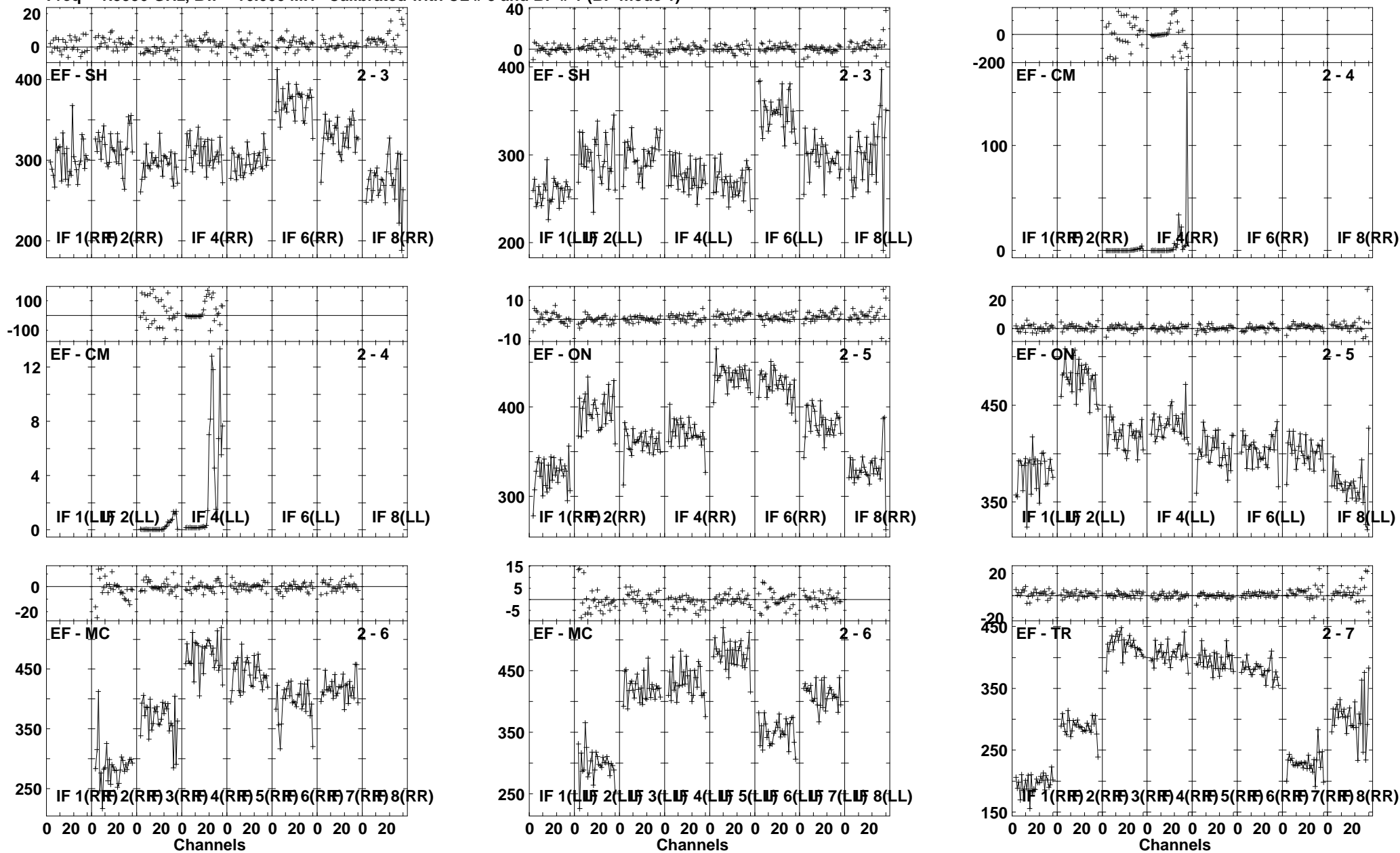

Lower frame: Milli Ampl Jy Top frame: Phas deg  
Vector averaged cross-power spectrum Several baselines displayed  
Timerange: 00:18:23:31 to 00:18:24:59

Plot file version 252 created 30-NOV-2010 14:34:56

J1128+59 EP068B 3.UVDATA.1

Freq = 1.5950 GHz, Bw = 16.000 MH Calibrated with CL # 3 and BP # 1 (BP mode 1)

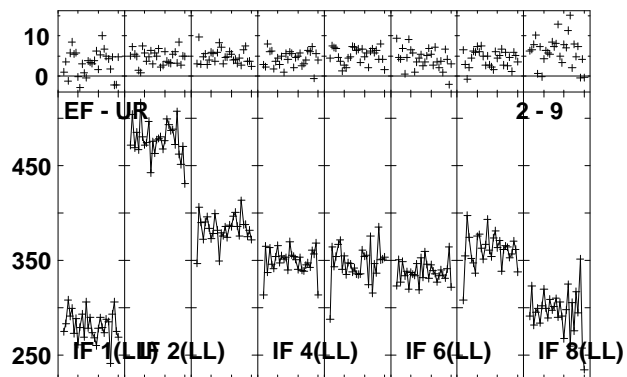
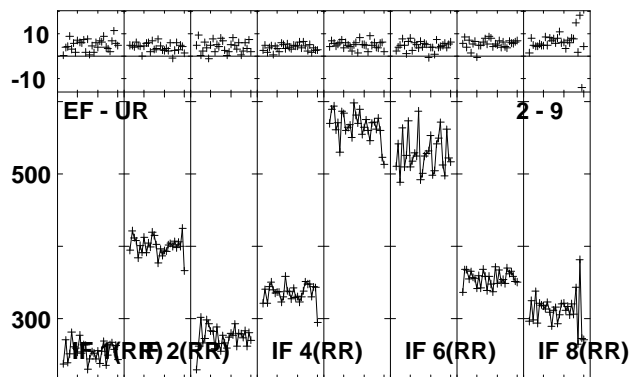
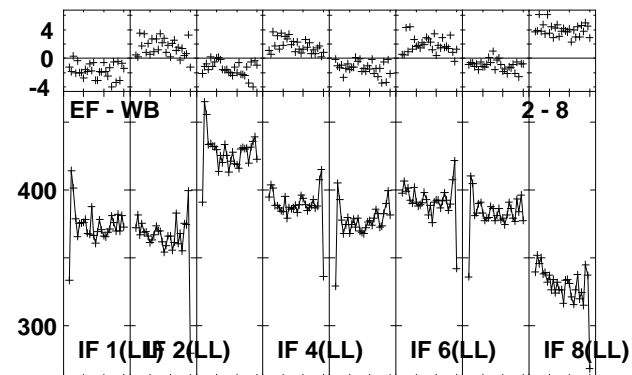
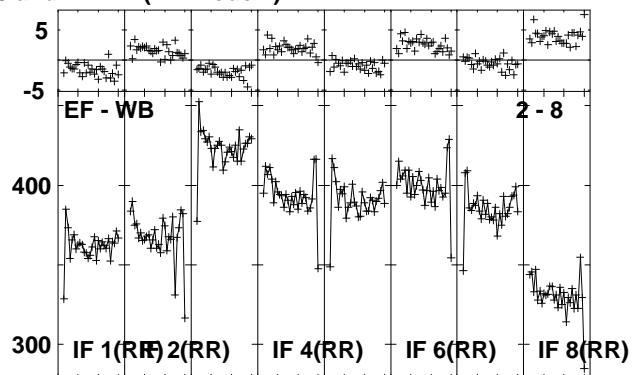
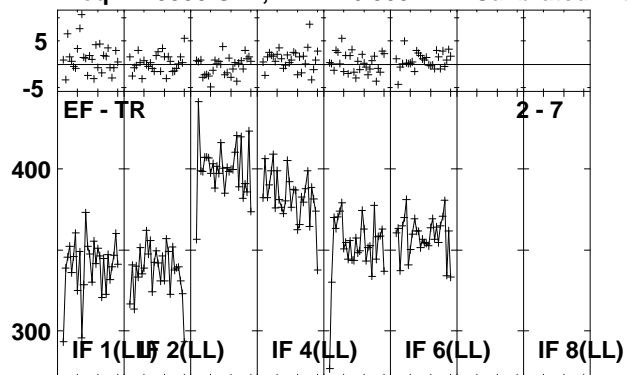

Lower frame: Milli Ampl Jy Top frame: Phas deg  
Vector averaged cross-power spectrum Several baselines displayed  
Timerange: 00/18:23:31 to 00/18:24:59

Plot file version 253 created 30-NOV-2010 14:34:58

ARP299C EP068B 3.UVDATA.1

Freq = 1.5950 GHz, Bw = 16.000 MH Calibrated with CL # 3 and BP # 1 (BP mode 1)

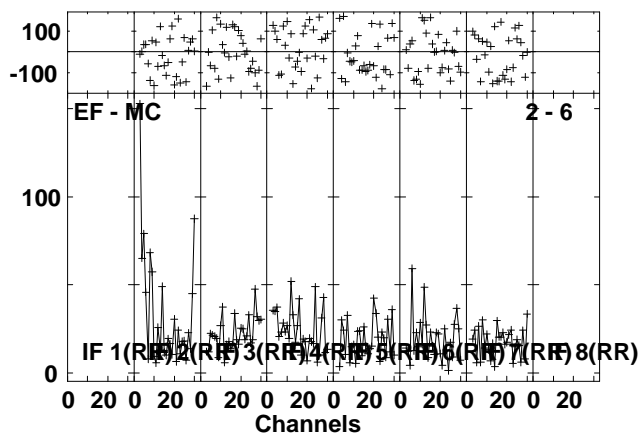
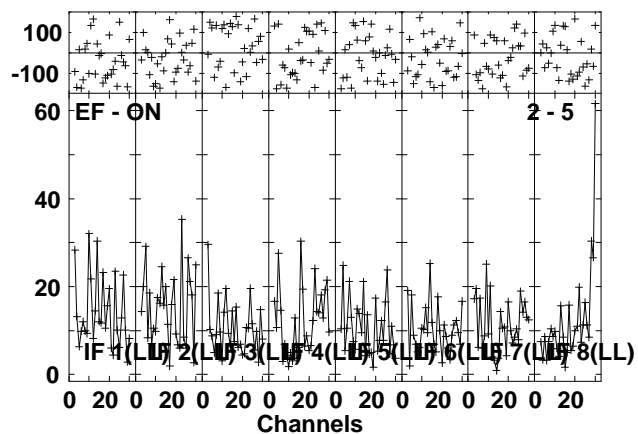
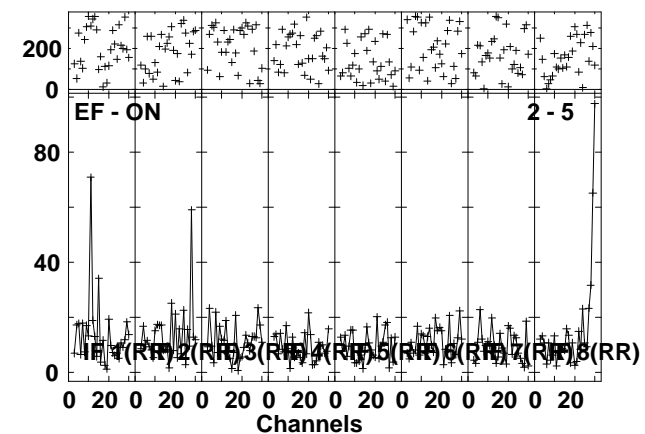
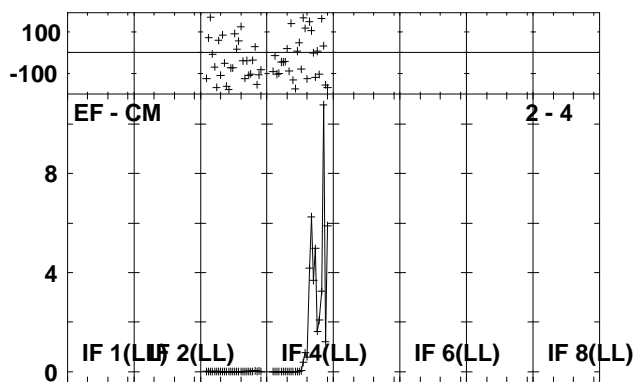
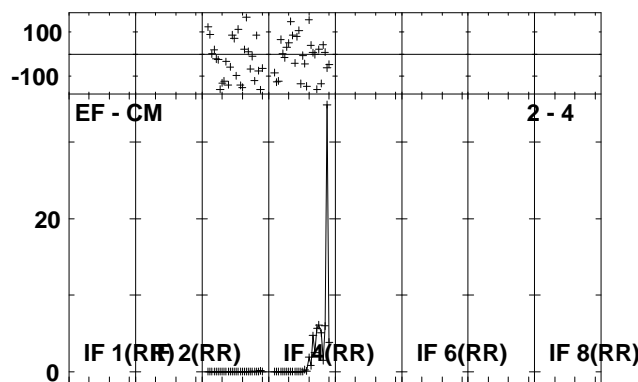
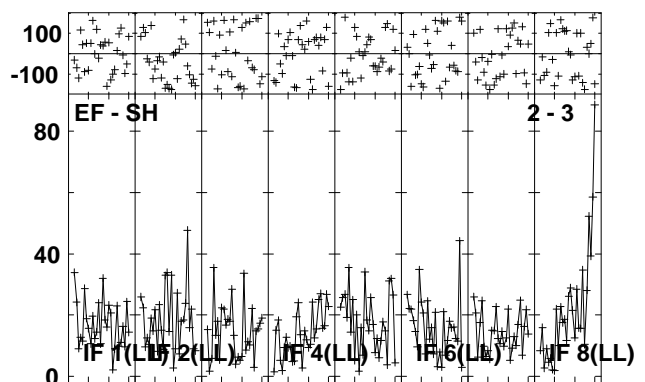
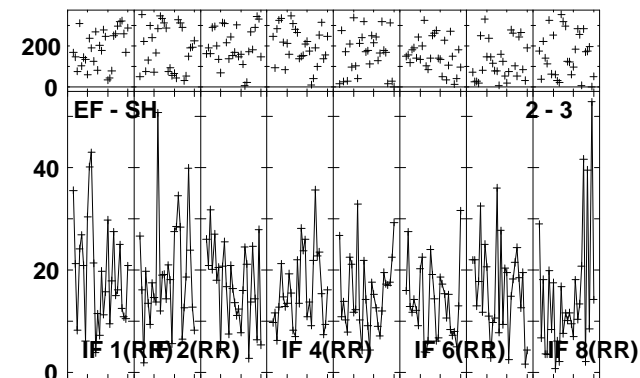
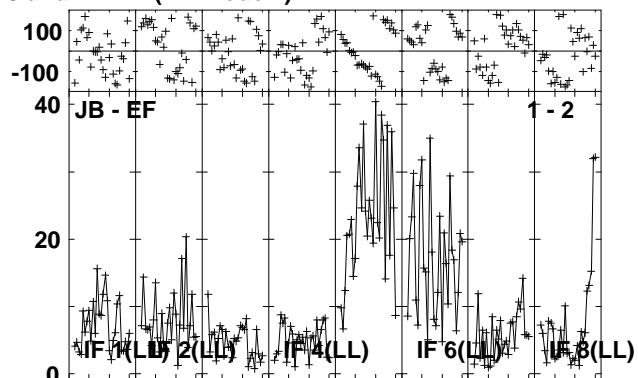
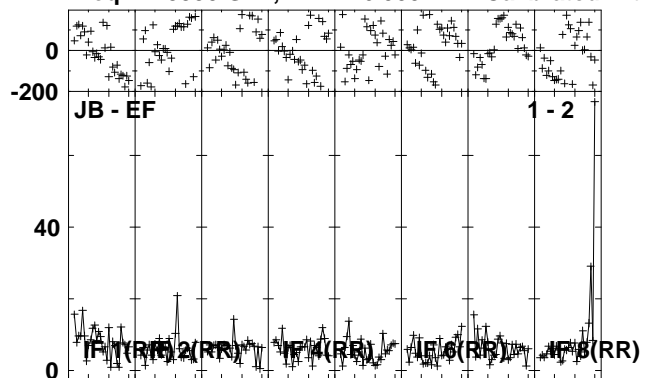

Lower frame: Milli Ampl Jy Top frame: Phas deg  
Vector averaged cross-power spectrum Several baselines displayed  
Timerange: 00:18:25:01 to 00:18:28:29

Plot file version 254 created 30-NOV-2010 14:35:00

ARP299C EP068B 3.UVDATA.1

Freq = 1.5950 GHz, Bw = 16.000 MH Calibrated with CL # 3 and BP # 1 (BP mode 1)

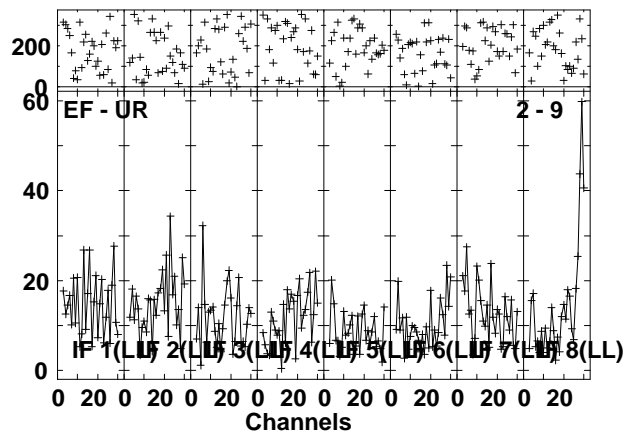
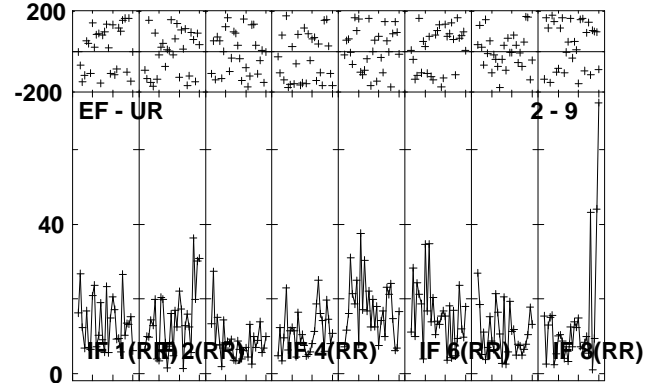
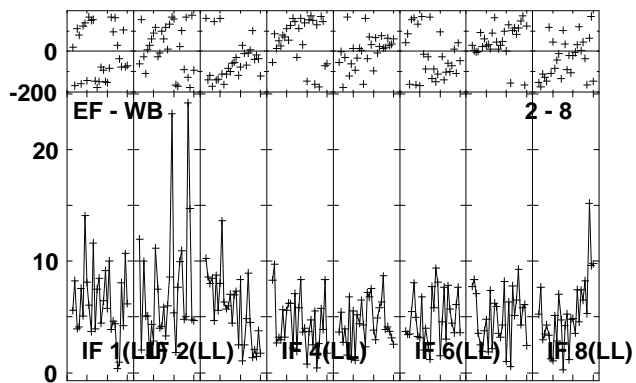
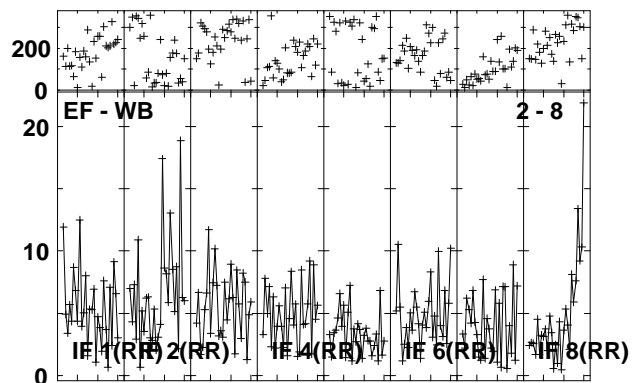
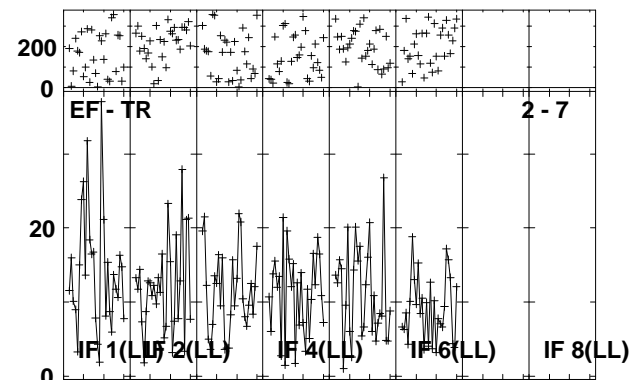
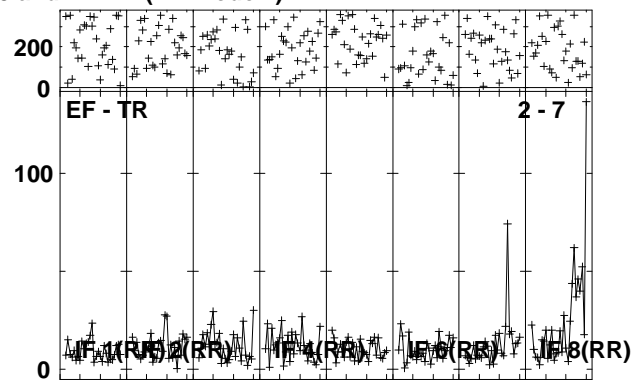
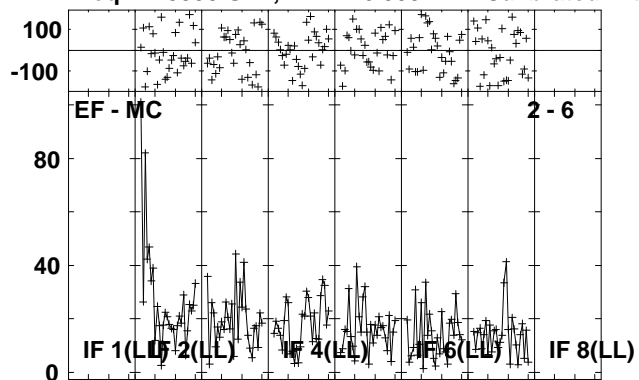

Lower frame: Milli Ampl Jy Top frame: Phas deg  
Vector averaged cross-power spectrum Several baselines displayed  
Timerange: 00:18:25:01 to 00:18:28:29

Plot file version 255 created 30-NOV-2010 14:35:03

J1128+59 EP068B 3.UVDATA.1

Freq = 1.5950 GHz, Bw = 16.000 MH Calibrated with CL # 3 and BP # 1 (BP mode 1)

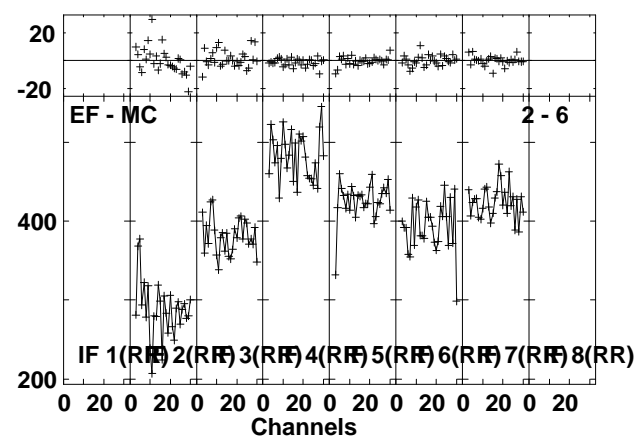
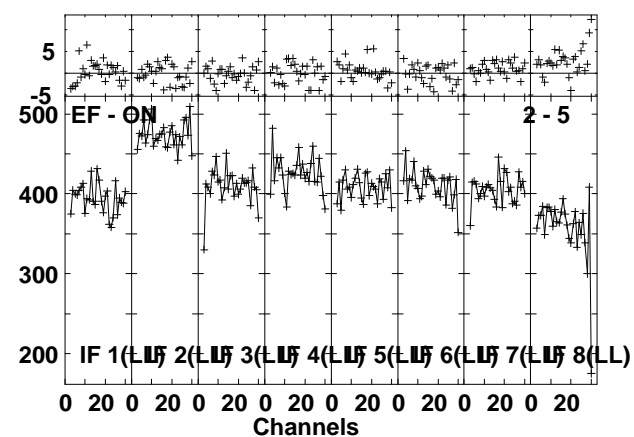
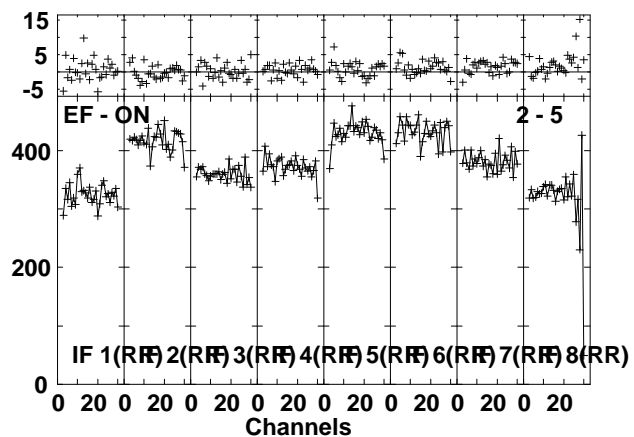
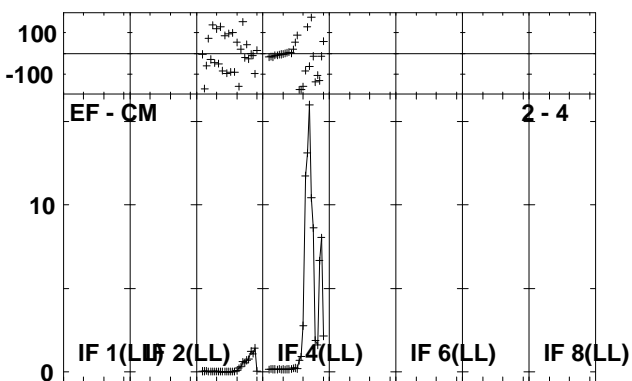
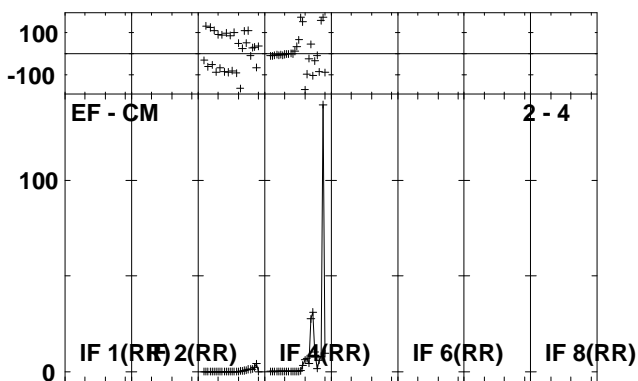
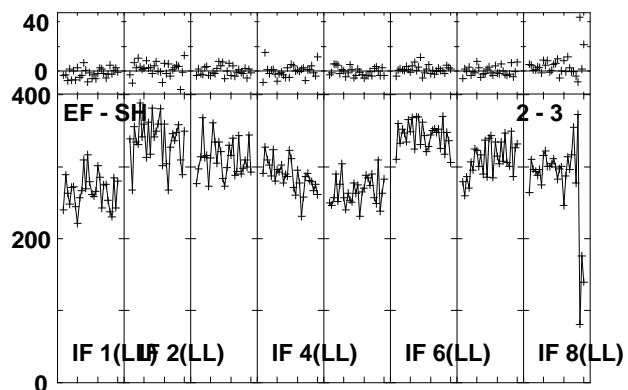
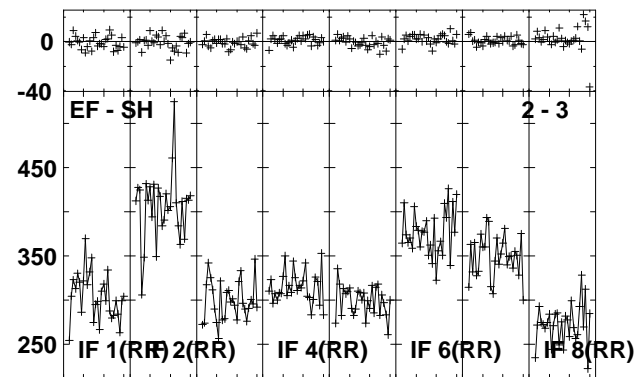
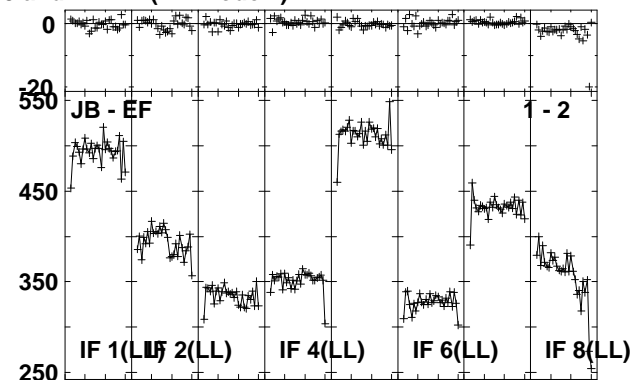
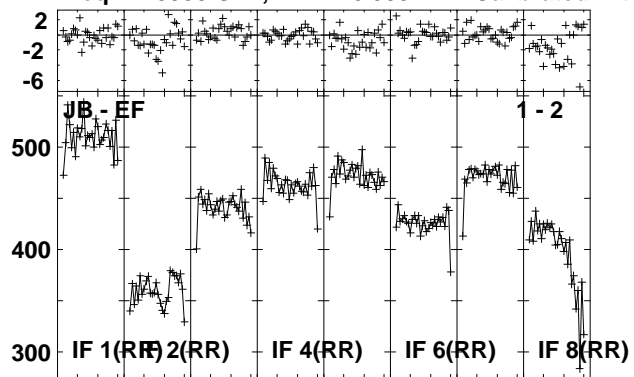

Lower frame: Milli Ampl Jy Top frame: Phas deg  
Vector averaged cross-power spectrum Several baselines displayed  
Timerange: 00/18:28:31 to 00/18:29:59

Plot file version 256 created 30-NOV-2010 14:35:04

J1128+59 EP068B 3.UVDATA.1

Freq = 1.5950 GHz, Bw = 16.000 MH Calibrated with CL # 3 and BP # 1 (BP mode 1)

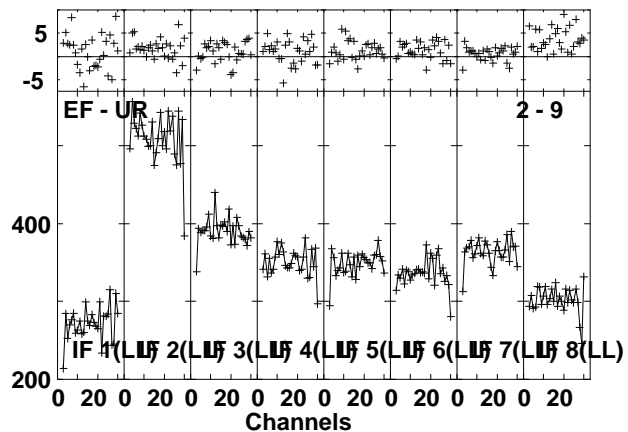
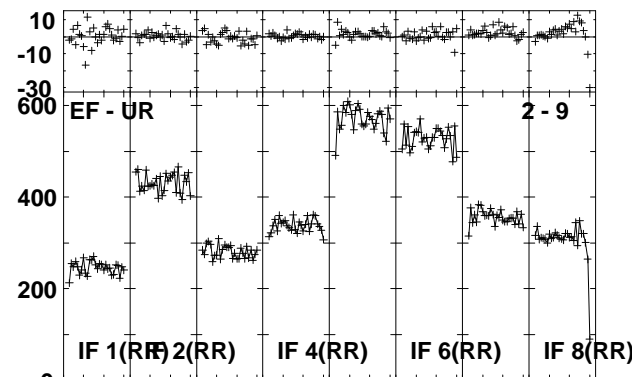
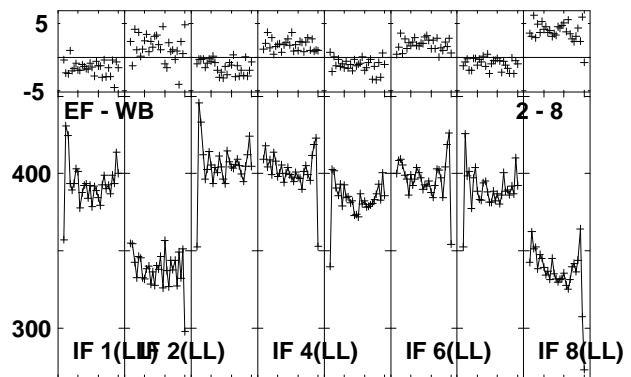
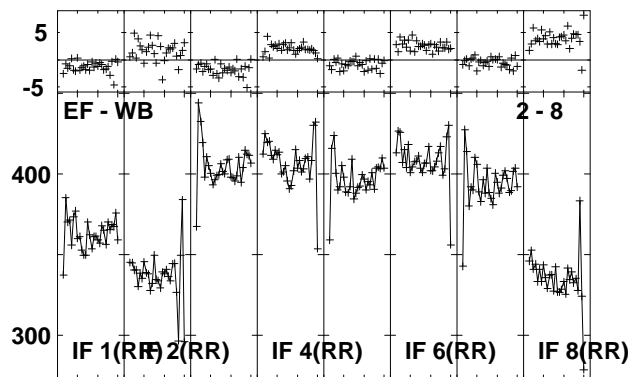
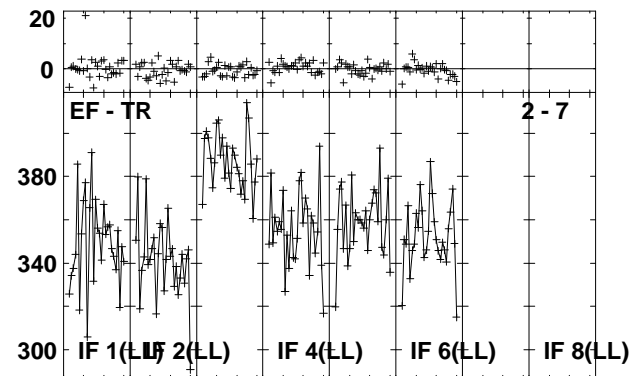
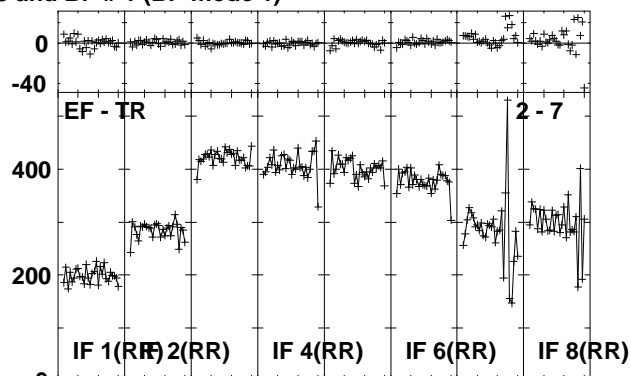
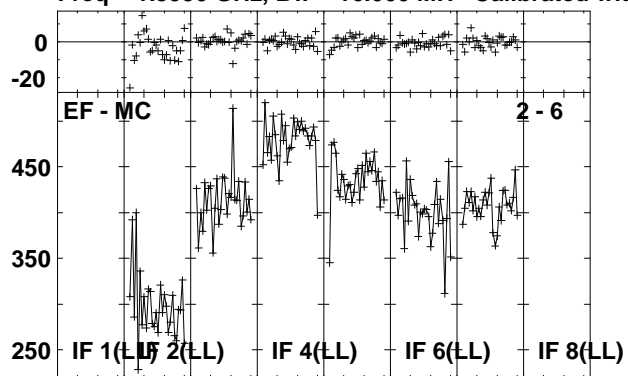

Lower frame: Milli Ampl Jy Top frame: Phas deg  
Vector averaged cross-power spectrum Several baselines displayed  
Timerange: 00/18:28:31 to 00/18:29:59