

Plot file version 1 created 06-JAN-2012 11:45:44

4C39.25 EP068D 5.UVDATA.1

Freq = 1.5950 GHz, Bw = 16.000 MH No calibration applied and no bandpass applied

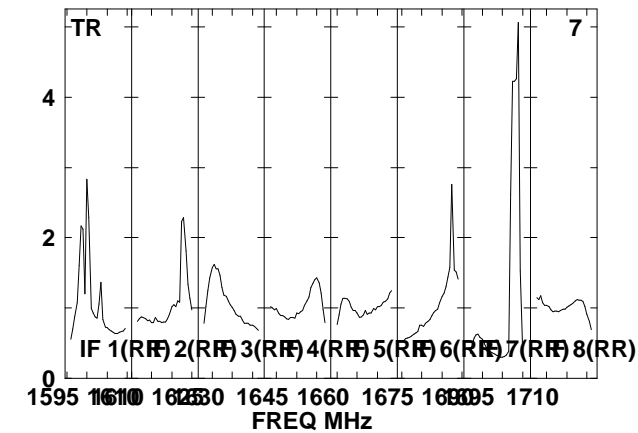
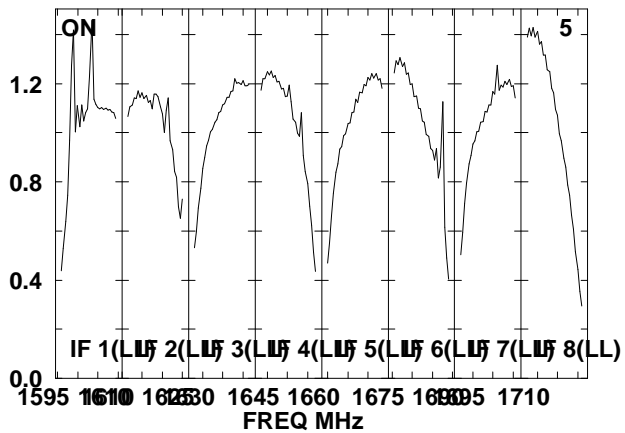
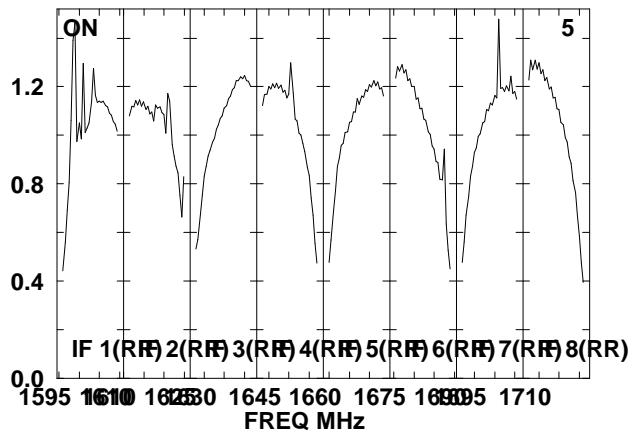
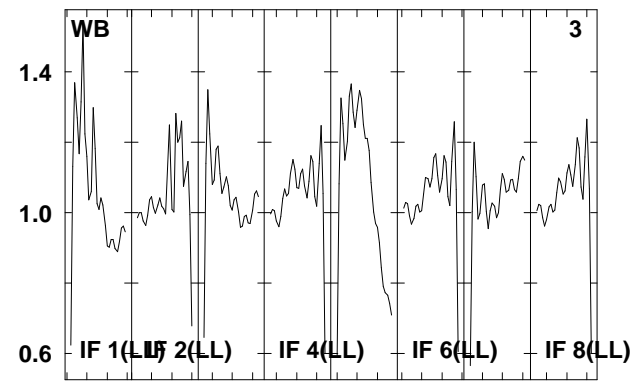
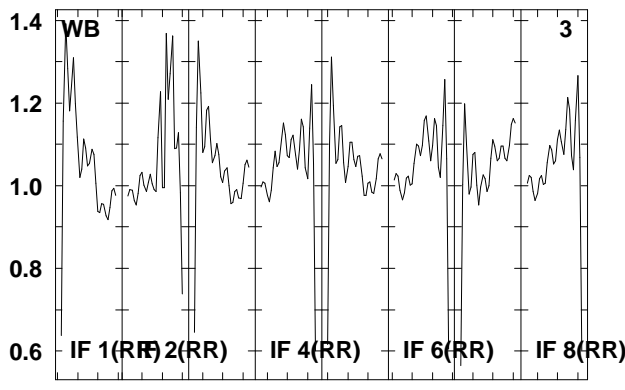
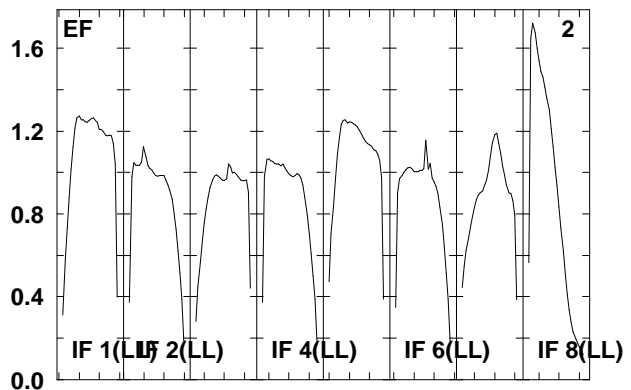
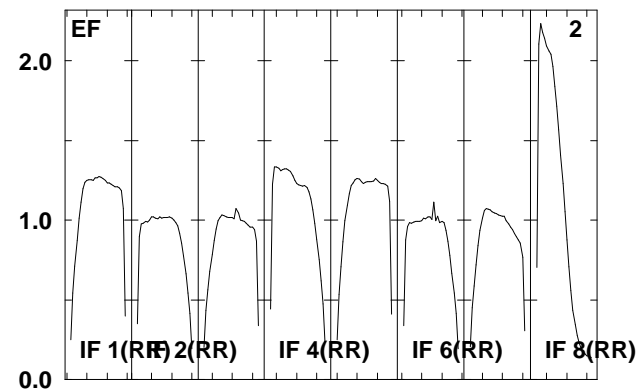
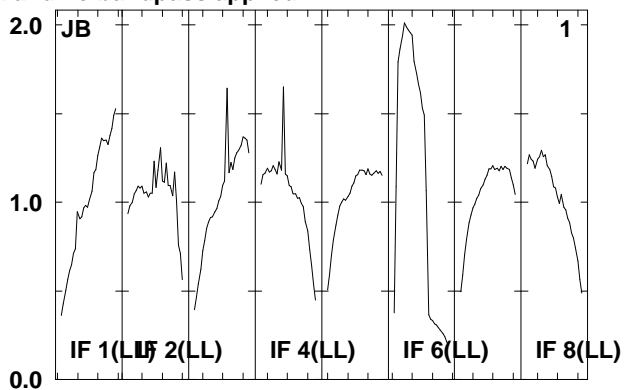
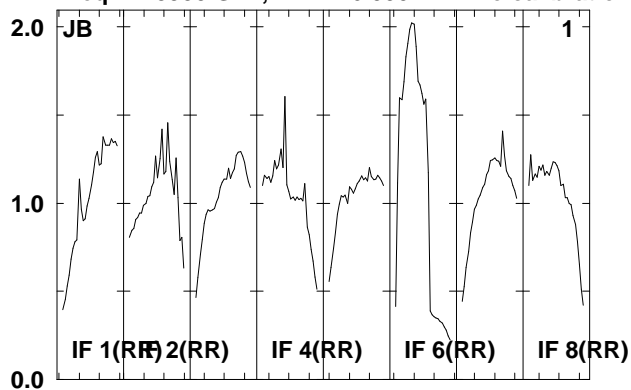

Lower frame: Real Jy
Total-power spectrum Antenna: *
Timerange: 00/12:10:01 to 00/12:17:59

Plot file version 2 created 06-JAN-2012 11:45:46

4C39.25 EP068D 5.UVDATA.1

Freq = 1.5950 GHz, Bw = 16.000 MH No calibration applied and no bandpass applied

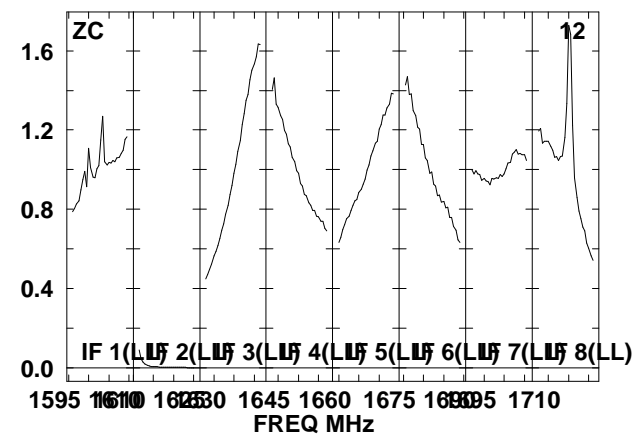
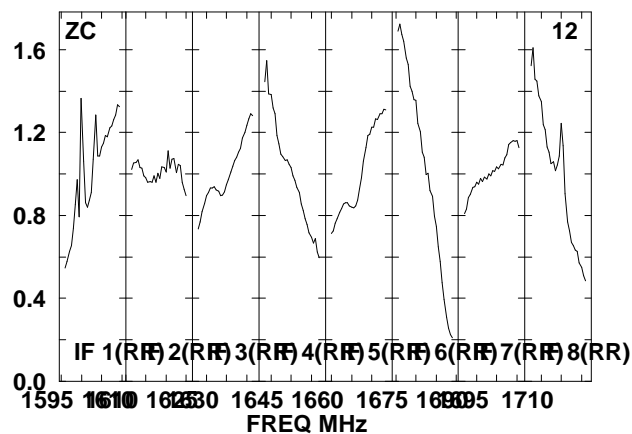
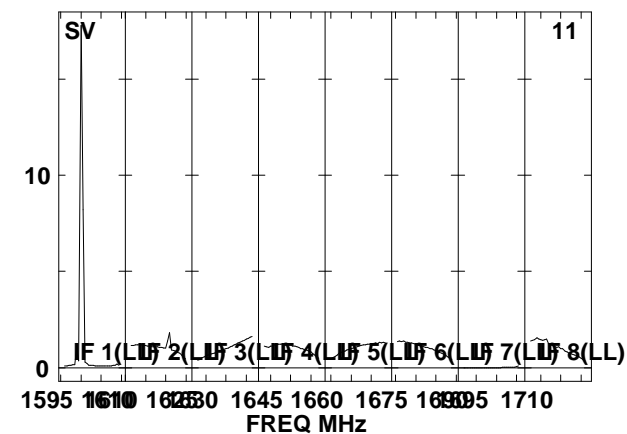
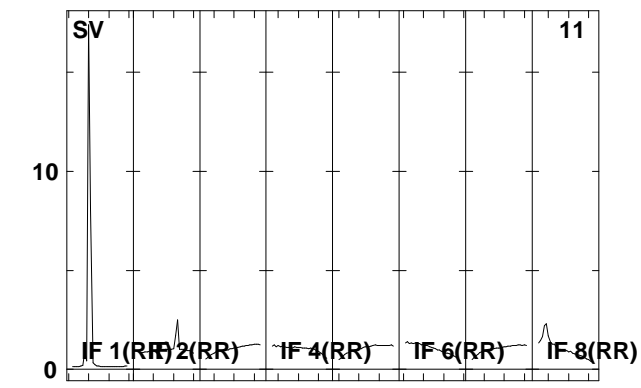
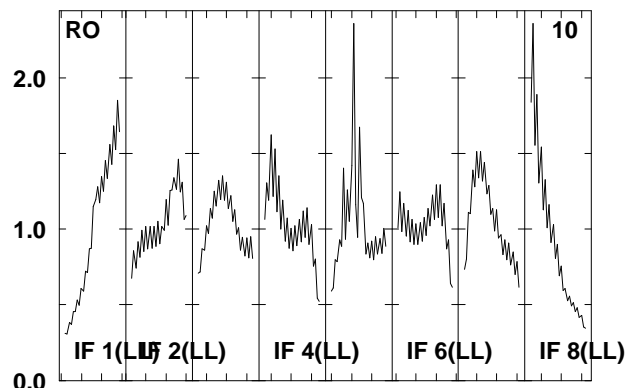
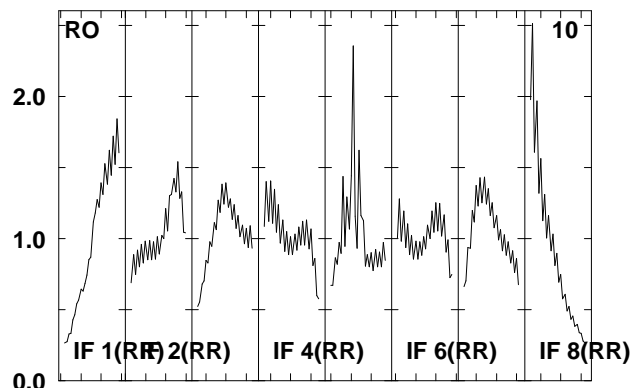
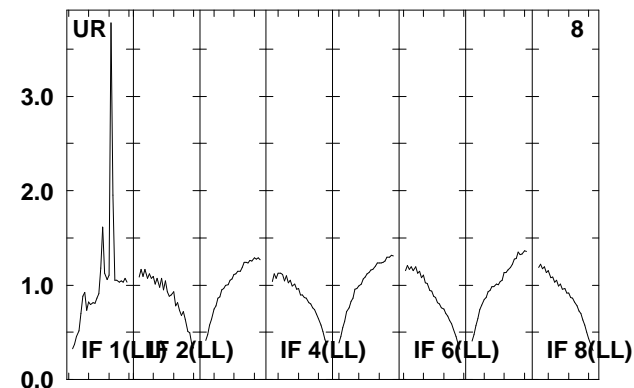
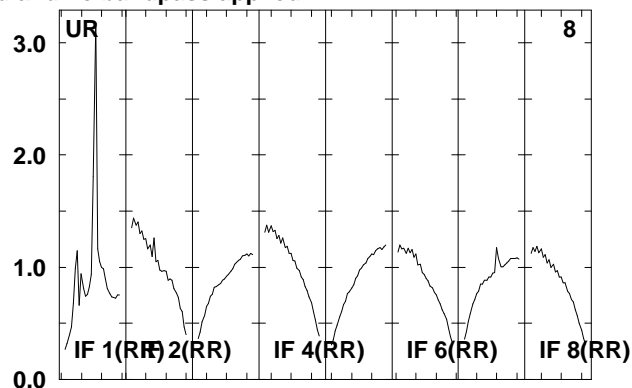
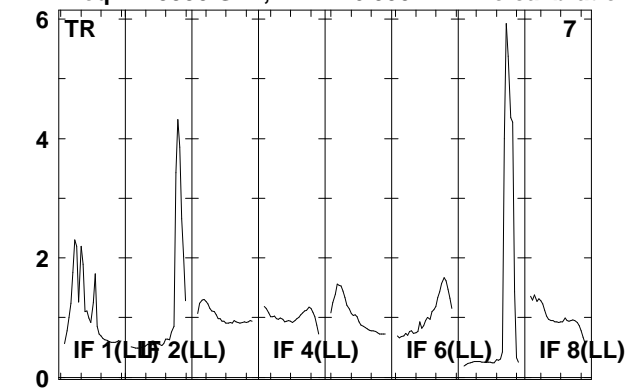

Lower frame: Real Jy
Total-power spectrum Antenna: *
Timerange: 00/12:10:01 to 00/12:17:59

Plot file version 3 created 06-JAN-2012 11:45:47

J1128+59 EP068D 5.UVDATA.1

Freq = 1.5950 GHz, Bw = 16.000 MH No calibration applied and no bandpass applied

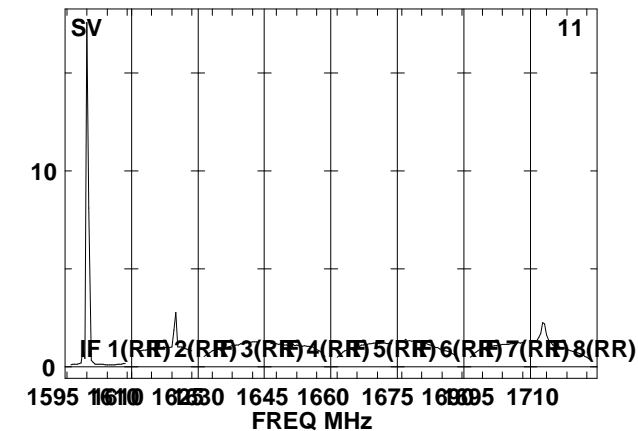
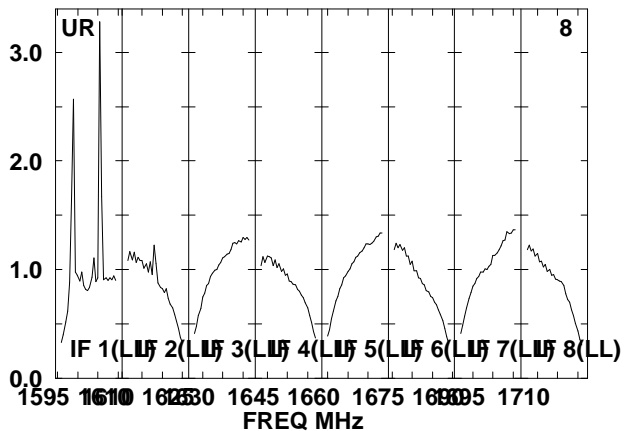
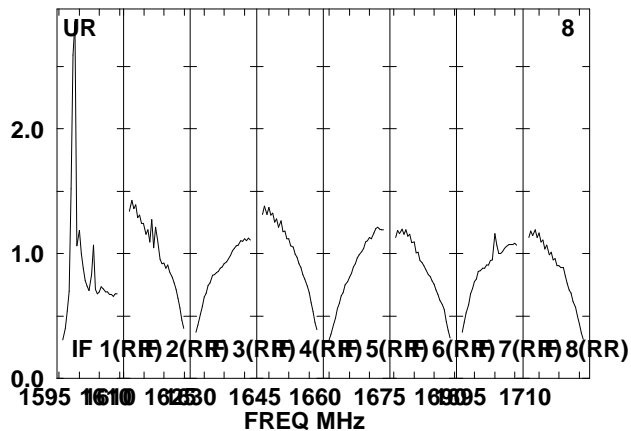
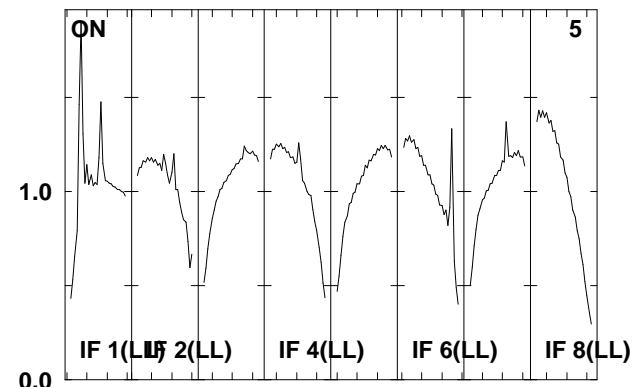
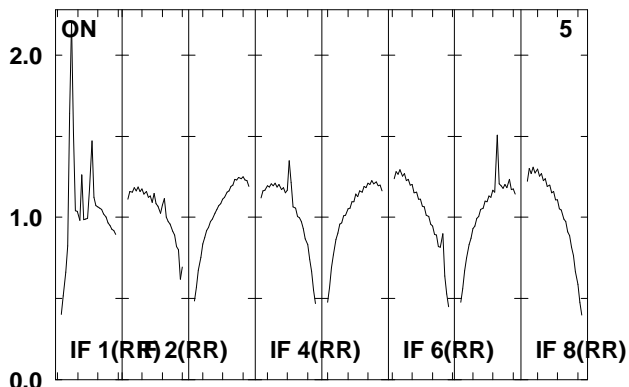
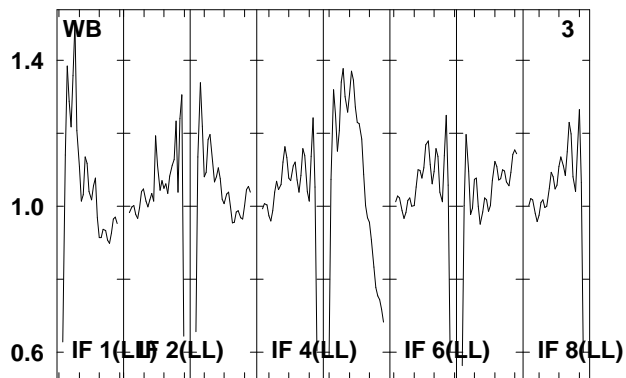
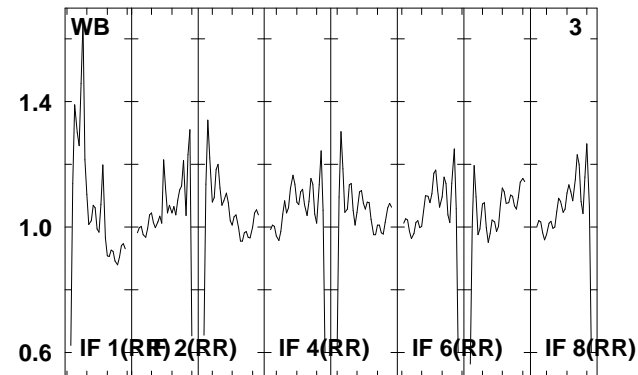
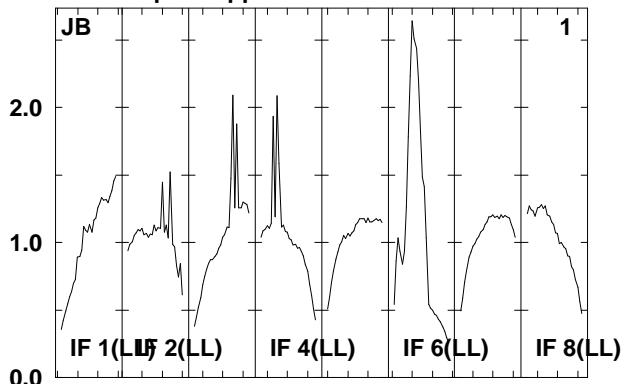
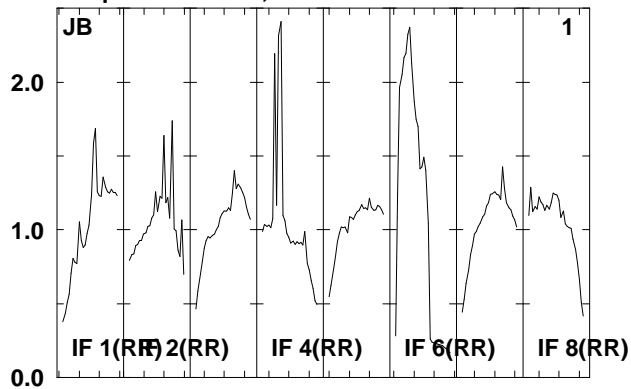

Lower frame: Real Jy
Total-power spectrum Antenna: *
Timerange: 00/12:19:21 to 00/12:21:59

Plot file version 4 created 06-JAN-2012 11:45:48

J1128+59 EP068D 5.UVDATA.1

Freq = 1.5950 GHz, Bw = 16.000 MH No calibration applied and no bandpass applied

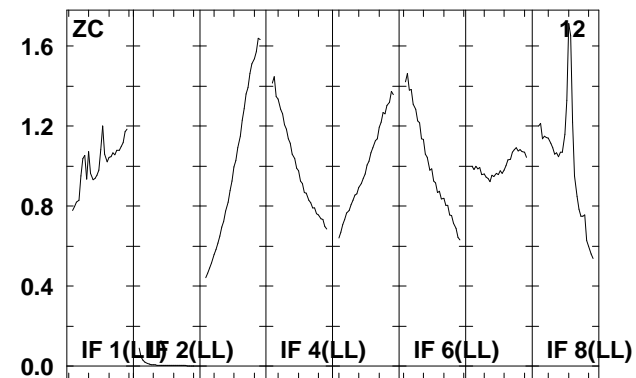
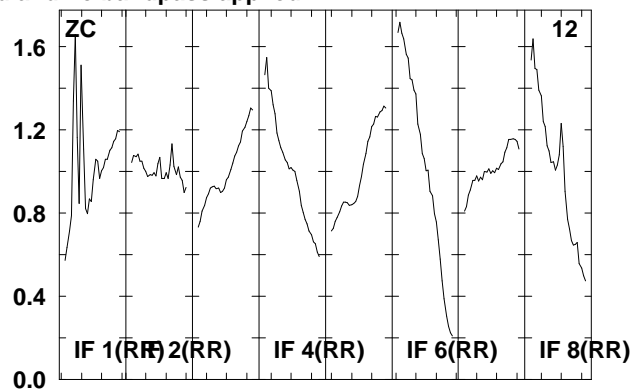
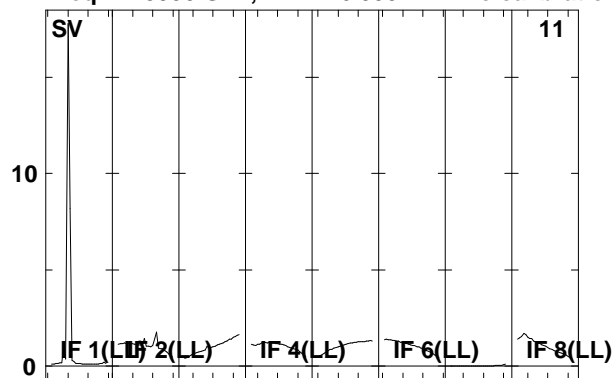

Lower frame: Real Jy
Total-power spectrum Antenna: *
Timerange: 00/12:19:21 to 00/12:21:59

Plot file version 5 created 06-JAN-2012 11:45:48

ARP299D EP068D 5.UVDATA.1

Freq = 1.5950 GHz, Bw = 16.000 MH No calibration applied and no bandpass applied

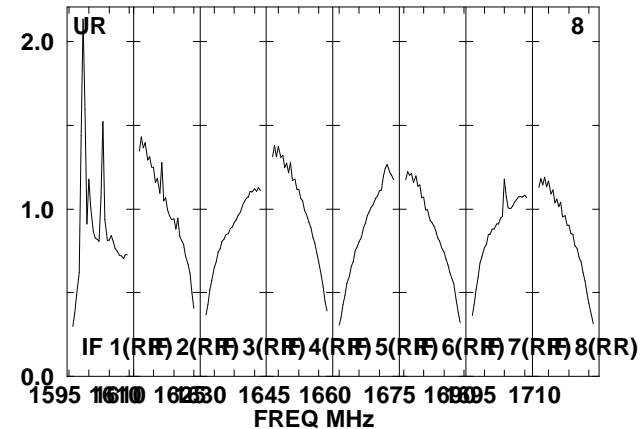
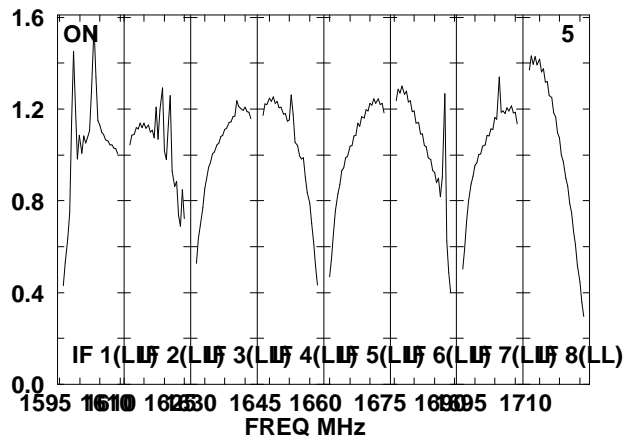
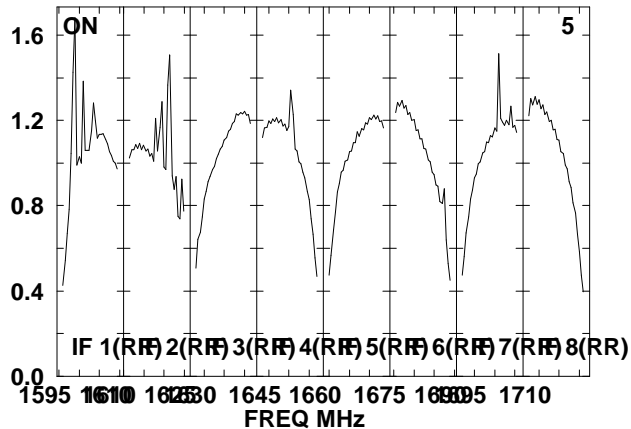
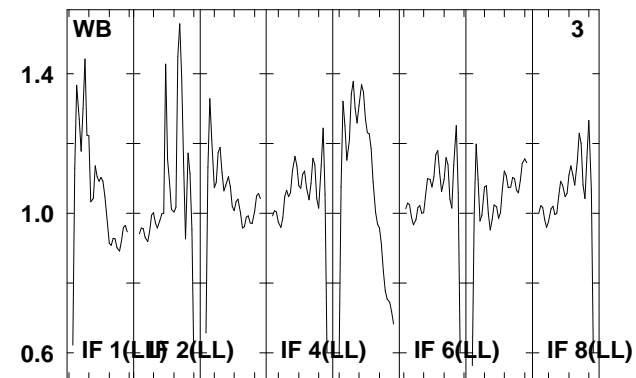
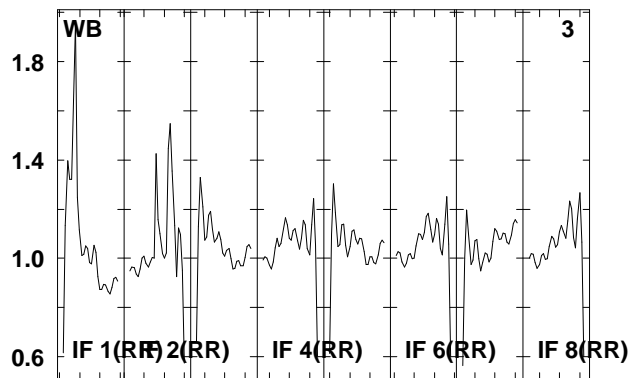
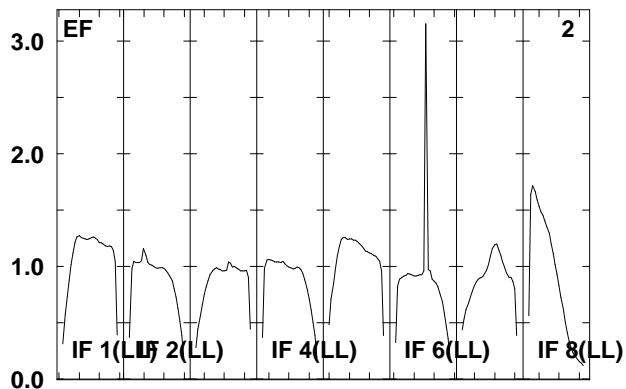
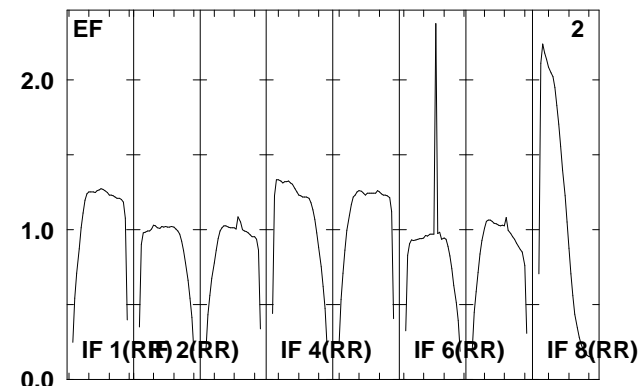
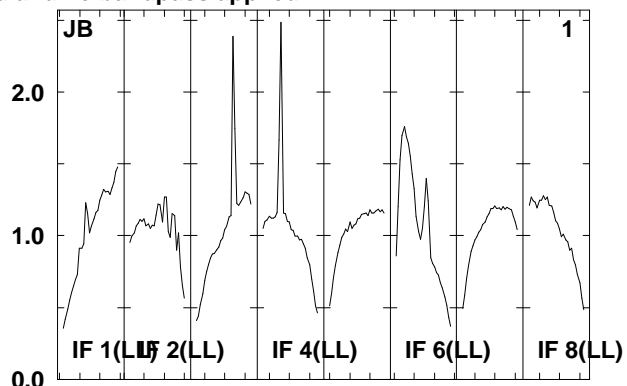
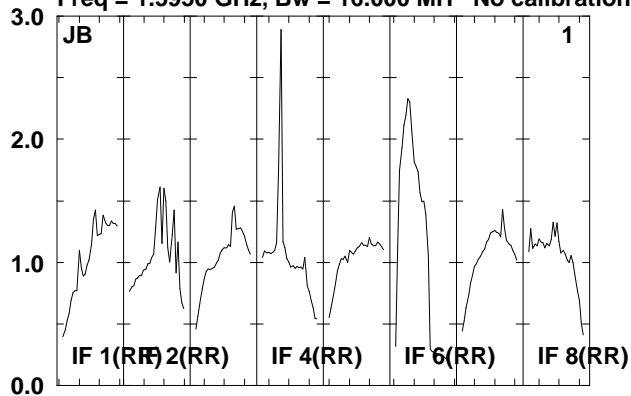

Lower frame: Real Jy
Total-power spectrum Antenna: *
Timerange: 00/12:22:05 to 00/12:25:29

Plot file version 6 created 06-JAN-2012 11:45:48

ARP299D EP068D 5.UVDATA.1

Freq = 1.5950 GHz, Bw = 16.000 MH No calibration applied and no bandpass applied

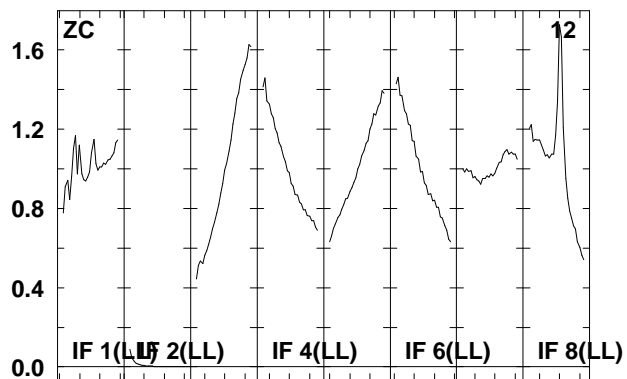
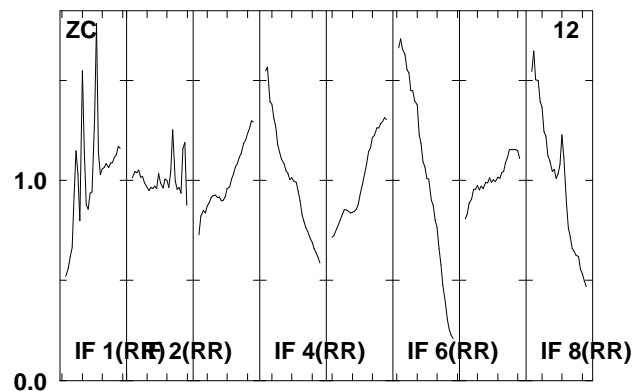
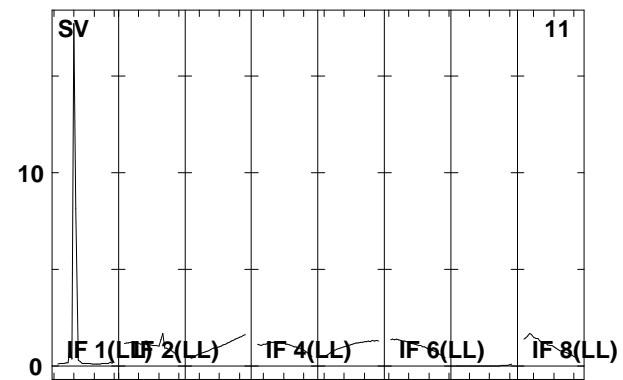
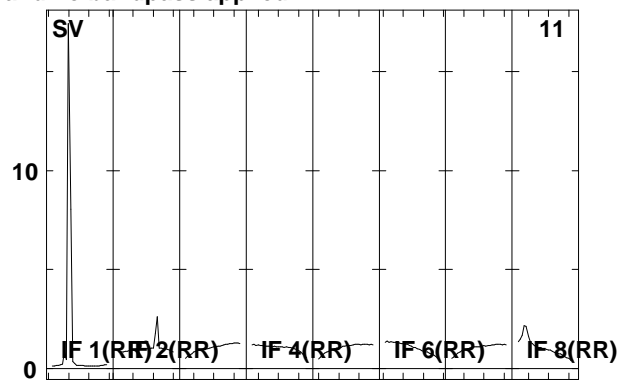
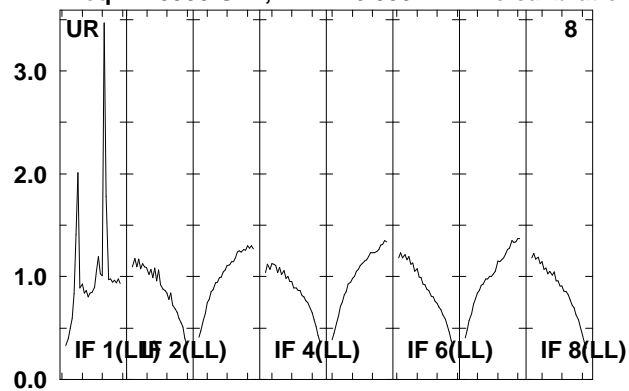

Lower frame: Real Jy
Total-power spectrum Antenna: *
Timerange: 00/12:22:05 to 00/12:25:29

Plot file version 7 created 06-JAN-2012 11:45:49

J1128+59 EP068D 5.UVDATA.1

Freq = 1.5950 GHz, Bw = 16.000 MH No calibration applied and no bandpass applied

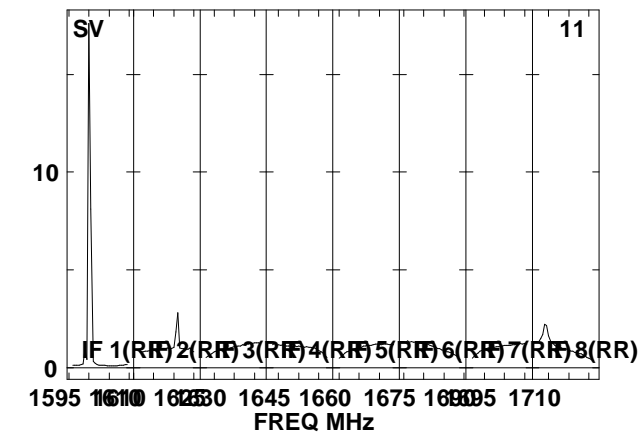
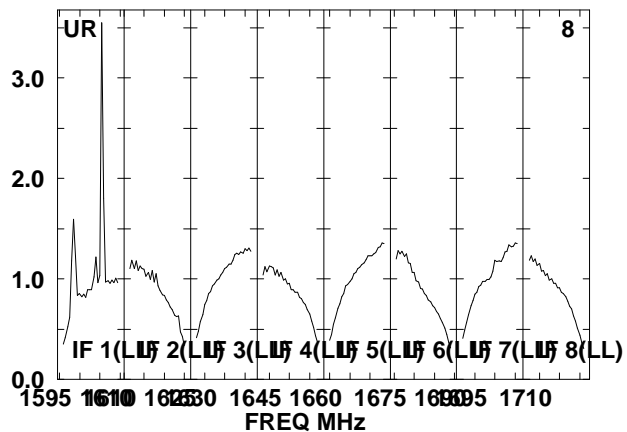
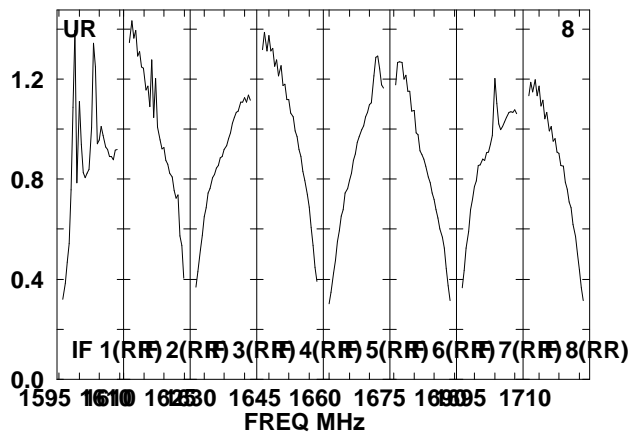
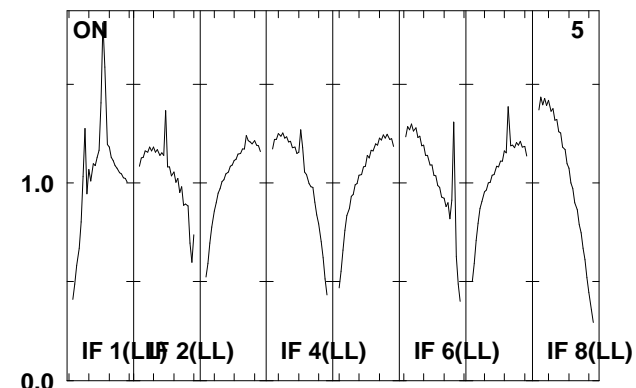
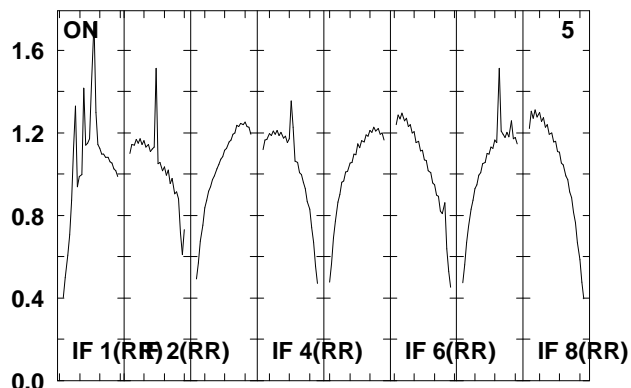
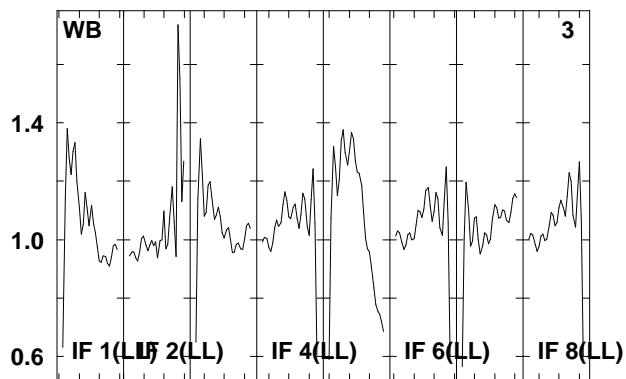
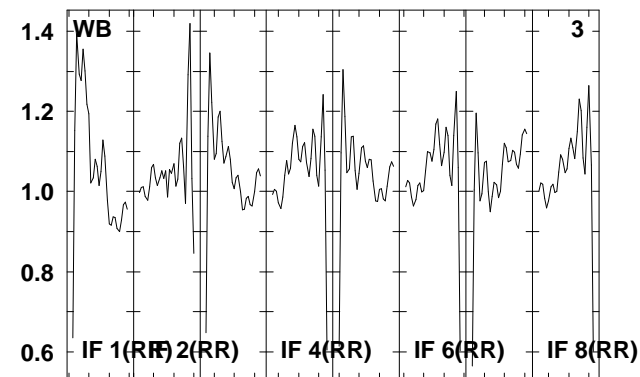
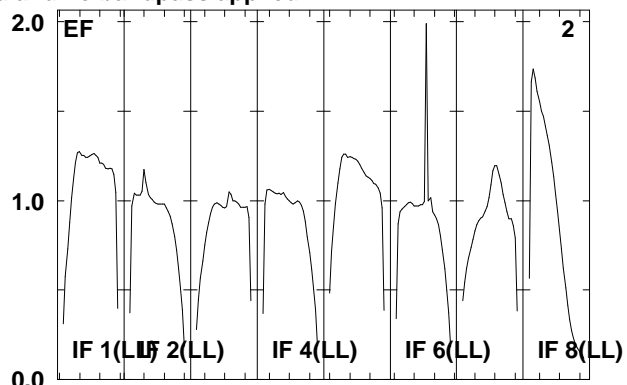
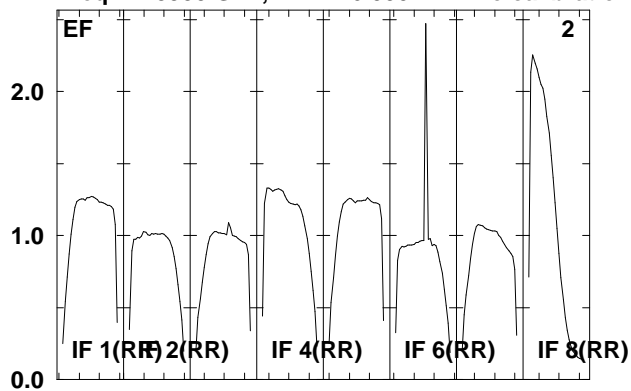

Lower frame: Real Jy
Total-power spectrum Antenna: *
Timerange: 00/12:25:35 to 00/12:26:59

Plot file version 8 created 06-JAN-2012 11:45:49

J1128+59 EP068D 5.UVDATA.1

Freq = 1.5950 GHz, Bw = 16.000 MH No calibration applied and no bandpass applied

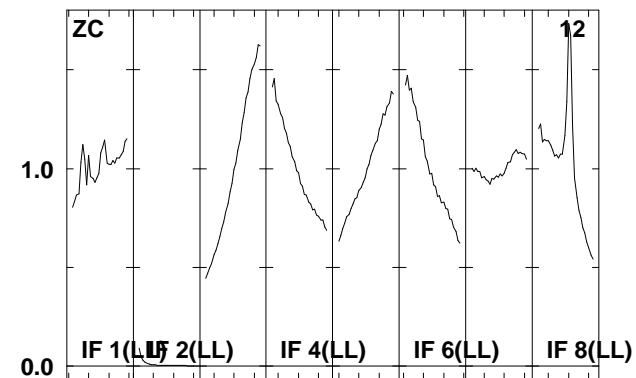
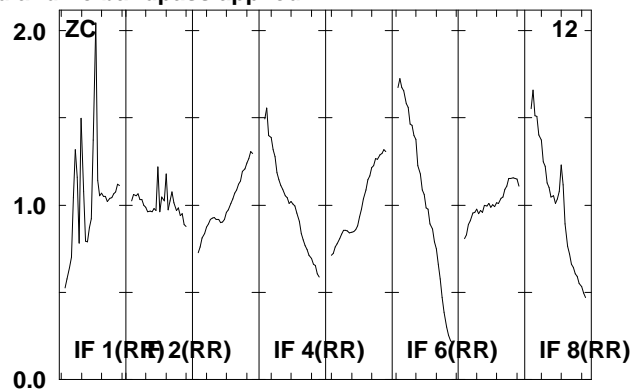
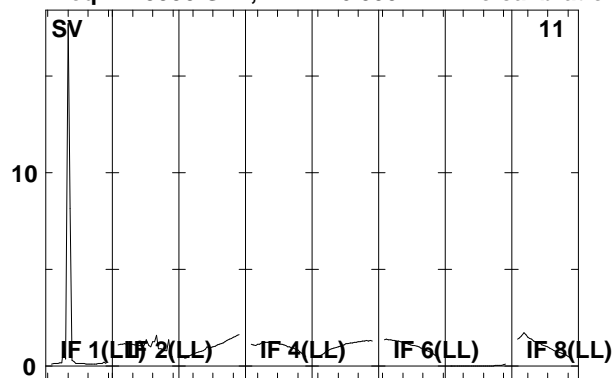

Lower frame: Real Jy
Total-power spectrum Antenna: *
Timerange: 00/12:25:35 to 00/12:26:59

Plot file version 9 created 06-JAN-2012 11:45:49

ARP299D EP068D 5.UVDATA.1

Freq = 1.5950 GHz, Bw = 16.000 MH No calibration applied and no bandpass applied

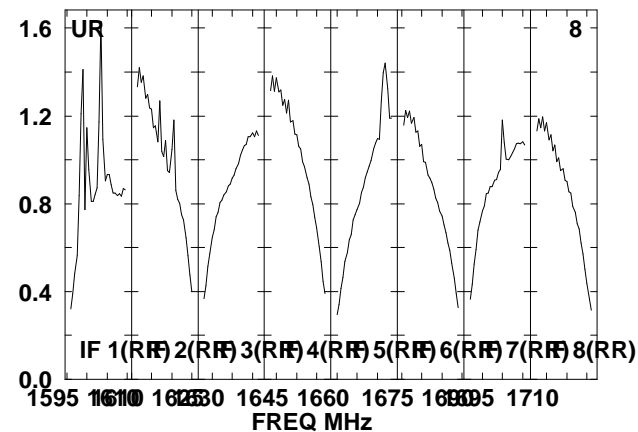
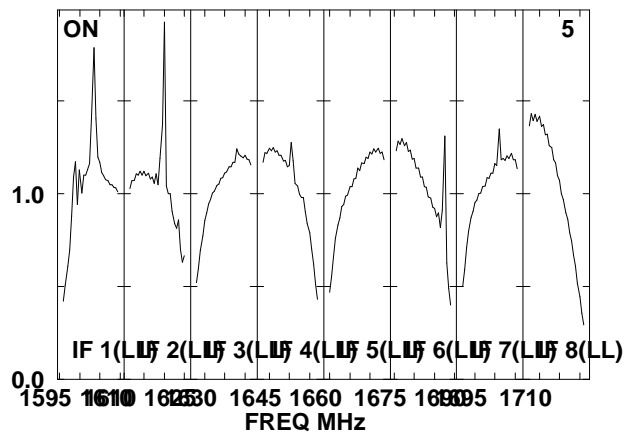
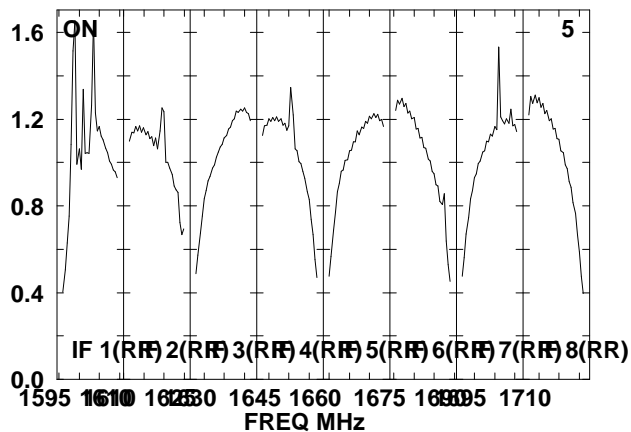
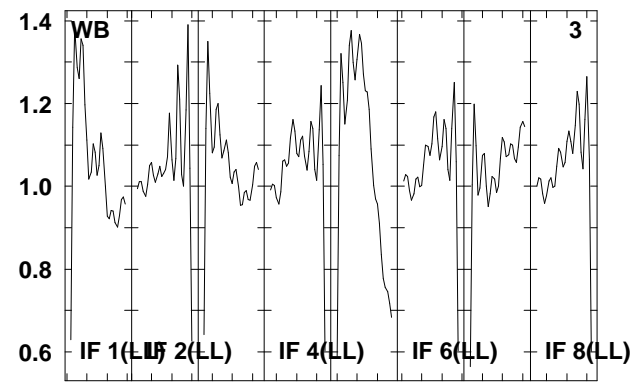
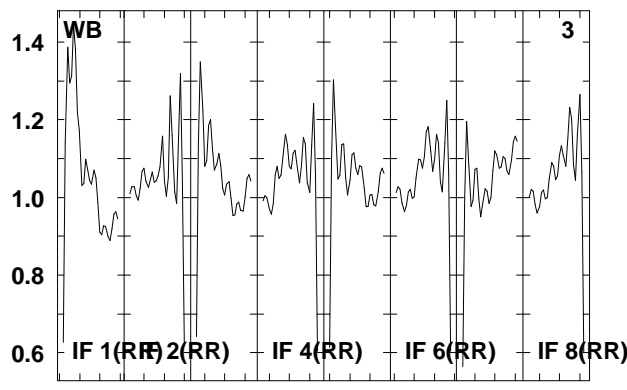
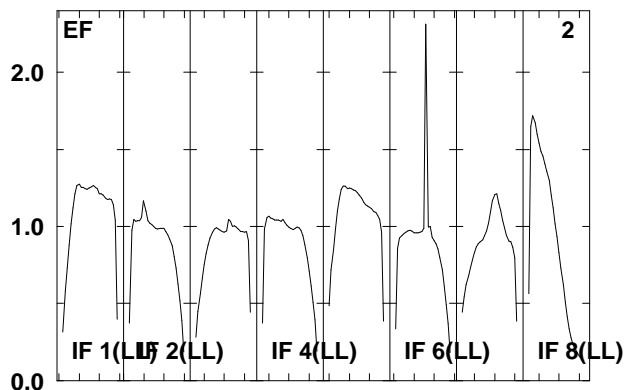
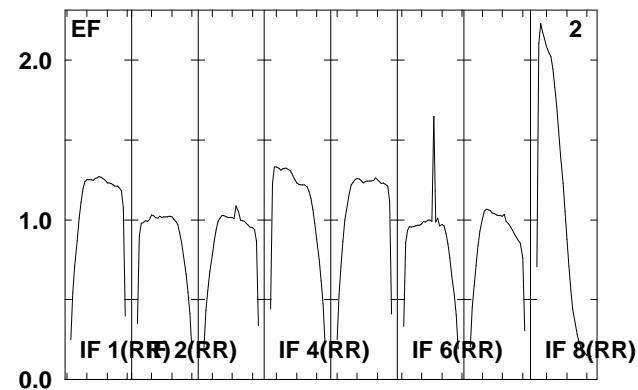
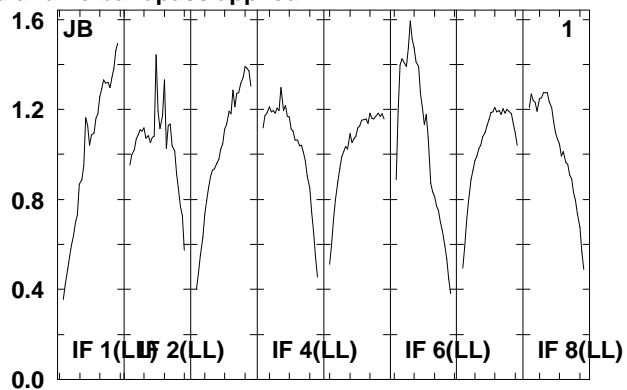
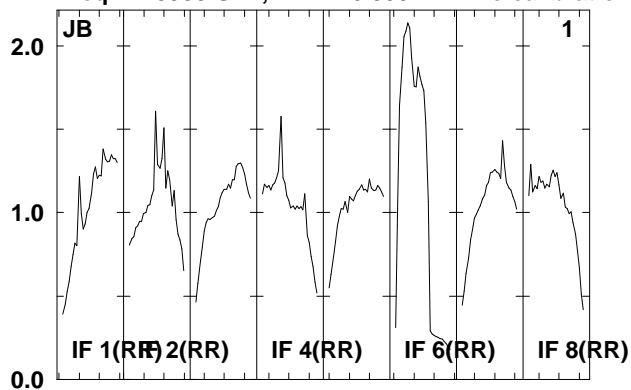

Lower frame: Real Jy
Total-power spectrum Antenna: *
Timerange: 00/12:27:01 to 00/12:30:29

Plot file version 10 created 06-JAN-2012 11:45:50
ARP299D EP068D 5.UVDATA.1
Freq = 1.5950 GHz, Bw = 16.000 MH No calibration applied and no bandpass applied

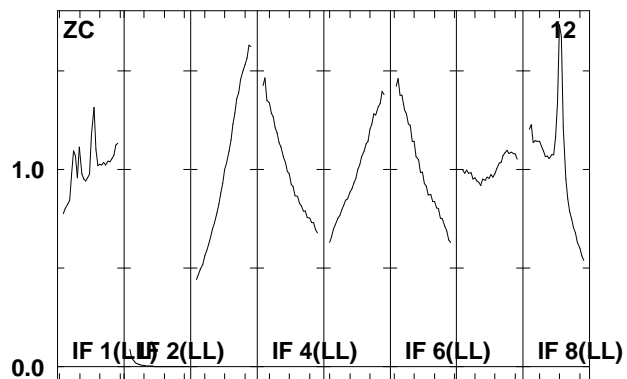
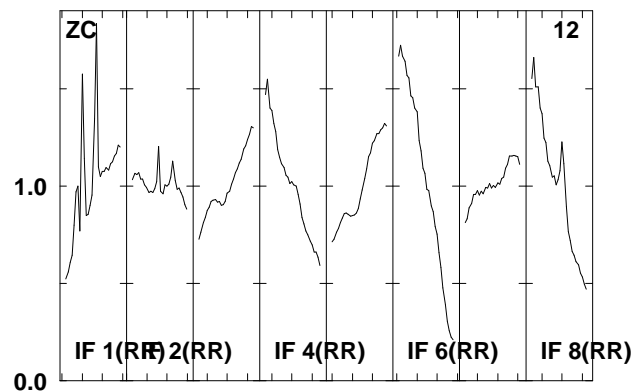
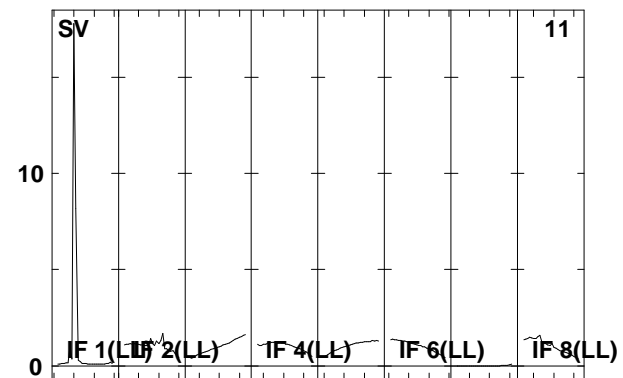
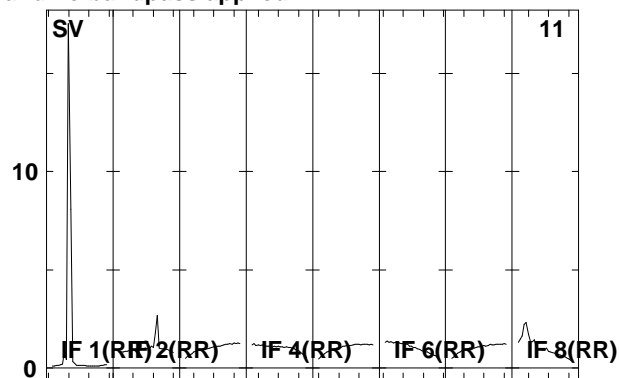
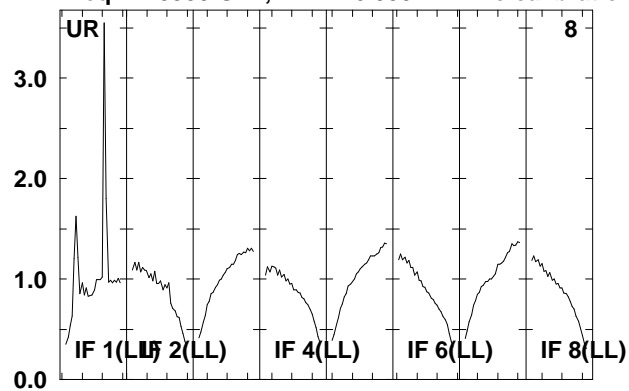

Lower frame: Real Jy
Total-power spectrum Antenna: *
Timerange: 00/12:27:01 to 00/12:30:29

Plot file version 11 created 06-JAN-2012 11:45:50

J1128+59 EP068D 5.UVDATA.1

Freq = 1.5950 GHz, Bw = 16.000 MH No calibration applied and no bandpass applied

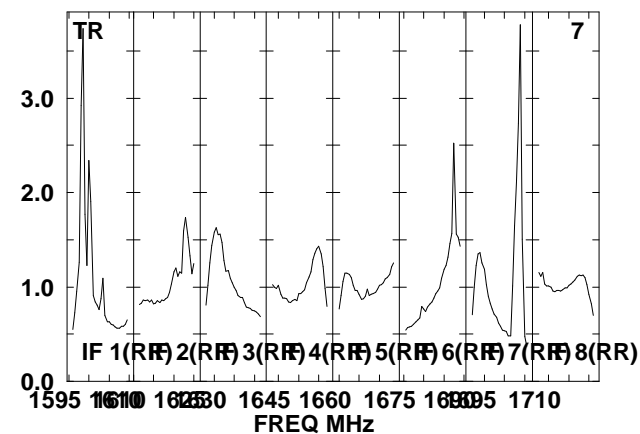
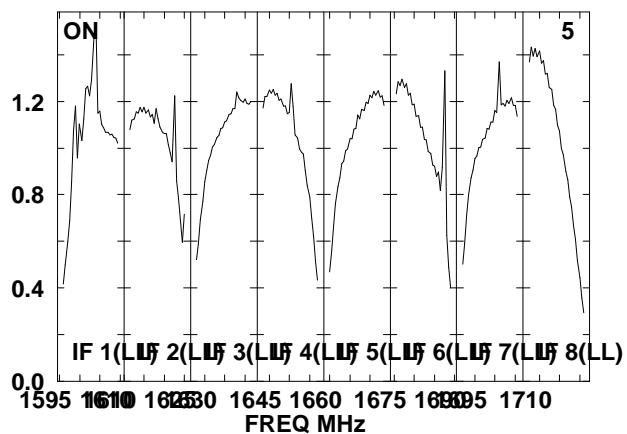
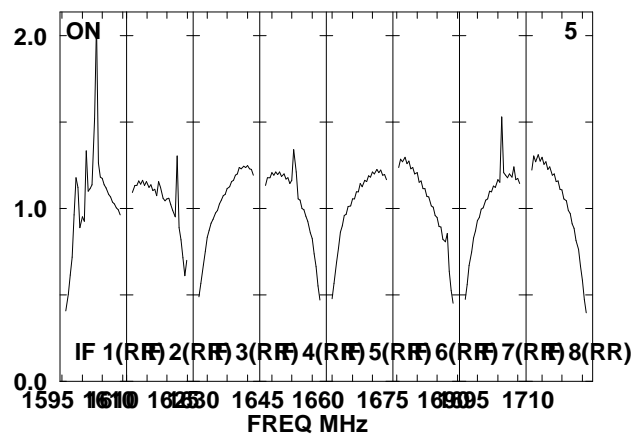
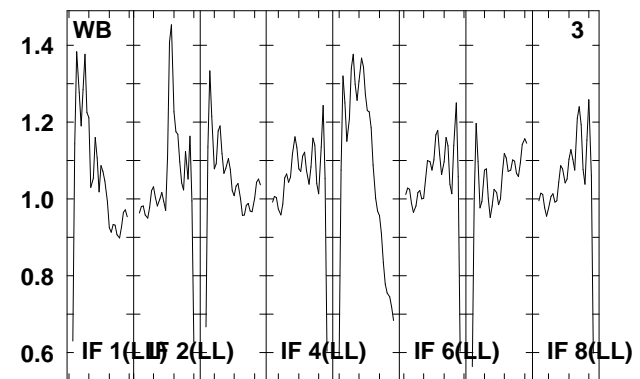
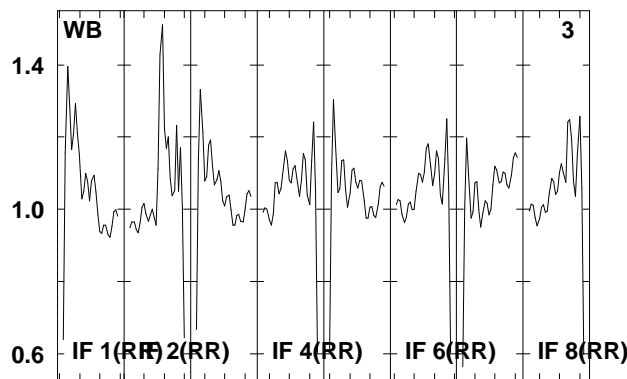
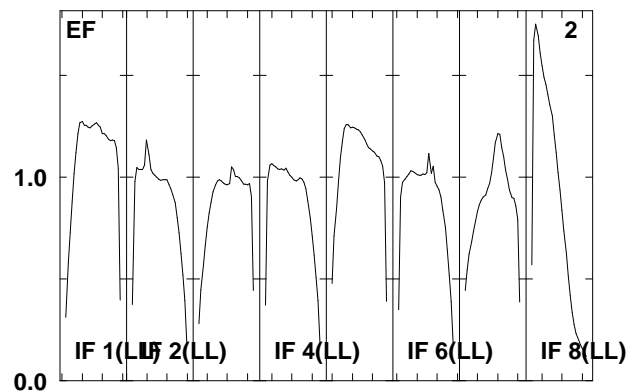
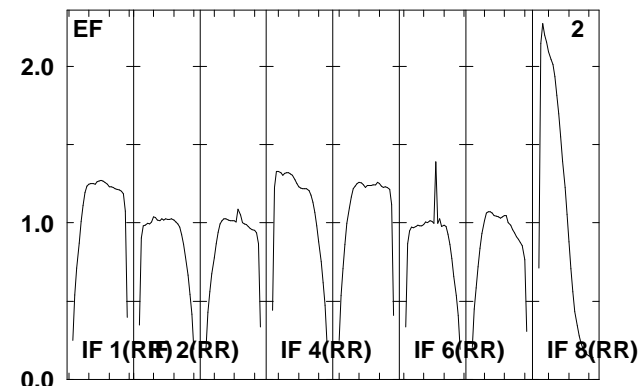
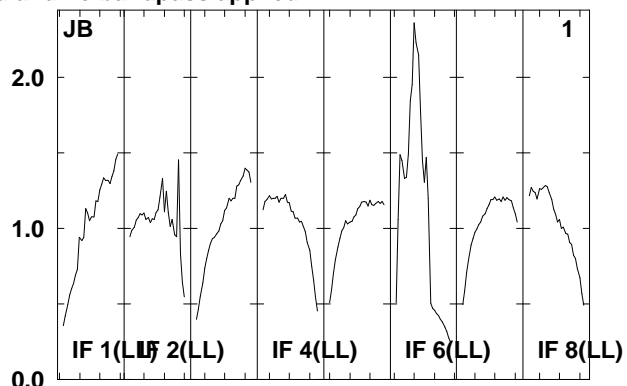
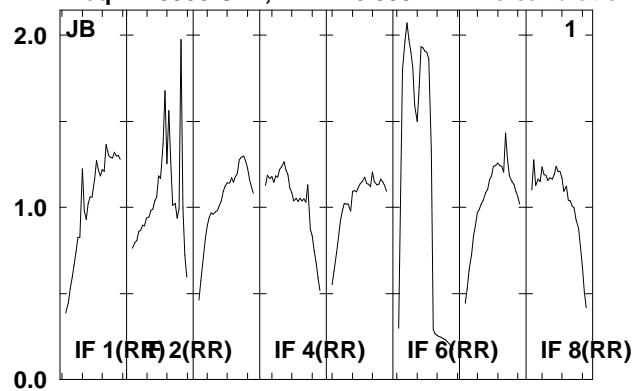

Lower frame: Real Jy
Total-power spectrum Antenna: *
Timerange: 00/12:31:31 to 00/12:32:59

Plot file version 12 created 06-JAN-2012 11:45:51

J1128+59 EP068D 5.UVDATA.1

Freq = 1.5950 GHz, Bw = 16.000 MH No calibration applied and no bandpass applied

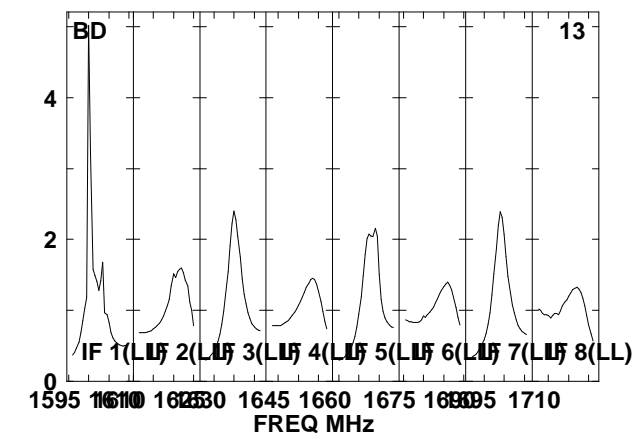
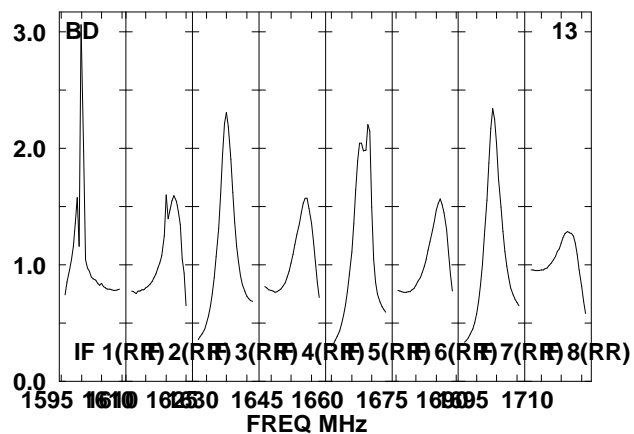
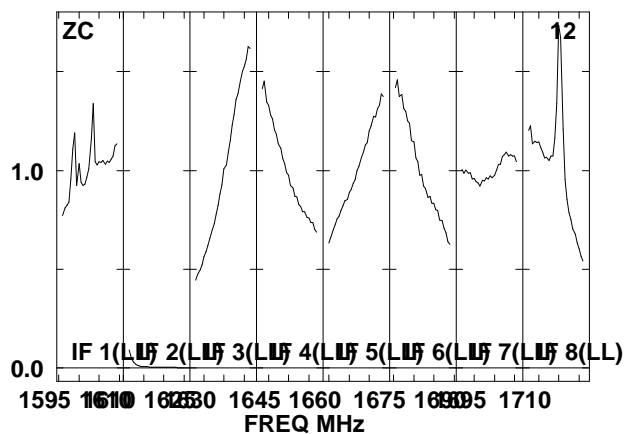
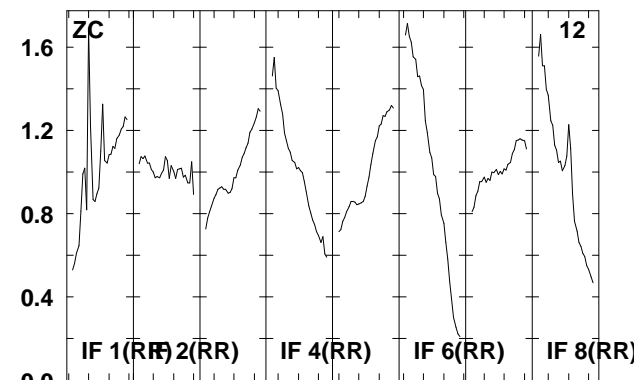
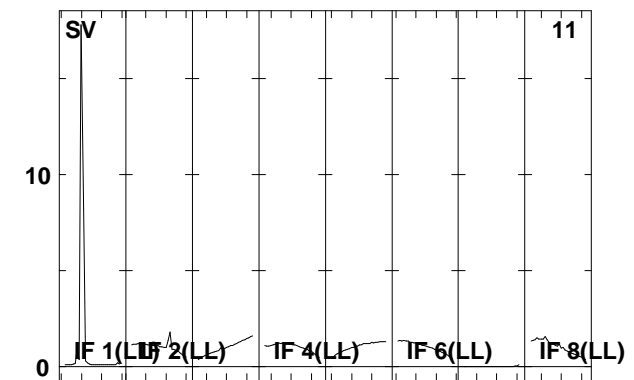
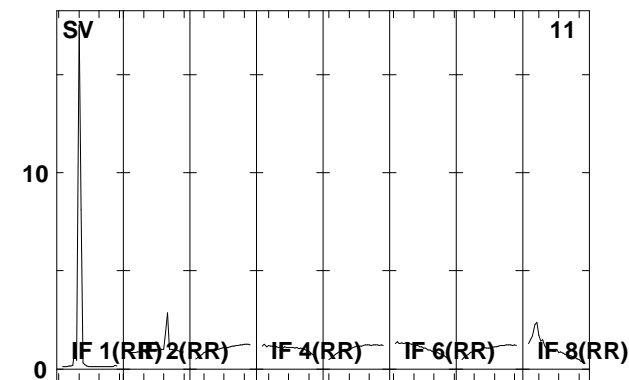
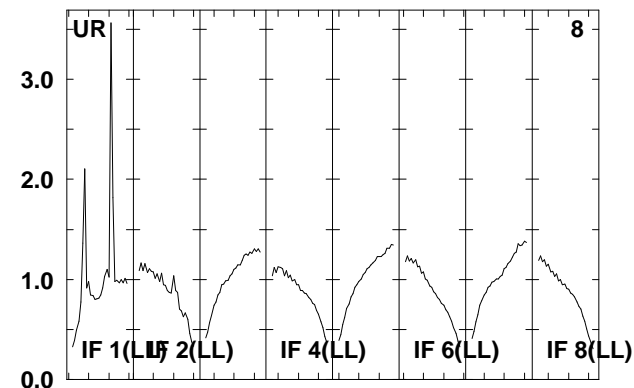
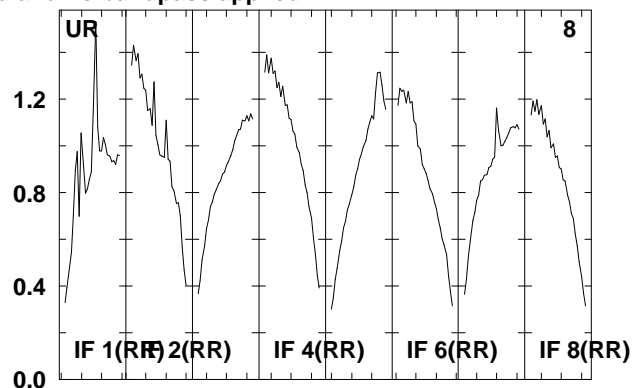
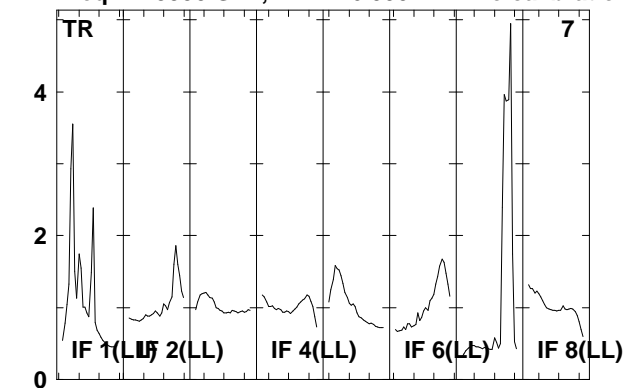

Lower frame: Real Jy
Total-power spectrum Antenna: *
Timerange: 00/12:31:31 to 00/12:32:59

Plot file version 13 created 06-JAN-2012 11:45:51

ARP299D EP068D 5.UVDATA.1

Freq = 1.5950 GHz, Bw = 16.000 MH No calibration applied and no bandpass applied

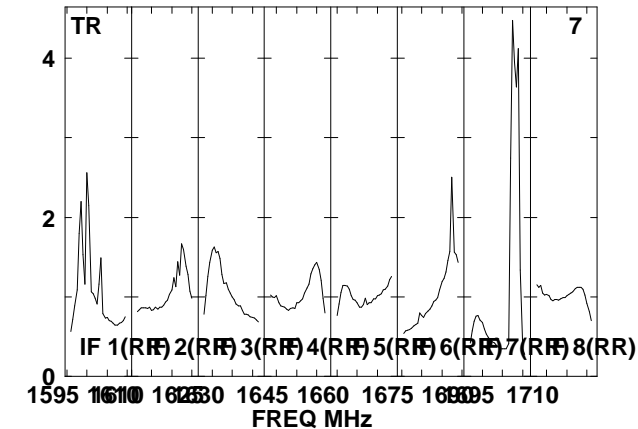
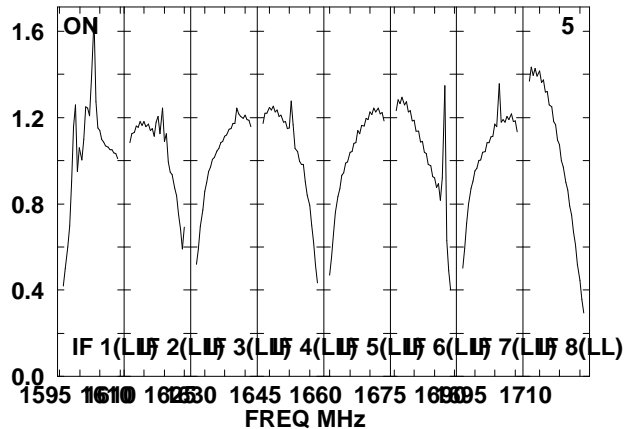
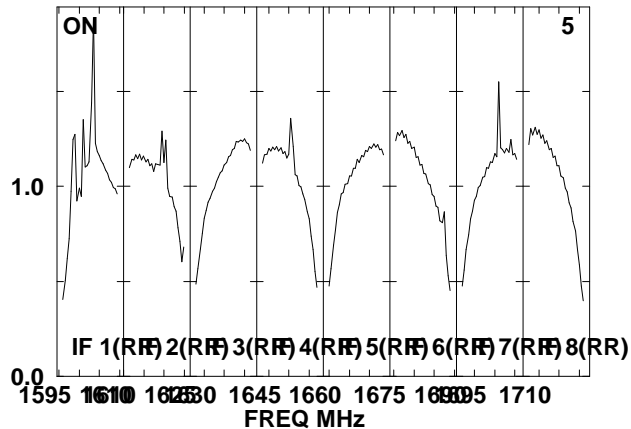
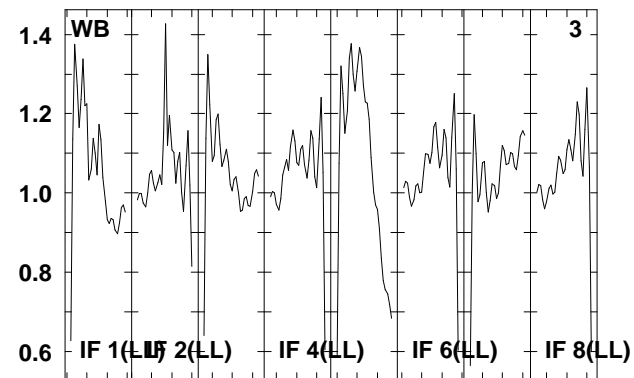
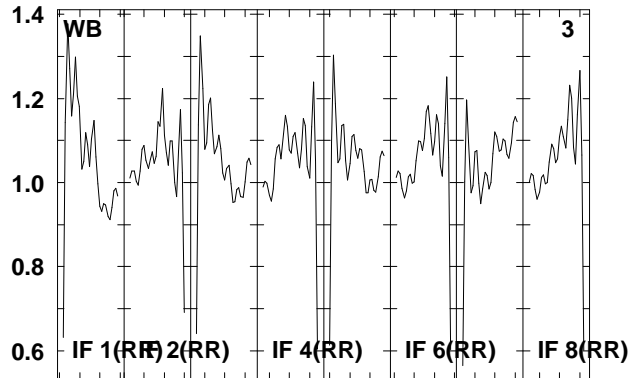
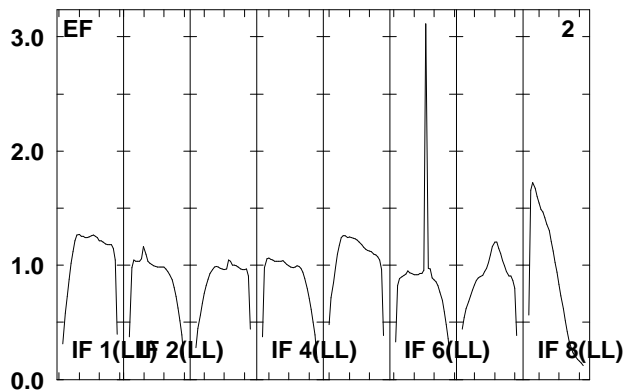
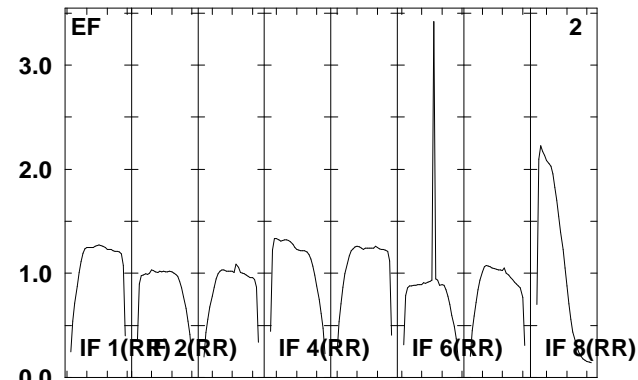
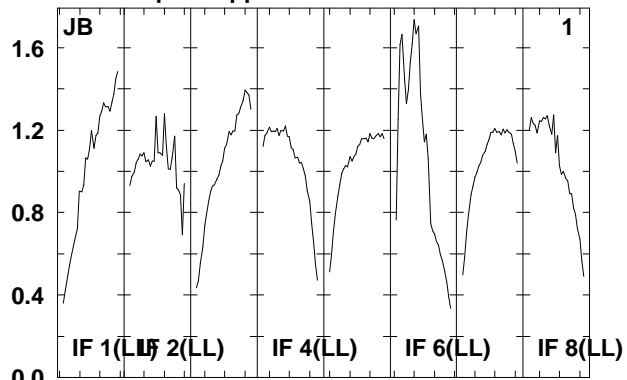
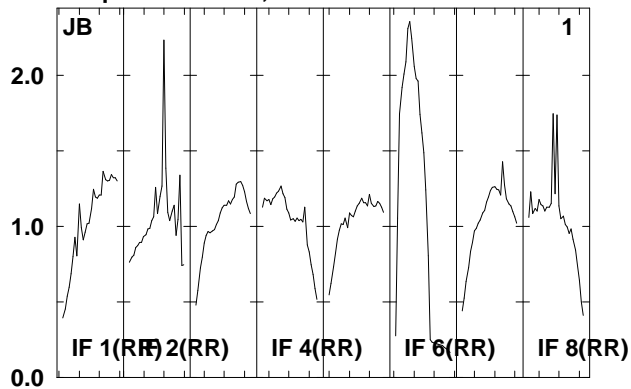

Lower frame: Real Jy
Total-power spectrum Antenna: *
Timerange: 00/12:33:05 to 00/12:36:29

Plot file version 14 created 06-JAN-2012 11:45:52

ARP299D EP068D 5.UVDATA.1

Freq = 1.5950 GHz, Bw = 16.000 MH No calibration applied and no bandpass applied

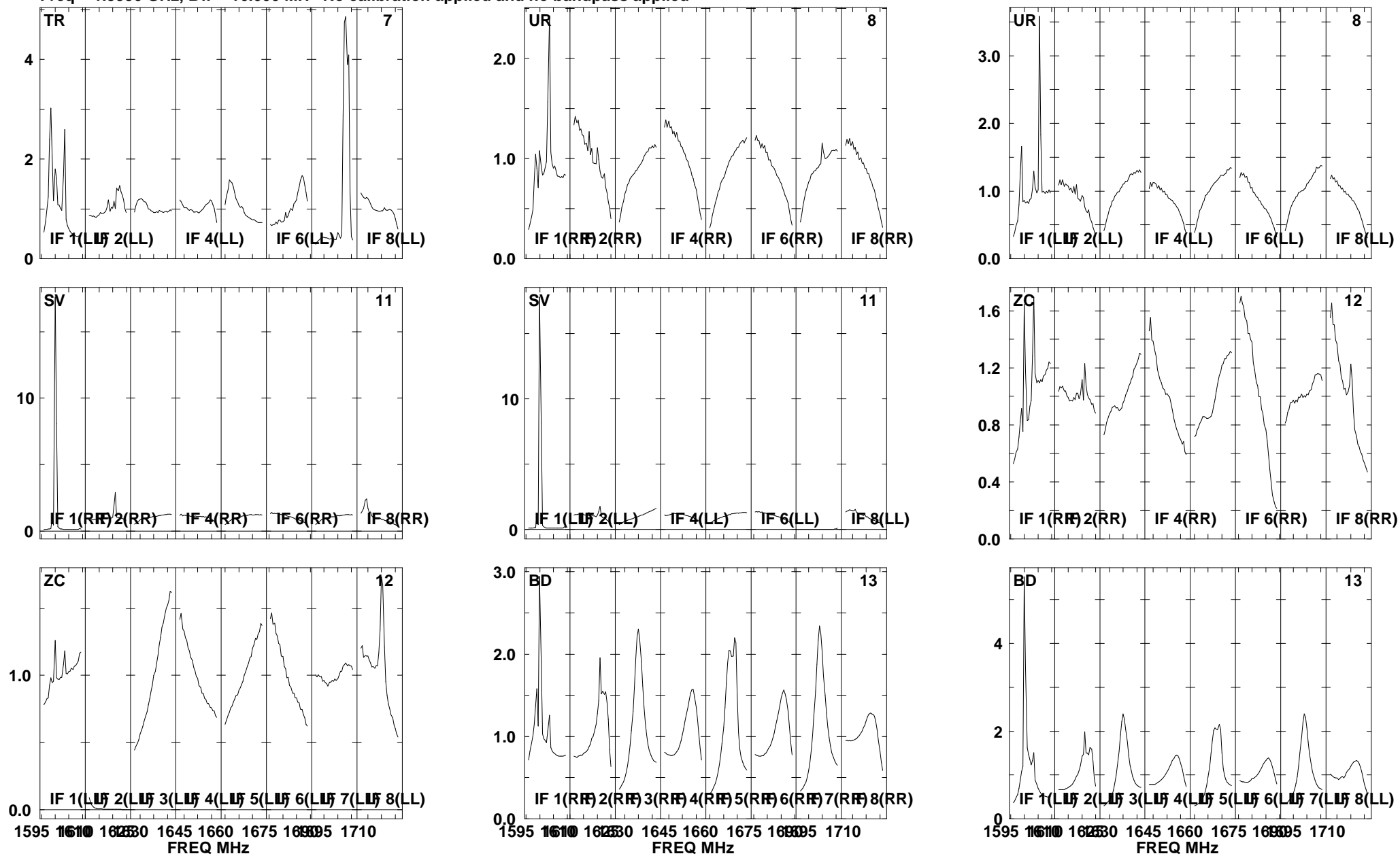

Lower frame: Real Jy
Total-power spectrum Antenna: *
Timerange: 00/12:33:05 to 00/12:36:29

Plot file version 15 created 06-JAN-2012 11:45:52

J1128+59 EP068D 5.UVDATA.1

Freq = 1.5950 GHz, Bw = 16.000 MH No calibration applied and no bandpass applied

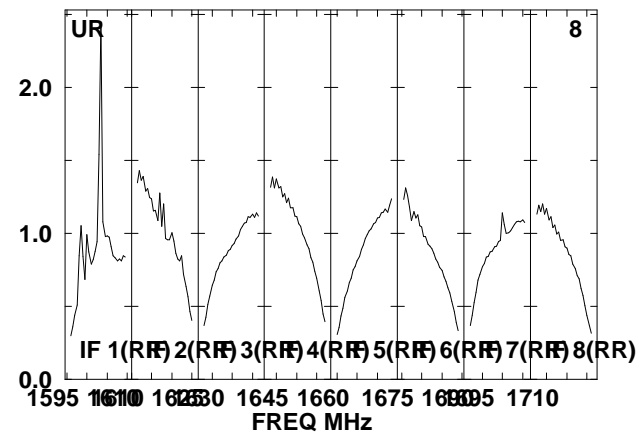
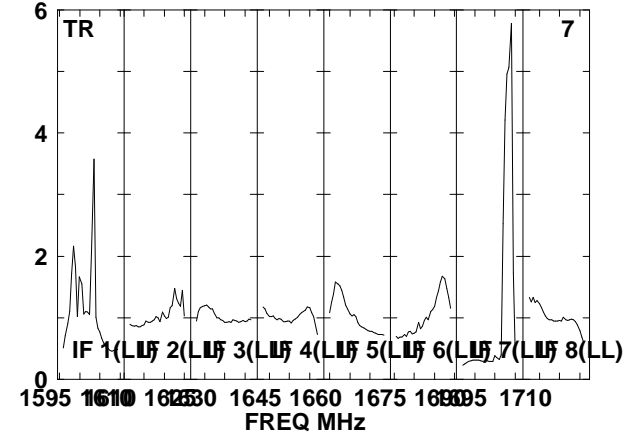
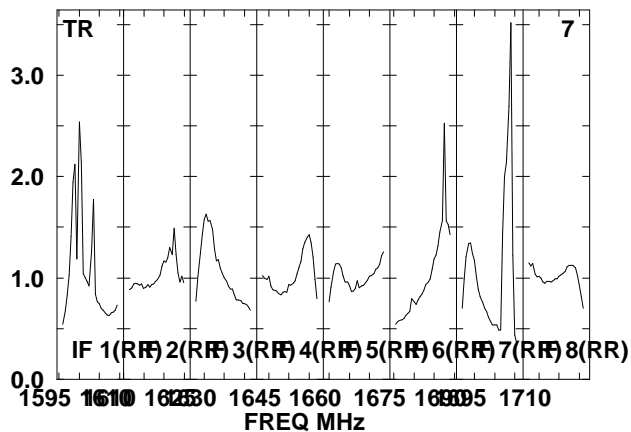
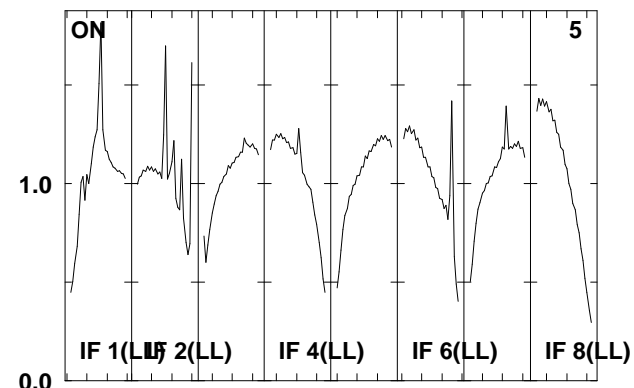
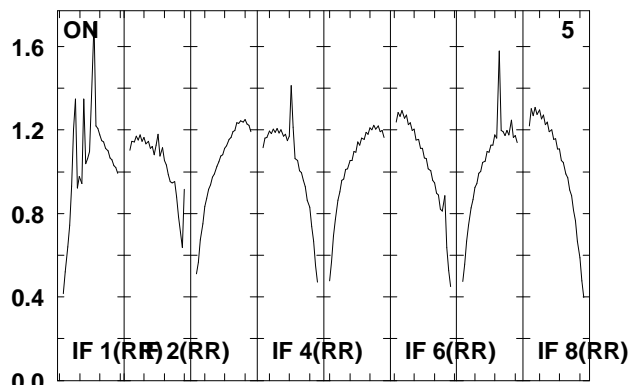
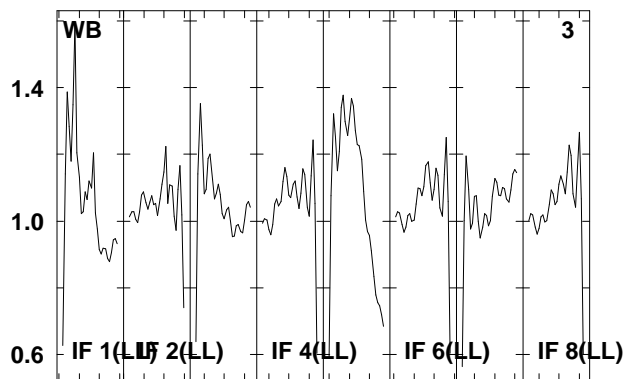
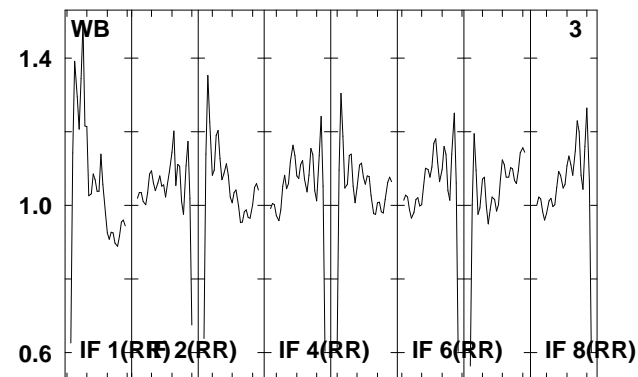
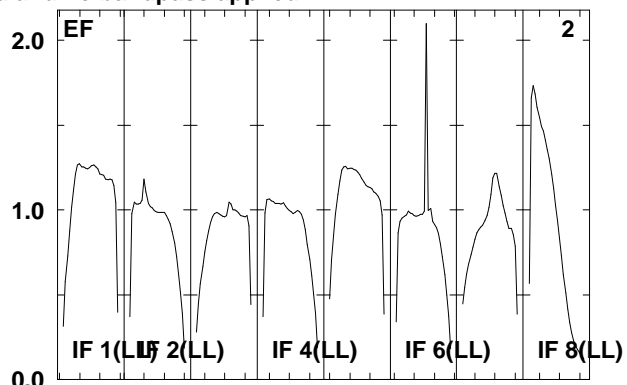
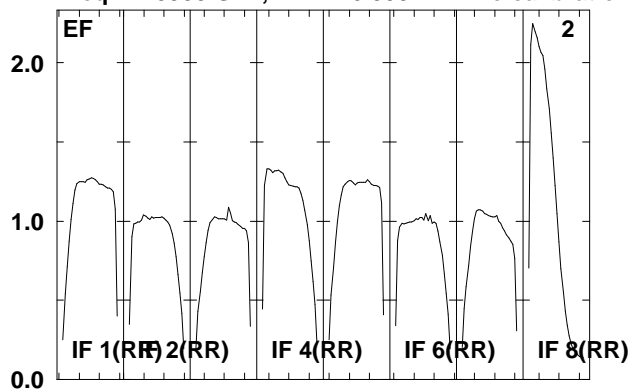

Lower frame: Real Jy
Total-power spectrum Antenna: *
Timerange: 00/12:36:35 to 00/12:37:59

Plot file version 16 created 06-JAN-2012 11:45:52

J1128+59 EP068D 5.UVDATA.1

Freq = 1.5950 GHz, Bw = 16.000 MH No calibration applied and no bandpass applied

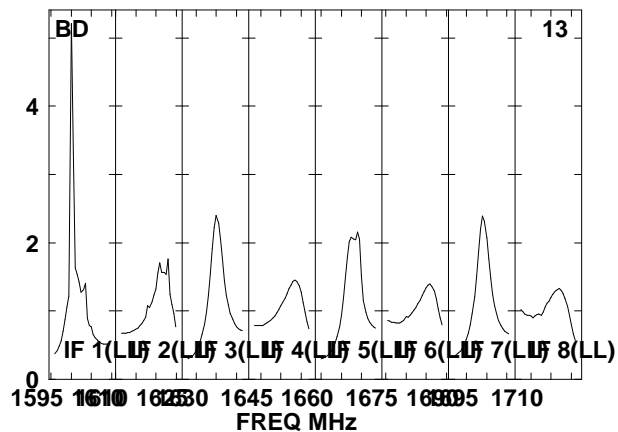
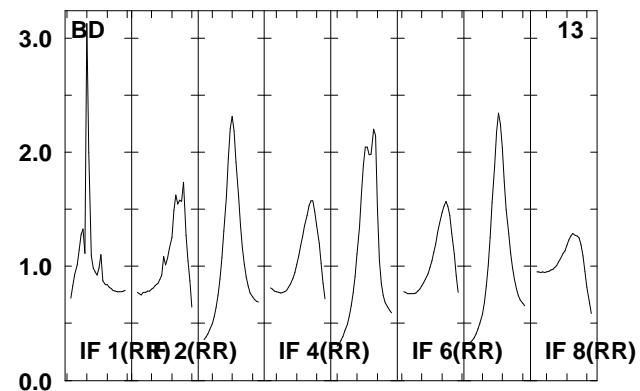
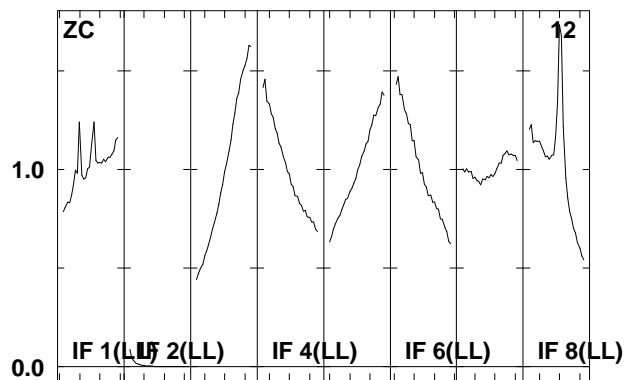
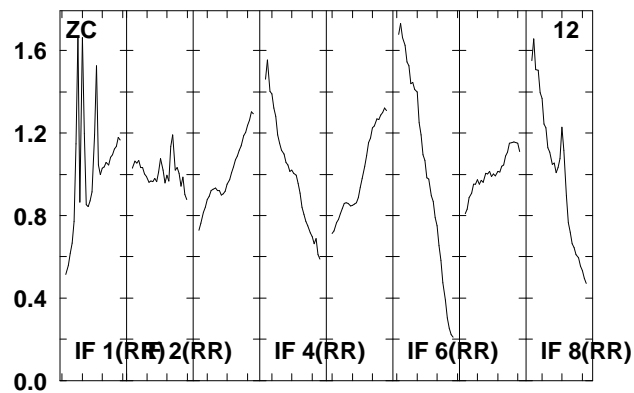
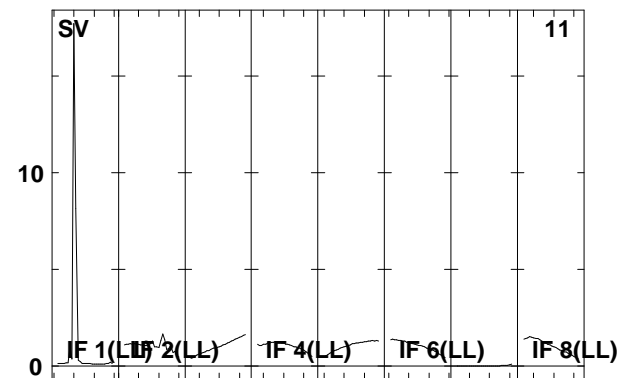
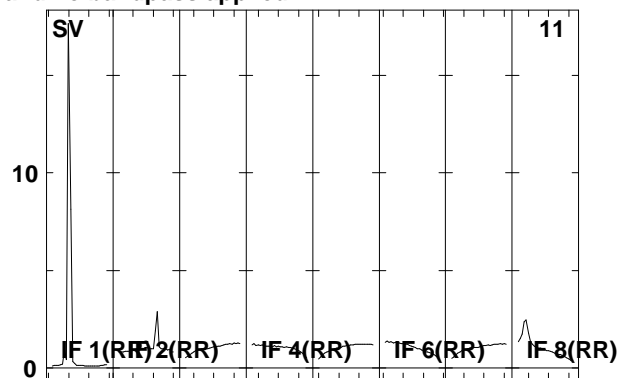
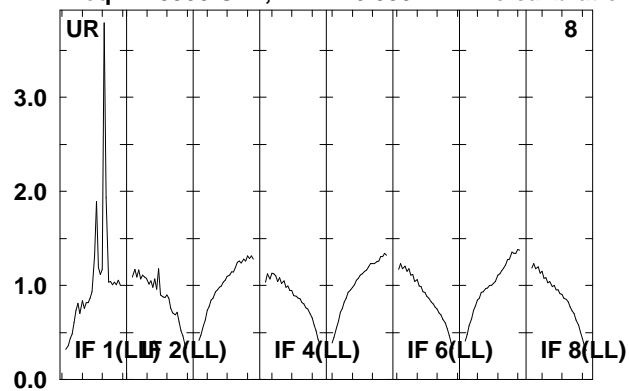

Lower frame: Real Jy

Total-power spectrum Antenna: *

Timerange: 00/12:36:35 to 00/12:37:59

Plot file version 17 created 06-JAN-2012 11:45:53

ARP299D EP068D 5.UVDATA.1

Freq = 1.5950 GHz, Bw = 16.000 MH No calibration applied and no bandpass applied

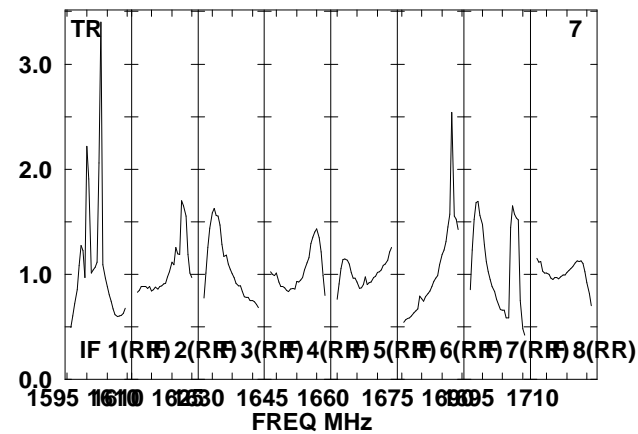
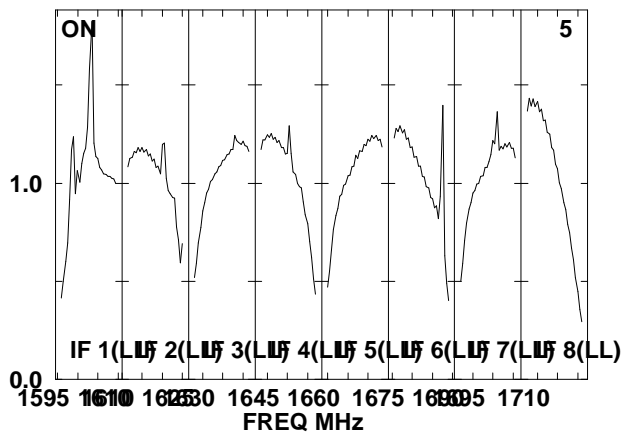
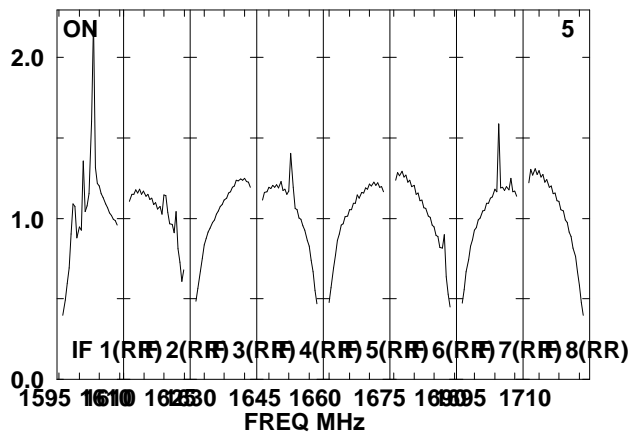
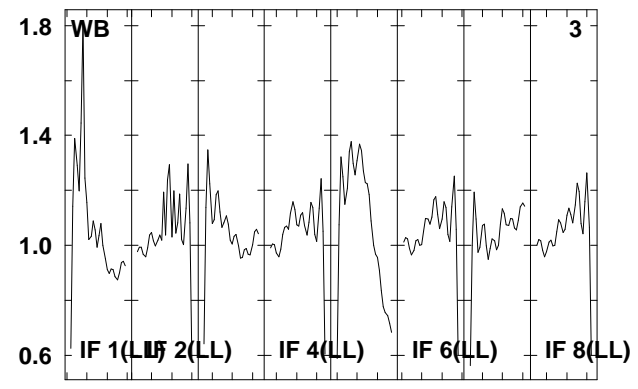
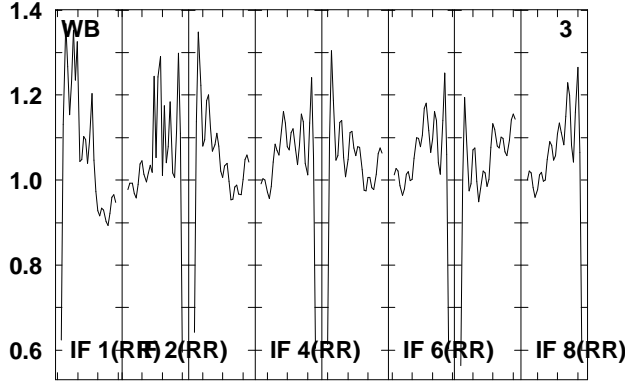
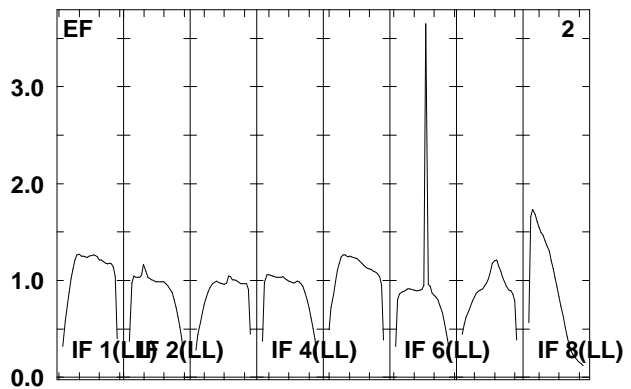
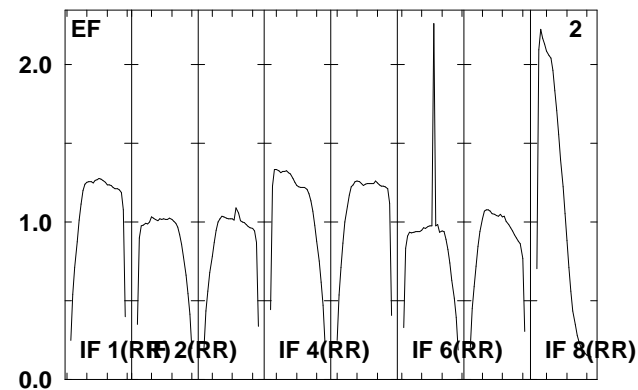
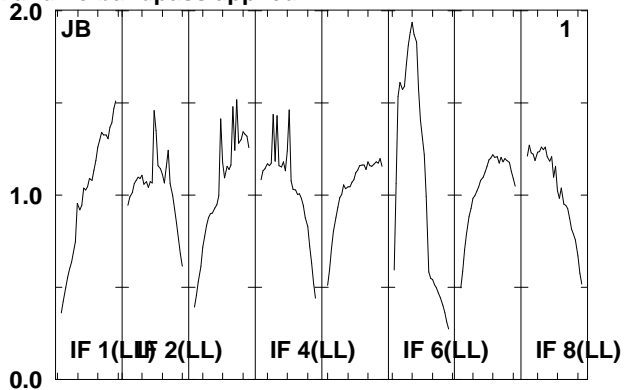
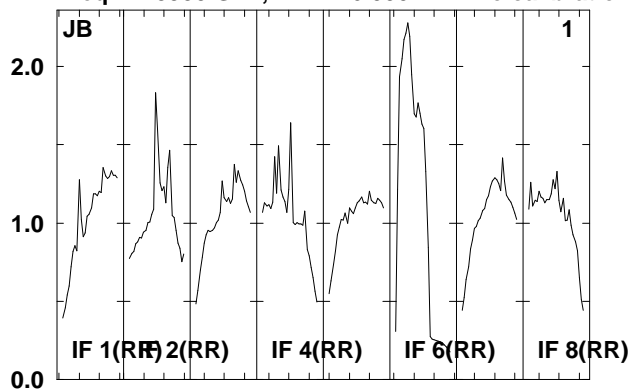

Lower frame: Real Jy
Total-power spectrum Antenna: *
Timerange: 00/12:38:01 to 00/12:41:29

Plot file version 18 created 06-JAN-2012 11:45:53

ARP299D EP068D 5.UVDATA.1

Freq = 1.5950 GHz, Bw = 16.000 MH No calibration applied and no bandpass applied

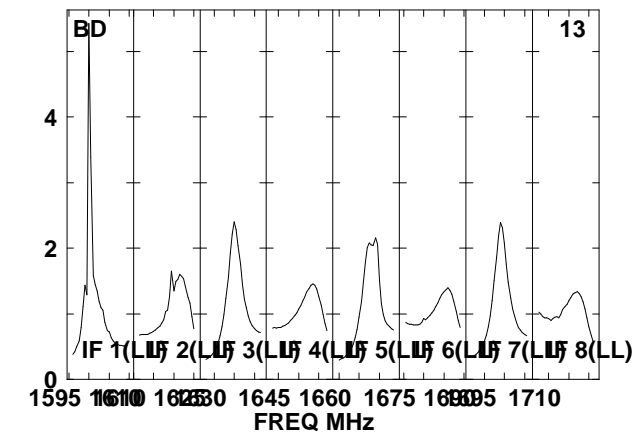
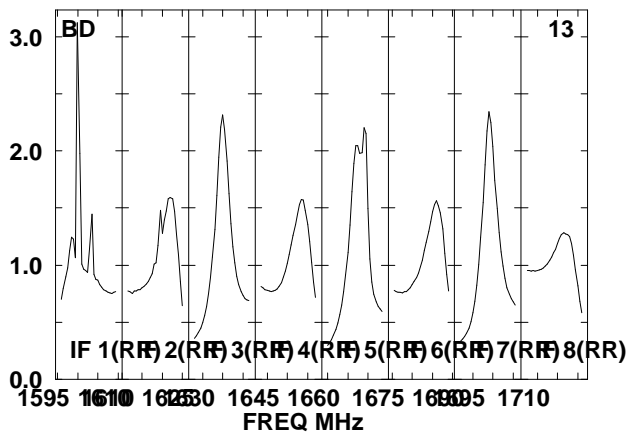
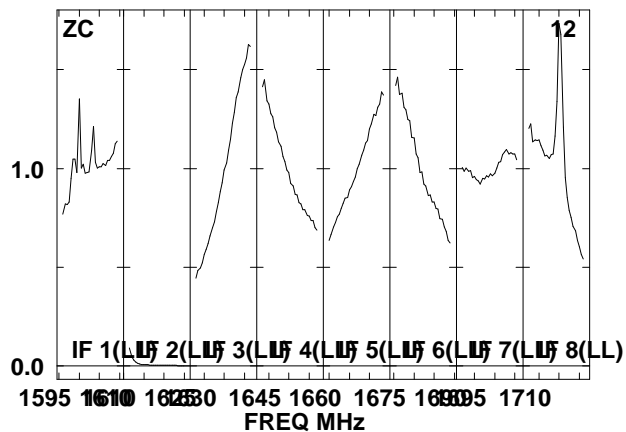
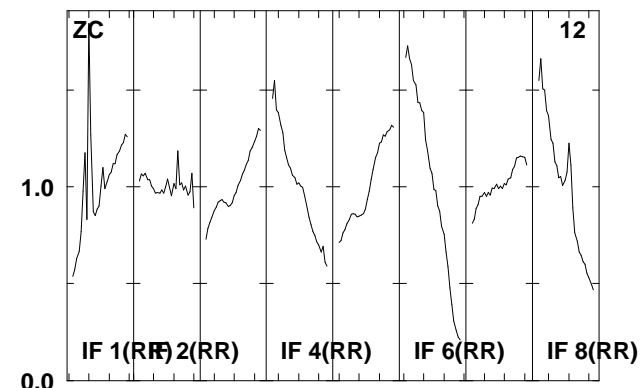
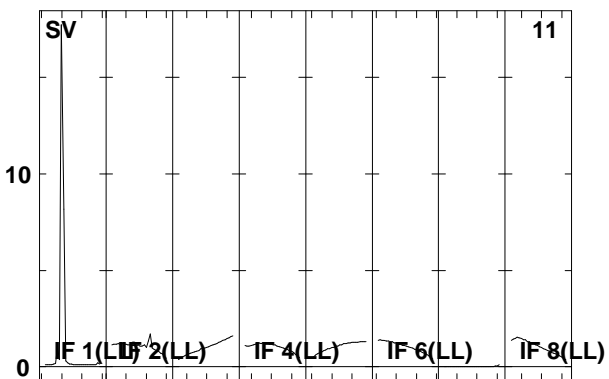
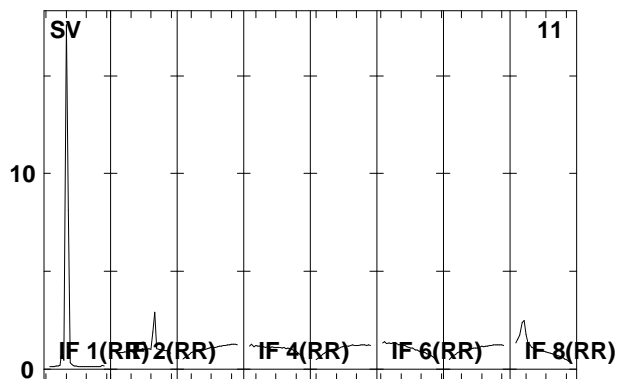
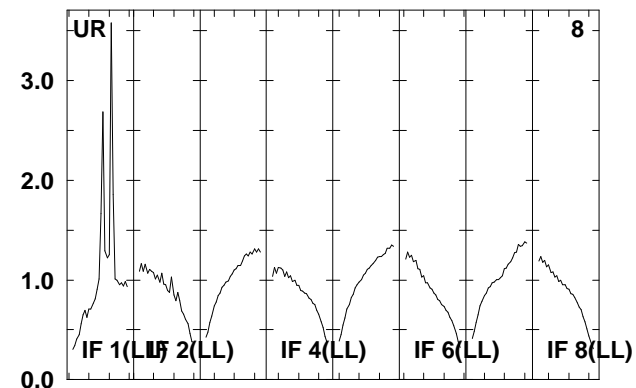
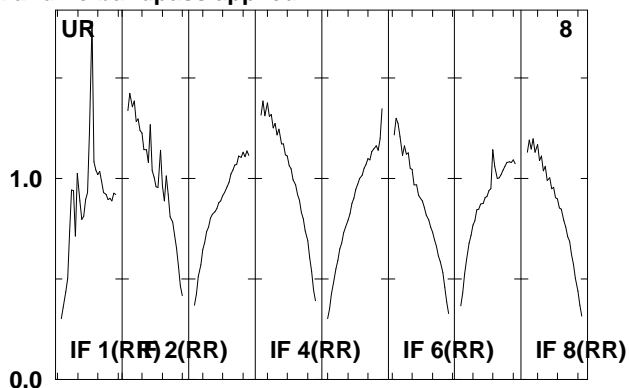
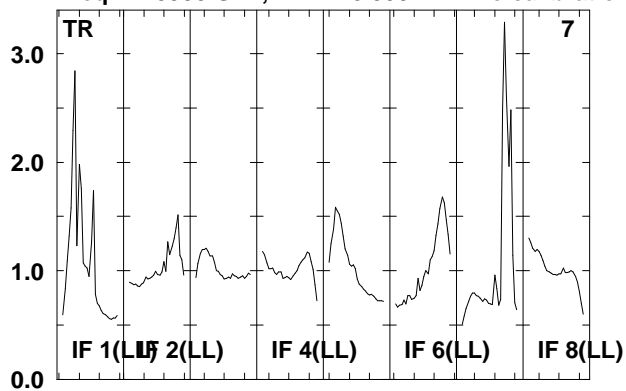

Lower frame: Real Jy
Total-power spectrum Antenna: *
Timerange: 00/12:38:01 to 00/12:41:29

Plot file version 19 created 06-JAN-2012 11:45:54

J1128+59 EP068D 5.UVDATA.1

Freq = 1.5950 GHz, Bw = 16.000 MH No calibration applied and no bandpass applied

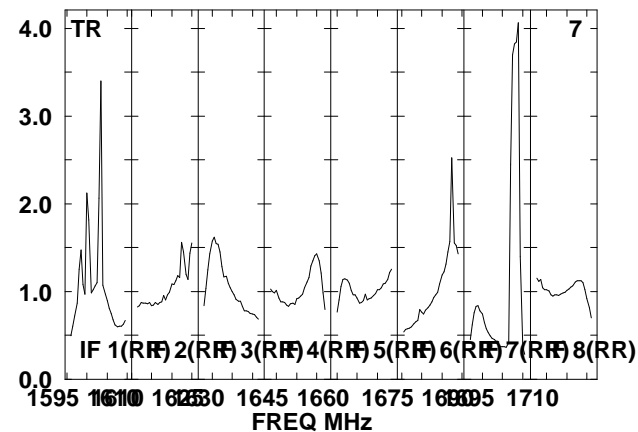
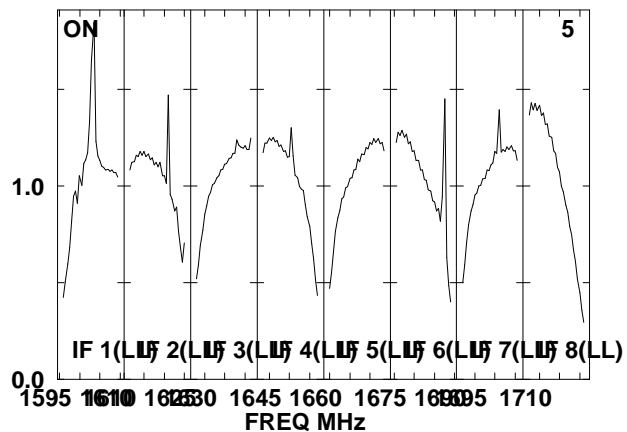
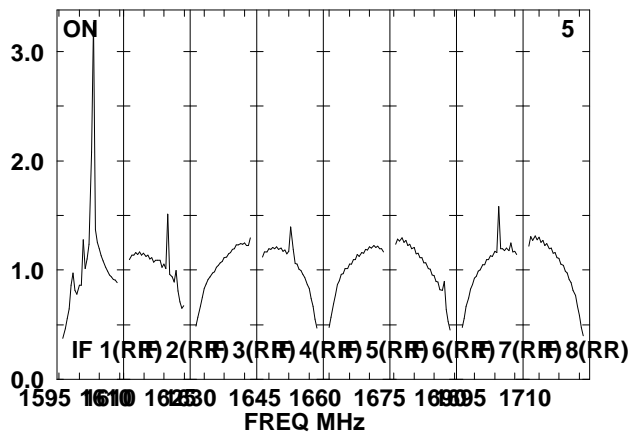
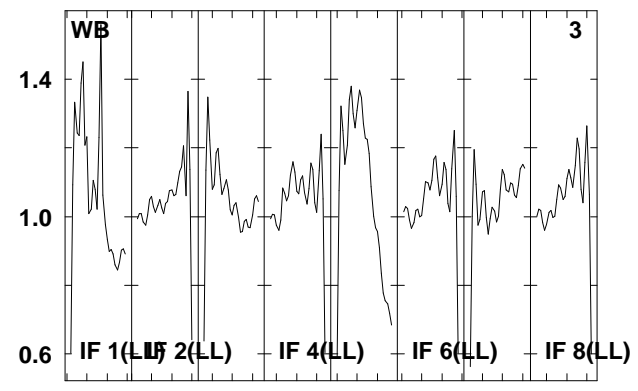
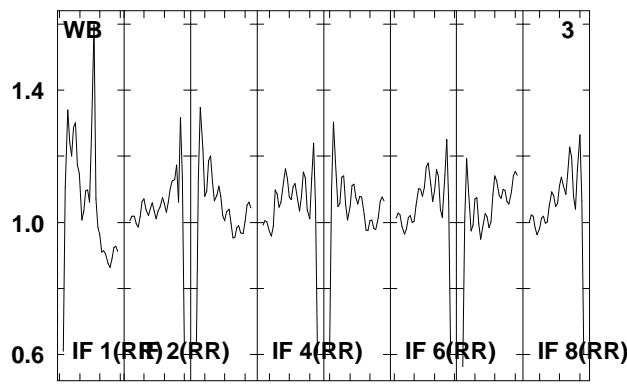
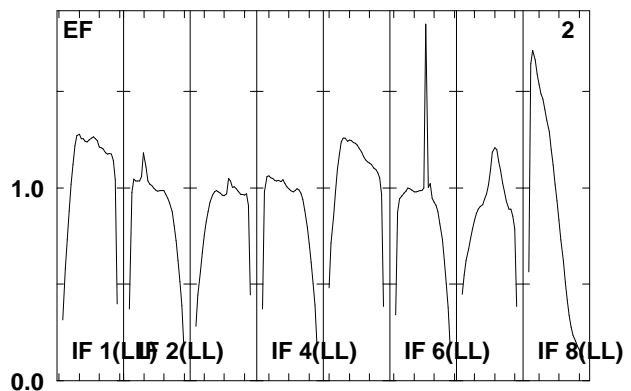
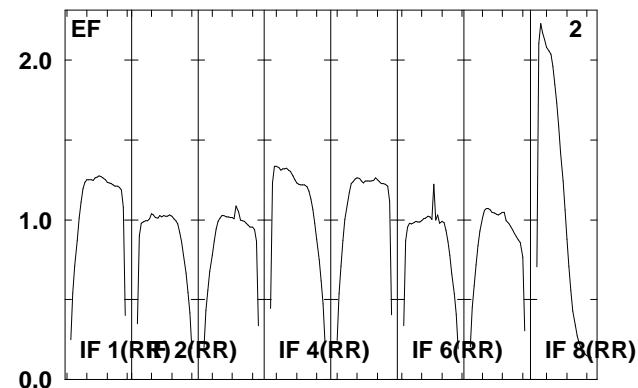
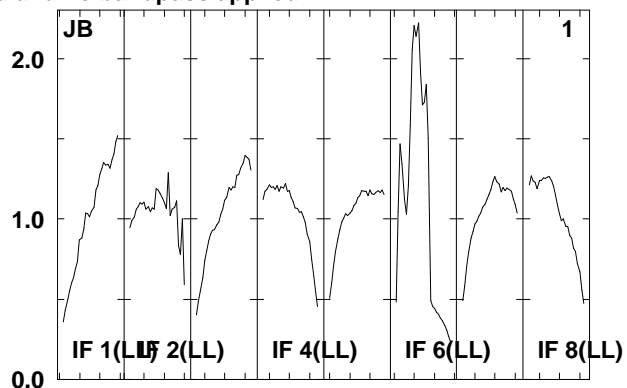
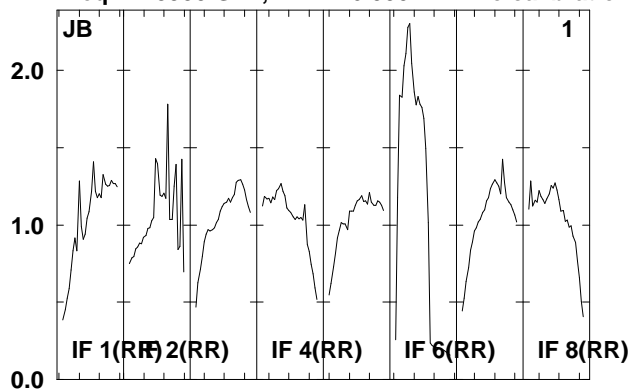

Lower frame: Real Jy
Total-power spectrum Antenna: *
Timerange: 00/12:41:35 to 00/12:42:59

Plot file version 20 created 06-JAN-2012 11:45:54

J1128+59 EP068D 5.UVDATA.1

Freq = 1.5950 GHz, Bw = 16.000 MH No calibration applied and no bandpass applied

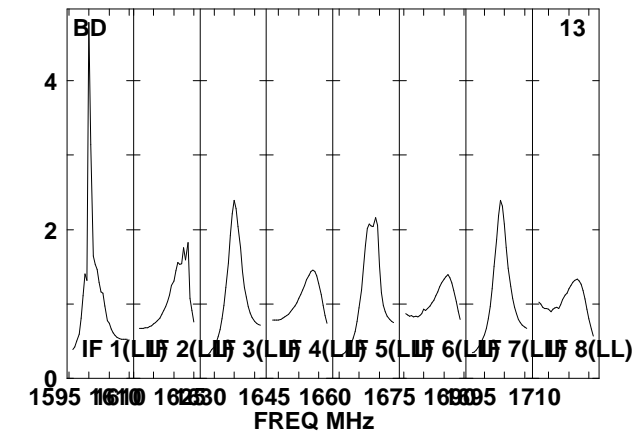
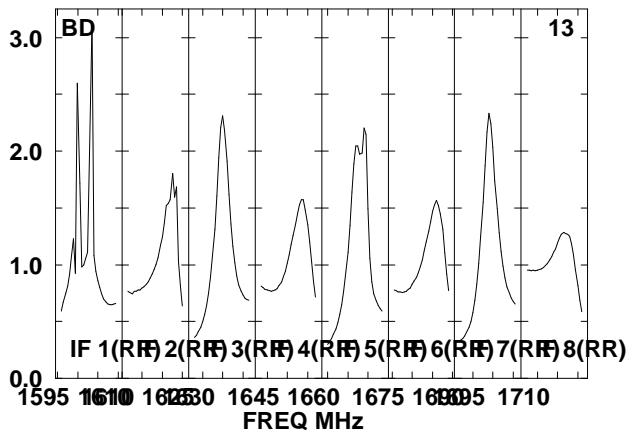
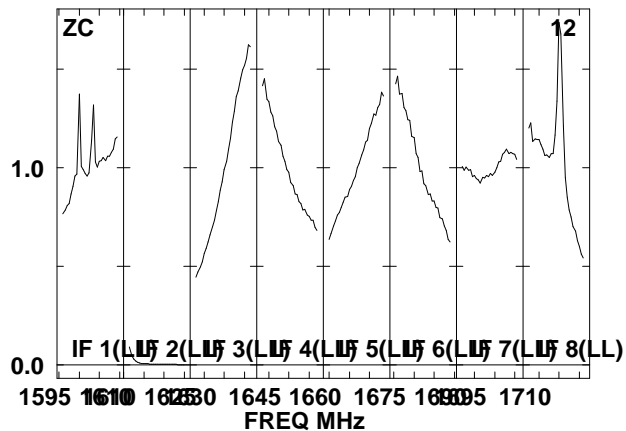
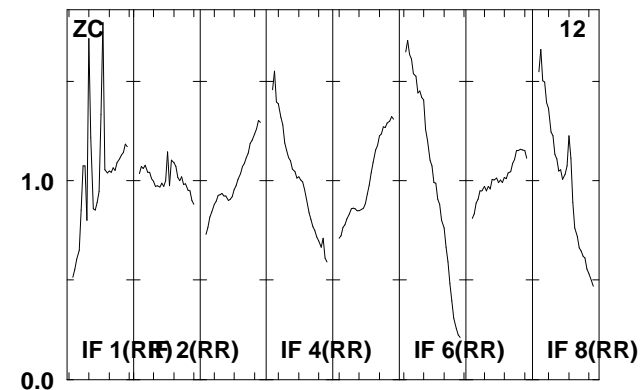
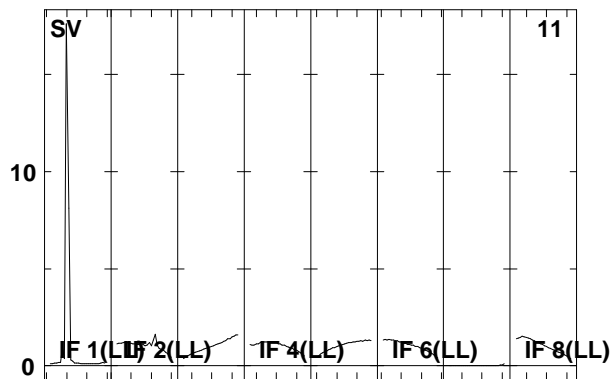
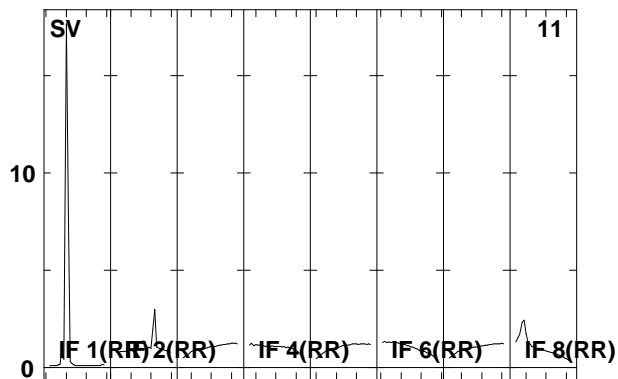
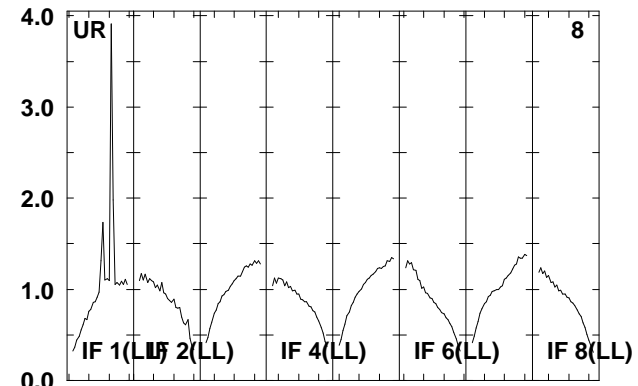
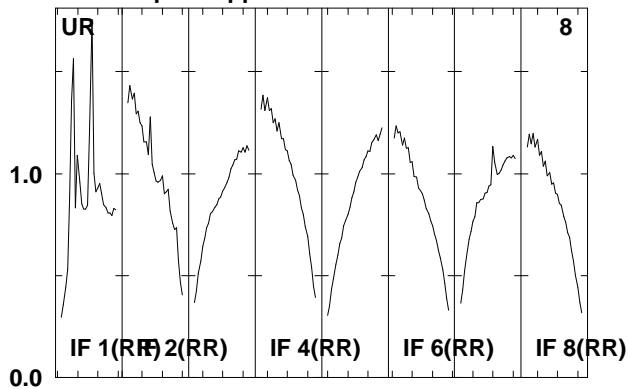
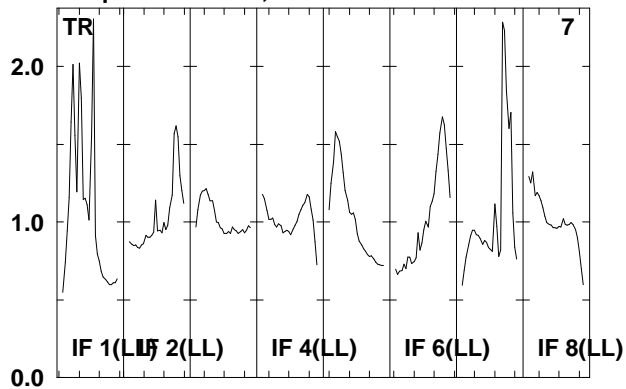

Lower frame: Real Jy

Total-power spectrum Antenna: *

Timerange: 00/12:41:35 to 00/12:42:59

Plot file version 21 created 06-JAN-2012 11:45:55

ARP299D EP068D 5.UVDATA.1

Freq = 1.5950 GHz, Bw = 16.000 MH No calibration applied and no bandpass applied

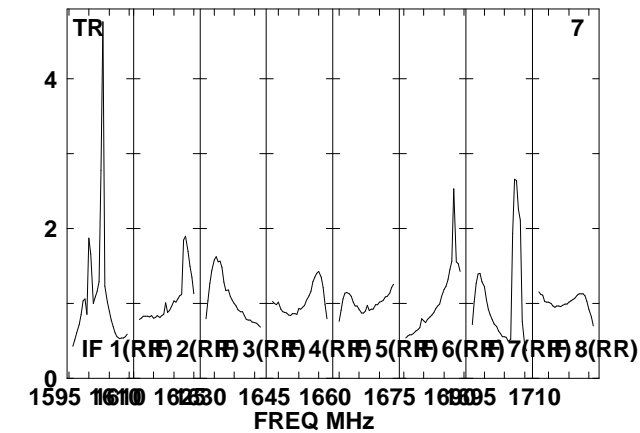
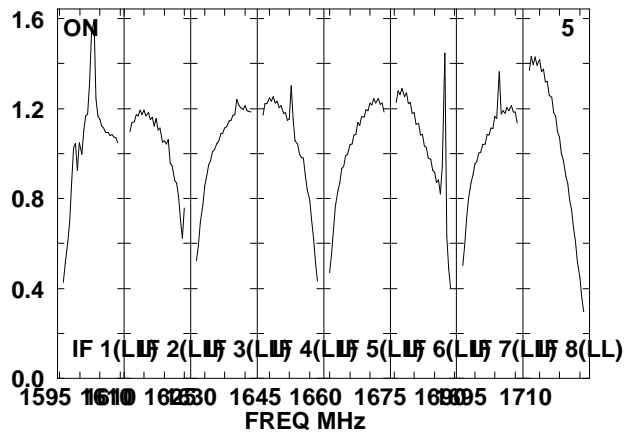
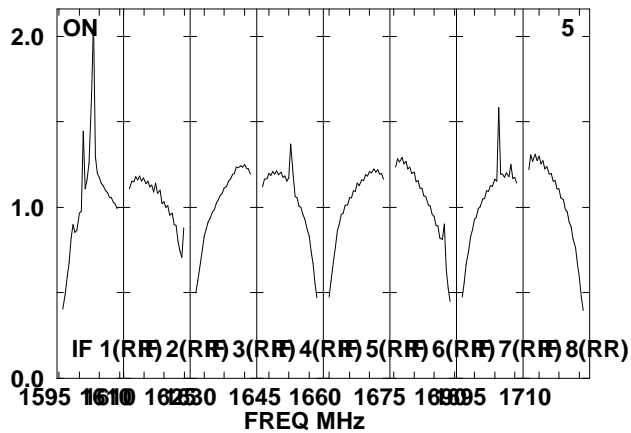
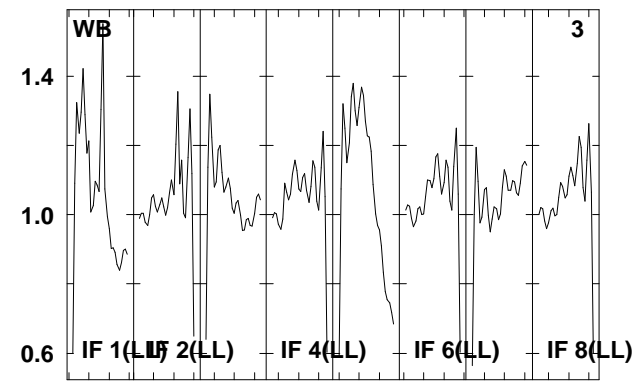
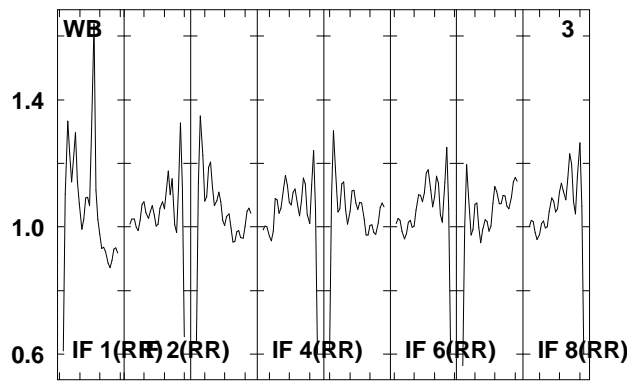
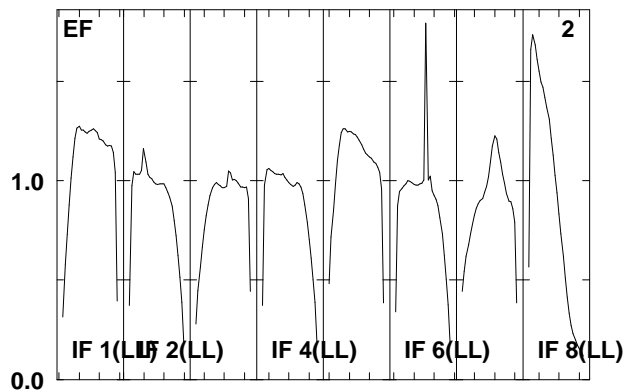
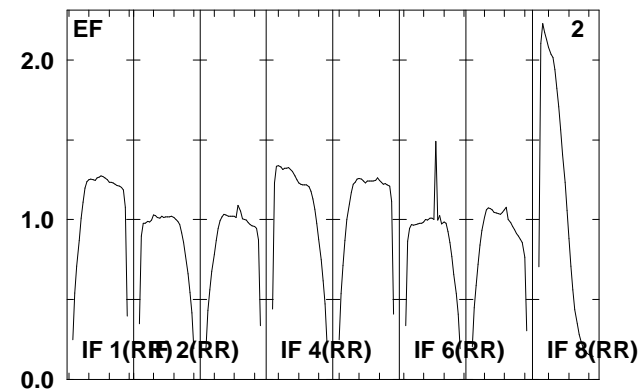
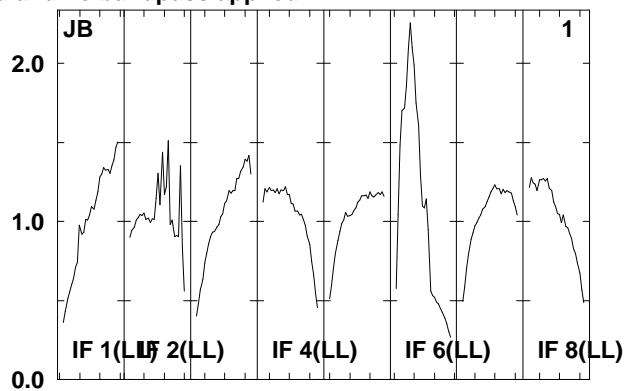
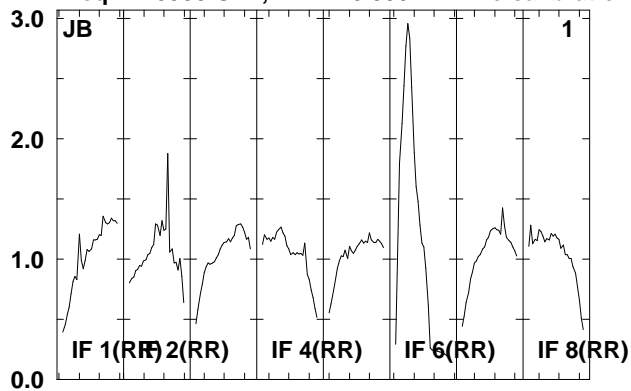

Lower frame: Real Jy
Total-power spectrum Antenna: *
Timerange: 00/12:43:05 to 00/12:46:29

Plot file version 22 created 06-JAN-2012 11:45:56

ARP299D EP068D 5.UVDATA.1

Freq = 1.5950 GHz, Bw = 16.000 MH No calibration applied and no bandpass applied

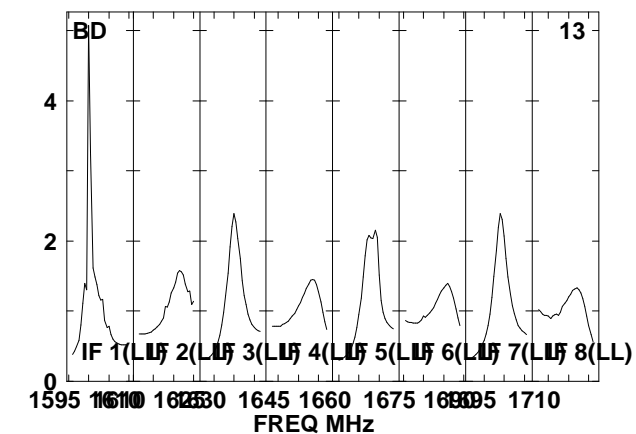
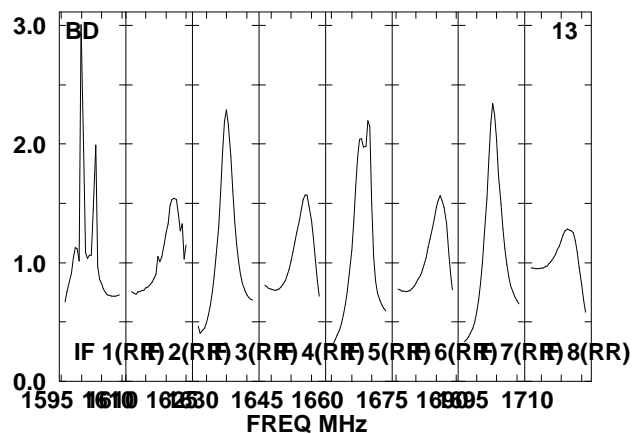
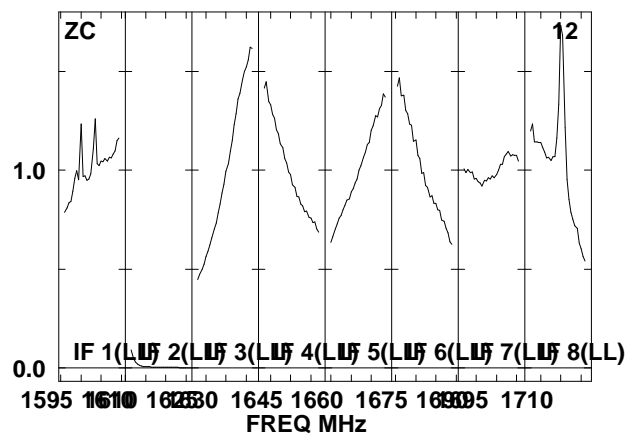
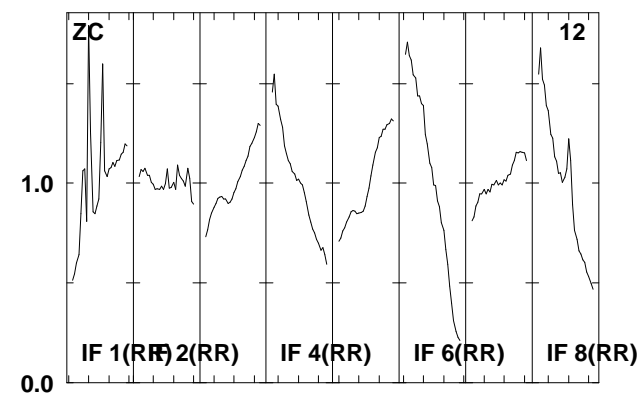
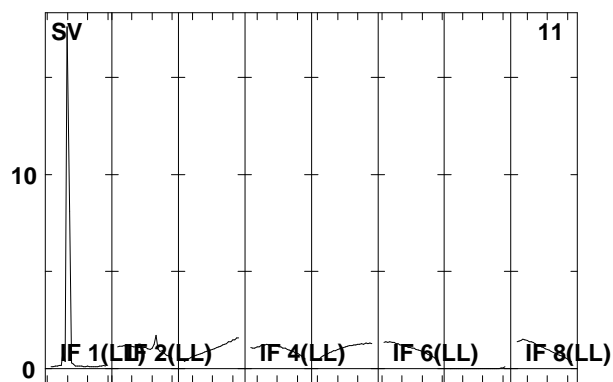
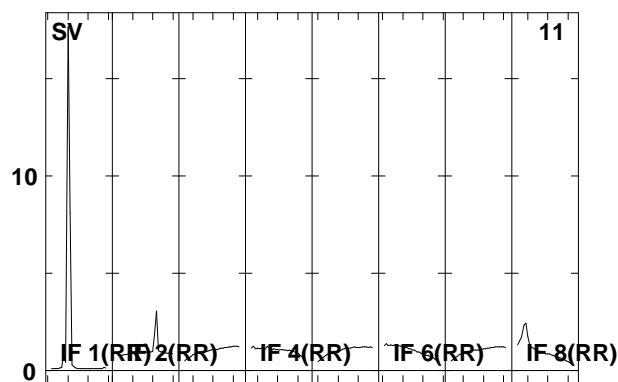
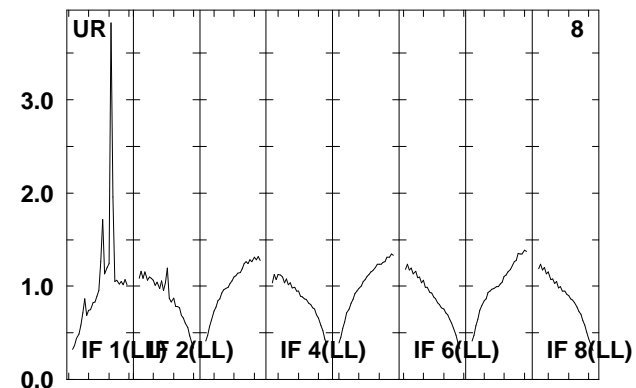
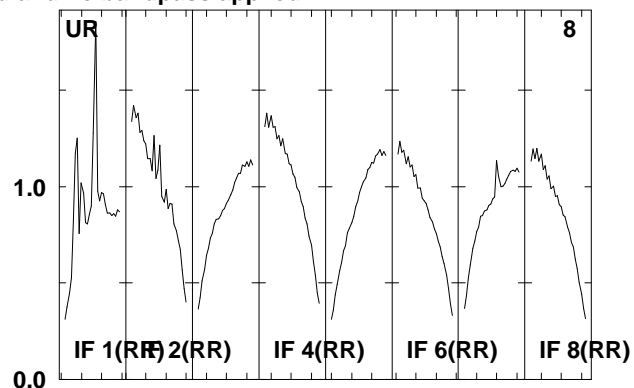
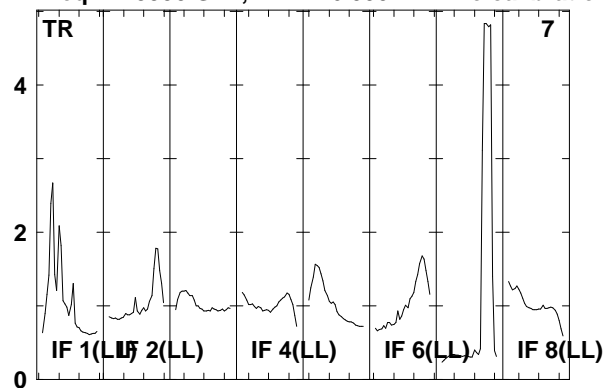

Lower frame: Real Jy

Total-power spectrum Antenna: *

Timerange: 00/12:43:05 to 00/12:46:29

Plot file version 23 created 06-JAN-2012 11:45:56

J1128+59 EP068D 5.UVDATA.1

Freq = 1.5950 GHz, Bw = 16.000 MH No calibration applied and no bandpass applied

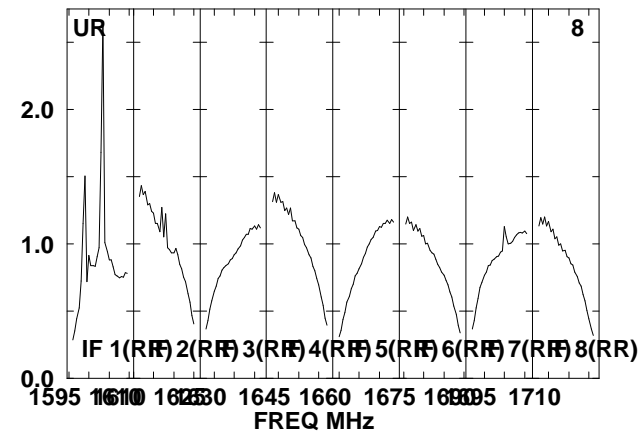
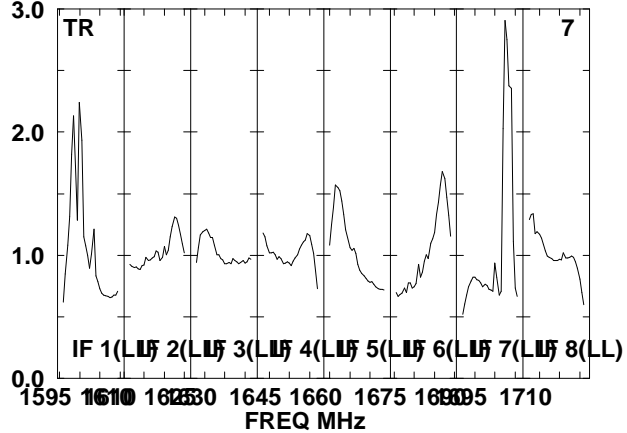
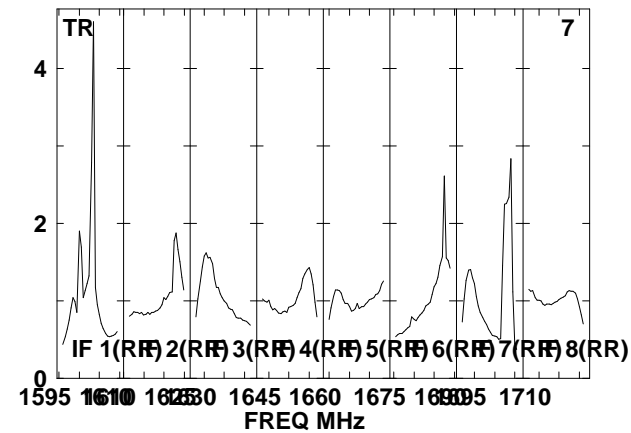
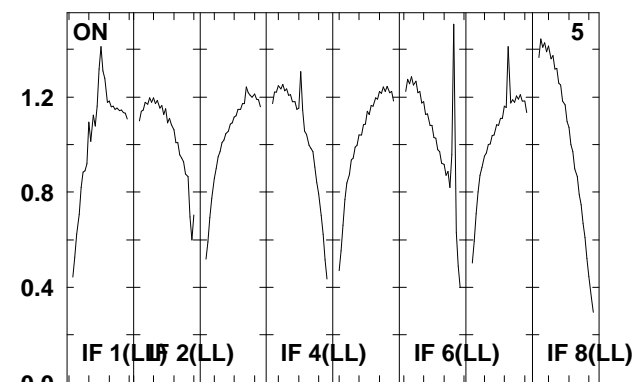
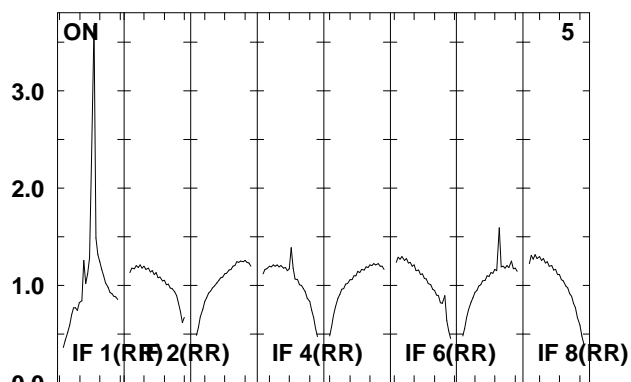
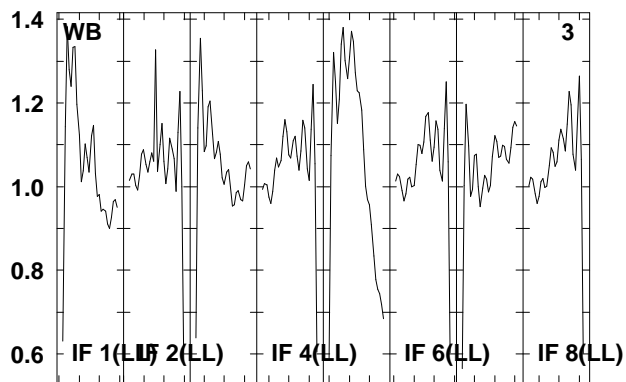
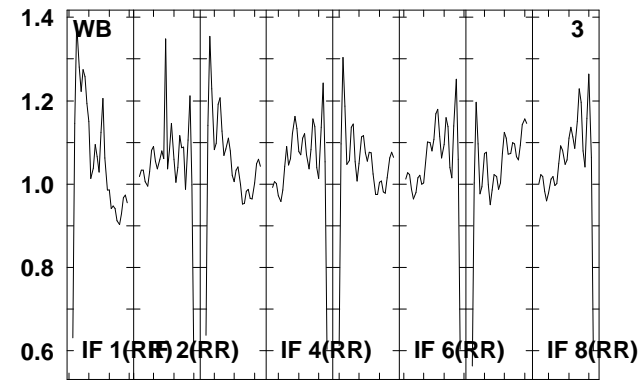
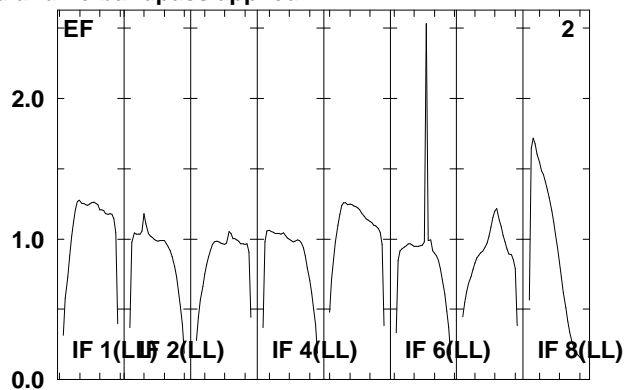
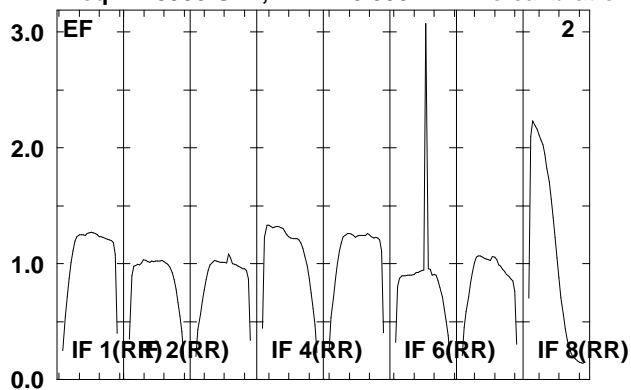

Lower frame: Real Jy
Total-power spectrum Antenna: *
Timerange: 00/12:47:31 to 00/12:48:59

Plot file version 24 created 06-JAN-2012 11:45:57

J1128+59 EP068D 5.UVDATA.1

Freq = 1.5950 GHz, Bw = 16.000 MH No calibration applied and no bandpass applied

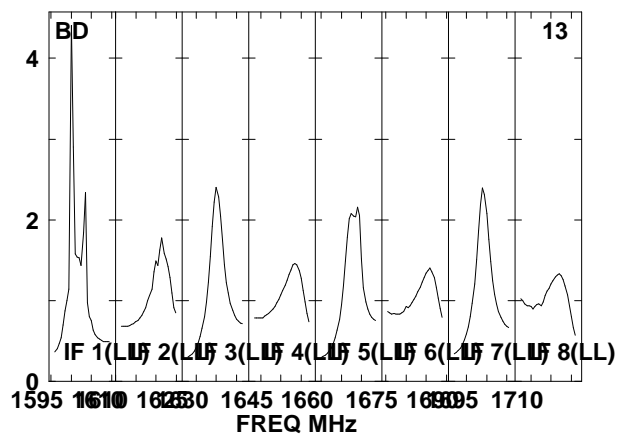
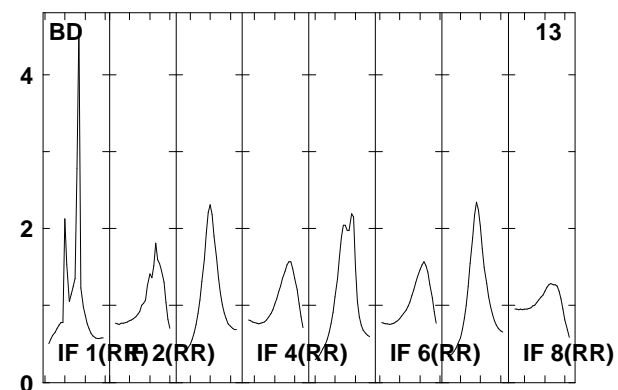
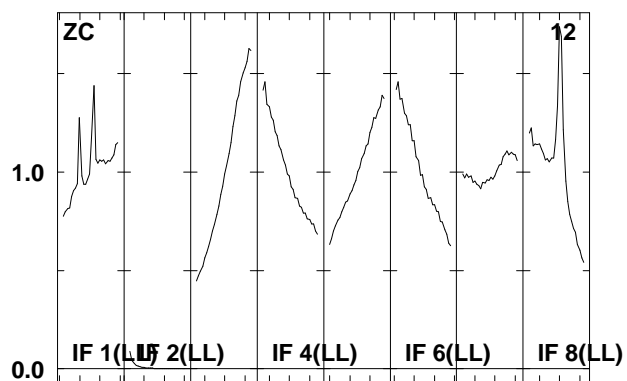
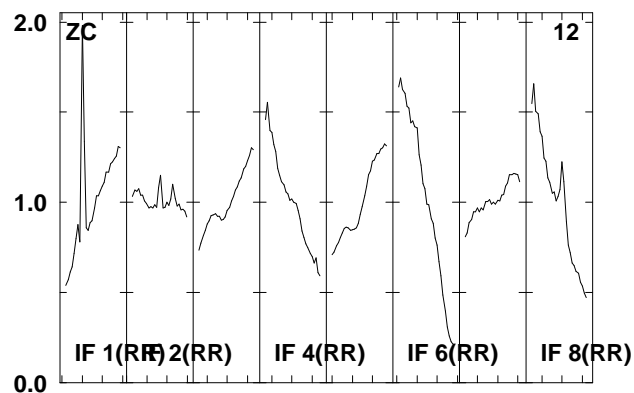
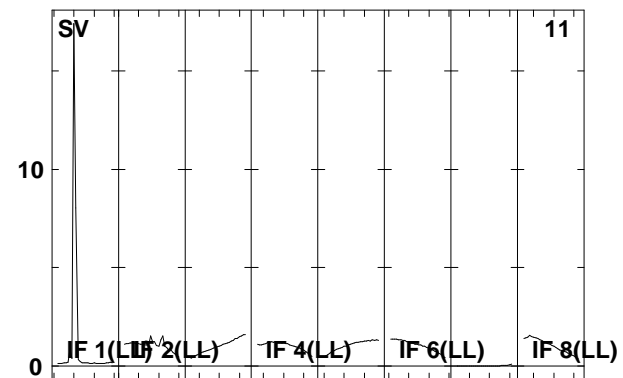
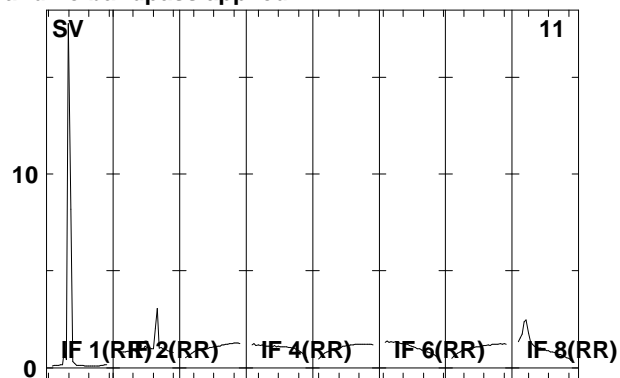
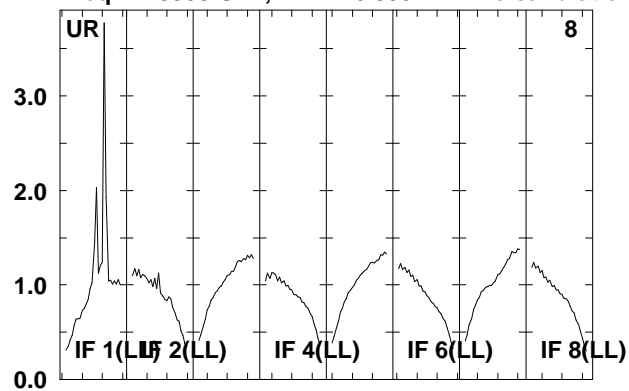

Lower frame: Real Jy

Total-power spectrum Antenna: *

Timerange: 00/12:47:31 to 00/12:48:59

Plot file version 25 created 06-JAN-2012 11:45:57

ARP299D EP068D 5.UVDATA.1

Freq = 1.5950 GHz, Bw = 16.000 MH No calibration applied and no bandpass applied

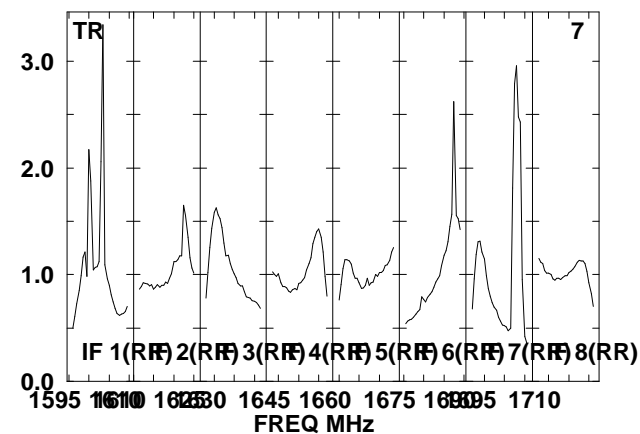
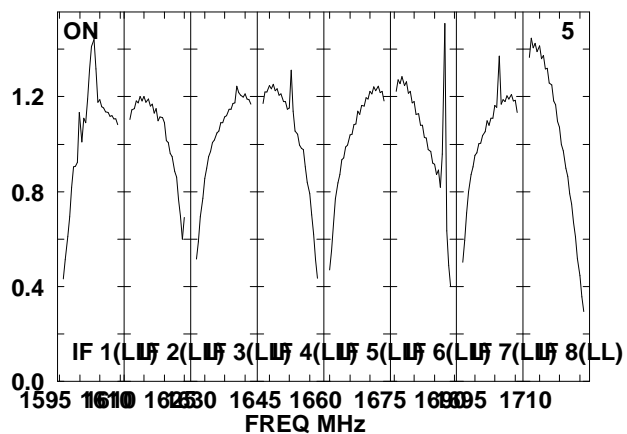
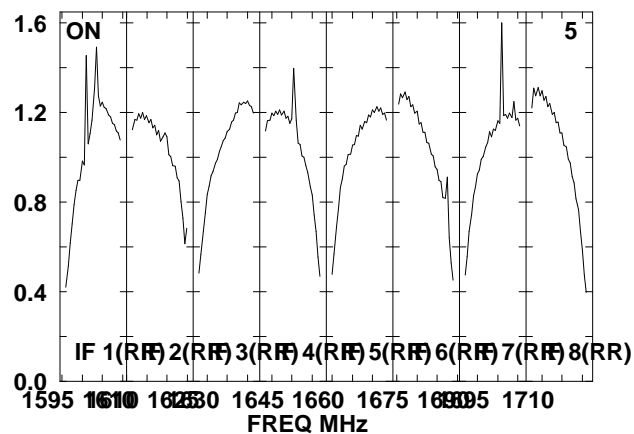
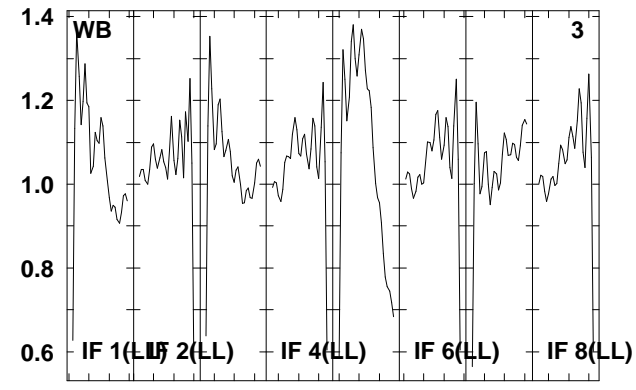
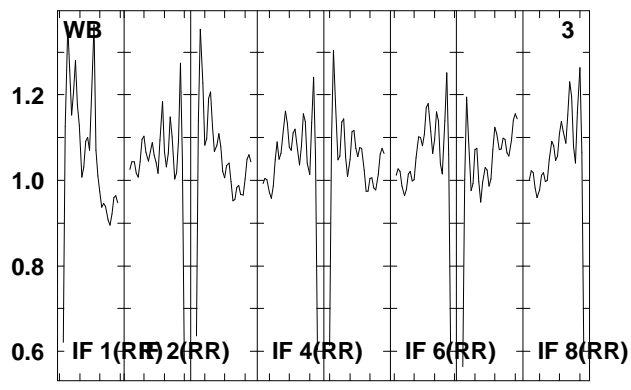
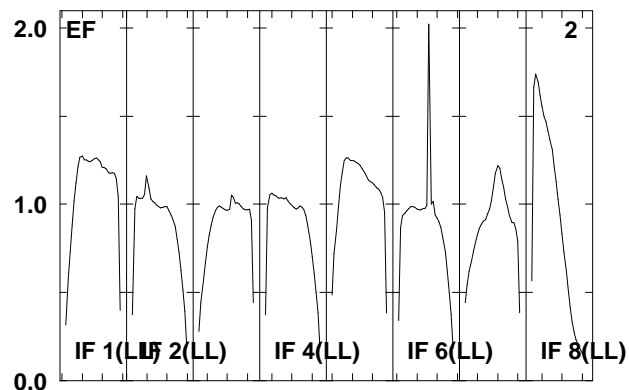
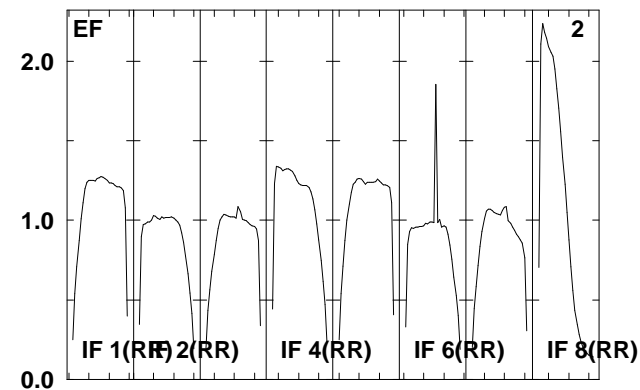
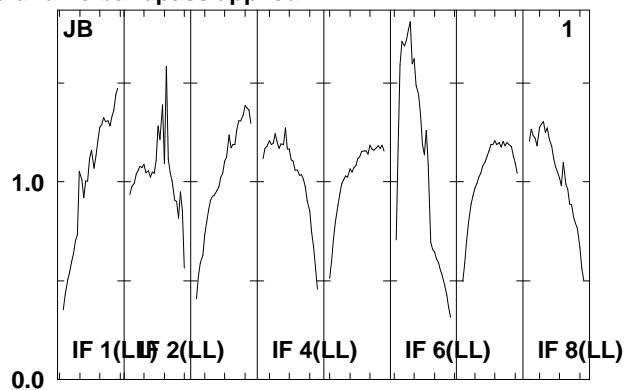
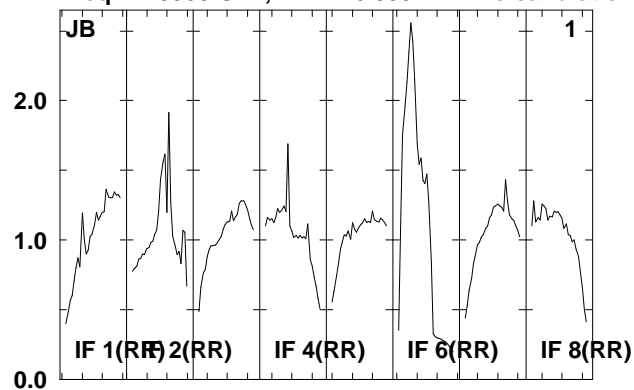

Lower frame: Real Jy
Total-power spectrum Antenna: *
Timerange: 00/12:49:01 to 00/12:52:29

Plot file version 26 created 06-JAN-2012 11:45:57

ARP299D EP068D 5.UVDATA.1

Freq = 1.5950 GHz, Bw = 16.000 MH No calibration applied and no bandpass applied

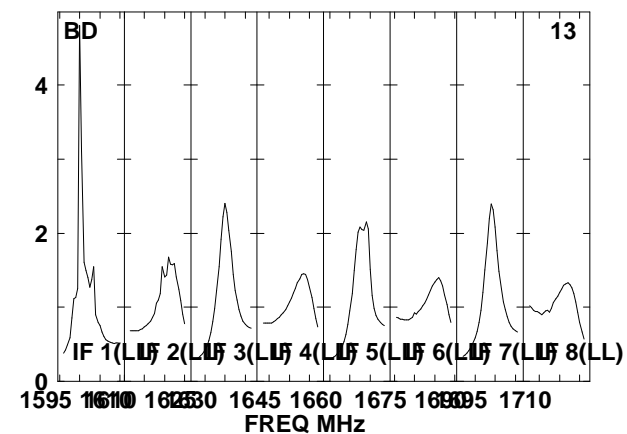
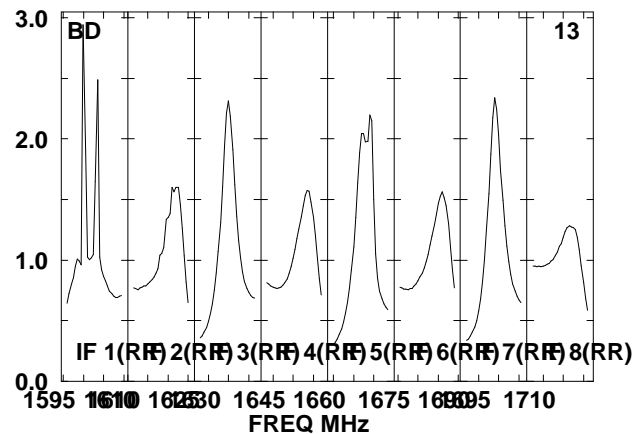
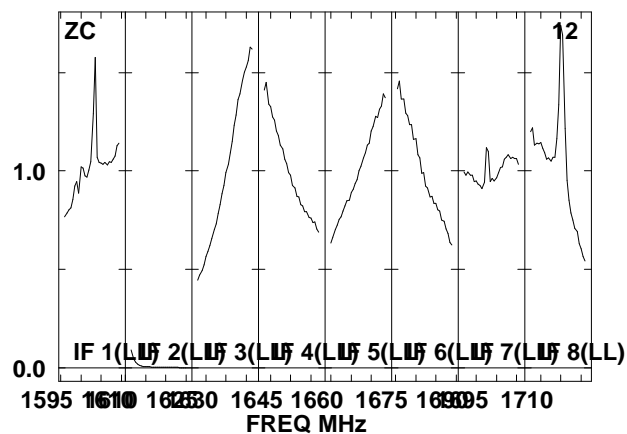
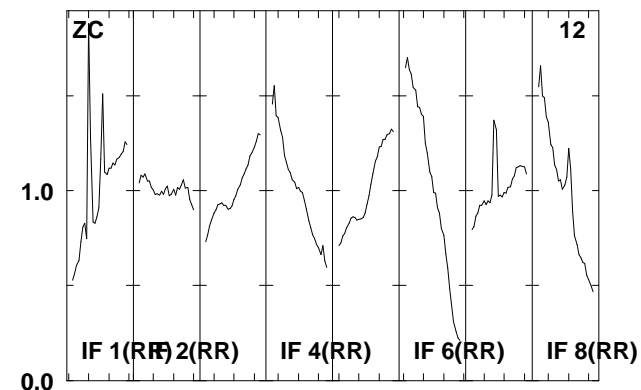
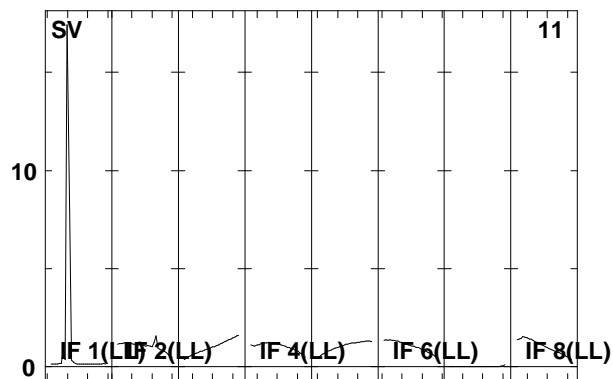
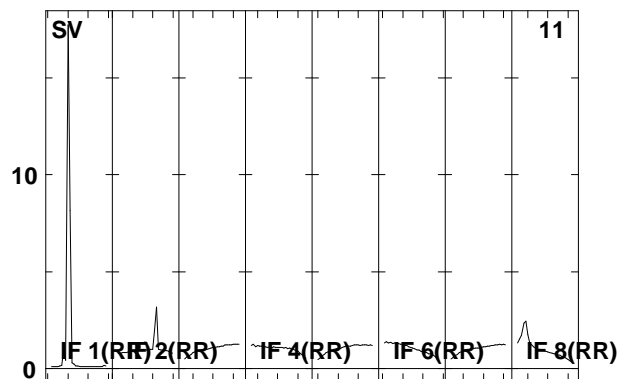
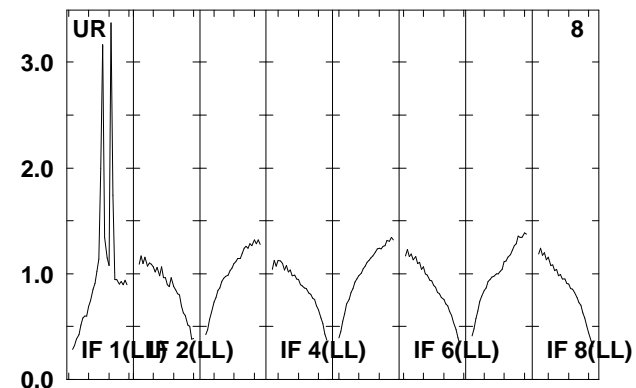
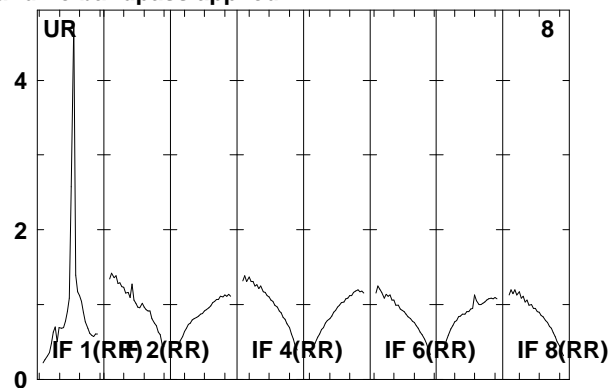
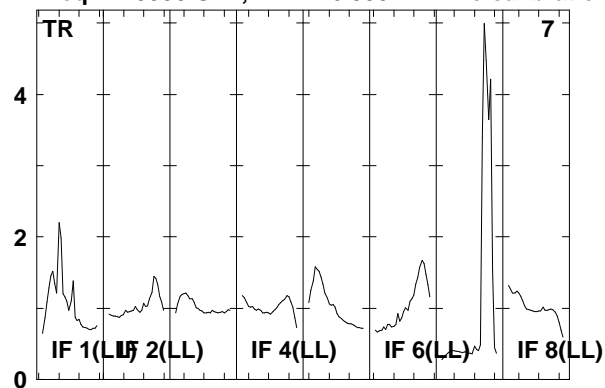

Lower frame: Real Jy

Total-power spectrum Antenna: *

Timerange: 00/12:49:01 to 00/12:52:29

Plot file version 27 created 06-JAN-2012 11:45:58

J1128+59 EP068D 5.UVDATA.1

Freq = 1.5950 GHz, Bw = 16.000 MH No calibration applied and no bandpass applied

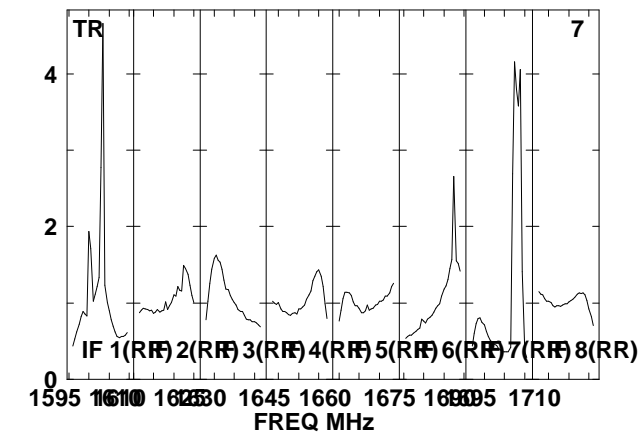
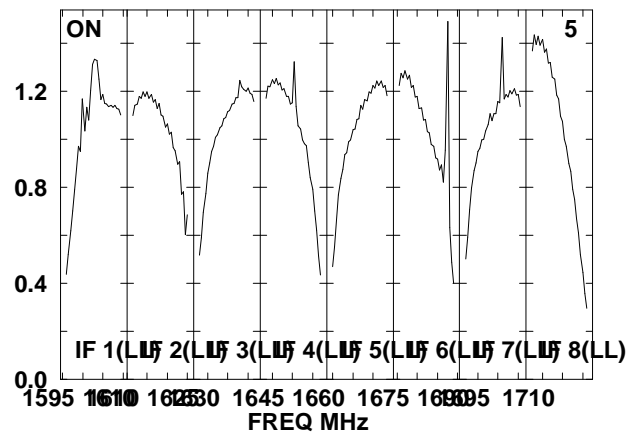
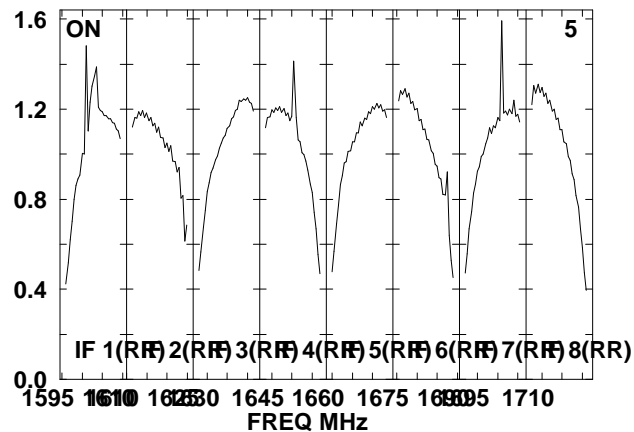
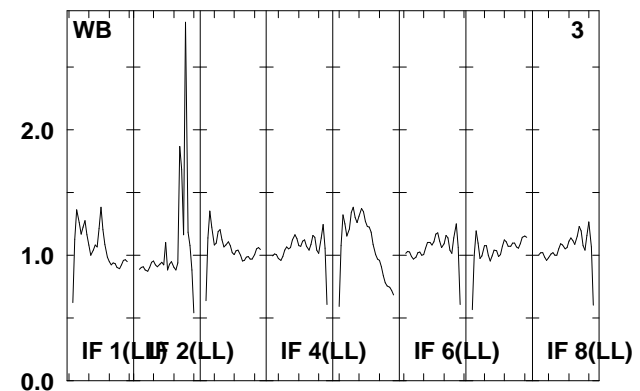
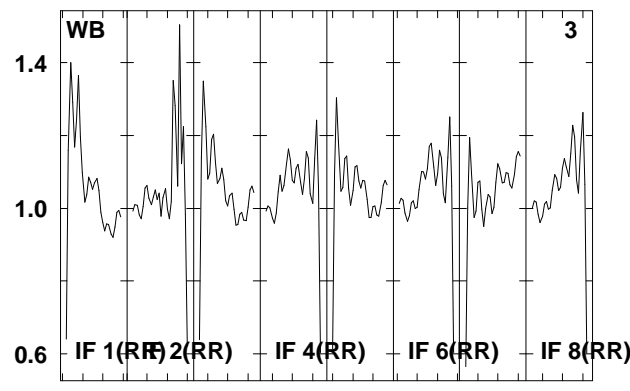
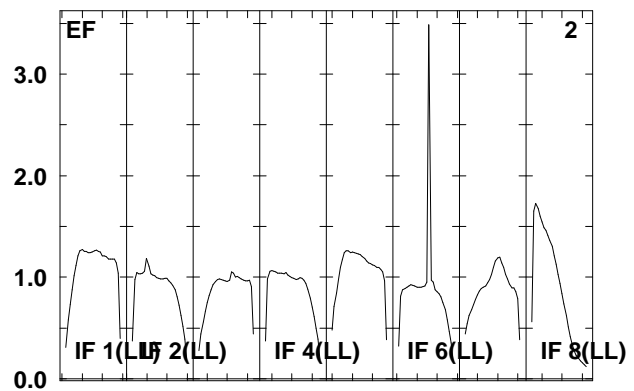
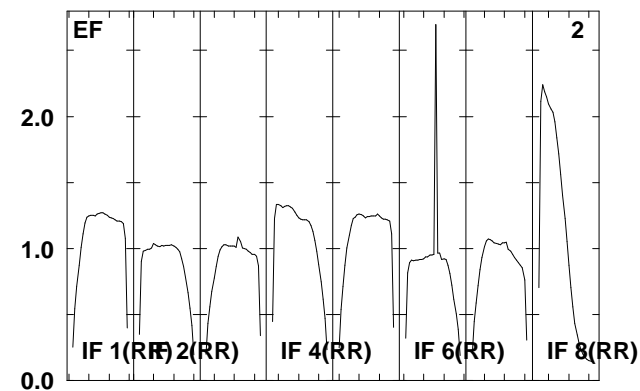
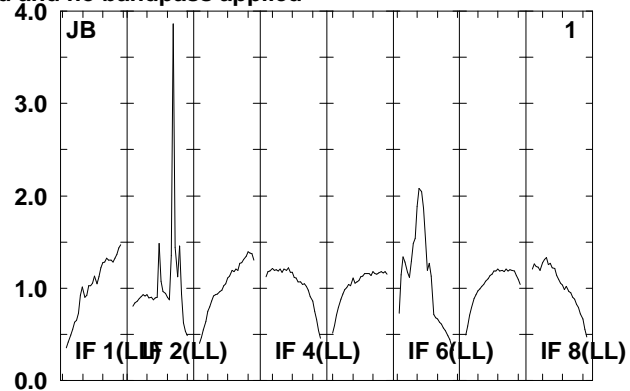
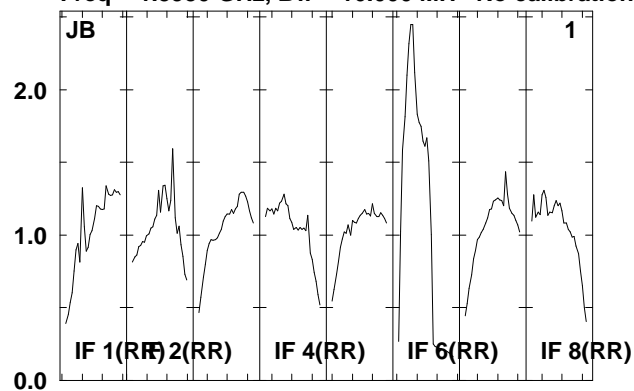

Lower frame: Real Jy
Total-power spectrum Antenna: *
Timerange: 00/12:52:35 to 00/12:53:59

Plot file version 28 created 06-JAN-2012 11:45:58

J1128+59 EP068D 5.UVDATA.1

Freq = 1.5950 GHz, Bw = 16.000 MH No calibration applied and no bandpass applied

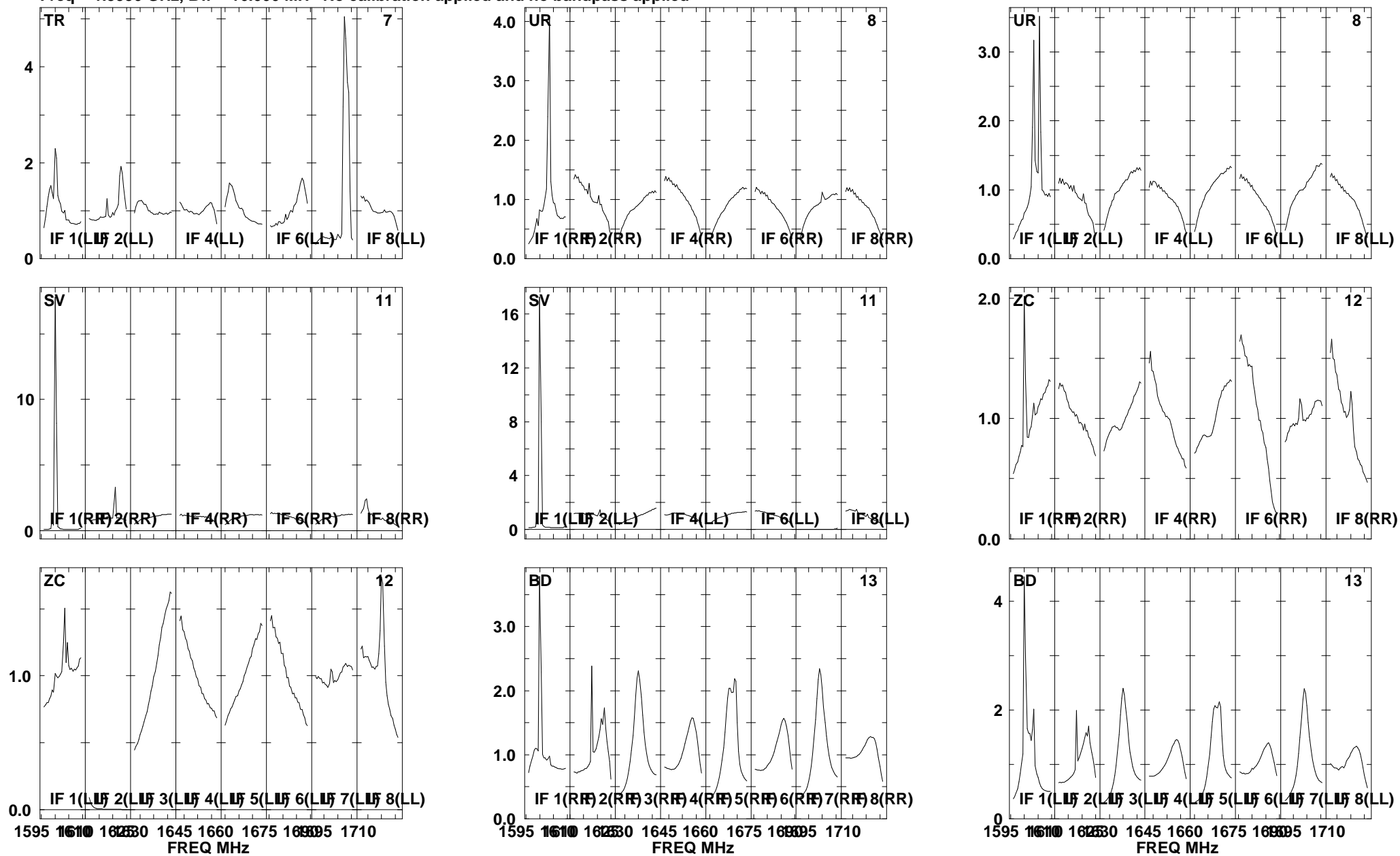

Lower frame: Real Jy

Total-power spectrum Antenna: *

Timerange: 00/12:52:35 to 00/12:53:59

Plot file version 29 created 06-JAN-2012 11:45:59

ARP299D EP068D 5.UVDATA.1

Freq = 1.5950 GHz, Bw = 16.000 MH No calibration applied and no bandpass applied

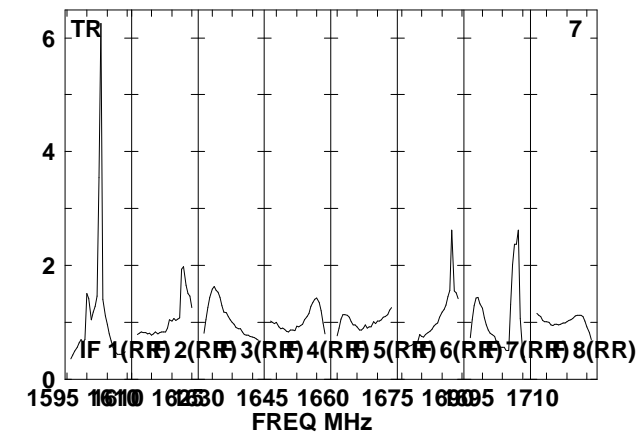
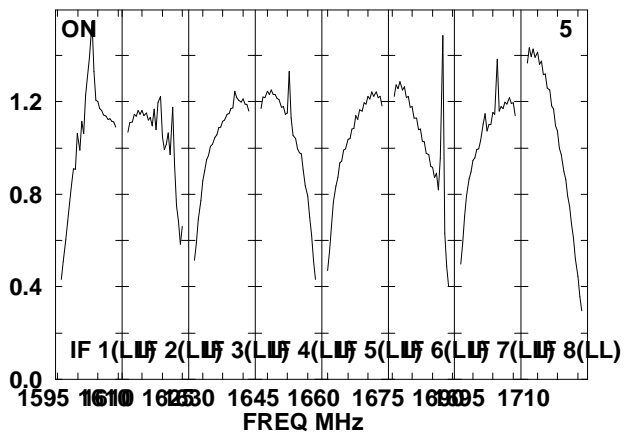
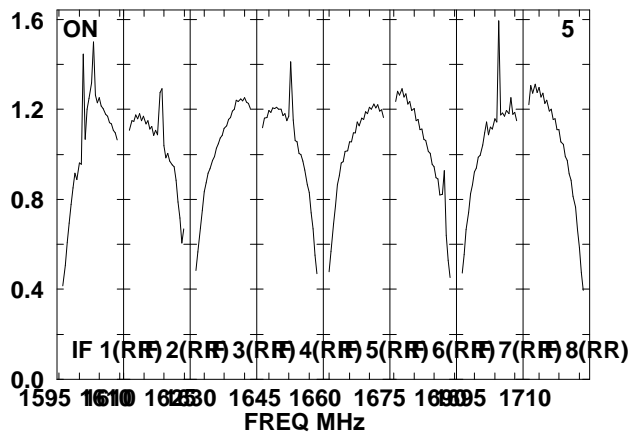
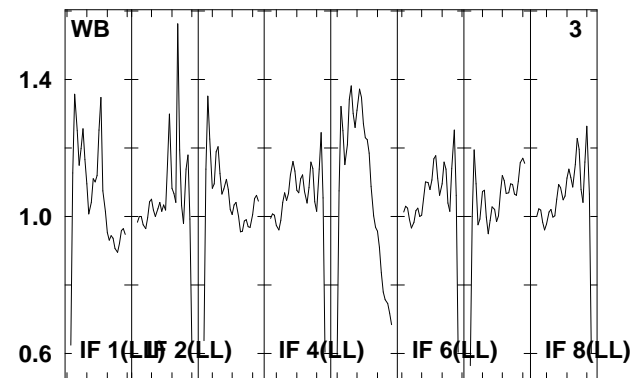
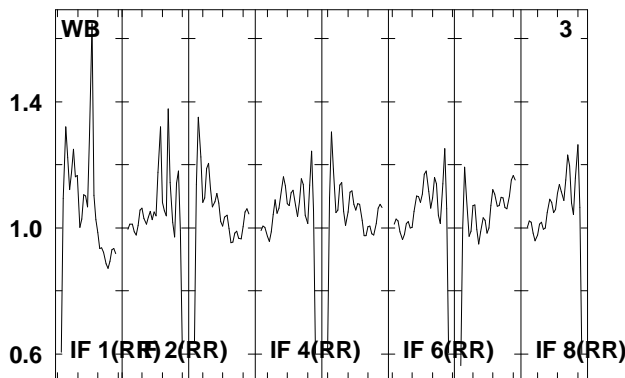
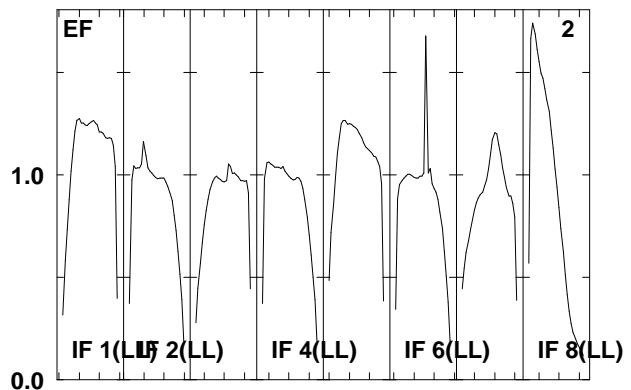
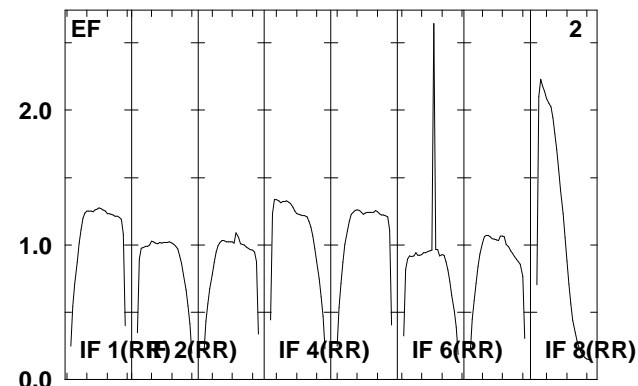
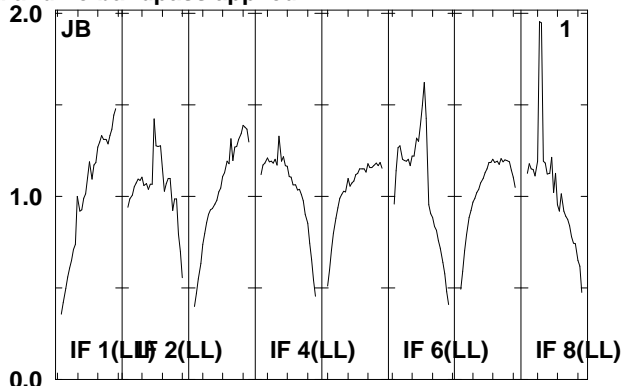
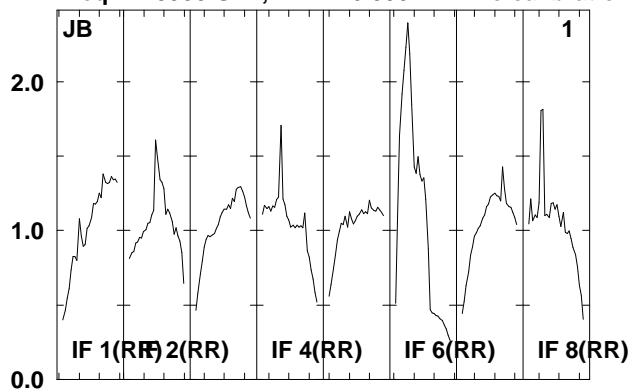

Lower frame: Real Jy
Total-power spectrum Antenna: *
Timerange: 00/12:54:05 to 00/12:57:29

Plot file version 30 created 06-JAN-2012 11:45:59

ARP299D EP068D 5.UVDATA.1

Freq = 1.5950 GHz, Bw = 16.000 MH No calibration applied and no bandpass applied

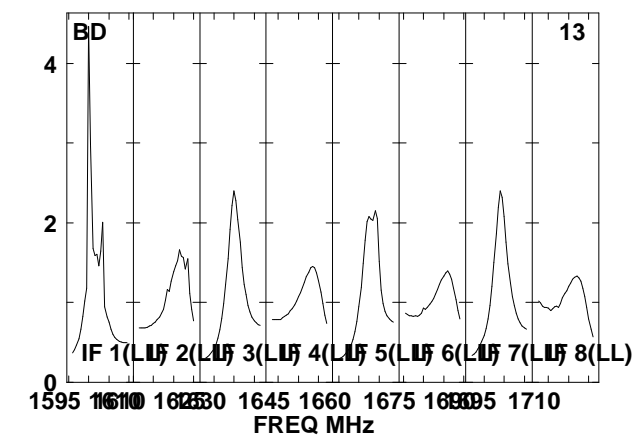
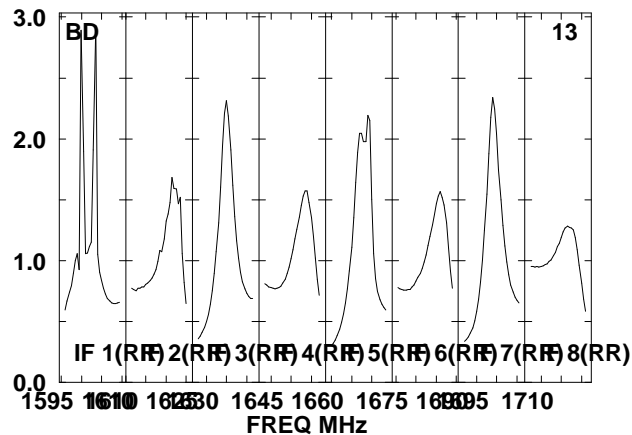
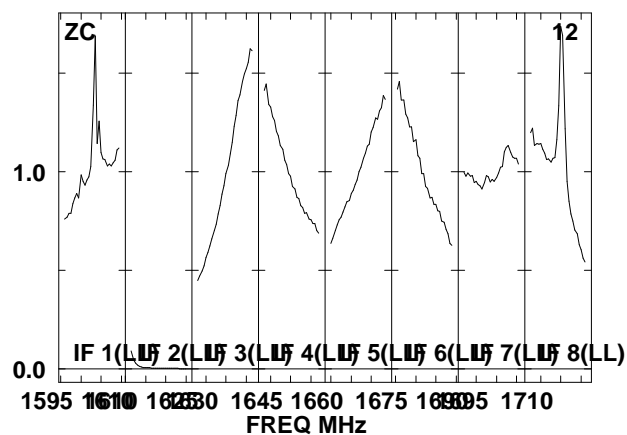
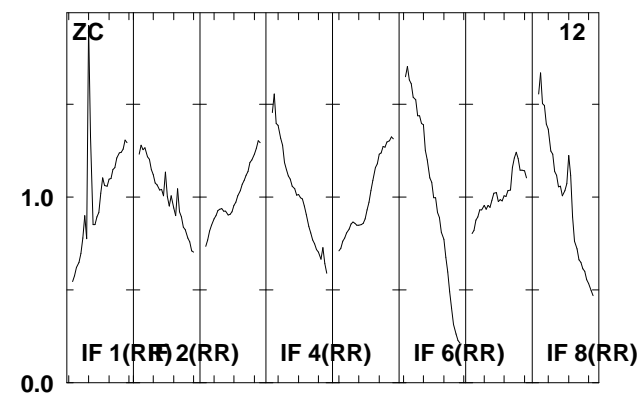
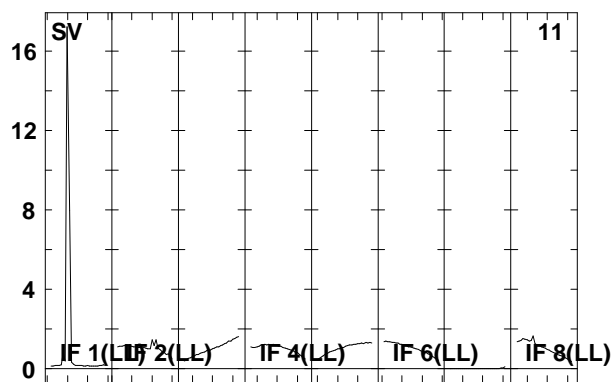
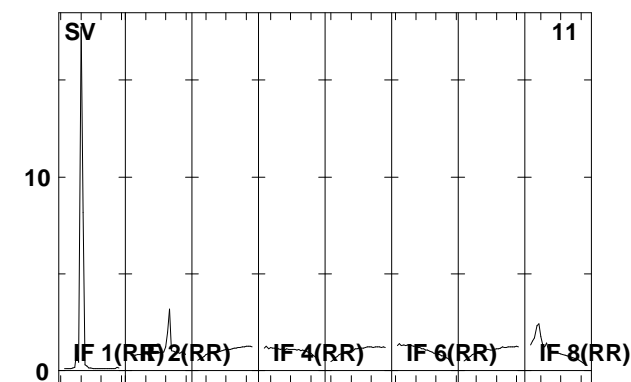
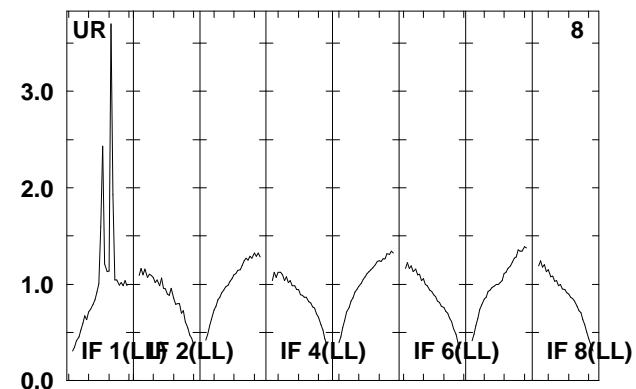
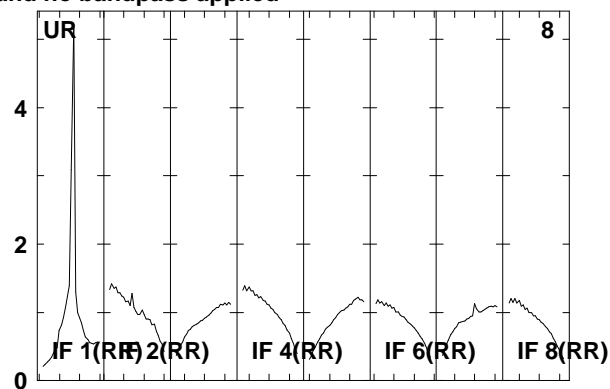
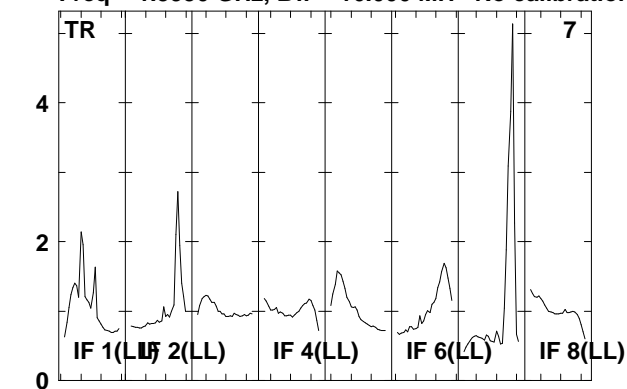

Lower frame: Real Jy

Total-power spectrum Antenna: *

Timerange: 00/12:54:05 to 00/12:57:29

Plot file version 31 created 06-JAN-2012 11:46:00

J1128+59 EP068D 5.UVDATA.1

Freq = 1.5950 GHz, Bw = 16.000 MH No calibration applied and no bandpass applied

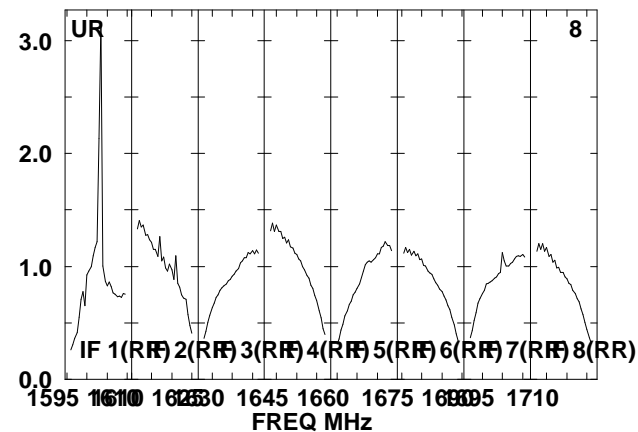
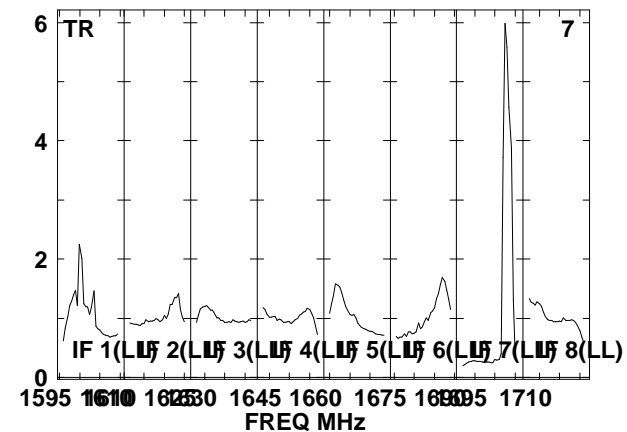
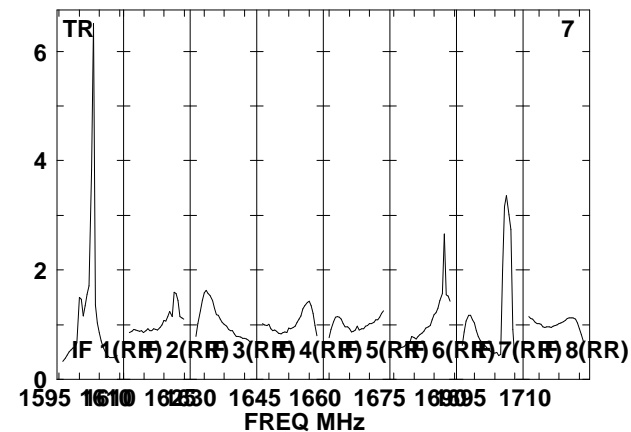
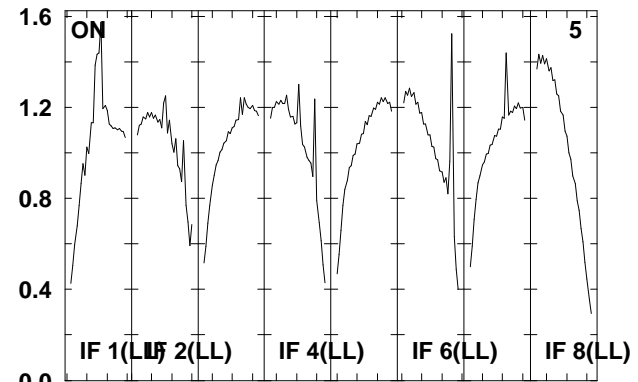
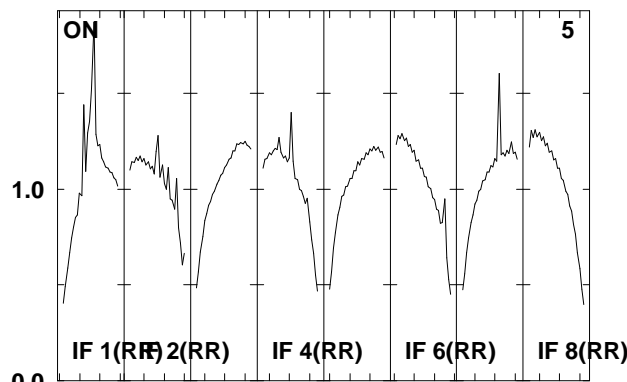
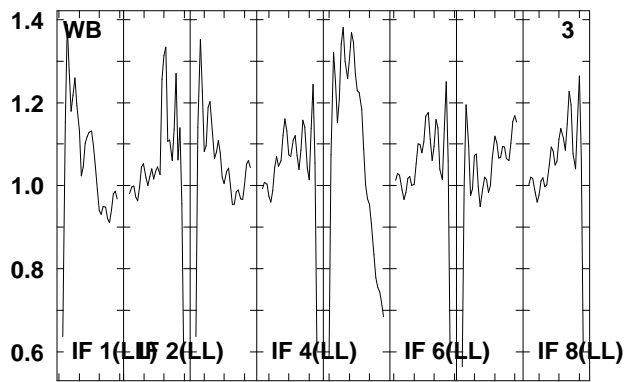
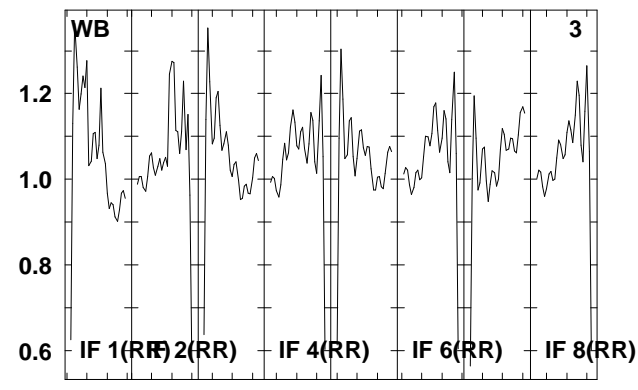
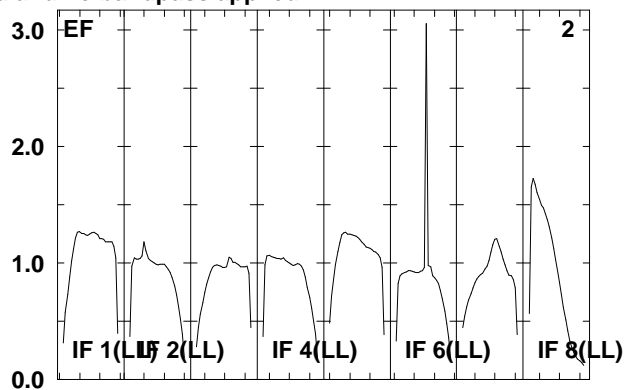
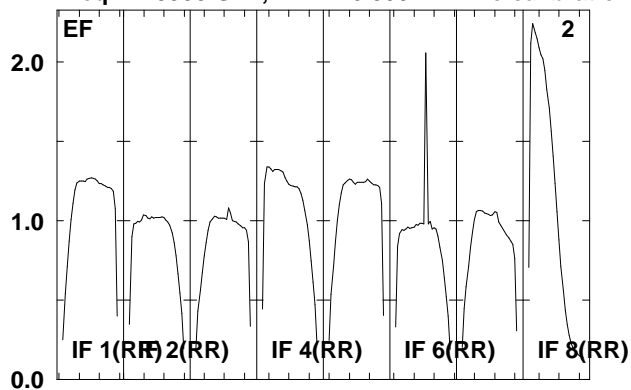

Lower frame: Real Jy
Total-power spectrum Antenna: *
Timerange: 00/12:58:31 to 00/12:59:59

Plot file version 32 created 06-JAN-2012 11:46:00

J1128+59 EP068D 5.UVDATA.1

Freq = 1.5950 GHz, Bw = 16.000 MH No calibration applied and no bandpass applied

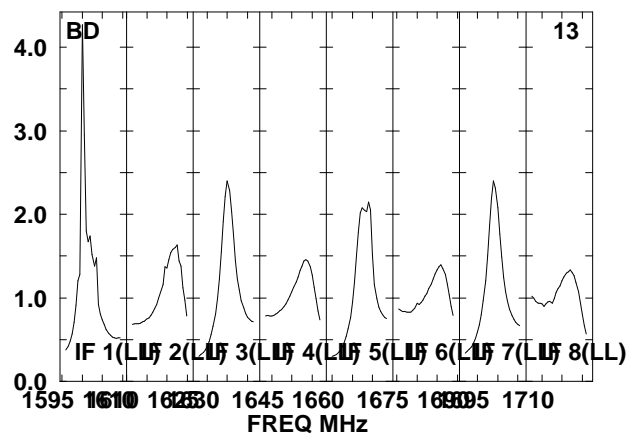
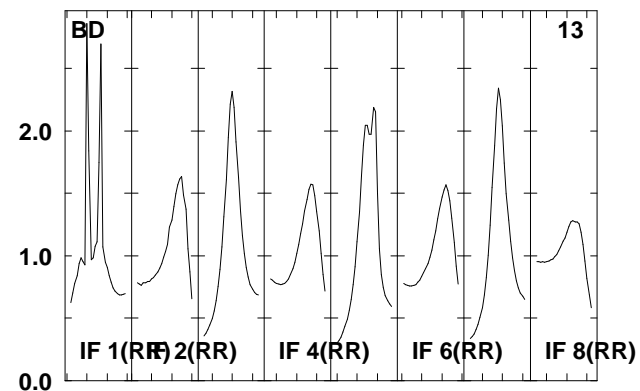
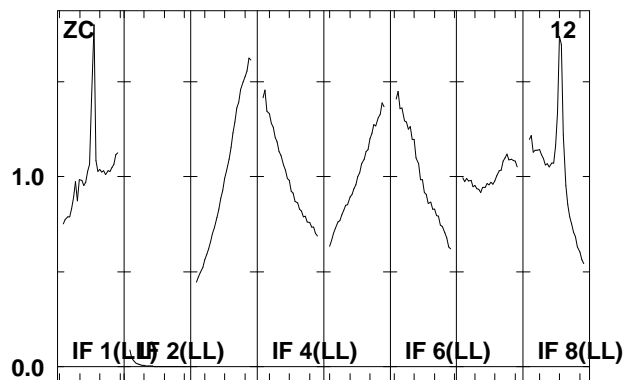
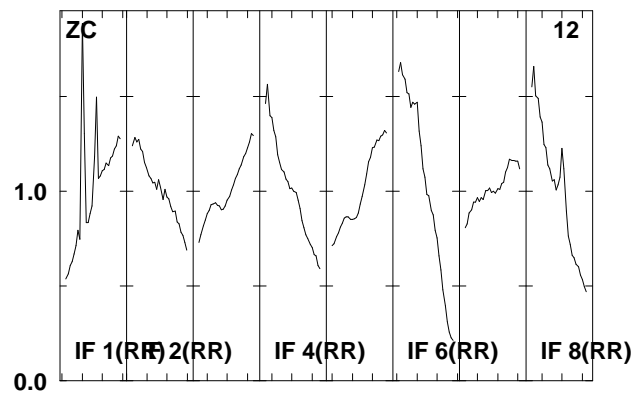
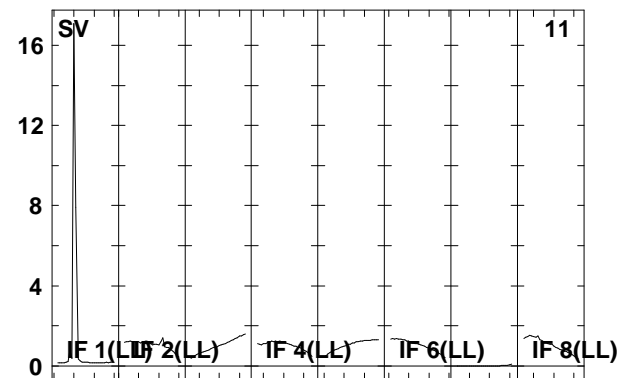
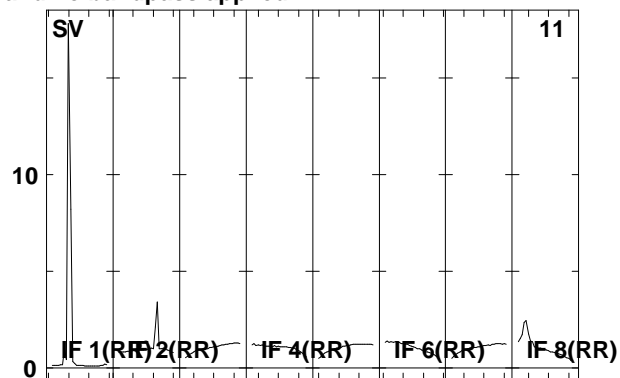
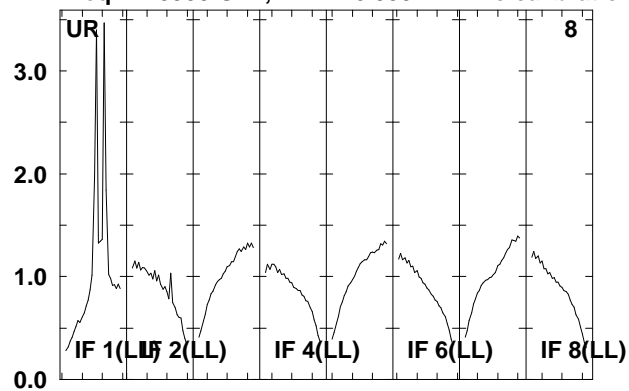

Lower frame: Real Jy

Total-power spectrum Antenna: *

Timerange: 00/12:58:31 to 00/12:59:59

Plot file version 33 created 06-JAN-2012 11:46:01

ARP299D EP068D 5.UVDATA.1

Freq = 1.5950 GHz, Bw = 16.000 MH No calibration applied and no bandpass applied

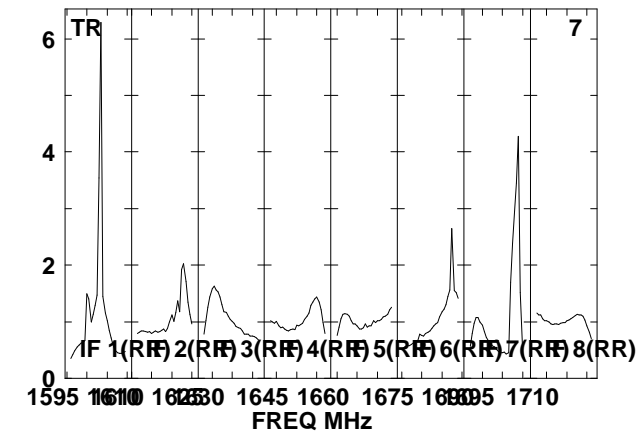
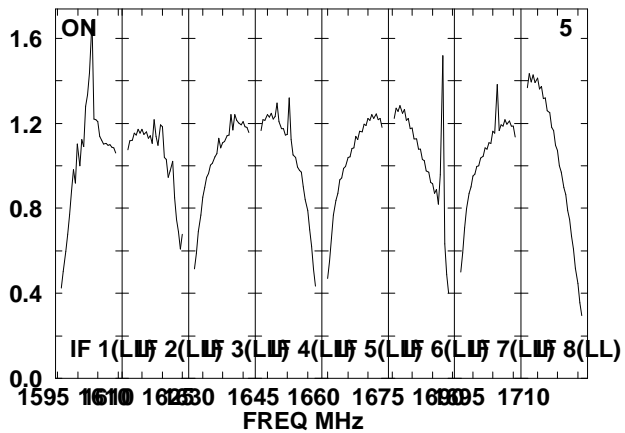
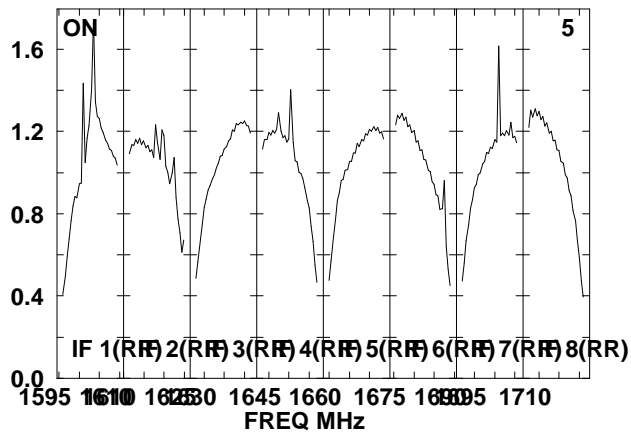
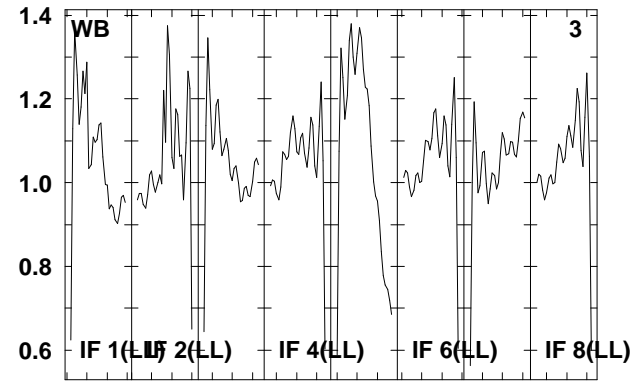
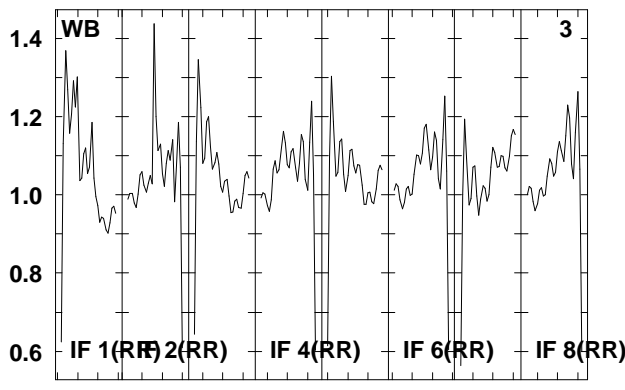
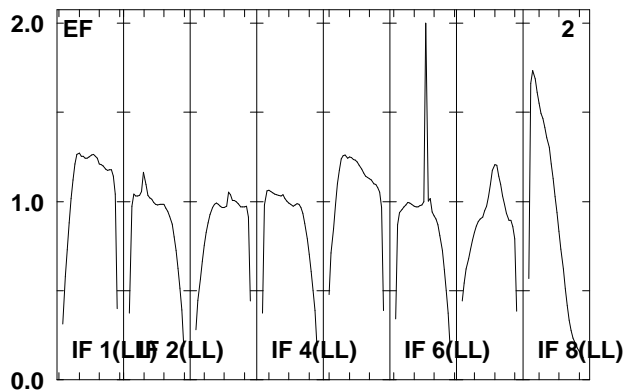
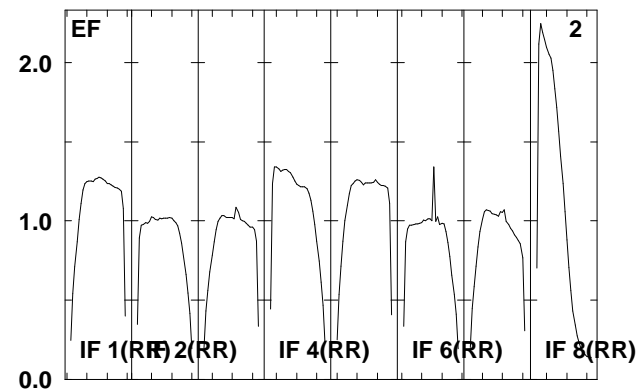
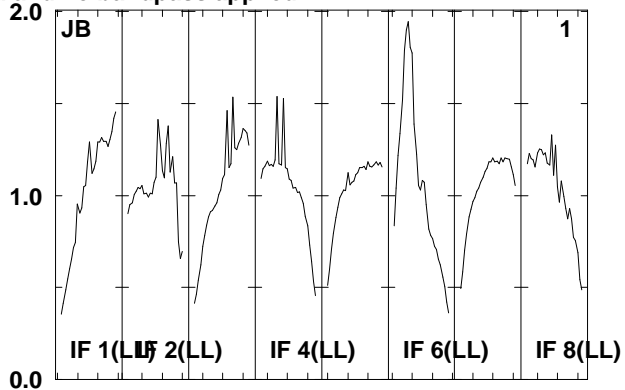
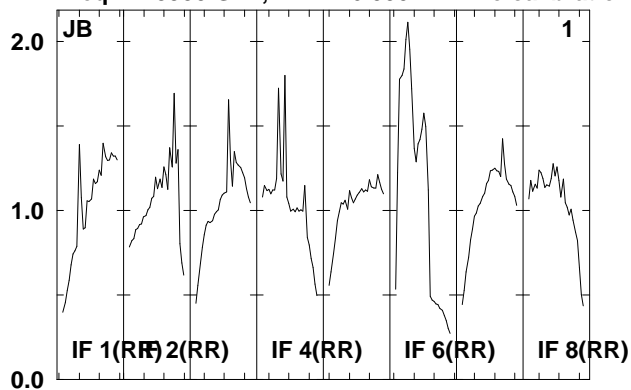

Lower frame: Real Jy
Total-power spectrum Antenna: *
Timerange: 00/13:00:01 to 00/13:03:29

Plot file version 34 created 06-JAN-2012 11:46:01

ARP299D EP068D 5.UVDATA.1

Freq = 1.5950 GHz, Bw = 16.000 MH No calibration applied and no bandpass applied

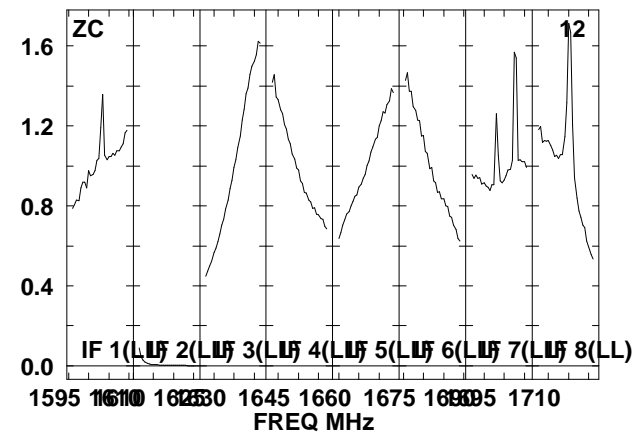
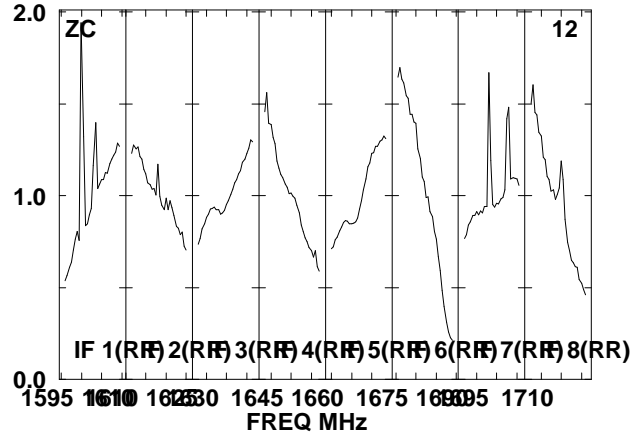
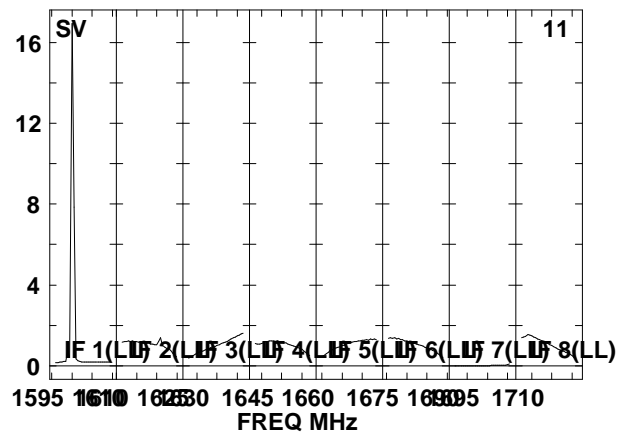
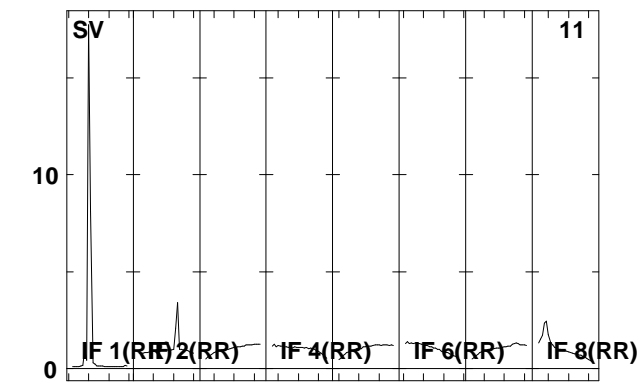
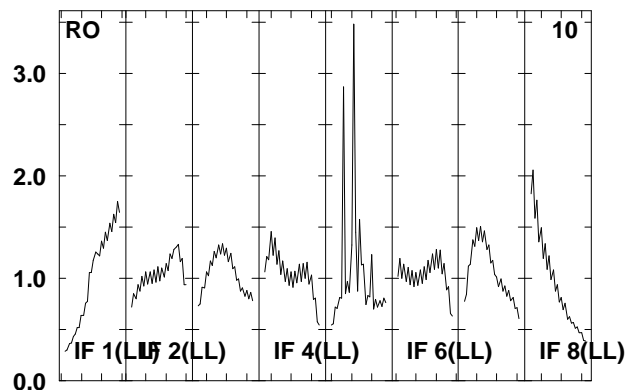
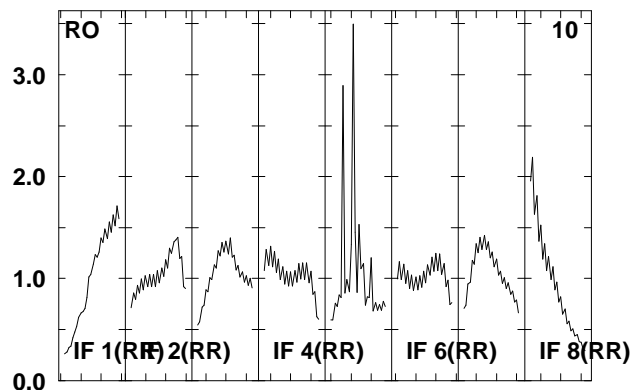
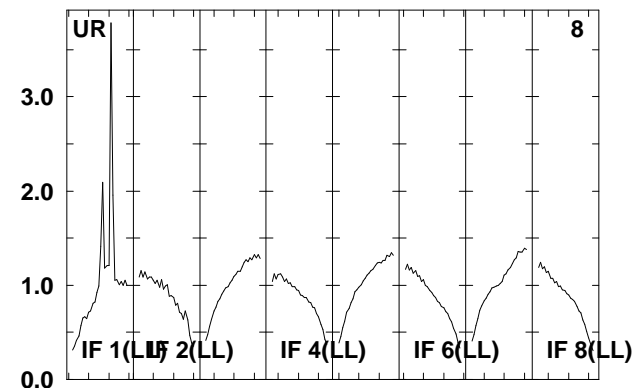
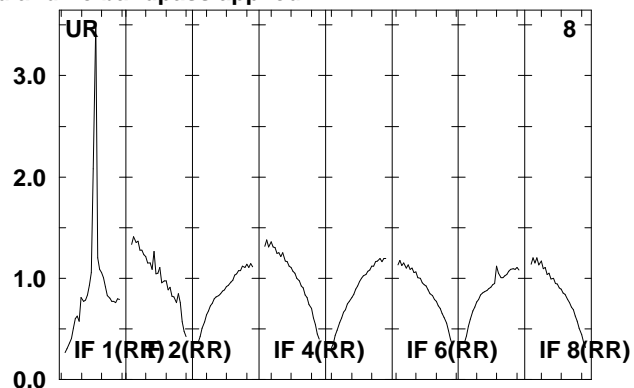
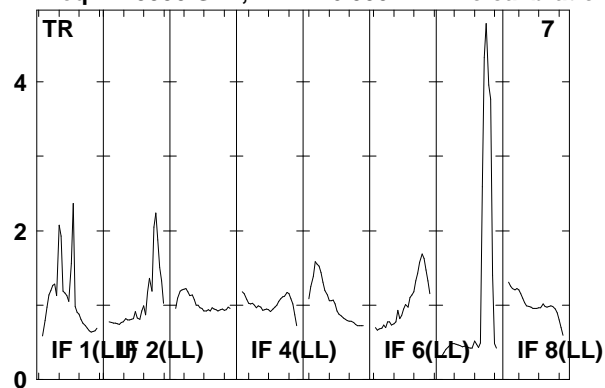

Lower frame: Real Jy

Total-power spectrum Antenna: *

Timerange: 00/13:00:01 to 00/13:03:29

Plot file version 35 created 06-JAN-2012 11:46:02

ARP299D EP068D 5.UVDATA.1

Freq = 1.5950 GHz, Bw = 16.000 MH No calibration applied and no bandpass applied

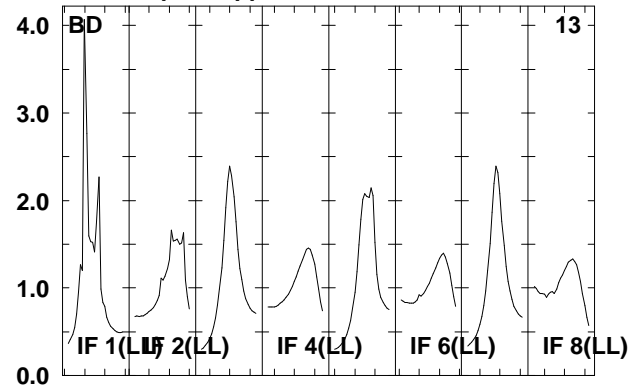
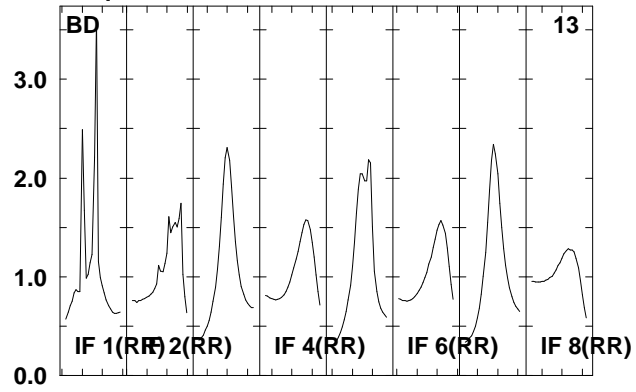

Lower frame: Real Jy
Total-power spectrum Antenna: *
Timerange: 00/13:00:01 to 00/13:03:29

Plot file version 36 created 06-JAN-2012 11:46:02

J1128+59 EP068D 5.UVDATA.1

Freq = 1.5950 GHz, Bw = 16.000 MH No calibration applied and no bandpass applied

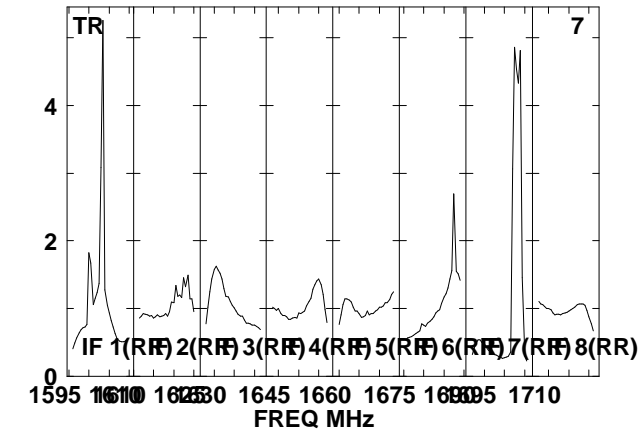
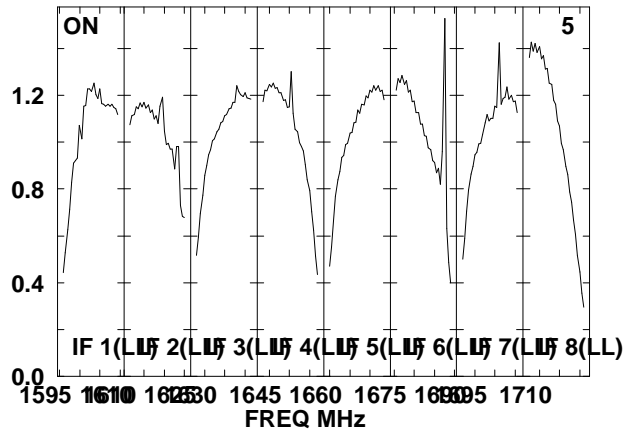
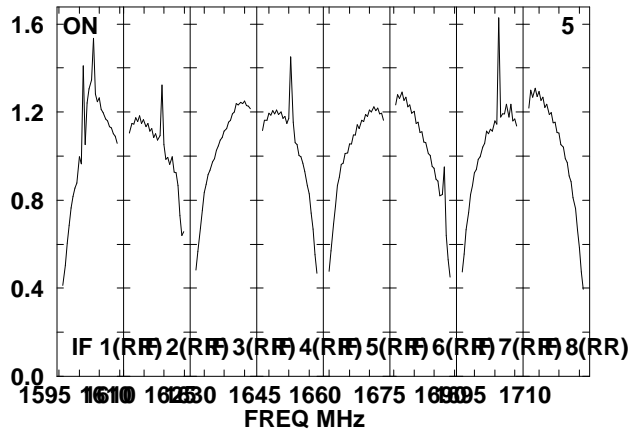
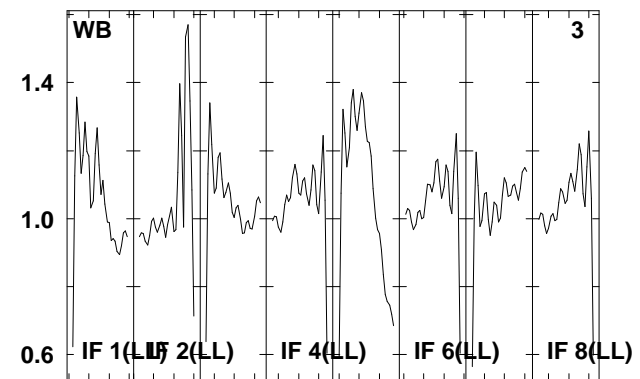
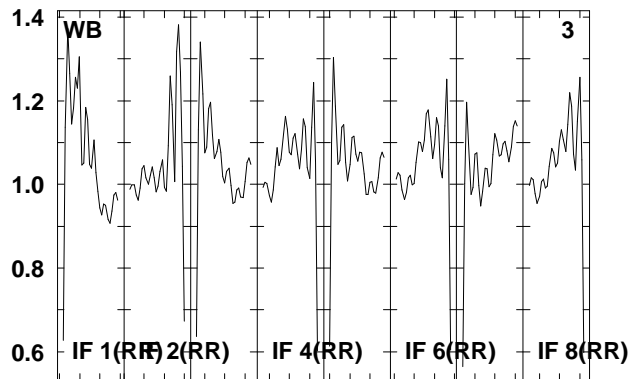
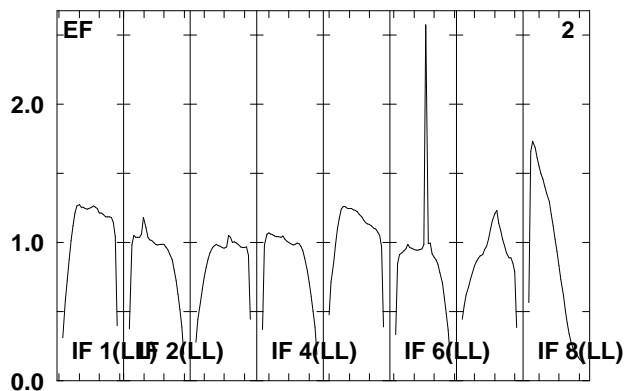
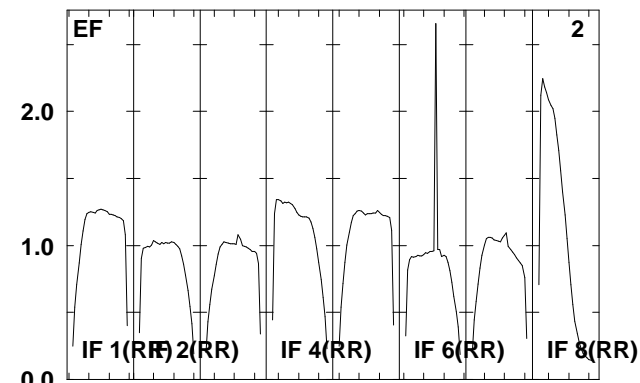
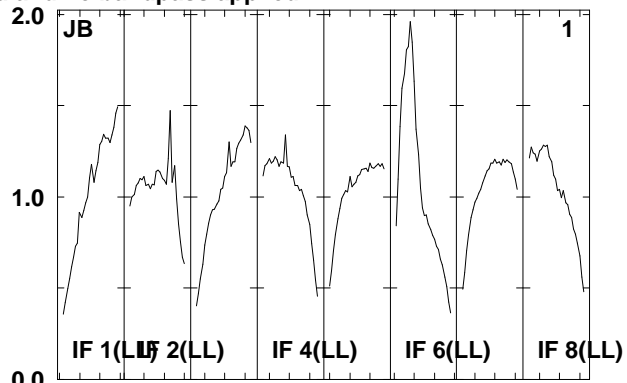
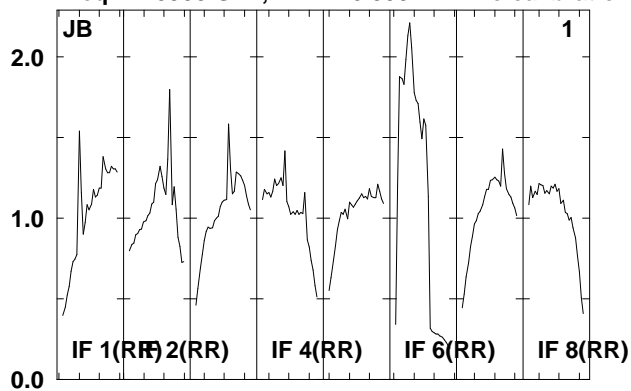

Lower frame: Real Jy
Total-power spectrum Antenna: *
Timerange: 00/13:03:35 to 00/13:04:59

Plot file version 37 created 06-JAN-2012 11:46:03

J1128+59 EP068D 5.UVDATA.1

Freq = 1.5950 GHz, Bw = 16.000 MH No calibration applied and no bandpass applied

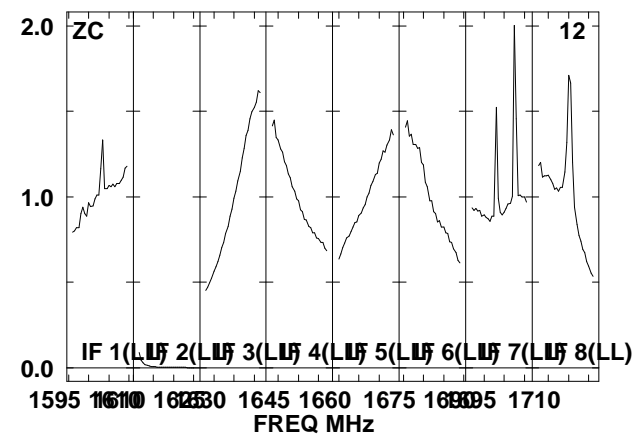
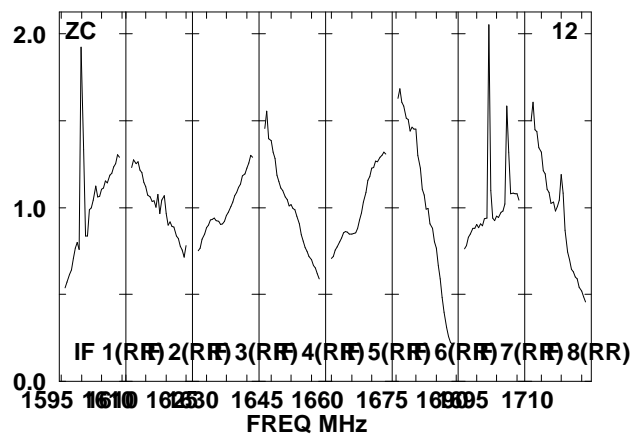
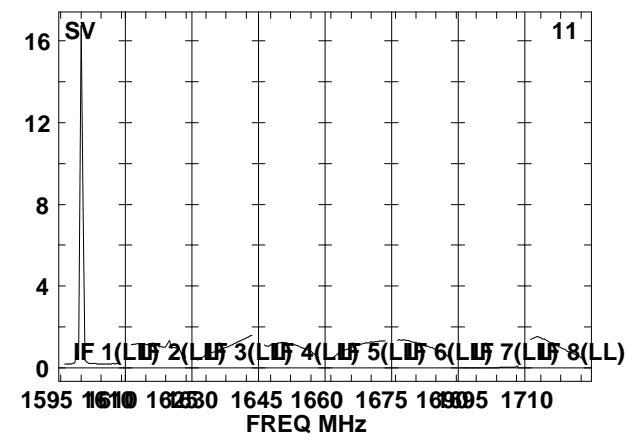
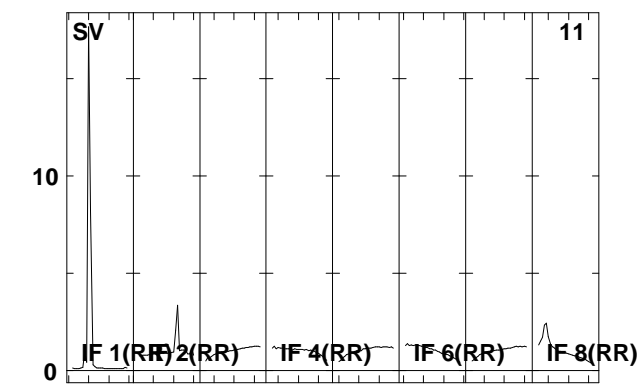
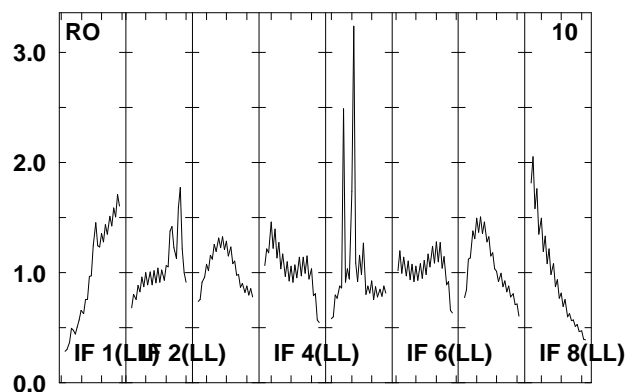
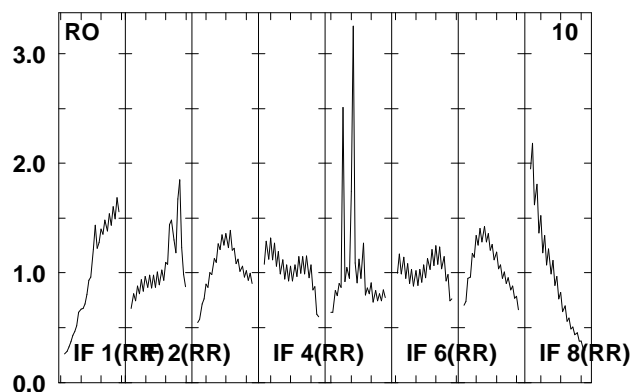
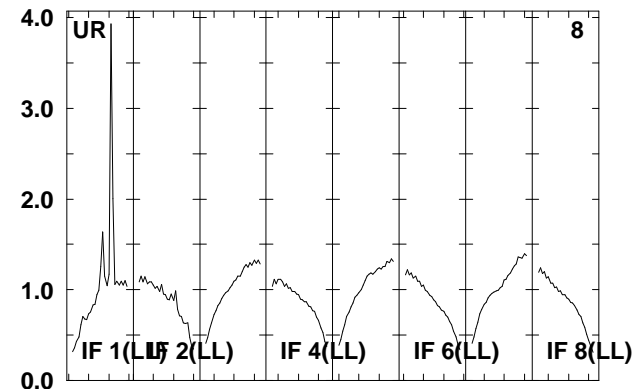
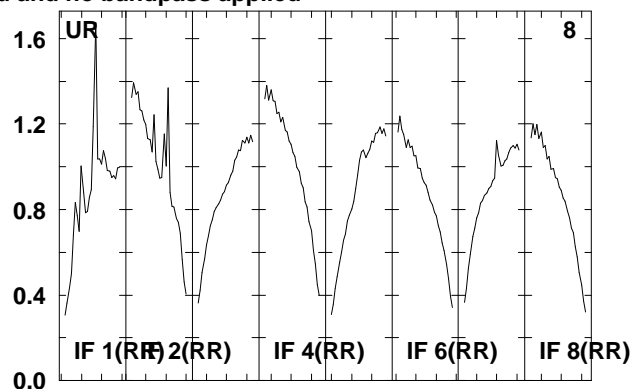
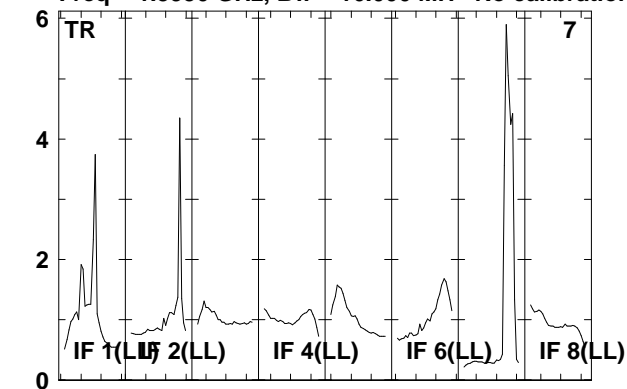

Lower frame: Real Jy
Total-power spectrum Antenna: *
Timerange: 00/13:03:35 to 00/13:04:59

Plot file version 38 created 06-JAN-2012 11:46:03

J1128+59 EP068D 5.UVDATA.1

Freq = 1.5950 GHz, Bw = 16.000 MH No calibration applied and no bandpass applied

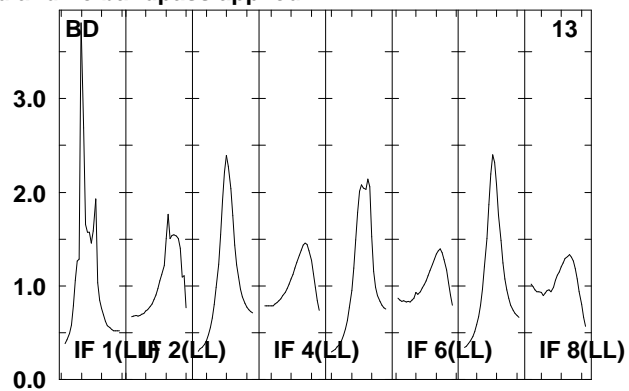
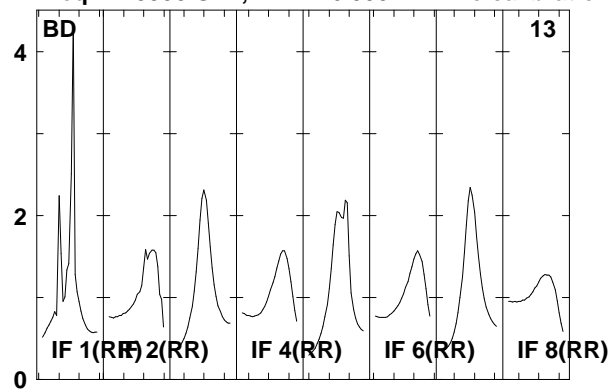

Lower frame: Real Jy
Total-power spectrum Antenna: *
Timerange: 00/13:03:35 to 00/13:04:59

Plot file version 39 created 06-JAN-2012 11:46:03

ARP299D EP068D 5.UVDATA.1

Freq = 1.5950 GHz, Bw = 16.000 MH No calibration applied and no bandpass applied

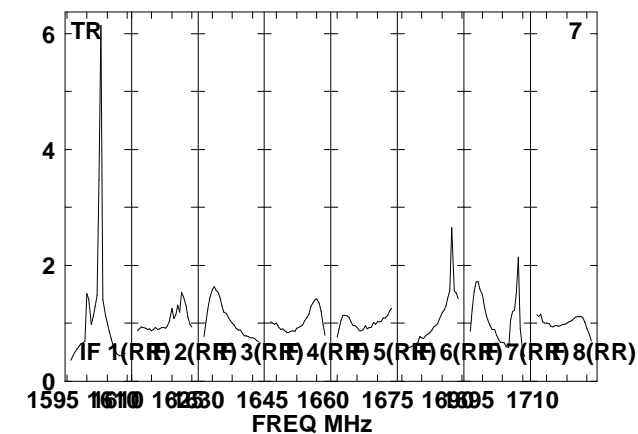
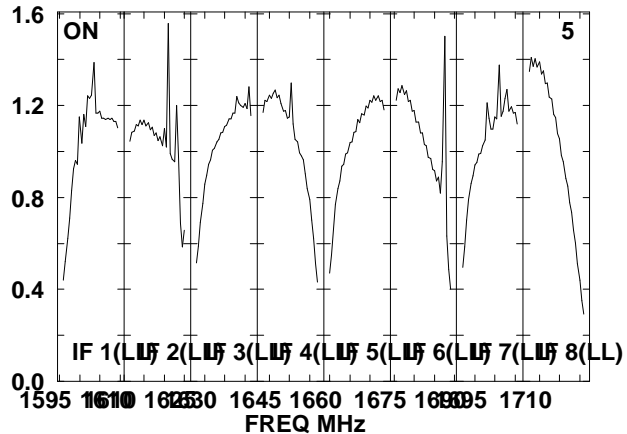
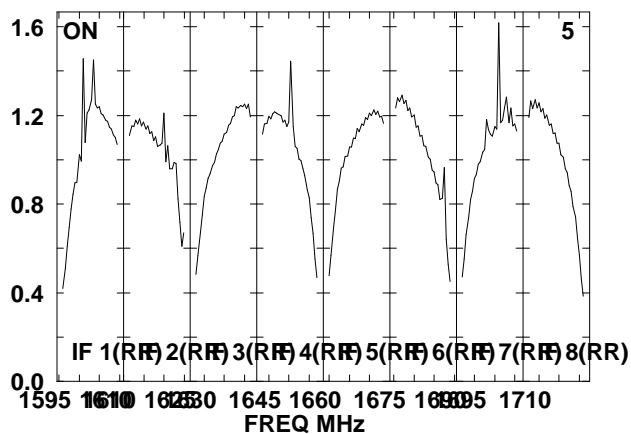
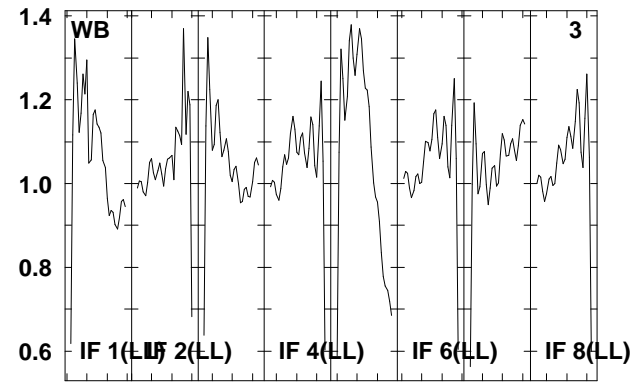
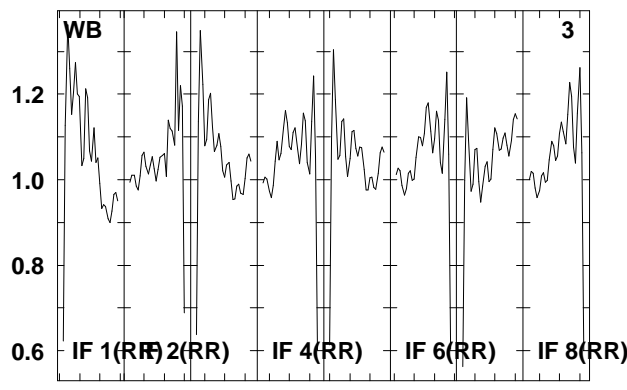
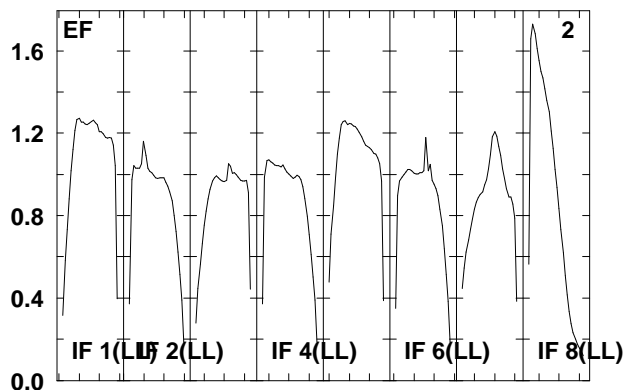
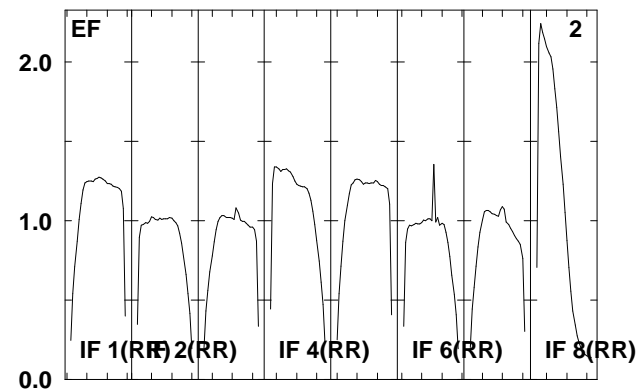
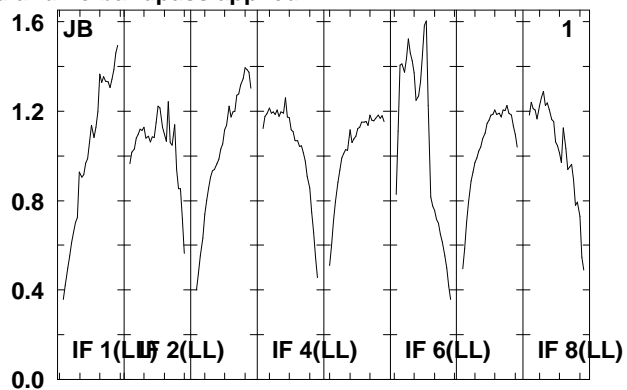
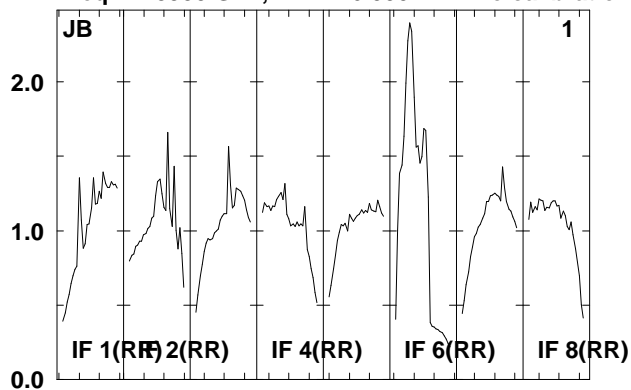

Lower frame: Real Jy
Total-power spectrum Antenna: *
Timerange: 00/13:05:05 to 00/13:08:29

Plot file version 40 created 06-JAN-2012 11:46:04

ARP299D EP068D 5.UVDATA.1

Freq = 1.5950 GHz, Bw = 16.000 MH No calibration applied and no bandpass applied

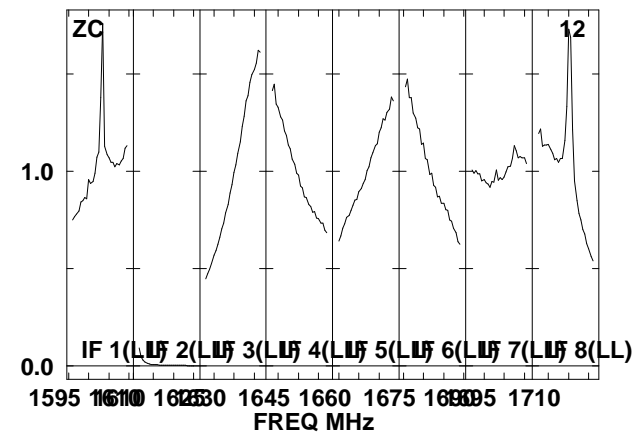
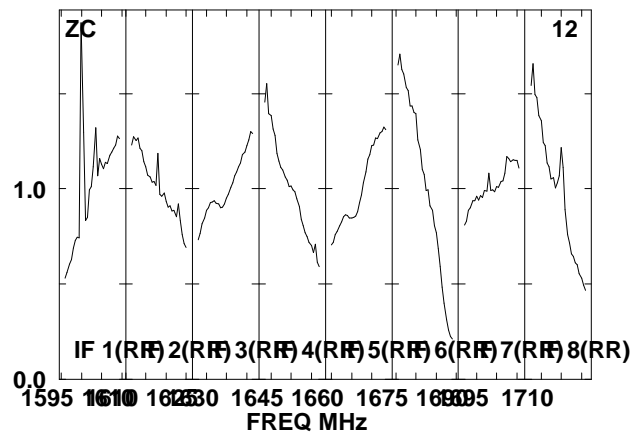
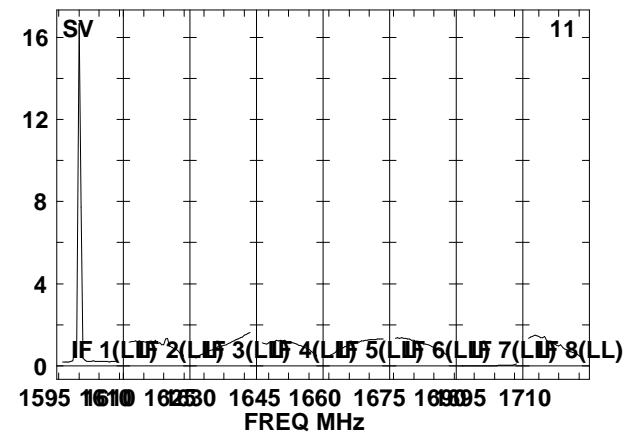
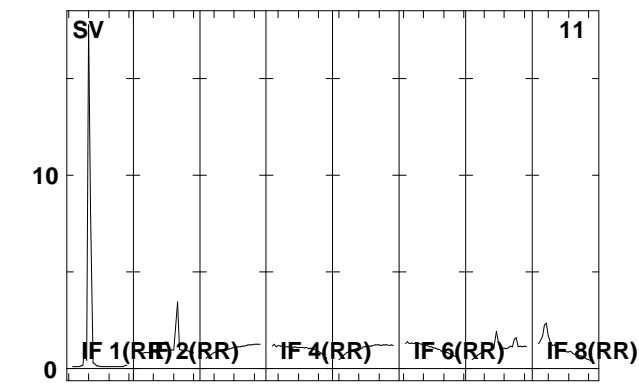
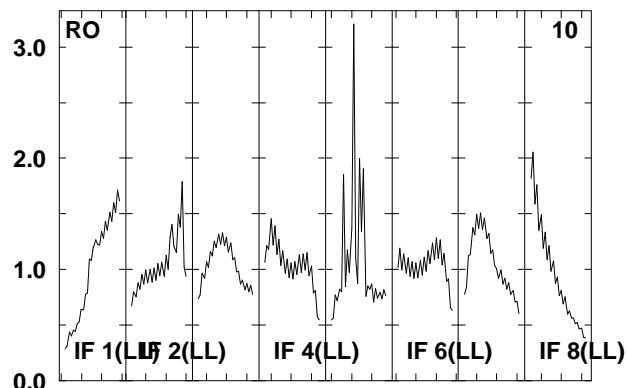
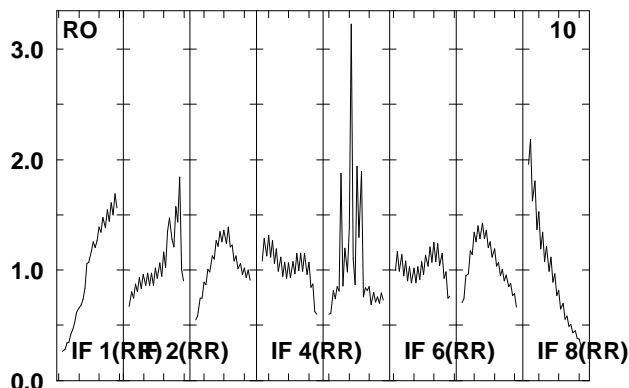
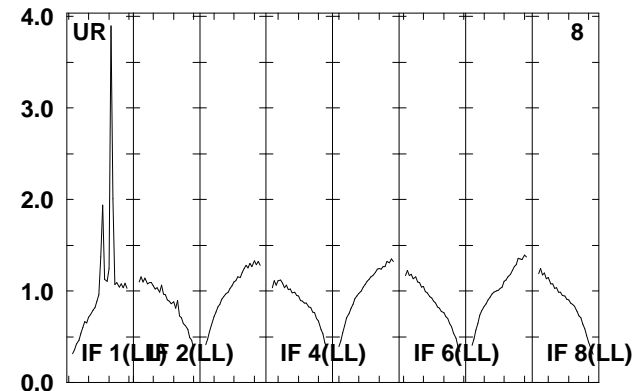
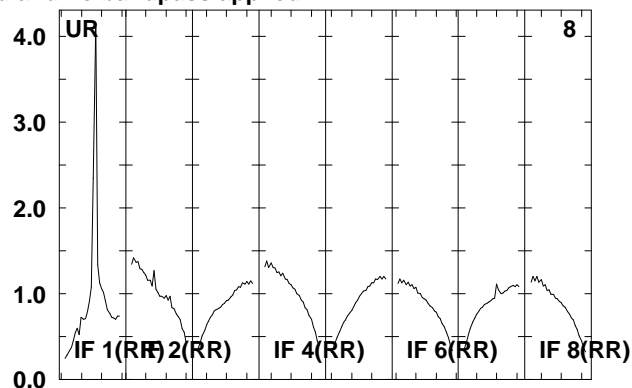
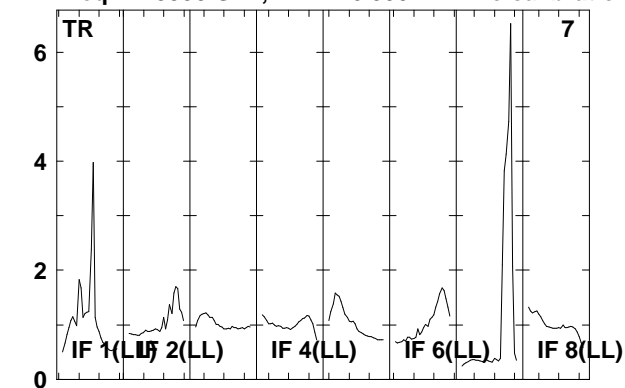

Lower frame: Real Jy

Total-power spectrum Antenna: *

Timerange: 00/13:05:05 to 00/13:08:29

Plot file version 41 created 06-JAN-2012 11:46:04
ARP299D EP068D 5.UVDATA.1
Freq = 1.5950 GHz, Bw = 16.000 MH No calibration applied and no bandpass applied

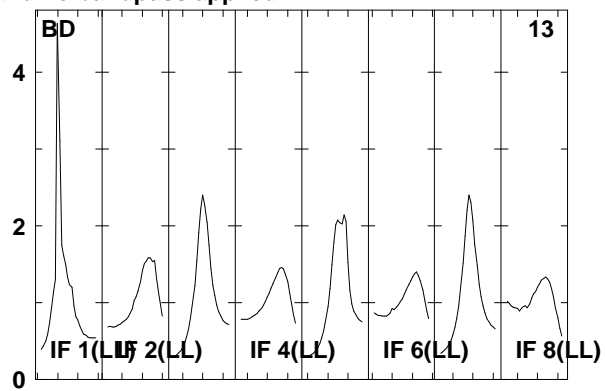
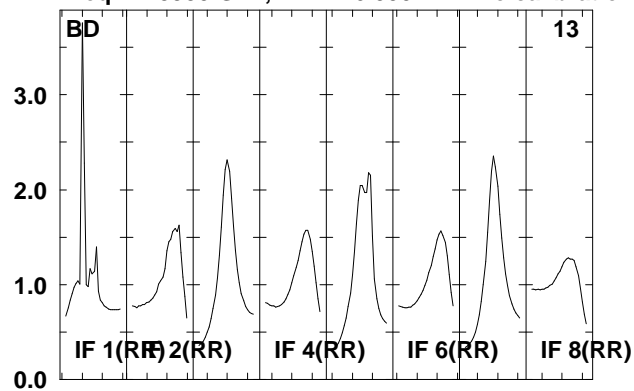

Lower frame: Real Jy
Total-power spectrum Antenna: *
Timerange: 00/13:05:05 to 00/13:08:29

Plot file version 42 created 06-JAN-2012 11:46:04

J1128+59 EP068D 5.UVDATA.1

Freq = 1.5950 GHz, Bw = 16.000 MH No calibration applied and no bandpass applied

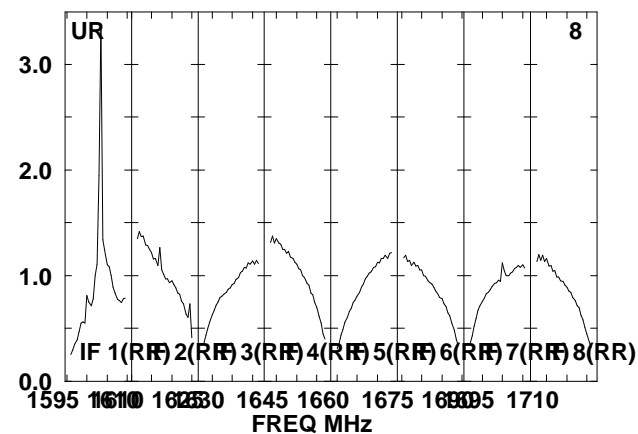
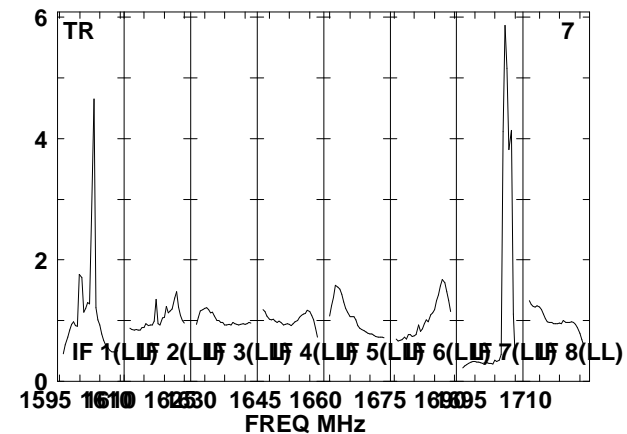
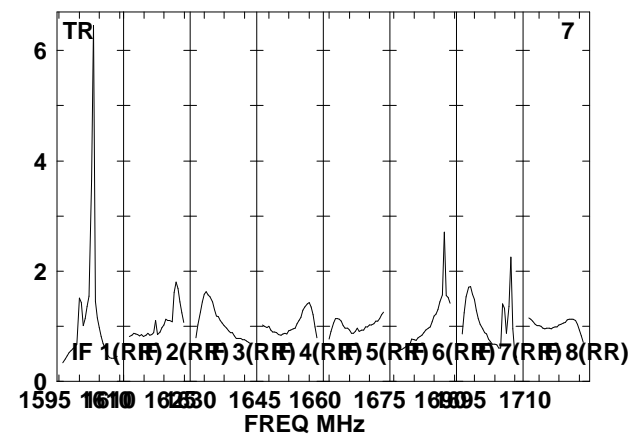
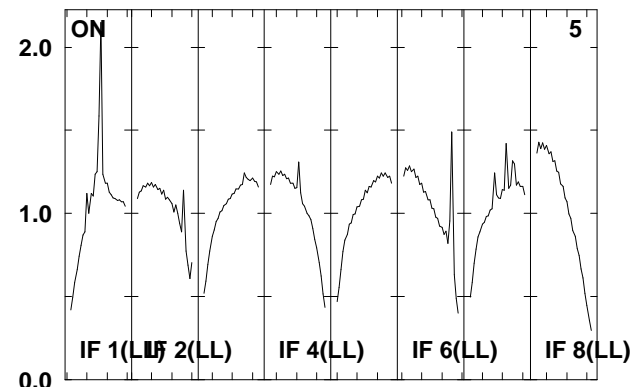
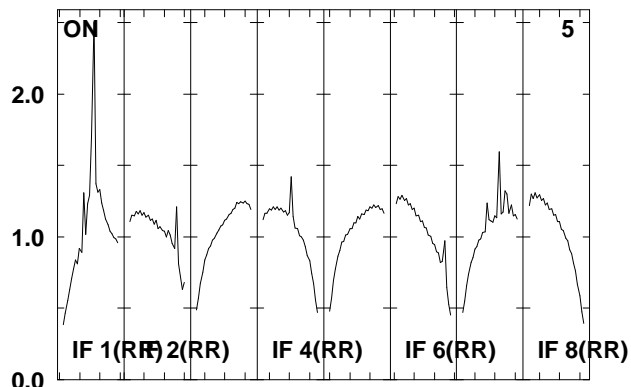
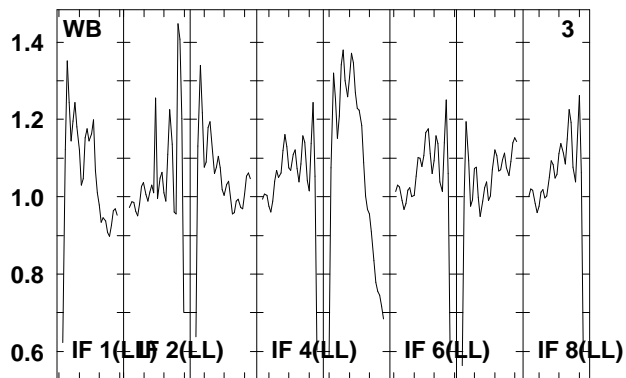
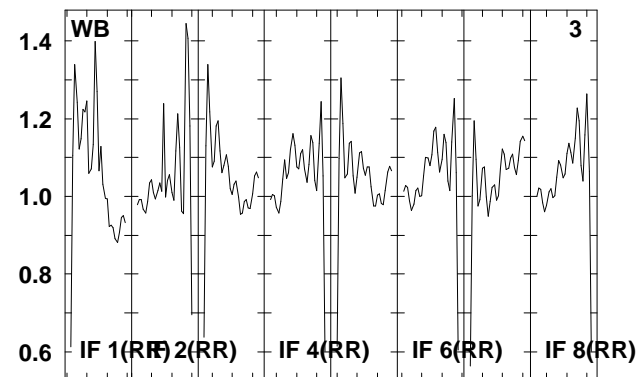
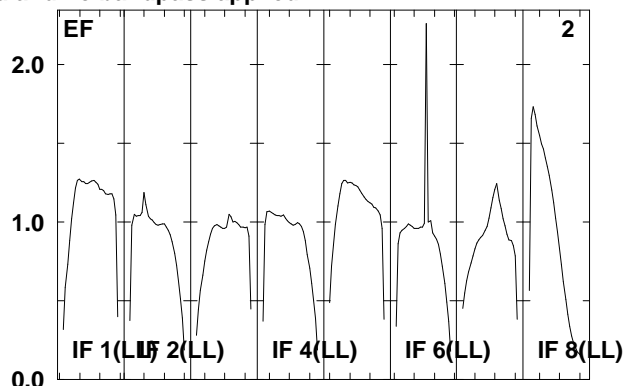
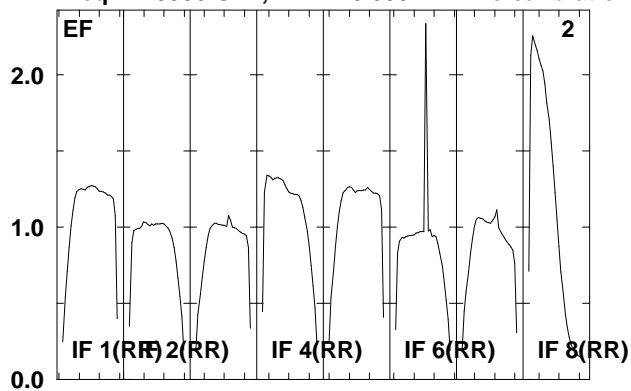

Lower frame: Real Jy
Total-power spectrum Antenna: *
Timerange: 00/13:08:35 to 00/13:09:59

Plot file version 43 created 06-JAN-2012 11:46:05

J1128+59 EP068D 5.UVDATA.1

Freq = 1.5950 GHz, Bw = 16.000 MH No calibration applied and no bandpass applied

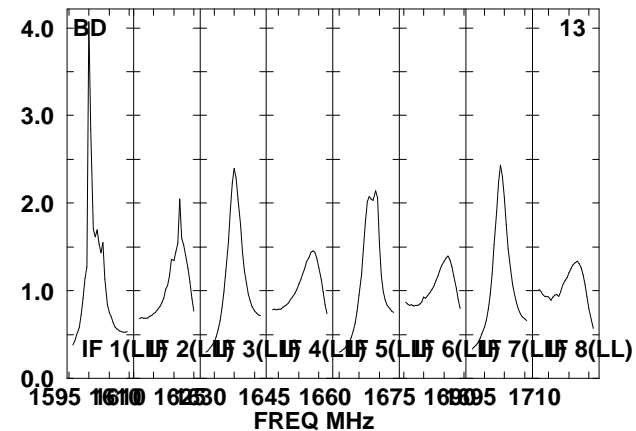
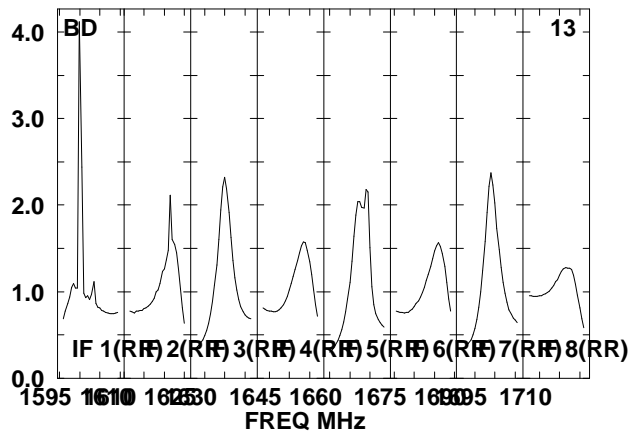
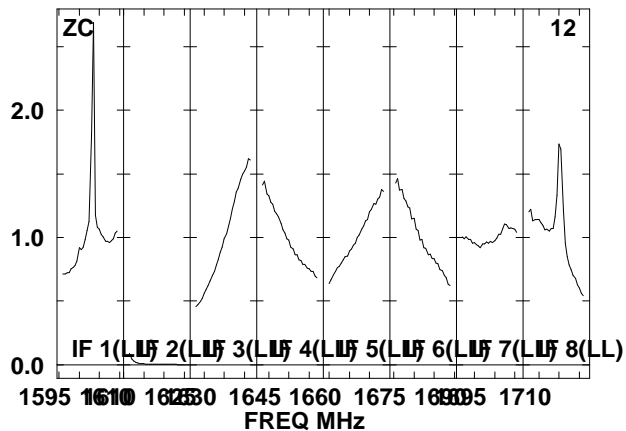
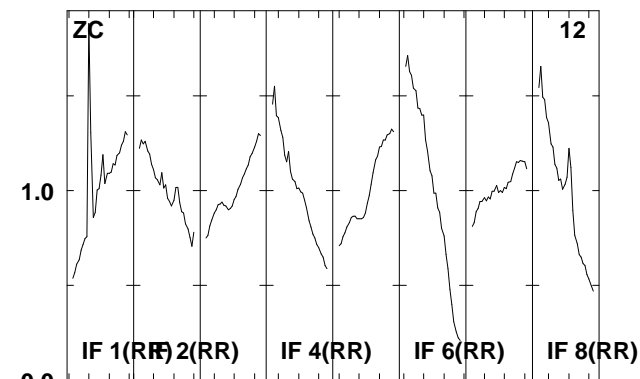
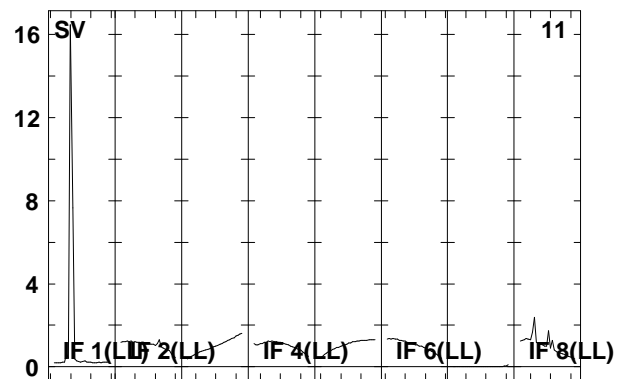
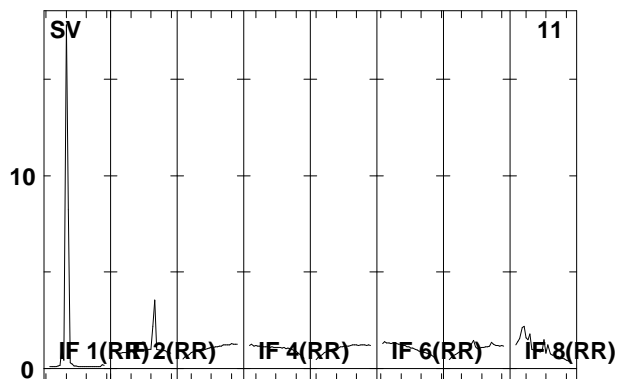
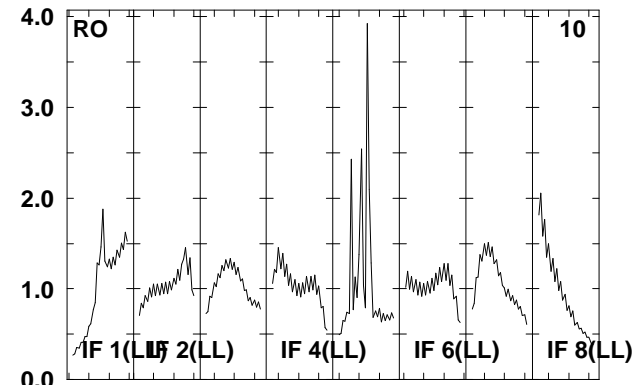
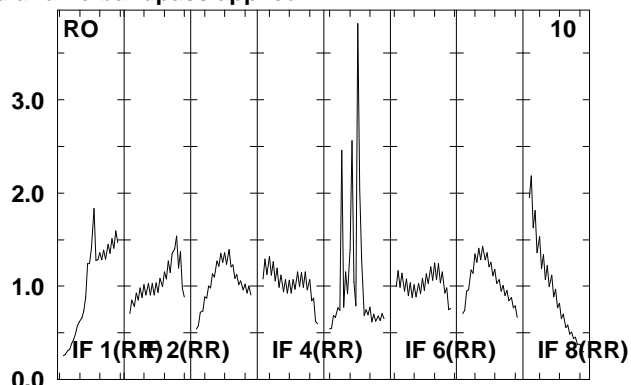
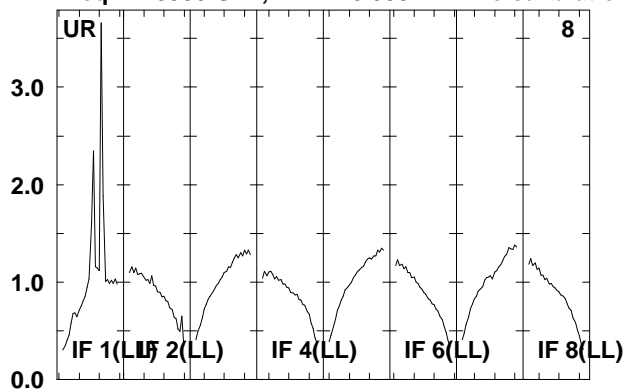

Lower frame: Real Jy
Total-power spectrum Antenna: *
Timerange: 00/13:08:35 to 00/13:09:59

Plot file version 44 created 06-JAN-2012 11:46:05

ARP299D EP068D 5.UVDATA.1

Freq = 1.5950 GHz, Bw = 16.000 MH No calibration applied and no bandpass applied

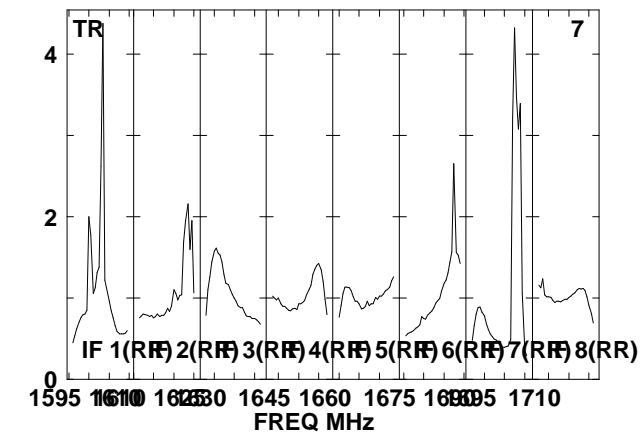
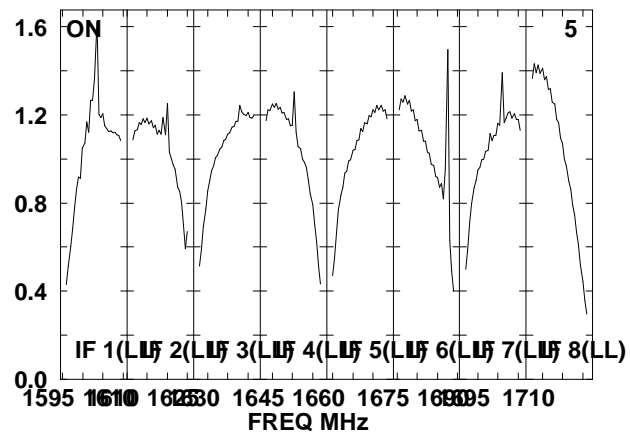
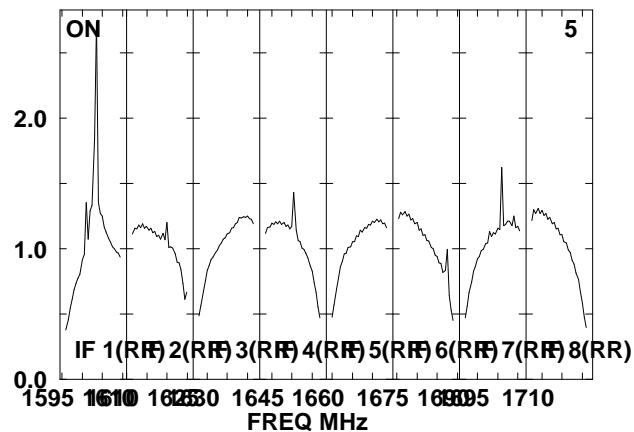
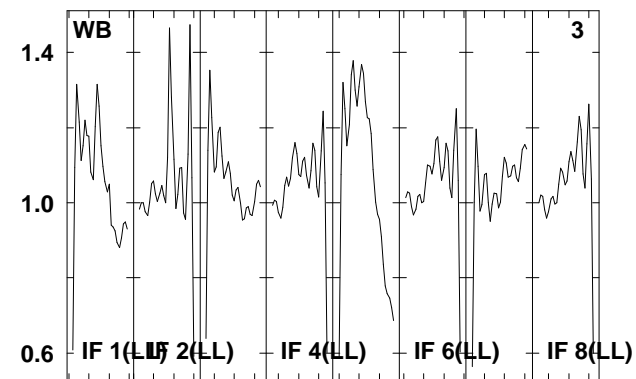
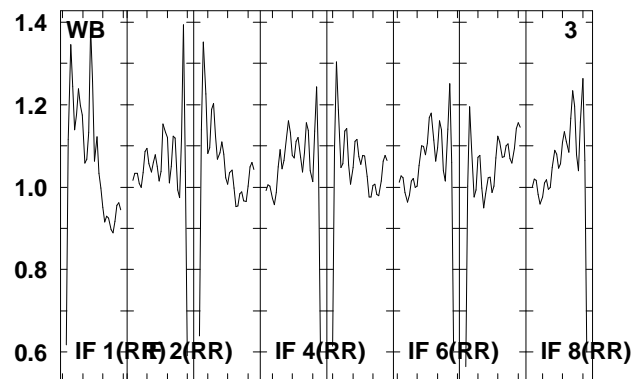
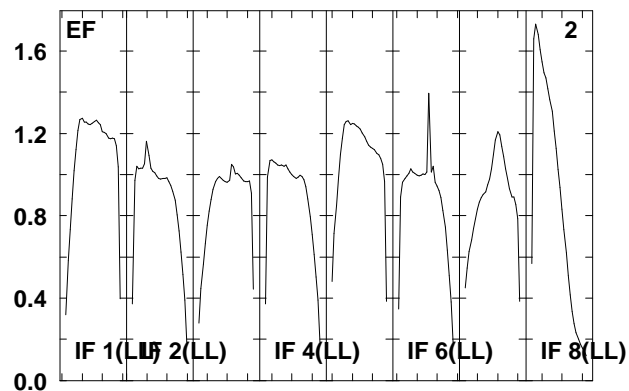
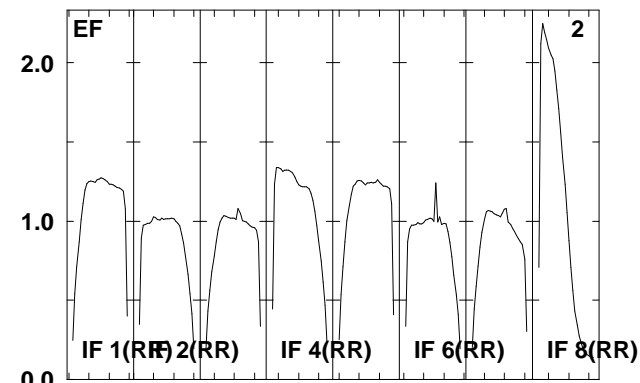
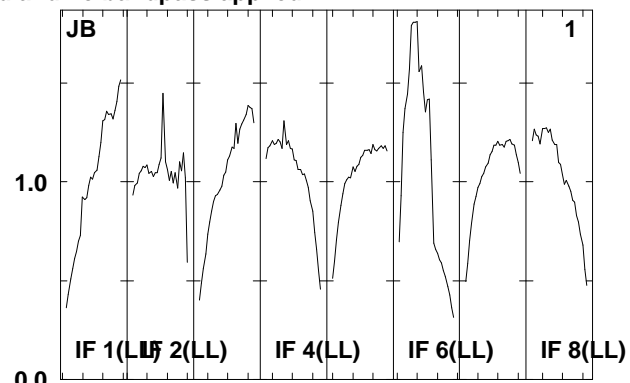
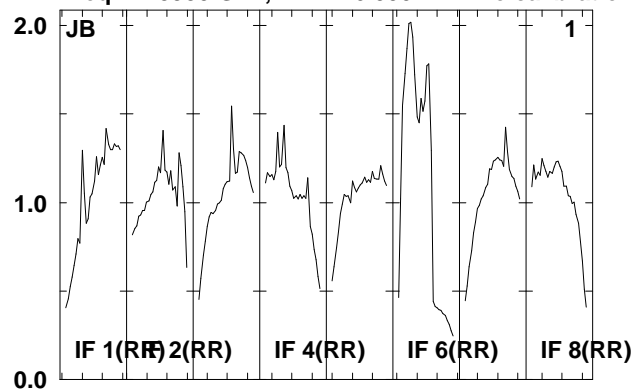

Lower frame: Real Jy
Total-power spectrum Antenna: *
Timerange: 00/13:10:01 to 00/13:13:29

Plot file version 45 created 06-JAN-2012 11:46:06

ARP299D EP068D 5.UVDATA.1

Freq = 1.5950 GHz, Bw = 16.000 MH No calibration applied and no bandpass applied

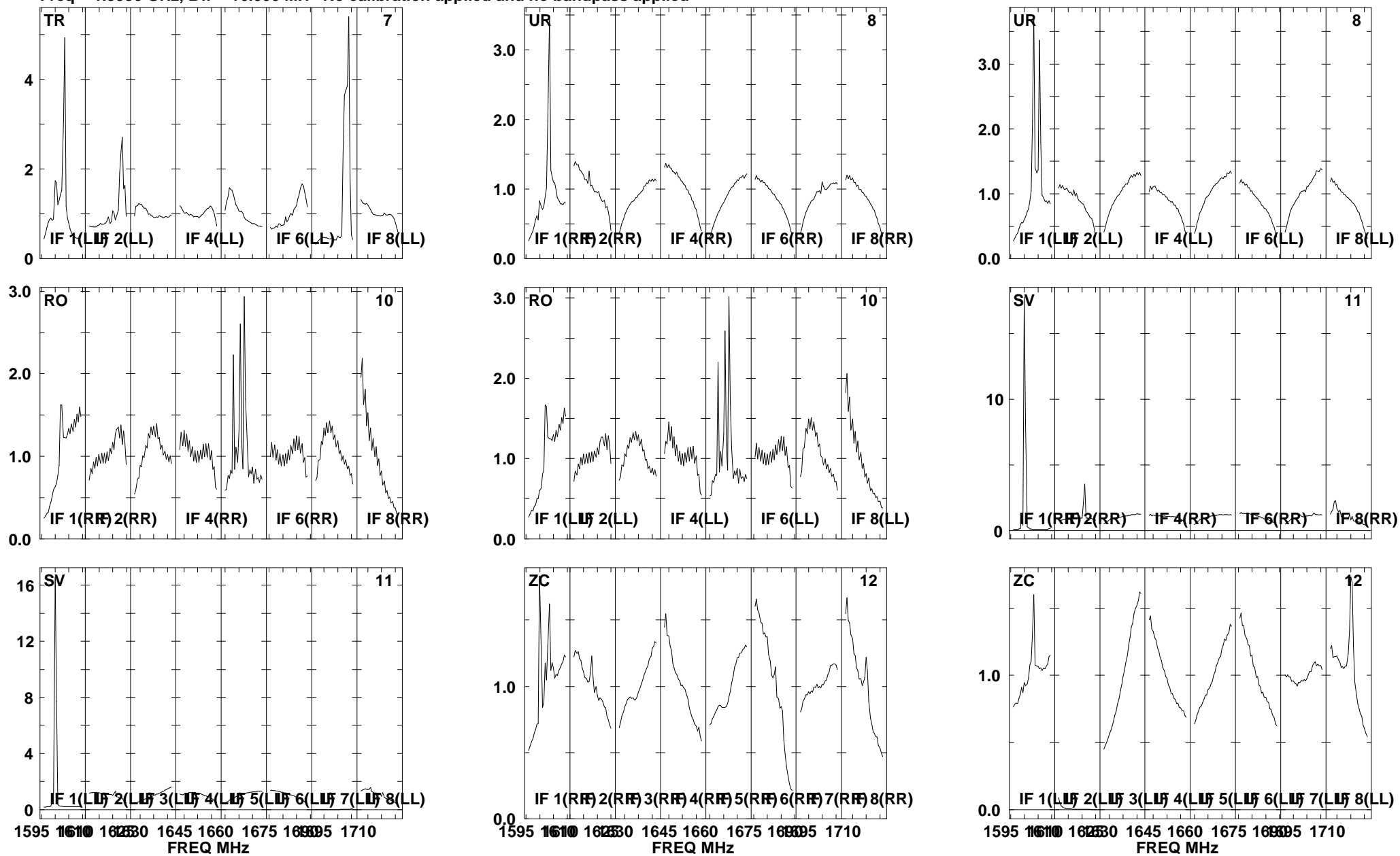

Lower frame: Real Jy

Total-power spectrum Antenna: *

Timerange: 00/13:10:01 to 00/13:13:29

Plot file version 46 created 06-JAN-2012 11:46:06

ARP299D EP068D 5.UVDATA.1

Freq = 1.5950 GHz, Bw = 16.000 MH No calibration applied and no bandpass applied

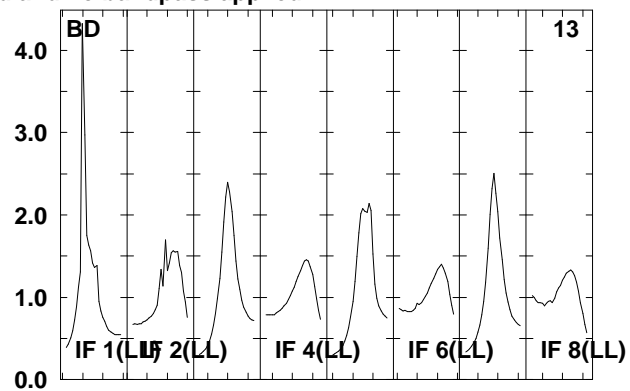
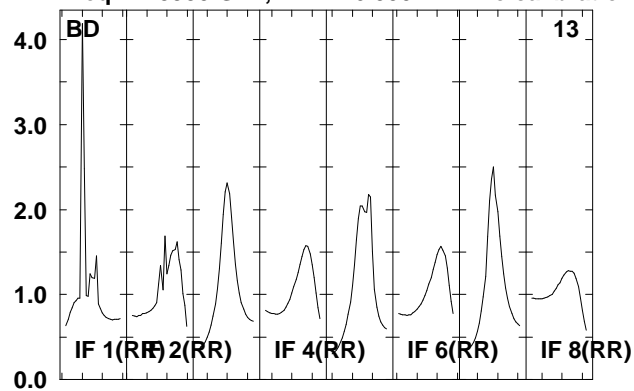

Lower frame: Real Jy
Total-power spectrum Antenna: *
Timerange: 00/13:10:01 to 00/13:13:29

Plot file version 47 created 06-JAN-2012 11:46:06

J1128+59 EP068D 5.UVDATA.1

Freq = 1.5950 GHz, Bw = 16.000 MH No calibration applied and no bandpass applied

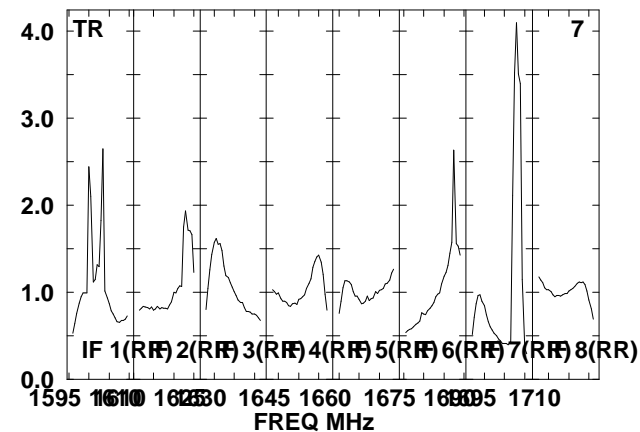
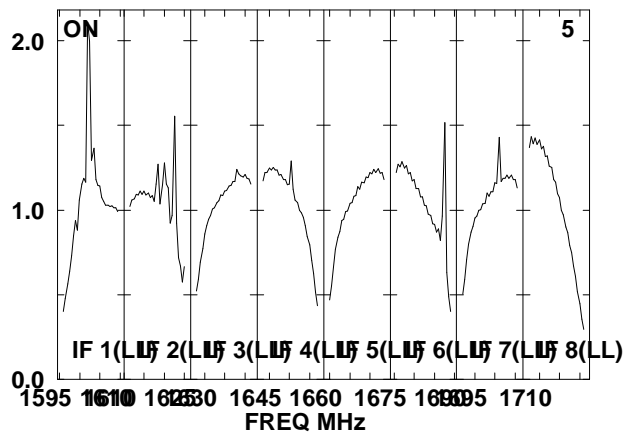
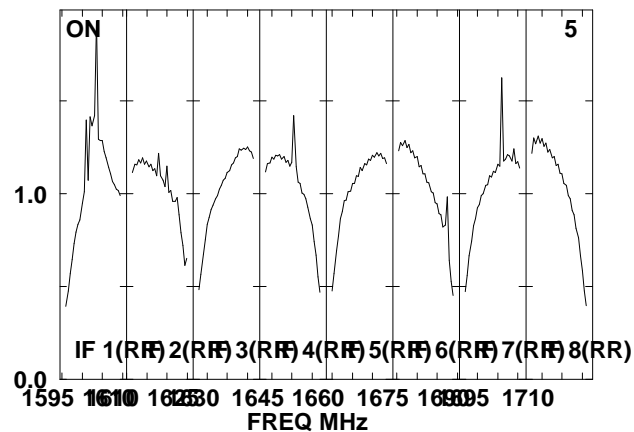
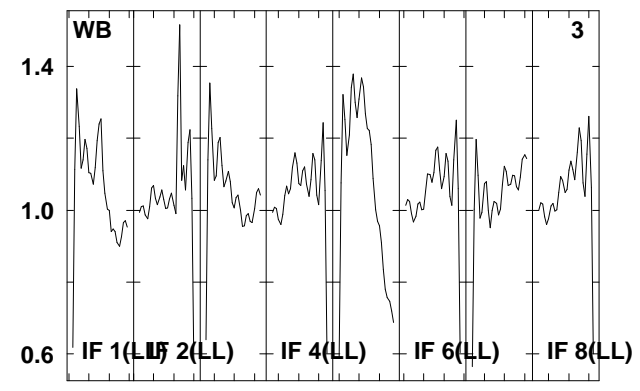
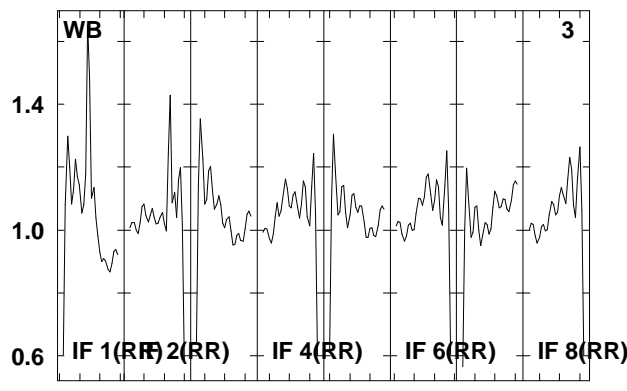
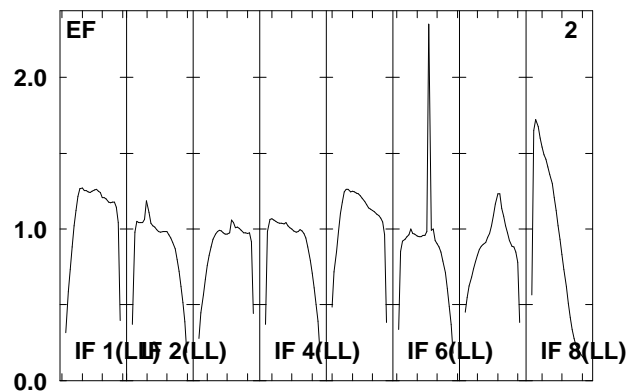
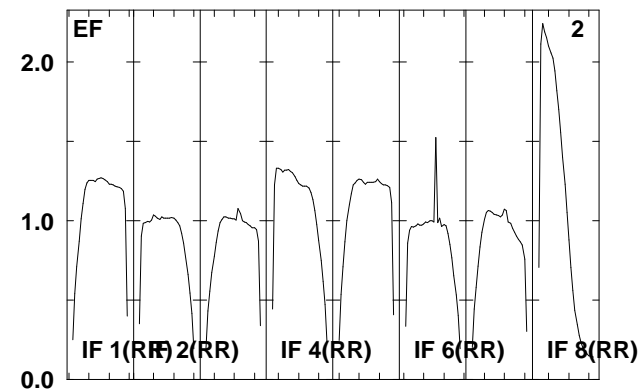
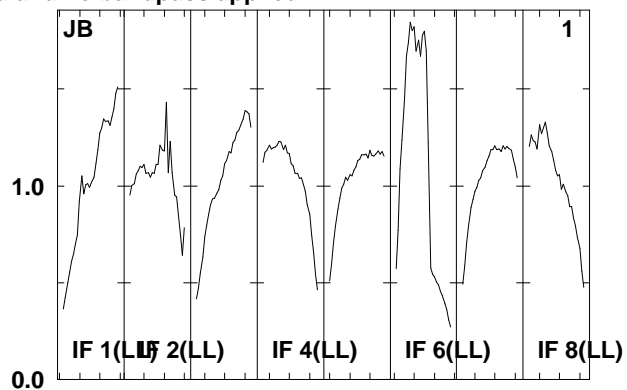
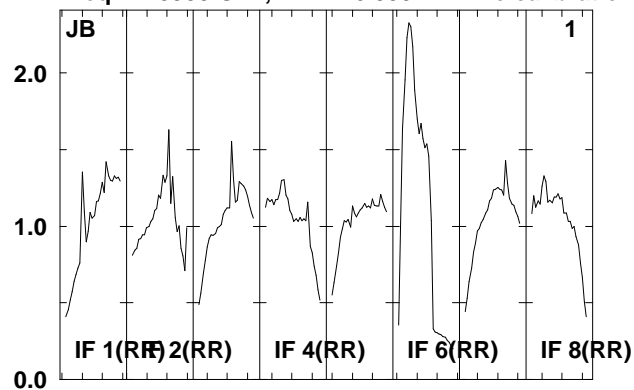

Lower frame: Real Jy
Total-power spectrum Antenna: *
Timerange: 00/13:14:31 to 00/13:15:59

Plot file version 48 created 06-JAN-2012 11:46:07

J1128+59 EP068D 5.UVDATA.1

Freq = 1.5950 GHz, Bw = 16.000 MH No calibration applied and no bandpass applied

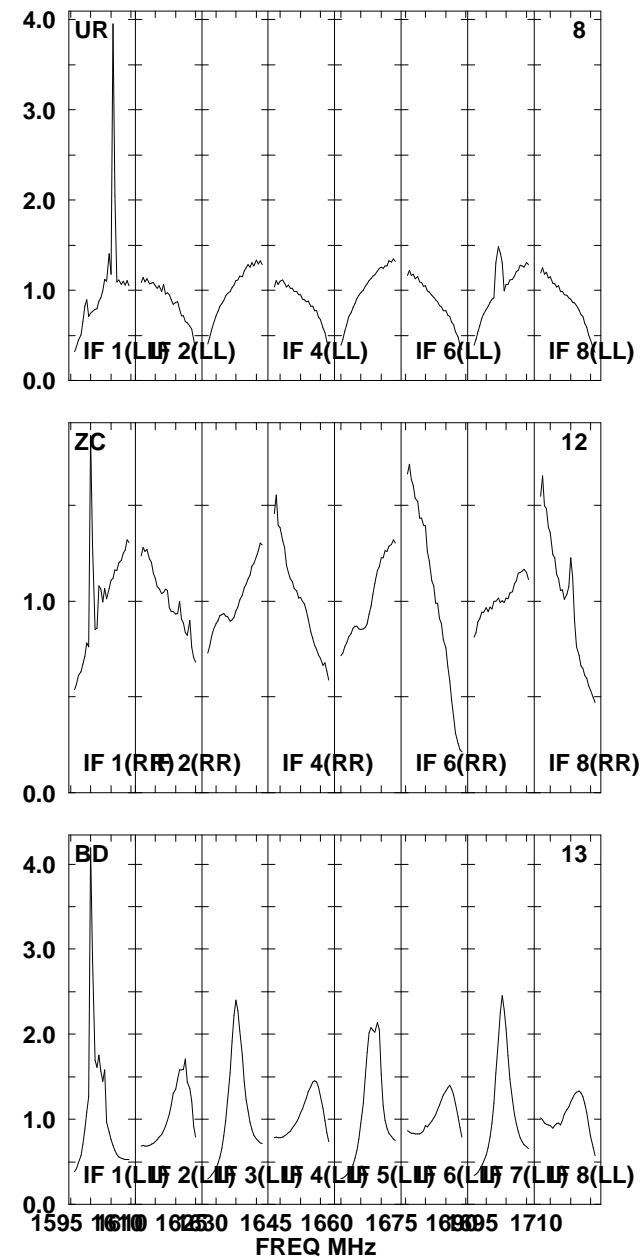
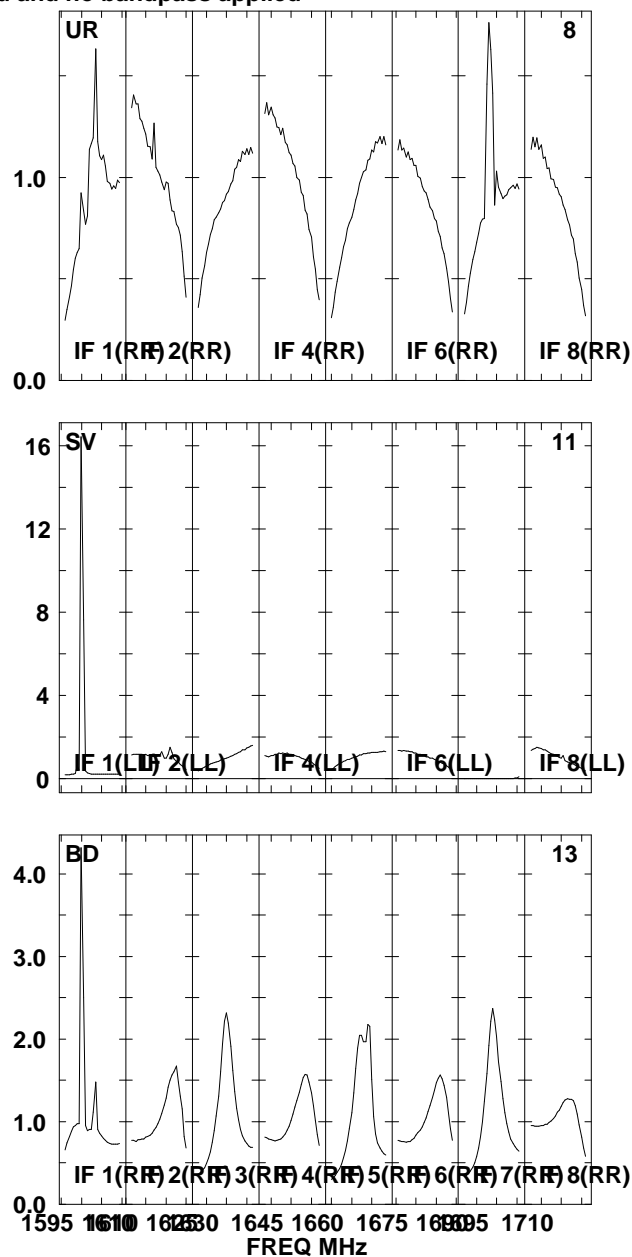
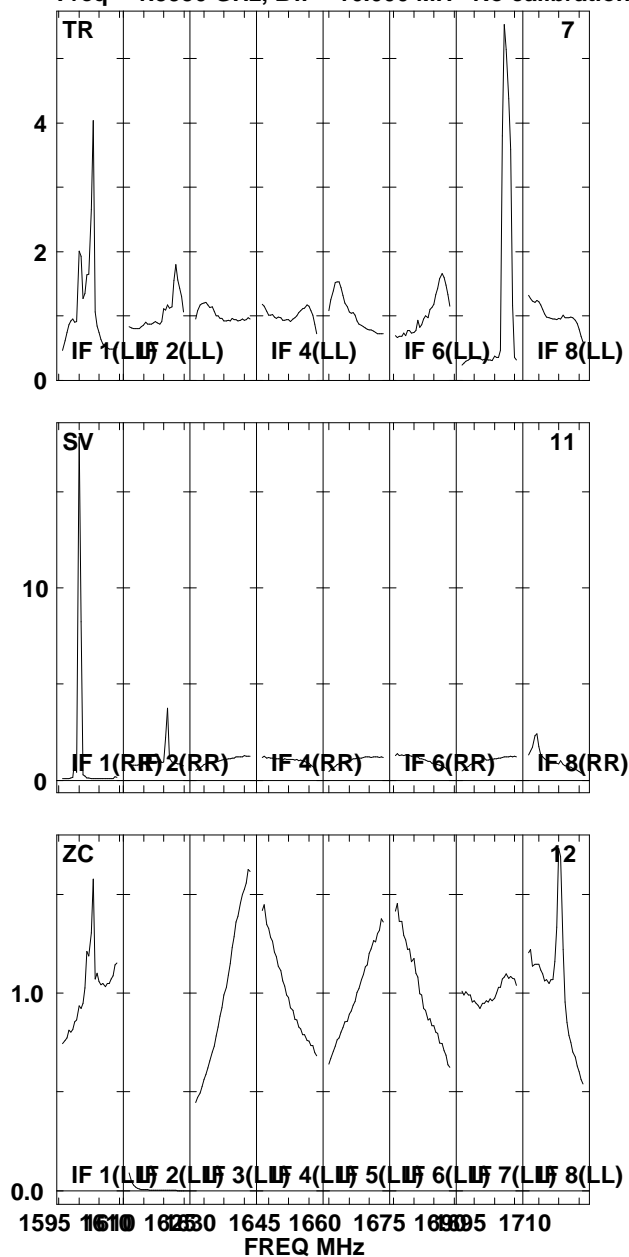

Lower frame: Real Jy
Total-power spectrum Antenna: *
Timerange: 00/13:14:31 to 00/13:15:59

Plot file version 49 created 06-JAN-2012 11:46:07

ARP299D EP068D 5.UVDATA.1

Freq = 1.5950 GHz, Bw = 16.000 MH No calibration applied and no bandpass applied

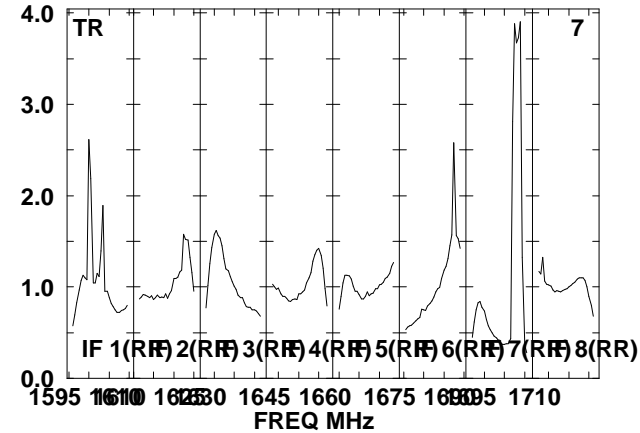
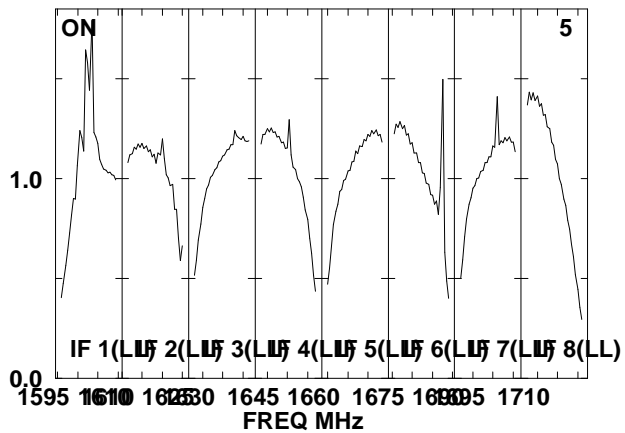
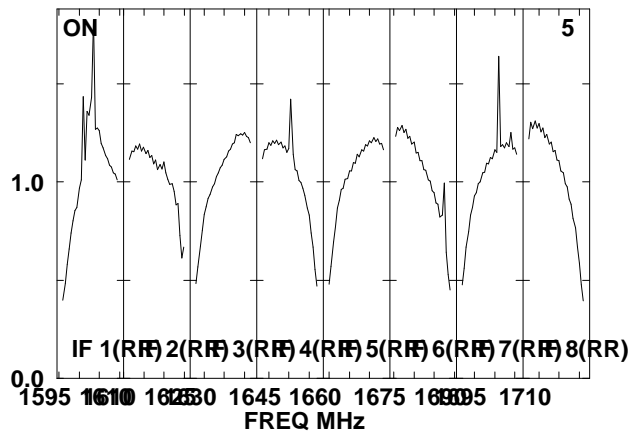
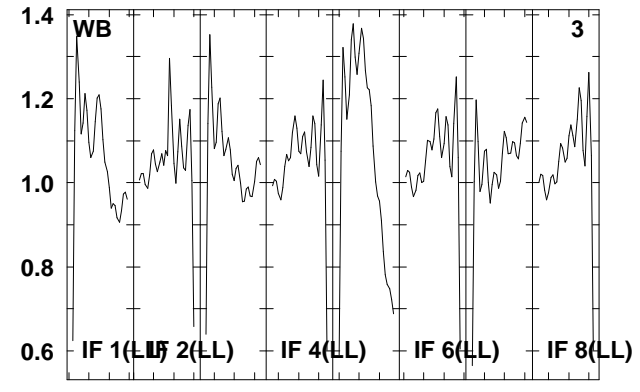
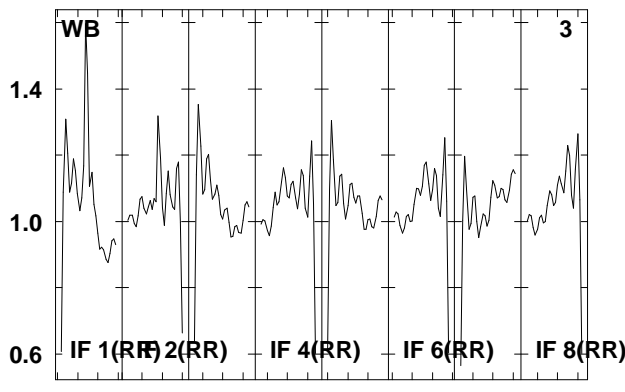
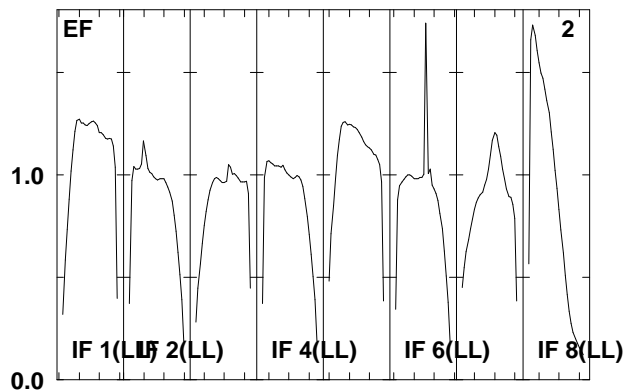
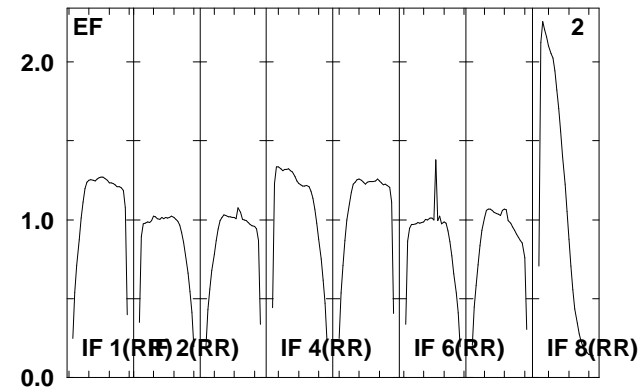
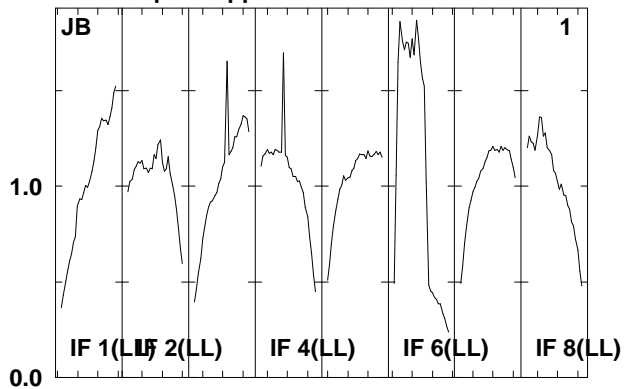
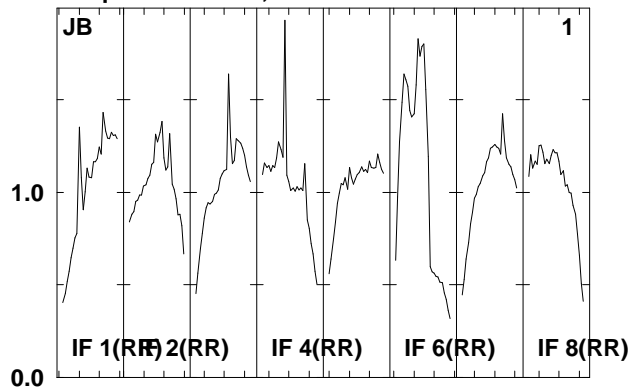

Lower frame: Real Jy
Total-power spectrum Antenna: *
Timerange: 00/13:16:05 to 00/13:19:29

Plot file version 50 created 06-JAN-2012 11:46:08

ARP299D EP068D 5.UVDATA.1

Freq = 1.5950 GHz, Bw = 16.000 MH No calibration applied and no bandpass applied

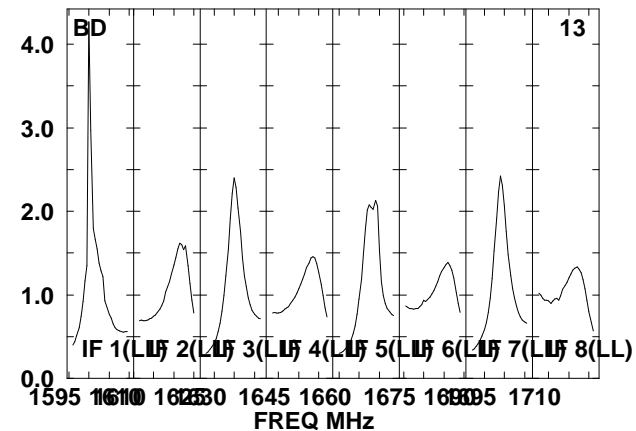
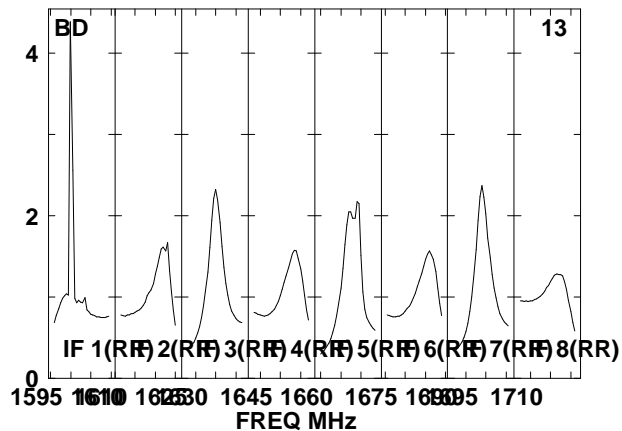
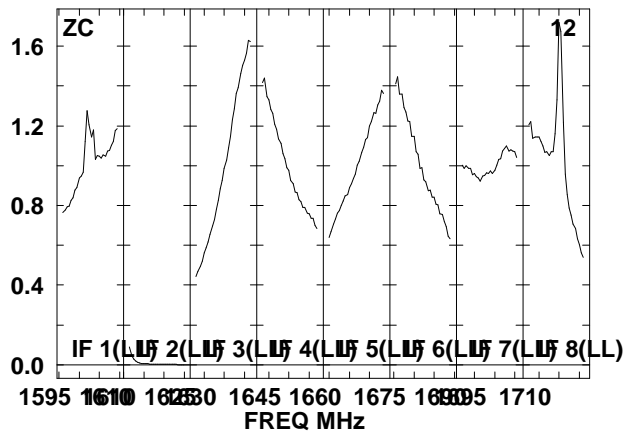
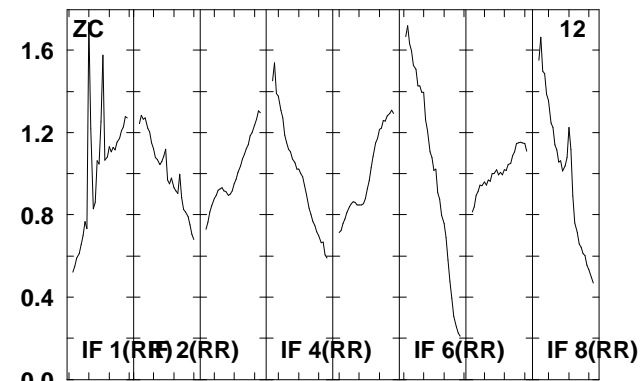
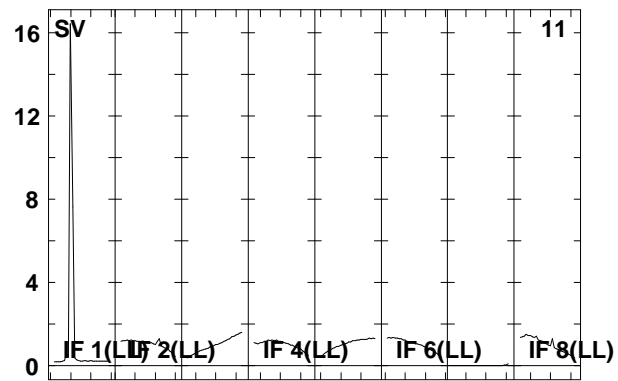
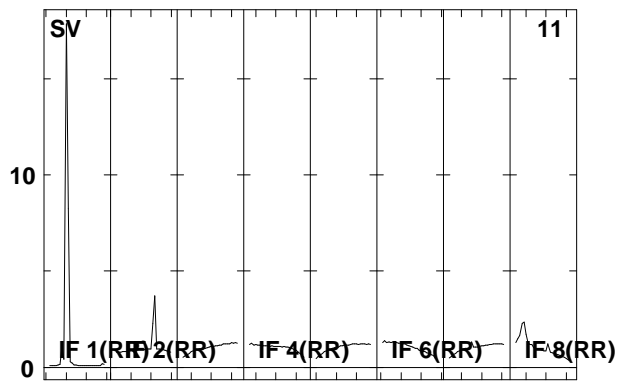
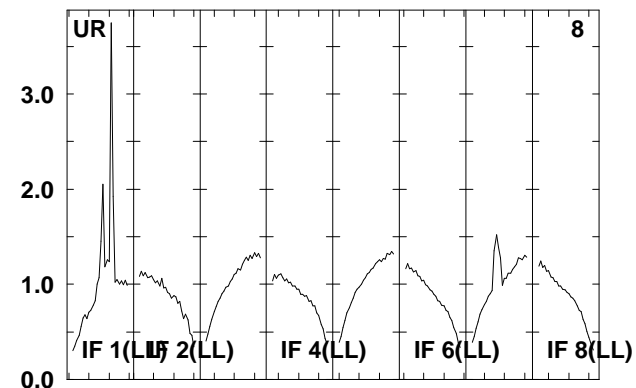
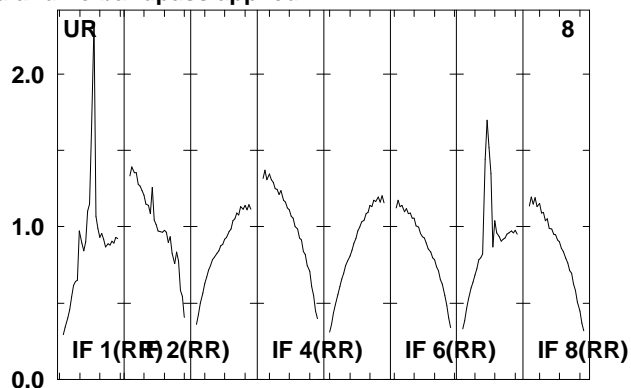
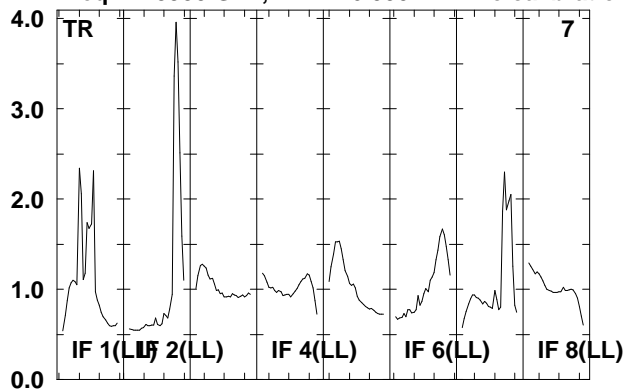

Lower frame: Real Jy
Total-power spectrum Antenna: *
Timerange: 00/13:16:05 to 00/13:19:29

Plot file version 51 created 06-JAN-2012 11:46:08

J1128+59 EP068D 5.UVDATA.1

Freq = 1.5950 GHz, Bw = 16.000 MH No calibration applied and no bandpass applied

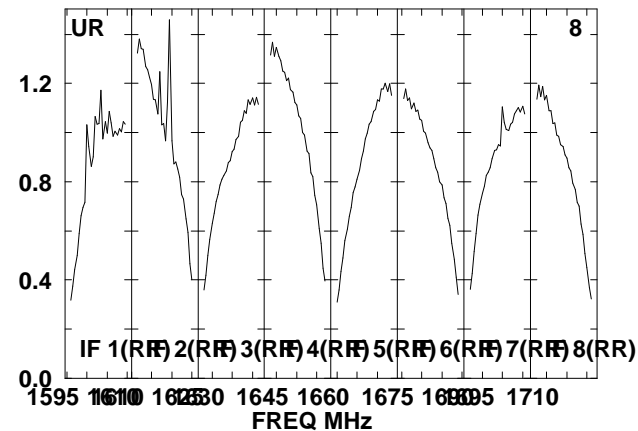
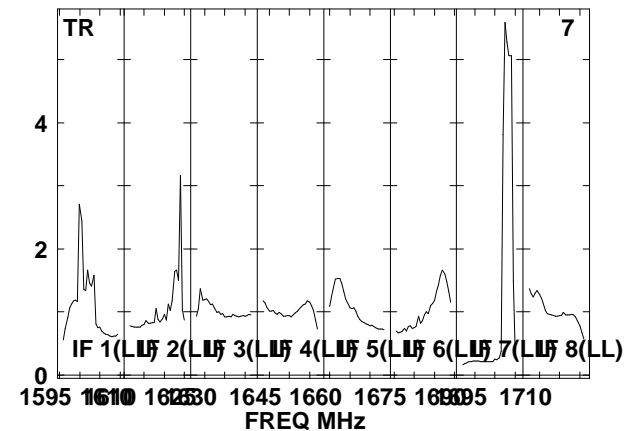
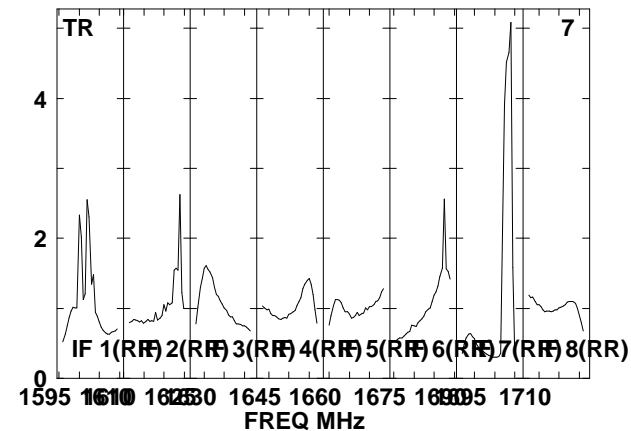
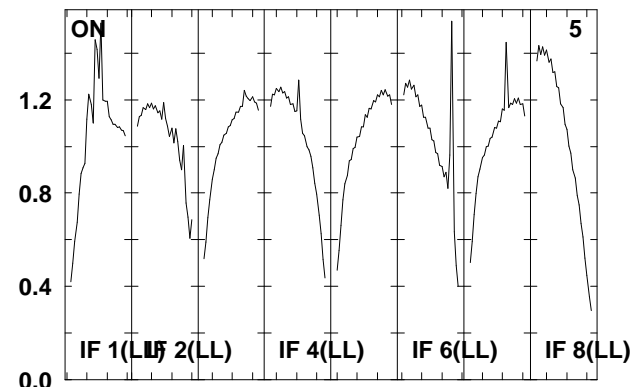
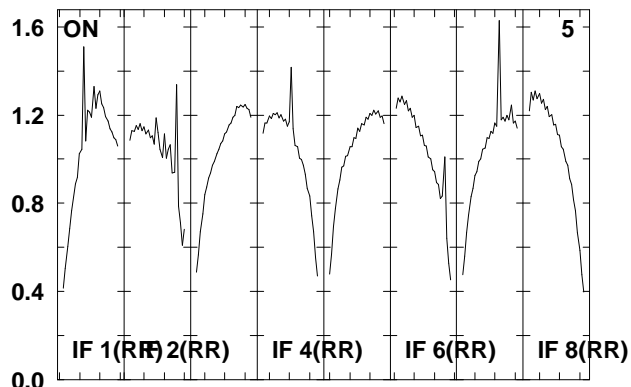
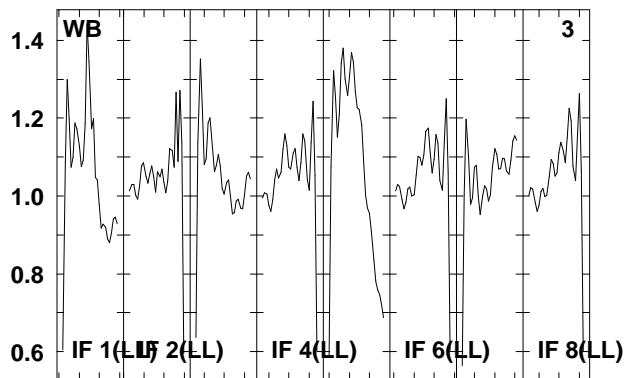
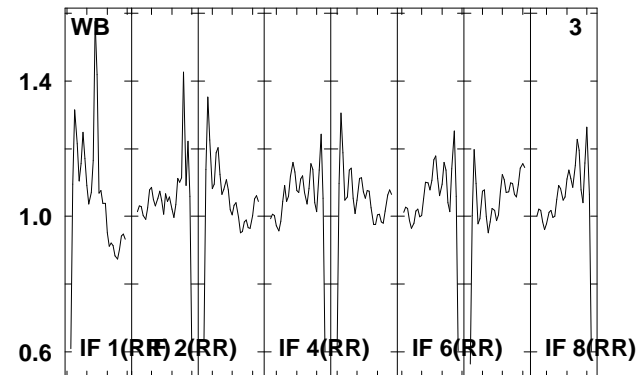
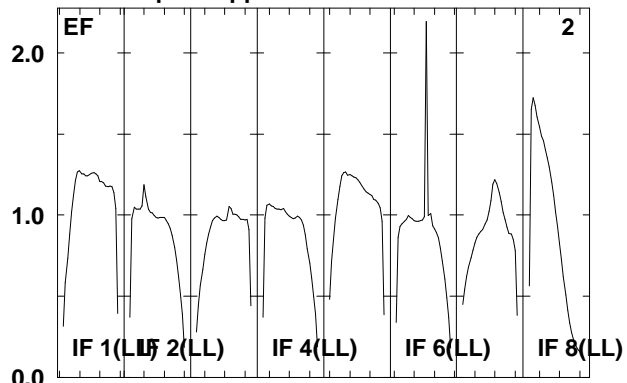
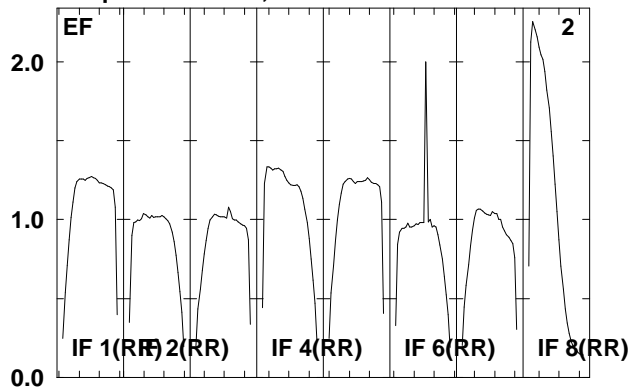

Lower frame: Real Jy
Total-power spectrum Antenna: *
Timerange: 00/13:19:35 to 00/13:20:59

Plot file version 52 created 06-JAN-2012 11:46:09

J1128+59 EP068D 5.UVDATA.1

Freq = 1.5950 GHz, Bw = 16.000 MH No calibration applied and no bandpass applied

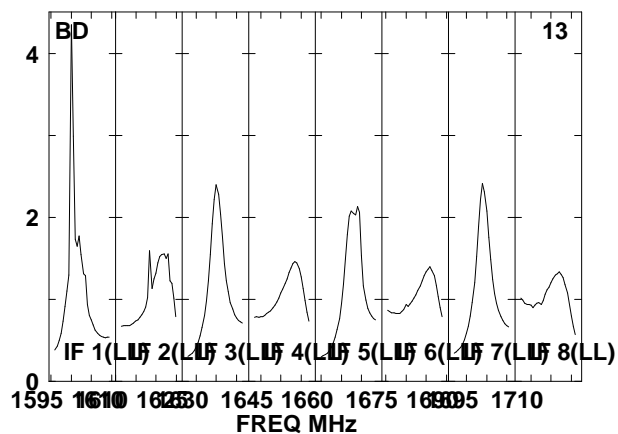
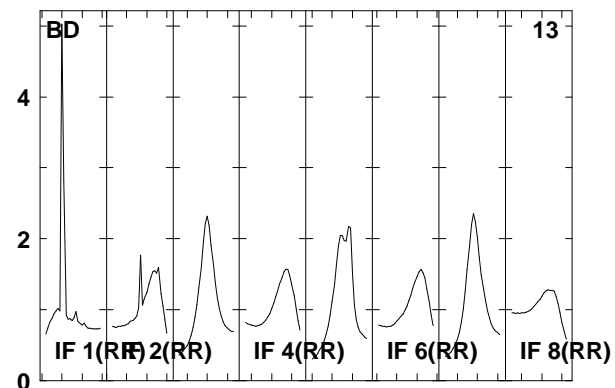
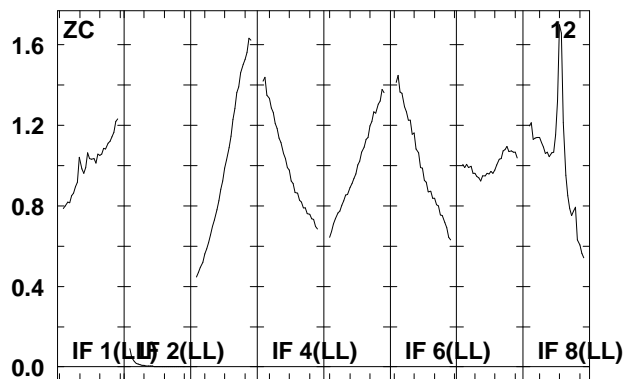
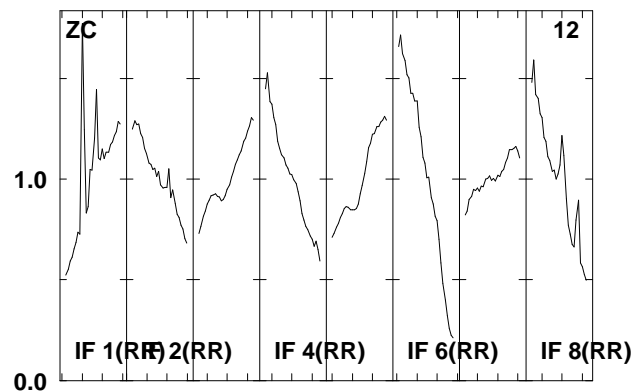
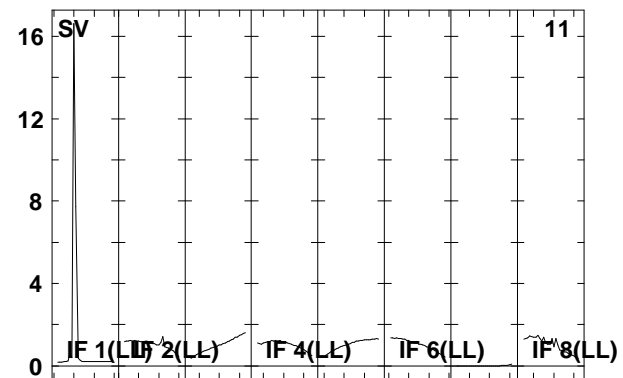
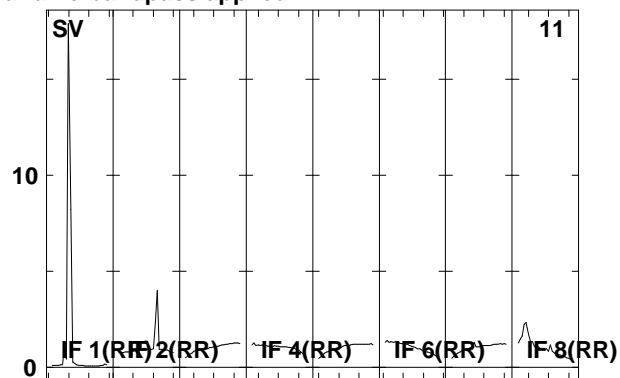
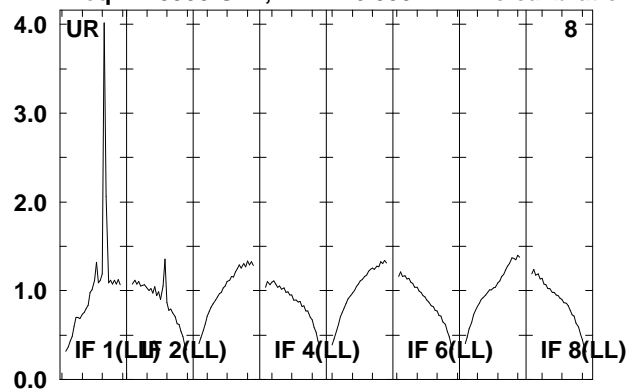

Lower frame: Real Jy

Total-power spectrum Antenna: *

Timerange: 00/13:19:35 to 00/13:20:59

Plot file version 53 created 06-JAN-2012 11:46:09

ARP299D EP068D 5.UVDATA.1

Freq = 1.5950 GHz, Bw = 16.000 MH No calibration applied and no bandpass applied

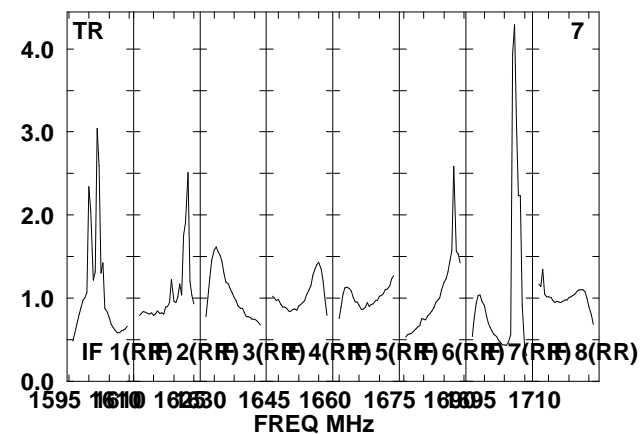
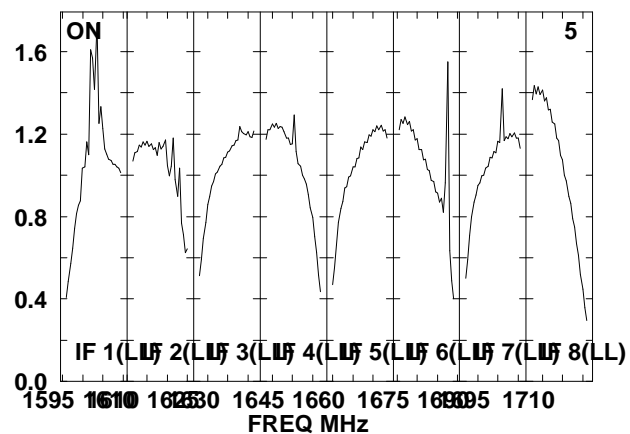
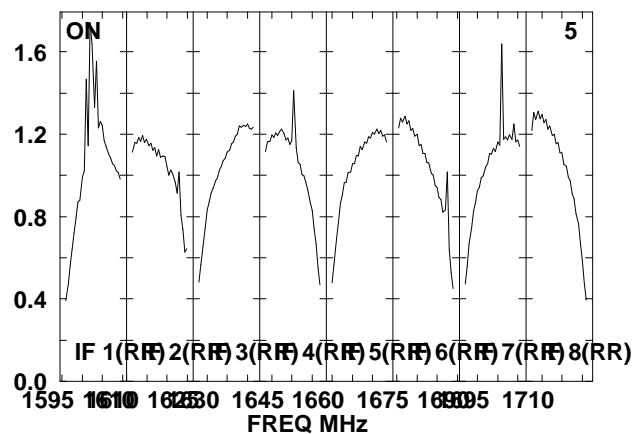
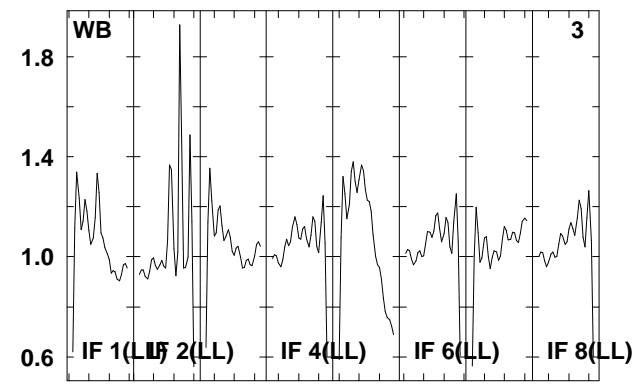
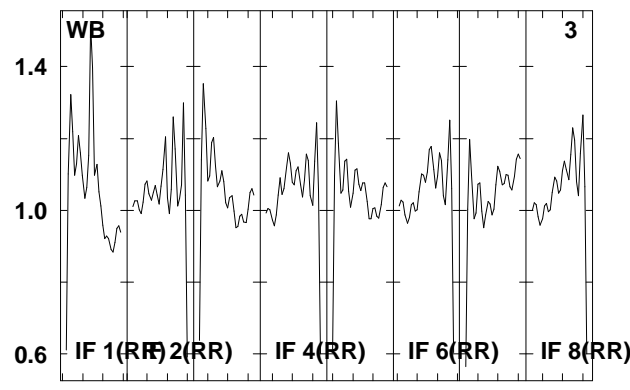
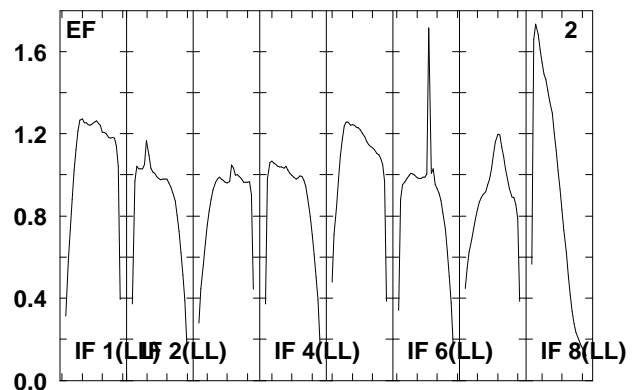
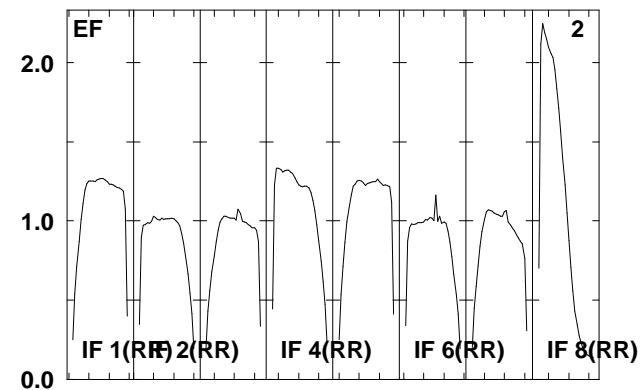
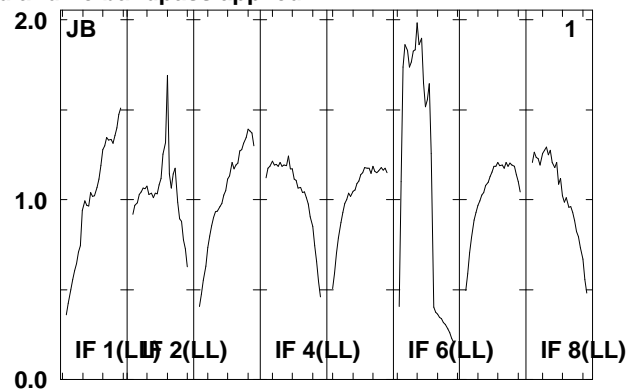
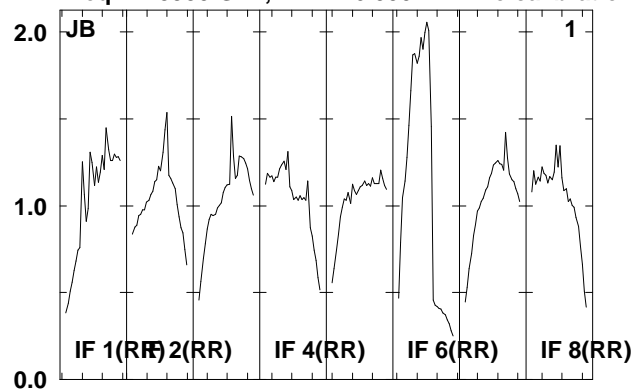

Lower frame: Real Jy
Total-power spectrum Antenna: *
Timerange: 00/13:21:01 to 00/13:24:29

Plot file version 54 created 06-JAN-2012 11:46:10

ARP299D EP068D 5.UVDATA.1

Freq = 1.5950 GHz, Bw = 16.000 MH No calibration applied and no bandpass applied

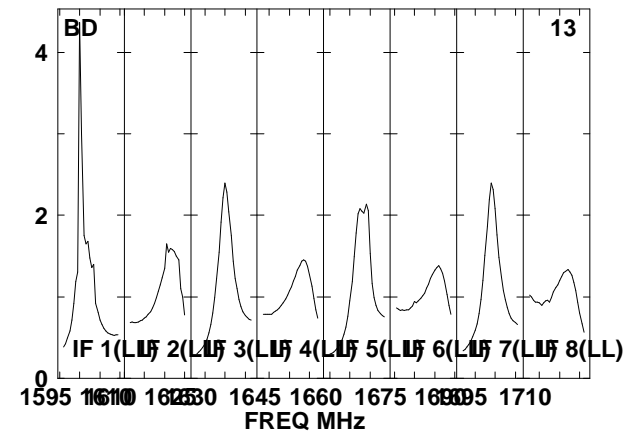
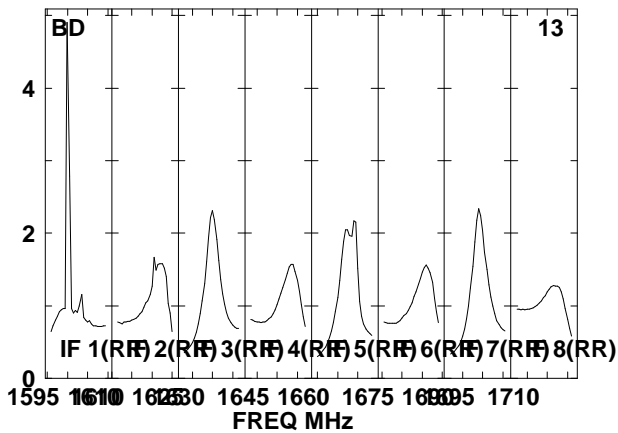
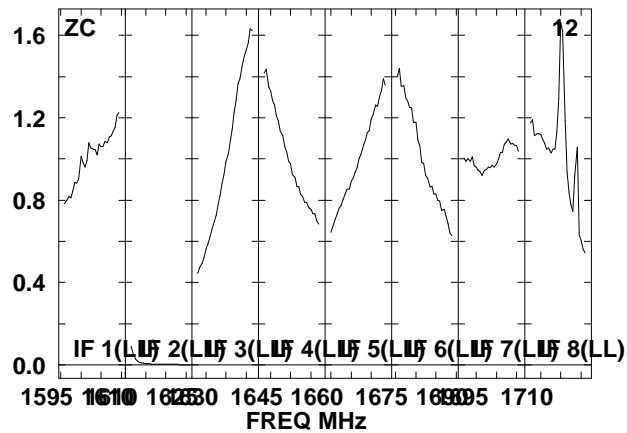
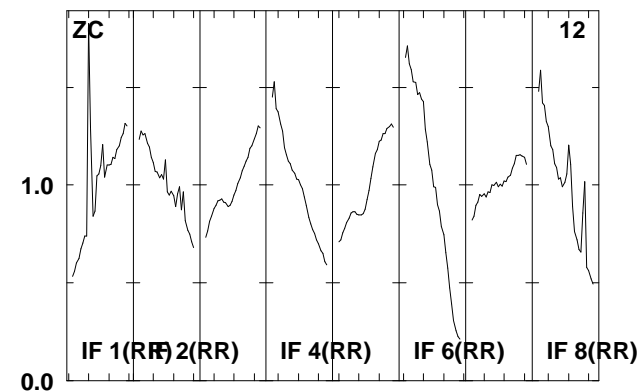
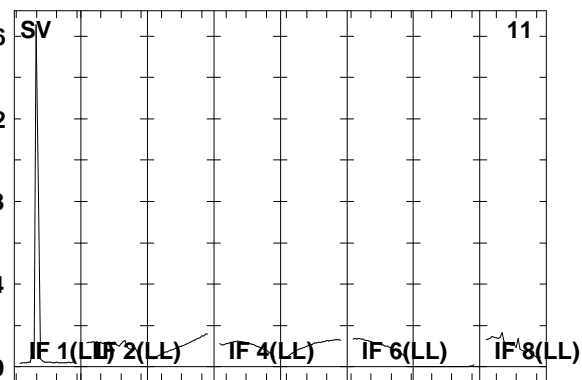
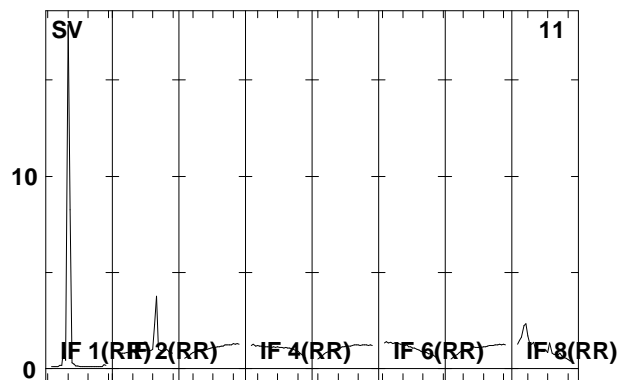
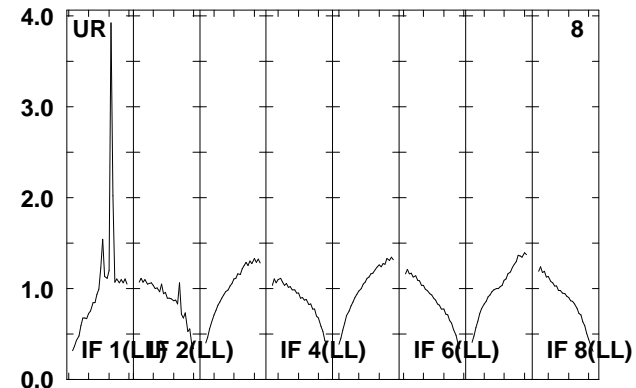
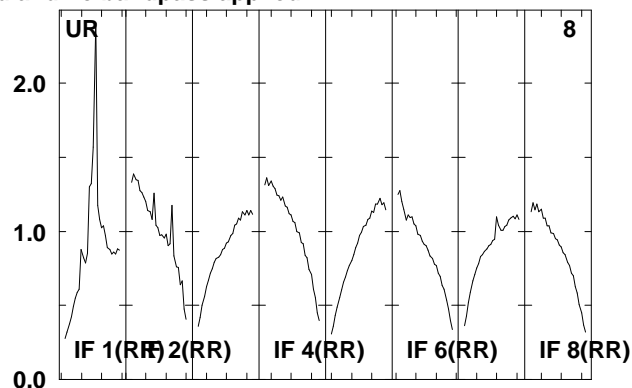
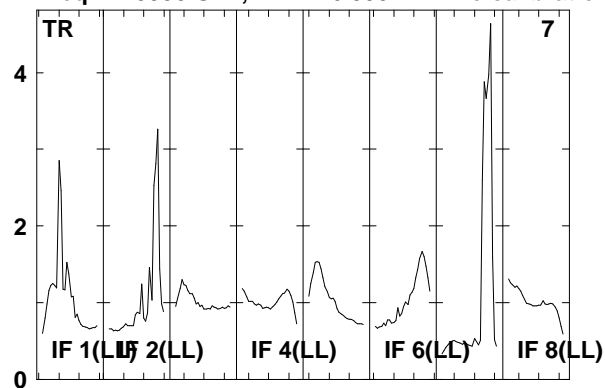

Lower frame: Real Jy
Total-power spectrum Antenna: *
Timerange: 00/13:21:01 to 00/13:24:29

Plot file version 55 created 06-JAN-2012 11:46:10

J1128+59 EP068D 5.UVDATA.1

Freq = 1.5950 GHz, Bw = 16.000 MH No calibration applied and no bandpass applied

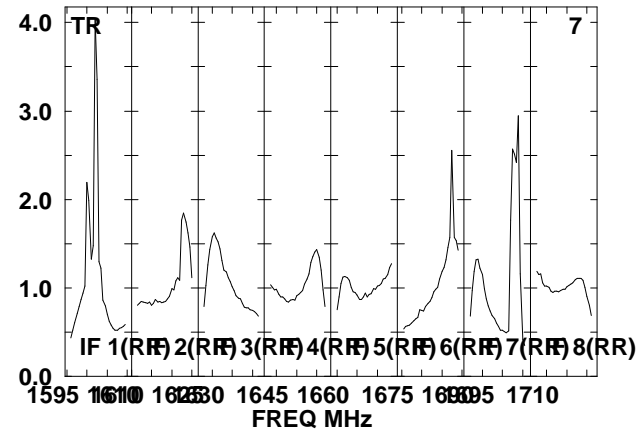
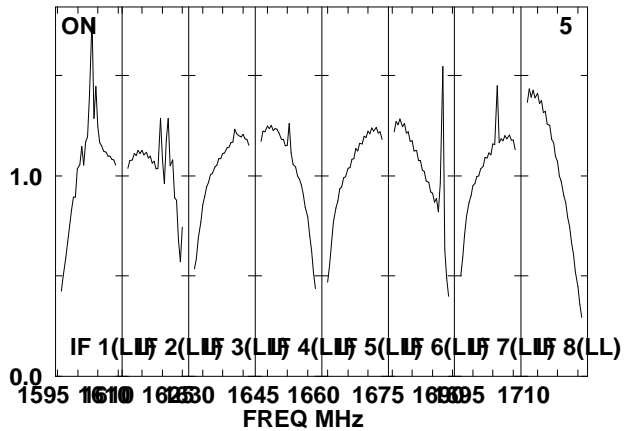
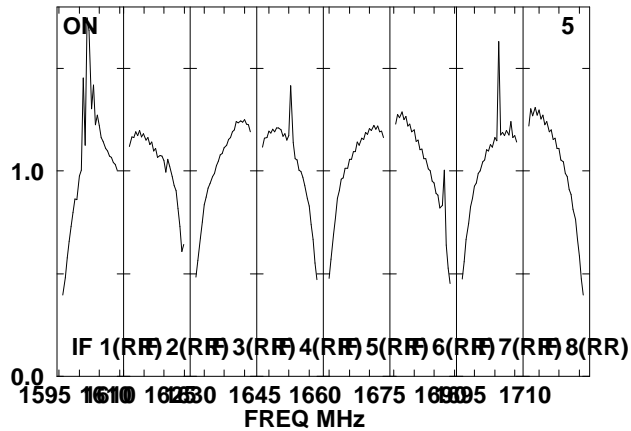
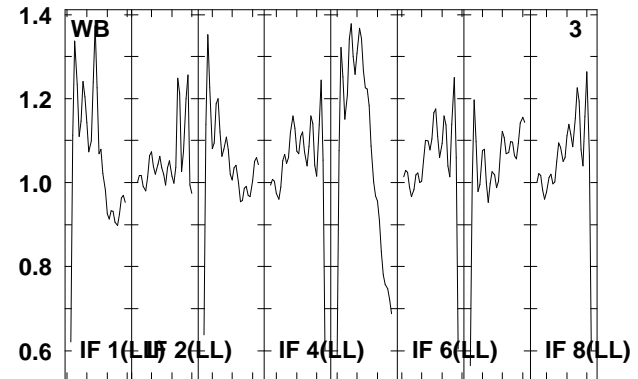
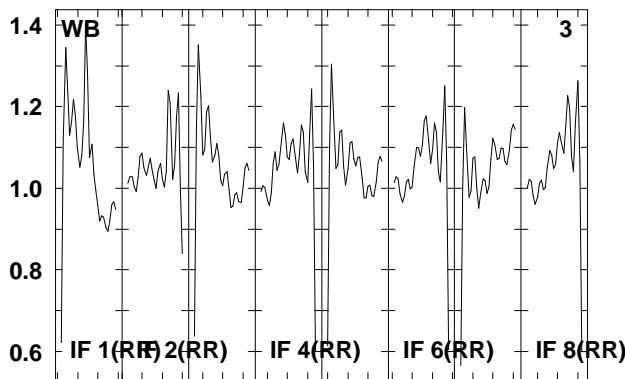
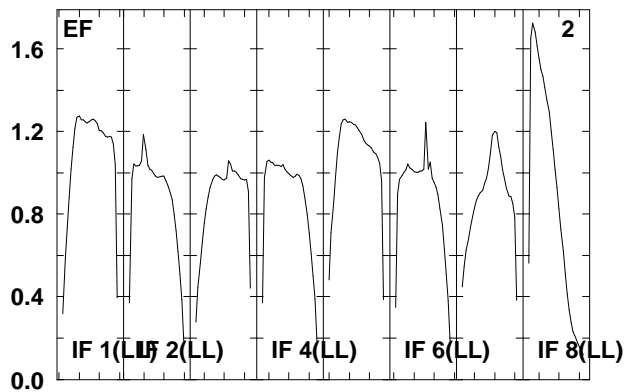
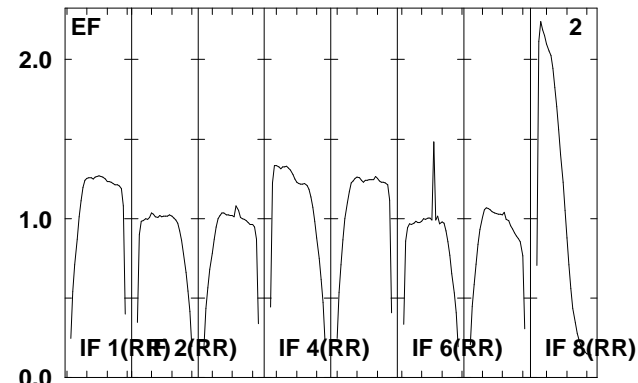
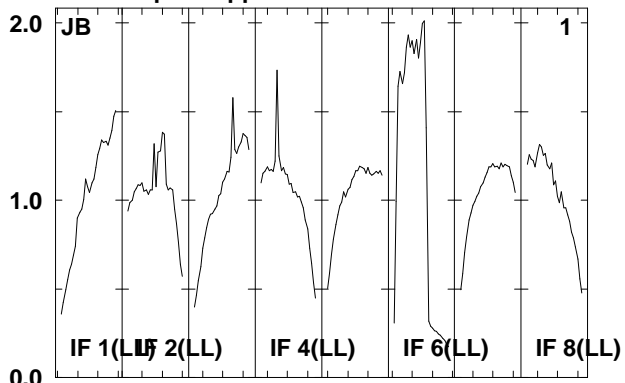
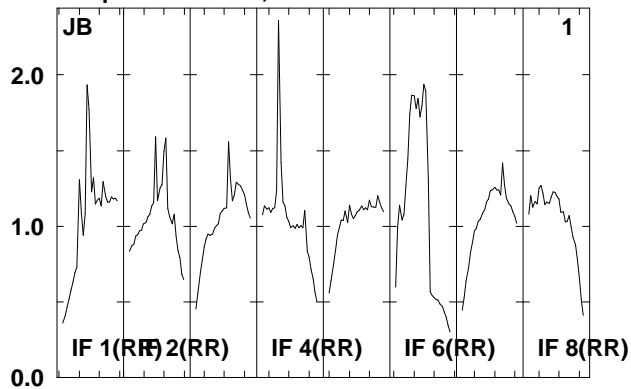

Lower frame: Real Jy
Total-power spectrum Antenna: *
Timerange: 00/13:24:35 to 00/13:25:59

Plot file version 56 created 06-JAN-2012 11:46:11

J1128+59 EP068D 5.UVDATA.1

Freq = 1.5950 GHz, Bw = 16.000 MH No calibration applied and no bandpass applied

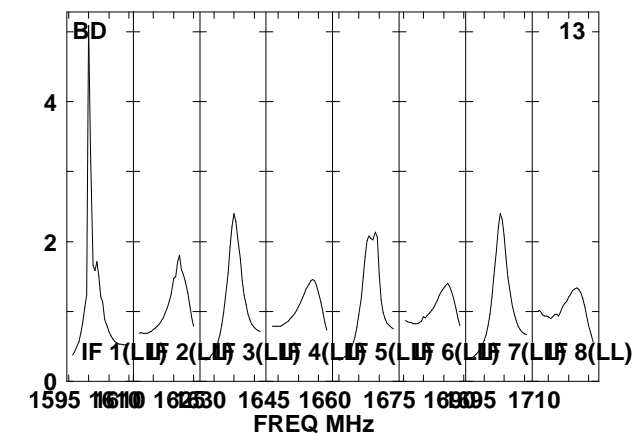
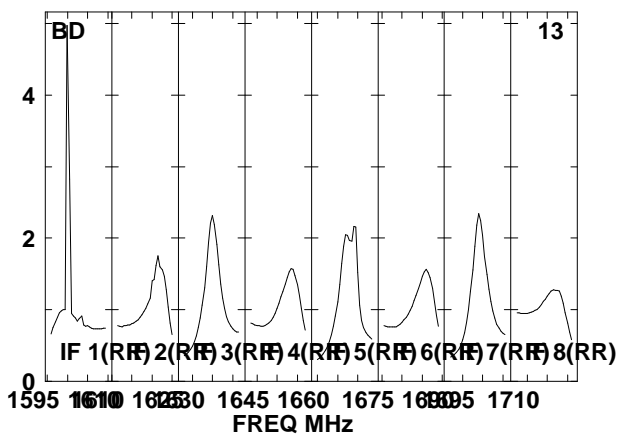
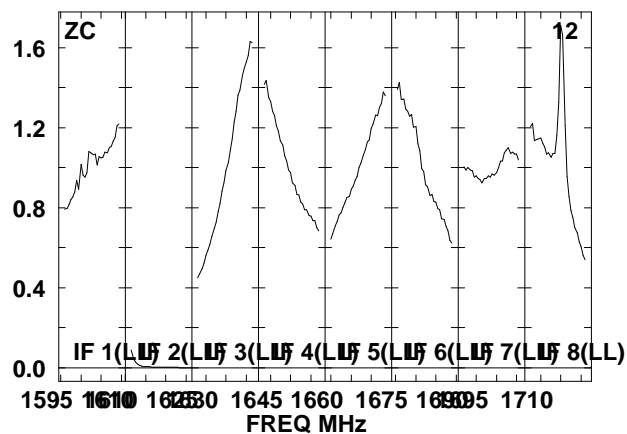
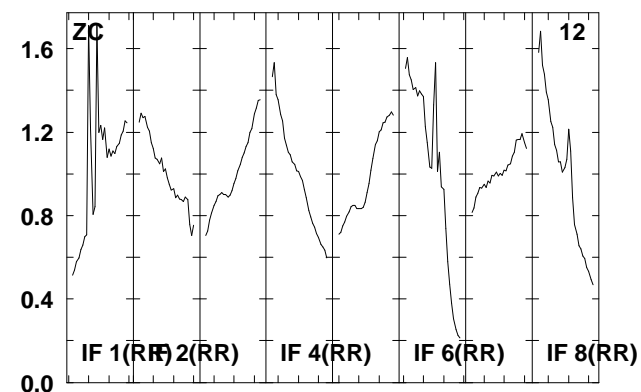
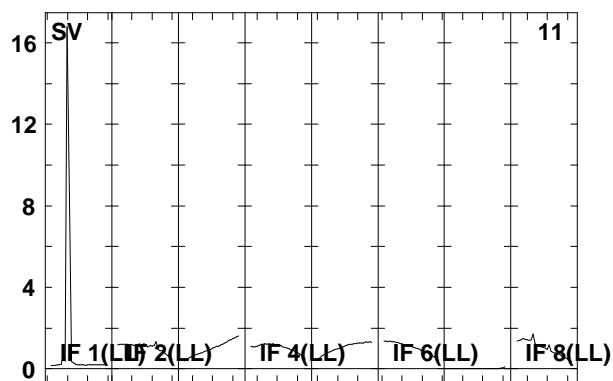
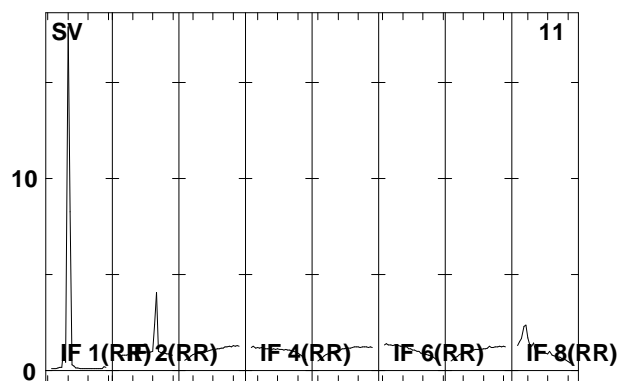
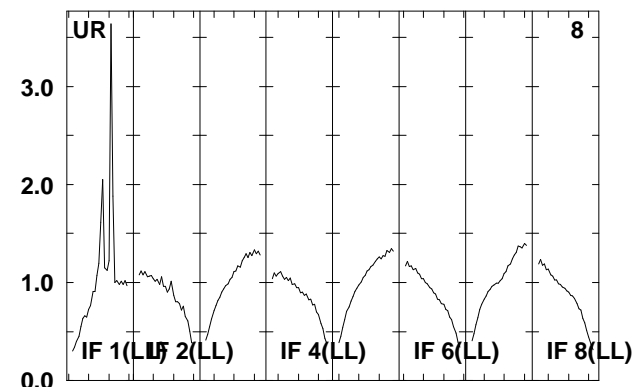
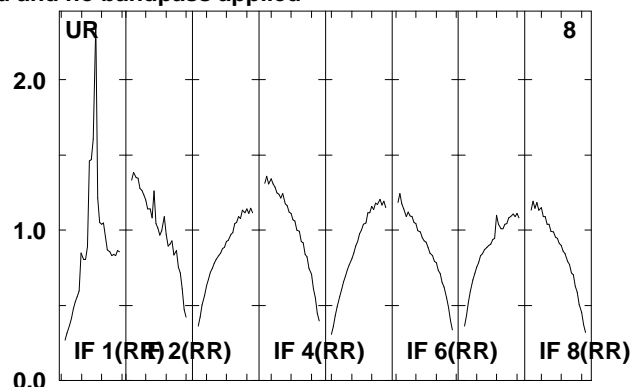
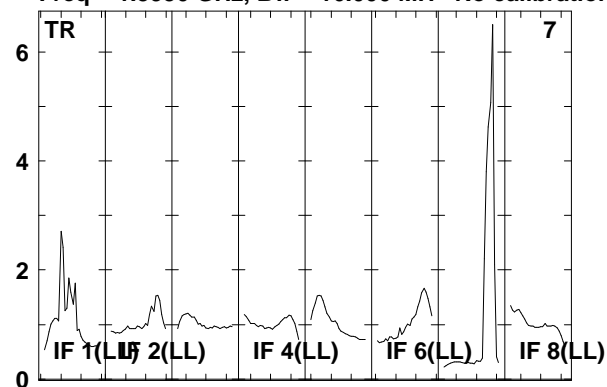

Lower frame: Real Jy
Total-power spectrum Antenna: *
Timerange: 00/13:24:35 to 00/13:25:59

Plot file version 57 created 06-JAN-2012 11:46:11

ARP299D EP068D 5.UVDATA.1

Freq = 1.5950 GHz, Bw = 16.000 MH No calibration applied and no bandpass applied

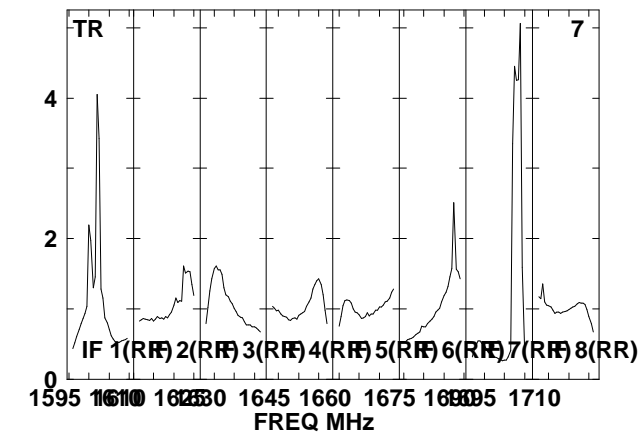
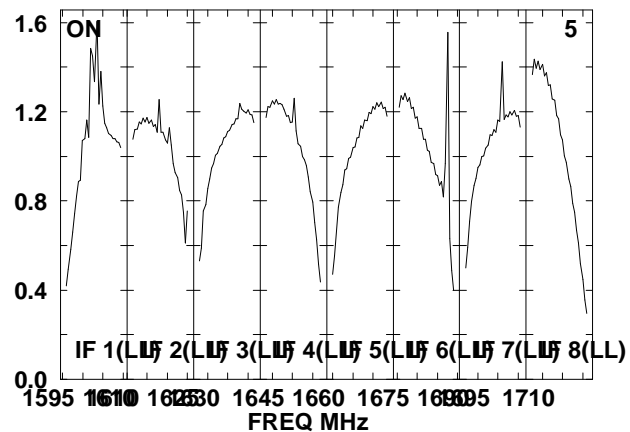
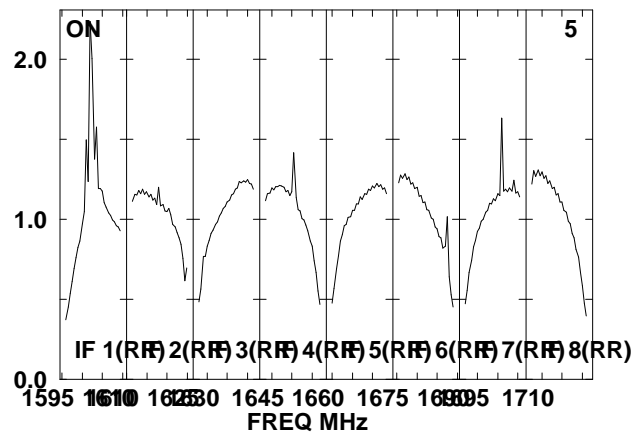
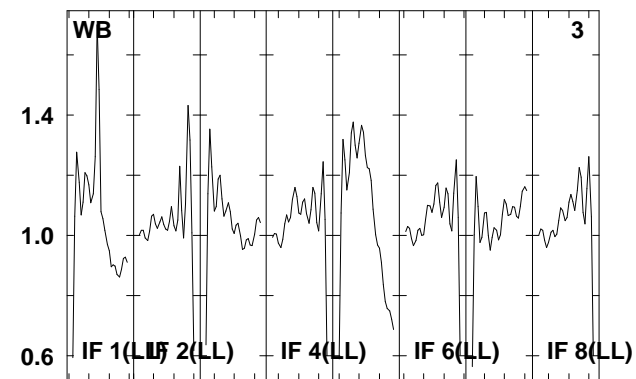
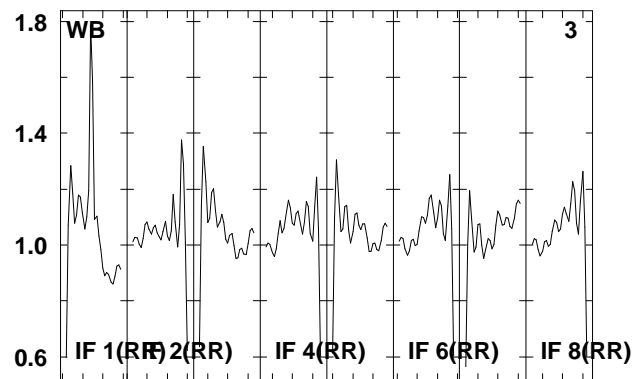
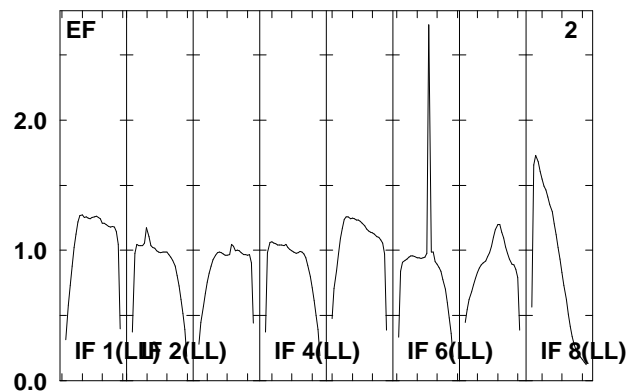
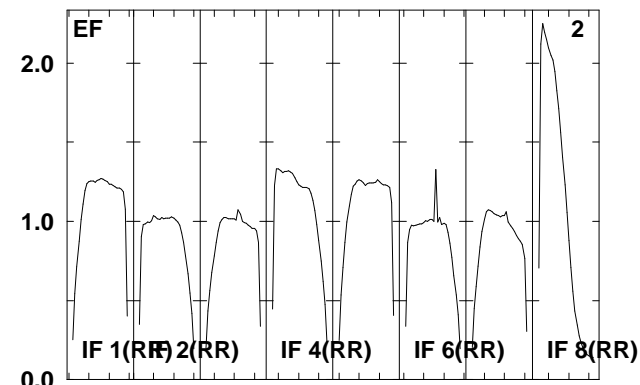
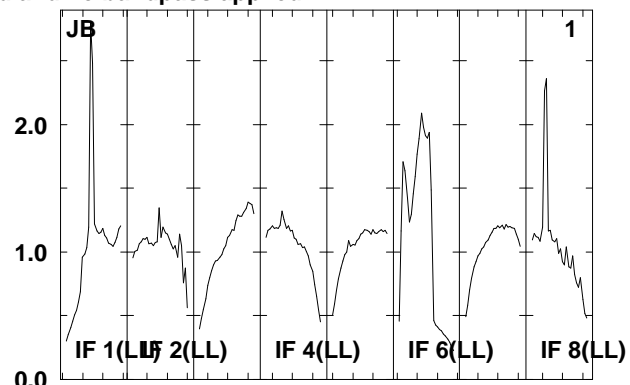
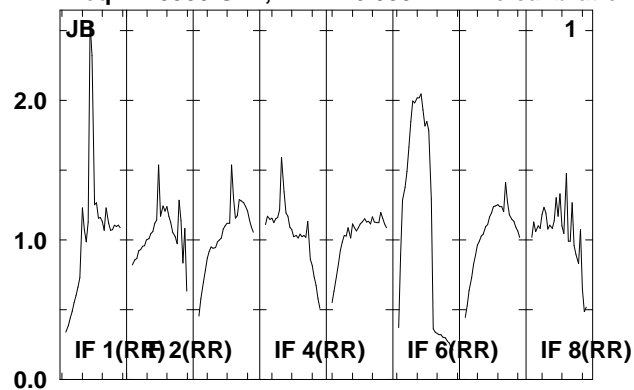

Lower frame: Real Jy

Total-power spectrum Antenna: *

Timerange: 00/13:26:05 to 00/13:29:29

Plot file version 58 created 06-JAN-2012 11:46:12

ARP299D EP068D 5.UVDATA.1

Freq = 1.5950 GHz, Bw = 16.000 MH No calibration applied and no bandpass applied

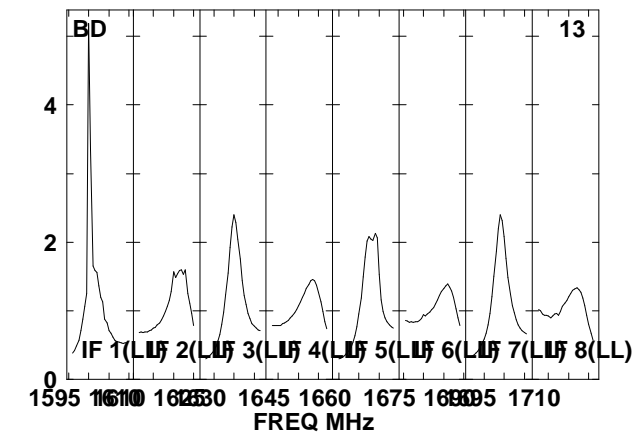
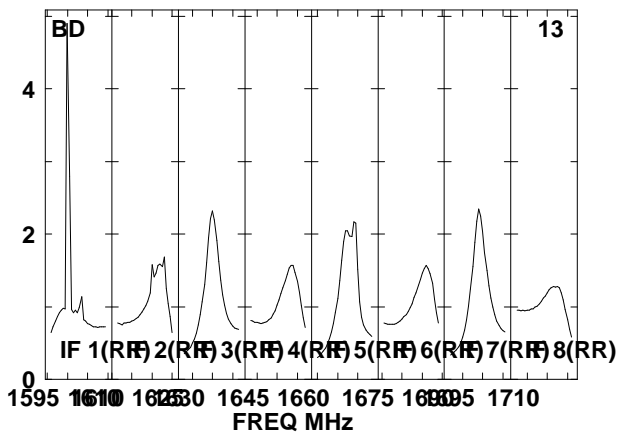
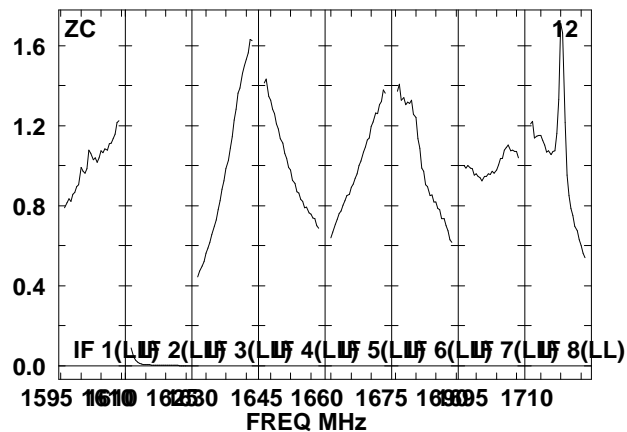
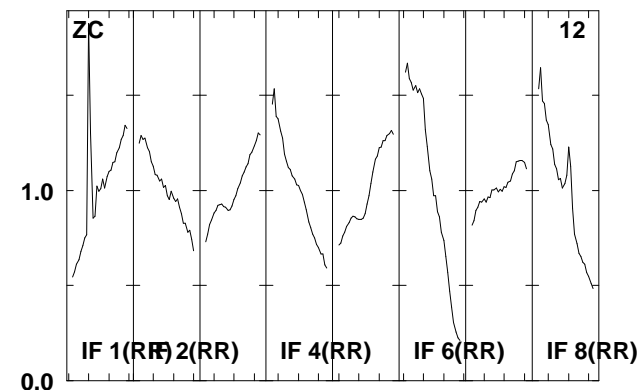
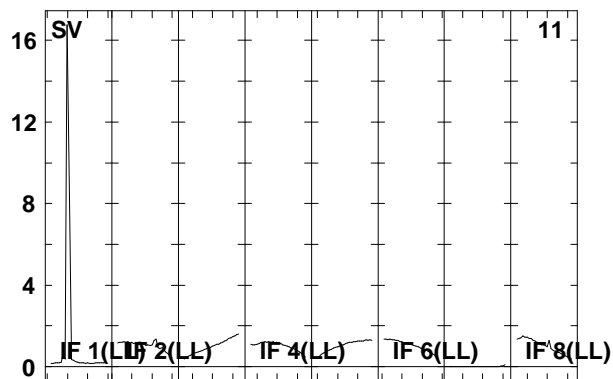
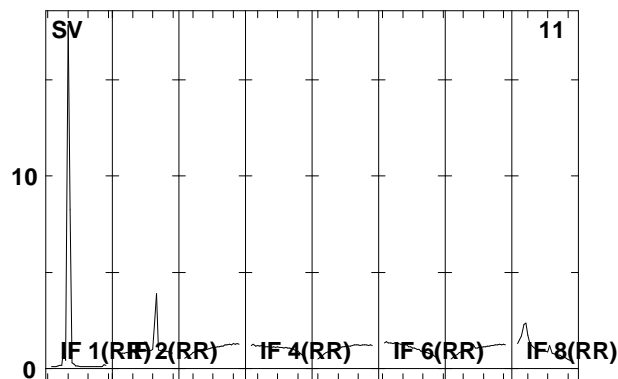
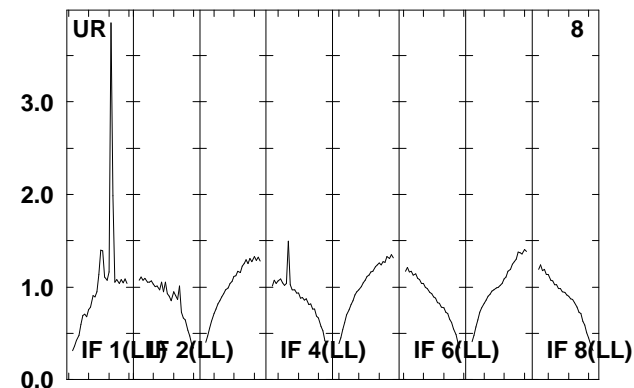
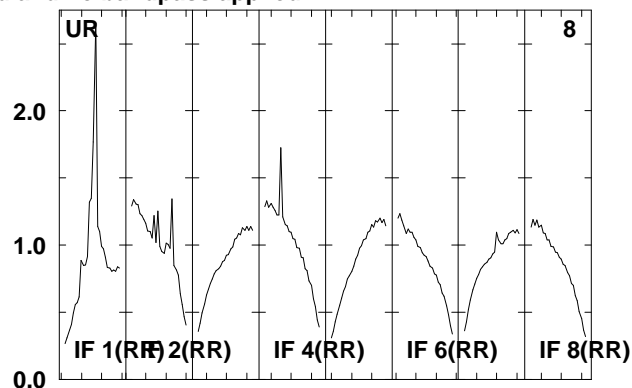
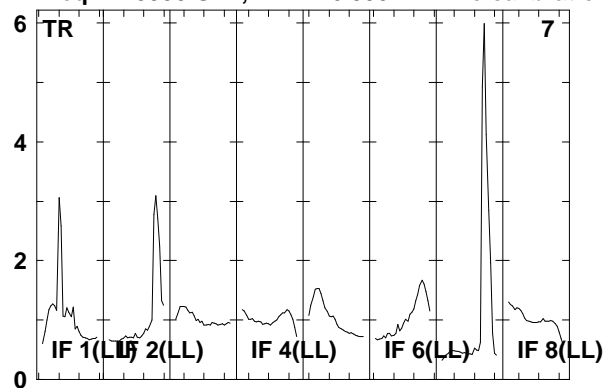

Lower frame: Real Jy
Total-power spectrum Antenna: *
Timerange: 00/13:26:05 to 00/13:29:29

Plot file version 59 created 06-JAN-2012 11:46:12

J1128+59 EP068D 5.UVDATA.1

Freq = 1.5950 GHz, Bw = 16.000 MH No calibration applied and no bandpass applied

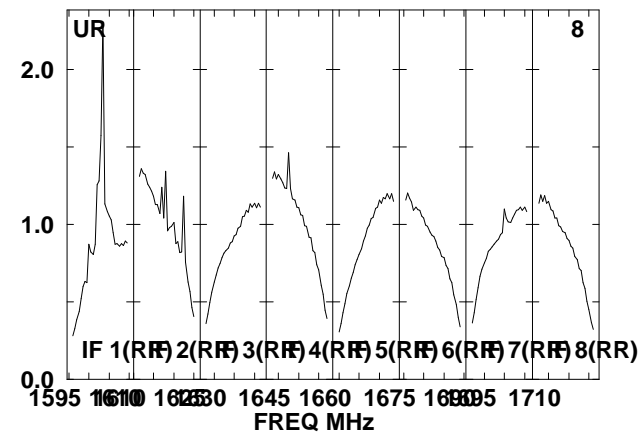
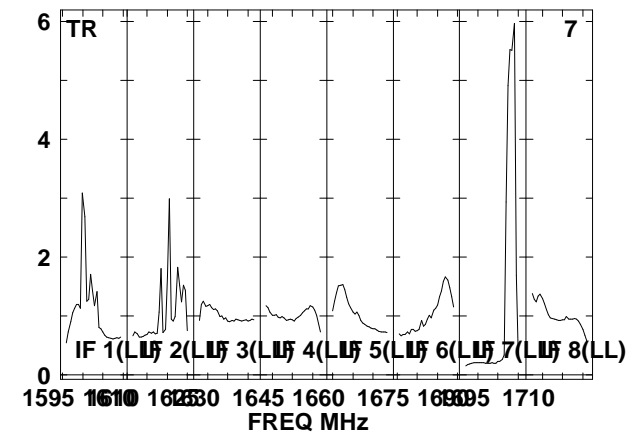
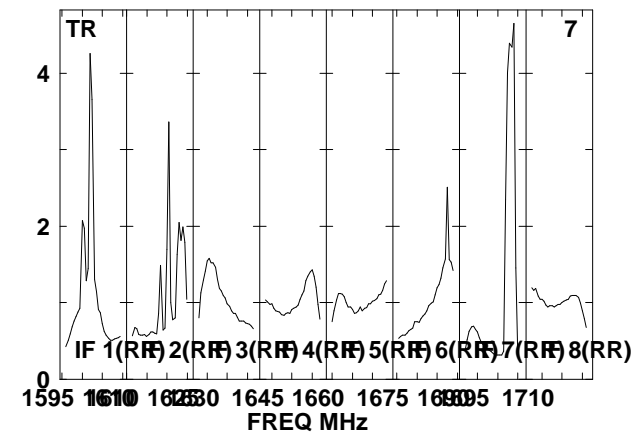
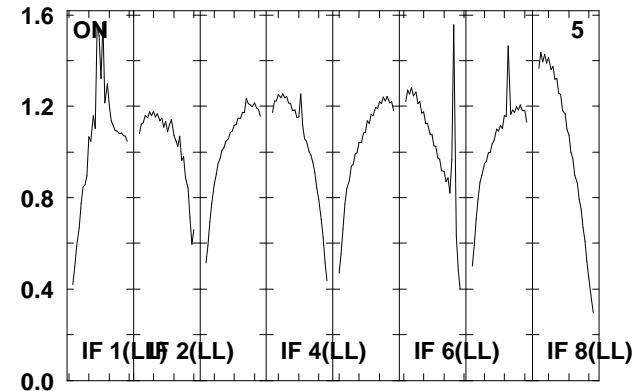
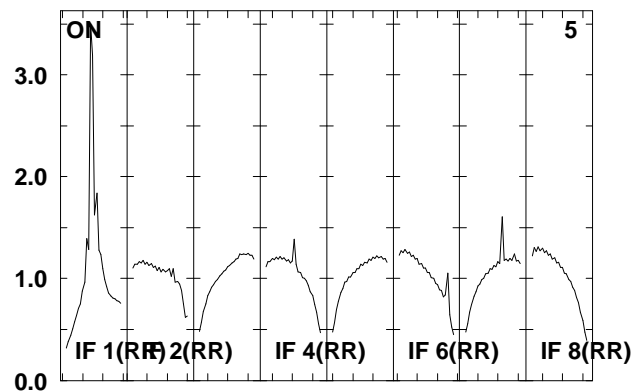
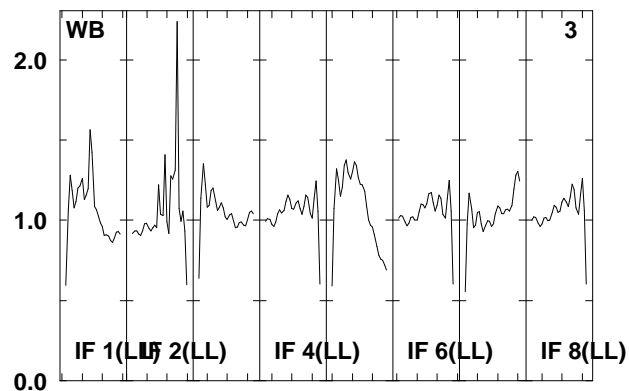
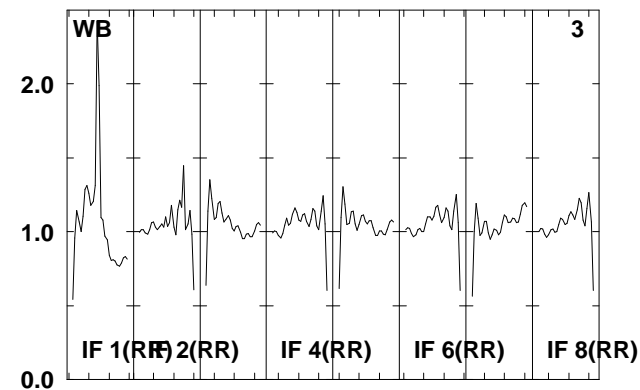
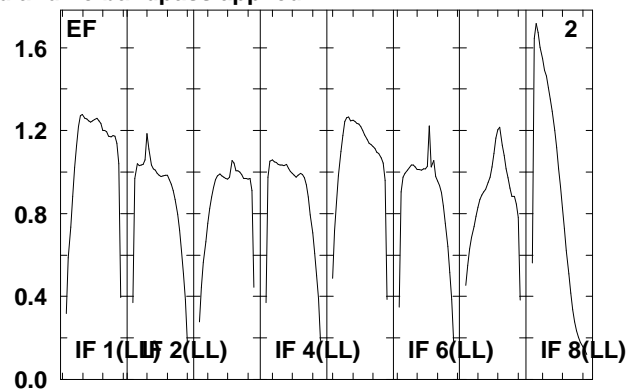
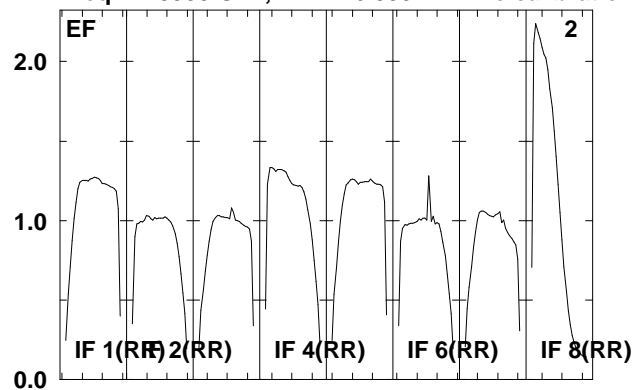

Lower frame: Real Jy
Total-power spectrum Antenna: *
Timerange: 00/13:30:31 to 00/13:31:59

Plot file version 60 created 06-JAN-2012 11:46:13

J1128+59 EP068D 5.UVDATA.1

Freq = 1.5950 GHz, Bw = 16.000 MH No calibration applied and no bandpass applied

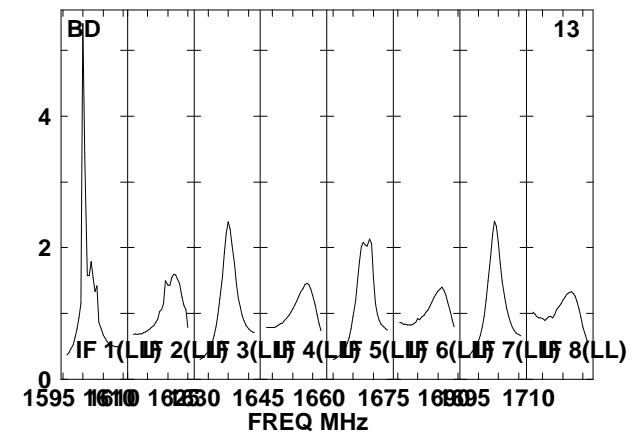
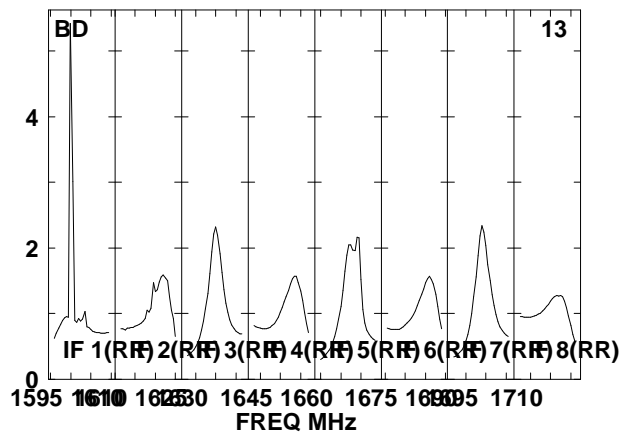
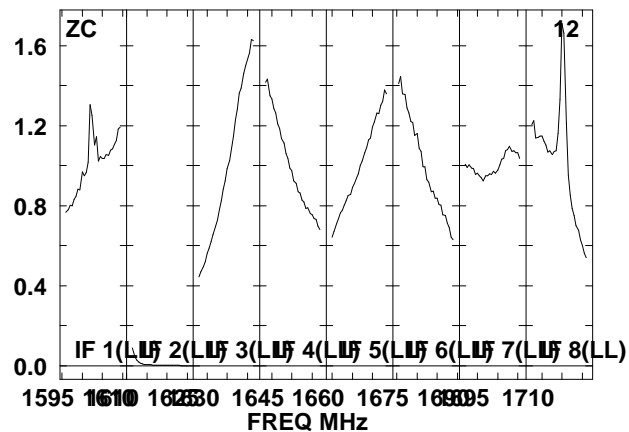
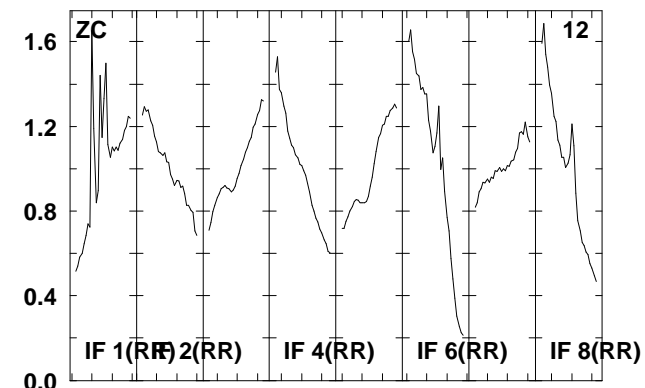
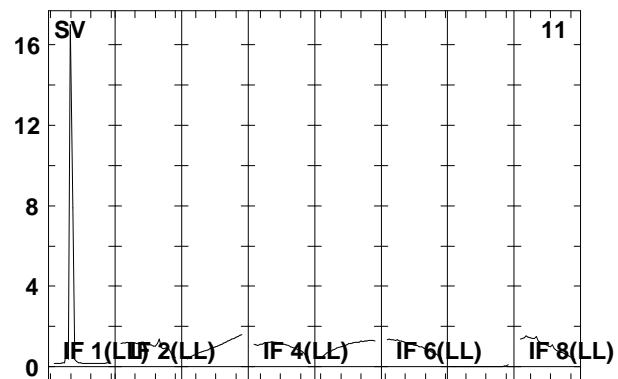
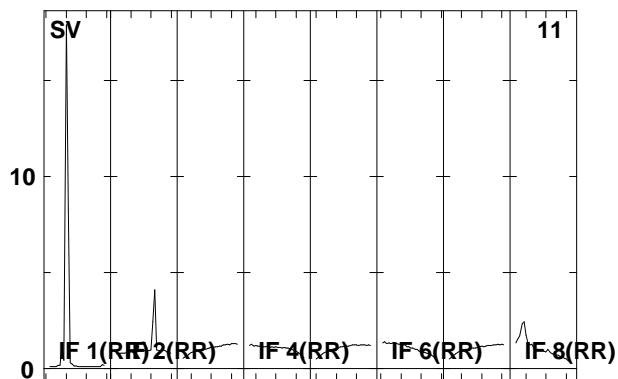
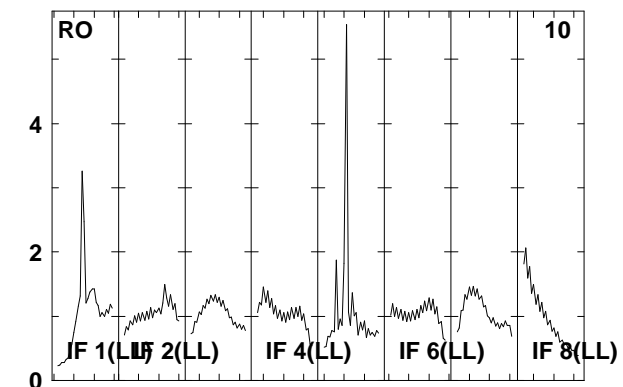
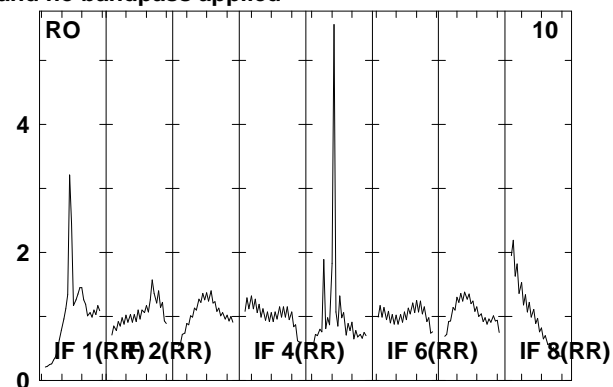
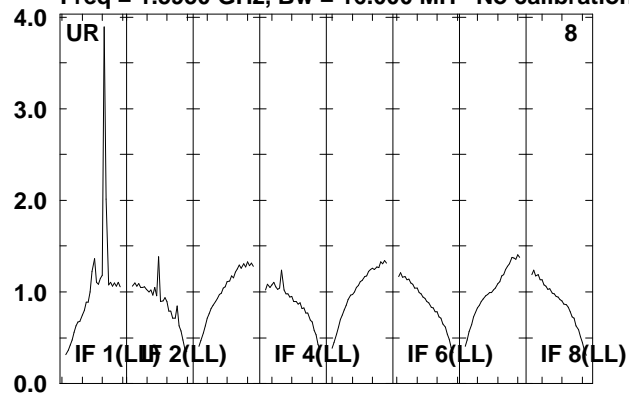

Lower frame: Real Jy
Total-power spectrum Antenna: *
Timerange: 00/13:30:31 to 00/13:31:59

Plot file version 61 created 06-JAN-2012 11:46:13

ARP299D EP068D 5.UVDATA.1

Freq = 1.5950 GHz, Bw = 16.000 MH No calibration applied and no bandpass applied

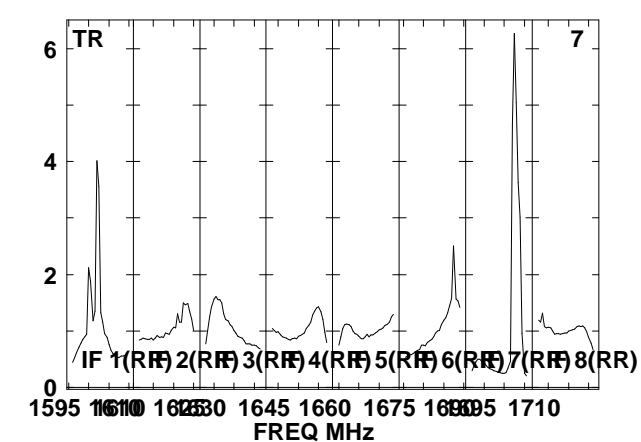
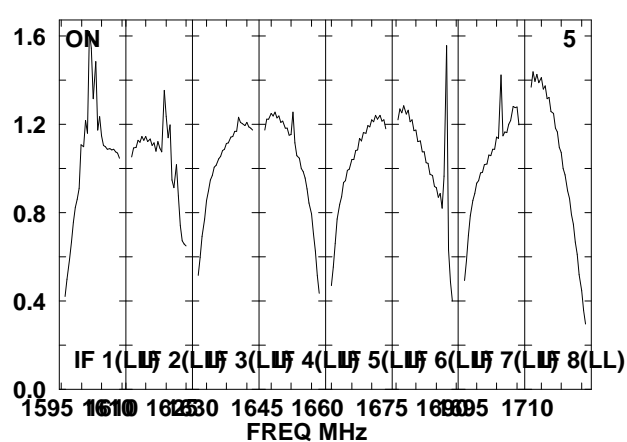
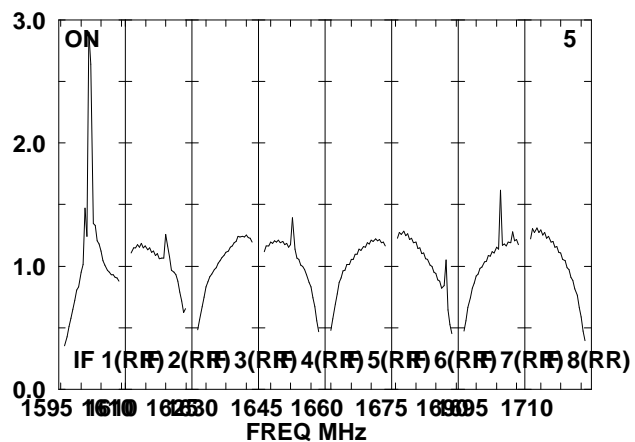
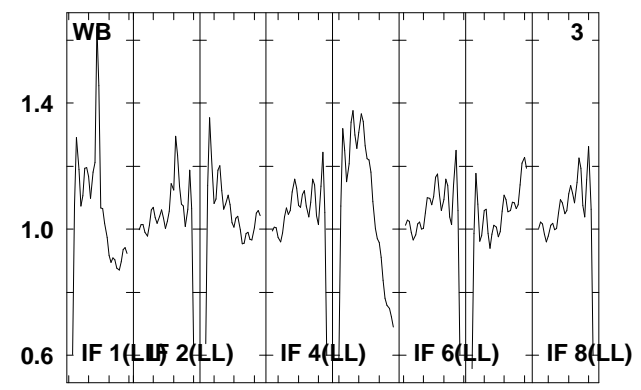
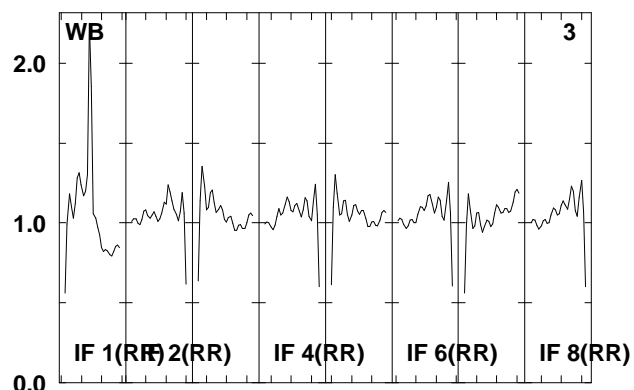
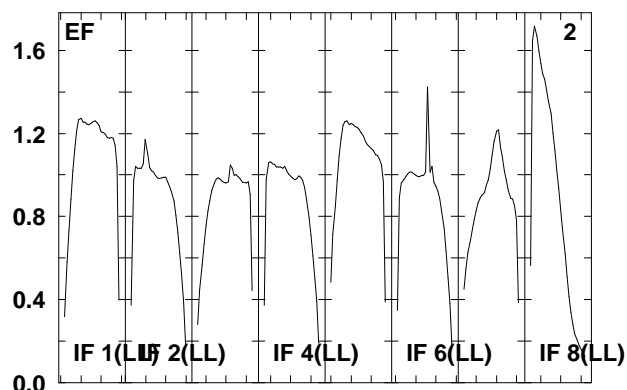
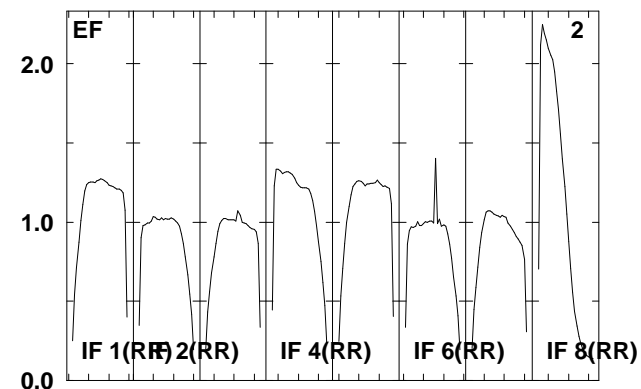
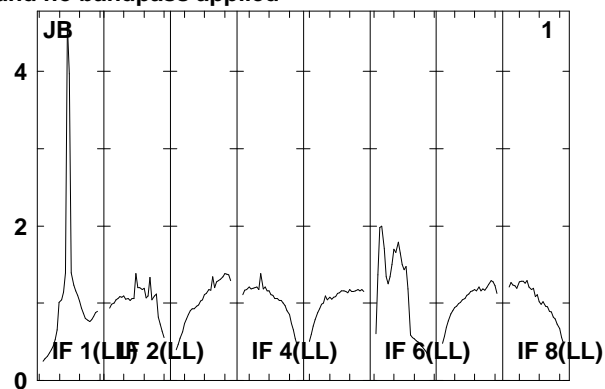
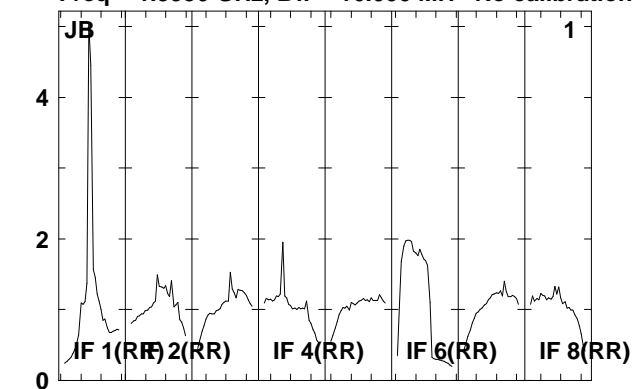

Lower frame: Real Jy
Total-power spectrum Antenna: *
Timerange: 00/13:32:01 to 00/13:35:29

Plot file version 62 created 06-JAN-2012 11:46:14

ARP299D EP068D 5.UVDATA.1

Freq = 1.5950 GHz, Bw = 16.000 MH No calibration applied and no bandpass applied

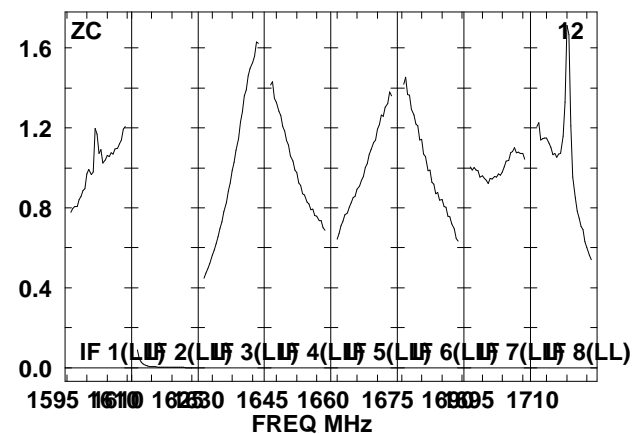
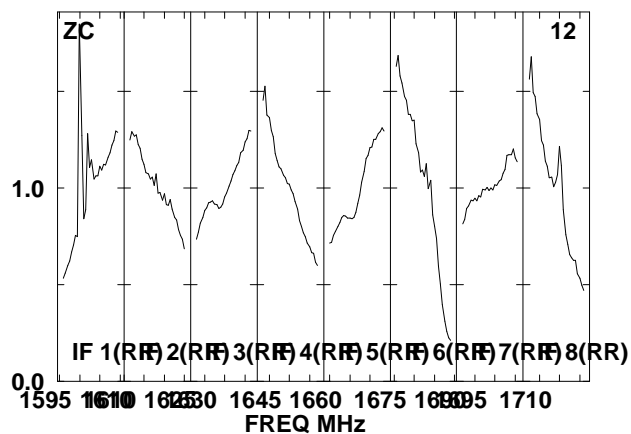
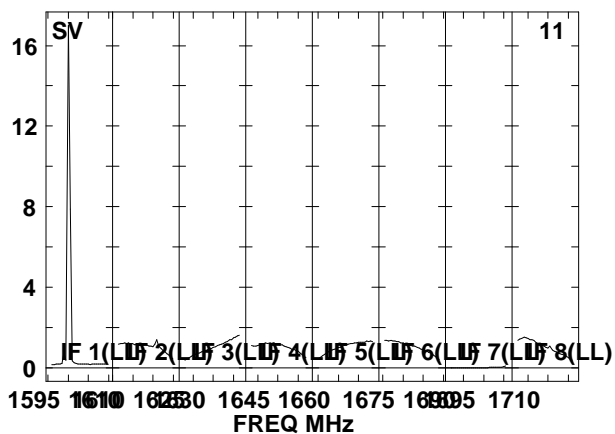
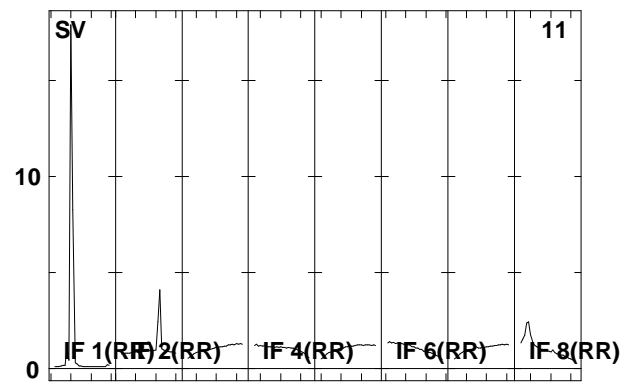
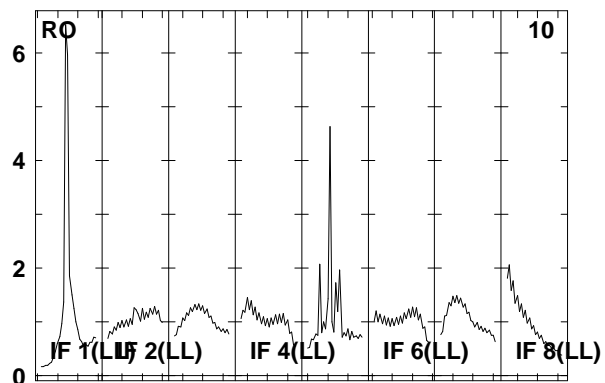
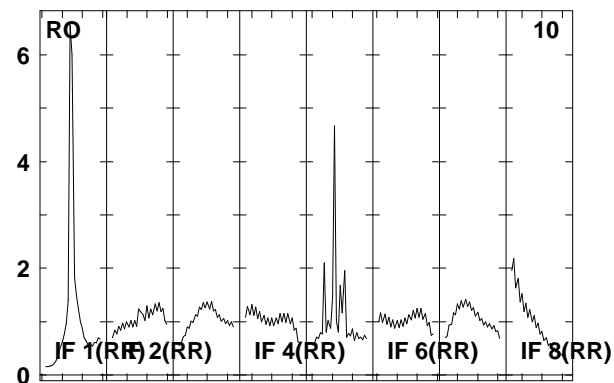
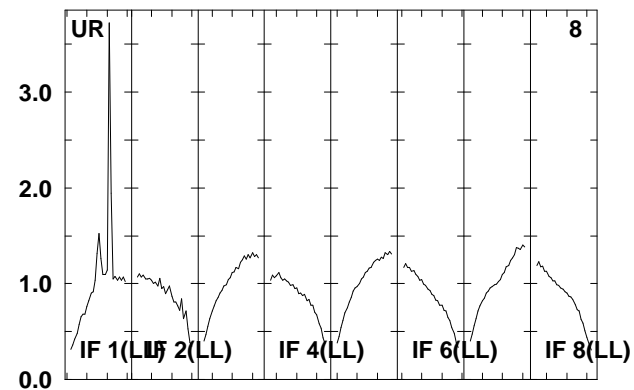
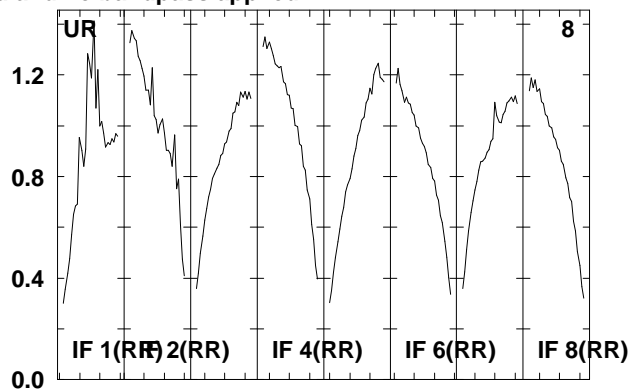
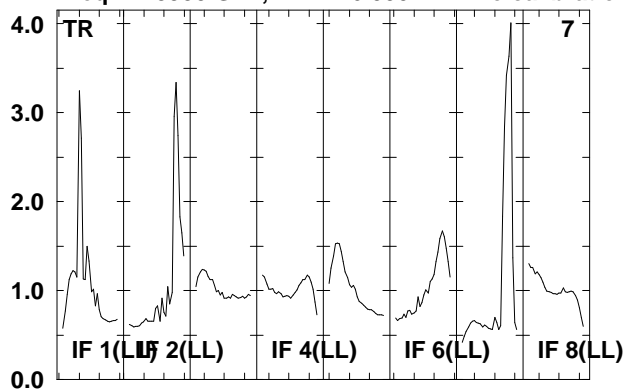

Lower frame: Real Jy
Total-power spectrum Antenna: *
Timerange: 00/13:32:01 to 00/13:35:29

Plot file version 63 created 06-JAN-2012 11:46:14

ARP299D EP068D 5.UVDATA.1

Freq = 1.5950 GHz, Bw = 16.000 MH No calibration applied and no bandpass applied

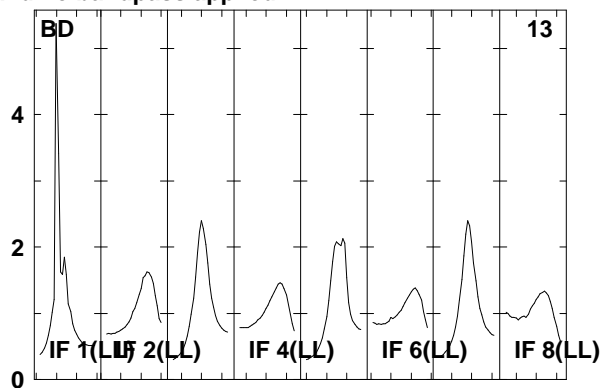
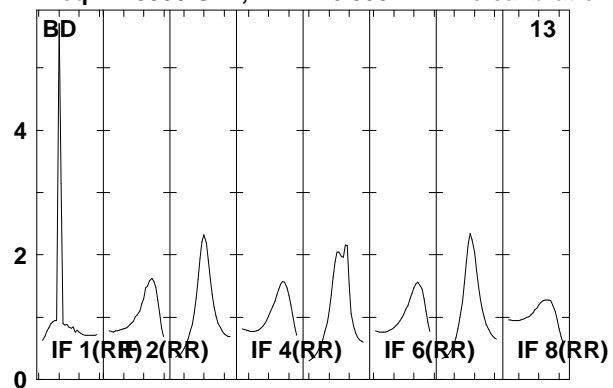

Lower frame: Real Jy
Total-power spectrum Antenna: *
Timerange: 00/13:32:01 to 00/13:35:29

Plot file version 64 created 06-JAN-2012 11:46:14

J1128+59 EP068D 5.UVDATA.1

Freq = 1.5950 GHz, Bw = 16.000 MH No calibration applied and no bandpass applied

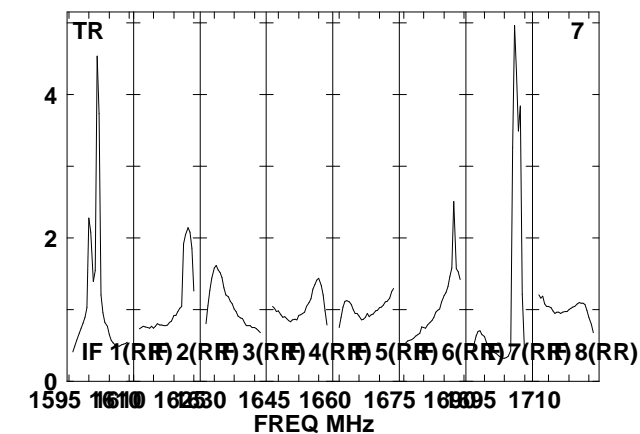
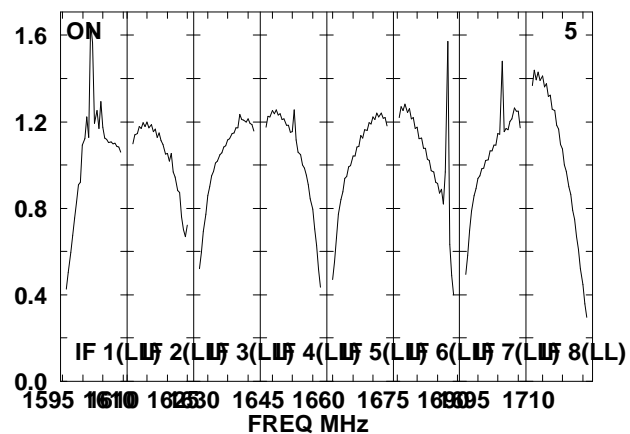
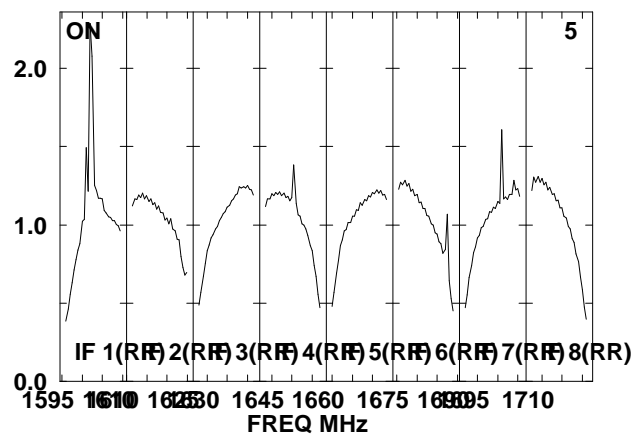
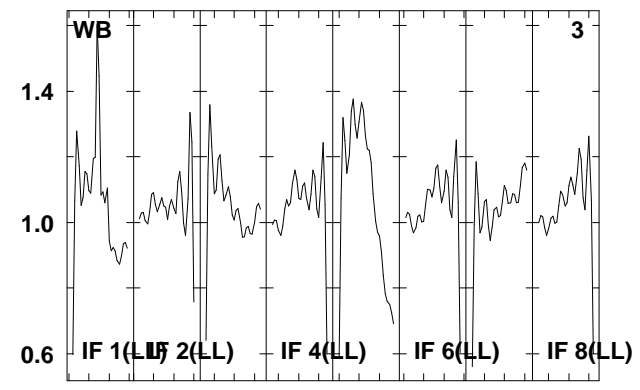
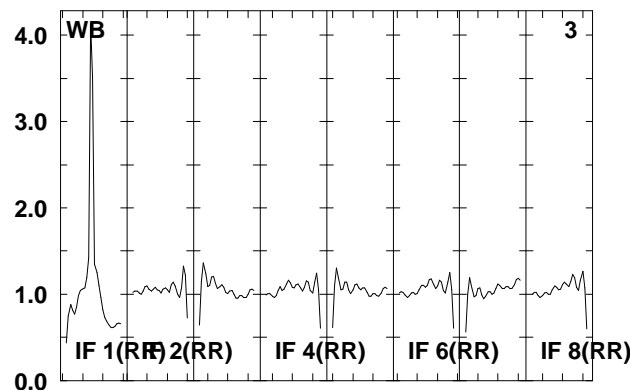
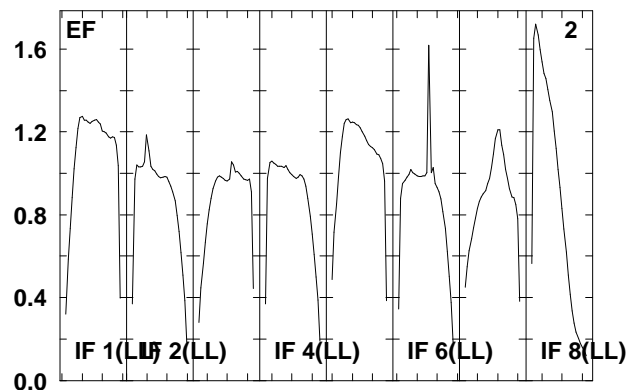
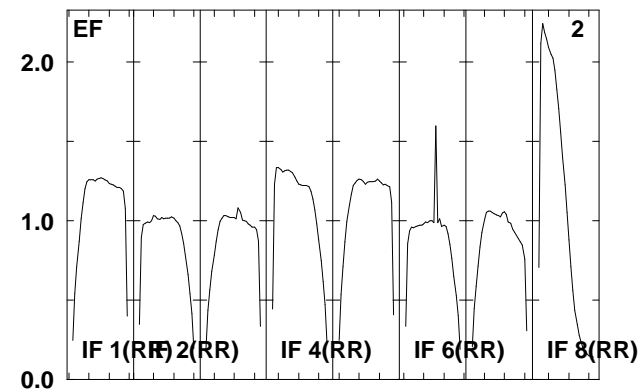
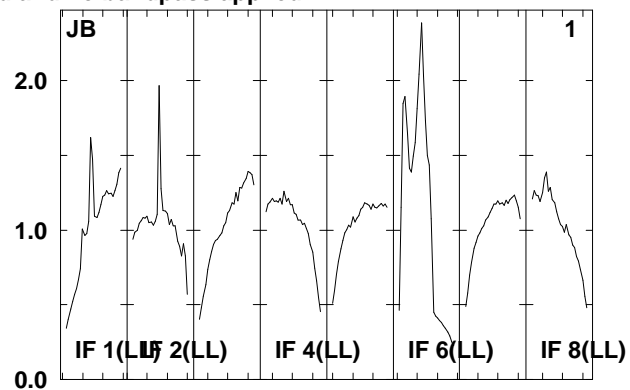
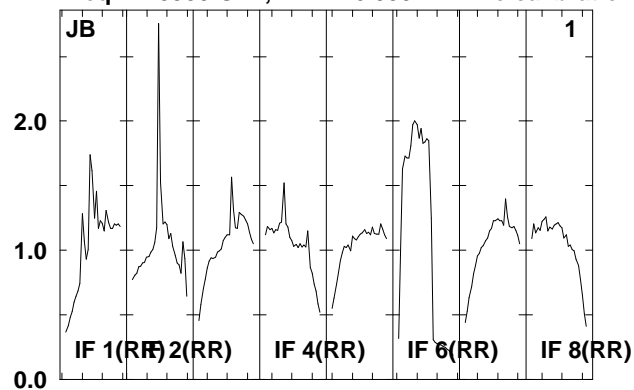

Lower frame: Real Jy
Total-power spectrum Antenna: *
Timerange: 00/13:35:35 to 00/13:36:59

Plot file version 65 created 06-JAN-2012 11:46:15

J1128+59 EP068D 5.UVDATA.1

Freq = 1.5950 GHz, Bw = 16.000 MH No calibration applied and no bandpass applied

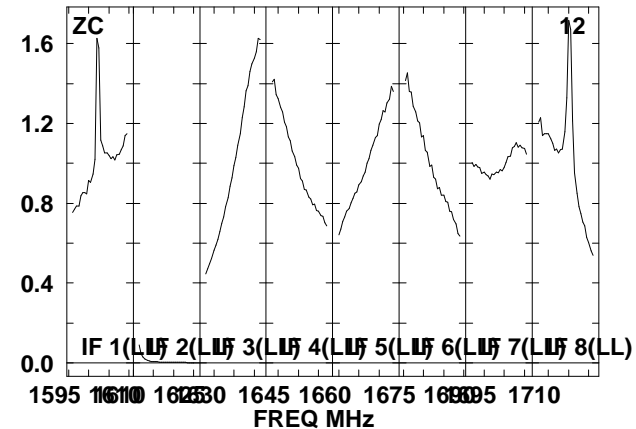
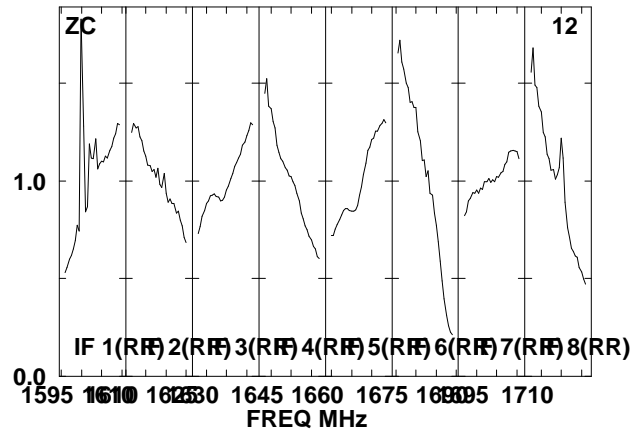
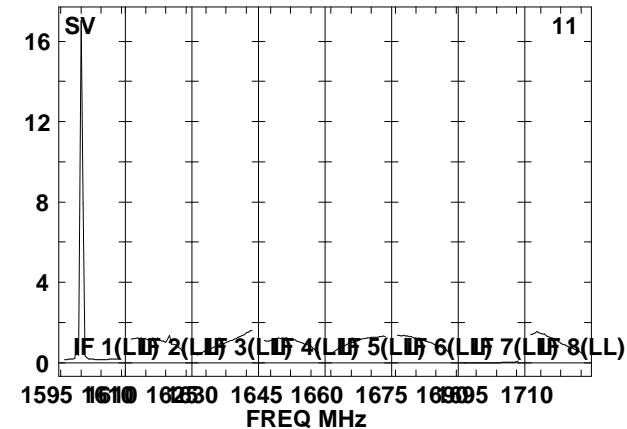
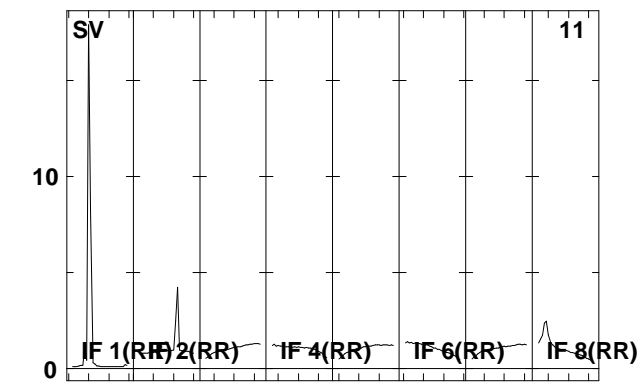
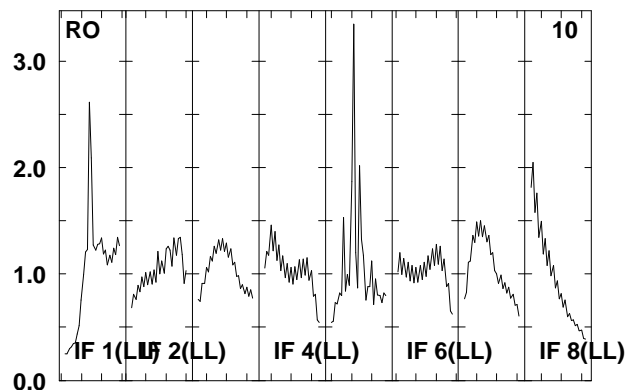
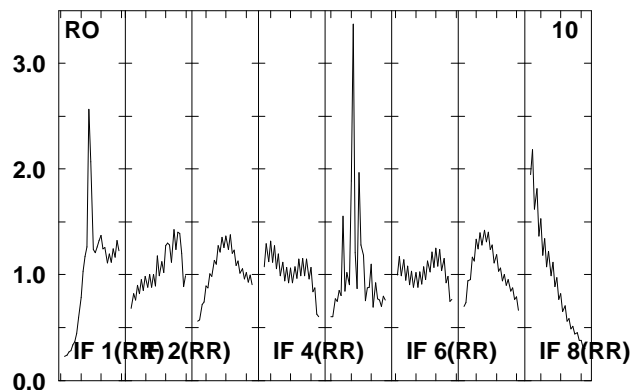
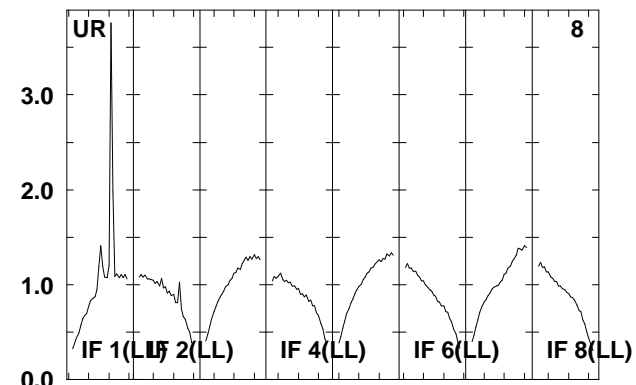
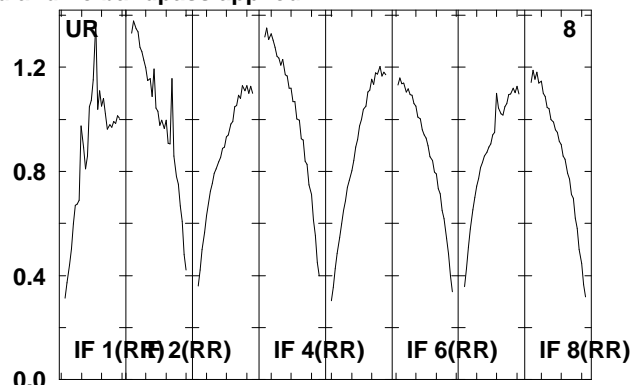
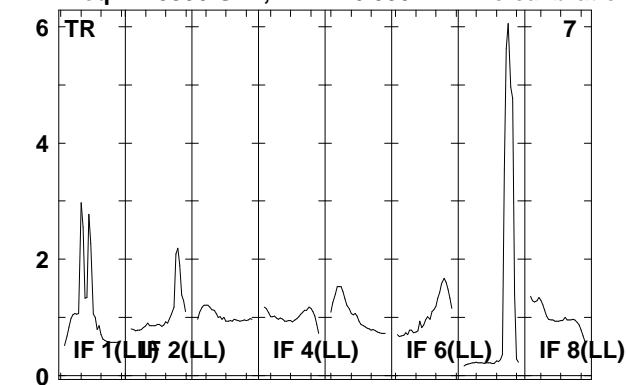

Lower frame: Real Jy
Total-power spectrum Antenna: *
Timerange: 00/13:35:35 to 00/13:36:59

Plot file version 66 created 06-JAN-2012 11:46:15

J1128+59 EP068D 5.UVDATA.1

Freq = 1.5950 GHz, Bw = 16.000 MH No calibration applied and no bandpass applied

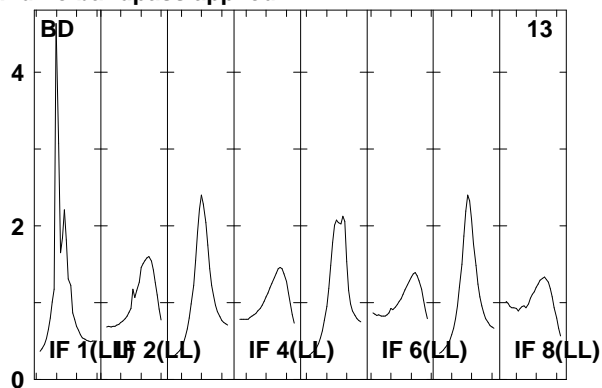
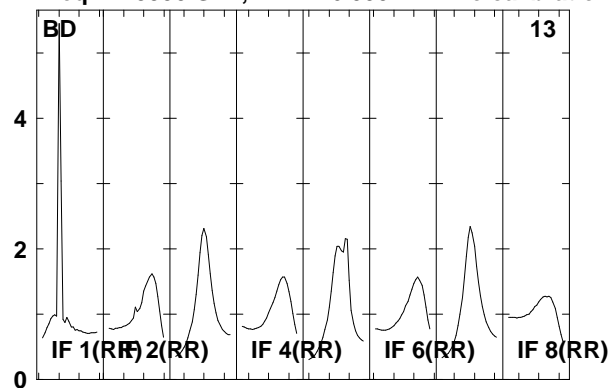

Lower frame: Real Jy
Total-power spectrum Antenna: *
Timerange: 00/13:35:35 to 00/13:36:59

Plot file version 67 created 06-JAN-2012 11:46:15
 ARP299D EP068D 5.UVDATA.1
 Freq = 1.5950 GHz, Bw = 16.000 MH No calibration applied and no bandpass applied

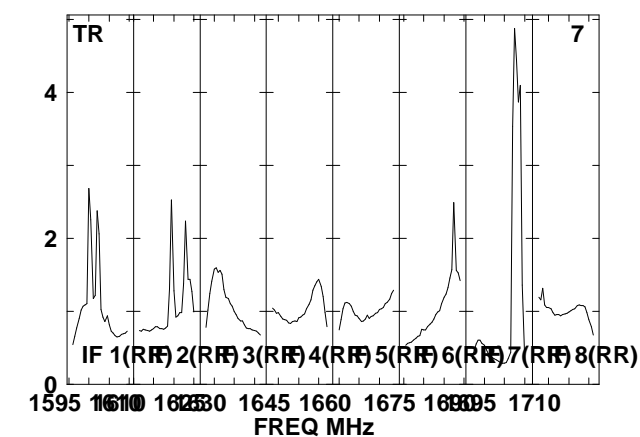
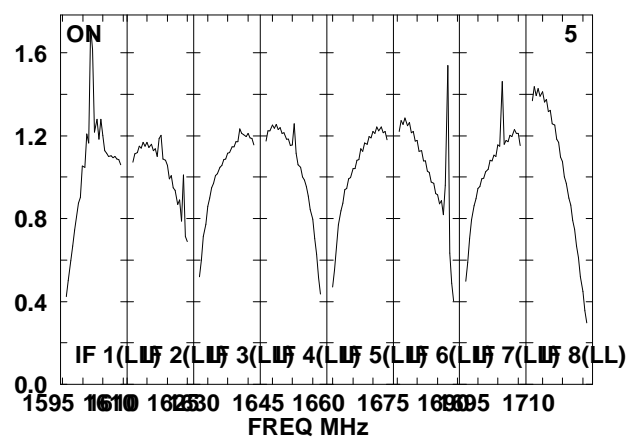
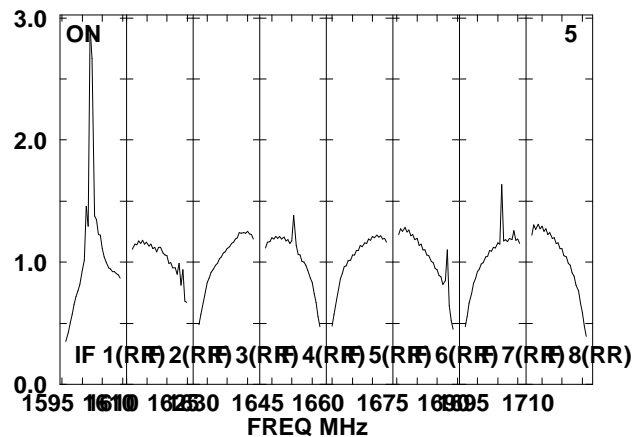
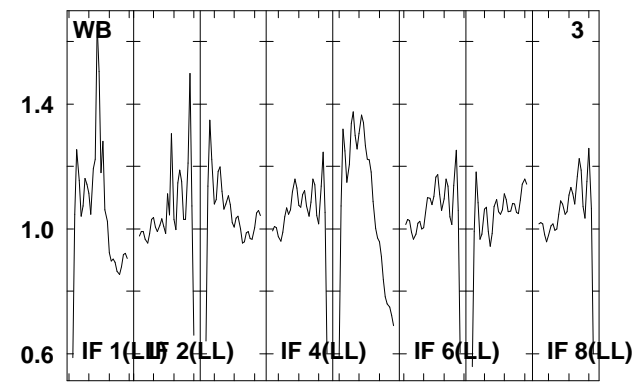
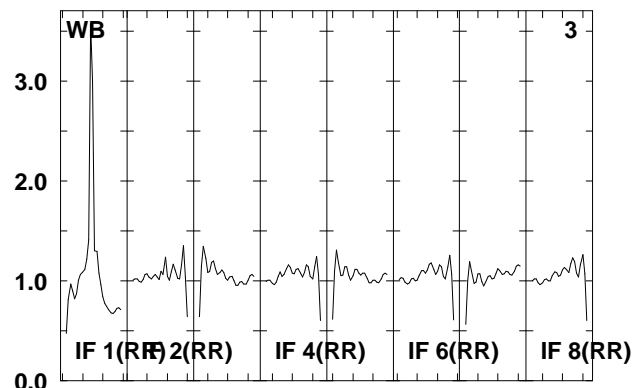
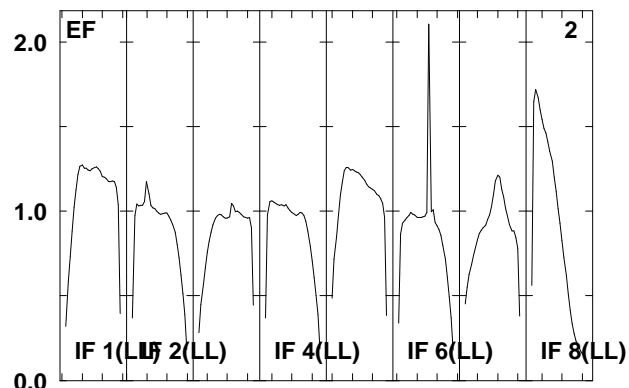
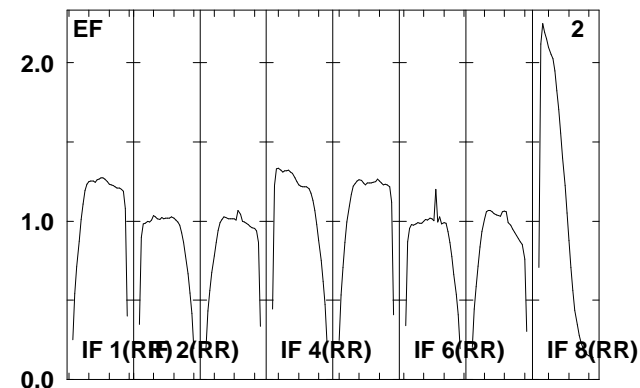
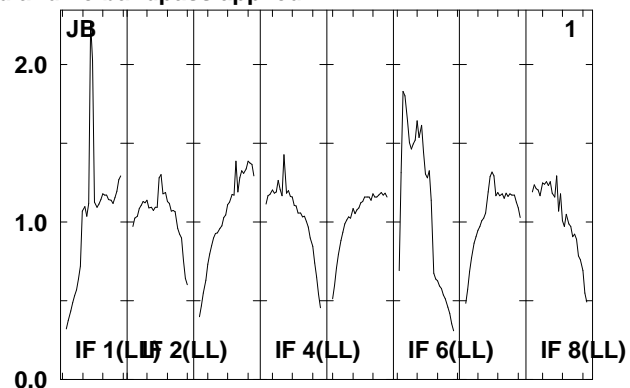
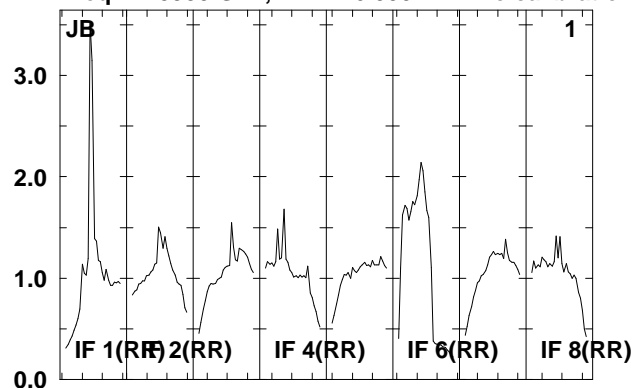

Lower frame: Real Jy
 Total-power spectrum Antenna: *
 Timerange: 00/13:37:05 to 00/13:40:29

Plot file version 68 created 06-JAN-2012 11:46:16

ARP299D EP068D 5.UVDATA.1

Freq = 1.5950 GHz, Bw = 16.000 MH No calibration applied and no bandpass applied

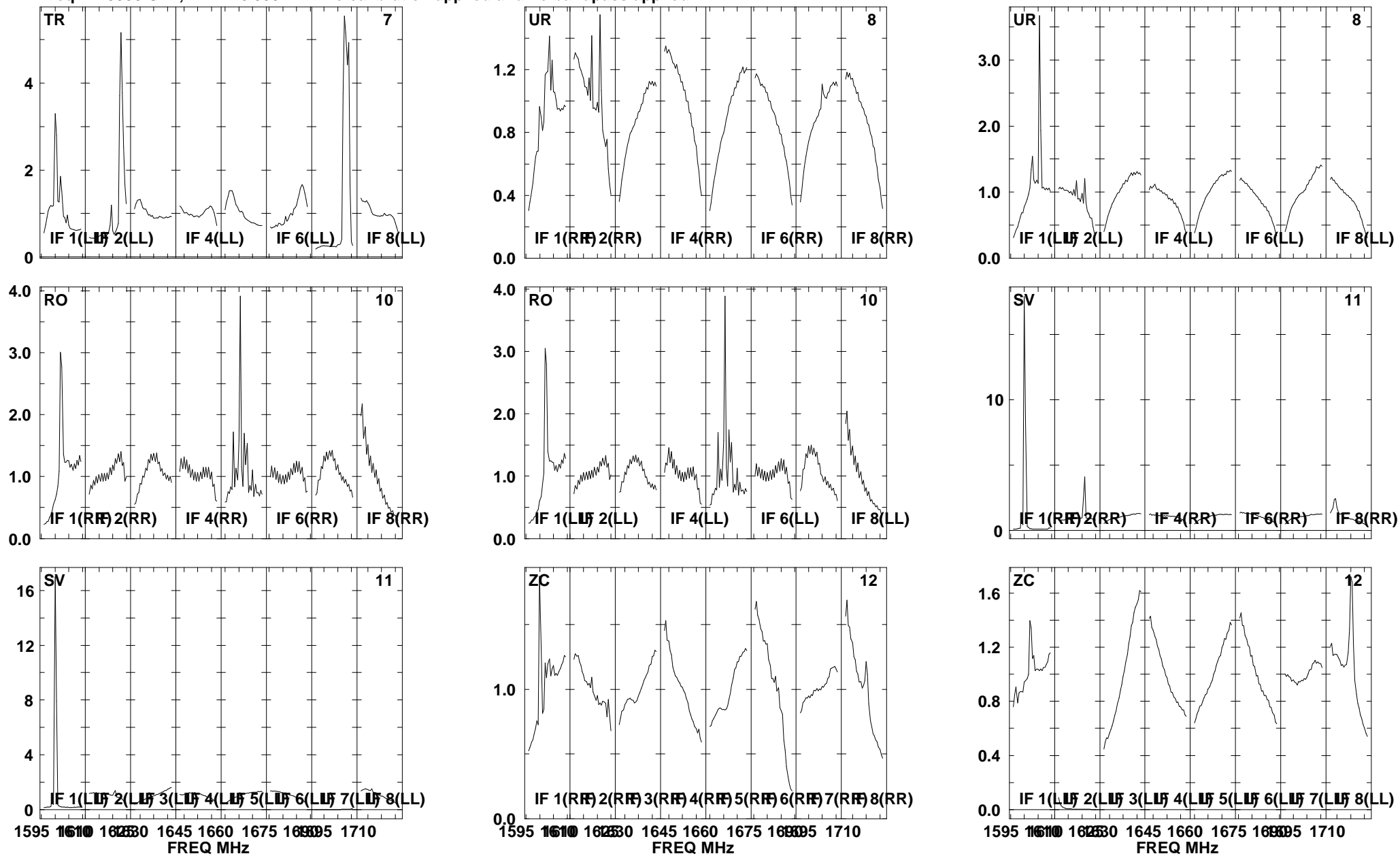

Lower frame: Real Jy
Total-power spectrum Antenna: *
Timerange: 00/13:37:05 to 00/13:40:29

Plot file version 69 created 06-JAN-2012 11:46:16
ARP299D EP068D 5.UVDATA.1
Freq = 1.5950 GHz, Bw = 16.000 MH No calibration applied and no bandpass applied

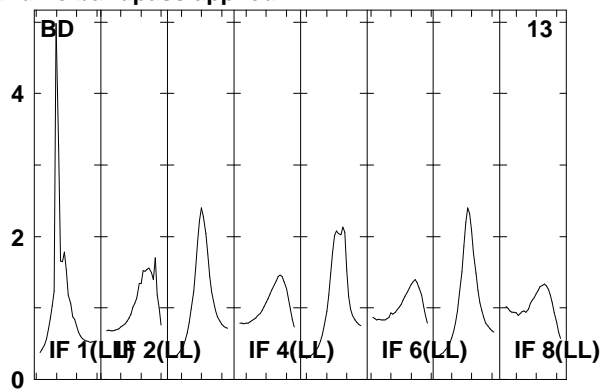
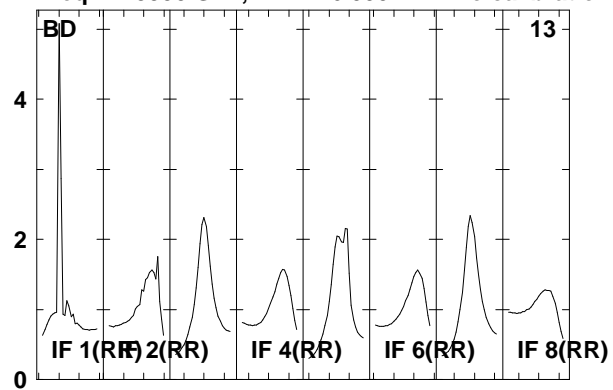

Lower frame: Real Jy
Total-power spectrum Antenna: *
Timerange: 00/13:37:05 to 00/13:40:29

Plot file version 70 created 06-JAN-2012 11:46:17

J1128+59 EP068D 5.UVDATA.1

Freq = 1.5950 GHz, Bw = 16.000 MH No calibration applied and no bandpass applied

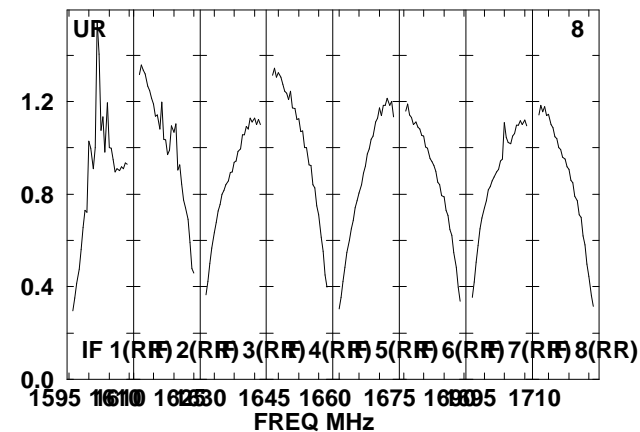
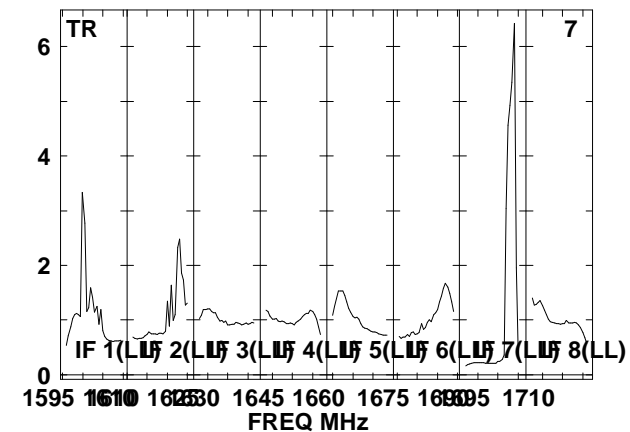
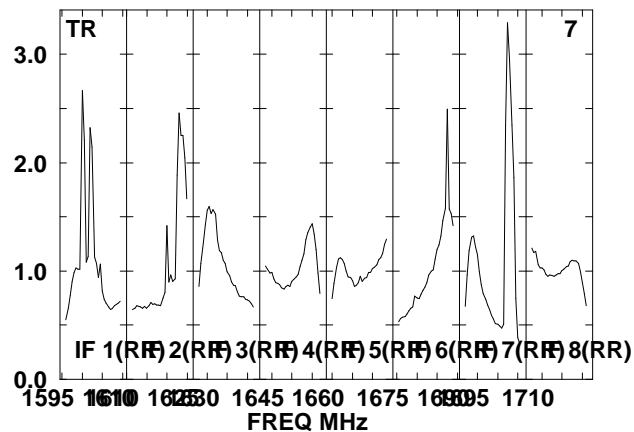
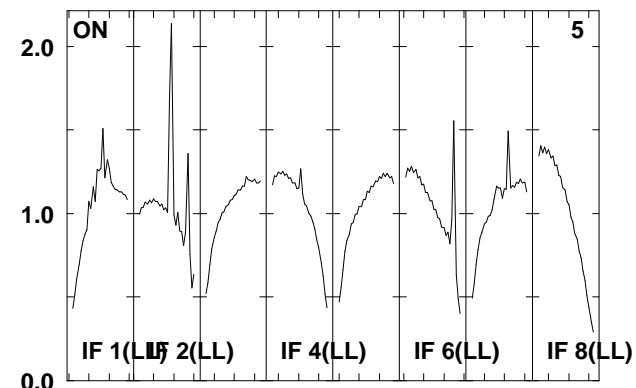
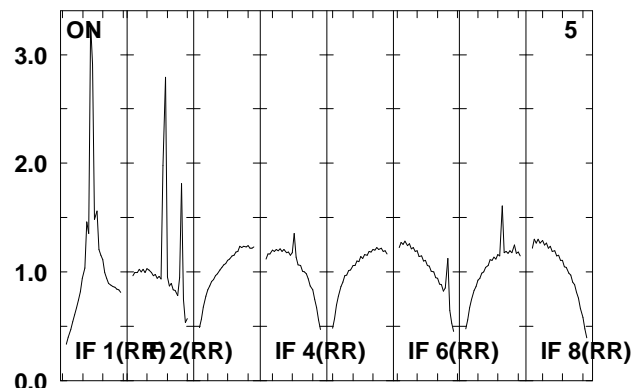
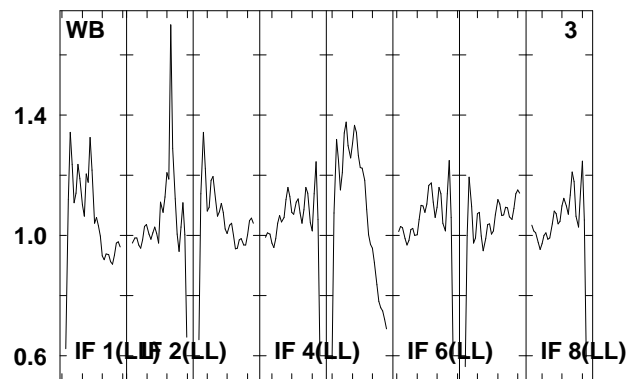
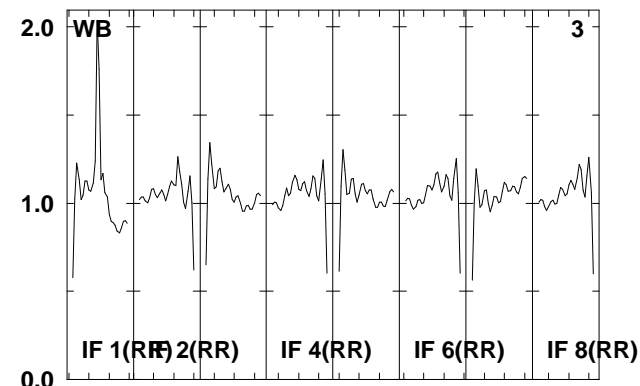
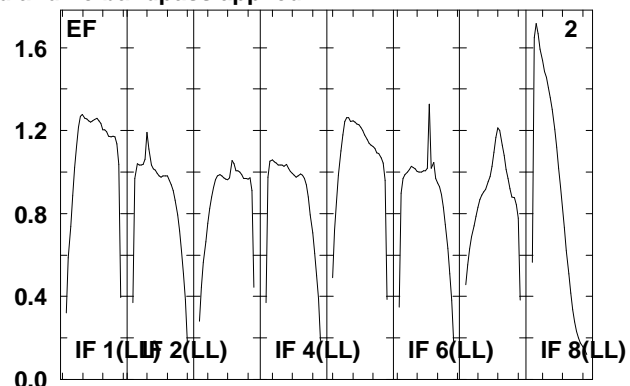
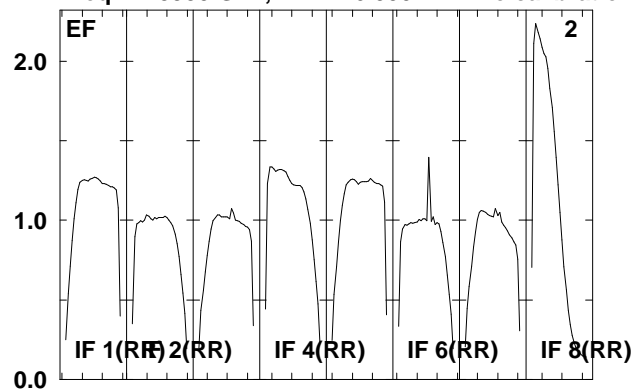

Lower frame: Real Jy
Total-power spectrum Antenna: *
Timerange: 00/13:40:35 to 00/13:41:59

Plot file version 71 created 06-JAN-2012 11:46:17

J1128+59 EP068D 5.UVDATA.1

Freq = 1.5950 GHz, Bw = 16.000 MH No calibration applied and no bandpass applied

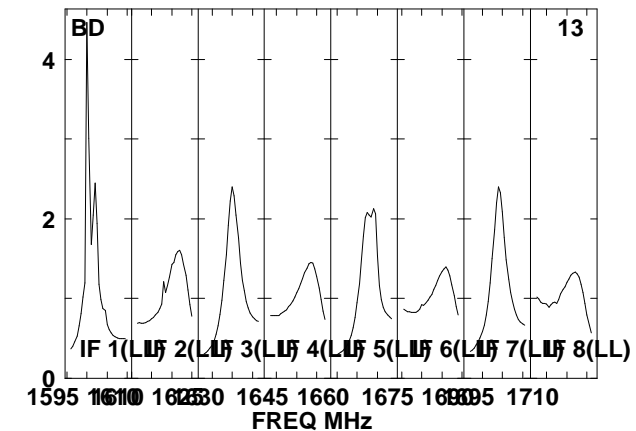
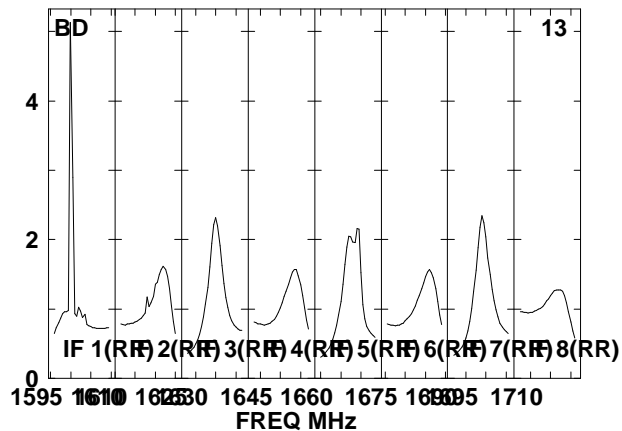
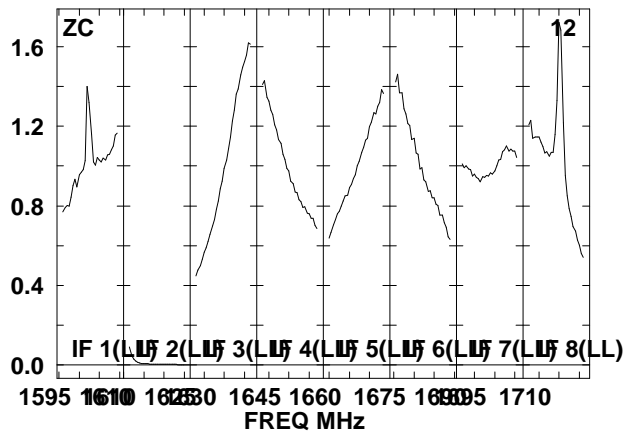
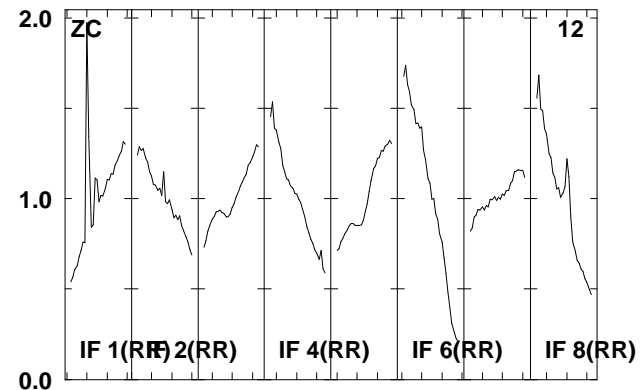
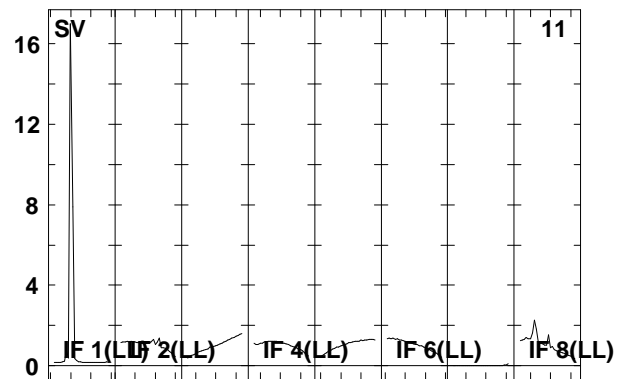
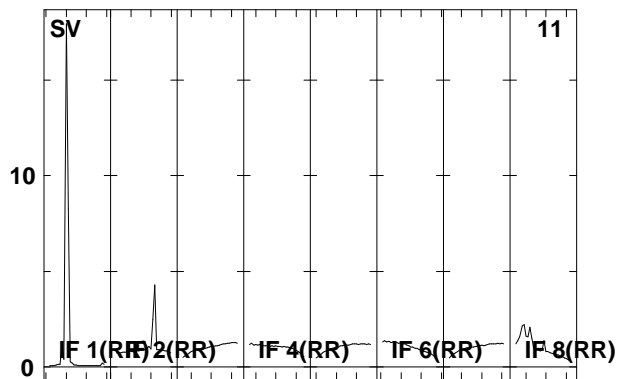
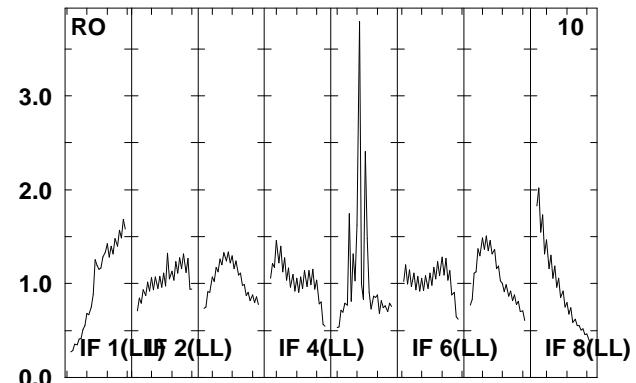
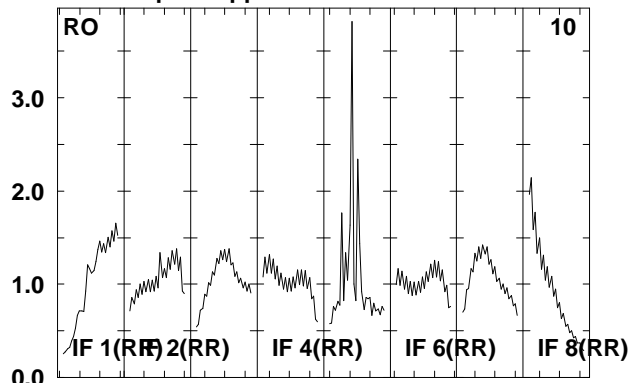
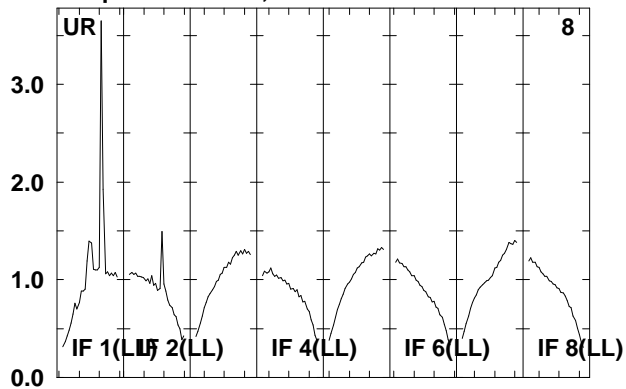

Lower frame: Real Jy

Total-power spectrum Antenna: *

Timerange: 00/13:40:35 to 00/13:41:59

Plot file version 72 created 06-JAN-2012 11:46:17

ARP299D EP068D 5.UVDATA.1

Freq = 1.5950 GHz, Bw = 16.000 MH No calibration applied and no bandpass applied

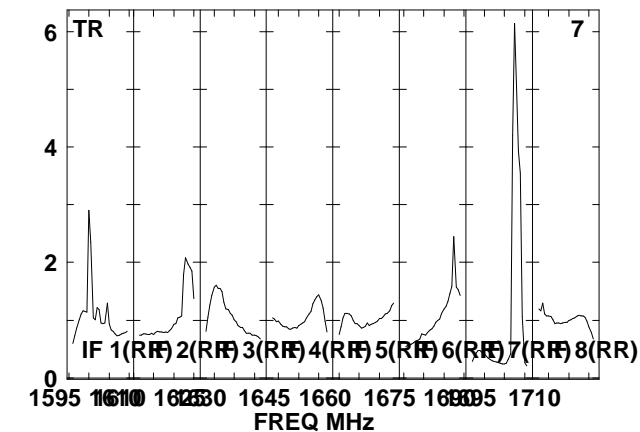
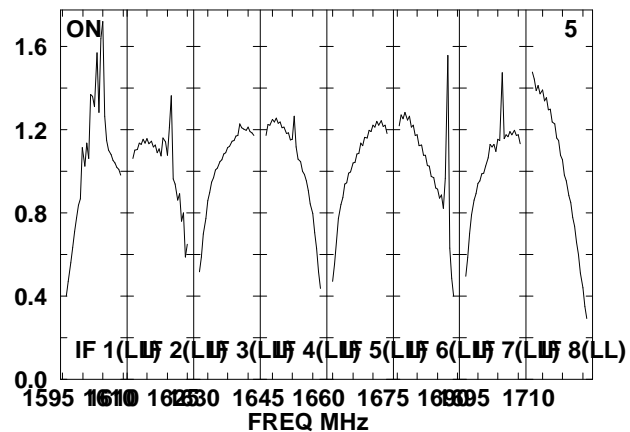
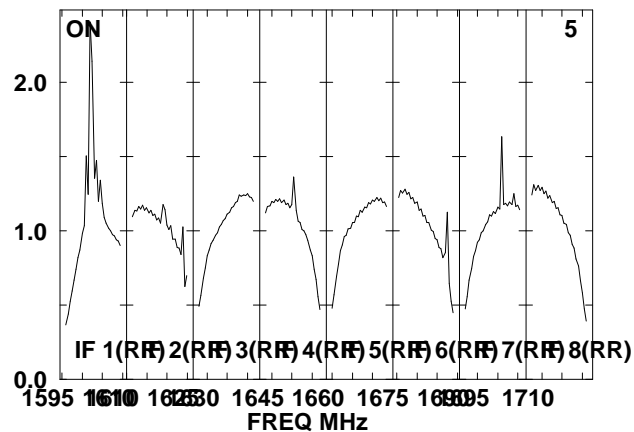
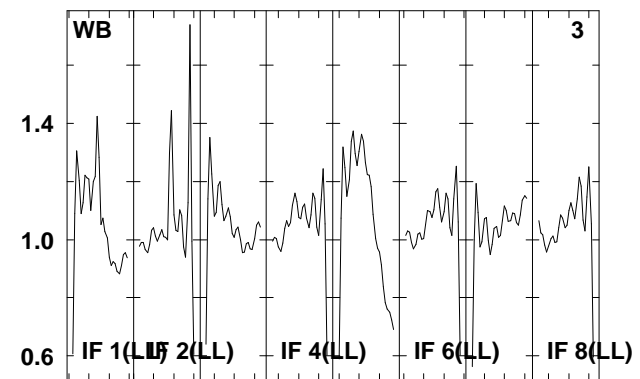
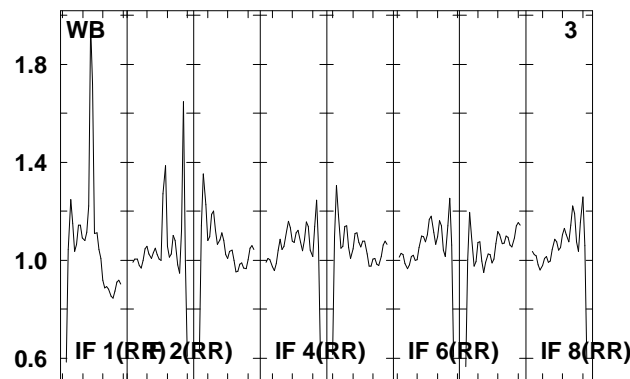
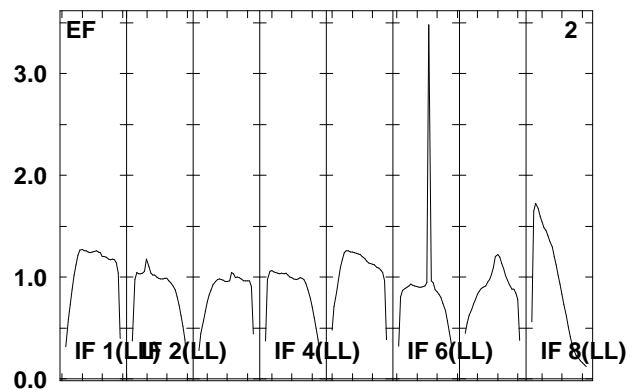
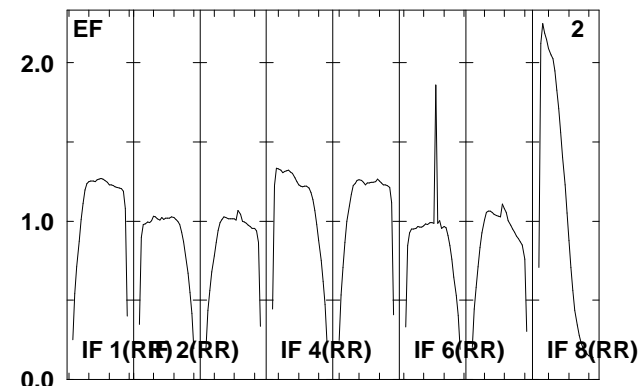
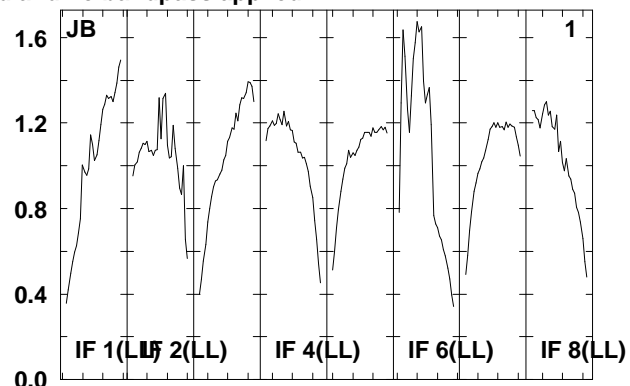
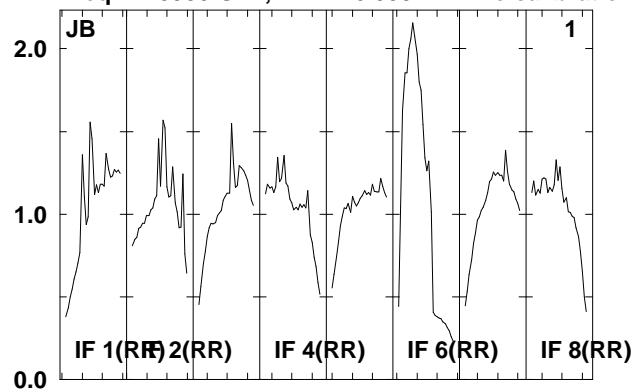

Lower frame: Real Jy
Total-power spectrum Antenna: *
Timerange: 00/13:42:01 to 00/13:45:29

Plot file version 73 created 06-JAN-2012 11:46:18

ARP299D EP068D 5.UVDATA.1

Freq = 1.5950 GHz, Bw = 16.000 MH No calibration applied and no bandpass applied

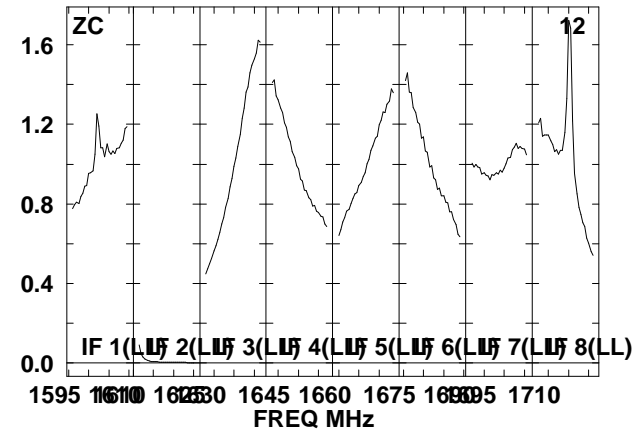
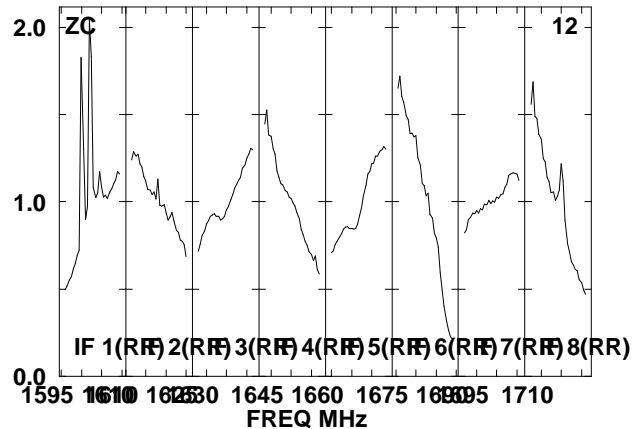
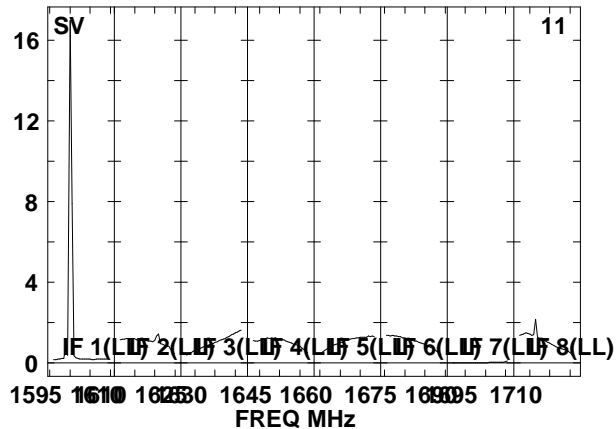
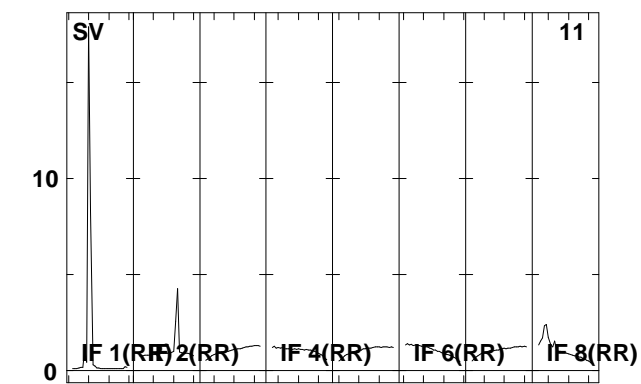
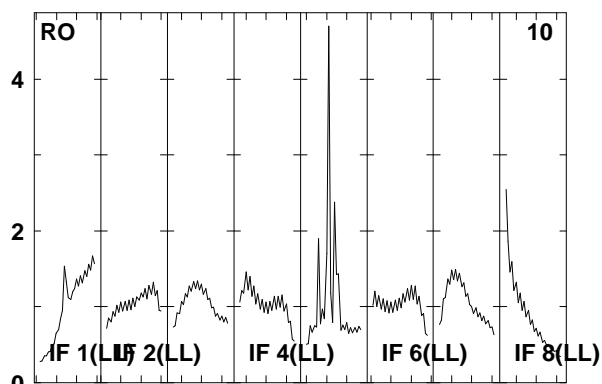
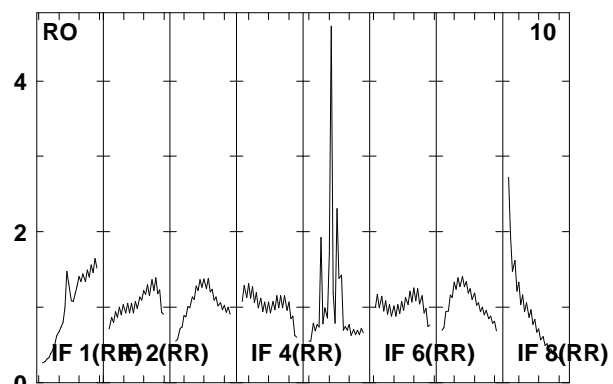
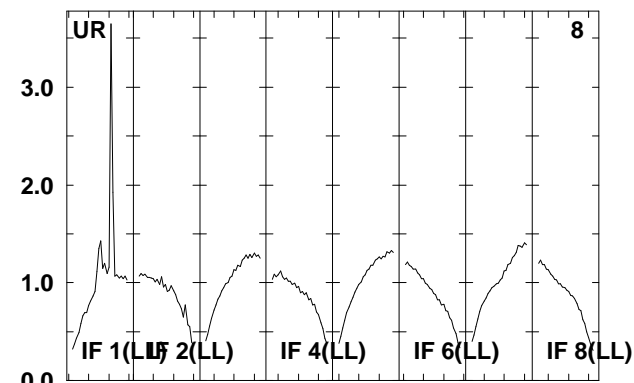
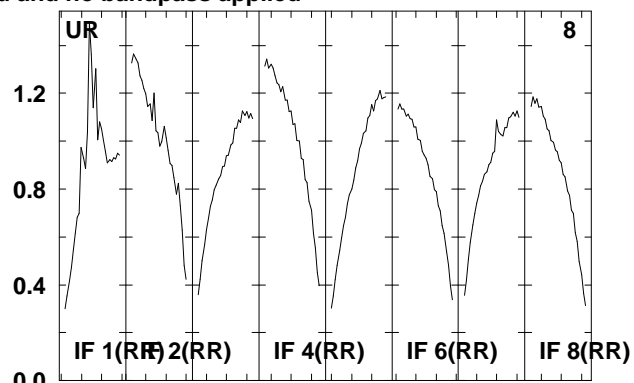
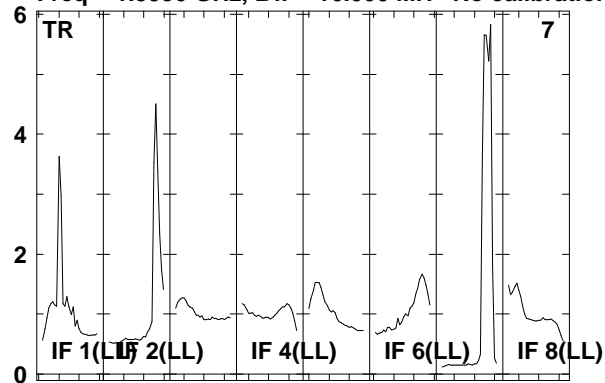

Lower frame: Real Jy

Total-power spectrum Antenna: *

Timerange: 00/13:42:01 to 00/13:45:29

Plot file version 74 created 06-JAN-2012 11:46:18

ARP299D EP068D 5.UVDATA.1

Freq = 1.5950 GHz, Bw = 16.000 MH No calibration applied and no bandpass applied

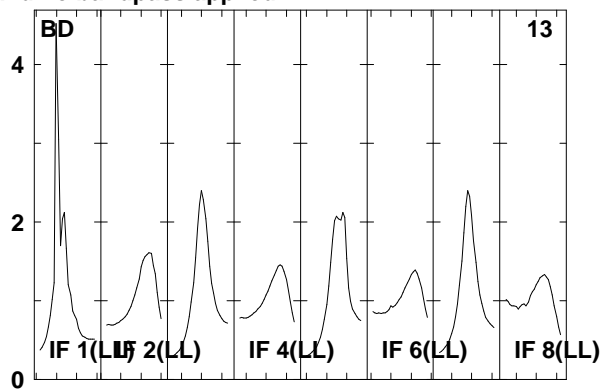
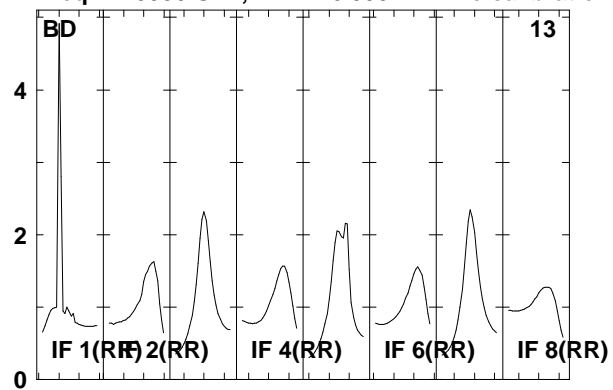

Lower frame: Real Jy

Total-power spectrum Antenna: *

Timerange: 00/13:42:01 to 00/13:45:29

Plot file version 75 created 06-JAN-2012 11:46:19

J1128+59 EP068D 5.UVDATA.1

Freq = 1.5950 GHz, Bw = 16.000 MH No calibration applied and no bandpass applied

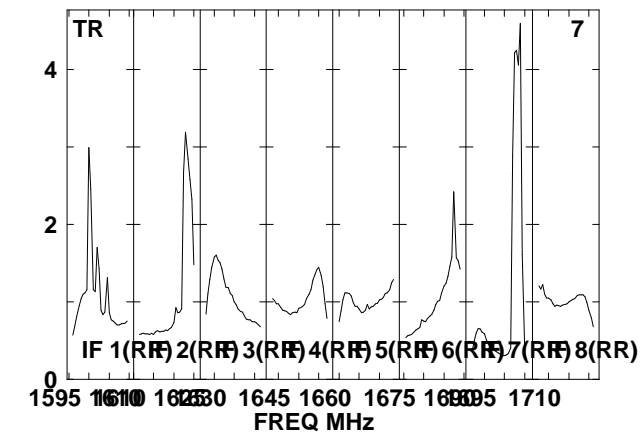
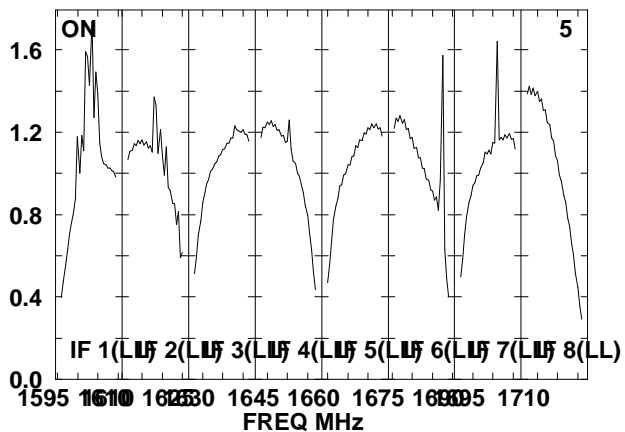
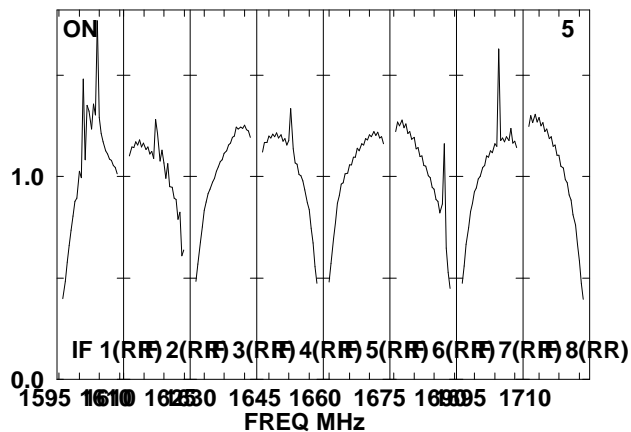
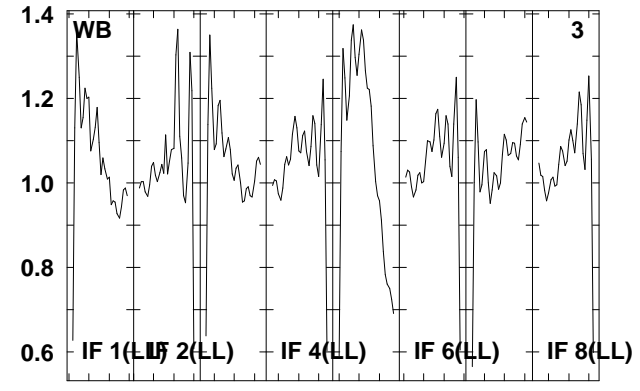
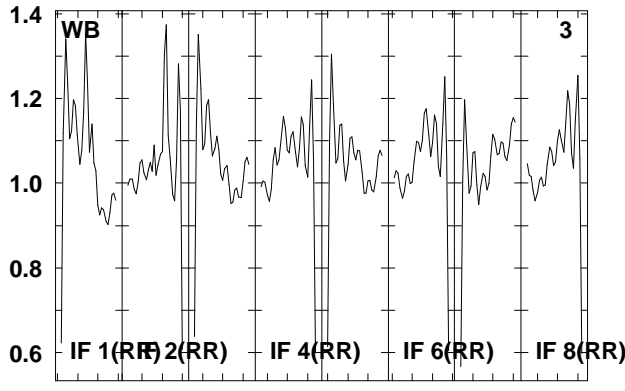
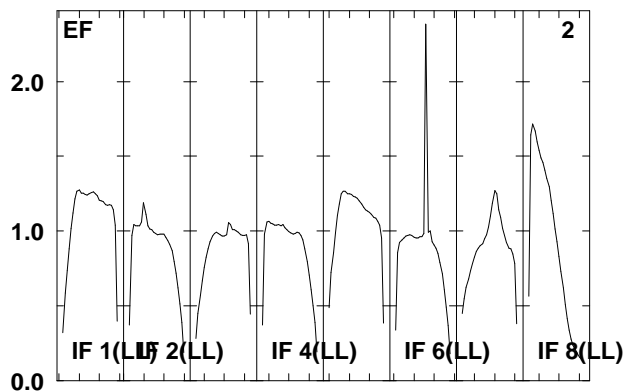
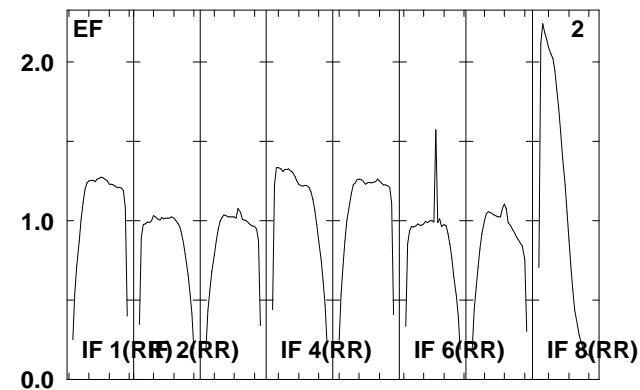
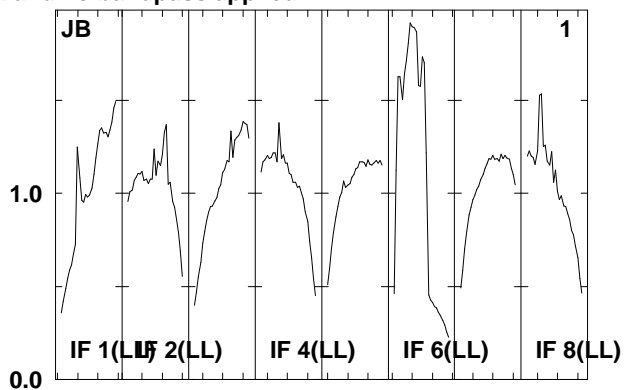
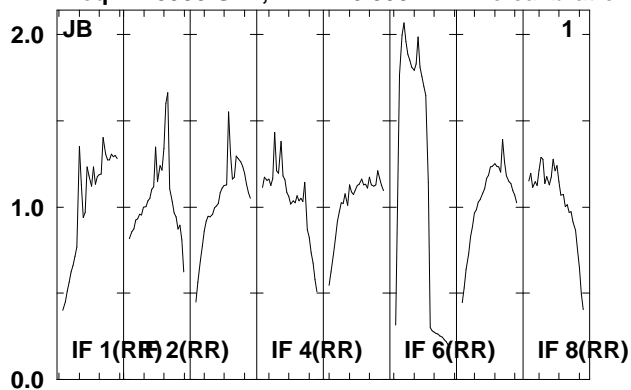

Lower frame: Real Jy
Total-power spectrum Antenna: *
Timerange: 00/13:46:31 to 00/13:47:59

Plot file version 76 created 06-JAN-2012 11:46:19

J1128+59 EP068D 5.UVDATA.1

Freq = 1.5950 GHz, Bw = 16.000 MH No calibration applied and no bandpass applied

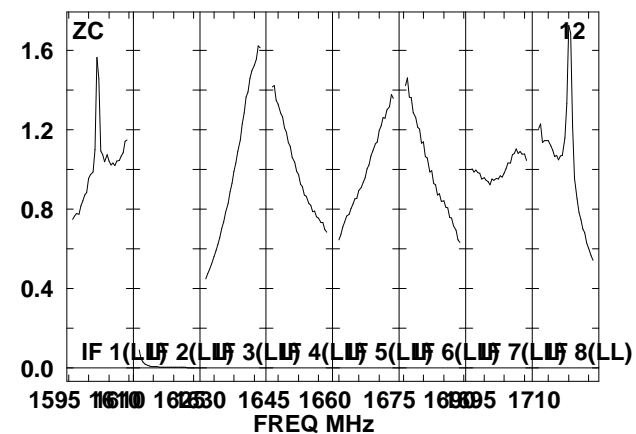
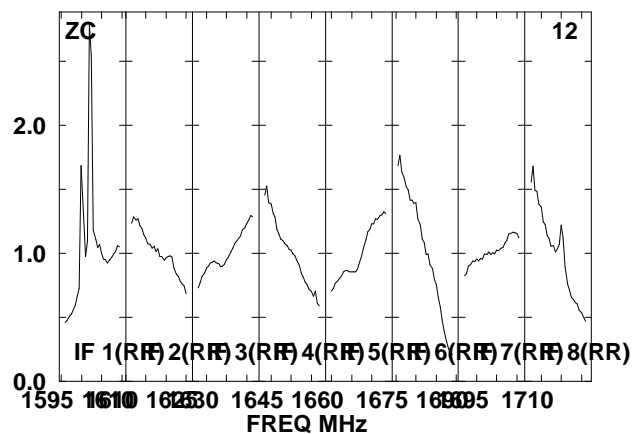
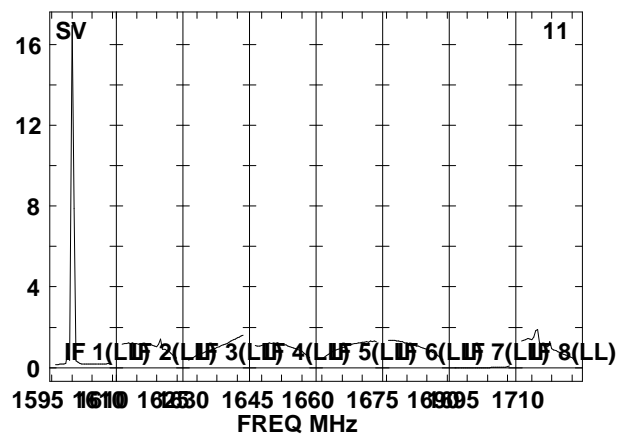
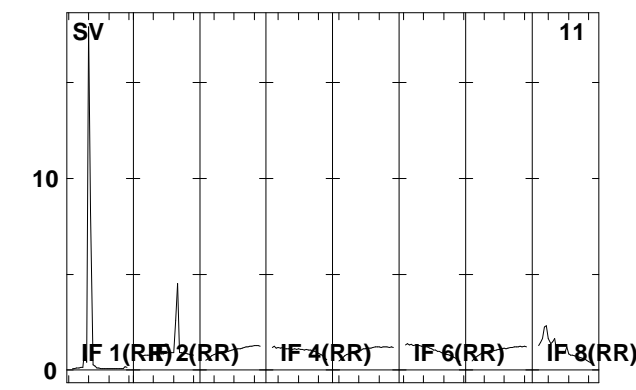
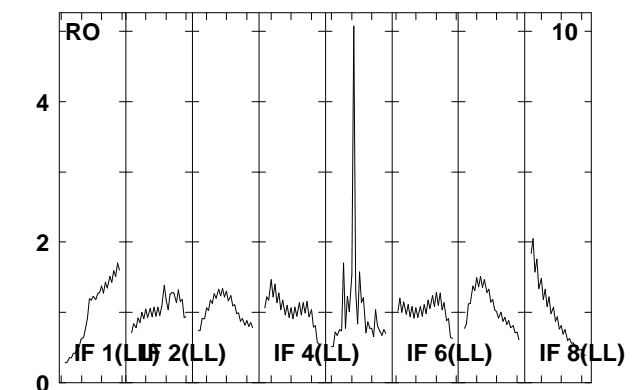
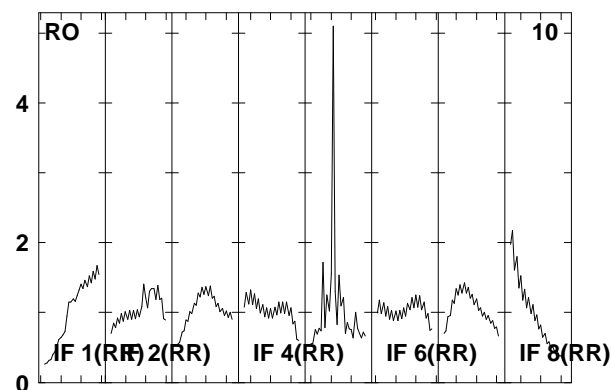
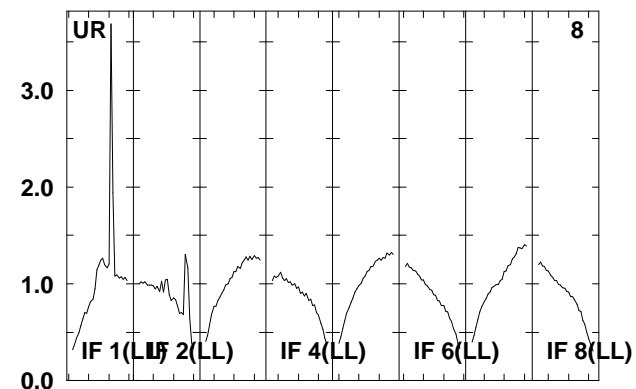
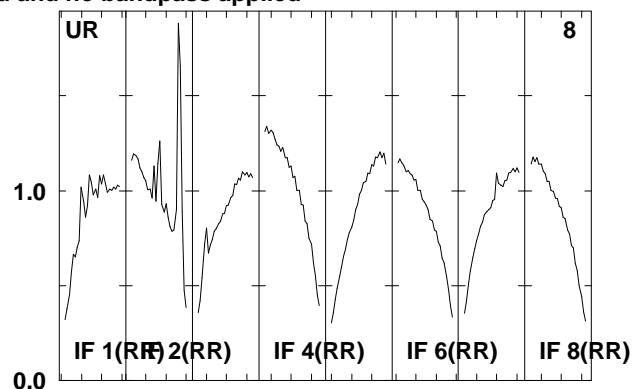
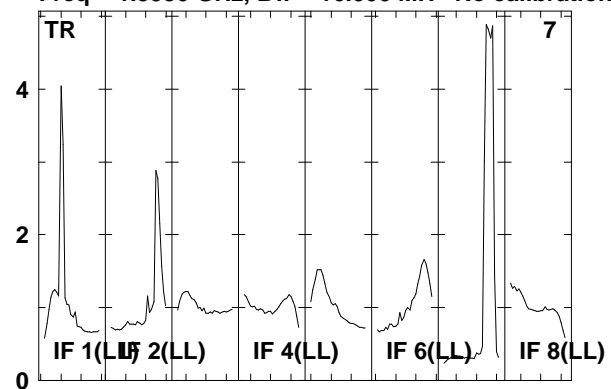

Lower frame: Real Jy

Total-power spectrum Antenna: *

Timerange: 00/13:46:31 to 00/13:47:59

Plot file version 77 created 06-JAN-2012 11:46:19

J1128+59 EP068D 5.UVDATA.1

Freq = 1.5950 GHz, Bw = 16.000 MH No calibration applied and no bandpass applied

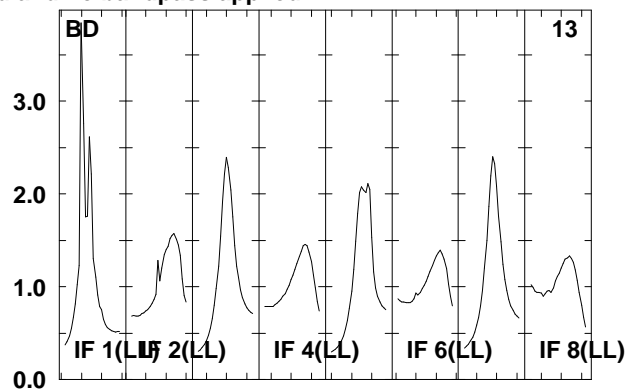
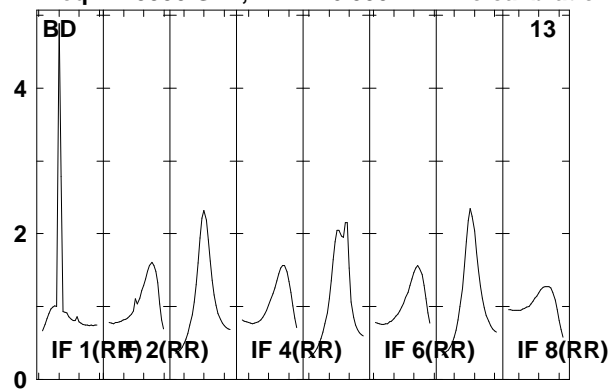

Lower frame: Real Jy
Total-power spectrum Antenna: *
Timerange: 00/13:46:31 to 00/13:47:59

Plot file version 78 created 06-JAN-2012 11:46:20

ARP299D EP068D 5.UVDATA.1

Freq = 1.5950 GHz, Bw = 16.000 MH No calibration applied and no bandpass applied

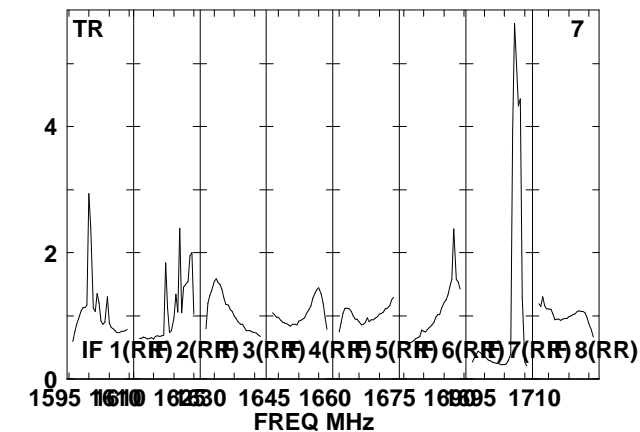
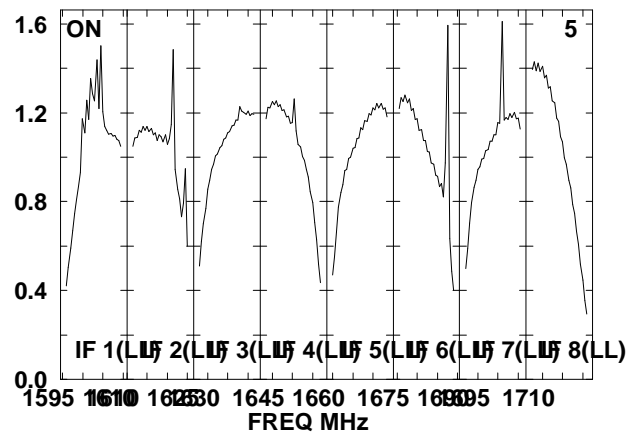
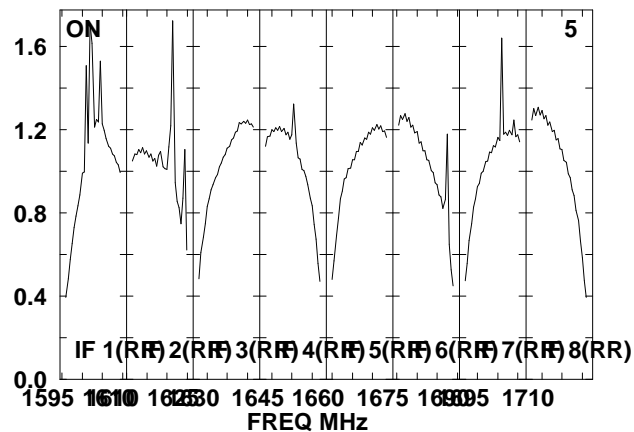
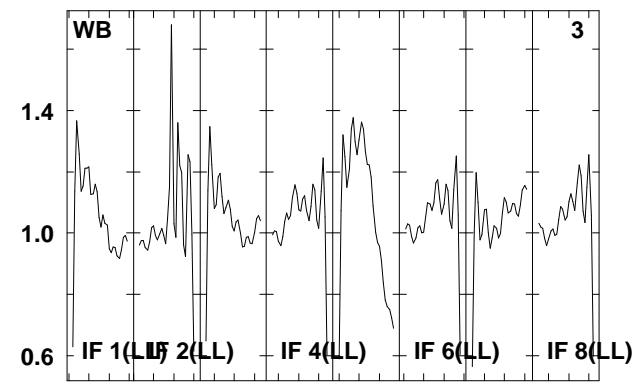
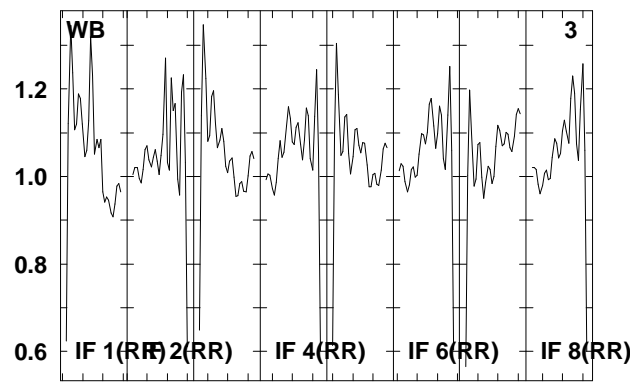
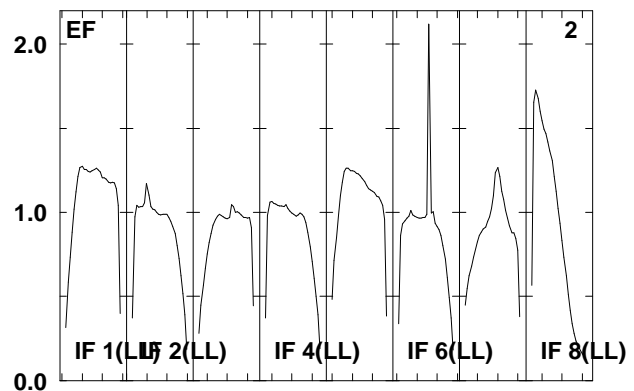
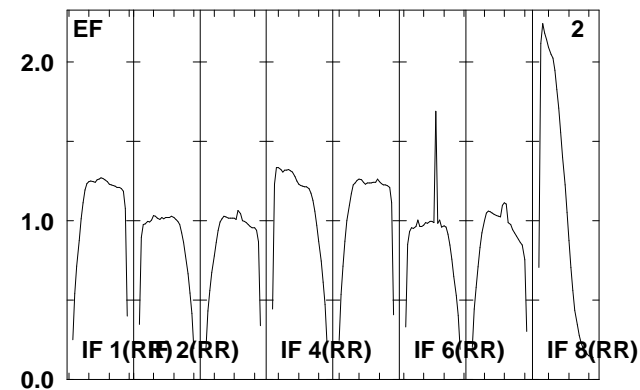
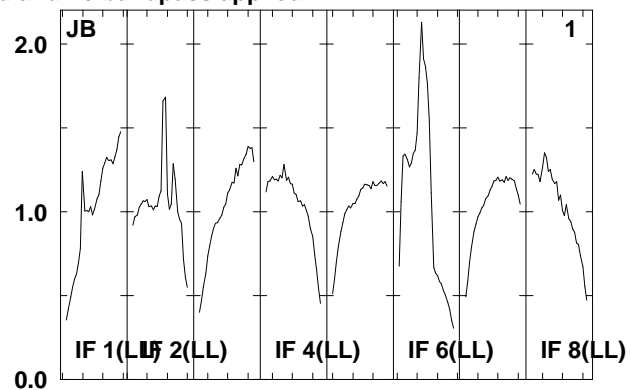
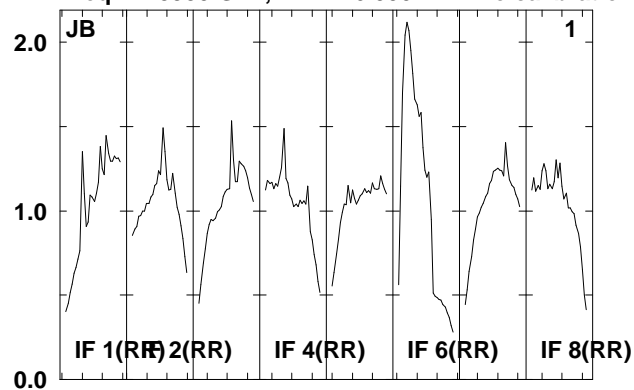

Lower frame: Real Jy
Total-power spectrum Antenna: *
Timerange: 00/13:48:05 to 00/13:51:29

Plot file version 79 created 06-JAN-2012 11:46:20

ARP299D EP068D 5.UVDATA.1

Freq = 1.5950 GHz, Bw = 16.000 MH No calibration applied and no bandpass applied

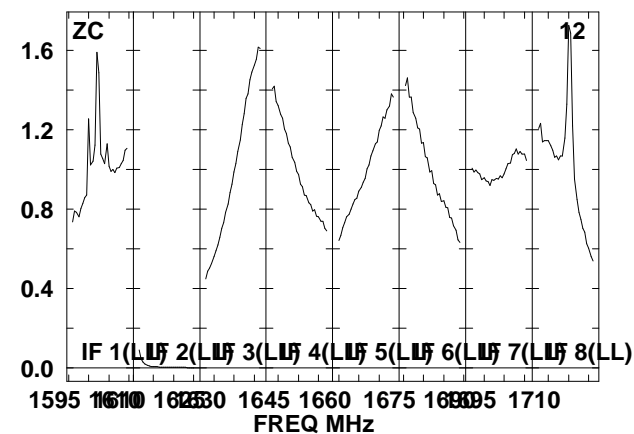
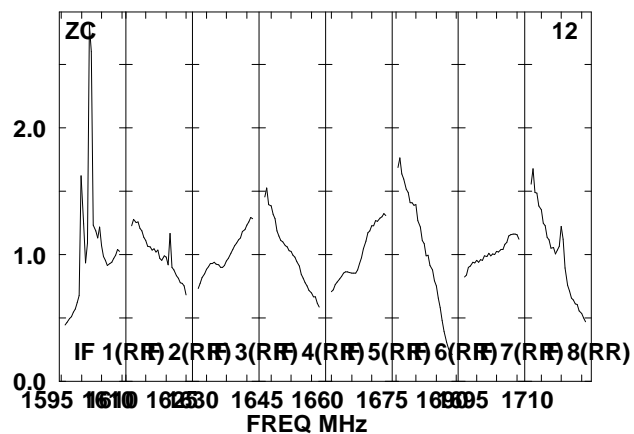
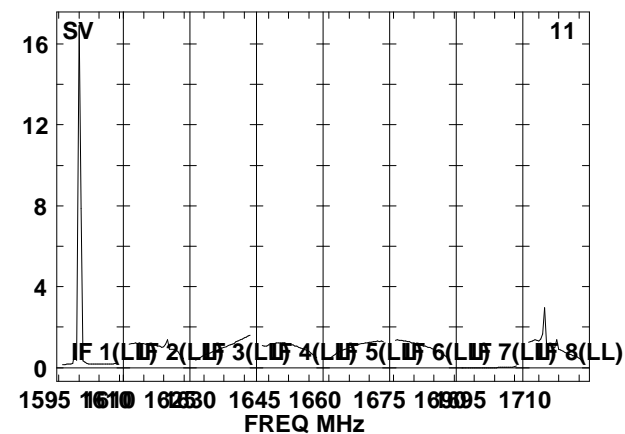
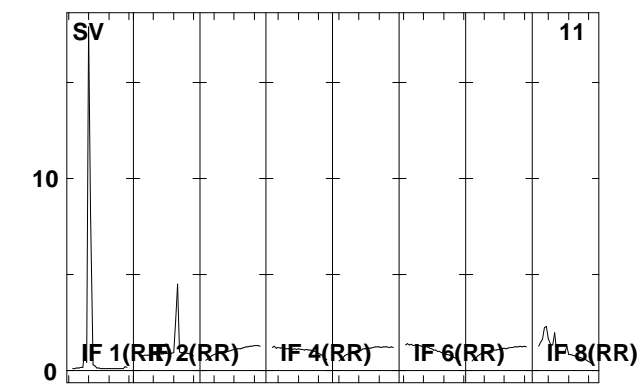
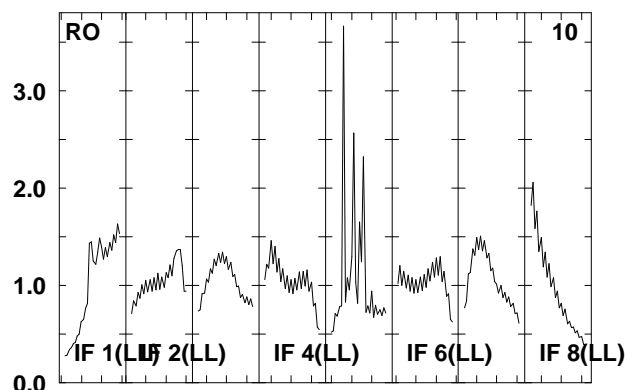
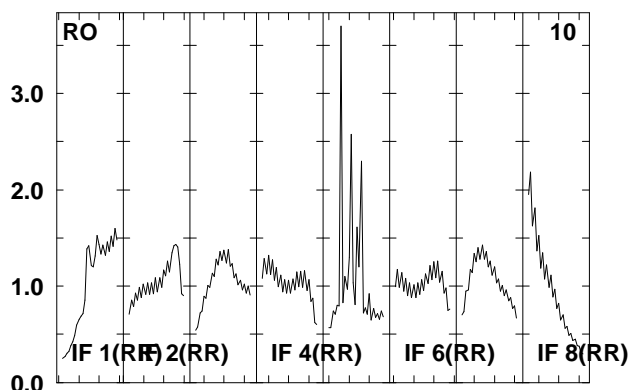
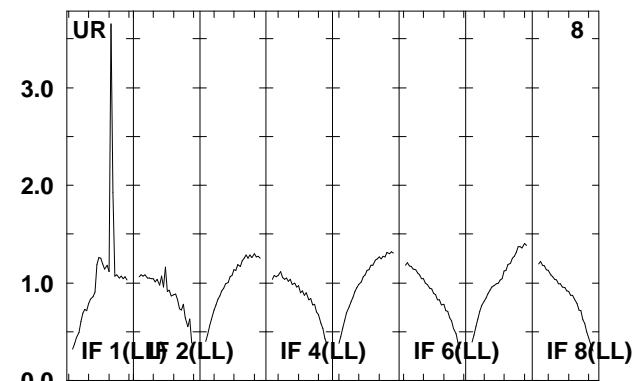
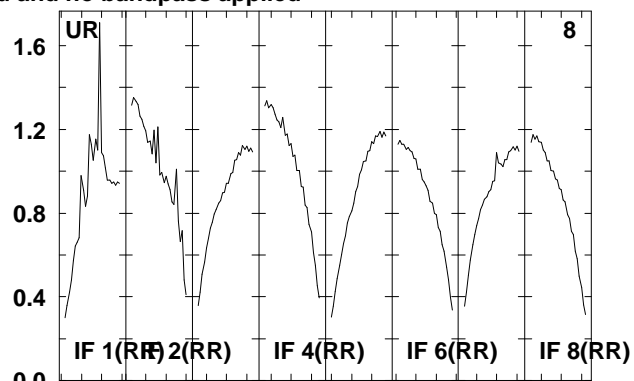
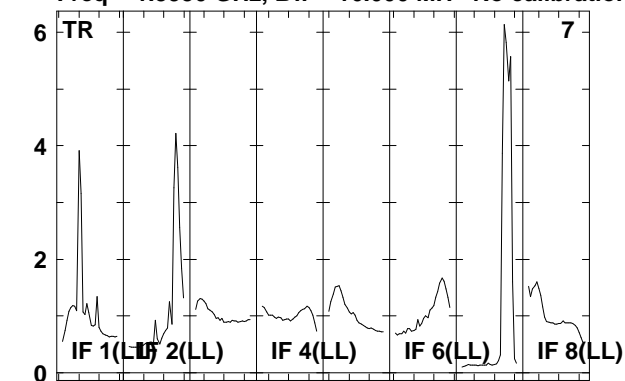

Lower frame: Real Jy
Total-power spectrum Antenna: *
Timerange: 00/13:48:05 to 00/13:51:29

Plot file version 80 created 06-JAN-2012 11:46:21

ARP299D EP068D 5.UVDATA.1

Freq = 1.5950 GHz, Bw = 16.000 MH No calibration applied and no bandpass applied

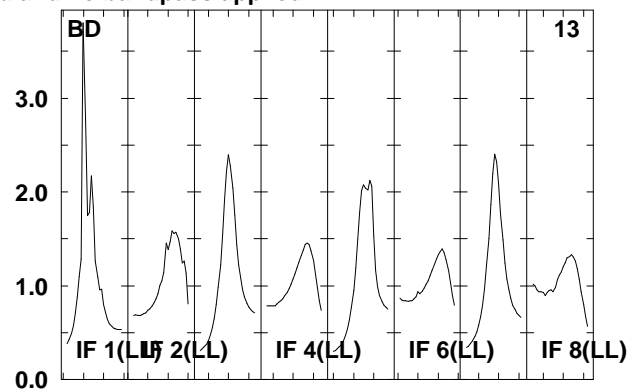
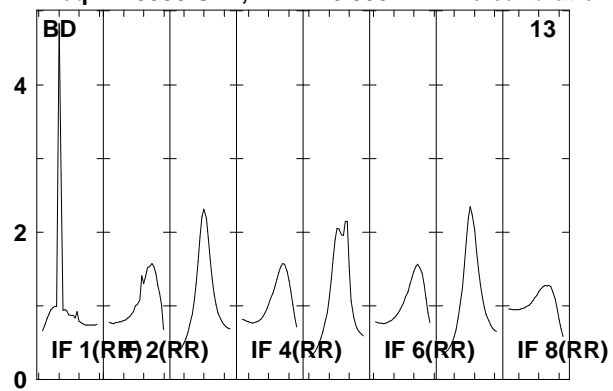

Lower frame: Real Jy
Total-power spectrum Antenna: *
Timerange: 00/13:48:05 to 00/13:51:29

Plot file version 81 created 06-JAN-2012 11:46:21

J1128+59 EP068D 5.UVDATA.1

Freq = 1.5950 GHz, Bw = 16.000 MH No calibration applied and no bandpass applied

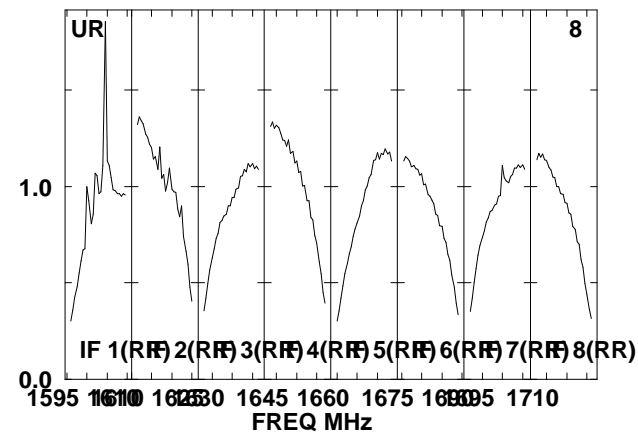
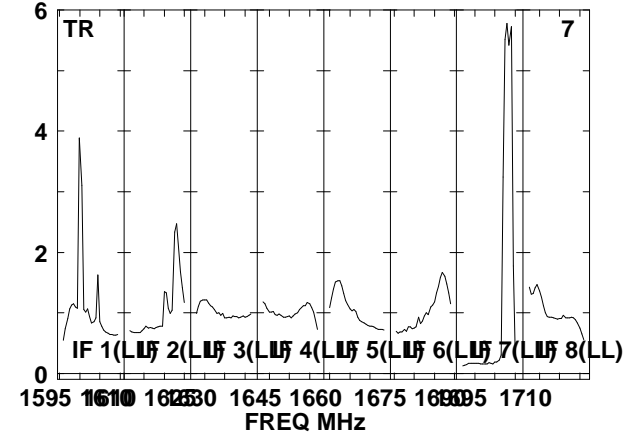
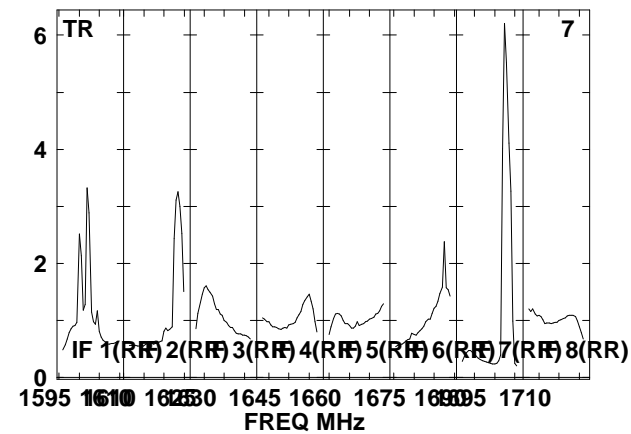
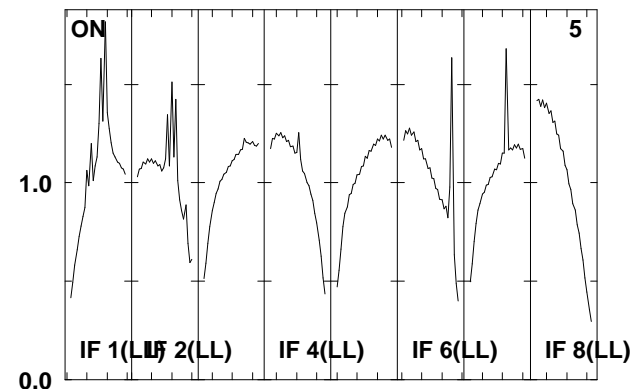
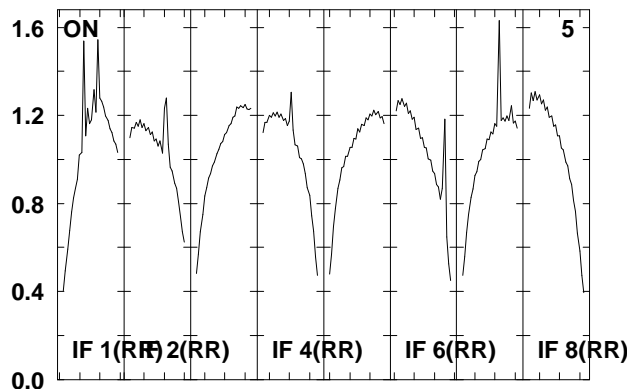
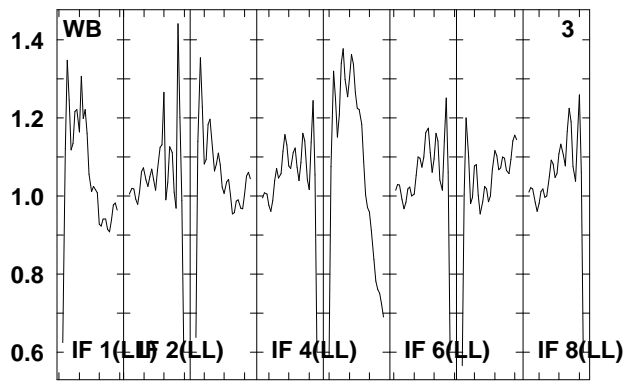
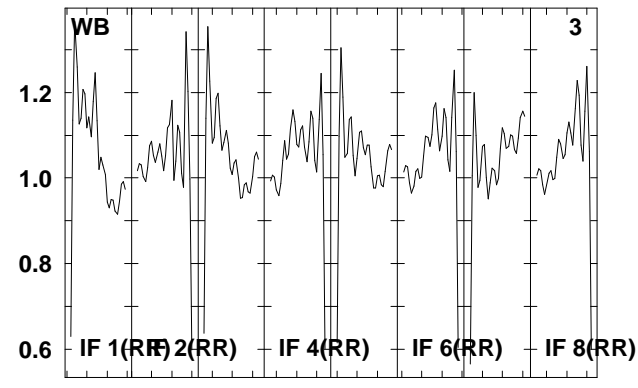
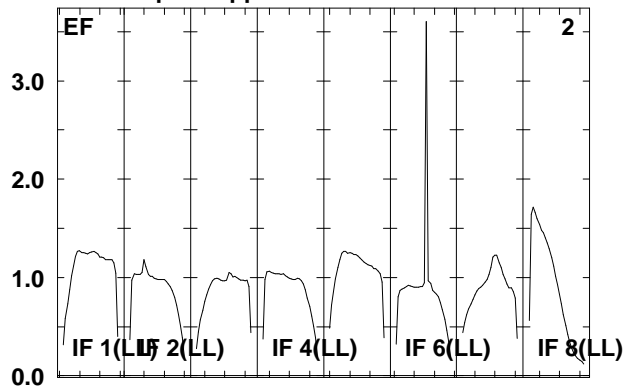
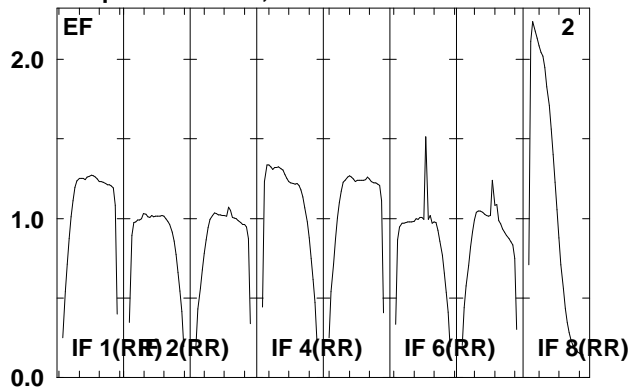

Lower frame: Real Jy
Total-power spectrum Antenna: *
Timerange: 00/13:51:35 to 00/13:52:59

Plot file version 82 created 06-JAN-2012 11:46:21

J1128+59 EP068D 5.UVDATA.1

Freq = 1.5950 GHz, Bw = 16.000 MH No calibration applied and no bandpass applied

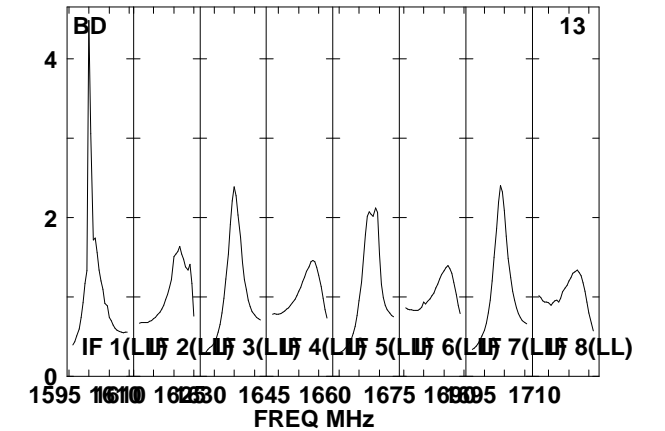
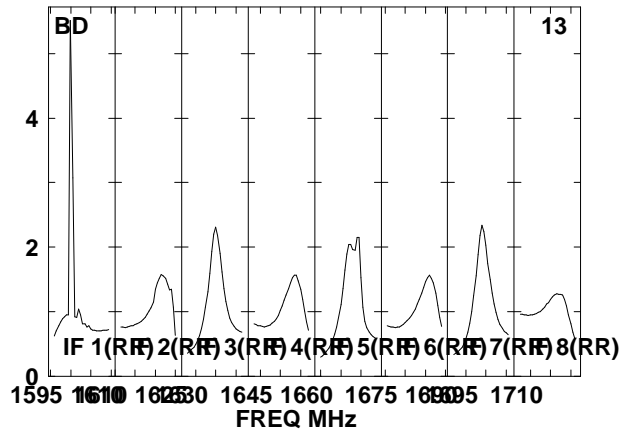
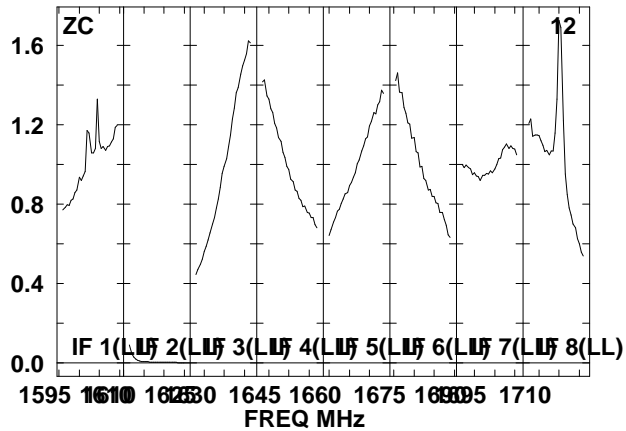
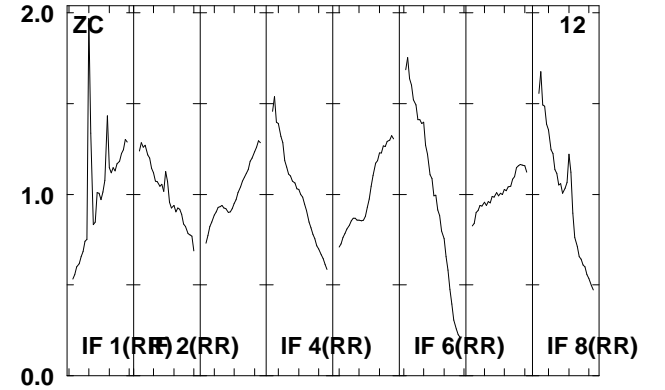
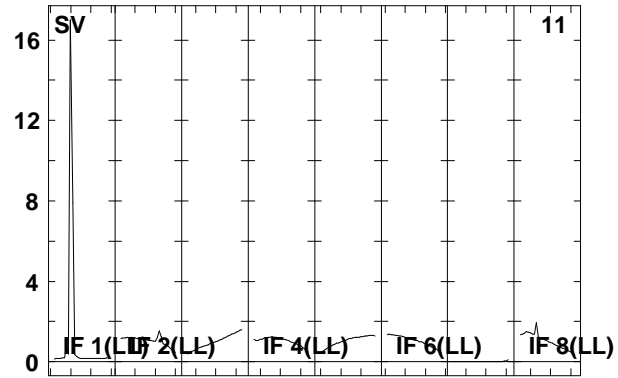
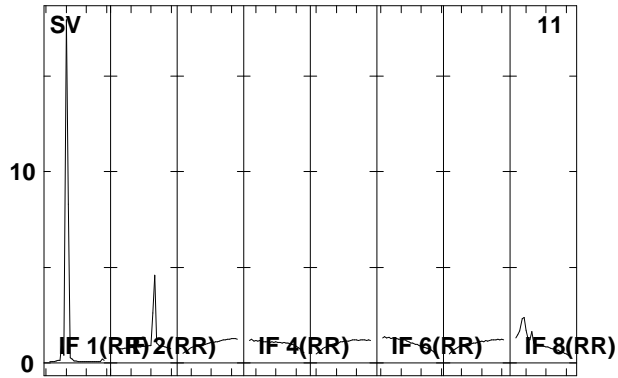
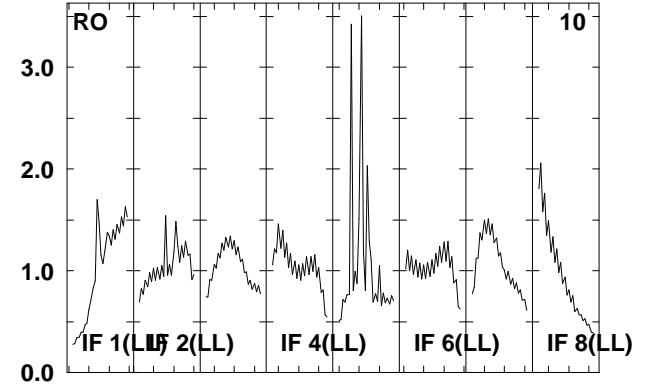
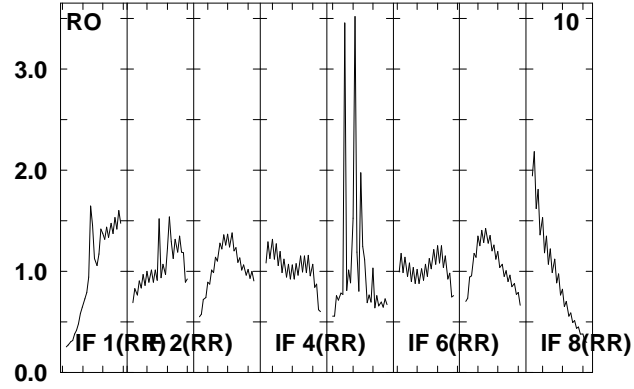
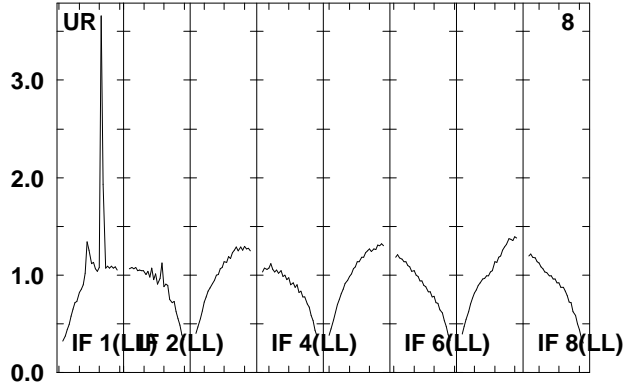

Lower frame: Real Jy
Total-power spectrum Antenna: *
Timerange: 00/13:51:35 to 00/13:52:59

Plot file version 83 created 06-JAN-2012 11:46:21

ARP299D EP068D 5.UVDATA.1

Freq = 1.5950 GHz, Bw = 16.000 MH No calibration applied and no bandpass applied

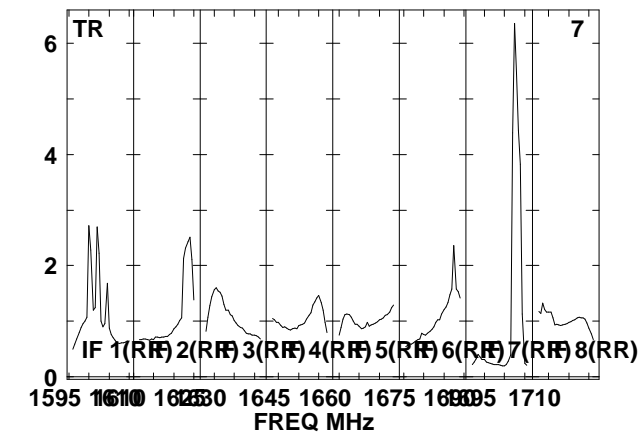
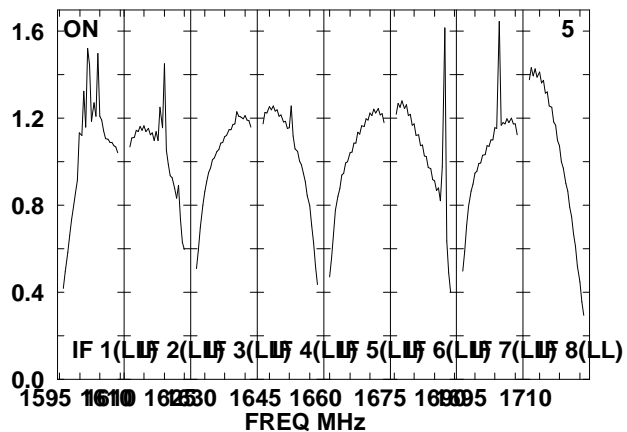
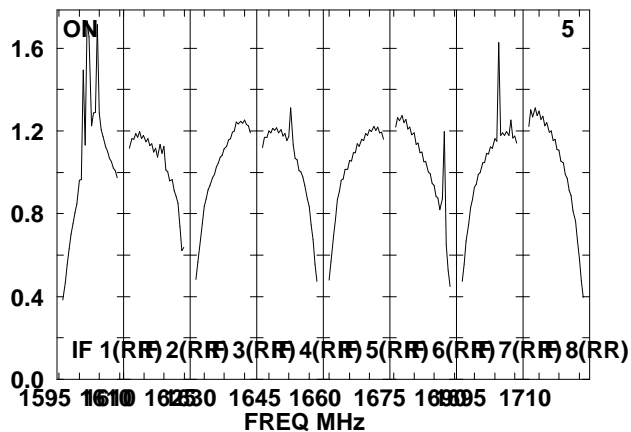
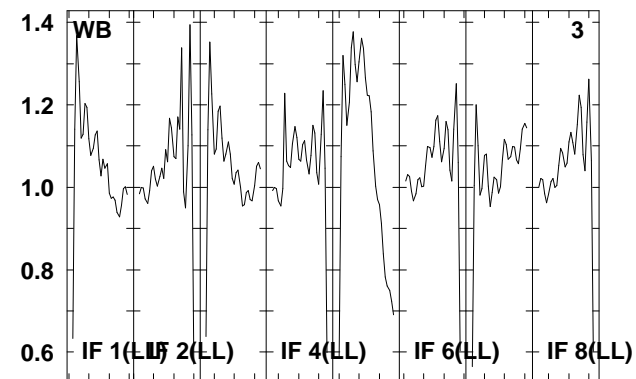
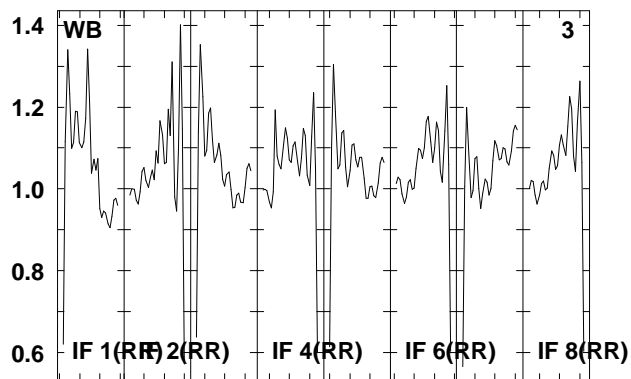
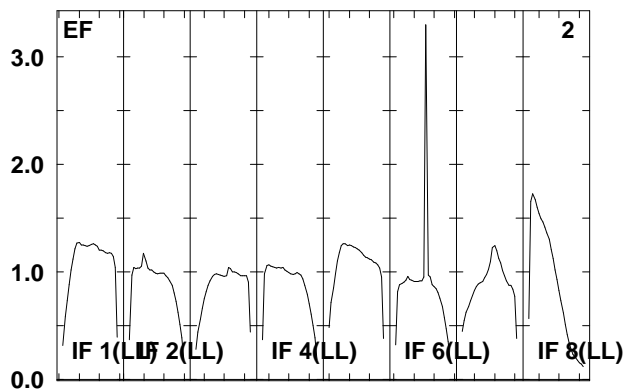
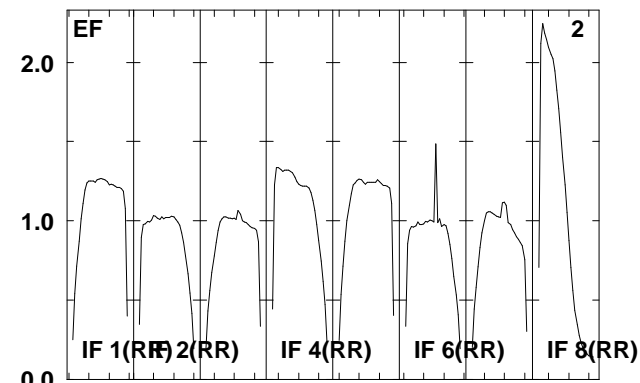
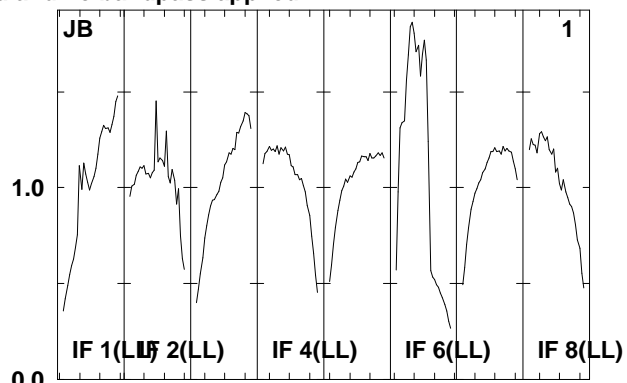
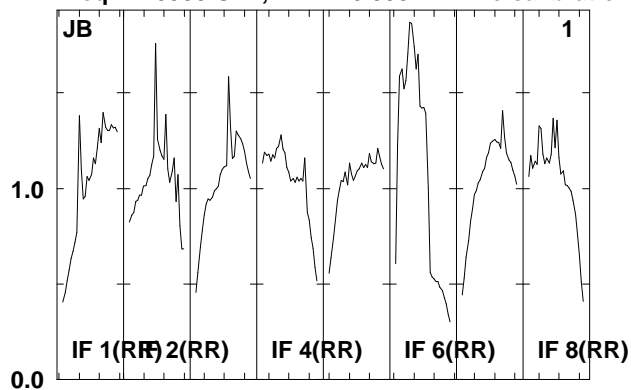

Lower frame: Real Jy
Total-power spectrum Antenna: *
Timerange: 00/13:53:01 to 00/13:56:29

Plot file version 84 created 06-JAN-2012 11:46:22

ARP299D EP068D 5.UVDATA.1

Freq = 1.5950 GHz, Bw = 16.000 MH No calibration applied and no bandpass applied

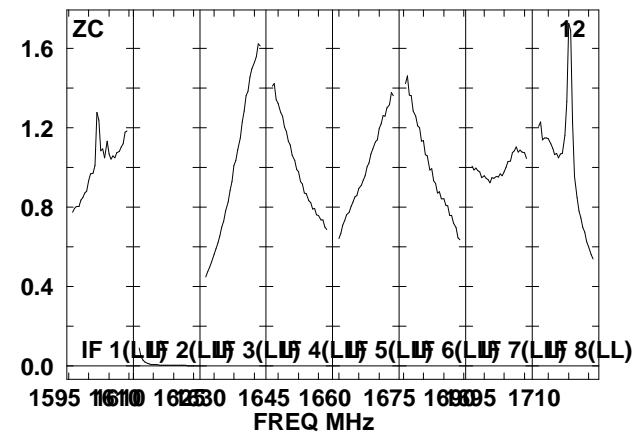
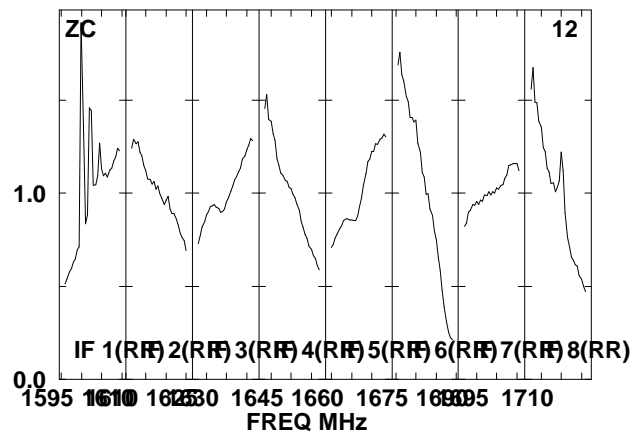
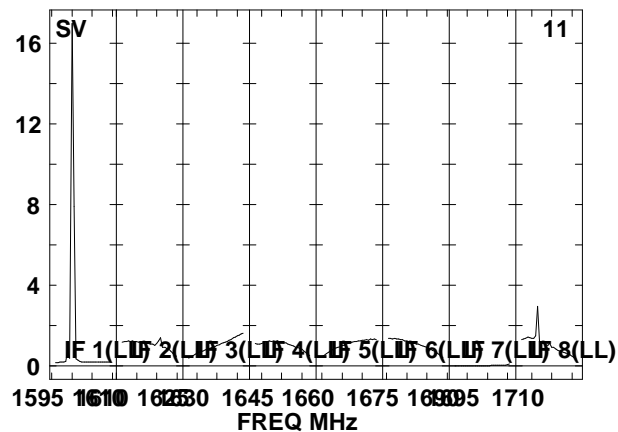
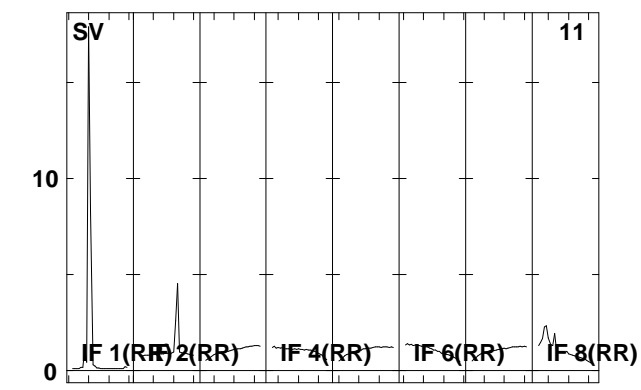
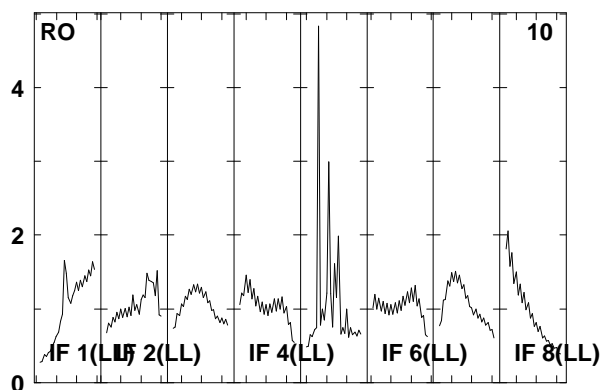
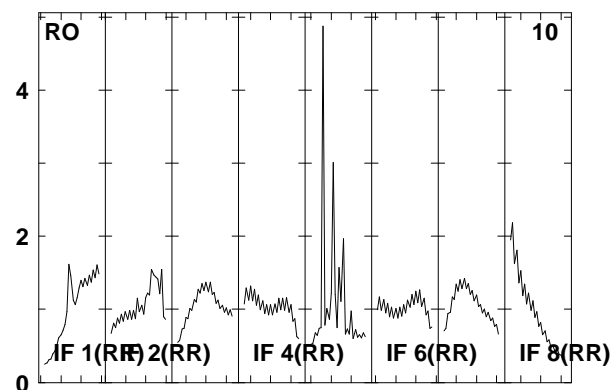
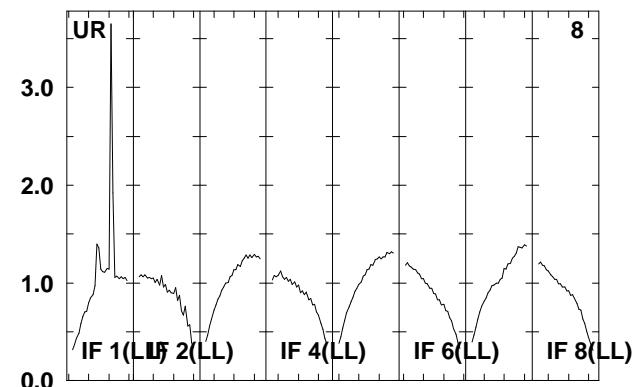
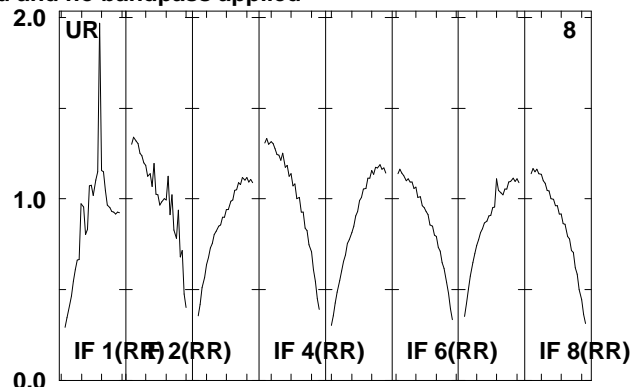
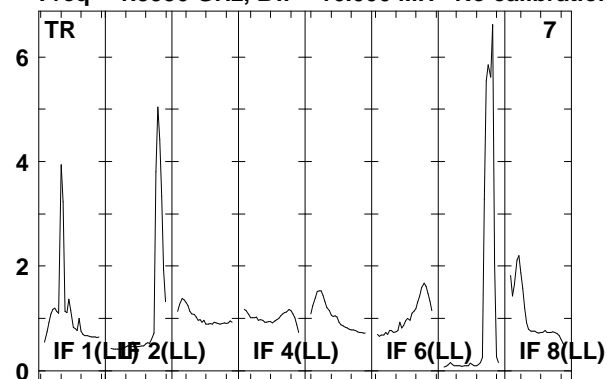

Lower frame: Real Jy
Total-power spectrum Antenna: *
Timerange: 00/13:53:01 to 00/13:56:29

Plot file version 85 created 06-JAN-2012 11:46:23

ARP299D EP068D 5.UVDATA.1

Freq = 1.5950 GHz, Bw = 16.000 MH No calibration applied and no bandpass applied

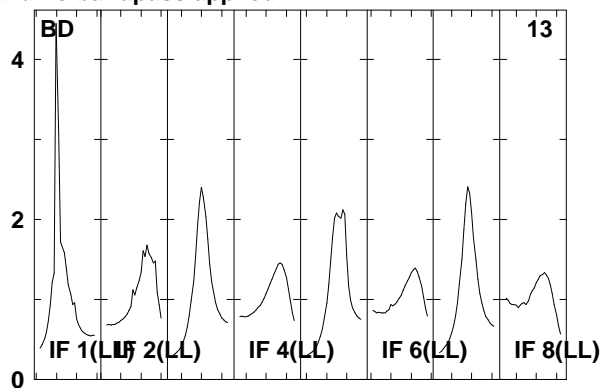
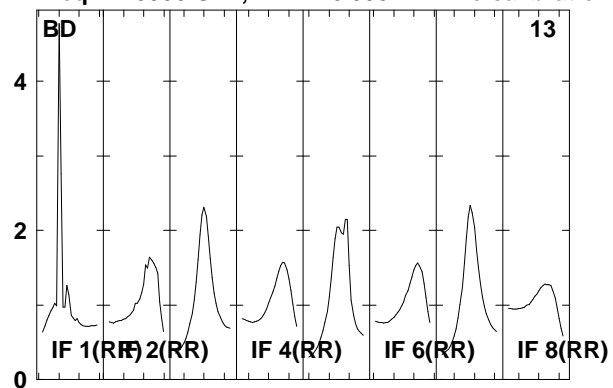

Lower frame: Real Jy
Total-power spectrum Antenna: *
Timerange: 00/13:53:01 to 00/13:56:29

Plot file version 86 created 06-JAN-2012 11:46:23

4C39.25 EP068D 5.UVDATA.1

Freq = 1.5950 GHz, Bw = 16.000 MH No calibration applied and no bandpass applied

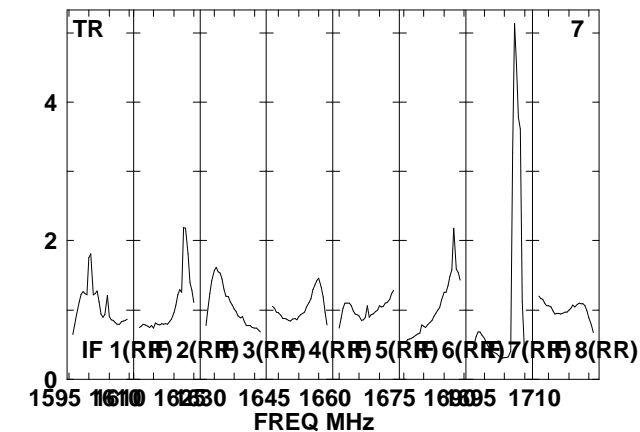
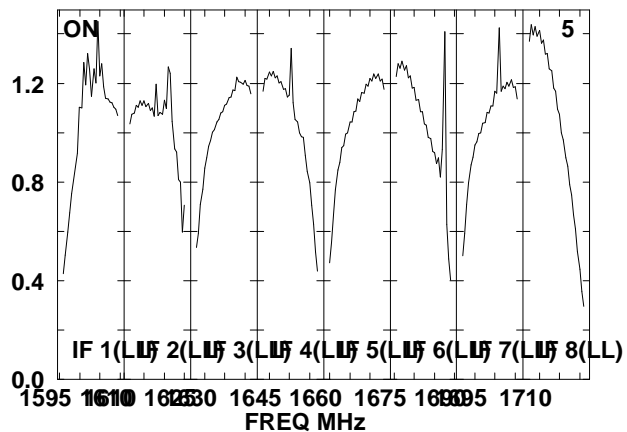
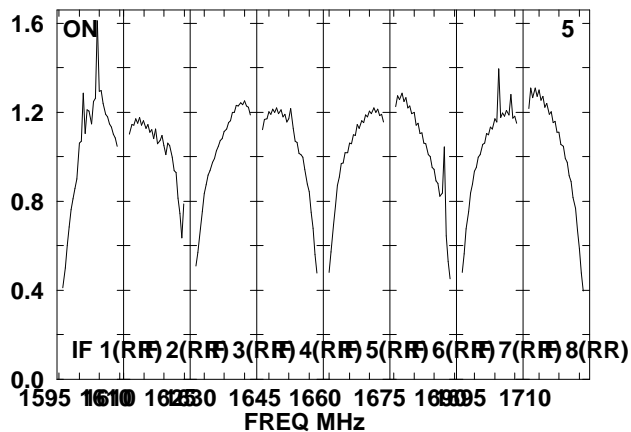
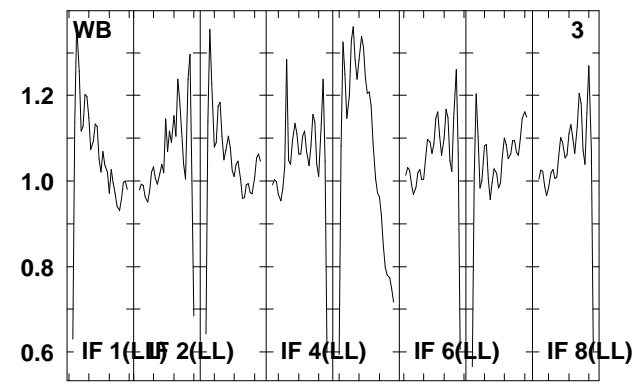
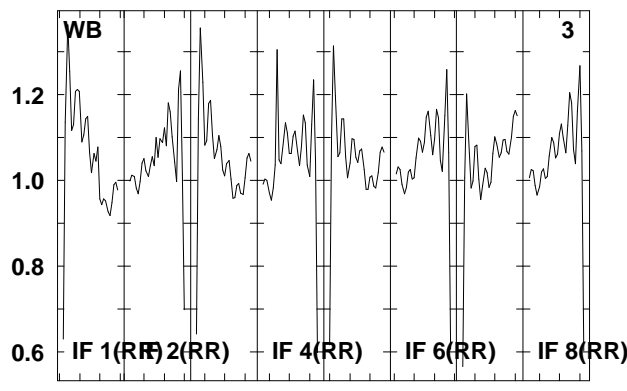
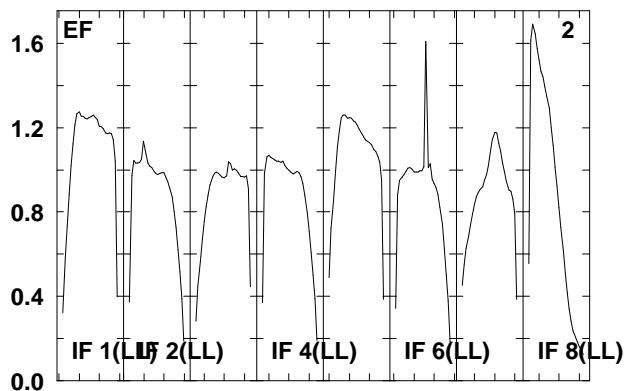
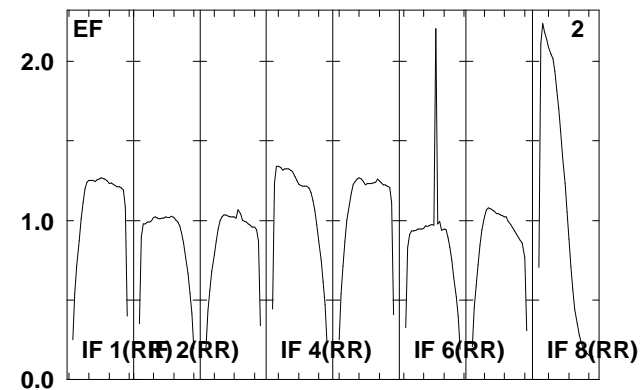
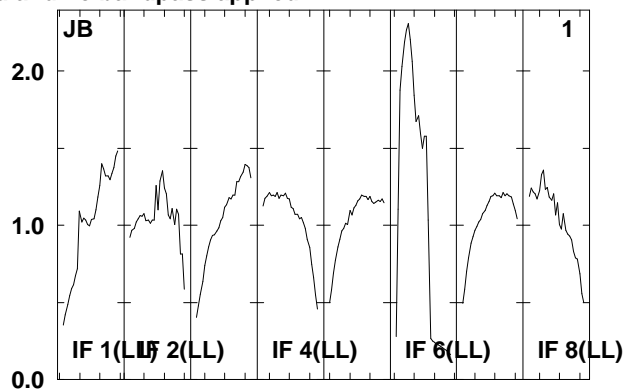
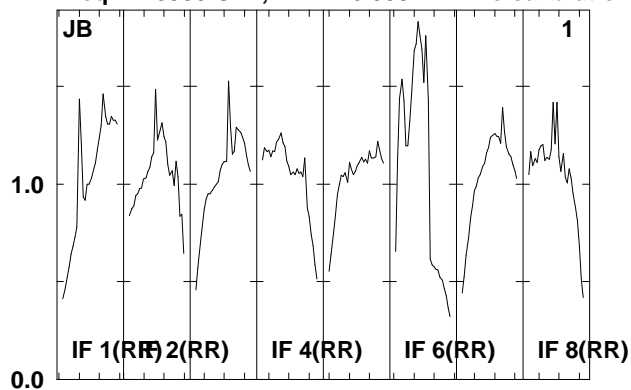

Lower frame: Real Jy
Total-power spectrum Antenna: *
Timerange: 00/13:57:31 to 00/14:04:59

Plot file version 87 created 06-JAN-2012 11:46:24

4C39.25 EP068D 5.UVDATA.1

Freq = 1.5950 GHz, Bw = 16.000 MH No calibration applied and no bandpass applied

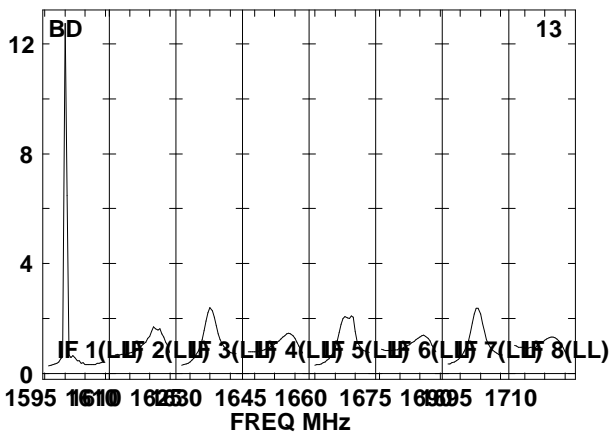
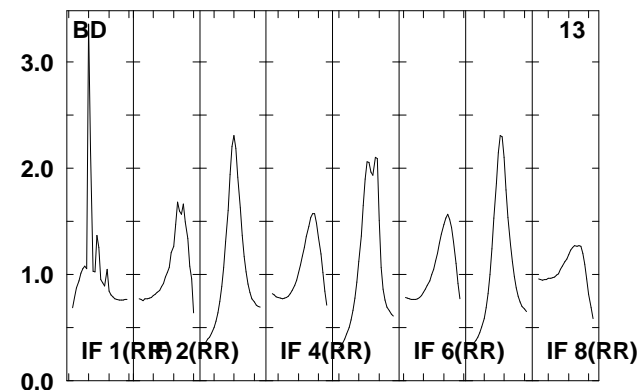
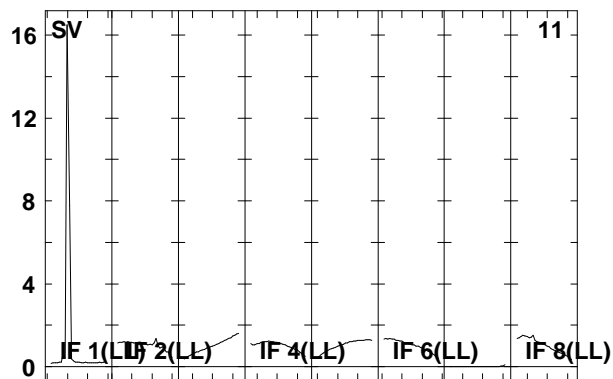
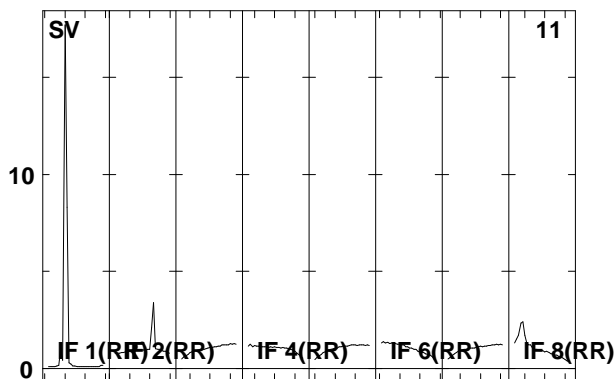
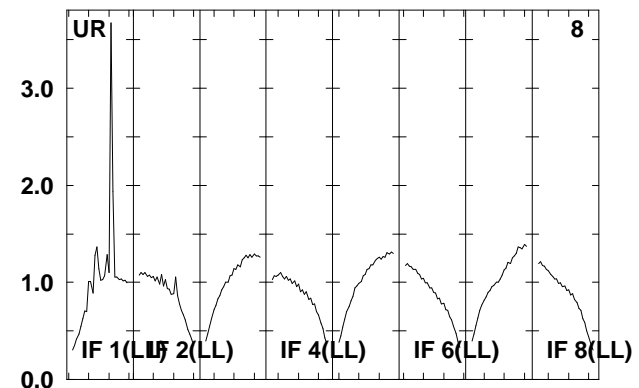
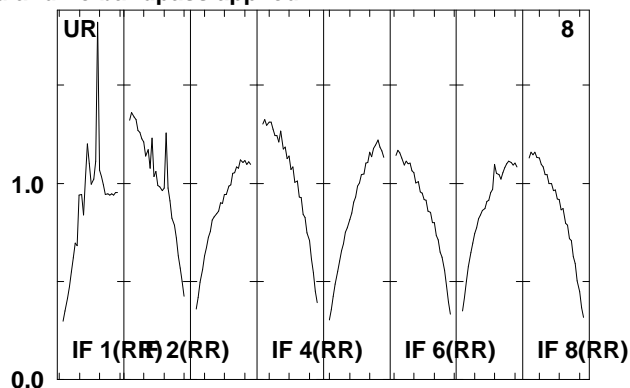
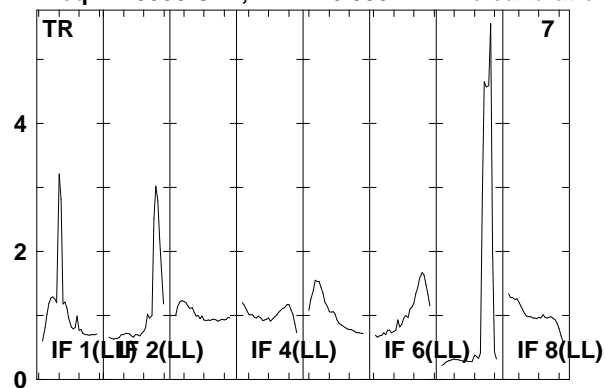

Lower frame: Real Jy

Total-power spectrum Antenna: *

Timerange: 00/13:57:31 to 00/14:04:59

Plot file version 88 created 06-JAN-2012 11:46:25

J1128+59 EP068D 5.UVDATA.1

Freq = 1.5950 GHz, Bw = 16.000 MH No calibration applied and no bandpass applied

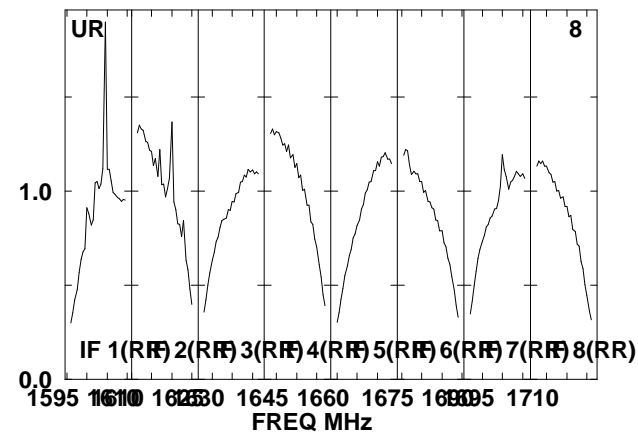
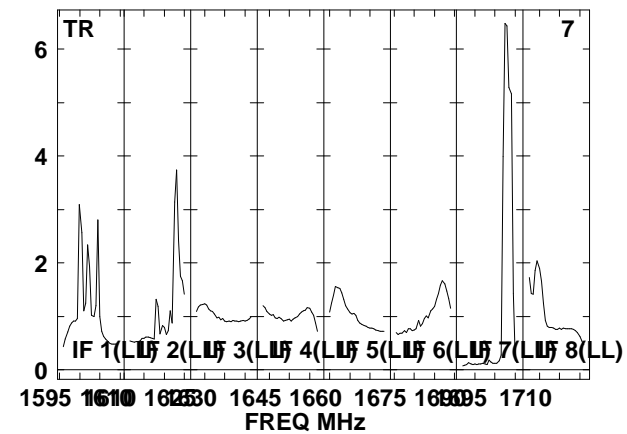
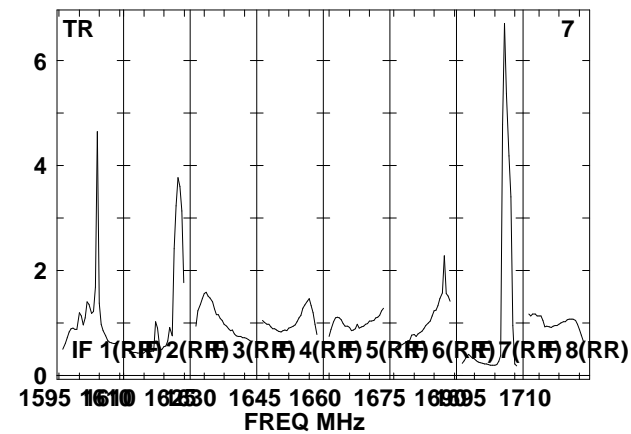
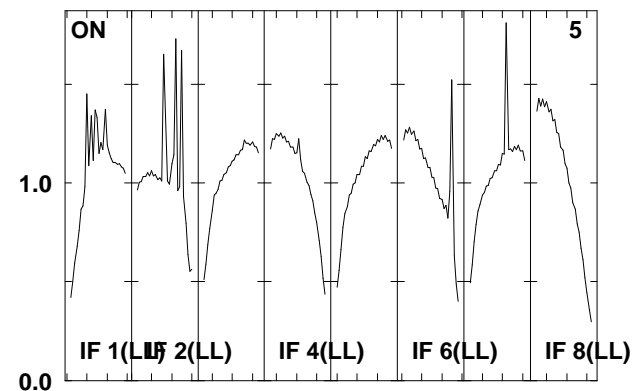
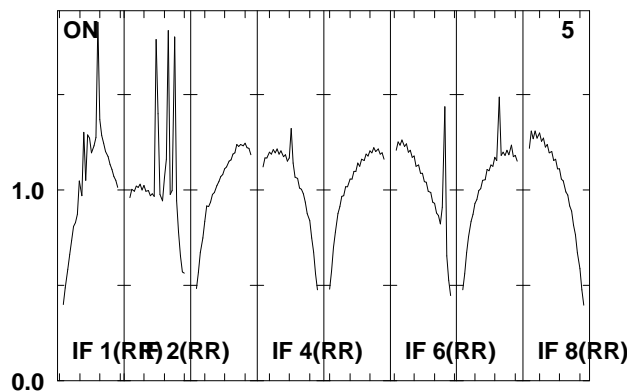
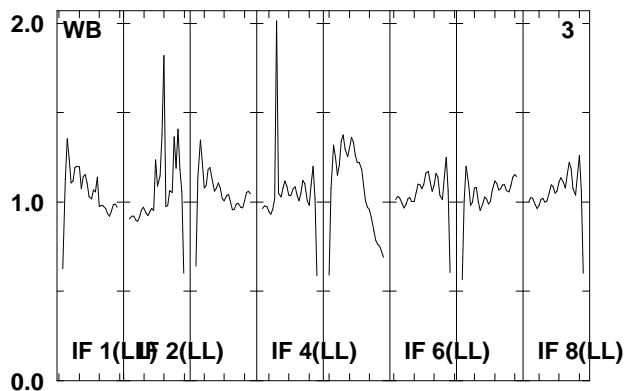
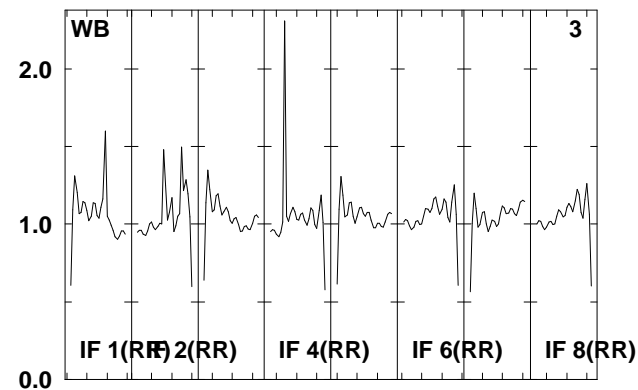
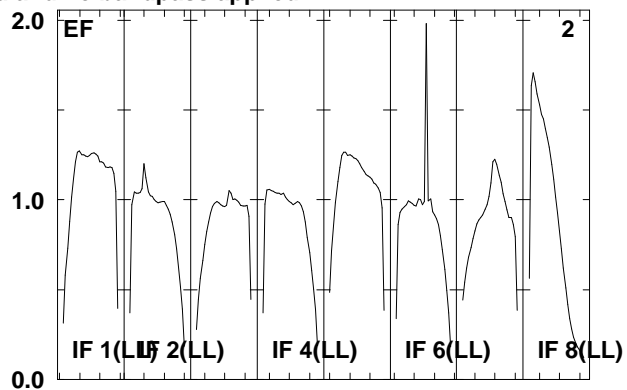
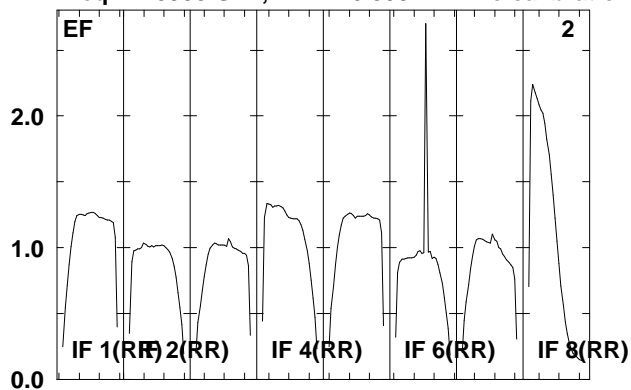

Lower frame: Real Jy
Total-power spectrum Antenna: *
Timerange: 00/14:06:01 to 00/14:08:59

Plot file version 89 created 06-JAN-2012 11:46:25

J1128+59 EP068D 5.UVDATA.1

Freq = 1.5950 GHz, Bw = 16.000 MH No calibration applied and no bandpass applied

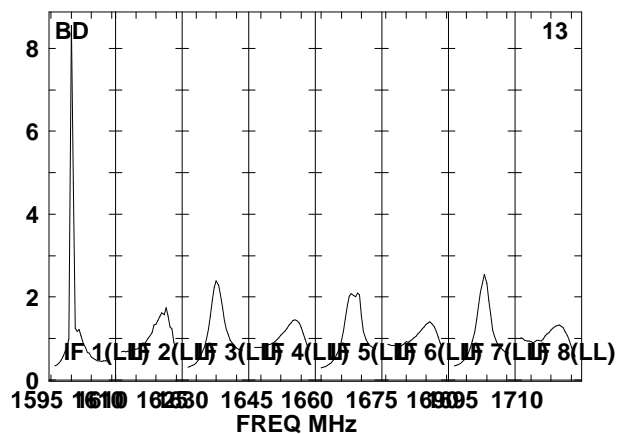
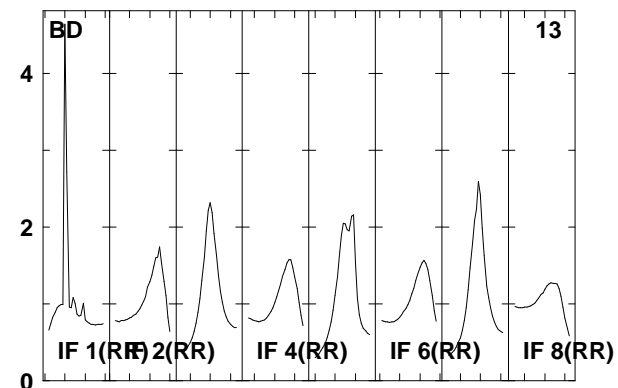
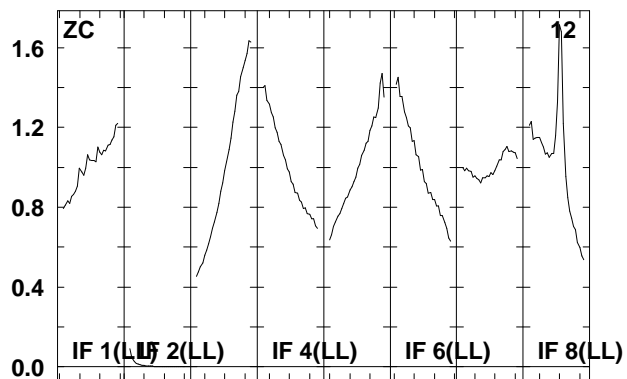
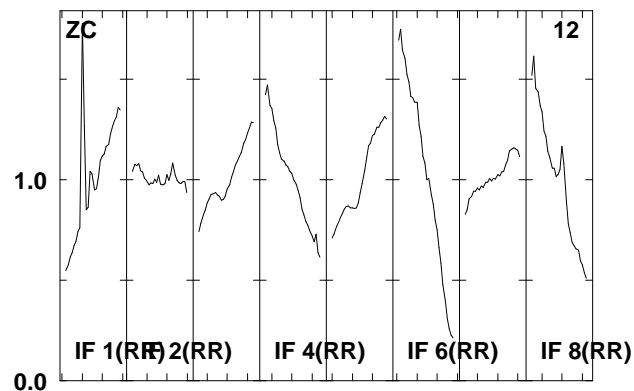
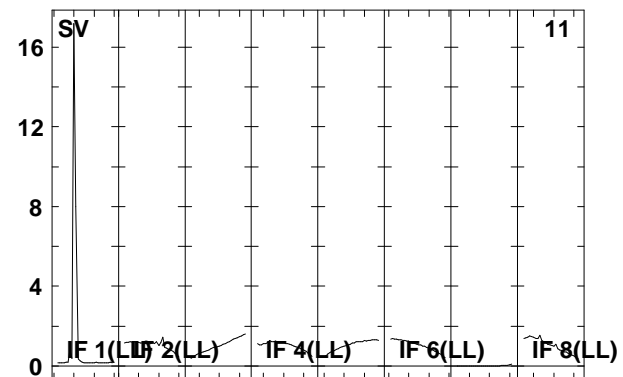
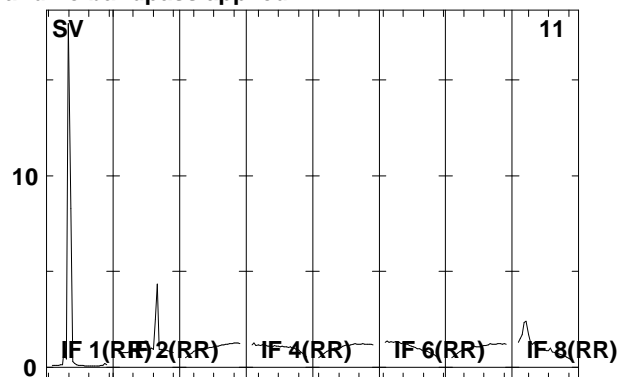
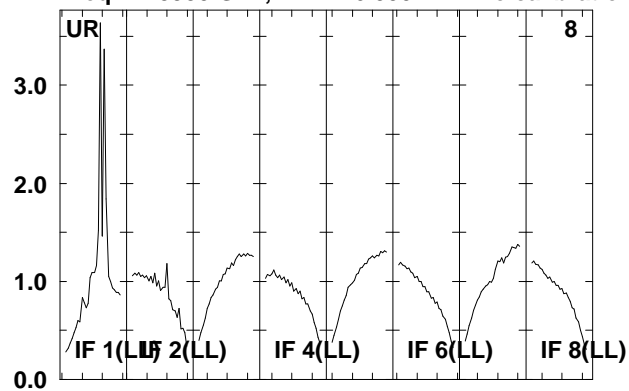

Lower frame: Real Jy

Total-power spectrum Antenna: *

Timerange: 00/14:06:01 to 00/14:08:59

Plot file version 90 created 06-JAN-2012 11:46:26

ARP299D EP068D 5.UVDATA.1

Freq = 1.5950 GHz, Bw = 16.000 MH No calibration applied and no bandpass applied

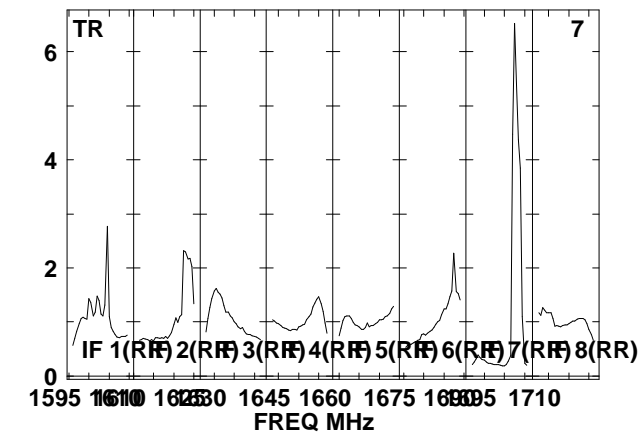
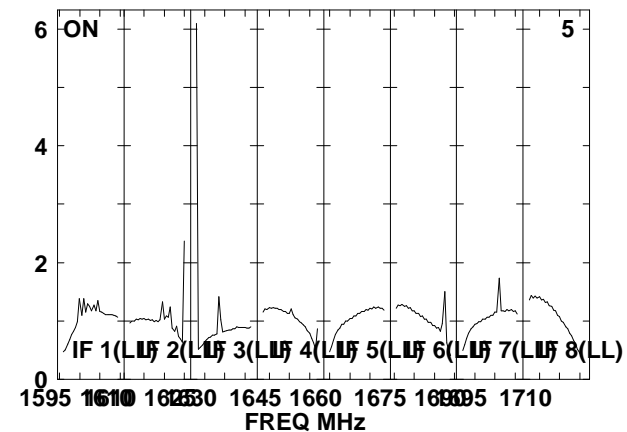
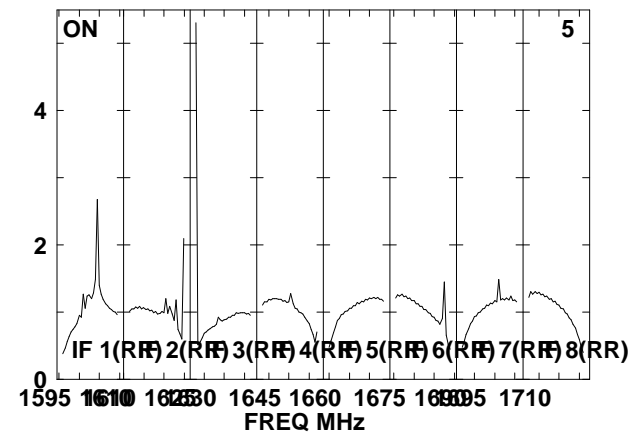
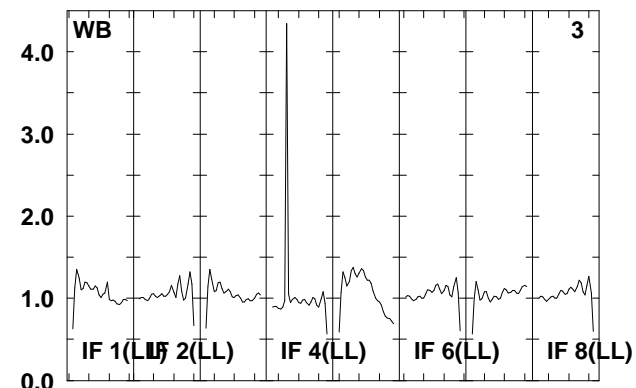
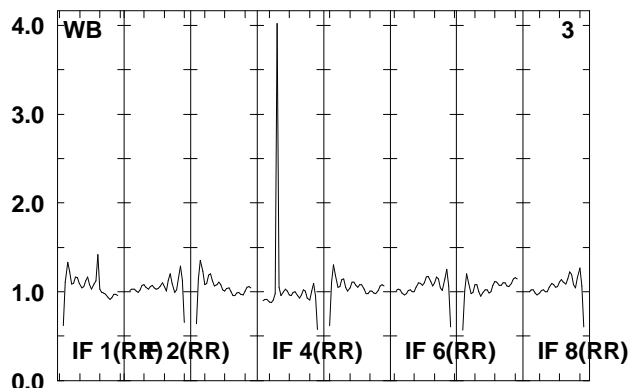
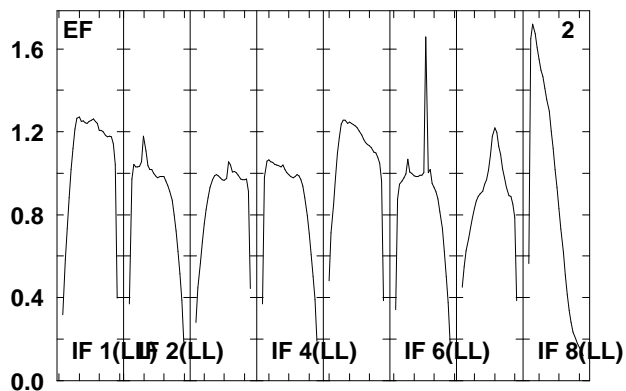
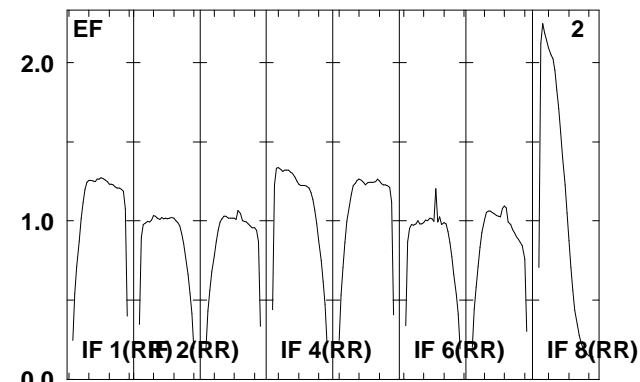
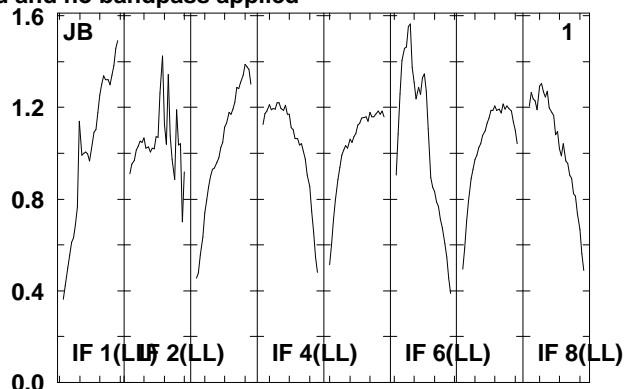
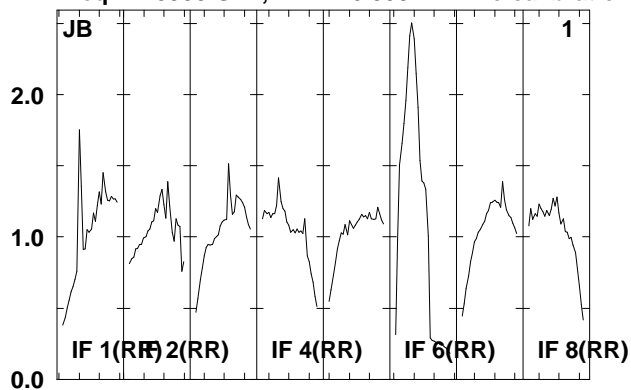

Lower frame: Real Jy
Total-power spectrum Antenna: *
Timerange: 00/14:09:01 to 00/14:12:29

Plot file version 91 created 06-JAN-2012 11:46:26

ARP299D EP068D 5.UVDATA.1

Freq = 1.5950 GHz, Bw = 16.000 MH No calibration applied and no bandpass applied

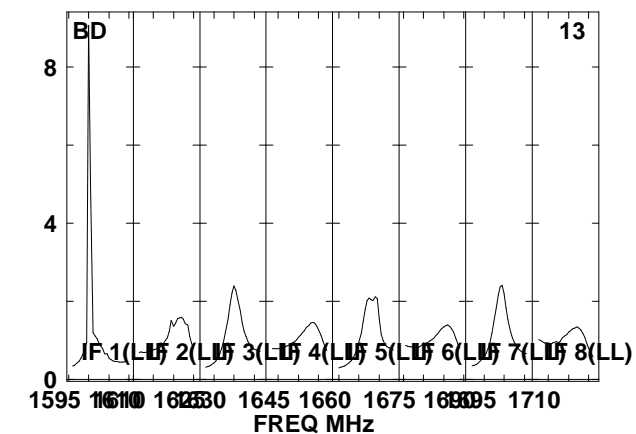
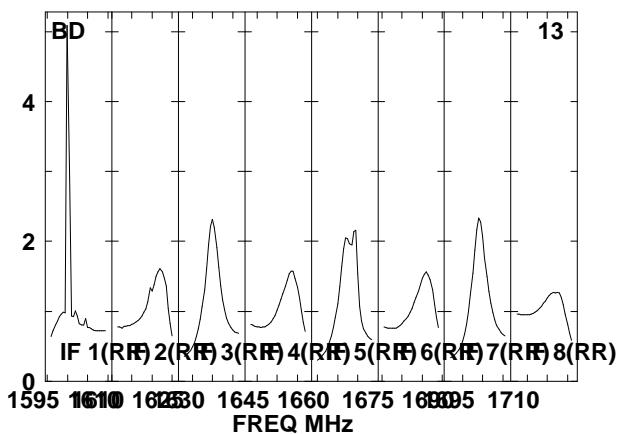
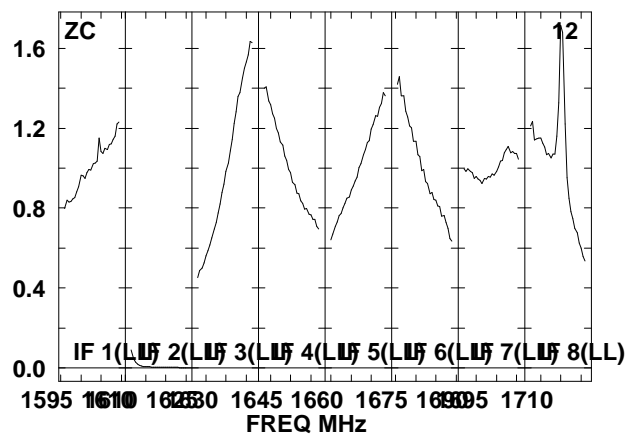
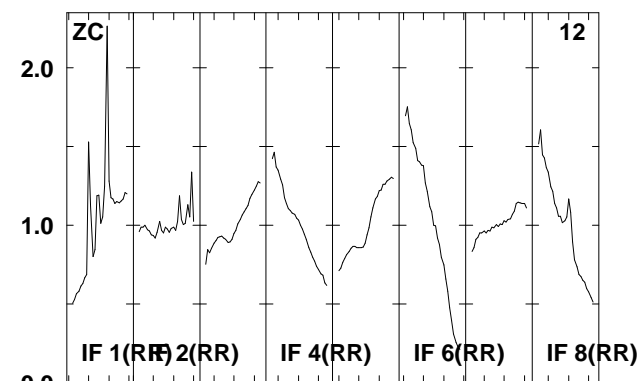
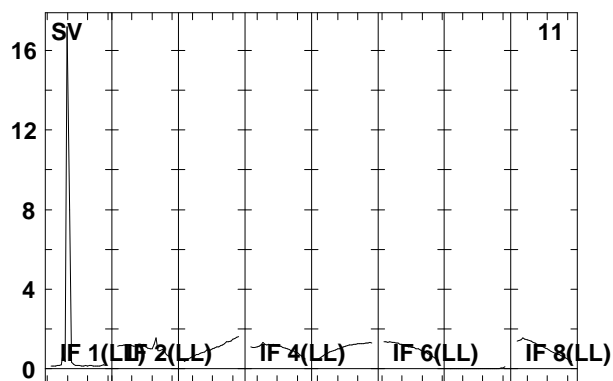
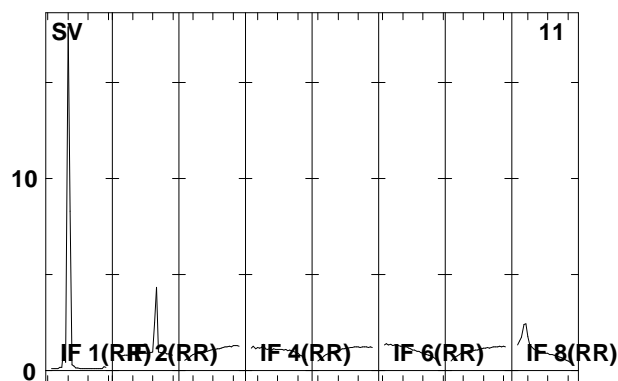
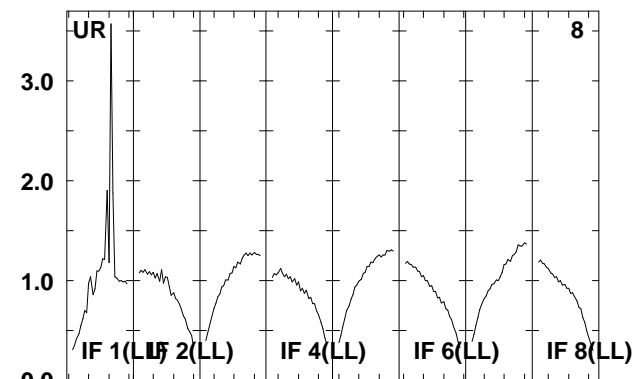
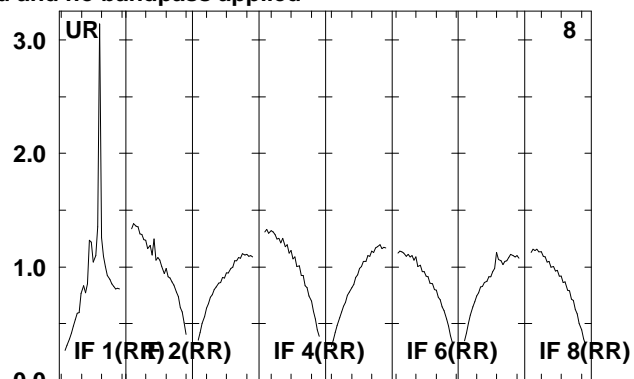
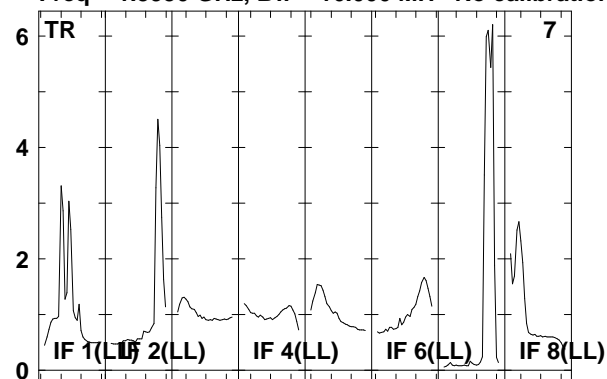

Lower frame: Real Jy
Total-power spectrum Antenna: *
Timerange: 00/14:09:01 to 00/14:12:29

Plot file version 92 created 06-JAN-2012 11:46:27

J1128+59 EP068D 5.UVDATA.1

Freq = 1.5950 GHz, Bw = 16.000 MH No calibration applied and no bandpass applied

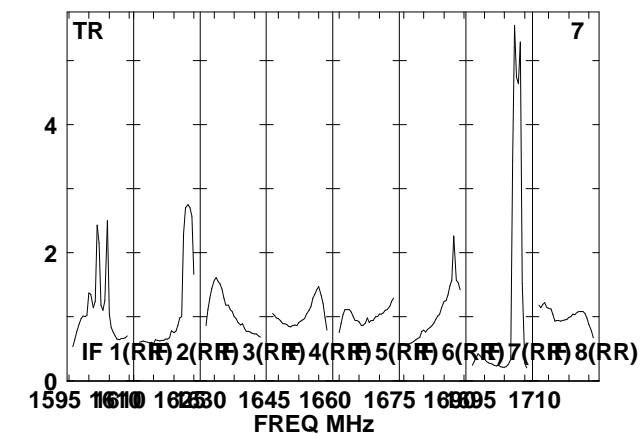
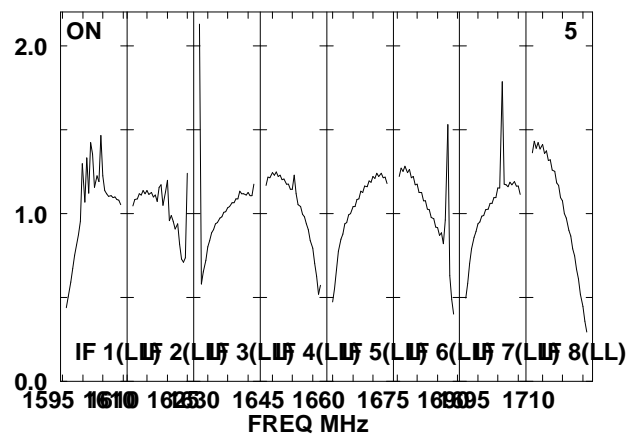
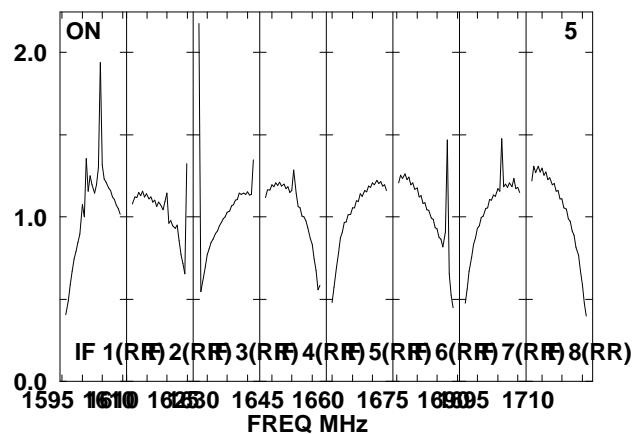
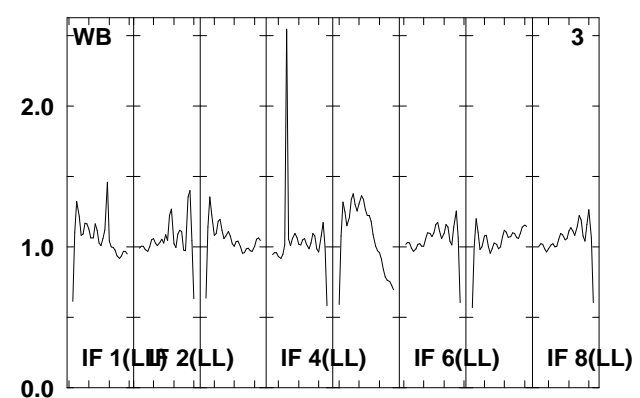
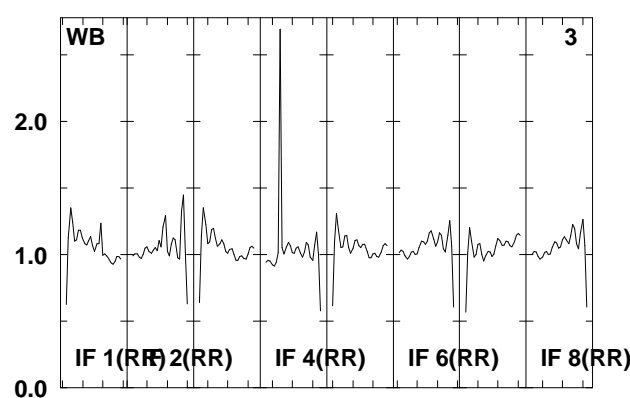
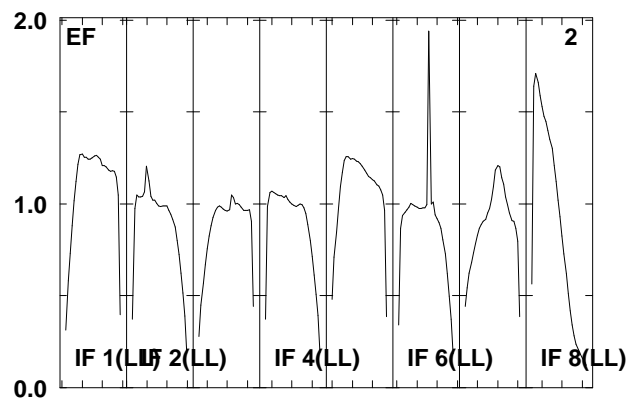
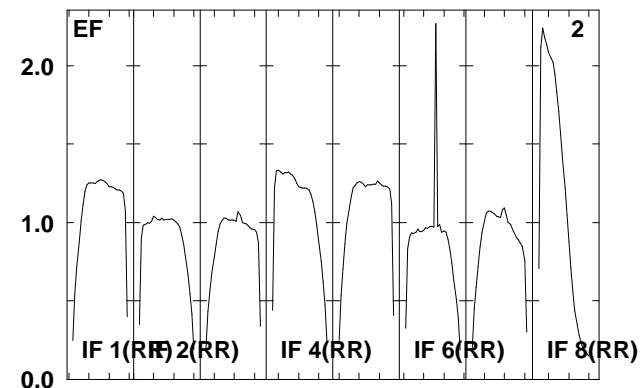
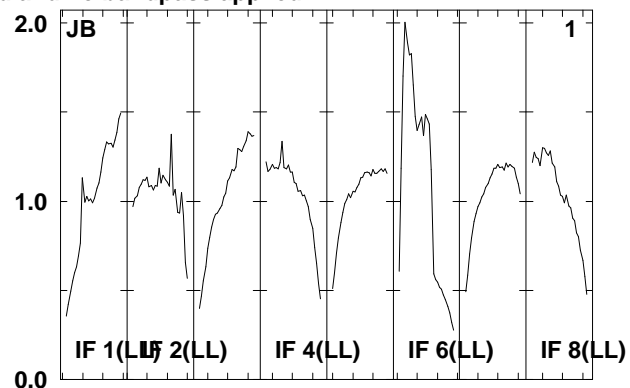
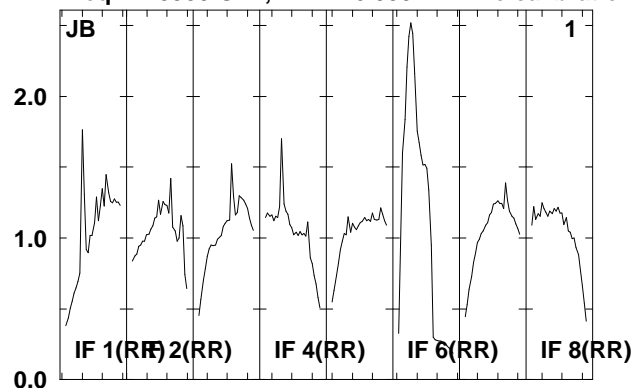

Lower frame: Real Jy
Total-power spectrum Antenna: *
Timerange: 00/14:12:35 to 00/14:13:59

Plot file version 93 created 06-JAN-2012 11:46:27

J1128+59 EP068D 5.UVDATA.1

Freq = 1.5950 GHz, Bw = 16.000 MH No calibration applied and no bandpass applied

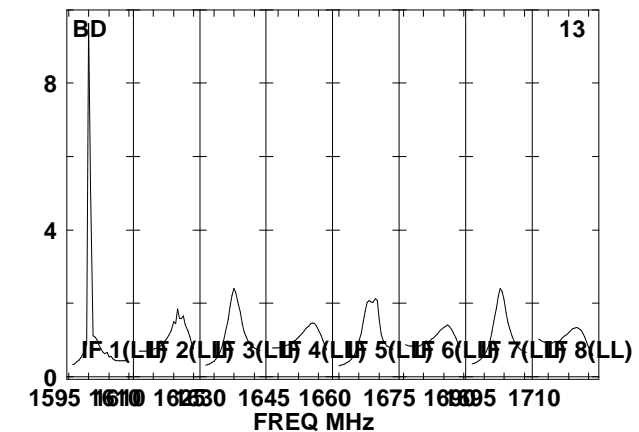
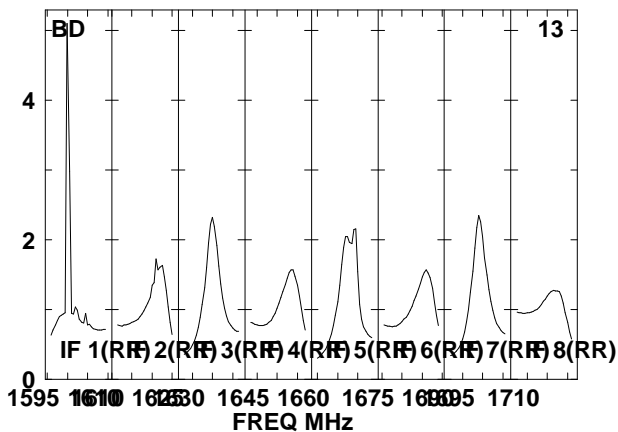
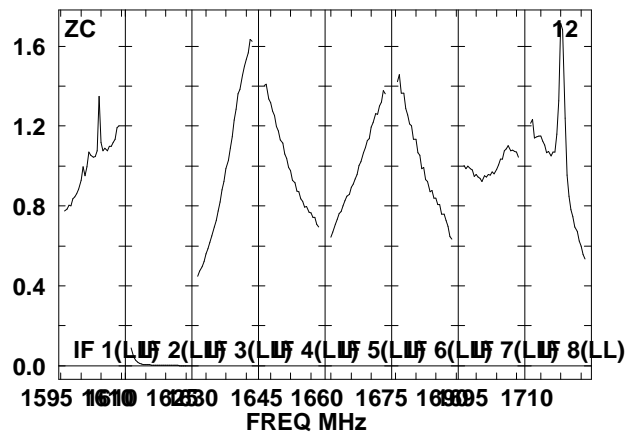
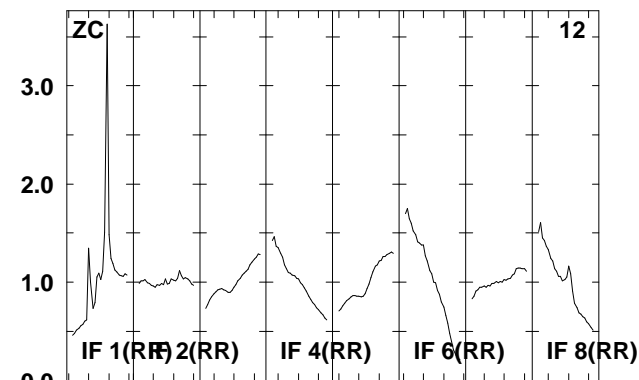
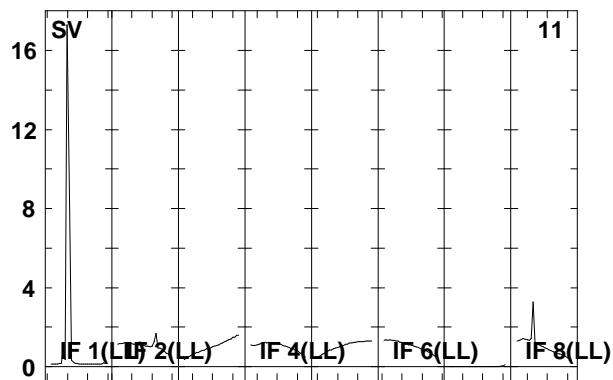
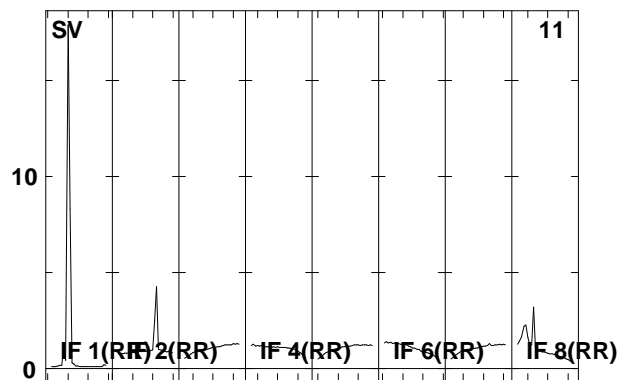
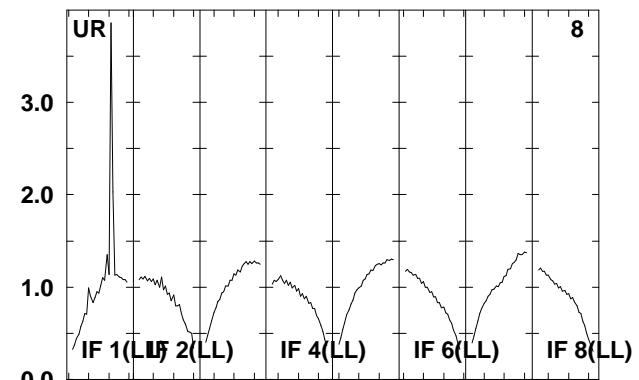
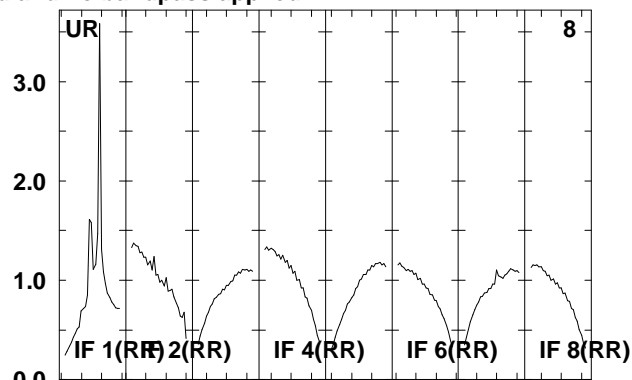
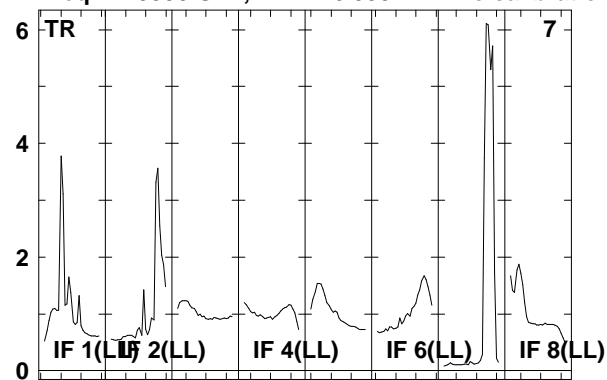

Lower frame: Real Jy

Total-power spectrum Antenna: *

Timerange: 00/14:12:35 to 00/14:13:59

Plot file version 94 created 06-JAN-2012 11:46:28

ARP299D EP068D 5.UVDATA.1

Freq = 1.5950 GHz, Bw = 16.000 MH No calibration applied and no bandpass applied

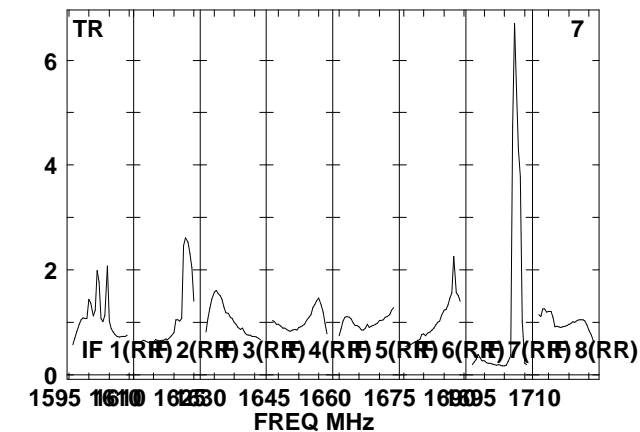
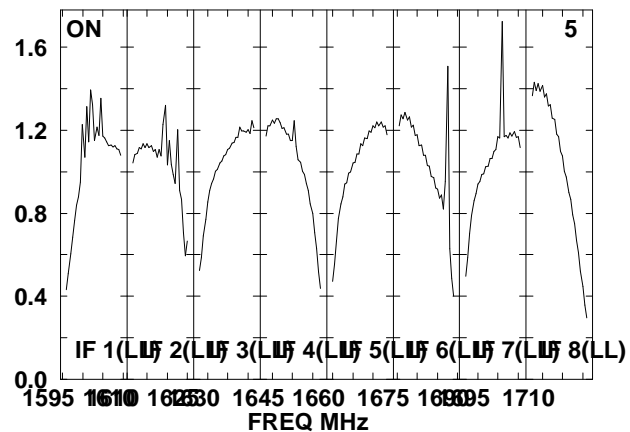
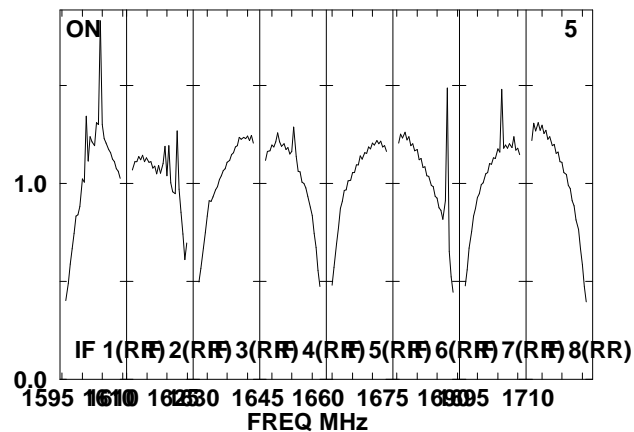
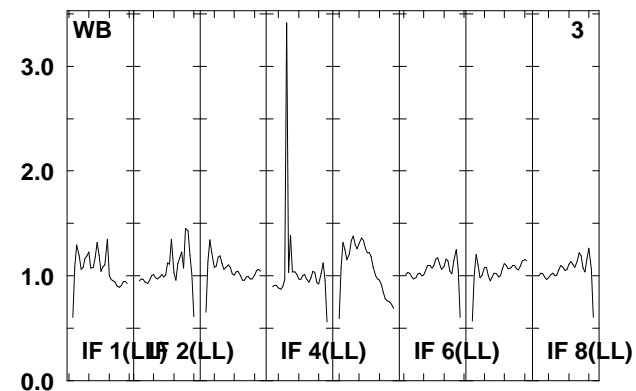
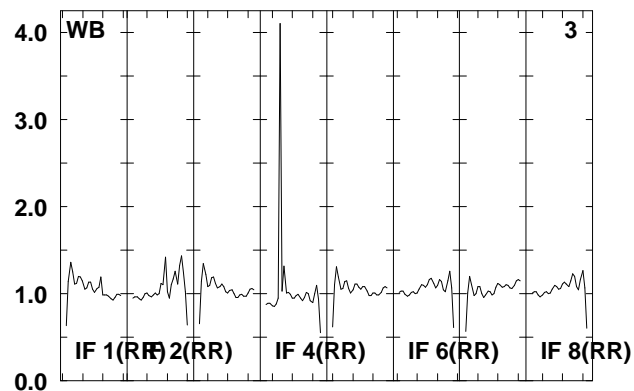
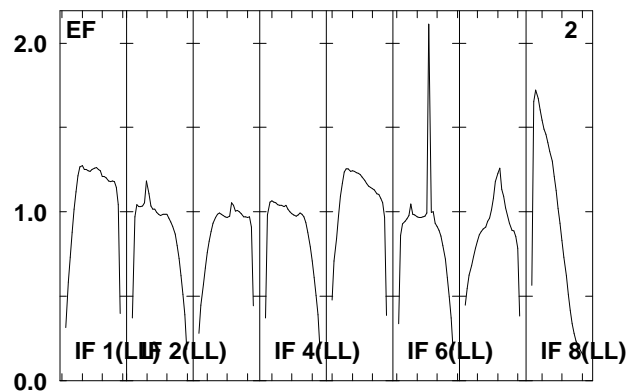
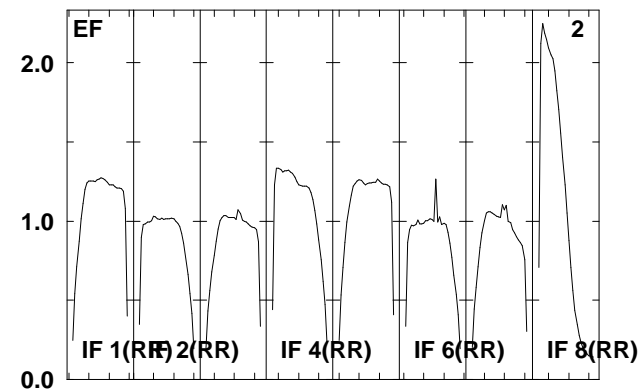
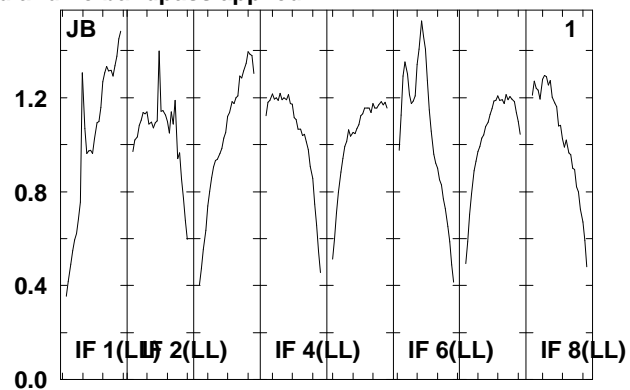
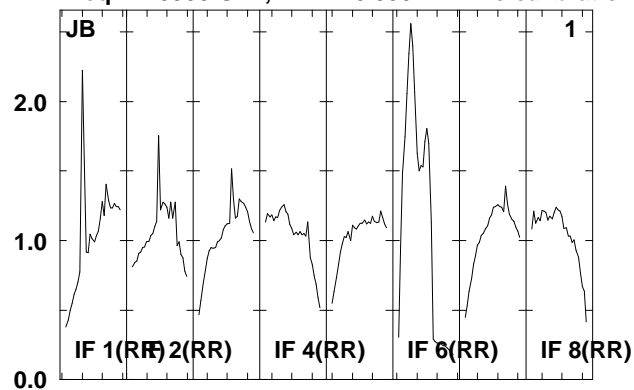

Lower frame: Real Jy
Total-power spectrum Antenna: *
Timerange: 00/14:14:05 to 00/14:17:29

Plot file version 95 created 06-JAN-2012 11:46:28

ARP299D EP068D 5.UVDATA.1

Freq = 1.5950 GHz, Bw = 16.000 MH No calibration applied and no bandpass applied

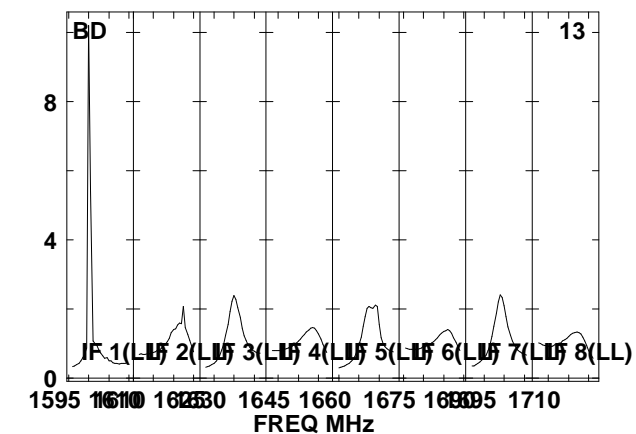
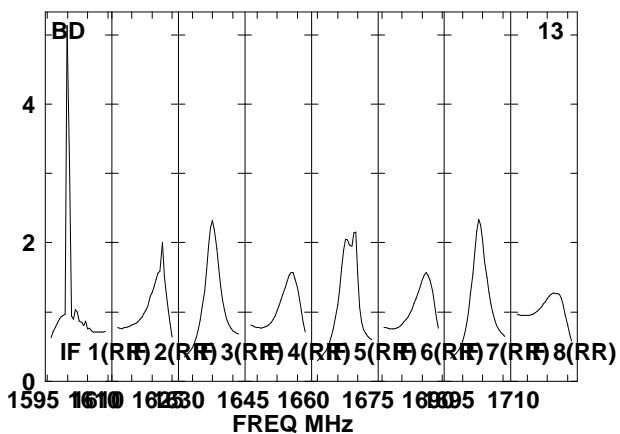
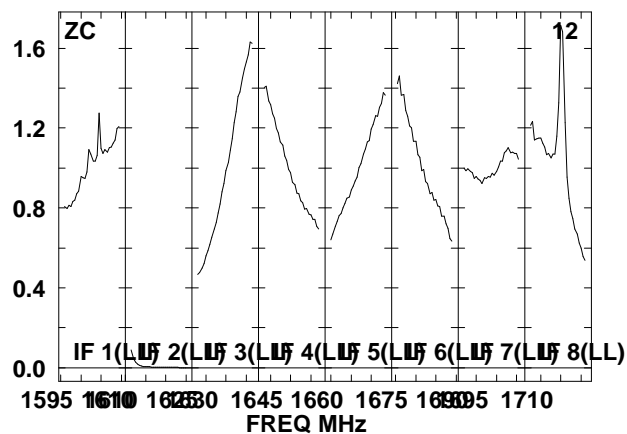
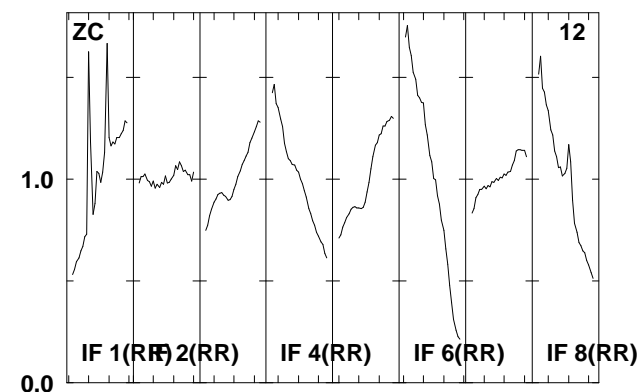
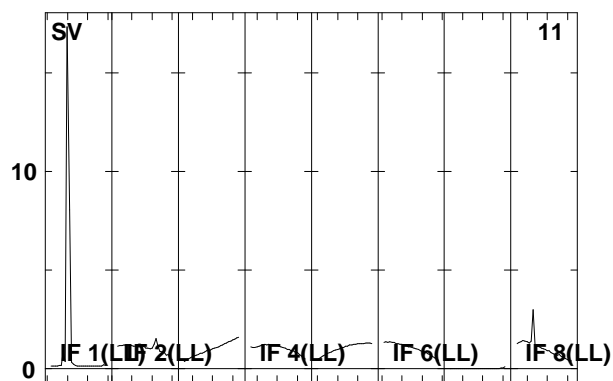
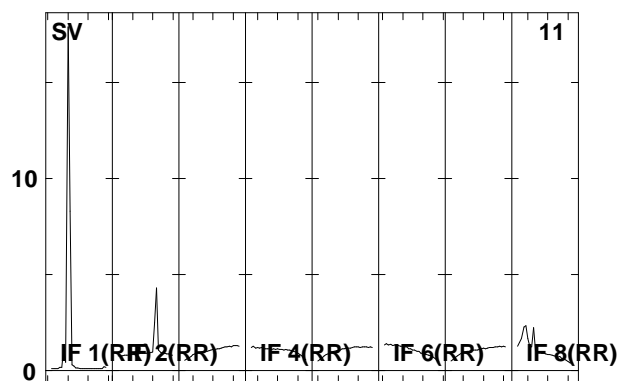
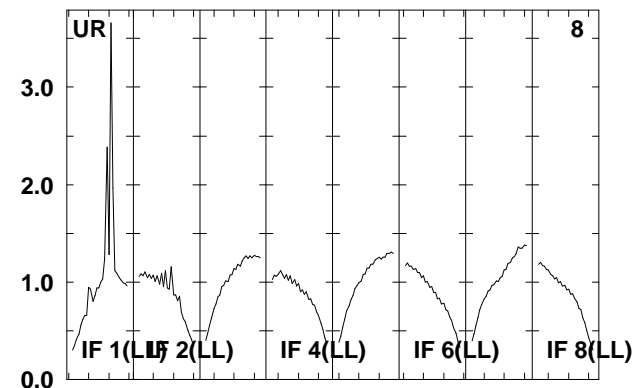
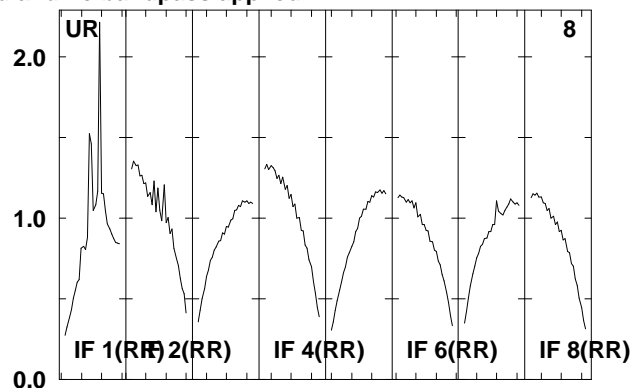
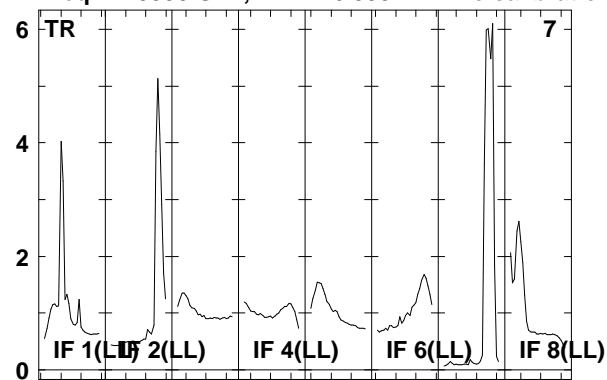

Lower frame: Real Jy

Total-power spectrum Antenna: *

Timerange: 00/14:14:05 to 00/14:17:29

Plot file version 96 created 06-JAN-2012 11:46:29

J1128+59 EP068D 5.UVDATA.1

Freq = 1.5950 GHz, Bw = 16.000 MH No calibration applied and no bandpass applied

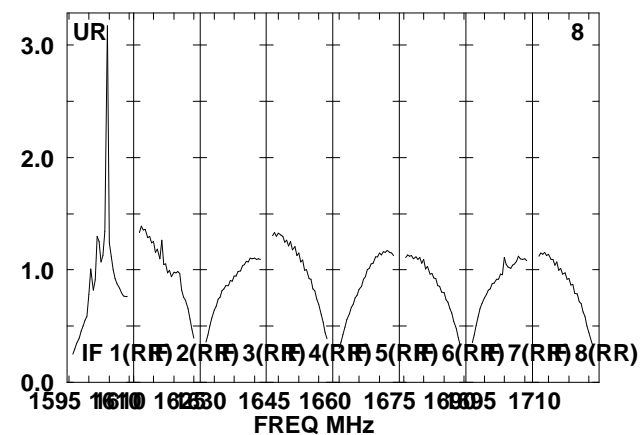
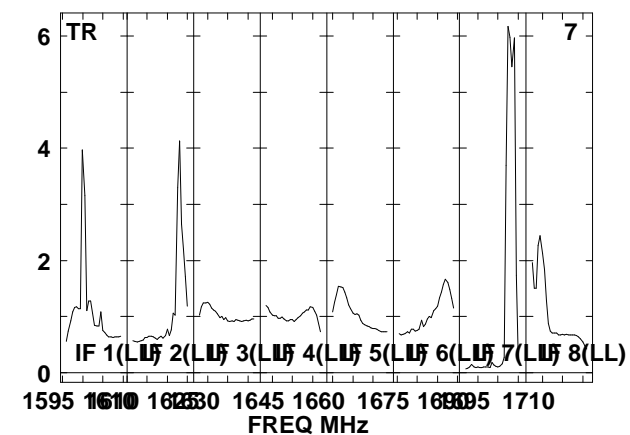
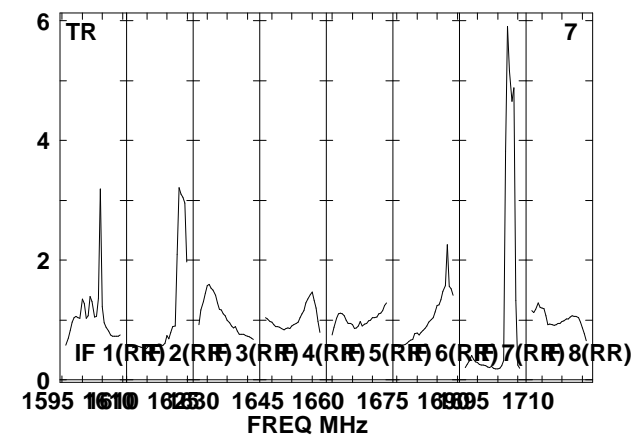
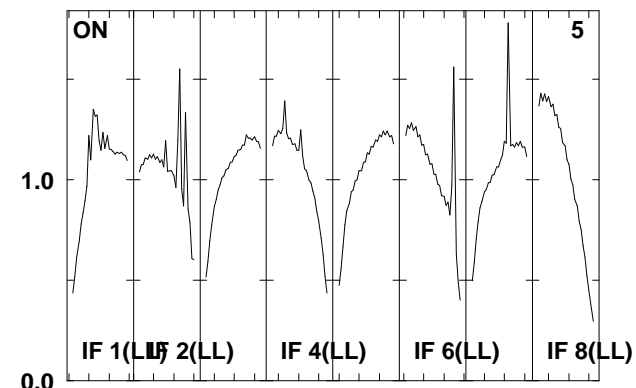
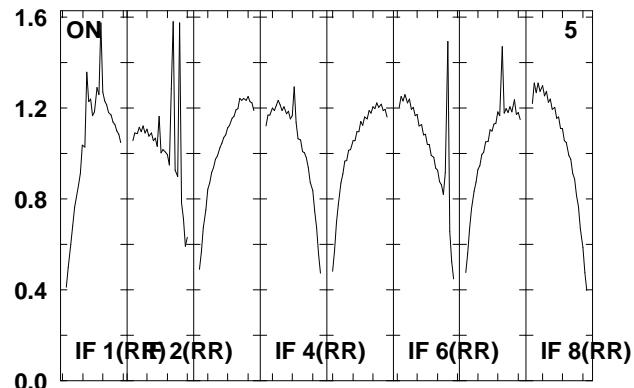
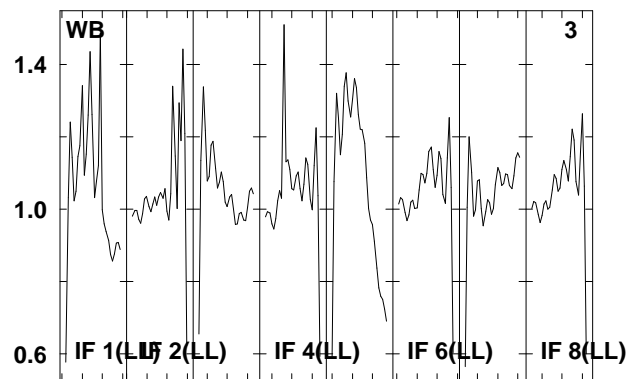
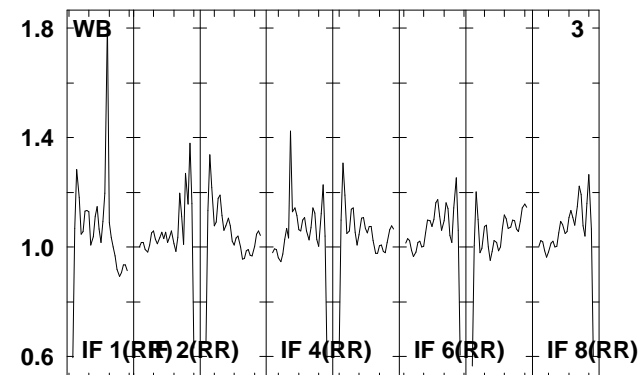
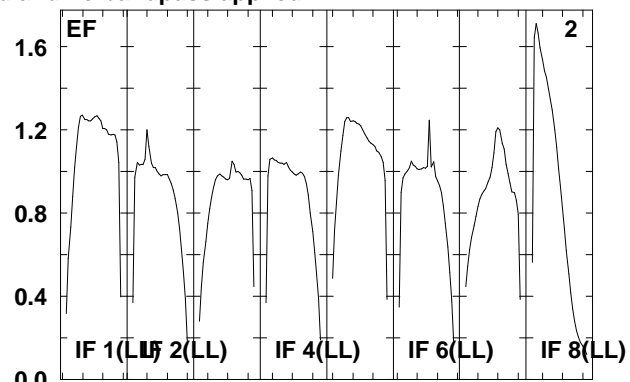
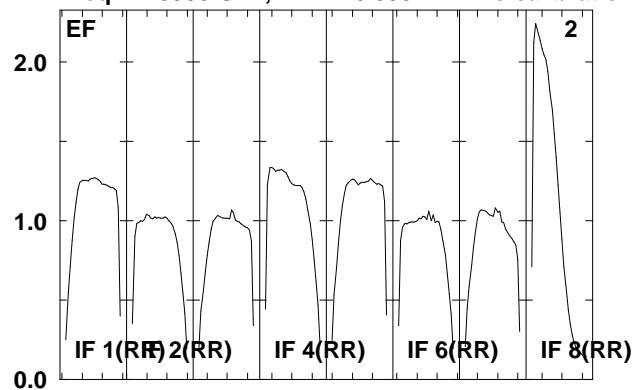

Lower frame: Real Jy
Total-power spectrum Antenna: *
Timerange: 00/14:18:31 to 00/14:19:59

Plot file version 97 created 06-JAN-2012 11:46:29

J1128+59 EP068D 5.UVDATA.1

Freq = 1.5950 GHz, Bw = 16.000 MH No calibration applied and no bandpass applied

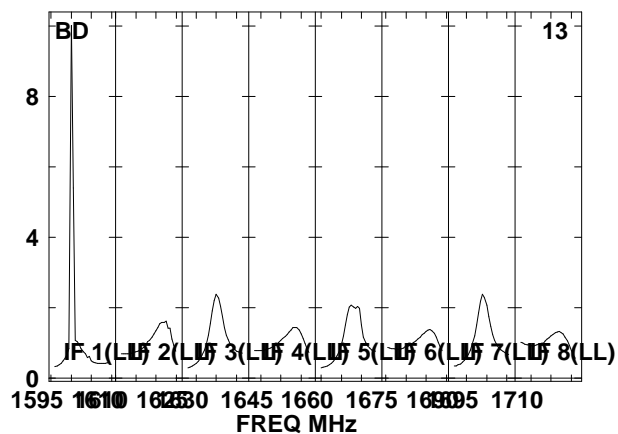
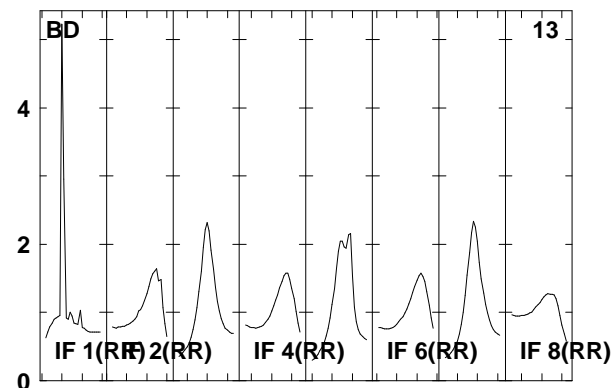
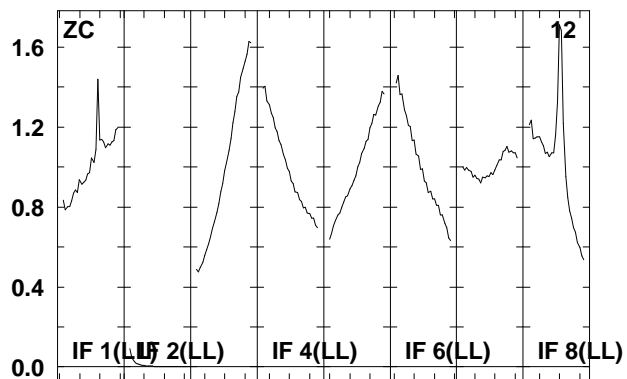
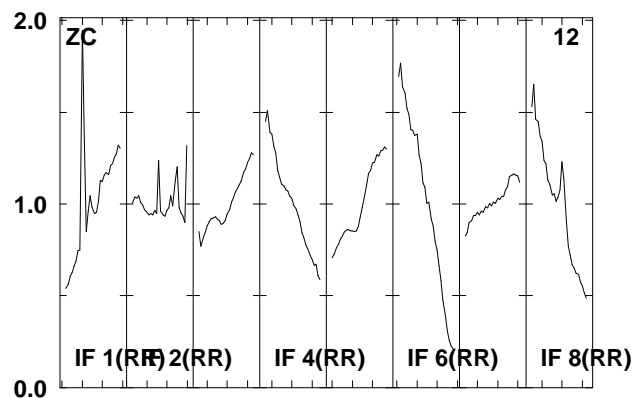
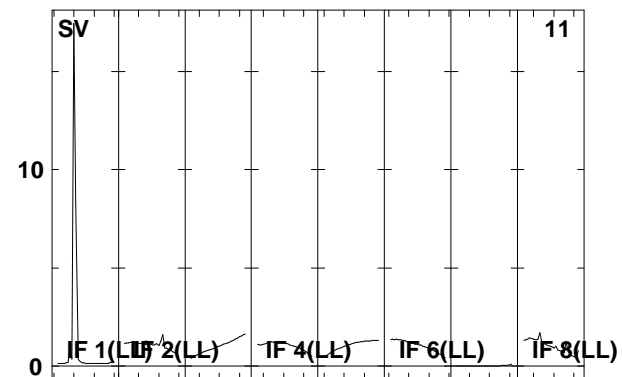
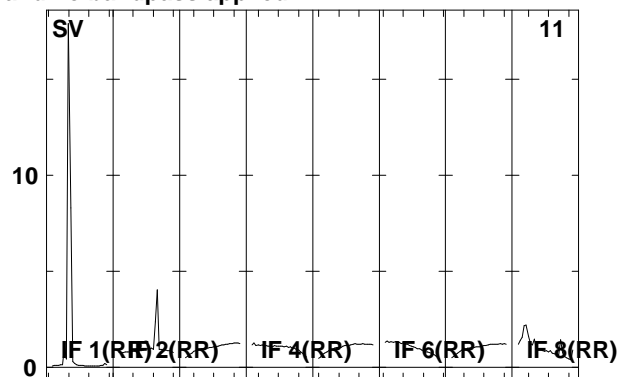
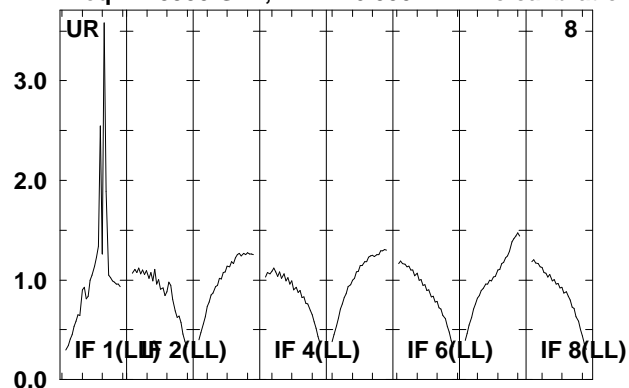

Lower frame: Real Jy

Total-power spectrum Antenna: *

Timerange: 00/14:18:31 to 00/14:19:59

Plot file version 98 created 06-JAN-2012 11:46:30

ARP299D EP068D 5.UVDATA.1

Freq = 1.5950 GHz, Bw = 16.000 MH No calibration applied and no bandpass applied

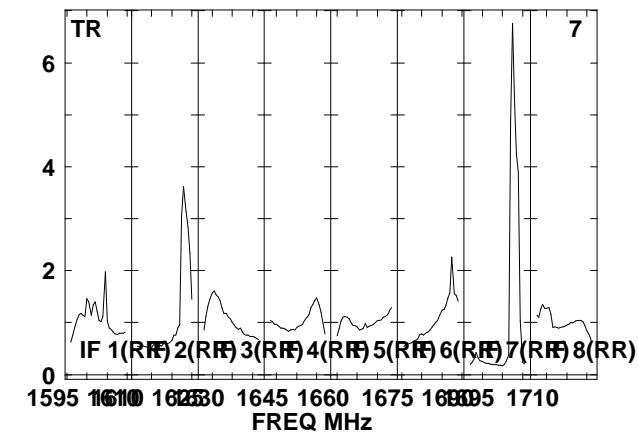
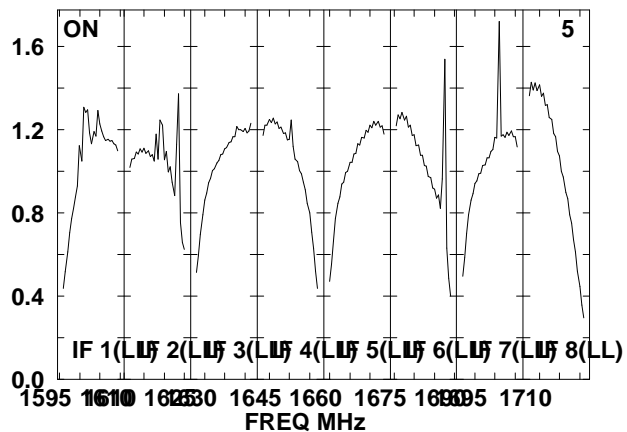
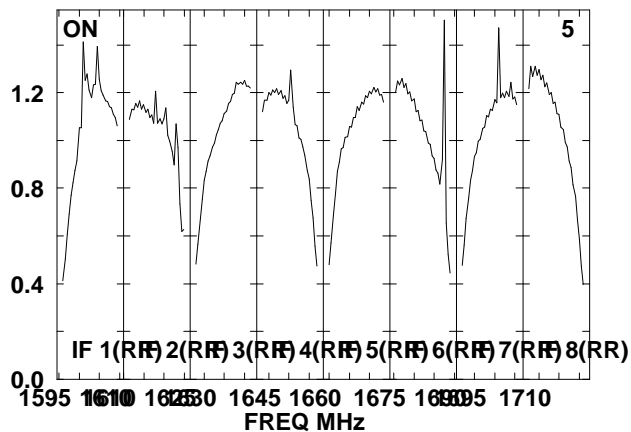
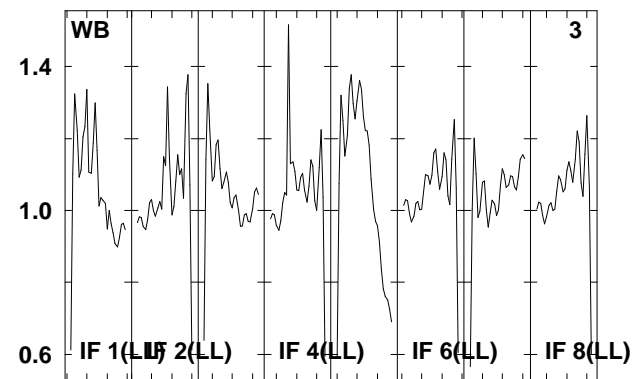
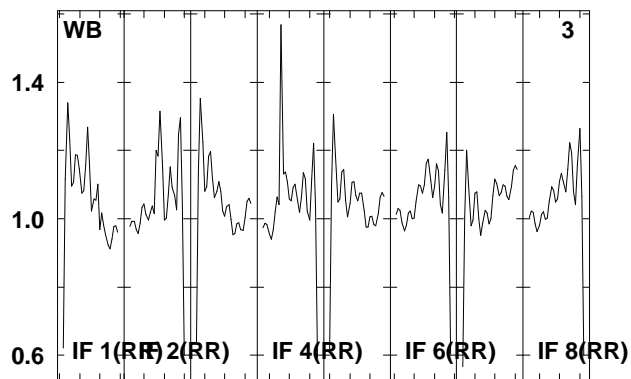
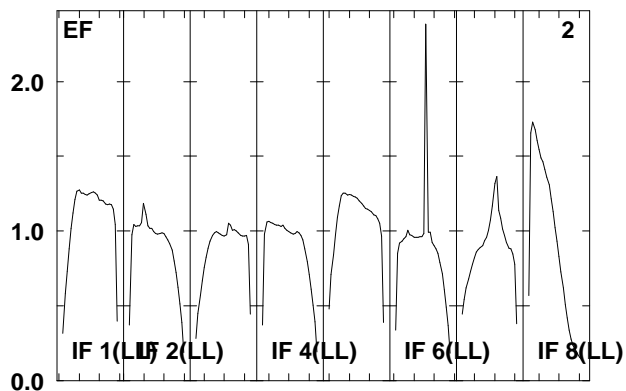
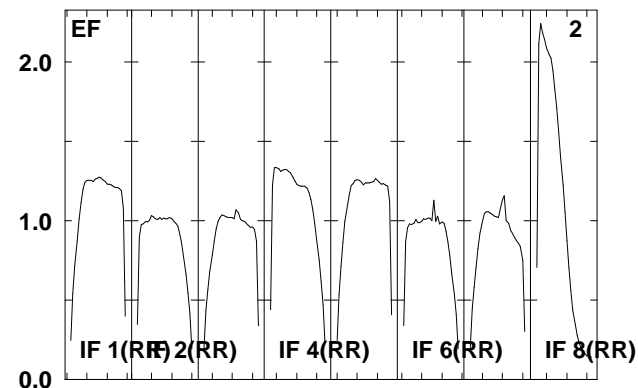
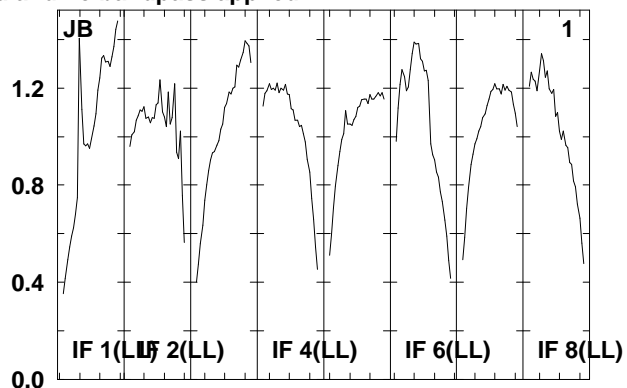
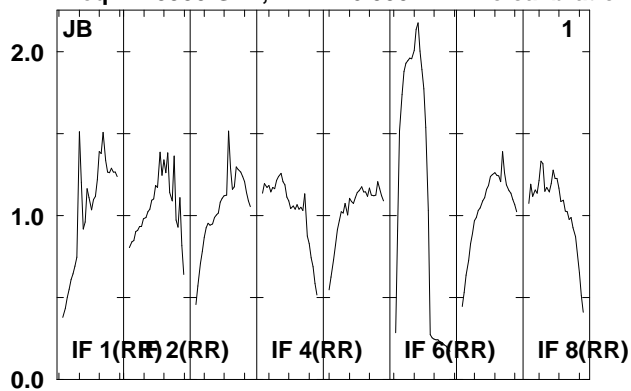

Lower frame: Real Jy
Total-power spectrum Antenna: *
Timerange: 00/14:20:01 to 00/14:23:29

Plot file version 99 created 06-JAN-2012 11:46:30

ARP299D EP068D 5.UVDATA.1

Freq = 1.5950 GHz, Bw = 16.000 MH No calibration applied and no bandpass applied

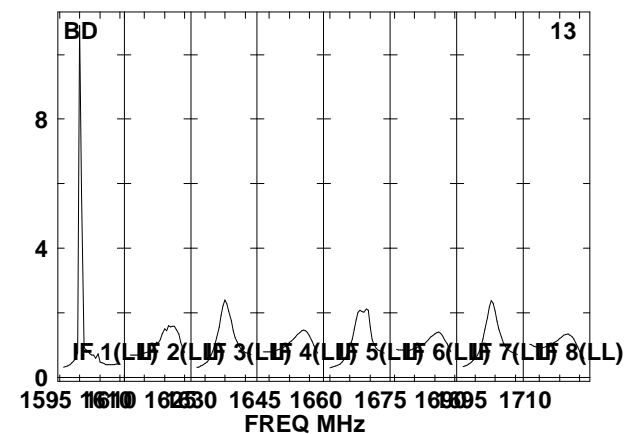
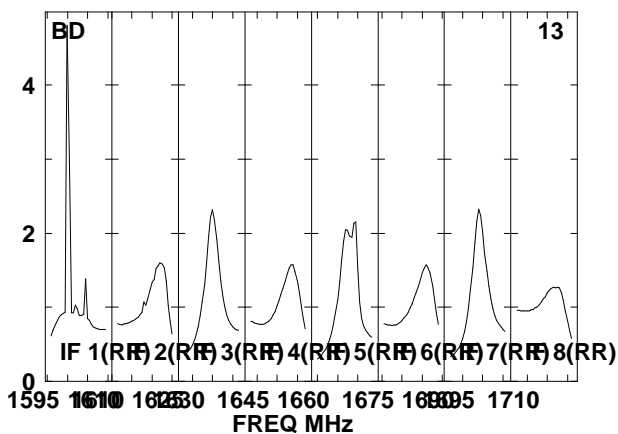
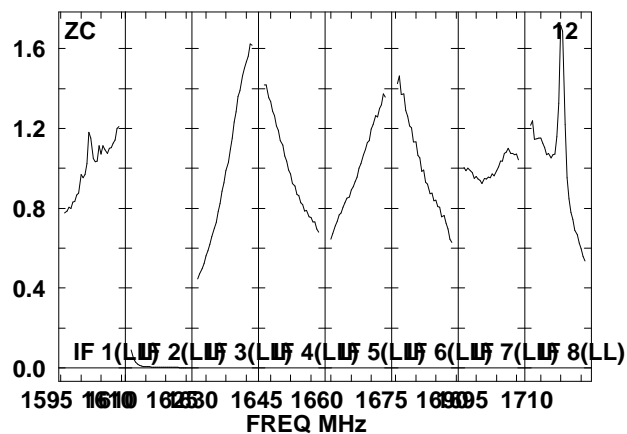
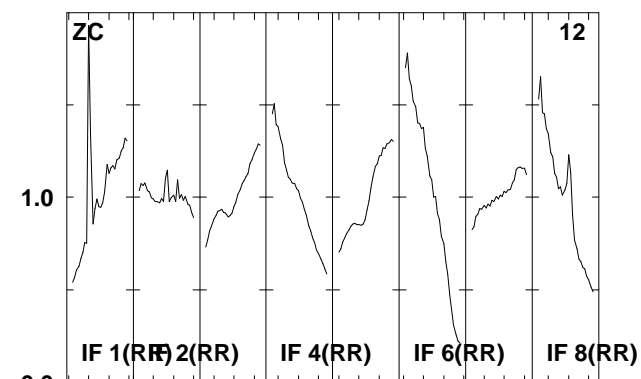
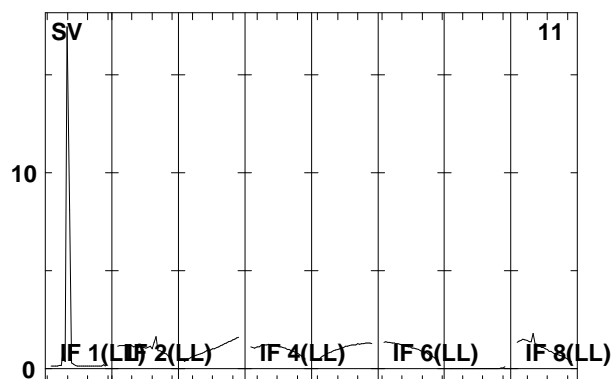
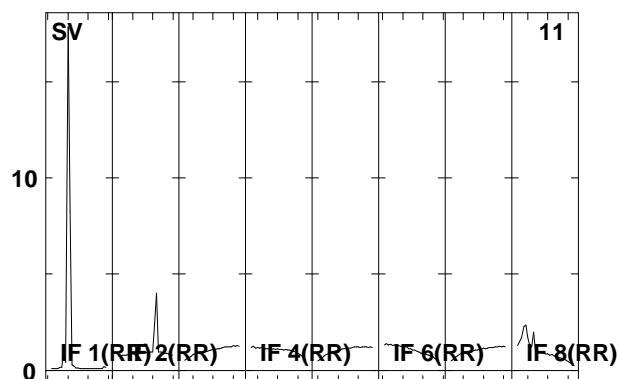
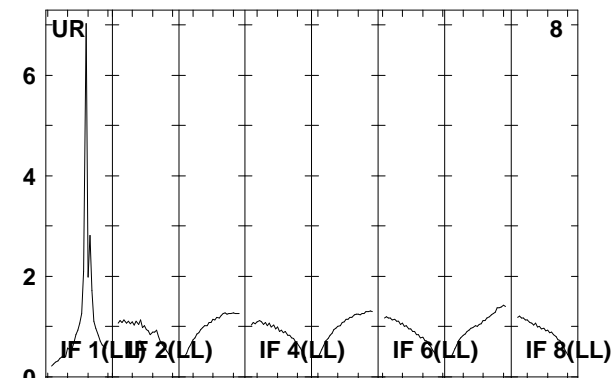
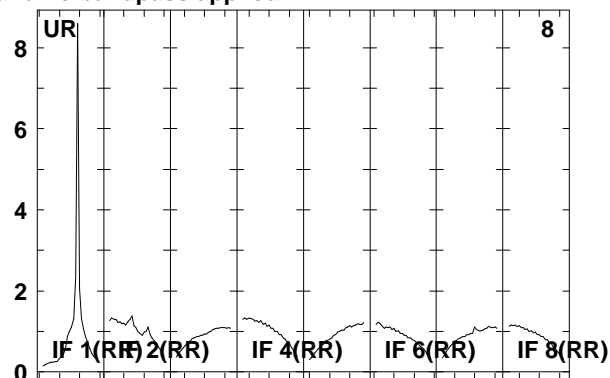
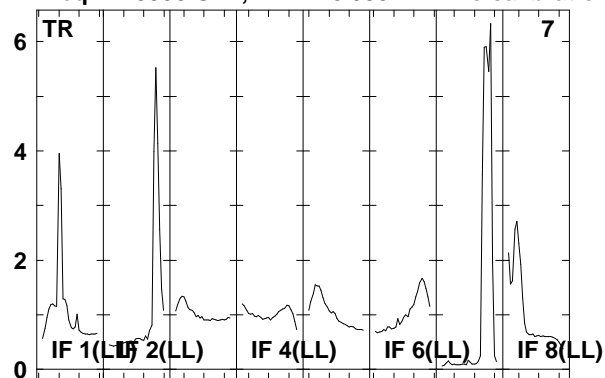

Lower frame: Real Jy
Total-power spectrum Antenna: *
Timerange: 00/14:20:01 to 00/14:23:29

Plot file version 100 created 06-JAN-2012 11:46:31

J1128+59 EP068D 5.UVDATA.1

Freq = 1.5950 GHz, Bw = 16.000 MH No calibration applied and no bandpass applied

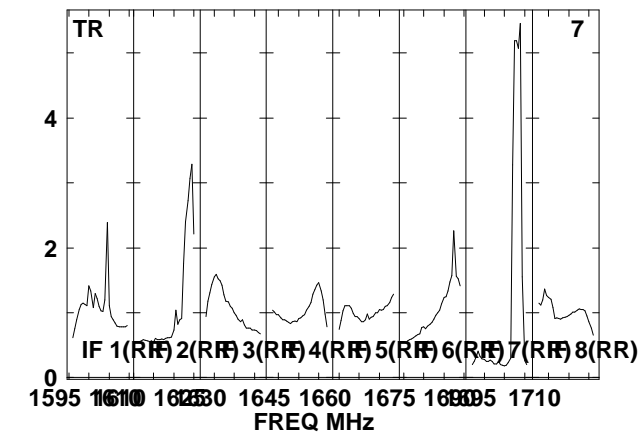
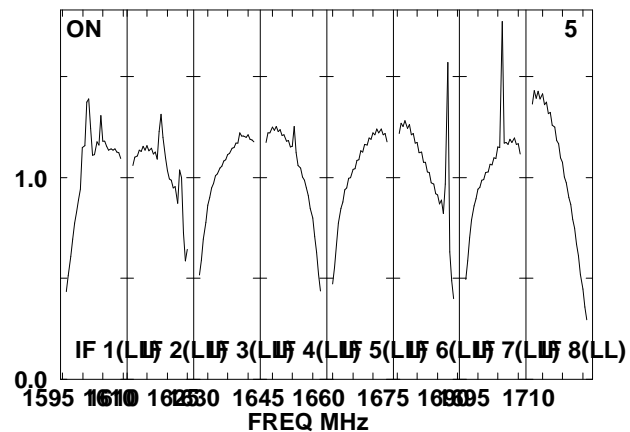
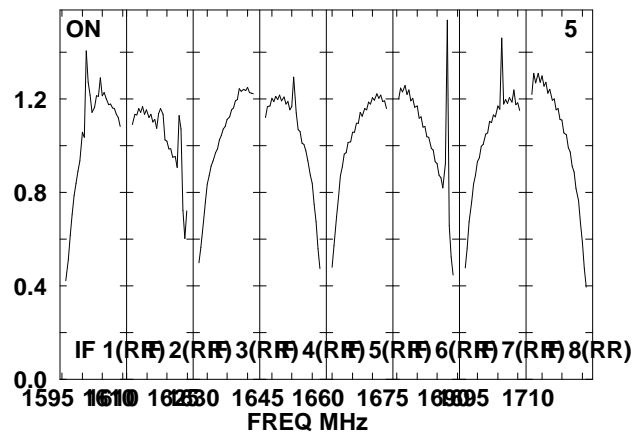
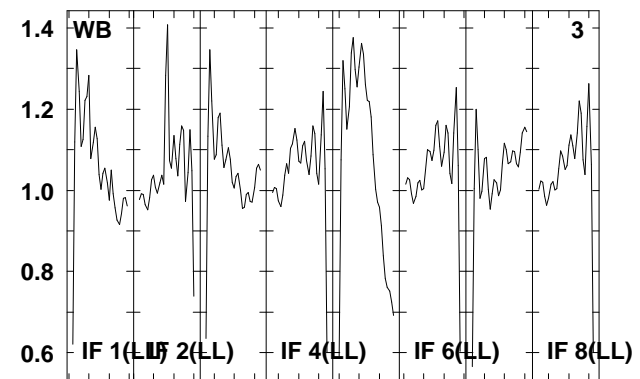
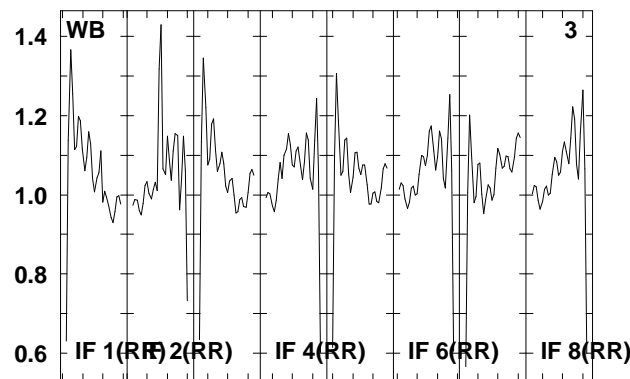
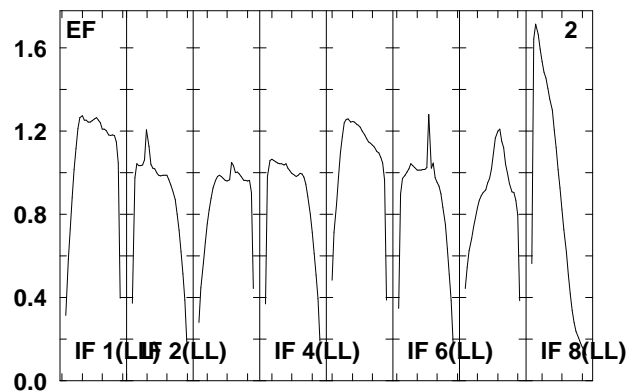
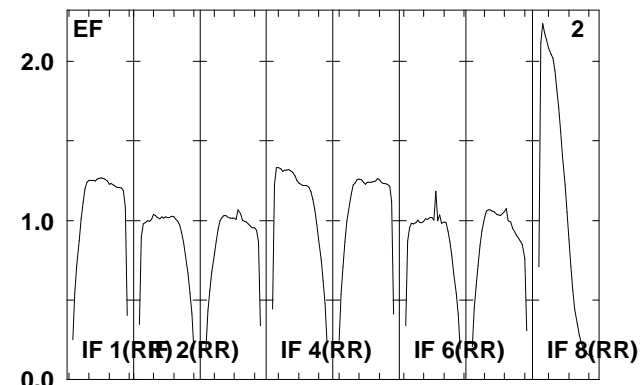
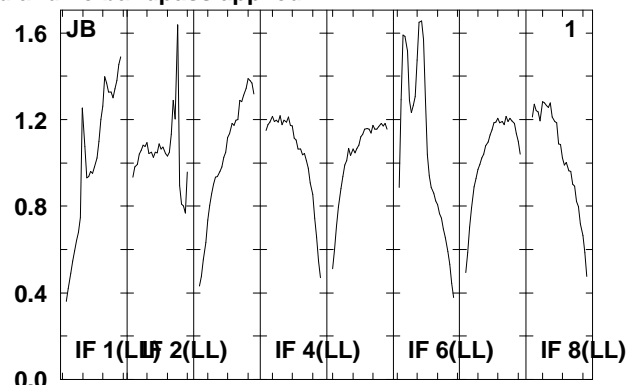
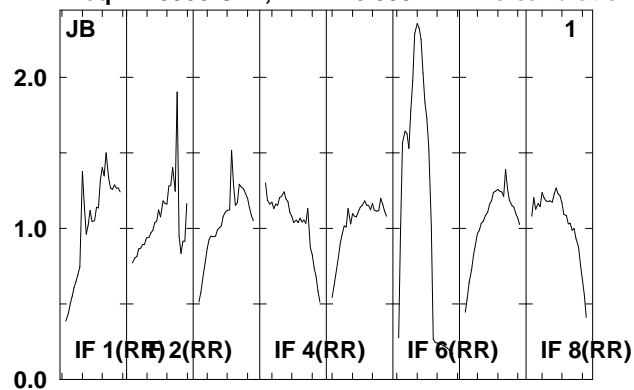

Lower frame: Real Jy
Total-power spectrum Antenna: *
Timerange: 00/14:23:35 to 00/14:24:59

Plot file version 101 created 06-JAN-2012 11:46:31

J1128+59 EP068D 5.UVDATA.1

Freq = 1.5950 GHz, Bw = 16.000 MH No calibration applied and no bandpass applied

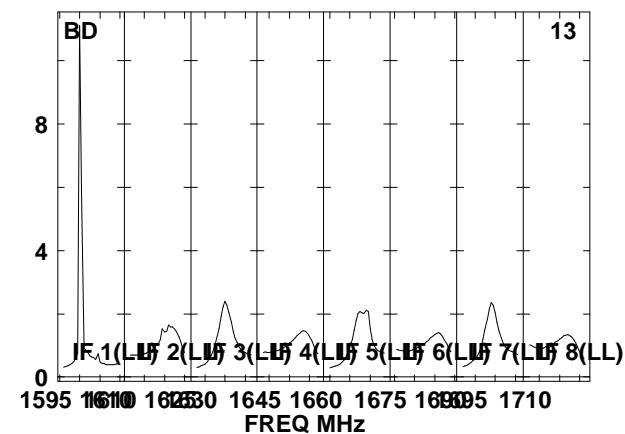
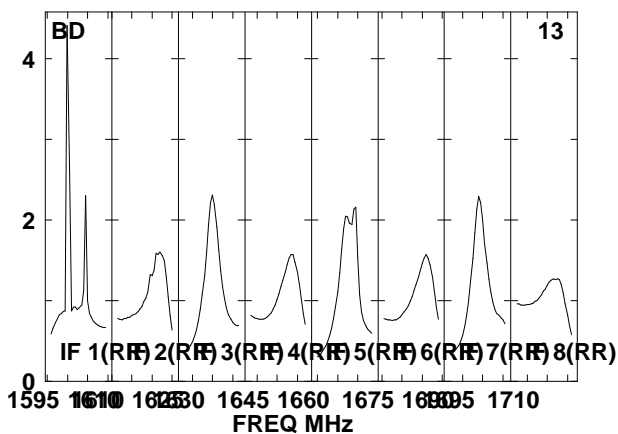
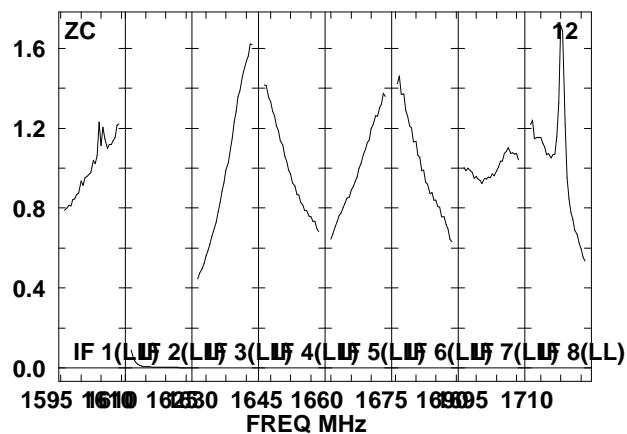
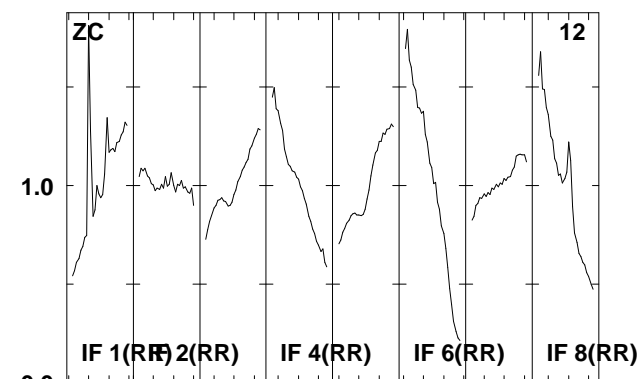
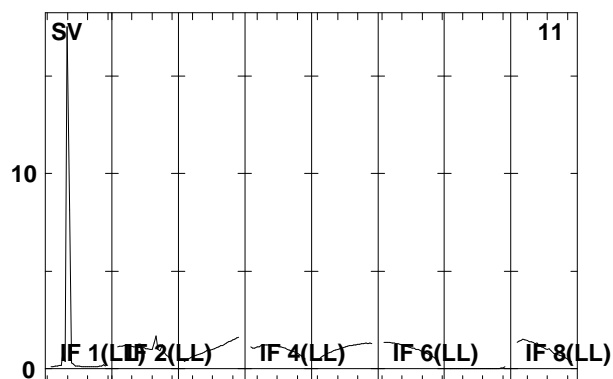
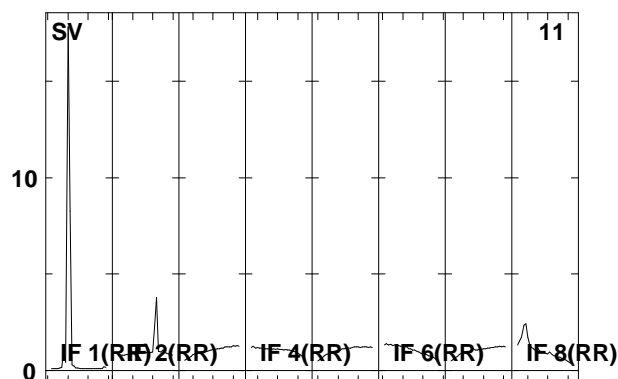
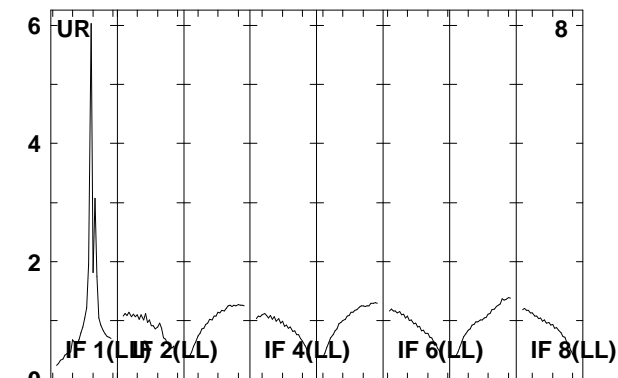
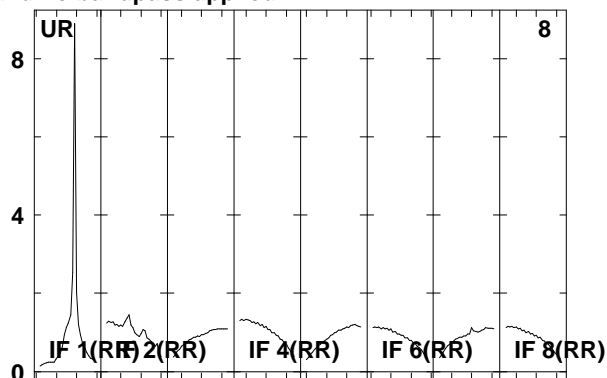
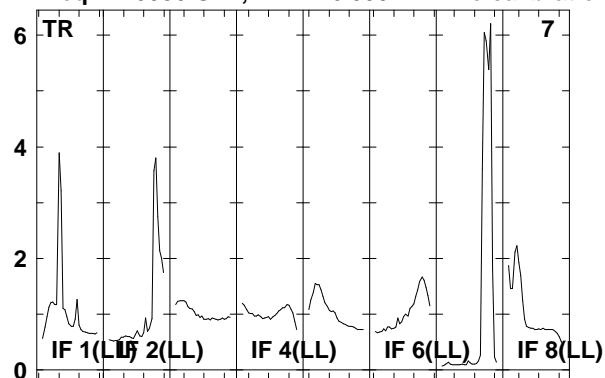

Lower frame: Real Jy

Total-power spectrum Antenna: *

Timerange: 00/14:23:35 to 00/14:24:59

Plot file version 102 created 06-JAN-2012 11:46:31

ARP299D EP068D 5.UVDATA.1

Freq = 1.5950 GHz, Bw = 16.000 MH No calibration applied and no bandpass applied

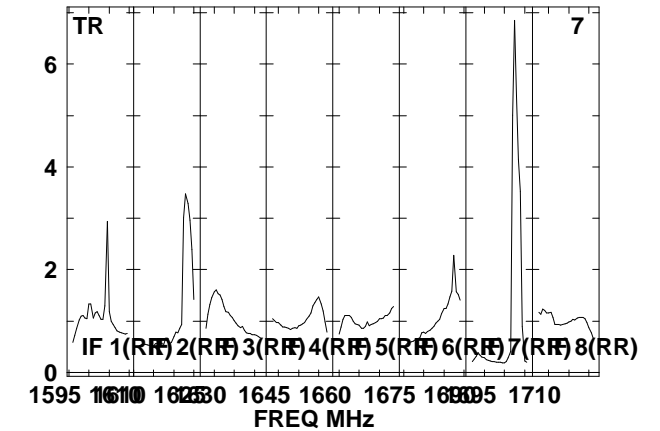
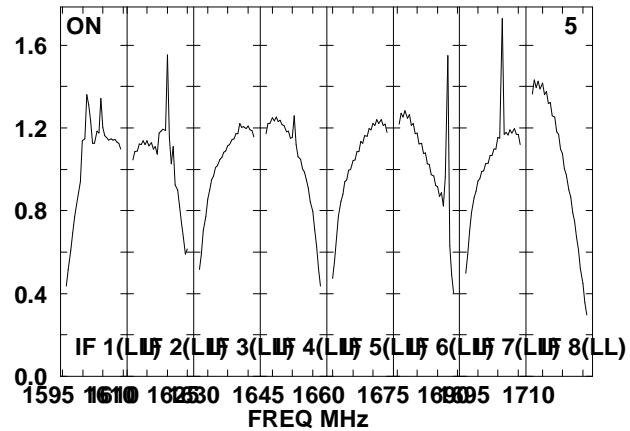
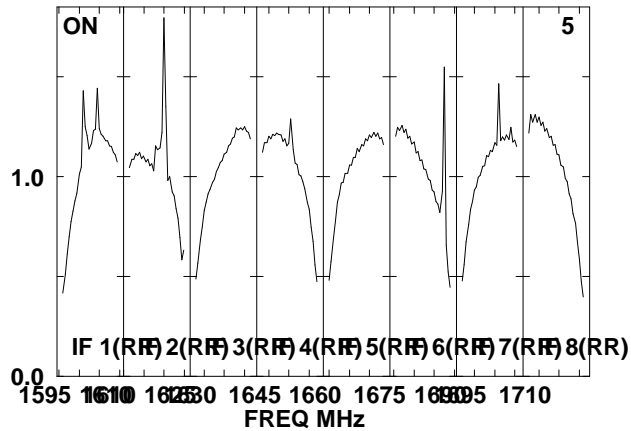
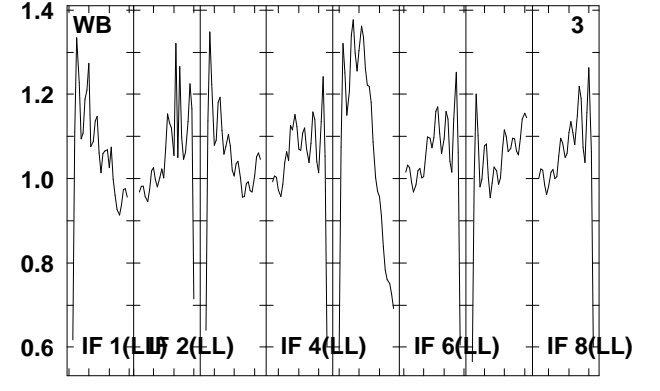
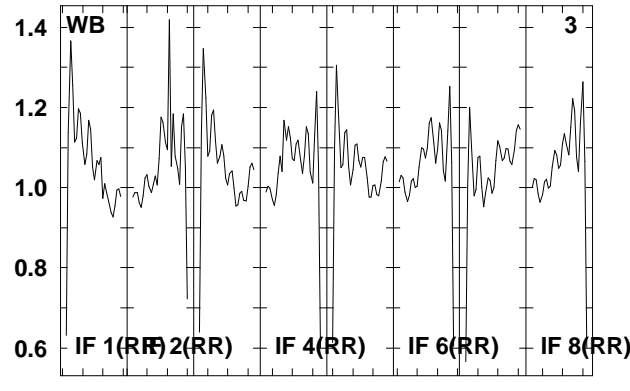
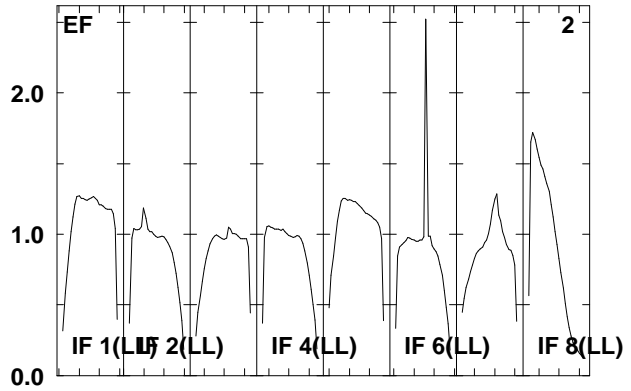
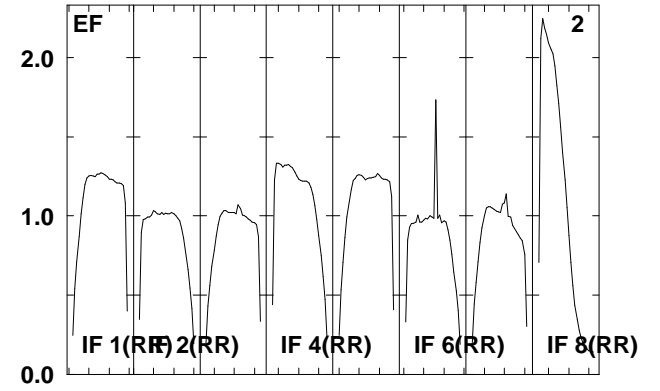
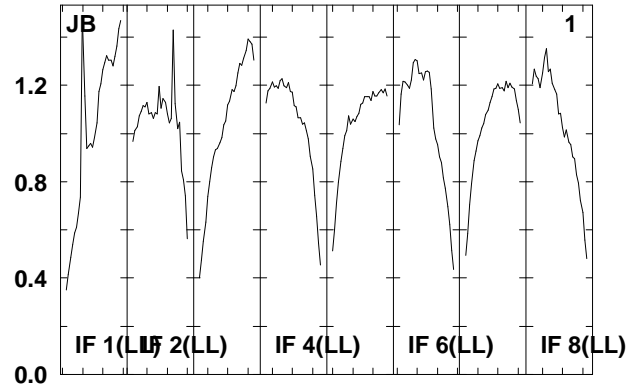
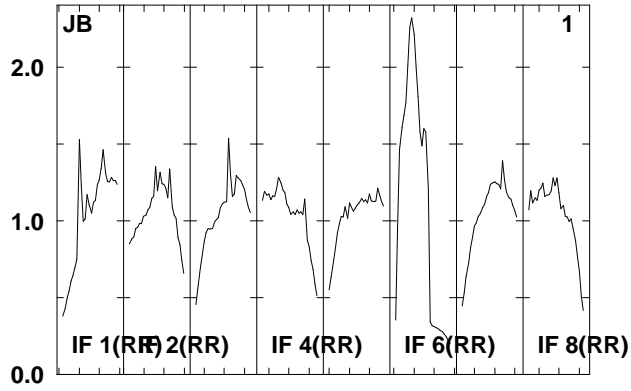

Lower frame: Real Jy
Total-power spectrum Antenna: *
Timerange: 00/14:25:05 to 00/14:28:29

Plot file version 103 created 06-JAN-2012 11:46:32

ARP299D EP068D 5.UVDATA.1

Freq = 1.5950 GHz, Bw = 16.000 MH No calibration applied and no bandpass applied

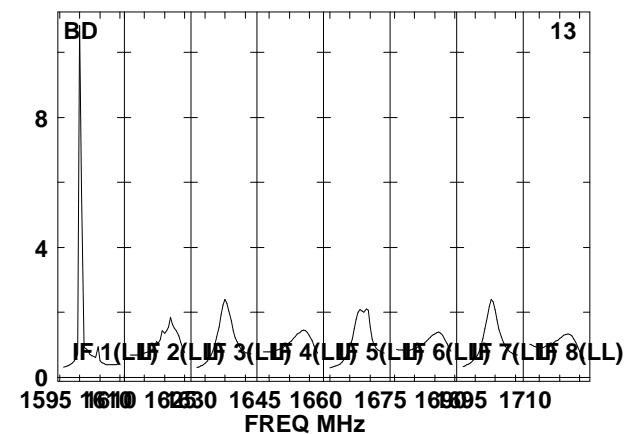
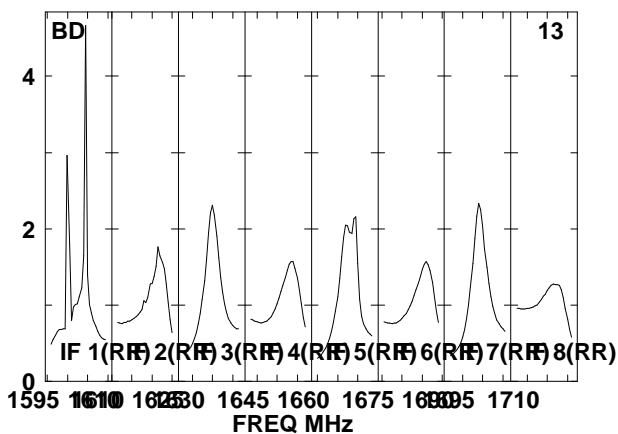
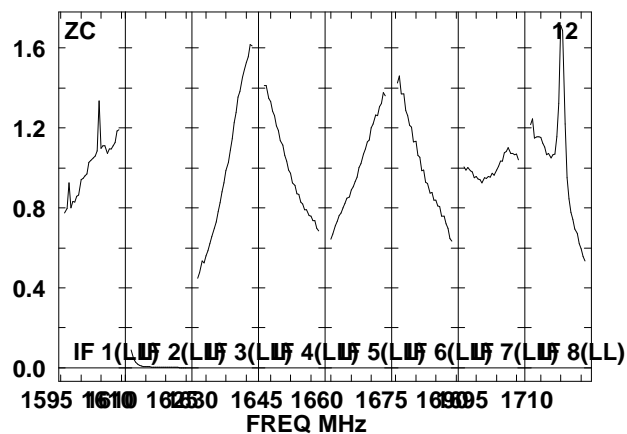
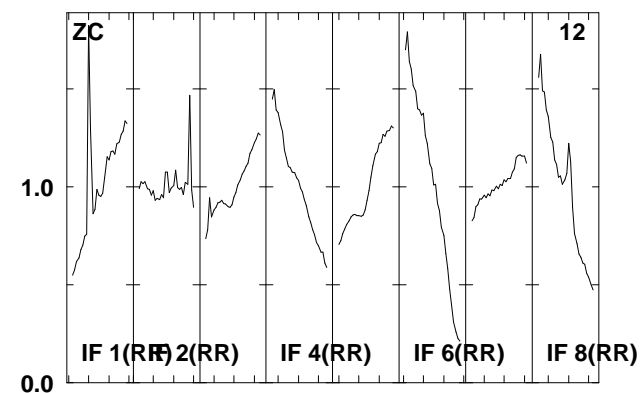
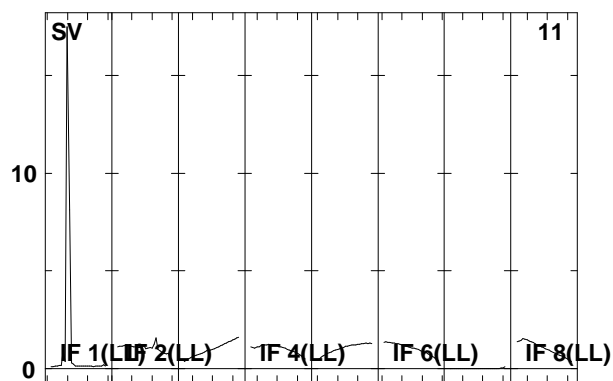
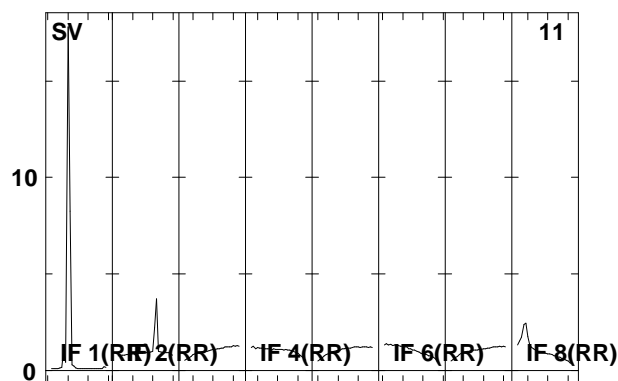
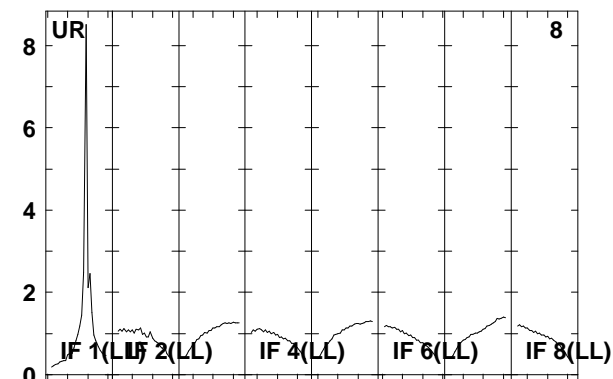
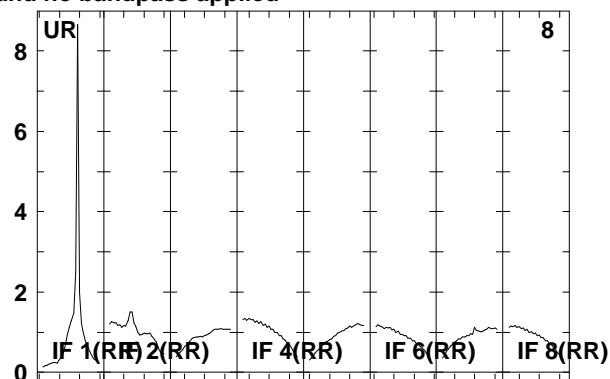
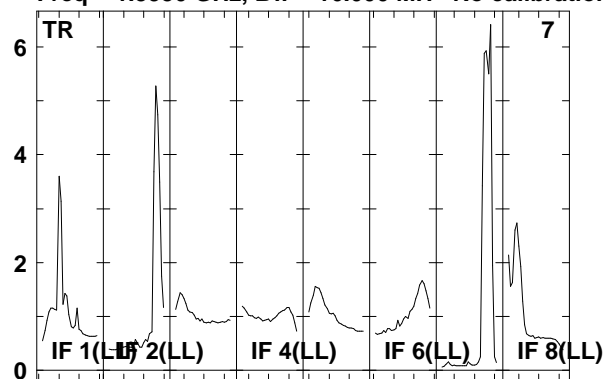

Lower frame: Real Jy
Total-power spectrum Antenna: *
Timerange: 00/14:25:05 to 00/14:28:29

Plot file version 104 created 06-JAN-2012 11:46:33

J1128+59 EP068D 5.UVDATA.1

Freq = 1.5950 GHz, Bw = 16.000 MH No calibration applied and no bandpass applied

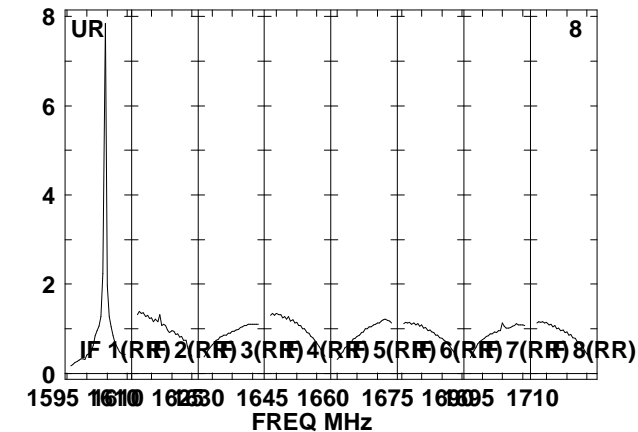
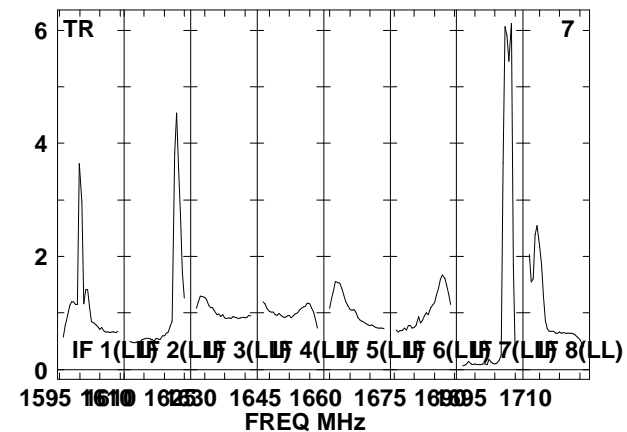
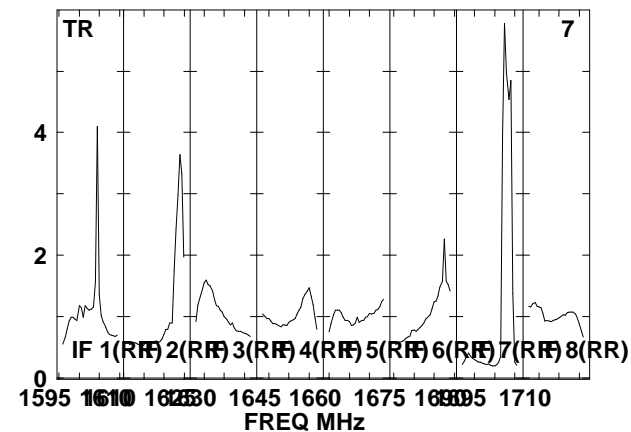
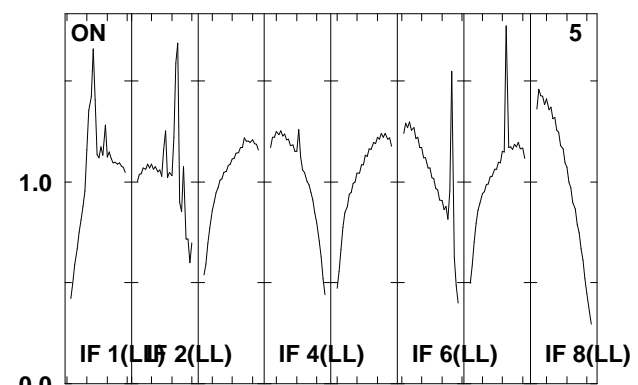
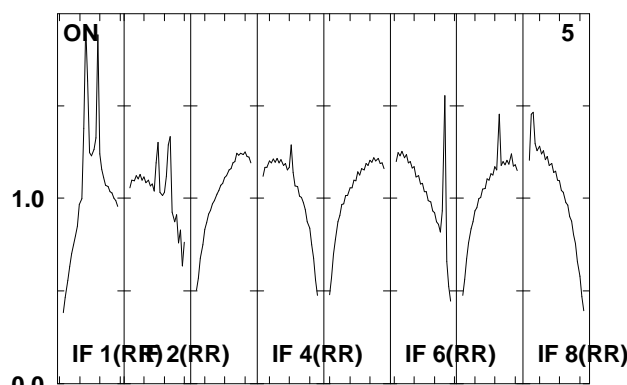
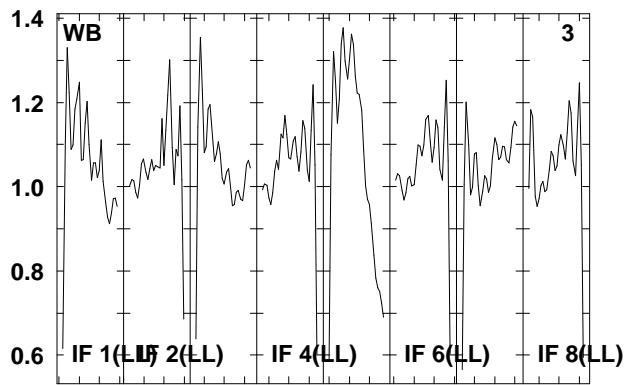
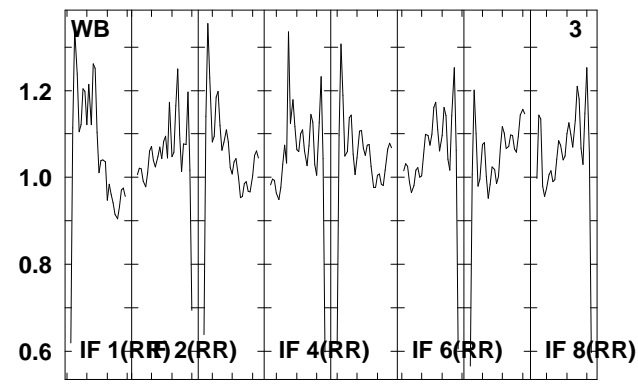
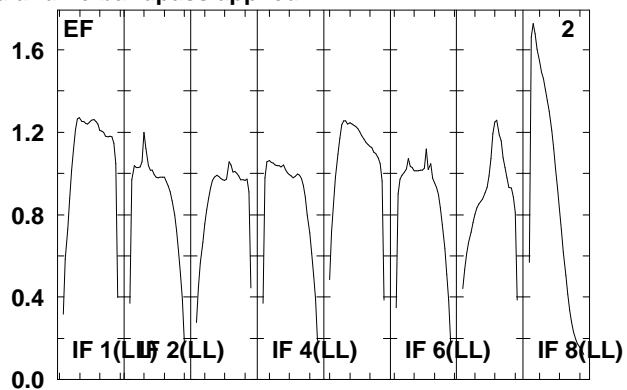
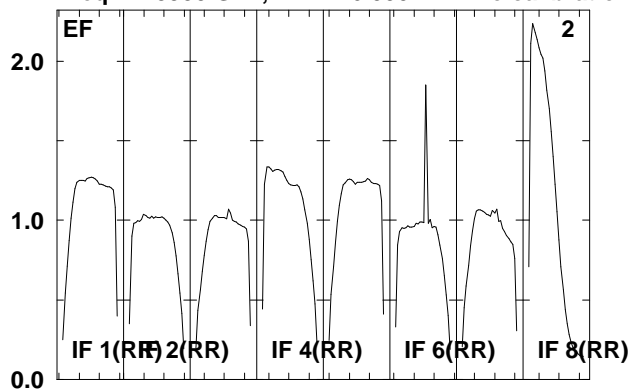

Lower frame: Real Jy
Total-power spectrum Antenna: *
Timerange: 00/14:28:35 to 00/14:29:59

Plot file version 105 created 06-JAN-2012 11:46:33

J1128+59 EP068D 5.UVDATA.1

Freq = 1.5950 GHz, Bw = 16.000 MH No calibration applied and no bandpass applied

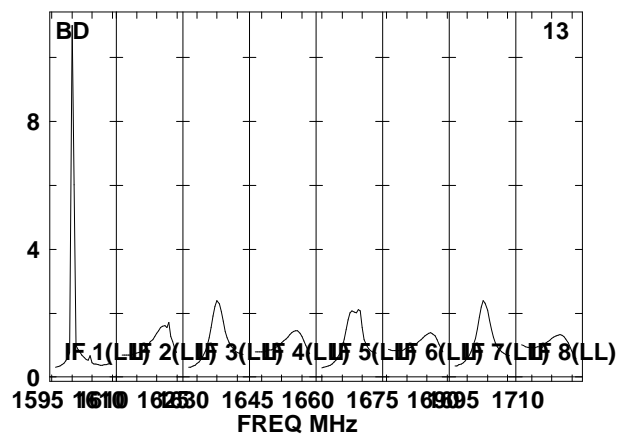
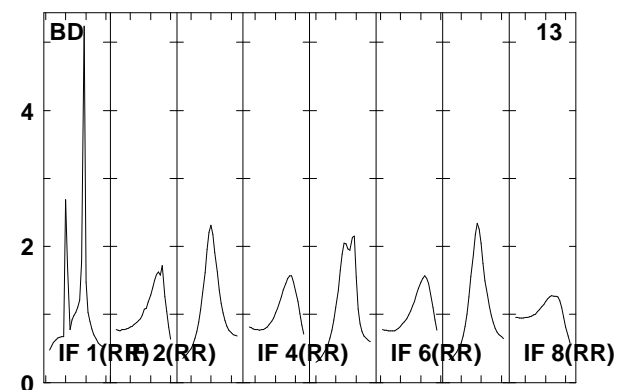
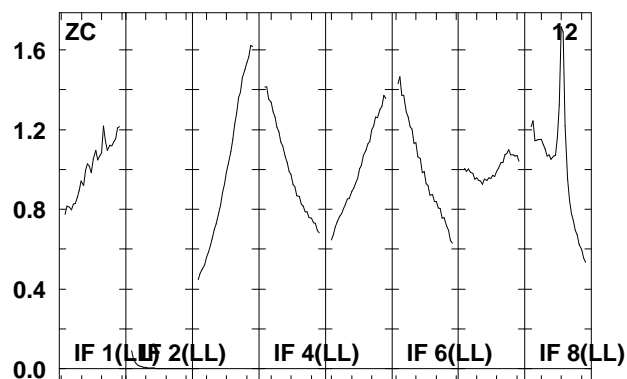
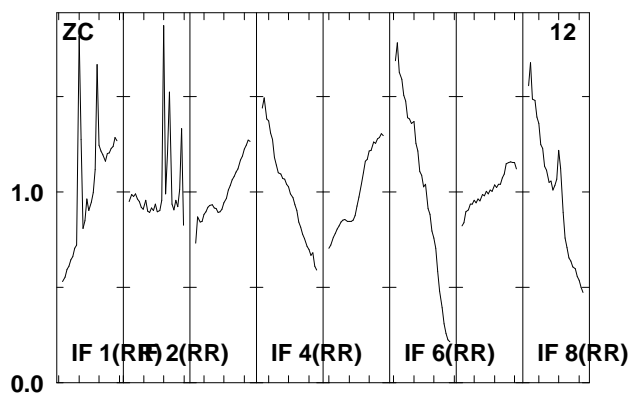
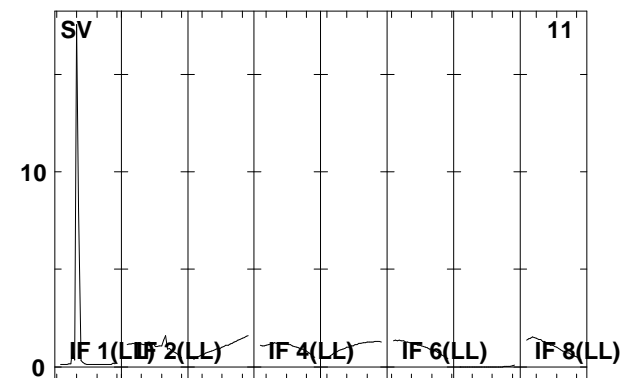
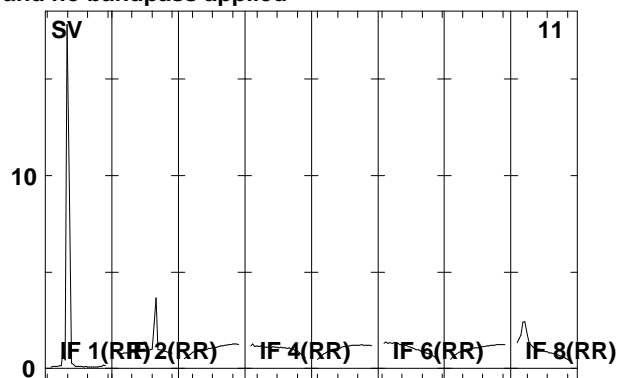
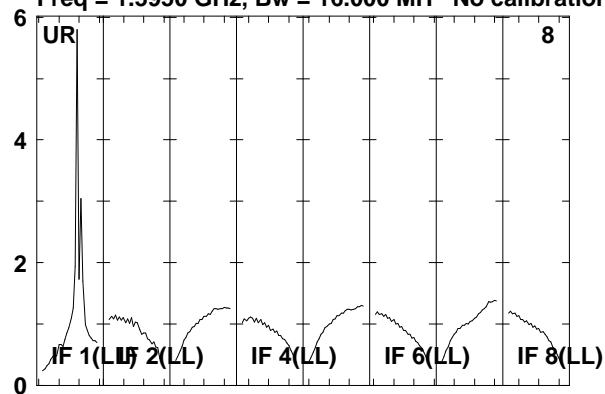

Lower frame: Real Jy

Total-power spectrum Antenna: *

Timerange: 00/14:28:35 to 00/14:29:59

Plot file version 106 created 06-JAN-2012 11:46:33

ARP299D EP068D 5.UVDATA.1

Freq = 1.5950 GHz, Bw = 16.000 MH No calibration applied and no bandpass applied

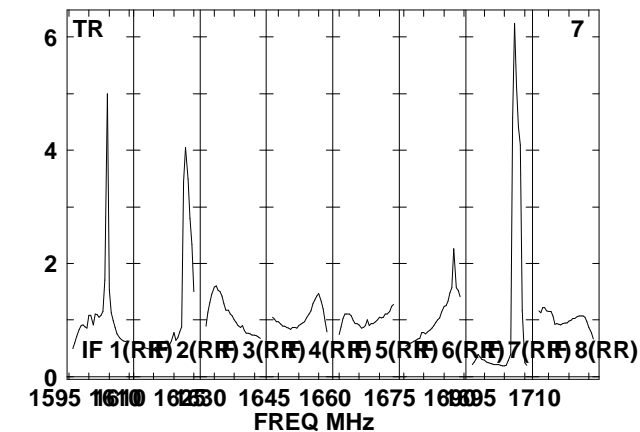
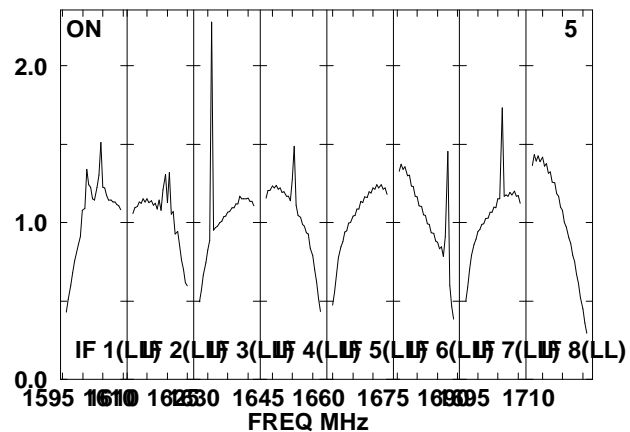
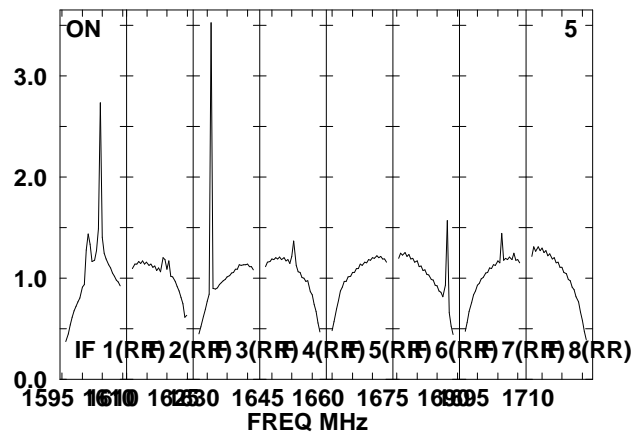
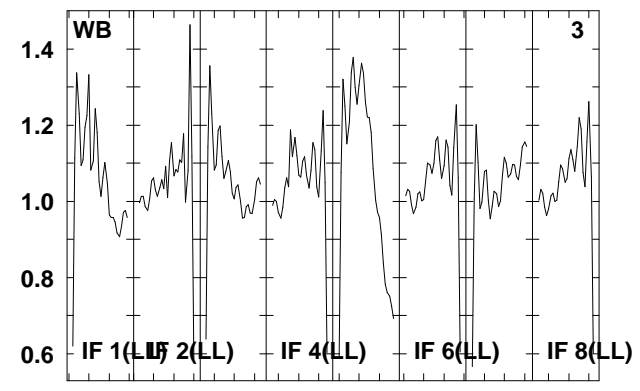
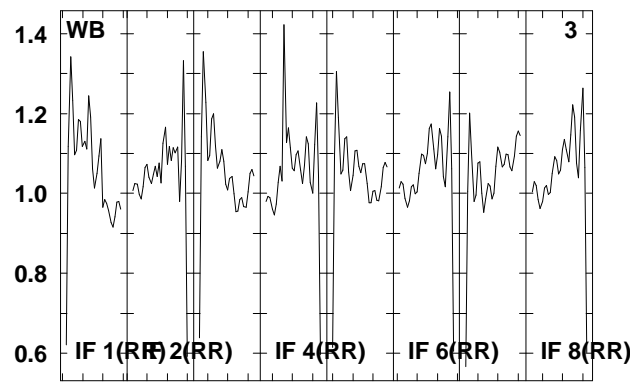
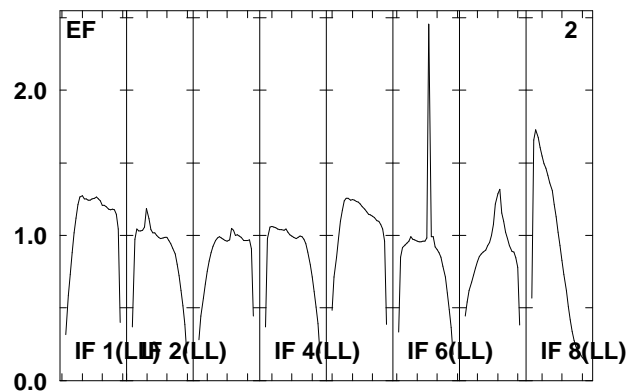
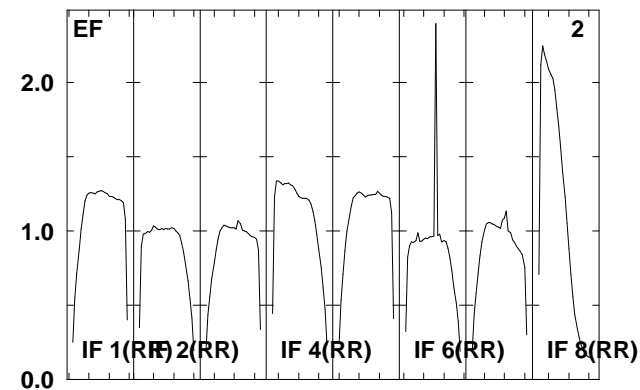
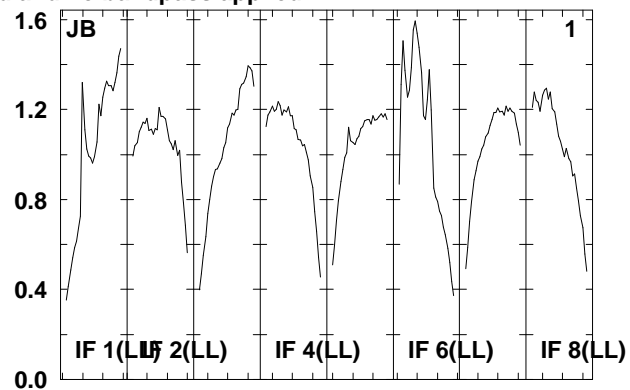
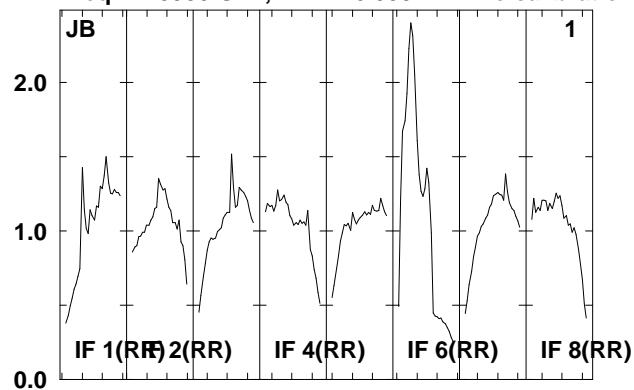

Lower frame: Real Jy
Total-power spectrum Antenna: *
Timerange: 00/14:30:01 to 00/14:33:29

Plot file version 107 created 06-JAN-2012 11:46:34

ARP299D EP068D 5.UVDATA.1

Freq = 1.5950 GHz, Bw = 16.000 MH No calibration applied and no bandpass applied

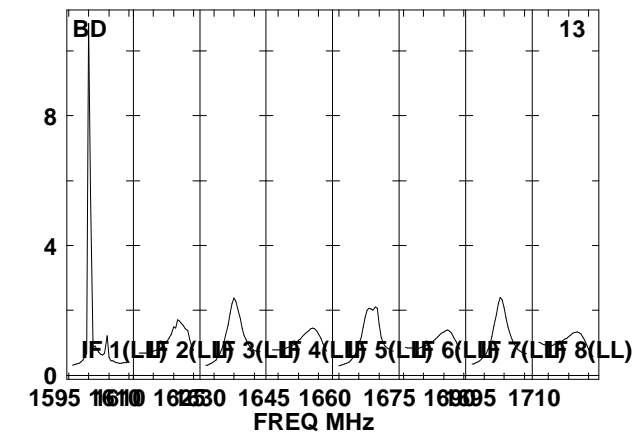
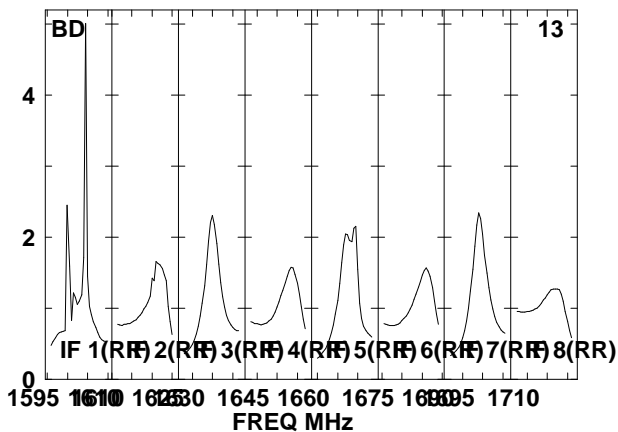
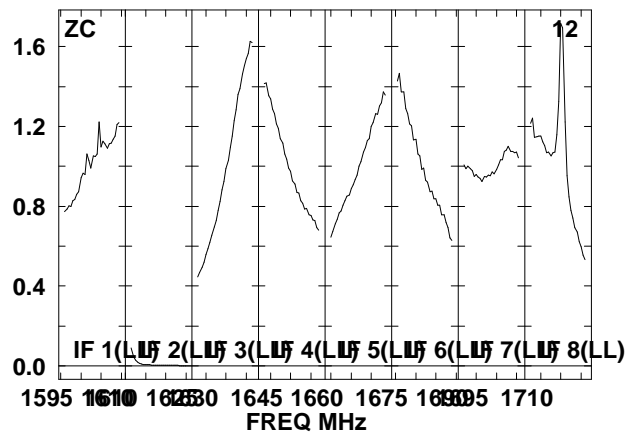
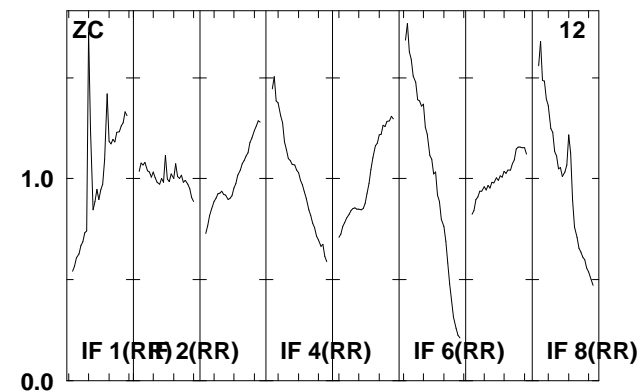
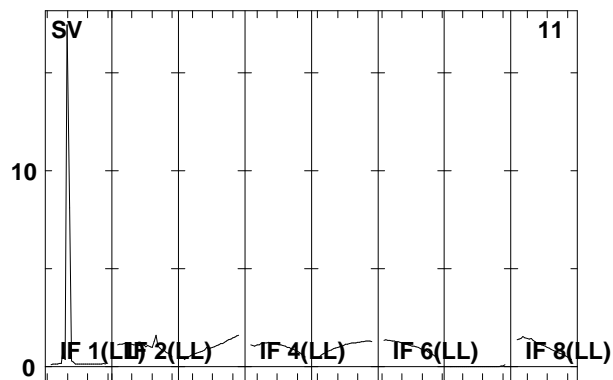
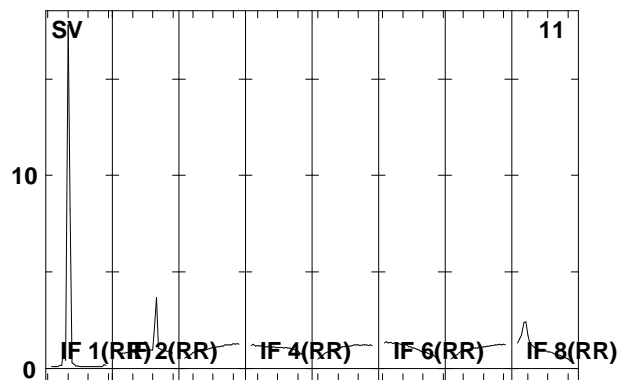
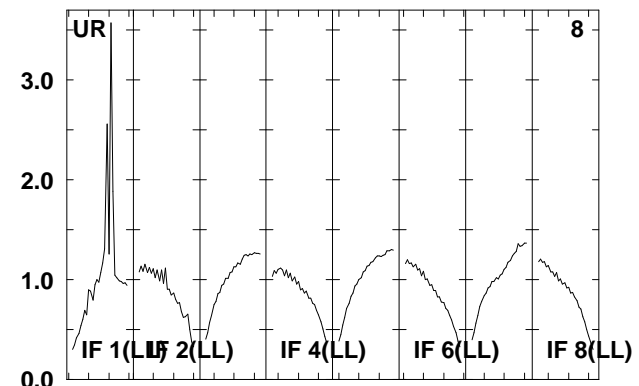
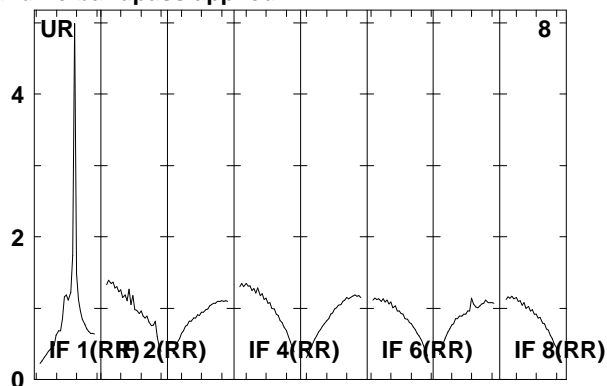
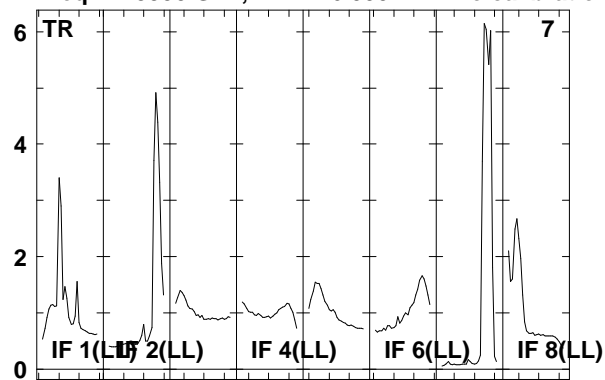

Lower frame: Real Jy
Total-power spectrum Antenna: *
Timerange: 00/14:30:01 to 00/14:33:29

Plot file version 108 created 06-JAN-2012 11:46:35

J1128+59 EP068D 5.UVDATA.1

Freq = 1.5950 GHz, Bw = 16.000 MH No calibration applied and no bandpass applied

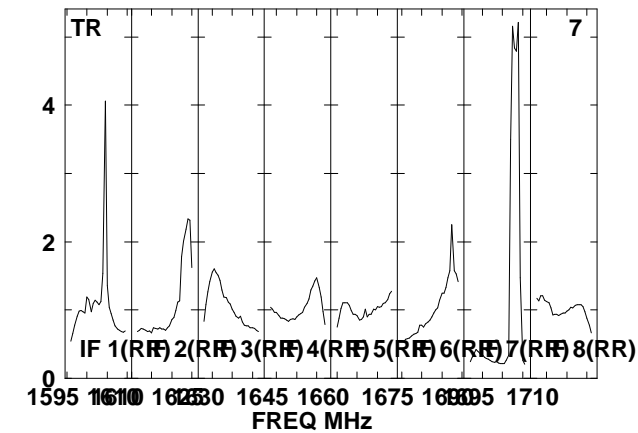
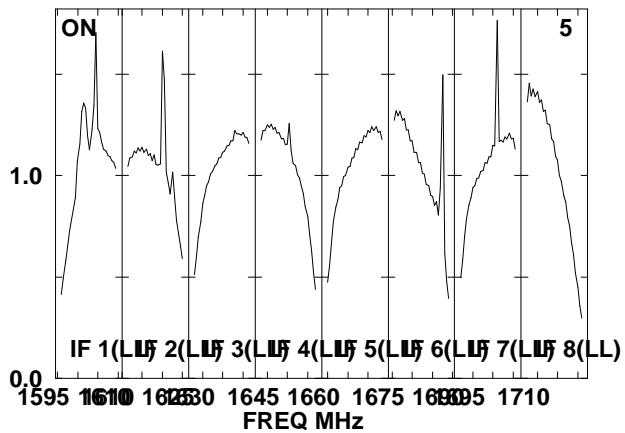
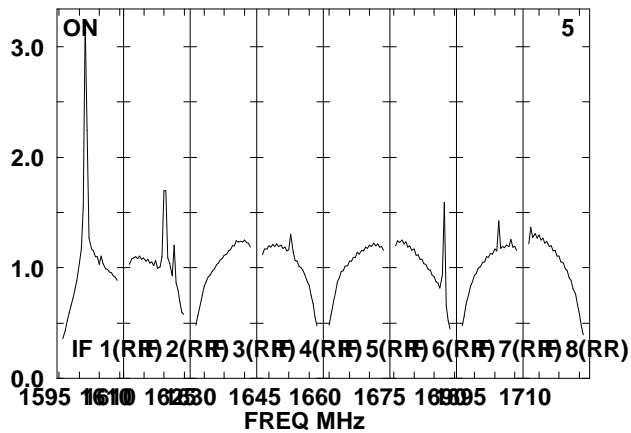
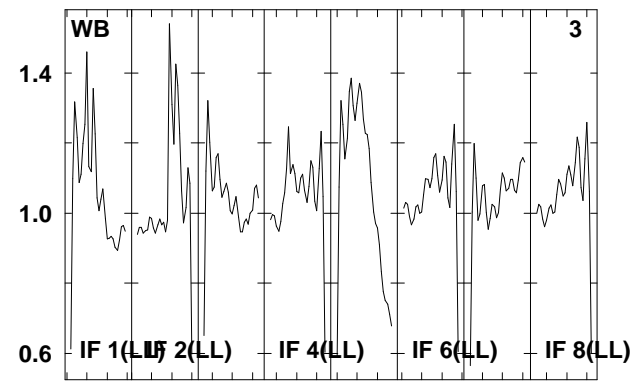
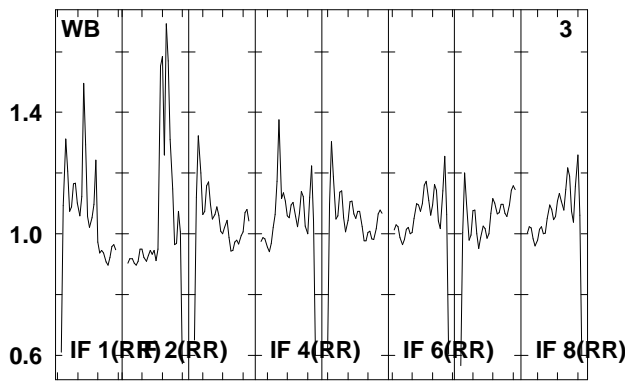
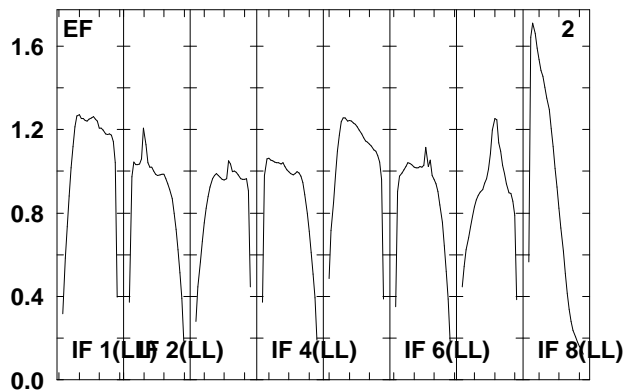
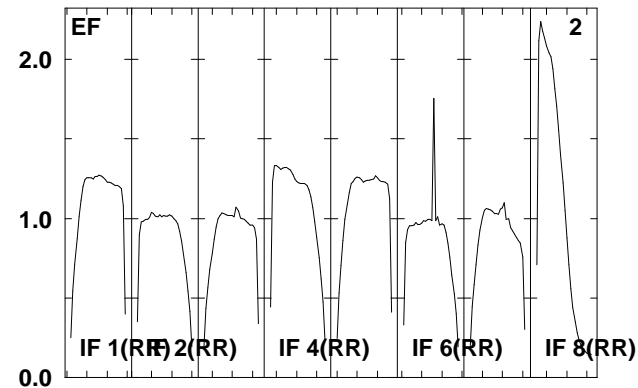
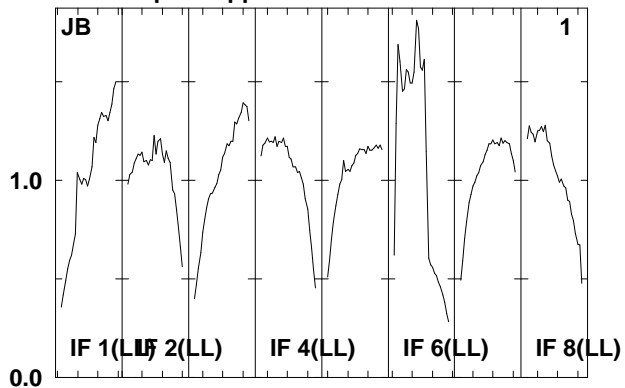
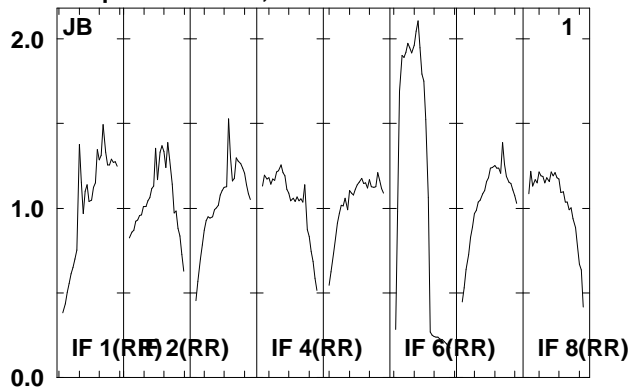

Lower frame: Real Jy
Total-power spectrum Antenna: *
Timerange: 00/14:34:31 to 00/14:35:59

Plot file version 109 created 06-JAN-2012 11:46:35

J1128+59 EP068D 5.UVDATA.1

Freq = 1.5950 GHz, Bw = 16.000 MH No calibration applied and no bandpass applied

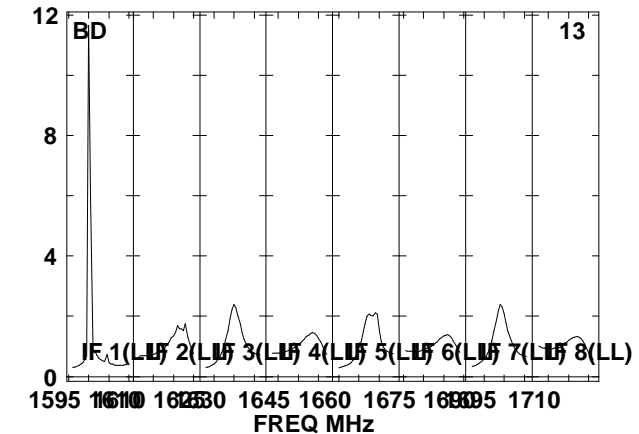
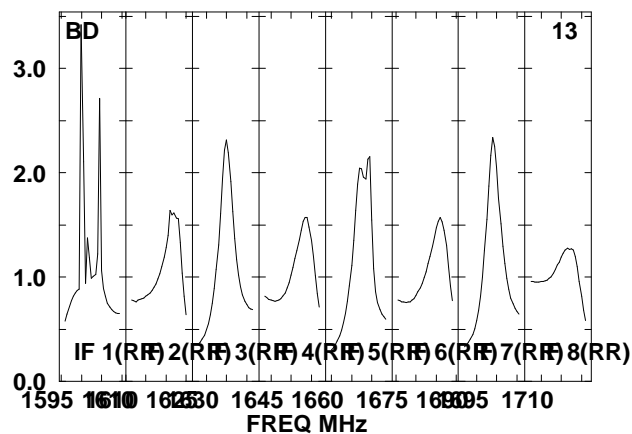
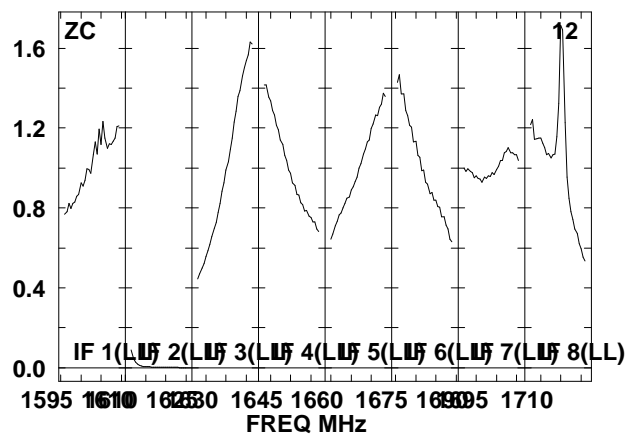
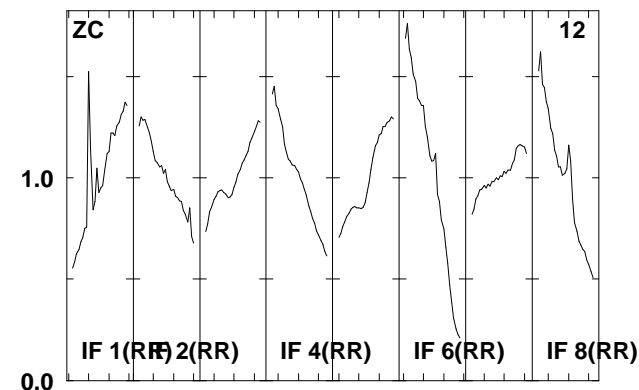
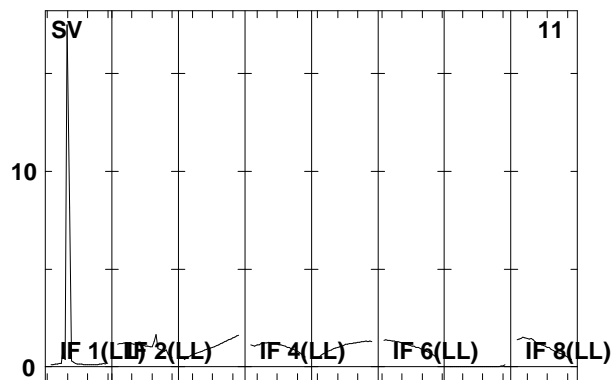
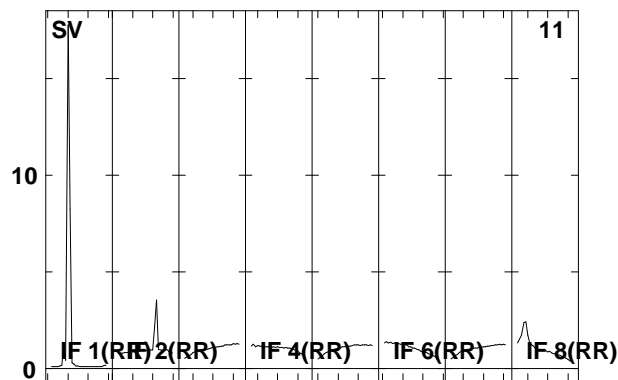
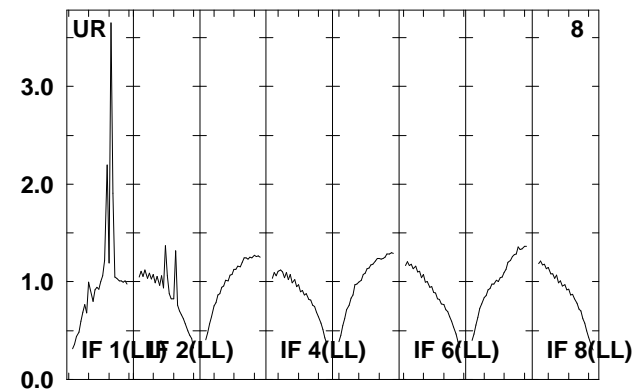
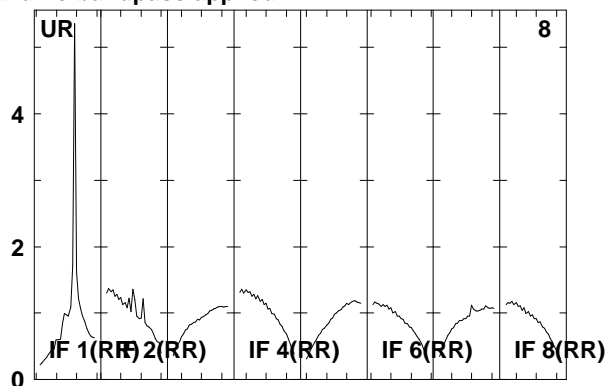
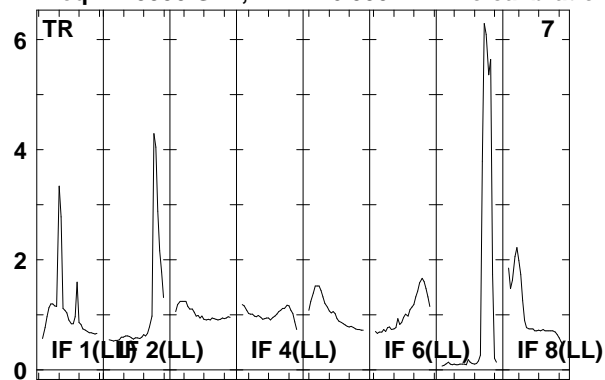

Lower frame: Real Jy

Total-power spectrum Antenna: *

Timerange: 00/14:34:31 to 00/14:35:59

Plot file version 110 created 06-JAN-2012 11:46:35

ARP299D EP068D 5.UVDATA.1

Freq = 1.5950 GHz, Bw = 16.000 MH No calibration applied and no bandpass applied

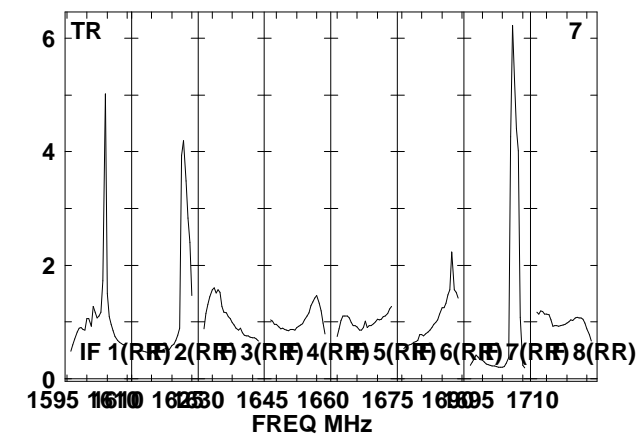
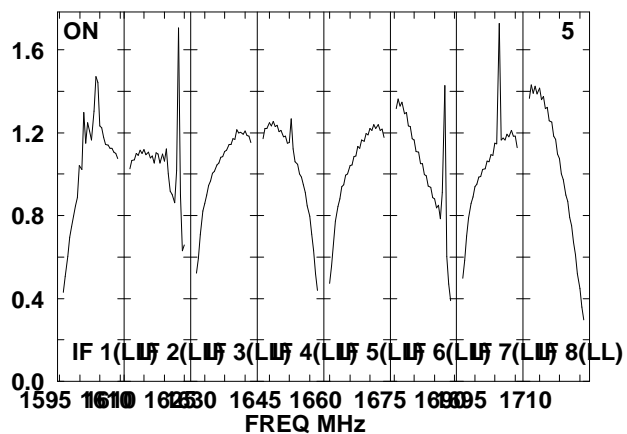
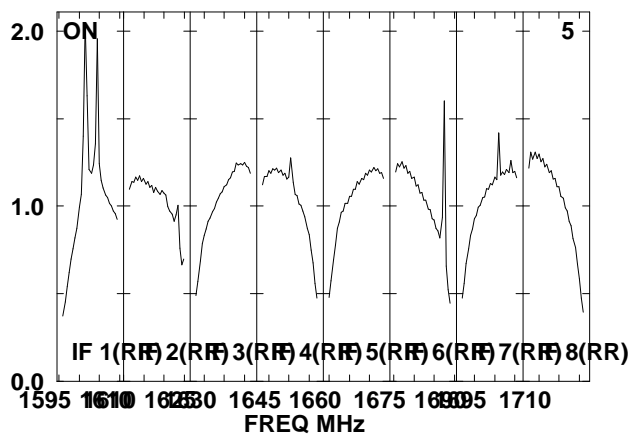
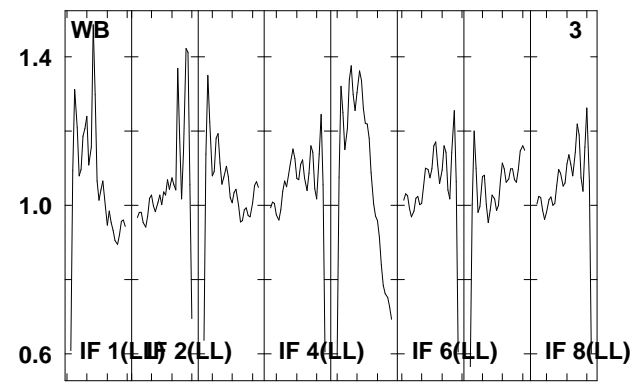
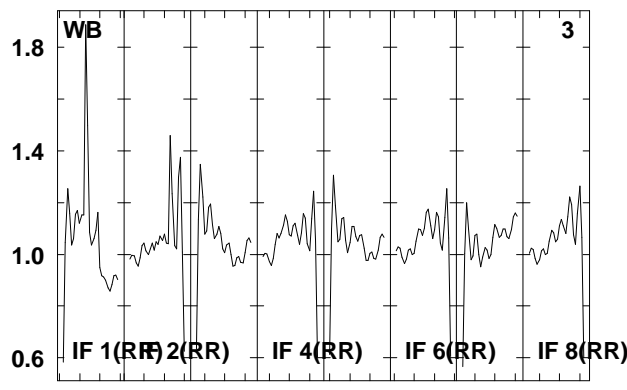
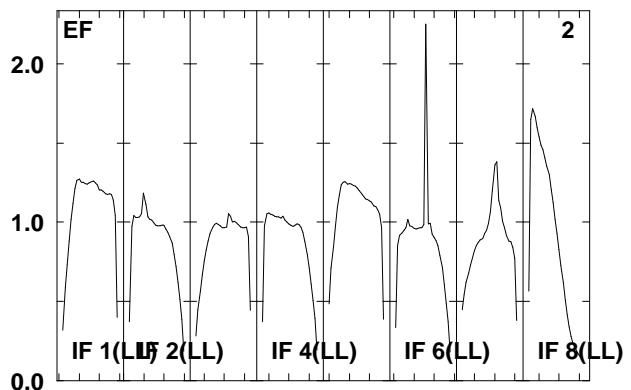
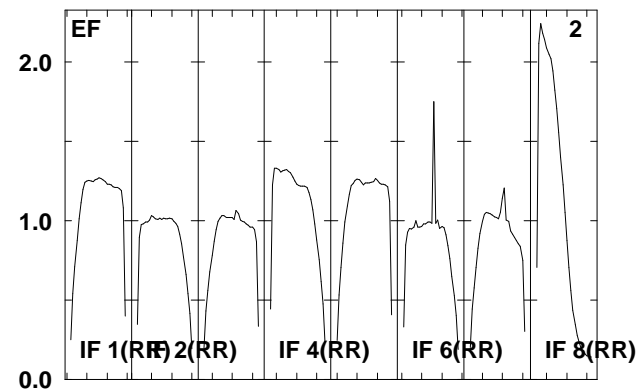
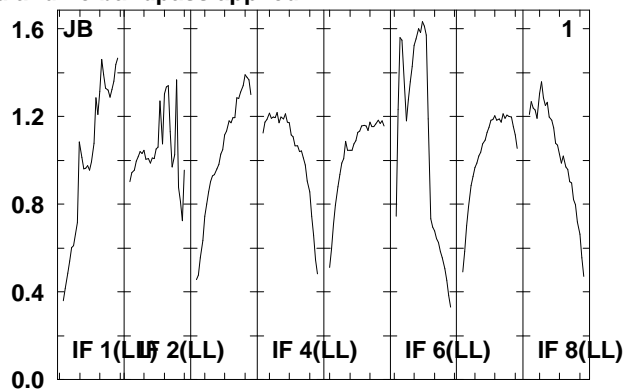
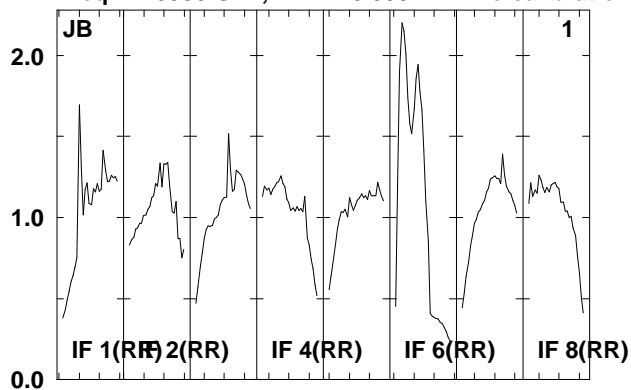

Lower frame: Real Jy
Total-power spectrum Antenna: *
Timerange: 00/14:36:05 to 00/14:39:29

Plot file version 111 created 06-JAN-2012 11:46:36

ARP299D EP068D 5.UVDATA.1

Freq = 1.5950 GHz, Bw = 16.000 MH No calibration applied and no bandpass applied

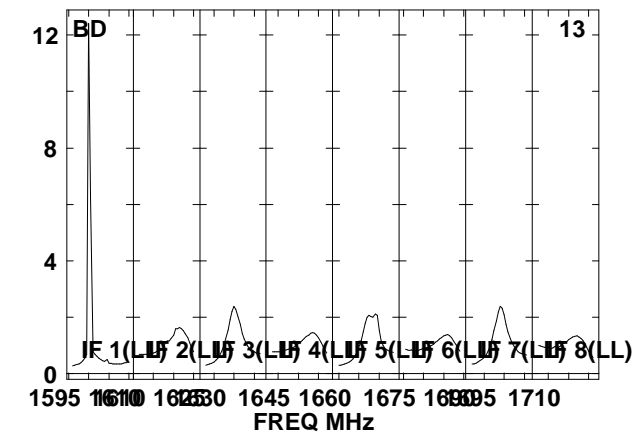
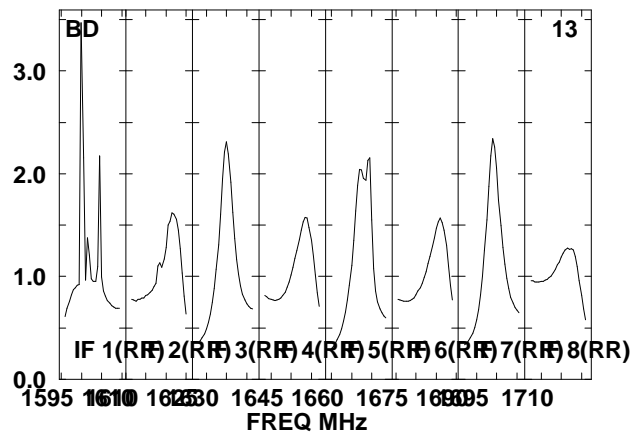
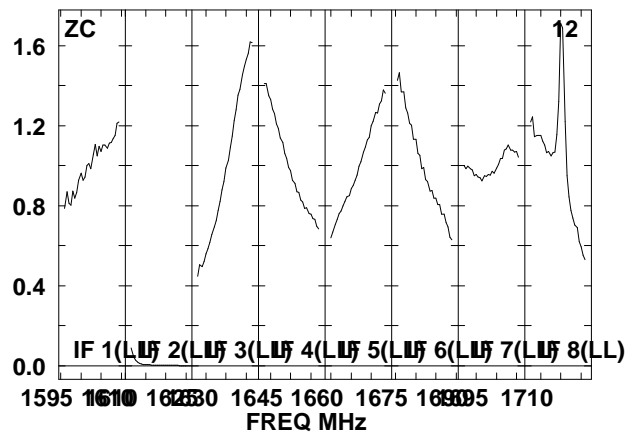
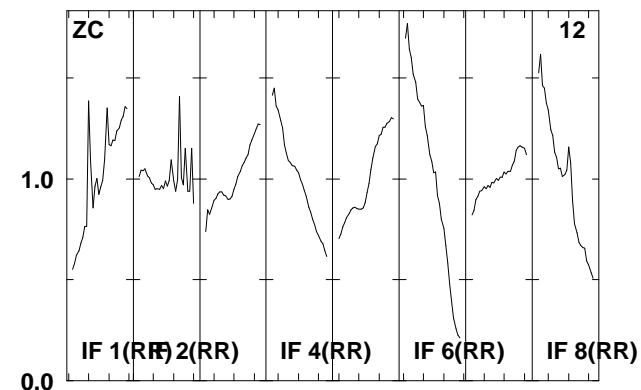
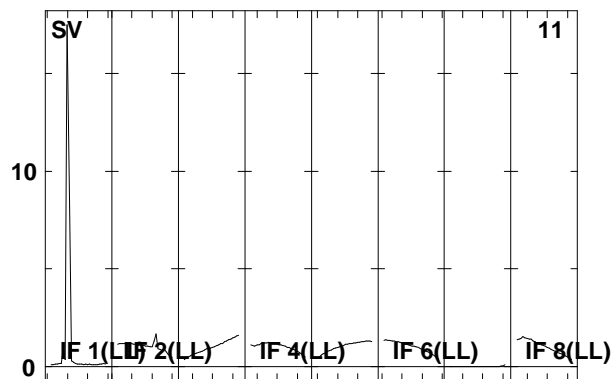
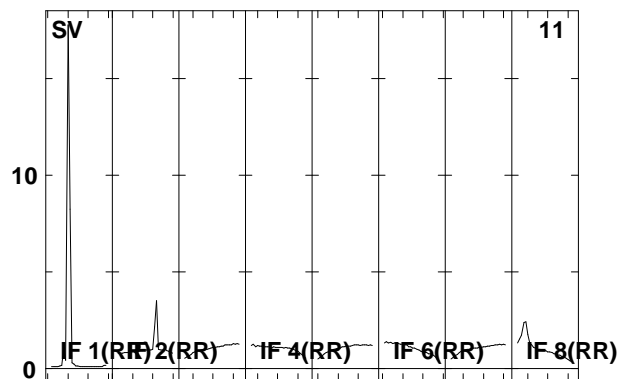
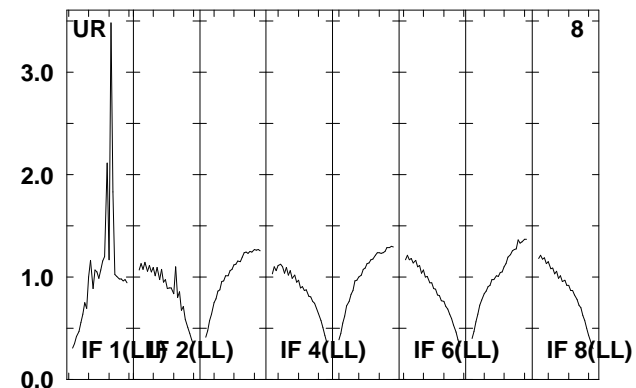
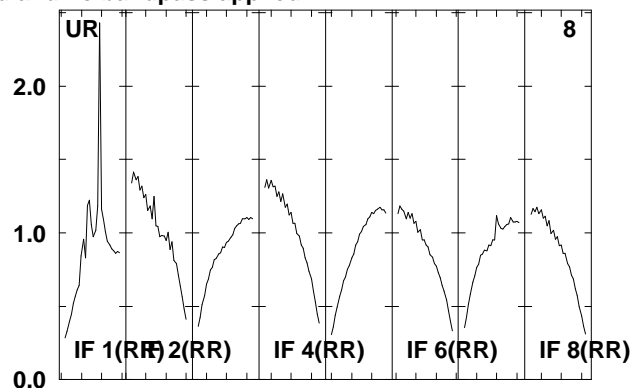
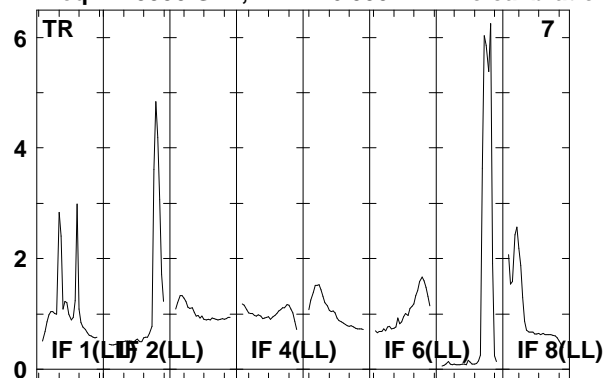

Lower frame: Real Jy
Total-power spectrum Antenna: *
Timerange: 00/14:36:05 to 00/14:39:29

Plot file version 112 created 06-JAN-2012 11:46:37

J1128+59 EP068D 5.UVDATA.1

Freq = 1.5950 GHz, Bw = 16.000 MH No calibration applied and no bandpass applied

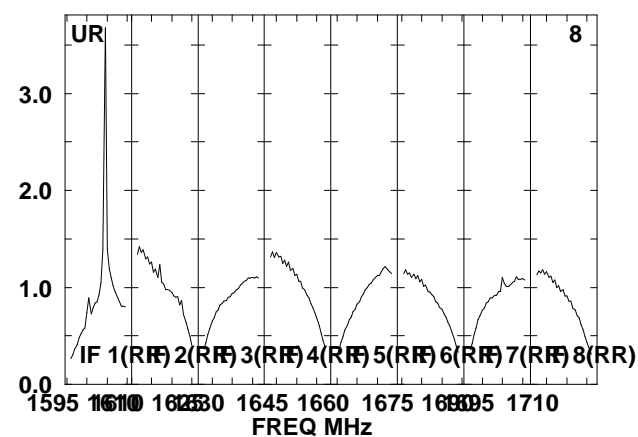
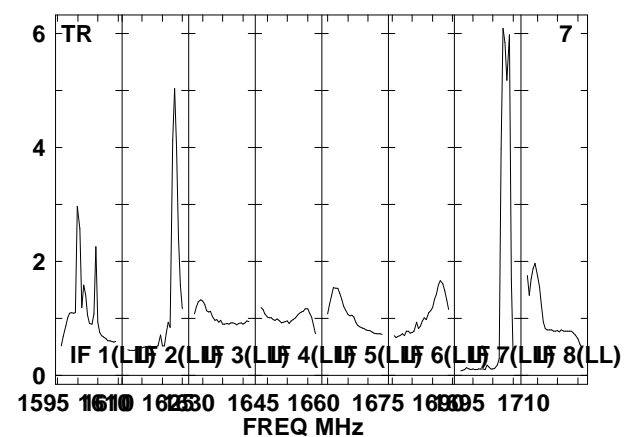
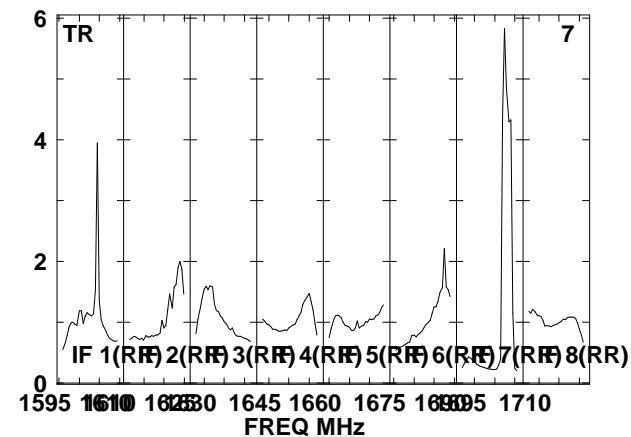
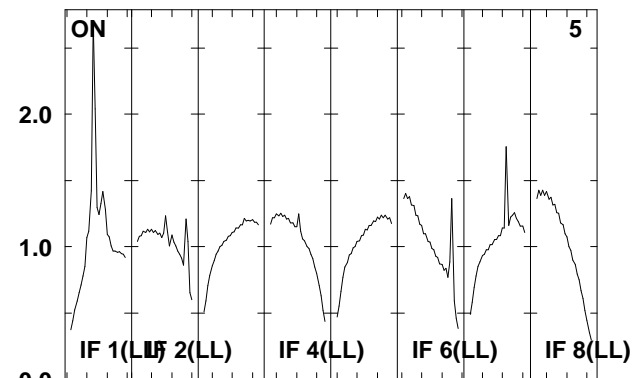
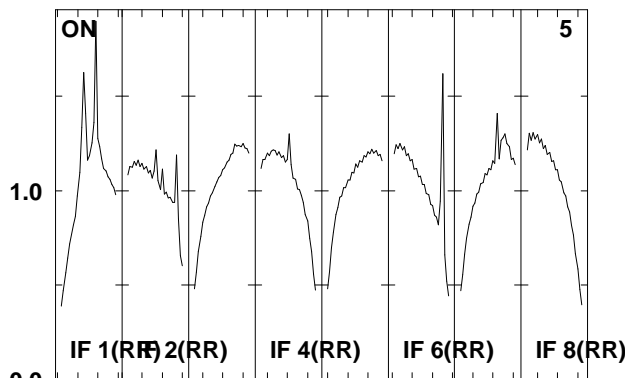
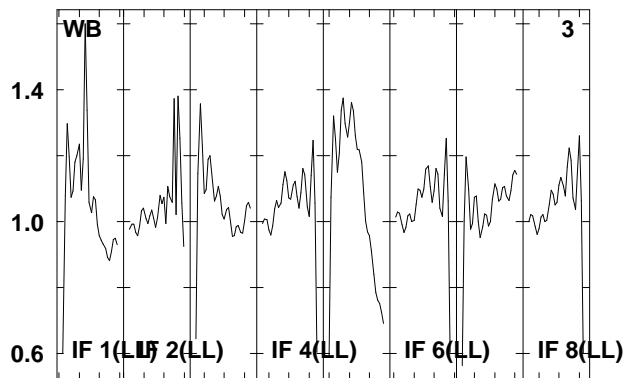
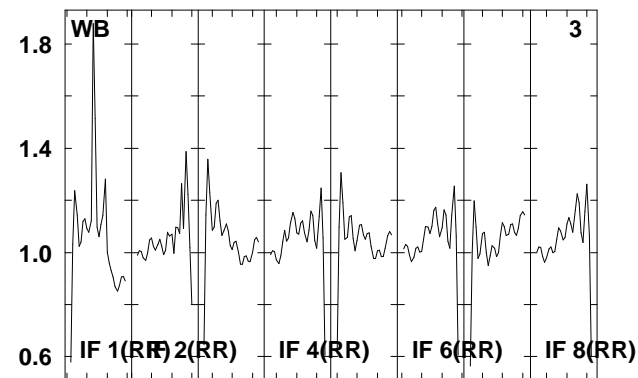
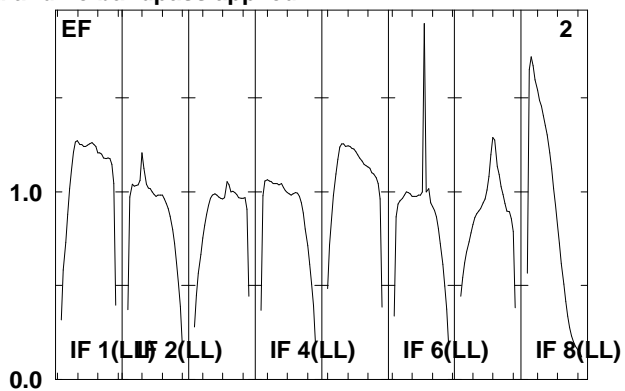
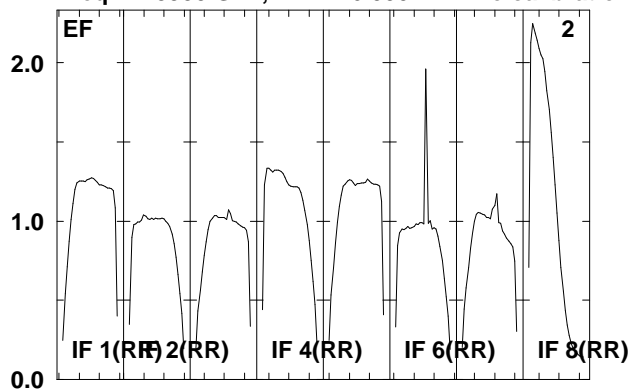

Lower frame: Real Jy
Total-power spectrum Antenna: *
Timerange: 00/14:39:35 to 00/14:40:59

Plot file version 113 created 06-JAN-2012 11:46:37

J1128+59 EP068D 5.UVDATA.1

Freq = 1.5950 GHz, Bw = 16.000 MH No calibration applied and no bandpass applied

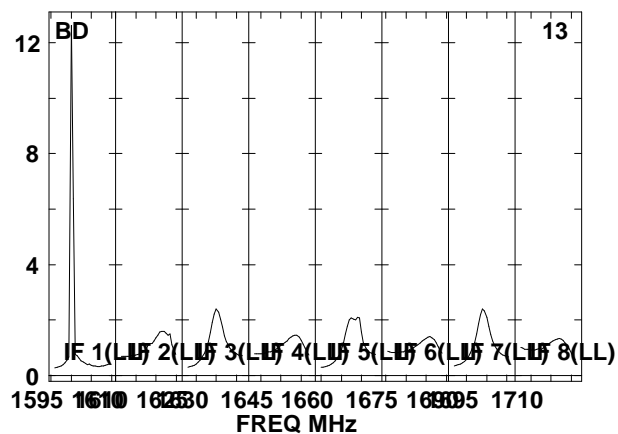
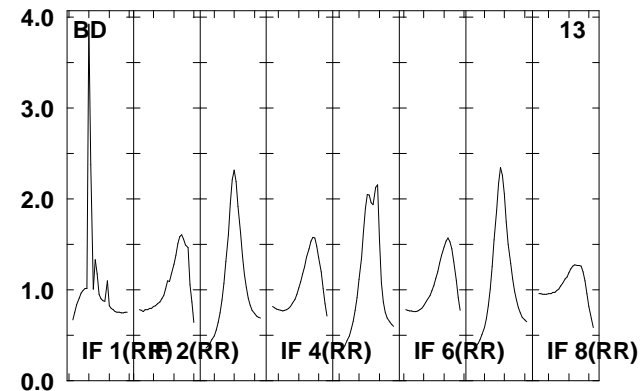
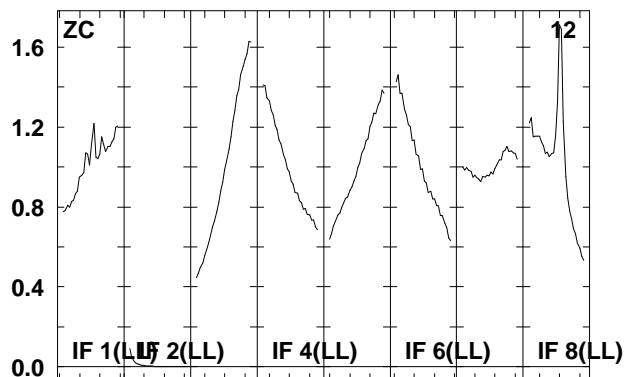
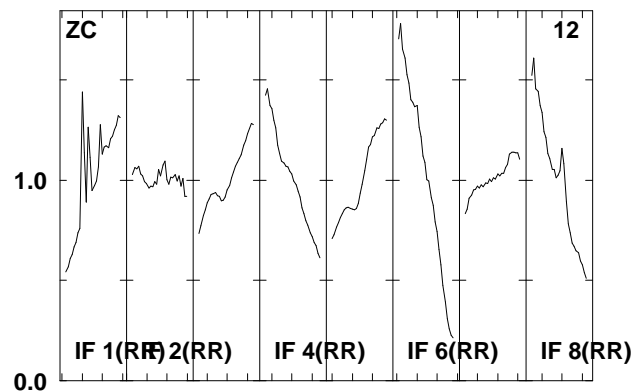
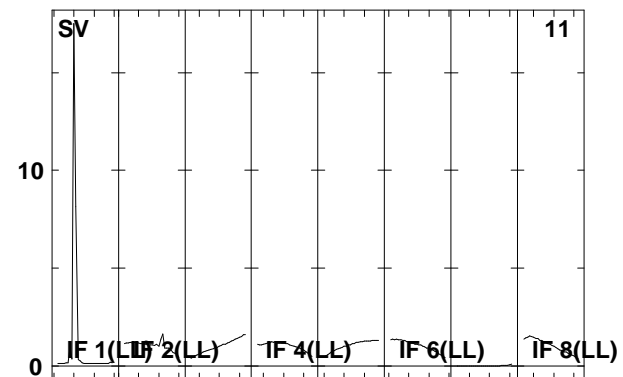
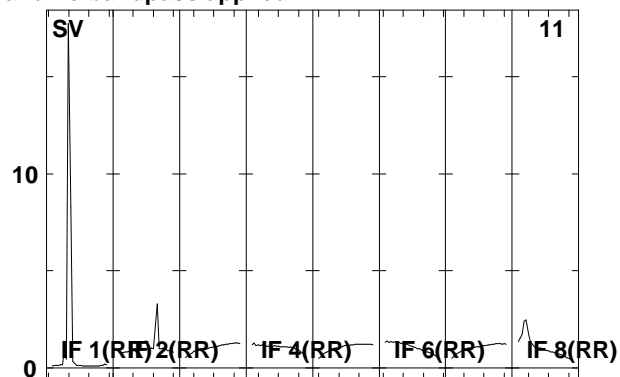
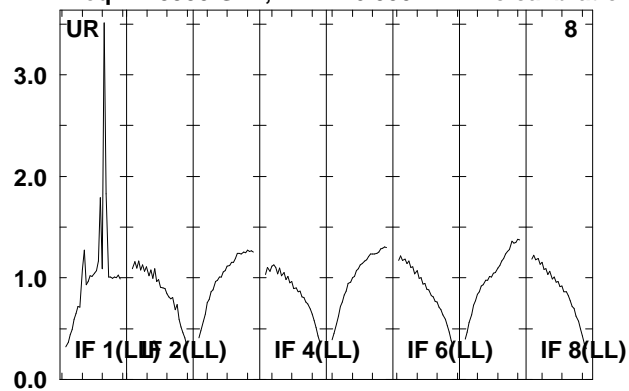

Lower frame: Real Jy

Total-power spectrum Antenna: *

Timerange: 00/14:39:35 to 00/14:40:59

Plot file version 114 created 06-JAN-2012 11:46:37

ARP299D EP068D 5.UVDATA.1

Freq = 1.5950 GHz, Bw = 16.000 MH No calibration applied and no bandpass applied

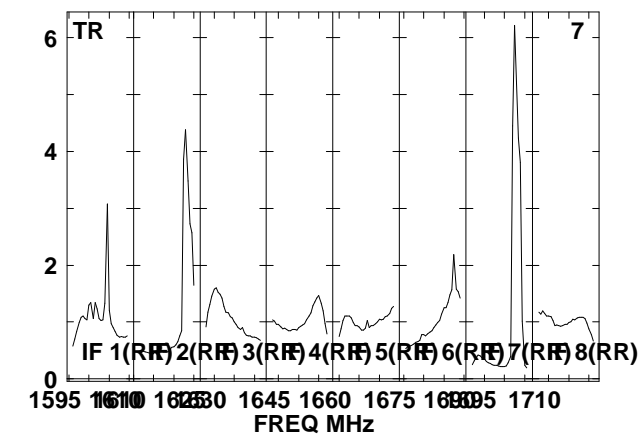
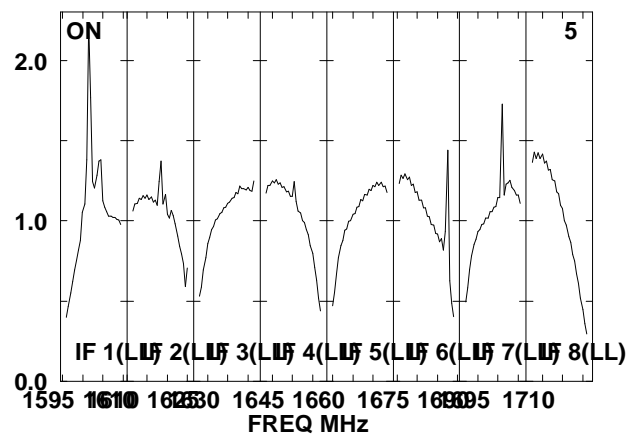
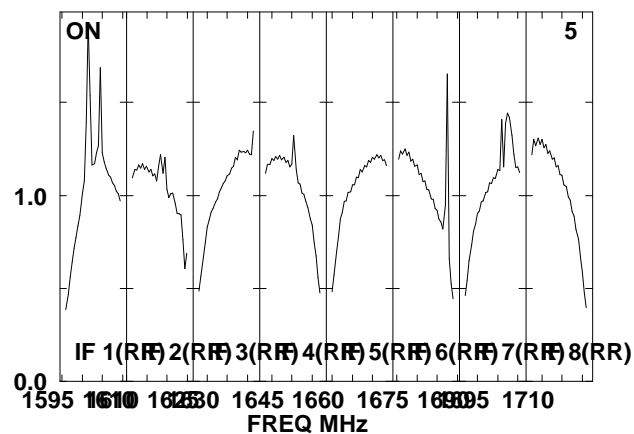
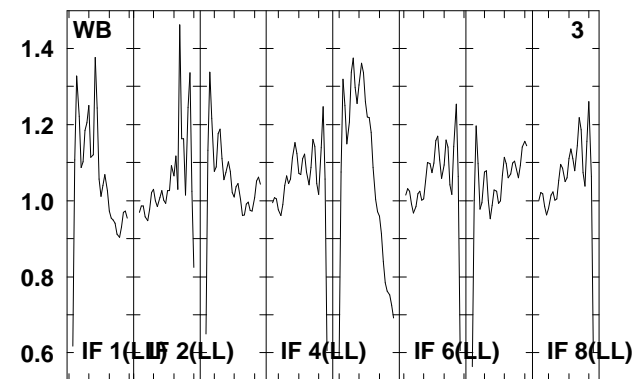
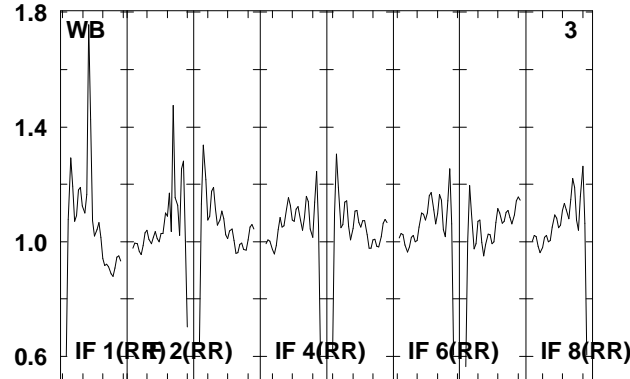
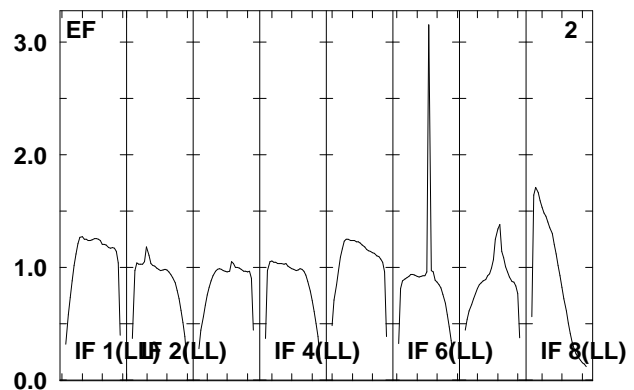
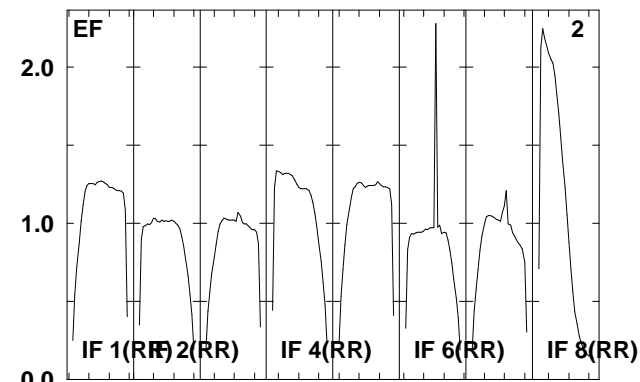
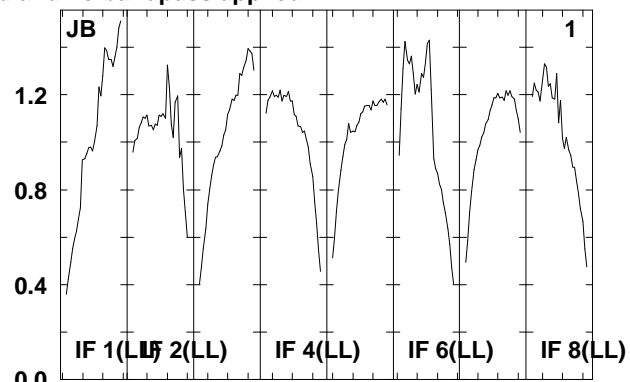
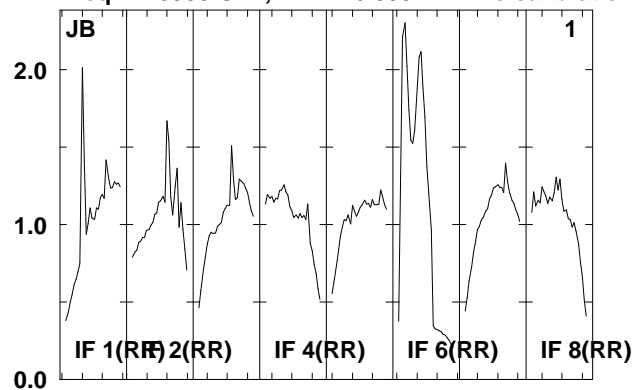

Lower frame: Real Jy
Total-power spectrum Antenna: *
Timerange: 00/14:41:01 to 00/14:44:29

Plot file version 115 created 06-JAN-2012 11:46:38

ARP299D EP068D 5.UVDATA.1

Freq = 1.5950 GHz, Bw = 16.000 MH No calibration applied and no bandpass applied

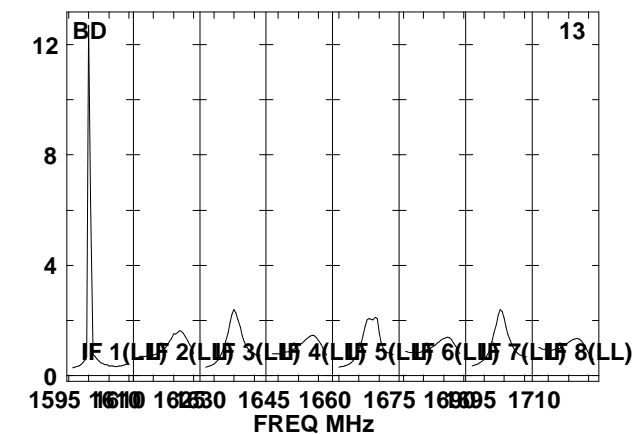
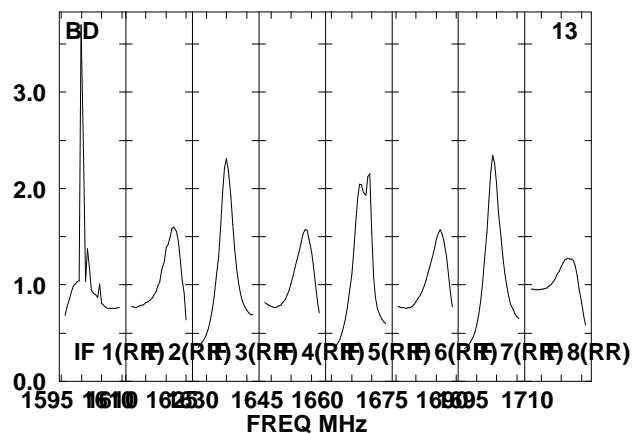
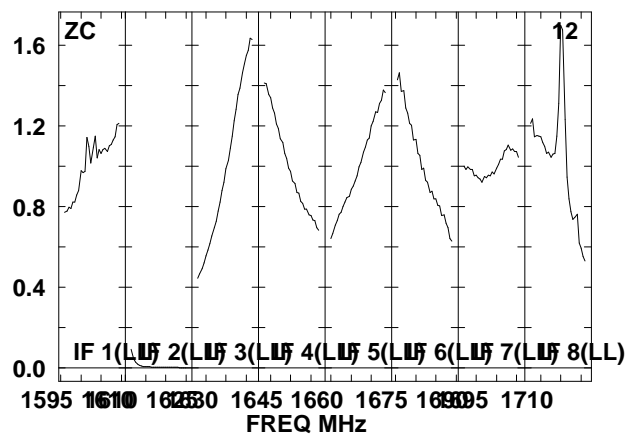
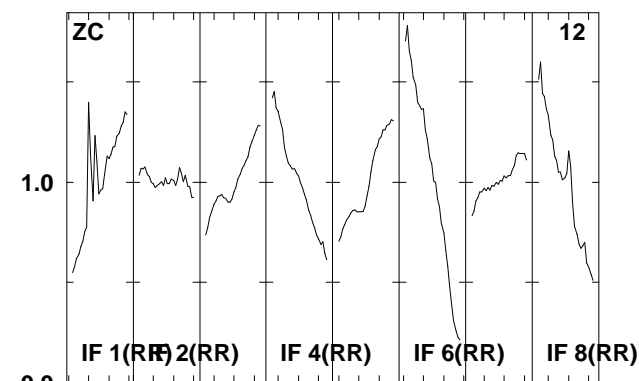
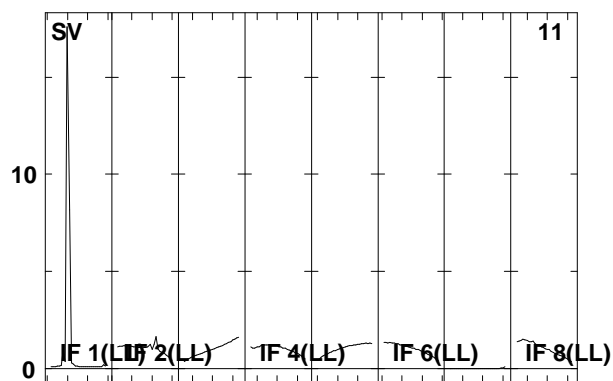
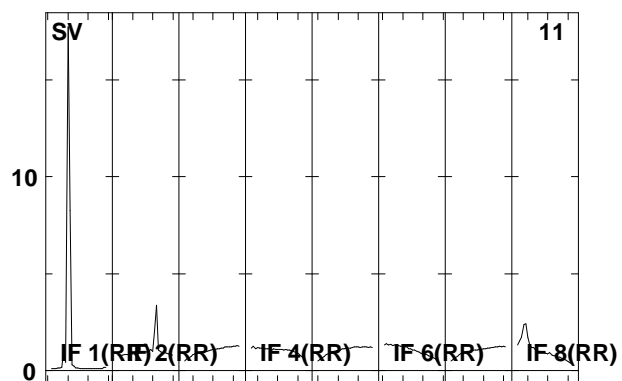
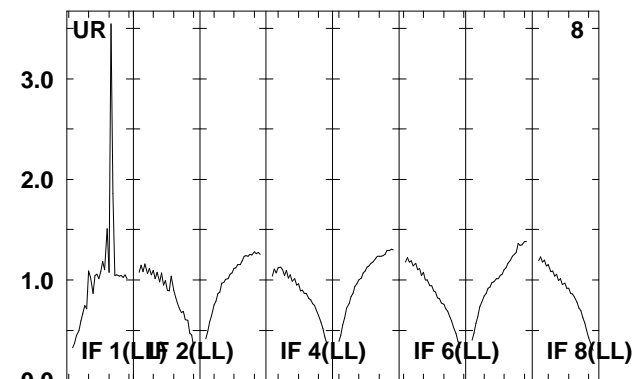
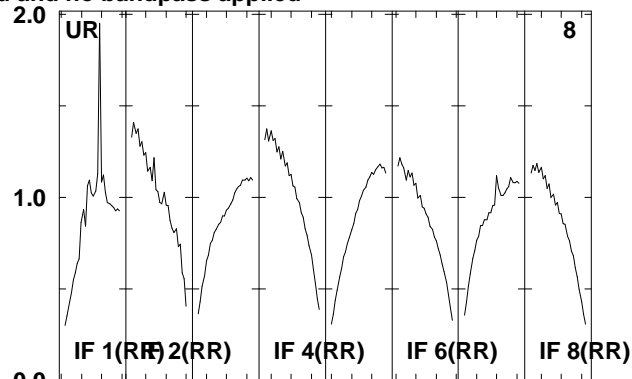
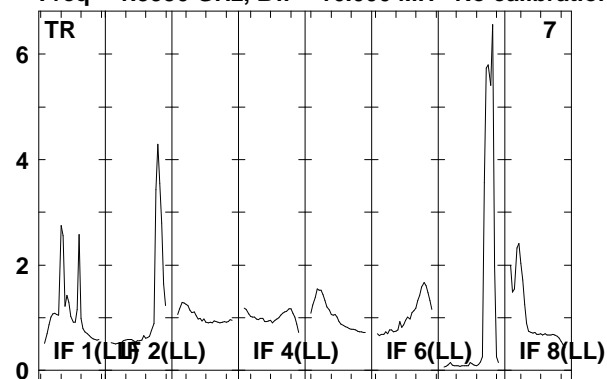

Lower frame: Real Jy
Total-power spectrum Antenna: *
Timerange: 00/14:41:01 to 00/14:44:29

Plot file version 116 created 06-JAN-2012 11:46:38

J1128+59 EP068D 5.UVDATA.1

Freq = 1.5950 GHz, Bw = 16.000 MH No calibration applied and no bandpass applied

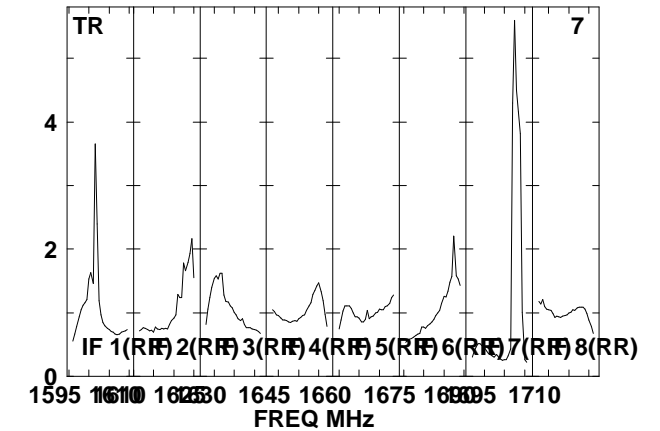
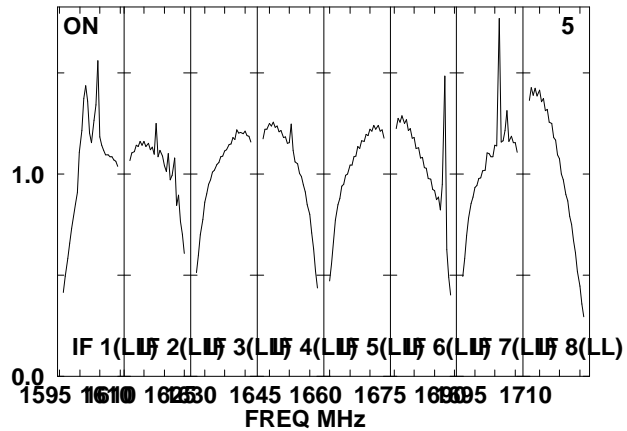
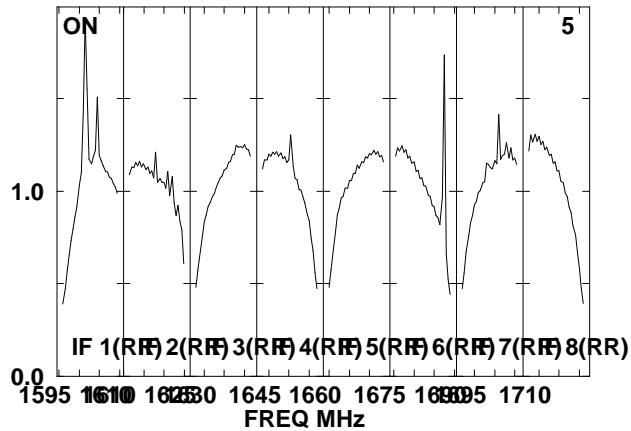
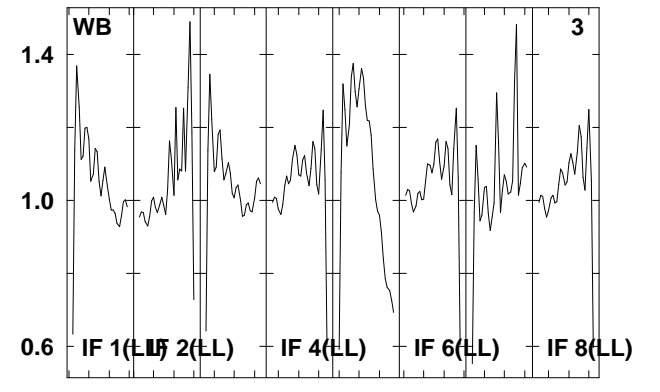
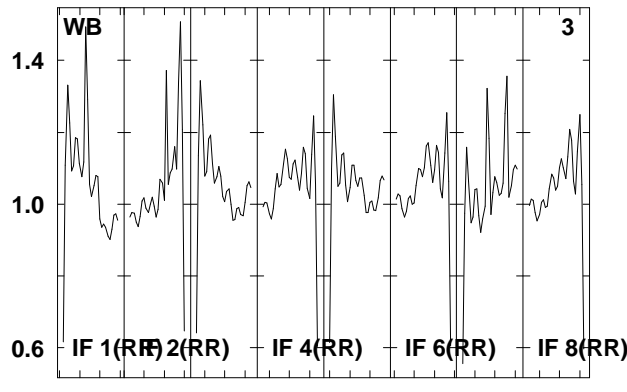
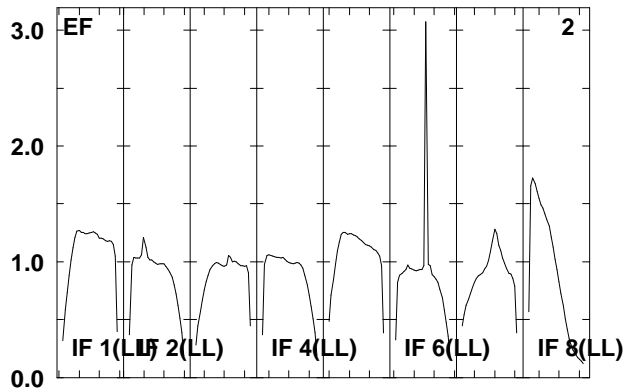
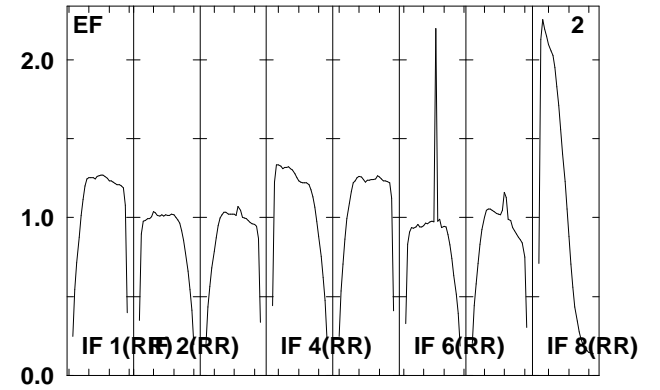
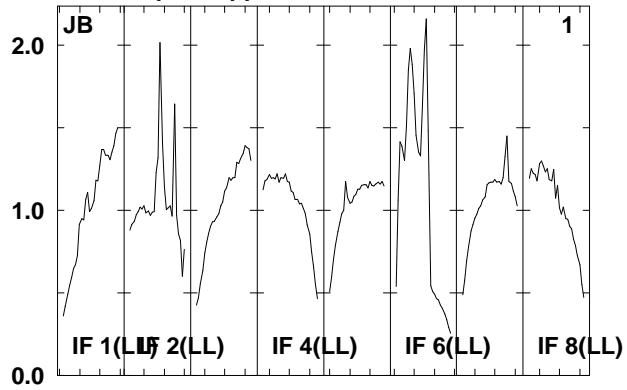
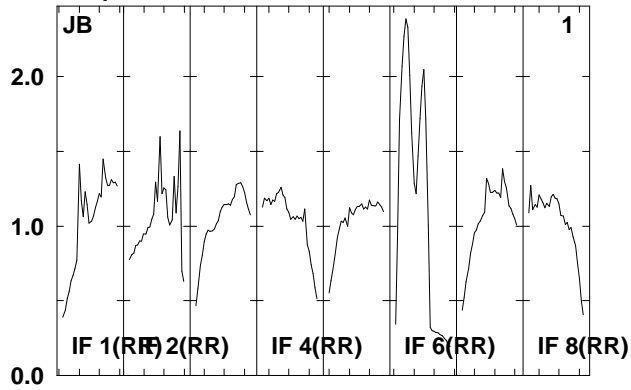

Lower frame: Real Jy
Total-power spectrum Antenna: *
Timerange: 00/14:45:31 to 00/14:46:59

Plot file version 117 created 06-JAN-2012 11:46:39

J1128+59 EP068D 5.UVDATA.1

Freq = 1.5950 GHz, Bw = 16.000 MH No calibration applied and no bandpass applied

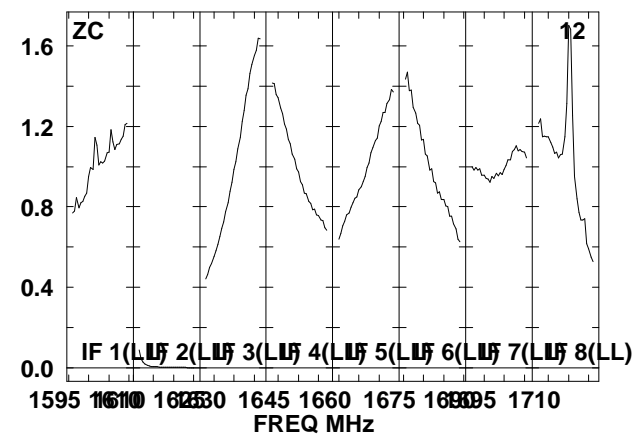
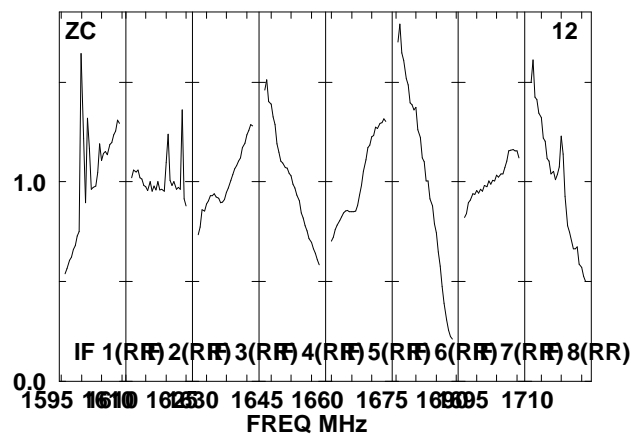
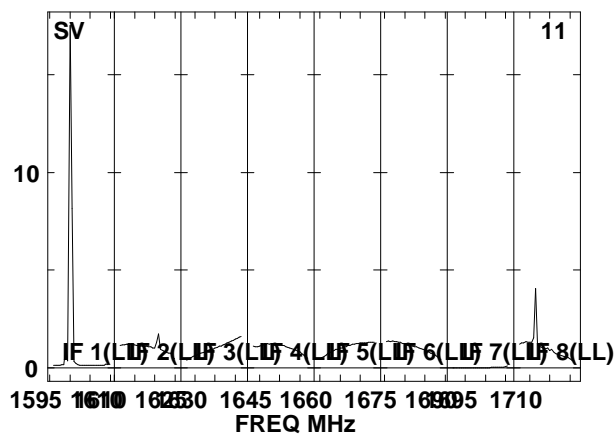
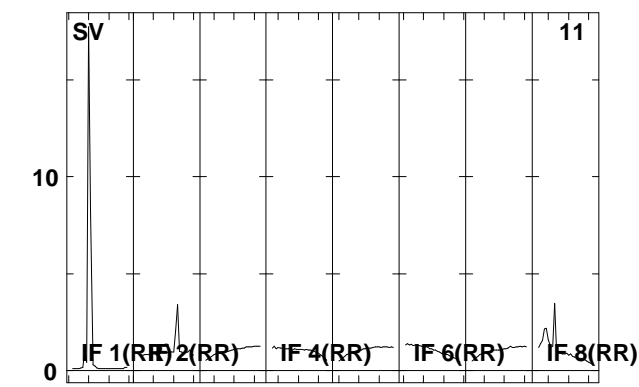
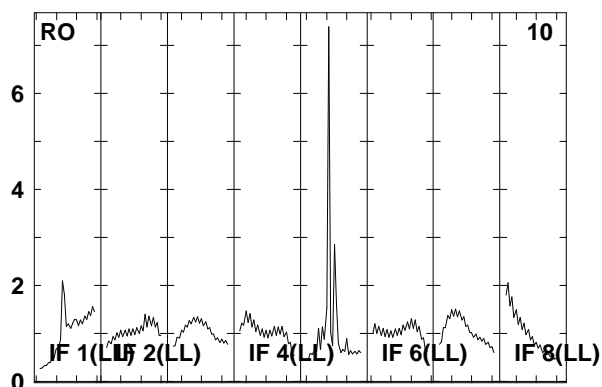
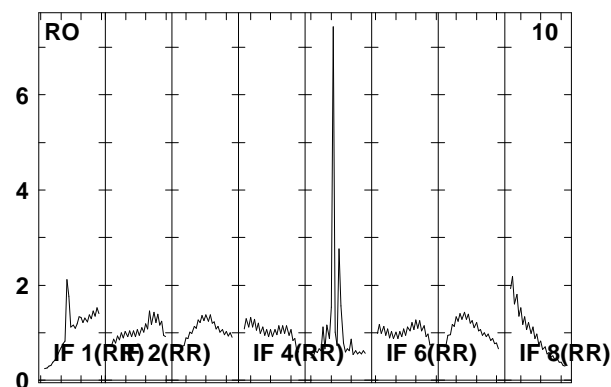
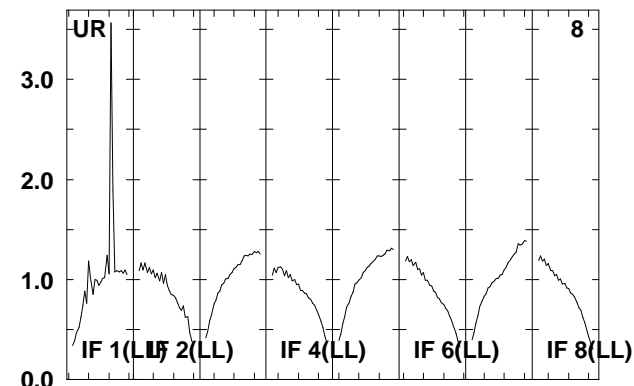
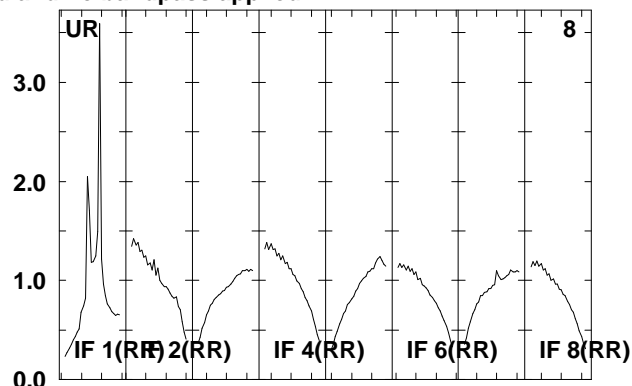
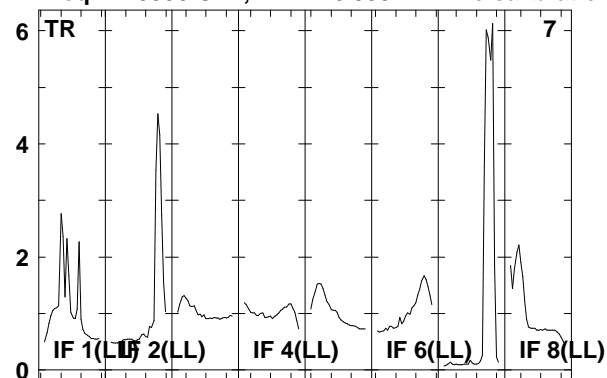

Lower frame: Real Jy
Total-power spectrum Antenna: *
Timerange: 00/14:45:31 to 00/14:46:59

Plot file version 118 created 06-JAN-2012 11:46:39

J1128+59 EP068D 5.UVDATA.1

Freq = 1.5950 GHz, Bw = 16.000 MH No calibration applied and no bandpass applied

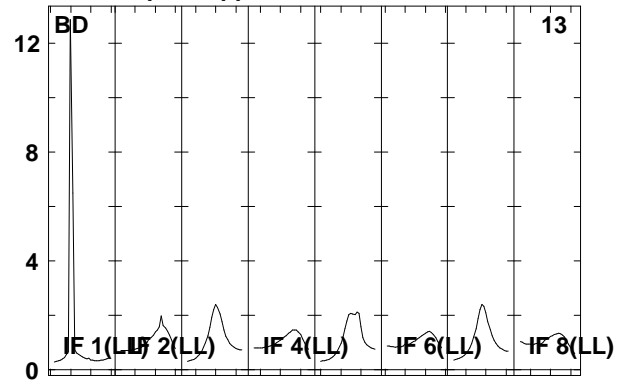
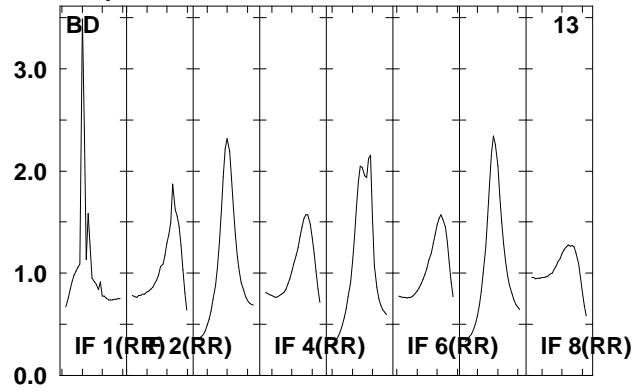

Lower frame: Real Jy
Total-power spectrum Antenna: *
Timerange: 00/14:45:31 to 00/14:46:59

Plot file version 119 created 06-JAN-2012 11:46:39

ARP299D EP068D 5.UVDATA.1

Freq = 1.5950 GHz, Bw = 16.000 MH No calibration applied and no bandpass applied

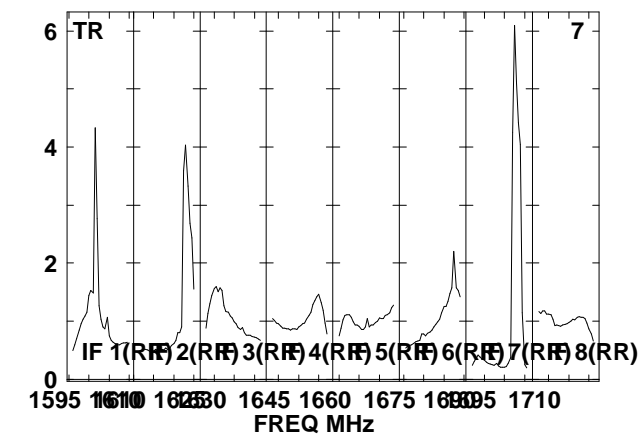
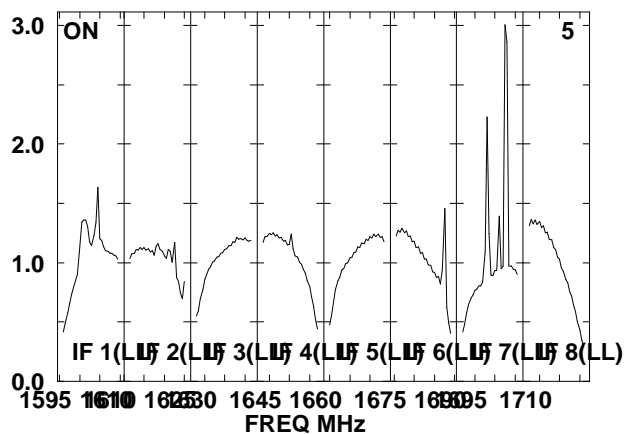
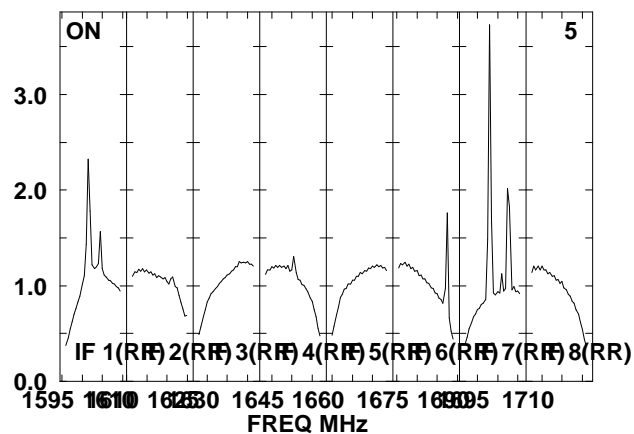
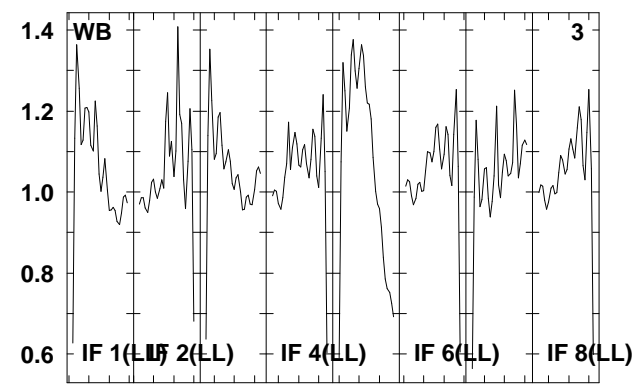
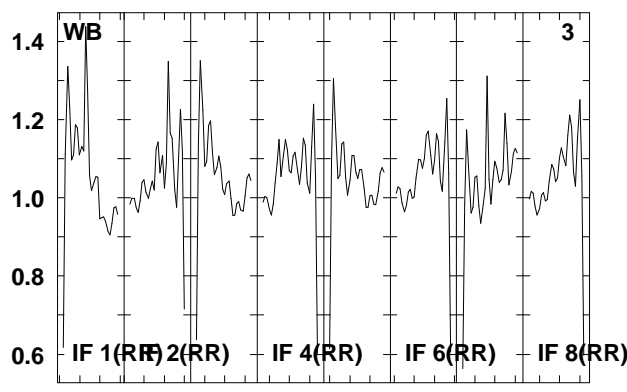
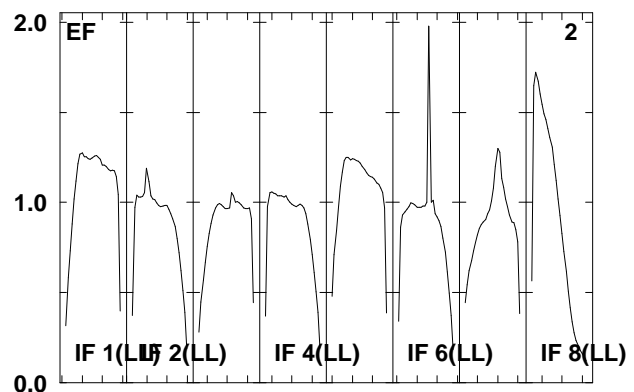
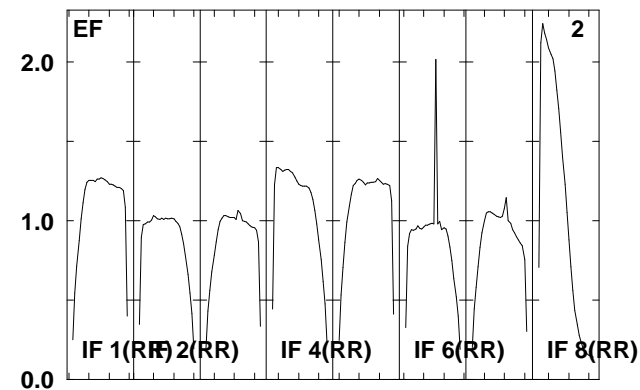
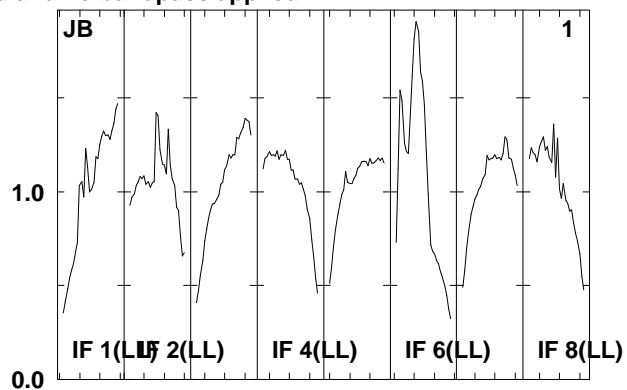
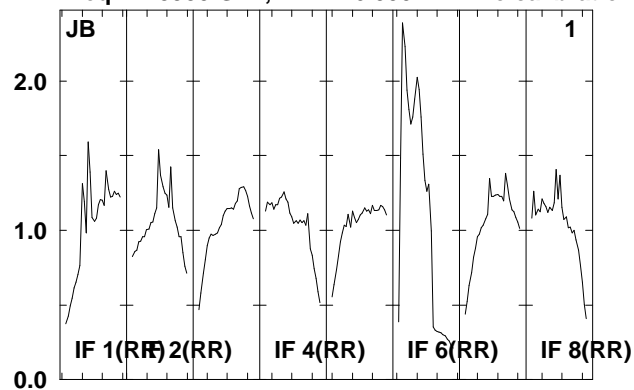

Lower frame: Real Jy
Total-power spectrum Antenna: *
Timerange: 00/14:47:05 to 00/14:50:29

Plot file version 120 created 06-JAN-2012 11:46:40

ARP299D EP068D 5.UVDATA.1

Freq = 1.5950 GHz, Bw = 16.000 MH No calibration applied and no bandpass applied

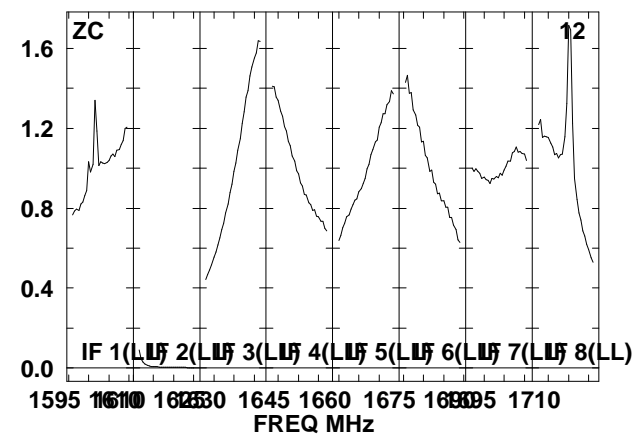
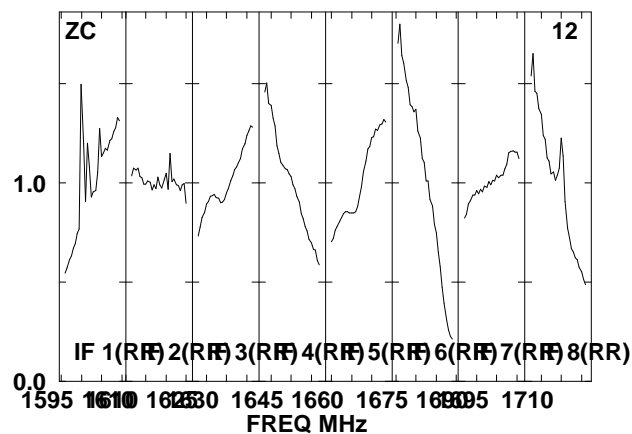
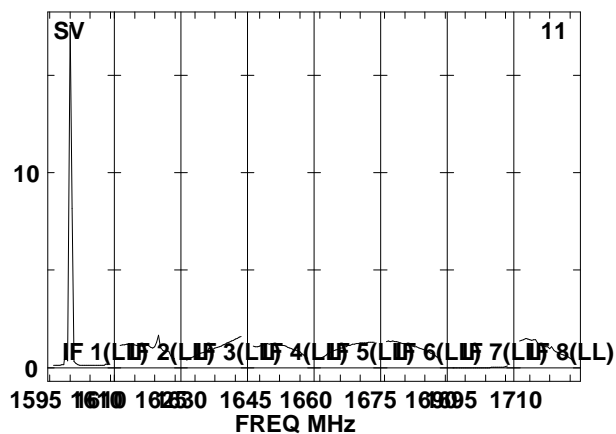
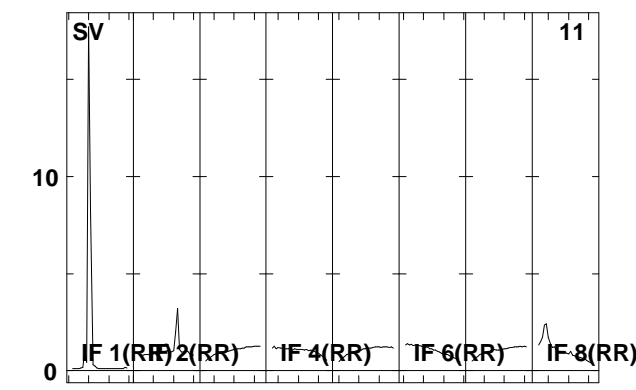
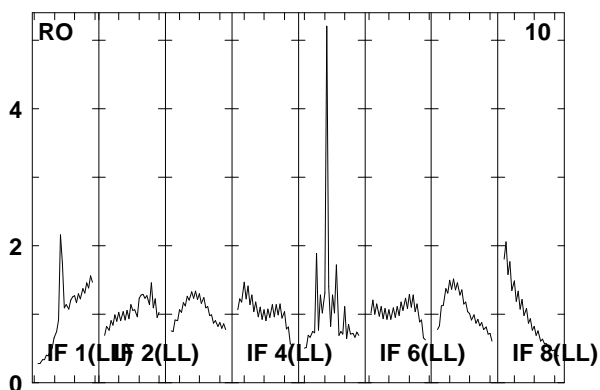
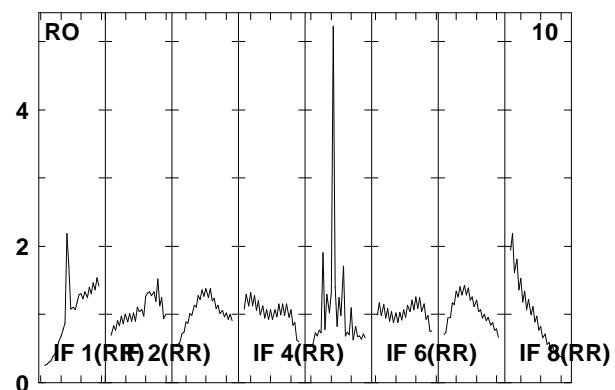
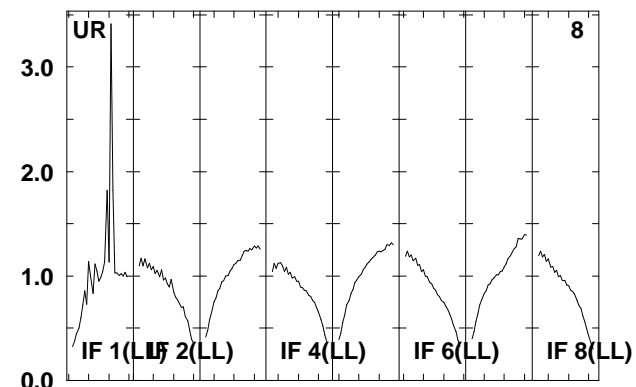
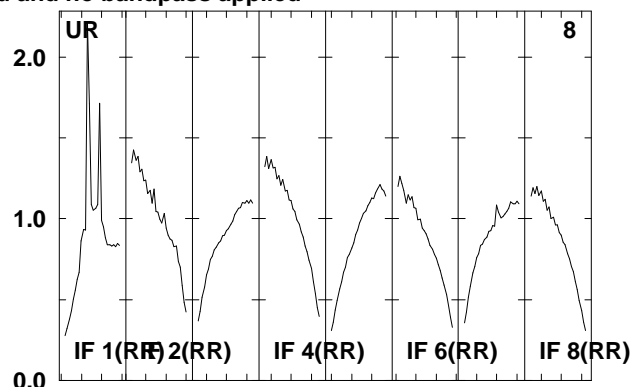
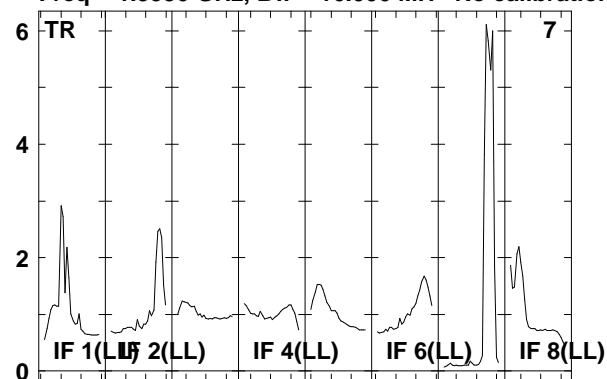

Lower frame: Real Jy

Total-power spectrum Antenna: *

Timerange: 00/14:47:05 to 00/14:50:29

Plot file version 121 created 06-JAN-2012 11:46:41

ARP299D EP068D 5.UVDATA.1

Freq = 1.5950 GHz, Bw = 16.000 MH No calibration applied and no bandpass applied

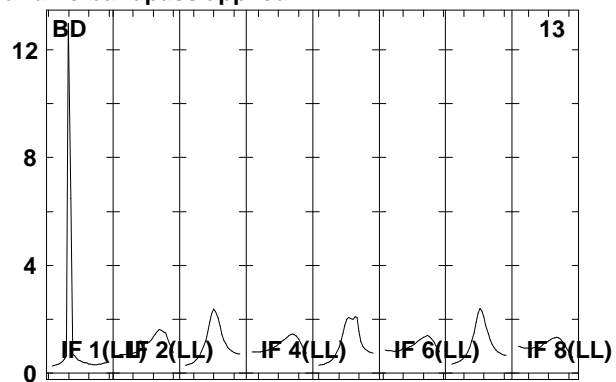
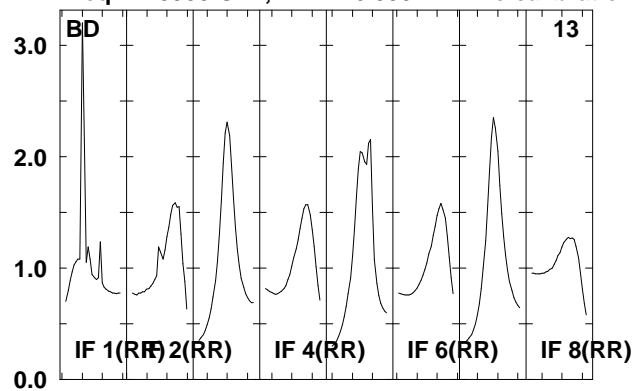

Lower frame: Real Jy
Total-power spectrum Antenna: *
Timerange: 00/14:47:05 to 00/14:50:29

Plot file version 122 created 06-JAN-2012 11:46:41

J1128+59 EP068D 5.UVDATA.1

Freq = 1.5950 GHz, Bw = 16.000 MH No calibration applied and no bandpass applied

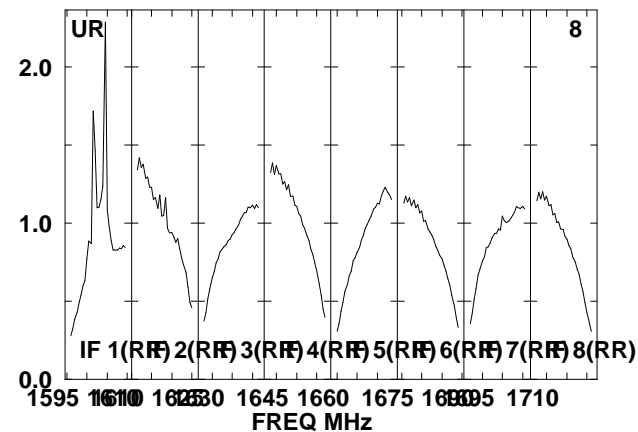
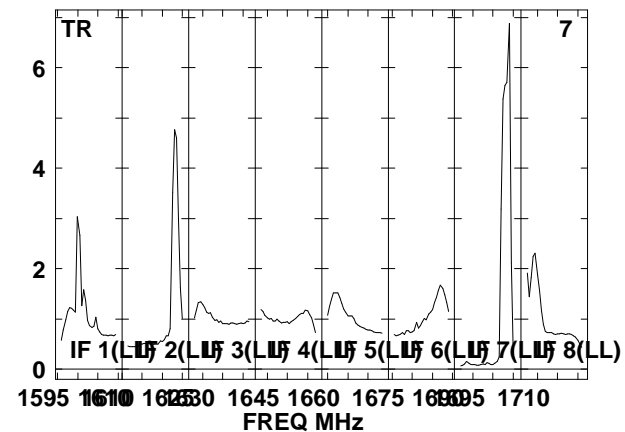
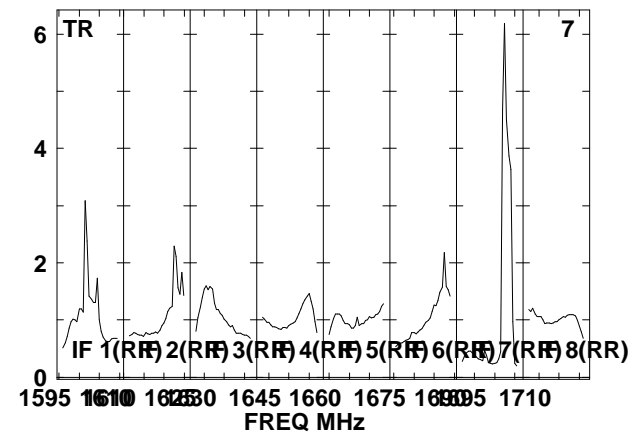
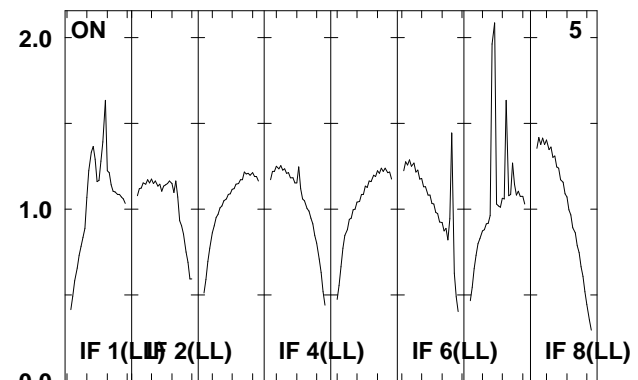
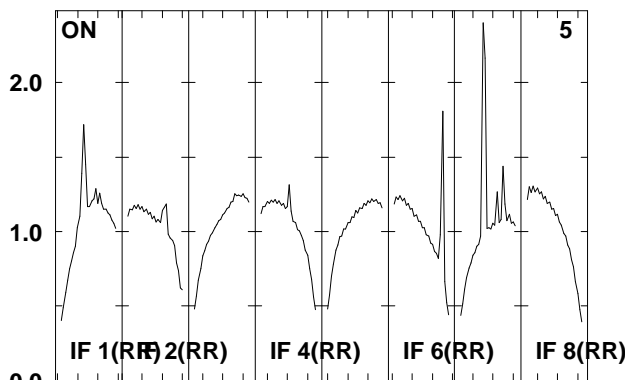
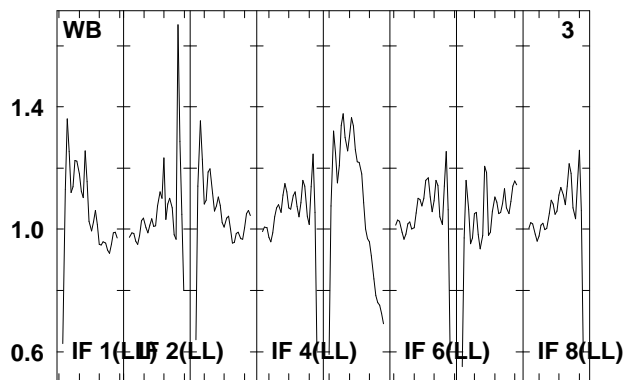
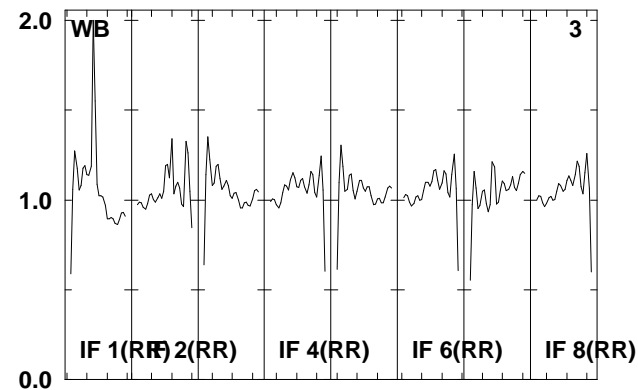
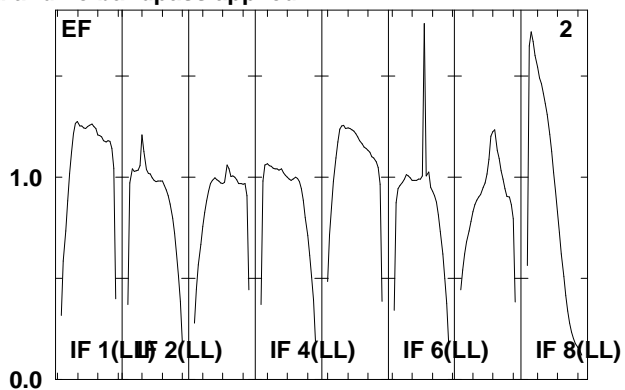
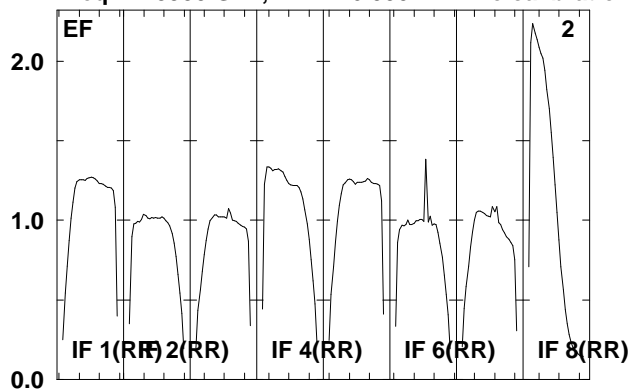

Lower frame: Real Jy
Total-power spectrum Antenna: *
Timerange: 00/14:50:35 to 00/14:51:59

Plot file version 123 created 06-JAN-2012 11:46:41

J1128+59 EP068D 5.UVDATA.1

Freq = 1.5950 GHz, Bw = 16.000 MH No calibration applied and no bandpass applied

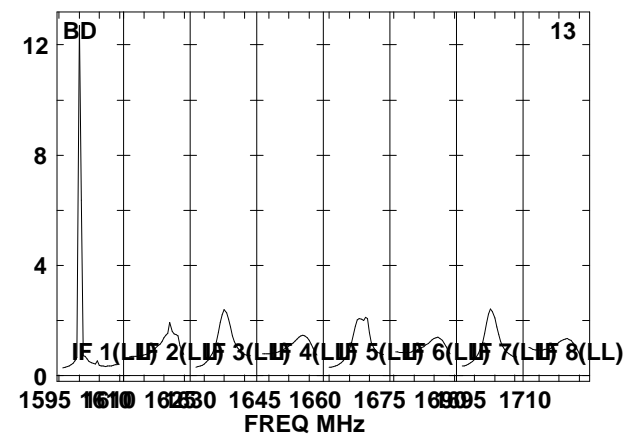
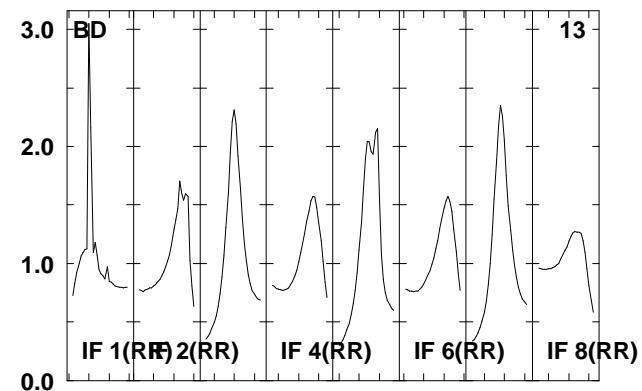
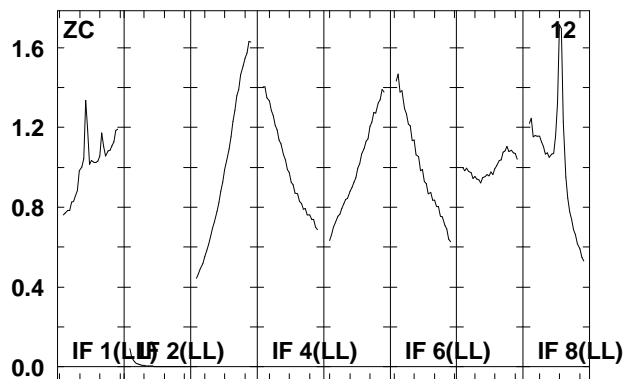
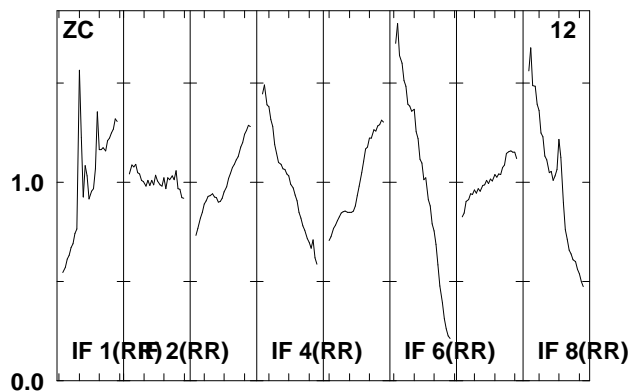
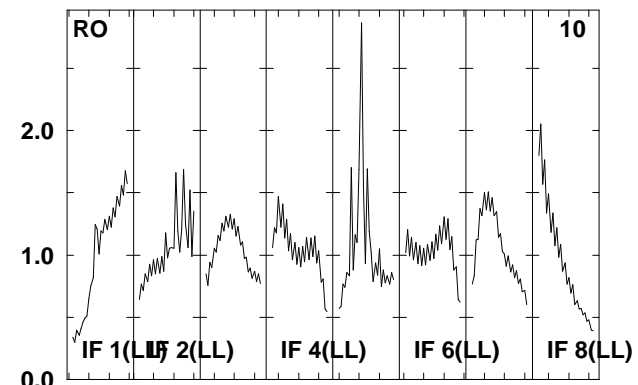
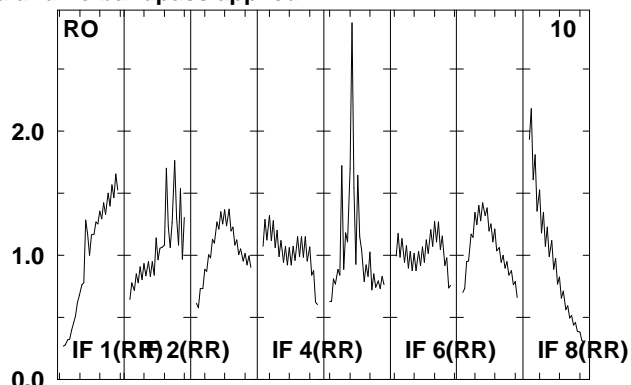
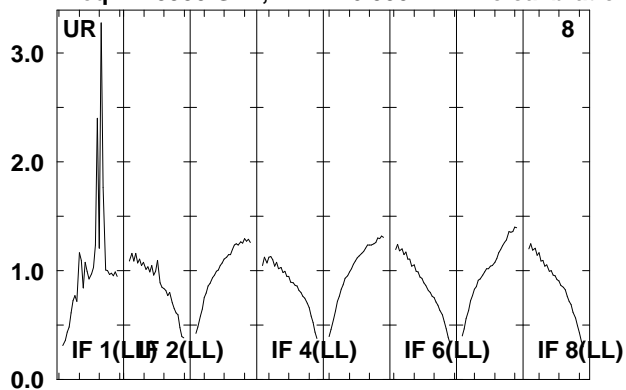

Lower frame: Real Jy

Total-power spectrum Antenna: *

Timerange: 00/14:50:35 to 00/14:51:59

Plot file version 124 created 06-JAN-2012 11:46:41

ARP299D EP068D 5.UVDATA.1

Freq = 1.5950 GHz, Bw = 16.000 MH No calibration applied and no bandpass applied

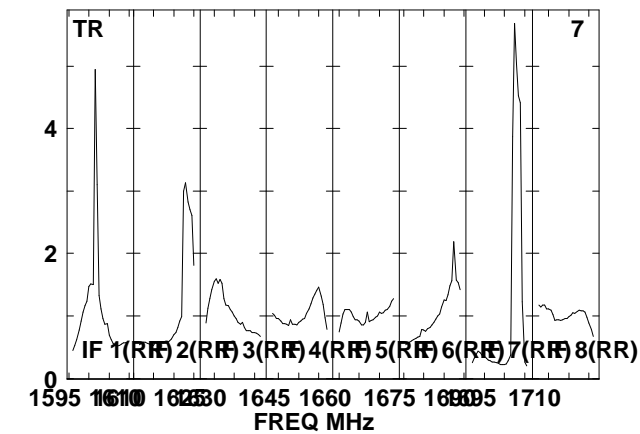
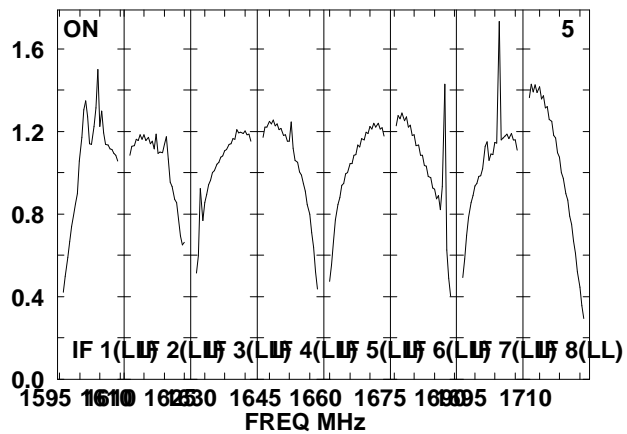
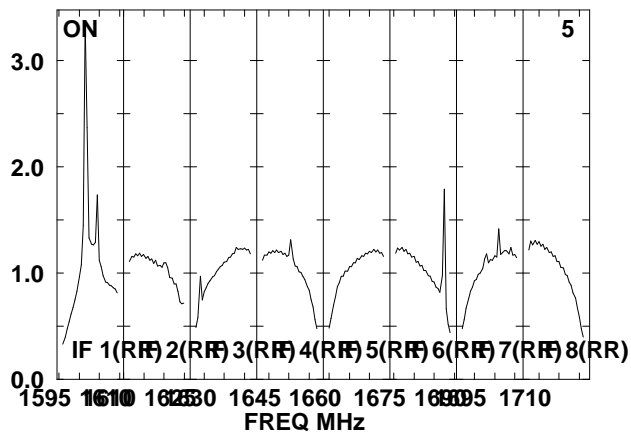
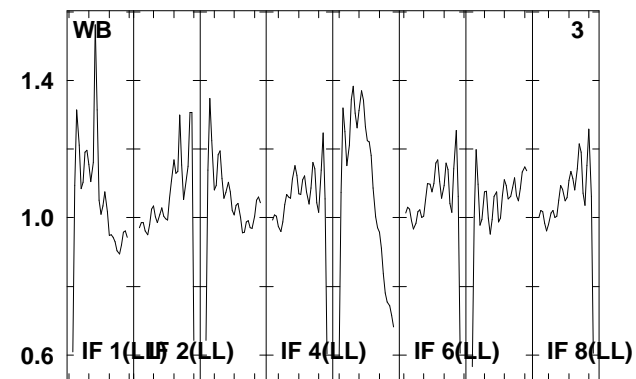
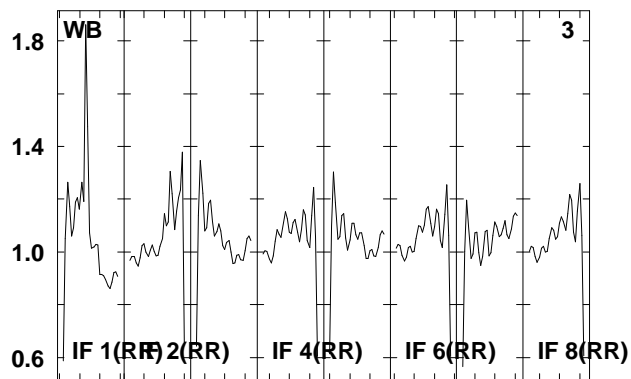
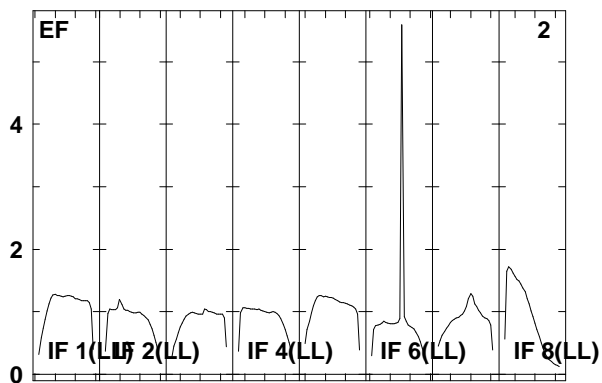
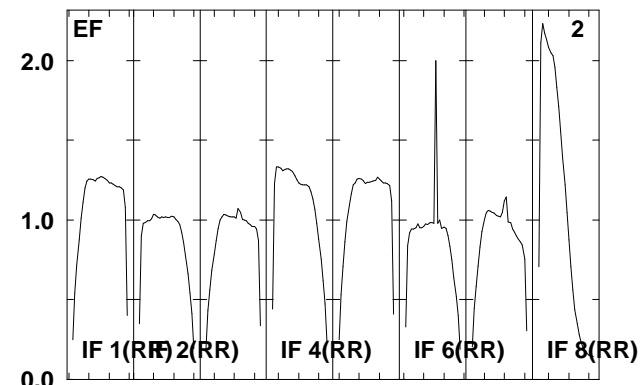
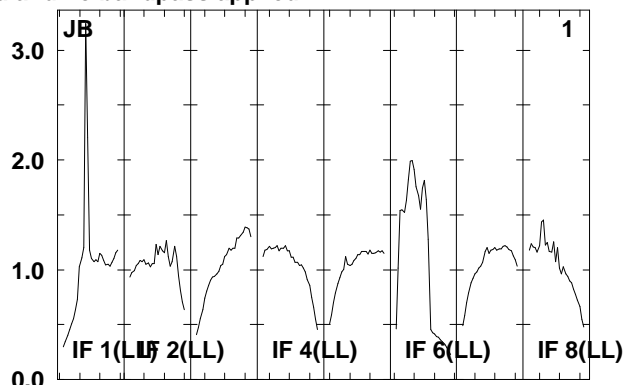
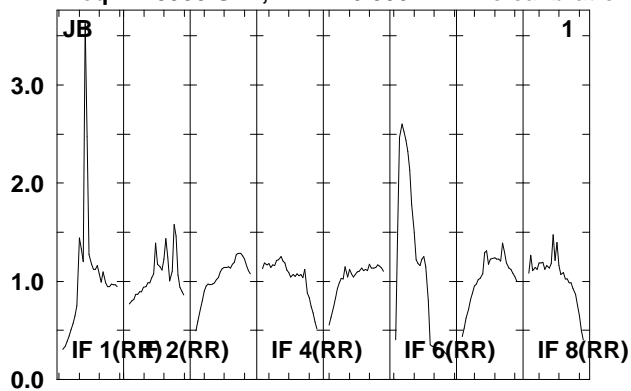

Lower frame: Real Jy
Total-power spectrum Antenna: *
Timerange: 00/14:52:01 to 00/14:55:29

Plot file version 125 created 06-JAN-2012 11:46:42

ARP299D EP068D 5.UVDATA.1

Freq = 1.5950 GHz, Bw = 16.000 MH No calibration applied and no bandpass applied

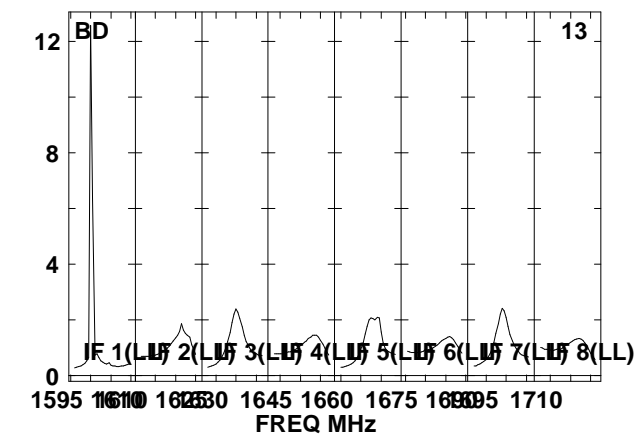
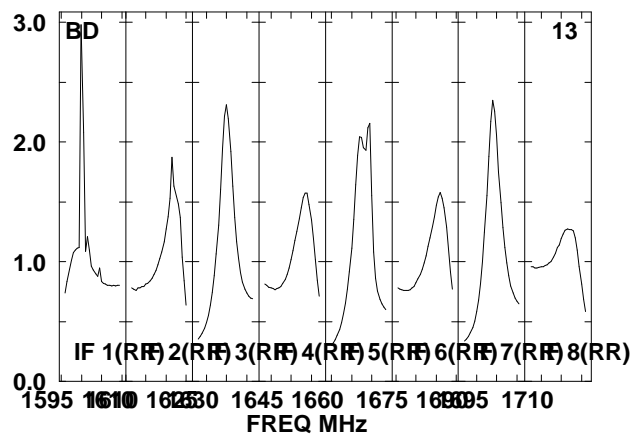
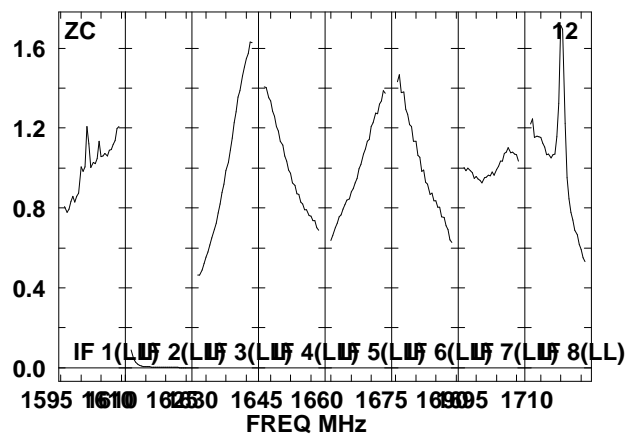
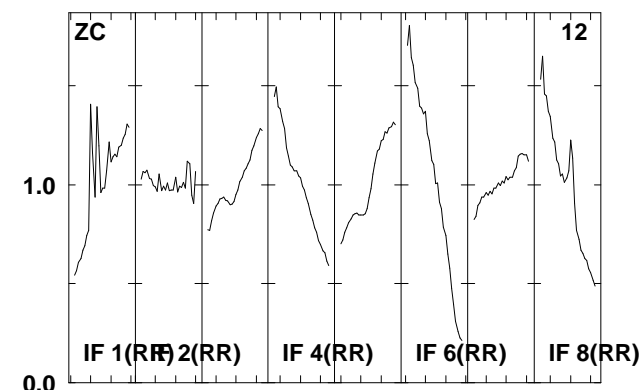
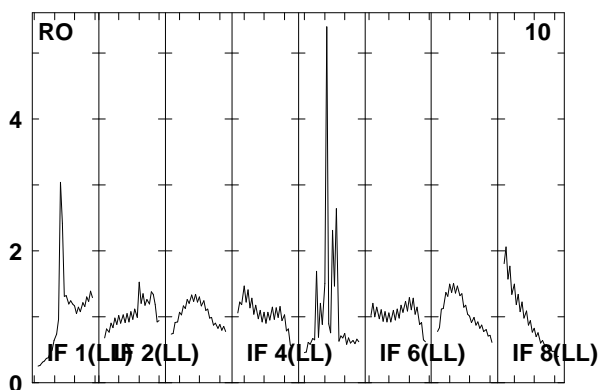
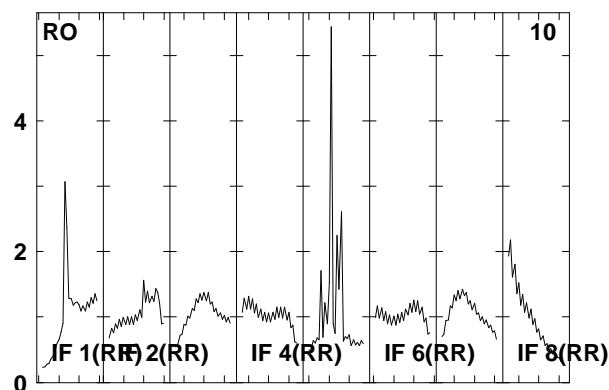
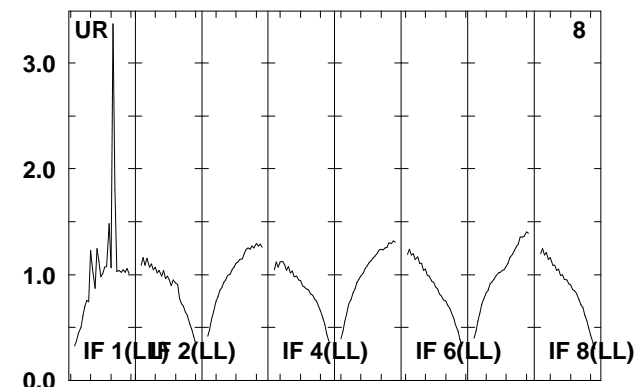
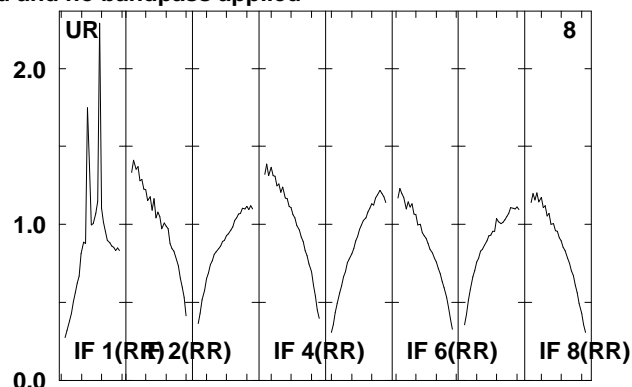
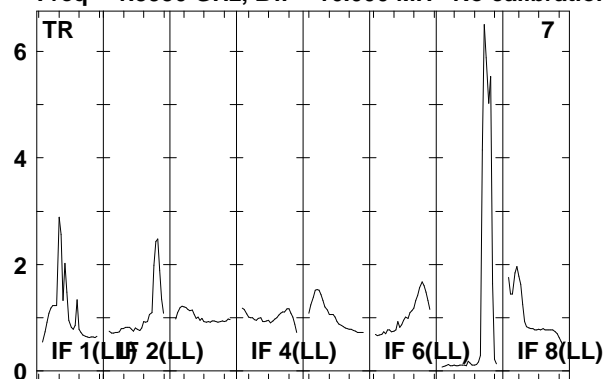

Lower frame: Real Jy

Total-power spectrum Antenna: *

Timerange: 00/14:52:01 to 00/14:55:29

Plot file version 126 created 06-JAN-2012 11:46:42

J1128+59 EP068D 5.UVDATA.1

Freq = 1.5950 GHz, Bw = 16.000 MH No calibration applied and no bandpass applied

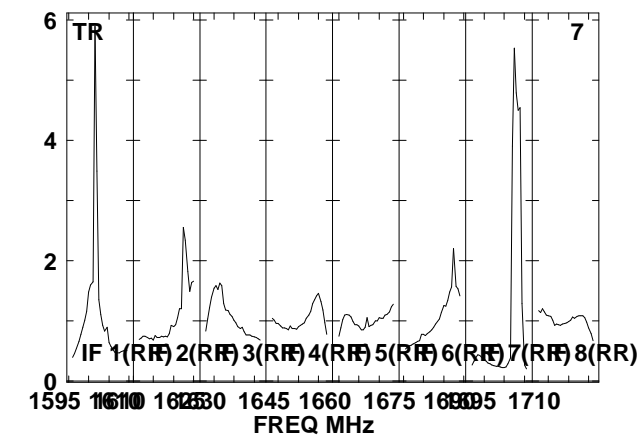
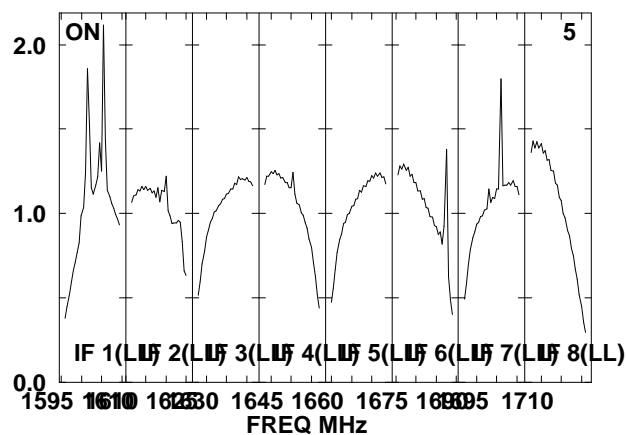
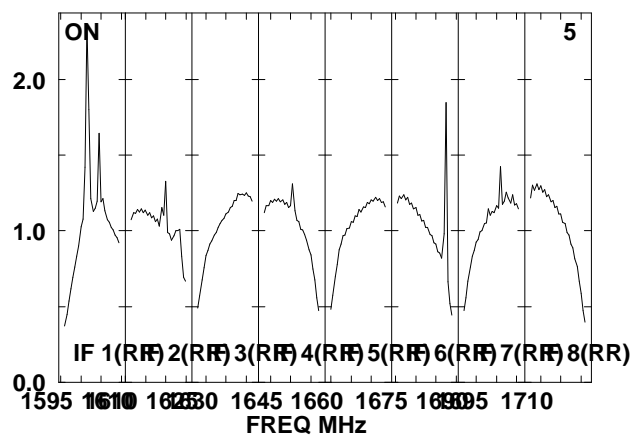
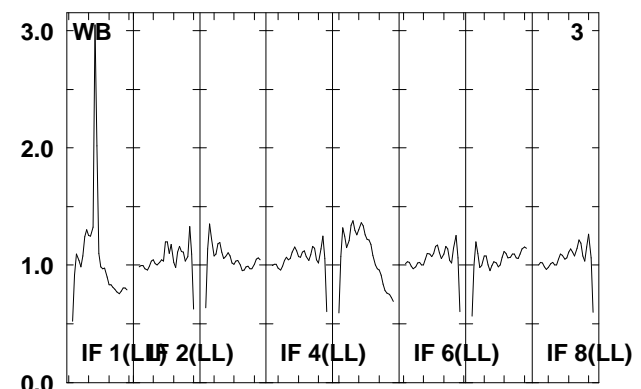
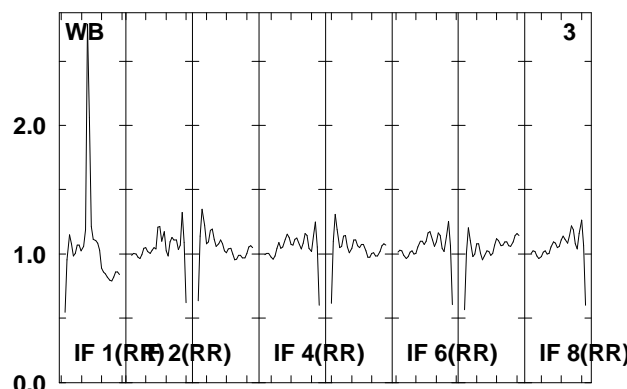
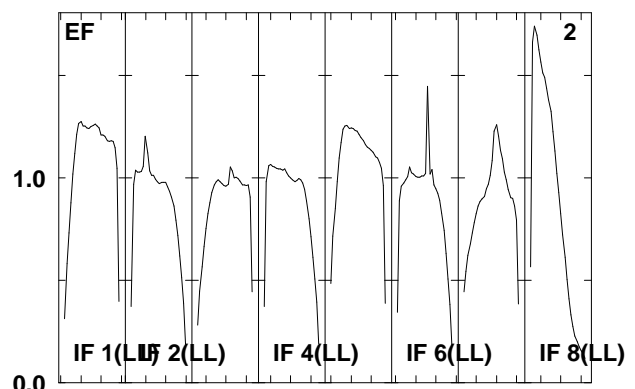
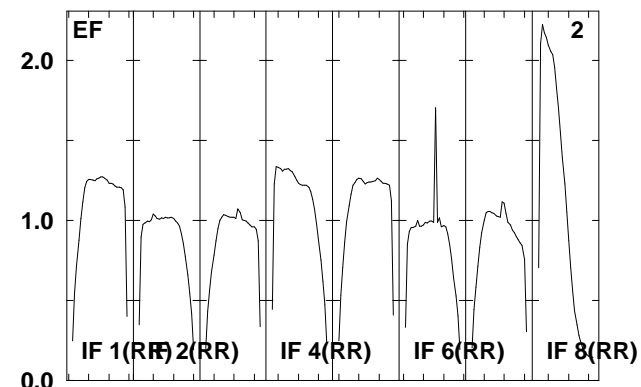
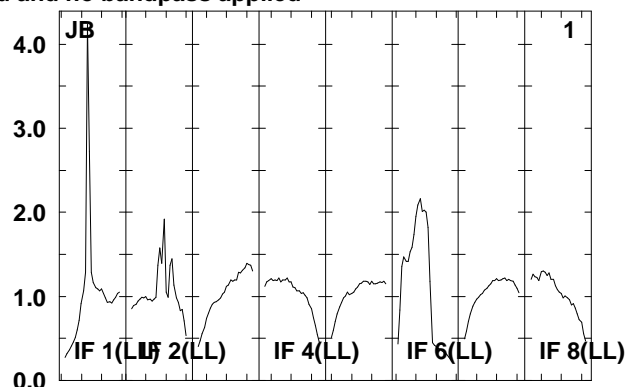
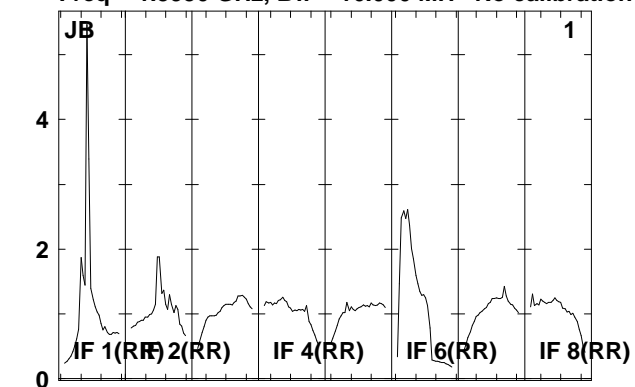

Lower frame: Real Jy
Total-power spectrum Antenna: *
Timerange: 00/14:55:35 to 00/14:56:59

Plot file version 127 created 06-JAN-2012 11:46:43

J1128+59 EP068D 5.UVDATA.1

Freq = 1.5950 GHz, Bw = 16.000 MH No calibration applied and no bandpass applied

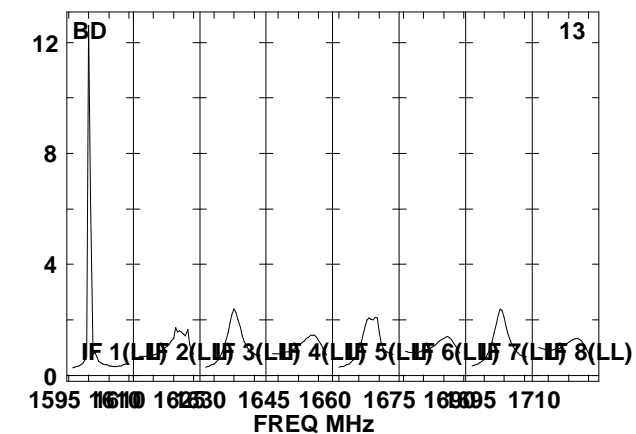
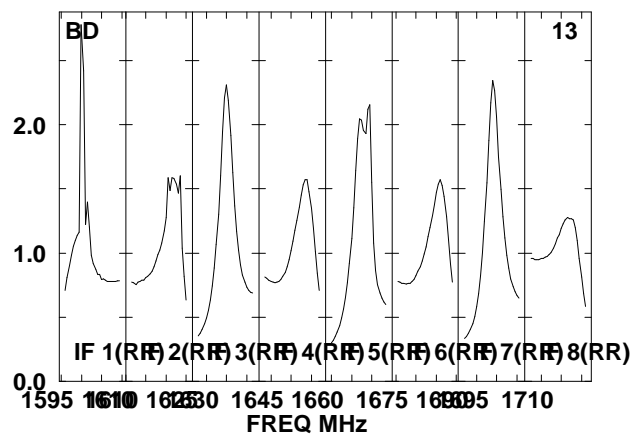
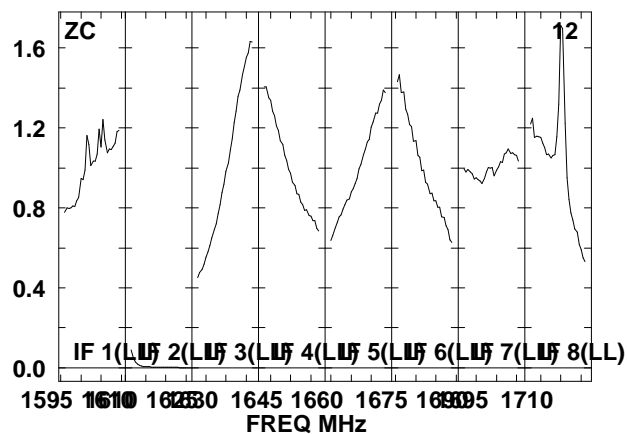
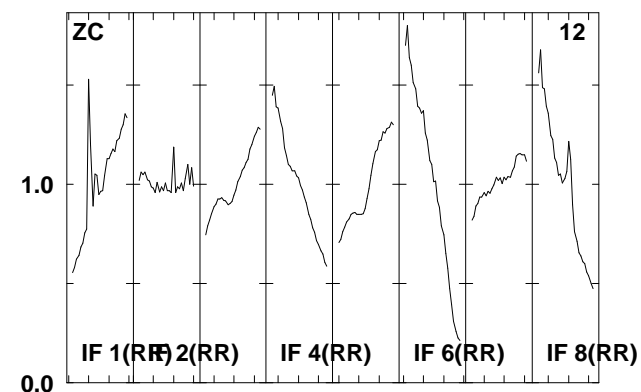
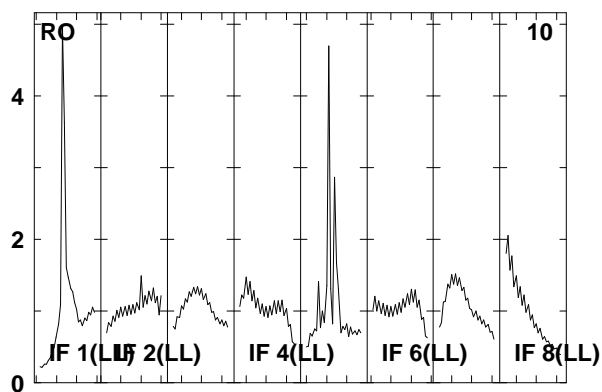
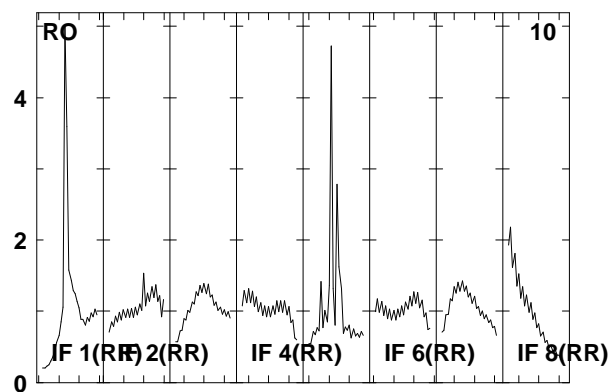
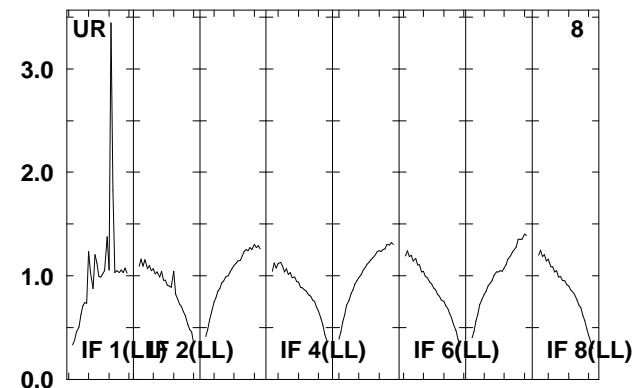
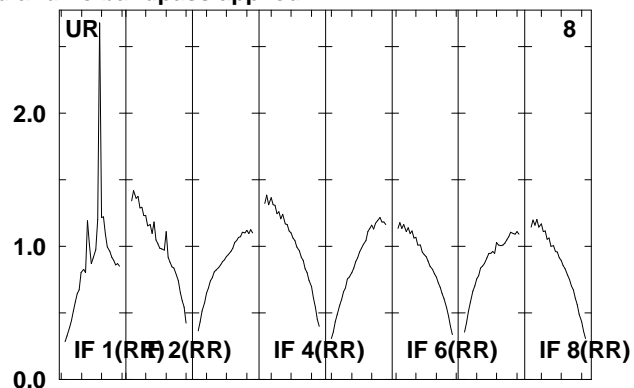
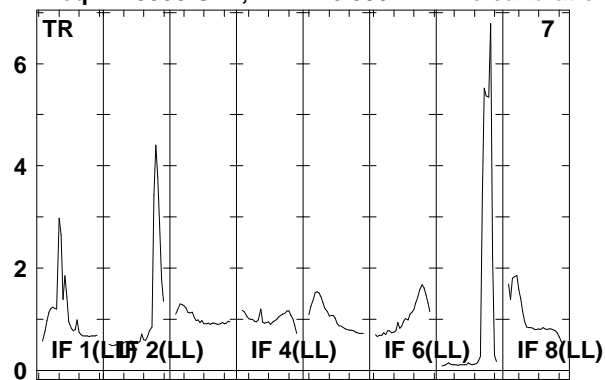

Lower frame: Real Jy

Total-power spectrum Antenna: *

Timerange: 00/14:55:35 to 00/14:56:59

Plot file version 128 created 06-JAN-2012 11:46:43

ARP299D EP068D 5.UVDATA.1

Freq = 1.5950 GHz, Bw = 16.000 MH No calibration applied and no bandpass applied

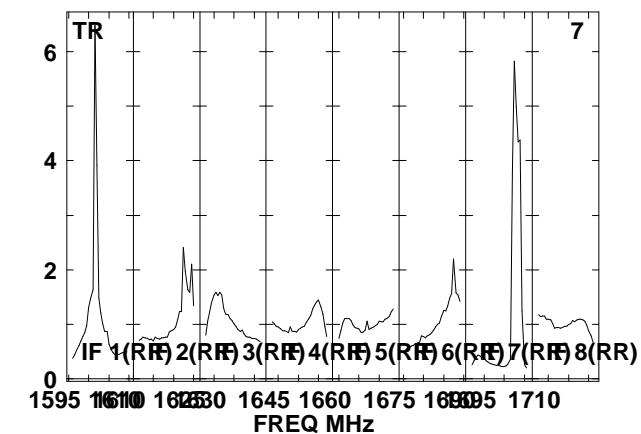
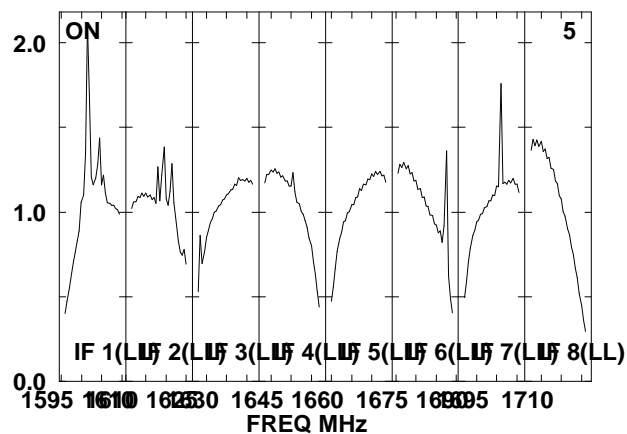
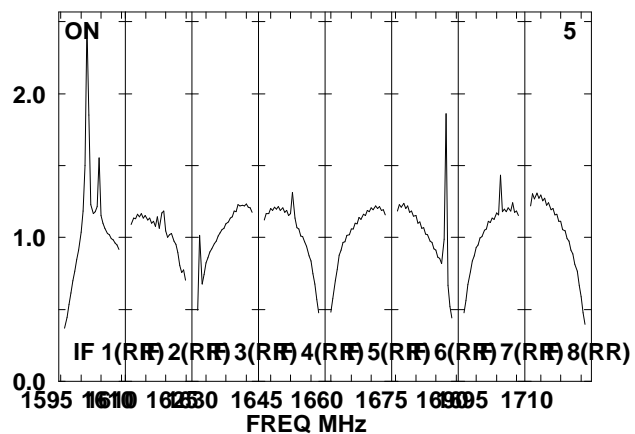
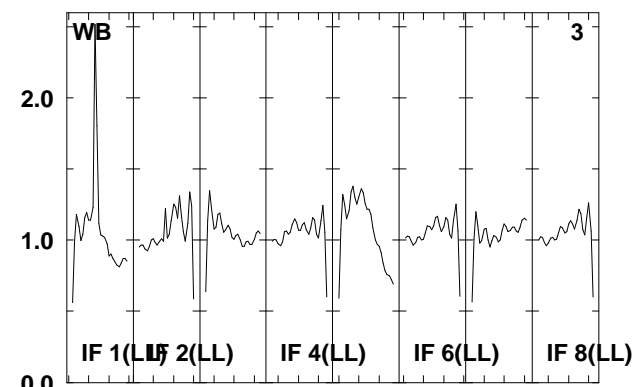
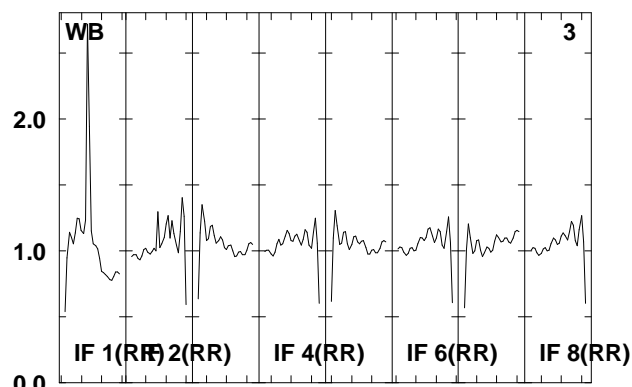
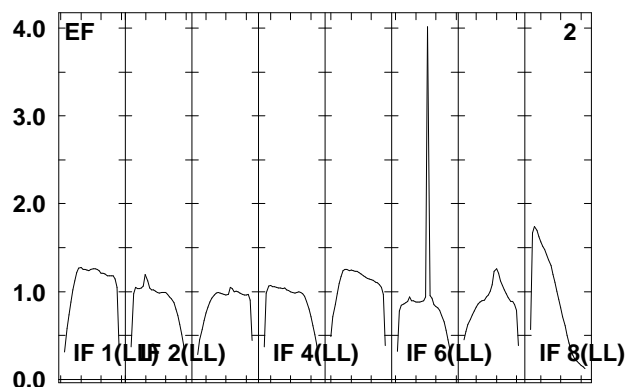
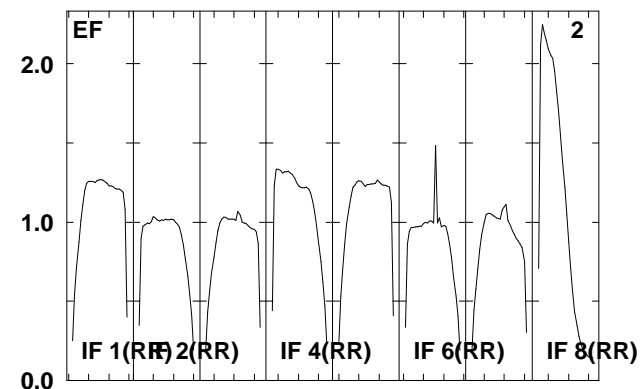
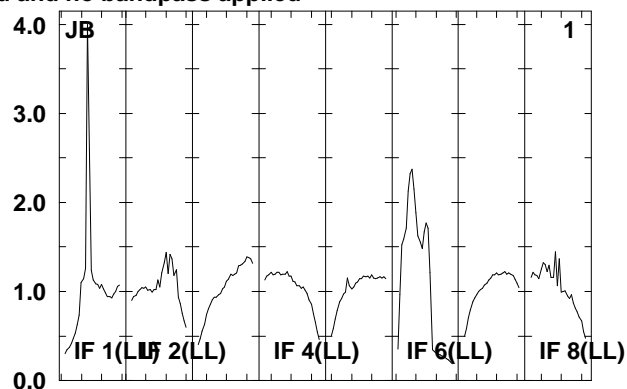
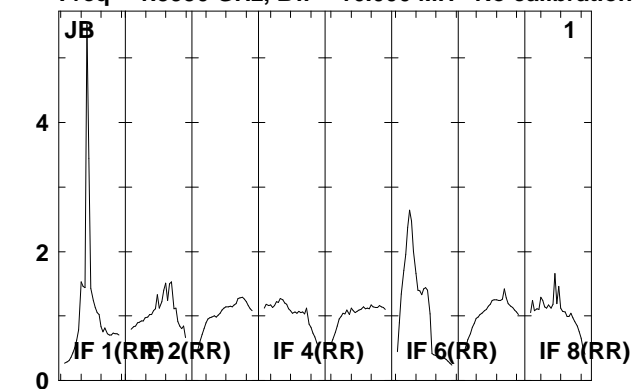

Lower frame: Real Jy
Total-power spectrum Antenna: *
Timerange: 00/14:57:05 to 00/15:00:29

Plot file version 129 created 06-JAN-2012 11:46:44

ARP299D EP068D 5.UVDATA.1

Freq = 1.5950 GHz, Bw = 16.000 MH No calibration applied and no bandpass applied

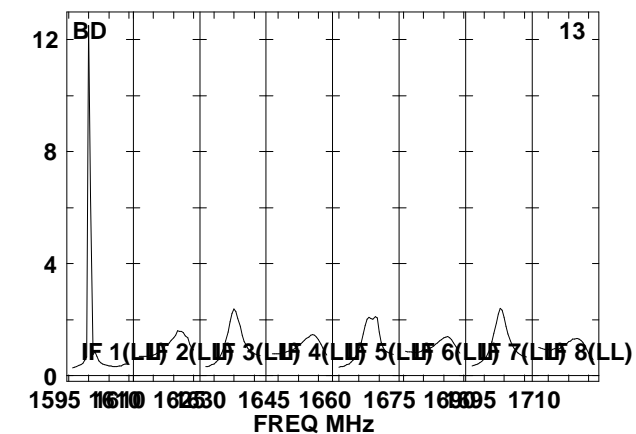
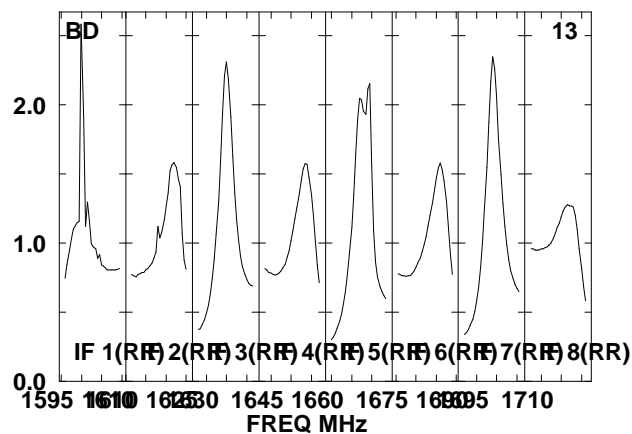
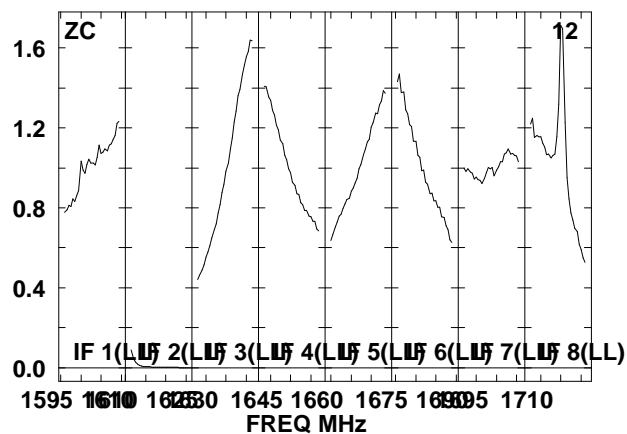
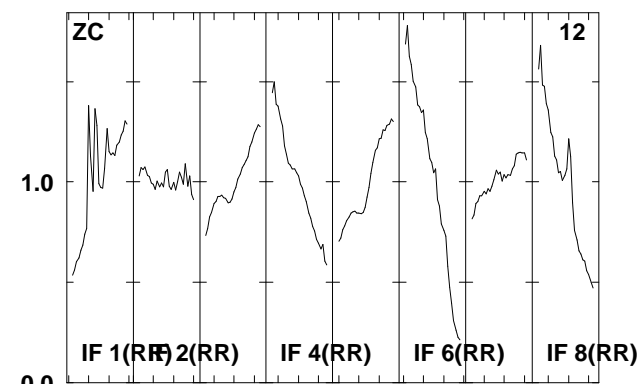
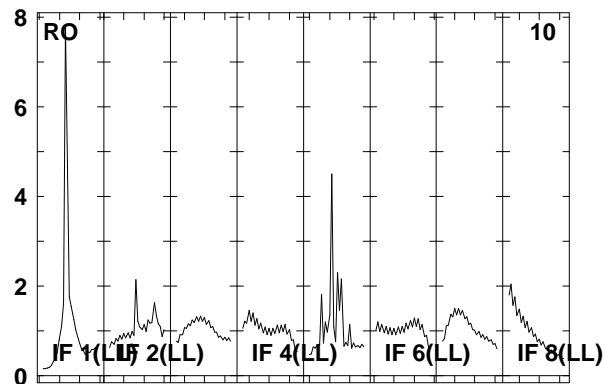
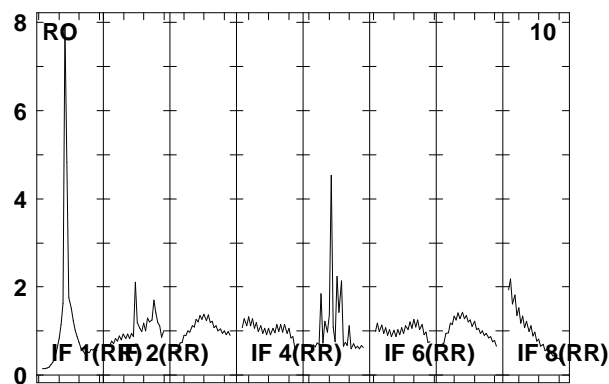
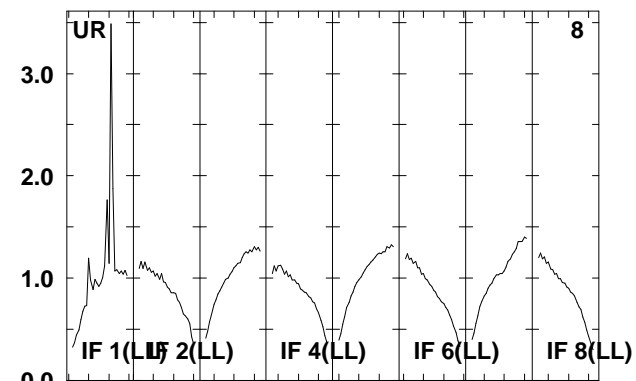
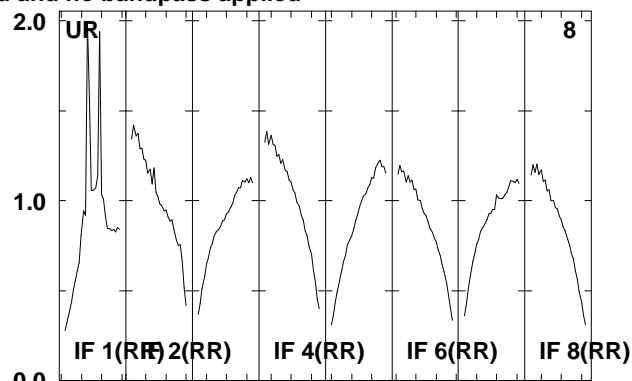
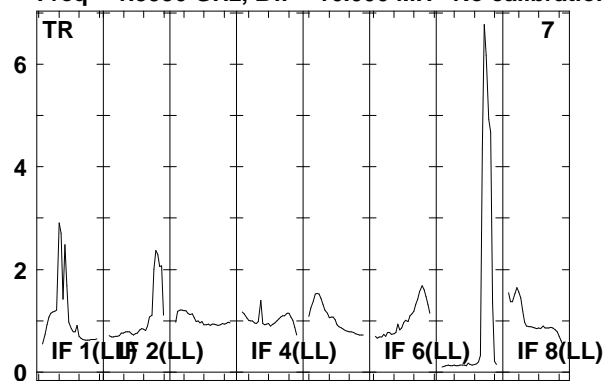

Lower frame: Real Jy
Total-power spectrum Antenna: *
Timerange: 00/14:57:05 to 00/15:00:29

Plot file version 130 created 06-JAN-2012 11:46:44

J1128+59 EP068D 5.UVDATA.1

Freq = 1.5950 GHz, Bw = 16.000 MH No calibration applied and no bandpass applied

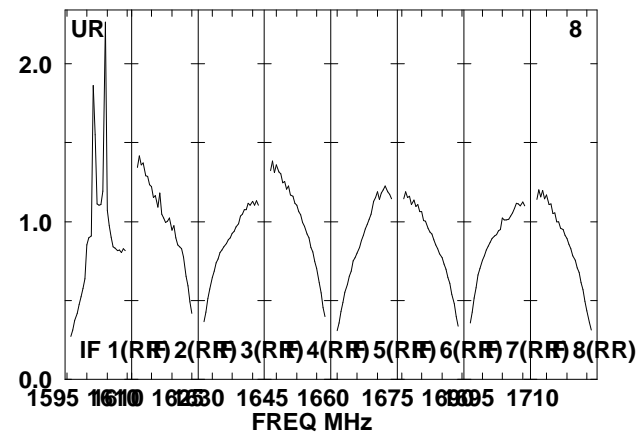
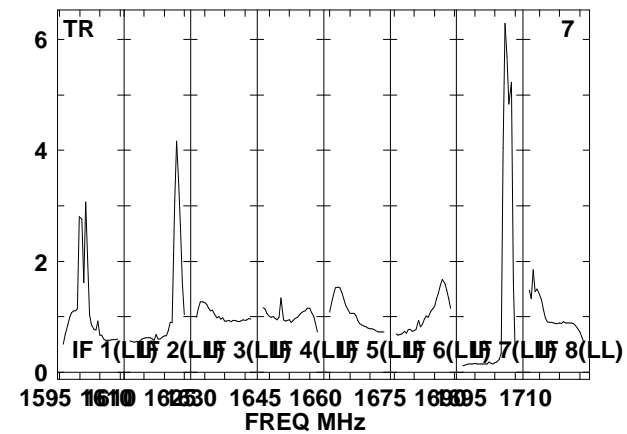
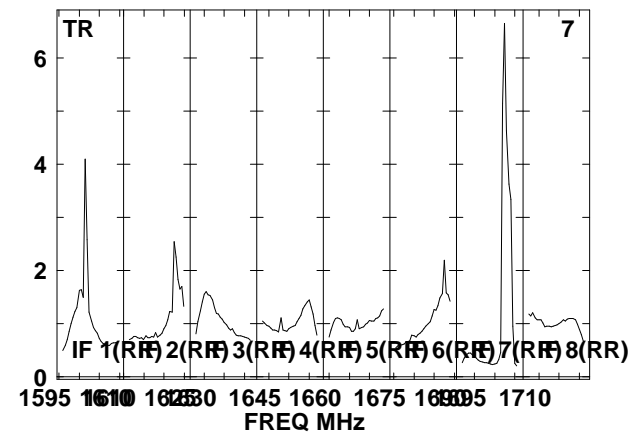
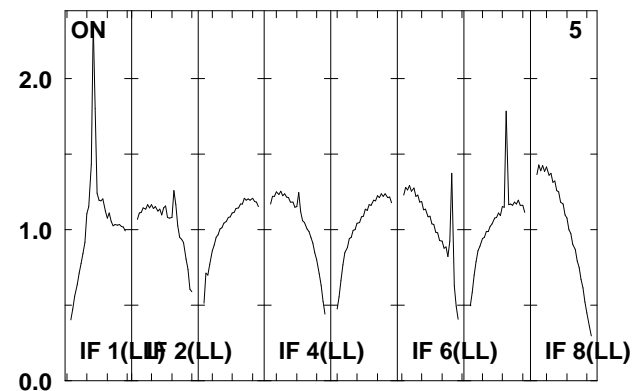
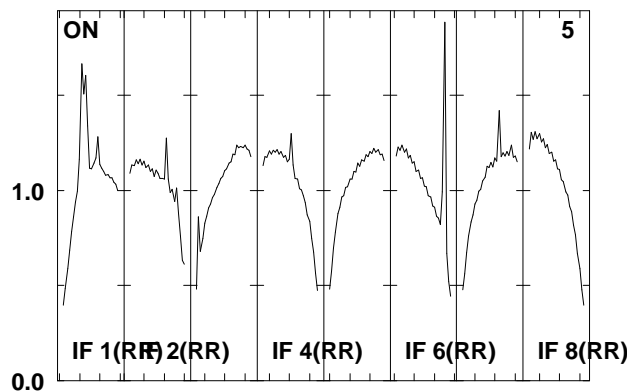
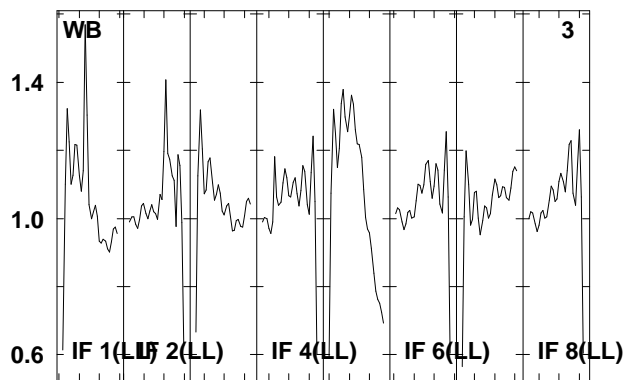
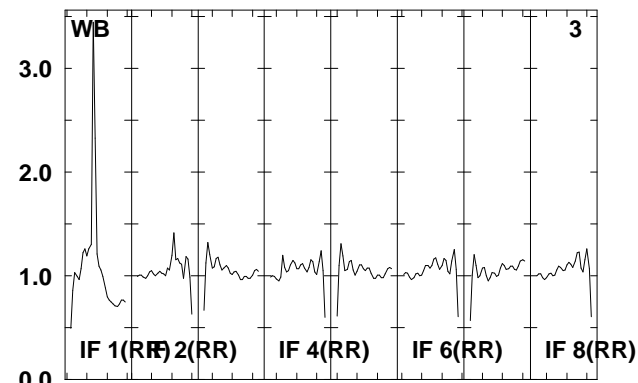
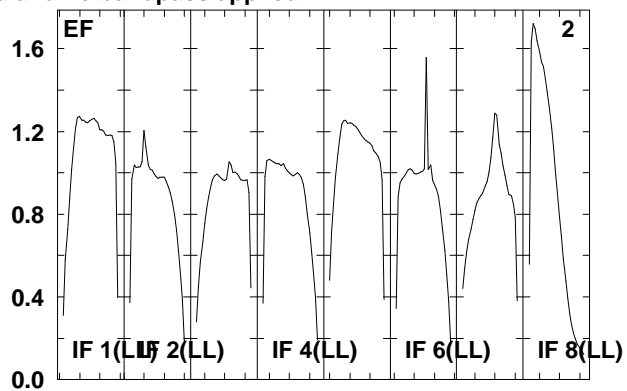
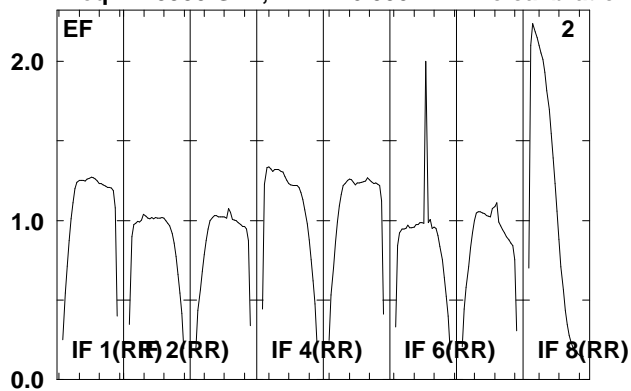

Lower frame: Real Jy
Total-power spectrum Antenna: *
Timerange: 00/15:01:31 to 00/15:02:59

Plot file version 131 created 06-JAN-2012 11:46:45

J1128+59 EP068D 5.UVDATA.1

Freq = 1.5950 GHz, Bw = 16.000 MH No calibration applied and no bandpass applied

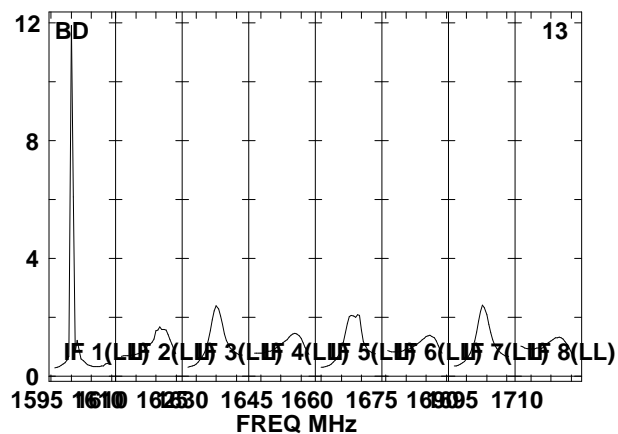
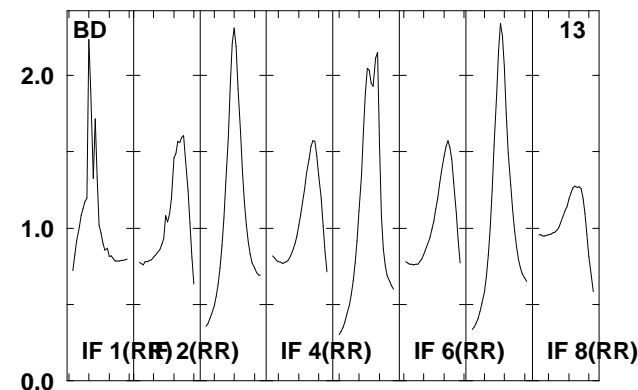
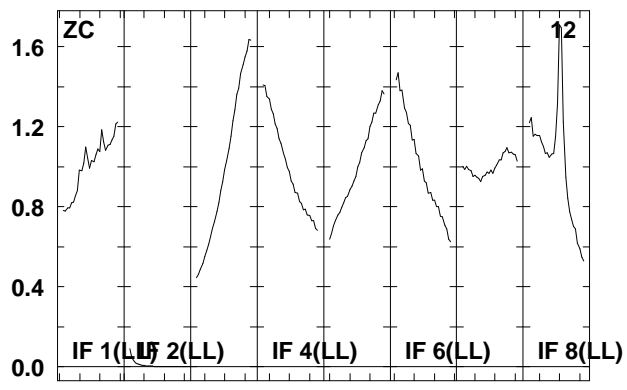
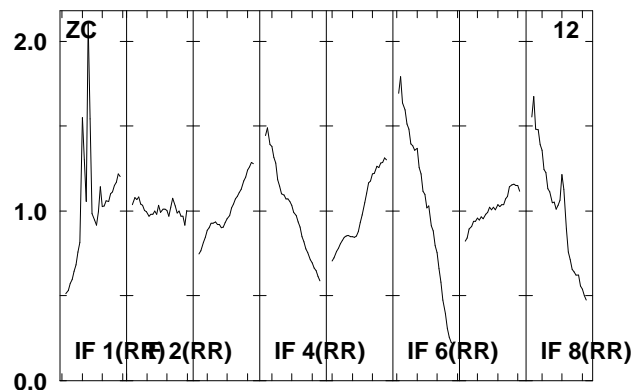
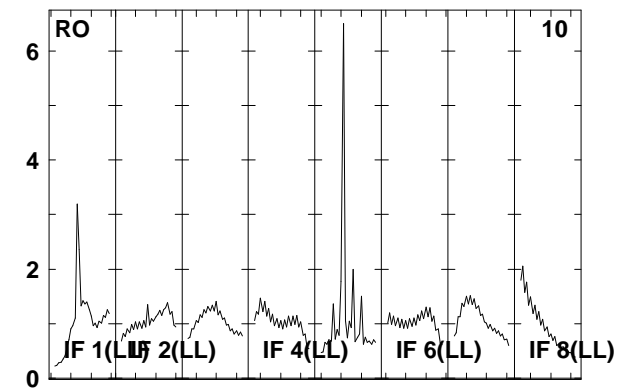
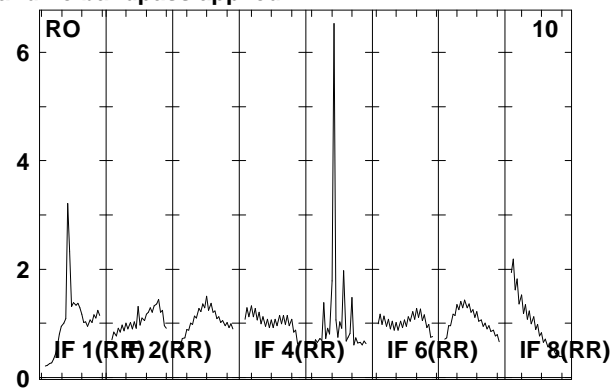
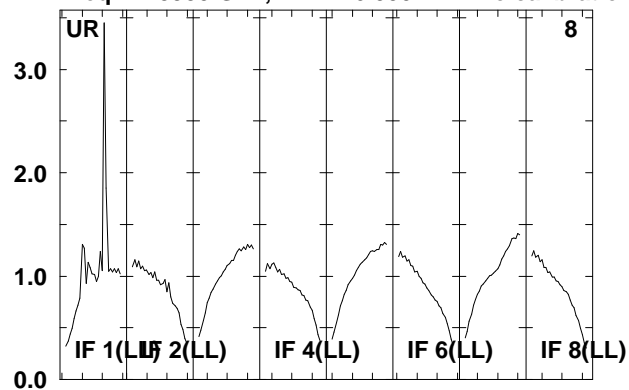

Lower frame: Real Jy

Total-power spectrum Antenna: *

Timerange: 00/15:01:31 to 00/15:02:59

Plot file version 132 created 06-JAN-2012 11:46:45

ARP299D EP068D 5.UVDATA.1

Freq = 1.5950 GHz, Bw = 16.000 MH No calibration applied and no bandpass applied

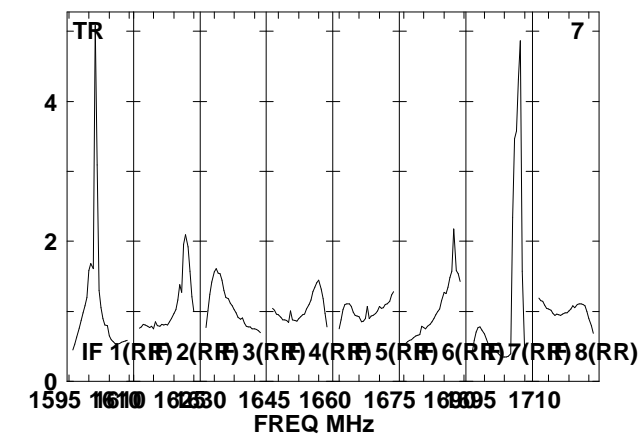
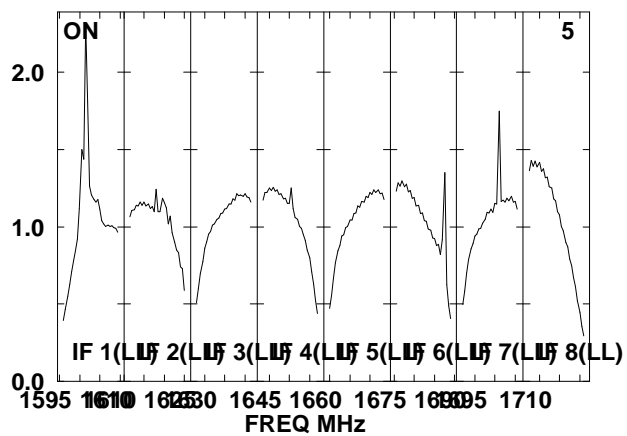
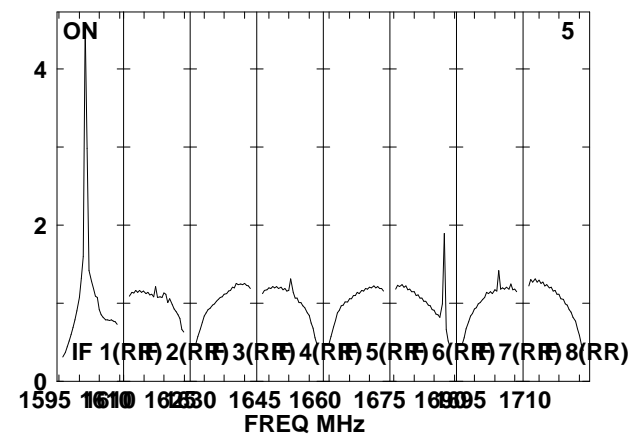
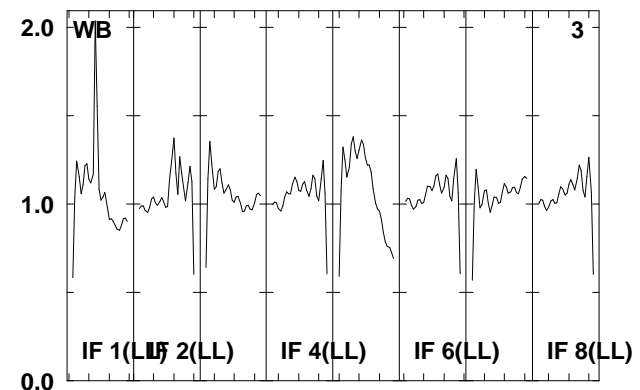
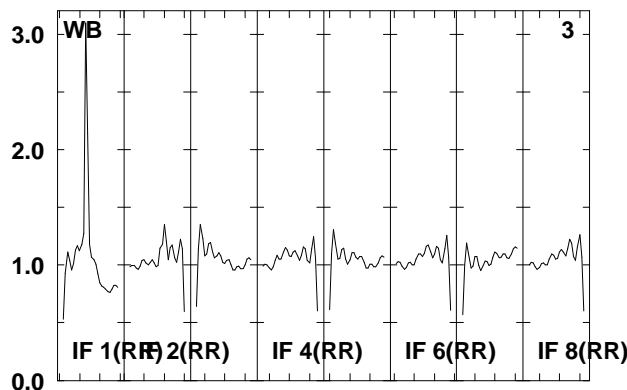
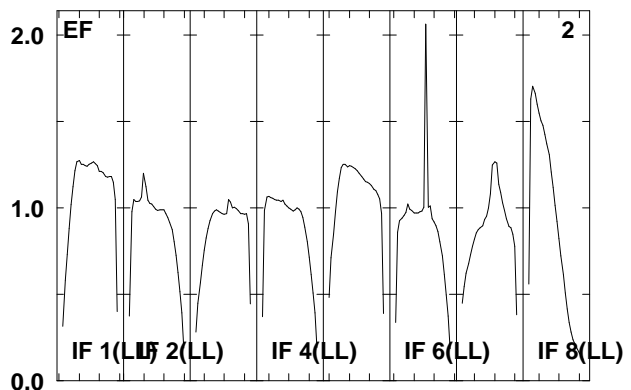
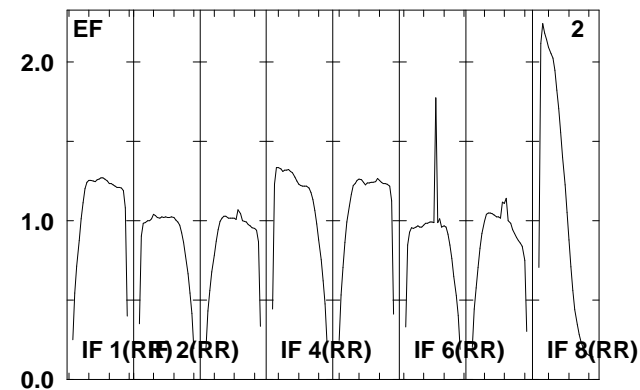
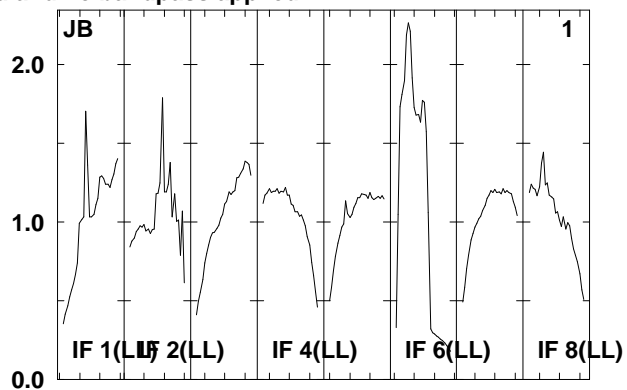
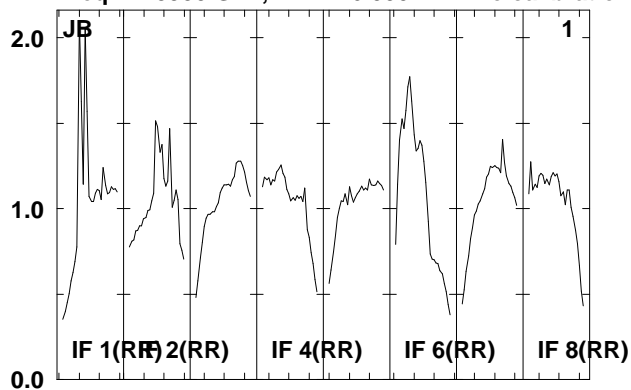

Lower frame: Real Jy
Total-power spectrum Antenna: *
Timerange: 00/15:03:01 to 00/15:06:29

Plot file version 133 created 06-JAN-2012 11:46:46

ARP299D EP068D 5.UVDATA.1

Freq = 1.5950 GHz, Bw = 16.000 MH No calibration applied and no bandpass applied

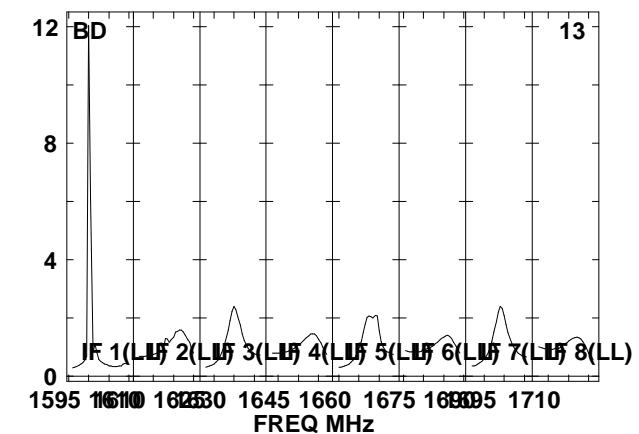
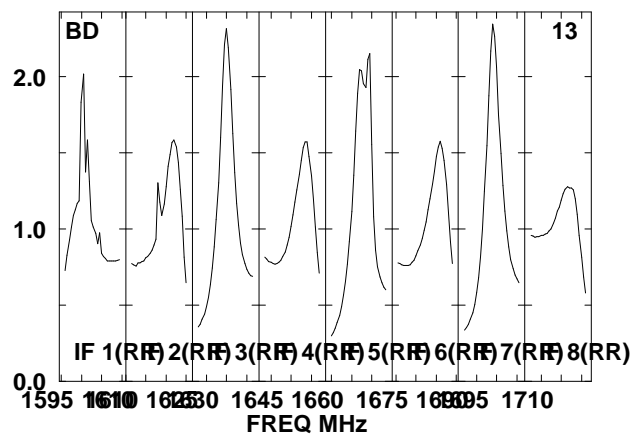
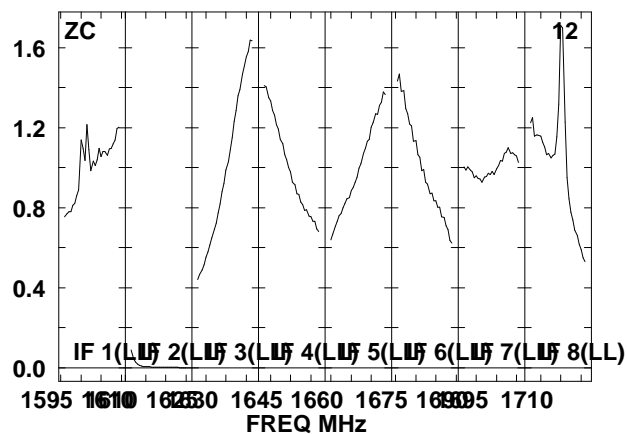
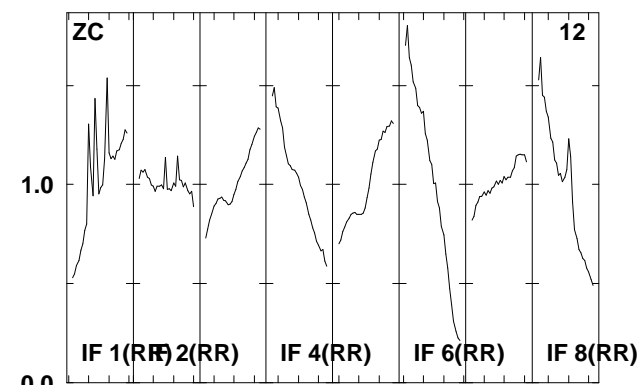
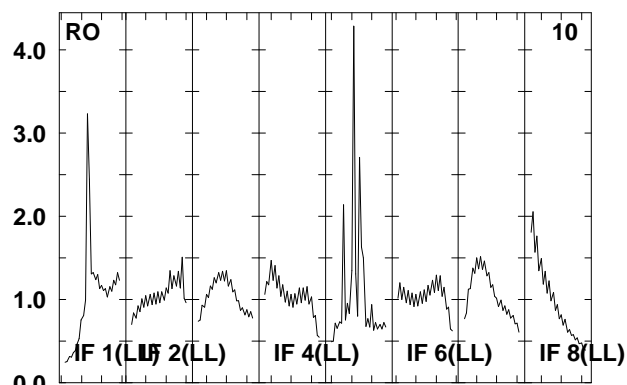
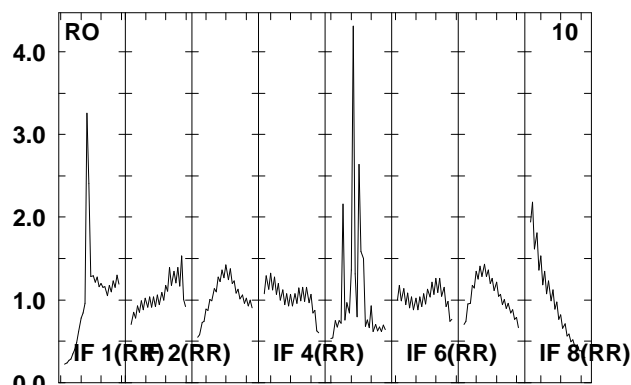
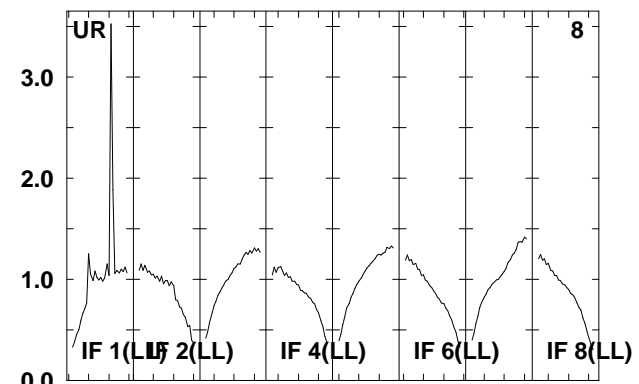
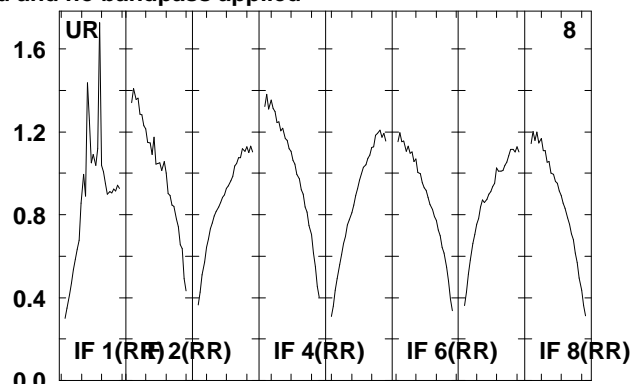
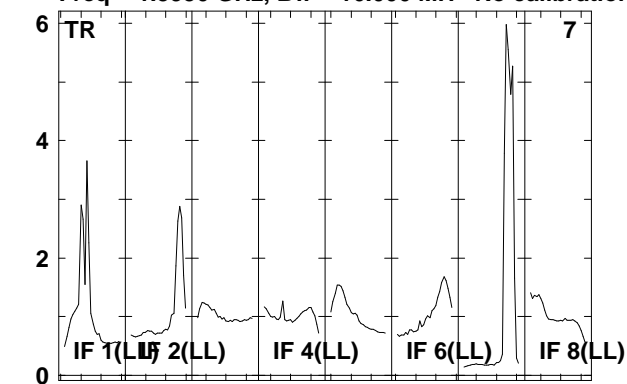

Lower frame: Real Jy
Total-power spectrum Antenna: *
Timerange: 00/15:03:01 to 00/15:06:29

Plot file version 134 created 06-JAN-2012 11:46:46

J1128+59 EP068D 5.UVDATA.1

Freq = 1.5950 GHz, Bw = 16.000 MH No calibration applied and no bandpass applied

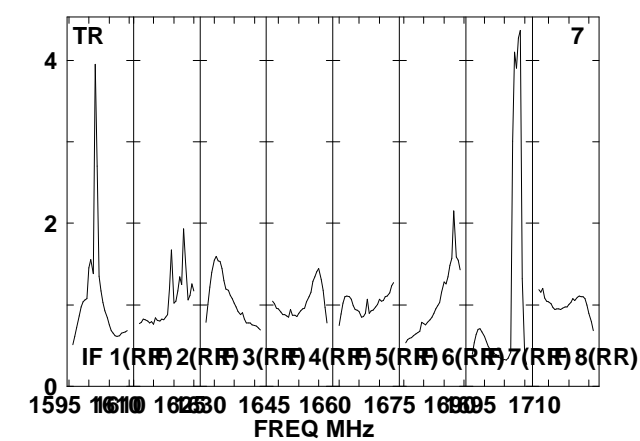
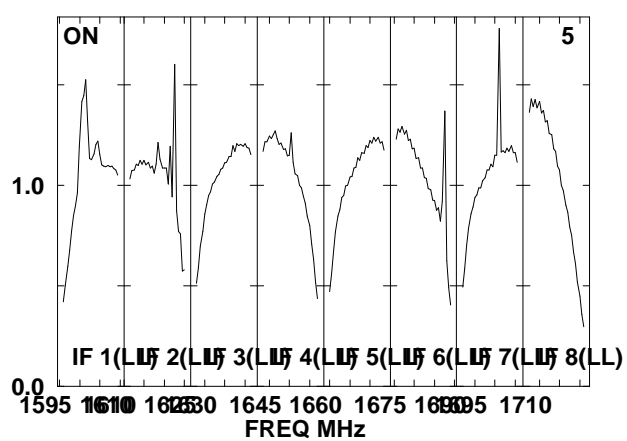
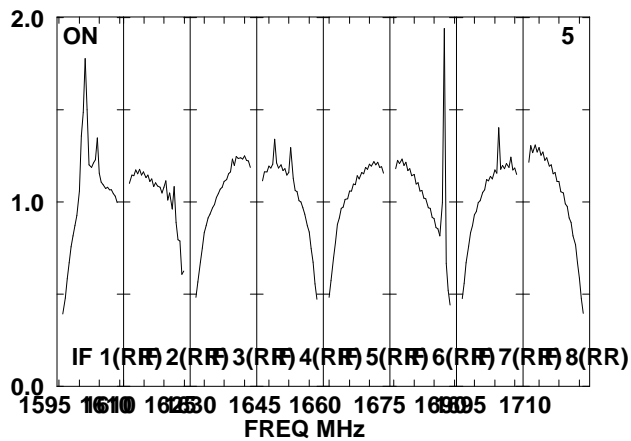
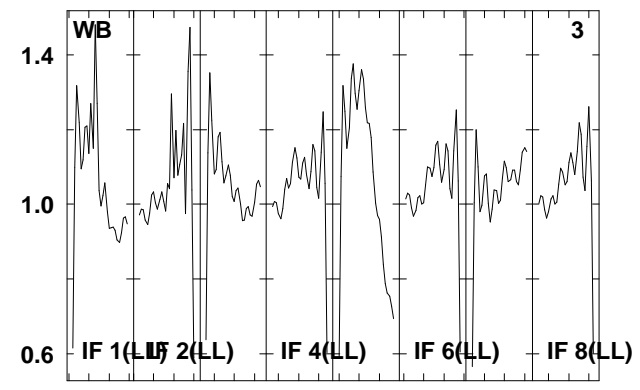
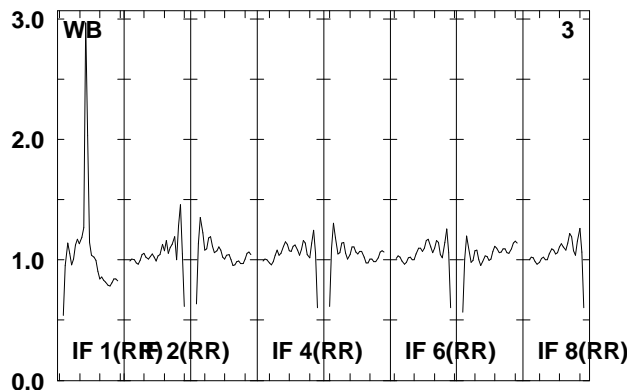
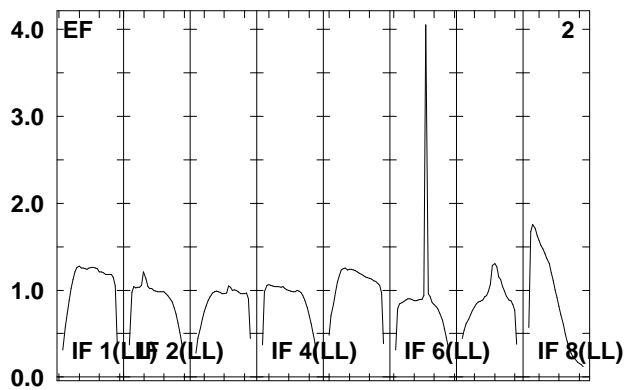
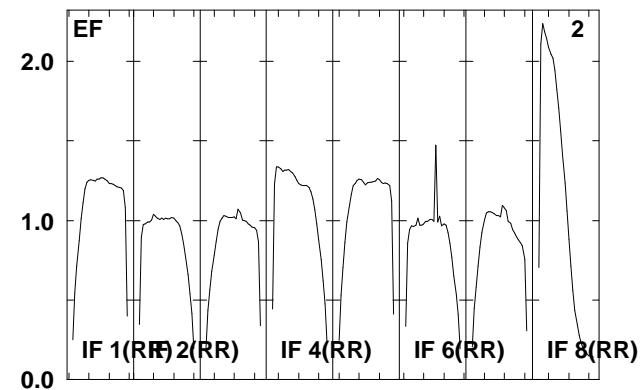
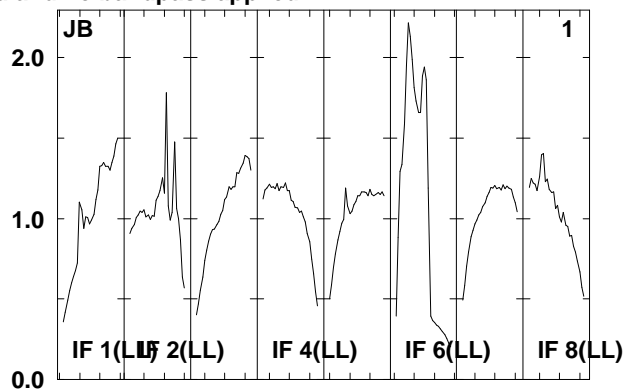
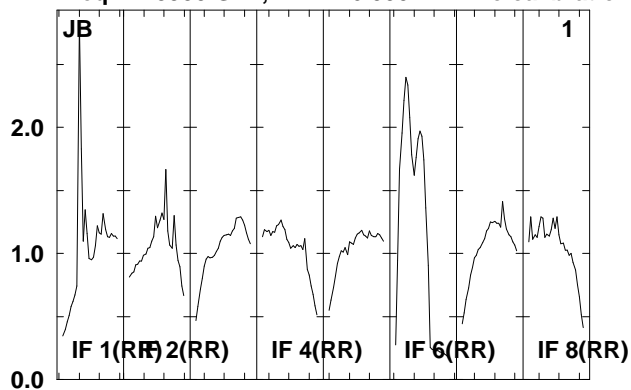

Lower frame: Real Jy
Total-power spectrum Antenna: *
Timerange: 00/15:06:35 to 00/15:07:59

Plot file version 135 created 06-JAN-2012 11:46:47

J1128+59 EP068D 5.UVDATA.1

Freq = 1.5950 GHz, Bw = 16.000 MH No calibration applied and no bandpass applied

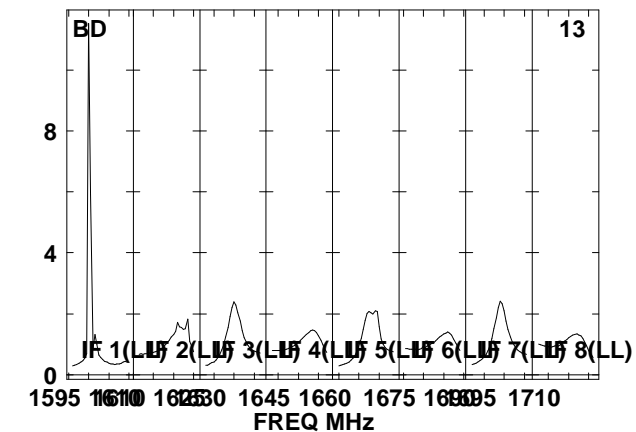
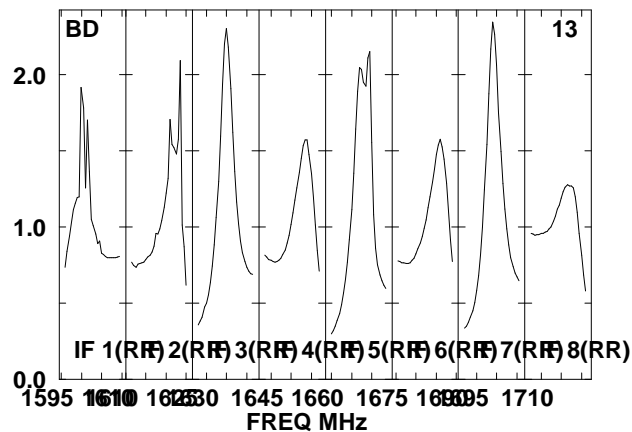
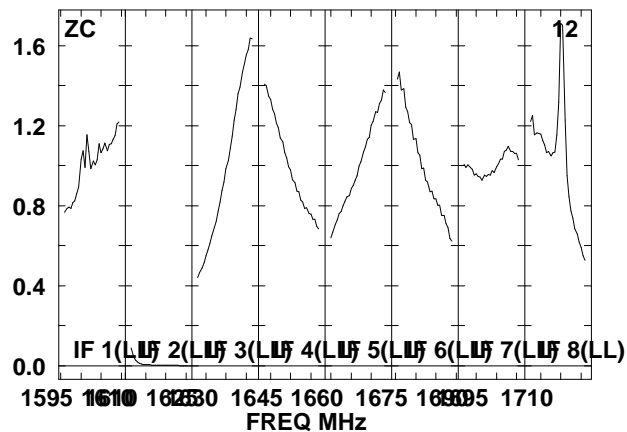
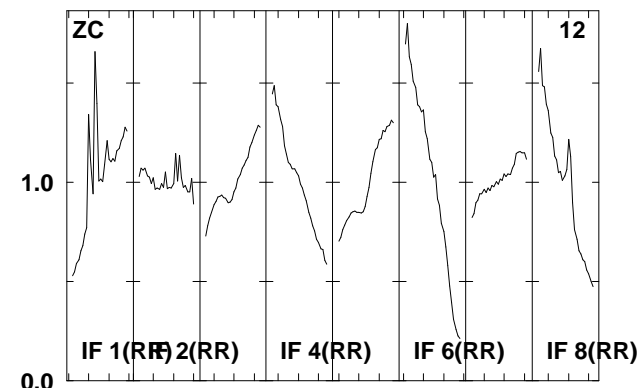
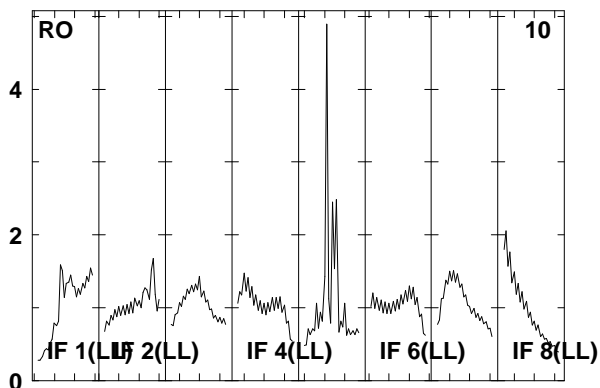
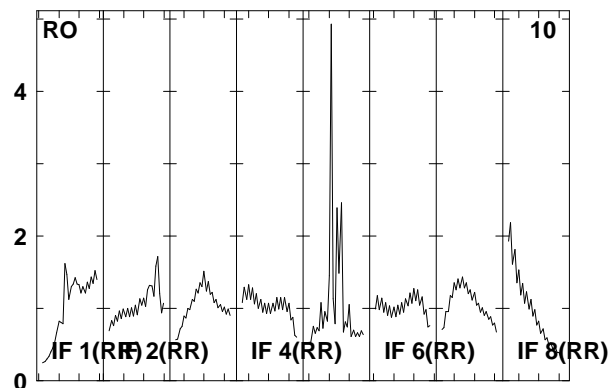
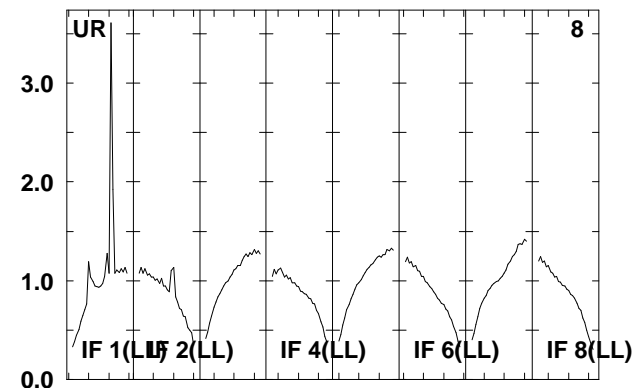
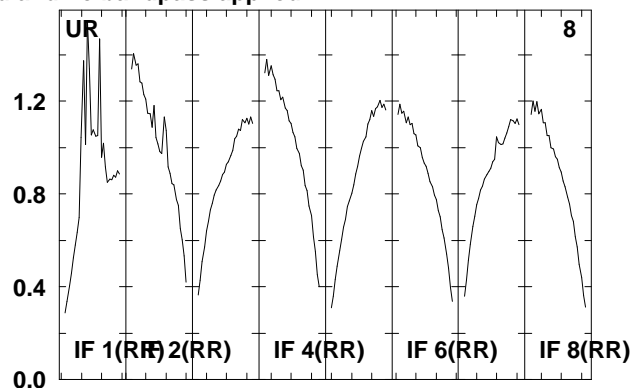
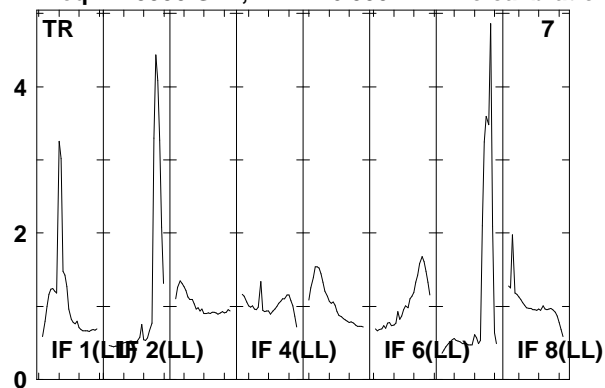

Lower frame: Real Jy

Total-power spectrum Antenna: *

Timerange: 00/15:06:35 to 00/15:07:59

Plot file version 136 created 06-JAN-2012 11:46:47

ARP299D EP068D 5.UVDATA.1

Freq = 1.5950 GHz, Bw = 16.000 MH No calibration applied and no bandpass applied

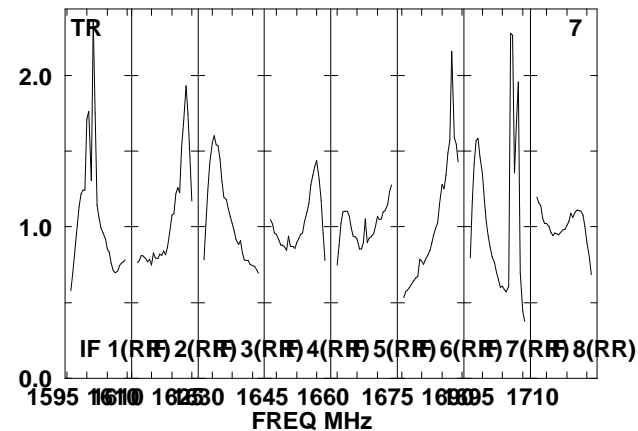
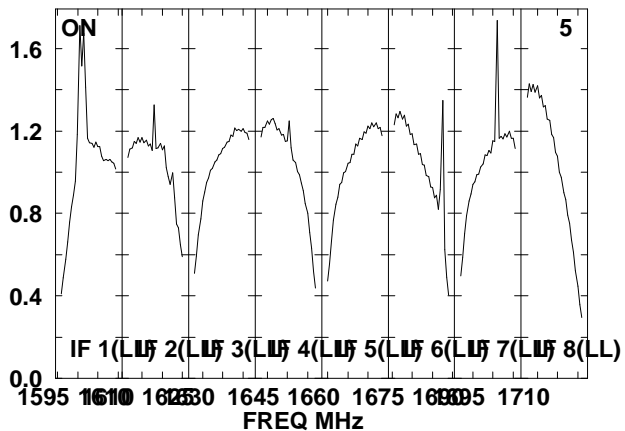
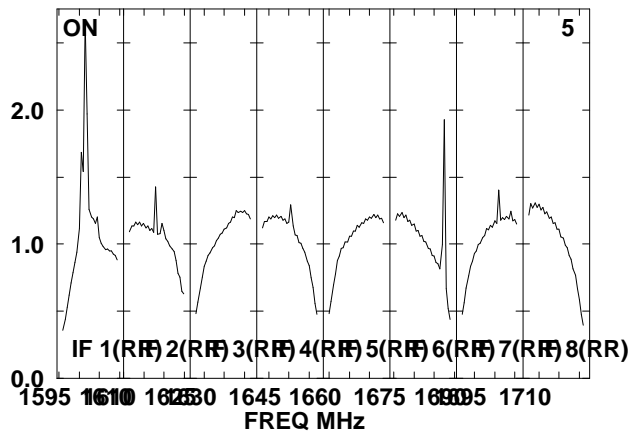
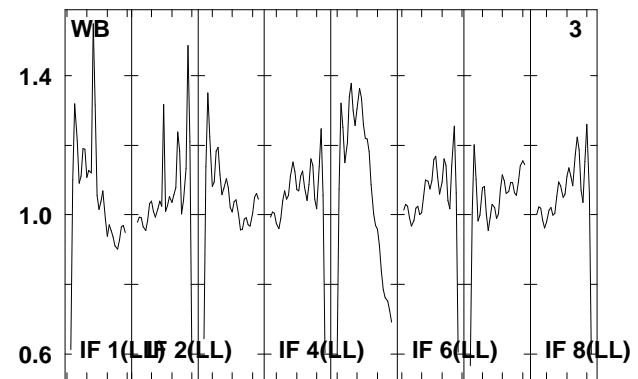
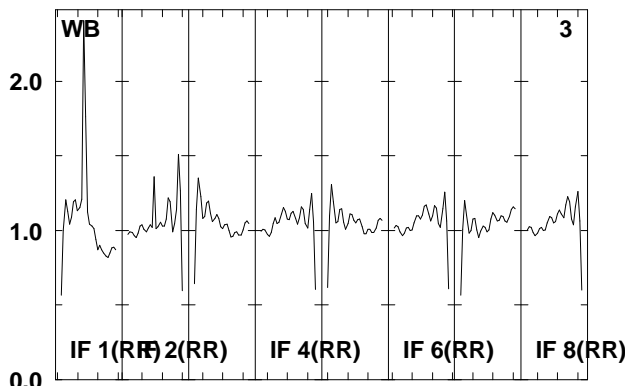
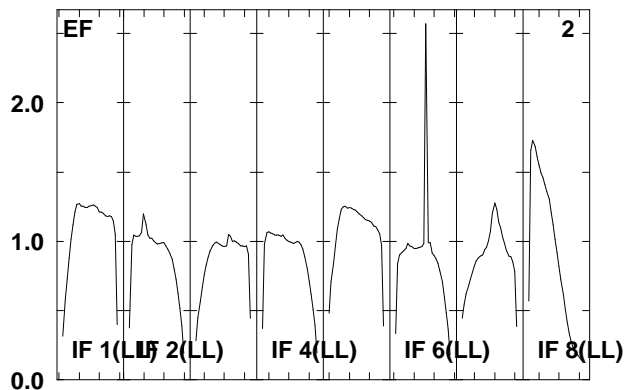
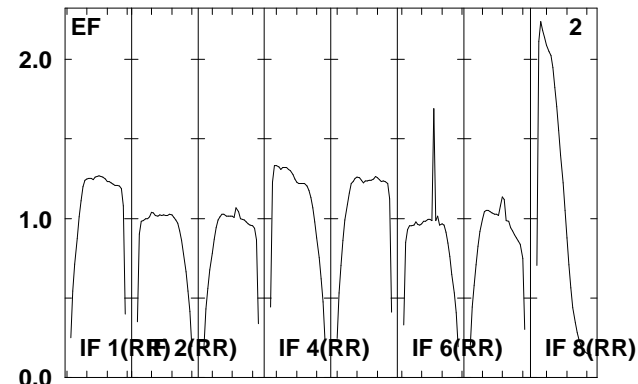
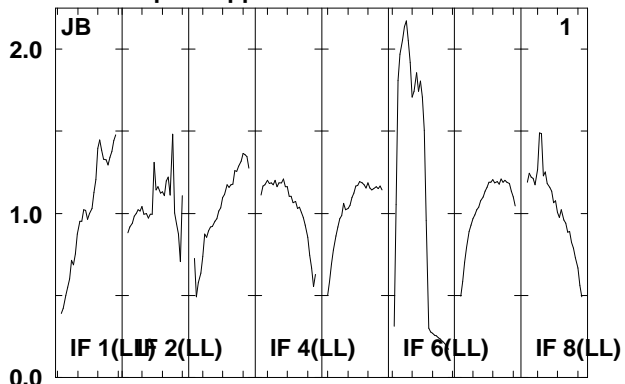
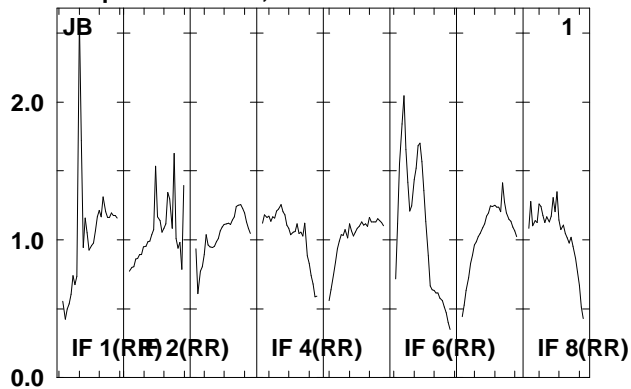

Lower frame: Real Jy
Total-power spectrum Antenna: *
Timerange: 00/15:08:05 to 00/15:11:29

Plot file version 137 created 06-JAN-2012 11:46:48

ARP299D EP068D 5.UVDATA.1

Freq = 1.5950 GHz, Bw = 16.000 MH No calibration applied and no bandpass applied

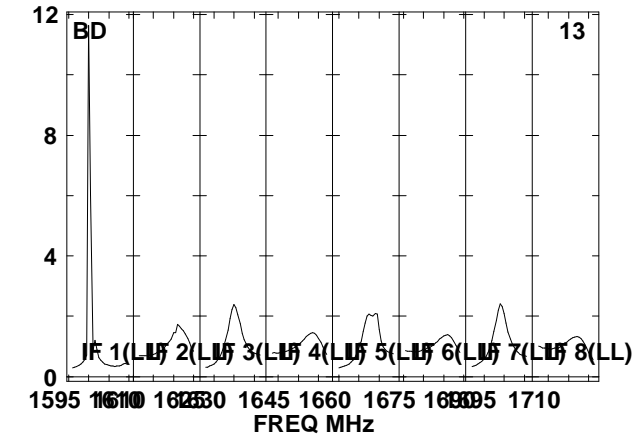
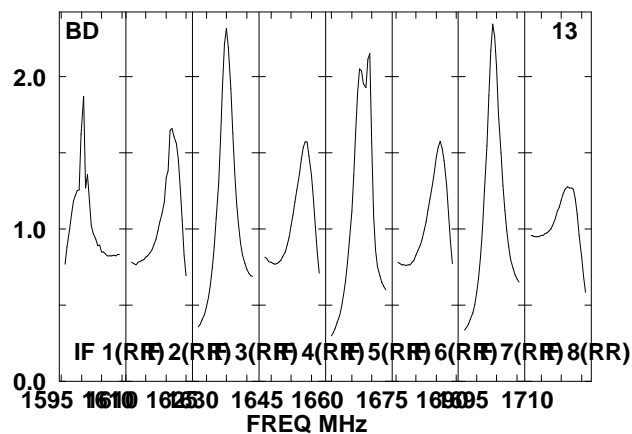
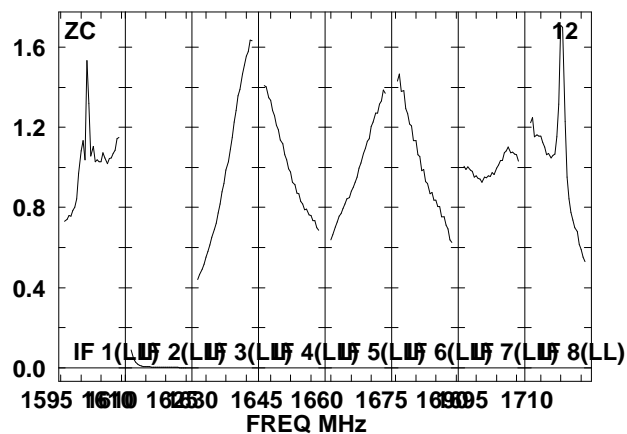
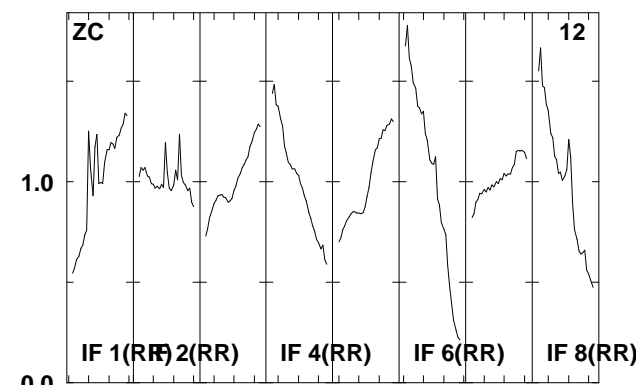
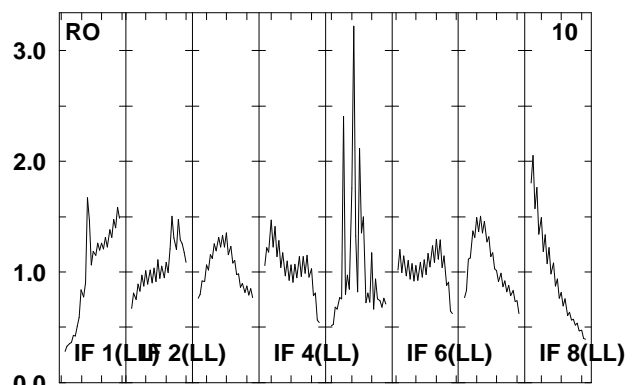
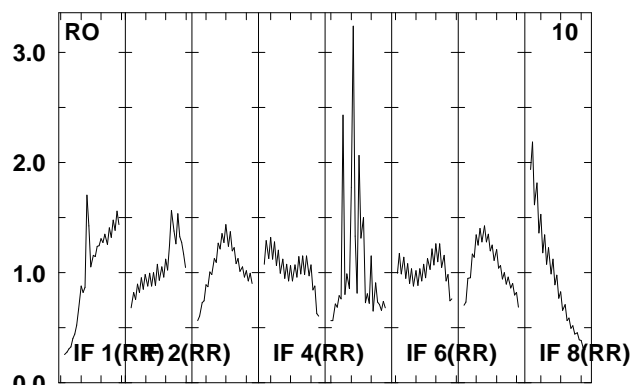
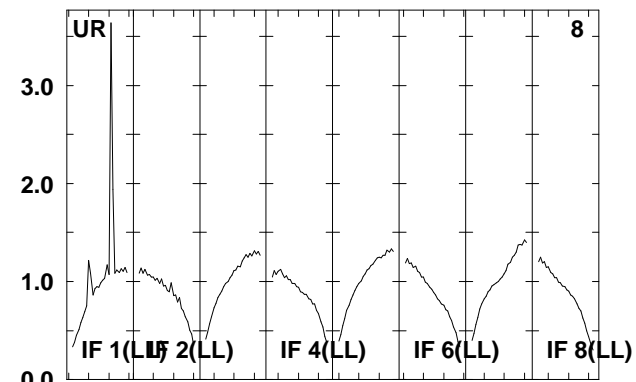
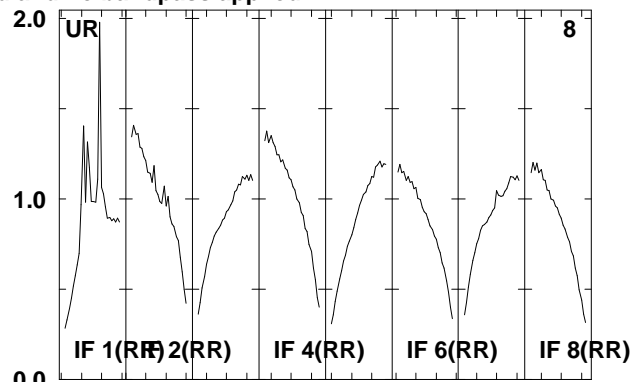
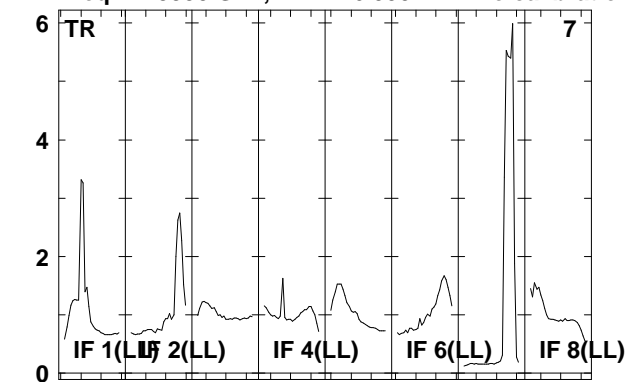

Lower frame: Real Jy

Total-power spectrum Antenna: *

Timerange: 00/15:08:05 to 00/15:11:29

Plot file version 138 created 06-JAN-2012 11:46:48

J1128+59 EP068D 5.UVDATA.1

Freq = 1.5950 GHz, Bw = 16.000 MH No calibration applied and no bandpass applied

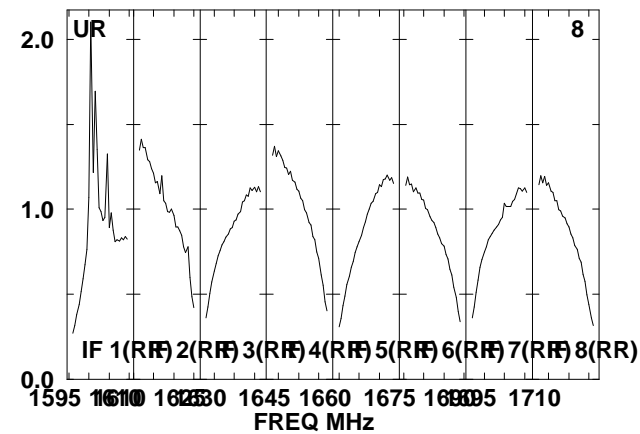
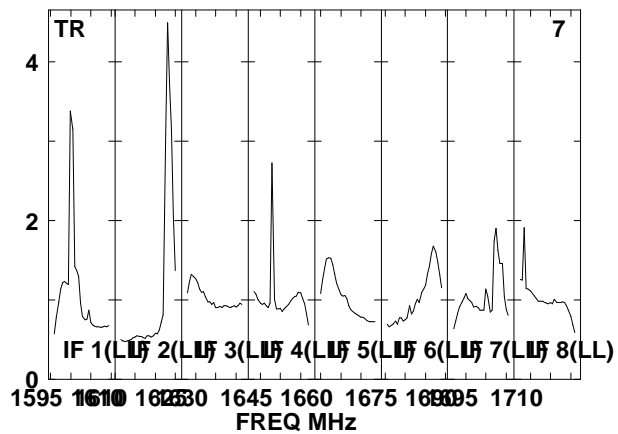
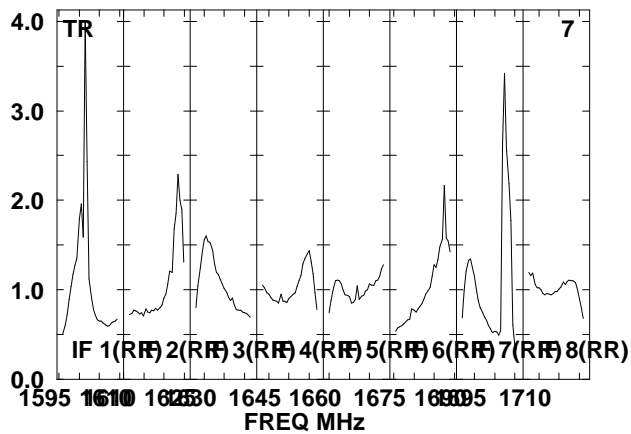
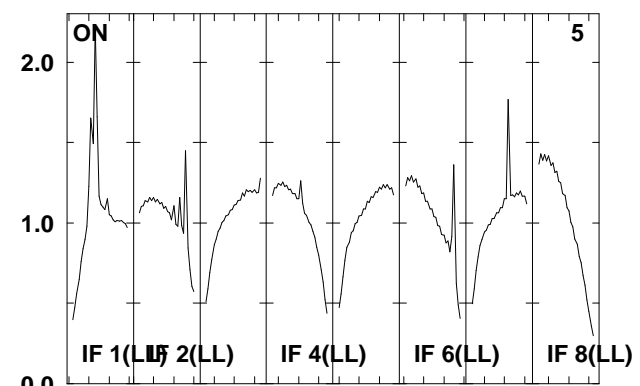
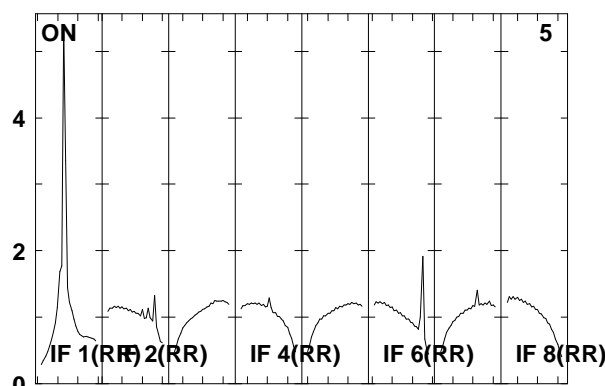
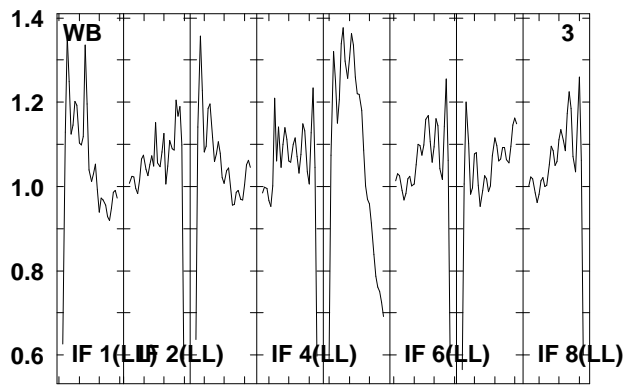
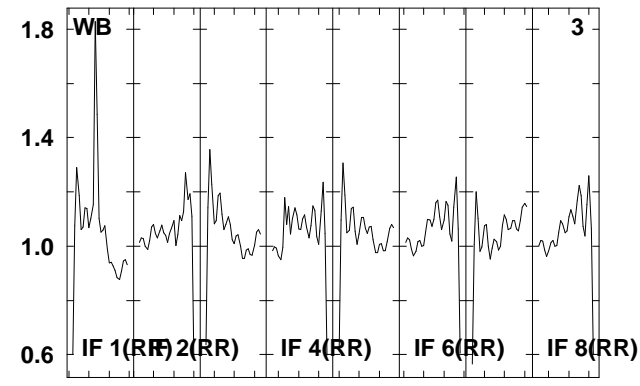
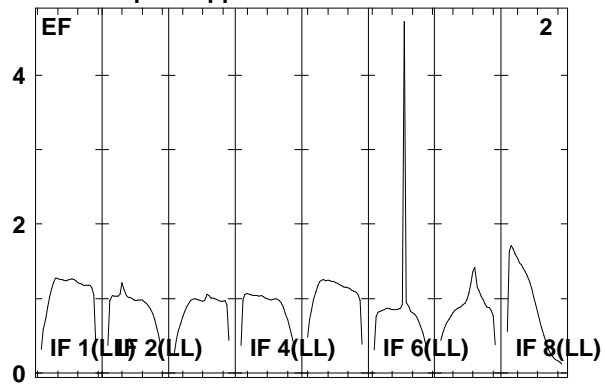
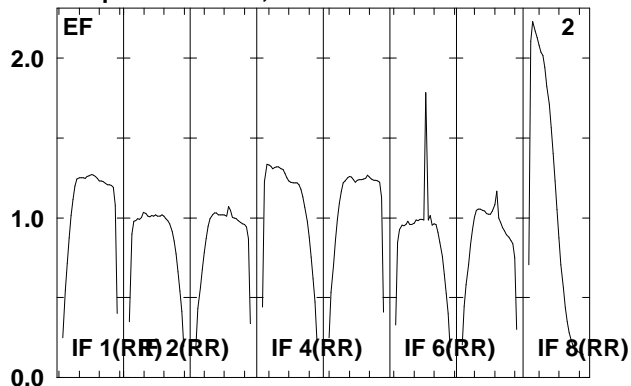

Lower frame: Real Jy
Total-power spectrum Antenna: *
Timerange: 00/15:11:35 to 00/15:12:59

Plot file version 139 created 06-JAN-2012 11:46:48

J1128+59 EP068D 5.UVDATA.1

Freq = 1.5950 GHz, Bw = 16.000 MH No calibration applied and no bandpass applied

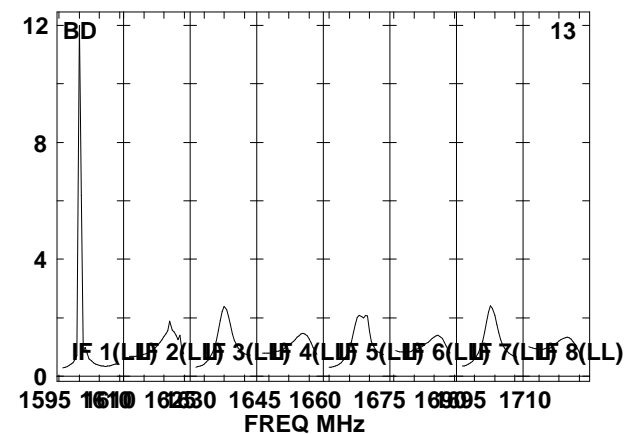
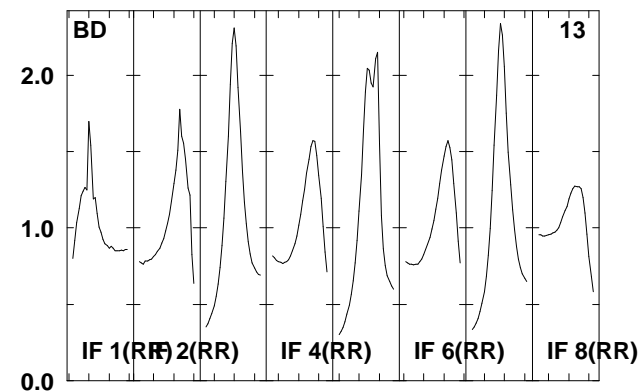
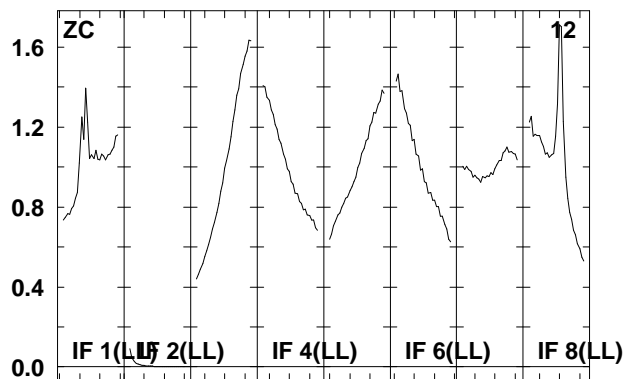
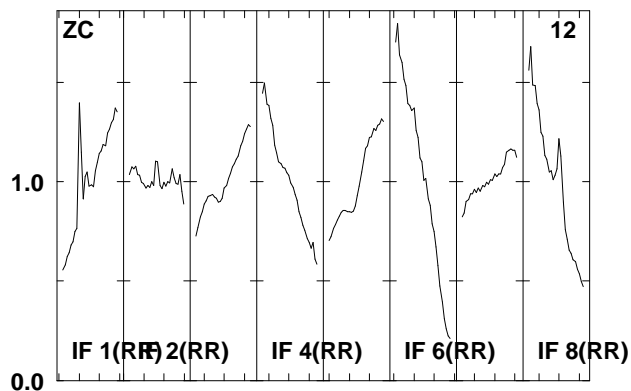
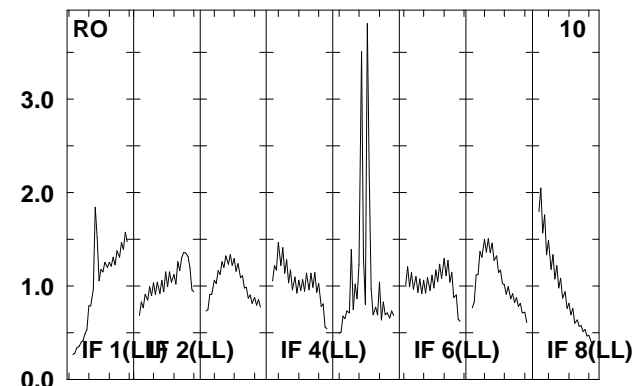
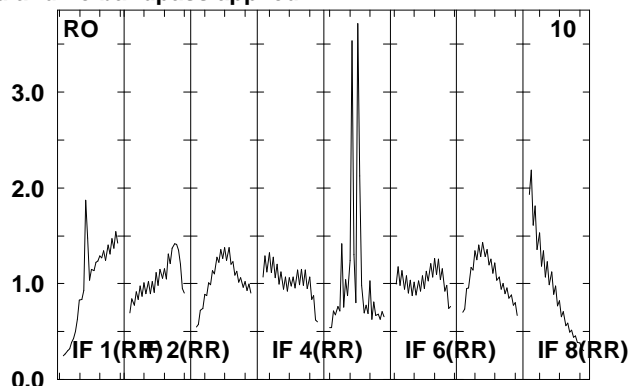
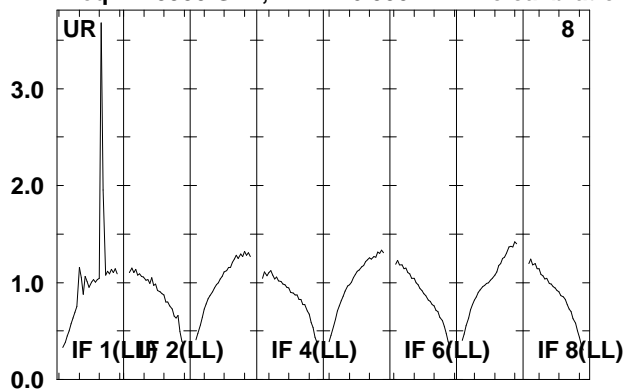

Lower frame: Real Jy

Total-power spectrum Antenna: *

Timerange: 00/15:11:35 to 00/15:12:59

Plot file version 140 created 06-JAN-2012 11:46:49

ARP299D EP068D 5.UVDATA.1

Freq = 1.5950 GHz, Bw = 16.000 MH No calibration applied and no bandpass applied

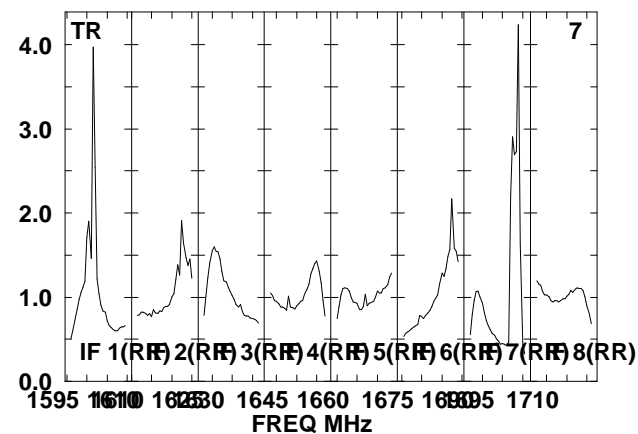
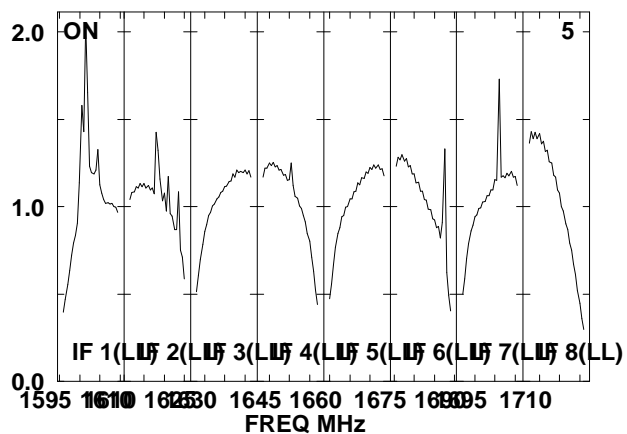
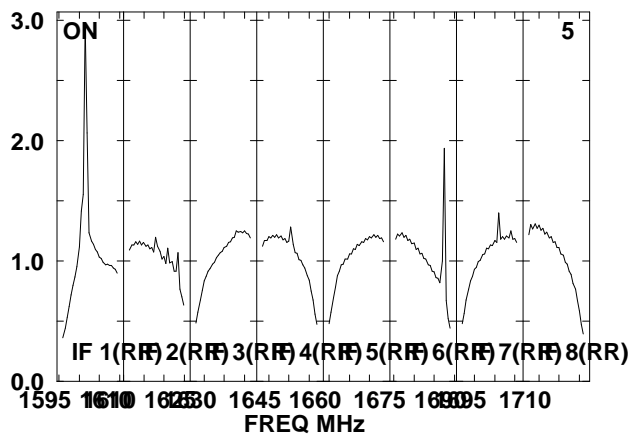
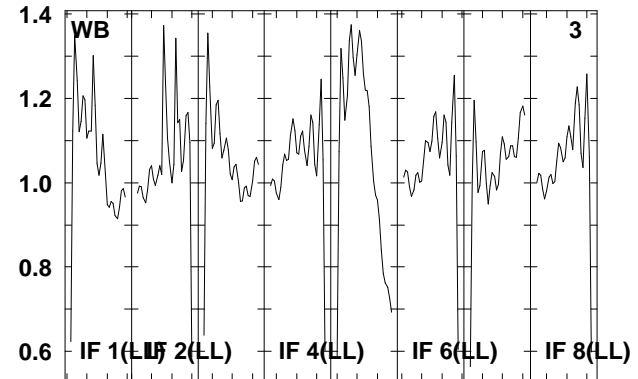
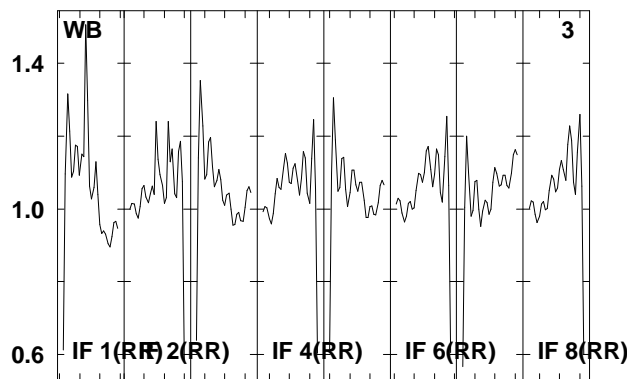
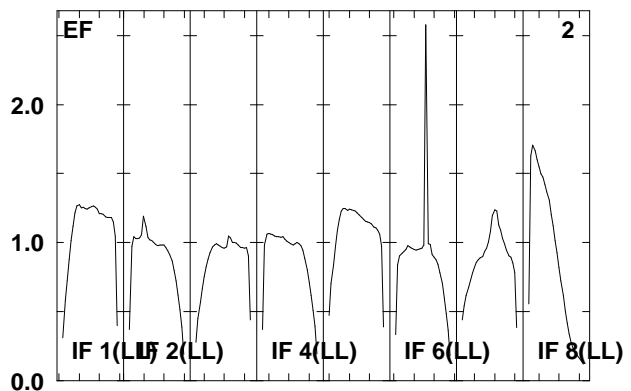
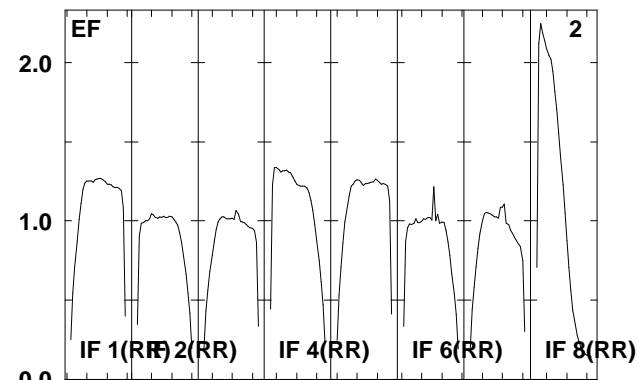
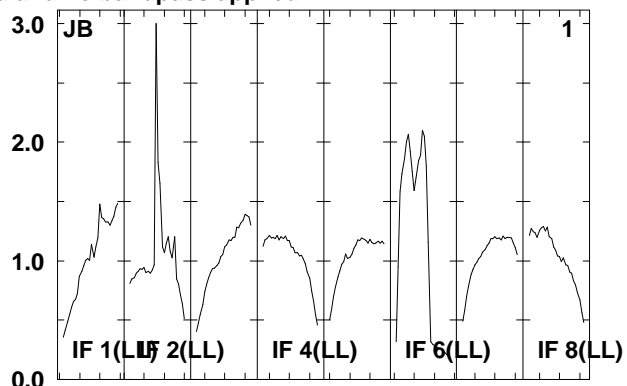
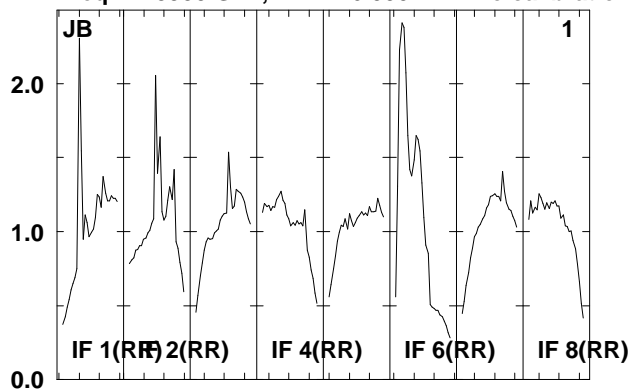

Lower frame: Real Jy
Total-power spectrum Antenna: *
Timerange: 00/15:13:01 to 00/15:16:29

Plot file version 141 created 06-JAN-2012 11:46:49

ARP299D EP068D 5.UVDATA.1

Freq = 1.5950 GHz, Bw = 16.000 MH No calibration applied and no bandpass applied

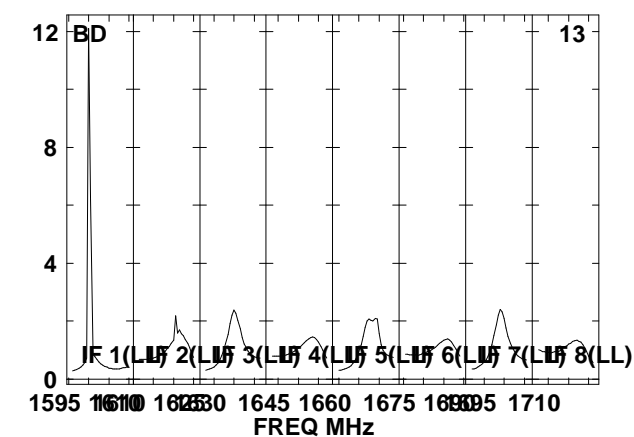
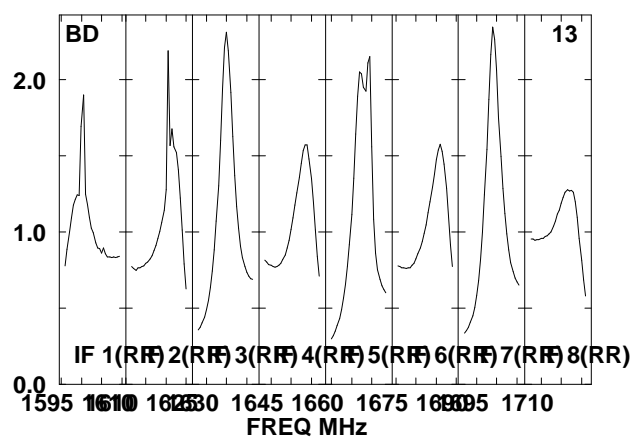
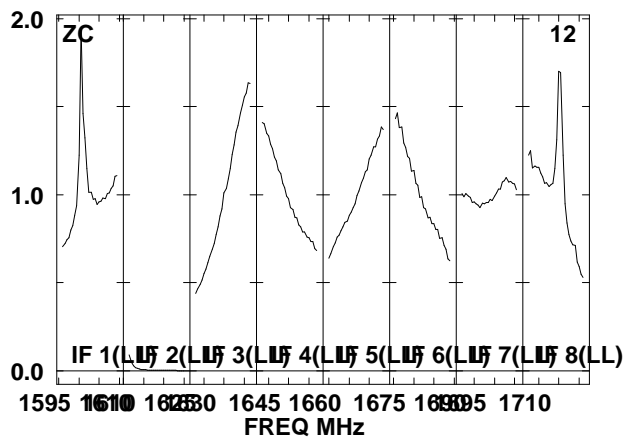
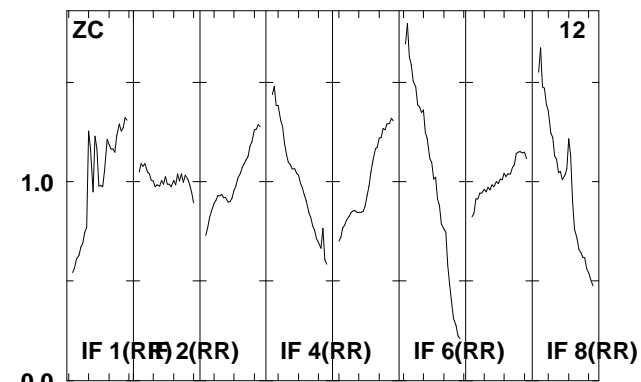
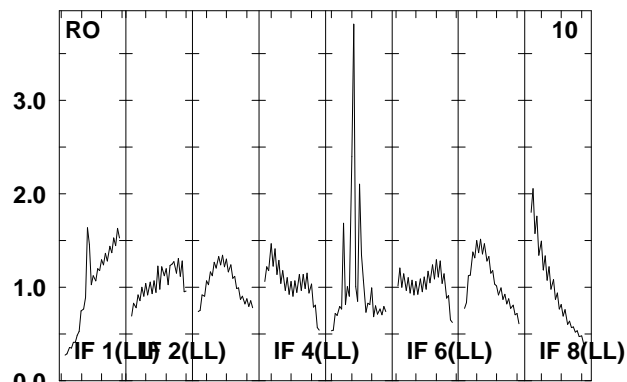
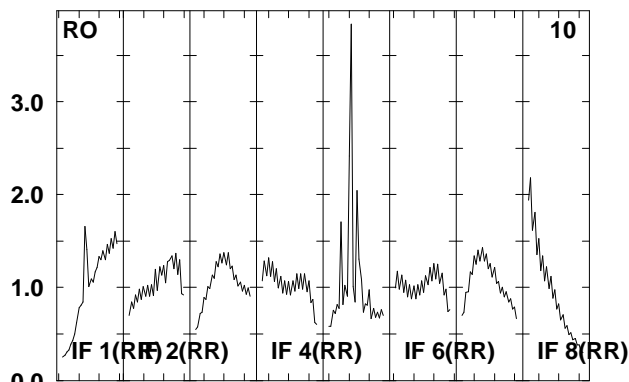
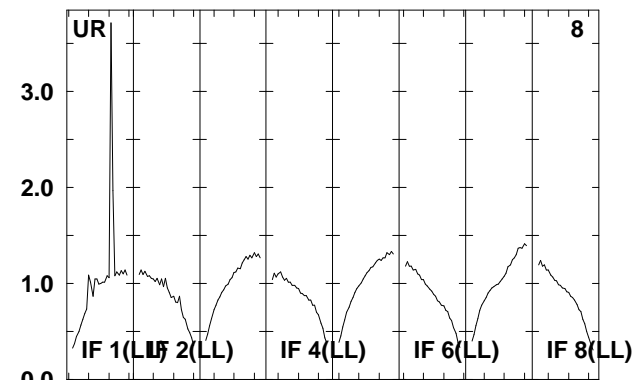
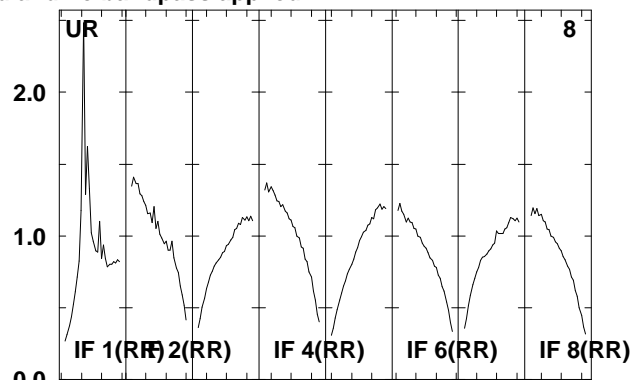
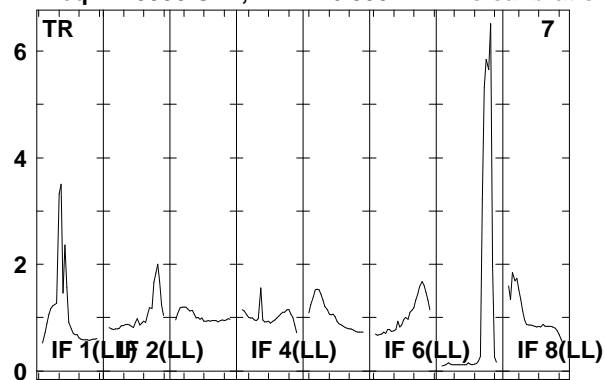

Lower frame: Real Jy
Total-power spectrum Antenna: *
Timerange: 00/15:13:01 to 00/15:16:29

Plot file version 142 created 06-JAN-2012 11:46:50

J1128+59 EP068D 5.UVDATA.1

Freq = 1.5950 GHz, Bw = 16.000 MH No calibration applied and no bandpass applied

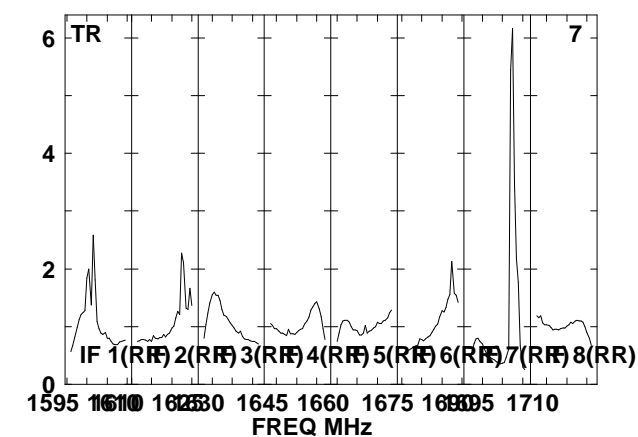
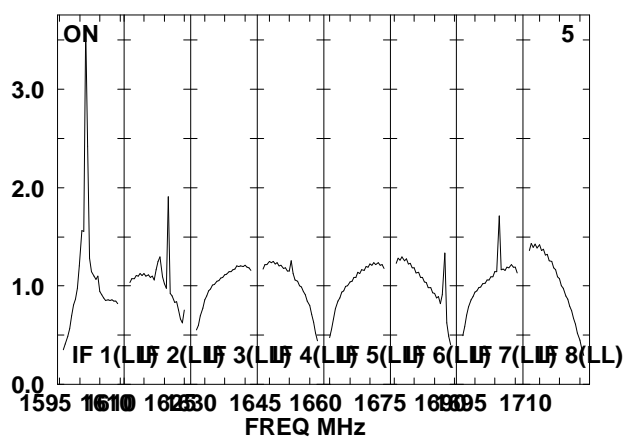
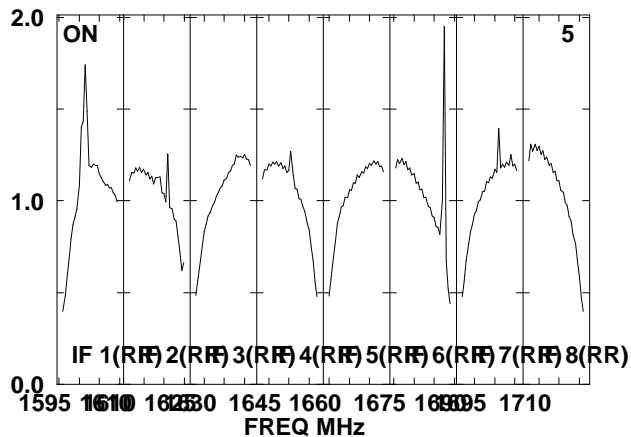
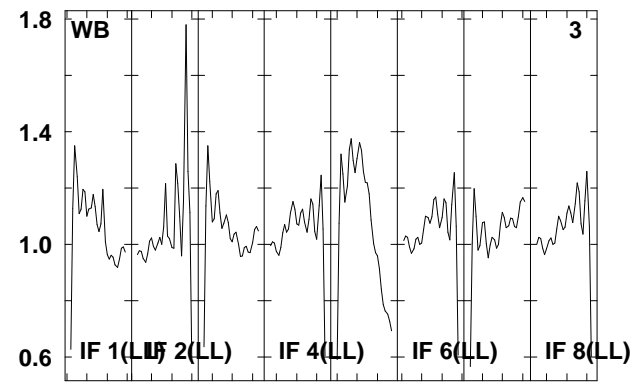
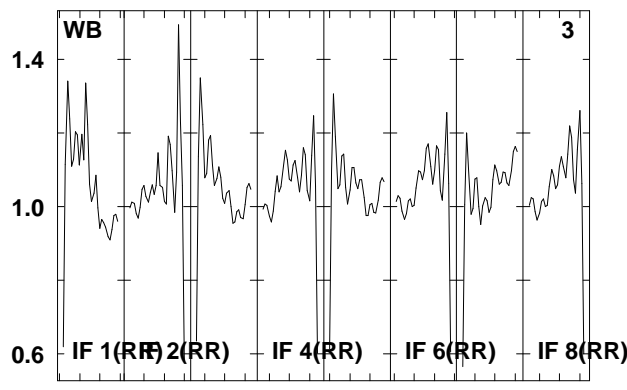
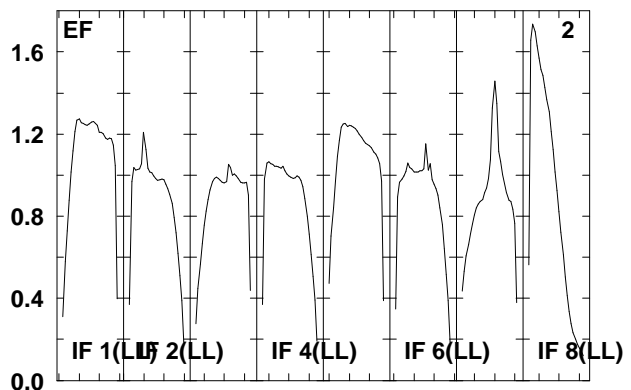
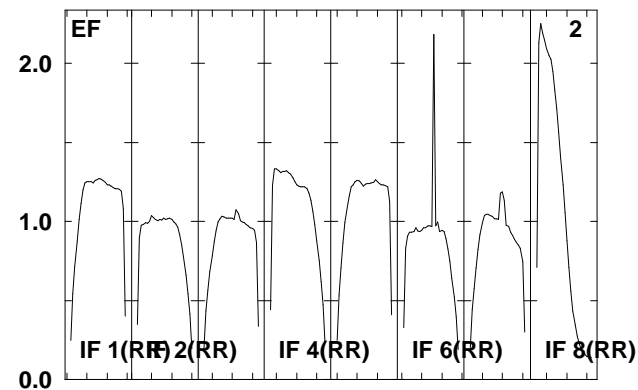
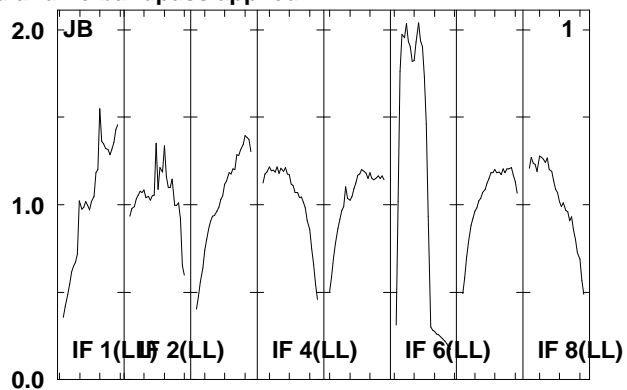
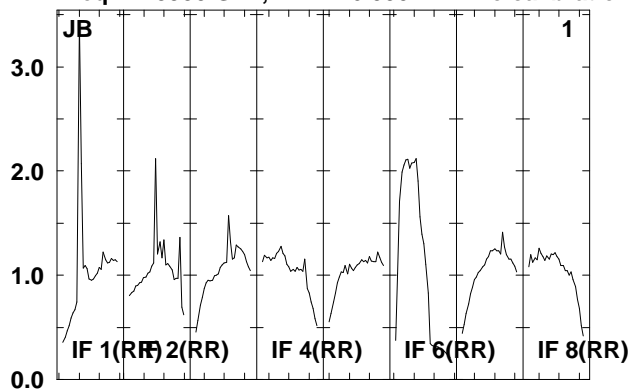

Lower frame: Real Jy
Total-power spectrum Antenna: *
Timerange: 00/15:17:31 to 00/15:18:59

Plot file version 143 created 06-JAN-2012 11:46:50

J1128+59 EP068D 5.UVDATA.1

Freq = 1.5950 GHz, Bw = 16.000 MH No calibration applied and no bandpass applied

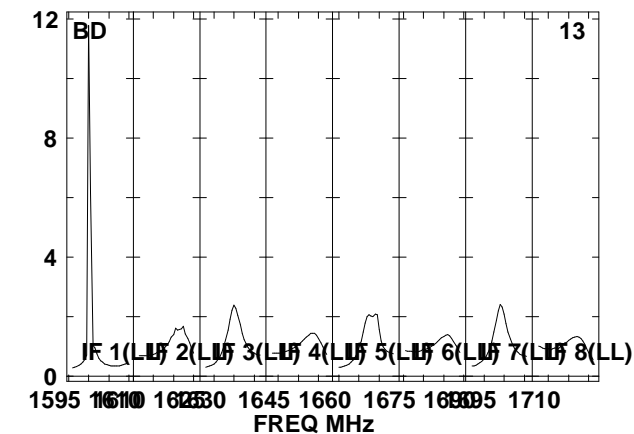
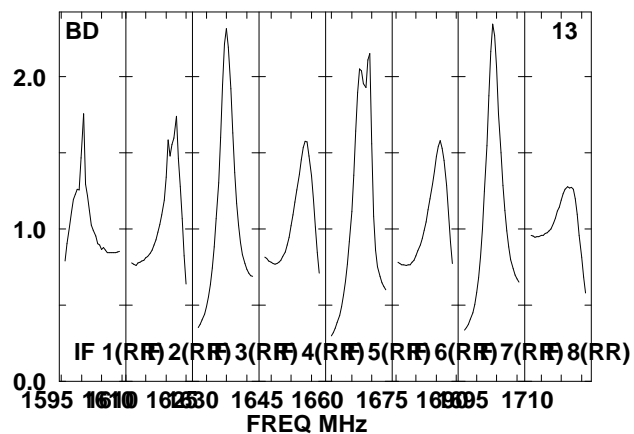
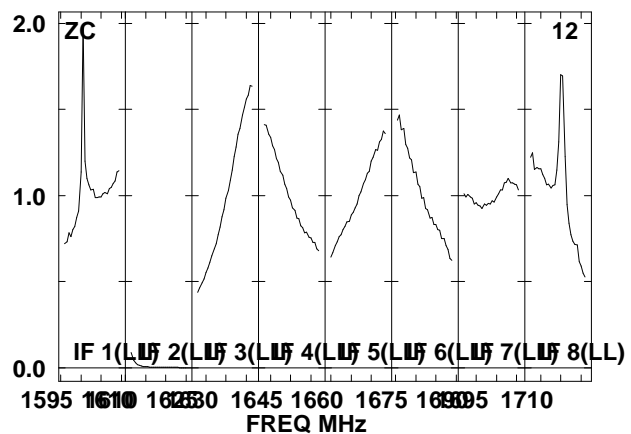
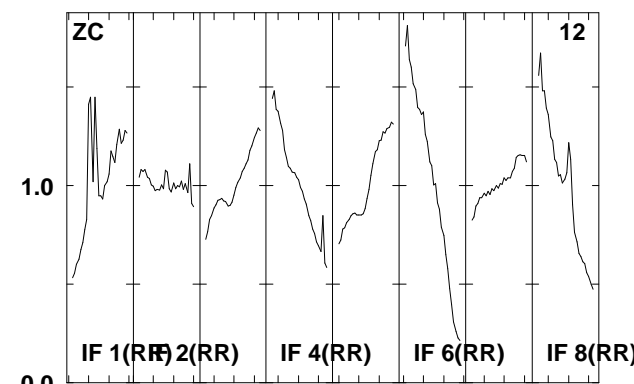
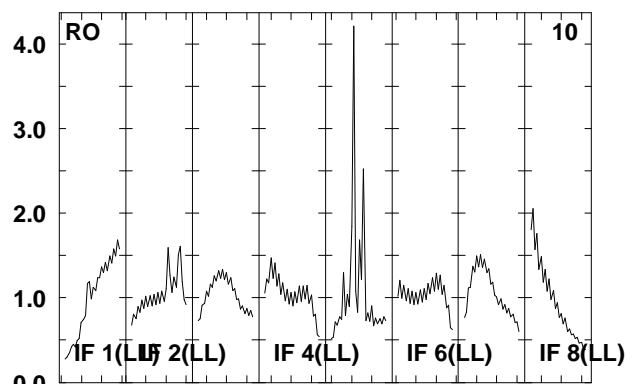
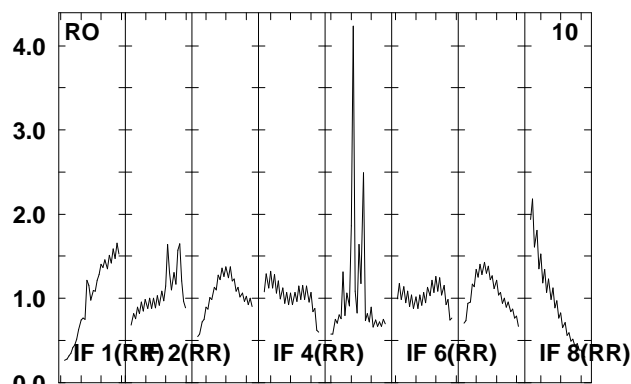
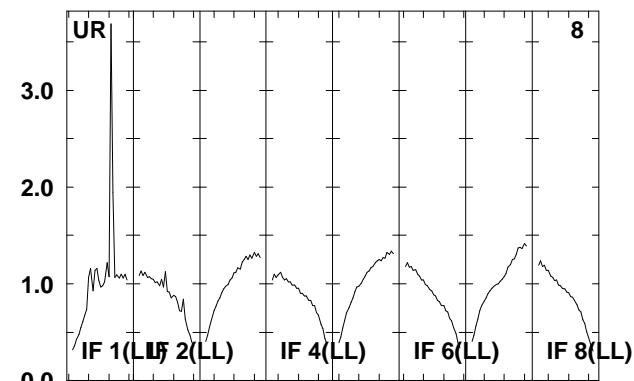
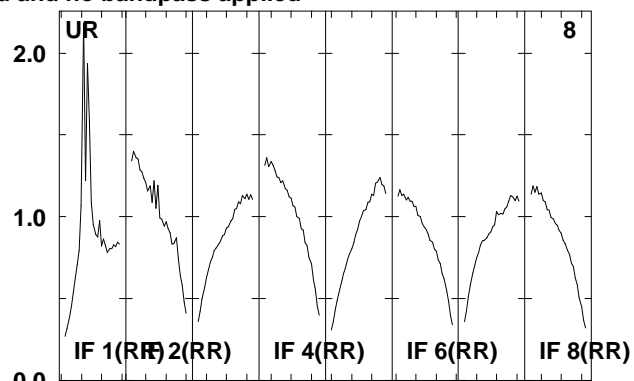
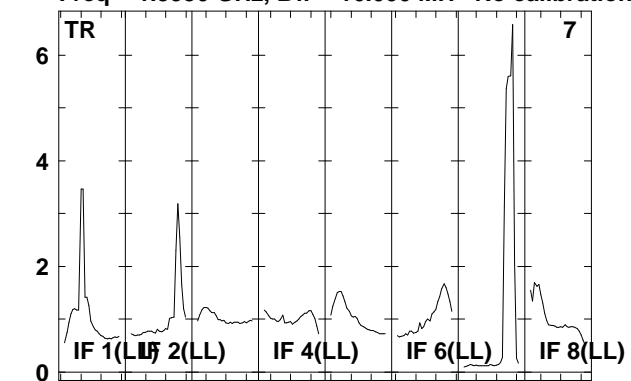

Lower frame: Real Jy

Total-power spectrum Antenna: *

Timerange: 00/15:17:31 to 00/15:18:59

Plot file version 144 created 06-JAN-2012 11:46:51

ARP299D EP068D 5.UVDATA.1

Freq = 1.5950 GHz, Bw = 16.000 MH No calibration applied and no bandpass applied

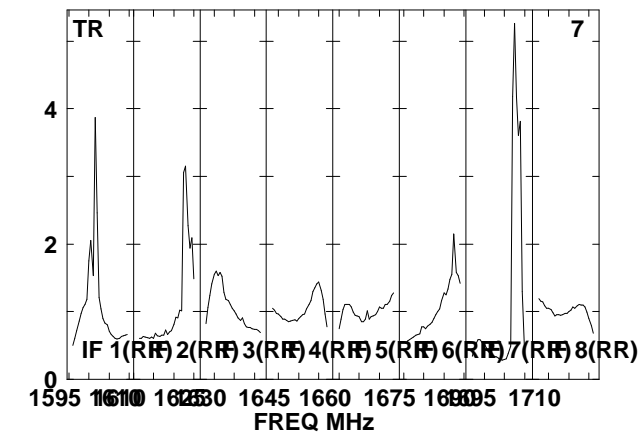
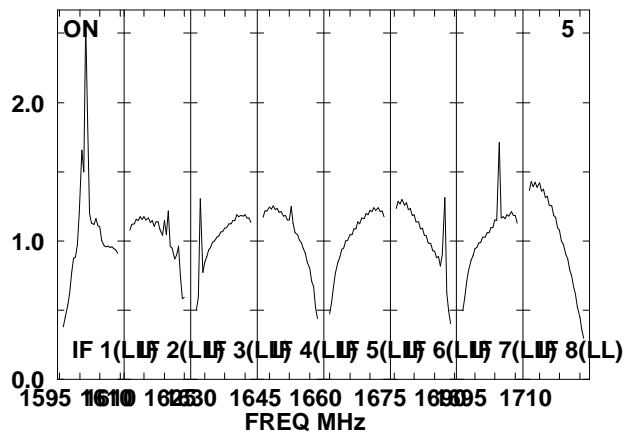
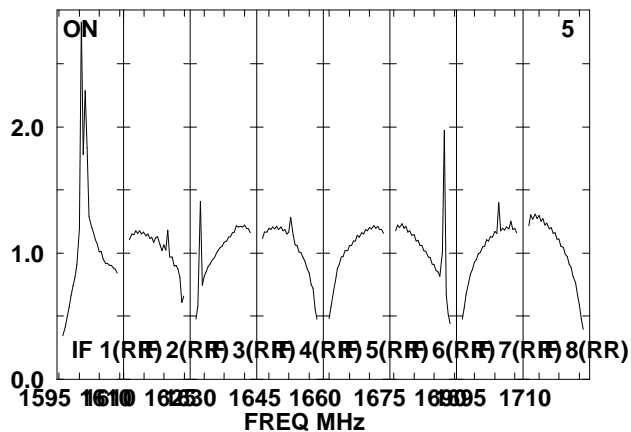
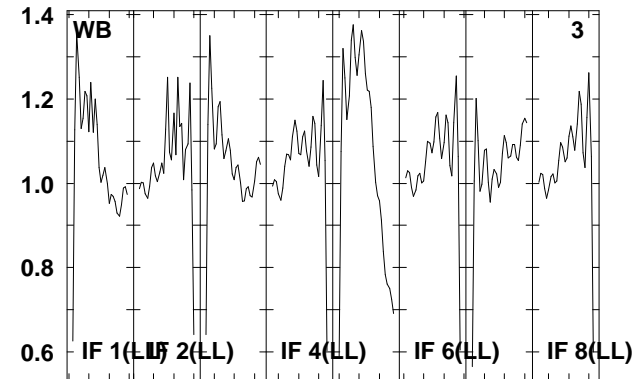
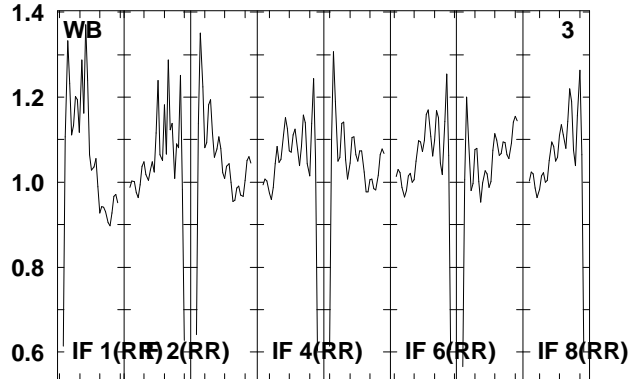
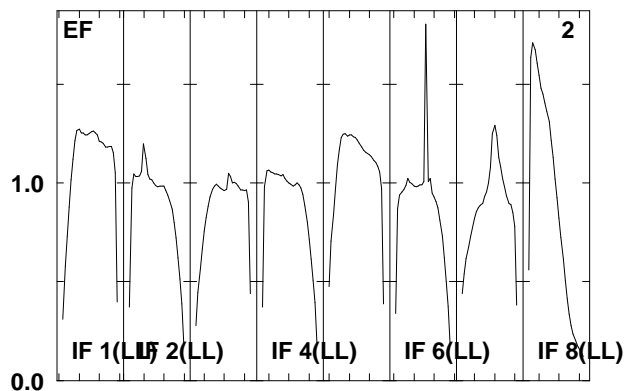
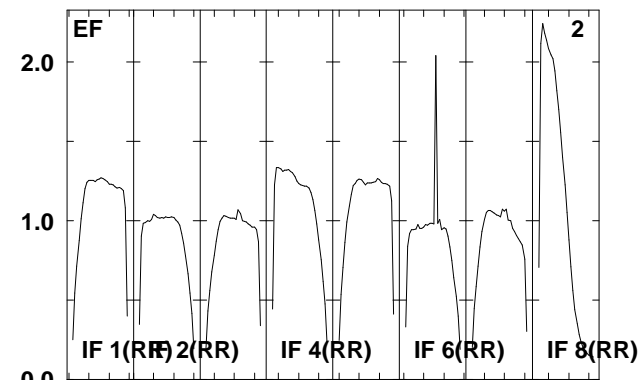
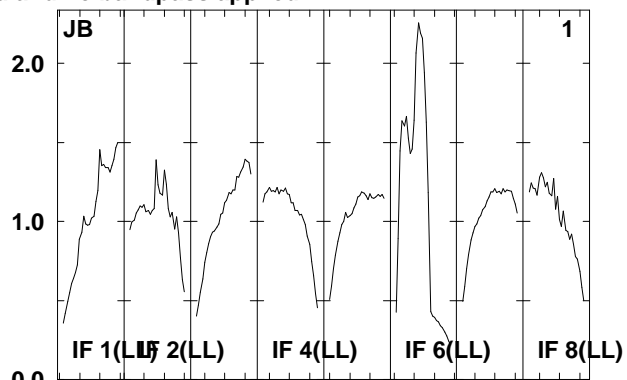
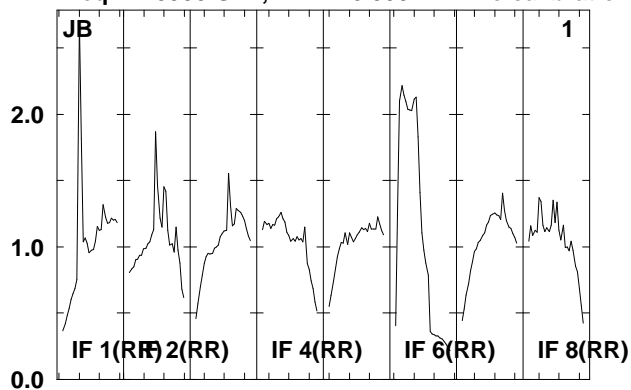

Lower frame: Real Jy
Total-power spectrum Antenna: *
Timerange: 00/15:19:05 to 00/15:22:29

Plot file version 145 created 06-JAN-2012 11:46:51

ARP299D EP068D 5.UVDATA.1

Freq = 1.5950 GHz, Bw = 16.000 MH No calibration applied and no bandpass applied

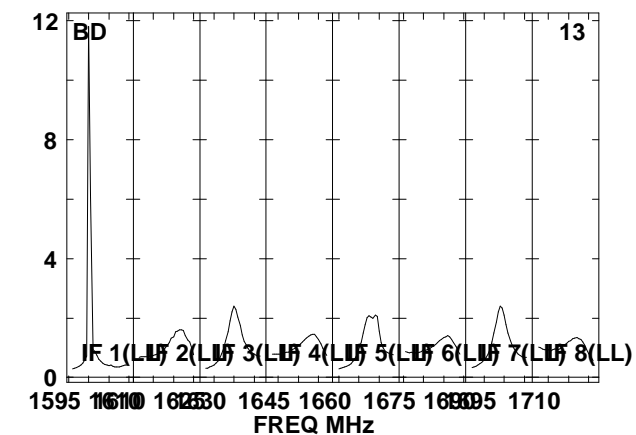
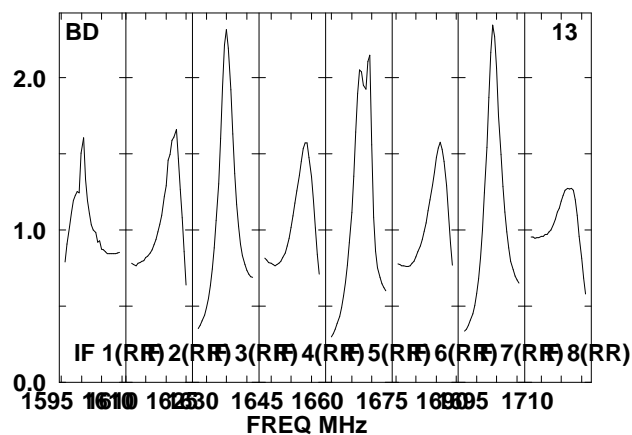
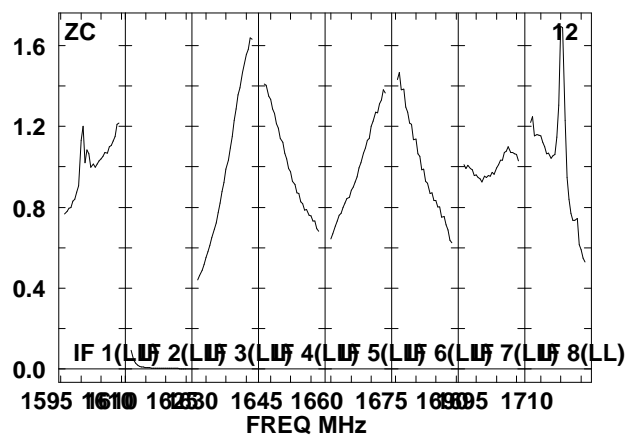
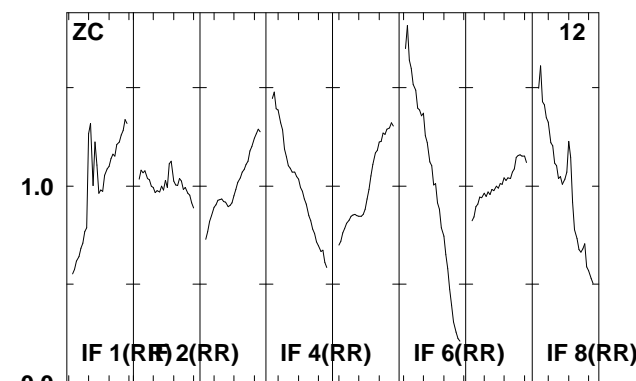
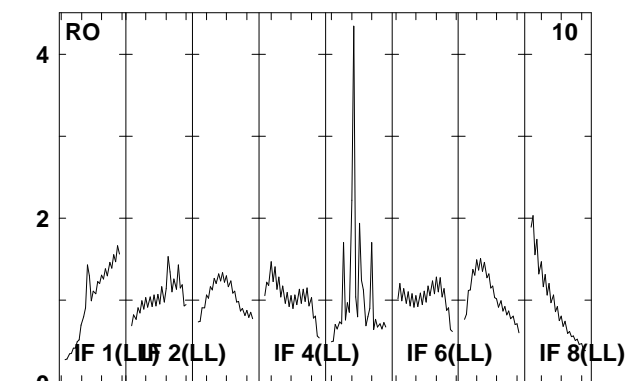
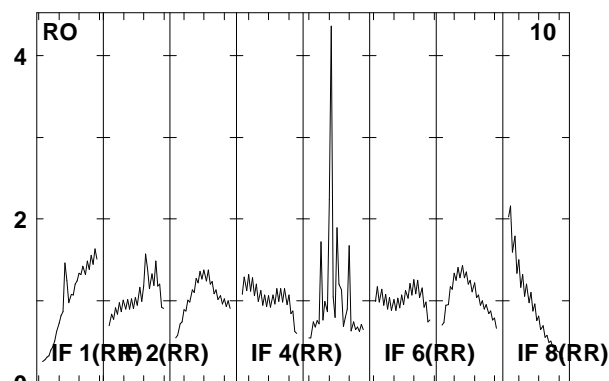
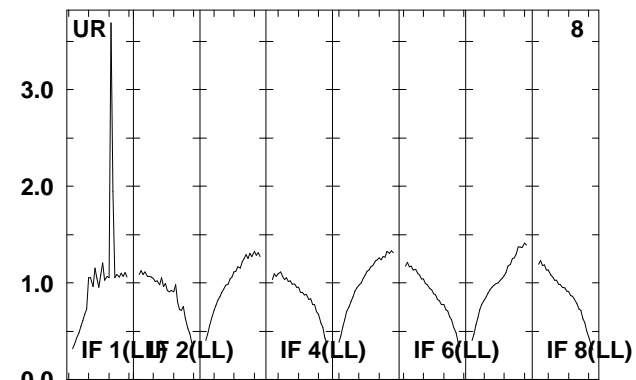
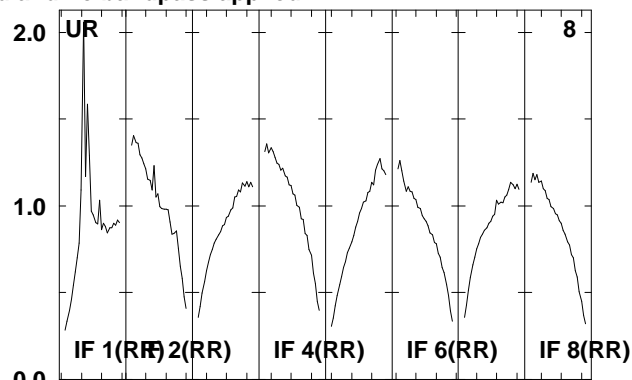
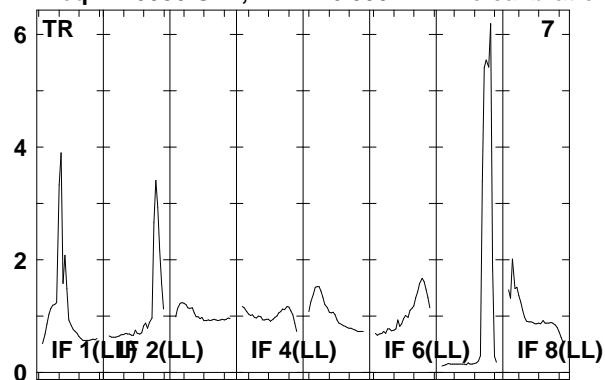

Lower frame: Real Jy

Total-power spectrum Antenna: *

Timerange: 00/15:19:05 to 00/15:22:29

Plot file version 146 created 06-JAN-2012 11:46:52

J1128+59 EP068D 5.UVDATA.1

Freq = 1.5950 GHz, Bw = 16.000 MH No calibration applied and no bandpass applied

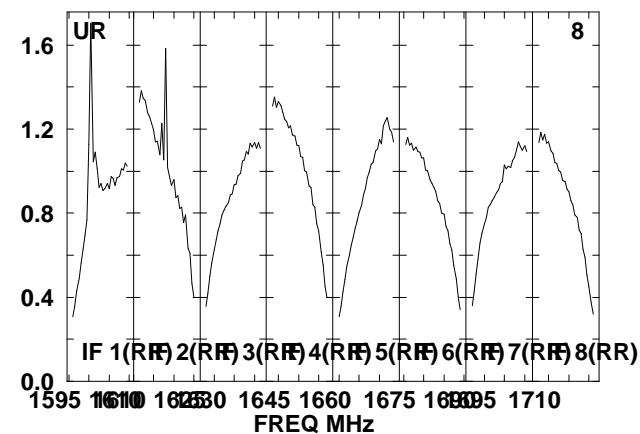
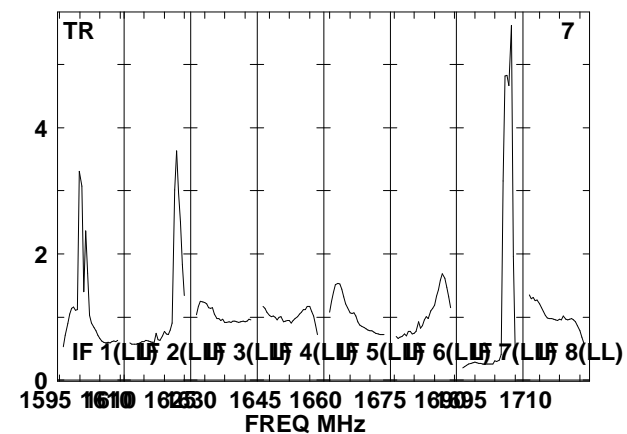
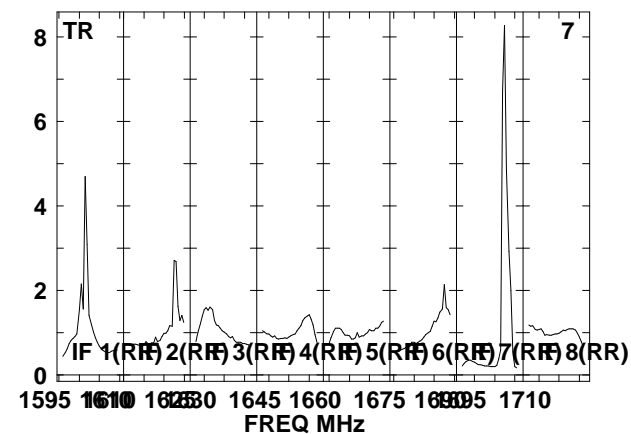
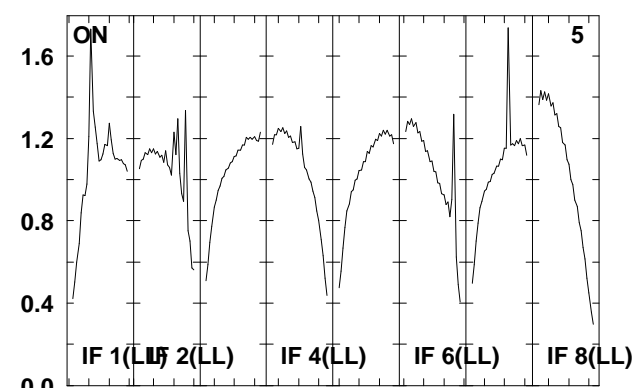
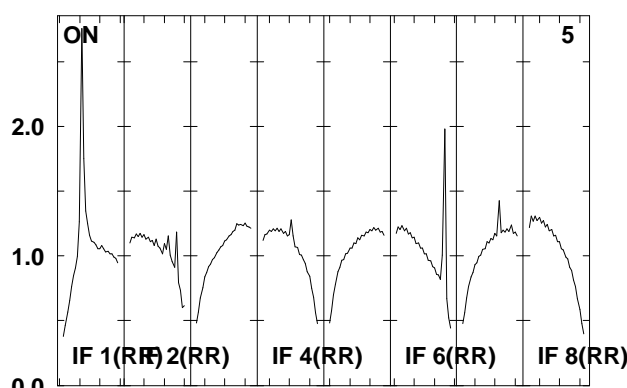
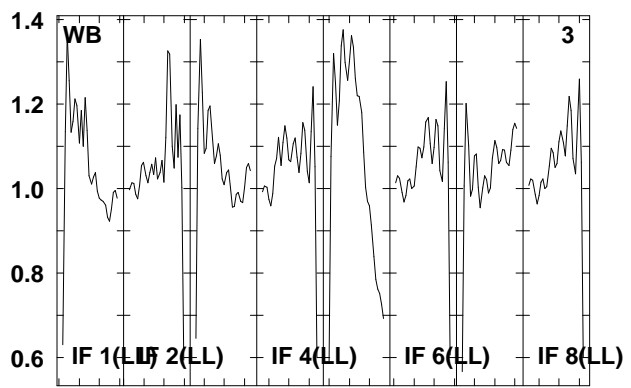
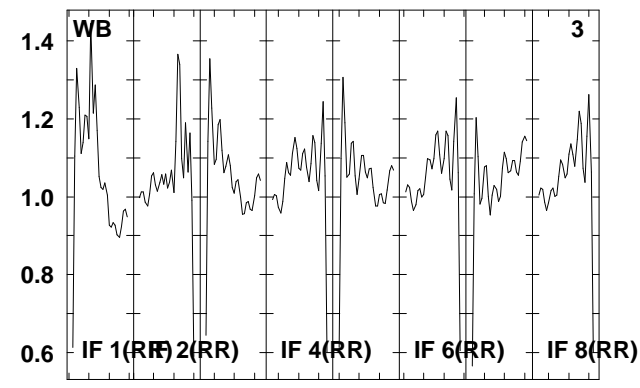
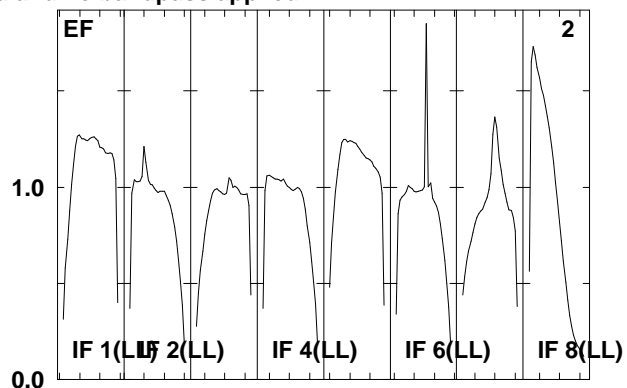
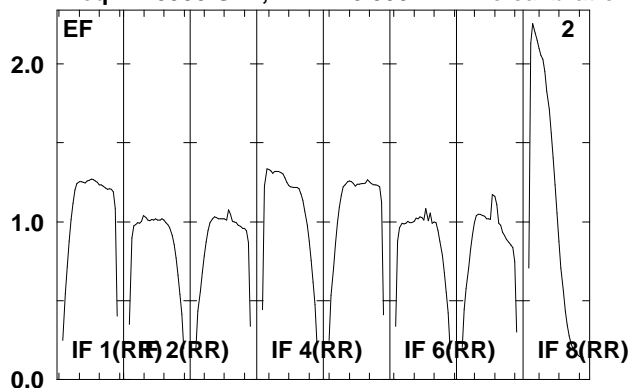

Lower frame: Real Jy
Total-power spectrum Antenna: *
Timerange: 00/15:22:35 to 00/15:23:59

Plot file version 147 created 06-JAN-2012 11:46:52

J1128+59 EP068D 5.UVDATA.1

Freq = 1.5950 GHz, Bw = 16.000 MH No calibration applied and no bandpass applied

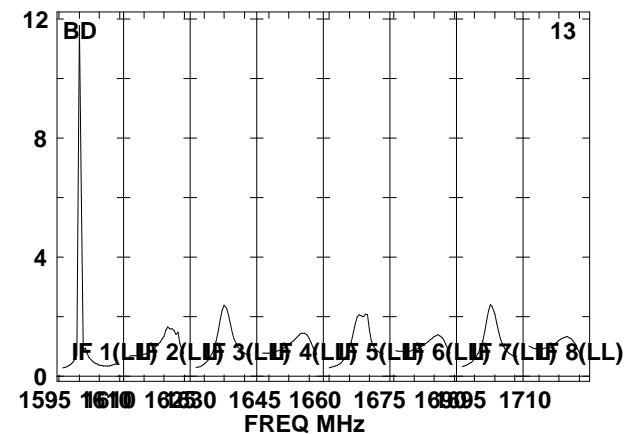
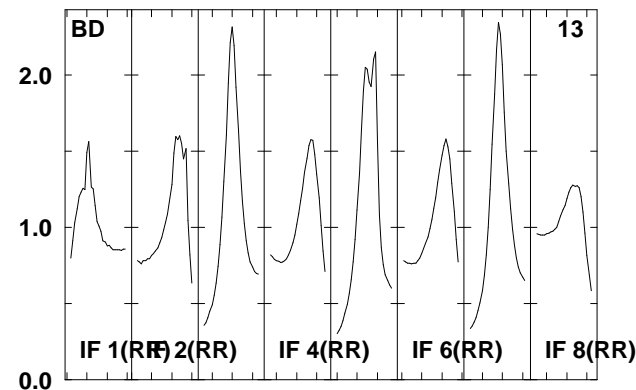
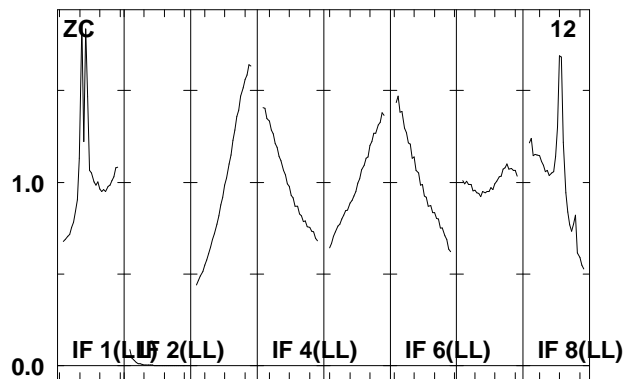
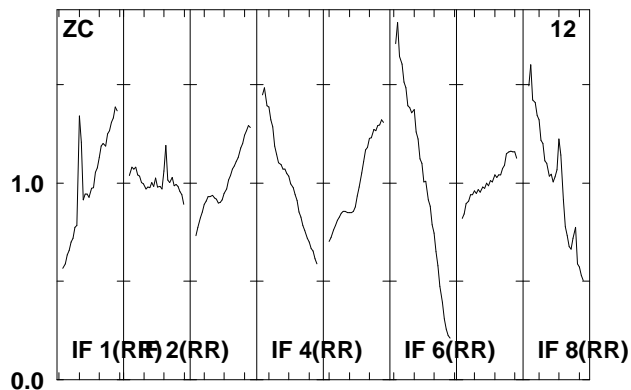
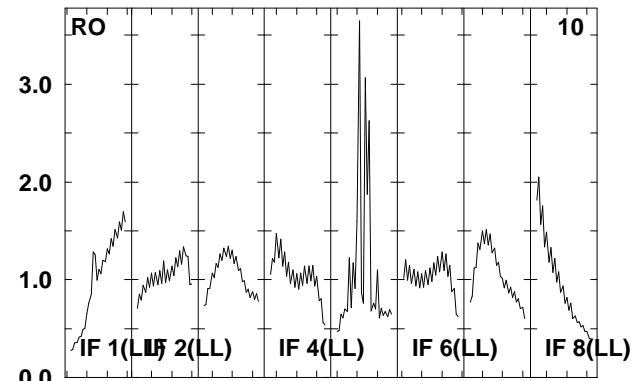
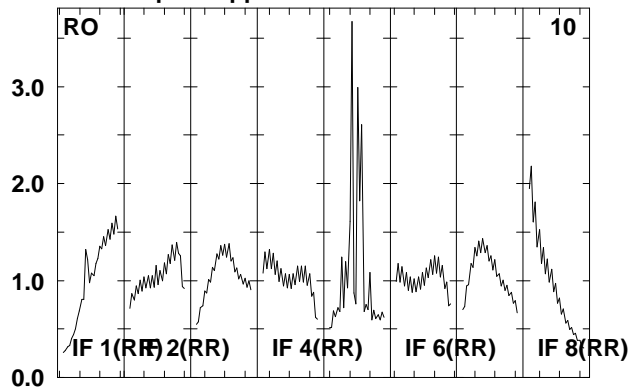
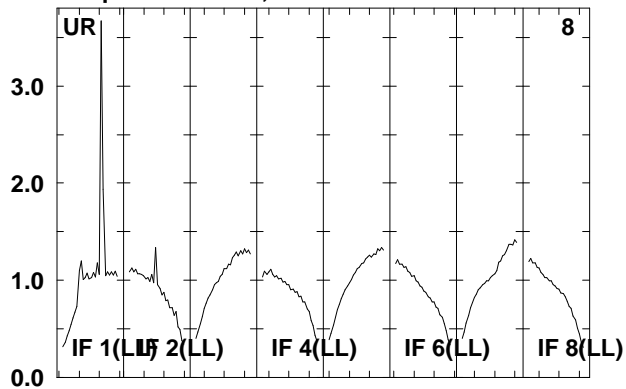

Lower frame: Real Jy

Total-power spectrum Antenna: *

Timerange: 00/15:22:35 to 00/15:23:59

Plot file version 148 created 06-JAN-2012 11:46:53

ARP299D EP068D 5.UVDATA.1

Freq = 1.5950 GHz, Bw = 16.000 MH No calibration applied and no bandpass applied

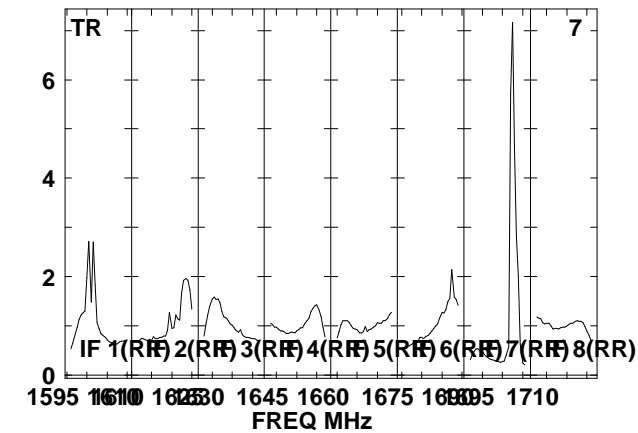
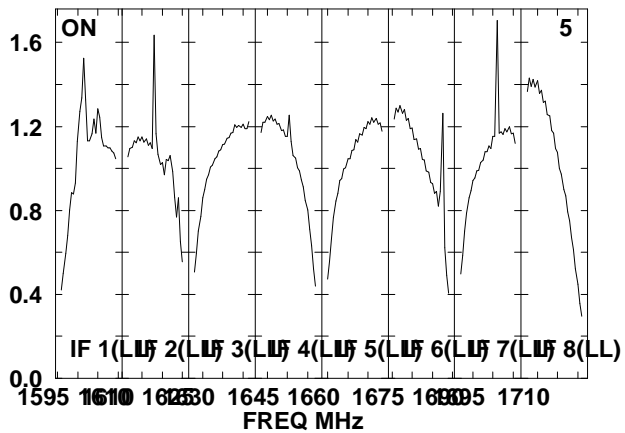
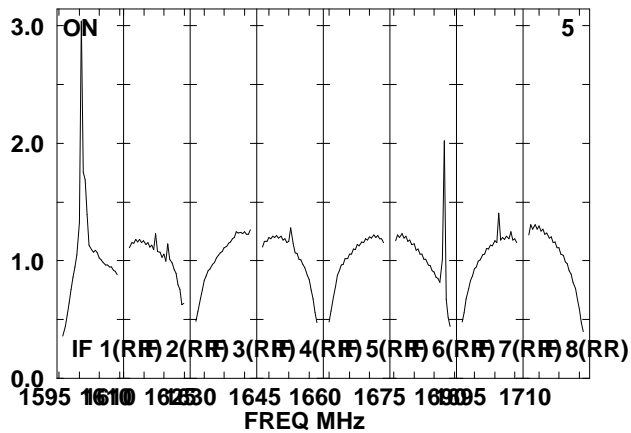
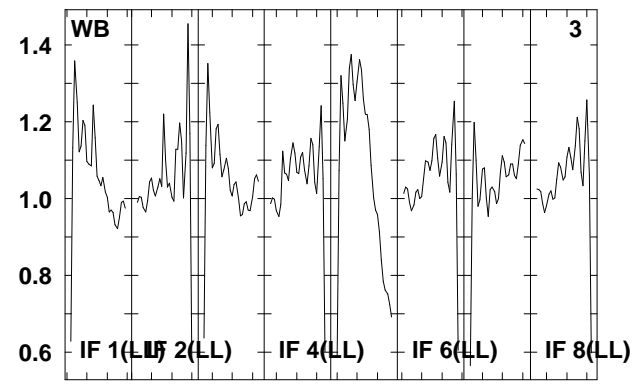
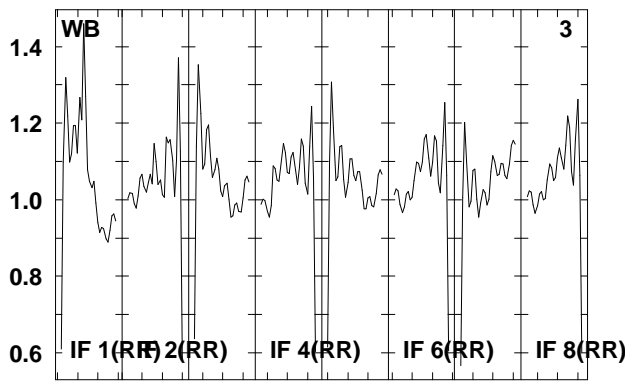
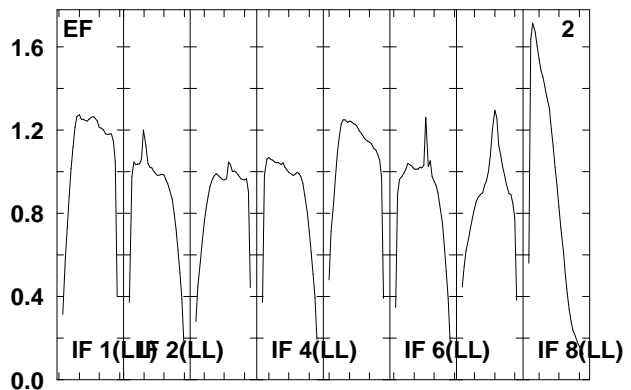
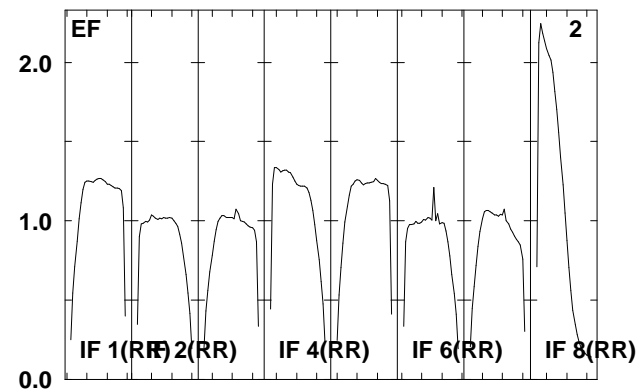
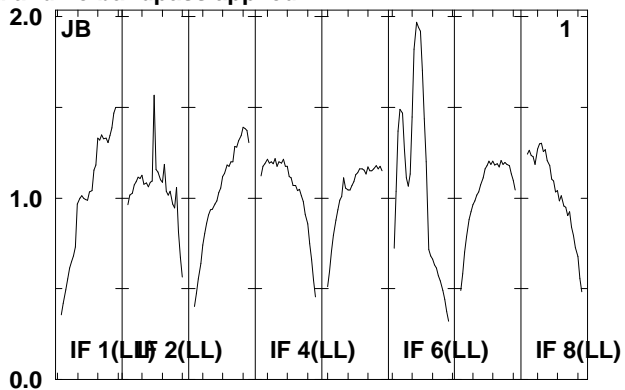
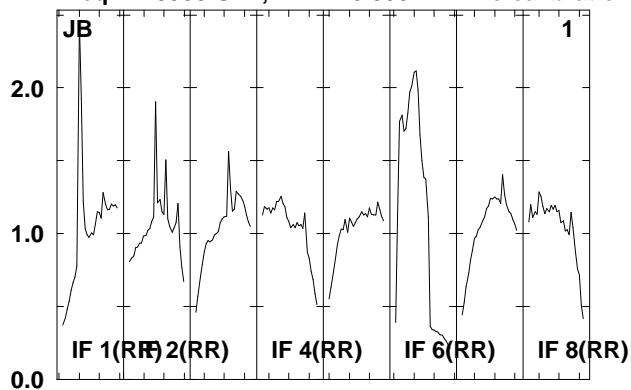

Lower frame: Real Jy
Total-power spectrum Antenna: *
Timerange: 00/15:24:01 to 00/15:27:29

Plot file version 149 created 06-JAN-2012 11:46:53

ARP299D EP068D 5.UVDATA.1

Freq = 1.5950 GHz, Bw = 16.000 MH No calibration applied and no bandpass applied

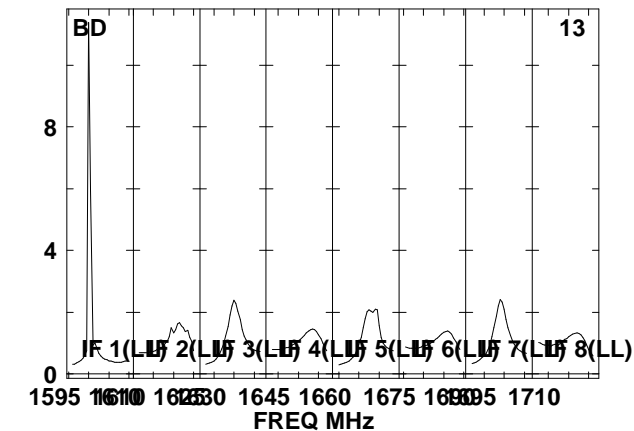
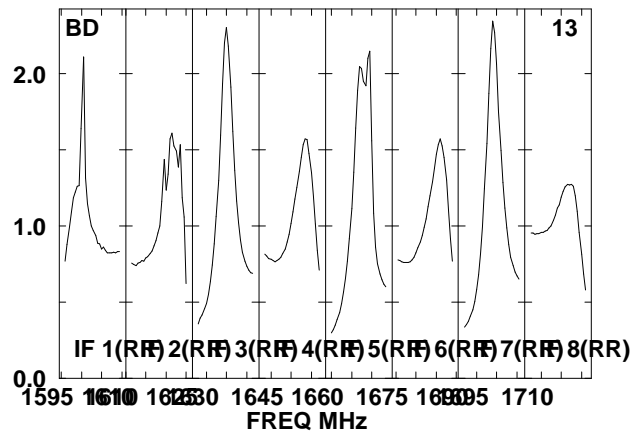
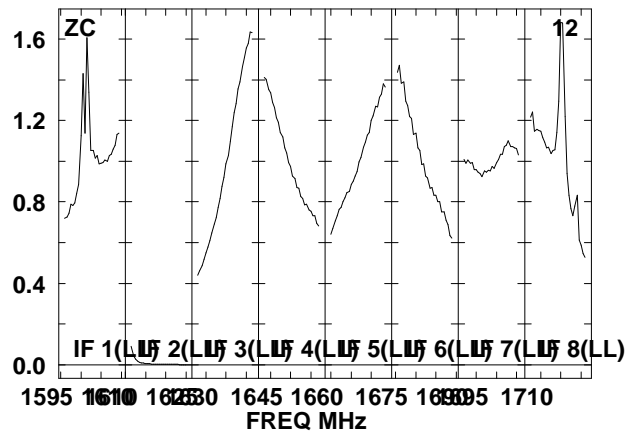
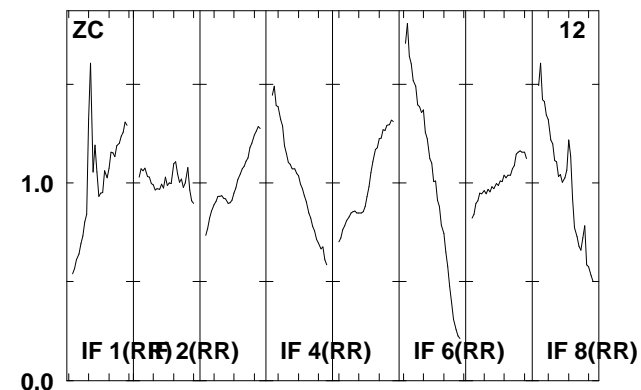
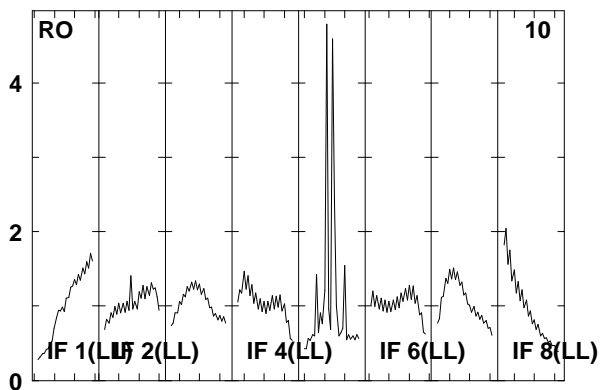
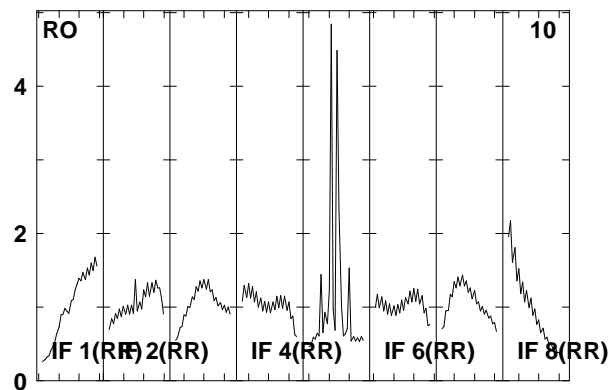
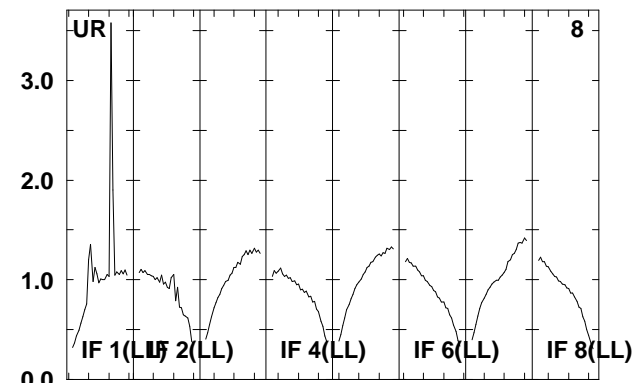
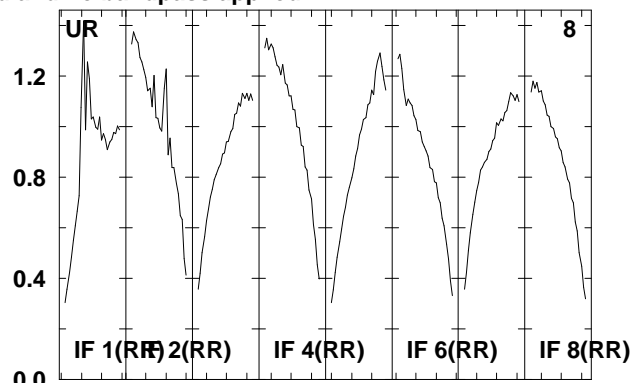
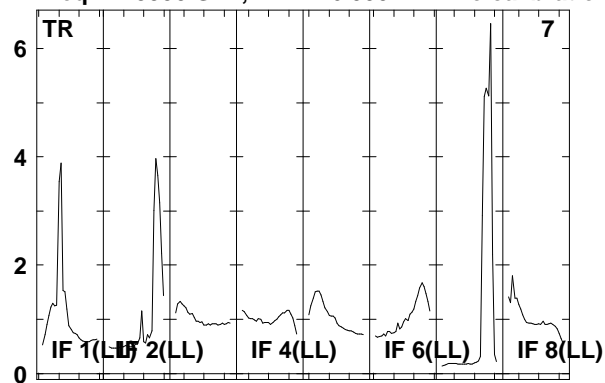

Lower frame: Real Jy
Total-power spectrum Antenna: *
Timerange: 00/15:24:01 to 00/15:27:29

Plot file version 150 created 06-JAN-2012 11:46:54

J1128+59 EP068D 5.UVDATA.1

Freq = 1.5950 GHz, Bw = 16.000 MH No calibration applied and no bandpass applied

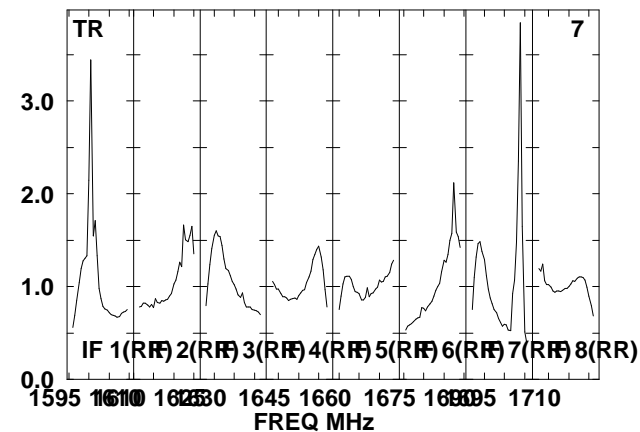
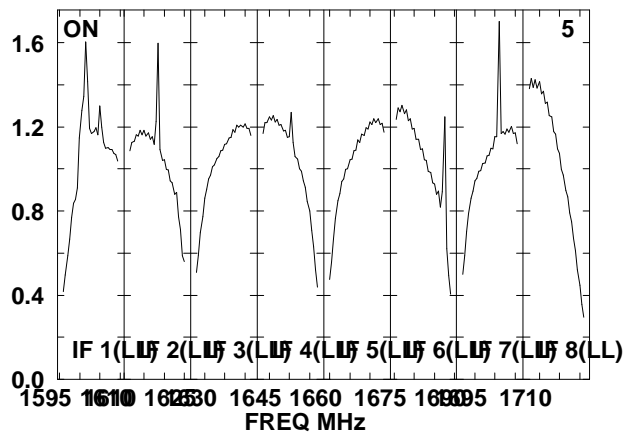
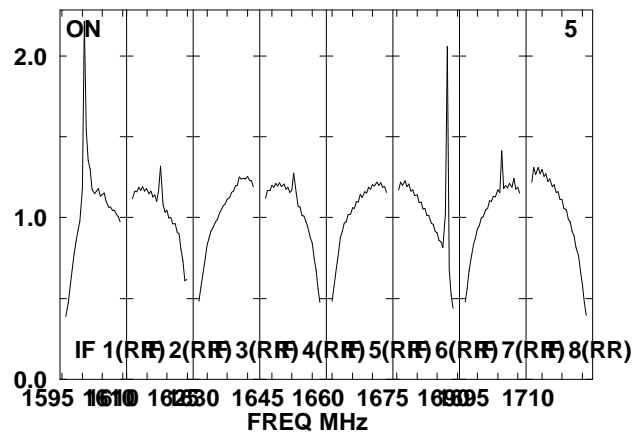
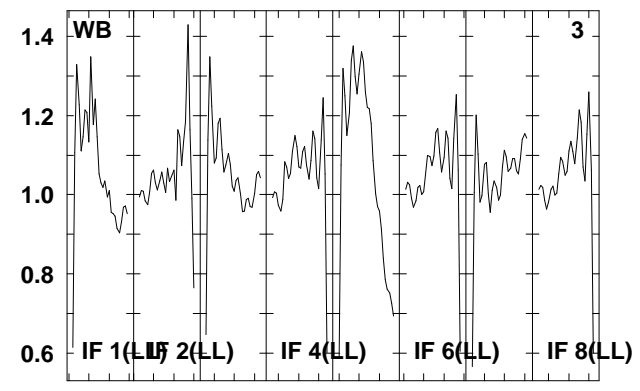
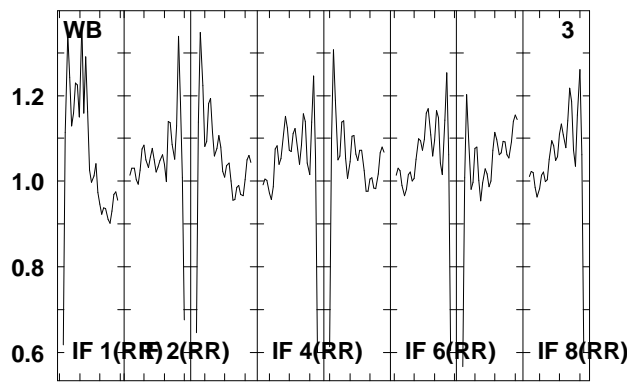
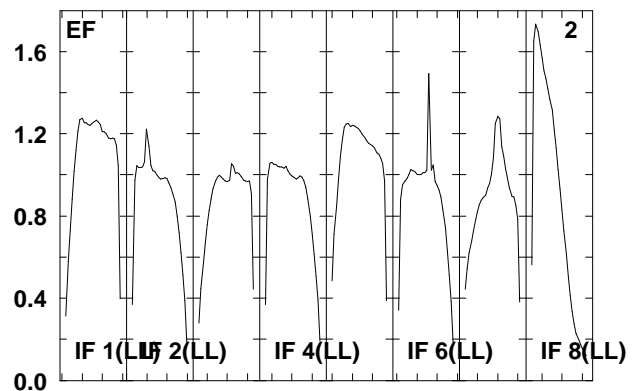
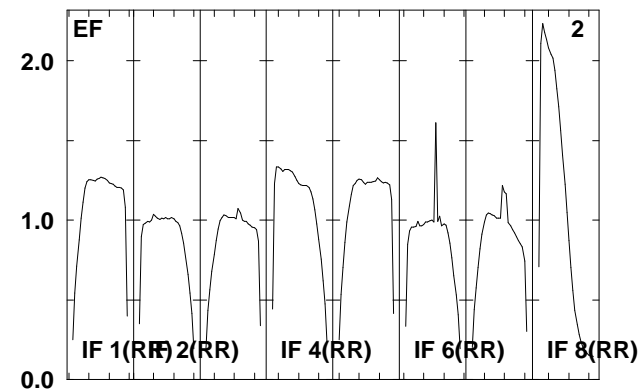
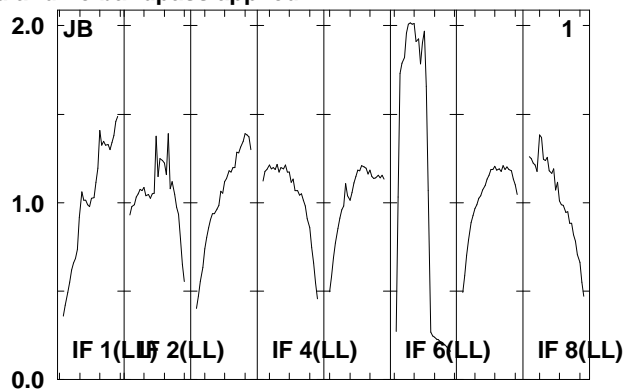
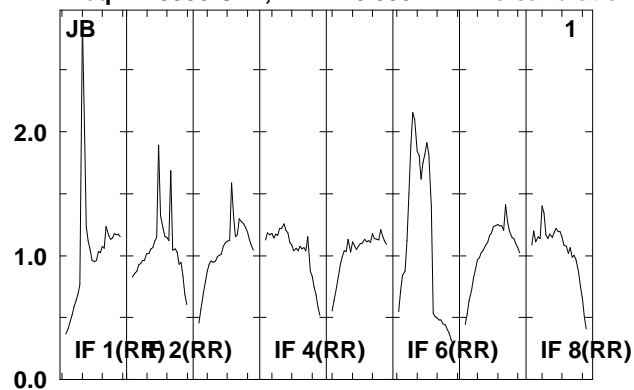

Lower frame: Real Jy
Total-power spectrum Antenna: *
Timerange: 00/15:27:35 to 00/15:28:59

Plot file version 151 created 06-JAN-2012 11:46:54

J1128+59 EP068D 5.UVDATA.1

Freq = 1.5950 GHz, Bw = 16.000 MH No calibration applied and no bandpass applied

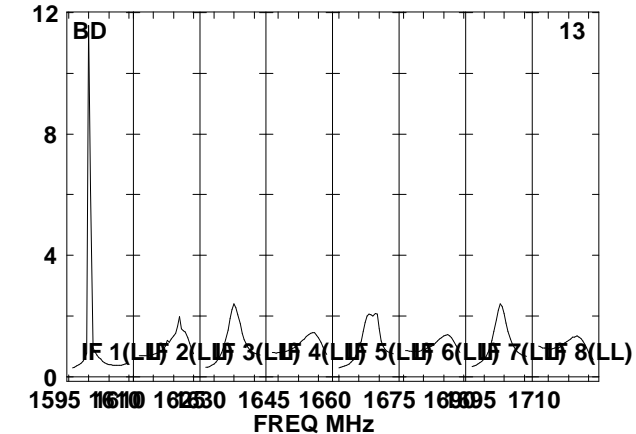
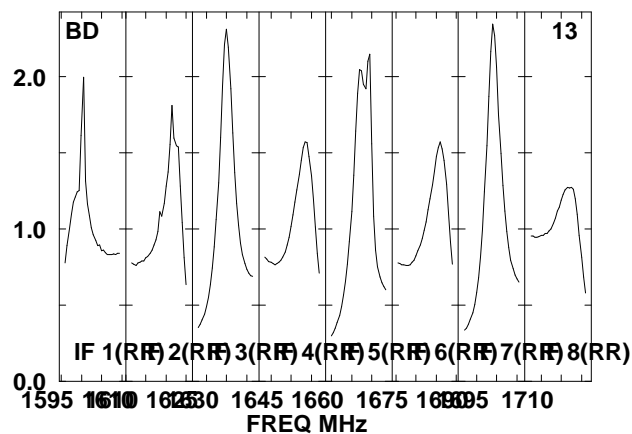
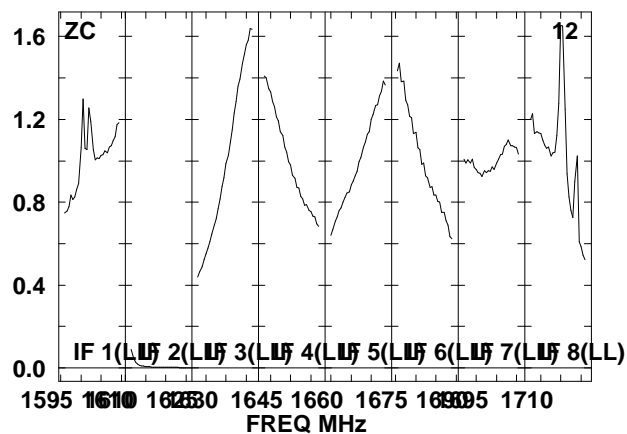
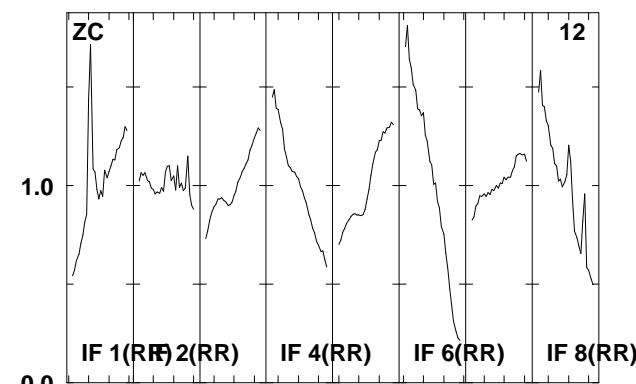
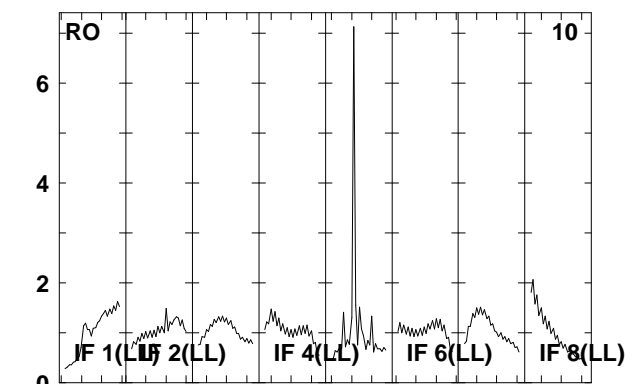
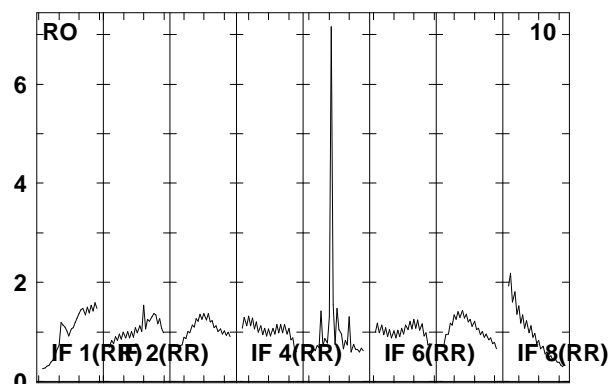
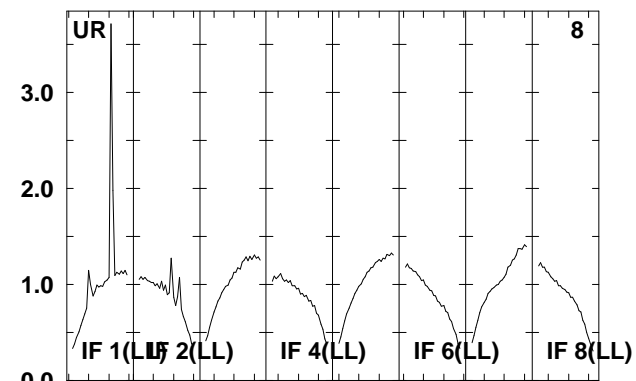
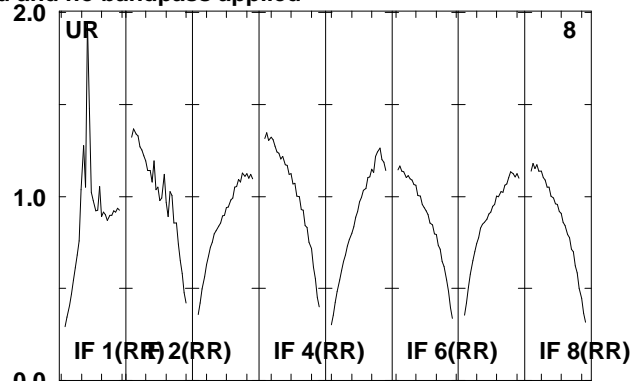
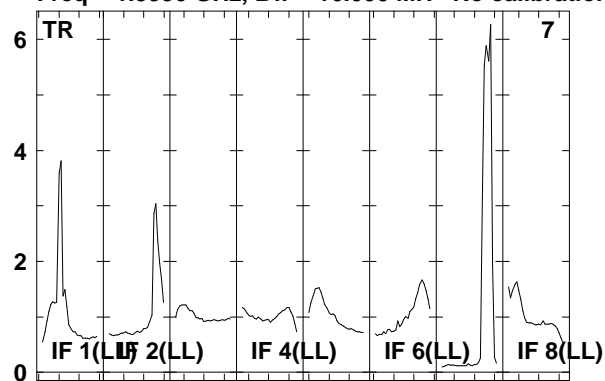

Lower frame: Real Jy
Total-power spectrum Antenna: *
Timerange: 00/15:27:35 to 00/15:28:59

Plot file version 152 created 06-JAN-2012 11:46:54

ARP299D EP068D 5.UVDATA.1

Freq = 1.5950 GHz, Bw = 16.000 MH No calibration applied and no bandpass applied

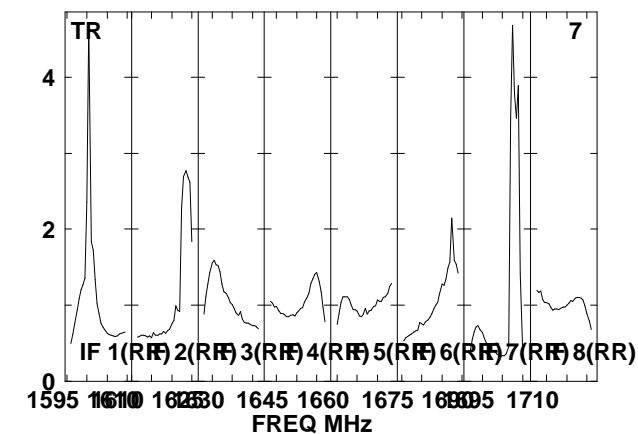
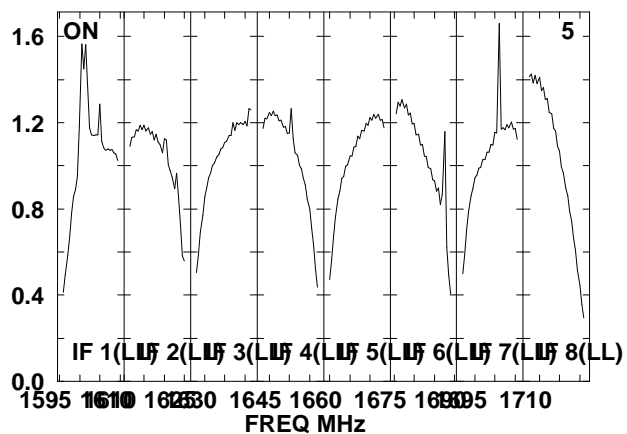
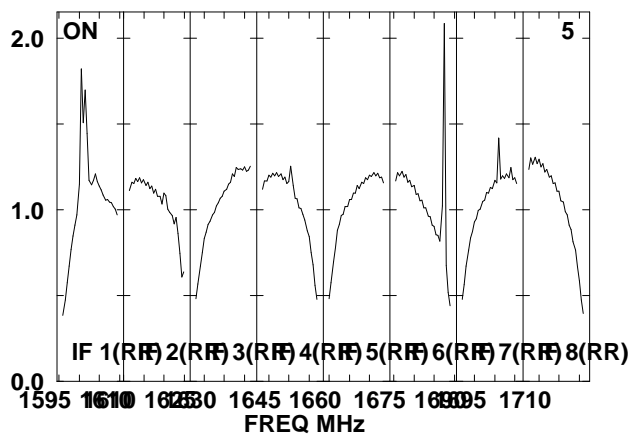
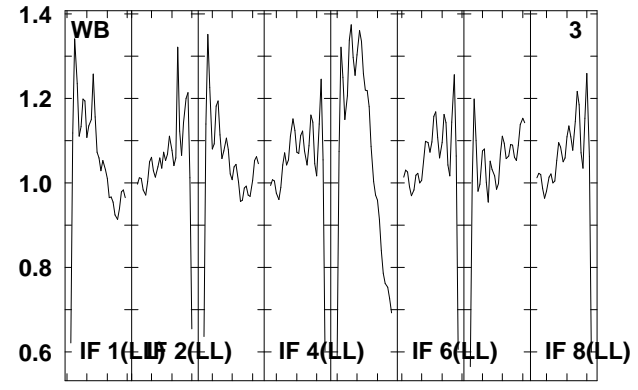
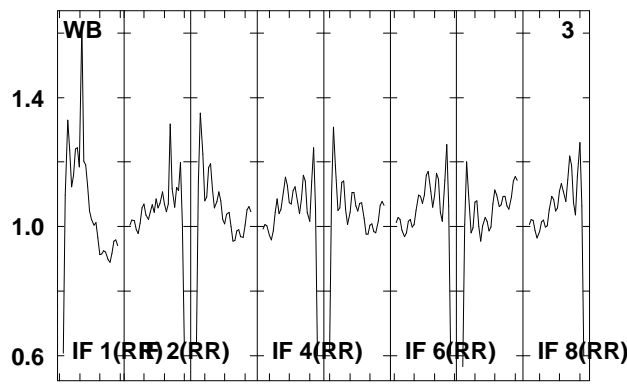
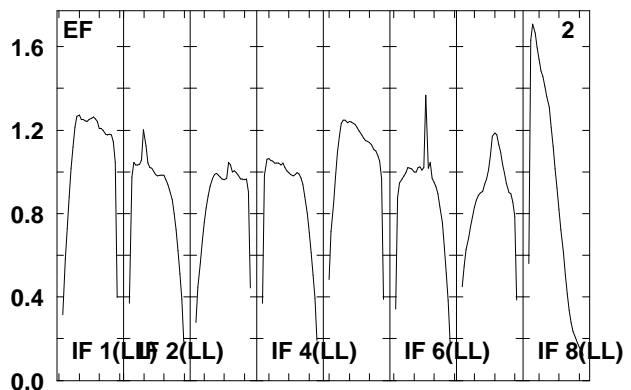
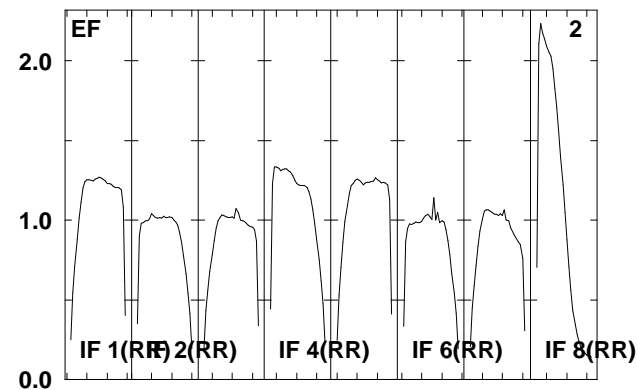
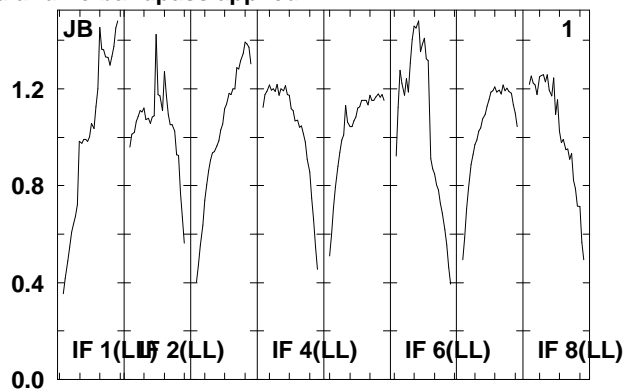
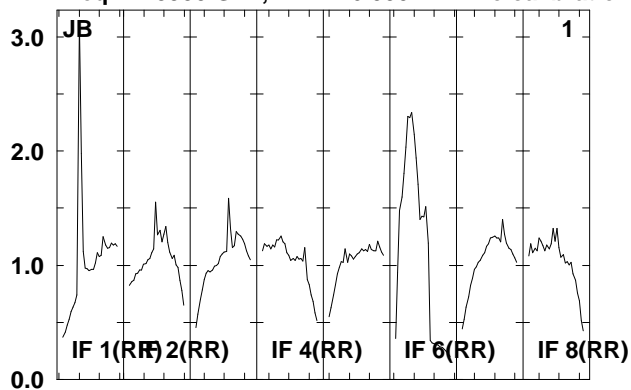

Lower frame: Real Jy
Total-power spectrum Antenna: *
Timerange: 00/15:29:05 to 00/15:32:29

Plot file version 153 created 06-JAN-2012 11:46:55

ARP299D EP068D 5.UVDATA.1

Freq = 1.5950 GHz, Bw = 16.000 MH No calibration applied and no bandpass applied

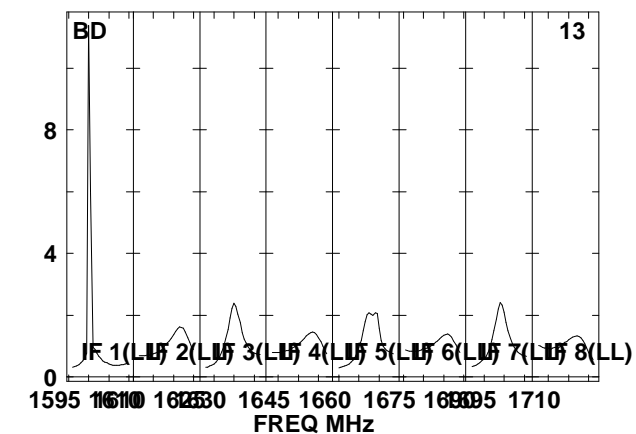
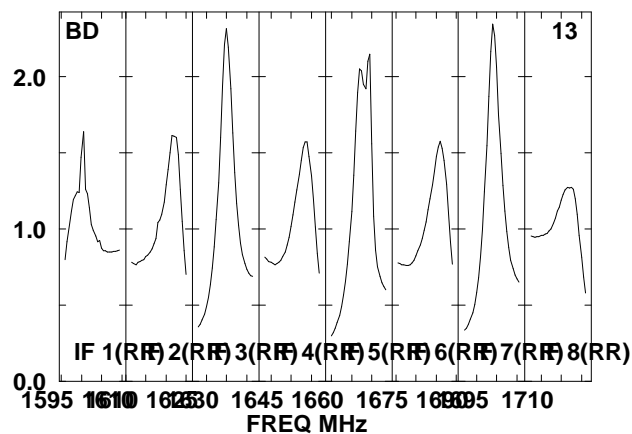
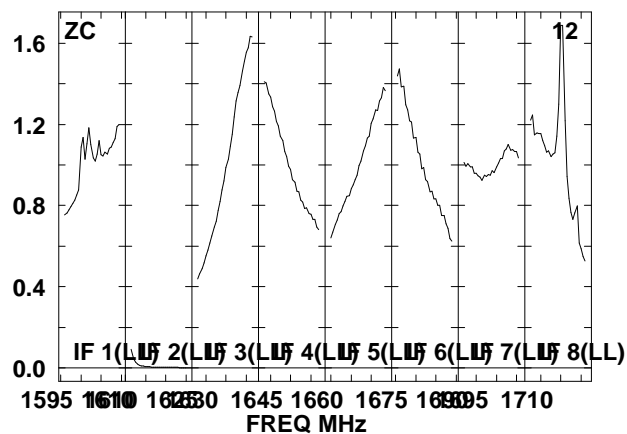
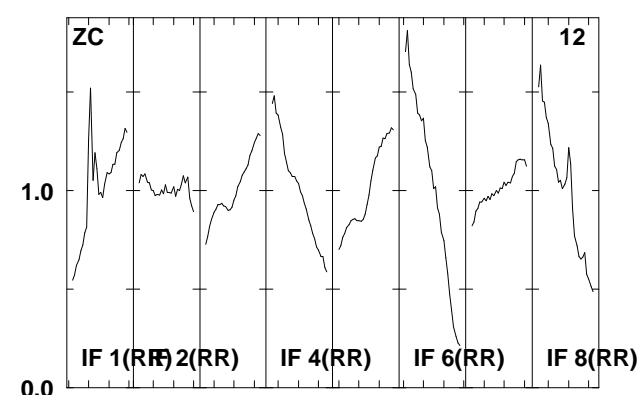
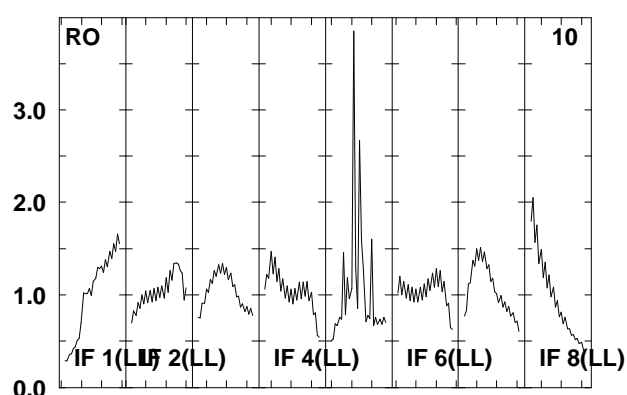
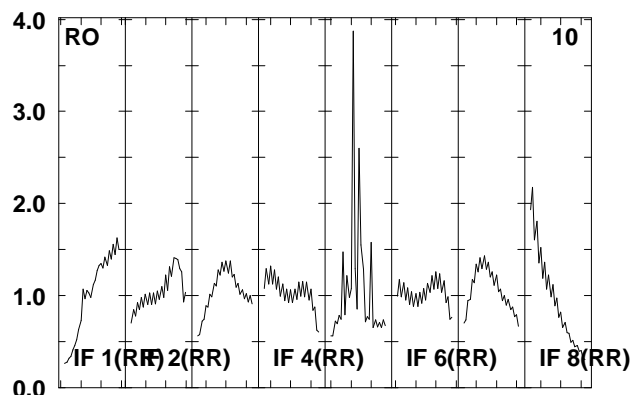
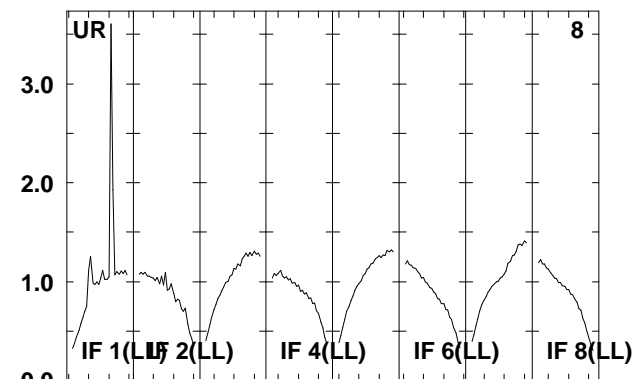
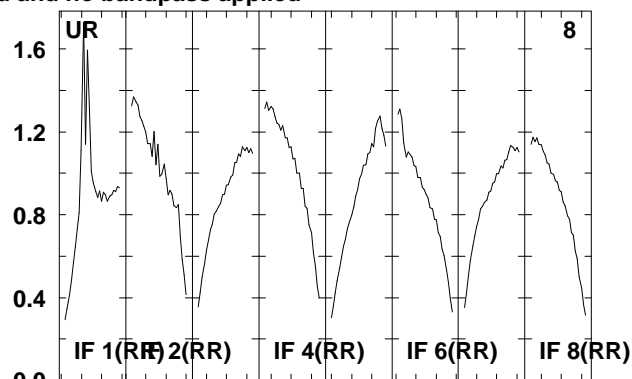
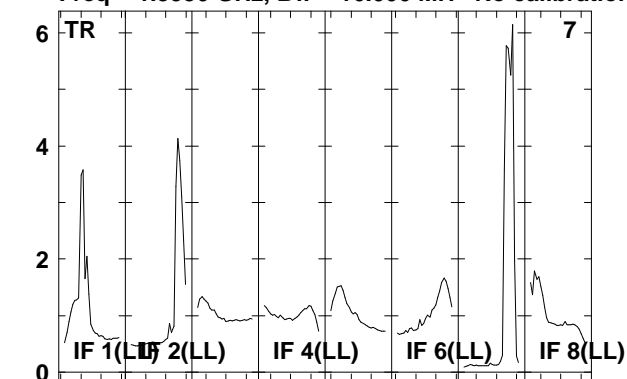

Lower frame: Real Jy
Total-power spectrum Antenna: *
Timerange: 00/15:29:05 to 00/15:32:29

Plot file version 154 created 06-JAN-2012 11:46:56

J1128+59 EP068D 5.UVDATA.1

Freq = 1.5950 GHz, Bw = 16.000 MH No calibration applied and no bandpass applied

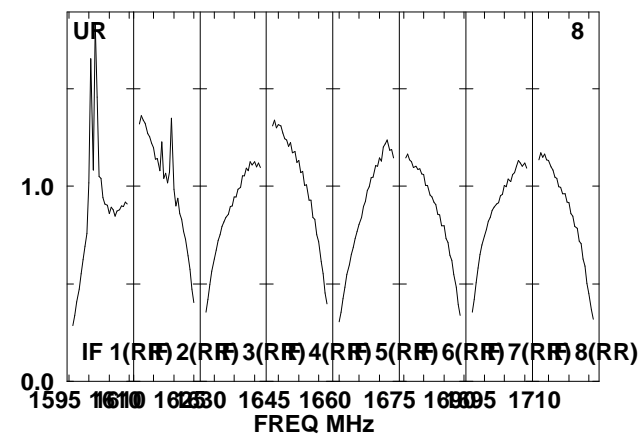
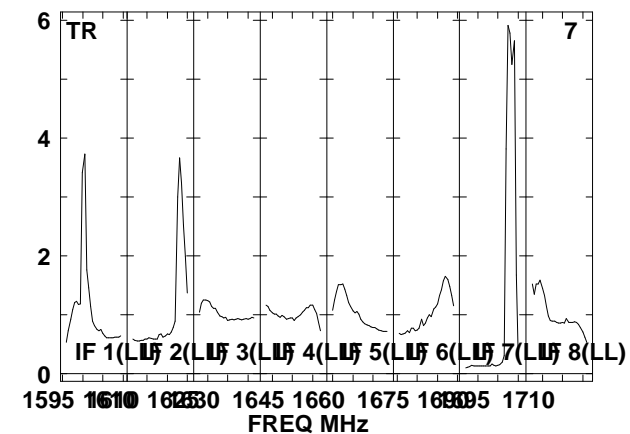
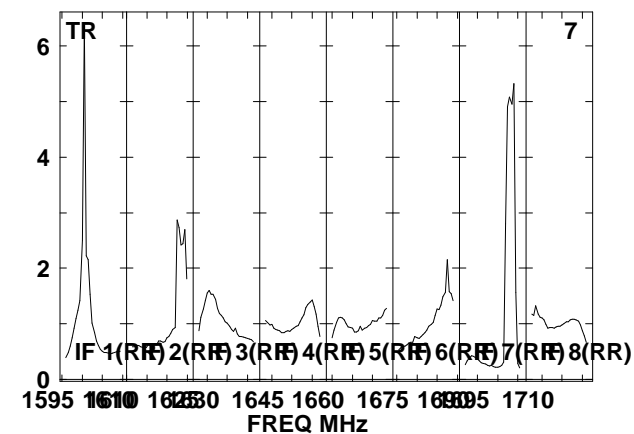
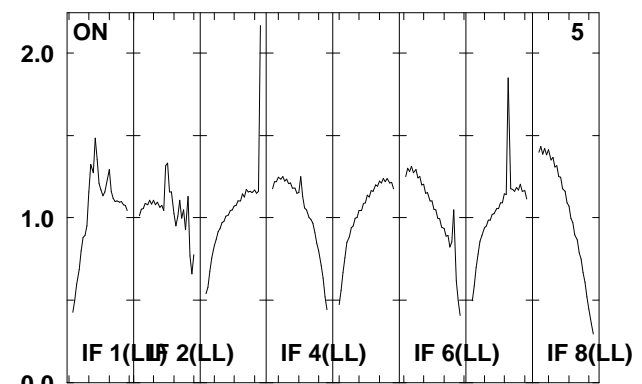
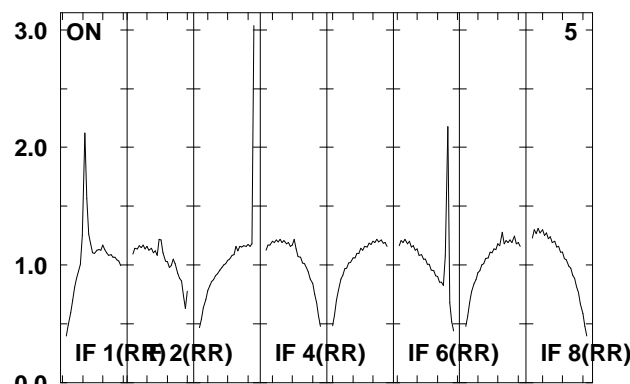
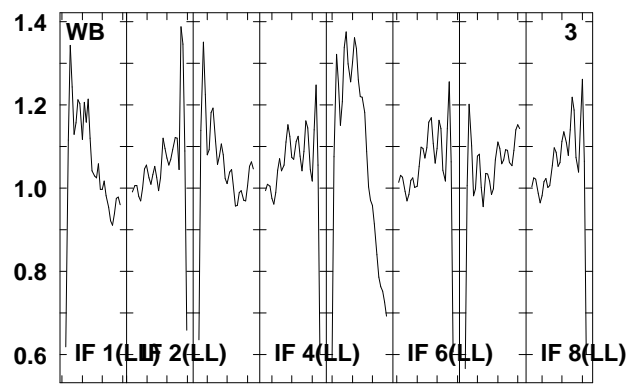
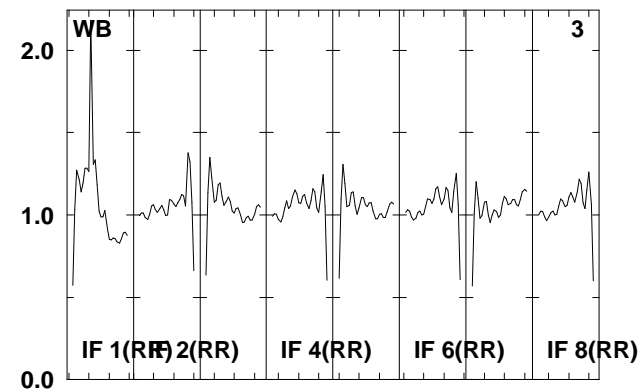
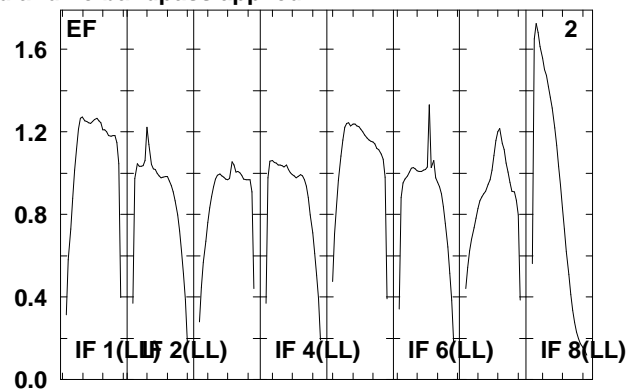
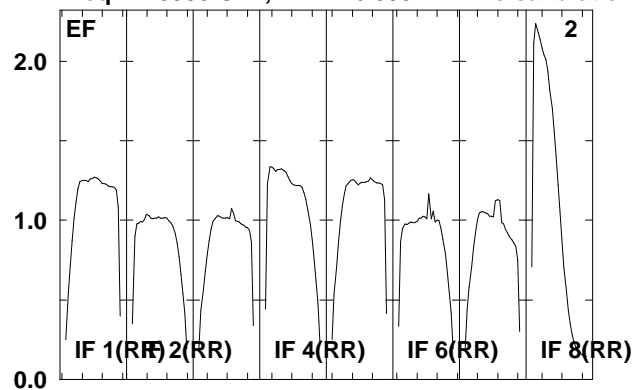

Lower frame: Real Jy
Total-power spectrum Antenna: *
Timerange: 00/15:33:31 to 00/15:34:59

Plot file version 155 created 06-JAN-2012 11:46:56

J1128+59 EP068D 5.UVDATA.1

Freq = 1.5950 GHz, Bw = 16.000 MH No calibration applied and no bandpass applied

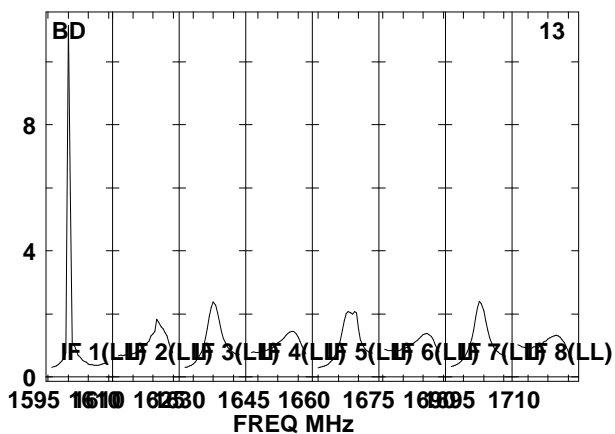
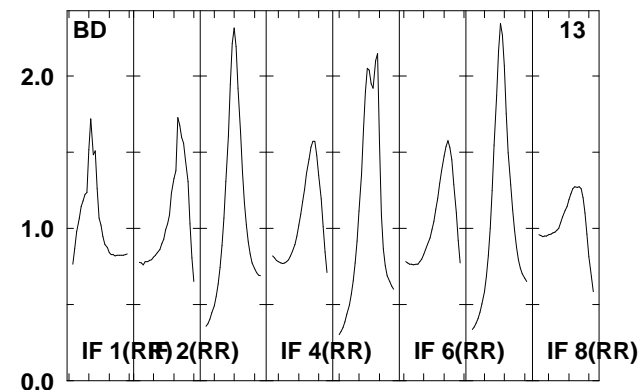
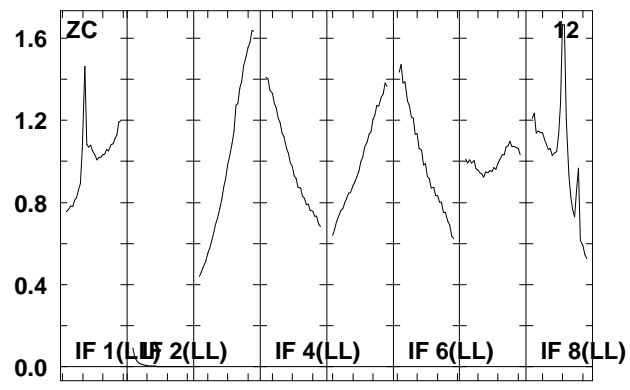
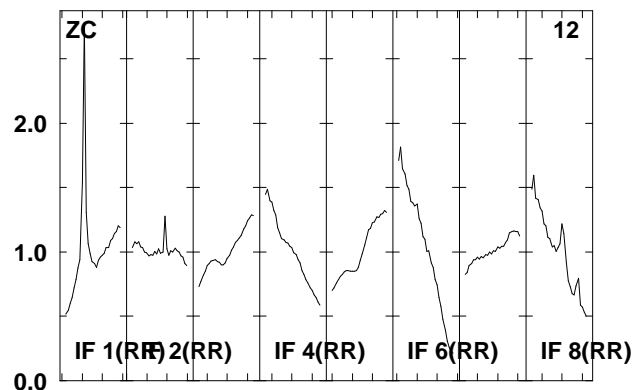
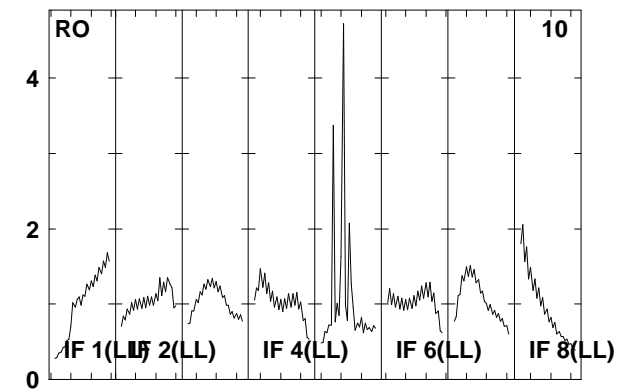
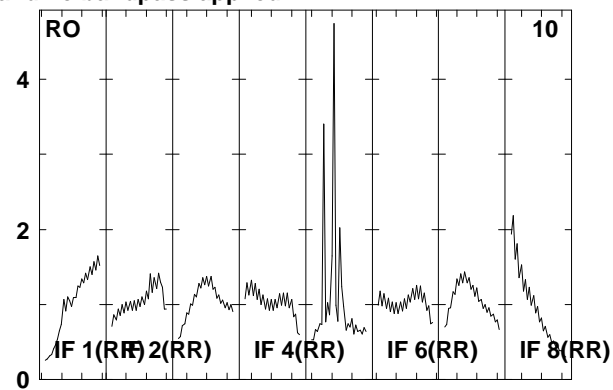
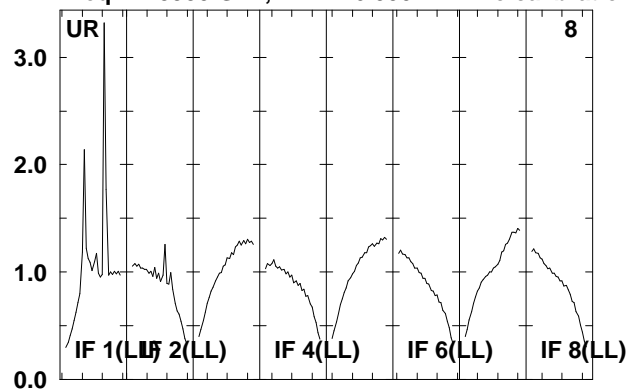

Lower frame: Real Jy

Total-power spectrum Antenna: *

Timerange: 00/15:33:31 to 00/15:34:59

Plot file version 156 created 06-JAN-2012 11:46:56

ARP299D EP068D 5.UVDATA.1

Freq = 1.5950 GHz, Bw = 16.000 MH No calibration applied and no bandpass applied

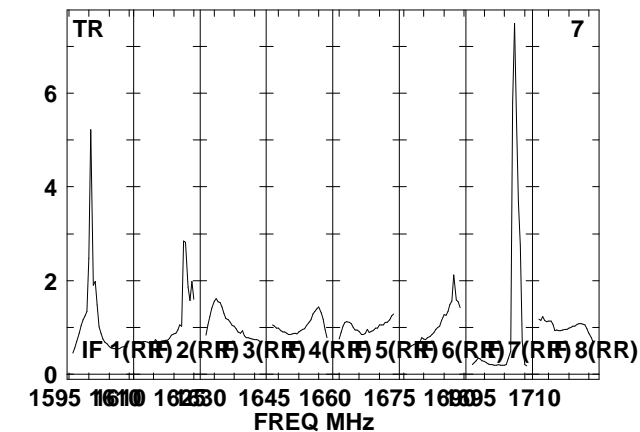
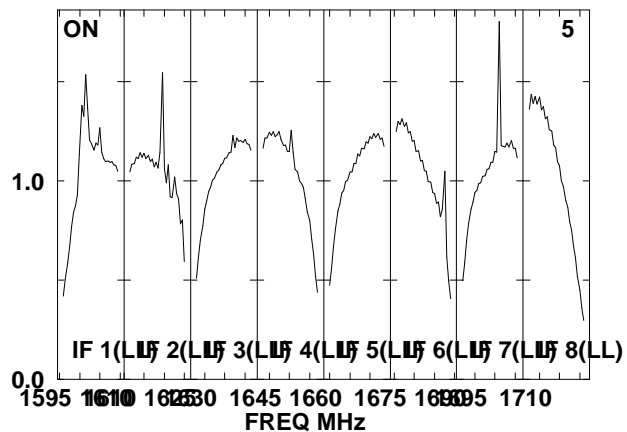
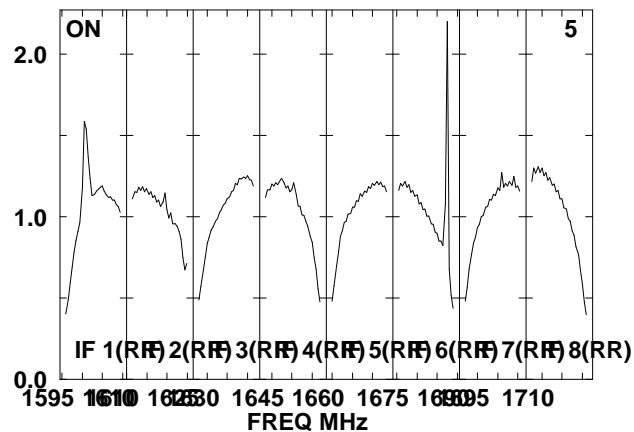
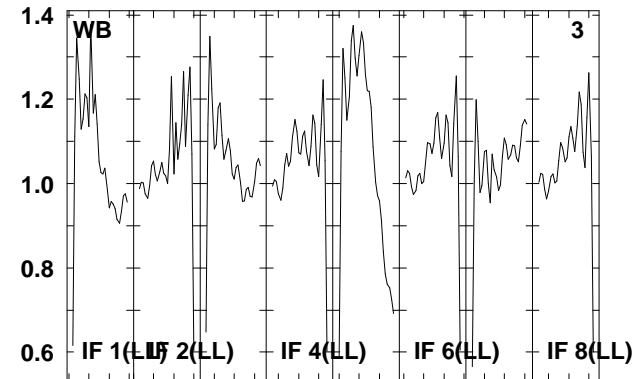
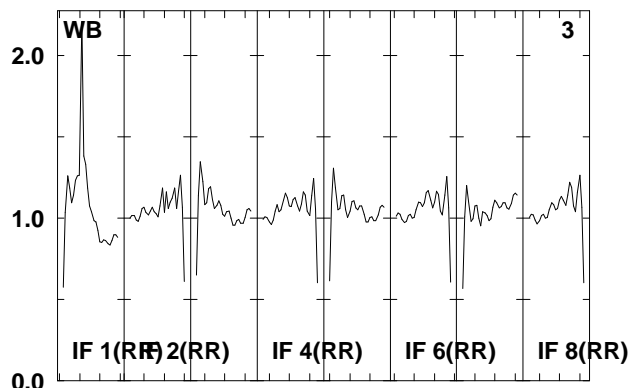
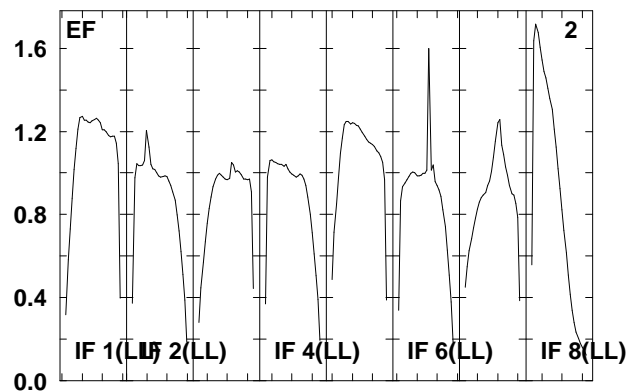
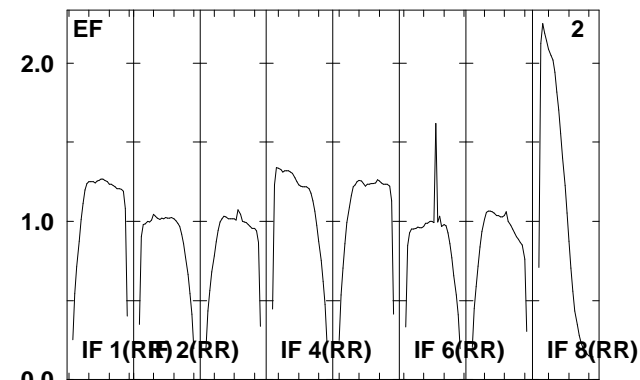
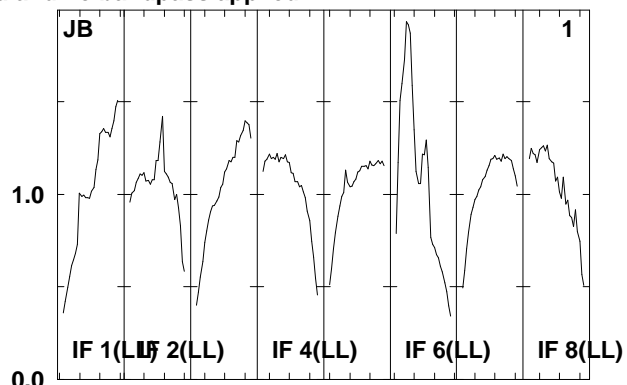
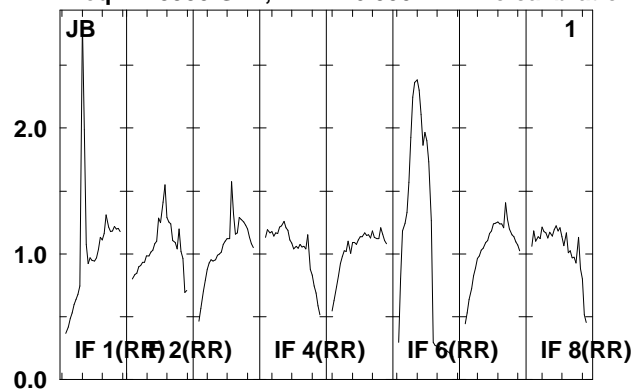

Lower frame: Real Jy
Total-power spectrum Antenna: *
Timerange: 00/15:35:01 to 00/15:38:29

Plot file version 157 created 06-JAN-2012 11:46:57

ARP299D EP068D 5.UVDATA.1

Freq = 1.5950 GHz, Bw = 16.000 MH No calibration applied and no bandpass applied

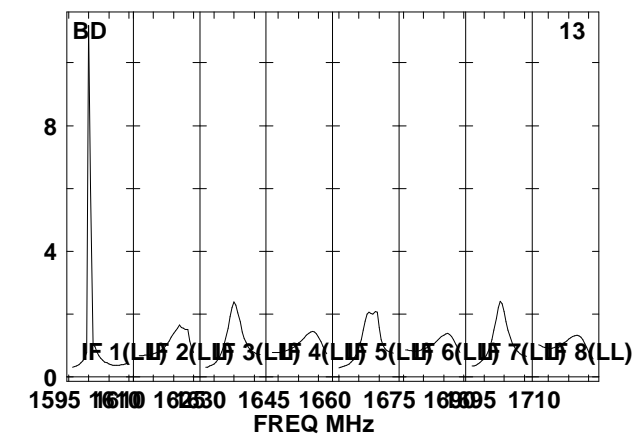
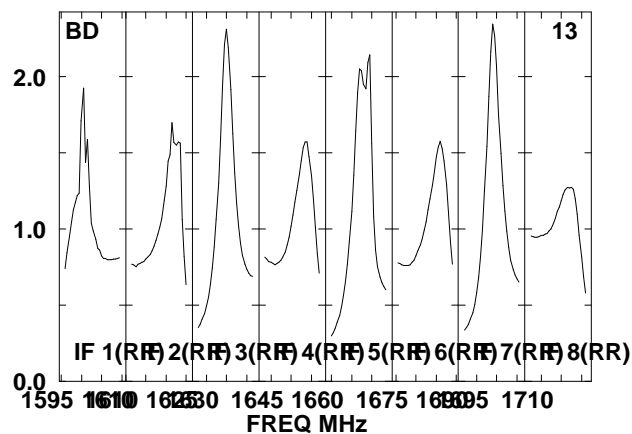
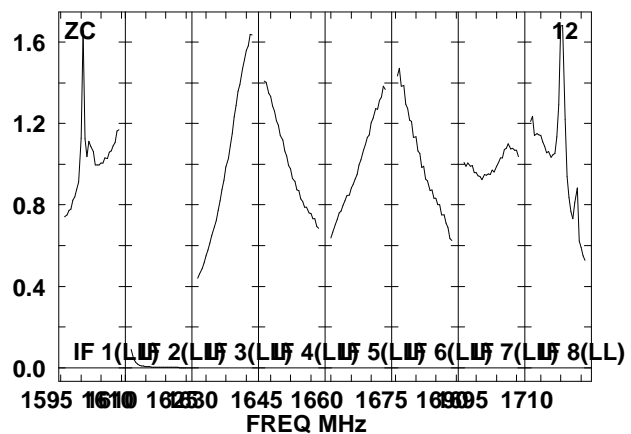
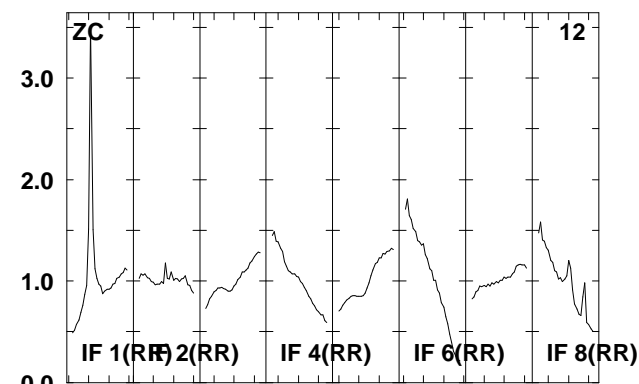
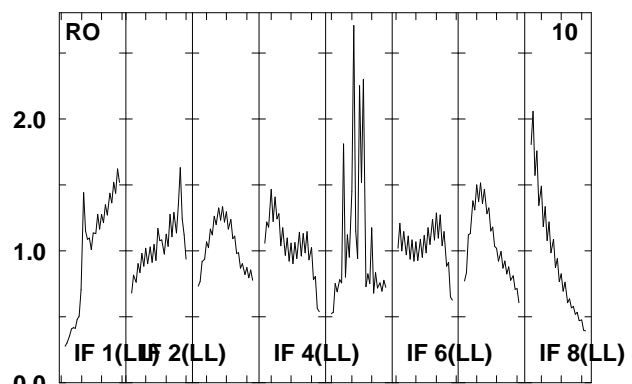
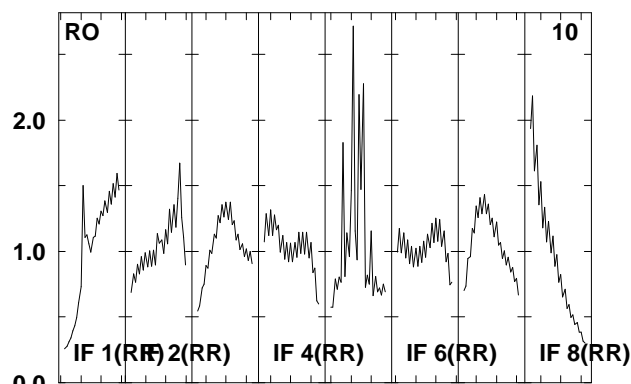
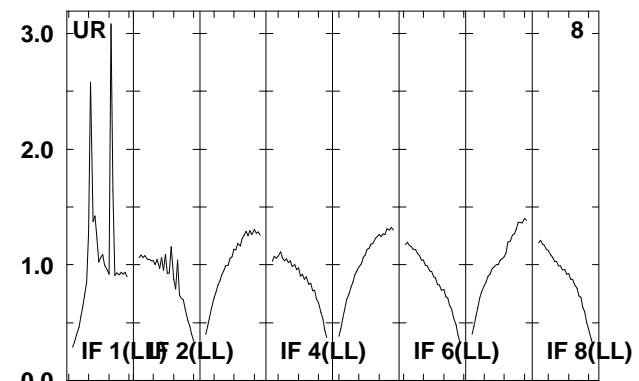
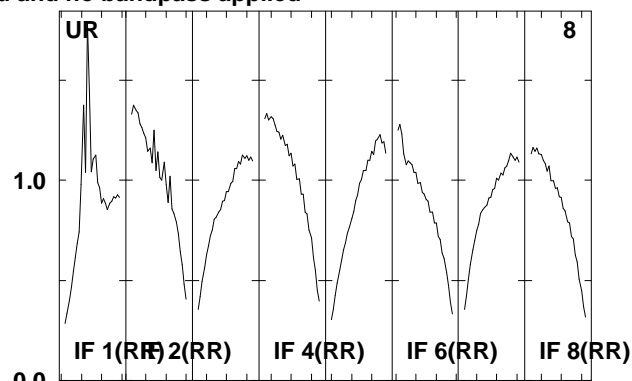
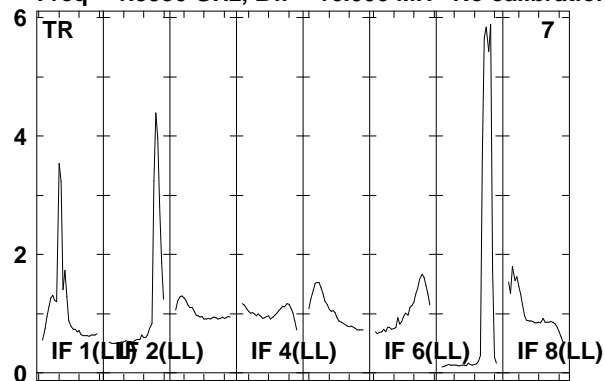

Lower frame: Real Jy
Total-power spectrum Antenna: *
Timerange: 00/15:35:01 to 00/15:38:29

Plot file version 158 created 06-JAN-2012 11:46:58

J1128+59 EP068D 5.UVDATA.1

Freq = 1.5950 GHz, Bw = 16.000 MH No calibration applied and no bandpass applied

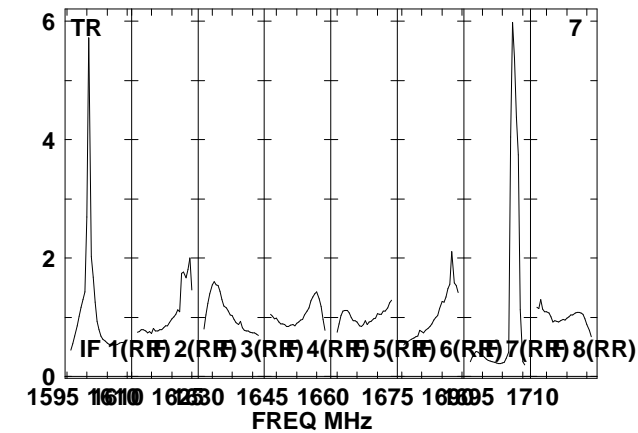
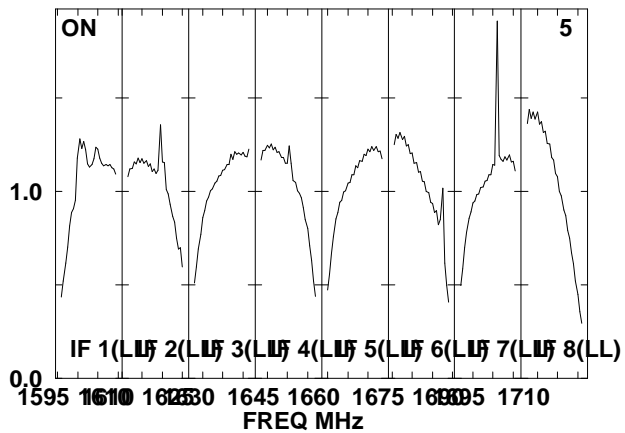
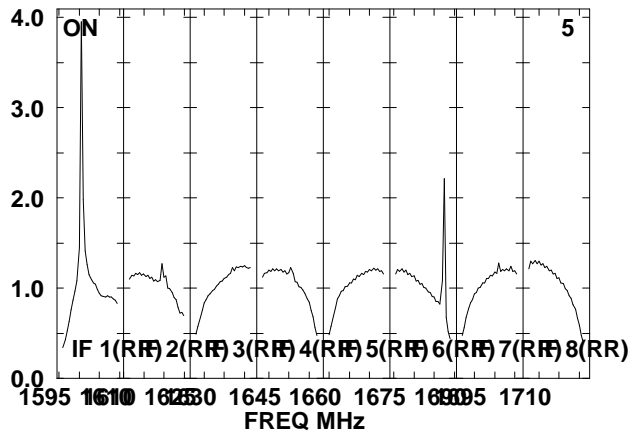
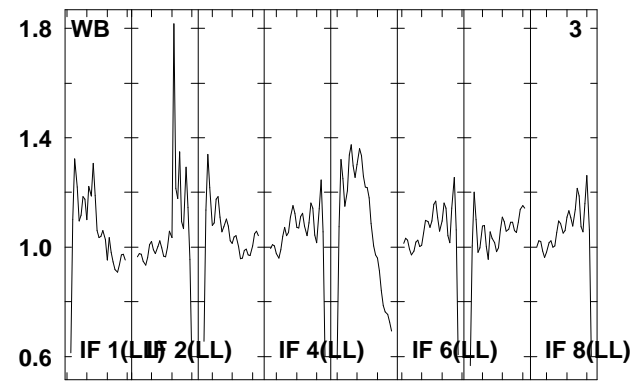
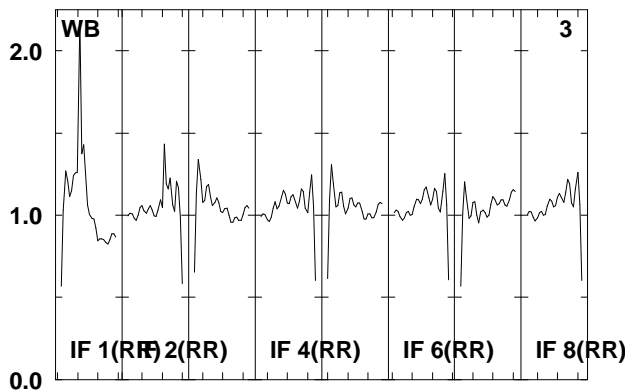
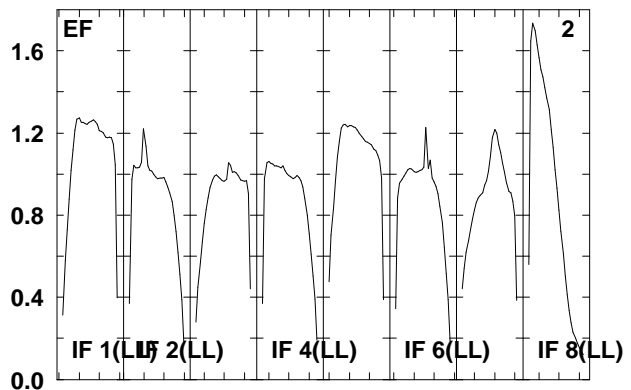
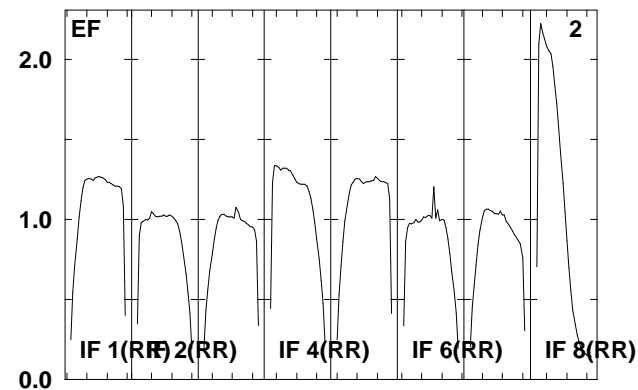
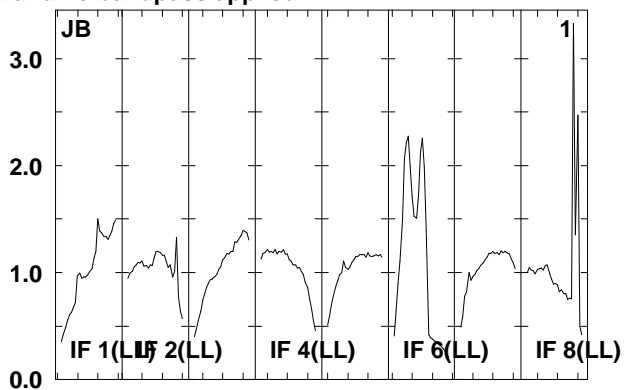
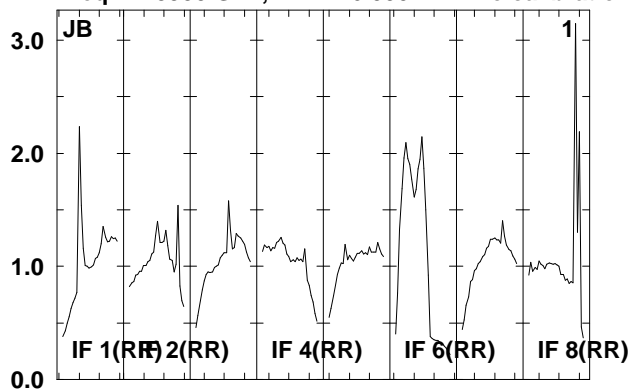

Lower frame: Real Jy
Total-power spectrum Antenna: *
Timerange: 00/15:38:35 to 00/15:39:59

Plot file version 159 created 06-JAN-2012 11:46:58

J1128+59 EP068D 5.UVDATA.1

Freq = 1.5950 GHz, Bw = 16.000 MH No calibration applied and no bandpass applied

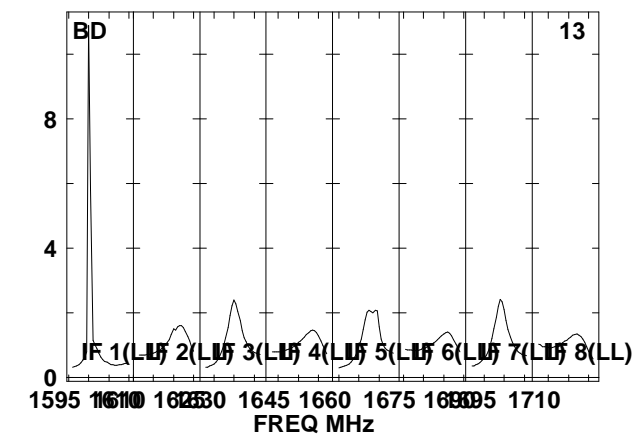
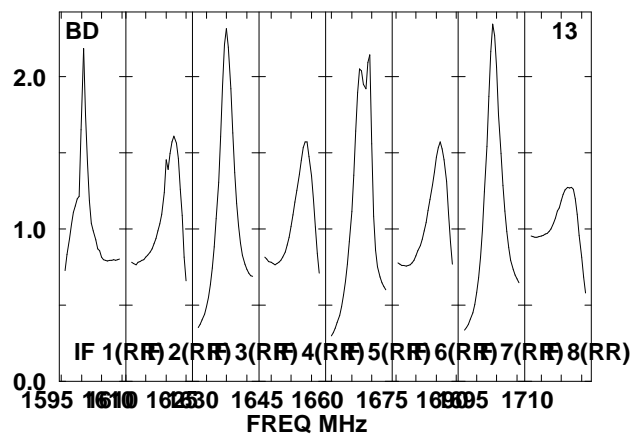
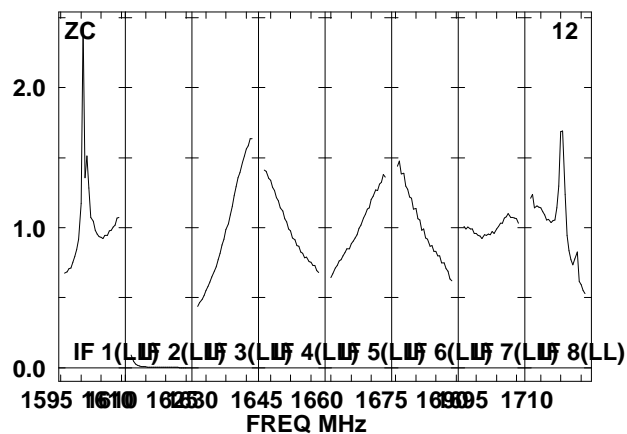
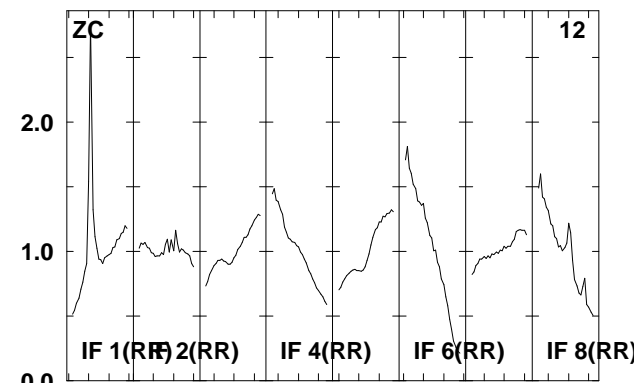
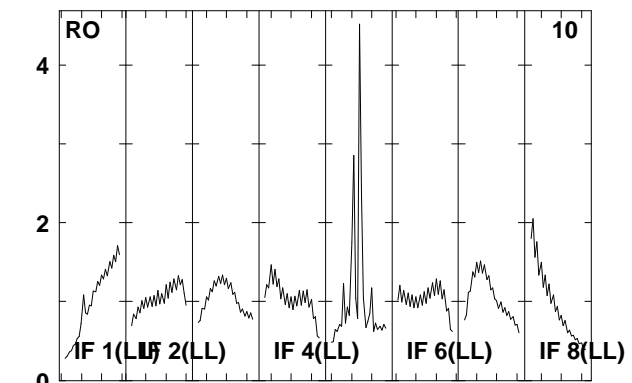
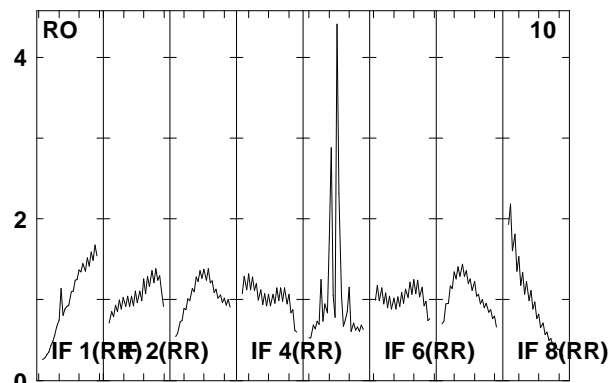
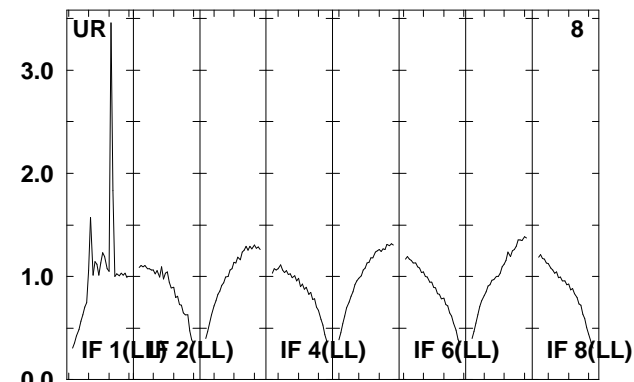
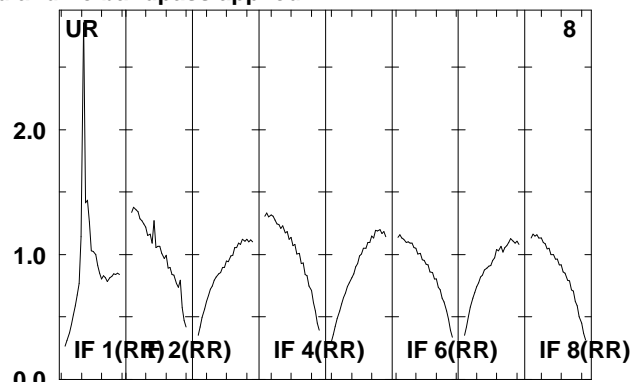
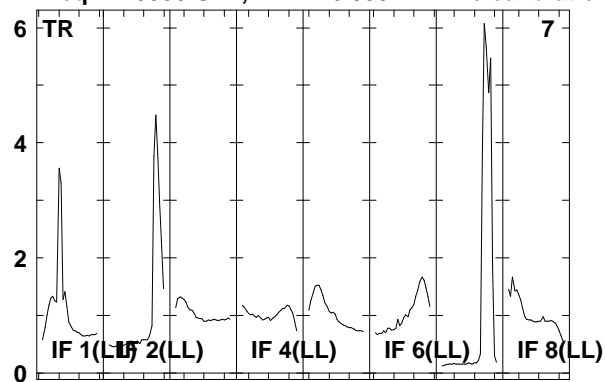

Lower frame: Real Jy
Total-power spectrum Antenna: *
Timerange: 00/15:38:35 to 00/15:39:59

Plot file version 160 created 06-JAN-2012 11:46:58

ARP299D EP068D 5.UVDATA.1

Freq = 1.5950 GHz, Bw = 16.000 MH No calibration applied and no bandpass applied

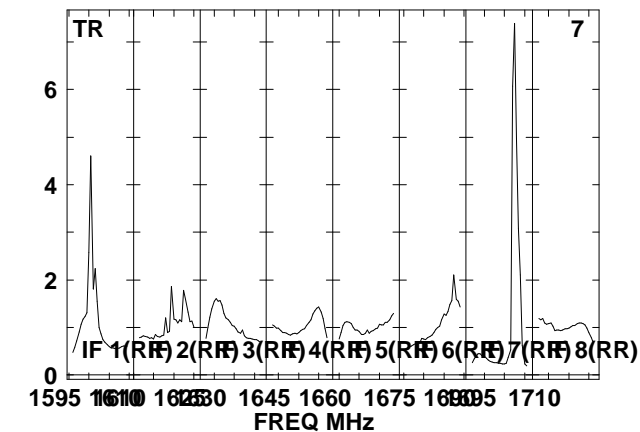
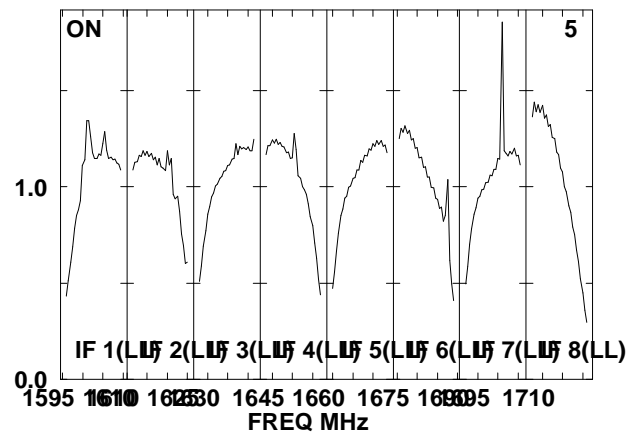
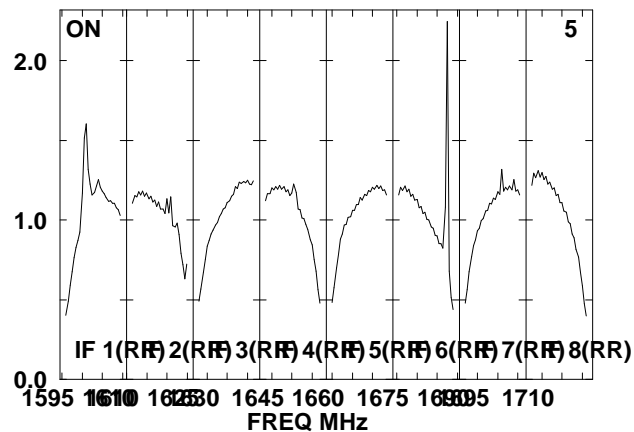
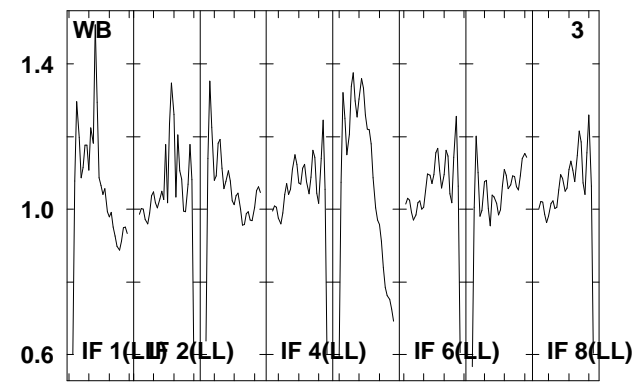
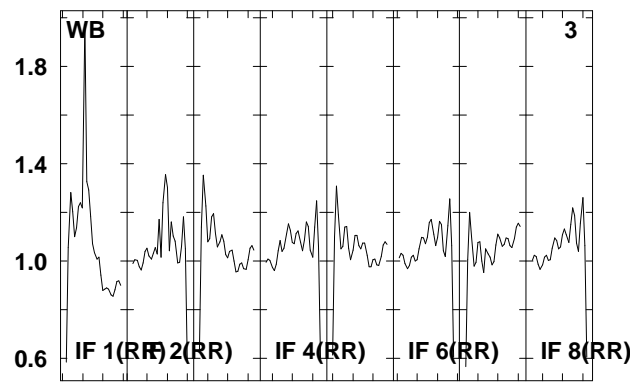
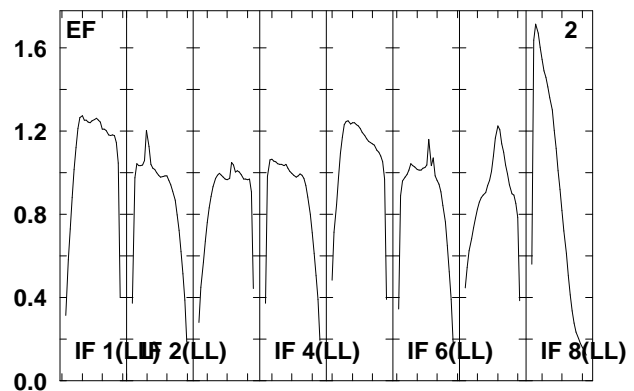
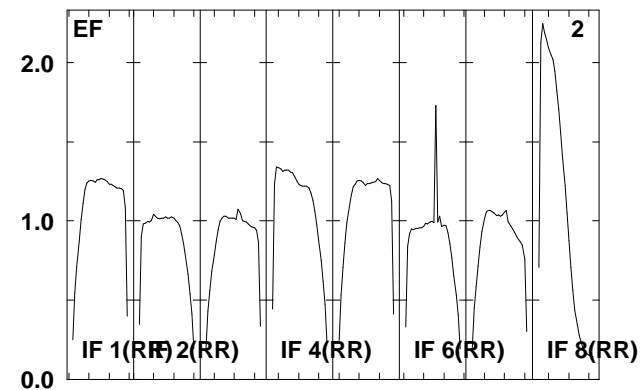
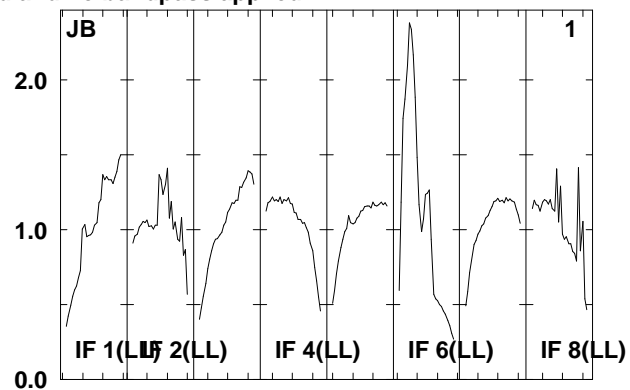
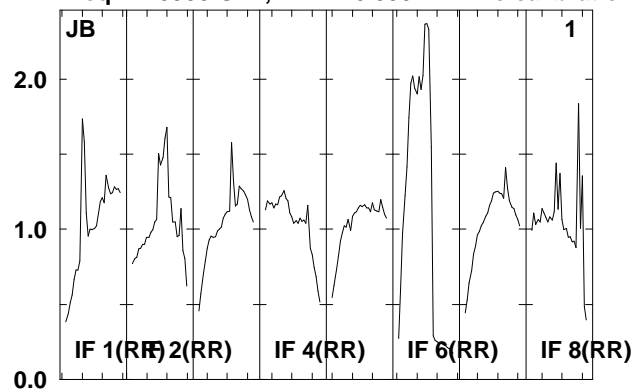

Lower frame: Real Jy
Total-power spectrum Antenna: *
Timerange: 00/15:40:05 to 00/15:43:29

Plot file version 161 created 06-JAN-2012 11:46:59

ARP299D EP068D 5.UVDATA.1

Freq = 1.5950 GHz, Bw = 16.000 MH No calibration applied and no bandpass applied

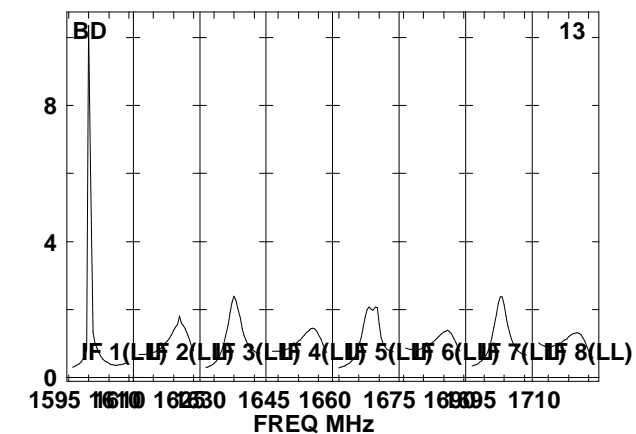
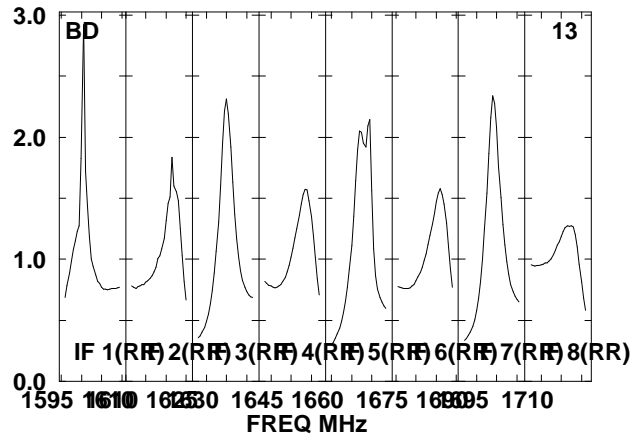
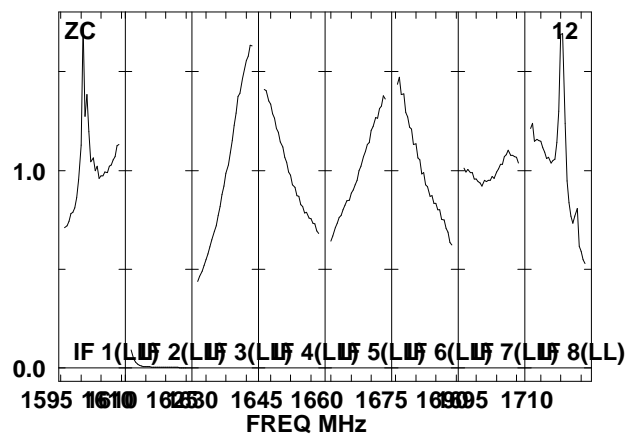
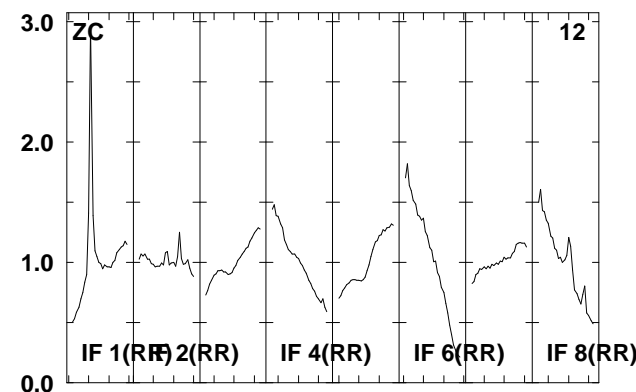
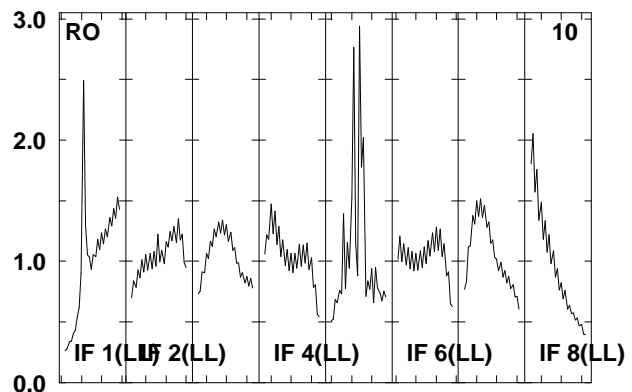
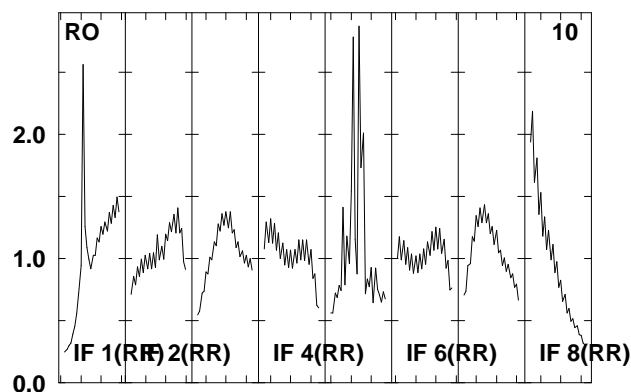
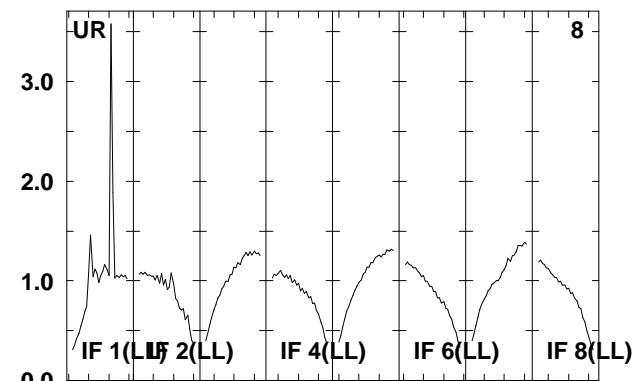
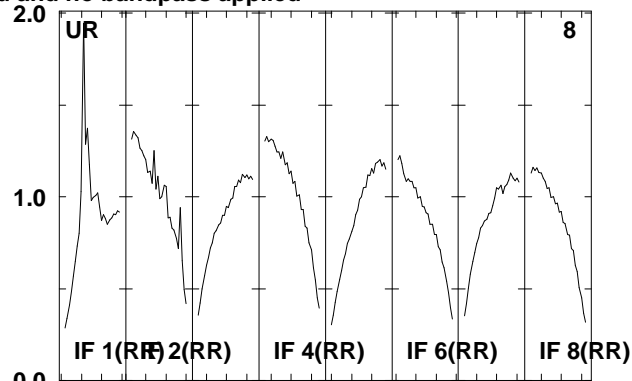
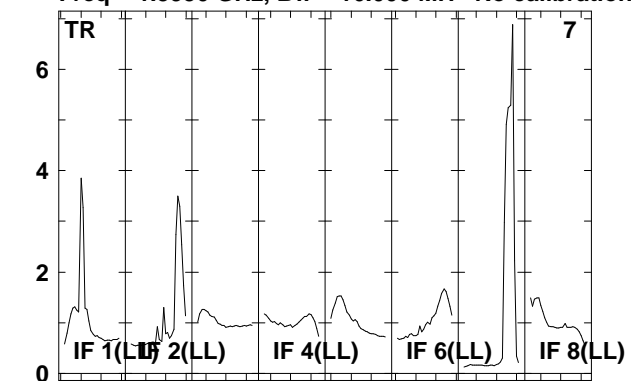

Lower frame: Real Jy

Total-power spectrum Antenna: *

Timerange: 00/15:40:05 to 00/15:43:29

Plot file version 162 created 06-JAN-2012 11:46:59

J1128+59 EP068D 5.UVDATA.1

Freq = 1.5950 GHz, Bw = 16.000 MH No calibration applied and no bandpass applied

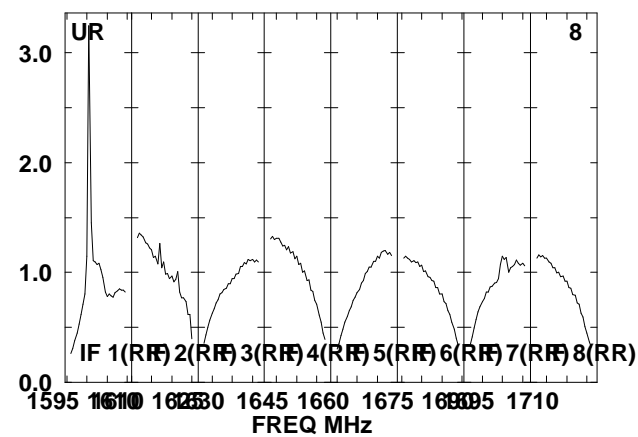
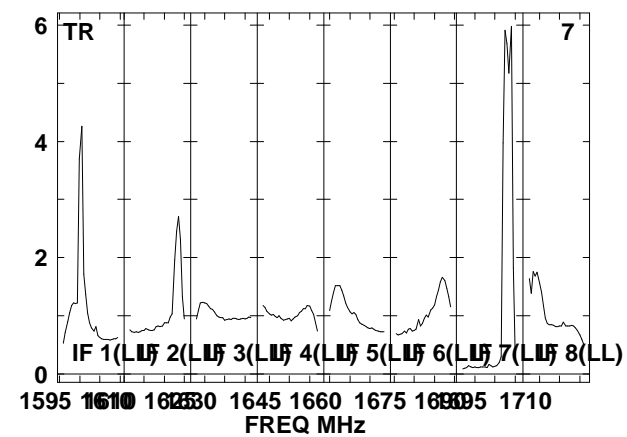
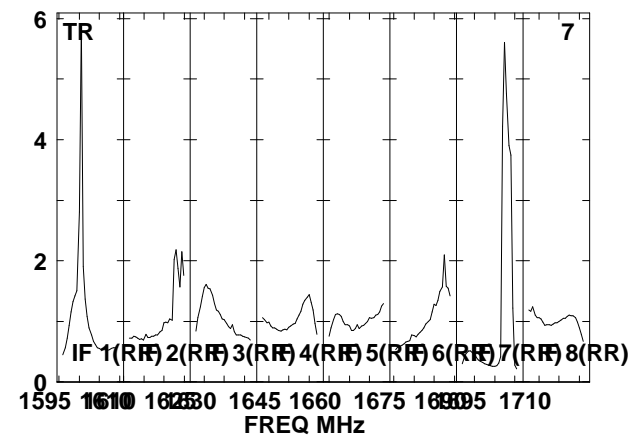
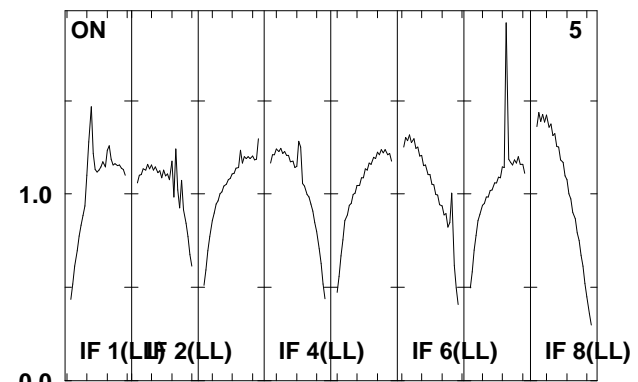
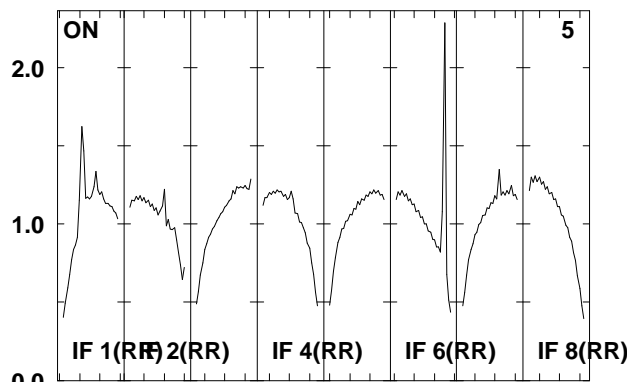
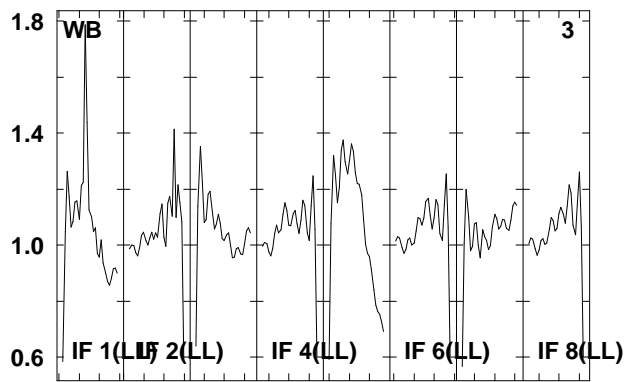
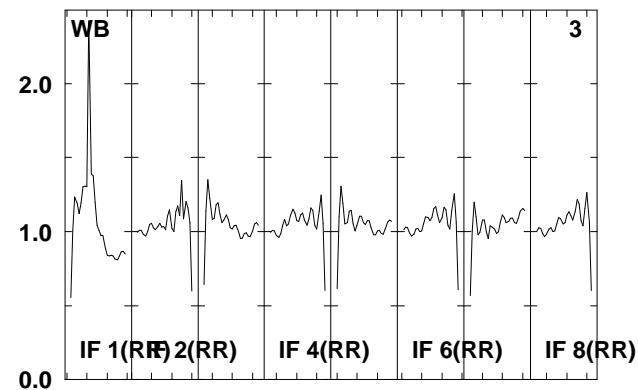
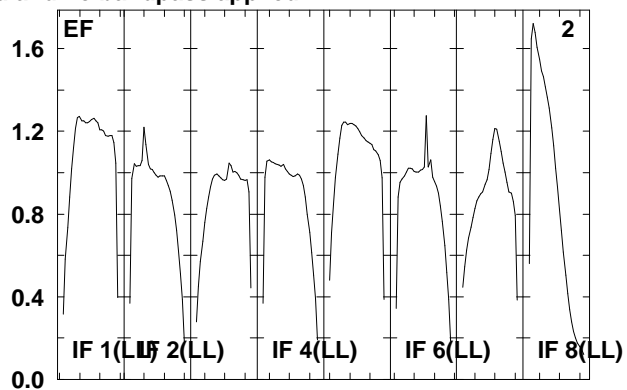
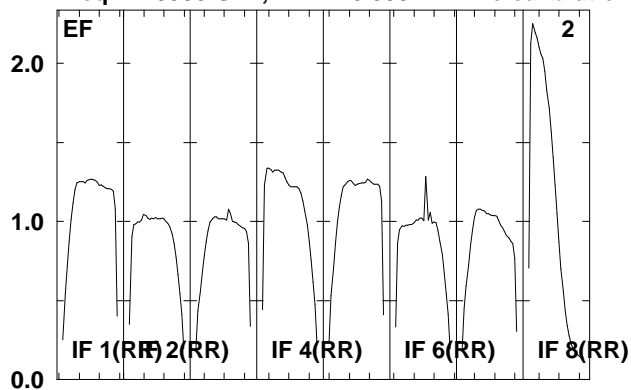

Lower frame: Real Jy
Total-power spectrum Antenna: *
Timerange: 00/15:43:35 to 00/15:44:59

Plot file version 163 created 06-JAN-2012 11:47:00

J1128+59 EP068D 5.UVDATA.1

Freq = 1.5950 GHz, Bw = 16.000 MH No calibration applied and no bandpass applied

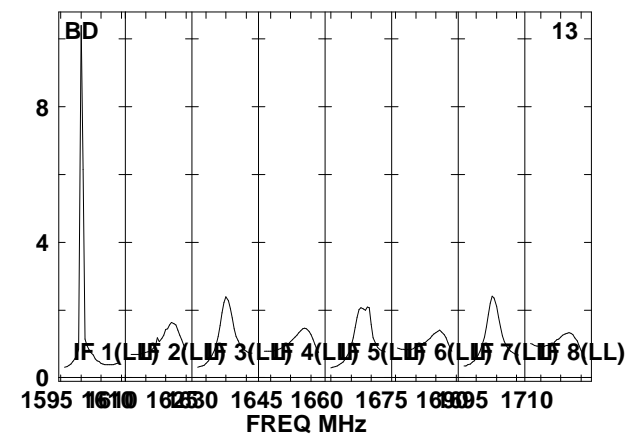
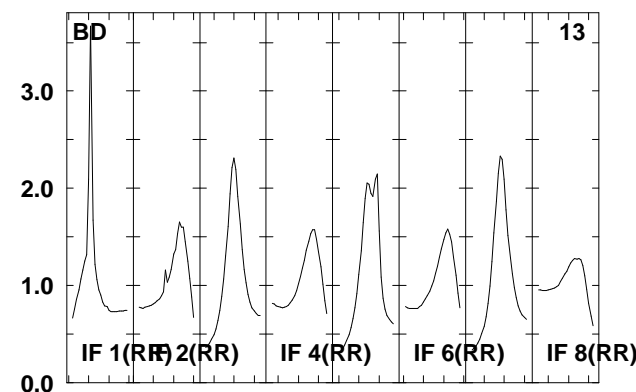
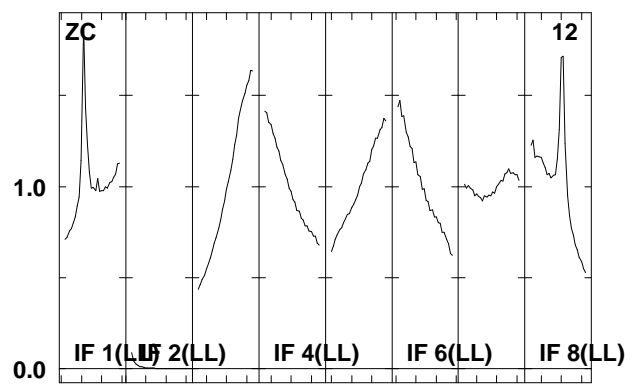
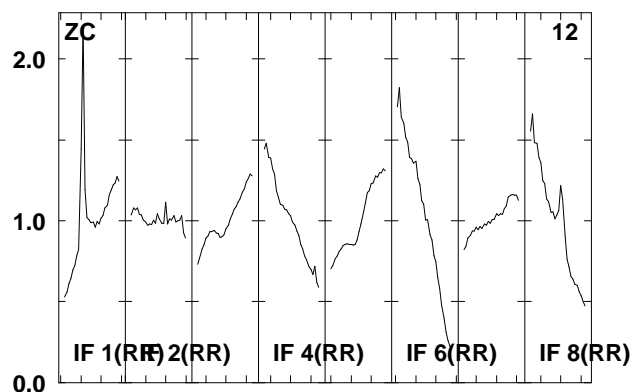
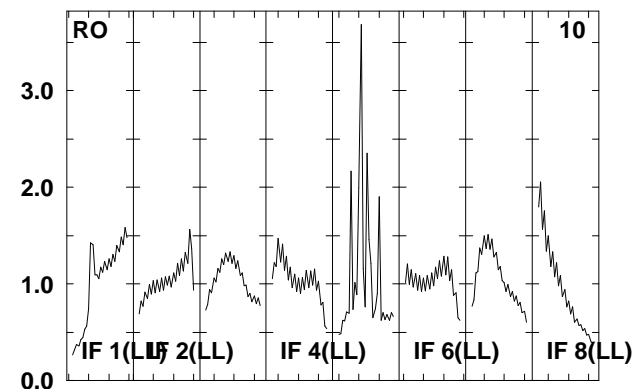
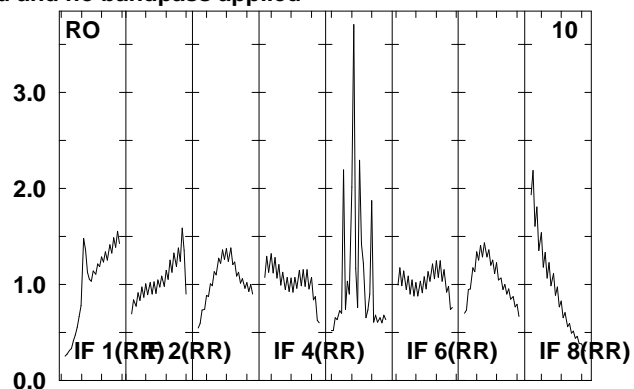
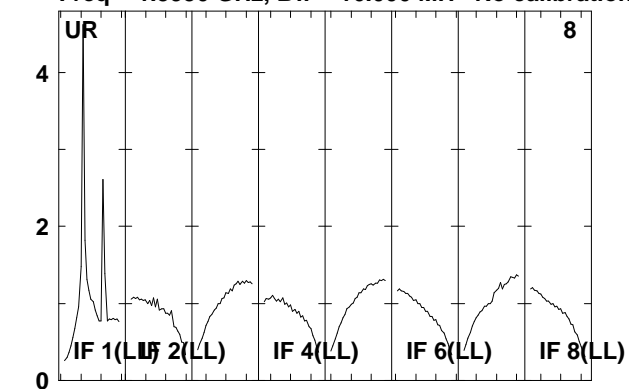

Lower frame: Real Jy

Total-power spectrum Antenna: *

Timerange: 00/15:43:35 to 00/15:44:59

Plot file version 164 created 06-JAN-2012 11:47:00

ARP299D EP068D 5.UVDATA.1

Freq = 1.5950 GHz, Bw = 16.000 MH No calibration applied and no bandpass applied

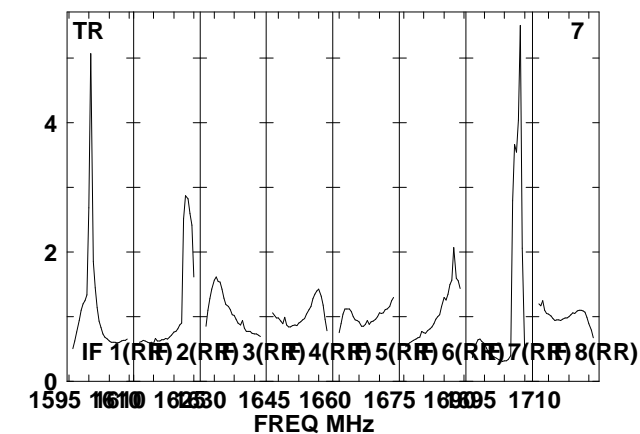
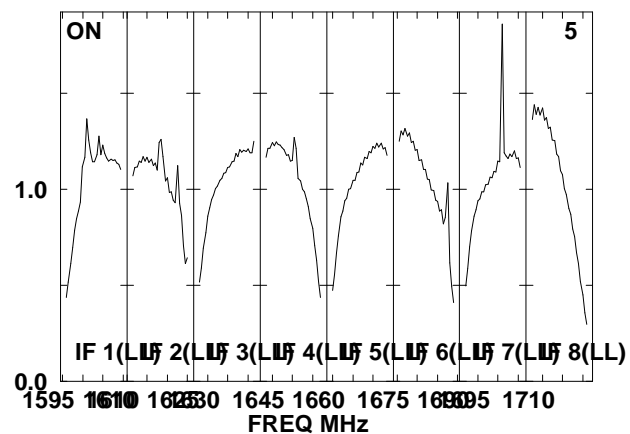
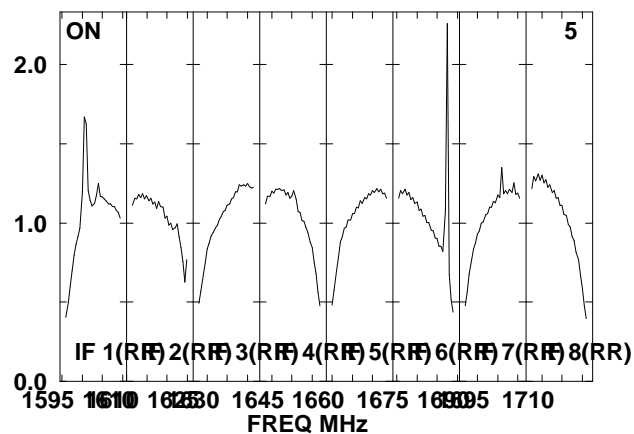
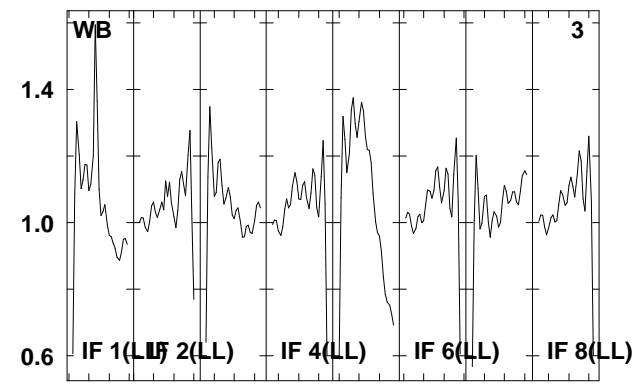
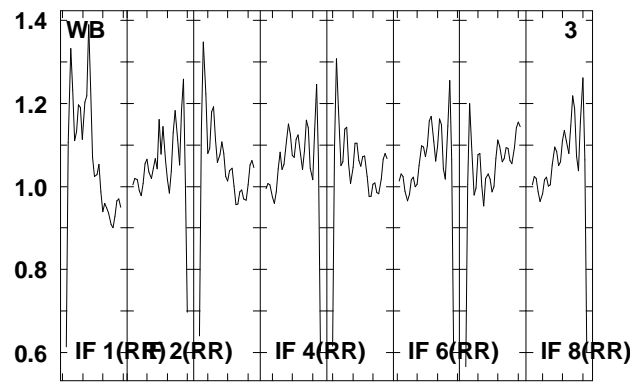
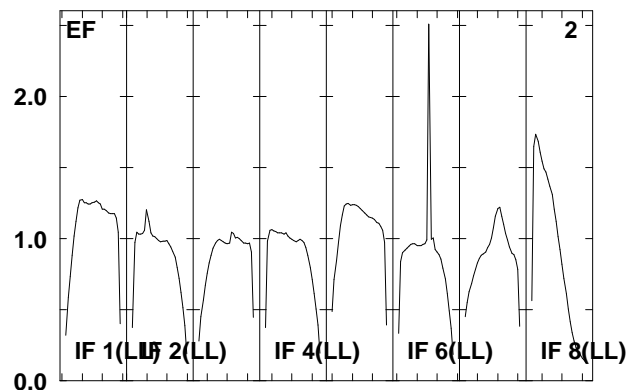
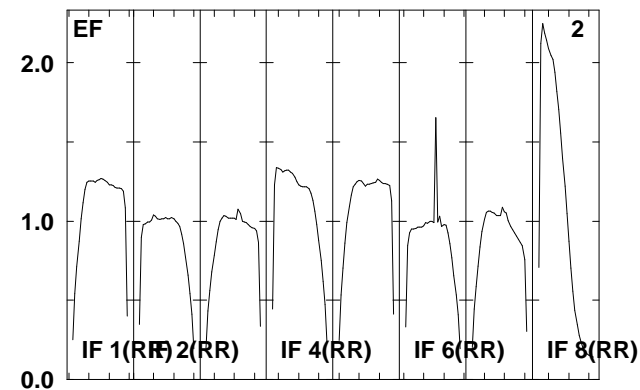
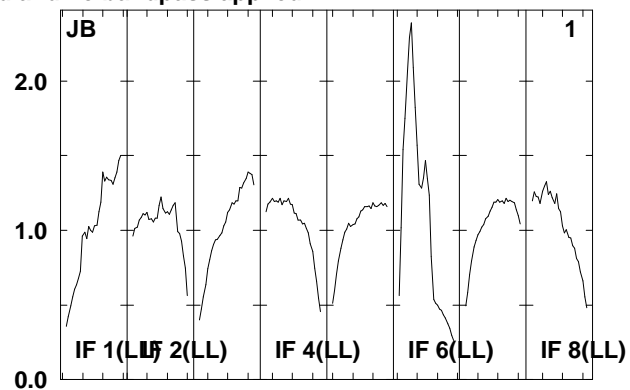
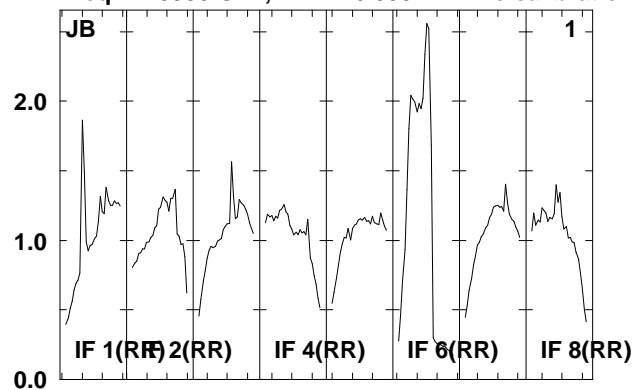

Lower frame: Real Jy
Total-power spectrum Antenna: *
Timerange: 00/15:45:01 to 00/15:48:29

Plot file version 165 created 06-JAN-2012 11:47:01

ARP299D EP068D 5.UVDATA.1

Freq = 1.5950 GHz, Bw = 16.000 MH No calibration applied and no bandpass applied

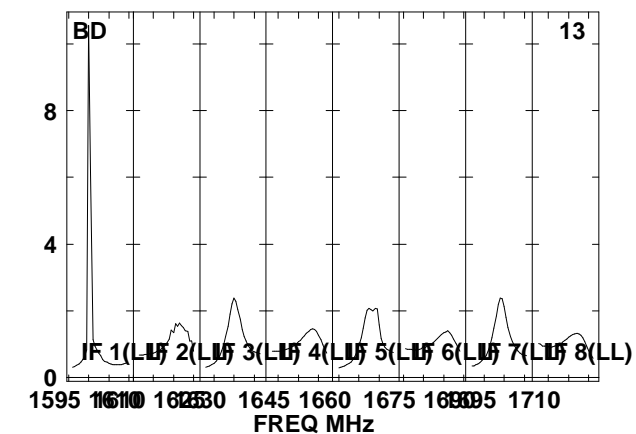
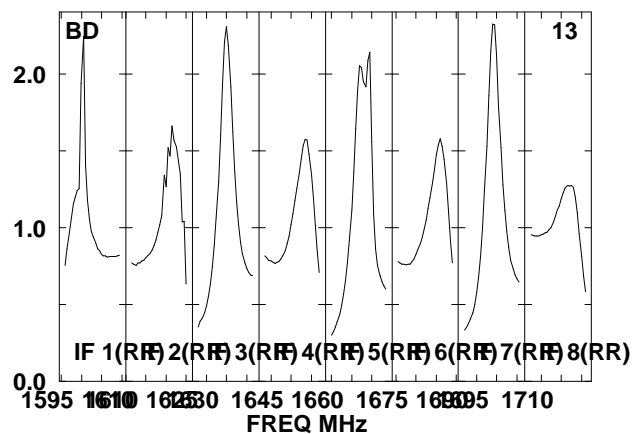
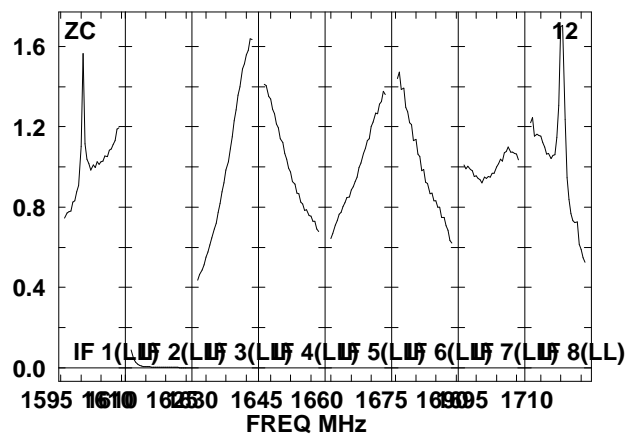
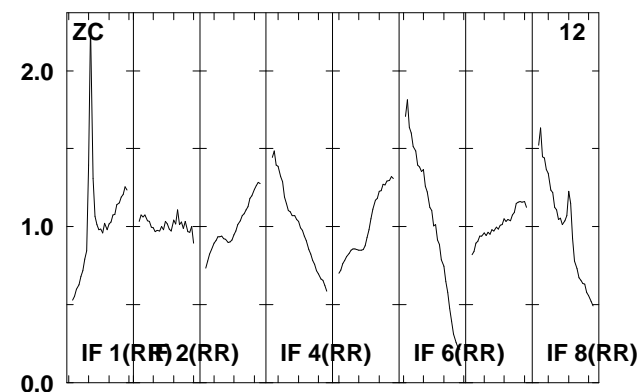
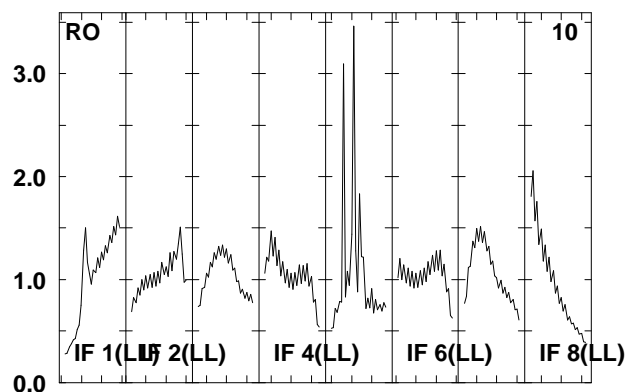
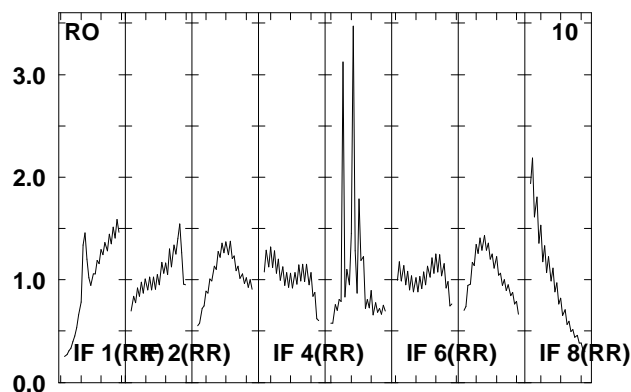
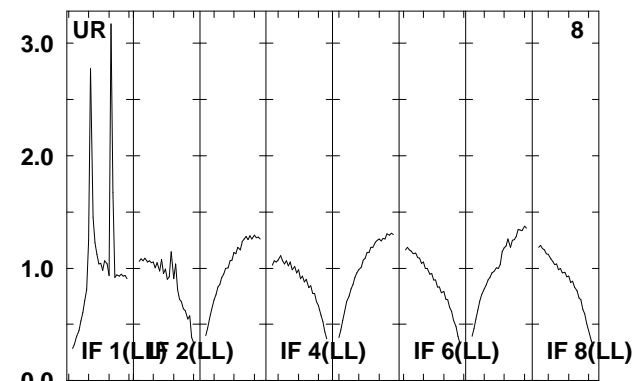
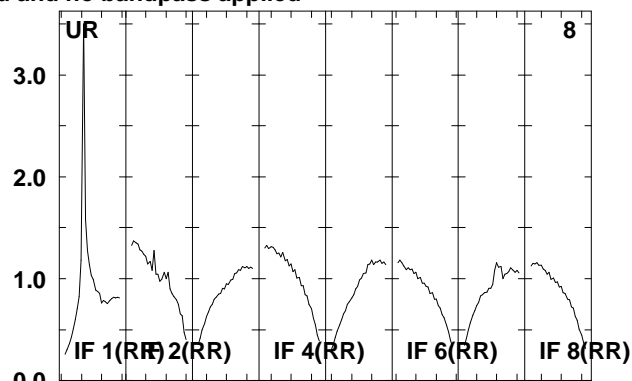
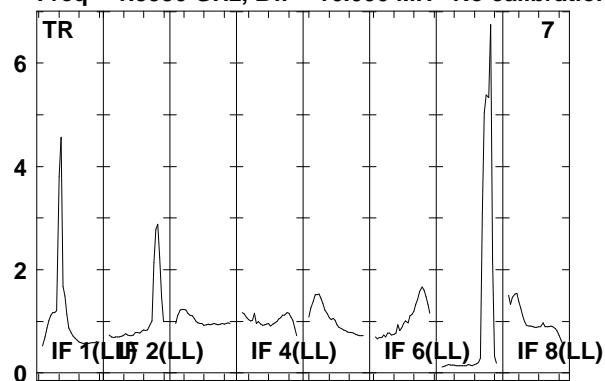

Lower frame: Real Jy
Total-power spectrum Antenna: *
Timerange: 00/15:45:01 to 00/15:48:29

Plot file version 166 created 06-JAN-2012 11:47:01

J1128+59 EP068D 5.UVDATA.1

Freq = 1.5950 GHz, Bw = 16.000 MH No calibration applied and no bandpass applied

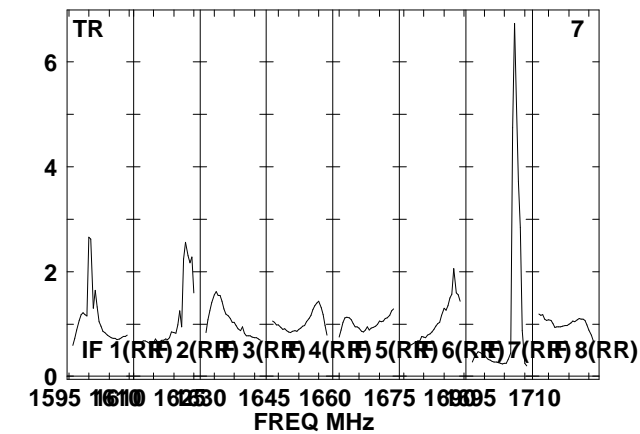
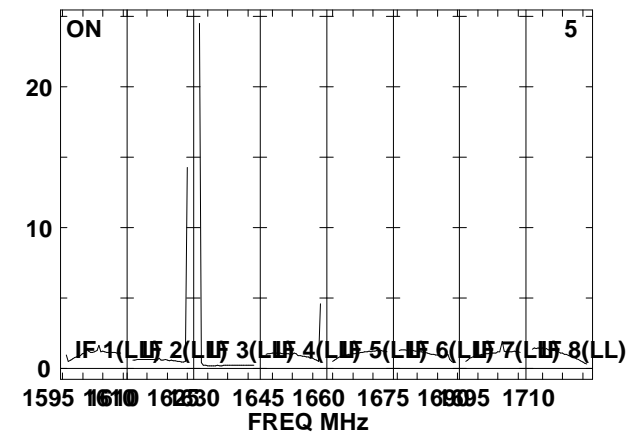
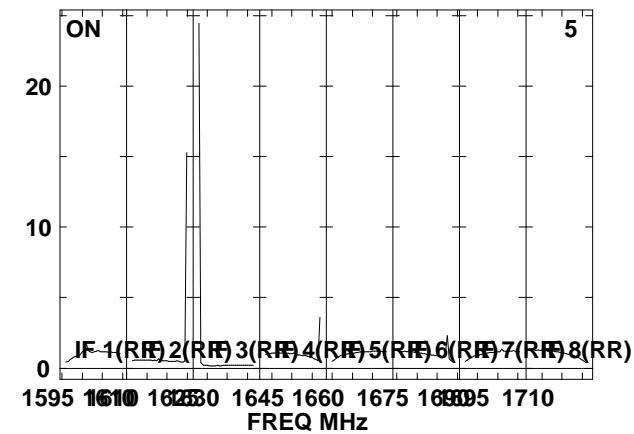
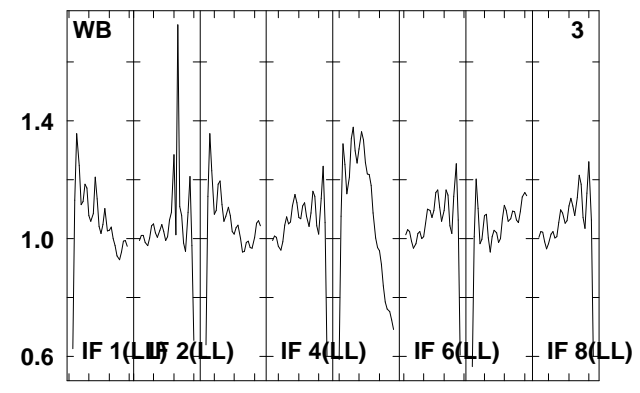
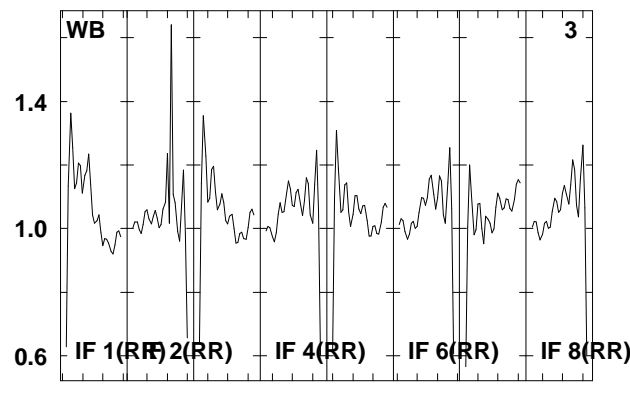
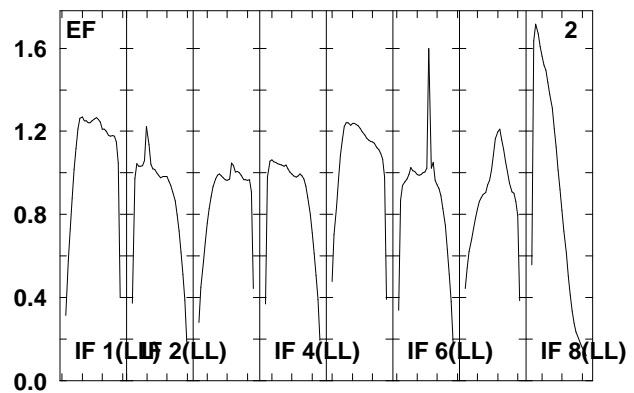
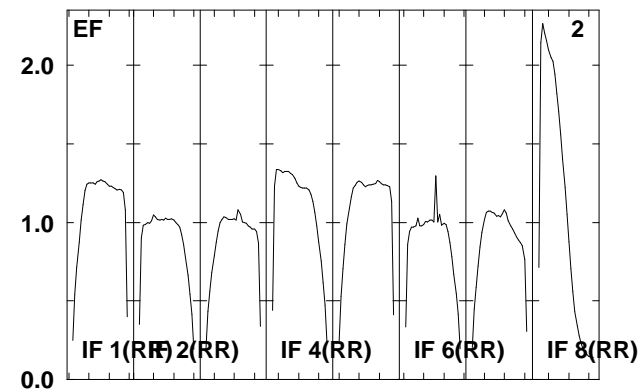
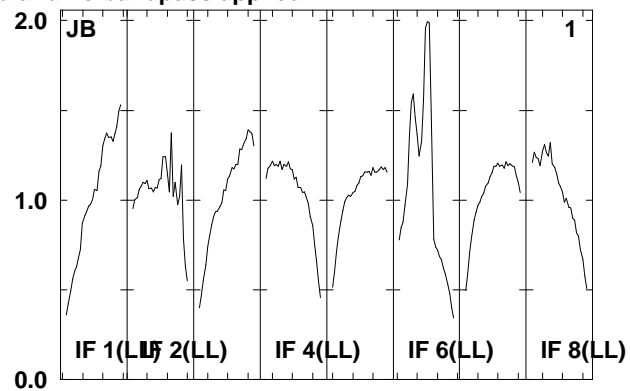
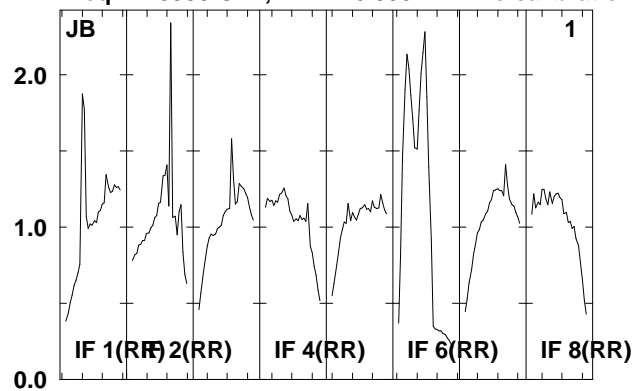

Lower frame: Real Jy
Total-power spectrum Antenna: *
Timerange: 00/15:49:31 to 00/15:50:59

Plot file version 167 created 06-JAN-2012 11:47:02

J1128+59 EP068D 5.UVDATA.1

Freq = 1.5950 GHz, Bw = 16.000 MH No calibration applied and no bandpass applied

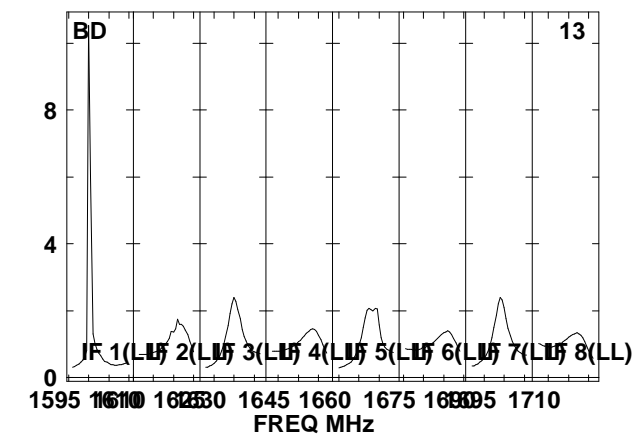
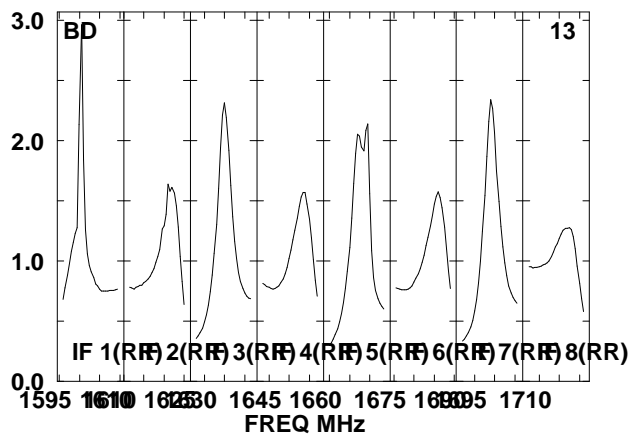
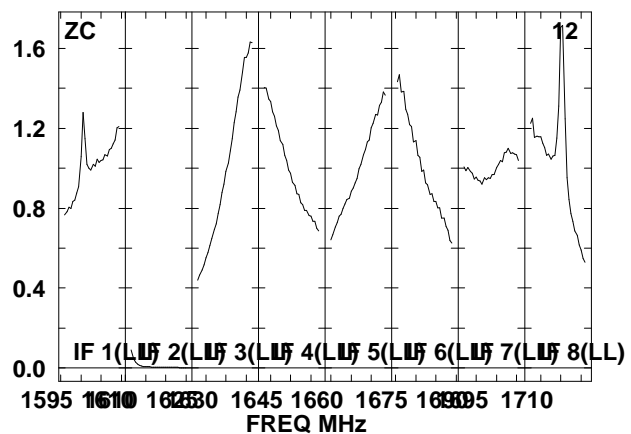
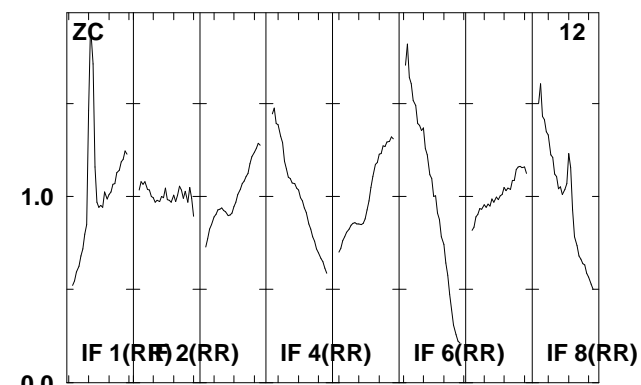
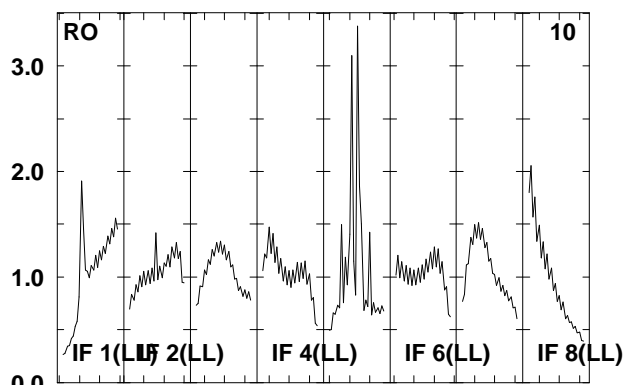
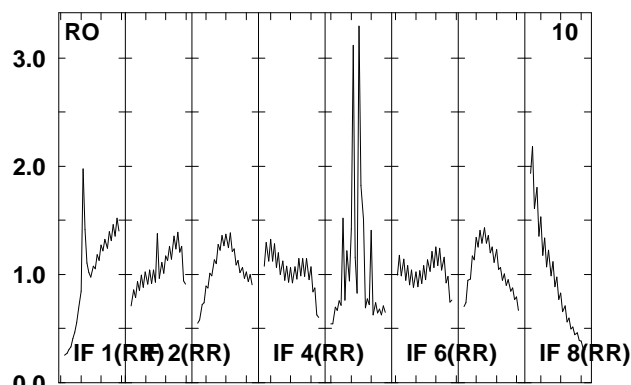
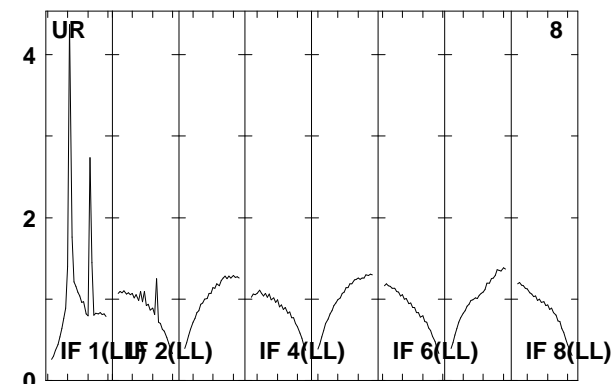
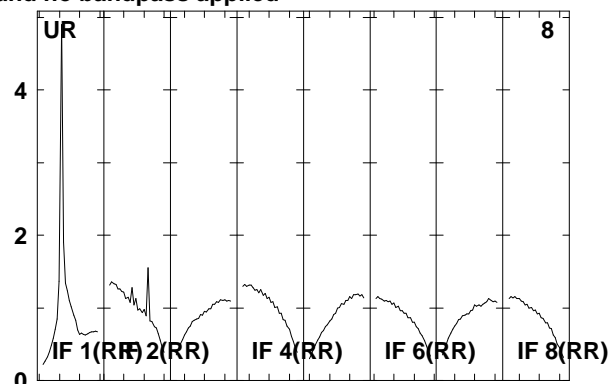
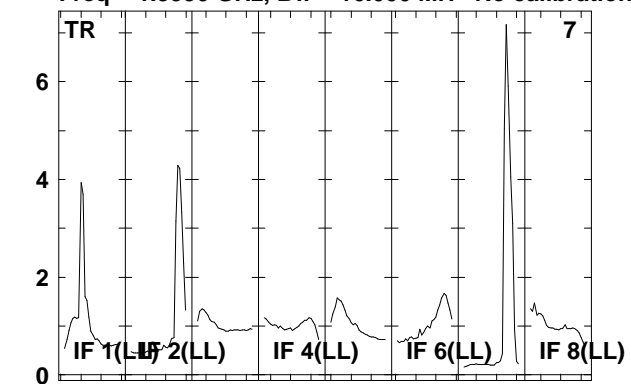

Lower frame: Real Jy
Total-power spectrum Antenna: *
Timerange: 00/15:49:31 to 00/15:50:59

Plot file version 168 created 06-JAN-2012 11:47:02

ARP299D EP068D 5.UVDATA.1

Freq = 1.5950 GHz, Bw = 16.000 MH No calibration applied and no bandpass applied

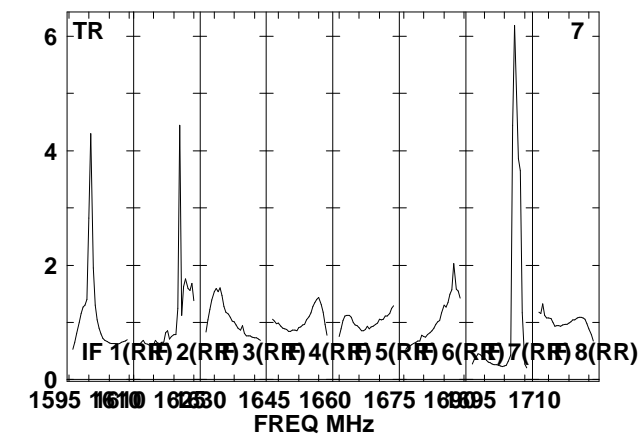
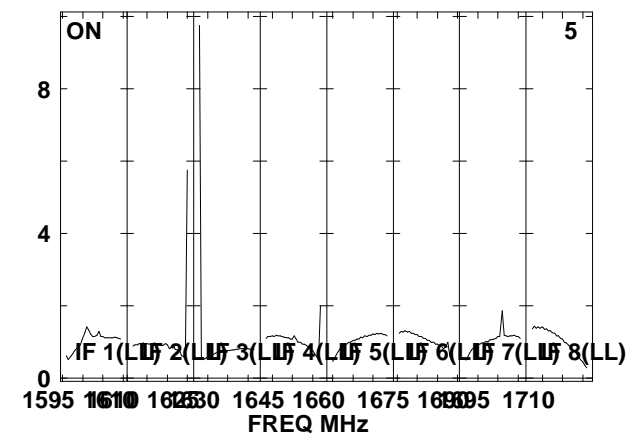
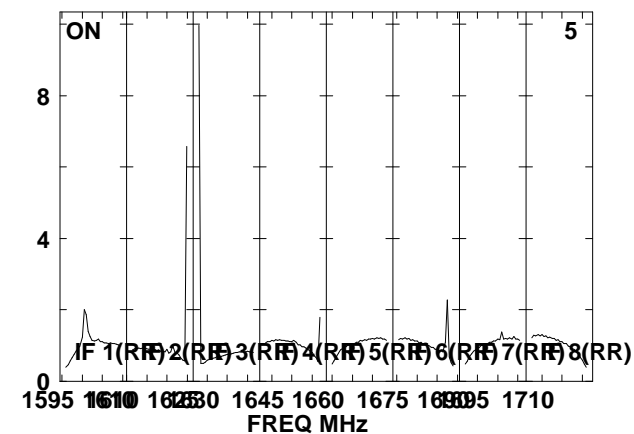
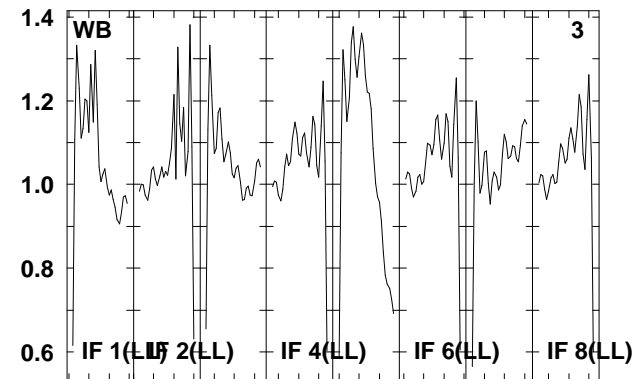
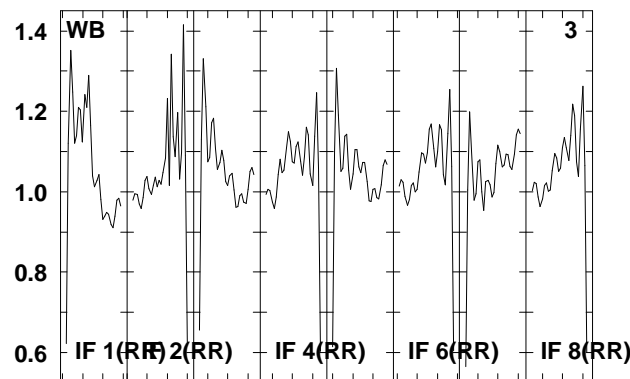
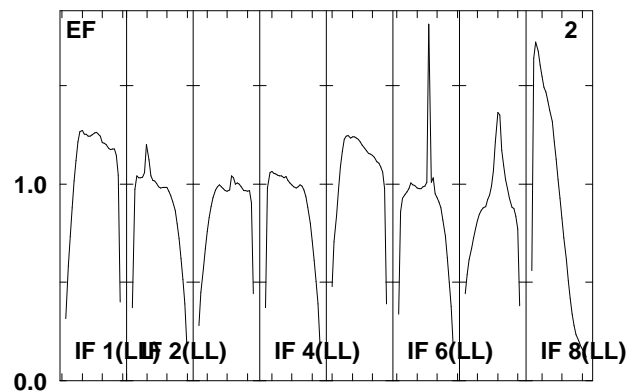
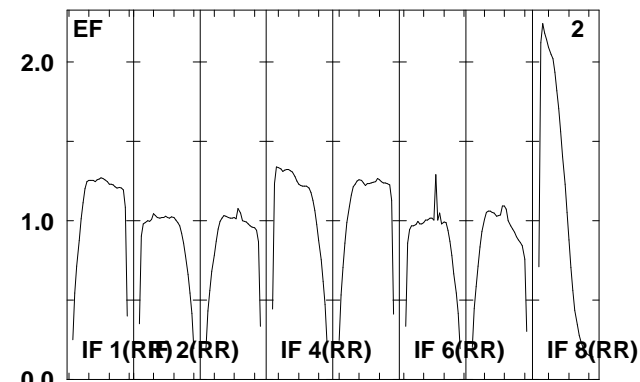
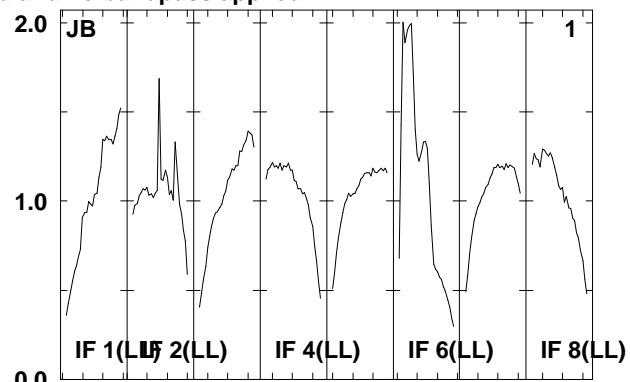
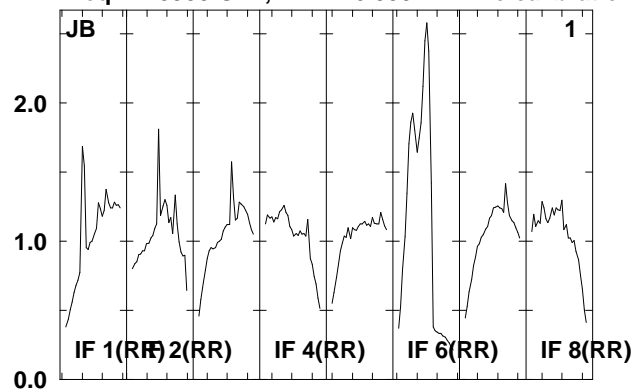

Lower frame: Real Jy
Total-power spectrum Antenna: *
Timerange: 00/15:51:05 to 00/15:54:29

Plot file version 169 created 06-JAN-2012 11:47:03

ARP299D EP068D 5.UVDATA.1

Freq = 1.5950 GHz, Bw = 16.000 MH No calibration applied and no bandpass applied

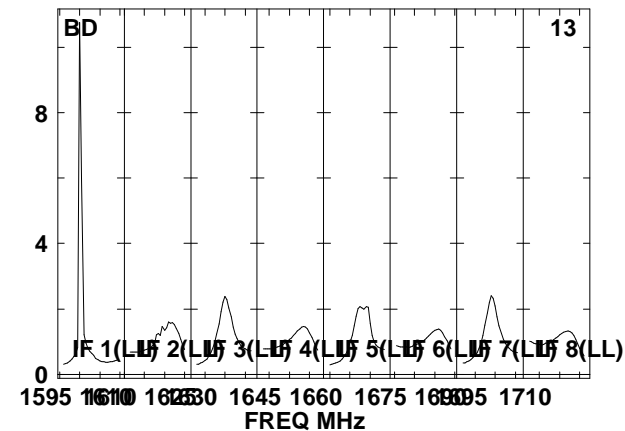
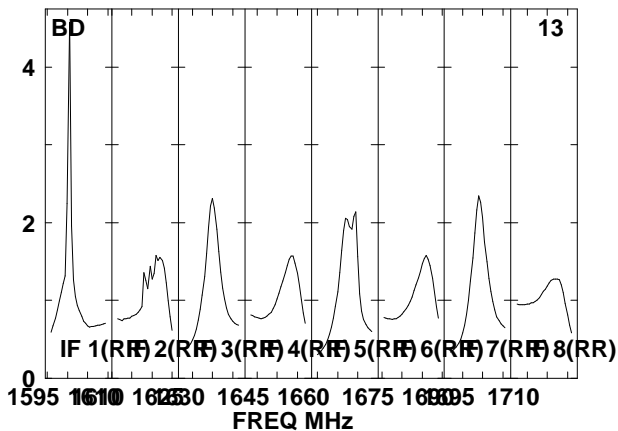
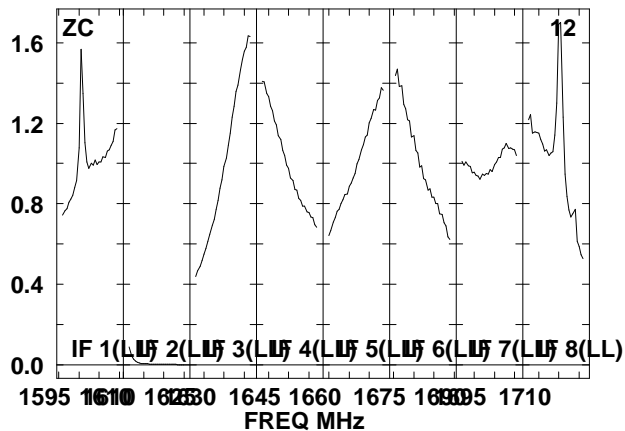
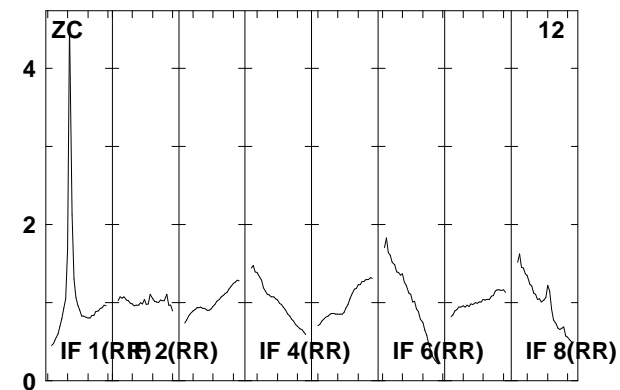
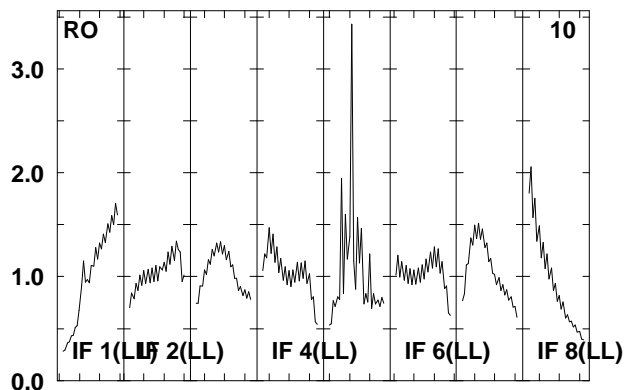
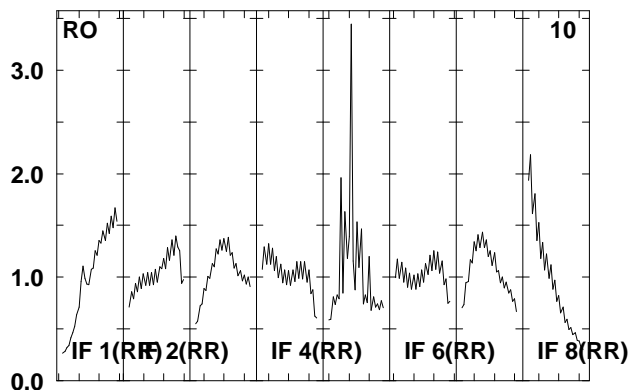
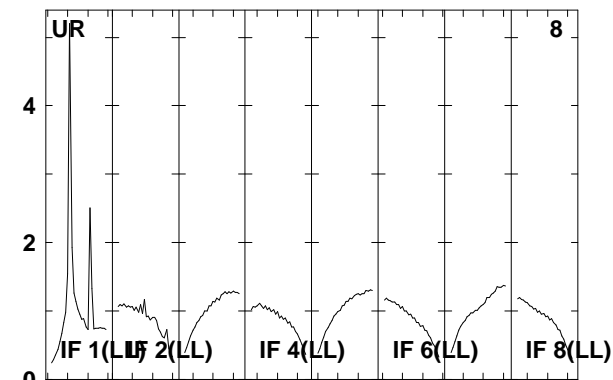
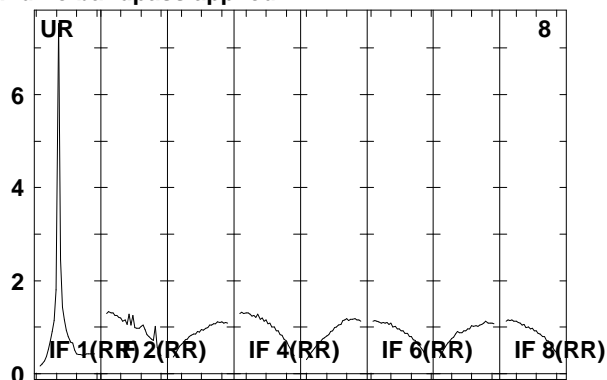
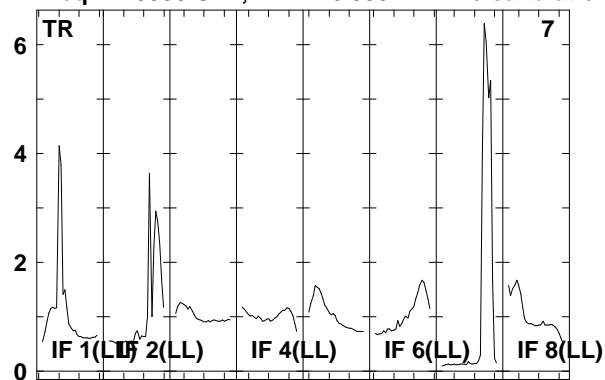

Lower frame: Real Jy

Total-power spectrum Antenna: *

Timerange: 00/15:51:05 to 00/15:54:29

Plot file version 170 created 06-JAN-2012 11:47:03

J1128+59 EP068D 5.UVDATA.1

Freq = 1.5950 GHz, Bw = 16.000 MH No calibration applied and no bandpass applied

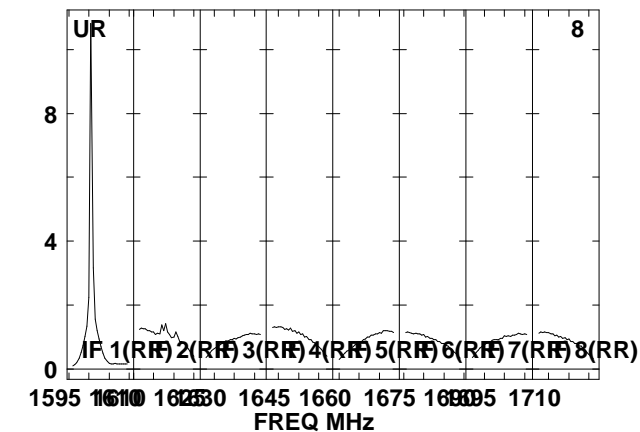
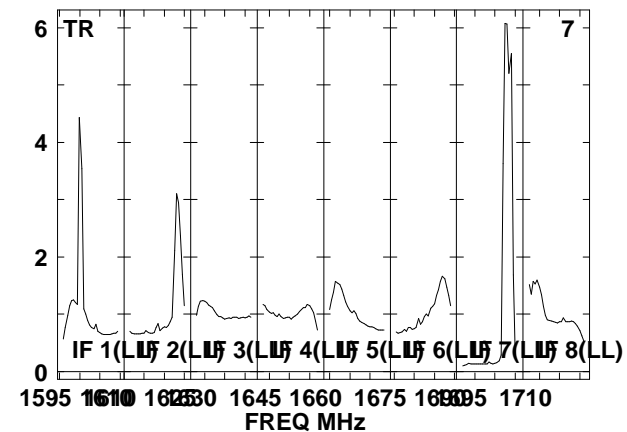
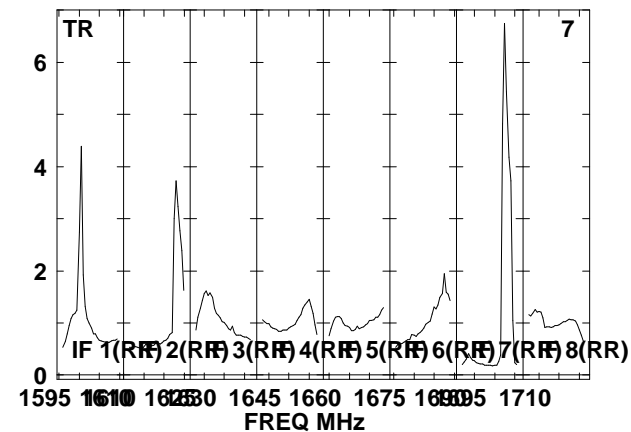
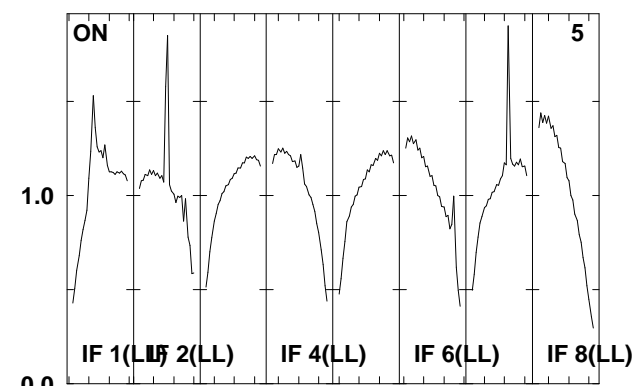
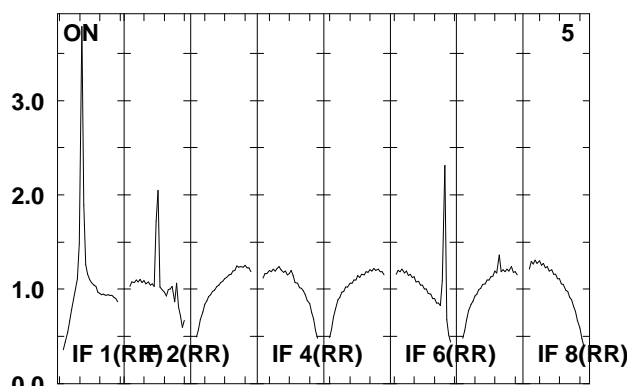
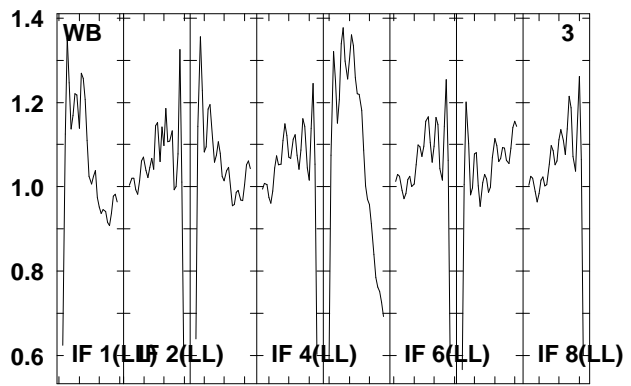
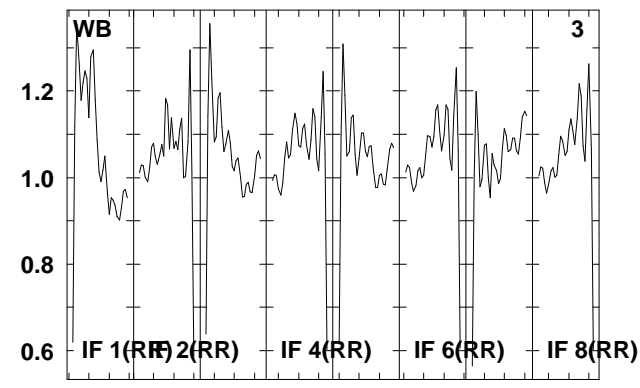
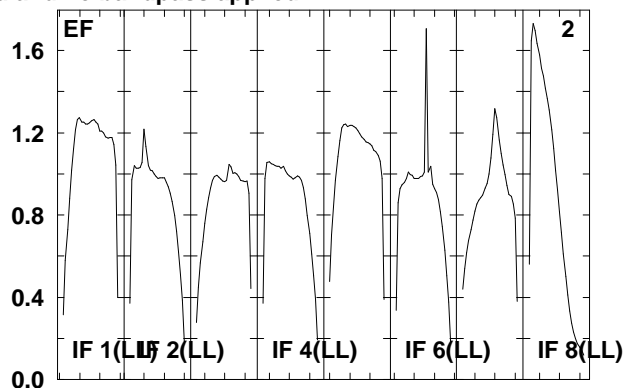
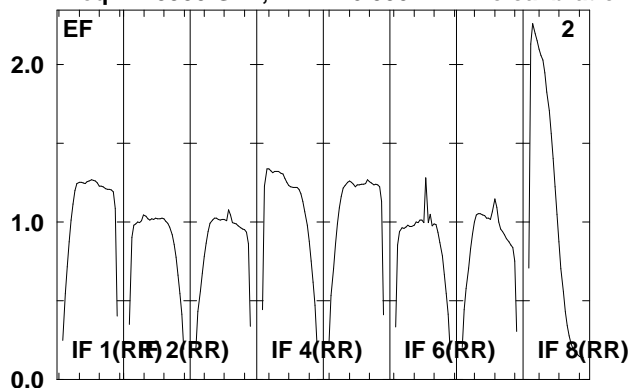

Lower frame: Real Jy
Total-power spectrum Antenna: *
Timerange: 00/15:54:35 to 00/15:55:59

Plot file version 171 created 06-JAN-2012 11:47:04

J1128+59 EP068D 5.UVDATA.1

Freq = 1.5950 GHz, Bw = 16.000 MH No calibration applied and no bandpass applied

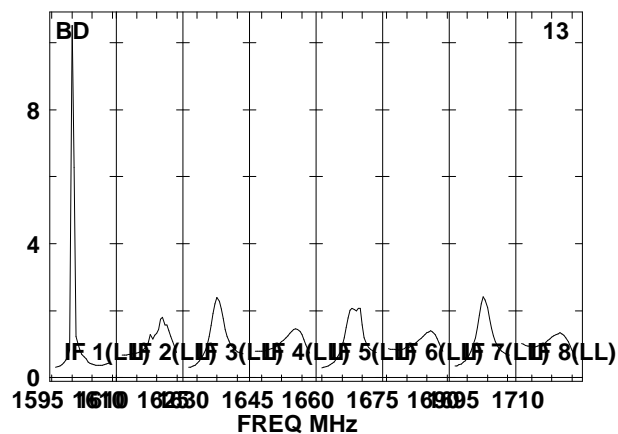
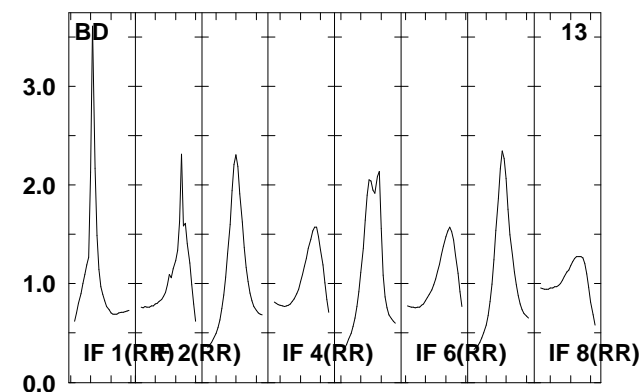
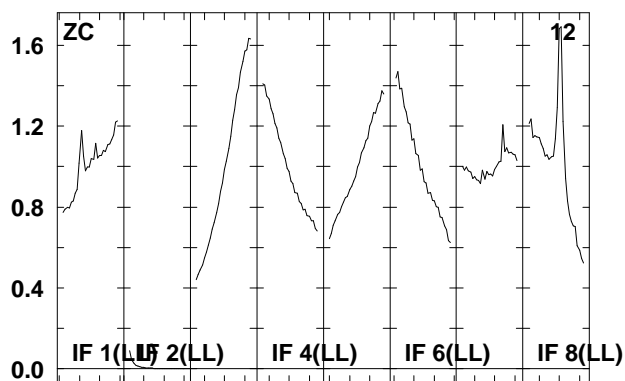
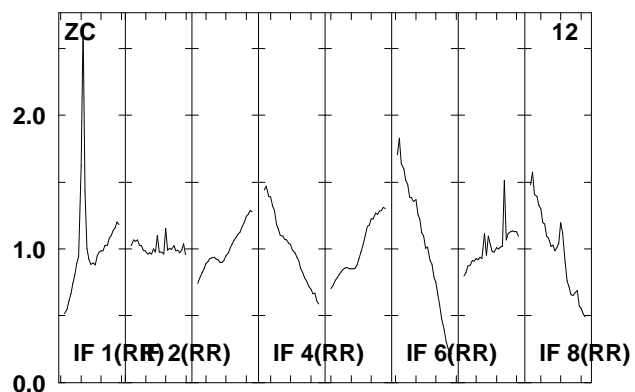
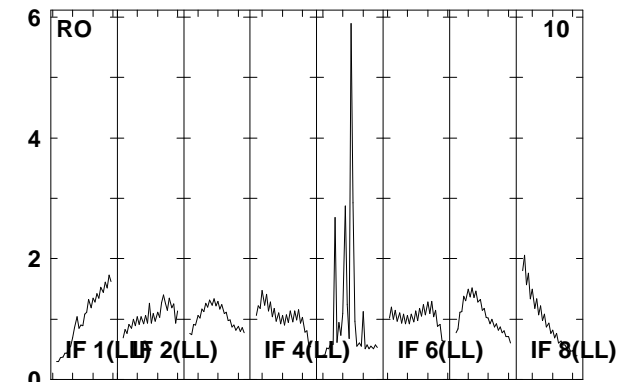
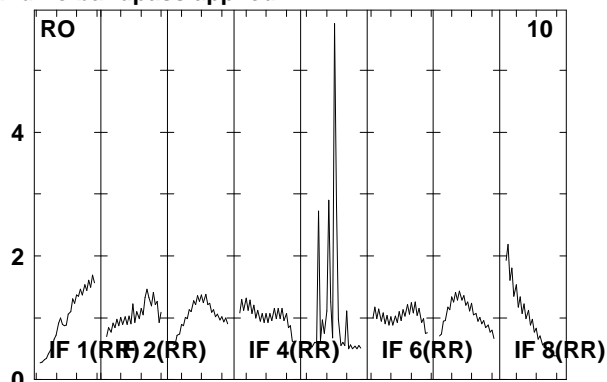
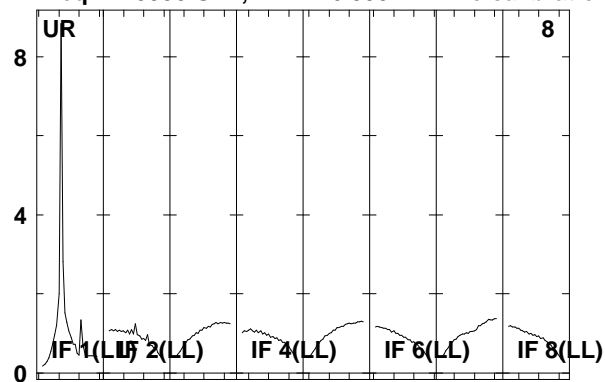

Lower frame: Real Jy

Total-power spectrum Antenna: *

Timerange: 00/15:54:35 to 00/15:55:59

Plot file version 172 created 06-JAN-2012 11:47:04

ARP299D EP068D 5.UVDATA.1

Freq = 1.5950 GHz, Bw = 16.000 MH No calibration applied and no bandpass applied

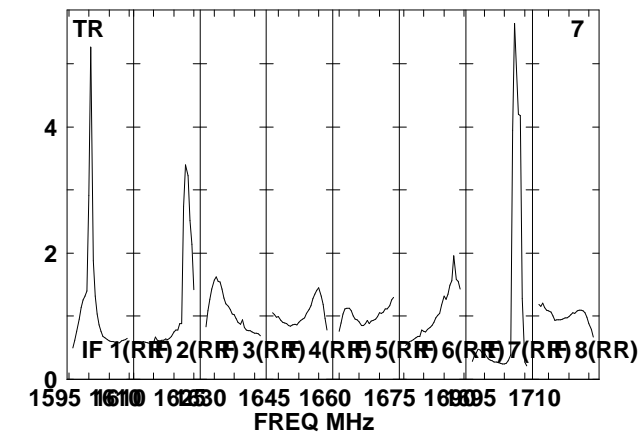
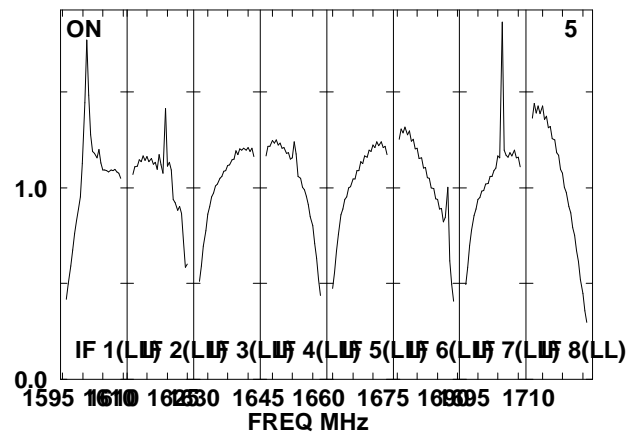
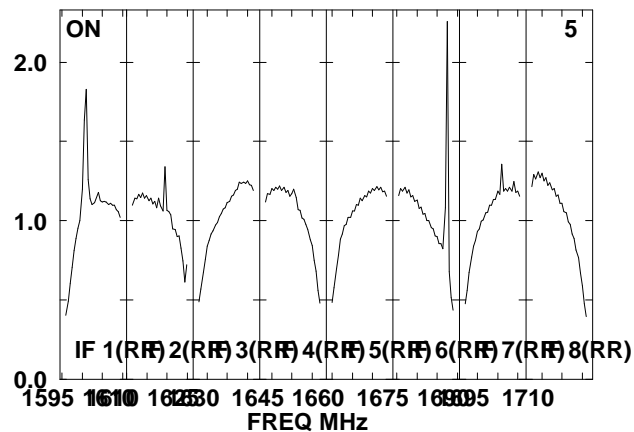
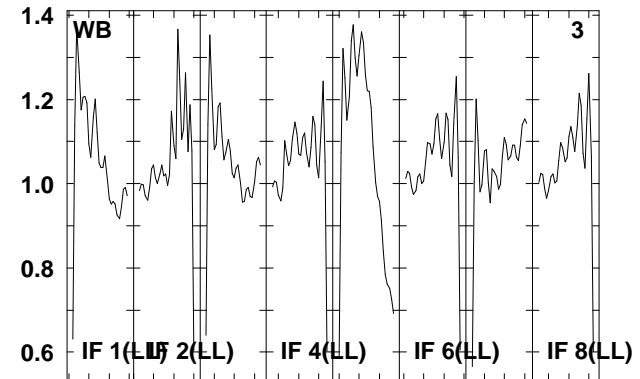
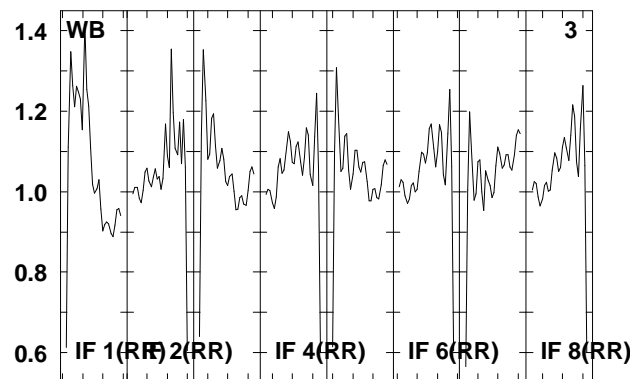
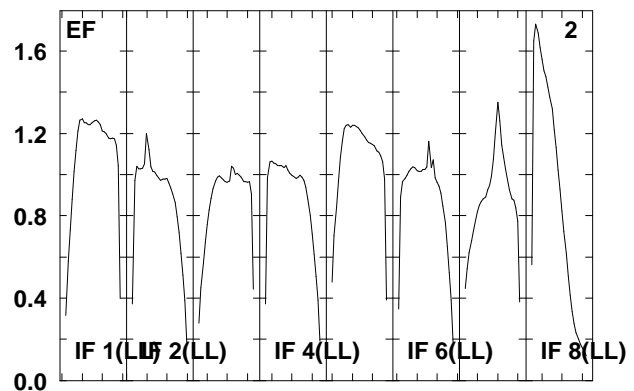
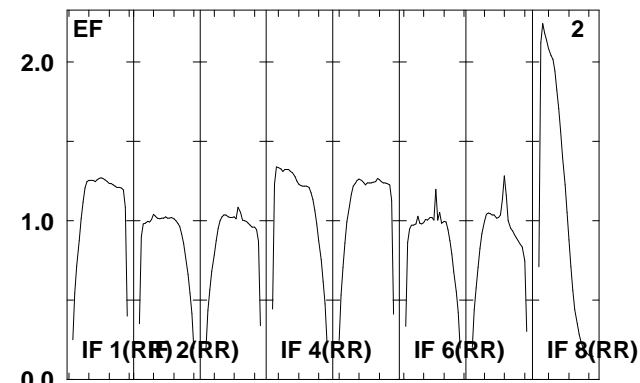
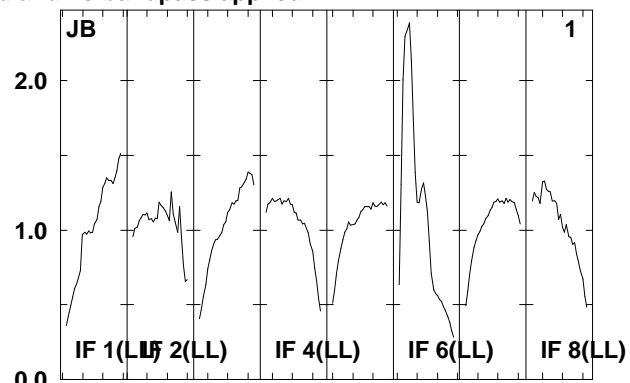
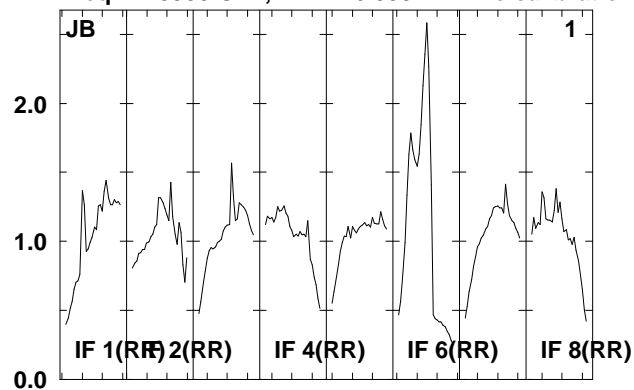

Lower frame: Real Jy
Total-power spectrum Antenna: *
Timerange: 00/15:56:01 to 00/15:59:29

Plot file version 173 created 06-JAN-2012 11:47:05

ARP299D EP068D 5.UVDATA.1

Freq = 1.5950 GHz, Bw = 16.000 MH No calibration applied and no bandpass applied

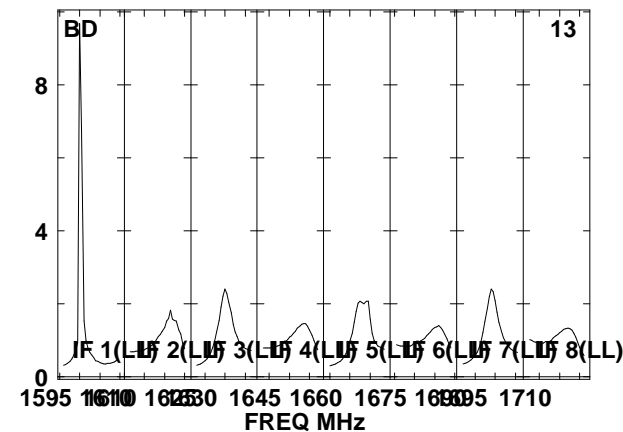
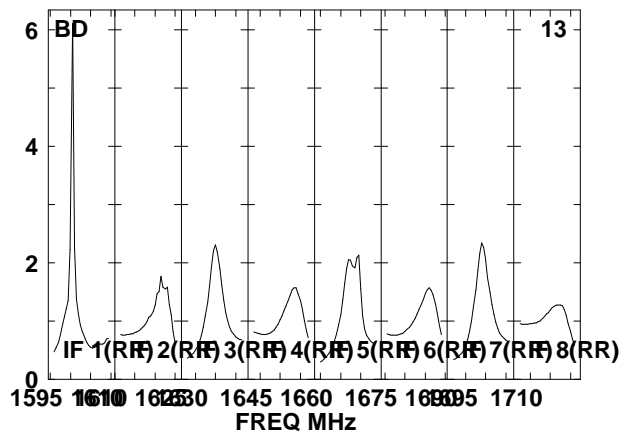
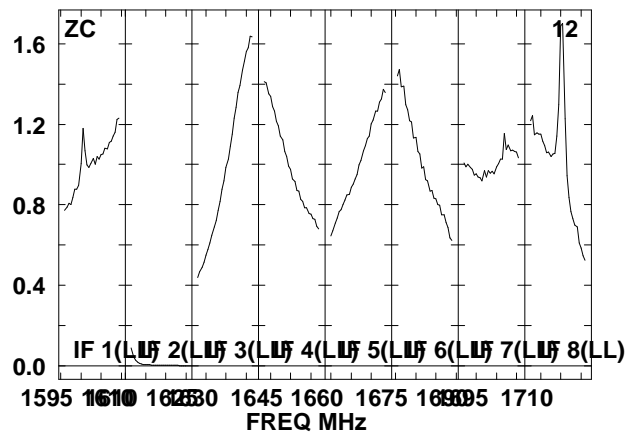
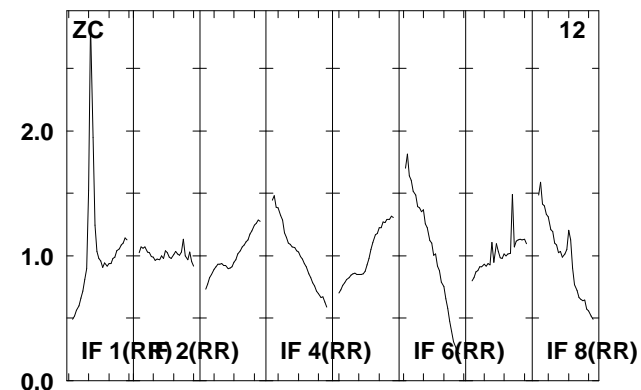
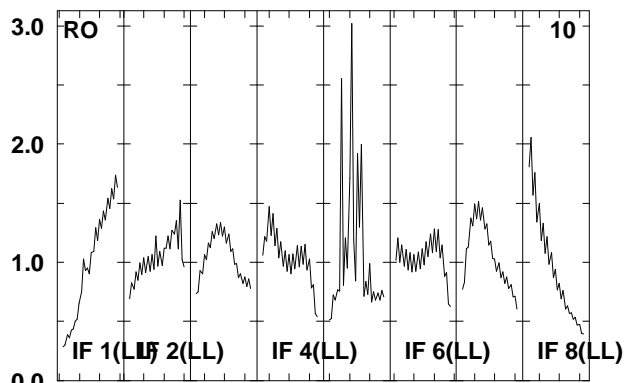
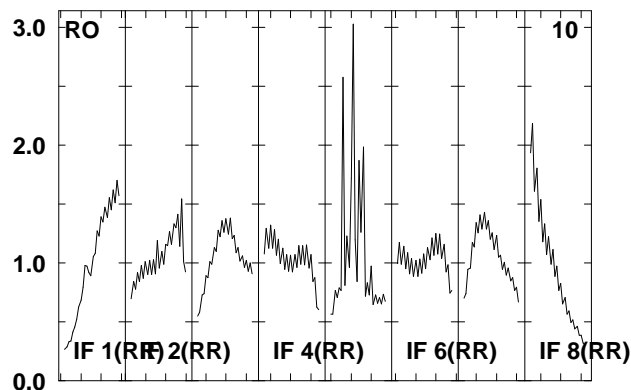
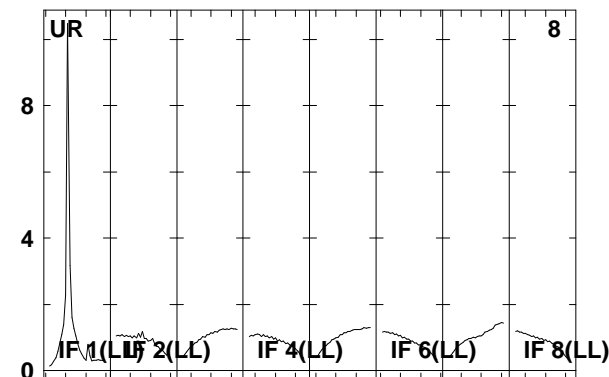
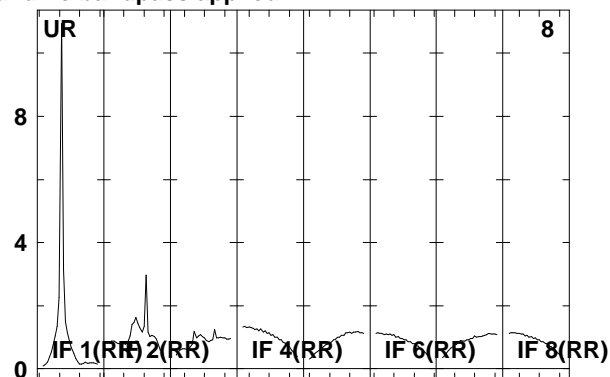
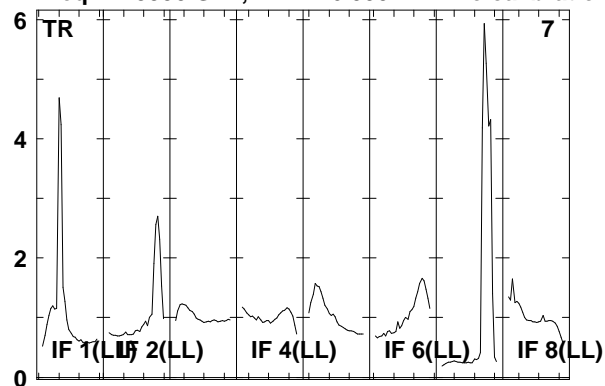

Lower frame: Real Jy

Total-power spectrum Antenna: *

Timerange: 00/15:56:01 to 00/15:59:29

Plot file version 174 created 06-JAN-2012 11:47:05

J1128+59 EP068D 5.UVDATA.1

Freq = 1.5950 GHz, Bw = 16.000 MH No calibration applied and no bandpass applied

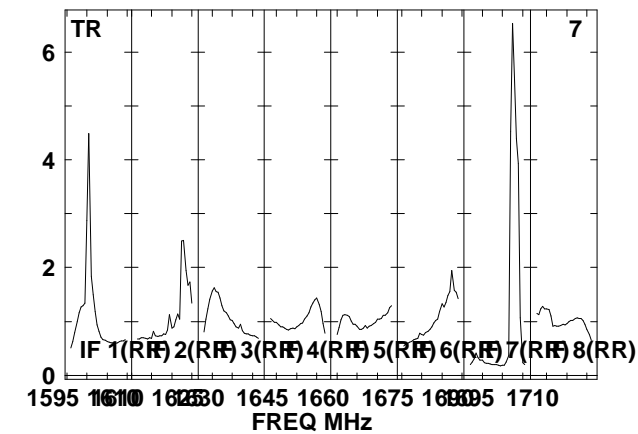
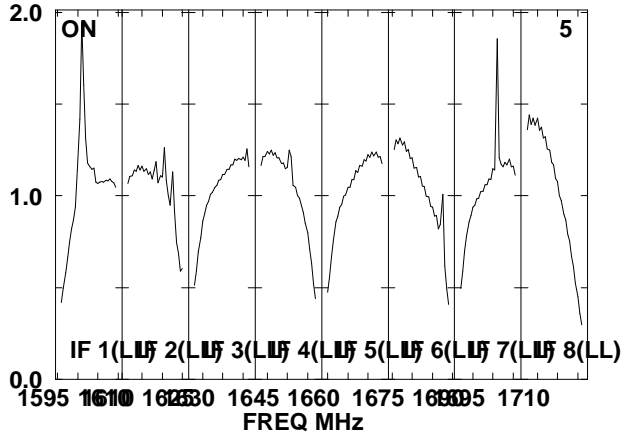
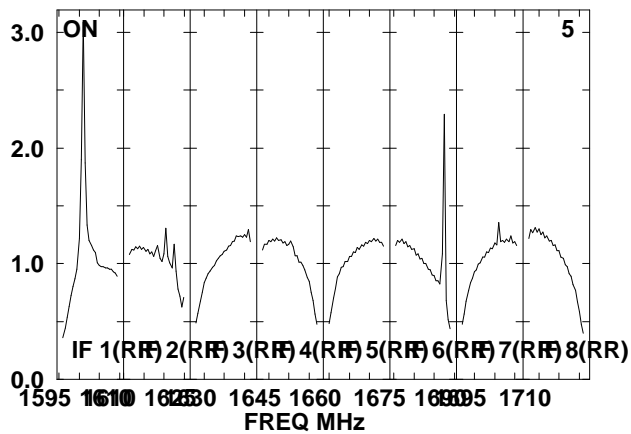
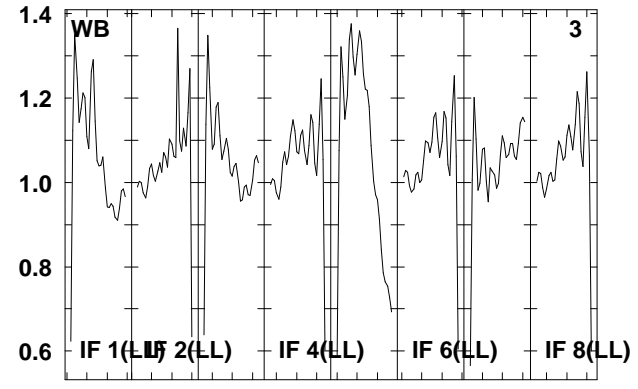
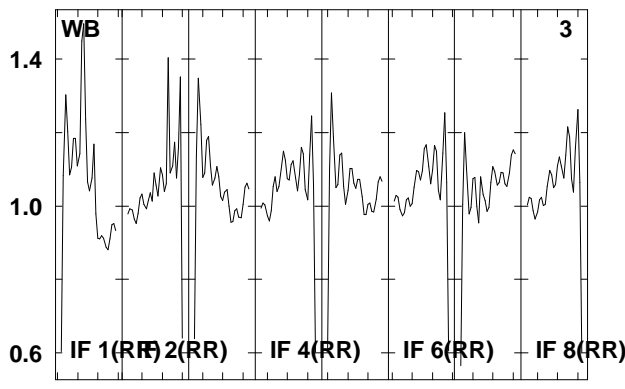
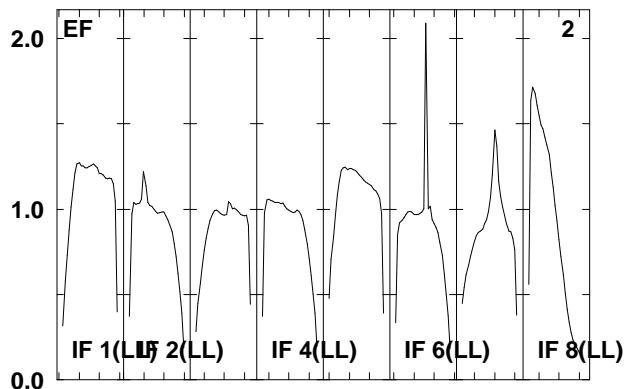
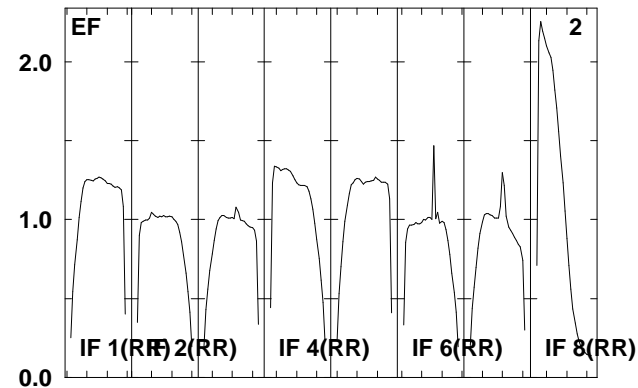
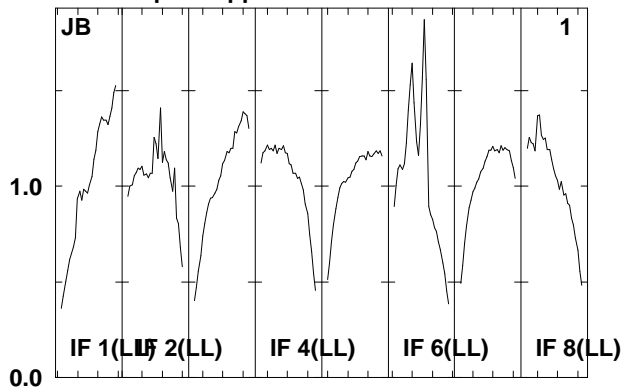
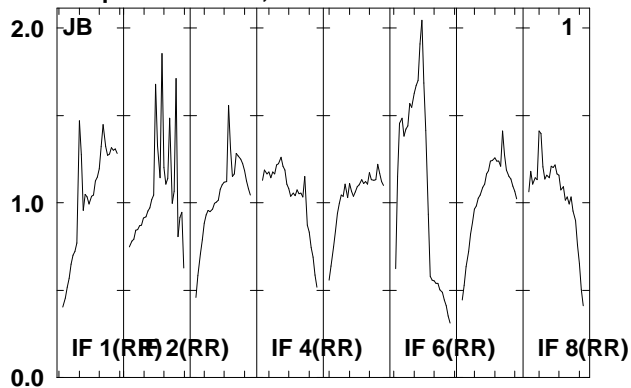

Lower frame: Real Jy
Total-power spectrum Antenna: *
Timerange: 00/15:59:35 to 00/16:00:59

Plot file version 175 created 06-JAN-2012 11:47:05

J1128+59 EP068D 5.UVDATA.1

Freq = 1.5950 GHz, Bw = 16.000 MH No calibration applied and no bandpass applied

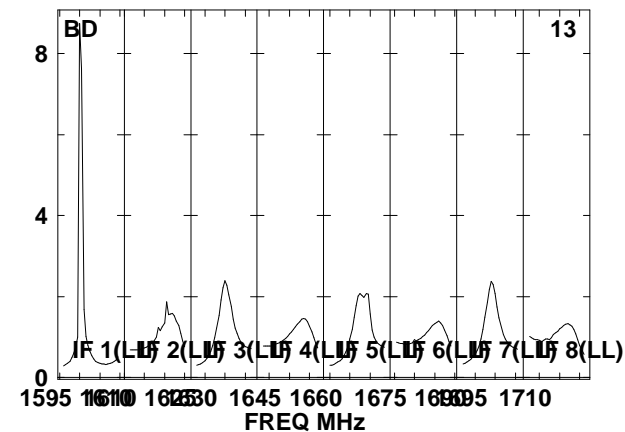
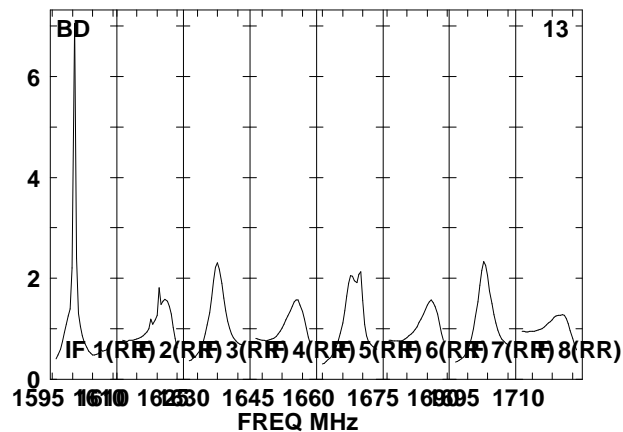
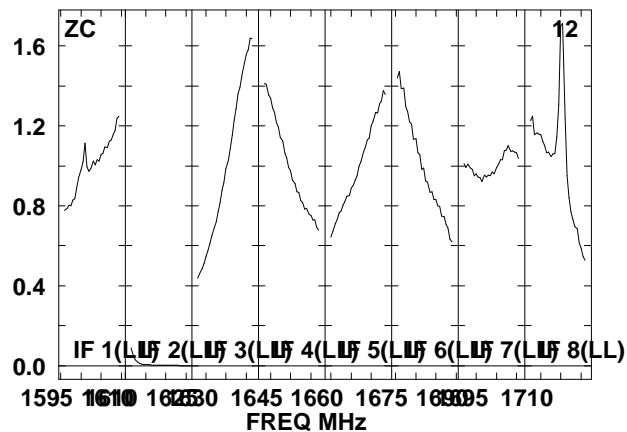
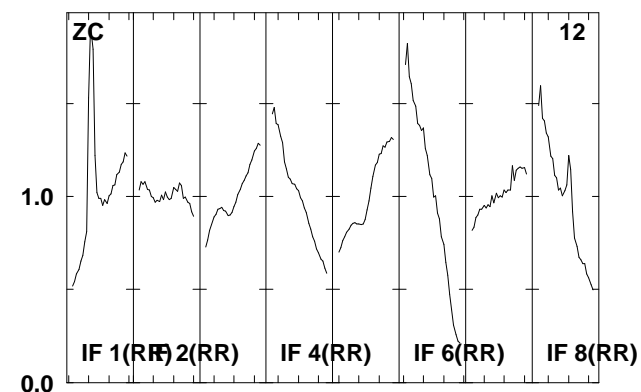
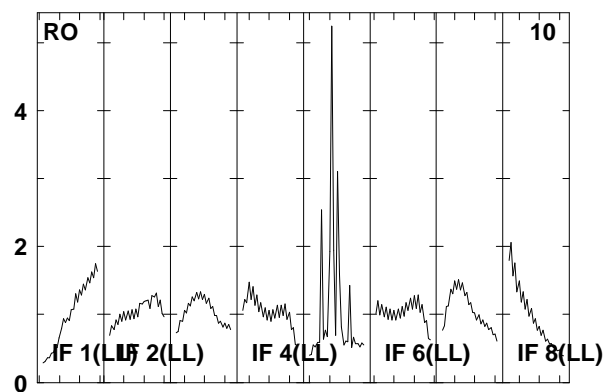
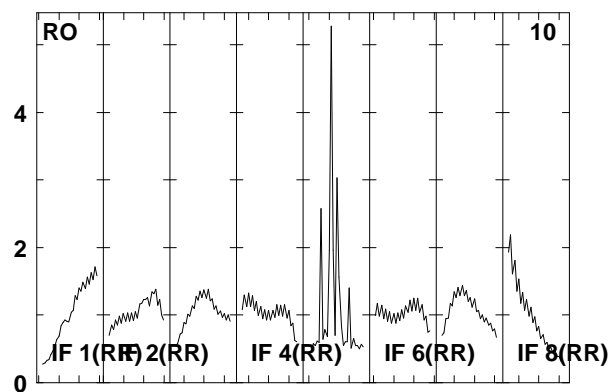
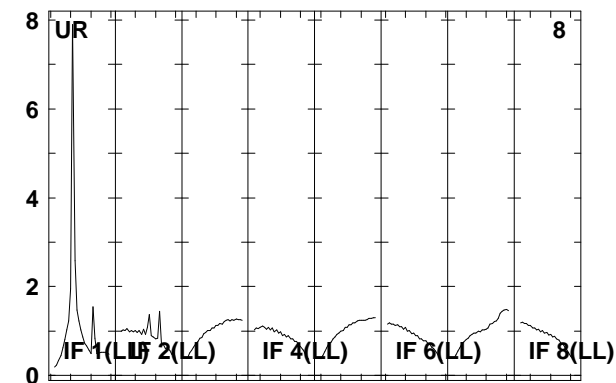
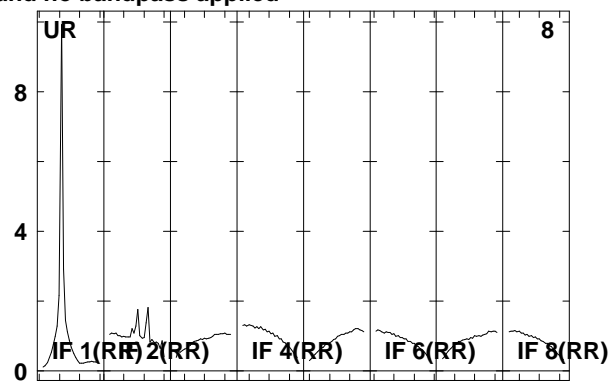
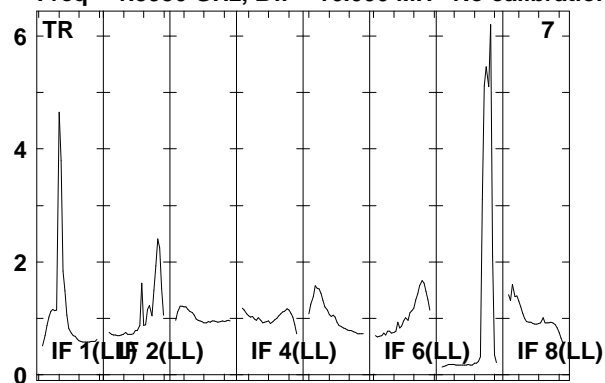

Lower frame: Real Jy
Total-power spectrum Antenna: *
Timerange: 00/15:59:35 to 00/16:00:59

Plot file version 176 created 06-JAN-2012 11:47:06

ARP299D EP068D 5.UVDATA.1

Freq = 1.5950 GHz, Bw = 16.000 MH No calibration applied and no bandpass applied

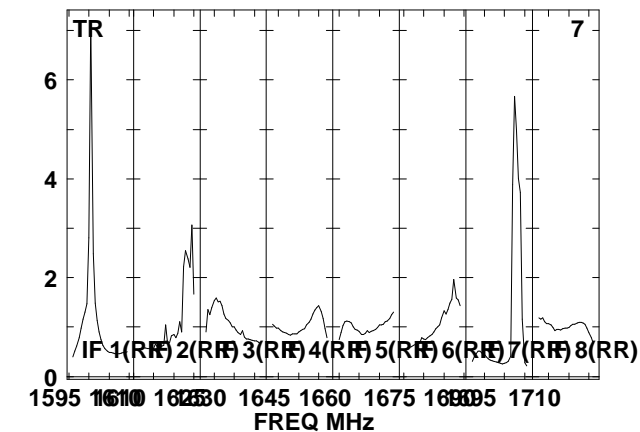
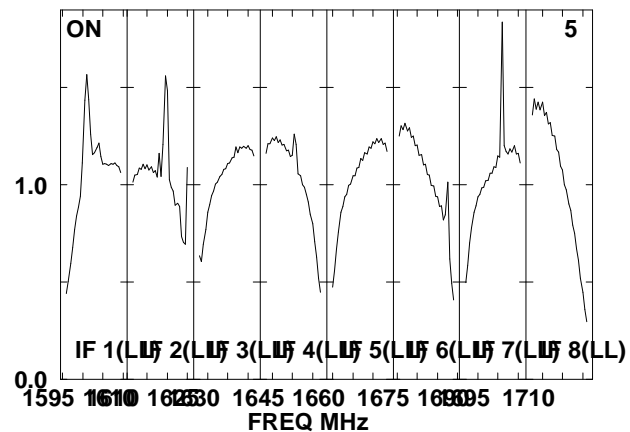
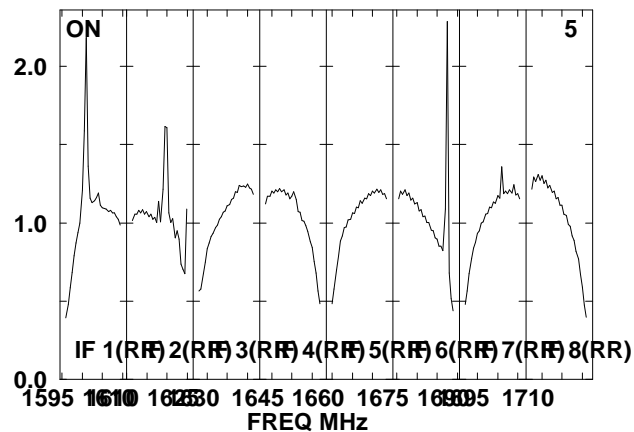
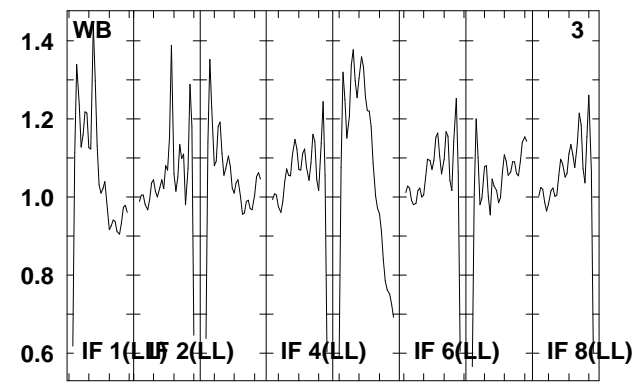
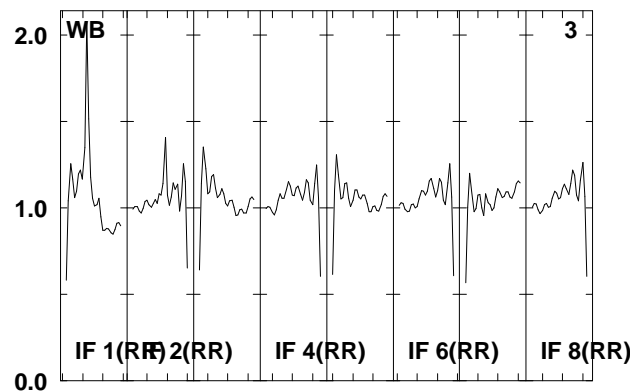
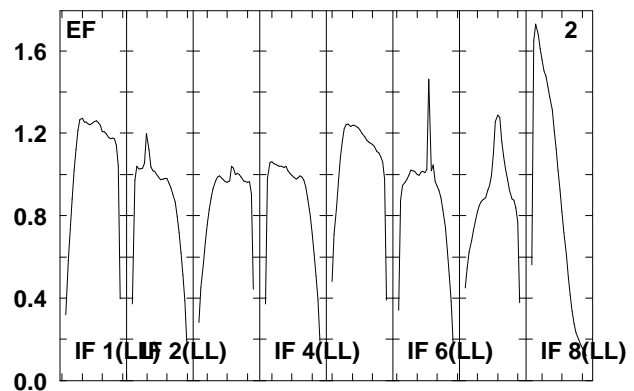
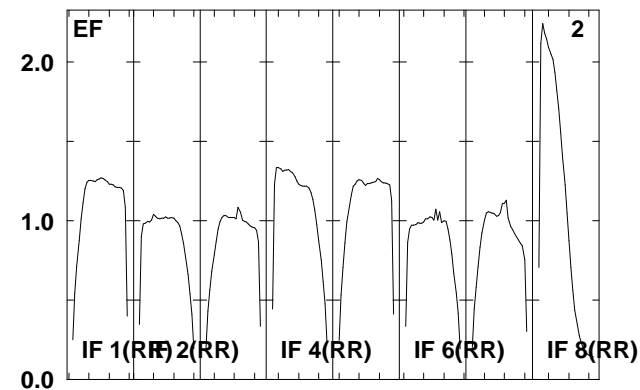
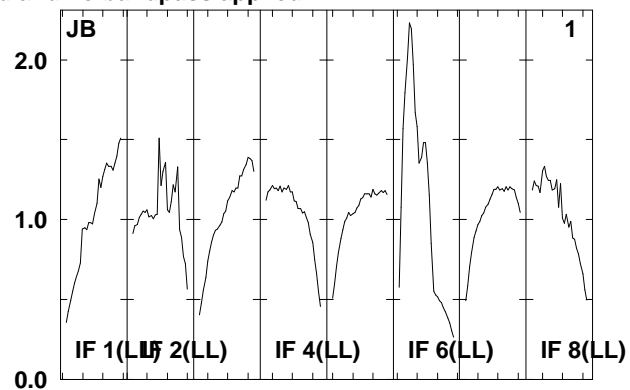
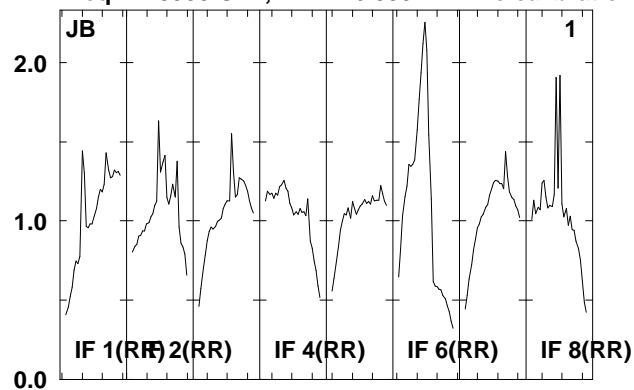

Lower frame: Real Jy
Total-power spectrum Antenna: *
Timerange: 00/16:01:05 to 00/16:04:29

Plot file version 177 created 06-JAN-2012 11:47:06

ARP299D EP068D 5.UVDATA.1

Freq = 1.5950 GHz, Bw = 16.000 MH No calibration applied and no bandpass applied

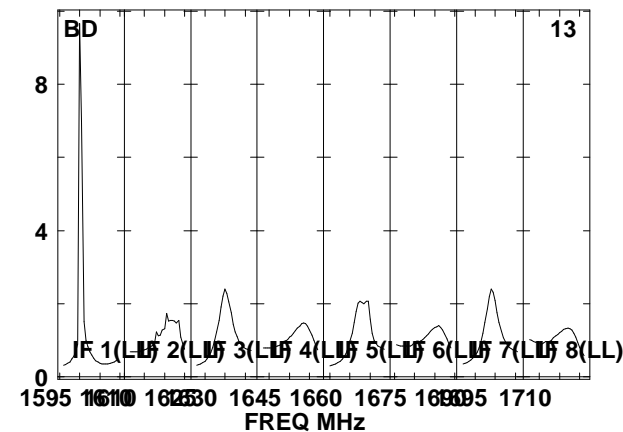
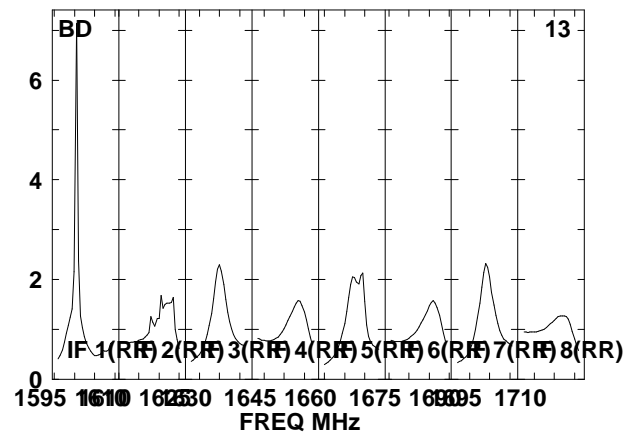
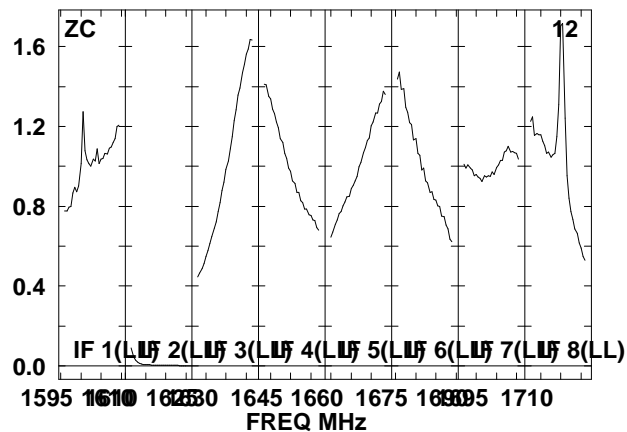
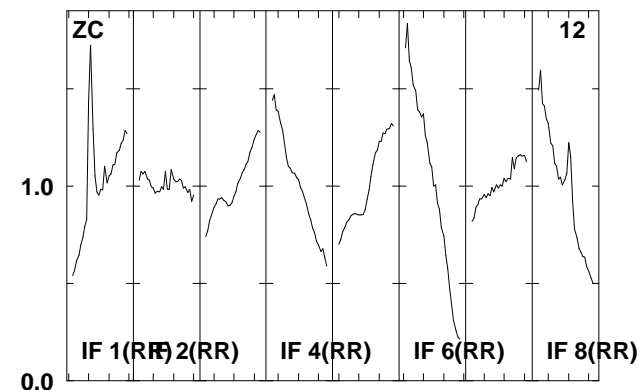
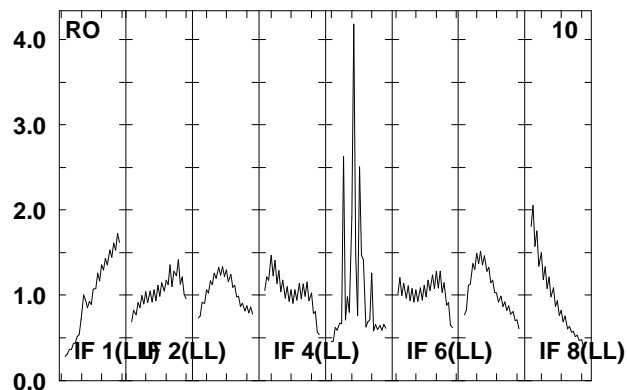
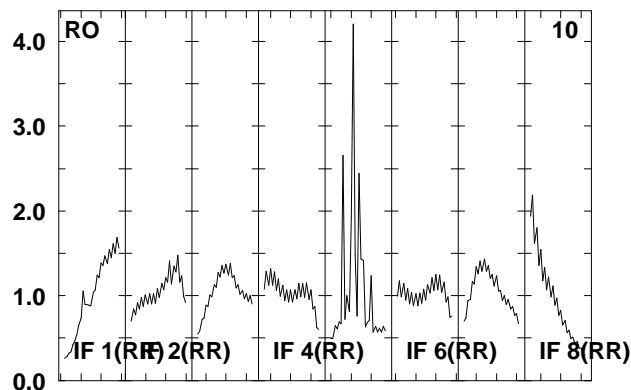
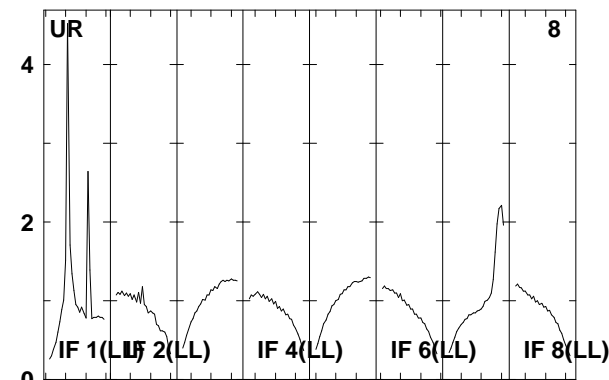
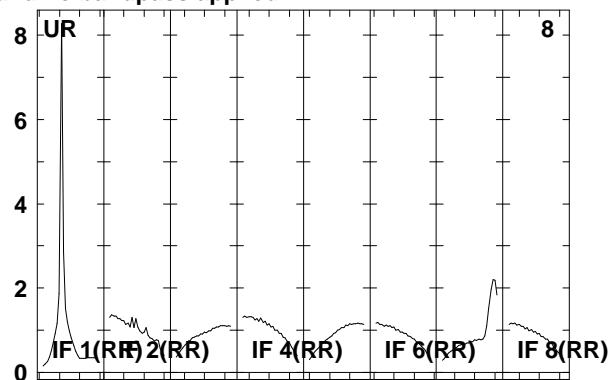
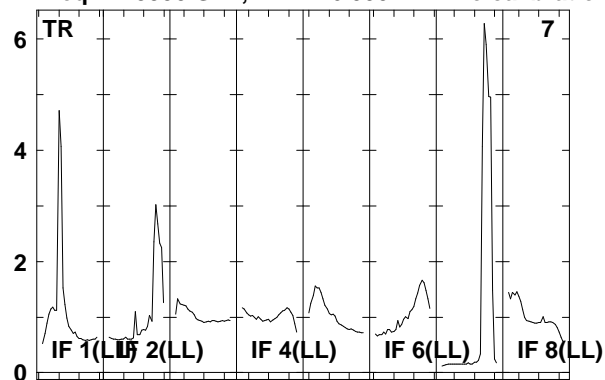

Lower frame: Real Jy
Total-power spectrum Antenna: *
Timerange: 00/16:01:05 to 00/16:04:29

Plot file version 178 created 06-JAN-2012 11:47:07

J1128+59 EP068D 5.UVDATA.1

Freq = 1.5950 GHz, Bw = 16.000 MH No calibration applied and no bandpass applied

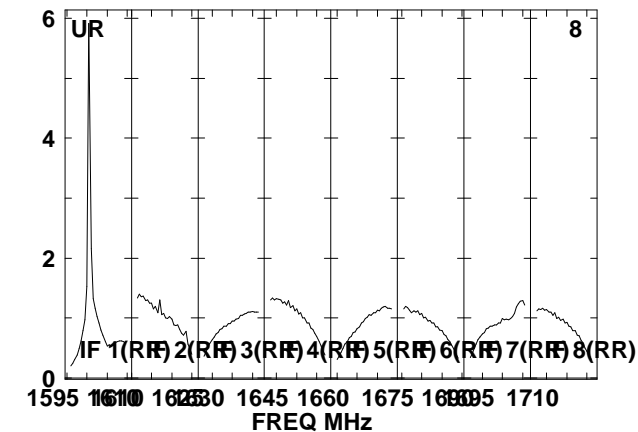
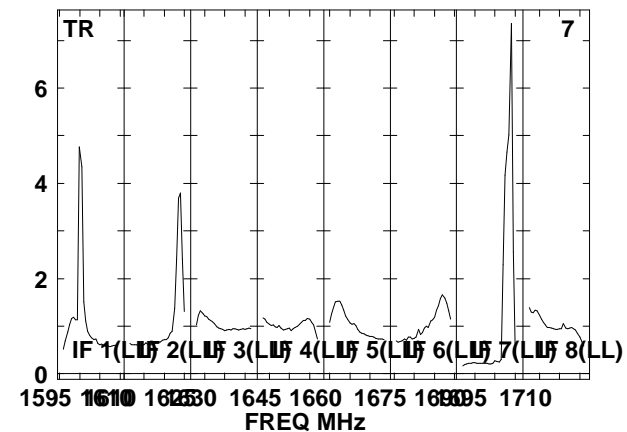
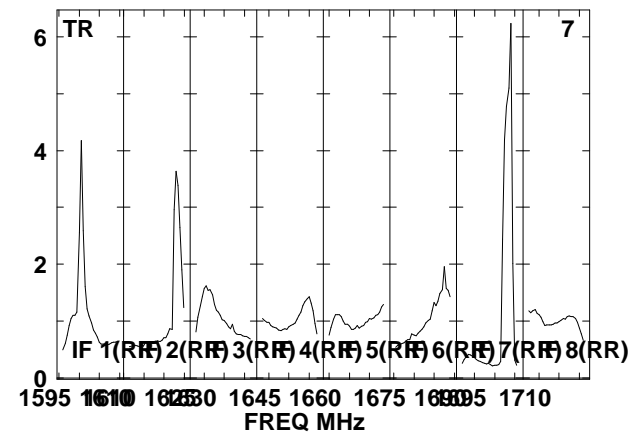
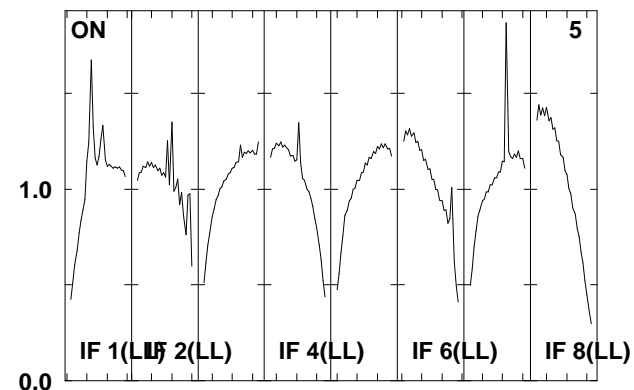
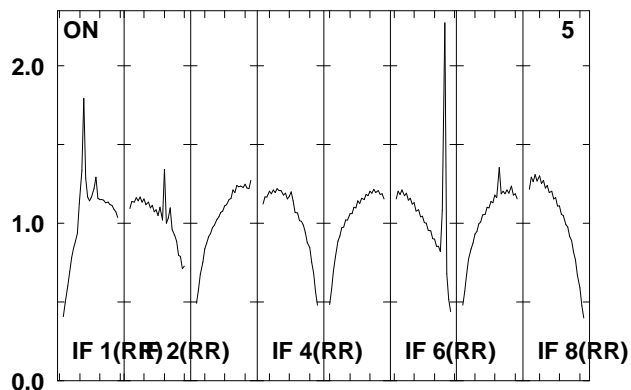
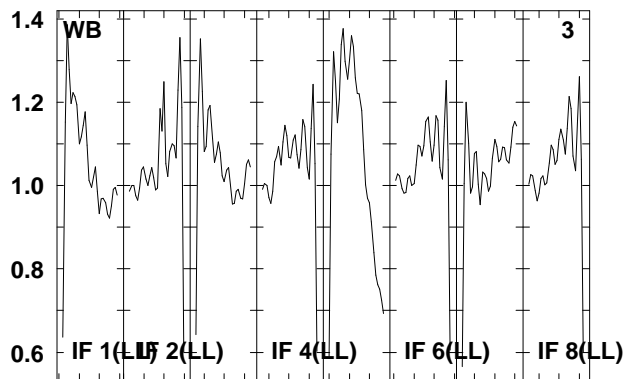
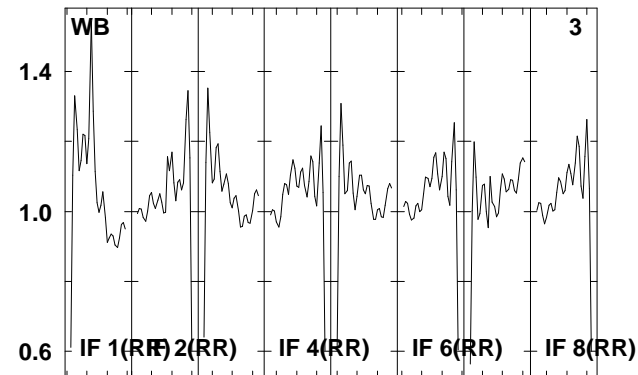
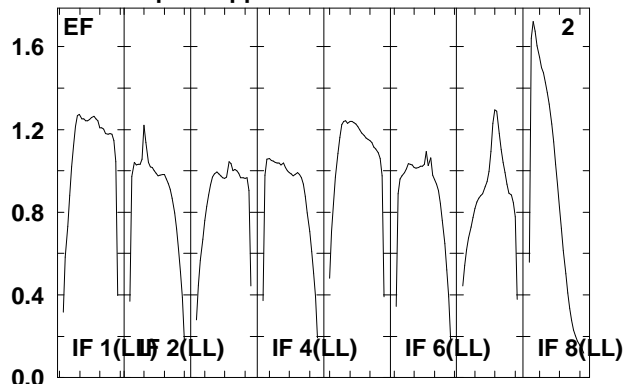
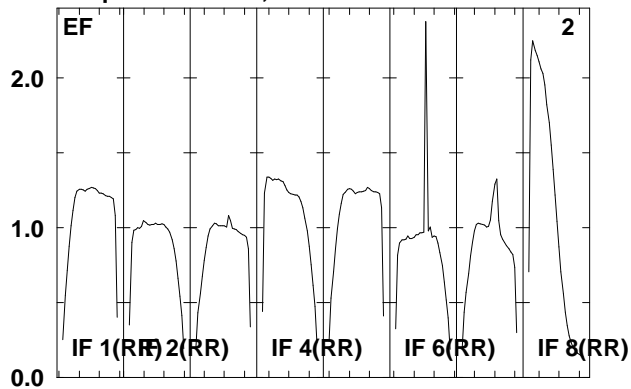

Lower frame: Real Jy
Total-power spectrum Antenna: *
Timerange: 00/16:05:31 to 00/16:06:59

Plot file version 179 created 06-JAN-2012 11:47:07

J1128+59 EP068D 5.UVDATA.1

Freq = 1.5950 GHz, Bw = 16.000 MH No calibration applied and no bandpass applied

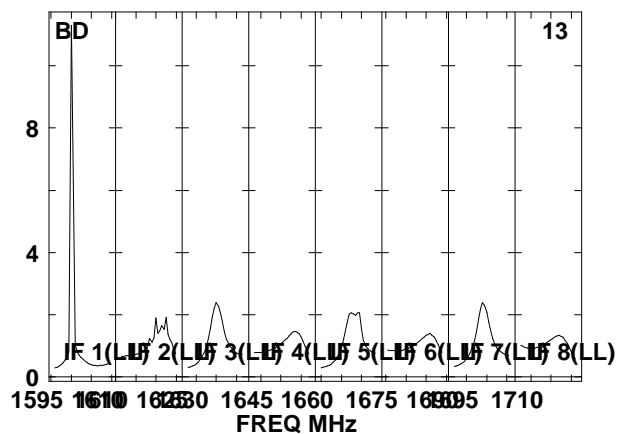
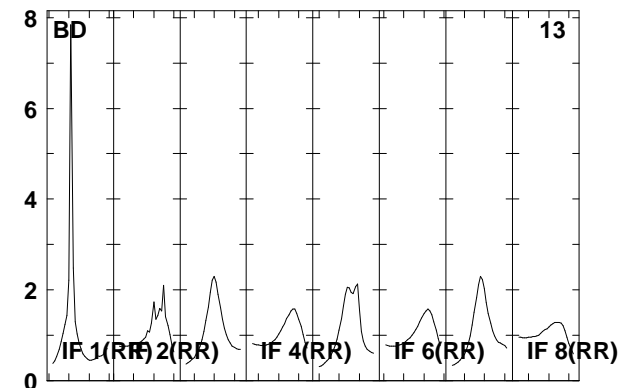
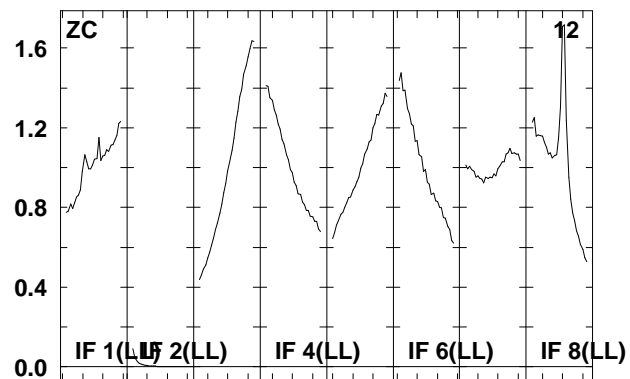
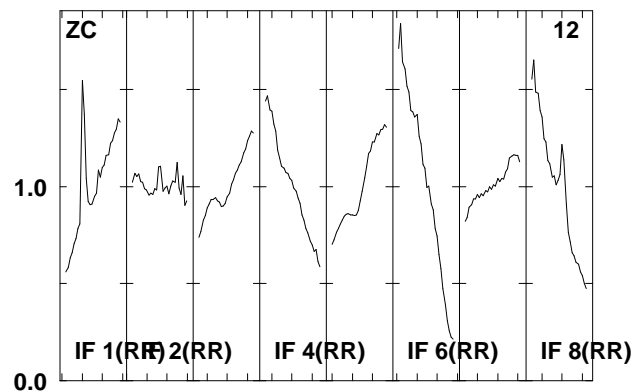
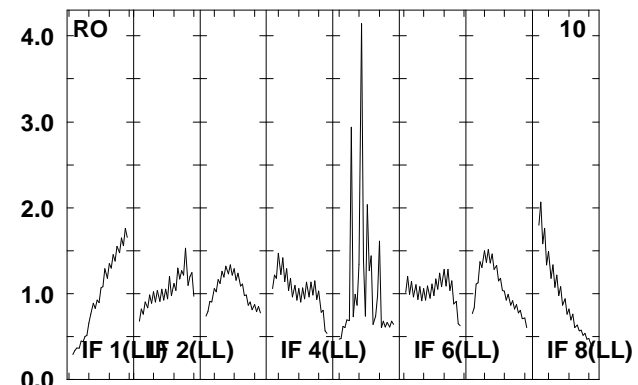
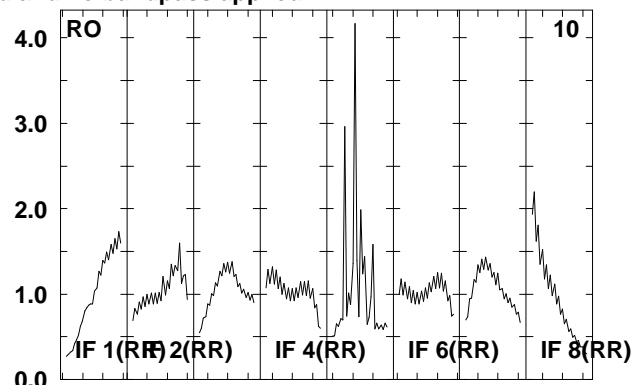
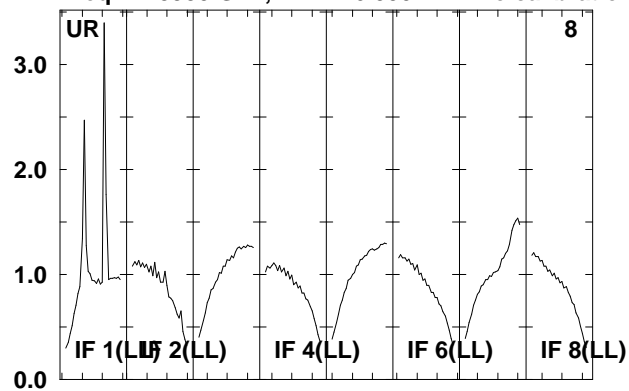

Lower frame: Real Jy

Total-power spectrum Antenna: *

Timerange: 00/16:05:31 to 00/16:06:59

Plot file version 180 created 06-JAN-2012 11:47:08

ARP299D EP068D 5.UVDATA.1

Freq = 1.5950 GHz, Bw = 16.000 MH No calibration applied and no bandpass applied

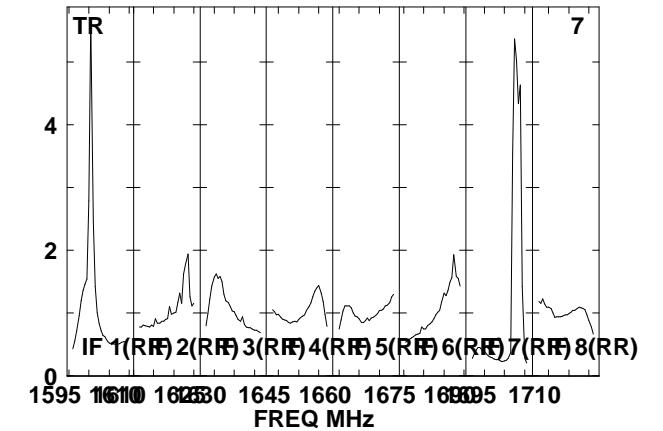
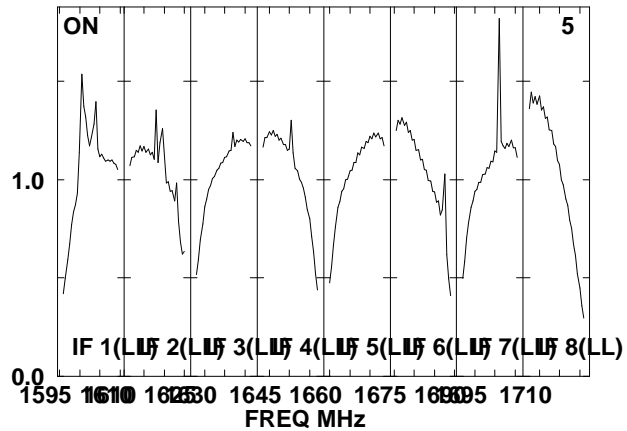
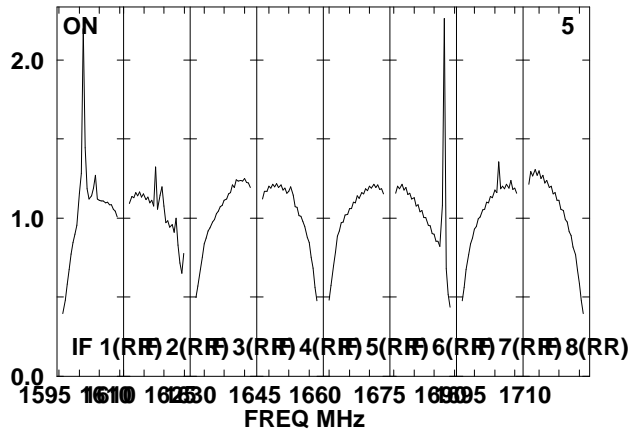
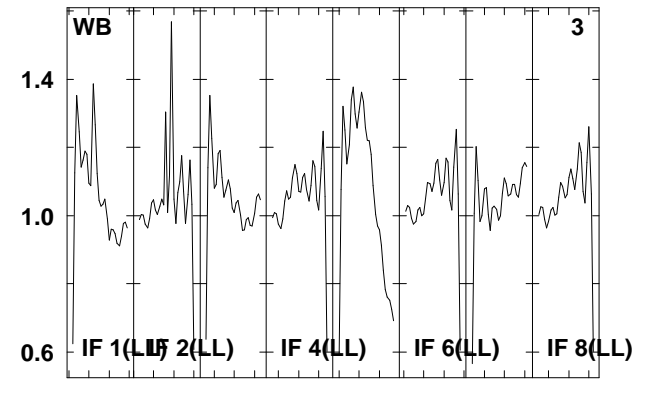
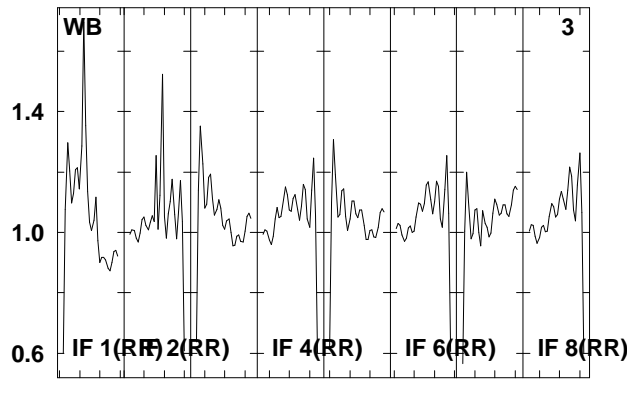
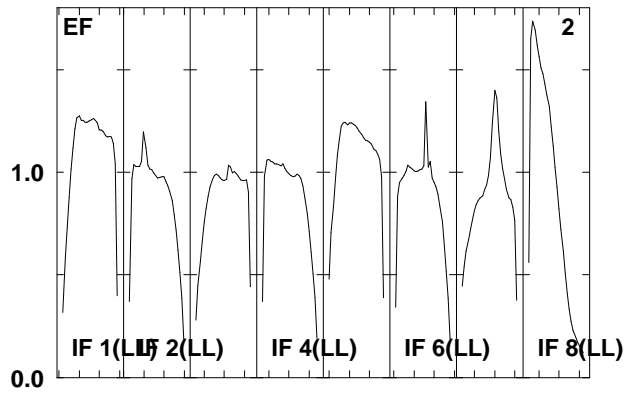
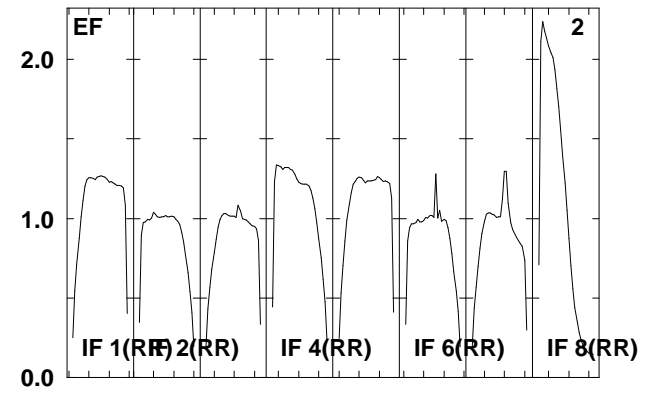
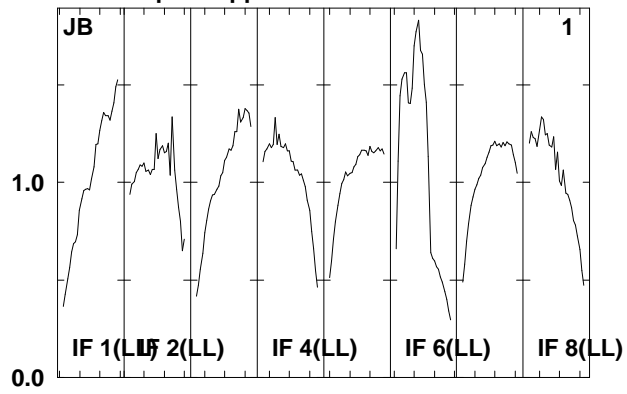
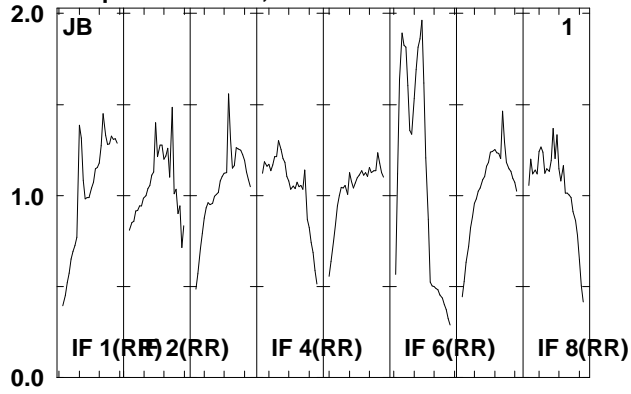

Lower frame: Real Jy
Total-power spectrum Antenna: *
Timerange: 00/16:07:01 to 00/16:10:29

Plot file version 181 created 06-JAN-2012 11:47:08

ARP299D EP068D 5.UVDATA.1

Freq = 1.5950 GHz, Bw = 16.000 MH No calibration applied and no bandpass applied

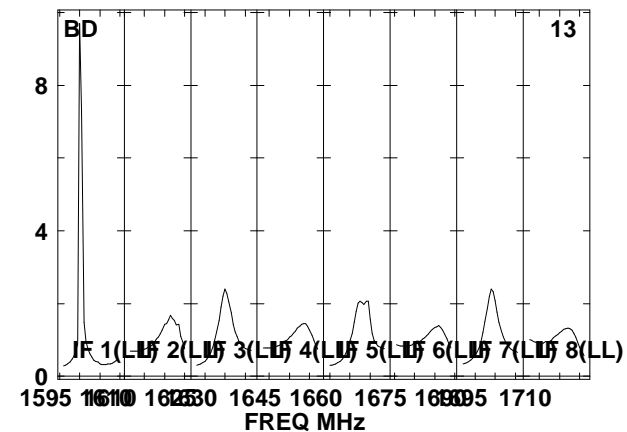
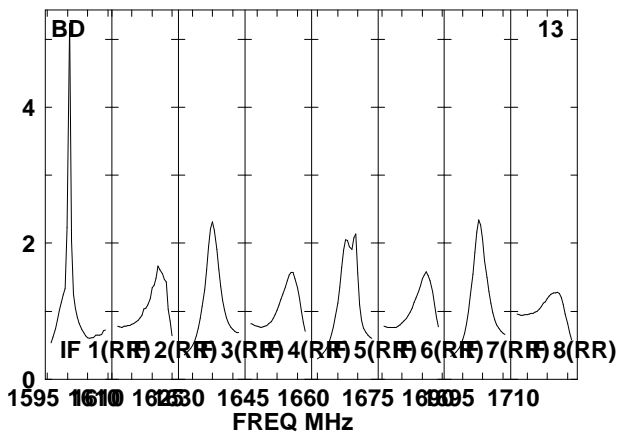
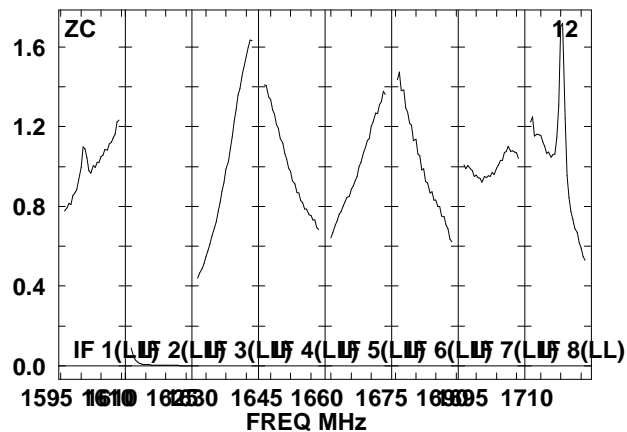
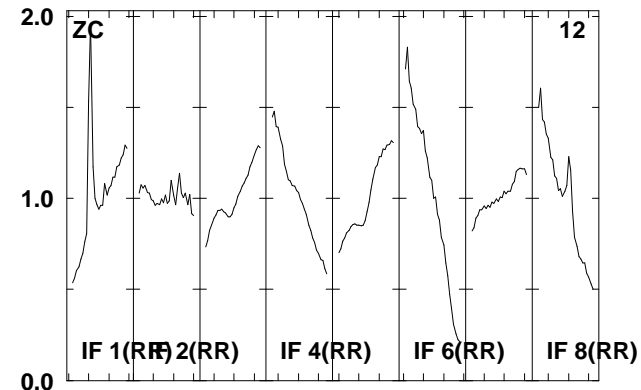
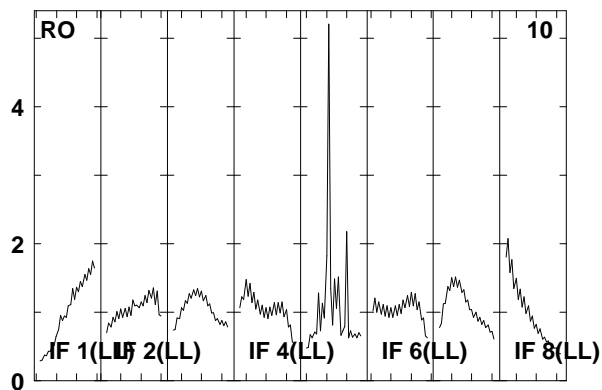
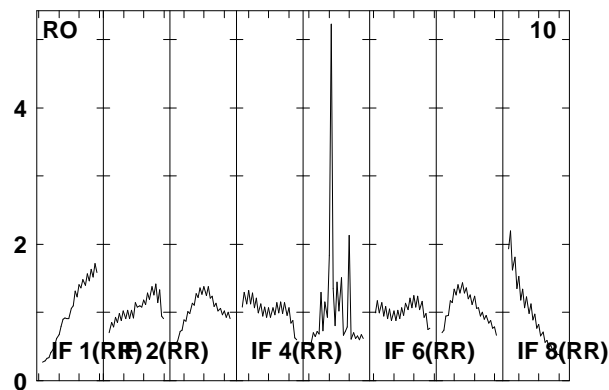
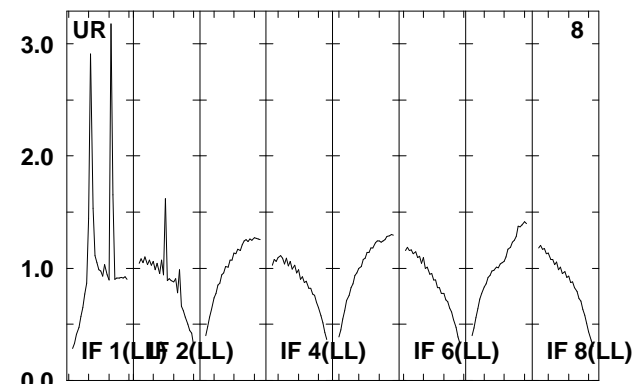
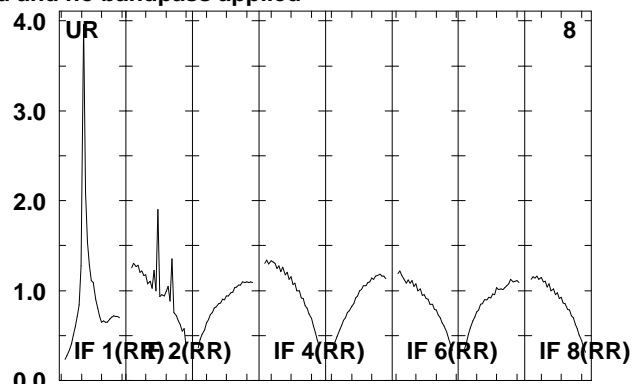
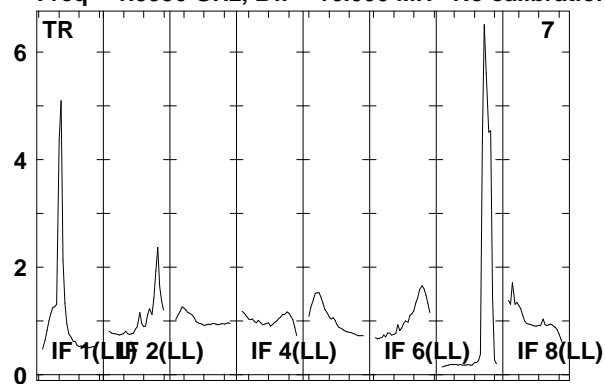

Lower frame: Real Jy
Total-power spectrum Antenna: *
Timerange: 00/16:07:01 to 00/16:10:29

Plot file version 182 created 06-JAN-2012 11:47:09

J1128+59 EP068D 5.UVDATA.1

Freq = 1.5950 GHz, Bw = 16.000 MH No calibration applied and no bandpass applied

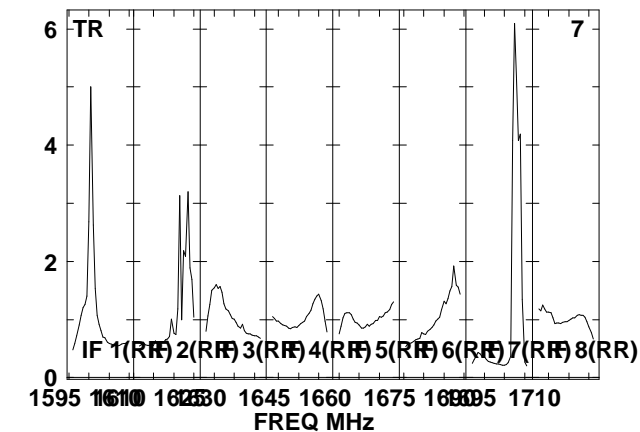
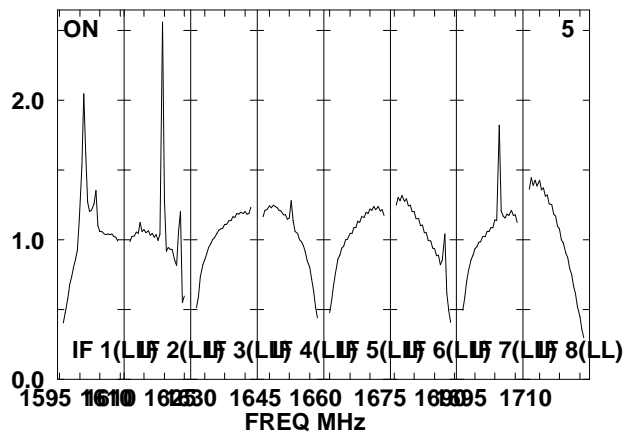
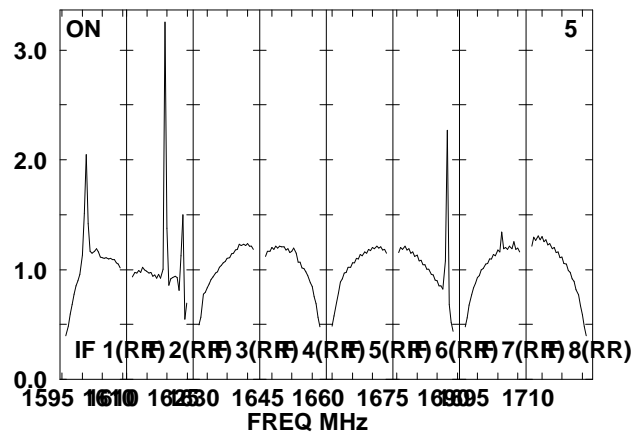
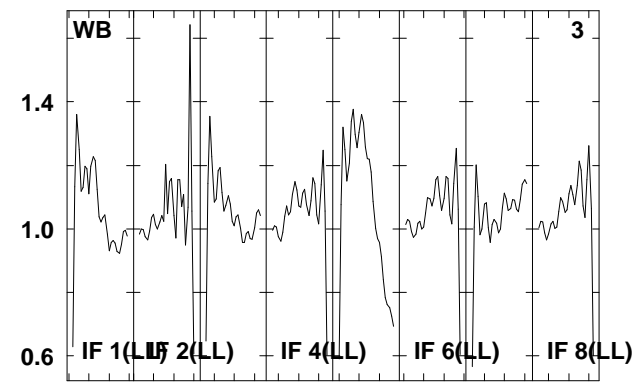
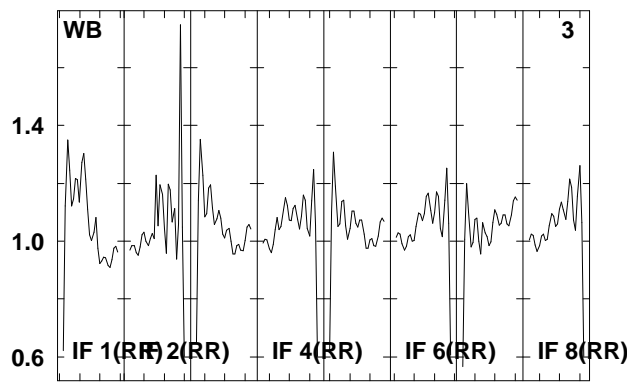
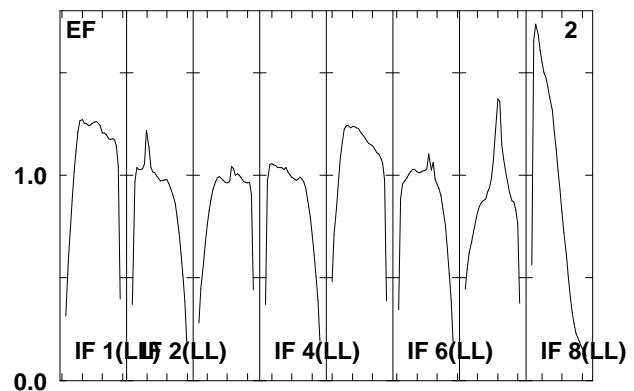
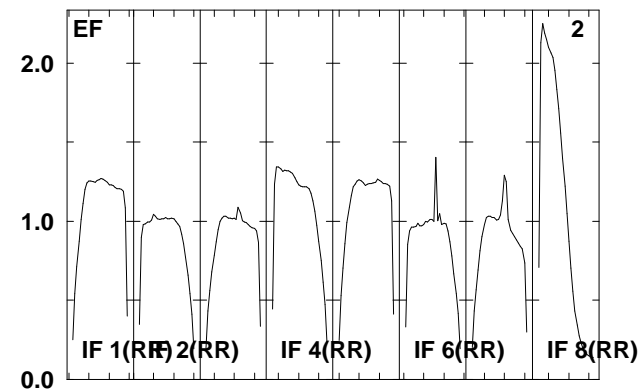
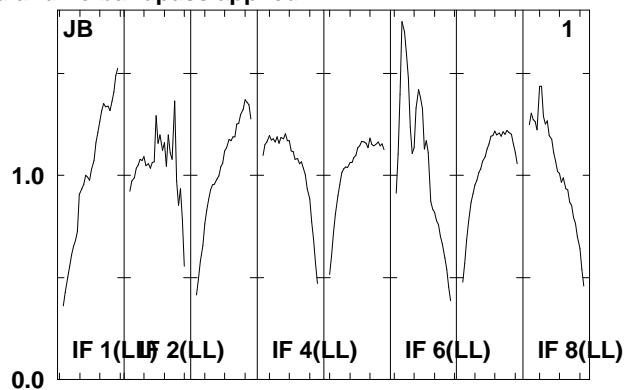
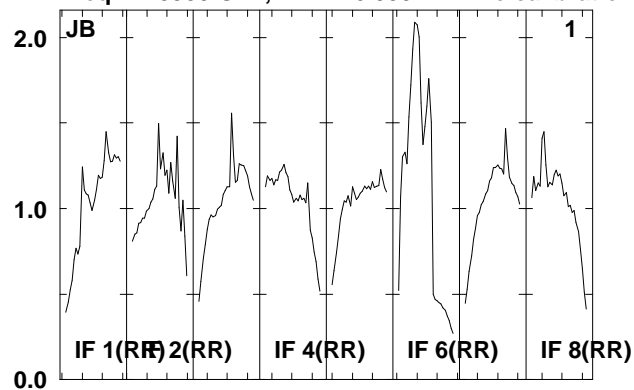

Lower frame: Real Jy
Total-power spectrum Antenna: *
Timerange: 00/16:10:35 to 00/16:11:59

Plot file version 183 created 06-JAN-2012 11:47:09

J1128+59 EP068D 5.UVDATA.1

Freq = 1.5950 GHz, Bw = 16.000 MH No calibration applied and no bandpass applied

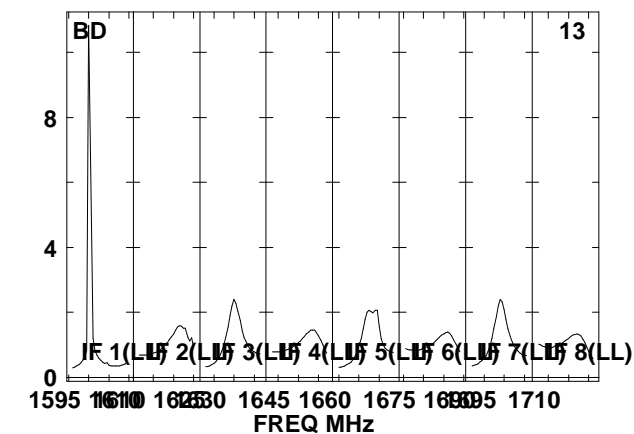
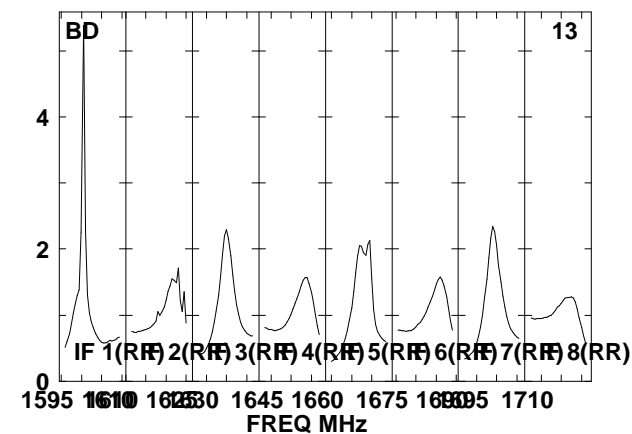
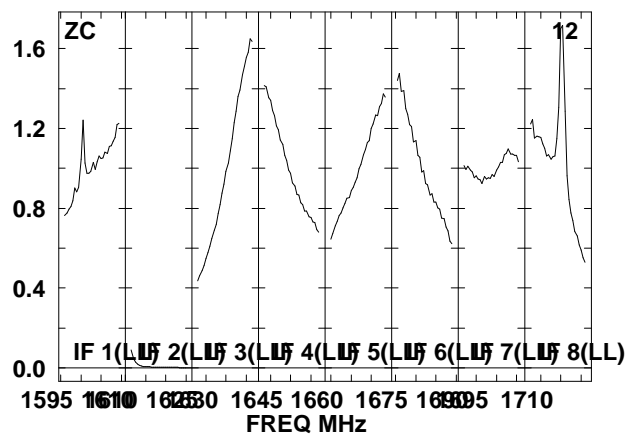
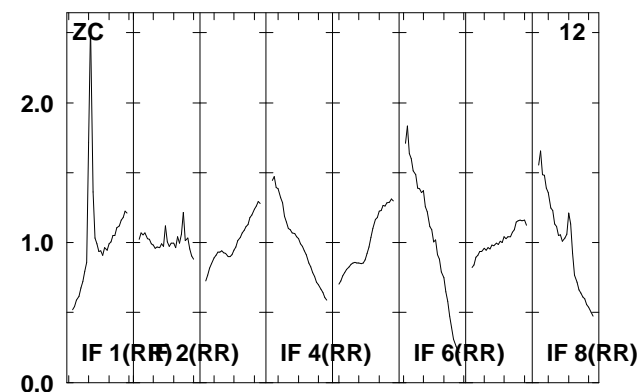
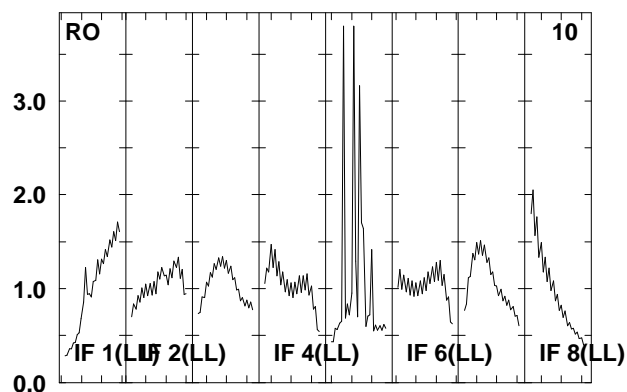
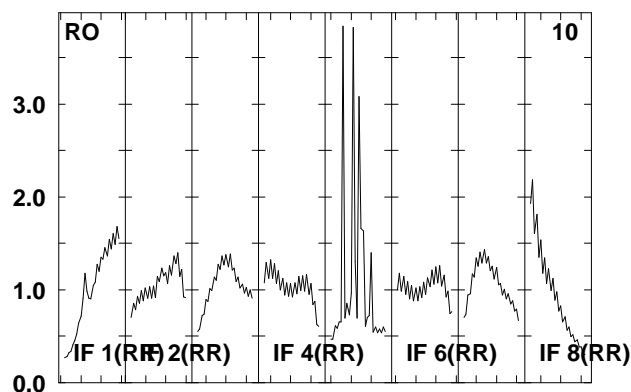
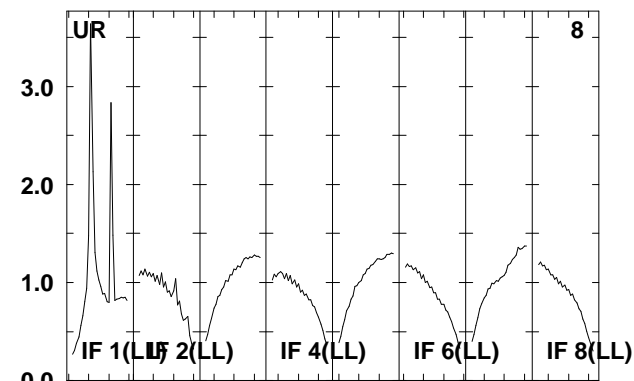
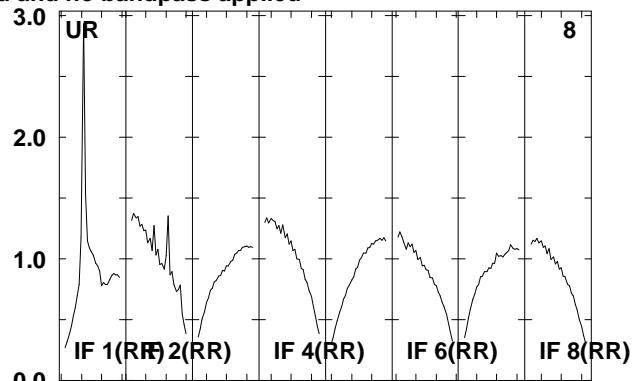
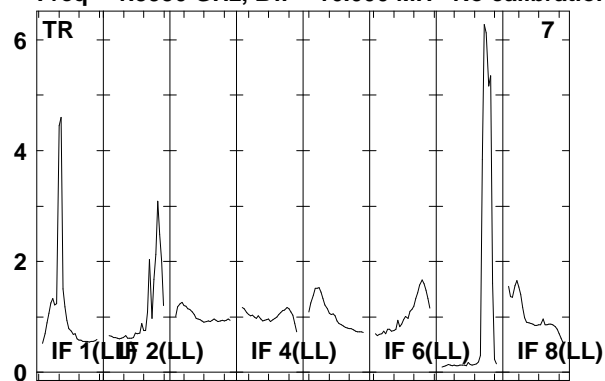

Lower frame: Real Jy
Total-power spectrum Antenna: *
Timerange: 00/16:10:35 to 00/16:11:59

Plot file version 184 created 06-JAN-2012 11:47:10

ARP299D EP068D 5.UVDATA.1

Freq = 1.5950 GHz, Bw = 16.000 MH No calibration applied and no bandpass applied

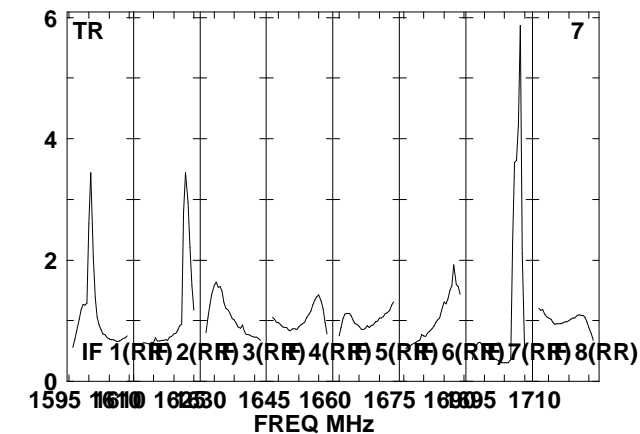
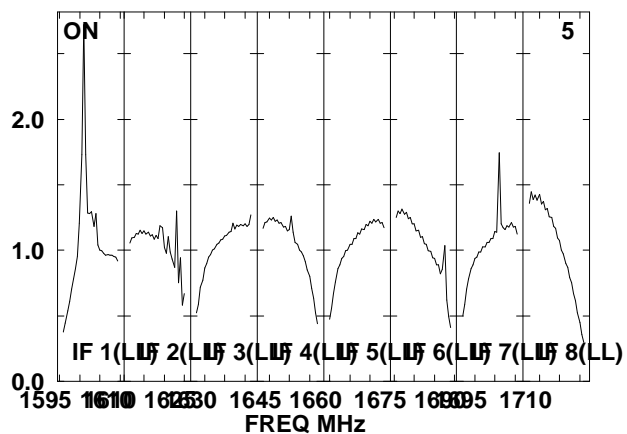
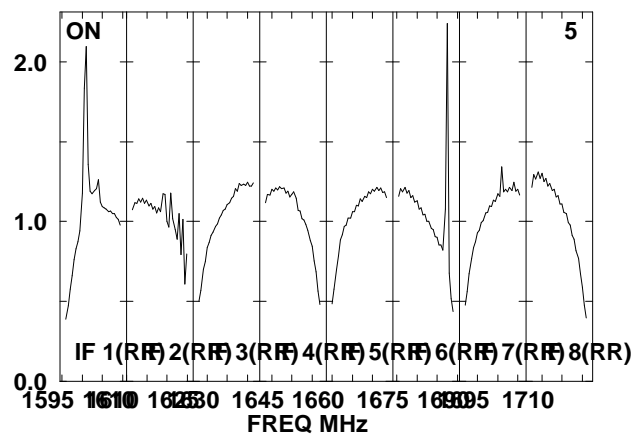
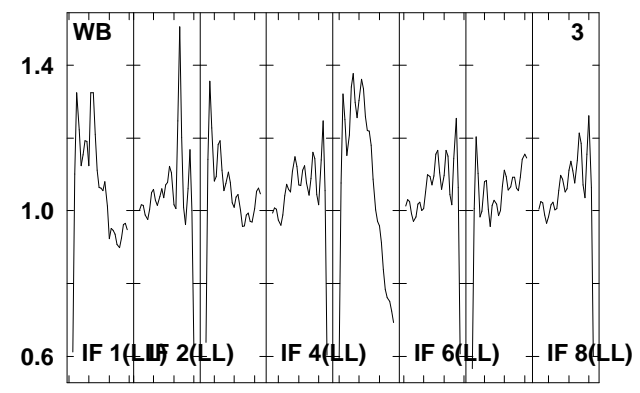
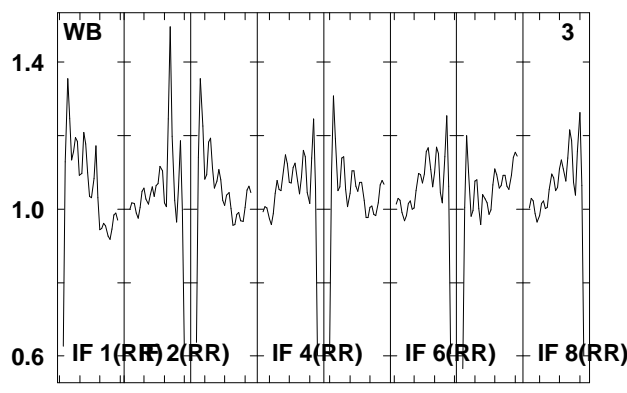
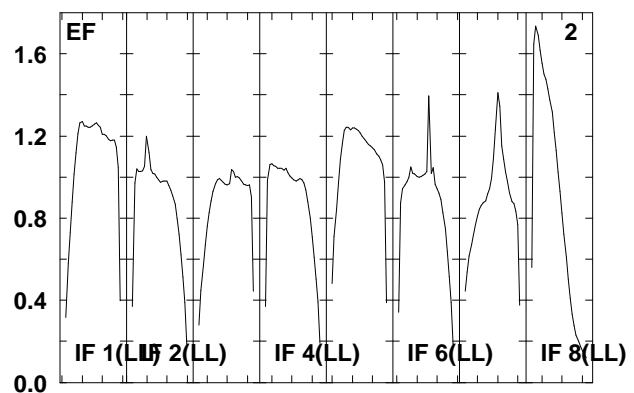
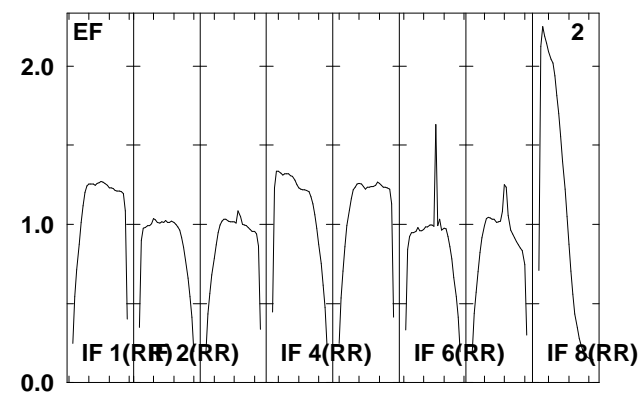
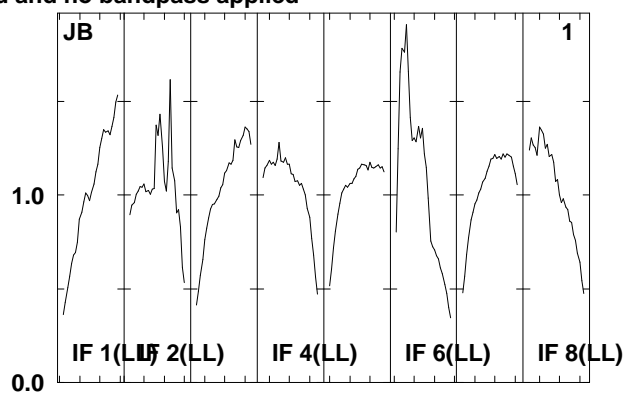
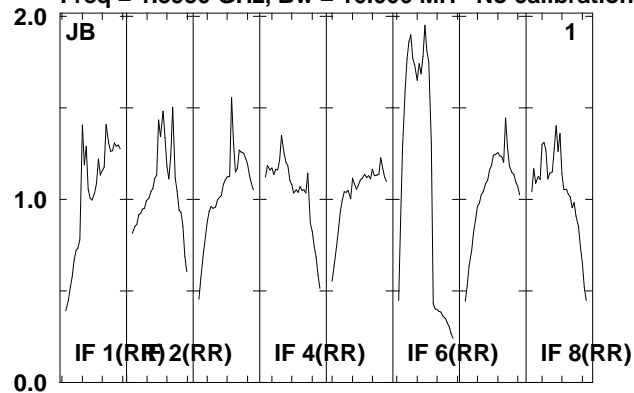

Lower frame: Real Jy
Total-power spectrum Antenna: *
Timerange: 00/16:12:05 to 00/16:15:29

Plot file version 185 created 06-JAN-2012 11:47:10

ARP299D EP068D 5.UVDATA.1

Freq = 1.5950 GHz, Bw = 16.000 MH No calibration applied and no bandpass applied

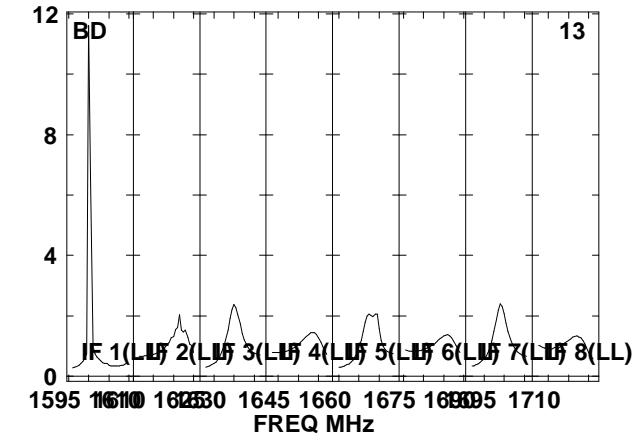
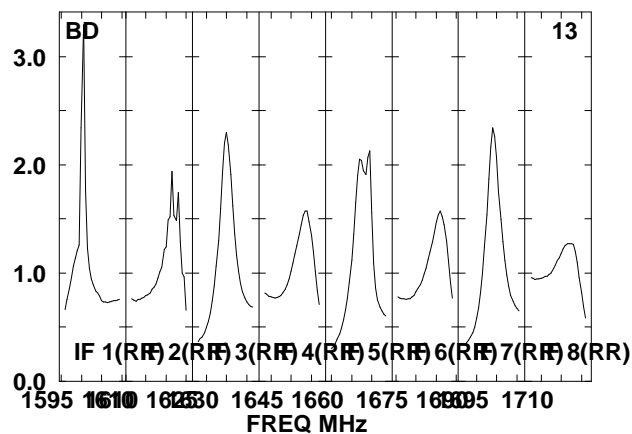
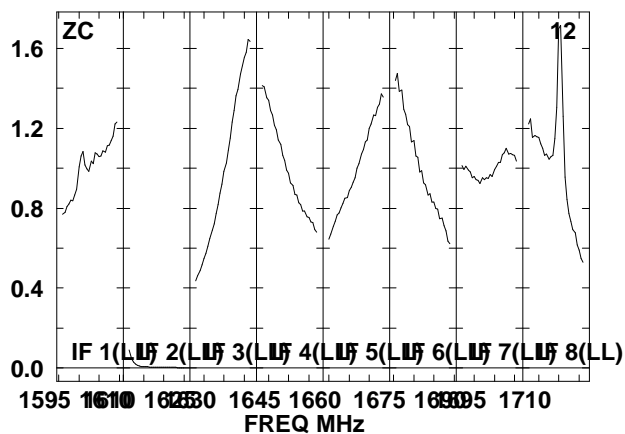
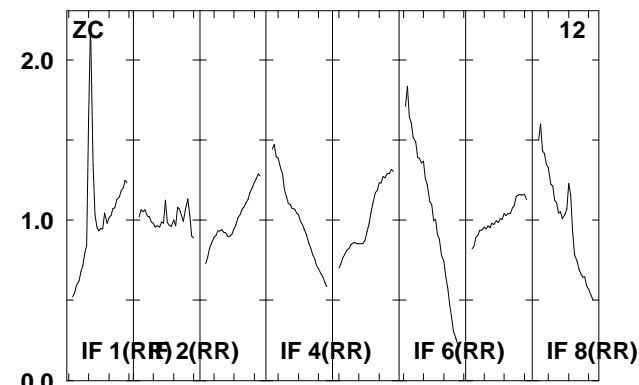
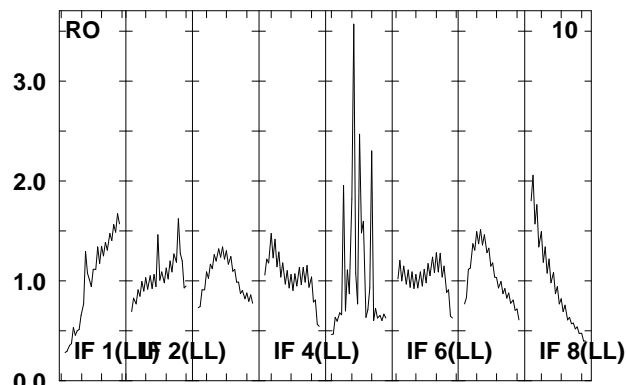
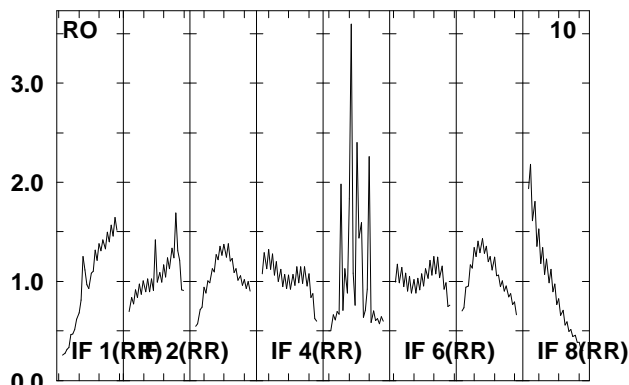
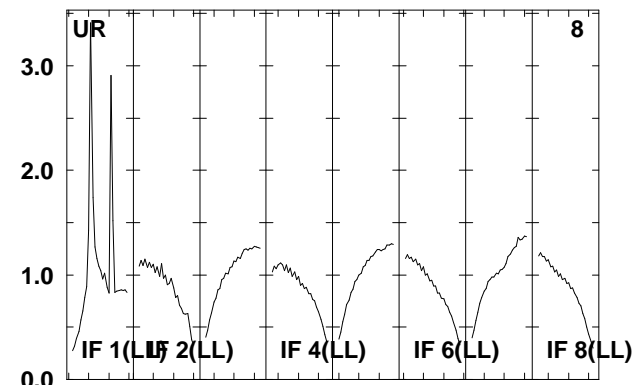
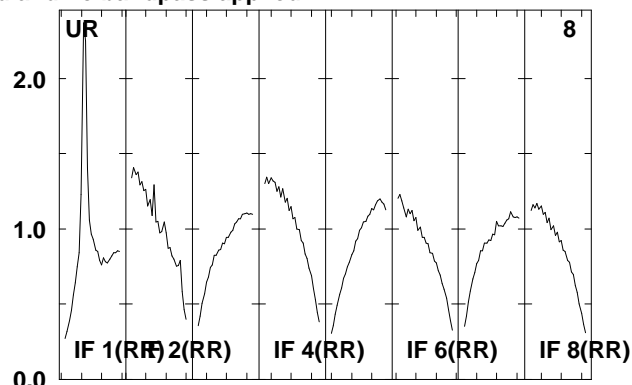
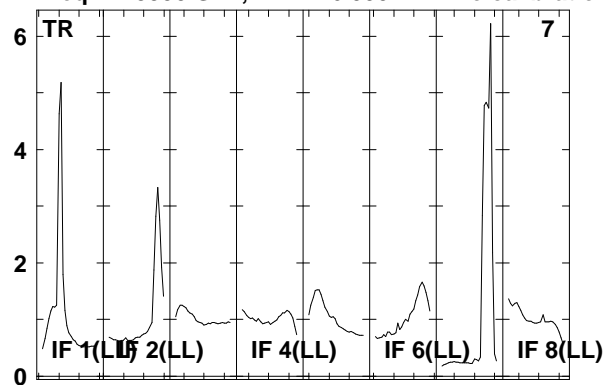

Lower frame: Real Jy
Total-power spectrum Antenna: *
Timerange: 00/16:12:05 to 00/16:15:29

Plot file version 186 created 06-JAN-2012 11:47:11

J1128+59 EP068D 5.UVDATA.1

Freq = 1.5950 GHz, Bw = 16.000 MH No calibration applied and no bandpass applied

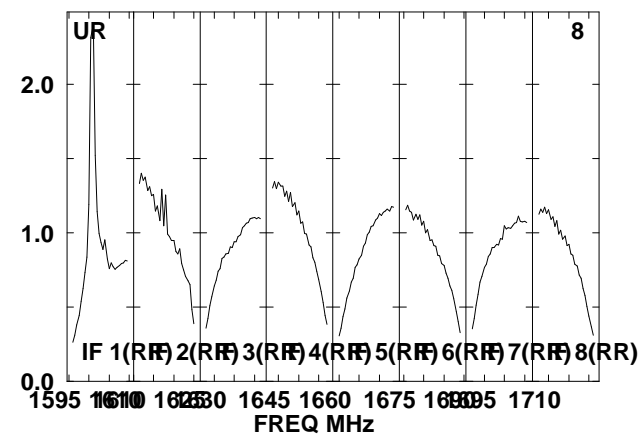
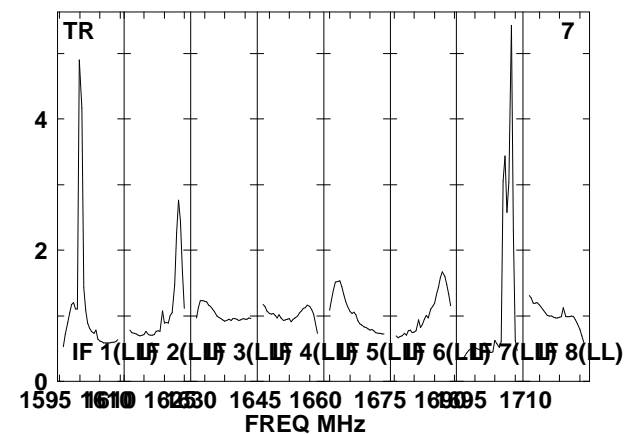
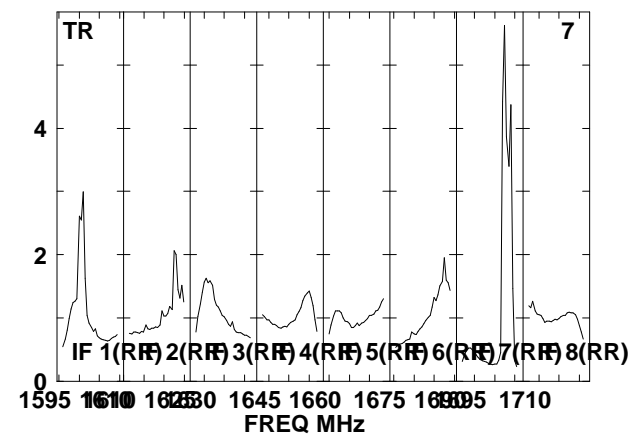
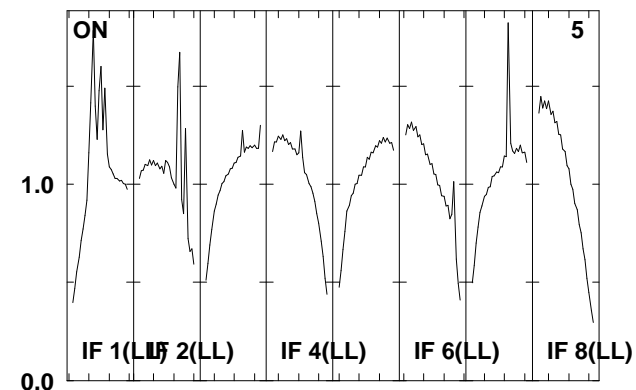
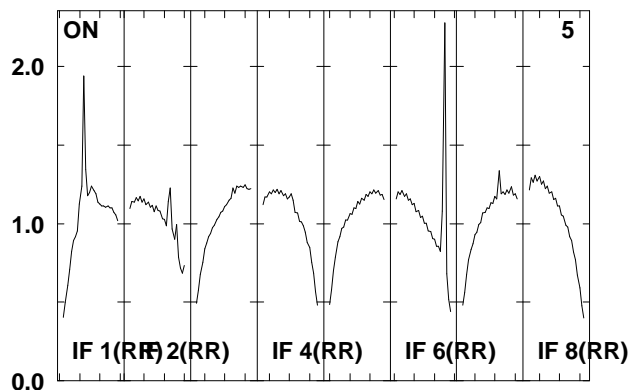
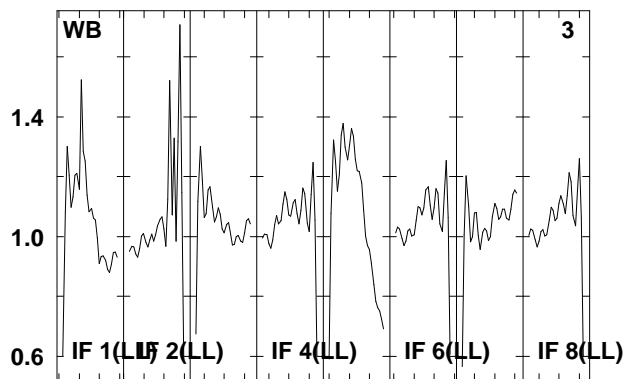
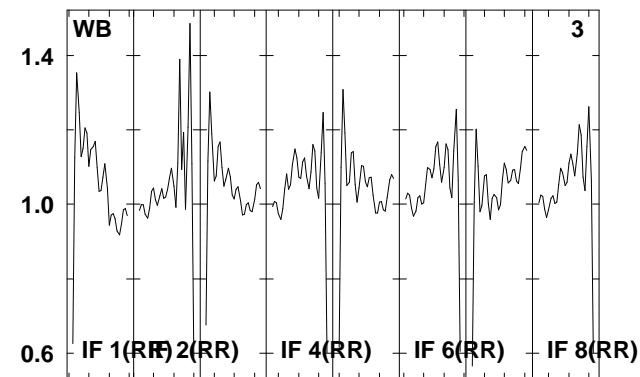
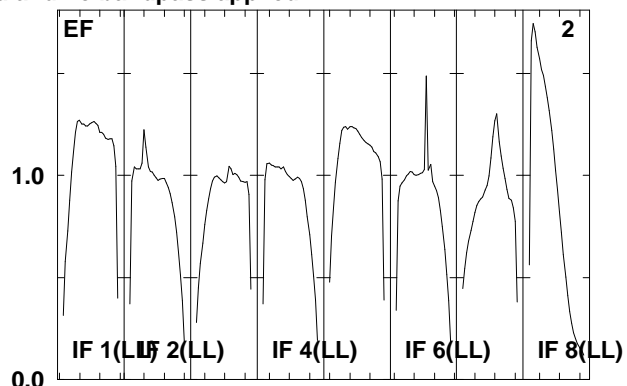
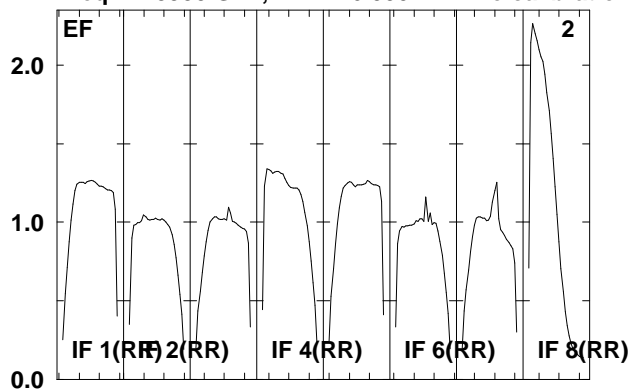

Lower frame: Real Jy
Total-power spectrum Antenna: *
Timerange: 00/16:15:35 to 00/16:16:59

Plot file version 187 created 06-JAN-2012 11:47:11

J1128+59 EP068D 5.UVDATA.1

Freq = 1.5950 GHz, Bw = 16.000 MH No calibration applied and no bandpass applied

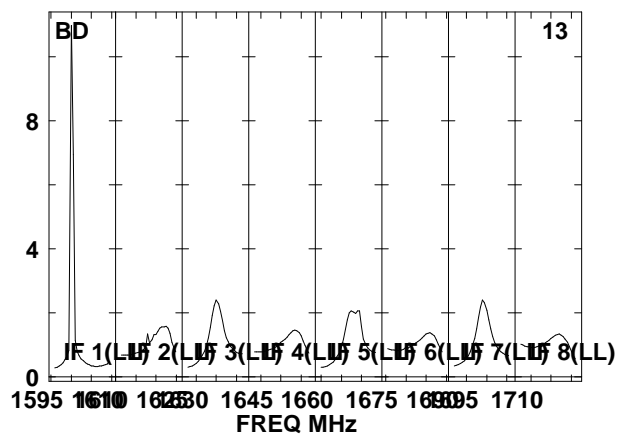
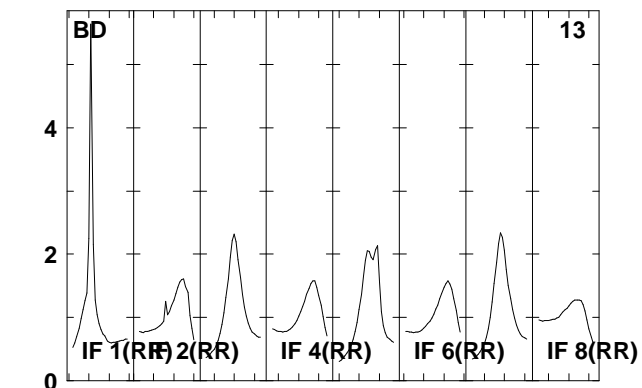
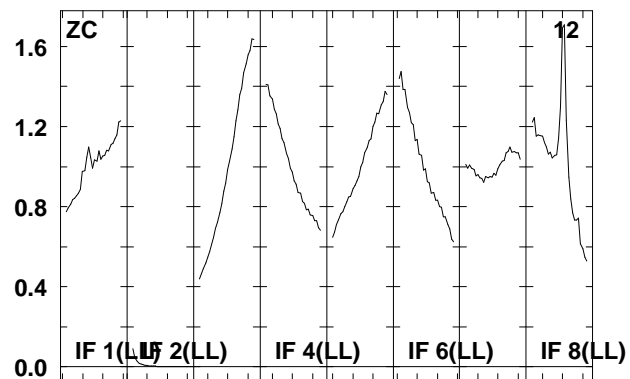
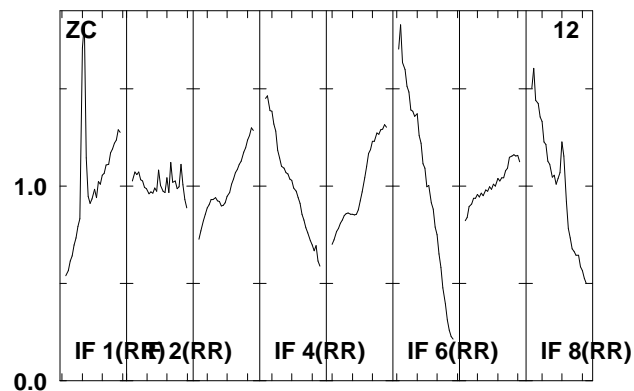
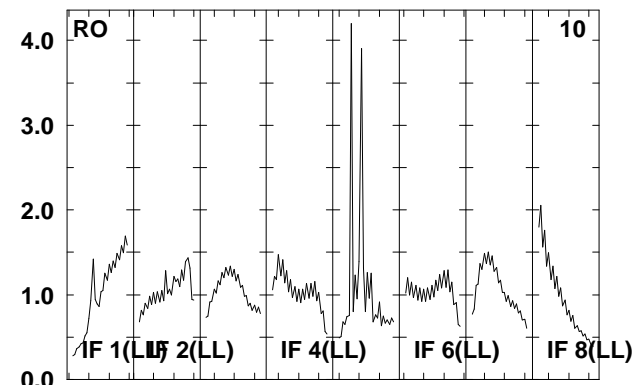
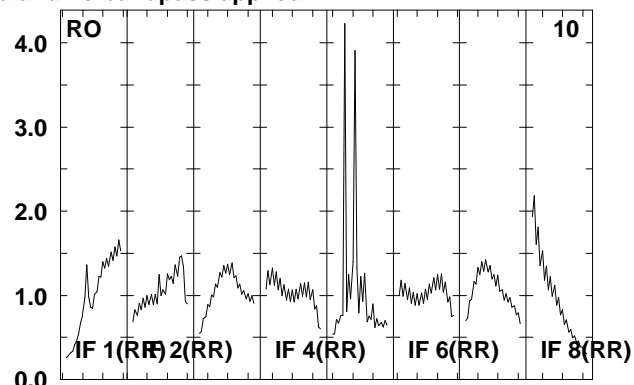
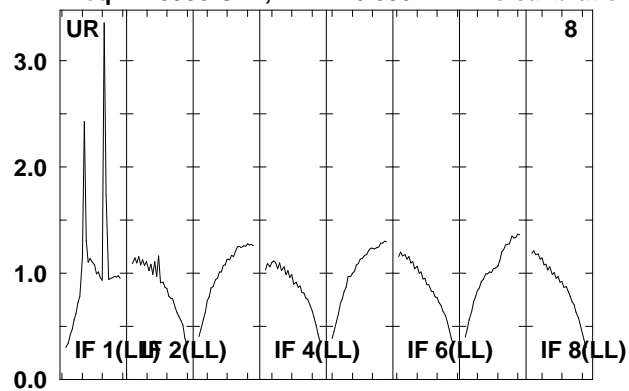

Lower frame: Real Jy

Total-power spectrum Antenna: *

Timerange: 00/16:15:35 to 00/16:16:59

Plot file version 188 created 06-JAN-2012 11:47:11

ARP299D EP068D 5.UVDATA.1

Freq = 1.5950 GHz, Bw = 16.000 MH No calibration applied and no bandpass applied

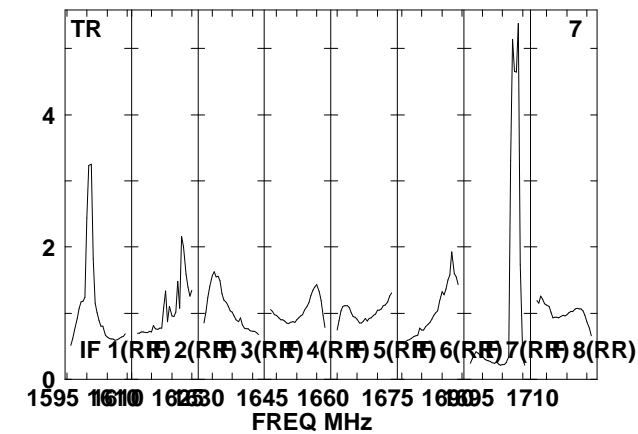
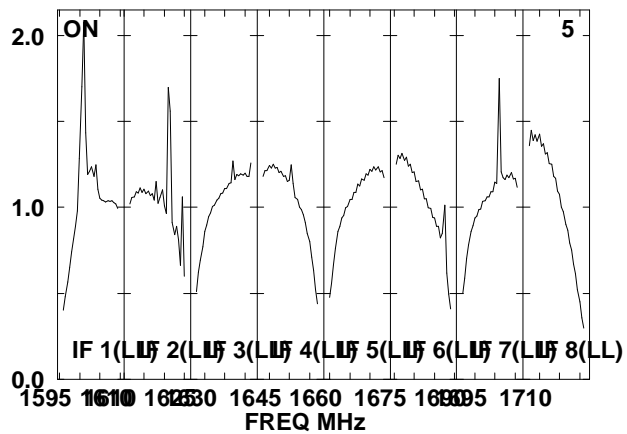
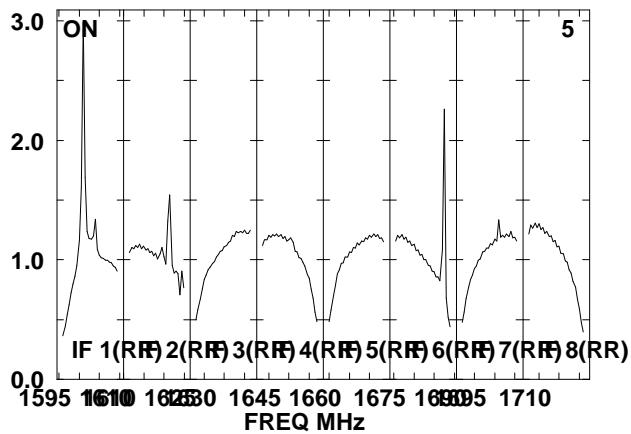
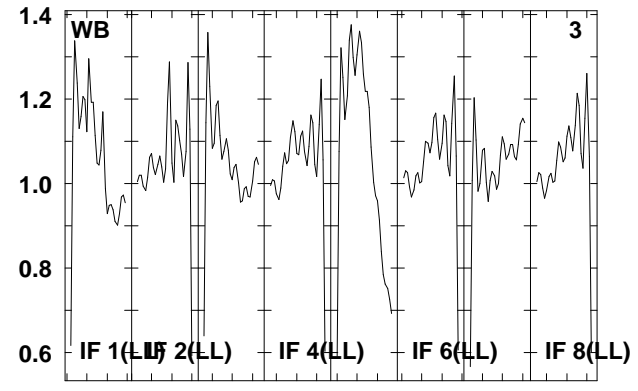
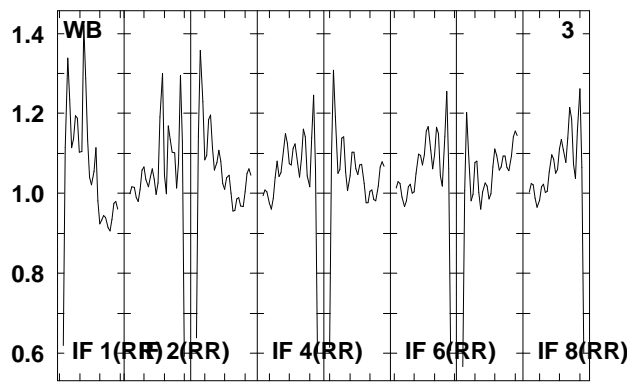
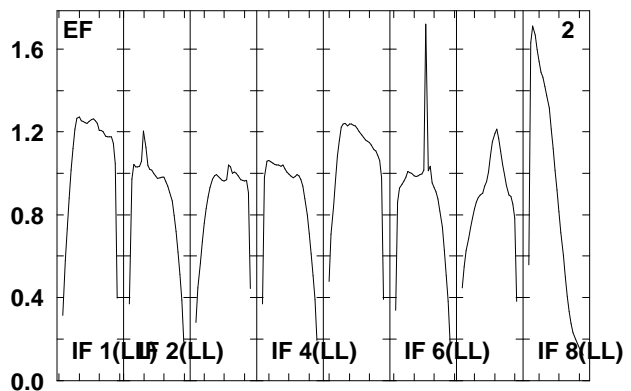
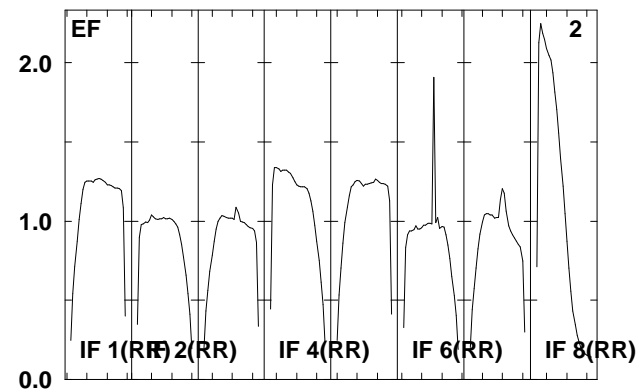
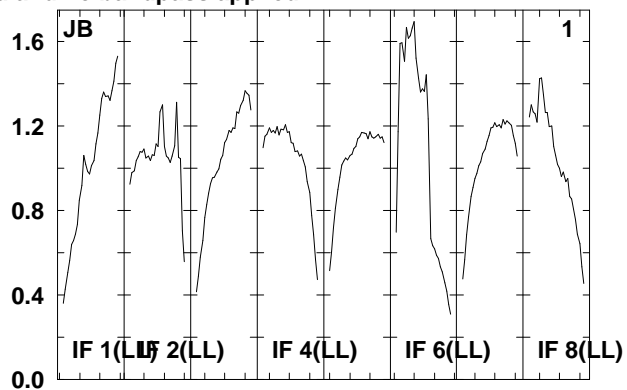
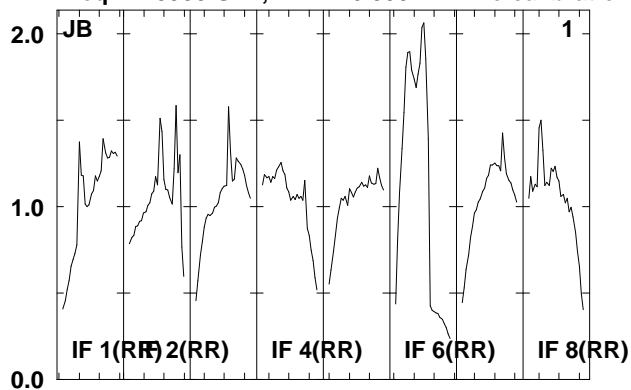

Lower frame: Real Jy
Total-power spectrum Antenna: *
Timerange: 00/16:17:01 to 00/16:20:29

Plot file version 189 created 06-JAN-2012 11:47:12

ARP299D EP068D 5.UVDATA.1

Freq = 1.5950 GHz, Bw = 16.000 MH No calibration applied and no bandpass applied

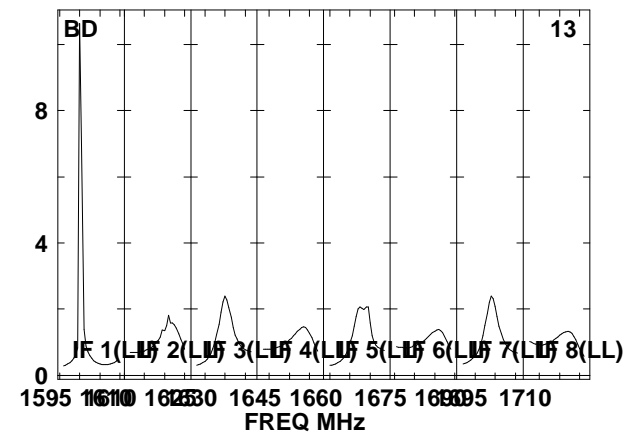
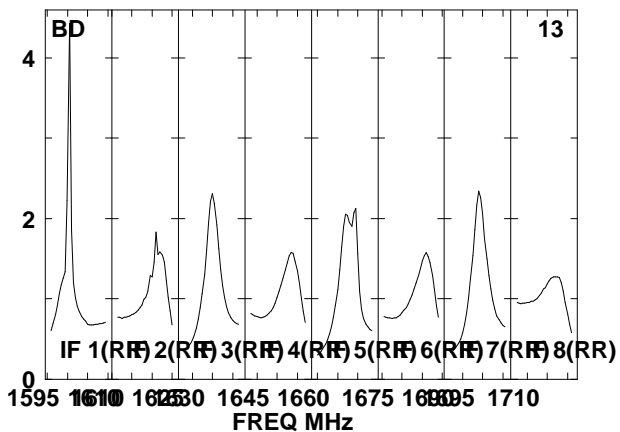
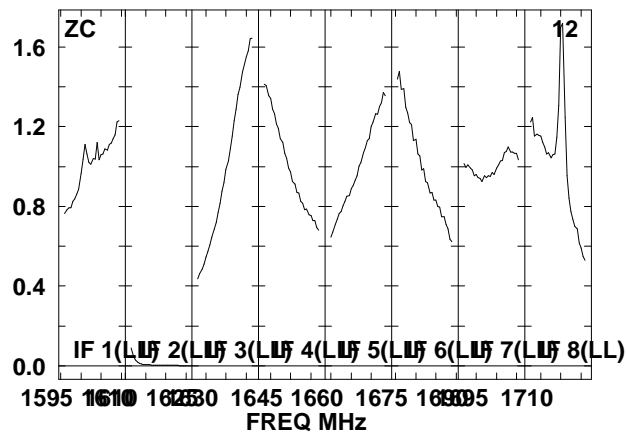
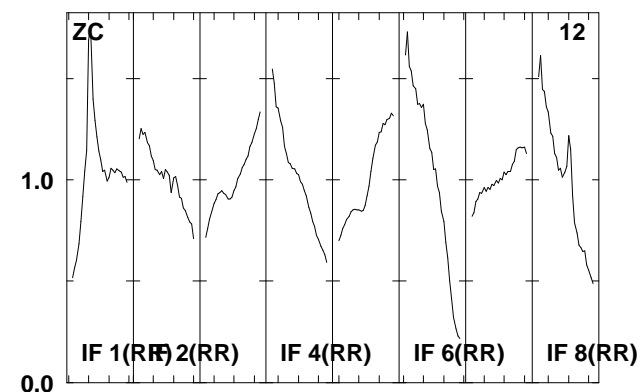
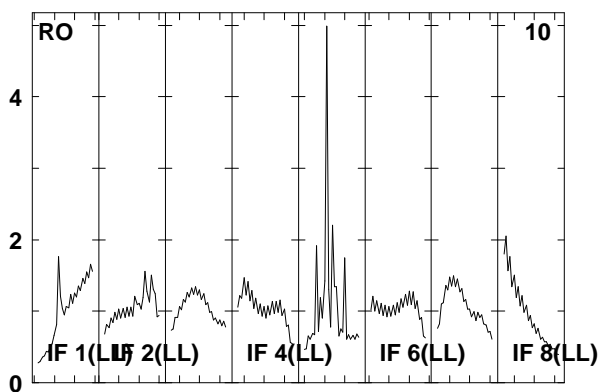
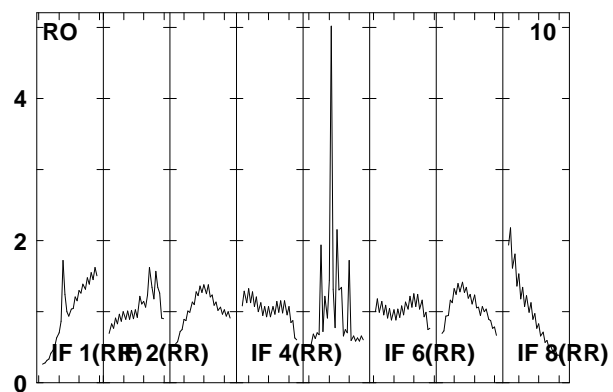
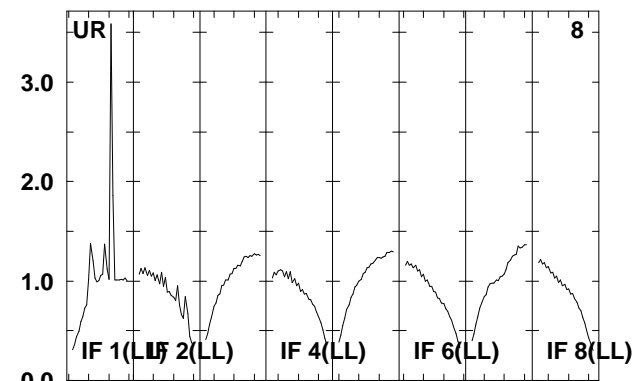
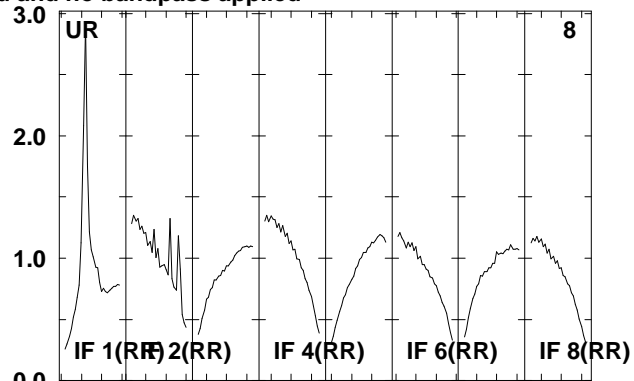
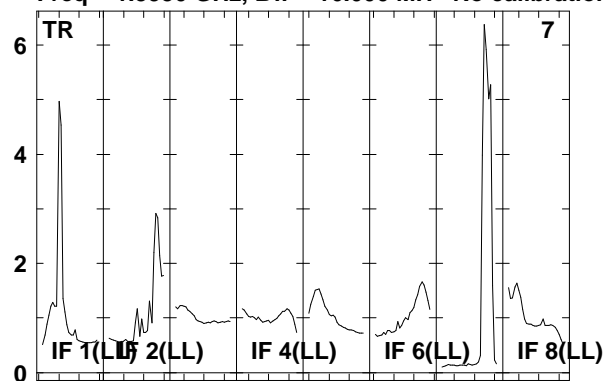

Lower frame: Real Jy
Total-power spectrum Antenna: *
Timerange: 00/16:17:01 to 00/16:20:29

Plot file version 190 created 06-JAN-2012 11:47:13

J1128+59 EP068D 5.UVDATA.1

Freq = 1.5950 GHz, Bw = 16.000 MH No calibration applied and no bandpass applied

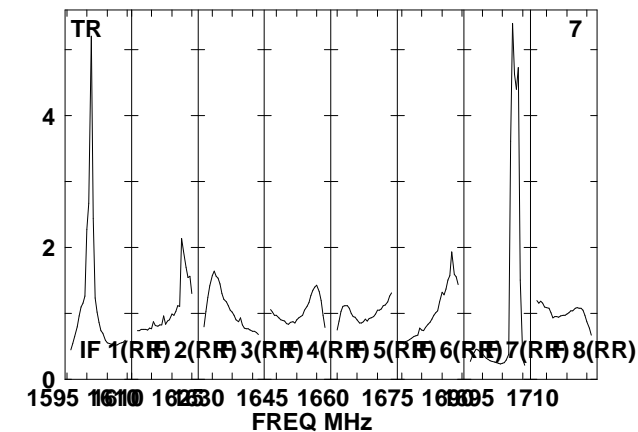
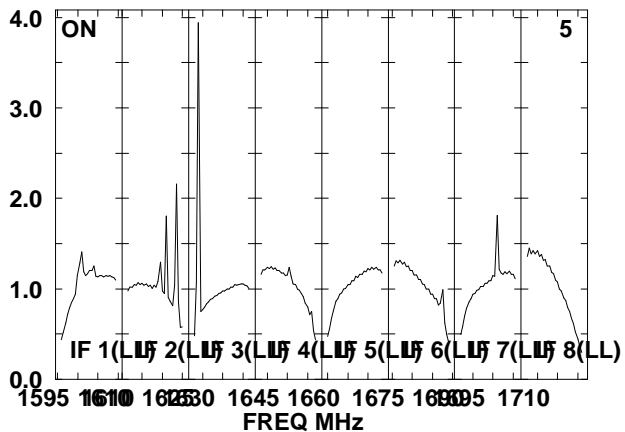
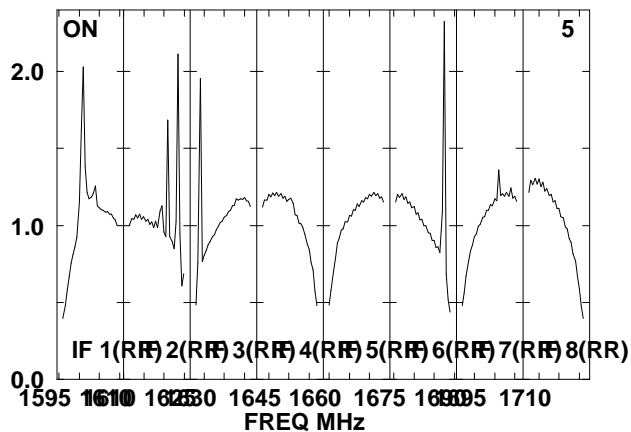
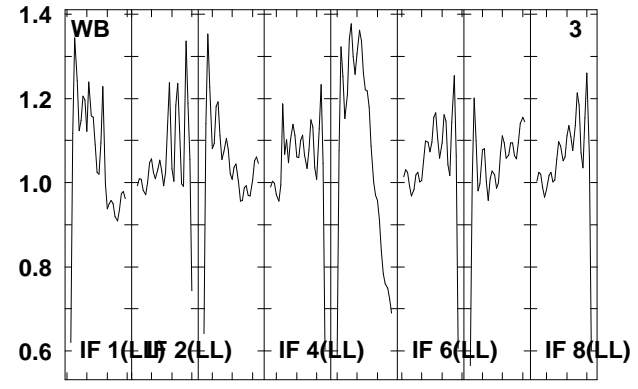
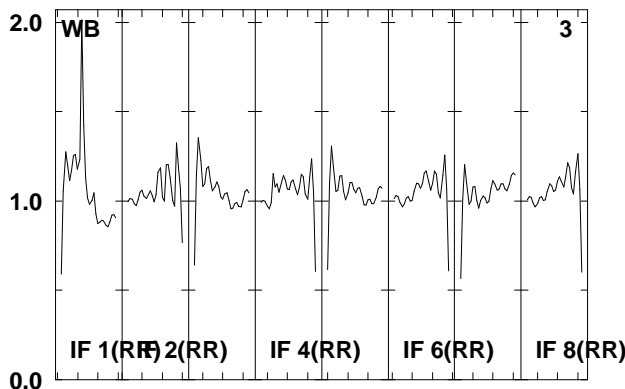
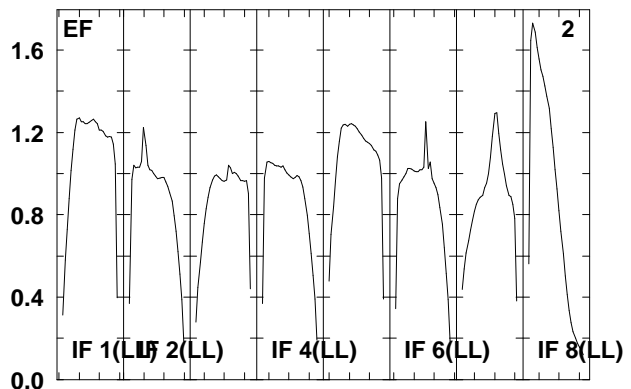
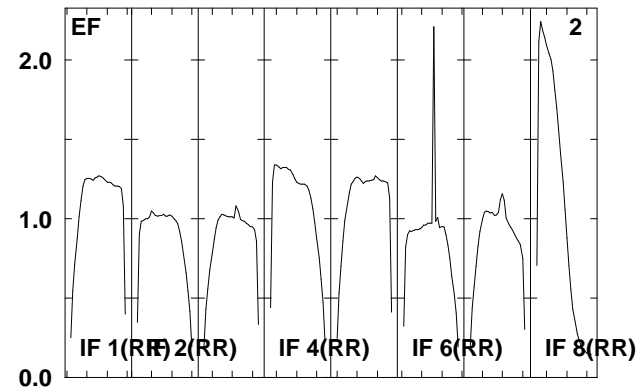
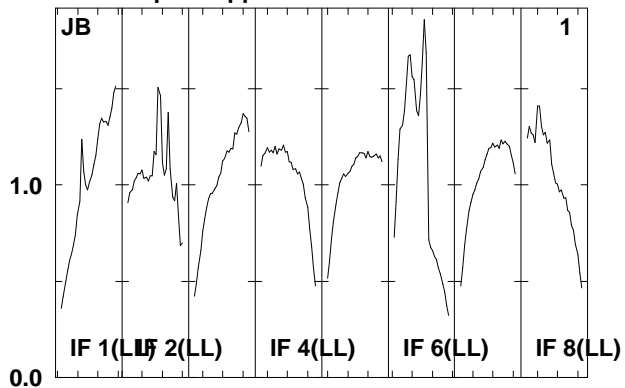
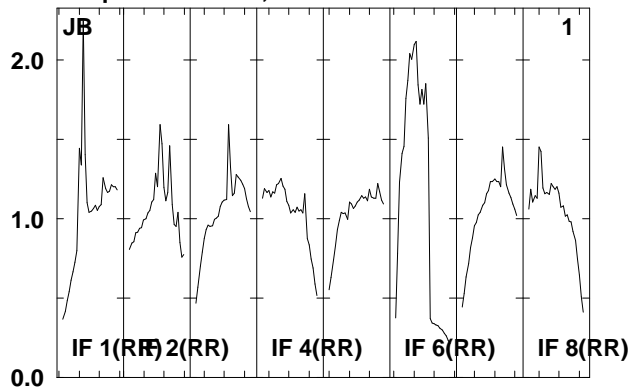

Lower frame: Real Jy
Total-power spectrum Antenna: *
Timerange: 00/16:21:31 to 00/16:22:59

Plot file version 191 created 06-JAN-2012 11:47:13

J1128+59 EP068D 5.UVDATA.1

Freq = 1.5950 GHz, Bw = 16.000 MH No calibration applied and no bandpass applied

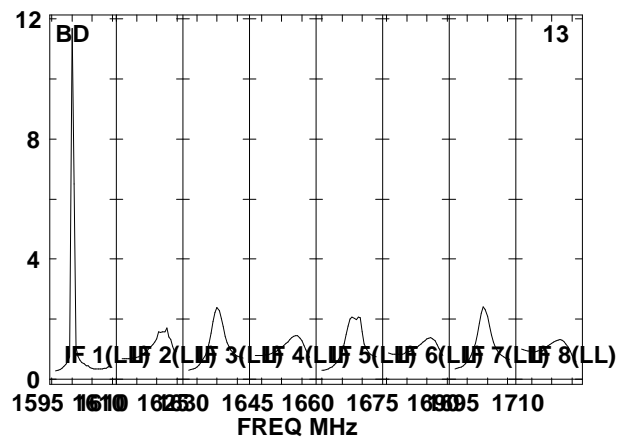
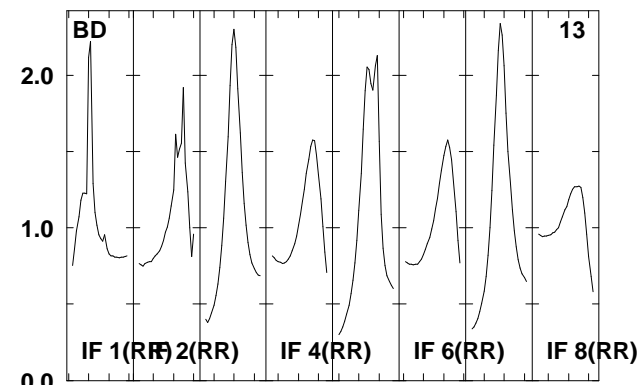
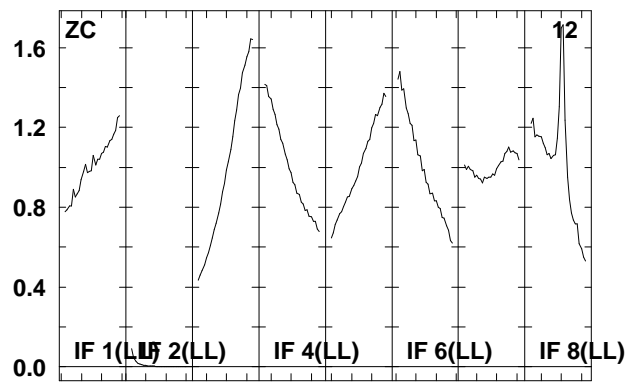
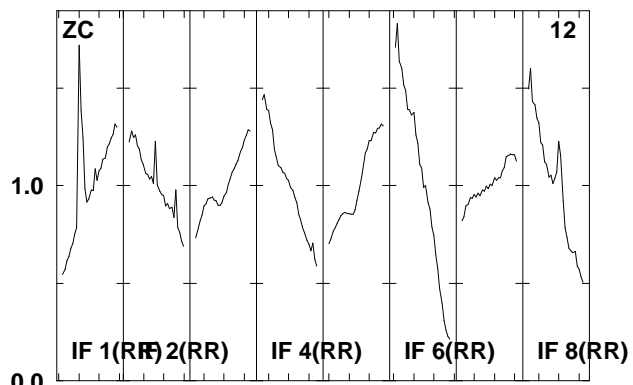
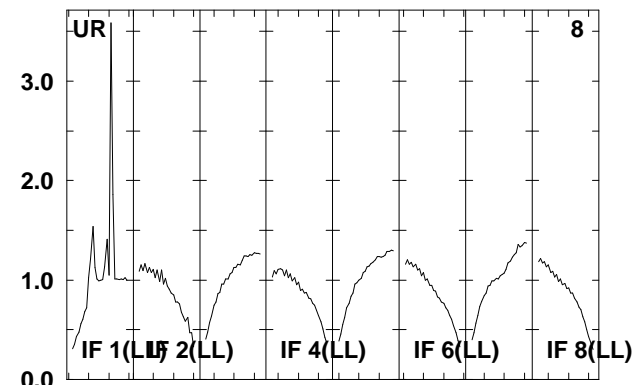
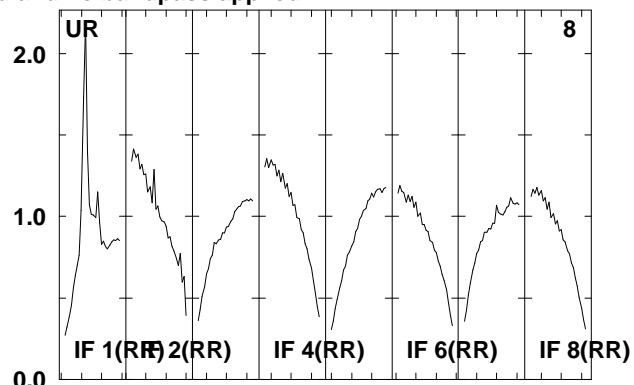
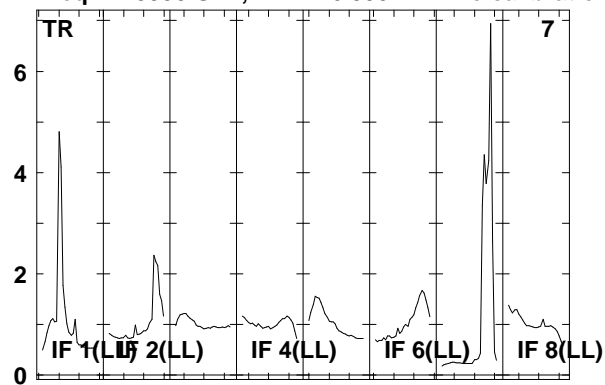

Lower frame: Real Jy

Total-power spectrum Antenna: *

Timerange: 00/16:21:31 to 00/16:22:59

Plot file version 192 created 06-JAN-2012 11:47:13

ARP299D EP068D 5.UVDATA.1

Freq = 1.5950 GHz, Bw = 16.000 MH No calibration applied and no bandpass applied

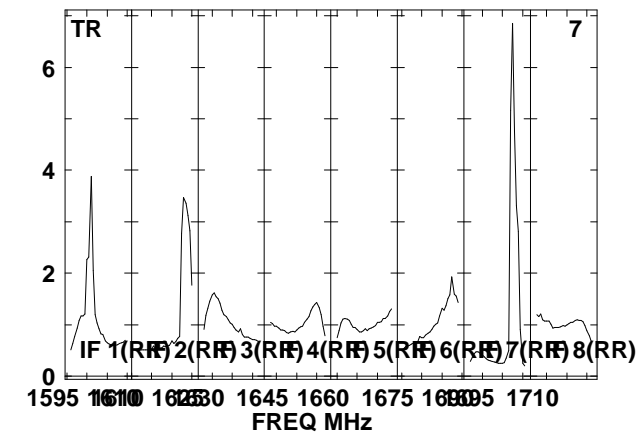
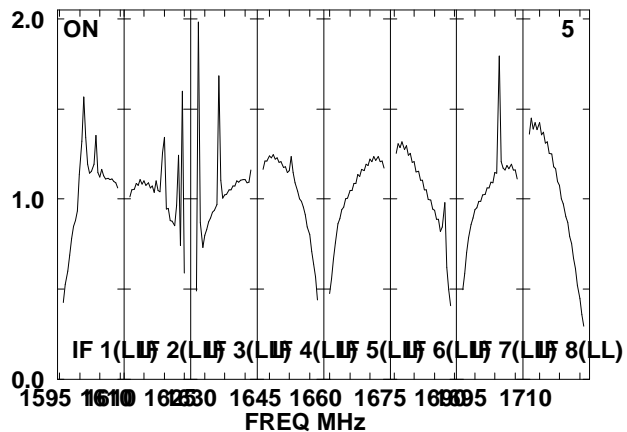
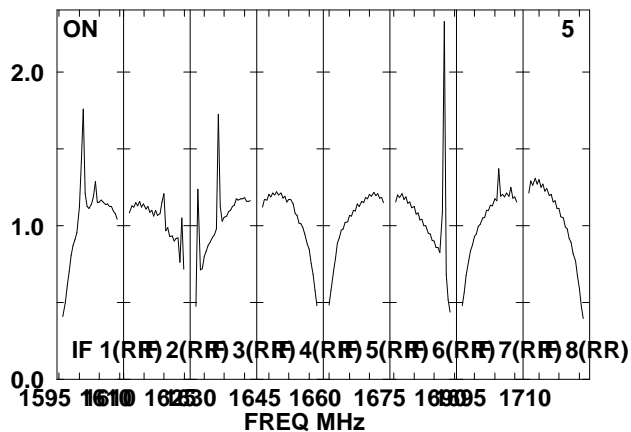
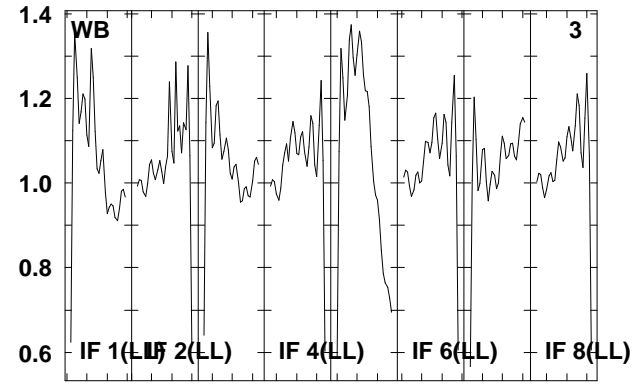
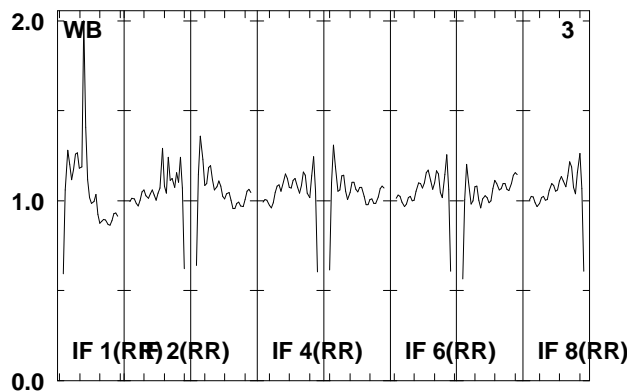
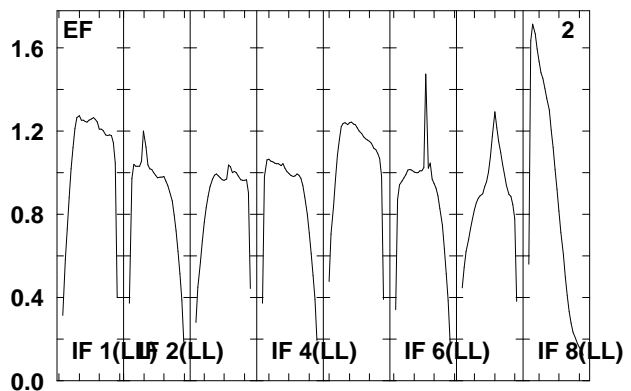
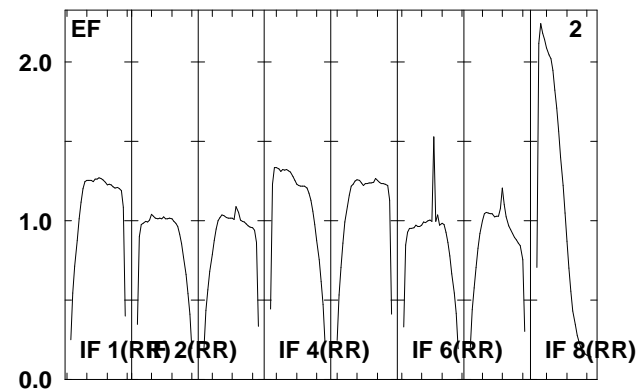
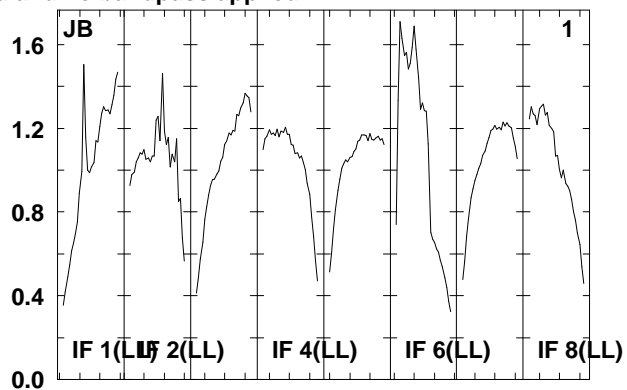
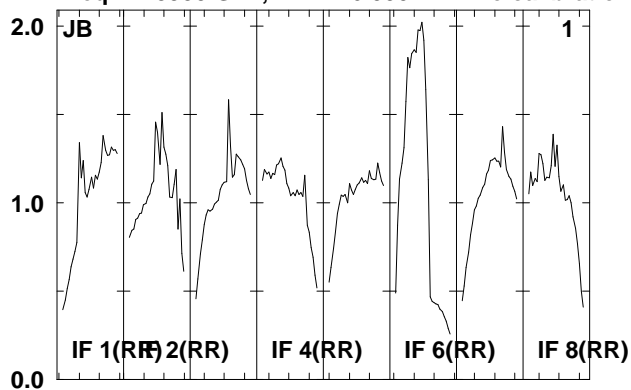

Lower frame: Real Jy
Total-power spectrum Antenna: *
Timerange: 00/16:23:05 to 00/16:26:29

Plot file version 193 created 06-JAN-2012 11:47:14

ARP299D EP068D 5.UVDATA.1

Freq = 1.5950 GHz, Bw = 16.000 MH No calibration applied and no bandpass applied

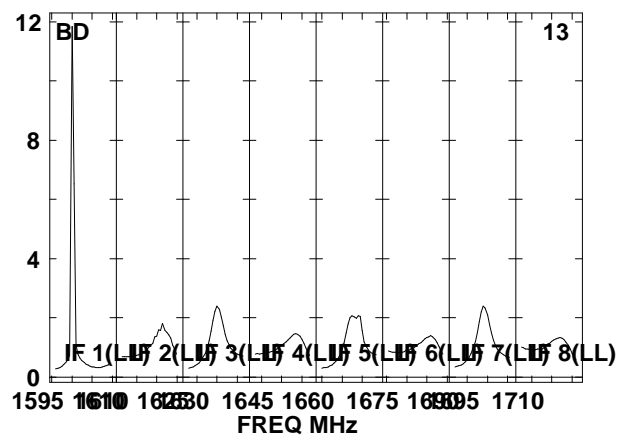
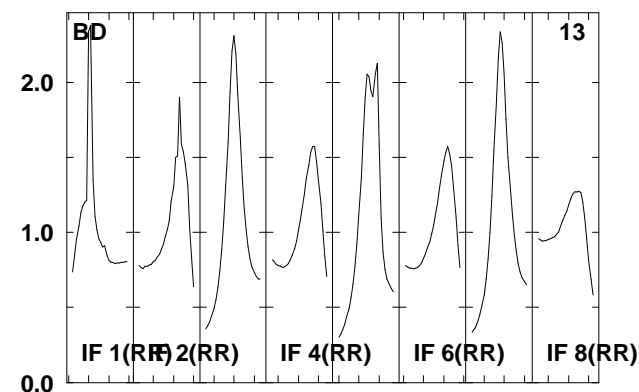
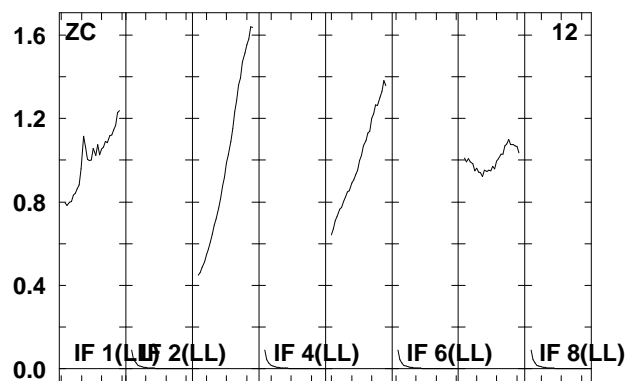
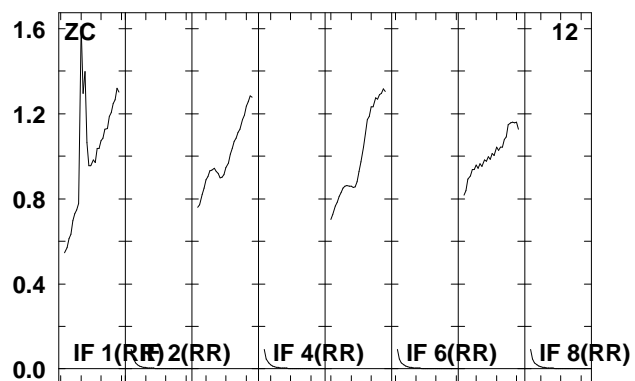
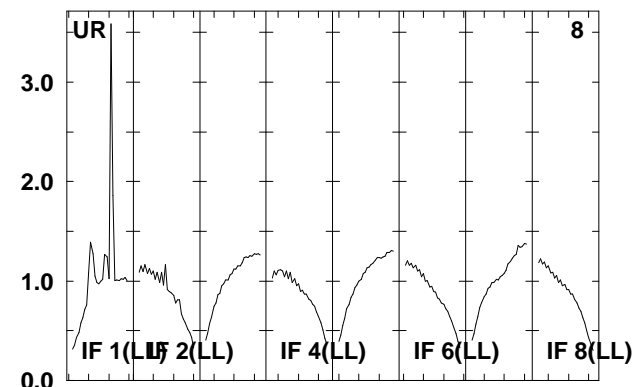
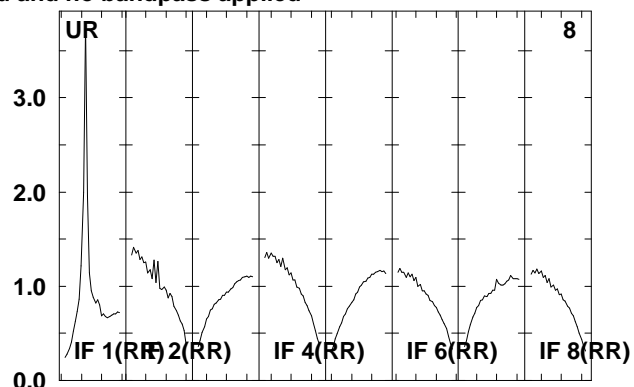
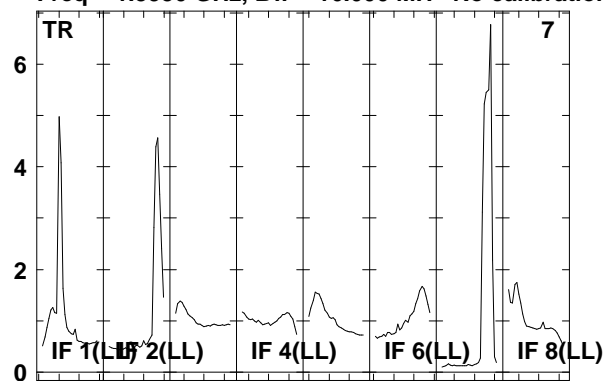

Lower frame: Real Jy

Total-power spectrum Antenna: *

Timerange: 00/16:23:05 to 00/16:26:29

Plot file version 194 created 06-JAN-2012 11:47:15

J1128+59 EP068D 5.UVDATA.1

Freq = 1.5950 GHz, Bw = 16.000 MH No calibration applied and no bandpass applied

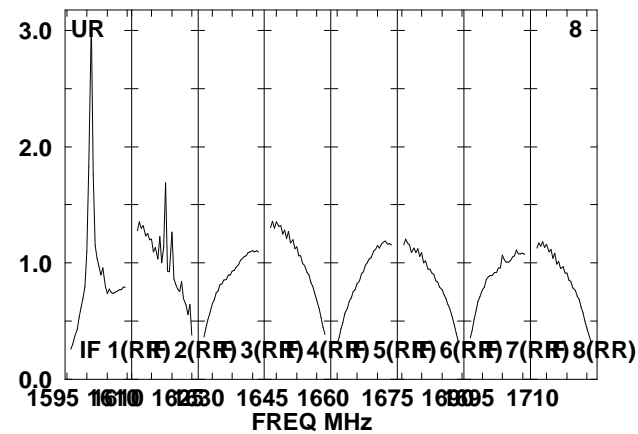
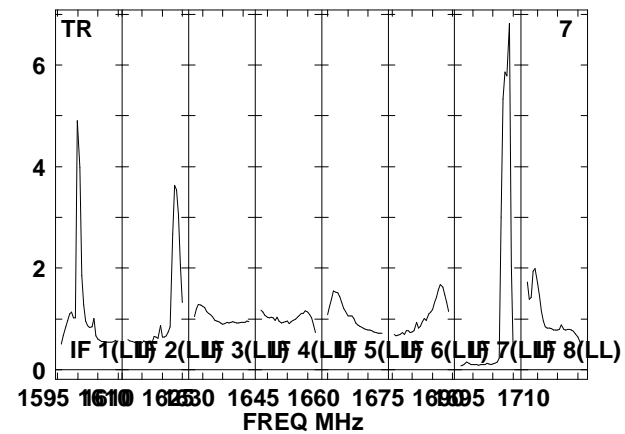
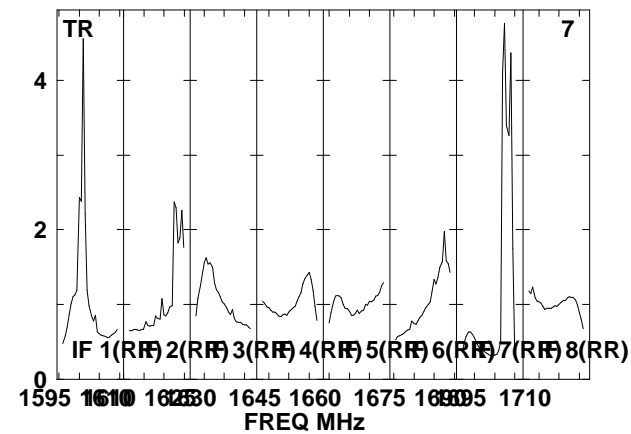
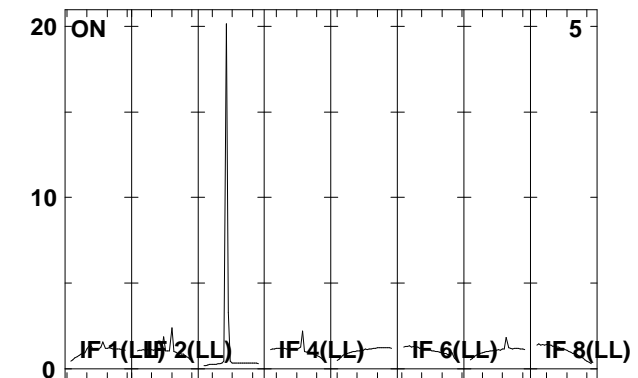
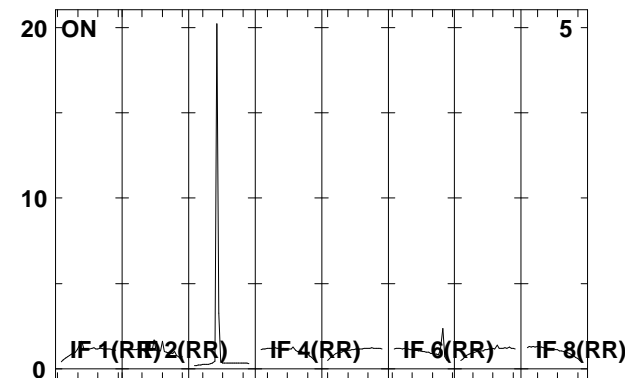
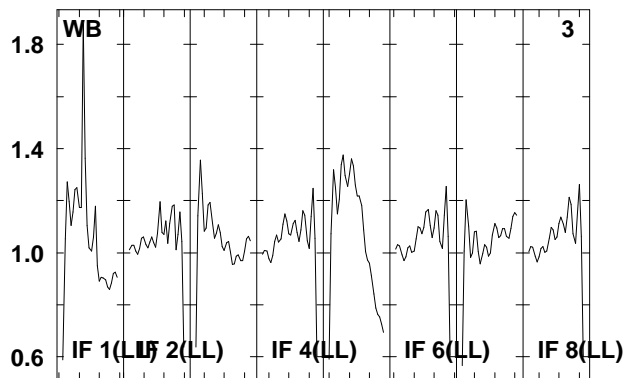
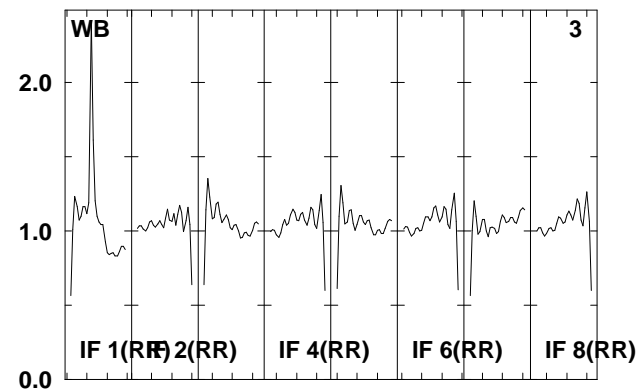
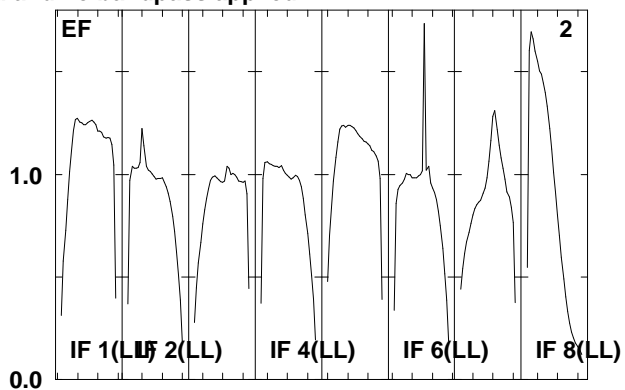
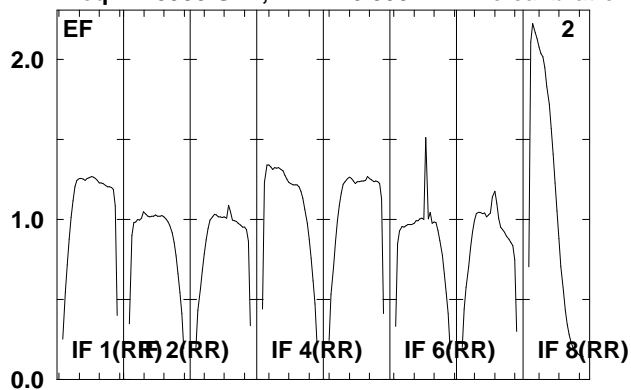

Lower frame: Real Jy
Total-power spectrum Antenna: *
Timerange: 00/16:26:35 to 00/16:27:59

Plot file version 195 created 06-JAN-2012 11:47:15

J1128+59 EP068D 5.UVDATA.1

Freq = 1.5950 GHz, Bw = 16.000 MH No calibration applied and no bandpass applied

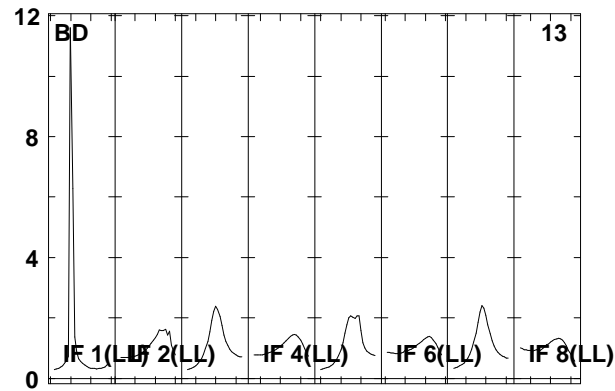
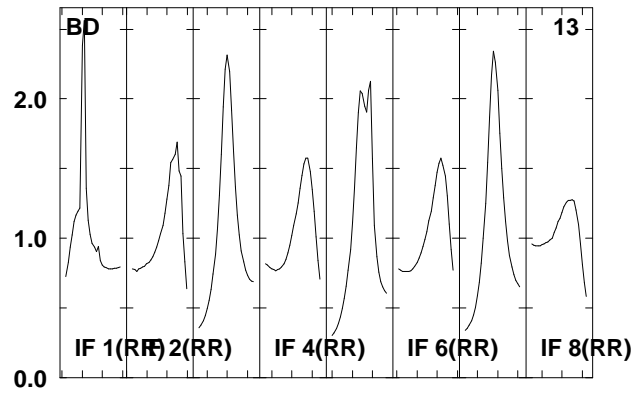
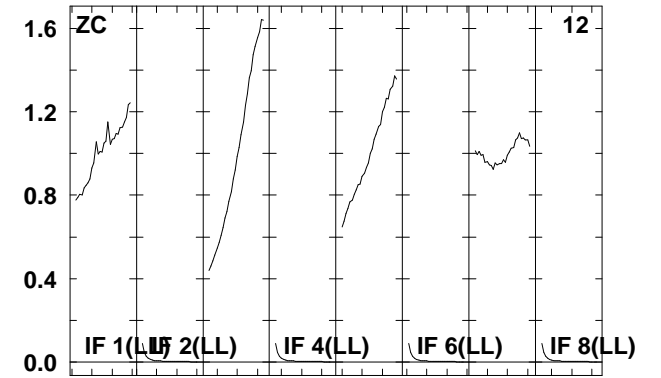
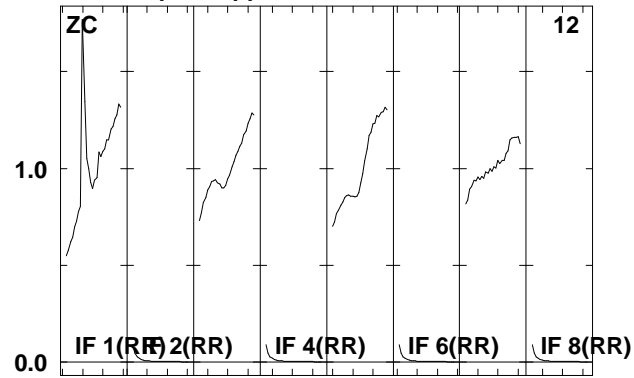
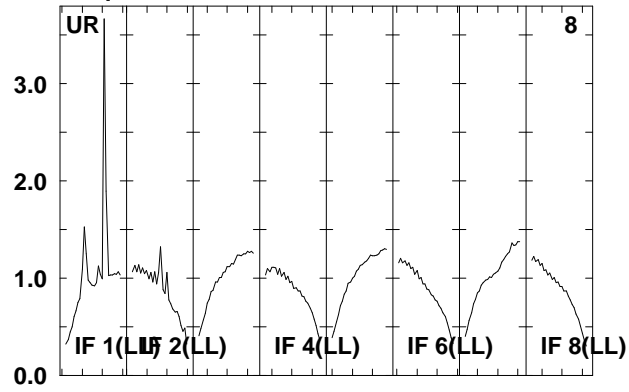

Lower frame: Real Jy
Total-power spectrum Antenna: *
Timerange: 00/16:26:35 to 00/16:27:59

Plot file version 196 created 06-JAN-2012 11:47:15

ARP299D EP068D 5.UVDATA.1

Freq = 1.5950 GHz, Bw = 16.000 MH No calibration applied and no bandpass applied

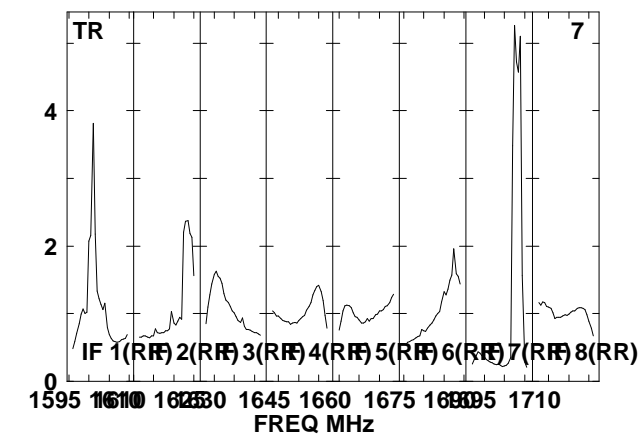
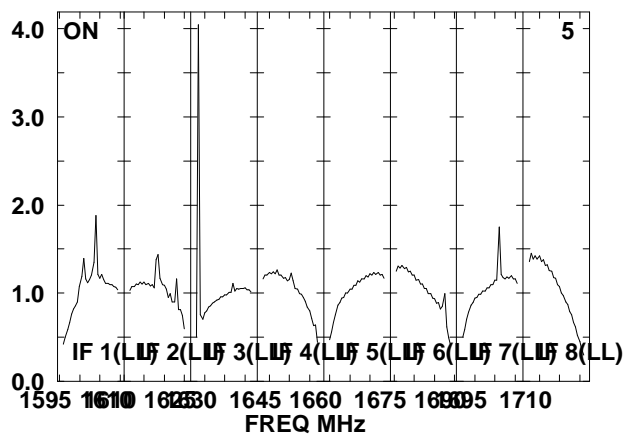
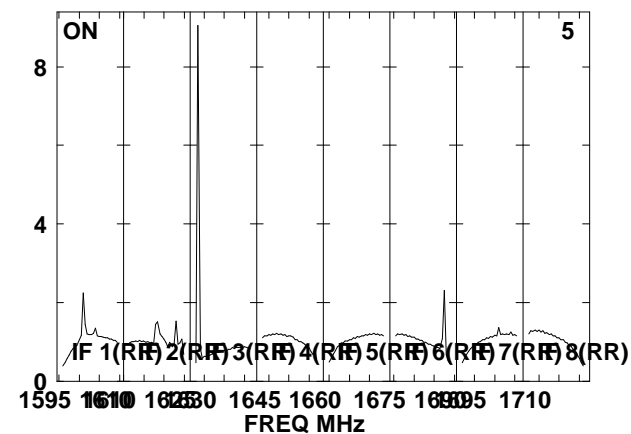
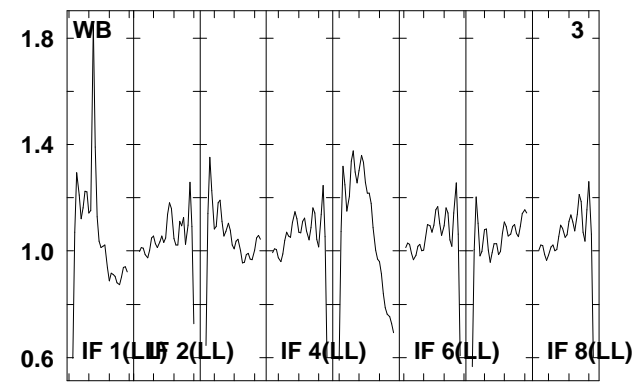
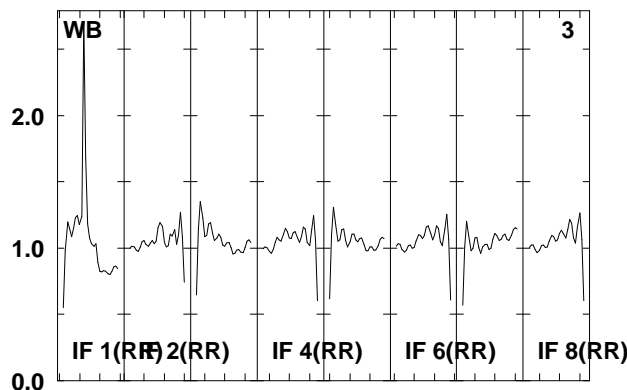
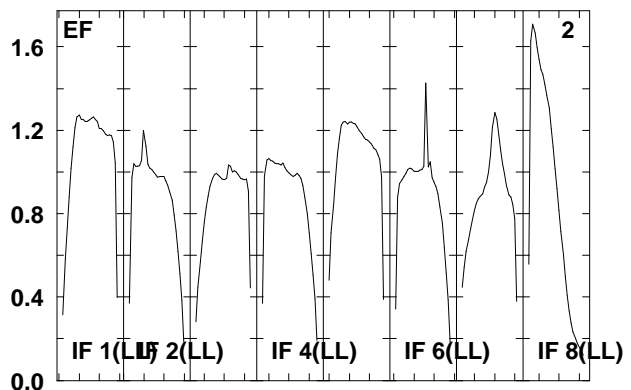
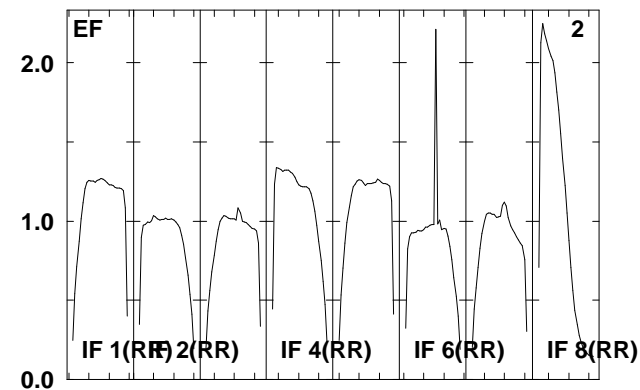
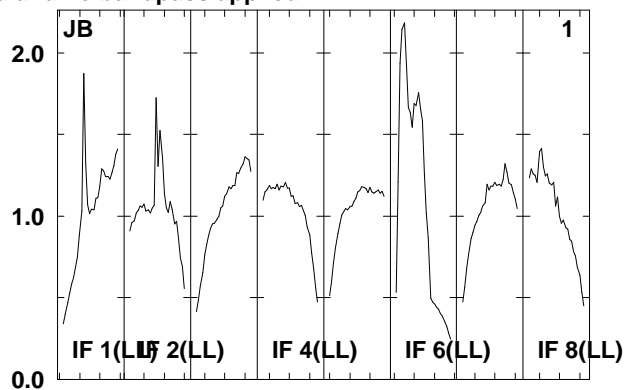
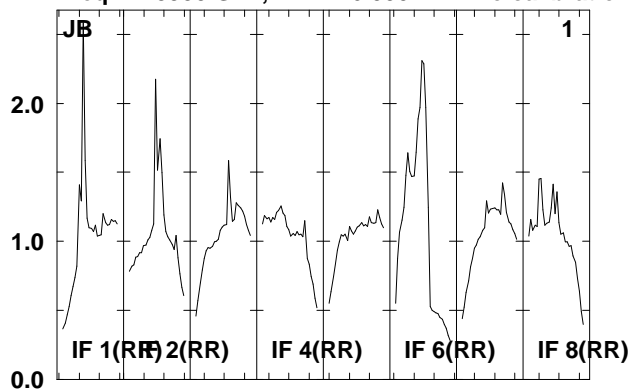

Lower frame: Real Jy
Total-power spectrum Antenna: *
Timerange: 00/16:28:01 to 00/16:31:29

Plot file version 197 created 06-JAN-2012 11:47:16

ARP299D EP068D 5.UVDATA.1

Freq = 1.5950 GHz, Bw = 16.000 MH No calibration applied and no bandpass applied

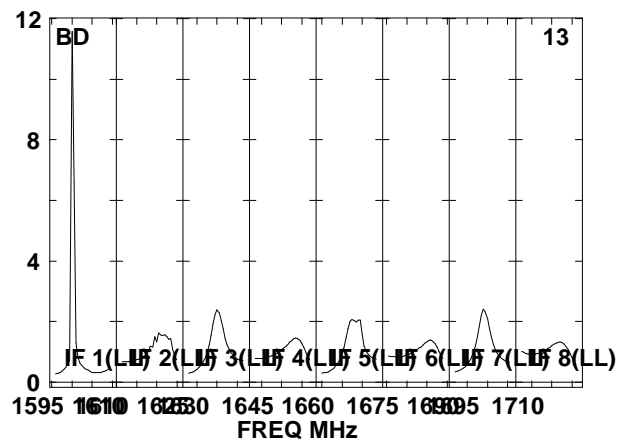
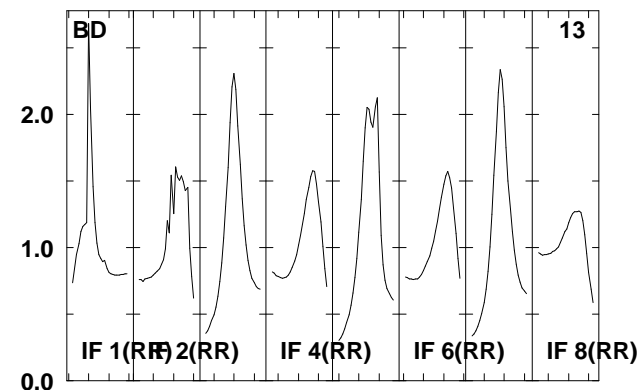
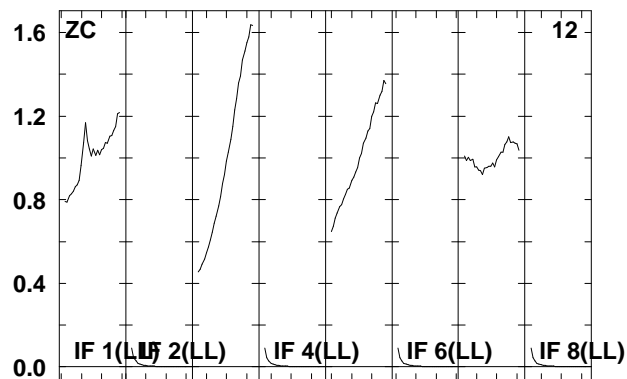
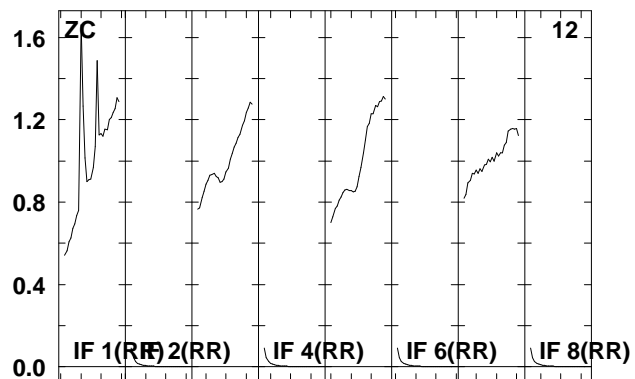
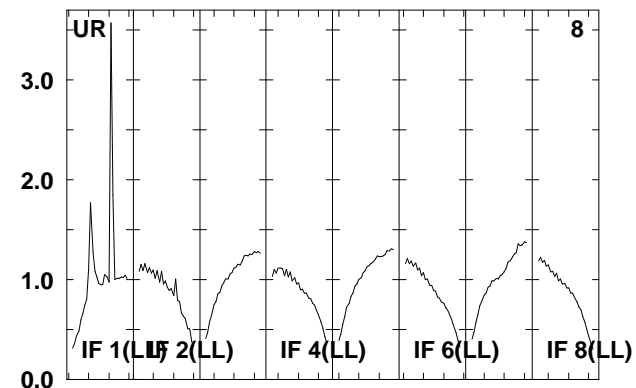
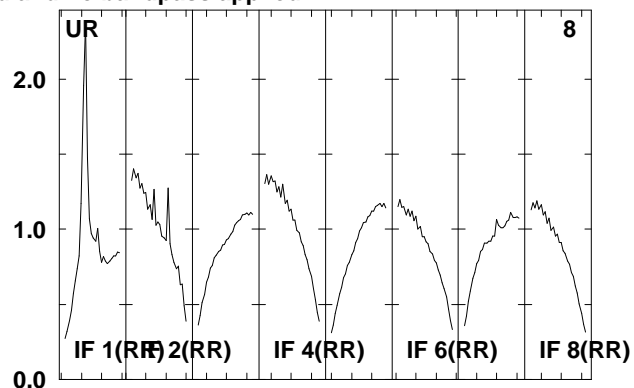
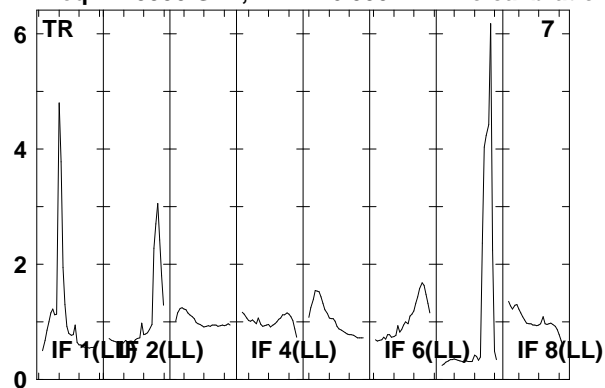

Lower frame: Real Jy

Total-power spectrum Antenna: *

Timerange: 00/16:28:01 to 00/16:31:29

Plot file version 198 created 06-JAN-2012 11:47:16

J1128+59 EP068D 5.UVDATA.1

Freq = 1.5950 GHz, Bw = 16.000 MH No calibration applied and no bandpass applied

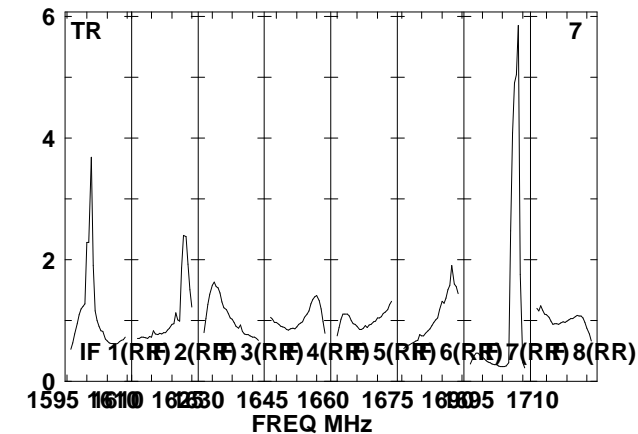
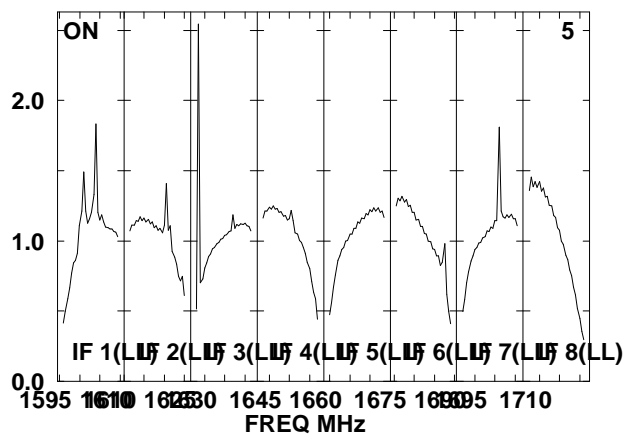
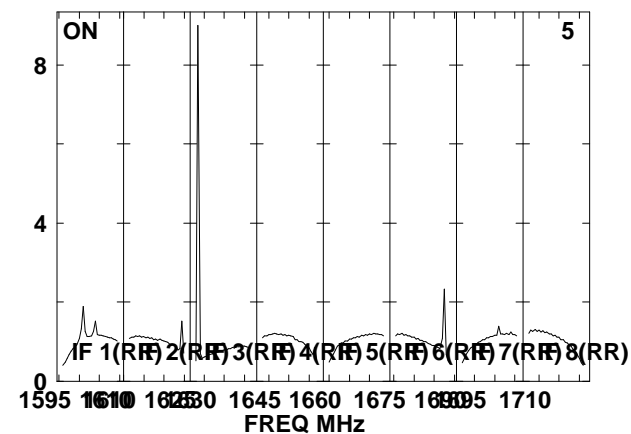
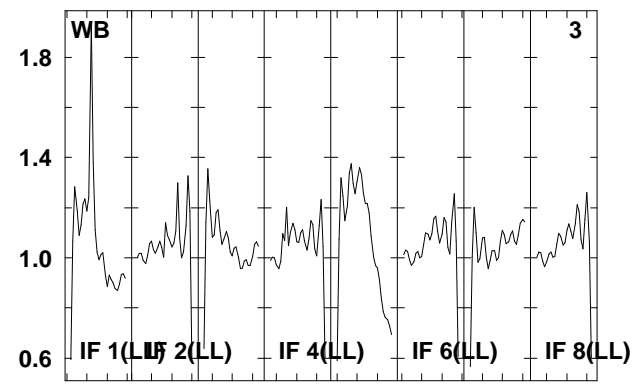
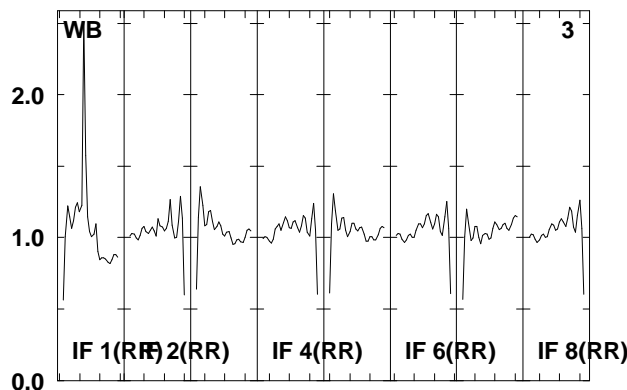
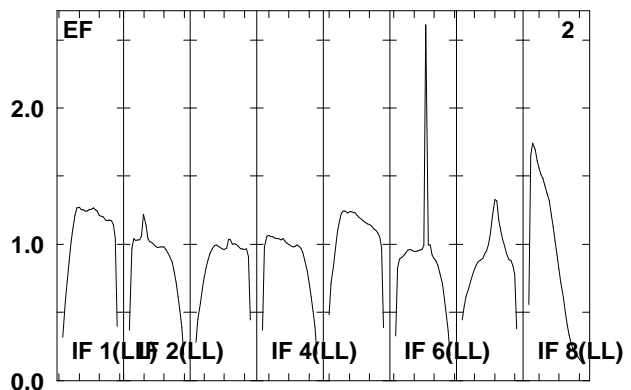
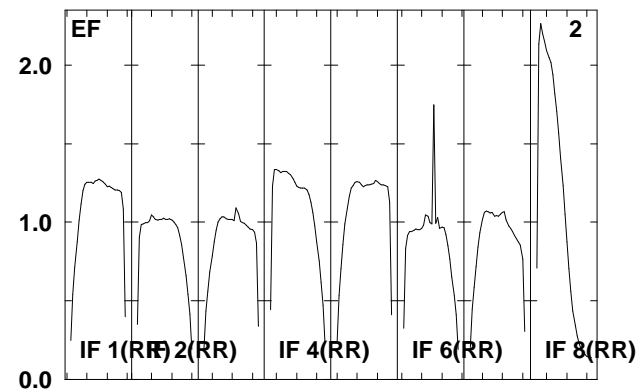
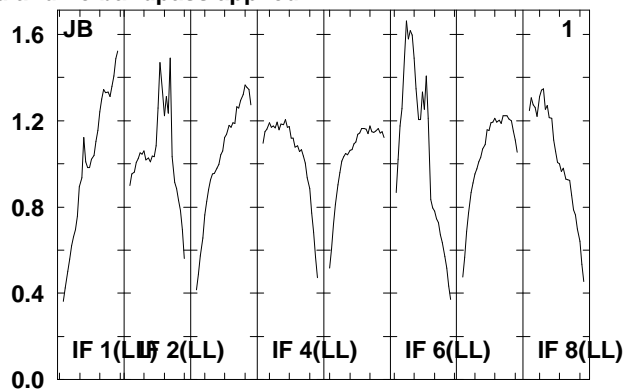
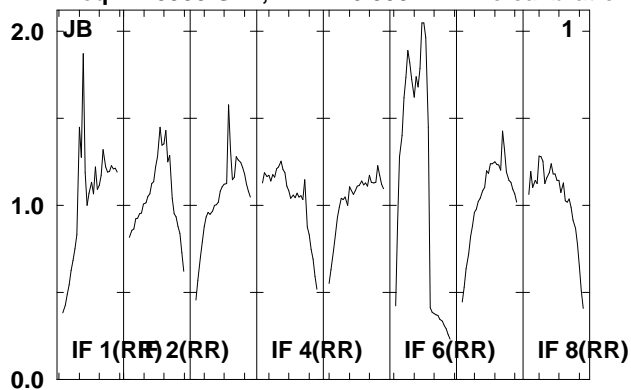

Lower frame: Real Jy
Total-power spectrum Antenna: *
Timerange: 00/16:31:35 to 00/16:32:59

Plot file version 199 created 06-JAN-2012 11:47:16

J1128+59 EP068D 5.UVDATA.1

Freq = 1.5950 GHz, Bw = 16.000 MH No calibration applied and no bandpass applied

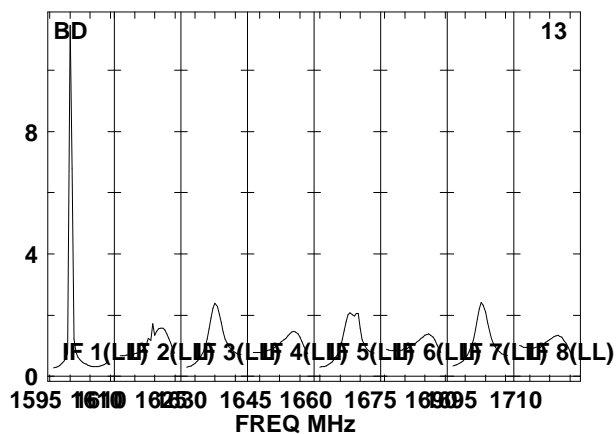
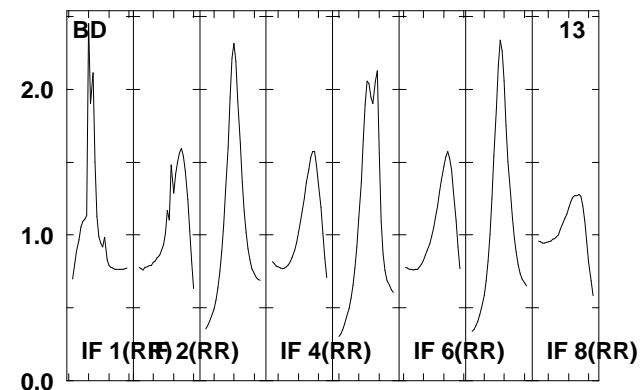
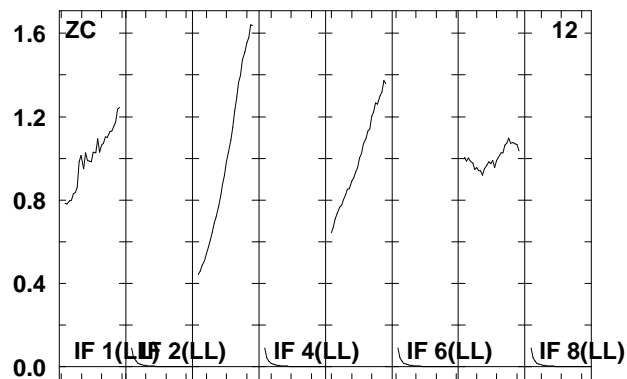
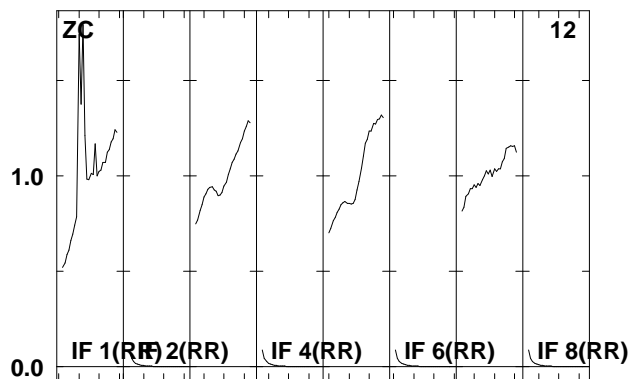
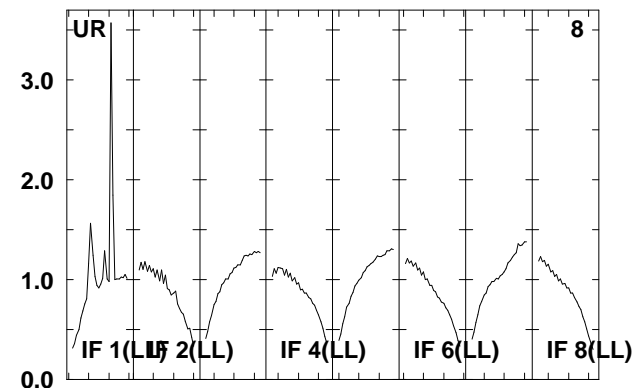
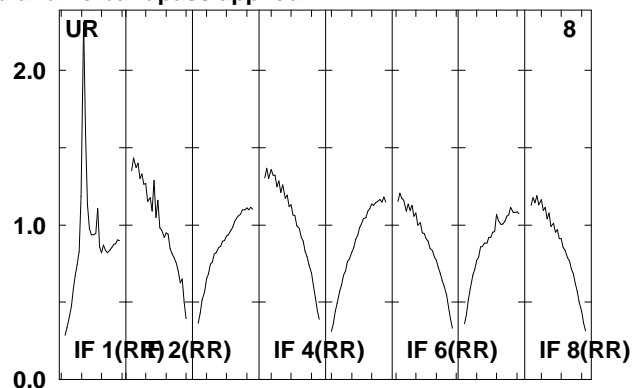
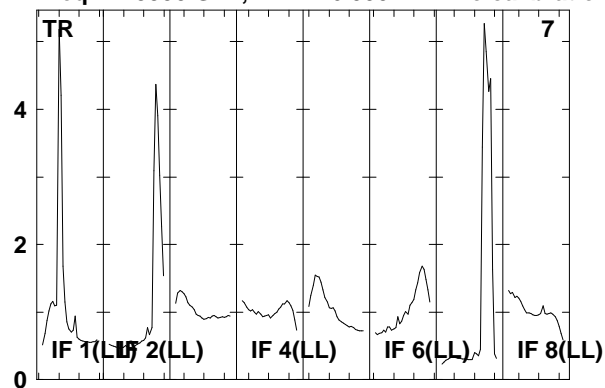

Lower frame: Real Jy

Total-power spectrum Antenna: *

Timerange: 00/16:31:35 to 00/16:32:59

Plot file version 200 created 06-JAN-2012 11:47:17

ARP299D EP068D 5.UVDATA.1

Freq = 1.5950 GHz, Bw = 16.000 MH No calibration applied and no bandpass applied

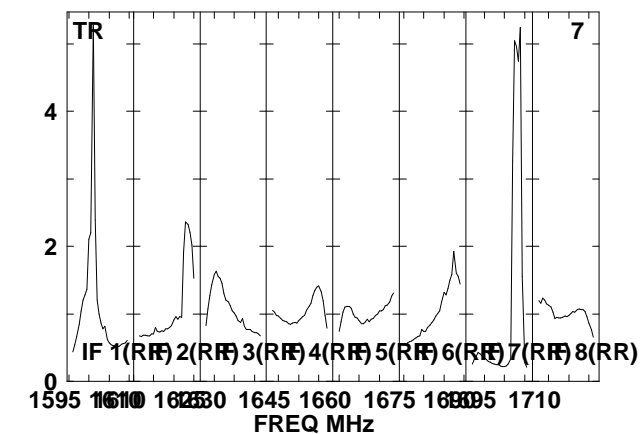
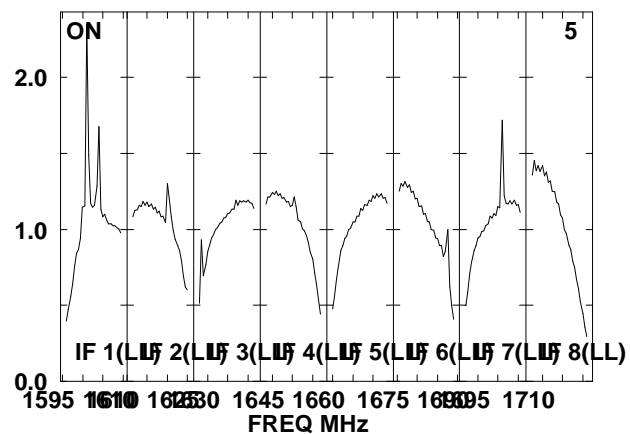
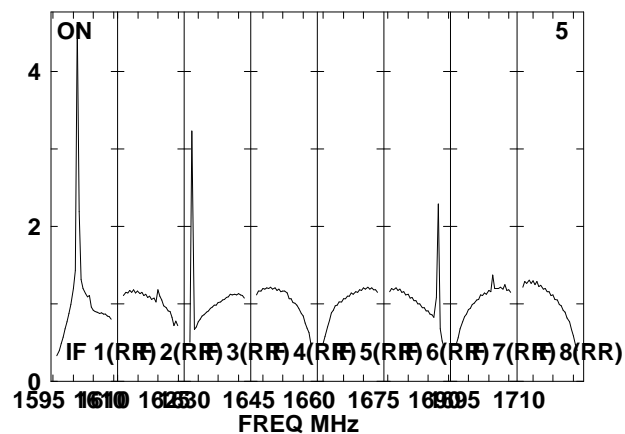
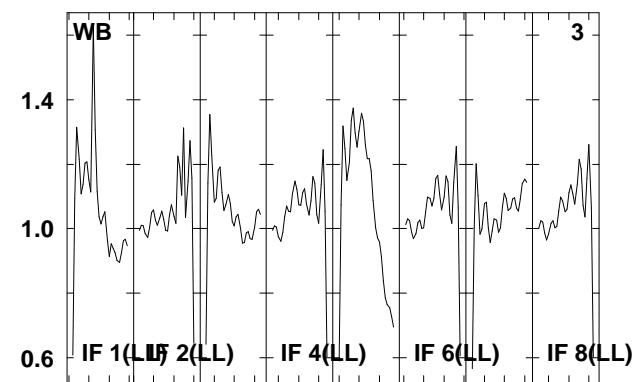
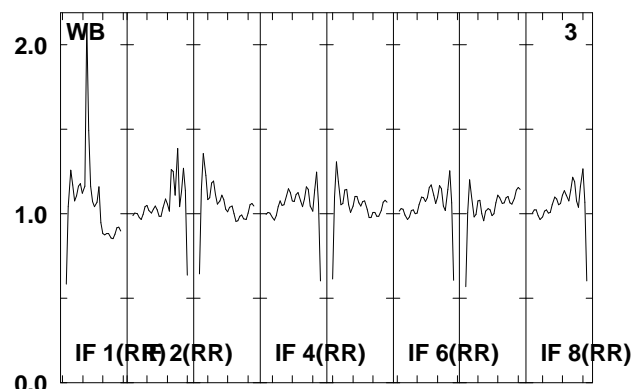
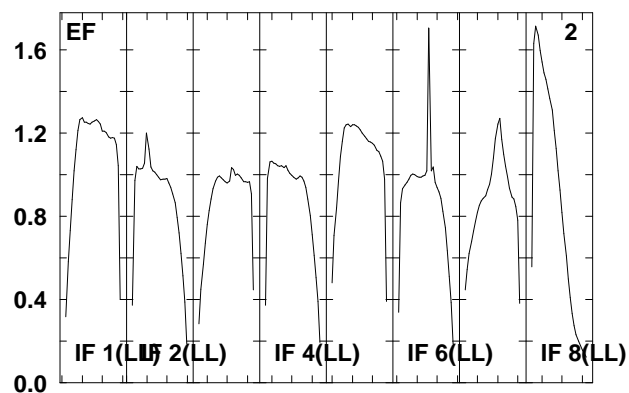
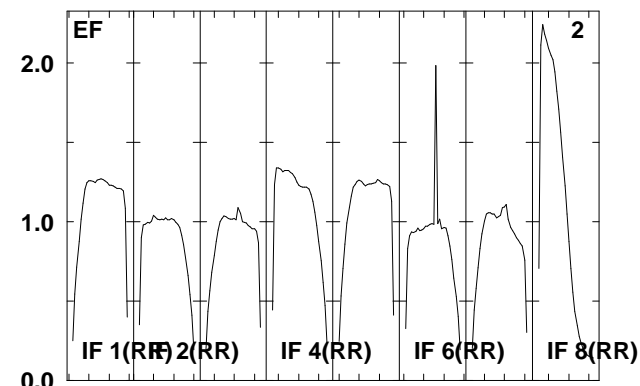
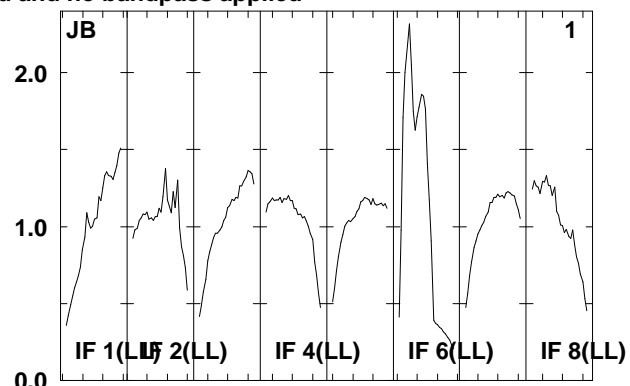
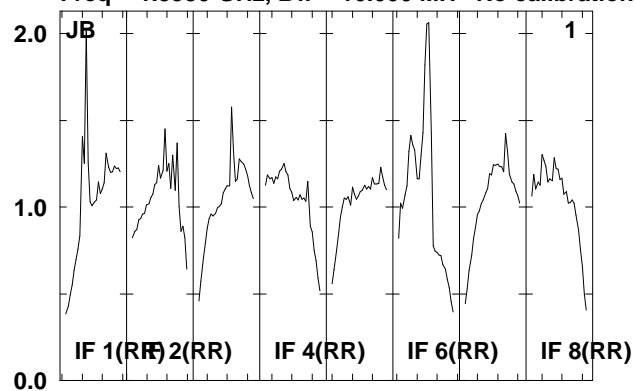

Lower frame: Real Jy
Total-power spectrum Antenna: *
Timerange: 00/16:33:05 to 00/16:36:29

Plot file version 201 created 06-JAN-2012 11:47:17

ARP299D EP068D 5.UVDATA.1

Freq = 1.5950 GHz, Bw = 16.000 MH No calibration applied and no bandpass applied

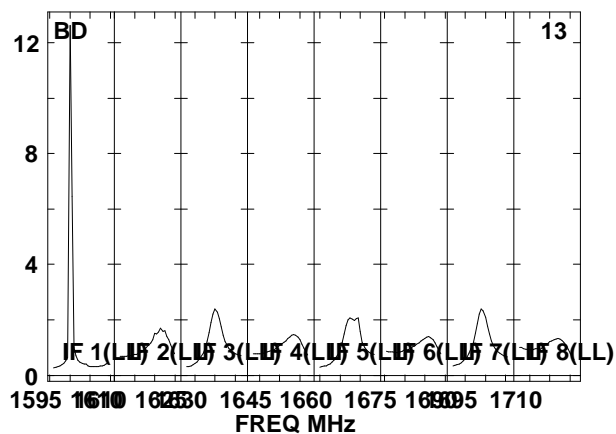
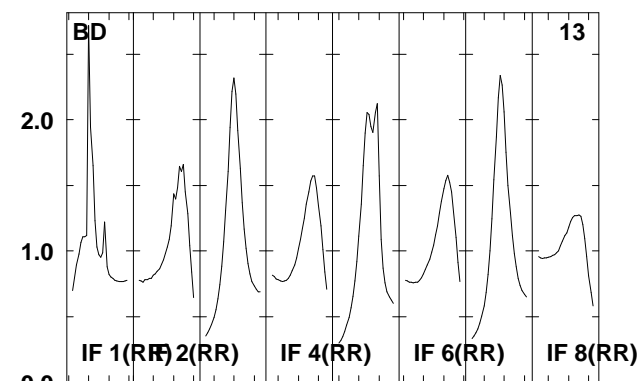
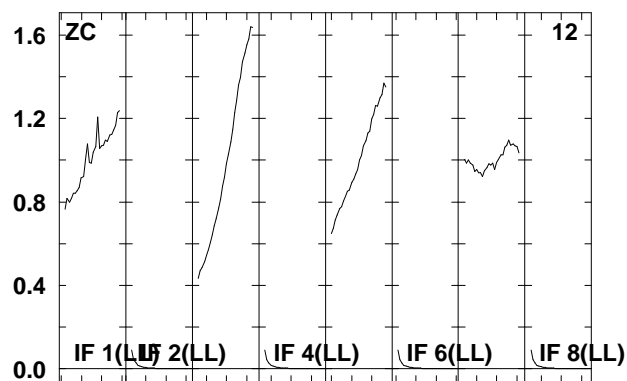
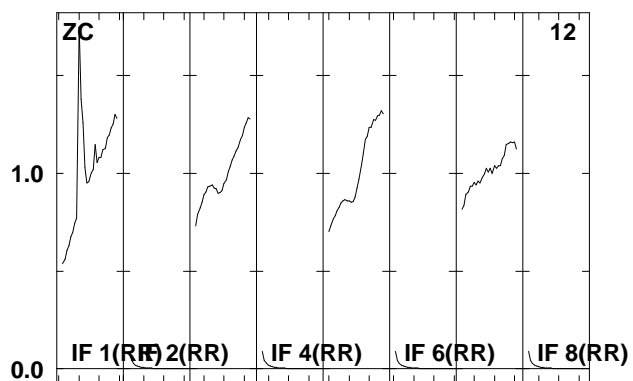
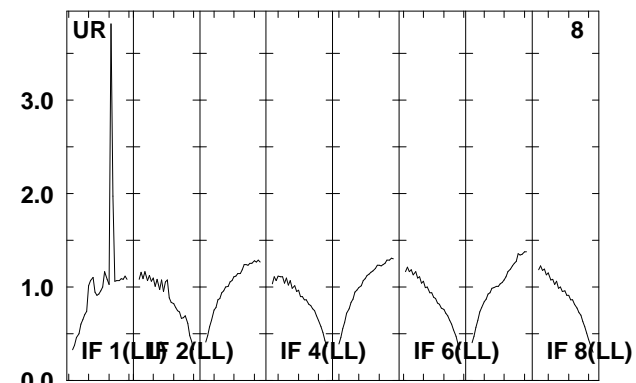
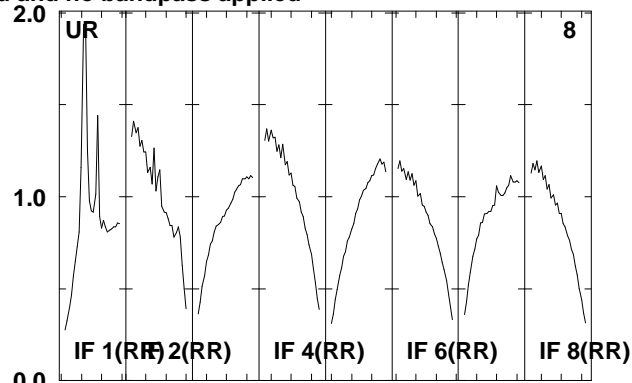
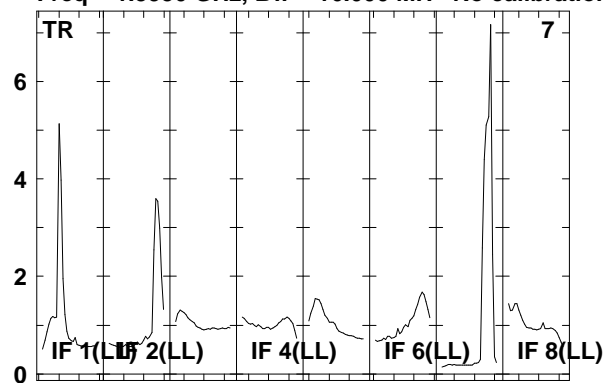

Lower frame: Real Jy

Total-power spectrum Antenna: *

Timerange: 00/16:33:05 to 00/16:36:29

Plot file version 202 created 06-JAN-2012 11:47:18

J1128+59 EP068D 5.UVDATA.1

Freq = 1.5950 GHz, Bw = 16.000 MH No calibration applied and no bandpass applied

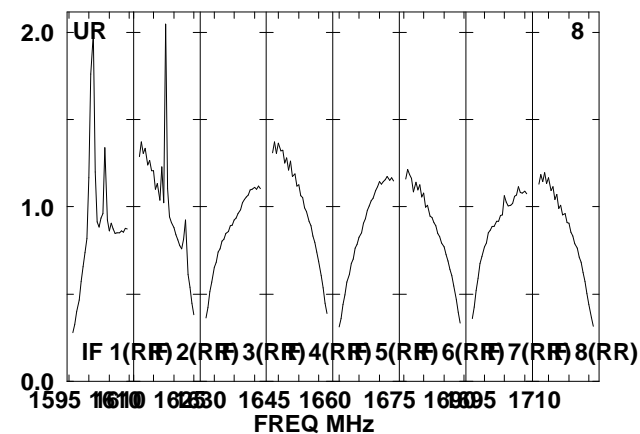
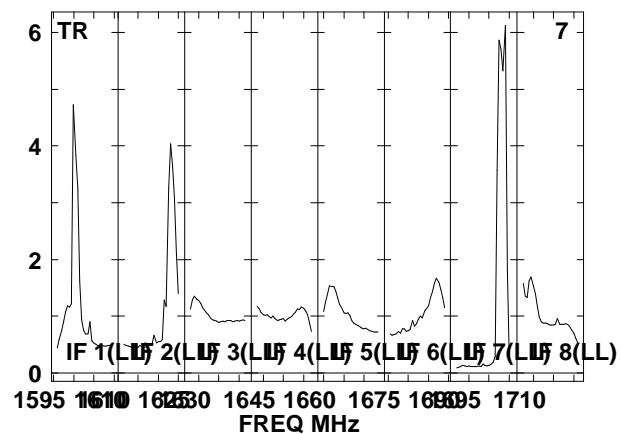
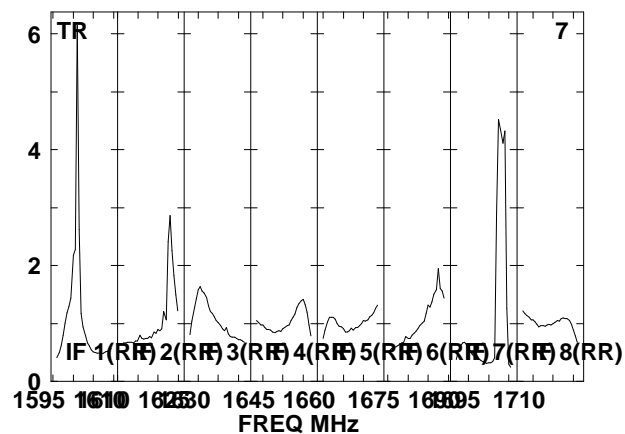
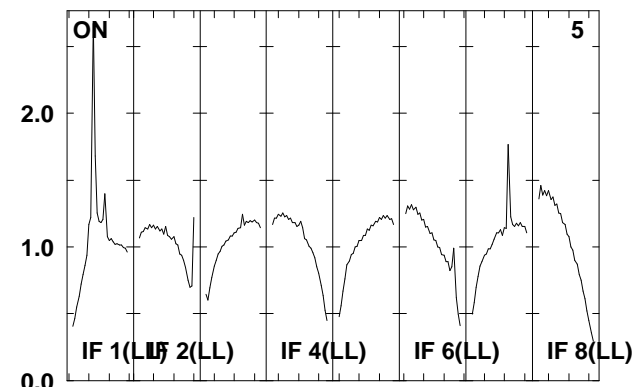
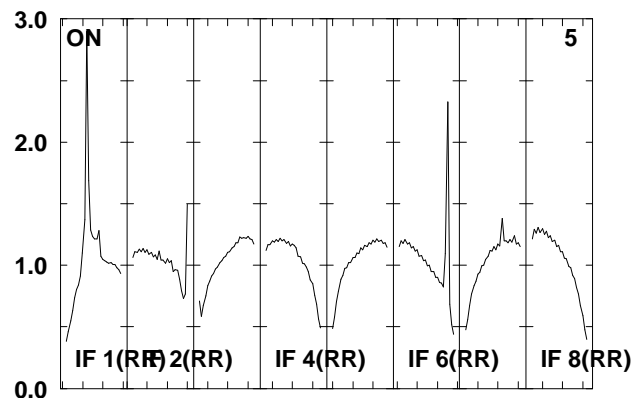
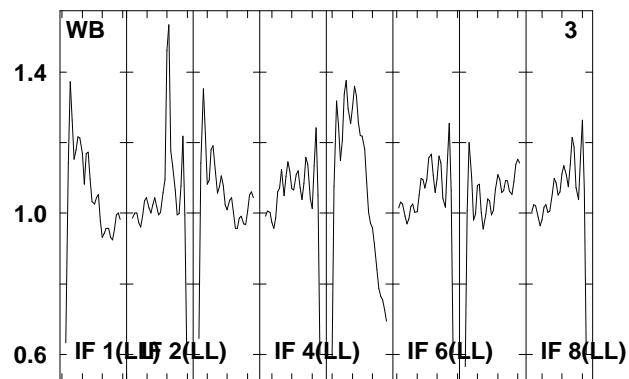
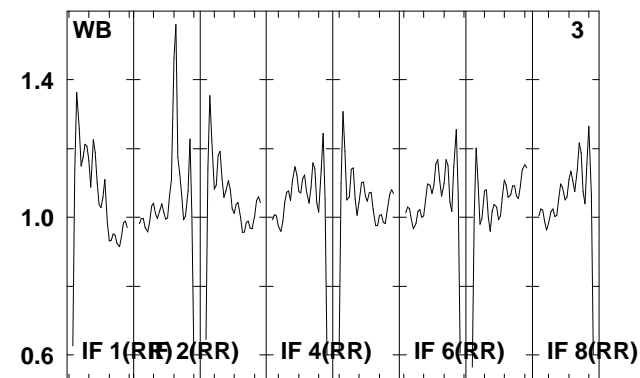
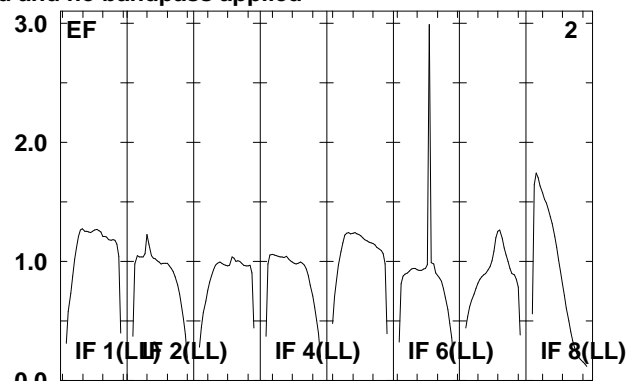
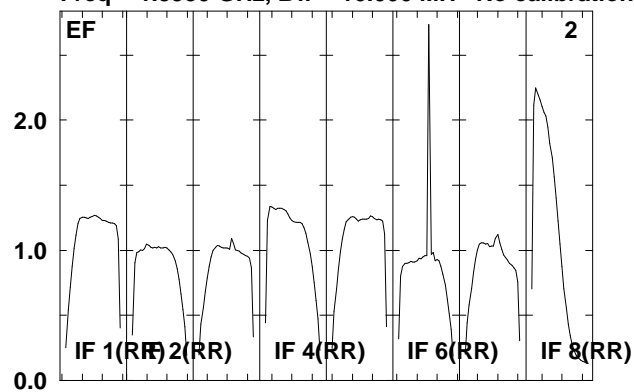

Lower frame: Real Jy
Total-power spectrum Antenna: *
Timerange: 00/16:37:31 to 00/16:38:59

Plot file version 203 created 06-JAN-2012 11:47:18

J1128+59 EP068D 5.UVDATA.1

Freq = 1.5950 GHz, Bw = 16.000 MH No calibration applied and no bandpass applied

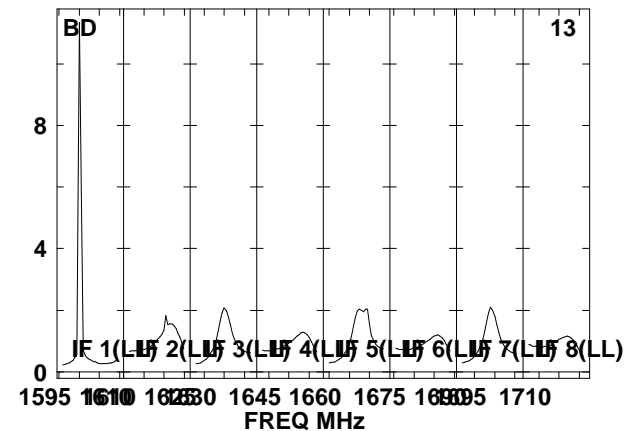
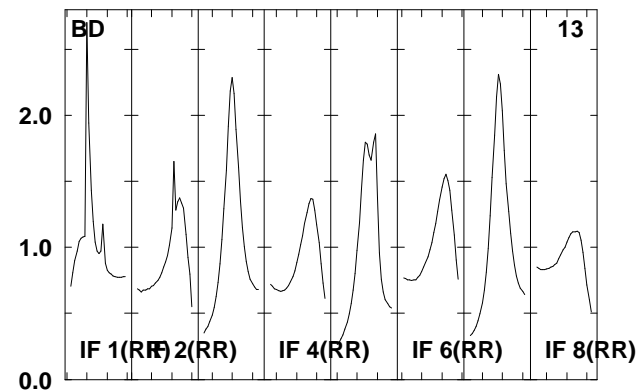
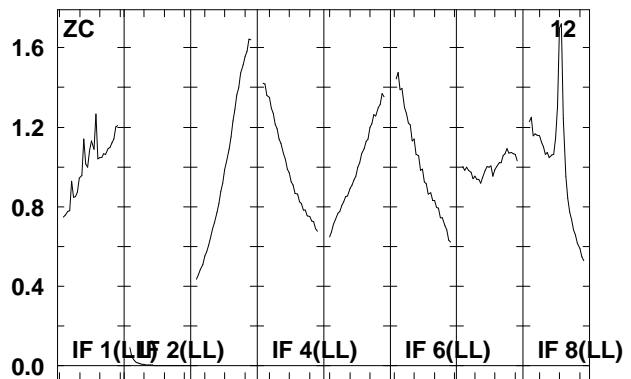
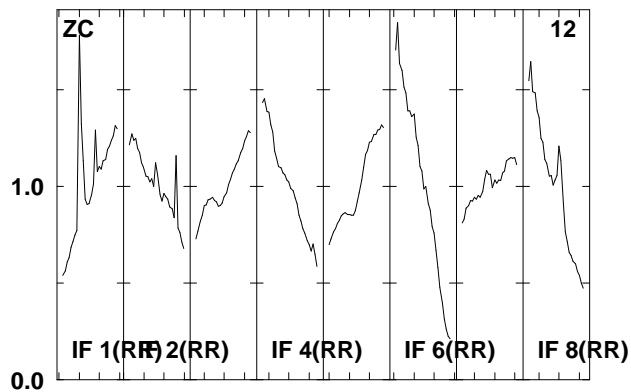
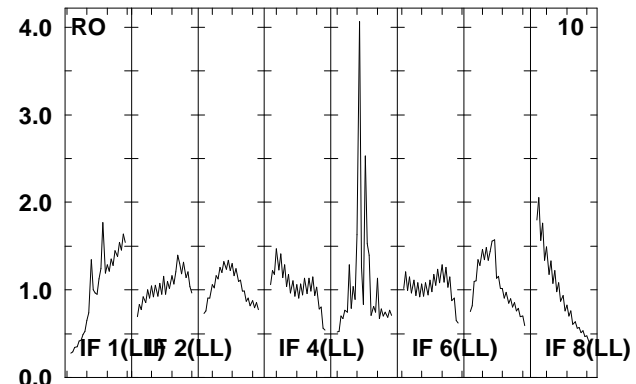
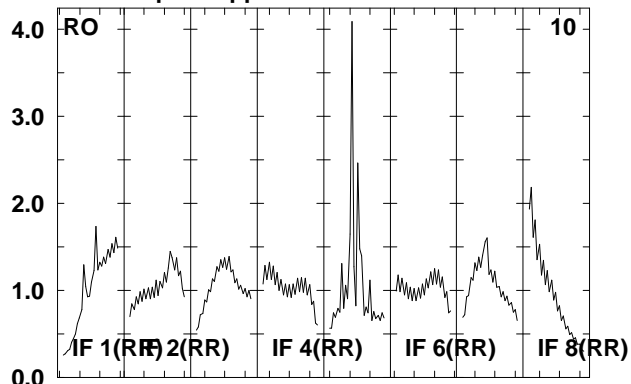
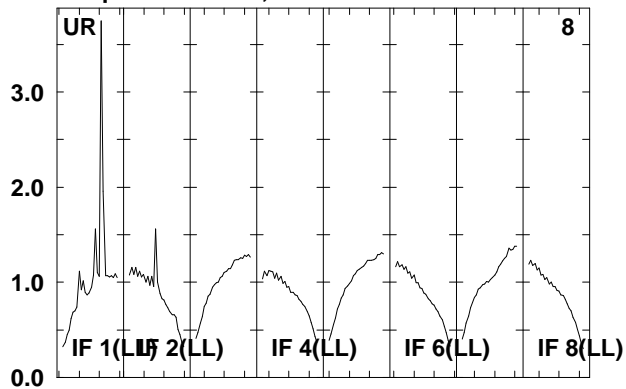

Lower frame: Real Jy

Total-power spectrum Antenna: *

Timerange: 00/16:37:31 to 00/16:38:59

Plot file version 204 created 06-JAN-2012 11:47:19

ARP299D EP068D 5.UVDATA.1

Freq = 1.5950 GHz, Bw = 16.000 MH No calibration applied and no bandpass applied

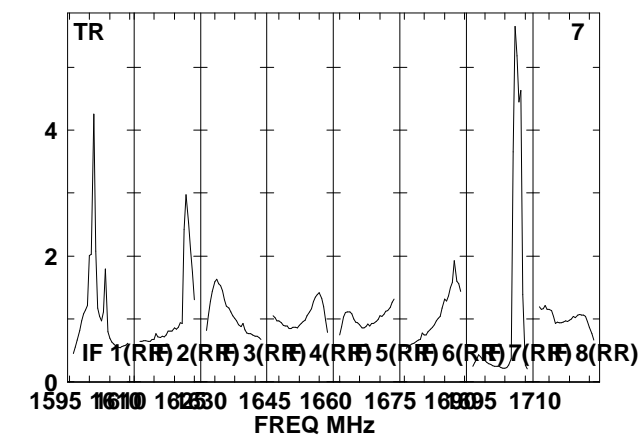
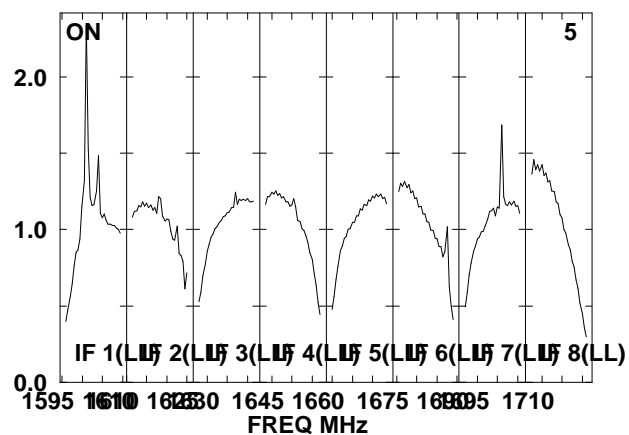
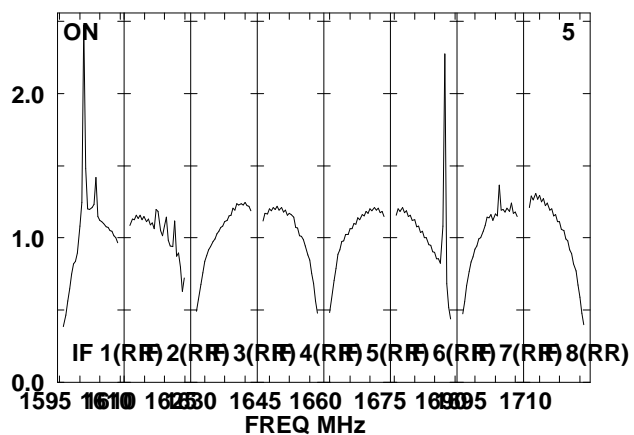
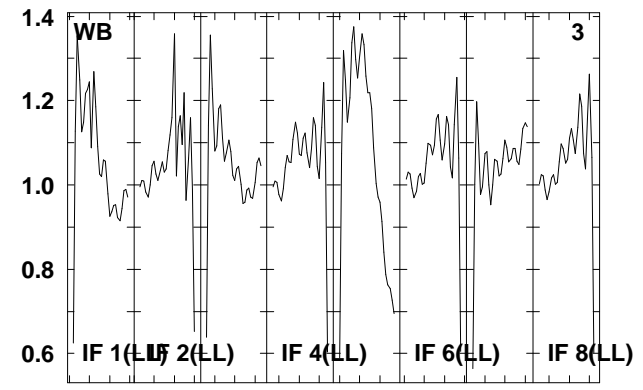
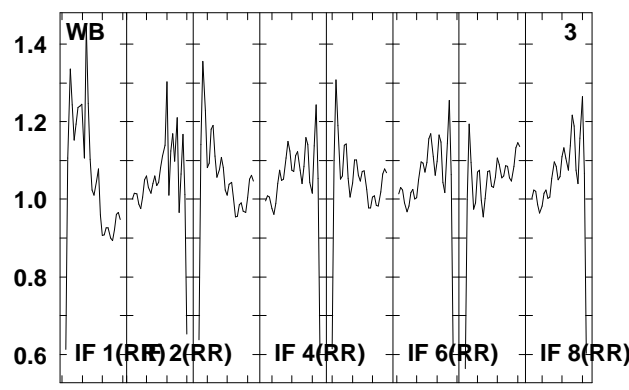
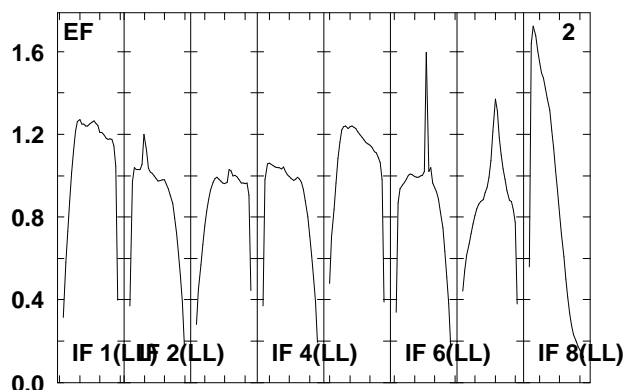
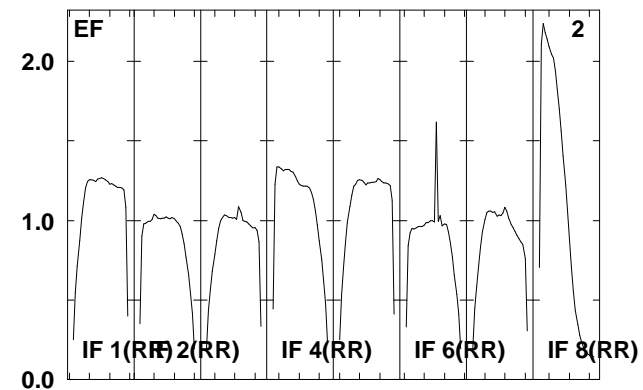
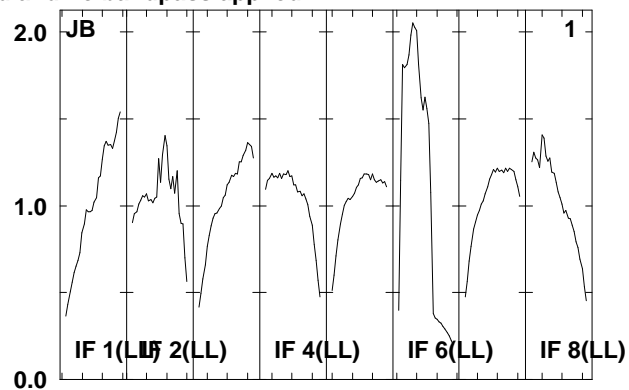
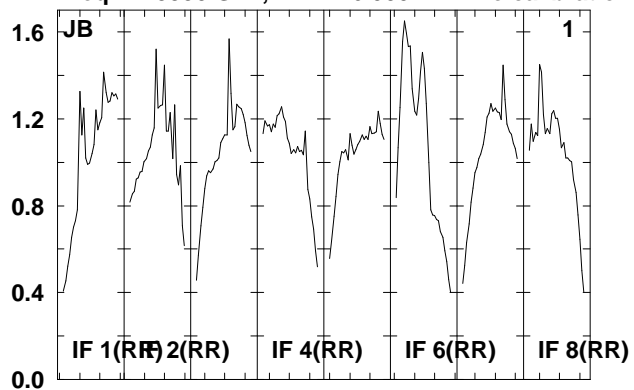

Lower frame: Real Jy
Total-power spectrum Antenna: *
Timerange: 00/16:39:01 to 00/16:42:29

Plot file version 205 created 06-JAN-2012 11:47:19

ARP299D EP068D 5.UVDATA.1

Freq = 1.5950 GHz, Bw = 16.000 MH No calibration applied and no bandpass applied

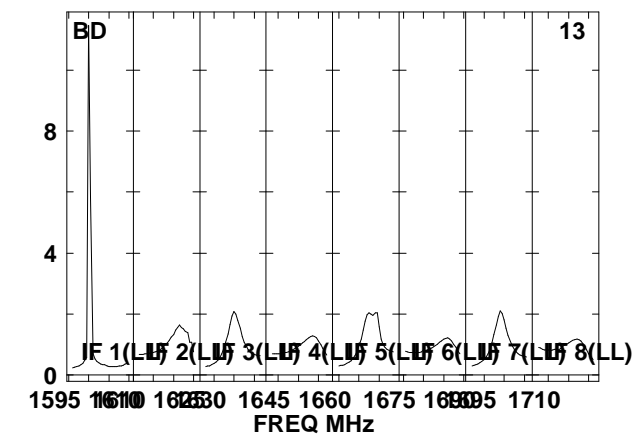
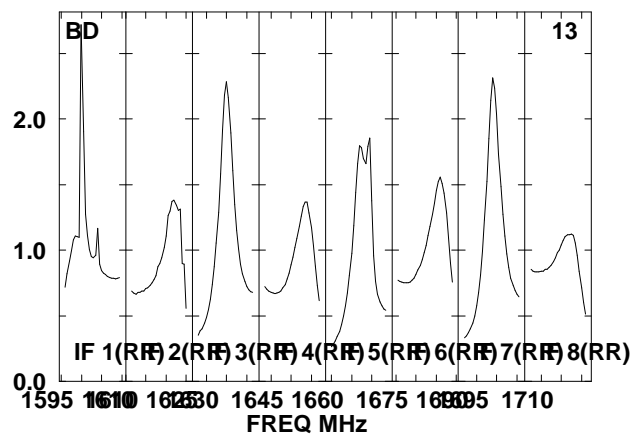
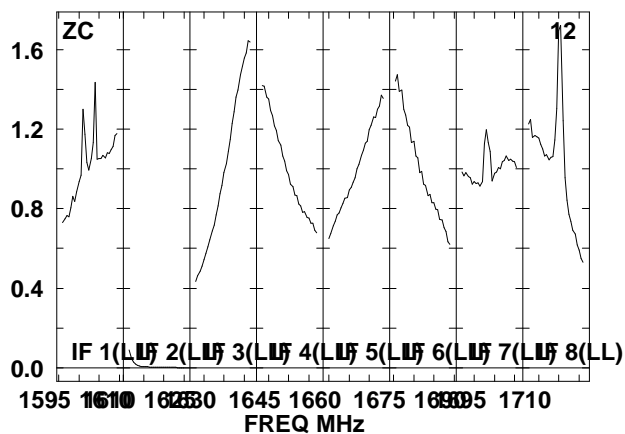
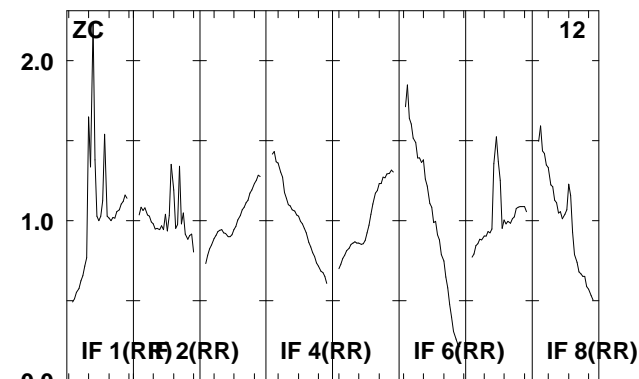
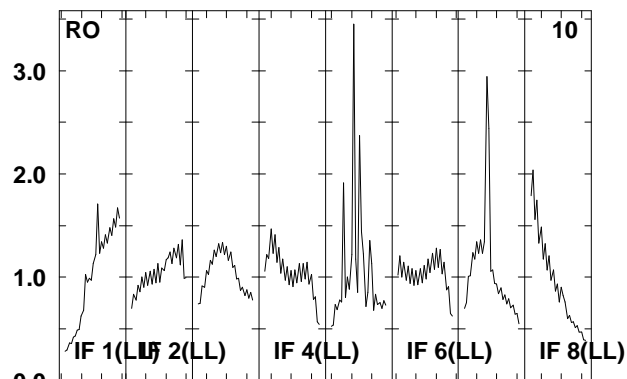
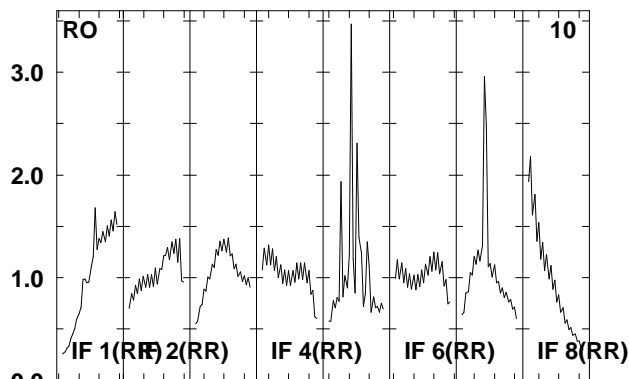
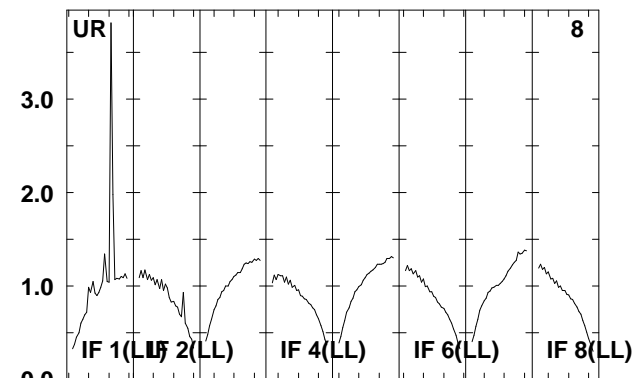
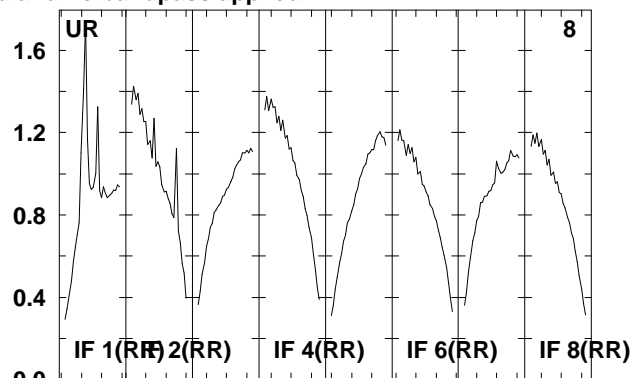
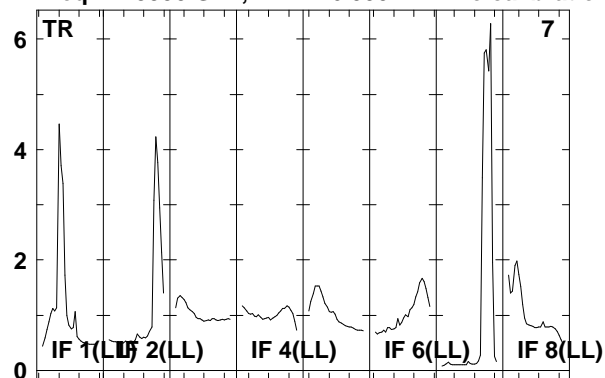

Lower frame: Real Jy
Total-power spectrum Antenna: *
Timerange: 00/16:39:01 to 00/16:42:29

Plot file version 206 created 06-JAN-2012 11:47:20

J1128+59 EP068D 5.UVDATA.1

Freq = 1.5950 GHz, Bw = 16.000 MH No calibration applied and no bandpass applied

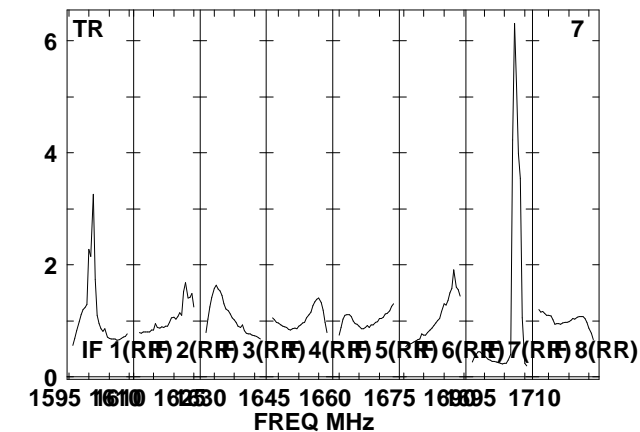
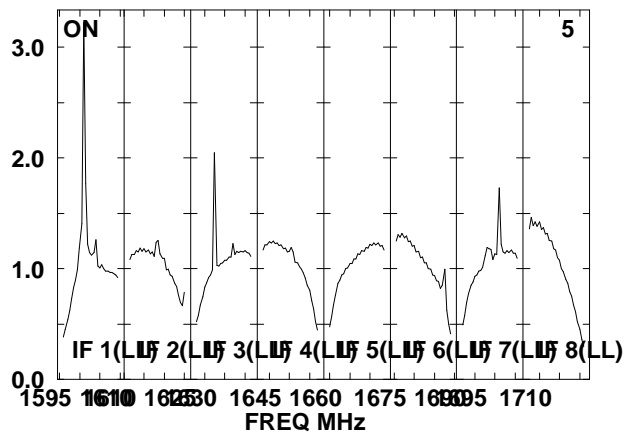
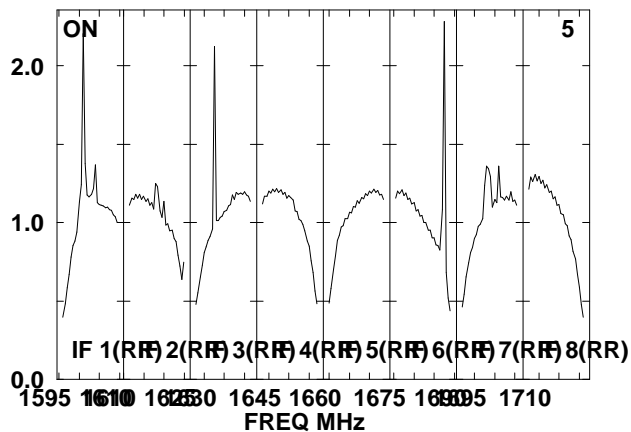
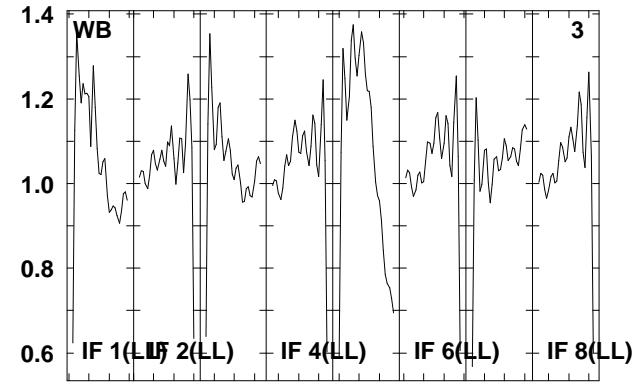
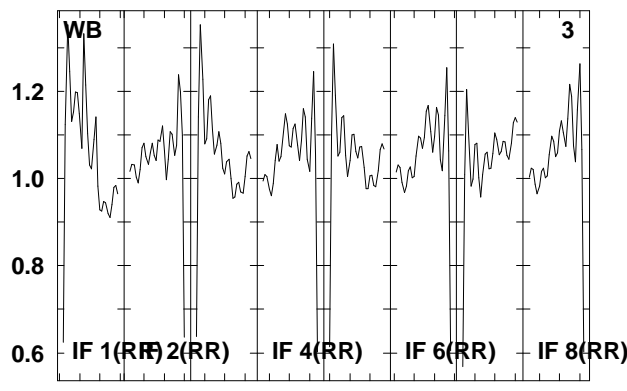
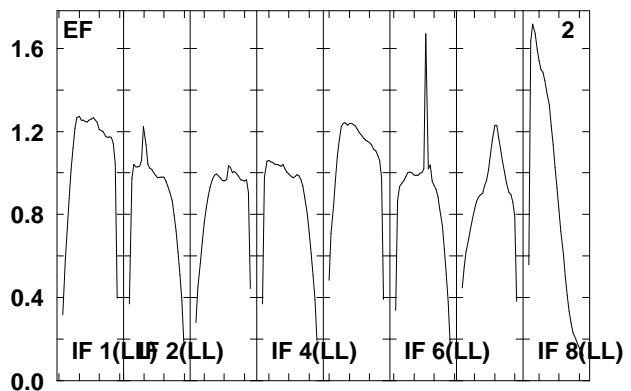
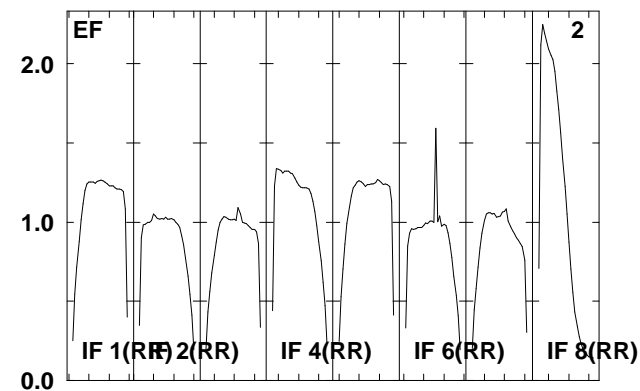
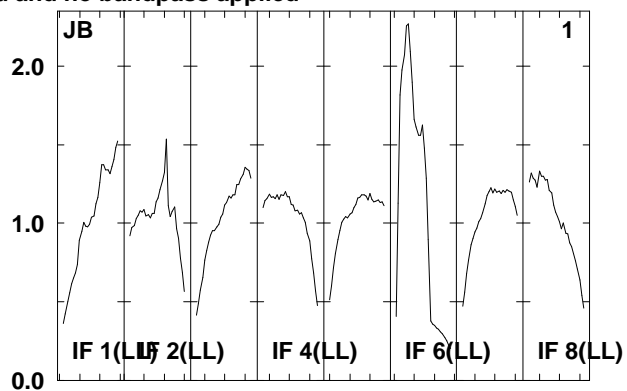
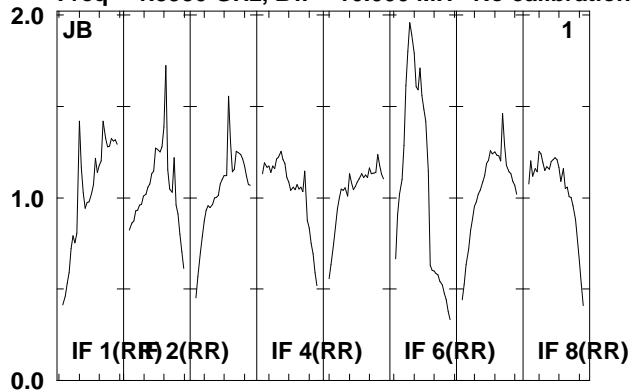

Lower frame: Real Jy
Total-power spectrum Antenna: *
Timerange: 00/16:42:35 to 00/16:43:59

Plot file version 207 created 06-JAN-2012 11:47:20

J1128+59 EP068D 5.UVDATA.1

Freq = 1.5950 GHz, Bw = 16.000 MH No calibration applied and no bandpass applied

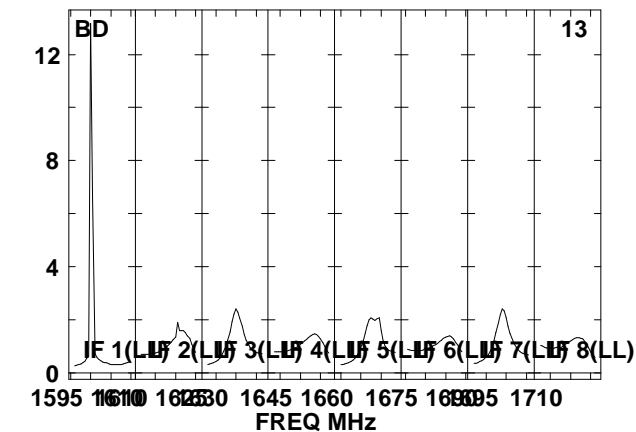
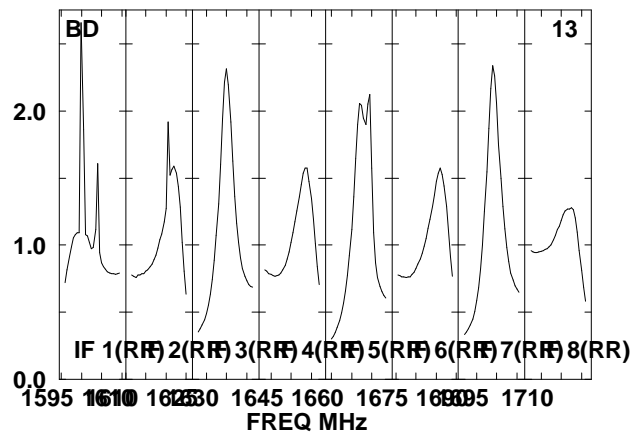
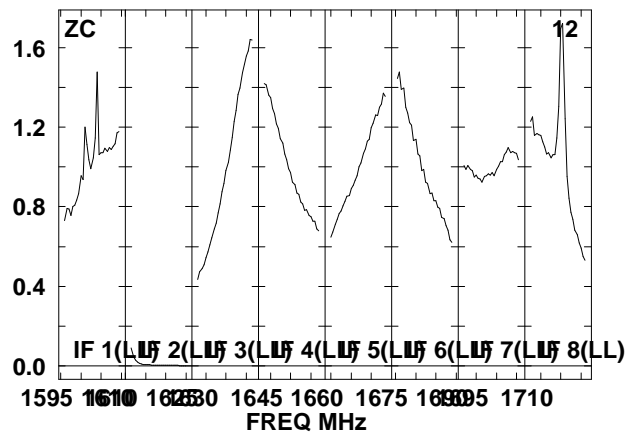
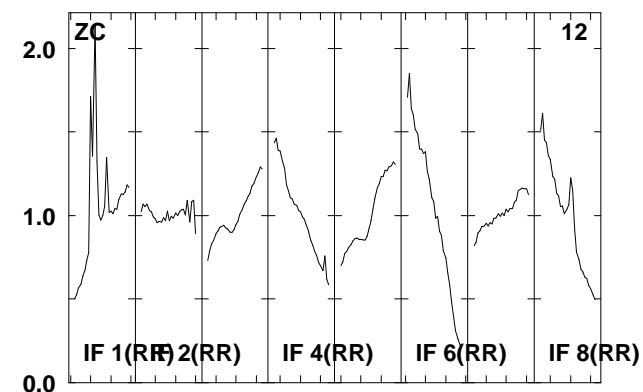
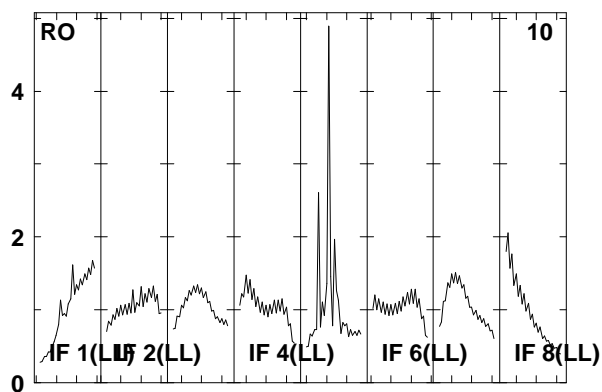
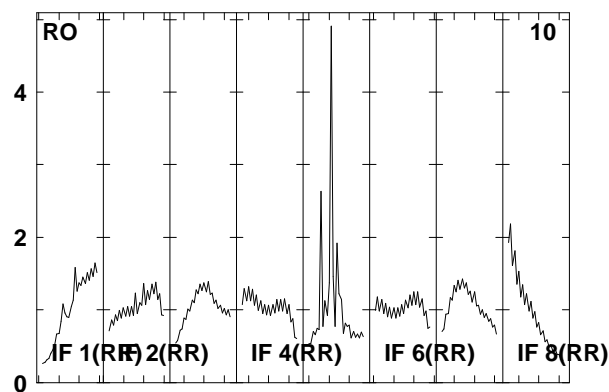
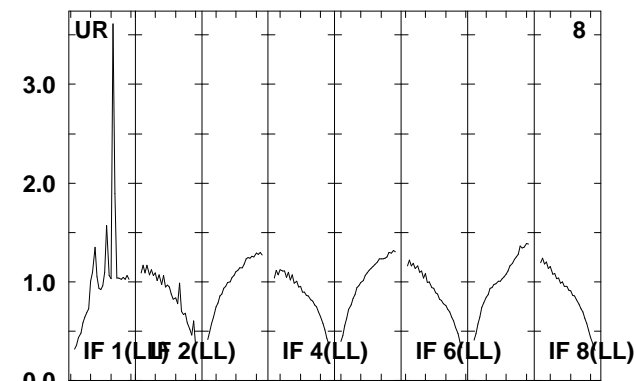
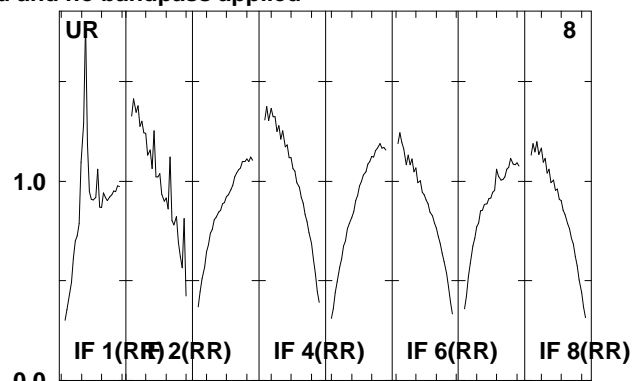
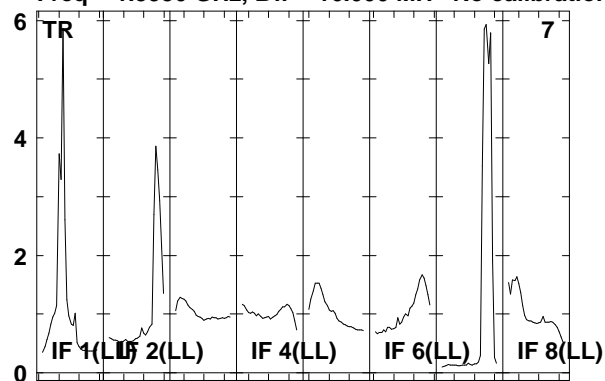

Lower frame: Real Jy

Total-power spectrum Antenna: *

Timerange: 00/16:42:35 to 00/16:43:59

Plot file version 208 created 06-JAN-2012 11:47:20

ARP299D EP068D 5.UVDATA.1

Freq = 1.5950 GHz, Bw = 16.000 MH No calibration applied and no bandpass applied

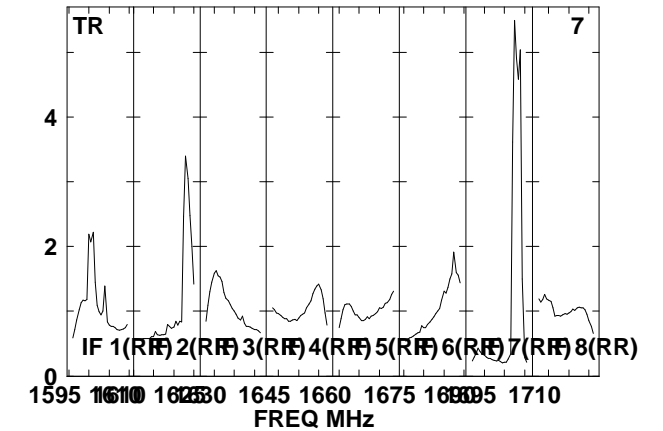
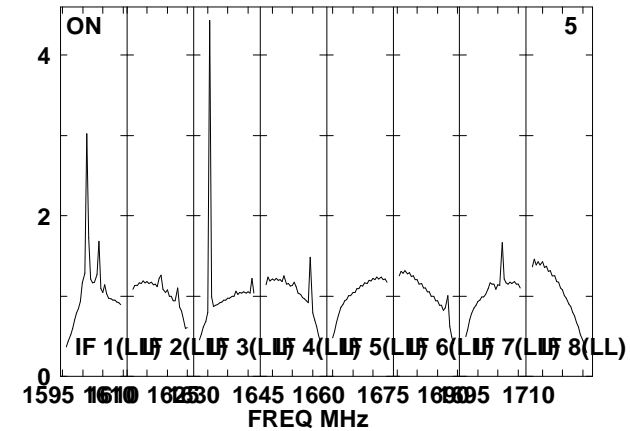
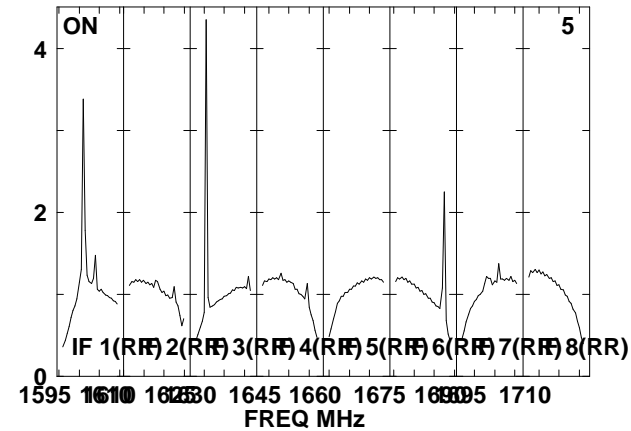
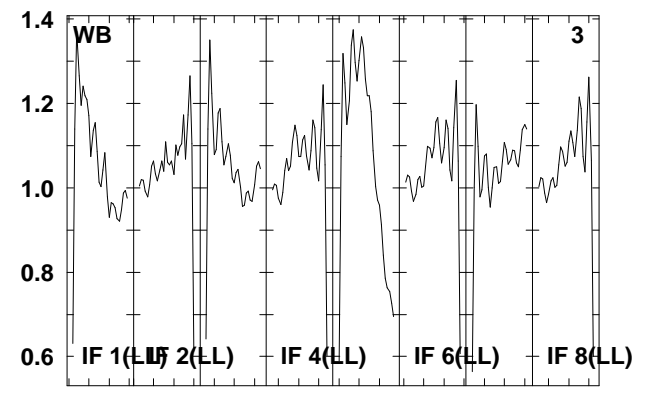
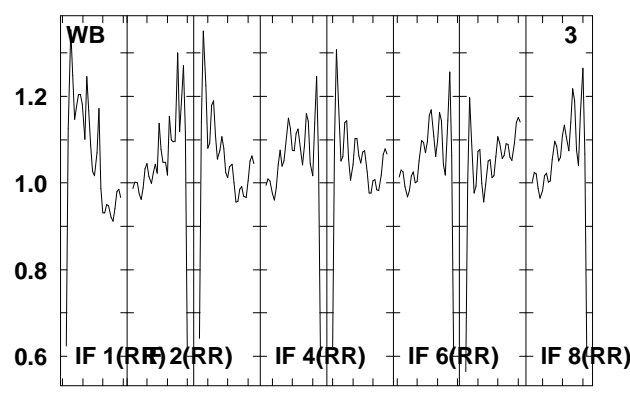
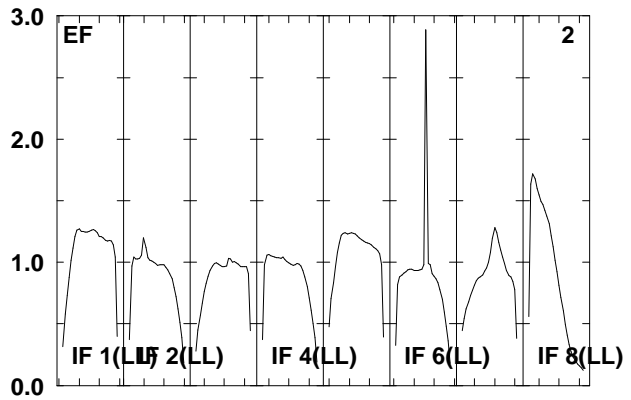
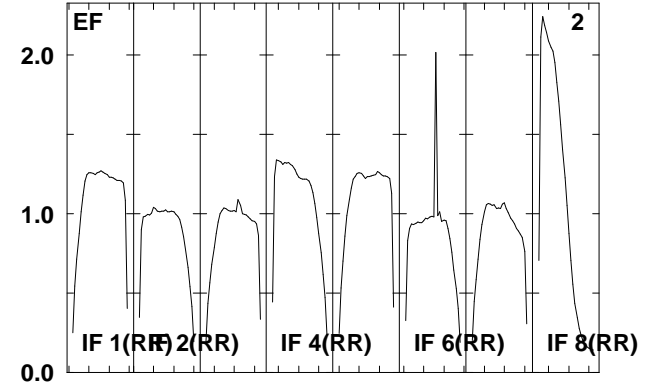
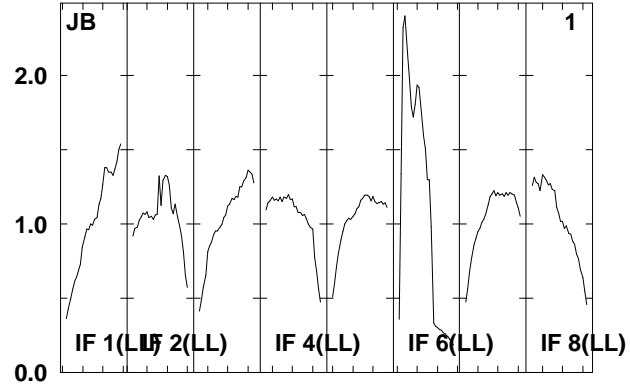
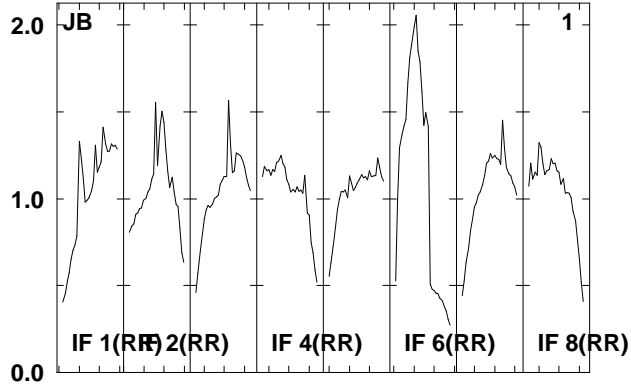

Lower frame: Real Jy
Total-power spectrum Antenna: *
Timerange: 00/16:44:05 to 00/16:47:29

Plot file version 209 created 06-JAN-2012 11:47:21

ARP299D EP068D 5.UVDATA.1

Freq = 1.5950 GHz, Bw = 16.000 MH No calibration applied and no bandpass applied

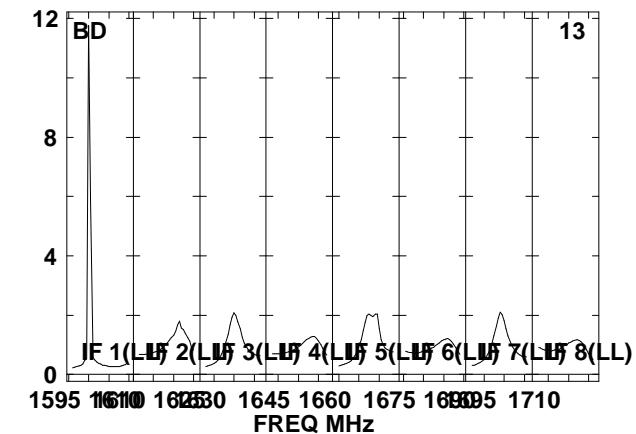
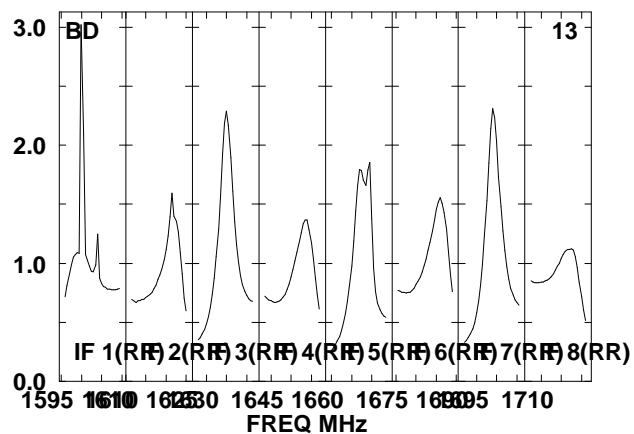
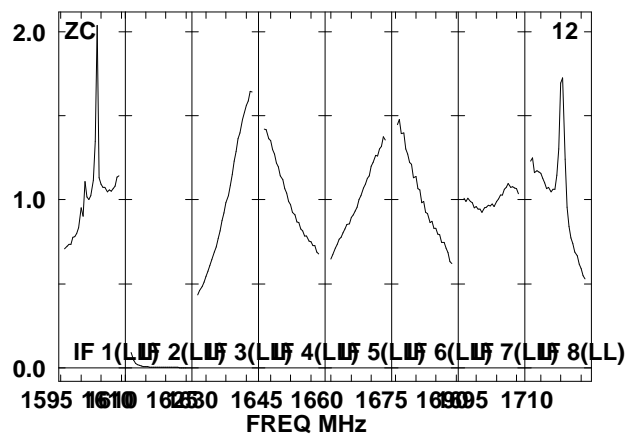
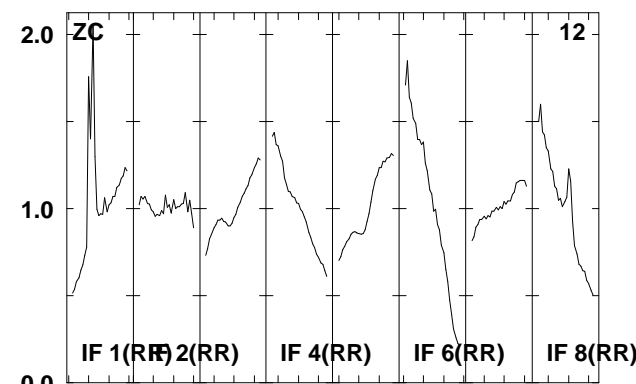
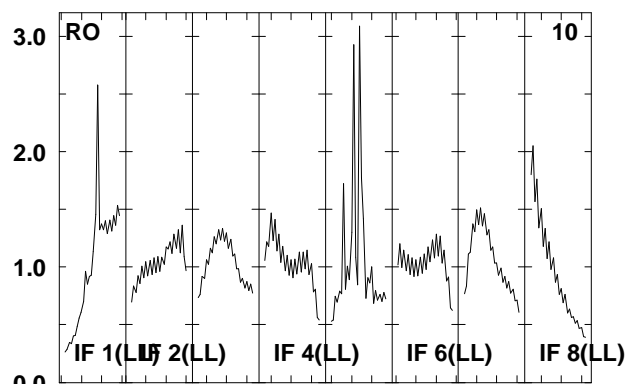
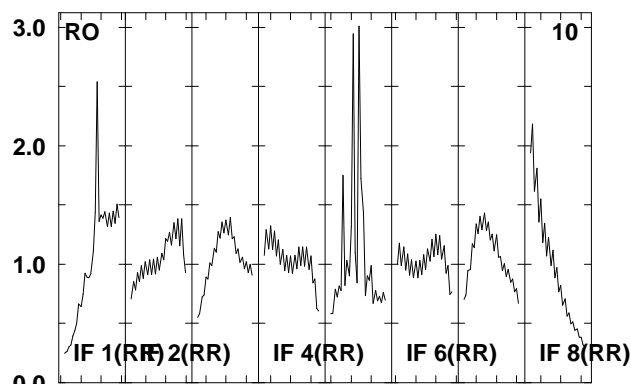
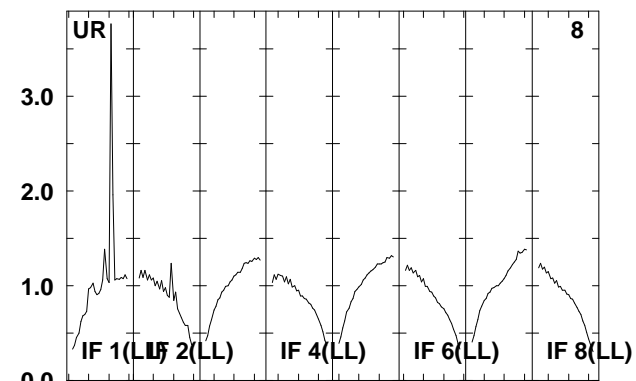
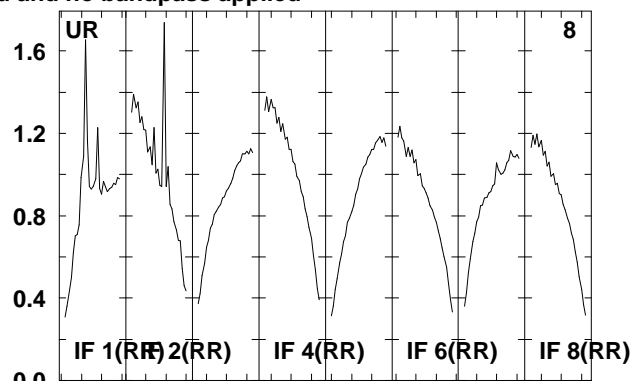
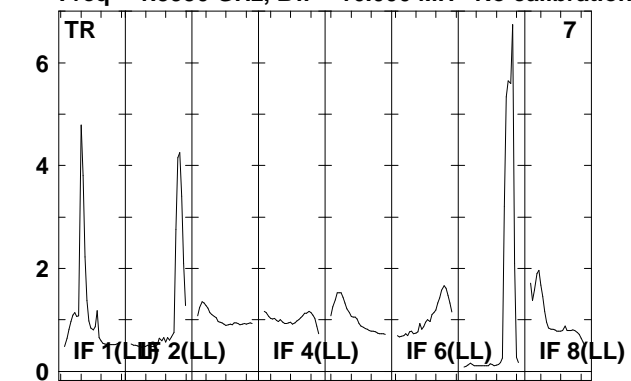

Lower frame: Real Jy

Total-power spectrum Antenna: *

Timerange: 00/16:44:05 to 00/16:47:29

Plot file version 210 created 06-JAN-2012 11:47:22

J1128+59 EP068D 5.UVDATA.1

Freq = 1.5950 GHz, Bw = 16.000 MH No calibration applied and no bandpass applied

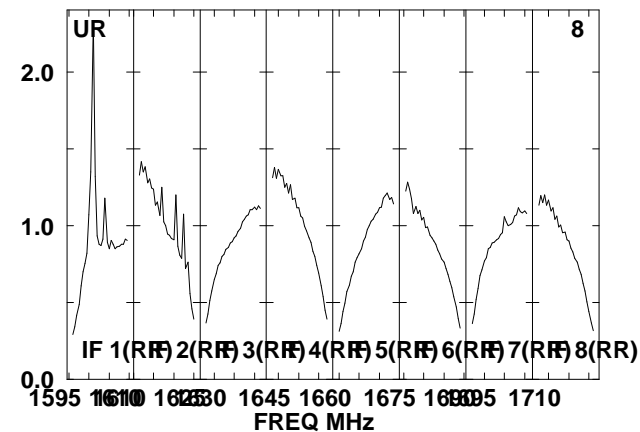
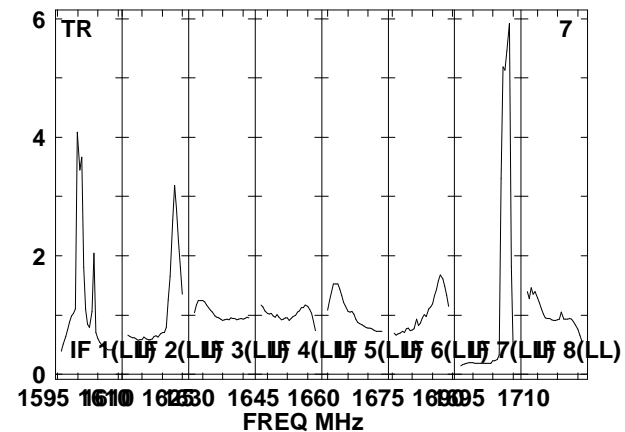
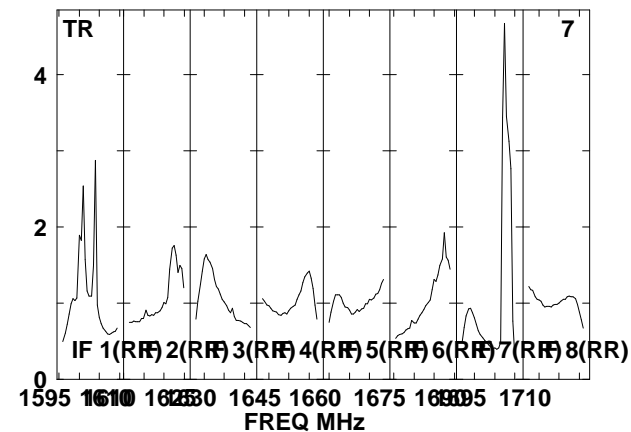
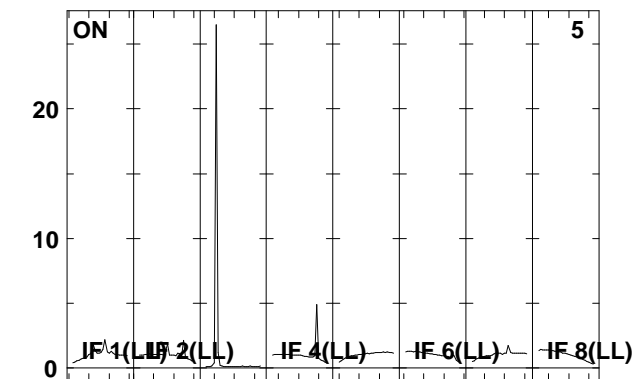
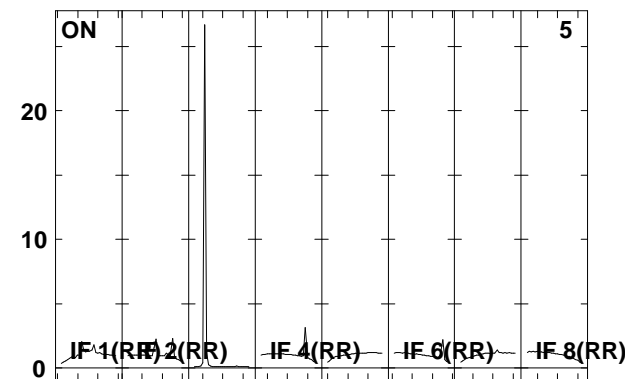
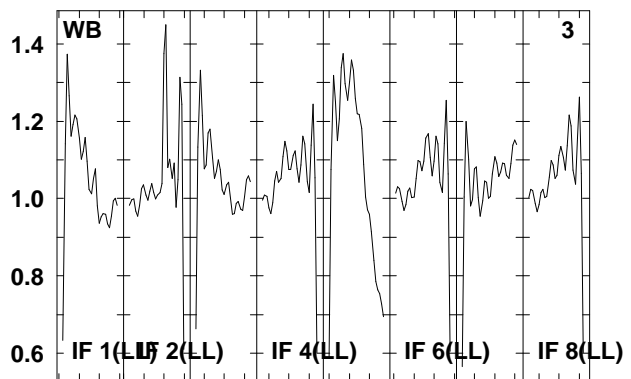
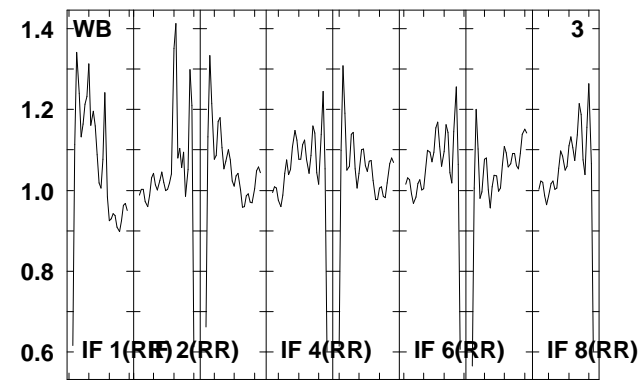
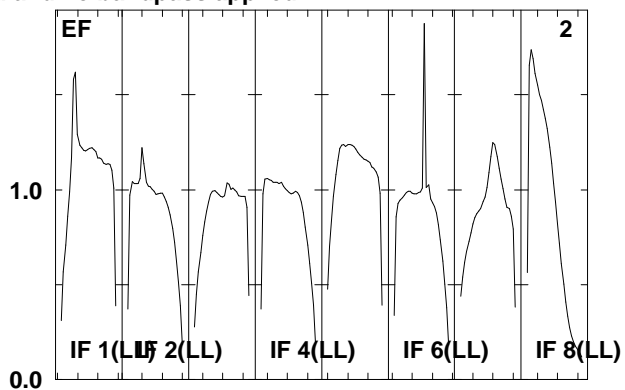
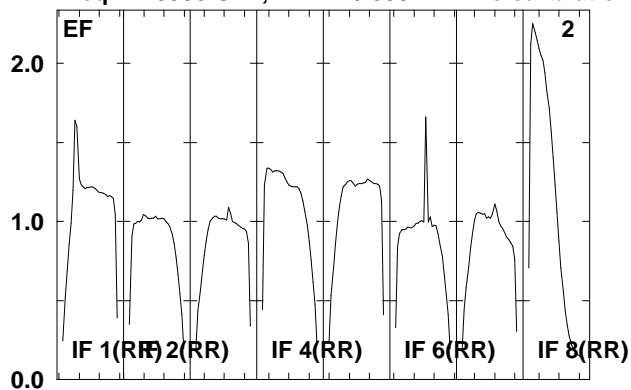

Lower frame: Real Jy
Total-power spectrum Antenna: *
Timerange: 00/16:47:35 to 00/16:48:59

Plot file version 211 created 06-JAN-2012 11:47:22

J1128+59 EP068D 5.UVDATA.1

Freq = 1.5950 GHz, Bw = 16.000 MH No calibration applied and no bandpass applied

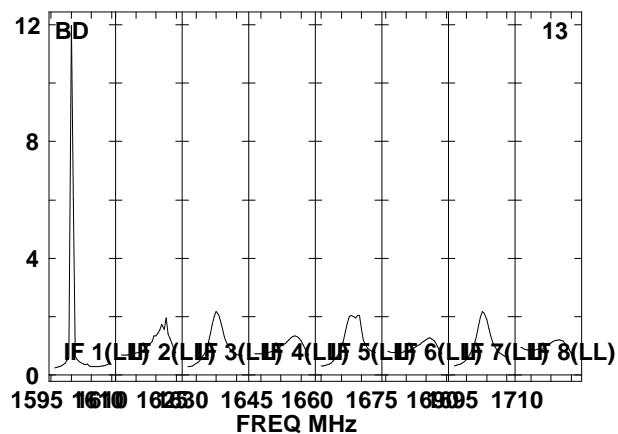
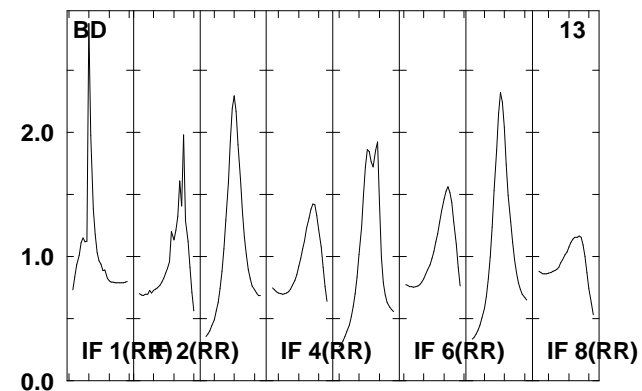
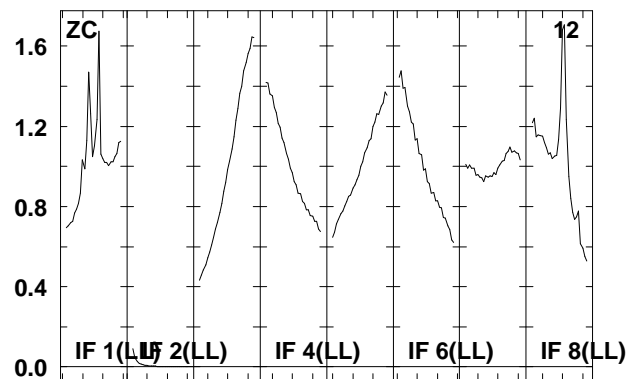
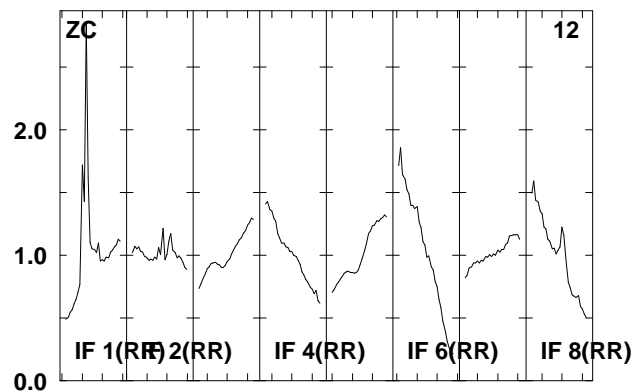
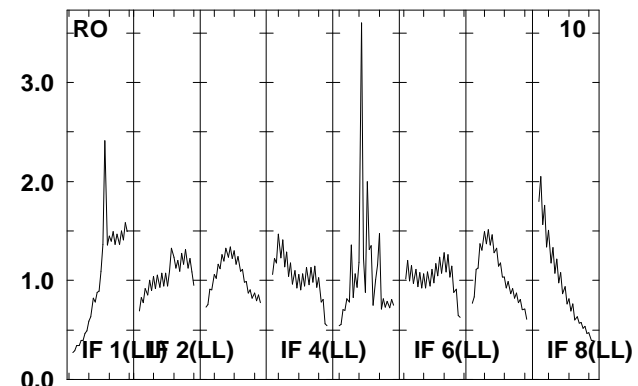
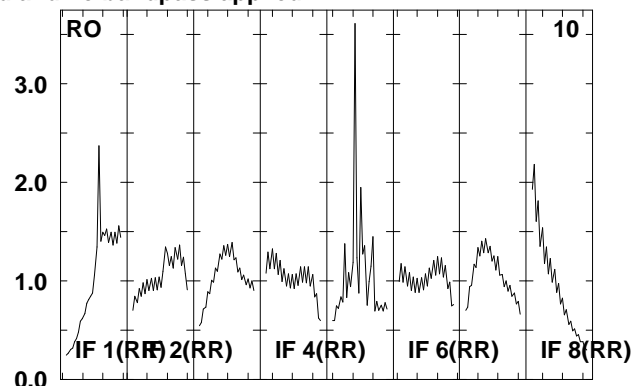
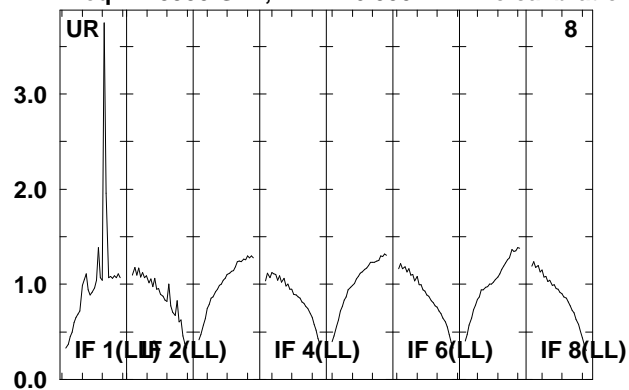

Lower frame: Real Jy

Total-power spectrum Antenna: *

Timerange: 00/16:47:35 to 00/16:48:59

Plot file version 212 created 06-JAN-2012 11:47:22

ARP299D EP068D 5.UVDATA.1

Freq = 1.5950 GHz, Bw = 16.000 MH No calibration applied and no bandpass applied

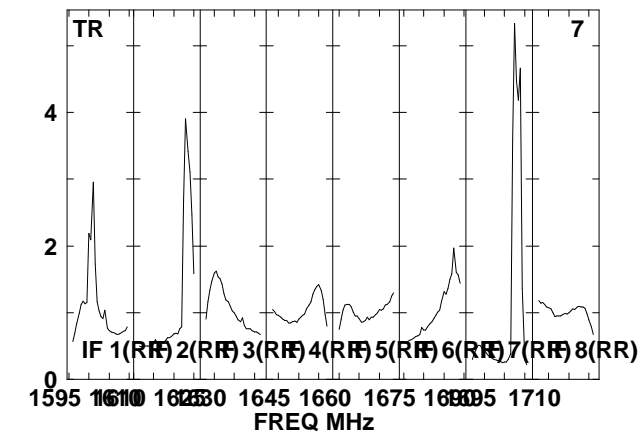
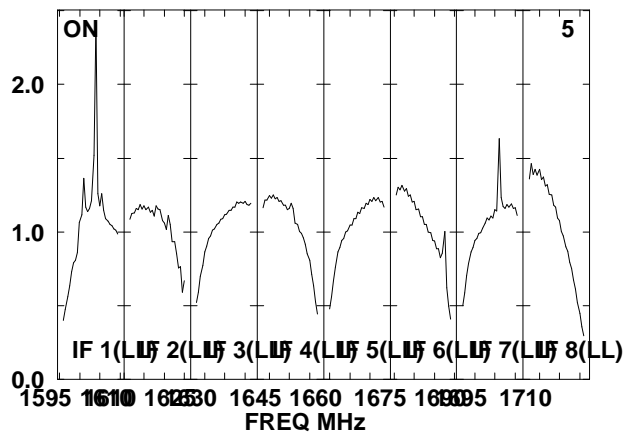
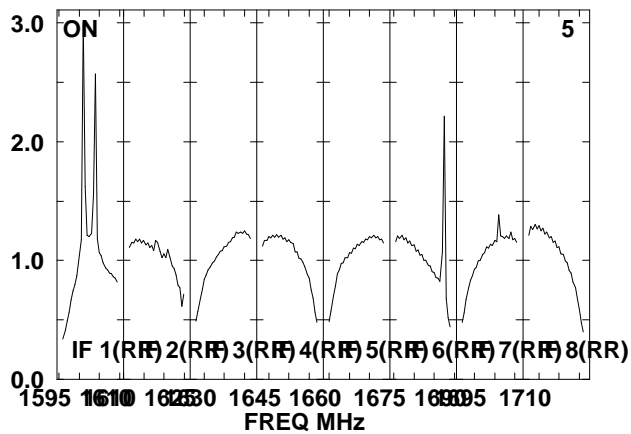
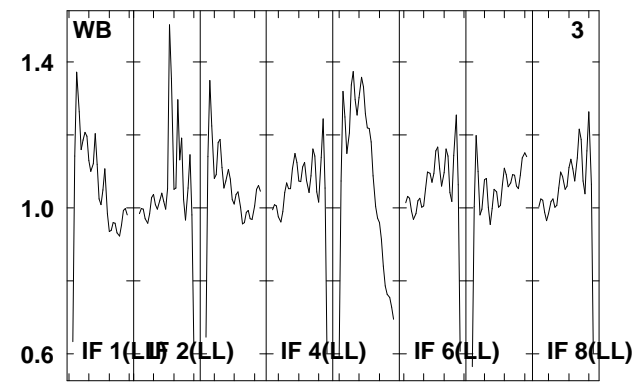
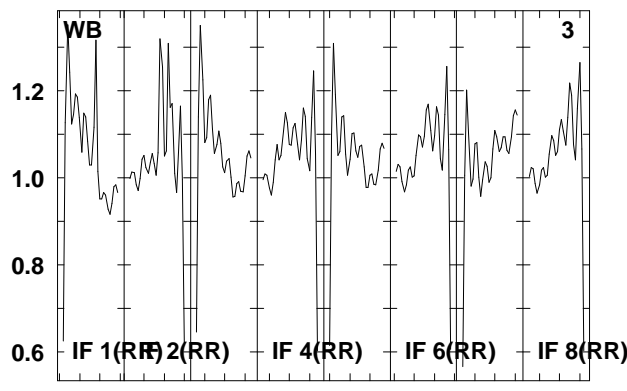
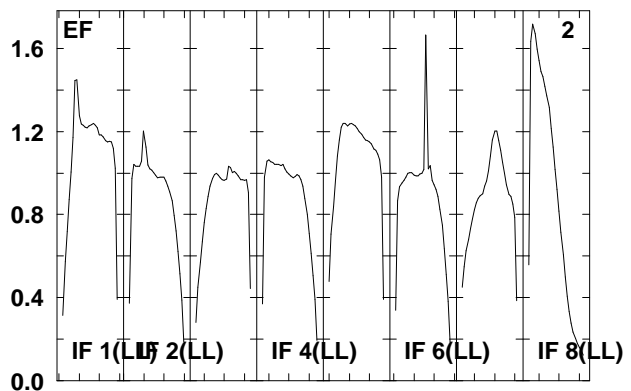
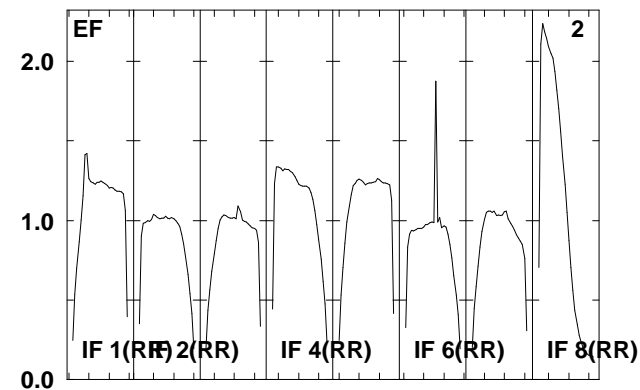
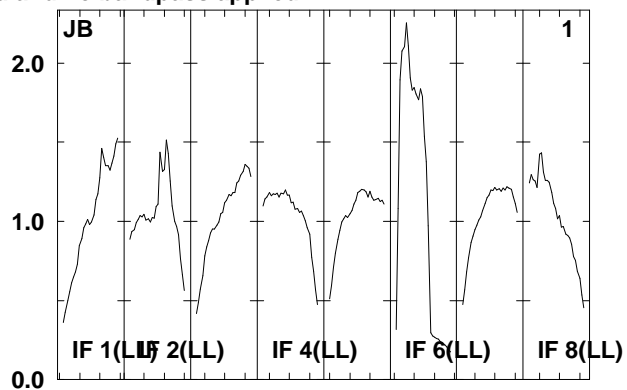
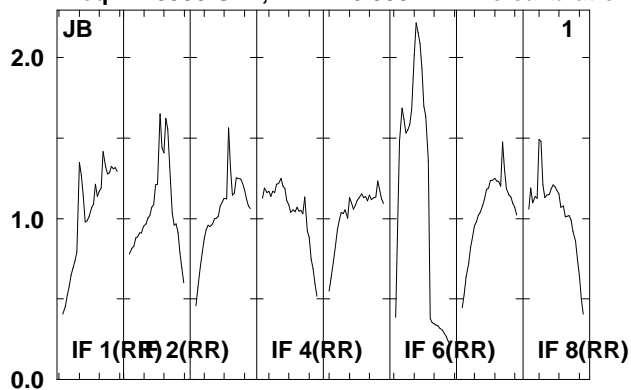

Lower frame: Real Jy
Total-power spectrum Antenna: *
Timerange: 00/16:49:01 to 00/16:52:29

Plot file version 213 created 06-JAN-2012 11:47:23

ARP299D EP068D 5.UVDATA.1

Freq = 1.5950 GHz, Bw = 16.000 MH No calibration applied and no bandpass applied

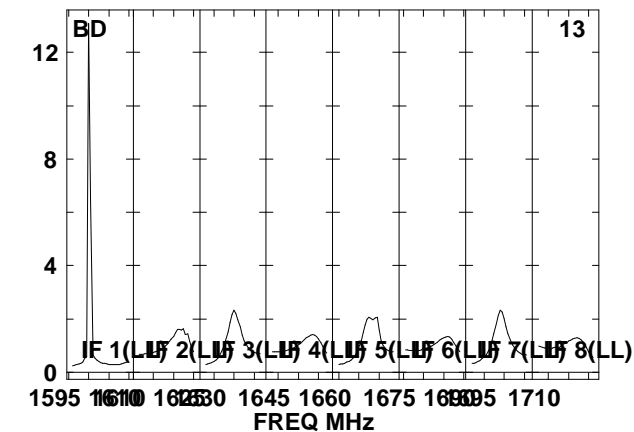
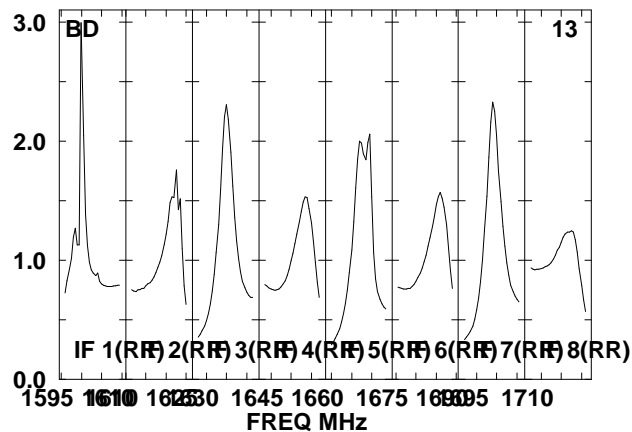
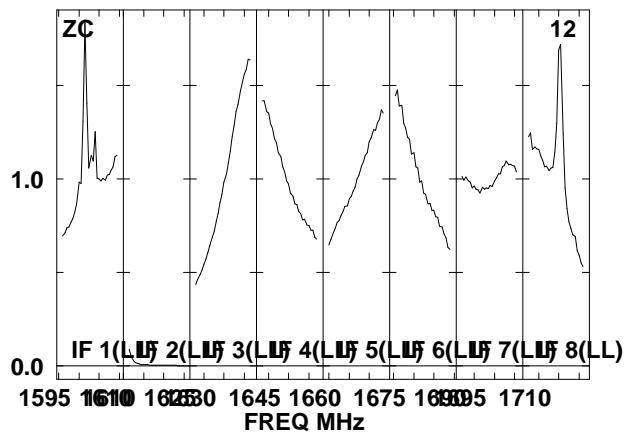
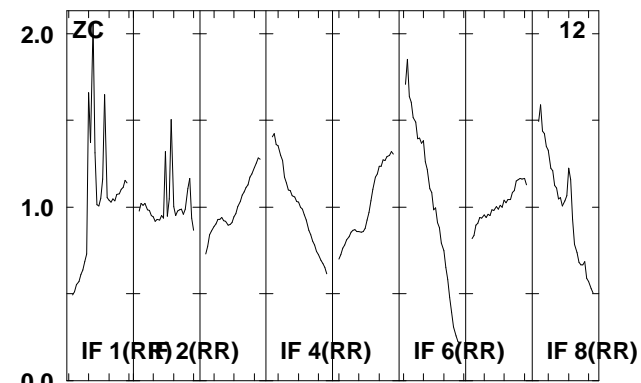
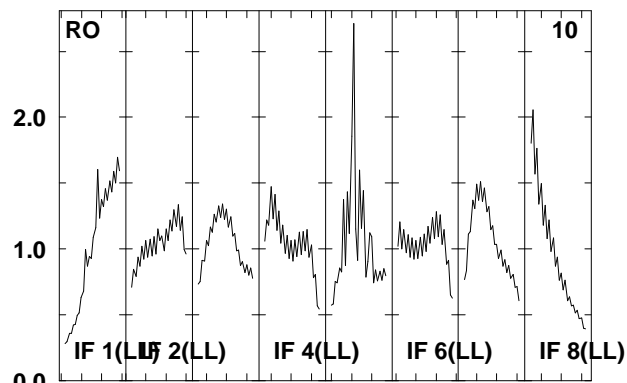
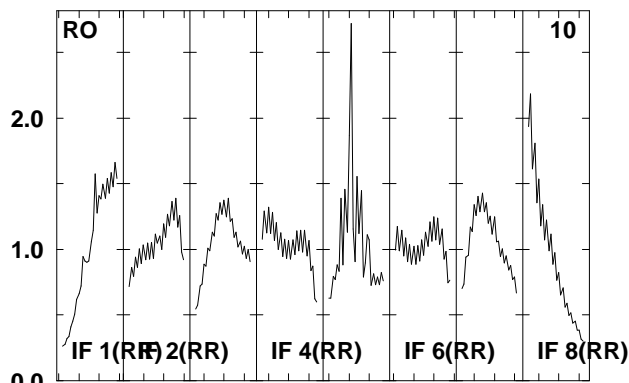
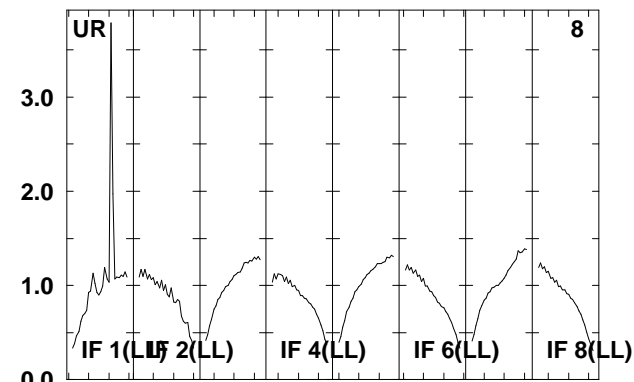
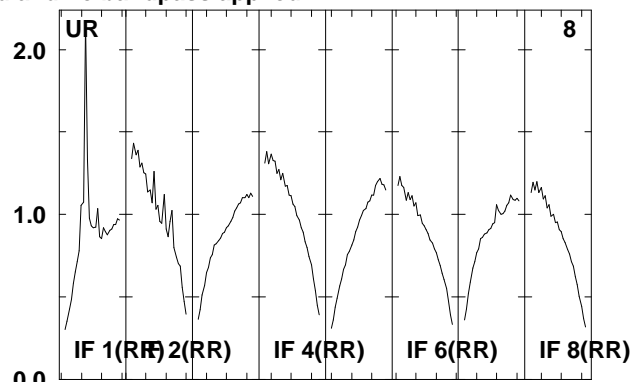
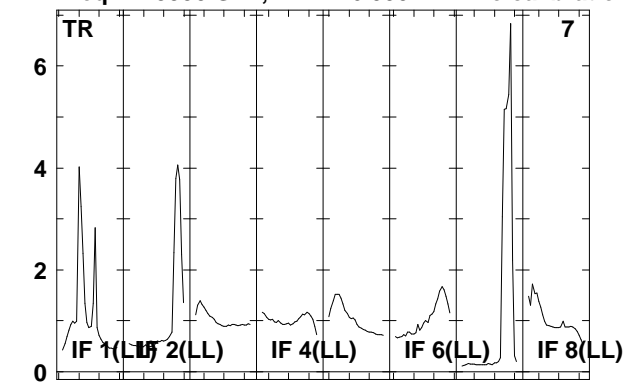

Lower frame: Real Jy
Total-power spectrum Antenna: *
Timerange: 00/16:49:01 to 00/16:52:29

Plot file version 214 created 06-JAN-2012 11:47:24

J1128+59 EP068D 5.UVDATA.1

Freq = 1.5950 GHz, Bw = 16.000 MH No calibration applied and no bandpass applied

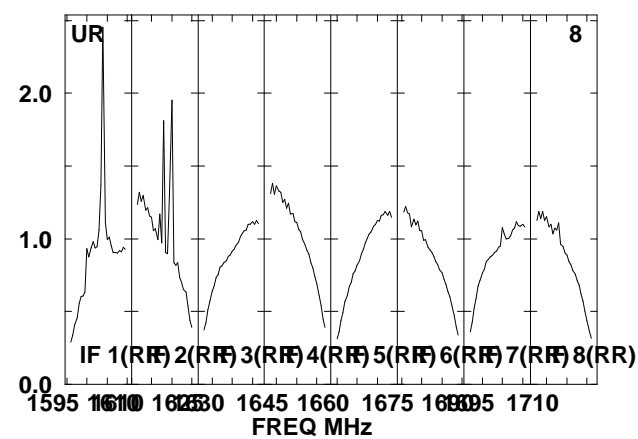
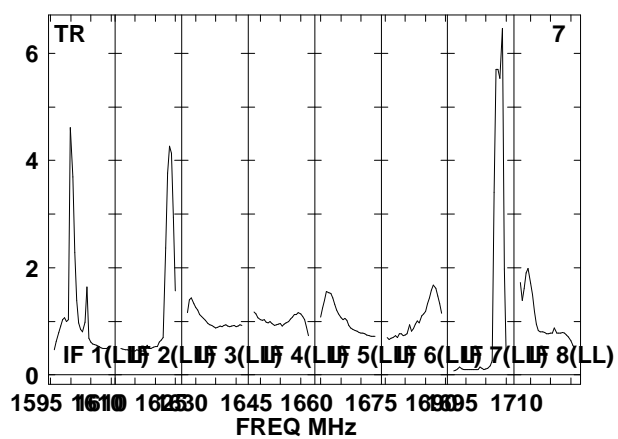
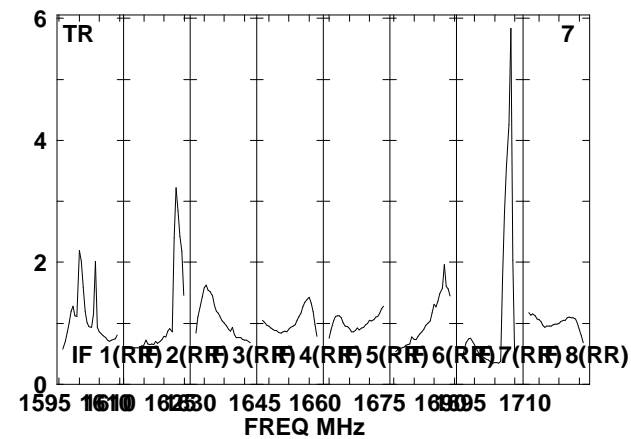
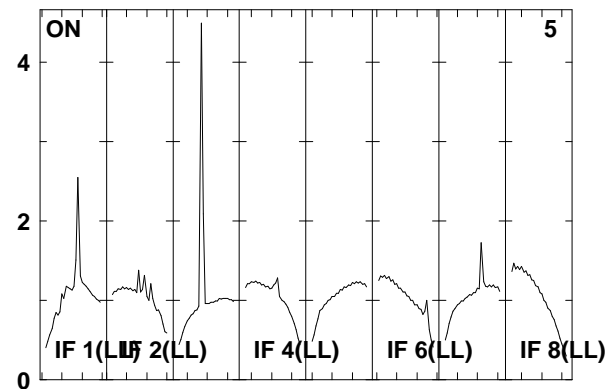
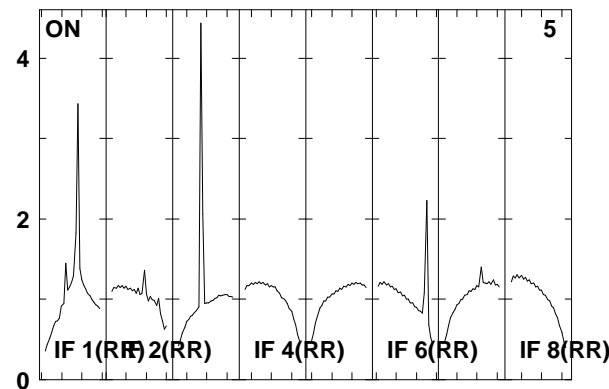
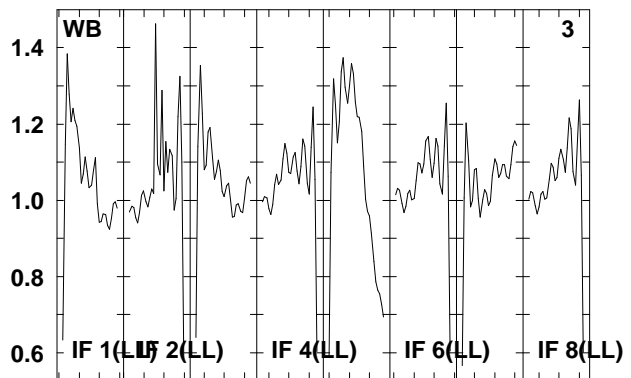
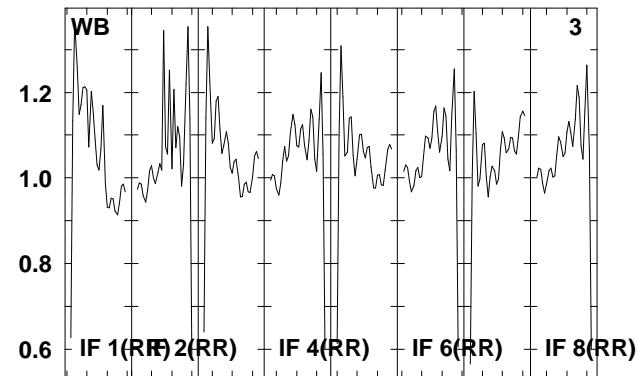
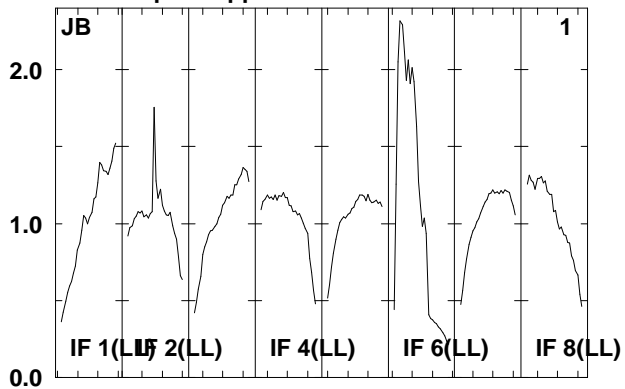
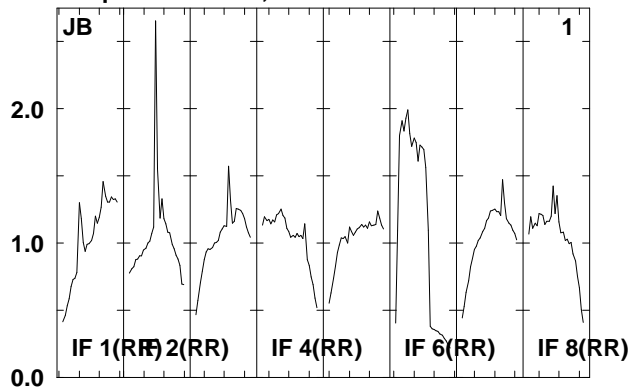

Lower frame: Real Jy
Total-power spectrum Antenna: *
Timerange: 00/16:53:31 to 00/16:54:59

Plot file version 215 created 06-JAN-2012 11:47:24

J1128+59 EP068D 5.UVDATA.1

Freq = 1.5950 GHz, Bw = 16.000 MH No calibration applied and no bandpass applied

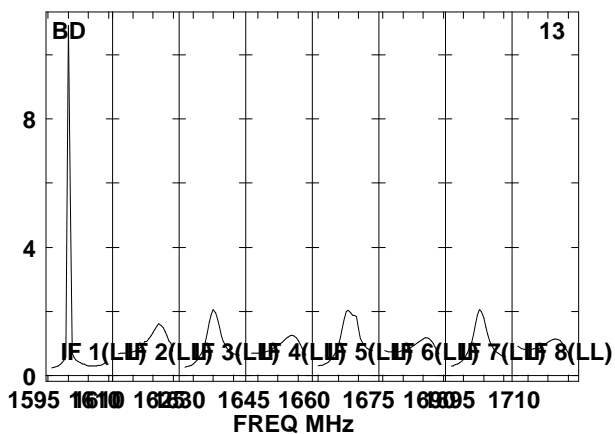
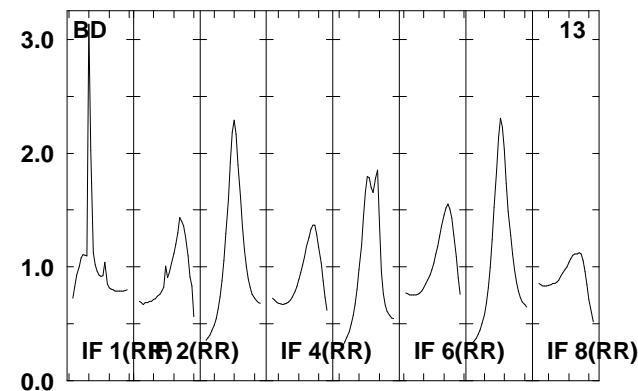
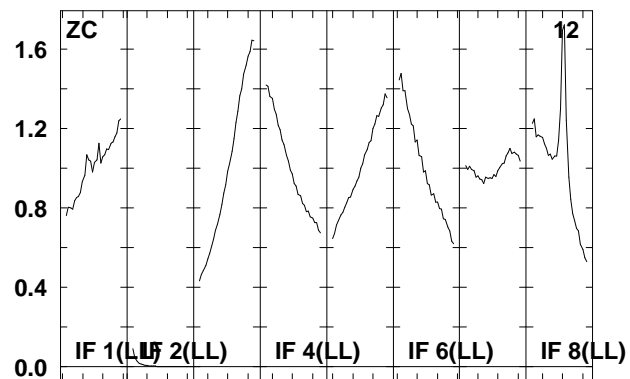
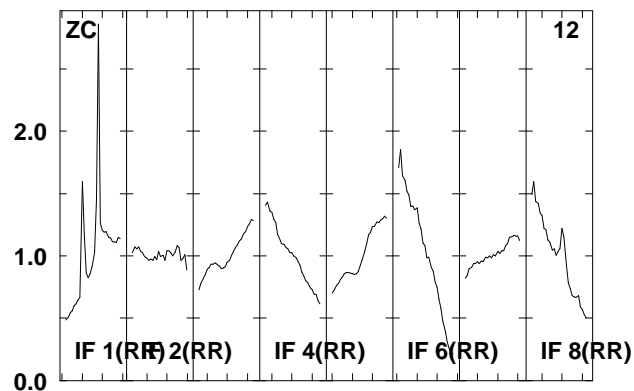
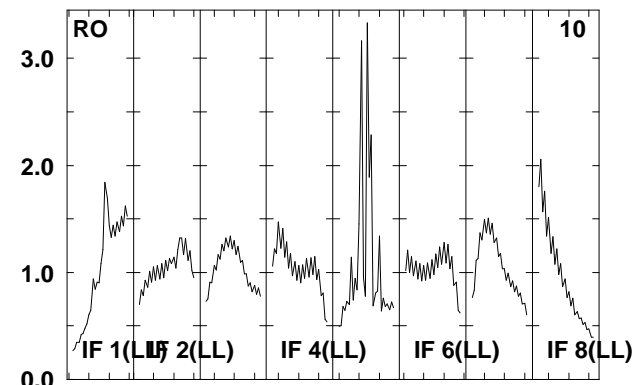
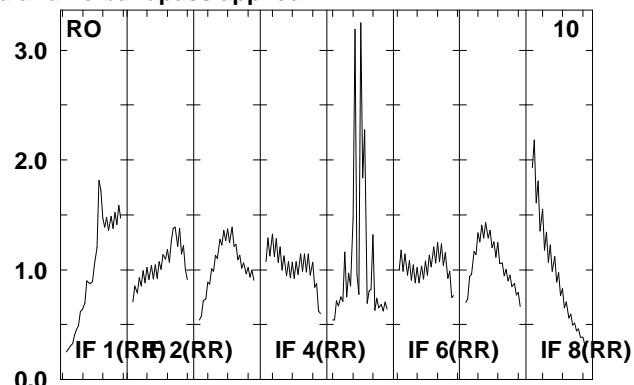
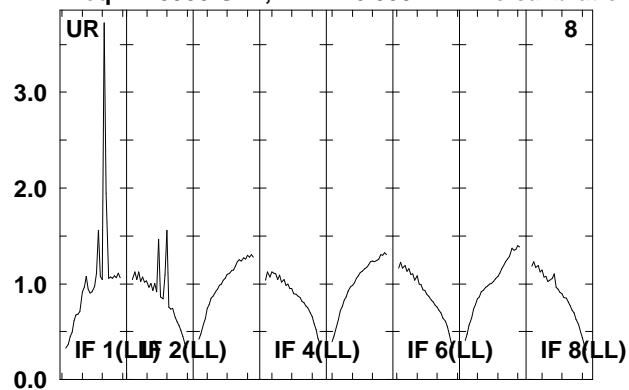

Lower frame: Real Jy

Total-power spectrum Antenna: *

Timerange: 00/16:53:31 to 00/16:54:59

Plot file version 216 created 06-JAN-2012 11:47:24

ARP299D EP068D 5.UVDATA.1

Freq = 1.5950 GHz, Bw = 16.000 MH No calibration applied and no bandpass applied

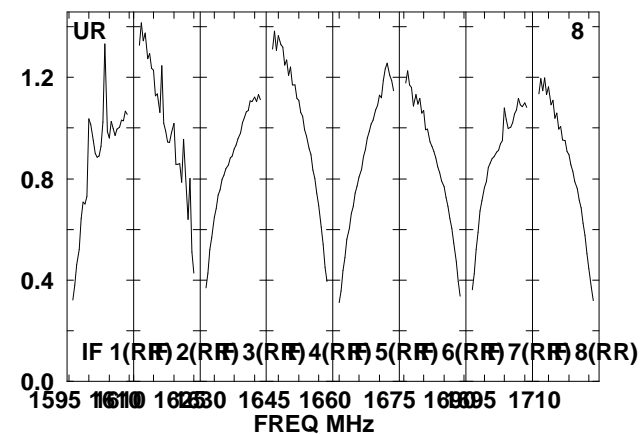
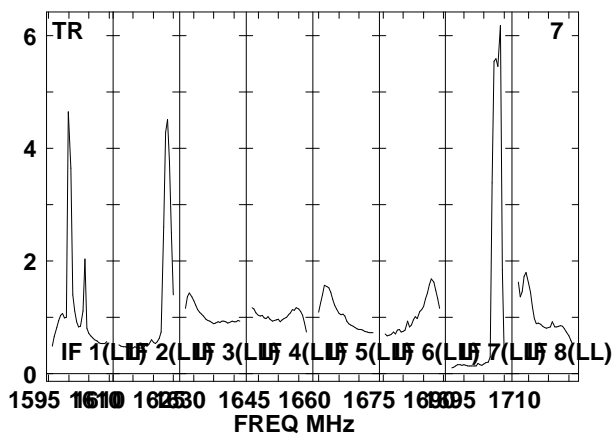
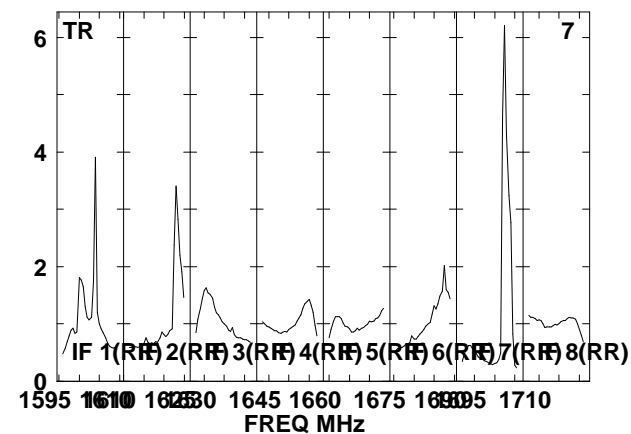
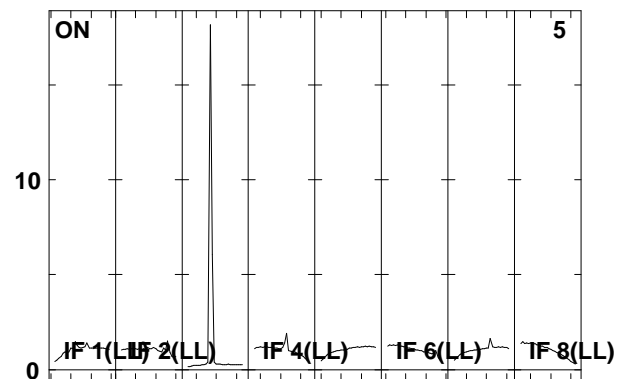
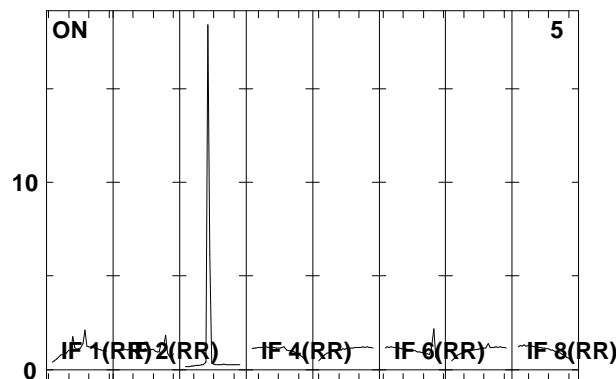
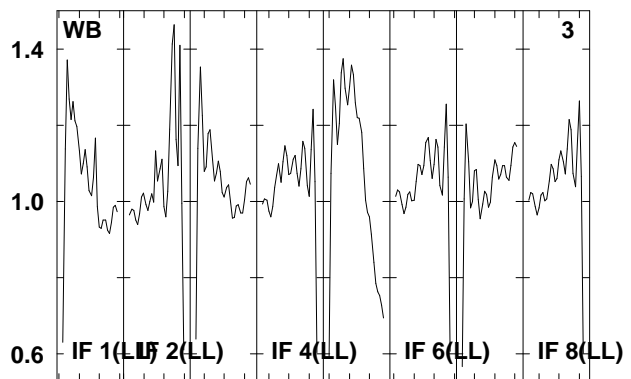
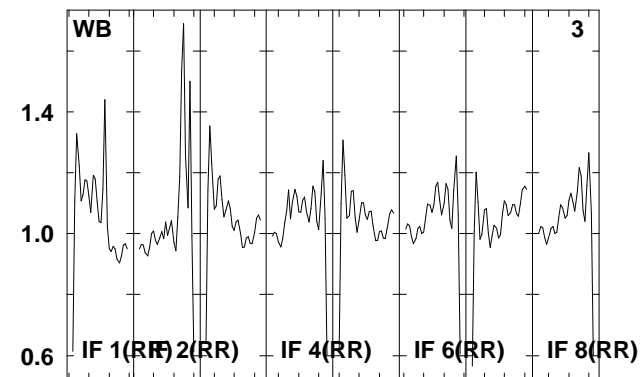
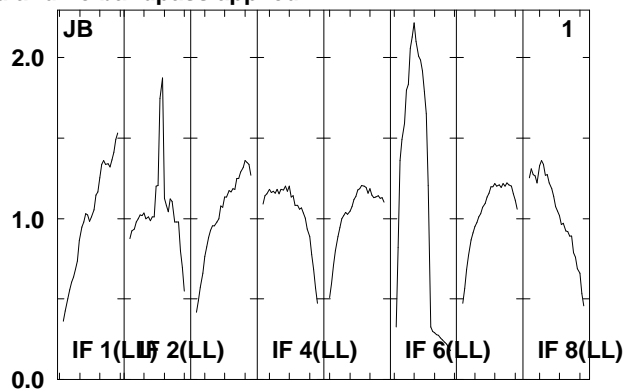
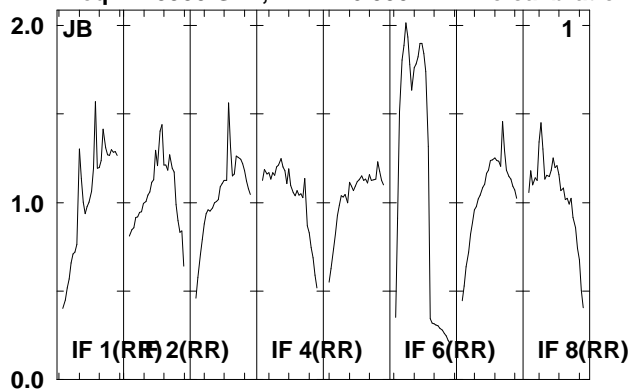

Lower frame: Real Jy
Total-power spectrum Antenna: *
Timerange: 00/16:55:05 to 00/16:58:29

Plot file version 217 created 06-JAN-2012 11:47:25

ARP299D EP068D 5.UVDATA.1

Freq = 1.5950 GHz, Bw = 16.000 MH No calibration applied and no bandpass applied

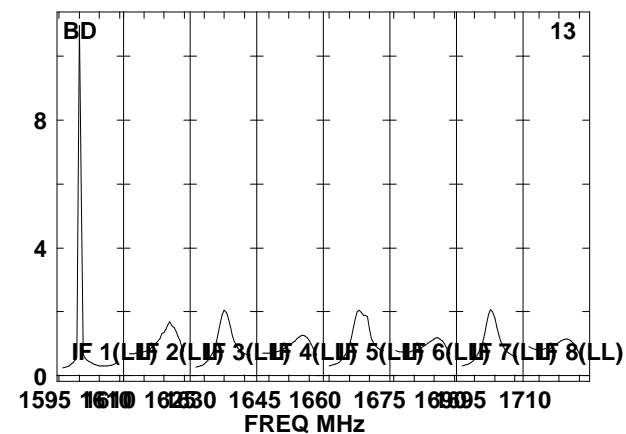
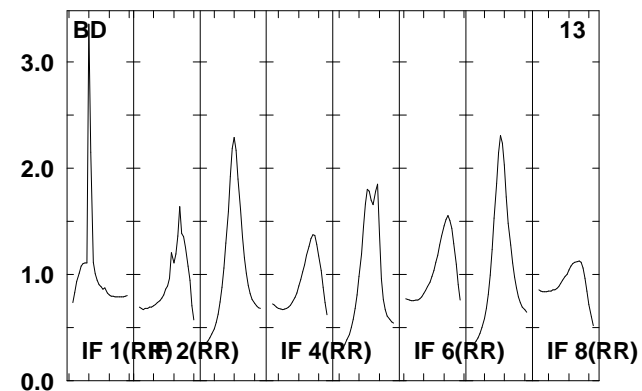
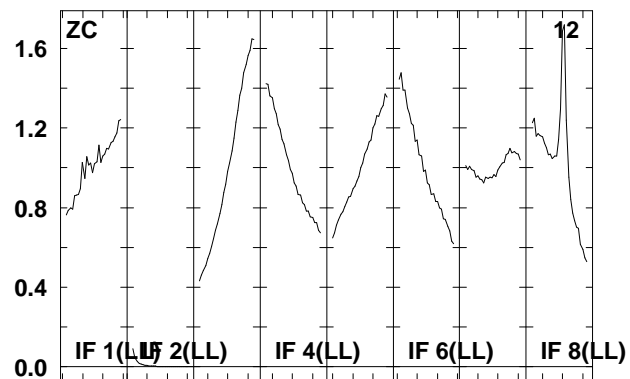
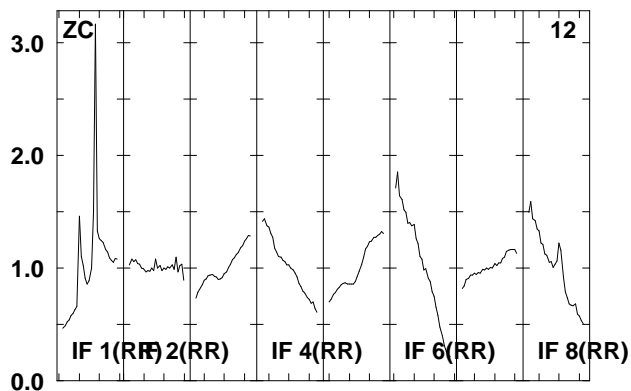
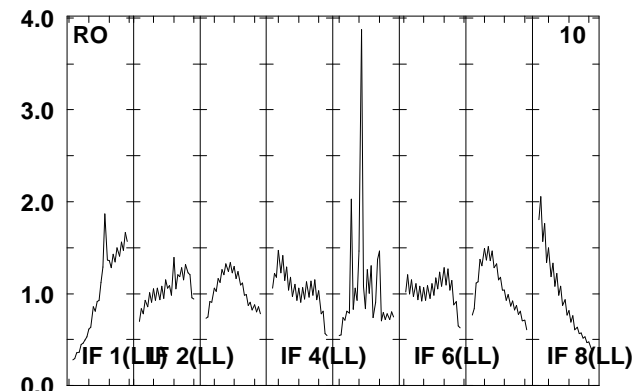
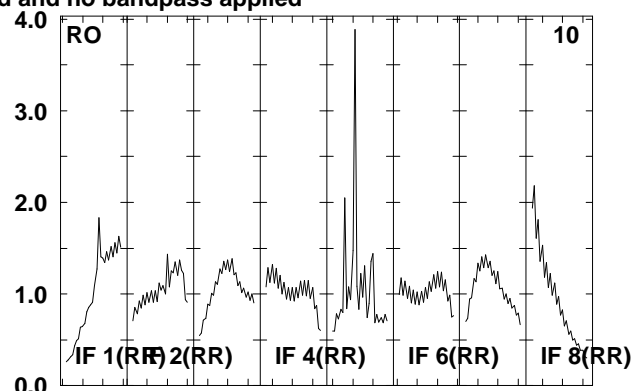
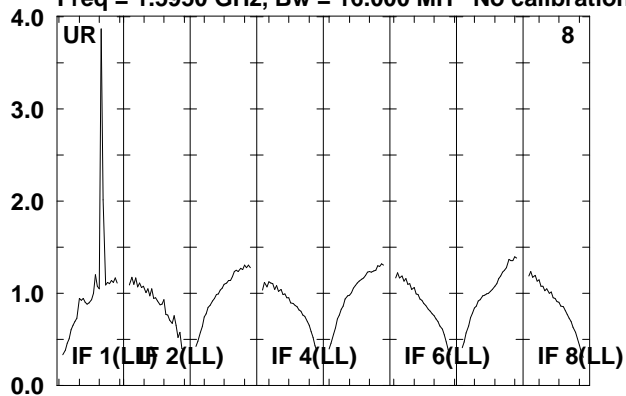

Lower frame: Real Jy

Total-power spectrum Antenna: *

Timerange: 00/16:55:05 to 00/16:58:29

Plot file version 218 created 06-JAN-2012 11:47:26

J1128+59 EP068D 5.UVDATA.1

Freq = 1.5950 GHz, Bw = 16.000 MH No calibration applied and no bandpass applied

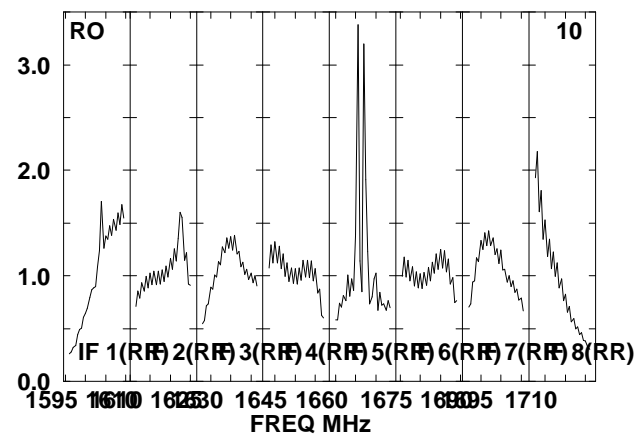
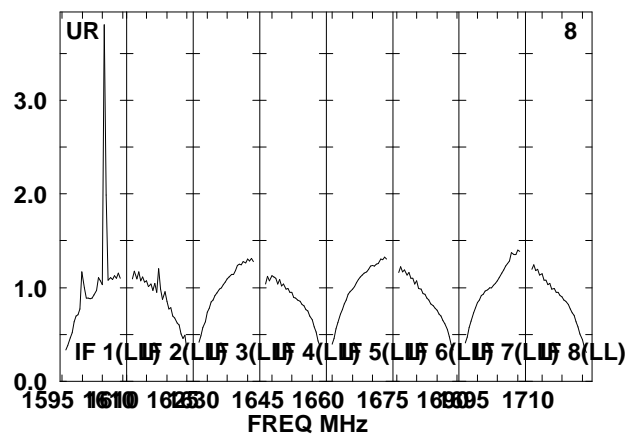
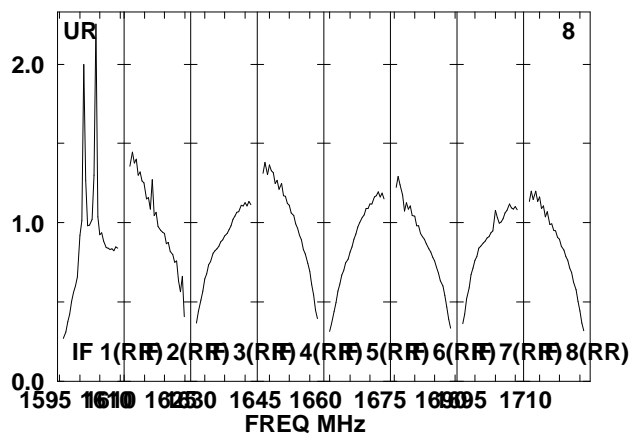
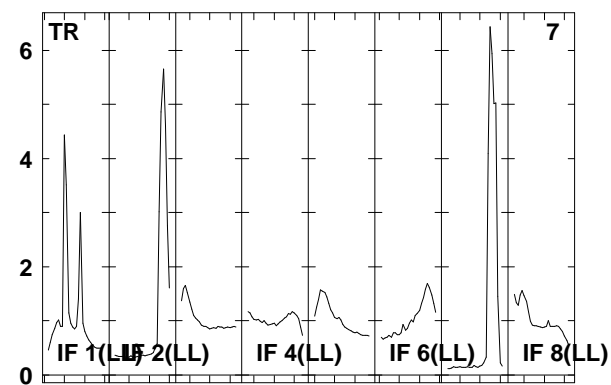
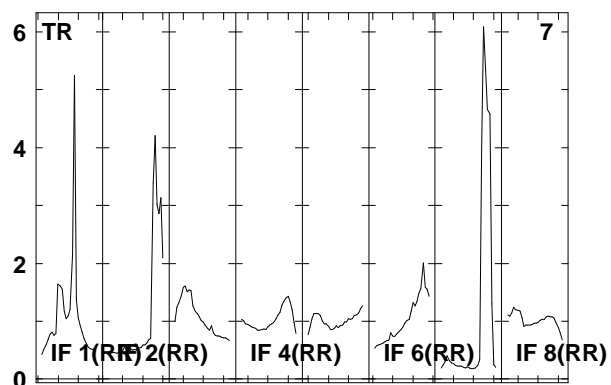
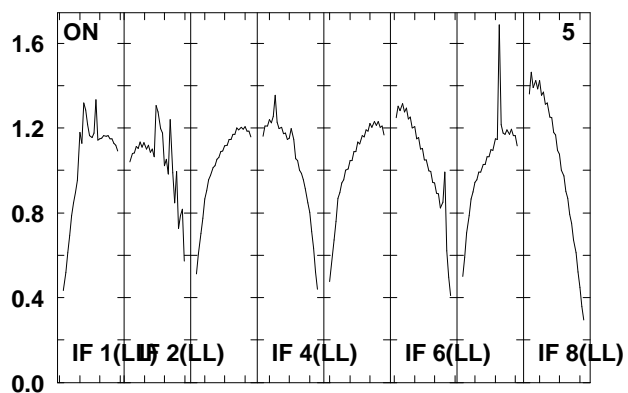
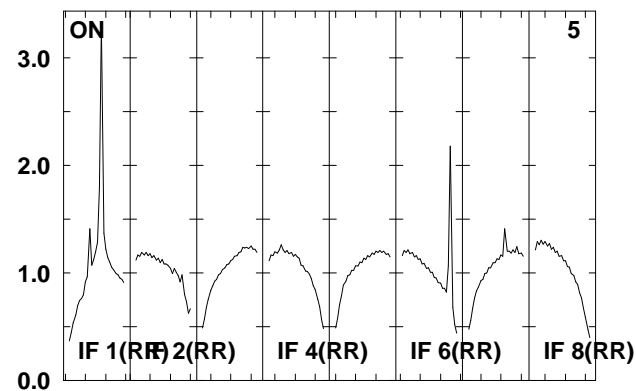
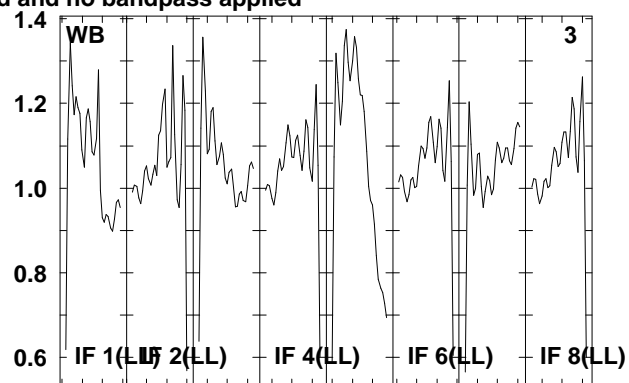
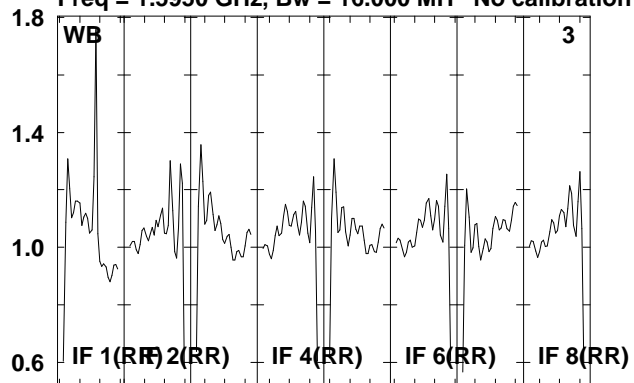

Lower frame: Real Jy
Total-power spectrum Antenna: *
Timerange: 00/16:58:35 to 00/16:59:59

Plot file version 219 created 06-JAN-2012 11:47:26
J1128+59 EP068D 5.UVDATA.1
Freq = 1.5950 GHz, Bw = 16.000 MH No calibration applied and no bandpass applied

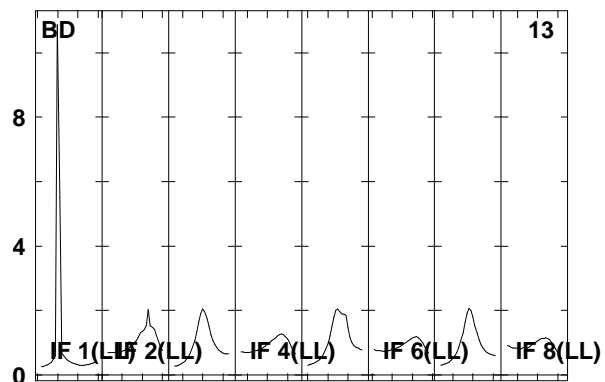
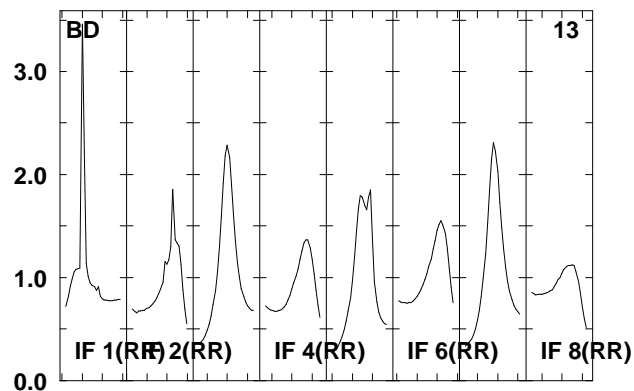
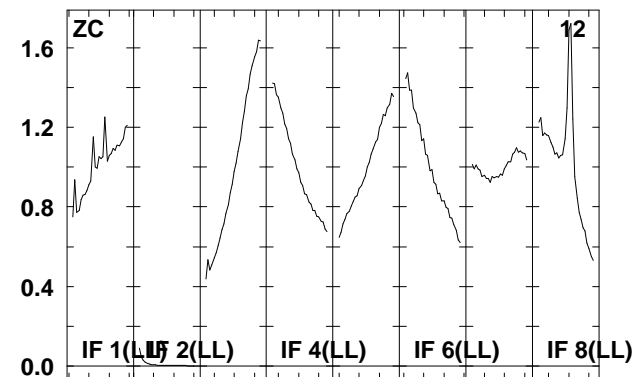
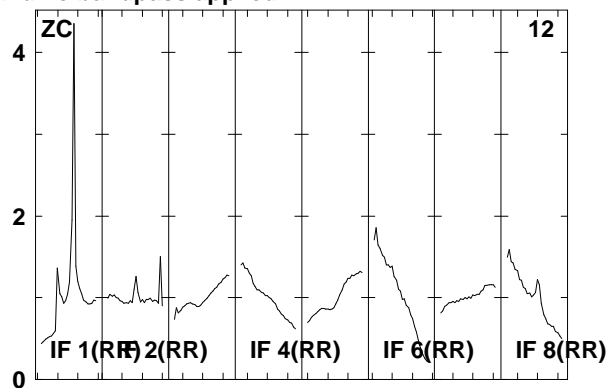
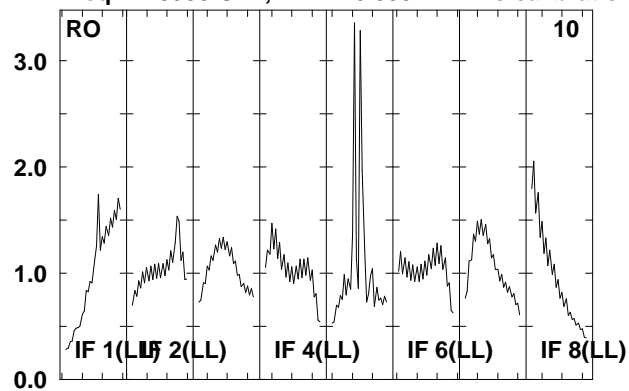

Lower frame: Real Jy
Total-power spectrum Antenna: *
Timerange: 00/16:58:35 to 00/16:59:59

Plot file version 220 created 06-JAN-2012 11:47:26

ARP299D EP068D 5.UVDATA.1

Freq = 1.5950 GHz, Bw = 16.000 MH No calibration applied and no bandpass applied

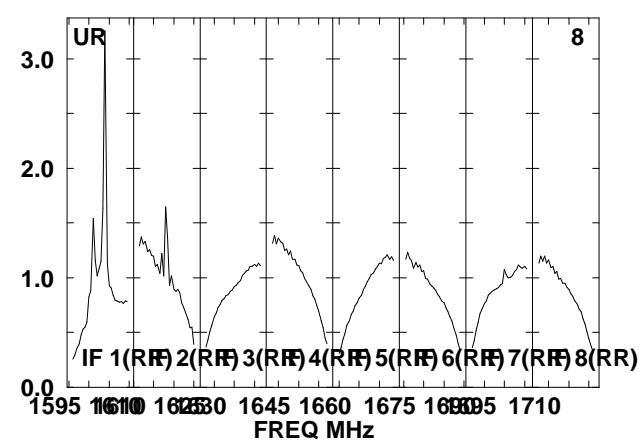
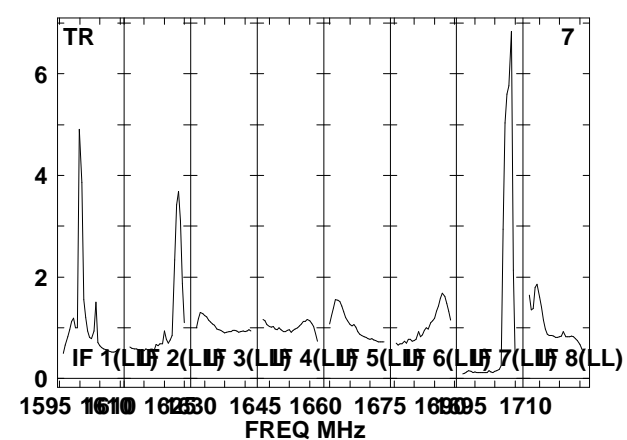
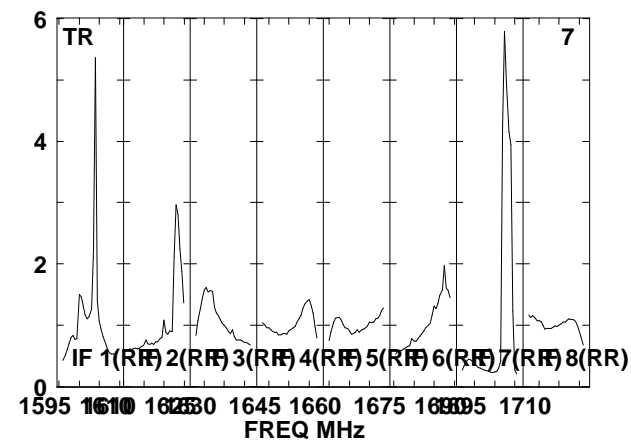
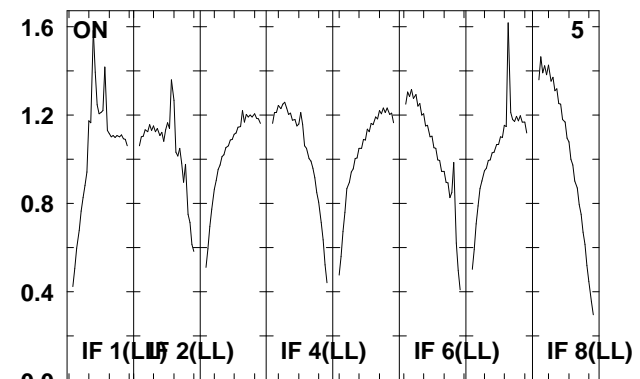
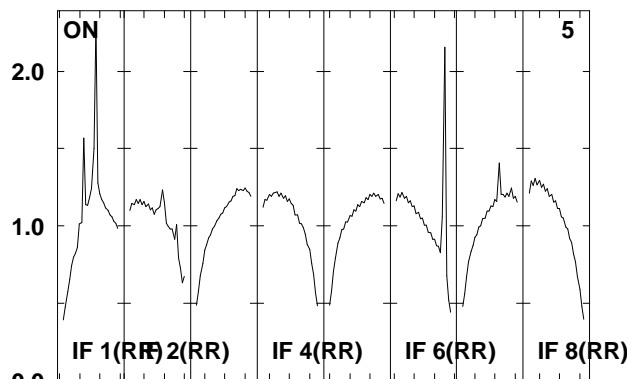
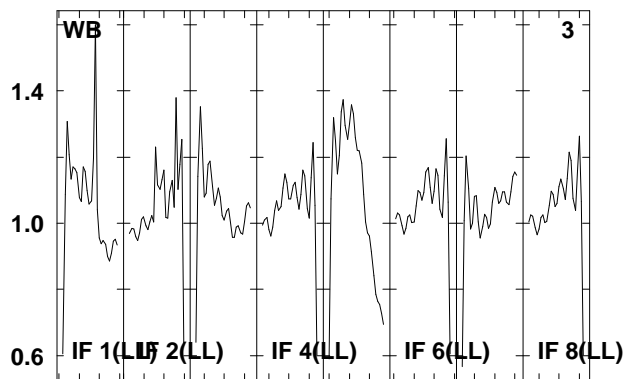
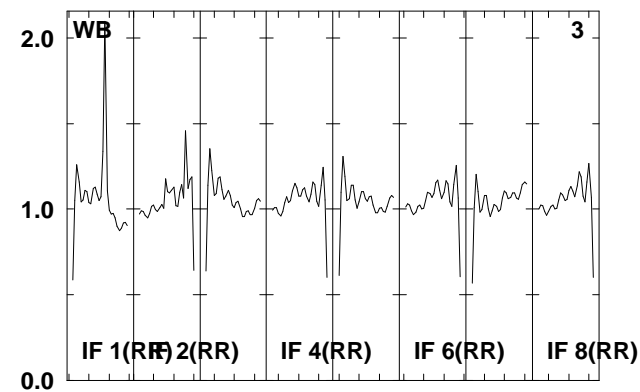
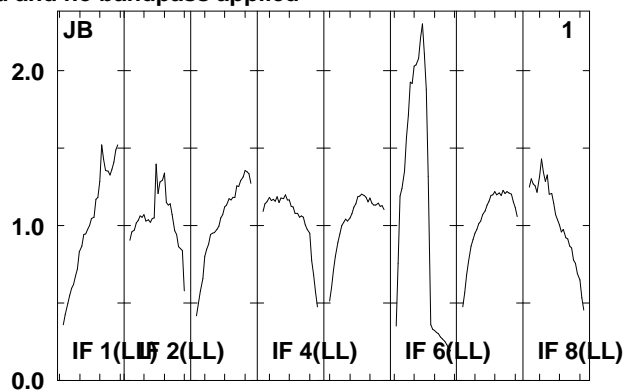
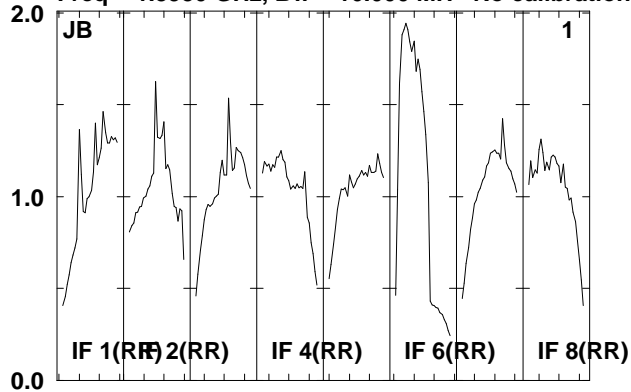

Lower frame: Real Jy
Total-power spectrum Antenna: *
Timerange: 00/17:00:01 to 00/17:03:29

Plot file version 221 created 06-JAN-2012 11:47:27

ARP299D EP068D 5.UVDATA.1

Freq = 1.5950 GHz, Bw = 16.000 MH No calibration applied and no bandpass applied

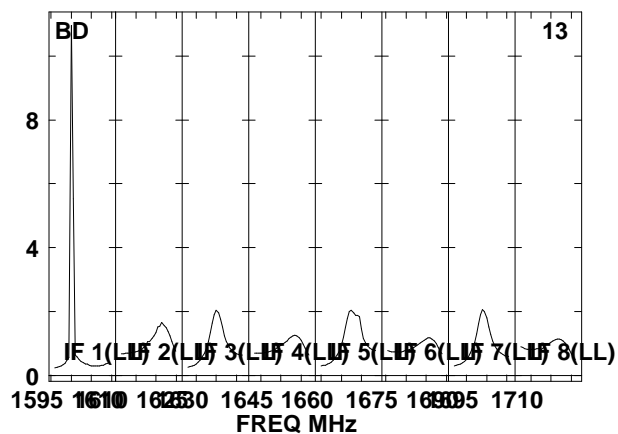
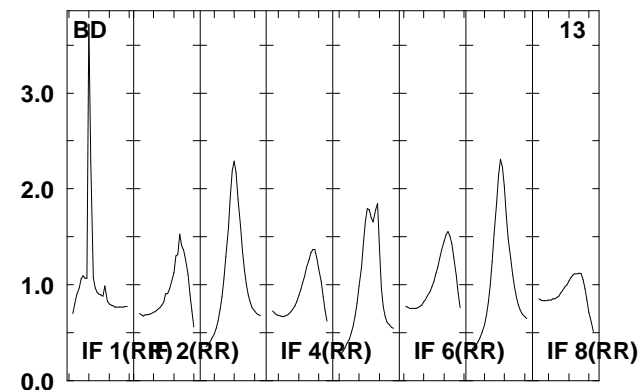
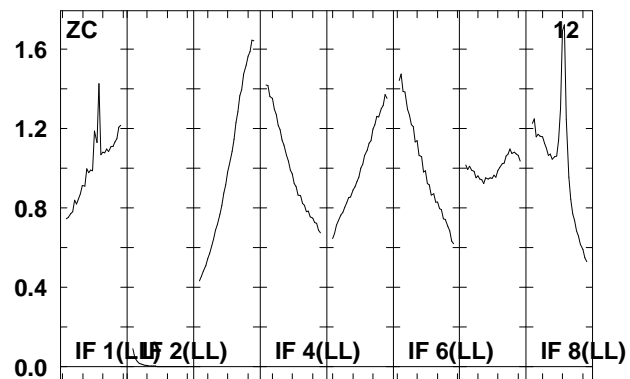
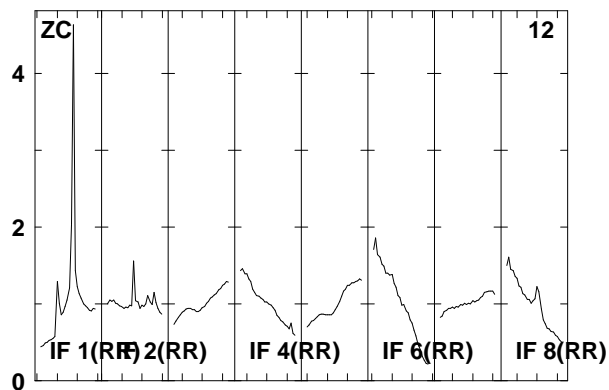
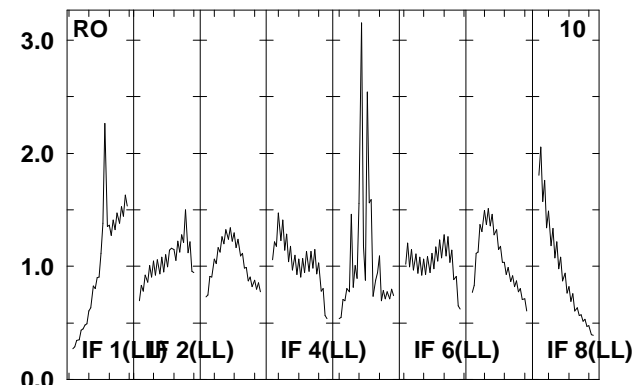
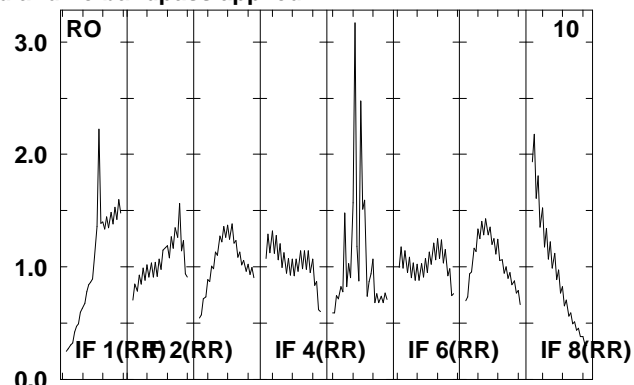
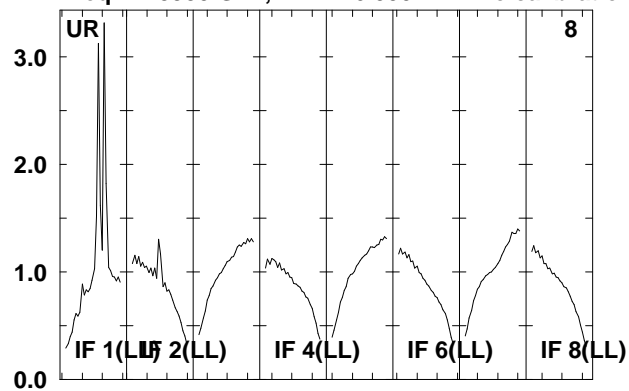

Lower frame: Real Jy

Total-power spectrum Antenna: *

Timerange: 00/17:00:01 to 00/17:03:29

Plot file version 222 created 06-JAN-2012 11:47:27

J1128+59 EP068D 5.UVDATA.1

Freq = 1.5950 GHz, Bw = 16.000 MH No calibration applied and no bandpass applied

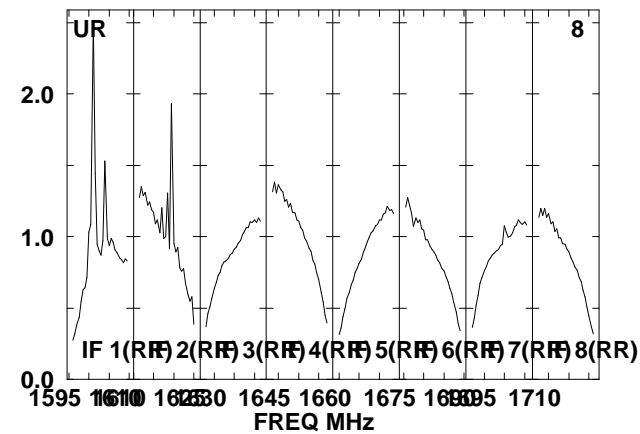
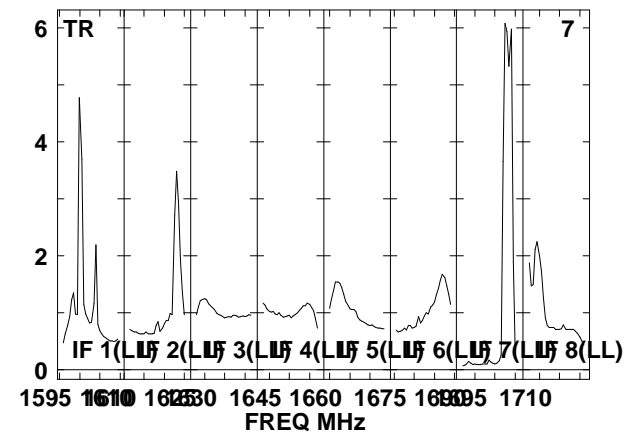
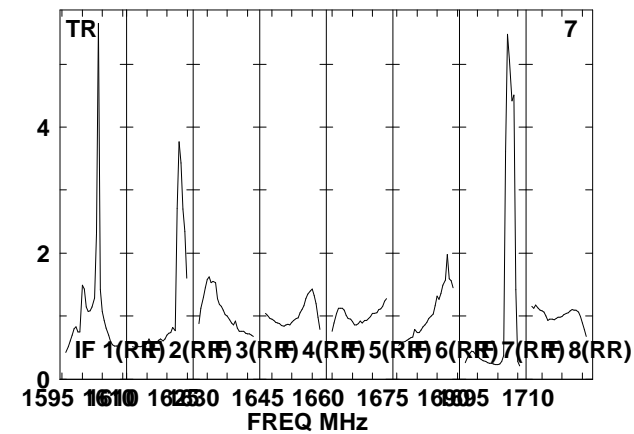
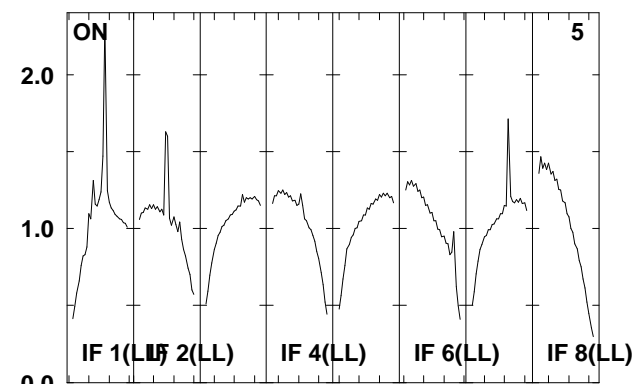
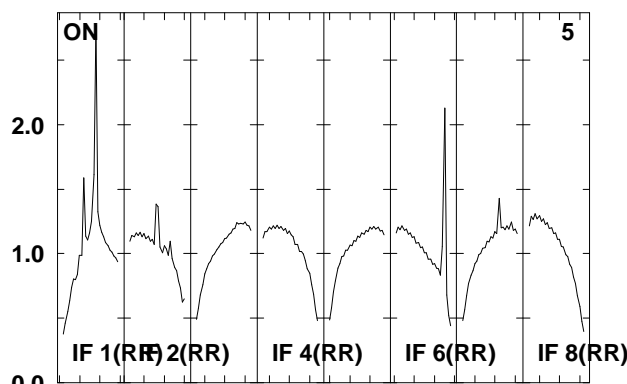
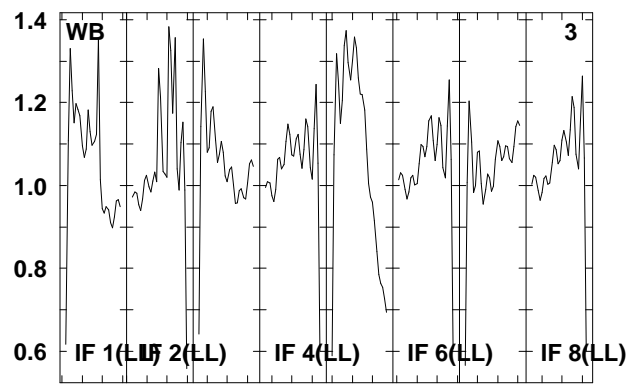
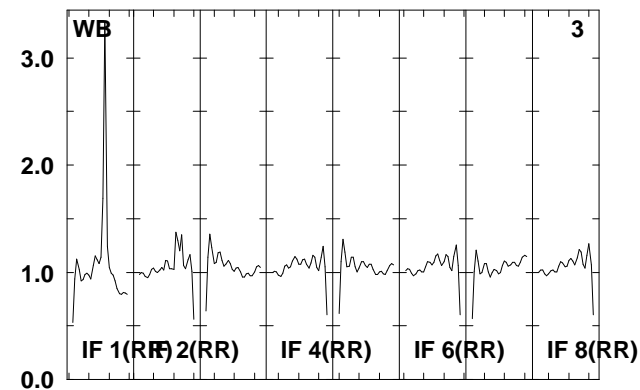
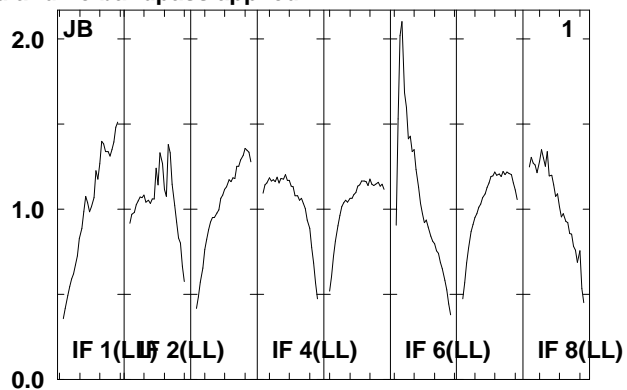
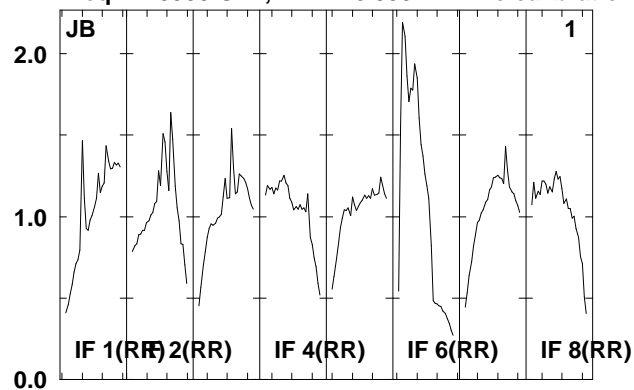

Lower frame: Real Jy
Total-power spectrum Antenna: *
Timerange: 00/17:03:35 to 00/17:04:59

Plot file version 223 created 06-JAN-2012 11:47:28

J1128+59 EP068D 5.UVDATA.1

Freq = 1.5950 GHz, Bw = 16.000 MH No calibration applied and no bandpass applied

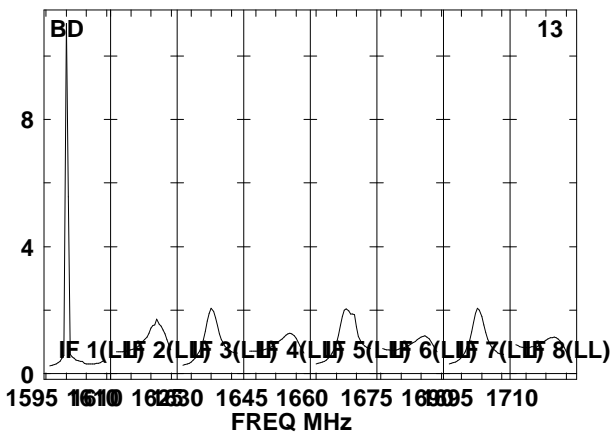
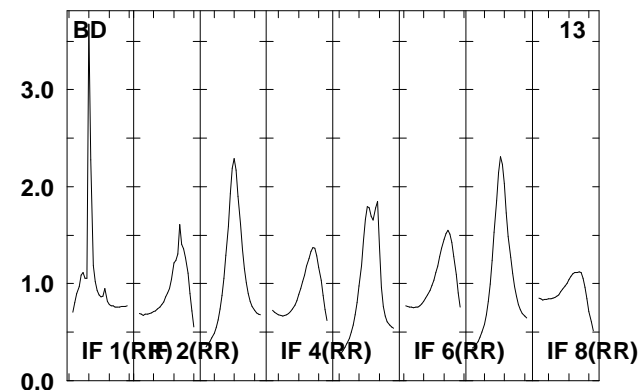
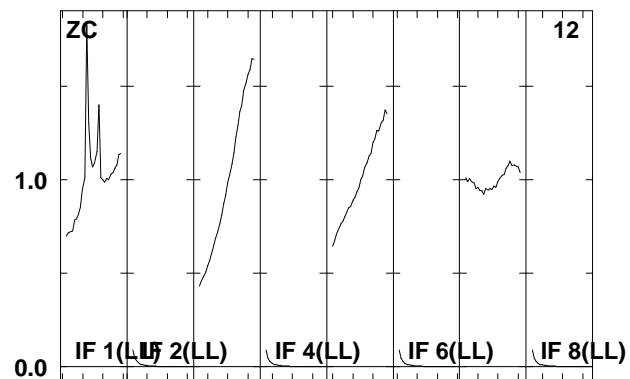
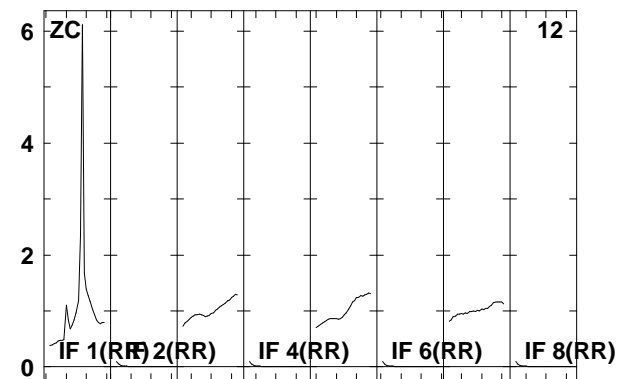
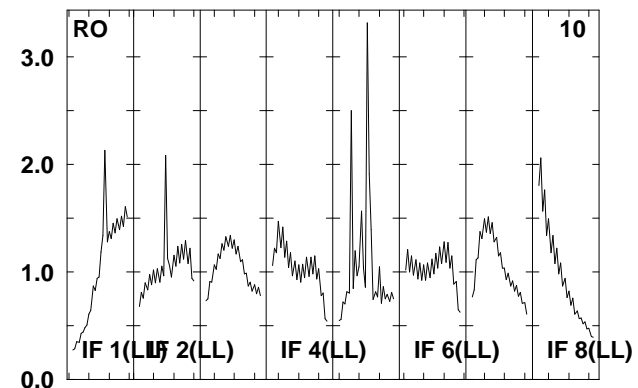
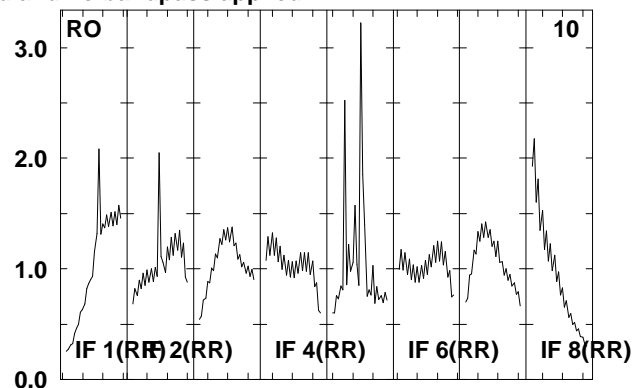
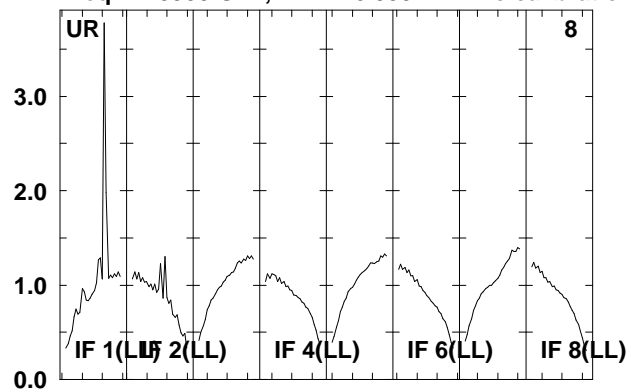

Lower frame: Real Jy

Total-power spectrum Antenna: *

Timerange: 00/17:03:35 to 00/17:04:59

Plot file version 224 created 06-JAN-2012 11:47:28

ARP299D EP068D 5.UVDATA.1

Freq = 1.5950 GHz, Bw = 16.000 MH No calibration applied and no bandpass applied

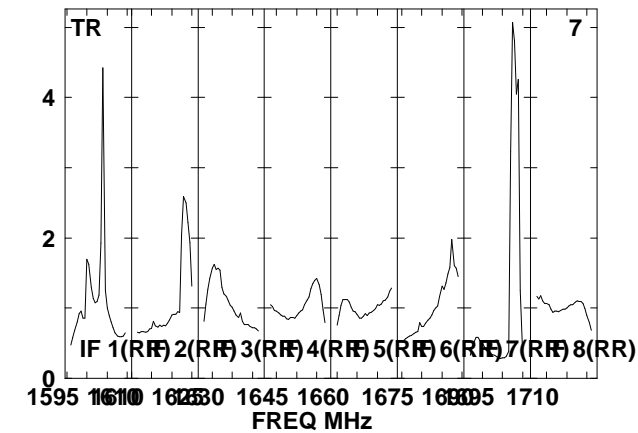
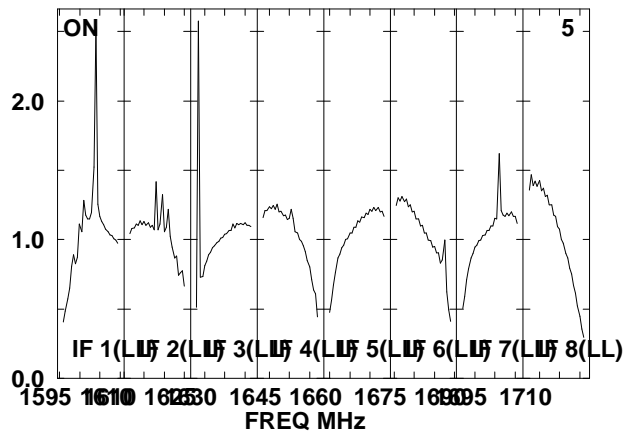
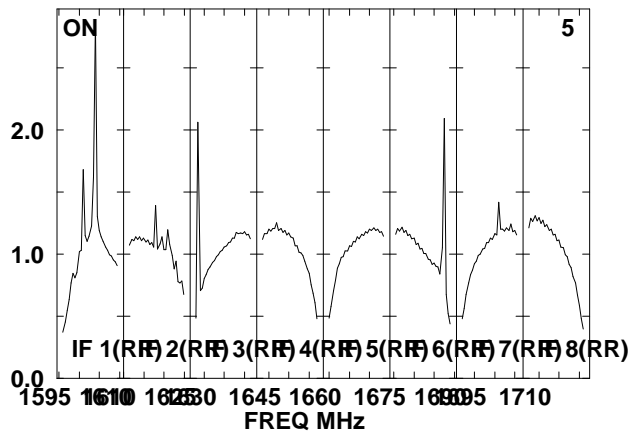
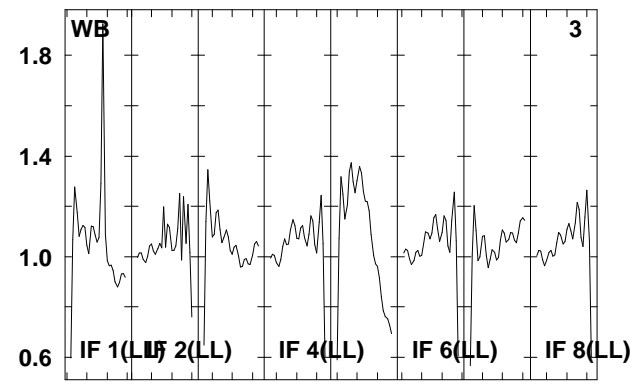
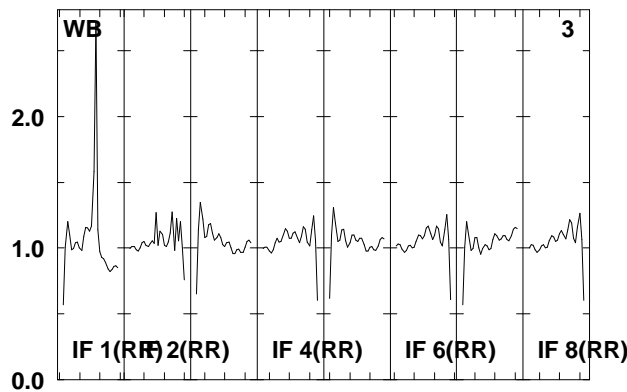
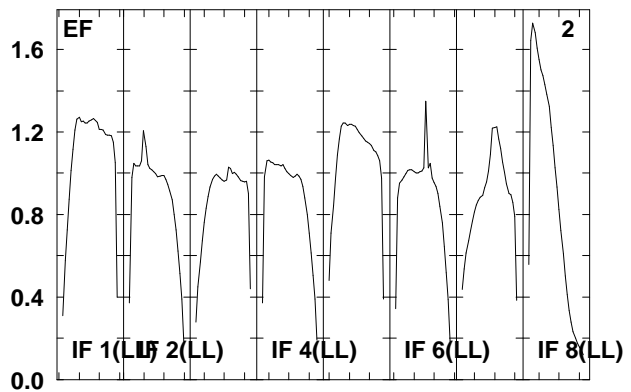
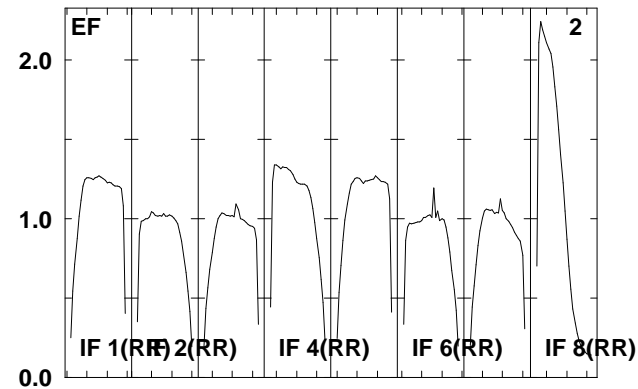
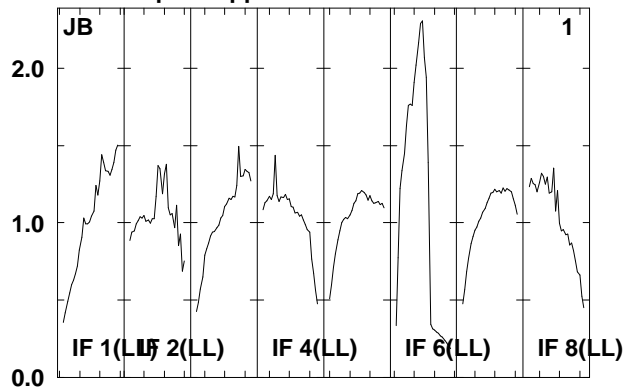
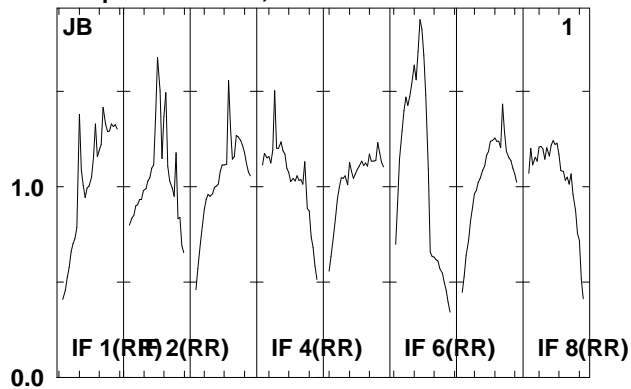

Lower frame: Real Jy
Total-power spectrum Antenna: *
Timerange: 00/17:05:05 to 00/17:08:29

Plot file version 225 created 06-JAN-2012 11:47:29

ARP299D EP068D 5.UVDATA.1

Freq = 1.5950 GHz, Bw = 16.000 MH No calibration applied and no bandpass applied

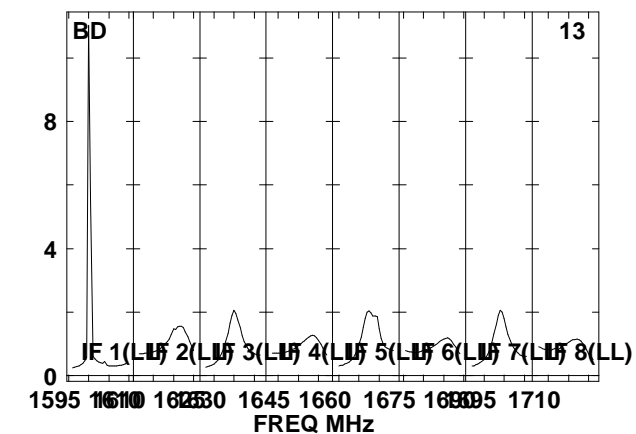
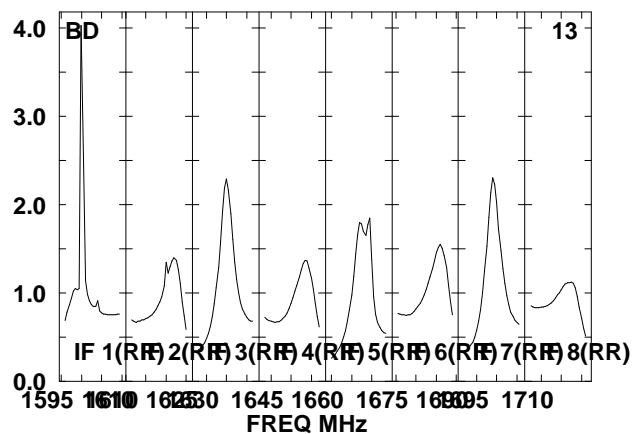
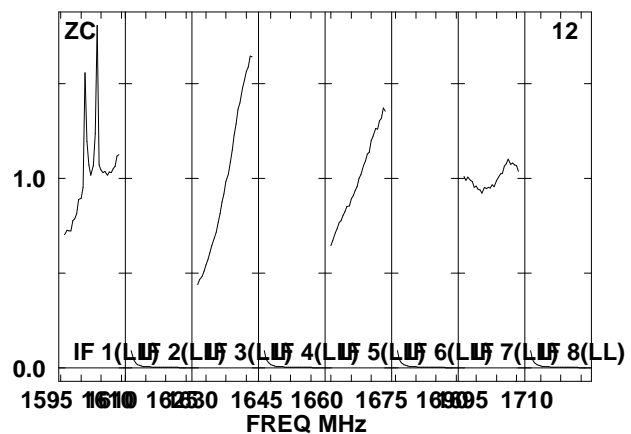
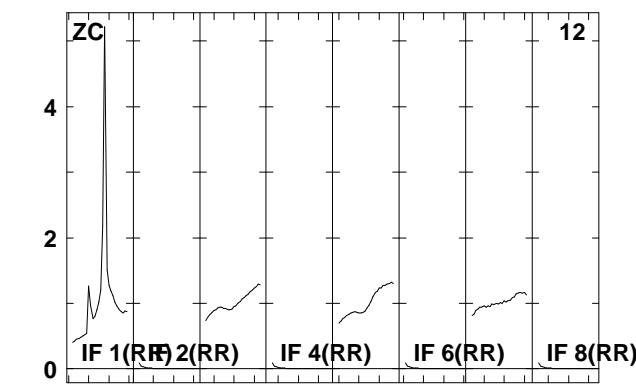
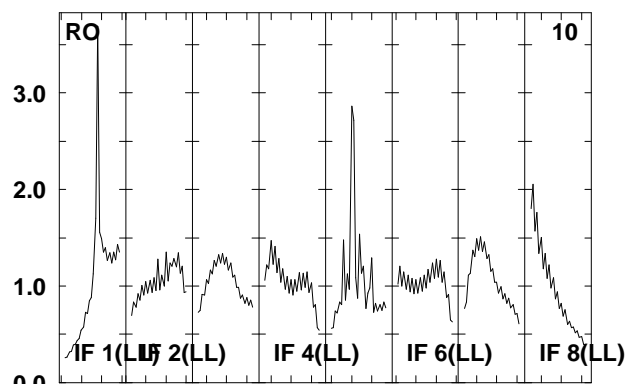
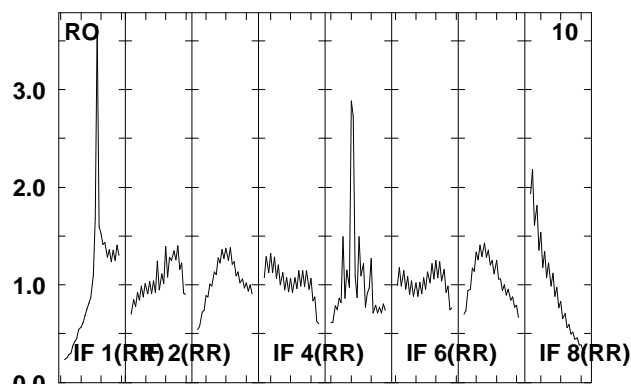
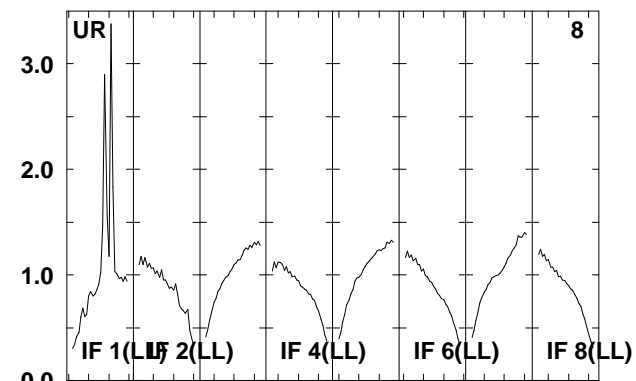
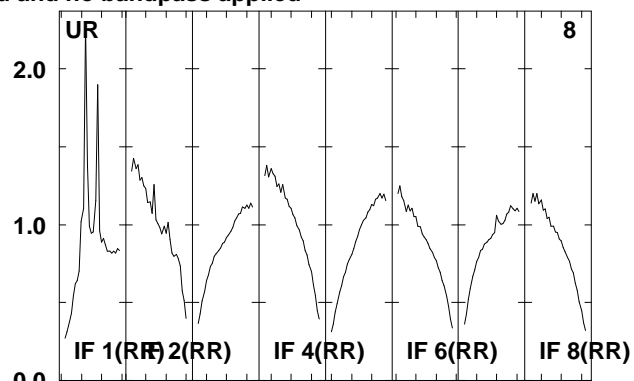
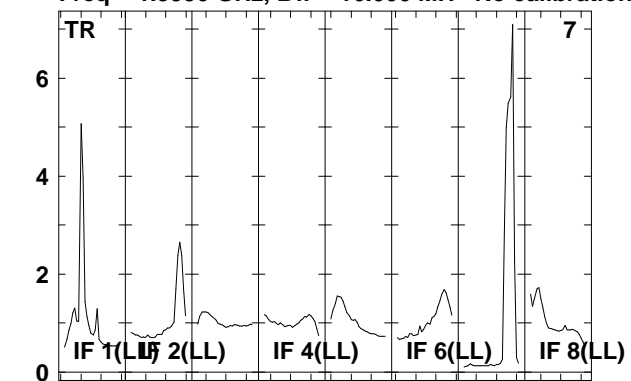

Lower frame: Real Jy

Total-power spectrum Antenna: *

Timerange: 00/17:05:05 to 00/17:08:29

Plot file version 226 created 06-JAN-2012 11:47:29

J1128+59 EP068D 5.UVDATA.1

Freq = 1.5950 GHz, Bw = 16.000 MH No calibration applied and no bandpass applied

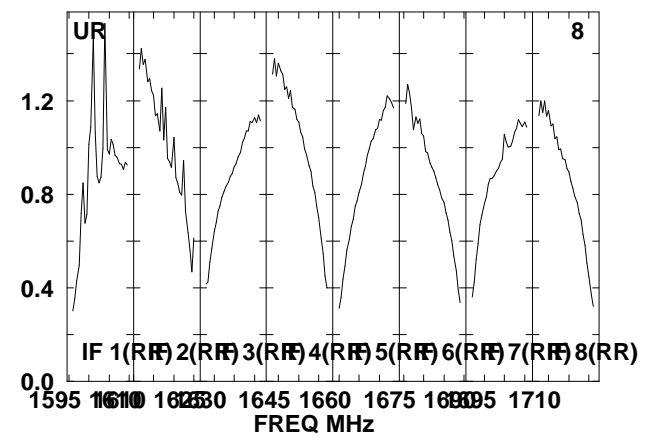
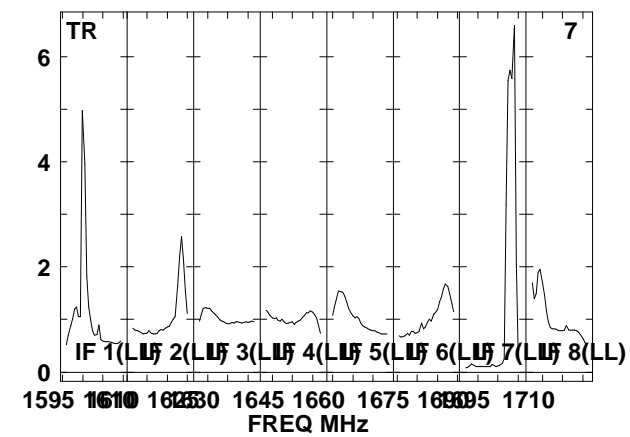
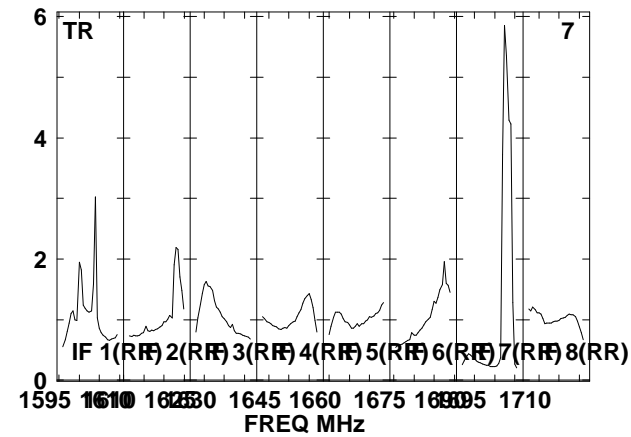
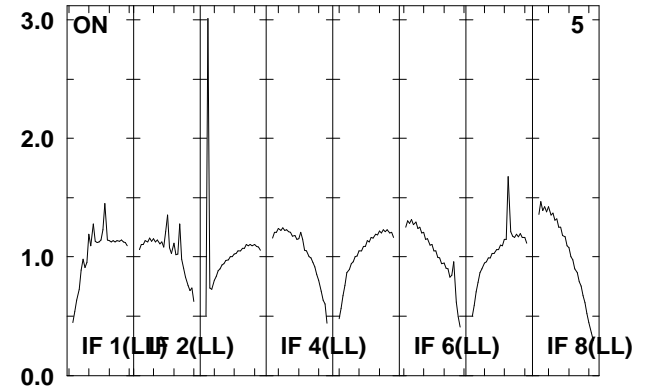
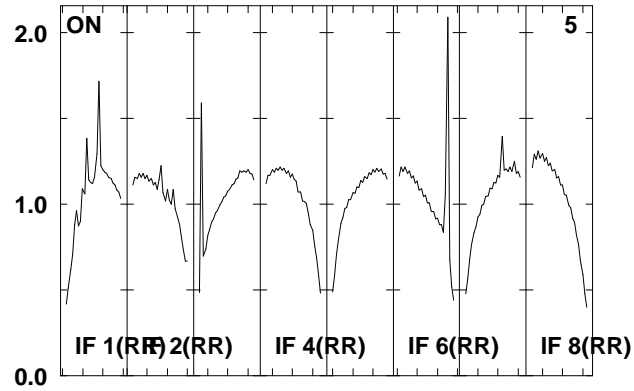
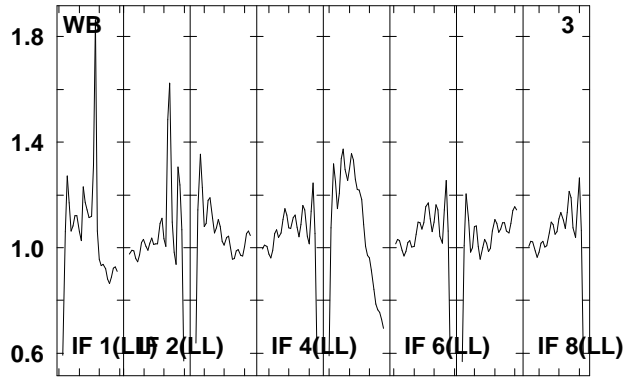
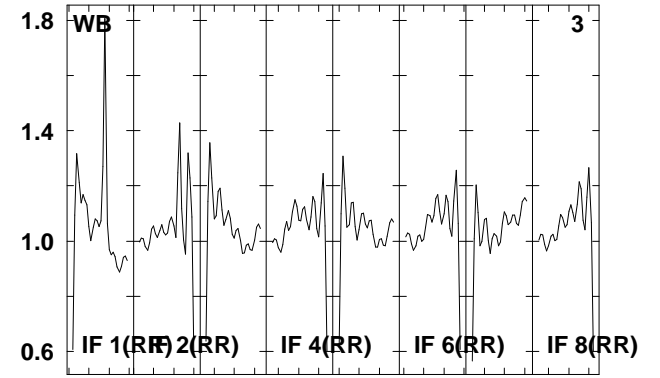
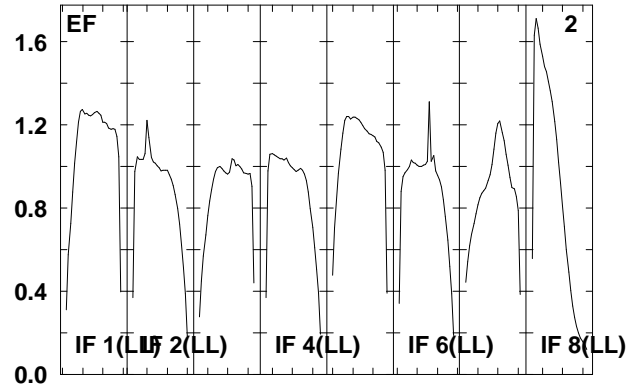
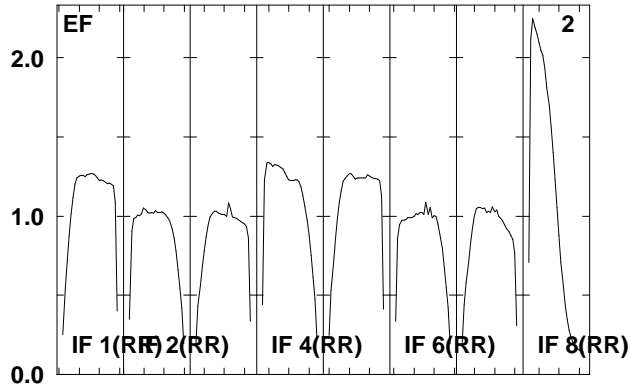

Lower frame: Real Jy
Total-power spectrum Antenna: *
Timerange: 00/17:09:31 to 00/17:10:59

Plot file version 227 created 06-JAN-2012 11:47:30

J1128+59 EP068D 5.UVDATA.1

Freq = 1.5950 GHz, Bw = 16.000 MH No calibration applied and no bandpass applied

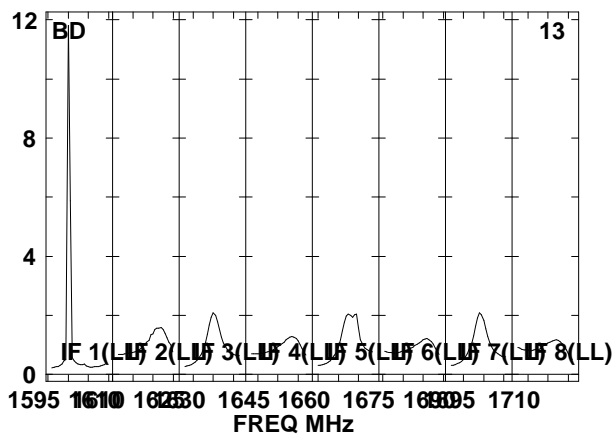
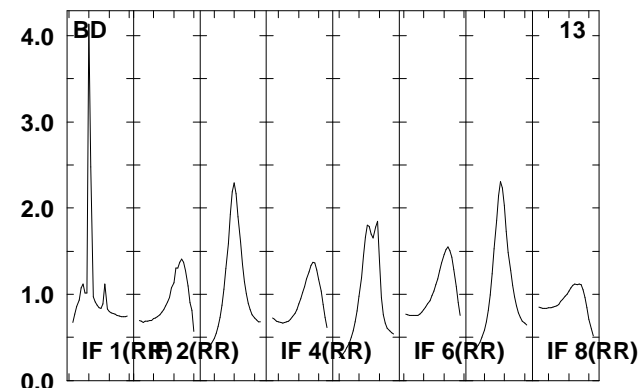
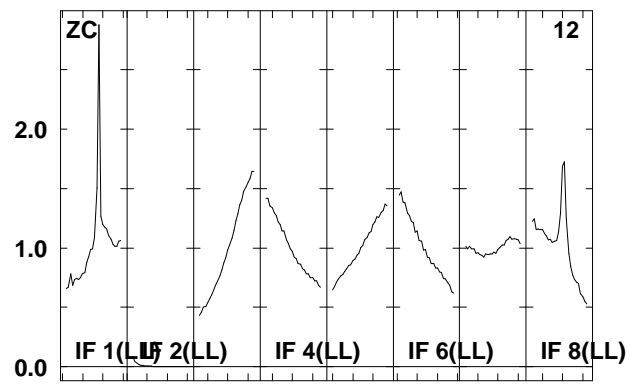
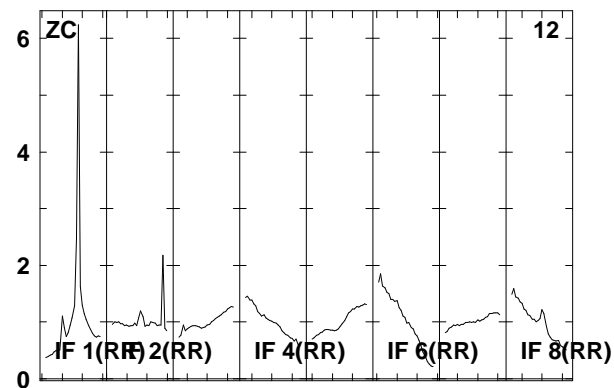
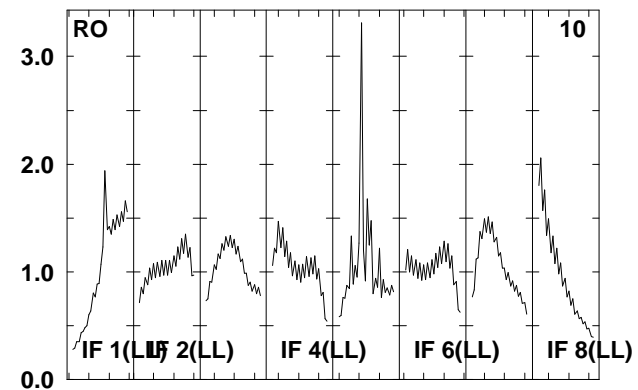
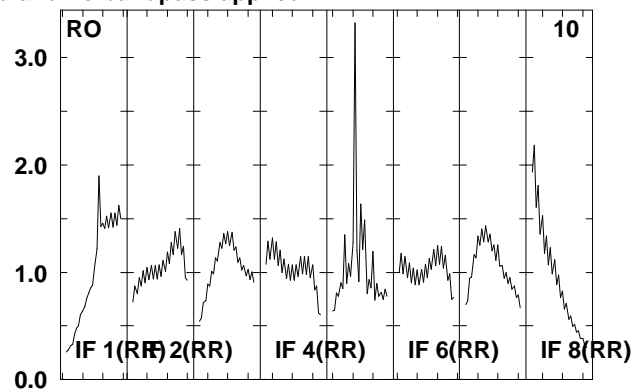
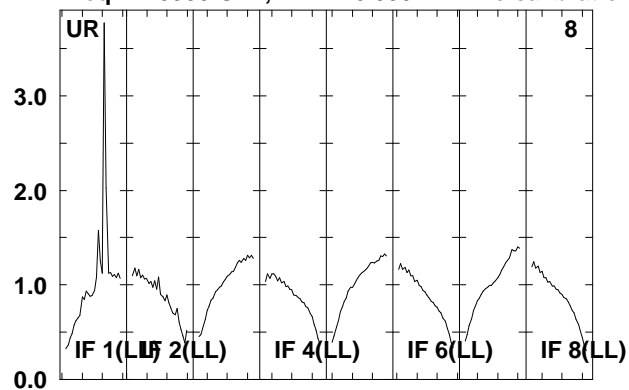

Lower frame: Real Jy

Total-power spectrum Antenna: *

Timerange: 00/17:09:31 to 00/17:10:59

Plot file version 228 created 06-JAN-2012 11:47:30

ARP299D EP068D 5.UVDATA.1

Freq = 1.5950 GHz, Bw = 16.000 MH No calibration applied and no bandpass applied

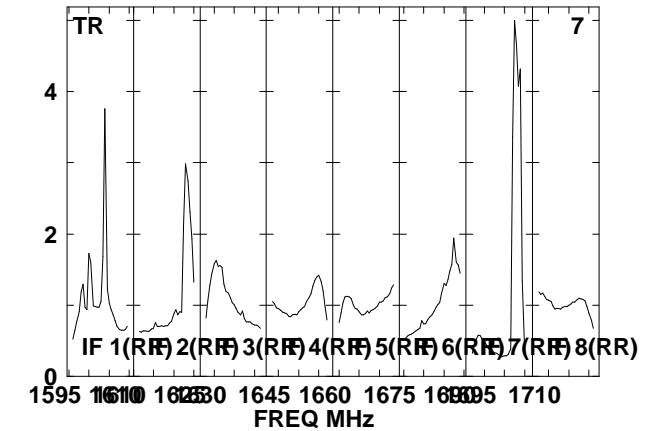
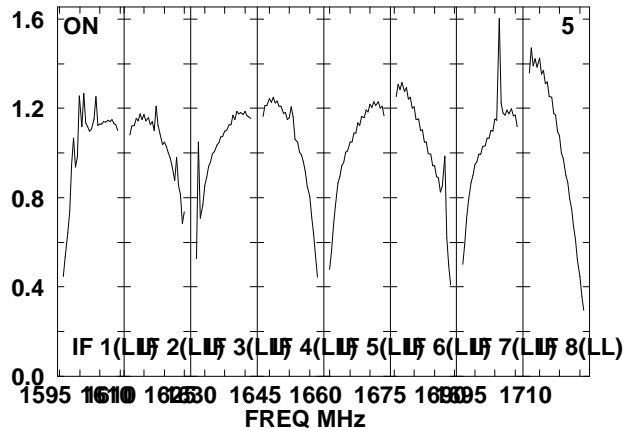
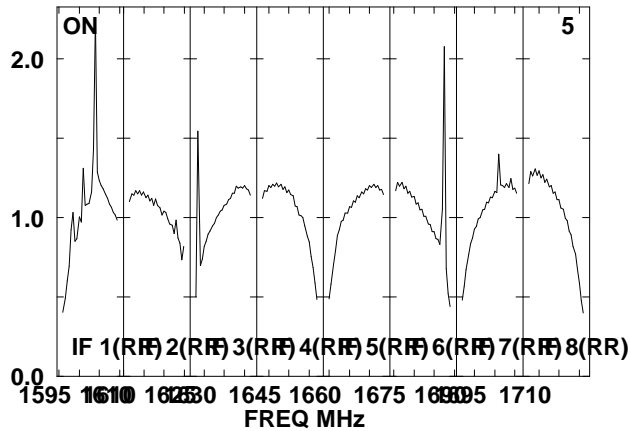
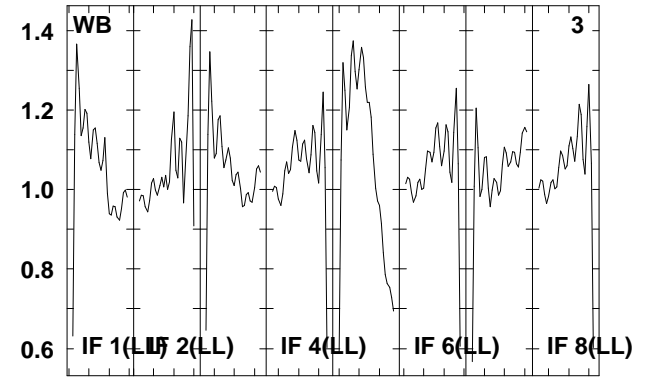
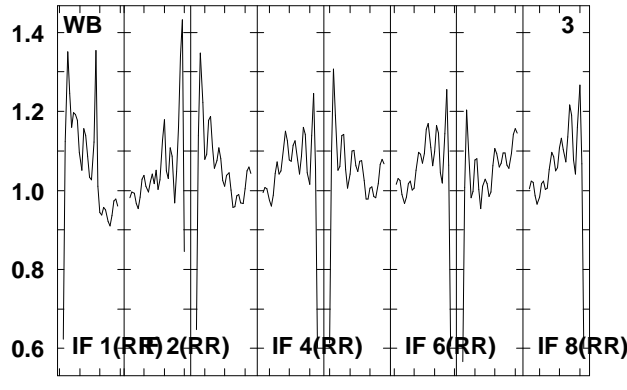
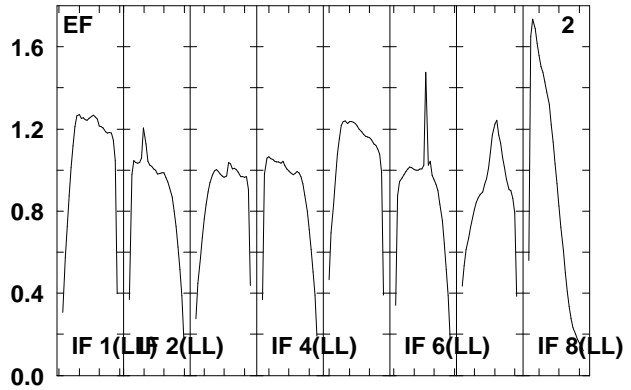
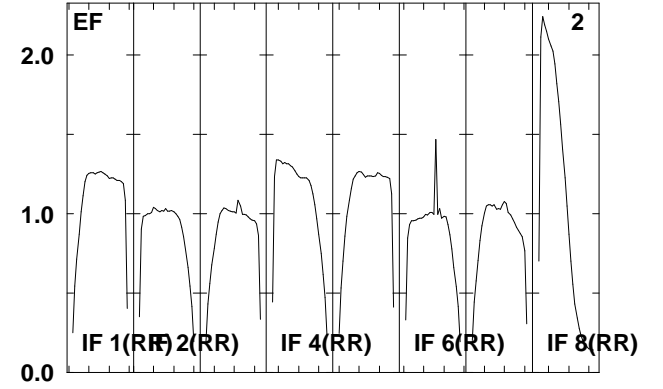
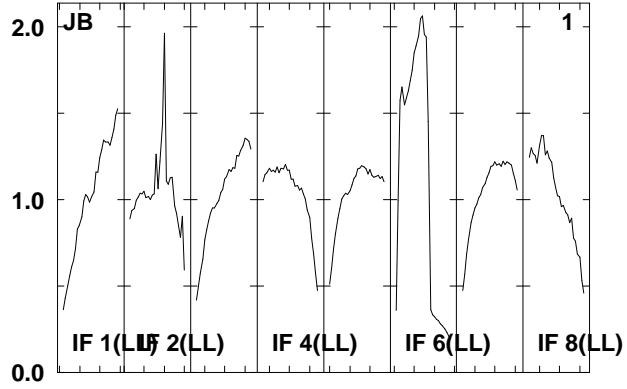
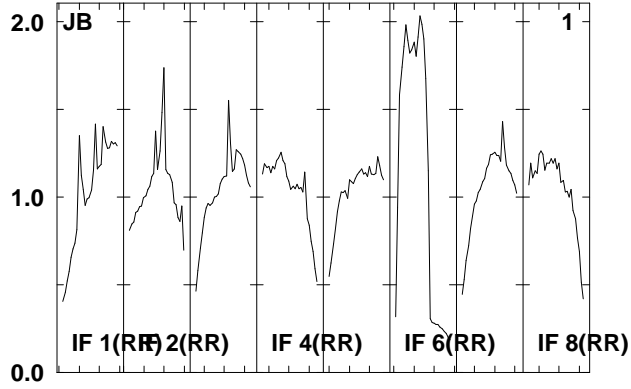

Lower frame: Real Jy
Total-power spectrum Antenna: *
Timerange: 00/17:11:01 to 00/17:14:29

Plot file version 229 created 06-JAN-2012 11:47:31

ARP299D EP068D 5.UVDATA.1

Freq = 1.5950 GHz, Bw = 16.000 MH No calibration applied and no bandpass applied

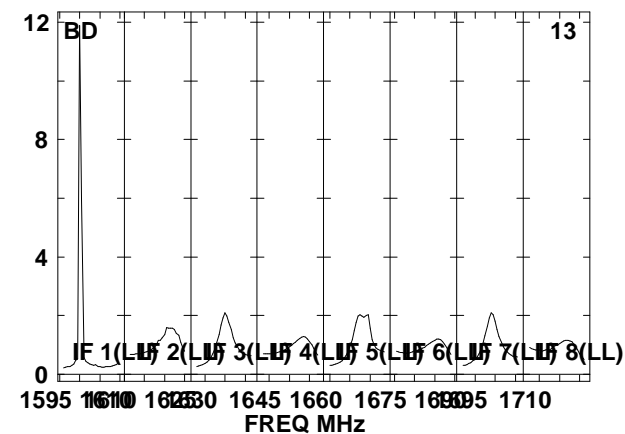
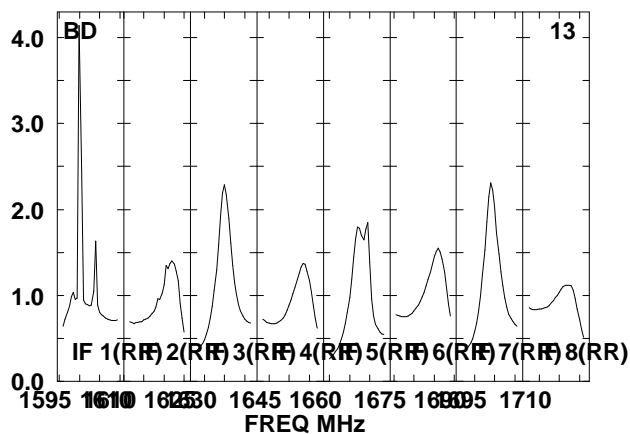
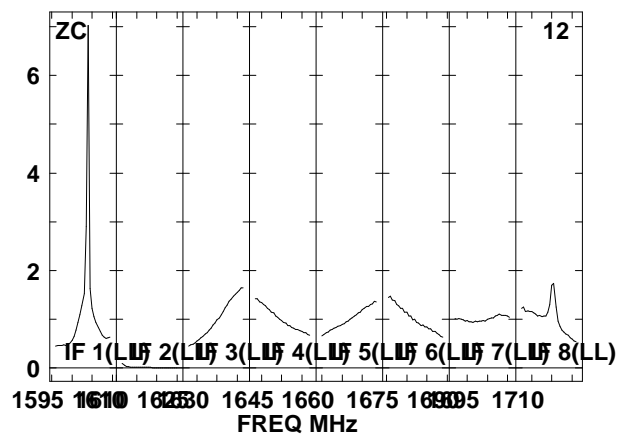
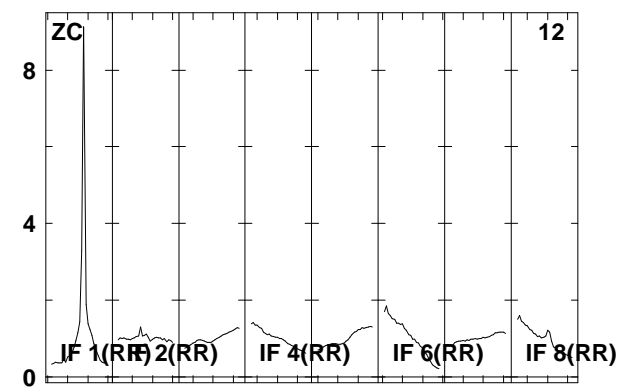
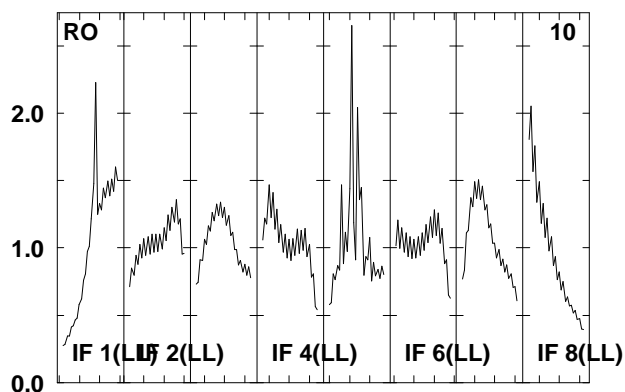
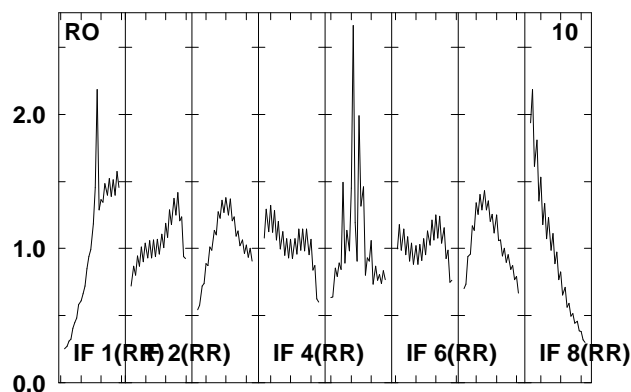
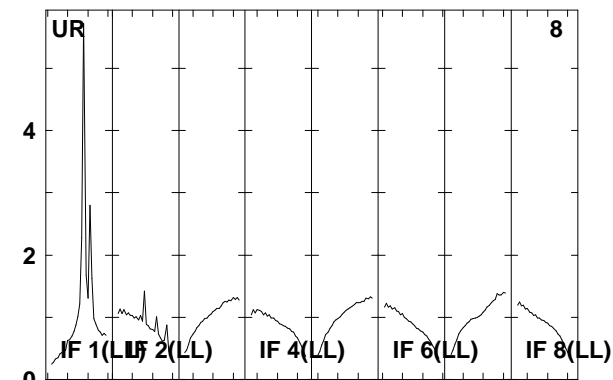
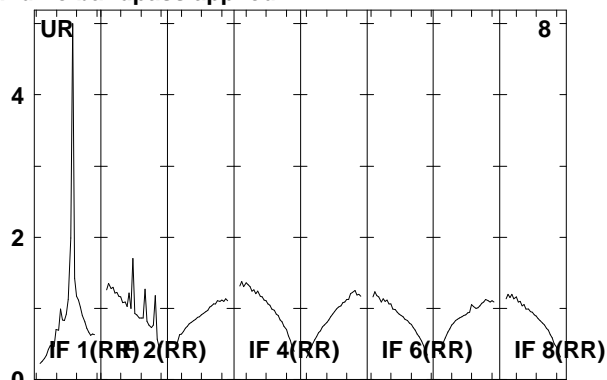
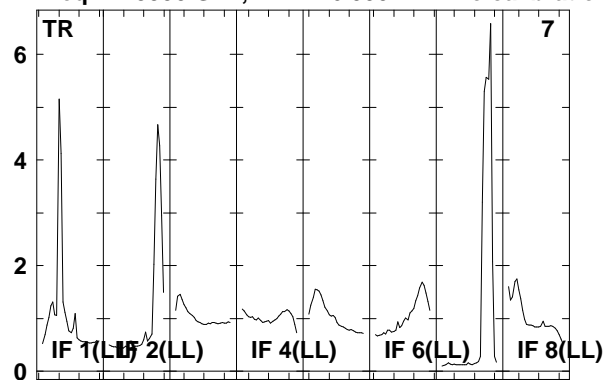

Lower frame: Real Jy
Total-power spectrum Antenna: *
Timerange: 00/17:11:01 to 00/17:14:29

Plot file version 230 created 06-JAN-2012 11:47:31

J1128+59 EP068D 5.UVDATA.1

Freq = 1.5950 GHz, Bw = 16.000 MH No calibration applied and no bandpass applied

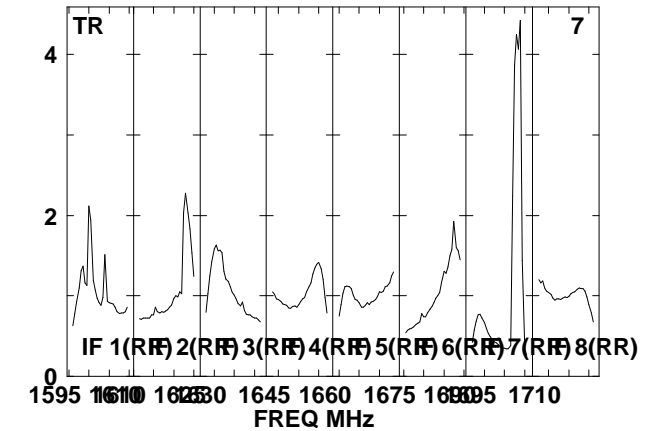
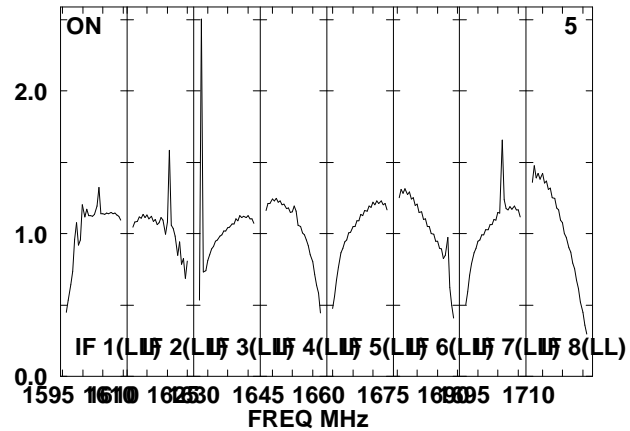
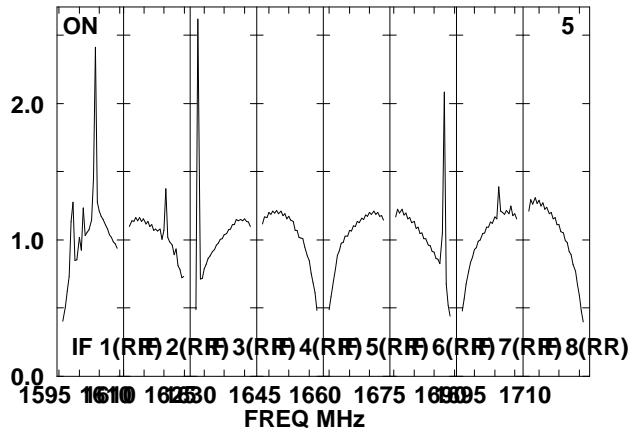
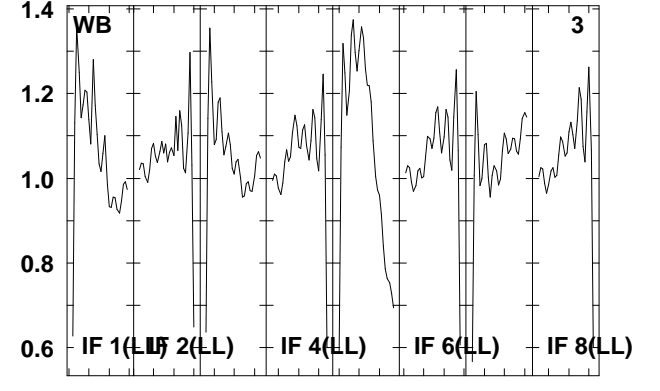
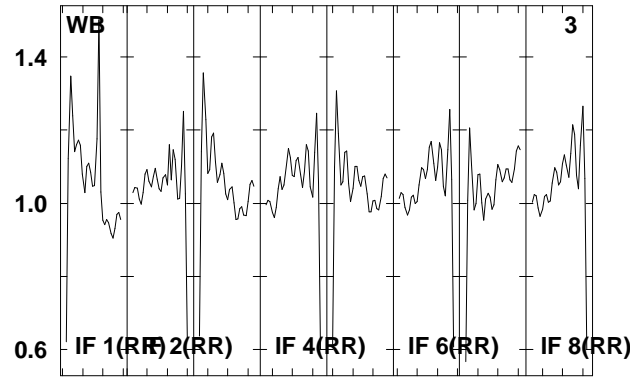
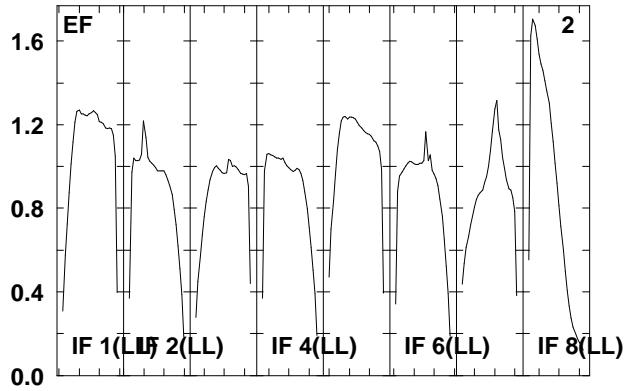
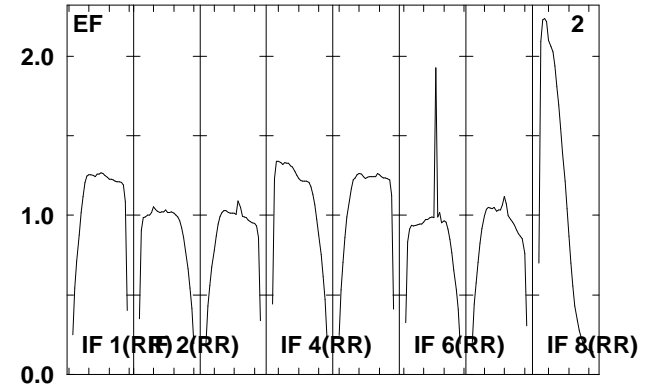
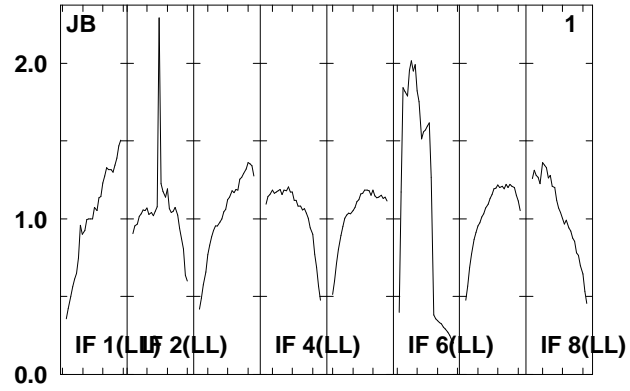
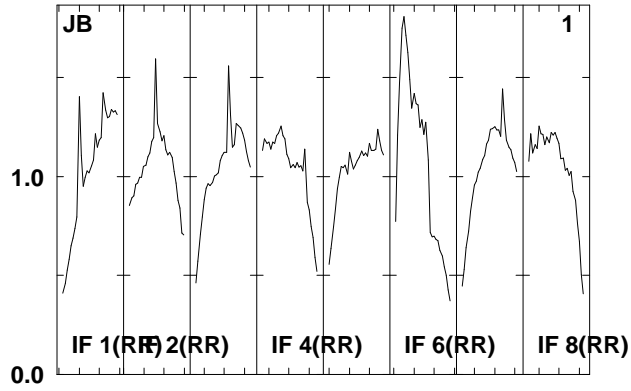

Lower frame: Real Jy
Total-power spectrum Antenna: *
Timerange: 00/17:14:35 to 00/17:15:59

Plot file version 231 created 06-JAN-2012 11:47:31

J1128+59 EP068D 5.UVDATA.1

Freq = 1.5950 GHz, Bw = 16.000 MH No calibration applied and no bandpass applied

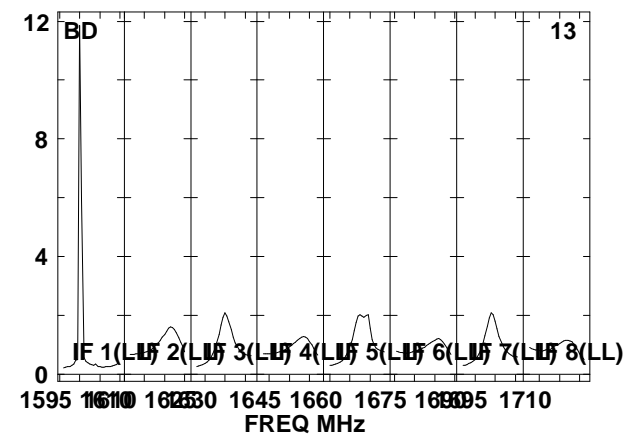
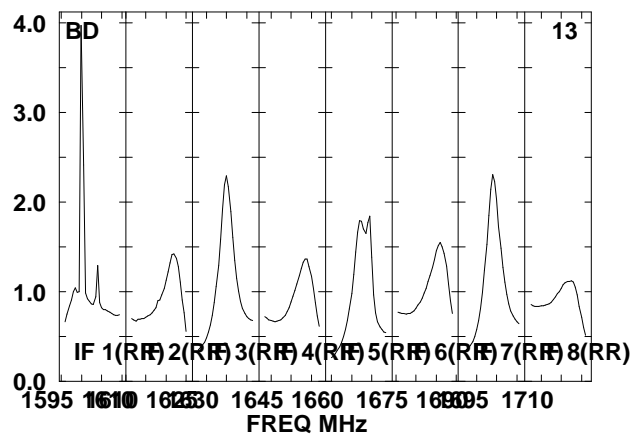
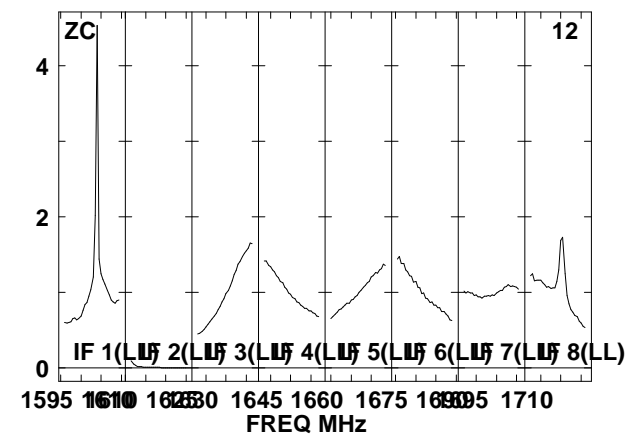
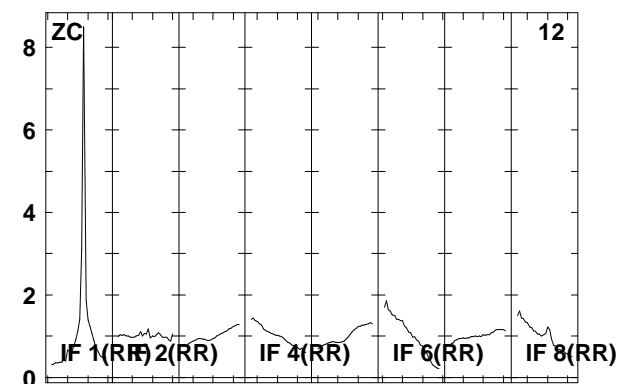
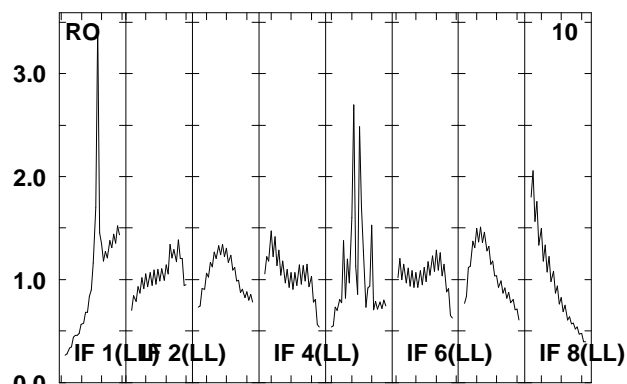
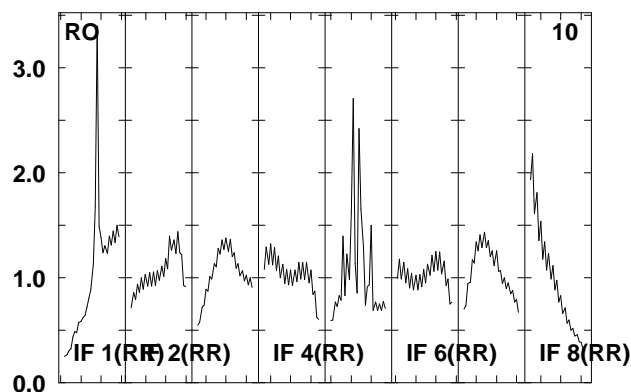
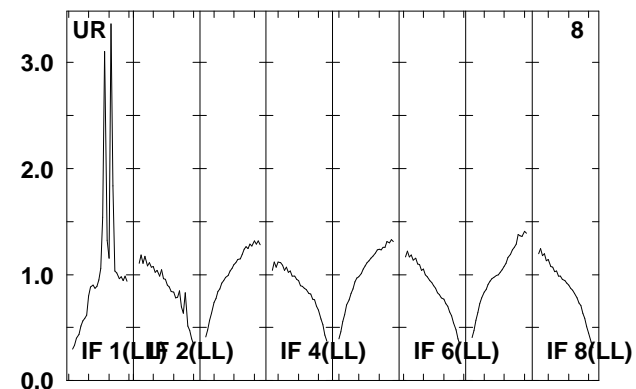
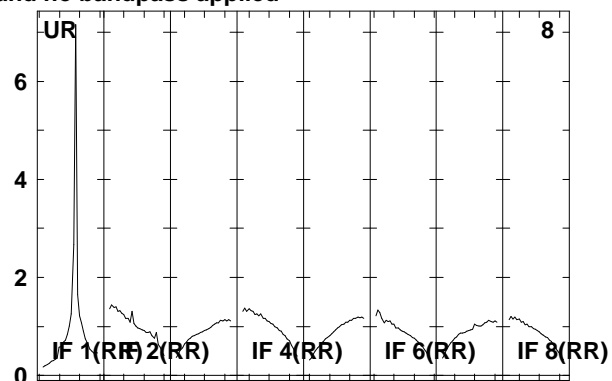
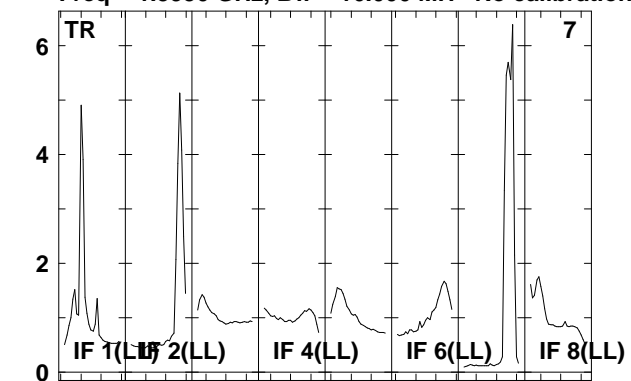

Lower frame: Real Jy
Total-power spectrum Antenna: *
Timerange: 00/17:14:35 to 00/17:15:59

Plot file version 232 created 06-JAN-2012 11:47:32

ARP299D EP068D 5.UVDATA.1

Freq = 1.5950 GHz, Bw = 16.000 MH No calibration applied and no bandpass applied

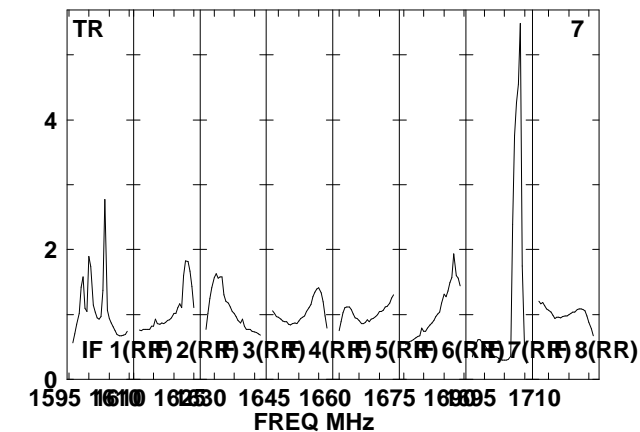
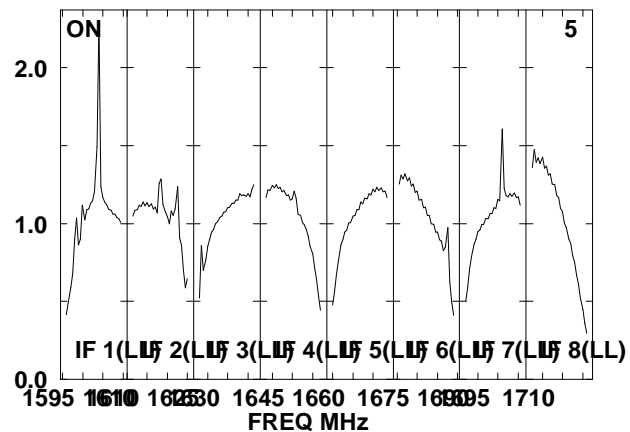
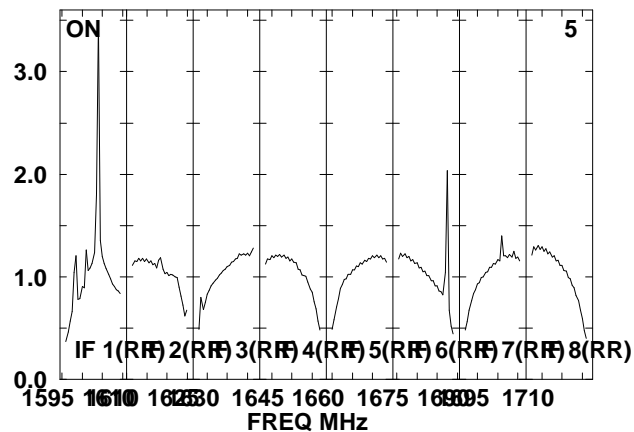
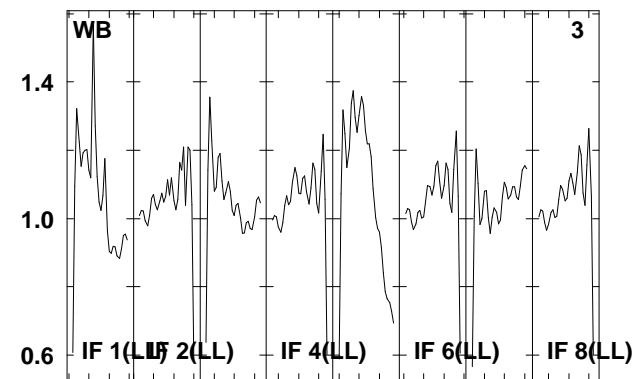
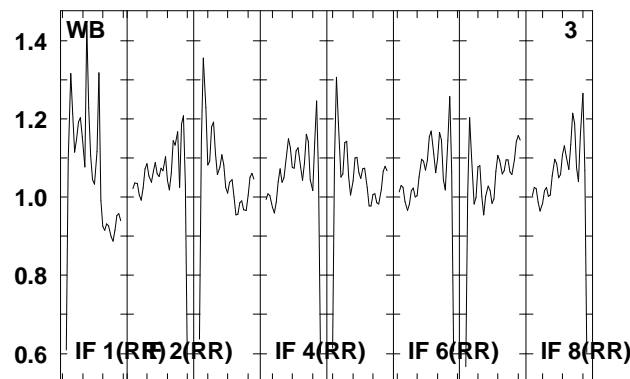
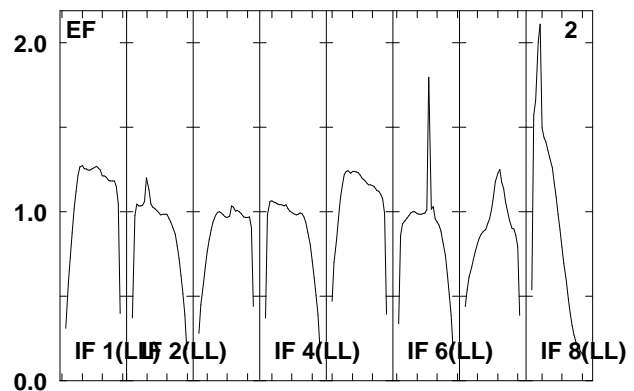
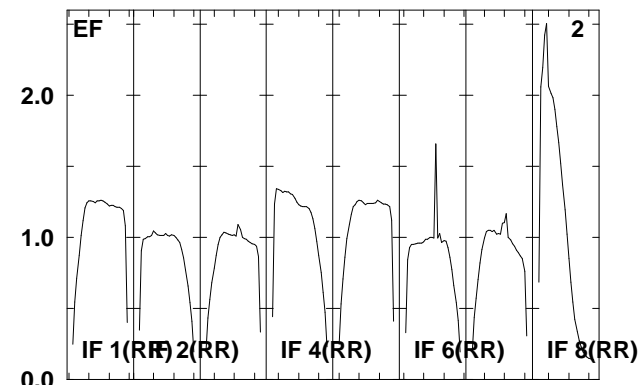
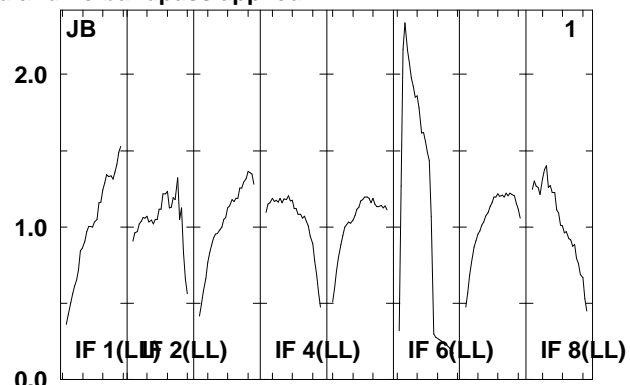
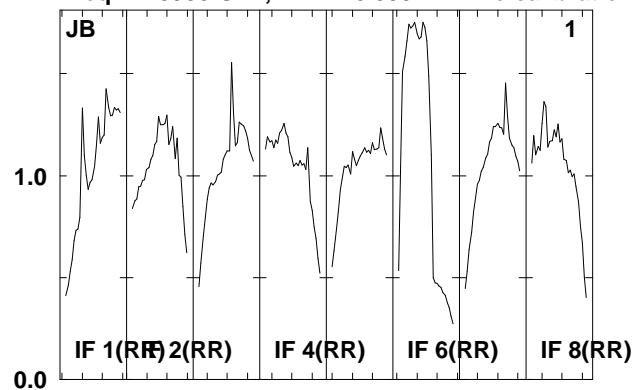

Lower frame: Real Jy
Total-power spectrum Antenna: *
Timerange: 00/17:16:05 to 00/17:19:29

Plot file version 233 created 06-JAN-2012 11:47:32

ARP299D EP068D 5.UVDATA.1

Freq = 1.5950 GHz, Bw = 16.000 MH No calibration applied and no bandpass applied

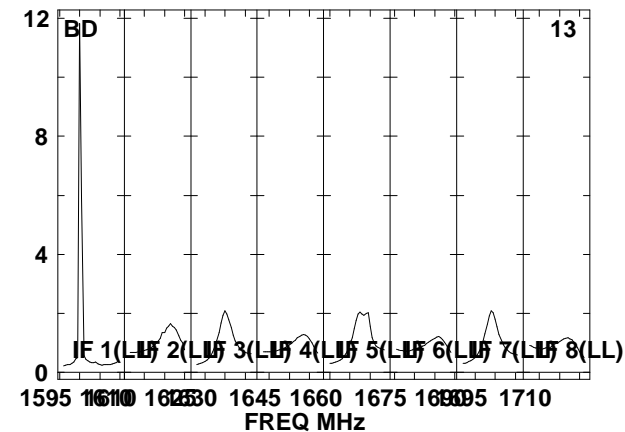
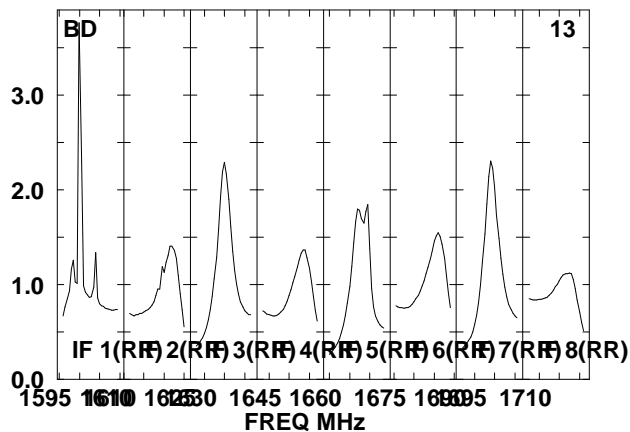
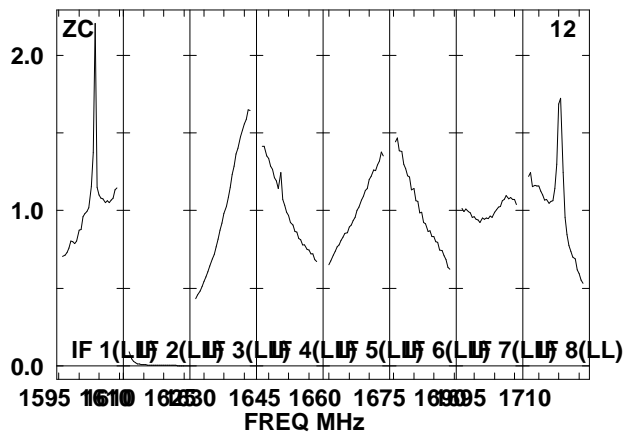
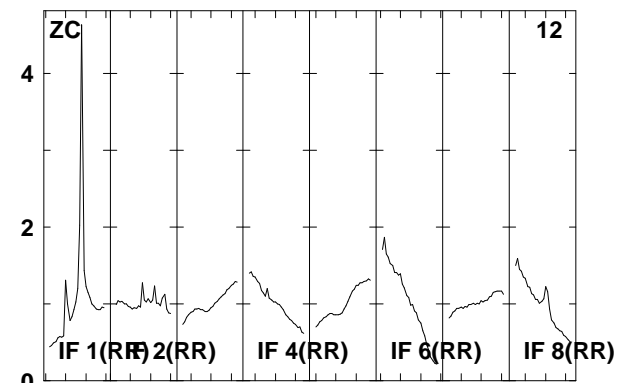
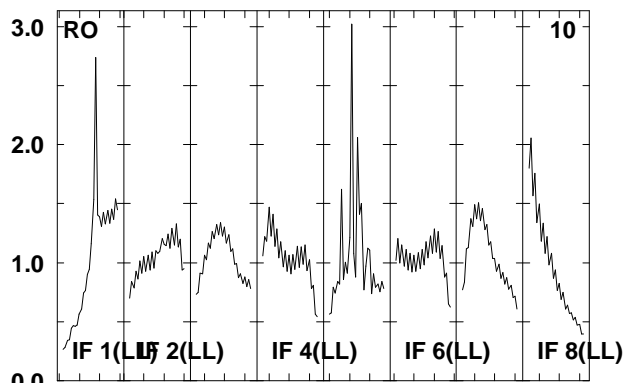
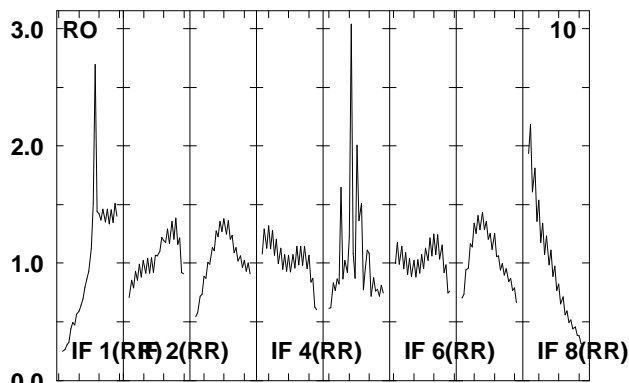
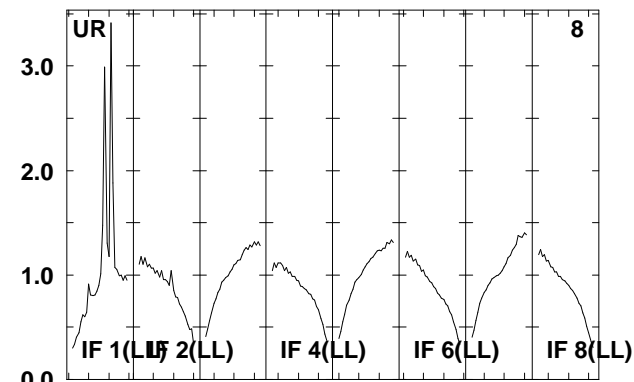
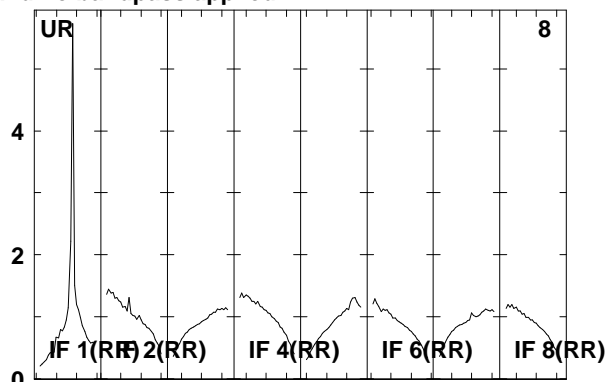
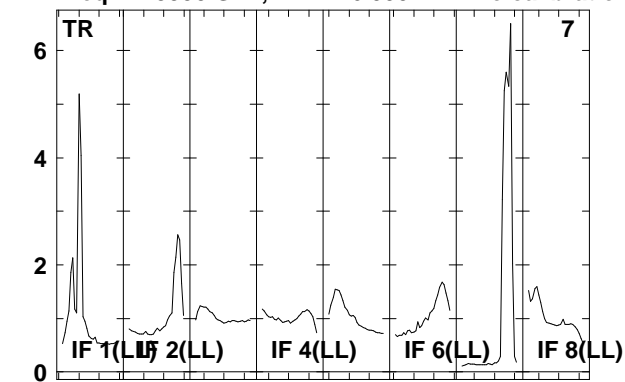

Lower frame: Real Jy
Total-power spectrum Antenna: *
Timerange: 00/17:16:05 to 00/17:19:29

Plot file version 234 created 06-JAN-2012 11:47:33

J1128+59 EP068D 5.UVDATA.1

Freq = 1.5950 GHz, Bw = 16.000 MH No calibration applied and no bandpass applied

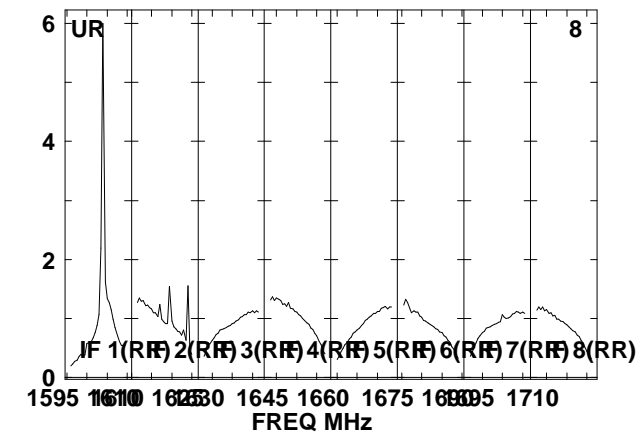
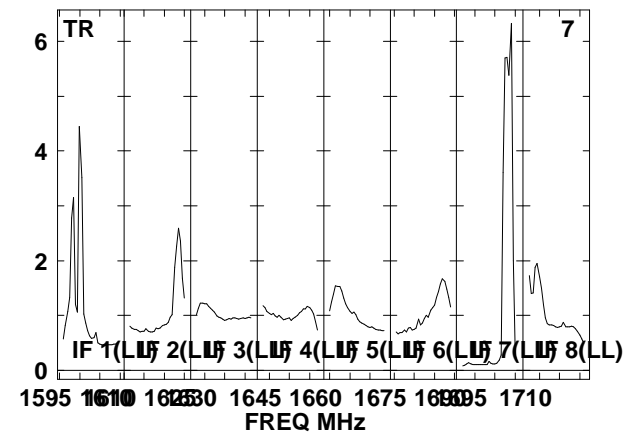
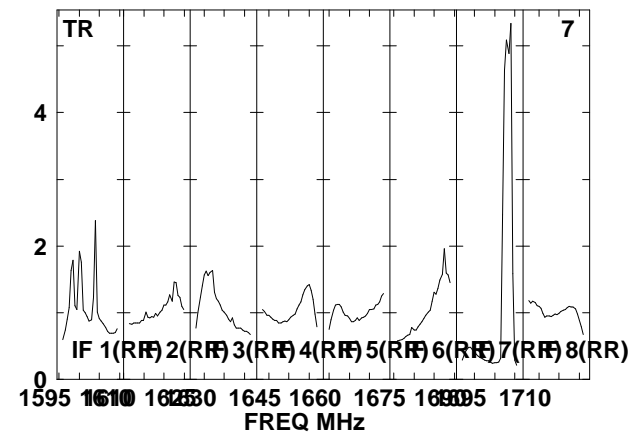
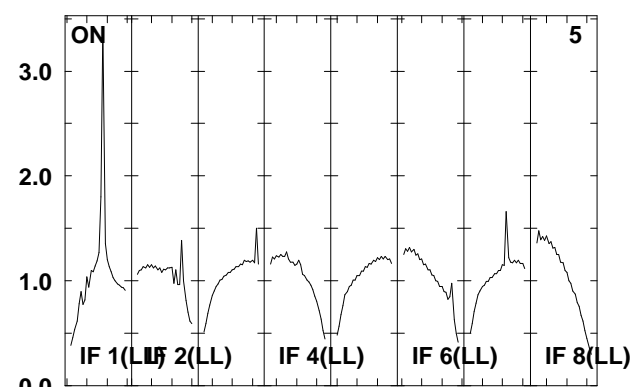
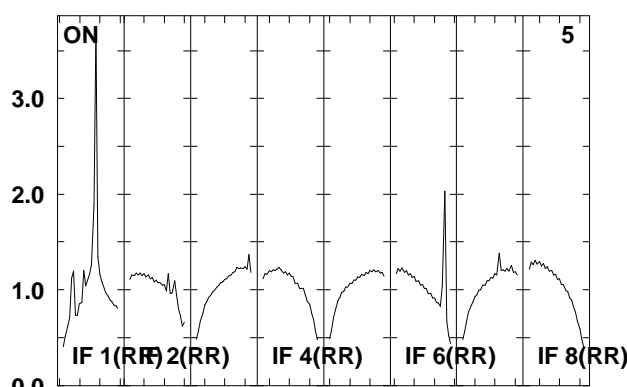
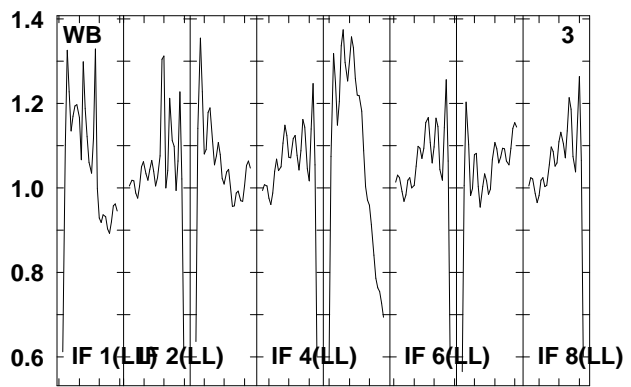
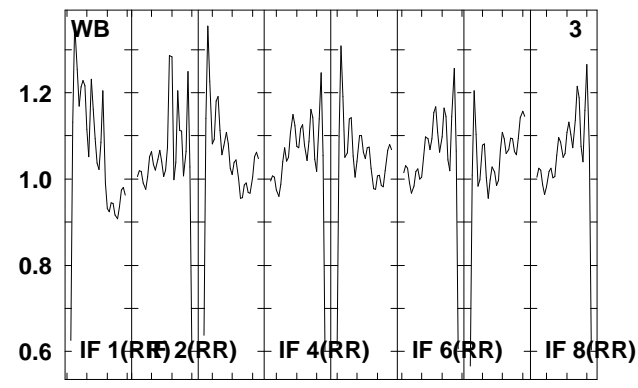
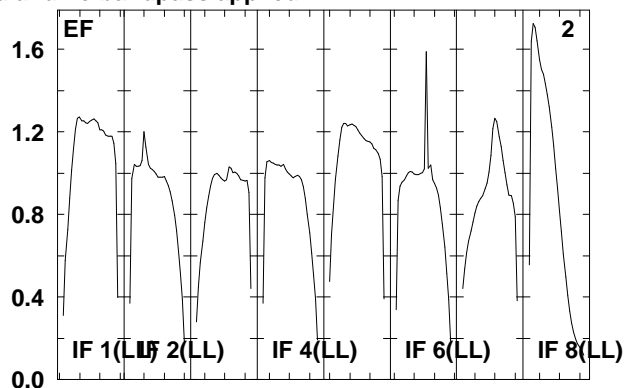
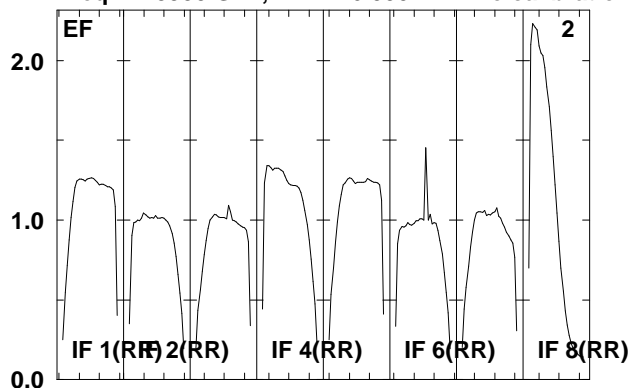

Lower frame: Real Jy
Total-power spectrum Antenna: *
Timerange: 00/17:19:35 to 00/17:20:59

Plot file version 235 created 06-JAN-2012 11:47:33

J1128+59 EP068D 5.UVDATA.1

Freq = 1.5950 GHz, Bw = 16.000 MH No calibration applied and no bandpass applied

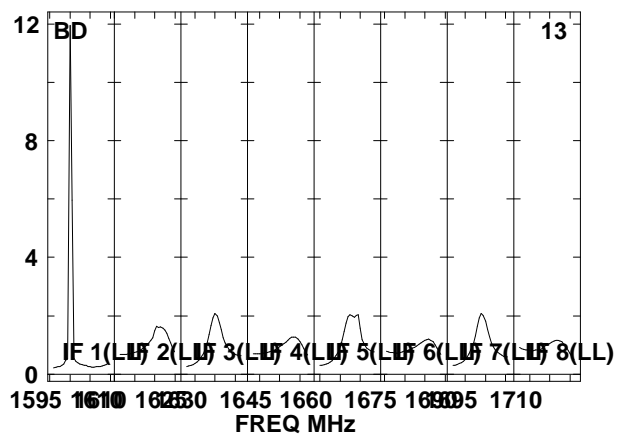
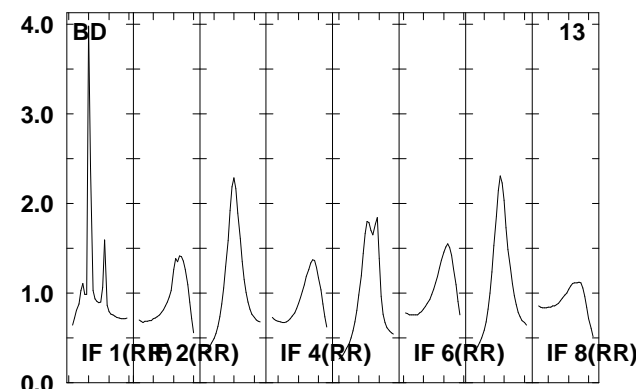
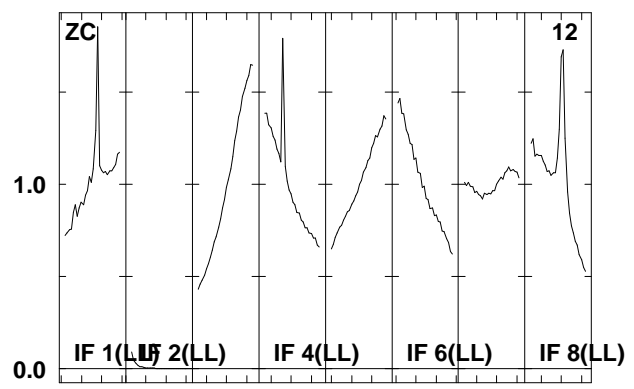
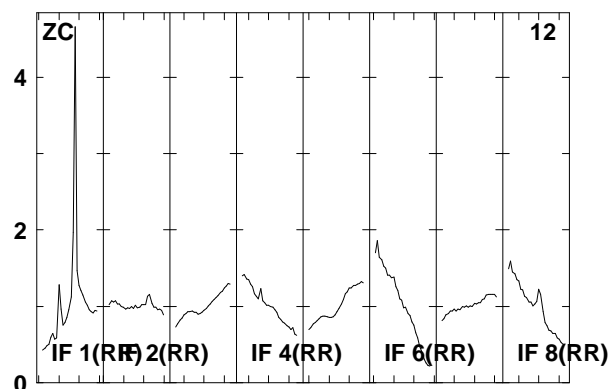
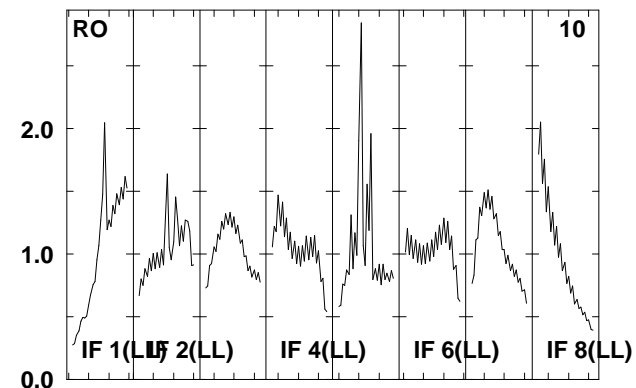
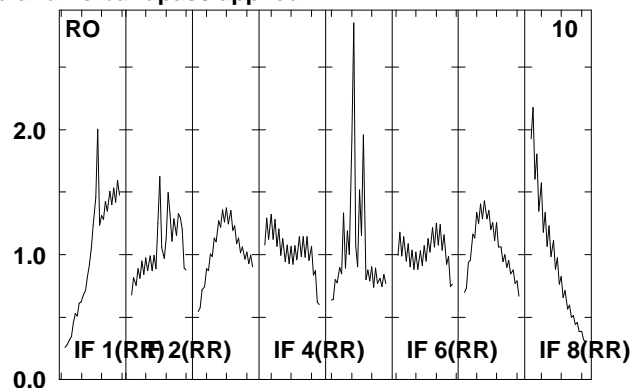
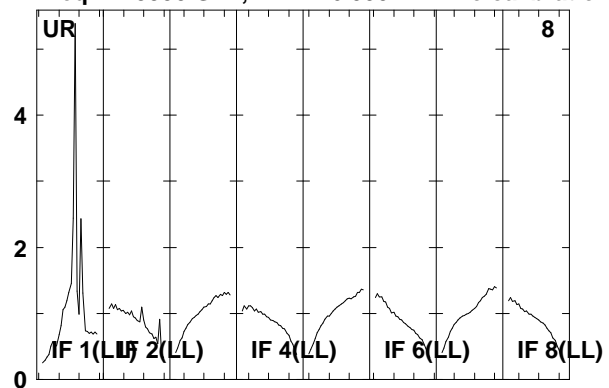

Lower frame: Real Jy

Total-power spectrum Antenna: *

Timerange: 00/17:19:35 to 00/17:20:59

Plot file version 236 created 06-JAN-2012 11:47:34

ARP299D EP068D 5.UVDATA.1

Freq = 1.5950 GHz, Bw = 16.000 MH No calibration applied and no bandpass applied

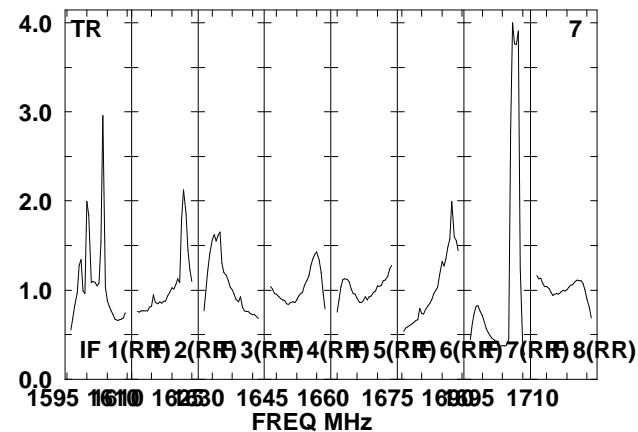
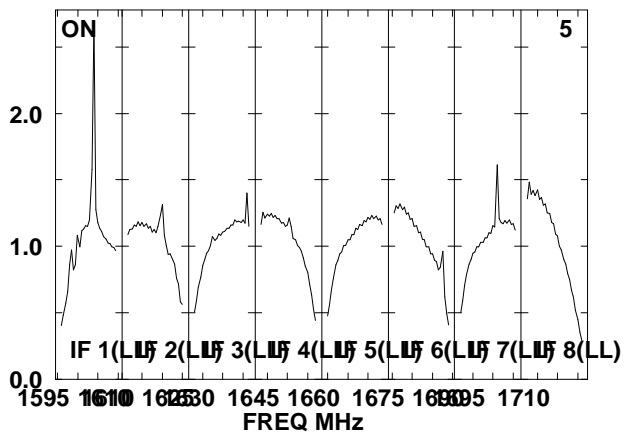
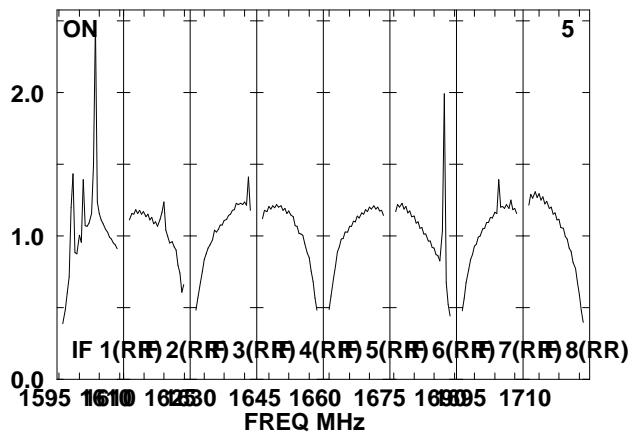
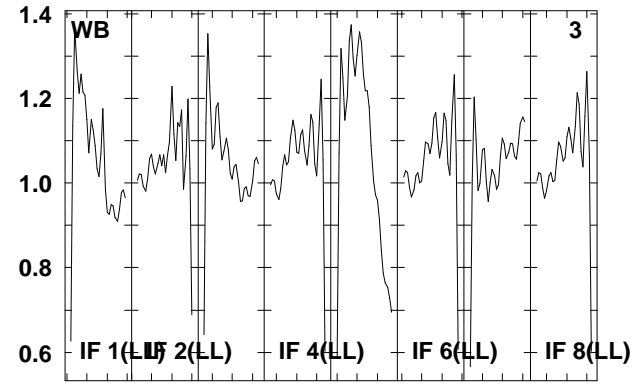
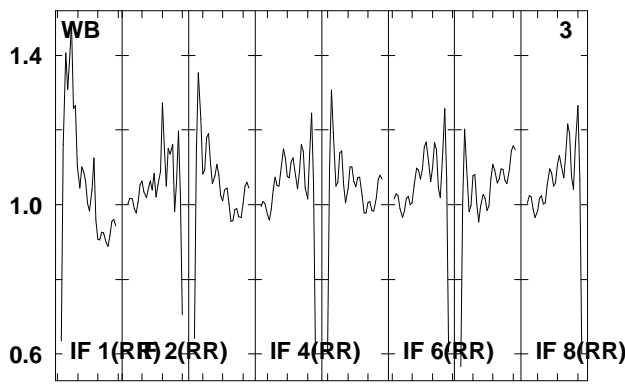
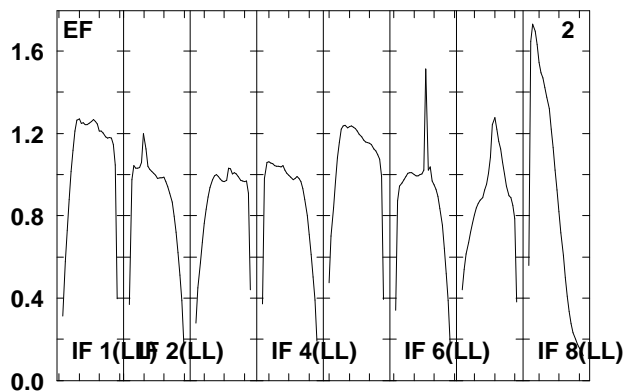
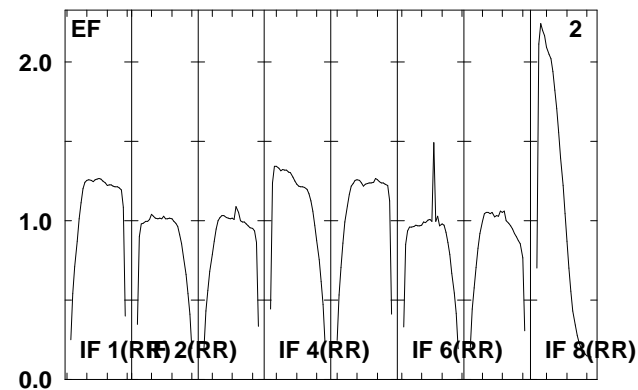
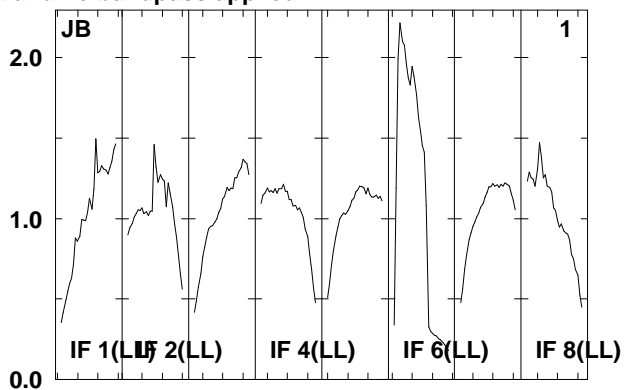
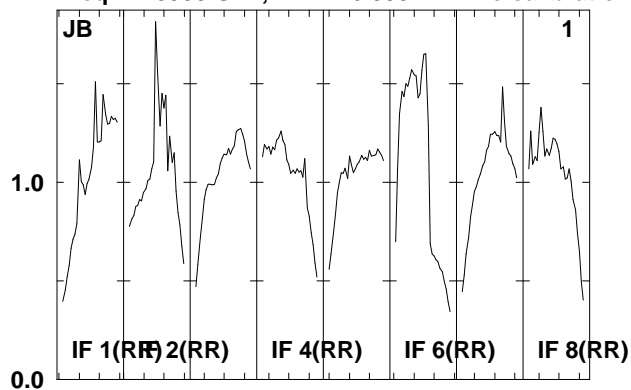

Lower frame: Real Jy
Total-power spectrum Antenna: *
Timerange: 00/17:21:01 to 00/17:24:29

Plot file version 237 created 06-JAN-2012 11:47:34

ARP299D EP068D 5.UVDATA.1

Freq = 1.5950 GHz, Bw = 16.000 MH No calibration applied and no bandpass applied

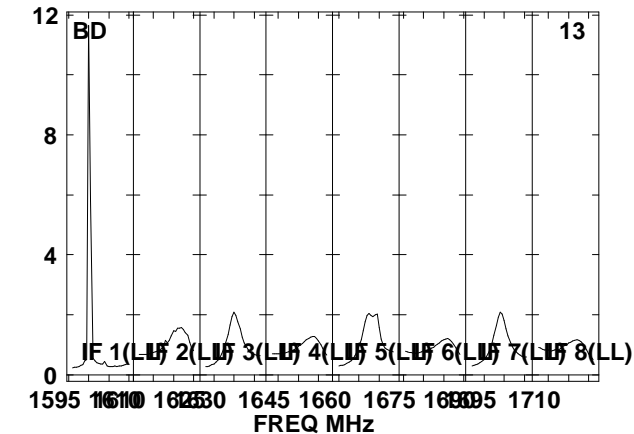
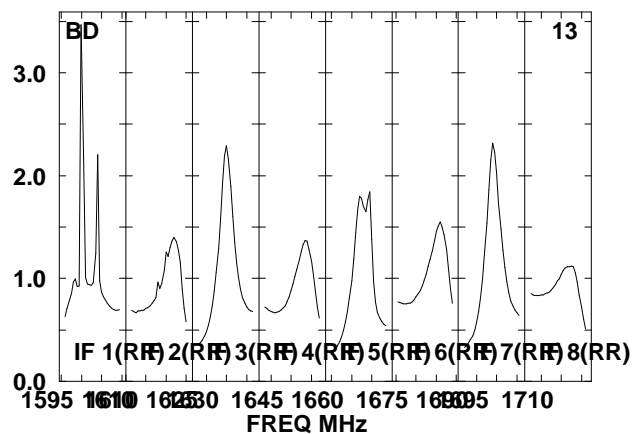
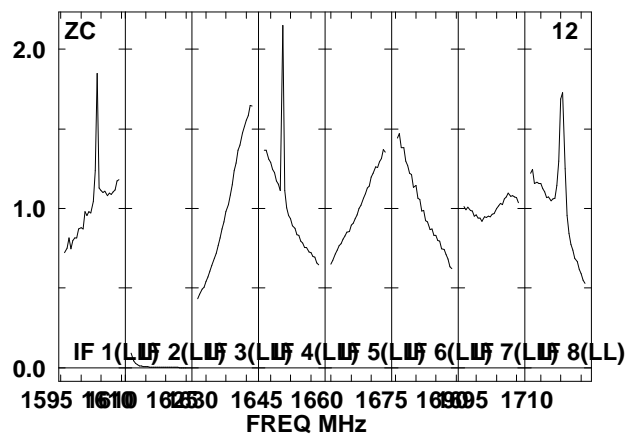
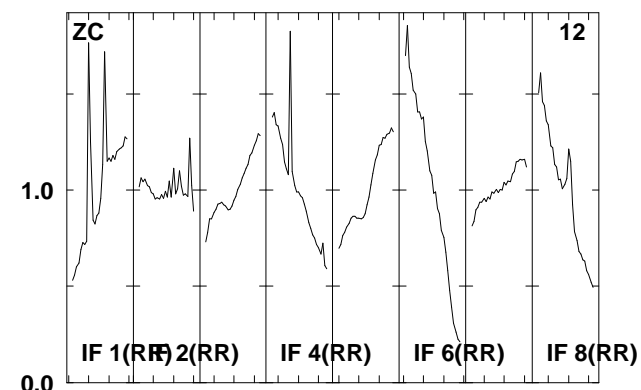
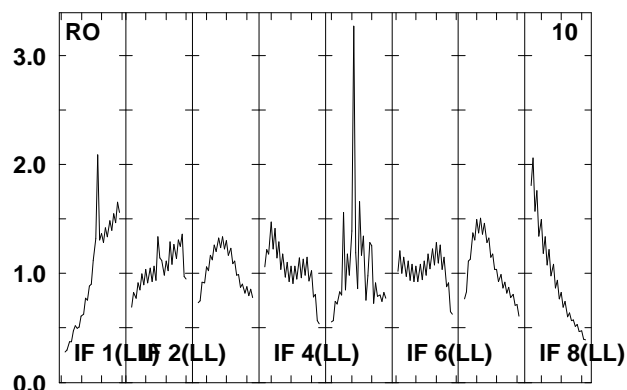
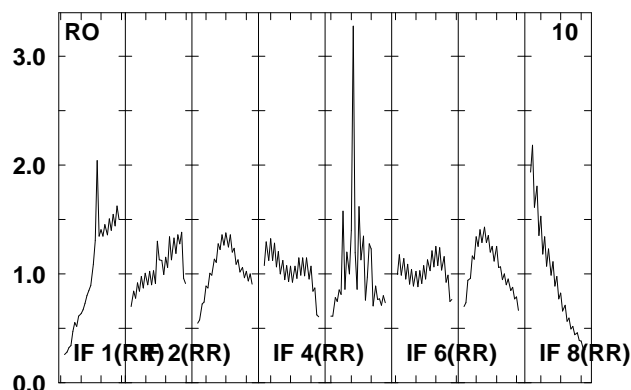
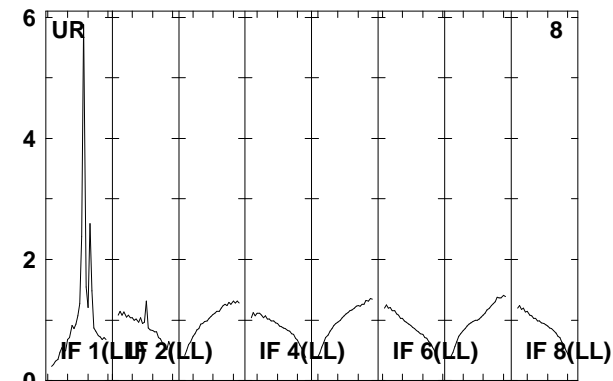
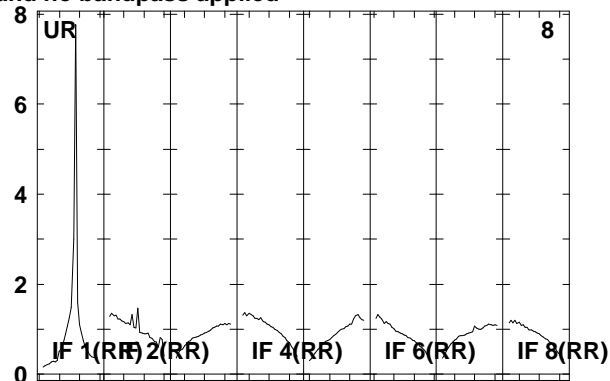
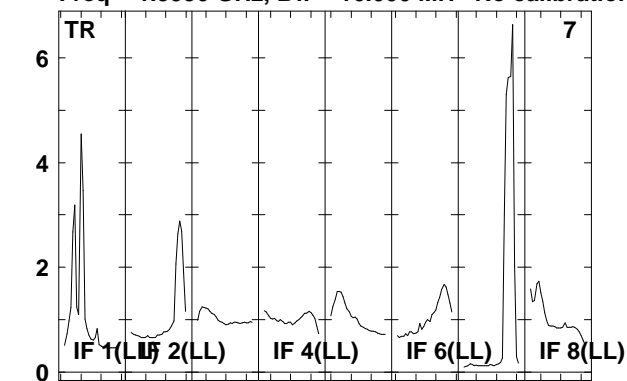

Lower frame: Real Jy

Total-power spectrum Antenna: *

Timerange: 00/17:21:01 to 00/17:24:29

Plot file version 238 created 06-JAN-2012 11:47:35

J1128+59 EP068D 5.UVDATA.1

Freq = 1.5950 GHz, Bw = 16.000 MH No calibration applied and no bandpass applied

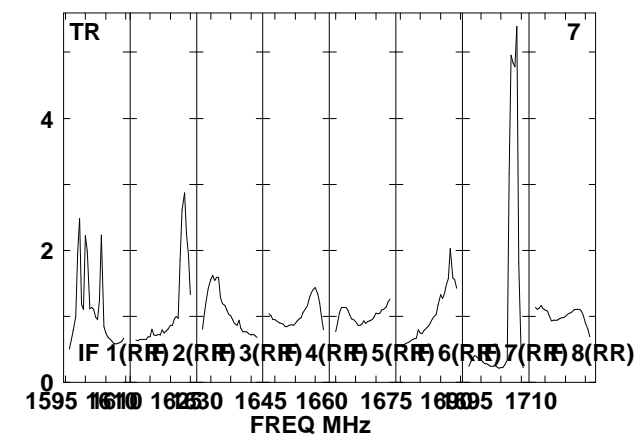
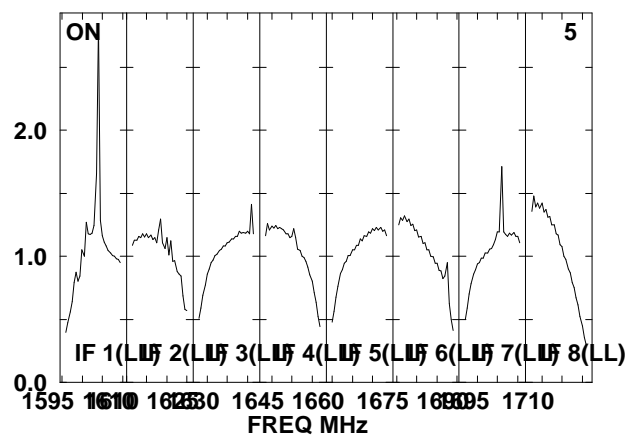
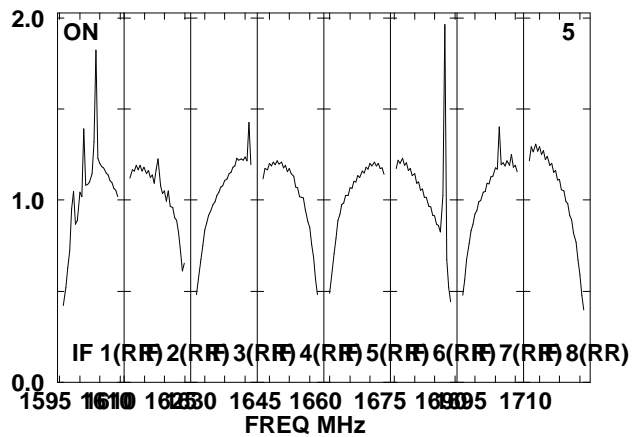
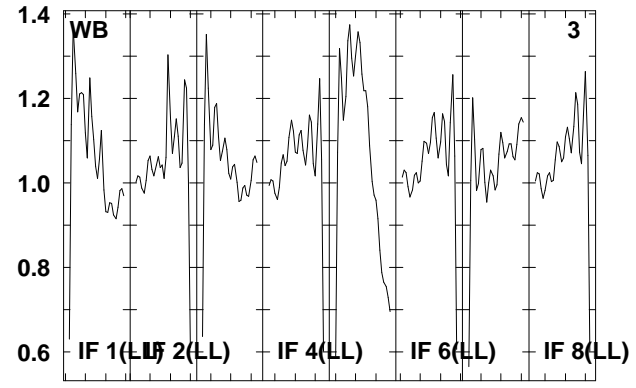
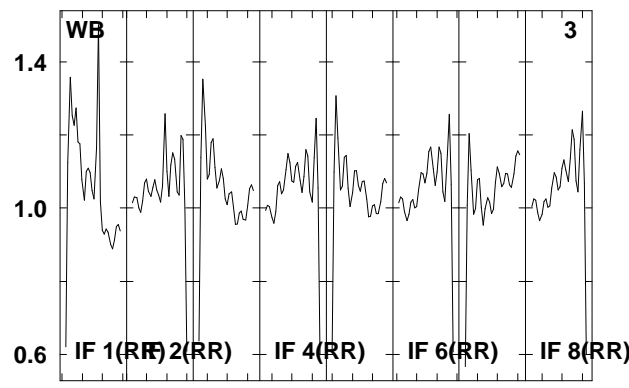
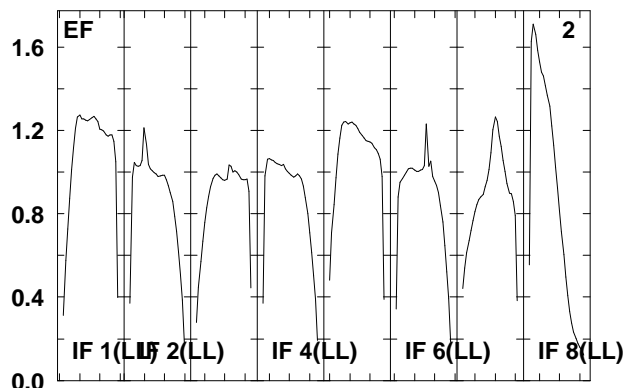
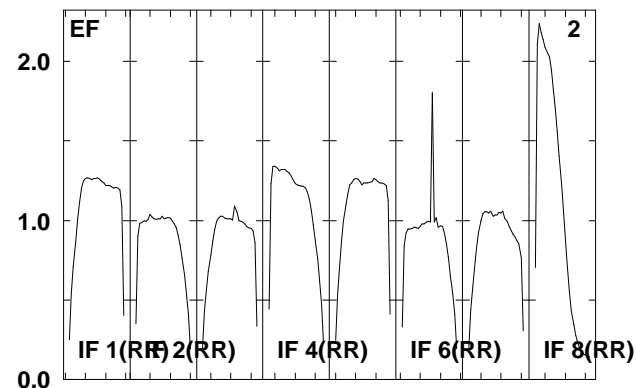
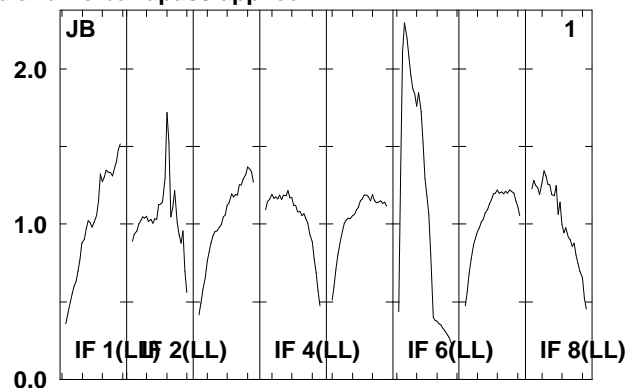
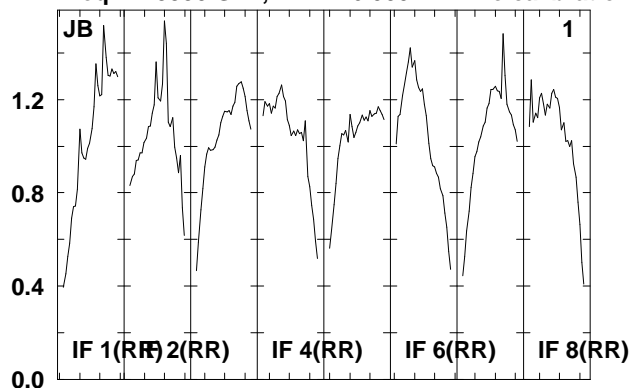

Lower frame: Real Jy
Total-power spectrum Antenna: *
Timerange: 00/17:25:31 to 00/17:26:59

Plot file version 239 created 06-JAN-2012 11:47:35

J1128+59 EP068D 5.UVDATA.1

Freq = 1.5950 GHz, Bw = 16.000 MH No calibration applied and no bandpass applied

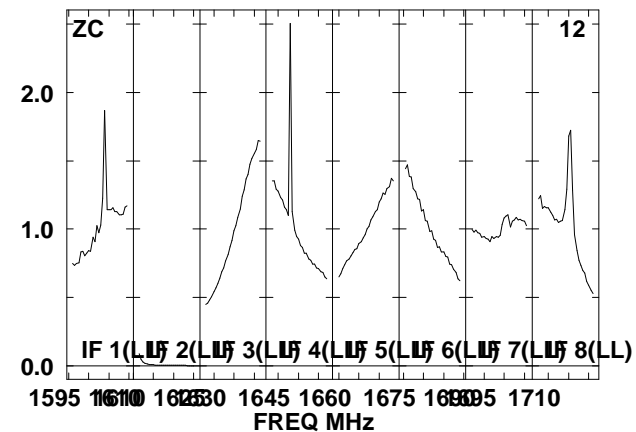
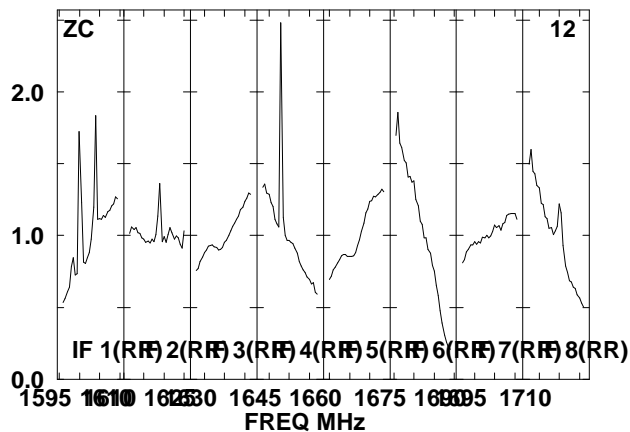
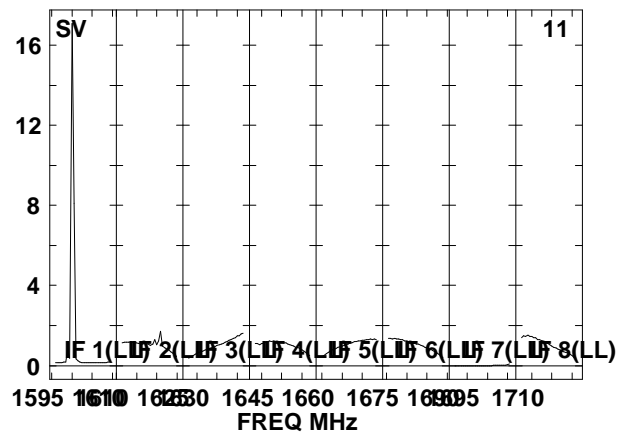
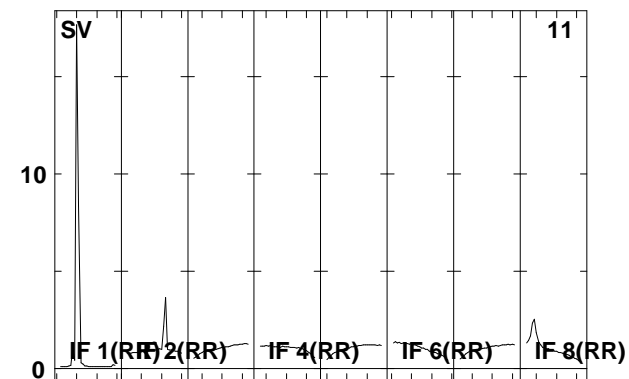
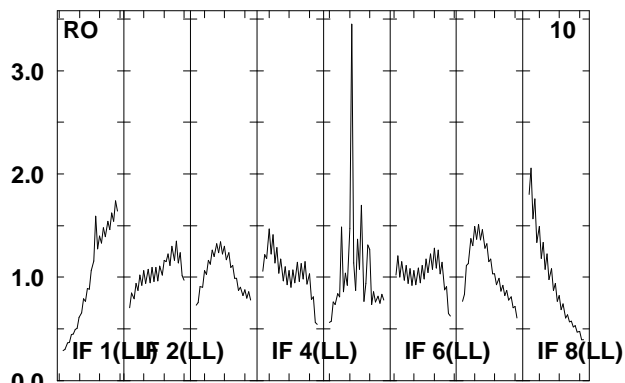
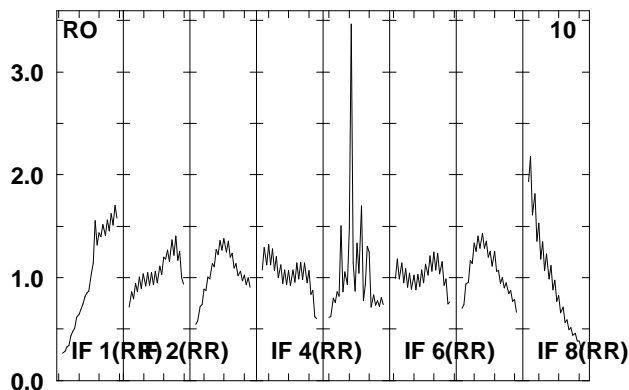
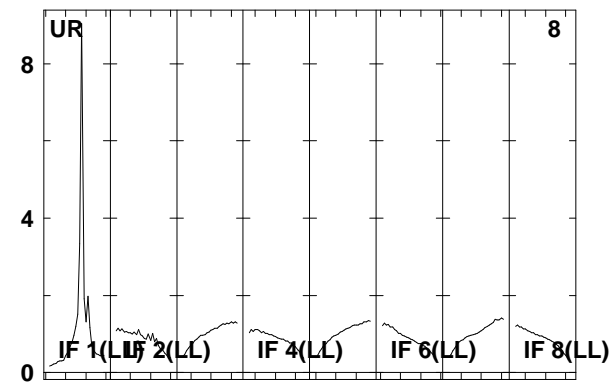
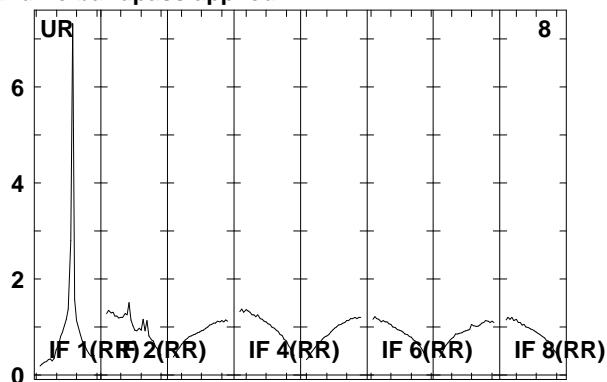
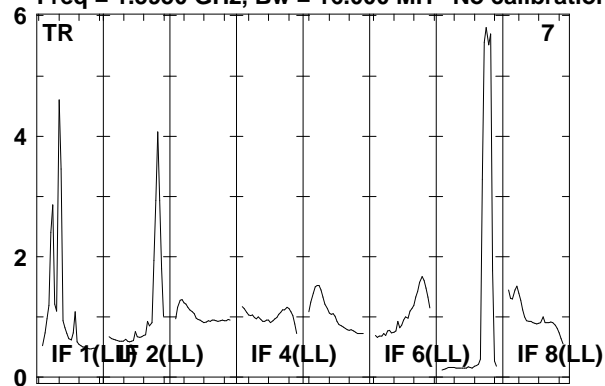

Lower frame: Real Jy

Total-power spectrum Antenna: *

Timerange: 00/17:25:31 to 00/17:26:59

Plot file version 240 created 06-JAN-2012 11:47:36

J1128+59 EP068D 5.UVDATA.1

Freq = 1.5950 GHz, Bw = 16.000 MH No calibration applied and no bandpass applied

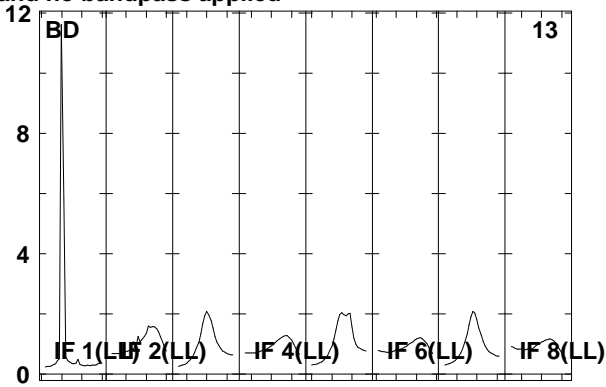
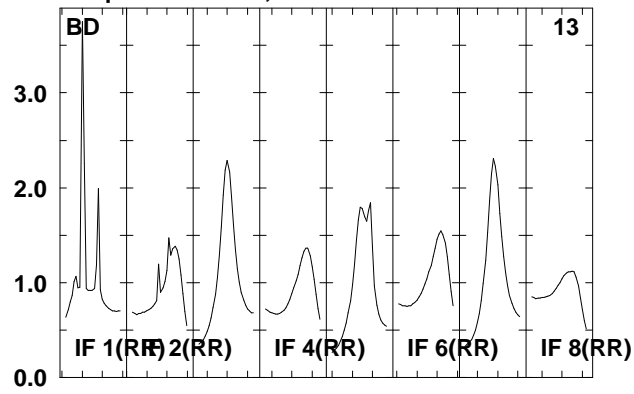

Lower frame: Real Jy
Total-power spectrum Antenna: *
Timerange: 00/17:25:31 to 00/17:26:59

Plot file version 241 created 06-JAN-2012 11:47:36

ARP299D EP068D 5.UVDATA.1

Freq = 1.5950 GHz, Bw = 16.000 MH No calibration applied and no bandpass applied

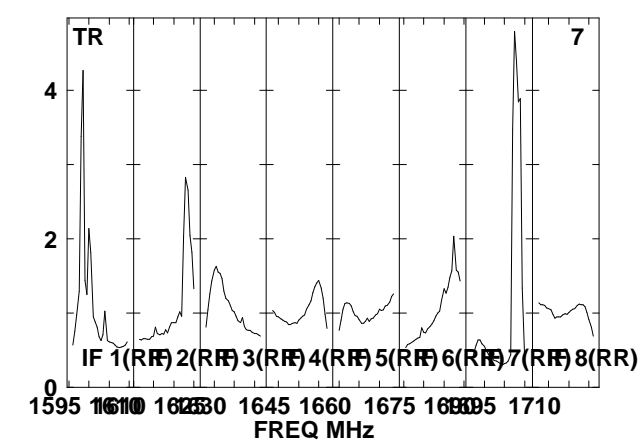
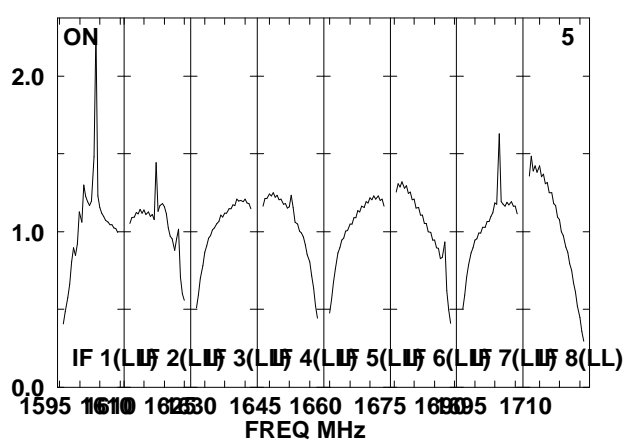
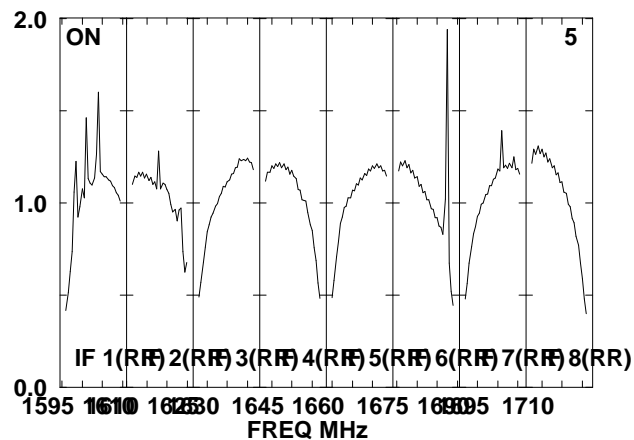
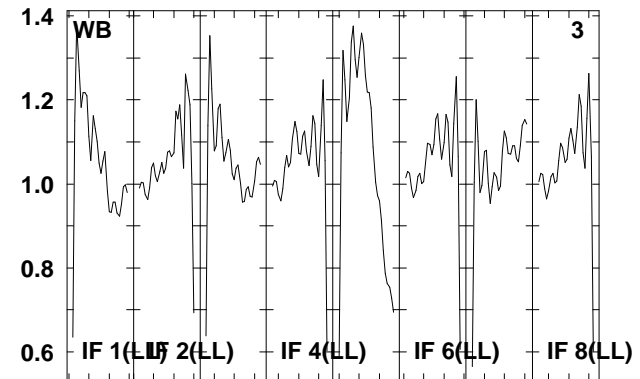
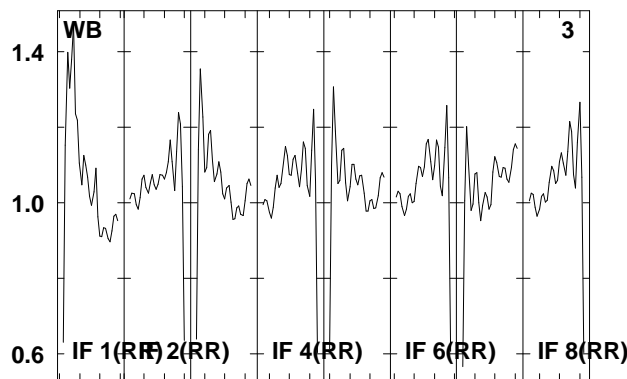
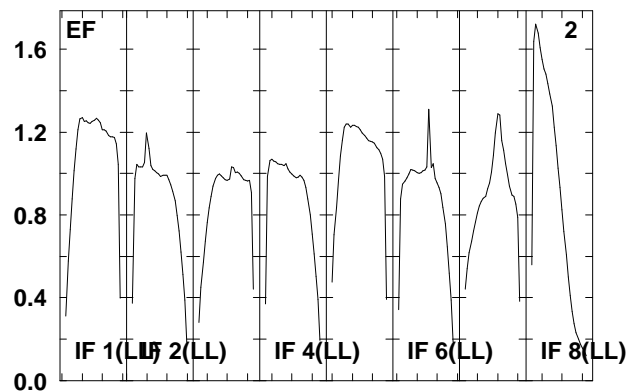
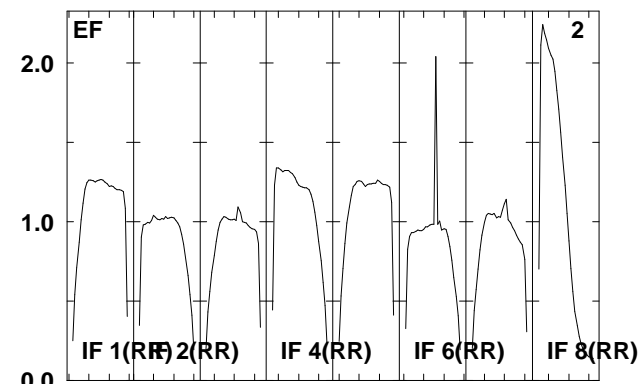
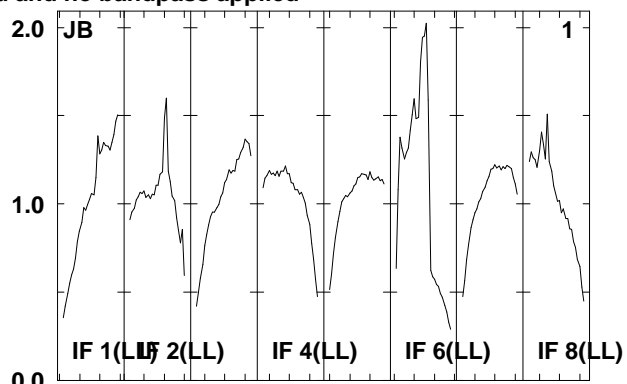
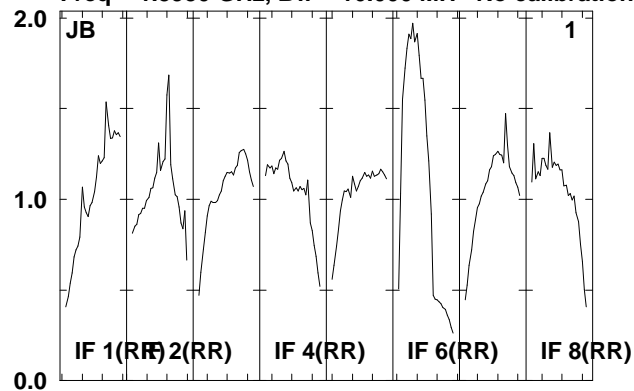

Lower frame: Real Jy

Total-power spectrum Antenna: *

Timerange: 00/17:27:05 to 00/17:30:29

Plot file version 242 created 06-JAN-2012 11:47:36

ARP299D EP068D 5.UVDATA.1

Freq = 1.5950 GHz, Bw = 16.000 MH No calibration applied and no bandpass applied

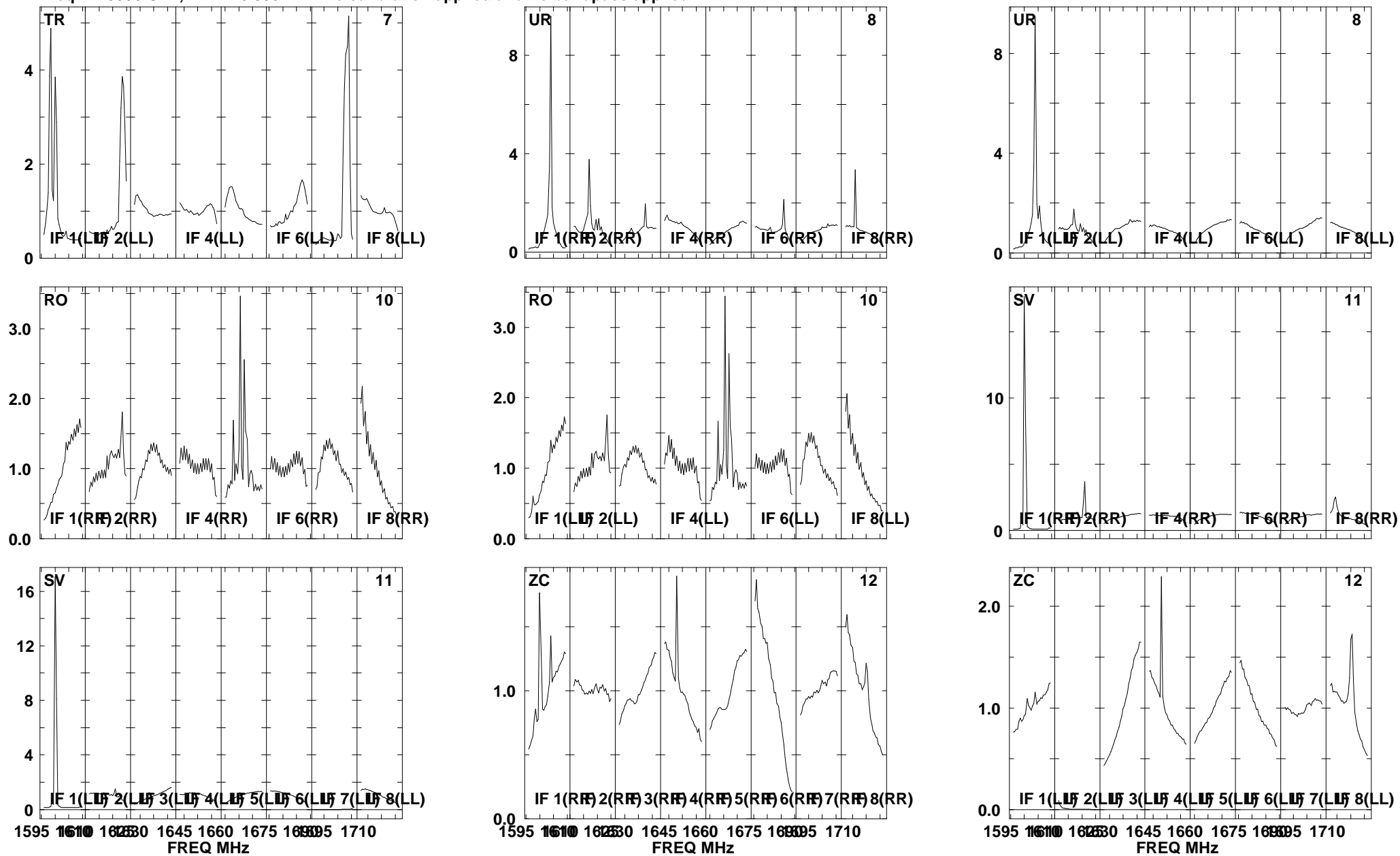

Lower frame: Real Jy
Total-power spectrum Antenna: *
Timerange: 00/17:27:05 to 00/17:30:29

Plot file version 243 created 06-JAN-2012 11:47:37

ARP299D EP068D 5.UVDATA.1

Freq = 1.5950 GHz, Bw = 16.000 MH No calibration applied and no bandpass applied

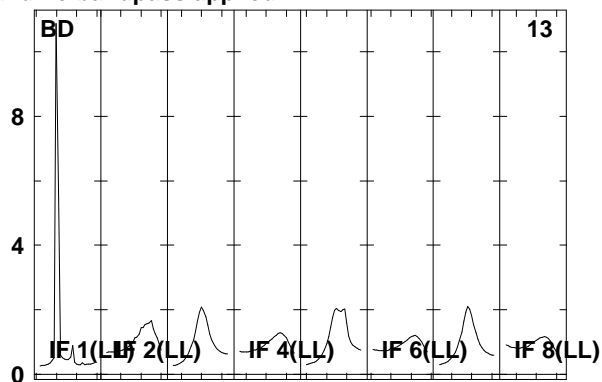
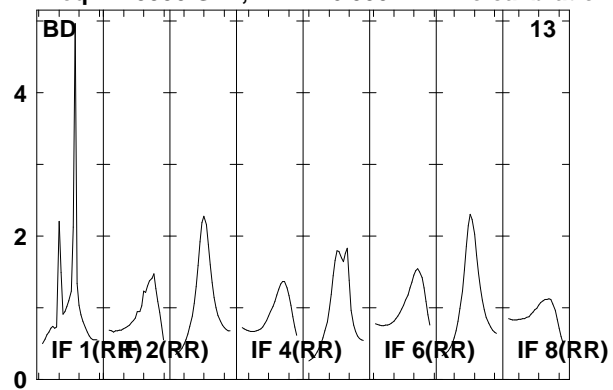

Lower frame: Real Jy
Total-power spectrum Antenna: *
Timerange: 00/17:27:05 to 00/17:30:29

Plot file version 244 created 06-JAN-2012 11:47:37

J1128+59 EP068D 5.UVDATA.1

Freq = 1.5950 GHz, Bw = 16.000 MH No calibration applied and no bandpass applied

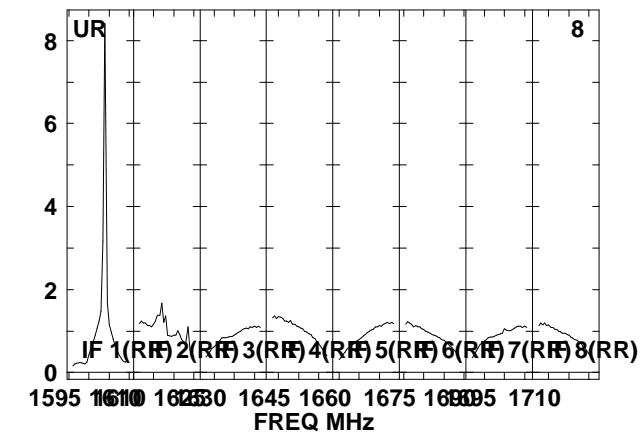
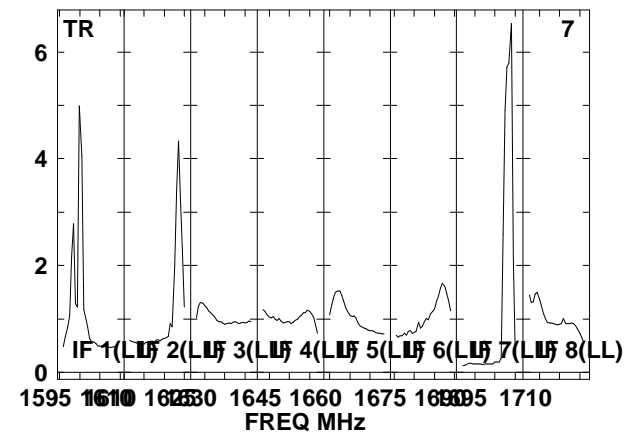
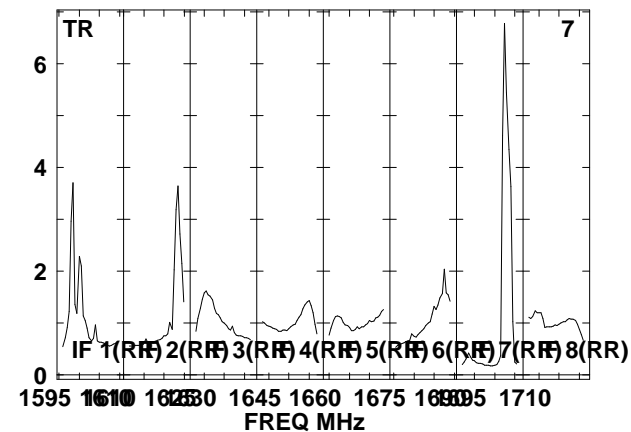
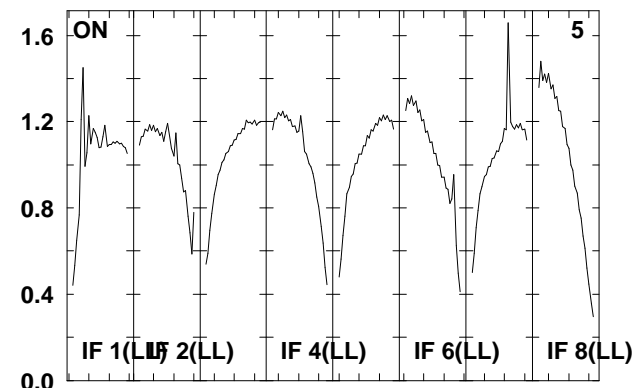
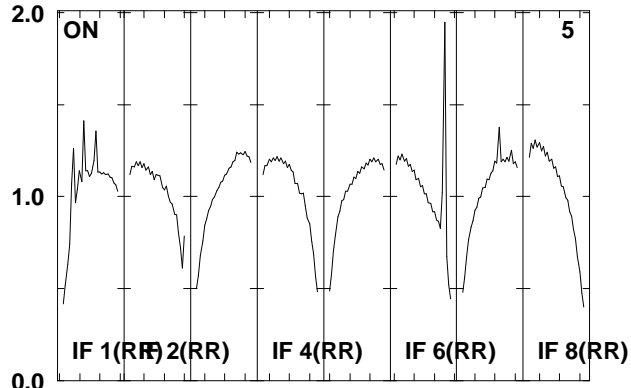
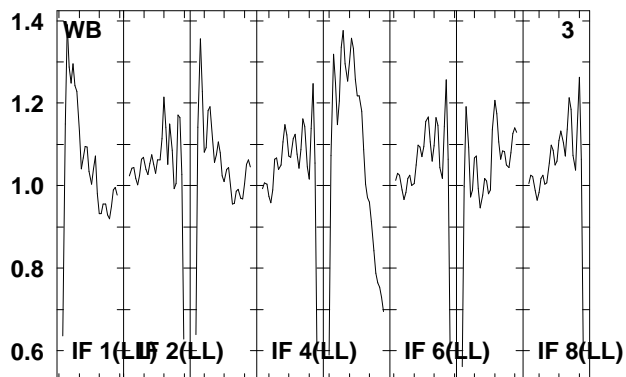
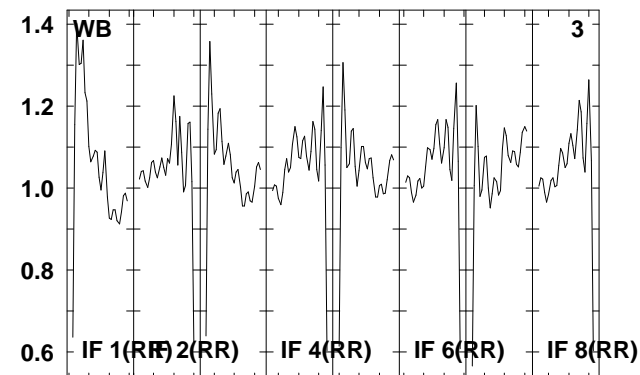
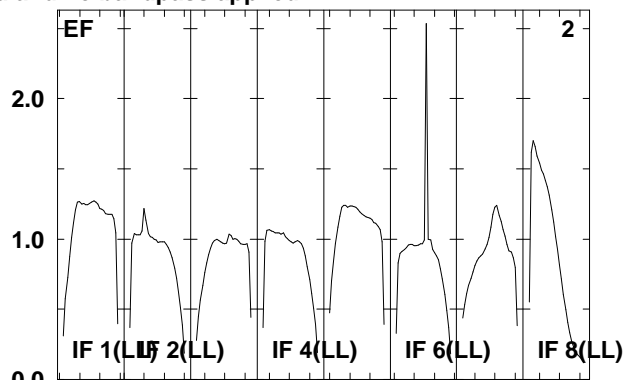
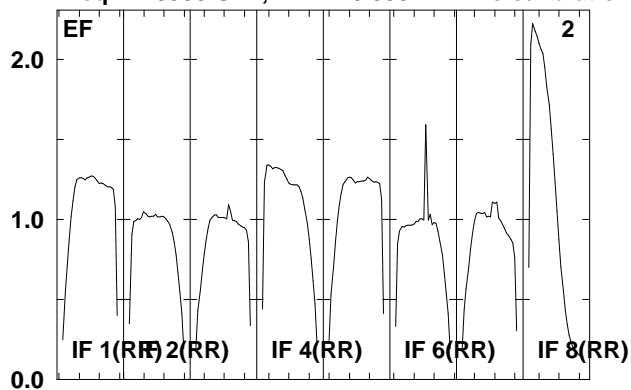

Lower frame: Real Jy
Total-power spectrum Antenna: *
Timerange: 00/17:30:35 to 00/17:31:59

Plot file version 245 created 06-JAN-2012 11:47:37

J1128+59 EP068D 5.UVDATA.1

Freq = 1.5950 GHz, Bw = 16.000 MH No calibration applied and no bandpass applied

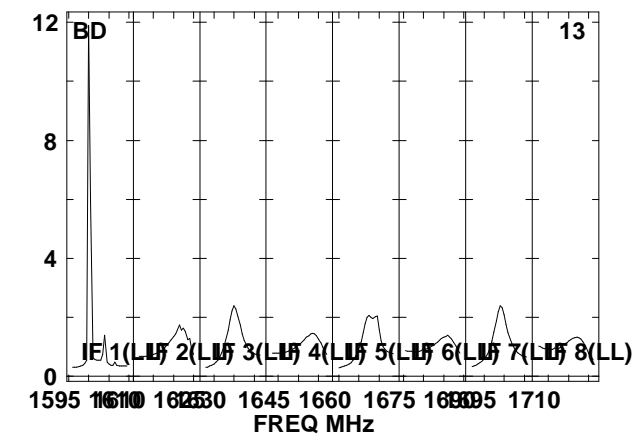
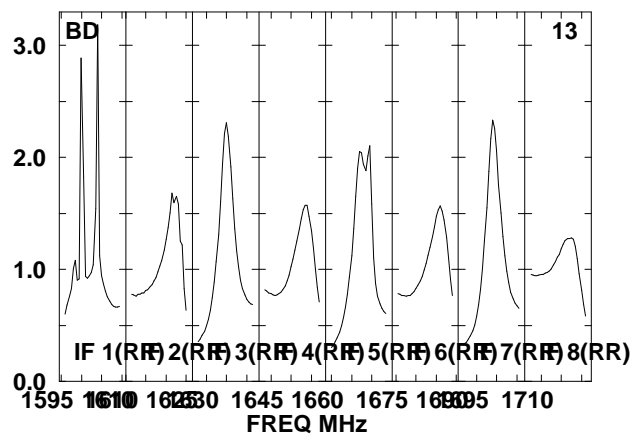
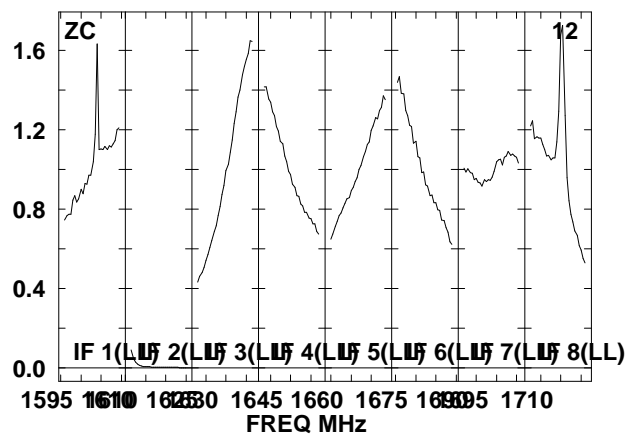
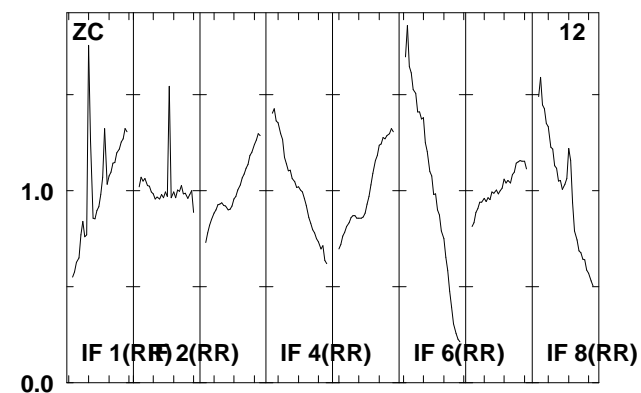
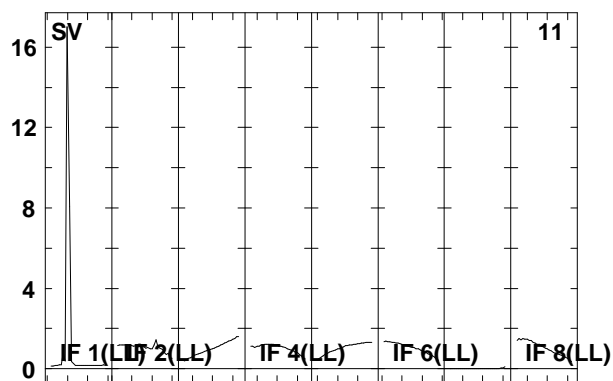
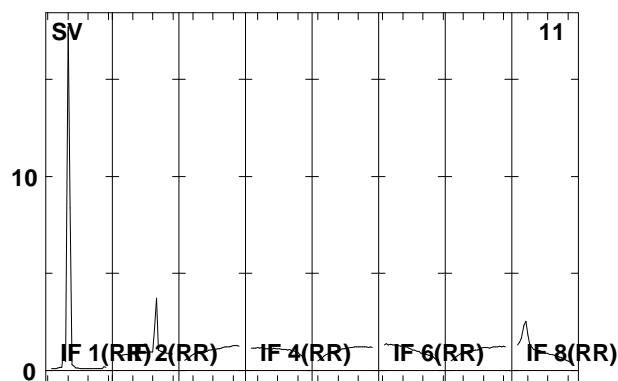
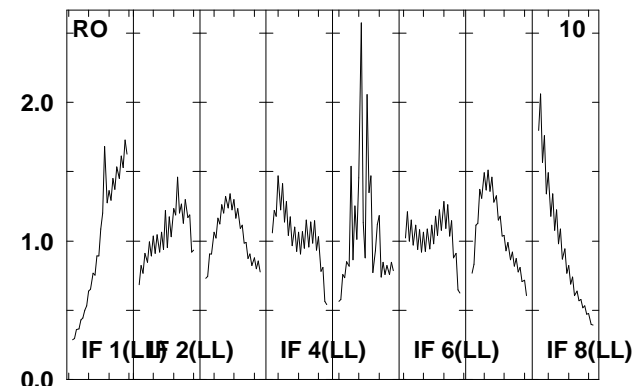
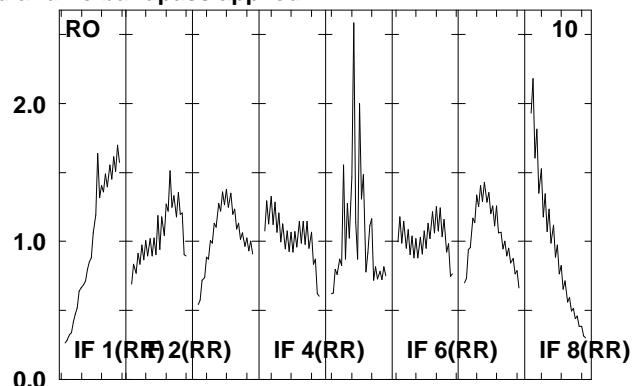
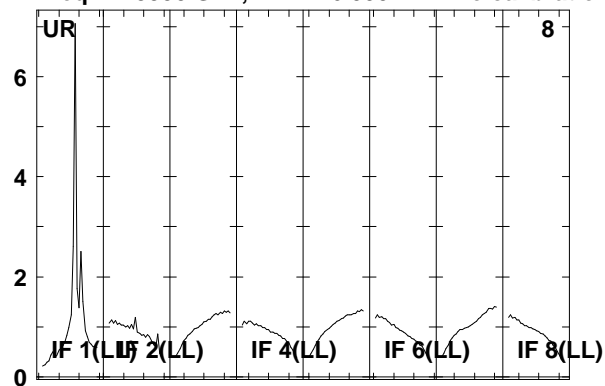

Lower frame: Real Jy

Total-power spectrum Antenna: *

Timerange: 00/17:30:35 to 00/17:31:59

Plot file version 246 created 06-JAN-2012 11:47:38

ARP299D EP068D 5.UVDATA.1

Freq = 1.5950 GHz, Bw = 16.000 MH No calibration applied and no bandpass applied

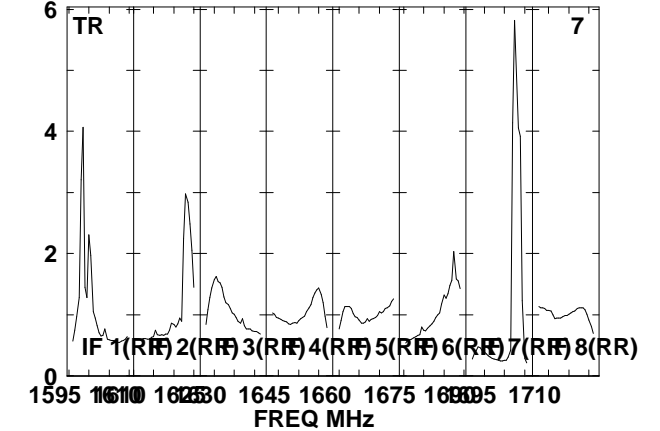
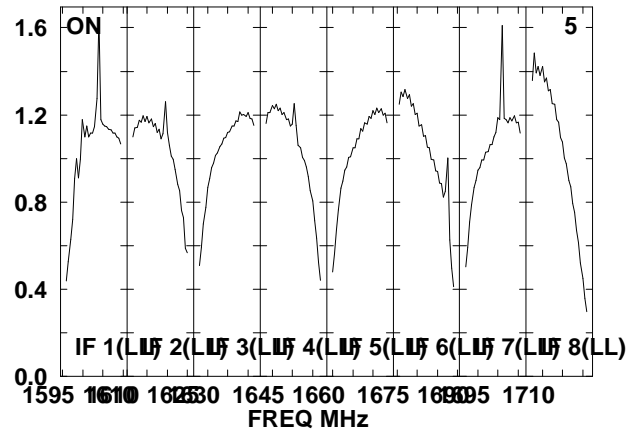
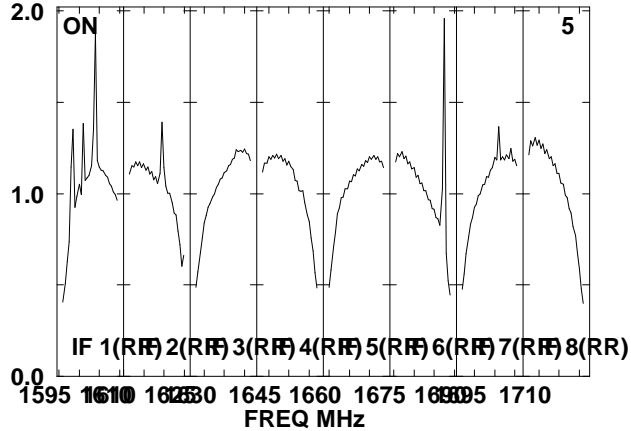
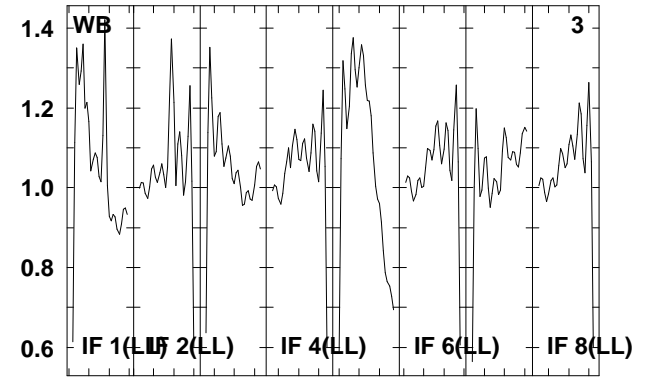
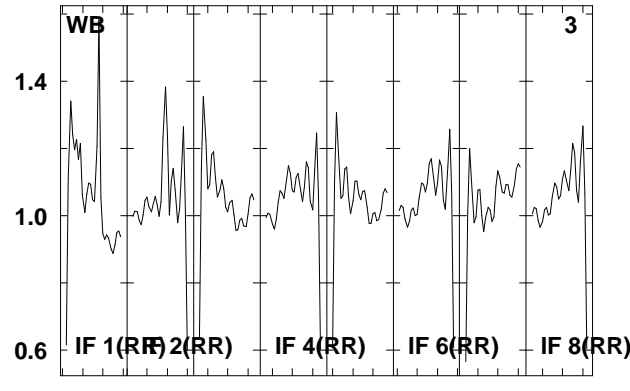
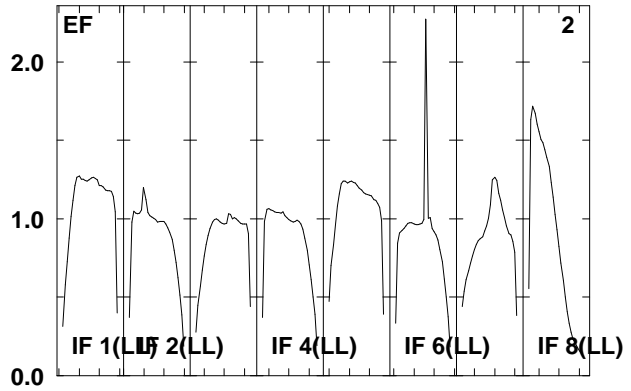
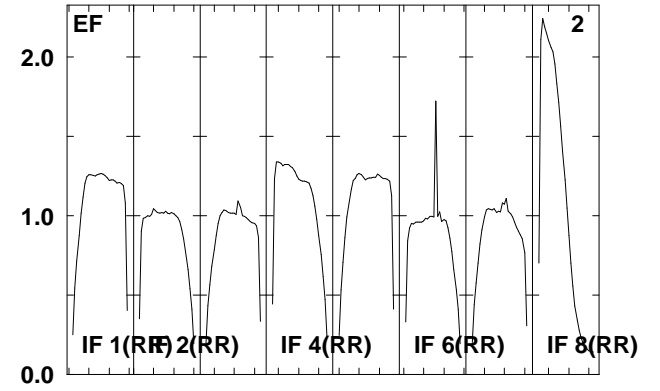
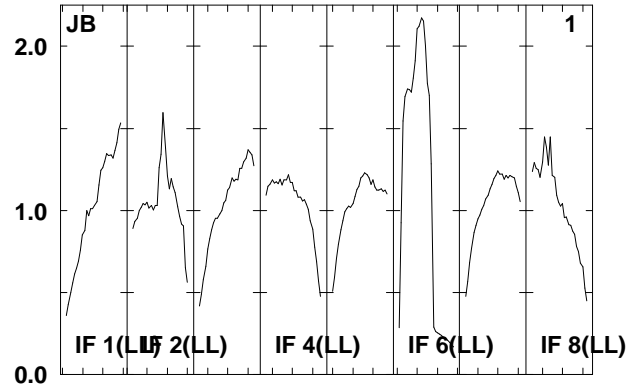
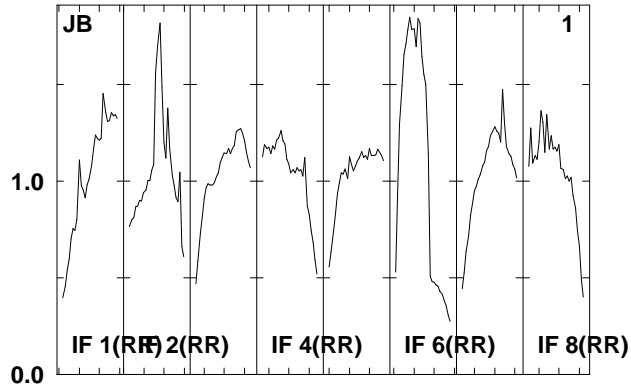

Lower frame: Real Jy
Total-power spectrum Antenna: *
Timerange: 00/17:32:01 to 00/17:35:29

Plot file version 247 created 06-JAN-2012 11:47:38

ARP299D EP068D 5.UVDATA.1

Freq = 1.5950 GHz, Bw = 16.000 MH No calibration applied and no bandpass applied

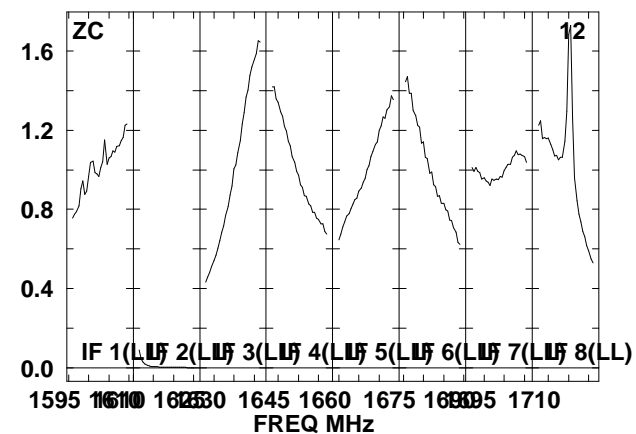
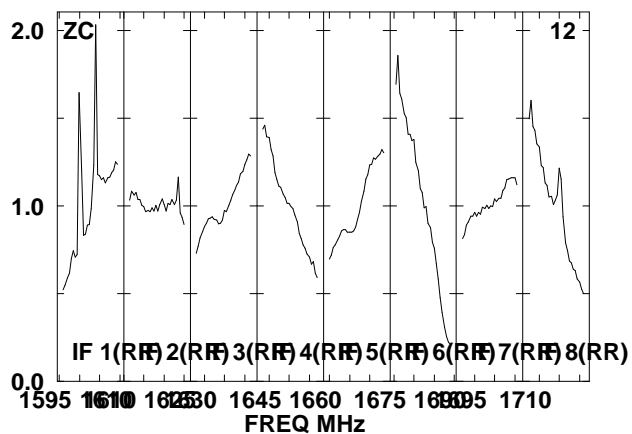
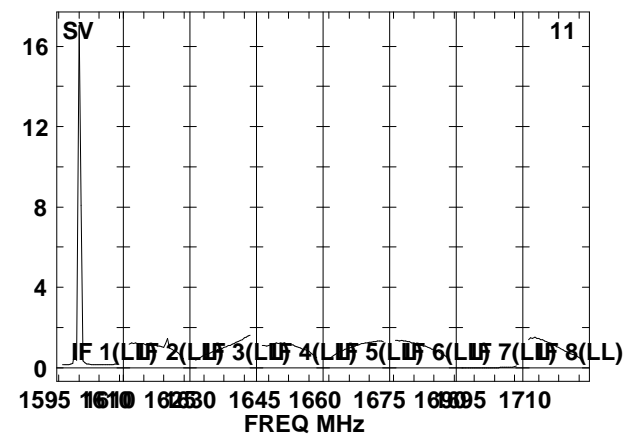
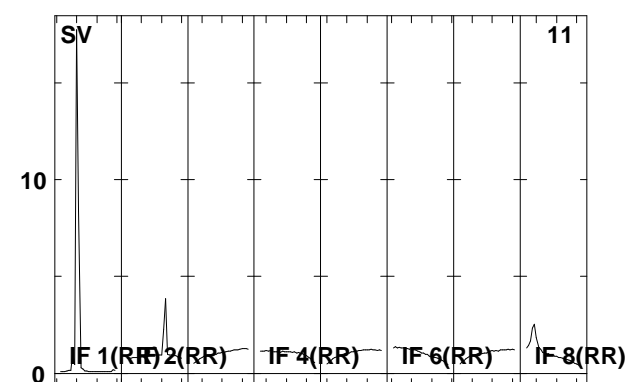
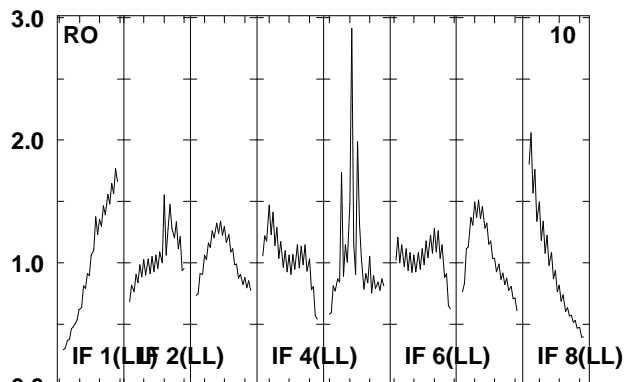
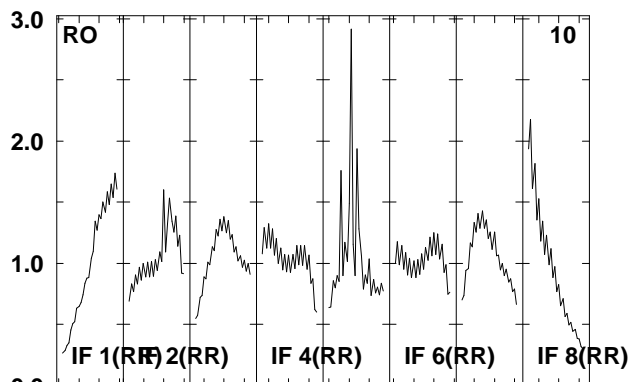
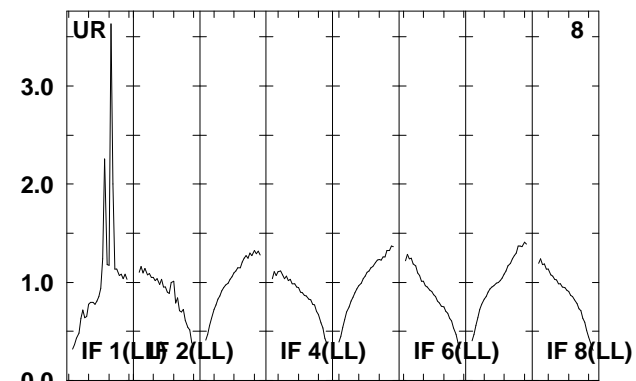
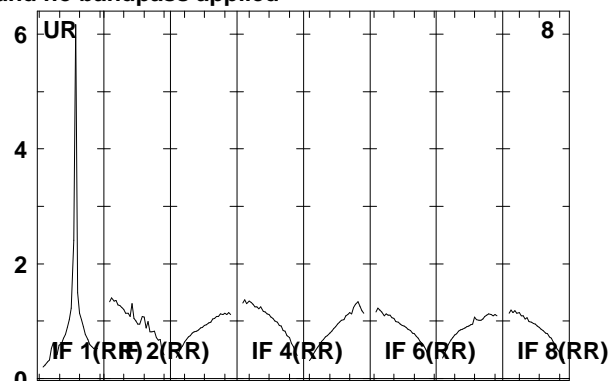
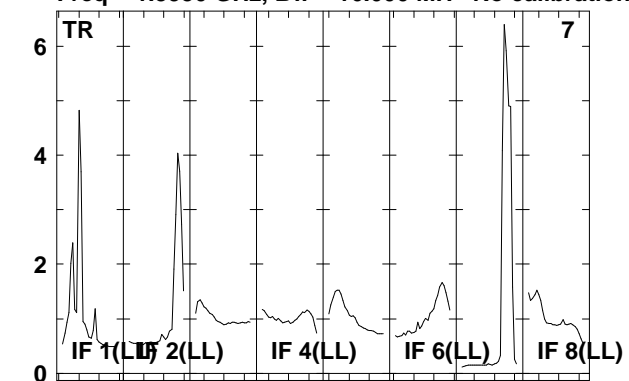

Lower frame: Real Jy
Total-power spectrum Antenna: *
Timerange: 00/17:32:01 to 00/17:35:29

Plot file version 248 created 06-JAN-2012 11:47:39

ARP299D EP068D 5.UVDATA.1

Freq = 1.5950 GHz, Bw = 16.000 MH No calibration applied and no bandpass applied

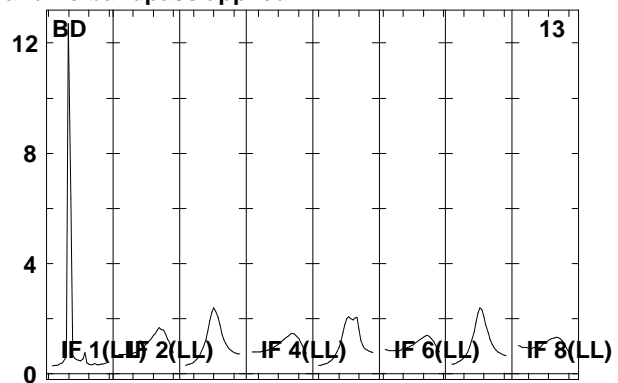
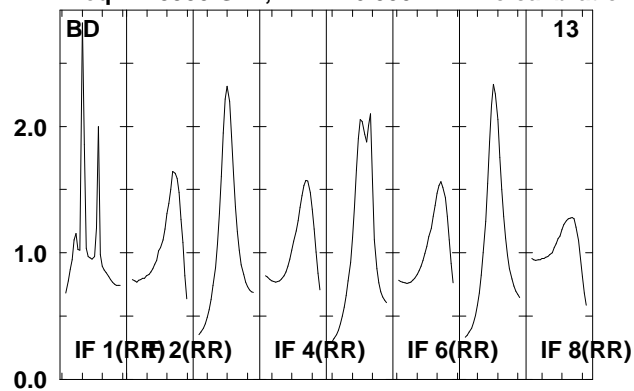

Lower frame: Real Jy
Total-power spectrum Antenna: *
Timerange: 00/17:32:01 to 00/17:35:29

Plot file version 249 created 06-JAN-2012 11:47:39

J1128+59 EP068D 5.UVDATA.1

Freq = 1.5950 GHz, Bw = 16.000 MH No calibration applied and no bandpass applied

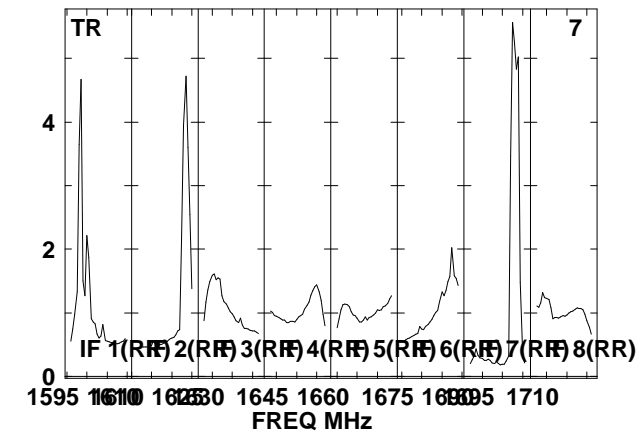
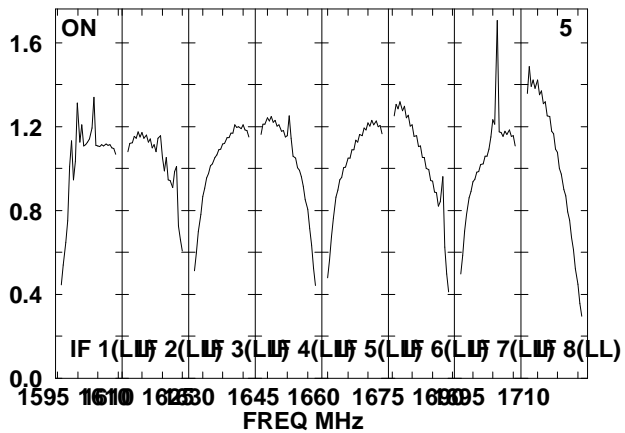
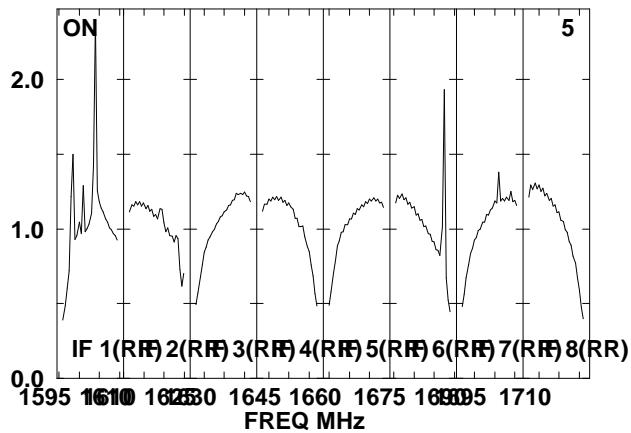
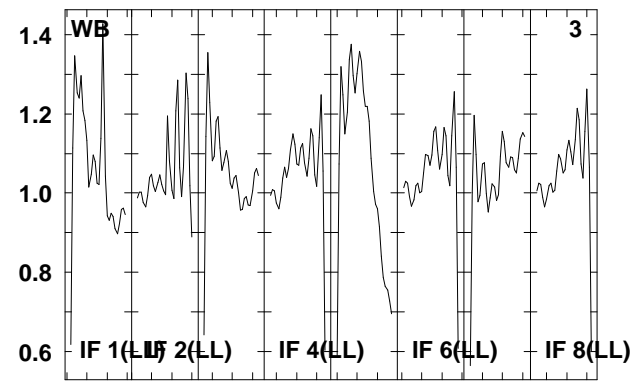
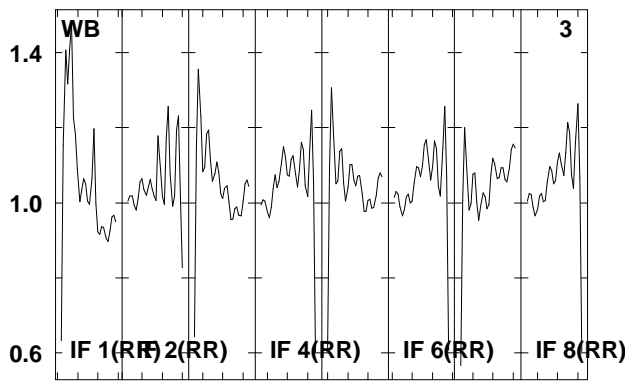
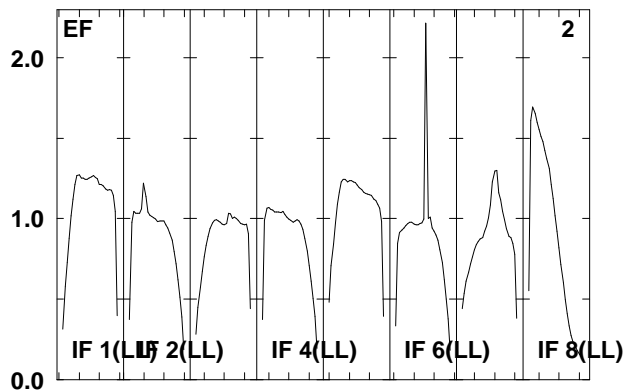
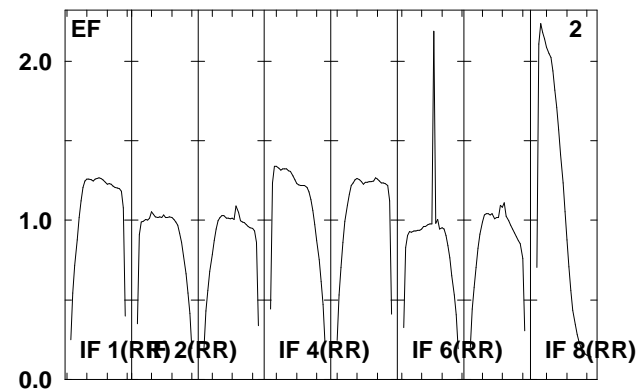
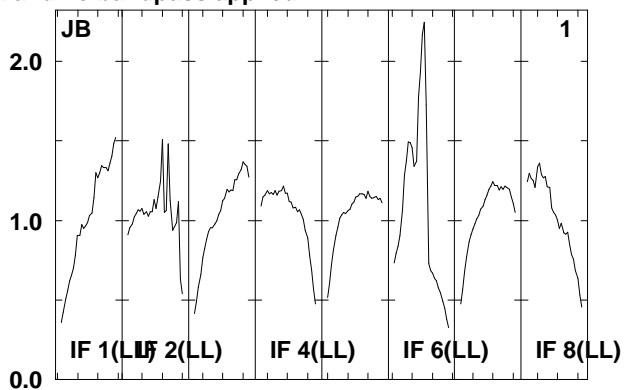
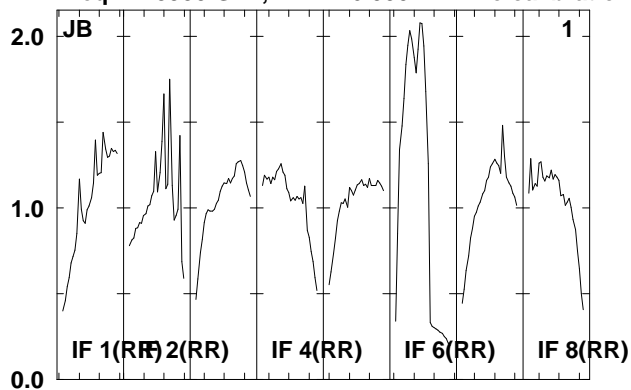

Lower frame: Real Jy
Total-power spectrum Antenna: *
Timerange: 00/17:35:35 to 00/17:36:59

Plot file version 250 created 06-JAN-2012 11:47:39

J1128+59 EP068D 5.UVDATA.1

Freq = 1.5950 GHz, Bw = 16.000 MH No calibration applied and no bandpass applied

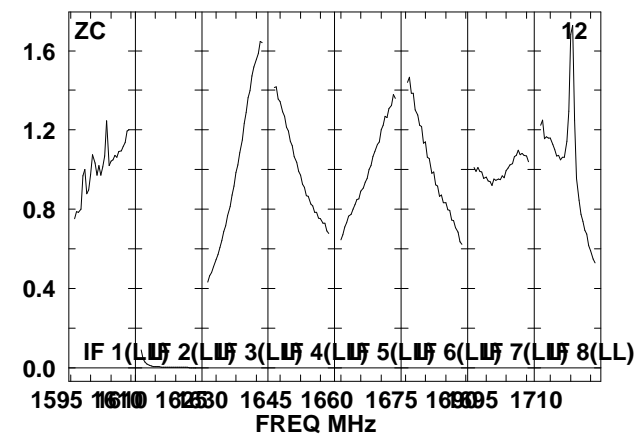
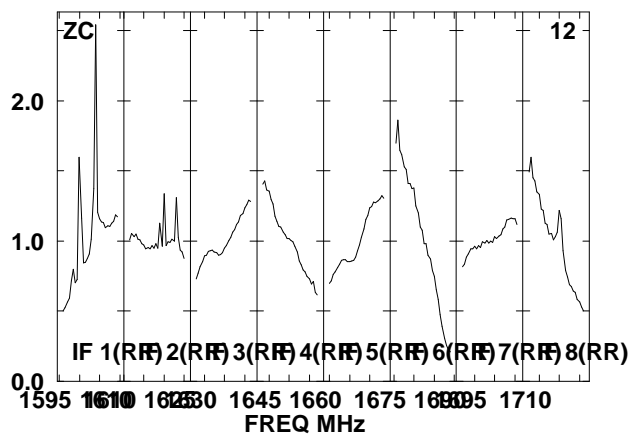
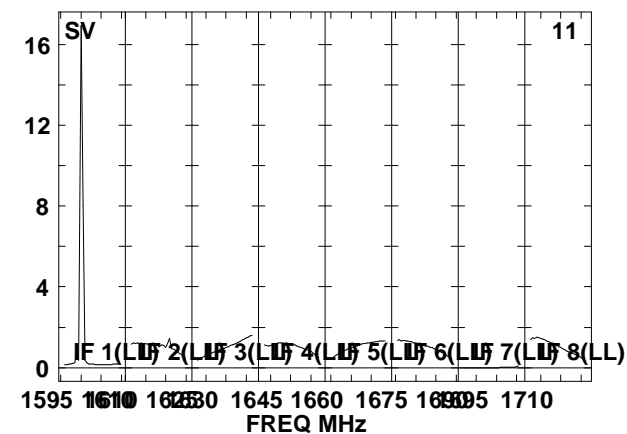
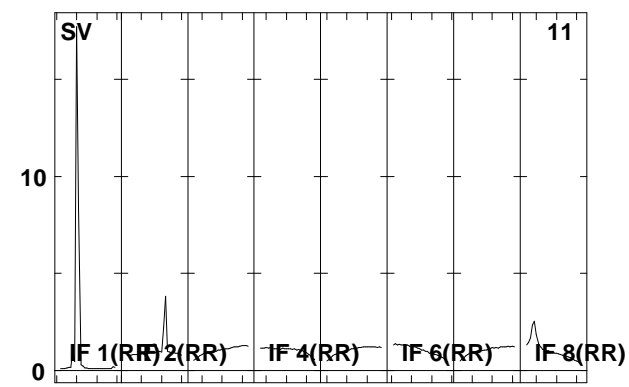
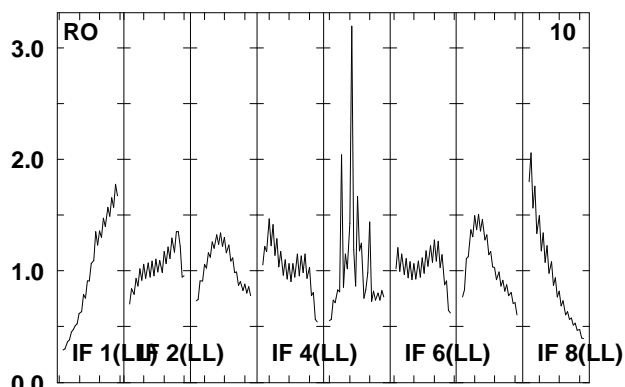
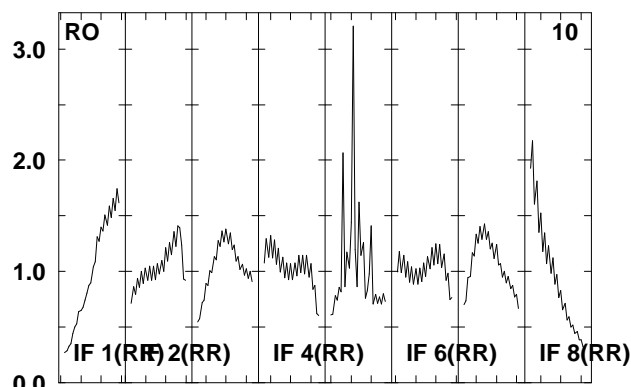
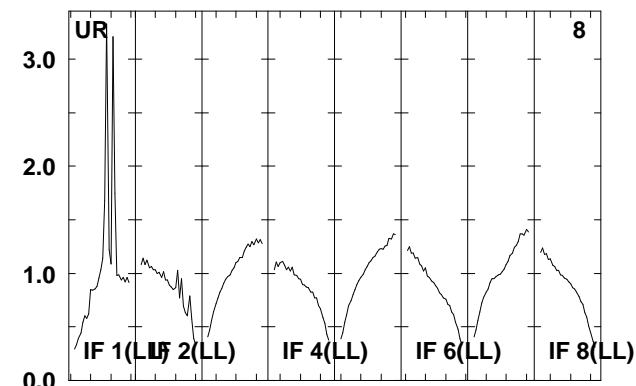
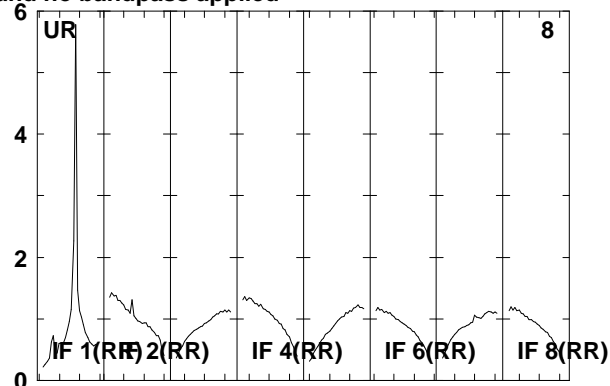
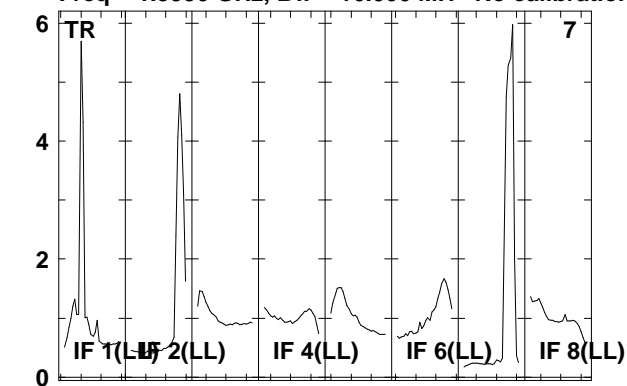

Lower frame: Real Jy

Total-power spectrum Antenna: *

Timerange: 00/17:35:35 to 00/17:36:59

Plot file version 251 created 06-JAN-2012 11:47:40

J1128+59 EP068D 5.UVDATA.1

Freq = 1.5950 GHz, Bw = 16.000 MH No calibration applied and no bandpass applied

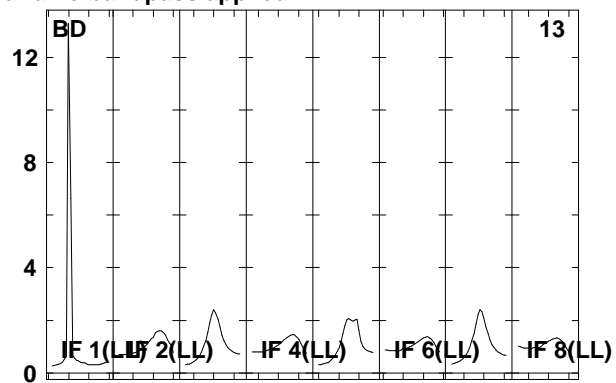
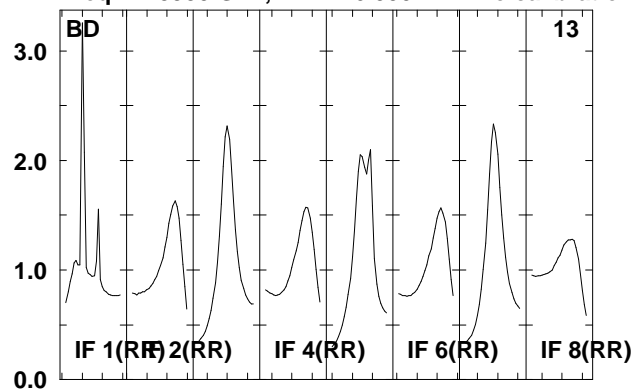

Lower frame: Real Jy
Total-power spectrum Antenna: *
Timerange: 00/17:35:35 to 00/17:36:59

Plot file version 252 created 06-JAN-2012 11:47:40

ARP299D EP068D 5.UVDATA.1

Freq = 1.5950 GHz, Bw = 16.000 MH No calibration applied and no bandpass applied

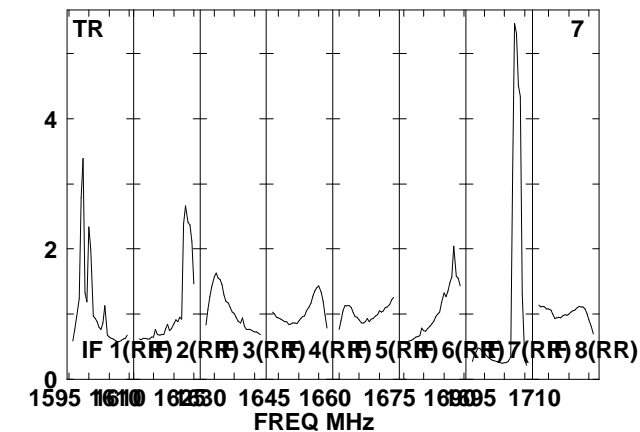
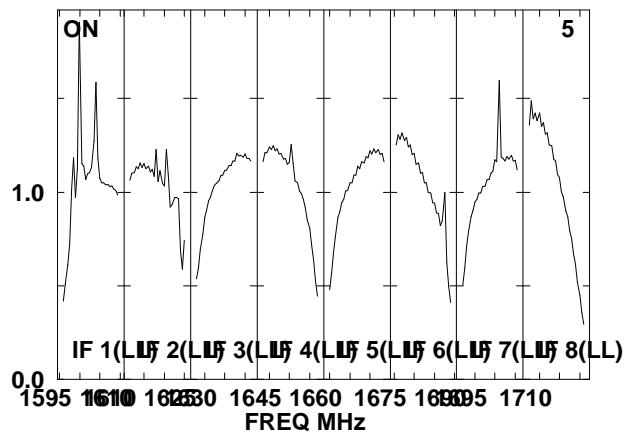
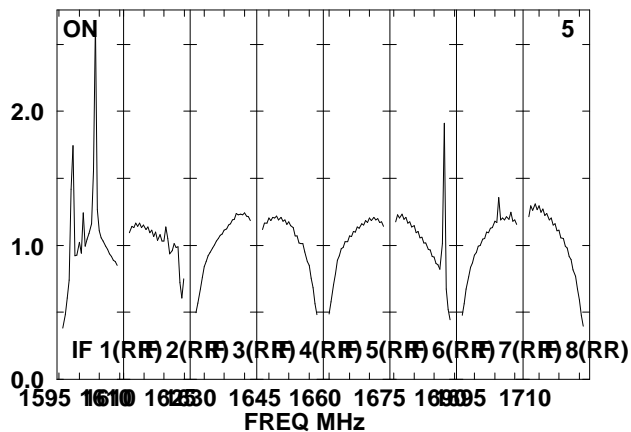
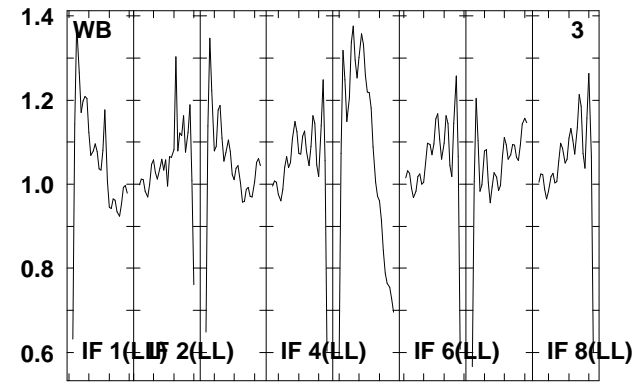
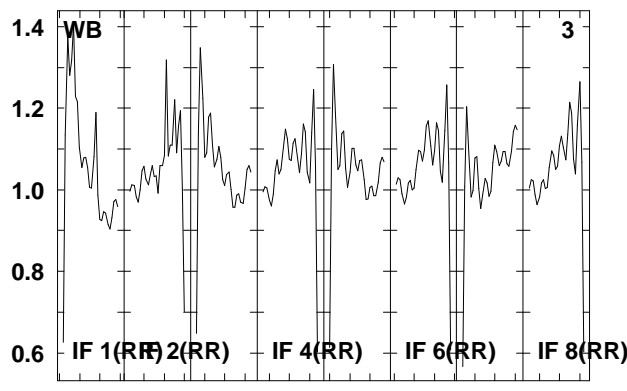
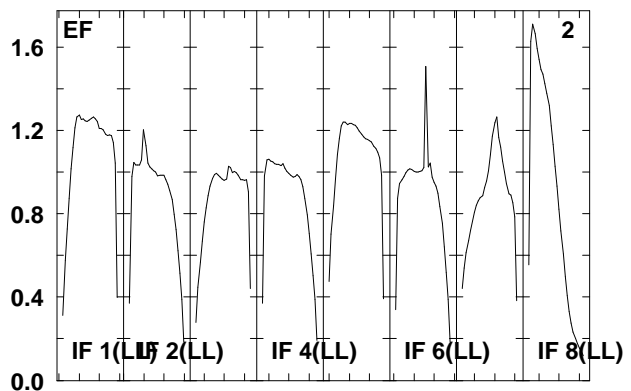
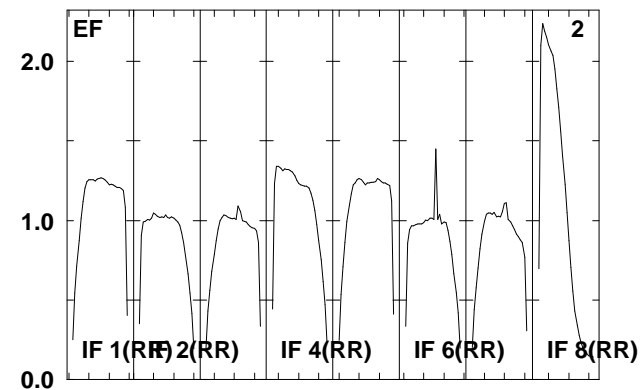
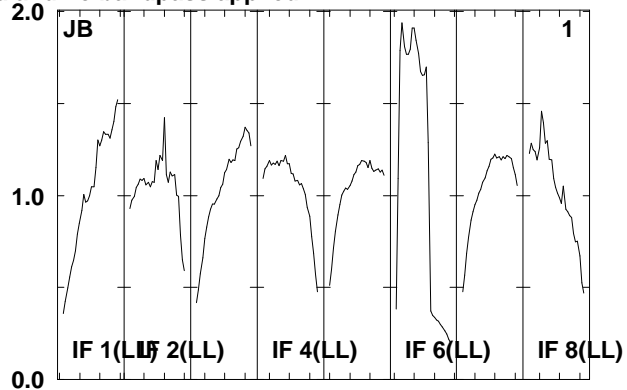
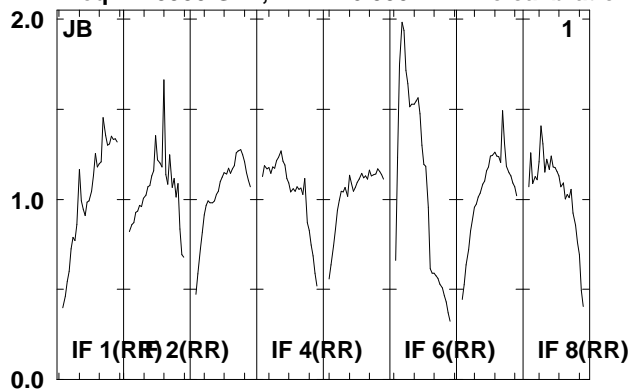

Lower frame: Real Jy
Total-power spectrum Antenna: *
Timerange: 00/17:37:05 to 00/17:40:29

Plot file version 253 created 06-JAN-2012 11:47:41

ARP299D EP068D 5.UVDATA.1

Freq = 1.5950 GHz, Bw = 16.000 MH No calibration applied and no bandpass applied

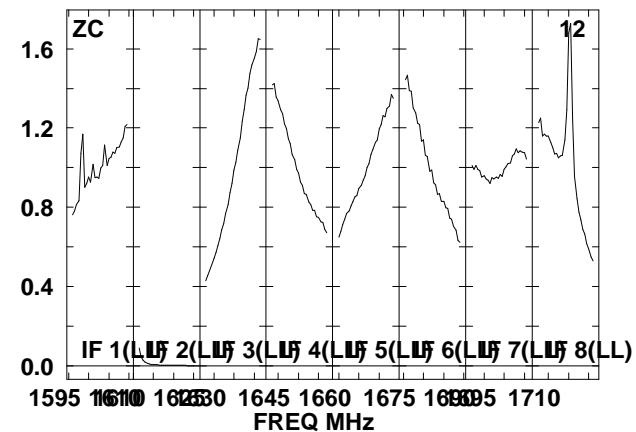
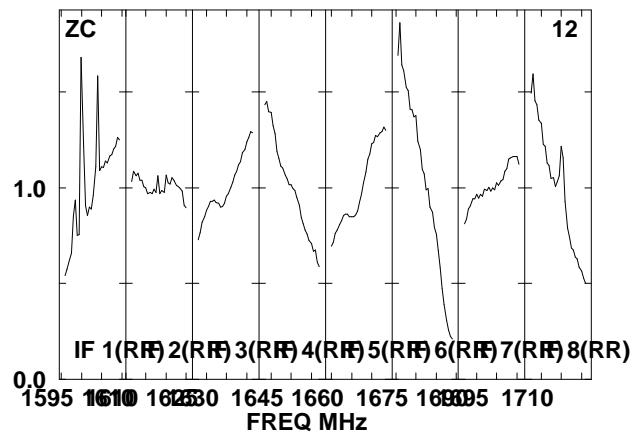
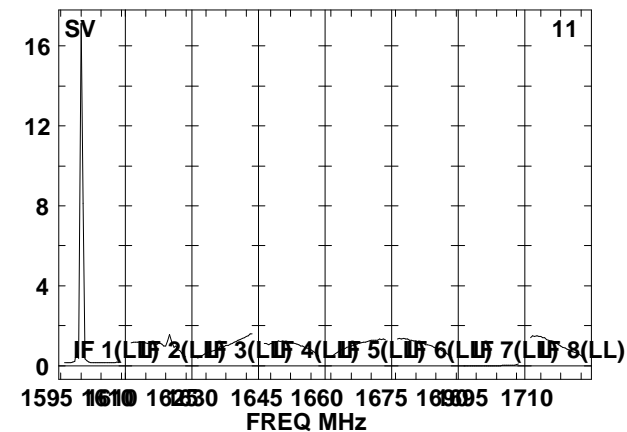
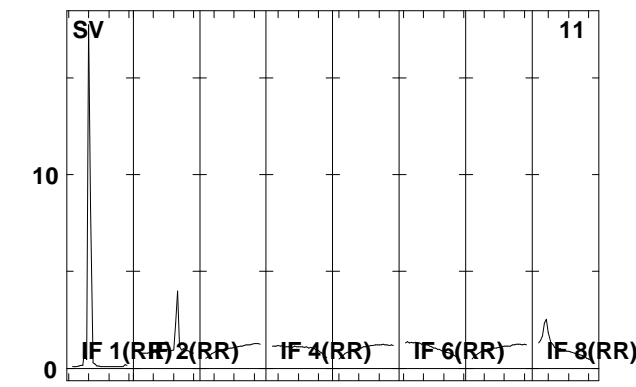
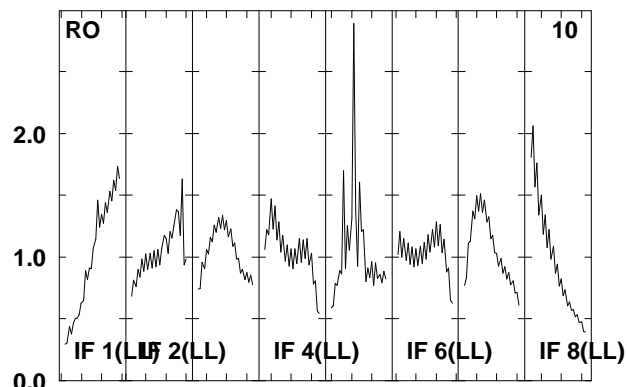
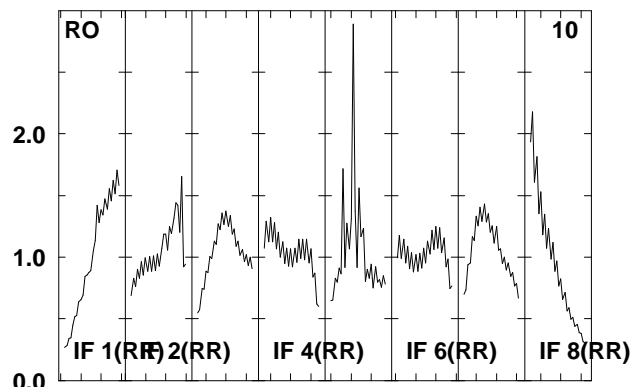
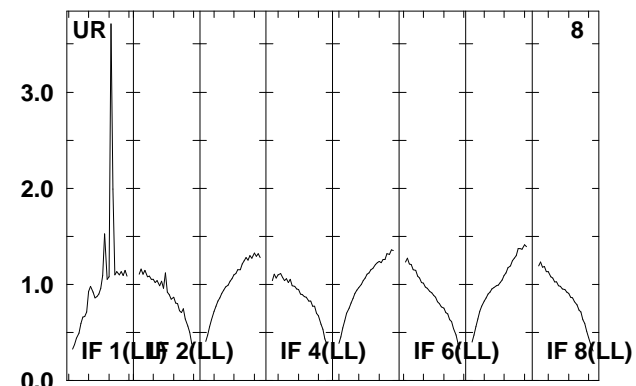
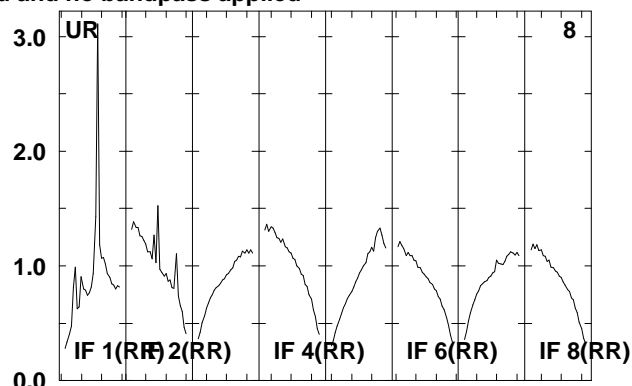
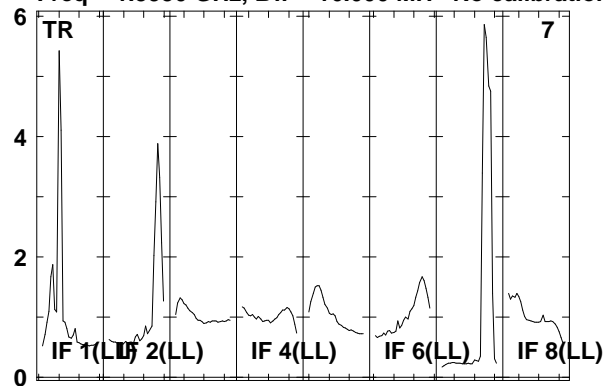

Lower frame: Real Jy

Total-power spectrum Antenna: *

Timerange: 00/17:37:05 to 00/17:40:29

Plot file version 254 created 06-JAN-2012 11:47:41

ARP299D EP068D 5.UVDATA.1

Freq = 1.5950 GHz, Bw = 16.000 MH No calibration applied and no bandpass applied

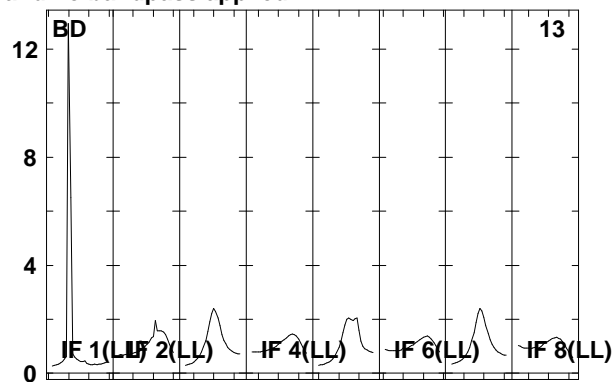
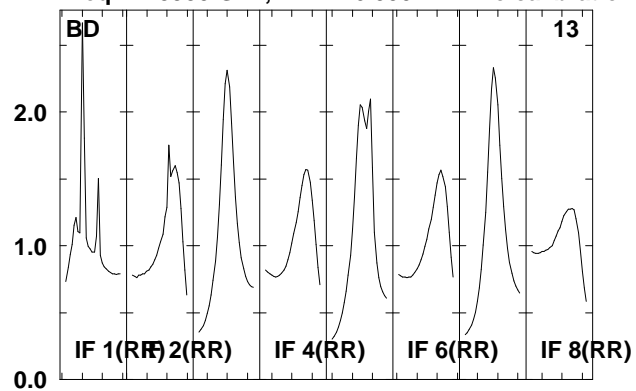

Lower frame: Real Jy
Total-power spectrum Antenna: *
Timerange: 00/17:37:05 to 00/17:40:29

Plot file version 255 created 06-JAN-2012 11:47:41

J1128+59 EP068D 5.UVDATA.1

Freq = 1.5950 GHz, Bw = 16.000 MH No calibration applied and no bandpass applied

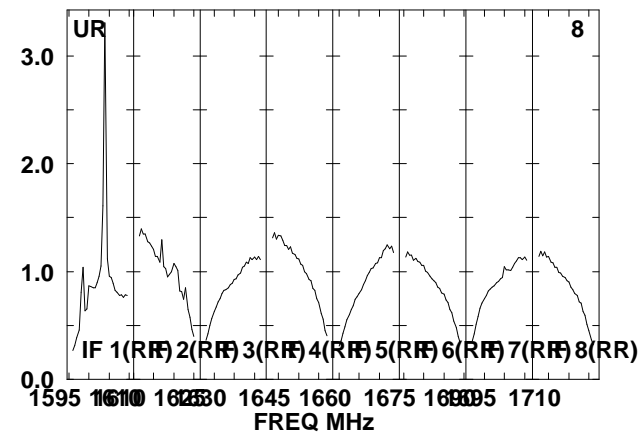
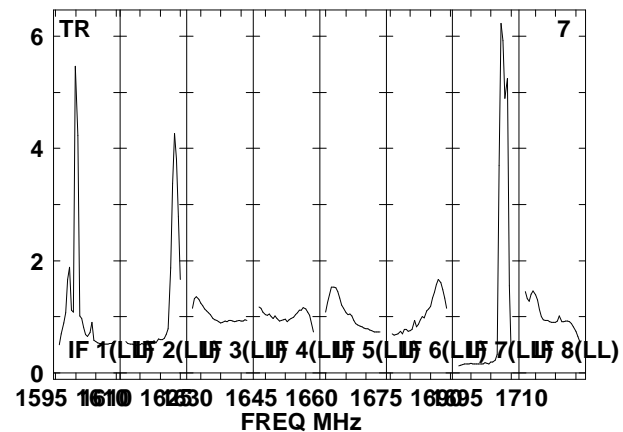
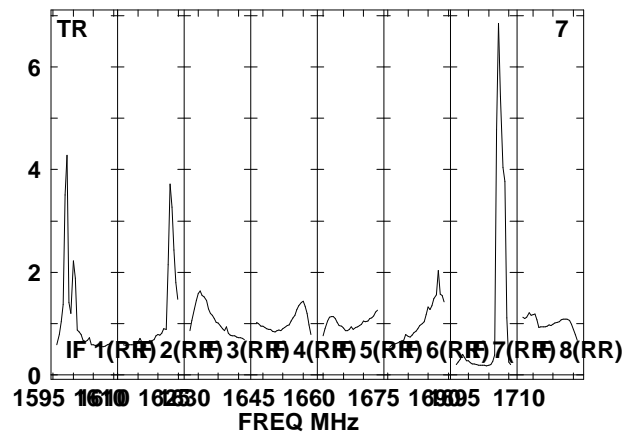
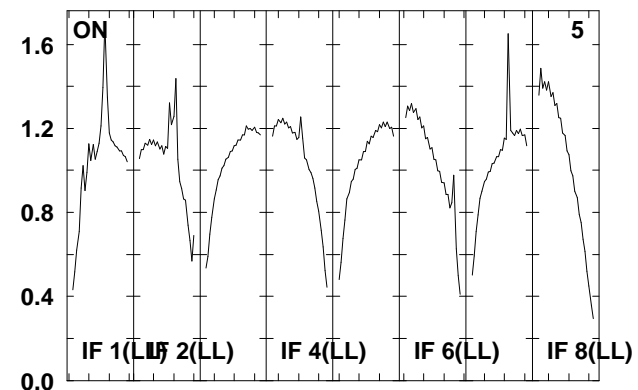
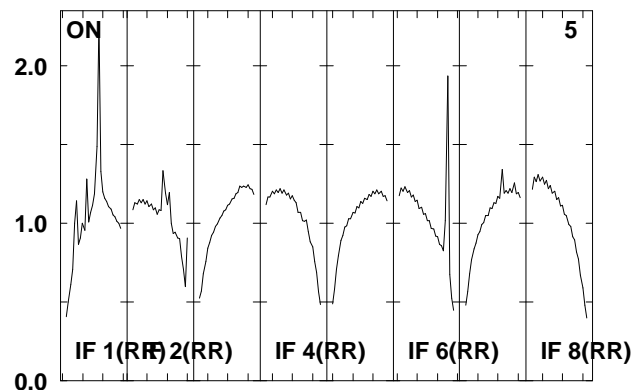
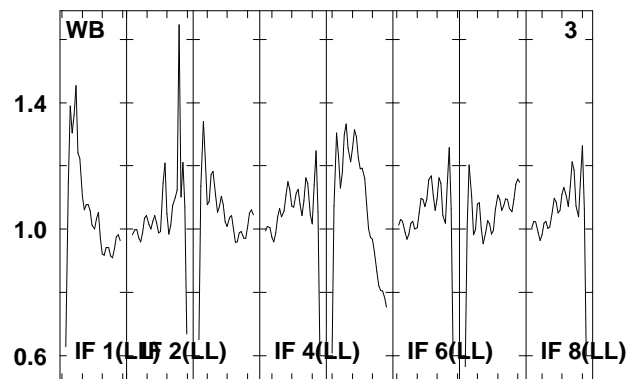
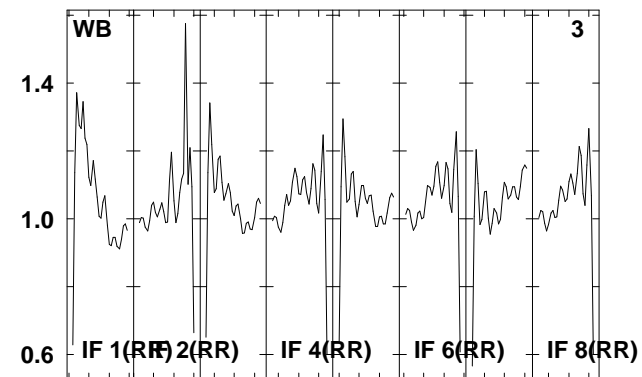
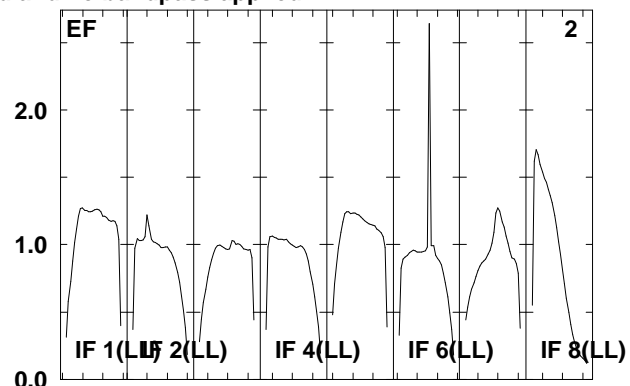
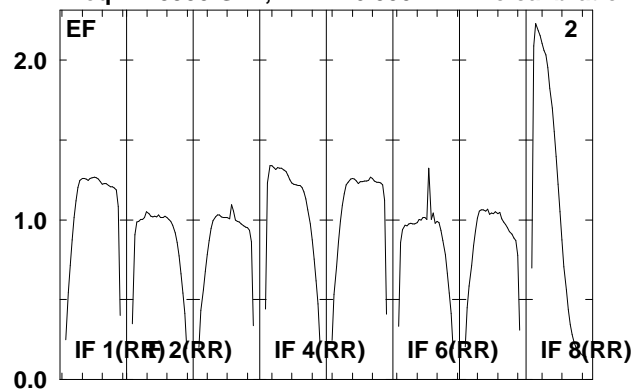

Lower frame: Real Jy
Total-power spectrum Antenna: *
Timerange: 00/17:41:31 to 00/17:42:59

Plot file version 256 created 06-JAN-2012 11:47:42

J1128+59 EP068D 5.UVDATA.1

Freq = 1.5950 GHz, Bw = 16.000 MH No calibration applied and no bandpass applied

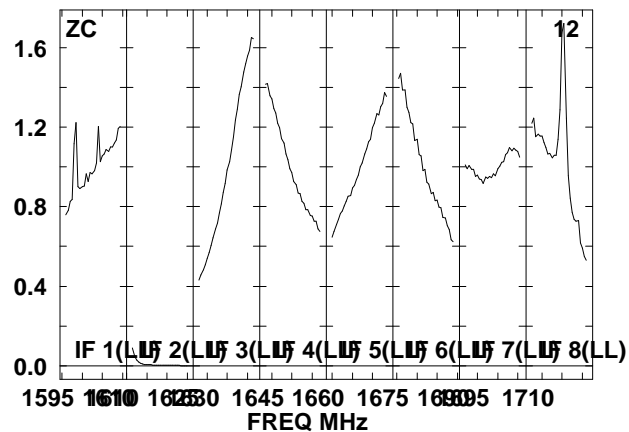
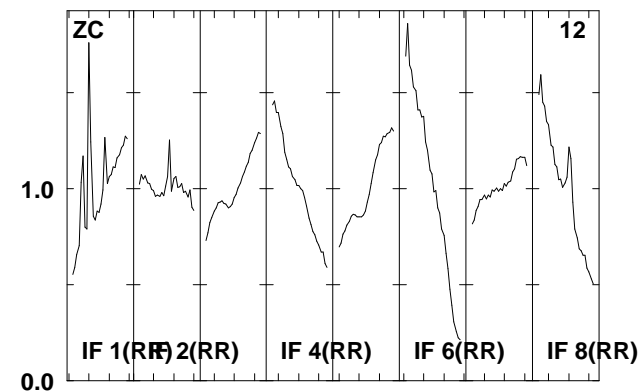
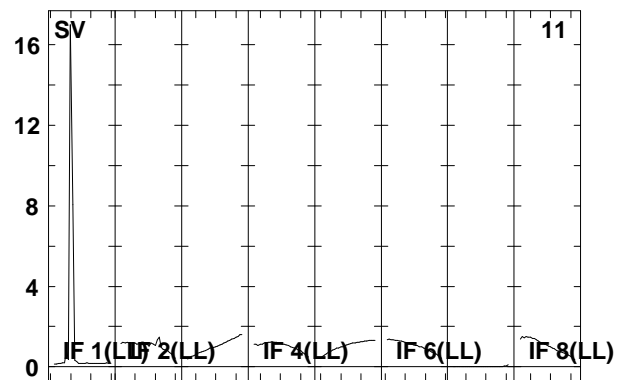
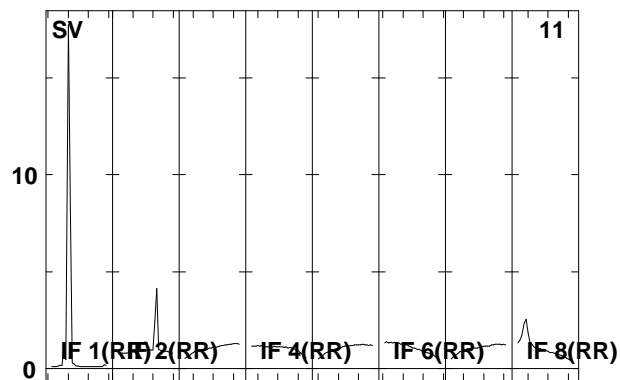
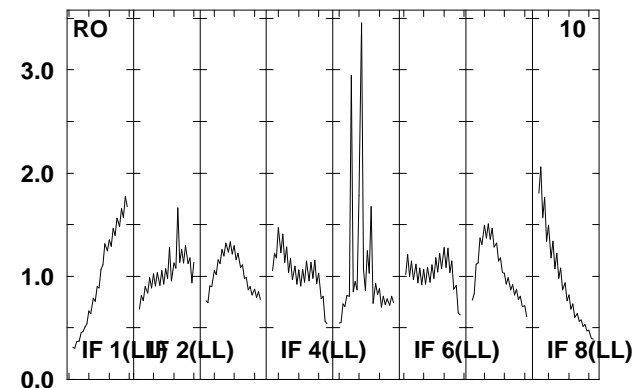
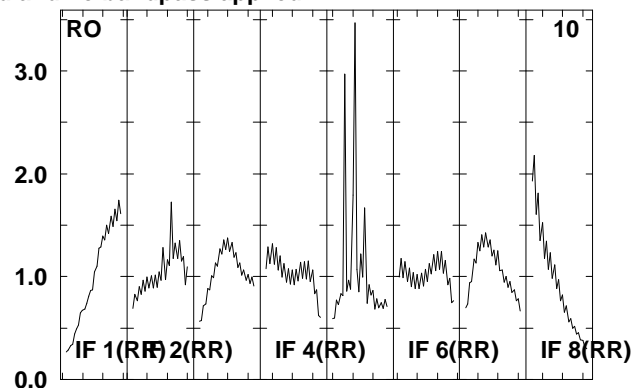
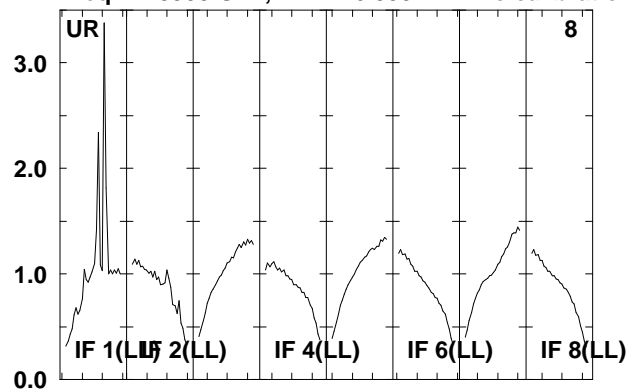

Lower frame: Real Jy

Total-power spectrum Antenna: *

Timerange: 00/17:41:31 to 00/17:42:59

Plot file version 257 created 06-JAN-2012 11:47:42

ARP299D EP068D 5.UVDATA.1

Freq = 1.5950 GHz, Bw = 16.000 MH No calibration applied and no bandpass applied

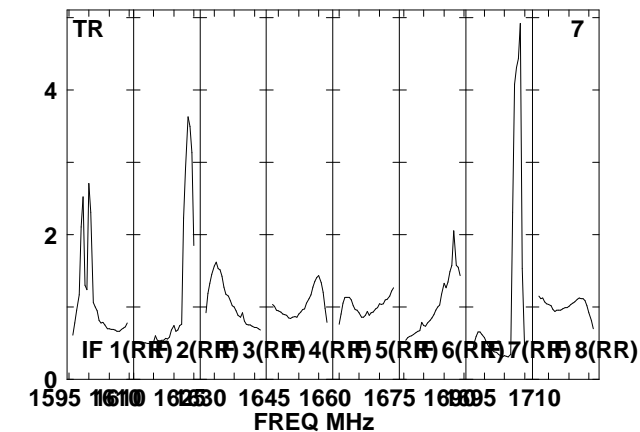
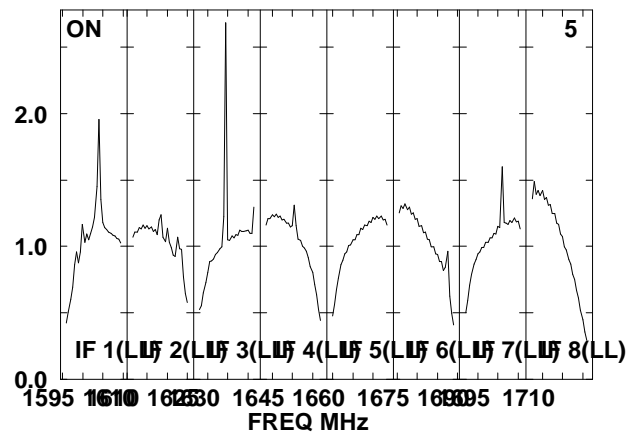
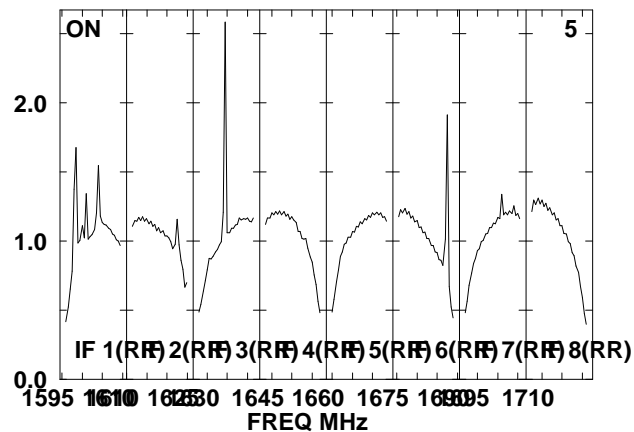
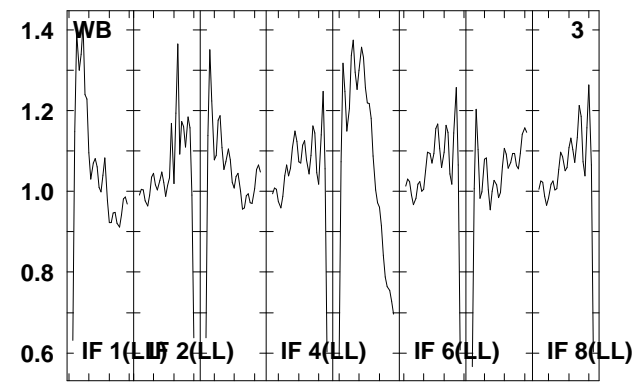
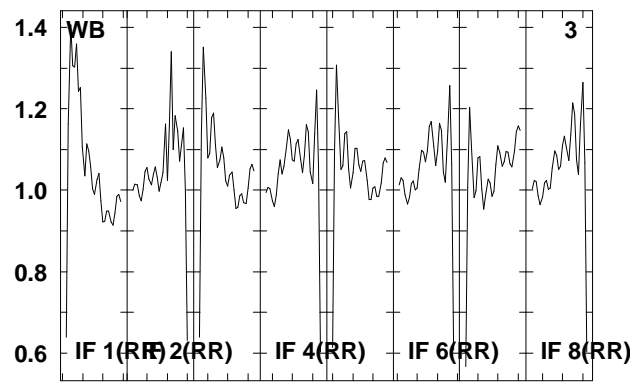
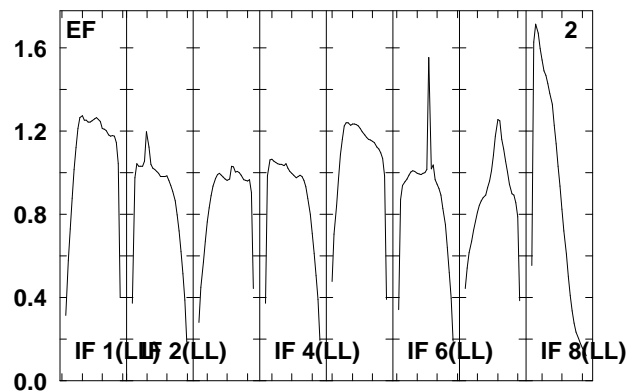
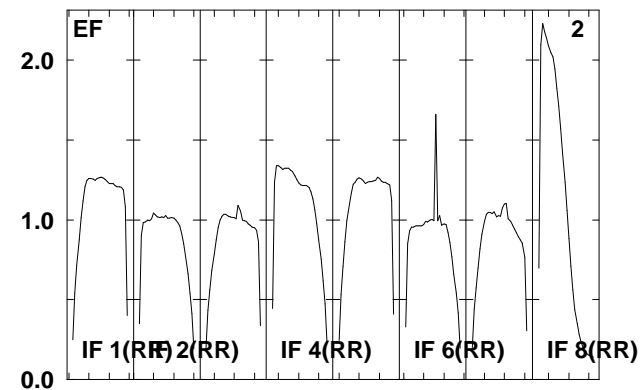
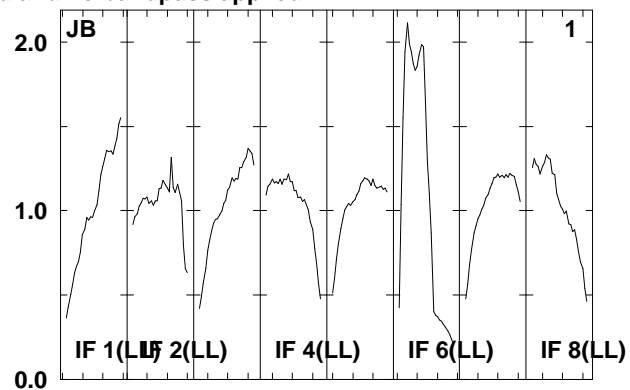
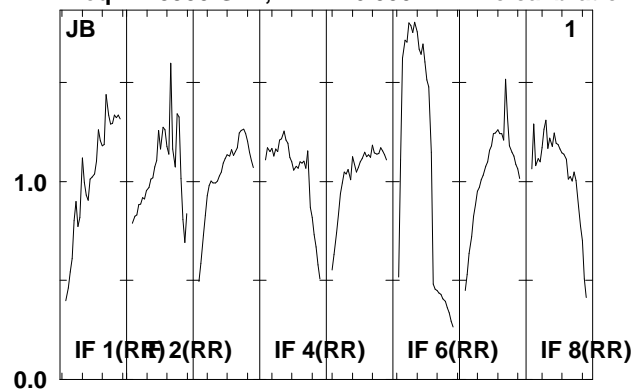

Lower frame: Real Jy
Total-power spectrum Antenna: *
Timerange: 00/17:43:01 to 00/17:46:29

Plot file version 258 created 06-JAN-2012 11:47:43

ARP299D EP068D 5.UVDATA.1

Freq = 1.5950 GHz, Bw = 16.000 MH No calibration applied and no bandpass applied

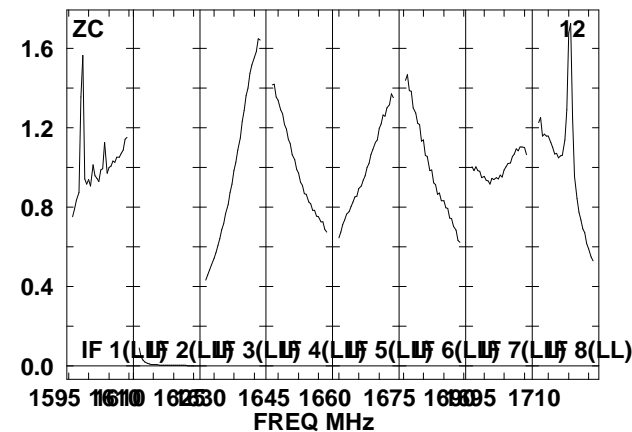
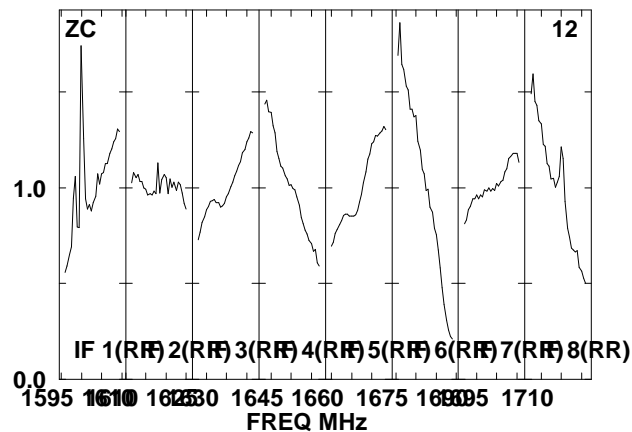
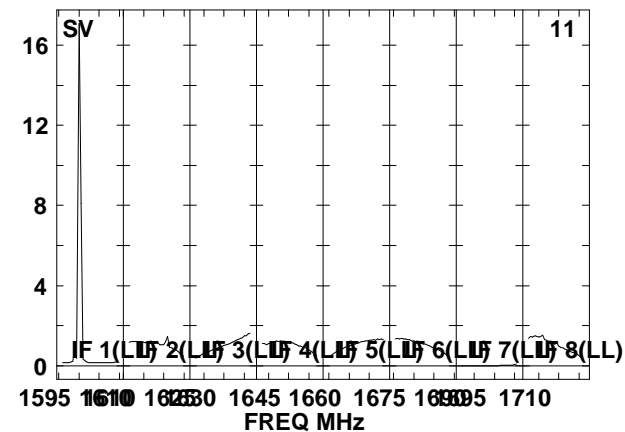
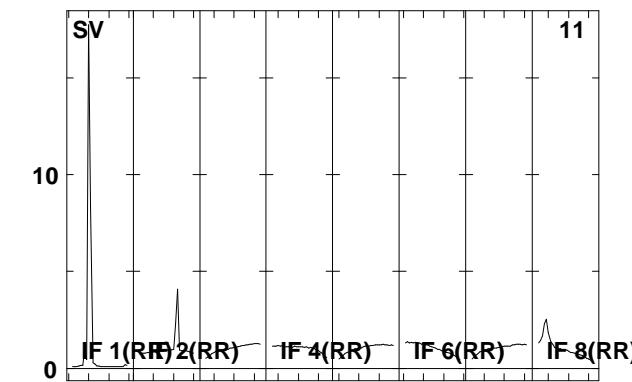
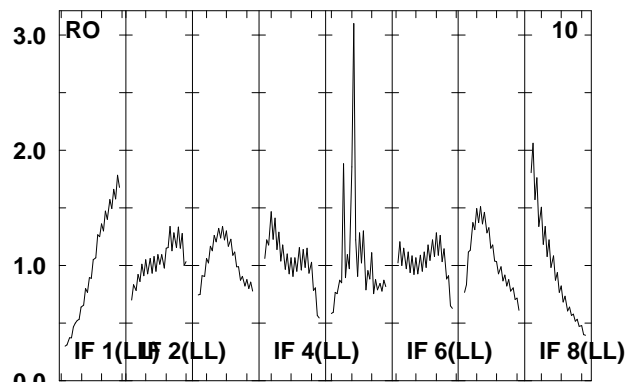
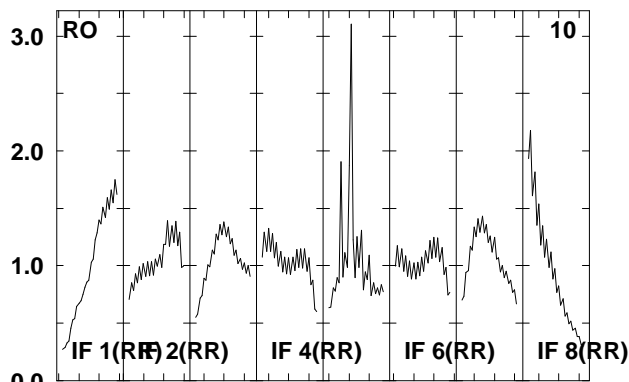
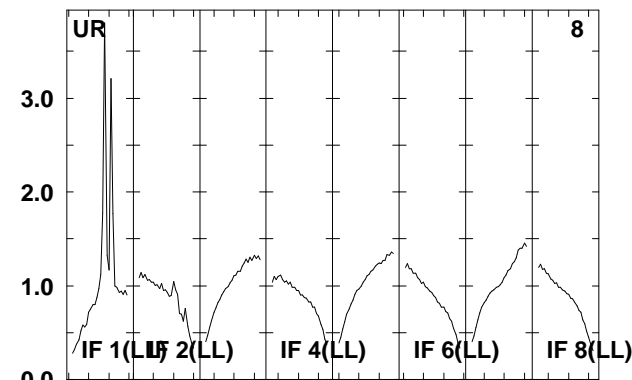
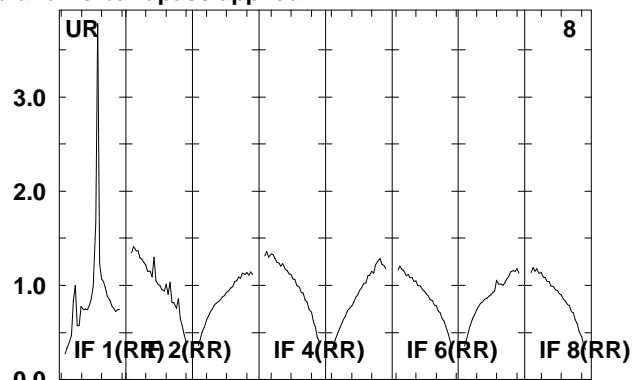
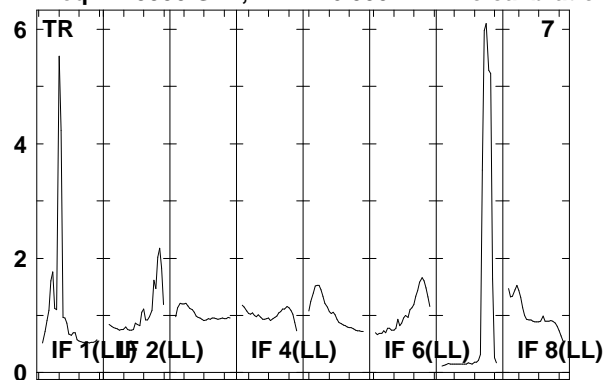

Lower frame: Real Jy
Total-power spectrum Antenna: *
Timerange: 00/17:43:01 to 00/17:46:29

Plot file version 259 created 06-JAN-2012 11:47:43

J1128+59 EP068D 5.UVDATA.1

Freq = 1.5950 GHz, Bw = 16.000 MH No calibration applied and no bandpass applied

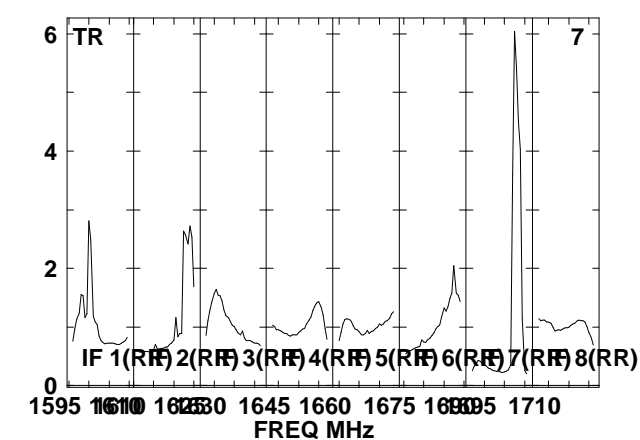
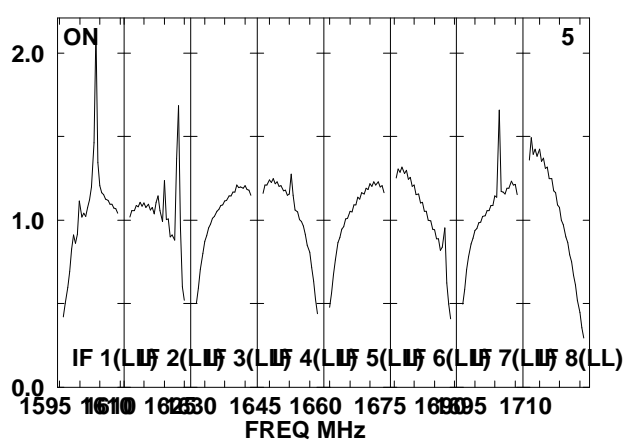
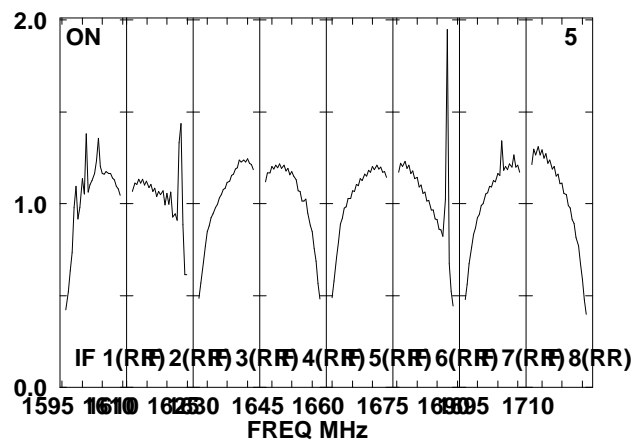
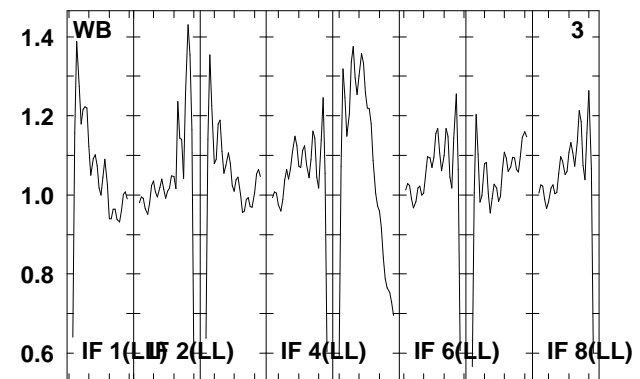
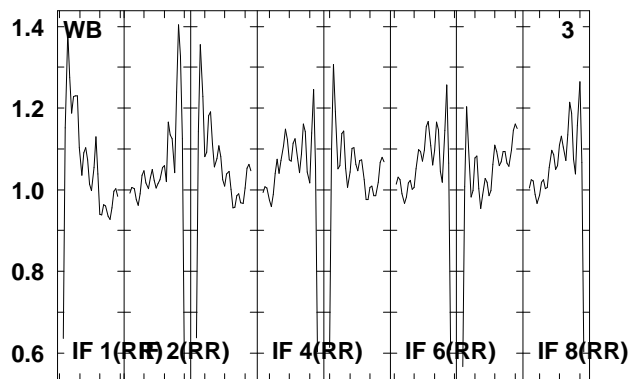
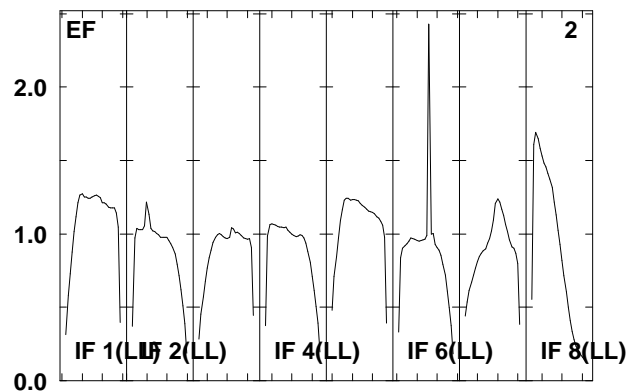
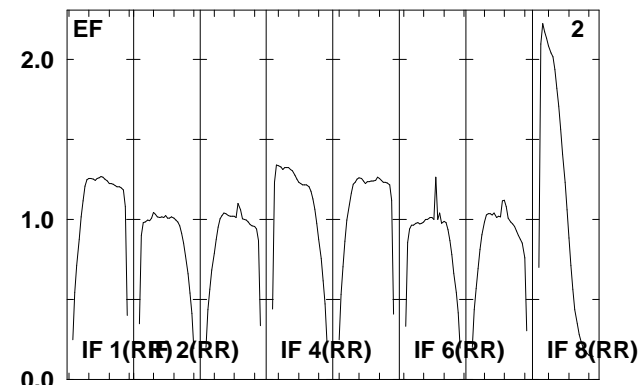
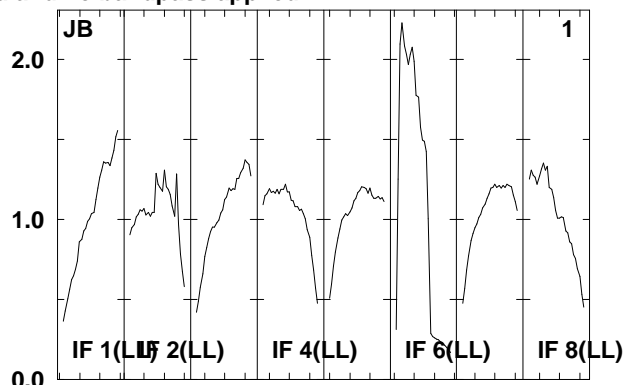
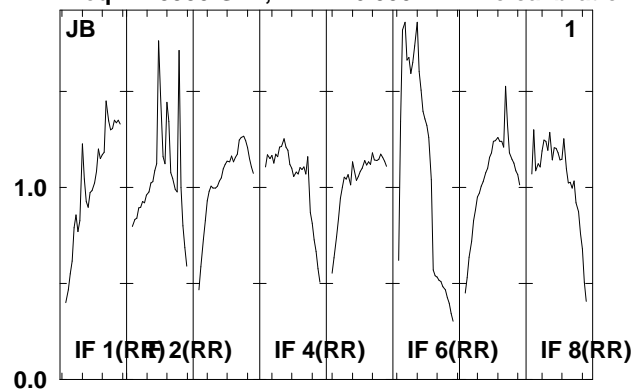

Lower frame: Real Jy
Total-power spectrum Antenna: *
Timerange: 00/17:46:35 to 00/17:47:59

Plot file version 260 created 06-JAN-2012 11:47:43

J1128+59 EP068D 5.UVDATA.1

Freq = 1.5950 GHz, Bw = 16.000 MH No calibration applied and no bandpass applied

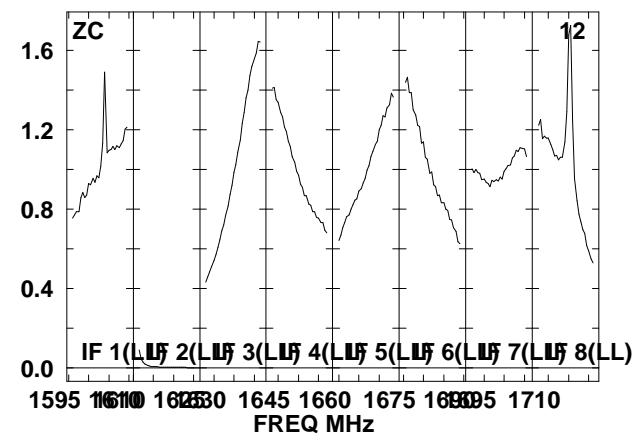
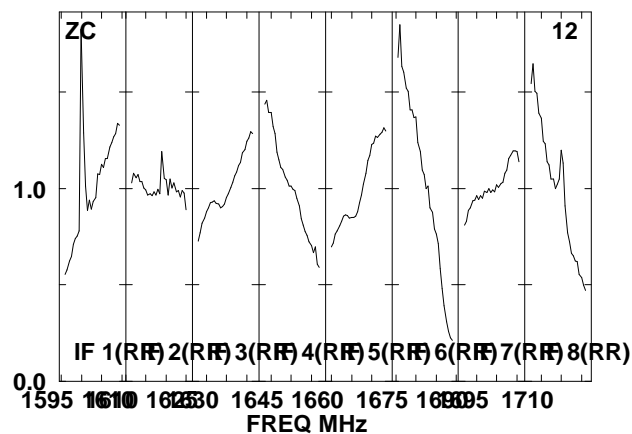
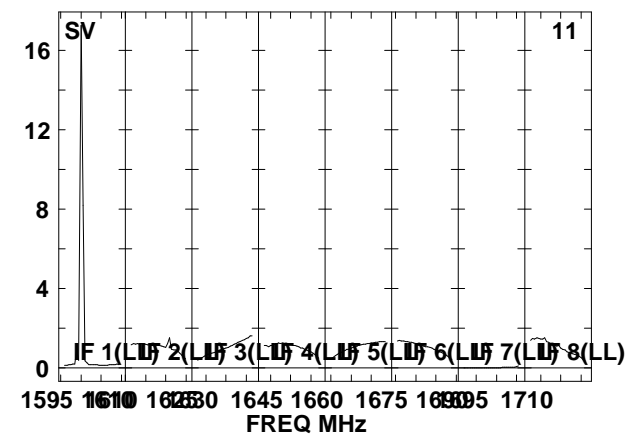
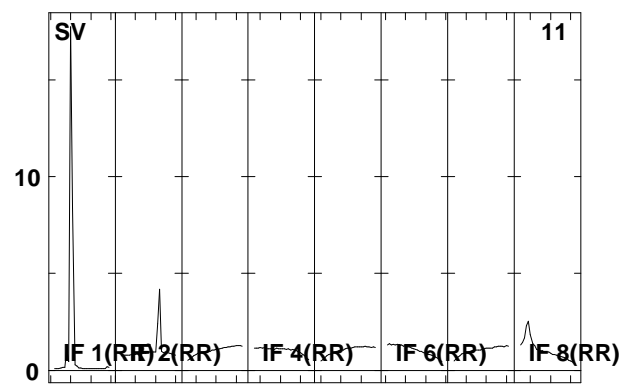
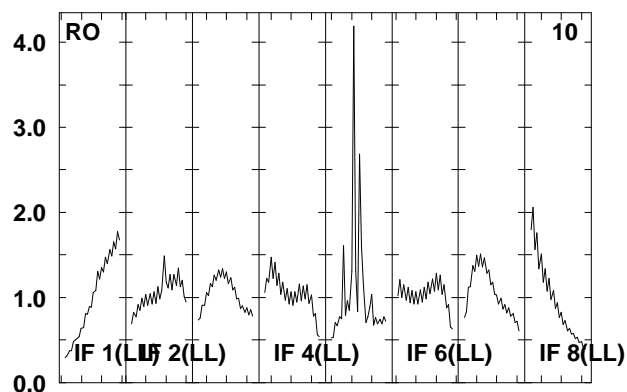
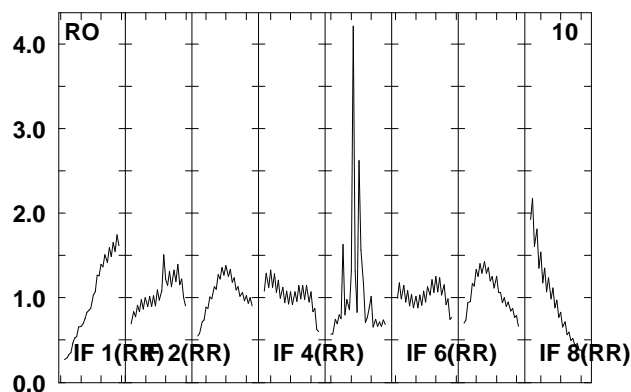
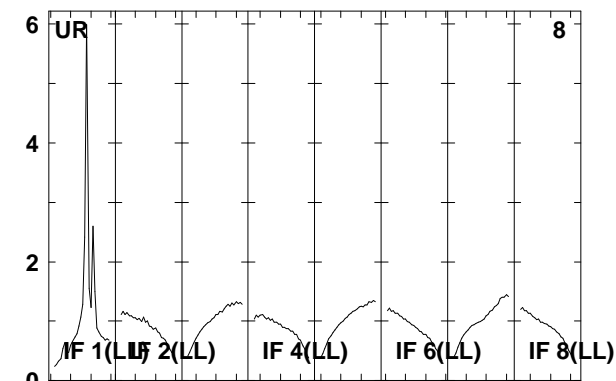
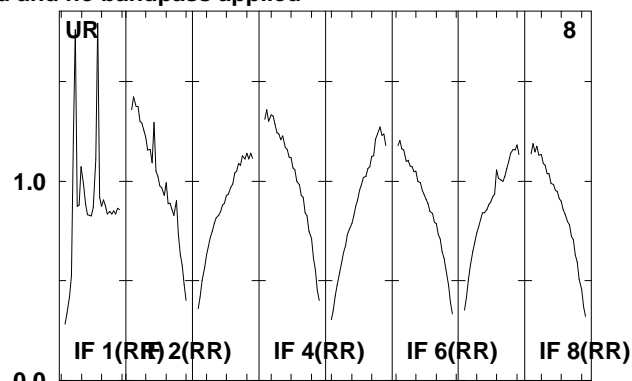
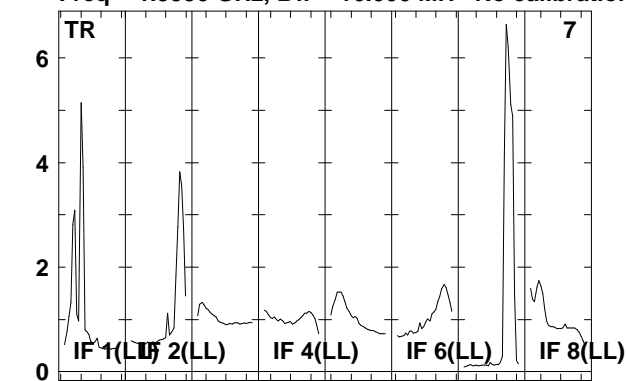

Lower frame: Real Jy

Total-power spectrum Antenna: *

Timerange: 00/17:46:35 to 00/17:47:59

Plot file version 261 created 06-JAN-2012 11:47:44

ARP299D EP068D 5.UVDATA.1

Freq = 1.5950 GHz, Bw = 16.000 MH No calibration applied and no bandpass applied

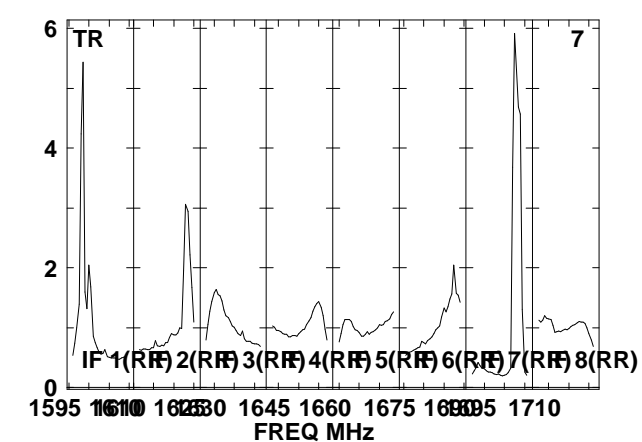
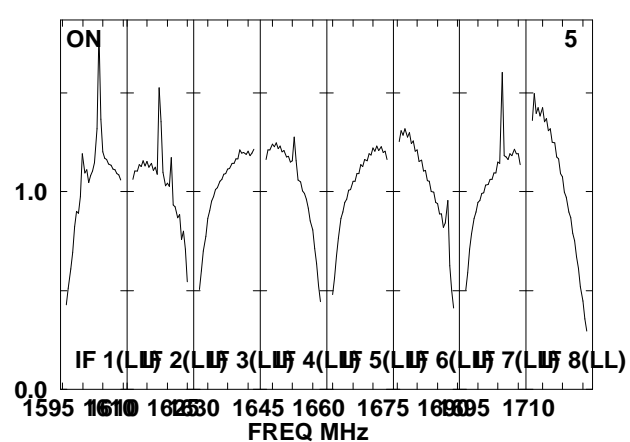
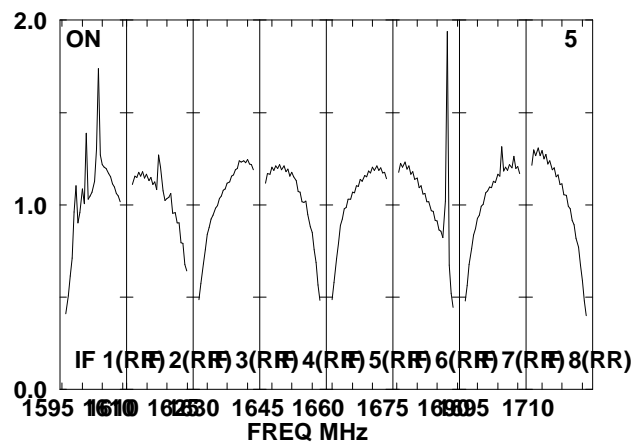
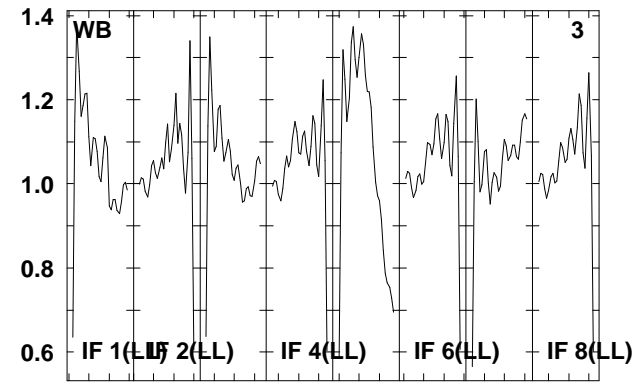
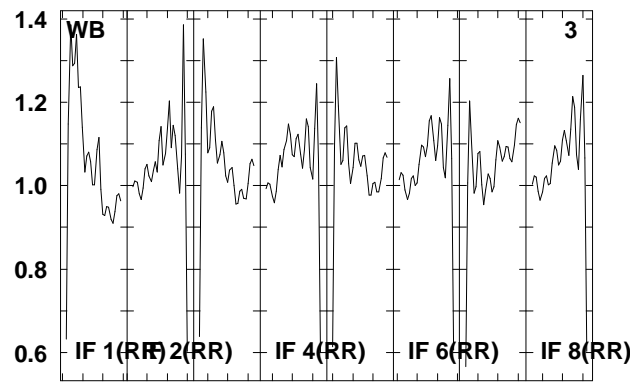
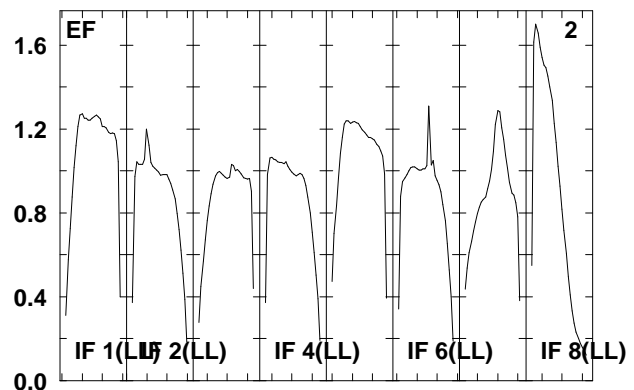
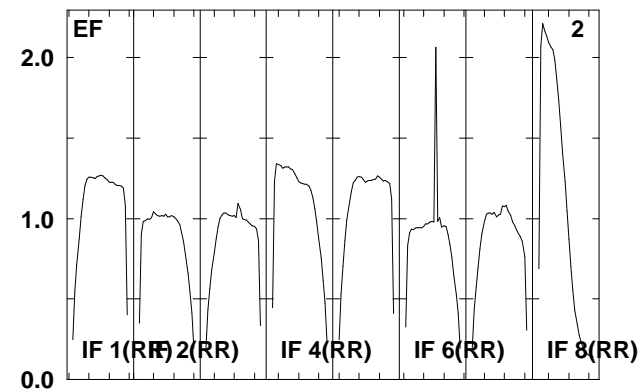
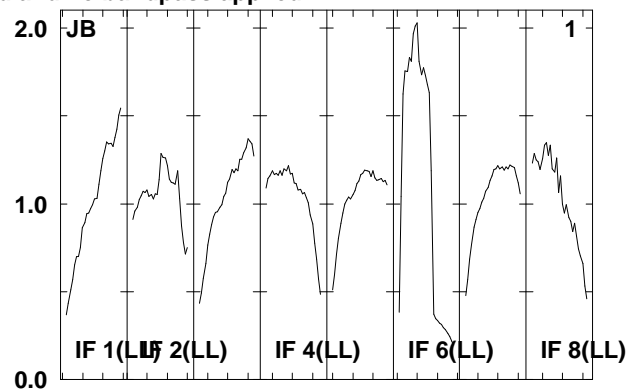
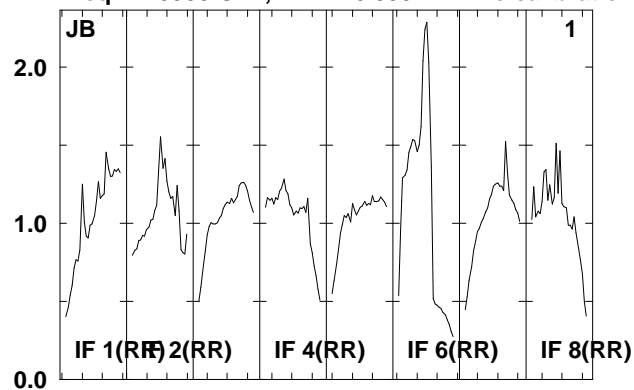

Lower frame: Real Jy

Total-power spectrum Antenna: *

Timerange: 00/17:48:05 to 00/17:51:29

Plot file version 262 created 06-JAN-2012 11:47:44

ARP299D EP068D 5.UVDATA.1

Freq = 1.5950 GHz, Bw = 16.000 MH No calibration applied and no bandpass applied

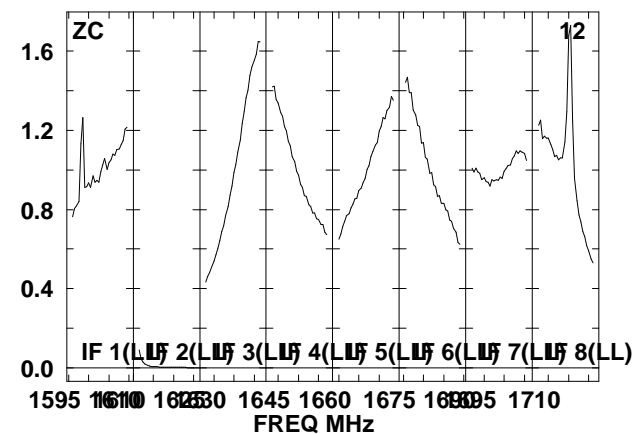
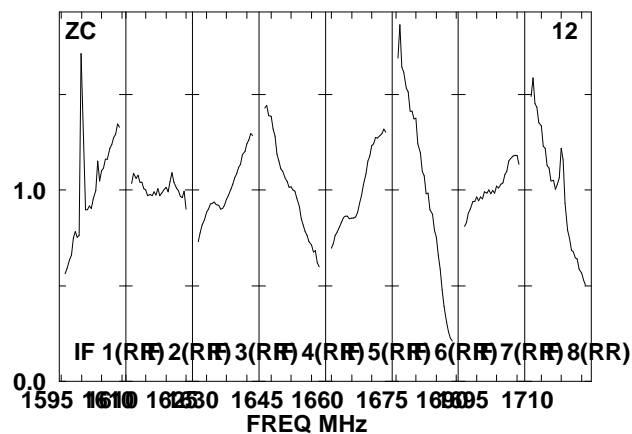
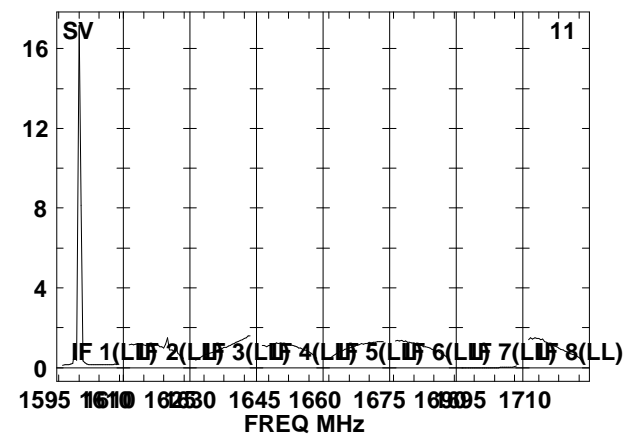
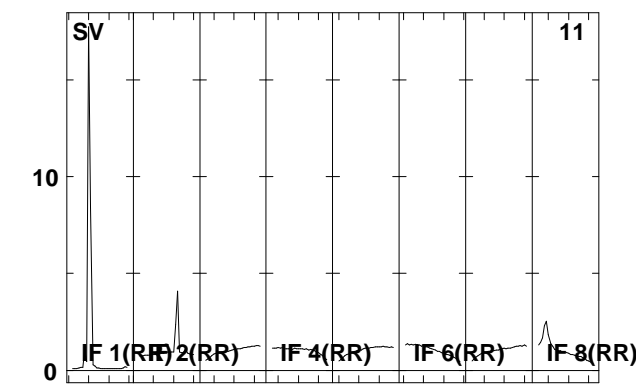
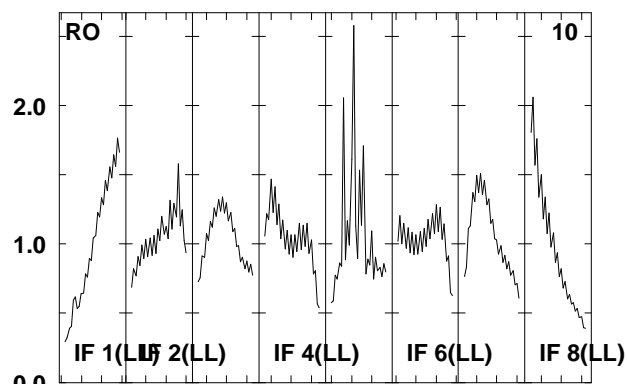
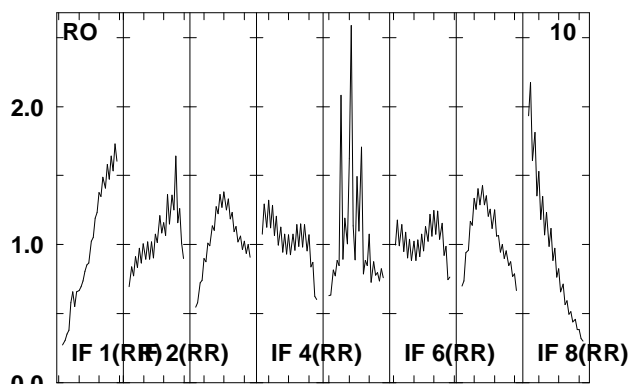
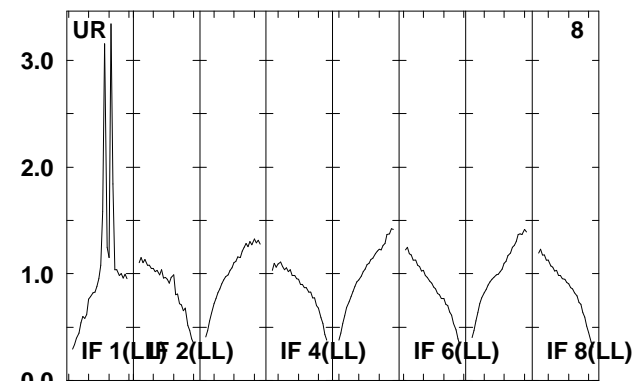
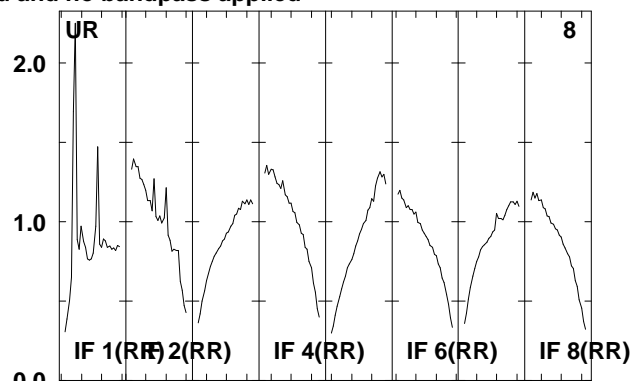
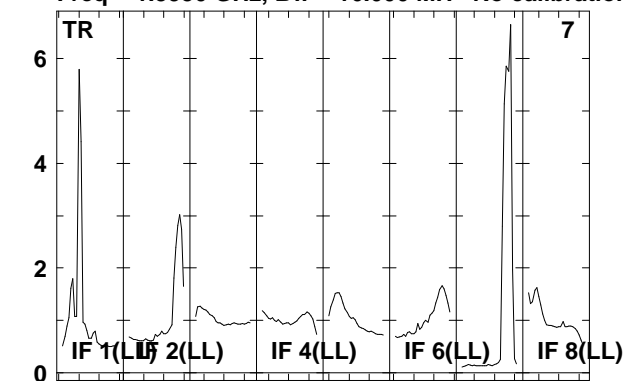

Lower frame: Real Jy
Total-power spectrum Antenna: *
Timerange: 00/17:48:05 to 00/17:51:29

Plot file version 263 created 06-JAN-2012 11:47:45

J1128+59 EP068D 5.UVDATA.1

Freq = 1.5950 GHz, Bw = 16.000 MH No calibration applied and no bandpass applied

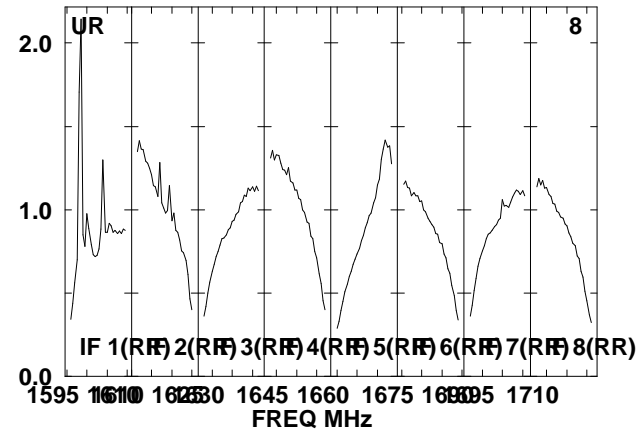
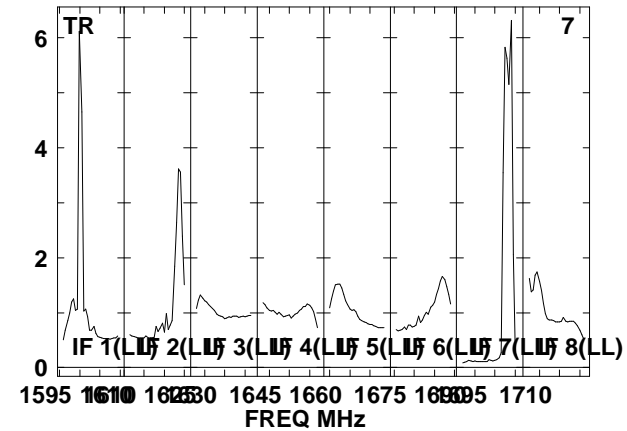
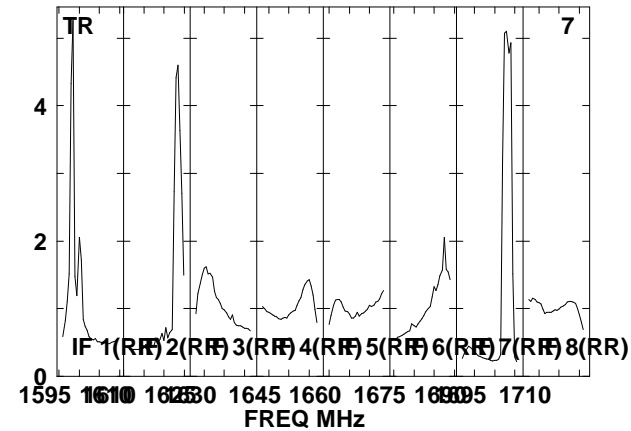
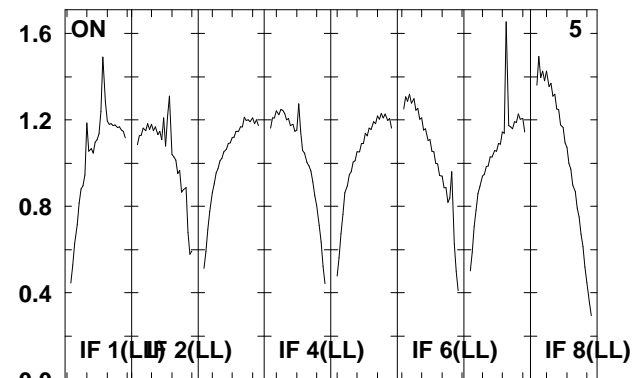
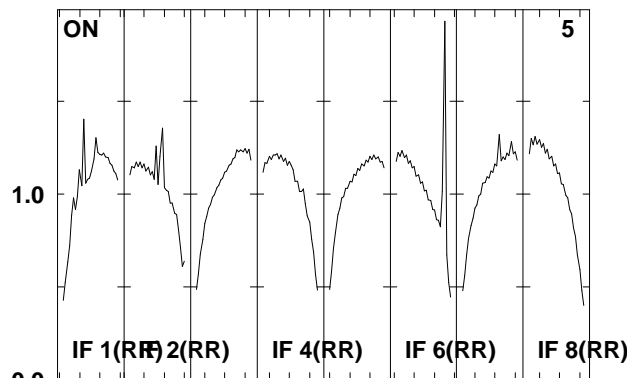
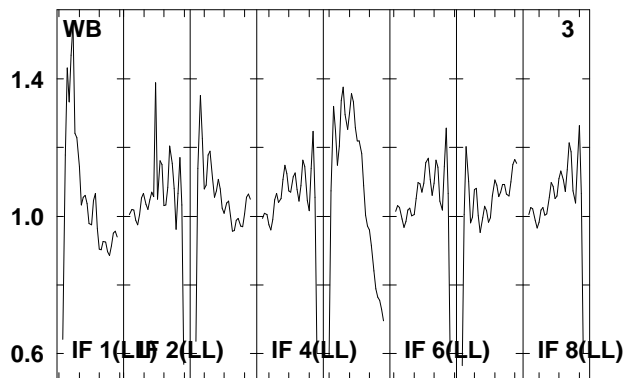
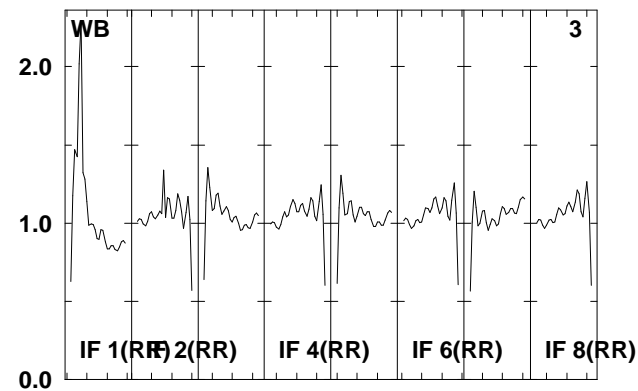
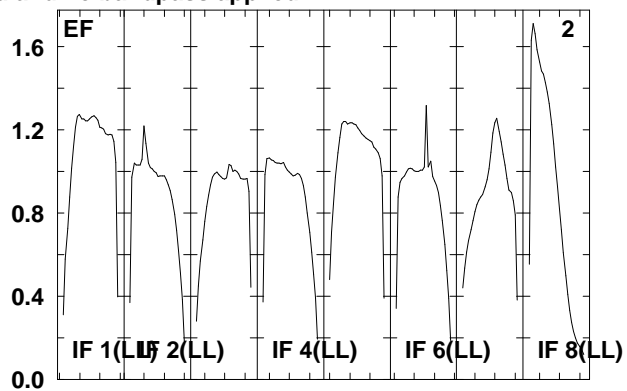
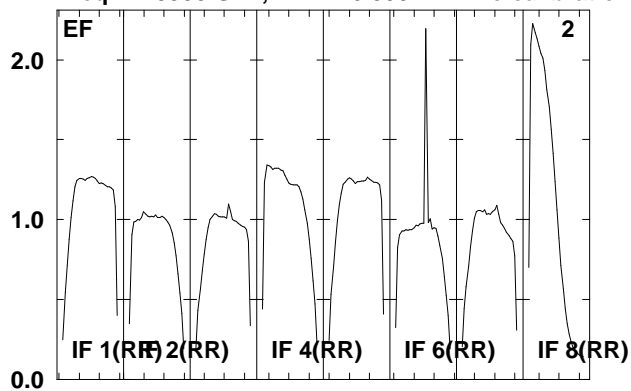

Lower frame: Real Jy
Total-power spectrum Antenna: *
Timerange: 00/17:52:31 to 00/17:53:59

Plot file version 264 created 06-JAN-2012 11:47:46

J1128+59 EP068D 5.UV DATA.1

Freq = 1.5950 GHz, Bw = 16.000 MH No calibration applied and no bandpass applied

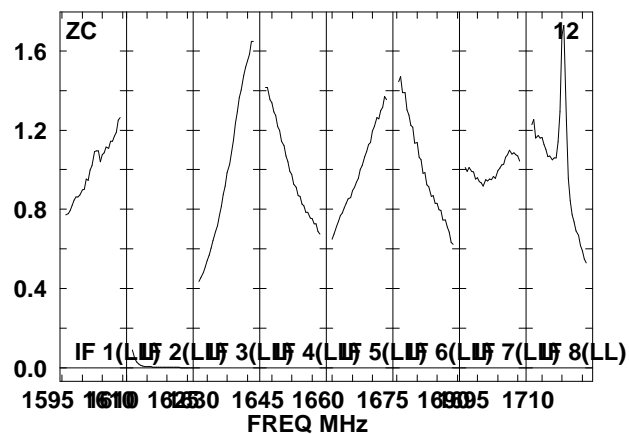
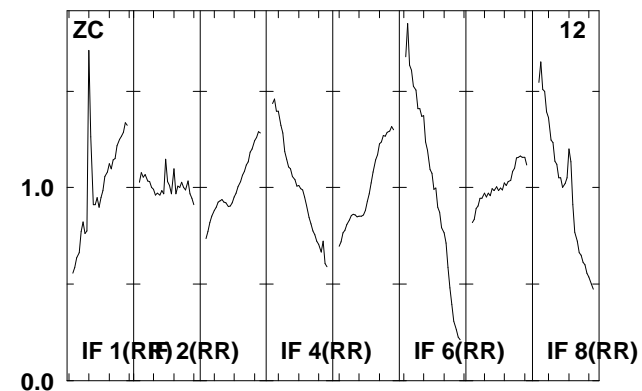
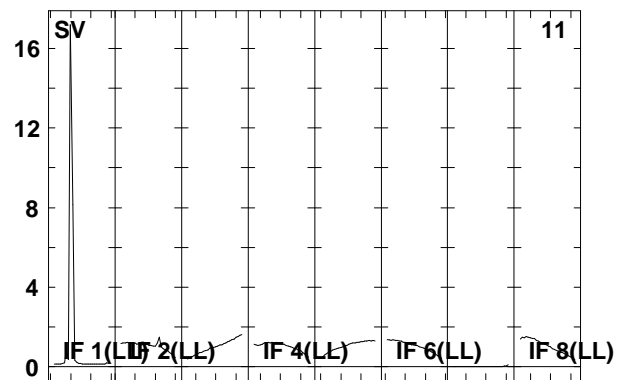
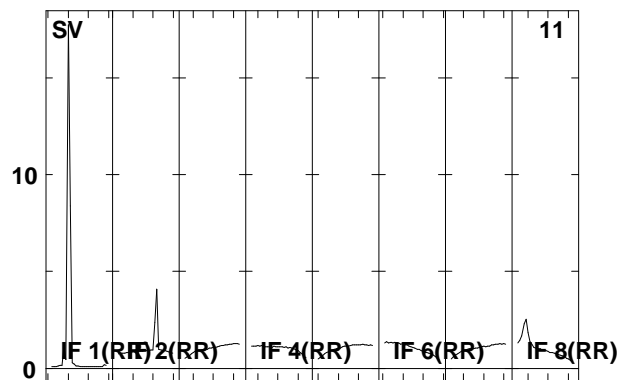
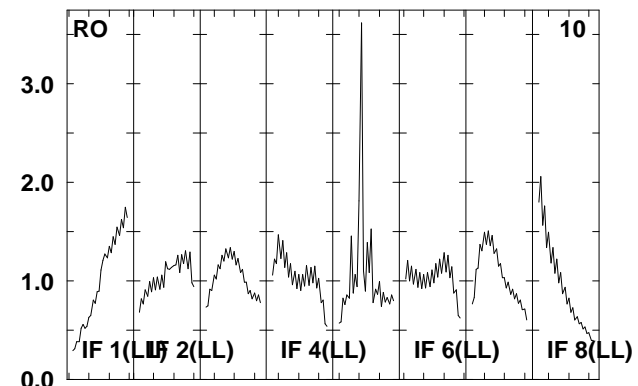
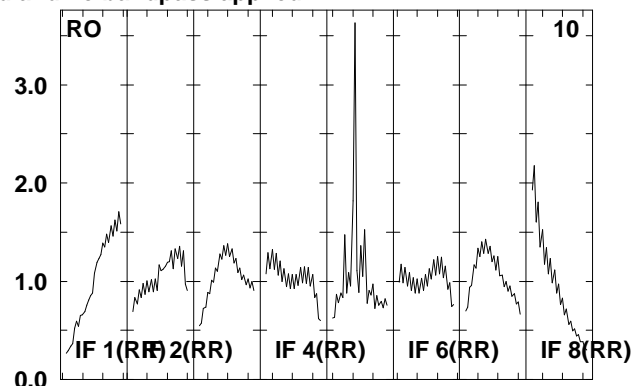
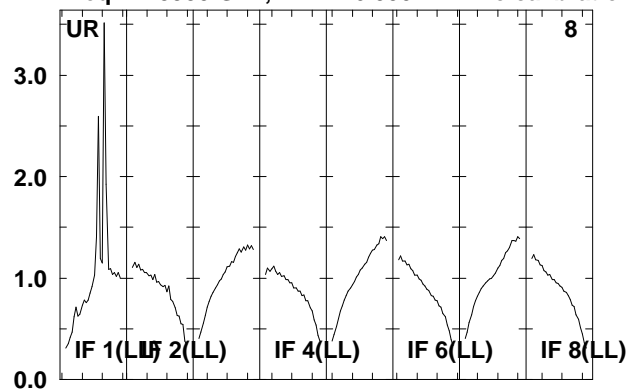

Lower frame: Real Jy

Total-power spectrum Antenna: *

Timerange: 00/17:52:31 to 00/17:53:59

Plot file version 265 created 06-JAN-2012 11:47:46

ARP299D EP068D 5.UVDATA.1

Freq = 1.5950 GHz, Bw = 16.000 MH No calibration applied and no bandpass applied

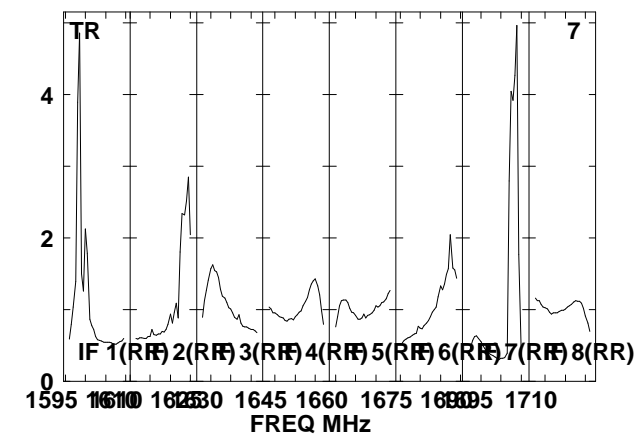
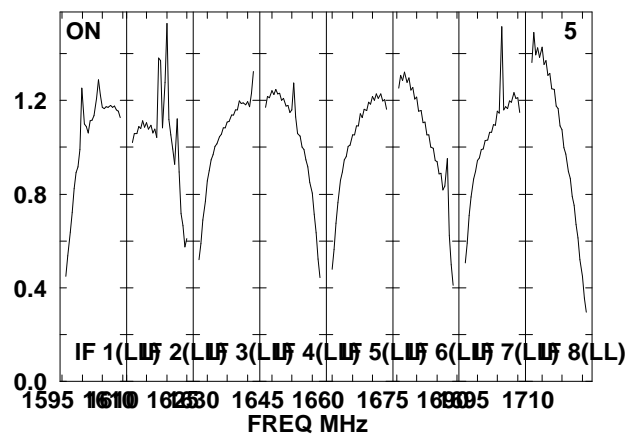
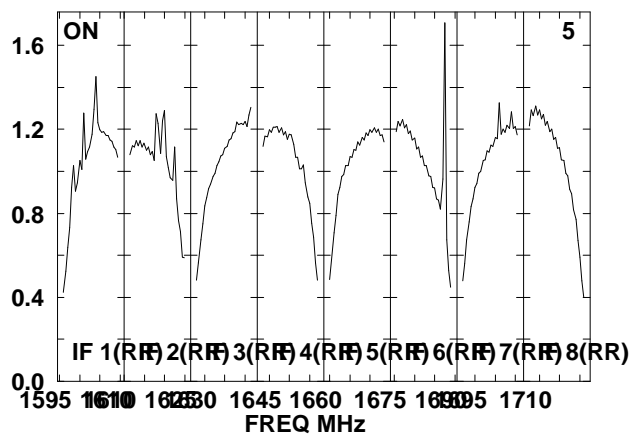
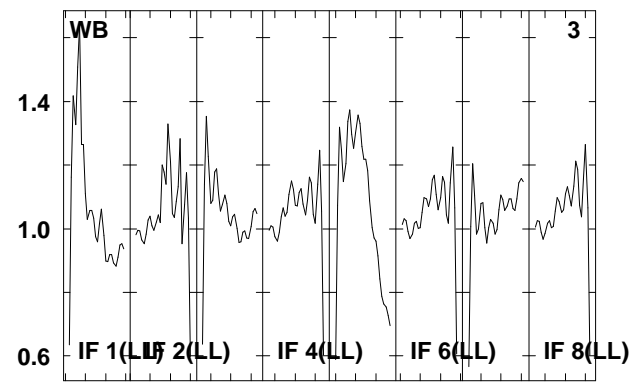
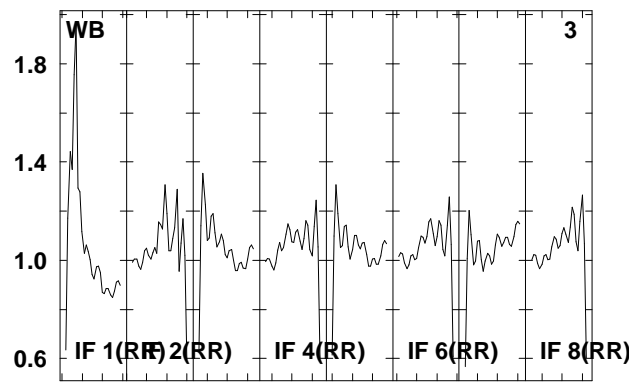
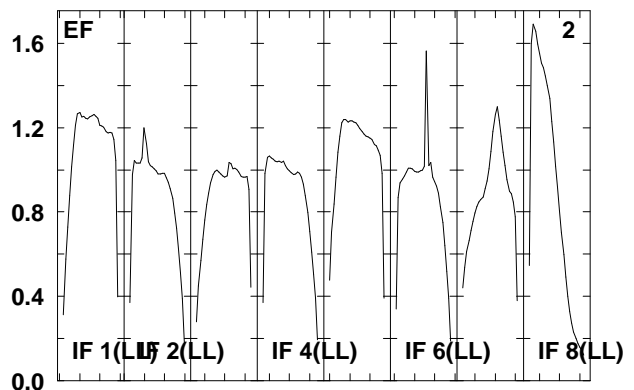
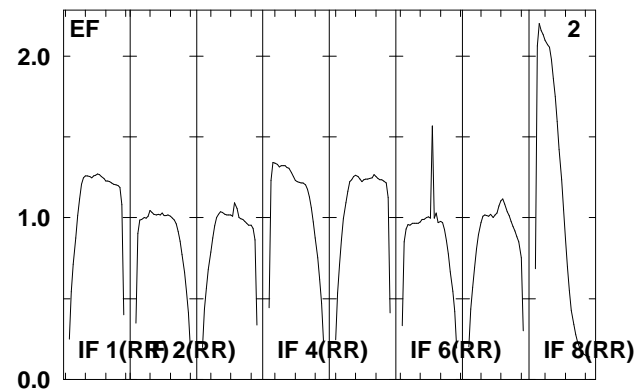
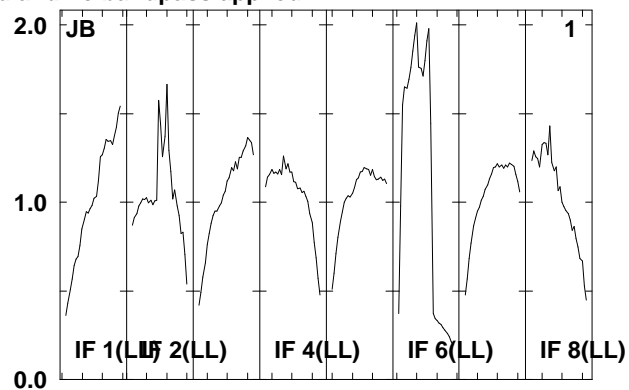
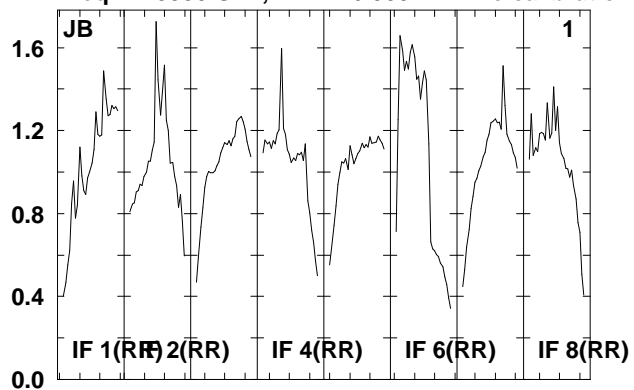

Lower frame: Real Jy
Total-power spectrum Antenna: *
Timerange: 00/17:54:01 to 00/17:57:29

Plot file version 266 created 06-JAN-2012 11:47:47

ARP299D EP068D 5.UVDATA.1

Freq = 1.5950 GHz, Bw = 16.000 MH No calibration applied and no bandpass applied

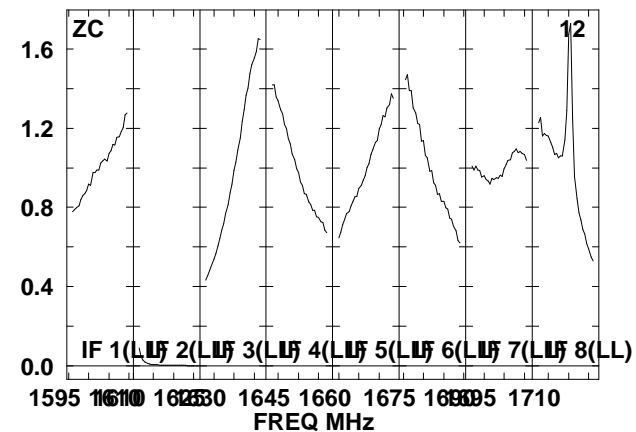
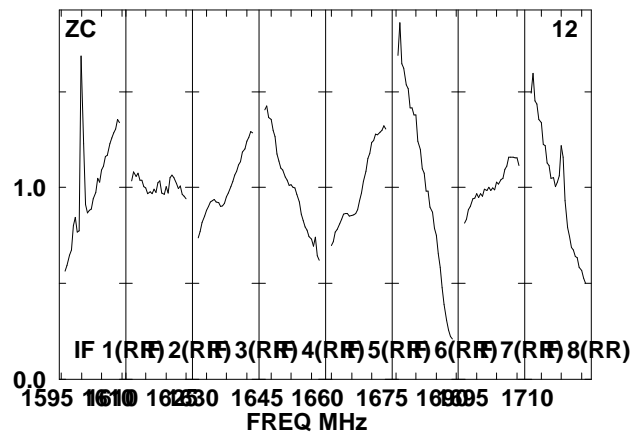
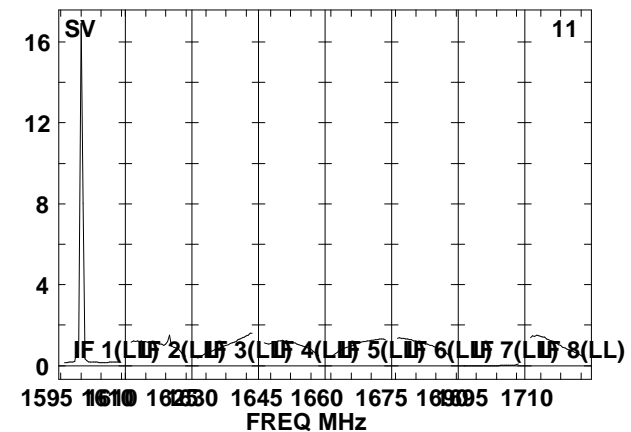
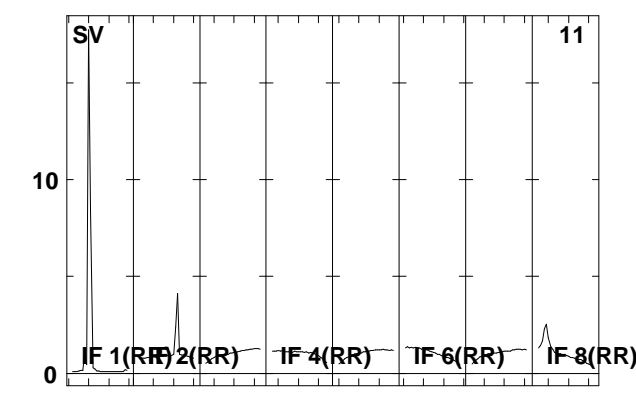
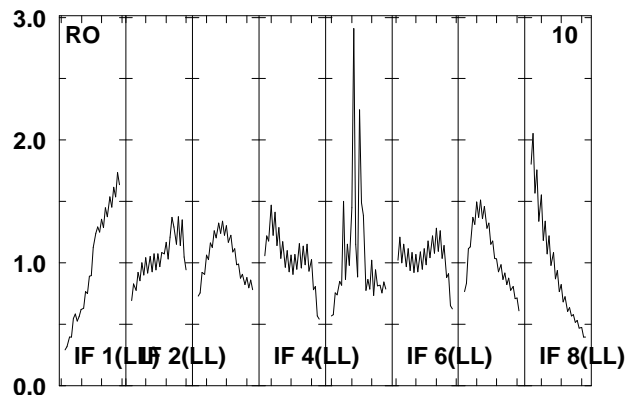
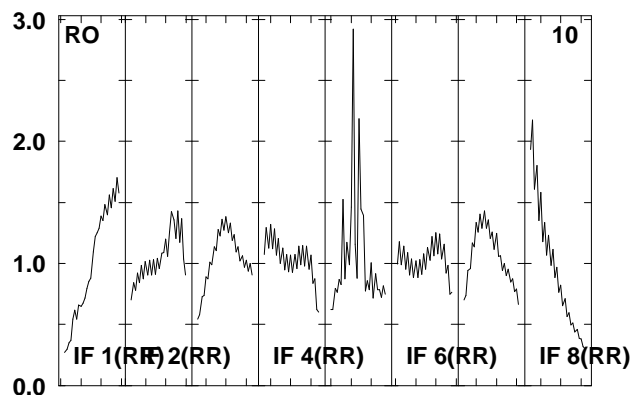
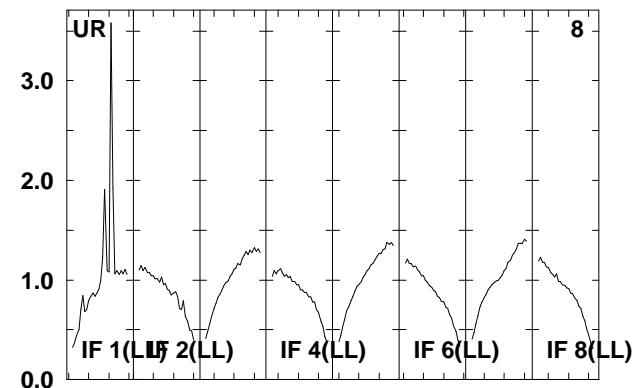
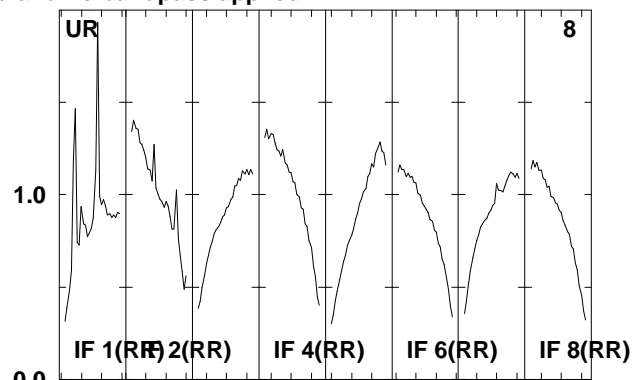
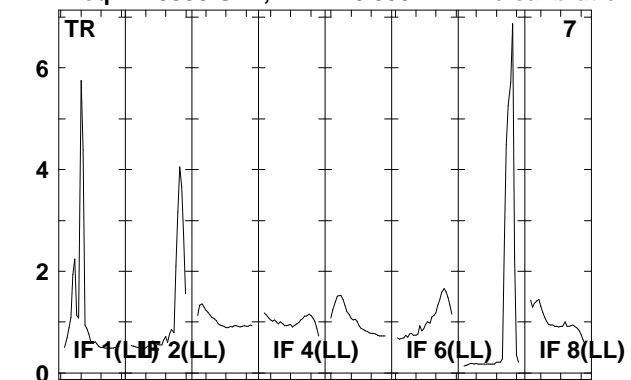

Lower frame: Real Jy
Total-power spectrum Antenna: *
Timerange: 00/17:54:01 to 00/17:57:29

Plot file version 267 created 06-JAN-2012 11:47:47

J1128+59 EP068D 5.UVDATA.1

Freq = 1.5950 GHz, Bw = 16.000 MH No calibration applied and no bandpass applied

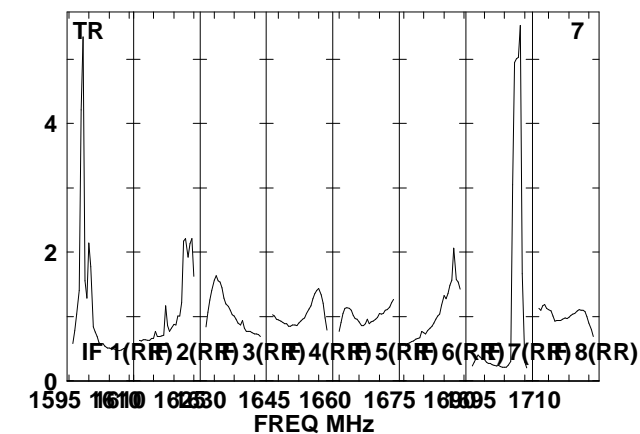
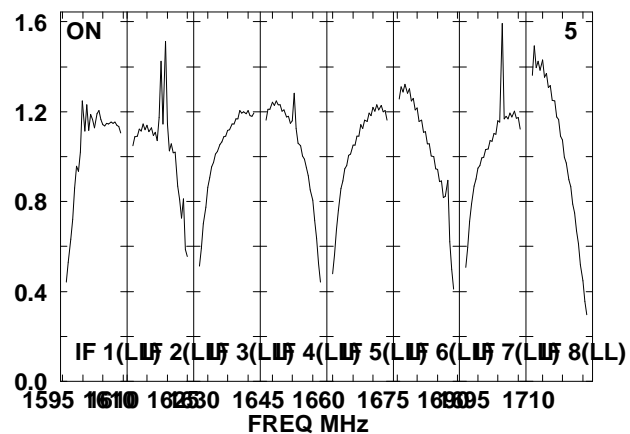
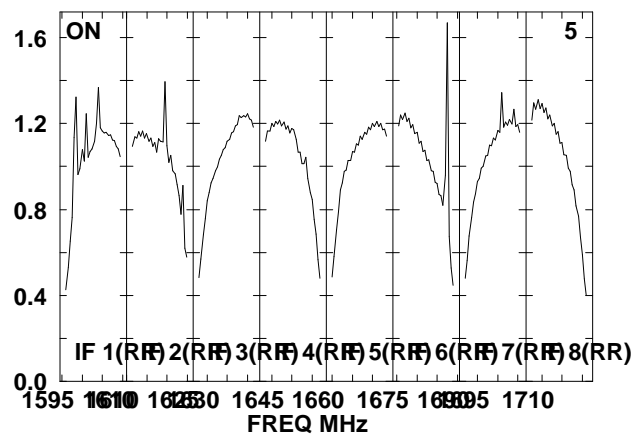
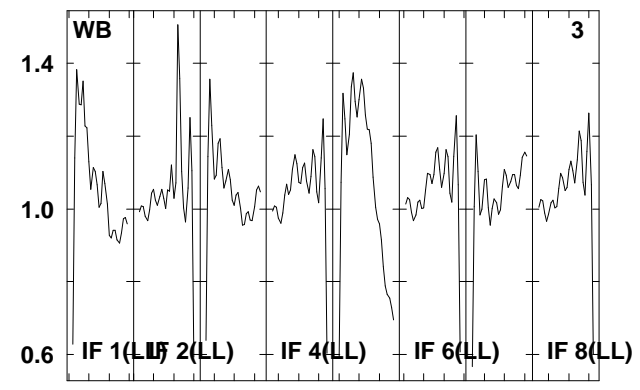
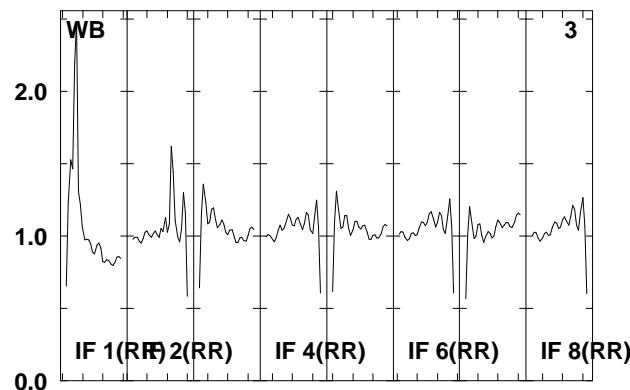
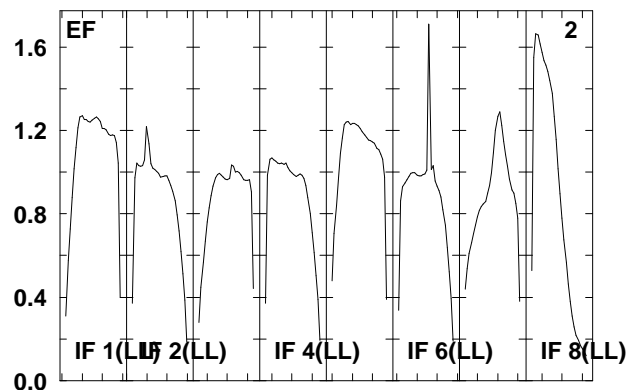
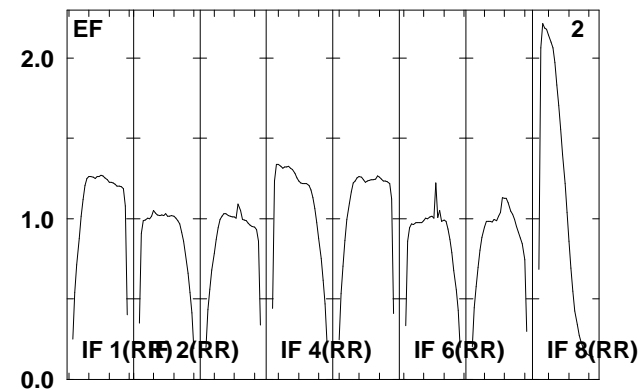
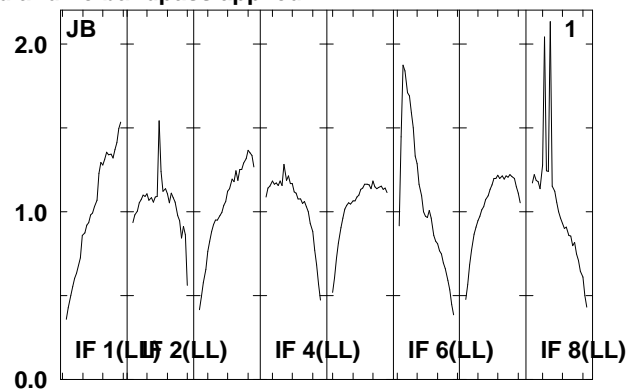
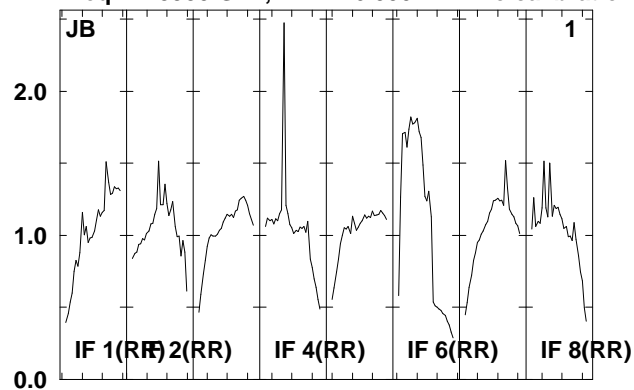

Lower frame: Real Jy
Total-power spectrum Antenna: *
Timerange: 00/17:57:35 to 00/17:58:59

Plot file version 268 created 06-JAN-2012 11:47:47

J1128+59 EP068D 5.UVDATA.1

Freq = 1.5950 GHz, Bw = 16.000 MH No calibration applied and no bandpass applied

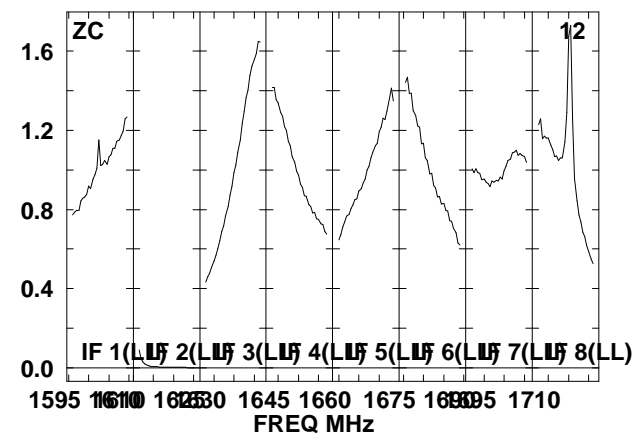
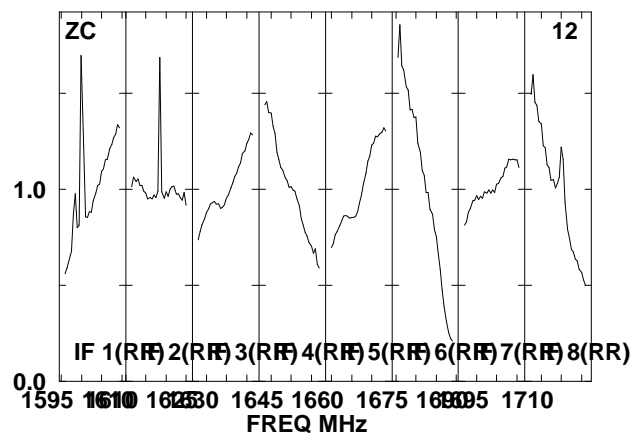
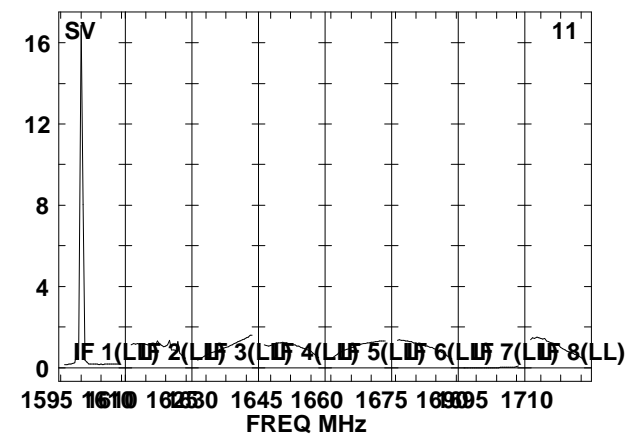
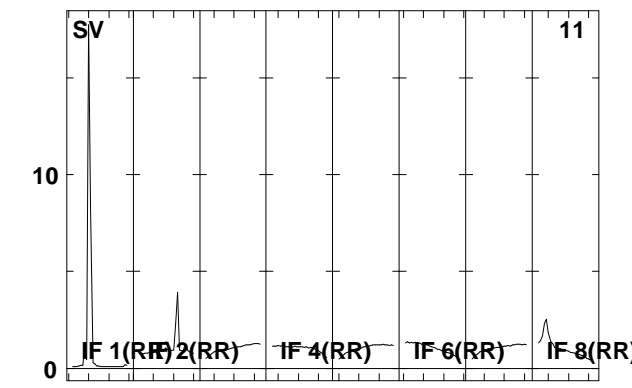
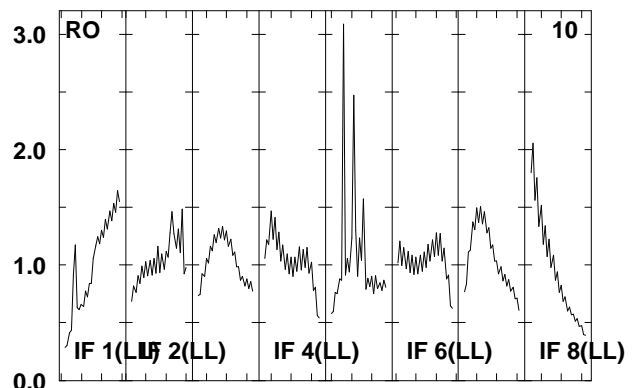
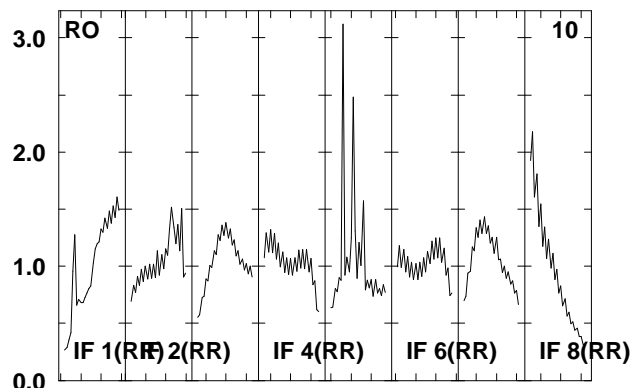
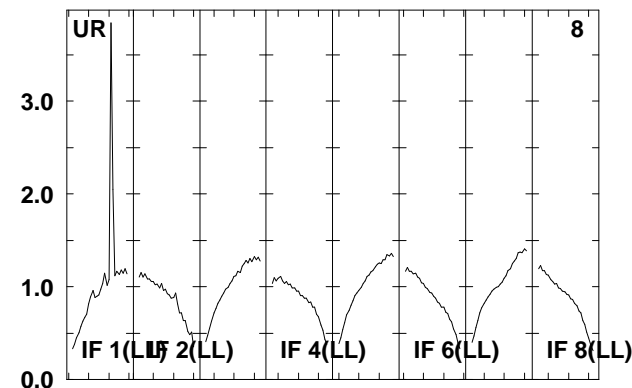
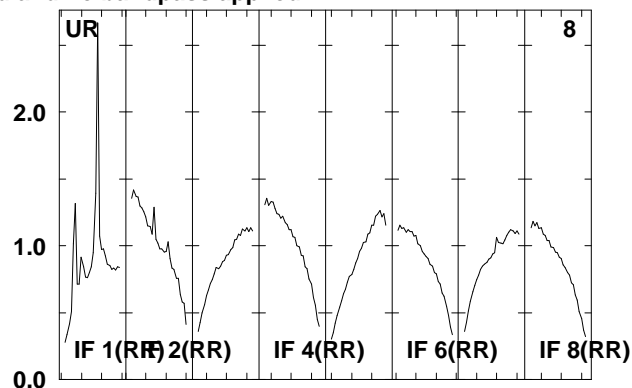
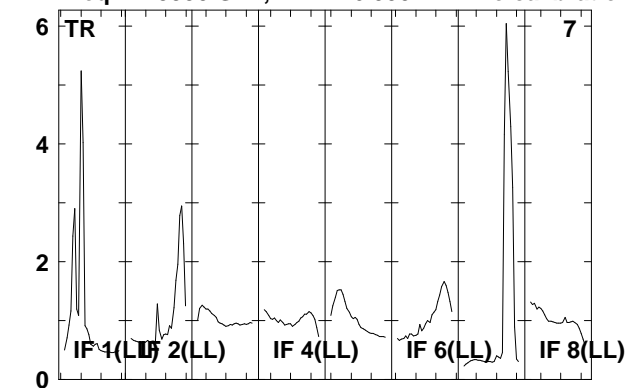

Lower frame: Real Jy
Total-power spectrum Antenna: *
Timerange: 00/17:57:35 to 00/17:58:59

Plot file version 269 created 06-JAN-2012 11:47:48

ARP299D EP068D 5.UVDATA.1

Freq = 1.5950 GHz, Bw = 16.000 MH No calibration applied and no bandpass applied

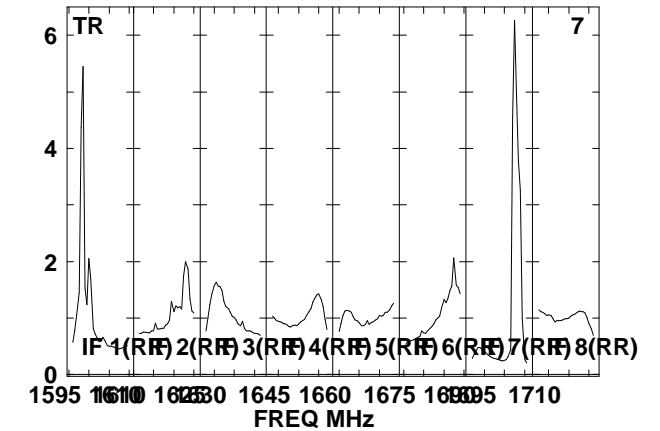
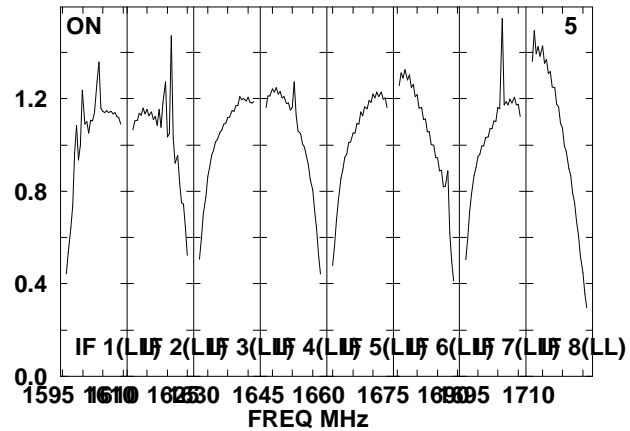
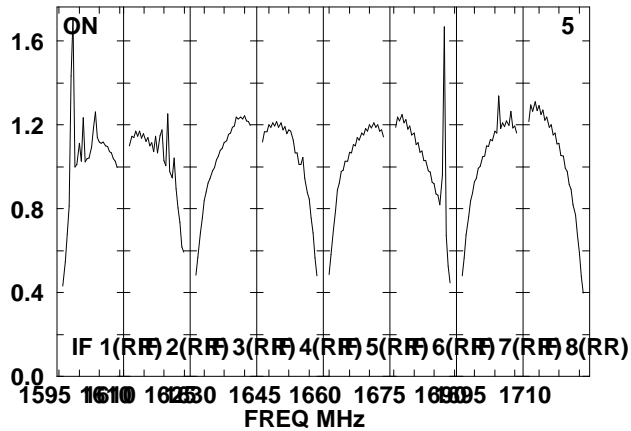
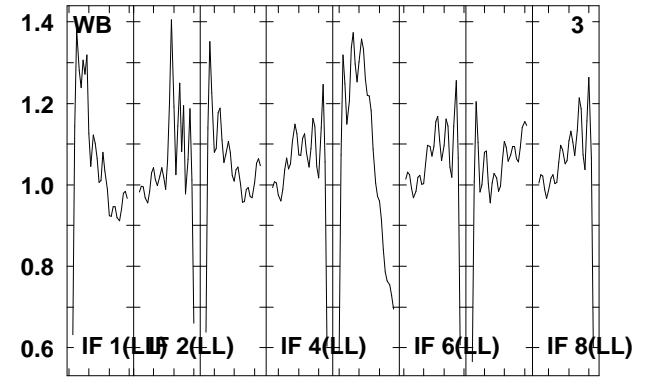
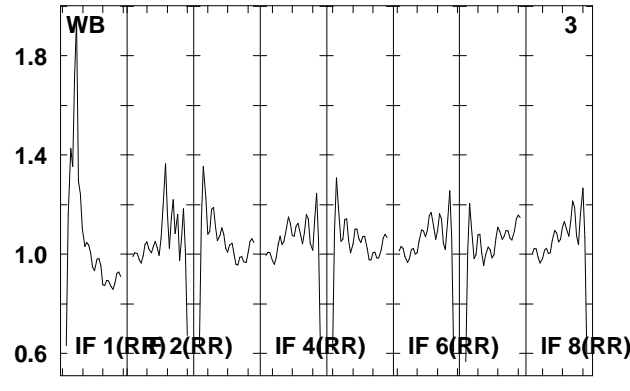
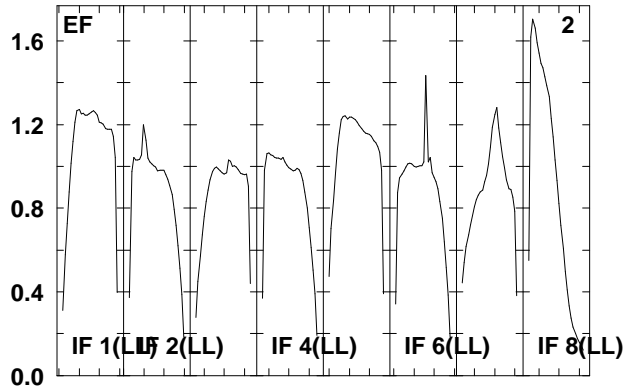
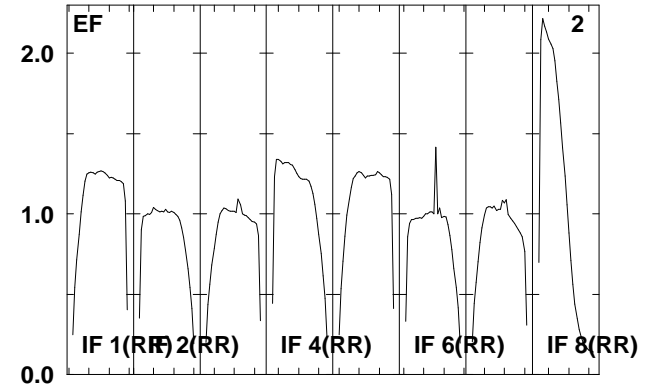
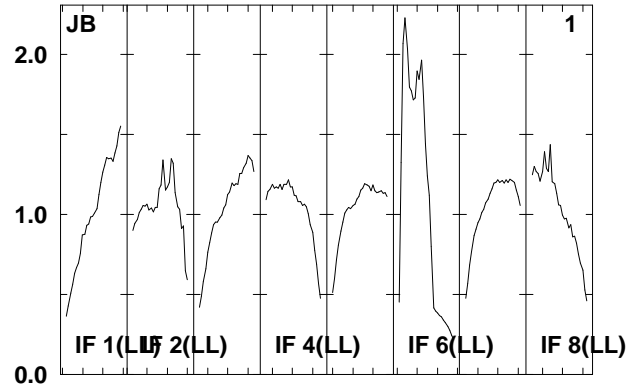
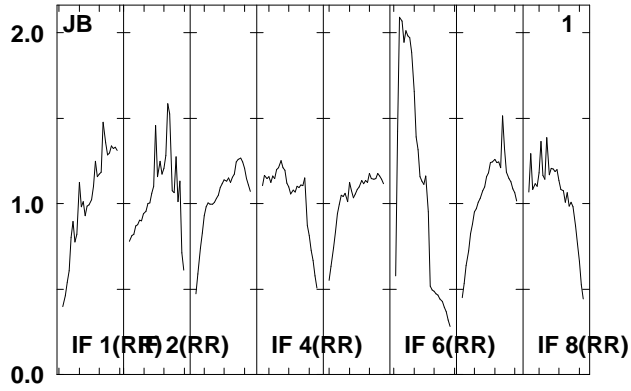

Lower frame: Real Jy
Total-power spectrum Antenna: *
Timerange: 00/17:59:05 to 00/18:02:29

Plot file version 270 created 06-JAN-2012 11:47:48

ARP299D EP068D 5.UVDATA.1

Freq = 1.5950 GHz, Bw = 16.000 MH No calibration applied and no bandpass applied

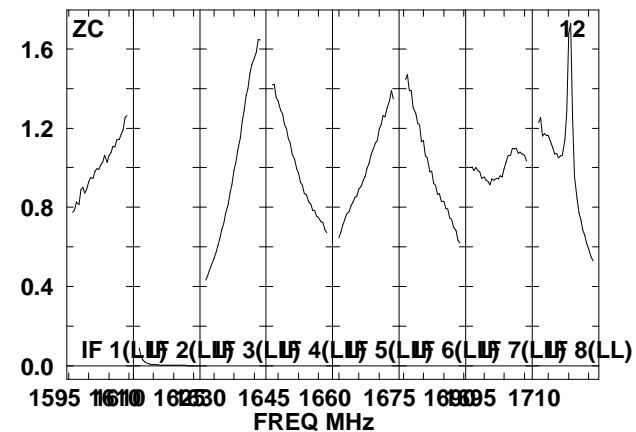
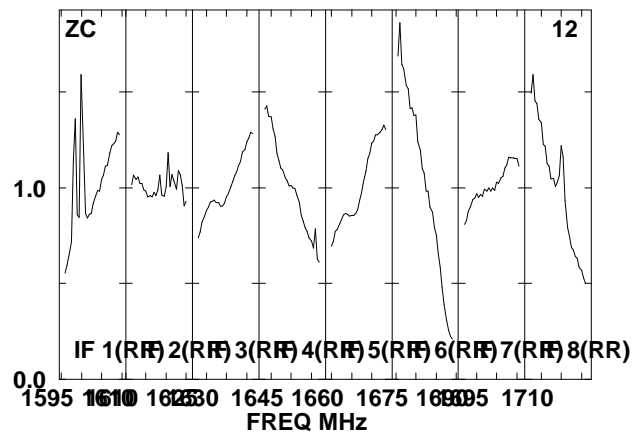
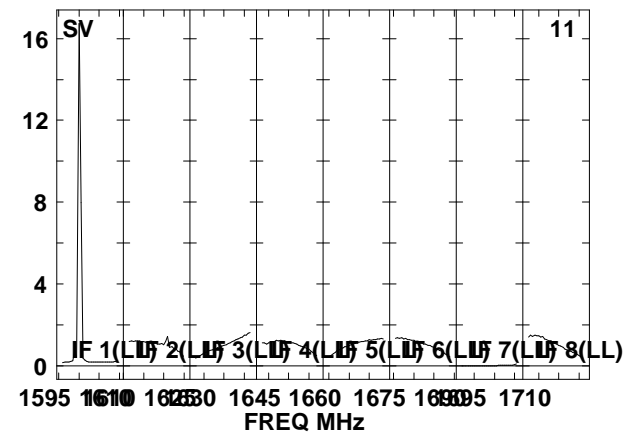
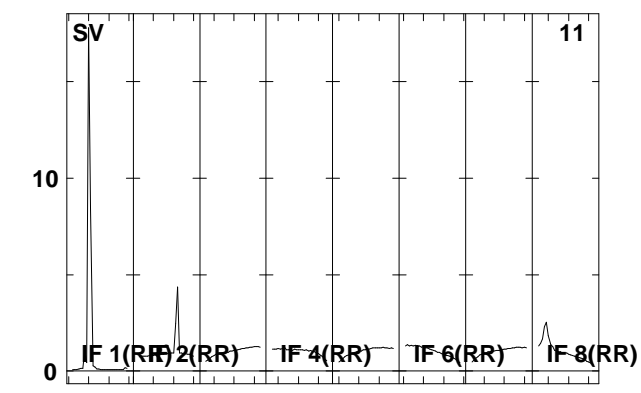
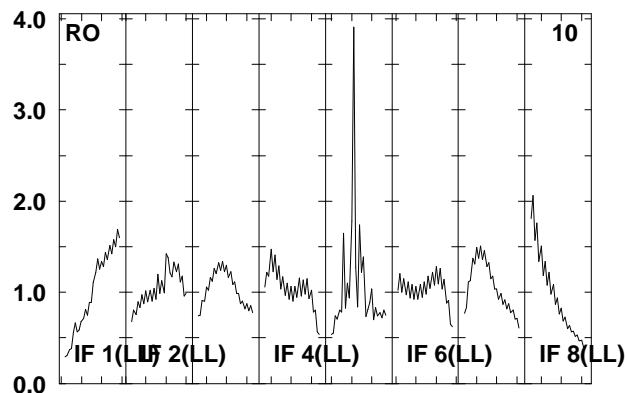
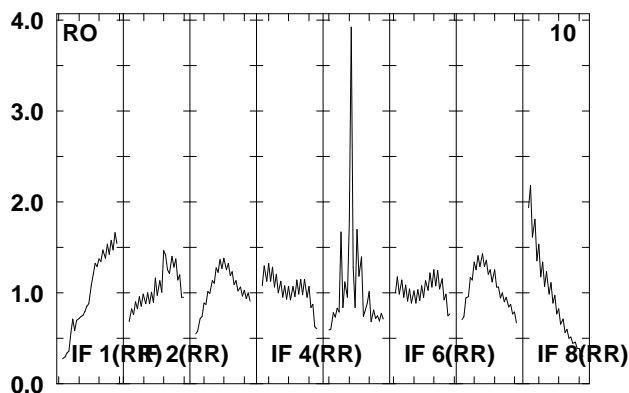
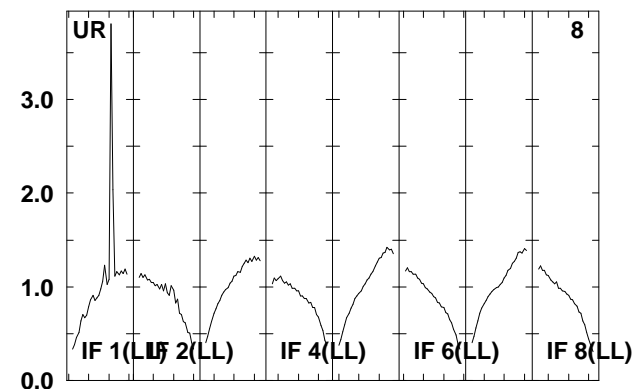
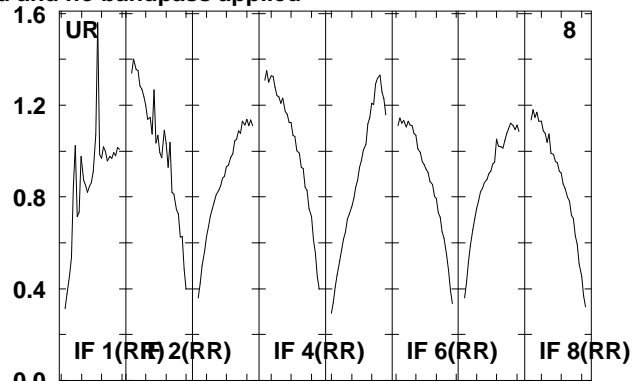
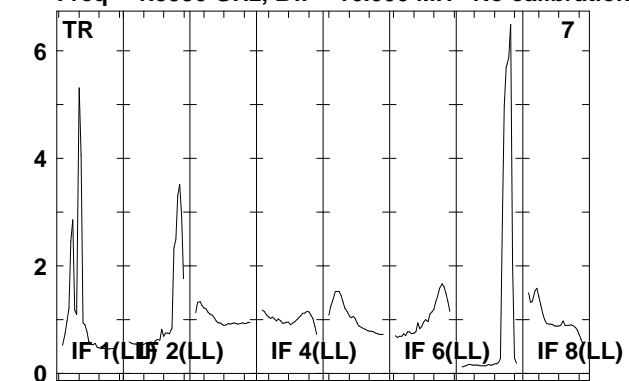

Lower frame: Real Jy

Total-power spectrum Antenna: *

Timerange: 00/17:59:05 to 00/18:02:29

Plot file version 271 created 06-JAN-2012 11:47:49

J1128+59 EP068D 5.UVDATA.1

Freq = 1.5950 GHz, Bw = 16.000 MH No calibration applied and no bandpass applied

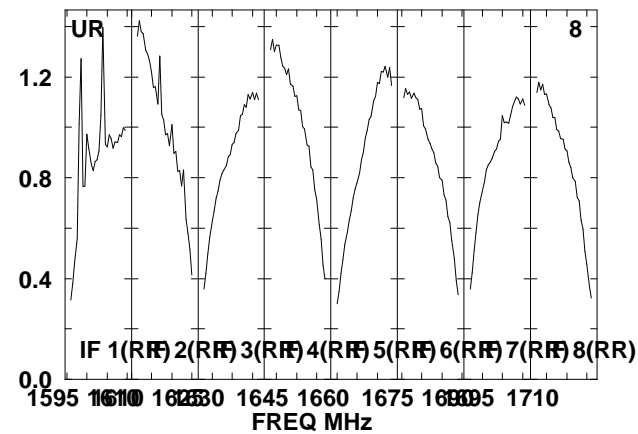
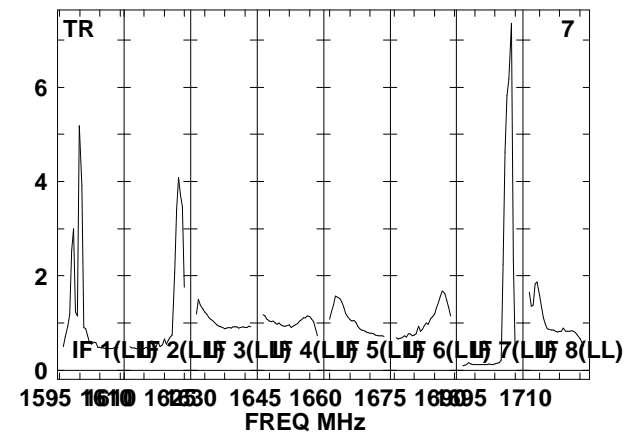
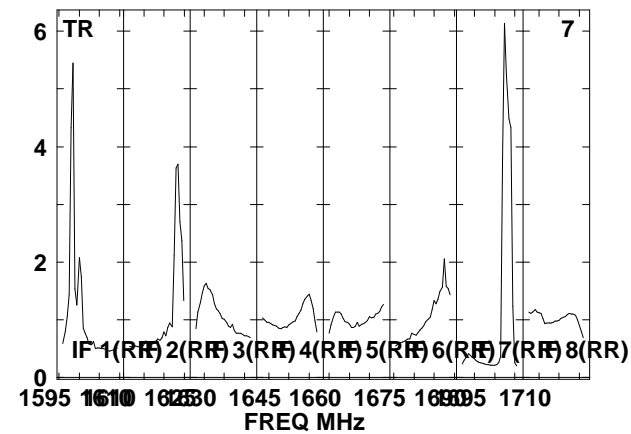
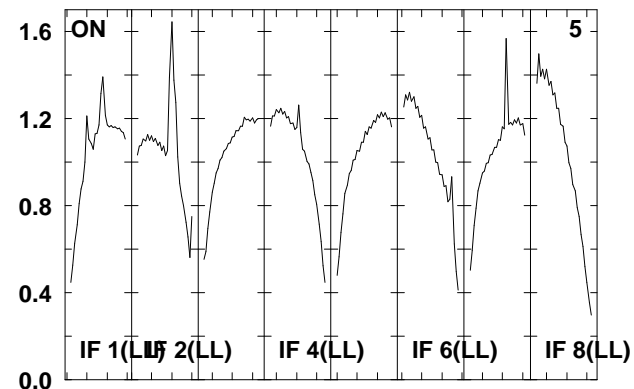
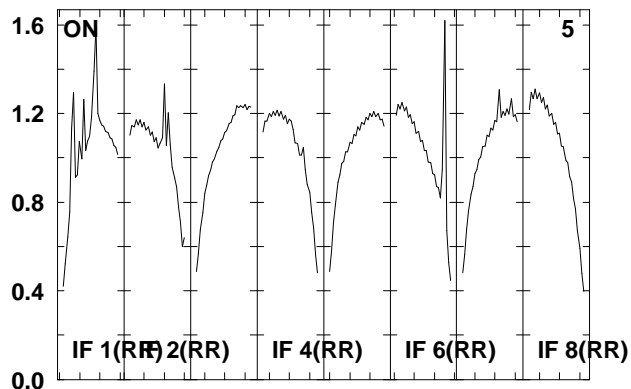
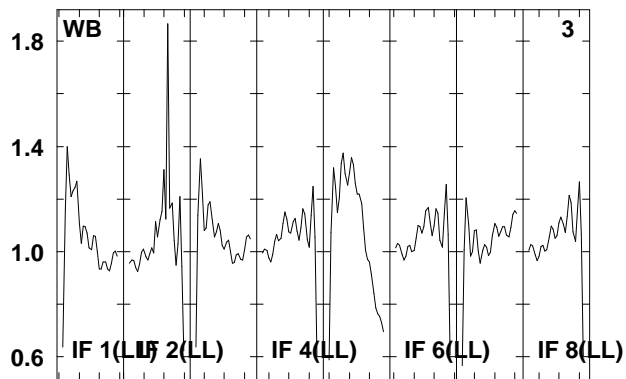
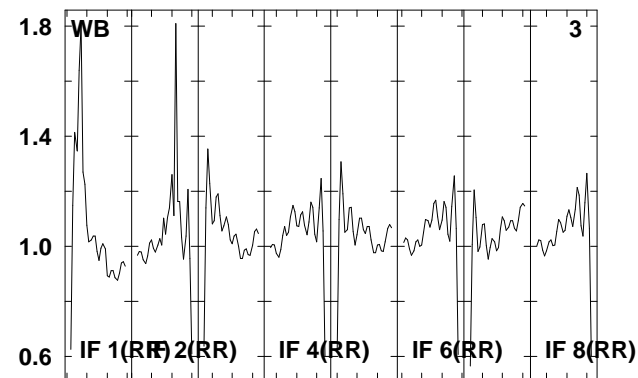
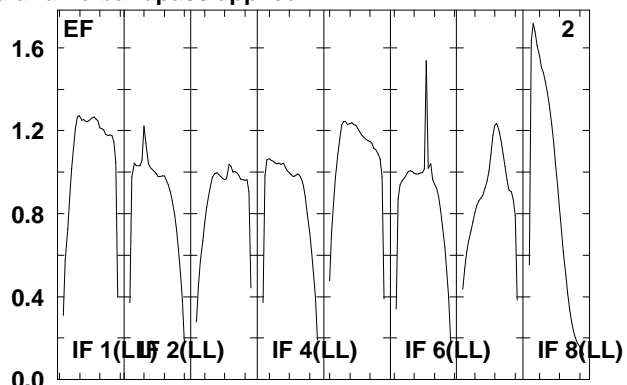
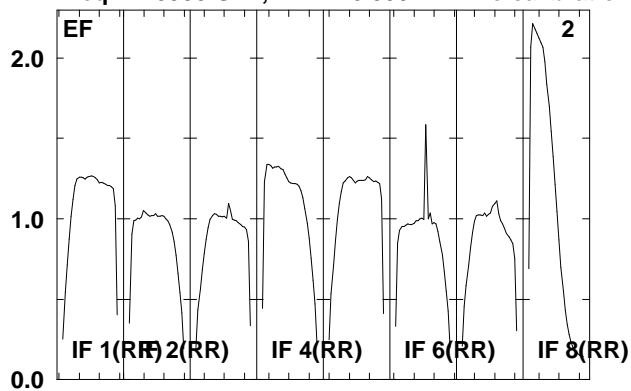

Lower frame: Real Jy
Total-power spectrum Antenna: *
Timerange: 00/18:03:31 to 00/18:04:59

Plot file version 272 created 06-JAN-2012 11:47:49

J1128+59 EP068D 5.UVDATA.1

Freq = 1.5950 GHz, Bw = 16.000 MH No calibration applied and no bandpass applied

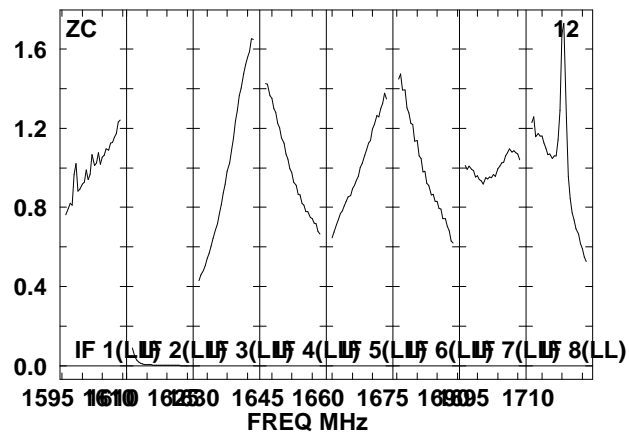
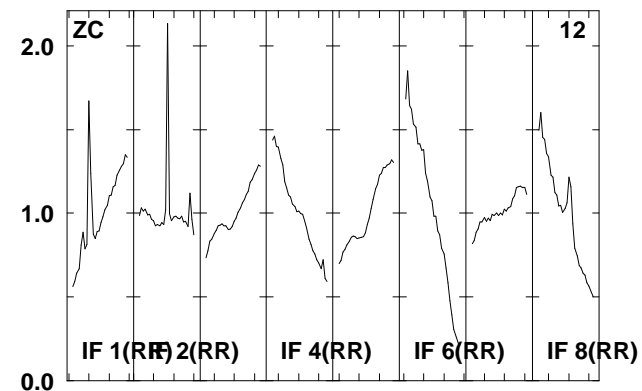
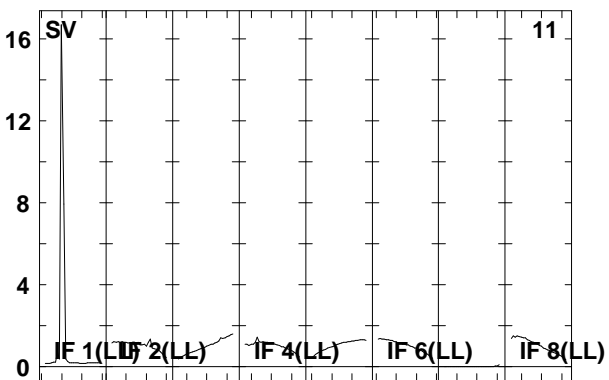
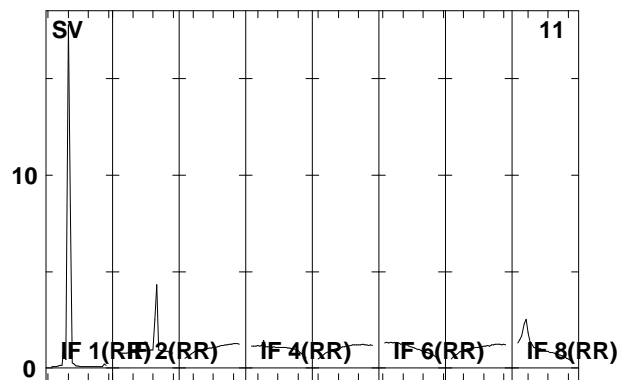
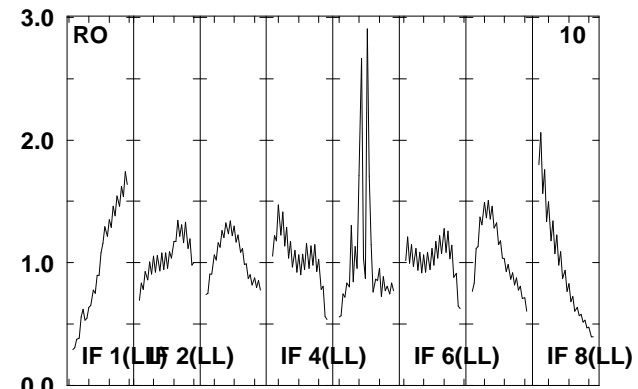
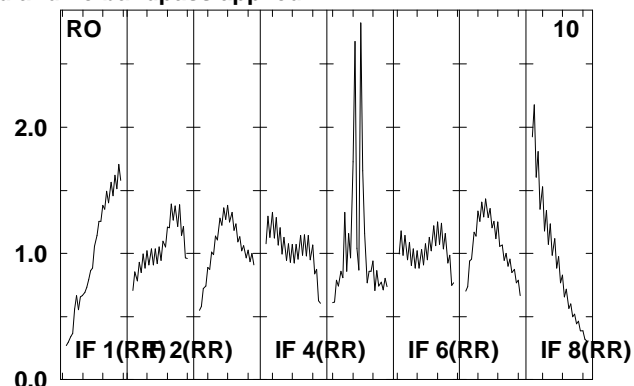
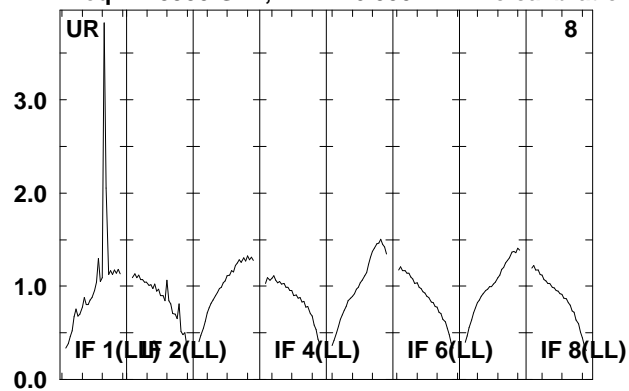

Lower frame: Real Jy

Total-power spectrum Antenna: *

Timerange: 00/18:03:31 to 00/18:04:59

Plot file version 273 created 06-JAN-2012 11:47:50

ARP299D EP068D 5.UVDATA.1

Freq = 1.5950 GHz, Bw = 16.000 MH No calibration applied and no bandpass applied

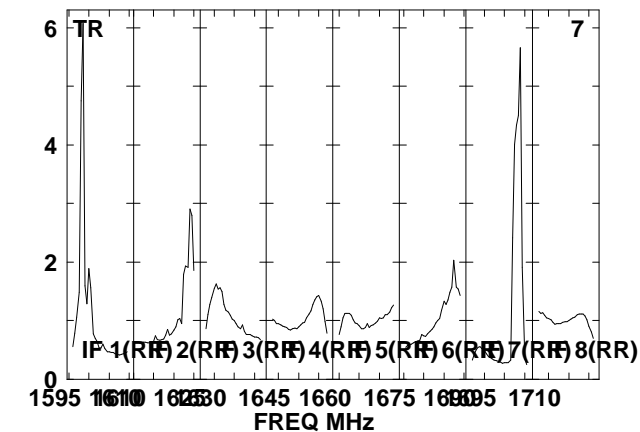
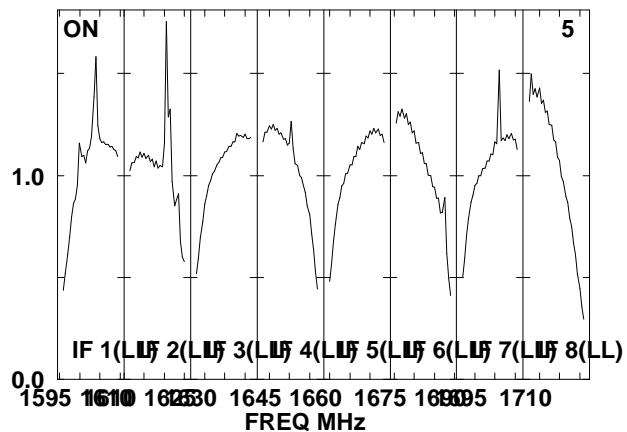
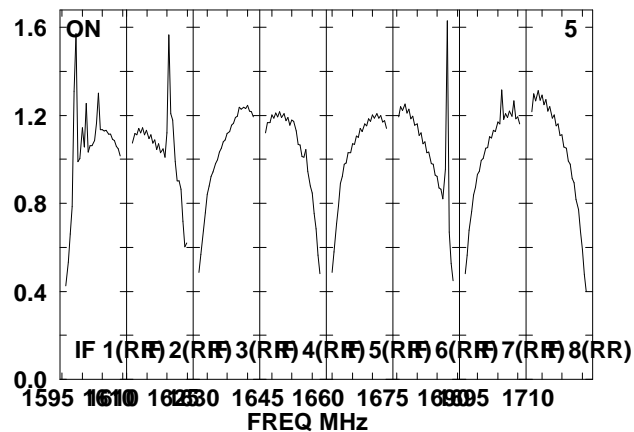
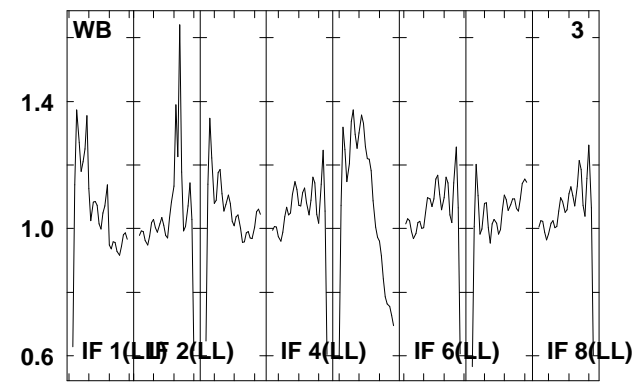
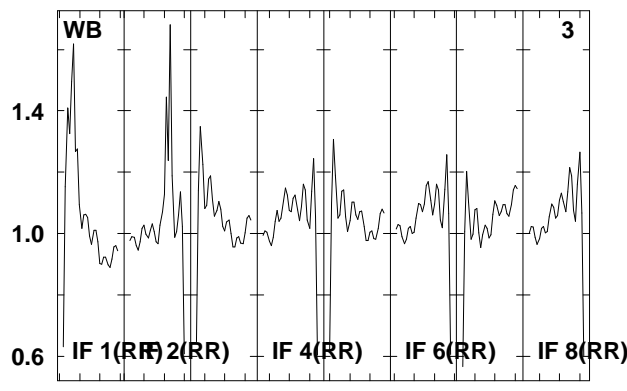
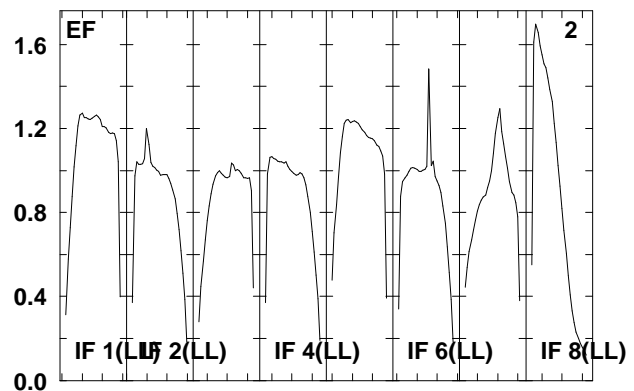
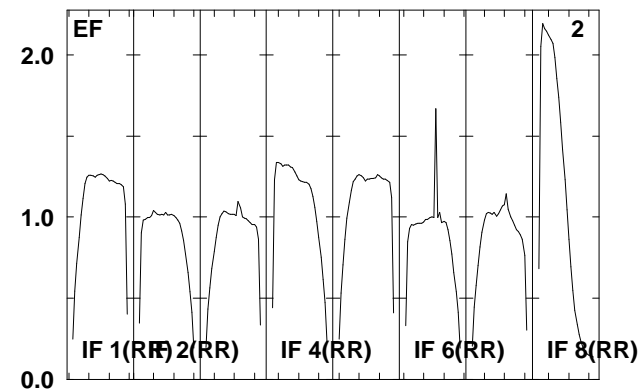
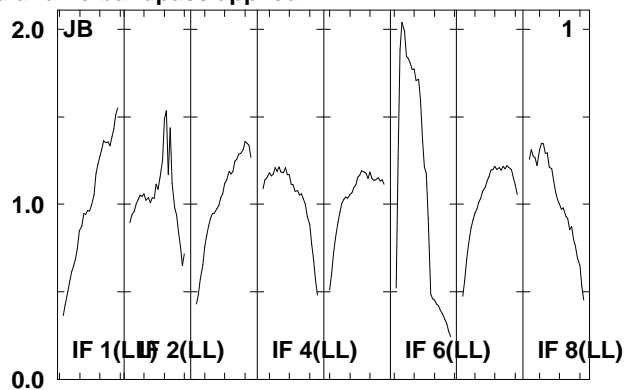
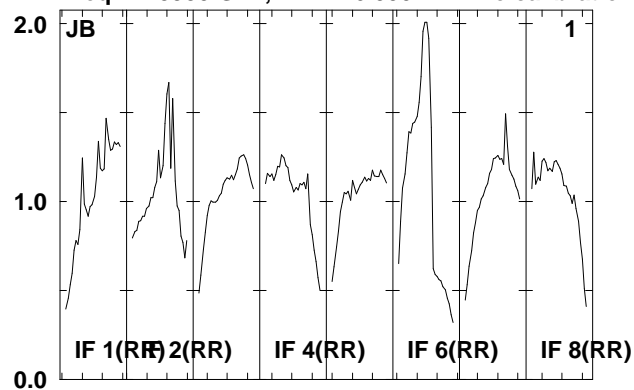

Lower frame: Real Jy
Total-power spectrum Antenna: *
Timerange: 00/18:05:01 to 00/18:08:29

Plot file version 274 created 06-JAN-2012 11:47:50

ARP299D EP068D 5.UVDATA.1

Freq = 1.5950 GHz, Bw = 16.000 MH No calibration applied and no bandpass applied

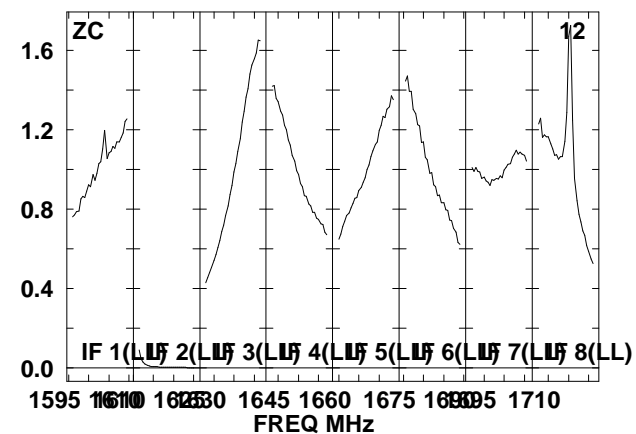
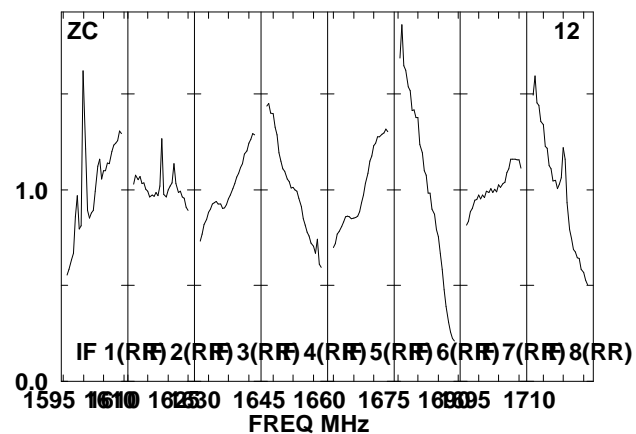
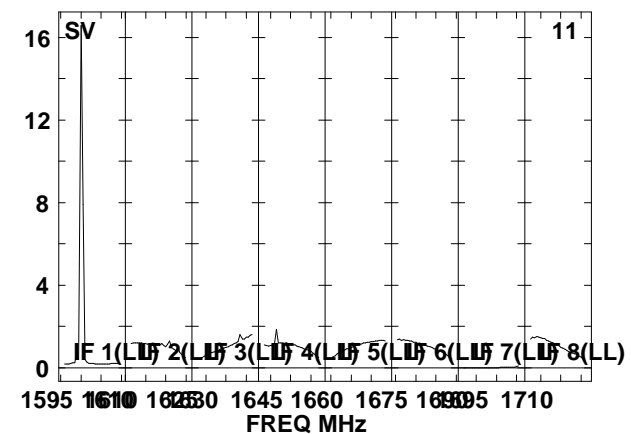
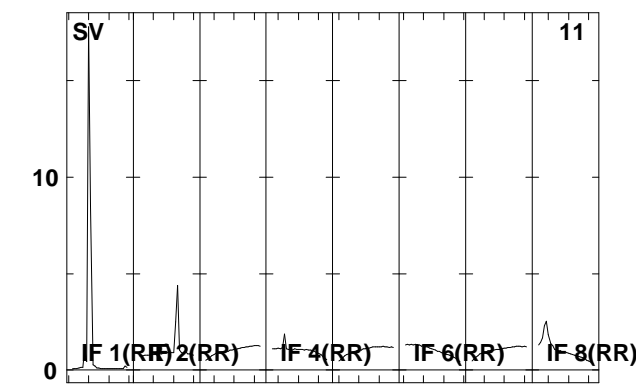
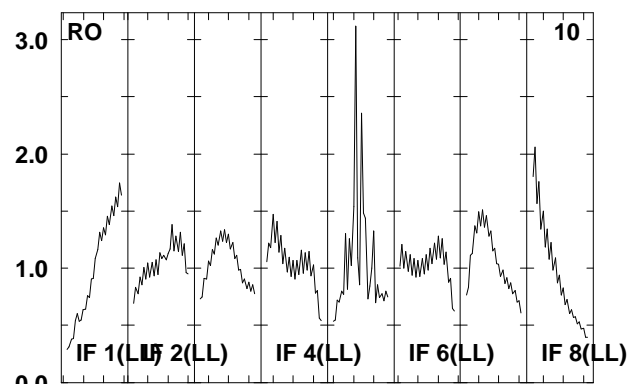
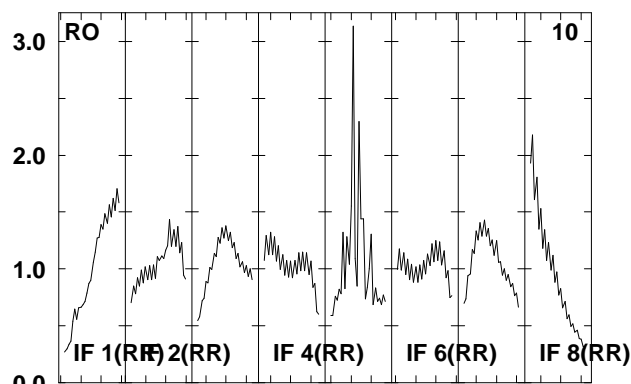
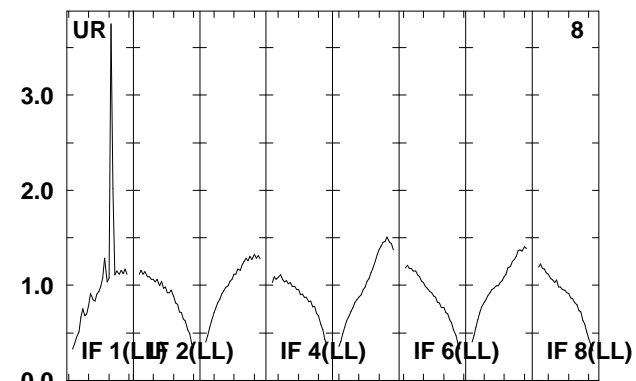
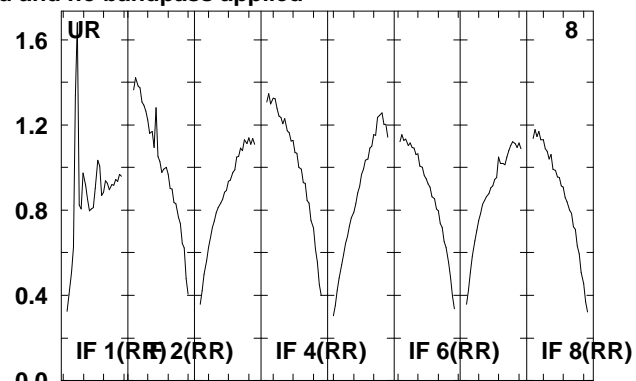
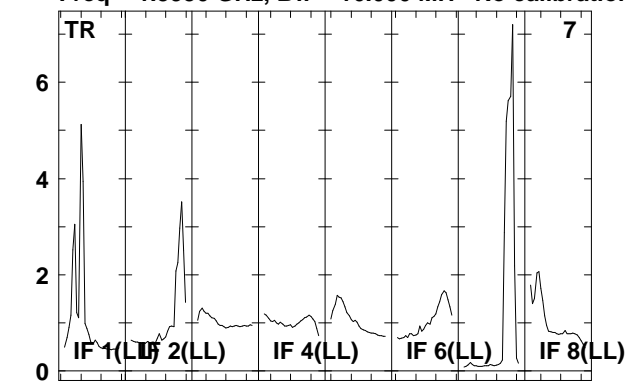

Lower frame: Real Jy
Total-power spectrum Antenna: *
Timerange: 00/18:05:01 to 00/18:08:29

Plot file version 275 created 06-JAN-2012 11:47:51

J1128+59 EP068D 5.UVDATA.1

Freq = 1.5950 GHz, Bw = 16.000 MH No calibration applied and no bandpass applied

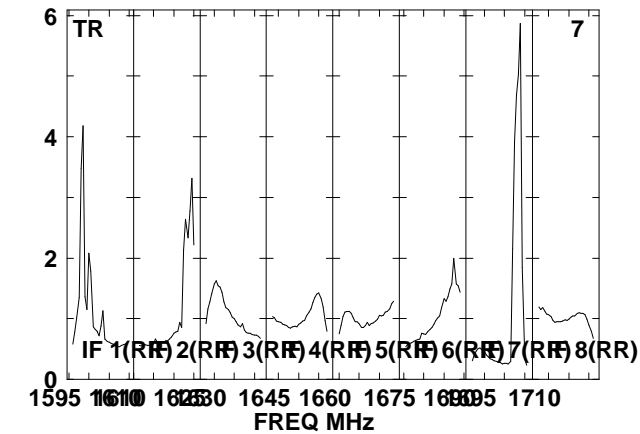
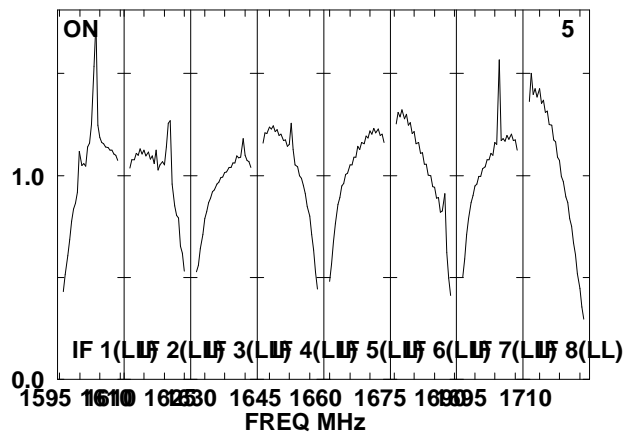
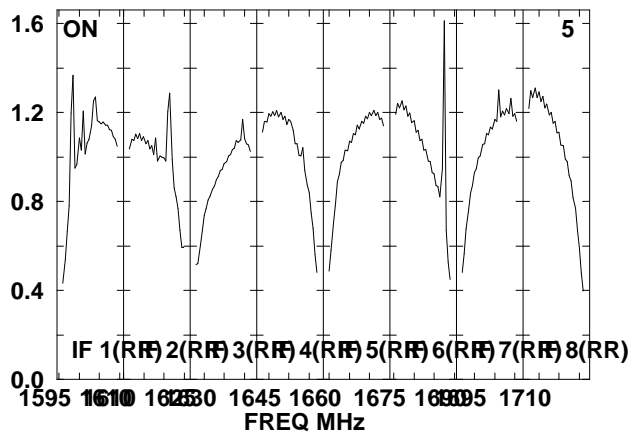
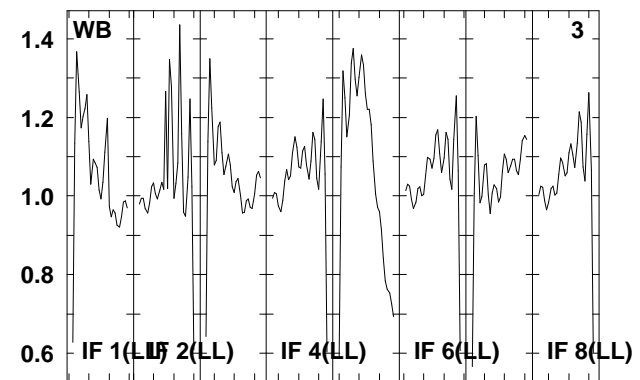
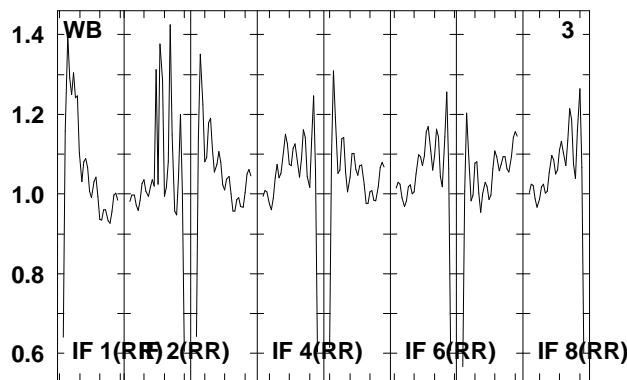
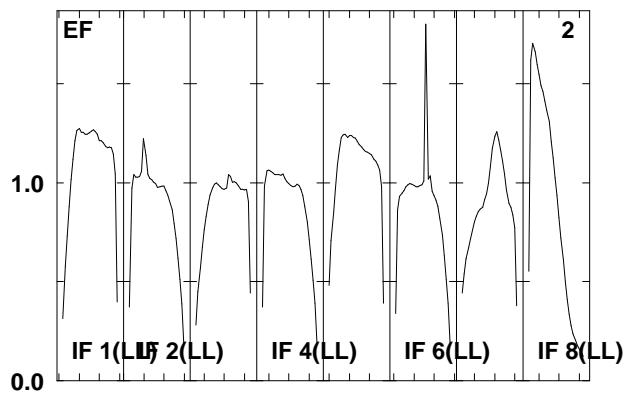
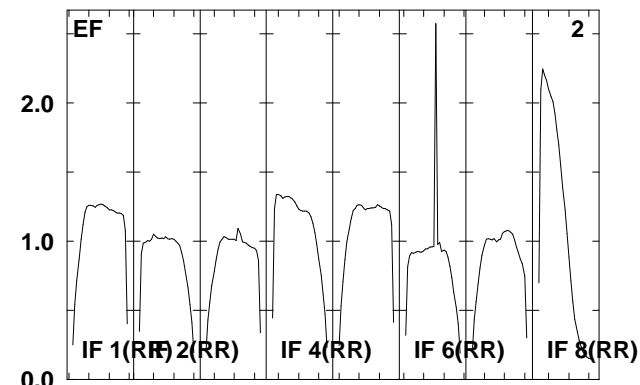
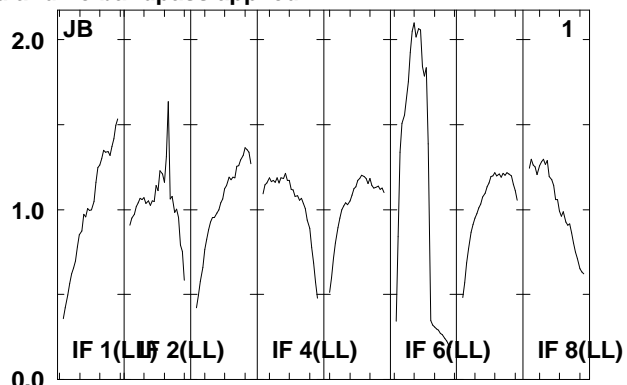
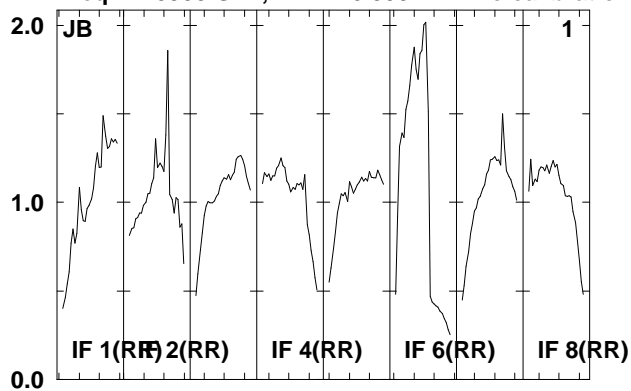

Lower frame: Real Jy
Total-power spectrum Antenna: *
Timerange: 00/18:08:35 to 00/18:09:59

Plot file version 276 created 06-JAN-2012 11:47:51

J1128+59 EP068D 5.UVDATA.1

Freq = 1.5950 GHz, Bw = 16.000 MH No calibration applied and no bandpass applied

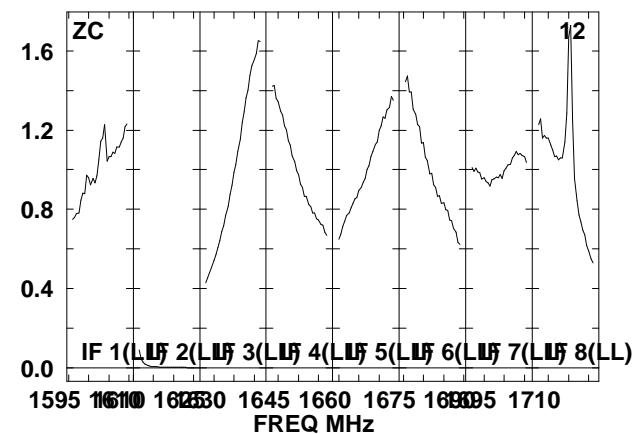
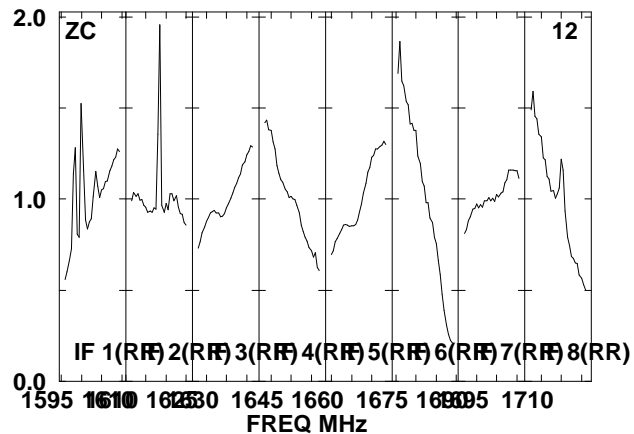
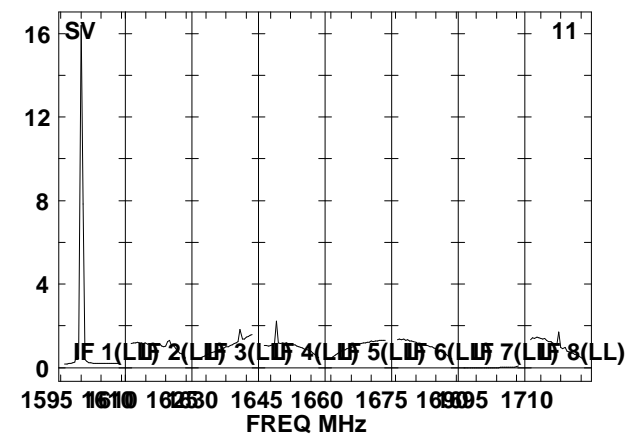
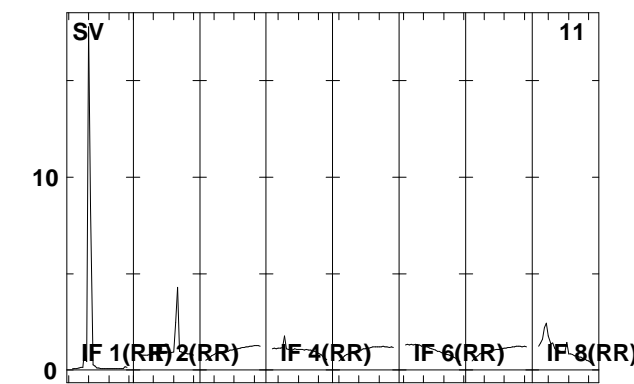
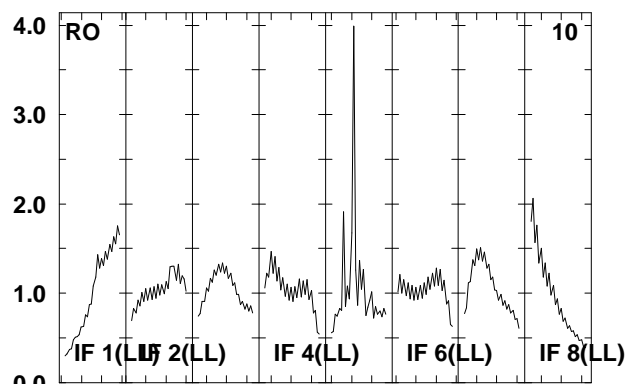
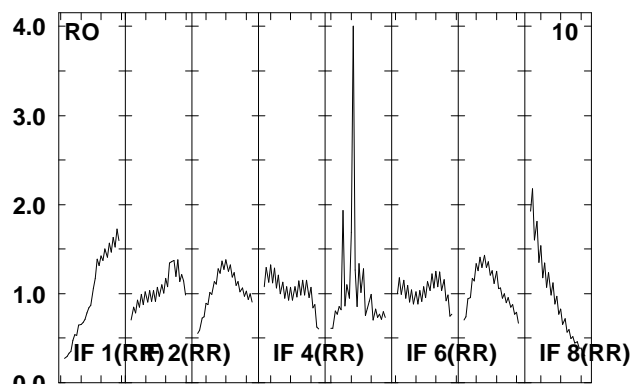
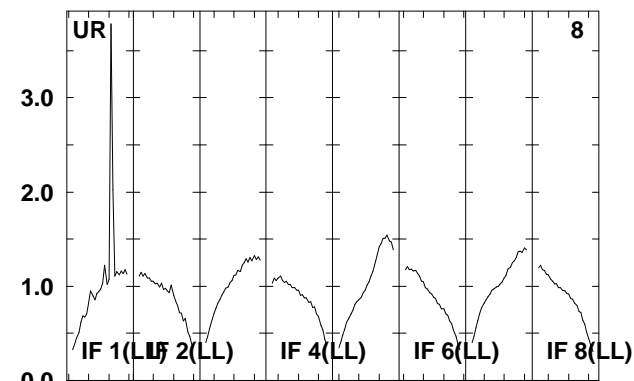
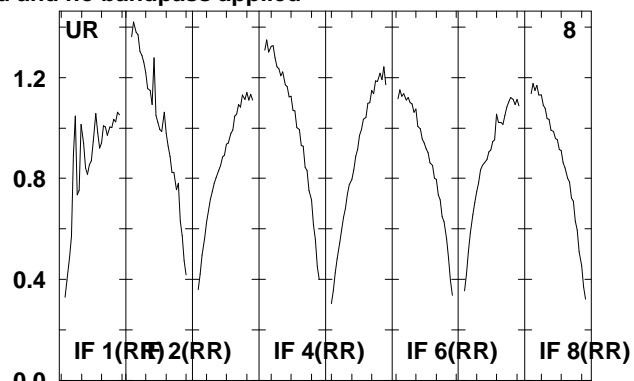
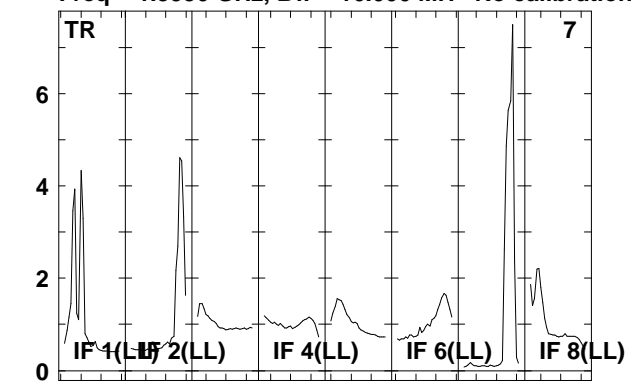

Lower frame: Real Jy

Total-power spectrum Antenna: *

Timerange: 00/18:08:35 to 00/18:09:59