

Plot file version 1 created 25-MAR-2014 17:50:42

4C39.25 EP087E 1.UVDATA.1

Freq = 1.5950 GHz, Bw = 16.000 MH Calibrated with CL # 3 and BP # 1 (BP mode 1)

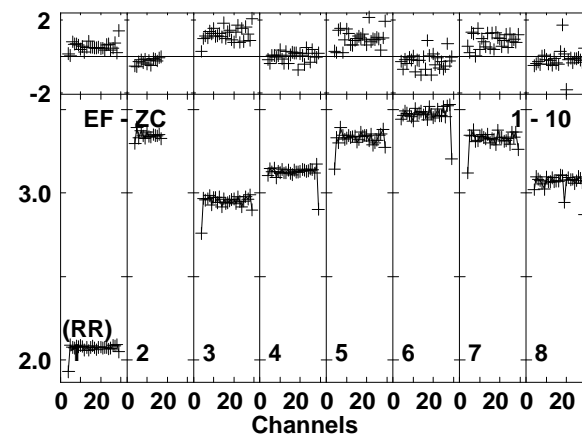
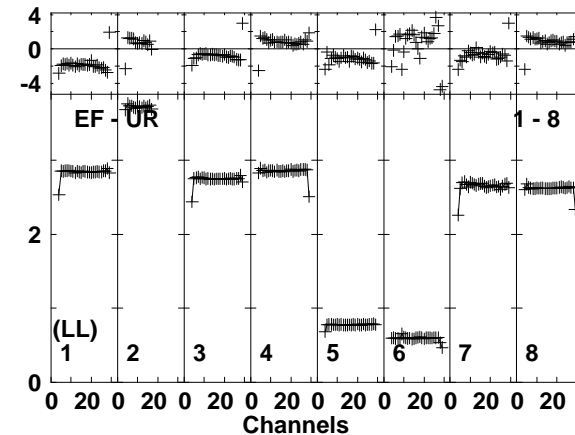
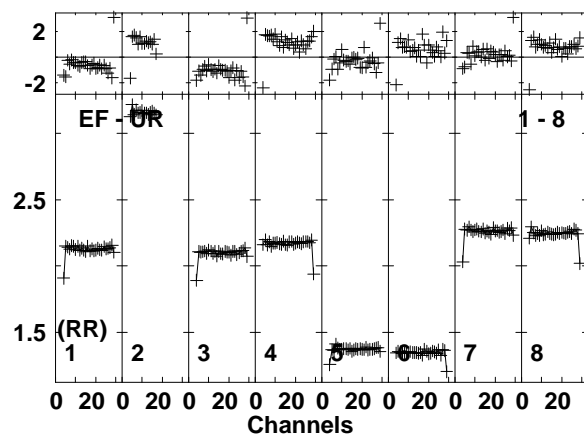
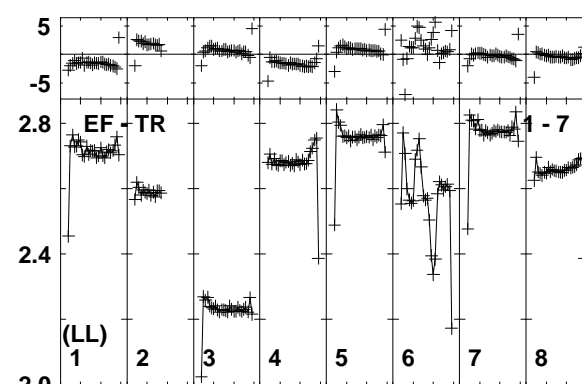
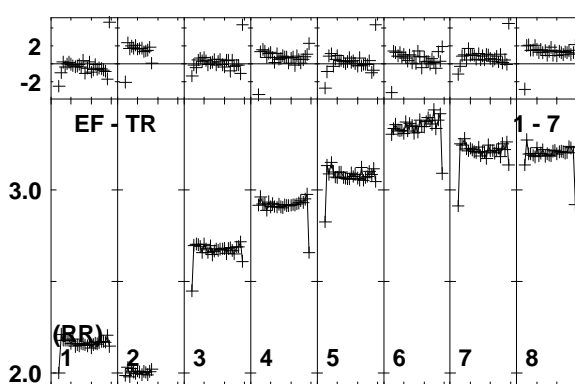
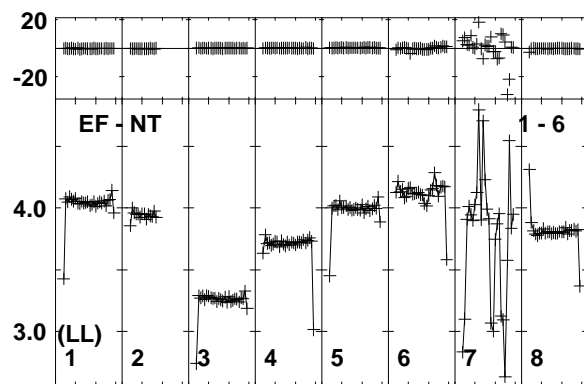
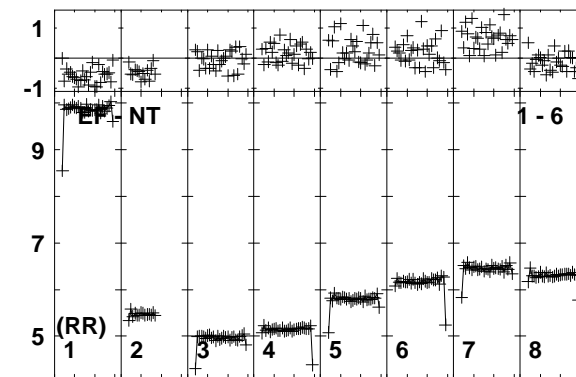
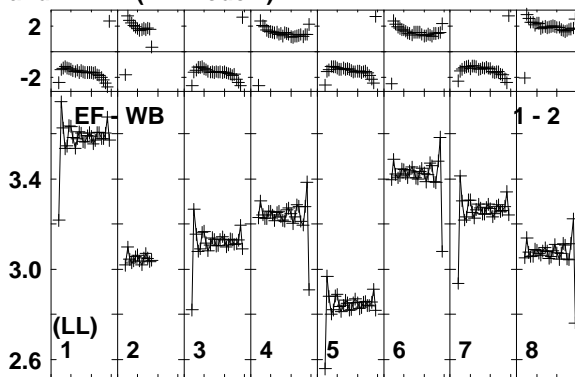
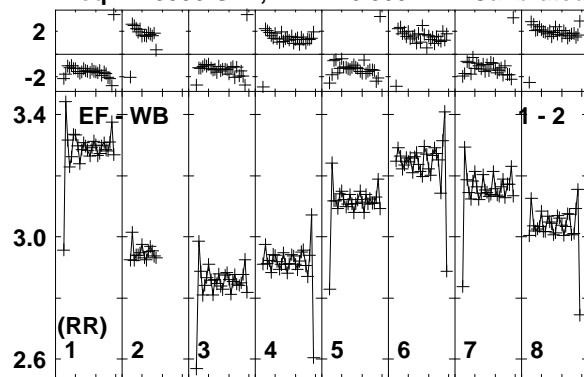

Lower frame: Ampl Jy Top frame: Phas deg
Vector averaged cross-power spectrum Baseline: EF (01) - WB (02)
Timerange: 00/03:00:01 to 00/03:05:59

Plot file version 2 created 25-MAR-2014 17:50:42

4C39.25 EP087E 1.UVDATA.1

Freq = 1.5950 GHz, Bw = 16.000 MH Calibrated with CL # 3 and BP # 1 (BP mode 1)

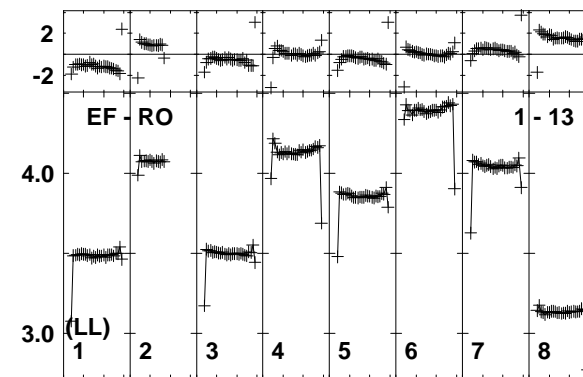
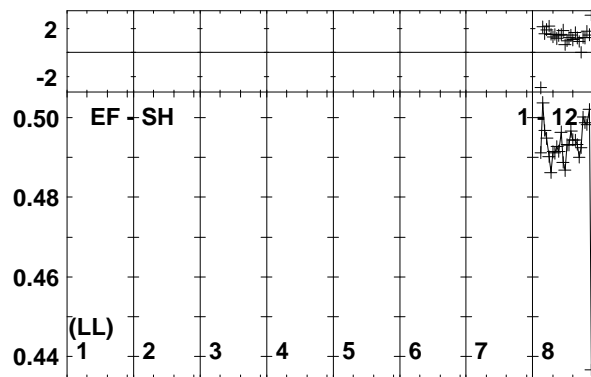
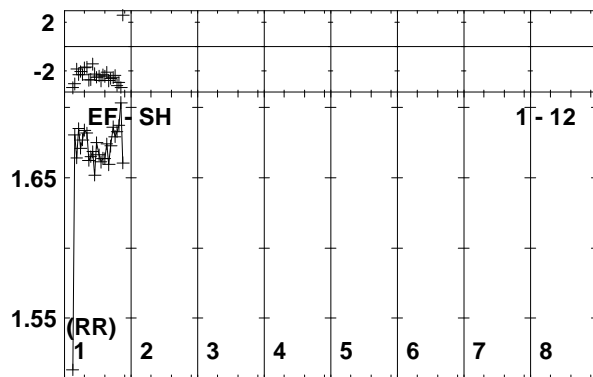
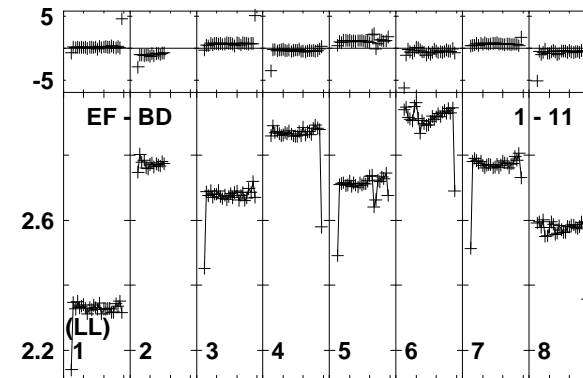
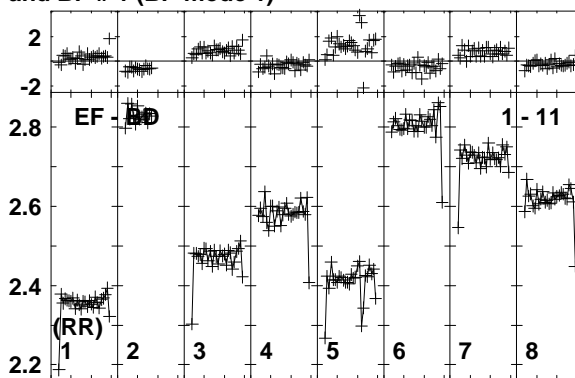
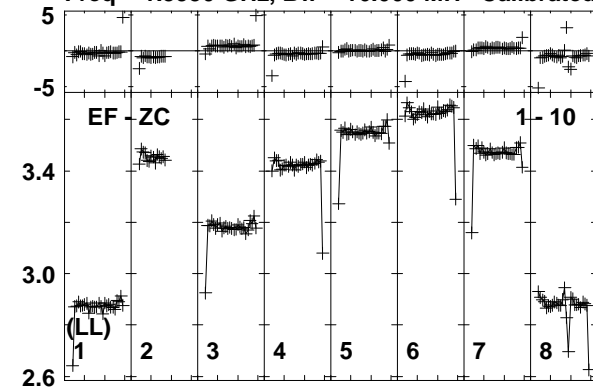

Lower frame: Ampl Jy Top frame: Phas deg
Vector averaged cross-power spectrum Baseline: EF (01) - ZC (10)
Timerange: 00/03:00:01 to 00/03:05:59

Plot file version 3 created 25-MAR-2014 17:50:42

J1128+5925 EP087E 1.UVDATA.1

Freq = 1.5950 GHz, Bw = 16.000 MH Calibrated with CL # 3 and BP # 1 (BP mode 1)

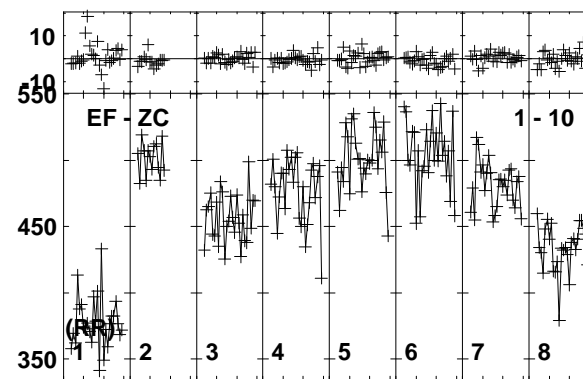
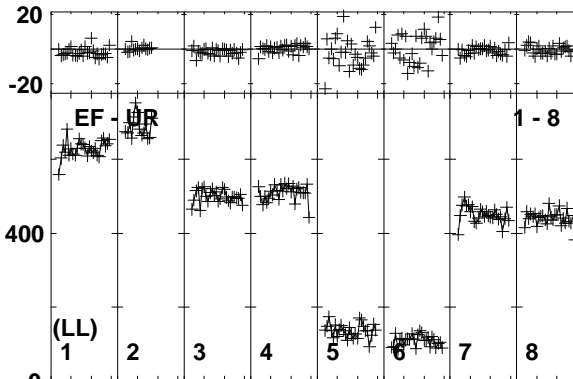
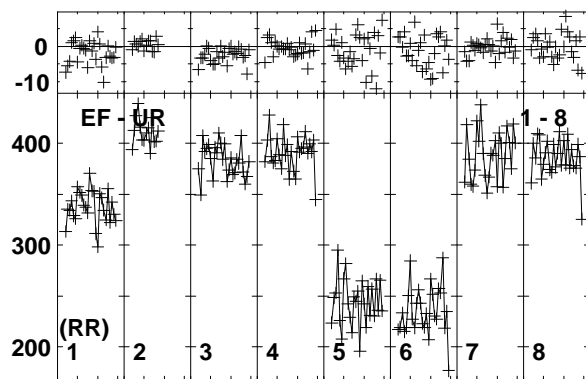
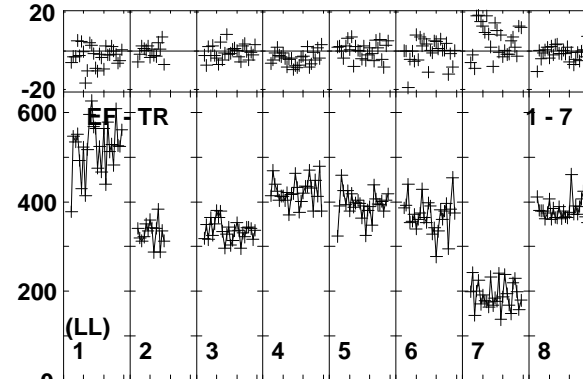
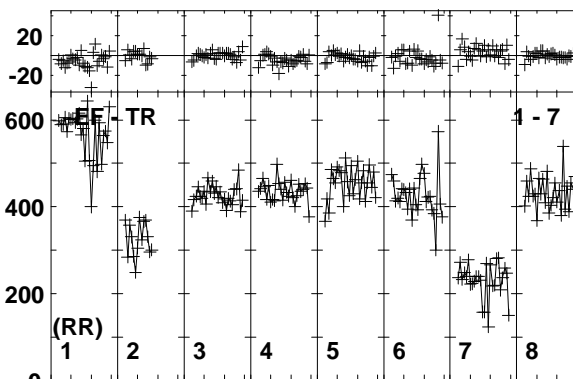
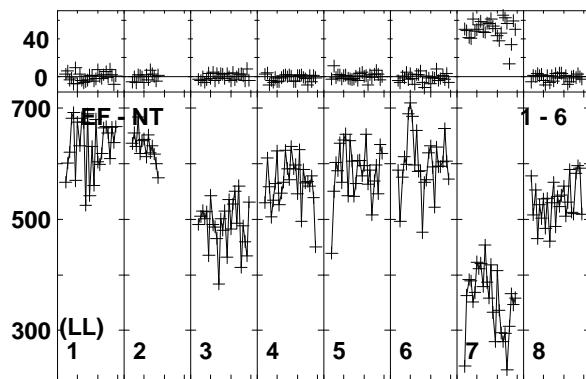
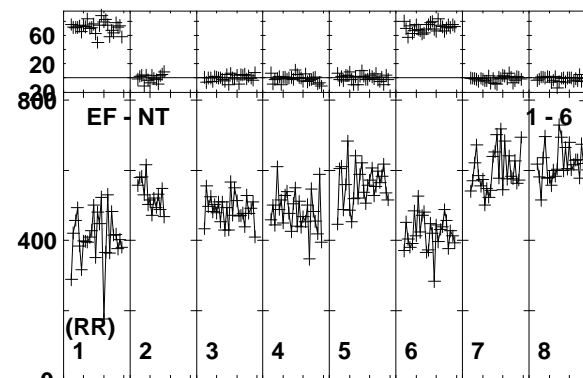
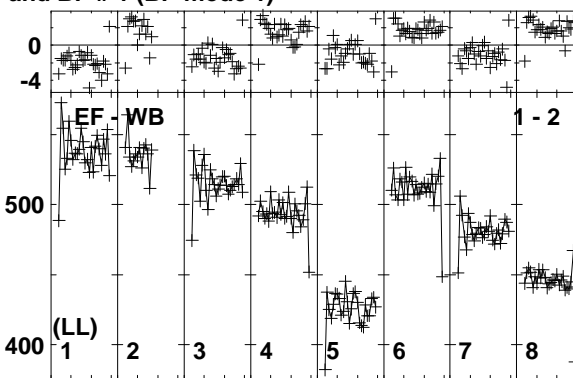
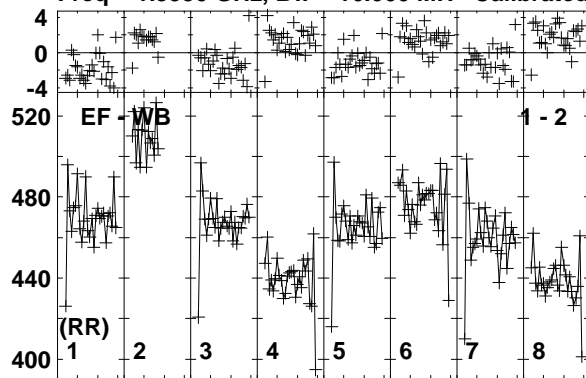

Lower frame: Milli Ampl Jy Top frame: Phas deg
Vector averaged cross-power spectrum Baseline: EF (01) - WB (02)
Timerange: 00/03:12:01 to 00/03:12:29

Plot file version 4 created 25-MAR-2014 17:50:43

J1128+5925 EP087E 1.UVDATA.1

Freq = 1.5950 GHz, Bw = 16.000 MH Calibrated with CL # 3 and BP # 1 (BP mode 1)

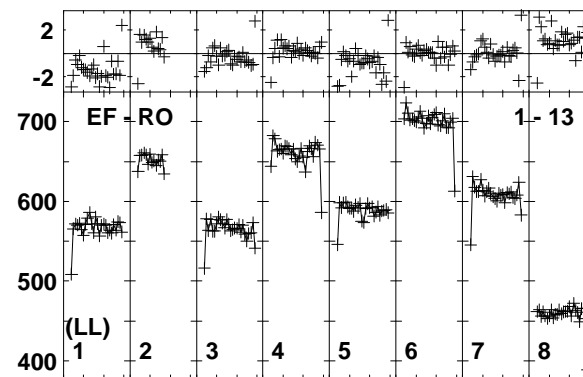
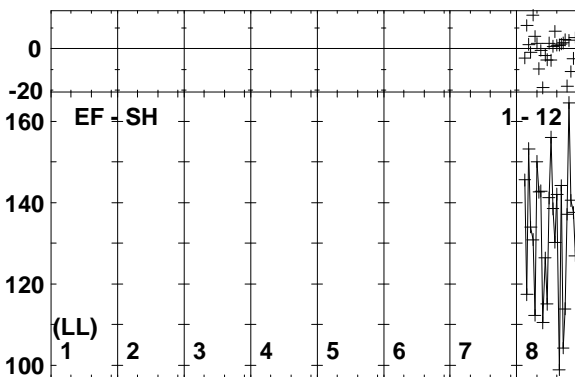
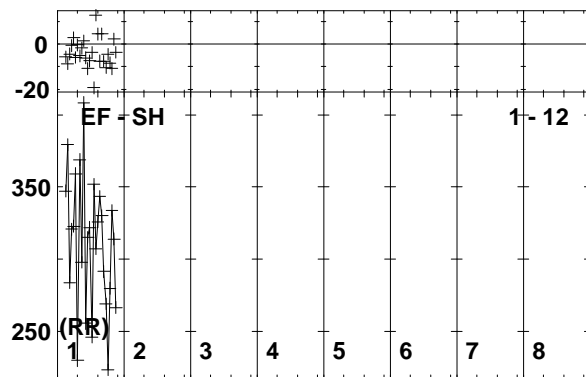
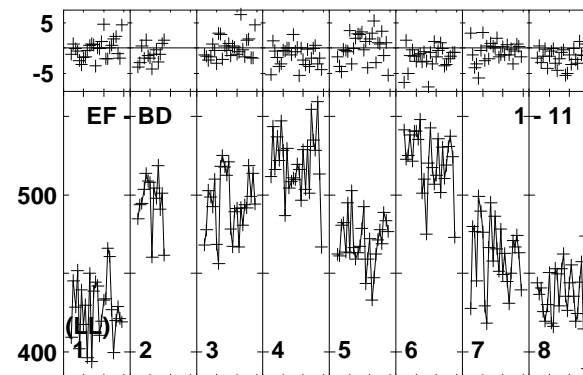
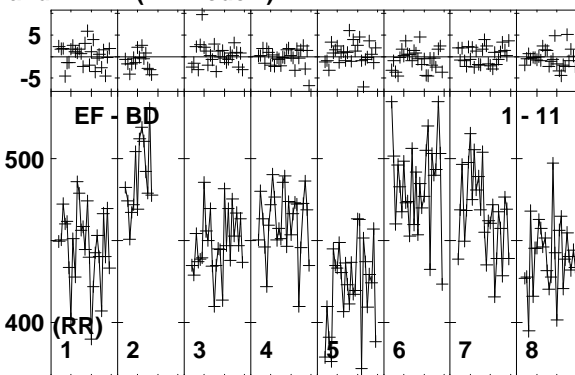
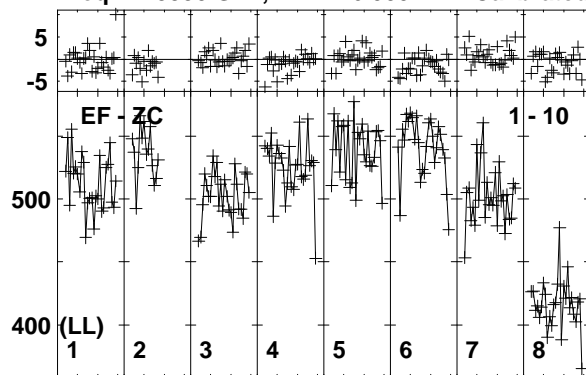

Lower frame: Milli Ampl Jy Top frame: Phas deg
Vector averaged cross-power spectrum Baseline: EF (01) - ZC (10)
Timerange: 00/03:12:01 to 00/03:12:29

Plot file version 5 created 25-MAR-2014 17:50:43

ARP299A EP087E 1.UVDATA.1

Freq = 1.5950 GHz, Bw = 16.000 MH Calibrated with CL # 3 and BP # 1 (BP mode 1)

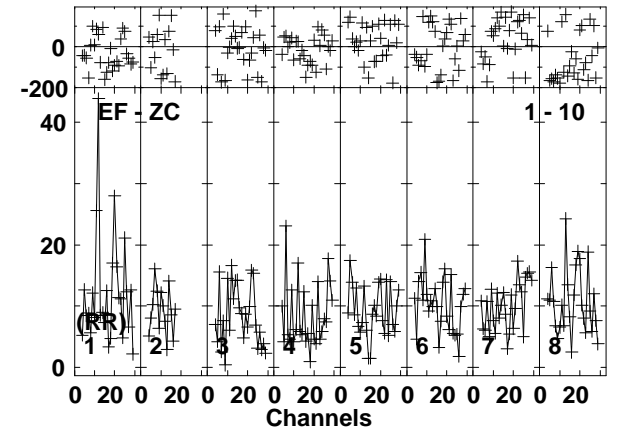
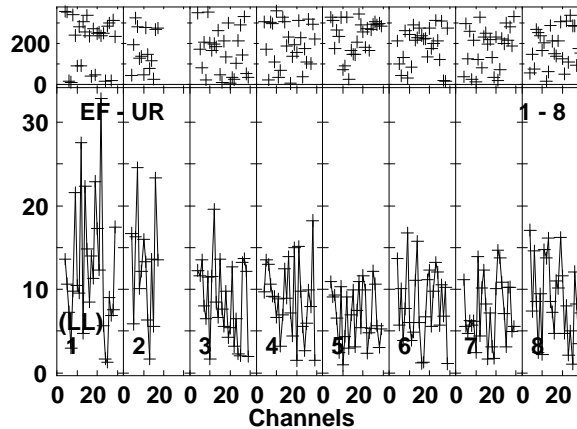
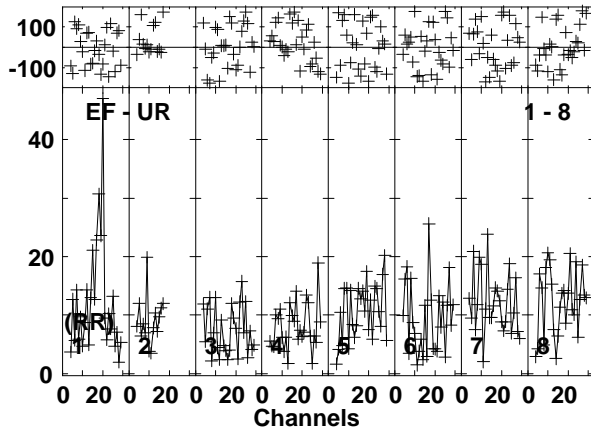
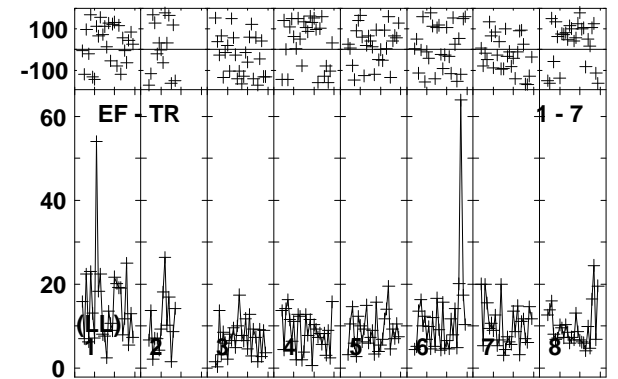
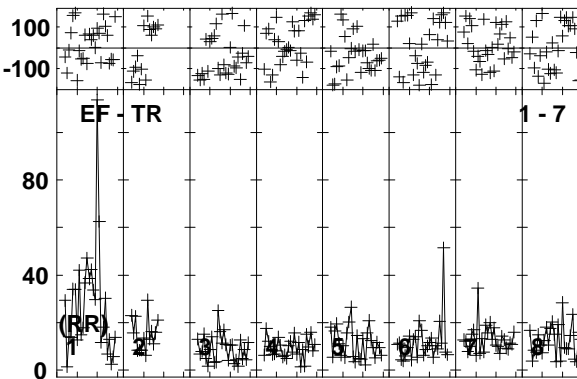
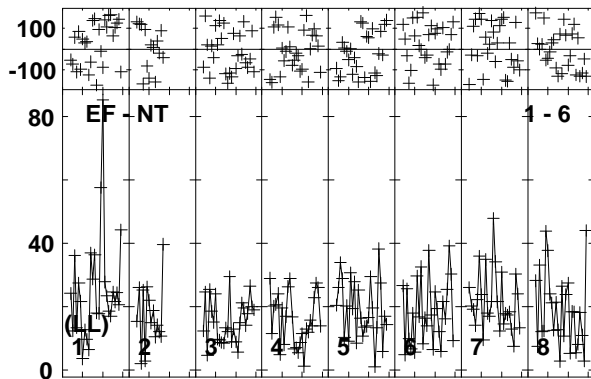
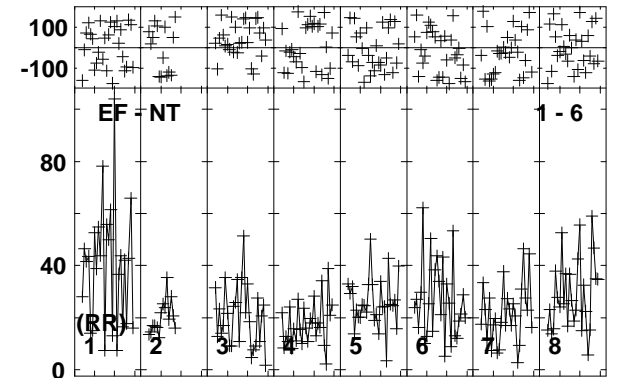
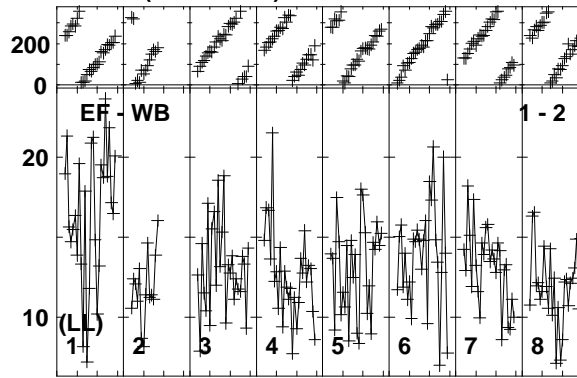
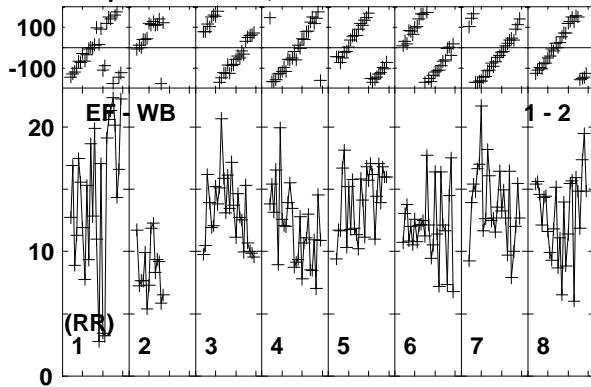

Lower frame: Milli Ampl Jy Top frame: Phas deg
Vector averaged cross-power spectrum Baseline: EF (01) - WB (02)
Timerange: 00/03:12:35 to 00/03:15:29

Plot file version 6 created 25-MAR-2014 17:50:43

ARP299A EP087E 1.UVDATA.1

Freq = 1.5950 GHz, Bw = 16.000 MH Calibrated with CL # 3 and BP # 1 (BP mode 1)

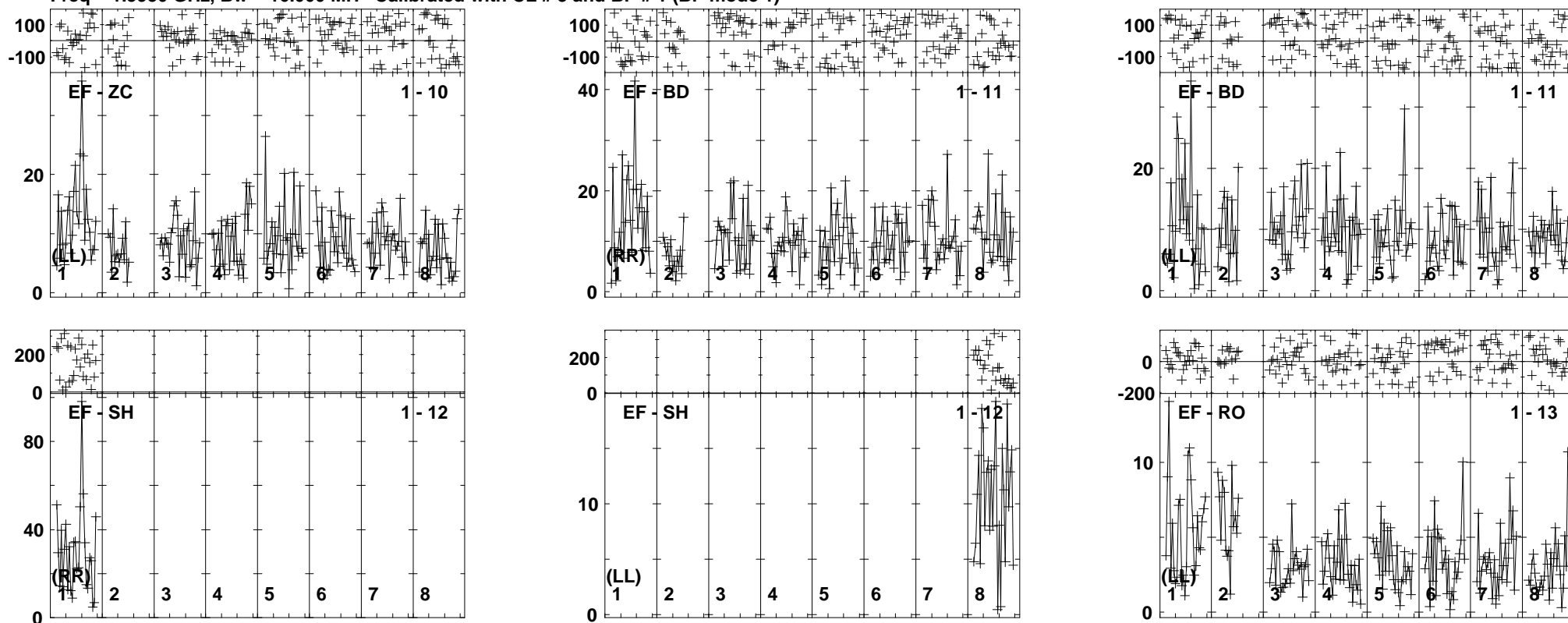

Lower frame: Milli Ampl Jy Top frame: Phas deg
Vector averaged cross-power spectrum Baseline: EF (01) - ZC (10)
Timerange: 00/03:12:35 to 00/03:15:29

Plot file version 7 created 25-MAR-2014 17:50:43

J1128+5925 EP087E 1.UVDATA.1

Freq = 1.5950 GHz, Bw = 16.000 MH Calibrated with CL # 3 and BP # 1 (BP mode 1)

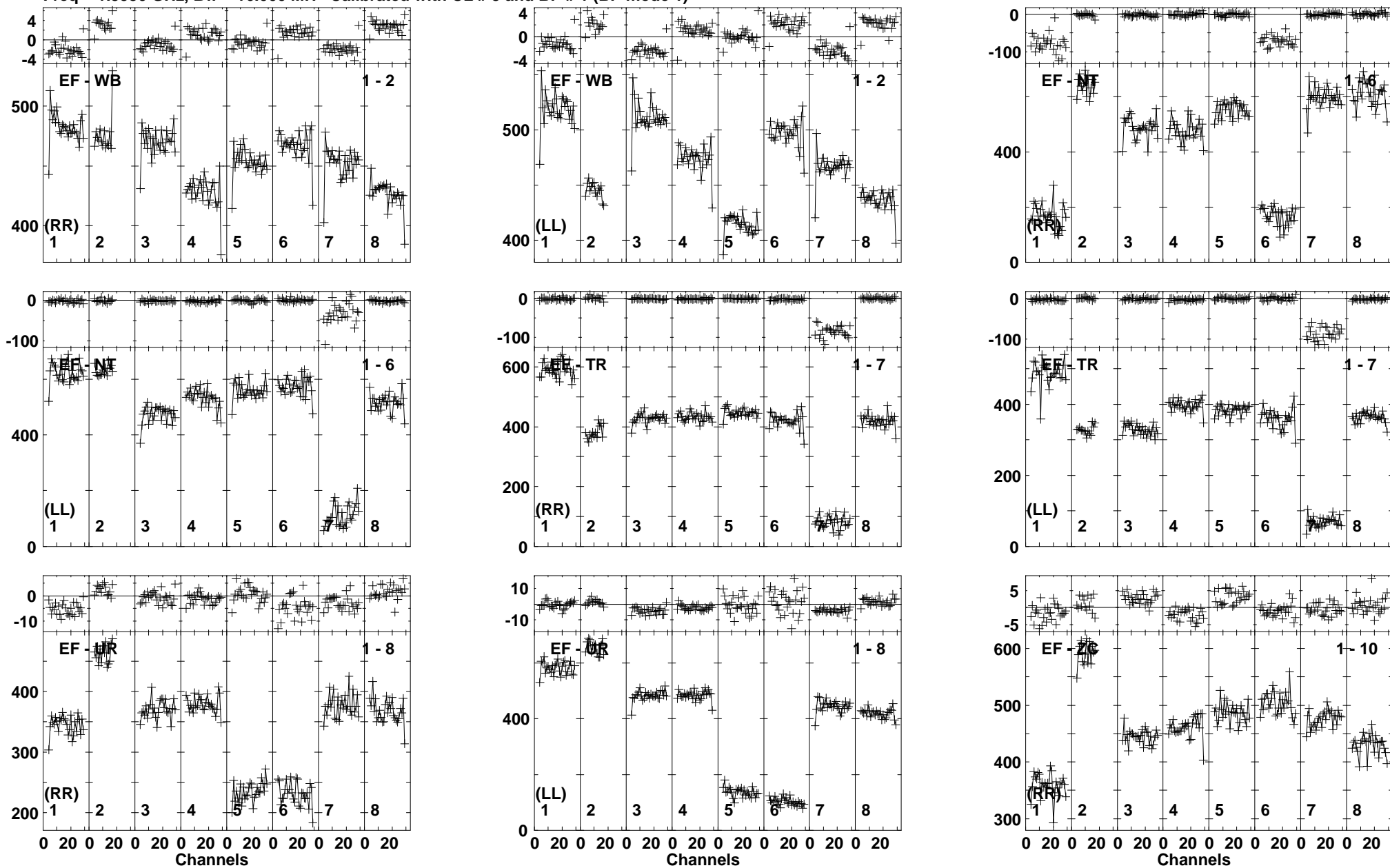

Plot file version 8 created 25-MAR-2014 17:50:44
 J1128+5925 EP087E 1.UVDATA.1
 Freq = 1.5950 GHz, Bw = 16.000 MH Calibrated with CL # 3 and BP # 1 (BP mode 1)

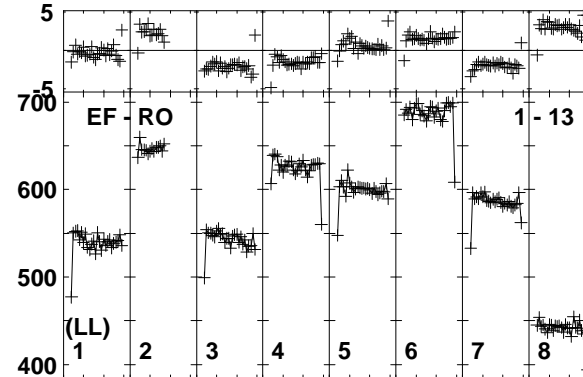
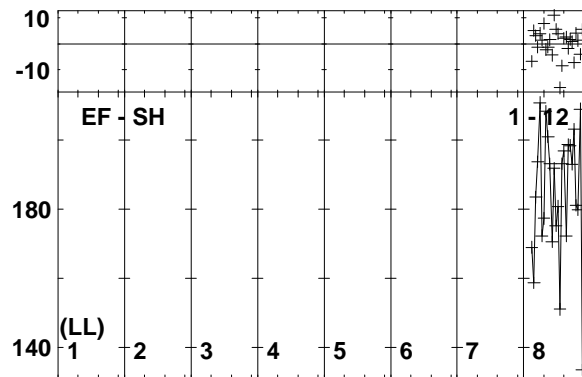
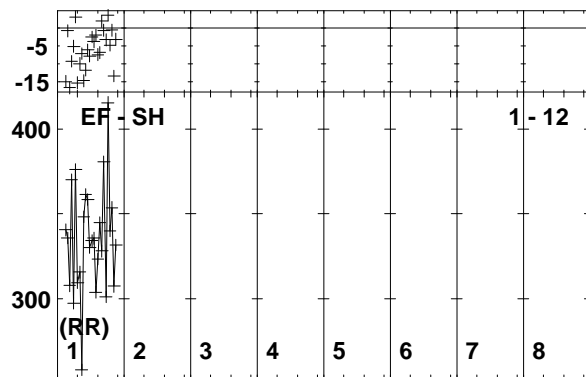
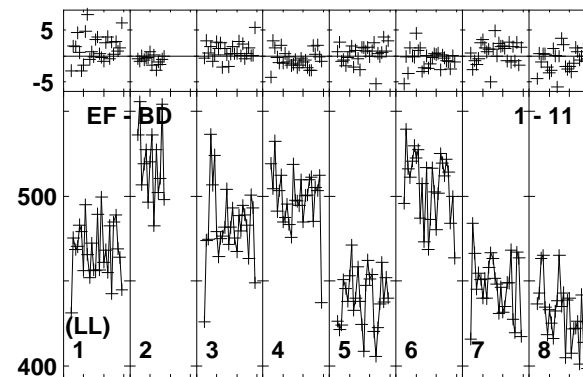
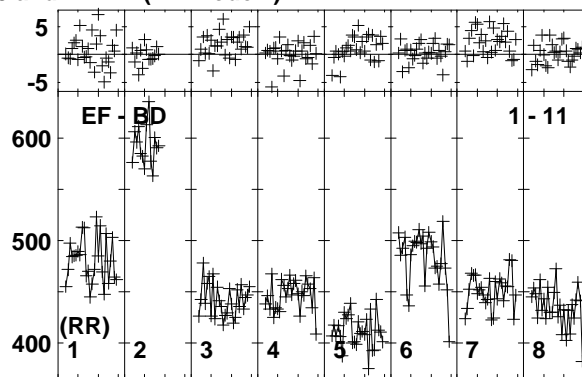
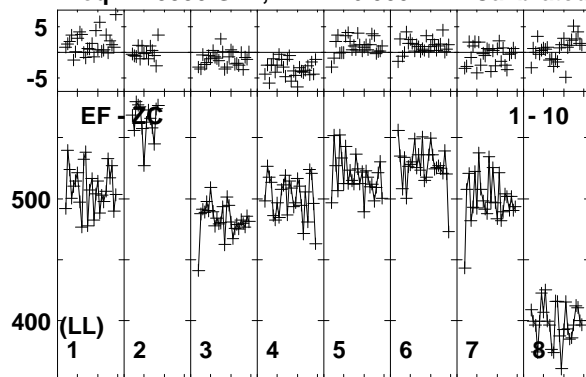

Lower frame: Milli Ampl Jy Top frame: Phas deg
 Vector averaged cross-power spectrum Baseline: EF (01) - ZC (10)
 Timerange: 00/03:15:35 to 00/03:16:39

Plot file version 9 created 25-MAR-2014 17:50:44

ARP299A EP087E 1.UVDATA.1

Freq = 1.5950 GHz, Bw = 16.000 MH Calibrated with CL # 3 and BP # 1 (BP mode 1)

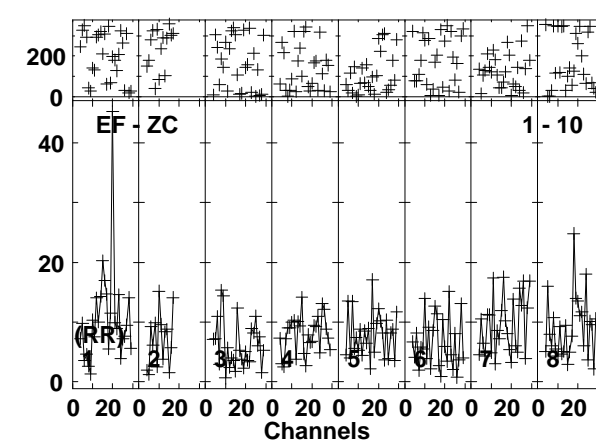
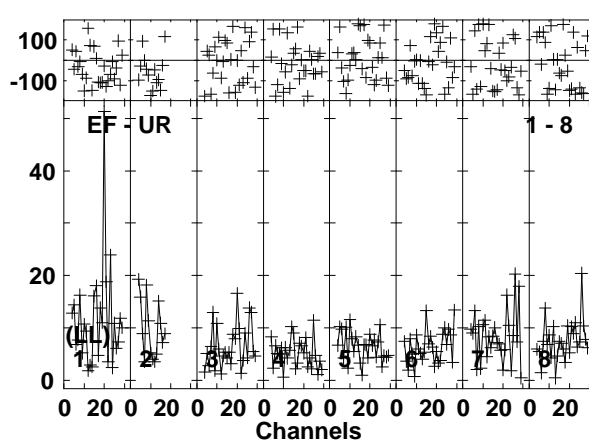
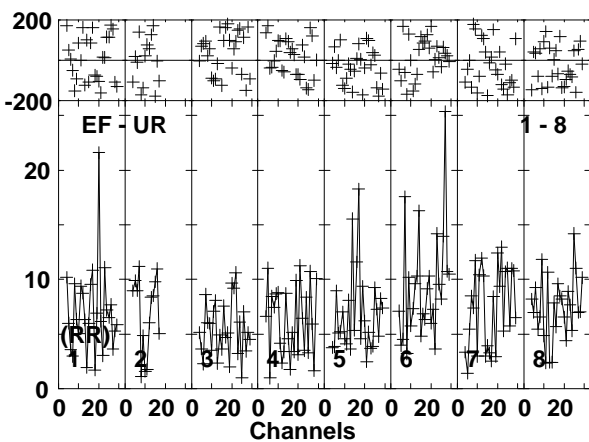
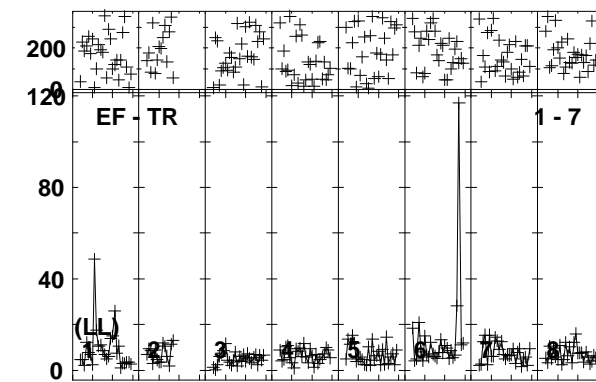
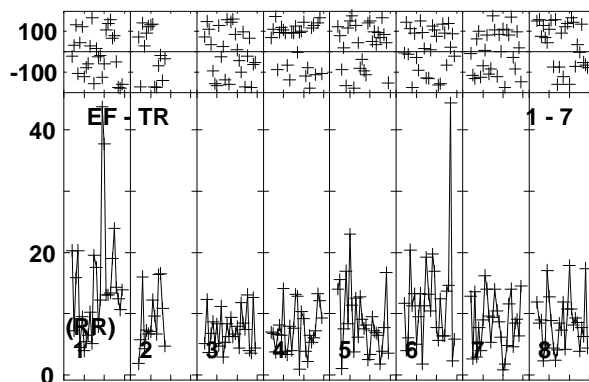
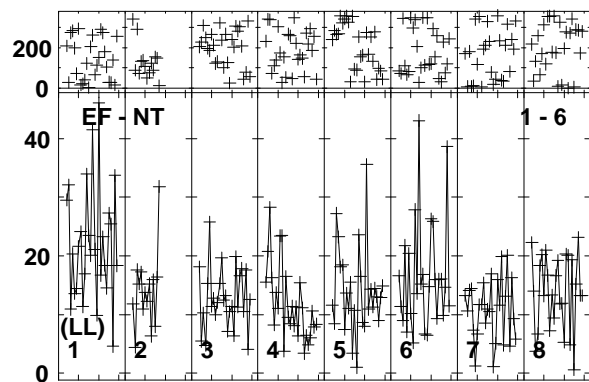
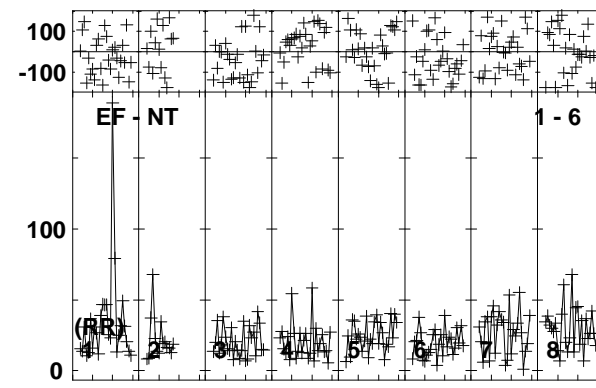
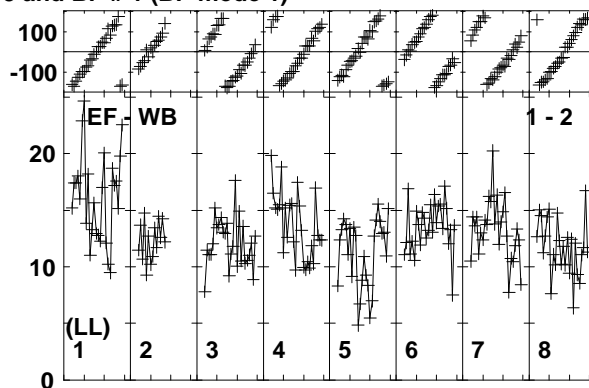
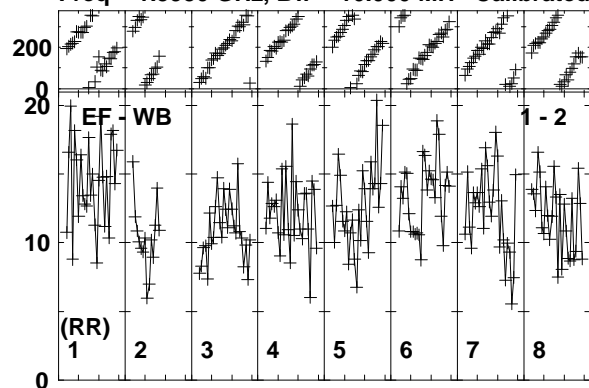

Lower frame: Milli Ampl Jy Top frame: Phas deg
Vector averaged cross-power spectrum Baseline: EF (01) - WB (02)
Timerange: 00/03:16:41 to 00/03:21:09

Plot file version 10 created 25-MAR-2014 17:50:44

ARP299A EP087E 1.UVDATA.1

Freq = 1.5950 GHz, Bw = 16.000 MH Calibrated with CL # 3 and BP # 1 (BP mode 1)

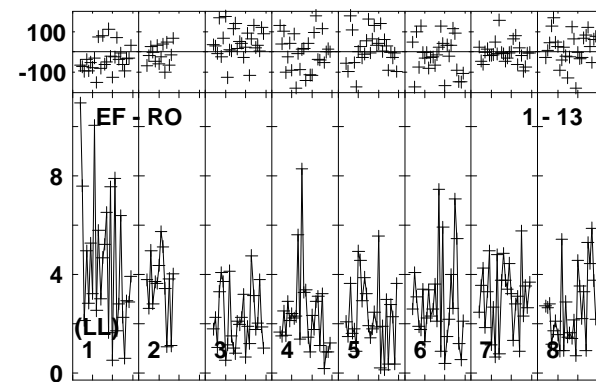
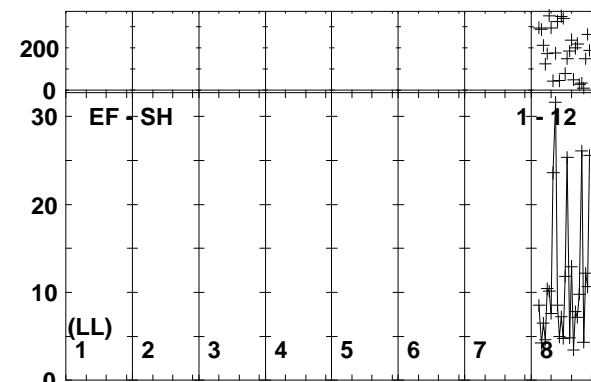
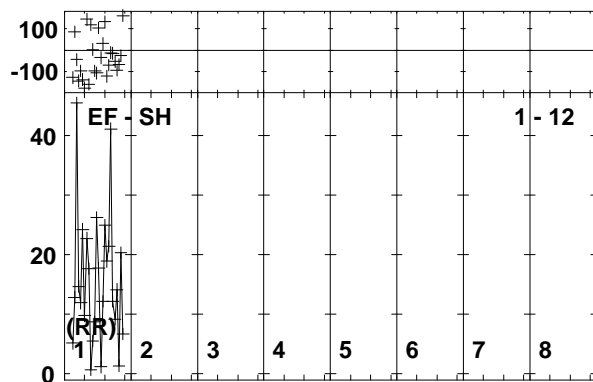
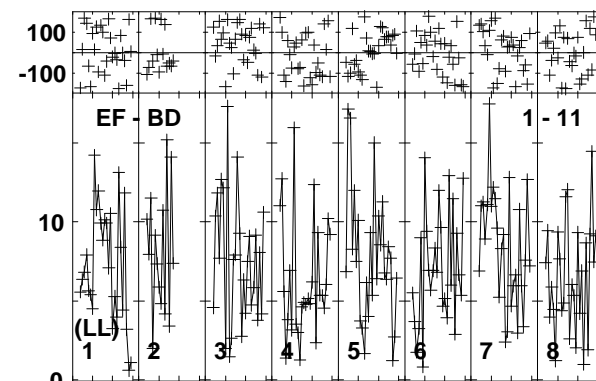
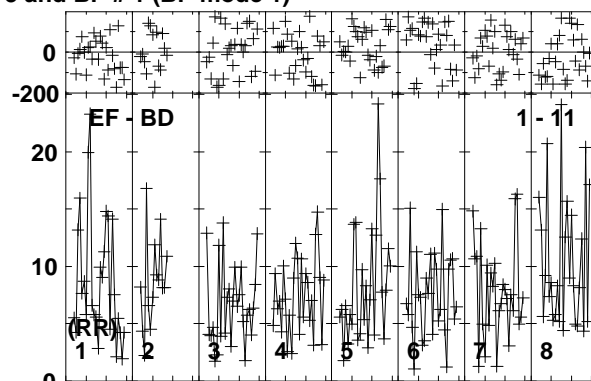
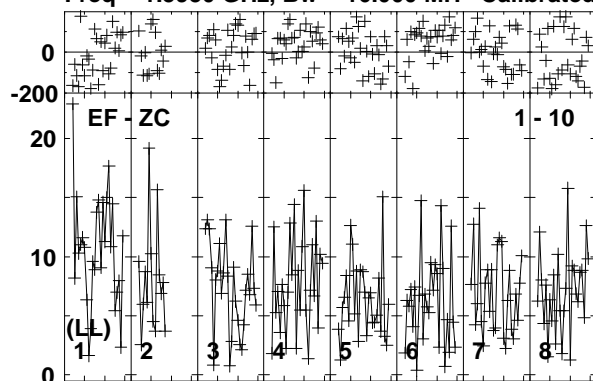

Lower frame: Milli Ampl Jy Top frame: Phas deg
Vector averaged cross-power spectrum Baseline: EF (01) - ZC (10)
Timerange: 00/03:16:41 to 00/03:21:09

Plot file version 11 created 25-MAR-2014 17:50:45

J1128+5925 EP087E 1.UVDATA.1

Freq = 1.5950 GHz, Bw = 16.000 MH Calibrated with CL # 3 and BP # 1 (BP mode 1)

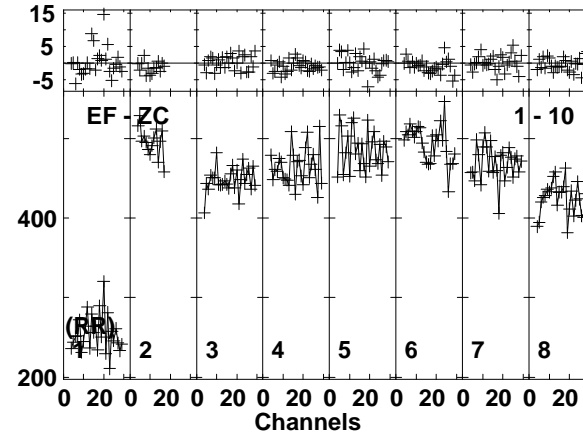
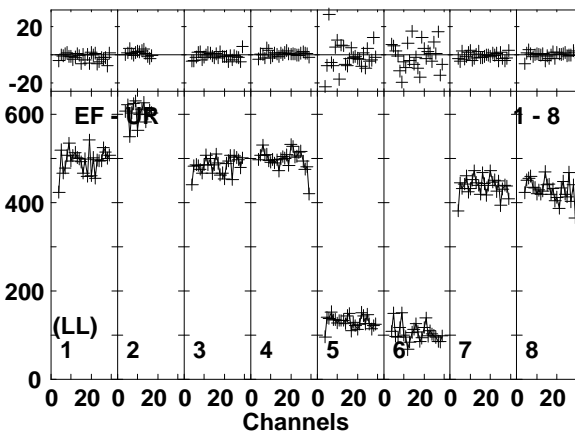
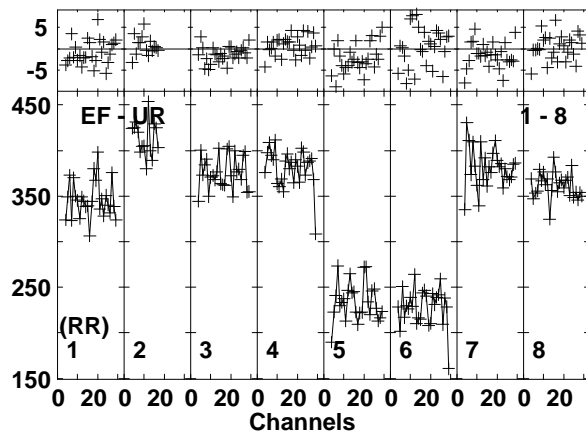
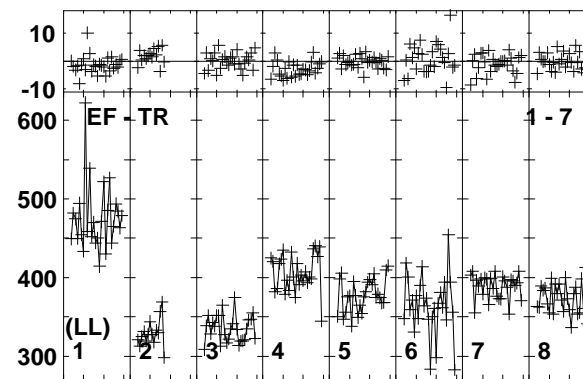
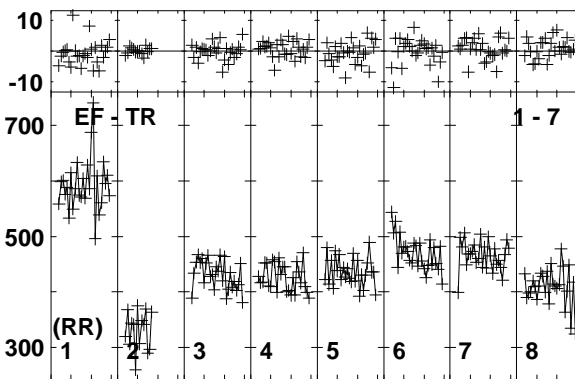
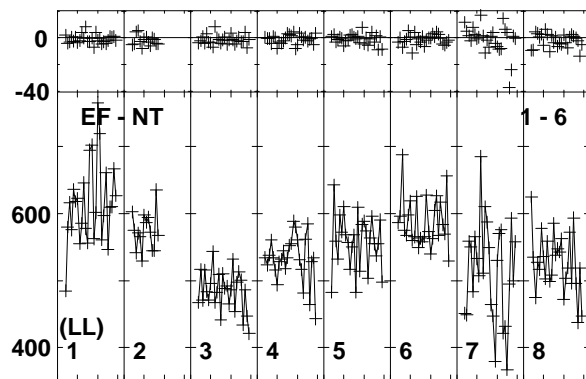
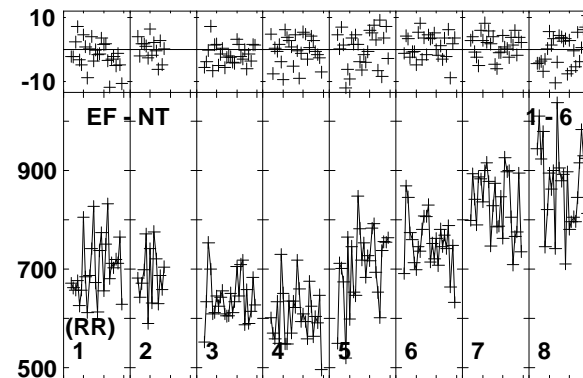
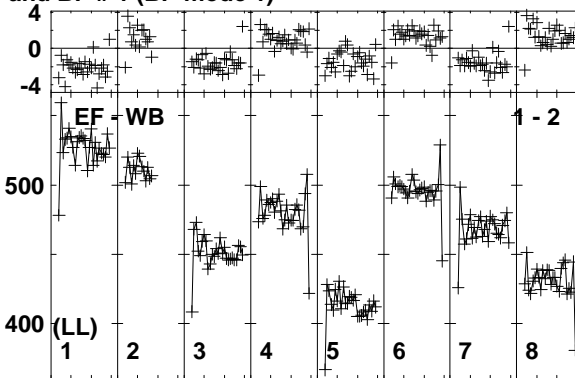
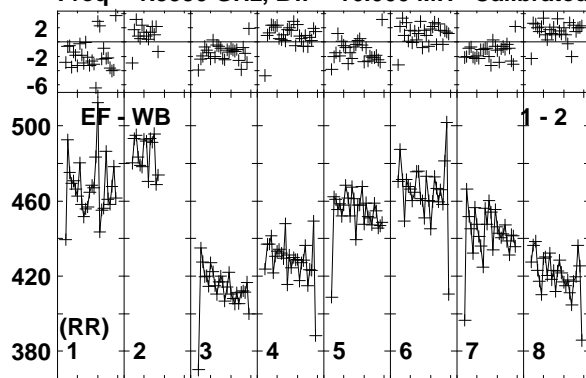

Lower frame: Milli Ampl Jy Top frame: Phas deg
Vector averaged cross-power spectrum Baseline: EF (01) - WB (02)
Timerange: 00/03:21:51 to 00/03:22:19

Plot file version 12 created 25-MAR-2014 17:50:45

J1128+5925 EP087E 1.UVDATA.1

Freq = 1.5950 GHz, Bw = 16.000 MH Calibrated with CL # 3 and BP # 1 (BP mode 1)

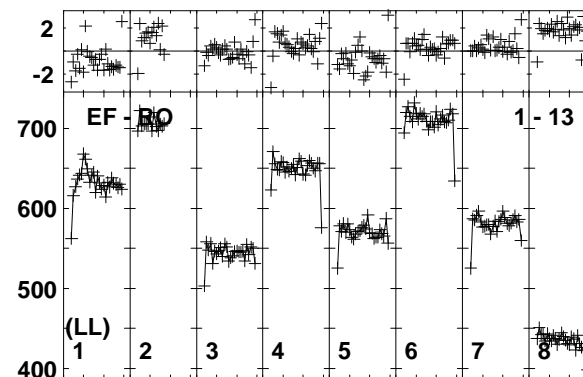
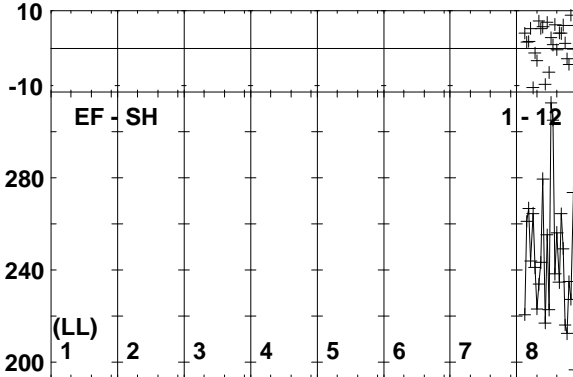
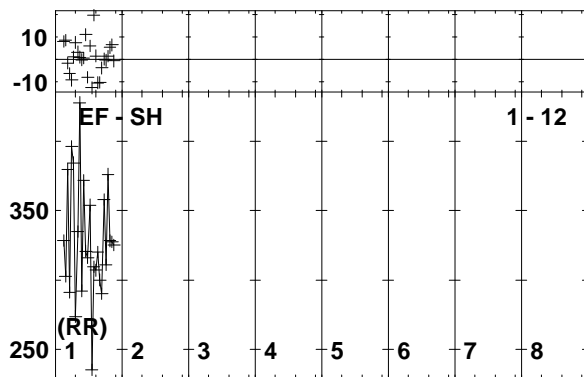
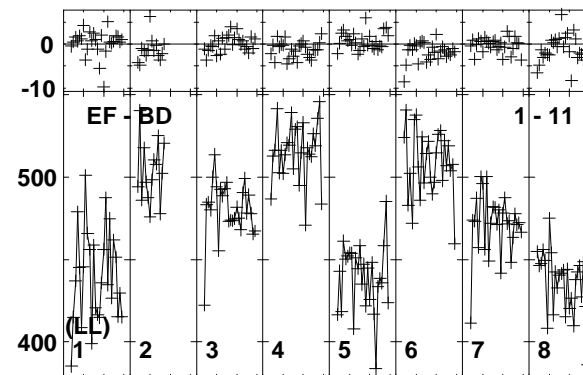
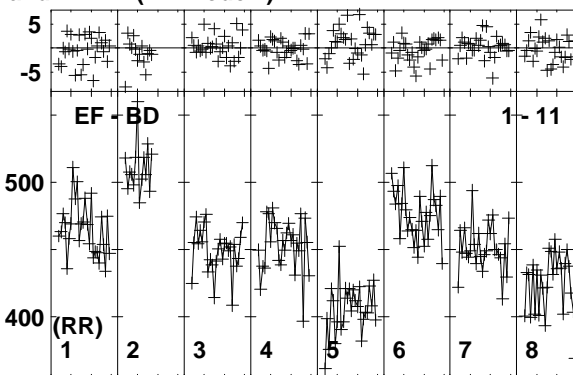
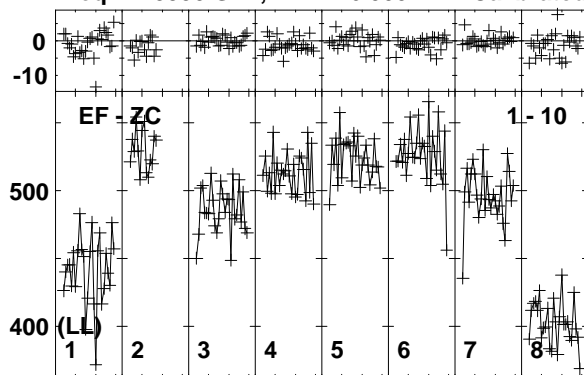

Lower frame: Milli Ampl Jy Top frame: Phas deg
Vector averaged cross-power spectrum Baseline: EF (01) - ZC (10)
Timerange: 00/03:21:51 to 00/03:22:19

Plot file version 13 created 25-MAR-2014 17:50:45

ARP299A EP087E 1.UVDATA.1

Freq = 1.5950 GHz, Bw = 16.000 MH Calibrated with CL # 3 and BP # 1 (BP mode 1)

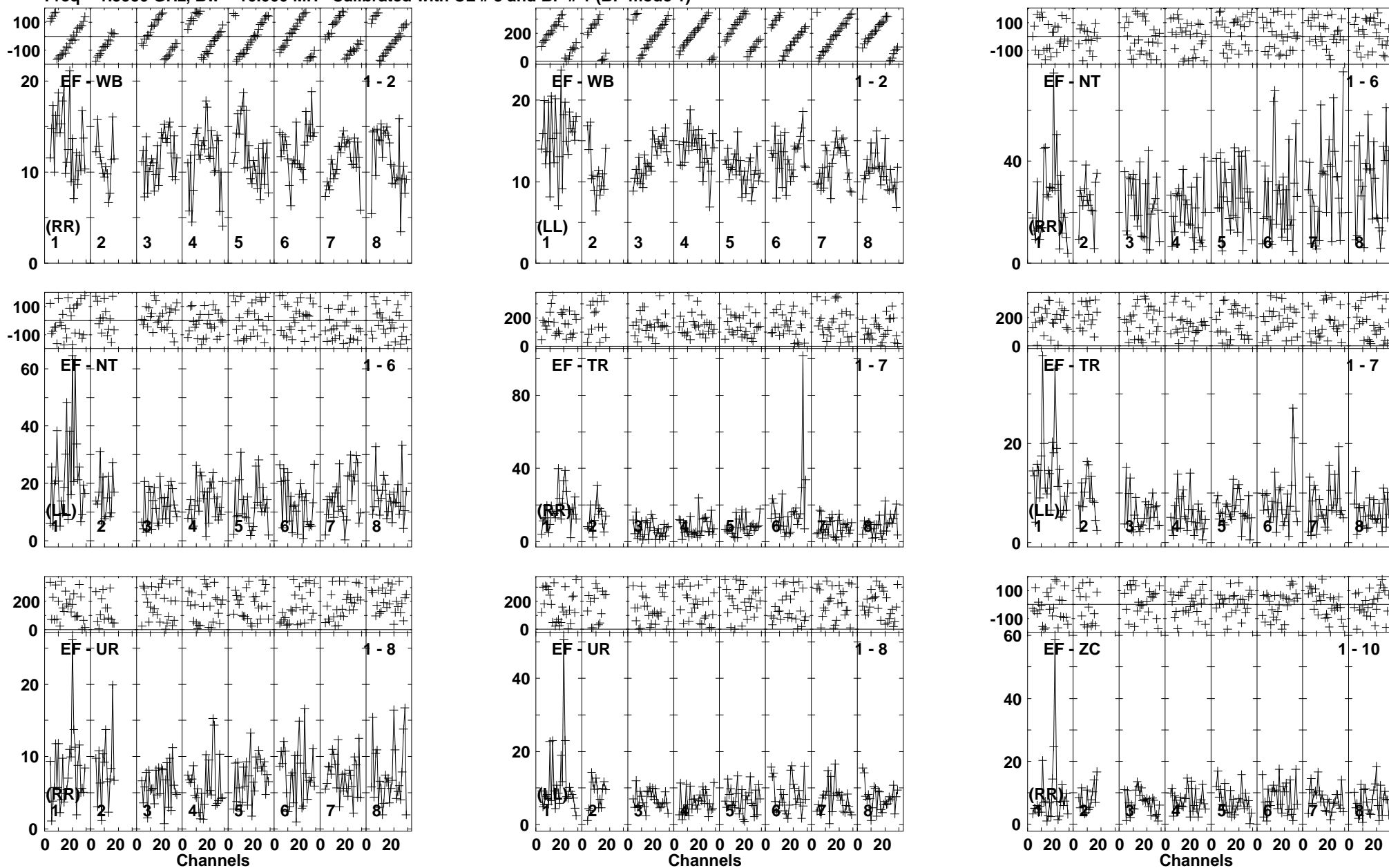

Lower frame: Milli Ampl Jy Top frame: Phas deg
Vector averaged cross-power spectrum Baseline: EF (01) - WB (02)
Timerange: 00/03:22:25 to 00/03:26:49

Plot file version 14 created 25-MAR-2014 17:50:45

ARP299A EP087E 1.UVDATA.1

Freq = 1.5950 GHz, Bw = 16.000 MH Calibrated with CL # 3 and BP # 1 (BP mode 1)

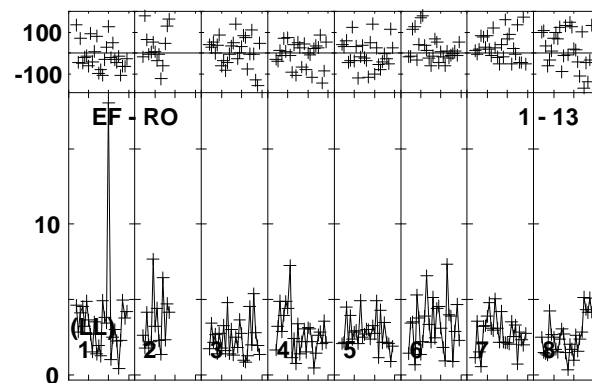
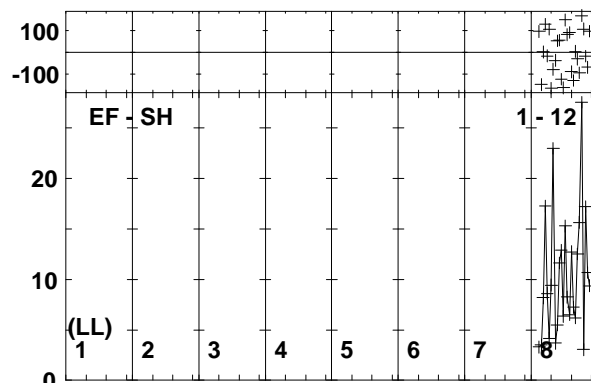
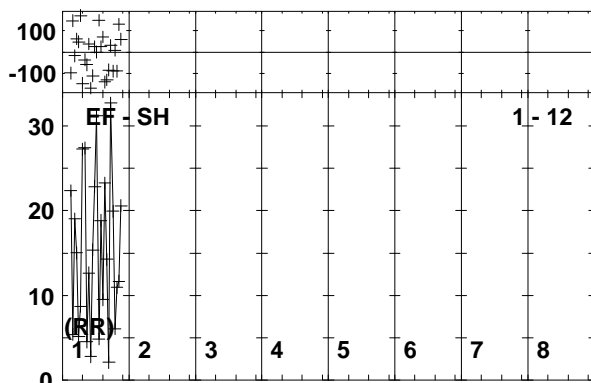
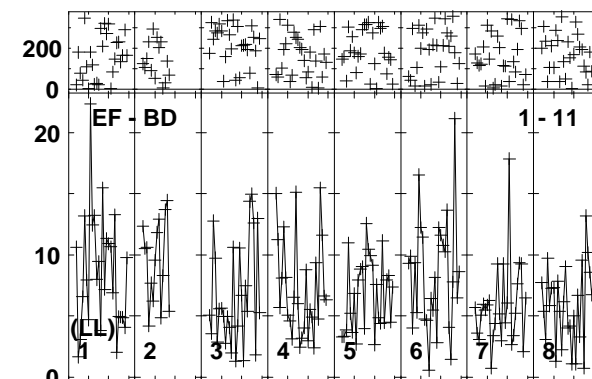
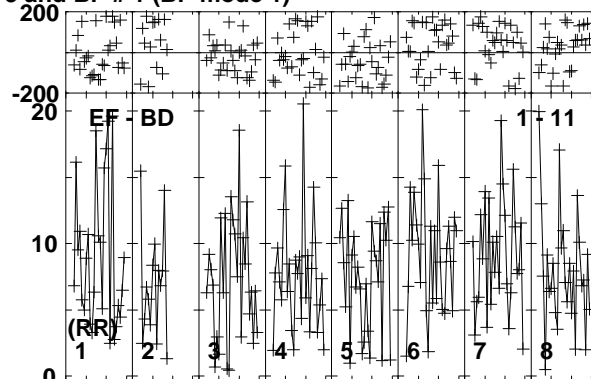
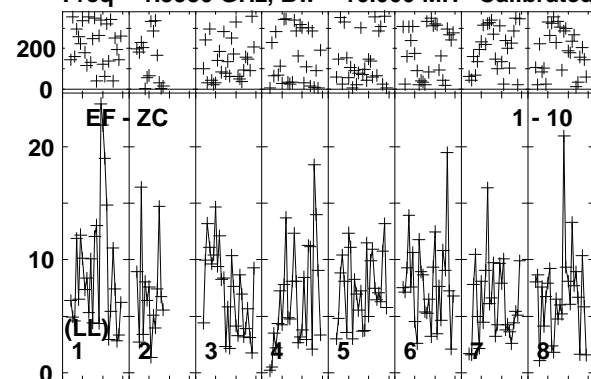

Lower frame: Milli Ampl Jy Top frame: Phas deg
Vector averaged cross-power spectrum Baseline: EF (01) - ZC (10)
Timerange: 00/03:22:25 to 00/03:26:49

Plot file version 15 created 25-MAR-2014 17:50:46

J1128+5925 EP087E 1.UVDATA.1

Freq = 1.5950 GHz, Bw = 16.000 MH Calibrated with CL # 3 and BP # 1 (BP mode 1)

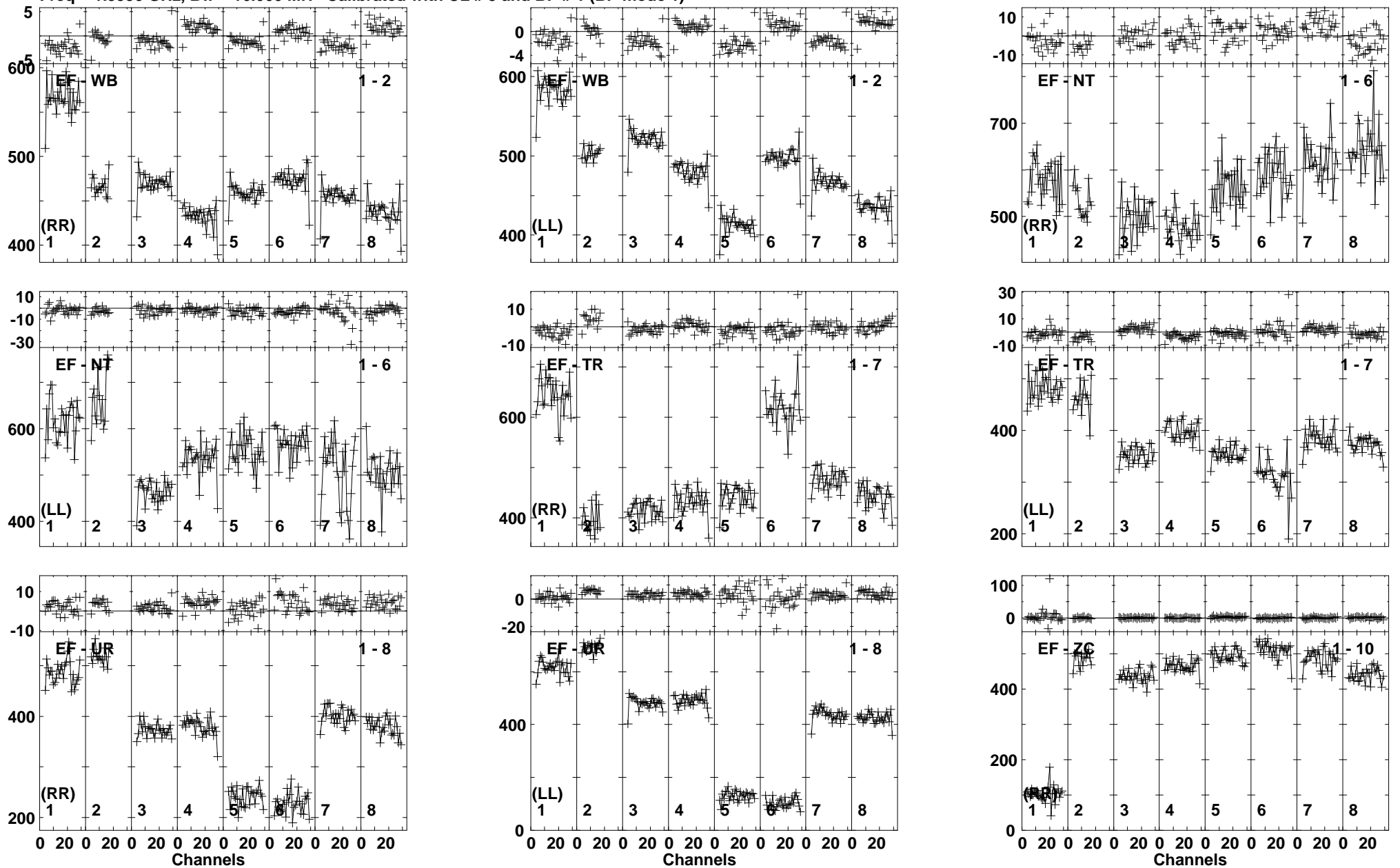

Lower frame: Milli Ampl Jy Top frame: Phas deg
Vector averaged cross-power spectrum Baseline: EF (01) - WB (02)
Timerange: 00/03/26:55 to 00/03/27:49

Plot file version 16 created 25-MAR-2014 17:50:46

J1128+5925 EP087E 1.UVDATA.1

Freq = 1.5950 GHz, Bw = 16.000 MH Calibrated with CL # 3 and BP # 1 (BP mode 1)

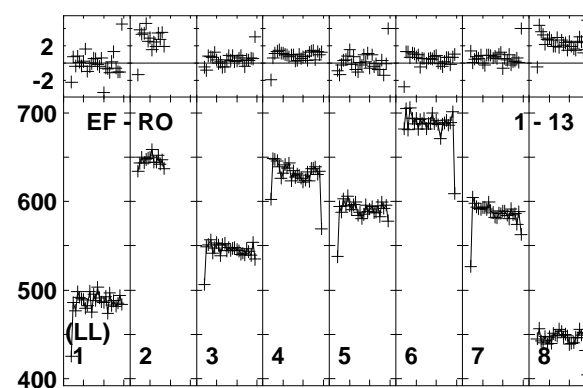
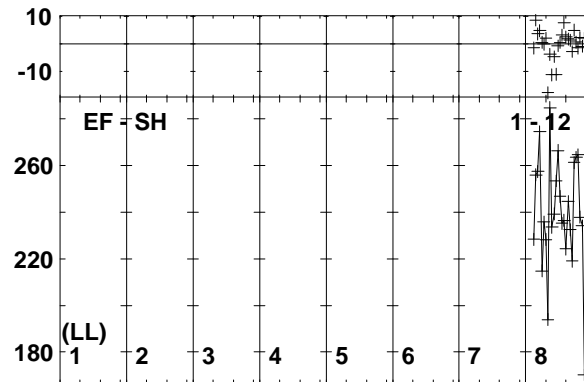
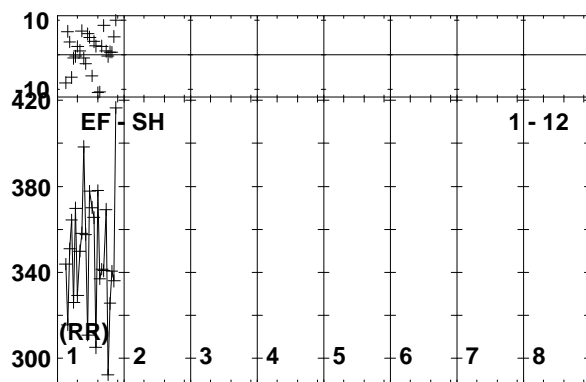
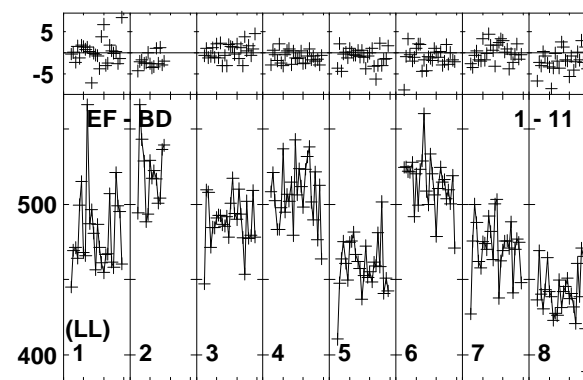
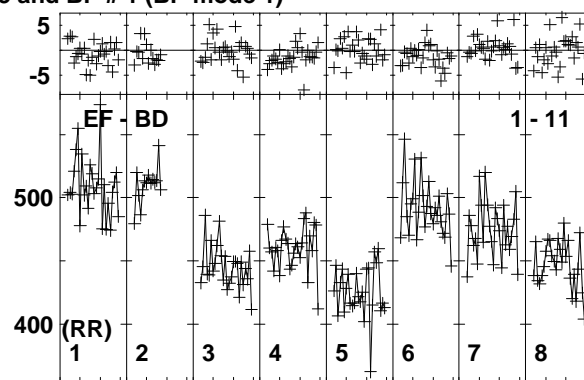
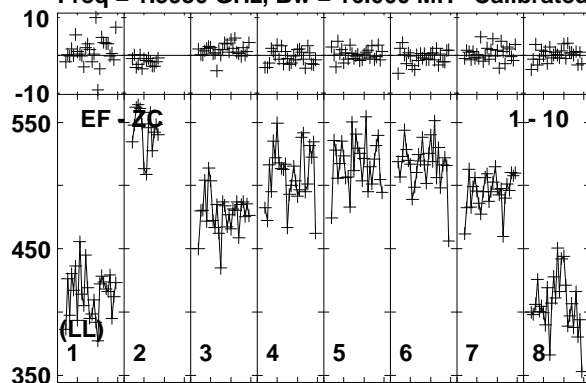

Lower frame: Milli Ampl Jy Top frame: Phas deg
Vector averaged cross-power spectrum Baseline: EF (01) - ZC (10)
Timerange: 00/03:26:55 to 00/03:27:49

Plot file version 17 created 25-MAR-2014 17:50:46

ARP299A EP087E 1.UVDATA.1

Freq = 1.5950 GHz, Bw = 16.000 MH Calibrated with CL # 3 and BP # 1 (BP mode 1)

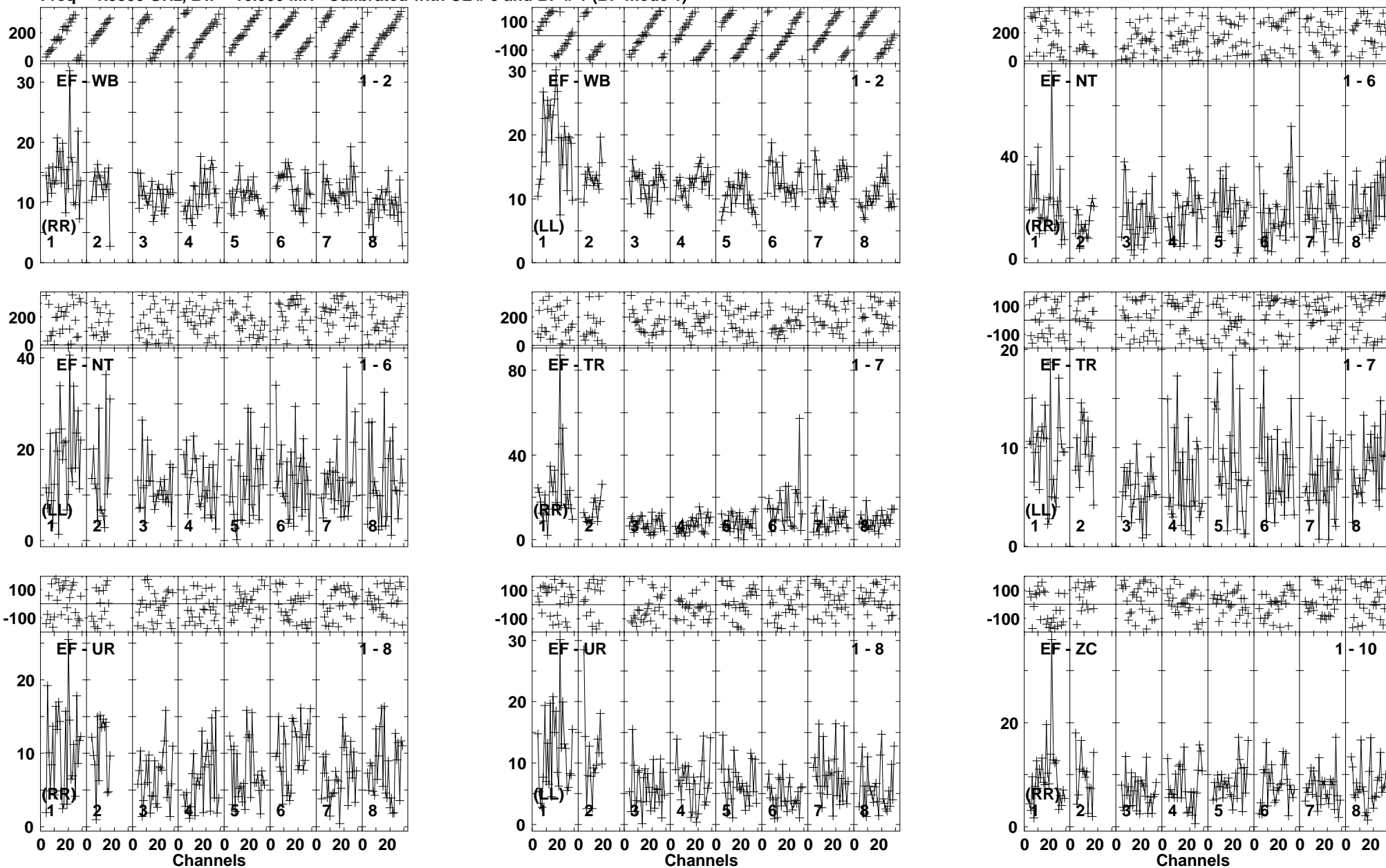

Lower frame: Milli Ampl Jy Top frame: Phas deg
Vector averaged cross-power spectrum Baseline: EF (01) - WB (02)
Timerange: 00/03:27:51 to 00/03:32:19

Plot file version 18 created 25-MAR-2014 17:50:47

ARP299A EP087E 1.UVDATA.1

Freq = 1.5950 GHz, Bw = 16.000 MH Calibrated with CL # 3 and BP # 1 (BP mode 1)

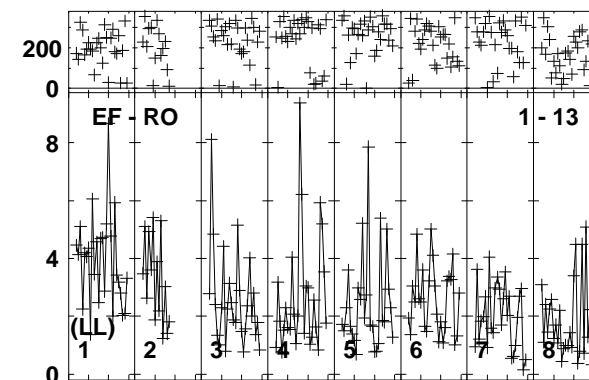
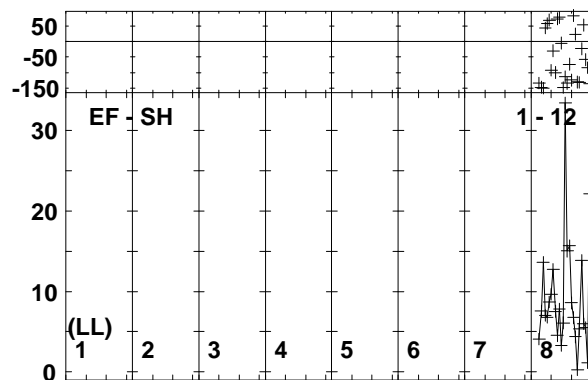
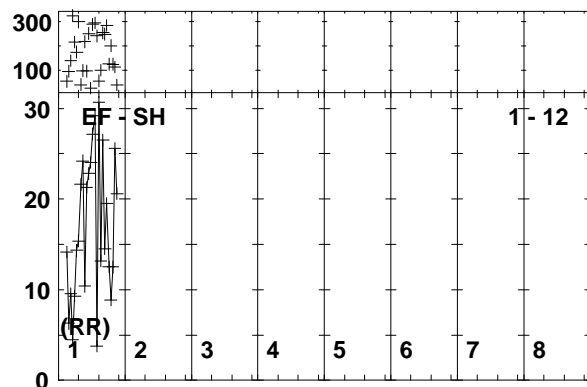
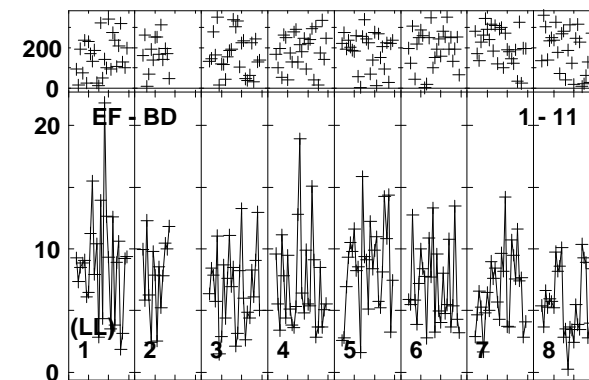
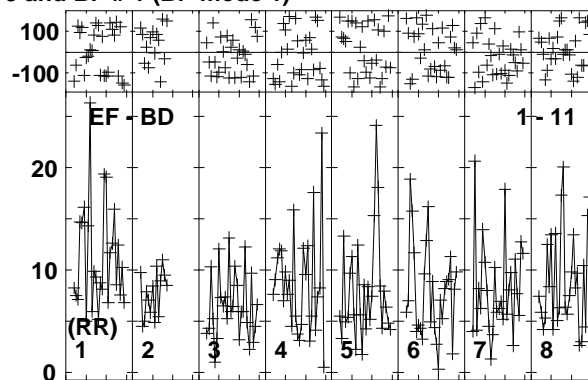
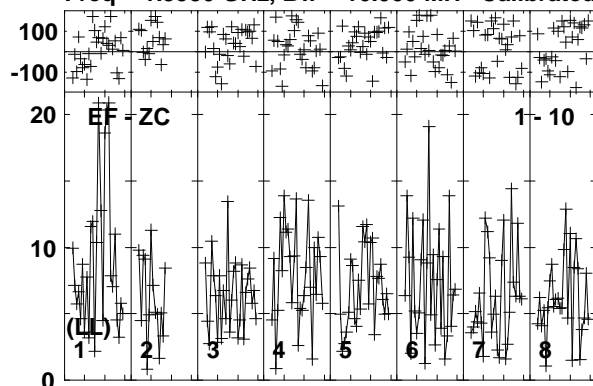

Lower frame: Milli Ampl Jy Top frame: Phas deg
Vector averaged cross-power spectrum Baseline: EF (01) - ZC (10)
Timerange: 00/03:27:51 to 00/03:32:19

Plot file version 19 created 25-MAR-2014 17:50:47

J1128+5925 EP087E 1.UVDATA.1

Freq = 1.5950 GHz, Bw = 16.000 MH Calibrated with CL # 3 and BP # 1 (BP mode 1)

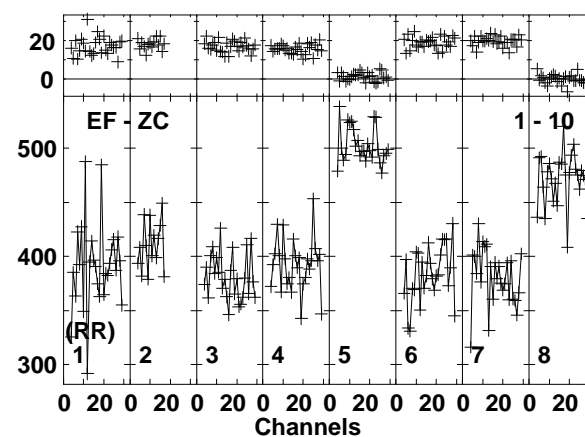
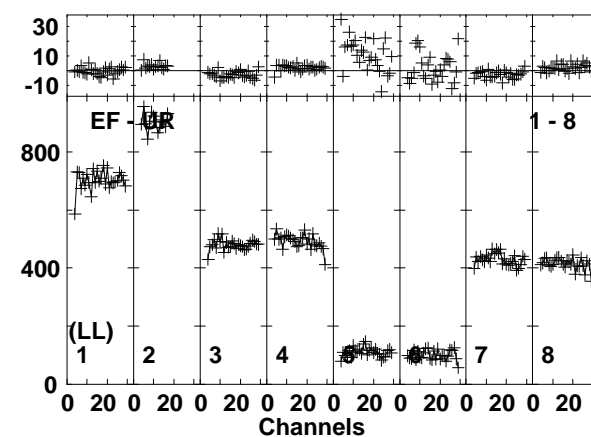
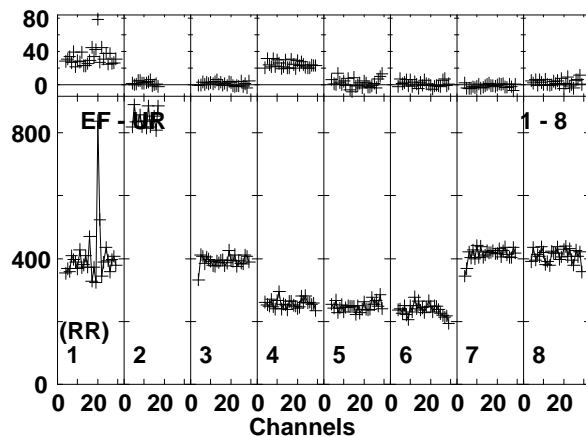
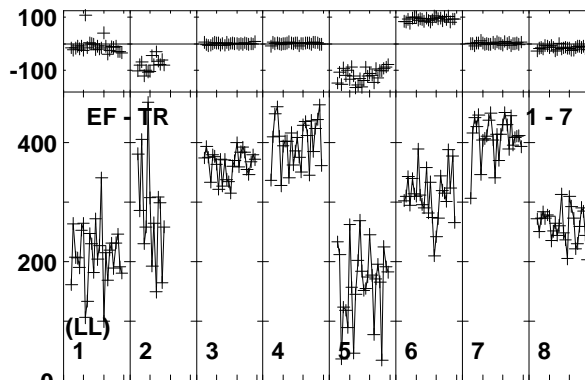
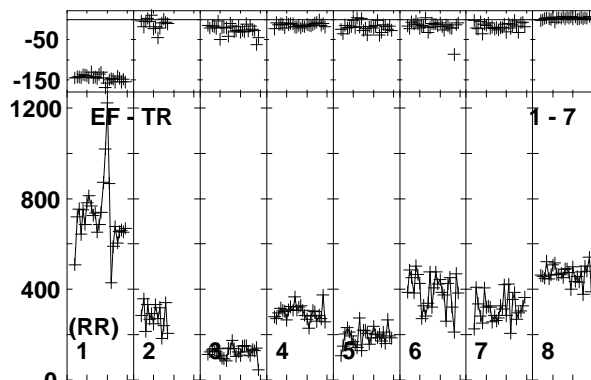
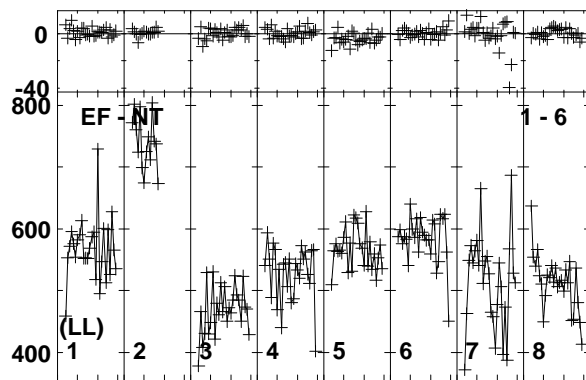
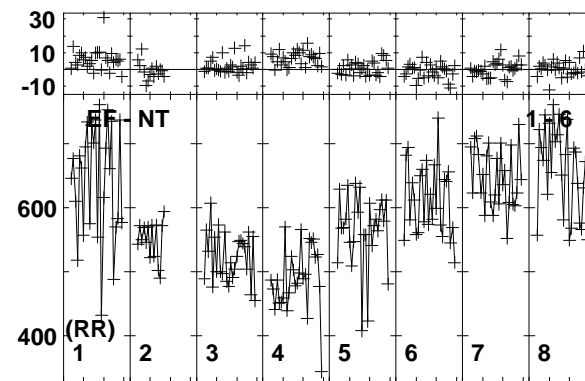
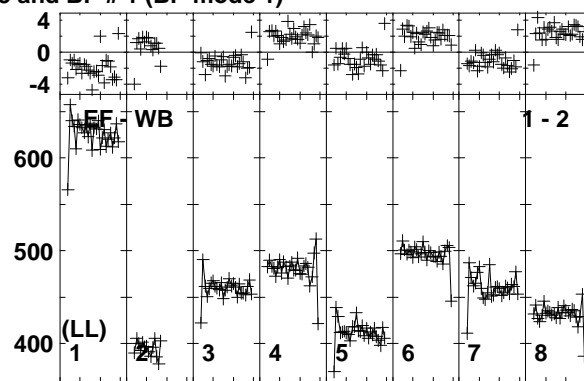
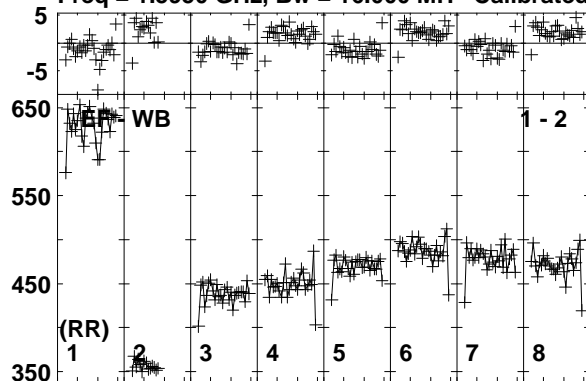

Lower frame: Milli Ampl Jy Top frame: Phas deg
Vector averaged cross-power spectrum Baseline: EF (01) - WB (02)
Timerange: 00/03:33:01 to 00/03:33:29

Plot file version 20 created 25-MAR-2014 17:50:47

J1128+5925 EP087E 1.UVDATA.1

Freq = 1.5950 GHz, Bw = 16.000 MH Calibrated with CL # 3 and BP # 1 (BP mode 1)

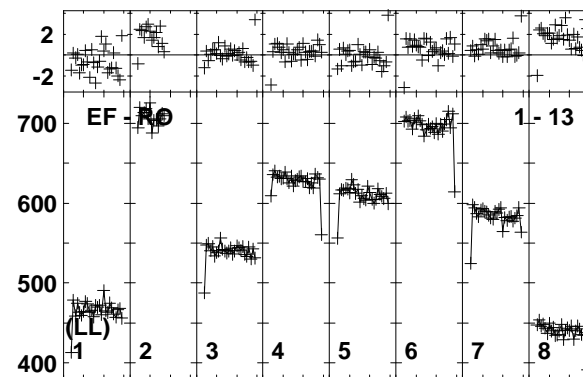
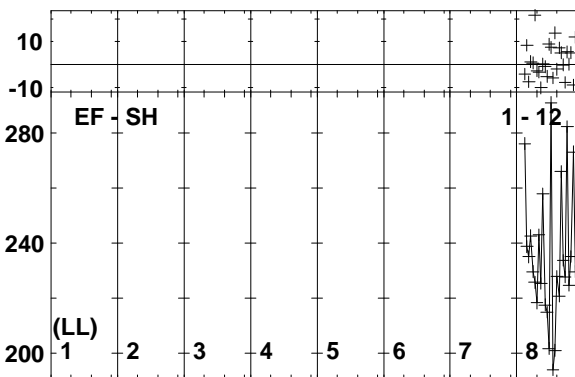
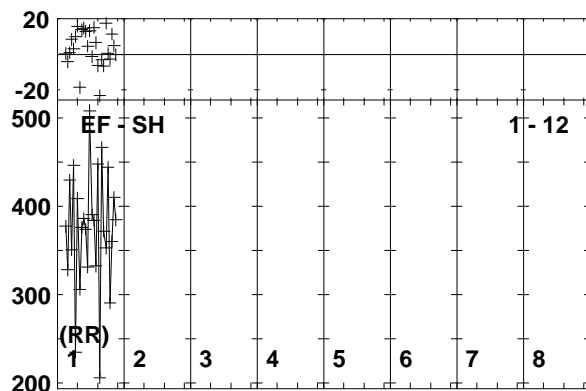
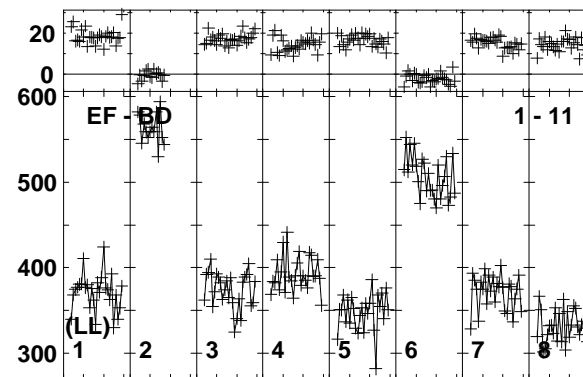
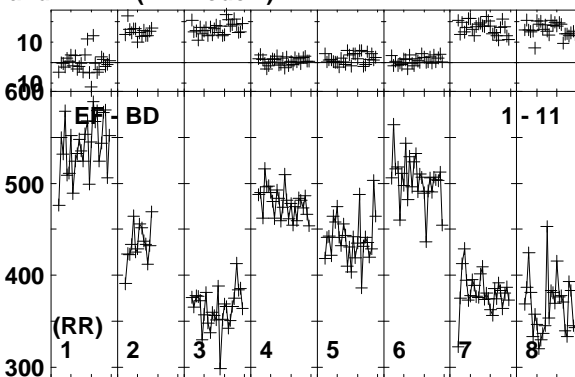
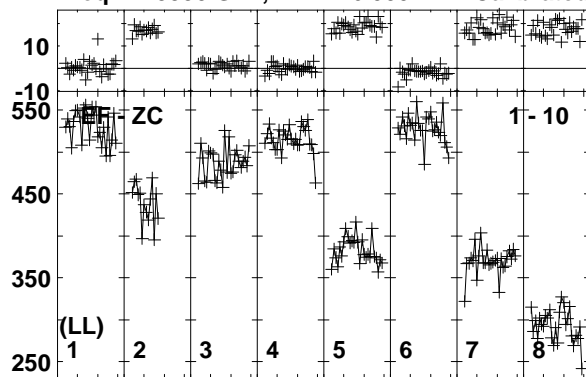

Lower frame: Milli Ampl Jy Top frame: Phas deg
Vector averaged cross-power spectrum Baseline: EF (01) - ZC (10)
Timerange: 00/03:33:01 to 00/03:33:29

Plot file version 21 created 25-MAR-2014 17:50:47

ARP299A EP087E 1.UVDATA.1

Freq = 1.5950 GHz, Bw = 16.000 MH Calibrated with CL # 3 and BP # 1 (BP mode 1)

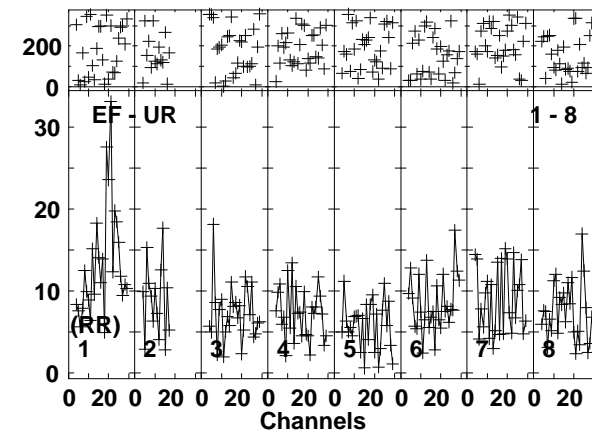
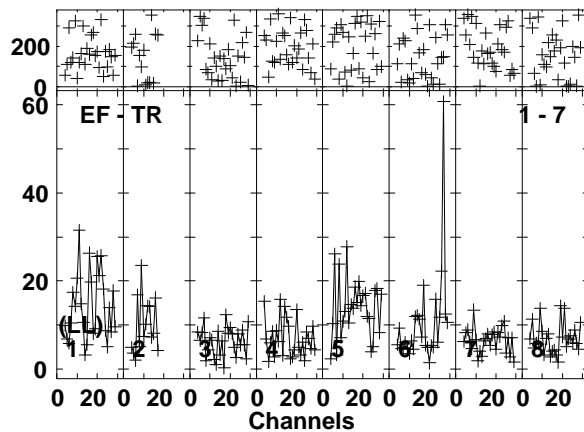
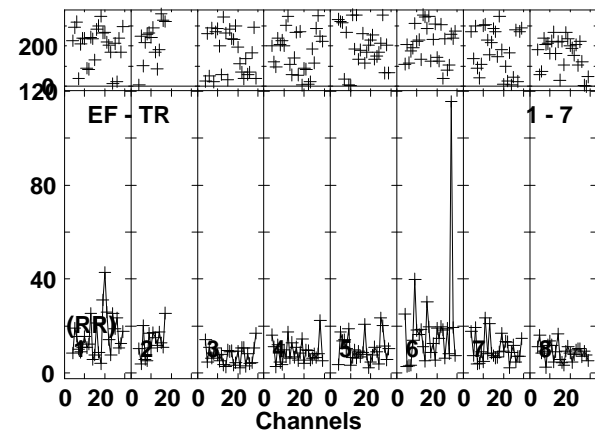
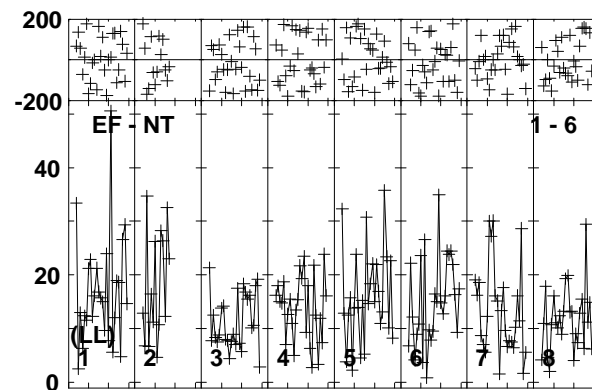
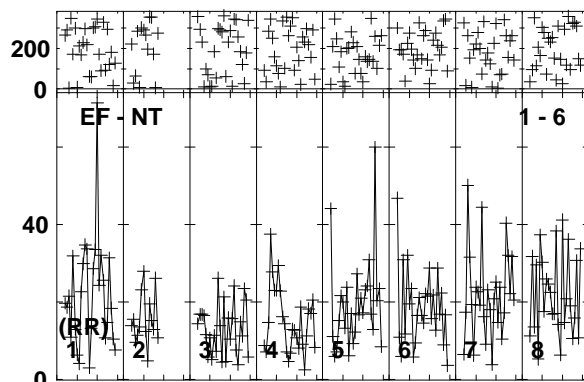
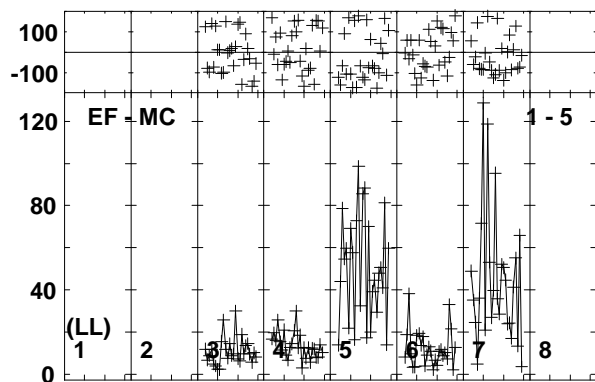
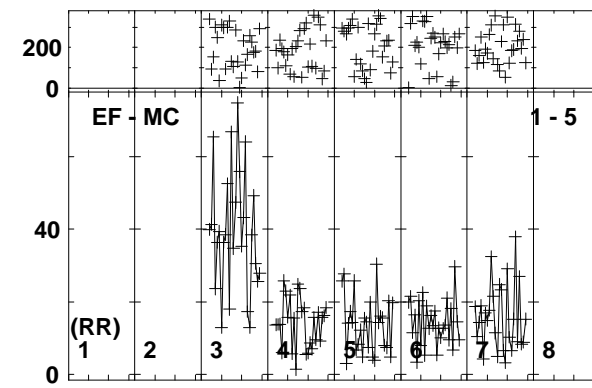
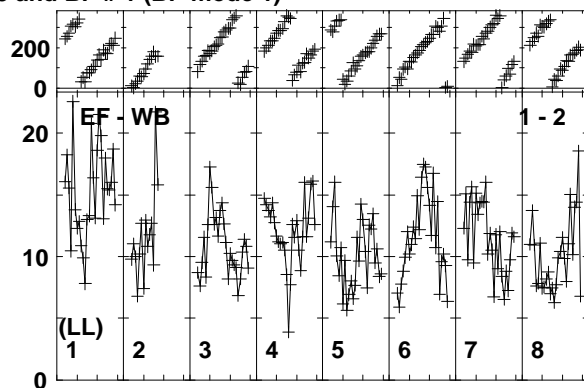
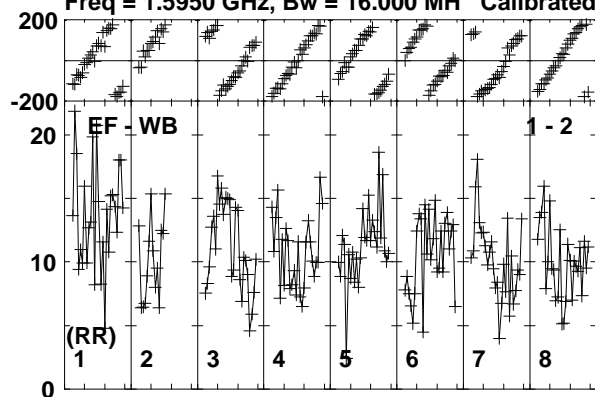

Lower frame: Milli Ampl Jy Top frame: Phas deg
Vector averaged cross-power spectrum Baseline: EF (01) - WB (02)
Timerange: 00/03:33:35 to 00/03:37:59

Plot file version 22 created 25-MAR-2014 17:50:48
 ARP299A EP087E 1.UVDATA.1
 Freq = 1.5950 GHz, Bw = 16.000 MH Calibrated with CL # 3 and BP # 1 (BP mode 1)

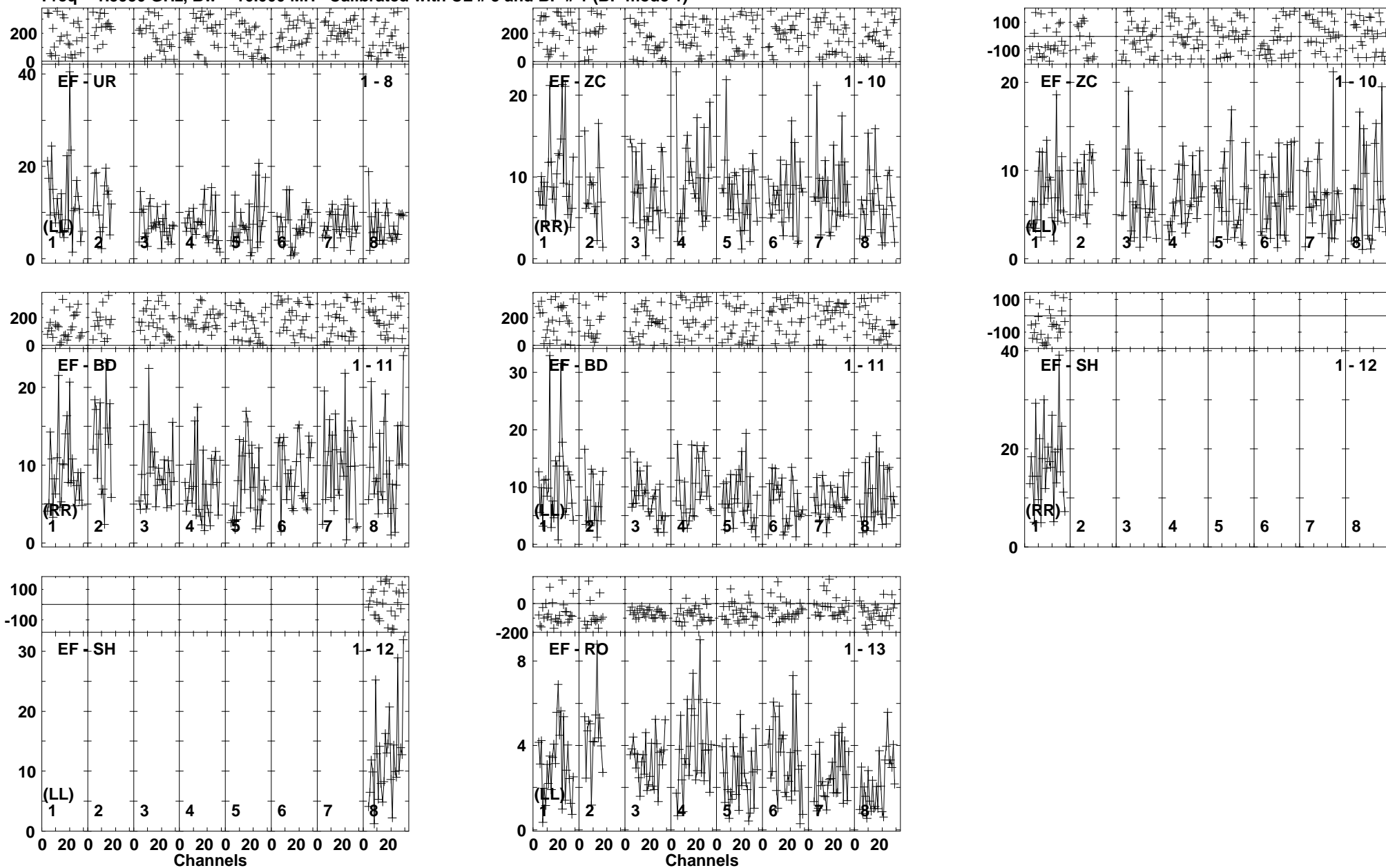

Lower frame: Milli Ampl Jy Top frame: Phas deg
 Vector averaged cross-power spectrum Baseline: EF (01) - UR (08)
 Timerange: 00/03:33:35 to 00/03:37:59

Plot file version 23 created 25-MAR-2014 17:50:48

J1128+5925 EP087E 1.UVDATA.1

Freq = 1.5950 GHz, Bw = 16.000 MH Calibrated with CL # 3 and BP # 1 (BP mode 1)

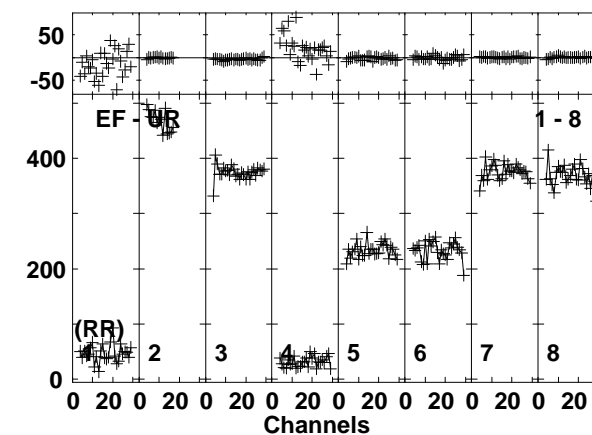
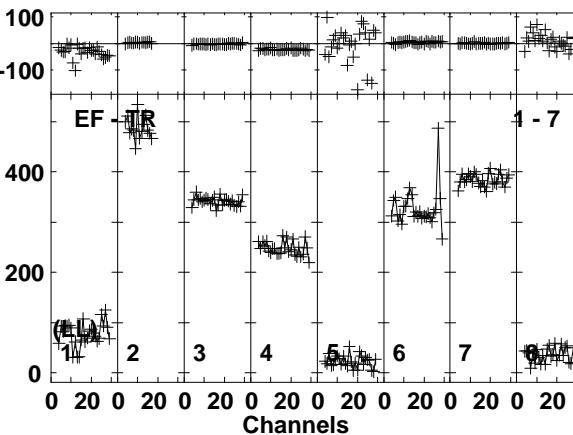
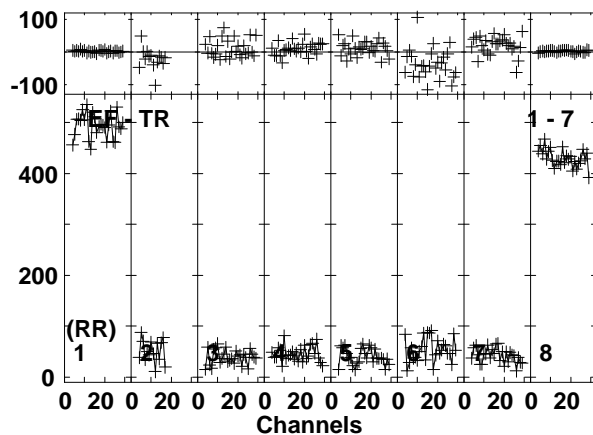
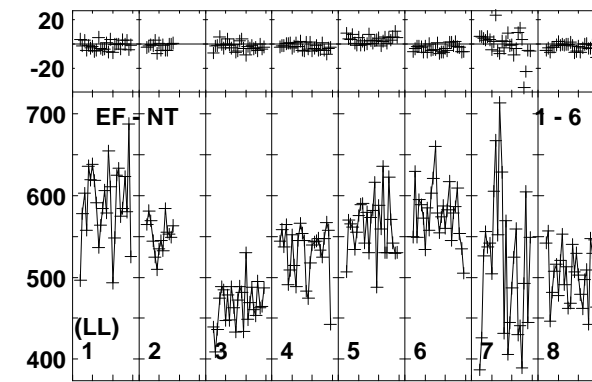
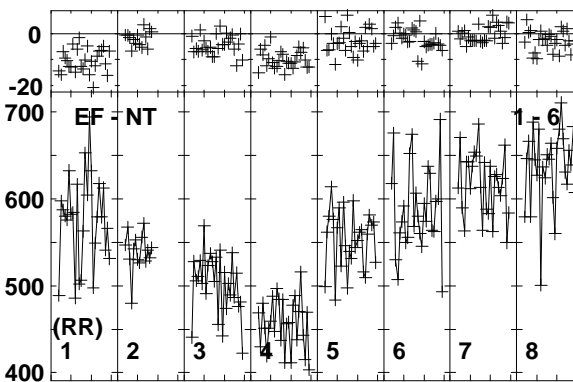
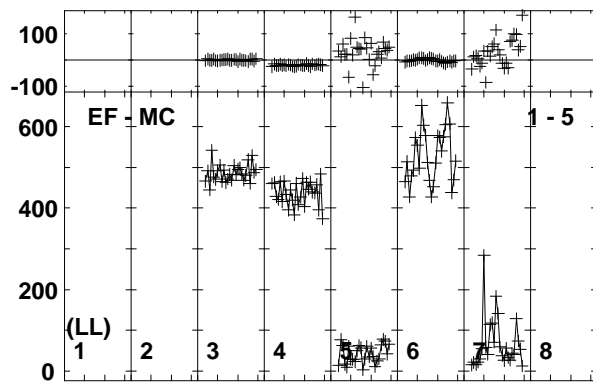
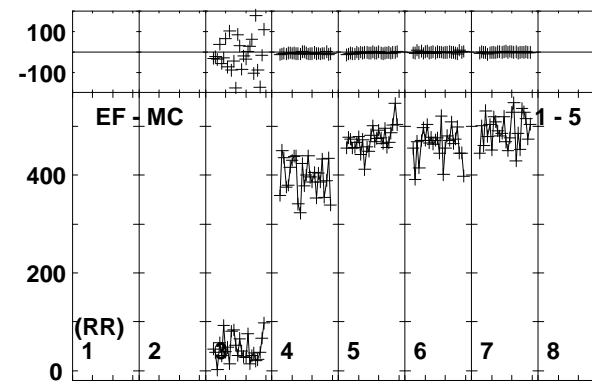
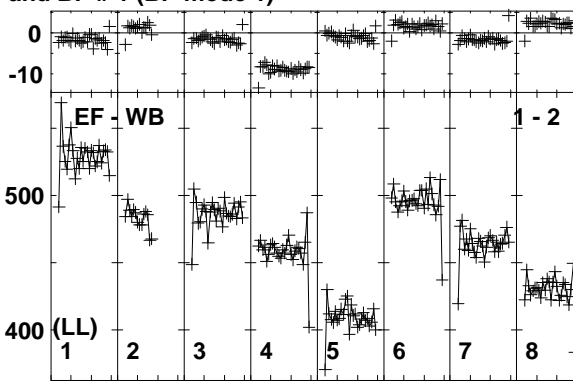
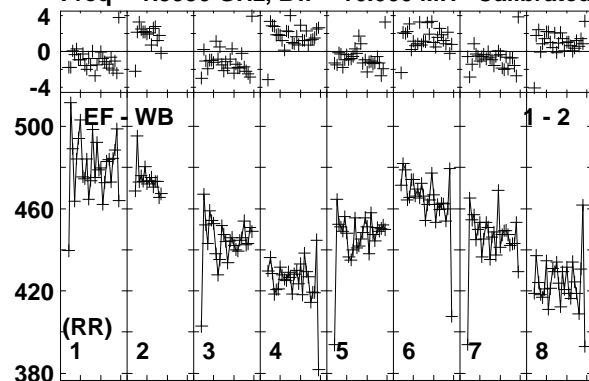

Lower frame: Milli Ampl Jy Top frame: Phas deg
Vector averaged cross-power spectrum Baseline: EF (01) - WB (02)
Timerange: 00/03:38:05 to 00/03:39:09

Plot file version 24 created 25-MAR-2014 17:50:48

J1128+5925 EP087E 1.UVDATA.1

Freq = 1.5950 GHz, Bw = 16.000 MH Calibrated with CL # 3 and BP # 1 (BP mode 1)

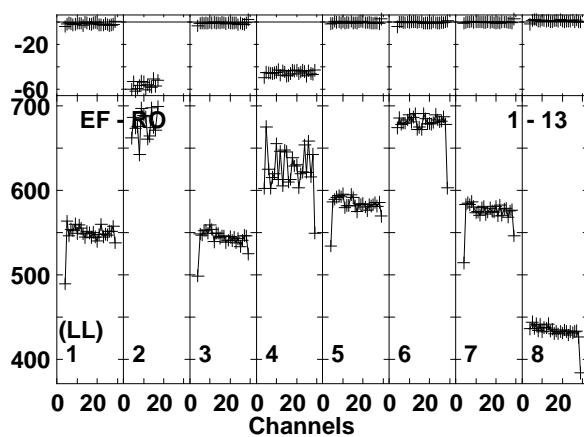
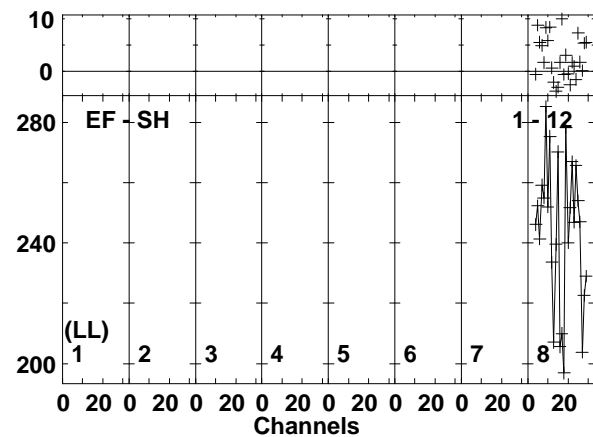
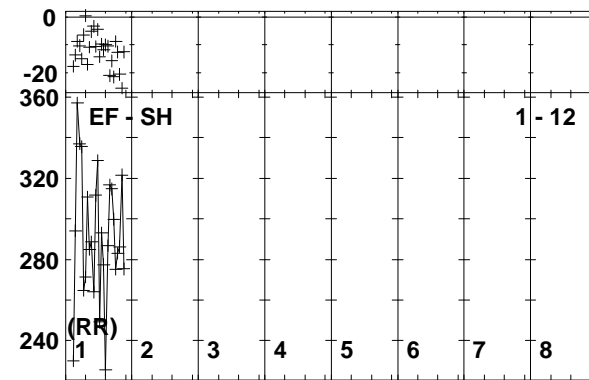
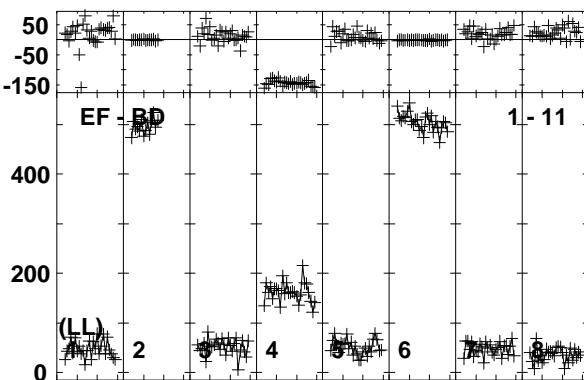
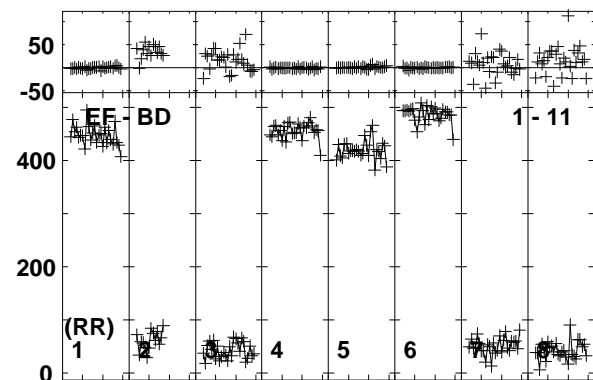
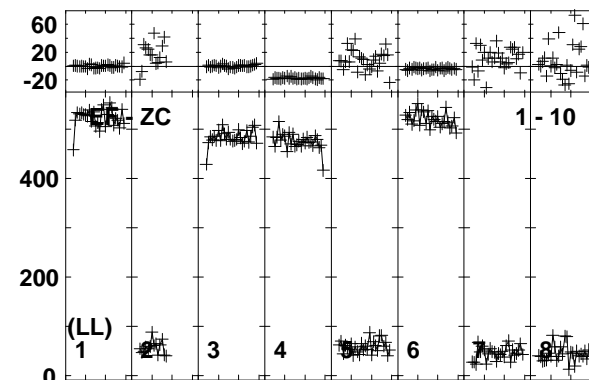
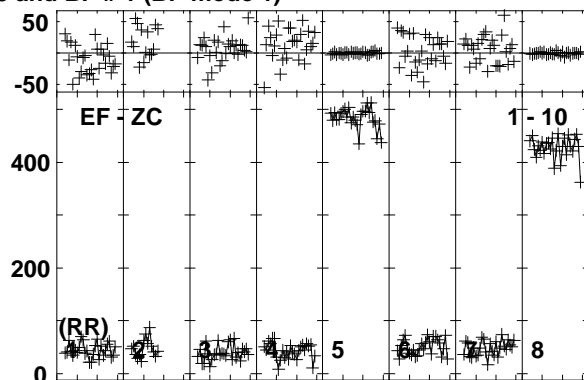
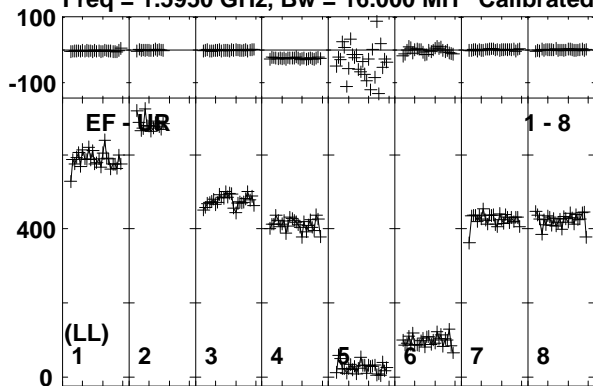

Lower frame: Milli Ampl Jy Top frame: Phas deg
Vector averaged cross-power spectrum Baseline: EF (01) - UR (08)
Timerange: 00/03:38:05 to 00/03:39:09

Plot file version 25 created 25-MAR-2014 17:50:48

ARP299A EP087E 1.UVDATA.1

Freq = 1.5950 GHz, Bw = 16.000 MH Calibrated with CL # 3 and BP # 1 (BP mode 1)

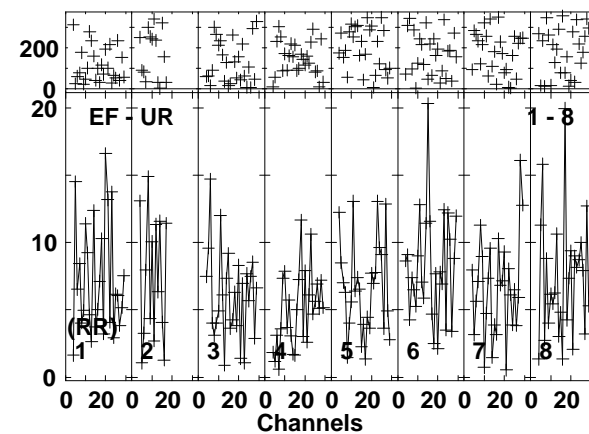
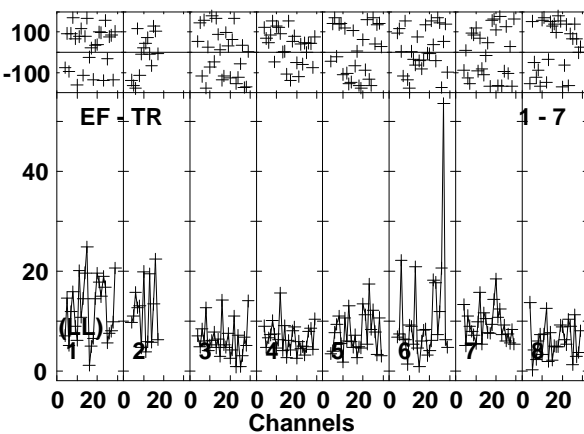
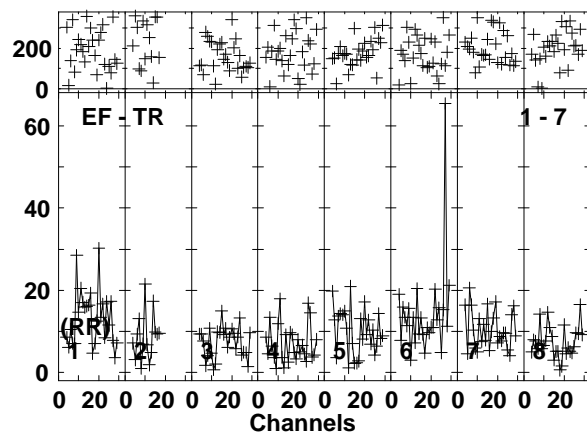
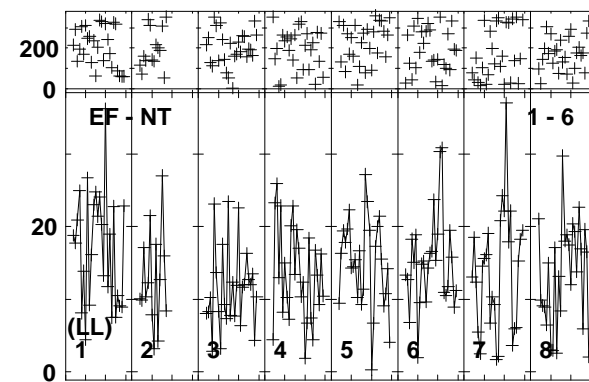
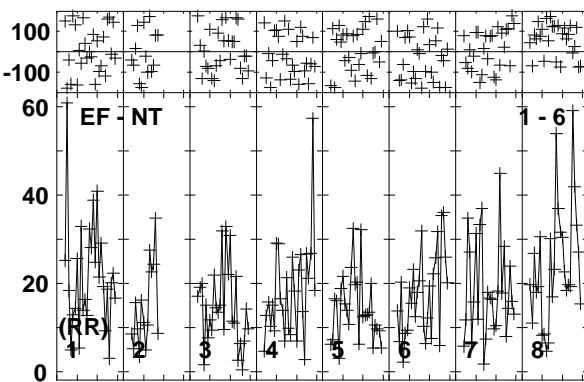
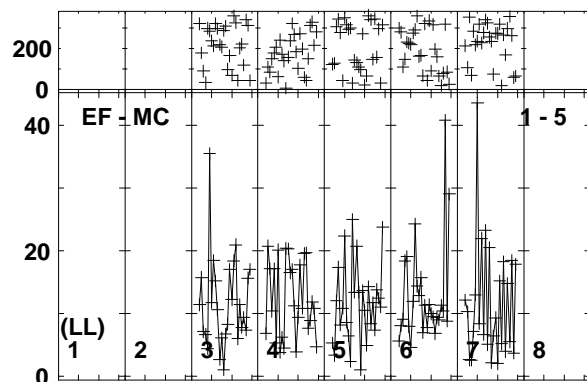
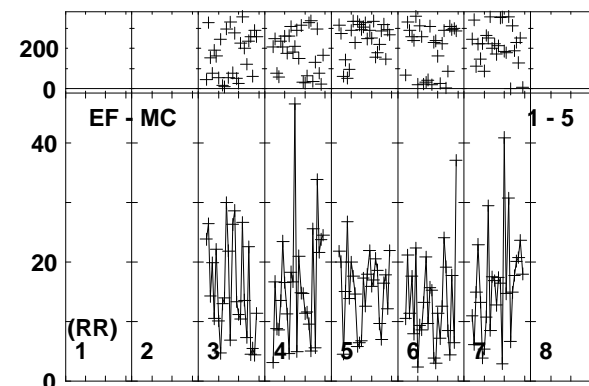
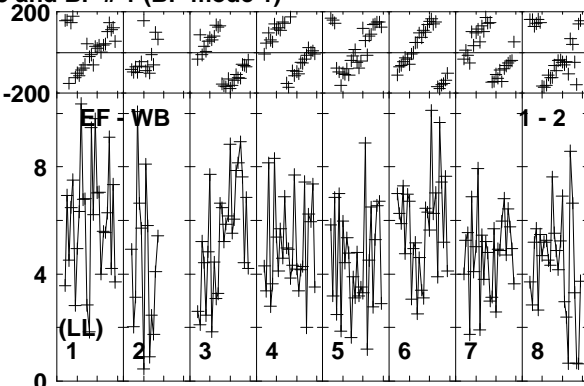
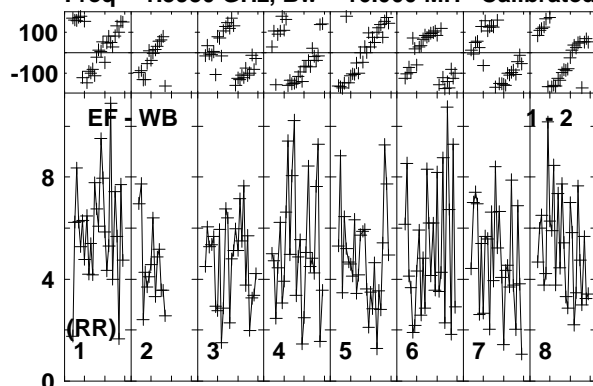

Lower frame: Milli Ampl Jy Top frame: Phas deg
Vector averaged cross-power spectrum Baseline: EF (01) - WB (02)
Timerange: 00/03:39:11 to 00/03:43:39

Plot file version 26 created 25-MAR-2014 17:50:49

ARP299A EP087E 1.UVDATA.1

Freq = 1.5950 GHz, Bw = 16.000 MH Calibrated with CL # 3 and BP # 1 (BP mode 1)

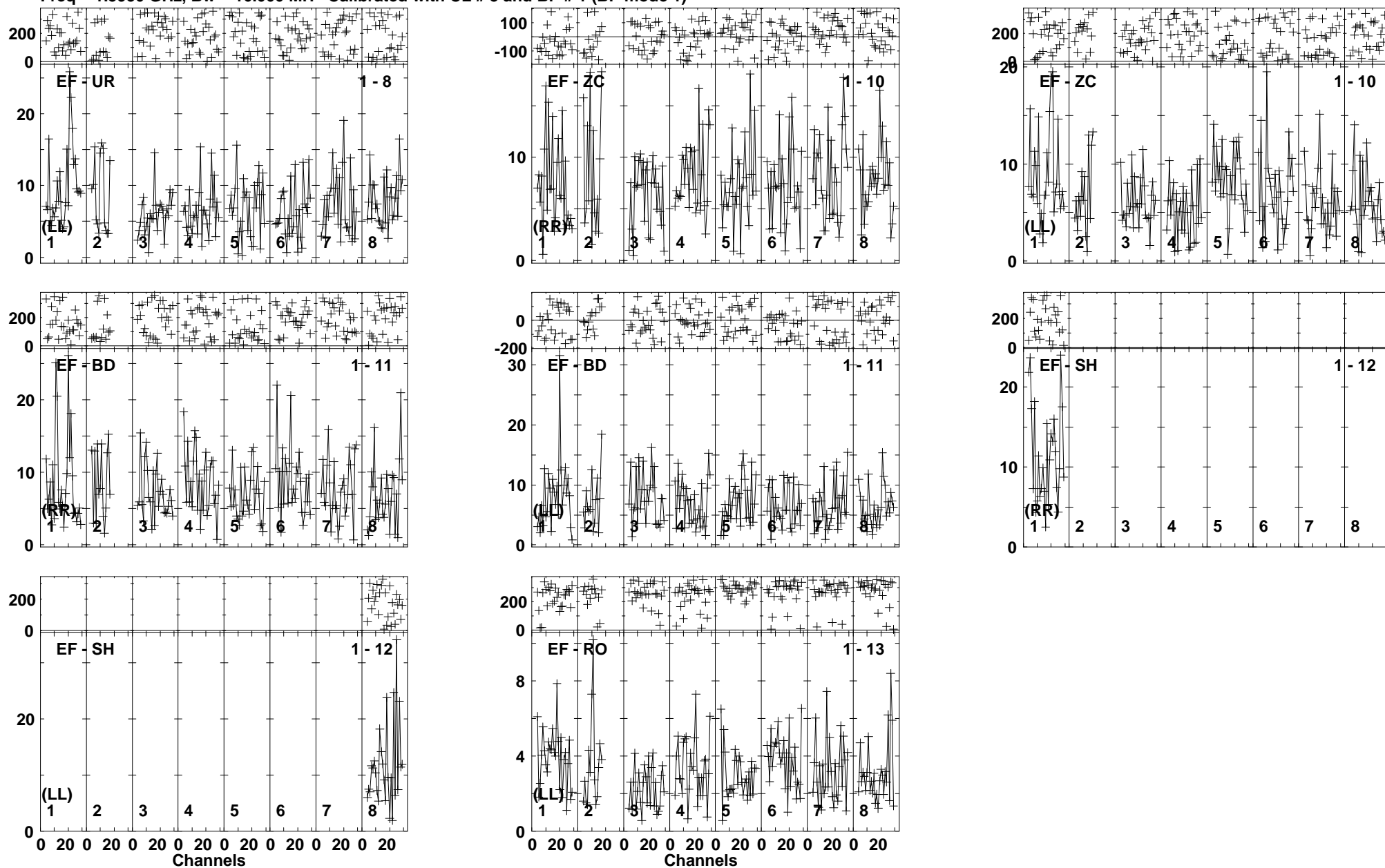

Lower frame: Milli Ampl Jy Top frame: Phas deg
Vector averaged cross-power spectrum Baseline: EF (01) - UR (08)
Timerange: 00/03:39:11 to 00/03:43:39

Plot file version 27 created 25-MAR-2014 17:50:49

J1128+5925 EP087E 1.UVDATA.1

Freq = 1.5950 GHz, Bw = 16.000 MH Calibrated with CL # 3 and BP # 1 (BP mode 1)

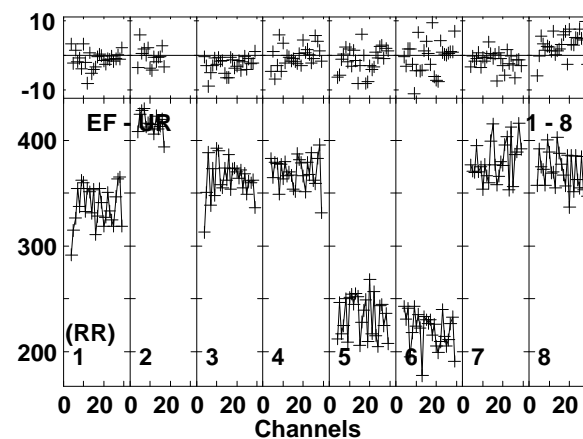
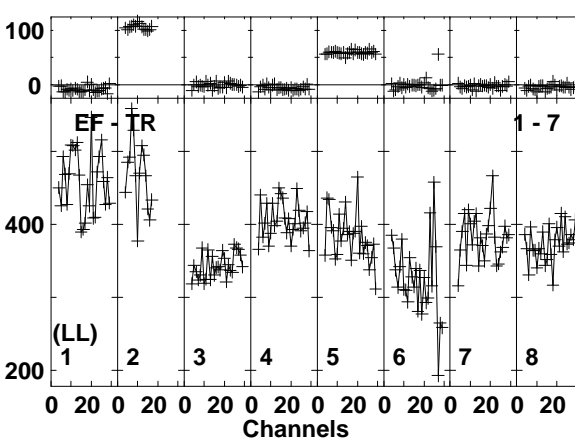
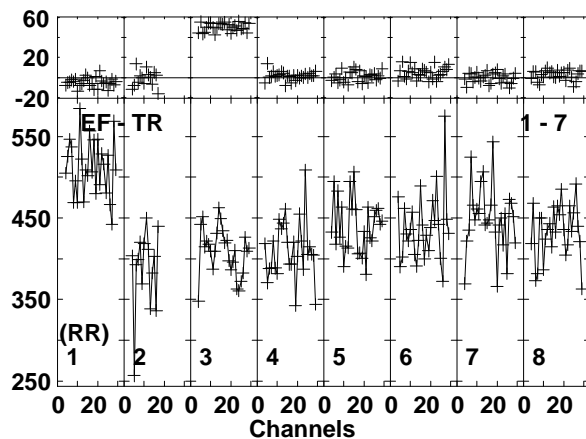
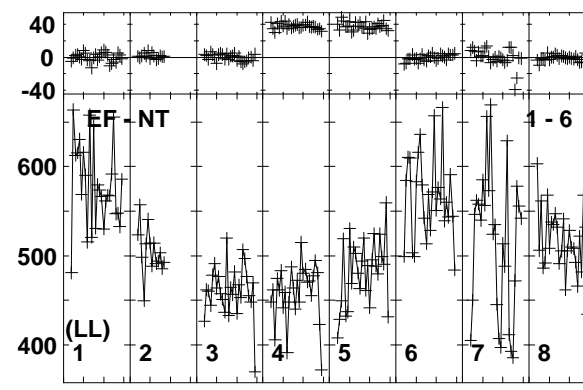
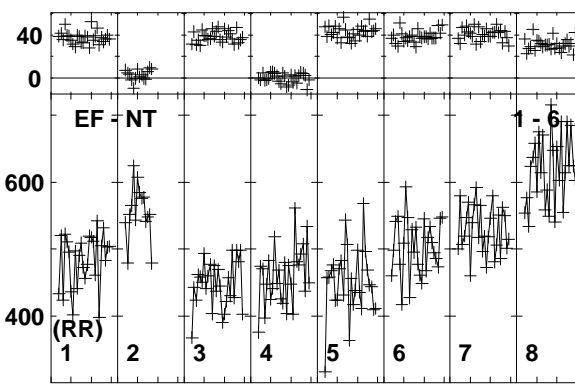
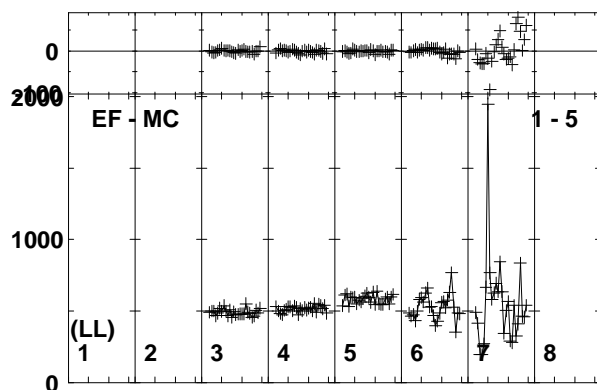
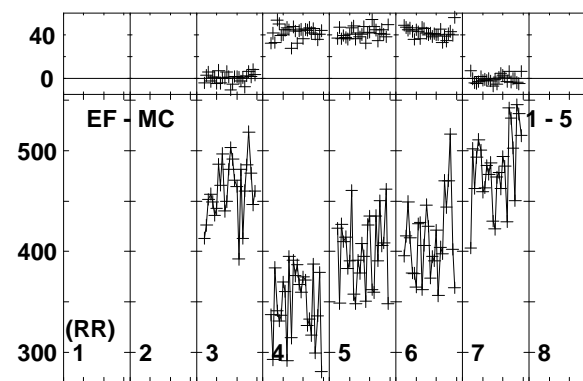
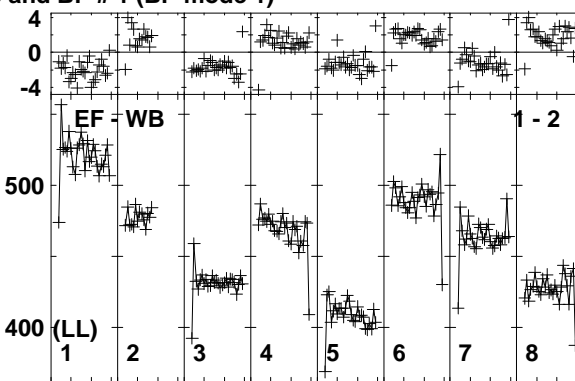
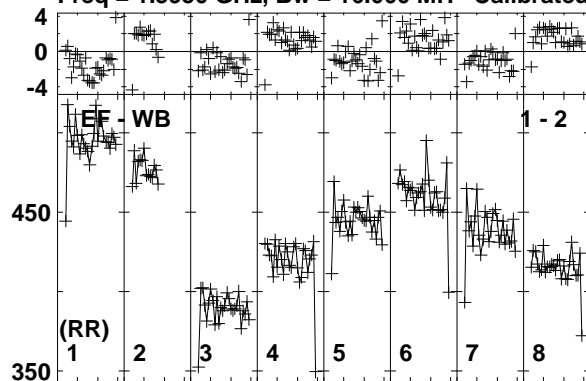

Lower frame: Milli Ampl Jy Top frame: Phas deg
Vector averaged cross-power spectrum Baseline: EF (01) - WB (02)
Timerange: 00/03:44:21 to 00/03:44:29

Plot file version 28 created 25-MAR-2014 17:50:49

J1128+5925 EP087E 1.UVDATA.1

Freq = 1.5950 GHz, Bw = 16.000 MH Calibrated with CL # 3 and BP # 1 (BP mode 1)

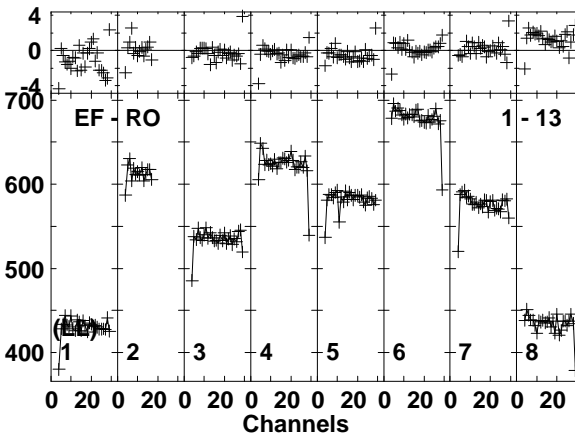
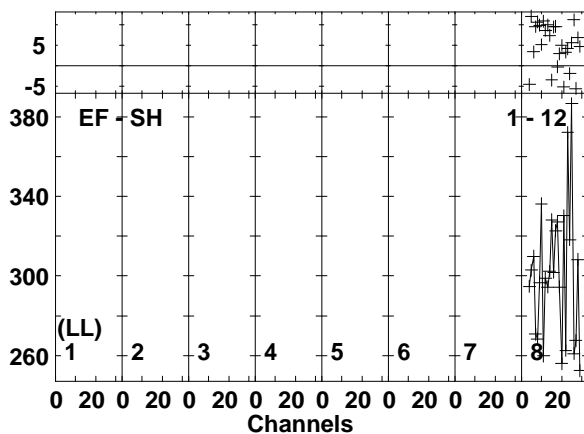
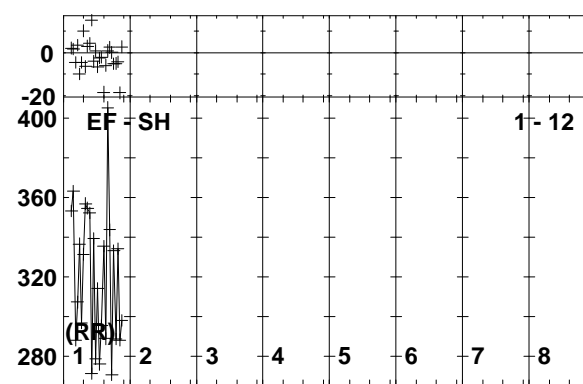
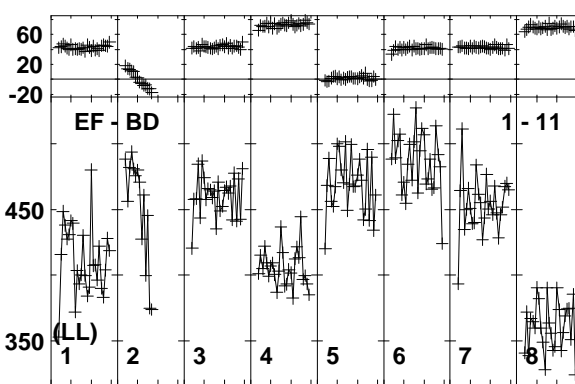
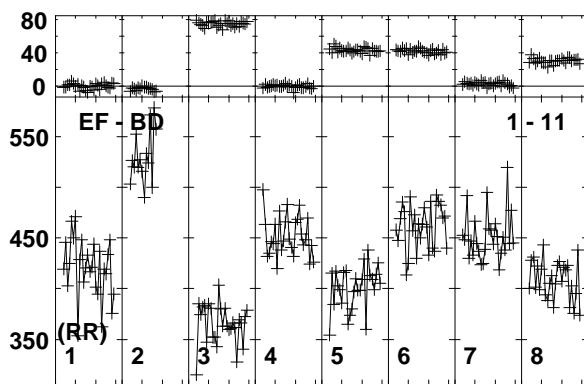
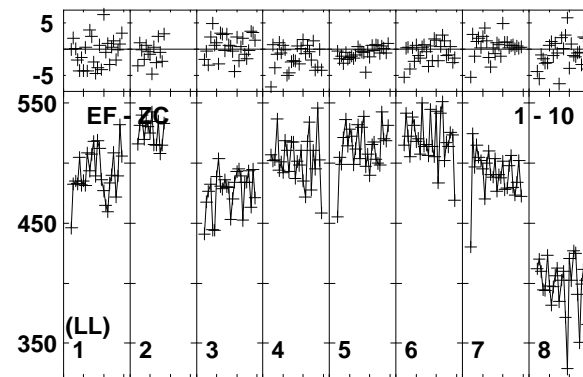
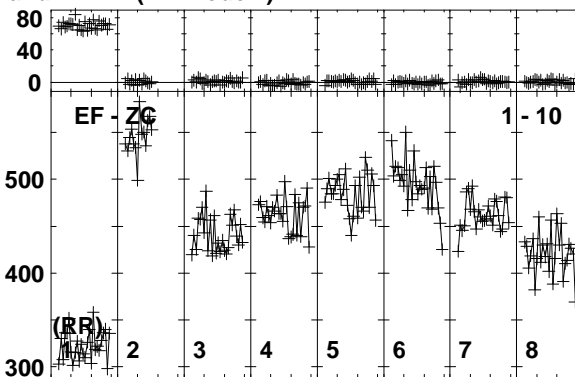
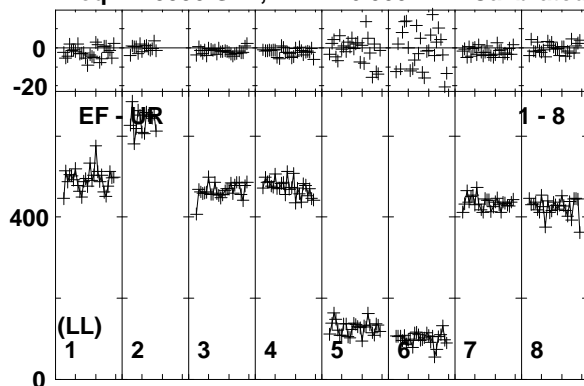

Lower frame: Milli Ampl Jy Top frame: Phas deg
Vector averaged cross-power spectrum Baseline: EF (01) - UR (08)
Timerange: 00/03:44:21 to 00/03:44:49

Plot file version 29 created 25-MAR-2014 17:50:49
 ARP299A EP087E 1.UVDATA.1
 Freq = 1.5950 GHz, Bw = 16.000 MH Calibrated with CL # 3 and BP # 1 (BP mode 1)

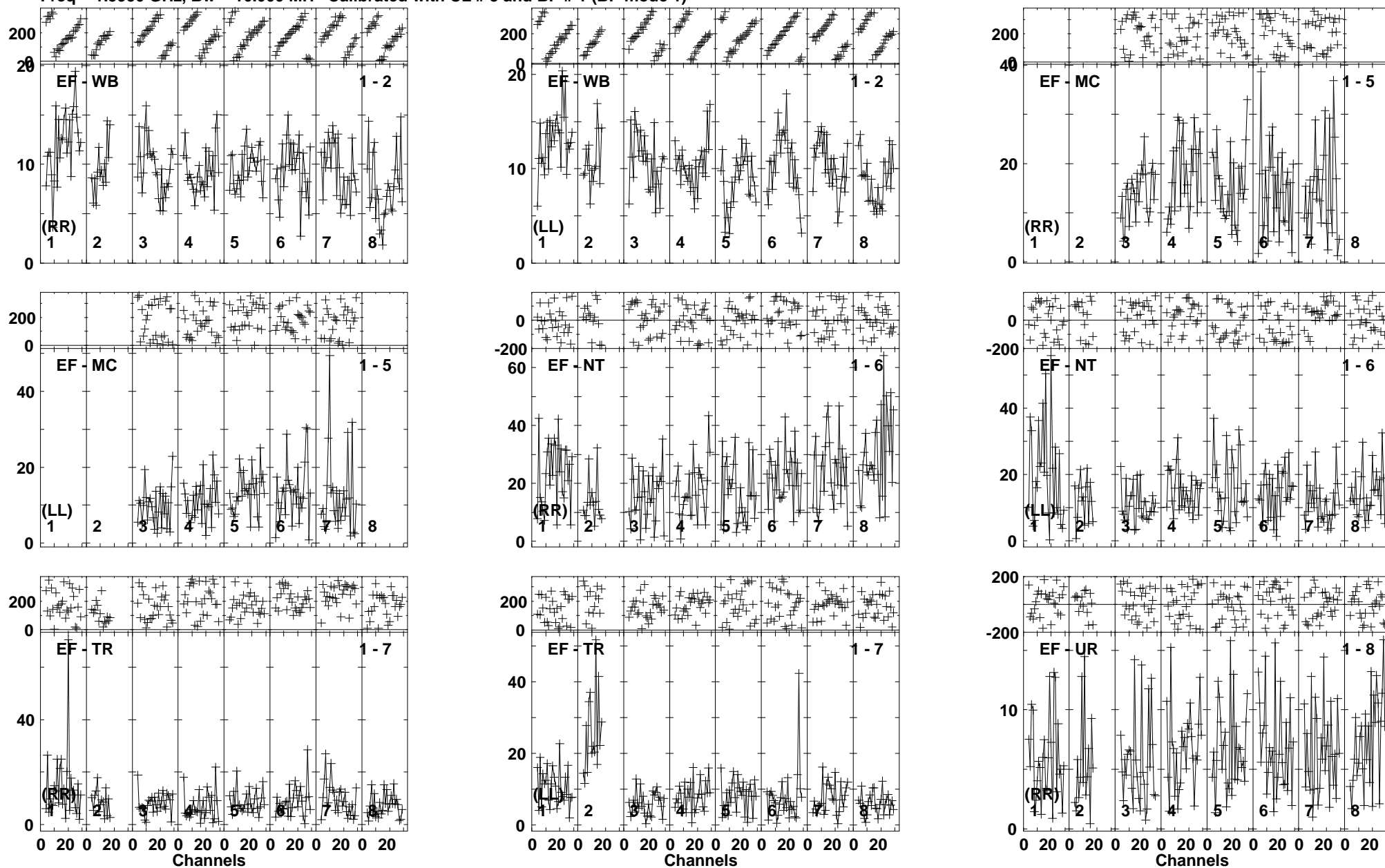

Lower frame: Milli Ampl Jy Top frame: Phas deg
 Vector averaged cross-power spectrum Baseline: EF (01) - WB (02)
 Timerange: 00/03:44:55 to 00/03:49:19

Plot file version 30 created 25-MAR-2014 17:50:50

ARP299A EP087E 1.UVDATA.1

Freq = 1.5950 GHz, Bw = 16.000 MH Calibrated with CL # 3 and BP # 1 (BP mode 1)

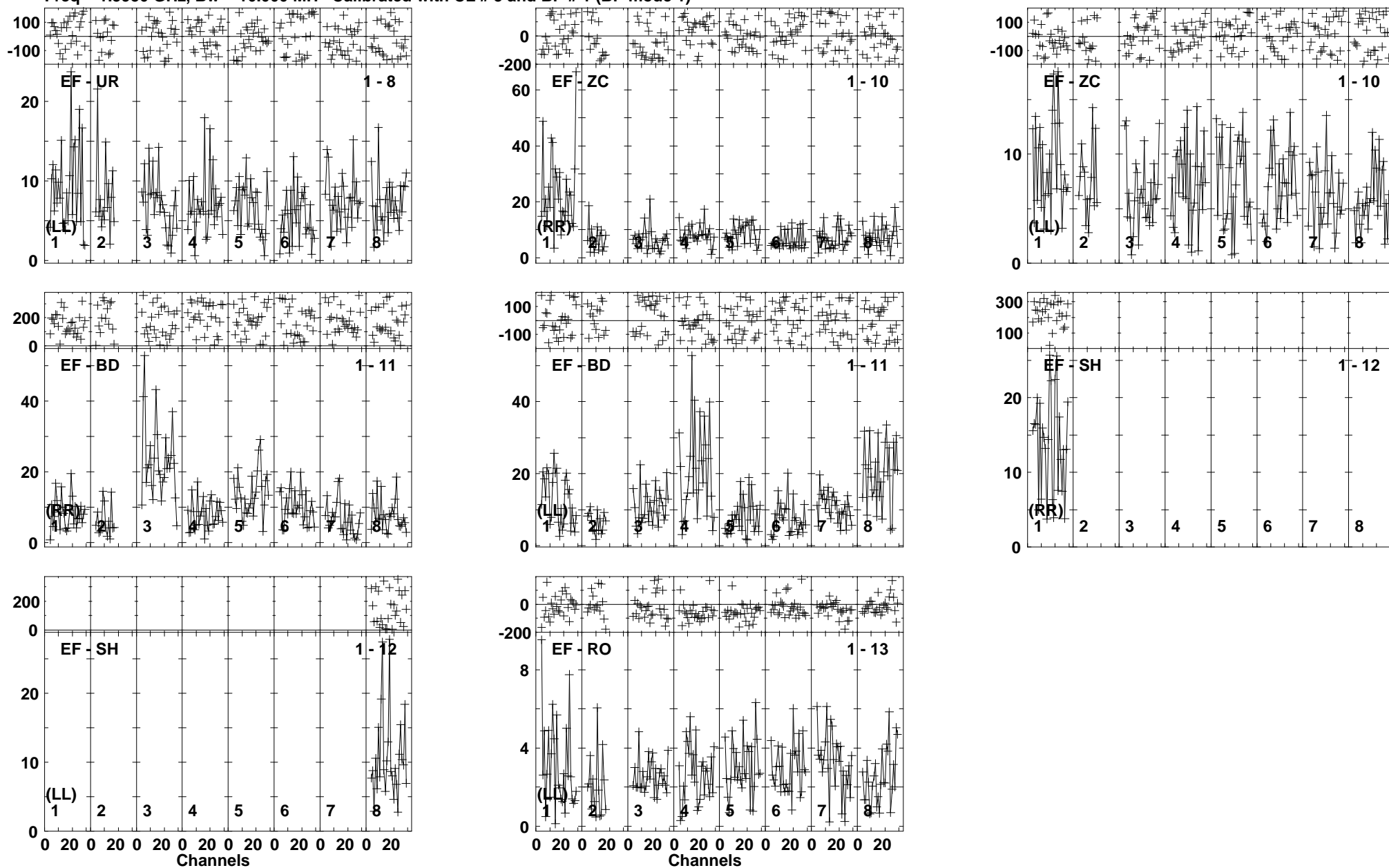

Lower frame: Milli Ampl Jy Top frame: Phas deg
Vector averaged cross-power spectrum Baseline: EF (01) - UR (08)
Timerange: 00/03:44:55 to 00/03:49:19

Plot file version 31 created 25-MAR-2014 17:50:50

J1128+5925 EP087E 1.UVDATA.1

Freq = 1.5950 GHz, Bw = 16.000 MH Calibrated with CL # 3 and BP # 1 (BP mode 1)

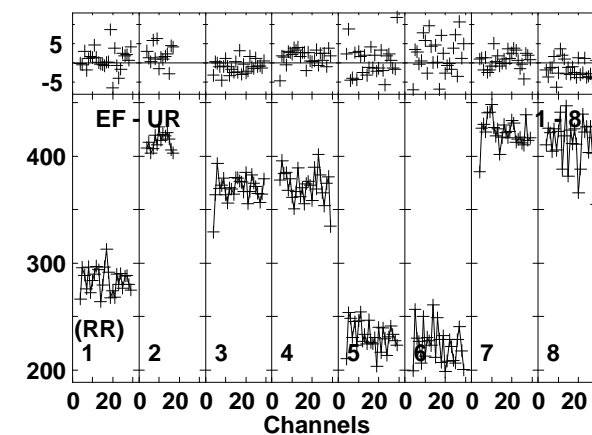
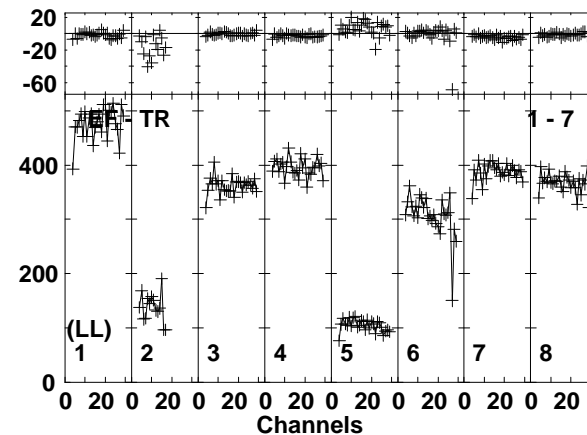
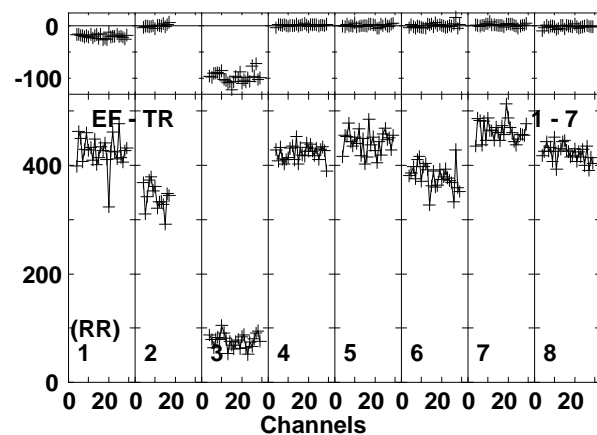
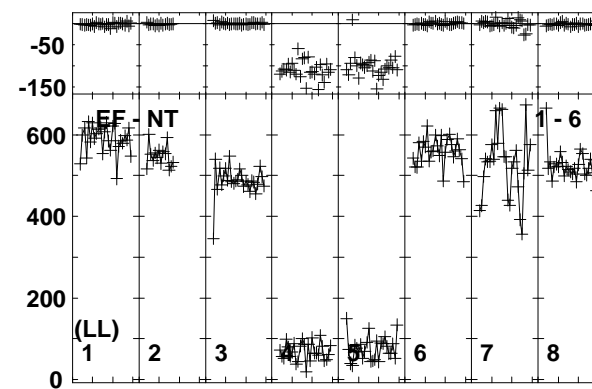
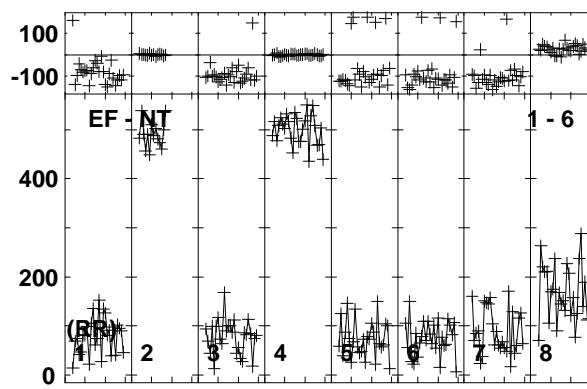
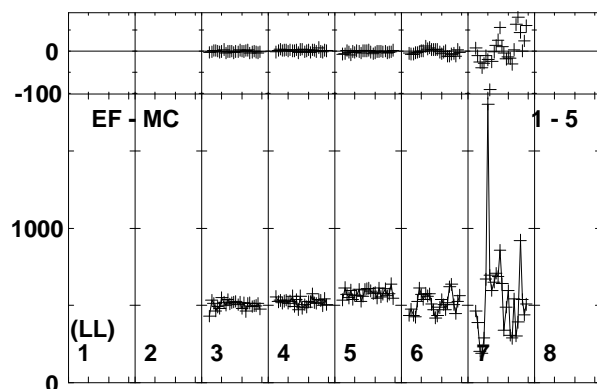
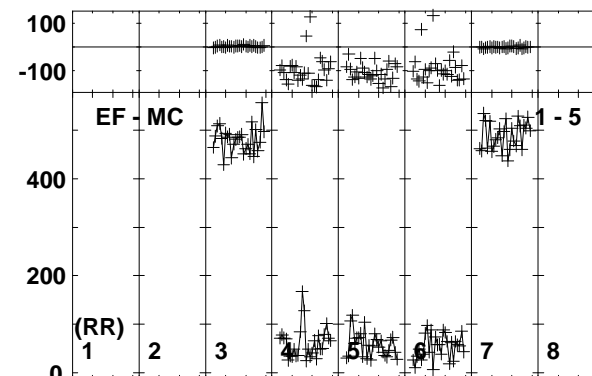
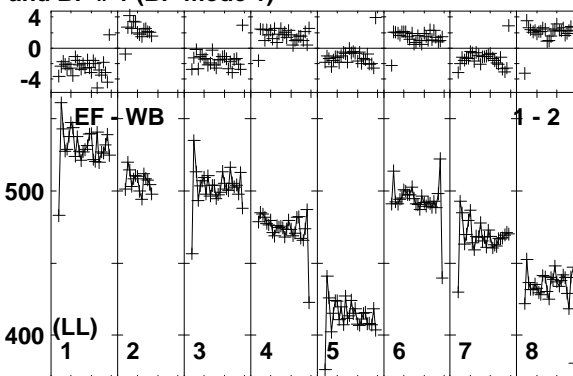
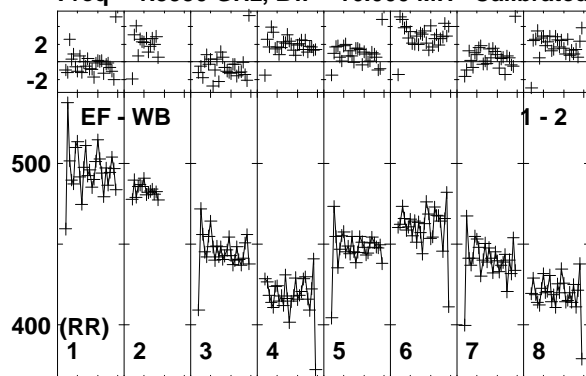

Lower frame: Milli Ampl Jy Top frame: Phas deg
Vector averaged cross-power spectrum Baseline: EF (01) - WB (02)
Timerange: 00/03:49:25 to 00/03:50:29

Plot file version 32 created 25-MAR-2014 17:50:50

J1128+5925 EP087E 1.UVDATA.1

Freq = 1.5950 GHz, Bw = 16.000 MH Calibrated with CL # 3 and BP # 1 (BP mode 1)

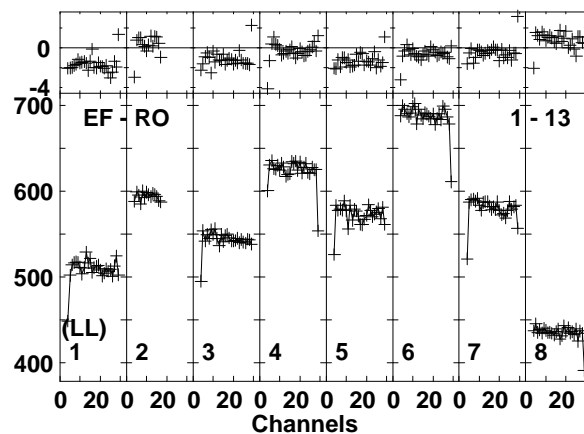
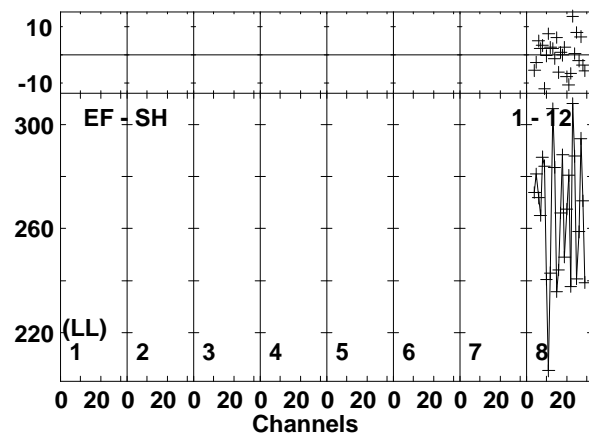
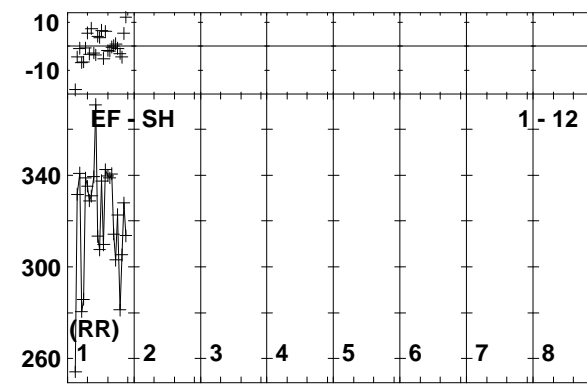
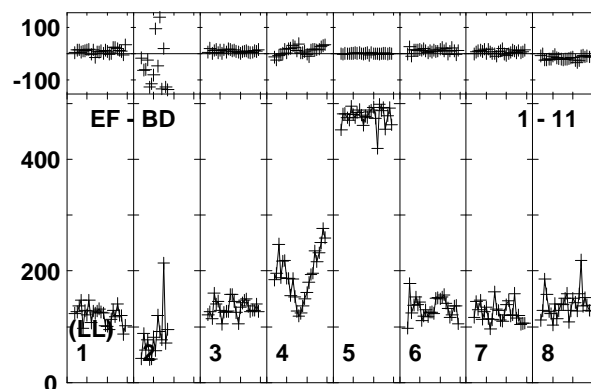
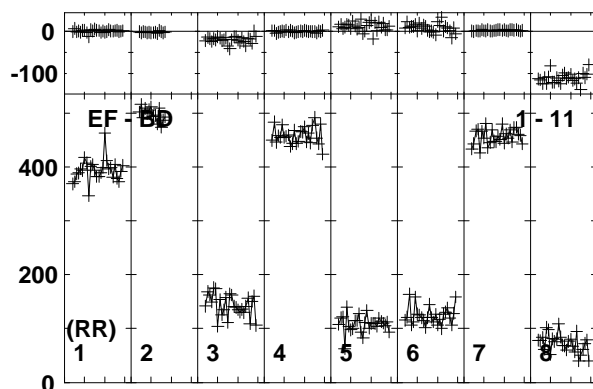
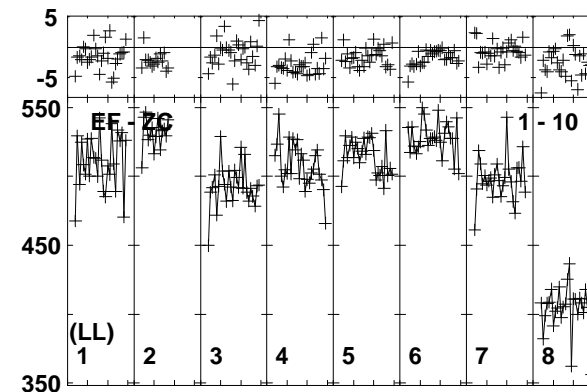
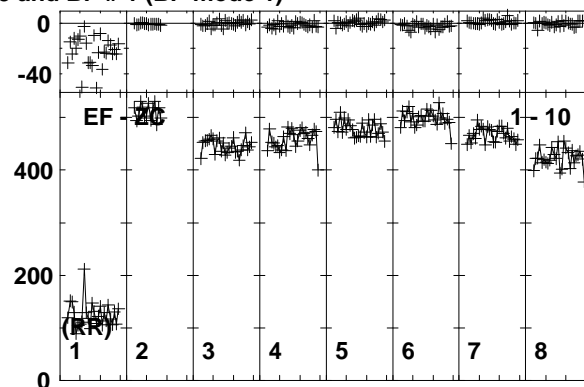
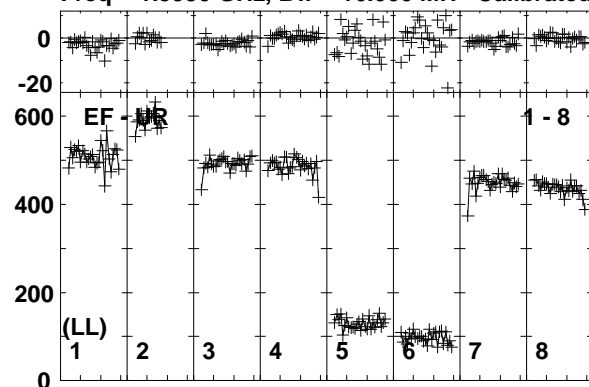

Lower frame: Milli Ampl Jy Top frame: Phas deg
Vector averaged cross-power spectrum Baseline: EF (01) - UR (08)
Timerange: 00/03:49:25 to 00/03:50:29

Plot file version 33 created 25-MAR-2014 17:50:51

ARP299A EP087E 1.UVDATA.1

Freq = 1.5950 GHz, Bw = 16.000 MH Calibrated with CL # 3 and BP # 1 (BP mode 1)

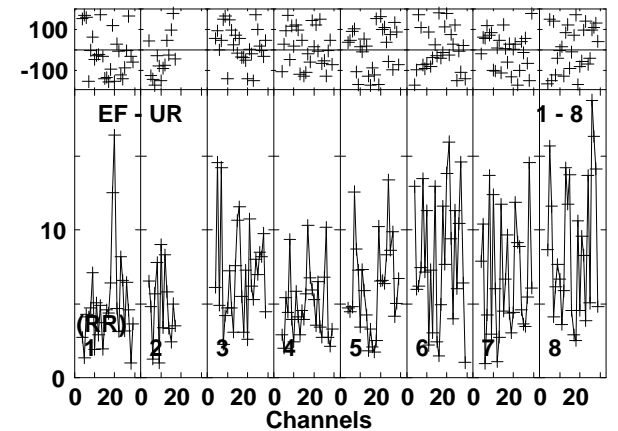
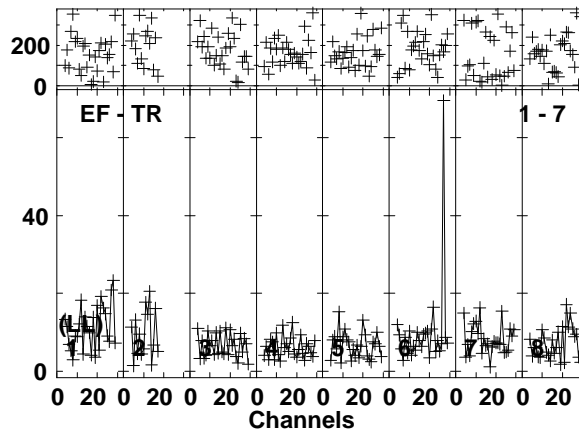
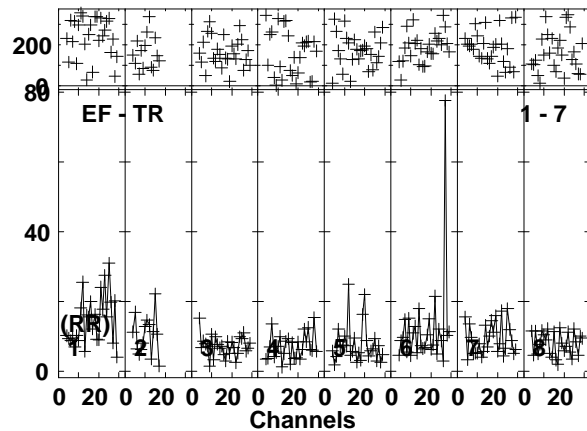
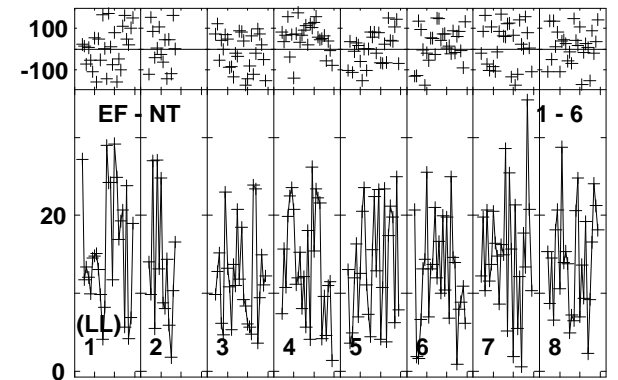
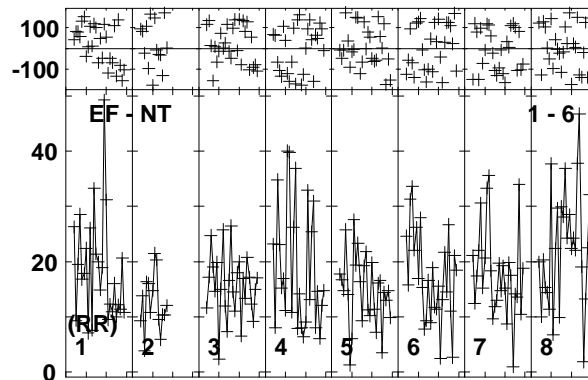
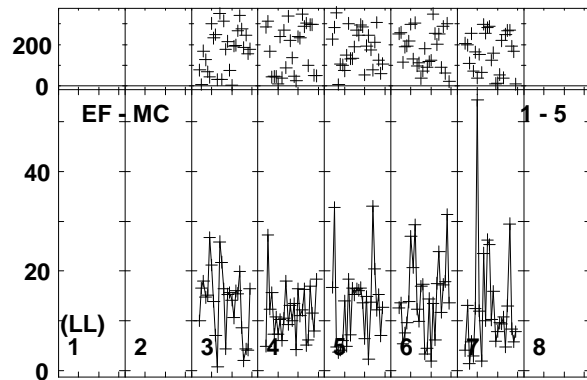
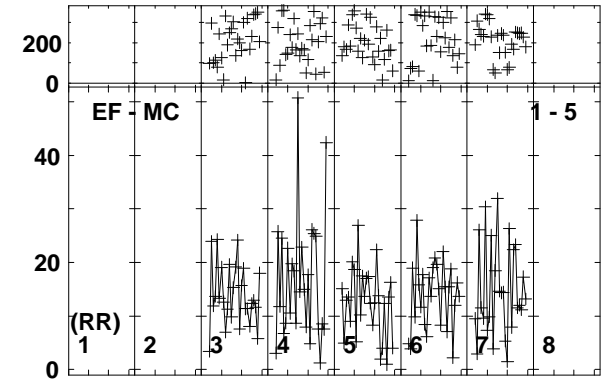
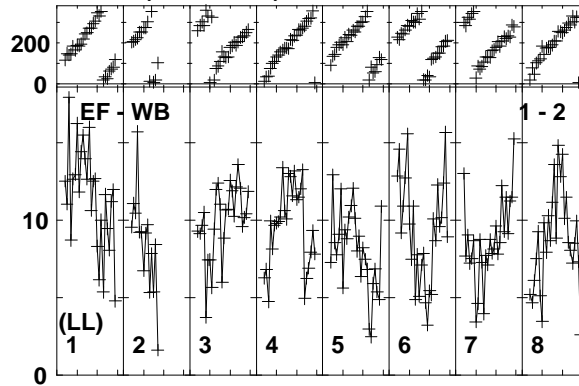
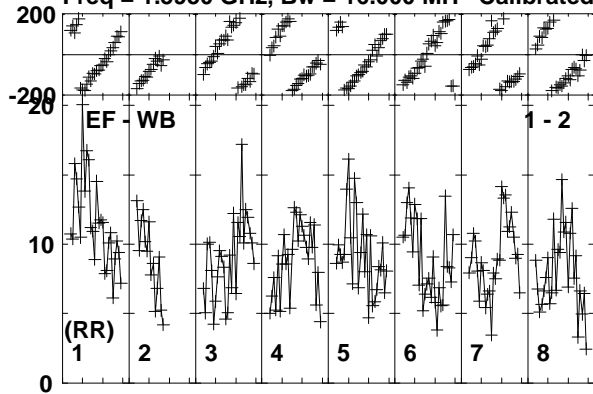

Lower frame: Milli Ampl Jy Top frame: Phas deg
Vector averaged cross-power spectrum Baseline: EF (01) - WB (02)
Timerange: 00/03:50:31 to 00/03:54:59

Plot file version 34 created 25-MAR-2014 17:50:51
 ARP299A EP087E 1.UVDATA.1
 Freq = 1.5950 GHz, Bw = 16.000 MH Calibrated with CL # 3 and BP # 1 (BP mode 1)

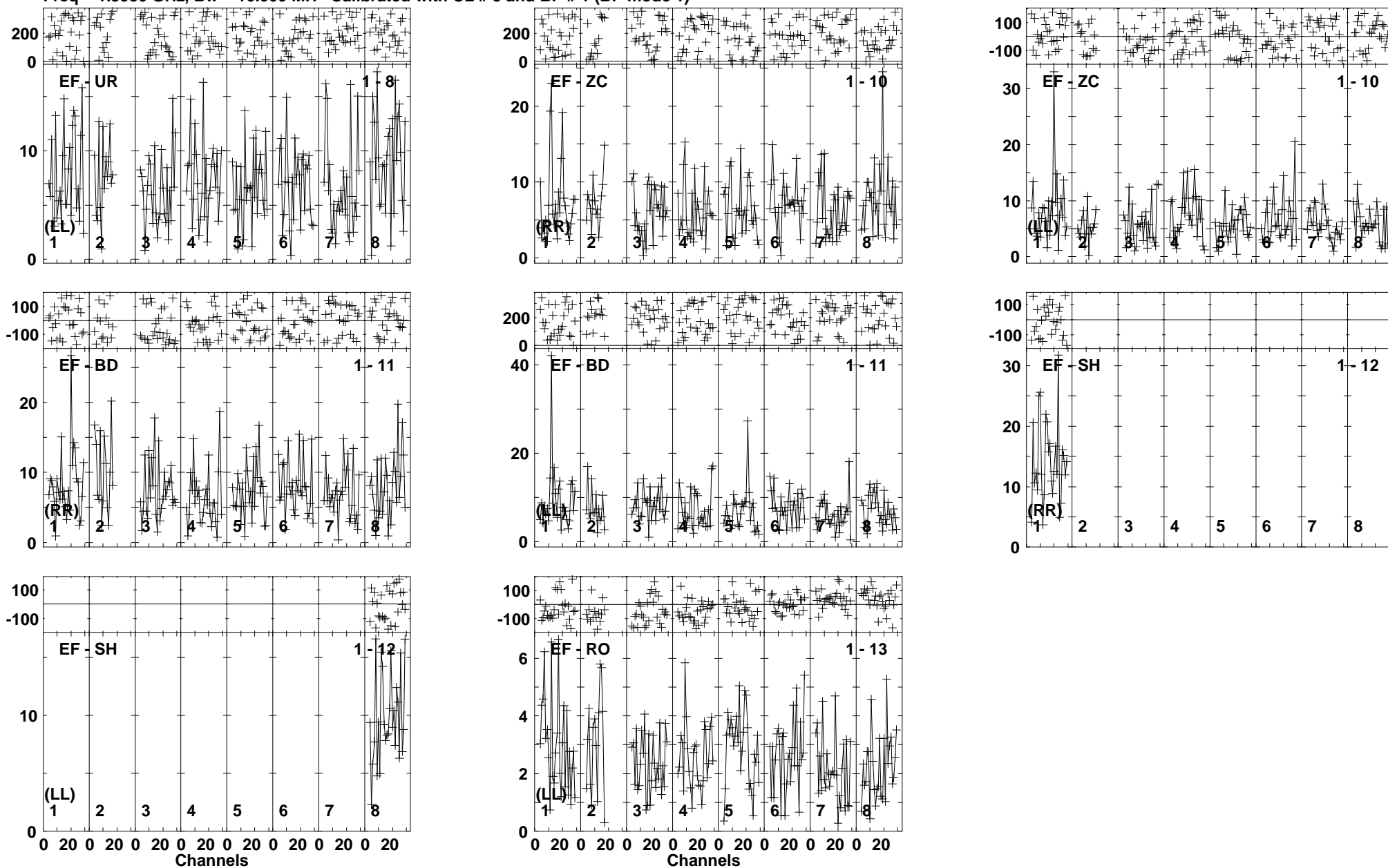

Lower frame: Milli Ampl Jy Top frame: Phas deg
 Vector averaged cross-power spectrum Baseline: EF (01) - UR (08)
 Timerange: 00/03:50:31 to 00/03:54:59

Plot file version 35 created 25-MAR-2014 17:50:51

J1128+5925 EP087E 1.UVDATA.1

Freq = 1.5950 GHz, Bw = 16.000 MH Calibrated with CL # 3 and BP # 1 (BP mode 1)

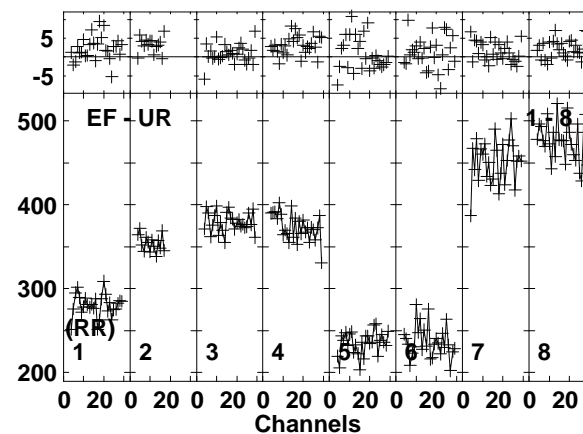
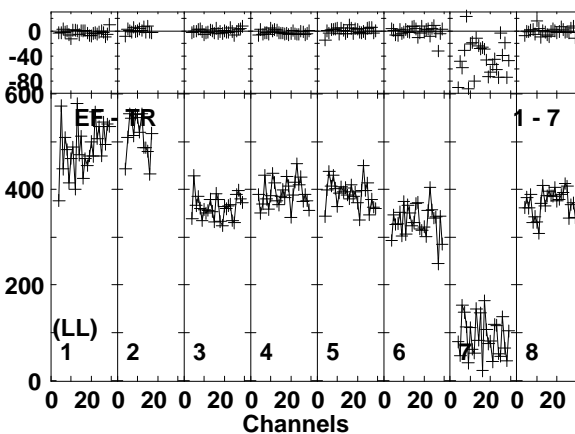
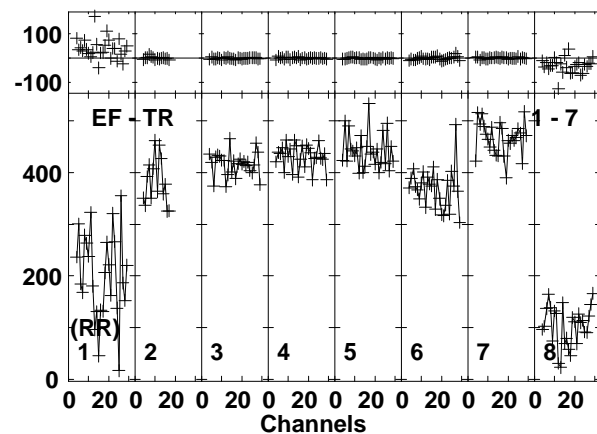
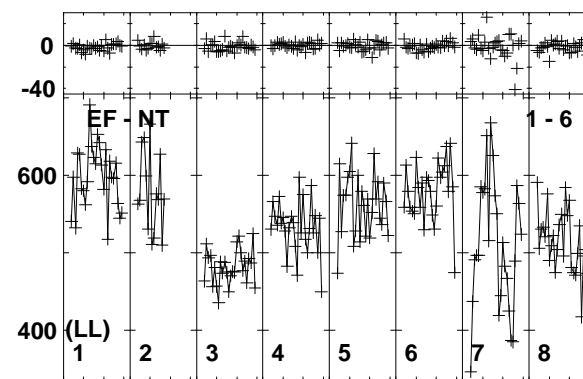
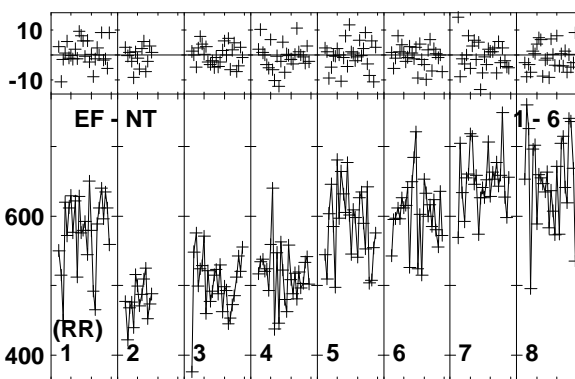
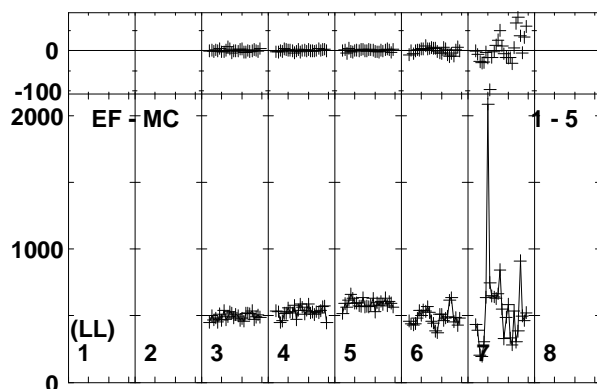
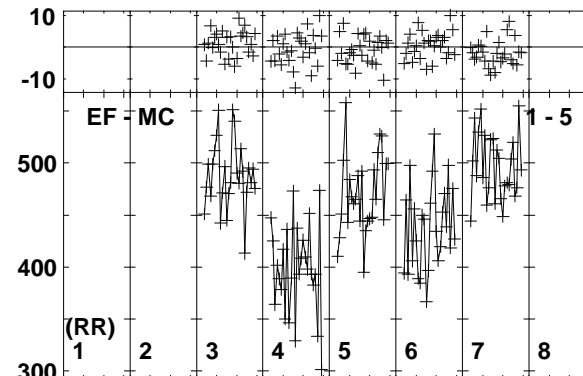
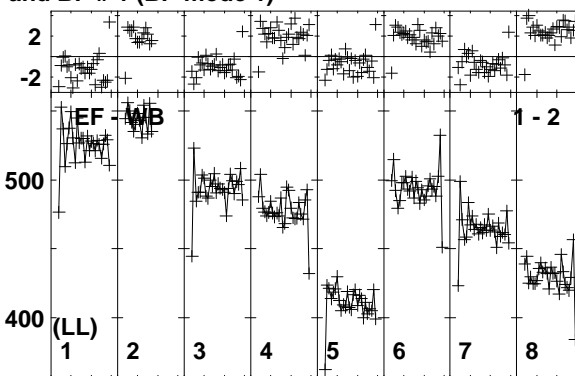
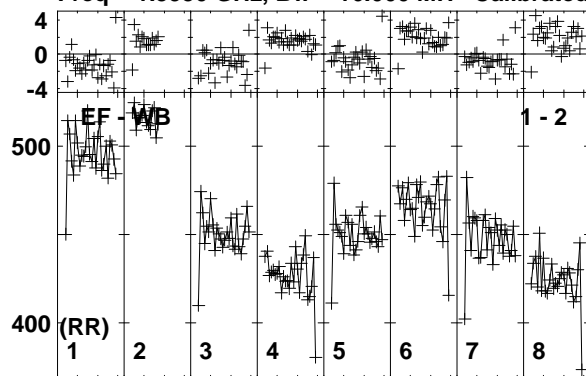

Lower frame: Milli Ampl Jy Top frame: Phas deg
Vector averaged cross-power spectrum Baseline: EF (01) - WB (02)
Timerange: 00/03:55:41 to 00/03:56:09

Plot file version 36 created 25-MAR-2014 17:50:52

J1128+5925 EP087E 1.UVDATA.1

Freq = 1.5950 GHz, Bw = 16.000 MH Calibrated with CL # 3 and BP # 1 (BP mode 1)

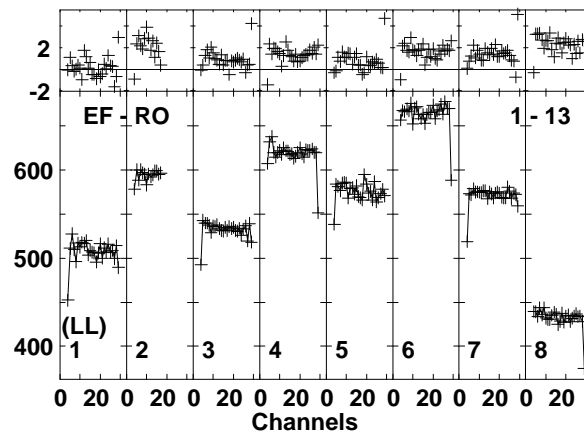
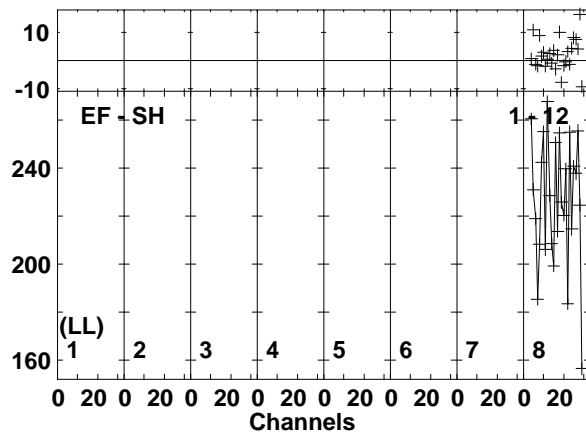
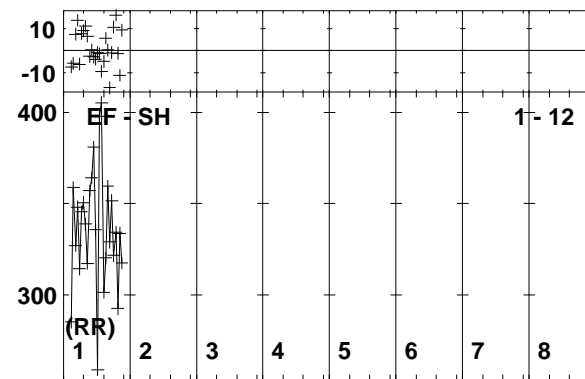
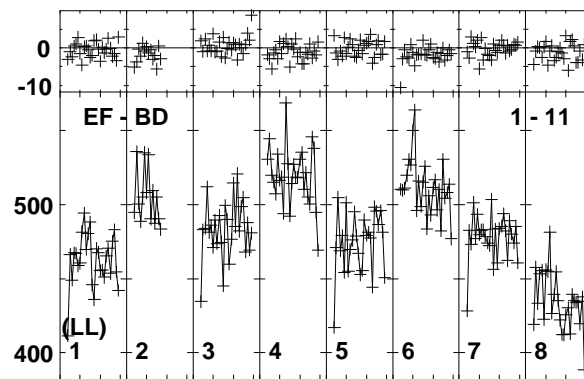
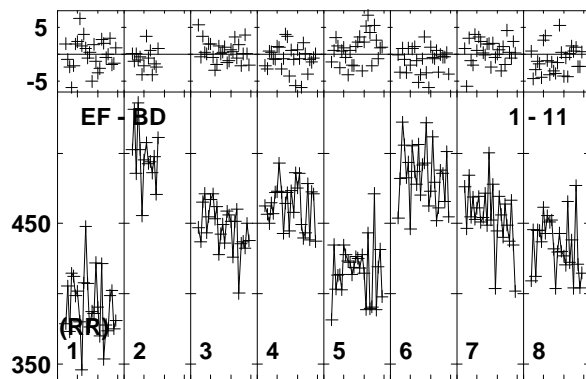
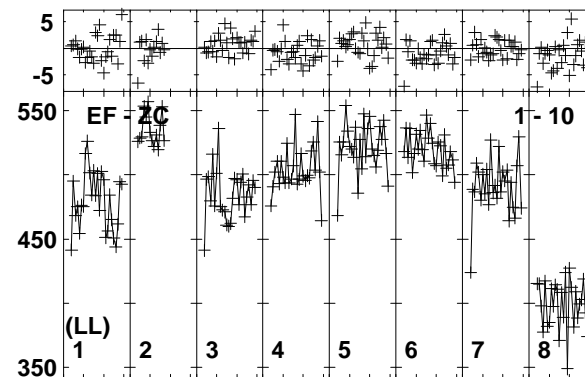
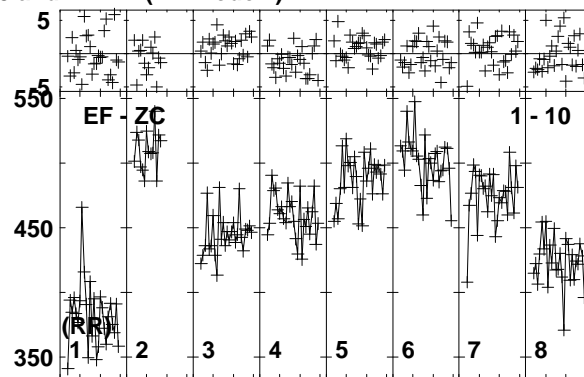
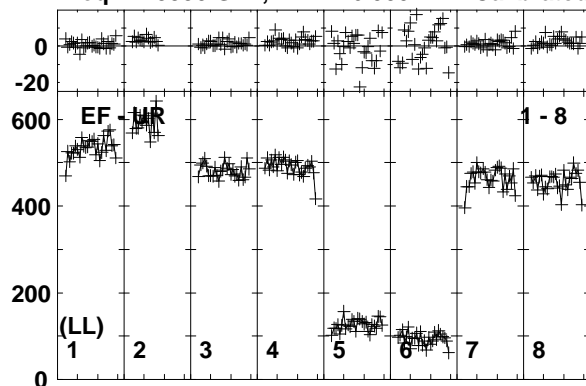

Lower frame: Milli Amply Jy Top frame: Phas deg
 Vector averaged cross-power spectrum Baseline: EF (01) - UR (08)
 Timerange: 00/03:55:41 to 00/03:56:09

Plot file version 37 created 25-MAR-2014 17:50:52
 ARP299A EP087E 1.UVDATA.1
 Freq = 1.5950 GHz, Bw = 16.000 MH Calibrated with CL # 3 and BP # 1 (BP mode 1)

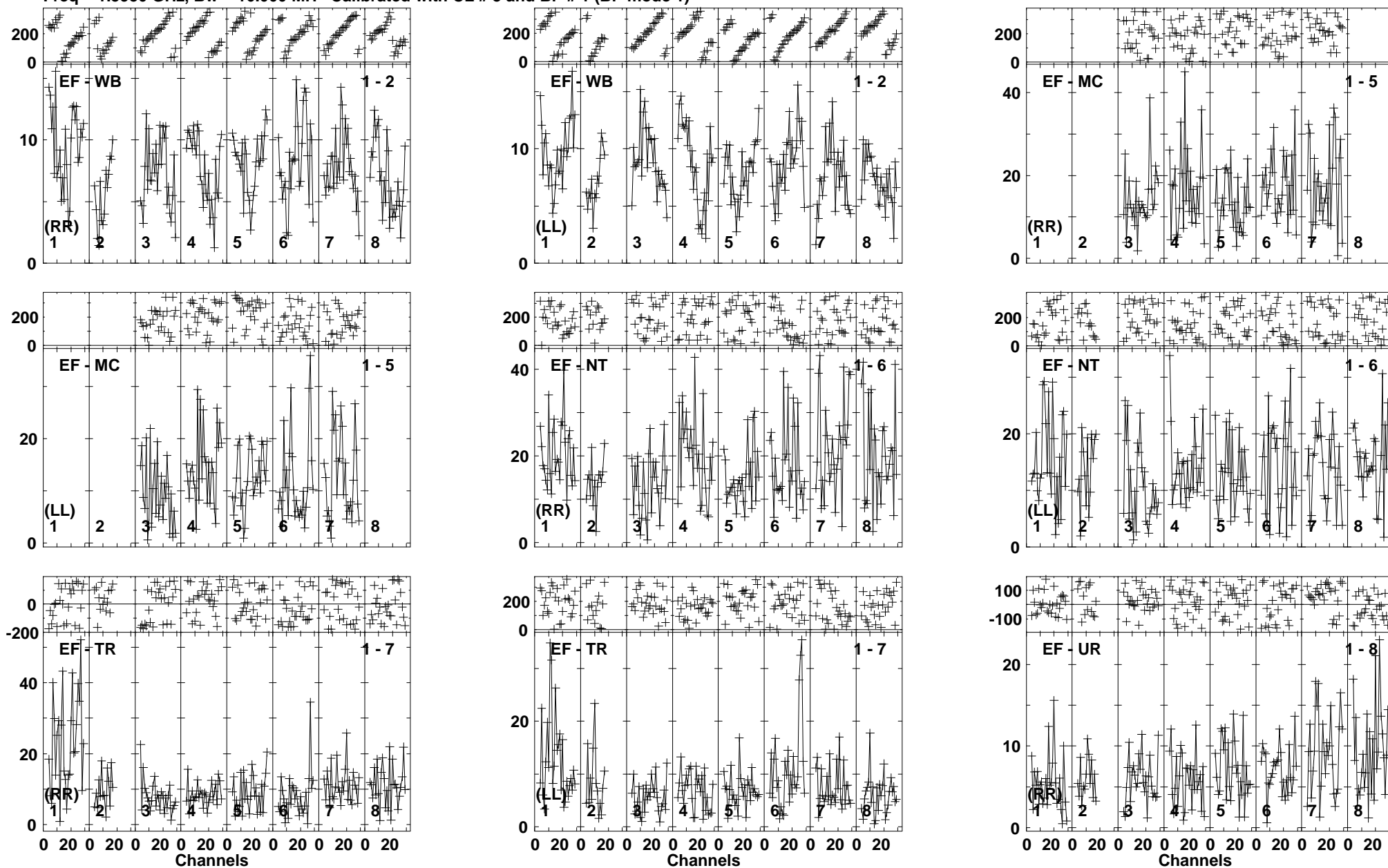

Lower frame: Milli Ampl Jy Top frame: Phas deg
 Vector averaged cross-power spectrum Baseline: EF (01) - WB (02)
 Timerange: 00/03:56:15 to 00/04:00:39

Plot file version 38 created 25-MAR-2014 17:50:52

ARP299A EP087E 1.UVDATA.1

Freq = 1.5950 GHz, Bw = 16.000 MH Calibrated with CL # 3 and BP # 1 (BP mode 1)

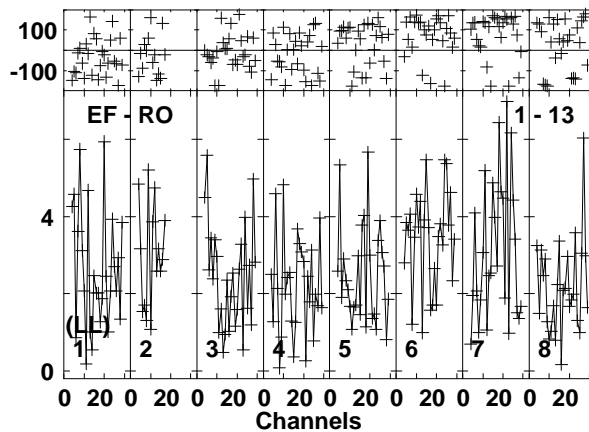
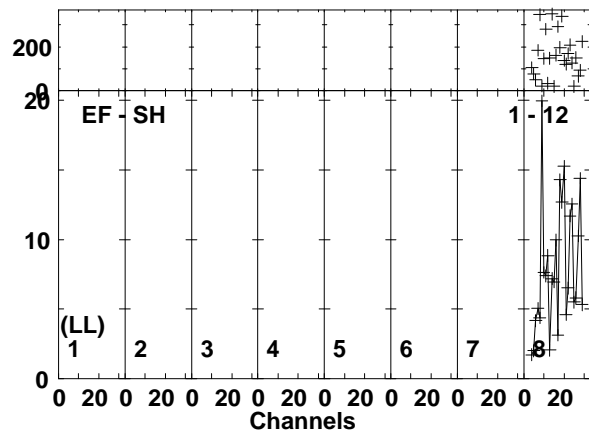
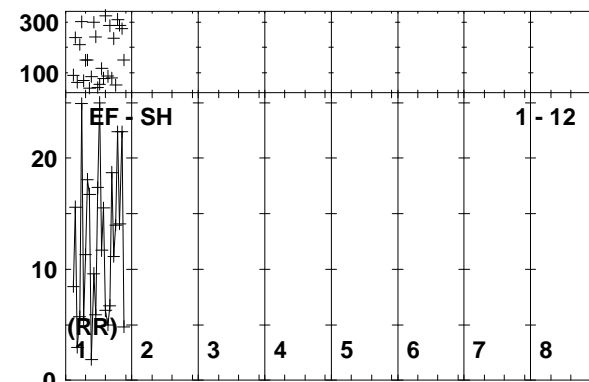
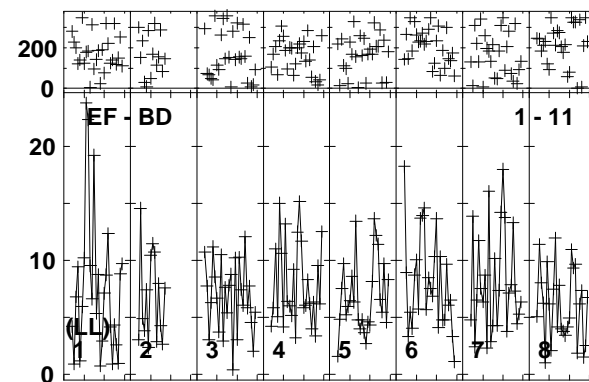
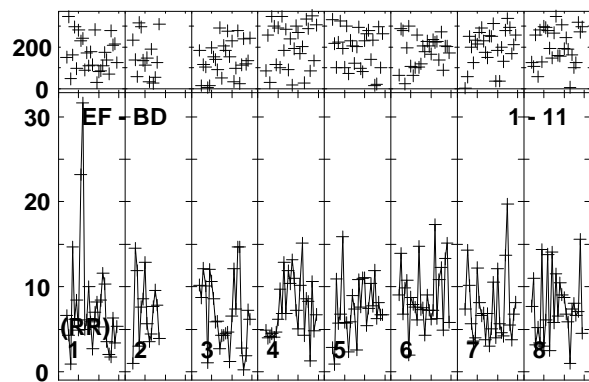
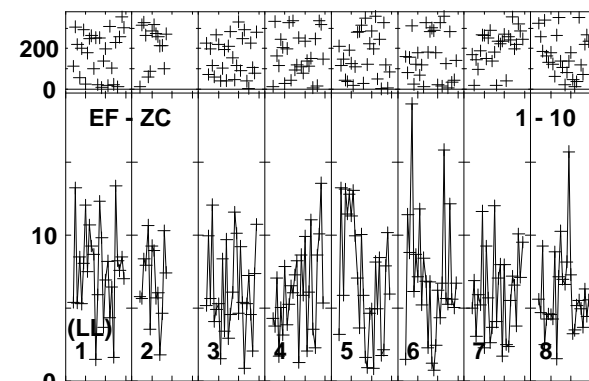
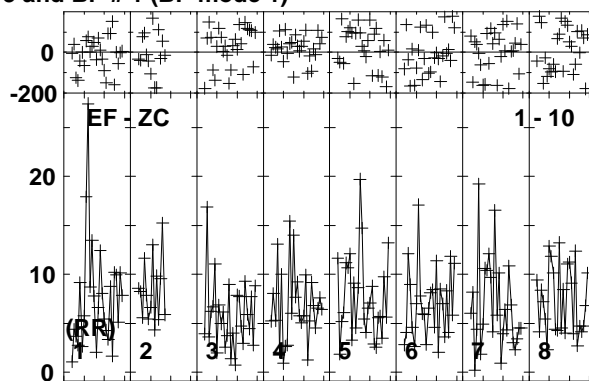
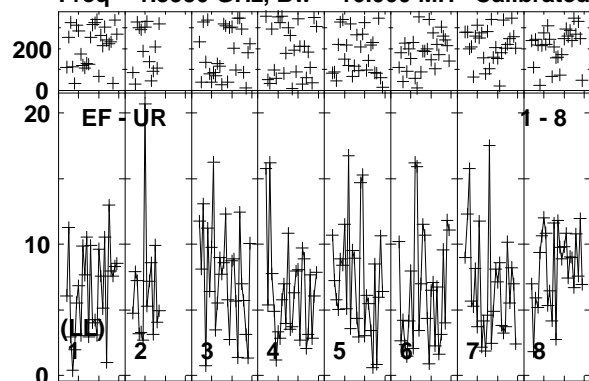

Lower frame: Milli Ampl Jy Top frame: Phas deg
Vector averaged cross-power spectrum Baseline: EF (01) - UR (08)
Timerange: 00/03:56:15 to 00/04:00:39

Plot file version 39 created 25-MAR-2014 17:50:52

J1128+5925 EP087E 1.UVDATA.1

Freq = 1.5950 GHz, Bw = 16.000 MH Calibrated with CL # 3 and BP # 1 (BP mode 1)

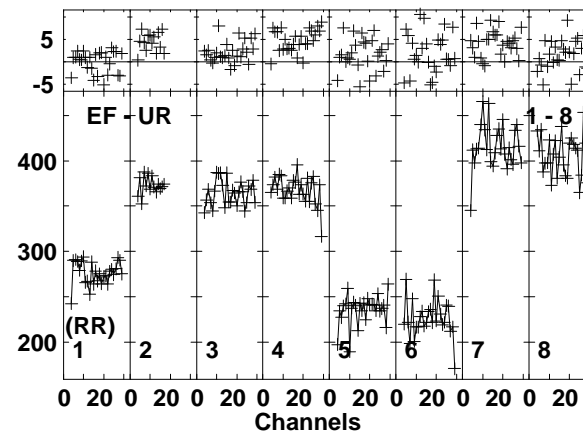
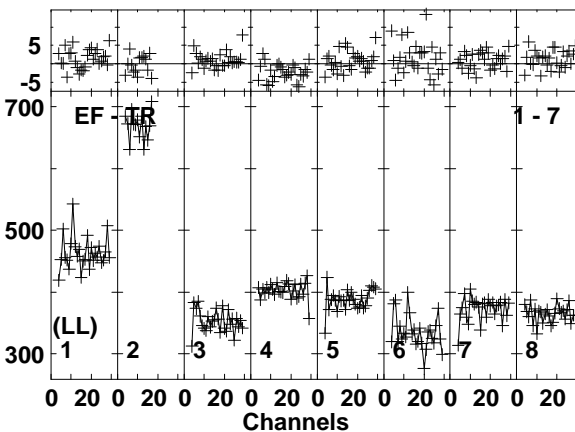
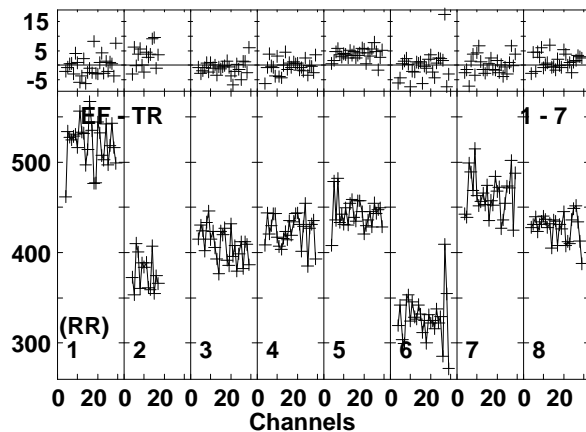
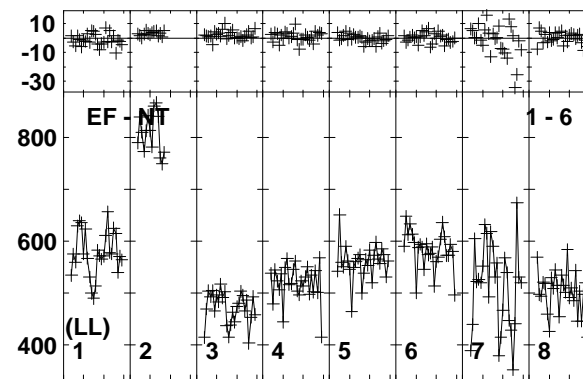
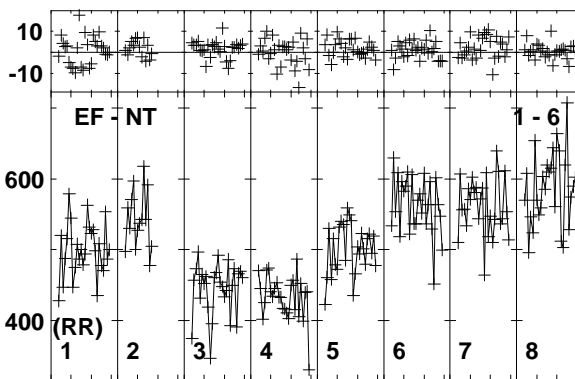
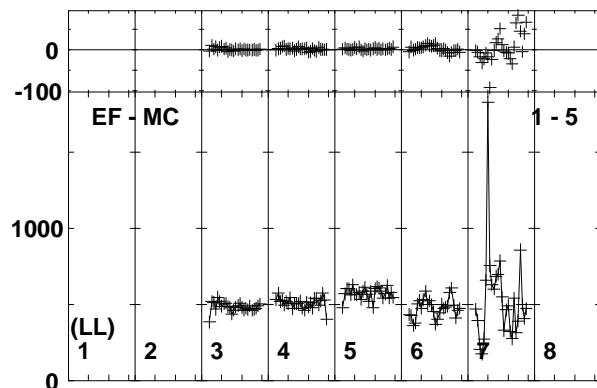
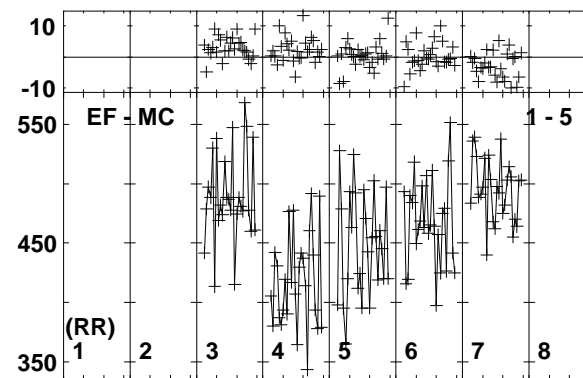
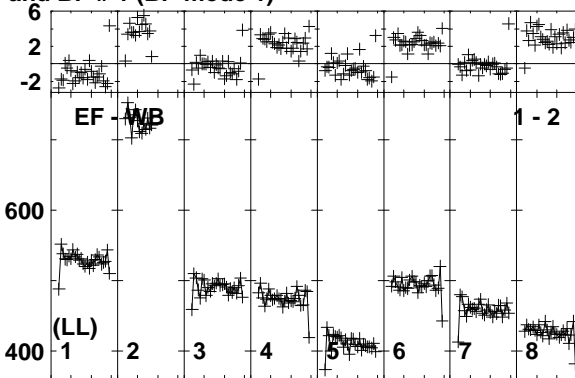
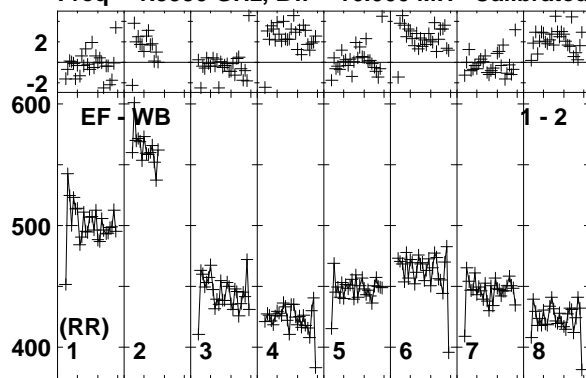

Lower frame: Milli Ampl Jy Top frame: Phas deg
Vector averaged cross-power spectrum Baseline: EF (01) - WB (02)
Timerange: 00/04:00:45 to 00/04:01:39

Plot file version 40 created 25-MAR-2014 17:50:53

J1128+5925 EP087E 1.UVDATA.1

Freq = 1.5950 GHz, Bw = 16.000 MH Calibrated with CL # 3 and BP # 1 (BP mode 1)

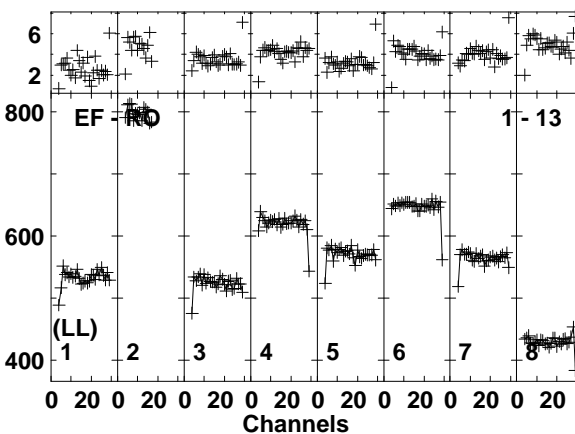
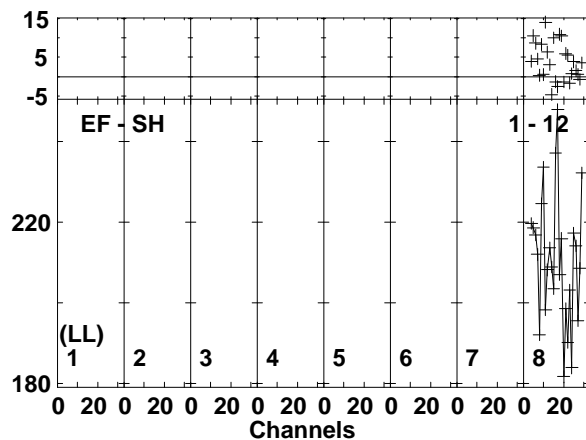
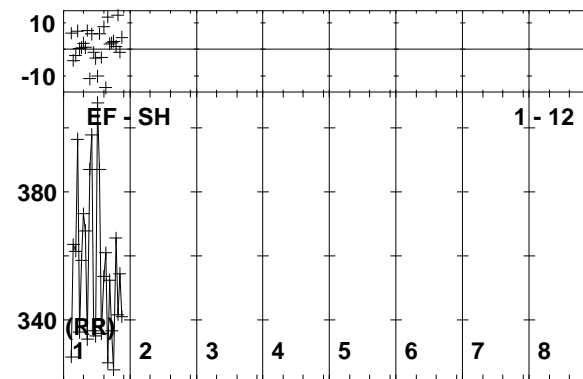
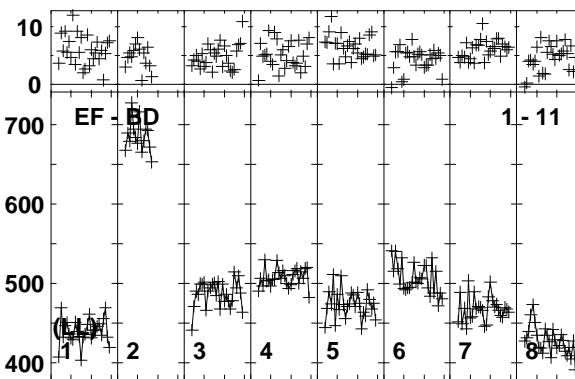
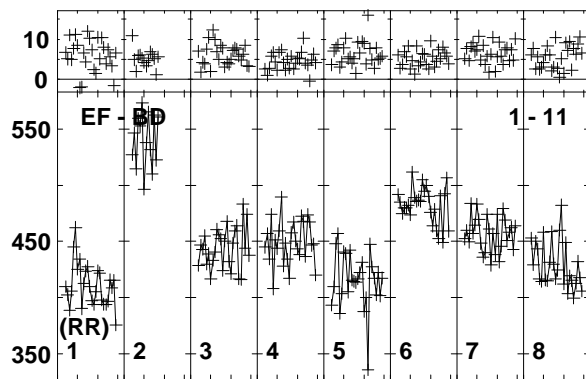
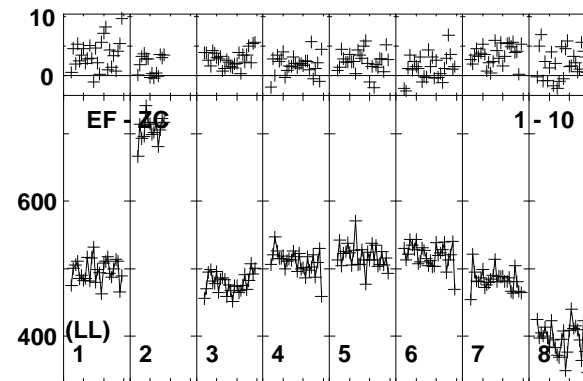
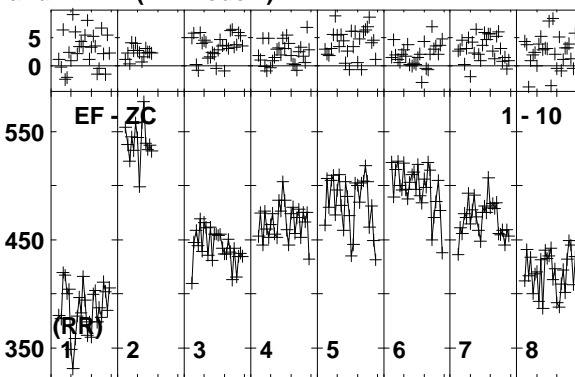
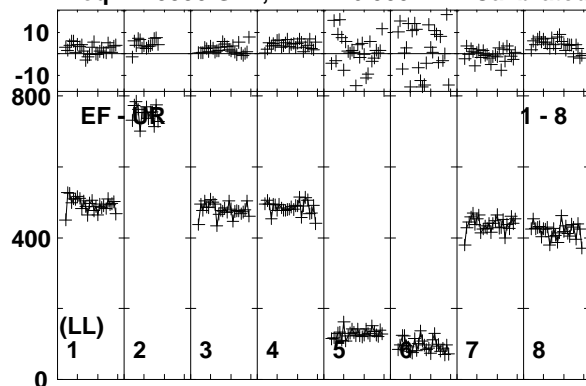

Lower frame: Milli Ampl Jy Top frame: Phas deg
Vector averaged cross-power spectrum Baseline: EF (01) - UR (08)
Timerange: 00/04:00:45 to 00/04:01:39

Plot file version 41 created 25-MAR-2014 17:50:53
 ARP299A EP087E 1.UVDATA.1
 Freq = 1.5950 GHz, Bw = 16.000 MH Calibrated with CL # 3 and BP # 1 (BP mode 1)

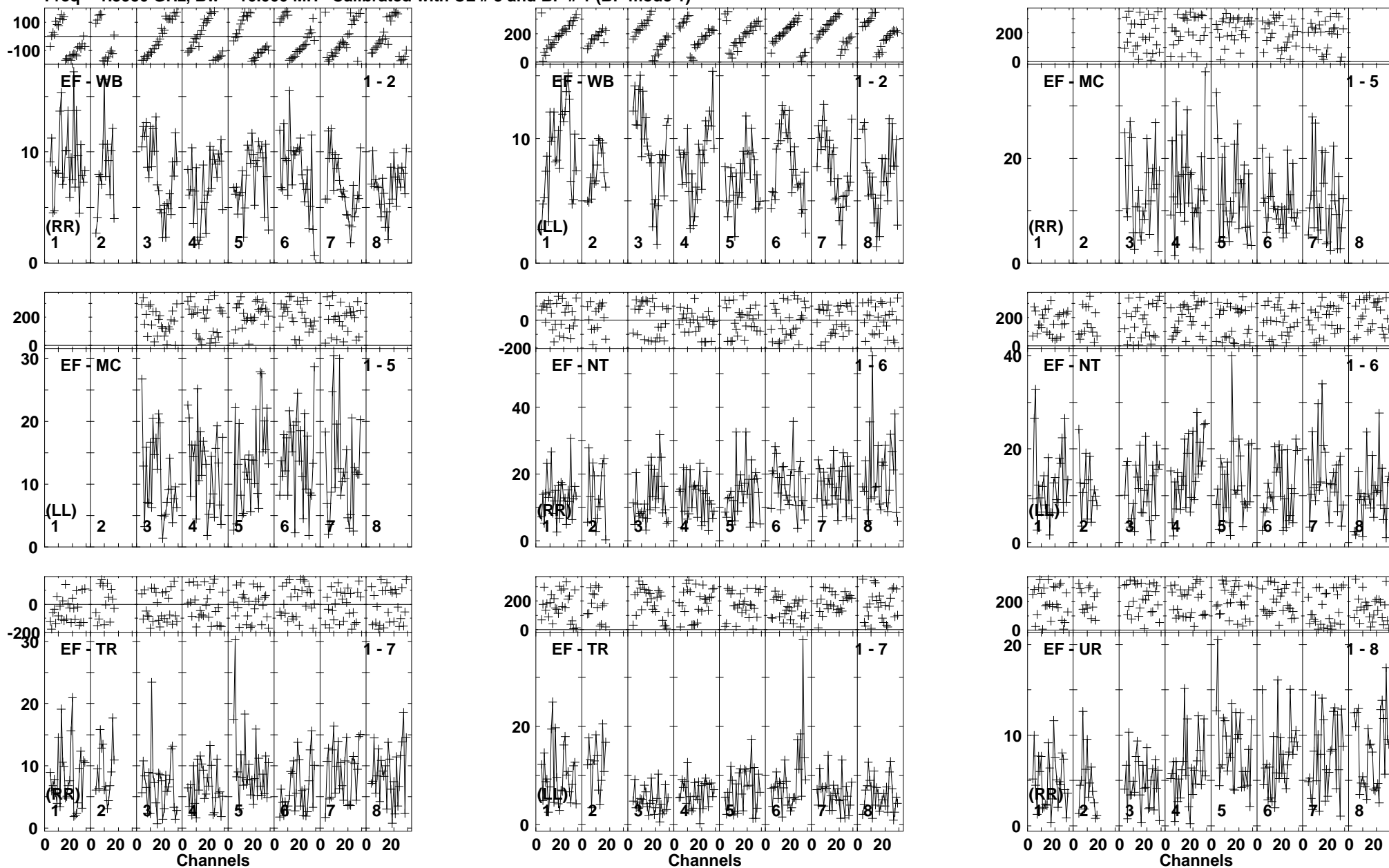

Lower frame: Milli Ampl Jy Top frame: Phas deg
 Vector averaged cross-power spectrum Baseline: EF (01) - WB (02)
 Timerange: 00/04:01:41 to 00/04:06:09

Plot file version 42 created 25-MAR-2014 17:50:53

ARP299A EP087E 1.UVDATA.1

Freq = 1.5950 GHz, Bw = 16.000 MH Calibrated with CL # 3 and BP # 1 (BP mode 1)

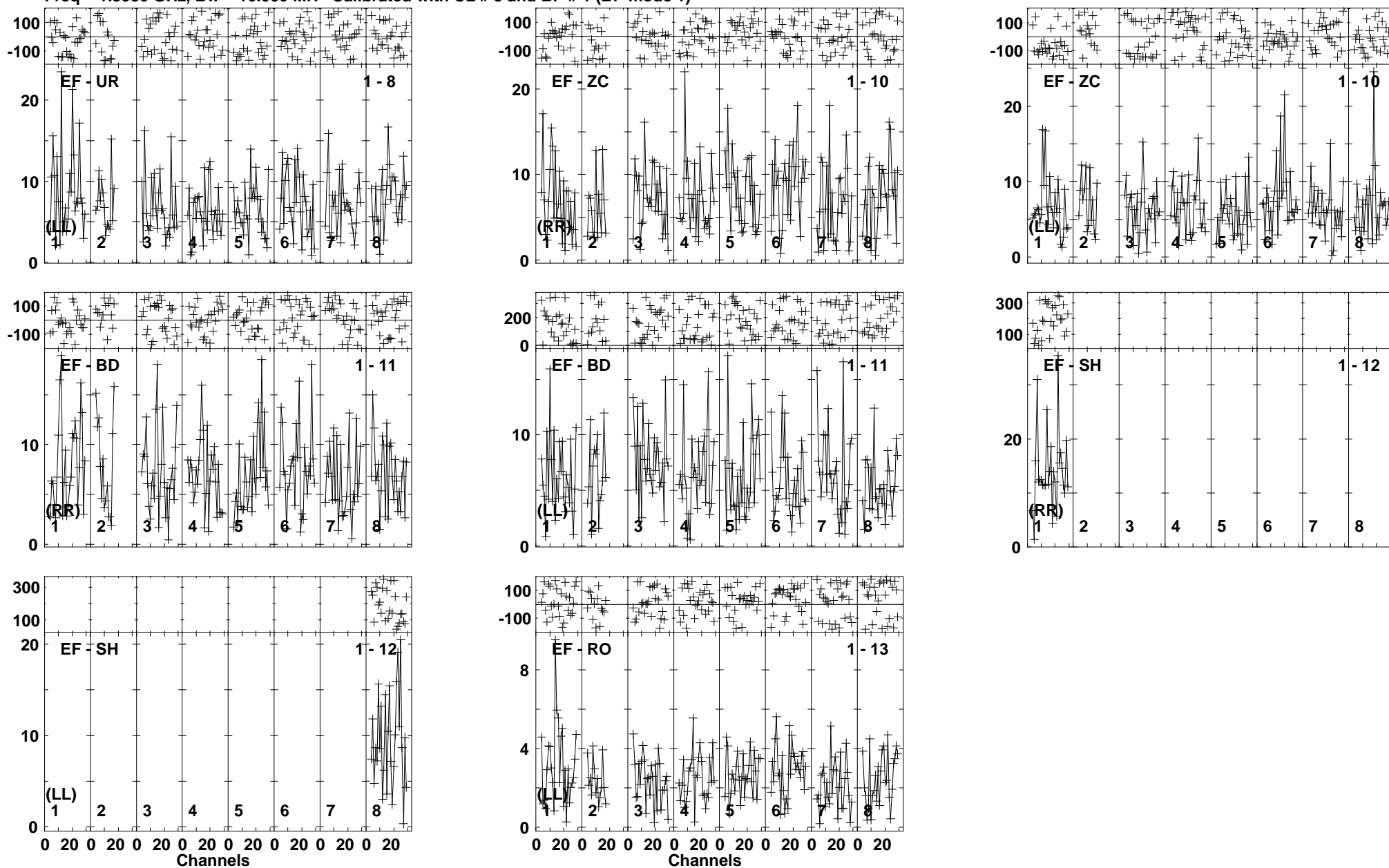

Lower frame: Milli Ampl Jy Top frame: Phas deg
Vector averaged cross-power spectrum Baseline: EF (01) - UR (08)
Timerange: 00/04:01:41 to 00/04:06:09

Plot file version 43 created 25-MAR-2014 17:50:53

J1128+5925 EP087E 1.UVDATA.1

Freq = 1.5950 GHz, Bw = 16.000 MH Calibrated with CL # 3 and BP # 1 (BP mode 1)

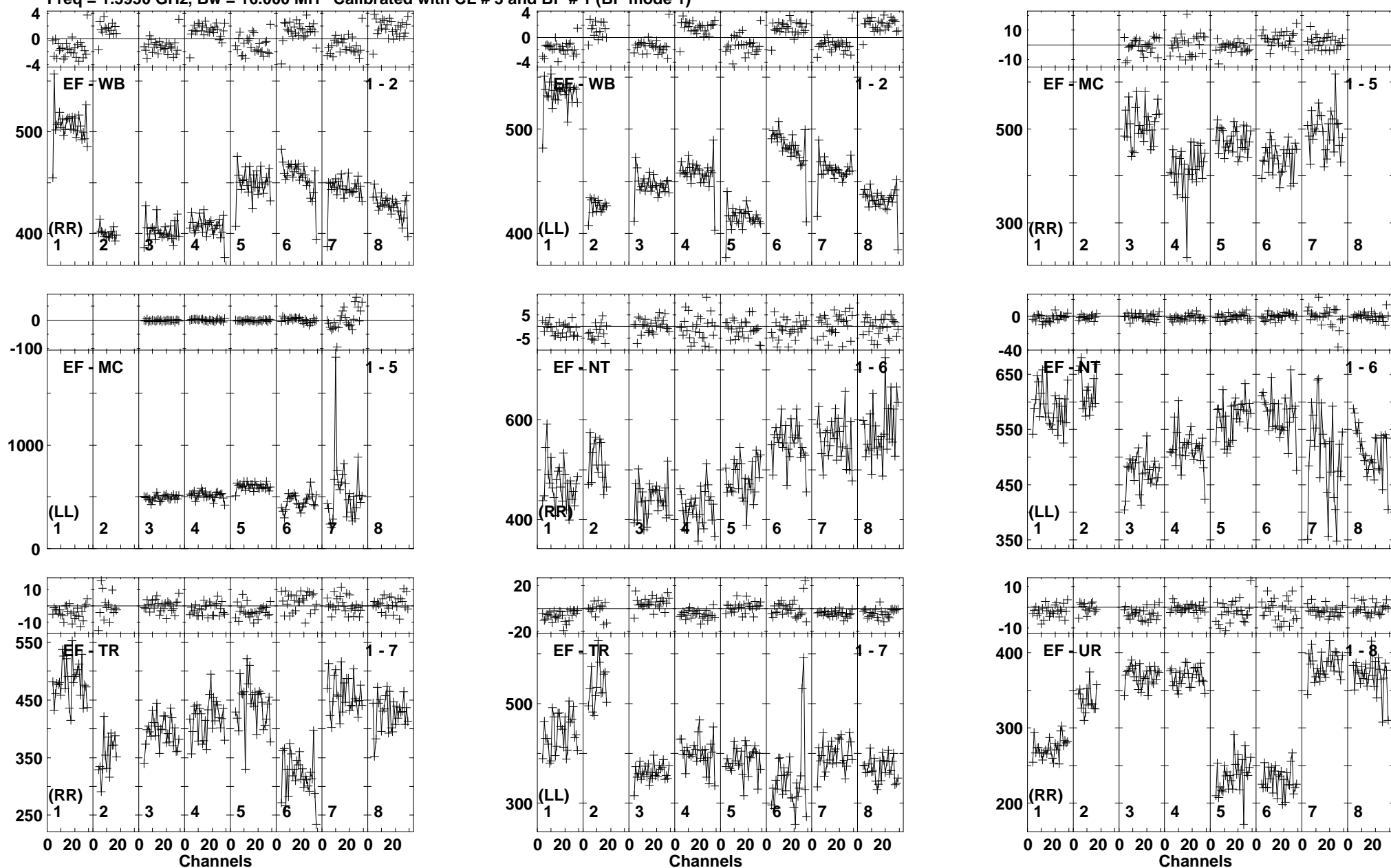

Lower frame: Milli Ampl Jy Top frame: Phas deg
Vector averaged cross-power spectrum Baseline: EF (01) - WB (02)
Timerange: 00/04:06:51 to 00/04:07:19

Plot file version 44 created 25-MAR-2014 17:50:54

J1128+5925 EP087E 1.UVDATA.1

Freq = 1.5950 GHz, Bw = 16.000 MH Calibrated with CL # 3 and BP # 1 (BP mode 1)

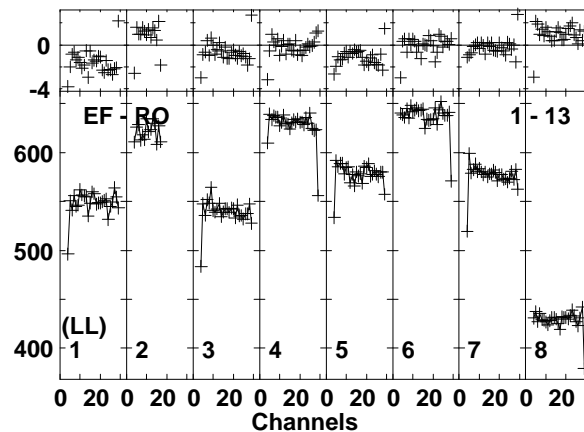
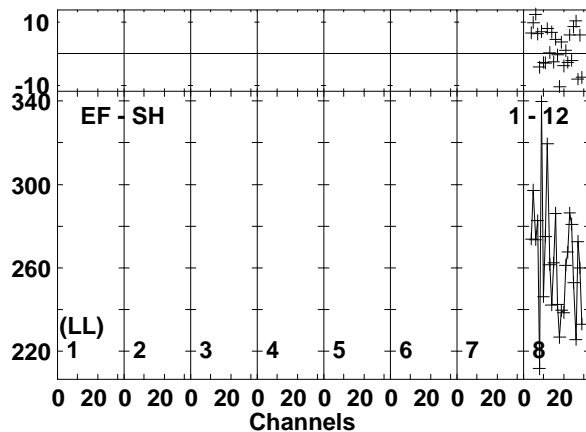
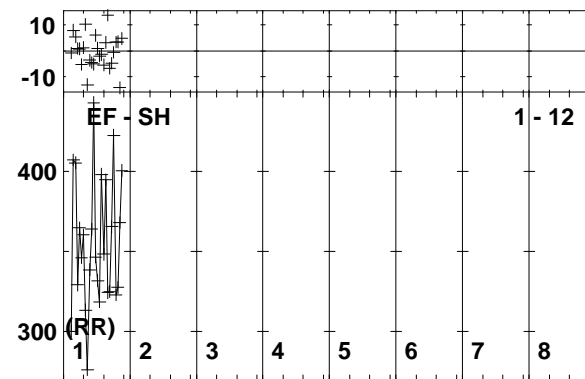
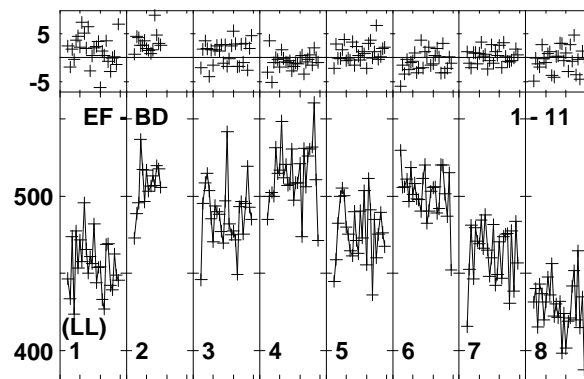
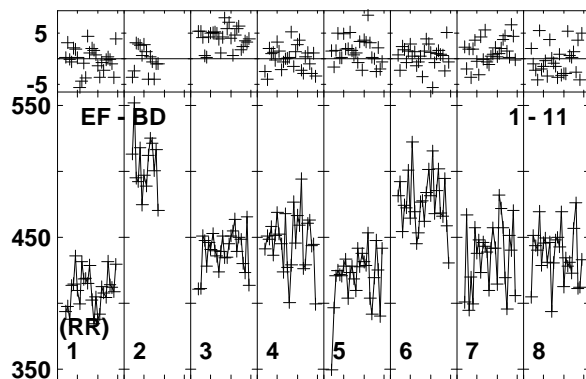
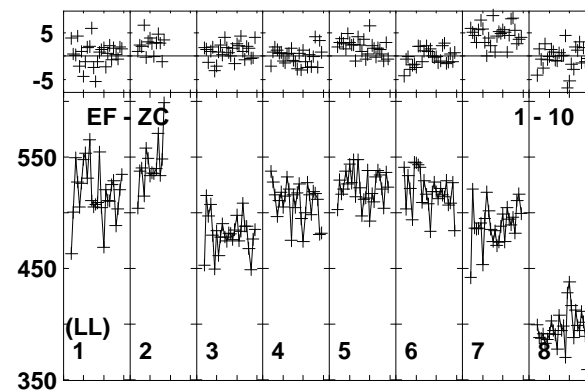
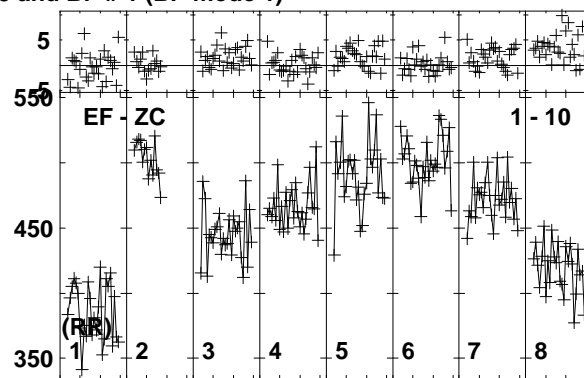
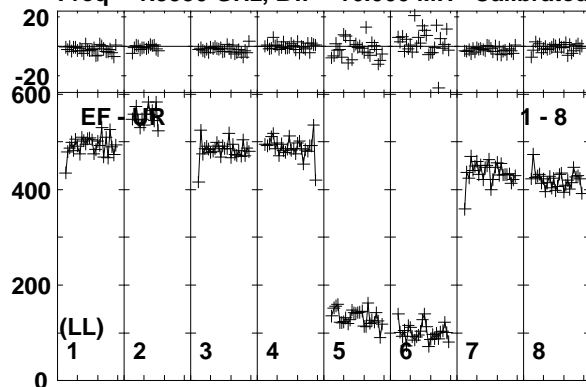

Lower frame: Milli Ampl Jy Top frame: Phas deg
Vector averaged cross-power spectrum Baseline: EF (01) - UR (08)
Timerange: 00/04:06:51 to 00/04:07:19

Plot file version 45 created 25-MAR-2014 17:50:54
 ARP299A EP087E 1.UVDATA.1
 Freq = 1.5950 GHz, Bw = 16.000 MH Calibrated with CL # 3 and BP # 1 (BP mode 1)

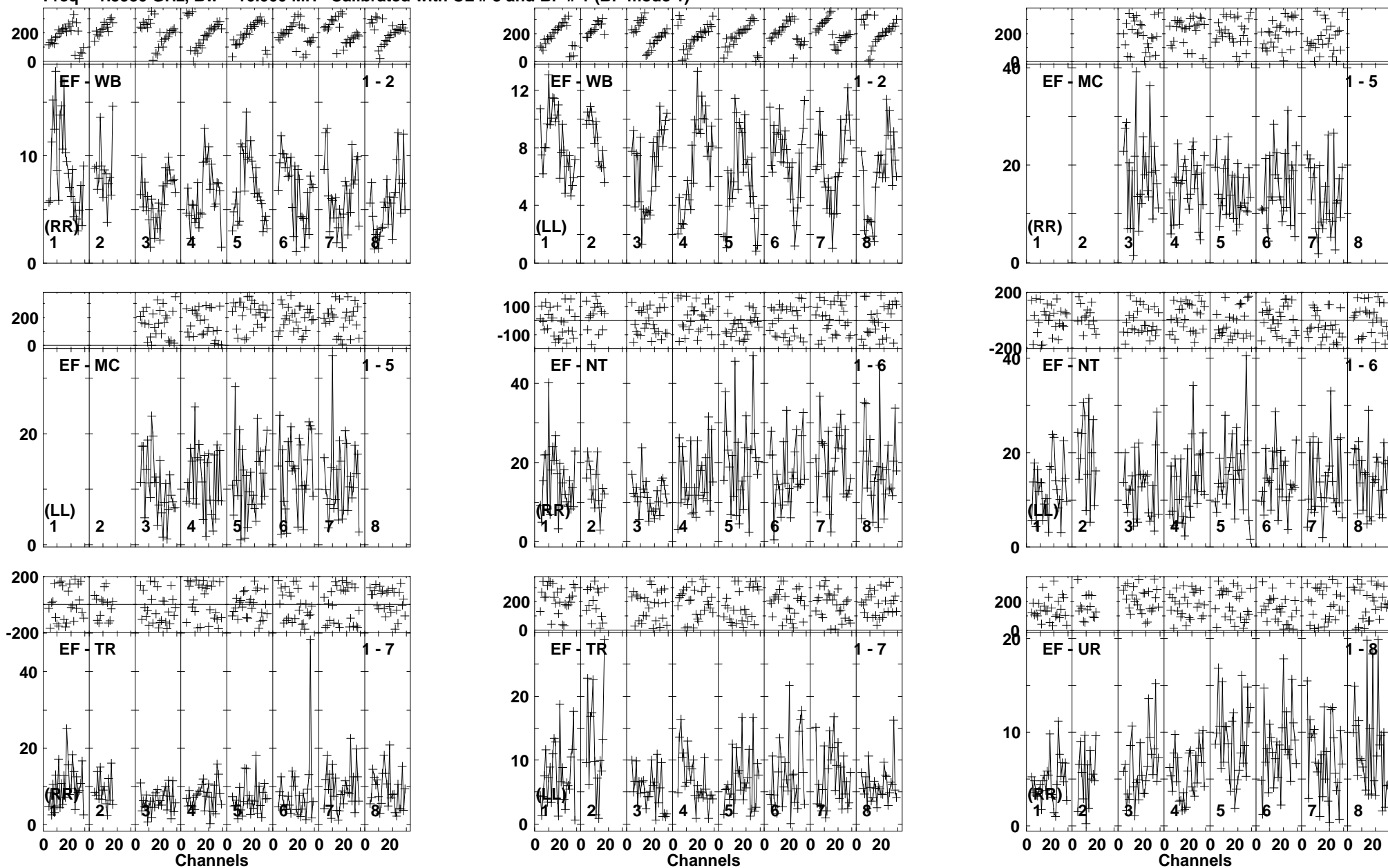

Lower frame: Milli Ampl Jy Top frame: Phas deg
 Vector averaged cross-power spectrum Baseline: EF (01) - WB (02)
 Timerange: 00/04:07:25 to 00/04:11:49

Plot file version 46 created 25-MAR-2014 17:50:54

ARP299A EP087E 1.UVDATA.1

Freq = 1.5950 GHz, Bw = 16.000 MH Calibrated with CL # 3 and BP # 1 (BP mode 1)

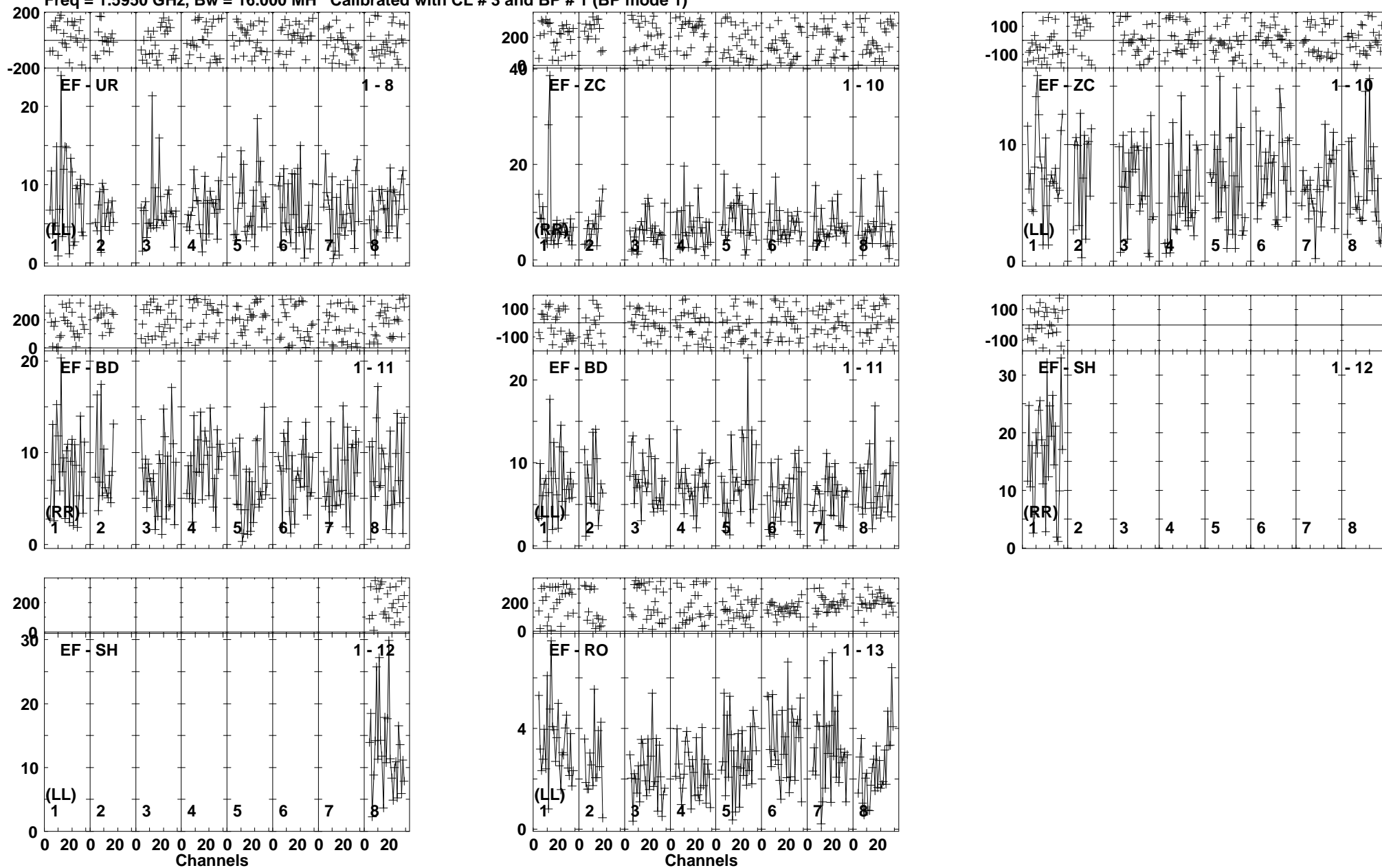

Lower frame: Milli Ampl Jy Top frame: Phas deg
Vector averaged cross-power spectrum Baseline: EF (01) - UR (08)
Timerange: 00/04:07:25 to 00/04:11:49

Plot file version 47 created 25-MAR-2014 17:50:55

J1128+5925 EP087E 1.UVDATA.1

Freq = 1.5950 GHz, Bw = 16.000 MH Calibrated with CL # 3 and BP # 1 (BP mode 1)

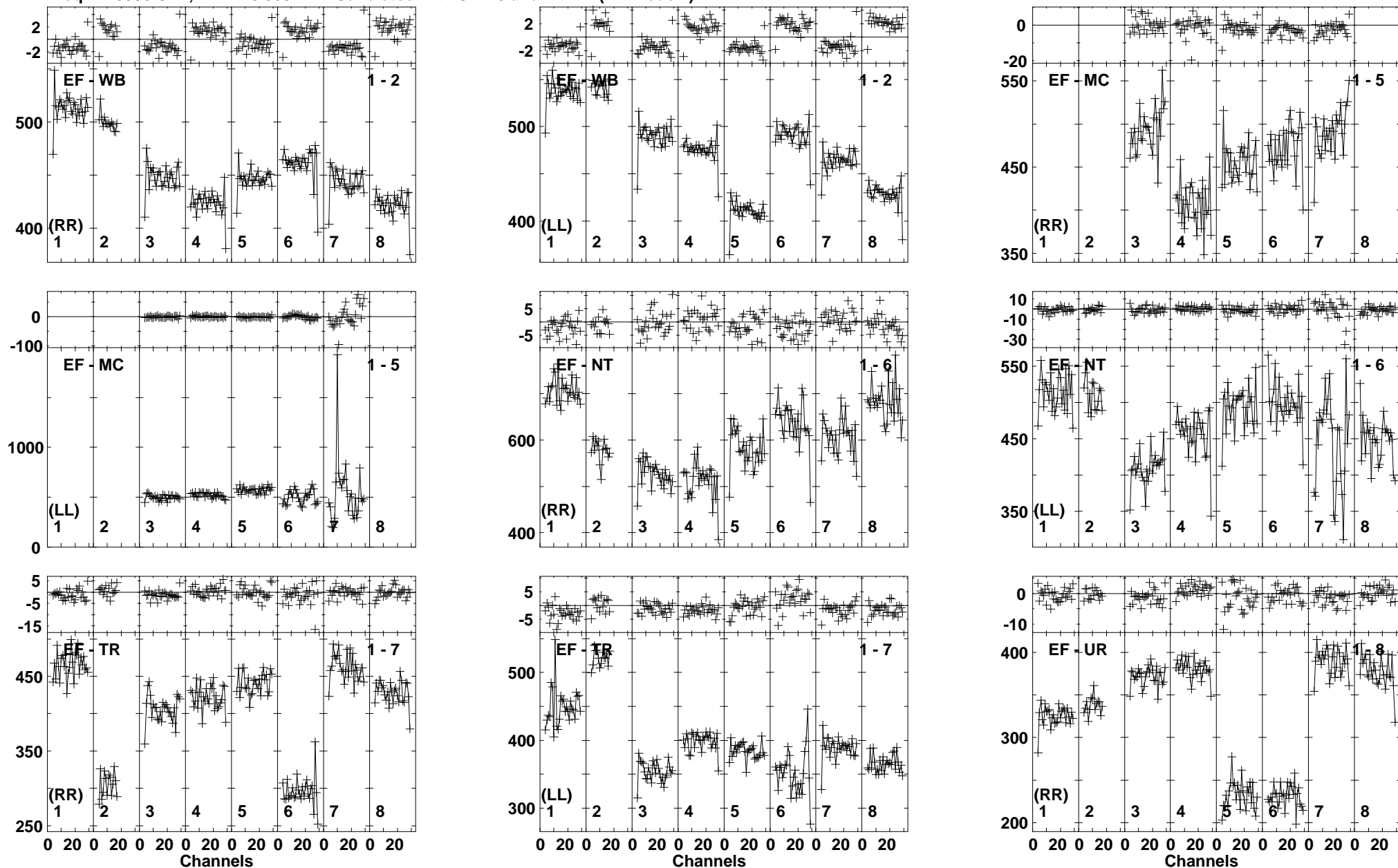

Lower frame: Milli Ampl Jy Top frame: Phas deg
Vector averaged cross-power spectrum Baseline: EF (01) - WB (02)
Timerange: 00/04:11:55 to 00/04:12:59

Plot file version 48 created 25-MAR-2014 17:50:55

J1128+5925 EP087E 1.UVDATA.1

Freq = 1.5950 GHz, Bw = 16.000 MH Calibrated with CL # 3 and BP # 1 (BP mode 1)

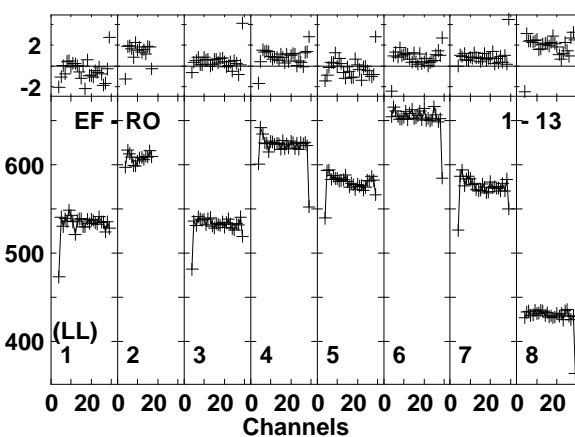
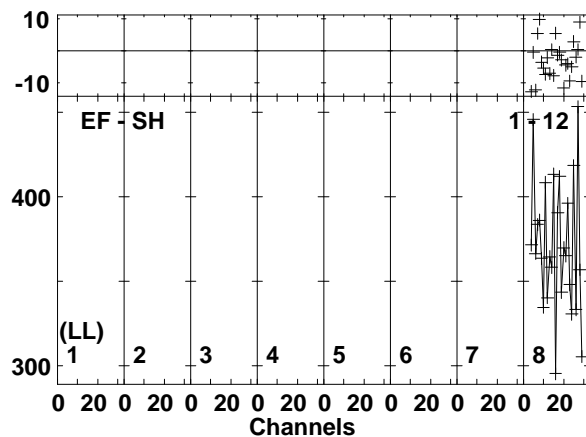
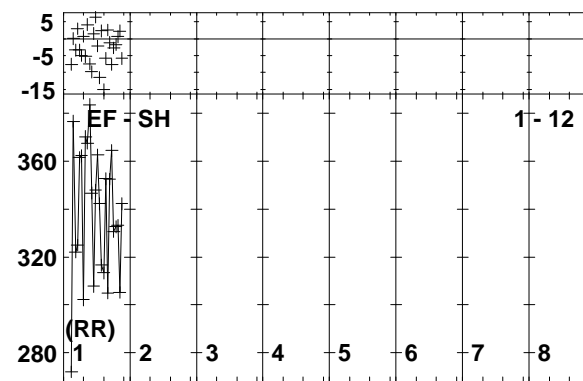
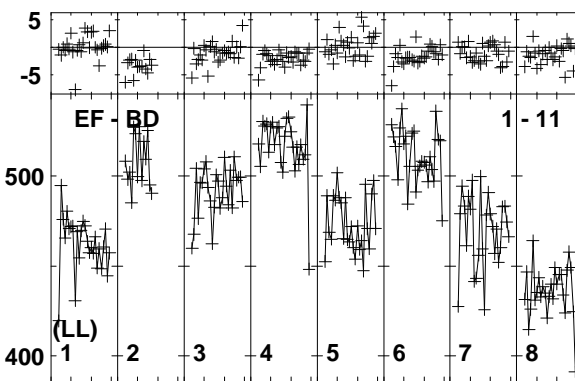
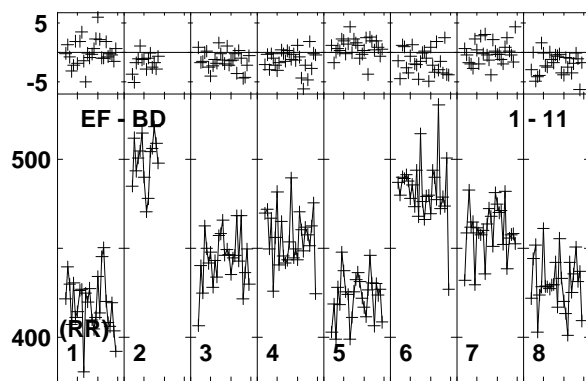
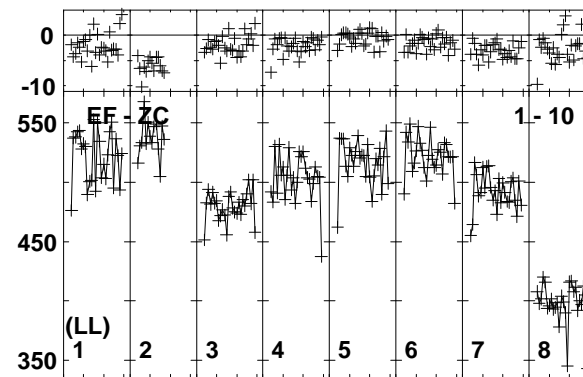
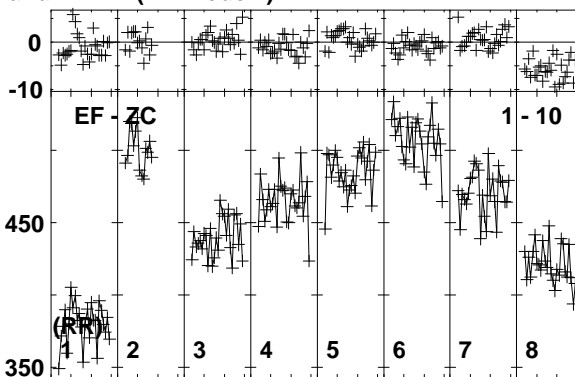
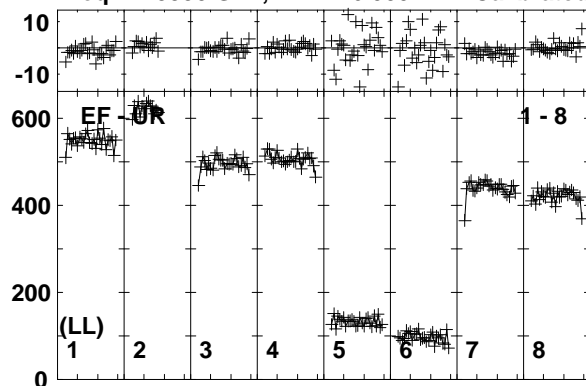

Lower frame: Milli Ampl Jy Top frame: Phas deg
Vector averaged cross-power spectrum Baseline: EF (01) - UR (08)
Timerange: 00/04:11:55 to 00/04:12:59

Plot file version 49 created 25-MAR-2014 17:50:55
 ARP299A EP087E 1.UVDATA.1
 Freq = 1.5950 GHz, Bw = 16.000 MH Calibrated with CL # 3 and BP # 1 (BP mode 1)

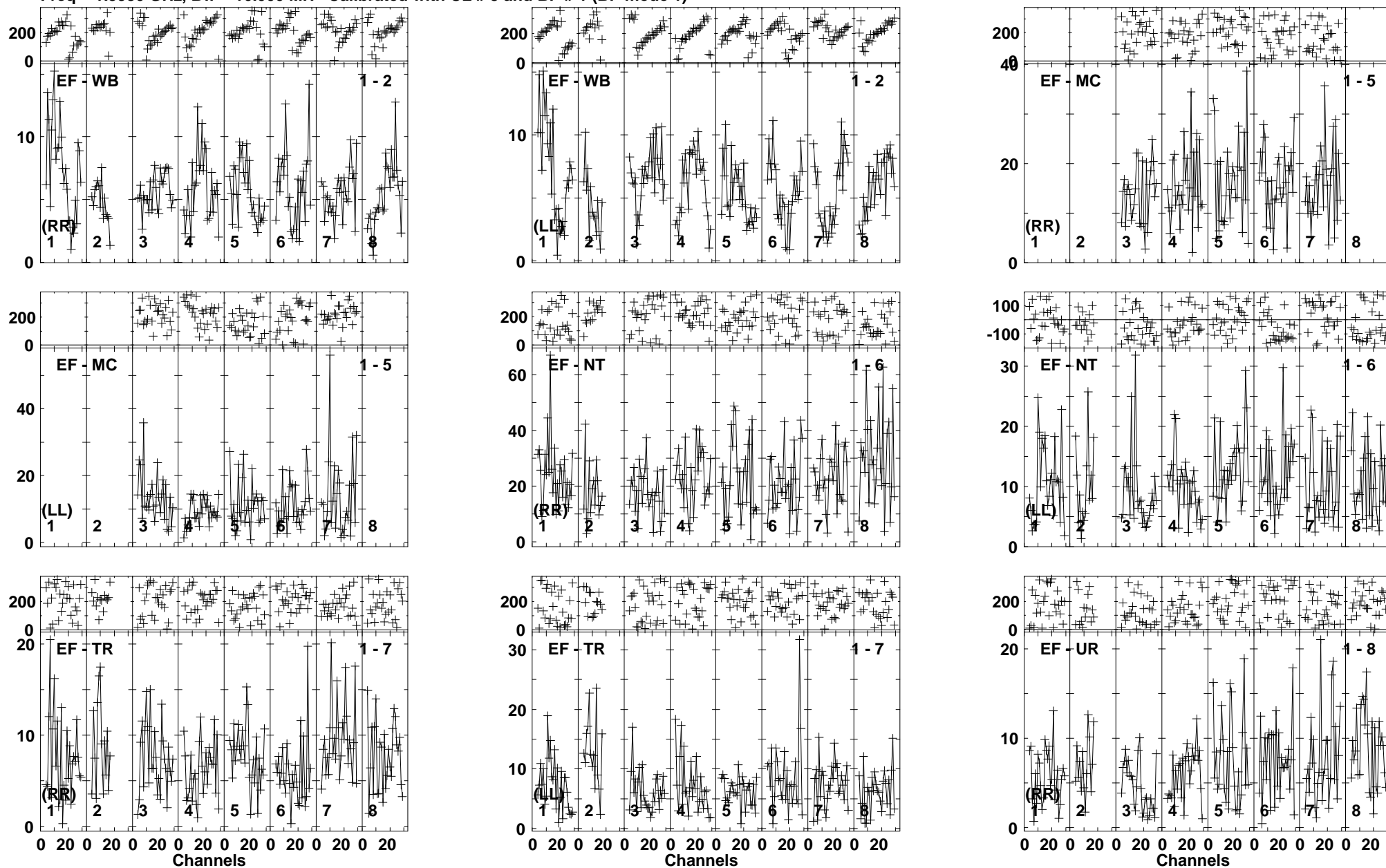

Lower frame: Milli Ampl Jy Top frame: Phas deg
 Vector averaged cross-power spectrum Baseline: EF (01) - WB (02)
 Timerange: 00/04:13:01 to 00/04:17:29

Plot file version 50 created 25-MAR-2014 17:50:56

ARP299A EP087E 1.UVDATA.1

Freq = 1.5950 GHz, Bw = 16.000 MH Calibrated with CL # 3 and BP # 1 (BP mode 1)

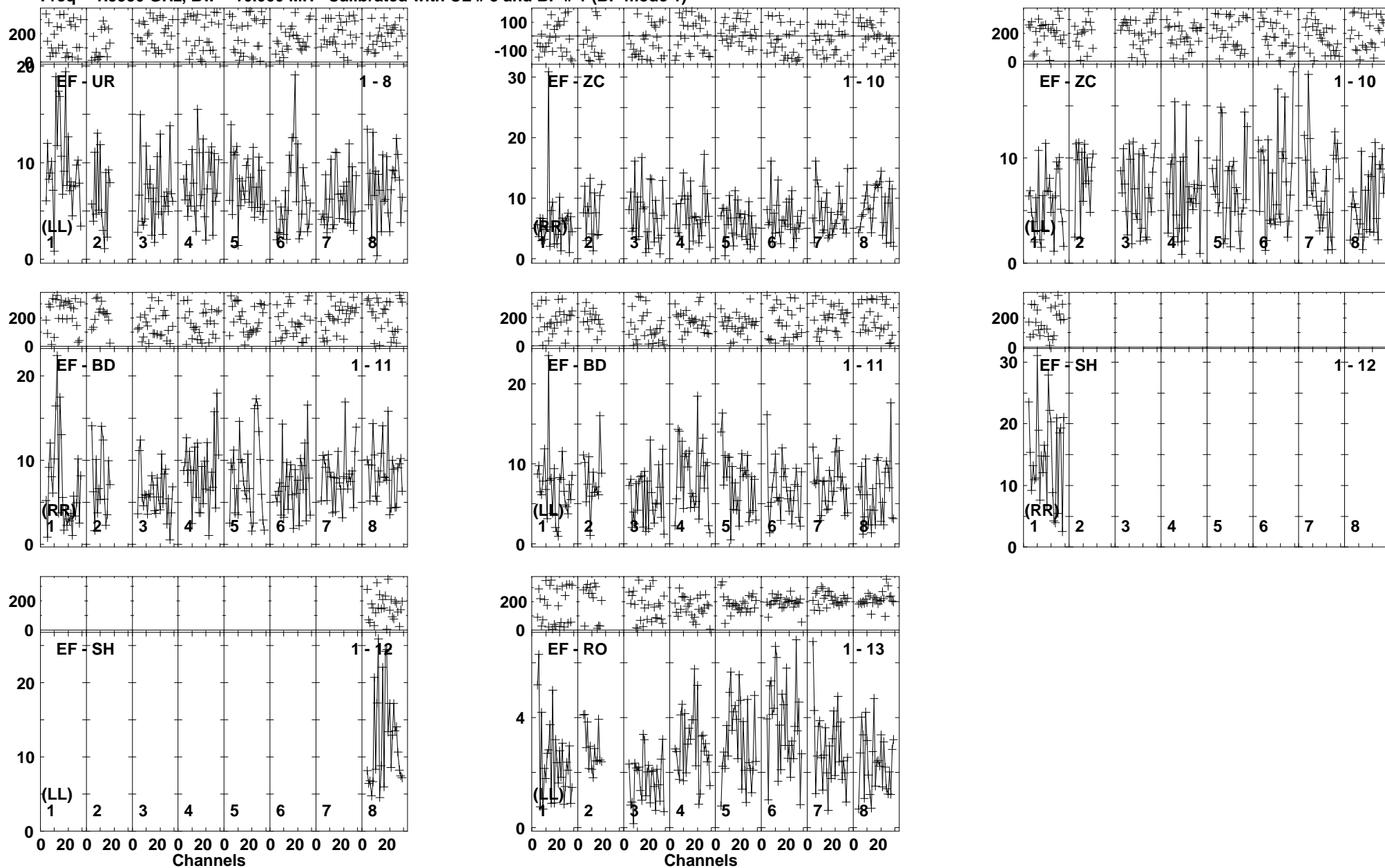

Lower frame: Milli Ampl Jy Top frame: Phas deg
Vector averaged cross-power spectrum Baseline: EF (01) - UR (08)
Timerange: 00/04:13:01 to 00/04:17:29

Plot file version 51 created 25-MAR-2014 17:50:56

J1128+5925 EP087E 1.UVDATA.1

Freq = 1.5950 GHz, Bw = 16.000 MH Calibrated with CL # 3 and BP # 1 (BP mode 1)

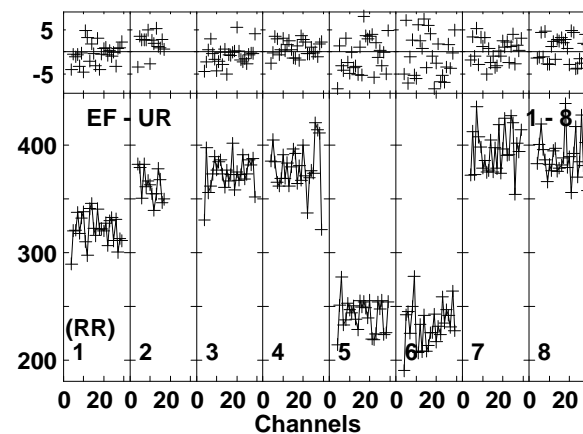
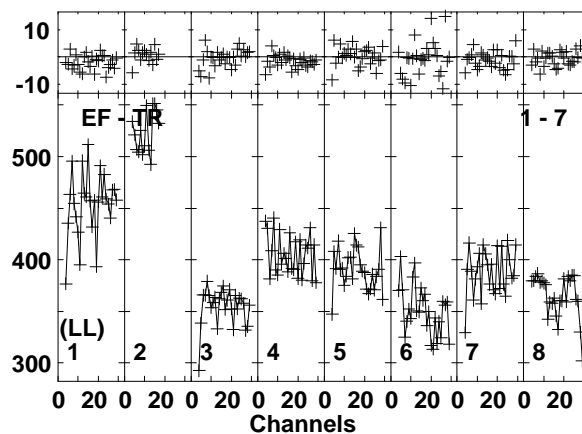
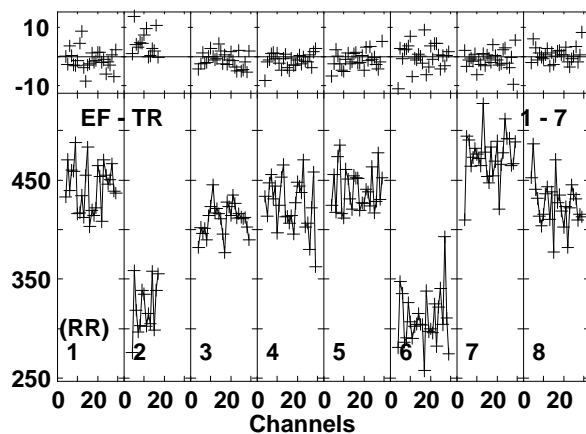
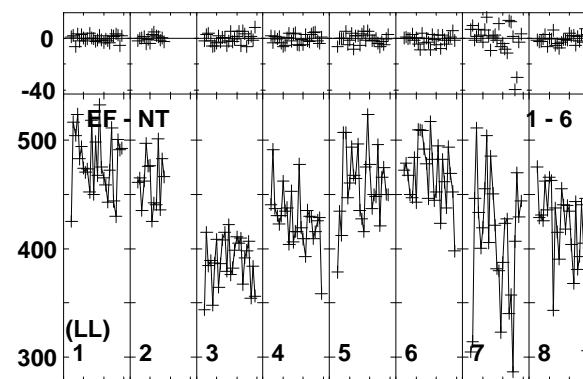
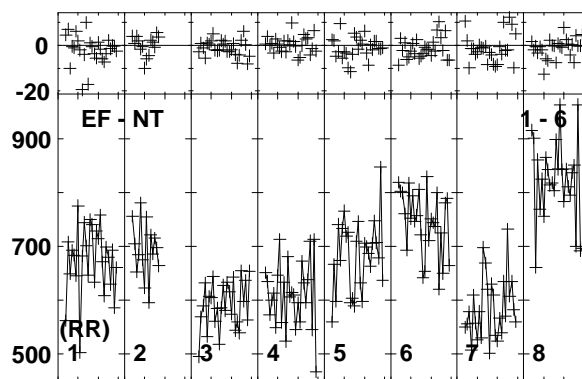
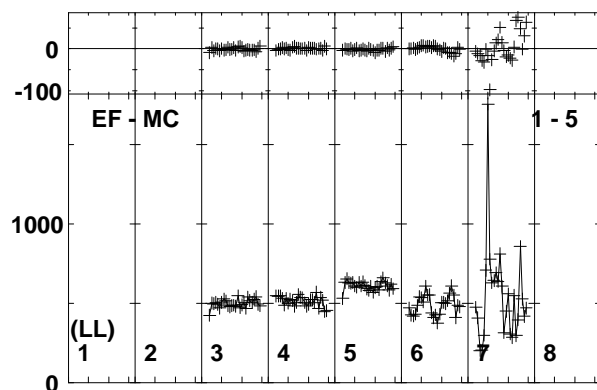
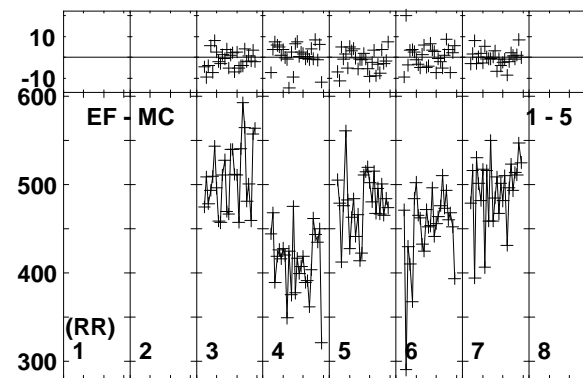
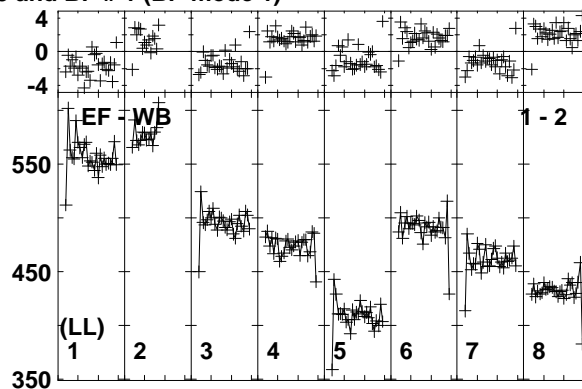
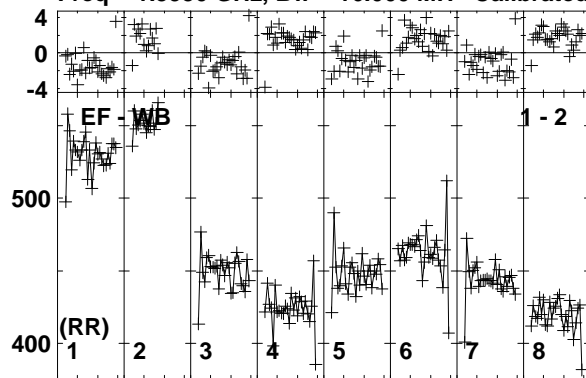

Lower frame: Milli Ampl Jy Top frame: Phas deg
Vector averaged cross-power spectrum Baseline: EF (01) - WB (02)
Timerange: 00/04:18:11 to 00/04:18:39

Plot file version 52 created 25-MAR-2014 17:50:56

J1128+5925 EP087E 1.UVDATA.1

Freq = 1.5950 GHz, Bw = 16.000 MH Calibrated with CL # 3 and BP # 1 (BP mode 1)

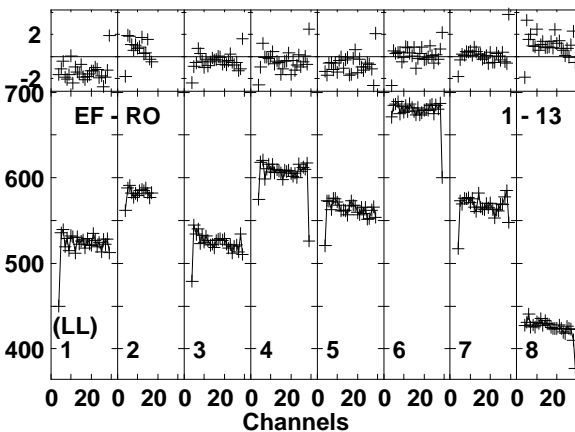
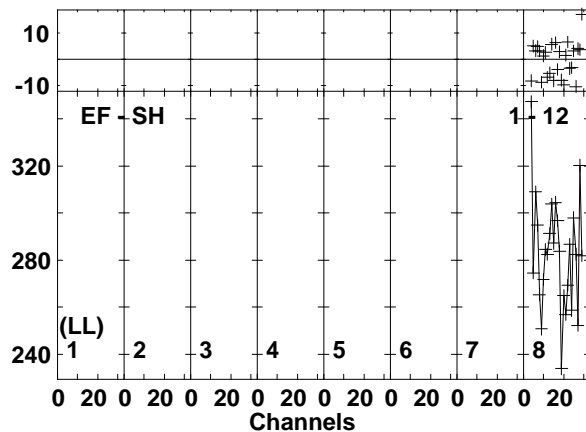
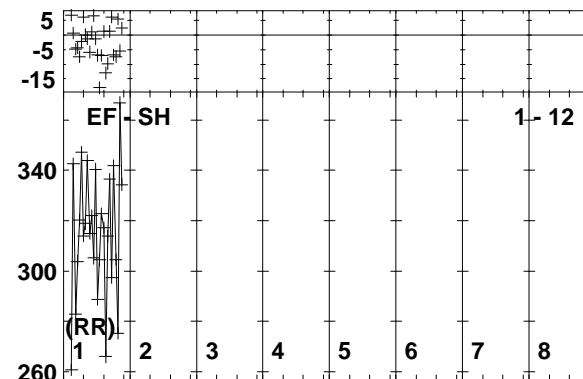
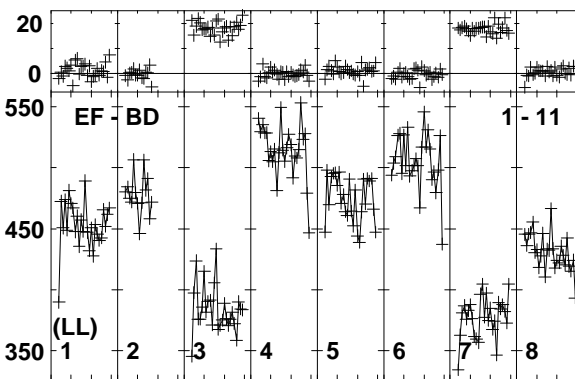
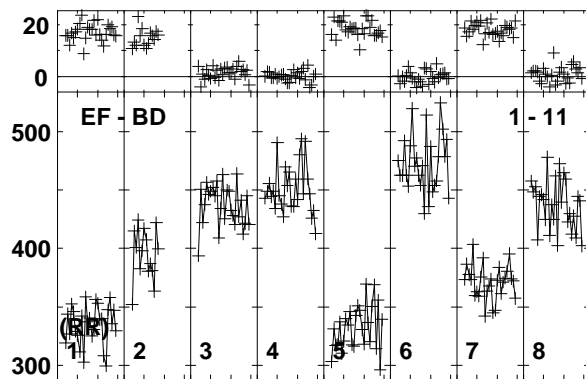
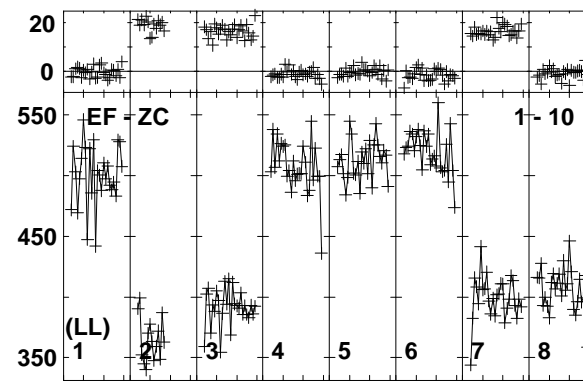
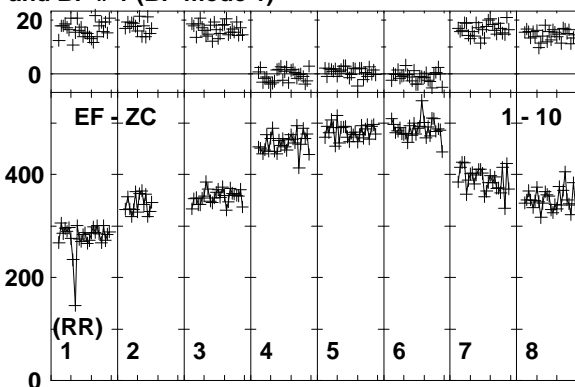
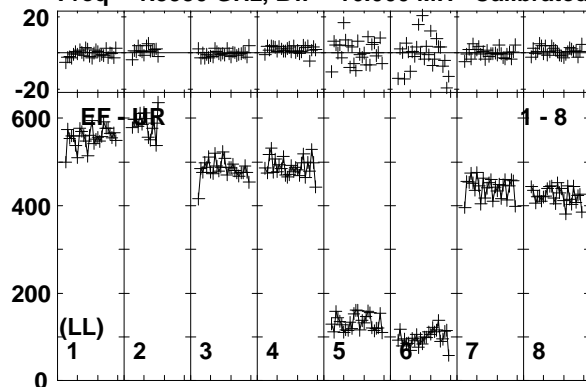

Lower frame: Milli Ampl Jy Top frame: Phas deg
Vector averaged cross-power spectrum Baseline: EF (01) - UR (08)
Timerange: 00/04:18:11 to 00/04:18:39

Plot file version 53 created 25-MAR-2014 17:50:56

ARP299A EP087E 1.UVDATA.1

Freq = 1.5950 GHz, Bw = 16.000 MH Calibrated with CL # 3 and BP # 1 (BP mode 1)

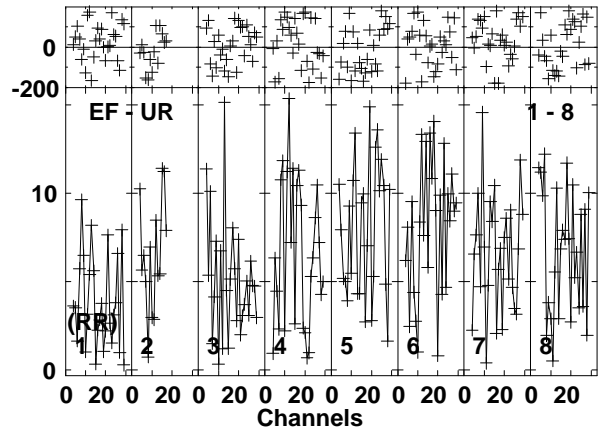
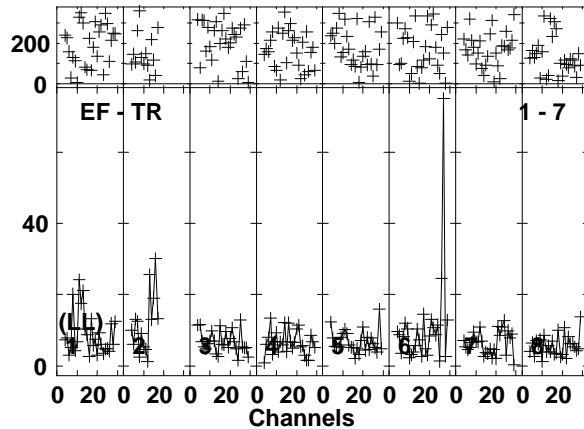
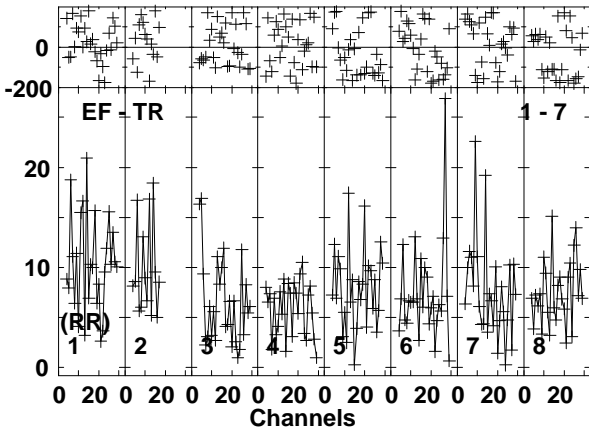
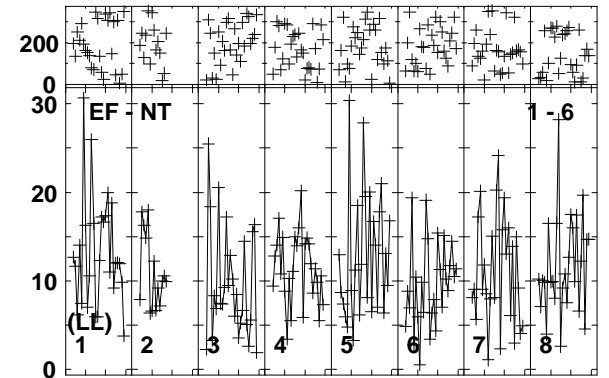
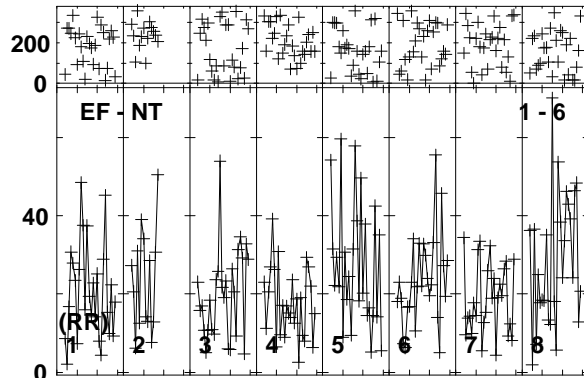
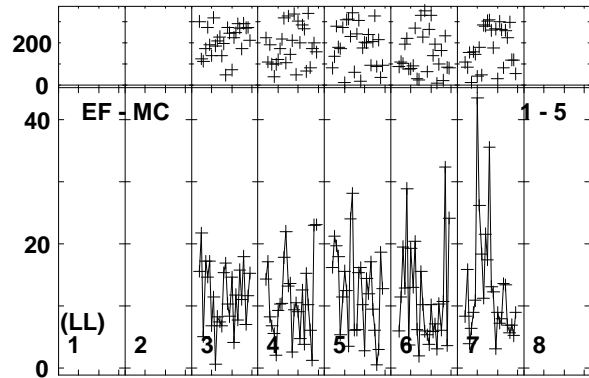
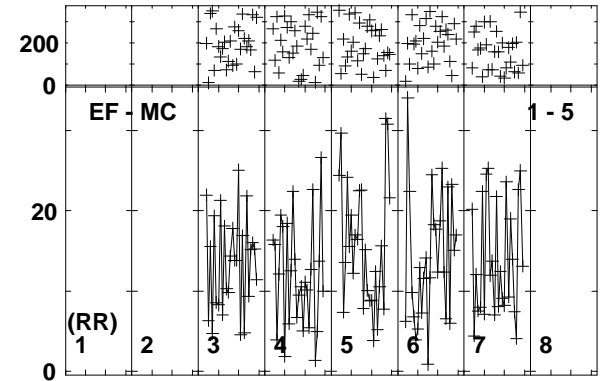
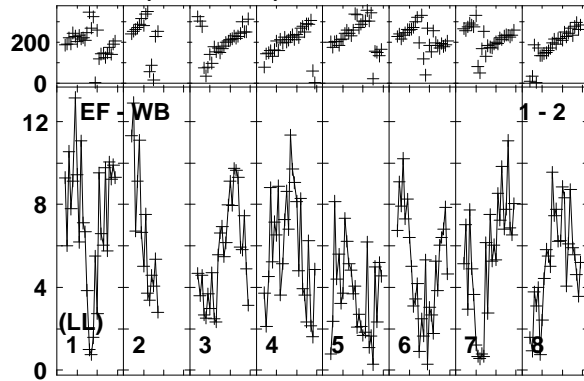
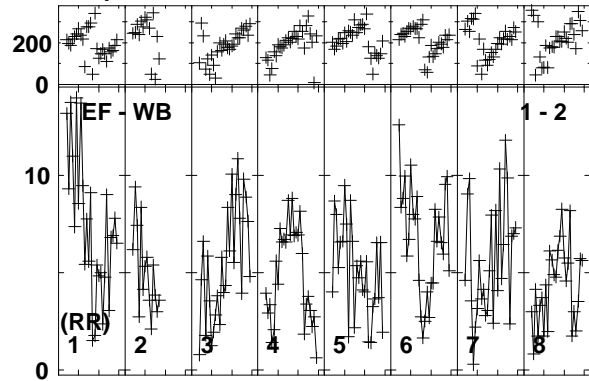

Lower frame: Milli Ampl Jy Top frame: Phas deg
Vector averaged cross-power spectrum Baseline: EF (01) - WB (02)
Timerange: 00/04:18:45 to 00/04:23:09

Plot file version 54 created 25-MAR-2014 17:50:57

ARP299A EP087E 1.UVDATA.1

Freq = 1.5950 GHz, Bw = 16.000 MH Calibrated with CL # 3 and BP # 1 (BP mode 1)

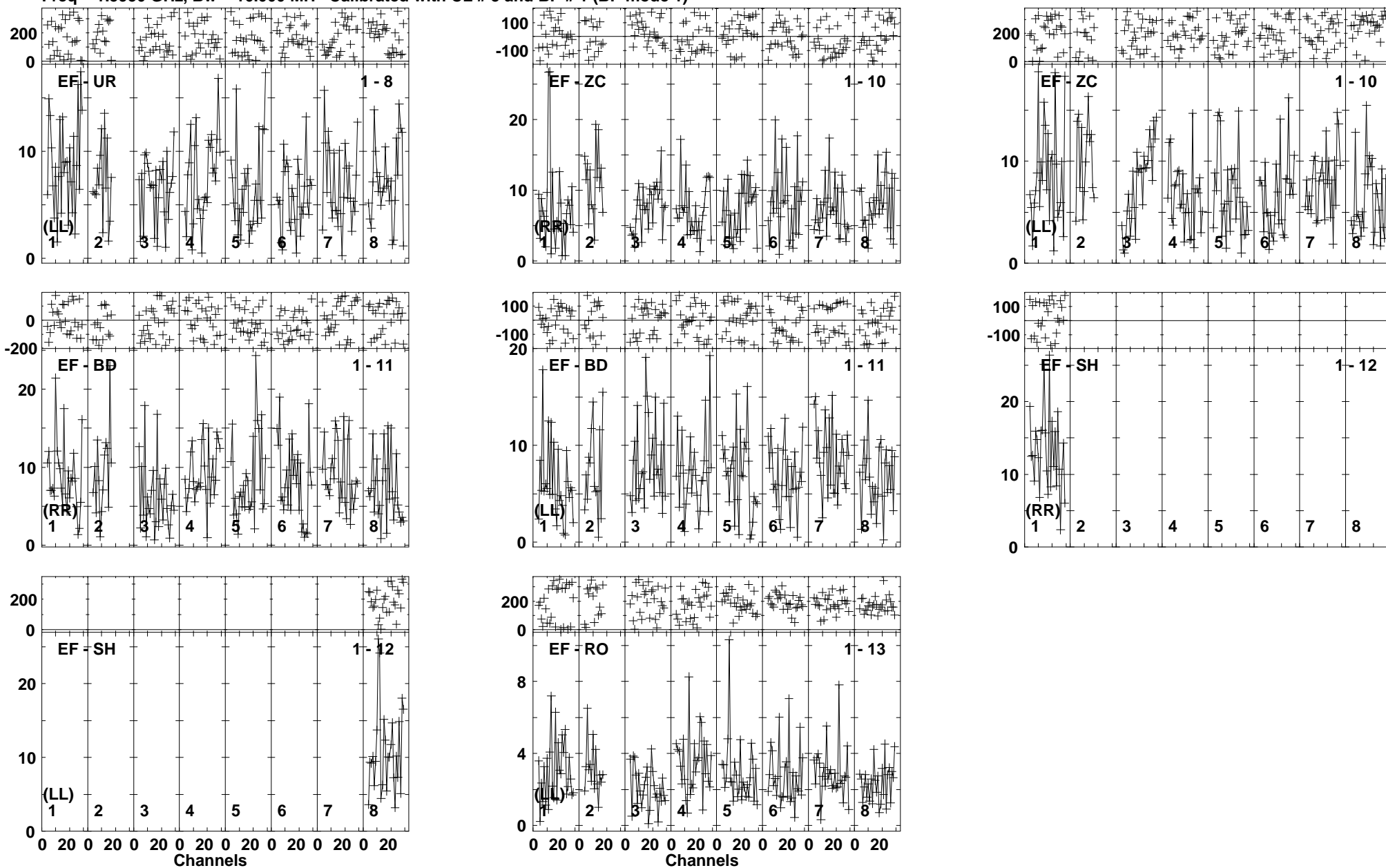

Lower frame: Milli Ampl Jy Top frame: Phas deg
Vector averaged cross-power spectrum Baseline: EF (01) - UR (08)
Timerange: 00/04:18:45 to 00/04:23:09

Plot file version 55 created 25-MAR-2014 17:50:57

J1128+5925 EP087E 1.UVDATA.1

Freq = 1.5950 GHz, Bw = 16.000 MH Calibrated with CL # 3 and BP # 1 (BP mode 1)

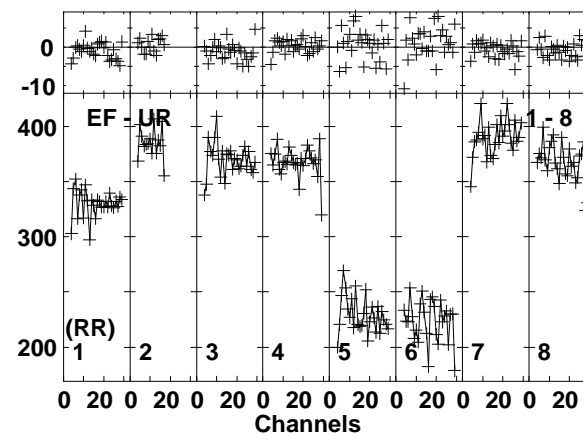
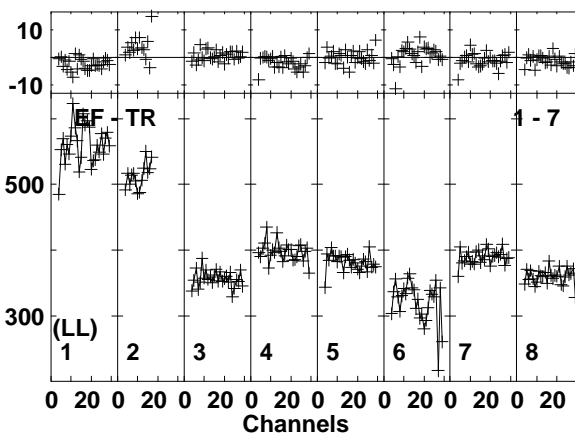
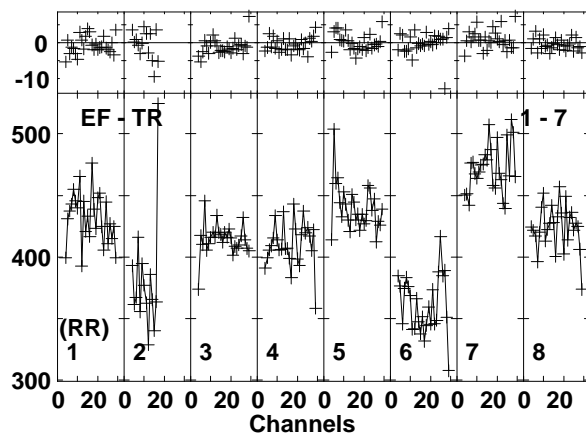
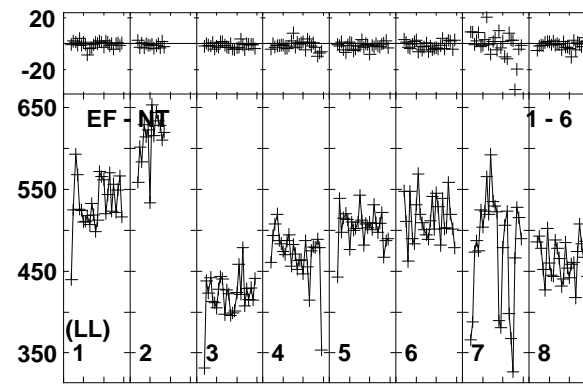
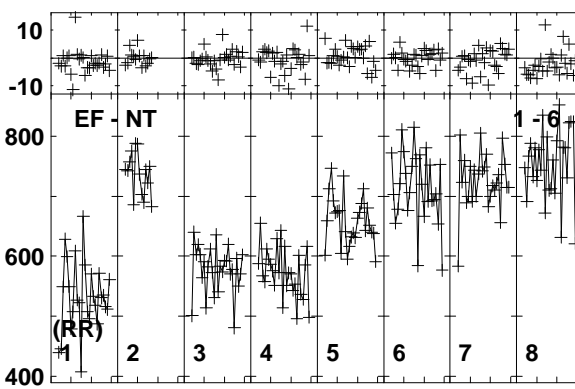
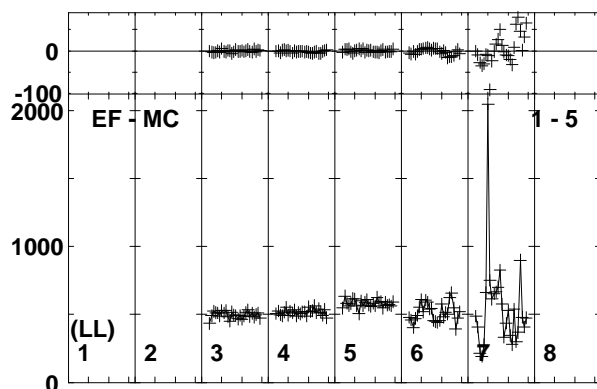
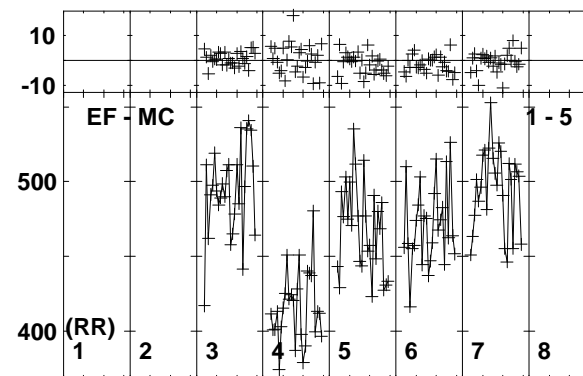
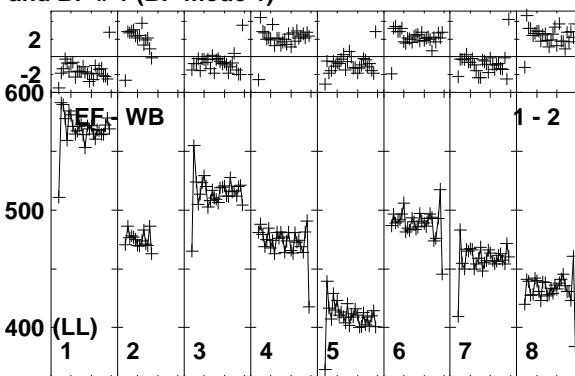
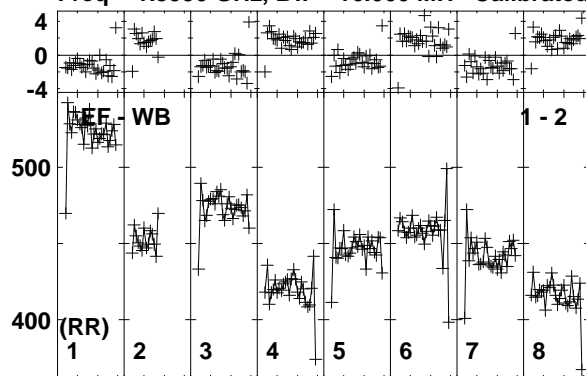

Lower frame: Milli Ampl Jy Top frame: Phas deg
Vector averaged cross-power spectrum Baseline: EF (01) - WB (02)
Timerange: 00/04:23:15 to 00/04:24:19

Plot file version 56 created 25-MAR-2014 17:50:57

J1128+5925 EP087E 1.UVDATA.1

Freq = 1.5950 GHz, Bw = 16.000 MH Calibrated with CL # 3 and BP # 1 (BP mode 1)

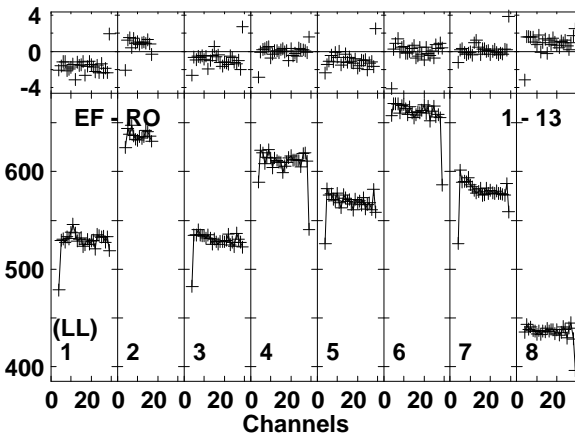
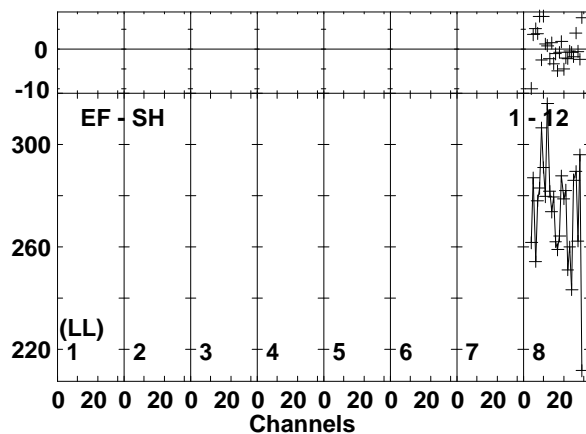
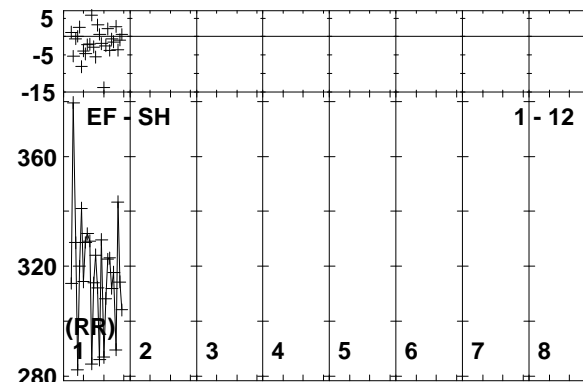
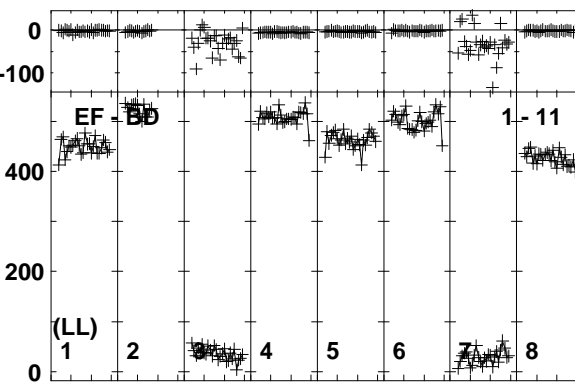
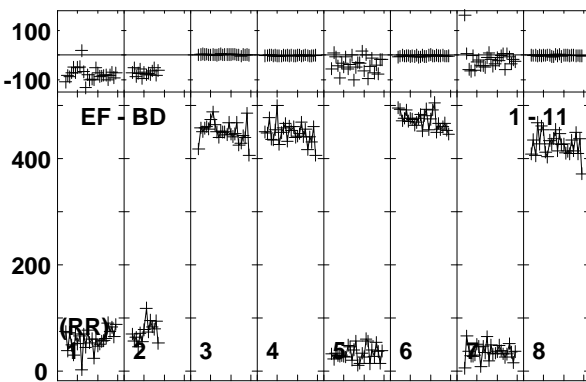
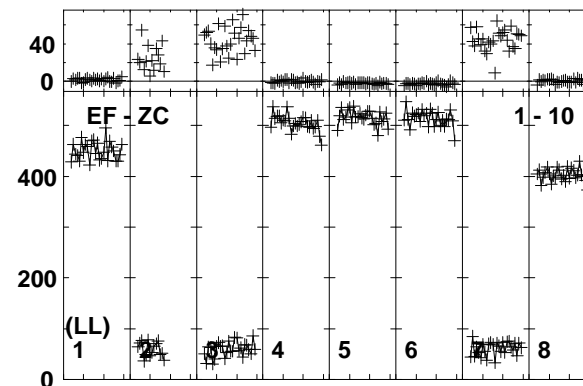
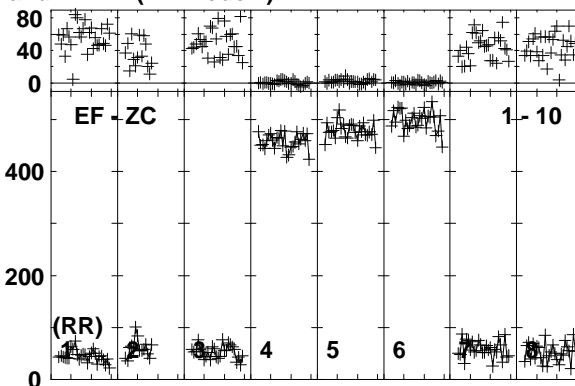
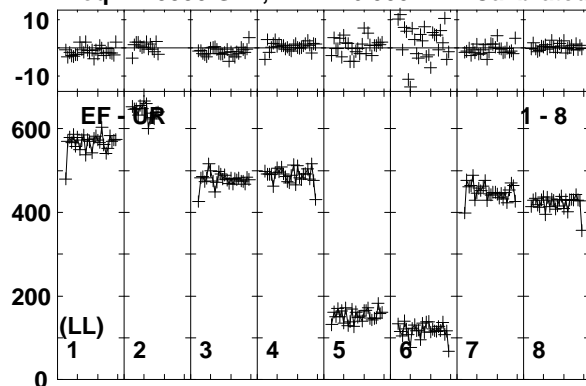

Lower frame: Milli Ampl Jy Top frame: Phas deg
Vector averaged cross-power spectrum Baseline: EF (01) - UR (08)
Timerange: 00/04:23:15 to 00/04:24:19

Plot file version 57 created 25-MAR-2014 17:50:58

ARP299A EP087E 1.UVDATA.1

Freq = 1.5950 GHz, Bw = 16.000 MH Calibrated with CL # 3 and BP # 1 (BP mode 1)

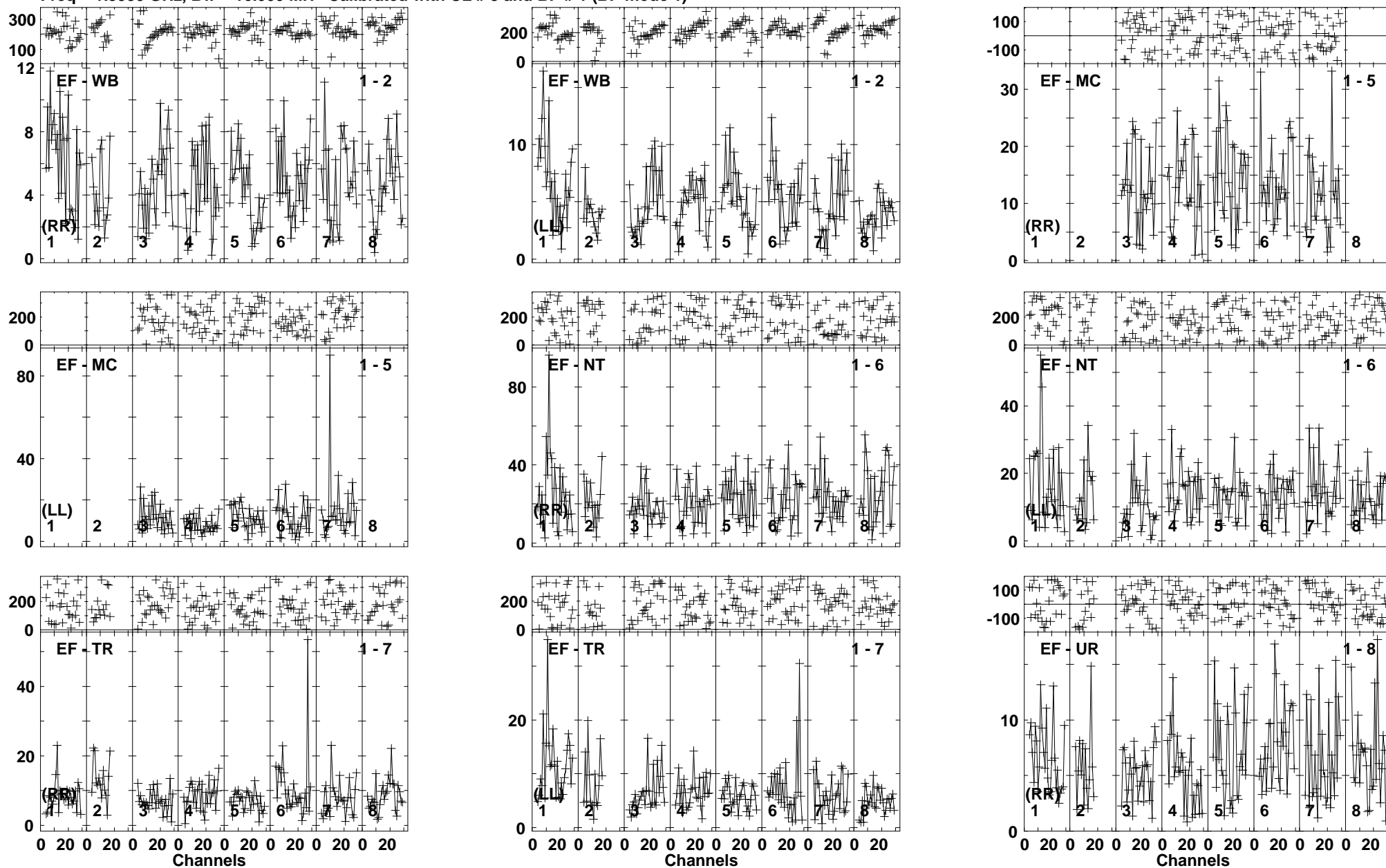

Lower frame: Milli Ampl Jy Top frame: Phas deg
Vector averaged cross-power spectrum Baseline: EF (01) - WB (02)
Timerange: 00/04:24:21 to 00/04:28:49

Plot file version 58 created 25-MAR-2014 17:50:58

ARP299A EP087E 1.UVDATA.1

Freq = 1.5950 GHz, Bw = 16.000 MH Calibrated with CL # 3 and BP # 1 (BP mode 1)

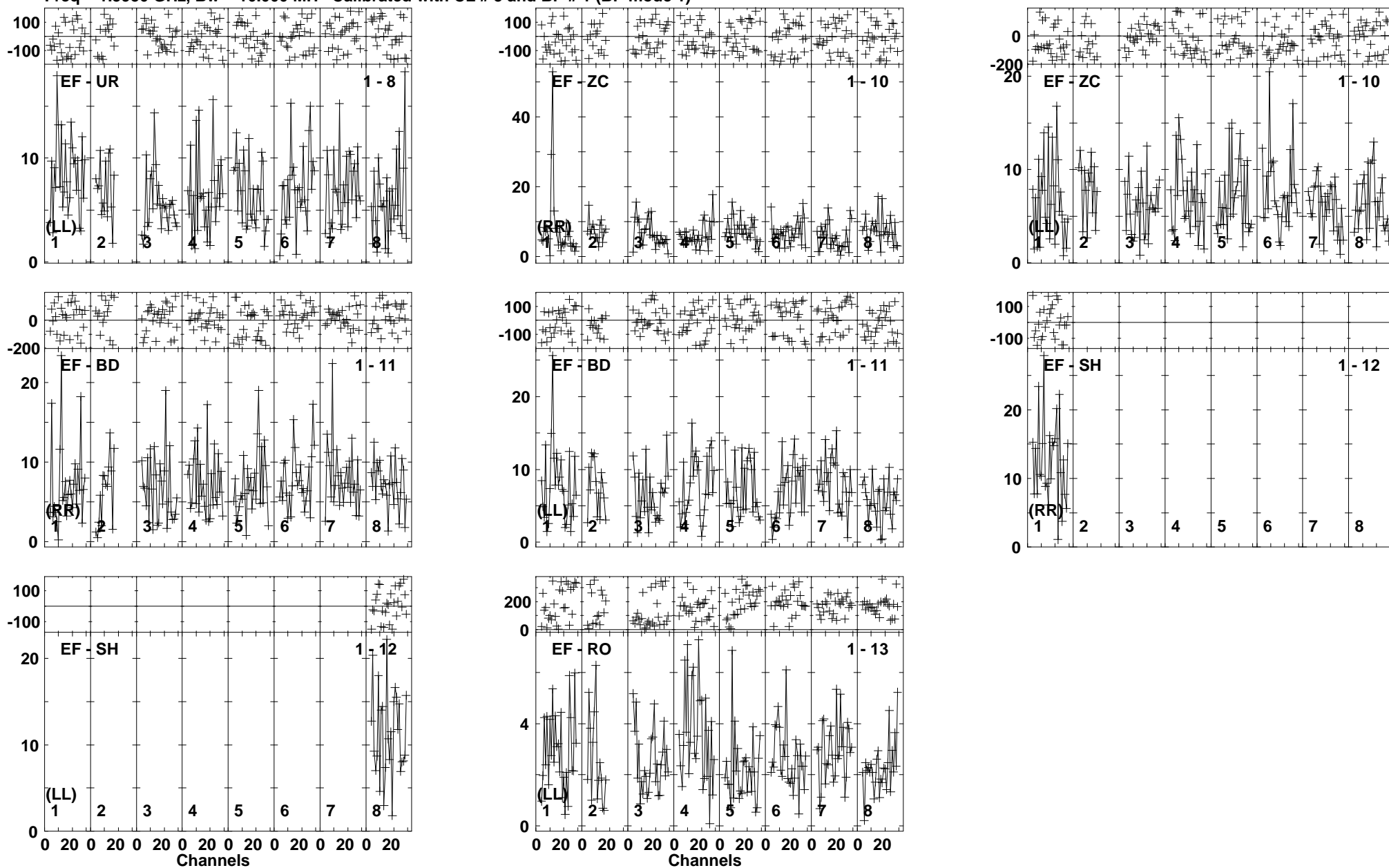

Lower frame: Milli Ampl Jy Top frame: Phas deg
Vector averaged cross-power spectrum Baseline: EF (01) - UR (08)
Timerange: 00/04:24:21 to 00/04:28:49

Plot file version 59 created 25-MAR-2014 17:50:58

J1128+5925 EP087E 1.UVDATA.1

Freq = 1.5950 GHz, Bw = 16.000 MH Calibrated with CL # 3 and BP # 1 (BP mode 1)

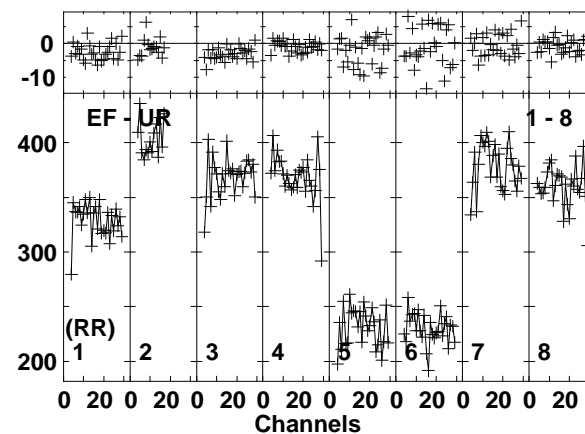
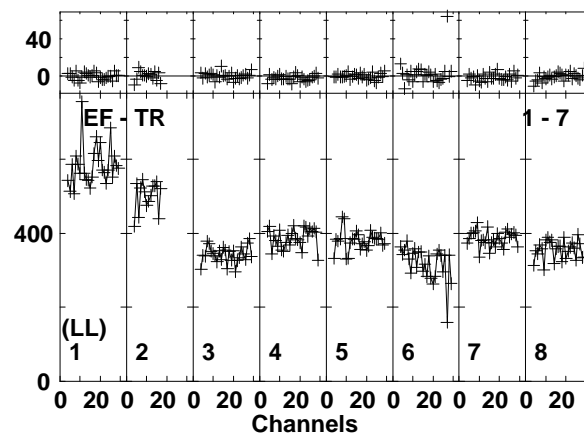
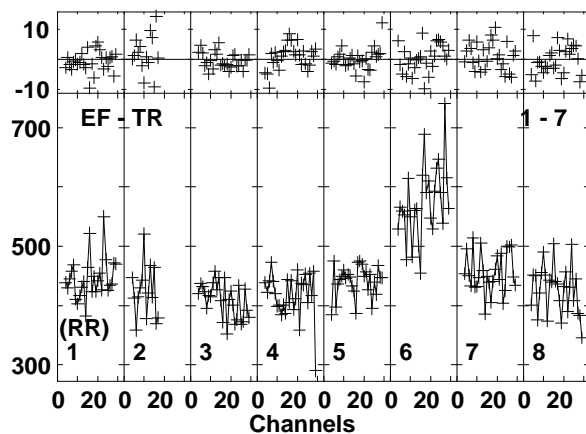
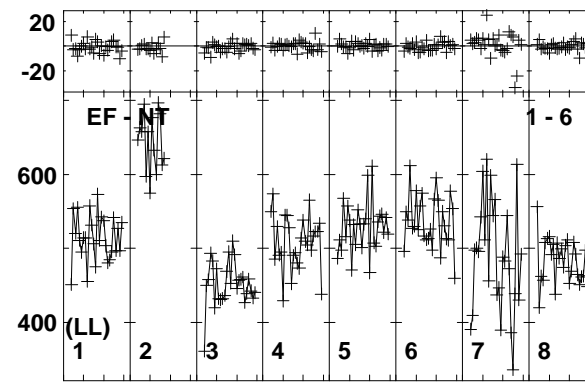
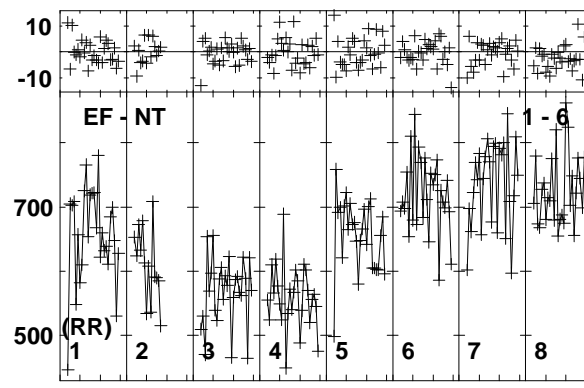
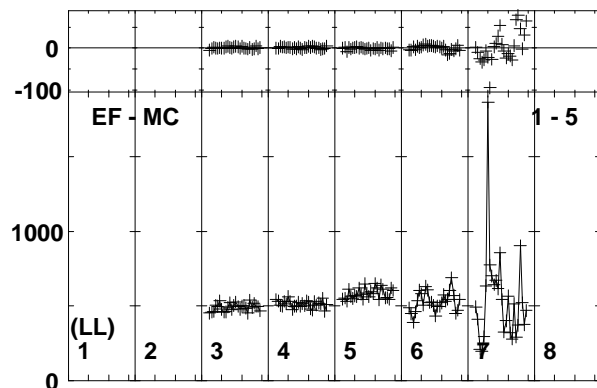
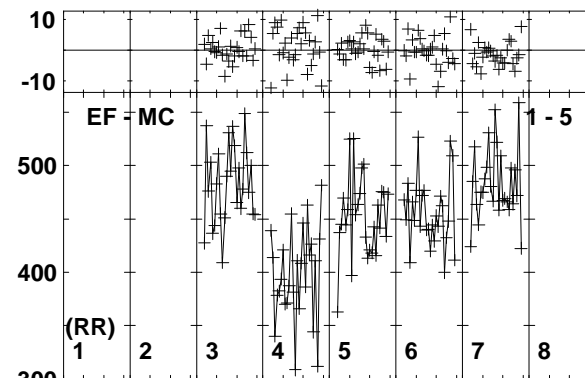
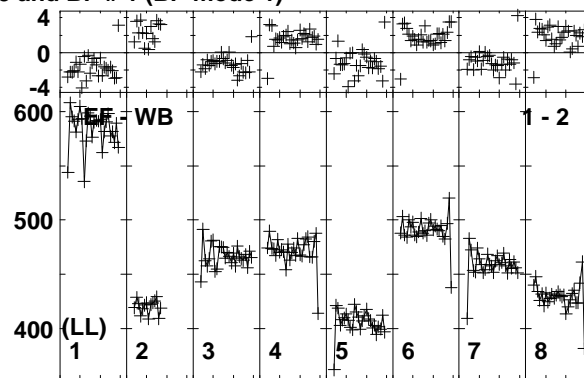
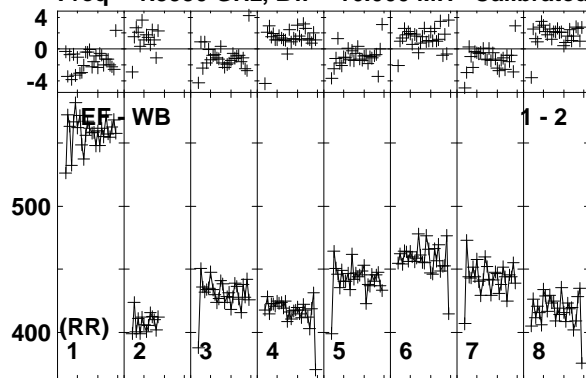

Lower frame: Milli Ampl Jy Top frame: Phas deg
Vector averaged cross-power spectrum Baseline: EF (01) - WB (02)
Timerange: 00/04:29:31 to 00/04:29:59

Plot file version 60 created 25-MAR-2014 17:50:59

J1128+5925 EP087E 1.UVDATA.1

Freq = 1.5950 GHz, Bw = 16.000 MH Calibrated with CL # 3 and BP # 1 (BP mode 1)

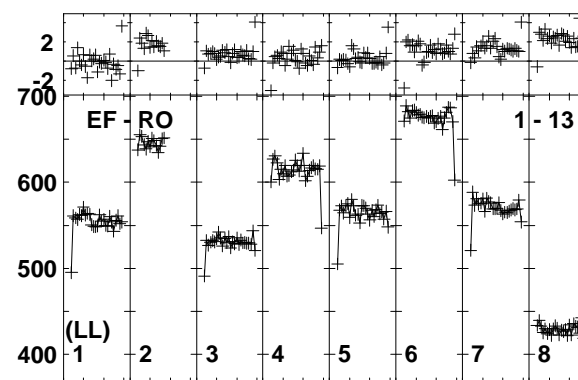
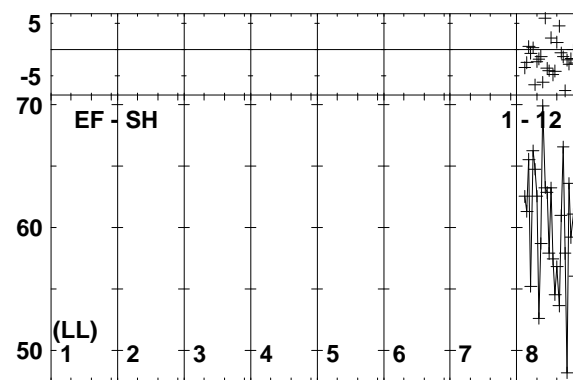
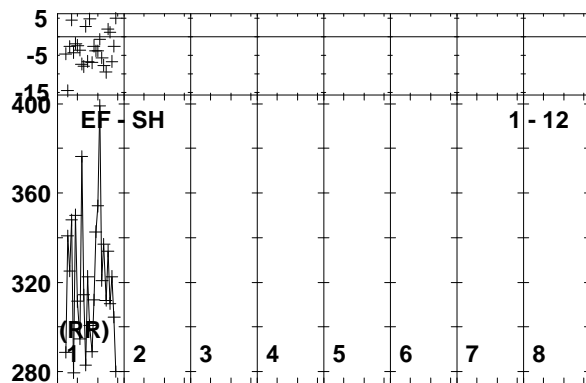
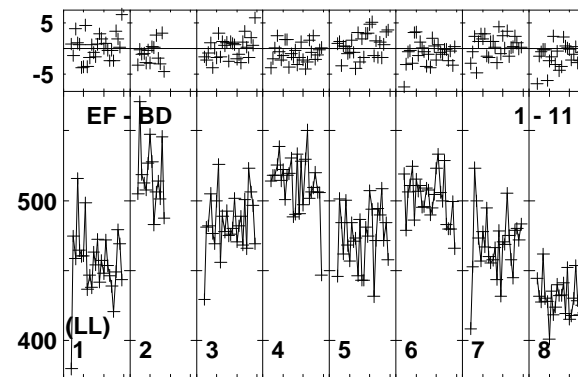
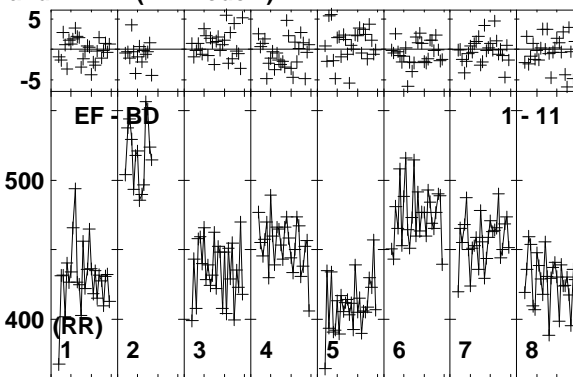
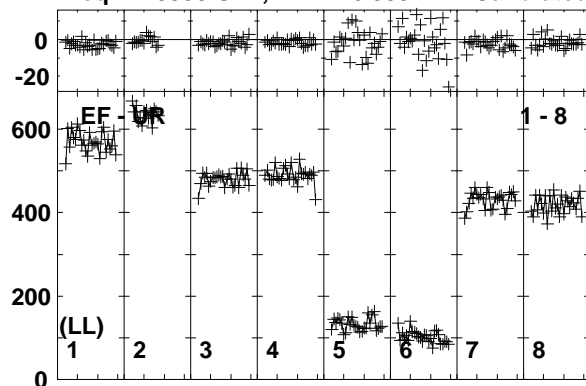

Lower frame: Milli Ampl Jy Top frame: Phas deg
Vector averaged cross-power spectrum Baseline: EF (01) - UR (08)
Timerange: 00/04:29:31 to 00/04:29:59

Plot file version 61 created 25-MAR-2014 17:50:59

ARP299A EP087E 1.UVDATA.1

Freq = 1.5950 GHz, Bw = 16.000 MH Calibrated with CL # 3 and BP # 1 (BP mode 1)

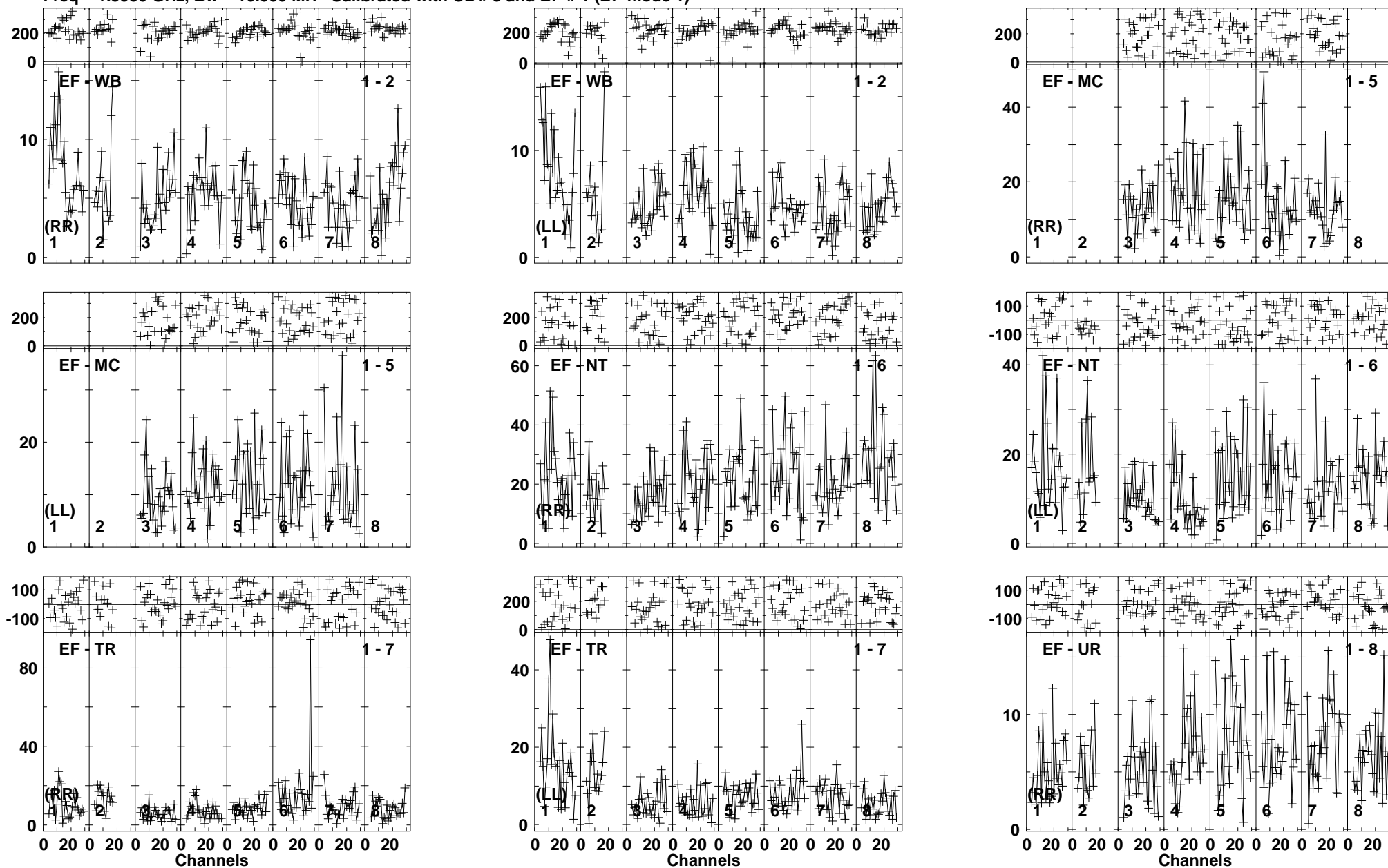

Lower frame: Milli Ampl Jy Top frame: Phas deg
Vector averaged cross-power spectrum Baseline: EF (01) - WB (02)
Timerange: 00/04:30:05 to 00/04:34:29

Plot file version 62 created 25-MAR-2014 17:50:59

ARP299A EP087E 1.UVDATA.1

Freq = 1.5950 GHz, Bw = 16.000 MH Calibrated with CL # 3 and BP # 1 (BP mode 1)

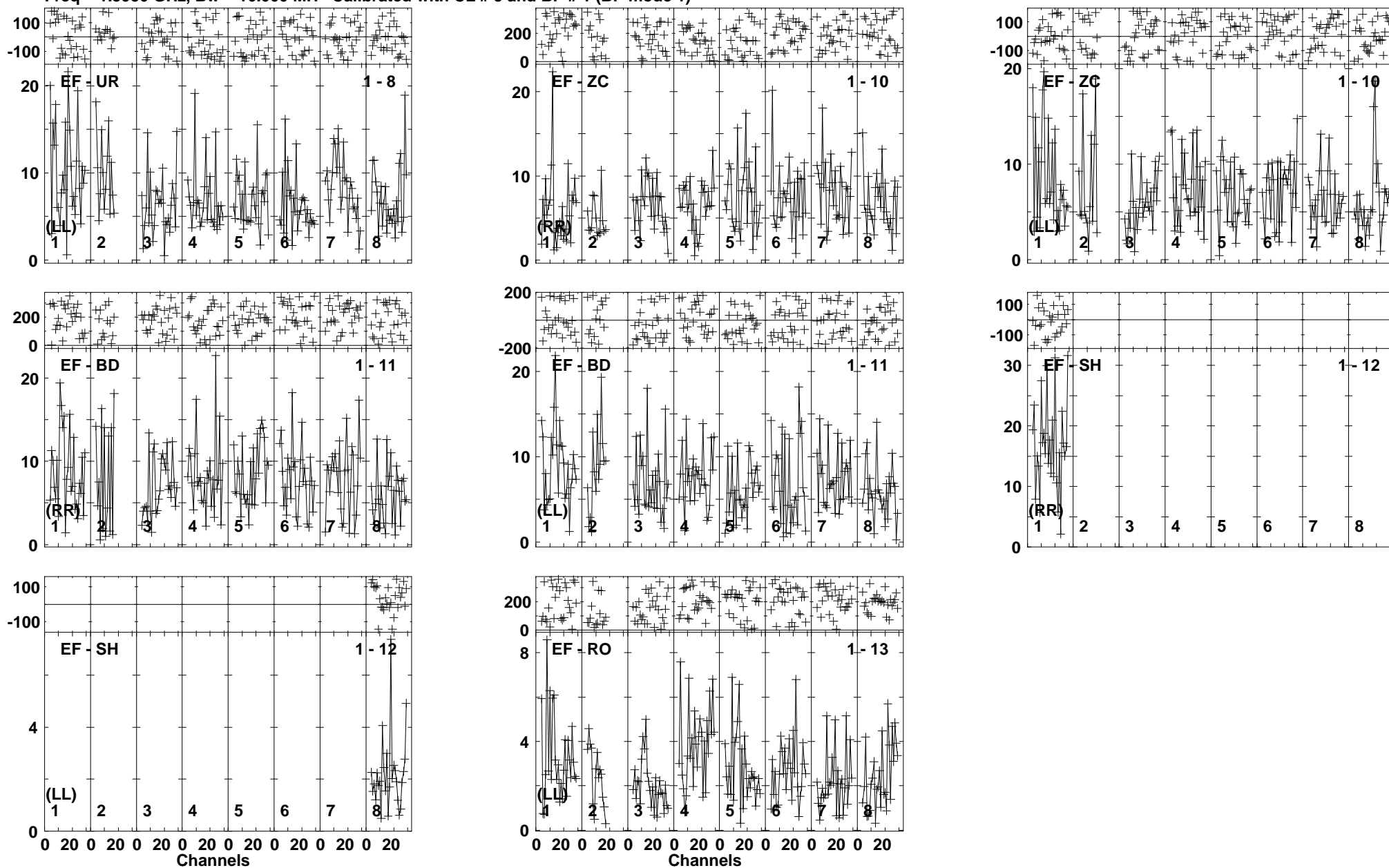

Lower frame: Milli Ampl Jy Top frame: Phas deg
Vector averaged cross-power spectrum Baseline: EF (01) - UR (08)
Timerange: 00/04:30:05 to 00/04:34:29

Plot file version 63 created 25-MAR-2014 17:51:00

J1128+5925 EP087E 1.UVDATA.1

Freq = 1.5950 GHz, Bw = 16.000 MH Calibrated with CL # 3 and BP # 1 (BP mode 1)

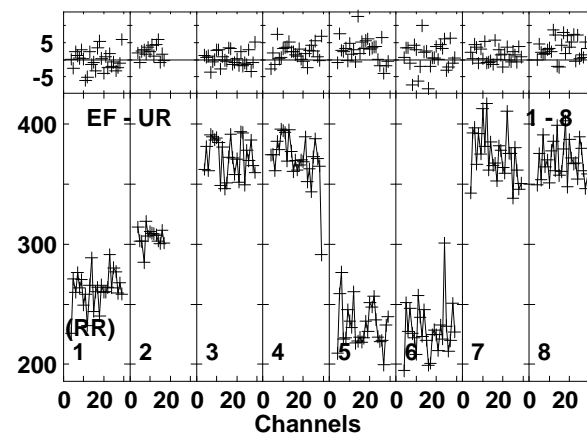
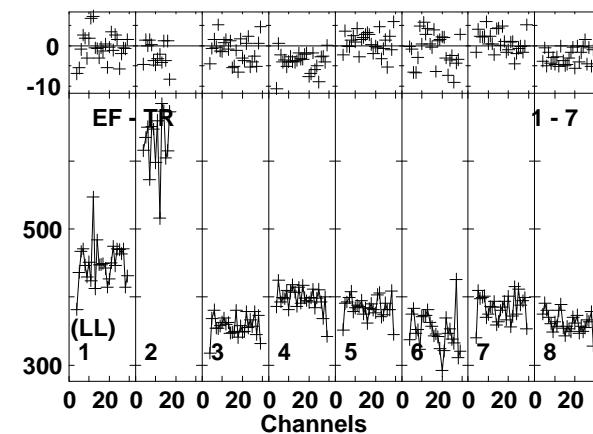
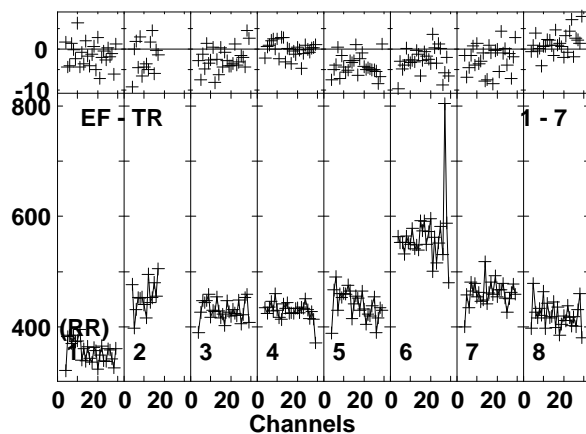
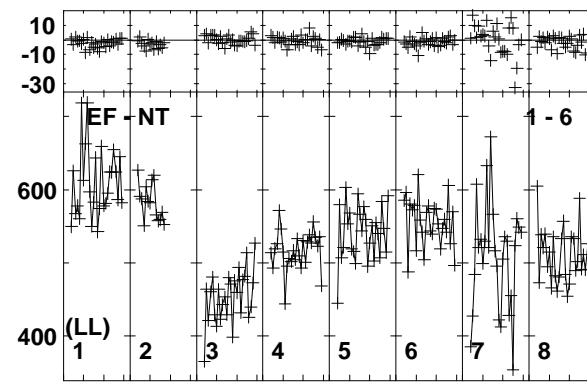
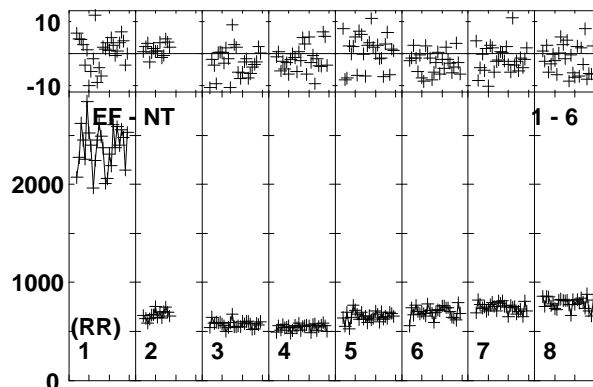
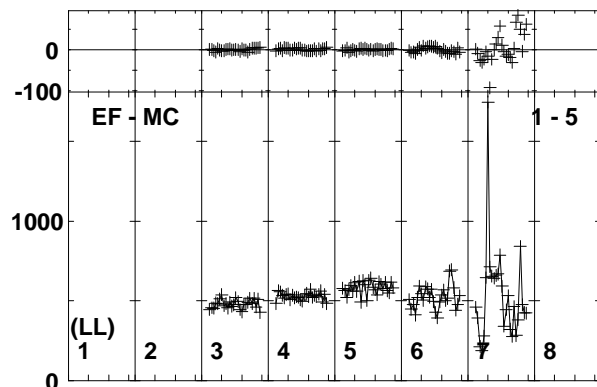
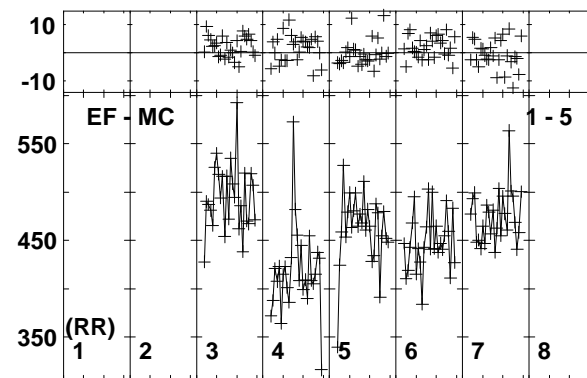
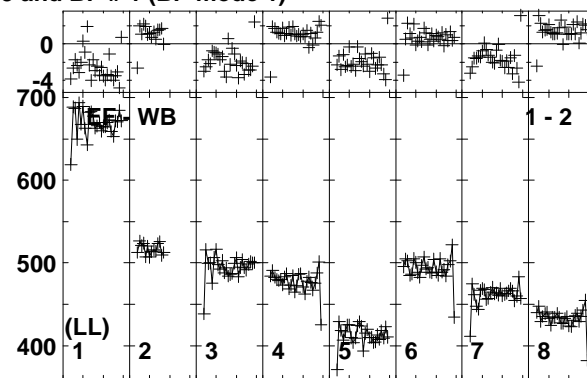
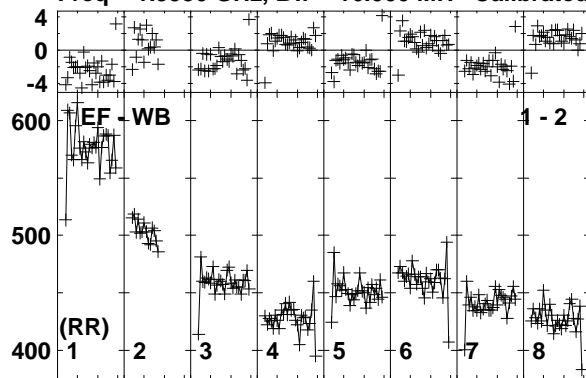

Lower frame: Milli Ampl Jy Top frame: Phas deg
Vector averaged cross-power spectrum Baseline: EF (01) - WB (02)
Timerange: 00/04:34:35 to 00/04:35:29

Plot file version 64 created 25-MAR-2014 17:51:00

J1128+5925 EP087E 1.UVDATA.1

Freq = 1.5950 GHz, Bw = 16.000 MH Calibrated with CL # 3 and BP # 1 (BP mode 1)

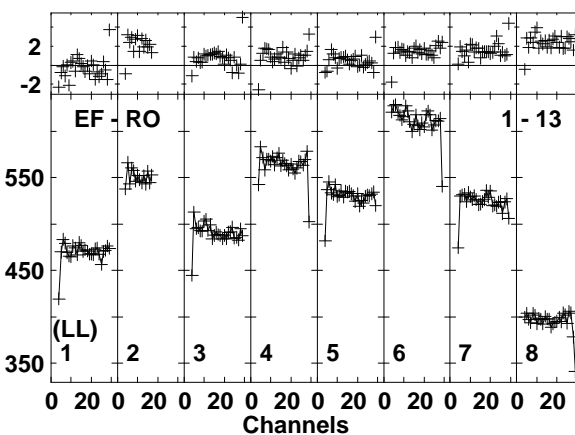
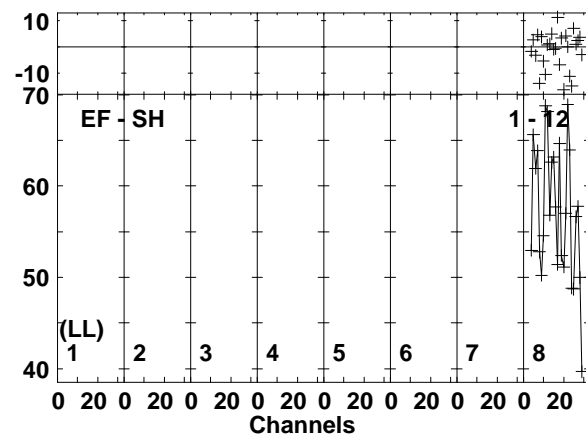
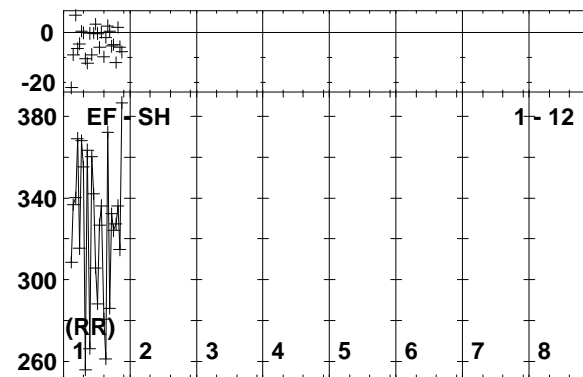
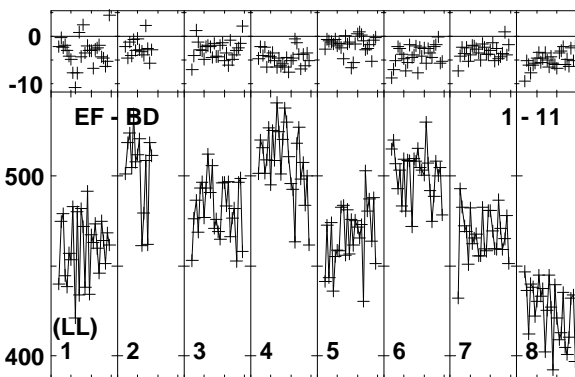
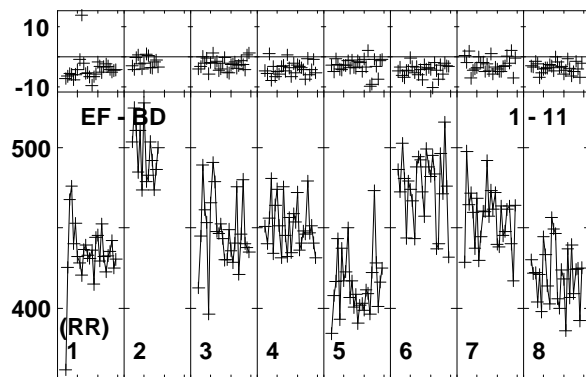
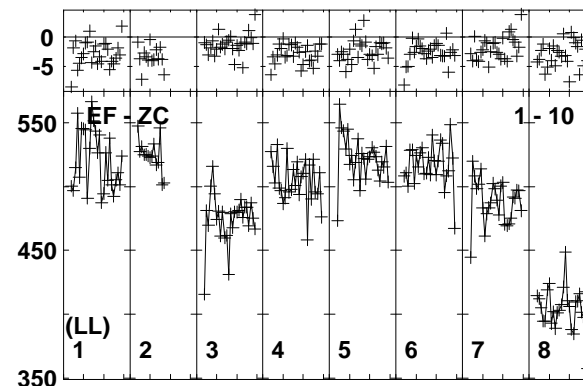
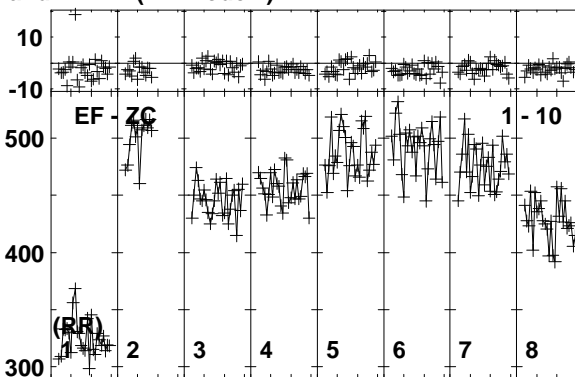
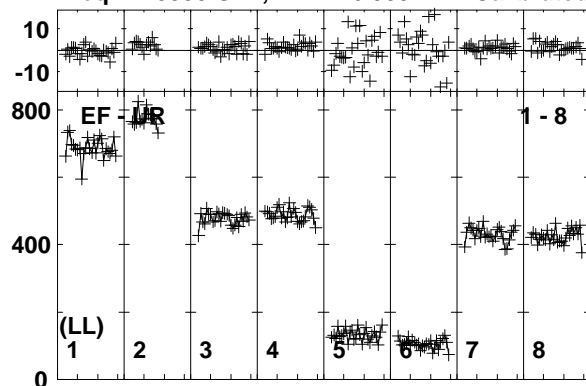

Lower frame: Milli Ampl Jy Top frame: Phas deg
Vector averaged cross-power spectrum Baseline: EF (01) - UR (08)
Timerange: 00/04:34:35 to 00/04:35:29

Plot file version 65 created 25-MAR-2014 17:51:00

ARP299A EP087E 1.UVDATA.1

Freq = 1.5950 GHz, Bw = 16.000 MH Calibrated with CL # 3 and BP # 1 (BP mode 1)

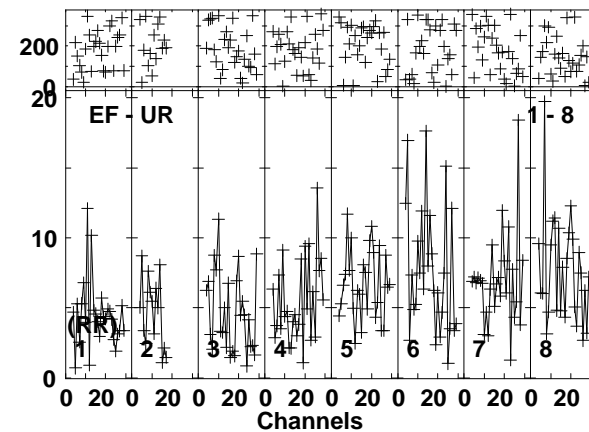
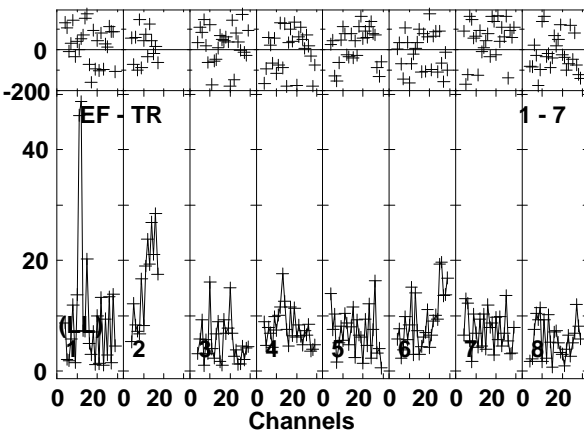
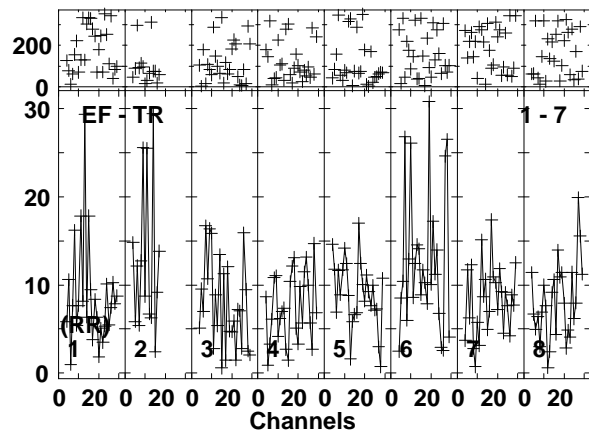
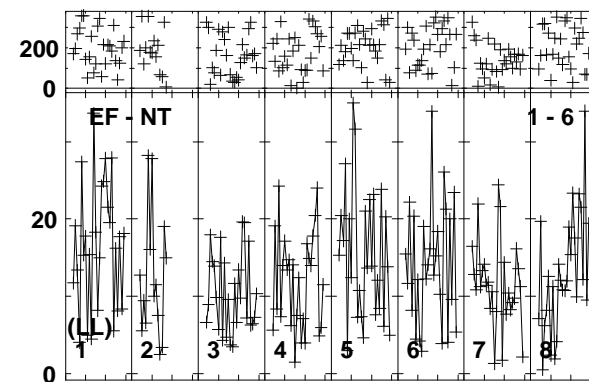
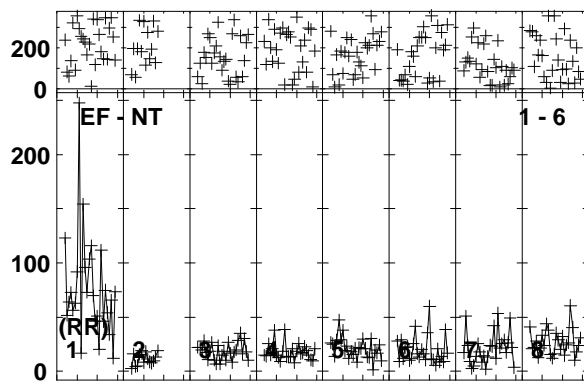
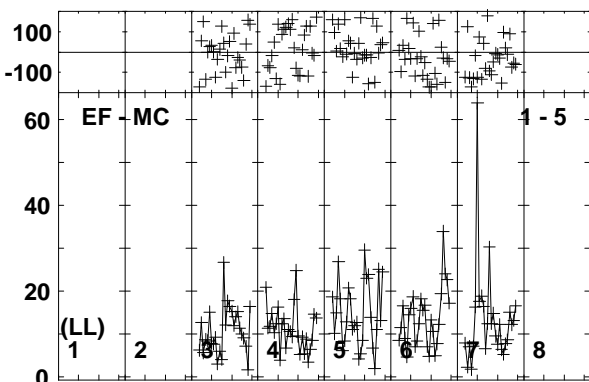
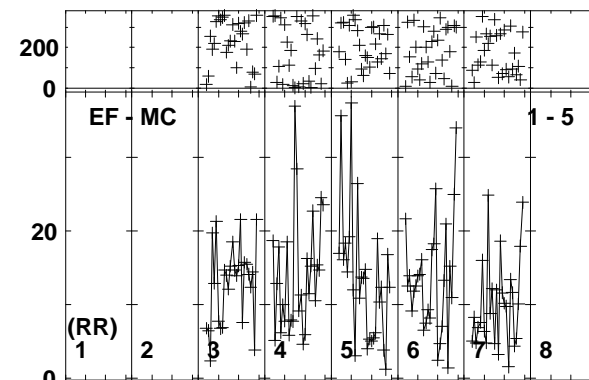
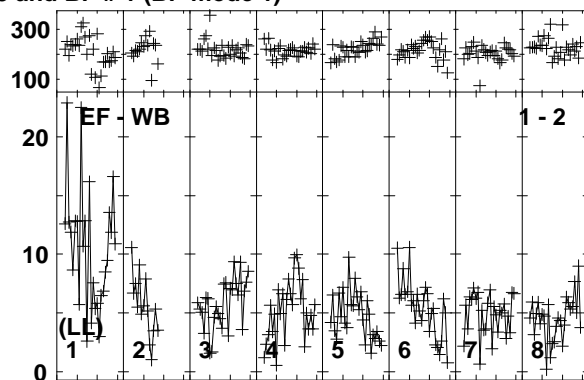
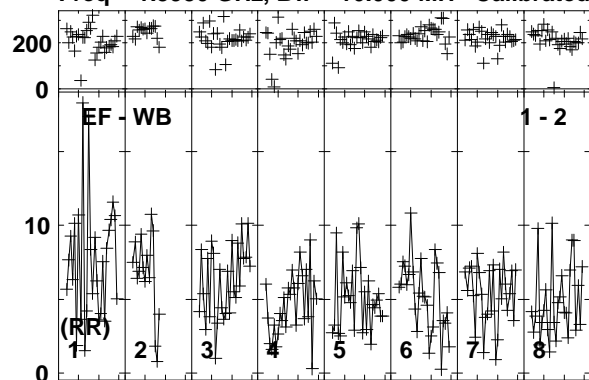

Lower frame: Milli Ampl Jy Top frame: Phas deg
Vector averaged cross-power spectrum Baseline: EF (01) - WB (02)
Timerange: 00/04:35:31 to 00/04:39:59

Plot file version 66 created 25-MAR-2014 17:51:00

ARP299A EP087E 1.UVDATA.1

Freq = 1.5950 GHz, Bw = 16.000 MH Calibrated with CL # 3 and BP # 1 (BP mode 1)

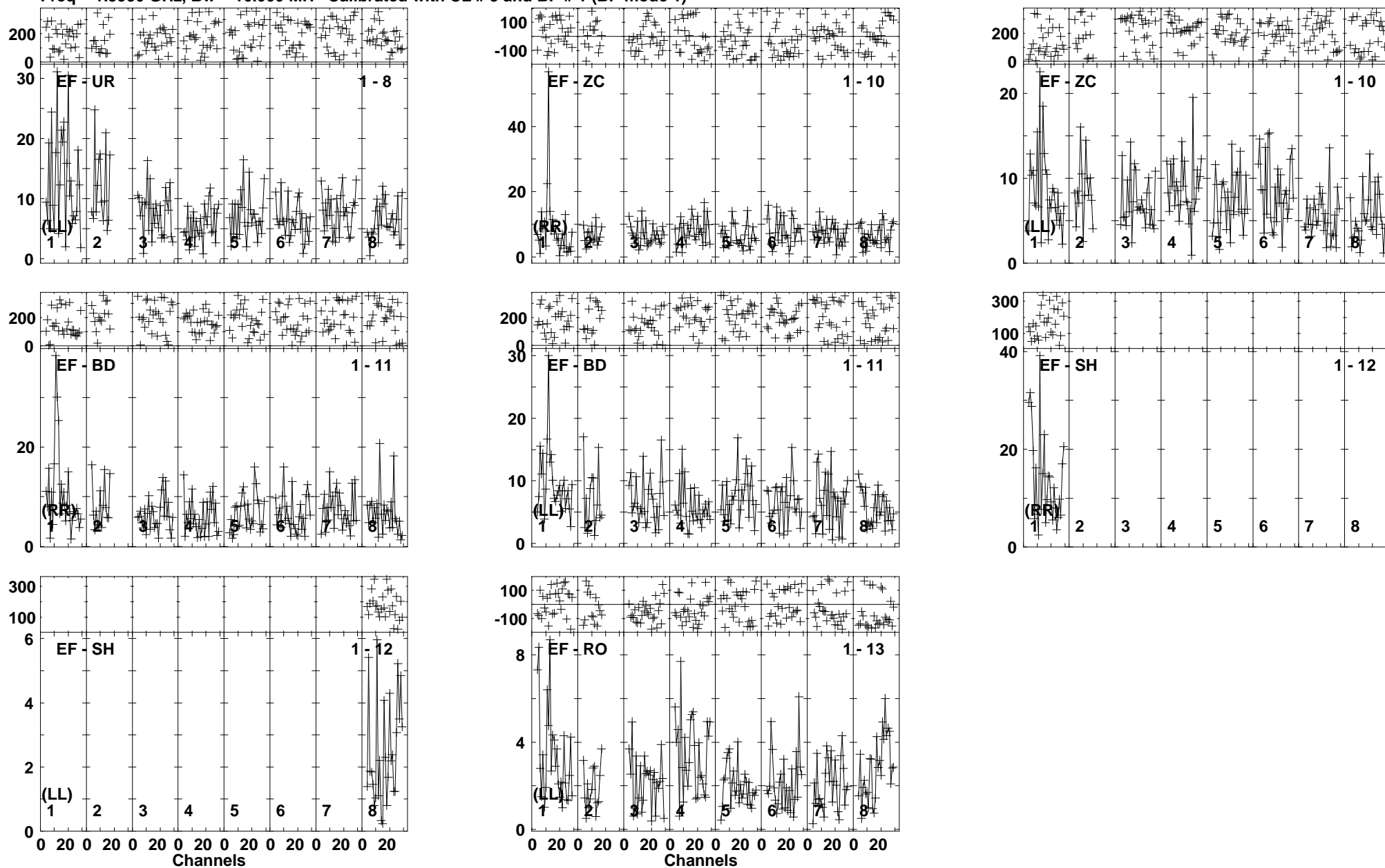

Lower frame: Milli Ampl Jy Top frame: Phas deg
Vector averaged cross-power spectrum Baseline: EF (01) - UR (08)
Timerange: 00/04:35:31 to 00/04:39:59

Plot file version 67 created 25-MAR-2014 17:51:01

J1128+5925 EP087E 1.UVDATA.1

Freq = 1.5950 GHz, Bw = 16.000 MH Calibrated with CL # 3 and BP # 1 (BP mode 1)

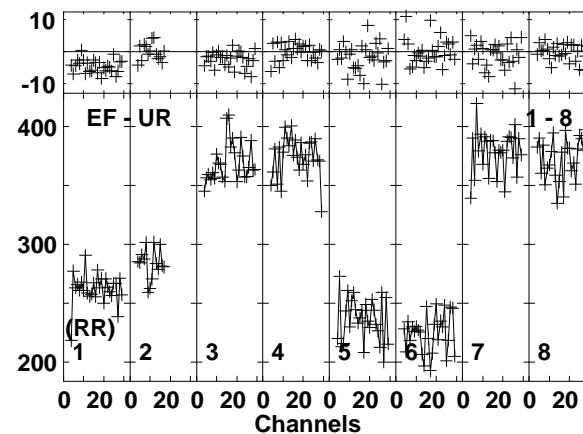
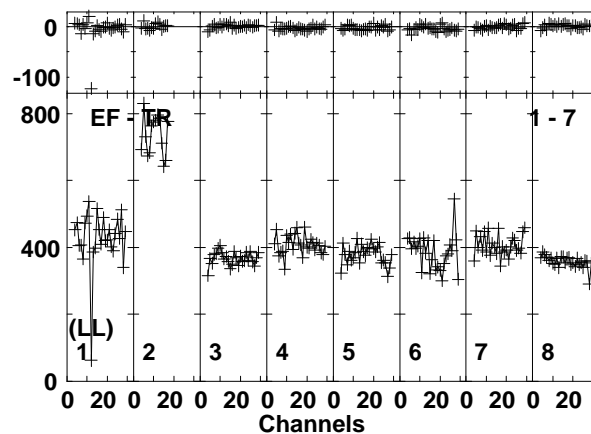
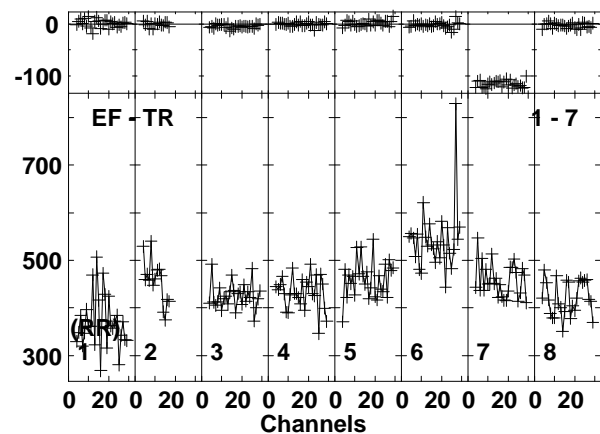
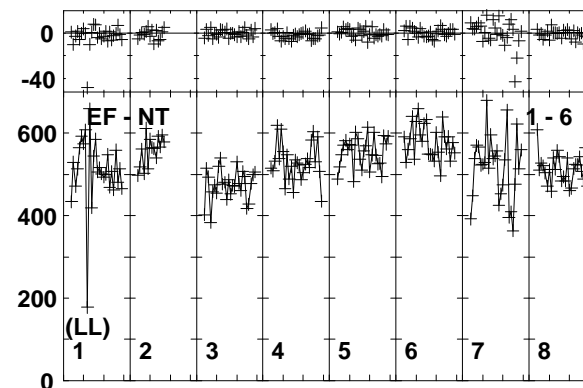
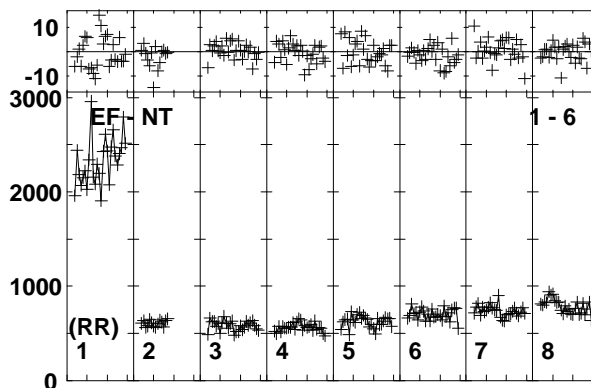
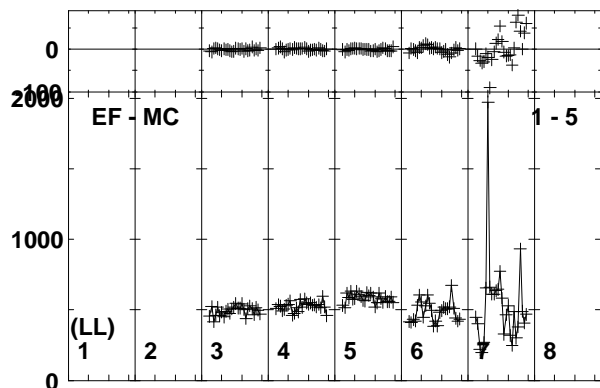
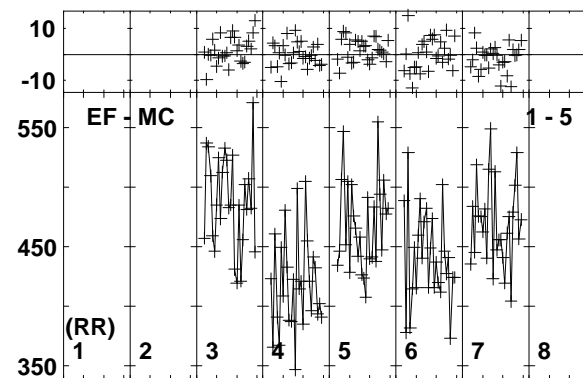
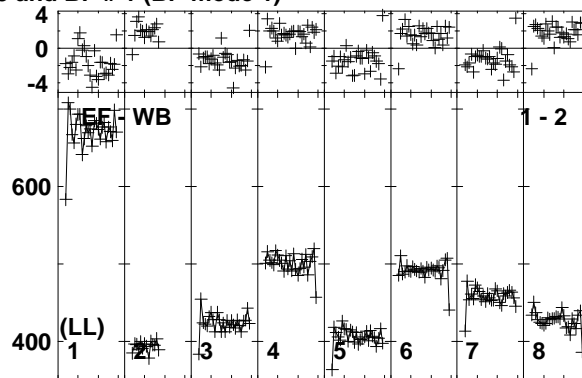
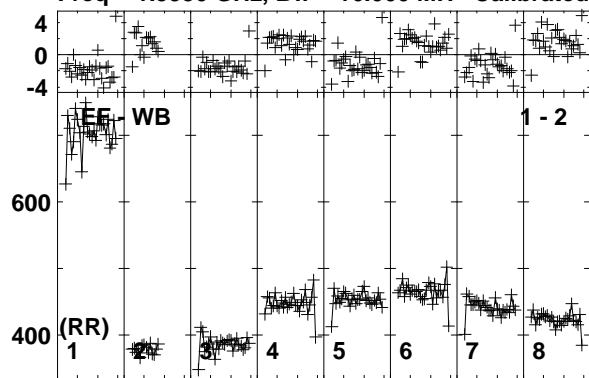

Lower frame: Milli Ampl Jy Top frame: Phas deg
Vector averaged cross-power spectrum Baseline: EF (01) - WB (02)
Timerange: 00/04:40:41 to 00/04:41:09

Plot file version 68 created 25-MAR-2014 17:51:01

J1128+5925 EP087E 1.UVDATA.1

Freq = 1.5950 GHz, Bw = 16.000 MH Calibrated with CL # 3 and BP # 1 (BP mode 1)

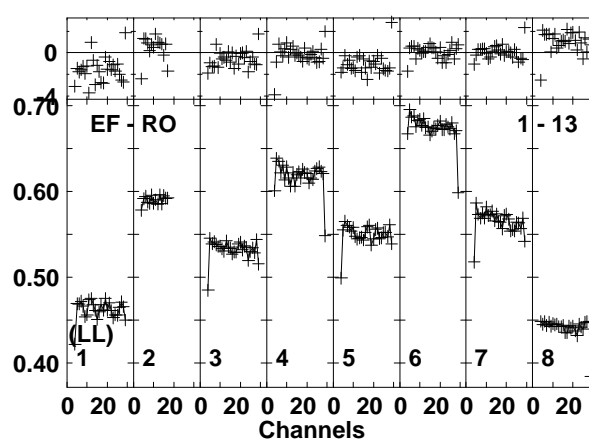
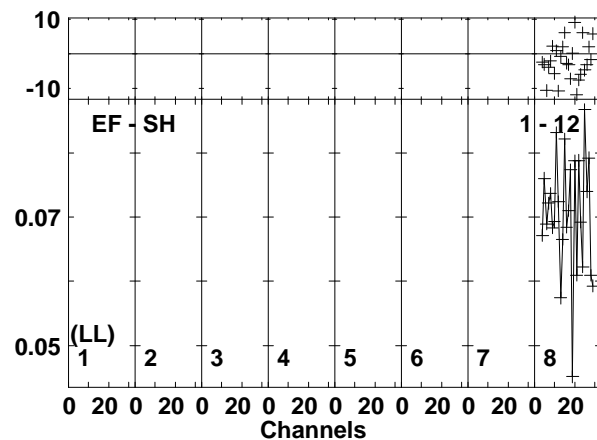
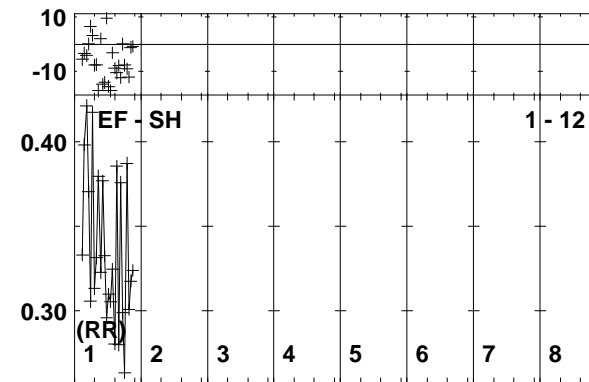
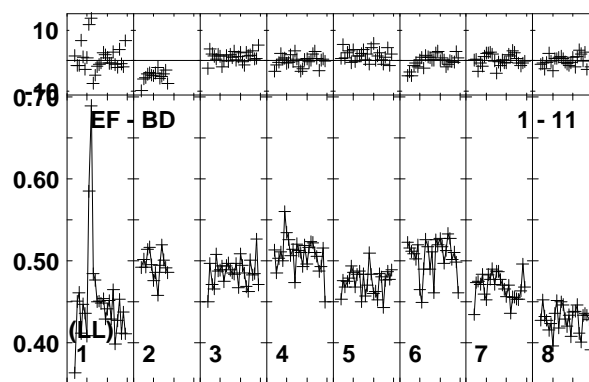
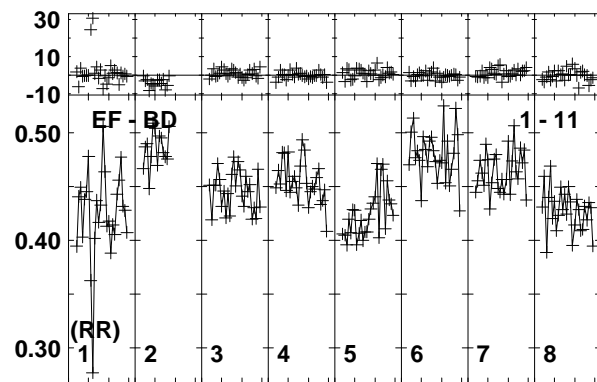
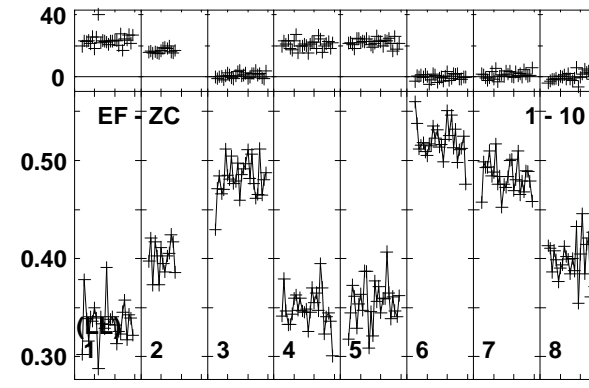
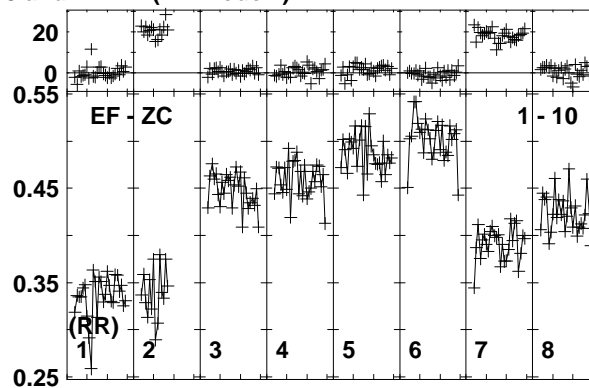
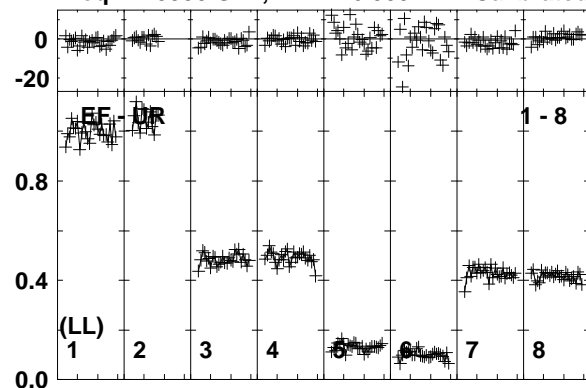

Lower frame: Ampl Jy Top frame: Phas deg
Vector averaged cross-power spectrum Baseline: EF (01) - UR (08)
Timerange: 00/04:40:41 to 00/04:41:09

Plot file version 69 created 25-MAR-2014 17:51:01

ARP299A EP087E 1.UVDATA.1

Freq = 1.5950 GHz, Bw = 16.000 MH Calibrated with CL # 3 and BP # 1 (BP mode 1)

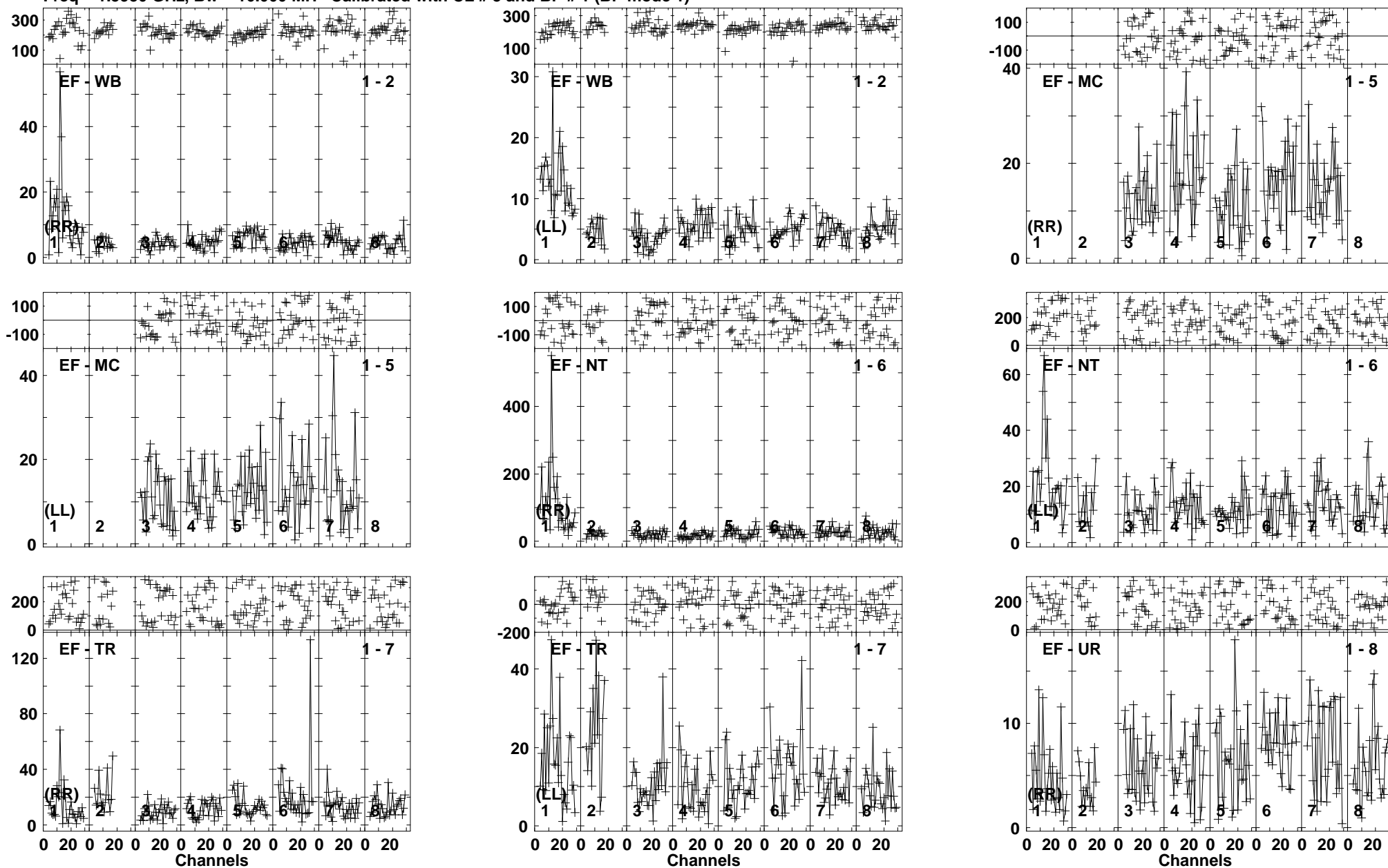

Lower frame: Milli Ampl Jy Top frame: Phas deg
Vector averaged cross-power spectrum Baseline: EF (01) - WB (02)
Timerange: 00/04:41:15 to 00/04:45:39

Plot file version 70 created 25-MAR-2014 17:51:02

ARP299A EP087E 1.UVDATA.1

Freq = 1.5950 GHz, Bw = 16.000 MH Calibrated with CL # 3 and BP # 1 (BP mode 1)

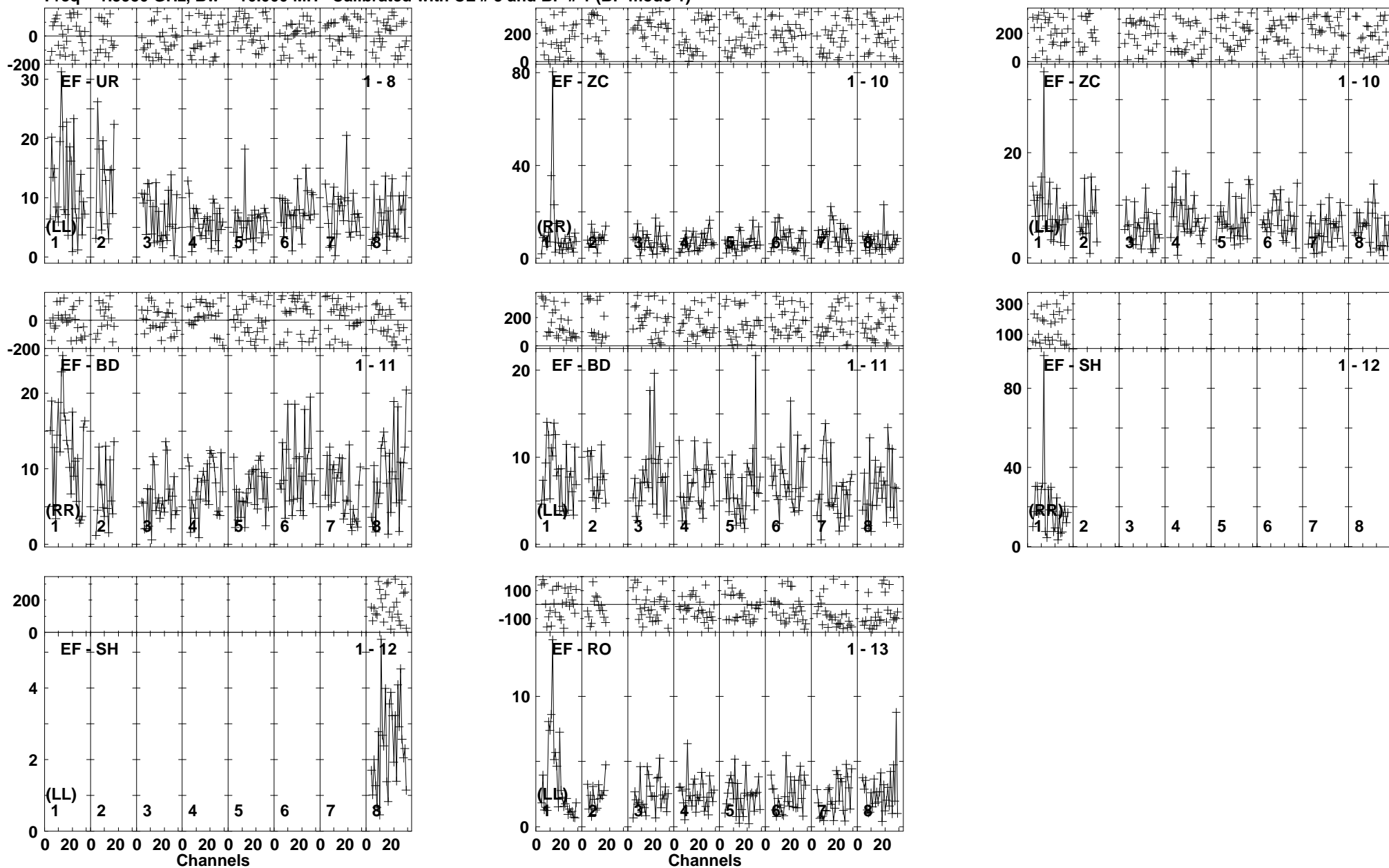

Lower frame: Milli Ampl Jy Top frame: Phas deg
Vector averaged cross-power spectrum Baseline: EF (01) - UR (08)
Timerange: 00/04:41:15 to 00/04:45:39

Plot file version 71 created 25-MAR-2014 17:51:02

J1128+5925 EP087E 1.UVDATA.1

Freq = 1.5950 GHz, Bw = 16.000 MH Calibrated with CL # 3 and BP # 1 (BP mode 1)

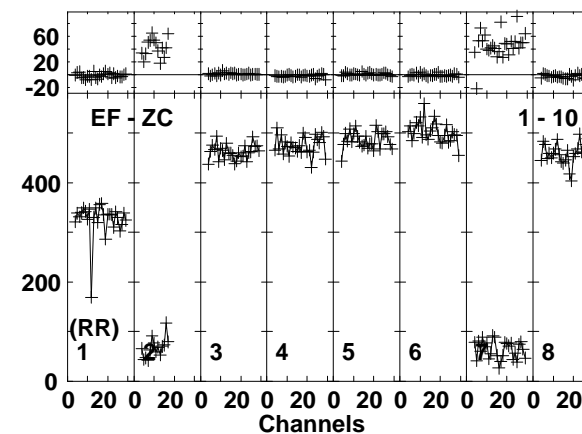
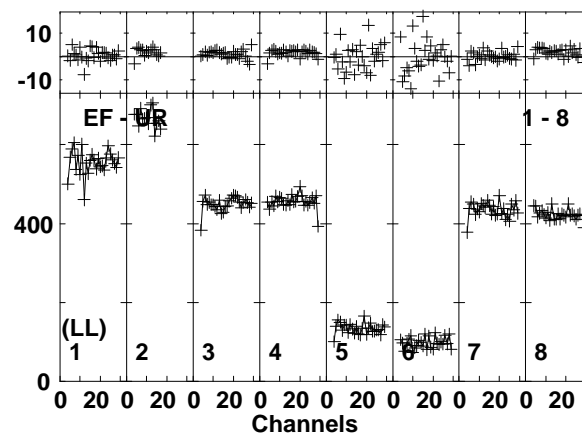
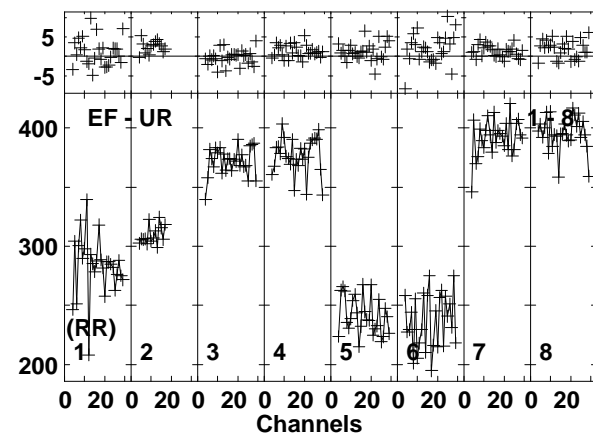
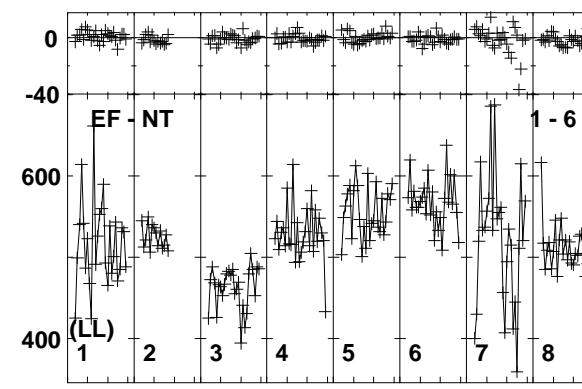
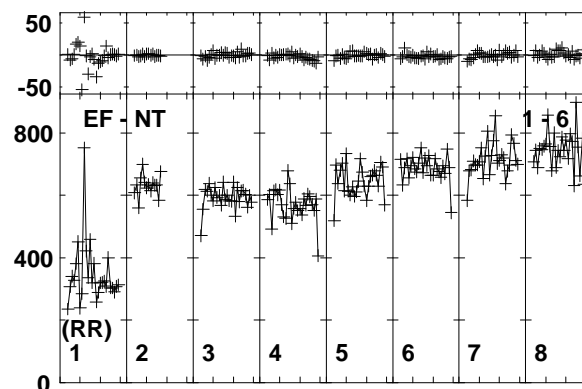
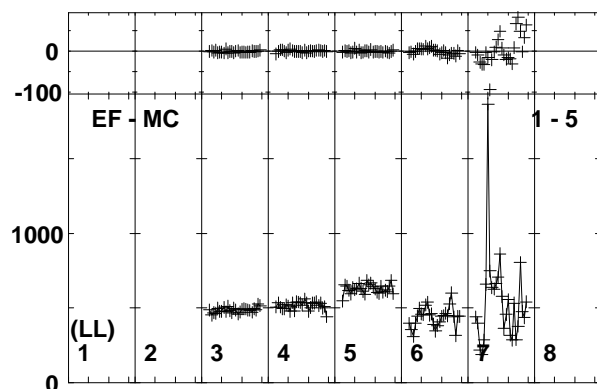
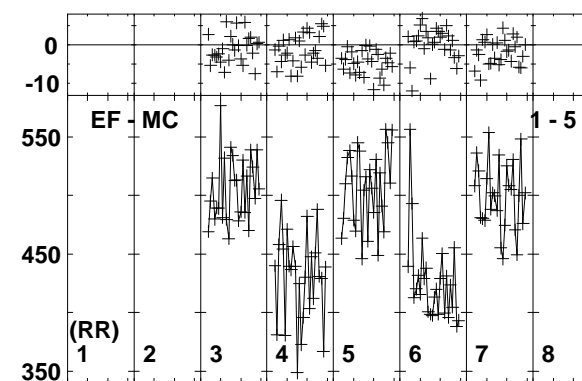
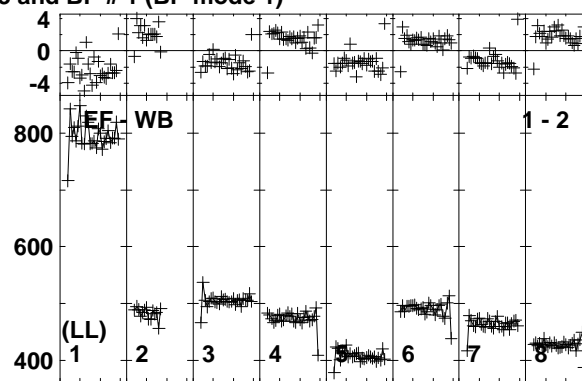
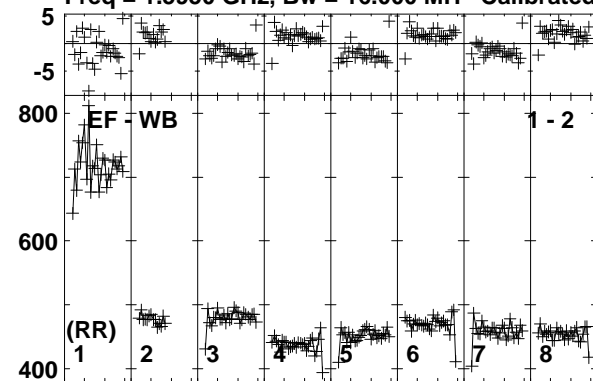

Lower frame: Milli Ampl Jy Top frame: Phas deg
Vector averaged cross-power spectrum Baseline: EF (01) - WB (02)
Timerange: 00/04:45:45 to 00/04:46:49

Plot file version 72 created 25-MAR-2014 17:51:02

J1128+5925 EP087E 1.UVDATA.1

Freq = 1.5950 GHz, Bw = 16.000 MH Calibrated with CL # 3 and BP # 1 (BP mode 1)

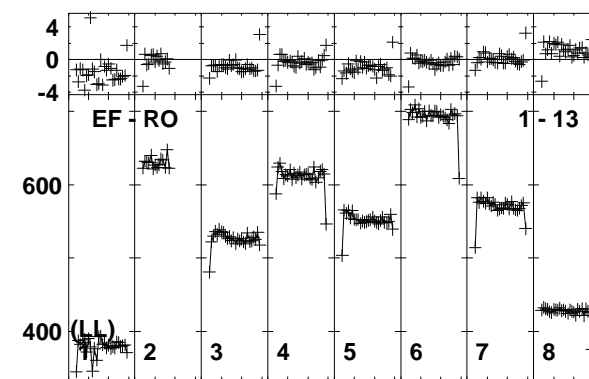
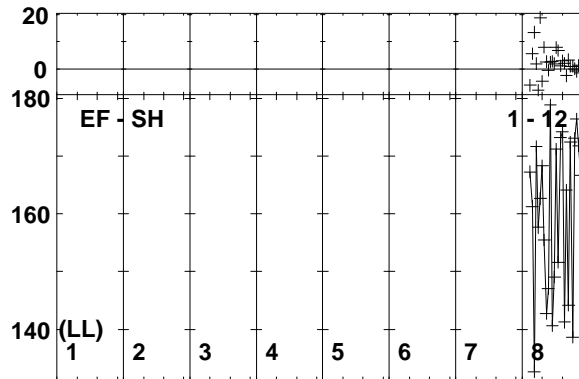
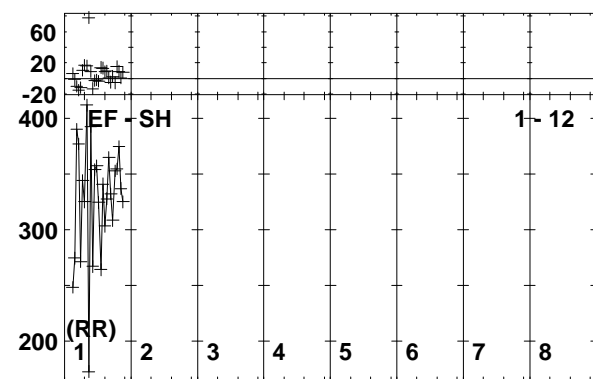
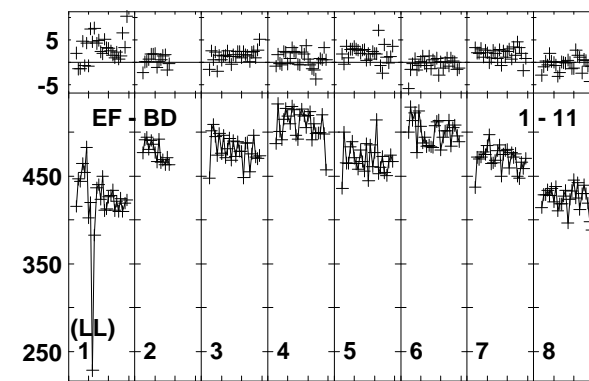
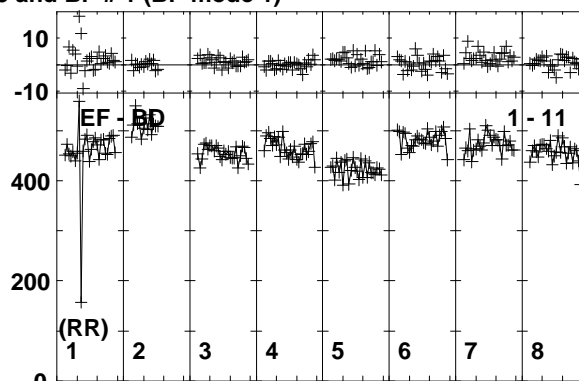
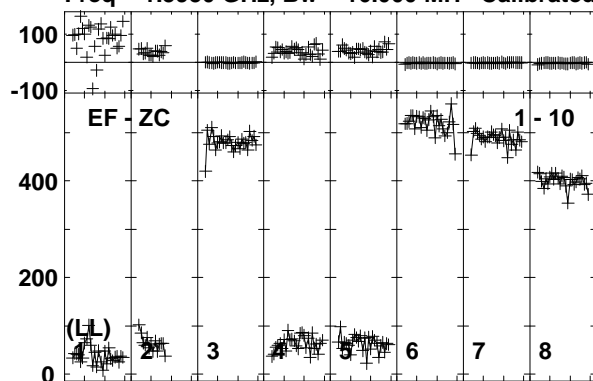

Lower frame: Milli Ampl Jy Top frame: Phas deg
Vector averaged cross-power spectrum Baseline: EF (01) - ZC (10)
Timerange: 00/04:45:45 to 00/04:46:49

Plot file version 73 created 25-MAR-2014 17:51:02

ARP299A EP087E 1.UVDATA.1

Freq = 1.5950 GHz, Bw = 16.000 MH Calibrated with CL # 3 and BP # 1 (BP mode 1)

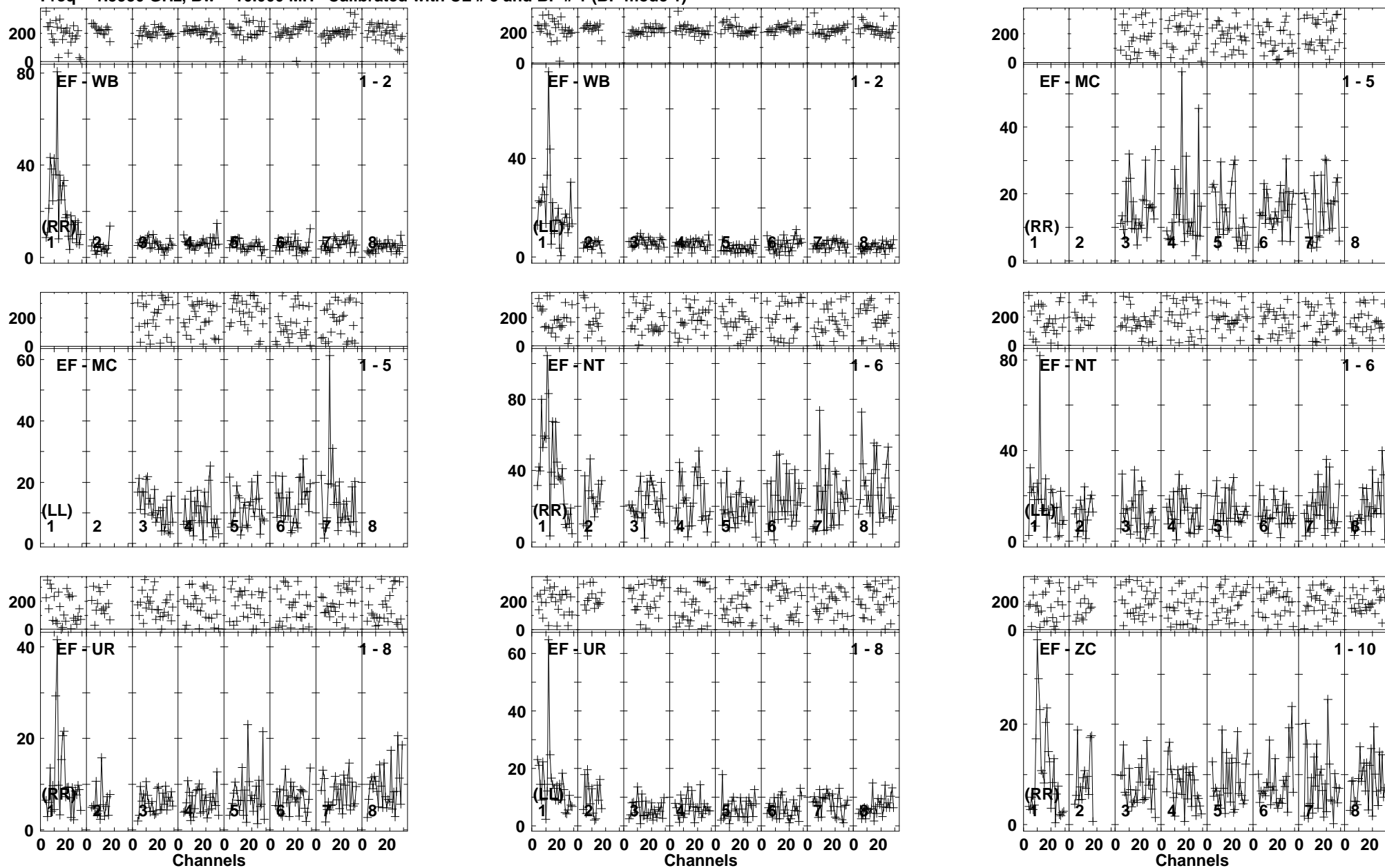

Lower frame: Milli Ampl Jy Top frame: Phas deg
Vector averaged cross-power spectrum Baseline: EF (01) - WB (02)
Timerange: 00/04:46:51 to 00/04:51:19

Plot file version 74 created 25-MAR-2014 17:51:03

ARP299A EP087E 1.UVDATA.1

Freq = 1.5950 GHz, Bw = 16.000 MH Calibrated with CL # 3 and BP # 1 (BP mode 1)

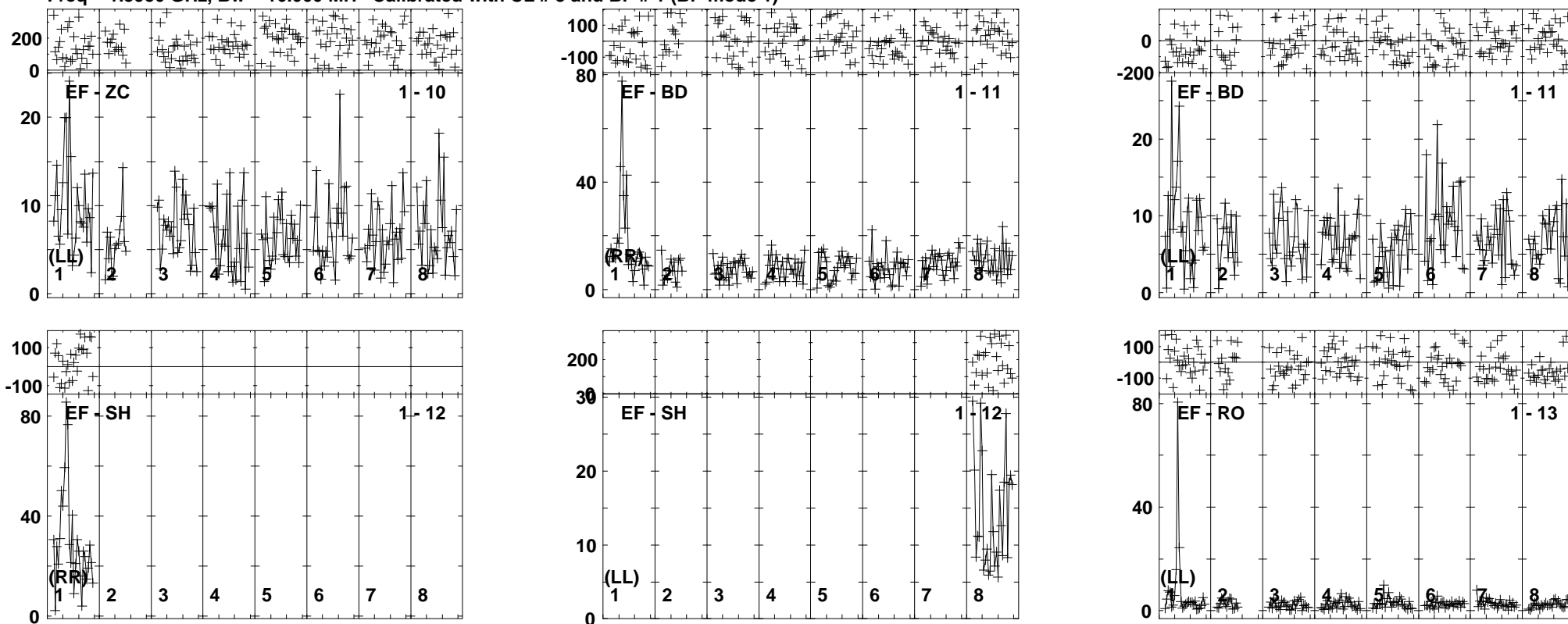

Lower frame: Milli Ampl Jy Top frame: Phas deg
Vector averaged cross-power spectrum Baseline: EF (01) - ZC (10)
Timerange: 00/04:46:51 to 00/04:51:19

Plot file version 75 created 25-MAR-2014 17:51:03
 J1128+5925 EP087E 1.UVDATA.1
 Freq = 1.5950 GHz, Bw = 16.000 MH Calibrated with CL # 3 and BP # 1 (BP mode 1)

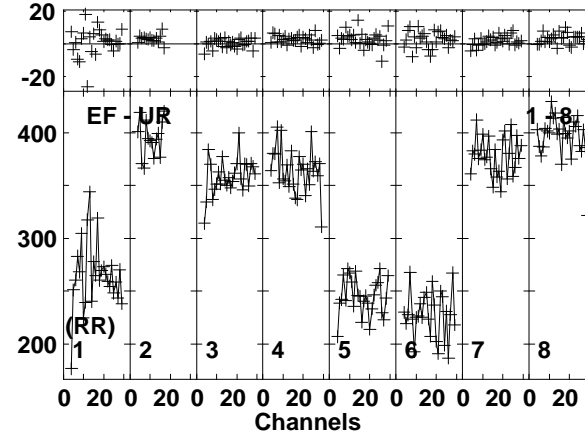
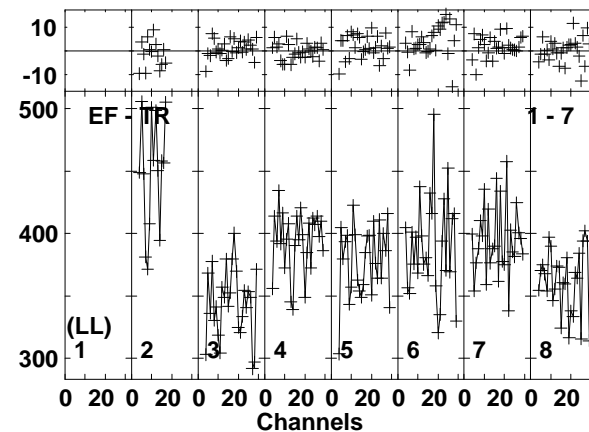
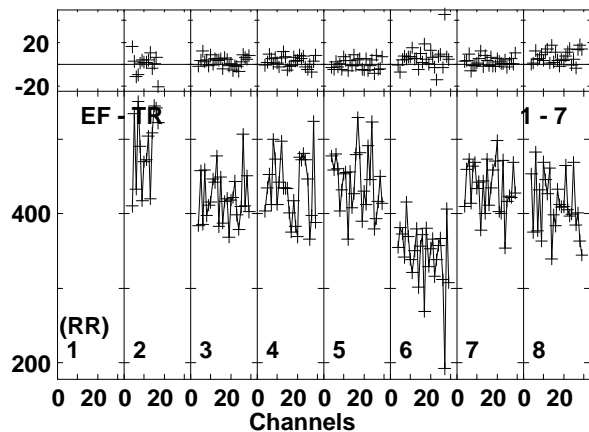
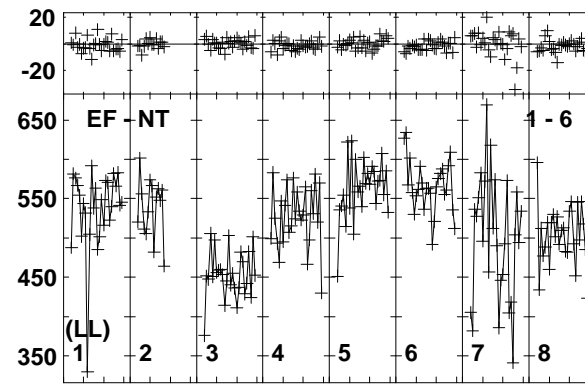
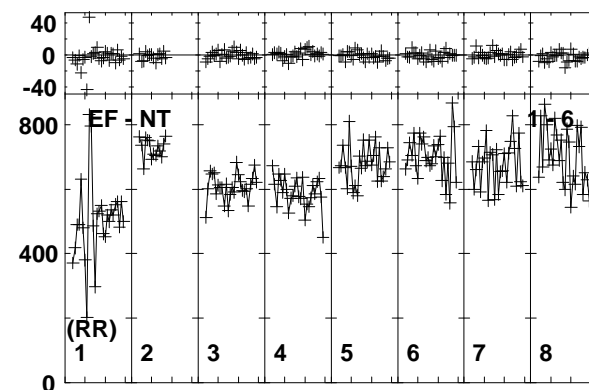
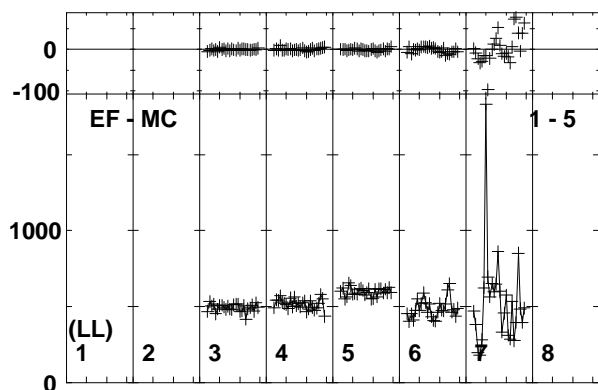
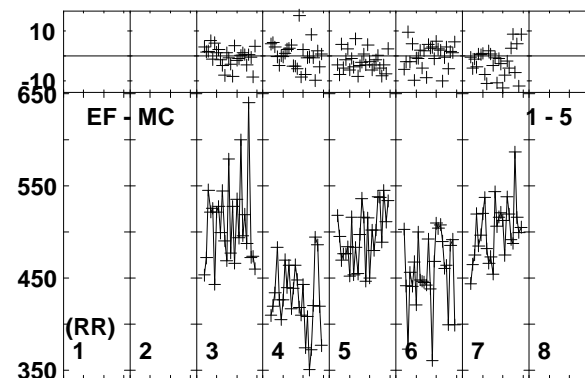
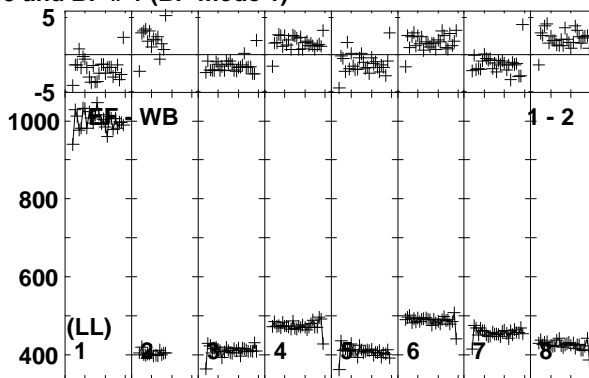
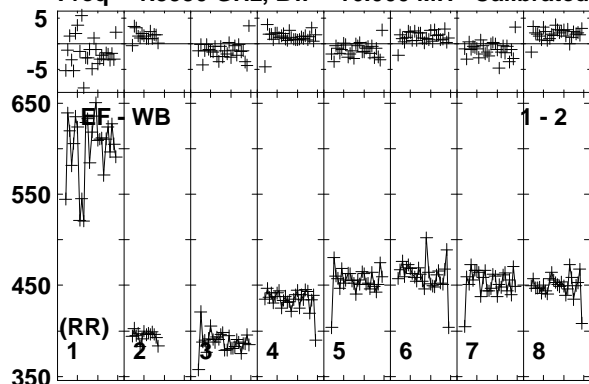

Lower frame: Milli Ampl Jy Top frame: Phas deg
 Vector averaged cross-power spectrum Baseline: EF (01) - WB (02)
 Timerange: 00/04:52:01 to 00/04:52:29

Plot file version 76 created 25-MAR-2014 17:51:03

J1128+5925 EP087E 1.UVDATA.1

Freq = 1.5950 GHz, Bw = 16.000 MH Calibrated with CL # 3 and BP # 1 (BP mode 1)

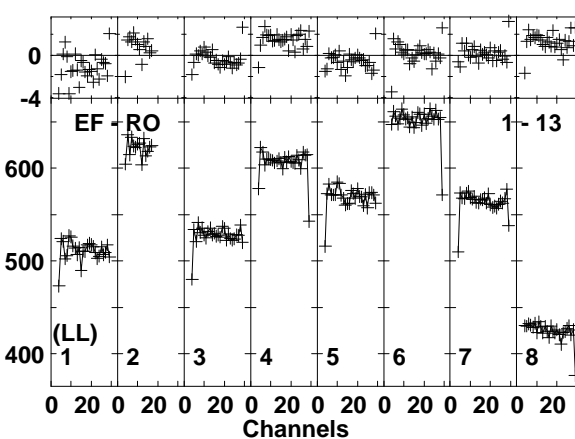
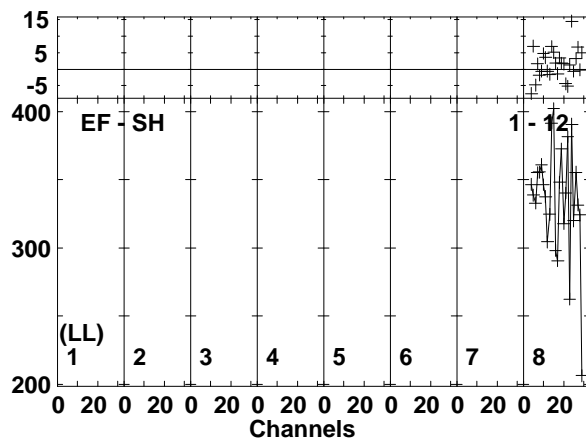
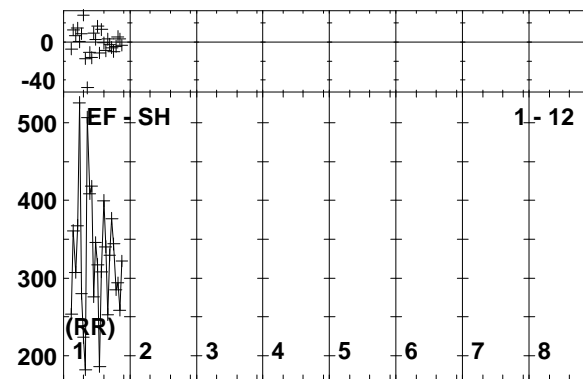
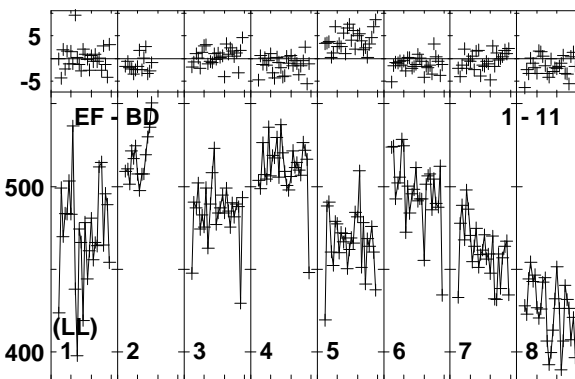
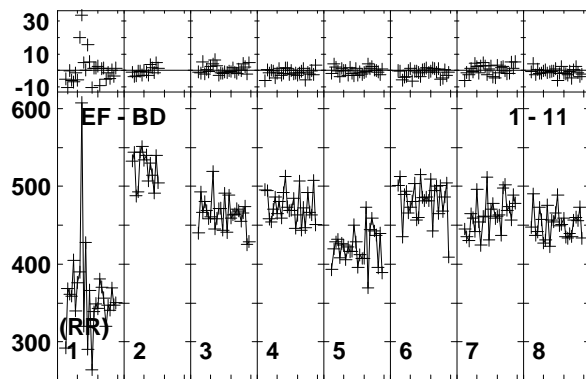
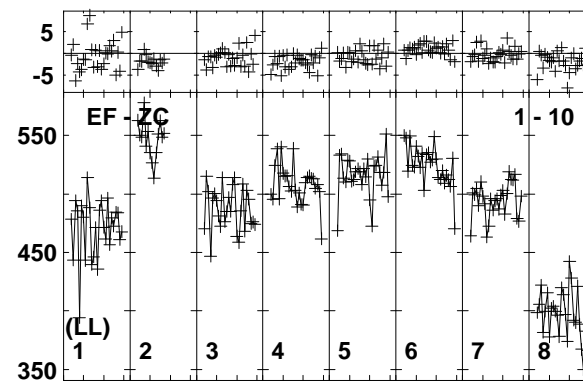
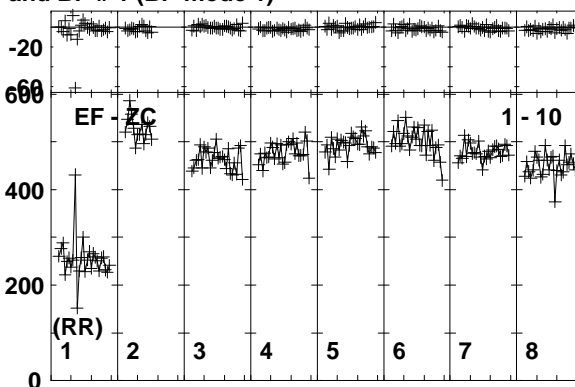
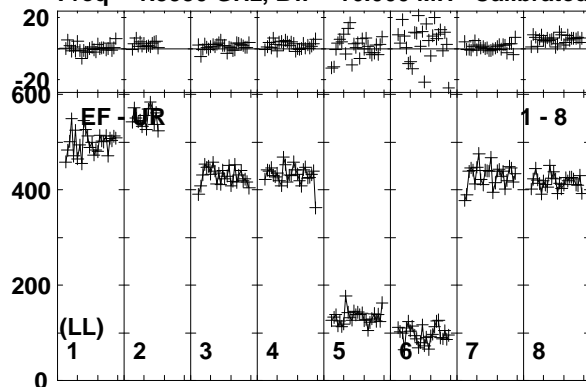

Lower frame: Milli Ampl Jy Top frame: Phas deg
Vector averaged cross-power spectrum Baseline: EF (01) - UR (08)
Timerange: 00/04:52:01 to 00/04:52:29

Plot file version 77 created 25-MAR-2014 17:51:03

ARP299A EP087E 1.UVDATA.1

Freq = 1.5950 GHz, Bw = 16.000 MH Calibrated with CL # 3 and BP # 1 (BP mode 1)

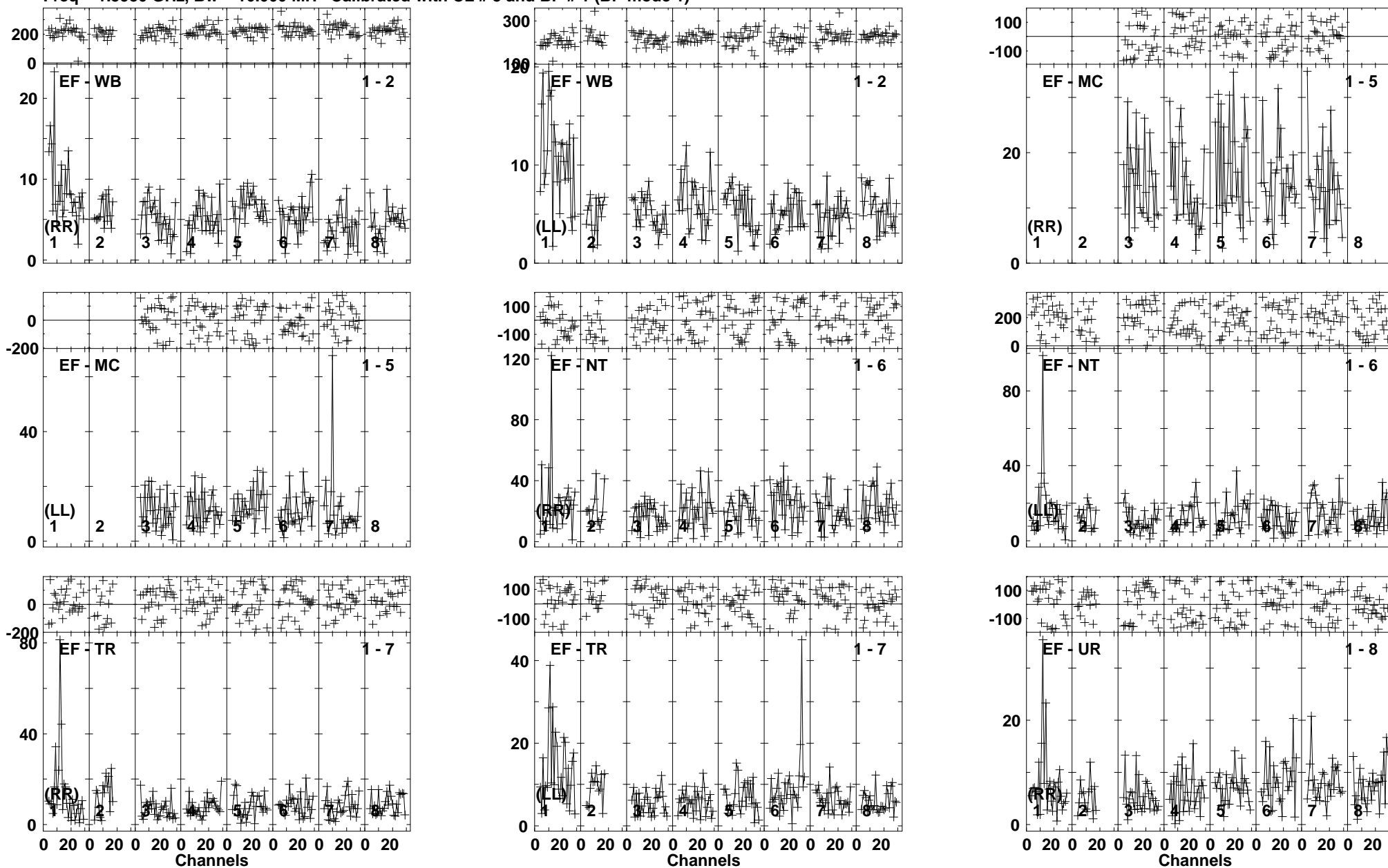

Lower frame: Milli Ampl Jy Top frame: Phas deg
Vector averaged cross-power spectrum Baseline: EF (01) - WB (02)
Timerange: 00/04:52:35 to 00/04:56:59

Plot file version 78 created 25-MAR-2014 17:51:04
 ARP299A EP087E 1.UVDATA.1
 Freq = 1.5950 GHz, Bw = 16.000 MH Calibrated with CL # 3 and BP # 1 (BP mode 1)

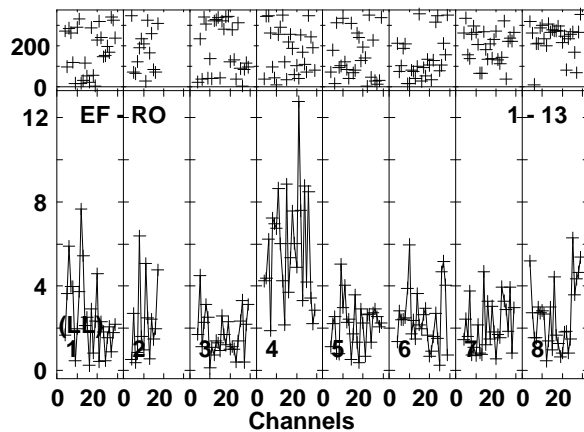
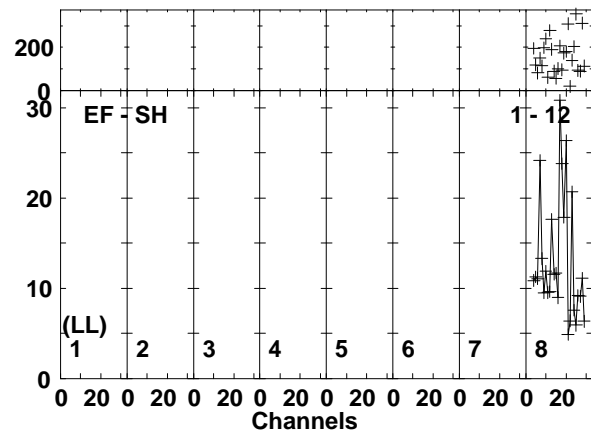
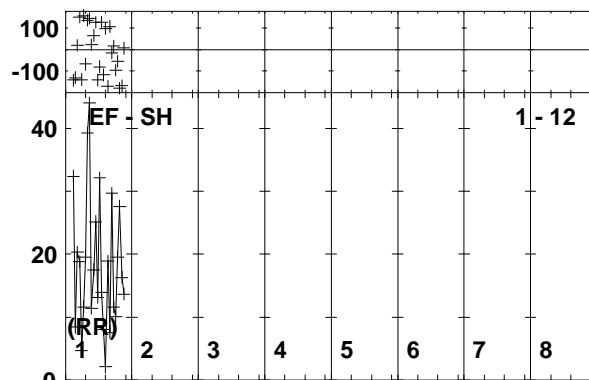
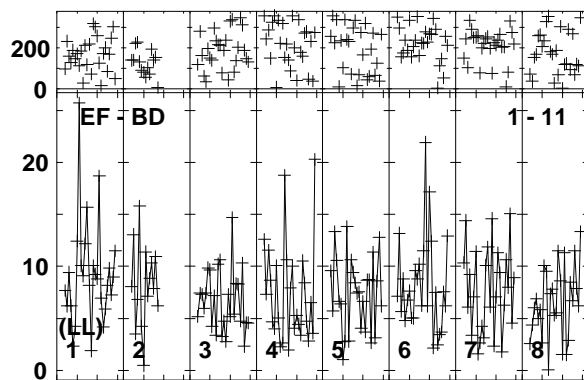
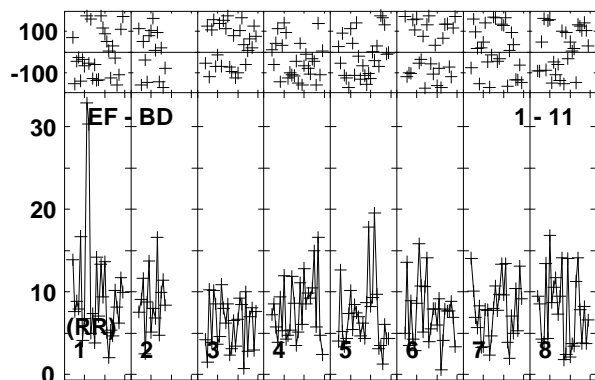
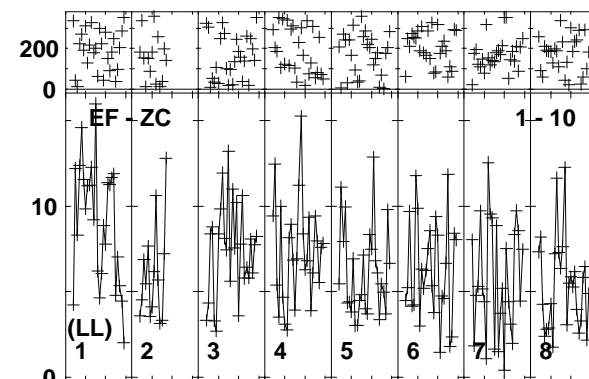
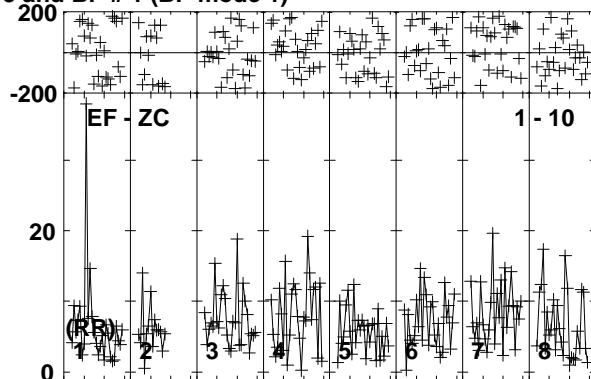
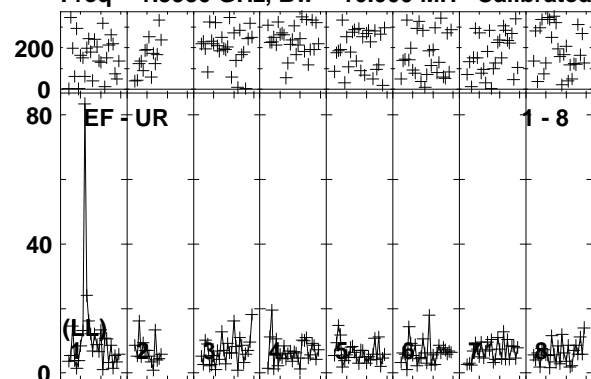

Lower frame: Milli Ampl Jy Top frame: Phas deg
 Vector averaged cross-power spectrum Baseline: EF (01) - UR (08)
 Timerange: 00/04:52:35 to 00/04:56:59

Plot file version 79 created 25-MAR-2014 17:51:04

J1128+5925 EP087E 1.UVDATA.1

Freq = 1.5950 GHz, Bw = 16.000 MH Calibrated with CL # 3 and BP # 1 (BP mode 1)

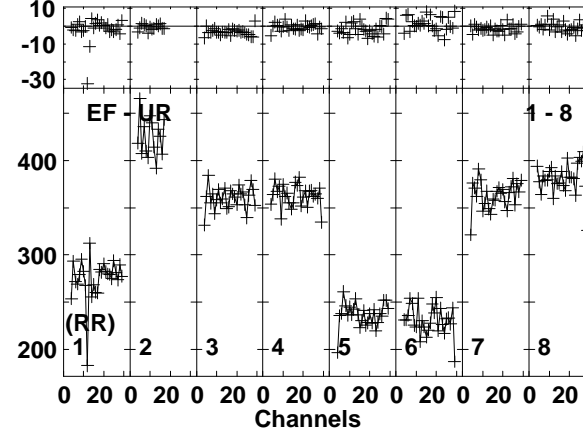
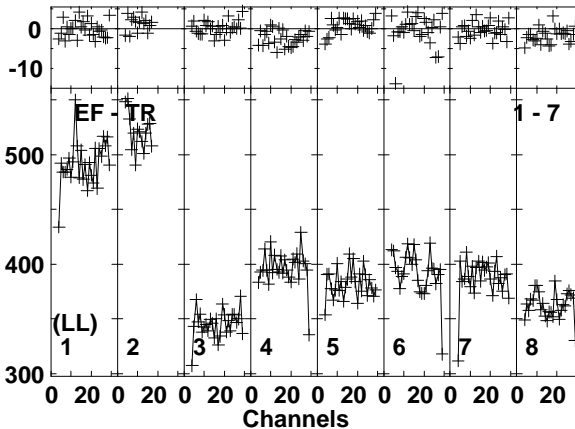
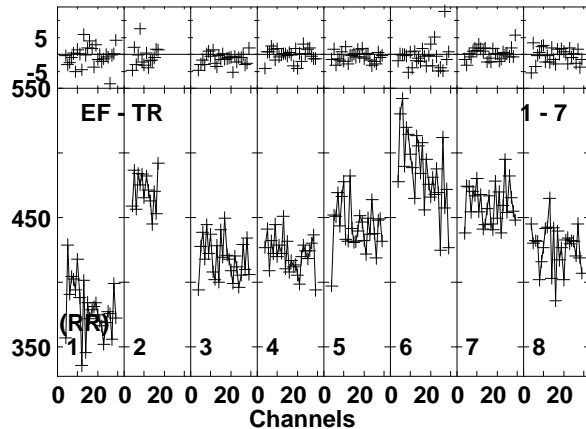
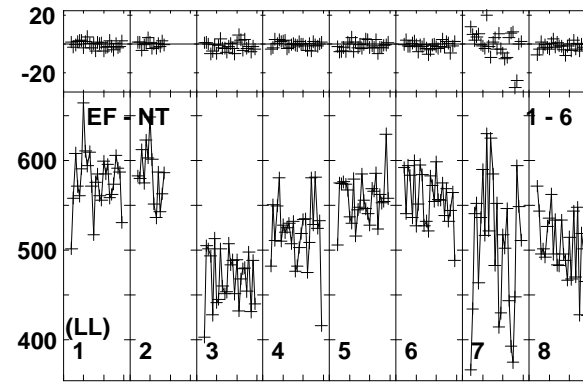
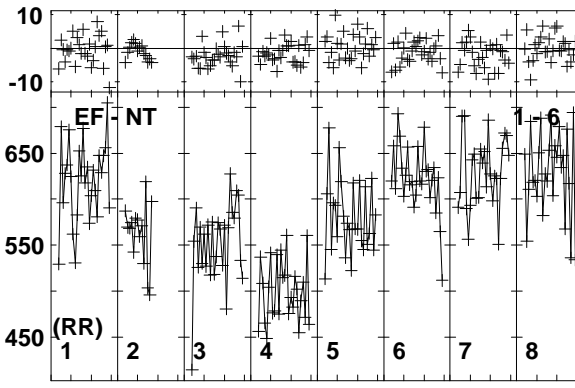
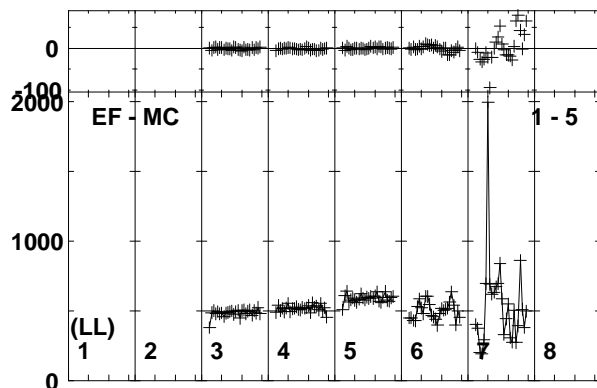
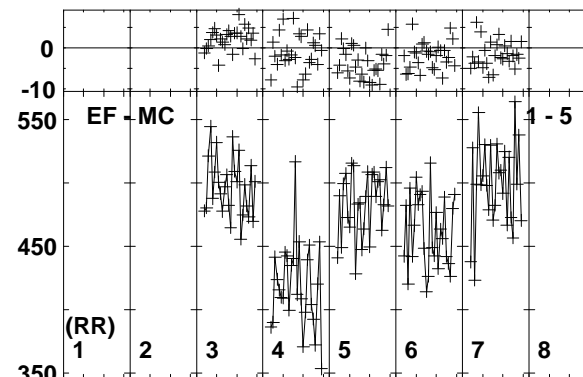
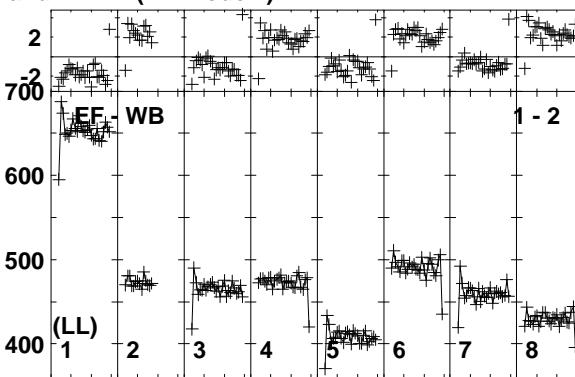
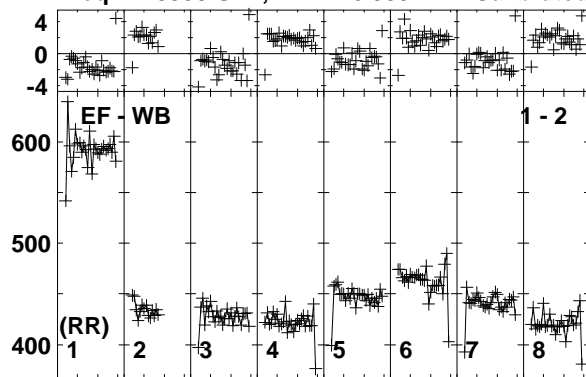

Lower frame: Milli Ampl Jy Top frame: Phas deg
Vector averaged cross-power spectrum Baseline: EF (01) - WB (02)
Timerange: 00/04:57:05 to 00/04:58:09

Plot file version 80 created 25-MAR-2014 17:51:04

J1128+5925 EP087E 1.UVDATA.1

Freq = 1.5950 GHz, Bw = 16.000 MH Calibrated with CL # 3 and BP # 1 (BP mode 1)

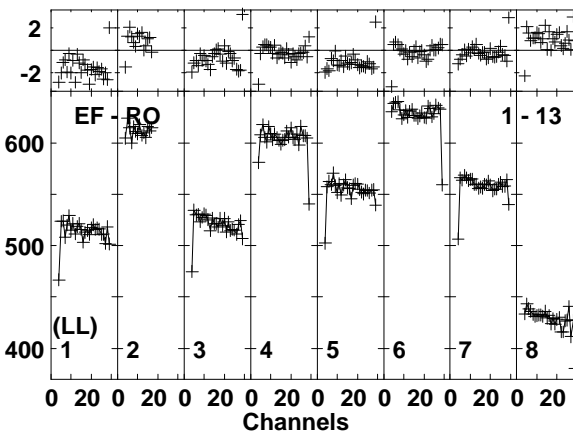
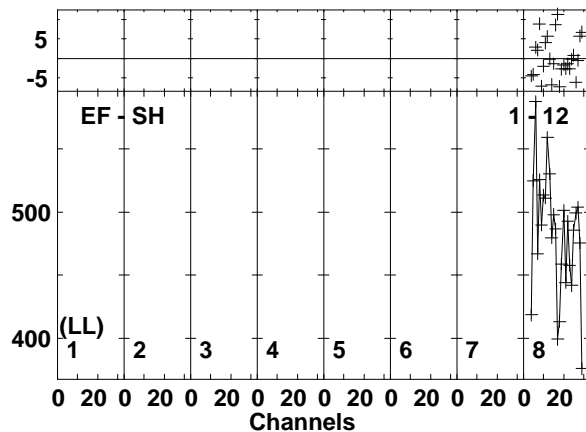
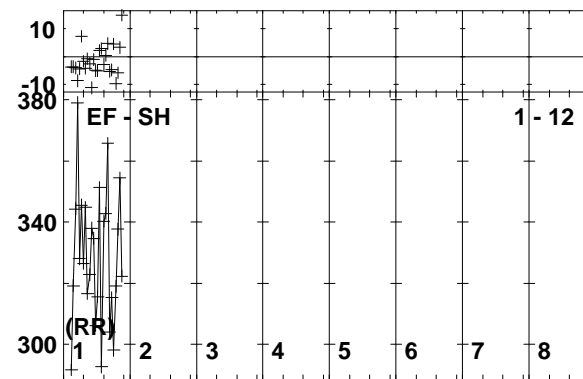
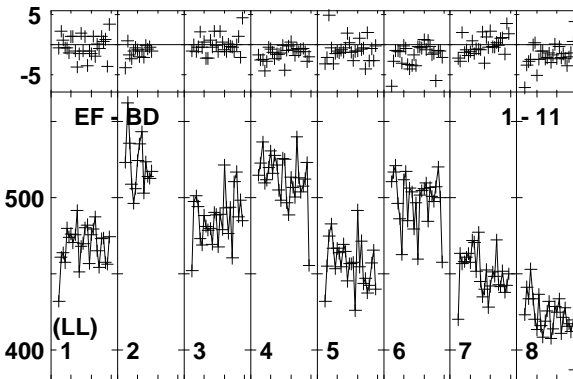
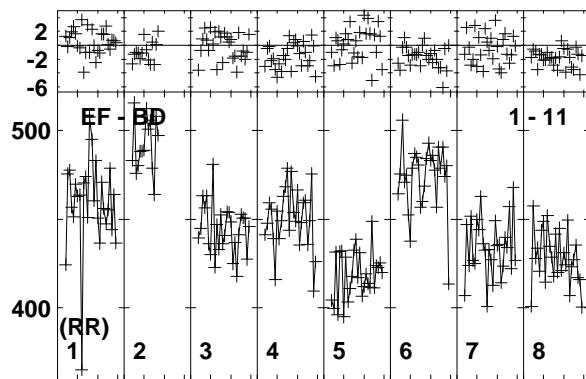
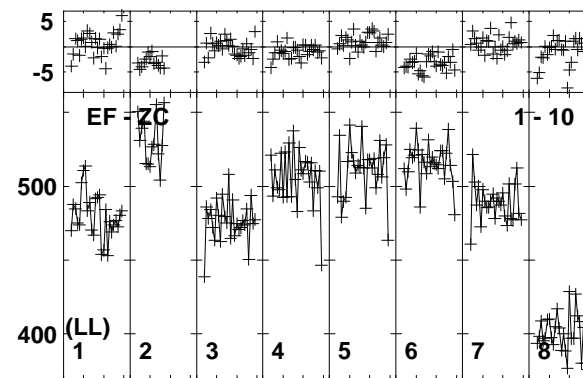
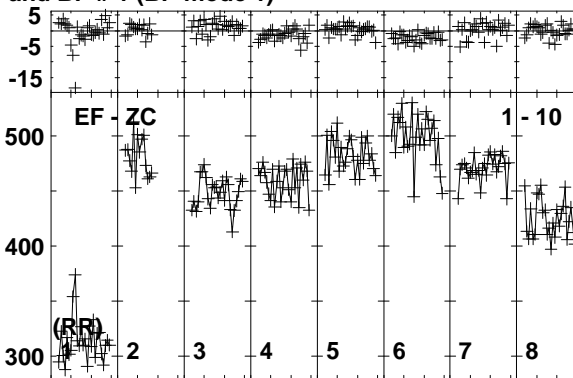
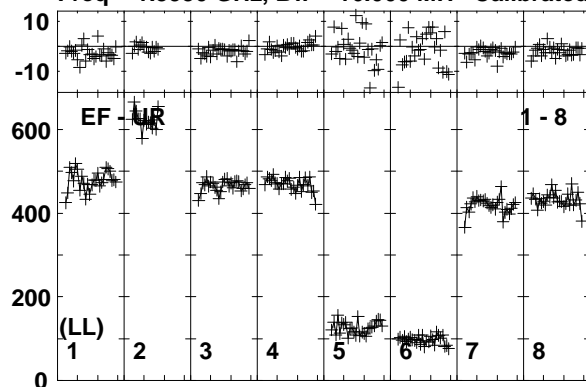

Lower frame: Milli Ampl Jy Top frame: Phas deg
Vector averaged cross-power spectrum Baseline: EF (01) - UR (08)
Timerange: 00/04:57:05 to 00/04:58:09

Plot file version 81 created 25-MAR-2014 17:51:05
 ARP299A EP087E 1.UVDATA.1
 Freq = 1.5950 GHz, Bw = 16.000 MH Calibrated with CL # 3 and BP # 1 (BP mode 1)

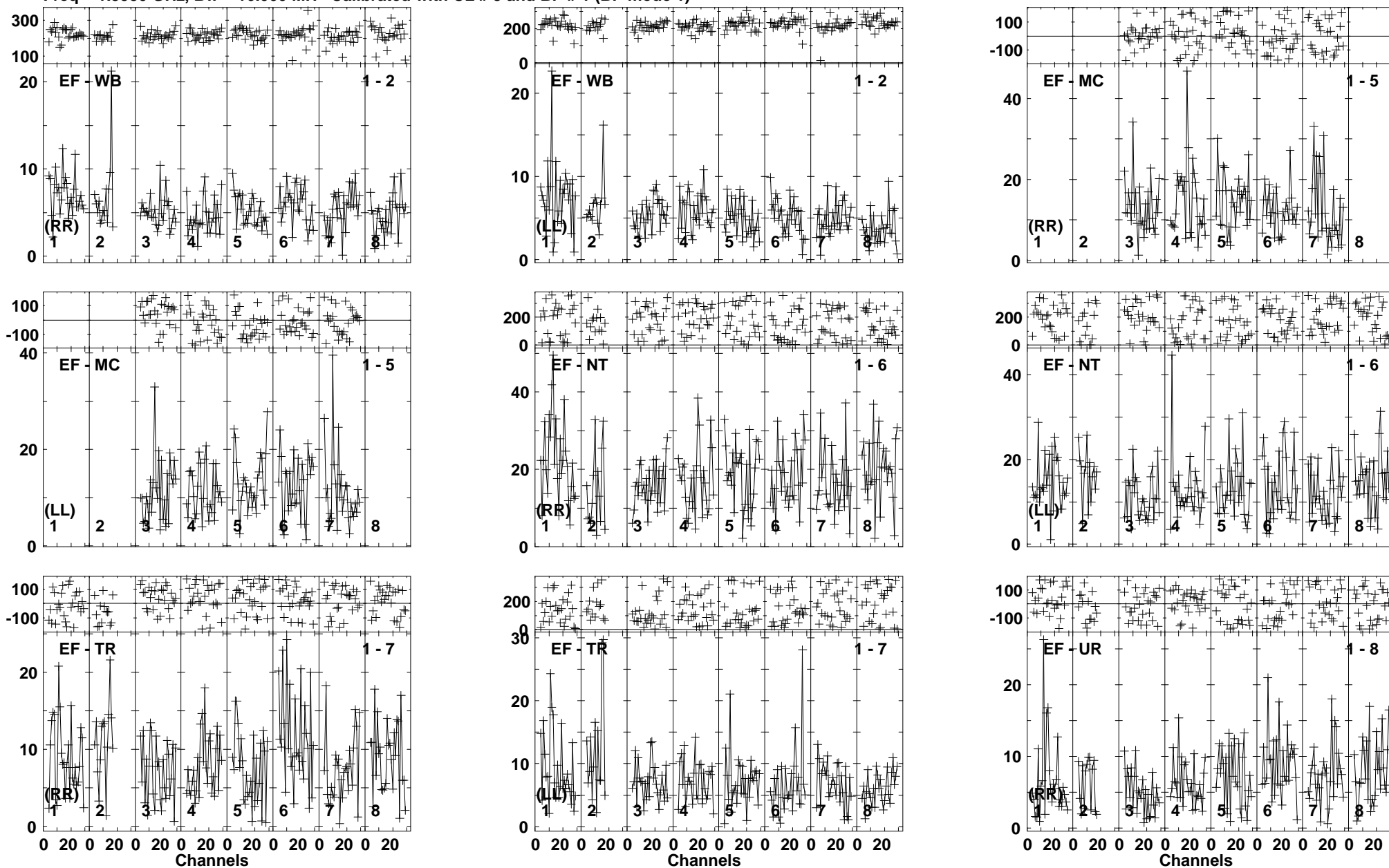

Lower frame: Milli Ampl Jy Top frame: Phas deg
 Vector averaged cross-power spectrum Baseline: EF (01) - WB (02)
 Timerange: 00/04:58:11 to 00/05:02:39

Plot file version 82 created 25-MAR-2014 17:51:05

ARP299A EP087E 1.UVDATA.1

Freq = 1.5950 GHz, Bw = 16.000 MH Calibrated with CL # 3 and BP # 1 (BP mode 1)

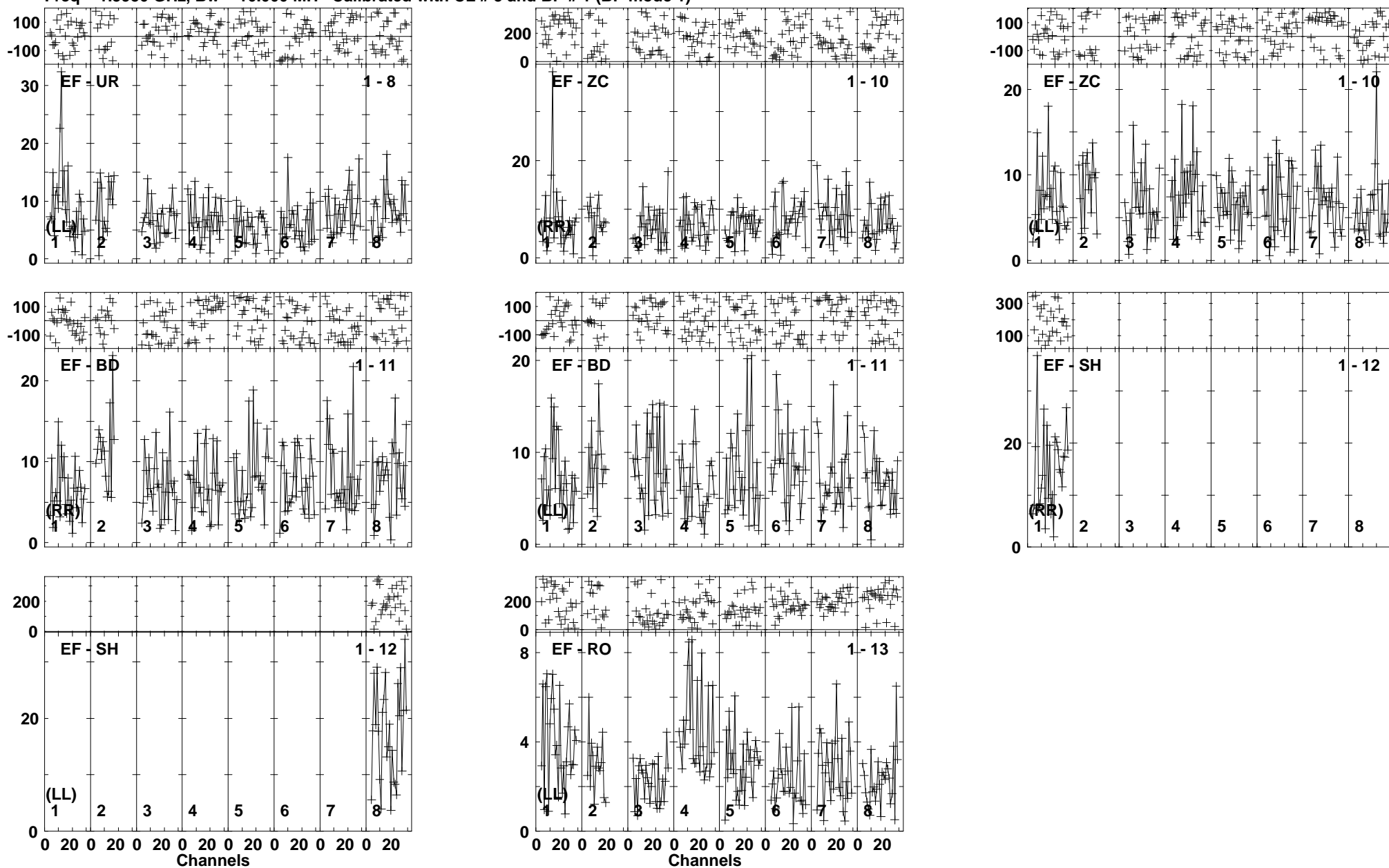

Lower frame: Milli Ampl Jy Top frame: Phas deg
Vector averaged cross-power spectrum Baseline: EF (01) - UR (08)
Timerange: 00/04:58:11 to 00/05:02:39

Plot file version 83 created 25-MAR-2014 17:51:05

J1128+5925 EP087E 1.UVDATA.1

Freq = 1.5950 GHz, Bw = 16.000 MH Calibrated with CL # 3 and BP # 1 (BP mode 1)

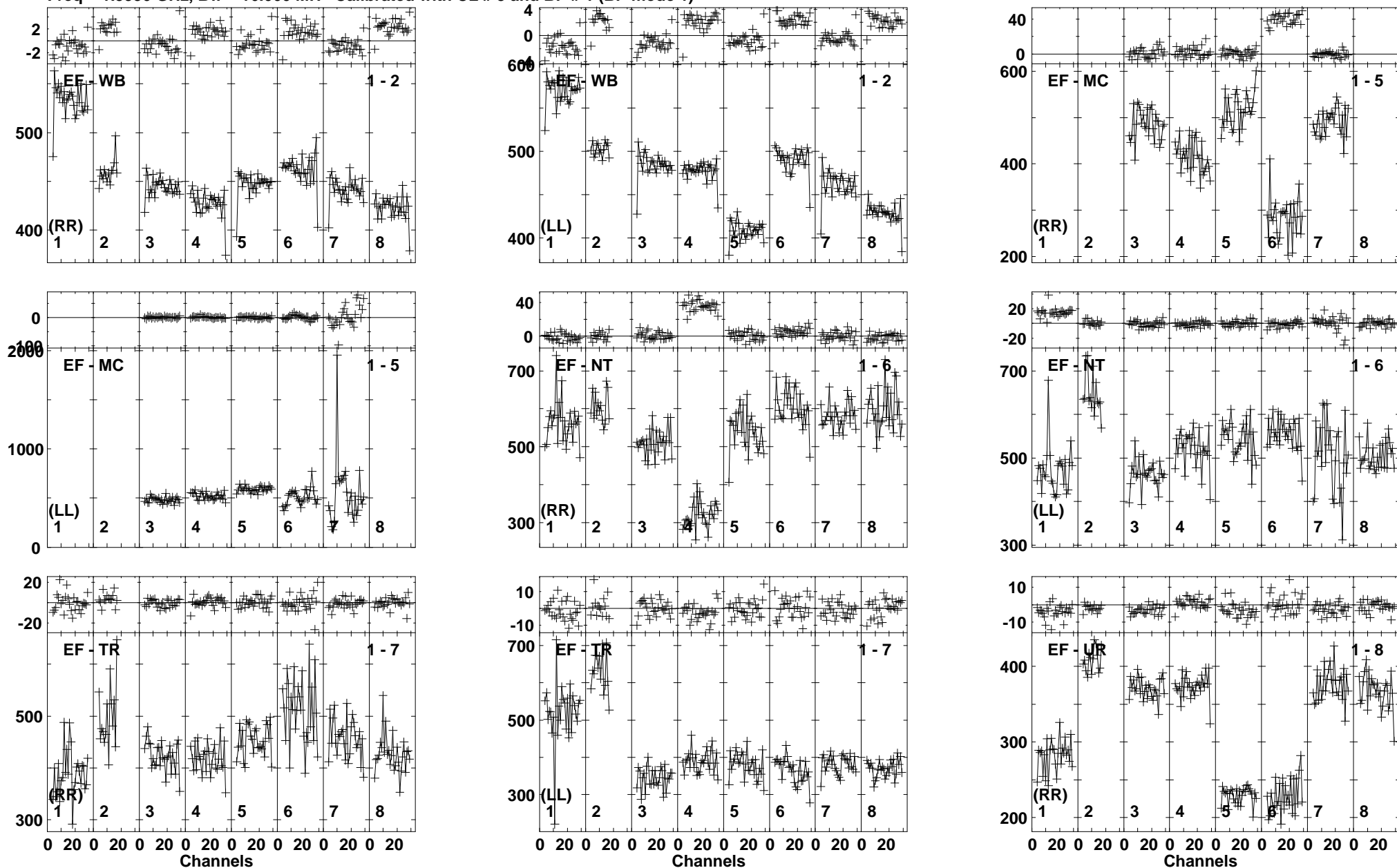

Lower frame: Milli Ampl Jy Top frame: Phas deg
Vector averaged cross-power spectrum Baseline: EF (01) - WB (02)
Timerange: 00/05:03:21 to 00/05:03:49

Plot file version 84 created 25-MAR-2014 17:51:05

J1128+5925 EP087E 1.UVDATA.1

Freq = 1.5950 GHz, Bw = 16.000 MH Calibrated with CL # 3 and BP # 1 (BP mode 1)

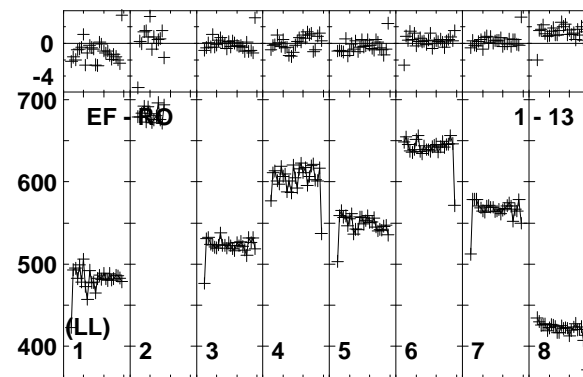
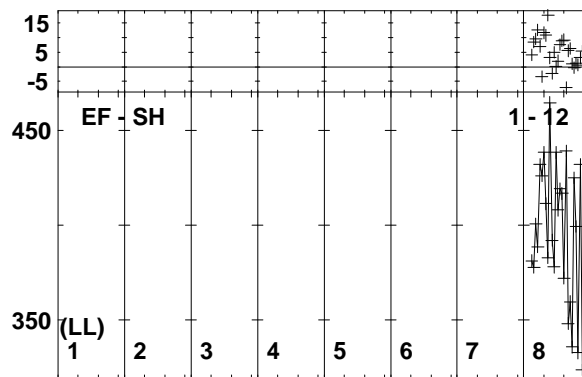
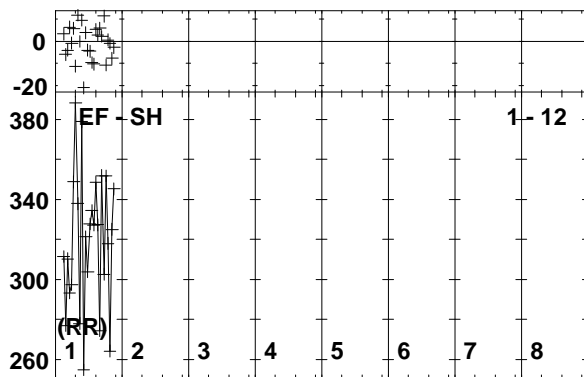
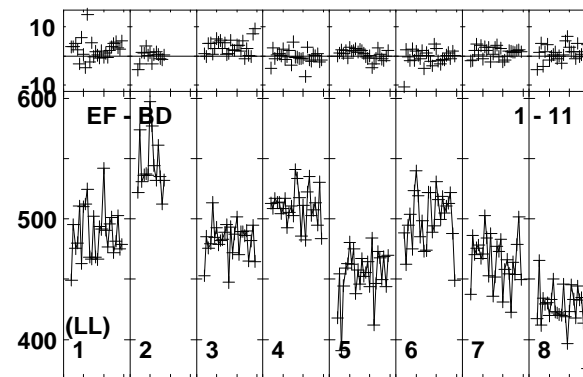
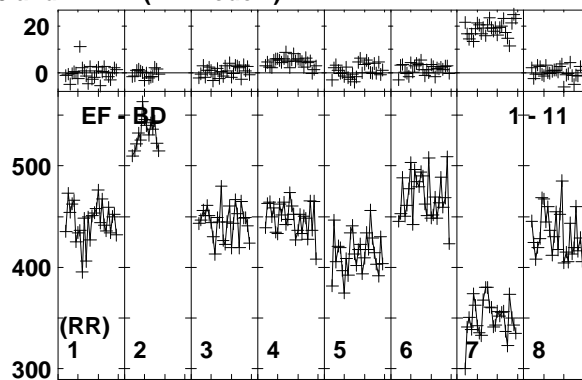
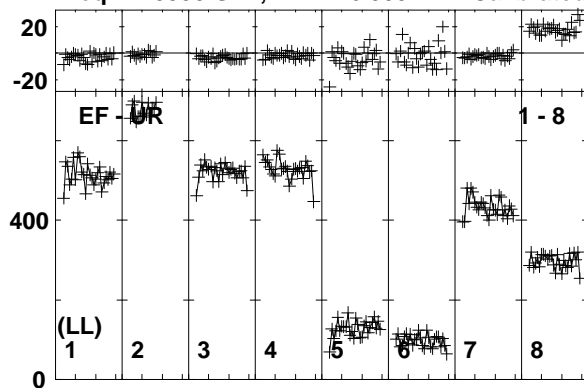

Lower frame: Milli Ampl Jy Top frame: Phas deg
Vector averaged cross-power spectrum Baseline: EF (01) - UR (08)
Timerange: 00/05:03:21 to 00/05:03:49

Plot file version 85 created 25-MAR-2014 17:51:06
 ARP299A EP087E 1.UVDATA.1
 Freq = 1.5950 GHz, Bw = 16.000 MH Calibrated with CL # 3 and BP # 1 (BP mode 1)

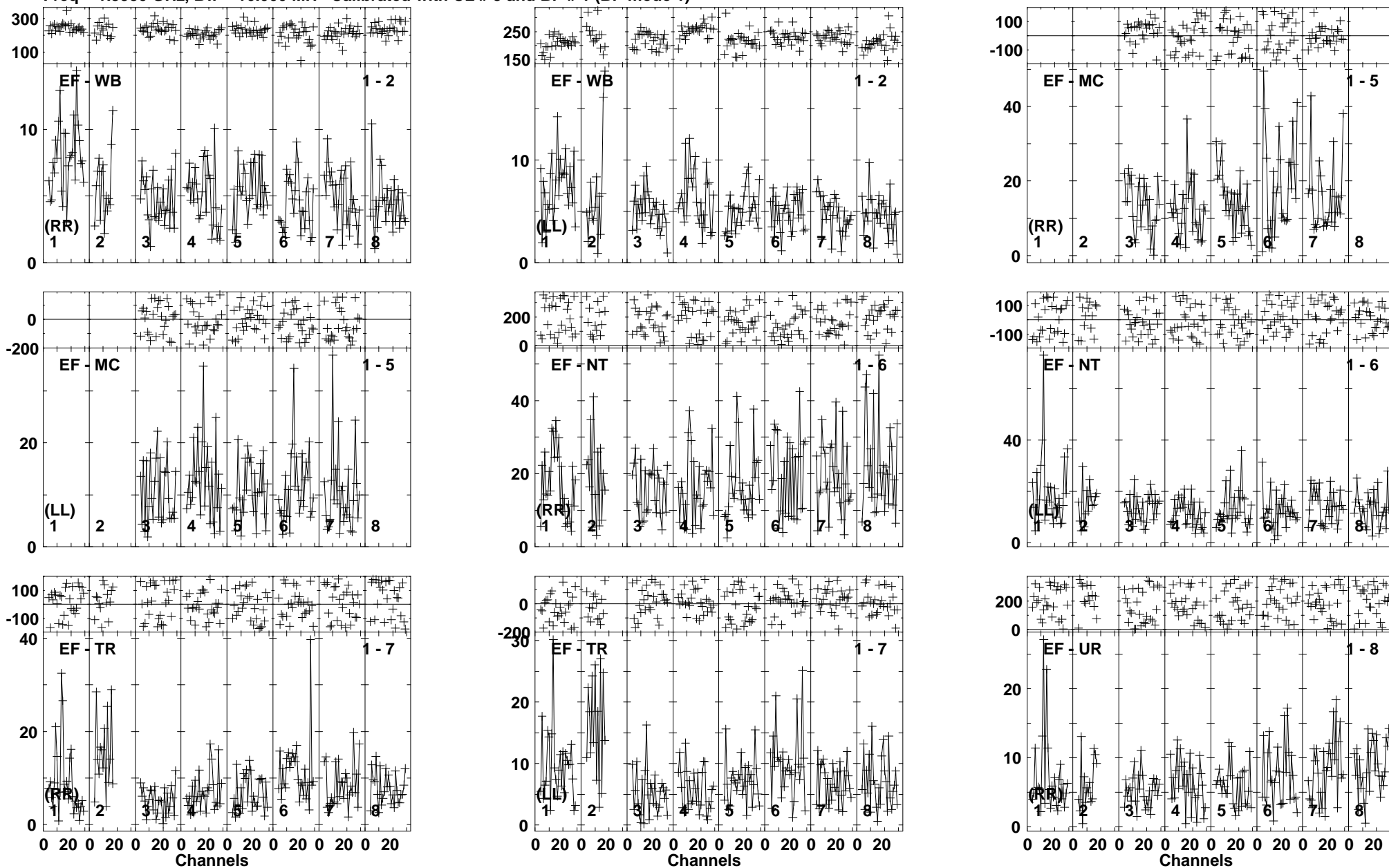

Lower frame: Milli Ampl Jy Top frame: Phas deg
 Vector averaged cross-power spectrum Baseline: EF (01) - WB (02)
 Timerange: 00/05:03:55 to 00/05:08:19

Plot file version 86 created 25-MAR-2014 17:51:06

ARP299A EP087E 1.UVDATA.1

Freq = 1.5950 GHz, Bw = 16.000 MH Calibrated with CL # 3 and BP # 1 (BP mode 1)

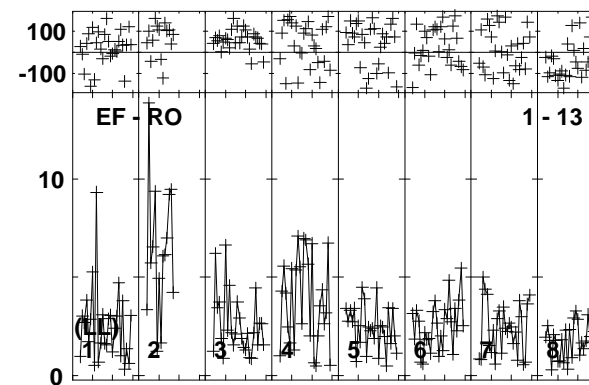
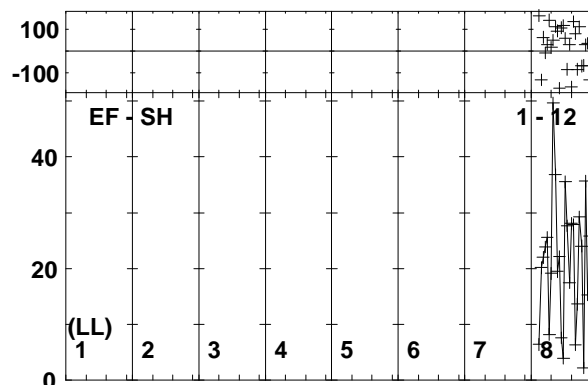
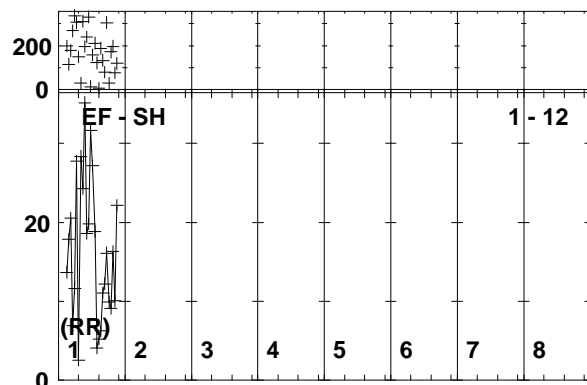
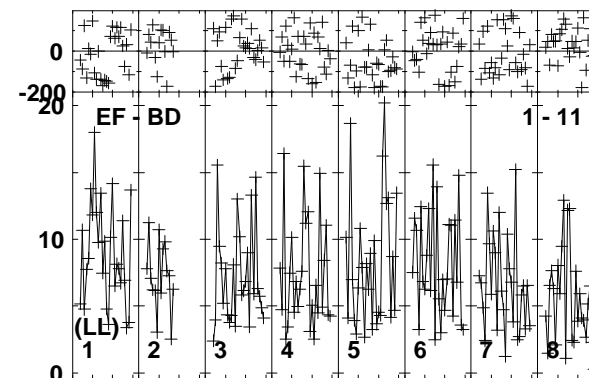
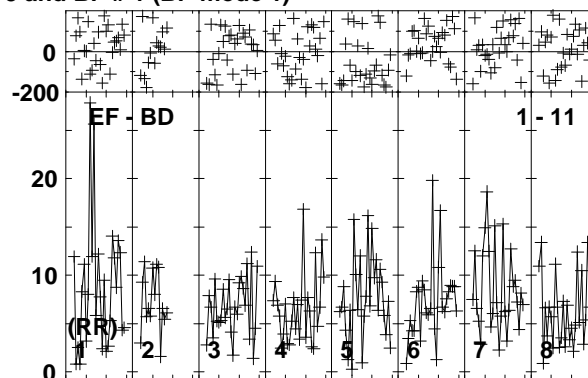
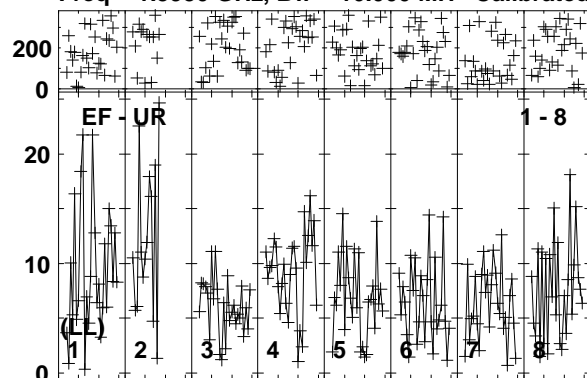

Lower frame: Milli Ampl Jy Top frame: Phas deg
Vector averaged cross-power spectrum Baseline: EF (01) - UR (08)
Timerange: 00/05:03:55 to 00/05:08:19

Plot file version 87 created 25-MAR-2014 17:51:06

J1128+5925 EP087E 1.UVDATA.1

Freq = 1.5950 GHz, Bw = 16.000 MH Calibrated with CL # 3 and BP # 1 (BP mode 1)

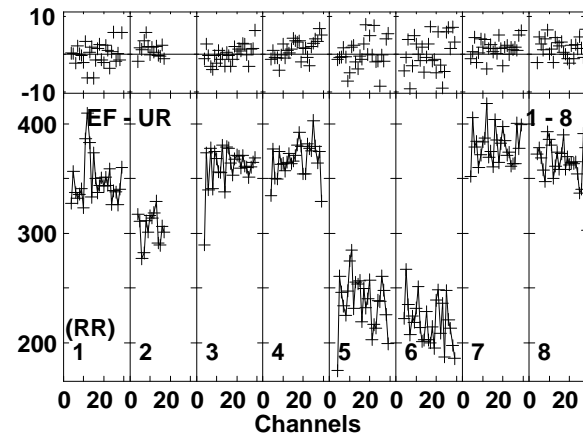
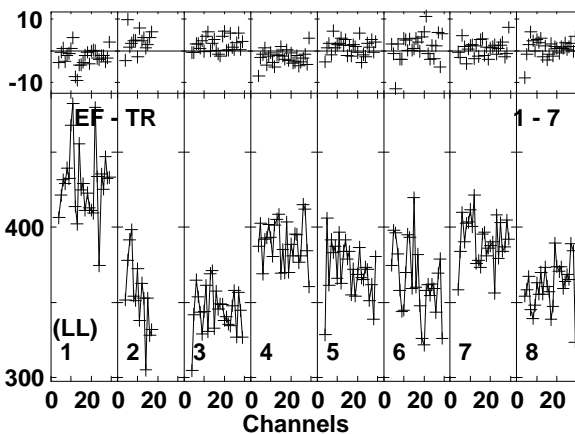
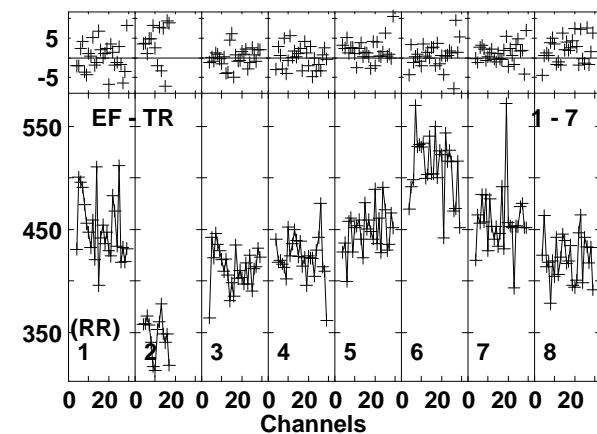
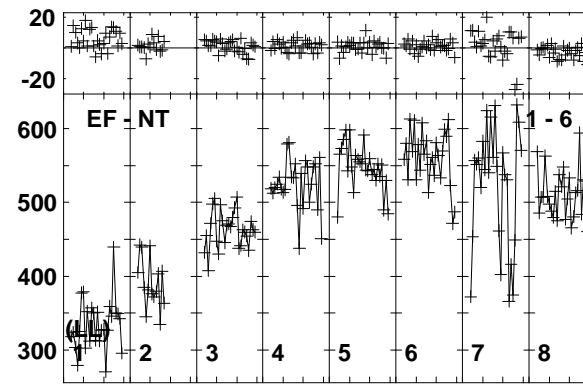
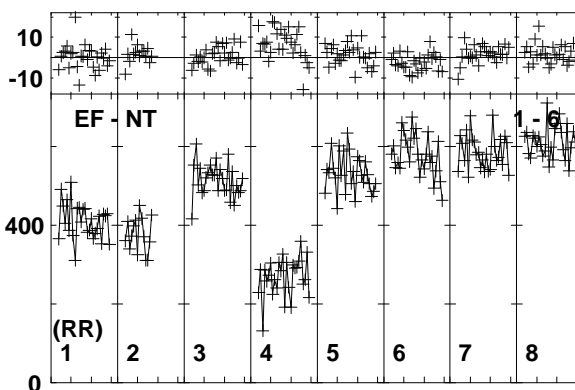
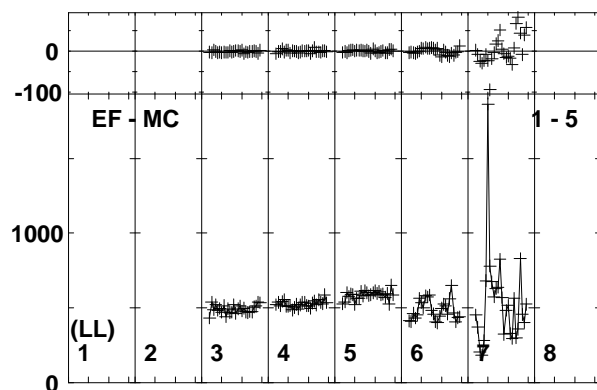
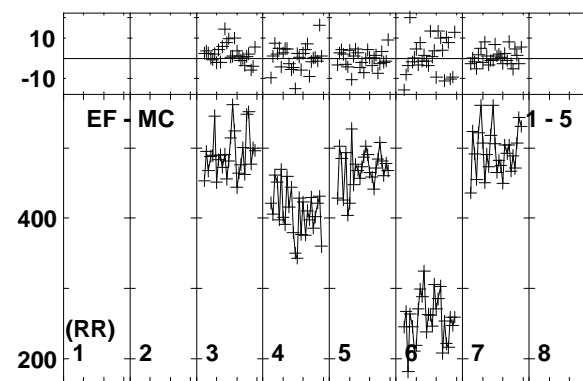
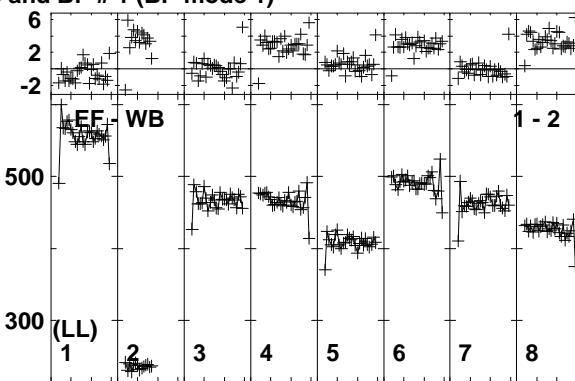
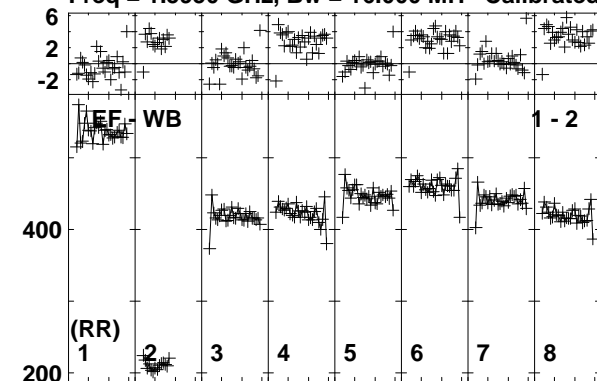

Lower frame: Milli Ampl Jy Top frame: Phas deg
Vector averaged cross-power spectrum Baseline: EF (01) - WB (02)
Timerange: 00/05:08:25 to 00/05:09:19

Plot file version 88 created 25-MAR-2014 17:51:06

J1128+5925 EP087E 1.UVDATA.1

Freq = 1.5950 GHz, Bw = 16.000 MH Calibrated with CL # 3 and BP # 1 (BP mode 1)

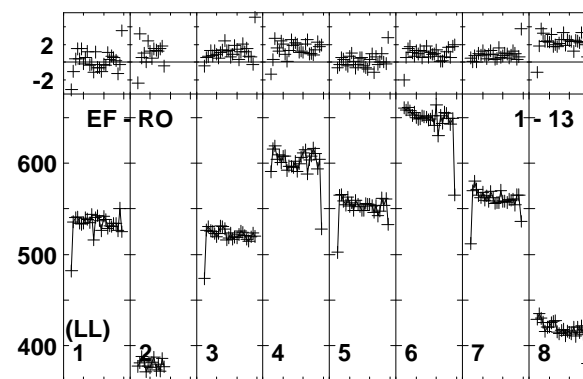
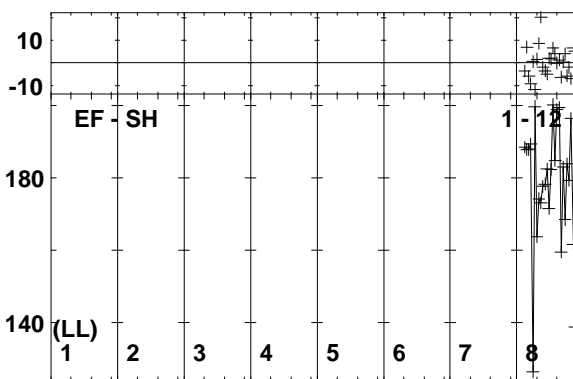
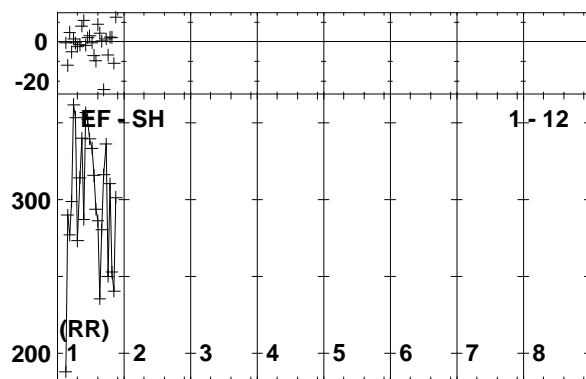
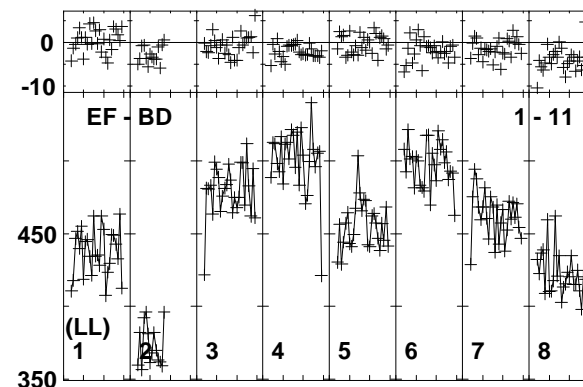
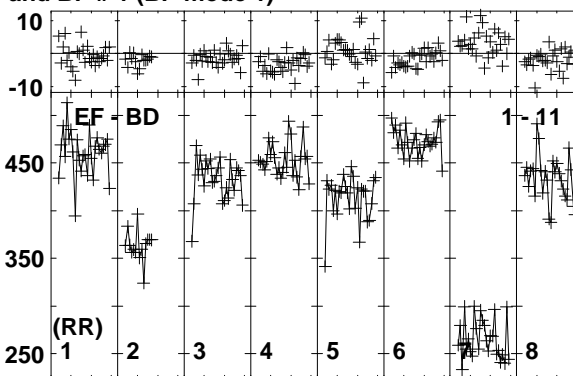
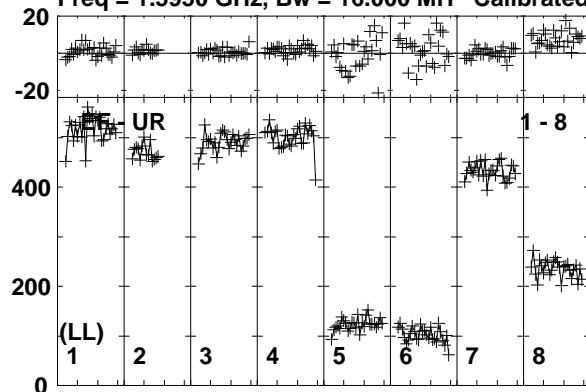

Lower frame: Milli Ampl Jy Top frame: Phas deg
Vector averaged cross-power spectrum Baseline: EF (01) - UR (08)
Timerange: 00/05:08:25 to 00/05:09:19

Plot file version 89 created 25-MAR-2014 17:51:07

ARP299A EP087E 1.UVDATA.1

Freq = 1.5950 GHz, Bw = 16.000 MH Calibrated with CL # 3 and BP # 1 (BP mode 1)

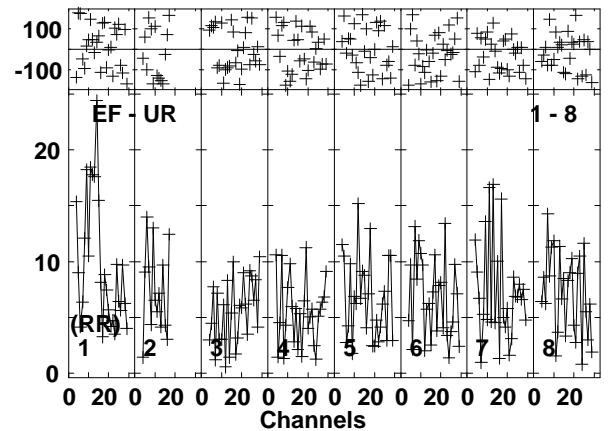
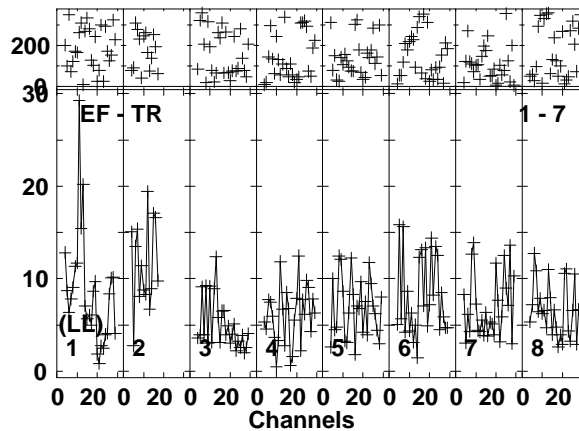
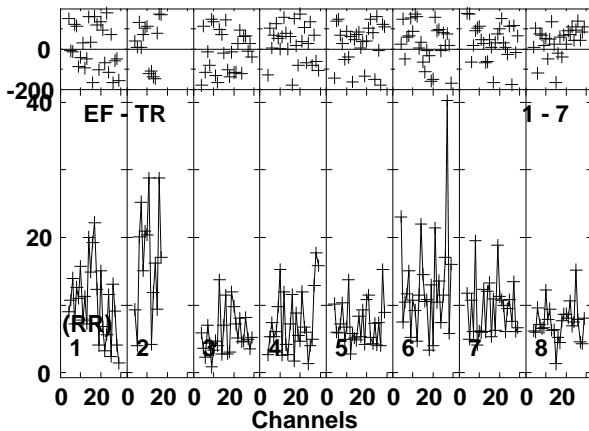
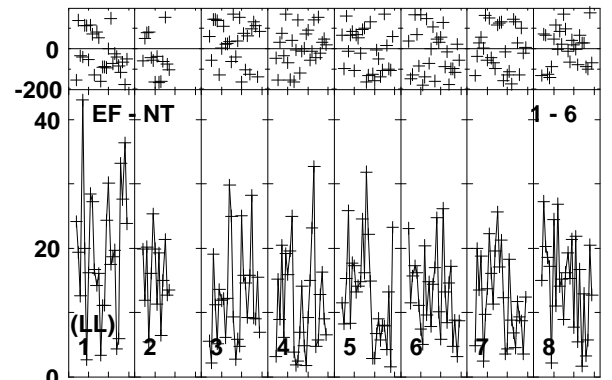
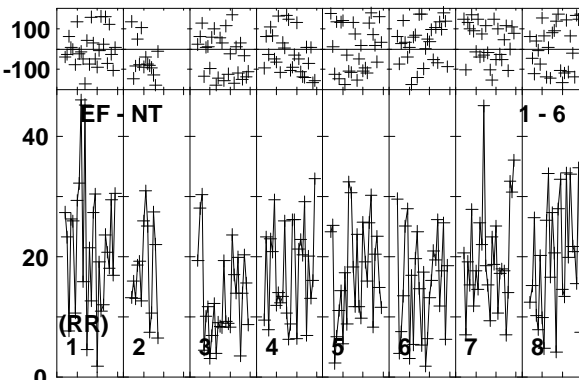
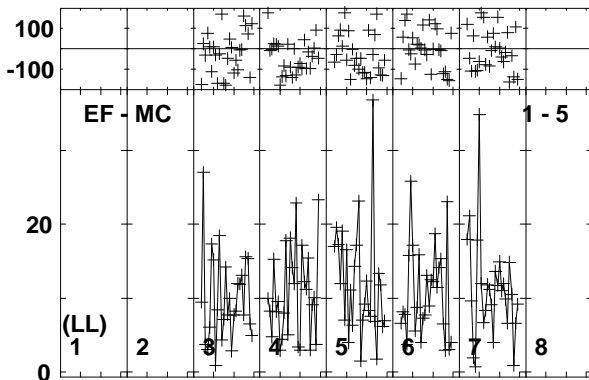
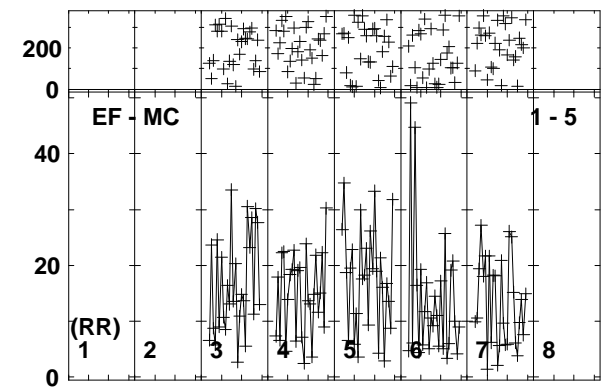
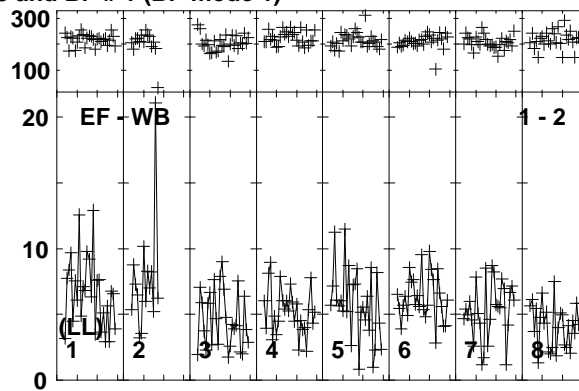
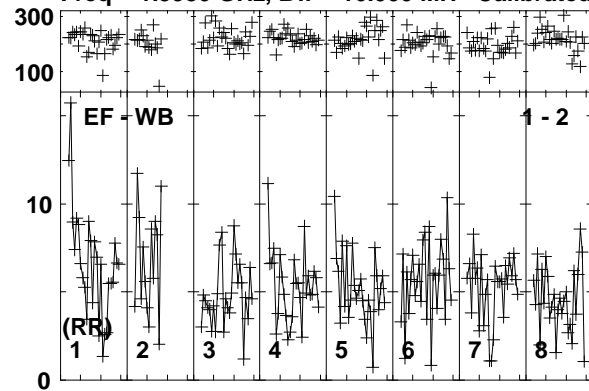

Lower frame: Milli Ampl Jy Top frame: Phas deg
Vector averaged cross-power spectrum Baseline: EF (01) - WB (02)
Timerange: 00/05:09:21 to 00/05:13:49

Plot file version 90 created 25-MAR-2014 17:51:07
 ARP299A EP087E 1.UVDATA.1
 Freq = 1.5950 GHz, Bw = 16.000 MH Calibrated with CL # 3 and BP # 1 (BP mode 1)

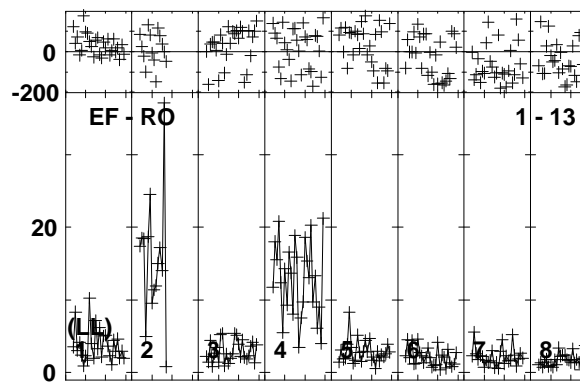
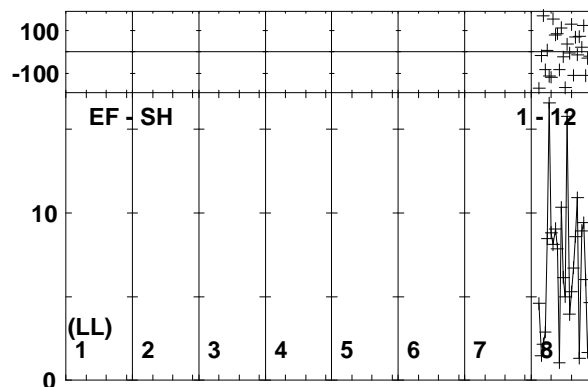
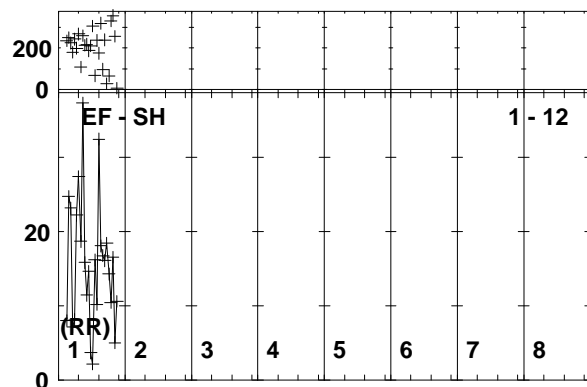
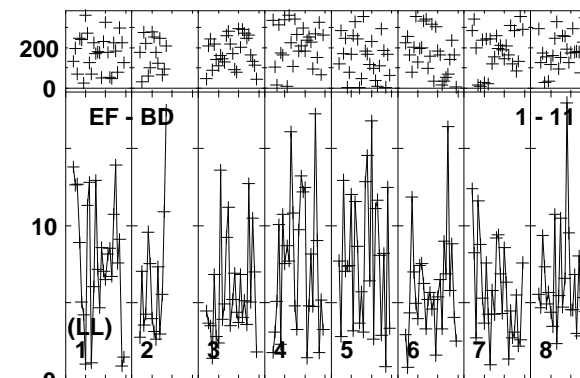
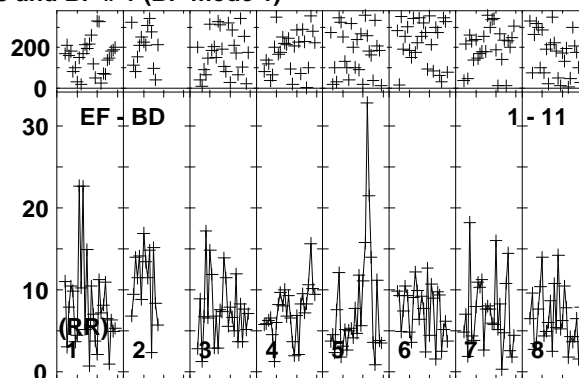
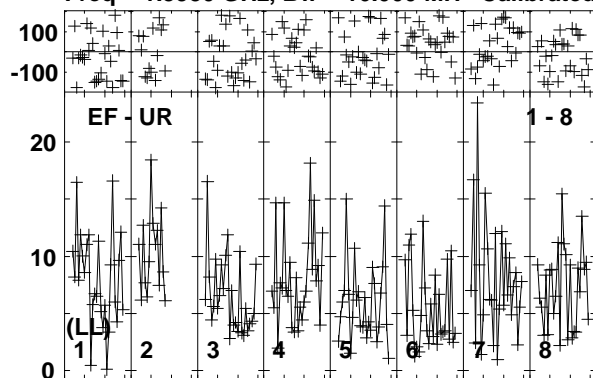

Lower frame: Milli Ampl Jy Top frame: Phas deg
 Vector averaged cross-power spectrum Baseline: EF (01) - UR (08)
 Timerange: 00/05:09:21 to 00/05:13:49

Plot file version 91 created 25-MAR-2014 17:51:07

J1128+5925 EP087E 1.UVDATA.1

Freq = 1.5950 GHz, Bw = 16.000 MH Calibrated with CL # 3 and BP # 1 (BP mode 1)

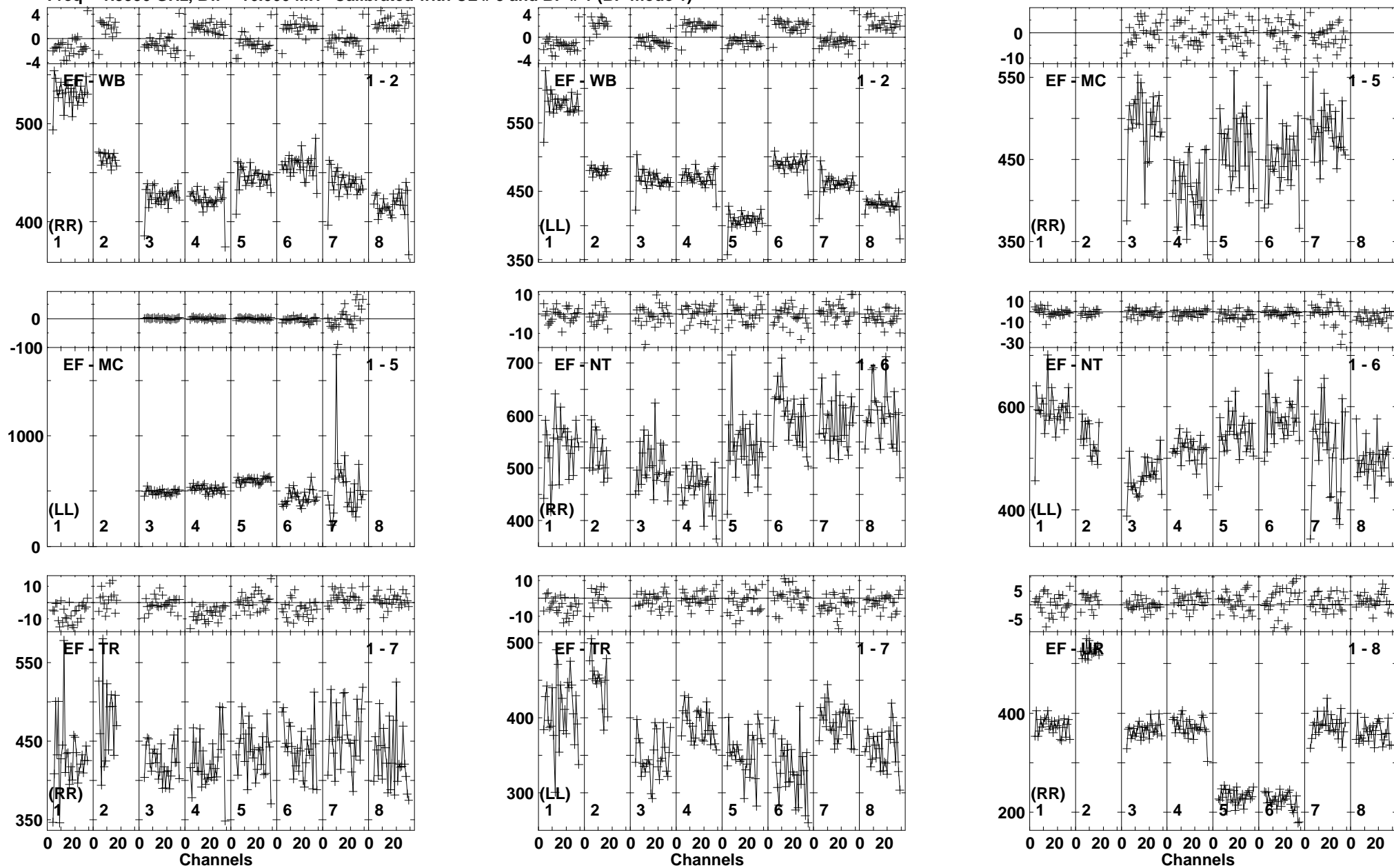

Lower frame: Milli Ampl Jy Top frame: Phas deg
Vector averaged cross-power spectrum Baseline: EF (01) - WB (02)
Timerange: 00/05:14:31 to 00/05:14:59

Plot file version 92 created 25-MAR-2014 17:51:07

J1128+5925 EP087E 1.UVDATA.1

Freq = 1.5950 GHz, Bw = 16.000 MH Calibrated with CL # 3 and BP # 1 (BP mode 1)

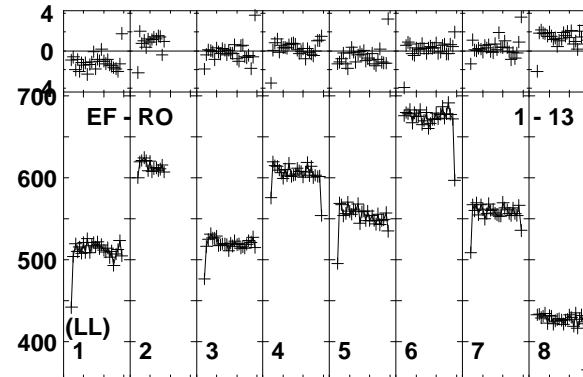
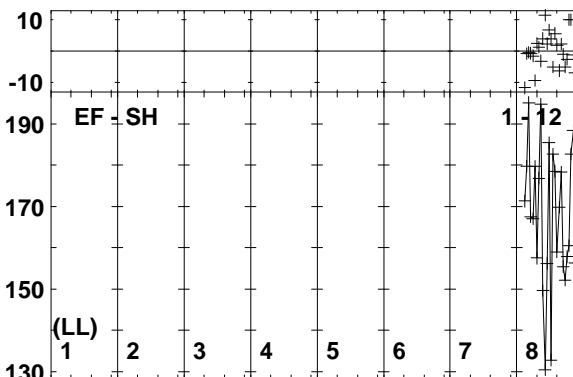
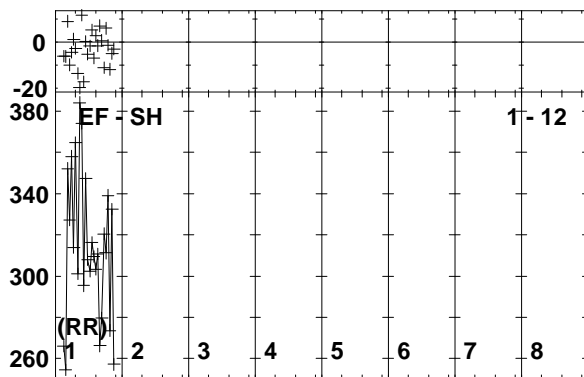
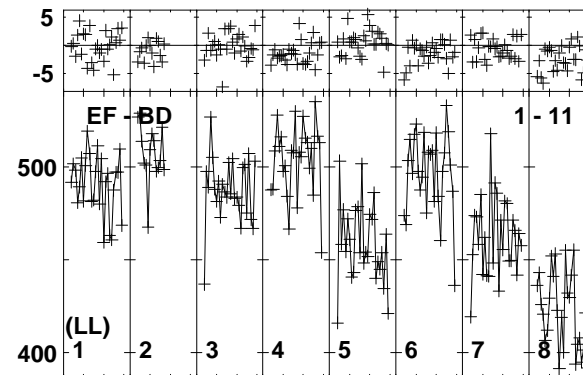
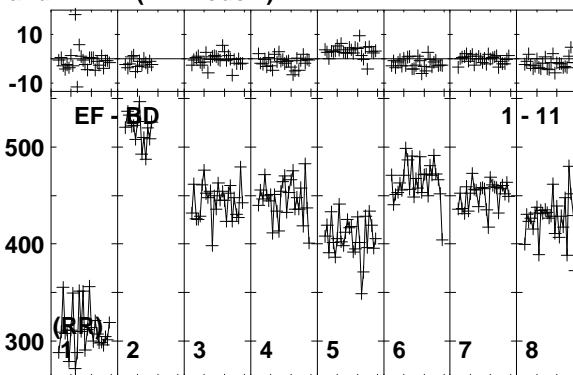
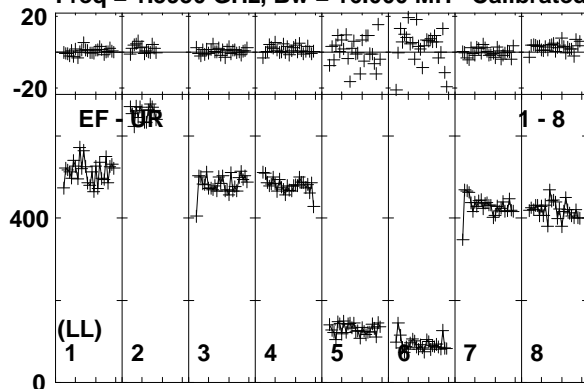

Lower frame: Milli Ampl Jy Top frame: Phas deg
Vector averaged cross-power spectrum Baseline: EF (01) - UR (08)
Timerange: 00/05:14:31 to 00/05:14:59

Plot file version 93 created 25-MAR-2014 17:51:08
 ARP299A EP087E 1.UVDATA.1
 Freq = 1.5950 GHz, Bw = 16.000 MH Calibrated with CL # 3 and BP # 1 (BP mode 1)

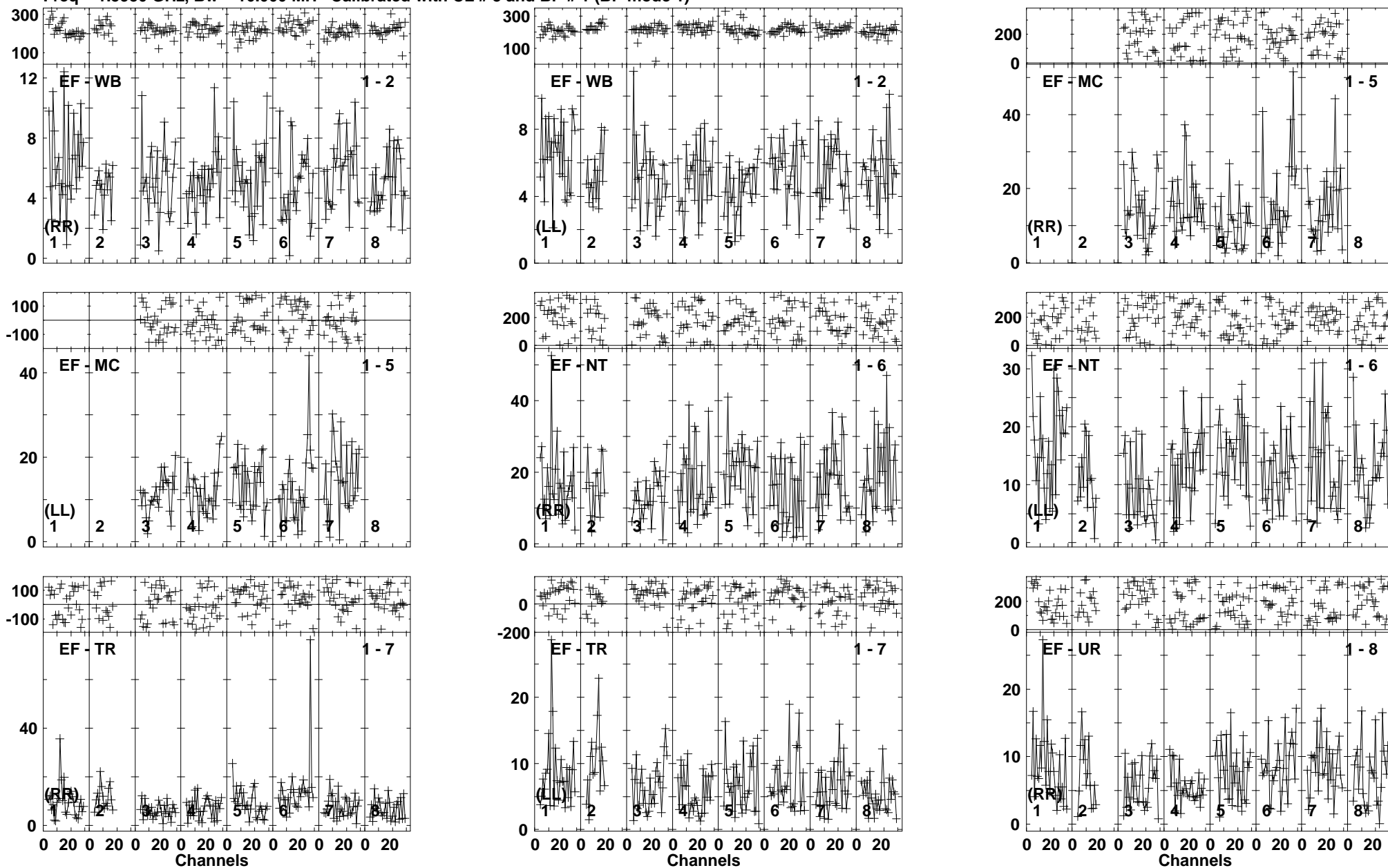

Lower frame: Milli Ampl Jy Top frame: Phas deg
 Vector averaged cross-power spectrum Baseline: EF (01) - WB (02)
 Timerange: 00/05:15:05 to 00/05:19:29

Plot file version 94 created 25-MAR-2014 17:51:08
 ARP299A EP087E 1.UVDATA.1
 Freq = 1.5950 GHz, Bw = 16.000 MH Calibrated with CL # 3 and BP # 1 (BP mode 1)

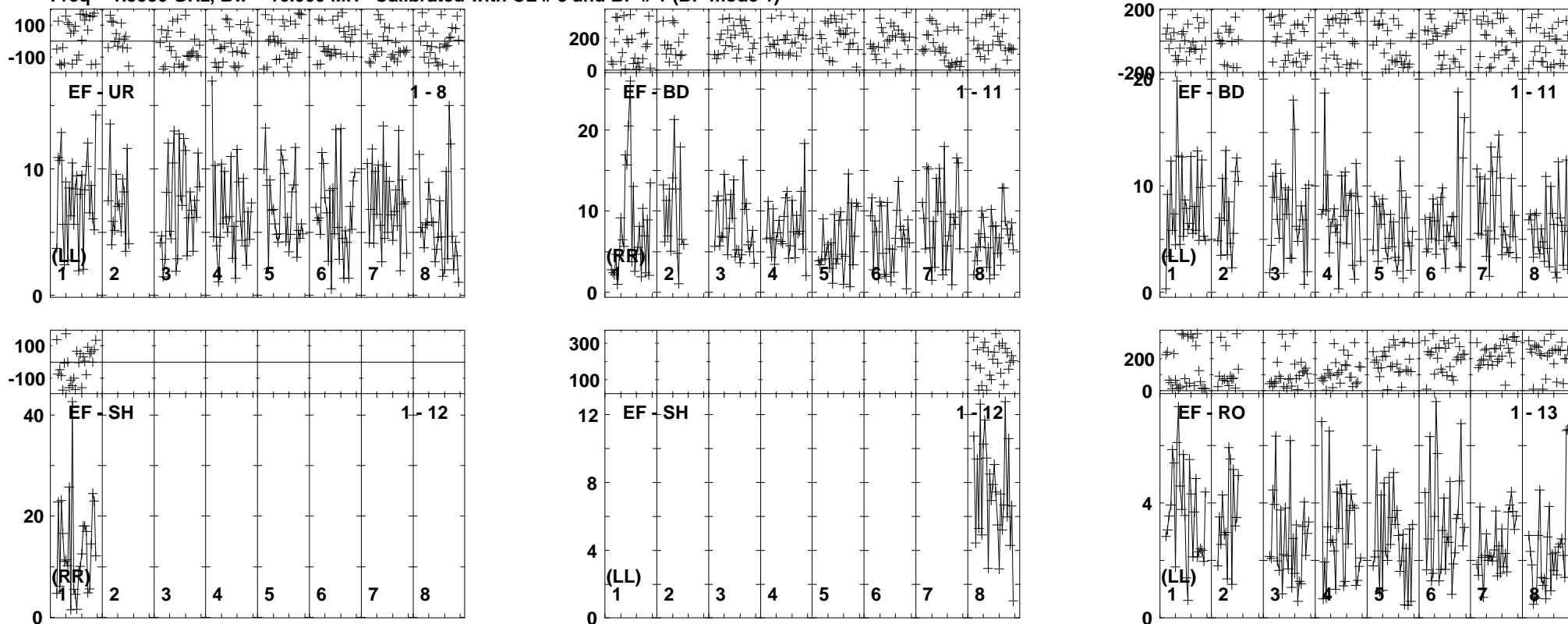

Lower frame: Milli Ampl Jy Top frame: Phas deg
 Vector averaged cross-power spectrum Baseline: EF (01) - UR (08)
 Timerange: 00/05:15:05 to 00/05:19:29

Plot file version 95 created 25-MAR-2014 17:51:08

J1128+5925 EP087E 1.UVDATA.1

Freq = 1.5950 GHz, Bw = 16.000 MH Calibrated with CL # 3 and BP # 1 (BP mode 1)

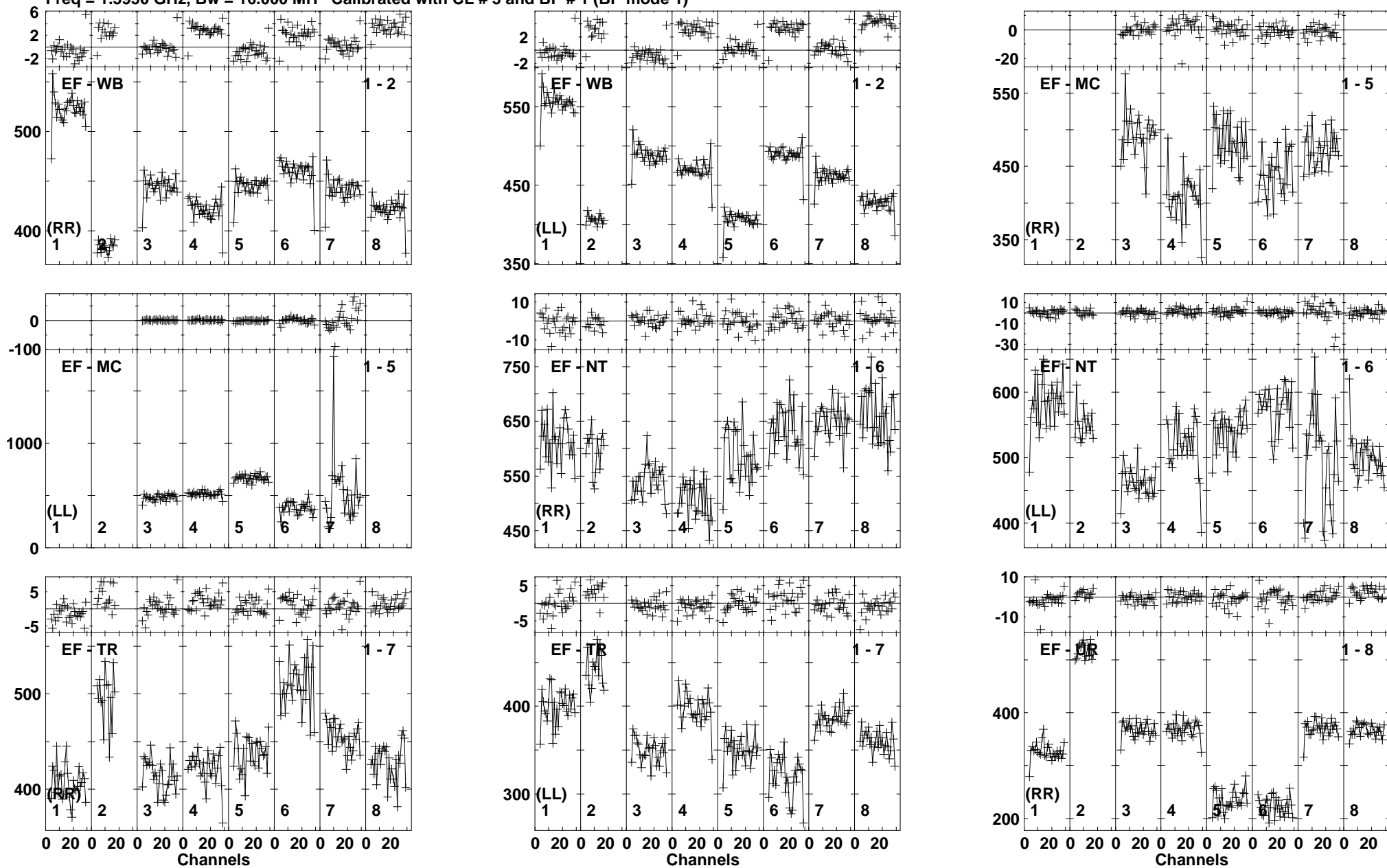

Lower frame: Milli Ampl Jy Top frame: Phas deg
Vector averaged cross-power spectrum Baseline: EF (01) - WB (02)
Timerange: 00/05:19:35 to 00/05:20:39

Plot file version 96 created 25-MAR-2014 17:51:09

J1128+5925 EP087E 1.UVDATA.1

Freq = 1.5950 GHz, Bw = 16.000 MH Calibrated with CL # 3 and BP # 1 (BP mode 1)

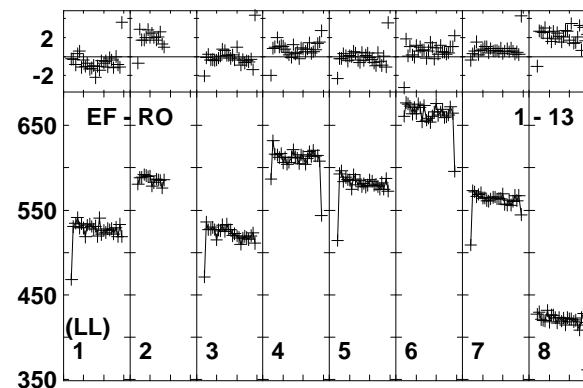
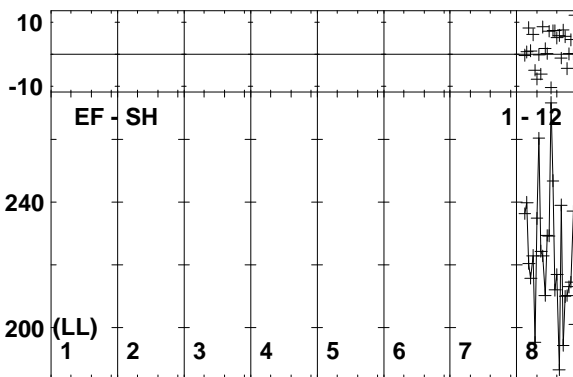
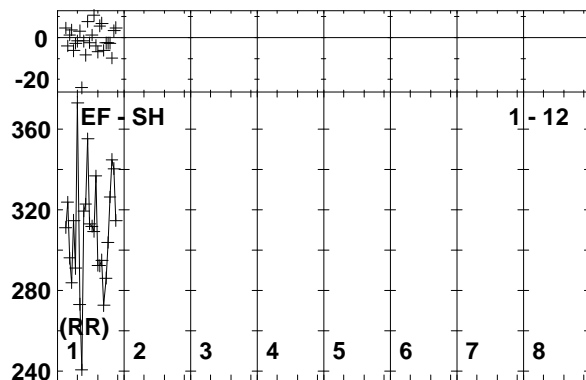
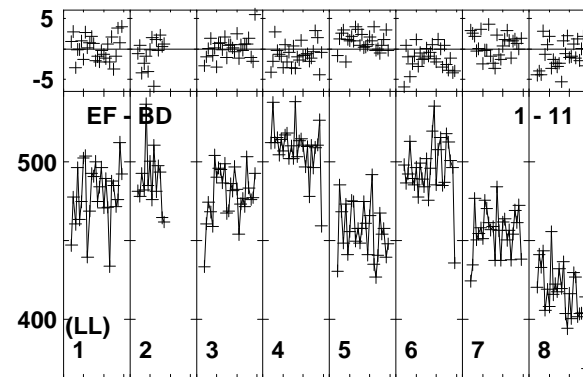
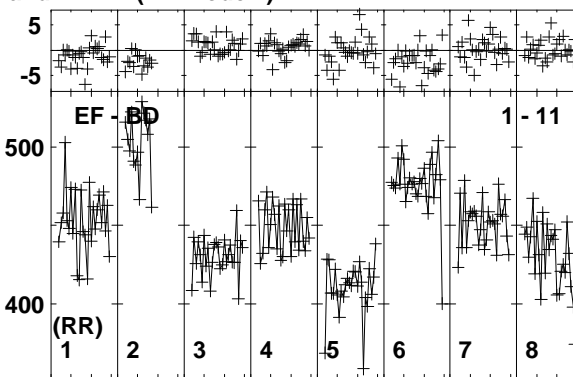
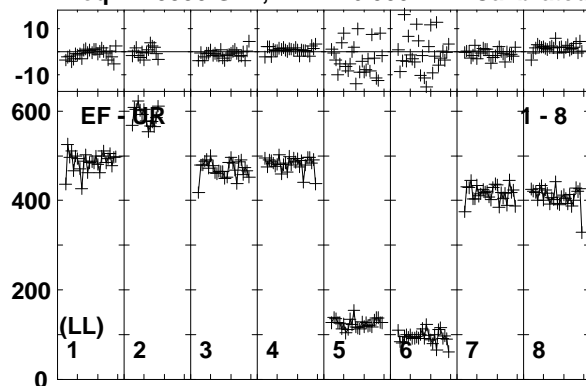

Lower frame: Milli Ampl Jy Top frame: Phas deg
Vector averaged cross-power spectrum Baseline: EF (01) - UR (08)
Timerange: 00/05:19:35 to 00/05:20:39

Plot file version 97 created 25-MAR-2014 17:51:09
 ARP299A EP087E 1.UVDATA.1
 Freq = 1.5950 GHz, Bw = 16.000 MH Calibrated with CL # 3 and BP # 1 (BP mode 1)

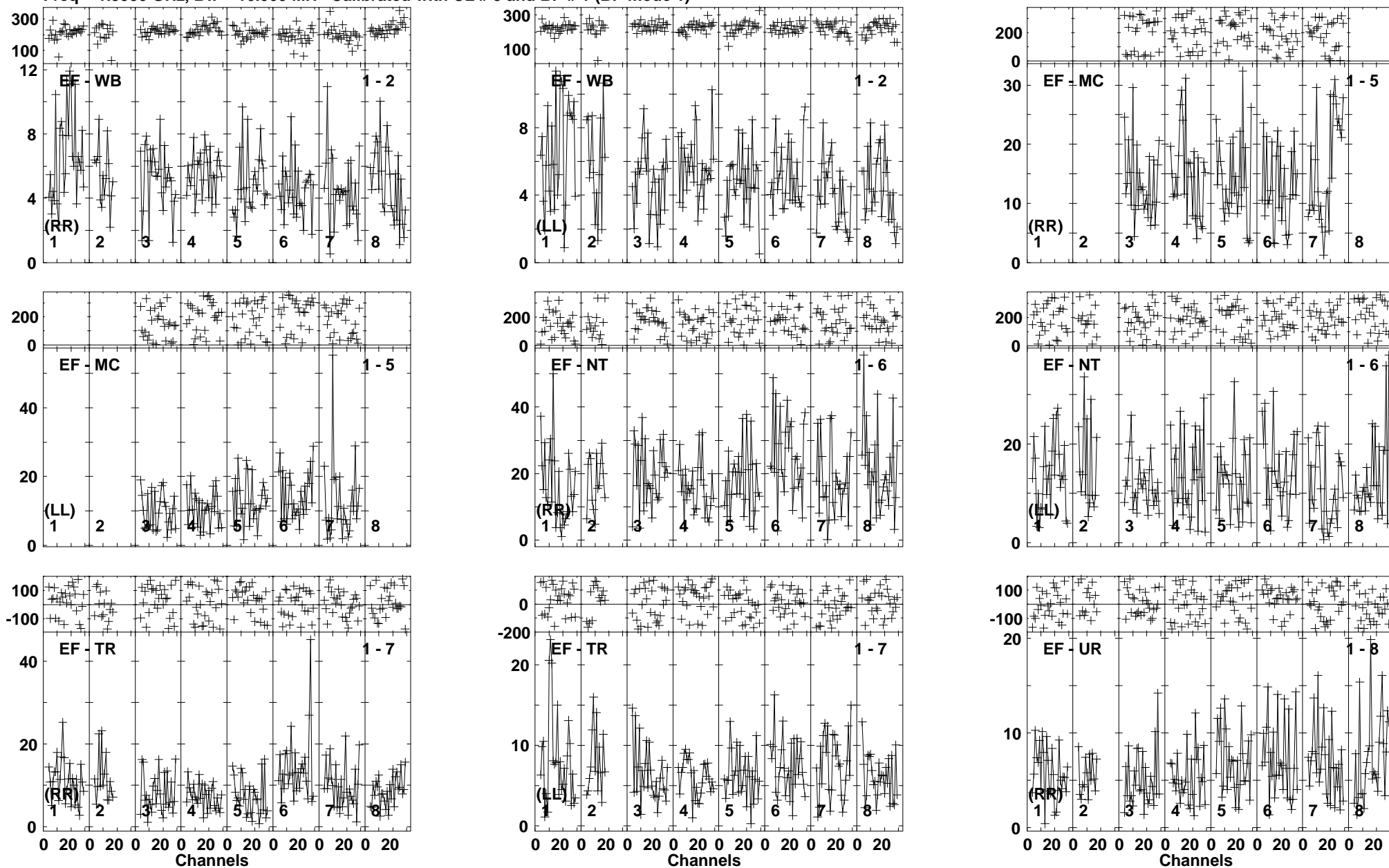

Lower frame: Milli Ampl Jy Top frame: Phas deg
 Vector averaged cross-power spectrum Baseline: EF (01) - WB (02)
 Timerange: 00/05:20:41 to 00/05:25:09

Plot file version 98 created 25-MAR-2014 17:51:09
 ARP299A EP087E 1.UVDATA.1
 Freq = 1.5950 GHz, Bw = 16.000 MH Calibrated with CL # 3 and BP # 1 (BP mode 1)

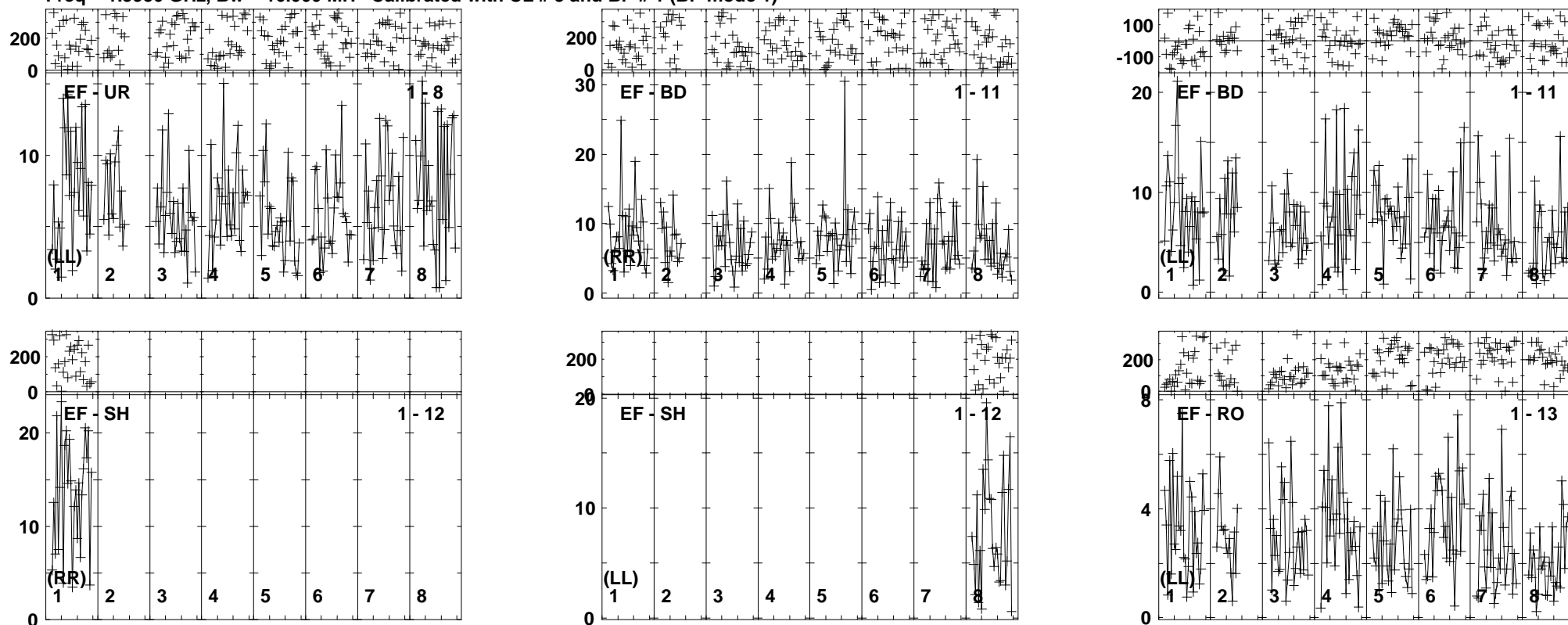

Lower frame: Milli Ampl Jy Top frame: Phas deg
 Vector averaged cross-power spectrum Baseline: EF (01) - UR (08)
 Timerange: 00/05:20:41 to 00/05:25:09

Plot file version 99 created 25-MAR-2014 17:51:09

J1128+5925 EP087E 1.UVDATA.1

Freq = 1.5950 GHz, Bw = 16.000 MH Calibrated with CL # 3 and BP # 1 (BP mode 1)

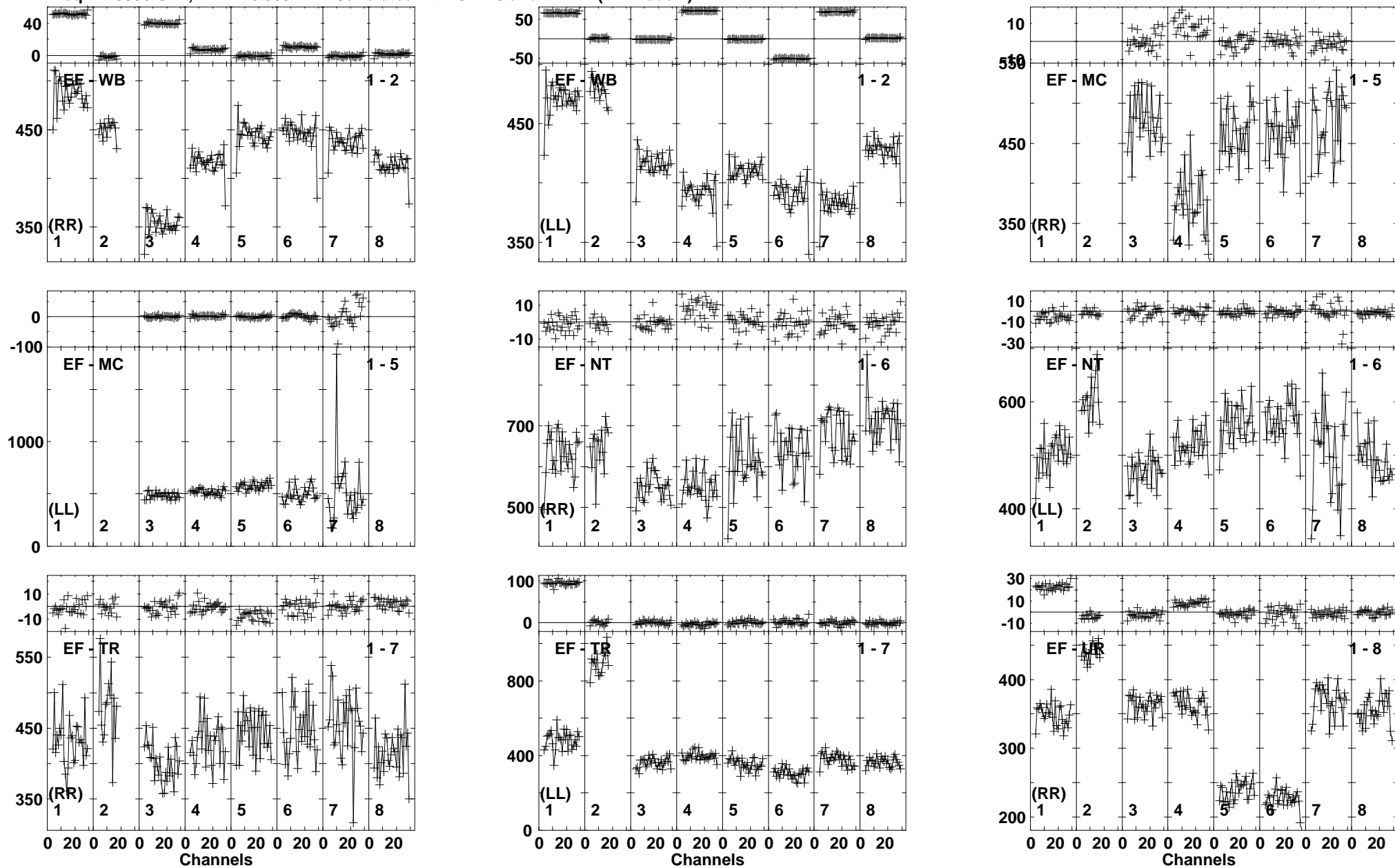

Lower frame: Milli Ampl Jy Top frame: Phas deg
Vector averaged cross-power spectrum Baseline: EF (01) - WB (02)
Timerange: 00/05:25:51 to 00/05:26:19

Plot file version 100 created 25-MAR-2014 17:51:10
 J1128+5925 EP087E 1.UVDATA.1
 Freq = 1.5950 GHz, Bw = 16.000 MH Calibrated with CL # 3 and BP # 1 (BP mode 1)

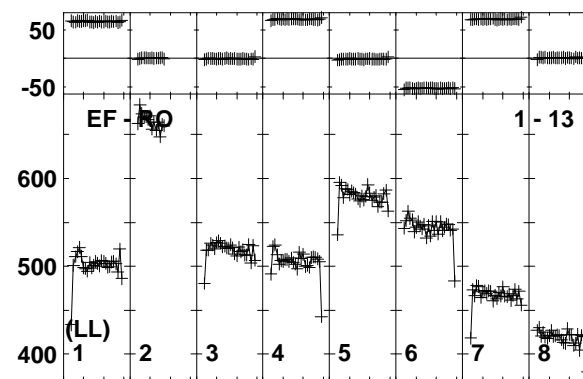
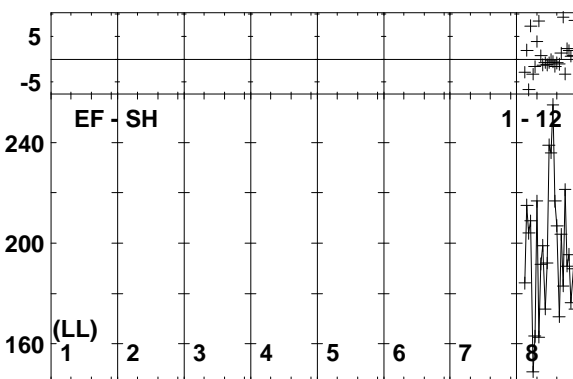
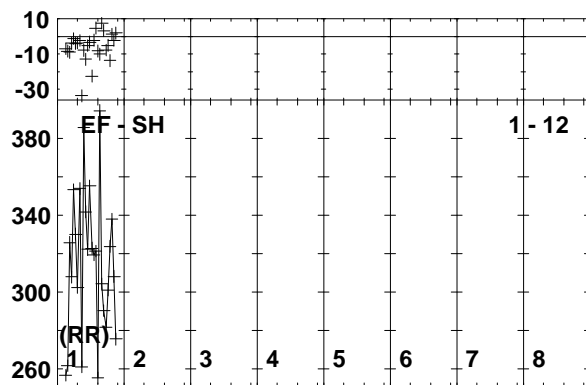
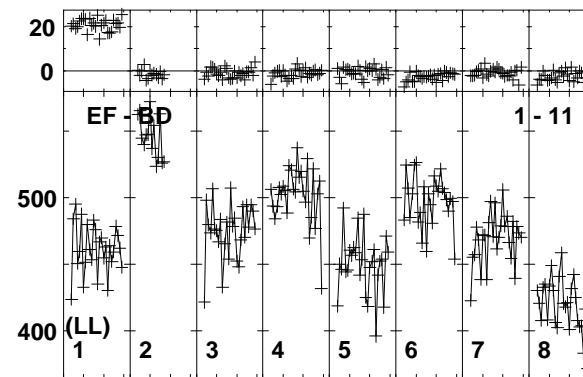
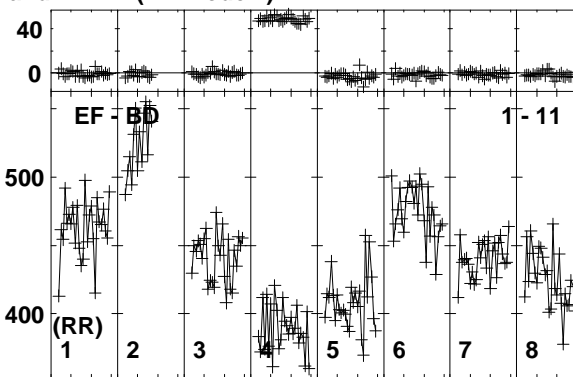
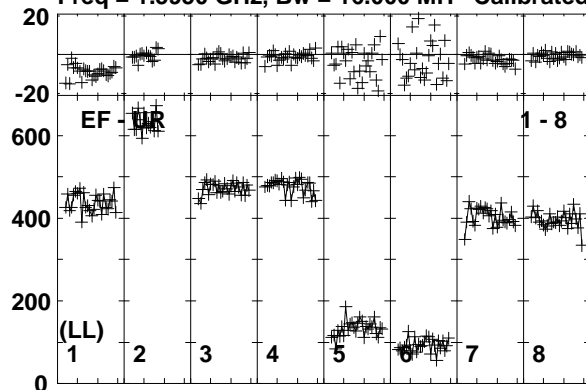

Lower frame: Milli Ampl Jy Top frame: Phas deg
 Vector averaged cross-power spectrum Baseline: EF (01) - UR (08)
 Timerange: 00/05:25:51 to 00/05:26:19

Plot file version 101 created 25-MAR-2014 17:51:10

ARP299A EP087E 1.UVDATA.1

Freq = 1.5950 GHz, Bw = 16.000 MH Calibrated with CL # 3 and BP # 1 (BP mode 1)

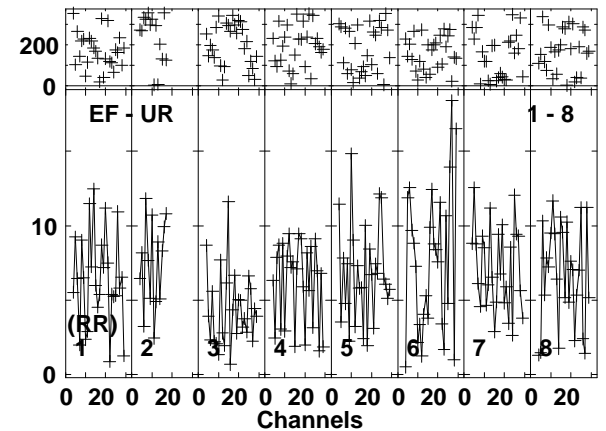
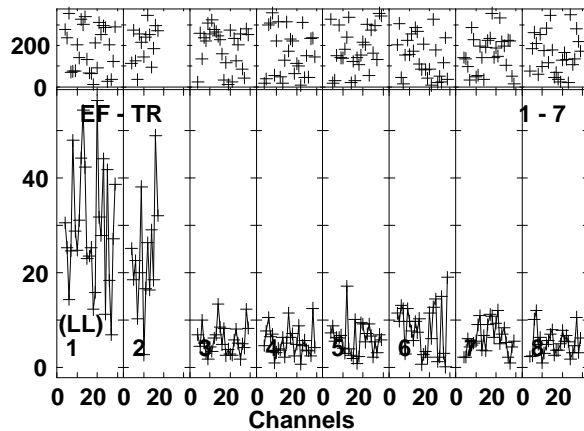
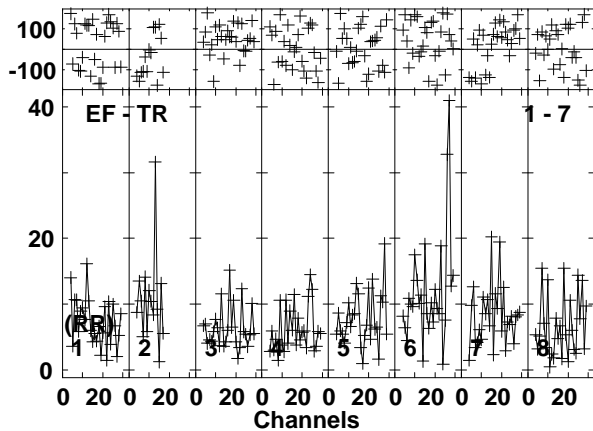
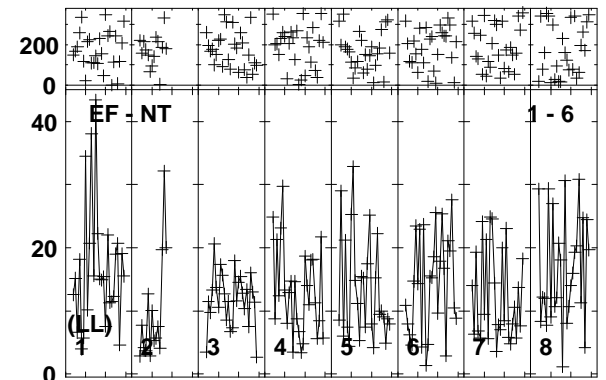
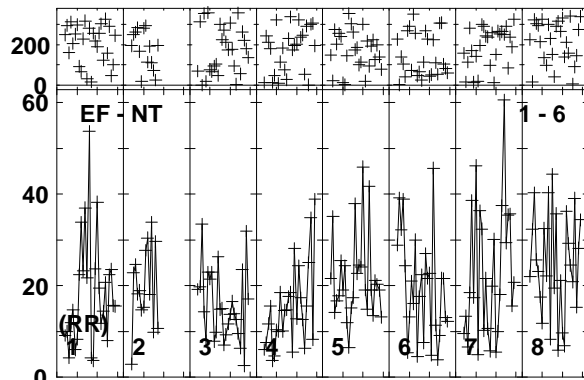
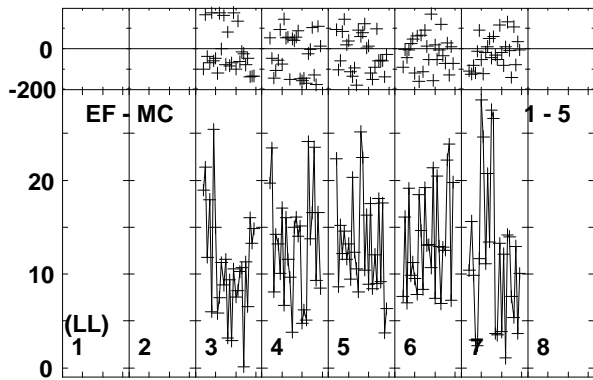
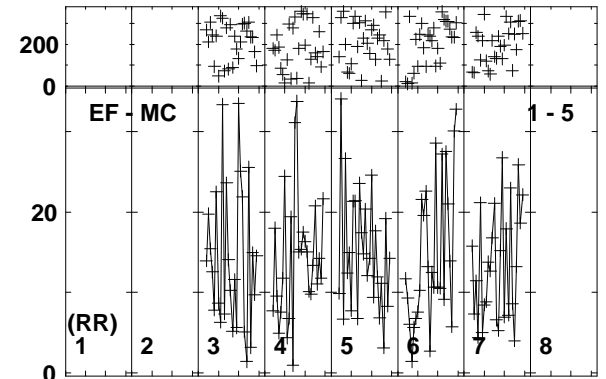
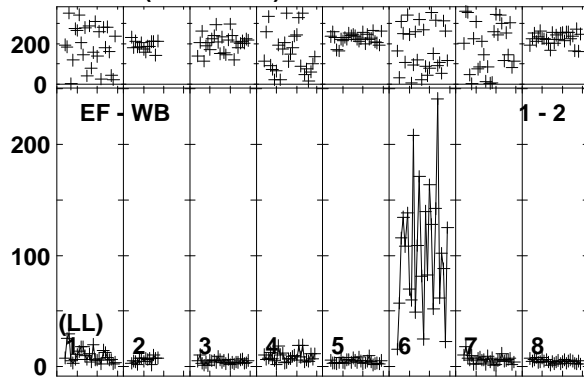
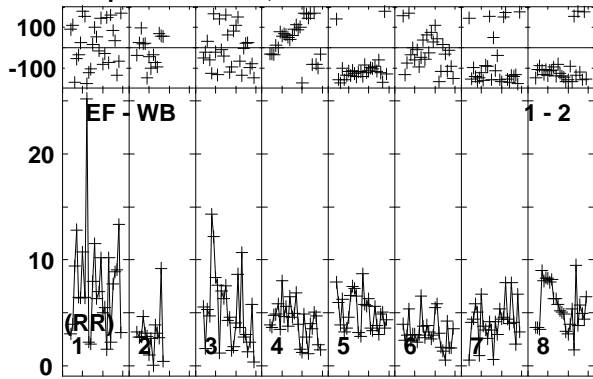

Lower frame: Milli Ampl Jy Top frame: Phas deg
Vector averaged cross-power spectrum Baseline: EF (01) - WB (02)
Timerange: 00/05:26:25 to 00/05:30:49

Plot file version 102 created 25-MAR-2014 17:51:10

ARP299A EP087E 1.UVDATA.1

Freq = 1.5950 GHz, Bw = 16.000 MH Calibrated with CL # 3 and BP # 1 (BP mode 1)

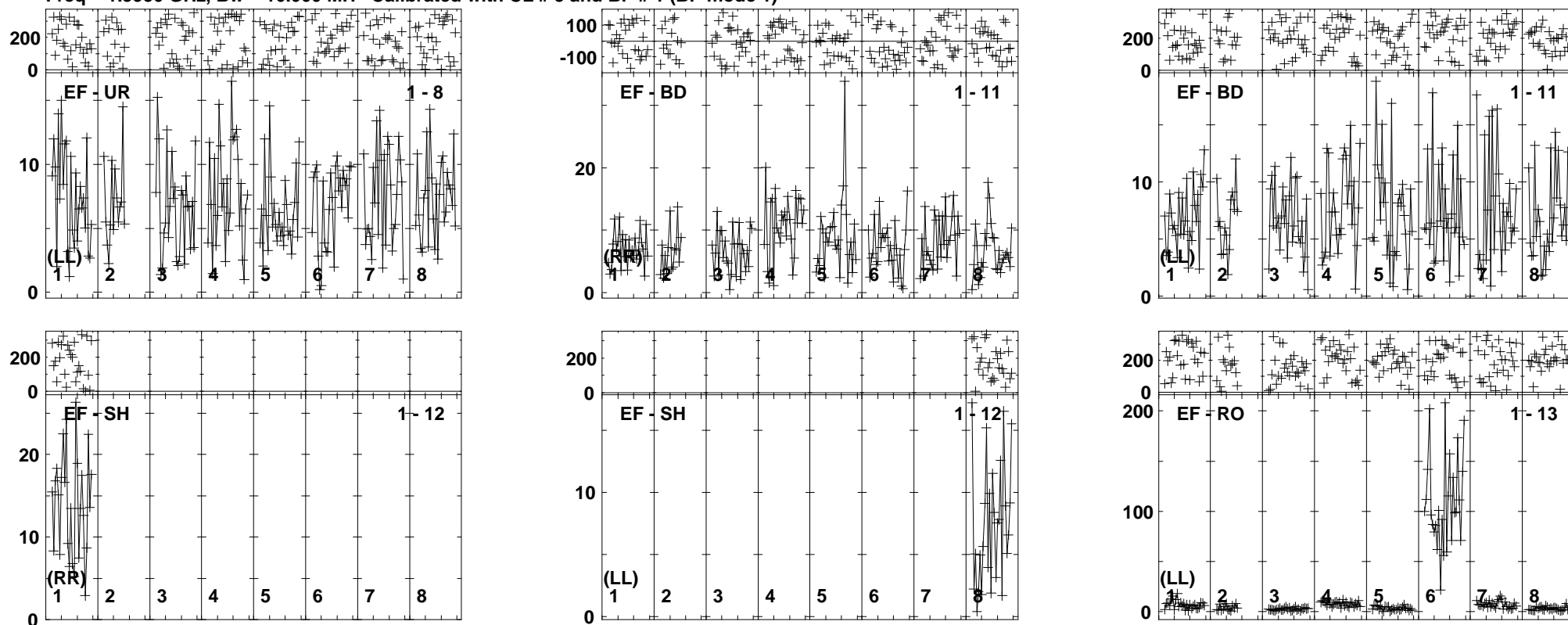

Lower frame: Milli Ampl Jy Top frame: Phas deg
Vector averaged cross-power spectrum Baseline: EF (01) - UR (08)
Timerange: 00/05:26:25 to 00/05:30:49

Plot file version 103 created 25-MAR-2014 17:51:11

J1128+5925 EP087E 1.UVDATA.1

Freq = 1.5950 GHz, Bw = 16.000 MH Calibrated with CL # 3 and BP # 1 (BP mode 1)

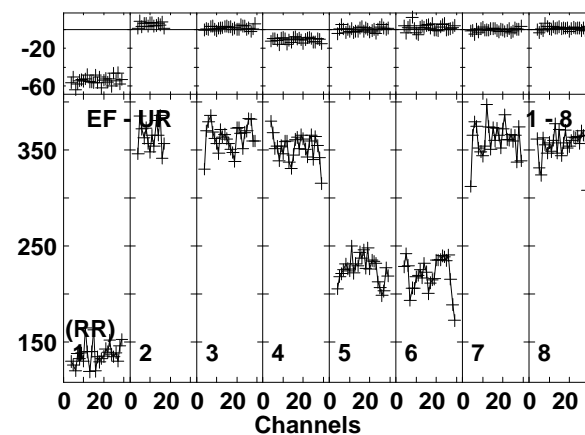
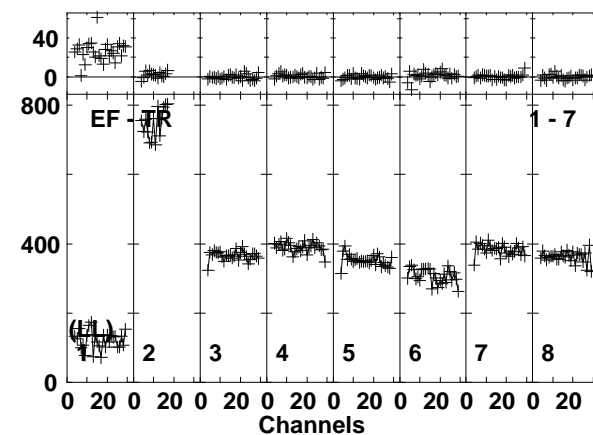
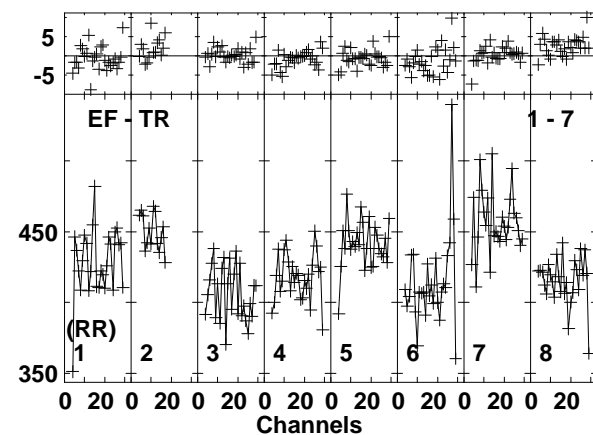
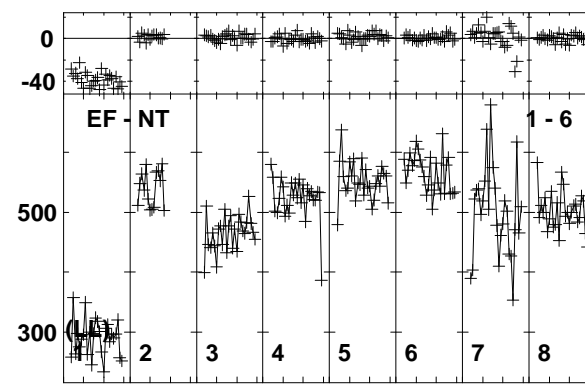
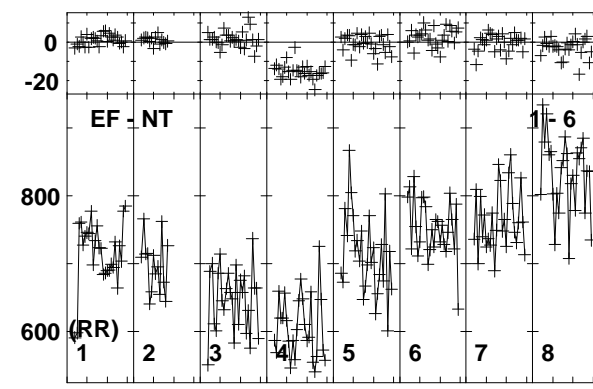
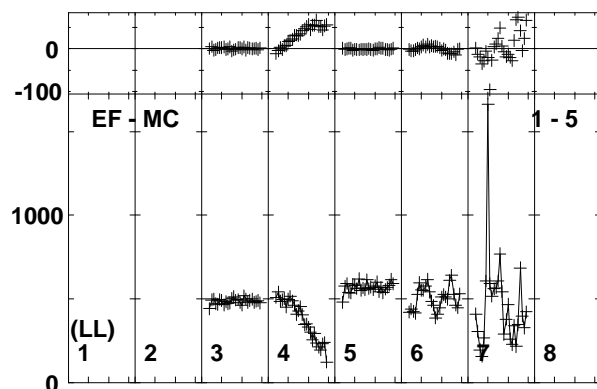
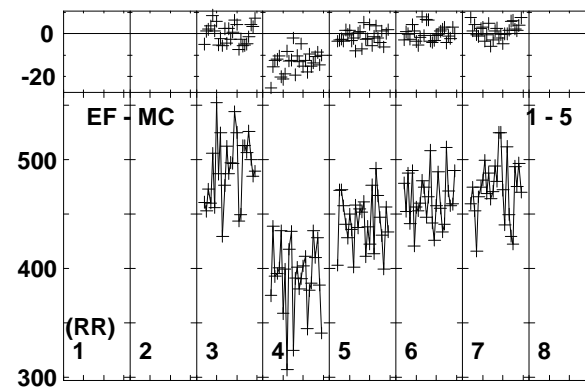
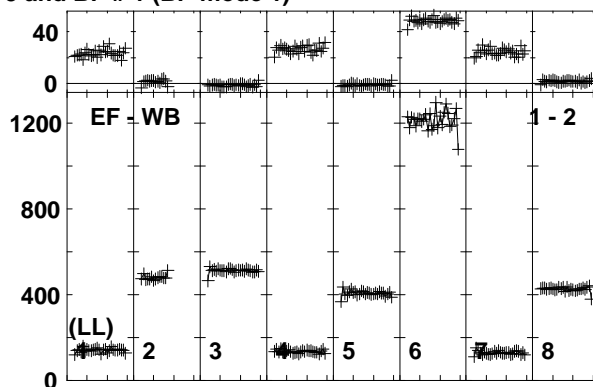
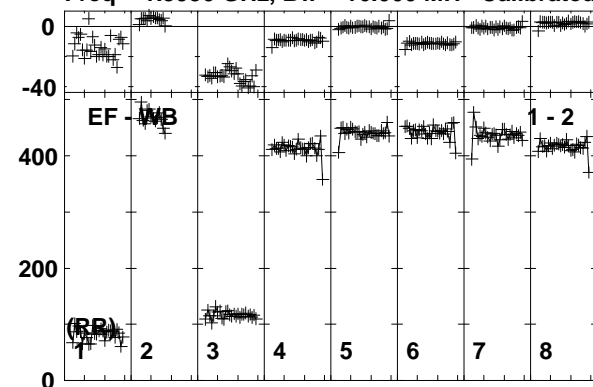

Lower frame: Milli Ampl Jy Top frame: Phas deg
Vector averaged cross-power spectrum Baseline: EF (01) - WB (02)
Timerange: 00/05:30:55 to 00/05:31:59

Plot file version 104 created 25-MAR-2014 17:51:11

J1128+5925 EP087E 1.UVDATA.1

Freq = 1.5950 GHz, Bw = 16.000 MH Calibrated with CL # 3 and BP # 1 (BP mode 1)

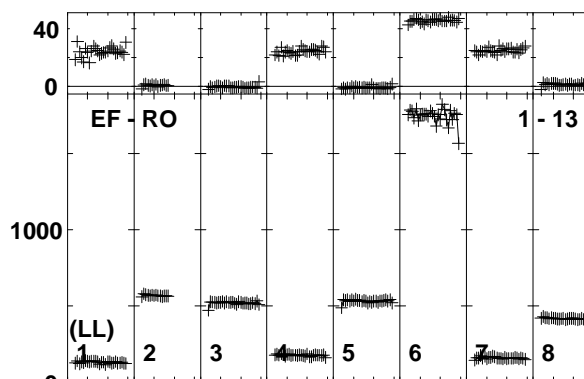
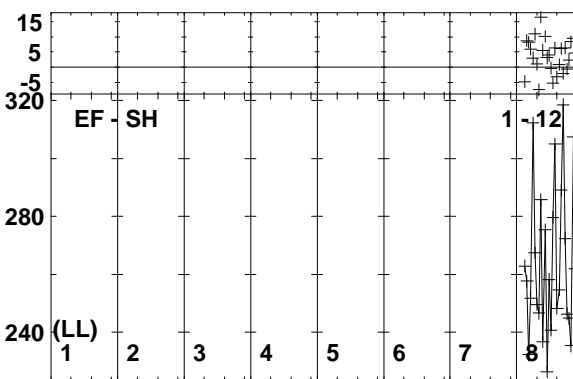
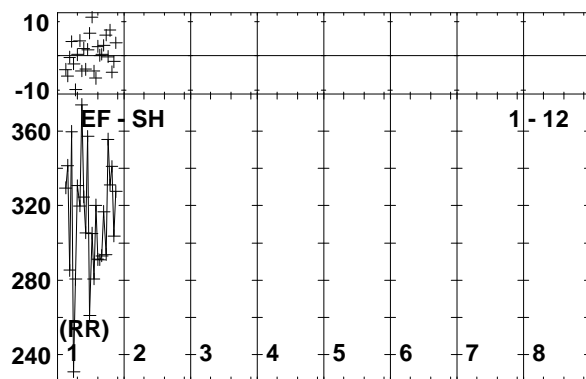
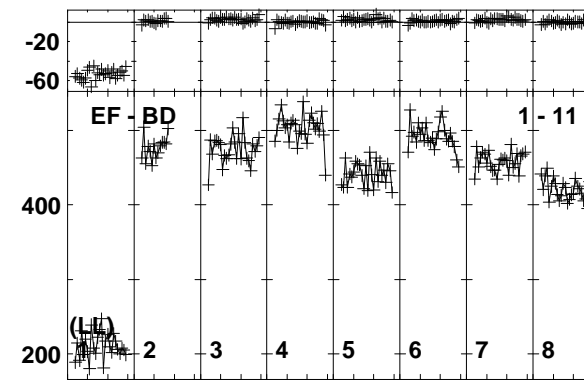
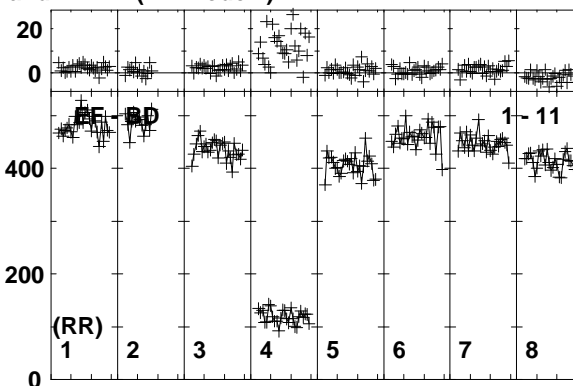
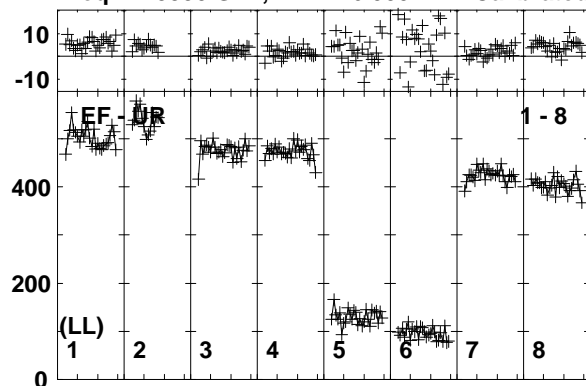

Lower frame: Milli Ampl Jy Top frame: Phas deg
Vector averaged cross-power spectrum Baseline: EF (01) - UR (08)
Timerange: 00/05:30:55 to 00/05:31:59

Plot file version 105 created 25-MAR-2014 17:51:11
 ARP299A EP087E 1.UVDATA.1
 Freq = 1.5950 GHz, Bw = 16.000 MH Calibrated with CL # 3 and BP # 1 (BP mode 1)

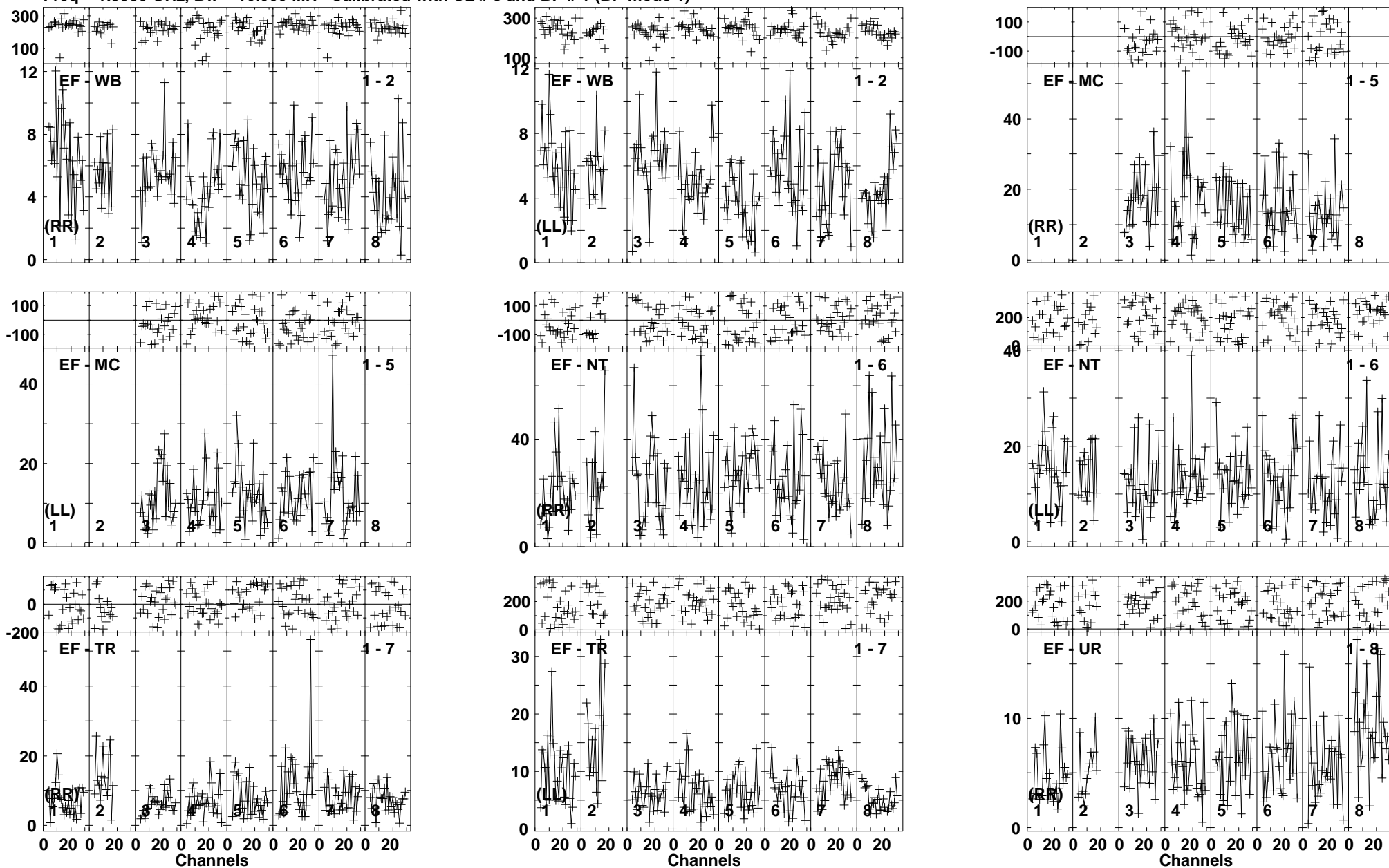

Lower frame: Milli Ampl Jy Top frame: Phas deg
 Vector averaged cross-power spectrum Baseline: EF (01) - WB (02)
 Timerange: 00/05:32:01 to 00/05:36:29

Plot file version 106 created 25-MAR-2014 17:51:11
 ARP299A EP087E 1.UVDATA.1
 Freq = 1.5950 GHz, Bw = 16.000 MH Calibrated with CL # 3 and BP # 1 (BP mode 1)

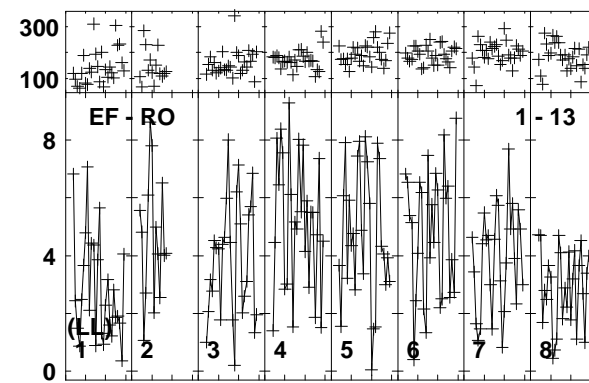
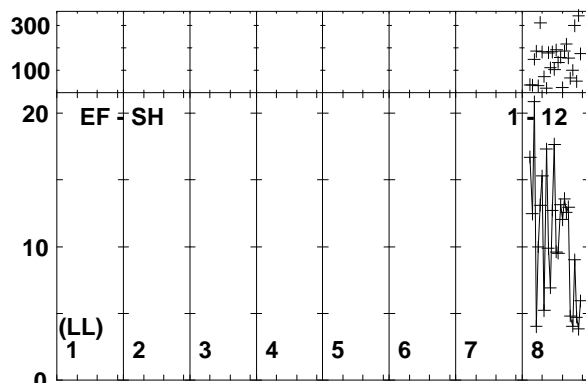
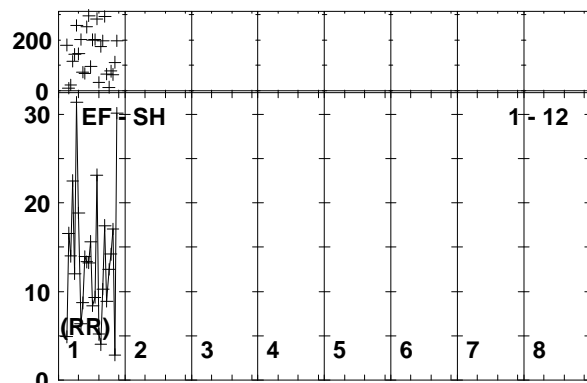
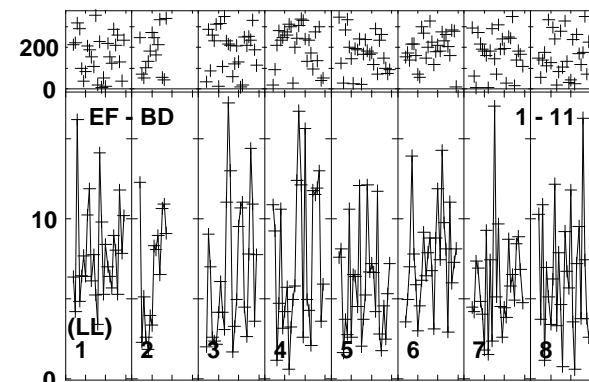
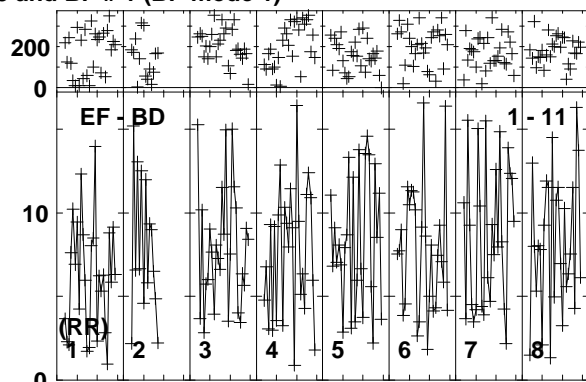
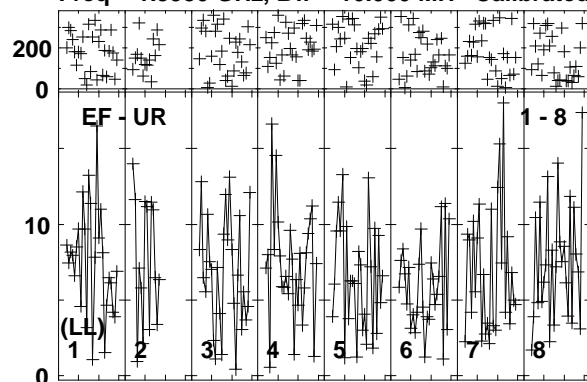

Lower frame: Milli Ampl Jy Top frame: Phas deg
 Vector averaged cross-power spectrum Baseline: EF (01) - UR (08)
 Timerange: 00/05:32:01 to 00/05:36:29

Plot file version 107 created 25-MAR-2014 17:51:12

J1128+5925 EP087E 1.UVDATA.1

Freq = 1.5950 GHz, Bw = 16.000 MH Calibrated with CL # 3 and BP # 1 (BP mode 1)

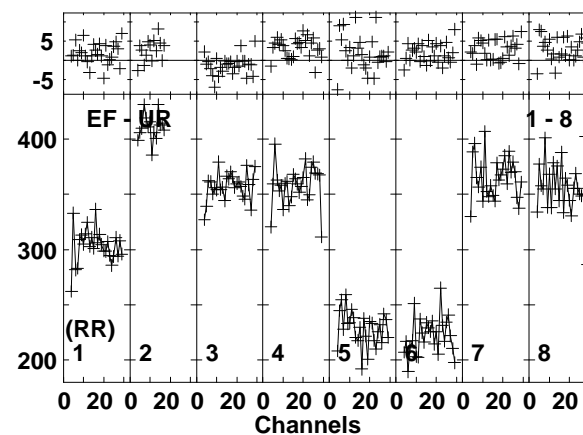
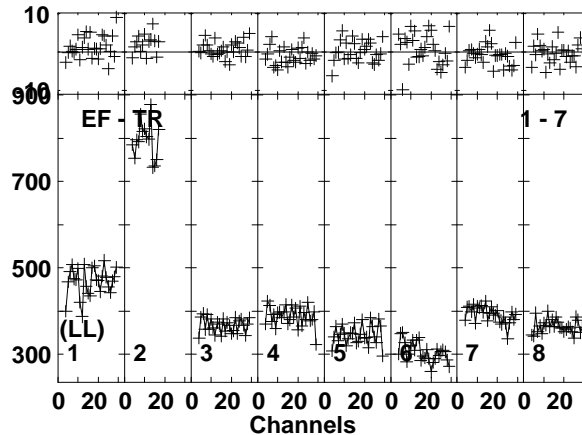
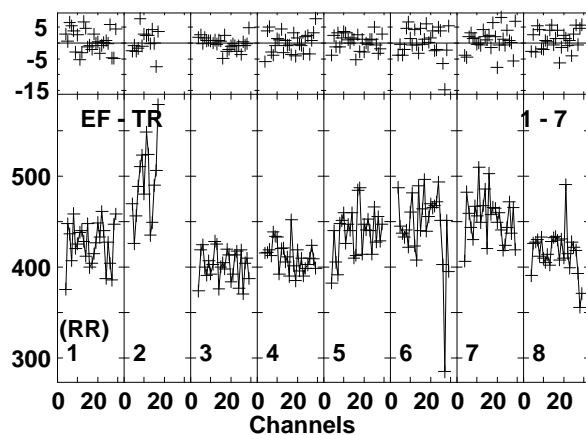
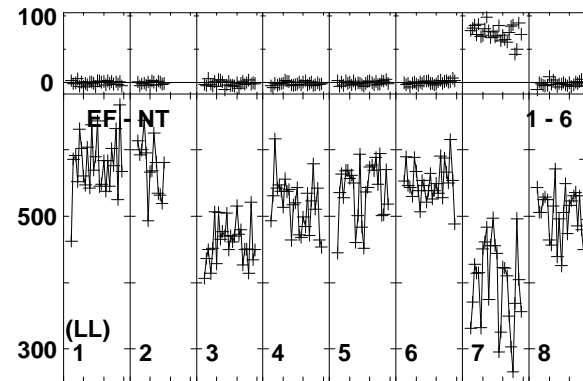
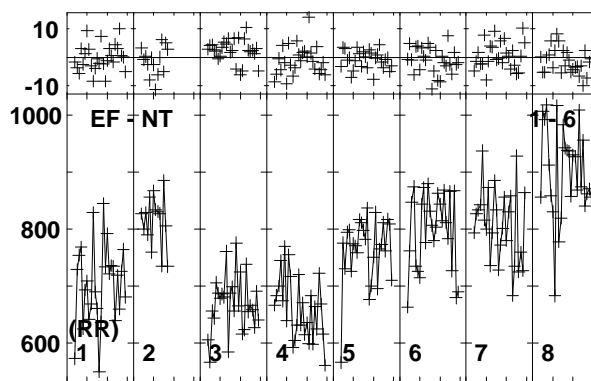
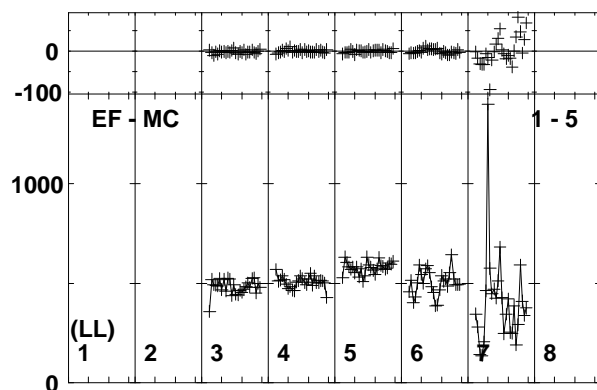
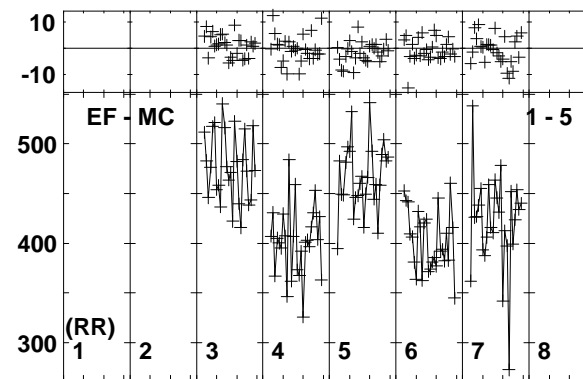
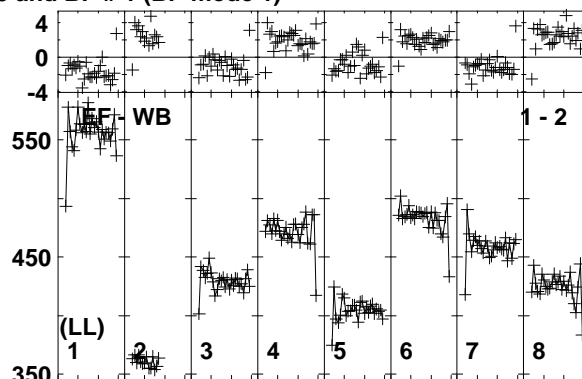
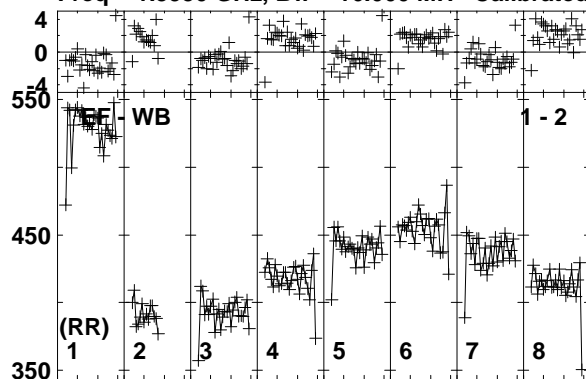

Lower frame: Milli Ampl Jy Top frame: Phas deg
Vector averaged cross-power spectrum Baseline: EF (01) - WB (02)
Timerange: 00/05:37:11 to 00/05:37:39

Plot file version 108 created 25-MAR-2014 17:51:12

J1128+5925 EP087E 1.UVDATA.1

Freq = 1.5950 GHz, Bw = 16.000 MH Calibrated with CL # 3 and BP # 1 (BP mode 1)

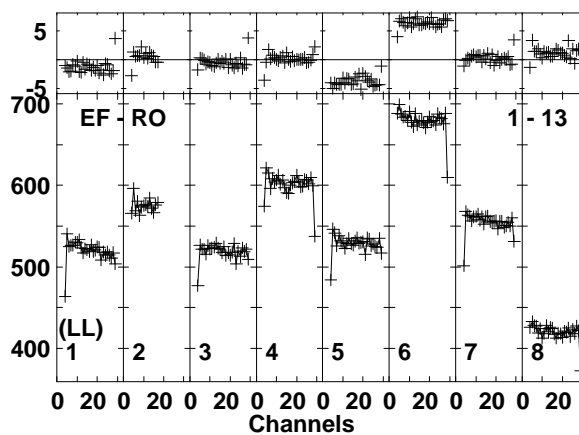
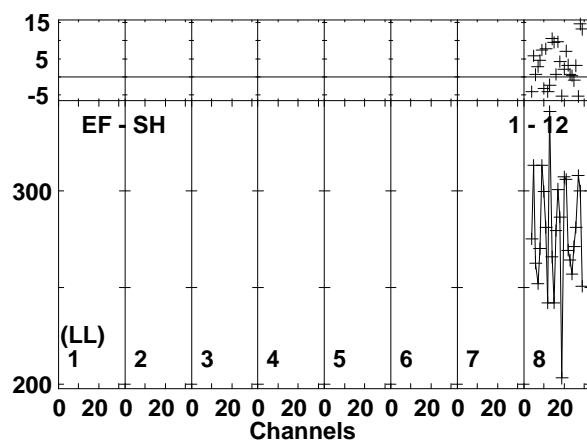
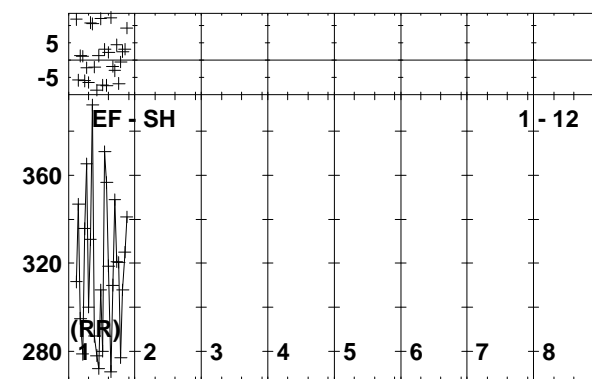
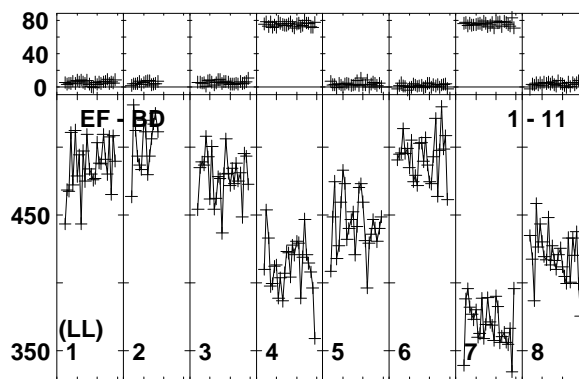
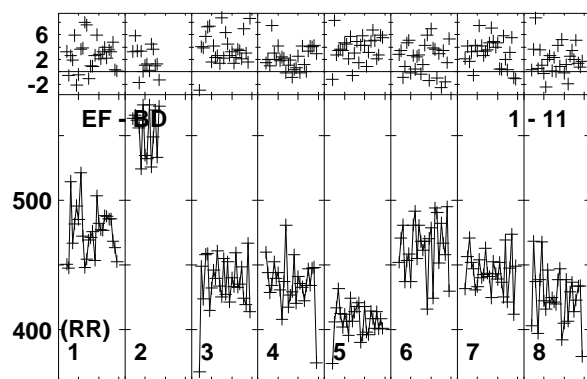
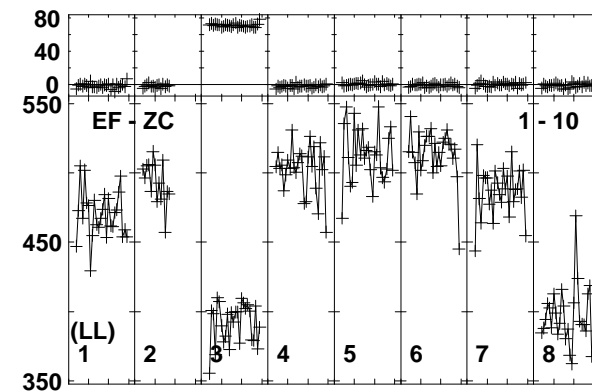
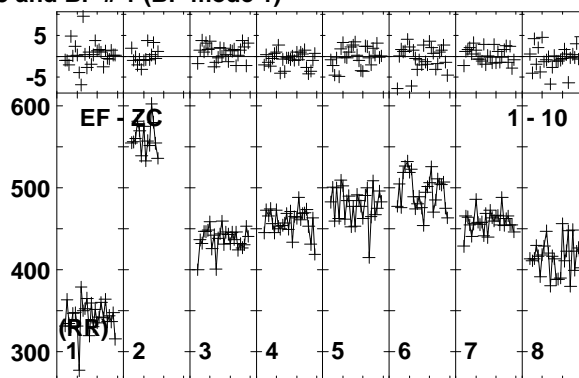
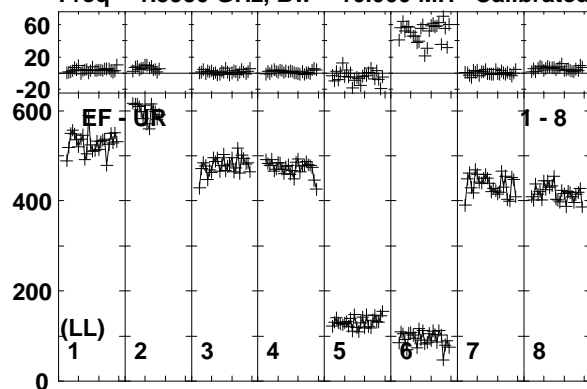

Lower frame: Milli Ampl Jy Top frame: Phas deg
Vector averaged cross-power spectrum Baseline: EF (01) - UR (08)
Timerange: 00/05:37:11 to 00/05:37:39

Plot file version 109 created 25-MAR-2014 17:51:12
 ARP299A EP087E 1.UVDATA.1
 Freq = 1.5950 GHz, Bw = 16.000 MH Calibrated with CL # 3 and BP # 1 (BP mode 1)

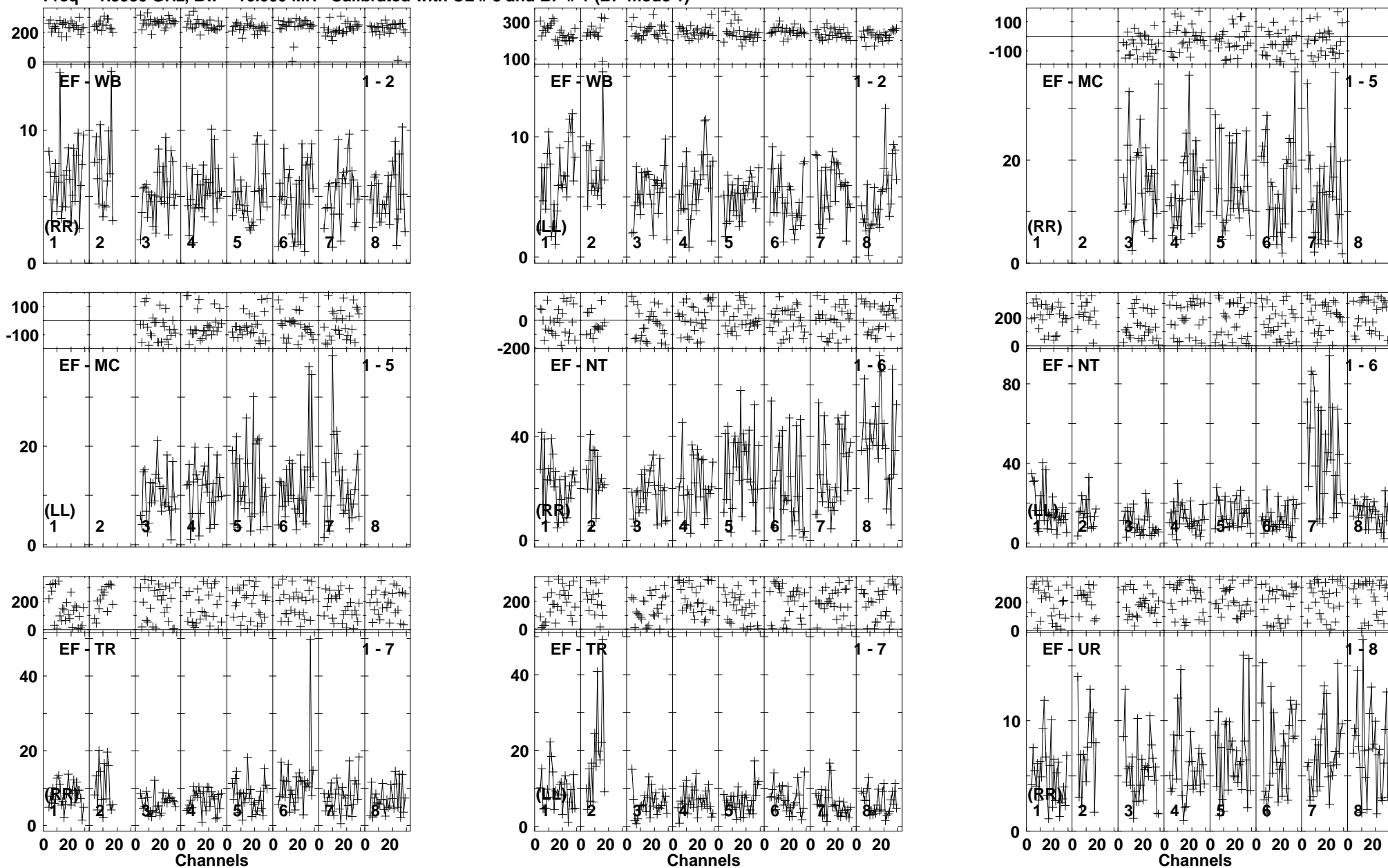

Lower frame: Milli Ampl Jy Top frame: Phas deg
 Vector averaged cross-power spectrum Baseline: EF (01) - WB (02)
 Timerange: 00/05:37:45 to 00/05:42:09

Plot file version 110 created 25-MAR-2014 17:51:12

ARP299A EP087E 1.UVDATA.1

Freq = 1.5950 GHz, Bw = 16.000 MH Calibrated with CL # 3 and BP # 1 (BP mode 1)

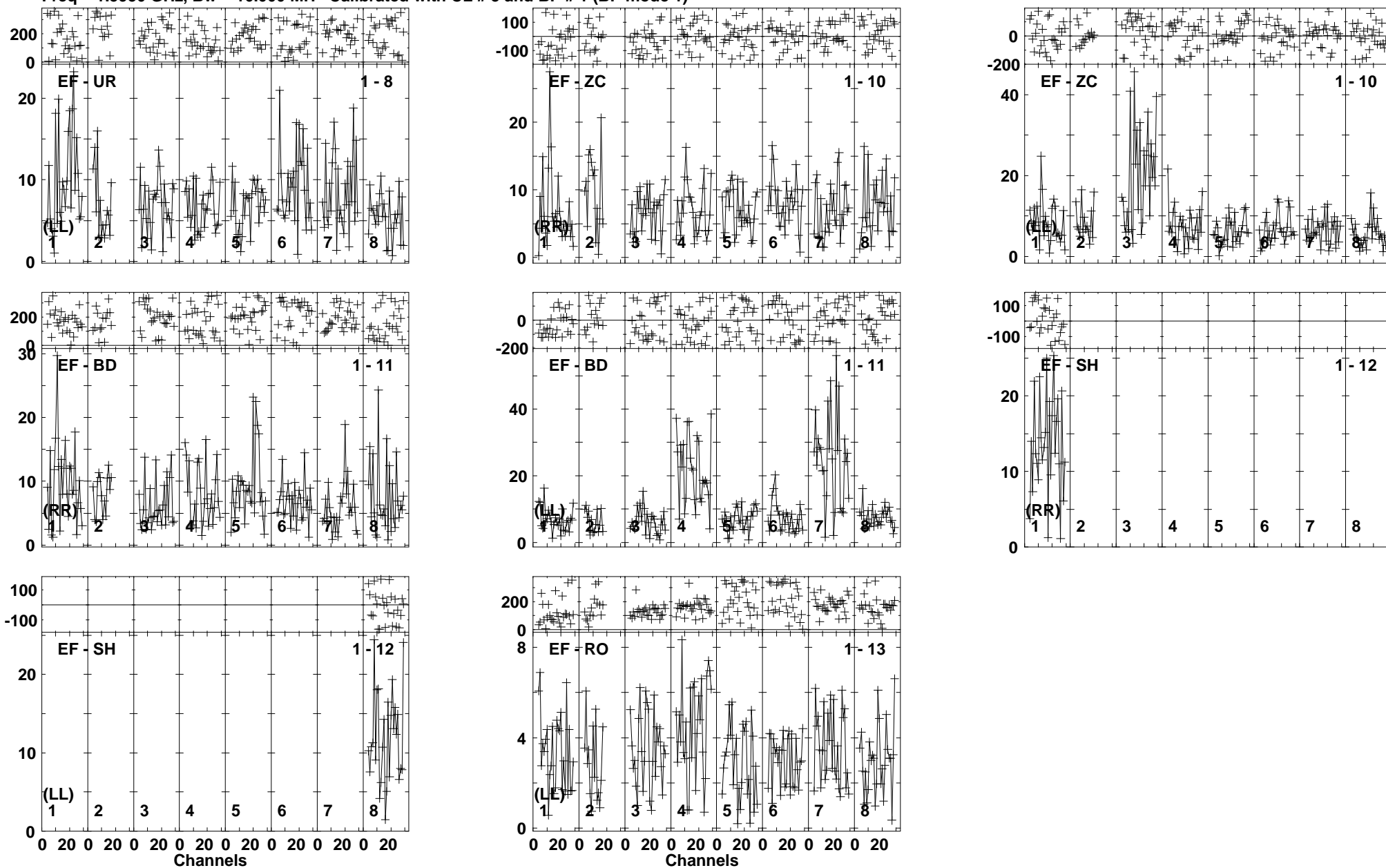

Lower frame: Milli Ampl Jy Top frame: Phas deg
Vector averaged cross-power spectrum Baseline: EF (01) - UR (08)
Timerange: 00/05:37:45 to 00/05:42:09

Plot file version 111 created 25-MAR-2014 17:51:13

J1128+5925 EP087E 1.UVDATA.1

Freq = 1.5950 GHz, Bw = 16.000 MH Calibrated with CL # 3 and BP # 1 (BP mode 1)

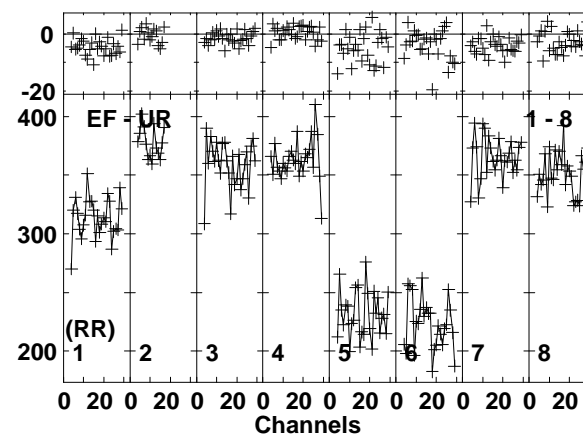
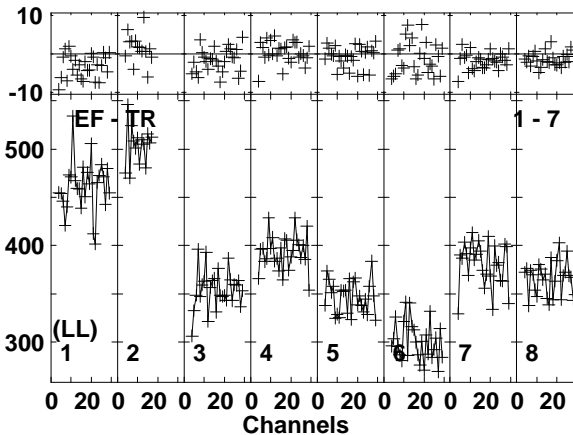
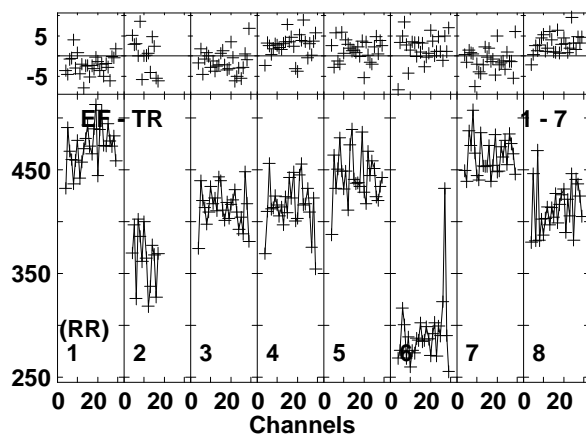
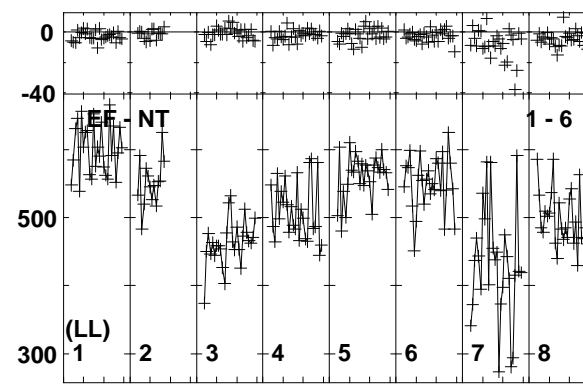
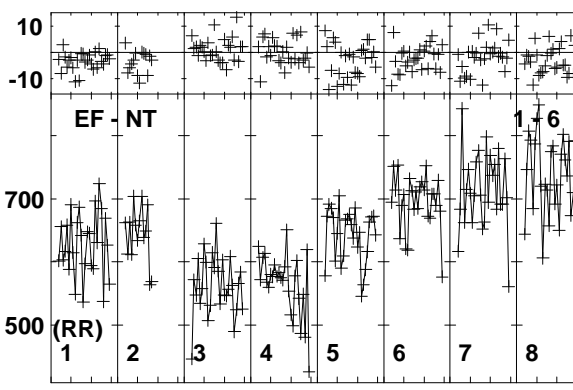
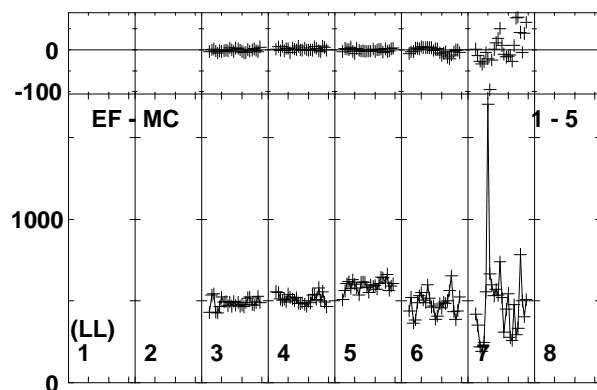
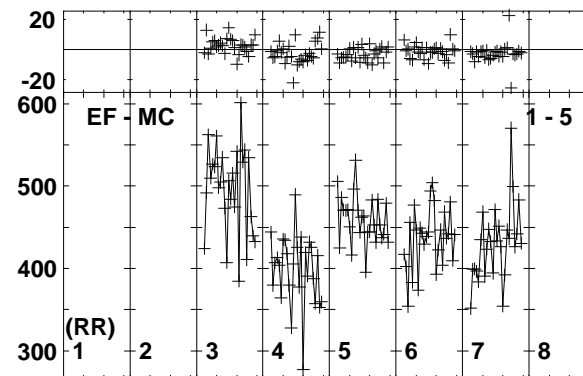
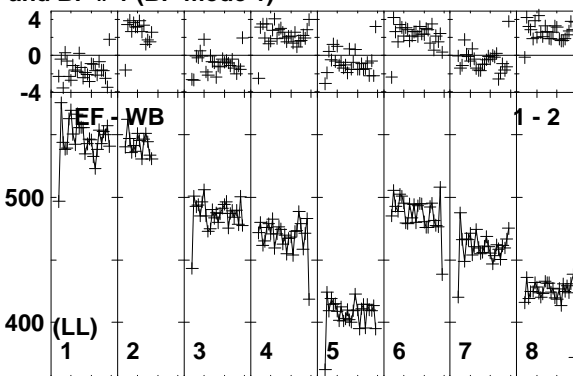
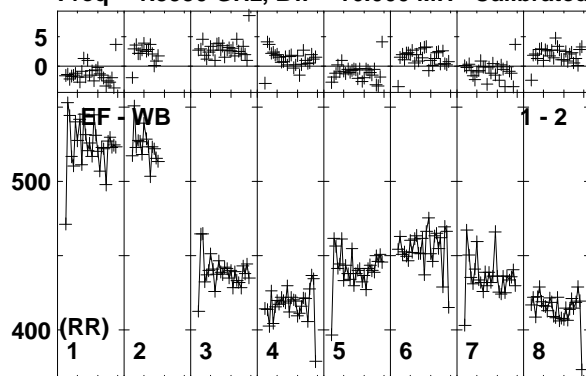

Lower frame: Milli Ampl Jy Top frame: Phas deg
Vector averaged cross-power spectrum Baseline: EF (01) - WB (02)
Timerange: 00/05:42:15 to 00/05:43:09

Plot file version 112 created 25-MAR-2014 17:51:13

J1128+5925 EP087E 1.UVDATA.1

Freq = 1.5950 GHz, Bw = 16.000 MH Calibrated with CL # 3 and BP # 1 (BP mode 1)

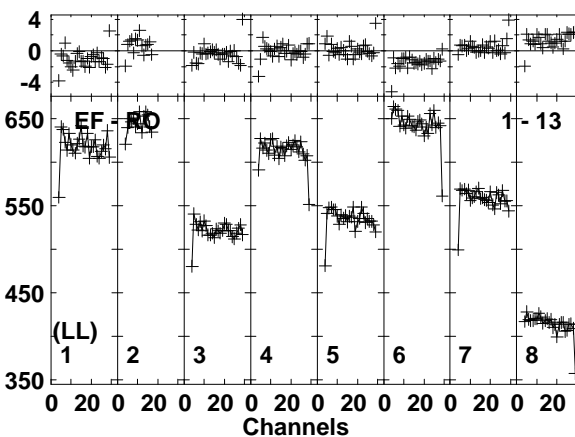
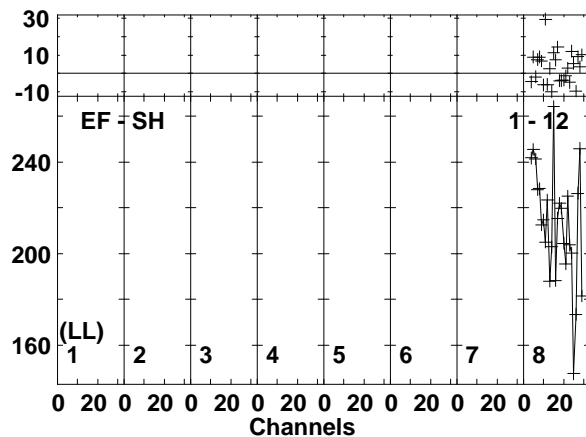
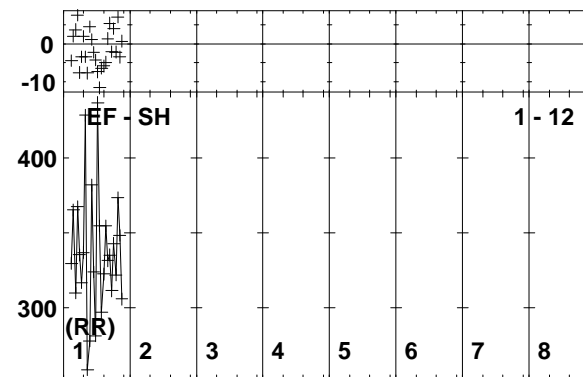
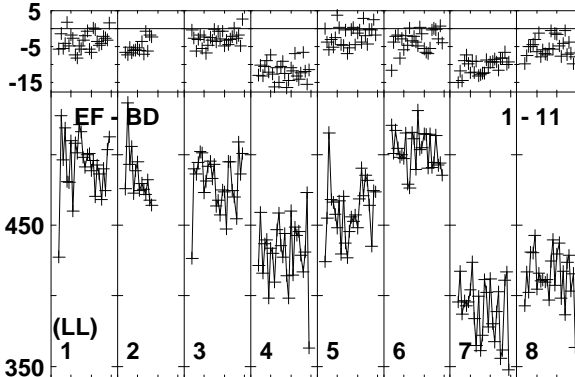
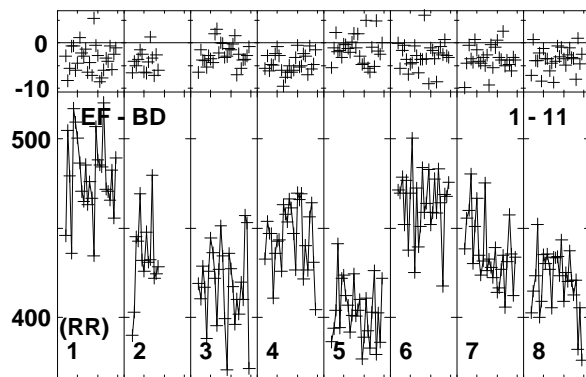
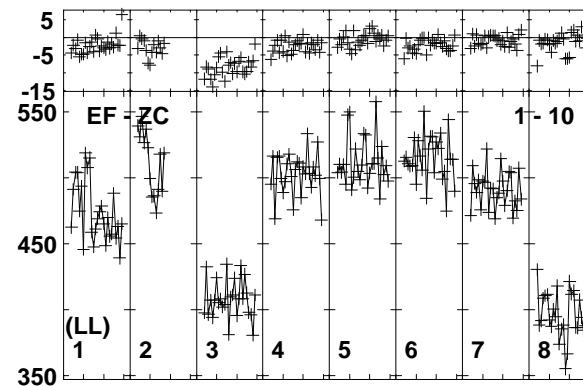
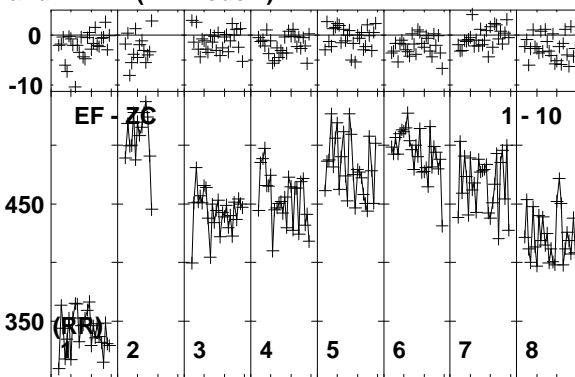
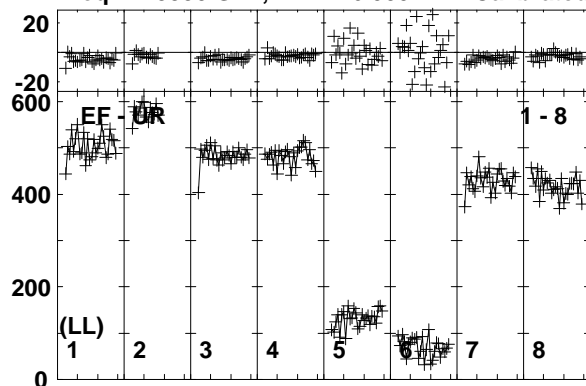

Lower frame: Milli Ampl Jy Top frame: Phas deg
Vector averaged cross-power spectrum Baseline: EF (01) - UR (08)
Timerange: 00/05:42:15 to 00/05:43:09

Plot file version 113 created 25-MAR-2014 17:51:13
 ARP299A EP087E 1.UVDATA.1
 Freq = 1.5950 GHz, Bw = 16.000 MH Calibrated with CL # 3 and BP # 1 (BP mode 1)

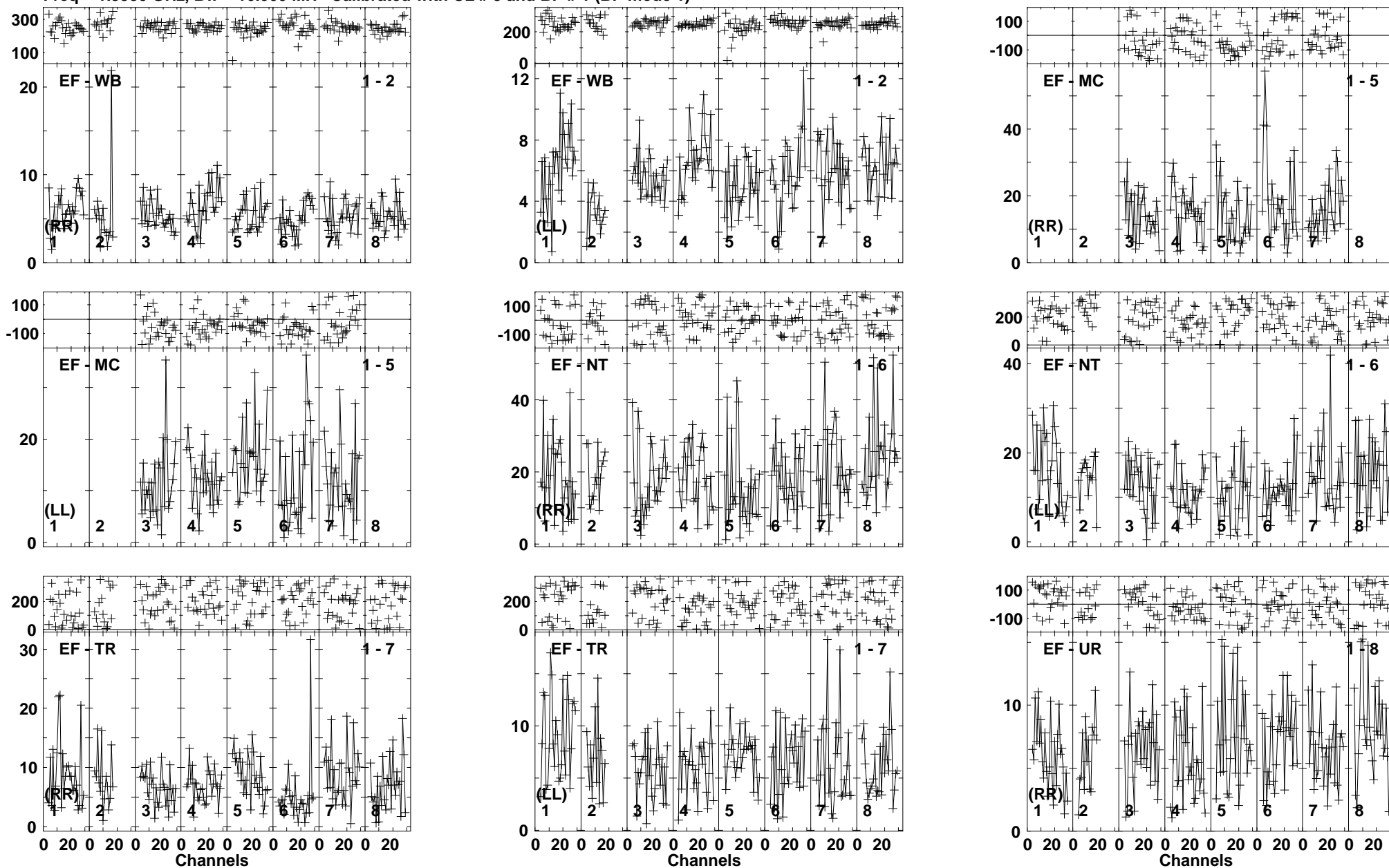

Lower frame: Milli Ampl Jy Top frame: Phas deg
 Vector averaged cross-power spectrum Baseline: EF (01) - WB (02)
 Timerange: 00/05:43:11 to 00/05:47:39

Plot file version 114 created 25-MAR-2014 17:51:13

ARP299A EP087E 1.UVDATA.1

Freq = 1.5950 GHz, Bw = 16.000 MH Calibrated with CL # 3 and BP # 1 (BP mode 1)

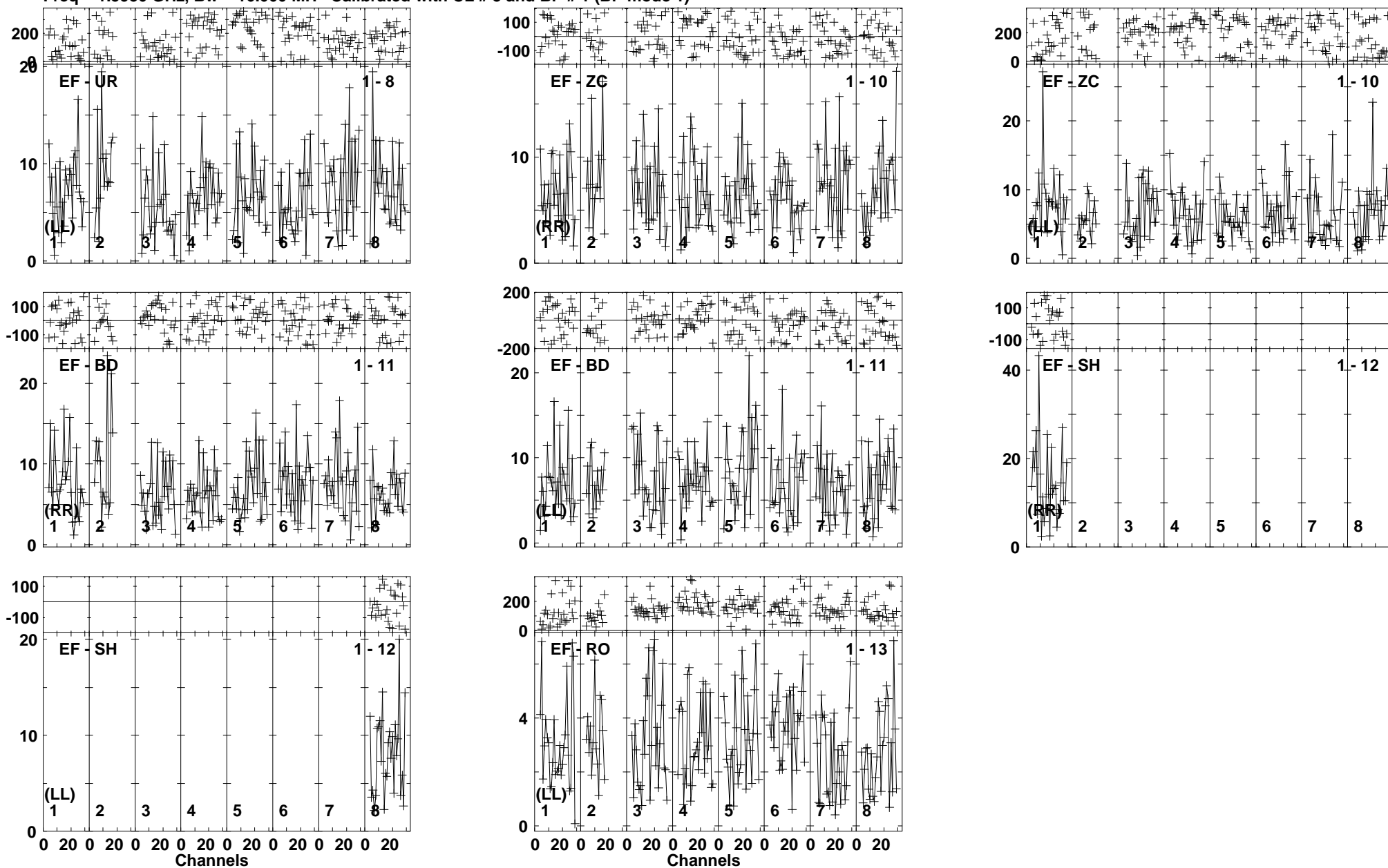

Lower frame: Milli Ampl Jy Top frame: Phas deg
Vector averaged cross-power spectrum Baseline: EF (01) - UR (08)
Timerange: 00/05:43:11 to 00/05:47:39

Plot file version 115 created 25-MAR-2014 17:51:14

J1128+5925 EP087E 1.UVDATA.1

Freq = 1.5950 GHz, Bw = 16.000 MH Calibrated with CL # 3 and BP # 1 (BP mode 1)

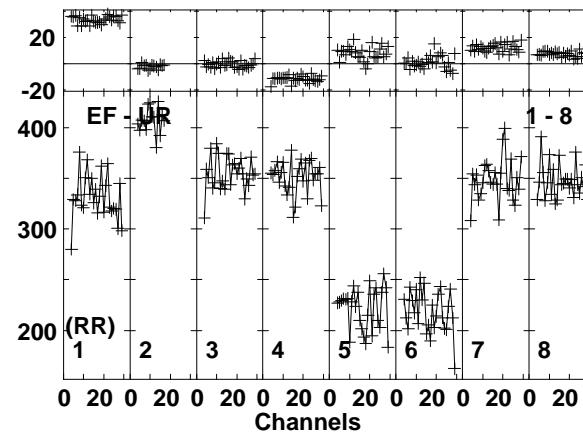
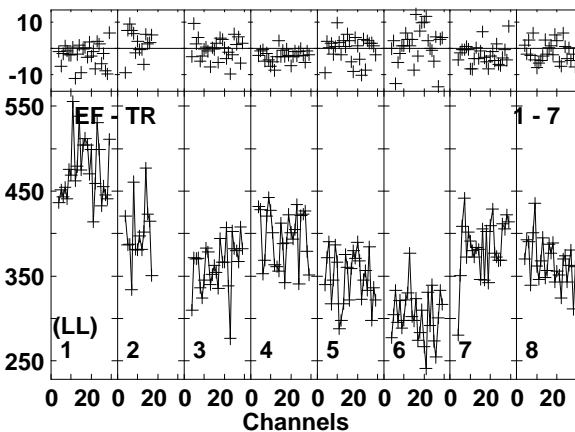
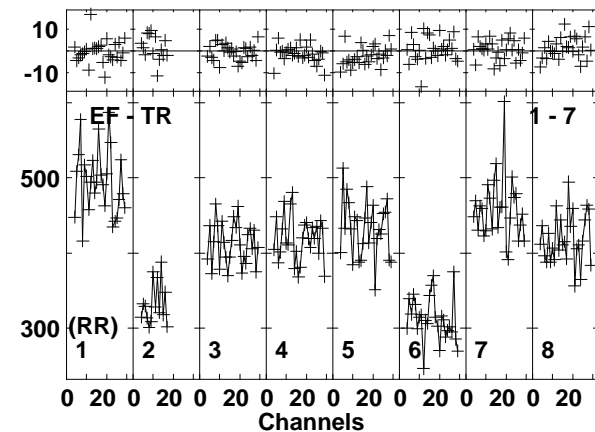
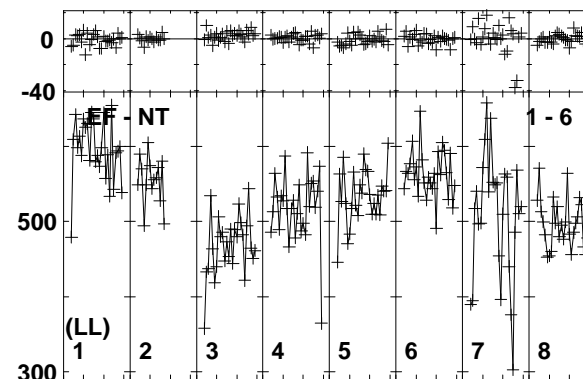
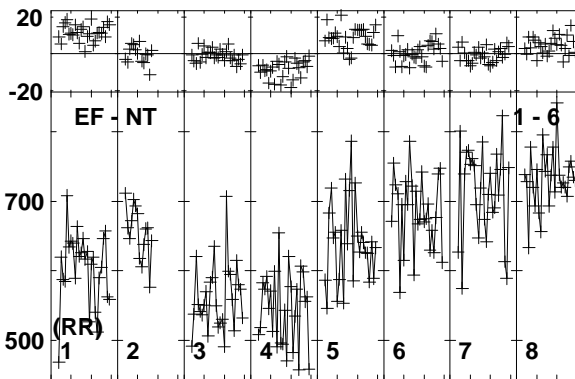
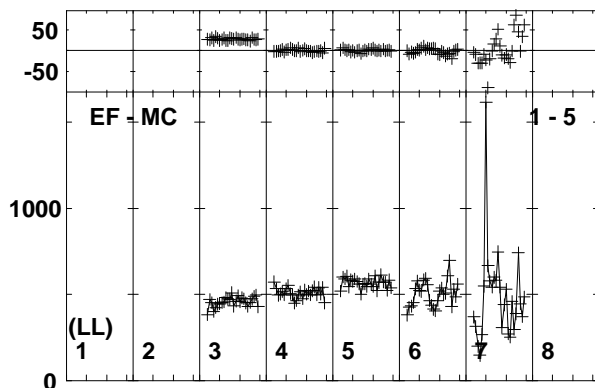
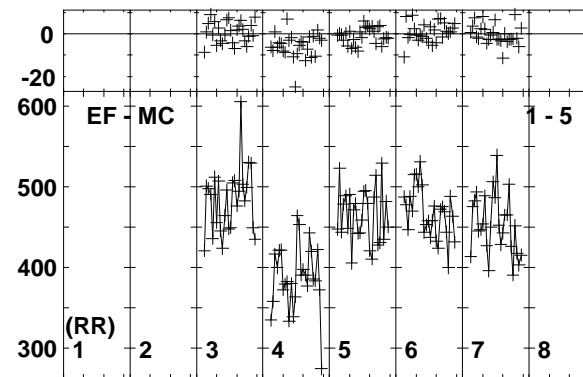
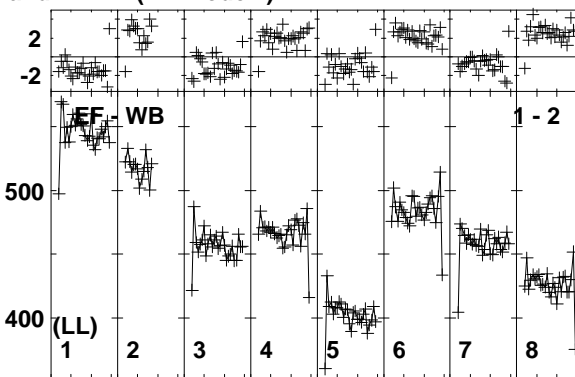
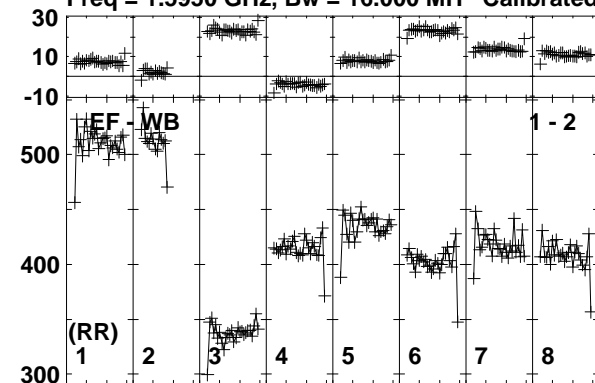

Lower frame: Milli Ampl Jy Top frame: Phas deg
Vector averaged cross-power spectrum Baseline: EF (01) - WB (02)
Timerange: 00/05:48:21 to 00/05:48:49

Plot file version 116 created 25-MAR-2014 17:51:14

J1128+5925 EP087E 1.UVDATA.1

Freq = 1.5950 GHz, Bw = 16.000 MH Calibrated with CL # 3 and BP # 1 (BP mode 1)

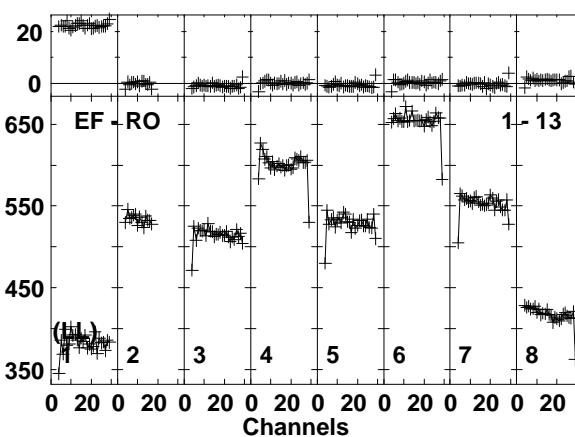
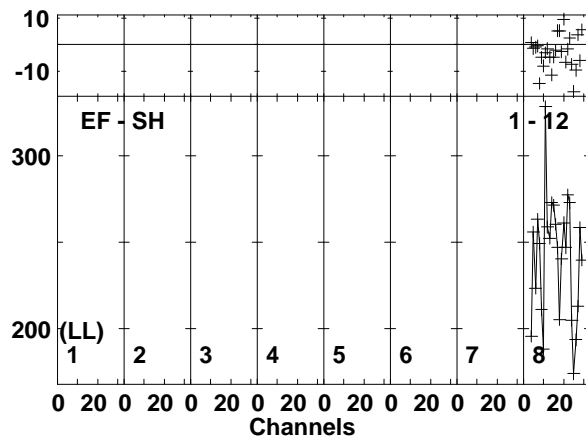
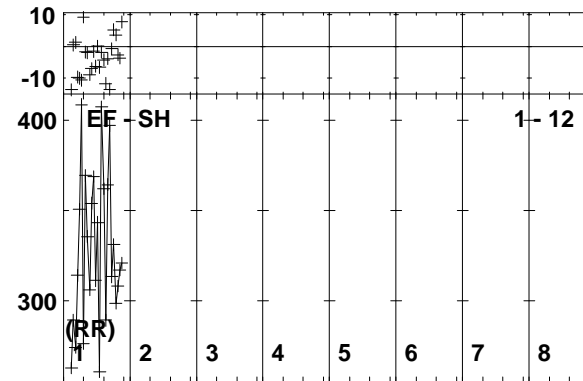
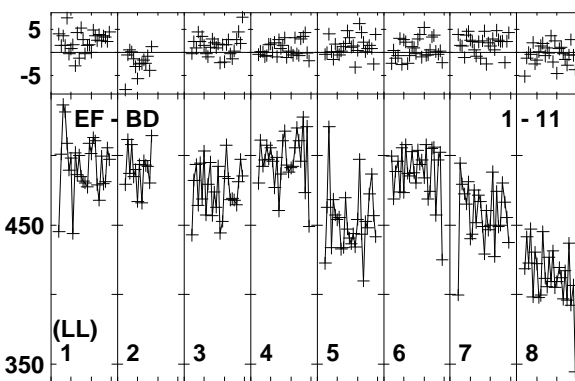
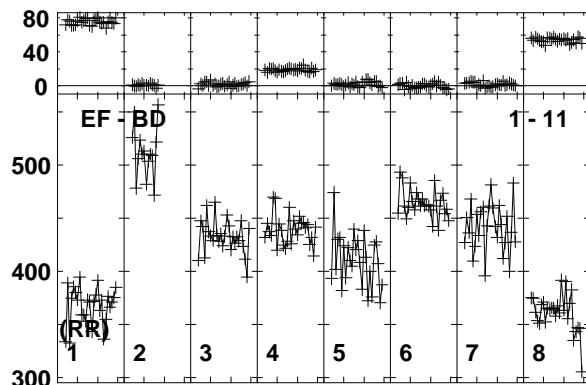
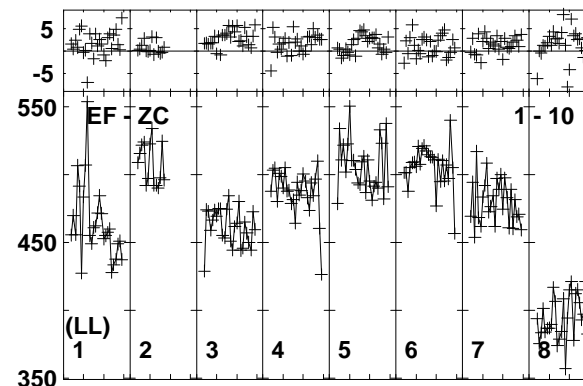
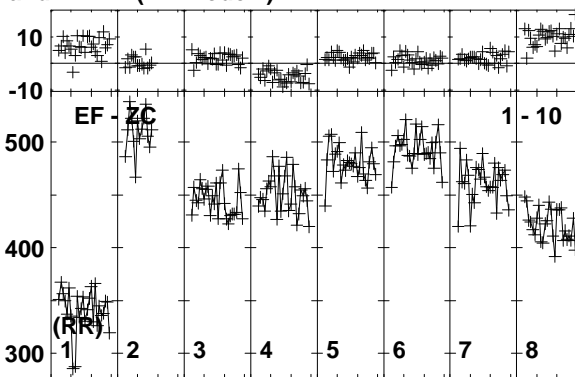
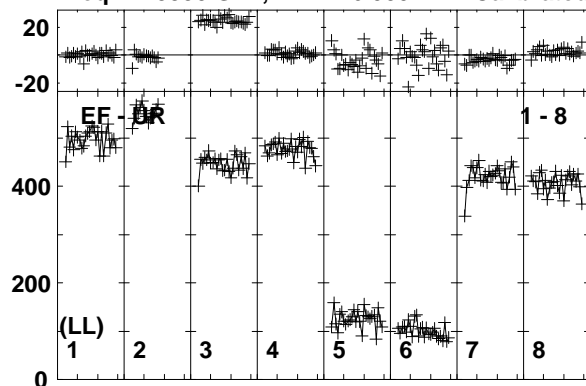

Lower frame: Milli Ampl Jy Top frame: Phas deg
Vector averaged cross-power spectrum Baseline: EF (01) - UR (08)
Timerange: 00/05:48:21 to 00/05:48:49

Plot file version 117 created 25-MAR-2014 17:51:14

ARP299A EP087E 1.UVDATA.1

Freq = 1.5950 GHz, Bw = 16.000 MH Calibrated with CL # 3 and BP # 1 (BP mode 1)

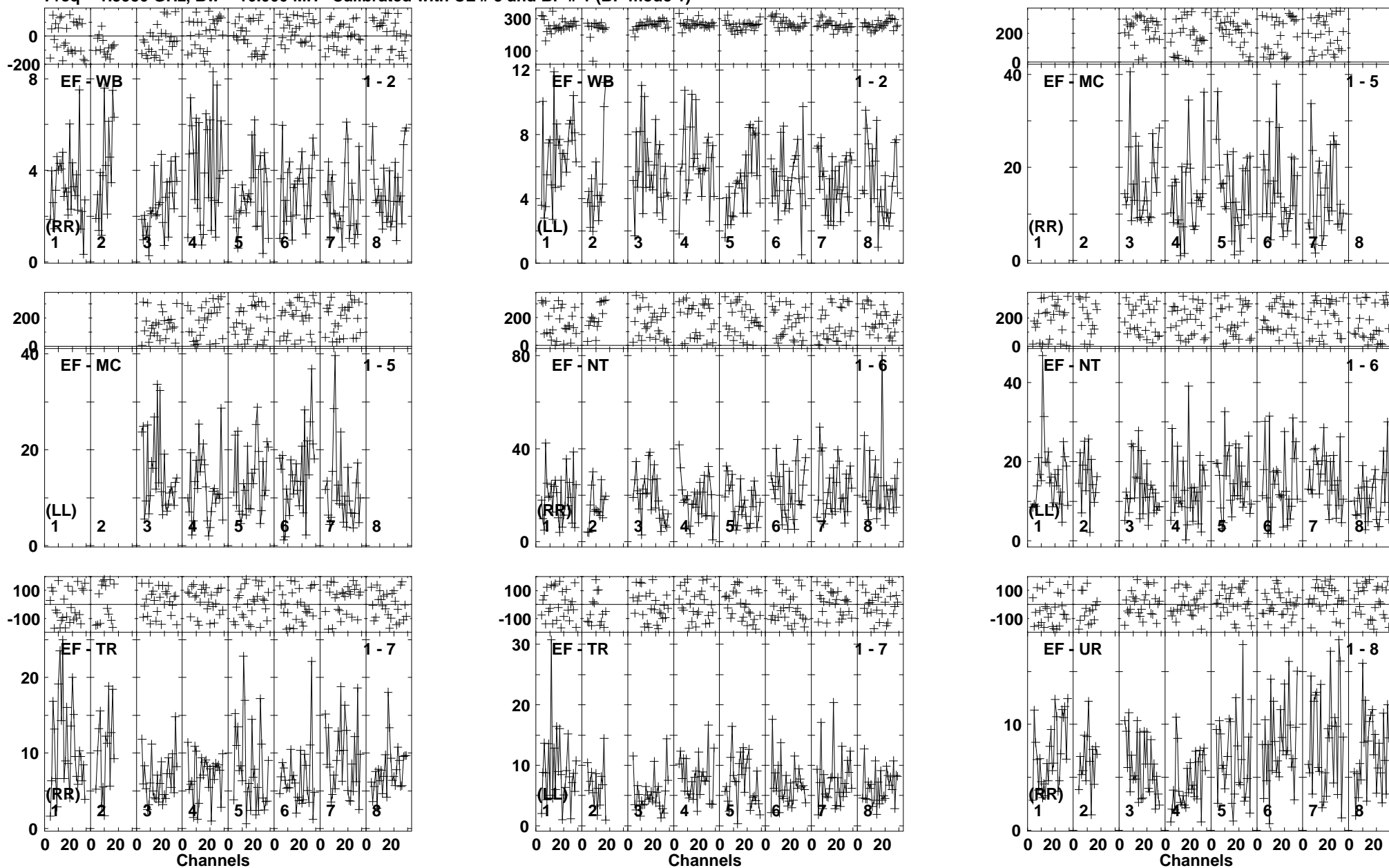

Lower frame: Milli Ampl Jy Top frame: Phas deg
Vector averaged cross-power spectrum Baseline: EF (01) - WB (02)
Timerange: 00/05:48:55 to 00/05:53:19

Plot file version 118 created 25-MAR-2014 17:51:15
 ARP299A EP087E 1.UVDATA.1
 Freq = 1.5950 GHz, Bw = 16.000 MH Calibrated with CL # 3 and BP # 1 (BP mode 1)

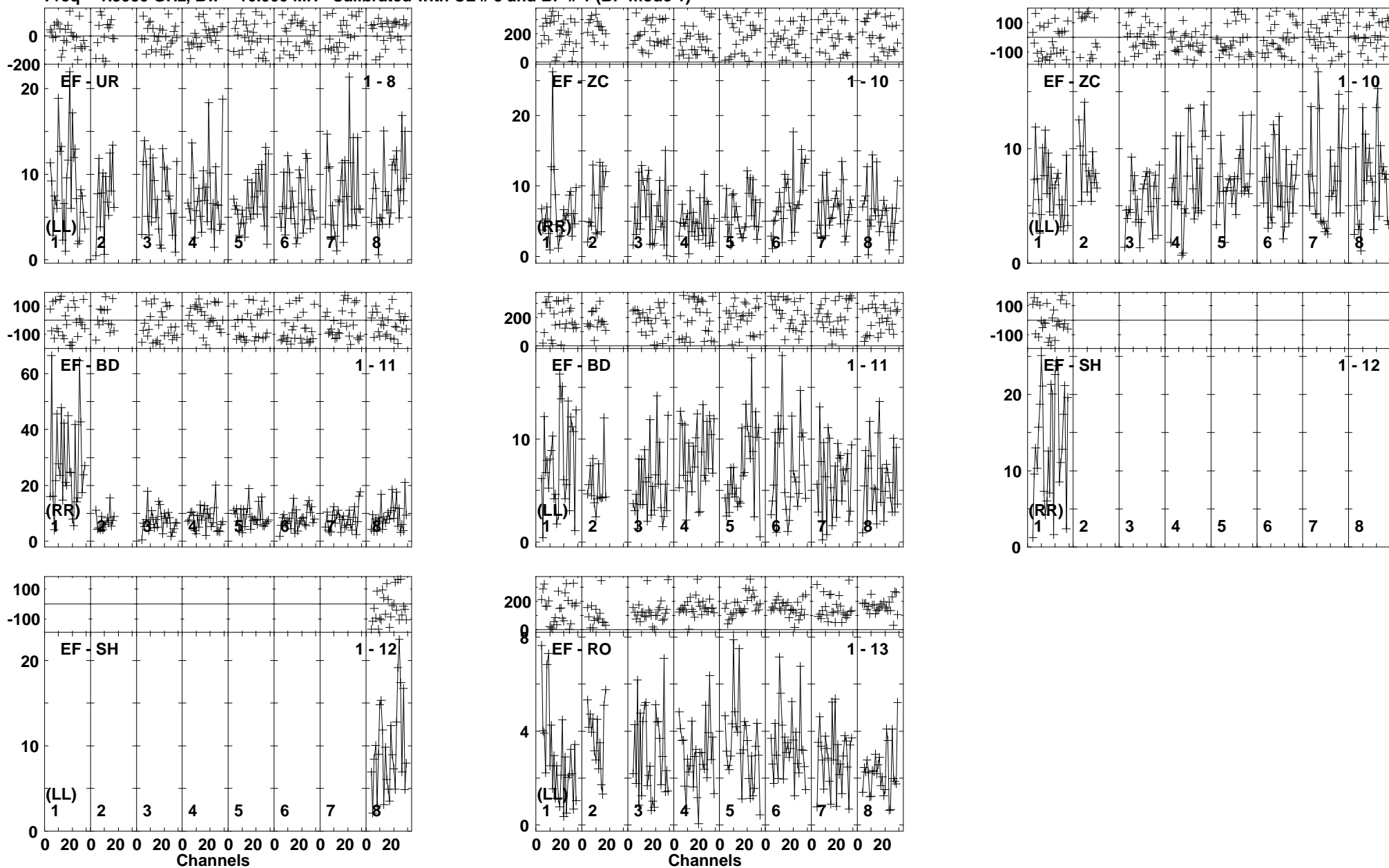

Lower frame: Milli Ampl Jy Top frame: Phas deg
 Vector averaged cross-power spectrum Baseline: EF (01) - UR (08)
 Timerange: 00/05:48:55 to 00/05:53:19

Plot file version 119 created 25-MAR-2014 17:51:15

J1128+5925 EP087E 1.UVDATA.1

Freq = 1.5950 GHz, Bw = 16.000 MH Calibrated with CL # 3 and BP # 1 (BP mode 1)

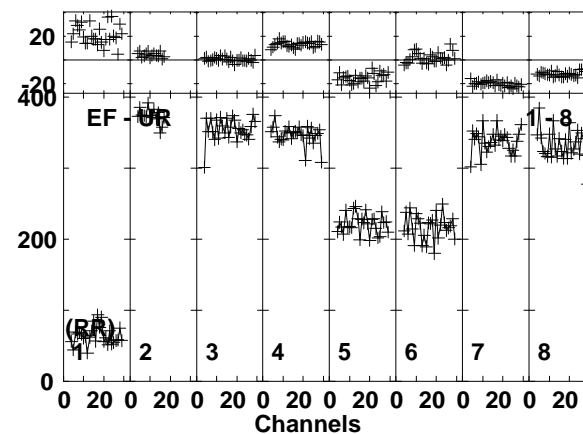
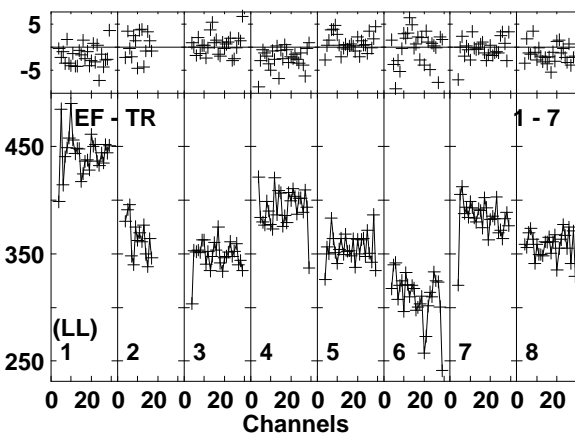
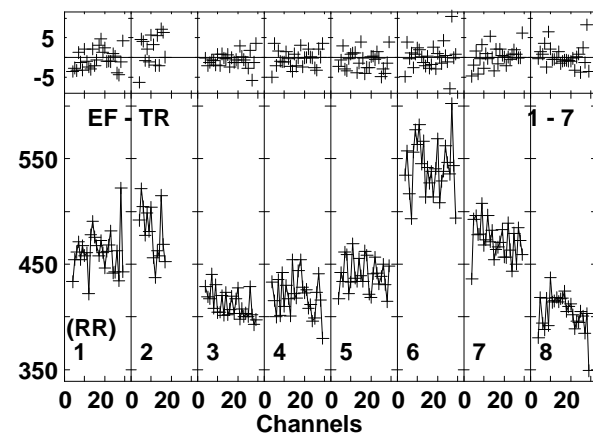
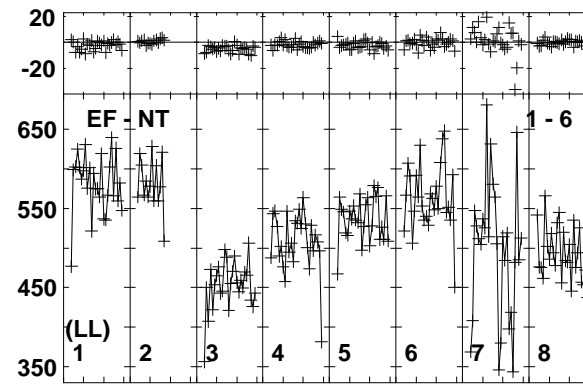
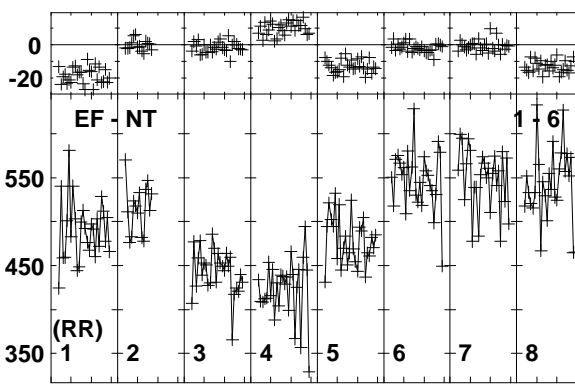
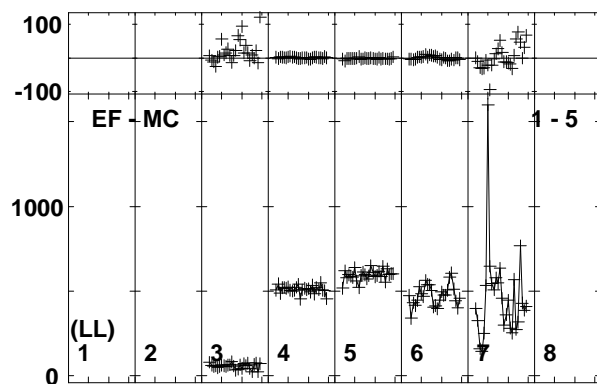
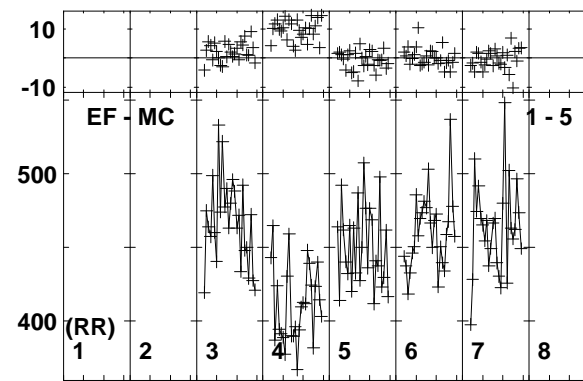
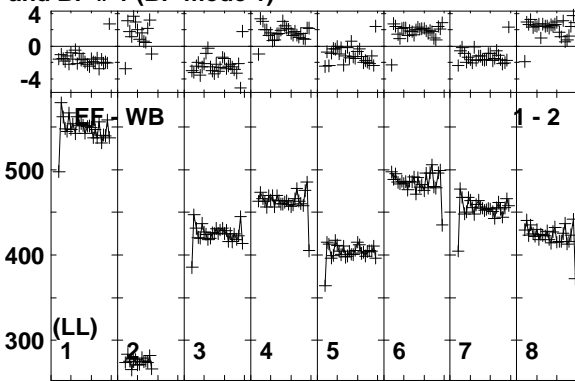
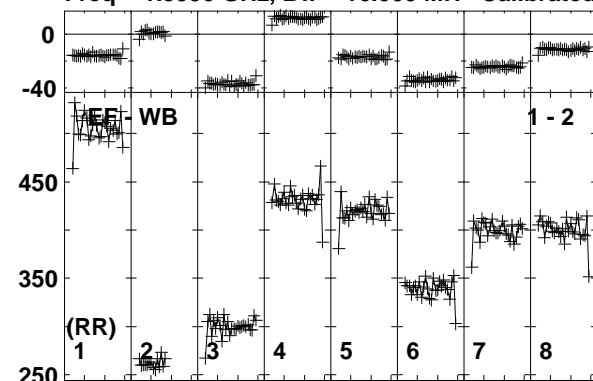

Lower frame: Milli Ampl Jy Top frame: Phas deg
Vector averaged cross-power spectrum Baseline: EF (01) - WB (02)
Timerange: 00/05:53:25 to 00/05:54:29

Plot file version 120 created 25-MAR-2014 17:51:15
 J1128+5925 EP087E 1.UVDATA.1
 Freq = 1.5950 GHz, Bw = 16.000 MH Calibrated with CL # 3 and BP # 1 (BP mode 1)

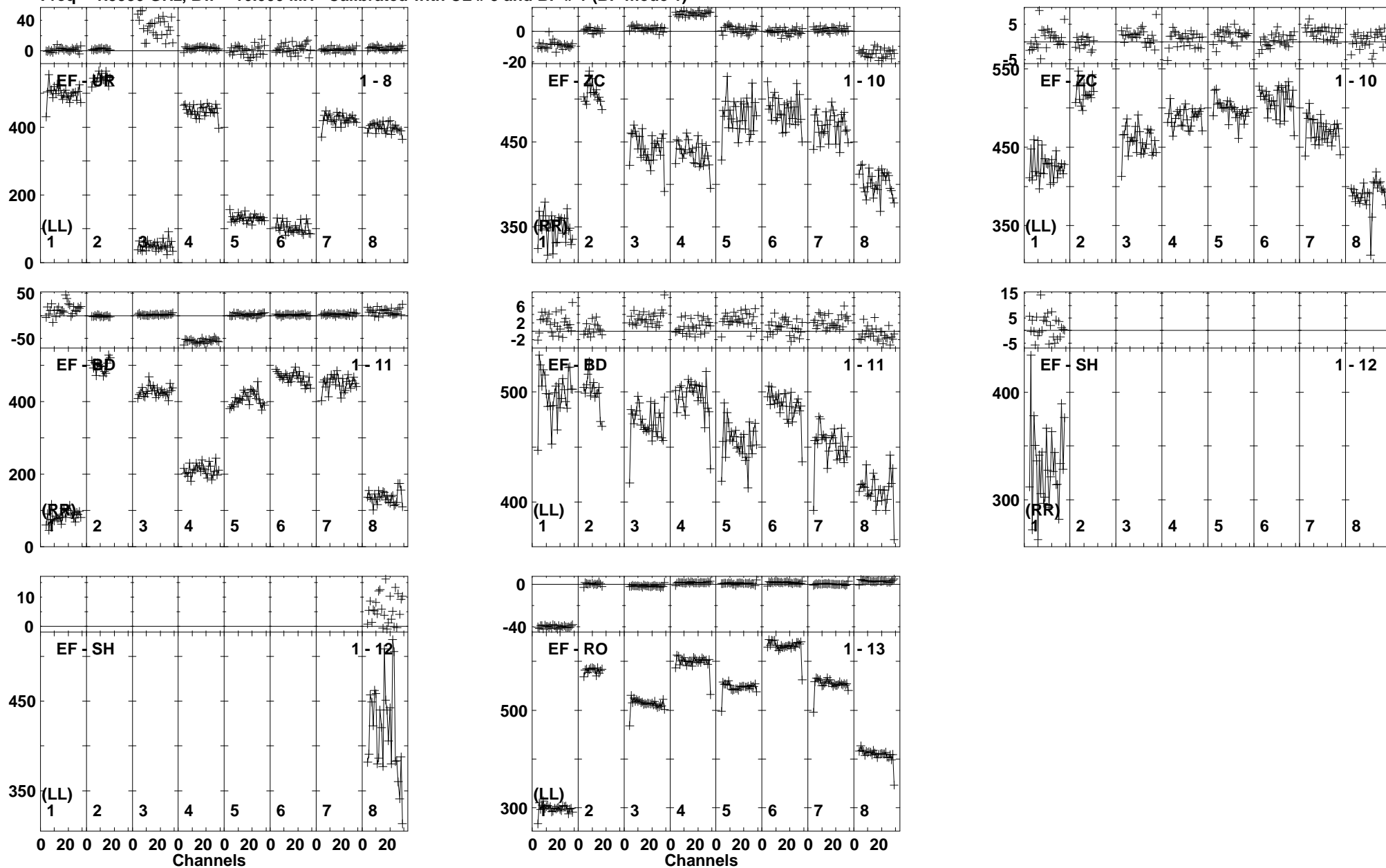

Lower frame: Milli Ampl Jy Top frame: Phas deg
 Vector averaged cross-power spectrum Baseline: EF (01) - UR (08)
 Timerange: 00/05:53:25 to 00/05:54:29

Plot file version 121 created 25-MAR-2014 17:51:16

ARP299A EP087E 1.UVDATA.1

Freq = 1.5950 GHz, Bw = 16.000 MH Calibrated with CL # 3 and BP # 1 (BP mode 1)

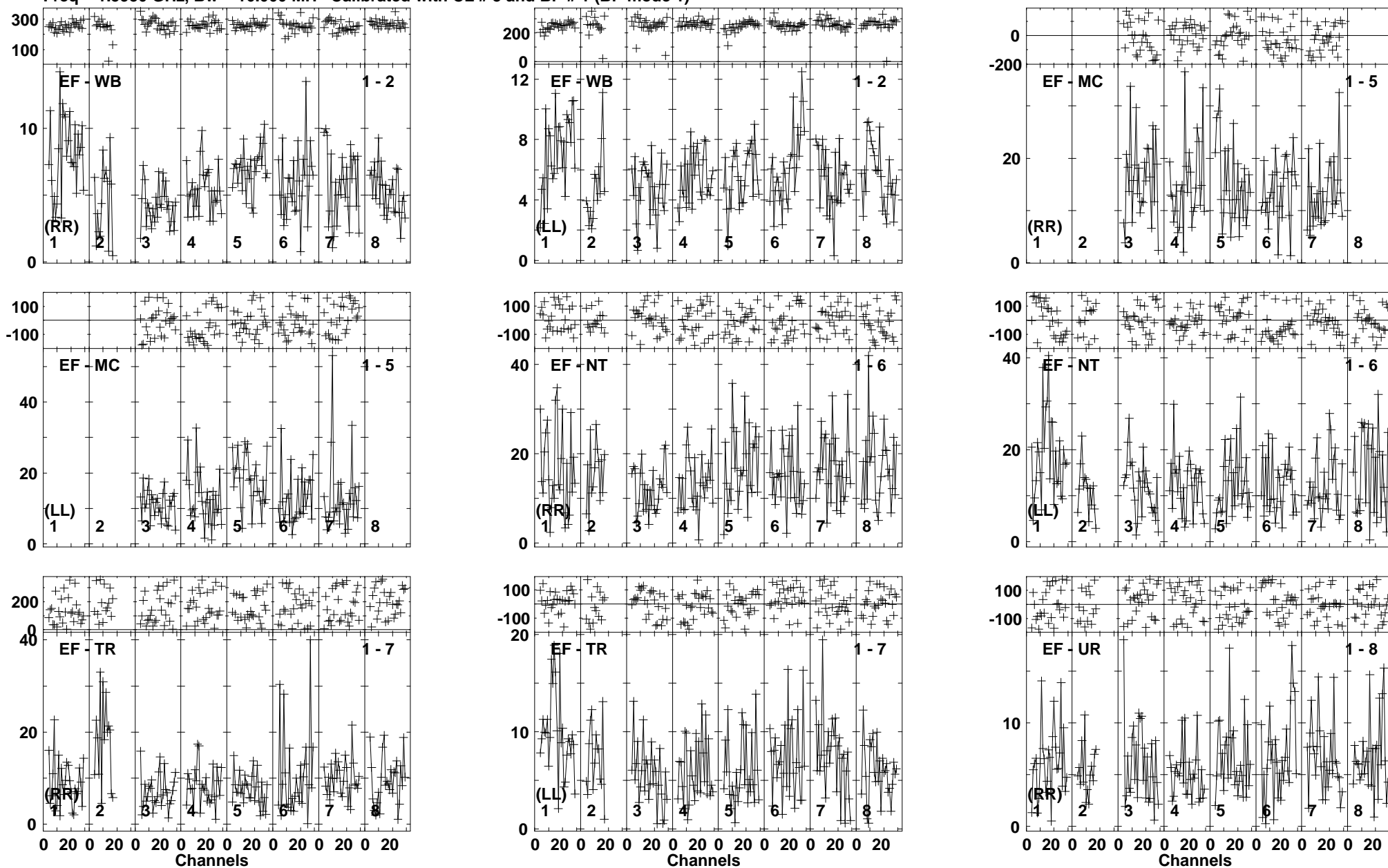

Lower frame: Milli Ampl Jy Top frame: Phas deg
Vector averaged cross-power spectrum Baseline: EF (01) - WB (02)
Timerange: 00/05:54:31 to 00/05:58:59

Plot file version 122 created 25-MAR-2014 17:51:16

ARP299A EP087E 1.UVDATA.1

Freq = 1.5950 GHz, Bw = 16.000 MH Calibrated with CL # 3 and BP # 1 (BP mode 1)

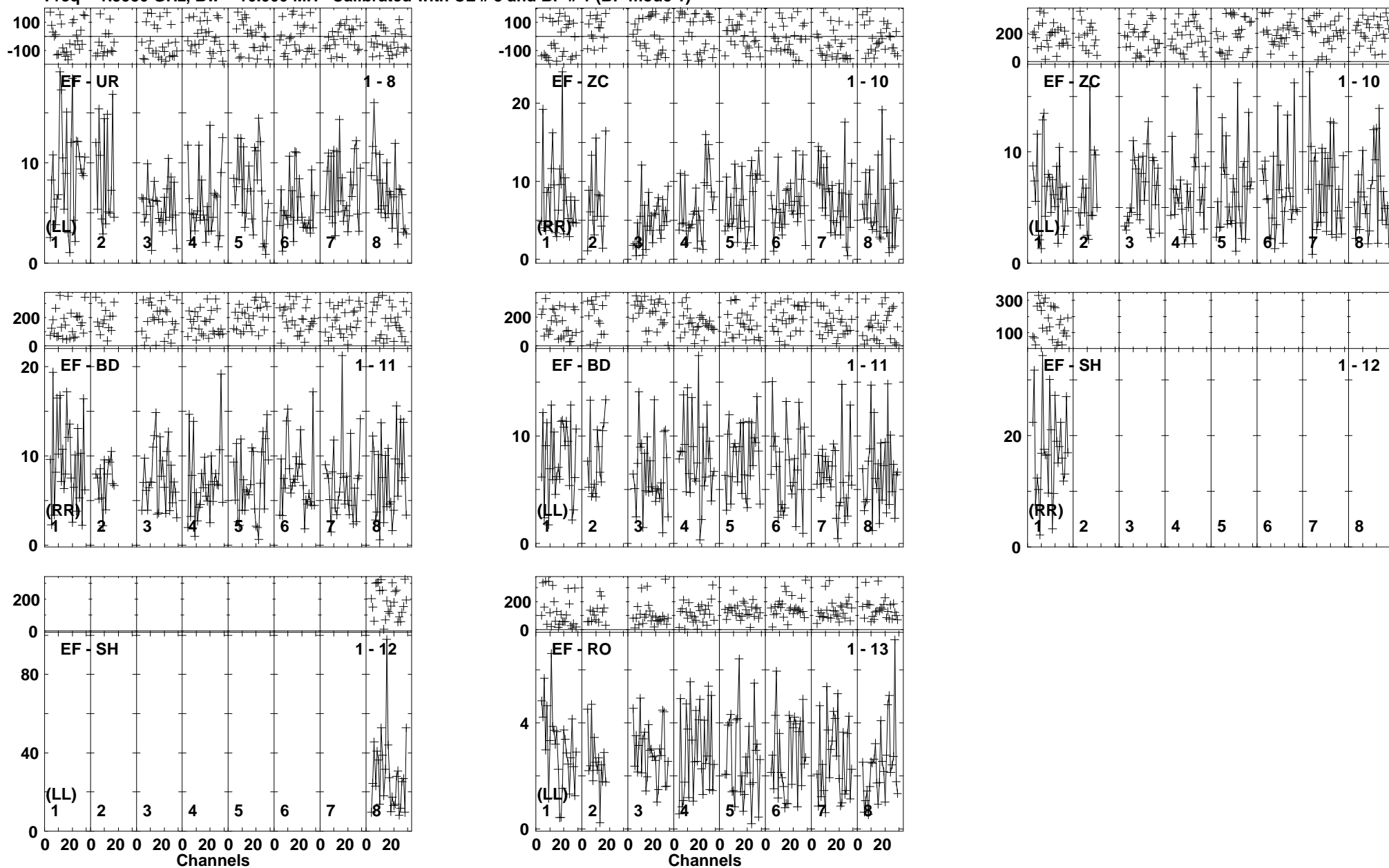

Lower frame: Milli Ampl Jy Top frame: Phas deg
Vector averaged cross-power spectrum Baseline: EF (01) - UR (08)
Timerange: 00/05:54:31 to 00/05:58:59

Plot file version 123 created 25-MAR-2014 17:51:16

J1128+5925 EP087E 1.UVDATA.1

Freq = 1.5950 GHz, Bw = 16.000 MH Calibrated with CL # 3 and BP # 1 (BP mode 1)

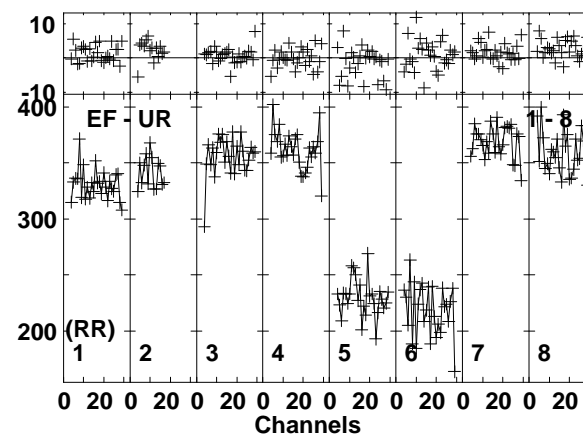
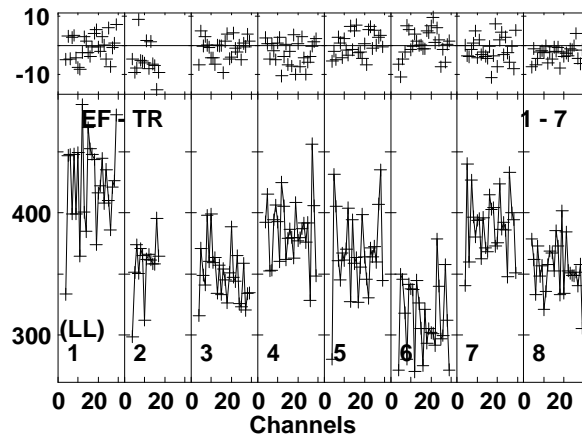
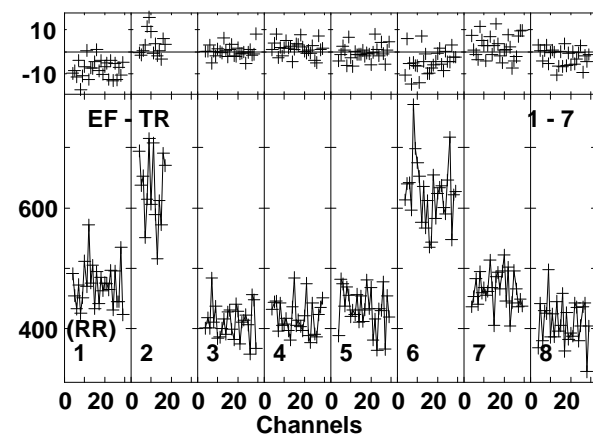
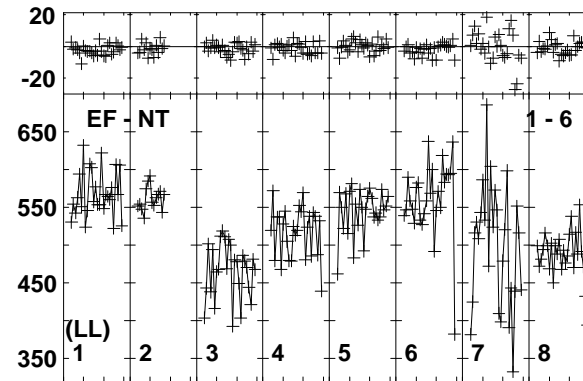
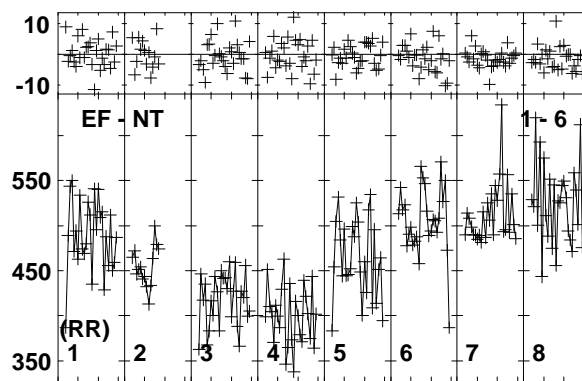
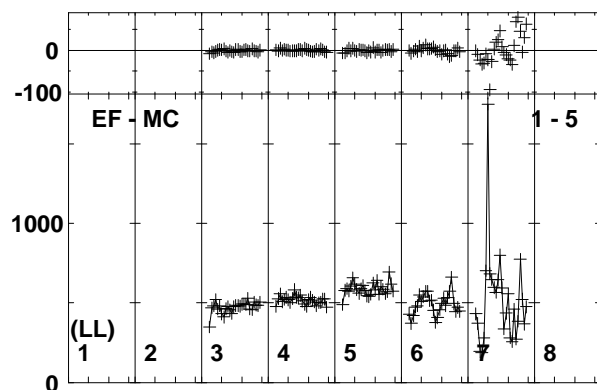
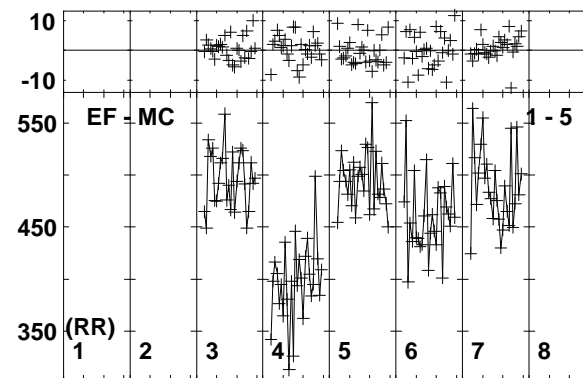
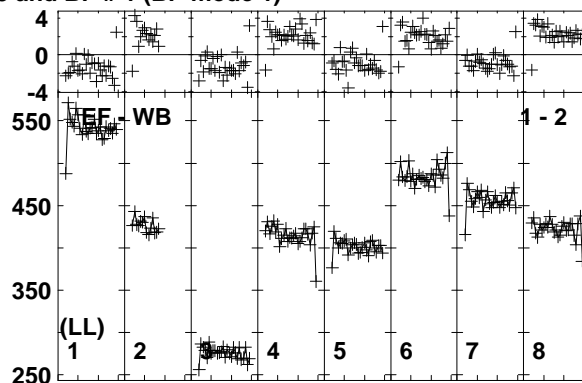
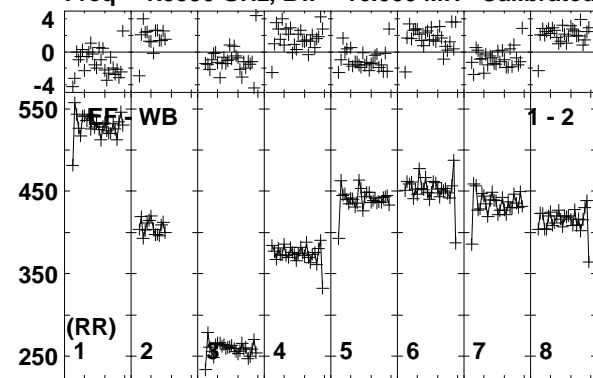

Lower frame: Milli Ampl Jy Top frame: Phas deg
Vector averaged cross-power spectrum Baseline: EF (01) - WB (02)
Timerange: 00/05:59:41 to 00/06:00:09

Plot file version 124 created 25-MAR-2014 17:51:16

J1128+5925 EP087E 1.UVDATA.1

Freq = 1.5950 GHz, Bw = 16.000 MH Calibrated with CL # 3 and BP # 1 (BP mode 1)

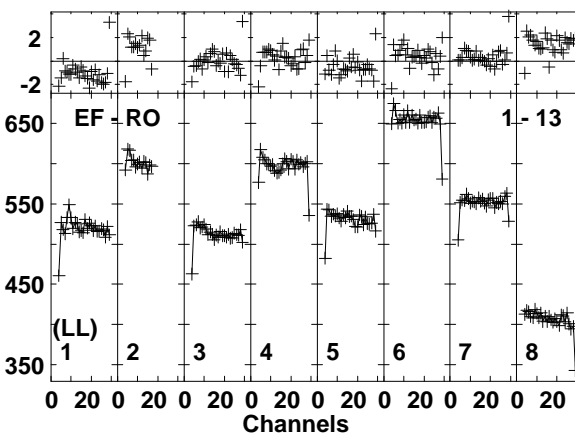
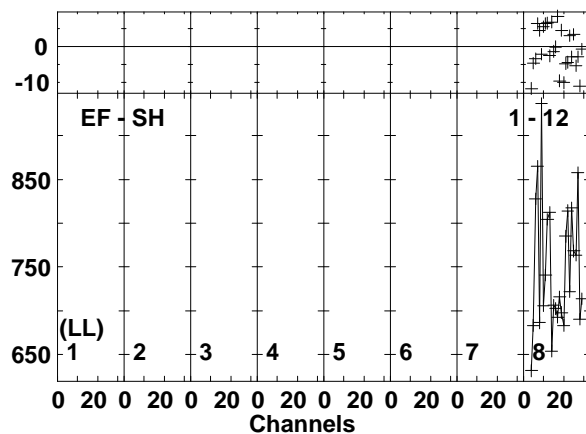
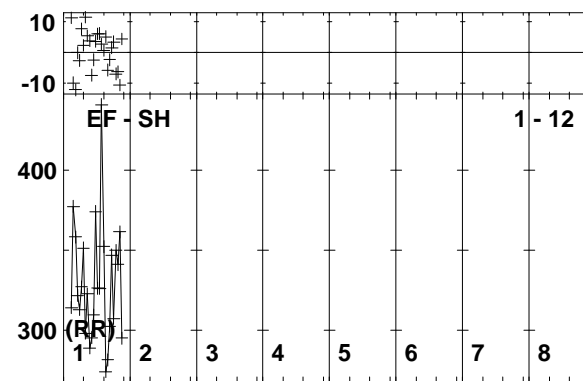
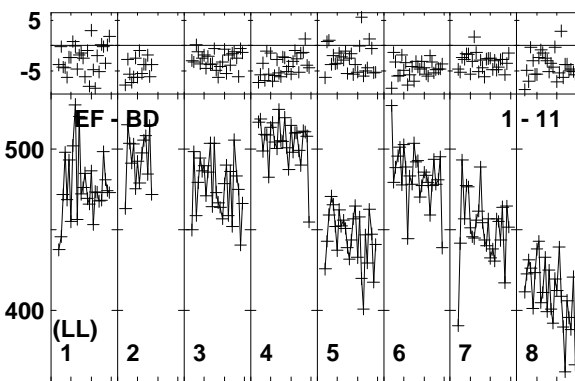
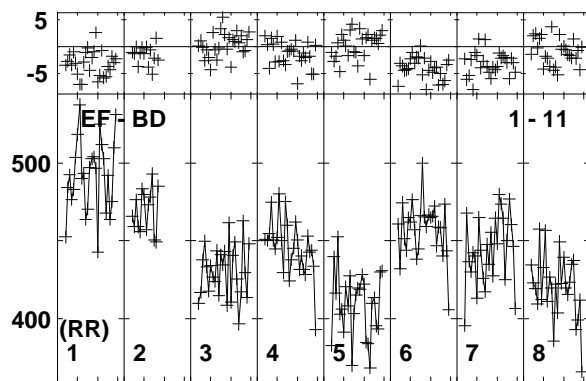
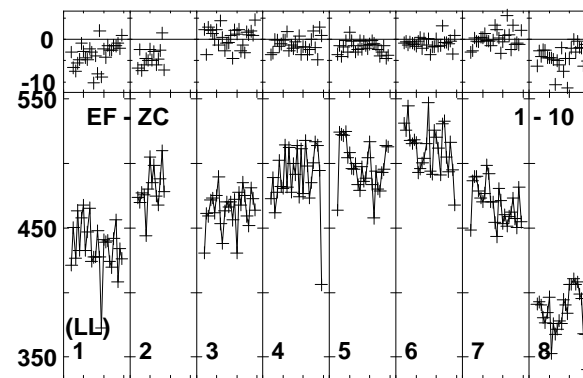
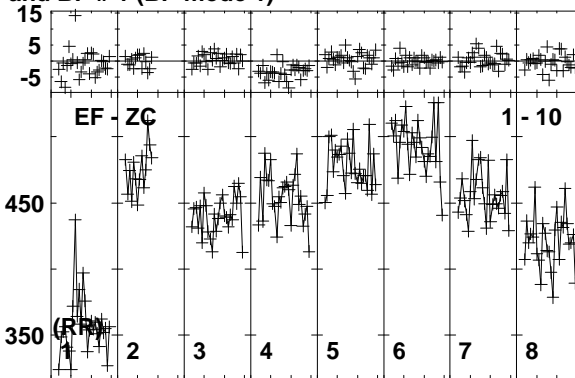
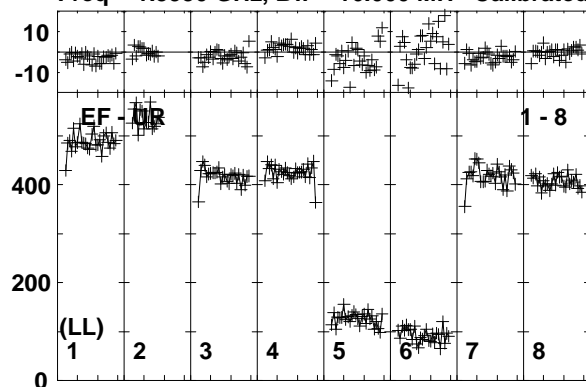

Lower frame: Milli Ampl Jy Top frame: Phas deg
Vector averaged cross-power spectrum Baseline: EF (01) - UR (08)
Timerange: 00/05:59:41 to 00/06:00:09

Plot file version 125 created 25-MAR-2014 17:51:17

ARP299A EP087E 1.UVDATA.1

Freq = 1.5950 GHz, Bw = 16.000 MH Calibrated with CL # 3 and BP # 1 (BP mode 1)

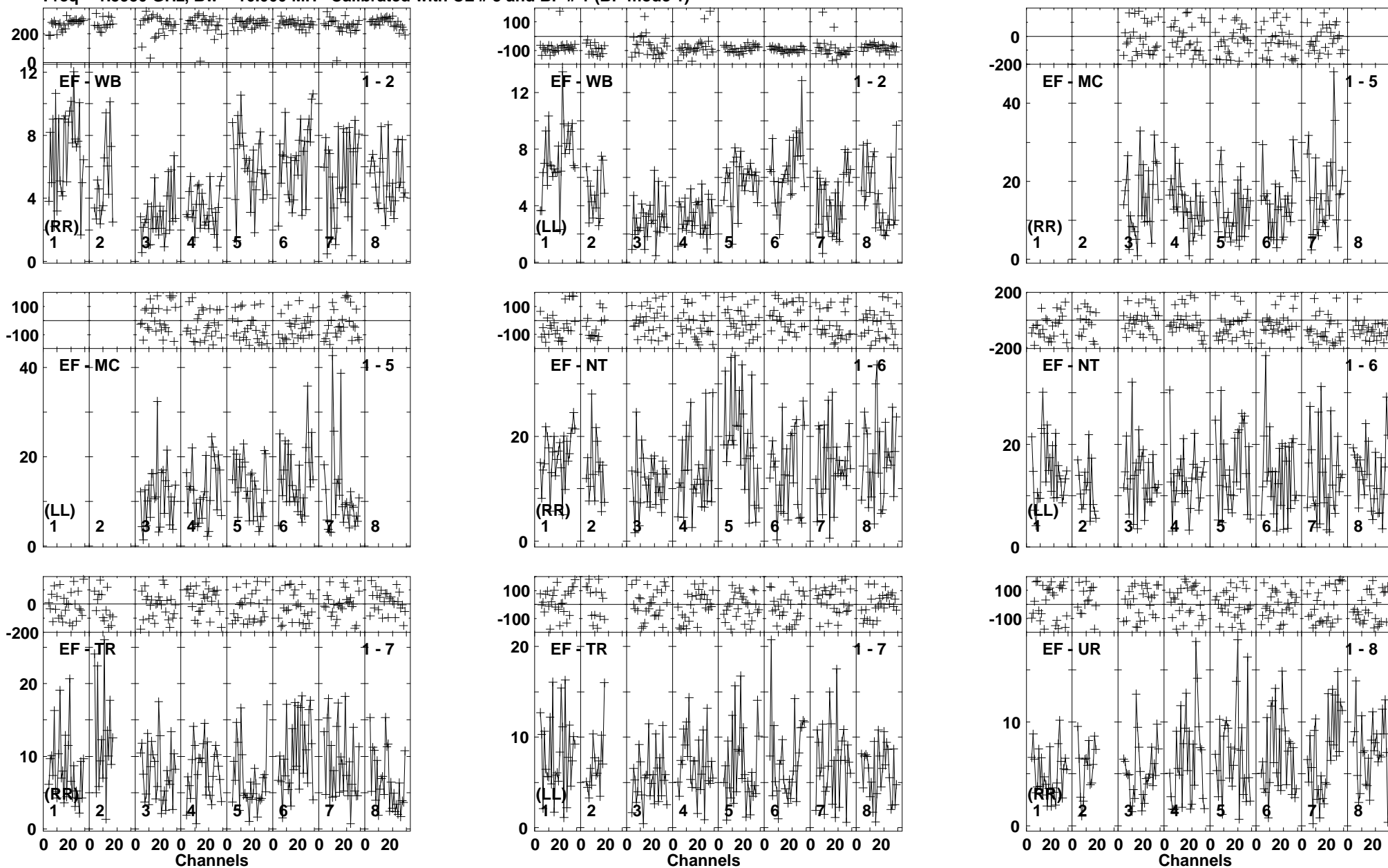

Lower frame: Milli Ampl Jy Top frame: Phas deg
Vector averaged cross-power spectrum Baseline: EF (01) - WB (02)
Timerange: 00/06:00:15 to 00/06:04:39

Plot file version 126 created 25-MAR-2014 17:51:17
 ARP299A EP087E 1.UVDATA.1
 Freq = 1.5950 GHz, Bw = 16.000 MH Calibrated with CL # 3 and BP # 1 (BP mode 1)

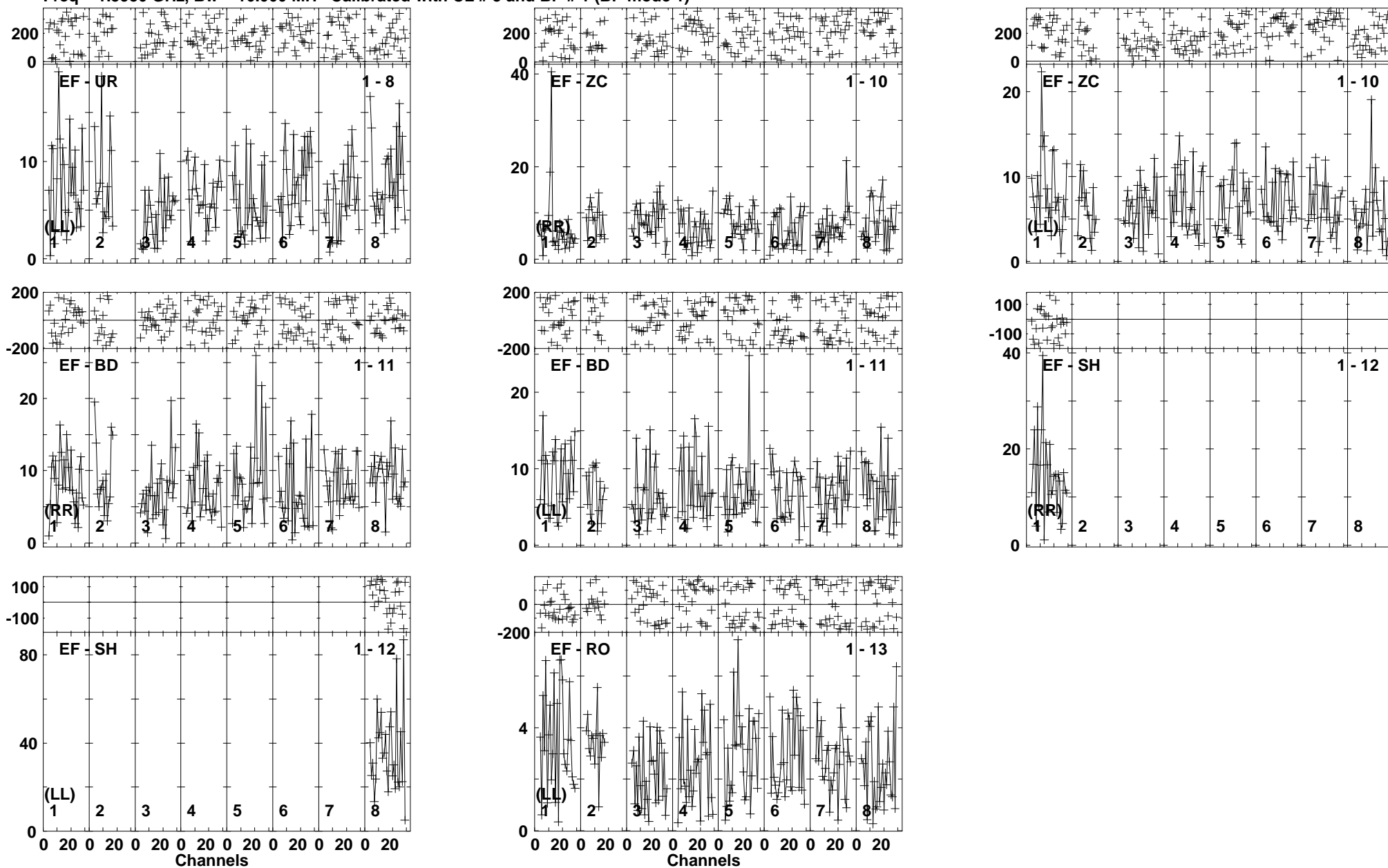

Lower frame: Milli Ampl Jy Top frame: Phas deg
 Vector averaged cross-spectrum Baseline: EF (01) - UR (08)
 Timerange: 00/06:00:15 to 00/06:04:39

Plot file version 127 created 25-MAR-2014 17:51:17

J1128+5925 EP087E 1.UVDATA.1

Freq = 1.5950 GHz, Bw = 16.000 MH Calibrated with CL # 3 and BP # 1 (BP mode 1)

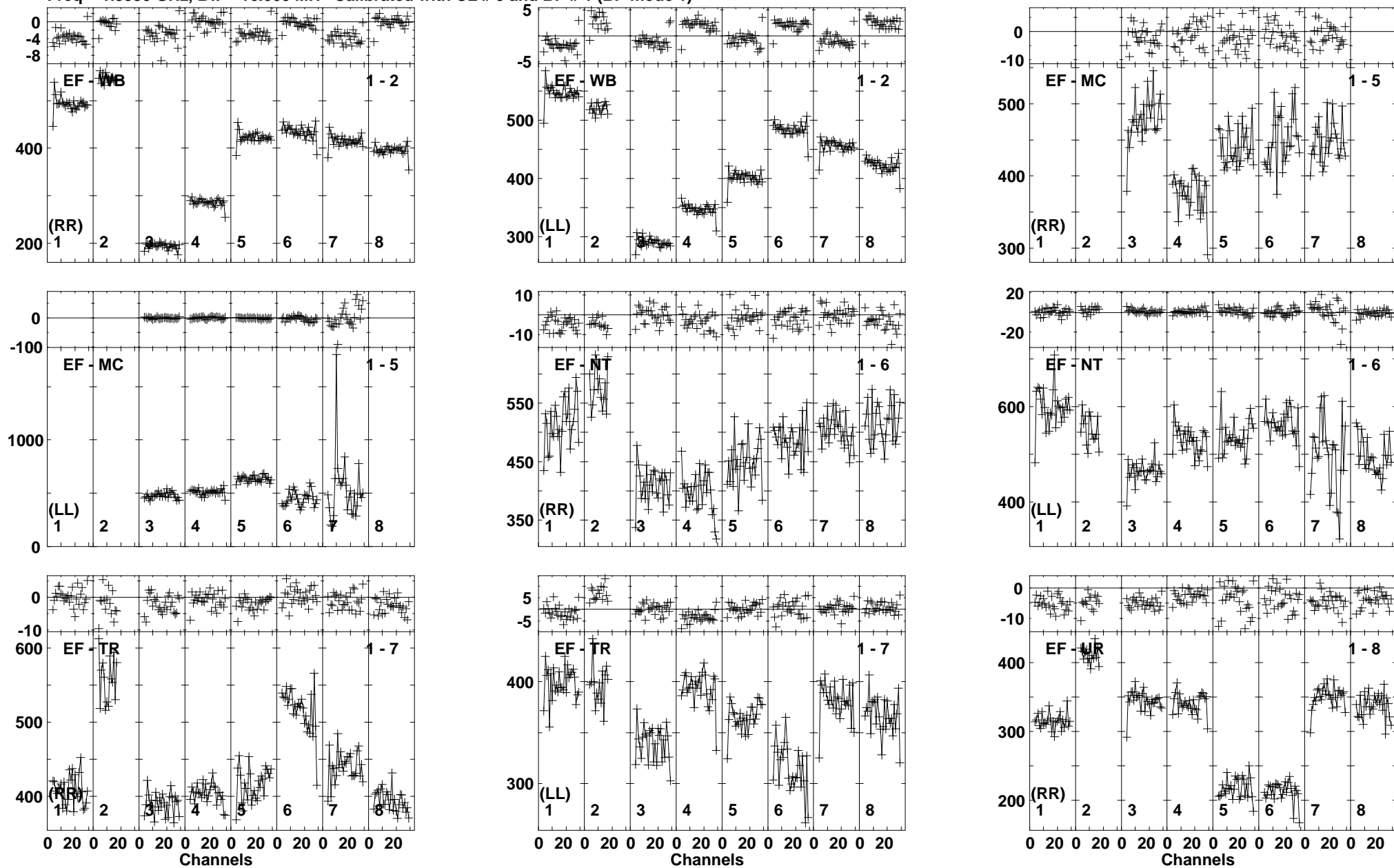

Plot file version 128 created 25-MAR-2014 17:51:18

J1128+5925 EP087E 1.UVDATA.1

Freq = 1.5950 GHz, Bw = 16.000 MH Calibrated with CL # 3 and BP # 1 (BP mode 1)

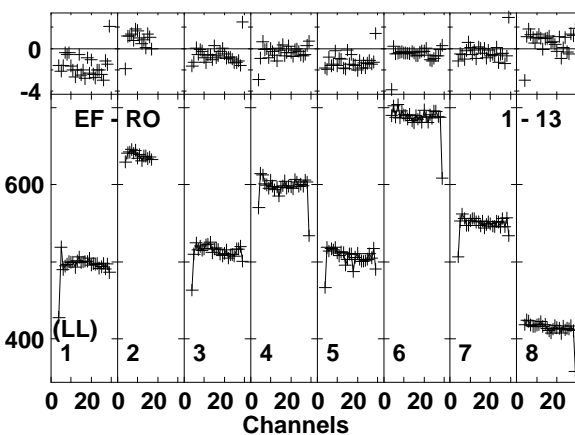
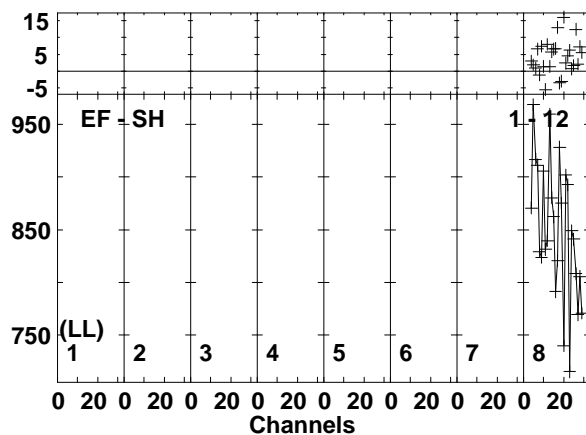
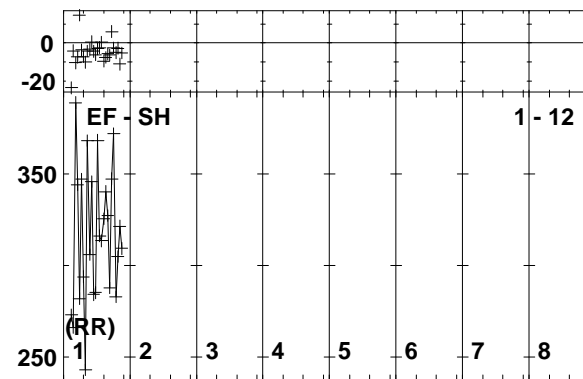
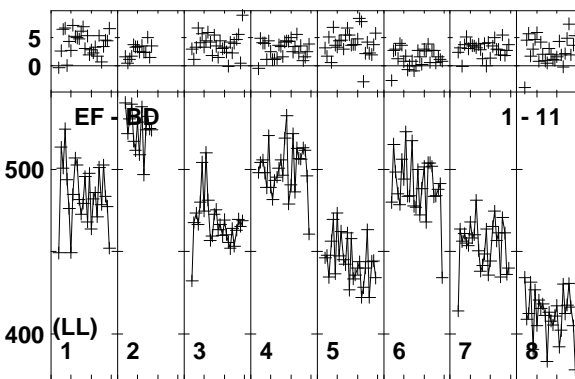
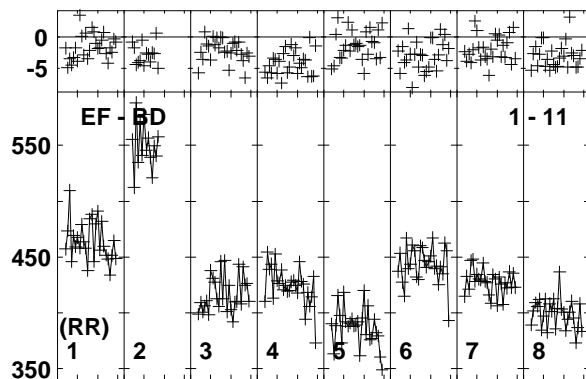
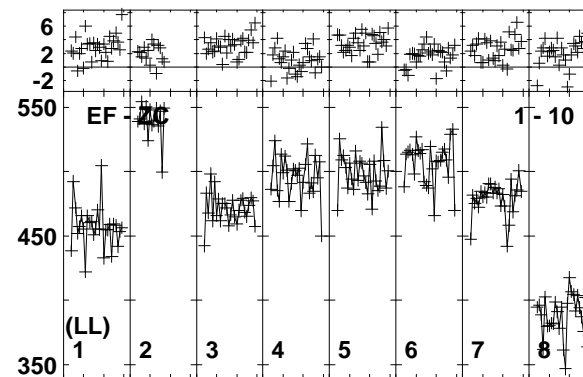
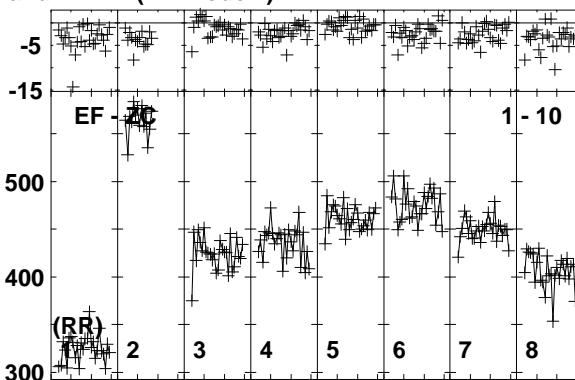
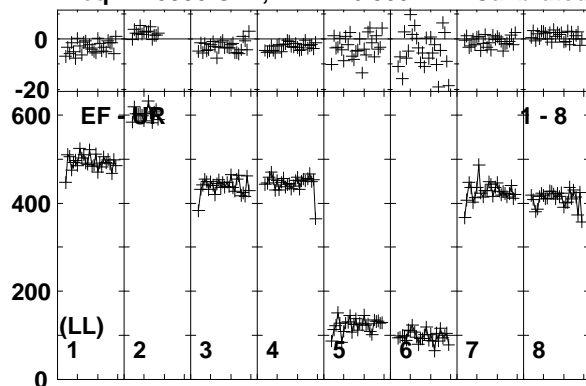

Lower frame: Milli Ampl Jy Top frame: Phas deg
Vector averaged cross-power spectrum Baseline: EF (01) - UR (08)
Timerange: 00/06:04:45 to 00/06:05:49

Plot file version 129 created 25-MAR-2014 17:51:18

ARP299A EP087E 1.UVDATA.1

Freq = 1.5950 GHz, Bw = 16.000 MH Calibrated with CL # 3 and BP # 1 (BP mode 1)

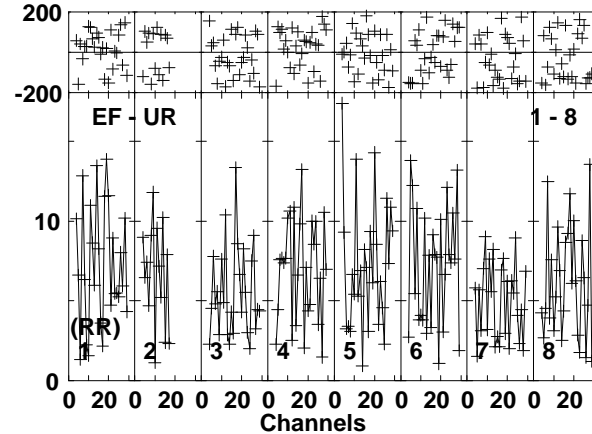
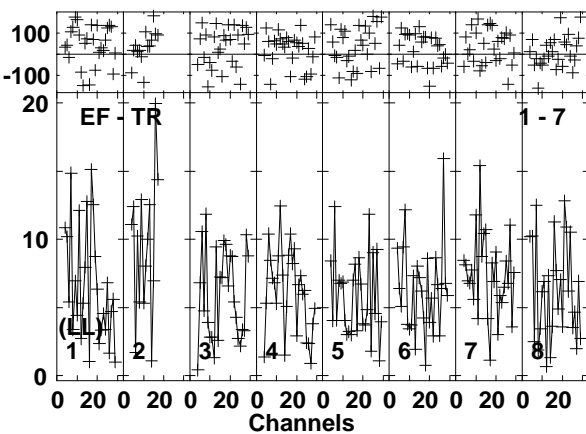
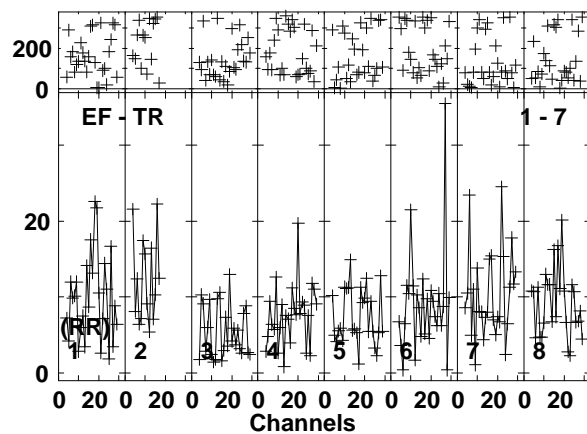
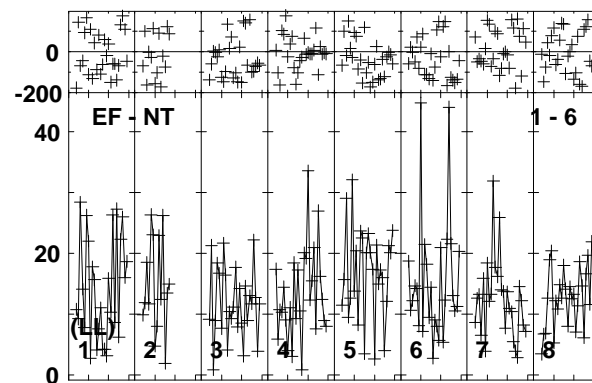
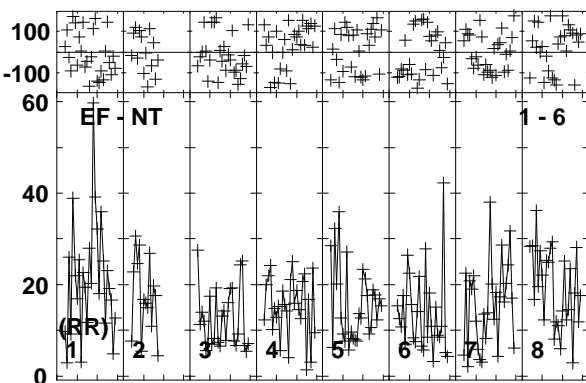
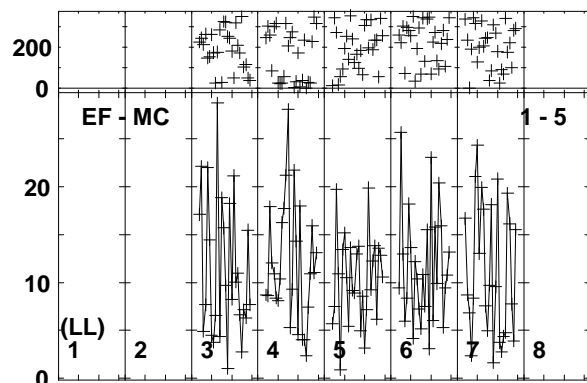
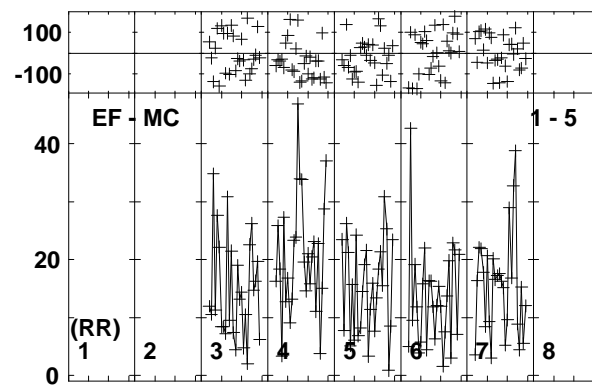
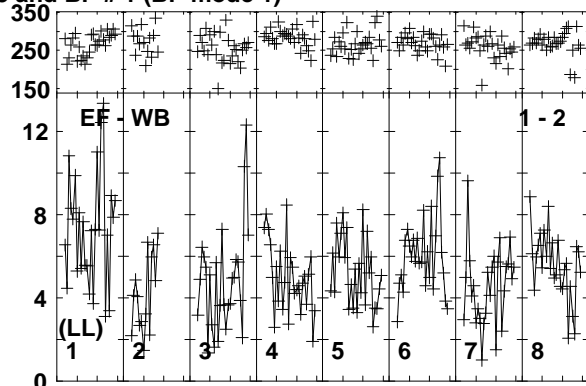
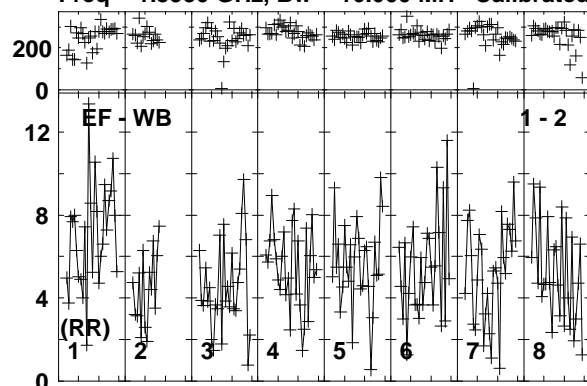

Lower frame: Milli Ampl Jy Top frame: Phas deg
Vector averaged cross-power spectrum Baseline: EF (01) - WB (02)
Timerange: 00/06:05:51 to 00/06:10:19

Plot file version 130 created 25-MAR-2014 17:51:18

ARP299A EP087E 1.UVDATA.1

Freq = 1.5950 GHz, Bw = 16.000 MH Calibrated with CL # 3 and BP # 1 (BP mode 1)

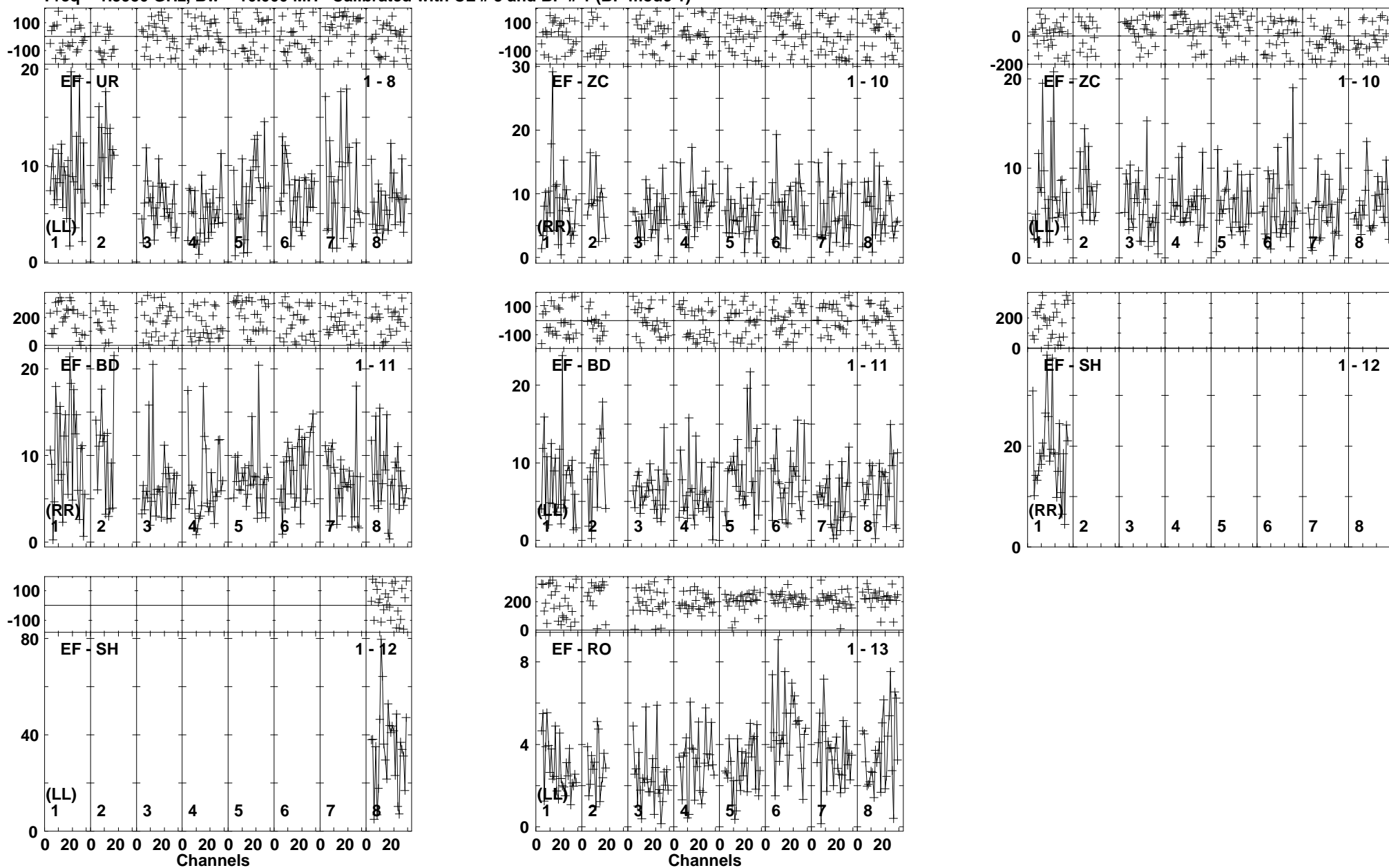

Lower frame: Milli Ampl Jy Top frame: Phas deg
Vector averaged cross-power spectrum Baseline: EF (01) - UR (08)
Timerange: 00/06:05:51 to 00/06:10:19

Plot file version 131 created 25-MAR-2014 17:51:19

J1128+5925 EP087E 1.UVDATA.1

Freq = 1.5950 GHz, Bw = 16.000 MH Calibrated with CL # 3 and BP # 1 (BP mode 1)

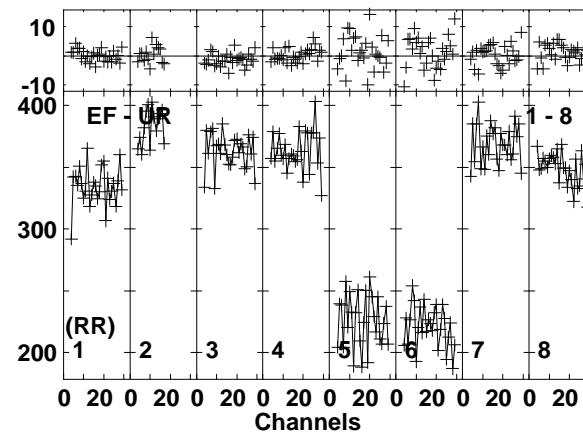
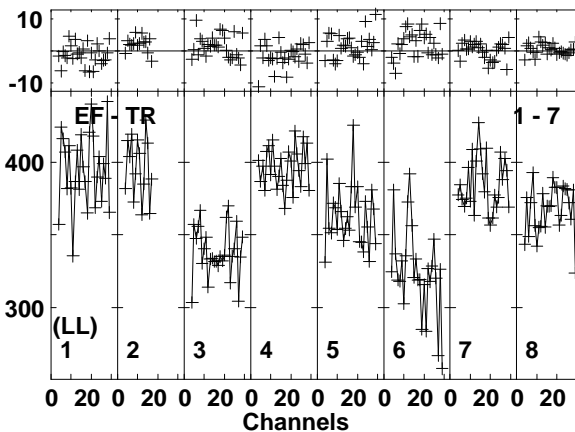
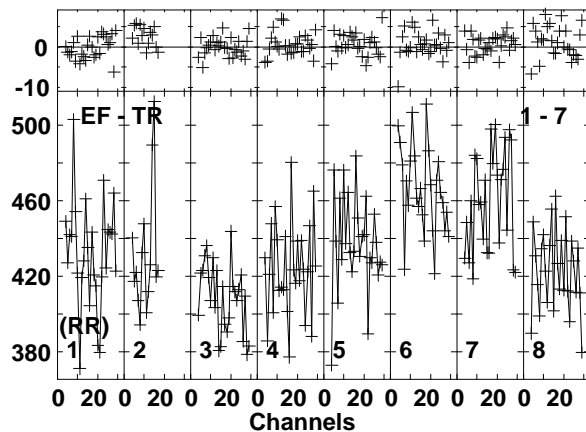
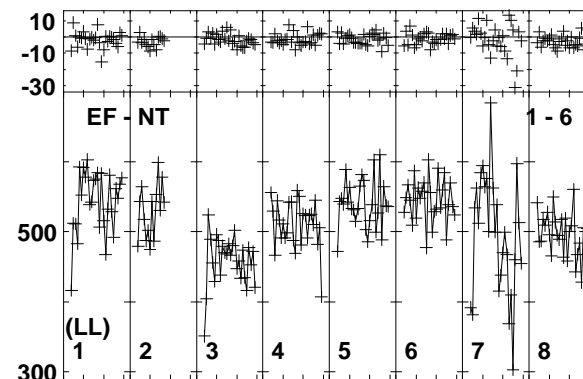
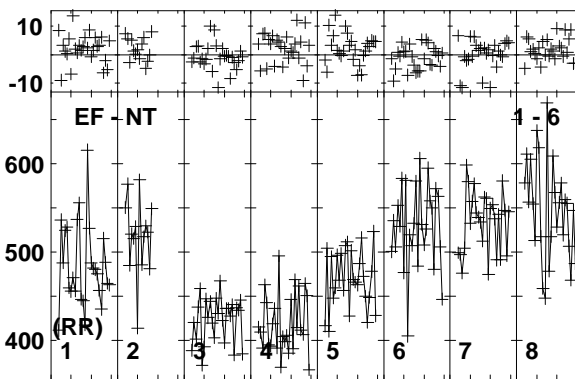
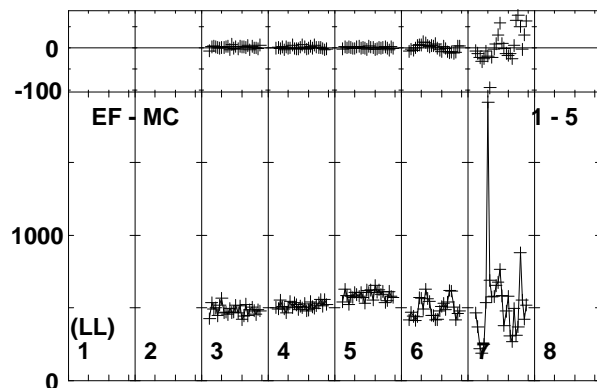
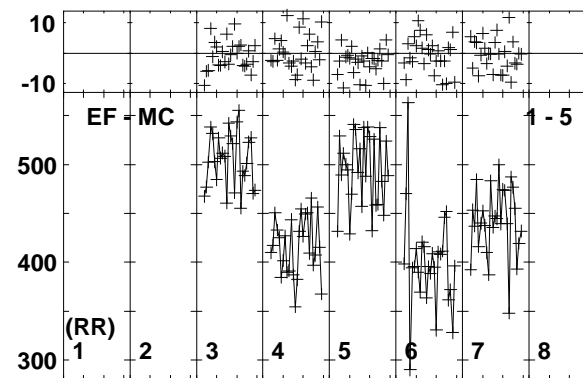
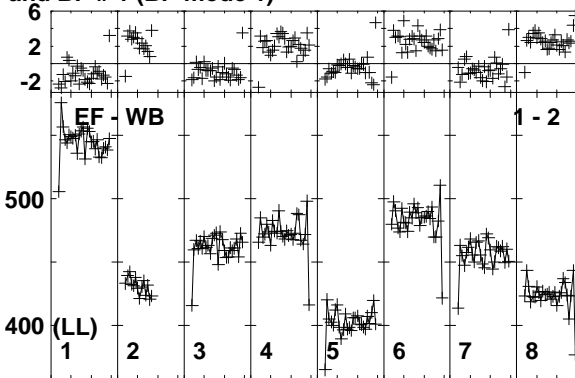
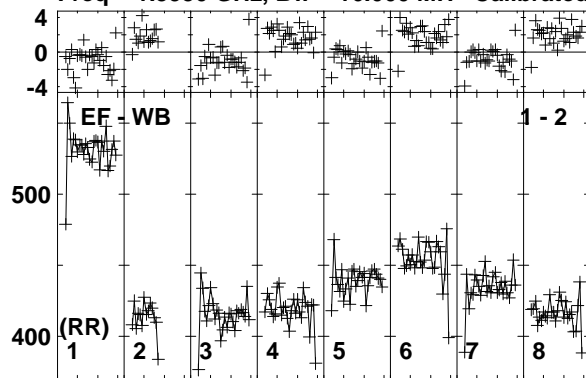

Lower frame: Milli Ampl Jy Top frame: Phas deg
Vector averaged cross-power spectrum Baseline: EF (01) - WB (02)
Timerange: 00/06:11:01 to 00/06:11:29

Plot file version 132 created 25-MAR-2014 17:51:19

J1128+5925 EP087E 1.UVDATA.1

Freq = 1.5950 GHz, Bw = 16.000 MH Calibrated with CL # 3 and BP # 1 (BP mode 1)

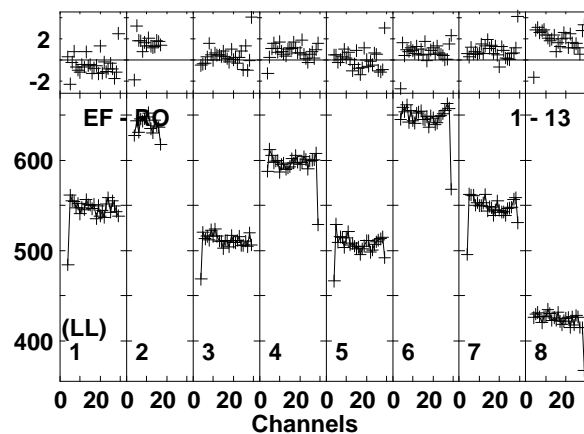
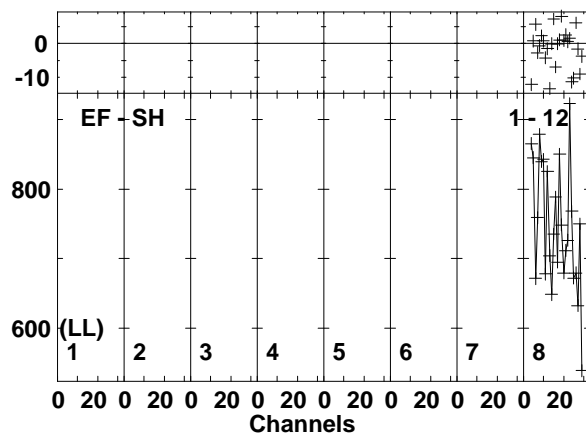
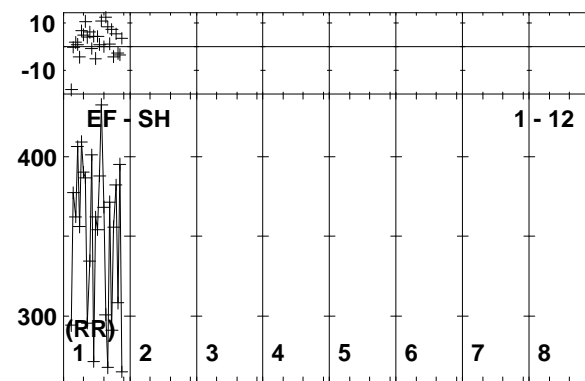
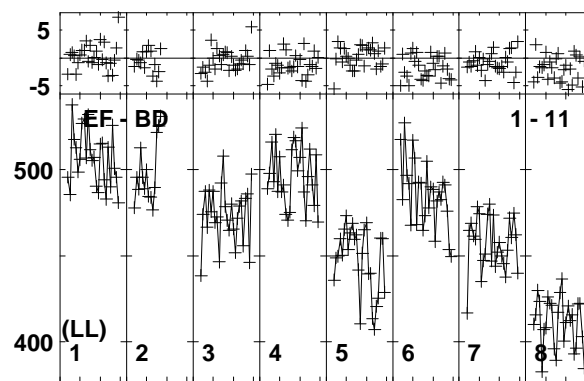
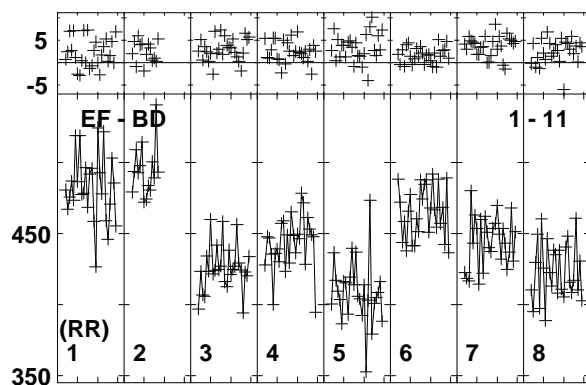
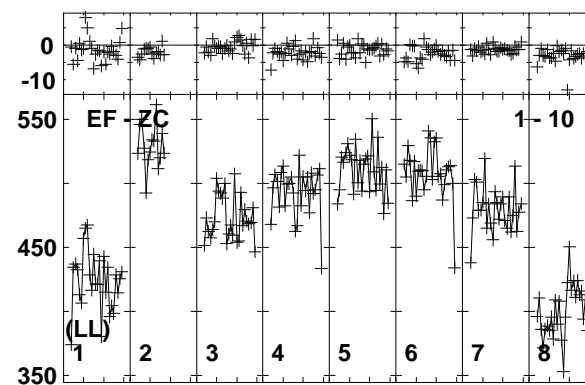
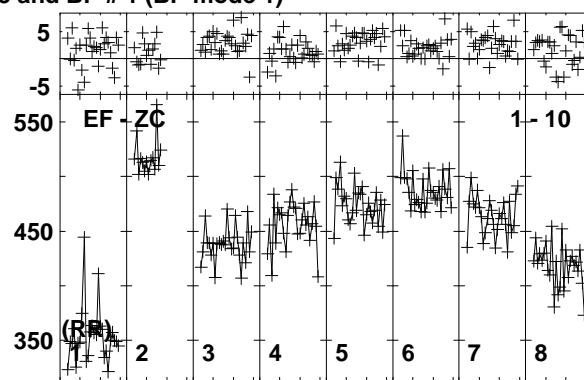
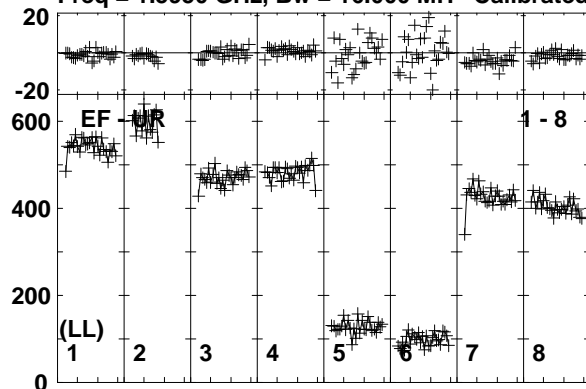

Lower frame: Milli Ampl Jy Top frame: Phas deg
Vector averaged cross-power spectrum Baseline: EF (01) - UR (08)
Timerange: 00/06:11:01 to 00/06:11:29

Plot file version 133 created 25-MAR-2014 17:51:19

ARP299A EP087E 1.UVDATA.1

Freq = 1.5950 GHz, Bw = 16.000 MH Calibrated with CL # 3 and BP # 1 (BP mode 1)

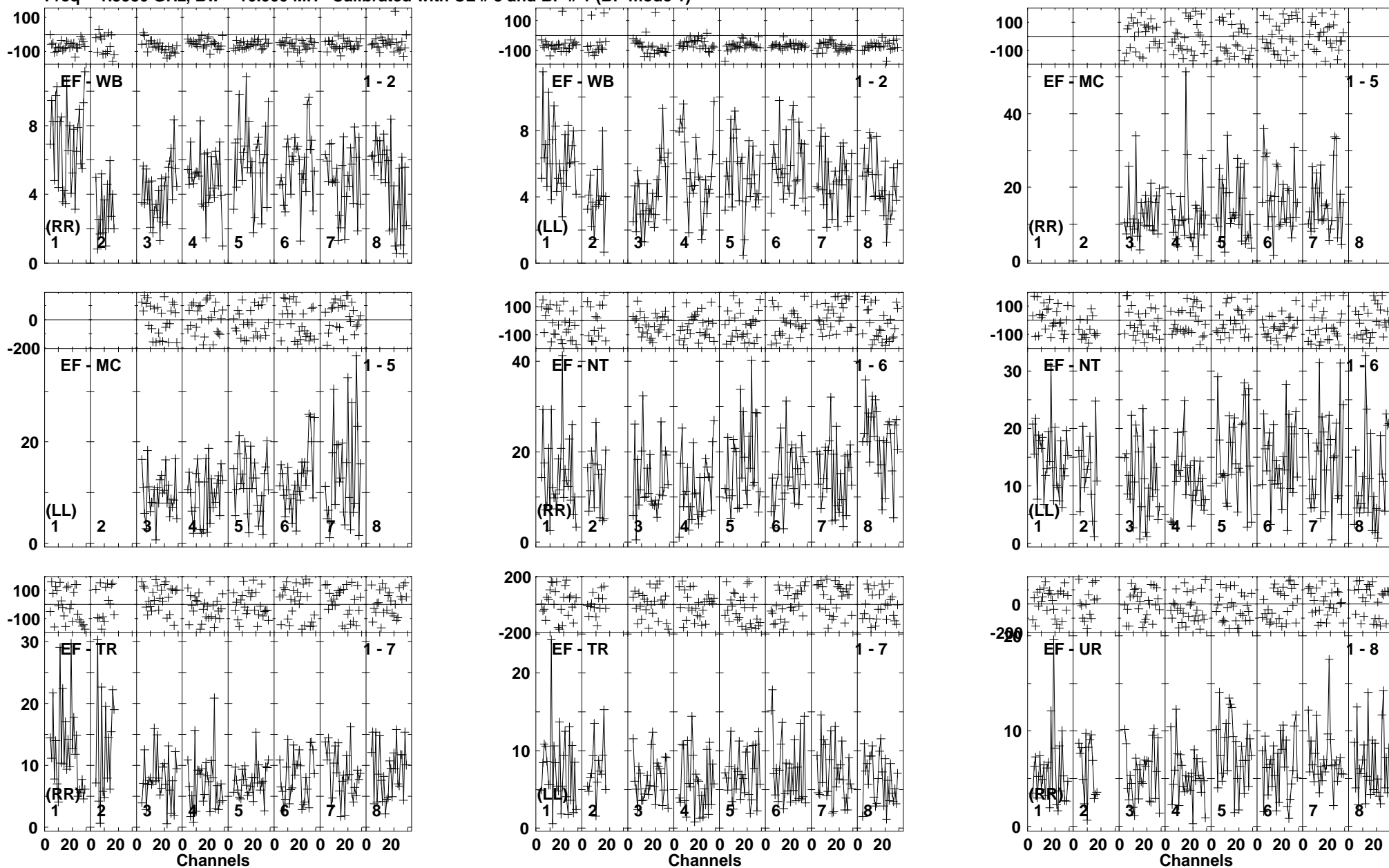

Lower frame: Milli Ampl Jy Top frame: Phas deg
Vector averaged cross-power spectrum Baseline: EF (01) - WB (02)
Timerange: 00/06:11:35 to 00/06:15:59

Plot file version 134 created 25-MAR-2014 17:51:19

ARP299A EP087E 1.UVDATA.1

Freq = 1.5950 GHz, Bw = 16.000 MH Calibrated with CL # 3 and BP # 1 (BP mode 1)

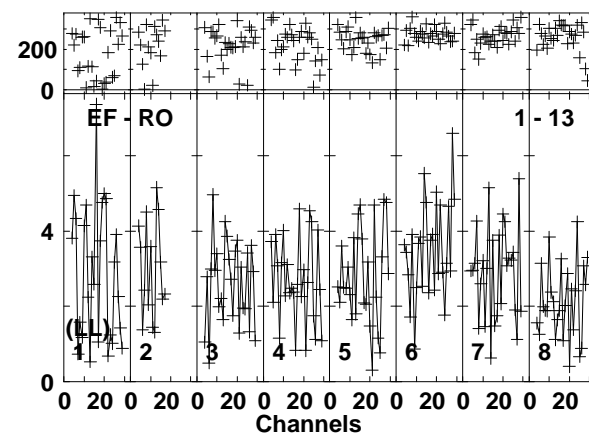
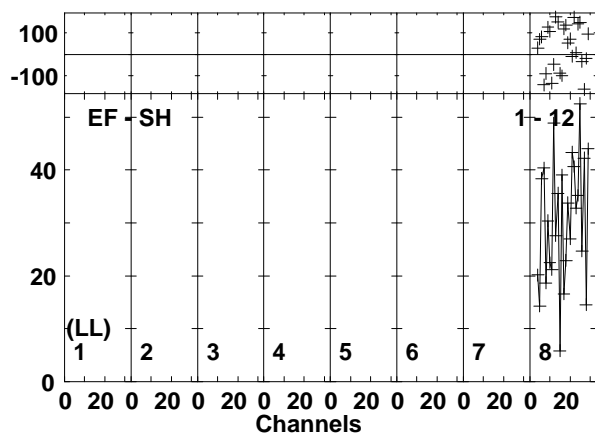
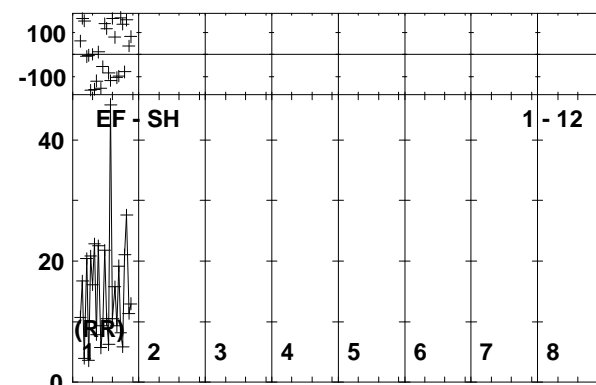
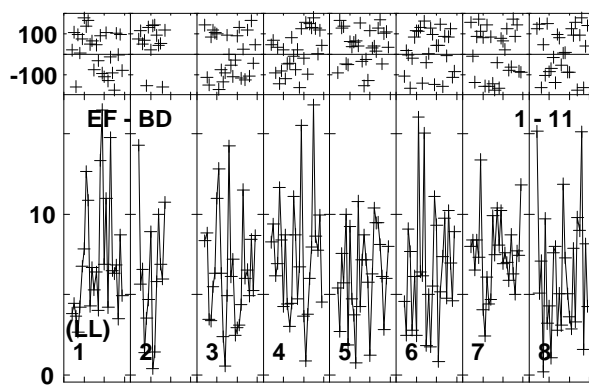
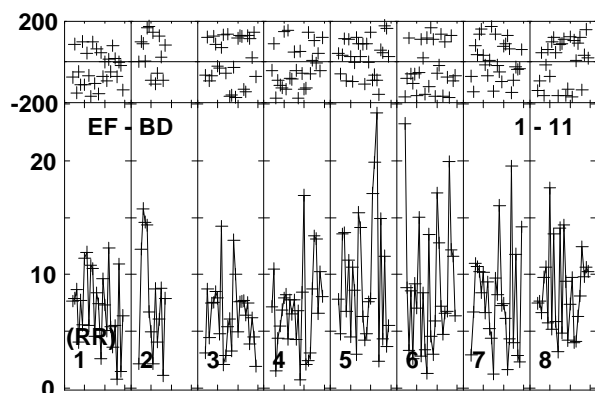
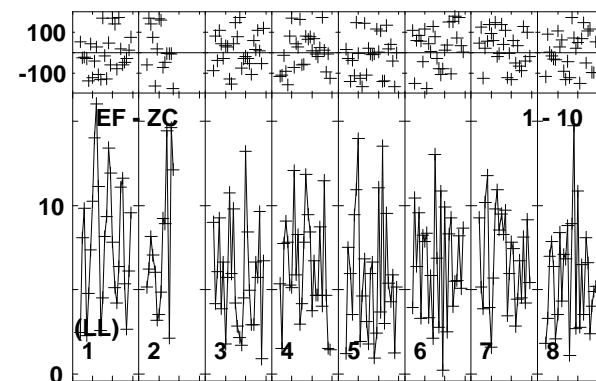
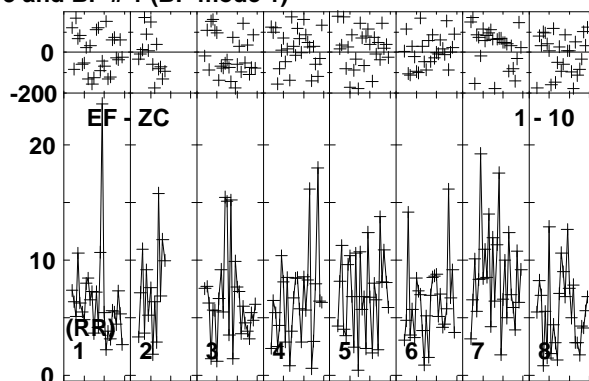
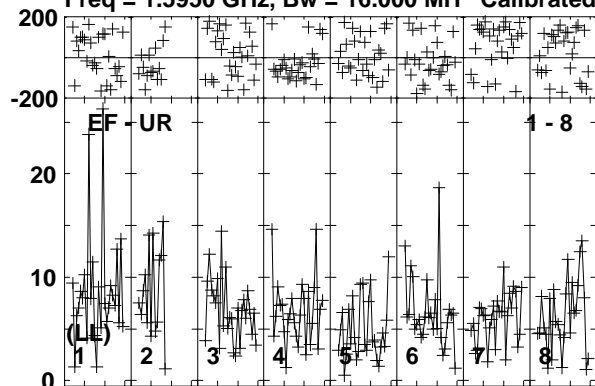

Lower frame: Milli Ampl Jy Top frame: Phas deg
Vector averaged cross-power spectrum Baseline: EF (01) - UR (08)
Timerange: 00/06:11:35 to 00/06:15:59

Plot file version 135 created 25-MAR-2014 17:51:20

J1128+5925 EP087E 1.UVDATA.1

Freq = 1.5950 GHz, Bw = 16.000 MH Calibrated with CL # 3 and BP # 1 (BP mode 1)

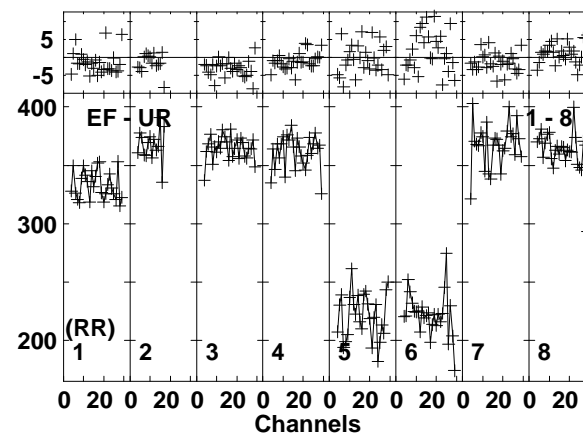
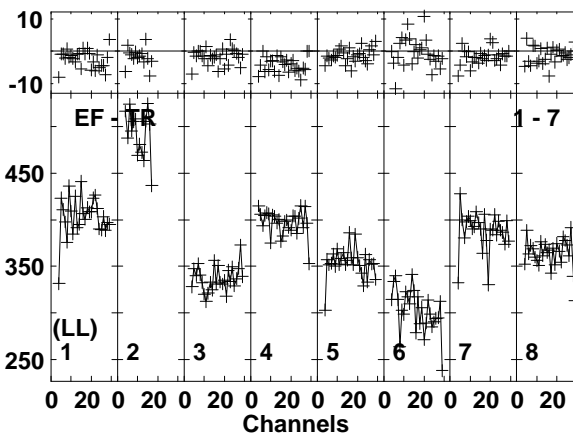
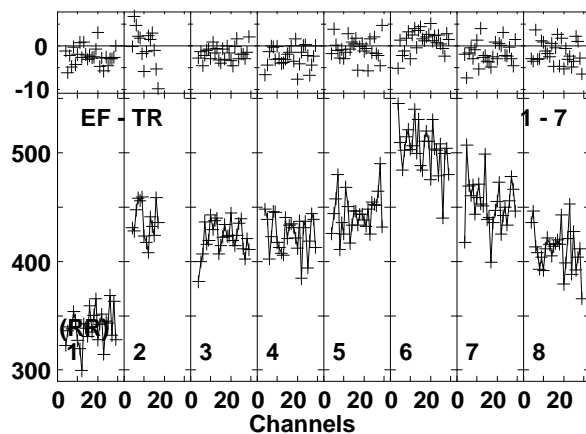
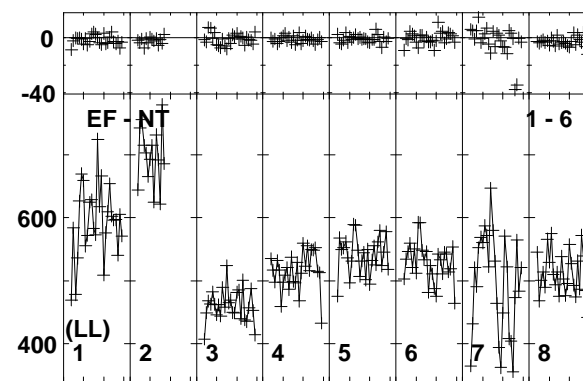
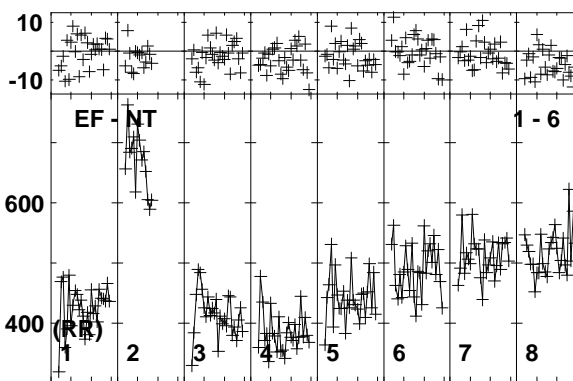
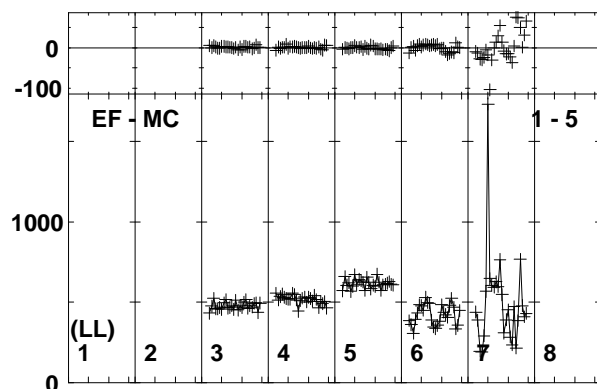
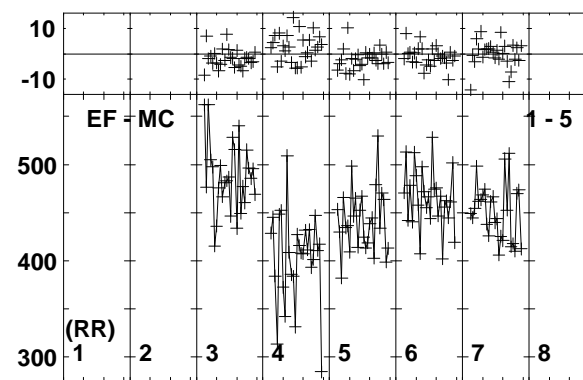
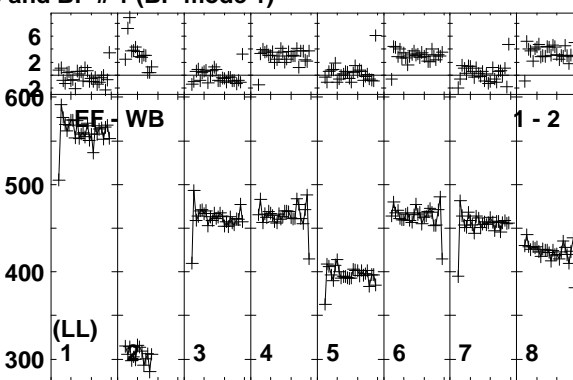
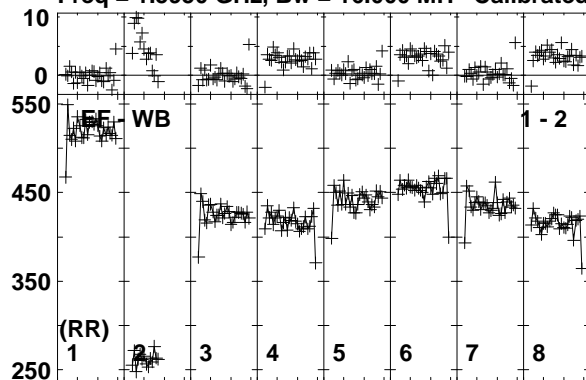

Lower frame: Milli Ampl Jy Top frame: Phas deg
Vector averaged cross-power spectrum Baseline: EF (01) - WB (02)
Timerange: 00/06:16:05 to 00/06:16:59

Plot file version 136 created 25-MAR-2014 17:51:20

J1128+5925 EP087E 1.UVDATA.1

Freq = 1.5950 GHz, Bw = 16.000 MH Calibrated with CL # 3 and BP # 1 (BP mode 1)

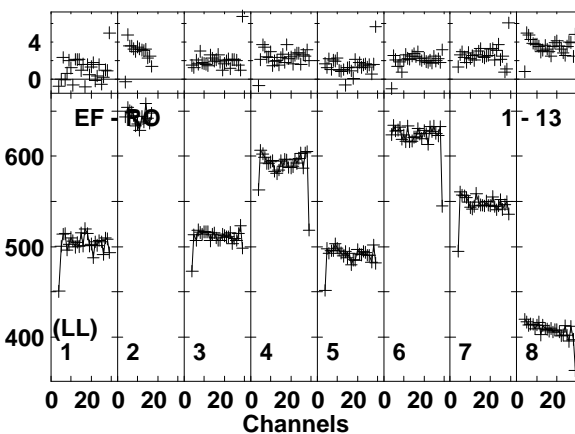
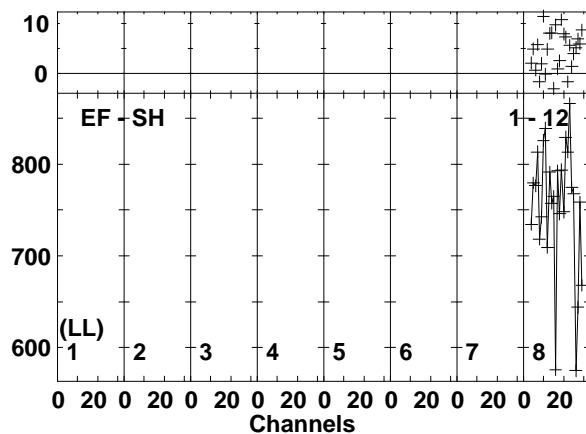
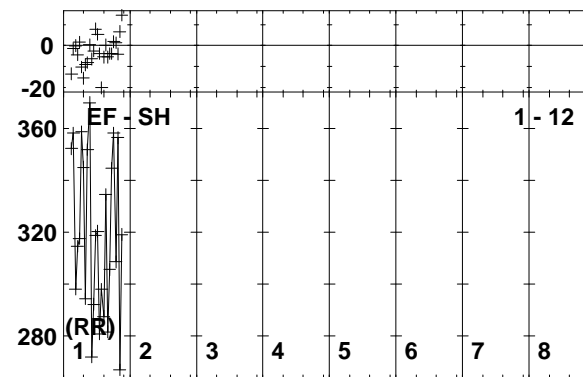
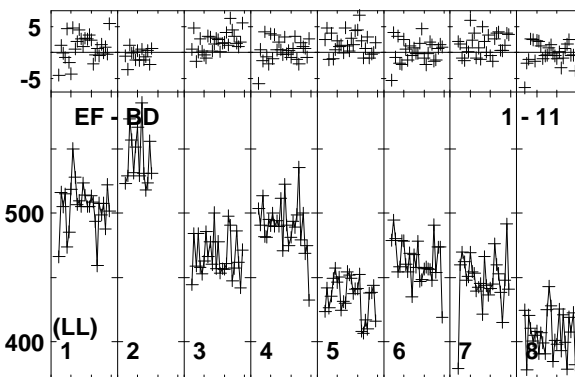
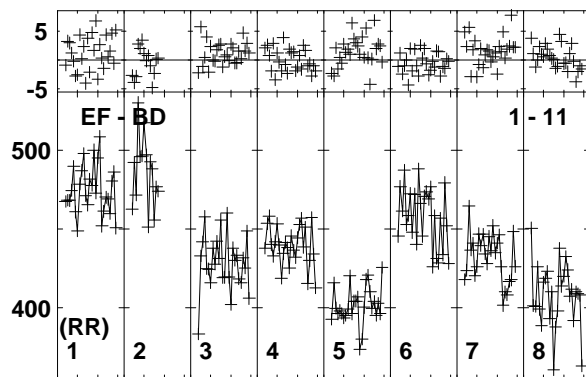
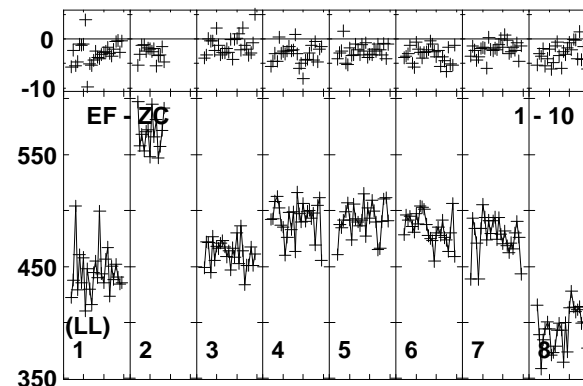
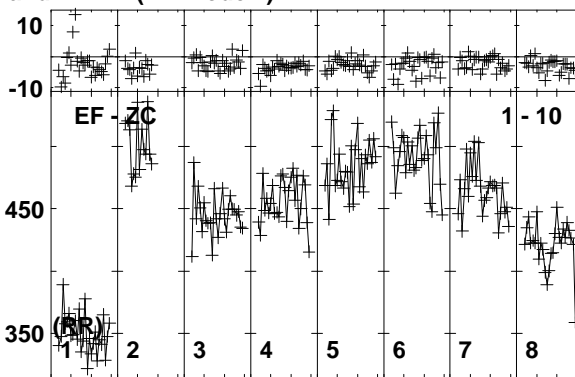
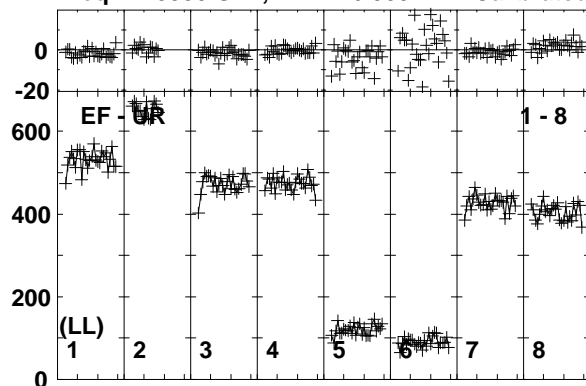

Lower frame: Milli Ampl Jy Top frame: Phas deg
Vector averaged cross-power spectrum Baseline: EF (01) - UR (08)
Timerange: 00/06:16:05 to 00/06:16:59

Plot file version 137 created 25-MAR-2014 17:51:20

ARP299A EP087E 1.UVDATA.1

Freq = 1.5950 GHz, Bw = 16.000 MH Calibrated with CL # 3 and BP # 1 (BP mode 1)

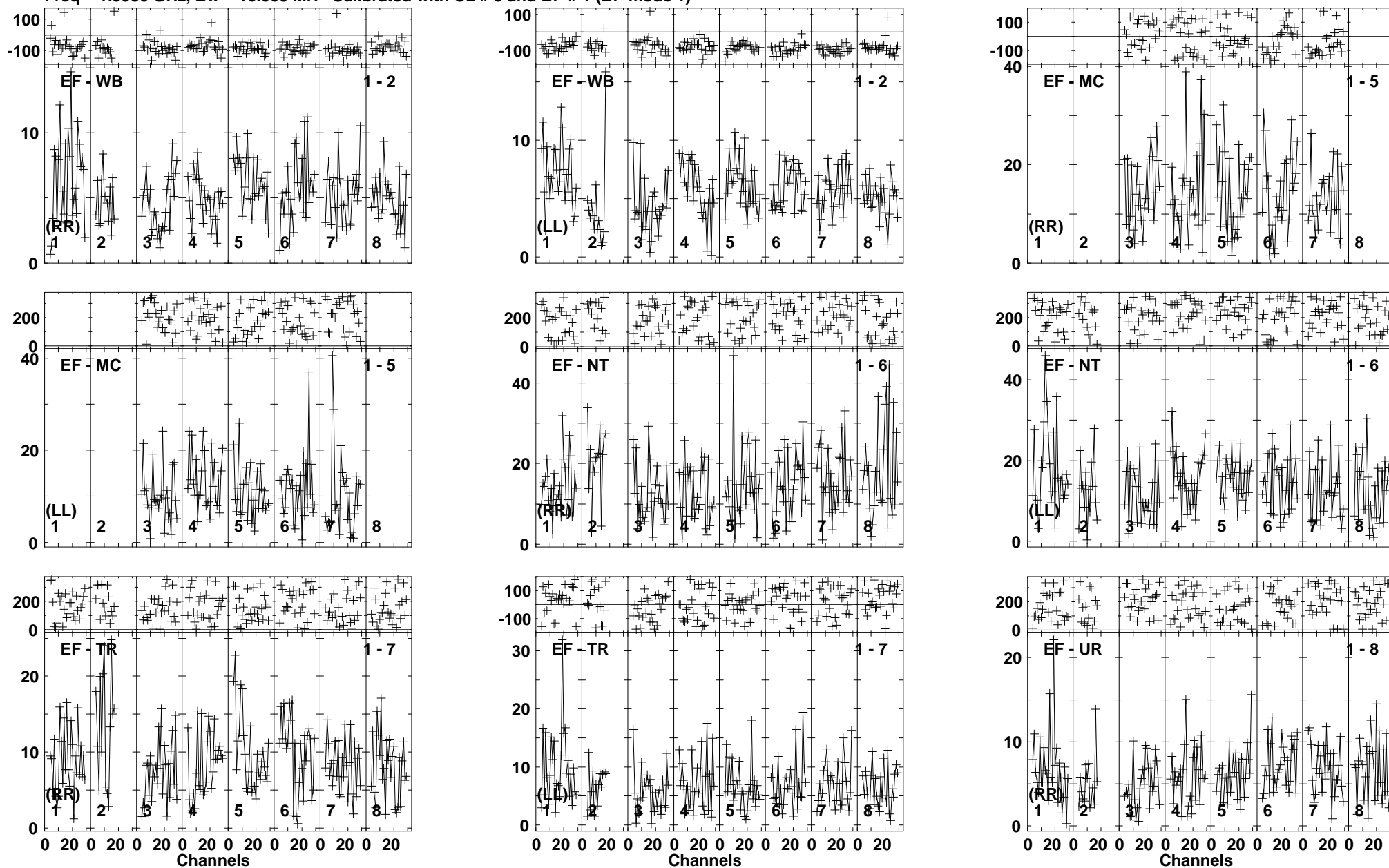

Lower frame: Milli Ampl Jy Top frame: Phas deg
Vector averaged cross-power spectrum Baseline: EF (01) - WB (02)
Timerange: 00/06:17:01 to 00/06:21:29

Plot file version 138 created 25-MAR-2014 17:51:21

ARP299A EP087E 1.UVDATA.1

Freq = 1.5950 GHz, Bw = 16.000 MH Calibrated with CL # 3 and BP # 1 (BP mode 1)

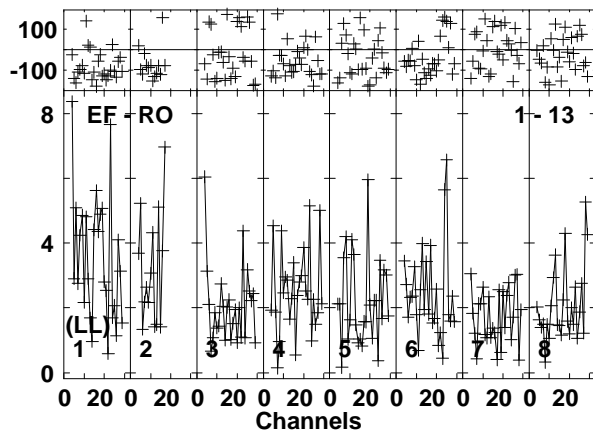
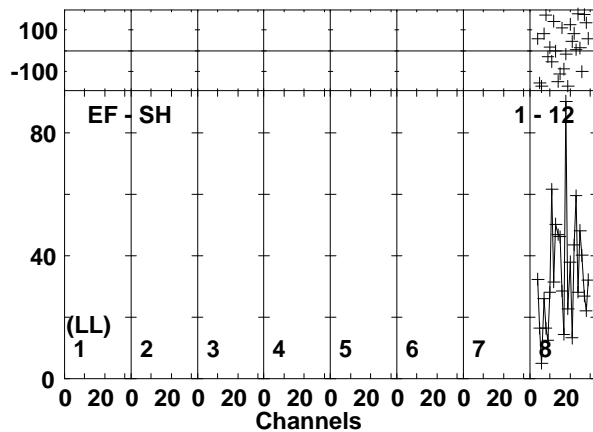
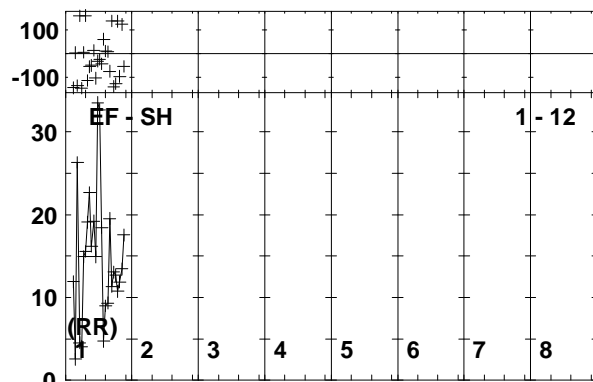
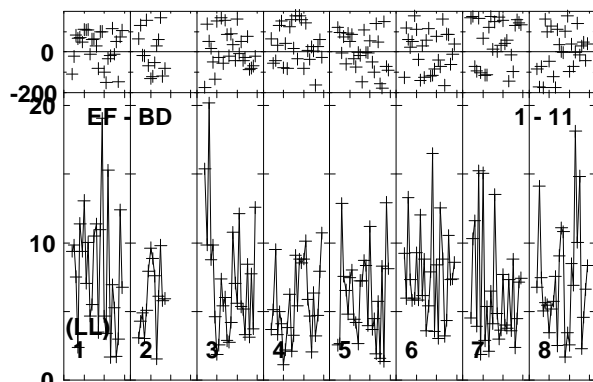
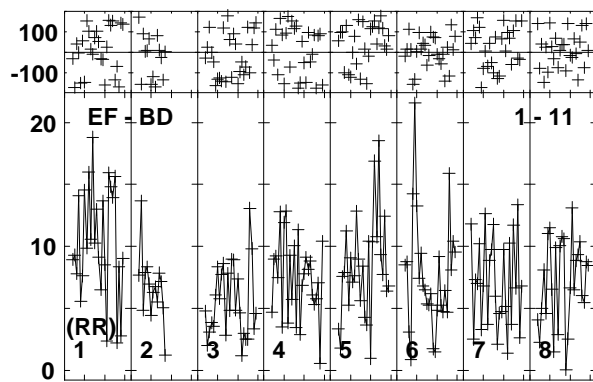
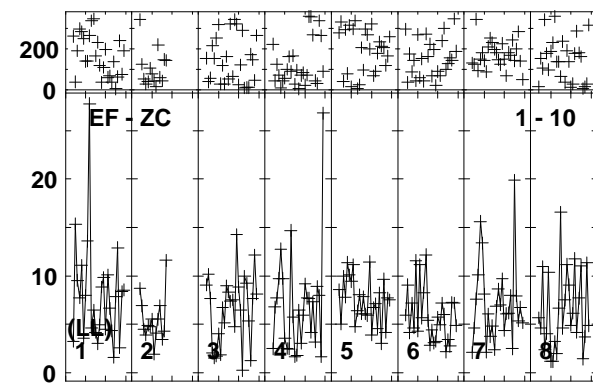
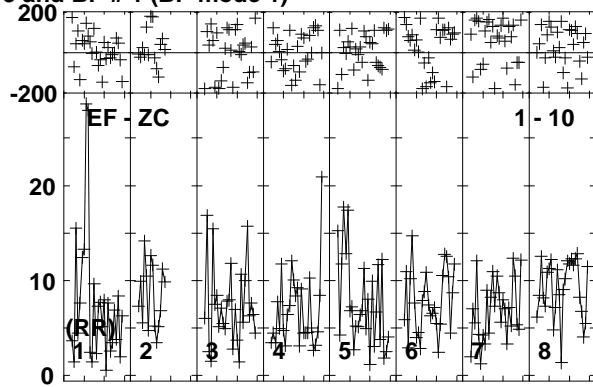
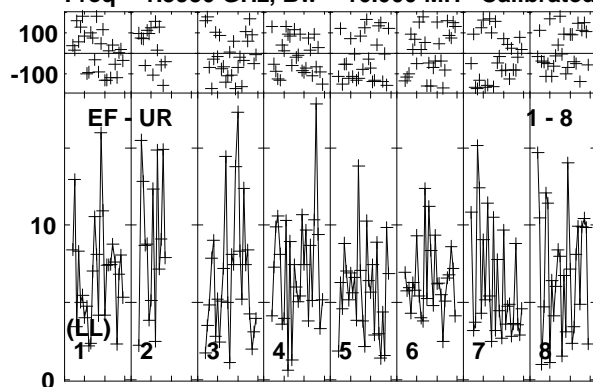

Lower frame: Milli Ampl Jy Top frame: Phas deg
Vector averaged cross-power spectrum Baseline: EF (01) - UR (08)
Timerange: 00/06:17:01 to 00/06:21:29

Plot file version 139 created 25-MAR-2014 17:51:21

J1128+5925 EP087E 1.UVDATA.1

Freq = 1.5950 GHz, Bw = 16.000 MH Calibrated with CL # 3 and BP # 1 (BP mode 1)

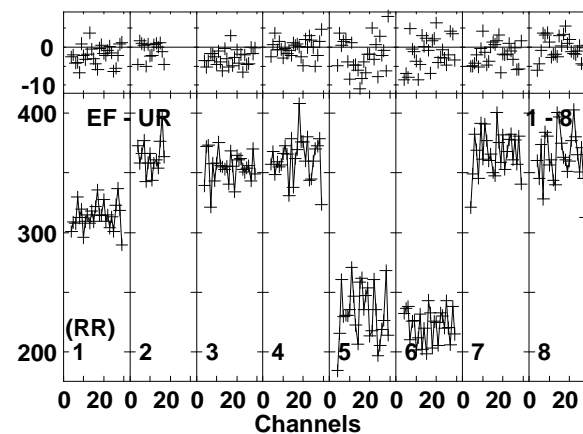
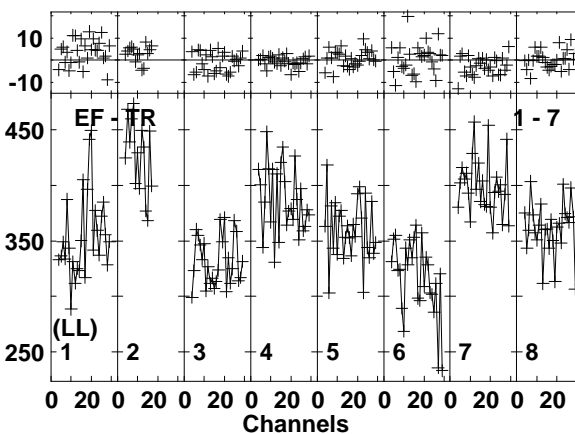
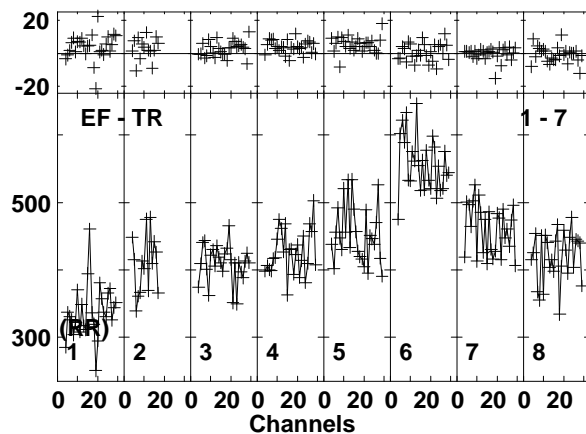
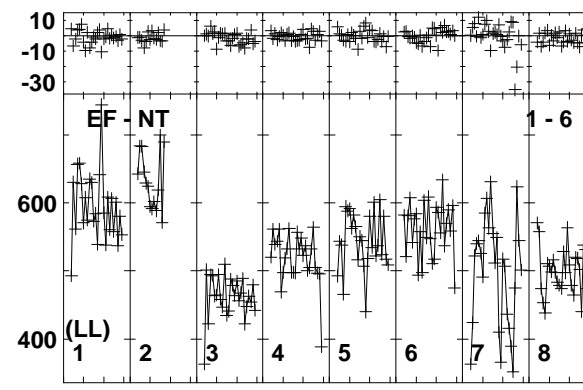
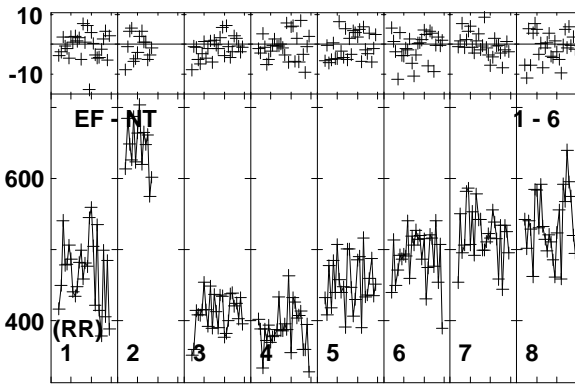
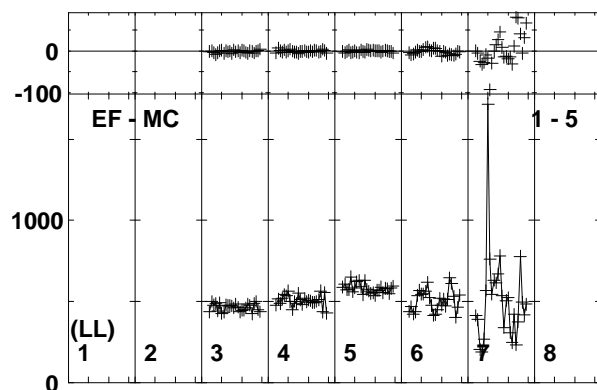
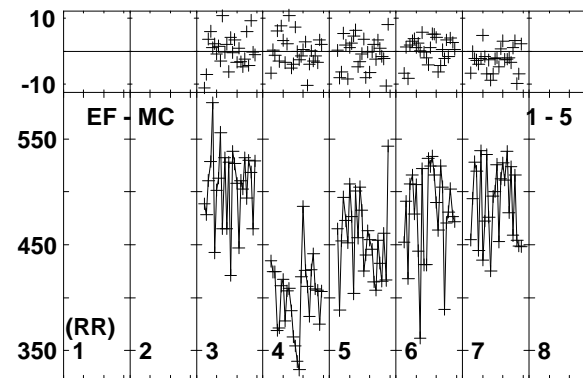
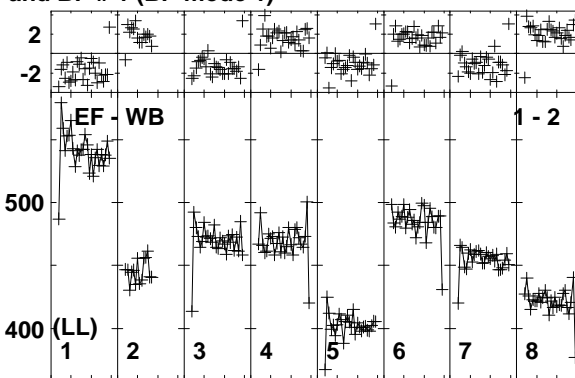
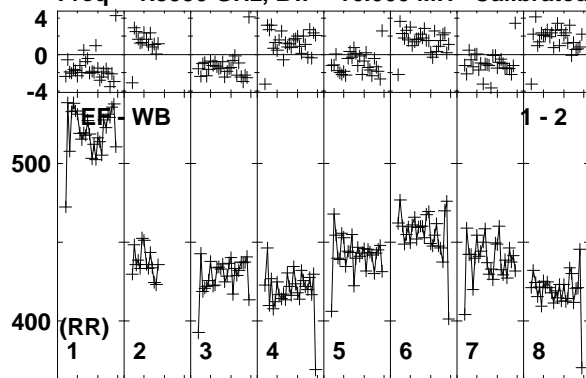

Lower frame: Milli Ampl Jy Top frame: Phas deg
Vector averaged cross-power spectrum Baseline: EF (01) - WB (02)
Timerange: 00/06:22:11 to 00/06:22:39

Plot file version 140 created 25-MAR-2014 17:51:21

J1128+5925 EP087E 1.UVDATA.1

Freq = 1.5950 GHz, Bw = 16.000 MH Calibrated with CL # 3 and BP # 1 (BP mode 1)

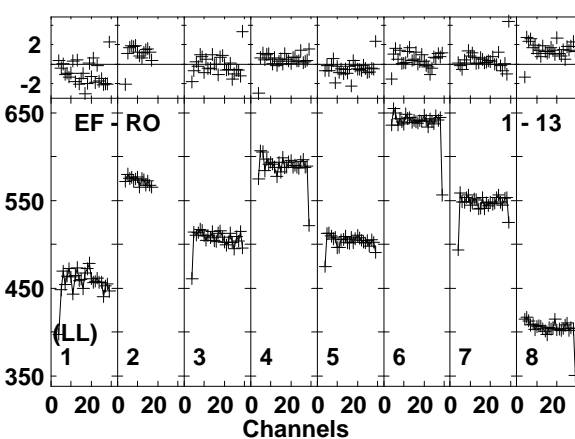
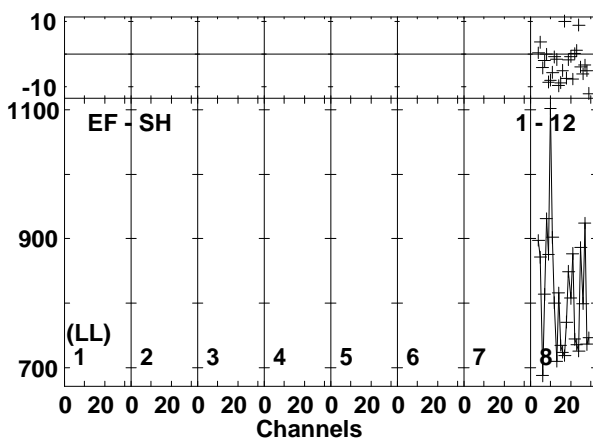
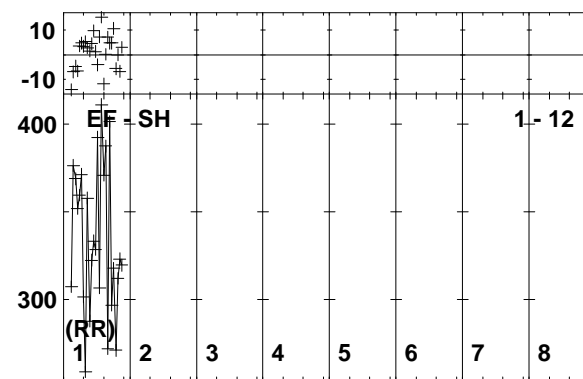
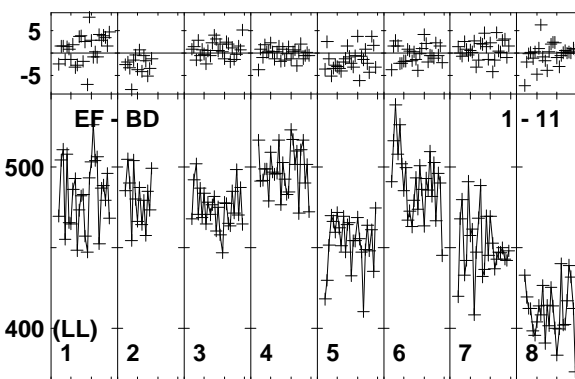
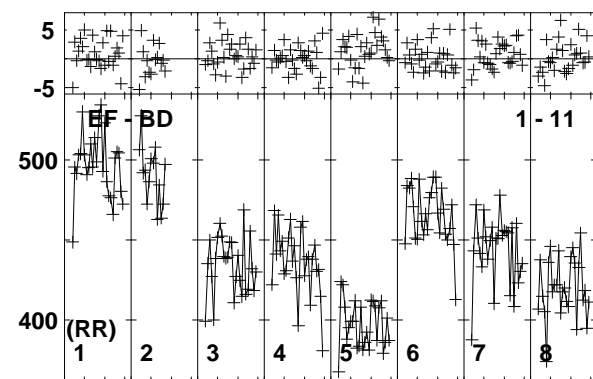
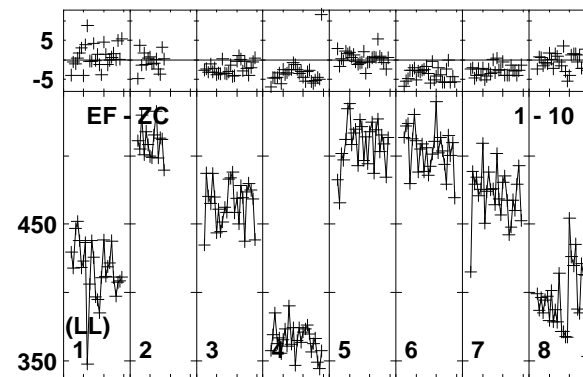
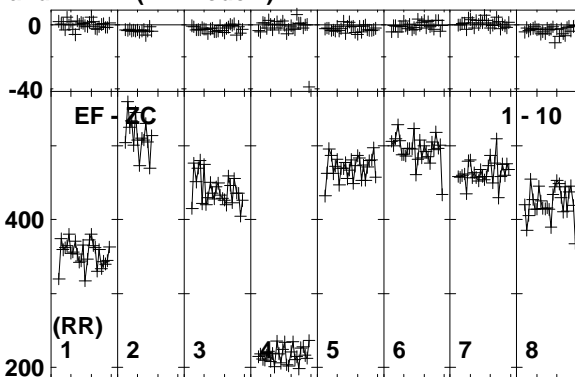
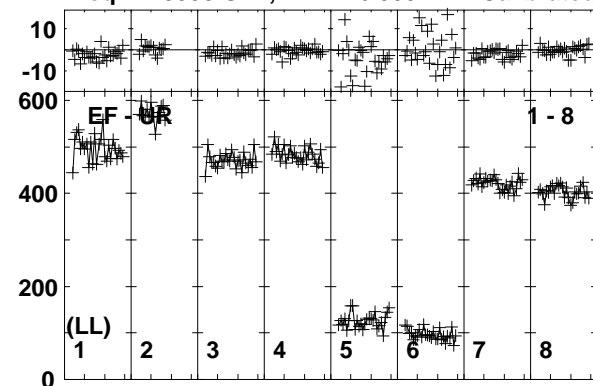

Lower frame: Milli Ampl Jy Top frame: Phas deg
Vector averaged cross-power spectrum Baseline: EF (01) - UR (08)
Timerange: 00/06:22:11 to 00/06:22:39

Plot file version 141 created 25-MAR-2014 17:51:21

ARP299A EP087E 1.UVDATA.1

Freq = 1.5950 GHz, Bw = 16.000 MH Calibrated with CL # 3 and BP # 1 (BP mode 1)

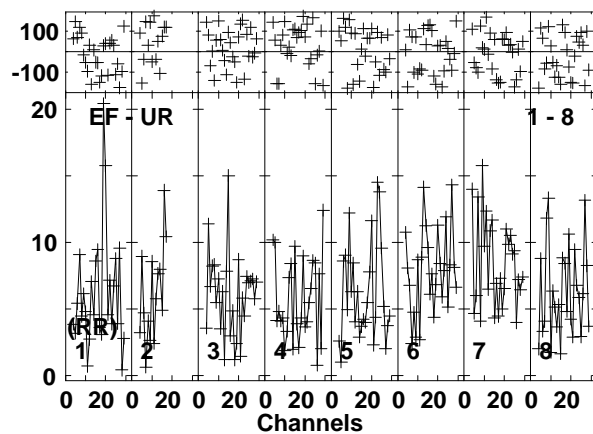
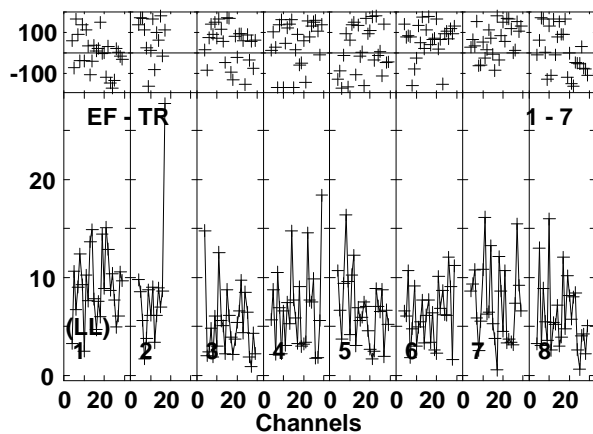
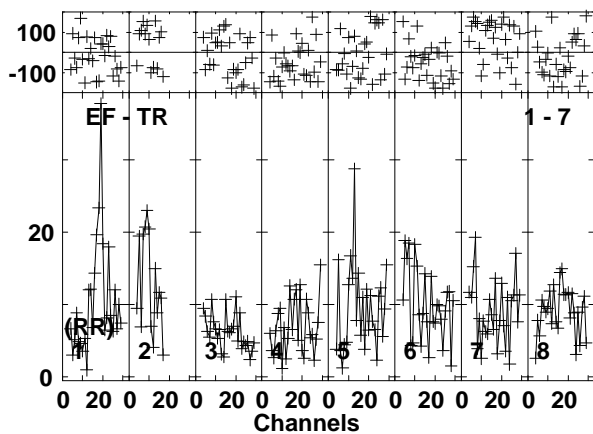
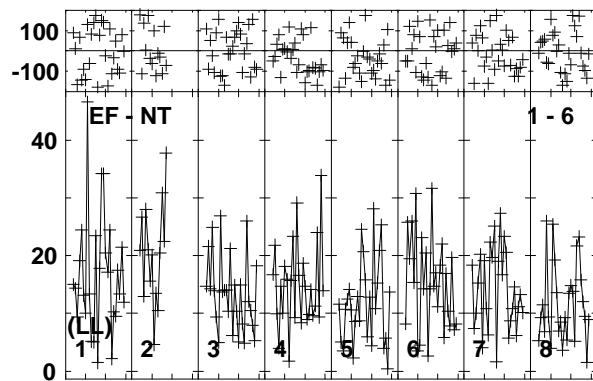
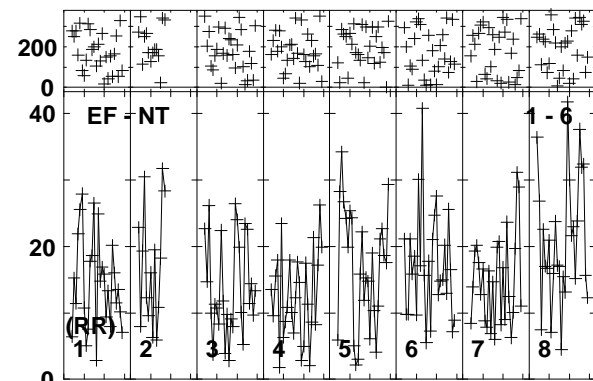
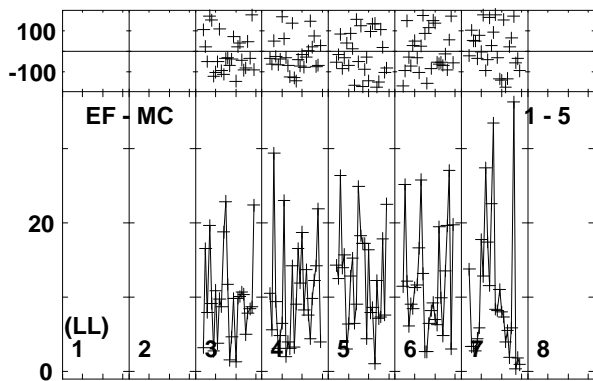
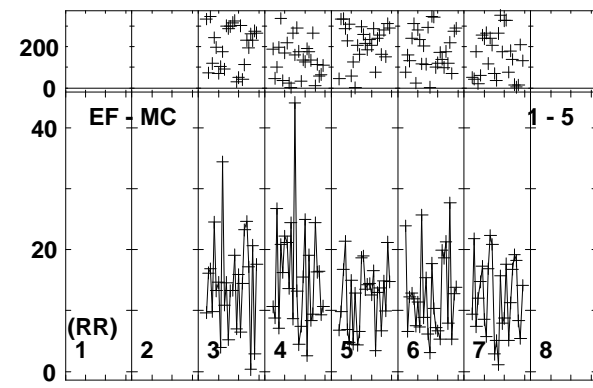
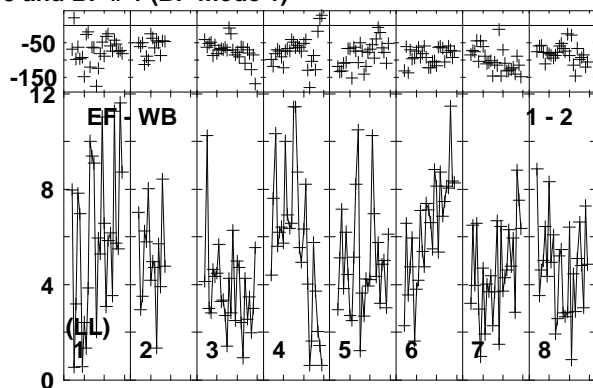
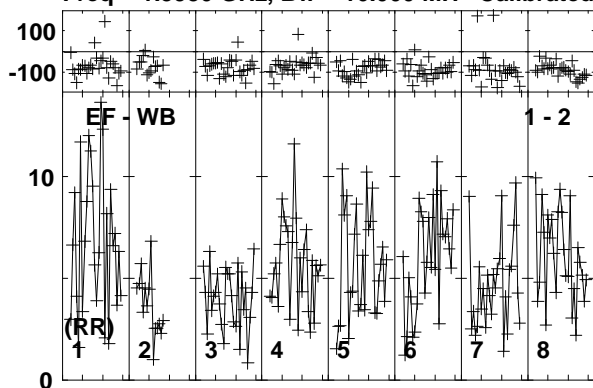

Lower frame: Milli Ampl Jy Top frame: Phas deg
Vector averaged cross-power spectrum Baseline: EF (01) - WB (02)
Timerange: 00/06:22:45 to 00/06:27:09

Plot file version 142 created 25-MAR-2014 17:51:22

ARP299A EP087E 1.UVDATA.1

Freq = 1.5950 GHz, Bw = 16.000 MH Calibrated with CL # 3 and BP # 1 (BP mode 1)

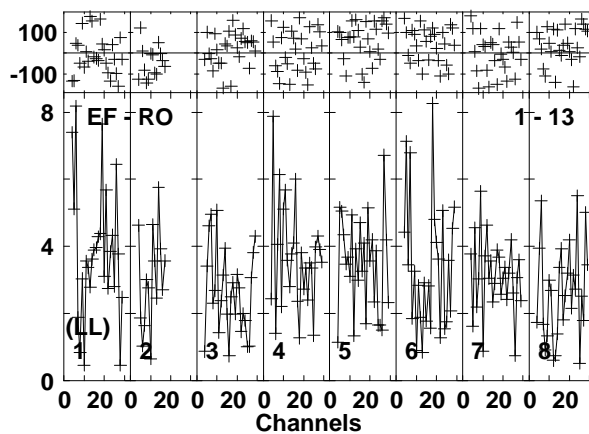
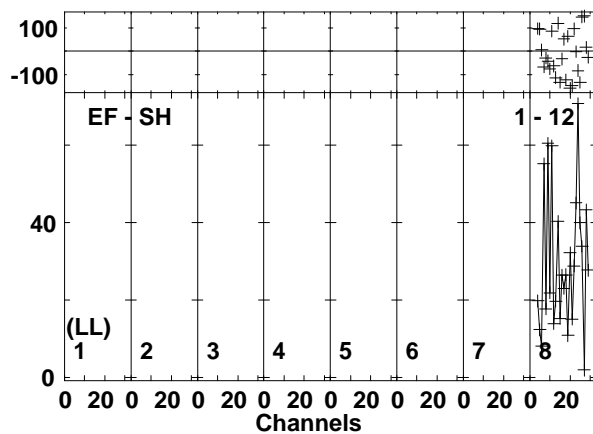
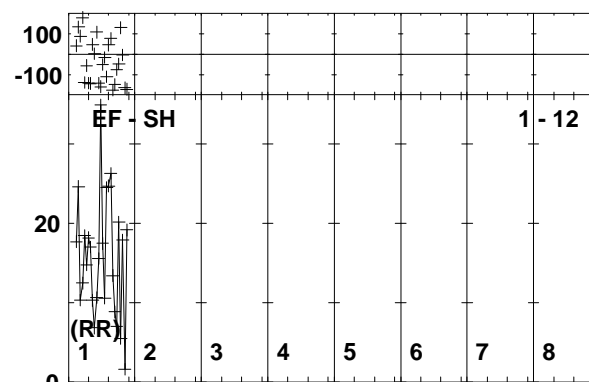
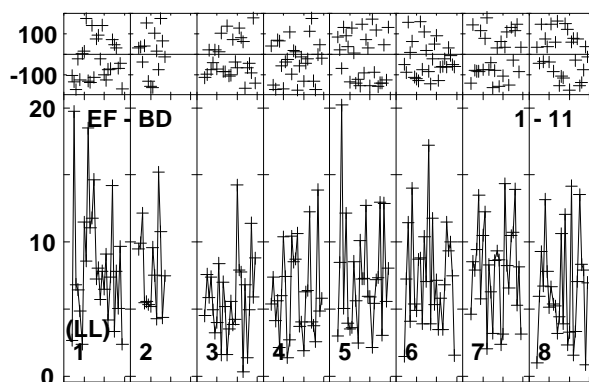
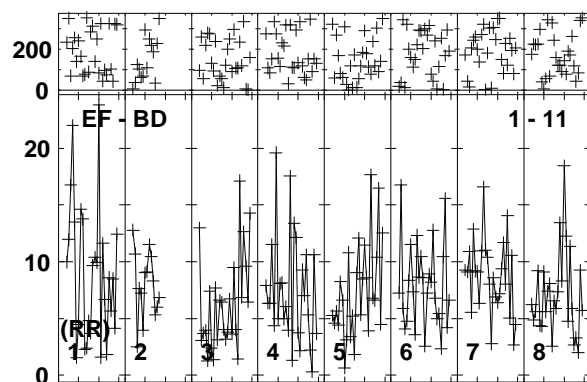
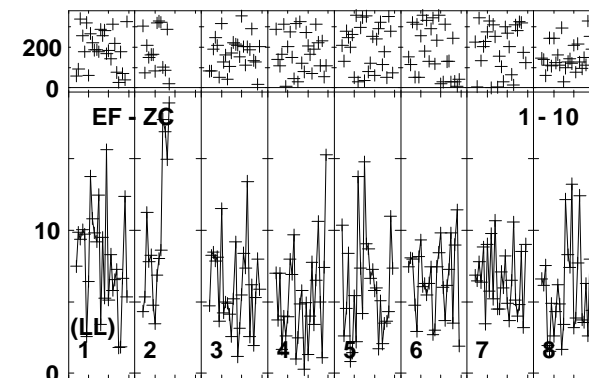
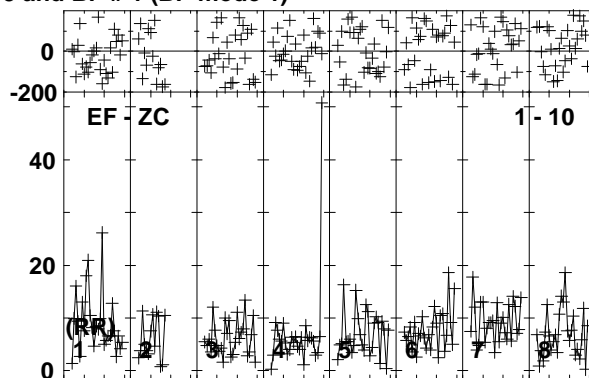
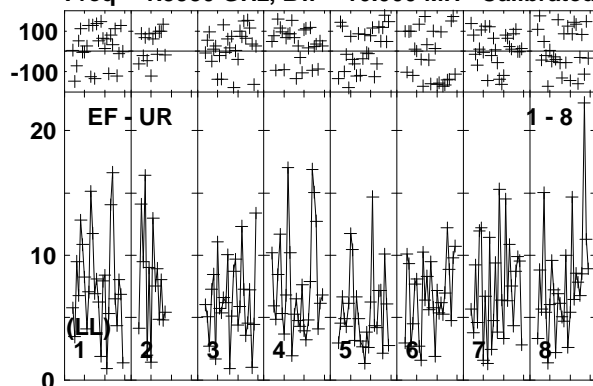

Lower frame: Milli Ampl Jy Top frame: Phas deg
Vector averaged cross-power spectrum Baseline: EF (01) - UR (08)
Timerange: 00/06:22:45 to 00/06:27:09

Plot file version 143 created 25-MAR-2014 17:51:22

J1128+5925 EP087E 1.UVDATA.1

Freq = 1.5950 GHz, Bw = 16.000 MH Calibrated with CL # 3 and BP # 1 (BP mode 1)

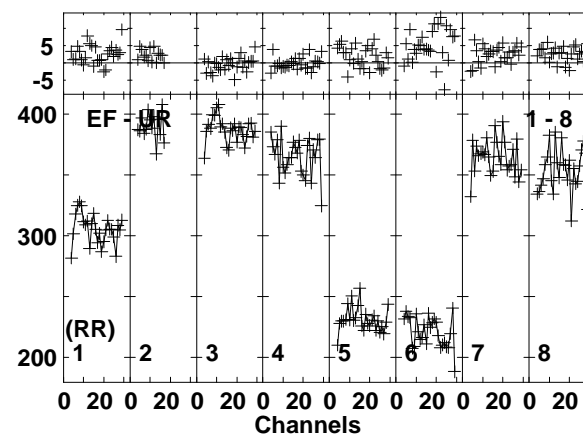
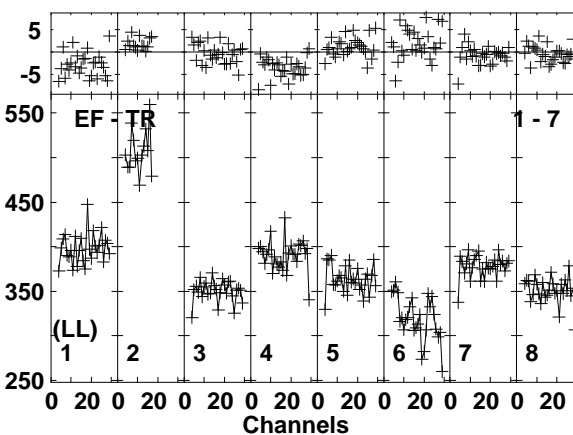
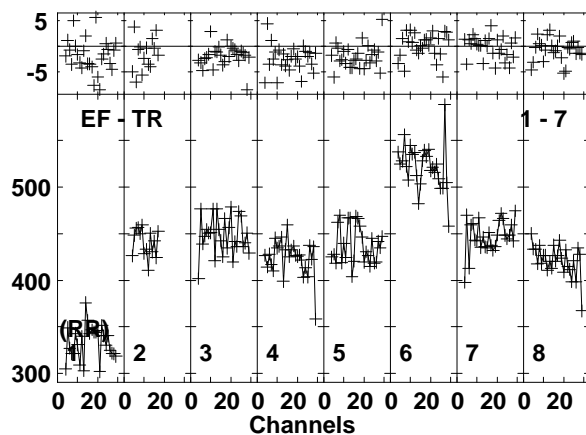
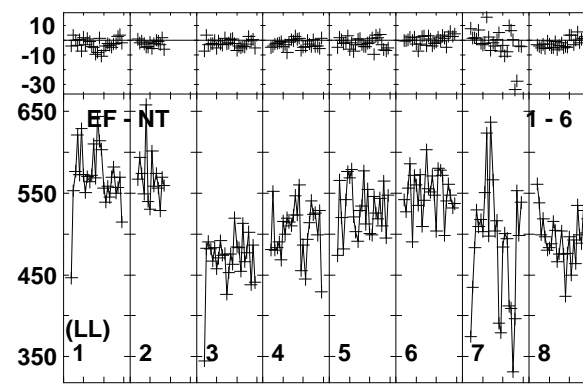
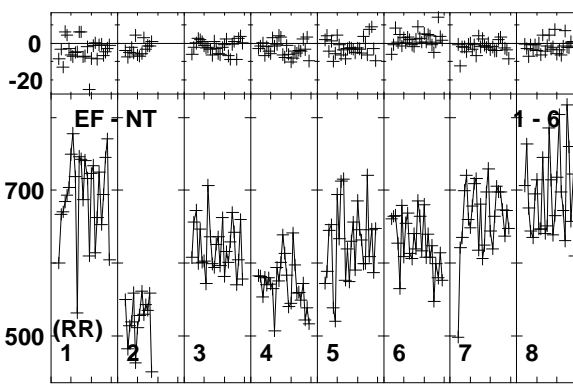
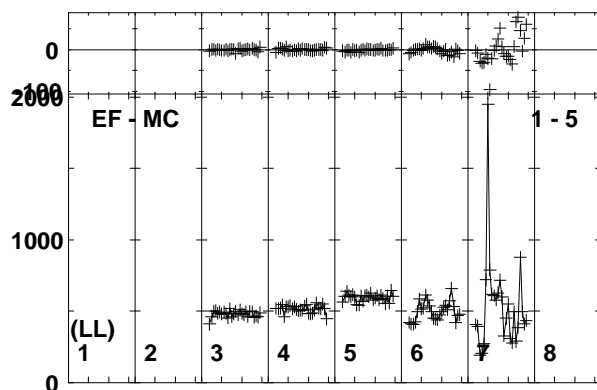
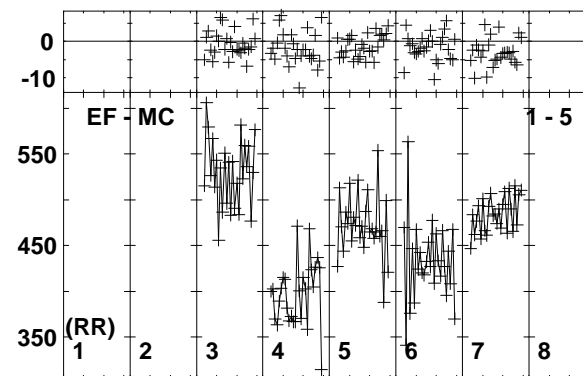
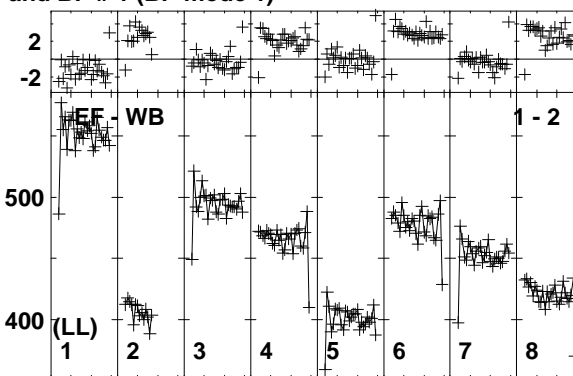
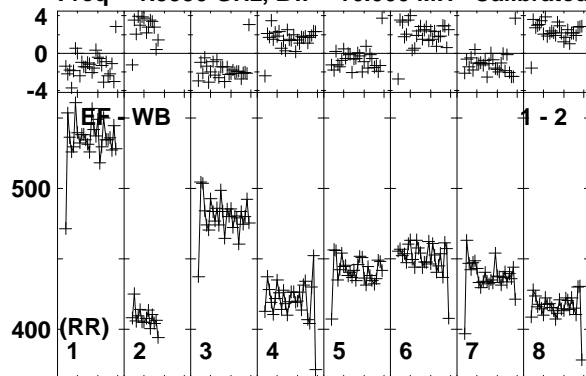

Lower frame: Milli Ampl Jy Top frame: Phas deg
Vector averaged cross-power spectrum Baseline: EF (01) - WB (02)
Timerange: 00/06:27:15 to 00/06:28:19

Plot file version 144 created 25-MAR-2014 17:51:22

J1128+5925 EP087E 1.UVDATA.1

Freq = 1.5950 GHz, Bw = 16.000 MH Calibrated with CL # 3 and BP # 1 (BP mode 1)

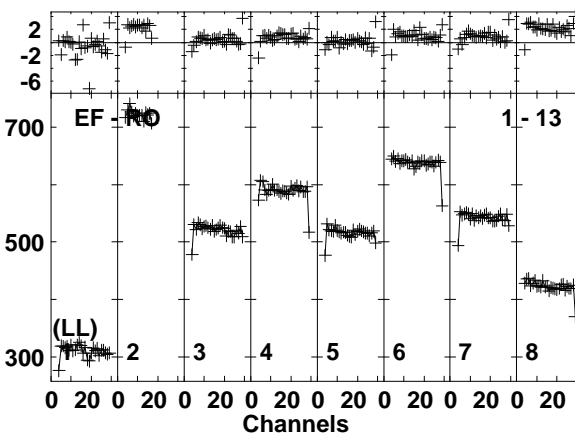
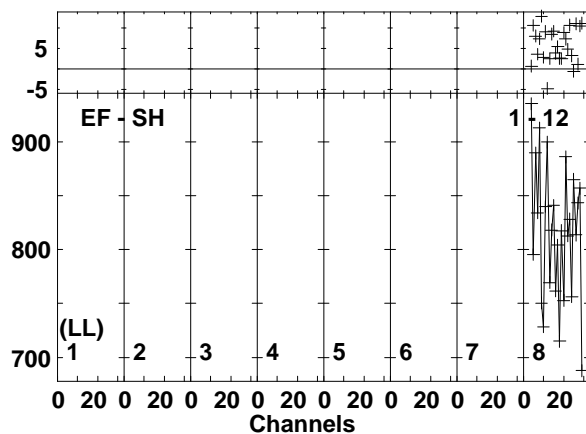
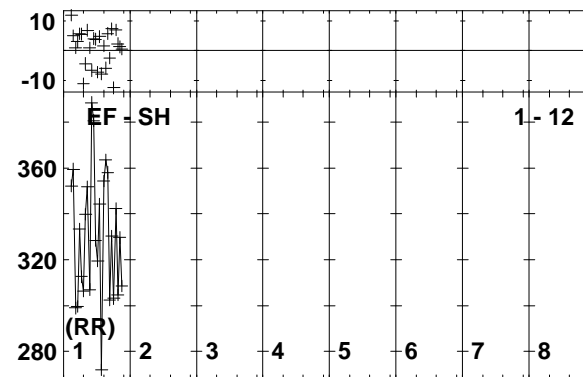
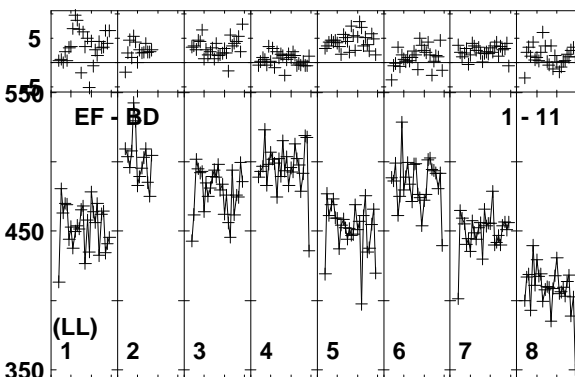
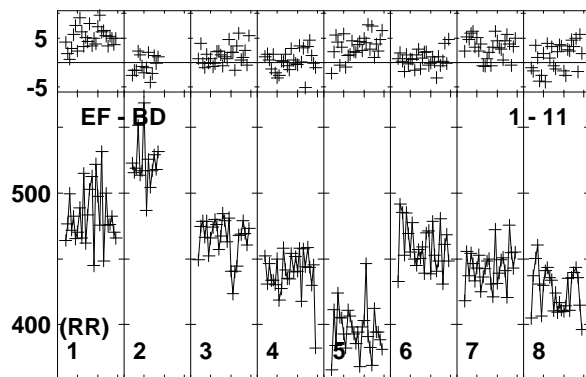
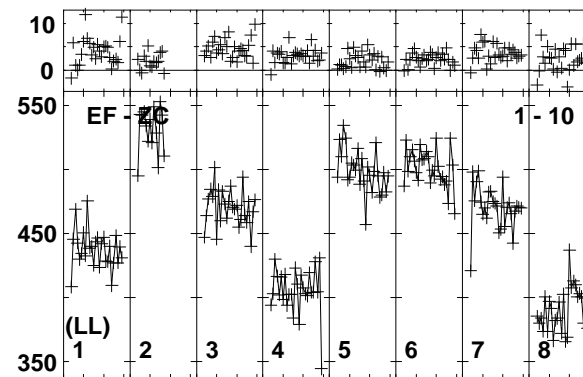
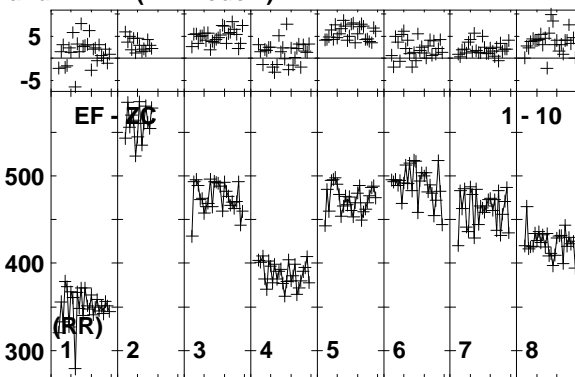
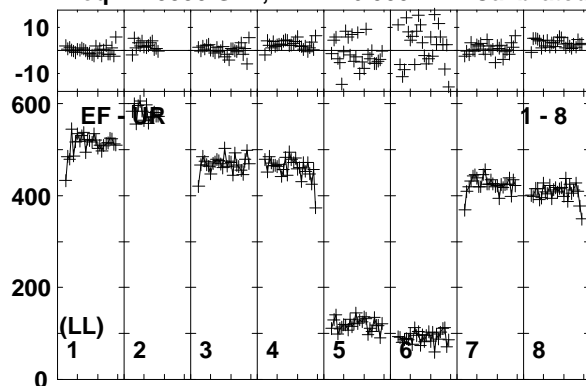

Lower frame: Milli Ampl Jy Top frame: Phas deg
Vector averaged cross-power spectrum Baseline: EF (01) - UR (08)
Timerange: 00/06:27:15 to 00/06:28:19

Plot file version 145 created 25-MAR-2014 17:51:22

ARP299A EP087E 1.UVDATA.1

Freq = 1.5950 GHz, Bw = 16.000 MH Calibrated with CL # 3 and BP # 1 (BP mode 1)

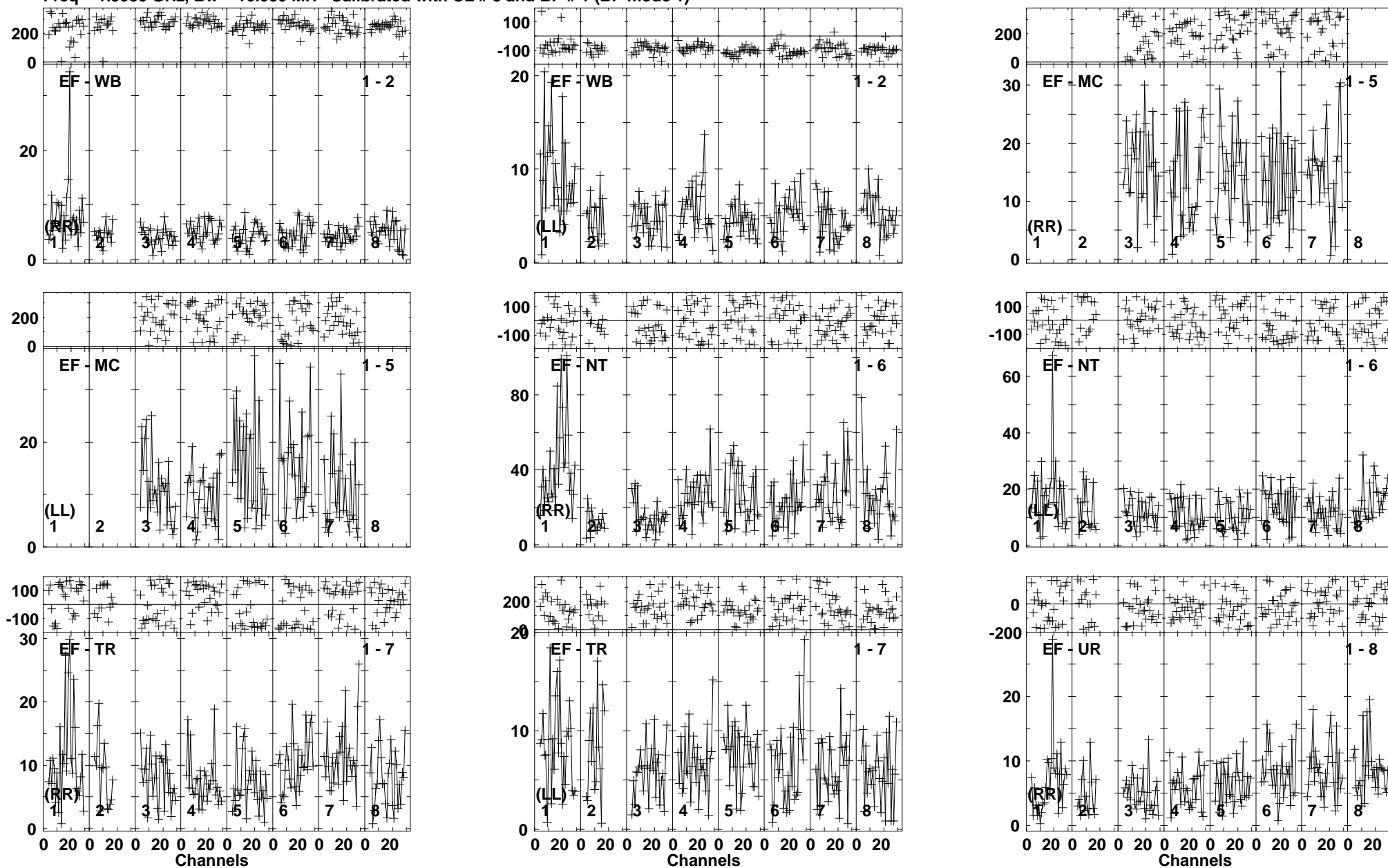

Lower frame: Milli Ampl Jy Top frame: Phas deg
Vector averaged cross-power spectrum Baseline: EF (01) - WB (02)
Timerange: 00/06:28:21 to 00/06:32:49

Plot file version 146 created 25-MAR-2014 17:51:23

ARP299A EP087E 1.UVDATA.1

Freq = 1.5950 GHz, Bw = 16.000 MH Calibrated with CL # 3 and BP # 1 (BP mode 1)

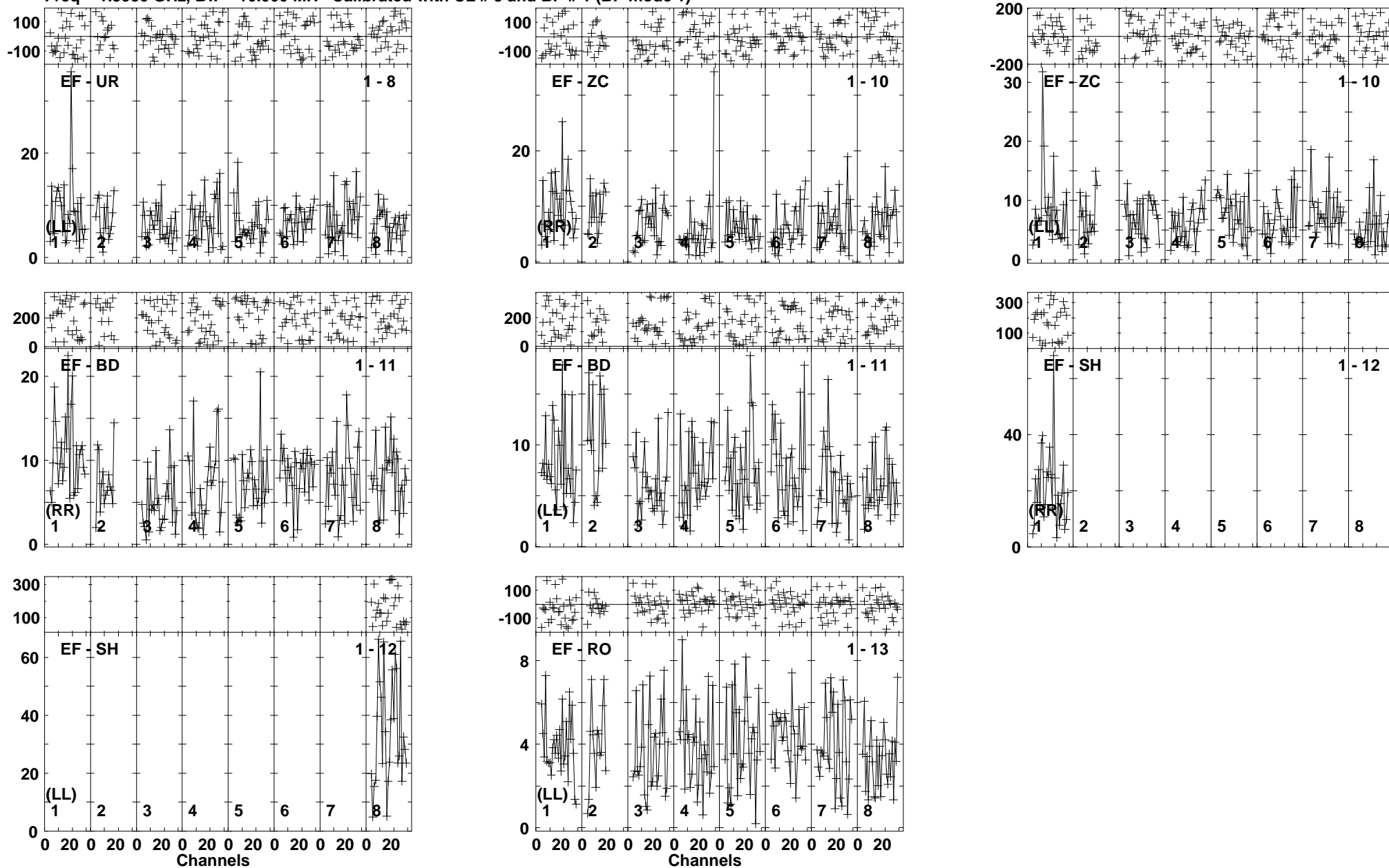

Lower frame: Milli Ampl Jy Top frame: Phas deg
Vector averaged cross-power spectrum Baseline: EF (01) - UR (08)
Timerange: 00/06:28:21 to 00/06:32:49

Plot file version 147 created 25-MAR-2014 17:51:23

J1128+5925 EP087E 1.UVDATA.1

Freq = 1.5950 GHz, Bw = 16.000 MH Calibrated with CL # 3 and BP # 1 (BP mode 1)

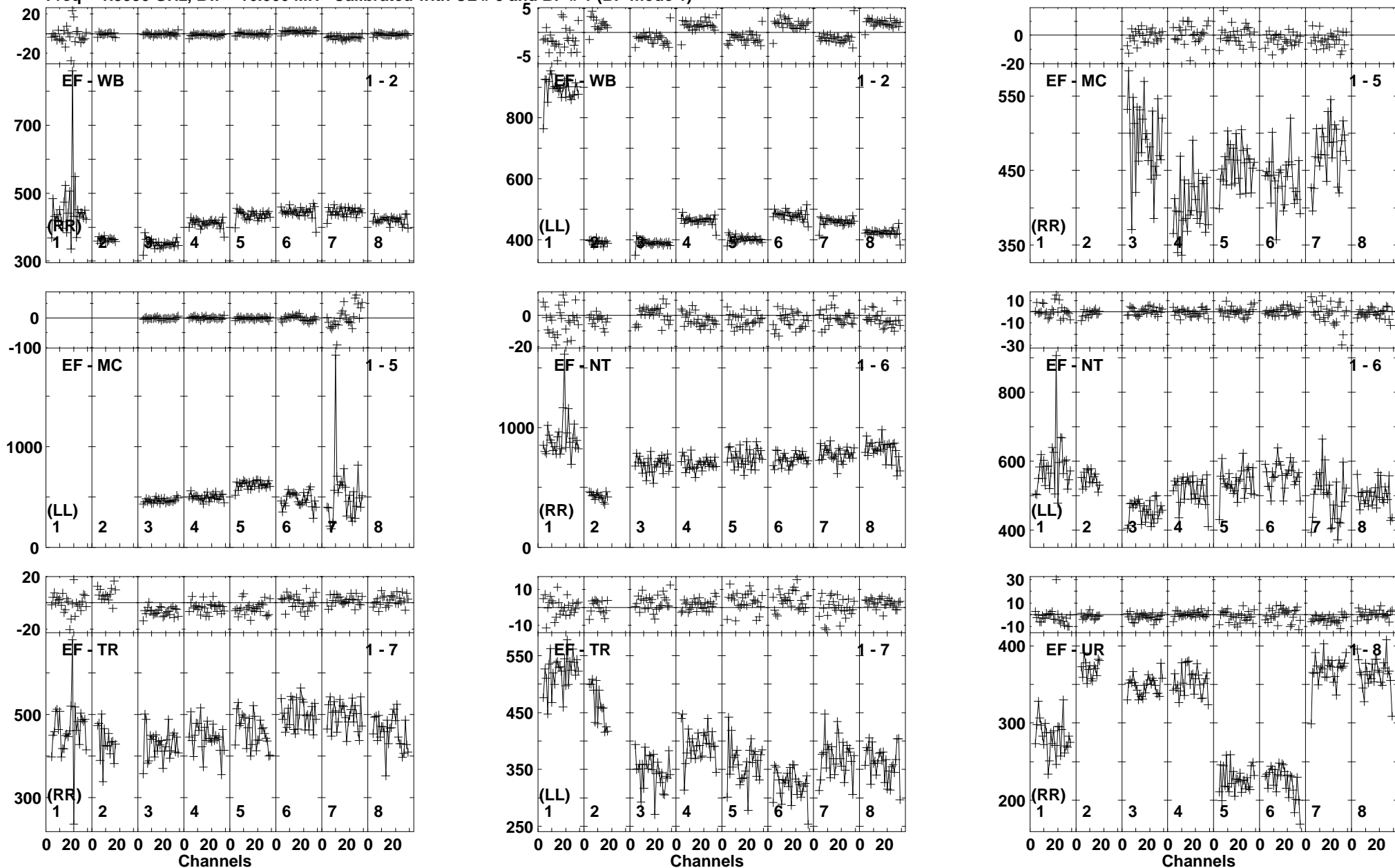

Lower frame: Milli Ampl Jy Top frame: Phas deg
Vector averaged cross-power spectrum Baseline: EF (01) - WB (02)
Timerange: 00/06:33:31 to 00/06:33:59

Plot file version 148 created 25-MAR-2014 17:51:23

J1128+5925 EP087E 1.UVDATA.1

Freq = 1.5950 GHz, Bw = 16.000 MH Calibrated with CL # 3 and BP # 1 (BP mode 1)

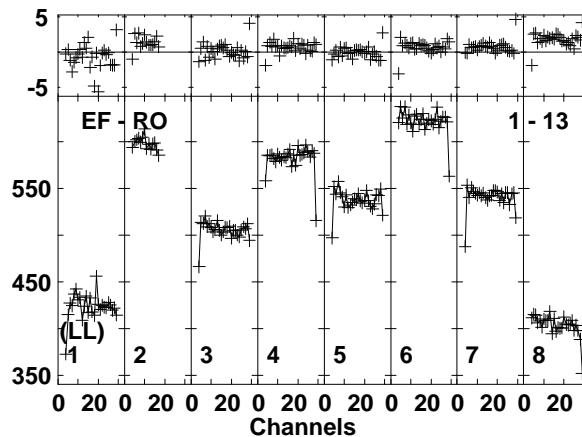
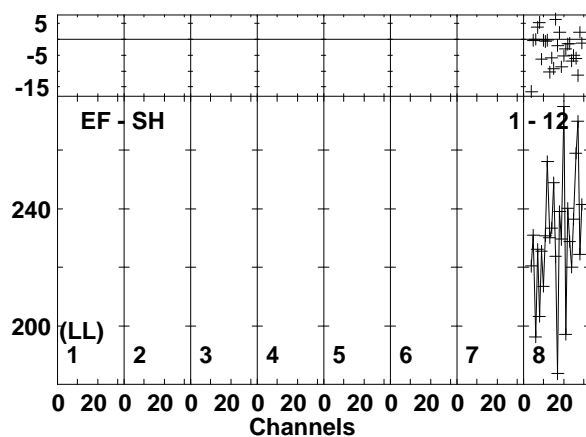
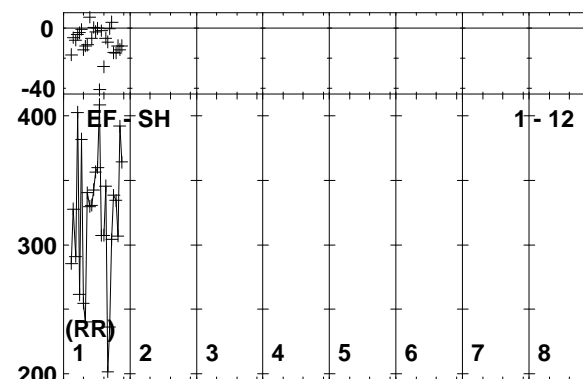
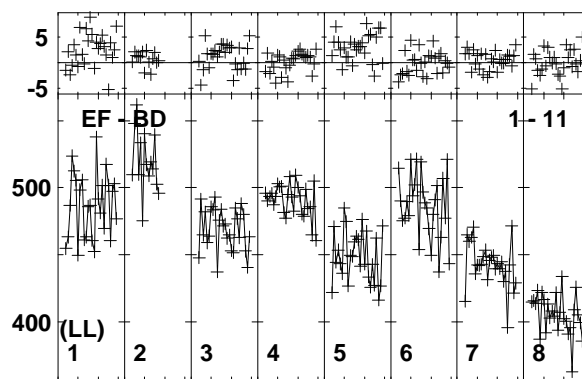
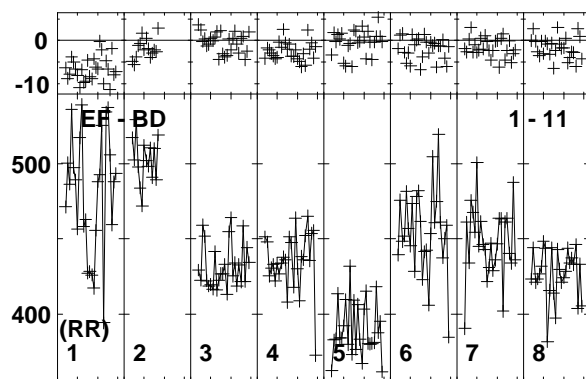
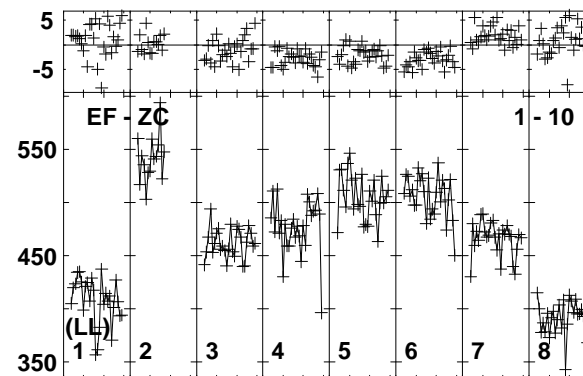
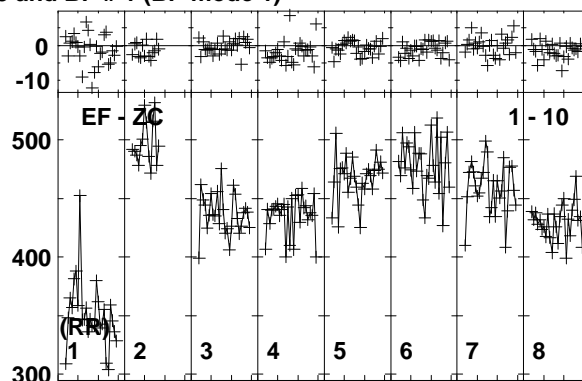
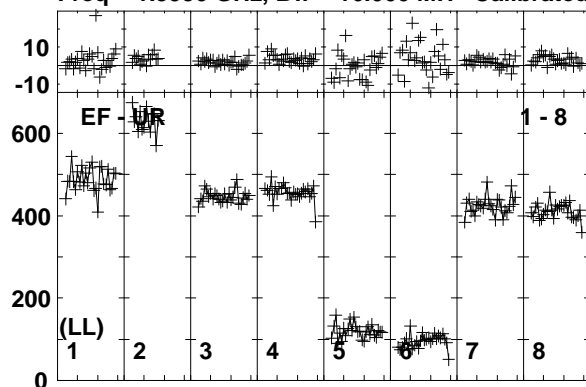

Lower frame: Milli Ampl Jy Top frame: Phas deg
Vector averaged cross-power spectrum Baseline: EF (01) - UR (08)
Timerange: 00/06:33:31 to 00/06:33:59

Plot file version 149 created 25-MAR-2014 17:51:24

ARP299A EP087E 1.UVDATA.1

Freq = 1.5950 GHz, Bw = 16.000 MH Calibrated with CL # 3 and BP # 1 (BP mode 1)

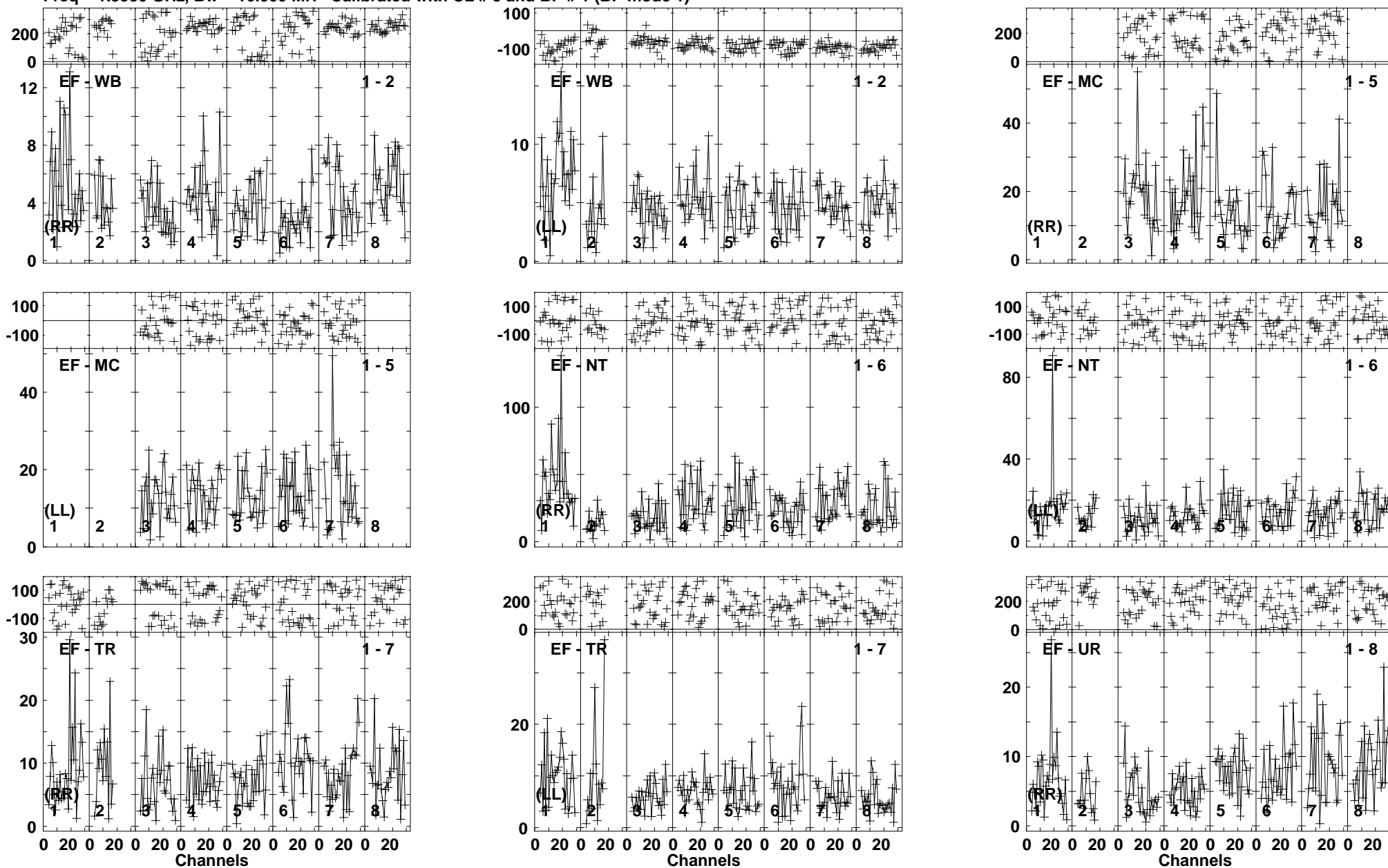

Lower frame: Milli Ampl Jy Top frame: Phas deg
Vector averaged cross-power spectrum Baseline: EF (01) - WB (02)
Timerange: 00/06:34:05 to 00/06:38:29

Plot file version 150 created 25-MAR-2014 17:51:24

ARP299A EP087E 1.UVDATA.1

Freq = 1.5950 GHz, Bw = 16.000 MH Calibrated with CL # 3 and BP # 1 (BP mode 1)

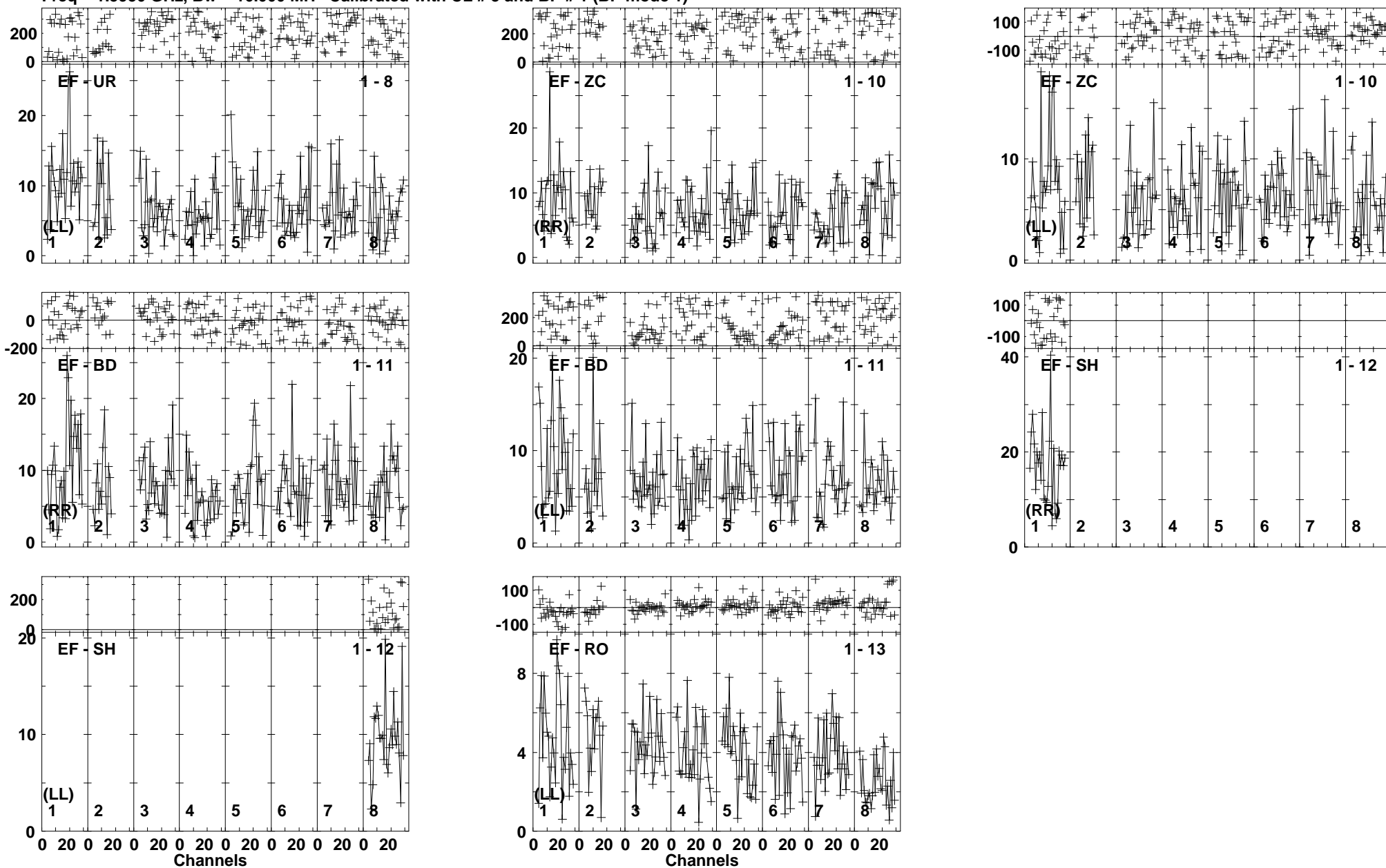

Lower frame: Milli Ampl Jy Top frame: Phas deg
Vector averaged cross-power spectrum Baseline: EF (01) - UR (08)
Timerange: 00/06:34:05 to 00/06:38:29

Plot file version 151 created 25-MAR-2014 17:51:24

J1128+5925 EP087E 1.UVDATA.1

Freq = 1.5950 GHz, Bw = 16.000 MH Calibrated with CL # 3 and BP # 1 (BP mode 1)

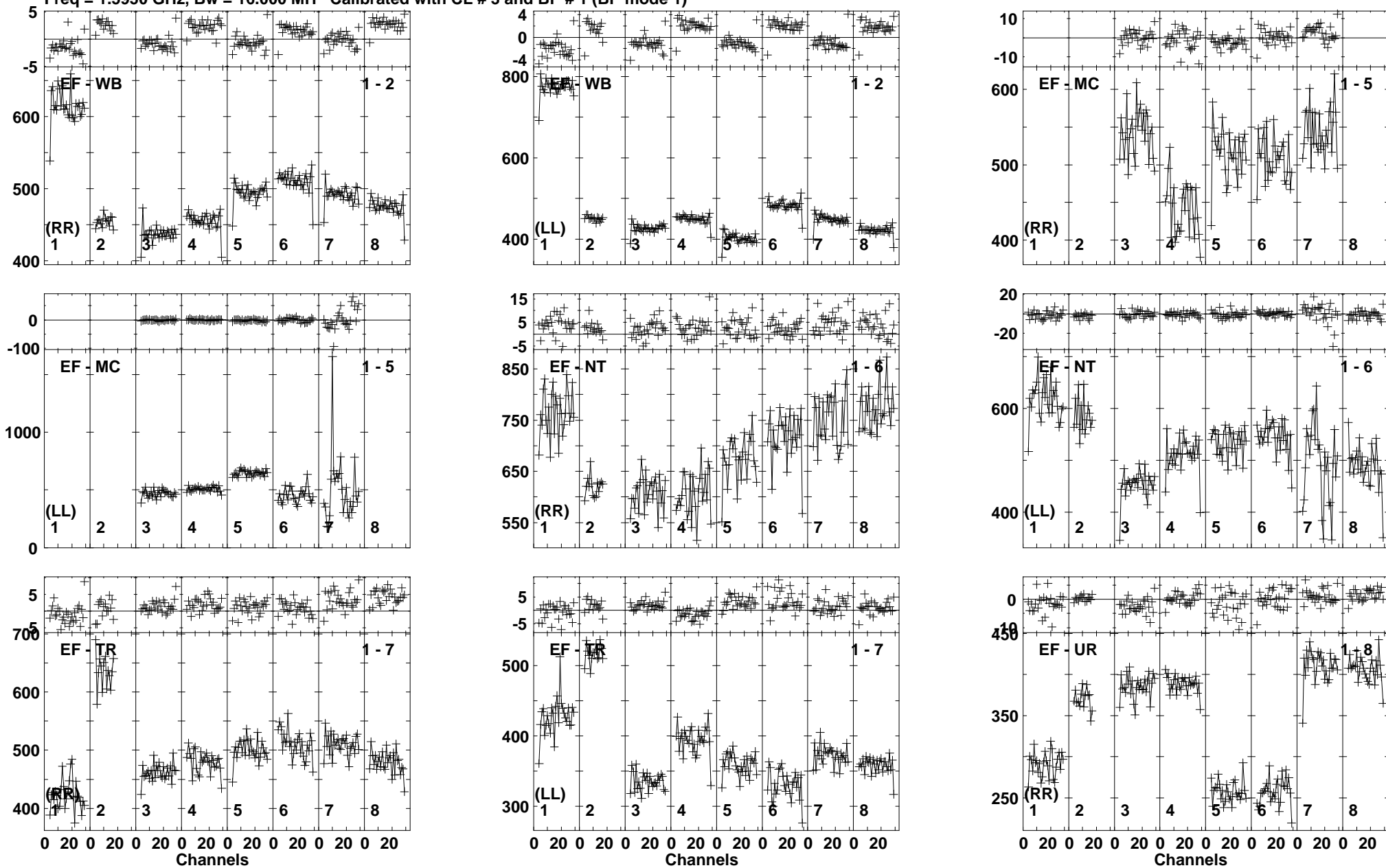

Lower frame: Milli Ampl Jy Top frame: Phas deg
Vector averaged cross-power spectrum Baseline: EF (01) - WB (02)
Timerange: 00/06:38:35 to 00/06:39:39

Plot file version 152 created 25-MAR-2014 17:51:25

J1128+5925 EP087E 1.UVDATA.1

Freq = 1.5950 GHz, Bw = 16.000 MH Calibrated with CL # 3 and BP # 1 (BP mode 1)

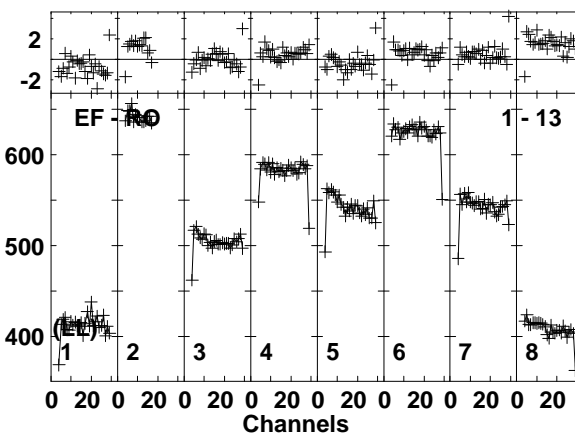
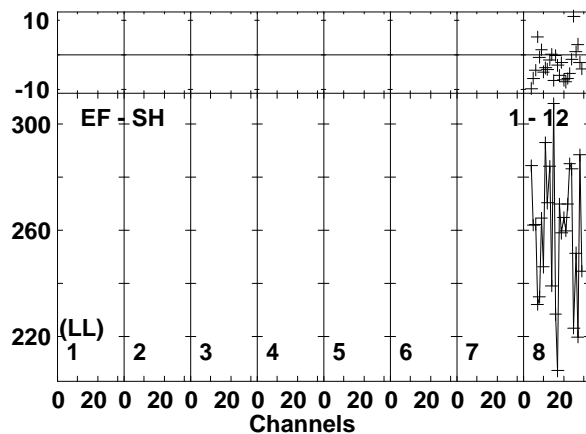
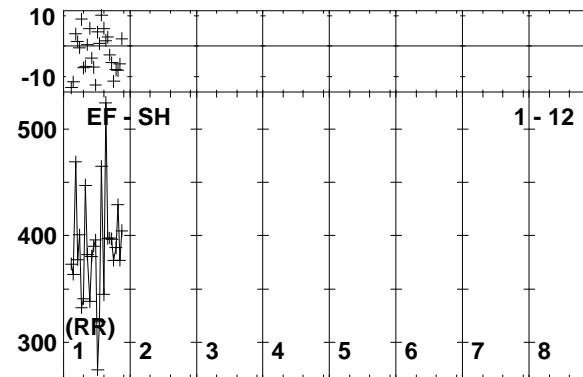
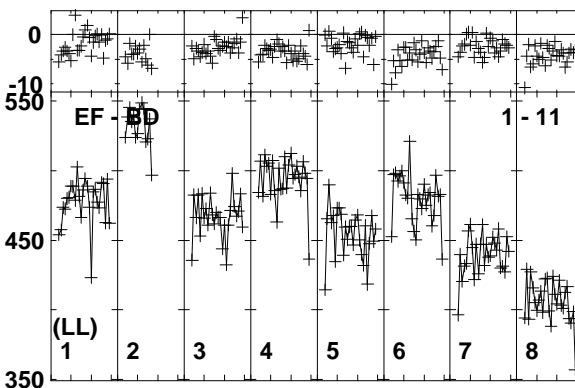
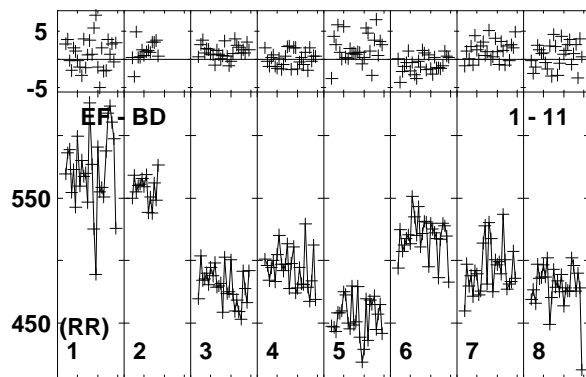
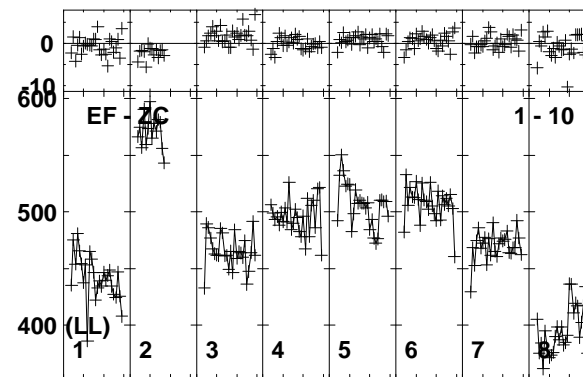
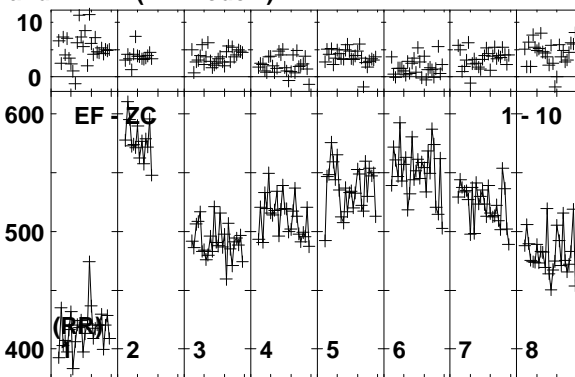
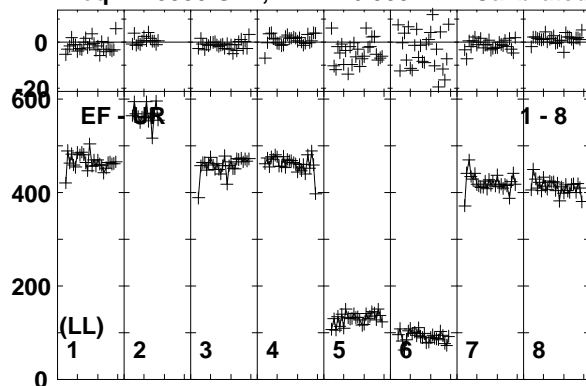

Lower frame: Milli Ampl Jy Top frame: Phas deg
Vector averaged cross-power spectrum Baseline: EF (01) - UR (08)
Timerange: 00/06:38:35 to 00/06:39:39

Plot file version 153 created 25-MAR-2014 17:51:25
 ARP299A EP087E 1.UVDATA.1
 Freq = 1.5950 GHz, Bw = 16.000 MH Calibrated with CL # 3 and BP # 1 (BP mode 1)

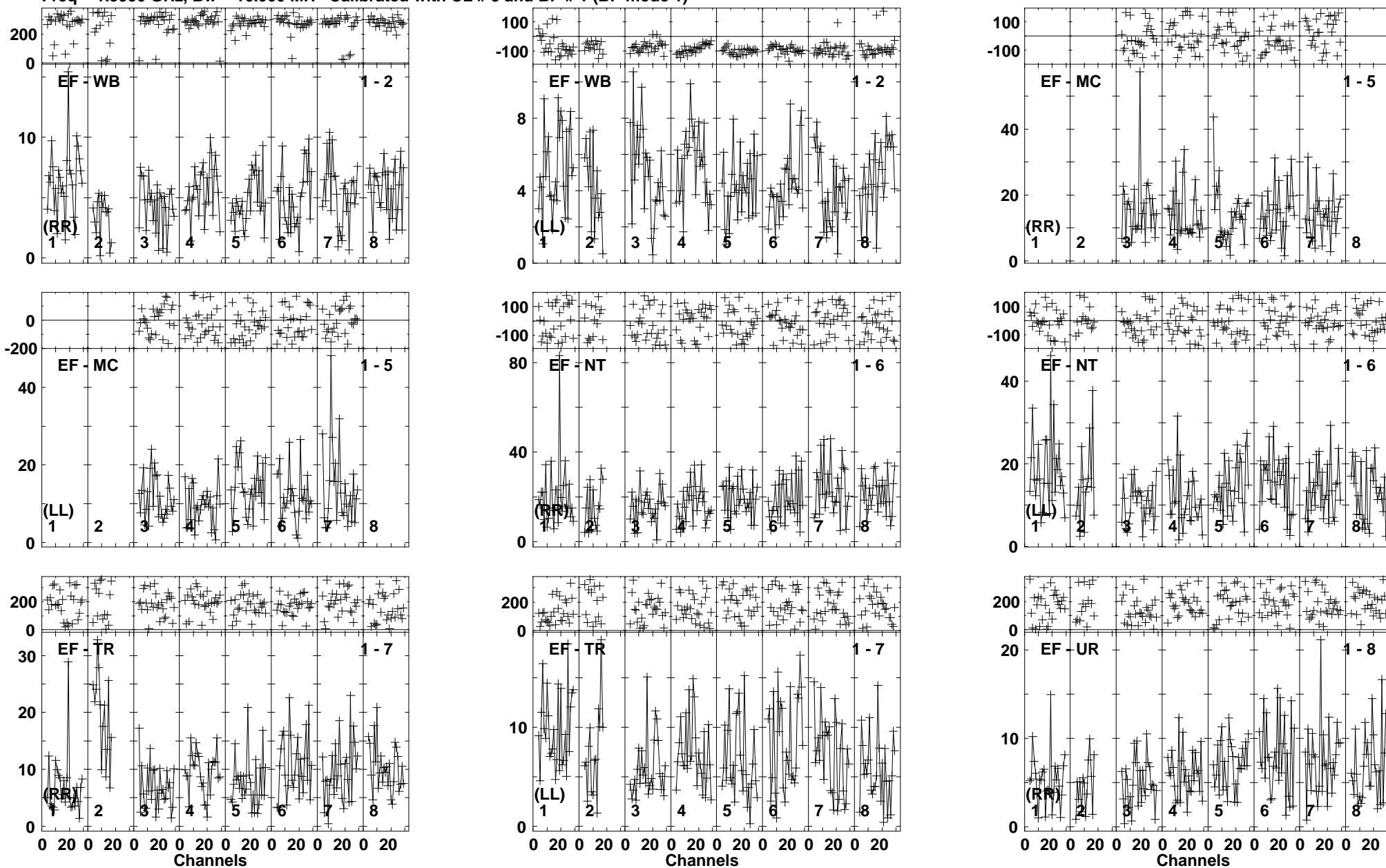

Lower frame: Milli Ampl Jy Top frame: Phas deg
 Vector averaged cross-power spectrum Baseline: EF (01) - WB (02)
 Timerange: 00/06:39:41 to 00/06:44:09

Plot file version 154 created 25-MAR-2014 17:51:25

ARP299A EP087E 1.UVDATA.1

Freq = 1.5950 GHz, Bw = 16.000 MH Calibrated with CL # 3 and BP # 1 (BP mode 1)

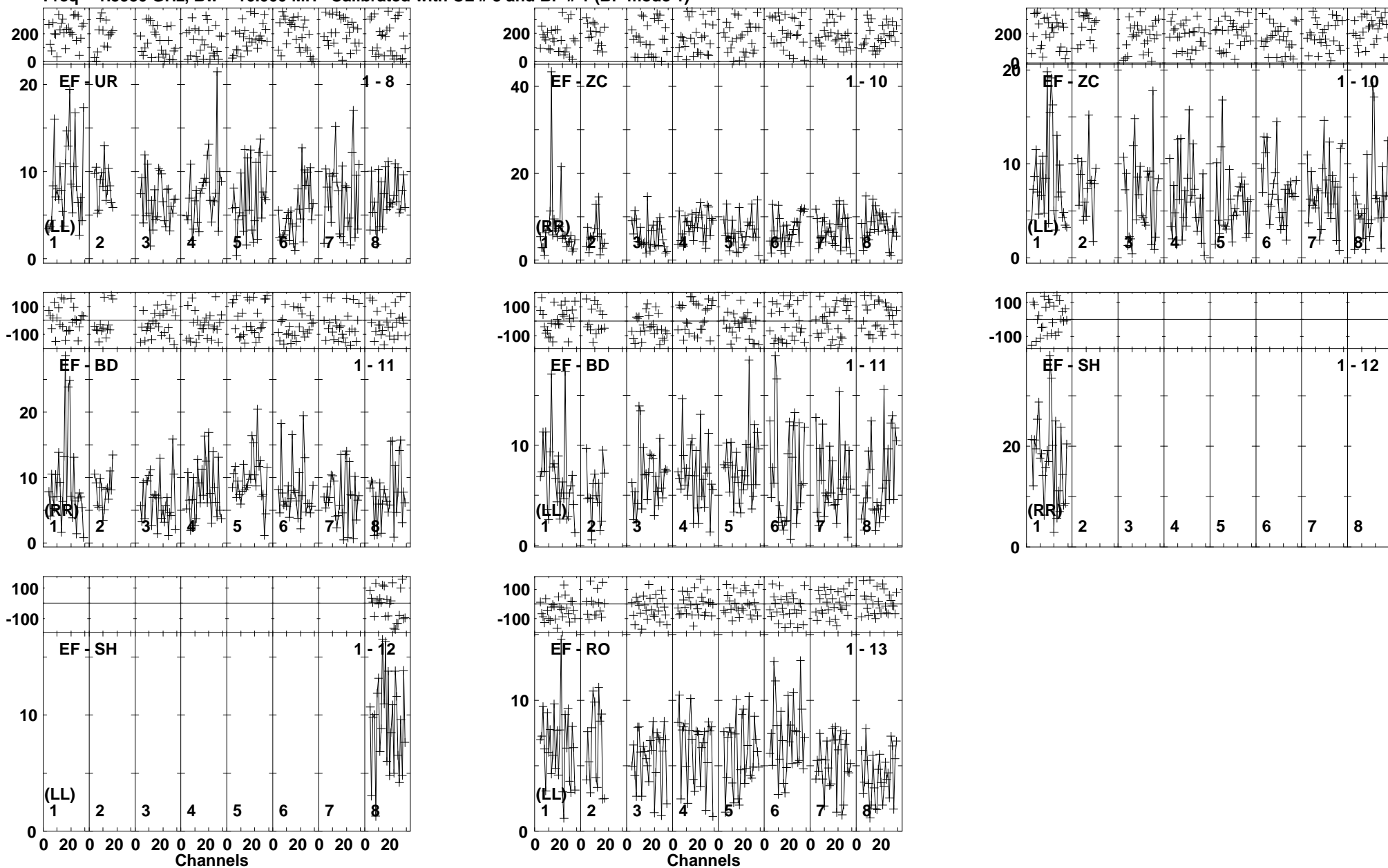

Lower frame: Milli Ampl Jy Top frame: Phas deg
Vector averaged cross-power spectrum Baseline: EF (01) - UR (08)
Timerange: 00/06:39:41 to 00/06:44:09

Plot file version 155 created 25-MAR-2014 17:51:26

J1128+5925 EP087E 1.UVDATA.1

Freq = 1.5950 GHz, Bw = 16.000 MH Calibrated with CL # 3 and BP # 1 (BP mode 1)

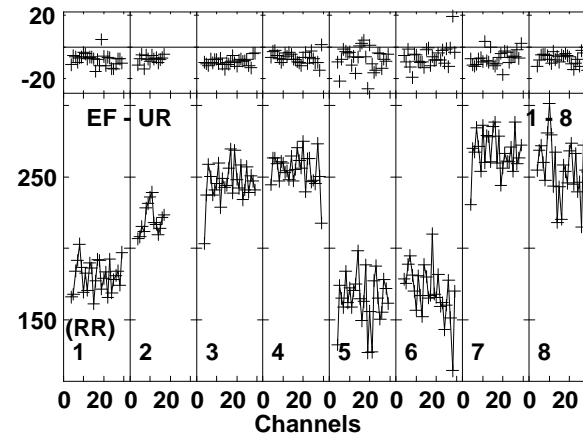
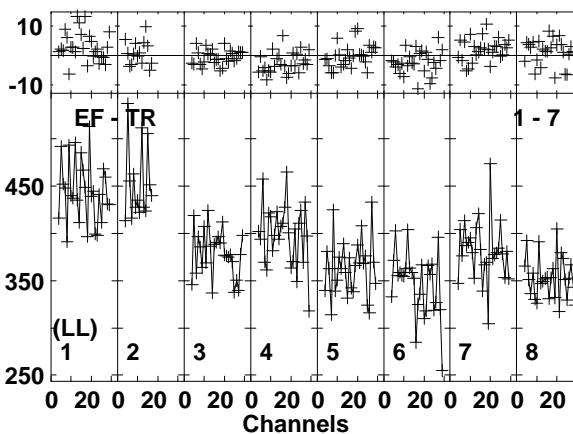
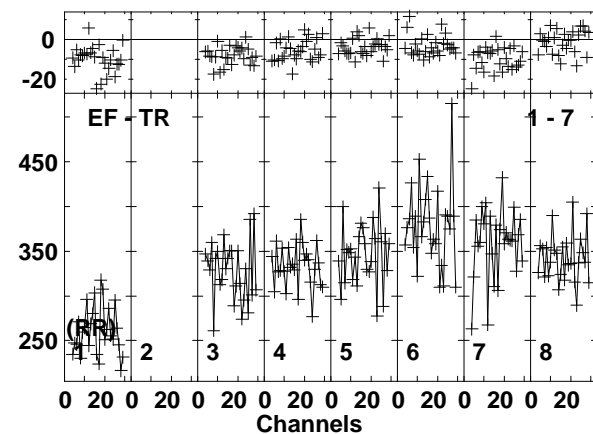
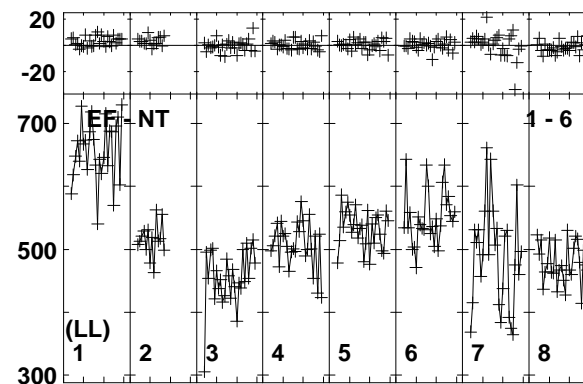
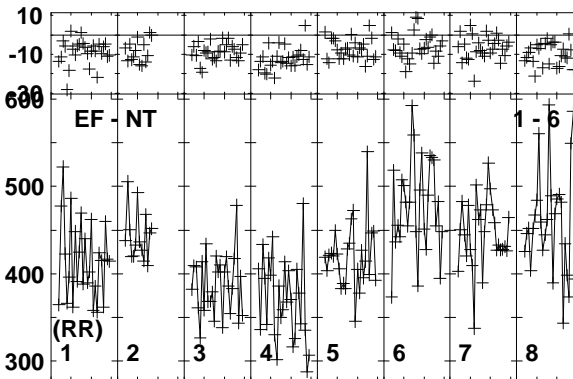
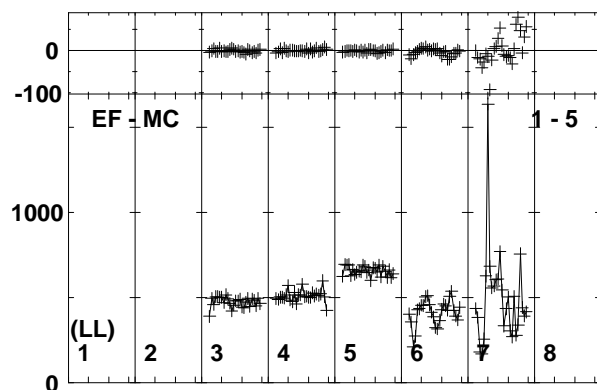
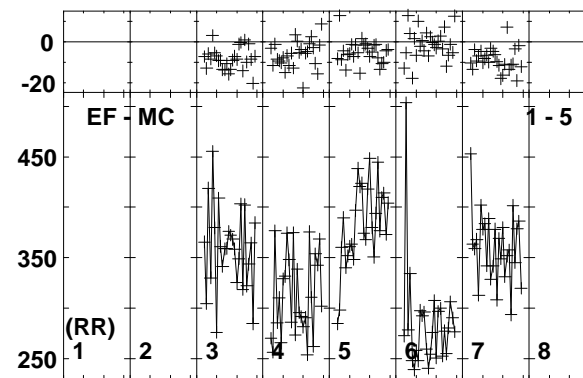
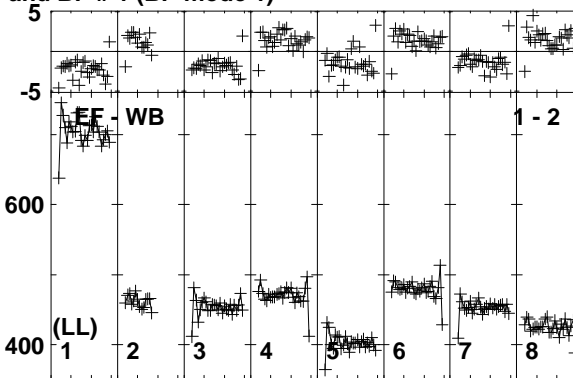
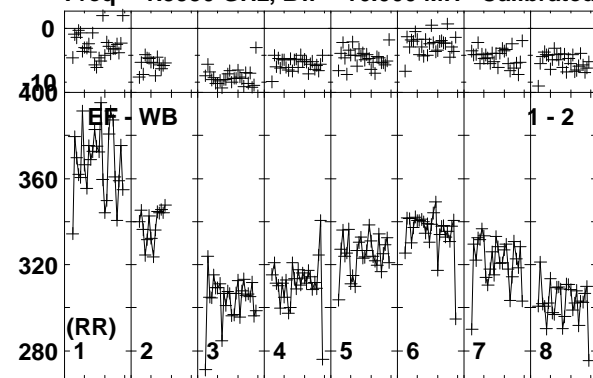

Lower frame: Milli Ampl Jy Top frame: Phas deg
Vector averaged cross-power spectrum Baseline: EF (01) - WB (02)
Timerange: 00/06:44:51 to 00/06:45:19

Plot file version 156 created 25-MAR-2014 17:51:26

J1128+5925 EP087E 1.UVDATA.1

Freq = 1.5950 GHz, Bw = 16.000 MH Calibrated with CL # 3 and BP # 1 (BP mode 1)

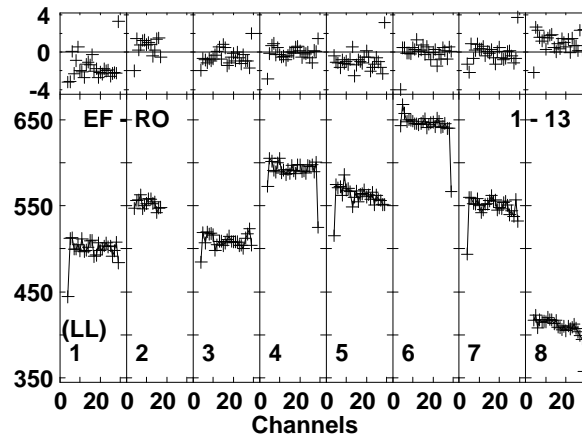
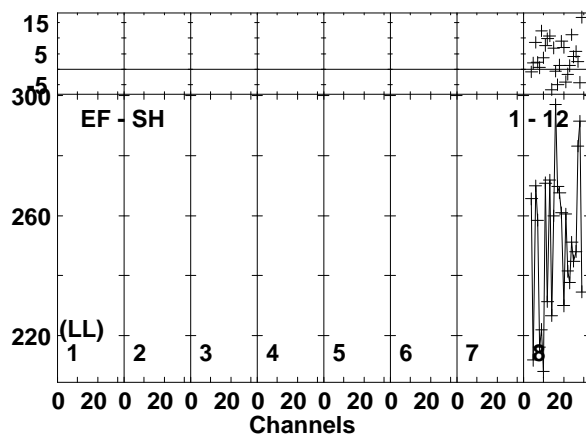
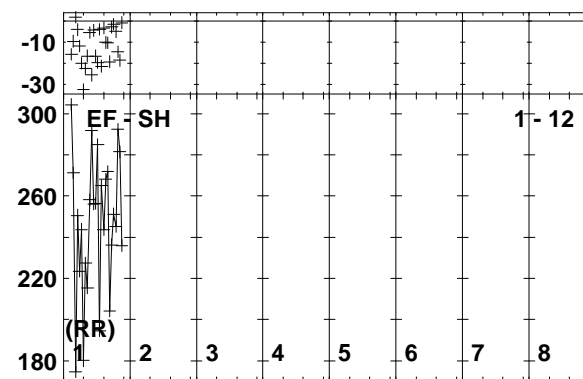
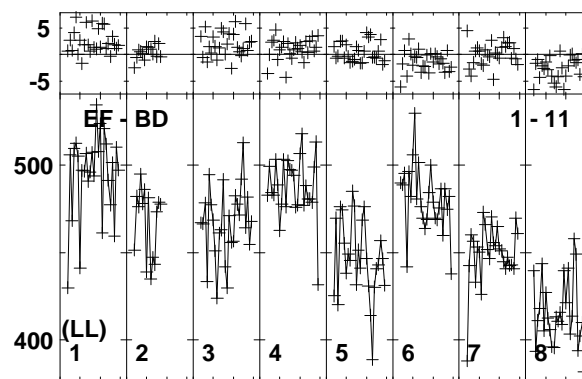
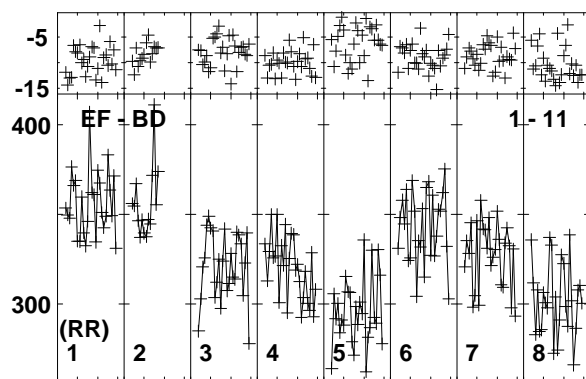
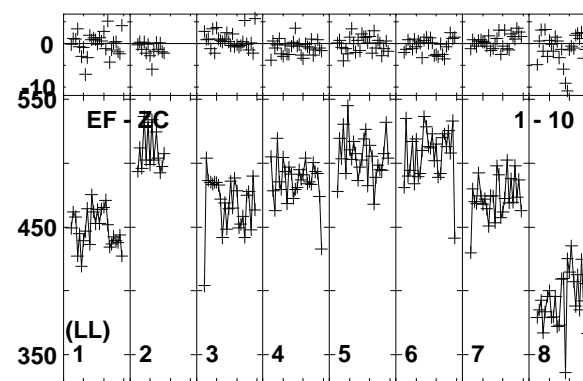
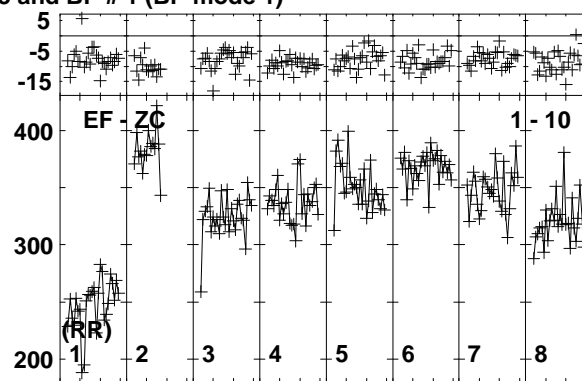
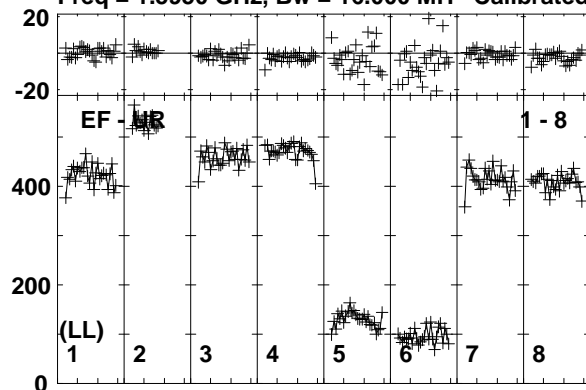

Lower frame: Milli Ampl Jy Top frame: Phas deg
Vector averaged cross-power spectrum Baseline: EF (01) - UR (08)
Timerange: 00/06:44:51 to 00/06:45:19

Plot file version 157 created 25-MAR-2014 17:51:26
 ARP299A EP087E 1.UVDATA.1
 Freq = 1.5950 GHz, Bw = 16.000 MH Calibrated with CL # 3 and BP # 1 (BP mode 1)

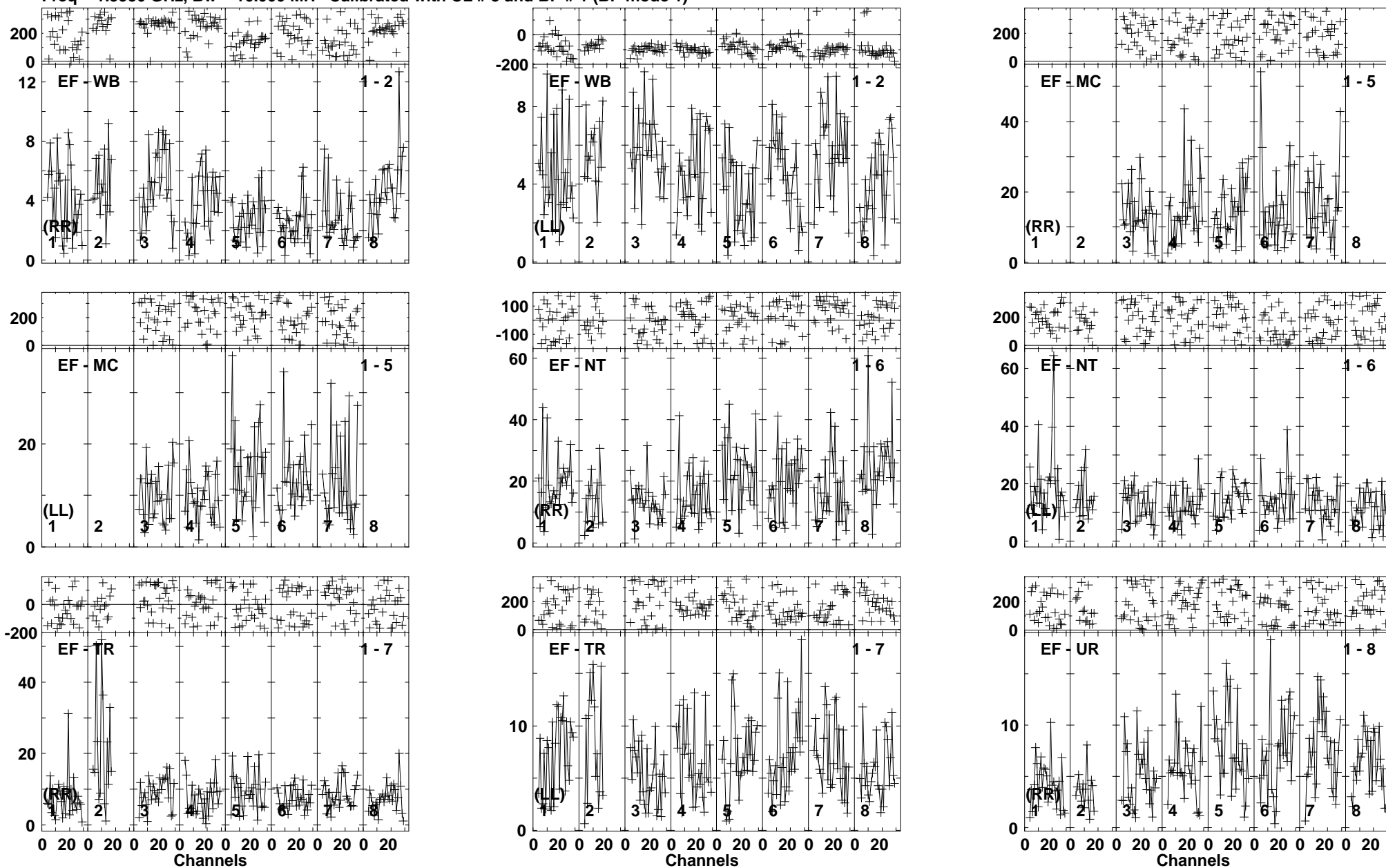

Lower frame: Milli Ampl Jy Top frame: Phas deg
 Vector averaged cross-power spectrum Baseline: EF (01) - WB (02)
 Timerange: 00/06:45:25 to 00/06:49:49

Plot file version 158 created 25-MAR-2014 17:51:26

ARP299A EP087E 1.UVDATA.1

Freq = 1.5950 GHz, Bw = 16.000 MH Calibrated with CL # 3 and BP # 1 (BP mode 1)

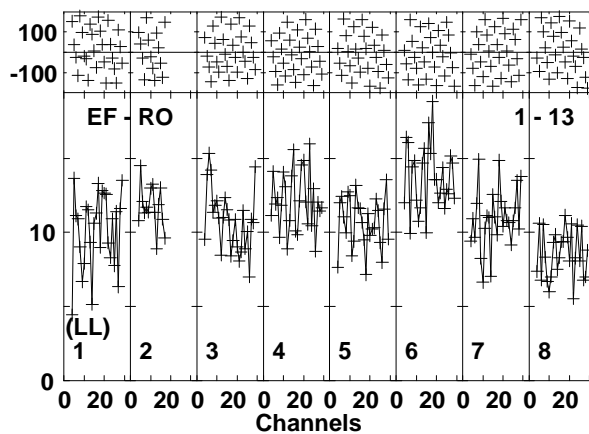
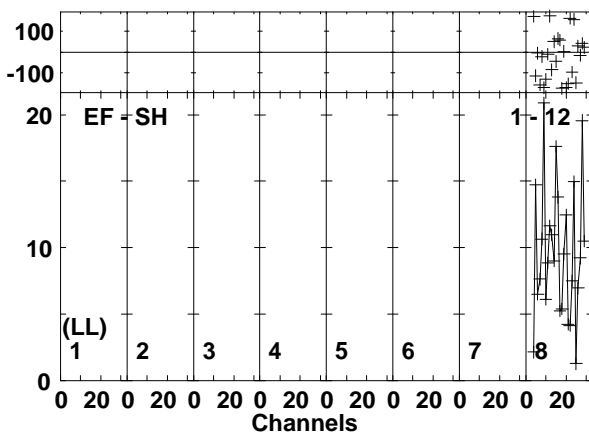
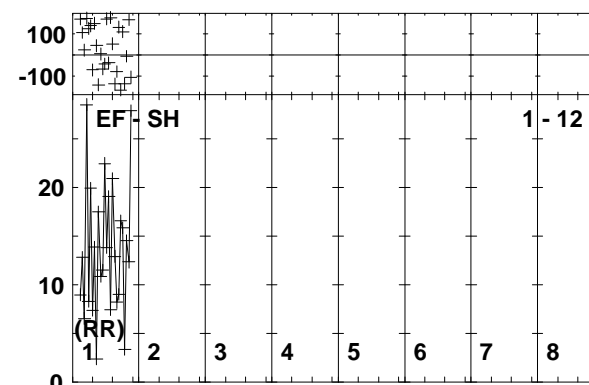
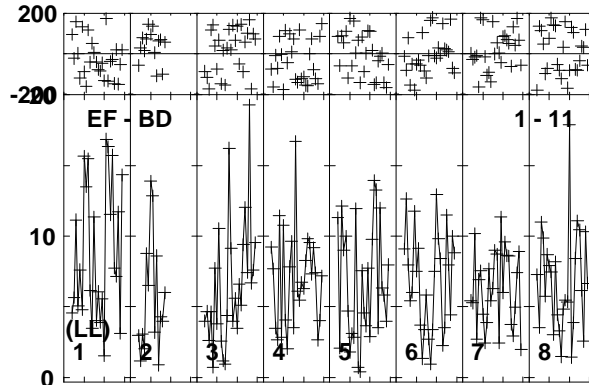
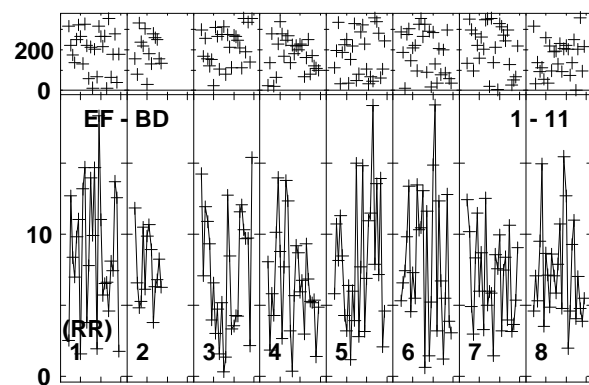
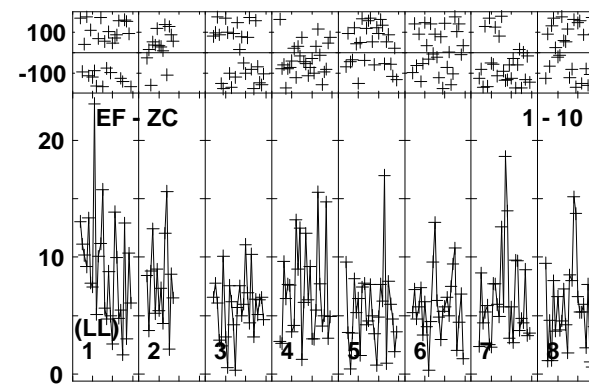
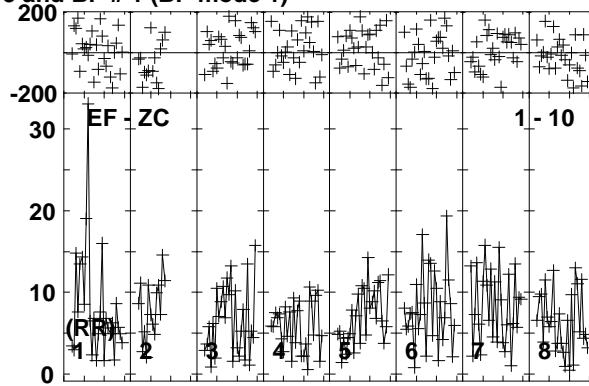
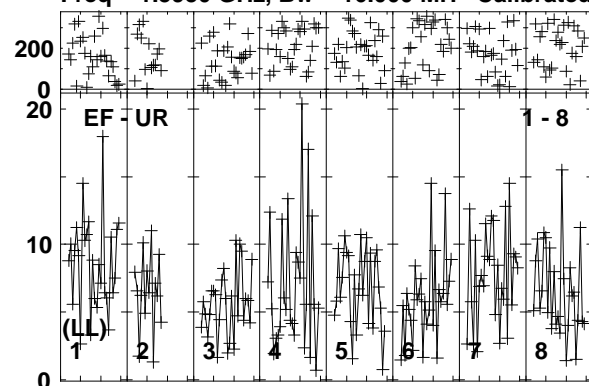

Lower frame: Milli Ampl Jy Top frame: Phas deg
Vector averaged cross-power spectrum Baseline: EF (01) - UR (08)
Timerange: 00/06:45:25 to 00/06:49:49

Plot file version 159 created 25-MAR-2014 17:51:27

J1128+5925 EP087E 1.UVDATA.1

Freq = 1.5950 GHz, Bw = 16.000 MH Calibrated with CL # 3 and BP # 1 (BP mode 1)

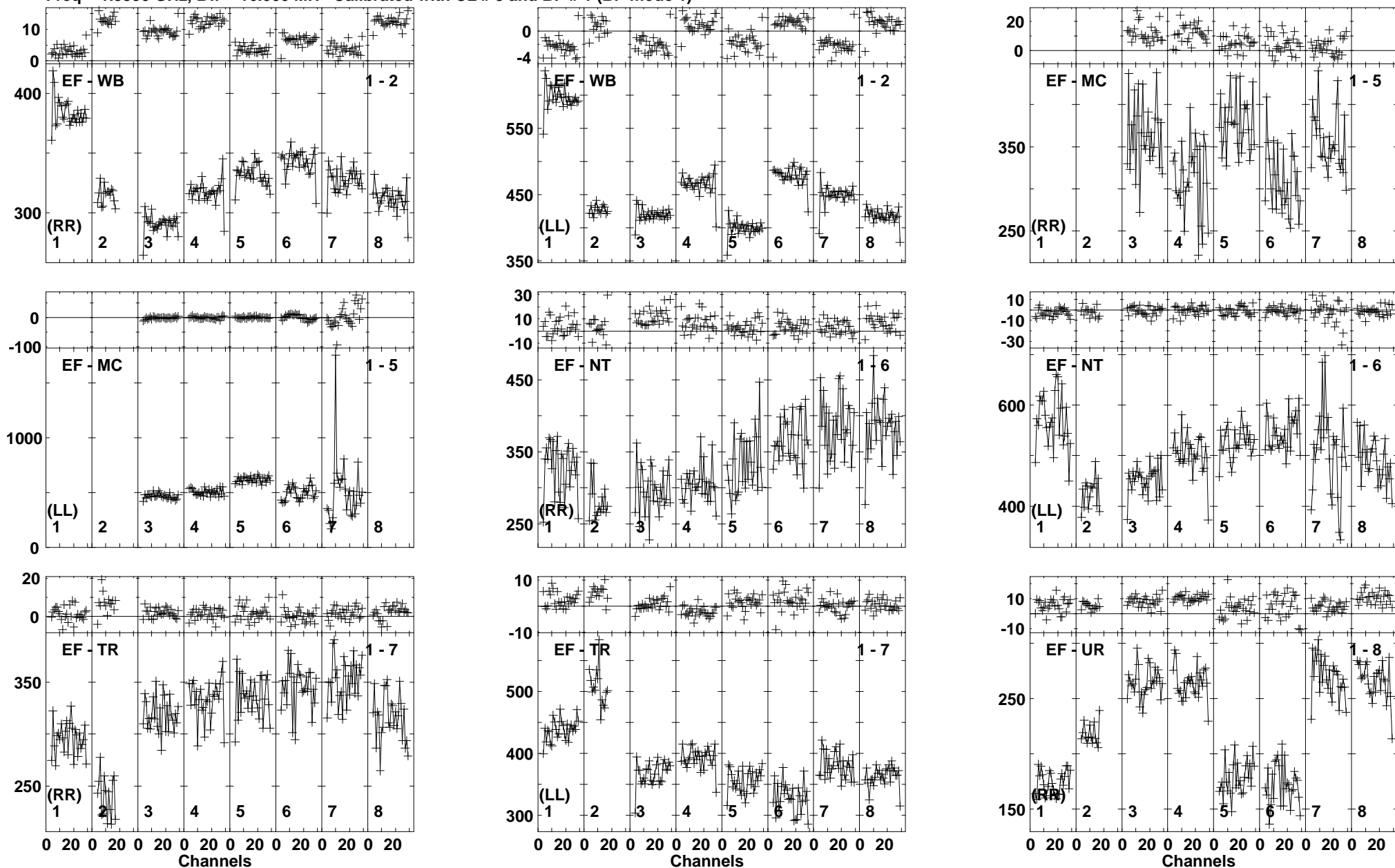

Plot file version 160 created 25-MAR-2014 17:51:27

J1128+5925 EP087E 1.UVDATA.1

Freq = 1.5950 GHz, Bw = 16.000 MH Calibrated with CL # 3 and BP # 1 (BP mode 1)

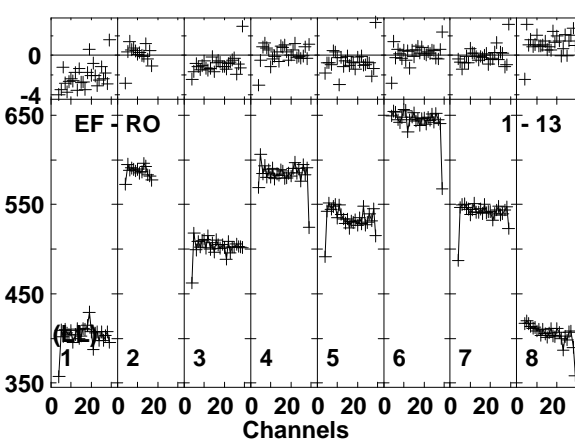
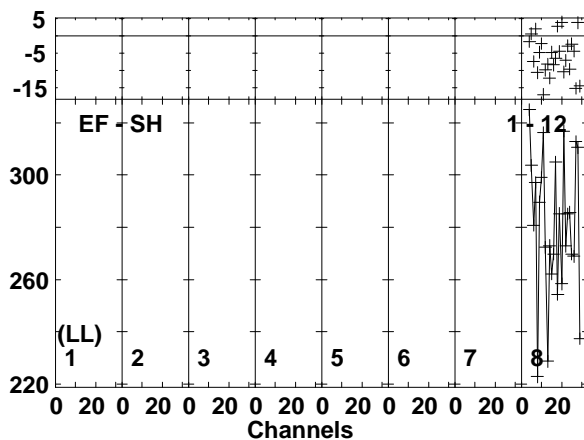
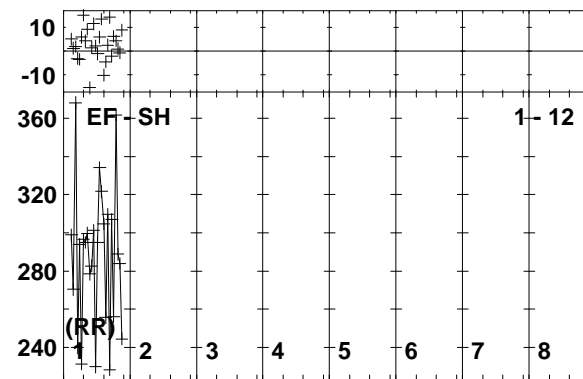
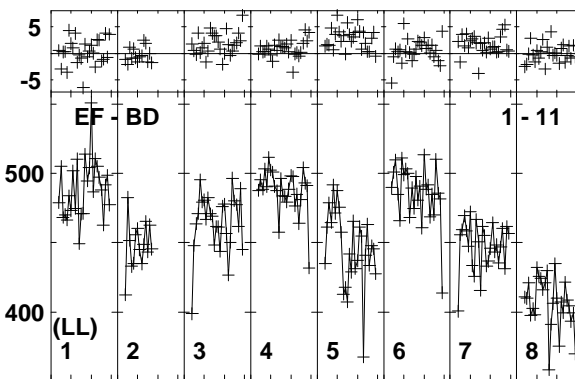
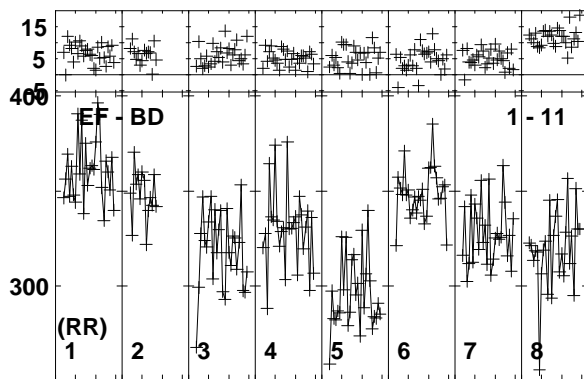
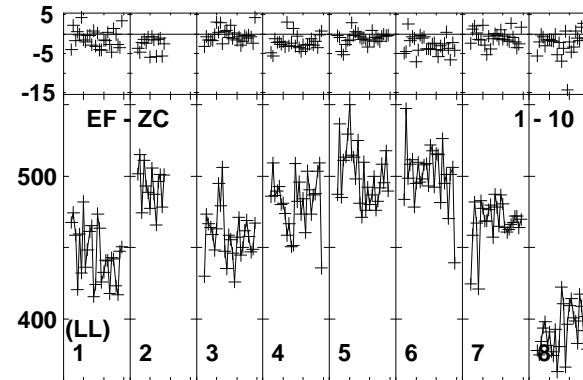
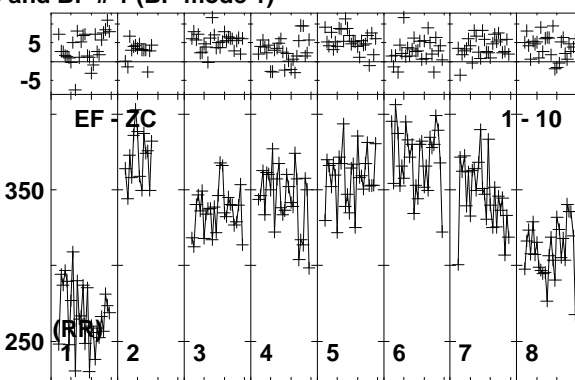
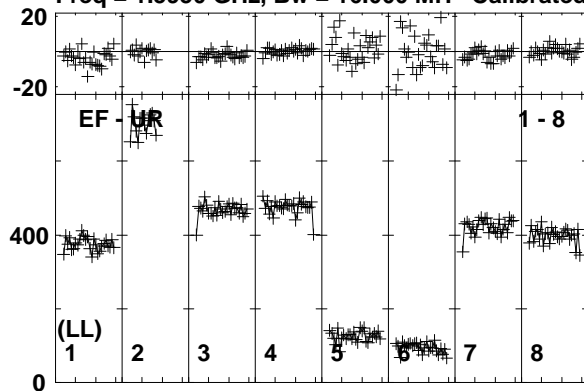

Lower frame: Milli Ampl Jy Top frame: Phas deg
Vector averaged cross-power spectrum Baseline: EF (01) - UR (08)
Timerange: 00/06:49:55 to 00/06:50:49

Plot file version 161 created 25-MAR-2014 17:51:27

ARP299A EP087E 1.UVDATA.1

Freq = 1.5950 GHz, Bw = 16.000 MH Calibrated with CL # 3 and BP # 1 (BP mode 1)

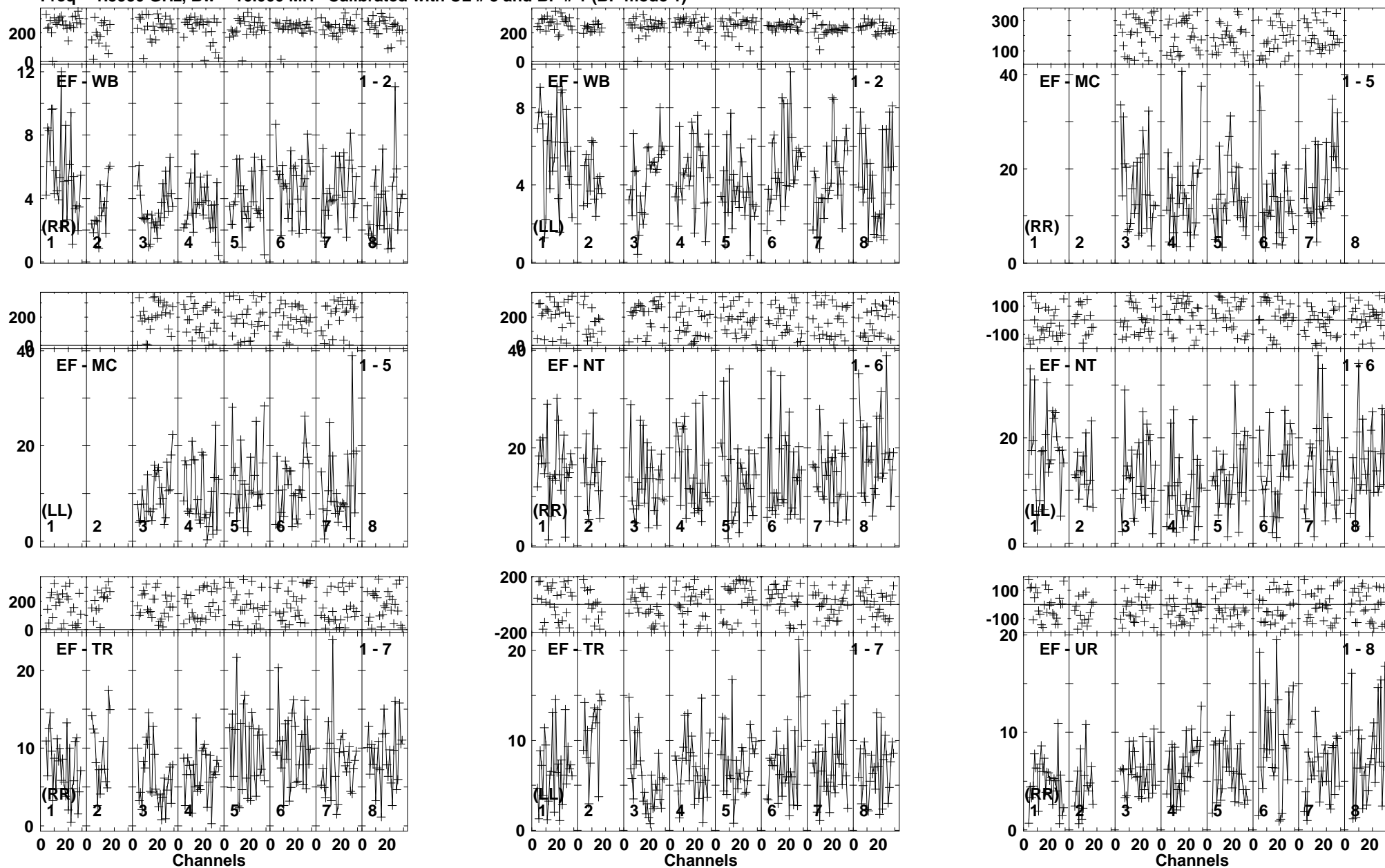

Lower frame: Milli Ampl Jy Top frame: Phas deg
Vector averaged cross-power spectrum Baseline: EF (01) - WB (02)
Timerange: 00/06:50:51 to 00/06:55:19

Plot file version 162 created 25-MAR-2014 17:51:28
 ARP299A EP087E 1.UVDATA.1
 Freq = 1.5950 GHz, Bw = 16.000 MH Calibrated with CL # 3 and BP # 1 (BP mode 1)

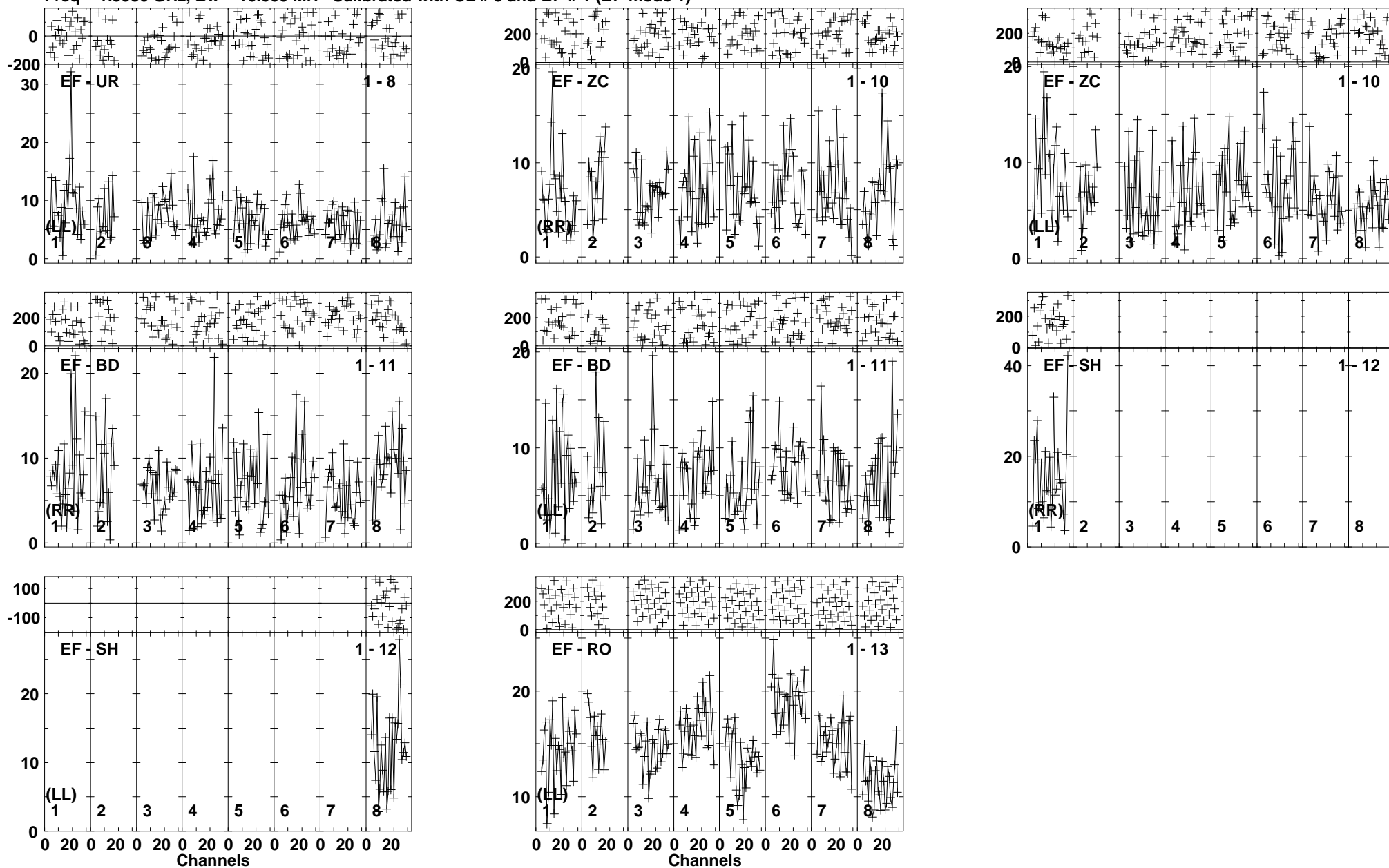

Lower frame: Milli Ampl Jy Top frame: Phas deg
 Vector averaged cross-power spectrum Baseline: EF (01) - UR (08)
 Timerange: 00/06:50:51 to 00/06:55:19

Plot file version 163 created 25-MAR-2014 17:51:28

J1128+5925 EP087E 1.UVDATA.1

Freq = 1.5950 GHz, Bw = 16.000 MH Calibrated with CL # 3 and BP # 1 (BP mode 1)

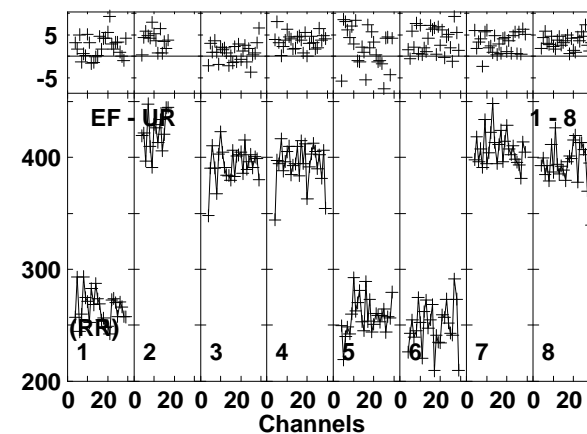
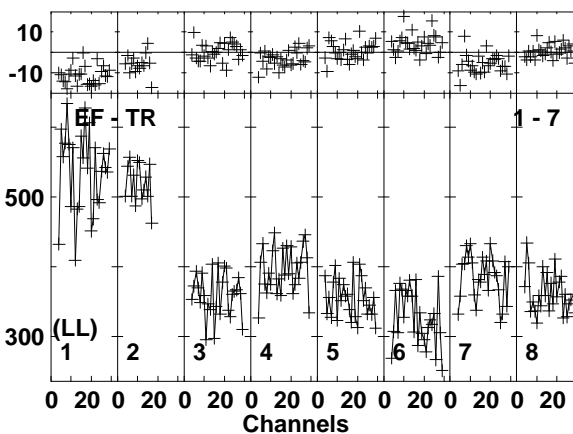
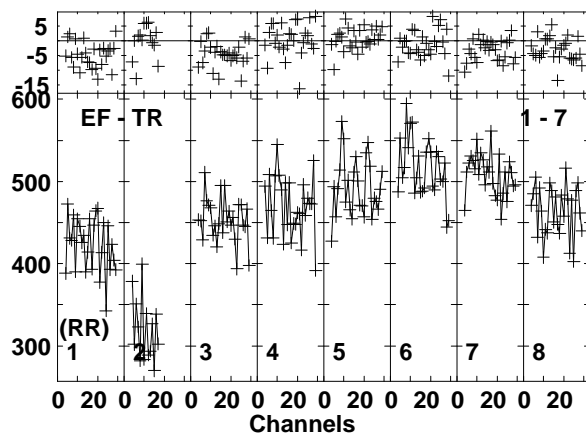
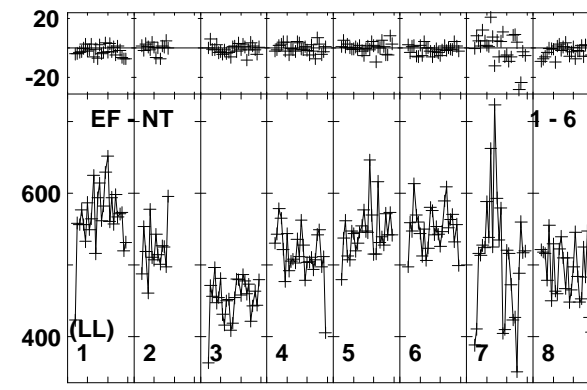
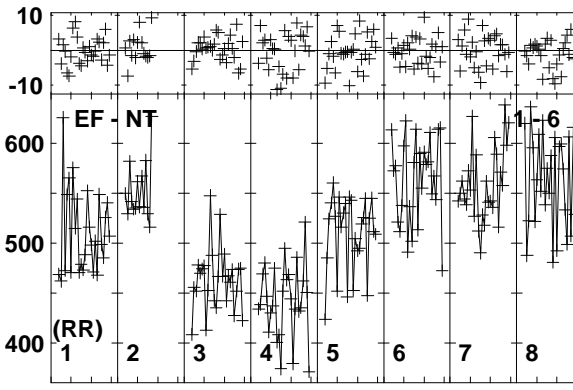
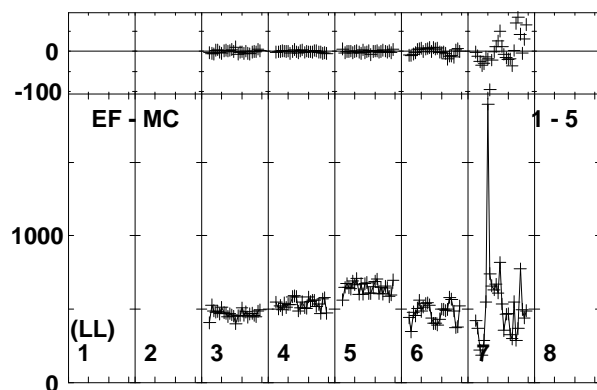
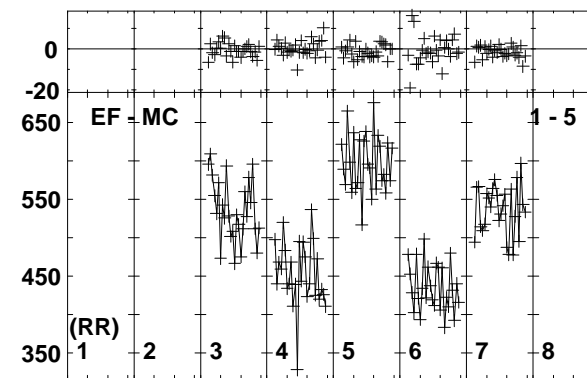
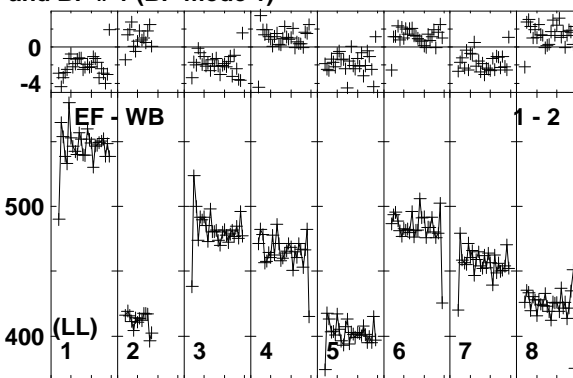
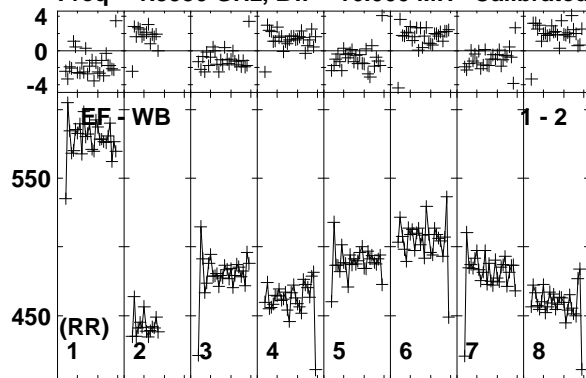

Lower frame: Milli Ampl Jy Top frame: Phas deg
Vector averaged cross-power spectrum Baseline: EF (01) - WB (02)
Timerange: 00/06:56:01 to 00/06:56:29

Plot file version 164 created 25-MAR-2014 17:51:28

J1128+5925 EP087E 1.UVDATA.1

Freq = 1.5950 GHz, Bw = 16.000 MH Calibrated with CL # 3 and BP # 1 (BP mode 1)

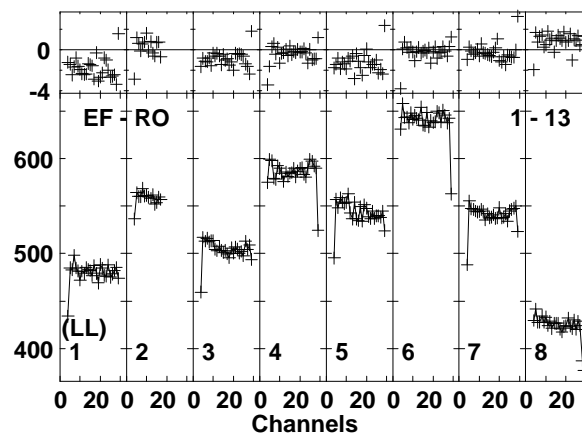
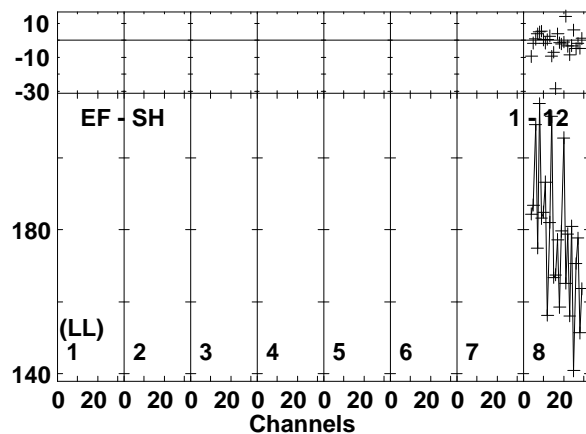
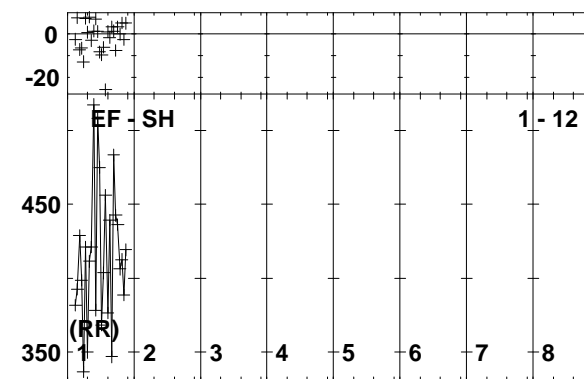
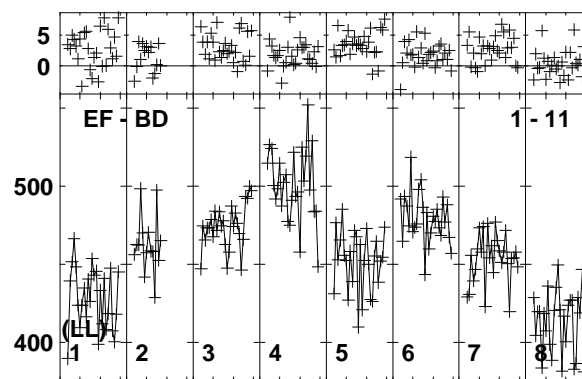
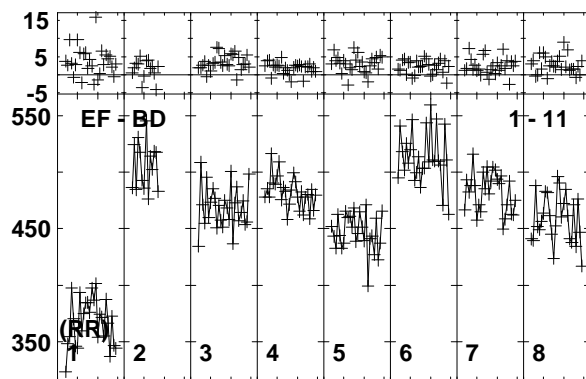
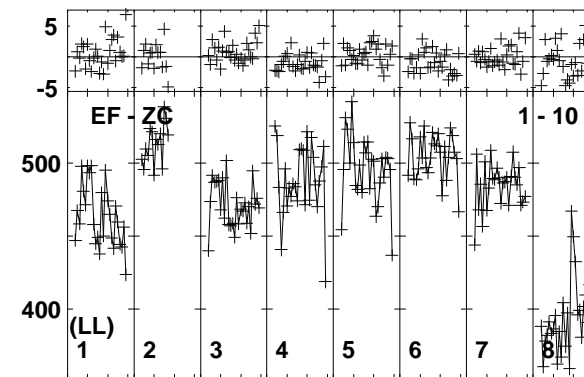
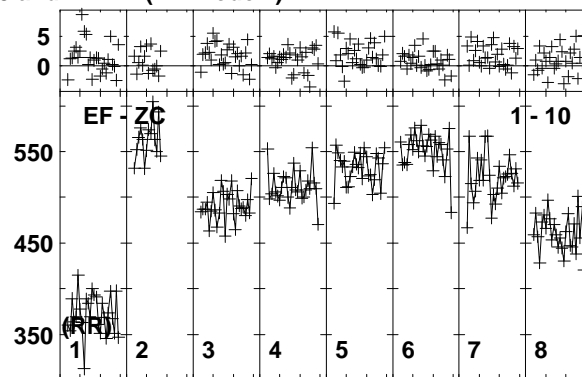
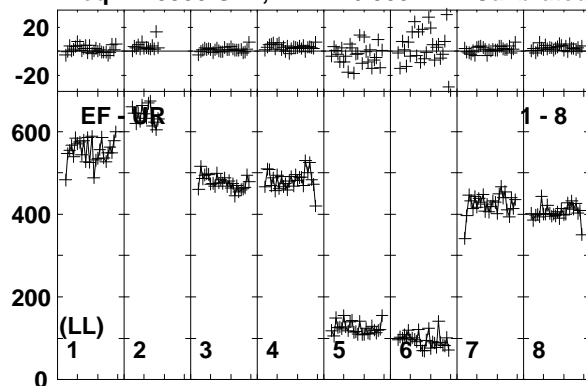

Lower frame: Milli Ampl Jy Top frame: Phas deg
Vector averaged cross-power spectrum Baseline: EF (01) - UR (08)
Timerange: 00/06:56:01 to 00/06:56:29

Plot file version 165 created 25-MAR-2014 17:51:28
 ARP299A EP087E 1.UVDATA.1
 Freq = 1.5950 GHz, Bw = 16.000 MH Calibrated with CL # 3 and BP # 1 (BP mode 1)

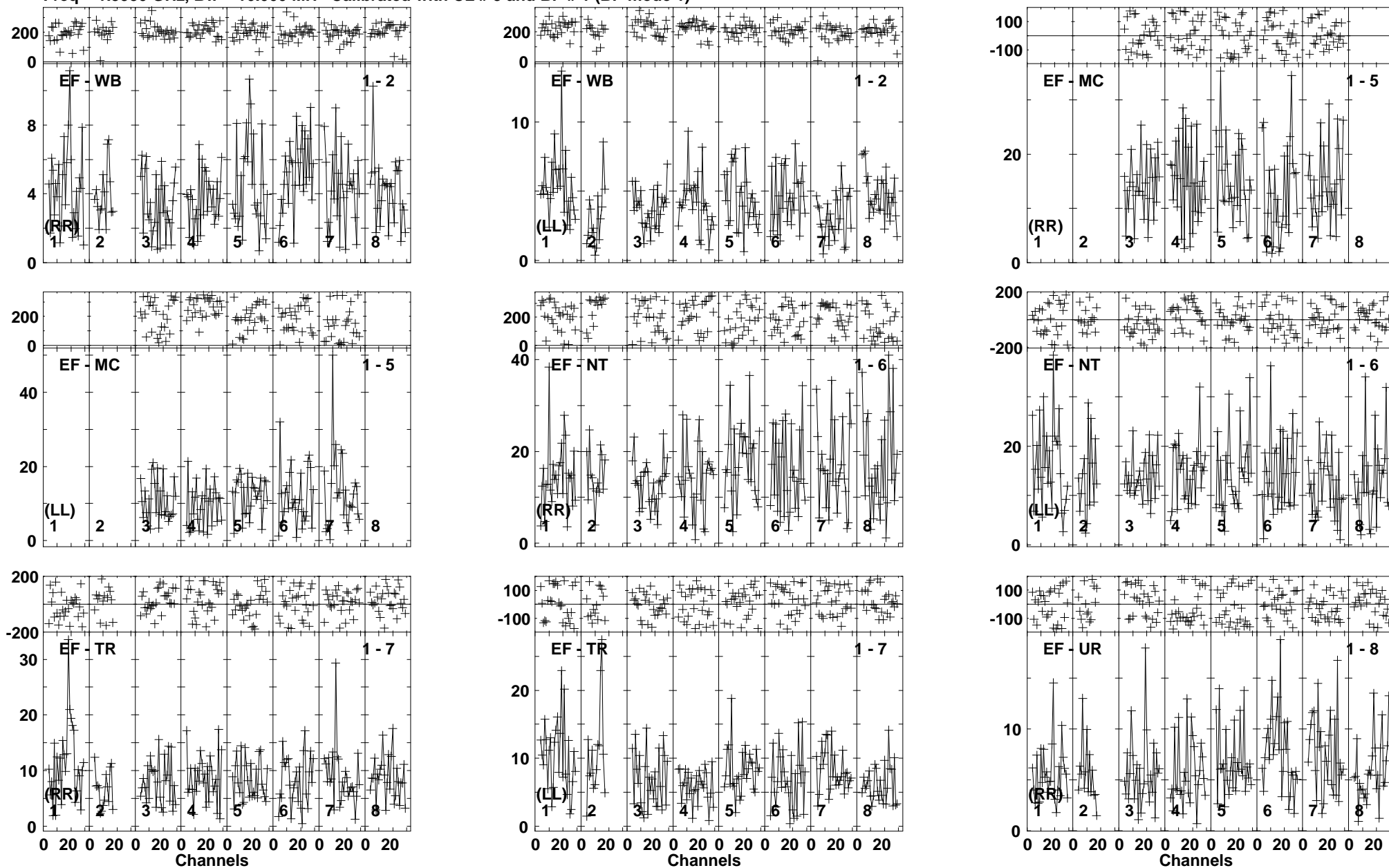

Lower frame: Milli Ampl Jy Top frame: Phas deg
 Vector averaged cross-power spectrum Baseline: EF (01) - WB (02)
 Timerange: 00/06:56:35 to 00/07:00:59

Plot file version 166 created 25-MAR-2014 17:51:29
 ARP299A EP087E 1.UVDATA.1
 Freq = 1.5950 GHz, Bw = 16.000 MH Calibrated with CL # 3 and BP # 1 (BP mode 1)

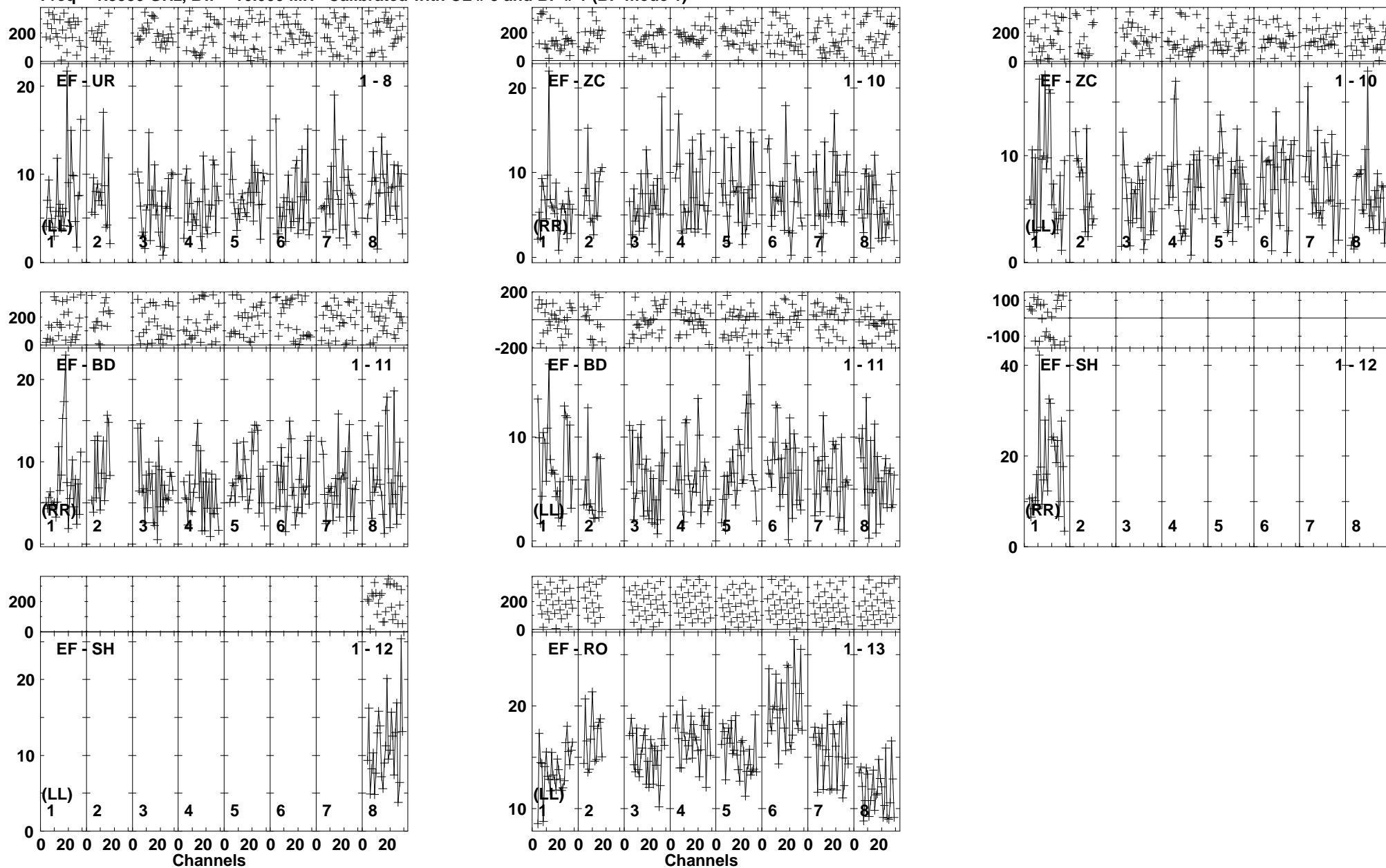

Lower frame: Milli Ampl Jy Top frame: Phas deg
 Vector averaged cross-power spectrum Baseline: EF (01) - UR (08)
 Timerange: 00/06:56:35 to 00/07:00:59

Plot file version 167 created 25-MAR-2014 17:51:29

J1128+5925 EP087E 1.UVDATA.1

Freq = 1.5950 GHz, Bw = 16.000 MH Calibrated with CL # 3 and BP # 1 (BP mode 1)

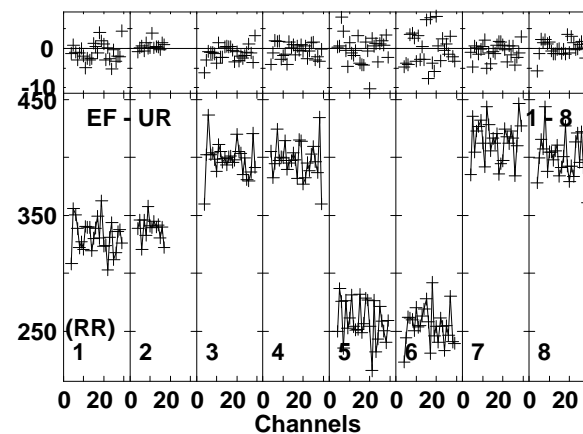
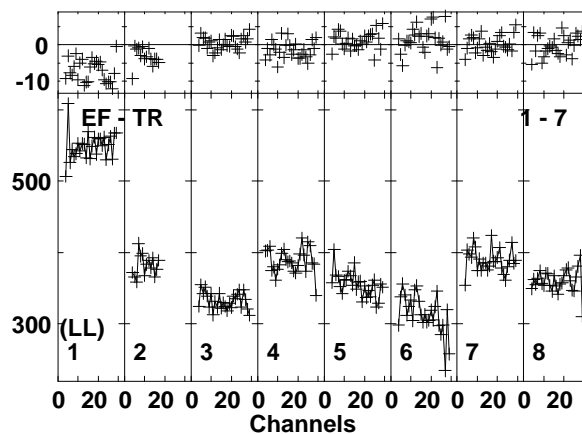
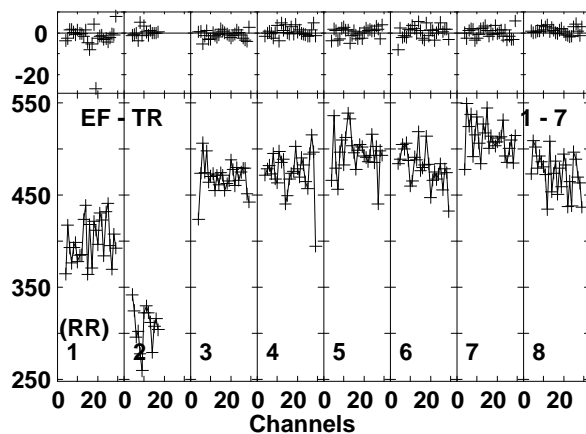
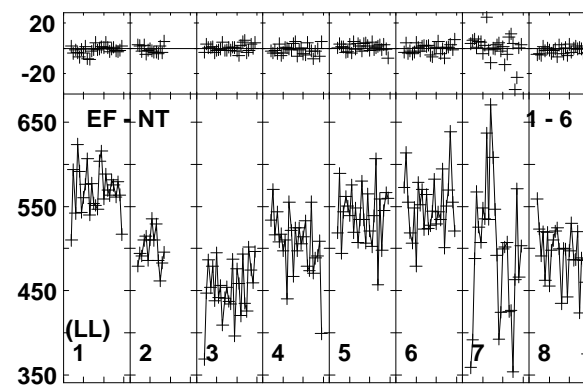
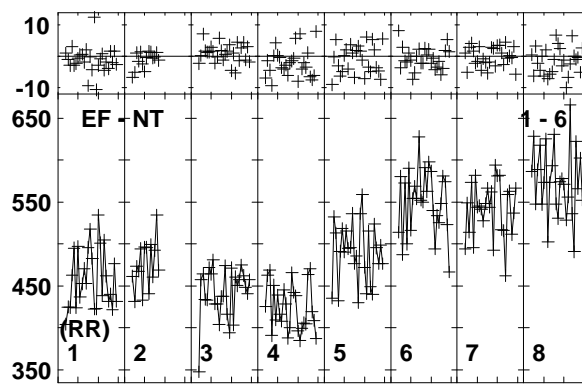
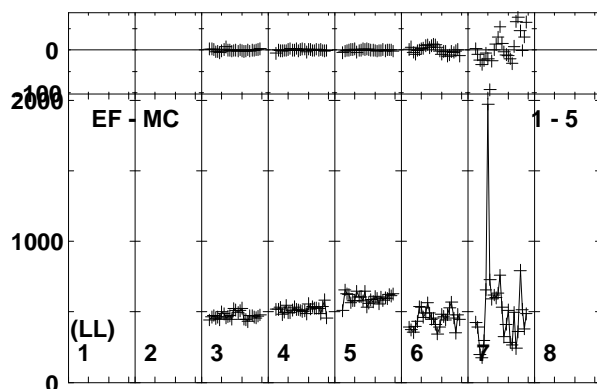
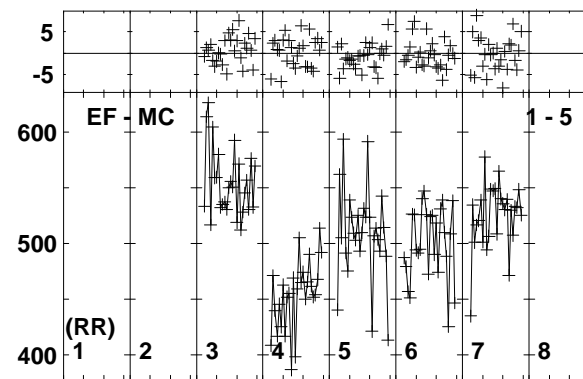
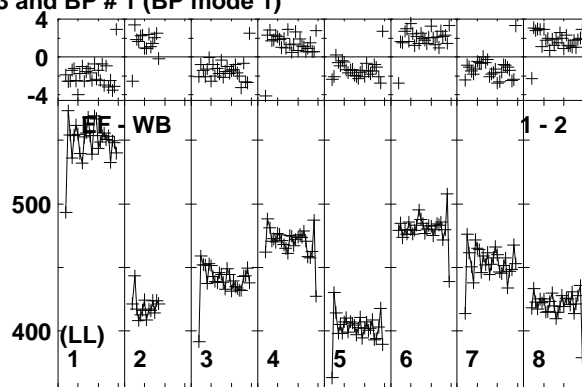
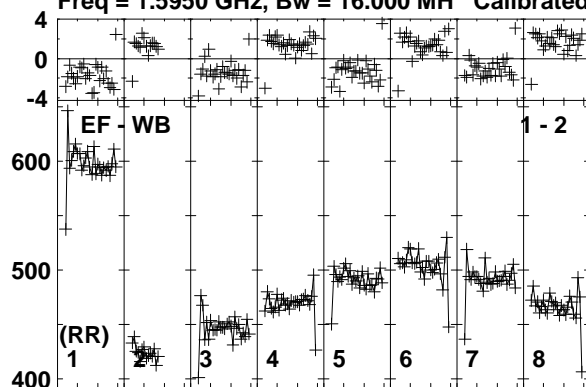

Lower frame: Milli Ampl Jy Top frame: Phas deg
Vector averaged cross-power spectrum Baseline: EF (01) - WB (02)
Timerange: 00/07:01:05 to 00/07:02:09

Plot file version 168 created 25-MAR-2014 17:51:29

J1128+5925 EP087E 1.UVDATA.1

Freq = 1.5950 GHz, Bw = 16.000 MH Calibrated with CL # 3 and BP # 1 (BP mode 1)

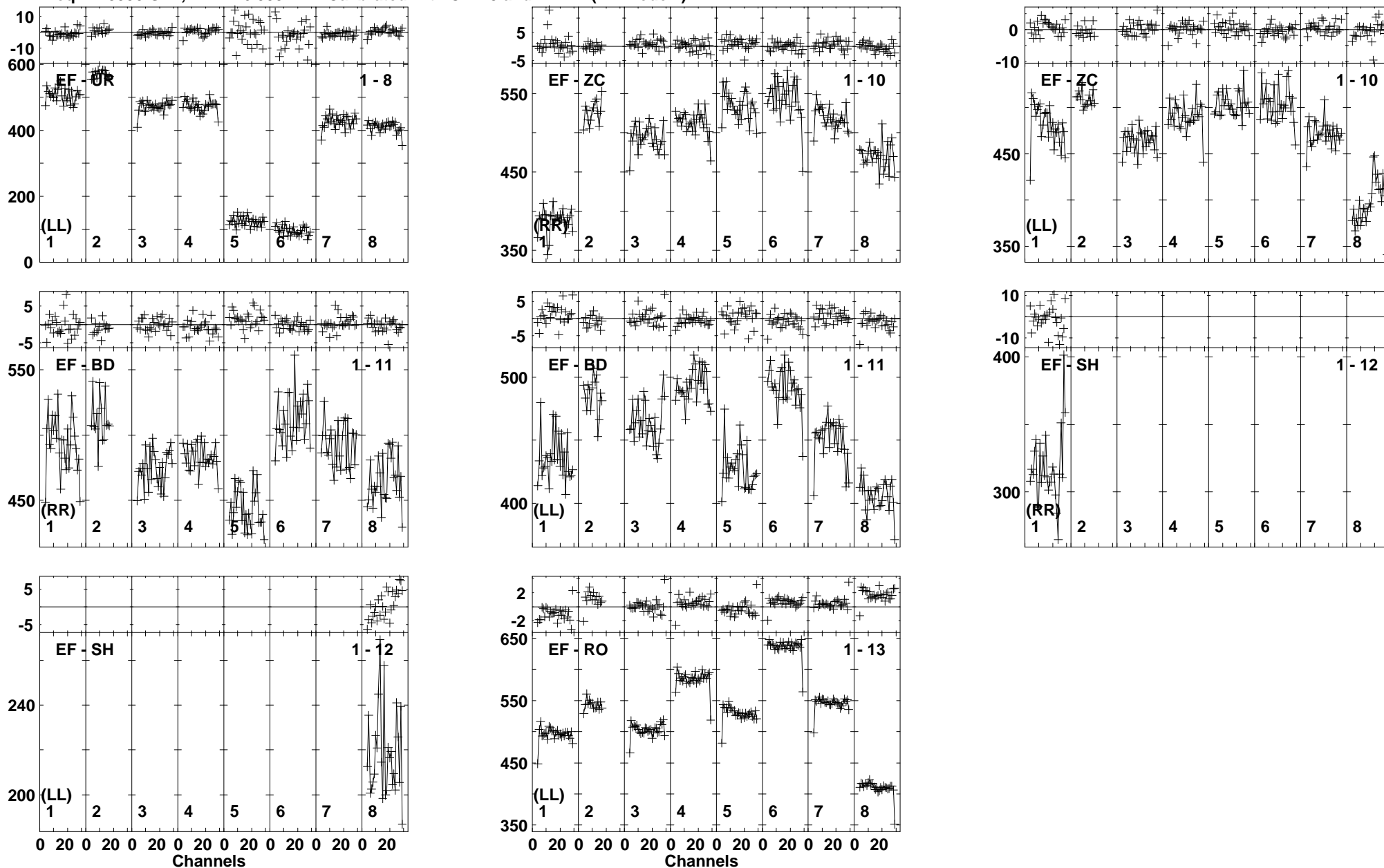

Plot file version 169 created 25-MAR-2014 17:51:30

ARP299A EP087E 1.UVDATA.1

Freq = 1.5950 GHz, Bw = 16.000 MH Calibrated with CL # 3 and BP # 1 (BP mode 1)

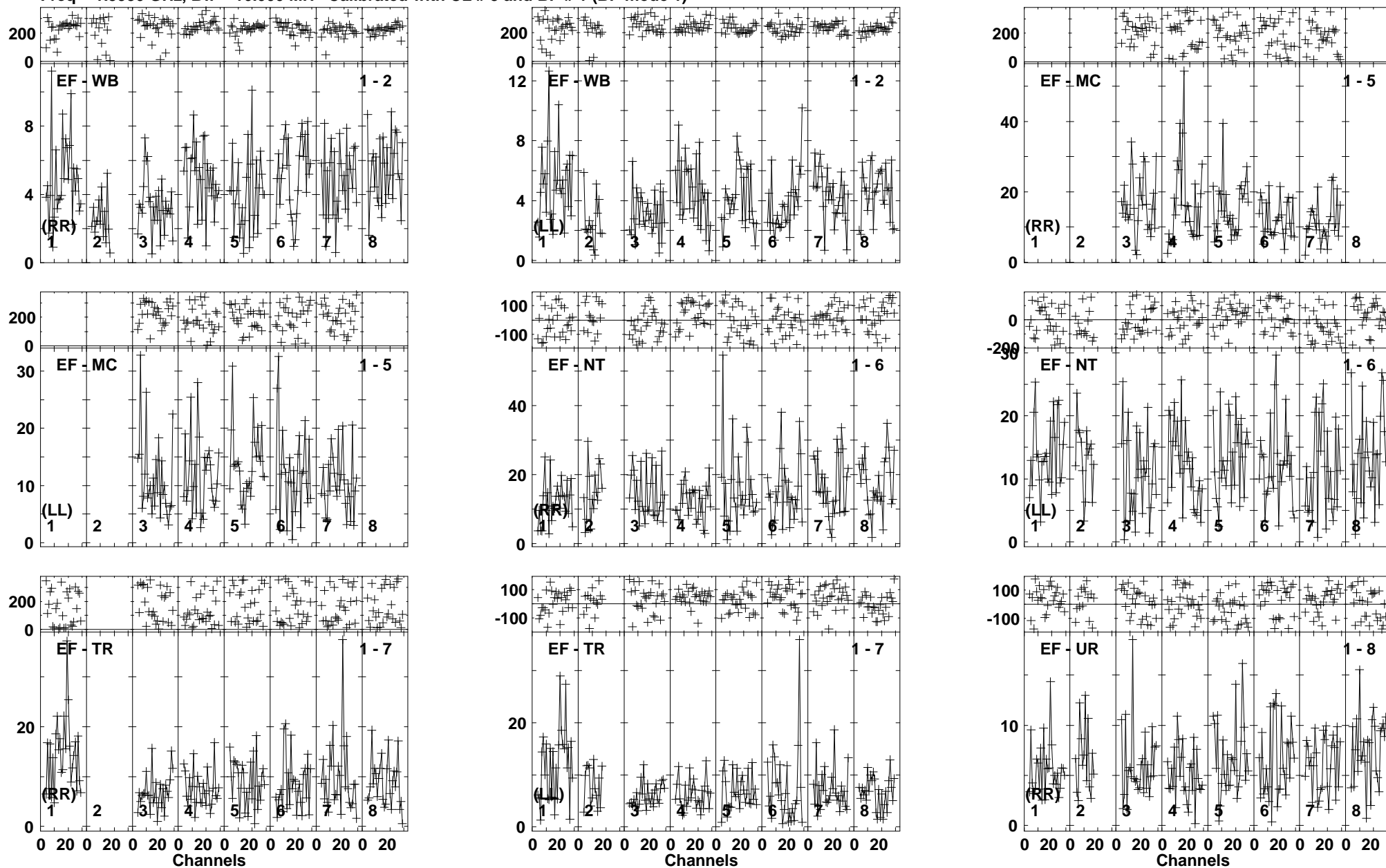

Lower frame: Milli Ampl Jy Top frame: Phas deg
Vector averaged cross-power spectrum Baseline: EF (01) - WB (02)
Timerange: 00/07:02:11 to 00/07:06:39

Plot file version 170 created 25-MAR-2014 17:51:30
 ARP299A EP087E 1.UVDATA.1
 Freq = 1.5950 GHz, Bw = 16.000 MH Calibrated with CL # 3 and BP # 1 (BP mode 1)

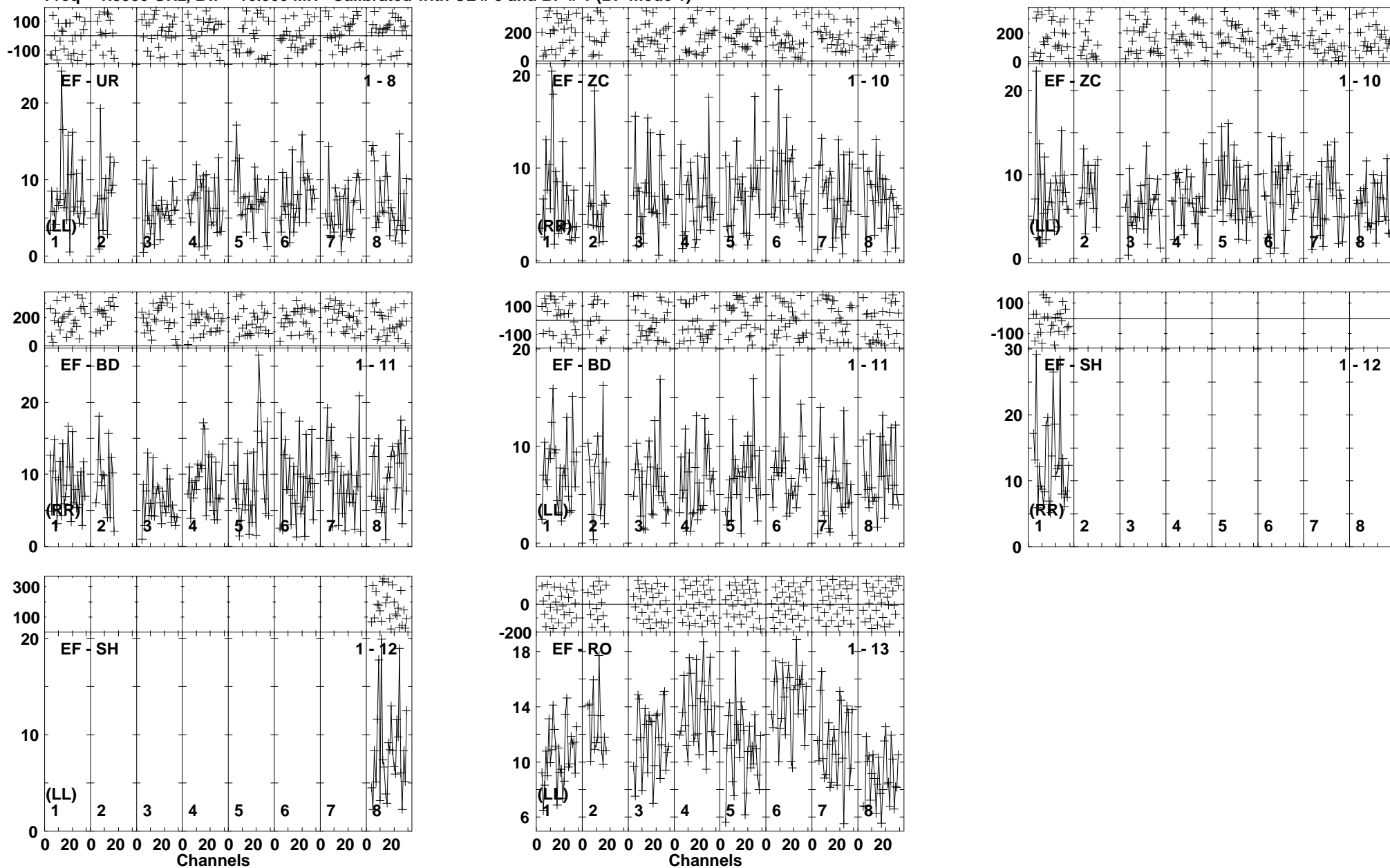

Lower frame: Milli Ampl Jy Top frame: Phas deg
 Vector average cross-power spectrum Baseline: EF (01) - UR (08)
 Timerange: 00/07:02:11 to 00/07:06:39

Plot file version 171 created 25-MAR-2014 17:51:30

J1128+5925 EP087E 1.UVDATA.1

Freq = 1.5950 GHz, Bw = 16.000 MH Calibrated with CL # 3 and BP # 1 (BP mode 1)

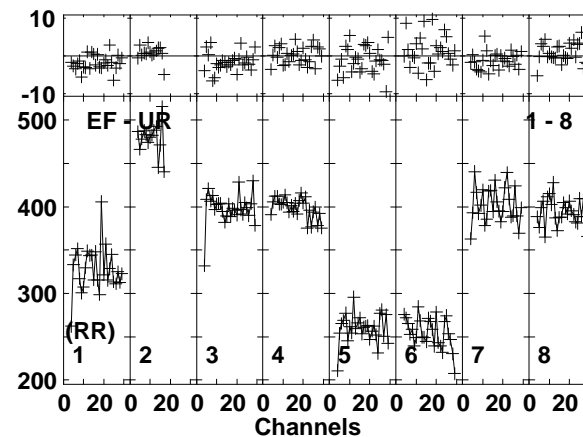
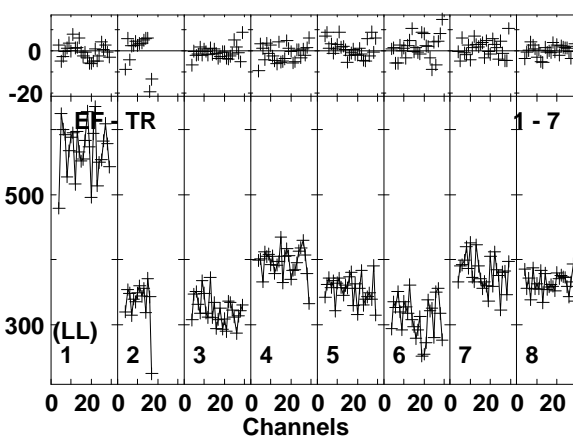
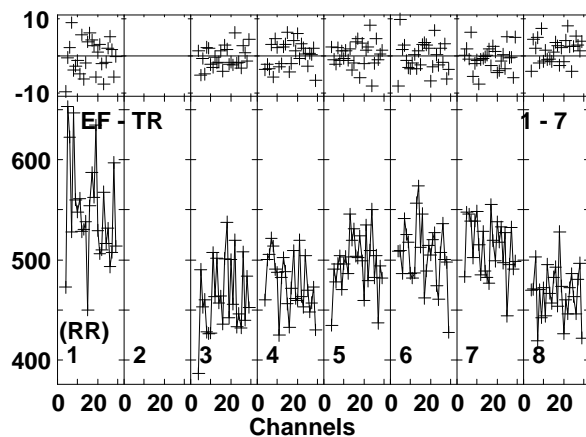
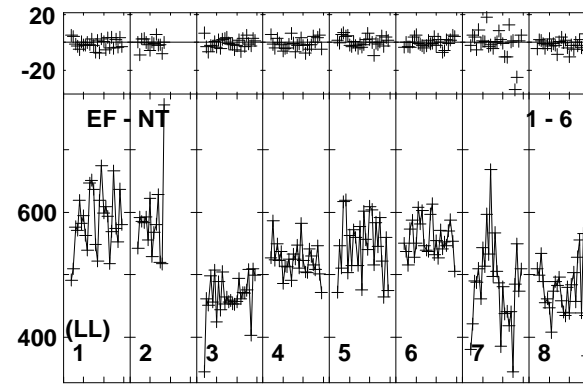
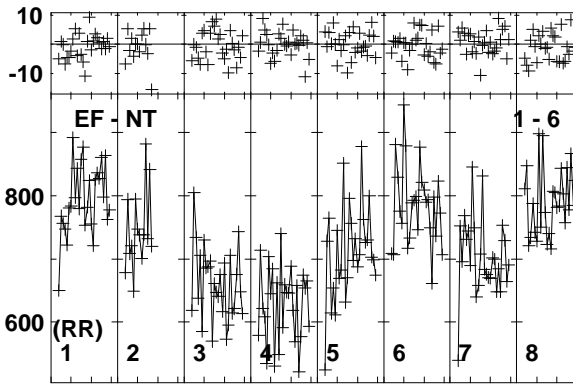
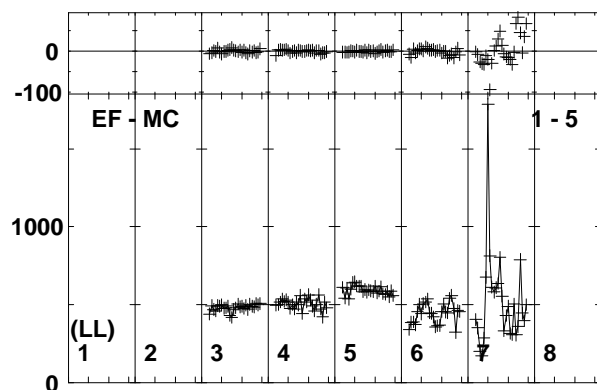
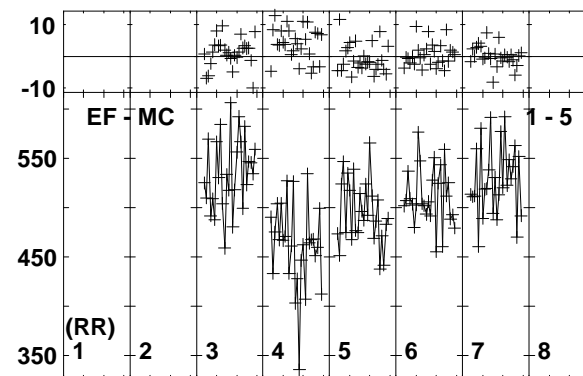
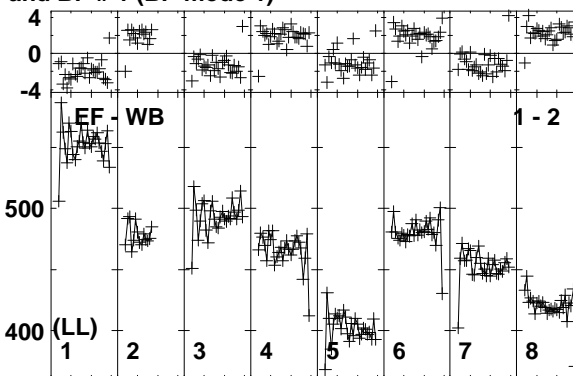
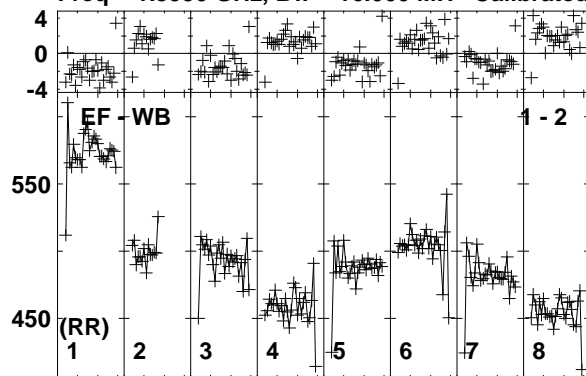

Lower frame: Milli Ampl Jy Top frame: Phas deg
Vector averaged cross-power spectrum Baseline: EF (01) - WB (02)
Timerange: 00/07:07:21 to 00/07:07:49

Plot file version 172 created 25-MAR-2014 17:51:30

J1128+5925 EP087E 1.UVDATA.1

Freq = 1.5950 GHz, Bw = 16.000 MH Calibrated with CL # 3 and BP # 1 (BP mode 1)

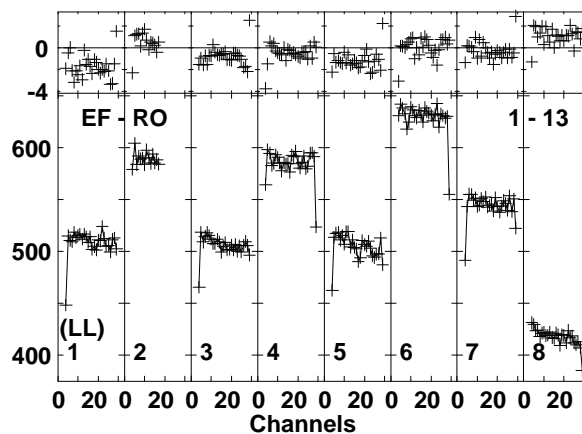
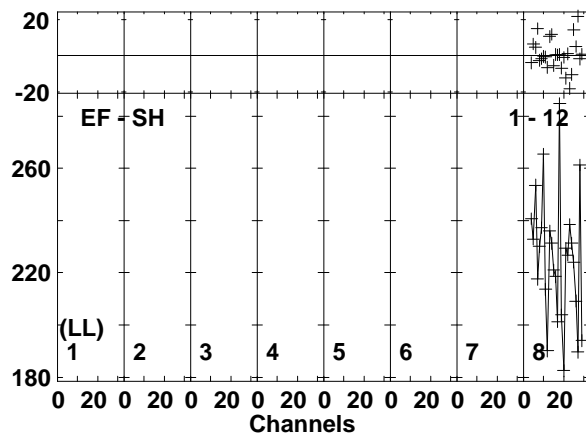
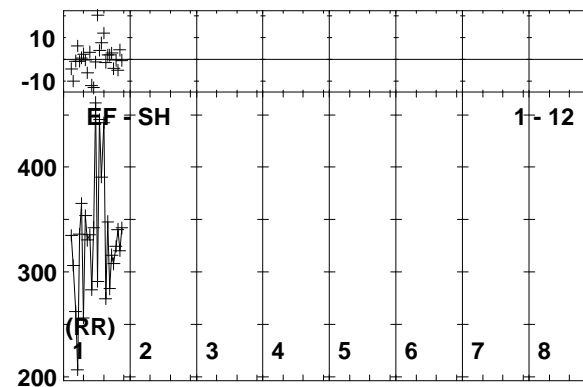
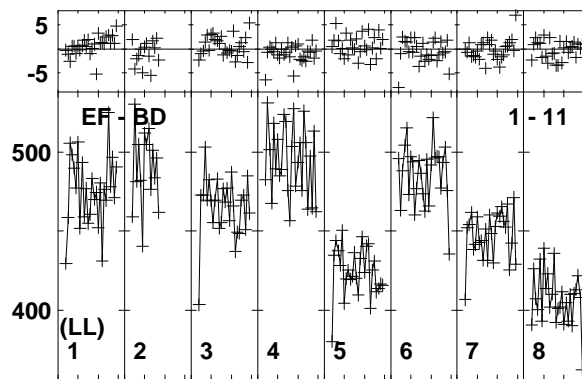
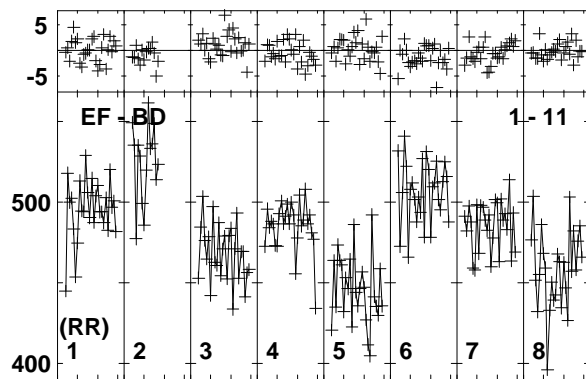
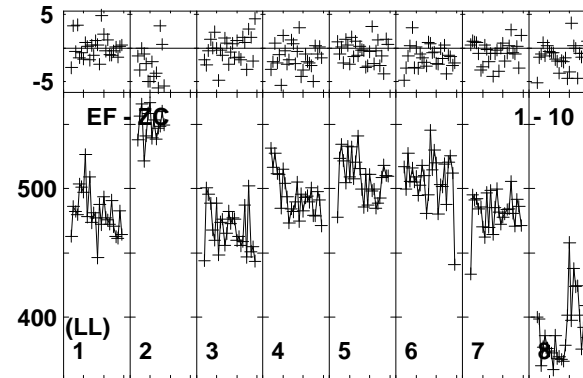
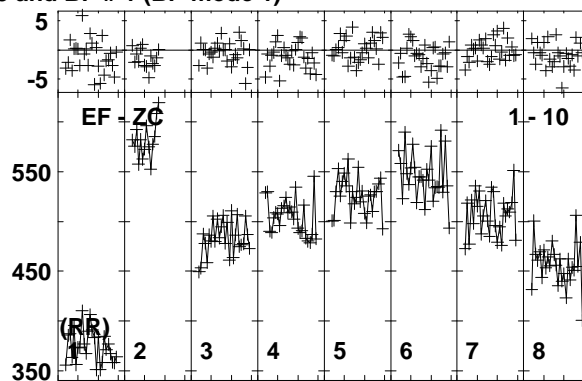
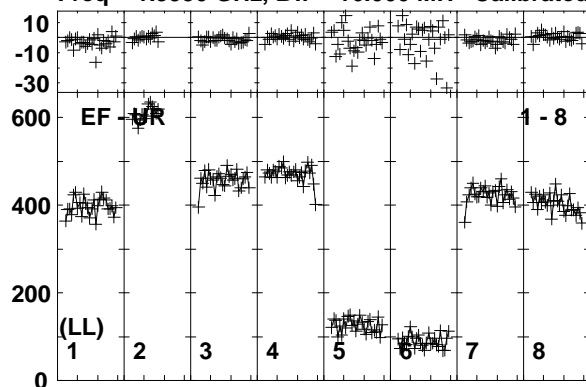

Lower frame: Milli Ampl Jy Top frame: Phas deg
Vector averaged cross-power spectrum Baseline: EF (01) - UR (08)
Timerange: 00/07:07:21 to 00/07:07:49

Plot file version 173 created 25-MAR-2014 17:51:31
 ARP299A EP087E 1.UVDATA.1
 Freq = 1.5950 GHz, Bw = 16.000 MH Calibrated with CL # 3 and BP # 1 (BP mode 1)

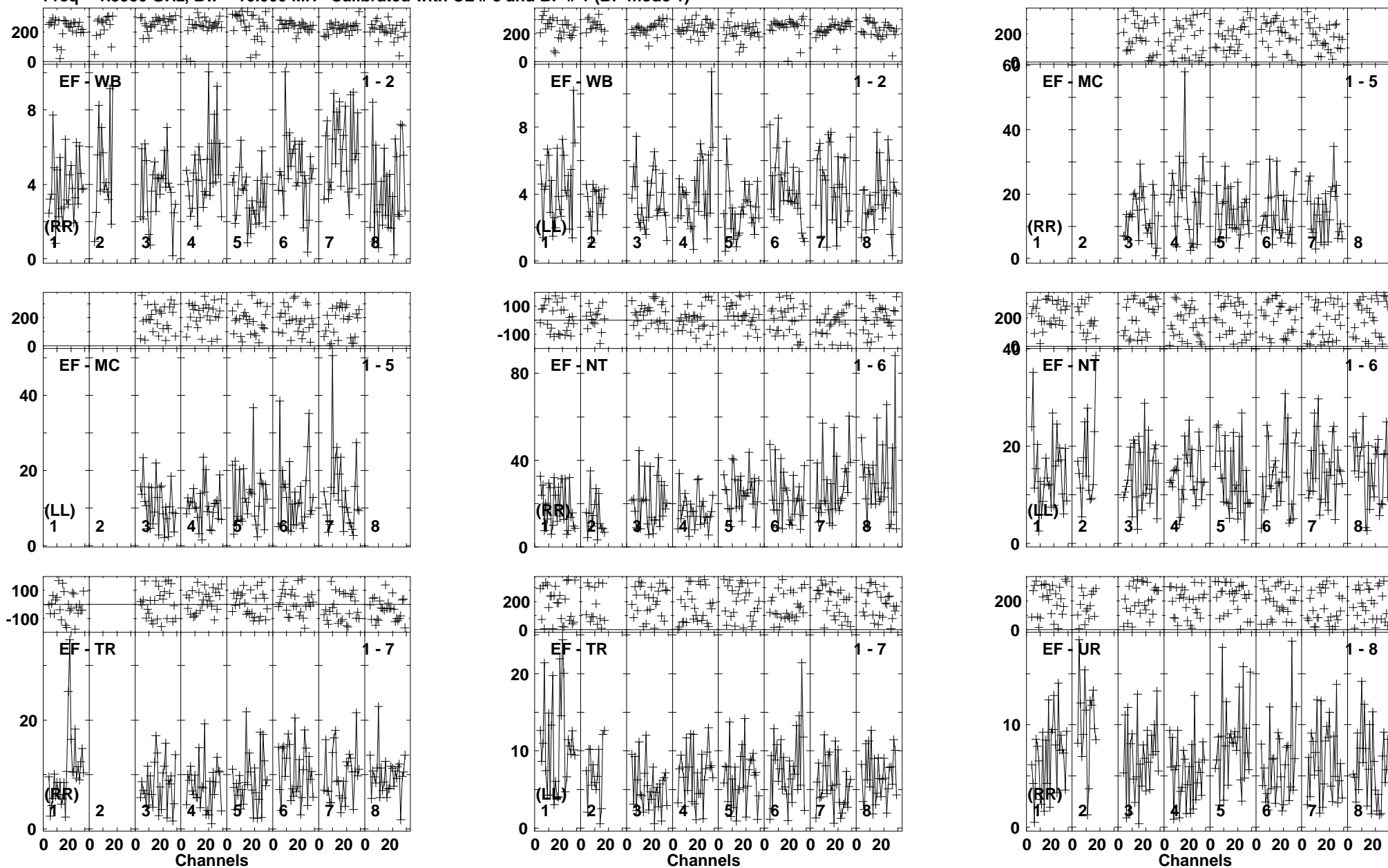

Lower frame: Milli Ampl Jy Top frame: Phas deg
 Vector averaged cross-power spectrum Baseline: EF (01) - WB (02)
 Timerange: 00/07:07:55 to 00/07:12:19

Plot file version 174 created 25-MAR-2014 17:51:31

ARP299A EP087E 1.UVDATA.1

Freq = 1.5950 GHz, Bw = 16.000 MH Calibrated with CL # 3 and BP # 1 (BP mode 1)

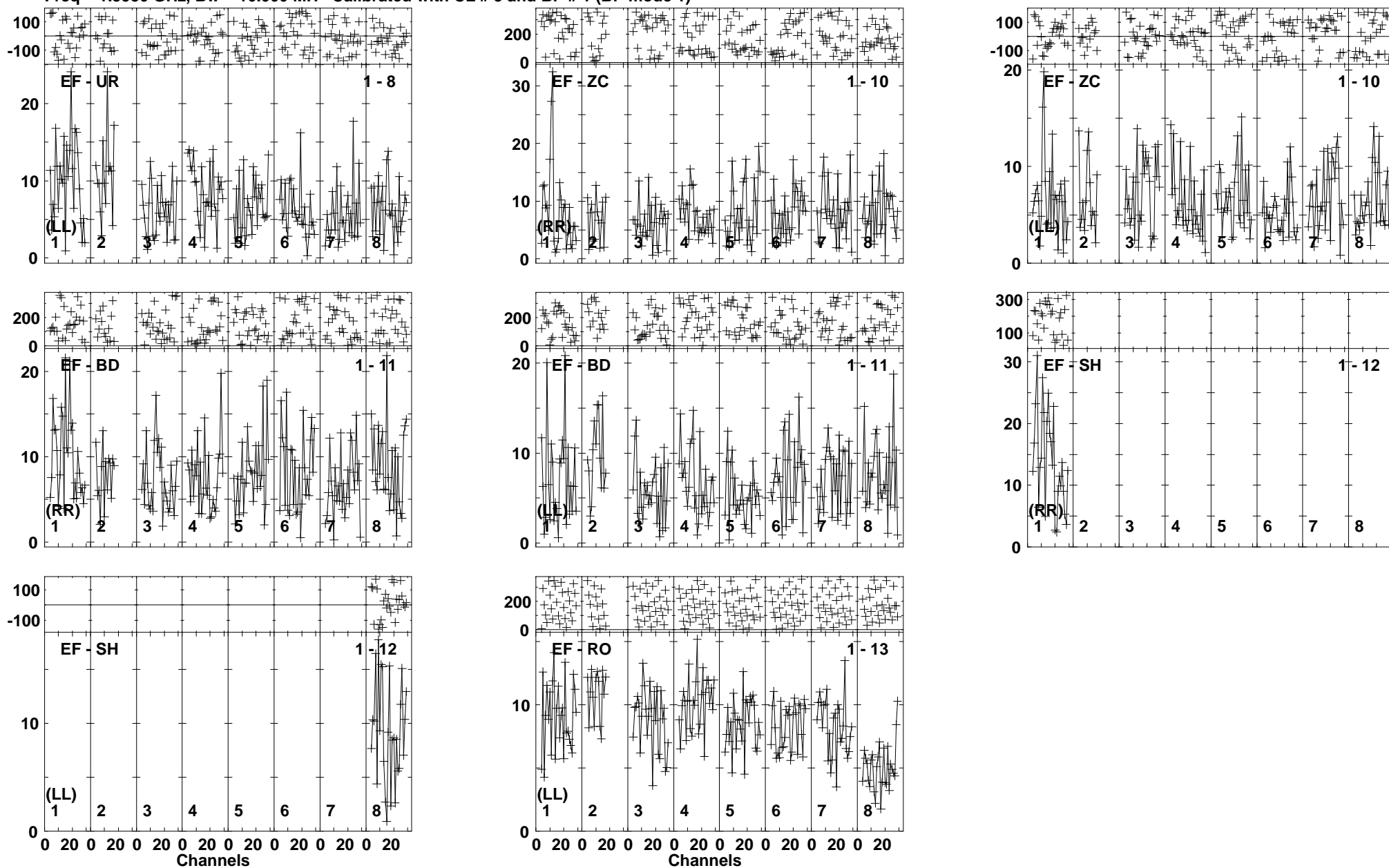

Lower frame: Milli Ampl Jy Top frame: Phas deg
Vector averaged cross-power spectrum Baseline: EF (01) - UR (08)
Timerange: 00/07:07:55 to 00/07:12:19

Plot file version 175 created 25-MAR-2014 17:51:31

J1128+5925 EP087E 1.UVDATA.1

Freq = 1.5950 GHz, Bw = 16.000 MH Calibrated with CL # 3 and BP # 1 (BP mode 1)

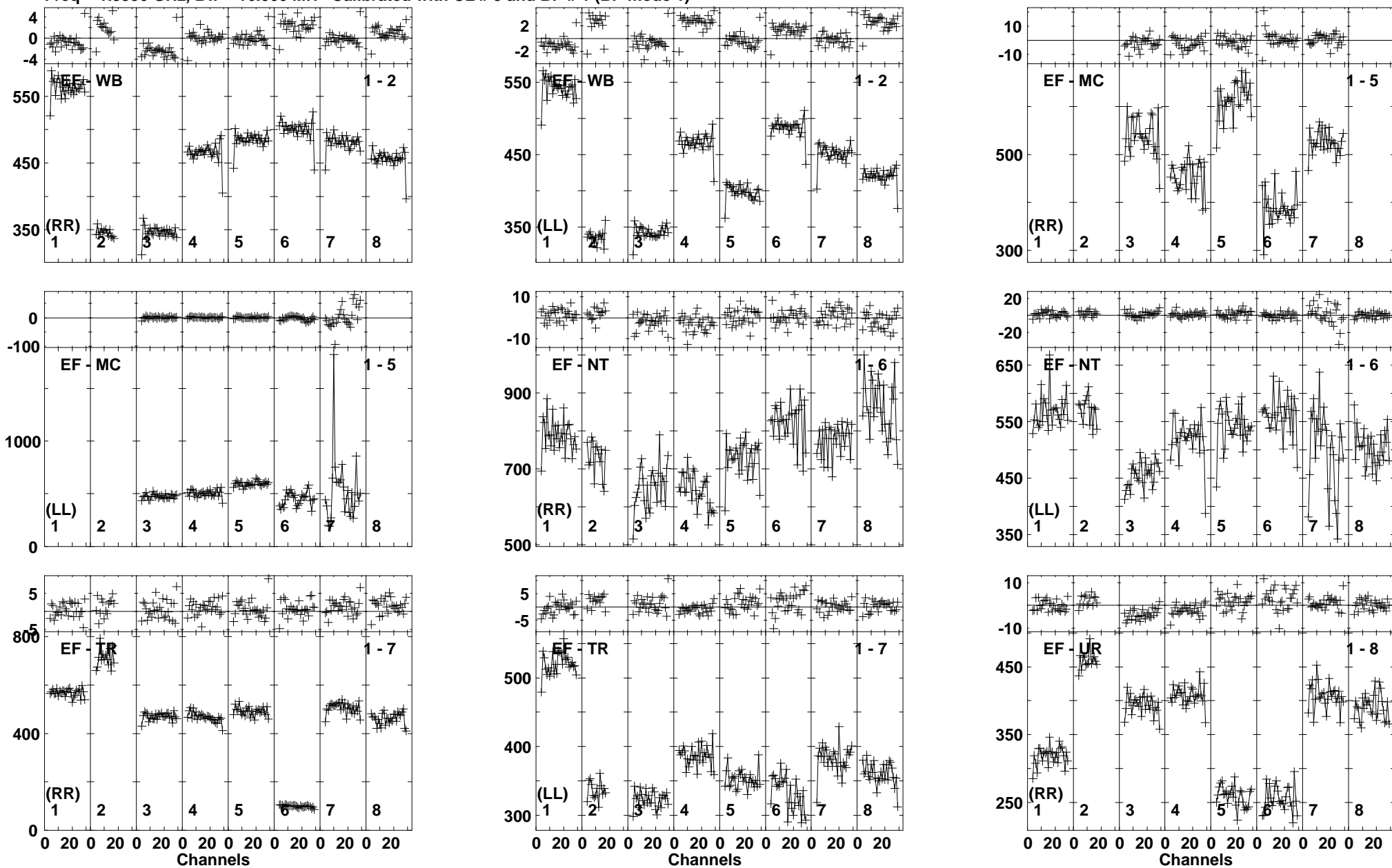

Lower frame: Milli Ampl Jy Top frame: Phas deg
Vector averaged cross-power spectrum Baseline: EF (01) - WB (02)
Timerange: 00/07:12:25 to 00/07:13:29

Plot file version 176 created 25-MAR-2014 17:51:32

J1128+5925 EP087E 1.UVDATA.1

Freq = 1.5950 GHz, Bw = 16.000 MH Calibrated with CL # 3 and BP # 1 (BP mode 1)

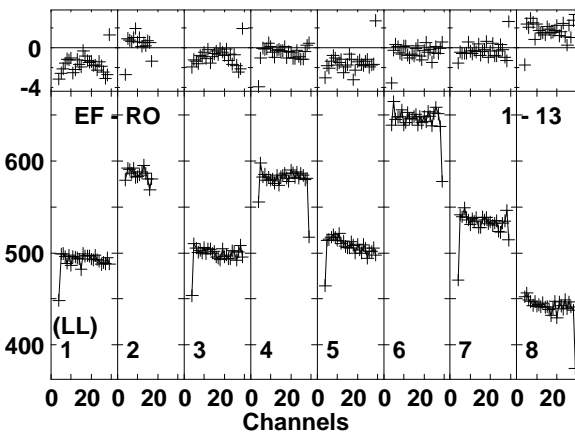
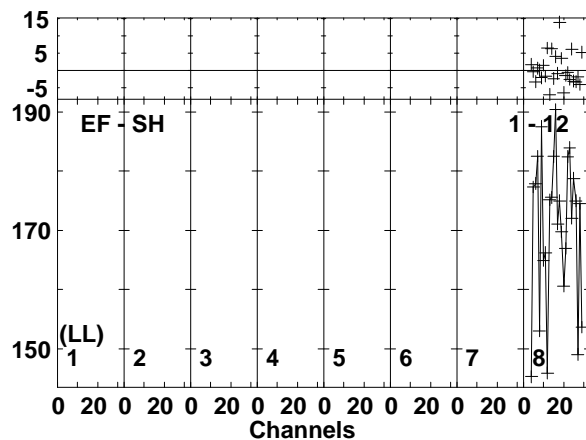
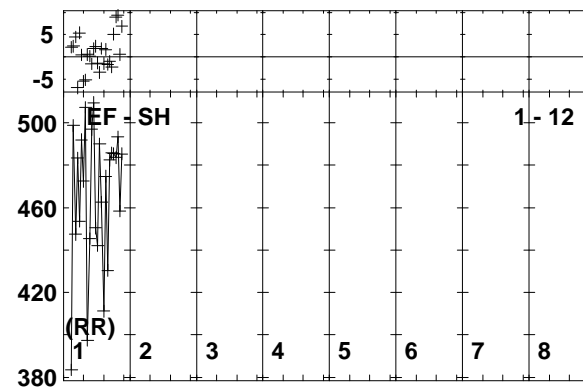
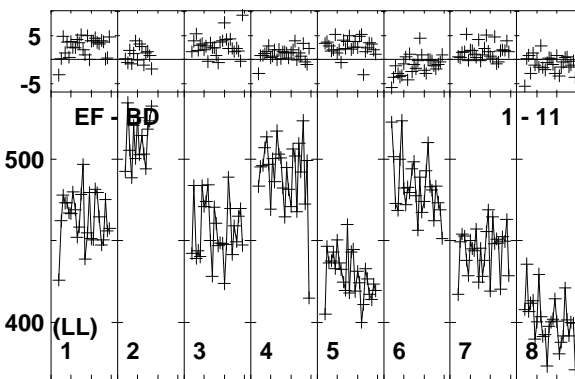
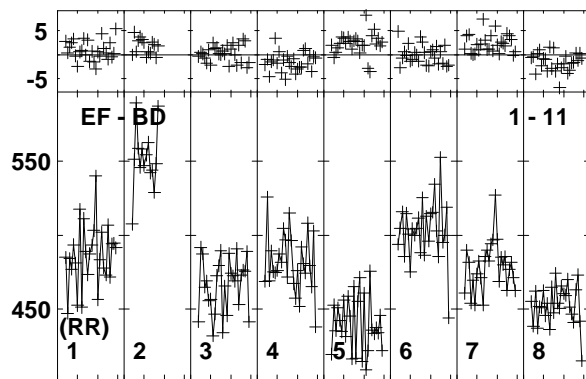
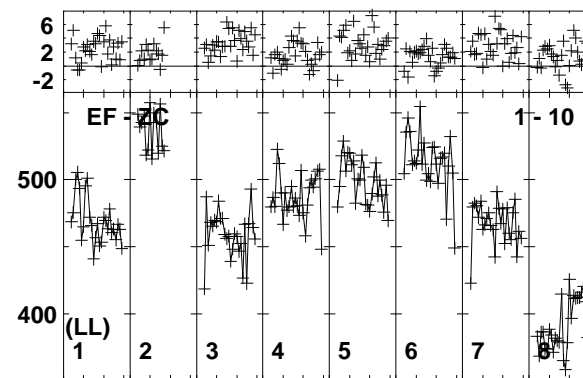
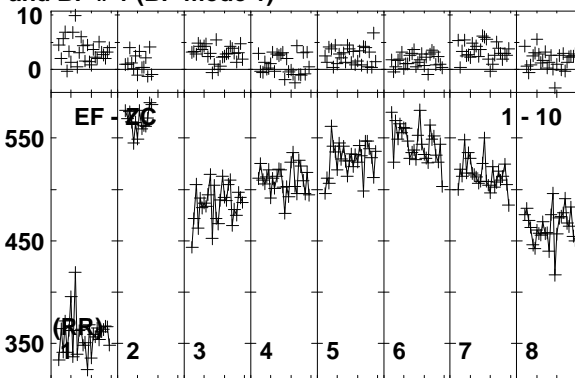
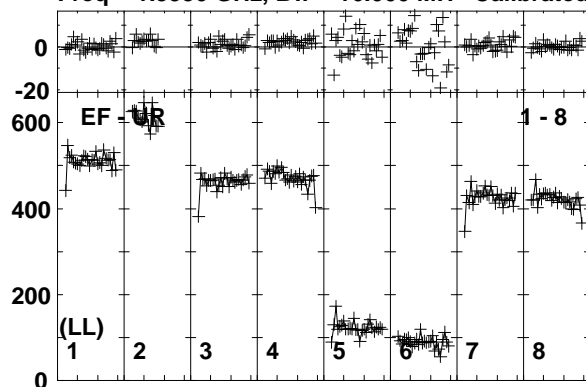

Lower frame: Milli Ampl Jy Top frame: Phas deg
Vector averaged cross-power spectrum Baseline: EF (01) - UR (08)
Timerange: 00/07:12:25 to 00/07:13:29

Plot file version 177 created 25-MAR-2014 17:51:32
 ARP299A EP087E 1.UVDATA.1
 Freq = 1.5950 GHz, Bw = 16.000 MH Calibrated with CL # 3 and BP # 1 (BP mode 1)

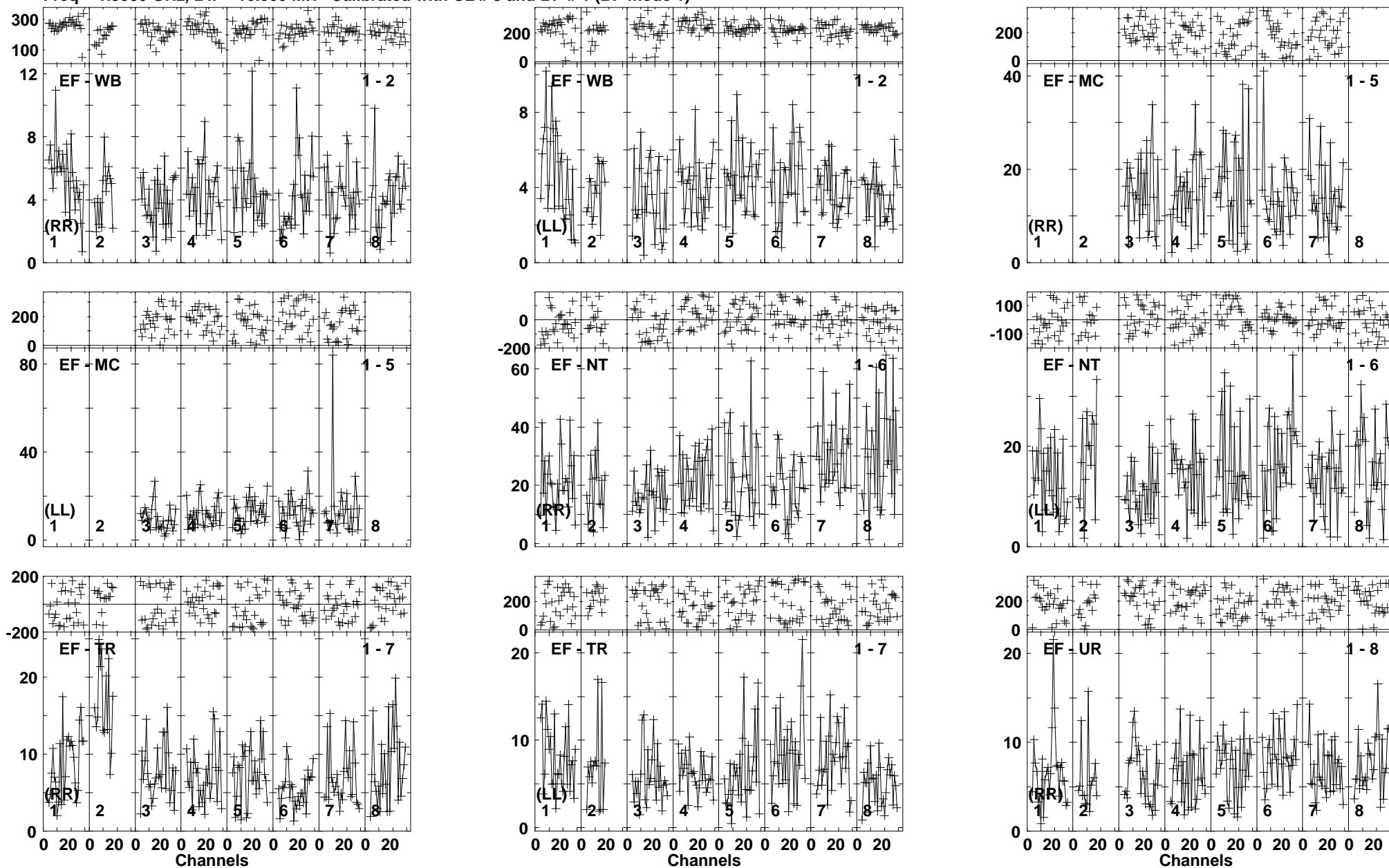

Lower frame: Milli Ampl Jy Top frame: Phas deg
 Vector averaged cross-power spectrum Baseline: EF (01) - WB (02)
 Timerange: 00/07:13:31 to 00/07:17:59

Plot file version 178 created 25-MAR-2014 17:51:32
 ARP299A EP087E 1.UVDATA.1
 Freq = 1.5950 GHz, Bw = 16.000 MH Calibrated with CL # 3 and BP # 1 (BP mode 1)

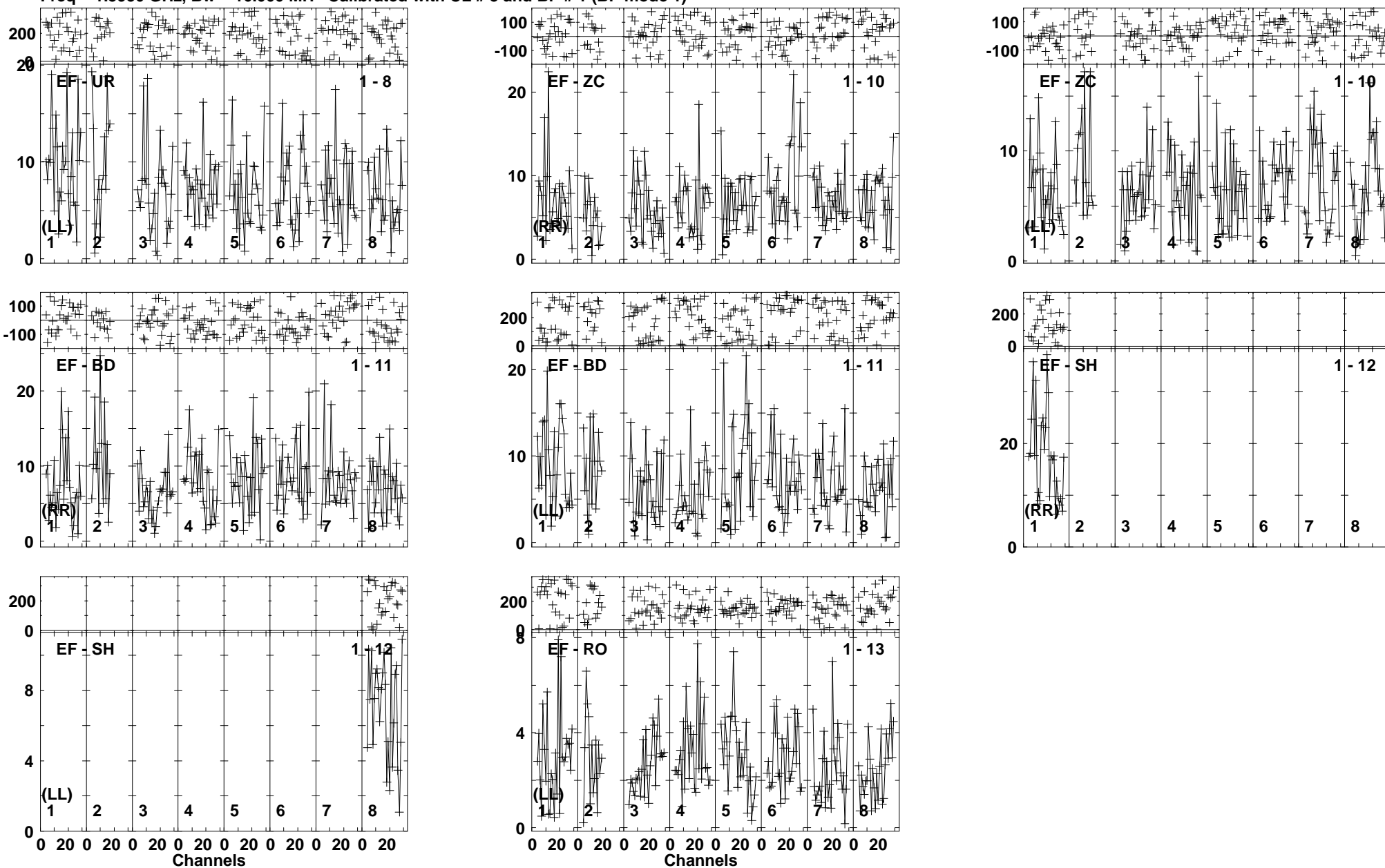

Lower frame: Milli Ampl Jy Top frame: Phas deg
 Vector averaged cross-power spectrum Baseline: EF (01) - UR (08)
 Timerange: 00/07:13:31 to 00/07:17:59

Plot file version 179 created 25-MAR-2014 17:51:32

J1128+5925 EP087E 1.UVDATA.1

Freq = 1.5950 GHz, Bw = 16.000 MH Calibrated with CL # 3 and BP # 1 (BP mode 1)

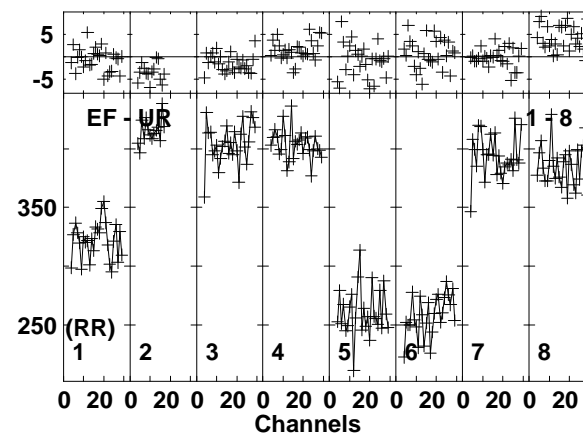
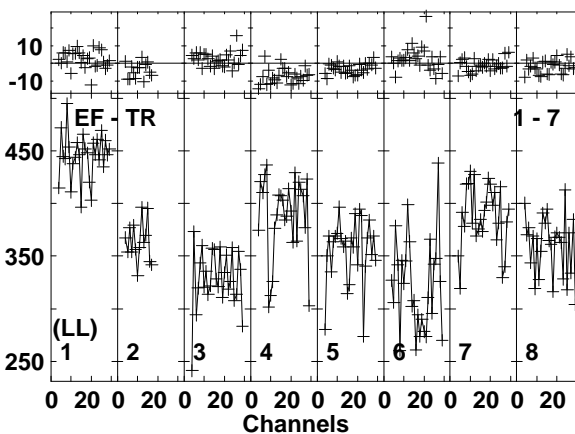
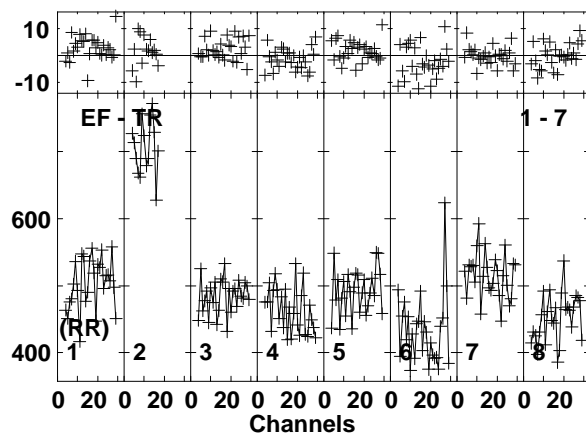
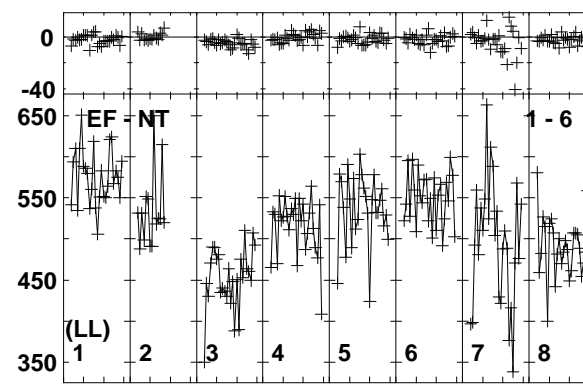
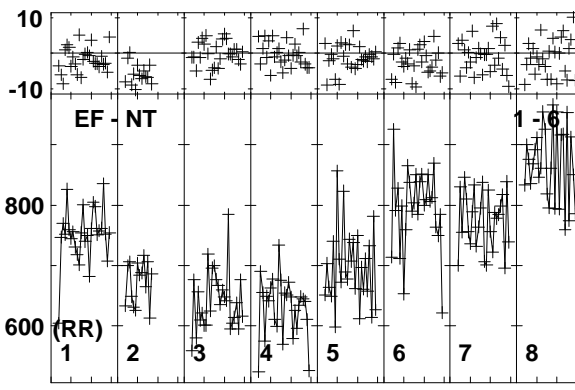
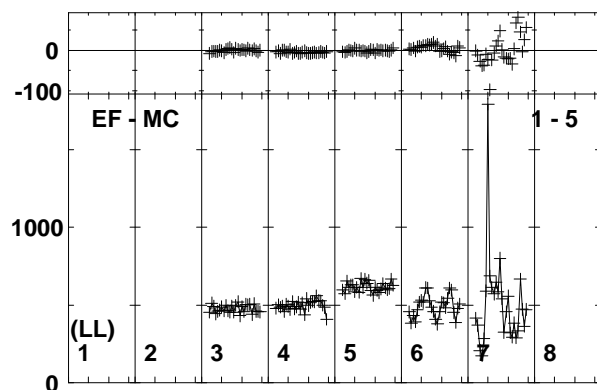
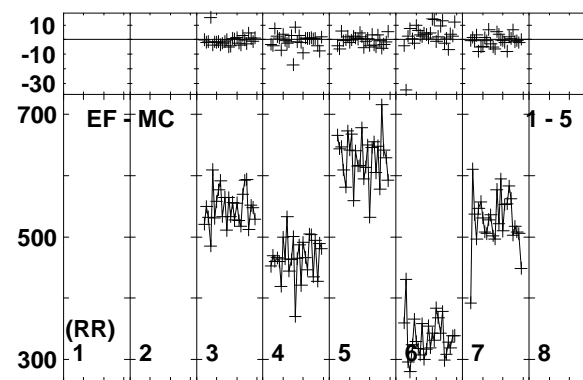
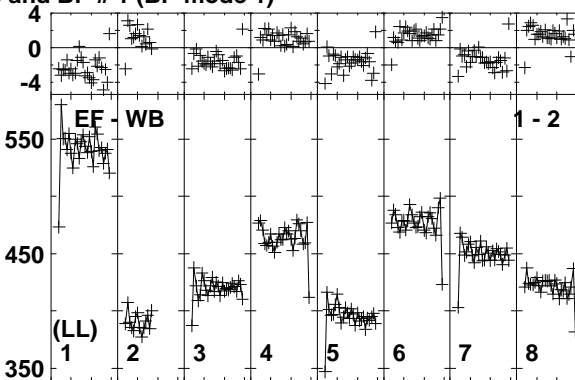
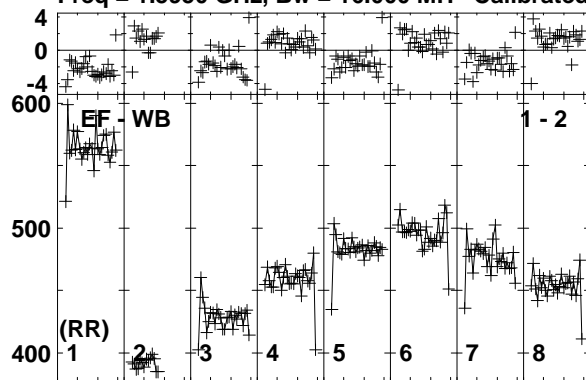

Lower frame: Milli Ampl Jy Top frame: Phas deg
Vector averaged cross-power spectrum Baseline: EF (01) - WB (02)
Timerange: 00/07:18:41 to 00/07:19:09

Plot file version 180 created 25-MAR-2014 17:51:33

J1128+5925 EP087E 1.UVDATA.1

Freq = 1.5950 GHz, Bw = 16.000 MH Calibrated with CL # 3 and BP # 1 (BP mode 1)

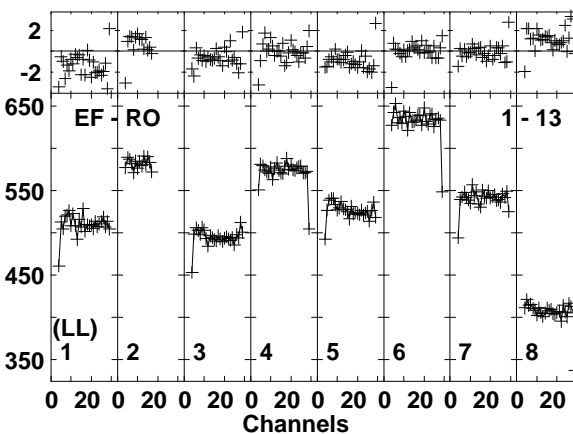
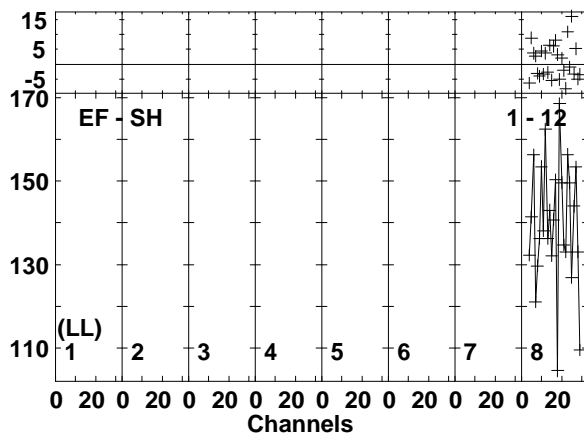
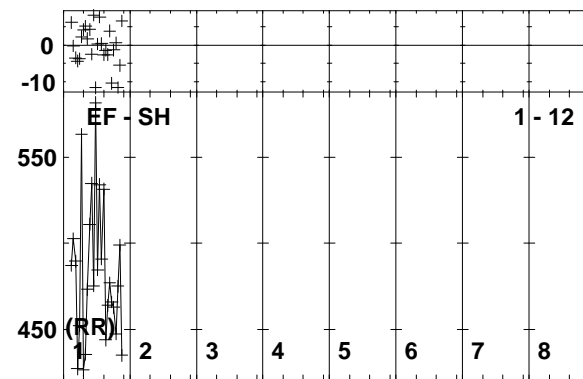
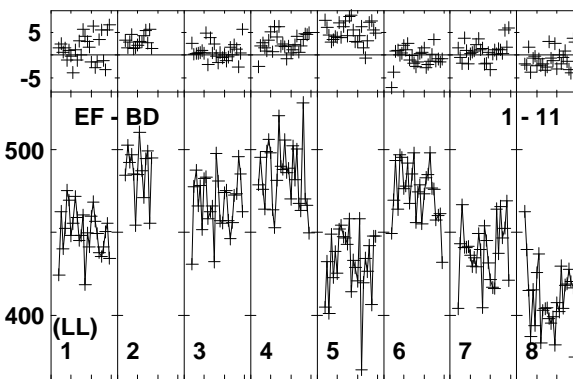
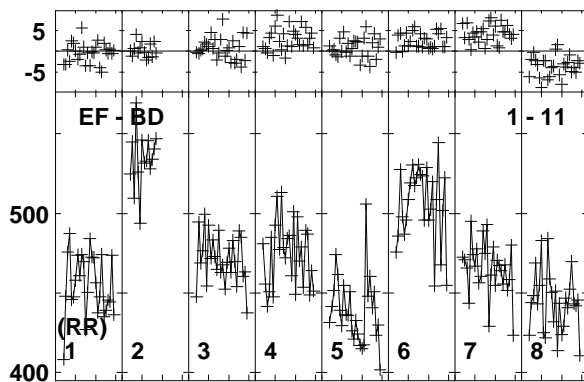
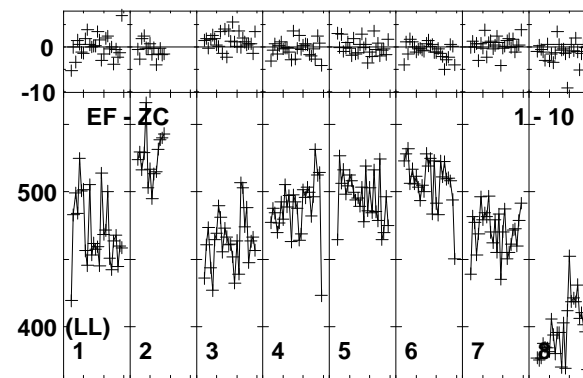
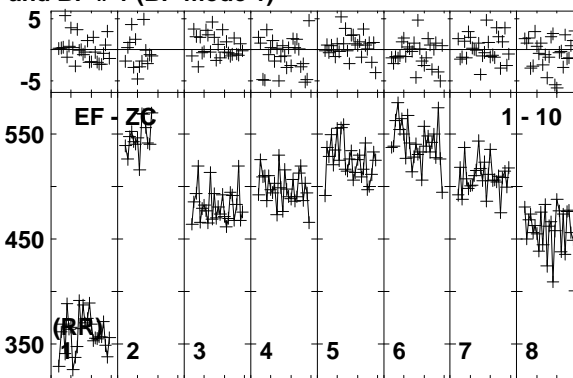
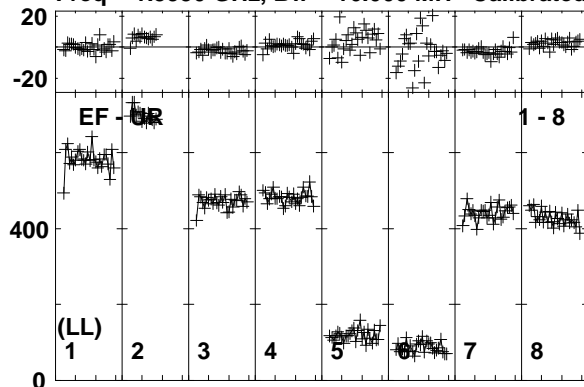

Lower frame: Milli Ampl Jy Top frame: Phas deg
Vector averaged cross-power spectrum Baseline: EF (01) - UR (08)
Timerange: 00/07:18:41 to 00/07:19:09

Plot file version 181 created 25-MAR-2014 17:51:33

ARP299A EP087E 1.UVDATA.1

Freq = 1.5950 GHz, Bw = 16.000 MH Calibrated with CL # 3 and BP # 1 (BP mode 1)

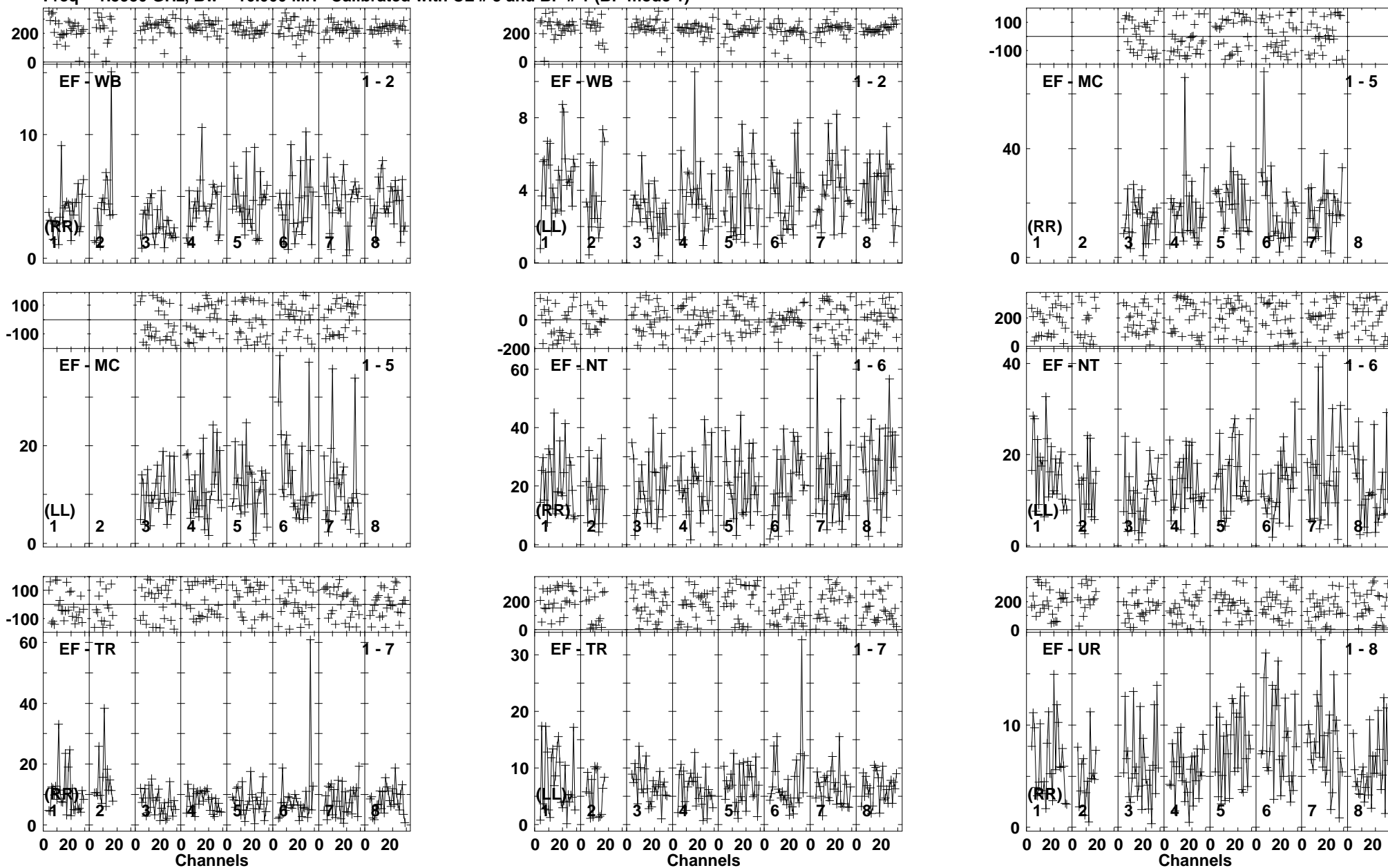

Lower frame: Milli Ampl Jy Top frame: Phas deg
Vector averaged cross-power spectrum Baseline: EF (01) - WB (02)
Timerange: 00/07:19:15 to 00/07:23:39

Plot file version 182 created 25-MAR-2014 17:51:33

ARP299A EP087E 1.UVDATA.1

Freq = 1.5950 GHz, Bw = 16.000 MH Calibrated with CL # 3 and BP # 1 (BP mode 1)

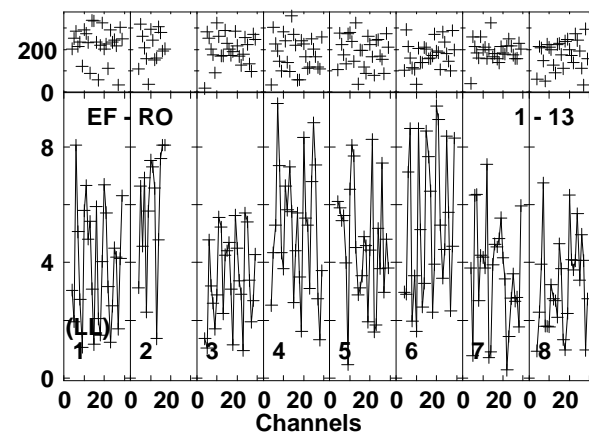
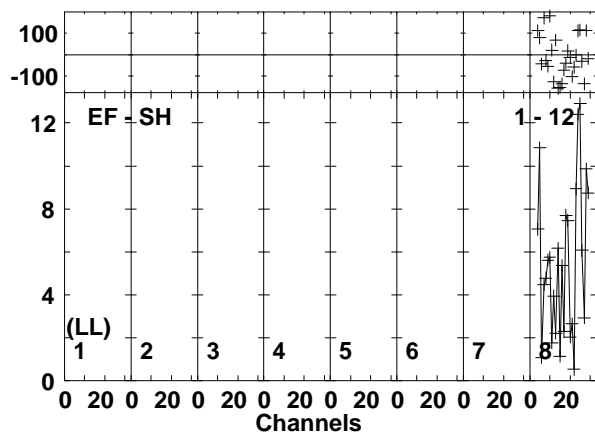
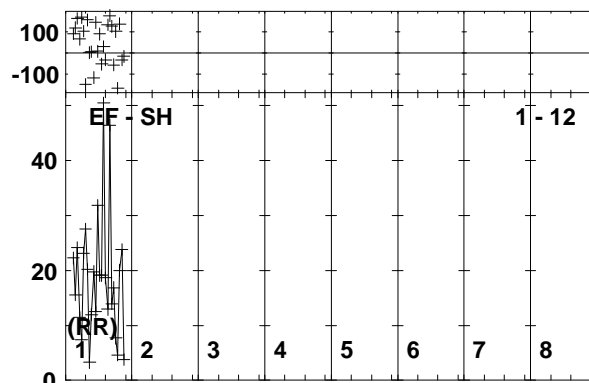
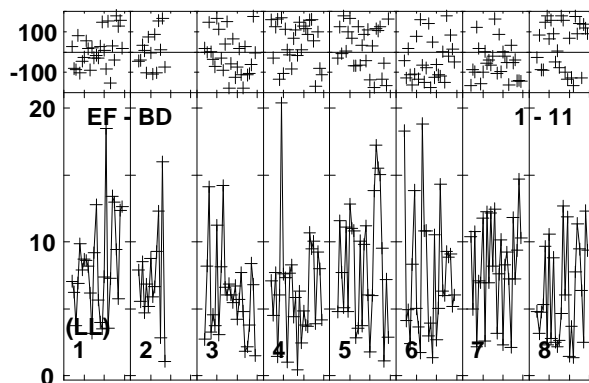
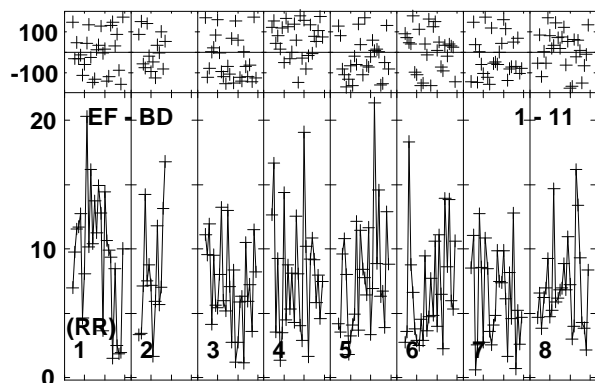
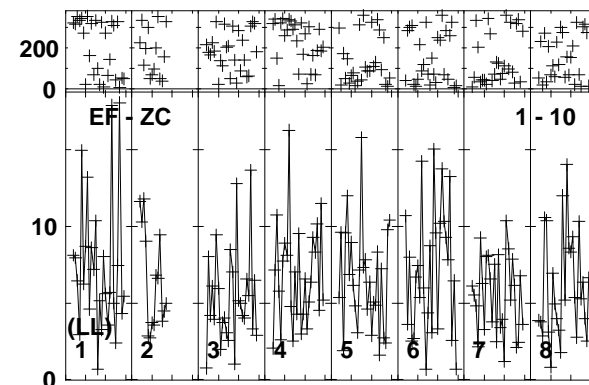
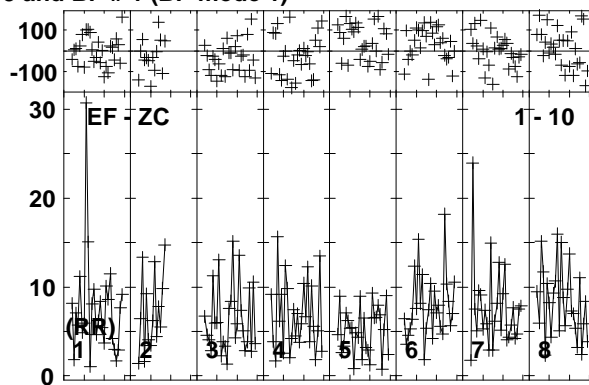
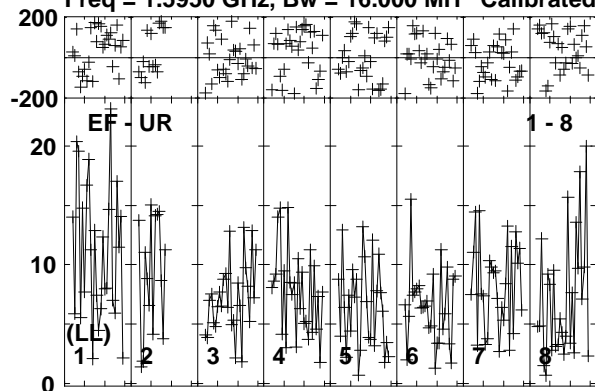

Lower frame: Milli Ampl Jy Top frame: Phas deg
Vector averaged cross-power spectrum Baseline: EF (01) - UR (08)
Timerange: 00/07:19:15 to 00/07:23:39

Plot file version 183 created 25-MAR-2014 17:51:34

J1128+5925 EP087E 1.UVDATA.1

Freq = 1.5950 GHz, Bw = 16.000 MH Calibrated with CL # 3 and BP # 1 (BP mode 1)

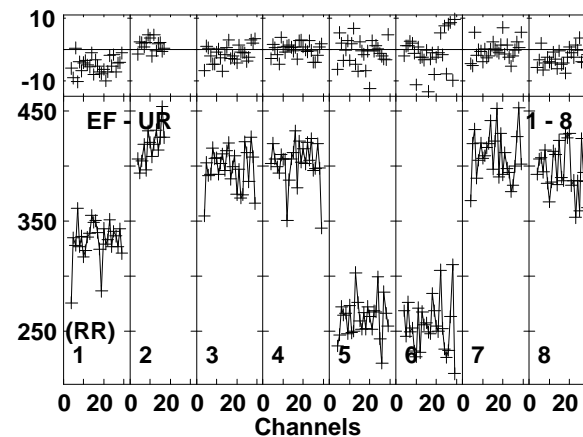
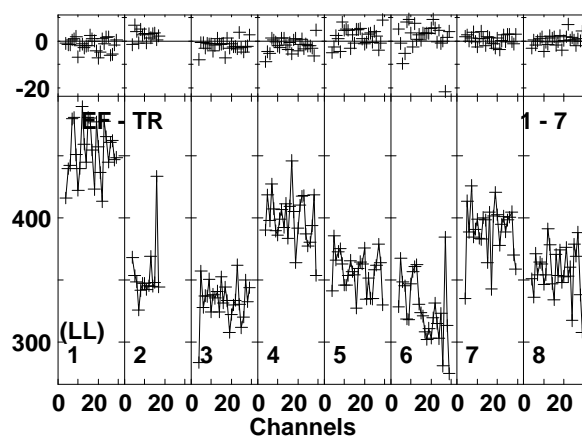
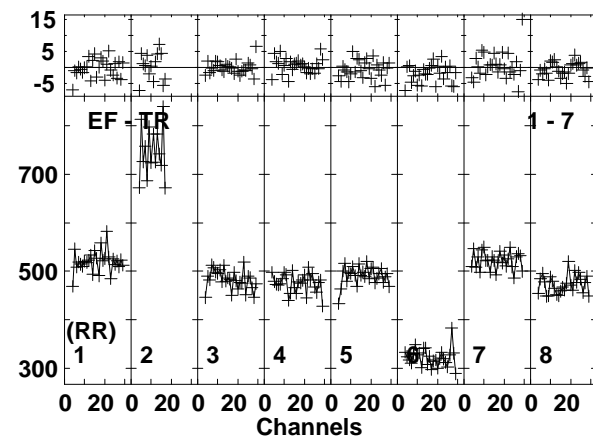
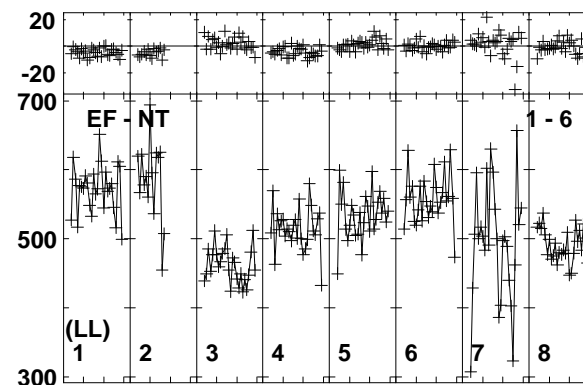
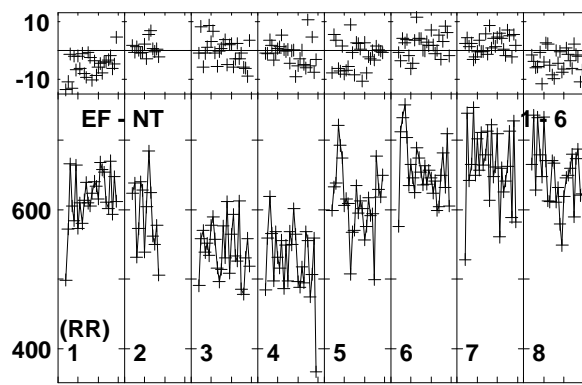
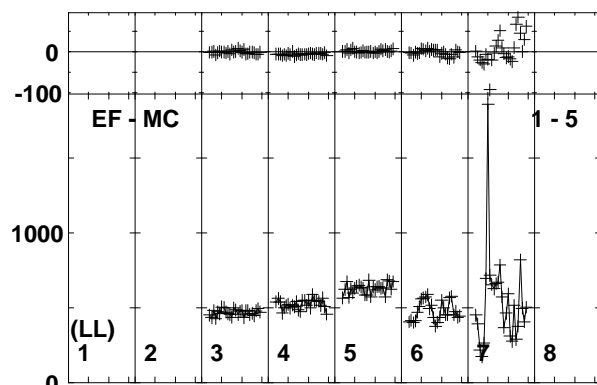
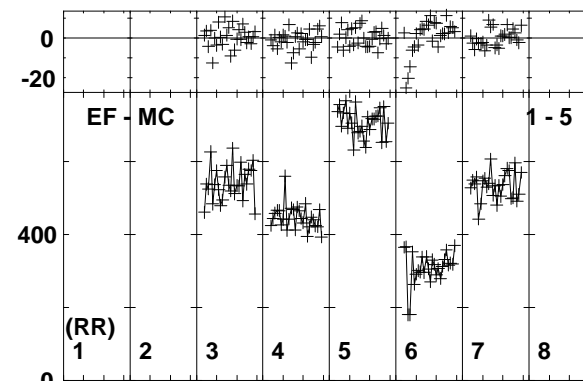
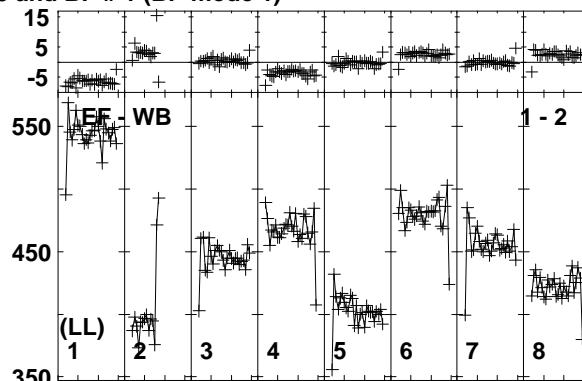
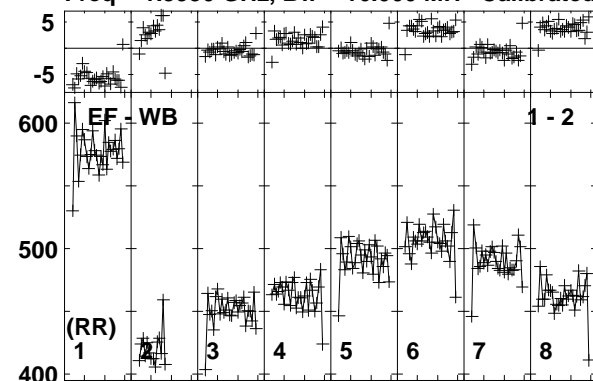

Lower frame: Milli Ampl Jy Top frame: Phas deg
Vector averaged cross-power spectrum Baseline: EF (01) - WB (02)
Timerange: 00/07:23:45 to 00/07:24:39

Plot file version 184 created 25-MAR-2014 17:51:34

J1128+5925 EP087E 1.UVDATA.1

Freq = 1.5950 GHz, Bw = 16.000 MH Calibrated with CL # 3 and BP # 1 (BP mode 1)

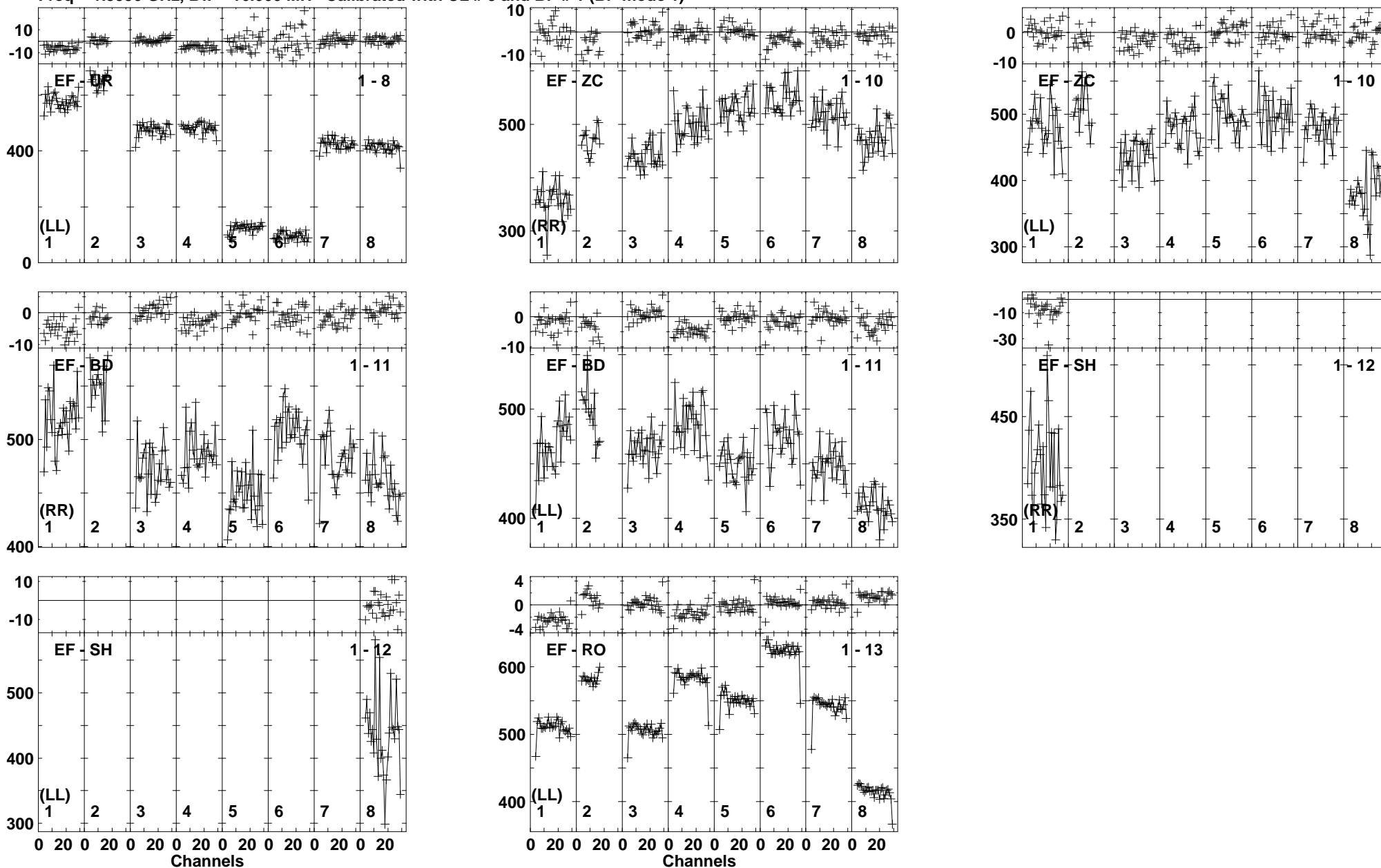

Lower frame: Milli Ampl Jy Top frame: Phas deg
Vector averaged cross-power spectrum Baseline: EF (01) - UR (08)
Timerange: 00/07:23:45 to 00/07:24:39

Plot file version 185 created 25-MAR-2014 17:51:34
 ARP299A EP087E 1.UVDATA.1
 Freq = 1.5950 GHz, Bw = 16.000 MH Calibrated with CL # 3 and BP # 1 (BP mode 1)

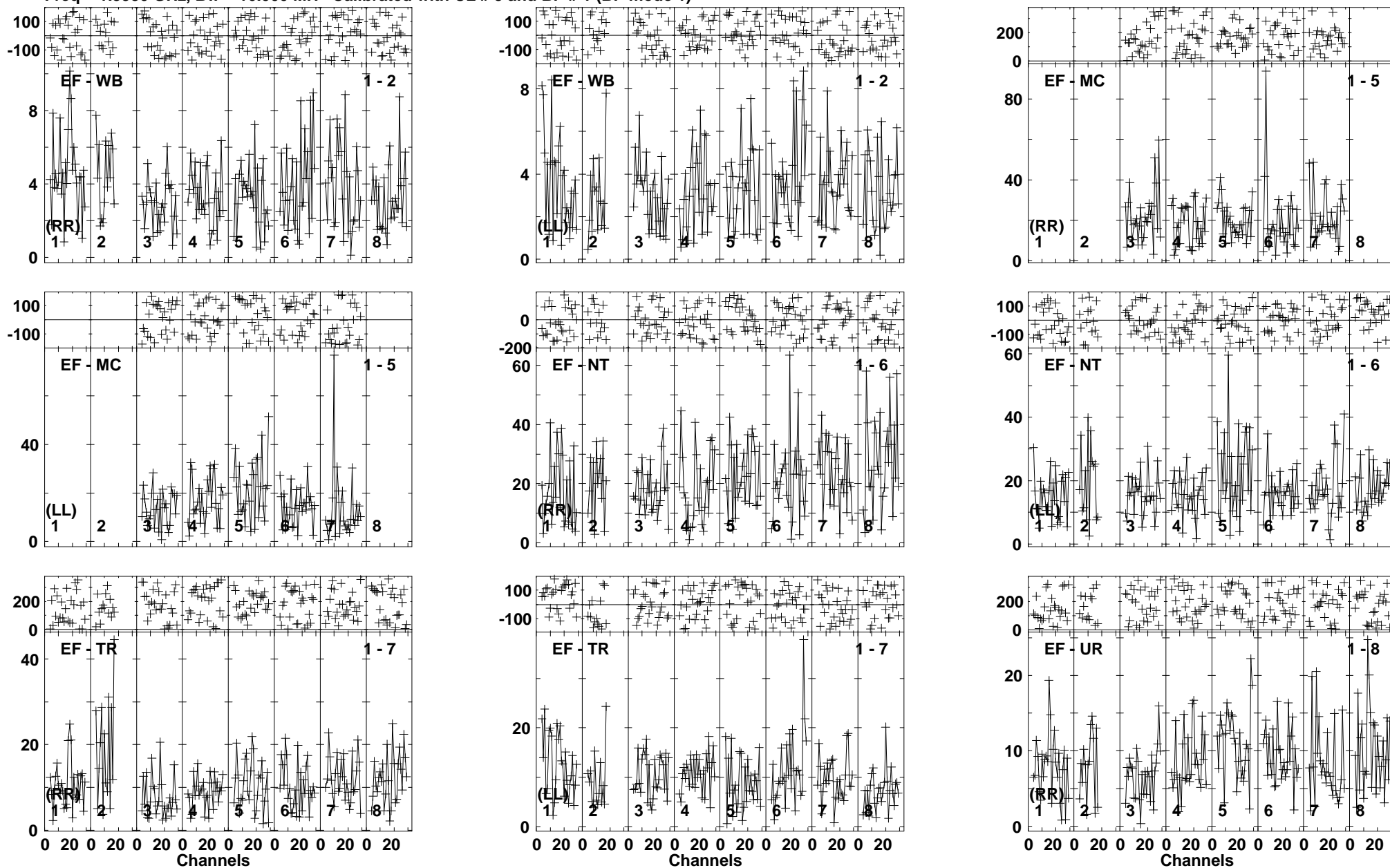

Lower frame: Milli Ampl Jy Top frame: Phas deg
 Vector averaged cross-power spectrum Baseline: EF (01) - WB (02)
 Timerange: 00/07:24:41 to 00/07:27:39

Plot file version 186 created 25-MAR-2014 17:51:34

ARP299A EP087E 1.UVDATA.1

Freq = 1.5950 GHz, Bw = 16.000 MH Calibrated with CL # 3 and BP # 1 (BP mode 1)

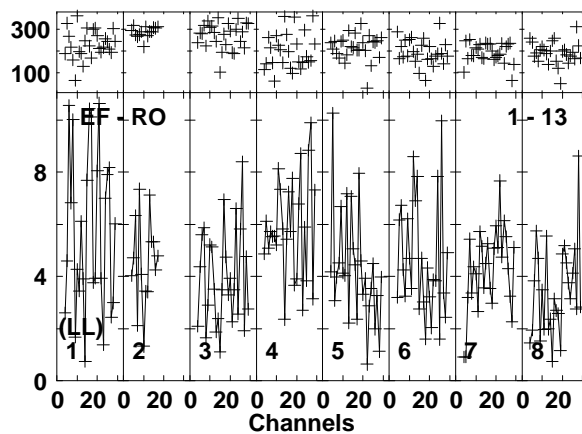
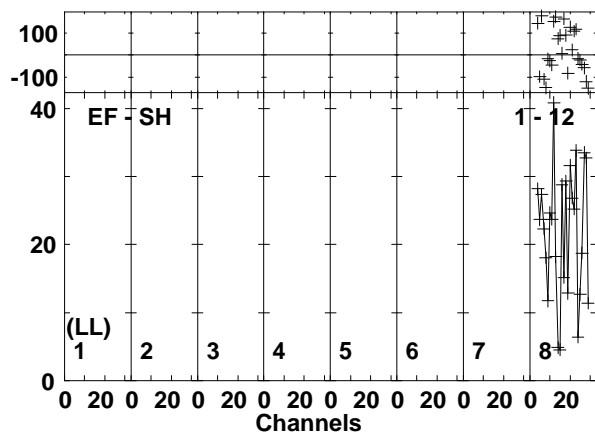
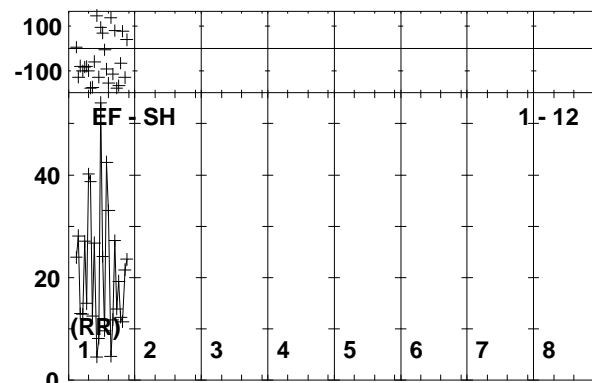
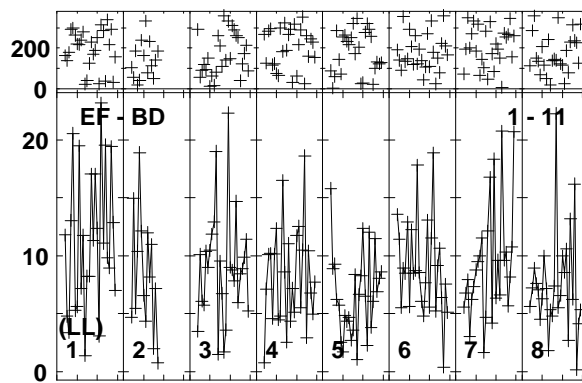
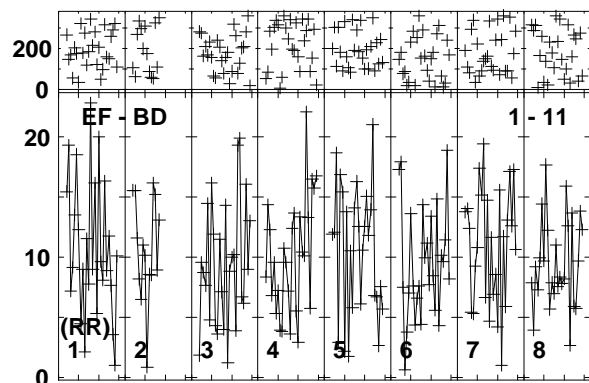
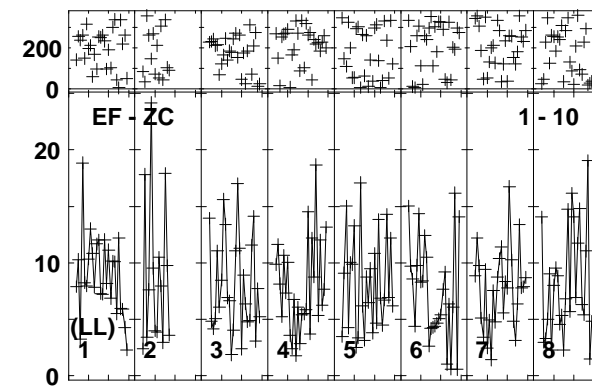
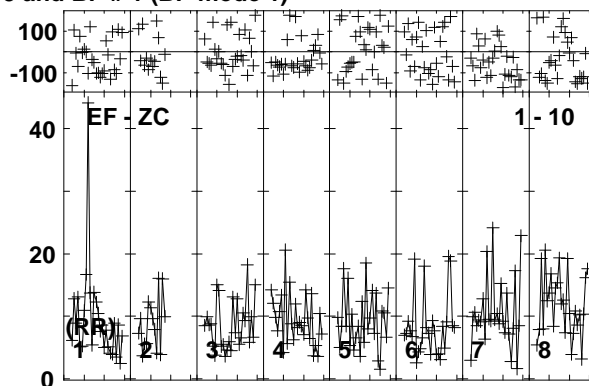
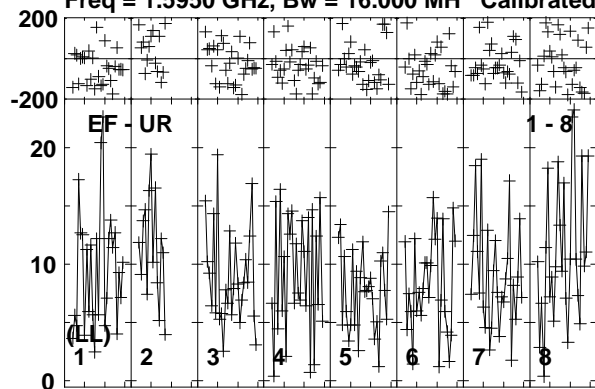

Lower frame: Milli Ampl Jy Top frame: Phas deg
Vector averaged cross-power spectrum Baseline: EF (01) - UR (08)
Timerange: 00/07:24:41 to 00/07:27:39

Plot file version 187 created 25-MAR-2014 17:51:35
 ARP299A EP087E 1.UVDATA.1
 Freq = 1.5950 GHz, Bw = 16.000 MH Calibrated with CL # 3 and BP # 1 (BP mode 1)

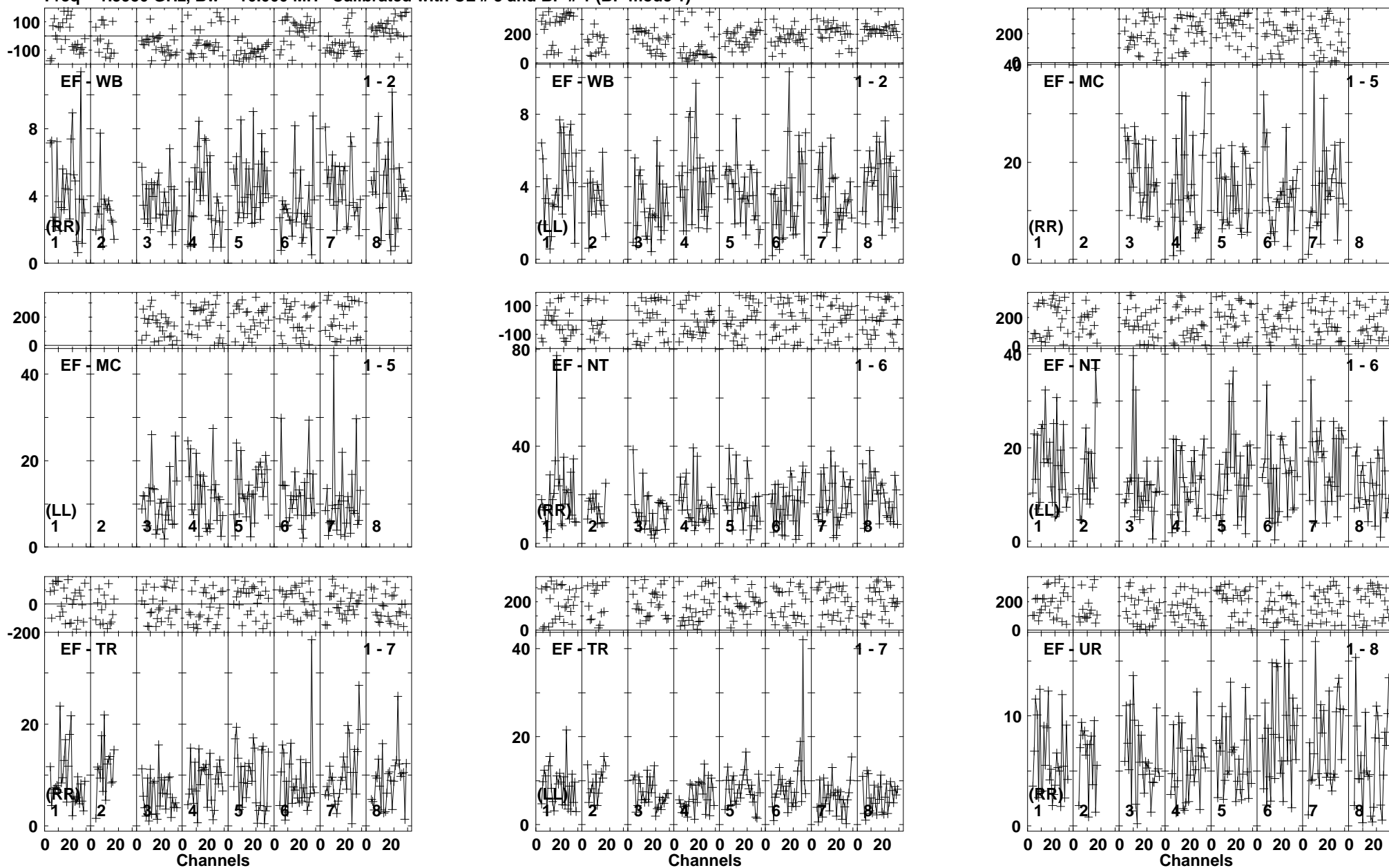

Lower frame: Milli Ampl Jy Top frame: Phas deg
 Vector averaged cross-power spectrum Baseline: EF (01) - WB (02)
 Timerange: 00/07:30:25 to 00/07:34:49

Plot file version 188 created 25-MAR-2014 17:51:36
 ARP299A EP087E 1.UVDATA.1
 Freq = 1.5950 GHz, Bw = 16.000 MH Calibrated with CL # 3 and BP # 1 (BP mode 1)

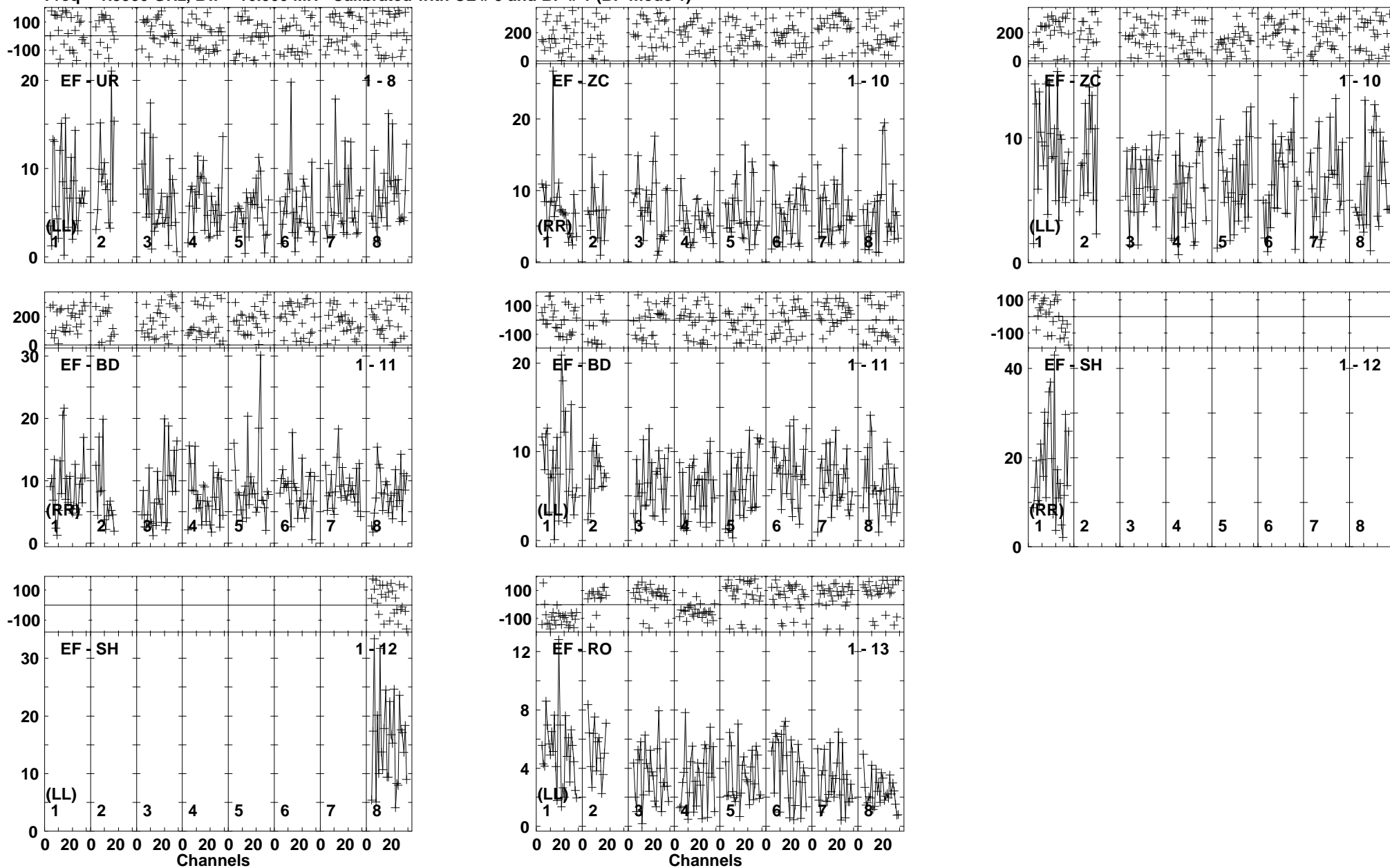

Lower frame: Milli Ampl Jy Top frame: Phas deg
 Vector averaged cross-power spectrum Baseline: EF (01) - UR (08)
 Timerange: 00/07:30:25 to 00/07:34:49

Plot file version 189 created 25-MAR-2014 17:51:36

J1128+5925 EP087E 1.UVDATA.1

Freq = 1.5950 GHz, Bw = 16.000 MH Calibrated with CL # 3 and BP # 1 (BP mode 1)

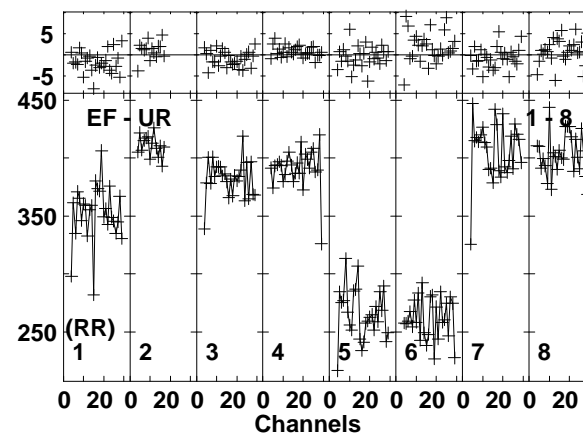
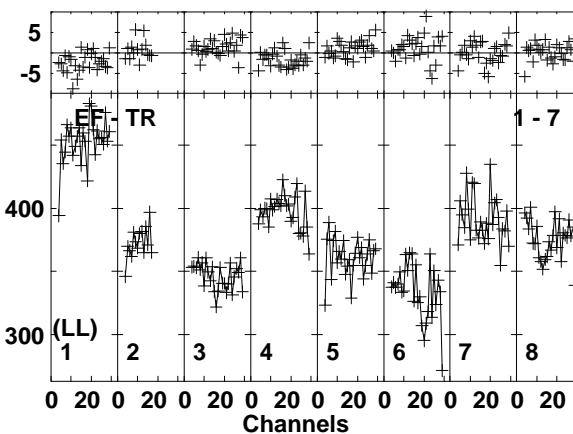
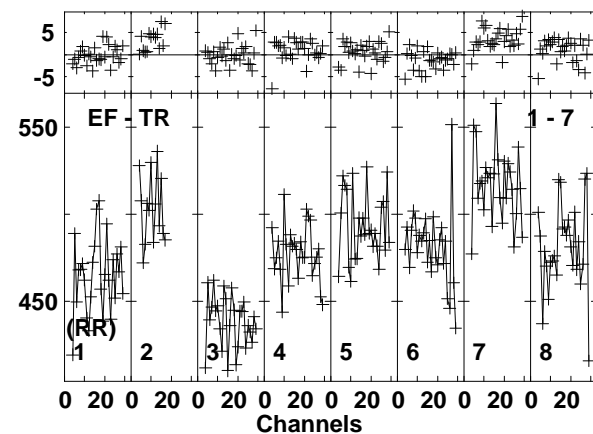
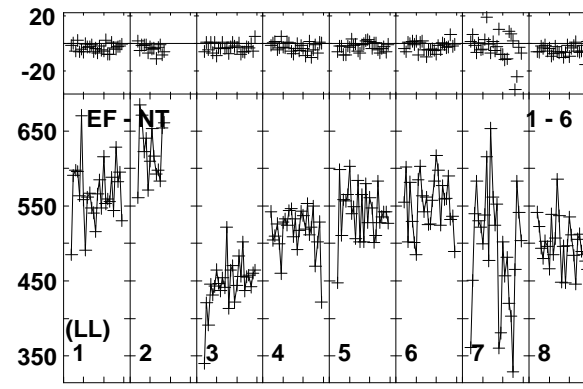
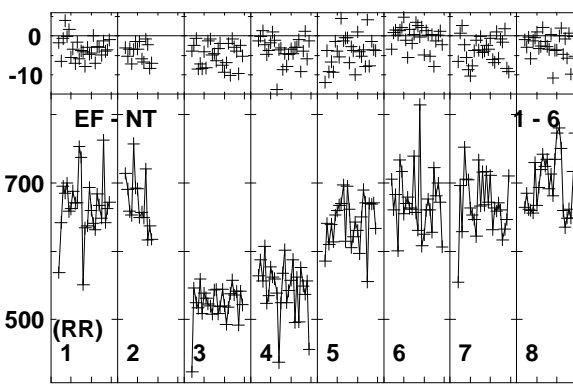
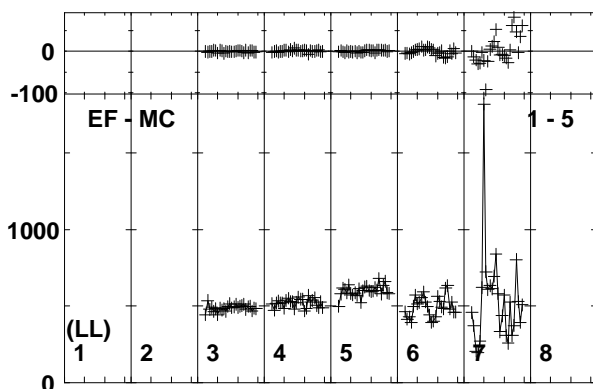
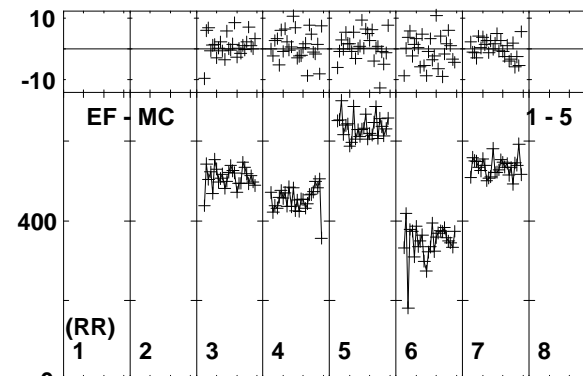
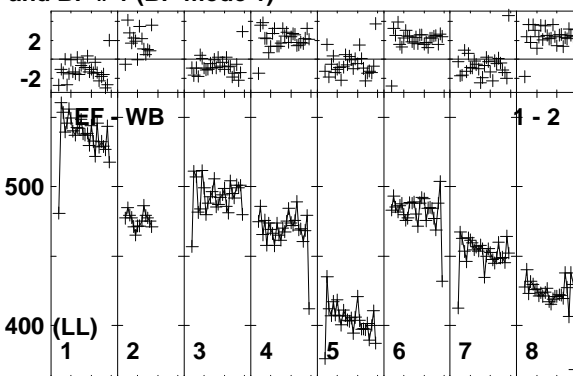
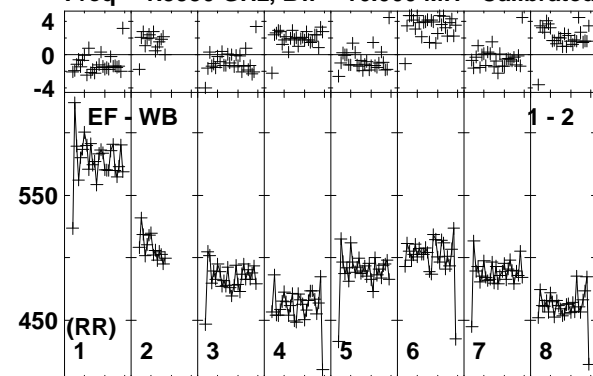

Lower frame: Milli Ampl Jy Top frame: Phas deg
Vector averaged cross-power spectrum Baseline: EF (01) - WB (02)
Timerange: 00/07:34:55 to 00/07:35:59

Plot file version 190 created 25-MAR-2014 17:51:36

J1128+5925 EP087E 1.UVDATA.1

Freq = 1.5950 GHz, Bw = 16.000 MH Calibrated with CL # 3 and BP # 1 (BP mode 1)

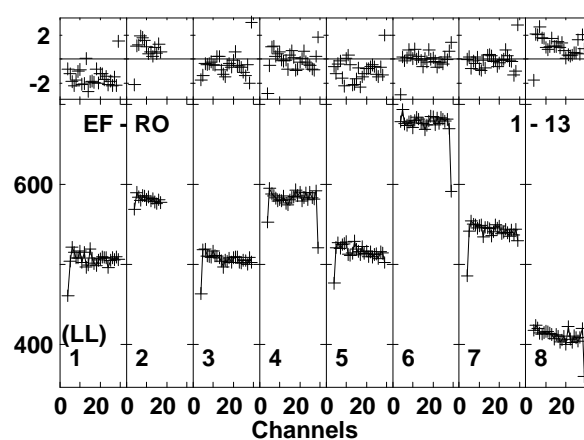
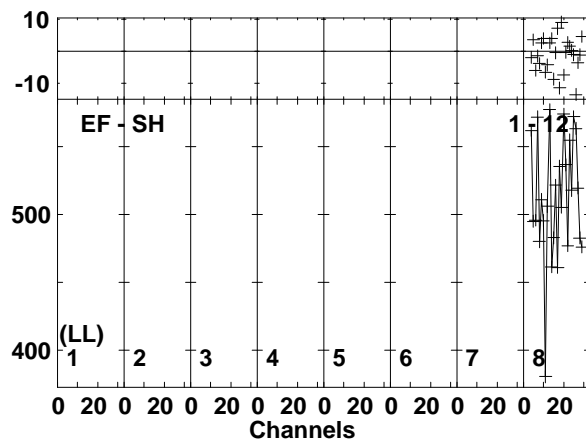
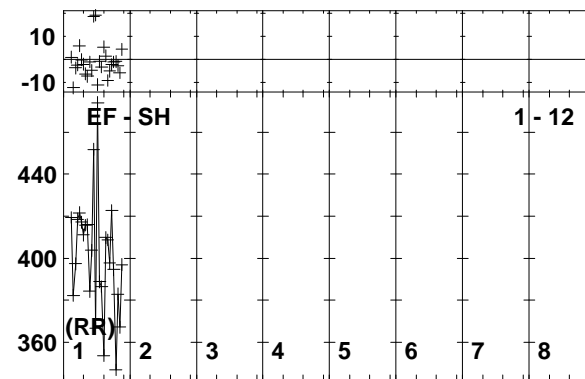
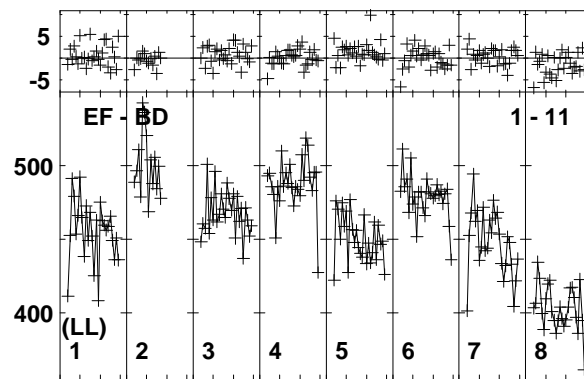
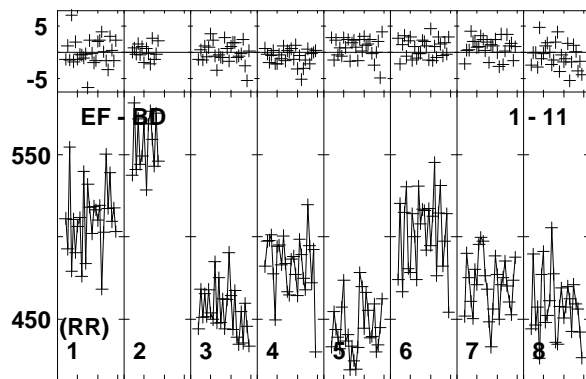
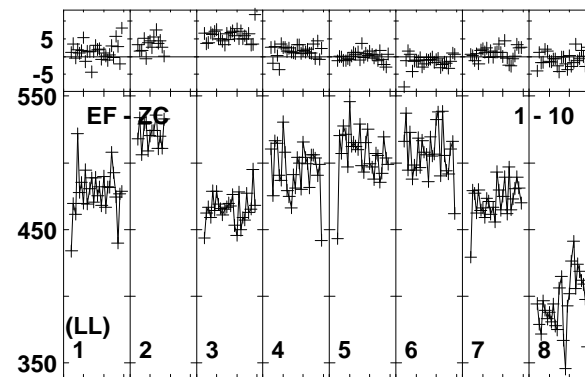
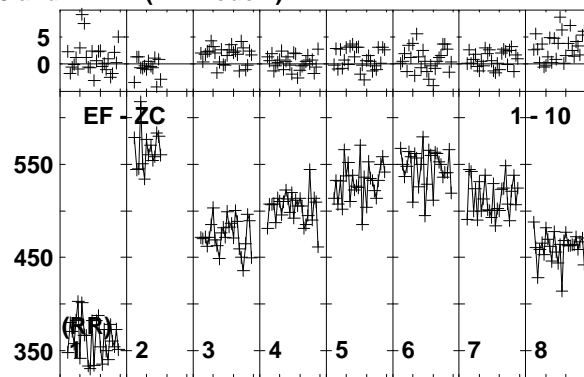
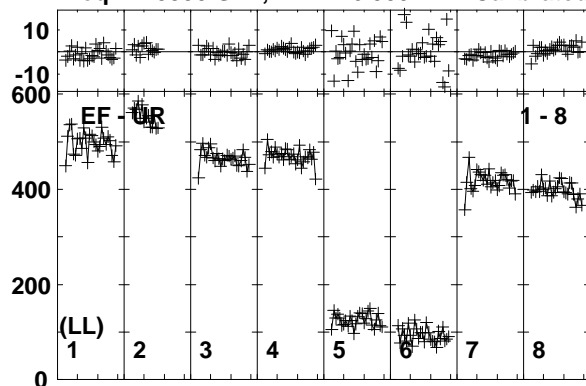

Lower frame: Milli Ampl Jy Top frame: Phas deg
Vector averaged cross-power spectrum Baseline: EF (01) - UR (08)
Timerange: 00/07:34:55 to 00/07:35:59

Plot file version 191 created 25-MAR-2014 17:51:36
 ARP299A EP087E 1.UVDATA.1
 Freq = 1.5950 GHz, Bw = 16.000 MH Calibrated with CL # 3 and BP # 1 (BP mode 1)

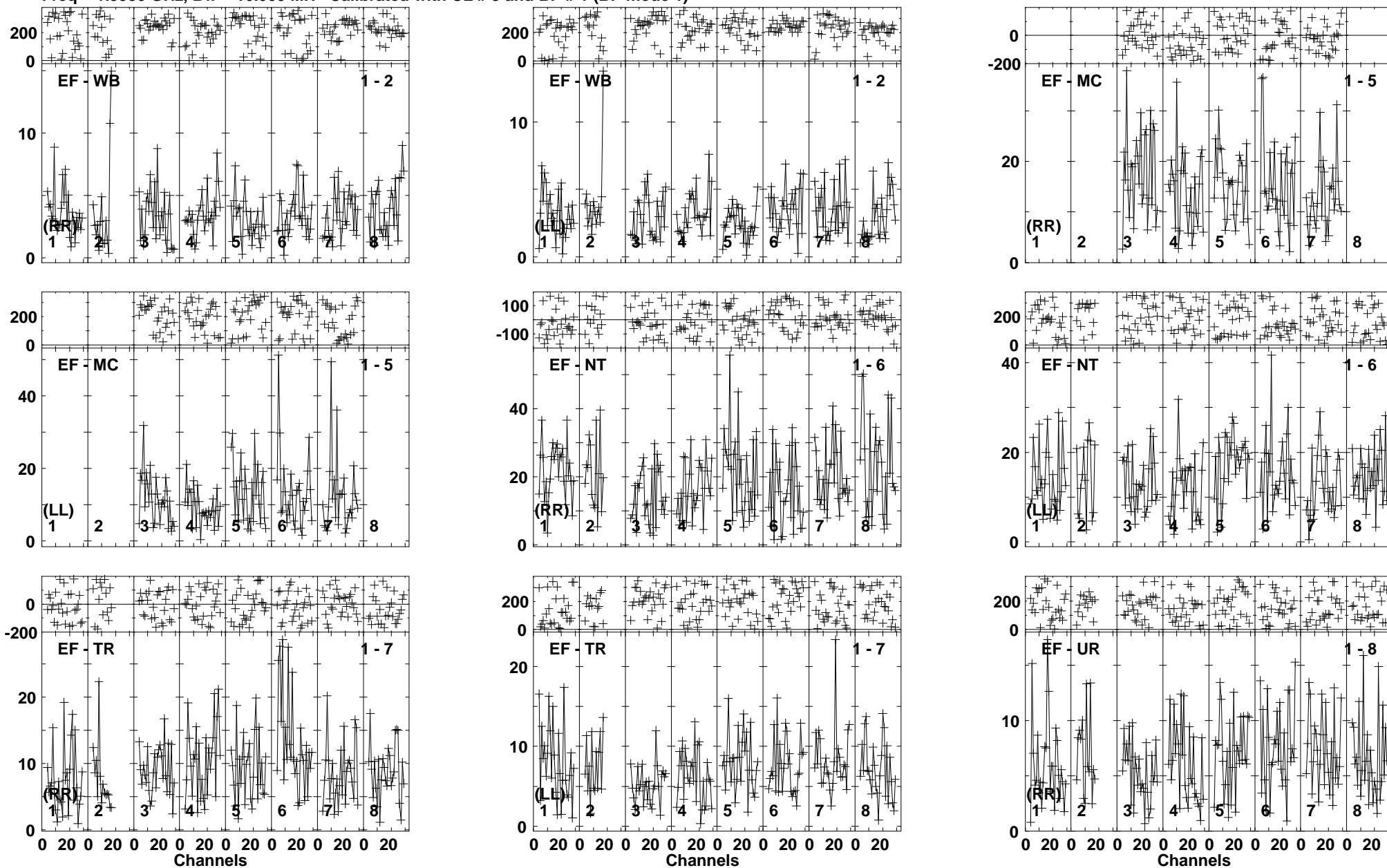

Lower frame: Milli Ampl Jy Top frame: Phas deg
 Vector averaged cross-power spectrum Baseline: EF (01) - WB (02)
 Timerange: 00/07:36:01 to 00/07:40:29

Plot file version 192 created 25-MAR-2014 17:51:37
 ARP299A EP087E 1.UVDATA.1
 Freq = 1.5950 GHz, Bw = 16.000 MH Calibrated with CL # 3 and BP # 1 (BP mode 1)

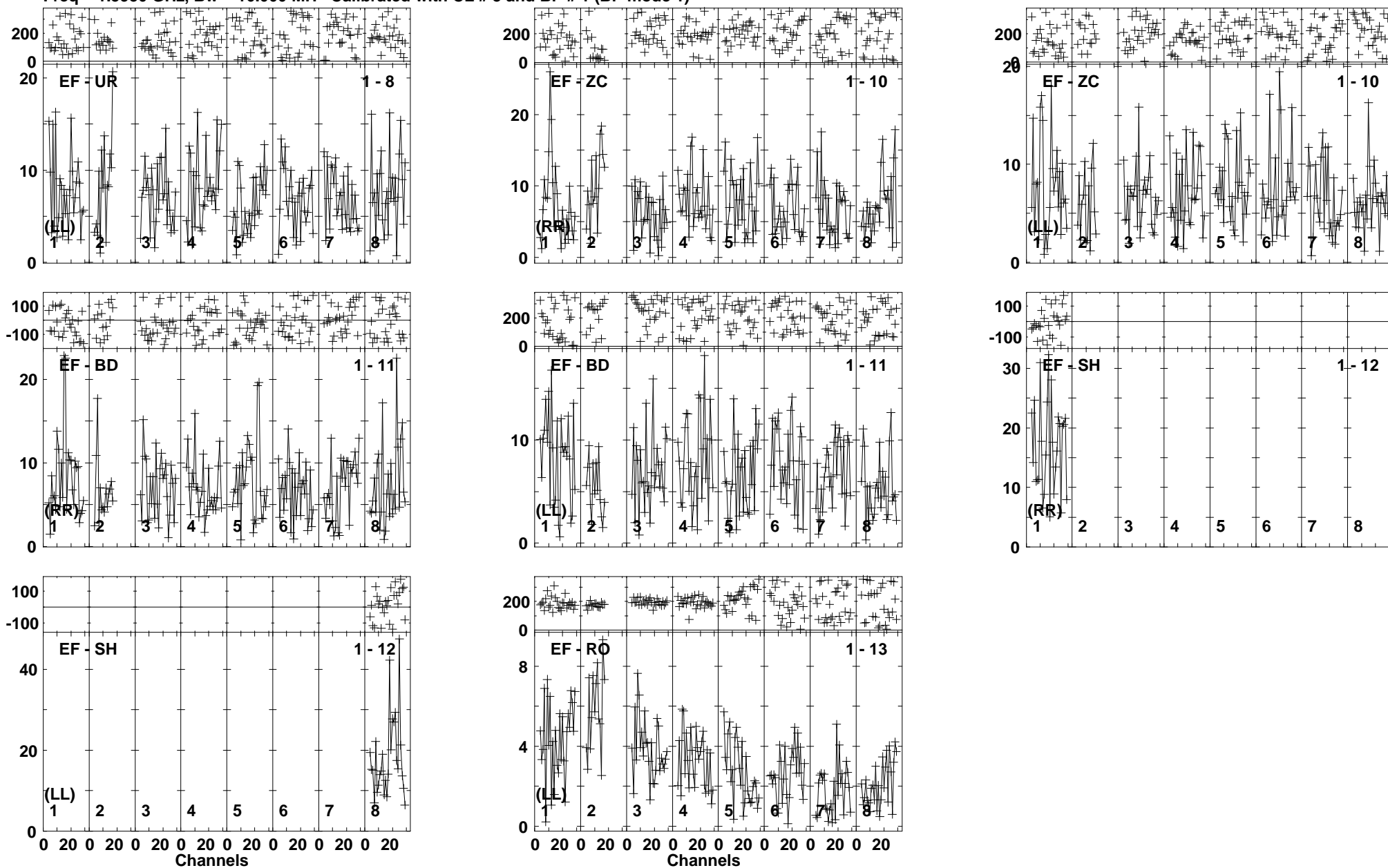

Lower frame: Milli Ampl Jy Top frame: Phas deg
 Vector averaged cross-power spectrum Baseline: EF (01) - UR (08)
 Timerange: 00/07:36:01 to 00/07:40:29

Plot file version 193 created 25-MAR-2014 17:51:38

ARP299A EP087E 1.UVDATA.1

Freq = 1.5950 GHz, Bw = 16.000 MH Calibrated with CL # 3 and BP # 1 (BP mode 1)

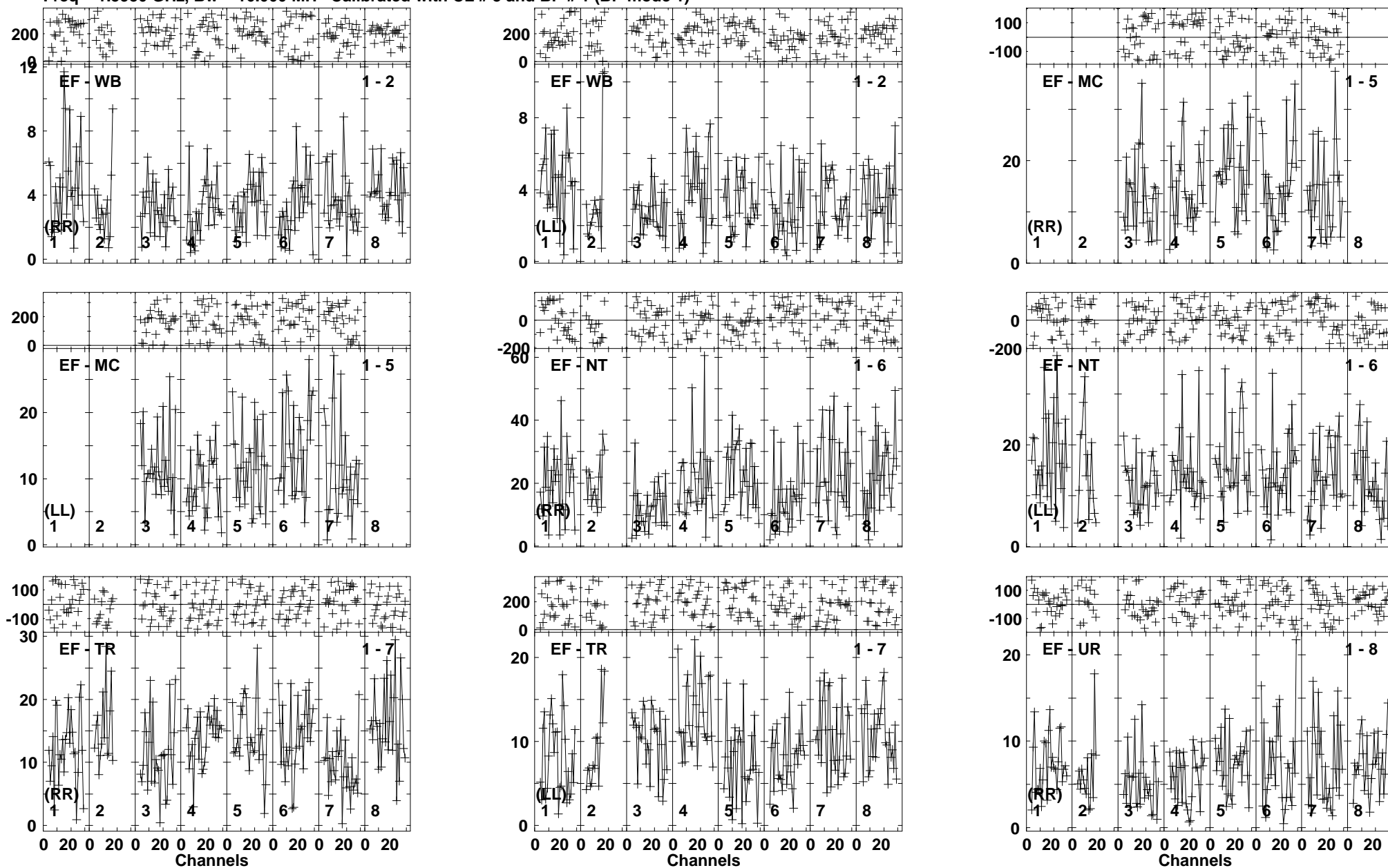

Lower frame: Milli Ampl Jy Top frame: Phas deg
Vector averaged cross-power spectrum Baseline: EF (01) - WB (02)
Timerange: 00/07:41:45 to 00/07:46:09

Plot file version 194 created 25-MAR-2014 17:51:38

ARP299A EP087E 1.UVDATA.1

Freq = 1.5950 GHz, Bw = 16.000 MH Calibrated with CL # 3 and BP # 1 (BP mode 1)

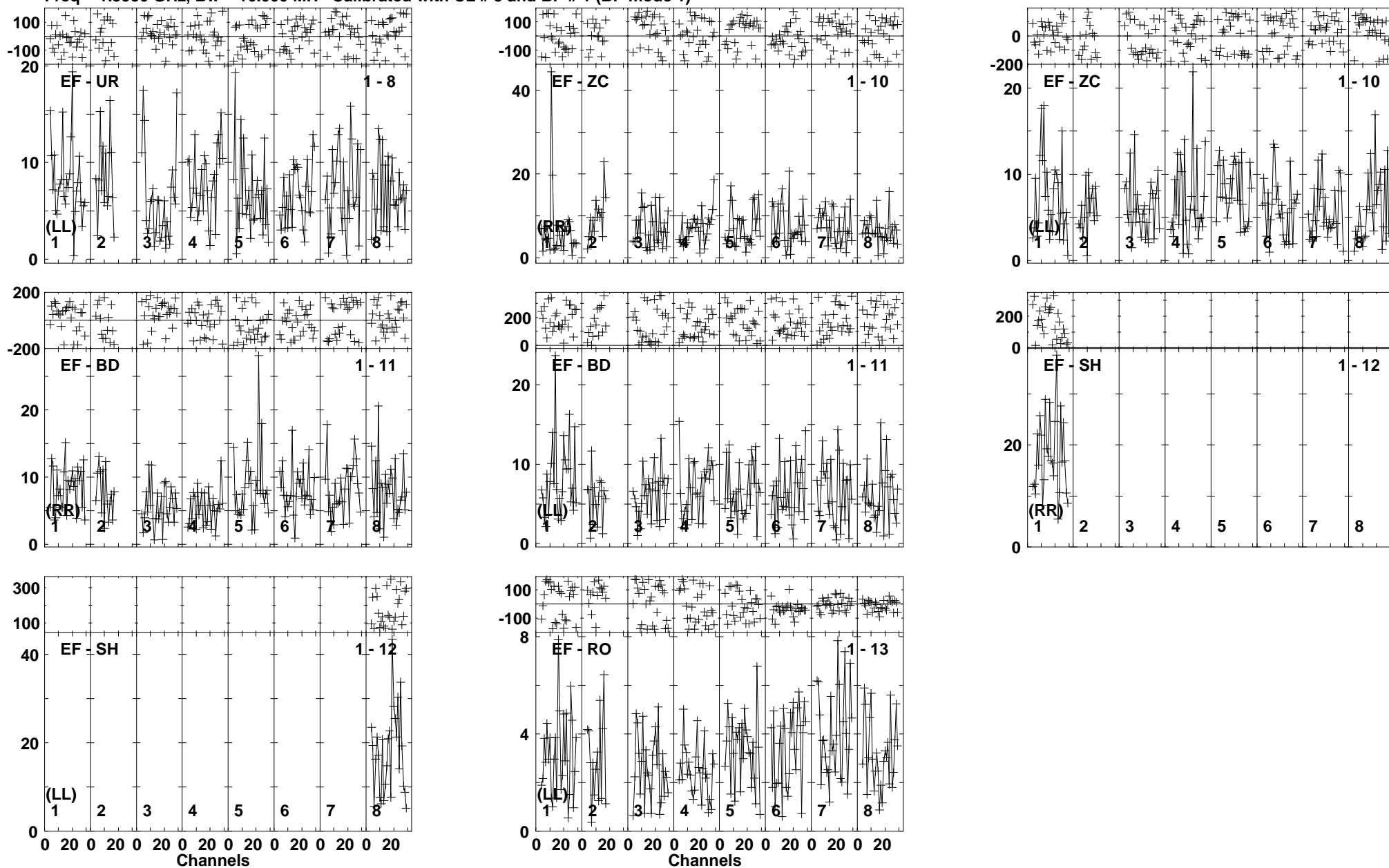

Lower frame: Milli Ampl Jy Top frame: Phas deg
Vector averaged cross-power spectrum Baseline: EF (01) - UR (08)
Timerange: 00/07:41:45 to 00/07:46:09

Plot file version 195 created 25-MAR-2014 17:51:38

J1128+5925 EP087E 1.UVDATA.1

Freq = 1.5950 GHz, Bw = 16.000 MH Calibrated with CL # 3 and BP # 1 (BP mode 1)

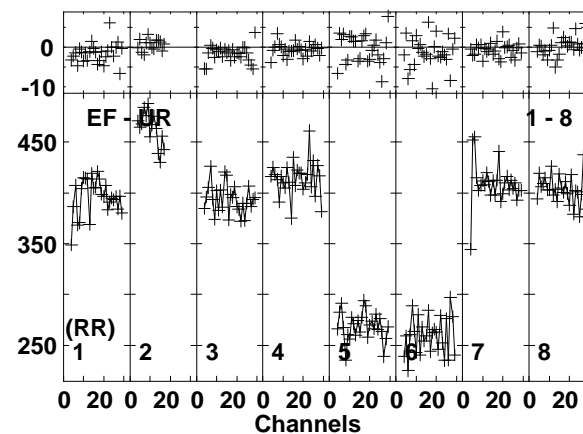
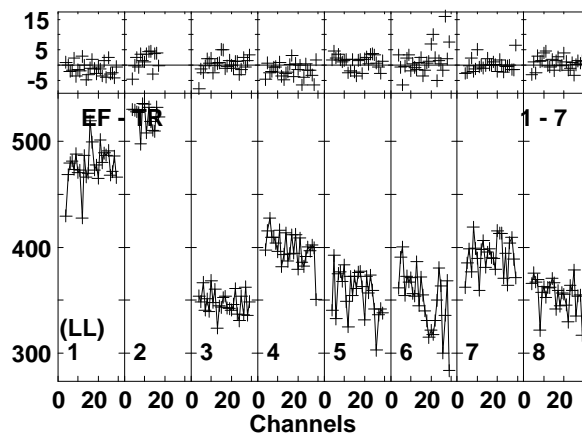
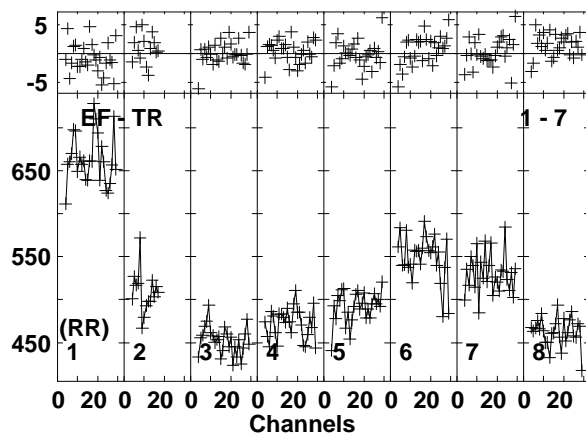
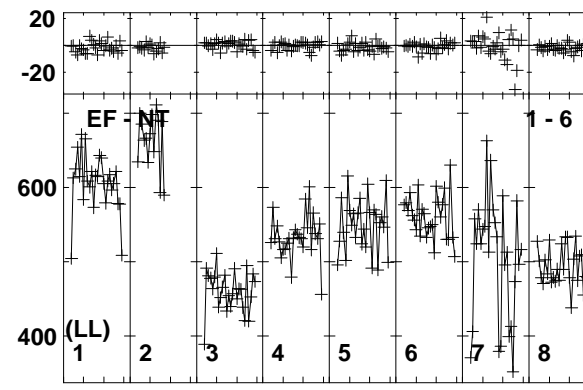
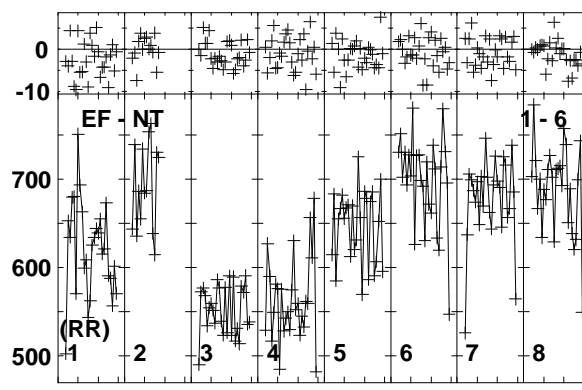
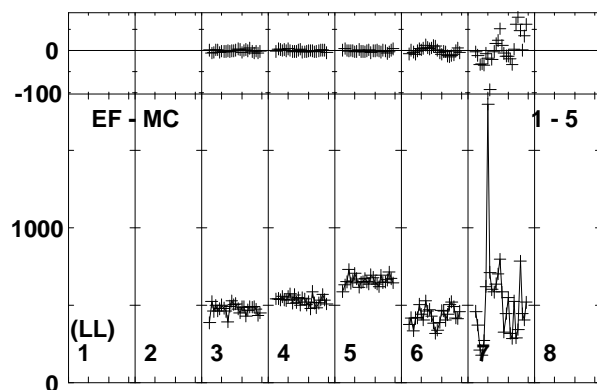
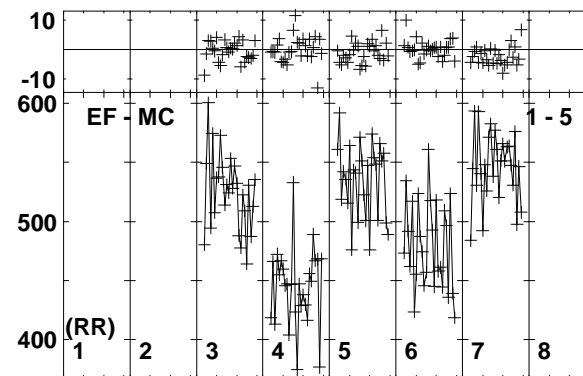
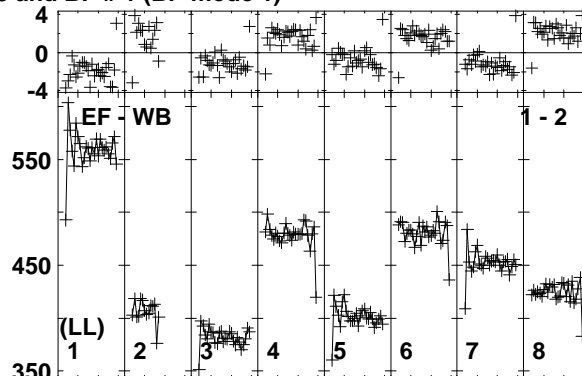
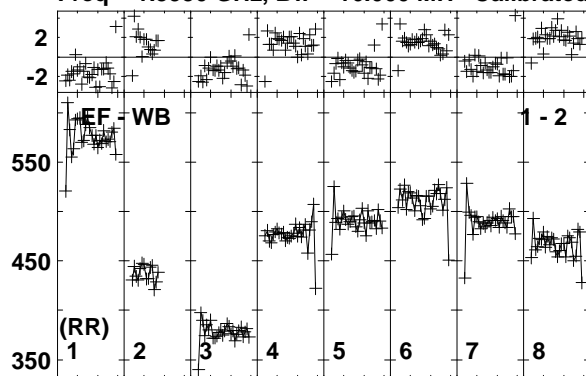

Lower frame: Milli Ampl Jy Top frame: Phas deg
Vector averaged cross-power spectrum Baseline: EF (01) - WB (02)
Timerange: 00/07:46:15 to 00/07:47:19

Plot file version 196 created 25-MAR-2014 17:51:38

J1128+5925 EP087E 1.UVDATA.1

Freq = 1.5950 GHz, Bw = 16.000 MH Calibrated with CL # 3 and BP # 1 (BP mode 1)

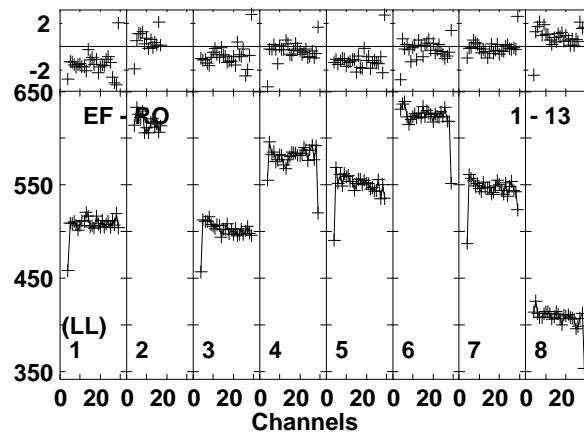
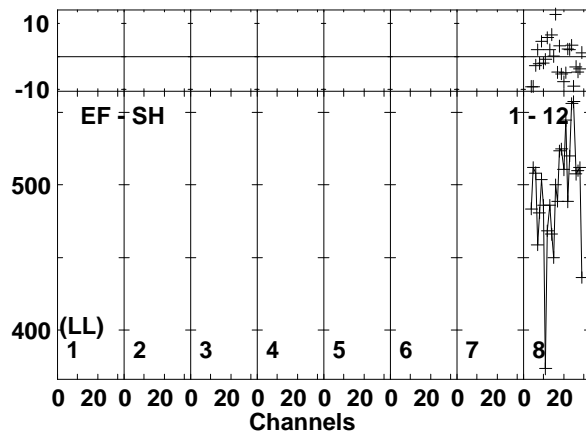
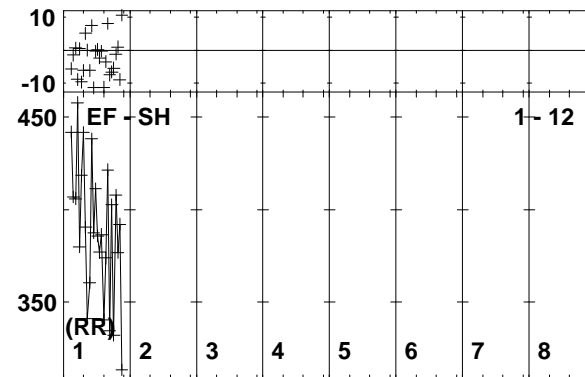
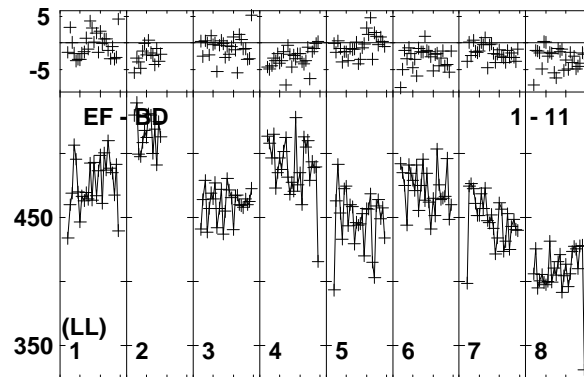
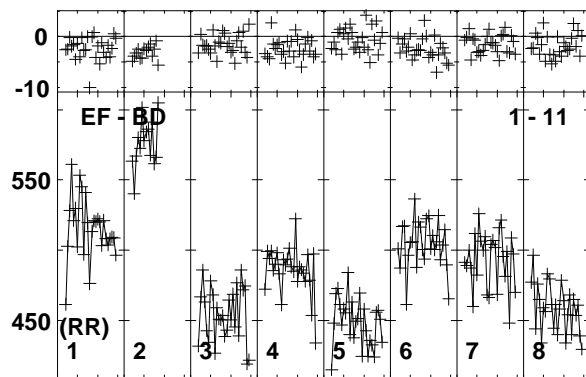
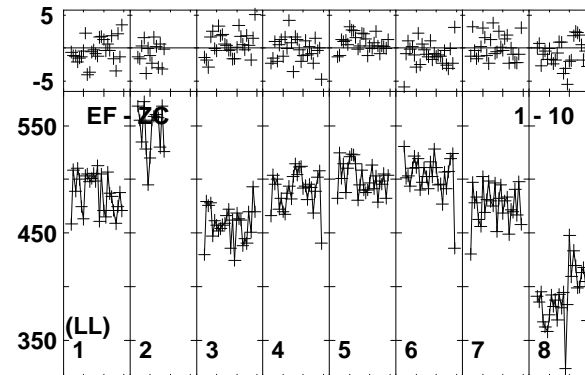
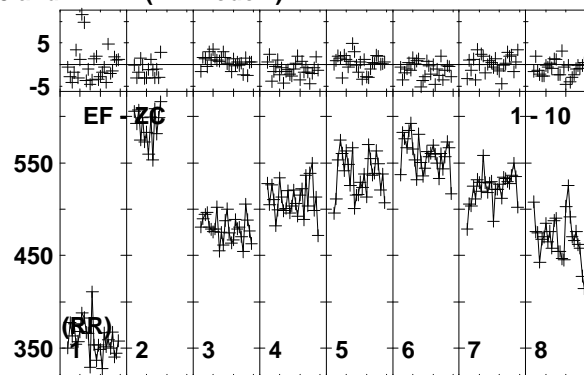
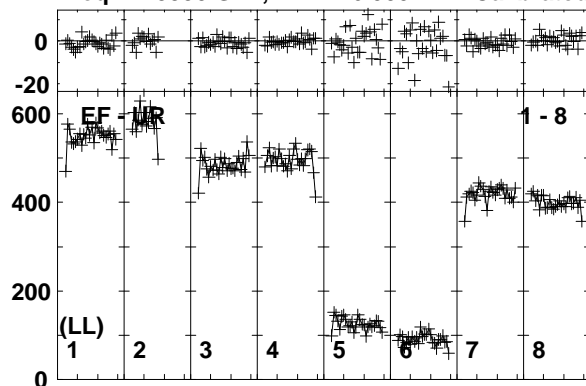

Lower frame: Milli Ampl Jy Top frame: Phas deg
Vector averaged cross-power spectrum Baseline: EF (01) - UR (08)
Timerange: 00/07:46:15 to 00/07:47:19

Plot file version 197 created 25-MAR-2014 17:51:39

ARP299A EP087E 1.UVDATA.1

Freq = 1.5950 GHz, Bw = 16.000 MH Calibrated with CL # 3 and BP # 1 (BP mode 1)

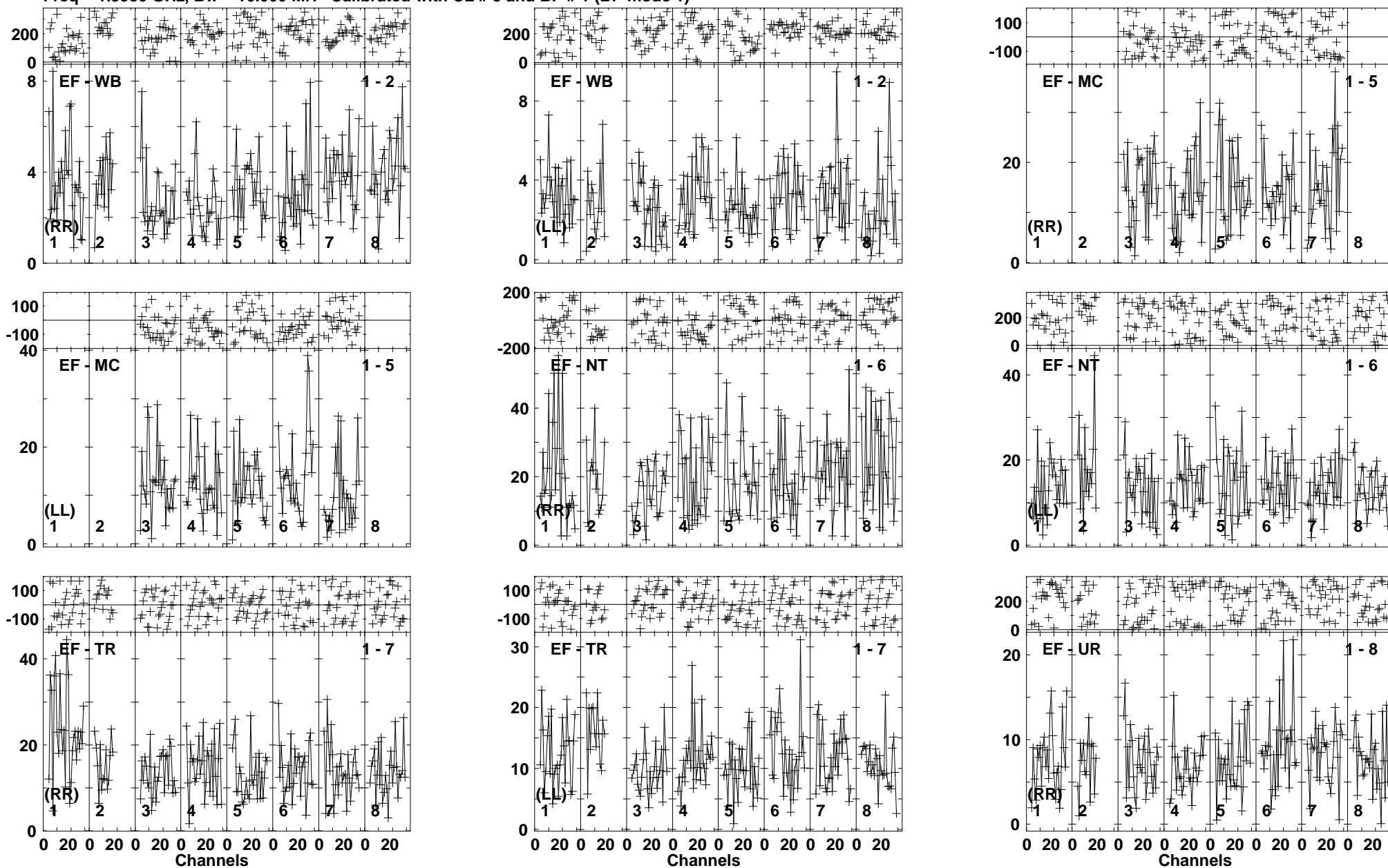

Lower frame: Milli Ampl Jy Top frame: Phas deg
Vector averaged cross-power spectrum Baseline: EF (01) - WB (02)
Timerange: 00/07:47:21 to 00/07:51:49

Plot file version 198 created 25-MAR-2014 17:51:39
 ARP299A EP087E 1.UVDATA.1
 Freq = 1.5950 GHz, Bw = 16.000 MH Calibrated with CL # 3 and BP # 1 (BP mode 1)

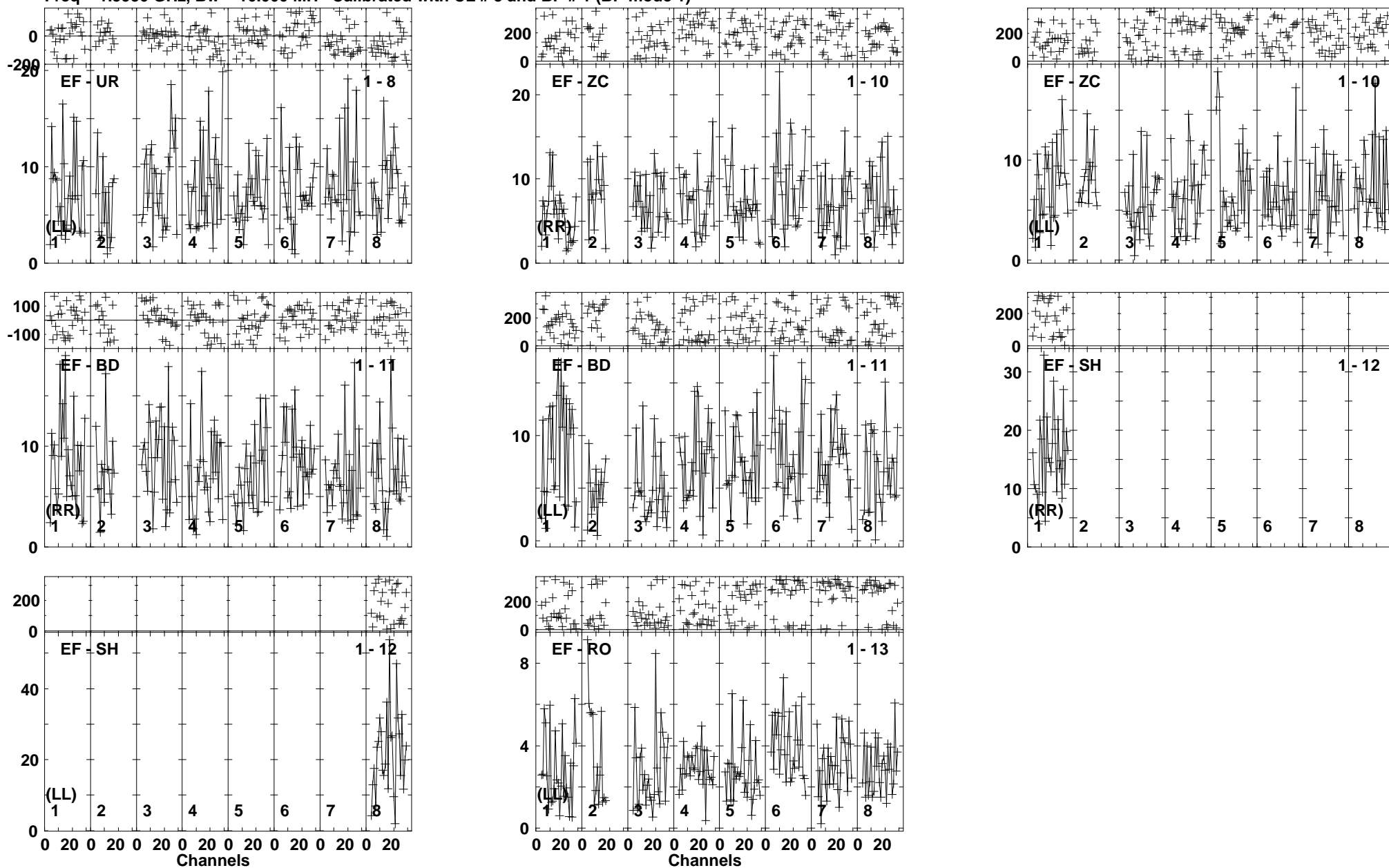

Lower frame: Milli Ampl Jy Top frame: Phas deg
 Vector averaged cross-power spectrum Baseline: EF (01) - UR (08)
 Timerange: 00/07:47:21 to 00/07:51:49

Plot file version 199 created 25-MAR-2014 17:51:39

J1128+5925 EP087E 1.UVDATA.1

Freq = 1.5950 GHz, Bw = 16.000 MH Calibrated with CL # 3 and BP # 1 (BP mode 1)

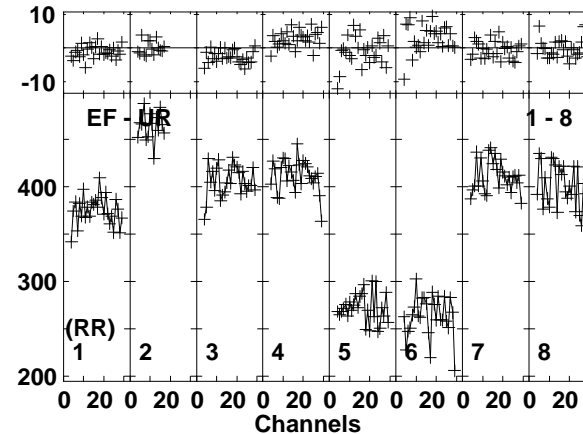
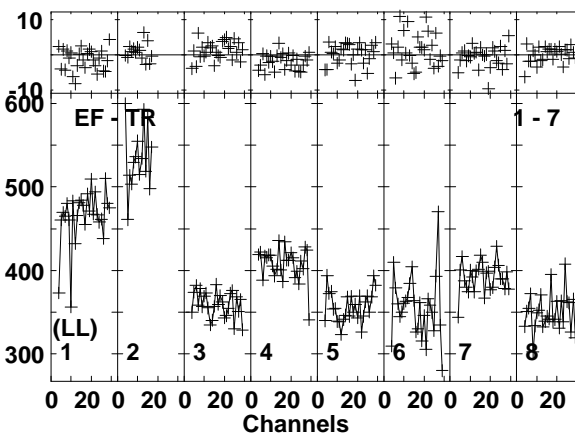
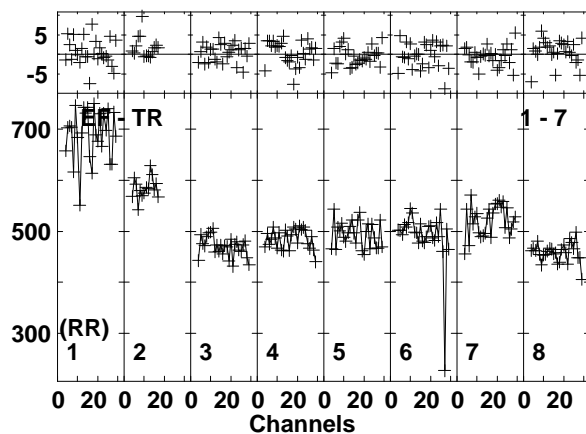
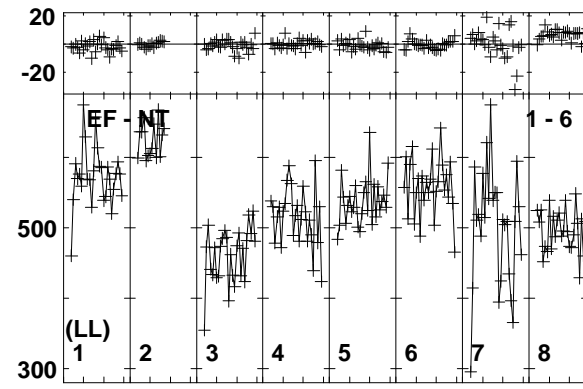
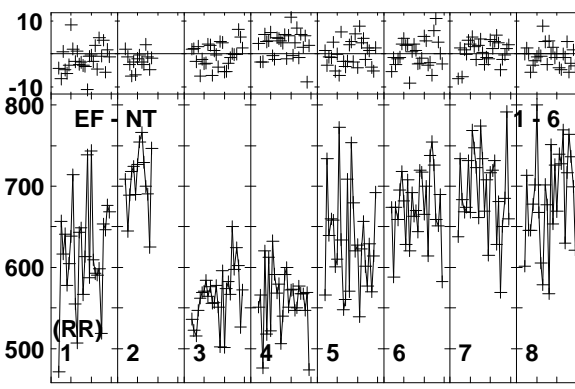
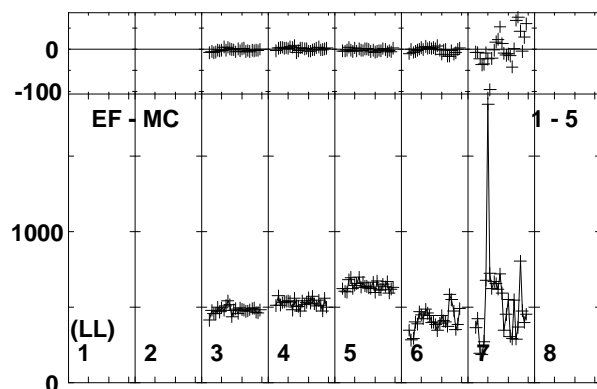
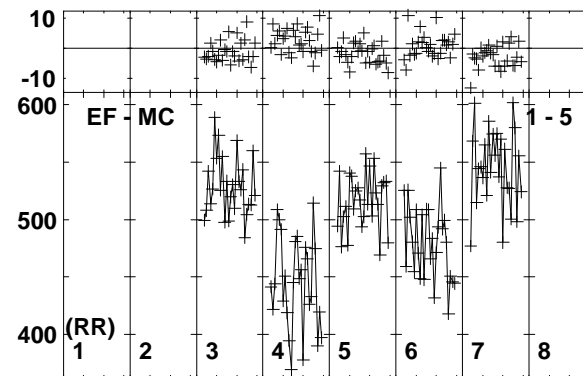
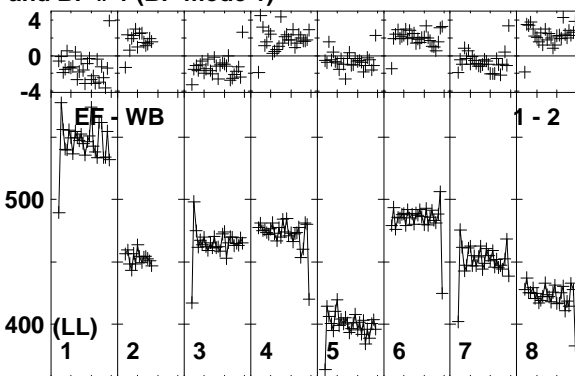
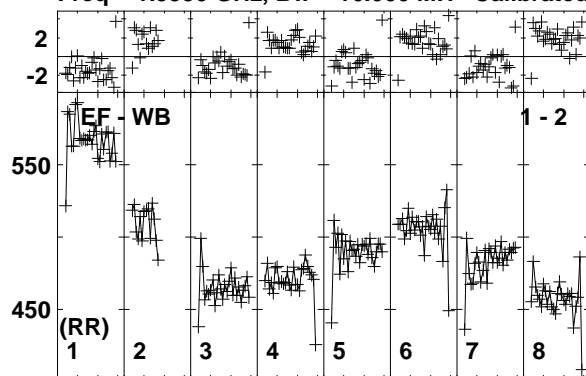

Lower frame: Milli Ampl Jy Top frame: Phas deg
Vector averaged cross-power spectrum Baseline: EF (01) - WB (02)
Timerange: 00/07:52:31 to 00/07:52:59

Plot file version 200 created 25-MAR-2014 17:51:39

J1128+5925 EP087E 1.UVDATA.1

Freq = 1.5950 GHz, Bw = 16.000 MH Calibrated with CL # 3 and BP # 1 (BP mode 1)

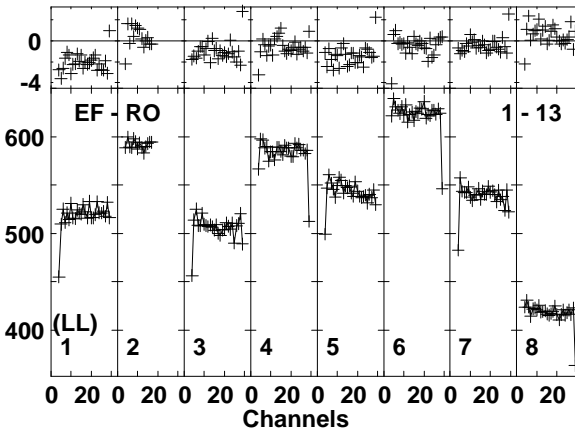
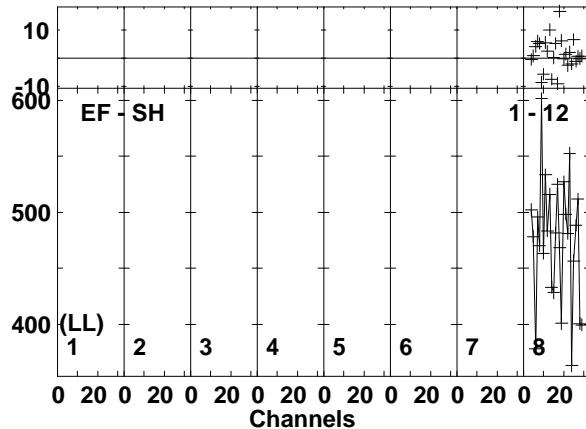
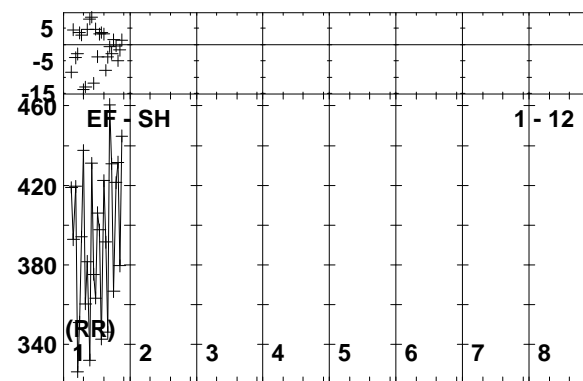
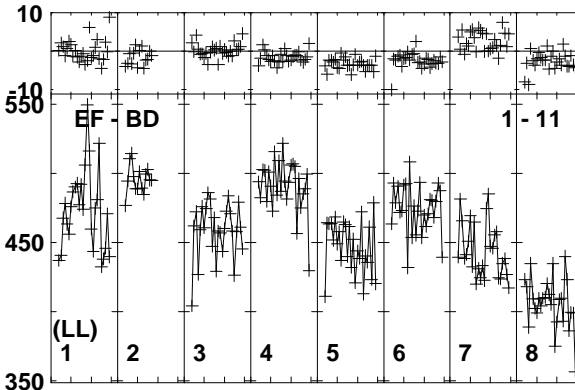
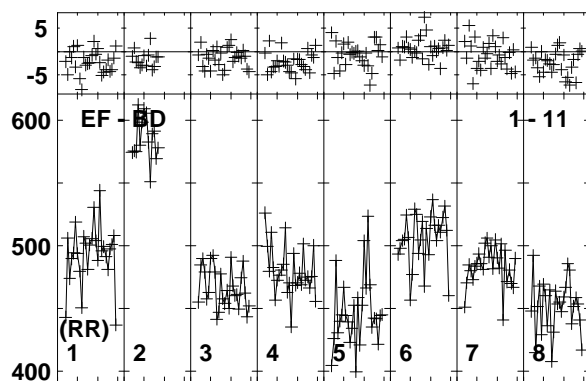
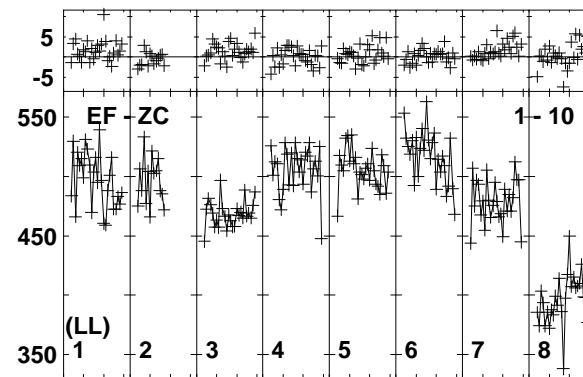
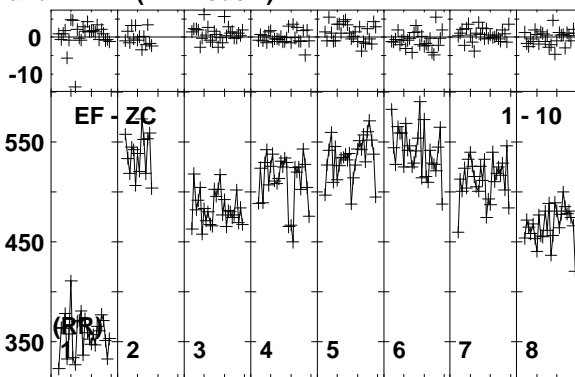
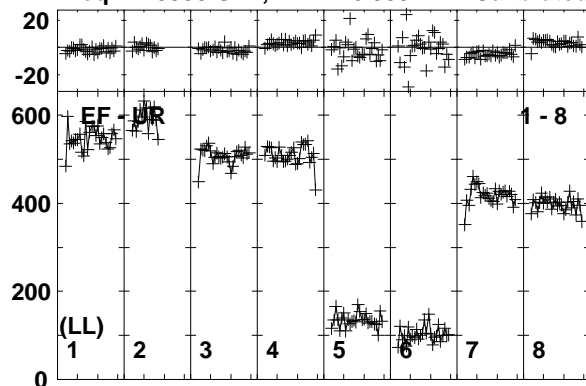

Lower frame: Milli Ampl Jy Top frame: Phas deg
Vector averaged cross-power spectrum Baseline: EF (01) - UR (08)
Timerange: 00/07:52:31 to 00/07:52:59

Plot file version 201 created 25-MAR-2014 17:51:40

ARP299A EP087E 1.UVDATA.1

Freq = 1.5950 GHz, Bw = 16.000 MH Calibrated with CL # 3 and BP # 1 (BP mode 1)

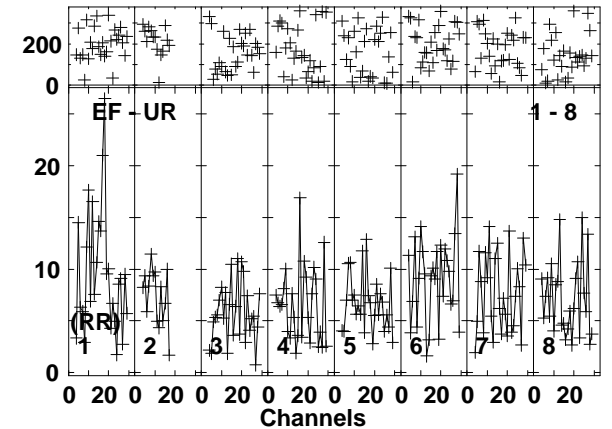
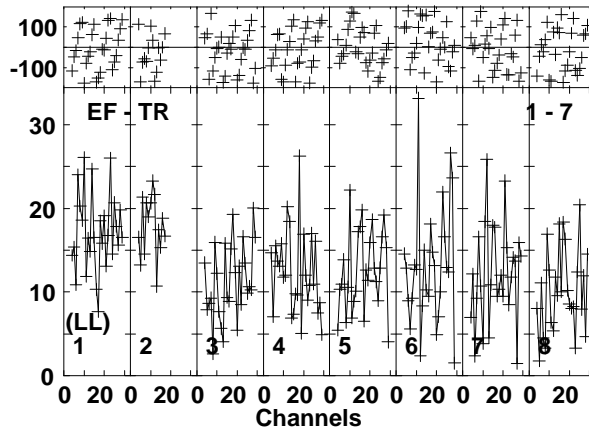
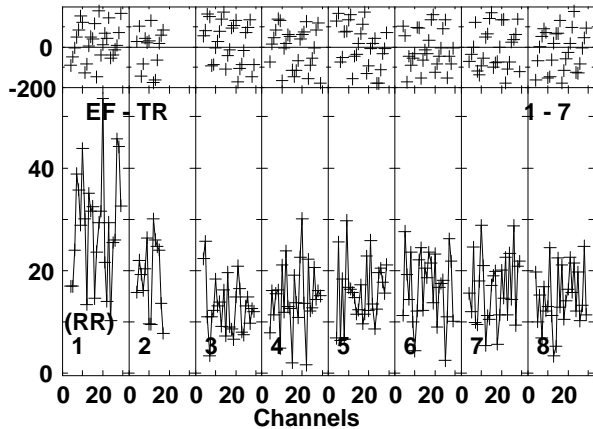
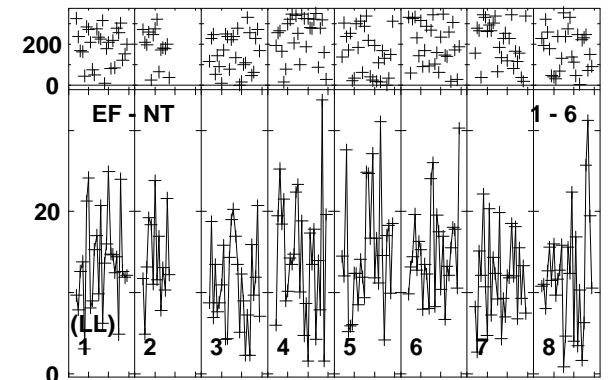
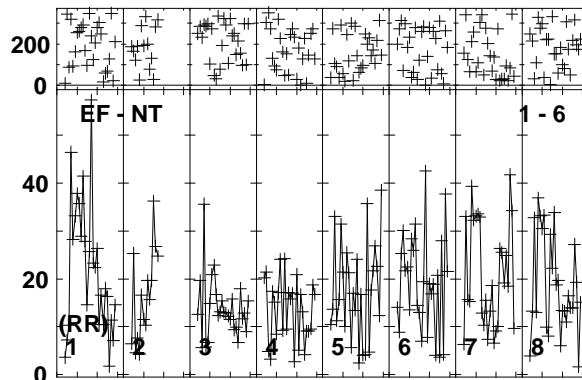
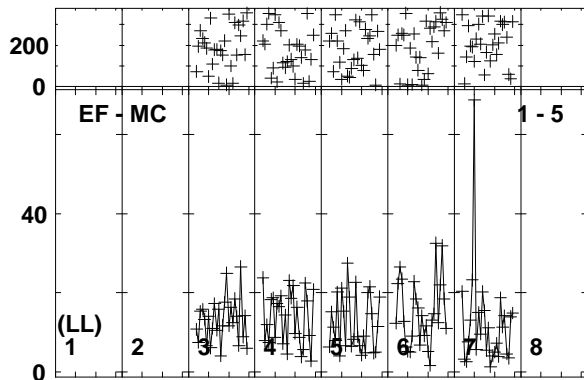
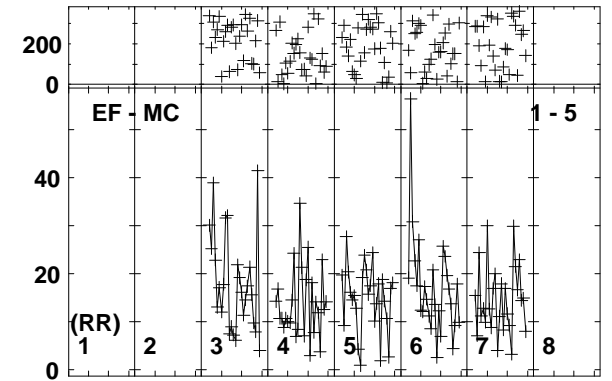
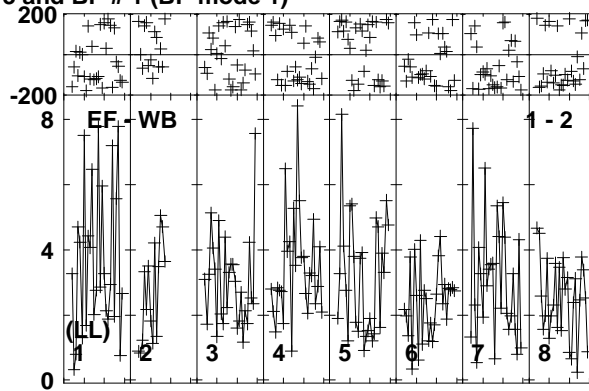
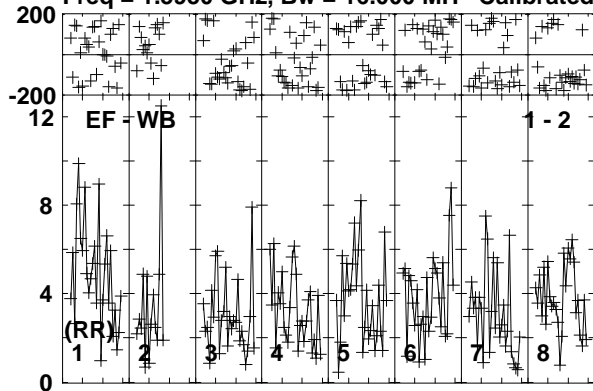

Lower frame: Milli Ampl Jy Top frame: Phas deg
Vector averaged cross-power spectrum Baseline: EF (01) - WB (02)
Timerange: 00/07:53:05 to 00/07:57:29

Plot file version 202 created 25-MAR-2014 17:51:40
 ARP299A EP087E 1.UVDATA.1
 Freq = 1.5950 GHz, Bw = 16.000 MH Calibrated with CL # 3 and BP # 1 (BP mode 1)

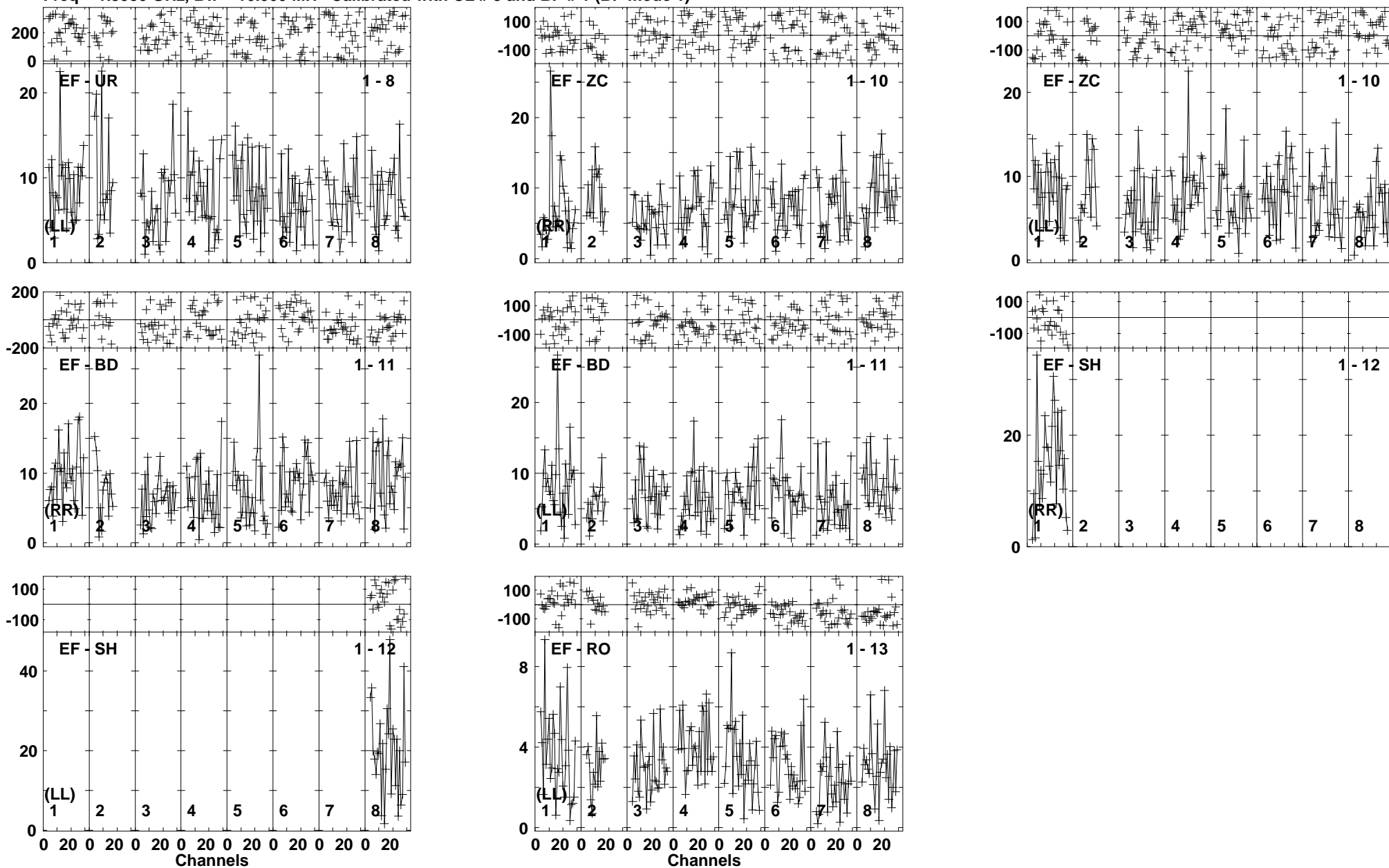

Lower frame: Milli Ampl Jy Top frame: Phas deg
 Vector averaged cross-power spectrum Baseline: EF (01) - UR (08)
 Timerange: 00/07:53:05 to 00/07:57:29

Plot file version 203 created 25-MAR-2014 17:51:40

J1128+5925 EP087E 1.UVDATA.1

Freq = 1.5950 GHz, Bw = 16.000 MH Calibrated with CL # 3 and BP # 1 (BP mode 1)

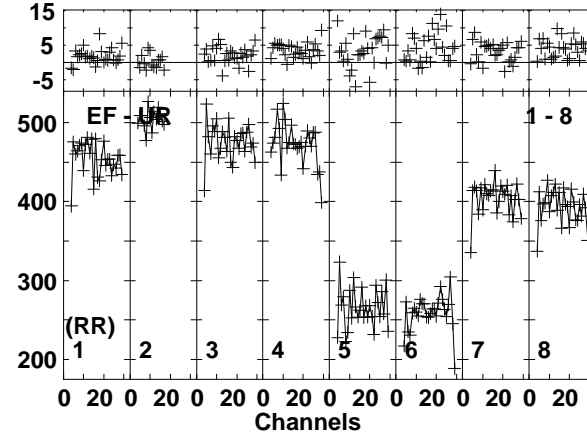
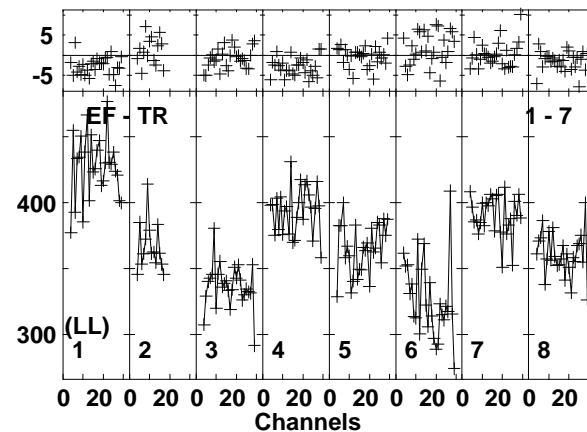
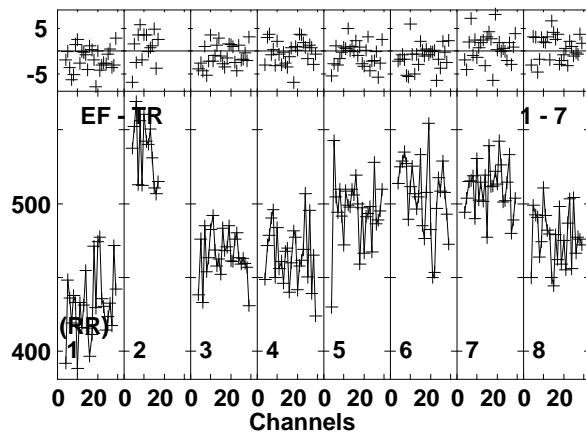
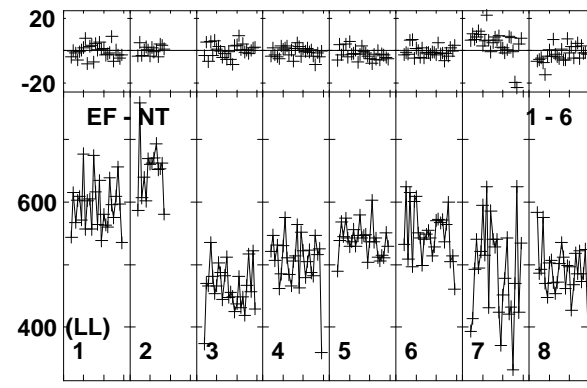
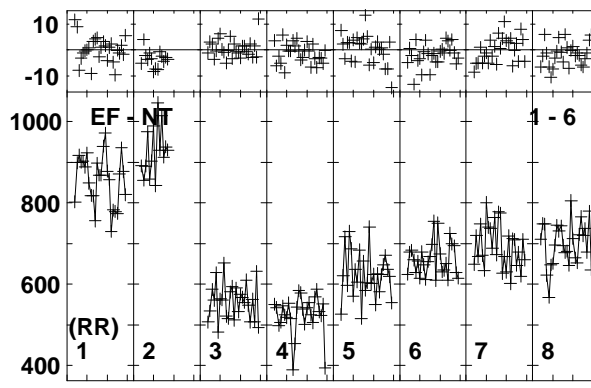
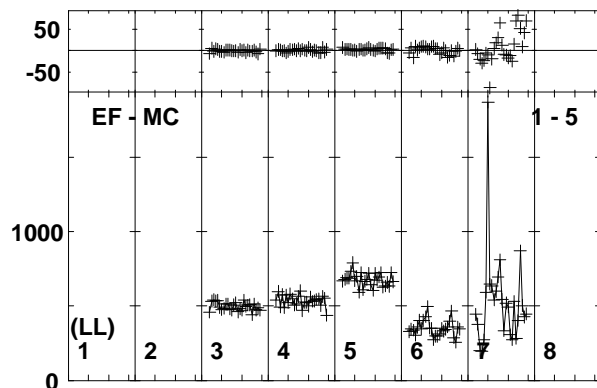
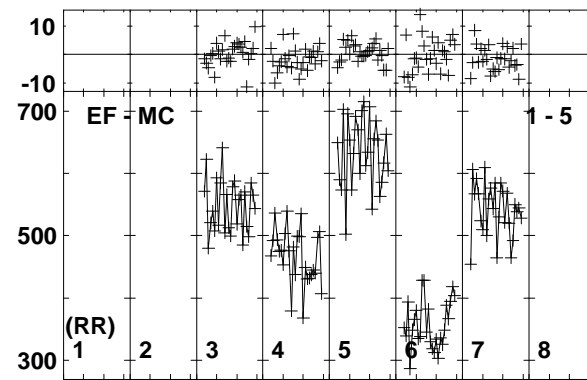
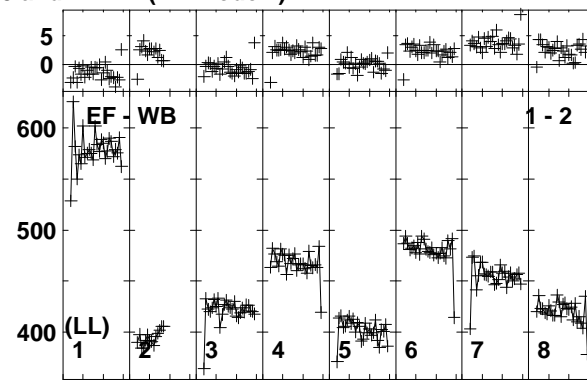
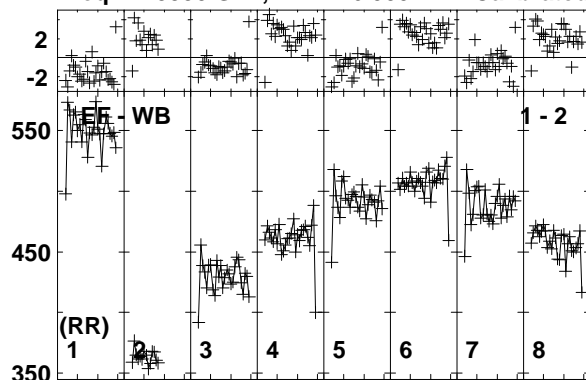

Lower frame: Milli Ampl Jy Top frame: Phas deg
Vector averaged cross-power spectrum Baseline: EF (01) - WB (02)
Timerange: 00/07:57:35 to 00/07:58:29

Plot file version 204 created 25-MAR-2014 17:51:41

J1128+5925 EP087E 1.UVDATA.1

Freq = 1.5950 GHz, Bw = 16.000 MH Calibrated with CL # 3 and BP # 1 (BP mode 1)

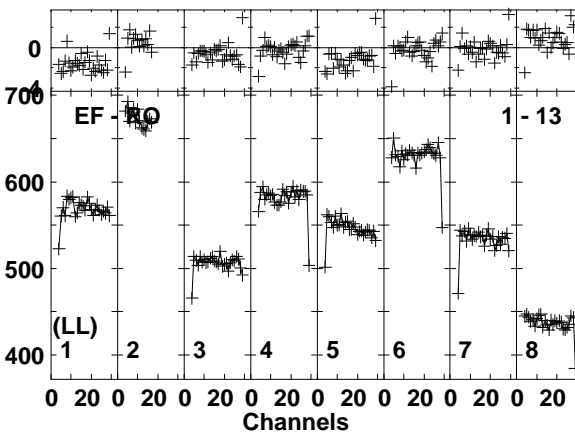
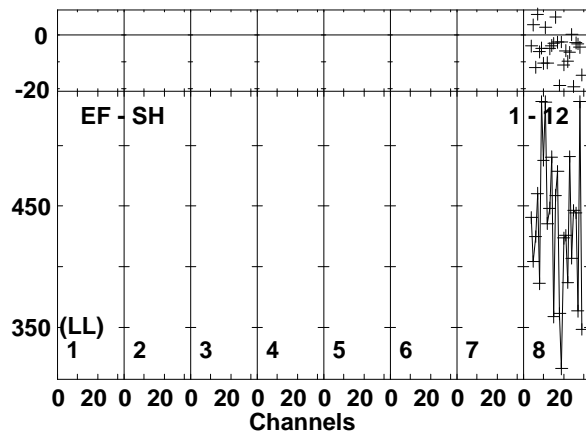
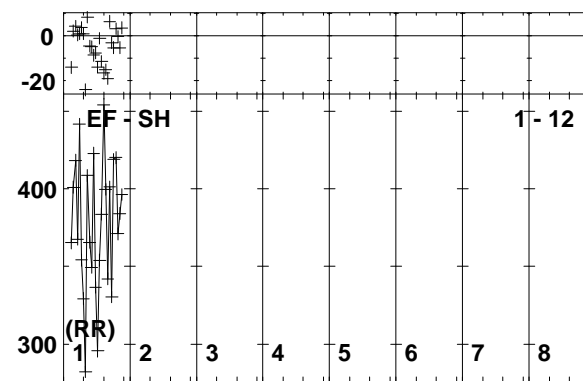
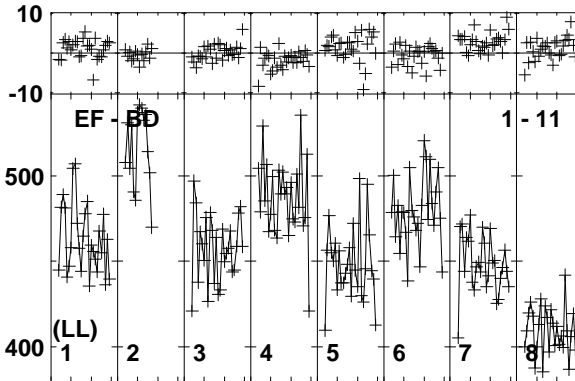
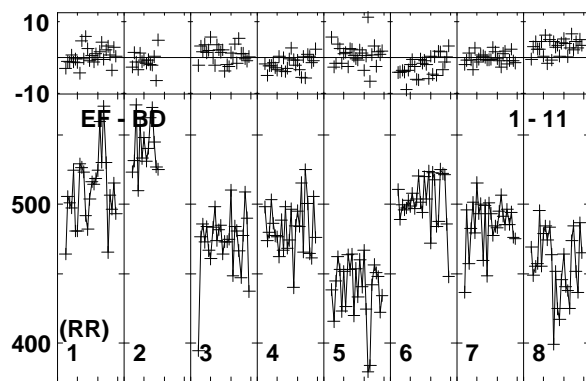
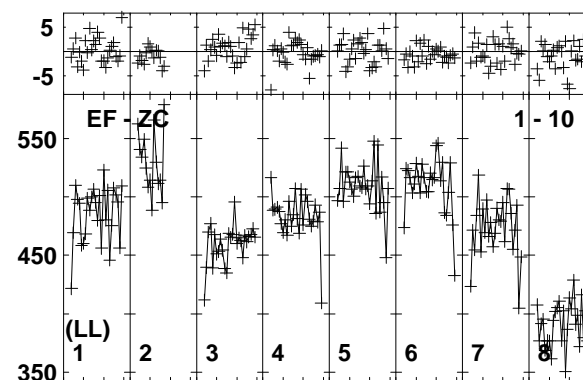
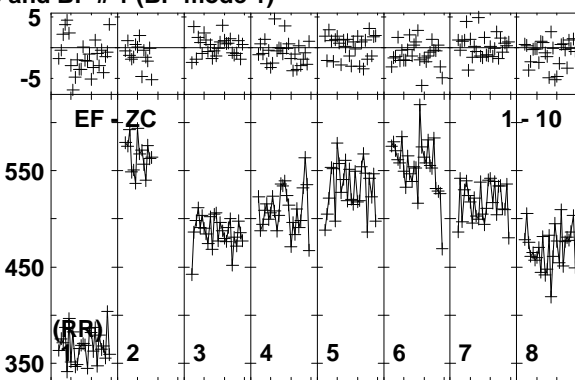
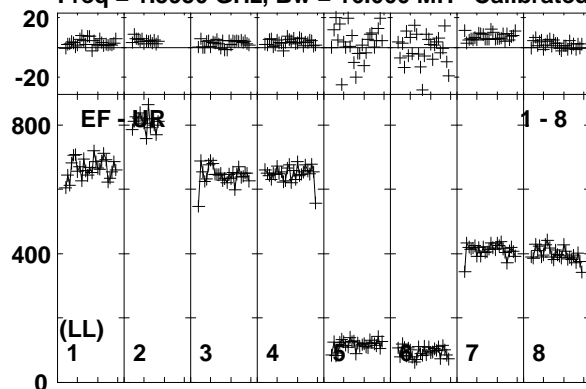

Lower frame: Milli Ampl Jy Top frame: Phas deg
Vector averaged cross-power spectrum Baseline: EF (01) - UR (08)
Timerange: 00/07:57:35 to 00/07:58:29

Plot file version 205 created 25-MAR-2014 17:51:41

ARP299A EP087E 1.UVDATA.1

Freq = 1.5950 GHz, Bw = 16.000 MH Calibrated with CL # 3 and BP # 1 (BP mode 1)

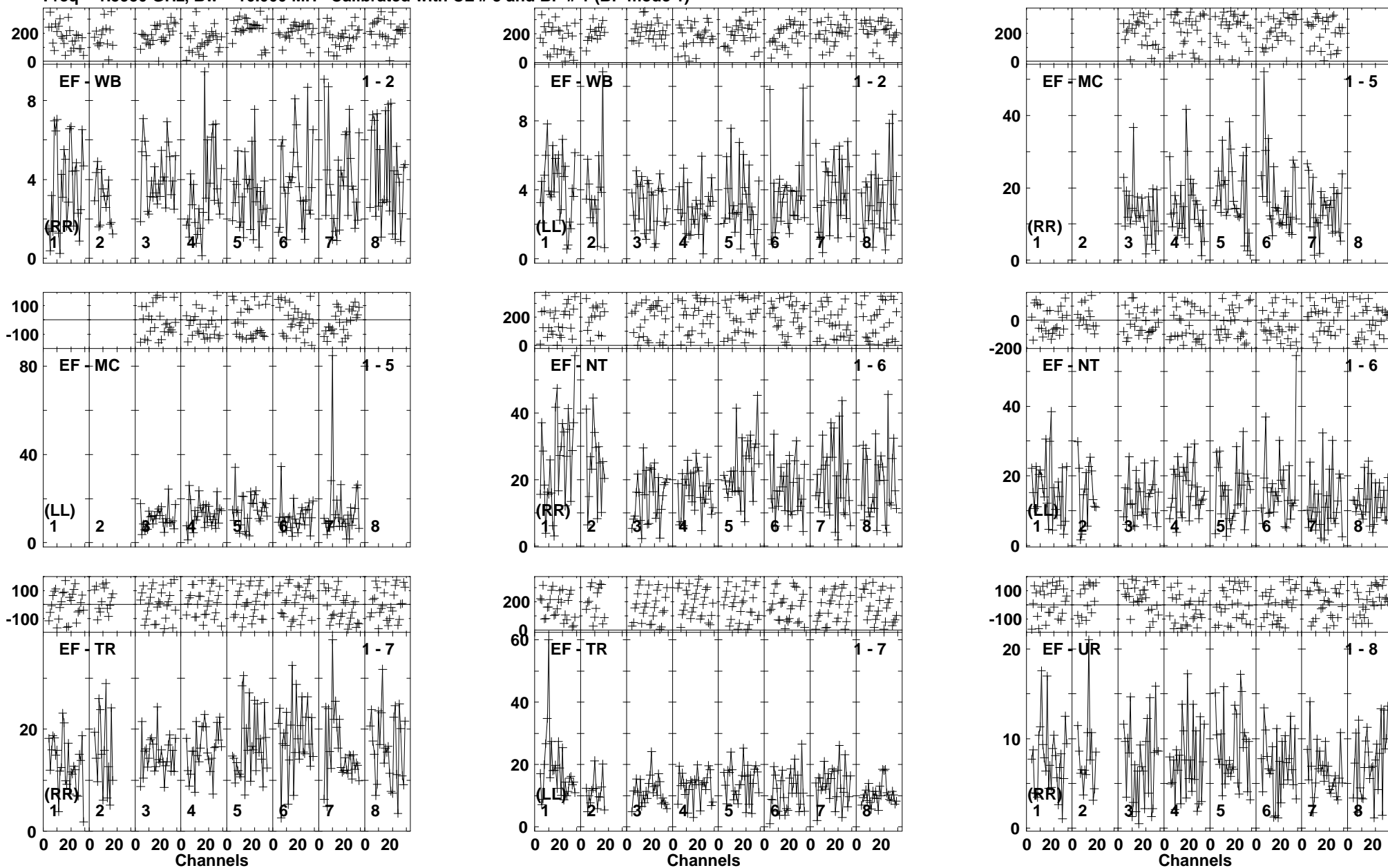

Lower frame: Milli Ampl Jy Top frame: Phas deg
Vector averaged cross-power spectrum Baseline: EF (01) - WB (02)
Timerange: 00/07:58:31 to 00/08:02:59

Plot file version 206 created 25-MAR-2014 17:51:41
 ARP299A EP087E 1.UVDATA.1
 Freq = 1.5950 GHz, Bw = 16.000 MH Calibrated with CL # 3 and BP # 1 (BP mode 1)

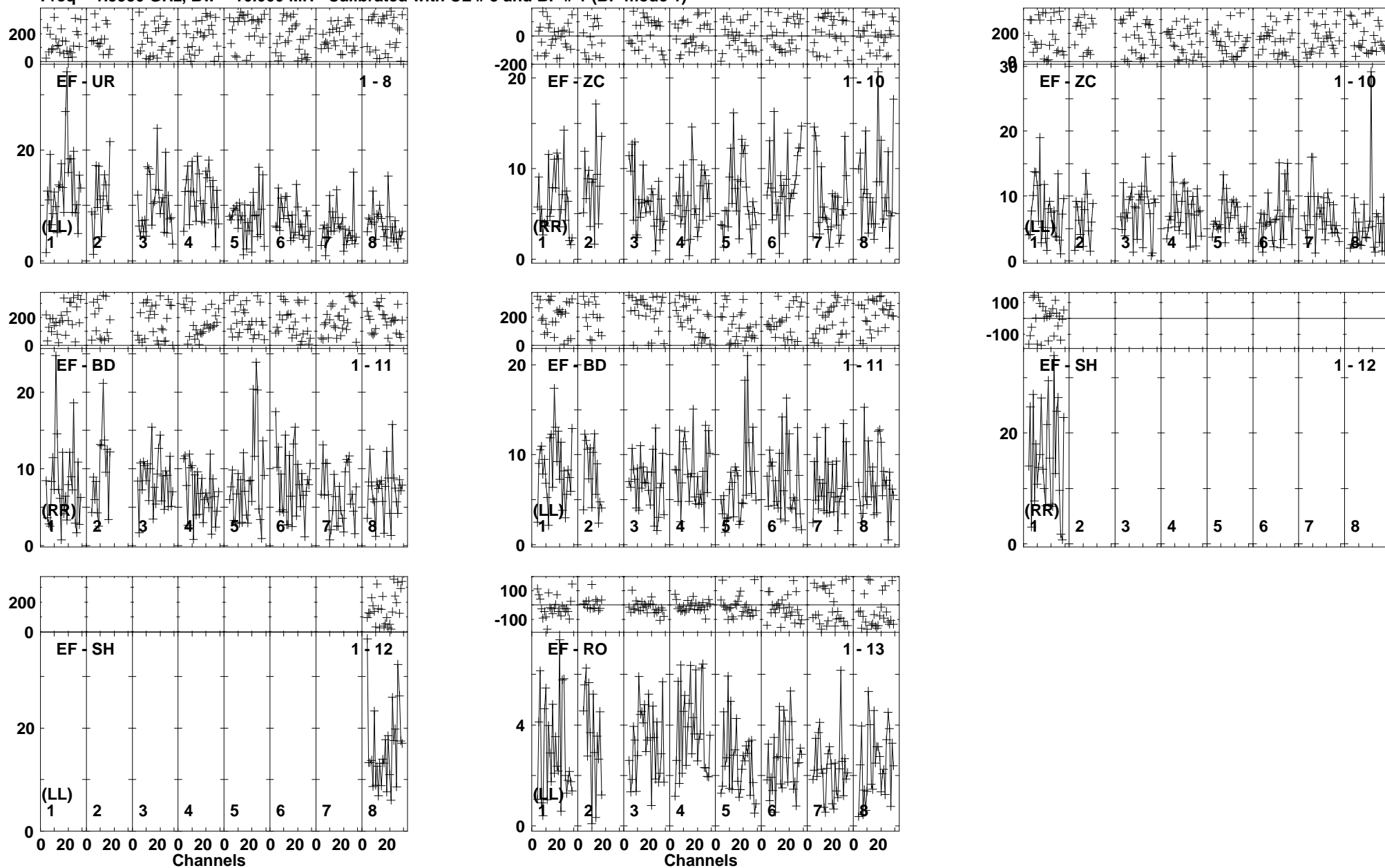

Lower frame: Milli Ampl Jy Top frame: Phas deg
 Vector averaged cross-power spectrum Baseline: EF (01) - UR (08)
 Timerange: 00/07:58:31 to 00/08:02:59

Plot file version 207 created 25-MAR-2014 17:51:42

J1128+5925 EP087E 1.UVDATA.1

Freq = 1.5950 GHz, Bw = 16.000 MH Calibrated with CL # 3 and BP # 1 (BP mode 1)

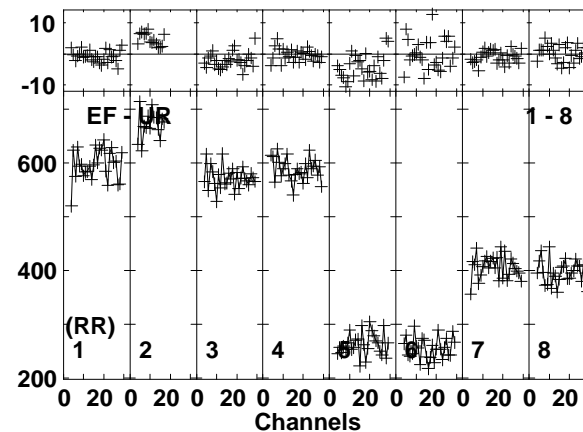
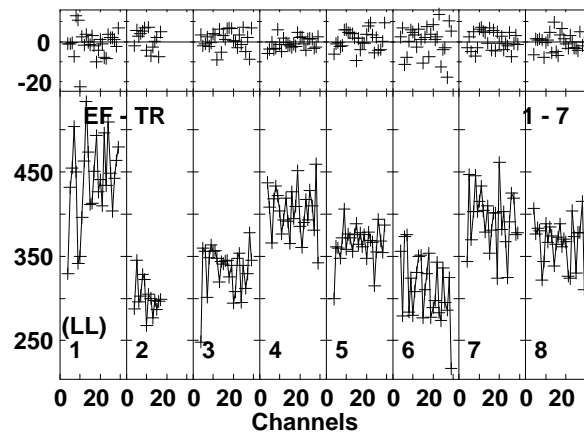
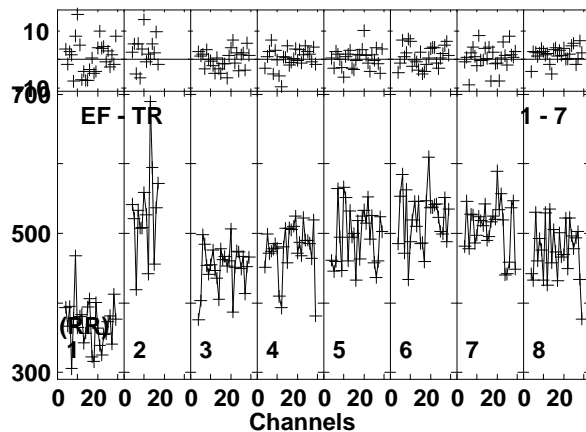
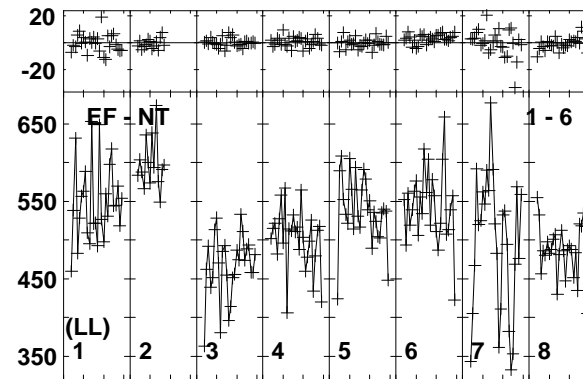
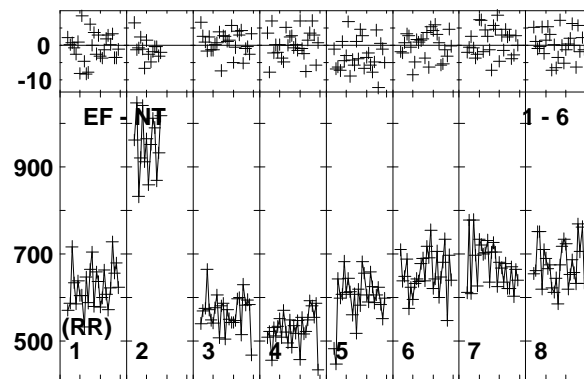
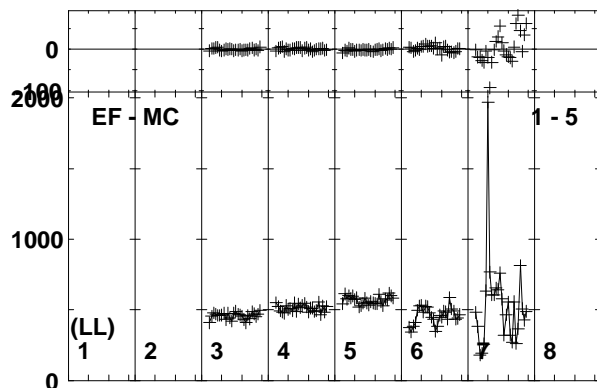
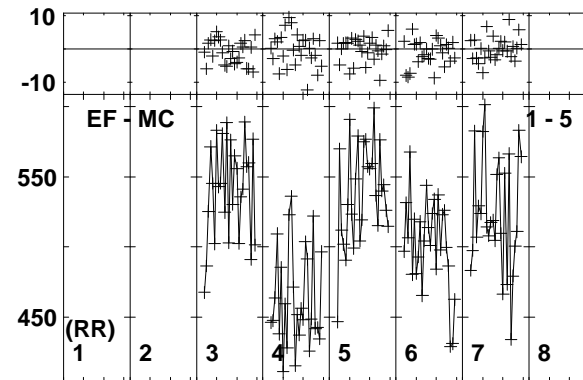
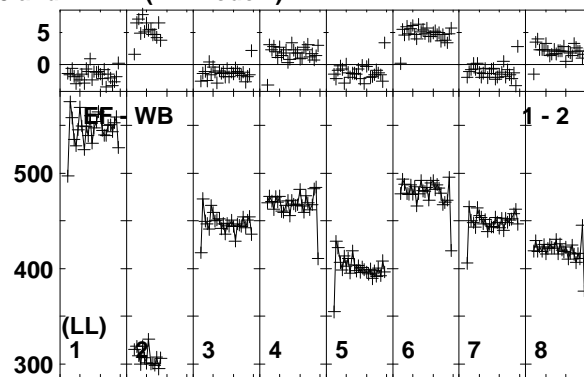
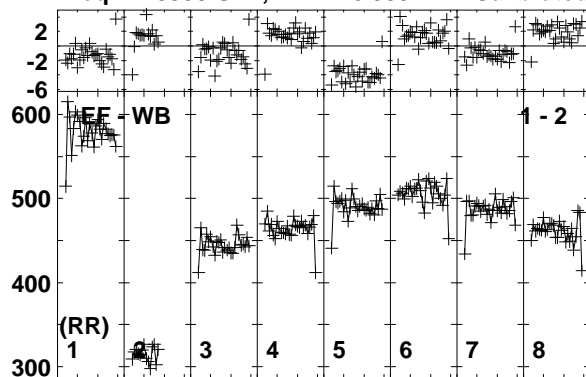

Lower frame: Milli Ampl Jy Top frame: Phas deg
Vector averaged cross-power spectrum Baseline: EF (01) - WB (02)
Timerange: 00/08:03:41 to 00/08:04:09

Plot file version 208 created 25-MAR-2014 17:51:42
 J1128+5925 EP087E 1.UVDATA.1
 Freq = 1.5950 GHz, Bw = 16.000 MH Calibrated with CL # 3 and BP # 1 (BP mode 1)

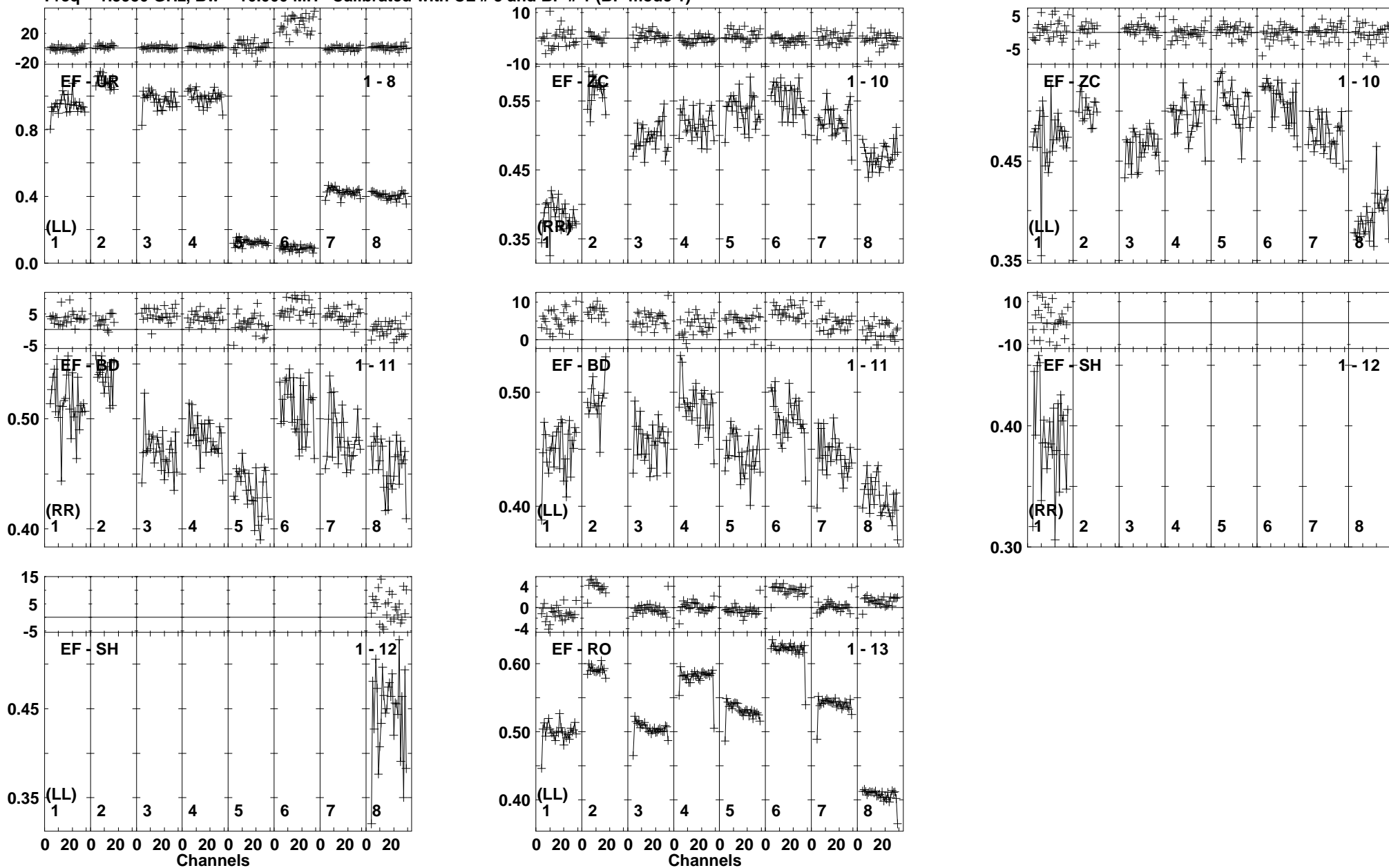

Lower frame: Ampl Jy Top frame: Phas deg
 Vector averaged cross-power spectrum Baseline: EF (01) - UR (08)
 Timerange: 00/08:03:41 to 00/08:04:09

Plot file version 209 created 25-MAR-2014 17:51:42
 ARP299A EP087E 1.UVDATA.1
 Freq = 1.5950 GHz, Bw = 16.000 MH Calibrated with CL # 3 and BP # 1 (BP mode 1)

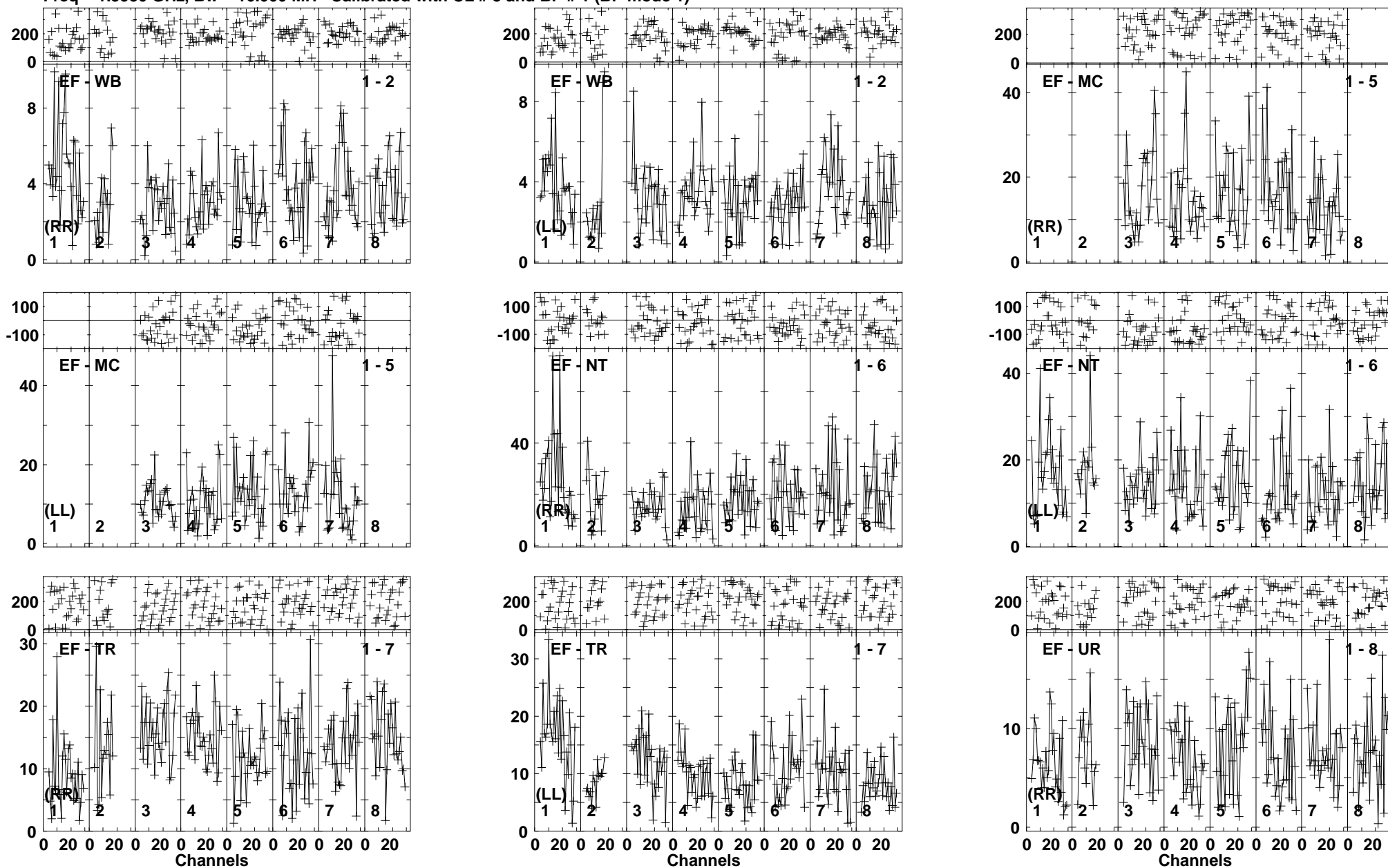

Lower frame: Milli Ampl Jy Top frame: Phas deg
 Vector averaged cross-power spectrum Baseline: EF (01) - WB (02)
 Timerange: 00/08:04:15 to 00/08:08:39

Plot file version 210 created 25-MAR-2014 17:51:42
 ARP299A EP087E 1.UVDATA.1
 Freq = 1.5950 GHz, Bw = 16.000 MH Calibrated with CL # 3 and BP # 1 (BP mode 1)

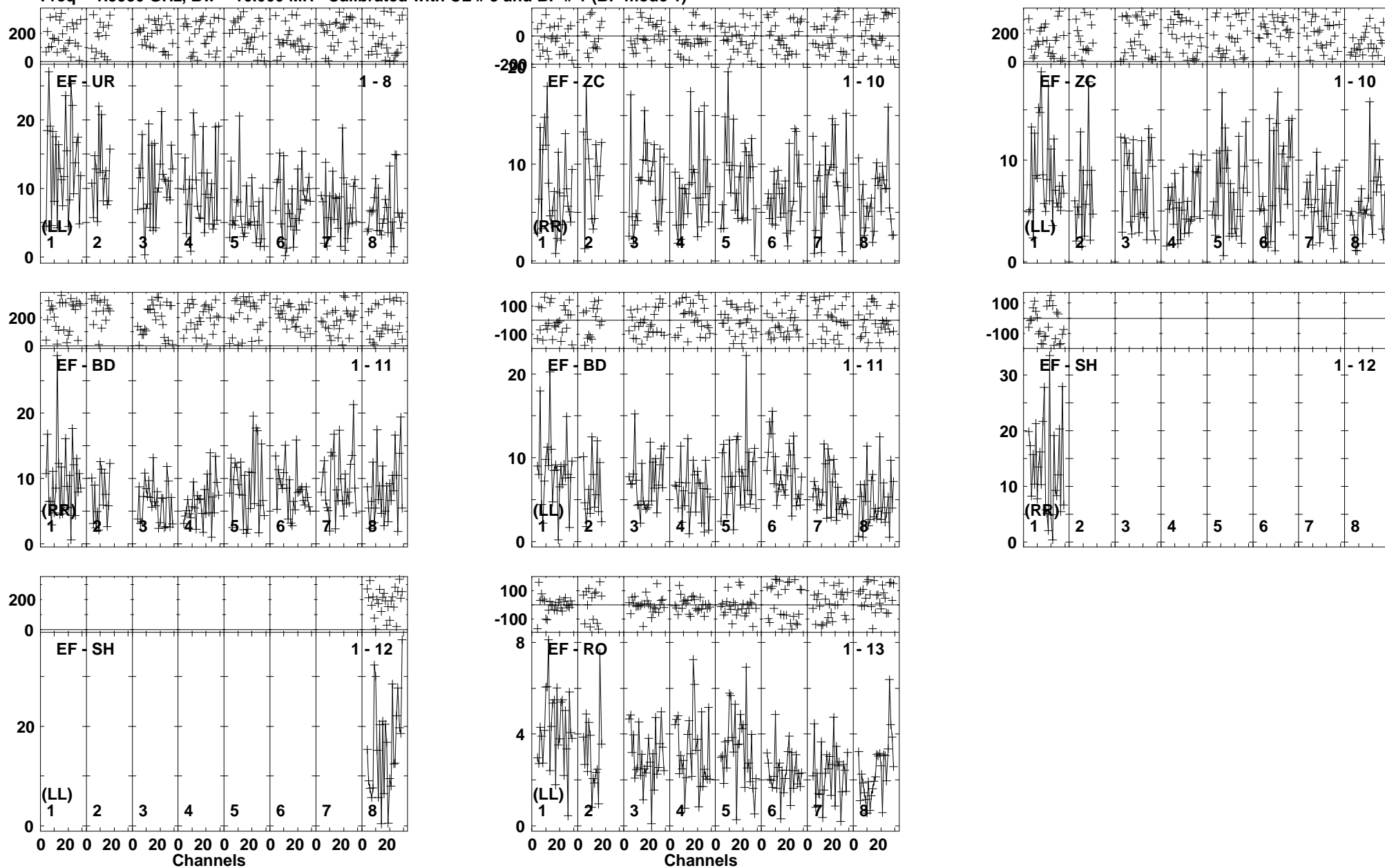

Lower frame: Milli Ampl Jy Top frame: Phas deg
 Vector averaged cross-power spectrum Baseline: EF (01) - UR (08)
 Timerange: 00/08:04:15 to 00/08:08:39

Plot file version 211 created 25-MAR-2014 17:51:43

J1128+5925 EP087E 1.UVDATA.1

Freq = 1.5950 GHz, Bw = 16.000 MH Calibrated with CL # 3 and BP # 1 (BP mode 1)

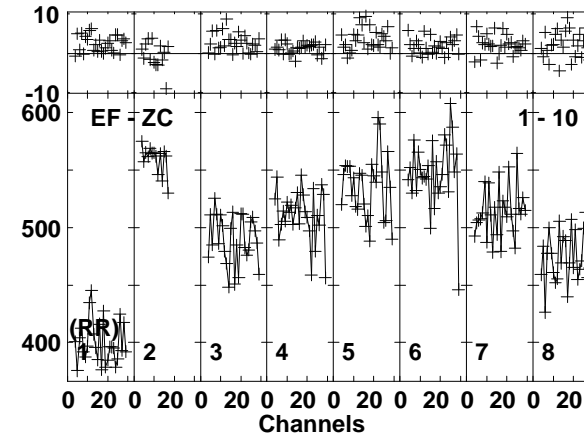
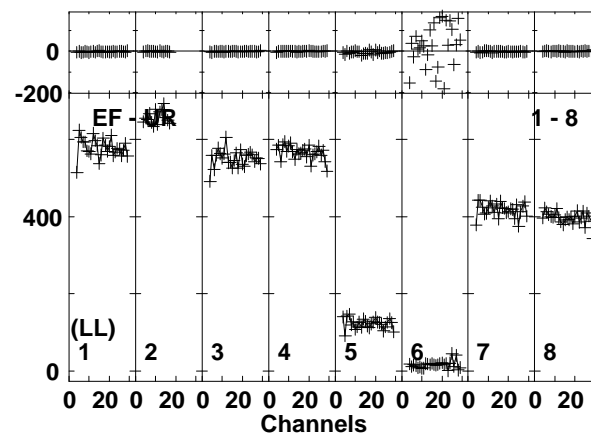
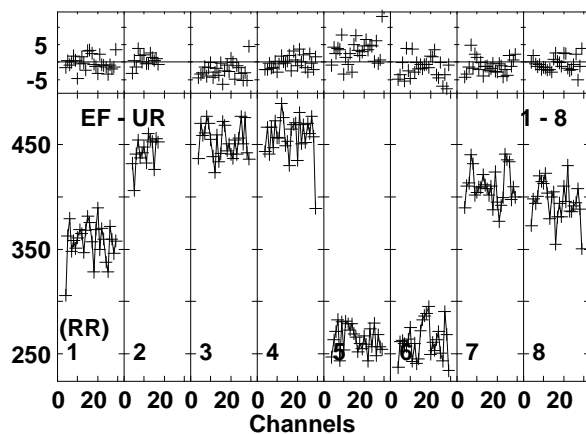
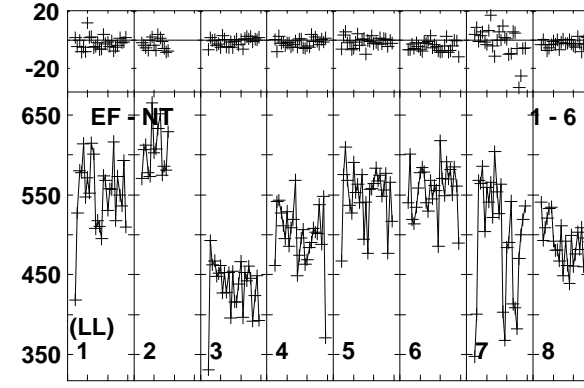
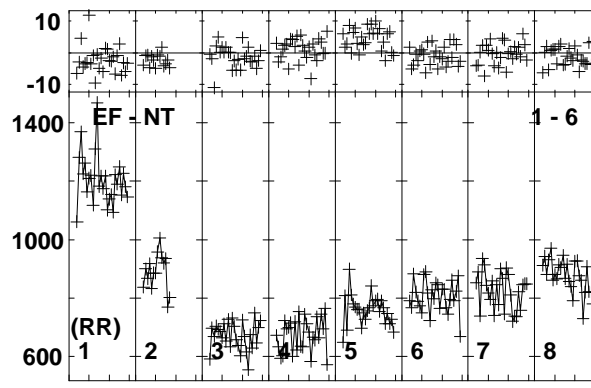
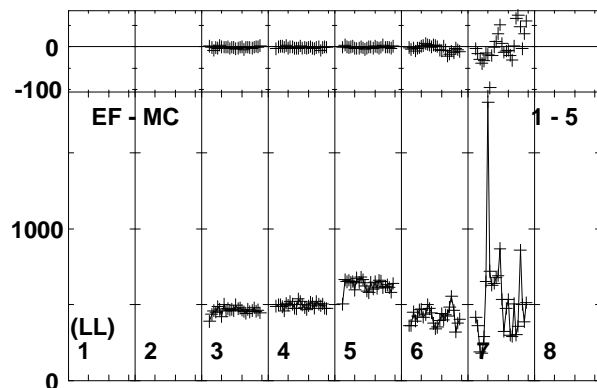
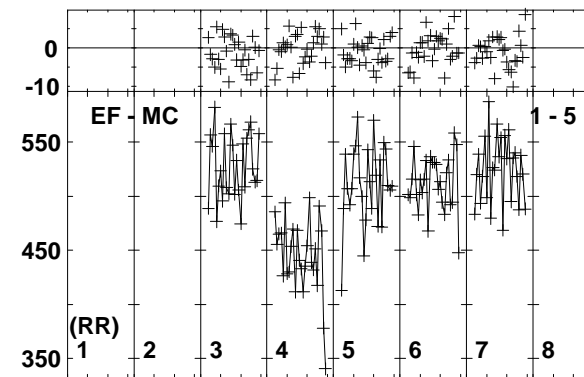
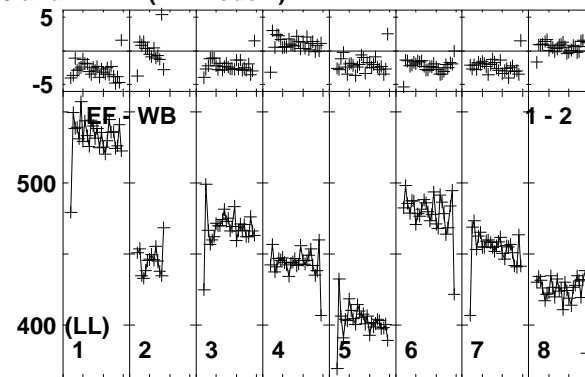
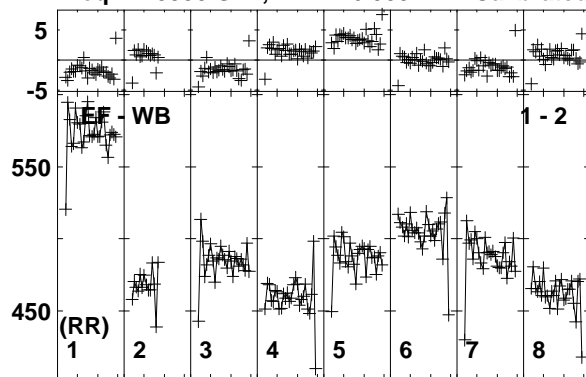

Lower frame: Milli Ampl Jy Top frame: Phas deg
Vector averaged cross-power spectrum Baseline: EF (01) - WB (02)
Timerange: 00/08:08:45 to 00/08:09:49

Plot file version 212 created 25-MAR-2014 17:51:43

J1128+5925 EP087E 1.UVDATA.1

Freq = 1.5950 GHz, Bw = 16.000 MH Calibrated with CL # 3 and BP # 1 (BP mode 1)

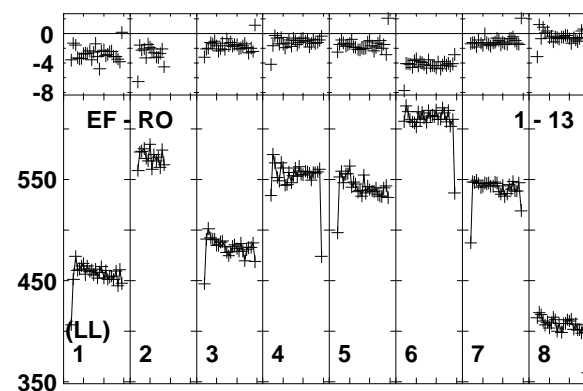
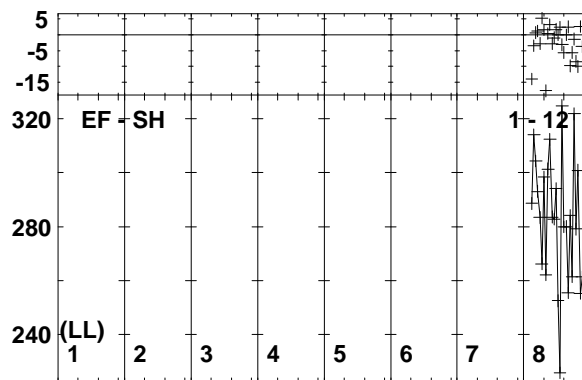
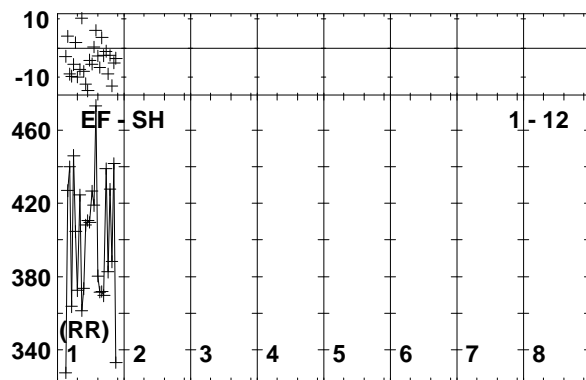
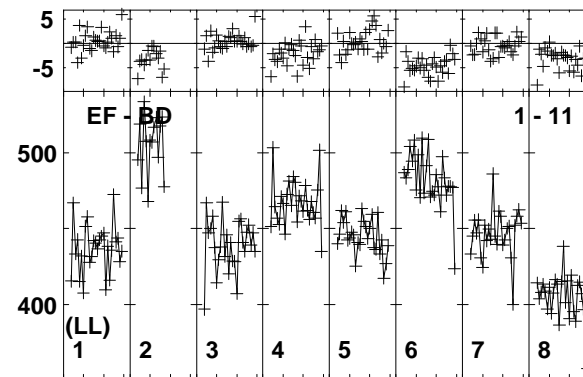
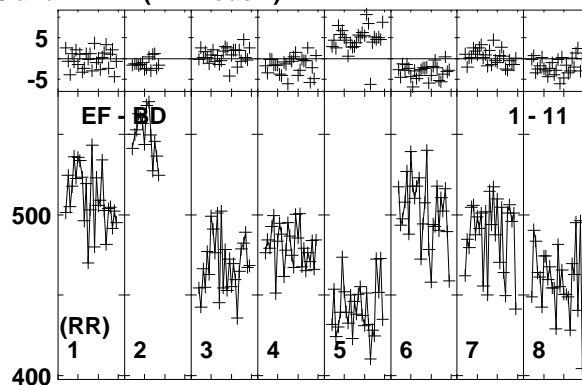
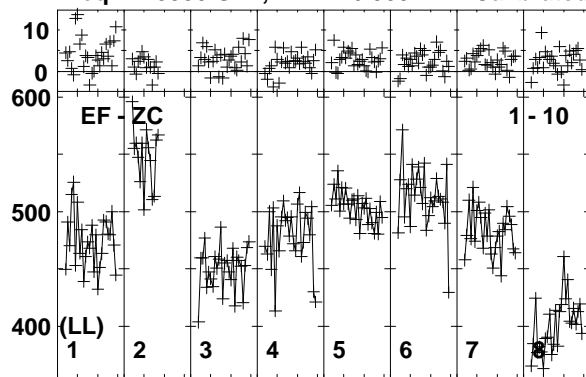

Lower frame: Milli Ampl Jy Top frame: Phas deg
Vector averaged cross-power spectrum Baseline: EF (01) - ZC (10)
Timerange: 00/08:08:45 to 00/08:09:49

Plot file version 213 created 25-MAR-2014 17:51:43

ARP299A EP087E 1.UVDATA.1

Freq = 1.5950 GHz, Bw = 16.000 MH Calibrated with CL # 3 and BP # 1 (BP mode 1)

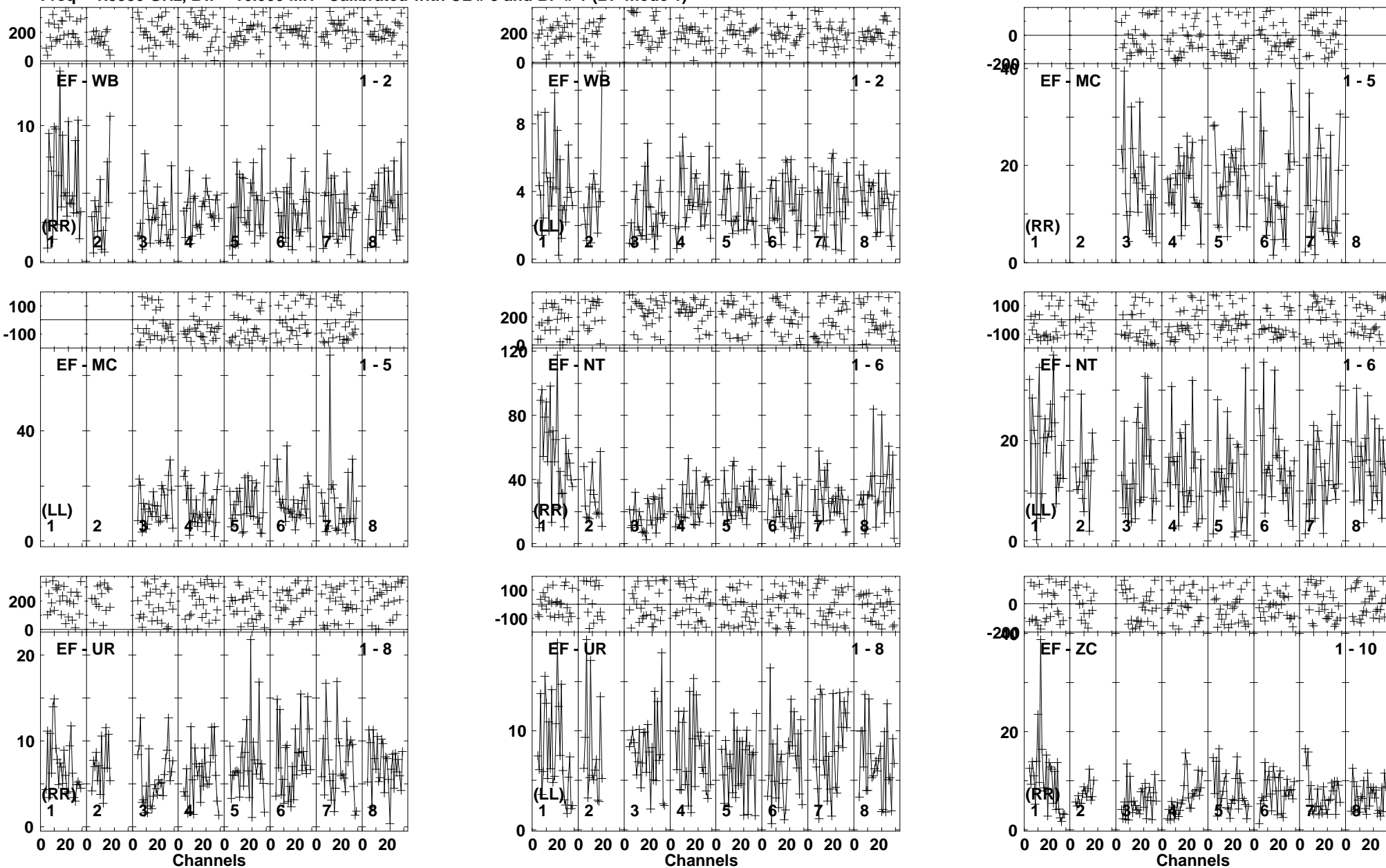

Lower frame: Milli Ampl Jy Top frame: Phas deg
Vector averaged cross-power spectrum Baseline: EF (01) - WB (02)
Timerange: 00/08:09:51 to 00/08:14:19

Plot file version 214 created 25-MAR-2014 17:51:44

ARP299A EP087E 1.UVDATA.1

Freq = 1.5950 GHz, Bw = 16.000 MH Calibrated with CL # 3 and BP # 1 (BP mode 1)

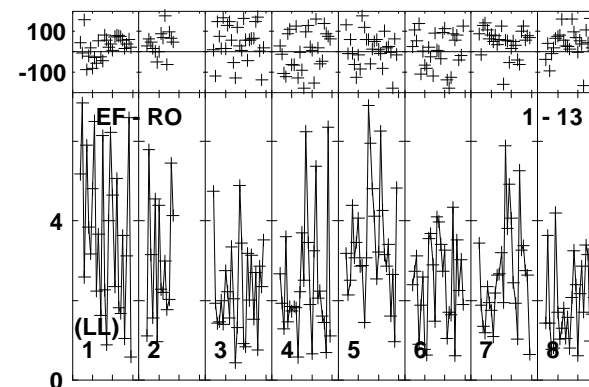
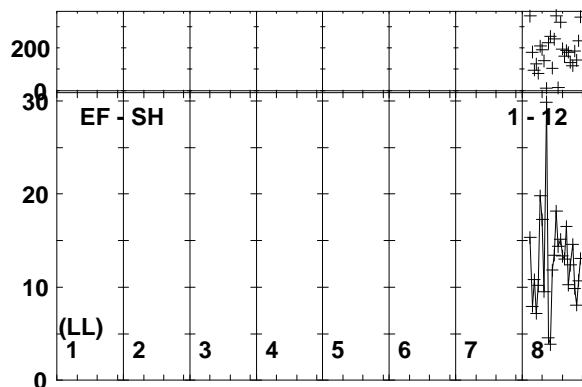
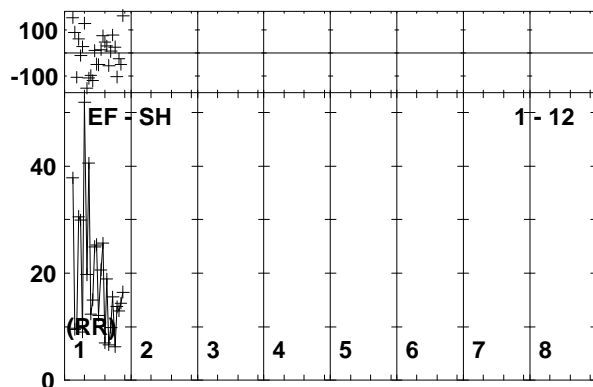
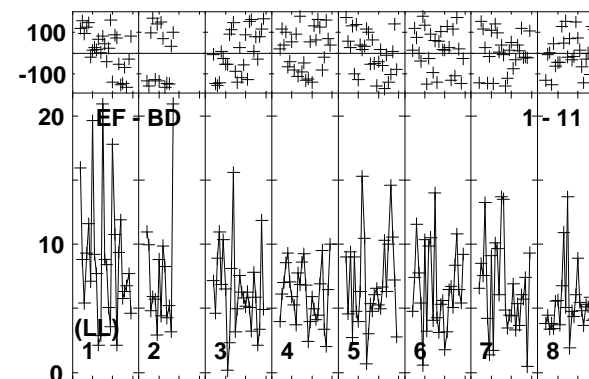
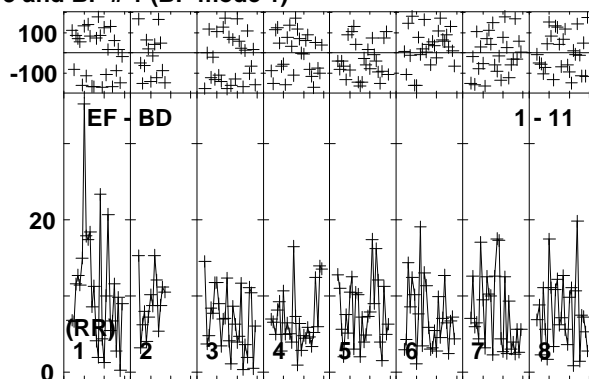
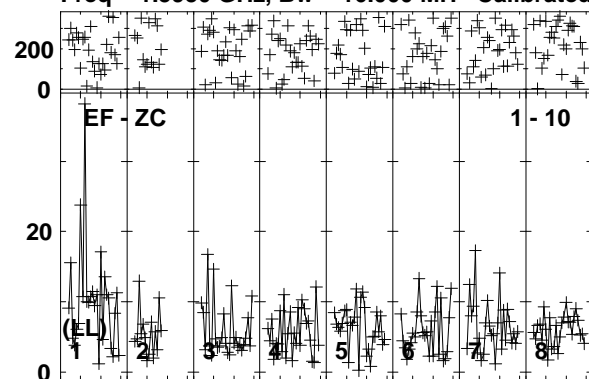

Lower frame: Milli Ampl Jy Top frame: Phas deg
Vector averaged cross-power spectrum Baseline: EF (01) - ZC (10)
Timerange: 00/08:09:51 to 00/08:14:19

Plot file version 215 created 25-MAR-2014 17:51:44

J1128+5925 EP087E 1.UVDATA.1

Freq = 1.5950 GHz, Bw = 16.000 MH Calibrated with CL # 3 and BP # 1 (BP mode 1)

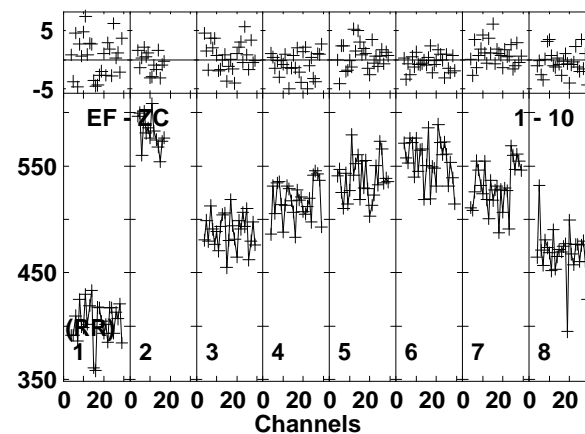
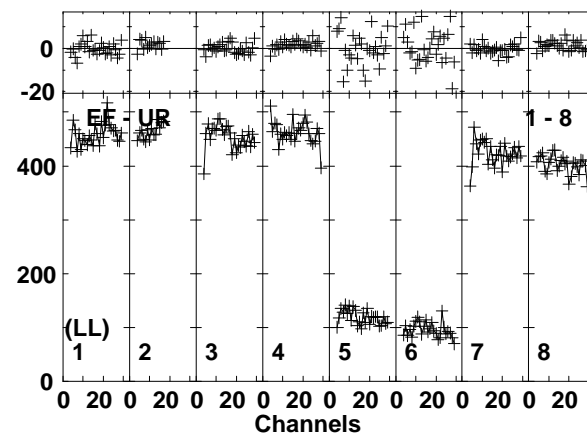
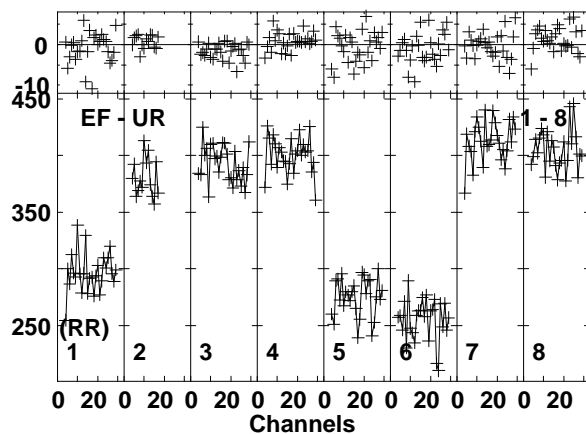
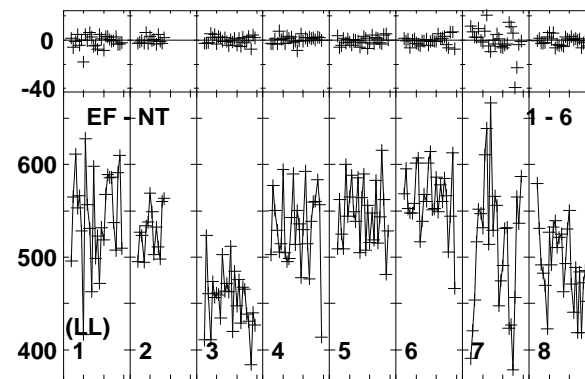
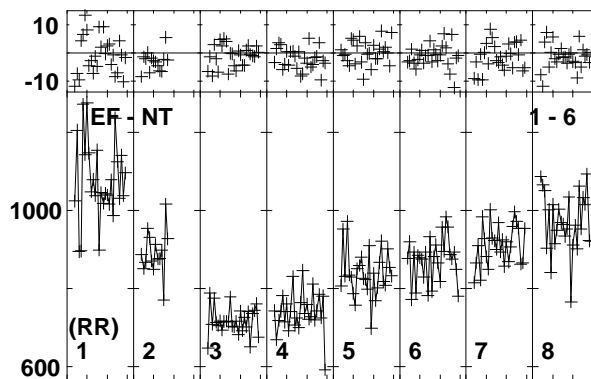
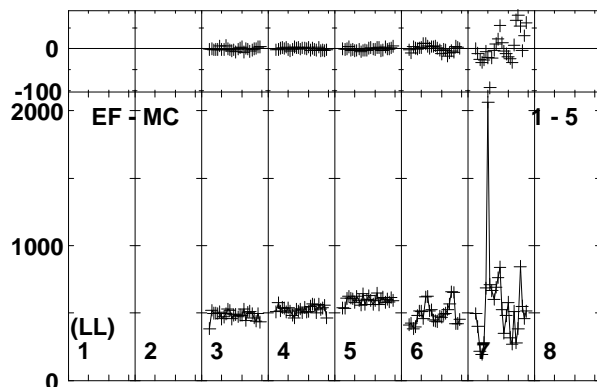
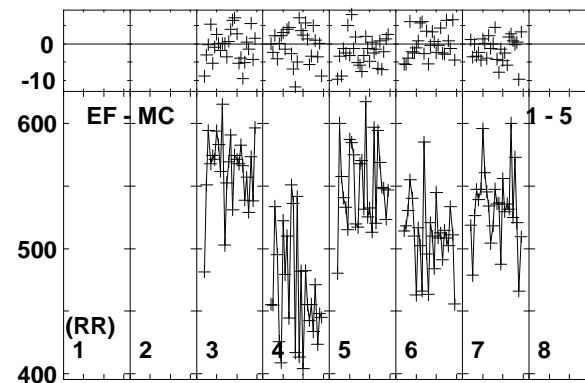
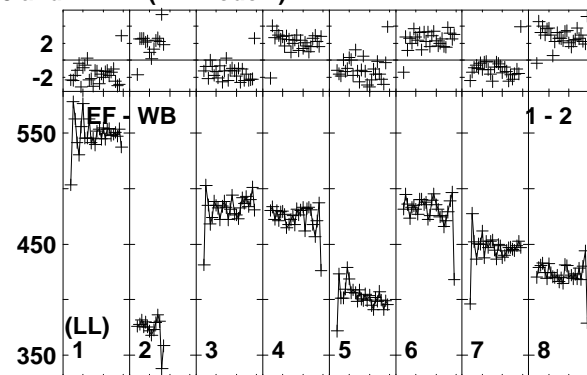
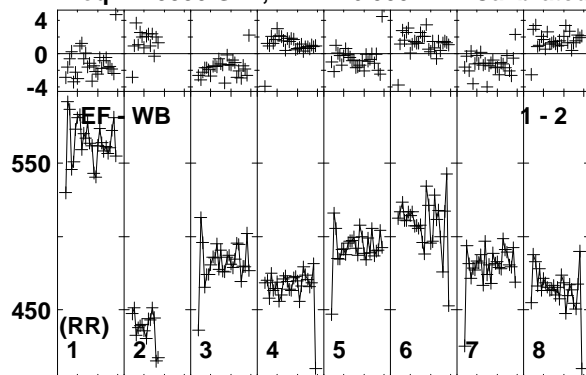

Lower frame: Milli Ampl Jy Top frame: Phas deg
Vector averaged cross-power spectrum Baseline: EF (01) - WB (02)
Timerange: 00/08:15:01 to 00/08:15:29

Plot file version 216 created 25-MAR-2014 17:51:44
 J1128+5925 EP087E 1.UVDATA.1
 Freq = 1.5950 GHz, Bw = 16.000 MH Calibrated with CL # 3 and BP # 1 (BP mode 1)

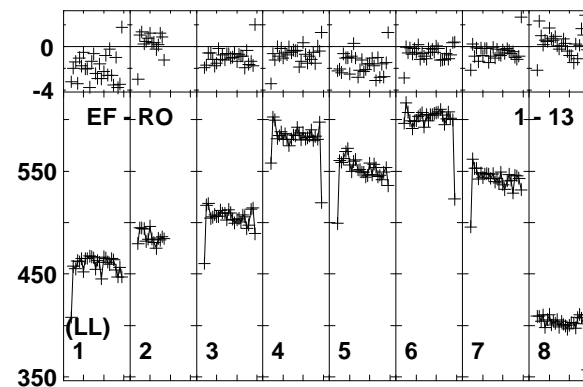
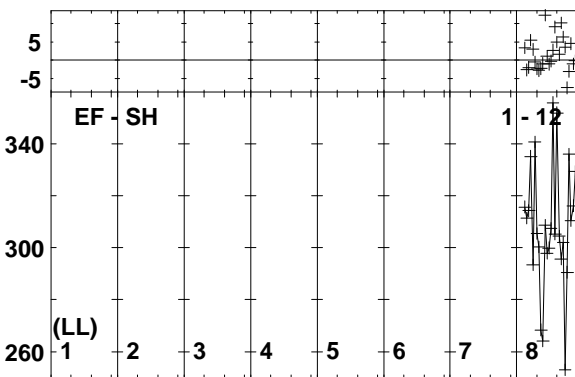
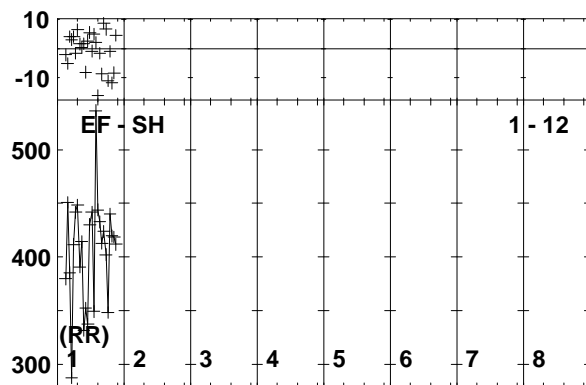
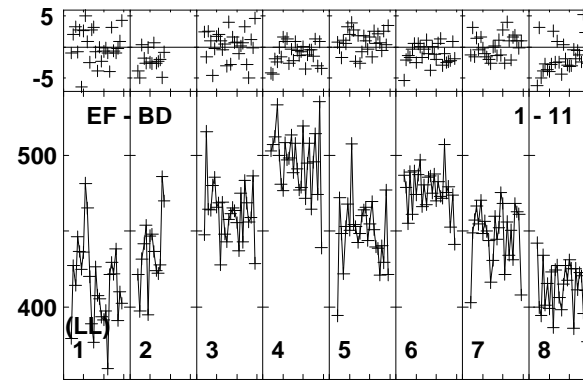
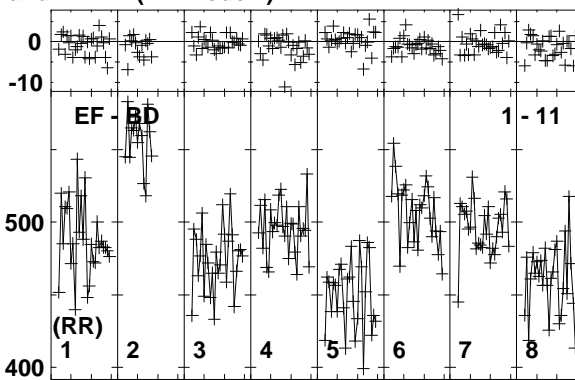
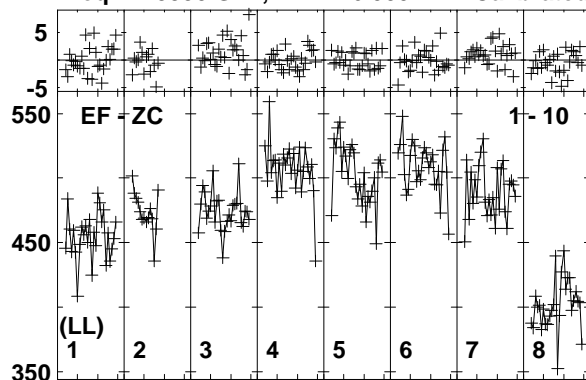

Lower frame: Milli Ampl Jy Top frame: Phas deg
 Vector averaged cross-power spectrum Baseline: EF (01) - ZC (10)
 Timerange: 00/08:15:01 to 00/08:15:29

Plot file version 217 created 25-MAR-2014 17:51:45
 ARP299A EP087E 1.UVDATA.1
 Freq = 1.5950 GHz, Bw = 16.000 MH Calibrated with CL # 3 and BP # 1 (BP mode 1)

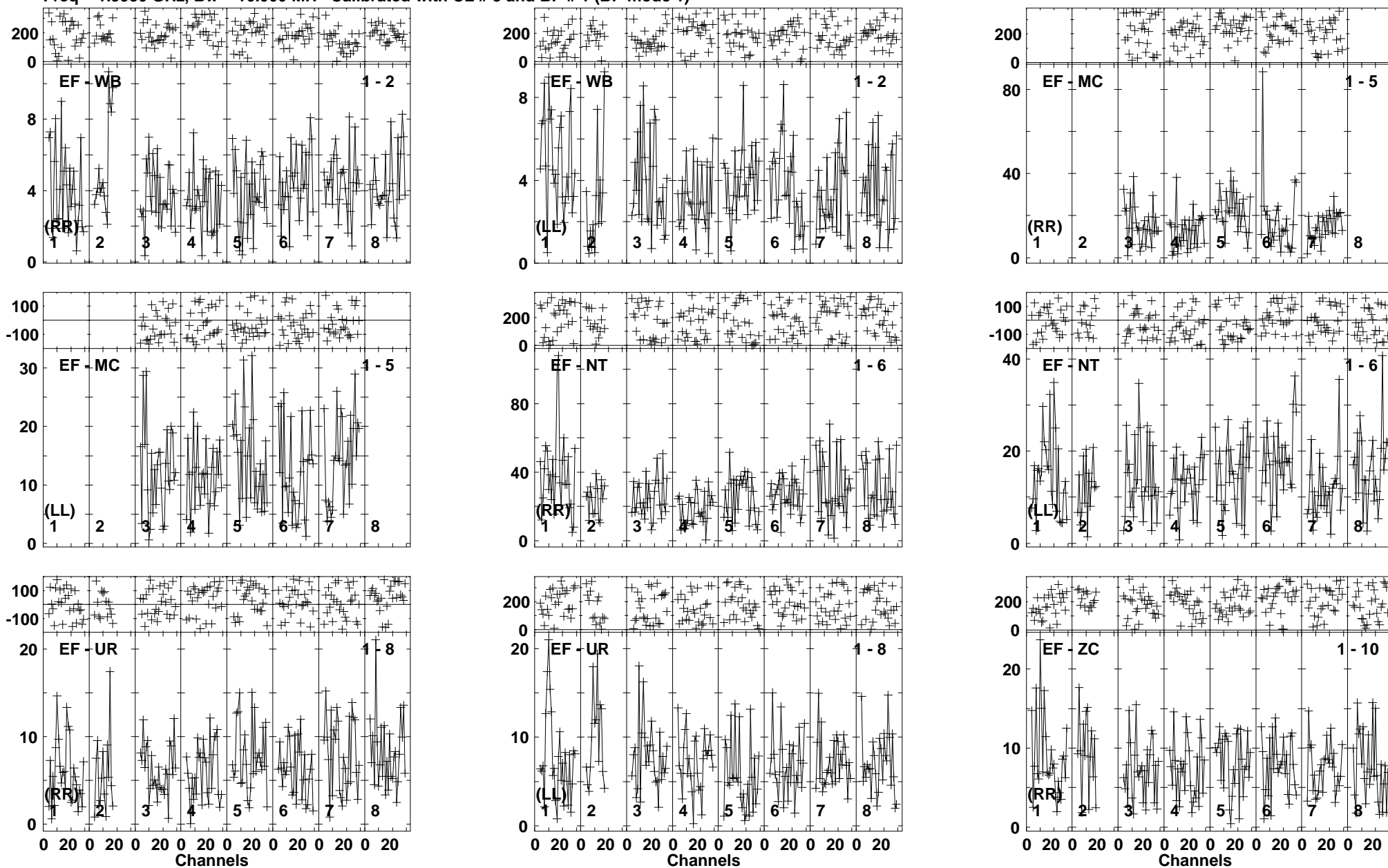

Lower frame: Milli Ampl Jy Top frame: Phas deg
 Vector averaged cross-power spectrum Baseline: EF (01) - WB (02)
 Timerange: 00/08:15:35 to 00/08:19:59

Plot file version 218 created 25-MAR-2014 17:51:45

ARP299A EP087E 1.UVDATA.1

Freq = 1.5950 GHz, Bw = 16.000 MH Calibrated with CL # 3 and BP # 1 (BP mode 1)

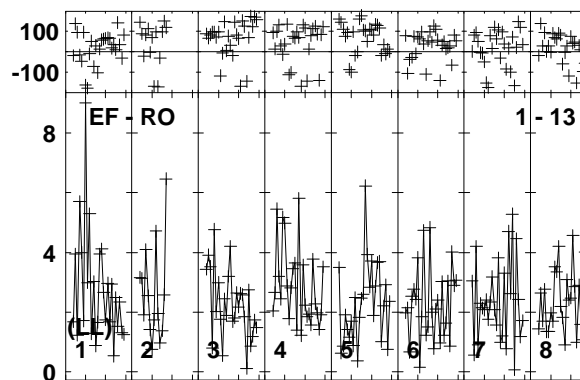
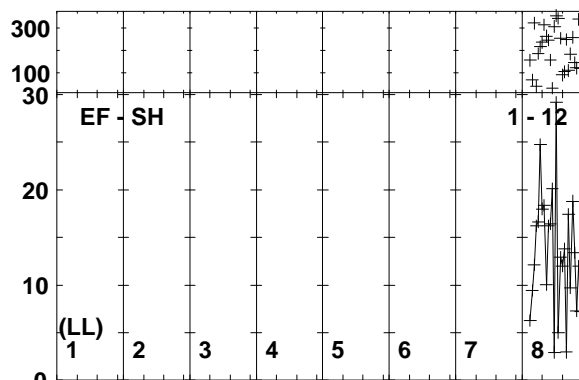
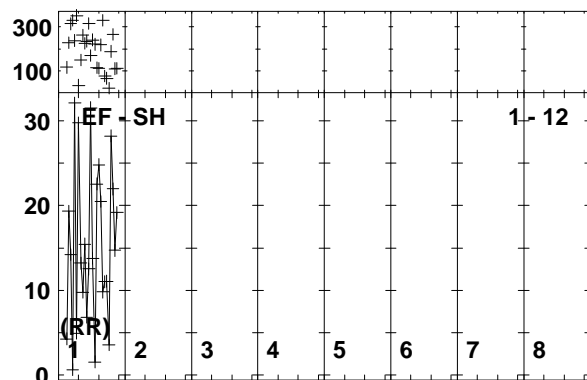
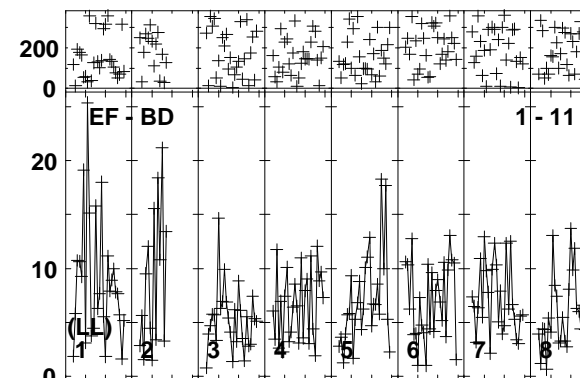
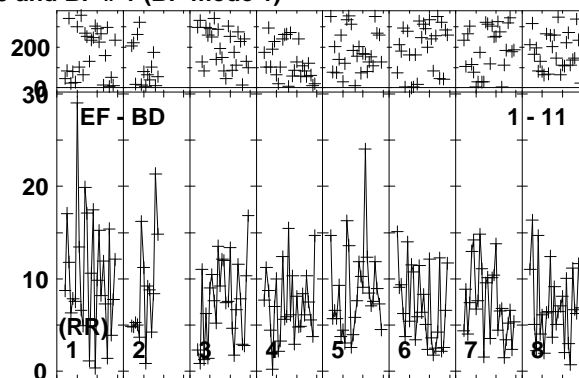
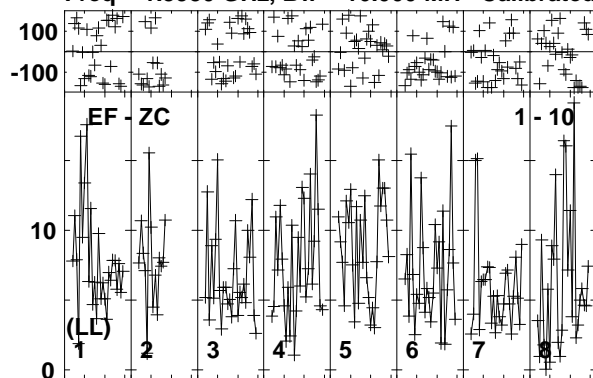

Lower frame: Milli Ampl Jy Top frame: Phas deg
Vector averaged cross-power spectrum Baseline: EF (01) - ZC (10)
Timerange: 00/08:15:35 to 00/08:19:59

Plot file version 219 created 25-MAR-2014 17:51:45

J1128+5925 EP087E 1.UVDATA.1

Freq = 1.5950 GHz, Bw = 16.000 MH Calibrated with CL # 3 and BP # 1 (BP mode 1)

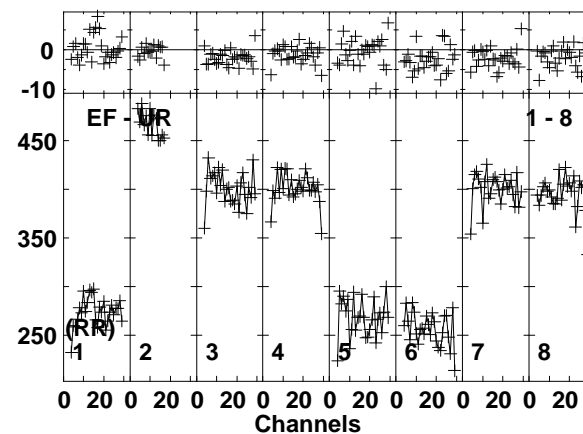
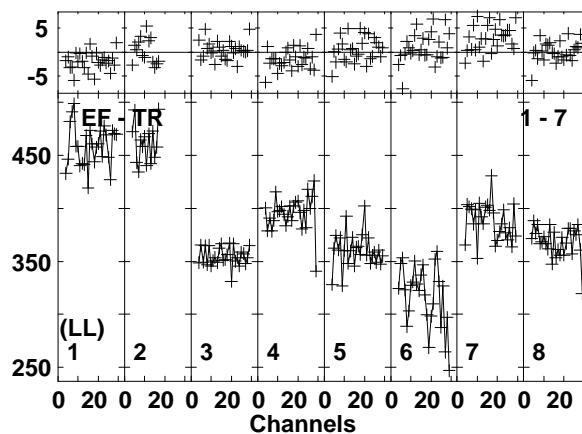
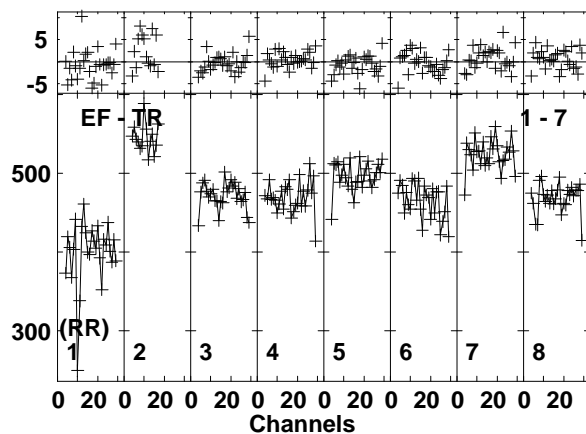
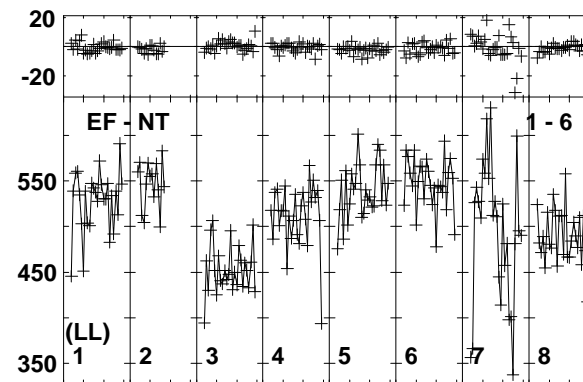
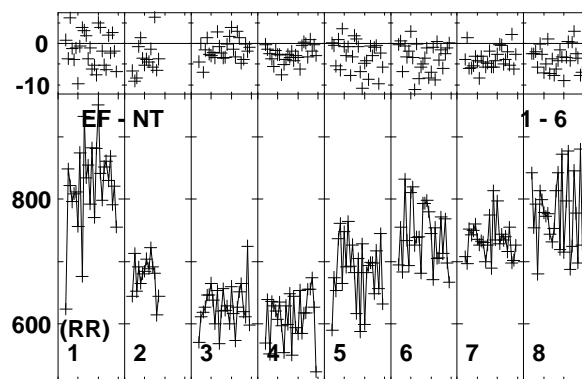
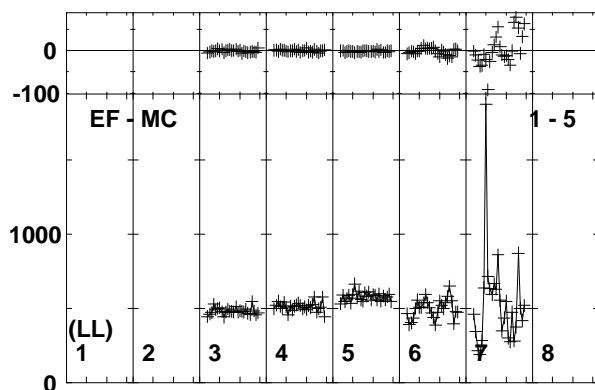
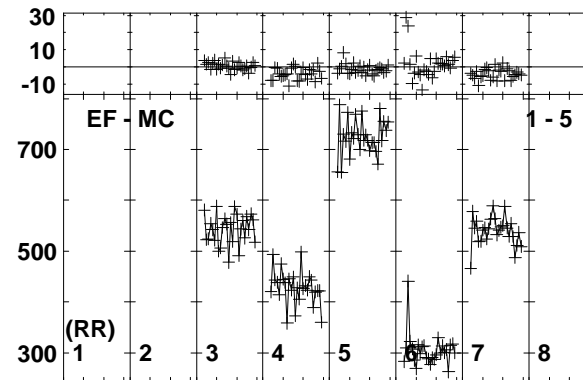
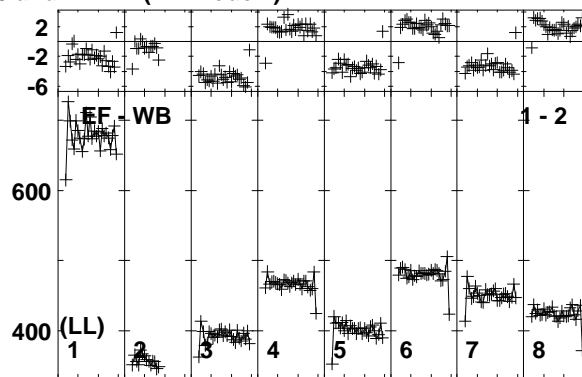
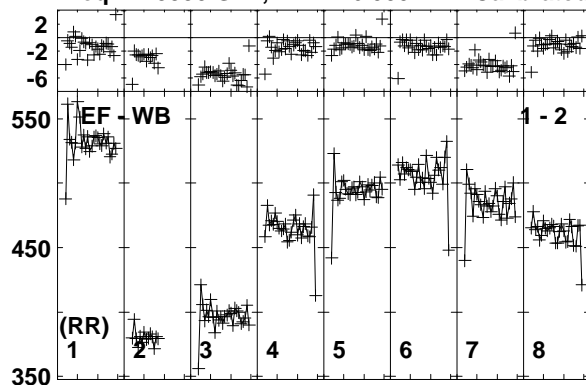

Lower frame: Milli Ampl Jy Top frame: Phas deg
Vector averaged cross-power spectrum Baseline: EF (01) - WB (02)
Timerange: 00/08:20:05 to 00/08:21:09

Plot file version 220 created 25-MAR-2014 17:51:46

J1128+5925 EP087E 1.UVDATA.1

Freq = 1.5950 GHz, Bw = 16.000 MH Calibrated with CL # 3 and BP # 1 (BP mode 1)

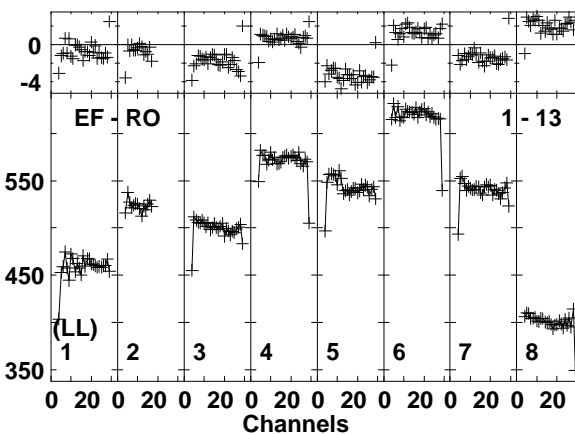
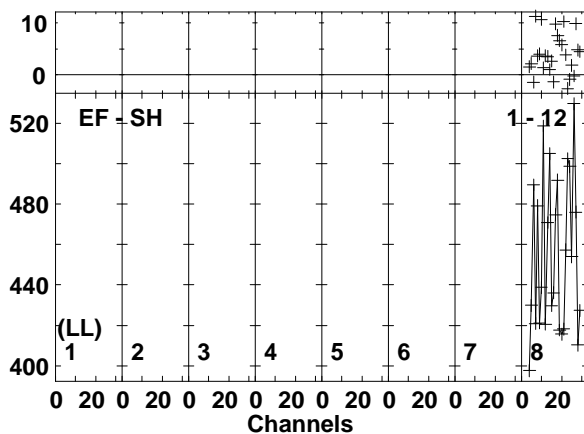
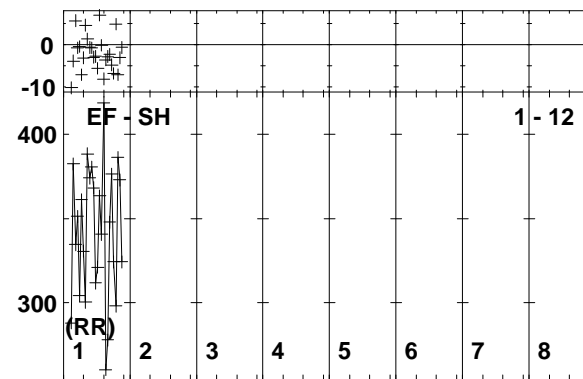
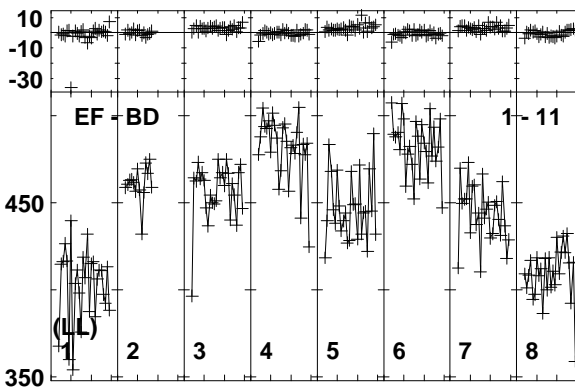
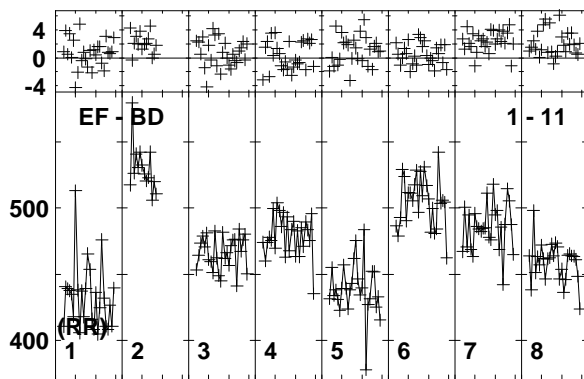
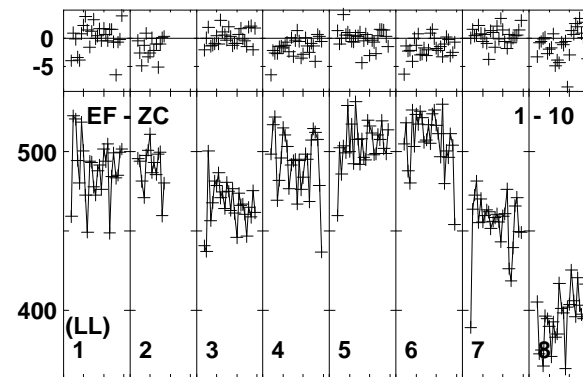
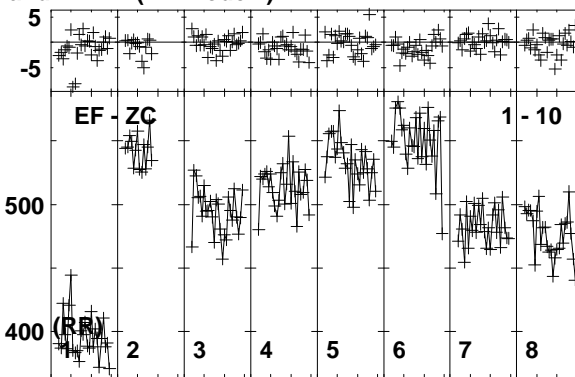
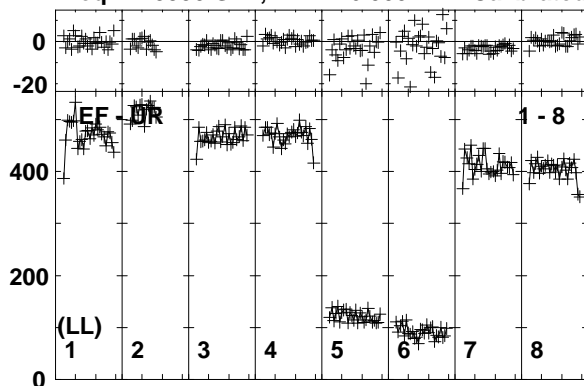

Lower frame: Milli Ampl Jy Top frame: Phas deg
Vector averaged cross-power spectrum Baseline: EF (01) - UR (08)
Timerange: 00/08:20:05 to 00/08:21:09

Plot file version 221 created 25-MAR-2014 17:51:46
 ARP299A EP087E 1.UVDATA.1
 Freq = 1.5950 GHz, Bw = 16.000 MH Calibrated with CL # 3 and BP # 1 (BP mode 1)

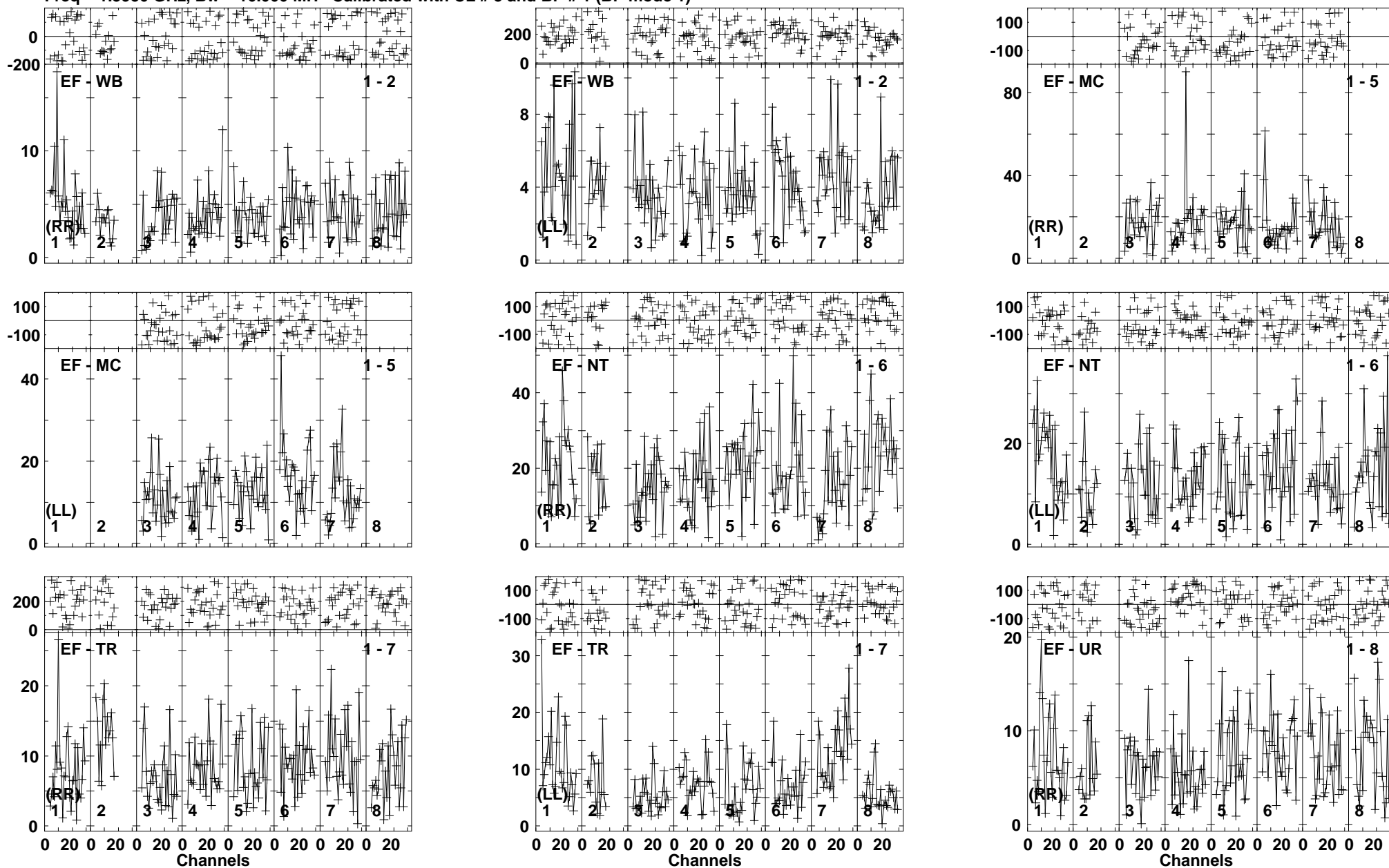

Lower frame: Milli Ampl Jy Top frame: Phas deg
 Vector averaged cross-power spectrum Baseline: EF (01) - WB (02)
 Timerange: 00/08:21:11 to 00/08:25:39

Plot file version 222 created 25-MAR-2014 17:51:46
 ARP299A EP087E 1.UVDATA.1
 Freq = 1.5950 GHz, Bw = 16.000 MH Calibrated with CL # 3 and BP # 1 (BP mode 1)

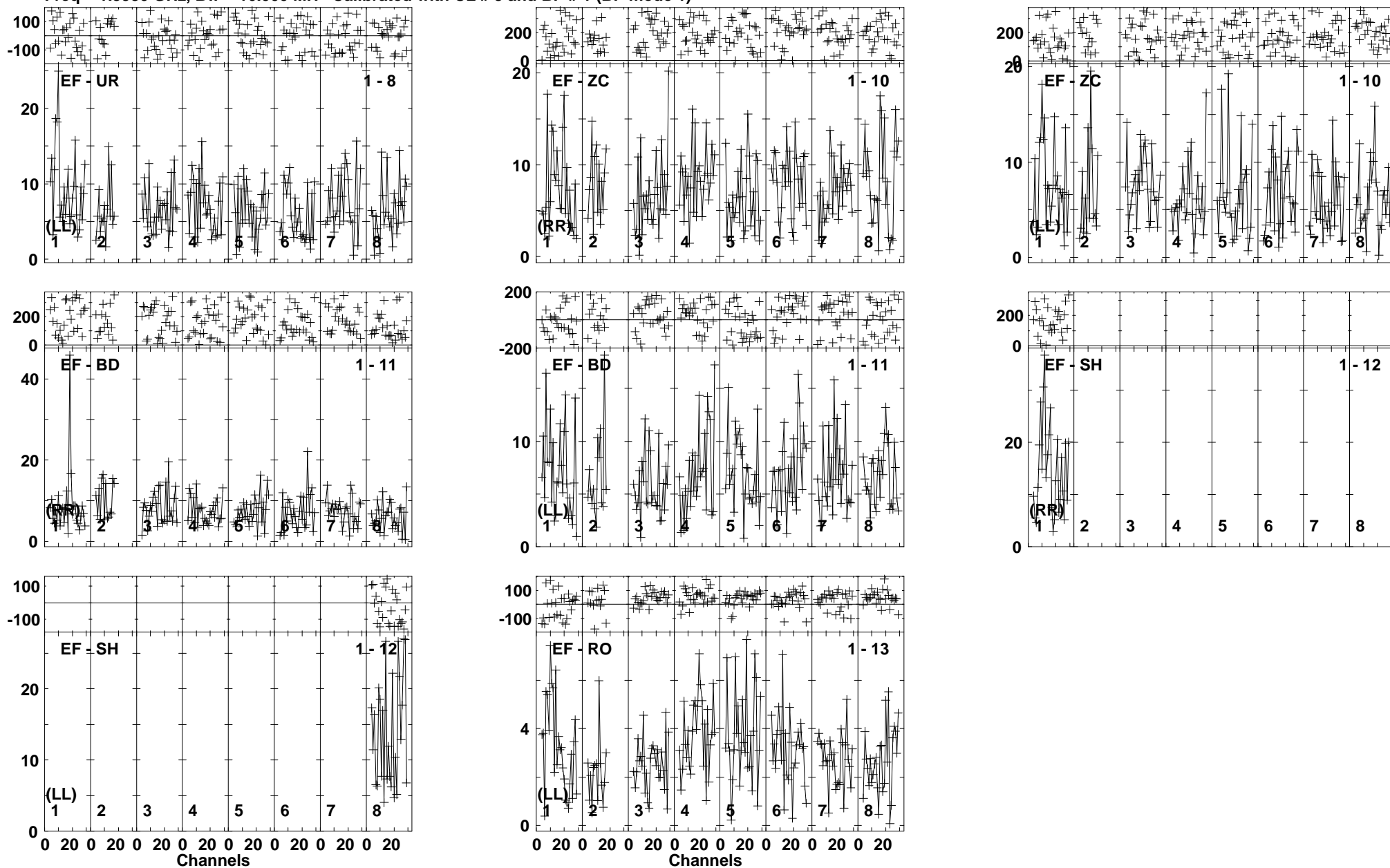

Lower frame: Milli Ampl Jy Top frame: Phas deg
 Vector averaged cross-power spectrum Baseline: EF (01) - UR (08)
 Timerange: 00/08:21:11 to 00/08:25:39

Plot file version 223 created 25-MAR-2014 17:51:46

J1128+5925 EP087E 1.UVDATA.1

Freq = 1.5950 GHz, Bw = 16.000 MH Calibrated with CL # 3 and BP # 1 (BP mode 1)

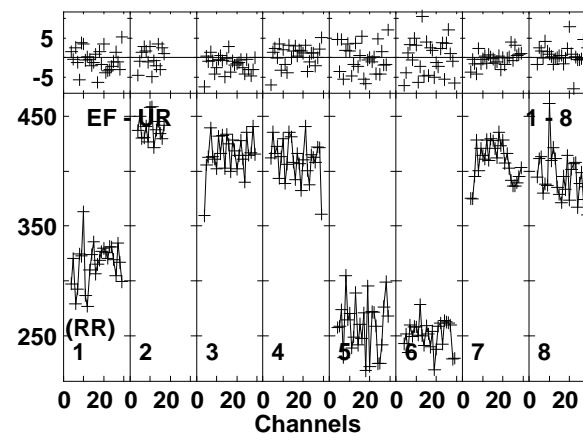
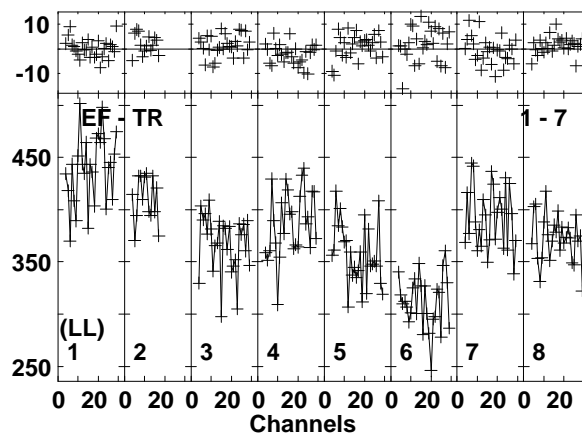
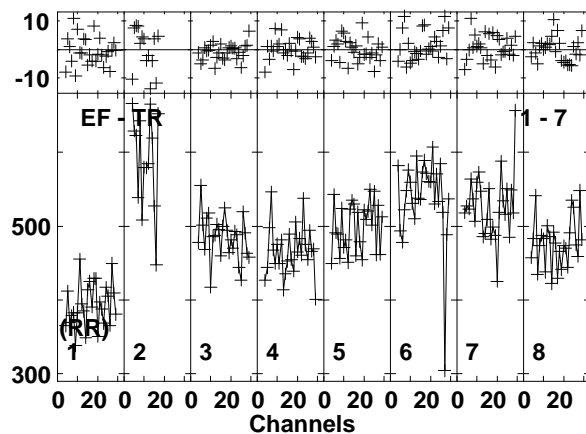
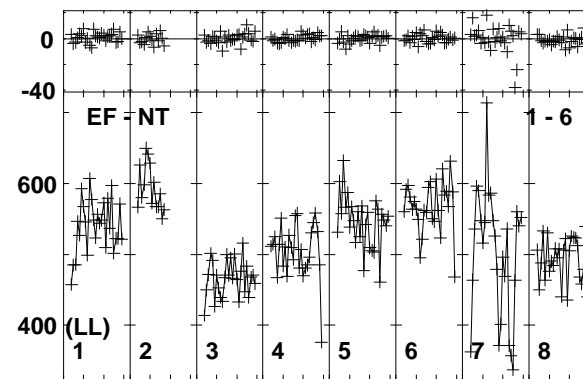
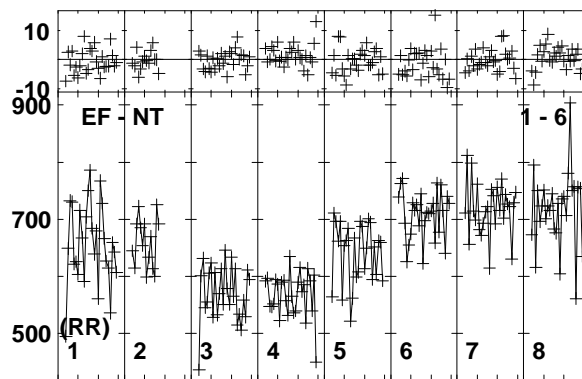
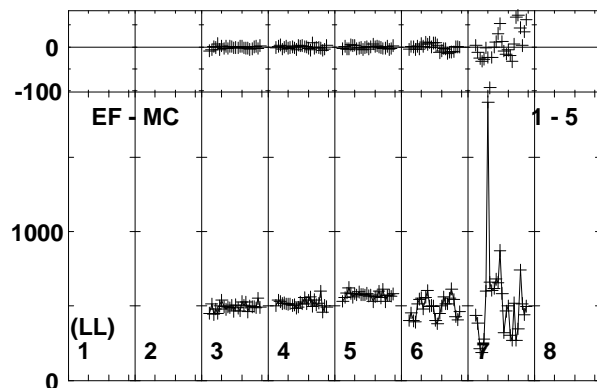
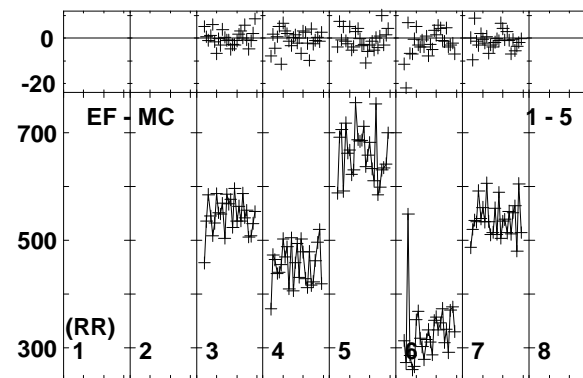
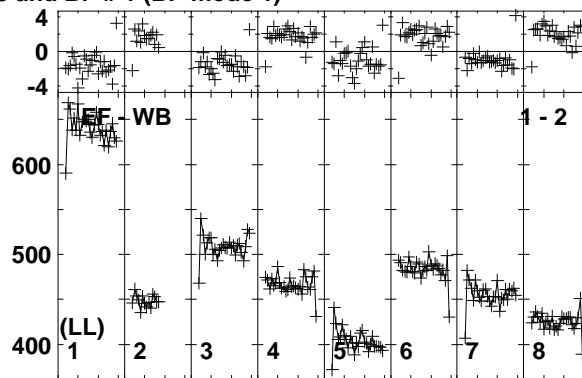
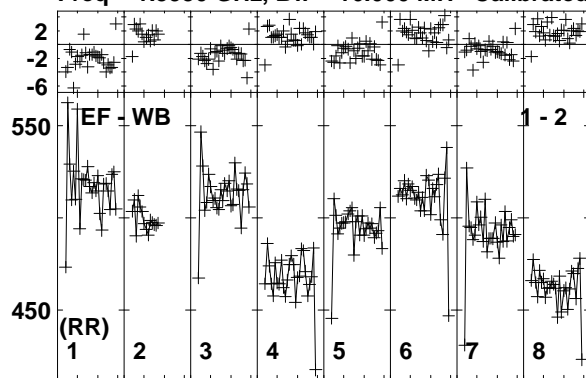

Lower frame: Milli Ampl Jy Top frame: Phas deg
Vector averaged cross-power spectrum Baseline: EF (01) - WB (02)
Timerange: 00/08:26:21 to 00/08:26:49

Plot file version 224 created 25-MAR-2014 17:51:47

J1128+5925 EP087E 1.UVDATA.1

Freq = 1.5950 GHz, Bw = 16.000 MH Calibrated with CL # 3 and BP # 1 (BP mode 1)

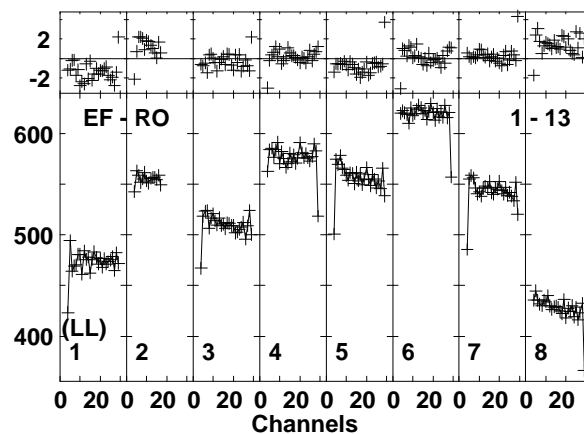
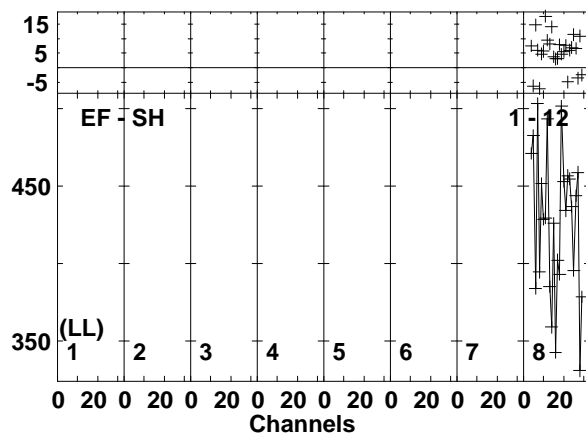
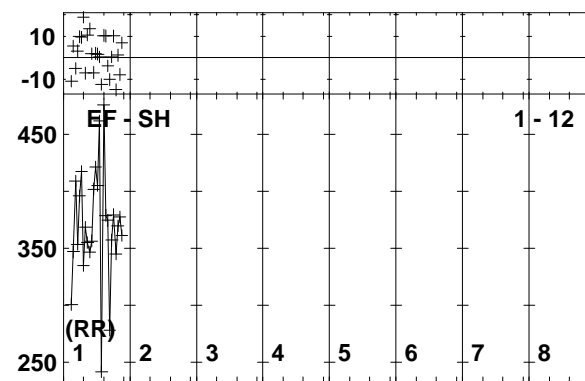
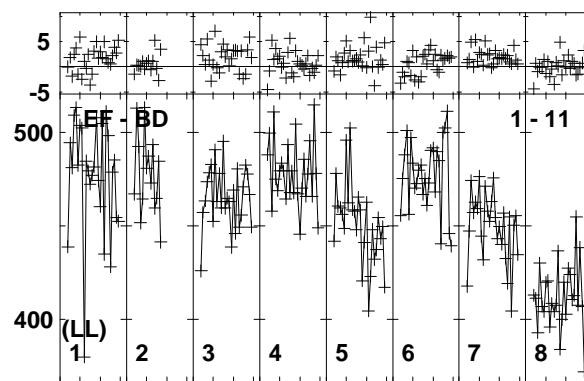
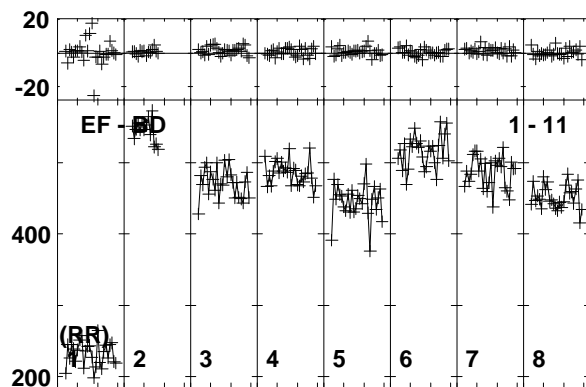
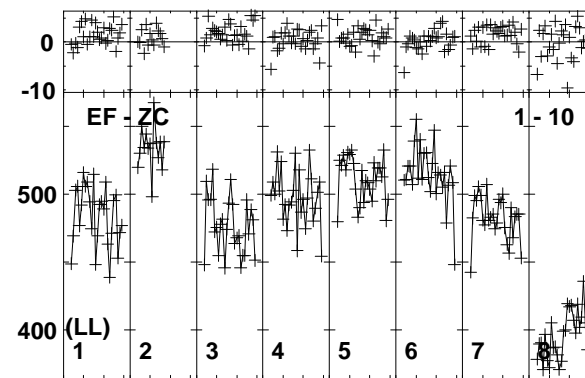
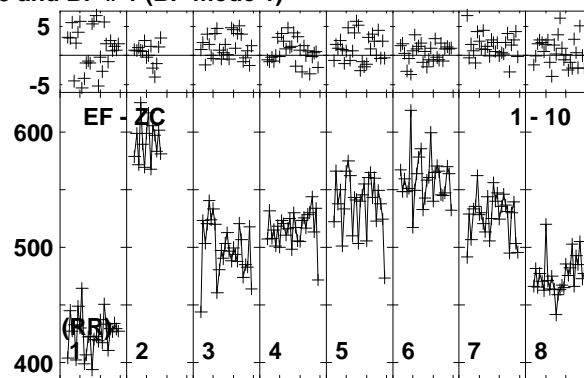
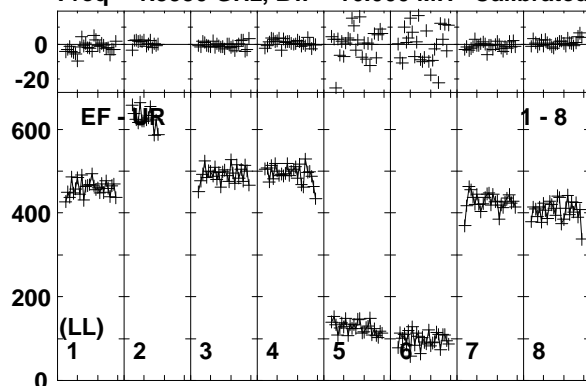

Lower frame: Milli Ampl Jy Top frame: Phas deg
Vector averaged cross-power spectrum Baseline: EF (01) - UR (08)
Timerange: 00/08:26:21 to 00/08:26:49

Plot file version 225 created 25-MAR-2014 17:51:47
 ARP299A EP087E 1.UVDATA.1
 Freq = 1.5950 GHz, Bw = 16.000 MH Calibrated with CL # 3 and BP # 1 (BP mode 1)

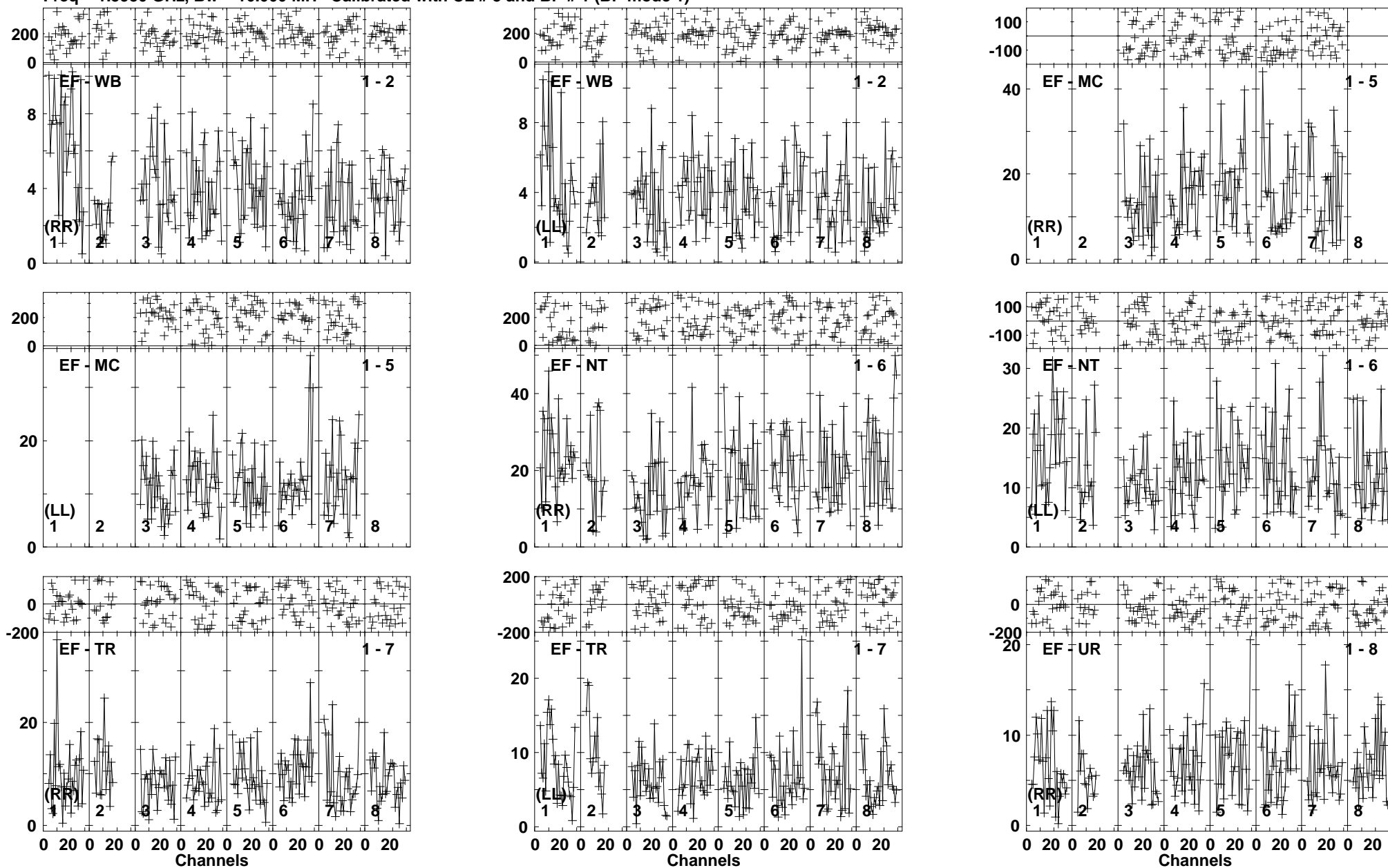

Lower frame: Milli Ampl Jy Top frame: Phas deg
 Vector averaged cross-power spectrum Baseline: EF (01) - WB (02)
 Timerange: 00/08:26:55 to 00/08:31:19

Plot file version 226 created 25-MAR-2014 17:51:47

ARP299A EP087E 1.UVDATA.1

Freq = 1.5950 GHz, Bw = 16.000 MH Calibrated with CL # 3 and BP # 1 (BP mode 1)

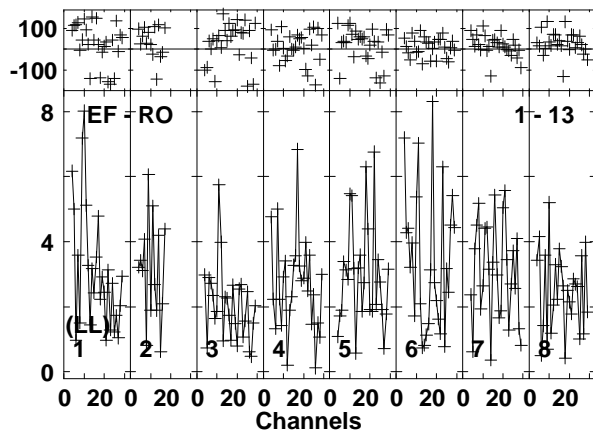
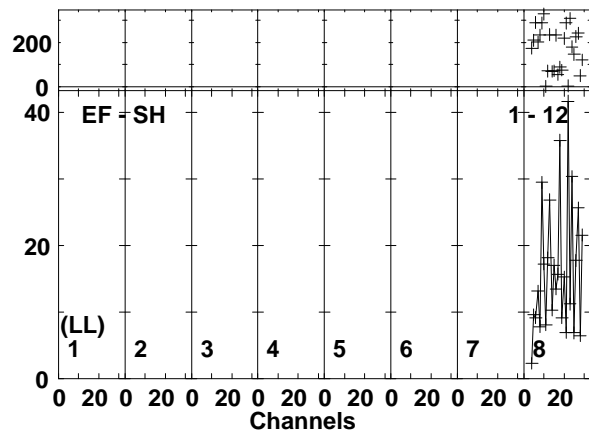
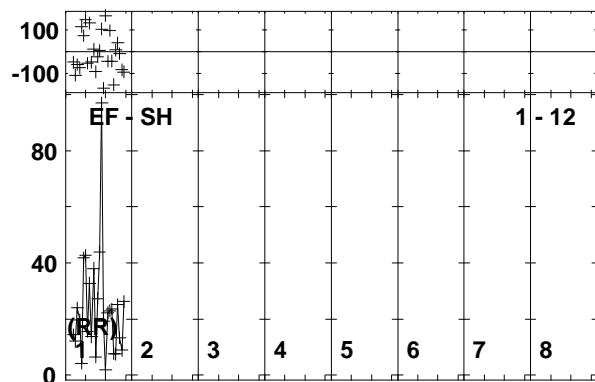
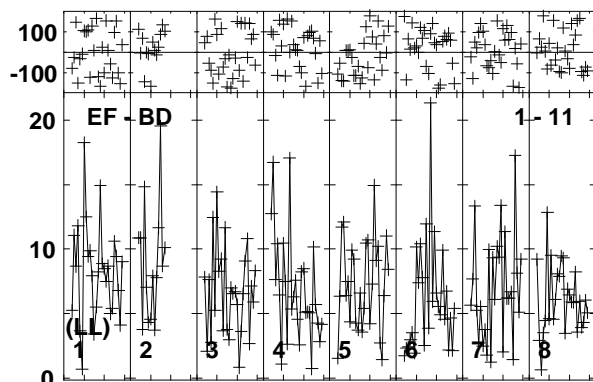
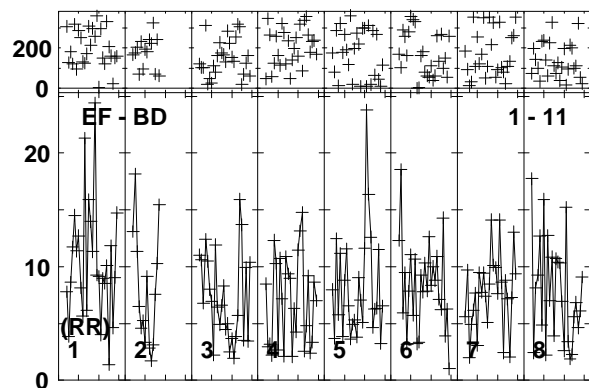
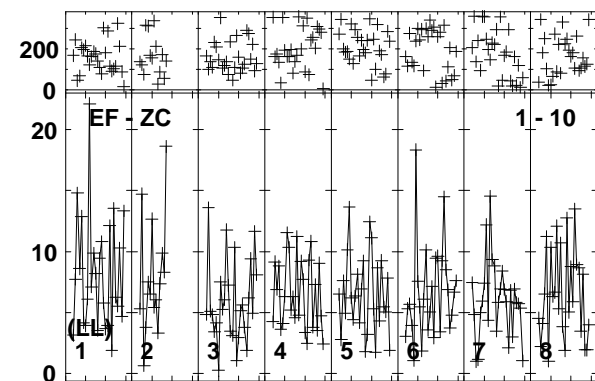
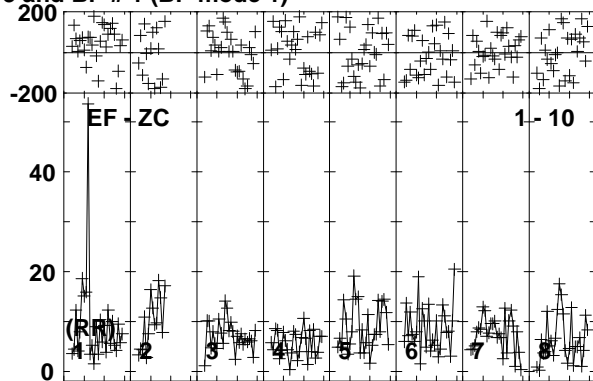
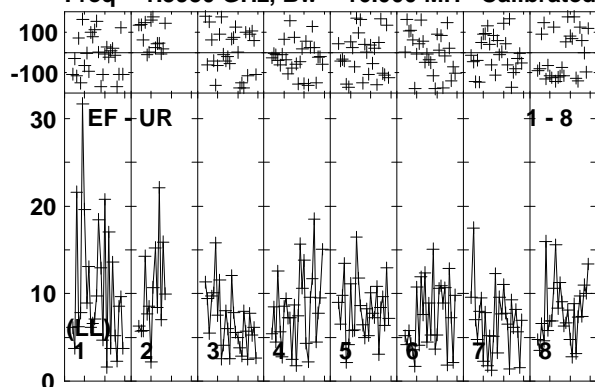

Lower frame: Milli Ampl Jy Top frame: Phas deg
Vector averaged cross-power spectrum Baseline: EF (01) - UR (08)
Timerange: 00/08:26:55 to 00/08:31:19

Plot file version 227 created 25-MAR-2014 17:51:48

J1128+5925 EP087E 1.UVDATA.1

Freq = 1.5950 GHz, Bw = 16.000 MH Calibrated with CL # 3 and BP # 1 (BP mode 1)

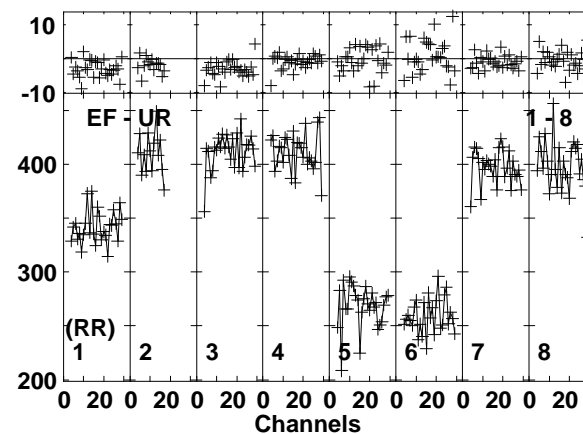
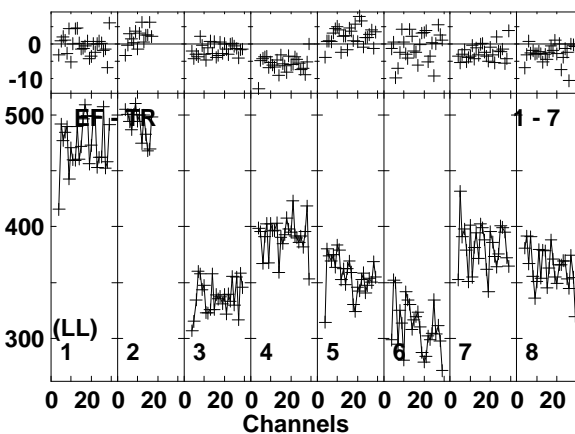
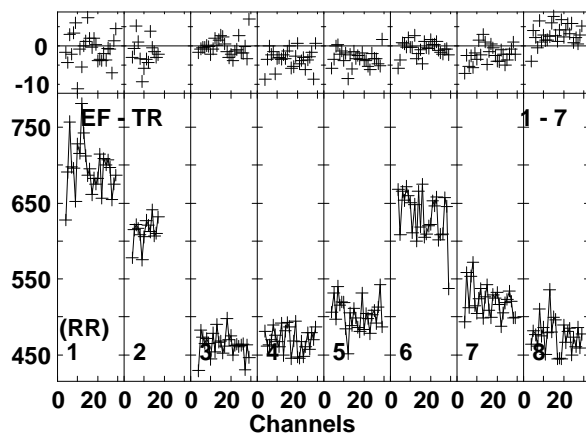
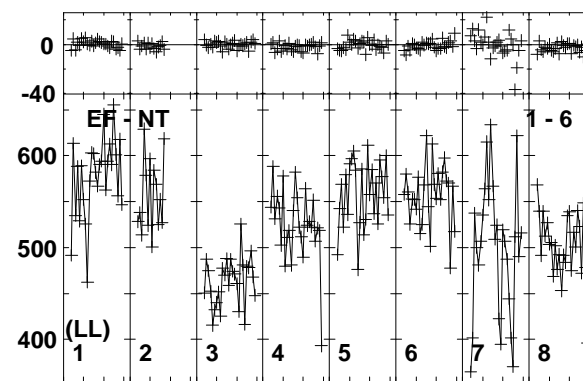
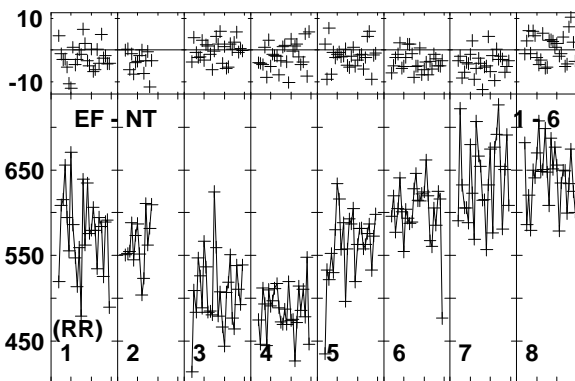
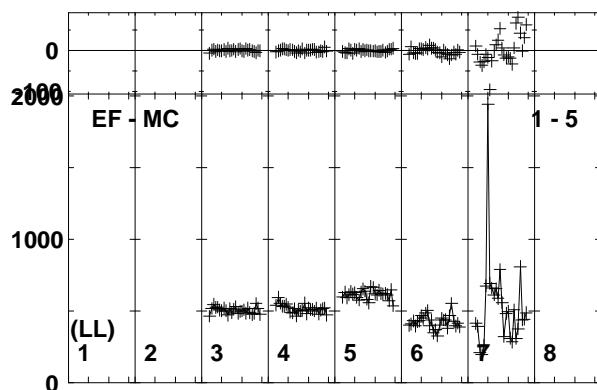
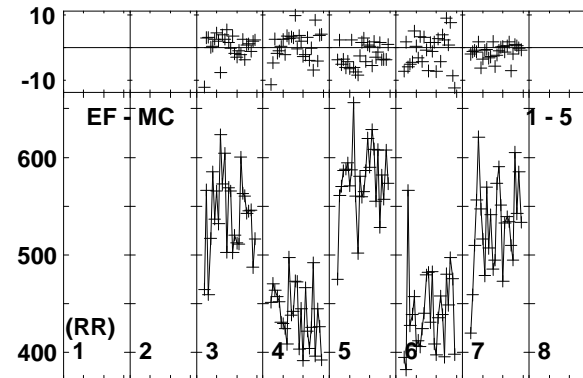
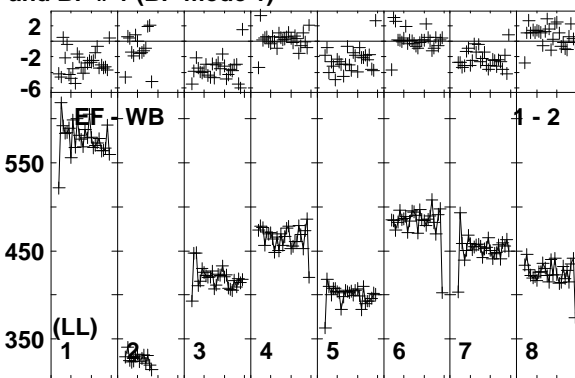
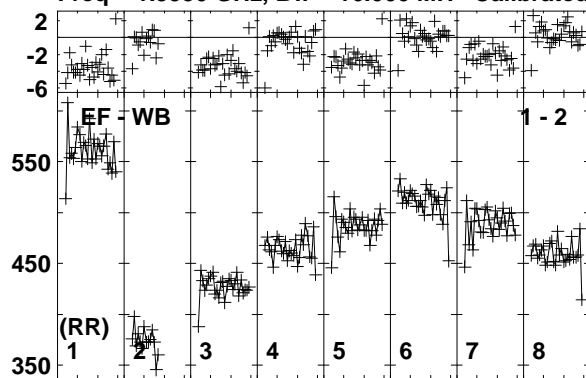

Lower frame: Milli Ampl Jy Top frame: Phas deg
Vector averaged cross-power spectrum Baseline: EF (01) - WB (02)
Timerange: 00/08:31:25 to 00/08:32:19

Plot file version 228 created 25-MAR-2014 17:51:48

J1128+5925 EP087E 1.UVDATA.1

Freq = 1.5950 GHz, Bw = 16.000 MH Calibrated with CL # 3 and BP # 1 (BP mode 1)

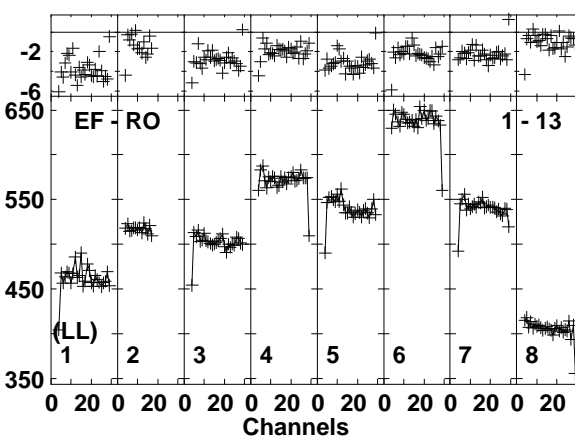
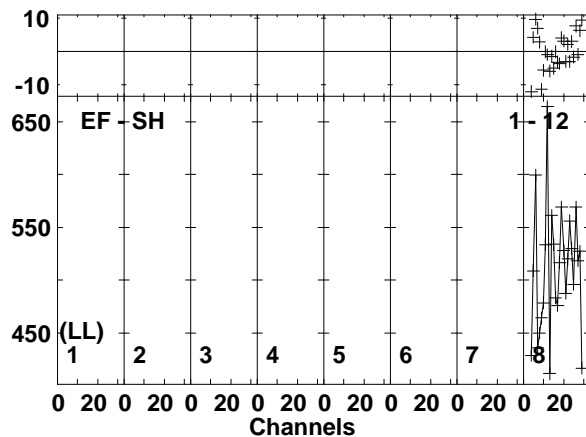
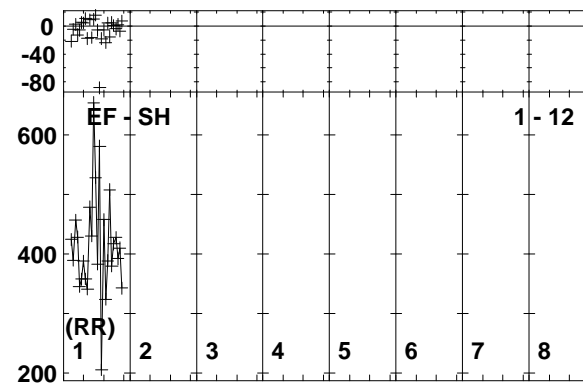
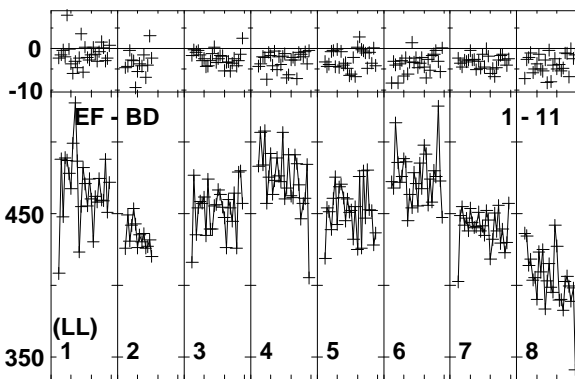
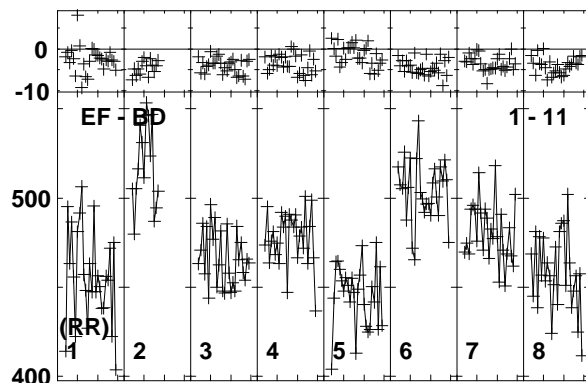
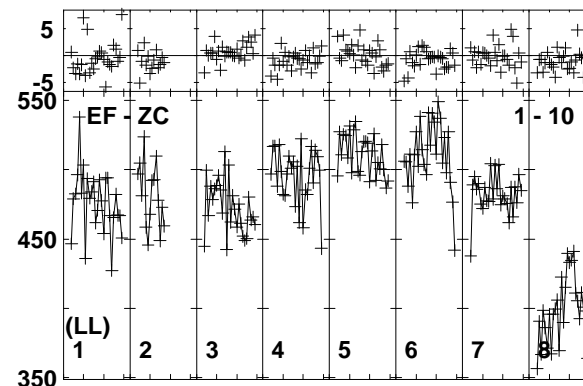
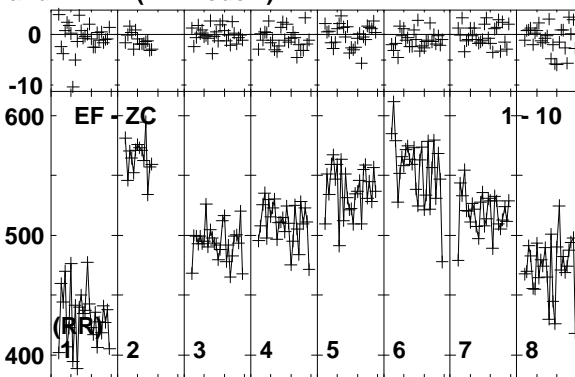
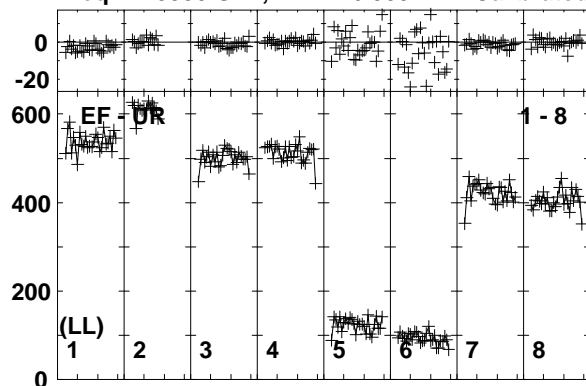

Lower frame: Milli Ampl Jy Top frame: Phas deg
Vector averaged cross-power spectrum Baseline: EF (01) - UR (08)
Timerange: 00/08:31:25 to 00/08:32:19

Plot file version 229 created 25-MAR-2014 17:51:48
 ARP299A EP087E 1.UVDATA.1
 Freq = 1.5950 GHz, Bw = 16.000 MH Calibrated with CL # 3 and BP # 1 (BP mode 1)

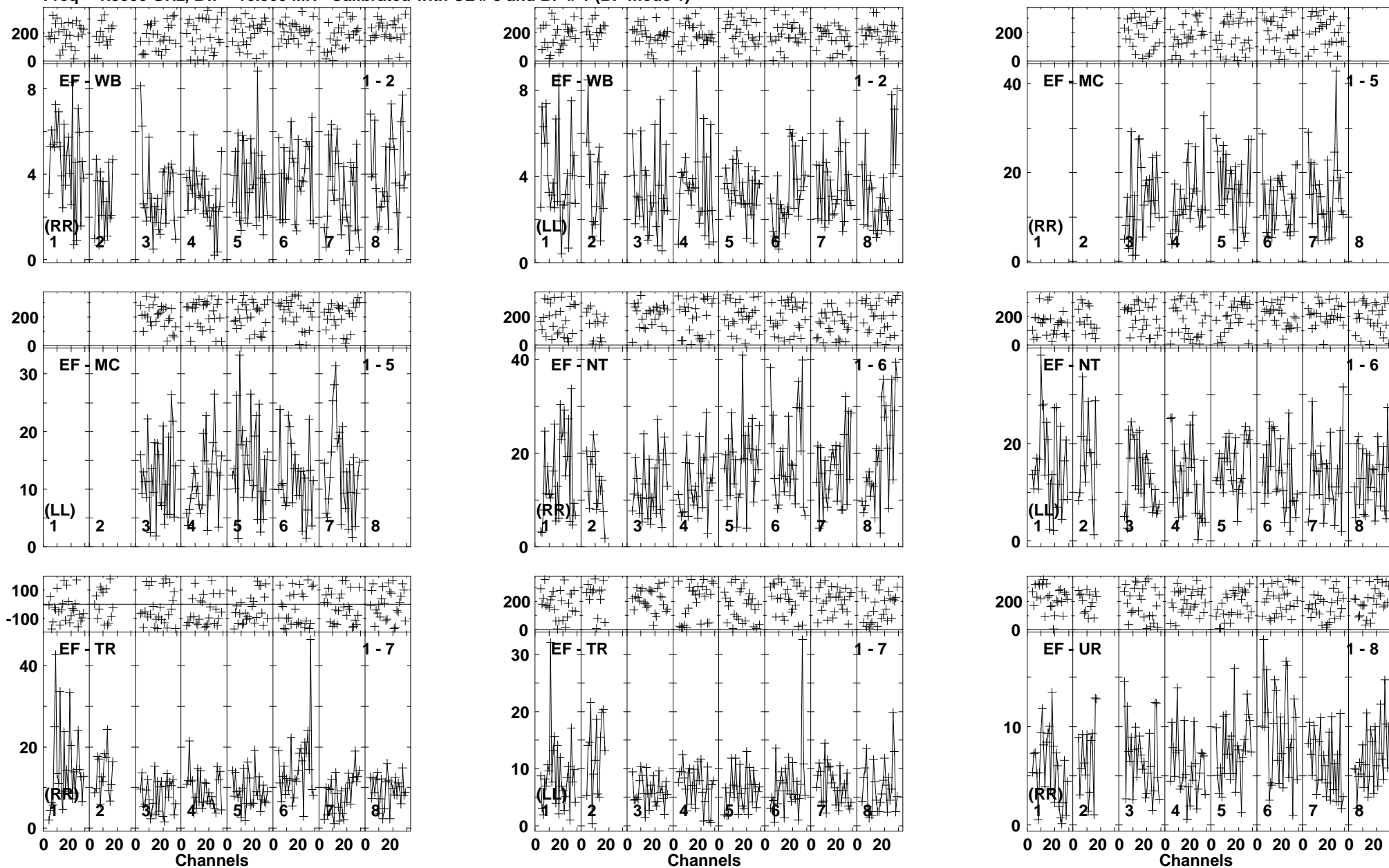

Lower frame: Milli Ampl Jy Top frame: Phas deg
 Vector averaged cross-power spectrum Baseline: EF (01) - WB (02)
 Timerange: 00/08:32:21 to 00/08:36:49

Plot file version 230 created 25-MAR-2014 17:51:49
 ARP299A EP087E 1.UVDATA.1
 Freq = 1.5950 GHz, Bw = 16.000 MH Calibrated with CL # 3 and BP # 1 (BP mode 1)

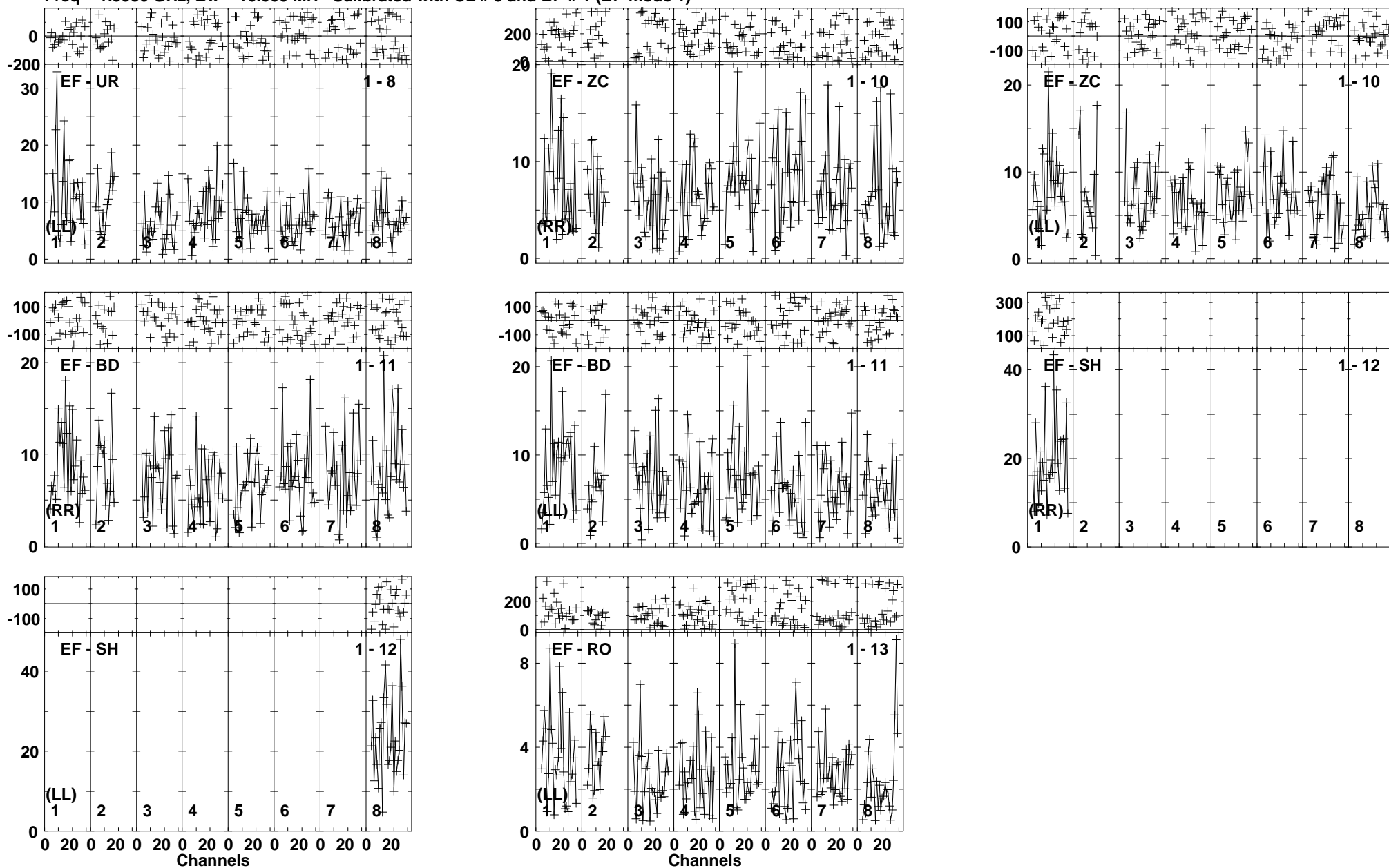

Lower frame: Milli Ampl Jy Top frame: Phas deg
 Vector averaged cross-power spectrum Baseline: EF (01) - UR (08)
 Timerange: 00/08:32:21 to 00/08:36:49

Plot file version 231 created 25-MAR-2014 17:51:49

J1128+5925 EP087E 1.UVDATA.1

Freq = 1.5950 GHz, Bw = 16.000 MH Calibrated with CL # 3 and BP # 1 (BP mode 1)

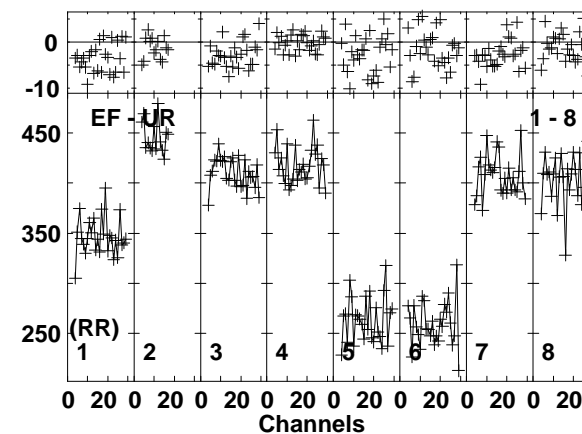
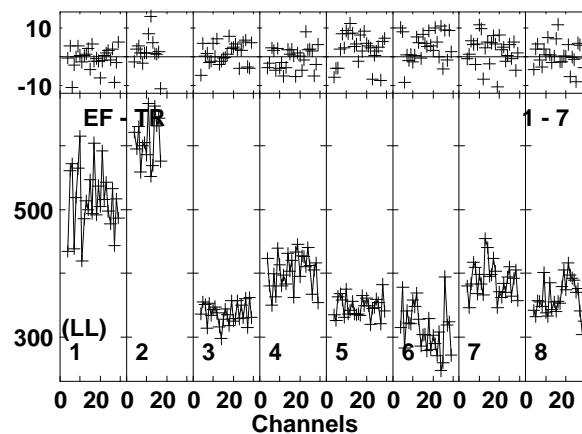
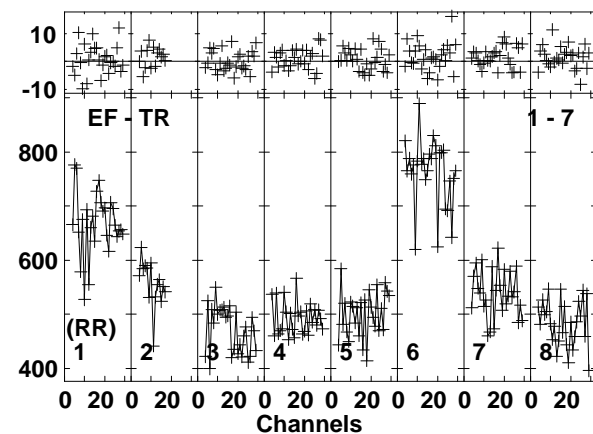
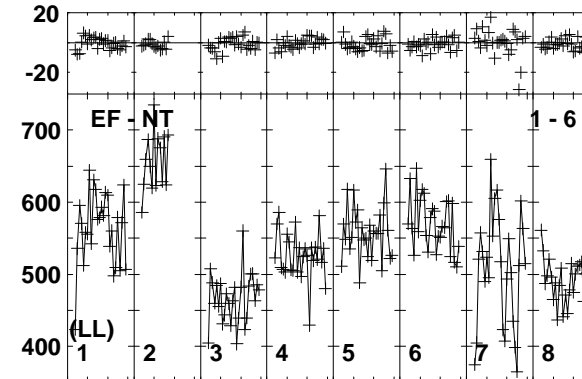
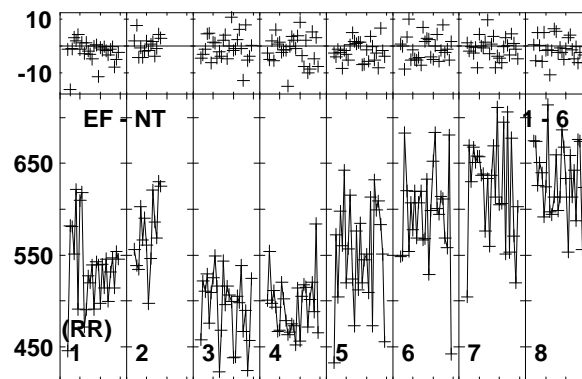
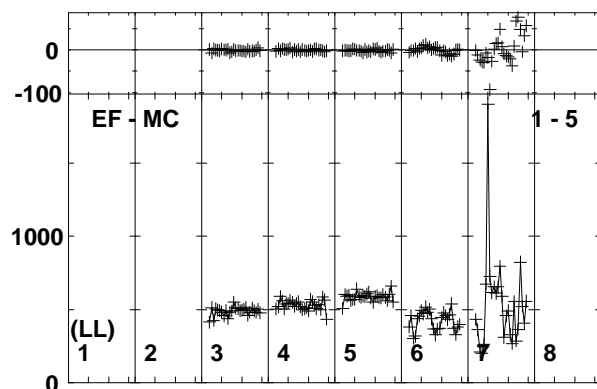
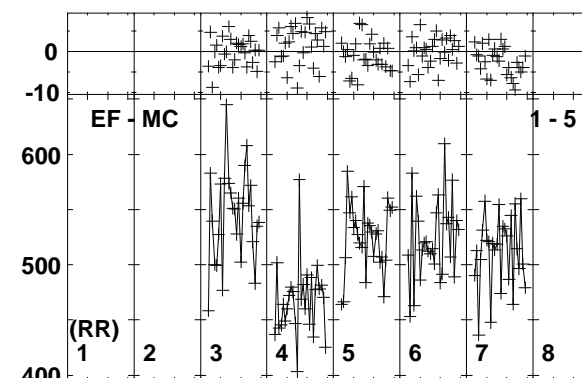
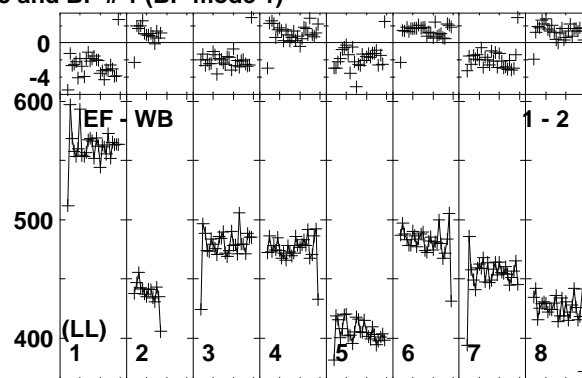
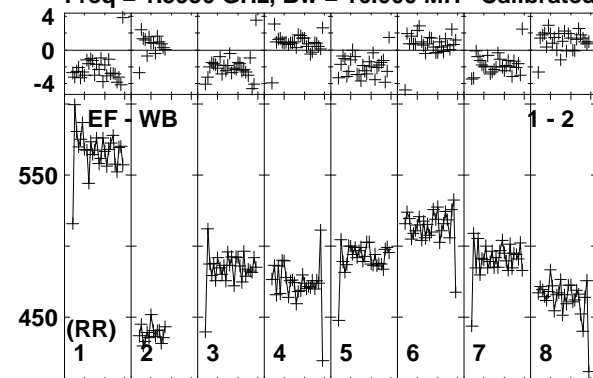

Lower frame: Milli Ampl Jy Top frame: Phas deg
Vector averaged cross-power spectrum Baseline: EF (01) - WB (02)
Timerange: 00/08:37:31 to 00/08:37:59

Plot file version 232 created 25-MAR-2014 17:51:49

J1128+5925 EP087E 1.UVDATA.1

Freq = 1.5950 GHz, Bw = 16.000 MH Calibrated with CL # 3 and BP # 1 (BP mode 1)

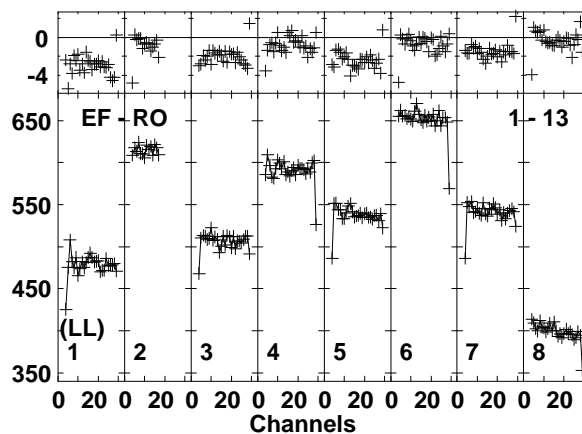
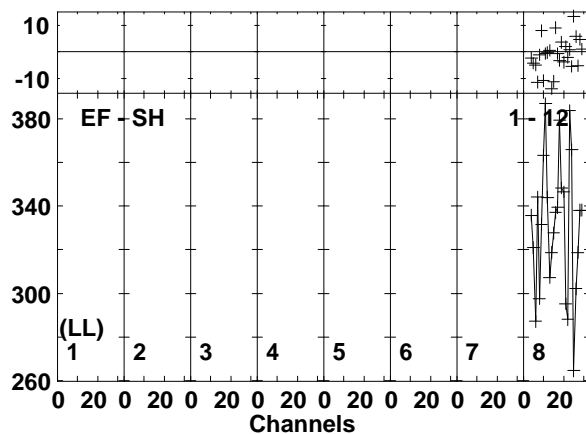
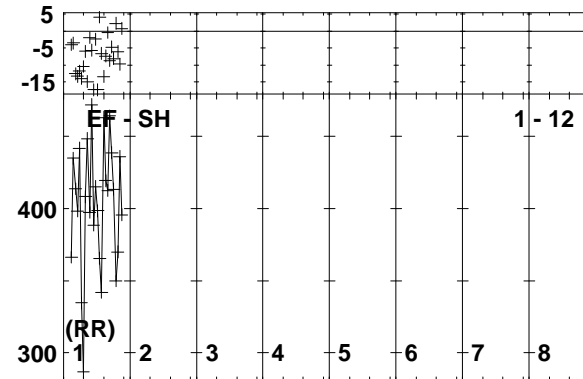
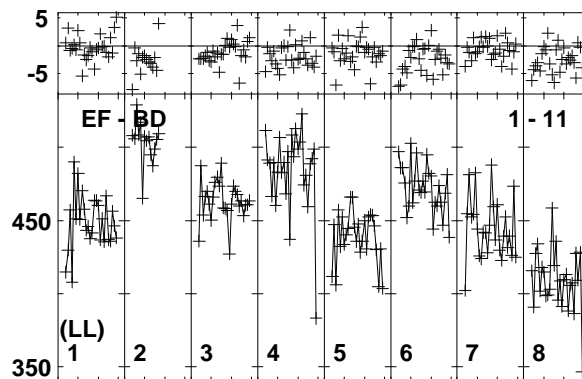
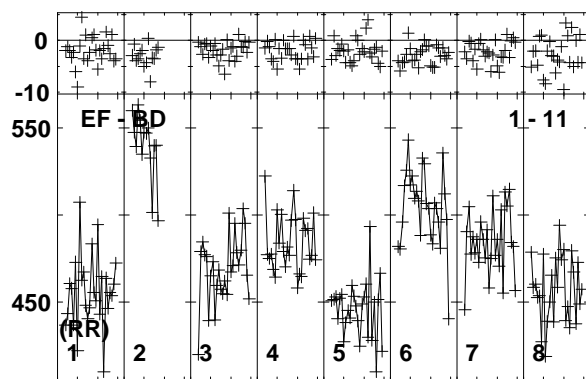
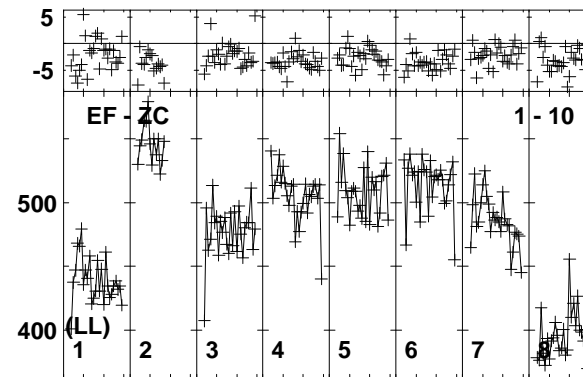
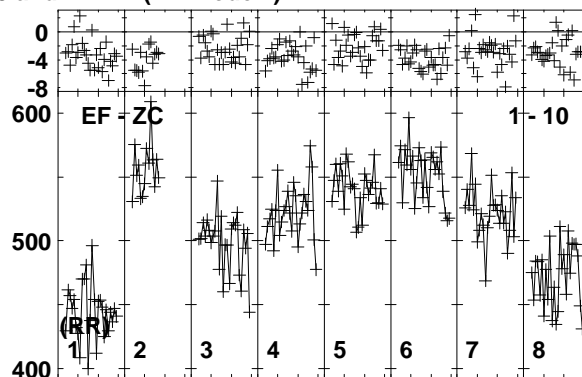
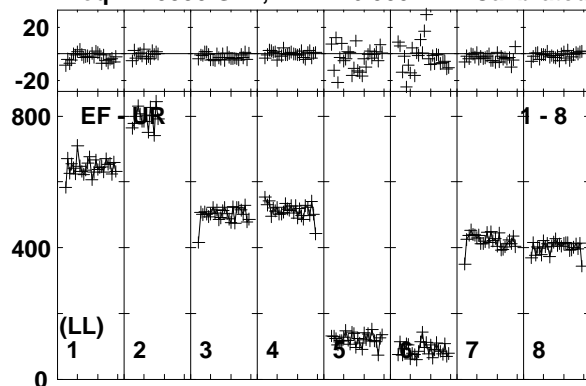

Lower frame: Milli Ampl Jy Top frame: Phas deg
Vector averaged cross-power spectrum Baseline: EF (01) - UR (08)
Timerange: 00/08:37:31 to 00/08:37:59

Plot file version 233 created 25-MAR-2014 17:51:49
 ARP299A EP087E 1.UVDATA.1
 Freq = 1.5950 GHz, Bw = 16.000 MH Calibrated with CL # 3 and BP # 1 (BP mode 1)

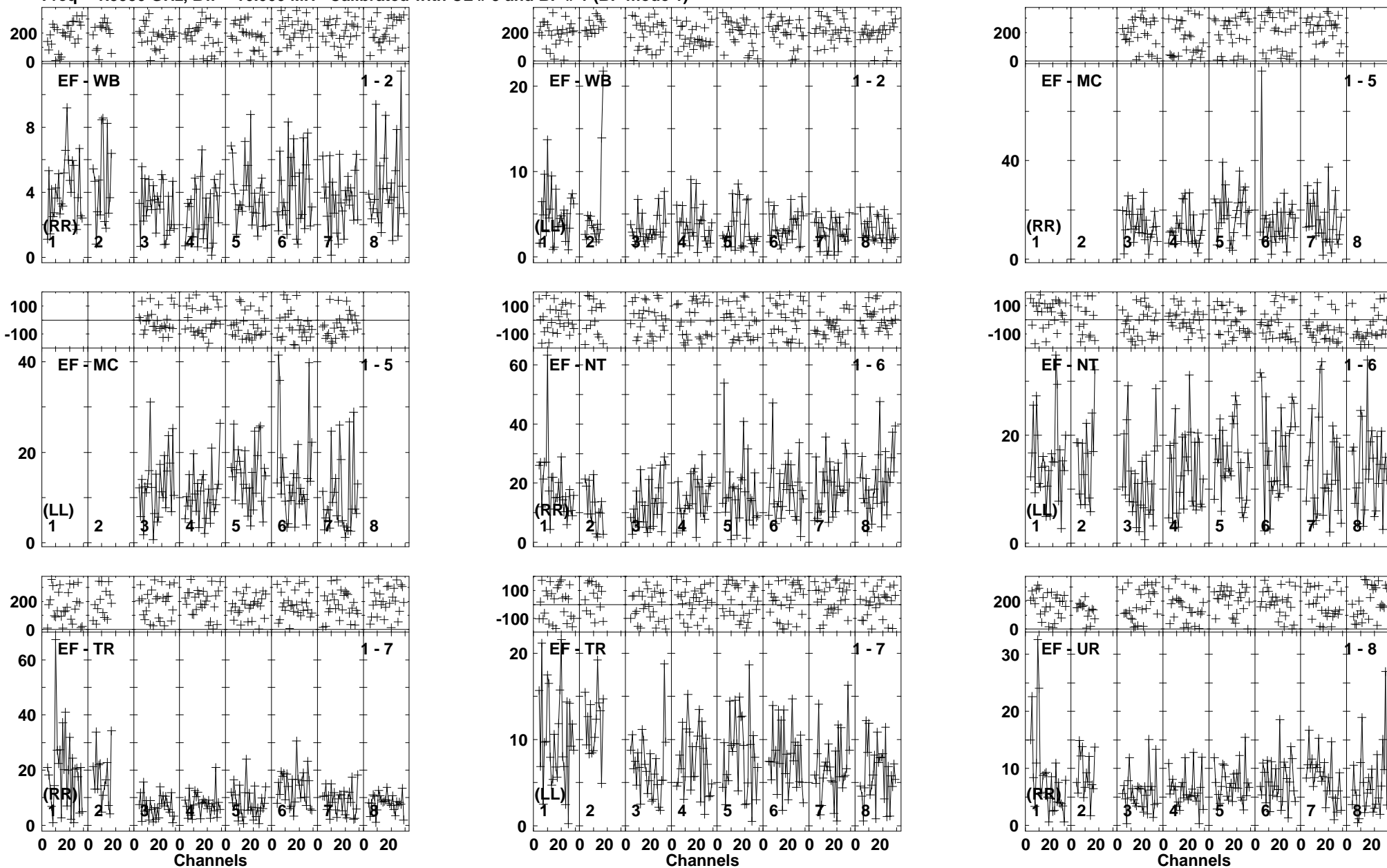

Lower frame: Milli Ampl Jy Top frame: Phas deg
 Vector averaged cross-power spectrum Baseline: EF (01) - WB (02)
 Timerange: 00/08:38:05 to 00/08:42:29

Plot file version 234 created 25-MAR-2014 17:51:50
 ARP299A EP087E 1.UVDATA.1
 Freq = 1.5950 GHz, Bw = 16.000 MH Calibrated with CL # 3 and BP # 1 (BP mode 1)

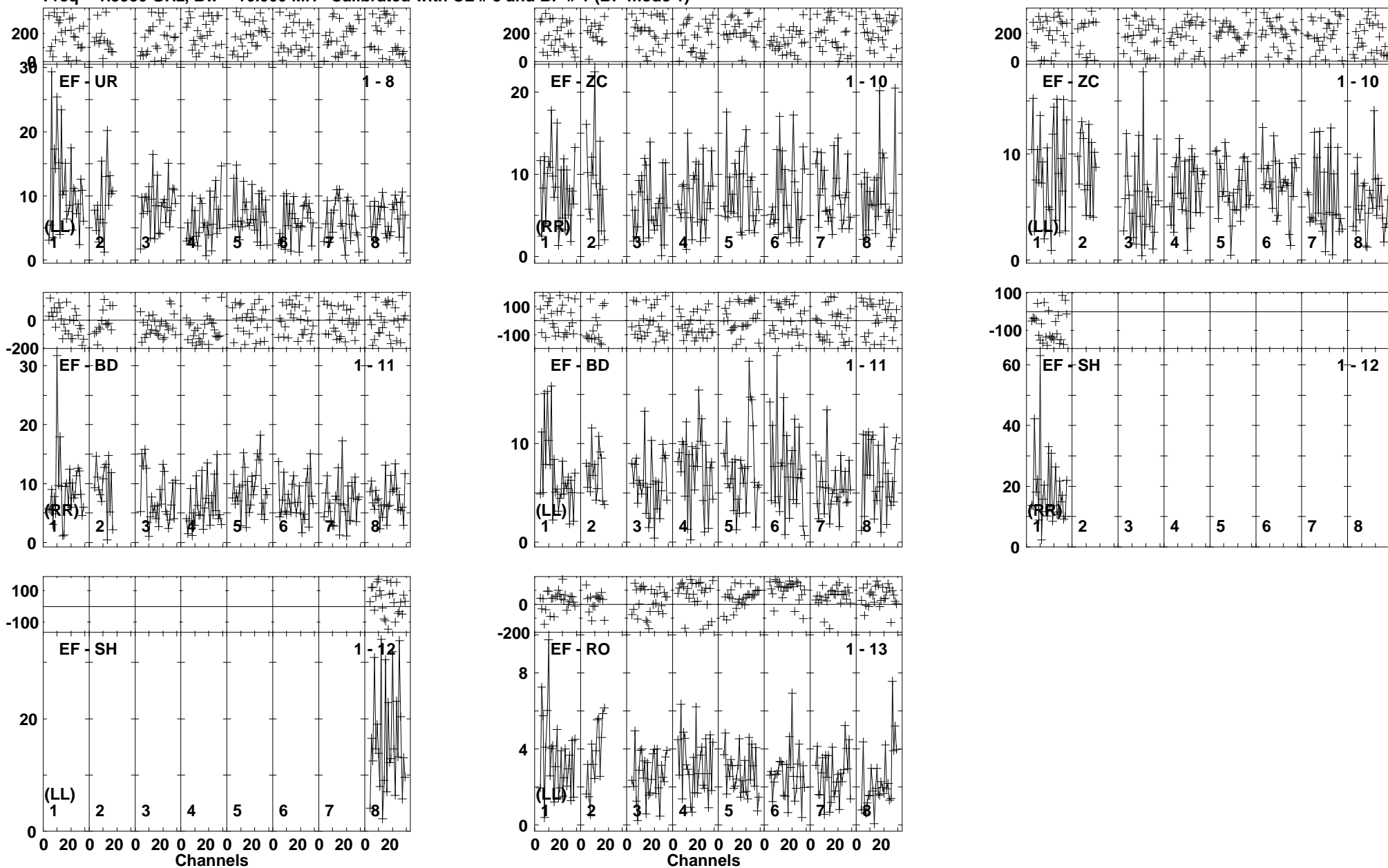

Lower frame: Milli Ampl Jy Top frame: Phas deg
 Vector averaged cross-power spectrum Baseline: EF (01) - UR (08)
 Timerange: 00/08:38:05 to 00/08:42:29

Plot file version 235 created 25-MAR-2014 17:51:50

J1128+5925 EP087E 1.UVDATA.1

Freq = 1.5950 GHz, Bw = 16.000 MH Calibrated with CL # 3 and BP # 1 (BP mode 1)

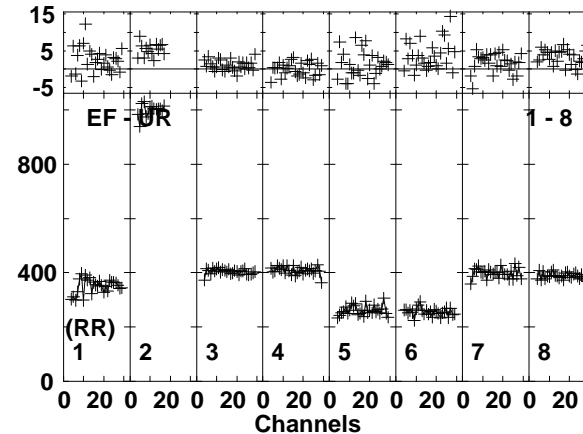
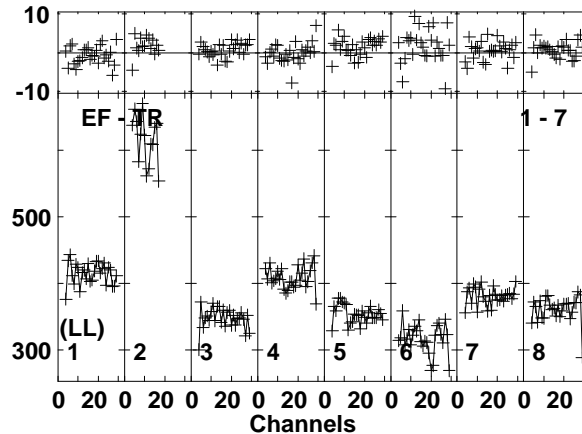
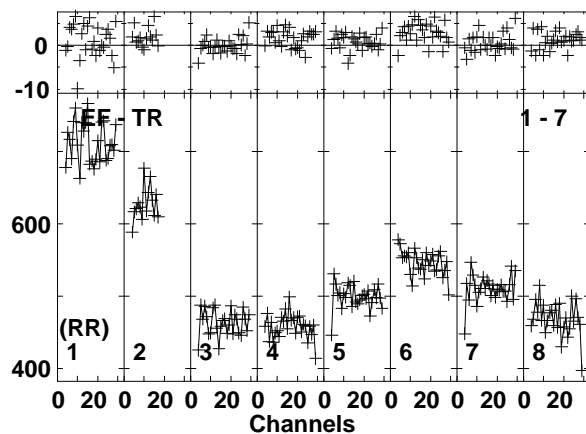
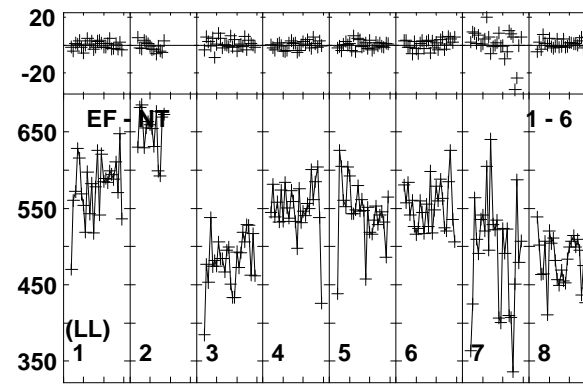
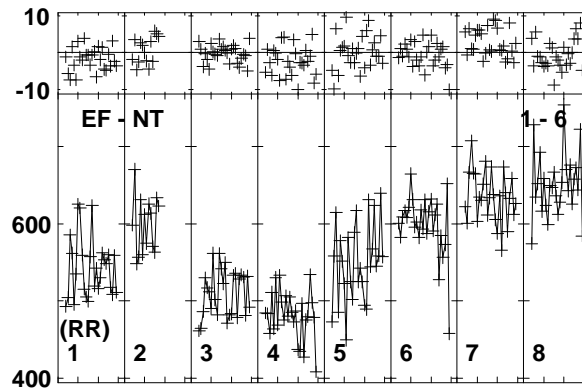
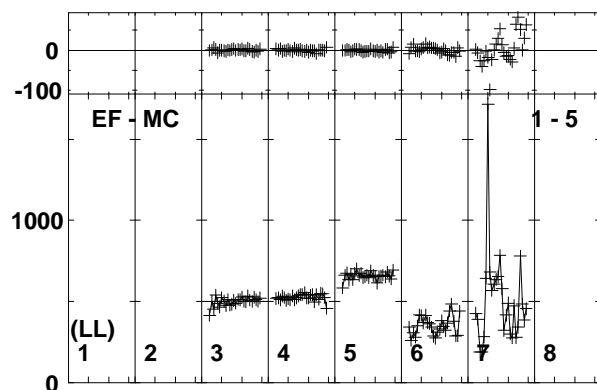
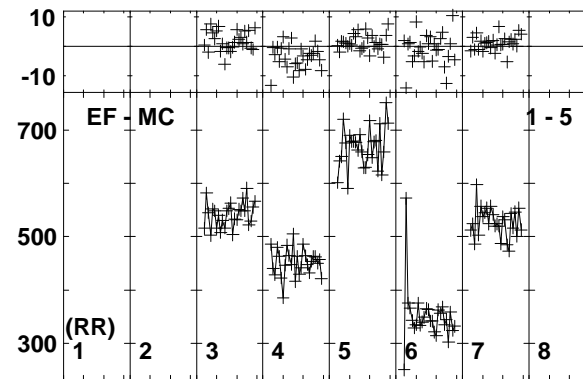
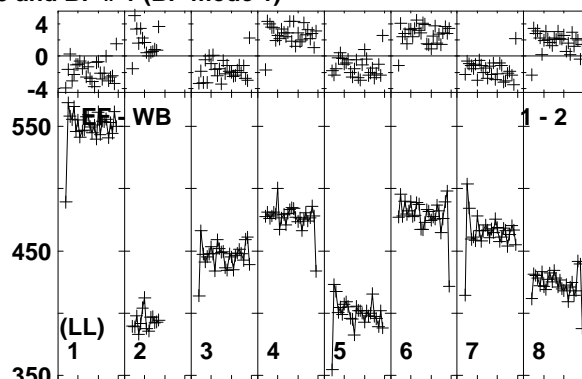
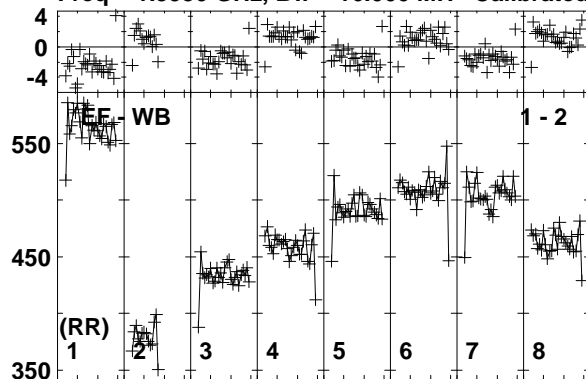

Lower frame: Milli Ampl Jy Top frame: Phas deg
Vector averaged cross-power spectrum Baseline: EF (01) - WB (02)
Timerange: 00/08:42:35 to 00/08:43:39

Plot file version 236 created 25-MAR-2014 17:51:50

J1128+5925 EP087E 1.UVDATA.1

Freq = 1.5950 GHz, Bw = 16.000 MH Calibrated with CL # 3 and BP # 1 (BP mode 1)

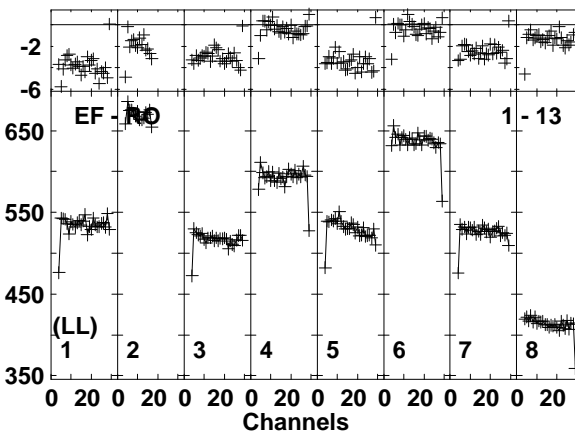
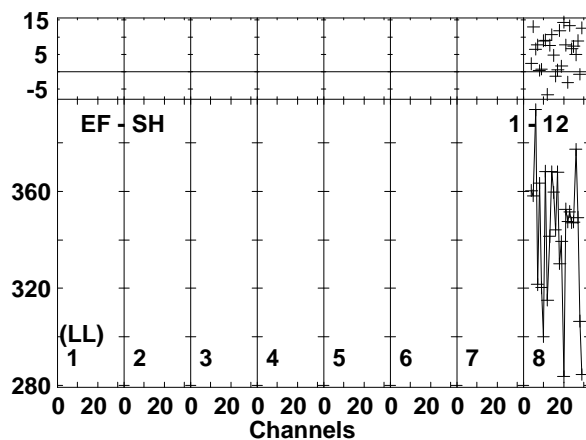
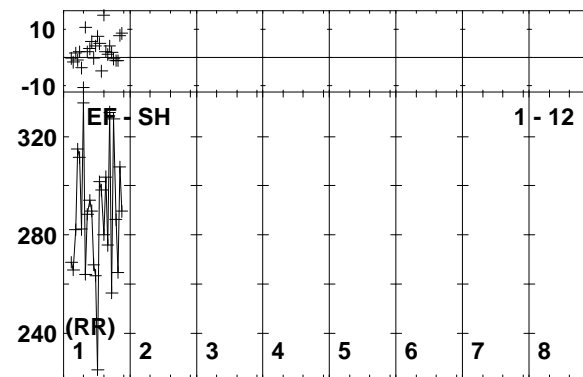
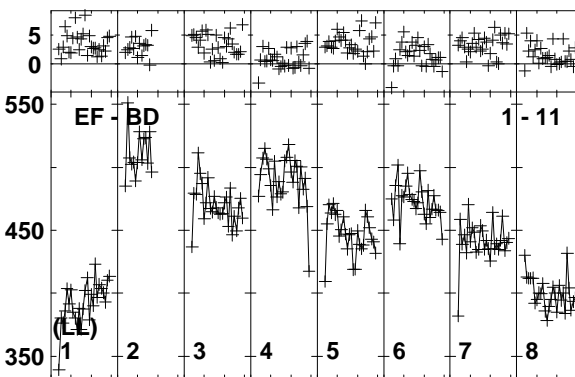
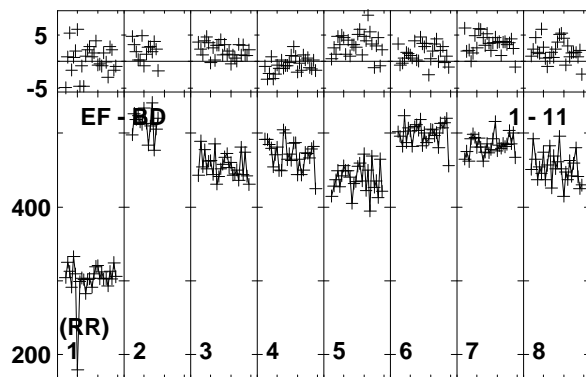
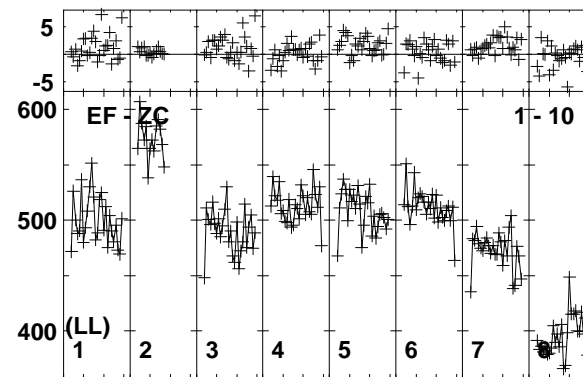
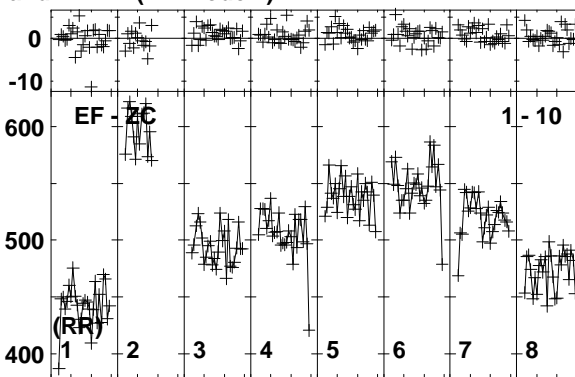
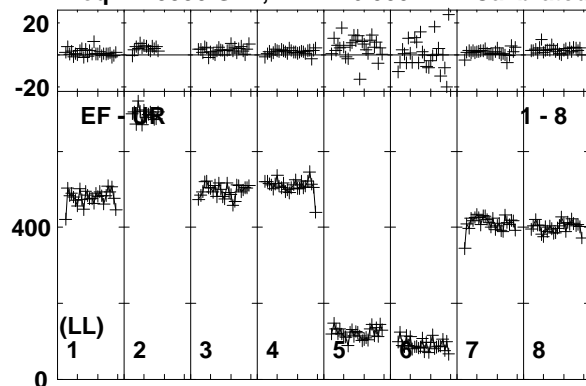

Lower frame: Milli Ampl Jy Top frame: Phas deg
Vector averaged cross-power spectrum Baseline: EF (01) - UR (08)
Timerange: 00/08:42:35 to 00/08:43:39

Plot file version 237 created 25-MAR-2014 17:51:51
 ARP299A EP087E 1.UVDATA.1
 Freq = 1.5950 GHz, Bw = 16.000 MH Calibrated with CL # 3 and BP # 1 (BP mode 1)

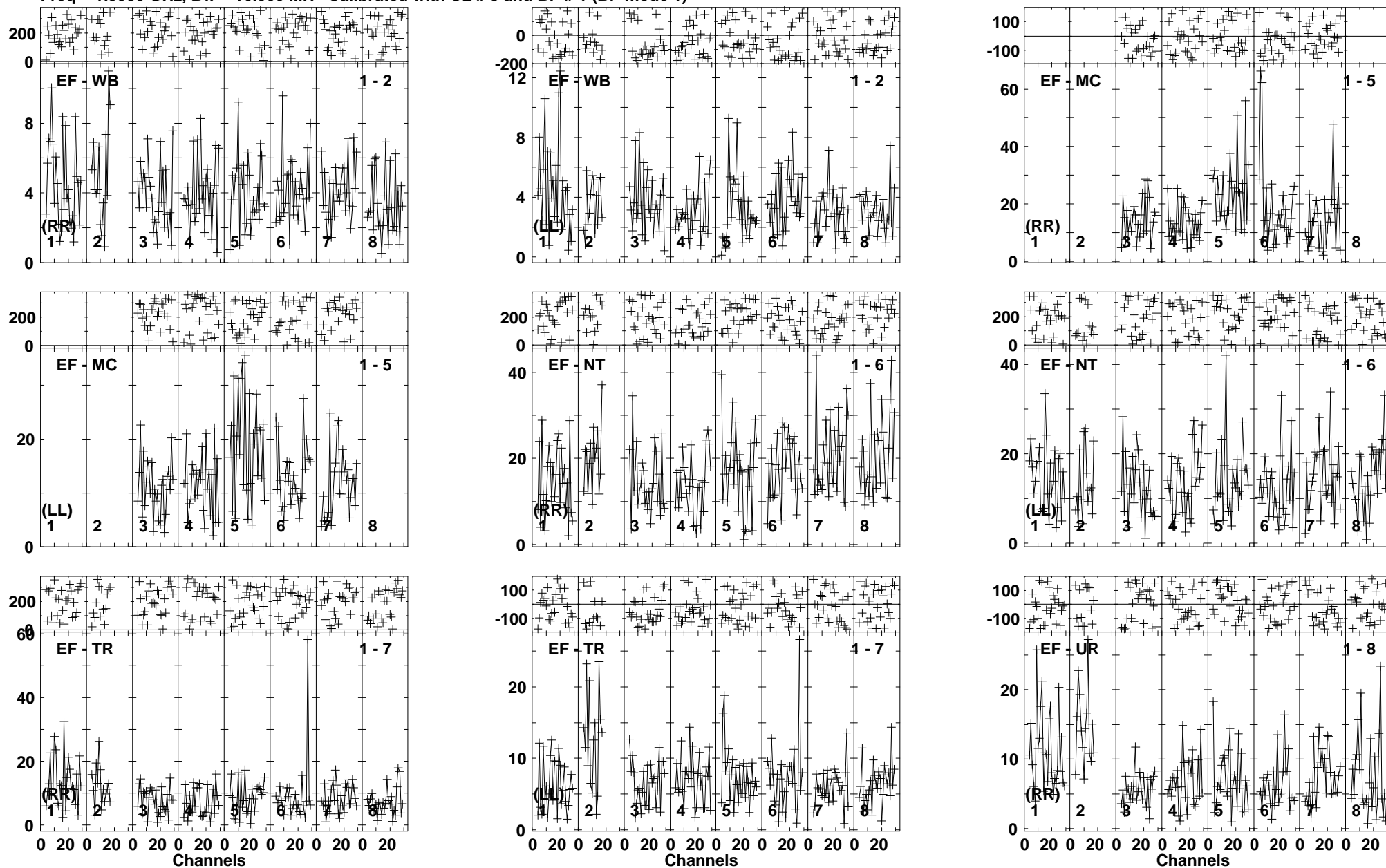

Lower frame: Milli Ampl Jy Top frame: Phas deg
 Vector averaged cross-power spectrum Baseline: EF (01) - WB (02)
 Timerange: 00/08:43:41 to 00/08:48:09

Plot file version 238 created 25-MAR-2014 17:51:51
 ARP299A EP087E 1.UVDATA.1
 Freq = 1.5950 GHz, Bw = 16.000 MH Calibrated with CL # 3 and BP # 1 (BP mode 1)

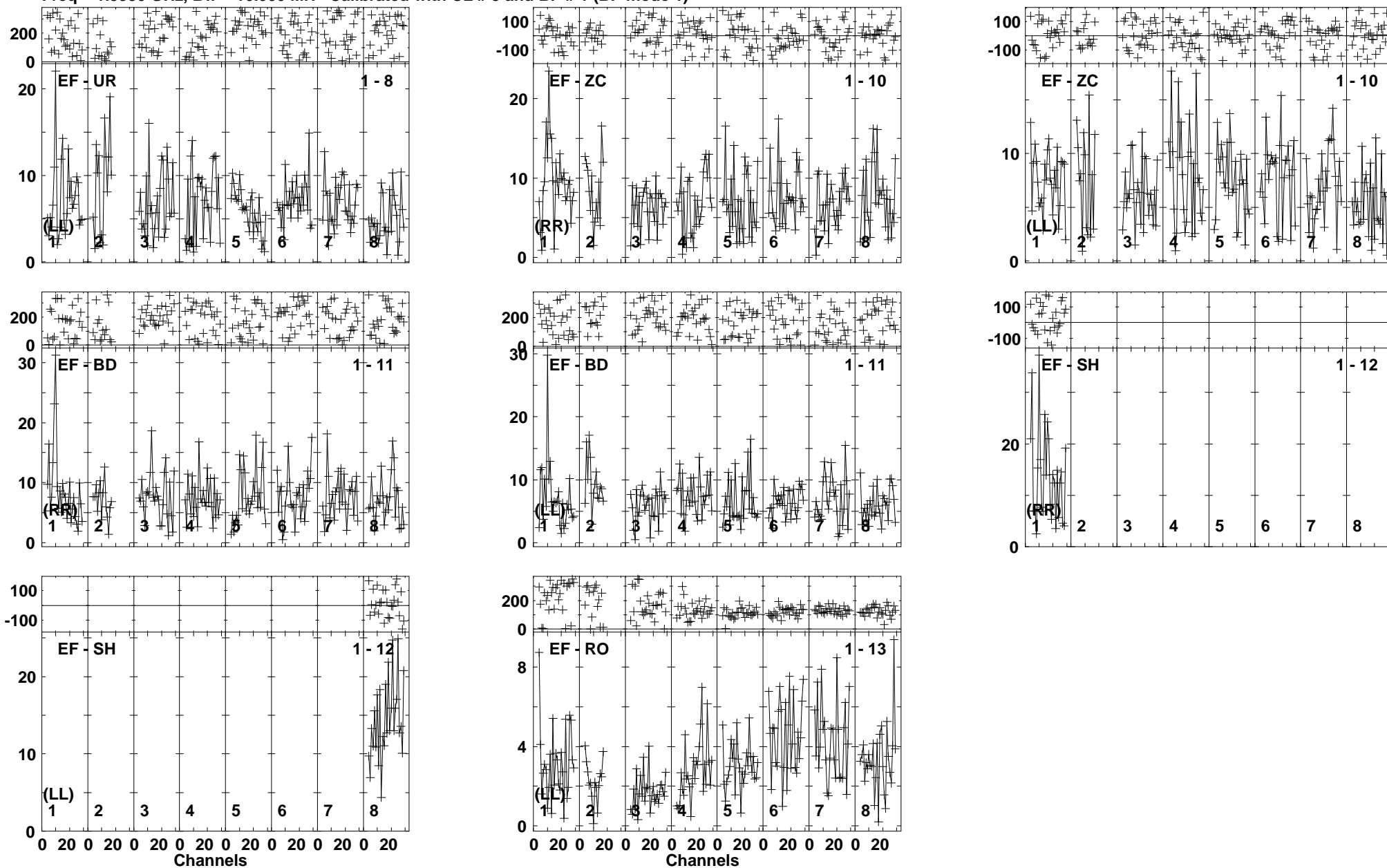

Lower frame: Milli Ampl Jy Top frame: Phas deg
 Vector averaged cross-power spectrum Baseline: EF (01) - UR (08)
 Timerange: 00/08:43:41 to 00/08:48:09

Plot file version 239 created 25-MAR-2014 17:51:51

J1128+5925 EP087E 1.UVDATA.1

Freq = 1.5950 GHz, Bw = 16.000 MH Calibrated with CL # 3 and BP # 1 (BP mode 1)

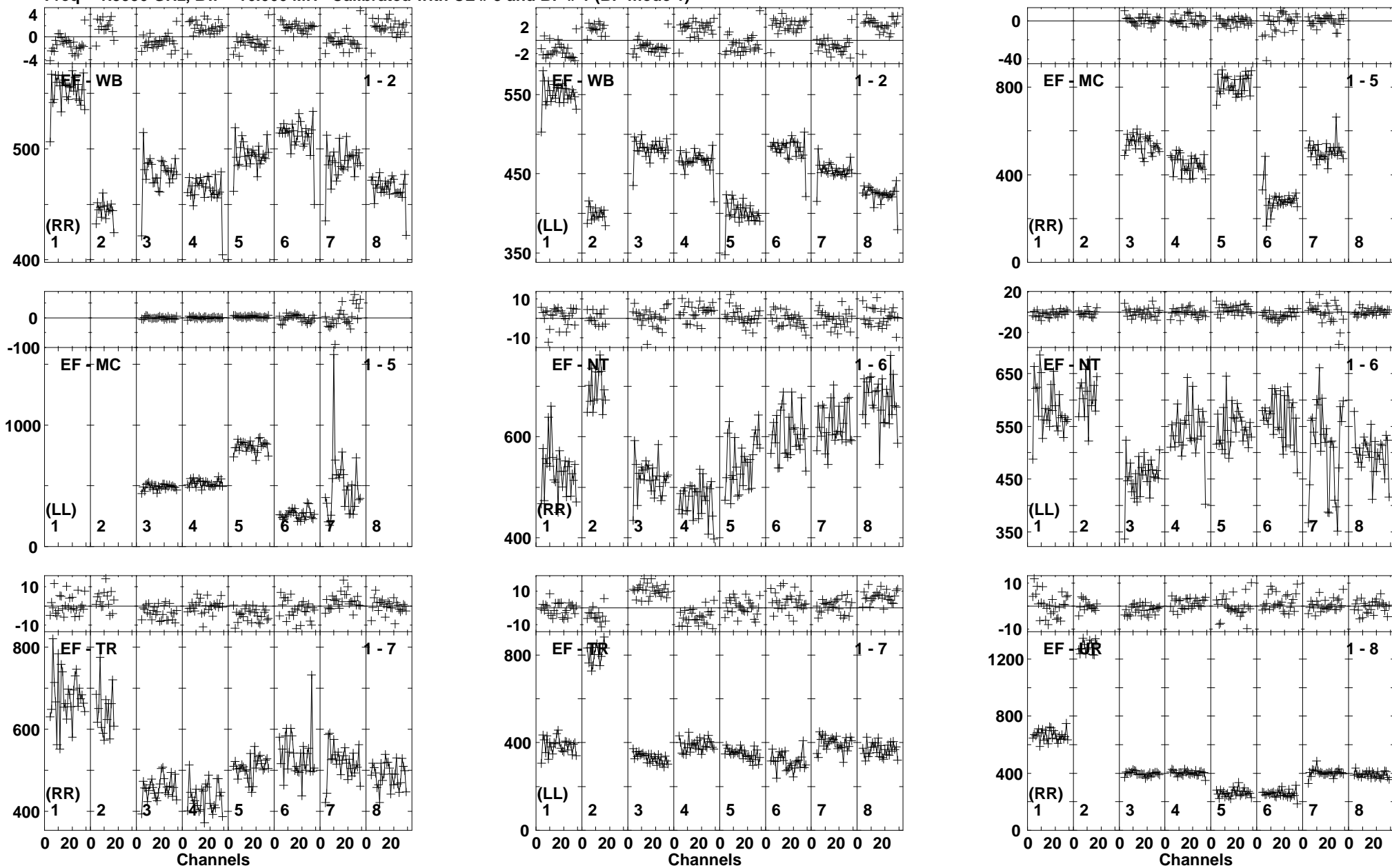

Lower frame: Milli Ampl Jy Top frame: Phas deg
Vector averaged cross-power spectrum Baseline: EF (01) - WB (02)
Timerange: 00/08:48:51 to 00/08:49:19

Plot file version 240 created 25-MAR-2014 17:51:52

J1128+5925 EP087E 1.UVDATA.1

Freq = 1.5950 GHz, Bw = 16.000 MH Calibrated with CL # 3 and BP # 1 (BP mode 1)

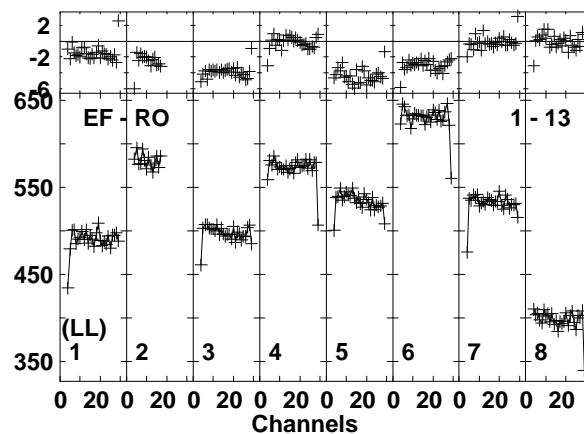
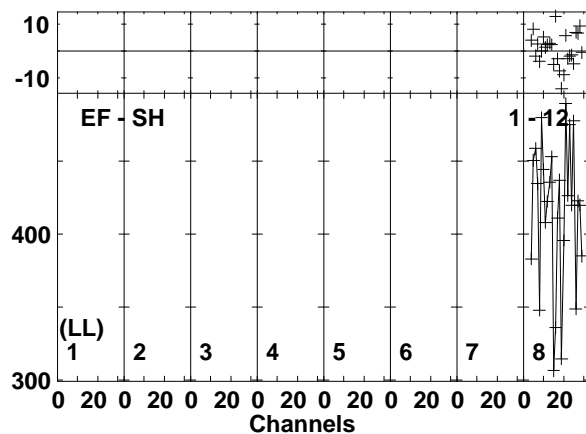
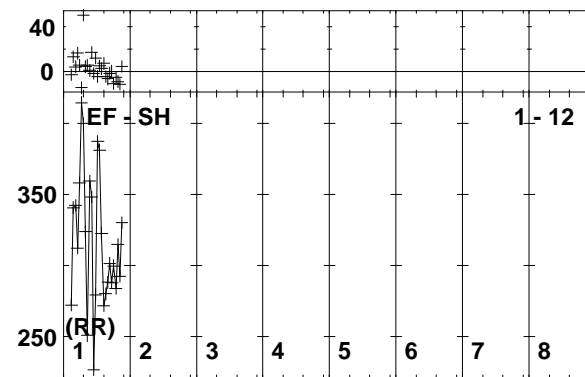
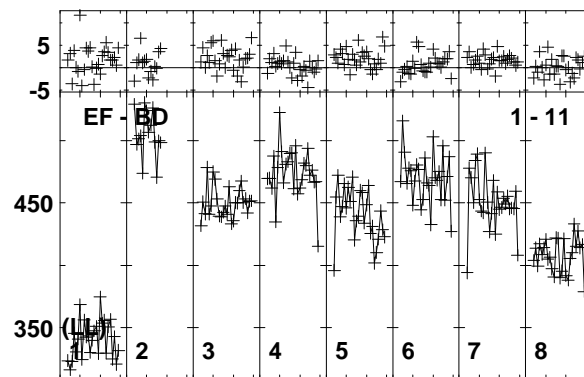
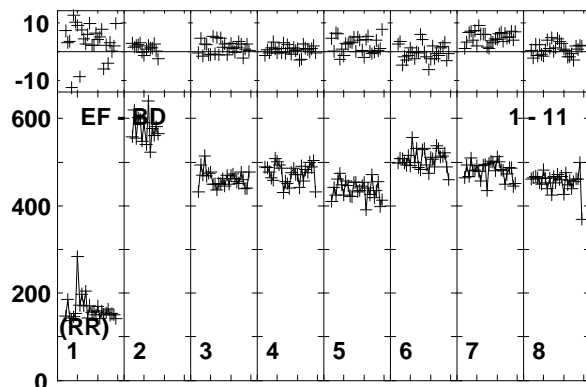
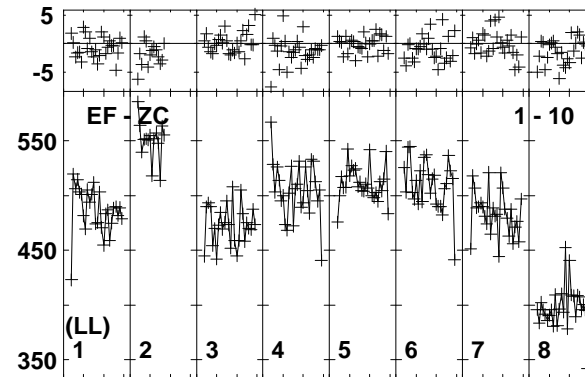
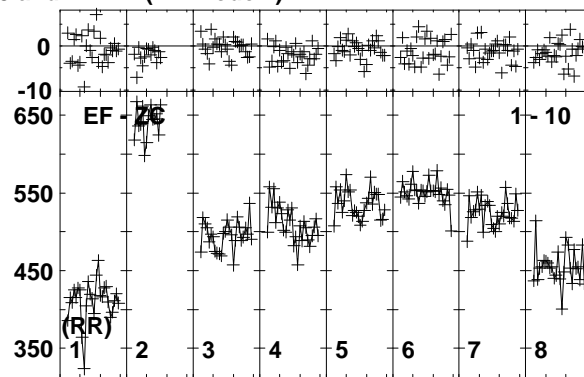
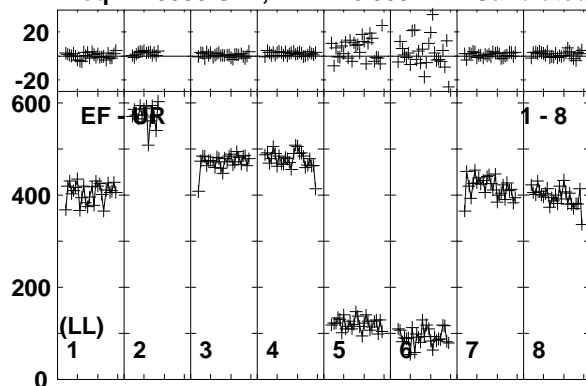

Lower frame: Milli Ampl Jy Top frame: Phas deg
Vector averaged cross-power spectrum Baseline: EF (01) - UR (08)
Timerange: 00/08:48:51 to 00/08:49:19

Plot file version 241 created 25-MAR-2014 17:51:52
 ARP299A EP087E 1.UVDATA.1
 Freq = 1.5950 GHz, Bw = 16.000 MH Calibrated with CL # 3 and BP # 1 (BP mode 1)

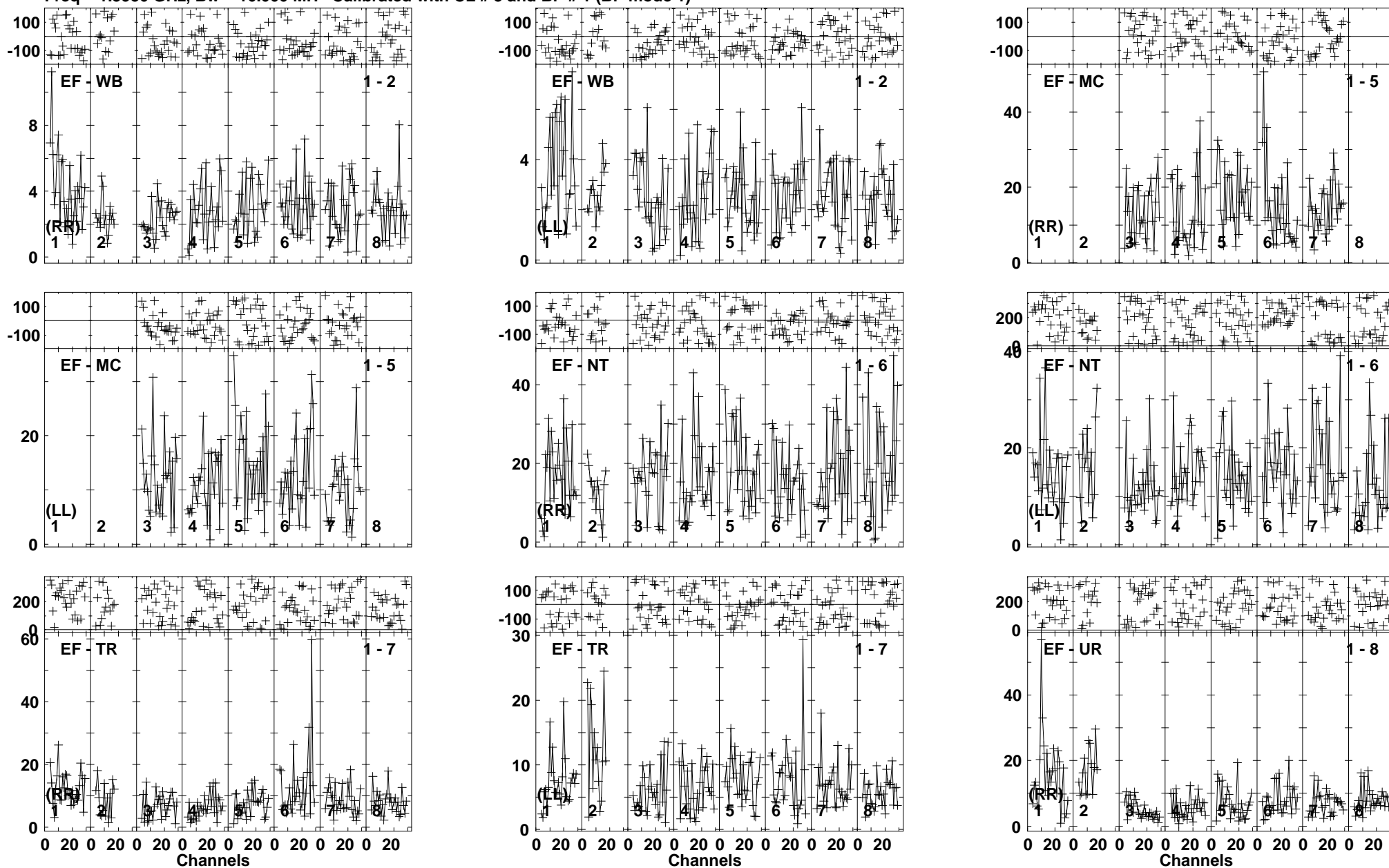

Lower frame: Milli Ampl Jy Top frame: Phas deg
 Vector averaged cross-power spectrum Baseline: EF (01) - WB (02)
 Timerange: 00/08:49:25 to 00/08:53:49

Plot file version 242 created 25-MAR-2014 17:51:52
 ARP299A EP087E 1.UVDATA.1
 Freq = 1.5950 GHz, Bw = 16.000 MH Calibrated with CL # 3 and BP # 1 (BP mode 1)

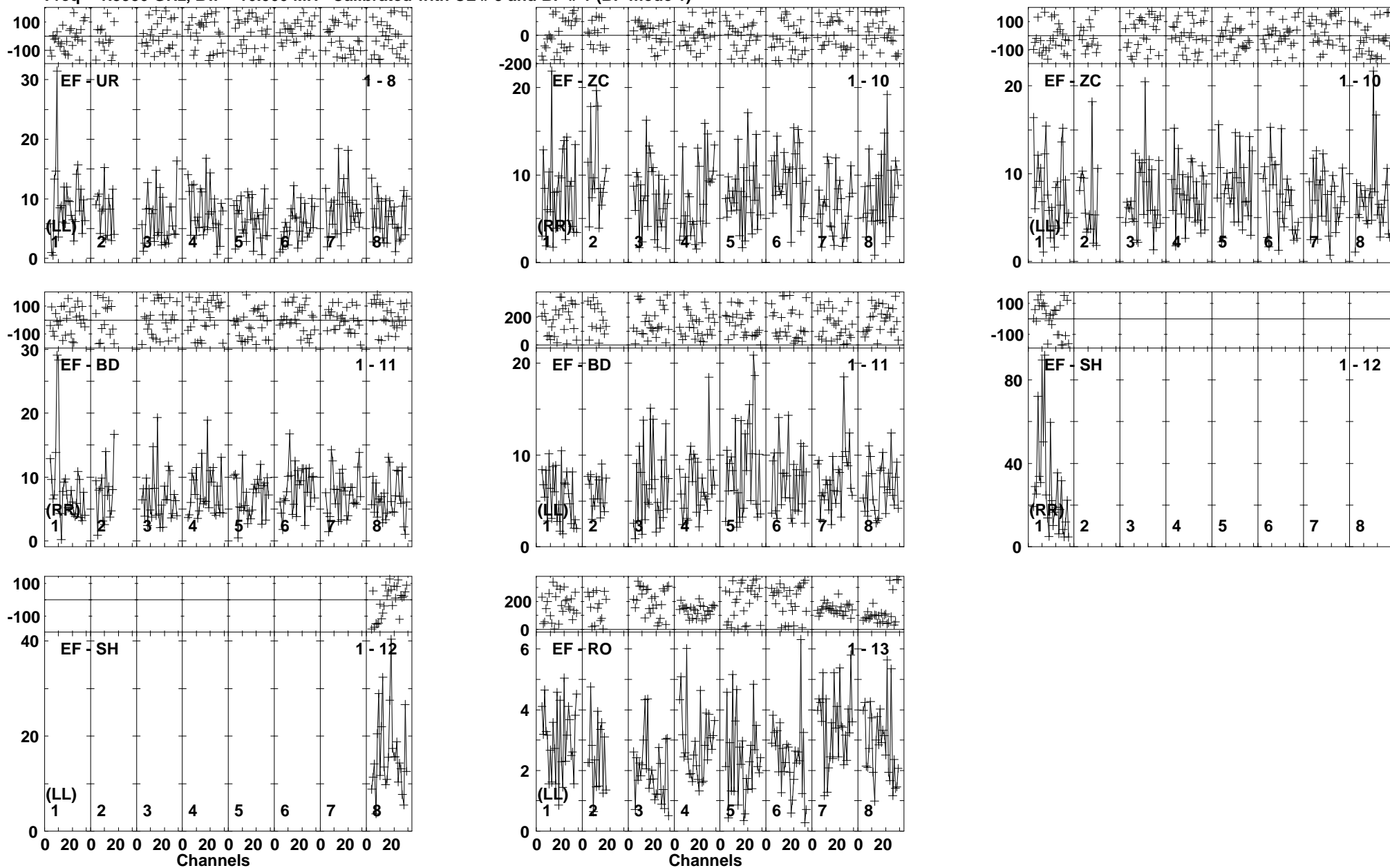

Lower frame: Milli Ampl Jy Top frame: Phas deg
 Vector averaged cross-power spectrum Baseline: EF (01) - UR (08)
 Timerange: 00/08:49:25 to 00/08:53:49

Plot file version 243 created 25-MAR-2014 17:51:52

J1128+5925 EP087E 1.UVDATA.1

Freq = 1.5950 GHz, Bw = 16.000 MH Calibrated with CL # 3 and BP # 1 (BP mode 1)

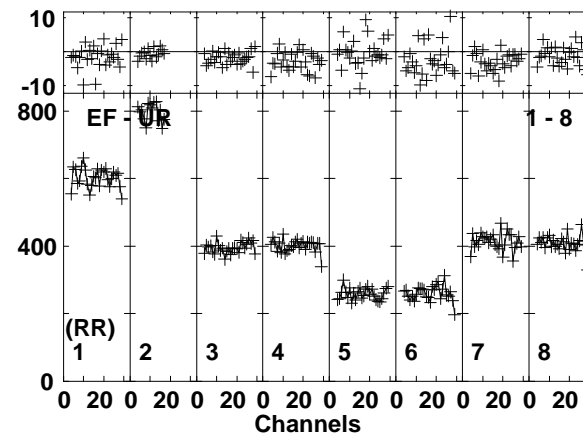
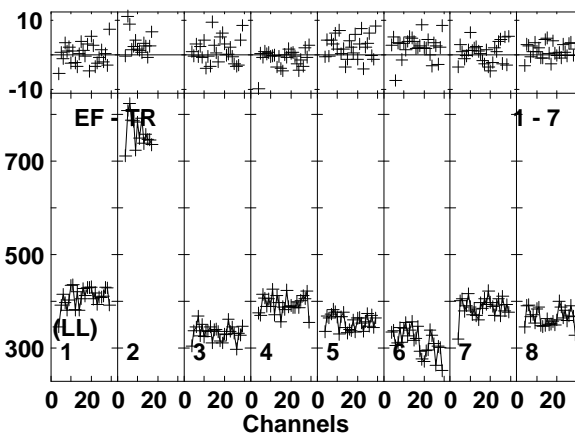
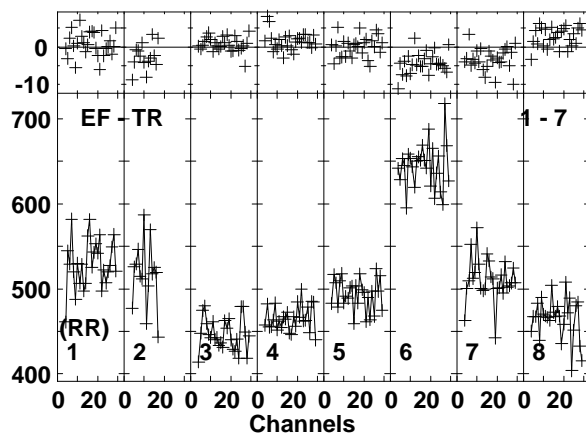
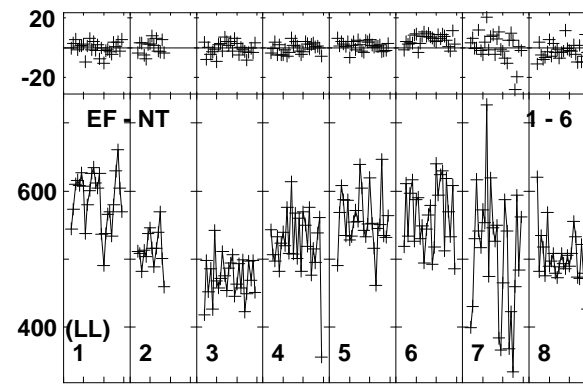
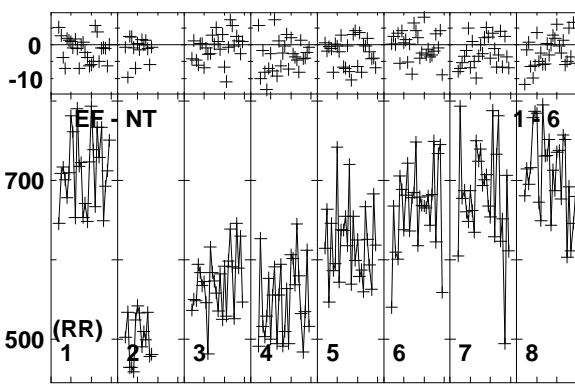
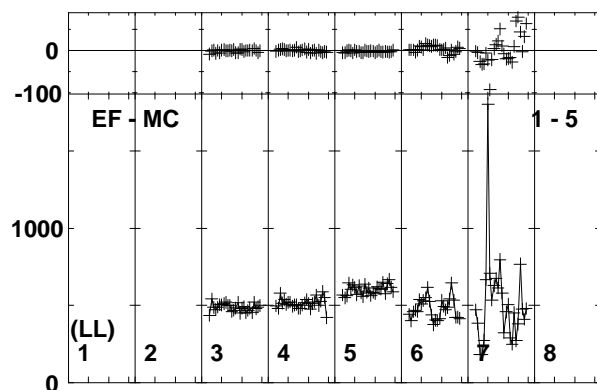
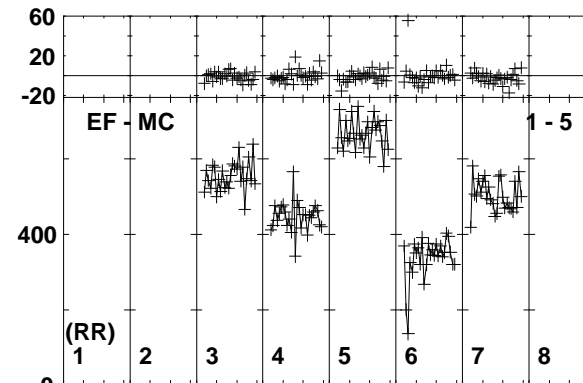
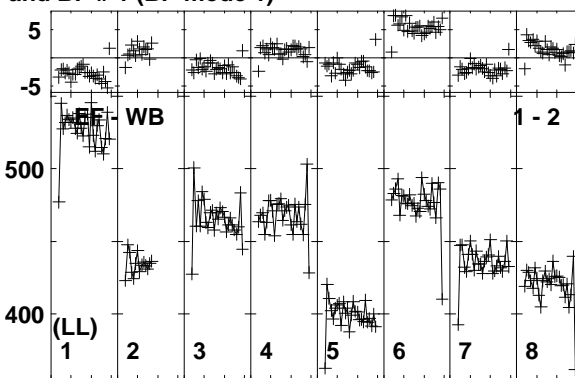
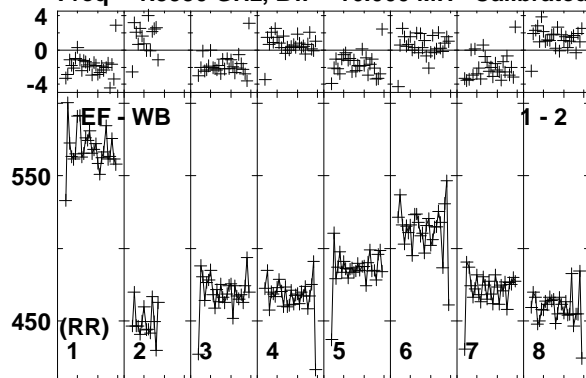

Lower frame: Milli Ampl Jy Top frame: Phas deg
Vector averaged cross-power spectrum Baseline: EF (01) - WB (02)
Timerange: 00/08:53:55 to 00/08:54:49

Plot file version 244 created 25-MAR-2014 17:51:53

J1128+5925 EP087E 1.UVDATA.1

Freq = 1.5950 GHz, Bw = 16.000 MH Calibrated with CL # 3 and BP # 1 (BP mode 1)

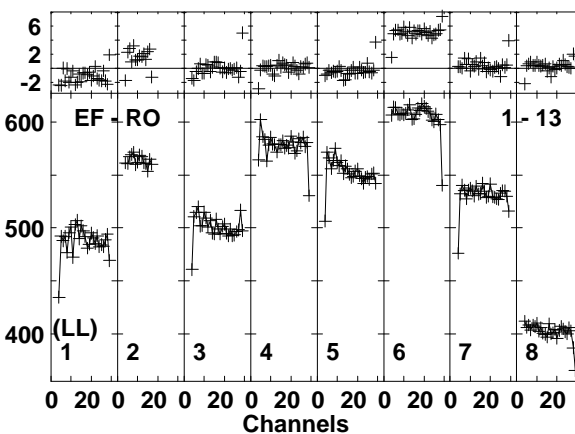
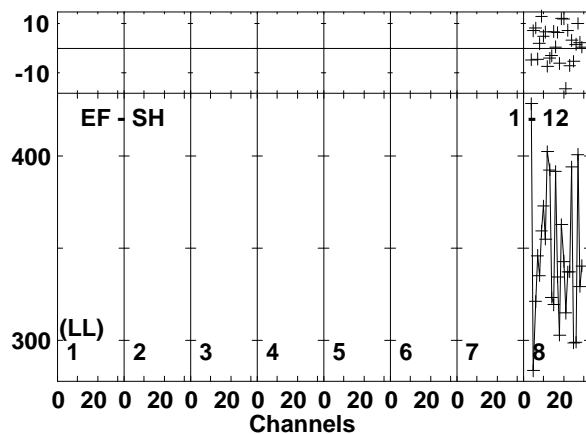
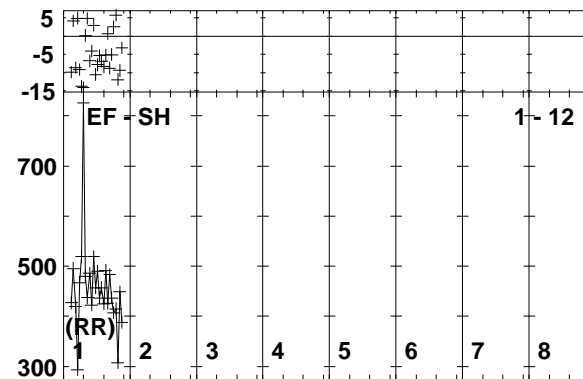
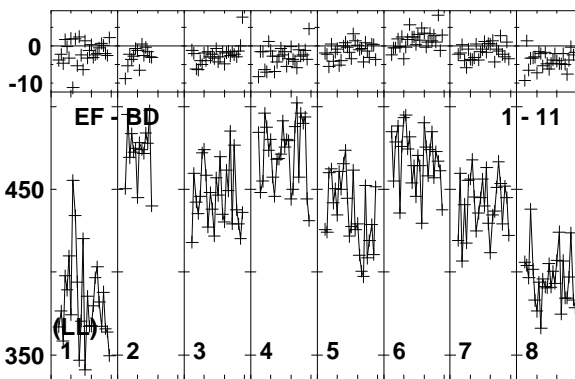
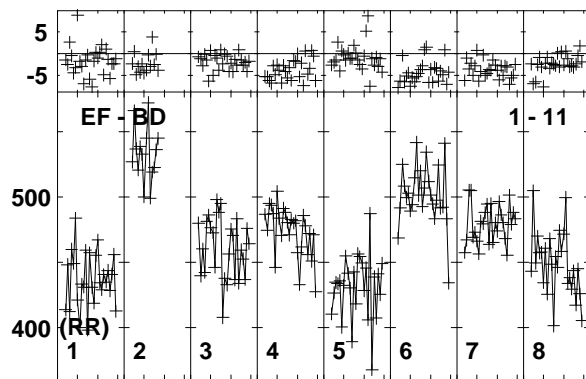
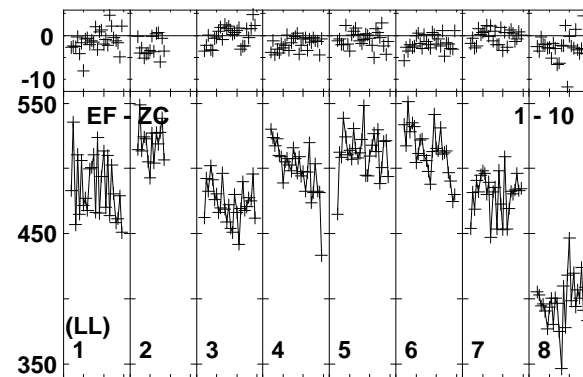
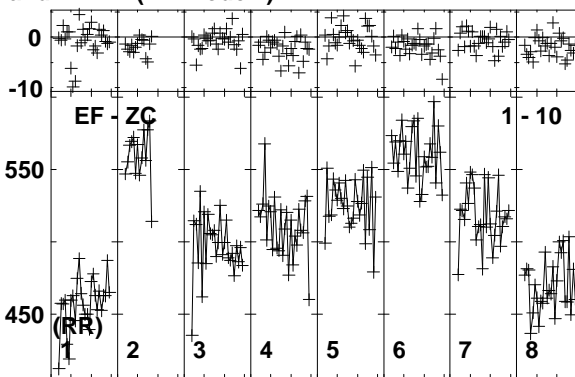
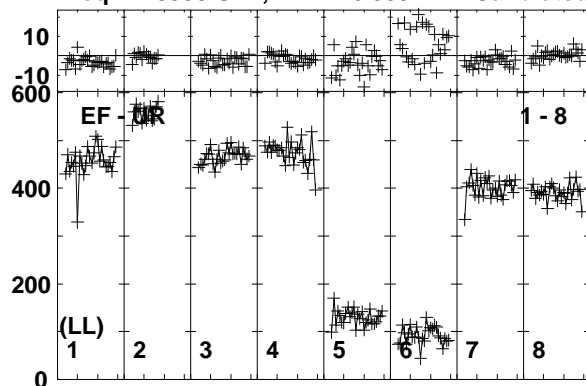

Lower frame: Milli Ampl Jy Top frame: Phas deg
Vector averaged cross-power spectrum Baseline: EF (01) - UR (08)
Timerange: 00/08:53:55 to 00/08:54:49

Plot file version 245 created 25-MAR-2014 17:51:53

ARP299A EP087E 1.UVDATA.1

Freq = 1.5950 GHz, Bw = 16.000 MH Calibrated with CL # 3 and BP # 1 (BP mode 1)

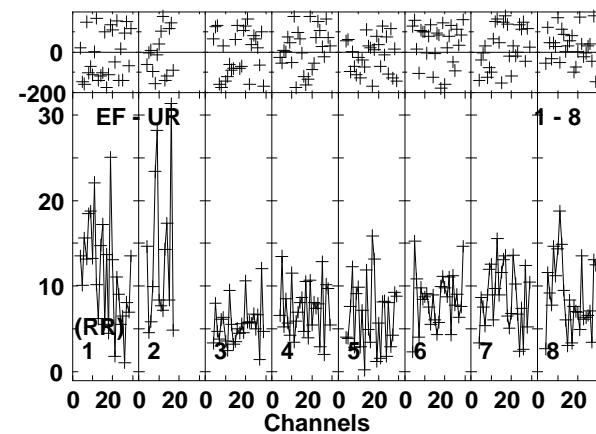
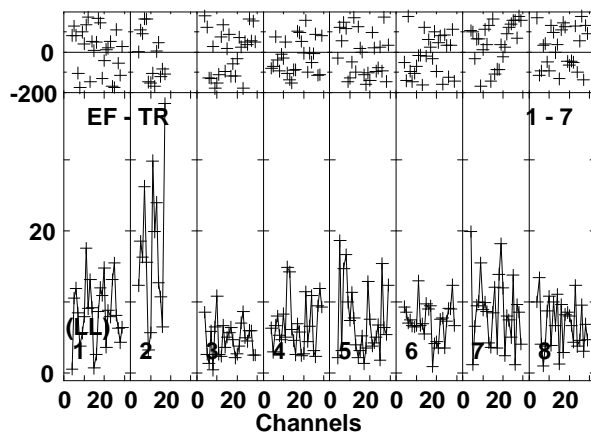
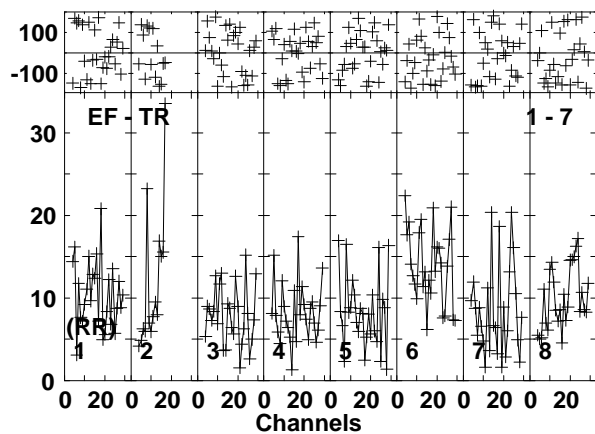
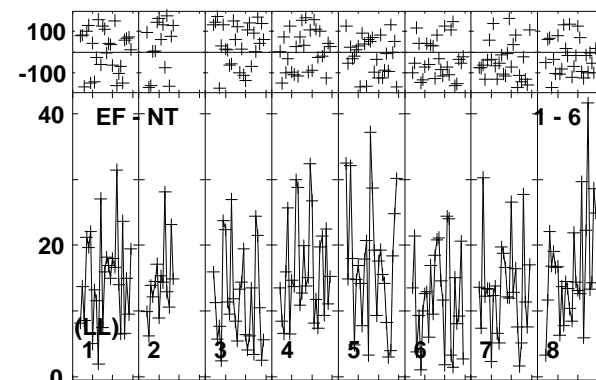
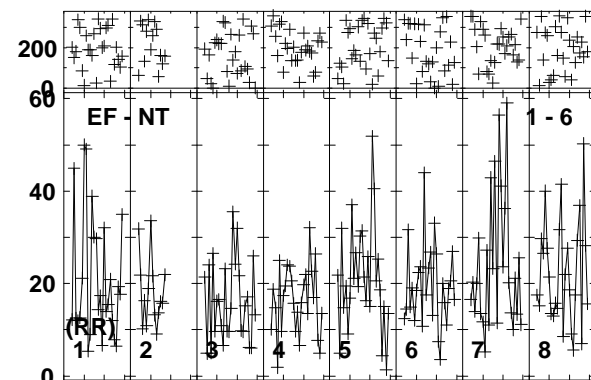
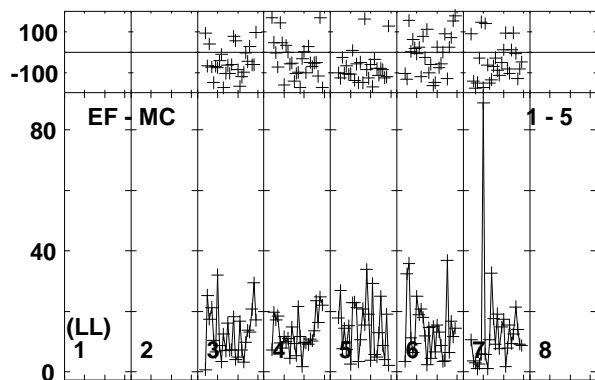
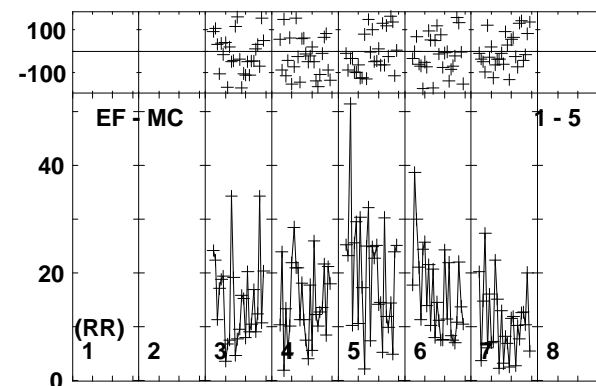
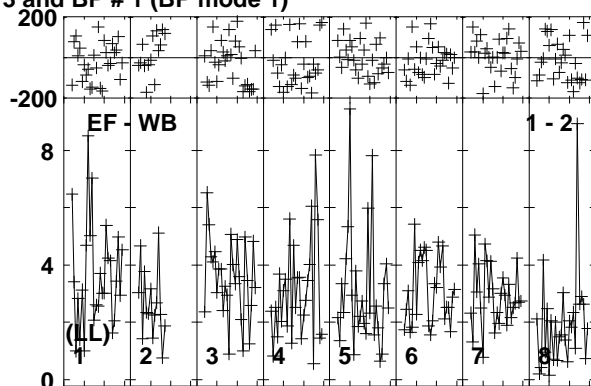
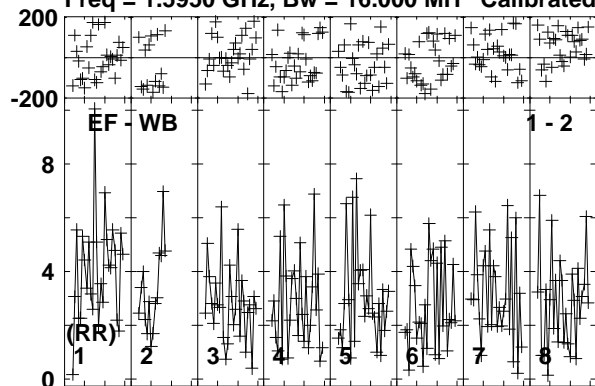

Lower frame: Milli Ampl Jy Top frame: Phas deg
Vector averaged cross-power spectrum Baseline: EF (01) - WB (02)
Timerange: 00/08:54:51 to 00/08:58:49

Plot file version 246 created 25-MAR-2014 17:51:53
 ARP299A EP087E 1.UVDATA.1
 Freq = 1.5950 GHz, Bw = 16.000 MH Calibrated with CL # 3 and BP # 1 (BP mode 1)

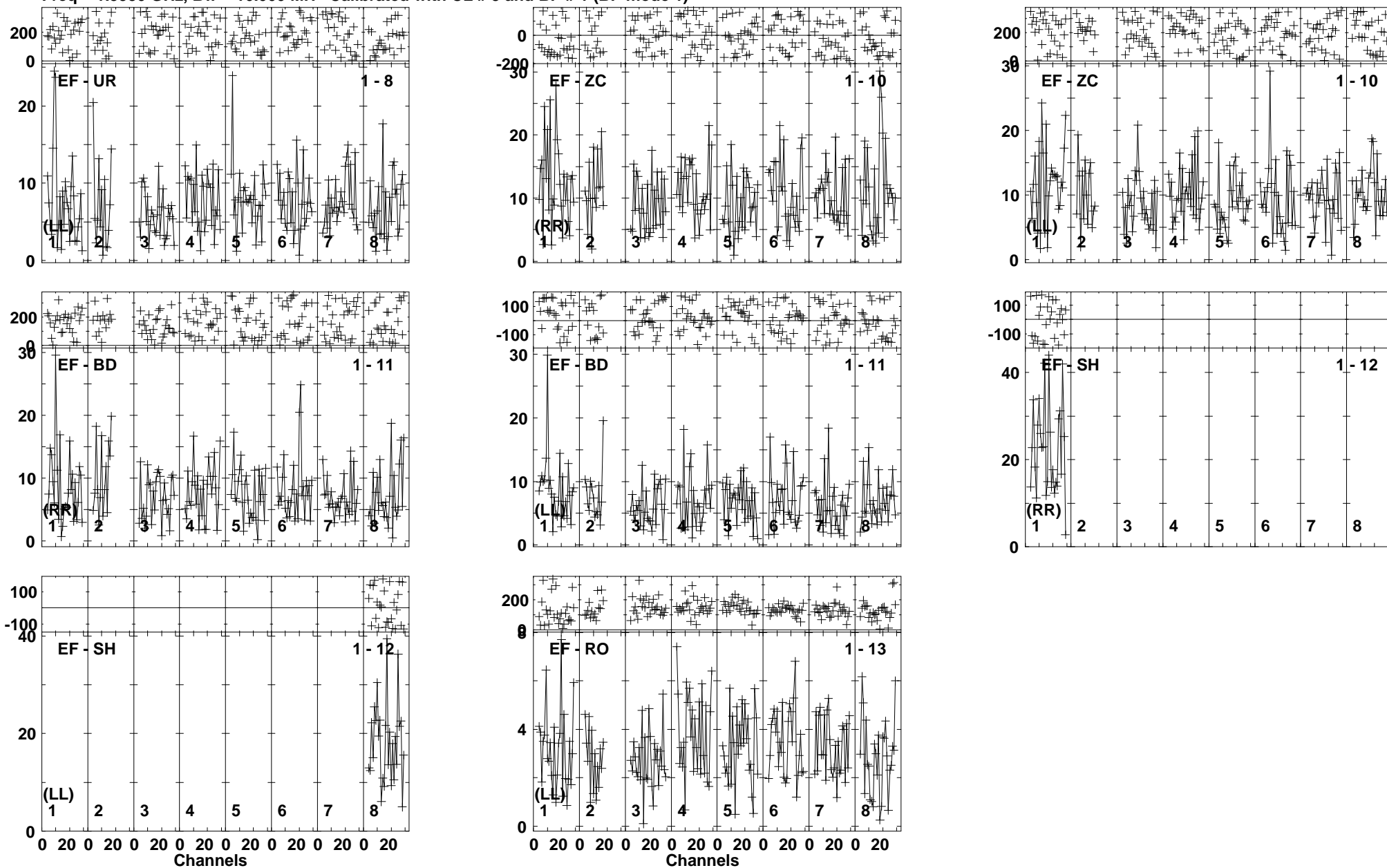

Lower frame: Milli Ampl Jy Top frame: Phas deg
 Vector averaged cross-power spectrum Baseline: EF (01) - UR (08)
 Timerange: 00/08:54:51 to 00/08:58:49

Plot file version 247 created 25-MAR-2014 17:51:53

J1128+5925 EP087E 1.UVDATA.1

Freq = 1.5950 GHz, Bw = 16.000 MH Calibrated with CL # 3 and BP # 1 (BP mode 1)

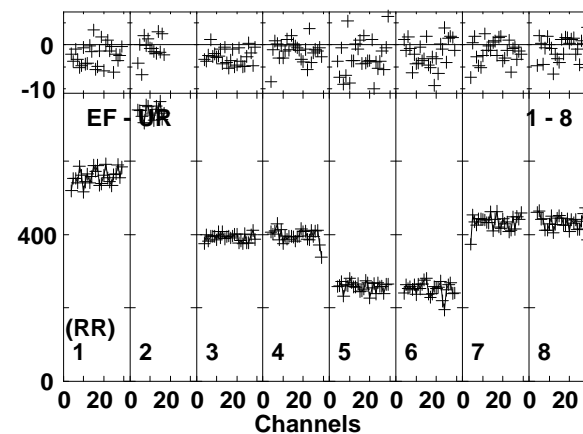
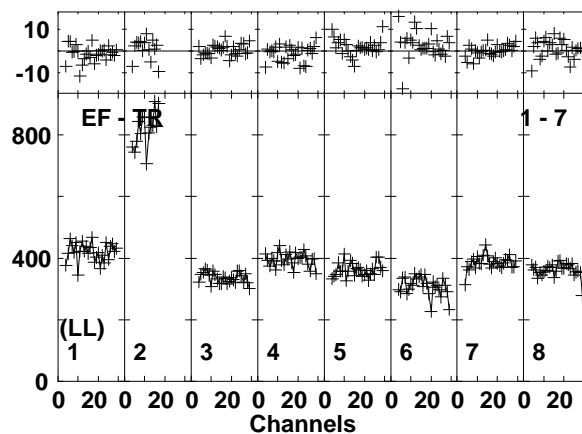
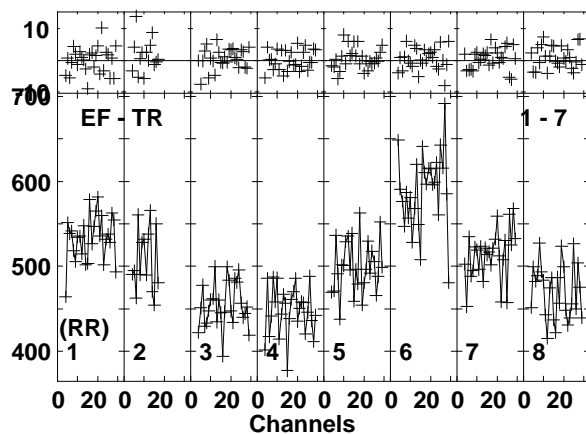
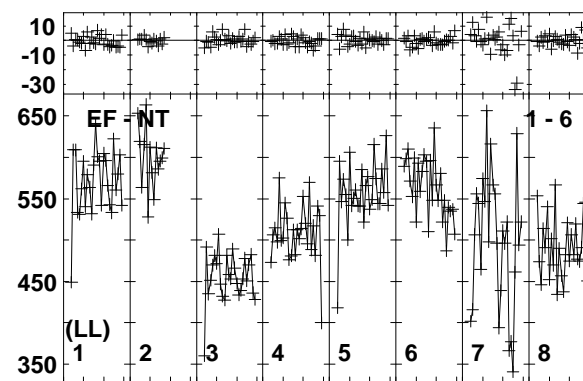
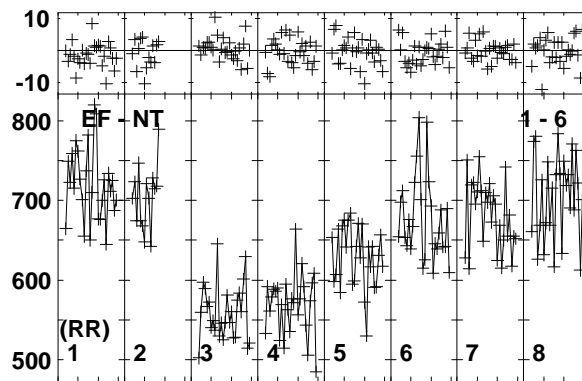
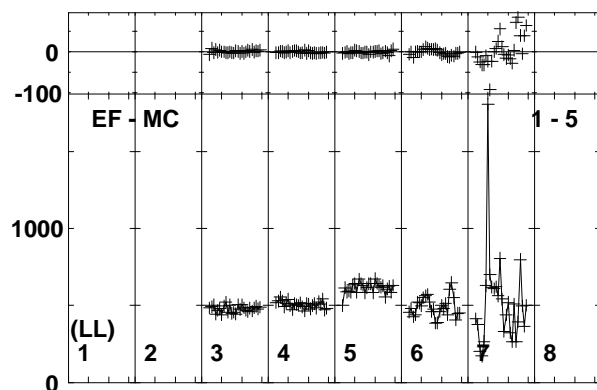
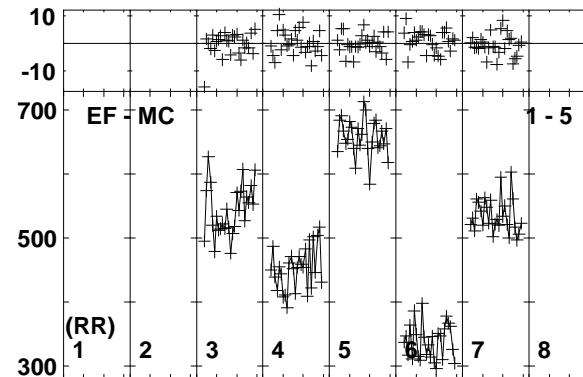
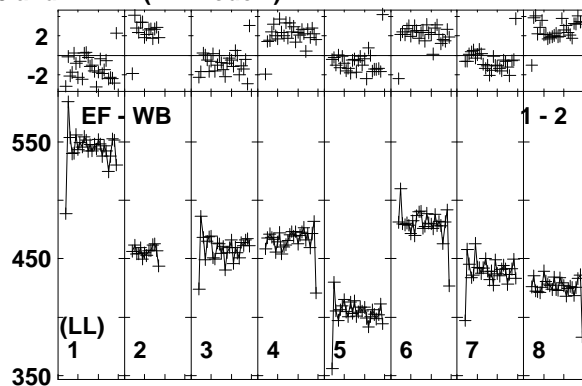
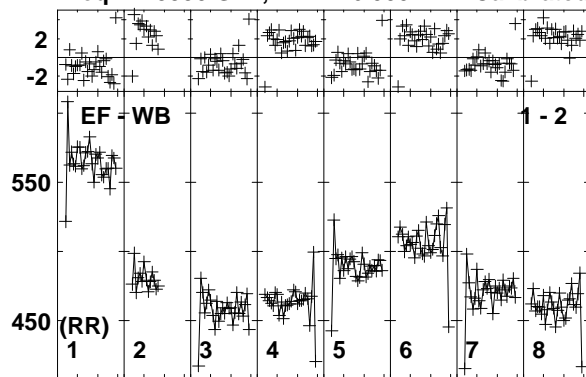

Lower frame: Milli Ampl Jy Top frame: Phas deg
Vector averaged cross-power spectrum Baseline: EF (01) - WB (02)
Timerange: 00/08:59:31 to 00/08:59:59

Plot file version 248 created 25-MAR-2014 17:51:54

J1128+5925 EP087E 1.UVDATA.1

Freq = 1.5950 GHz, Bw = 16.000 MH Calibrated with CL # 3 and BP # 1 (BP mode 1)

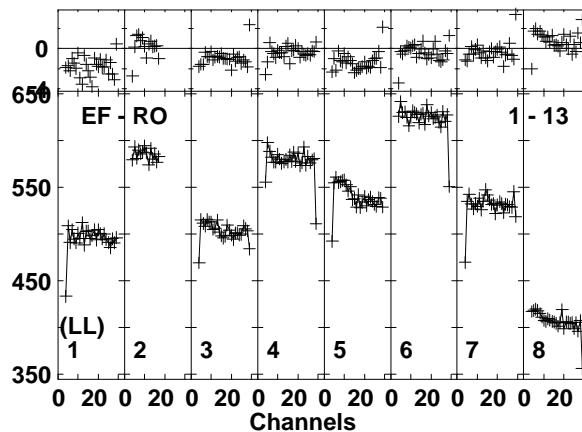
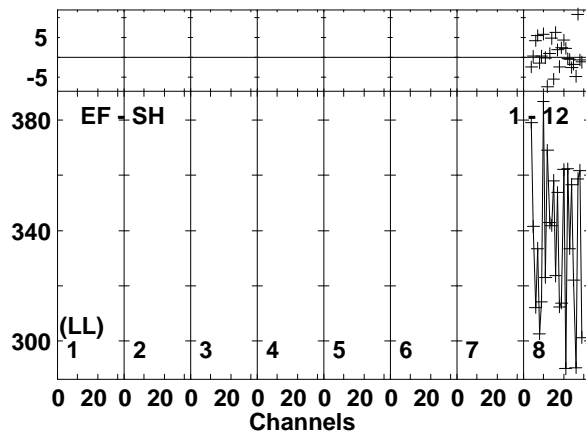
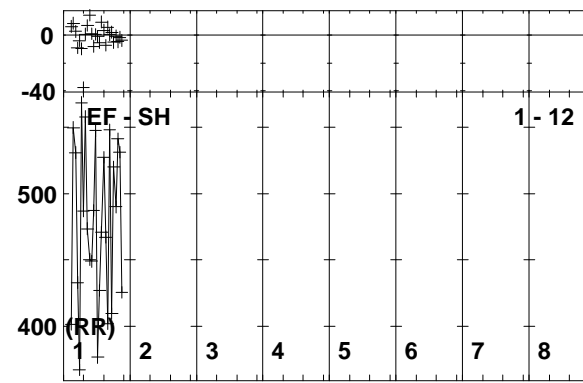
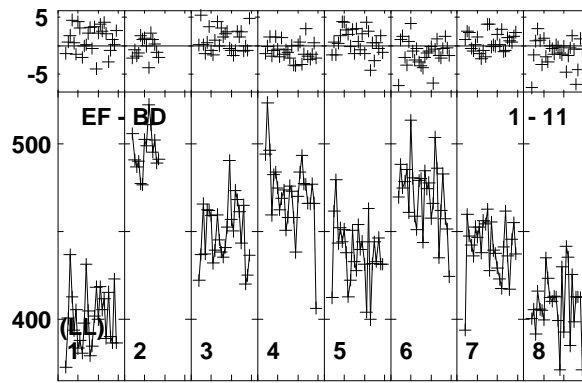
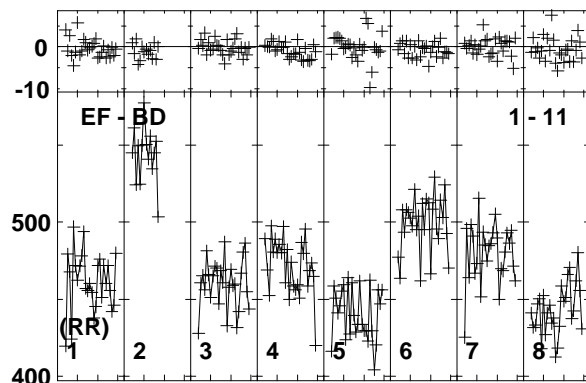
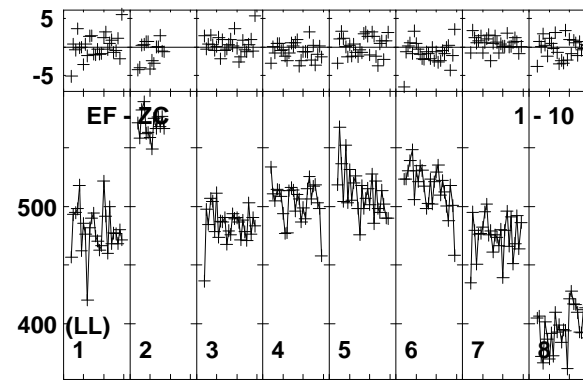
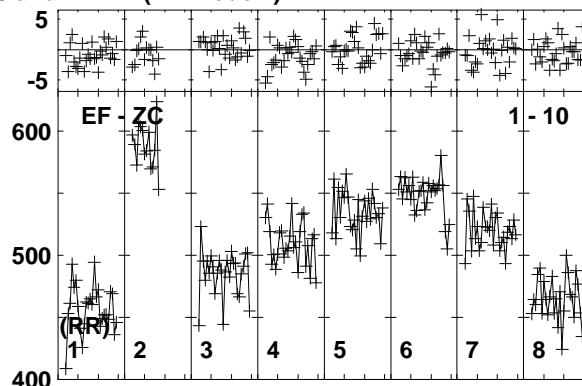
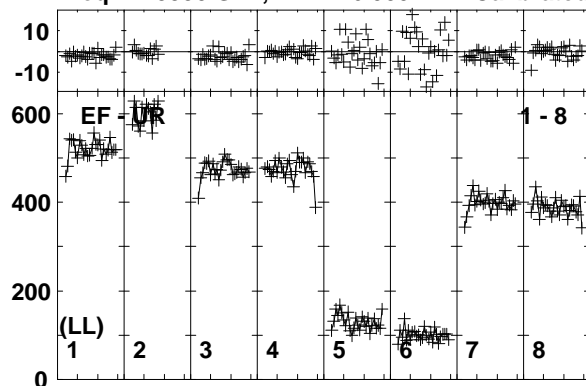

Lower frame: Milli Ampl Jy Top frame: Phas deg
Vector averaged cross-power spectrum Baseline: EF (01) - UR (08)
Timerange: 00/08:59:31 to 00/08:59:59